

Payen®

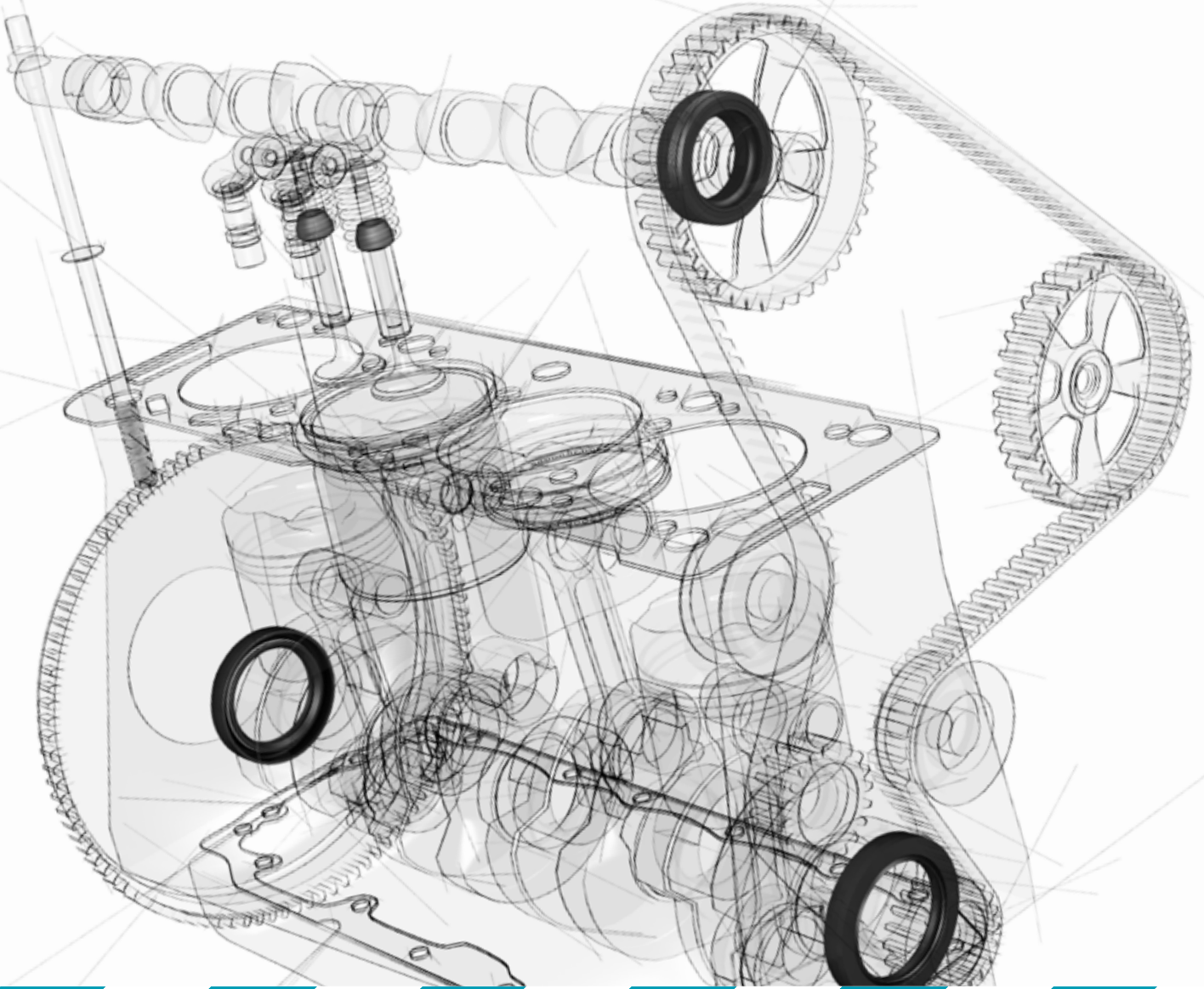

Oil Seals
Wellendichringe
Bagues d'étanchéité
Retenes de aceite
Paraoli
Uszczelnienia olejowe
Сальники
موانع تسرب الزيت

CATPA1801



2018-2020

ENGINE EXPERTISE BY  **FEDERAL-MOGUL**
MOTORPARTS



 GLYCO

 GOETZE

Niral

 Payen

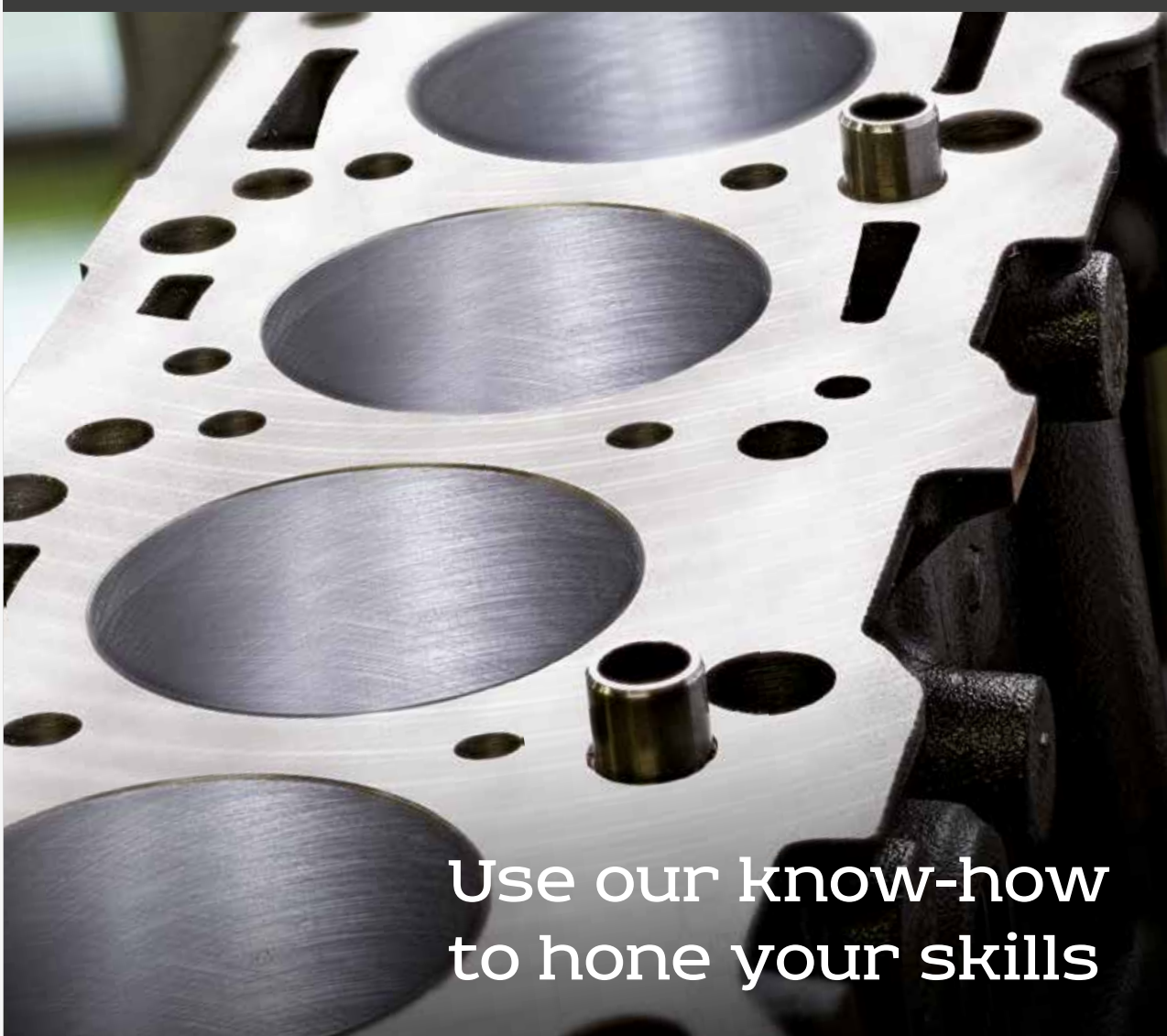

Use our know-how to hone your skills

With each diagnosis, each revision, your engine expertise becomes richer. Your skills get broader and deeper. And it's just the same at Federal-Mogul. That's why people rely on you. For example, your eye for detail and your feel for precise cylinder liner honing guarantee optimum engine performance. Your expertise helps us understand which parts you need, and how we can give you even more support to make it easier for you to achieve perfection with each engine job.

Because our engine expertise... is based on yours.



ENGINE EXPERTISE
BY  **FEDERAL-MOGUL**
MOTORPARTS



 **GLYCO**

 **GOETZE**

Nirral

 **Payen**



**KEEP IT REAL
KEEP OUT COUNTERFEIT**

The authenticity of all our engine and sealing products is protected by the MAPP Code (Manufacturers Against Product Piracy) and the PrioSpot® Authentication device, featured on a special Anti-Counterfeit label on the packaging. In this way you can be sure of our trusted Federal-Mogul quality!

HOW TO CHECK THE AUTHENTICITY OF YOUR PRODUCTS

1 Check if the packaging is closed and the label is intact

2 Verify the unique alphanumeric code and data matrix code

- Type in the alphanumeric code at www.fmecat.eu
- or
- Read the Data Matrix Code with a 2-D scanner
- or
- Read the Data Matrix Code on your smartphone with a barcode reader app

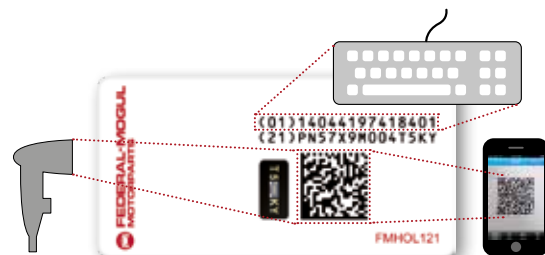

3 Verify the unique security code on the PrioSpot® Label

- Different code on each packaging



- Code contains the last 4 digits of the alphanumeric code
- The code and the Federal-Mogul logo shimmer in rainbow colours only in direct light
- Only in direct light a digit, repeating the last digit of the security code, is visible. This digit will move up and down when you change the angle of the PrioSpot®



ENGINE EXPERTISE
BY **FEDERAL-MOGUL**
MOTORPARTS



GLYCO

GOETZE

Niral

Payen

TERMS OF BUSINESS

IMPORTANT

Reproduction of this catalogue or parts thereof is only allowed with our explicit permission in writing. Pictorial representations and design are copyrighted. Claims for damages, of any form whatsoever, resulting from details made in this catalogue or from incorrect use, application, storage or handling, are explicitly excluded. Contractual rights and any resulting or related claims based thereon, irrespective of form, initially come into being on the basis of a separate written agreement, in particular on the basis of our general terms of sale and delivery.

All former statements lose their validity with the publication of this catalogue.

The catalogue is not an operating manual for the use and installation of cylinder head gaskets, oil seals and cylinder headbolts. It does not contain any advice in a legal sense. The catalogue neither replaces the constantly applicable technical regulations – particularly for tolerances – nor the installation and maintenance stipulations of the individual engine manufacturer.

Also, it is not possible to forego the expertise of those carrying out the installation and application. The individual references made in this catalogue for the installation and the application of cylinder head gaskets, oil seals and cylinder headbolts are instructions solely for the technically qualified specialist and are to be checked and verified by them for their suitability in each case. Federal-Mogul accepts no responsibility for application decisions.

The contents of the catalogue are not intended to create or substitute any contractual agreement which has to be reserved exclusively to a separate agreement between 2 identified parties, whereby seller can be only one of our Federal-Mogul entities as mentioned on the inside back cover.

The right is retained to correct errors and alterations, particularly with regard to amendments in the engine manufacturers' details and stipulations.

ZUR BEACHTUNG

Die Reproduktion dieses Katalogs ist nur mit unserer ausdrücklichen Genehmigung gestattet. Bildliche Darstellungen und der Entwurf sind urheberrechtlich geschützt. Schadenersatzansprüche in jedweder Form unter Berufung auf die Angaben in diesem Katalog oder infolge unsachgemäßen Gebrauchs, unsachgemäßer Anwendung, Lagerung oder Handhabung sind ausdrücklich ausgeschlossen. Vertragliche Rechte und etwaige hieraus folgende oder abgeleitete Ansprüche jedweder Art werden erst durch getrennte schriftliche Vereinbarung, im Besonderen auf der Grundlage unserer allgemeinen Verkaufs- und Lieferbedingungen, begründet. Mit Erscheinen dieses Katalogs verlieren alle früheren Angaben ihre Gültigkeit.

Der Katalog stellt keine Anleitung für den Gebrauch und den Einbau von Zylinderkopfdichtungen, Wellendichtringe und Zylinderkopfschrauben dar. Es werden keine Ratschläge im rechtlichen Sinne abgegeben. Der Katalog ersetzt weder die jeweils geltenden technischen Maßgaben – insbesondere für Toleranzen – noch die Einbau- und Wartungsvorschriften des jeweiligen Motorenherstellers. Auch ist die Sachkenntnis derer, die den Einbau und die Anwendung vornehmen, eine wesentliche Größe. Die Aussagen in diesem Katalog zum Einbau und Einsatz von Zylinderkopfdichtungen, Wellendichtringe und Zylinderkopfschrauben richten sich ausschließlich an den technisch versierten Fachmann und sind von diesem von Fall zu Fall auf Eignung und Gültigkeit zu überprüfen. Federal-Mogul übernimmt keine Verantwortung für Anwendungsentscheidungen.

Der Inhalt des Katalogs begründet oder ersetzt keine vertragliche Vereinbarung, welche ausschließlich einer getrennten Vereinbarung zwischen zwei bestimmten Parteien vorbehalten sein muss, in der die Verkäuferpartei eine unserer innen im Rückdeckel genannten Federal-Mogul Gesellschaften ist. Das Recht auf Berichtigung von Irrtümern und Abänderungen, insbesondere hinsichtlich geänderter Angaben und Bestimmungen der Motorenhersteller, bleibt vorbehalten.

IMPORTANTE

La riproduzione di questo catalogo, anche parziale, è permessa soltanto in seguito ad una autorizzazione scritta. I grafici ed i disegni sono a marchio depositato ed è coperto da copyright. Reclami per difetti, di qualsiasi natura essi siano, relativi al contenuto di questo catalogo, o all'uso improprio, verranno respinti. Le pretese avanzate od i reclami dovranno essere in conformità con le nostre condizioni generali di vendita.

Il presente catalogo annulla e sostituisce tutte le edizioni precedenti.

Il catalogo non è un manuale per l'utilizzo ed il montaggio di guarnizioni testa cilindro, paraoli e viti testa. Non contiene indicazioni in questo senso. Esso non sostituisce le descrizioni tecniche, sempre prioritarie, in particolare per le tolleranze, né le istruzioni relative al montaggio ed alla manutenzione date dai costruttori dei rispettivi motori. Non può in nessun caso essere paragonato alla conoscenza professionale necessaria per il montaggio e l'utilizzo. Le considerazioni sul montaggio di guarnizioni testa cilindro, paraoli e viti testa, fatte su questo catalogo, sono destinate esclusivamente a professionisti con formazione tecnica i quali verificheranno l'esattezza delle informazioni, in ogni caso. Le responsabilità derivanti dall'utilizzo improprio dello stesso non potranno essere addebitate alla Federal-Mogul.

I contenuti del catalogo non sostituiscono in alcun modo gli accordi contrattuali che sono riservati esclusivamente a due contraenti definiti; come venditore si intende una delle società Federal-Mogul menzionate sul retro del catalogo.

Ci riserviamo il diritto di apportare correzioni e modifiche al contenuto del catalogo su istruzioni ricevute dal costruttore del motore.

IMPORTANT

La reproduction de ce catalogue, même partielle, n'est autorisée qu'avec notre accord préalable et par écrit. Les illustrations graphiques et la présentation font l'objet d'un copyright. Nous excluons toutes réclamations ayant pour objet ce catalogue ou pouvant résulter de son incompréhension, portant sur de mauvaises utilisations, manipulations, manutentions ou mauvais stockage. Des droits contractuels et des droits dérivés, de quelque nature qu'ils soient, ne peuvent résulter que d'un accord écrit, sur la base de nos conditions générales de ventes et de livraisons. Ce catalogue annule et remplace toute édition antérieure.

Le catalogue n'est pas une notice d'utilisation et de montage des joints de culasse, bagues d'étanchéité et vis de culasse. Il ne contient pas de directives en tant que telles. Le catalogue ne remplace ni les prescriptions techniques, toujours prioritaires, particulièrement pour les tolérances, ni les prescriptions de montage et d'entretien des fabricants des moteurs figurant dans ce catalogue. Il ne peut en aucun cas remplacer les connaissances professionnelles nécessaires pour le montage et l'utilisation des produits. Les remarques données pour le montage et l'utilisation des joints de culasse, bagues d'étanchéité et vis de culasse sont exclusivement destinées au professionnel averti et de formation technique, à qui il appartiendra de vérifier la conformité des indications pour chaque cas. La responsabilité quant aux décisions d'utilisation ne peut être prise en charge par Federal-Mogul.

Le contenu de ce catalogue ne peut constituer ou remplacer un contrat qui doit faire l'objet d'un document séparé établi entre 2 parties, dont l'une doit être une entité légale de Federal-Mogul (dont la liste figure sur la couverture arrière). Nous nous réservons le droit d'apporter toutes corrections d'erreurs et modifications, suite notamment à de nouvelles données fournies par les constructeurs.

TERMS OF BUSINESS

IMPORANTE

Queda totalmente prohibida la reproducción, total o parcial, del contenido de este catálogo, salvo previa autorización nuestra, realizada por escrito. Están, asimismo, reservados todos los derechos sobre el diseño y presentación del catálogo. No se aceptará ningún tipo de reclamación que esté basada en la interpretación de los datos contenidos en este catálogo, así como en el incorrecto uso, manipulación o almacenamiento de nuestras piezas. Únicamente se aceptarán reclamaciones que estén basadas en derechos contractuales o en los motivos arriba indicados, siempre que exista un acuerdo especial y por escrito basado en nuestras condiciones generales de venta y suministro.

Con la edición de este catálogo queda anulada toda la información contenida en catálogos anteriores. El catálogo no es un manual para el uso e instalación de las juntas de culata, retenes de aceite y tornillos de culata, y no representa una asesoría técnica en el sentido legal. Los datos del catálogo no sustituyen, en ningún caso, a las especificaciones técnicas, tanto en lo que se refiere a tolerancias como a las instrucciones de instalación y mantenimiento, indicadas por los fabricantes de los motores, especificaciones que serán siempre prioritarias. Se entiende que el uso y montaje de estas piezas está encomendado a personal debidamente cualificado. Las indicaciones sobre uso y montaje de las juntas de culata, retenes de aceite y tornillos de culata, contenidas en este catálogo, están exclusivamente dirigidas a profesionales con la debida capacitación y formación técnica, que deben decidir en cada caso sobre la exactitud de las mismas. La responsabilidad de estas decisiones no puede ser, en ningún caso atribuidas a Federal-Mogul.

La información facilitada en el catálogo no representa o sustituye ningún tipo de acuerdo, quedando a tal efecto, el acuerdo por separado entre dos partes donde sólo entidades de Federal-Mogul, pueden ser identificadas como la parte vendedora como se menciona en la contraportada. Los datos e instrucciones contenidos en este catálogo podrán ser corregidos o modificados sin previo aviso.

WAŻNE

Reprodukcja tego katalogu lub jego części jest możliwa tylko za wyraźną zgodą na piśmie. Ilustracje i grafika są chronione prawem autorskim. Roszczenia dotyczące szkód, niezależnie od formy, wynikających z przedstawionych w tym katalogu treści lub z nieprawidłowego użycia, zastosowania, przechowywania lub obsługi są w sposób wyraźny wyłączone. Prawa umowne i inne wynikające lub związane z roszczeniami na nimi opartymi, niezależnie od formy, są tworzone na podstawie oddzielnej umowy pisemnej, w szczególności na podstawie naszych ogólnych warunków sprzedaży i dostawy.

Wszystkie wcześniejsze oświadczenia tracą ważność wraz z opublikowaniem tego katalogu.

Katalog nie jest instrukcją obsługi i instalacji uszczelek głowicowych, uszczelnień olejowych i śrub głowicowych. Nie zawiera porad w sensie prawnym. Katalog nie zastępuje obowiązujących uregulowań technicznych – zwłaszcza w zakresie tolerancji – ani opisów montażu i konserwacji poszczególnych producentów silników.

Nie jest również możliwe pominięcie doświadczenia osób dokonujących doboru i przeprowadzających montaż części. Poszczególne odniesienia zawarte w tym katalogu, a dotyczące doboru, montażu i stosowania uszczelek głowicowych, uszczelnień olejowych i śrub głowicowych, są instrukcjami wyłącznie dla wykwalifikowanego technicznie specjalisty, który w każdym przypadku musi je sprawdzić i zweryfikować ich przydatność. Federal-Mogul nie przyjmuje odpowiedzialności za decyzje dotyczące zastosowania.

Zawartość tego katalogu nie stanowi ani nie zastępuje umowy, która może być zawarta jedynie jako oddzielny dokument podpisany przez dwie strony, przy czym sprzedawcą może być tylko jedna z jednostek koncernu Federal-Mogul, zgodnie z opisem na wewnętrznej stronie tylnej okładki.

Zachowane zostaje prawo korygowania błędów i wprowadzania zmian, zwłaszcza odnośnie zmian dotyczących parametrów i warunków pracy określonych przez producentów silników.

ВАЖНО

Воспроизводство данного каталога или ее частей позволено только с нашим явным разрешением в письменной форме. Иллюстрации и дизайн защищены авторским правом. Требования о возмещении ущерба, любой формы, исходя из содержания каталога или от неправильного использования, хранения или обращения, явно исключены. Договорные права и любые связанные требования базировались вслед за тем, независимо от формы, отдельного первоначально письменного соглашения, в особенности на основе наших общих условий продаж и поставок. Все прежние утверждения теряют свою юридическую силу с публикацией данного каталога.

Каталог не операционное руководство для использования и установок уплотнений, сальников и болтов головки блока цилиндра. Оно не содержит совета в юридическом смысле. Каталог не заменяет постоянно применимые технические инструкции – особенно при допусках – соглашения установки и обслуживания отдельного автопроизводителя. Кроме того, не возможно предсказать профессионализм тех, кто выполняют установку и ремонт.

Отдельные ссылки, сделанные в этом каталоге для установки и замены уплотнений, сальников и болтов головки блока цилиндра являются инструкциями исключительно для технически компетентного специалиста и должны быть проверены ими для их пригодности в каждом случае. Federal-Mogul не несет ответственность за ремонтные работы. Содержание каталога не предназначено, чтобы создавать или заменять любые договорные соглашения, которое должны быть сохранены исключительно к отдельному соглашению между 2мя сторонами, посредством чего продавец может быть только одним из юридических лиц Federal-Mogul как упомянуто на странице обратной стороны. Сохраняется право, исправлять ошибки и изменения, особенно относительно к поправкам по деталям изготовителей двигателя и их условиям.

هام

لا يُسمح بنسخ هذا الدليل أو أي جزء منه إلا بتصريح كتابي صريح. جميع التمثيلات التصويرية والتصميمات محفوظة بموجب حقوق الطبع والنشر، ولا تتحمل الشركة صراحة أي مطالبات بخسائر، أيًا كانت صورتها، تنشأ عن التفاصيل الواردة في هذا الدليل أو نتيجة لسوء الاستخدام أو التطبيق أو التخزين أو النقل. أي حقوق تعاقدية أو أي مطالبات لها علاقة بتلك الحقوق أو تنشأ تأسيسًا عليها، بغض النظر عن صورتها، تنشأ تأسيسًا على اتفاق كتابي منفصل، وبخاصة تأسيسًا على شروط البيع والتسليم الخاصة بنا. تفقد كل البيانات السابقة صلاحيتها بمجرد نشر هذا الدليل.

هذا الدليل ليس دليلًا للتشغيل لتوضيح استخدام وتركيب المكابس أو البطانة أو التجميع. كما لا يحتوي على أي نصيحة بالمعنى القانوني، ولا يحل هذا الدليل محل القواعد الفنية المطبقة باستمرار خاصة فيما يتعلق بالتحميل، كما لا يحل محل شروط التركيب والصيانة الخاصة بمصنعي المحركات الفردية.

كذلك لا يمكن الاستعانة عن خبرة الفنيين الذين يقومون بالتركيب أو التطبيق. وجميع الإشارات الواردة في هذا الدليل والتي تتعلق بتركيب وتطبيق المكابس والبطانة وعمليات التجميع هي إرشادات للمختصين الفنيين المؤهلين فحسب ويتم مراجعتها والتأكد من ملاءمتها في كل حالة على حدة. ولا تتحمل شركة Federal-Mogul أي مسؤولية تتعلق بقرارات التطبيق.

ليس المقصود بمحتوى هذا الدليل أن يخلق أو يستبدل أي اتفاقات تعاقدية يتم الاحتفاظ بها حصريًا في اتفاقية منفصلة بين طرفين محددين، والتي يمكن أن يكون بموجبها أحد الكيانات التابعة لشركة Federal-Mogul هو الطرف البائع كما هو موضح في الوجه الداخلي للغلاف الخارجي. وتحتفظ الشركة بحقوقها في تصحيح أي أخطاء وإجراء أي تعديلات وبخاصة فيما يتعلق بتعديل تفاصيل مصنع المحرك والأحكام المنصوص عليها.

CONTENTS



Terms of business	II
Contents	IV
Manufacturers list	V
How to use this catalogue	VI
Seal design	XIV
Materials specifications	XXII
Installation tips	XXX
Pro-Fit Service Products	XXXIV
Applications by manufacturer	1
Numerical parts list (buyers guide)	1324
Size guide	1340
Differential seals chart by size	1360
Oil seal sets	1362
O-ring seals size guide	1364
Washers size guide	1366



Condizioni generali	II
Contenuti	IV
Elenco costruttori	V
Come si utilizza il catalogo	VIII
Disegni Paraoli	XVI
Specifiche materiali	XXIV
Consigli per l'installazione	XXXI
Prodotti per l'Assistenza Pro-Fit	XXXVIII
Applicazioni per costruttore	1
Elenco parti numeriche (guida acquirente)	1324
Guida alle dimensioni	1340
Grafico tenute differenziali in base alle dimensioni	1360
Set tenute motore in base a dimensioni e codice	1362
Guida dimensioni tenute o-ring	1364
Guida dimensioni rondelle	1366



Condiciones de venta	III
Índice	IV
Lista de fabricantes	V
Cómo utilizar este catálogo	X
Diseños de sellado	XVIII
Especificaciones de los materiales	XXVI
Consejos sobre montaje	XXXII
Productos de Servicio Pro-Fit	XLII
Aplicaciones por constructor	1
Lista de referencias (guía del comprador)	1324
Guía de tamaños	1340
Tabla de juntas de diferencial por tamaño	1360
Conjuntos de retenes de por tamaño y referencia	1362
Guía de tamaños de juntas tóricas	1364
Guía de tamaños de arandelas	1366



Geschäftsbedingungen	II
Inhaltsverzeichnis	IV
Herstellerliste	V
So benutzen Sie diesen Katalog	VII
Dichtungsausführungen	XV
Werkstoffspezifikationen	XXIII
Montagetipps	XXX
Pro-Fit Serviceprodukte	XXXVI
Anwendungen nach Hersteller	1
Nummerische Teileliste (Bestellhinweise)	1324
Größenleitfaden	1340
Dichtungentabelle nach Größe	1360
Öldichtungssätze nach Größe und Artikelnummer	1362
Größenleitfaden für O-Dichtringe	1364
Größenleitfaden für Dichtungsscheiben	1366



Conditions générales de vente	II
Contenu	IV
Liste des fabricants	V
Comment se servir de ce catalogue	IX
Formes des bagues	XVII
Spécifications des matériaux	XXV
Astuces de montage	XXXI
Produits de Service Pro-Fit	XL
Applications par constructeur	1
Liste numérique des références (guide d'achat)	1324
Guide de dimensionnement	1340
Tableau différentiel des bagues d'étanchéité par taille	1360
Pochettes de bagues d'étanchéité par taille et par référence	1362
Guide de dimensions de joints toriques	1364
Guide de dimensions de rondelles	1366



Warunki współpracy	III
Spis treści	IV
Lista producentów	V
Jak używać tego katalogu	XI
Typy uszczelek	XIX
Specyfikacje materiałów	XXVII
Wskazówki dotyczące montażu	XXXII
Produkty Serwisowe Pro-Fit	XLIV
Lista zastosowań wg kolejności producentów	1
Numeryczna lista części (poradnik kupującego)	1324
Poradnik dotyczący rozmiarów	1340
Tabela uszczelek do mechanizmu różnicowego wg rozmiaru	1360
Zestawy uszczelnień olejowych wg rozmiaru i nr referencyjnego	1362
Poradnik dotyczący rozmiarów oringów	1364
Poradnik dotyczący podkładek	1366

MANUFACTURERS LIST





Условия сотрудничества	III
Содержание	V
Список производителей	V
Как пользоваться каталогом	XII
Конструкции уплотнений	XX
Спецификации материала	XXVIII
Советы по установке	XXXIII
Сервисная Продукция Pro-Fit	XLVI
Модели автомобилей, сортировка по производителю	1
Список артикулов деталей (с геометрическими параметрами)	1324
Справочная информация по размерам	1340
Таблица размеров сальников	1360
Список комплектов сальников с размерами	1362
Справочная информация по размерам уплотнительных колец	1364
Справочная информация по размерам шайб	1366



III	شروط العمل
V	المحتويات
V	قوائم المصنعين
XIII	كيفية استخدام هذا الكatalog
XXI	تصميمات موانع التسرب
XXIX	مواصفات المواد
XXXIII	إرشادات التركيب
XLVIII	منتجات خدمة بروفيت
1	الاستخدامات حسب جهة التصنيع
1324	قائمة بالأجزاء الرقمية (دليل المشتريين)
1340	دليل الأحجام
1360	جدول موانع التسرب للترس النفاضلي (الدفرنسيل) حسب الأحجام
1362	مجموعات موانع تسرب الزيت حسب الحجم والمرجع
1364	دليل أحجام موانع التسرب الدائرية
1366	دليل أحجام الحلقات

ABARTH	(SEE FIAT)
ALFA ROMEO	1
ALPINA	(SEE BMW)
ARO	(SEE RENAULT)
AUDI	24
AUSTIN	88
AUTOBIANCHI	(SEE LANCIA)
BEDFORD	92
BMW	97
BUICK	124
CADILLAC	128
CATERHAM	(SEE OPEL)
CHEVROLET	131
CHRYSLER	152
CITROËN	160
CUMMINS	197
DACIA	200
DAEWOO	206
DAF	214
DAIHATSU	223
DEUTZ	233
DODGE	244
FIAT	250
FORD	318
HONDA	407
HYUNDAI	437
INFINITI	(SEE FIAT)
ISUZU	453
IVECO	465
JAGUAR	494
JEEP	498
KHD	(SEE DEUTZ)
KIA	503
LADA	515
LANCIA	519
LAND ROVER	538
LEXUS	(SEE TOYOTA)
LEYLAND	547
LOTUS	(SEE OPEL)
MAN	551
MAZDA	583
MERCEDES-BENZ	608
MG	720
MINI	724
MITSUBISHI	729
MORGAN	(SEE FIAT)
NISSAN	752
OPEL	795
PERKINS	873
PEUGEOT	878
PORSCHE	921
PROTON	933
PUCH	937
RENAULT	941
ROVER	1025
RVI	(SEE RENAULT)
SAAB	1037
SAMSUNG	(SEE RENAULT)
SCANIA	1045
SEAT	1056
SKODA	1088
SMART	1110
SSANGYONG	1114
SUBARU	1119
SUZUKI	1128
TALBOT	(SEE PEUGEOT)
TOYOTA	1141
VAUXHALL	(SEE OPEL)
VOLKSWAGEN	1191
VOLVO	1289
YUGO	(SEE FIAT)

🇬🇧 HOW TO USE THIS CATALOGUE

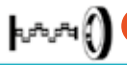
PEUGEOT					
6 		7 		8 	
2 135 2.0L		Diesel			
1	AHZ (DW10CD)	4 Cyl.	16 Valves	1997cc	TD28621
	RHC (DW10CTED4)	4 Cyl.	16 Valves	1997cc	TD28710
	RHE (DW10CTED4)	4 Cyl.	16 Valves	1997cc	TD25633
	RHH (DW10CTED4)	4 Cyl.	16 Valves	1997cc	TD23536
9	HR5122 S	NA5035 (x2) 27.00 x 47.00 x 7.00mm, FPM	NA5191 F 42.00 x 62.00 x 7.00mm, PTFE		NA5192 R

1 Engine information

2 Panel number

3 Cubic capacity

4 Number of cylinders

5 Number of valves

6 Valve stem seal part numbers

S = Set

I = Inlet

E = Exhaust

7 Camshaft oil seal part numbers

F = Front

R = Rear

(x2) indicating 2 required per engine

Dimensions in mm:

Inner Diameter x Outer Diameter (OD) x Width

FPM: see Material Codes table below

8 Crankshaft oil seal part numbers

F = Front

R = Rear

Dimensions in mm:

Inner Diameter x Outer Diameter (OD) x Width

PTFE: see Material Codes table below

9 New parts

MATERIAL CODES

NBR Nitrile







ACM Polyacrylate

AEM Ethylene-Acrylate

VMQ Silicon

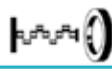
FKM Fluoroelastomer

PTFE Polytetrafluoroethylene

PEUGEOT							
6 		7 		8 			
2	135 2.0L	Diesel					
1	AHZ (DW10CD)	4	4 Cyl.	16 Valves	5	1997cc 3	TD28621
	RHC (DW10CTED4)		4 Cyl.	16 Valves		1997cc	TD28710
	RHE (DW10CTED4)		4 Cyl.	16 Valves		1997cc	TD25633
	RHH (DW10CTED4)		4 Cyl.	16 Valves		1997cc	TD23536
9	HR5122 	NA5035 (x2) 27.00 x 47.00 x 7.00mm, FPM		NA5191  42.00 x 62.00 x 7.00mm, PTFE			NA5192 

- 1 Motorangaben
- 2 Infotafelnummer
- 3 Hubraum
- 4 Zylinderanzahl
- 5 Anzahl Ventile
- 6 Teilenummern Ventilschaftdichtung
 - S** = Dichtsatz
 - I** = Einlass
 - E** = Auslass
- 7 Teilenummern Nockenwellen-Öldichtung
 - F** = Vorne
 - R** = Hinten
 (x2) = pro Motor 2 erforderlich
 Abmessungen in mm:
 Innendurchmesser x Außendurchmesser (OD) x Breite
 FPM: siehe Werkstoffcodes-Tabelle unten
- 8 Teilenummern Kurbelwellen-Öldichtung
 - F** = Vorne
 - R** = Hinten
 Abmessungen in mm:
 Innendurchmesser x Außendurchmesser (OD) x Breite
 PTFE: siehe Werkstoffcodes-Tabelle unten
- 9 Neuaufnahmen

WERKSTOFFCODES

NBR	Nitril	VMQ	Silikon
ACM	Polyacrylat	FKM	Fluorelastomer
AEM	Ethylen-Acrylat	PTFE	Polytetrafluoroethylen







COME SI UTILIZZA IL CATALOGO

PEUGEOT					
6		7		8	
2	135 2.0L	Diesel			
1	AHZ (DW10CD)	4	4 Cyl.	5	16 Valves 1997cc 3
	RHC (DW10CTED4)		4 Cyl.		16 Valves 1997cc TD28710
	RHE (DW10CTED4)		4 Cyl.		16 Valves 1997cc TD25633
	RHH (DW10CTED4)		4 Cyl.		16 Valves 1997cc TD23536
9	HR5122 S	NA5035 (x2) 27.00 x 47.00 x 7.00mm, FPM		NA5191 F 42.00 x 62.00 x 7.00mm, PTFE NA5192 R	

- 1 Dati motore
- 2 Numero pannello
- 3 Capacità cubica
- 4 Numero cilindri
- 5 Numero di valvole
- 6 Numeri parte tenuta stelo valvola
S = Set
I = Aspirazione
E = Scarico
- 7 Numeri parte tenuta olio albero a camme
F = Anteriore
R = Posteriore
 (x2) indica 2 necessarie per motore
 Dimensioni in mm:
 Diametro interno x diametro esterno (OD) x larghezza
 FPM: v. tabella seguente Codici Materiali
- 8 Numeri parte tenuta olio albero a gomiti
F = Anteriore
R = Posteriore
 Dimensioni in mm:
 Diametro interno x diametro esterno (OD) x larghezza
 PTFE: v. tabella seguente Codici Materiali
- 9 Nuovi riferimenti

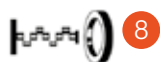
CODICI MATERIALI

NBR Nitrile	VMQ Silicone
ACM Poliacrilato	FKM Fluoroelastomero
AEM Acrilato di etilene	PTFE Politetrafluoroetilene



PEUGEOT						
 6		 7		 8		
2	135 2.0L	Diesel				
1	AHZ (DW10CD)	4	4 Cyl.	16 Valves	5 1997cc 3	TD28621
	RHC (DW10CTED4)		4 Cyl.	16 Valves	1997cc	TD28710
	RHE (DW10CTED4)		4 Cyl.	16 Valves	1997cc	TD25633
	RHH (DW10CTED4)		4 Cyl.	16 Valves	1997cc	TD23536
9	HR5122 	NA5035 (x2) 27.00 x 47.00 x 7.00mm, FPM		NA5191  42.00 x 62.00 x 7.00mm, PTFE		NA5192 

- 1** Information du moteur
- 2** Numéro de fiche
- 3** Cylindrée
- 4** Nombre de cylindres
- 5** Nombre de soupapes
- 6** Références des joints de soupapes
 - S** = Pochette
 - I** = Admission
 - E** = Échappement
- 7** Références de bagues d'étanchéité d'arbre à cames
 - F** = Avant
 - R** = Arrière
 (x2) indique qu'il en faut 2 par moteur
 Dimensions en mm :
 Diamètre intérieur x diamètre extérieur (OD) x largeur
 FPM : voir tableau des codes de matériaux ci-dessous
- 8** Références de bagues d'étanchéité de vilebrequin
 - F** = Avant
 - R** = Arrière
 Dimensions en mm :
 Diamètre intérieur x diamètre extérieur (OD) x largeur
 PTFE : voir tableau des codes de matériaux ci-dessous
- 9** Nouvelles pièces

CODES MATÉRIAUX

NBR Élastomères nitrile	VMQ Siliciume
ACM Élastomères polyacryliques	FKM Fluoroélastomère
AEM Acrylate d'éthylène	PTFE PolyTetraFluoroEthylène



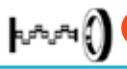



🇪🇸 CÓMO UTILIZAR ESTE CATÁLOGO

PEUGEOT					
6 		7 		8 	
2	135 2.0L	Diesel			
1	AHZ (DW10CD)	4 Cyl.	16 Valves	1997cc	TD28621
	RHC (DW10CTED4)	4 Cyl.	16 Valves	1997cc	TD28710
	RHE (DW10CTED4)	4 Cyl.	16 Valves	1997cc	TD25633
	RHH (DW10CTED4)	4 Cyl.	16 Valves	1997cc	TD23536
9	HR5122 S	NA5035 (x2) 27.00 x 47.00 x 7.00mm, FPM	NA5191 F 42.00 x 62.00 x 7.00mm, PTFE NA5192 R		

- 1 Información del motor
- 2 Número de panel
- 3 Capacidad cúbica
- 4 Número de cilindros
- 5 Número de válvulas
- 6 Referencias de juntas del vástago de la válvula
S = Conjunto
I = Admisión
E = Escape
- 7 Referencias de retenes de aceite del árbol de levas
F = Delantero
R = Trasero
(x2) indica que se necesitan 2 por motor
Dimensiones en mm:
Diámetro interior x Diámetro exterior (OD) x Ancho
FPM: ver tabla de códigos de materiales a continuación
- 8 Referencias de retenes de aceite del cigüeñal
F = Delantero
R = Trasero
Dimensiones en mm:
Diámetro interior x Diámetro exterior (OD) x Ancho
PTFE: ver tabla de códigos de materiales a continuación
- 9 Referencias nuevas

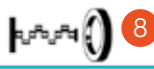
CÓDIGOS DE MATERIALES

NBR Nitrilo	VMQ Silicona
ACM Poliacrilato	FKM Fluoroelastómero
AEM Acrilato de etileno	PTFE Politetrafluoroetileno

PEUGEOT					
					
2 135 2.0L	Diesel				
1 AHZ (DW10CD)	4 4 Cyl.	16 Valves	5 1997cc	3	TD28621
RHC (DW10CTED4)	4 Cyl.	16 Valves	1997cc		TD28710
RHE (DW10CTED4)	4 Cyl.	16 Valves	1997cc		TD25633
RHH (DW10CTED4)	4 Cyl.	16 Valves	1997cc		TD23536
9 HR5122 	NA5035 (x2) 27.00 x 47.00 x 7.00mm, FPM	NA5191  42.00 x 62.00 x 7.00mm, PTFE			
		NA5192 			

1 Informacje o silniku

2 Numer panelu

3 Pojemność skokowa

4 Liczba cylindrów

5 Liczba zaworów

6 Numery uszczelnień prowadnic zaworowych

S = Zestaw

I = Dolotowy

E = Wylotowy

7 Numery uszczelnień wałka rozrządu

F = Przód

R = Tył

(x2) oznacza 2 szt. wymagane dla silnika

Wymiary w mm:

Wewnętrzna średnica x zewnętrzna średnica (OD) x szerokość

FPM: patrz tabela poniżej z kodami materiałów

8 Numery uszczelnień olejowych wału korbowego

F = Przód

R = Tył

Wymiary w mm:

Wewnętrzna średnica x zewnętrzna średnica (OD) x szerokość

PTFE: patrz tabela poniżej z kodami materiałów

9 Nowe części

KODY MATERIAŁU

NBR Nityl

ACM Poliakrylan

AEM Kauczuk etylenowo-akrylowy

VMQ Sylikon

FKM Fluoroelastomer

PTFE Politetrafluoroetylen

КАК ПОЛЬЗОВАТЬСЯ КАТАЛОГОМ

PEUGEOT					
6		7		8	
2 135 2.0L Diesel					
1	AHZ (DW10CD)	4 Cyl.	16 Valves	1997cc	TD28621
	RHC (DW10CTED4)	4 Cyl.	16 Valves	1997cc	TD28710
	RHE (DW10CTED4)	4 Cyl.	16 Valves	1997cc	TD25633
	RHH (DW10CTED4)	4 Cyl.	16 Valves	1997cc	TD23536
9	HR5122 S	NA5035 (x2) 27.00 x 47.00 x 7.00mm, FPM	NA5191 F 42.00 x 62.00 x 7.00mm, PTFE	NA5192 R	

1 Информация о двигателе

2 Номер панели

3 Рабочий объем

4 Количество цилиндров

5 Количество клапанов

6 Артикулы маслоъемных колпачков

S = комплект

I = Впуск

E = Выпуск

7 Артикулы сальников распределительного вала

F = Передний

R = Задний

(x2) означает, что для двигателя необходимы 2 детали

Габаритные размеры в мм:

внутренний диаметр x внешний диаметр x ширина

FPM (фторкаучук): см. коды материалов в таблице ниже

8 Артикулы сальников коленчатого вала

F = Передний

R = Задний

Габаритные размеры в мм:

внутренний диаметр x внешний диаметр x ширина

ПТФЭ (PTFE): см. коды материалов в таблице ниже

9 Новые детали

КОДЫ МАТЕРИАЛОВ

NBR нитрил

ACM полиакрилат

AEM этилен-ацетат

VMQ силикон

FKM флуороэластомер

PTFE политетрафторэтилен

PEUGEOT



2 135 2.0L

Diesel

AHZ (DW10CD) 1	4 Cyl. 4	16 Valves 5	1997cc 3	TD28621
RHC (DW10CTED4)	4 Cyl.	16 Valves	1997cc	TD28710
RHE (DW10CTED4)	4 Cyl.	16 Valves	1997cc	TD25633
RHH (DW10CTED4)	4 Cyl.	16 Valves	1997cc	TD23536

HR5122 9

NA5035 (x2)
27.00 x 47.00 x 7.00mm, FPM

NA5191 42.00 x 62.00 x 7.00mm, PTFE
NA5192

أرقام قطع موانع تسرب الزيت لعمود الكرنك 8

F = أمامي

R = خلفي

الأبعاد بالمليمتر:

القطر الداخلي x القطر الخارجي (OD) x العرض

بولي تيترا فلورو إيثيلين: انظر جدول أكواد المواد أدناه

القطع الجديدة 9

معلومات المحرك 1

رقم اللوحة 2

السعة اللترية (المكعبة) 3

عدد الأسطوانات 4

عدد الصمامات 5

أرقام قطع موانع تسرب ساق الصمام 6

S = مجموعة

I = السحب

E = العادم

أرقام قطع موانع تسرب زيت عمود الكامات 7

F = أمامي

R = خلفي

(x2) تشير إلى جزئين مطلوبين لكل محرك

الأبعاد بالمليمتر:

القطر الداخلي x القطر الخارجي (OD) x العرض

مطاط الفلوروكربون: انظر جدول أكواد المواد أدناه

أكواد المواد

VMQ سيليكون ميثيل الفينيل

FKM مطاط صناعي قائم على الفلوروكربون

PTFE بولي تيترا فلورو إيثيلين

NBR مطاط بيوتاديين النتريل

ACM بولي اكريليت (مطاط الاكريليك)

AEM إيثيلين أكريليت

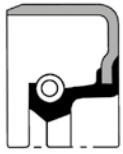

822N & 823N

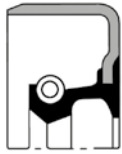

822S & 823S

RADIAL LIP SEAL WITH AN ALL METAL OUTER CASE

Static sealing is achieved by OD to housing interference, and/or the use of a separate sealing compound. 823 versions are coated on the OD. The **822S & 823S** type features a dust lip which prevents dirt from reaching the point of sealing.



824N



824S

RADIAL LIP SEAL WITH A DOUBLE STEEL CASING

This design results in greater rigidity in larger shaft size applications and helps prevent from damage or distortion during assembly. The **824S** type features a dust lip which prevents dirt from reaching the point of sealing.



827N



827S

RADIAL LIP SEAL WITH A FULLY ELASTOMERIC OD

The flexibility of this outer covering permits a positive static seal in the housing bores, even those subject to high thermal expansion or in split housings. The **827S** type features a dust lip which prevents dirt from reaching the point of sealing.

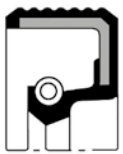

827NW

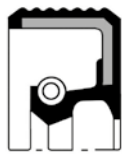

827SW

RADIAL LIP SEAL WITH A FULLY ELASTOMERIC CORRUGATED OD

This feature provides higher interference fit with ease and also with greater margin of safety in housing bores subject to high thermal expansion or in split housings. The **827SW** type features a dust lip which prevents dirt from reaching the point of sealing.



829N



829S

RADIAL LIP SEAL WITH PART ELASTOMERIC & PART STEEL OUTER SURFACE

This type of seal provides accurate central & axial positioning on assembly with excellent OD static seal and good seal retention. Suitable for split housings and housing bores subject to high thermal expansion. The **829S** type features a dust lip which prevents dirt from reaching the point of sealing.

840 – Integrated seal & housing design with FPM or ACM sealing lip

841 – Integrated seal & housing design with PTFE sealing lip

- LD Anticlockwise hydrodynamic aid
- RD Clockwise hydrodynamic aid
- DD Bi-directional
- W Ribbed/corrugated outer surface
- SS Multiple dust lips
- SP Special

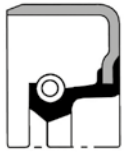

822N und 823N

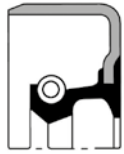

822S und 823S

RADIALE LIPPENDICHTUNG MIT VOLLMETALLUMMANTELUNG

Statische Abdichtung wird erzielt durch eine feste Passung von OD und Gehäuse und/ oder durch die Verwendung einer separaten Dichtmasse. 823 Varianten sind am OD beschichtet. Varianten **822S** und **823S** verfügen über eine Staublippe, die verhindert, dass Schmutz in die Dichtung eindringt.



824N



824S

RADIALE LIPPENDICHTUNG MIT DOPPELTER STAHLUMMANTELUNG

Diese Ausführung bietet mehr Steifigkeit bei Anwendungen mit größeren Wellen und verhindert Schäden oder Verformung beim Einbau. Die Variante **824S** verfügt über eine Staublippe, die verhindert, dass Schmutz in die Dichtung eindringt.



827N

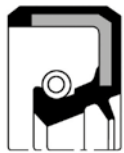

827S

RADIALE LIPPENDICHTUNG MIT VOLLELASTOMER-OD

Die Flexibilität dieser Außendeckschicht ermöglicht eine positive statische Abdichtung der Gehäusebohrungen, auch solche mit hoher Wärmeausdehnung oder in geteilten Gehäusen. Variante **827S** verfügt über eine Staublippe, die verhindert, dass Schmutz in die Dichtung eindringt.

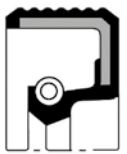

827NW

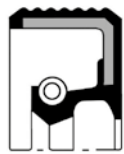

827SW

RADIALE LIPPENDICHTUNG MIT GEWELLTEM VOLLELASTOMER-OD

Dieses Merkmal bietet eine bessere Passung sowie einen größeren Sicherheits-spielraum bei Gehäusebohrungen mit hoher Wärmeausdehnung oder in geteilten Gehäusen. Die Variante **827SW** verfügt über eine Staublippe, die verhindert, dass Schmutz in die Dichtung eindringt.

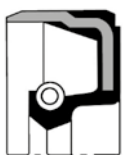

829N

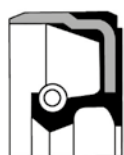

829S

RADIALE LIPPENDICHTUNG MIT OD TEILWEISE AUS ELASTOMER UND TEILWEISE AUS STAHL

Dieser Dichtungstyp bietet eine präzise zentrale und axiale Positionierung bei der Montage mit überragender statischer OD-Dichtung und guter Dichtungsretention. Geeignet für geteilte Gehäuse und Gehäusebohrungen mit hoher Wärmeausdehnung. Die Variante **829S** verfügt über eine Staublippe, die verhindert, dass Schmutz in die Dichtung eindringt.

840 – Integrierte Dichtungs- und Gehäusekonstruktion mit FPM- oder ACM-Dichtlippe

841 – Integrierte Dichtungs- und Gehäusekonstruktion mit PTFE-Dichtlippe

LD	Hydrodynamische Dichthilfe Gegenuhrzeigersinn
RD	Hydrodynamische Dichthilfe Uhrzeigersinn
DD	Bidirektional
W	Gerippte/Gewellte Außenfläche
SS	Mehrfache Staublippen
SP	Spezial

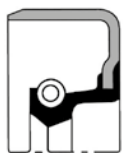

822N & 823N

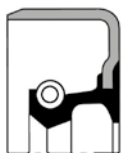

822S & 823S

GUARNIZIONE RADIALE A LABBRO CON CARCASSA METALLICA ESTERNA

La tenuta statica viene garantita dall'interferenza tra la superficie esterna e la carcassa, e/o grazie all'utilizzo di una pasta sigillante aggiuntiva. La superficie esterna delle versioni **823** è rivestita. Le versioni **822S** & **823S** possiedono un labbro parapolvere che impedisce l'ingresso di sporcizia.



824N

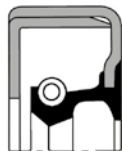

824S

GUARNIZIONE RADIALE A LABBRO CON DOPPIA CARCASSA IN ACCIAIO

Questa struttura garantisce una maggiore rigidità nelle applicazioni con albero di grandi dimensioni ed evita danni o distorsioni durante il montaggio. La versione **824S** possiede un labbro parapolvere che impedisce l'ingresso di sporcizia.



827N



827S

GUARNIZIONE RADIALE A LABBRO CON SUPERFICIE ESTERNA COMPLETAMENTE A BASE DI ELASTOMERI

La flessibilità di questo rivestimento esterno assicura una ottima tenuta statica nei fori della carcassa, anche quelli soggetti a forte dilatazione termica o nelle carcasse sdoppiate. La versione **827S** possiede un labbro parapolvere che impedisce l'ingresso di sporcizia.

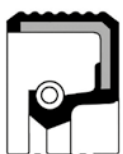

827NW

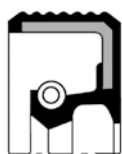

827SW

GUARNIZIONE RADIALE A LABBRO CON SUPERFICIE ESTERNA CORRUGATA COMPLETAMENTE A BASE DI ELASTOMERI

Una maggiore interferenza di montaggio consente un più ampio margine di sicurezza nei fori della carcassa soggetti a forte dilatazione termica o nelle carcasse sdoppiate. La versione **827SW** possiede un labbro parapolvere che impedisce l'ingresso di sporcizia.

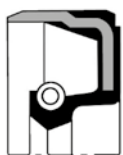

829N

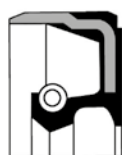

829S

GUARNIZIONE RADIALE A LABBRO CON SUPERFICIE ESTERNA IN PARTE IN ACCIAIO E IN PARTE A BASE DI ELASTOMERI

Questo tipo di guarnizione garantisce un più preciso posizionamento centrale ed assiale sull'assieme con una eccezionale tenuta statica della superficie esterna e una buona garanzia di tenuta nel tempo. Adatto per carcasse sdoppiate e fori della carcassa soggetti a forte dilatazione termica. La versione **829S** possiede un labbro parapolvere che impedisce l'ingresso di sporcizia.

840 - Guarnizione con carcassa integrata con labbro di tenuta in FPM o ACM

841 - Guarnizione con carcassa integrata con labbro di tenuta in PTFE

LD	Idrodinamico, senso antiorario
RD	Idrodinamico, senso orario
DD	Bidirezionale
W	Superficie esterna nervata/corrugata
SS	Labbri parapolvere multipli
SP	Special

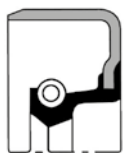

822N & 823N

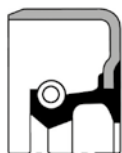

822S & 823S

BAGUE À LÈVRE RADIALE AVEC CAGE EXTÉRIEURE ENTIÈREMENT MÉTALLIQUE

L'étanchéité statique est réalisée par serrage entre le diamètre extérieur et le logement, et/ou à l'aide d'une pâte d'étanchéité séparée. Les versions **823** sont revêtues sur le diamètre extérieur. Les types **822S** & **823S** comportent une lèvre anti-poussière qui empêche les impuretés d'atteindre le point d'étanchéité.



824N

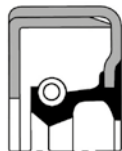

824S

BAGUE À LÈVRE RADIALE AVEC DOUBLE CAGE EN ACIER

Ce modèle procure une plus grande rigidité pour des arbres de taille plus importante et permet d'éviter tout endommagement ou déformation lors du montage. Le type **824S** comporte une lèvre anti-poussière qui empêche les impuretés d'atteindre le point d'étanchéité.



827N



827S

BAGUE À LÈVRE RADIALE À DIAMÈTRE EXTÉRIEUR ENTIÈREMENT EN ÉLASTOMÈRE

La flexibilité de cette enveloppe externe permet une parfaite étanchéité statique dans les alésages de logement, y compris ceux soumis à des dilatations thermiques importantes ou avec des logements en plusieurs parties.

Le type **827S** comporte une lèvre anti-poussière qui empêche les impuretés d'atteindre le point d'étanchéité.



827NW

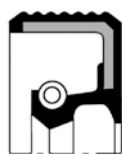

827SW

BAGUE À LÈVRE RADIALE À DIAMÈTRE EXTÉRIEUR ONDULÉ ENTIÈREMENT EN ÉLASTOMÈRE

Ce dispositif permet d'obtenir un ajustement plus serré et ce avec facilité, et une marge de sécurité plus grande, dans les alésages de logement soumis à des dilatations thermiques importantes ou avec des logements en plusieurs parties.

Le type **827SW** comporte une lèvre anti-poussière qui empêche les impuretés d'atteindre le point d'étanchéité.

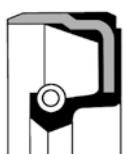

829N

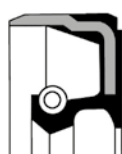

829S

BAGUE À LÈVRE RADIALE À SURFACE EXTÉRIEURE EN PARTIE EN ÉLASTOMÈRE ET EN PARTIE EN ACIER

Ce modèle de bague d'étanchéité offre un centrage et un positionnement axial précis lors du montage ainsi qu'une excellente étanchéité statique du diamètre extérieur et un bon maintien de la bague. Convient particulièrement bien

pour des logements en plusieurs parties et des alésages de logement soumis à des dilatations thermiques importantes. Le type **829S** comporte une lèvre anti-poussière qui empêche les impuretés d'atteindre le point d'étanchéité.

840 – Modèle à bague et logement intégrés avec lèvre d'étanchéité en FPM ou ACM

841 – Modèle à bague et logement intégrés avec lèvre d'étanchéité en PTFE

LD	Soutien hydrodynamique en sens antihoraire
RD	Soutien hydrodynamique en sens horaire
DD	Bidirectionnel
W	Surface extérieure nervurée/ondulée
SS	Lèvres anti-poussière multiples
SP	Spécial

DISEÑOS DE SELLADO



822N & 823N

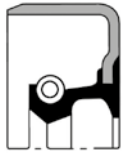

822S & 823S

RETÉN DE BORDE RADIAL CON CUBIERTA EXTERIOR METÁLICA

El sellado estático se logra por la interferencia del OD a la carcasa y/o el uso de un compuesto de sellado independiente. 823 versiones recubiertas en el OD. Los tipos **822S** y **823S** cuentan con un borde guardapolvo que evita que entre suciedad en el punto de sellado.

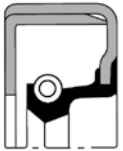

824N



824S

RETÉN DE BORDE RADIAL CON DOBLE CUBIERTA DE ACERO

Este diseño proporciona una mayor rigidez en aplicaciones con ejes de mayor tamaño y evita que se produzcan daños o deformaciones durante el montaje. El tipo **824S** cuenta con un borde guardapolvo que evita que entre suciedad en el punto de sellado.



827N



827S

RETÉN DE BORDE RADIAL CON OD TOTALMENTE ELASTOMÉRICO

La flexibilidad de esta cubierta exterior permite un sellado estático positivo en el diámetro interno de la carcasa, incluso en aquellos expuestos a una alta expansión térmica o en carcasas divididas. El tipo **827S** cuenta con un borde guardapolvo que evita que entre suciedad en el punto de sellado.

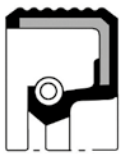

827NW

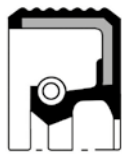

827SW

RETÉN DE BORDE RADIAL CON OD CORRUGADO TOTALMENTE ELASTOMÉRICO

Esta característica proporciona un ajuste de apriete superior con comodidad así como un mayor margen de seguridad en el diámetro interno de la carcasa expuesto a una alta expansión térmica o en carcasas divididas. El **827SW** cuenta con un borde guardapolvo que evita que entre suciedad en el punto de sellado.

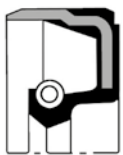

829N



829S

RETÉN DE BORDE RADIAL CON SUPERFICIE PARCIALMENTE ELASTOMÉRICA Y PARCIALMENTE DE ACERO

Este tipo de retén proporciona un posicionamiento central y axial preciso en el conjunto con un excelente sellado estático del OD y una buena retención del sellado. Adecuado para carcasas divididas y diámetros internos expuestos a una alta expansión térmica. El **829S** cuenta con un borde guardapolvo que evita que entre suciedad en el punto de sellado.

840 – Diseño integrado del retén y la carcasa con labio de sellado FPM o ACM

841 – Diseño integrado del retén y la carcasa con labio de sellado PTFE

LD	Ayuda hidrodinámica con giro a la izquierda
RD	Ayuda hidrodinámica con giro a la derecha
DD	Bidireccional
W	Superficie exterior acanalada/corrugada
SS	Bordes guardapolvo múltiples
SP	Especial



822N i 823N

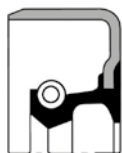

822S i 823S

PROMIENIOWE USZCZELNIENIE WARGOWE Z ZEWNĘTRZNĄ OBUDOWĄ WYKONANĄ W CAŁOŚCI Z METALU

Uszczelnienie statyczne jest właściwe dzięki spasowaniu średnicy zewnętrznej (OD) z obudową, oraz/lub wykorzystaniu oddzielnego środka uszczelniającego. Wersje 823 mają pokrycie na średnicy zewnętrznej (OD). Typ **822S** i **823S** posiada krawędź pyłową, która uniemożliwia dostęp pyłu do miejsca uszczelnienia.



824N

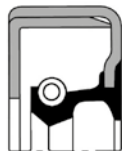

824S

PROMIENIOWE USZCZELNIENIE WARGOWE Z PODWÓJNĄ OBUDOWĄ

Ta konstrukcja zapewnia lepszą sztywność w aplikacjach z większym rozmiarem wału i pomaga chronić przed uszkodzeniami lub zniekształceniami podczas montażu. Typ **824S** posiada krawędź pyłową, która uniemożliwia przenikanie pyłu do miejsca uszczelnienia.



827N



827S

PROMIENIOWE USZCZELNIENIE WARGOWE Z CAŁKOWICIE ELASTOMEROWĄ ŚREDNICĄ ZEWNĘTRZNĄ (OD)

Elastyczność tej zewnętrznej powłoki umożliwia dodatkowo statyczne uszczelnienie w otworach obudowy, nawet tych, które są narażone na znaczne rozszerzenie termiczne lub w dzielonych obudowach. Typ **827S** posiada krawędź pyłową, która uniemożliwia dostęp pyłu do miejsca uszczelnienia.

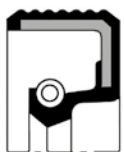

827NW

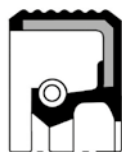

827SW

PROMIENIOWE USZCZELNIENIE WARGOWE Z CAŁKOWICIE ELASTOMEROWĄ POFAŁDOWANĄ ŚREDNICĄ ZEWNĘTRZNĄ (OD)

Ta opcja zapewnia lepsze spasowanie z wciskiem oraz większy margines bezpieczeństwa w otworach obudowy podatnych na znaczne rozszerzenie termiczne lub w dzielonych obudowach. Typ **827SW** posiada krawędź pyłową, która uniemożliwia dostęp pyłu do miejsca uszczelnienia.

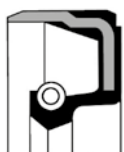

829N

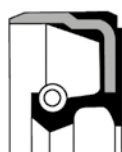

829S

PROMIENIOWE USZCZELNIENIE WARGOWE Z CZĘŚCIOWO ELASTOMEROWĄ I CZĘŚCIOWO STALOWĄ ZEWNĘTRZNĄ POWIERZCHNIĄ

Ten typ uszczelnienia zapewnia precyzyjne centralne i osiowe osadzenie w zespole oraz doskonałe statyczne uszczelnienie średnicy zewnętrznej (OD) i dobre zachowanie uszczelnienia. Odpowiednie do dzielonej obudowy oraz otworów w obudowie podatnym na znaczne rozszerzenia termiczne. Typ **829S** posiada krawędź pyłową, która uniemożliwia przenikanie pyłu do miejsca uszczelnienia.

840 – Zintegrowany typ uszczelnienia i obudowy z krawędzią uszczelniającą FPM lub ACM

841 – Zintegrowany typ uszczelnienia i obudowy z krawędzią uszczelniającą PTFE

LD	Hydrodynamiczna praca w lewo
RD	Hydrodynamiczna praca w prawo
DD	Dwukierunkowe
W	Żebrowana/pofałdowana zewnętrzna powierzchnia
SS	Wiele krawędzi przeciwpływowych
SP	Specjalne

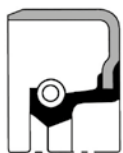

822N и 823N

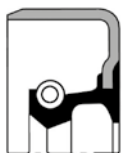

822S и 823S

МАНЖЕТНОЕ УПЛОТНЕНИЕ С ПОЛНОСТЬЮ МЕТАЛЛИЧЕСКИМ ВНЕШНИМ КОРПУСОМ

Статическое уплотнение обеспечивается между посадочным отверстием и внешней поверхностью сальника и/или использованием специального уплотнительного вещества. Версии **823** имеют внешнее покрытие. В типах 822S и 823S есть пылезащитная кромка, предотвращающая попадание загрязнений к месту уплотнения.



824N

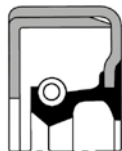

824S

МАНЖЕТНОЕ УПЛОТНЕНИЕ С ДВОЙНЫМ МЕТАЛЛИЧЕСКИМ КОРПУСОМ

Благодаря этой конструкции повышается прочность в агрегатах с большим размером вала, также она помогает предотвращать повреждения и деформацию в процессе сборки. Тип **824S** имеет пылезащитную кромку, предотвращающую попадание загрязнений к месту уплотнения.



827N



827S

МАНЖЕТНОЕ УПЛОТНЕНИЕ С ВНЕШНИМ ПОКРЫТИЕМ ИЗ ЭЛАСТОМЕРА

Высокая эластичность такого типа внешнего покрытия позволяет обеспечить надежное статическое уплотнение в посадочных отверстиях корпуса, в том числе подверженных тепловому расширению под воздействием высоких температур, а также в разъемных корпусах. Тип **827S** имеет пылезащитную кромку, предотвращающую попадание загрязнений к месту уплотнения.

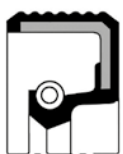

827NW

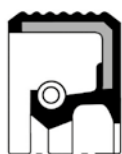

827SW

МАНЖЕТНОЕ УПЛОТНЕНИЕ С РИФЛЕННЫМ ПОКРЫТИЕМ ИЗ ЭЛАСТОМЕРА

Такая особенность обеспечивает более плотную посадку с простой установкой и увеличивает надежность в отверстиях корпуса, подвергающихся тепловому расширению под воздействием высоких температур, а также в разъемных корпусах. Тип **827SW** имеет пылезащитную кромку, предотвращающую попадание загрязнений к месту уплотнения.

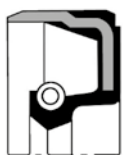

829N

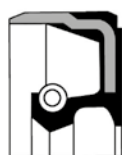

829S

МАНЖЕТНОЕ УПЛОТНЕНИЕ С НАРУЖНЫМ ПОКРЫТИЕМ ЧАСТИЧНО ИЗ МЕТАЛЛА, ЧАСТИЧНО ИЗ ЭЛАСТОМЕРА

Такое уплотнение обеспечивает точное позиционирование при сборке с высокоэффективным статическим уплотнением по внешней поверхности сальника. Подходит для разъемных корпусов и отверстий в корпусах, подверженных тепловому расширению под воздействием высоких температур. Тип **829S** имеет пылезащитную кромку, предотвращающую попадание загрязнений к месту уплотнения.

840 – Интегрированный в корпус сальник с манжетным уплотнением из фторполимерной (FPM) или полиакрилатной (ACM) резины
841 – Интегрированный в корпус сальник с манжетным уплотнением из фторопласта (PTFE)

- LD Манжета с гидродинамическим рельефом (для валов с вращением против часовой стрелки)
- RD Манжета с гидродинамическим рельефом (для валов с вращением по часовой стрелке)
- DD Манжета с гидродинамическим рельефом (для двунаправленного вращения вала)
- W Оребренная/рифленая внешняя поверхность
- SS Несколько пылезащитных кромок
- SP Особый

موانع تسرب قطرية الحافة بغلاف خارجي معدني كامل

يتم السد الاستاتيكي من خلال القطر الخارجي لتداخل المبيت أو استخدام مركبات سد منفصلة أو كليهما. ويتم طلاء القطر الخارجي من إصدارات 823. وتتميز أنواع 822S و 823S باحتوائها على حافة واقية تمنع وصول الأتربة إلى نقطة السد.

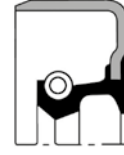

822S & 823S

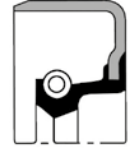

822N & 823N

مانعة تسرب قطرية الحافة بغلاف فولاذي مزدوج

يجعل هذا التصميم الأعمدة الأكبر حجمًا أكثر صلابة ويساعد في منع التلف أو الاعوجاج أثناء التركيب. ويتميز نوع 824S باحتوائه على حافة واقية من التراب، والتي تمنع وصول الأتربة إلى نقطة السد.

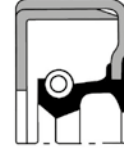

824S



824N

مانعة تسرب قطرية الحافة بقطر خارجي كامل المرنة

تسمح مرونة هذا الغطاء الخارجي بإنتاج مانع تسرب استاتيكي موجب بتجاويف المبيت، وحتى في حالة التجاويف القابلة للتمدد بسبب الحرارة العالية أو في حالة المبيئات المنقسمة. ويتميز نوع 827S باحتوائه على حافة واقية تمنع وصول الأتربة لنقطة السد.



827S

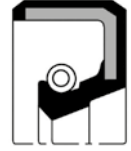

827N

مانعة تسرب قطرية الحافة بقطر خارجي موج كامل المرنة

توفر هذه الخاصية تركيب تداخلي أفضل مع توفير قدر أكبر من السلامة لاقطار التجاويف المعرضة للتمدد بسبب الحرارة العالية أو في حالة التجاويف المنقسمة. يتميز نوع 827SW باحتوائه على حافة واقية تمنع وصول الأتربة إلى نقطة السد.

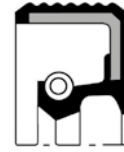

827SW

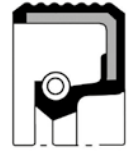

827NW

مانعة تسرب قطرية الحافة تحوي على جزء مرن وجزء سطحي خارجي من الفولاذ

هذا النوع من موانع التسرب يوفر موضع مركزي ومحوري دقيق عند التركيب كما توفر موانع التسرب قطر خارجي استاتيكي وقدرة ممتازة على إحكام الغلق، ويعد هذا النوع من السدادات ملائمًا للتجويفات المنقسمة اقطار التجويفات المعرضة للتمدد بفضل الحرارة العالية. ويتميز نوع 829S باحتوائه على حافة واقية من التراب، والتي تمنع وصول الأتربة إلى نقطة السد.



829S

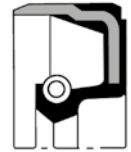

829N

840 - موانع تسرب مضمنة وتجويفات مزودة بحافة سد من مطاط الفلوروكربون أو مطاط الاكريليك

841 - موانع تسرب مضمنة وتجويفات مزودة بحافة سد مصنعة من مادة بولي تيترا فلورو إيثيلين

LD	مساعدة هيدرودينامية عكس اتجاه عقارب الساعة
RD	مساعدة هيدرودينامية في اتجاه عقارب الساعة
DD	ثنائية الاتجاه
W	سطح خارجي مضلع/موج
SS	حواف متعددة مضادة للأتربة
SP	خاصة

🇬🇧 MATERIALS SPECIFICATIONS

SEALING ELEMENT COMPOUNDS

MATERIALS AND COMPOUNDS AVAILABLE FOR SEALING ELEMENTS

The environments in which a seal will operate should be determined before selecting the sealing element or lip material. Two of the most important factors in material selection are Lubricant Temperature and Type.

Federal-Mogul Oil Seals offer a variety of sealing lip materials and compounds. The temperature limitations and fluid/lubricant compatibility for most compounds are shown within the Compound Selection Chart on the following pages.

Seals are used in a wide range of applications. The seal is part of a system and is dependent on proper shaft and bore operation to function correctly.

Runout, lubrication, shaft-to-bore misalignment, shaft speed, temperature, and other factors vary greatly from one application to another and each may affect the seal's life. In a perfect

system, these factors would be nominalized to achieve maximum life for all components. To assist our customers in getting maximum performance from their sealing system, we have provided recommendations below.

Operating a seal at one extreme condition will have small effect on seal life. However, when a seal is operating at multiple extremes in the system, it will have a much greater impact on performance. Therefore, we ask you to use the following recommendations as a guide to achieving the maximum performance from your seal. Each materials or compound has been assigned a specific letter code and is referenced in various tables and listings throughout this manual.

Elastomer	Code	Advantages	Disadvantages/Limitations	Normal operating temperature range 0C	Substitute	Code
Nitrile	NBR	Low cost. Good low temperature capability. Low swell in hydrocarbon fluids. Good tear resistance.	Limited heat resistance. Poor resistance to lubricants containing EP additives, hydrocarbon/oxygenate blends e.g.petro and methanol.	-30 to 120	Polyacrylate Ethylene-Acrylic Fluroelastomer PTFE	ACM AEM FKM PTFE
Polyacrylate	ACM	Good resistance to fuel, lubricating oils and high temperatures. Good resistance to EP lubricants.	Limited low temperature capability. Subject to attack in aqueous media.	-30 to 150	Ethylene-Acrylic Fluroelastomer PTFE	AEM FKM PTFE
Ethylene-Acrylate	AEM	Good resistance to lubricating oils, coolant and high temperatures. Good resistance to EP lubricants. Wider temperature operating range than ACM	Not recommended for exposure to fuel, brake fluid or aromatic hydrocarbons.	-40 to 175	Fluroelastomer PTFE	FKM PTFE
Silicone	VMQ	Good dry heat resistance. Excellent low temperature capability.	Easily damaged during installation. Poor chemical resistance to certain EP additives and oxidised oil. High swell, poor abrasion resistance.	-60 to 200	Fluroelastomer PTFE	FKM PTFE
Fluro-elastomer	FKM	Excellent high temperature capabilities. Compatible with a wide range of fluids.	Poor low temperature flexibility.	-40 to 200	PTFE	PTFE
PTFE	PTFE	Excellent dry running capabilities. Low friction characteristics. Excellent chemical resistance. Resistant to hydrocarbon/oxygenate blends.	Poor abrasion resistance in dirty environments. Susceptible to damage during installation.	-70 to 230	None	

DICHTELEMENTMASSEN

WERK- UND VERBUNDSTOFFE FÜR DICHELEMENTE

Vor Auswahl des Dichtelement- oder Lippenwerkstoffes sollten die Bedingungen der Einsatzumgebung einer Dichtung bestimmt werden. Zwei der wichtigsten Faktoren bei der Werkstoffauswahl sind Schmiermitteltemperatur und -typ.

Die Öldichtungen von Federal-Mogul bieten eine große Auswahl an Werk- und Verbundstoffen für Dichtlippen. Die Temperaturgrenzen und Flüssigkeits-/Schmierstoffkompatibilität für die meisten Verbundstoffe sind in der Verbundstoffauswahltabelle auf den nachfolgenden Seiten angegeben.

Dichtungen werden in vielen verschiedenen Anwendungen eingesetzt. Die Dichtung ist Bestandteil eines Systems. Für die korrekte Dichtungsfunktion ist ein ordnungsgemäßer Bohrungs- und Wellenbetrieb erforderlich.

Rundlauf, Schmierung, Wellen-Bohrungsversatz, Wellendrehzahl, Temperatur sowie andere Faktoren sind je nach Anwendung sehr unterschiedlich und können sich jeweils auf die Lebensdauer der Dichtung auswirken. In einem idealen System wären dies nominelle Faktoren, um eine maximale Lebensdauer aller Komponenten zu erzielen. Die nachstehenden Empfehlungen sollen dazu beitragen, dass unsere Kunden die optimale Leistung vom Dichtungssystem erhalten.

Wenn eine Dichtung einer einzigen extremen Betriebsbedingung ausgesetzt ist, hat dies nur geringe Auswirkungen auf ihre Lebensdauer. Mehrere extreme Betriebsbedingungen im System führen jedoch zu einer weitaus größeren Beeinträchtigung der Leistung der Dichtung. Wir bitten Sie daher, folgende Empfehlungen zu beachten, um die optimale Leistung Ihrer Dichtung zu erzielen. Jedem Werkstoff oder Verbundstoff wurde ein bestimmter Buchstabencode zugeordnet, auf den in diversen Tabellen und Listen in dieser Anleitung Bezug genommen wird.

Elastomer	Code	Vorteile	Nachteile/Einschränkungen	Normaler Betriebstemperaturbereich ° C	Substitute	Code
Nitril	NBR	Kostengünstig. Gute Tieftemperaturfähigkeit. Geringes Anschwellen in Kohlenwasserstoff-Flüssigkeiten. Gute Reißfestigkeit.	Eingeschränkte Hitzebeständigkeit. Schlechte Beständigkeit gegen Schmiermittel mit EP-Zusätzen, Kohlenwasserstoff-Sauerstoff-Mischungen, z. B. Benzin und Methanol.	-30 bis 120	Polyacrylat Ethylen-Acrylat Fluoroelastomer PTFE	ACM AEM FKM PTFE
Polyacrylat	ACM	Gute Beständigkeit gegen Kraftstoff, Schmierstoffe und Hitze. Gute Beständigkeit gegen EP-Schmiermittel.	Eingeschränkte Tieftemperaturfähigkeit. Wird in wässrigen Medien angegriffen.	-30 bis 150	Ethylen-Acrylat Fluoroelastomer PTFE	AEM FKM PTFE
Ethylen-Acrylat	AEM	Gute Beständigkeit gegen Schmierstoffe, Kühlmittel und Hitze. Gute Beständigkeit gegen EP-Schmiermittel. Größerer Betriebstemperaturbereich als ACM	Nicht geeignet für den Einsatz mit Kraftstoff, Bremsflüssigkeit oder aromatischen Kohlenwasserstoffen.	-40 bis 175	Fluoroelastomer PTFE	FKM PTFE
Silikon	VMQ	Gute Hitzebeständigkeit. Ausgezeichnete Tieftemperaturfähigkeit.	Anfällig für Schäden beim Einbau. Schlechte chemische Beständigkeit gegen bestimmte EP- Zusätze und oxidiertes Öl. Starkes Anschwellen, schlechte Abriebfestigkeit	-60 bis 200	Fluoroelastomer PTFE	FKM PTFE
Fluoroelastomer	FKM	Ausgezeichnete Hitze-eigenschaften. Kompatibel mit vielen verschiedenen Flüssigkeiten.	Schlechte Tieftemperaturflexibilität.	-40 bis 200	PTFE	PTFE
PTFE	PTFE	Ausgezeichnete Trockenlauffähigkeit. Reibungsarme Eigenschaften. Ausgezeichnete chemische Beständigkeit. Beständig gegen Kohlenwasserstoff-Sauerstoff-Mischungen	Schlechte Abriebfestigkeit in schmutzigen Umgebungen. Anfällig für Schäden beim Einbau.	-70 bis 230	Keine	

COMPOSTI ELEMENTI DI TENUTA

MATERIALI E COMPOSTI DISPONIBILI PER ELEMENTI DI TENUTA

Sarà necessario determinare gli ambienti in cui dovrà operare la tenuta prima di selezionare l'elemento di tenuta o il materiale del labbro. Due dei più importanti fattori nella selezione dei materiali sono il tipo e la temperatura del lubrificante.

Le tenute olio Federal-Mogul offrono un'ampia gamma di composti e materiali di labbro e tenuta. Le limitazioni di temperatura e la compatibilità fluido/lubrificante per la maggior parte dei composti sono mostrate nel grafico di selezione dei composti alle pagine seguenti.

Le tenute sono usate in un'ampia gamma di applicazioni. La tenuta fa parte di un sistema e dipende dal corretto funzionamento dell'albero e dell'alesaggio per poter lavorare in modo idoneo.

L'inattività, la lubrificazione, il disallineamento albero-alesaggio, la velocità dell'albero, la temperatura e altri fattori variano considerevolmente da un'applicazione all'altra e ciascuno di essi può influenzare la vita utile della tenuta. In un sistema perfetto, questi fattori verrebbero nominalizzati per ottenere la vita massima di tutti i componenti. Per prestare assistenza ai nostri clienti nell'ottenere le prestazioni massime dai propri sistemi di tenuta, consigliamo di attenersi alle raccomandazioni seguenti.

L'utilizzo di una tenuta a una sola condizione estrema avrà effetti minimi sulla vita della tenuta. Tuttavia, quando una tenuta opera a condizioni estreme multiple nel sistema, vi sarà un impatto assai maggiore sulle prestazioni. Di conseguenza, invitiamo a rispettare le raccomandazioni seguenti come guida per ottenere le massime prestazioni dalla tenuta. Ciascun materiale o composto è stato assegnato a un codice con lettere specifiche e viene indicato in varie tabelle ed elenchi nel presente manuale.

Elastomero	Codice	Vantaggi	Svantaggi/limitazioni	Intervallo temperatura d'esercizio normale 0c	Sostitut.	Codice
nitrile	NBR	Costo ridotto. Buona capacità a temperatura bassa. Basso rigonfiamento con i fluidi idrocarburi. Buona resistenza all'usura.	Resistenza limitata al calore. Scarsa resistenza ai lubrificanti contenenti additivi EP, miscele idrocarburi/ossigenati, ad es. Benzina e metanolo	da -30 a 120	Poliacrilato Acrilato di etilene Fluoroelastomero PTFE	ACM AEM FKM PTFE
Poliacrilato	ACM	Buona resistenza a carburanti, oli lubrificanti, alte temperature. Buona resistenza ai lubrificanti EP.	Capacità limitata a bassa temperatura. Soggetto ad attacchi in mezzi acquosi.	da -30 a 150	Acrilato di etilene Fluoroelastomero PTFE	AEM FKM PTFE
Acrilato di etilene	AEM	Buona resistenza a oli lubrificanti, refrigeranti e alte temperature. Buona resistenza ai lubrificanti EP. Intervallo più ampio di temperature d'esercizio rispetto a ACM	Non raccomandato per esposizione a carburante, olio freno o idrocarburi aromatici.	da -40 a 175	Fluoroelastomero PTFE	FKM PTFE
Silicone	VMQ	Buona resistenza al calore secco. Eccellente capacità a bassa temperatura.	Facilmente danneggiabile durante installazione. Scarsa resistenza chimica a certi additivi EP e olio ossidato. Elevato rigonfiamento, scarsa resistenza all'abrasione.	da -60 a 200	Fluoroelastomero PTFE	FKM PTFE
Fluoro-Elastomero	FKM	Eccellenti capacità ad alte temperature. Compatibile con un'ampia gamma di fluidi.	Scarsa flessibilità a bassa temperatura.	da -40 a 200	PTFE	PTFE
PTFE	PTFE	Eccellenti capacità di lavoro a secco. Basse caratteristiche d'attrito. Ottima resistenza agli agenti chimici. Resistente a miscele di idrocarburi/ossigenati.	Scarsa resistenza all'abrasione in ambienti sporchi. Suscettibile a danni durante l'installazione.	da -70 a 230	Nessuna	

PRODUITS POUR ORGANES D'ÉTANCHÉITÉ MATÉRIAUX ET PRODUITS DISPONIBLES POUR ORGANES D'ÉTANCHÉITÉ

Le milieu dans lequel une bague d'étanchéité est utilisée doit être déterminé avant de choisir le matériau de l'organe d'étanchéité ou de la lèvres. Deux des facteurs les plus importants lors de la sélection des matériaux sont la température et le type de lubrifiant.

La gamme des bagues d'étanchéité de Federal-Mogul propose différents matériaux et composants dans ses lèvres d'étanchéité. Les limites de température et la compatibilité fluide/lubrifiant pour la plupart des produits sont indiquées dans le tableau de sélection des produits dans les pages suivantes.

Les bagues d'étanchéité sont utilisées dans un large éventail d'applications. La bague d'étanchéité fait partie intégrante d'un système et dépend de la réalisation de l'arbre et de l'alésage pour fonctionner correctement.

Les faux-ronde, la lubrification, un mauvais alignement de l'arbre par rapport à l'alésage, la vitesse de l'arbre, la température et d'autres facteurs varient considérablement d'une application à l'autre et tous ces facteurs peuvent affecter la durée de vie de la bague d'étanchéité. Dans un système parfait, les valeurs de ces facteurs seraient nominales afin d'atteindre une durée de vie maximale pour tous les composants. Pour aider nos clients à tirer les performances maximales de leur système d'étanchéité, nous fournissons les recommandations ci-dessous.

Si une des conditions de fonctionnement est extrême, elle n'affectera pas beaucoup la durée de vie d'une bague d'étanchéité. Mais, si la plupart des conditions de fonctionnement d'une bague d'étanchéité sont extrêmes, elles auront un impact beaucoup plus important sur les performances. Veuillez donc suivre nos recommandations pour obtenir les meilleures performances de votre bague d'étanchéité. Chaque matériau ou produit a un code alphabétique spécifique qui est référencé dans différents tableaux et listes dans ce manuel.

Élastomère	Code	Avantages	Inconvénients/limites	Plage de température de service normale °C	Variante	Code
Nitrile	NBR	Bon marché. Bonne résistance aux températures basses. Faible gonflement au contact des hydrocarbures. Bonne résistance au déchirement.	Résistance à la chaleur limitée Faible résistance aux lubrifiants contenant des additifs extrême pression, mélanges hydrocarbures/composés oxygénés, comme l'essence et le méthanol.	-30 à 120	Polyacrylate Acrylate d'éthylène Fluoroélastomère PTFE	ACM AEM FKM PTFE
Polyacrylate	ACM	Bonne résistance aux carburants, aux huiles lubrifiantes et aux hautes températures. Bonne résistance aux lubrifiants extrême pression.	Résistance limitée aux basses températures. Sujet à l'attaque en milieu aqueux.	-30 à 150	Acrylate d'éthylène Fluoroélastomère PTFE	AEM FKM PTFE
Acrylate d'éthylène	AEM	Bonne résistance aux huiles lubrifiantes, aux liquides de refroidissement et aux hautes températures. Bonne résistance aux lubrifiants extrême pression. Plus grande plage de température de service que l'ACM	Non recommandé pour exposition aux carburants, aux liquides de frein ou aux hydrocarbures aromatiques.	-40 à 175	Fluoroélastomère PTFE	FKM PTFE
Silicone	VMQ	Bonne résistance à la chaleur sèche. Excellente résistance aux basses températures.	Facilement endommagé pendant le montage. Faible résistance chimique à certains additifs EP et à l'huile oxydée. Fort gonflement, faible résistance à l'abrasion.	-60 à 200	Fluoroélastomère PTFE	FKM PTFE
Fluoroélastomère	FKM	Excellente résistance aux températures élevées. Compatible avec un large éventail de liquides.	Faible flexibilité aux basses températures.	-40 à 200	PTFE	PTFE
PTFE	PTFE	Excellentes capacités de fonctionnement à sec. Faibles caractéristiques de frottement. Excellente résistance chimique. Résistance aux mélanges hydrocarbures/composés oxygénés.	Faible résistance à l'abrasion dans les environnements salissants. Facilement endommagé pendant le montage.	-70 à 230	None	

ESPECIFICACIONES DE LOS MATERIALES

COMPUESTOS DE ELEMENTOS DE SELLADO

MATERIALES Y COMPUESTOS DISPONIBLES PARA ELEMENTOS DE SELLADO

Antes de seleccionar el elemento de sellado o el material del labio, se debe determinar en qué entornos se utilizará el retén. Dos de los factores más importantes a la hora de seleccionar el material son la temperatura y el tipo de lubricante.

Los retenes de aceite de Federal-Mogul están disponibles en varios materiales y compuestos de labio de sellado. Los rangos de temperatura y la compatibilidad de los líquidos/lubricantes para la mayoría de los compuestos se muestran en la tabla de selección de compuestos que aparecen en las siguientes páginas.

Los retenes se emplean en una gran variedad de aplicaciones. El retén forma parte de un sistema y su correcto funcionamiento depende de la buena operación del eje y de un diámetro adecuado.

Otros factores como el descentramiento, la lubricación, la mala alineación entre el eje y el diámetro, la velocidad del eje o la temperatura pueden variar significativamente de una aplicación a otra y cada uno de ellos puede afectar a la vida útil del retén. En un sistema perfectamente equilibrado, estos factores deberían estar bien medidos con el fin de garantizar la máxima vida útil de todos los componentes. Para ayudar a nuestros clientes a obtener el máximo rendimiento de sus sistemas de sellado, hemos elaborado las siguientes recomendaciones.

El funcionamiento de un retén en condiciones extremas apenas debería afectar a su vida útil. Sin embargo, cuando el retén funciona en un sistema sometido a diversas condiciones extremas, su rendimiento se verá afectado en una medida mucho mayor. Por ello, le sugerimos que utilice las siguientes recomendaciones como guía para obtener el máximo rendimiento de su retén. Cada uno de los materiales o compuestos tiene asignado un código específico formado por distintas letras y este aparece en varias de las tablas y listas que contiene este manual.

Elastómero	CÓDIGO	VENTAJAS	INCONVENIENTES/LIMITACIONES	Temperatura normal	Substitute	Code
Nitrilo	NBR	Bajo coste. Buena capacidad a baja temperatura. Baja expansión en hidrocarburos líquidos. Buena resistencia al desgaste.	Resistencia al calor limitada. Mala resistencia a los lubricantes que contienen aditivos de EP, mezclas de hidrocarburo/oxígeno, p. ej., gasolina y metanol.	De -30 a 120	Poliacrilato Etileno acrílico Fluoroelastómero PTFE	ACM AEM FKM PTFE
Poliacrilato	ACM	Buena resistencia a los combustibles, los aceites lubricantes y las altas temperaturas. Buena resistencia a los lubricantes EP.	Capacidad a baja temperatura limitada. Vulnerable a los ataques en entornos acuosos.	De -30 a 150	Etileno acrílico Fluoroelastómero PTFE	AEM FKM PTFE
Etileno acrílico	AEM	Buena resistencia a los aceites lubricantes, los refrigerantes y las altas temperaturas. Buena resistencia a los lubricantes EP. Mayor rango de temperatura de funcionamiento que el ACM	No recomendado para una exposición a combustibles, líquido de frenos o hidrocarburos aromáticos.	De -40 a 175	Fluoroelastómero PTFE	FKM PTFE
Silicona	VMQ	Buena resistencia al calor seco. Excelente capacidad a baja temperatura.	Puede dañarse fácilmente durante el montaje. Mala resistencia química a ciertos aditivos de EP y aceites oxidados. Alta expansión, mala resistencia a la abrasión.	De -60 a 200	Fluoroelastómero PTFE	FKM PTFE
Fluoro-elastómero	FKM	Excelente capacidad a alta temperatura. Compatible con una gran variedad de líquidos.	Mala flexibilidad a baja temperatura.	De -40 a 200	PTFE	PTFE
PTFE	PTFE	Excelente capacidad de funcionamiento en seco. Baja fricción. Excelente resistencia química. Resistente a mezclas de hidrocarburo/oxígeno.	Mala resistencia a la abrasión en entornos sucios. Susceptible de sufrir daños durante el montaje.	De -70 a 230	Ninguna	

ELEMENTY USZCZELNIAJĄCE

MATERIAŁY I SKŁADNIKI DOSTĘPNE DLA ELEMENTÓW USZCZELNIAJĄCYCH

Środowisko, w którym uszczelnienie będzie pracować, powinno być określone przed wyborem produktu uszczelniającego. Dwa z najważniejszych czynników w zakresie wyboru produktu to temperatura pracy i typ środka smarnego.

Uszczelnienia olejowe Federal-Mogul obejmują szeroką gamę materiałów i zabezpieczeń krawędzi uszczelniających. Ograniczenia temperaturowe oraz zgodności płynu/środku smarnego w przypadku większości uszczelnień są przedstawione w tabeli na kolejnych stronach.

Uszczelnienia są stosowane w wielu różnych zastosowaniach. Uszczelnienie wchodzi w skład całego zespołu i jego prawidłowe działanie jest zależne od warunków pracy wału względem otworu.

Odchyłki bicia, smarowanie, niewspółosiowość wału względem otworu, prędkość obrotowa wału, temperatura oraz inne czynniki w dużej mierze różnią się w zależności od aplikacji i każdy z tych parametrów może mieć wpływ na żywotność uszczelnienia. W prawidłowym zespole parametry te byłyby zrównoważone i umożliwiałyby uzyskanie maksymalnej żywotności wszystkich elementów. Aby umożliwić naszym klientom uzyskanie maksymalnej wydajności uszczelnienia, poniżej zamieszczamy zalecenia.

Praca uszczelnienia w ekstremalnych warunkach będzie miała niewielki wpływ na żywotność uszczelnienia. Jednak, gdy uszczelnienie pracuje w zakresie wielu ekstremalnych czynników w danym zespole, będzie to miało znaczenie większy wpływ na parametry pracy. W związku z tym zalecamy stosowanie się do następujących zaleceń, które zapewnią maksymalne parametry robocze uszczelnienia. Wszystkie materiały i składniki posiadają określony kod, który jest podany w tabelach i zestawieniach w tym katalogu.

Elastomer	Kod	Zalety	Wady/ograniczenia	Standardowy zakres temperatury pracy 0c	Zamiennik	Kod
Nitryl	NBR	Niski koszt. Dobre parametry w niskiej temperaturze. Słabe puchnięcie w płynach węglowodorowych. Dobra odporność na rozerwanie.	Ograniczona odporność na ciepło. Słaba odporność na środki smarne zawierające dodatki EP, mieszanki węglowodorowo-tlenowe, np. Benzyna i metanol.	Od -30 do 120	Poliakrylan Kauczuk etylenowo-akrylowy Fluoroelastomer PTFE	ACM AEM FKM PTFE
Poliakrylan	ACM	Dobra odporność na paliwo, oleje smarowe oraz wysokie temperatury. Dobra odporność na środki smarne EP.	Ograniczone parametry w niskiej temperaturze. Podatność na zagrożenia w środowisku wodnym.	Od -30 do 150	Kauczuk etylenowo-akrylowy Fluoroelastomer PTFE	AEM FKM PTFE
Kauczuk etylenowo-akrylowy	AEM	Dobra odporność na działanie olejów smarnych, płynu chłodzącego i wysokich temperatur. Dobra odporność na środki smarne EP. Szerszy zakres temperatury roboczej niż ACM	Niezalecany kontakt z paliwem, płynem hamulcowym i aromatycznymi węglowodorami.	Od -40 do 175	Fluoroelastomer PTFE	FKM PTFE
Silikon	VMQ	Dobra odporność na ciepło na sucho. Doskonałe parametry w niskiej temperaturze.	Łatwe uszkodzenie podczas montażu. Słaba odporność chemiczna na określone dodatki EP oraz utleniony olej. Wysoka pęcznienie, słaba odporność na ścieranie.	Od -60 do 200	Fluoroelastomer PTFE	FKM PTFE
Fluoro-elastomer	FKM	Doskonałe parametry w wysokiej temperaturze. Zgodność z szeroką gamą płynów.	Słaba elastyczność w niskiej temperaturze.	Od -40 do 200	PTFE	PTFE
PTFE	PTFE	Doskonałe parametry podczas pracy na sucho. Niski poziom tarcia. Doskonałą odporność chemiczną. Odporność na działanie mieszanek węglowodorowych/tlenowych.	Słaba odporność na ścieranie w zanieczyszczonych środowiskach. Podatność na uszkodzenie podczas montażu.	Od -70 do 230	Brak	

СОСТАВЫ УПЛОТНИТЕЛЬНЫХ ЭЛЕМЕНТОВ

МАТЕРИАЛЫ И СОСТАВЫ ДЛЯ УПЛОТНИТЕЛЬНЫХ ЭЛЕМЕНТОВ

До выбора уплотнительного элемента или манжеты следует определить, в каких условиях будет работать уплотнение. Два важнейших фактора при выборе материала — это температура и тип смазки.

Масляные уплотнения (сальники) Federal-Mogul — это широкий спектр различных материалов и составов для уплотнительных элементов. Температурные ограничения и совместимость с жидкими рабочими средами и смазками для большинства составов указаны в таблице выбора состава на следующих страницах.

Уплотнения используются в самых различных агрегатах. Уплотнение является частью системы и его правильное функционирование зависит от корректной работы оси и отверстия.

Вытекание смазки, неверное положение относительно оси и отверстия, скорость вращения вала, температура и другие факторы сильно отличаются в разных агрегатах, и каждый из них влияет на срок службы уплотнения. В идеальном случае эти факторы сводятся к минимуму, что позволяет достичь максимального срока службы всех компонентов. В помощь нашим клиентам для достижения максимальной эффективности в системе уплотнений ниже мы приводим некоторые рекомендации.

Работа уплотнения при одном экстремальном жестком факторе не окажет большого влияния на срок эксплуатации компонента. Однако если в системе несколько условий являются экстремальными, это окажет сильное воздействие на функционирование уплотнения. Поэтому мы просим руководствоваться данными рекомендациями для достижения максимальной эффективности уплотнения. Всем материалам и составам присвоен собственный буквенный код, которым они обозначаются в различных таблицах в данном руководстве.

Эластомер	Код	Преимущества	Недостатки/ограничения	Нормальная рабочая температура диапазон 0с	Замена	Код
нитрил	NBR	Низкая стоимость. Хорошие характеристики при низких температурах. Малое расширение в углеводородных жидких средах. Хорошее сопротивление износу.	Ограниченная теплоустойчивость. Плохая устойчивость к смазкам, содержащим противозадирный пакет присадок EP, смеси с углеводородами и кислородом, напр., бензин и метанол.	от -30 до 120	Полиакрилат Этилен-акриловый Флуорэластомер PTFE	ACM AEM FKM PTFE
Полиакрилат	ACM	Хорошая устойчивость к топливу, смазочным маслам и высоким температурам. Хорошая устойчивость к смазкам с присадками EP.	Ограниченная работоспособность при низких температурах. Подвержен повреждениям в водных средах.	от -30 до 150	Этилен-акриловый Флуорэластомер PTFE	AEM FKM PTFE
Этилен-акрилат	AEM	Хорошая устойчивость к смазочным маслам, охлаждающим жидкостям и высоким температурам. Хорошая устойчивость к смазочным веществам с присадками EP. Более широкий диапазон рабочих температур, чем у ACM	Не рекомендуется воздействие топлива, тормозной жидкости и ароматических углеводородов.	от -40 до 175	Флуорэластомер PTFE	FKM PTFE
Силикон	VMQ	Хорошая устойчивость к высоким температурам в сухих условиях. Прекрасные характеристики при низких температурах.	Легко повредить во время установки. Низкая химическая устойчивость к некоторым присадкам EP и окисленным маслам. Хорошо расширяется, низкая устойчивость к истиранию.	от -60 до 200	Флуорэластомер PTFE	FKM PTFE
Флуорэластомер	FKM	Прекрасные рабочие показатели при высоких температурах. Подходит для использования с широким рядом жидких рабочих сред.	Плохая эластичность при низких температурах.	от -40 до 200	PTFE	PTFE
ПТФЭ	PTFE	Прекрасные рабочие показатели в сухих условиях. Низкие фрикционные показатели. Прекрасная устойчивость к химическим воздействиям. Устойчивость к воздействию углеводородов и окислению в смеси.	Невысокая устойчивость к истиранию в условиях повышенной загрязненности. Восприимчивость к повреждениям во время установки.	от -70 до 230	Нет	

مركبات عناصر مانع التسرب المواد والمركبات المتاحة لعناصر السد

يعتمد مستوى النفاذ والتشحيم واختلال محاذاة العمود إلى التجويف وسرعة العمود ودرجة الحرارة وعوامل متعددة أخرى على طبيعة الاستخدام بدرجة كبيرة، وقد يؤثر كل منها على عمر موانع التسرب الفعلي، إذ يتم تسمية هذه العوامل في الأنظمة المتكاملة لتحقيق أطول فترة استخدام ممكنة لجميع المكونات. لمساعدة عملائنا في الحصول على أفضل أداء من أنظمة موانع التسرب، انظر التوصيات أدناه.

يؤثر تشغيل مانعة التسرب في ظروف قاصى واحد بقدر ضئيل على عمر مانعة التسرب الافتراضي. ومع ذلك فعندما تستخدم موانع التسرب في ظروف قصوى متعددة، يتأثر أدائها بشكل ملحوظ. ولذلك، نطلب من عملائنا اتباع التوصيات التالية كدليل يُمكنهم من الحصول على أفضل أداء من موانع التسرب. تم تخصيص كود حرفي لكل مادة أو مركب وتم الإشارة إليه في جداول وقوائم مختلفة خلال هذا الدليل الإرشادي.

يتعين تحديد البيئة التي سيتم استخدام مانعة التسرب فيها قبل اختيار عناصر مانعة التسرب أو مواد الحافة. يوجد عاملان مهمان يجب مراعاتهما عند اختيار المواد، وهما نوع ودرجة حرارة مادة التشحيم.

توفر موانع تسرب زيت فديرال موجل مجموعة متنوعة من مواد ومركبات حواف مانعة السد. تُعرض حدود درجة الحرارة وتوافق السائل/ مادة التشحيم مع معظم المركبات في مخطط اختيار المركبات في الصفحات التالية.

تستخدم موانع التسرب في تطبيقات متنوعة. تعد مانعة التسرب بمثابة جزء من نظام، كما تعتمد على عملية ثقب وعمود ملائم كي تعمل بشكل صحيح.

المادة اللدنة	الكود	المزايا	المساوي/أوجه القصور	التشغيل العادي درجة الحرارة نطاق درجة حرارة ٠ مئوية	البديل	الكود
النتريل	NBR مطاط بيوتاديين	انخفاض التكلفة. قدرة مناسبة على تحمل درجات الحرارة المنخفضة. انتفاخها بقدر ضئيل عند استخدامها مع السوائل الهيدروكربونية. مقاومة جيدة للاهتراء.	مقاومة محدودة للحرارة. مقاومة ضعيفة لمواد التشحيم الحامضية لإضافات الضغط الشديد (خلات هيدروكربونية/ مشبعة بالأوكسجين)، البترول والمينترول على سبيل المثال.	-٣٠ إلى ١٢٠	بولي اكريليت إيثيلين اكريليت مطاط صناعي قائم على الفلوروكربون بولي تيترا فلورو إيثيلين	ACM مطاط الاكريليك AEM إيثيلين اكريليت مطاط صناعي قائم على مادة FKM الفلوروكربون بولي تيترا PTFE فلورو إيثيلين
بولي اكريليت	ACM الاكريليك مطاط	مقاومة جيدة للوقود وزيت التشحيم ودرجات الحرارة المرتفعة. مقاومة جيدة لمواد تشحيم الضغط الشديد.	قدرة محدودة على احتمال درجات الحرارة المنخفضة. معرضة للتلف في الوسائط المائية.	-٣٠ إلى ١٥٠	إيثيلين اكريليك مطاط صناعي قائم على الفلوروكربون بولي تيترا فلورو إيثيلين	AEM إيثيلين اكريليت مطاط صناعي قائم على مادة FKM الفلوروكربون بولي تيترا PTFE فلورو إيثيلين
إيثيلين اكريليت	AEM إيثيلين أكريليت	مقاومة جيدة لزيت التشحيم وسوائل التبريد ودرجات الحرارة العالية. مقاومة جيدة لمواد تشحيم الضغط الشديد. إمكانية الاستخدام في نطاق درجات حرارة أكثر تنوعاً من نطاق استخدام مطاط الاكريليك	لا ينصح بتعرضها للوقود، أو سوائل الكبح أو المواد الهيدروكربونية العطرية.	-٤٠ إلى ١٧٥	مطاط صناعي قائم على الفلوروكربون بولي تيترا فلورو إيثيلين	FKM مطاط صناعي قائم على مادة الفلوروكربون PTFE بولي تيترا فلورو إيثيلين
ميتيل الفينيل	VMQ سيليكون	مقاومة حرارية جافة جيدة. قدرة ممتازة على تحمل درجات الحرارة المنخفضة.	سهولة التلف أثناء التركيب. مقاومة كيميائية ضعيفة لإضافات مواد الضغط الشديد وزيت مؤكسدة معينة. تنتفخ بشكل كبير مع مقاومة تآكل محدودة.	-٦٠ إلى ٢٠٠	مطاط صناعي قائم على الفلوروكربون بولي تيترا فلورو إيثيلين	FKM مطاط صناعي قائم على مادة الفلوروكربون PTFE بولي تيترا فلورو إيثيلين
مطاط صناعي قائم على مادة الفلوروكربون	FKM مطاط صناعي قائم على مادة الفلوروكربون	قدرة ممتازة على تحمل درجات الحرارة المرتفعة. متوافقة مع نطاق واسع من السوائل.	مرونة منخفضة على تحمل درجات الحرارة المنخفضة.	-٤٠ إلى ٢٠٠	بولي تيترا فلورو إيثيلين	PTFE بولي تيترا فلورو إيثيلين
بولي تيترا فلورو إيثيلين	PTFE بولي تيترا فلورو إيثيلين	قدرة تشغيل ممتازة في البيئات الجافة. خصائص احتكاك منخفضة. مقاومة ممتازة للمواد الكيميائية. مقاومة لخلات هيدروكربونية / مشبعة بالأوكسجين.	مقاومة ضعيفة ضد التآكل في البيئات الملوثة. عرضة للتلف أثناء التركيب.	-٧٠ إلى ٢٢٠	لا يوجد	

INSTRUCTIONS

- Check that the bore is clean and free from burrs that may damage the seal outer diameter.
- Check the shaft for any burrs, dirt or paint that may damage the seal or provide a leak path. If the old seal has worn a groove in the shaft this will need to be repaired. Also check the shaft end for any burrs or sharp edges. If the shaft end is not chamfered or radiused then use an installation sleeve to avoid damage to the seal.
- If a shaft has splines or keyways cover these with a sleeve or tape to avoid seal damage.
- Check the seal for any damage such as cuts or scratches that may have occurred during transit. Replace a damaged seal.
- Make sure the seal is fitted in the correct direction. The seal lip normally faces the sealed fluid.
- For non-PTFE seals, the elastomeric lip should be lightly lubricated prior to assembly. If the seal has an elastomeric outer diameter then this should also be lightly oiled to ease assembly. Seals with metallic outside diameters do not require this surface to be lubricated. Do not oil the seal lip or shaft if a PTFE seal is used.
- Use an installation tool to fit the seal to avoid the seal being misaligned or poorly fitted.
- Steel hammers are not recommended as the shock of the impact can dislodge the garter spring which will cause the seal to leak. If a hammer is used, use just enough force to seat the seal in the bore.

TIPS & TRICKS

- PTFE seals require careful fitting using the plastic collar provided with the seal.
- Don't remove the plastic collar before fitting and avoid touching the PTFE lip to prevent contamination.
- Always fit on a clean and dry shaft without any oil or grease.
- Fully tighten bolts used in fitting an integrated seal before removing the plastic collar.
- Once the plastic collar is removed, make 2 full rotations, allow 4 hours for the seal to recover onto the shaft before starting the engine.

ANLEITUNG

- Prüfen Sie, dass die Bohrung sauber und gratfrei ist, damit die Außenfläche der Dichtung keinen Schaden nimmt.
- Prüfen Sie die Welle auf Grate, Schmutz- oder Lackrückstände, die die Dichtung beschädigen oder eine Leckage erzeugen können. Wenn die alte Dichtung eine Einkerbung in der Welle hinterlassen hat, muss diese beseitigt werden. Prüfen Sie das Wellenende ebenfalls auf Grate oder scharfe Kanten. Falls das Wellenende nicht abgeschrägt oder abgerundet ist, verwenden Sie eine Montagehülse, um Schäden an der Dichtung zu verhindern.
- Wenn die Welle über Keilnuten oder Keilzähne verfügt, decken Sie diese mit einer Montagehülse oder mit Klebeband ab, um Schäden an der Dichtung zu verhindern.
- Prüfen Sie die Dichtung auf eventuelle Transportschäden, z. B. Kratzer oder Ritze. Tauschen Sie eine beschädigte Dichtung aus.
- Stellen Sie sicher, dass die Dichtung in korrekter Ausrichtung eingebaut wird. Die Dichtungslippe zeigt üblicherweise in Richtung der eingeschlossenen Flüssigkeit.
- Bei Nicht-PTFE-Dichtungen sollte die Elastomerlippe vor dem Einbau leicht geschmiert werden. Wenn die Dichtung über eine Elastomeraußenfläche verfügt, muss diese ebenfalls leicht geschmiert werden, um den Einbau zu erleichtern. Bei Dichtungen mit Metall-OD ist kein Schmiermittel auf der Außenfläche erforderlich. Bei Verwendung einer PTFE-Dichtung dürfen Dichtlippe oder Welle nicht geschmiert werden.
- Verwenden Sie für den Einbau der Dichtung ein Montagewerkzeug, um falsche Ausrichtung oder mangelhaften Sitz zu verhindern.
- Von der Verwendung eines Stahlhammers wird abgeraten, da sich durch die Schockwirkung des Stoßes die Schlauchfeder lösen und Leckagen der Dichtung verursachen kann. Falls doch ein Hammer verwendet wird, nur leichte Hammerschläge anwenden, um die Dichtung in die Bohrung einzupassen.

TIPPS UND TRICKS

- PTFE-Dichtungen müssen mithilfe der mitgelieferten Kunststoffmanschette sorgfältig eingebaut werden.
- Die Kunststoffmanschette darf nicht vor dem Einbau entfernt werden und die PTFE-Lippe darf nicht berührt werden, um eine Kontamination zu verhindern.
- Die Dichtung muss stets auf einer sauberen, trockenen Welle ohne Öl- oder Fettrückstände montiert werden.
- Die beim Einbau einer integrierten Dichtung verwendeten Schrauben vollständig anziehen, bevor die Kunststoffmanschette entfernt wird.
- Nach Entfernen der Kunststoffmanschette 2 Motorumdrehungen von Hand ausführen und die Dichtung vor dem Starten des Motors 4 Stunden lang auf der Welle ruhen lassen.



🇮🇹 CONSIGLI PER L'INSTALLAZIONE

ISTRUZIONI

- Verificare che l'alesaggio sia pulito e privo di sbavature che possono danneggiare il diametro esterno della tenuta.
- Verificare che l'albero sia privo di eventuali sbavature, sporco o vernice che possa danneggiare la tenuta o offrire un percorso di fuoriuscita. Se la vecchia tenuta ha una scanalatura usurata nell'albero, sarà necessario provvedere alla riparazione. Controllare inoltre che l'estremità dell'albero non presenti sbavature o bordi affilati. Se l'estremità dell'albero non è bisellata o arrotondata, utilizzare un manico di installazione per evitare danni alla tenuta.
- Se un albero ha linguette o scanalature, coprirle con un manico o un nastro per evitare danni alla tenuta.
- Verificare che sulla tenuta non vi siano danni, quali tagli o graffiature che possano essere avvenute durante il trasporto. Sostituire una tenuta danneggiata.
- Verificare che la tenuta sia installata nella direzione corretta. Il labbro della tenuta è normalmente rivolto verso il fluido da sigillare.
- Per le tenute non in PTFE, il labbro elastomerico deve essere leggermente lubrificato prima dell'assemblaggio. Se la tenuta ha un diametro esterno elastomerico, anch'esso deve essere leggermente lubrificato per facilitare l'assemblaggio. Le tenute con diametri esterni in metallo non richiedono che questa superficie venga lubrificata. Non lubrificare il labbro della tenuta o l'albero se viene usata una tenuta in PTFE.
- Usare un utensile di installazione per montare la tenuta, evitando che questa sia disallineata o installata in maniera errata.
- I martelli in ferro non sono raccomandati, in quanto l'urto prodotto dall'impatto può de-alloggiare la molla garter, causando una fuoriuscita dalla tenuta. Se viene usato un martello, applicare solo la forza sufficiente a posizionare la tenuta nell'alesaggio.

CONSIGLI E TRUCCHI

- Le tenute in PTFE richiedono un'attenta installazione utilizzando il collare in plastica in dotazione con la tenuta.
- Non rimuovere il collare in plastica prima dell'installazione ed evitare di toccare il labbro in PTFE per prevenire la contaminazione.
- Installare sempre su un albero asciutto e pulito senza alcun olio o lubrificante.
- Serrare completamente i bulloni usati per installare una tenuta integrata prima di rimuovere il collare in plastica.
- Dopo aver rimosso il collare in plastica, effettuare 2 rotazioni complete, lasciare per 4 ore che la tenuta aderisca all'albero prima di avviare il motore.



🇫🇷 ASTUCES DE MONTAGE

INSTRUCTIONS

- Vérifiez que l'alésage est propre et ne présente pas de bavures susceptibles d'endommager la surface extérieure de la bague.
- Vérifiez que l'arbre ne présente aucune bavure, saleté ou peinture susceptible d'endommager la bague ou de provoquer des fuites. Si l'ancienne bague d'étanchéité a creusé une gorge dans l'arbre, celle-ci devra être réparée. Vérifiez également que l'extrémité de l'arbre ne présente aucune bavure ou arête vive. Si l'extrémité de l'arbre n'est pas chanfreinée ou arrondie, utilisez un manchon de montage pour éviter d'endommager la bague.
- Si l'arbre est doté de cannelures ou de rainures de clavettes, recouvrez-les par un manchon ou un ruban adhésif pour éviter d'endommager la bague d'étanchéité.
- Vérifiez que la bague n'est pas endommagée par des coupures ou des éraflures qui auraient pu se produire pendant le transport. Remplacez la bague si elle est endommagée.
- Veillez à monter la bague dans le bon sens. La lèvre de la bague doit normalement être orientée vers le côté du fluide
- Lubrifiez légèrement la lèvre élastomère des bagues qui ne sont pas en PTFE avant le montage. Si la surface extérieure de la bague d'étanchéité est élastomère, elle doit également être légèrement huilée pour faciliter l'assemblage. Il n'est pas nécessaire de lubrifier les bagues d'étanchéité dont la surface extérieure est métallique. N'huilez pas la lèvre ni l'arbre dans le cas d'une bague d'étanchéité en PTFE.
- Utilisez un outil d'installation pour monter la bague d'étanchéité afin d'éviter au mauvais alignement ou un mauvais montage de celle-ci.
- Les marteaux en acier ne sont pas recommandés, car le choc de l'impact peut déloger le ressort jarretière et la bague fuira. En cas d'utilisation d'un marteau, employez seulement la force nécessaire pour placer la bague dans l'alésage.

CONSEILS ET ASTUCES

- Les bagues en PTFE nécessitent un ajustement soigneux à l'aide du collier en plastique fourni.
- Ne retirez pas le collier en plastique avant le montage et évitez de toucher la lèvre en PTFE pour éviter toute contamination.
- Montez toujours la bague sur un arbre propre et sec, dépourvu d'huile ou de graisse.
- Serrez complètement les vis utilisées pour le montage d'une bague intégrée avant de retirer le collier en plastique.
- Après avoir retiré le collier en plastique, faites 2 rotations complètes, attendez 4 heures pour que la bague récupère sa forme sur l'arbre avant de démarrer le moteur.



CONSEJOS SOBRE MONTAJE

INSTRUCCIONES

- Compruebe que el diámetro esté limpio y que no tenga rebabas que puedan dañar el diámetro exterior del retén.
- Compruebe que el eje no tenga rebabas, suciedad o pintura que pueda dañar el retén o provocar fugas. Si el eje de un retén presenta surcos, deberá ser reparado. Compruebe también que el extremo del eje no tenga rebabas ni bordes cortantes. Si el extremo del eje no está biselado ni redondeado, utilice una camisa de montaje para evitar daños en el retén.
- Si el eje tiene ranuras o muescas, cúbralas con una camisa o con cinta adhesiva para evitar que se dañe el retén.
- Compruebe que el retén no presente daños, tales como cortes o arañazos, que podrían haberse producido durante el transporte. Si el retén está dañado, sustitúyalo.
- Asegúrese de que el retén esté colocado en sentido correcto. Normalmente, el borde de sellado debe estar dirigido hacia el fluido de sellado.
- Para los retenes de un material diferente al PTFE, el borde elastomérico debe lubricarse ligeramente antes del montaje. Si el retén tiene un diámetro exterior elastomérico, este también debe lubricarse ligeramente para facilitar el montaje. Los retenes con diámetro exterior metálico no requieren la lubricación de esta superficie. No lubrique el eje ni el borde de sellado si se utiliza un retén de PTFE.
- Utilice una herramienta de instalación para montar el retén y evitar que este quede desalineado o mal colocado.
- No se recomienda el uso de martillos de acero ya que el impacto de los golpes puede desplazar la banda del resorte, lo que a su vez puede provocar fugas en el retén. Si se utiliza un martillo, emplee la fuerza justa para introducir el retén en el diámetro.

CONSEJOS Y TRUCOS

- Los retenes de PTFE requieren una colocación muy cuidadosa, empleando el anillo de plástico suministrado con el retén.
- No retire el anillo de plástico antes de colocar el retén y evite tocar el borde de PTFE a fin de evitar la contaminación.
- Coloque siempre un eje limpio y seco, sin residuos de aceite o grasa.
- Antes de retirar el anillo de plástico, apriete completamente los pernos de fijación del retén.
- Una vez que haya retirado el anillo de plástico, gire el retén completamente dos veces y deje pasar cuatro horas para que el retén se acomode en el eje antes de encender el motor.



WSKAZÓWKI DOTYCZĄCE MONTAŻU

INSTRUKCJE

- Należy sprawdzić, czy otwór jest czysty i wolny od opiłków, które mogłyby spowodować uszkodzenie zewnętrznego obwodu uszczelnienia.
- Należy sprawdzić, czy wałek nie ma opiłków, nie jest brudny lub pokryty farbą, która mogłaby spowodować uszkodzenie uszczelnienia lub wyciek. Jeśli wałek ma wytarty rowek od starego uszczelnienia, będzie to wymagało naprawy. Należy również sprawdzić czop końcowy wałka, czy nie ma żadnych opiłków lub ostrych krawędzi. Jeśli czop końcowy wałka nie jest szlifowany lub zaokrąglony, należy użyć rękawa montażowego, aby uniknąć uszkodzenia uszczelnienia.
- Jeśli wałek ma kliny lub wpusty, należy zakryć je rękawem lub taśmą, aby uniknąć uszkodzenia uszczelnienia.
- Należy sprawdzić, czy uszczelnienie nie ma uszkodzeń, np. przecięć lub zarysowań, które mogły wystąpić podczas transportu. Wymienić uszkodzone uszczelnienie.
- Należy upewnić się, czy uszczelnienie jest zamontowane w prawidłowym kierunku. Krawędź uszczelnienia jest skierowana w stronę uszczelnianego płynu.
- W przypadku uszczelnień innych niż PTFE, elastomerowa krawędź powinna być lekko nasmarowana przed montażem. Jeśli uszczelnienie ma elastomerową zewnętrzną średnicę, również należy ją lekko nasmarować, aby ułatwić montaż. Uszczelnienia z metalową zewnętrzną średnicą nie wymagają smarowania tej powierzchni. Nie należy smarować krawędzi uszczelnienia lub wałka, jeśli zastosowane jest uszczelnienie PTFE.
- Należy użyć narzędzia montażowego, aby zamontować uszczelnienie, w celu uniknięcia nieprawidłowego jego montażu.
- Użycie metalowych młotków nie jest zalecane, ponieważ siła uderzenia może przemieścić sprężynę pierścieniową, powodując wyciek spod uszczelnienia. W przypadku użycia młotka należy użyć siły, która jedynie umożliwi osadzenie uszczelnienia w otworze.

WSKAZÓWKI I PORADY

- Uszczelnienia PTFE wymagają ostrożnego montażu przy użyciu plastikowego kołnierza dostarczonego z uszczelnieniem.
- Nie należy usuwać przed montażem plastikowego kołnierza oraz należy unikać dotykania krawędzi PTFE, aby uniknąć zanieczyszczenia.
- Zawsze należy montować czysty i suchy wał, bez pozostałości oleju lub smaru.
- Dokręcić do końca śruby wykorzystane przy montażu zintegrowanego uszczelnienia, przed zdjęciem plastikowego kołnierza.
- Gdy plastikowy kołnierz zostanie usunięty, należy wykonać 2 pełne obroty i przed uruchomieniem silnika odczekać 4 godziny, aby uszczelnienie powróciło do poprzedniego stanu na wale.



ИНСТРУКЦИИ

- Убедитесь, что посадочное отверстие чистое, в нем нет заусенцев, которые могли бы повредить внешнюю поверхность сальника.
- Убедитесь, что на рабочей поверхности вала нет заусенцев, загрязнений или краски, которые могли бы повредить уплотнение или спровоцировать протечку. Если старое уплотнение проточило канавку на поверхности вала, ее нужно устранить. Также проверьте конец вала на отсутствие заусенцев и острых краев. Если на конце вала нет фаски или скругления, то во избежание повреждения уплотнения используйте установочную муфту.
- Если на поверхности вала есть шлицы или шпоночные канавки, закройте их муфтой или скотчем, чтобы не повредить уплотнительную кромку сальника при его установке.
- Проверьте сальник на предмет повреждений, таких как порезы или царапины, которые могли возникнуть при транспортировке. Замените поврежденный сальник.
- Убедитесь, что сальник устанавливается в правильном направлении. Как правило, кромка уплотнения направлена в сторону жидкой рабочей среды.
- Для уплотнений не из ПТФЭ: перед установкой кромку из эластомера следует слегка смазать. Если внешняя сторона уплотнения изготовлена из эластомера, ее следует также слегка смазать для облегчения установки. Уплотнения с внешней стороной из металла не нуждаются в смазке. Не смазывайте уплотнительную кромку сальника или вал, если используется уплотнение из ПТФЭ.
- Для установки сальника на место используйте установочный инструмент, чтобы избежать плохой или неправильной посадки.
- Не рекомендуется использовать стальной молоток, так как такое воздействие может сместить кольцевую пружину, нарушив герметичность сальника. В случае использования молотка не прилагайте усилий сверх необходимого для посадки сальника на место.

СОВЕТЫ

- Сальники с уплотнительной кромкой из ПТФЭ требуют аккуратной установки с использованием пластиковой втулки, входящей в комплект.
- Не снимайте защитную пластиковую втулку перед установкой и старайтесь не трогать кромку ПТФЭ во избежание ее загрязнения.
- Всегда устанавливайте сальник на чистую сухую поверхность вала без масла или смазки.
- При установке интегрированного сальника сначала полностью затяните болты и только затем снимайте защитную пластиковую втулку.
- После снятия защитной пластиковой втулки сделайте 2 полных оборота вала и оставьте сальник на 4 часа, чтобы уплотнительная кромка сальника адаптировалась к поверхности вала. Только затем запустите двигатель.

تعليمات

- تحقق من نظافة التجويف وخلوه من النتوءات، والتي قد تتسبب في تلف القطر الخارجي لمانعة التسرب.
- تحقق من عدم وجود أية نتوءات أو أتربة أو طلاء داخل العمود، فقد يتسبب ذلك في تلف مانعة التسرب أو إحداث مسار تسريب. في حالة ظهور شق في عمود مانعة التسرب القديمة، يكون من الضروري إصلاحه. تأكد أيضا من خلو نهاية العمود من أية نتوءات أو حواف حادة. في حالة كانت نهاية العمود غير مشطوبة أو تتخذ شكل نصف قطر، يلزم استخدام جلبة تركيب لتجنب تلف مانعة التسرب.
- في حالة احتواء العمود على أخاديد أو طرق المفاتيح، يجب تغطية ذلك بجلبة أو شريط لتجنب تلف السدادة.
- تحقق من خلو مانعة التسرب من أي شكل من أشكال التلف كالقطع أو الخدوش، والتي قد تحدث أثناء نقلها. استبدل مانعة التسرب التالفة.
- تأكد من تركيب مانعة التسرب في الاتجاه الصحيح. عادة ما تواجه حافة مانعة التسرب السائل محكم الإغلاق.
- يتعين تشحيم الحافة المرنة في موانع التسرب المصنعة من مادة غير بولي تيترا فلورو إيثيلين بشكل طفيف قبل تركيبها. في حالة احتواء مانعة التسرب على قطر خارجي مرن، يتعين تشحيم هذا القطر أيضا لتسهيل عملية التركيب. لا يلزم تشحيم أسطح موانع التسرب التي تضم قطر معدني خارجي. لا تقم بتشحيم عمود أو حافة مانعة التسرب في حالة استخدام سدادة مصنعة من مادة بولي تيترا فلورو إيثيلين.
- استخدم أداة تركيب لإحكام تركيب مانعة التسرب وتجنب اختلال محاذاتها أو تركيبها بشكل خاطئ.
- لا ينصح باستخدام المطارق الفولاذية، إذ قد يؤدي الاصطدام القوي إلى إزاحة النابض الطوق، ما قد يؤدي إلى تسريب مانعة التسرب. في حالة استخدام المطارق، استخدم فقط القوة الكافية لإدخال مانعة التسرب في التجويف الخاص بها.

نصائح وإرشادات

- يطلب الحذر عند تركيب موانع تسرب بولي تيترا فلورو إيثيلين مع ضرورة استخدام الطوق البلاستيكي المرفق مع مانعة التسرب.
- يحظر إزالة الطوق البلاستيكي قبل تثبيت مانعة التسرب، وتجنب لمس الحافة المصنعة من مادة بولي تيترا فلورو إيثيلين لمنع التلوث.
- احرص دائما على تركيب عمود نظيف وجاف دون وجود آثار زيت أو تشحيم عليه.
- احكم ربط البراغي المستخدمة لتثبيت مانعة التسرب المضمنة قبل إزالة الطوق البلاستيكي.
- قم بإجراء تدويرين كاملين فور إزالة الطوق البلاستيكي، واترك فترة 4 ساعات لمانعة التسرب كي تستقر على العمود قبل تشغيل المحرك.



PRO-FIT SERVICE PRODUCTS

A range to save you time, money and effort

Payen's freshly conceived Pro-Fit range offers you all of its professional service products under one hallmark. It guarantees you tools and materials of excellent quality that enable you to carry out a quick and clean OE-standard fitment at a competitive price. Discover what Payen has to offer you:

ALL-PURPOSE SEALING

Silicone application gun

- compact size
- convenient usage

Reference to order: **LZ005**

Sealing compound: adheres to any surface in all makes of engines and vehicles

- Easy and clean application
- 1-hour curing time at room temperature
- Resistant to temperatures from -70 to +300°C
- Impervious to oil, fuel, antifreeze and salt spray
- Seals cylinder liners, synthetic housings, and all surfaces in engines, gearboxes and axles

Reference to order: **HR397** (to use with gun) or **HR397T**

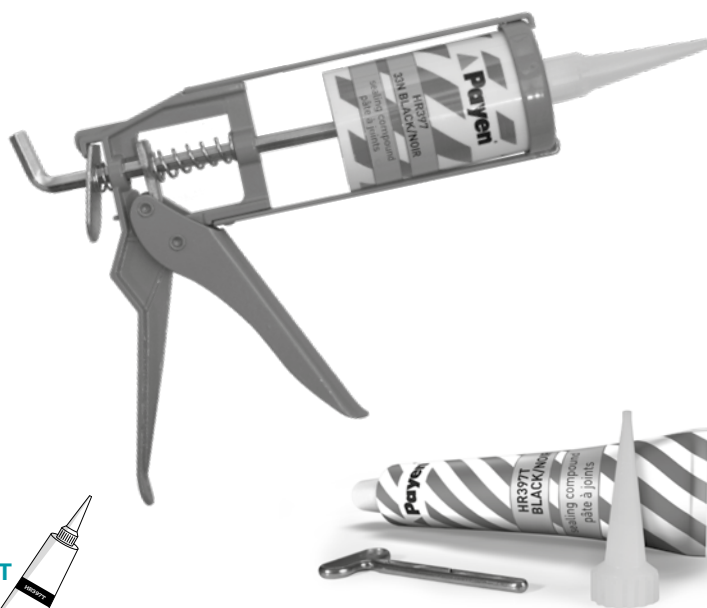

SNAP-UPS

Attaching the oil pan is no longer a two-man job

- Keep oil pan and gasket in place while you insert the bolts
- Fast and easy
- Available in two sizes: 6 & 8 mm
- Packed per 4
- Linked on TecDoc

Reference to order:

LZ002 6 mm



LZ003 8 mm



WELLSEAL JOINTING COMPOUND

The complete answer to your sealing problems

- Easy to use and free from abrasive fillers
- Non-corrosive, non-flammable and non-hardening
- Ideal for threaded connections or flat-faced joints
- Can be used with or without gasket (depending on assembly design)
- Highly resistant to commonly used lubricants and coolants

Reference to order: **WS3000**



WASHER BOX

Quick and easy washer selection

- Increased efficiency
- Contains 210 washers and 2 oil drain plugs
- 14 references, ranging from 10 to 22 mm
- Handy reference chart on the inside of the lid
- Can be customised on request

Reference to order: **HL5192**



GENERAL PURPOSE GASKET SHEETS

- Suitable for a wide range of oil, air and coolant sealing applications
- OE-quality
- Useful solution for non-standard applications
- Selection of different thicknesses and sizes available

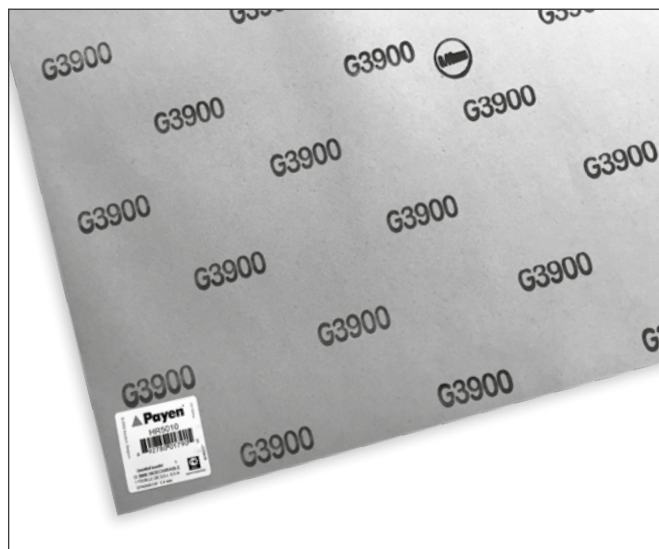

References to order:

	QTY	L	W	THK
HR5000	6 sheets	0.50m	0.50m	0.40mm
HR5001	6 sheets	0.50m	0.50m	0.80mm
HR5002	6 sheets	0.50m	0.50m	1.50mm
HR5003	3 sheets	1.00m	1.00m	0.40mm
HR5004	3 sheets	1.00m	1.00m	0.80mm
HR5005	2 sheets	1.00m	1.00m	1.50mm
HR5006	4 sheets	0.67m	0.22m	1.15mm
HR5007	4 sheets	0.45m	0.285m	1.25mm
HR5008	2 sheets	0.40m	0.40m	0.25mm
HR5009	6 sheets	0.50m	0.50m	0.20mm
HR5010	6 sheets	0.50m	0.50m	0.40mm
HR5011	6 sheets	0.50m	0.50m	0.80mm
HR5012	6 sheets	0.50m	0.50m	1.60mm
HR5013	1 sheet	0.50m	0.50m	1.80mm
HR5015	4 sheets	0.50m	0.60m	2.00mm
HR5016	4 sheets	0.50m	0.60m	2.50mm
HR5017	4 sheets	0.50m	0.60m	3.00mm
HR5018	4 sheets	0.50m	0.60m	4.00mm
HR5019	4 sheets	0.50m	0.60m	5.00mm
HR5020	4 sheets	0.45m	0.60m	2.00mm
HR5021	4 sheets	0.45m	0.60m	3.00mm
HR5022	2 sheets	0.50m	0.70m	3.00mm
HR5024	2 sheets	0.50m	0.70m	5.00mm
HR5025	2 sheets	0.50m	0.70m	6.00mm
HR5026	2 sheets	0.50m	0.70m	8.00mm
HR5027	2 sheets	0.50m	0.70m	10.00mm
HR5028	250 rolls	12.20m	12.70mm	0.08mm
HR5029	10 rolls	12.20m	12.70mm	0.08mm
HR763	3 sheets	1.00m	1.00m	0.20mm
HR764	3 sheets	1.00m	1.00m	0.40mm
HR765	3 sheets	1.00m	1.00m	0.80mm
HR766	3 sheets	1.00m	1.00m	1.60mm

Ein Sortiment, mit dem Sie Zeit, Geld und Arbeit sparen

Das neue Pro-Fit Sortiment von Payen bietet Ihnen alle professionellen Serviceprodukte unter einem Markenzeichen. Es garantiert Ihnen Werkzeuge und Werkstoffe mit überragender Qualität für eine schnelle, saubere und kostengünstige Montage in Erstausrüstungsqualität. Entdecken Sie, was Payen zu bieten hat!

UNIVERSALABDICHTUNG

Silikonpistole

- Kompakt
- Benutzerfreundlich

Bestellnummer: **LZ005**

Dichtmasse: Haftet an allen Dichtflächen aller Motor- und Fahrzeugmarken

- Einfaches, sauberes Auftragen
- Härtet bei Raumtemperatur in 1 Stunde aus
- Temperaturbeständig zwischen -70 und +300 °C
- Beständig gegenüber Öl, Kraftstoff, Frostschutzmittel und Salzsprühnebel
- Zur Abdichtung von Zylinderlaufbuchsen, Kunststoffgehäusen und allen Dichtflächen in Motoren, Getrieben und Achsen

Bestellnummer: **HR397** (zur Verwendung mit Silikonpistole) oder **HR397T**

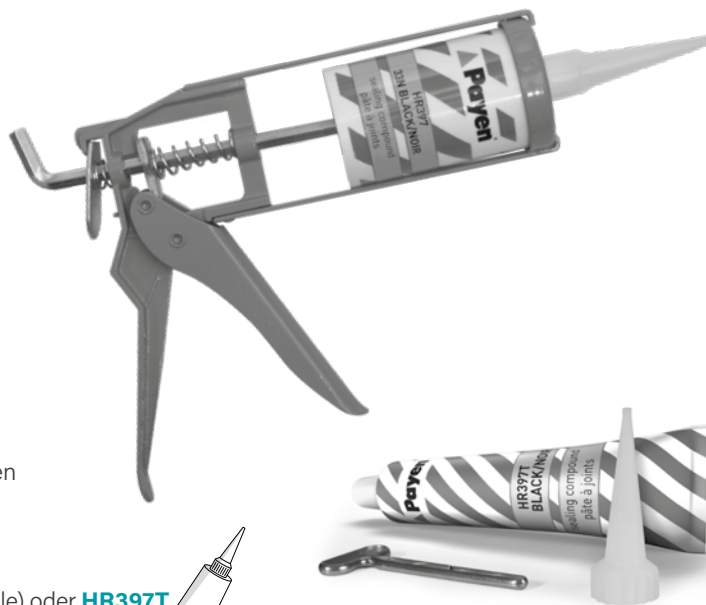

SNAP-UPS

Der Einbau einer Ölwanne ist jetzt keine Zweimannarbeit mehr

- Halten Ölwanne und Dichtung fest, während Sie die Schrauben einsetzen
- Schnell und einfach
- Erhältlich in zwei Größen: 6 und 8 mm
- Viererpacks
- In TecDoc verknüpft

Bestellnummer:

LZ002 6 mm

LZ003 8 mm

WELLSEAL DICHTMASSE

Die komplette Lösung für Ihre Dichtungsprobleme

- Einfache Anwendung und frei von abrasivem Füllmaterial
- Nicht korrodierend, nicht brennbar und nicht härtend
- Ideal für Verschraubungen oder Flachverbindungen
- Kann mit oder ohne Dichtung verwendet werden (je nach Konstruktion)
- Äußerst widerstandsfähig gegenüber häufig verwendeten Schmier- und Kühlmitteln

Bestellnummer: **WS3000**



DICHTRING-SORTIMENTSBOX

Schnelle und einfache Auswahl von Dichtringen

- Gesteigerte Effizienz
- Enthält 210 Dichtringe und 2 Ölablassschrauben
- 14 Artikel von 10 bis 22 mm
- Praktische Artikelnummertabelle auf der Deckelinnenseite
- Auf Wunsch kundenspezifisch anpassbar

Bestellnummer: **HL5192**



UNIVERSALDICHTUNGSPLETTEN

- Geeignet für viele verschiedene Öl-, Luft- und Kühlmittelanwendungsbereiche
- Erstausrüstungsqualität
- Praktische Lösung für nicht standardmäßige Anwendungen
- Unterschiedliche Dicken und Größen erhältlich

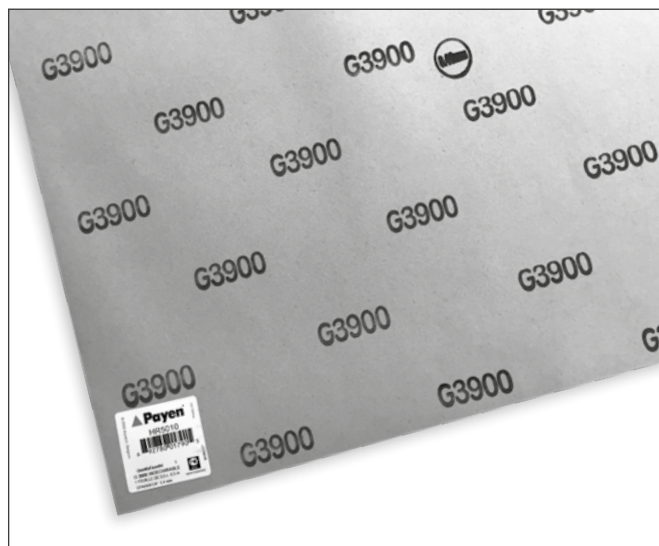

Bestellnummern:

	ANZ	L	B	D
HR5000	6 Platten	0,50 m	0,50 m	0,40 mm
HR5001	6 Platten	0,50 m	0,50 m	0,80 mm
HR5002	6 Platten	0,50 m	0,50 m	1,50 mm
HR5003	3 Platten	1,00 m	1,00 m	0,40 mm
HR5004	3 Platten	1,00 m	1,00 m	0,80 mm
HR5005	2 Platten	1,00 m	1,00 m	1,50 mm
HR5006	4 Platten	0,67 m	0,22 m	1,15 mm
HR5007	4 Platten	0,45 m	0,285 m	1,25 mm
HR5008	2 Platten	0,40 m	0,40 m	0,25 mm
HR5009	6 Platten	0,50 m	0,50 m	0,20 mm
HR5010	6 Platten	0,50 m	0,50 m	0,40 mm
HR5011	6 Platten	0,50 m	0,50 m	0,80 mm
HR5012	6 Platten	0,50 m	0,50 m	1,60 mm
HR5013	1 Platte	0,50 m	0,50 m	1,80 mm
HR5015	4 Platten	0,50 m	0,60 m	2,00 mm
HR5016	4 Platten	0,50 m	0,60 m	2,50 mm
HR5017	4 Platten	0,50 m	0,60 m	3,00 mm
HR5018	4 Platten	0,50 m	0,60 m	4,00 mm
HR5019	4 Platten	0,50 m	0,60 m	5,00 mm
HR5020	4 Platten	0,45 m	0,60 m	2,00 mm
HR5021	4 Platten	0,45 m	0,60 m	3,00 mm
HR5022	2 Platten	0,50 m	0,70 m	3,00 mm
HR5024	2 Platten	0,50 m	0,70 m	5,00 mm
HR5025	2 Platten	0,50 m	0,70 m	6,00 mm
HR5026	2 Platten	0,50 m	0,70 m	8,00 mm
HR5027	2 Platten	0,50 m	0,70 m	10,00 mm
HR5028	250 Rollen	12,20 m	12,70 mm	0,08 mm
HR5029	10 Rollen	12,20 m	12,70 mm	0,08 mm
HR763	3 Platten	1,00 m	1,00 m	0,20 mm
HR764	3 Platten	1,00 m	1,00 m	0,40 mm
HR765	3 Platten	1,00 m	1,00 m	0,80 mm
HR766	3 Platten	1,00 m	1,00 m	1,60 mm

Una gamma per risparmiare tempo, denaro e sforzi

La neonata gamma Pro-Fit di Payen ti offre i suoi prodotti per l'assistenza professionale sotto un unico marchio. Ti garantisce strumenti e materiali di qualità eccellente, che consentono di svolgere operazioni di montaggio di OE standard nella massima rapidità e pulizia, a un prezzo altamente competitivo. Scopri tutta l'offerta di Payen:

TENUTE MULTI-FUNZIONE

Pistole applicatrice per silicone

- dimensioni compatte
- massima comodità di utilizzo

Codice per effettuare l'ordine: **LZ005**

Composto di tenuta: aderisce a qualsiasi superficie in tutte le realizzazioni di motori e veicoli

- Applicazione facile e pulita
- Tempo di indurimento a temperatura ambiente: 1 ora
- Resistente a temperature da -70 a +300°C
- Impermeabile a olio, carburante, nebbia salina e spray antigelo
- Rivestimenti cilindri di tenuta, alloggiamenti sintetici e tutte le superfici di motori, scatole ingranaggi e assali

Codice per effettuare l'ordine: **HR397** (per utilizzo con postola) o **HR397T**



SNAP-UPS

L'attacco della coppia dell'olio non è più un'operazione che richiede l'intervento di due persone

- Mantenere in posizione la coppa dell'olio e la guarnizione mentre vengono inseriti i bulloni
- Facile e rapido
- Disponibile in due dimensioni: 6 e 8 mm
- Confezione da 4
- Collegato su TecDoc

Codice per effettuare l'ordine:

LZ002 6 mm



LZ003 8 mm



SIGILLANTE WELLSEAL

La risposta completa ai tuoi problemi di tenuta

- Facile da usare e privo di filler abrasivi
- Non corrosivo, non infiammabile, non indurente
- Ideale per collegamenti filettati o per giunti a testa piatta
- Utilizzabile con o senza guarnizione (in base alla progettazione del gruppo)
- Altamente resistente a refrigeranti e lubrificanti comunemente utilizzati

Codice per effettuare l'ordine: **WS3000**



PACCO RONDELLE

Scelta rapida e facile delle rondelle

- Maggiore efficacia
- Contiene 210 rondelle e 2 tappi di scarico dell'olio
- 14 codici, da 10 a 22 mm
- Tabella di consultazione disponibile all'interno del coperchio
- Personalizzabile su richiesta

Codice per effettuare l'ordine: **HL5192**



GUARNIZIONI A FOGLI PER FINALITÀ GENERALI

- Idonee per un'ampia gamma di applicazioni di tenuta per refrigerante, aria e olio
- Qualità OE
- Soluzione utile per applicazioni non standard
- Disponibilità di diverse dimensioni e diversi spessori tra cui scegliere

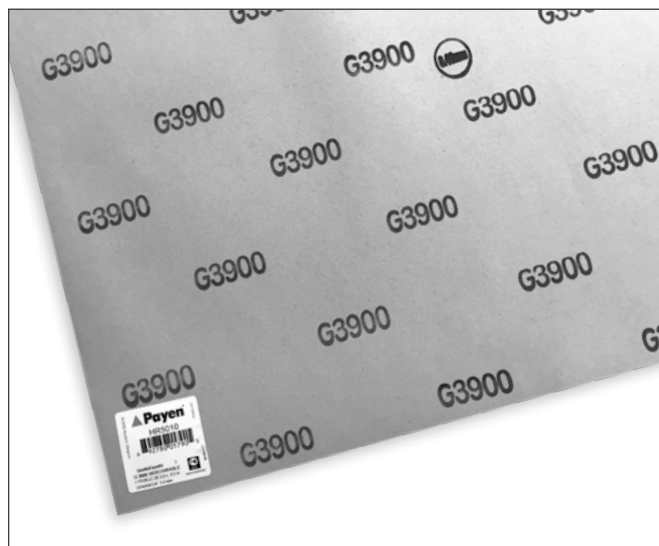

Codice per effettuare l'ordine:

	QTÀ	L	P	SPESS
HR5000	6 fogli	0,50m	0,50m	0,40mm
HR5001	6 fogli	0,50m	0,50m	0,80mm
HR5002	6 fogli	0,50m	0,50m	1,50mm
HR5003	3 fogli	1,00m	1,00m	0,40mm
HR5004	3 fogli	1,00m	1,00m	0,80mm
HR5005	2 fogli	1,00m	1,00m	1,50mm
HR5006	4 fogli	0,67m	0,22m	1,15mm
HR5007	4 fogli	0,45m	0,285m	1,25mm
HR5008	2 fogli	0,40m	0,40m	0,25mm
HR5009	6 fogli	0,50m	0,50m	0,20mm
HR5010	6 fogli	0,50m	0,50m	0,40mm
HR5011	6 fogli	0,50m	0,50m	0,80mm
HR5012	6 fogli	0,50m	0,50m	1,60mm
HR5013	1 foglio	0,50m	0,50m	1,80mm
HR5015	4 fogli	0,50m	0,60m	2,00mm
HR5016	4 fogli	0,50m	0,60m	2,50mm
HR5017	4 fogli	0,50m	0,60m	3,00mm
HR5018	4 fogli	0,50m	0,60m	4,00mm
HR5019	4 fogli	0,50m	0,60m	5,00mm
HR5020	4 fogli	0,45m	0,60m	2,00mm
HR5021	4 fogli	0,45m	0,60m	3,00mm
HR5022	2 fogli	0,50m	0,70m	3,00mm
HR5024	2 fogli	0,50m	0,70m	5,00mm
HR5025	2 fogli	0,50m	0,70m	6,00mm
HR5026	2 fogli	0,50m	0,70m	8,00mm
HR5027	2 fogli	0,50m	0,70m	10,00mm
HR5028	250 rotoli	12,20m	12,70mm	0,08mm
HR5029	10 rotoli	12,20m	12,70mm	0,08mm
HR763	3 fogli	1,00m	1,00m	0,20mm
HR764	3 fogli	1,00m	1,00m	0,40mm
HR765	3 fogli	1,00m	1,00m	0,80mm
HR766	3 fogli	1,00m	1,00m	1,60mm

Une gamme pour vous faire gagner du temps, de l'argent et des efforts

La toute nouvelle gamme Pro-Fit de Payen vous propose tous ses produits de service professionnels sous une seule marque. Elle garantit des outils et des matériaux d'excellente qualité qui vous permettent d'effectuer un montage rapide et propre de qualité d'origine à un prix compétitif. Découvrez ce que Payen vous propose :

PÂTE À JOINT UNIVERSELLE

Pistolet à cartouche de silicone

- taille compacte
- utilisation pratique

Référence pour la commande : **LZ005**

Produit d'étanchéité : adhère à toutes les surfaces de toutes les marques de moteurs et de véhicules

- Application facile et propre
- Temps de prise 1 heure à température ambiante
- Résistant aux températures de -70 à +300 °C
- Imperméable aux huiles, aux carburants, aux liquides antigel et aux brouillards salins
- Assure l'étanchéité des chemises de cylindres, des boîtiers plastiques et de toutes les surfaces de moteurs, boîtes de vitesses et d'essieux

Référence pour la commande : **HR397** (en cartouche) ou **HR397T** (en tube)



SNAP-UPS

La pose du carter d'huile par une seule personne

- Ils maintiennent le carter d'huile et le joint d'étanchéité en place pendant que vous insérez les vis
- Rapide et simple
- Disponible en deux tailles : 6 et 8 mm
- Emballés par 4

Référence pour la commande :

LZ002 6 mm



LZ003 8 mm



PÂTE À JOINT WELLSEAL

La réponse complète à vos problèmes d'étanchéité

- Facile à utiliser et sans matières abrasives
- Non corrosif, ininflammable et non durcissable
- Idéal pour les raccords filetés ou les assemblages à joint plat
- Peut être utilisé avec ou sans joint d'étanchéité (selon le montage)
- Très résistant aux lubrifiants et aux liquides de refroidissement courants

Référence pour la commande : **WS3000**



COFFRET DE JOINTS DE BOUCHONS DE VIDANGE

Trouver facilement et rapidement

le bon joint

- Contient 210 rondelles et 2 bouchons de vidange d'huile
- 14 références, de 10 à 22 mm
- Tableau de référence pratique à l'intérieur du couvercle
- Personnalisable avec 3 cases vides

Référence pour la commande : **HL5192**

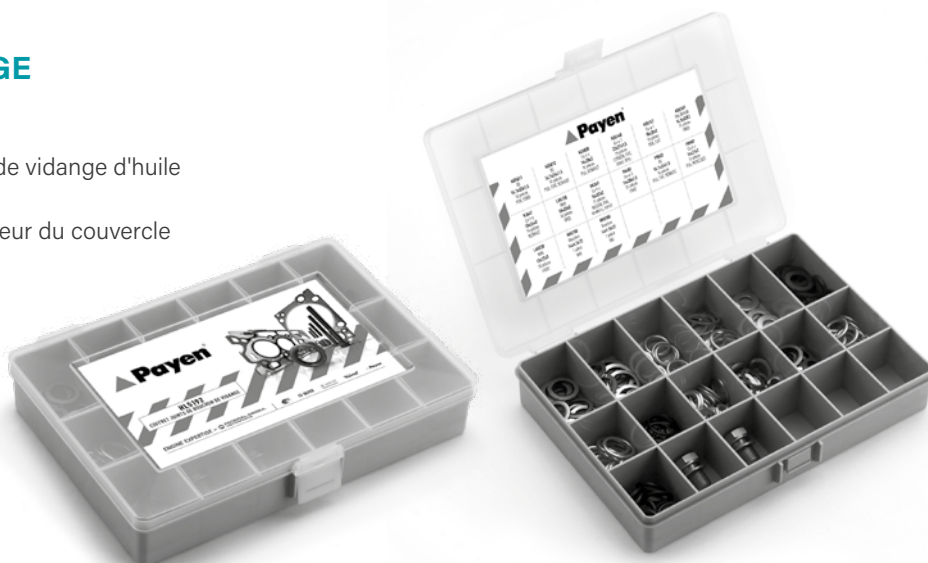

JOINT PLAT POLYVALENT EN FEUILLES

- Convient à un large éventail d'applications en étanchéité d'huile, d'air et de liquide de refroidissement
- Qualité d'origine
- Solution pratique et utile pour applications non-standard
- Choix de différentes épaisseurs et tailles disponibles

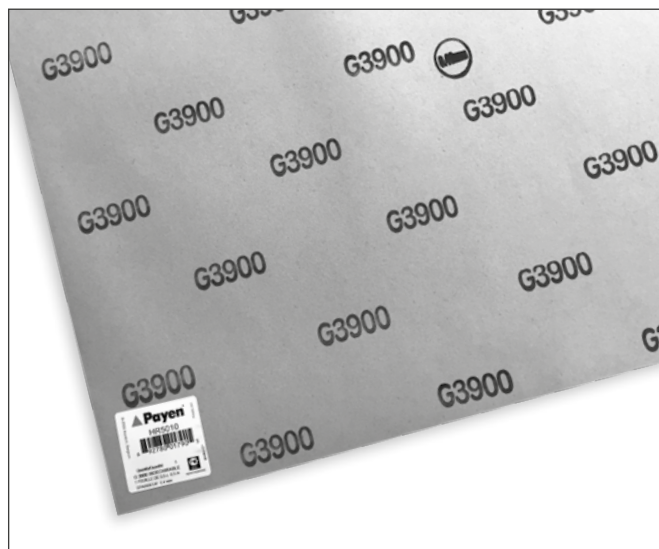

Références pour la commande :

	QTÉ	L	I	ép.
HR5000	6 feuilles	0,50 m	0,50 m	0,40 mm
HR5001	6 feuilles	0,50 m	0,50 m	0,80 mm
HR5002	6 feuilles	0,50 m	0,50 m	1,50 mm
HR5003	3 feuilles	1,00 m	1,00 m	0,40 mm
HR5004	3 feuilles	1,00 m	1,00 m	0,80 mm
HR5005	2 feuilles	1,00 m	1,00 m	1,50 mm
HR5006	4 feuilles	0,67 m	0,22 m	1,15 mm
HR5007	4 feuilles	0,45 m	0,285 m	1,25 mm
HR5008	2 feuilles	0,40 m	0,40 m	0,25 mm
HR5009	6 feuilles	0,50 m	0,50 m	0,20 mm
HR5010	6 feuilles	0,50 m	0,50 m	0,40 mm
HR5011	6 feuilles	0,50 m	0,50 m	0,80 mm
HR5012	6 feuilles	0,50 m	0,50 m	1,60 mm
HR5013	1 feuille	0,50 m	0,50 m	1,80 mm
HR5015	4 feuilles	0,50 m	0,60 m	2,00 mm
HR5016	4 feuilles	0,50 m	0,60 m	2,50 mm
HR5017	4 feuilles	0,50 m	0,60 m	3,00 mm
HR5018	4 feuilles	0,50 m	0,60 m	4,00 mm
HR5019	4 feuilles	0,50 m	0,60 m	5,00 mm
HR5020	4 feuilles	0,45 m	0,60 m	2,00 mm
HR5021	4 feuilles	0,45 m	0,60 m	3,00 mm
HR5022	2 feuilles	0,50 m	0,70 m	3,00 mm
HR5024	2 feuilles	0,50 m	0,70 m	5,00 mm
HR5025	2 feuilles	0,50 m	0,70 m	6,00 mm
HR5026	2 feuilles	0,50 m	0,70 m	8,00 mm
HR5027	2 feuilles	0,50 m	0,70 m	10,00 mm
HR5028	250 rouleaux	12,20 m	12,70 mm	0,08 mm
HR5029	10 rouleaux	12,20 m	12,70 mm	0,08 mm
HR763	3 feuilles	1,00 m	1,00 m	0,20 mm
HR764	3 feuilles	1,00 m	1,00 m	0,40 mm
HR765	3 feuilles	1,00 m	1,00 m	0,80 mm
HR766	3 feuilles	1,00 m	1,00 m	1,60 mm

Una gama para ahorrar tiempo, dinero y esfuerzo

La nueva gama Pro-Fit de Payen te ofrece todos sus productos de servicio profesional en una sola marca. Garantiza herramientas y materiales de excelente calidad que permiten llevar a cabo un montaje rápido y limpio según la norma de Equipo Original a un precio competitivo. Descubre lo que Payen le puede ofrecer:

SELLADO MULTIUSO

Pistola de aplicación de silicona

- tamaño compacto
- uso práctico

Referencia para pedidos: **LZ005**

Compuesto de sellado: se adhiere a cualquier superficie de todos los fabricantes de motores y vehículos

- Aplicación fácil y limpia
- Tiempo de secado de 1 hora a temperatura ambiente
- Resistente a temperaturas de -70 a +300 °C
- Impermeable al aceite, combustible, anticongelante y niebla salina
- Sella las camisas del cilindro, los alojamientos sintéticos y todas las superficies de los motores, las cajas de cambios y los ejes



Referencia para pedidos: **HR397** (para uso con pistola) o **HR397T**



SNAP-UPS

Ya no es necesario que haya dos personas para fijar el cárter de aceite

- La junta del cárter de aceite y el cárter se mantendrán en su lugar mientras insertas los pernos
- Fácil y rápido
- Disponibles en dos tamaños: 6 y 8 mm
- Paquetes de 4
- Asociado con TecDoc

Referencia para pedidos:

LZ002 6 mm



LZ003 8 mm



COMPUESTO PARA JUNTAS WELLSEAL

La respuesta completa a los problemas de sellado

- Fácil de utilizar y sin rellenos abrasivos
- No corrosivo, no inflamable y no endurecedor
- Ideal para conexiones roscadas o juntas planas
- Se puede utilizar con o sin junta (dependiendo del diseño del conjunto)
- Muy resistente a los lubricantes y refrigerantes de uso general

Referencia para pedidos: **WS3000**



CAJA DE ARANDELAS

Selección rápida y fácil de arandelas

- Mayor eficacia
- Contiene 210 arandelas y 2 tapones de drenaje de aceite
- 14 referencias, que van de 10 a 22 mm
- Práctica tabla de referencias en el interior de la tapa
- Se puede personalizar bajo petición

Referencia para pedidos: **HL5192**



HOJAS DE JUNTAS DE USO GENERAL

- Adecuado para una amplia gama de aplicaciones de sellado de aceite, aire y refrigerante
- Calidad de Equipo Original
- Práctica solución para aplicaciones no estándar
- Selección de diferentes espesores y tamaños disponibles

Referencias para pedidos:

	CAN.	L	A	GR.
HR5000	6 hojas	0,50 m	0,50 m	0,40 mm
HR5001	6 hojas	0,50 m	0,50 m	0,80 mm
HR5002	6 hojas	0,50 m	0,50 m	1,50 mm
HR5003	3 hojas	1,00 m	1,00 m	0,40 mm
HR5004	3 hojas	1,00 m	1,00 m	0,80 mm
HR5005	2 hojas	1,00 m	1,00 m	1,50mm
HR5006	4 hojas	0,67 m	0,22 m	1,15 mm
HR5007	4 hojas	0,45 m	0,285 m	1,25 mm
HR5008	2 hojas	0,40 m	0,40 m	0,25 mm
HR5009	6 hojas	0,50 m	0,50 m	0,20 mm
HR5010	6 hojas	0,50 m	0,50 m	0,40 mm
HR5011	6 hojas	0,50 m	0,50 m	0,80 mm
HR5012	6 hojas	0,50 m	0,50 m	1,60 mm
HR5013	1 hoja	0,50 m	0,50 m	1,80 mm
HR5015	4 hojas	0,50 m	0,60 m	2,00 mm
HR5016	4 hojas	0,50 m	0,60 m	2,50 mm
HR5017	4 hojas	0,50 m	0,60 m	3,00 mm
HR5018	4 hojas	0,50 m	0,60 m	4,00 mm
HR5019	4 hojas	0,50 m	0,60 m	5,00 mm
HR5020	4 hojas	0,45 m	0,60 m	2,00 mm
HR5021	4 hojas	0,45 m	0,60 m	3,00 mm
HR5022	2 hojas	0,50 m	0,70 m	3,00 mm
HR5024	2 hojas	0,50 m	0,70 m	5,00 mm
HR5025	2 hojas	0,50 m	0,70 m	6,00 mm
HR5026	2 hojas	0,50 m	0,70 m	8,00 mm
HR5027	2 hojas	0,50 m	0,70 m	10,00 mm
HR5028	250 rollos	12,20 m	12,70 mm	0,08 mm
HR5029	10 rollos	12,20 m	12,70 mm	0,08 mm
HR763	3 hojas	1,00 m	1,00 m	0,20 mm
HR764	3 hojas	1,00 m	1,00 m	0,40 mm
HR765	3 hojas	1,00 m	1,00 m	0,80 mm
HR766	3 hojas	1,00 m	1,00 m	1,60 mm

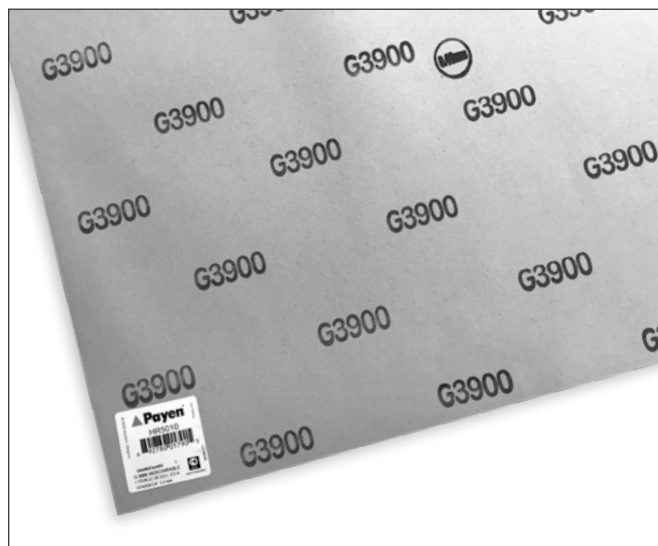

Gama produktów, dzięki którym zaoszczędzić czas, pieniądze i pracę

Świeżo opracowana gama produktów Pro-Fit firmy Payen to w pełni profesjonalne produkty serwisowe dostępne pod jedną marką. Marka ta gwarantuje doskonałą jakość narzędzi i materiałów, umożliwiając szybki i czysty montaż zgodnie ze standardami OE i w przystępnej cenie. Poznaj ofertę Payen:

UNIWERSALNE USZCZELNIENIE

Pistolet do nakładania silikonu

- kompaktowy rozmiar
- wygodna obsługa

Nr ref. zamówienia: **LZ005**

Środek uszczelniający: doskonałe przyleganie do każdej powierzchni wszystkich marek silników i pojazdów

- Łatwa i czysta aplikacja
- 1-godzinny czas utwardzania w temperaturze pokojowej
- Odporność na temperaturę od -70 do +300°C
- Nie przepuszcza oleju, paliwa, płynu chłodzącego ani roztworu soli
- Uszczelnia tuleje cylindrowe, syntetyczne obudowy oraz wszystkie powierzchnie w silniku, skrzyni biegów oraz osiach

Nr ref. zamówienia: **HR397** (wkład do pistoletu) lub **HR397T**

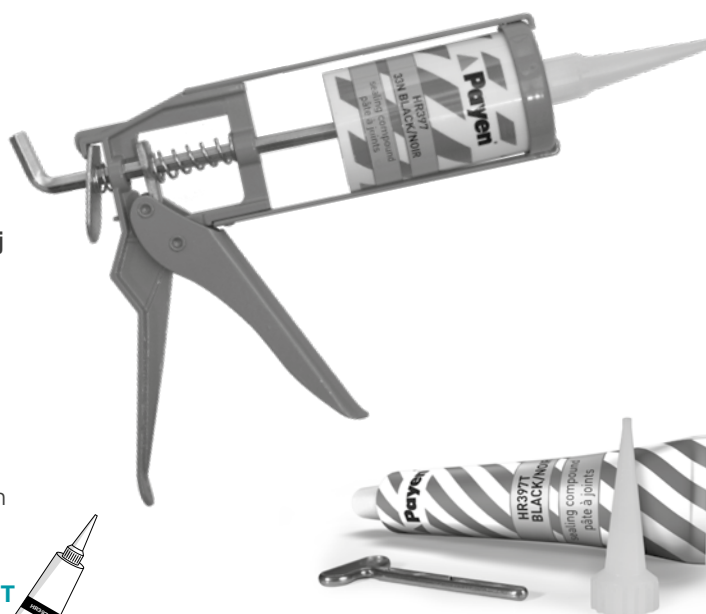

SNAP-UPS

Montaż miski olejowej może już teraz przeprowadzić jedna osoba

- Miska olejowa i uszczelka znajdują się na swoim miejscu podczas przykręcania śrub
- Szybki i sprawny montaż
- Dostępne w dwóch rozmiarach: 6 i 8 mm
- 4 szt. w opakowaniu
- Odnośnik w TecDoc

Nr ref. zamówienia:

LZ002 6 mm



LZ003 8 mm



MATERIAŁ USZCZELNIAJĄCY WELLSEAL

Kompleksowe rozwiązanie problemów związanych z uszczelnianiem

- Łatwe użycie i brak ciernych wypełniaczy
- Produkt nie powoduje korozji, jest niepalny i nie twardnieje
- Idealnie nadaje się do gwintowanych połączeń lub płaskich powierzchni stykowych
- Można stosować z uszczelką lub bez uszczelki (w zależności od typu mocowania)
- Wysoka odporność na powszechnie stosowane środki smarne i środki chłodzące

Nr ref. zamówienia: **WS3000**



OPAKOWANIE Z PODKŁADKAMI

Szybki i sprawny wybór podkładek

- Wyższa wydajność pracy
- 210 podkładek i 2 korki spustowe oleju
- 14 nr ref., od 10 do 22 mm
- Pomocna tabela referencyjna wewnątrz pokrywy
- Możliwość dopasowania do własnych potrzeb

Nr ref. zamówienia: **HL5192**



UNIWERSALNE ARKUSZE USZCZELEK

- Nadają się do wielu różnych aplikacji uszczelnień instalacji olejowej, powietrznej i środka chłodzącego
- Jakość OE
- Przydatne rozwiązanie do niestandardowych zastosowań
- Do wyboru różne grubości i rozmiary

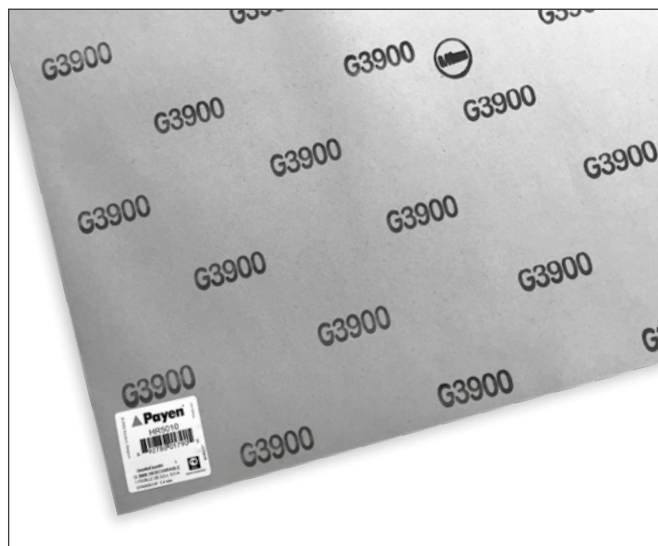

Nr ref. zamówienia:

	QTY	L	W	THK
HR5000	6 arkuszy	0,50 m	0,50 m	0,40 mm
HR5001	6 arkuszy	0,50 m	0,50 m	0,80 mm
HR5002	6 arkuszy	0,50 m	0,50 m	1,50 mm
HR5003	3 arkusze	1,00 m	1,00 m	0,40 mm
HR5004	3 arkusze	1,00 m	1,00 m	0,80 mm
HR5005	2 arkusze	1,00 m	1,00 m	1,50mm
HR5006	4 arkusze	0,67 m	0,22 m	1,15 mm
HR5007	4 arkusze	0,45 m	0,285 m	1,25 mm
HR5008	2 arkusze	0,40 m	0,40 m	0,25 mm
HR5009	6 arkuszy	0,50 m	0,50 m	0,20 mm
HR5010	6 arkuszy	0,50 m	0,50 m	0,40 mm
HR5011	6 arkuszy	0,50 m	0,50 m	0,80 mm
HR5012	6 arkuszy	0,50 m	0,50 m	1,60 mm
HR5013	1 arkusz	0,50 m	0,50 m	1,80 mm
HR5015	4 arkusze	0,50 m	0,60 m	2,00 mm
HR5016	4 arkusze	0,50 m	0,60 m	2,50 mm
HR5017	4 arkusze	0,50 m	0,60 m	3,00 mm
HR5018	4 arkusze	0,50 m	0,60 m	4,00 mm
HR5019	4 arkusze	0,50 m	0,60 m	5,00 mm
HR5020	4 arkusze	0,45 m	0,60 m	2,00 mm
HR5021	4 arkusze	0,45 m	0,60 m	3,00 mm
HR5022	2 arkusze	0,50 m	0,70 m	3,00 mm
HR5024	2 arkusze	0,50 m	0,70 m	5,00 mm
HR5025	2 arkusze	0,50 m	0,70 m	6,00 mm
HR5026	2 arkusze	0,50 m	0,70 m	8,00 mm
HR5027	2 arkusze	0,50 m	0,70 m	10,00 mm
HR5028	250 rolek	12,20 m	12,70 mm	0,08 mm
HR5029	10 rolek	12,20 m	12,70 mm	0,08 mm
HR763	3 arkusze	1,00 m	1,00 m	0,20 mm
HR764	3 arkusze	1,00 m	1,00 m	0,40 mm
HR765	3 arkusze	1,00 m	1,00 m	0,80 mm
HR766	3 arkusze	1,00 m	1,00 m	1,60 mm

Линейка, которая сэкономит вам время, деньги и силы

Бренд Rayen недавно представил Pro-Fit — профессиональную сервисную продукцию в одной линейке. Вы гарантированно получаете инструменты и материалы отличного качества, которые позволят вам быстро и качественно выполнить установку по стандартам оригинальных комплектующих по невысокой цене. Посмотрите, что Rayen предлагает вам:

УНИВЕРСАЛЬНЫЙ ГЕРМЕТИК

Пистолет для нанесения силикона

- компактный размер
- удобство использования

Артикул для заказа: **LZ005**

Герметизирующий состав: держится на любой поверхности двигателей всех производителей на всех автомобилях

- Простое и чистое нанесение
- Время схватывания: 1 час при комнатной температуре
- Устойчивость к температурам от -70 до +300°C
- Устойчивость к воздействию масла, топлива, антифриза и солевой смеси
- Герметизирует гильзы цилиндров, синтетические корпуса, а также любые поверхности двигателей, коробок передач и осе

Артикул для заказа: **HR397** (для шприца) или **HR397T**

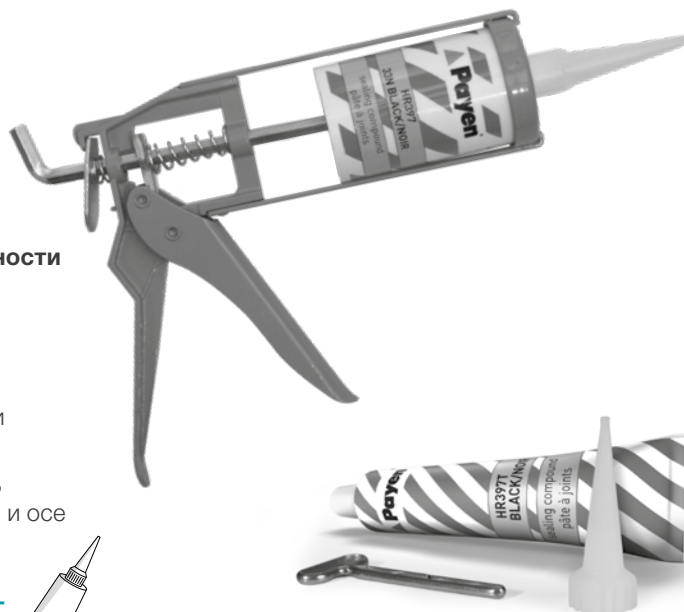

ДЕРЖАТЕЛИ SNAP-UPS

Установка масляного поддона больше не является задачей для двух работников

- Масляный поддон и прокладка остаются на месте, пока вы вставляете болты
- Быстро и просто
- Два размера: 6 мм и 8 мм
- В упаковке 4 шт
- Ссылка на TecDoc

Артикул для заказа:

LZ002 6 мм



LZ003 8 мм



УПЛОТНИТЕЛЬНАЯ ПАСТА WELLSEAL

Универсальный ответ на все вопросы герметизации

- Проста в использовании, не содержит абразивов
- Не подвержена коррозии, не воспламеняется, не затвердевает
- Прекрасно подходит для резьбовых соединений и соединений плоских поверхностей
- Можно использовать с прокладкой или без нее (в зависимости от конструкции)
- Великолепная устойчивость к воздействию распространенных смазочных веществ и охлаждаителей

Артикул для заказа: **WS3000**



КОМПЛЕКТ УПЛОТНИТЕЛЬНЫХ ШАЙБ

Быстрый и простой выбор уплотнительной шайбы

- Повышается эффективность
- Содержит 210 шайб и 2 маслосливные пробки
- 14 наименований от 10 до 22 мм
- Удобная справочная таблица на внутренней стороне крышки
- Может быть составлен в индивидуальном порядке под заказ

Артикул для заказа: **HL5192**



ЛИСТЫ ДЛЯ ПРОКЛАДОК ОБЩЕГО НАЗНАЧЕНИЯ

- Подходят для герметизации в различных узлах масляной, воздушной и охлаждающей систем
- Качество оригинальных комплектующих
- Полезное решение для нестандартных случаев
- Можно выбрать различную толщину и размер

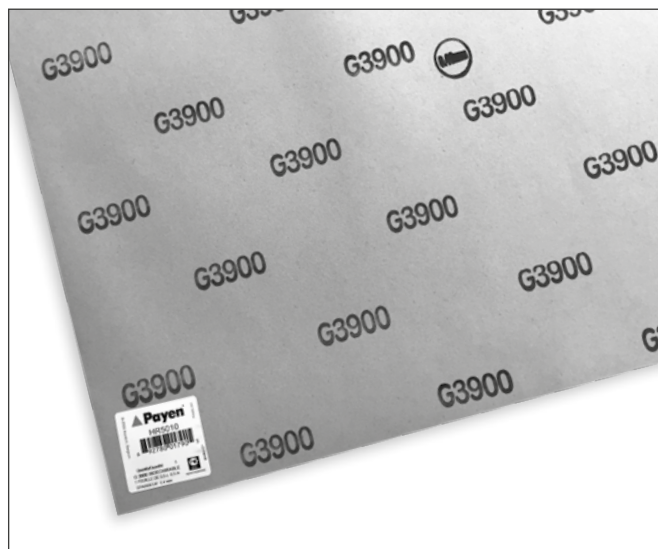

Артикулы для заказа:

	КОЛ-ВО	ДЛИНА	ШИРИНА	ТОЛЩИНА
HR5000	6 листов	0,50 м	0,50 м	0,40 мм
HR5001	6 листов	0,50 м	0,50 м	0,80 мм
HR5002	6 листов	0,50 м	0,50 м	1,50 мм
HR5003	3 листа	1,00 м	1,00 м	0,40 мм
HR5004	3 листа	1,00 м	1,00 м	0,80 мм
HR5005	2 листа	1,00 м	1,00 м	1,50 мм
HR5006	4 листа	0,67 м	0,22 м	1,15 мм
HR5007	4 листа	0,45 м	0,285 м	1,25 мм
HR5008	2 листа	0,40 м	0,40 м	0,25 мм
HR5009	6 листов	0,50 м	0,50 м	0,20 мм
HR5010	6 листов	0,50 м	0,50 м	0,40 мм
HR5011	6 листов	0,50 м	0,50 м	0,80 мм
HR5012	6 листов	0,50 м	0,50 м	1,60 мм
HR5013	1 лист	0,50 м	0,50 м	1,80 мм
HR5015	4 листа	0,50 м	0,60 м	2,00 мм
HR5016	4 листа	0,50 м	0,60 м	2,50 мм
HR5017	4 листа	0,50 м	0,60 м	3,00 мм
HR5018	4 листа	0,50 м	0,60 м	4,00 мм
HR5019	4 листа	0,50 м	0,60 м	5,00 мм
HR5020	4 листа	0,45 м	0,60 м	2,00 мм
HR5021	4 листа	0,45 м	0,60 м	3,00 мм
HR5022	2 листа	0,50 м	0,70 м	3,00 мм
HR5024	2 листа	0,50 м	0,70 м	5,00 мм
HR5025	2 листа	0,50 м	0,70 м	6,00 мм
HR5026	2 листа	0,50 м	0,70 м	8,00 мм
HR5027	2 листа	0,50 м	0,70 м	10,00 мм
HR5028	250 рулонов	12,20 м	12,70 мм	0,08 мм
HR5029	10 рулонов	12,20 м	12,70 мм	0,08 мм
HR763	3 листа	1,00 м	1,00 м	0,20 мм
HR764	3 листа	1,00 м	1,00 м	0,40 мм
HR765	3 листа	1,00 м	1,00 м	0,80 мм
HR766	3 листа	1,00 м	1,00 м	1,60 мм

نقدم مجموعة من المنتجات توفر لك الوقت والجهد والمال

تقدم لك مجموعة Pro-Fit الرائعة المصنعة حديثاً الخاصة بـ Payen منتجات خدمة مهنية تحت علامة واحدة، وتضمن لك أدوات ومواد ذات جودة ممتازة يمكنك من تنفيذ إجراءات تتوافق مع معايير المعدات الأصلية بأسعار تنافسية. اكتشف منتجات Payen المقدمة لك:

مانع تسرب لجميع الأغراض

مسدس تطبيق:

- صغيرة الحجم
- وسهل الاستخدام

مرفوم طلب الشراء: LZ005



معجون مانع التسرب: يلتصق بأسطح المركبات والمحركات بكافة أنواعها

- استخدام سهل ونظيف
- يستغرق زمن الجفاف والتماسك ساعة واحدة في درجة حرارة الغرفة
- مقاوم لدرجات الحرارة من -٧٠ إلى ٣٠٠ درجة مئوية
- يمنع تسرب الزيت والوقود وريزاد الملح ومانع التجمد
- يمنع تسرب بطانات الأسطوانة والغلاف الاصطناعي وجميع أسطح المحركات والتروس والمحاور



مرفوم طلب الشراء: HR397

رقم القطعة للطلب: (مع استعمال مسدس) أو HR397T

مركب حشو لمنع التسريب

الحل المثالي لمشاكل التسريب

- سهل الاستخدام و خالي من أى مواد تسبب التآكل
- مقاوم للتآكل وغير قابل للاشتعال أو التصلب
- مثالي للاتصال الملولب أو للوصلات مسطحة الأوجه
- يمكن أن يتم استخدامها مع أو بدون حشو (يعتمد على تصميم التجميع)
- مقاومه عاليه لمواد التشحيم و المبردات الشائعة

مرفوم الشراء: WS3000



سهل وسريع الاستخدام

- لم يعد يستدعي تركيب وعاء الزيت أكثر من عامل
- احرص علي إبقاء وعاء الزيت والحشية في المكان أثناء إدخال البراغي
- سهل وسريع
- متوافر بحجمين: ٦ و ٨ مم
- معبأة في ٤
- مرتبط ببرنامج TecDoc

مرفوم الشراء:

LZ002 ٦ مم

LZ003 ٨ مم



صندوق الحلقات

إختيار سريع وسهل للحلقات

- زيادة كفاءة التشغيل
- تحتوي على ٢١٠ حلقة وسدادتين لتصريف الزيت
- ٤ حلقة تتراوح من ١٠ إلى ٢٢ مم
- رسم بياني مرجعي على الجزء الداخلي من الغطاء
- إمكانية تعديل المواصفات عند الطلب

مرقام الشراء: HL5192

غلاف حشو متعدد الأغراض

- مناسب لمجموعه واسعه من إستخدامات منع التسريب من نفض أو هواء أو تبريد
- جودة المعادات الأصلية
- حل مثالي للاستخدامات غير القياسية
- لاختيار من بين مجموعة مختلفة من الاحجام والسمكات المتوفرة

مرقام الشراء:

THK	W	L	QTY	
٠,٤٠ مم	٠,٥٠ م	٠,٥٠ م	٦ صفحات	HR5000
٠,٨٠ مم	٠,٥٠ م	٠,٥٠ م	٦ صفحات	HR5001
١,٥٠ مم	٠,٥٠ م	٠,٥٠ م	٦ صفحات	HR5002
٠,٤٠ مم	١,٠٠ م	١,٠٠ م	٣ صفحات	HR5003
٠,٨٠ مم	١,٠٠ م	١,٠٠ م	٣ صفحات	HR5004
١,٥٠ مم	١,٠٠ م	١,٠٠ م	٢ صفحات	HR5005
١,١٥ مم	٠,٢٢ م	٠,٦٧ م	٤ صفحات	HR5006
١,٢٥ مم	٠,٢٨٥ م	٠,٤٥ م	٤ صفحات	HR5007
٠,٢٥ مم	٠,٤٠ م	٠,٤٠ م	٢ صفحات	HR5008
٠,٢٠ مم	٠,٥٠ م	٠,٥٠ م	٦ صفحات	HR5009
٠,٤٠ مم	٠,٥٠ م	٠,٥٠ م	٦ صفحات	HR5010
٠,٨٠ مم	٠,٥٠ م	٠,٥٠ م	٦ صفحات	HR5011
١,٦٠ مم	٠,٥٠ م	٠,٥٠ م	٦ صفحات	HR5012
١,٨٠ مم	٠,٥٠ م	٠,٥٠ م	١ صفحات	HR5013
٢,٠٠ مم	٠,٦٠ م	٠,٥٠ م	٤ صفحات	HR5015
٢,٥٠ مم	٠,٦٠ م	٠,٥٠ م	٤ صفحات	HR5016
٣,٠٠ مم	٠,٦٠ م	٠,٥٠ م	٤ صفحات	HR5017
٤,٠٠ مم	٠,٦٠ م	٠,٥٠ م	٤ صفحات	HR5018
٥,٠٠ مم	٠,٦٠ م	٠,٥٠ م	٤ صفحات	HR5019
٢,٠٠ مم	٠,٦٠ م	٠,٤٥ م	٤ صفحات	HR5020
٣,٠٠ مم	٠,٦٠ م	٠,٤٥ م	٤ صفحات	HR5021
٣,٠٠ مم	٠,٧٠ م	٠,٥٠ م	٢ صفحات	HR5022
٥,٠٠ مم	٠,٧٠ م	٠,٥٠ م	٢ صفحات	HR5024
٦,٠٠ مم	٠,٧٠ م	٠,٥٠ م	٢ صفحات	HR5025
٨,٠٠ مم	٠,٧٠ م	٠,٥٠ م	٢ صفحات	HR5026
١٠,٠٠ مم	٠,٧٠ م	٠,٥٠ م	٢ صفحات	HR5027
٠,٠٨ مم	١٢,٧٠ مم	١٢,٢٠ مم	٢٠ لفة	HR5028
٠,٠٨ مم	١٢,٧٠ مم	١٢,٢٠ مم	١٠ لفت	HR5029
٠,٢٠ مم	١,٠٠ م	١,٠٠ م	٣ صفحات	HR763
٠,٤٠ مم	١,٠٠ م	١,٠٠ م	٣ صفحات	HR764
٠,٨٠ مم	١,٠٠ م	١,٠٠ م	٣ صفحات	HR765
١,٦٠ مم	١,٠٠ م	١,٠٠ م	٣ صفحات	HR766

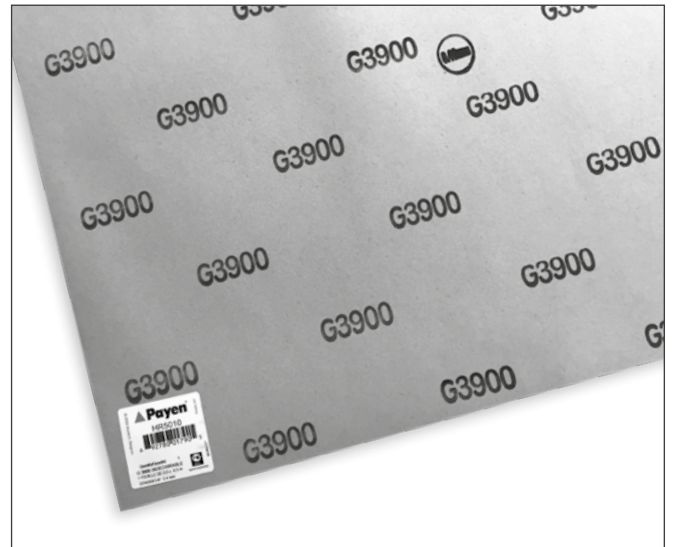



CC



9

4C (960_)	03/13→	960 A1.000	Petrol	1742	4	16	29
4C Spider (961_)	10/14→	960 A1.000	Petrol	1742	4	16	29
6 (119_)	04/79→12/86	AR 01928	Petrol	2492	6	12	59
33 (905_)	05/83→12/87	AR 30143	Petrol	1490	4	8	15
33 (905_)	05/83→12/87	AR 30504	Petrol	1490	4	8	15
33 (905_)	05/83→12/89	AR 30502	Petrol	1351	4	8	8
33 (905_)	05/83→12/93	AR 30182	Petrol	1490	4	8	15
33 (905_)	06/83→12/86	AR 30520	Petrol	1490	4	8	15
33 (905_)	06/83→12/89	AR 30585	Petrol	1186	4	8	2
33 (905_)	06/83→12/89	AR 30586	Petrol	1351	4	8	8
33 (905_)	06/83→06/90	AR 30168	Petrol	1351	4	8	8
33 (905_)	06/83→06/90	AR 30587	Petrol	1351	4	8	8
33 (905_)	01/84→12/89	AR 30514	Petrol	1490	4	8	15
33 (905_)	06/84→12/89	AR 30146	Petrol	1490	4	8	15
33 (905_)	06/84→12/89	AR 30508	Petrol	1490	4	8	15
33 (905_)	06/84→12/89	AR 30588	Petrol	1490	4	8	15
33 (905_)	01/86→12/89	AR 30550	Petrol	1712	4	8	23
33 (905_)	09/88→12/89	AR 30558	Petrol	1712	4	8	23
33 (907A_)	01/90→04/93	AR 30734	Petrol	1490	4	8	15
33 (907A_)	01/90→09/94	AR 30736	Petrol	1712	4	8	23
33 (907A_)	01/90→09/94	AR 30737	Petrol	1712	4	8	23
33 (907A_)	01/90→09/94	AR 30746	Petrol	1712	4	16	24
33 (907A_)	01/90→09/94	AR 30747	Petrol	1712	4	16	24
33 (907A_)	01/90→09/94	AR 30751	Petrol	1490	4	8	15
33 (907A_)	07/90→08/91	AR 30750	Petrol	1490	4	8	15
33 (907A_)	07/90→09/92	AR 30743	Petrol	1186	4	8	5
33 (907A_)	06/91→09/94	AR 30753	Petrol	1351	4	8	13
33 (907A_)	06/91→09/94	AR 30755	Petrol	1351	4	8	13
33 (907A_)	04/92→09/94	AR 30737 A	Petrol	1712	4	8	23
33 Sportwagon (905A_)	01/84→12/88	AR 30587	Petrol	1351	4	8	8
33 Sportwagon (905A_)	09/84→12/86	AR 30520	Petrol	1490	4	8	15
33 Sportwagon (905A_)	09/84→12/87	AR 30182	Petrol	1490	4	8	15
33 Sportwagon (905A_)	09/84→12/87	AR 30514	Petrol	1490	4	8	15
33 Sportwagon (905A_)	12/86→12/89	AR 30146	Petrol	1490	4	8	15
33 Sportwagon (905A_)	12/86→12/89	AR 30508	Petrol	1490	4	8	15
33 Sportwagon (905A_)	12/86→12/89	AR 30588	Petrol	1490	4	8	15
33 Sportwagon (905A_)	03/88→12/89	AR 30550	Petrol	1712	4	8	23
33 Sportwagon (905A_)	09/88→12/89	AR 30558	Petrol	1712	4	8	23
33 Sportwagon (905A_)	09/88→12/89	AR 30737	Petrol	1712	4	8	23
33 Sportwagon (907B_)	01/90→03/92	AR 30736	Petrol	1712	4	8	23
33 Sportwagon (907B_)	01/90→09/94	AR 30737	Petrol	1712	4	8	23
33 Sportwagon (907B_)	01/90→09/94	AR 30747	Petrol	1712	4	16	24
33 Sportwagon (907B_)	01/90→09/94	AR 30751	Petrol	1490	4	8	15
33 Sportwagon (907B_)	07/90→09/94	AR 30746	Petrol	1712	4	16	24
33 Sportwagon (907B_)	07/90→09/94	AR 30755	Petrol	1351	4	8	13
33 Sportwagon (907B_)	06/91→09/94	AR 30753	Petrol	1351	4	8	13
75 (162B_)	05/85→08/86	AR 01646	Petrol	2492	6	12	57
75 (162B_)	05/85→08/86	AR 01911	Petrol	2492	6	12	58
75 (162B_)	05/85→10/88	AR 06212	Petrol	1962	4	8	42
75 (162B_)	05/85→09/89	AR 06100	Petrol	1567	4	8	18
75 (162B_)	05/85→05/90	AR 01648	Petrol	2492	6	12	57
75 (162B_)	05/85→02/92	AR 06224	Petrol	1962	4	8	42
75 (162B_)	05/85→02/92	AR 61101	Petrol	1567	4	8	18
75 (162B_)	09/85→06/89	AR 06202	Petrol	1779	4	8	30
75 (162B_)	02/86→01/90	AR 06158	Petrol	1779	4	8	30
75 (162B_)	02/86→02/92	AR 06134	Petrol	1779	4	8	30
75 (162B_)	01/87→02/92	AR 06124	Petrol	2959	6	12	64
75 (162B_)	01/87→02/92	AR 06166	Petrol	1962	4	8	42
75 (162B_)	09/88→02/92	AR 06168	Petrol	1779	4	8	30
75 (162B_)	09/88→02/92	AR 61102	Petrol	1779	4	8	30
75 (162B)	05/89→12/92	AR 61202	Petrol	1779	4	8	30
75 (162B_)	08/89→02/92	AR 61201	Petrol	1779	4	8	30
75 (162B_)	08/89→02/92	AR 67101	Petrol	1773	4	8	32
75 (162B_)	02/90→02/92	AR 61503	Petrol	2959	6	12	64
90 (162_)	10/84→07/87	AR 01646	Petrol	2492	6	12	57
90 (162_)	10/84→07/87	AR 01713	Petrol	1962	4	8	42
90 (162_)	10/84→07/87	AR 01911	Petrol	2492	6	12	58
90 (162_)	10/84→07/87	AR 06202	Petrol	1779	4	8	30
90 (162_)	10/84→07/87	AR 06210	Petrol	1997	6	12	43
90 (162_)	10/84→07/87	AR 06212	Petrol	1962	4	8	42
145 (930_)	07/94→12/96	AR 33501	Petrol	1351	4	8	13
145 (930_)	07/94→10/97	AR 30736	Petrol	1712	4	8	23
145 (930_)	07/94→02/99	AR 67501	Diesel	1929	4	8	33
145 (930_)	10/94→12/96	AR 33201	Petrol	1596	4	8	22
145 (930_)	10/94→12/96	AR 33401	Petrol	1712	4	16	26
145 (930_)	10/94→02/99	AR 33601	Diesel	1929	4	8	33
145 (930_)	10/95→01/01	AR 67204	Petrol	1970	4	16	40
145 (930_)	12/96→12/98	AR 38401	Petrol	1747	4	16	25



145 (930_)	12/96→12/98	AR 67106	Petrol	1747	4	16	25
145 (930_)	12/96→12/98	AR 67199	Petrol	1747	4	16	25
145 (930_)	12/96→01/01	AR 33503	Petrol	1370	4	16	14
145 (930_)	12/96→01/01	AR 38201	Petrol	1598	4	16	21
145 (930_)	12/96→01/01	AR 38501	Petrol	1370	4	16	14
145 (930_)	12/96→01/01	AR 67601	Petrol	1598	4	16	21
145 (930_)	09/97→12/00	AR 32102	Petrol	1598	4	16	21
145 (930_)	03/98→01/01	AR 32201	Petrol	1747	4	16	25
145 (930_)	03/98→01/01	AR 32301	Petrol	1970	4	16	46
145 (930_)	02/99→01/01	AR 32302	Diesel	1910	4	8	34
146 (930_)	12/94→12/96	AR 33201	Petrol	1596	4	8	22
146 (930_)	12/94→12/96	AR 33401	Petrol	1712	4	16	26
146 (930_)	12/94→12/96	AR 33501	Petrol	1351	4	8	13
146 (930_)	12/94→02/99	AR 33601	Diesel	1929	4	8	33
146 (930_)	12/94→02/99	AR 67501	Diesel	1929	4	8	33
146 (930_)	10/95→01/01	AR 67204	Petrol	1970	4	16	40
146 (930_)	11/96→01/01	AR 33503	Petrol	1370	4	16	14
146 (930_)	11/96→01/01	AR 38201	Petrol	1598	4	16	21
146 (930_)	11/96→01/01	AR 38401	Petrol	1747	4	16	25
146 (930_)	11/96→01/01	AR 38501	Petrol	1370	4	16	14
146 (930_)	11/96→01/01	AR 67106	Petrol	1747	4	16	25
146 (930_)	11/96→01/01	AR 67601	Petrol	1598	4	16	21
146 (930_)	09/97→12/00	AR 32102	Petrol	1598	4	16	21
146 (930_)	03/98→01/01	AR 32201	Petrol	1747	4	16	25
146 (930_)	03/98→01/01	AR 32301	Petrol	1970	4	16	46
146 (930_)	02/99→01/01	AR 32302	Diesel	1910	4	8	34
147 (937_)	01/01→03/10	AR 32104	Petrol	1598	4	16	21
147 (937_)	01/01→03/10	AR 32310	Petrol	1970	4	16	46
147 (937_)	01/01→03/10	AR 37203	Petrol	1598	4	16	21
147 (937_)	04/01→03/10	937 A2.000	Diesel	1910	4	8	34
147 (937_)	07/02→05/05	937 A1.000	Petrol	1970	4	16	40
147 (937_)	11/02→03/10	192 A5.000	Diesel	1910	4	16	35
147 (937_)	02/03→03/10	932 A.000	Petrol	3179	6	24	72
147 (937_)	06/03→03/10	182 B9.000	Diesel	1910	4	8	34
147 (937_)	09/03→09/04	937 A4.000	Diesel	1910	4	16	35
147 (937_)	09/04→03/10	937 A5.000	Diesel	1910	4	16	35
147 (937_)	10/04→03/10	192 B1.000	Diesel	1910	4	16	35
147 (937_)	10/04→03/10	939 A7.000	Diesel	1910	4	8	34
147 (937_)	07/05→03/10	937 A3.000	Diesel	1910	4	8	34
147 (937_)	06/08→03/10	937 A6.000	Diesel	1910	4	16	35
155 (167_)	01/92→12/96	AR 67101	Petrol	1773	4	8	32
155 (167_)	01/92→12/96	AR 67102	Petrol	1773	4	8	32
155 (167_)	01/92→12/97	AR 67203	Petrol	1995	4	16	49
155 (167_)	02/92→02/95	AR 67201	Petrol	1995	4	8	48
155 (167_)	02/92→02/95	AR 67202	Petrol	1995	4	8	48
155 (167_)	02/92→09/96	AR 67301	Petrol	2492	6	12	61
155 (167_)	02/92→12/97	AR 67402	Petrol	1756	4	8	32
155 (167_)	10/92→12/97	AR 67302	Petrol	2492	6	12	62
155 (167_)	10/92→12/97	AR 67303	Petrol	2492	6	12	61
155 (167_)	04/93→04/96	AR 67103	Petrol	1748	4	8	27
155 (167_)	04/93→04/96	AR 67105	Petrol	1748	4	8	27
155 (167_)	04/93→12/97	AR 67501	Diesel	1929	4	8	33
155 (167_)	04/93→12/97	VM 07 B	Diesel	2499	4	8	63
155 (167_)	04/93→12/97	VM 31 B	Diesel	2499	4	8	63
155 (167_)	03/95→12/97	AR 67204	Petrol	1970	4	16	40
155 (167_)	03/95→12/97	AR 67299	Petrol	1970	4	16	47
155 (167_)	05/96→12/97	AR 67106	Petrol	1747	4	16	25
155 (167_)	05/96→12/97	AR 67601	Petrol	1598	4	16	21
156 (932_)	09/97→10/00	AR 32201	Petrol	1747	4	16	25
156 (932_)	09/97→10/00	AR 32302	Diesel	1910	4	8	34
156 (932_)	09/97→12/01	AR 32401	Petrol	2492	6	24	60
156 (932_)	09/97→12/01	AR 32402	Petrol	2492	6	24	60
156 (932_)	09/97→06/02	AR 32301	Petrol	1970	4	16	46
156 (932_)	09/97→06/02	AR 32310	Petrol	1970	4	16	46
156 (932_)	09/97→09/03	AR 32501	Diesel	2387	5	10	51
156 (932_)	09/97→09/05	AR 32102	Petrol	1598	4	16	21
156 (932_)	09/97→09/05	AR 32103	Petrol	1598	4	16	21
156 (932_)	09/97→09/05	AR 32104	Petrol	1598	4	16	21
156 (932_)	09/97→09/05	AR 67601	Petrol	1598	4	16	21
156 (932_)	10/00→05/01	AR 37101	Diesel	1910	4	8	34
156 (932_)	10/00→09/05	839 A6.000	Diesel	2387	5	10	51
156 (932_)	10/00→09/05	AR 32205	Petrol	1747	4	16	31
156 (932_)	10/00→09/05	AR 32405	Petrol	2492	6	24	60
156 (932_)	05/01→09/05	937 A2.000	Diesel	1910	4	8	34
156 (932_)	01/02→09/05	932 A2.000	Petrol	1970	4	16	40
156 (932_)	03/02→09/05	841 C000	Diesel	2387	5	10	51
156 (932_)	03/02→09/05	932 A.000	Petrol	3179	6	24	72
156 (932_)	03/02→09/05	937 A1.000	Petrol	1970	4	16	40



CC



9

156 (932_)	11/02→11/04	192 B1.000	Diesel	1910	4	16	35
156 (932_)	11/02→09/05	192 A5.000	Diesel	1910	4	16	35
156 (932_)	06/03→09/05	841 M.000	Diesel	2387	5	20	52
156 (932_)	06/03→09/05	841 N.000	Diesel	2387	5	20	52
156 (932_)	10/03→09/05	841 G.000	Diesel	2387	5	20	52
156 (932_)	11/03→09/05	937 A4.000	Diesel	1910	4	16	35
156 (932_)	07/04→09/05	937 A5.000	Diesel	1910	4	16	35
156 Sportwagon (932_)	01/00→05/06	AR 32102	Petrol	1598	4	16	21
156 Sportwagon (932_)	05/00→10/00	AR 32201	Petrol	1747	4	16	25
156 Sportwagon (932_)	05/00→10/00	AR 32302	Diesel	1910	4	8	34
156 Sportwagon (932_)	05/00→06/02	AR 32301	Petrol	1970	4	16	46
156 Sportwagon (932_)	05/00→06/02	AR 32310	Petrol	1970	4	16	46
156 Sportwagon (932_)	05/00→08/03	AR 32401	Petrol	2492	6	24	60
156 Sportwagon (932_)	05/00→09/03	AR 32501	Diesel	2387	5	10	51
156 Sportwagon (932_)	05/00→05/06	AR 32103	Petrol	1598	4	16	21
156 Sportwagon (932_)	05/00→05/06	AR 32104	Petrol	1598	4	16	21
156 Sportwagon (932_)	05/00→05/06	AR 67601	Petrol	1598	4	16	21
156 Sportwagon (932_)	10/00→05/01	AR 37101	Diesel	1910	4	8	34
156 Sportwagon (932_)	10/00→05/06	839 A6.000	Diesel	2387	5	10	51
156 Sportwagon (932_)	10/00→05/06	AR 32205	Petrol	1747	4	16	31
156 Sportwagon (932_)	10/00→05/06	AR 32405	Petrol	2492	6	24	60
156 Sportwagon (932_)	05/01→05/06	937 A2.000	Diesel	1910	4	8	34
156 Sportwagon (932_)	03/02→05/06	841 C000	Diesel	2387	5	10	51
156 Sportwagon (932_)	03/02→05/06	932 A.000	Petrol	3179	6	24	72
156 Sportwagon (932_)	03/02→05/06	932 A2.000	Petrol	1970	4	16	40
156 Sportwagon (932_)	03/02→05/06	937 A1.000	Petrol	1970	4	16	40
156 Sportwagon (932_)	11/02→11/04	192 B1.000	Diesel	1910	4	16	35
156 Sportwagon (932_)	11/02→05/06	192 A5.000	Diesel	1910	4	16	35
156 Sportwagon (932_)	06/03→05/06	841 M.000	Diesel	2387	5	20	52
156 Sportwagon (932_)	06/03→05/06	841 N.000	Diesel	2387	5	20	52
156 Sportwagon (932_)	10/03→05/06	841 G.000	Diesel	2387	5	20	52
156 Sportwagon (932_)	11/03→05/06	937 A4.000	Diesel	1910	4	16	35
156 Sportwagon (932_)	07/04→05/06	937 A5.000	Diesel	1910	4	16	35
159 (939_)	09/05→11/11	937 A7.000	Diesel	1910	4	8	34
159 (939_)	09/05→11/11	937 A8.000	Diesel	1910	4	16	35
159 (939_)	09/05→11/11	939 A1.000	Diesel	1910	4	8	34
159 (939_)	09/05→11/11	939 A2.000	Diesel	1910	4	16	35
159 (939_)	09/05→11/11	939 A3.000	Diesel	2387	5	20	52
159 (939_)	09/05→11/11	939 A5.000	Petrol	2198	4	16	50
159 (939_)	09/05→11/11	939 A6.000	Petrol	1859	4	16	36
159 (939_)	09/05→11/11	939 A7.000	Diesel	1910	4	8	34
159 (939_)	09/05→11/11	939 A8.000	Diesel	1910	4	16	35
159 (939_)	03/07→11/11	939 A4.000	Petrol	1796	4	16	28
159 (939_)	05/07→11/11	939 A9.000	Diesel	2387	5	20	52
159 (939_)	05/09→11/11	844 A2.000	Diesel	1956	4	16	39
159 (939_)	05/09→11/11	939 B3.000	Diesel	1956	4	16	39
159 (939_)	05/09→12/12	939 B1.000	Petrol	1742	4	16	29
159 (939_)	06/10→11/11	939 B4.000	Diesel	1956	4	16	39
159 Sportwagon (939_)	03/06→11/11	937 A7.000	Diesel	1910	4	8	34
159 Sportwagon (939_)	03/06→11/11	937 A8.000	Diesel	1910	4	16	35
159 Sportwagon (939_)	03/06→11/11	939 A1.000	Diesel	1910	4	8	34
159 Sportwagon (939_)	03/06→11/11	939 A2.000	Diesel	1910	4	16	35
159 Sportwagon (939_)	03/06→11/11	939 A3.000	Diesel	2387	5	20	52
159 Sportwagon (939_)	03/06→11/11	939 A5.000	Petrol	2198	4	16	50
159 Sportwagon (939_)	03/06→11/11	939 A6.000	Petrol	1859	4	16	36
159 Sportwagon (939_)	03/07→11/11	939 A4.000	Petrol	1796	4	16	28
159 Sportwagon (939_)	05/07→12/12	939 A9.000	Diesel	2387	5	20	52
159 Sportwagon (939_)	05/09→11/11	844 A2.000	Diesel	1956	4	16	39
159 Sportwagon (939_)	05/09→11/11	939 B1.000	Petrol	1742	4	16	29
159 Sportwagon (939_)	05/09→11/11	939 B3.000	Diesel	1956	4	16	39
159 Sportwagon (939_)	06/10→11/11	939 B4.000	Diesel	1956	4	16	39
164 (164_)	06/87→09/92	AR 06412	Petrol	2959	6	12	64
164 (164_)	06/87→09/92	VM 84 A	Diesel	2499	4	8	63
164 (164_)	06/87→10/92	AR 06420	Petrol	1962	4	8	44
164 (164_)	06/87→12/93	AR 06410	Petrol	2959	6	12	64
164 (164_)	06/87→09/98	AR 06416	Petrol	1962	4	8	44
164 (164_)	10/87→09/98	AR 06476	Petrol	1995	4	8	45
164 (164_)	09/90→09/92	AR 06430	Petrol	2959	6	12	64
164 (164_)	09/90→09/92	AR 64301	Petrol	2959	6	12	64
164 (164_)	03/91→09/92	AR 64101	Petrol	1996	6	12	43
164 (164_)	09/91→09/98	AR 66301	Petrol	2959	6	24	66
164 (164_)	09/92→09/98	AR 64102	Petrol	1996	6	12	43
164 (164_)	09/92→09/98	AR 64103	Petrol	1995	4	8	48
164 (164_)	09/92→09/98	AR 64303	Petrol	2959	6	12	69
164 (164_)	09/92→09/98	AR 64304	Petrol	2959	6	24	66
164 (164_)	09/92→09/98	AR 64305	Petrol	2959	6	12	65
164 (164_)	09/92→09/98	AR 64306	Petrol	2959	6	24	64
164 (164_)	09/92→09/98	AR 64399	Petrol	2959	6	12	68











CC



9

164 (164_)	09/92→09/98	AR 66201	Petrol	2492	6	12	57
164 (164_)	09/92→09/98	AR 66302	Petrol	2959	6	24	66
164 (164_)	09/92→09/98	AR 66303	Petrol	2959	6	12	65
164 (164_)	09/92→09/98	VM 08 B	Diesel	2499	4	8	63
164 (164_)	09/92→09/98	VM 32 B	Diesel	2499	4	8	63
164 (164_)	11/92→09/98	AR 64307	Petrol	2959	6	24	66
164 (164_)	11/92→09/98	AR 64308	Petrol	2959	6	24	66
164 (164)	10/94→08/97	AR 64399	Petrol	2959	6	12	68
164 (164_)	03/95→10/97	AR 66306	Petrol	2959	6	24	71
166 (936_)	09/98→10/00	AR 34102	Petrol	1996	6	12	43
166 (936_)	09/98→10/00	AR 34103	Petrol	1970	4	16	46
166 (936_)	09/98→10/00	AR 34202	Diesel	2387	5	10	51
166 (936_)	09/98→12/06	AR 34201	Petrol	2492	6	24	60
166 (936_)	09/98→06/07	AR 34301	Petrol	2959	6	24	66
166 (936_)	09/98→06/07	AR 34302	Petrol	2959	6	24	67
166 (936_)	10/00→06/07	839 A6.000	Diesel	2387	5	10	51
166 (936_)	10/00→06/07	AR 36101	Petrol	2959	6	24	66
166 (936_)	10/00→06/07	AR 36201	Petrol	2492	6	24	60
166 (936_)	10/00→06/07	AR 36301	Petrol	1970	4	16	47
166 (936_)	04/02→06/07	841 C.000	Diesel	2387	5	10	51
166 (936_)	10/03→06/07	841 G.000	Diesel	2387	5	20	52
166 (936_)	10/03→06/07	841 H.000	Diesel	2387	5	20	52
166 (936_)	10/03→06/07	841 M.000	Diesel	2387	5	20	52
166 (936_)	10/03→06/07	841 N.000	Diesel	2387	5	20	52
166 (936_)	10/03→06/07	936 A.000	Petrol	3179	6	24	72
166 (936_)	07/05→06/07	936 B.000	Diesel	2387	5	20	52
1750-2000 (105_)	03/68→10/72	AR 00548	Petrol	1779	4	8	30
1750-2000 (105_)	10/71→07/75	AR 10520	Petrol	1962	4	8	42
A11 / A12 Platform/Chassis	01/67→12/71	AR 00500	Petrol	1290	4	8	7
A11 / A12 Platform/Chassis	01/67→12/83	AR 00504	Petrol	1290	4	8	7
Alfasud (901_)	06/72→09/84	AR 30102	Petrol	1186	4	8	2
Alfasud (901_)	11/73→09/84	AR 30104	Petrol	1186	4	8	2
Alfasud (901_)	09/77→09/84	AR 30164	Petrol	1351	4	8	8
Alfasud (901_)	09/77→09/84	AR 30184	Petrol	1286	4	8	8
Alfasud (901_)	01/78→02/80	AR 30180	Petrol	1286	4	8	8
Alfasud (901_)	01/79→09/84	AR 30124	Petrol	1490	4	8	15
Alfasud (901_)	01/79→09/84	AR 30160	Petrol	1351	4	8	8
Alfasud (901_)	03/80→09/84	AR 30102 S	Petrol	1186	4	8	3
Alfasud (901_)	03/80→12/84	AR 30128	Petrol	1490	4	8	15
Alfasud (901_)	03/80→12/84	AR 30168	Petrol	1351	4	8	8
Alfasud (901_)	01/83→12/84	AR 30146	Petrol	1490	4	8	15
Alfasud Giardinetta (904_)	01/78→07/79	AR 30180	Petrol	1286	4	8	8
Alfasud Giardinetta (904_)	01/78→12/81	AR 30102	Petrol	1186	4	8	2
Alfasud Giardinetta (904_)	03/80→12/81	AR 30160	Petrol	1351	4	8	8
Alfasud Sprint (902_)	09/76→12/81	AR 30184	Petrol	1286	4	8	8
Alfasud Sprint (902_)	05/78→02/80	AR 30164	Petrol	1351	4	8	8
Alfasud Sprint (902_)	05/78→12/81	AR 30124	Petrol	1490	4	8	15
Alfasud Sprint (902_)	07/79→01/87	AR 30128	Petrol	1490	4	8	15
Alfasud Sprint (902_)	07/79→12/89	AR 30168	Petrol	1351	4	8	8
Alfasud Sprint (902_)	01/80→12/89	AR 30146	Petrol	1490	4	8	15
Alfasud Sprint (902_)	03/87→12/89	AR 30550	Petrol	1712	4	8	23
Alfasud Sprint (902_)	10/87→12/89	AR 30558	Petrol	1712	4	8	23
Alfetta (116_)	07/74→12/77	AR 01608 X	Petrol	1779	4	8	30
Alfetta (116_)	09/74→02/80	AR 01623	Petrol	1962	4	8	42
Alfetta (116_)	01/75→12/84	AR 01600	Petrol	1570	4	8	18
Alfetta (116_)	07/78→12/84	AR 01655	Petrol	1962	4	8	42
Alfetta (116_)	07/78→12/84	AR 01713	Petrol	1962	4	8	42
Alfetta (116_)	07/78→12/84	AR 10520	Petrol	1962	4	8	42
Alfetta (116_)	10/79→12/84	AR 01608	Petrol	1779	4	8	30
Alfetta (116_)	10/79→12/84	AR 01678	Petrol	1779	4	8	30
Alfetta GT (116_)	01/74→12/76	AR 01608	Petrol	1779	4	8	30
Alfetta GT (116_)	01/74→12/76	AR 01608 X	Petrol	1779	4	8	30
Alfetta GT (116_)	09/74→12/77	AR 11634	Petrol	1962	4	8	42
Alfetta GT (116_)	01/76→09/82	AR 01600	Petrol	1570	4	8	18
Alfetta GT (116_)	06/77→12/84	AR 01655	Petrol	1962	4	8	42
Alfetta GT (116_)	07/78→01/86	AR 01623	Petrol	1962	4	8	42
AR 6 Box (280_)	04/85→02/86	8144.61.200	Diesel	2445	4	8	54
AR 6 Box (280_)	04/85→12/89	160 D100	Diesel	1929	4	8	33
AR 6 Box (280_)	03/86→12/89	8144.67.220	Diesel	2499	4	8	56
AR 6 Box (280_)	09/86→12/89	8144.21.220	Diesel	2445	4	8	53
AR 6 Bus (280_)	04/85→12/89	160 D100	Diesel	1929	4	8	33
AR 8 Box (280_)	04/78→08/86	8140.61.200	Diesel	2445	4	8	54
AR 8 Box (280_)	04/85→12/89	8140.21.200 D.I.	Diesel	2445	4	8	53
AR 8 Box (280_)	09/86→12/89	8144.67.220	Diesel	2499	4	8	56
AR 8 Platform/Chassis (280_)	04/78→08/86	8140.61.200	Diesel	2445	4	8	54
AR 8 Platform/Chassis (280_)	04/85→12/88	8140.21.200 D.I.	Diesel	2445	4	8	53
AR 8 Platform/Chassis (280_)	09/86→12/89	8144.67.220	Diesel	2499	4	8	56
Arna (920_)	03/83→12/86	AR 30102	Petrol	1186	4	8	2

							
Arna (920_)	03/83→12/86	AR 30168	Petrol	1351	4	8	8
Arna (920_)	03/83→12/86	AR 31010	Petrol	1351	4	8	8
Arna (920_)	01/85→12/86	AR 30100	Petrol	1351	4	8	8
Arna (920_)	01/85→12/86	AR 30182	Petrol	1490	4	8	15
Arna (920_)	01/85→12/86	AR 30500	Petrol	1186	4	8	4
Arna (920_)	01/85→12/86	AR 31000	Petrol	1186	4	8	2
Arna (920_)	05/85→12/86	AR 30146	Petrol	1490	4	8	15
Berlina Saloon	09/68→12/72	AR 00548	Petrol	1779	4	8	30
Berlina Saloon	09/68→12/72	AR 01608	Petrol	1779	4	8	30
Berlina Saloon	09/69→12/74	AR 01629	Petrol	1962	4	8	42
Brera (939_)	01/06→06/10	939 A3.000	Diesel	2387	5	20	52
Brera (939_)	01/06→05/11	939 A5.000	Petrol	2198	4	16	50
Brera (939_)	05/07→06/10	939 A9.000	Diesel	2387	5	20	52
Brera (939_)	03/08→06/10	844 A2.000	Diesel	1956	4	16	39
Brera (939_)	05/09→06/10	939 B1.000	Petrol	1742	4	16	29
Brera (939_)	05/09→06/10	939 B3.000	Diesel	1956	4	16	39
F11 / F12 Box	01/67→12/71	AR 00500	Petrol	1290	4	8	7
F11 / F12 Box	01/67→12/83	AR 00504	Petrol	1290	4	8	7
F11 / F12 Bus	01/67→12/71	AR 00500	Petrol	1290	4	8	7
F11 / F12 Bus	01/67→12/83	AR 00504	Petrol	1290	4	8	7
Giulia (105_)	01/62→12/78	AR 00112	Petrol	1570	4	8	18
Giulia (105_)	01/63→12/78	AR 00516	Petrol	1570	4	8	18
Giulia (105_)	01/64→08/69	AR 00506	Petrol	1290	4	8	7
Giulia (105_)	06/64→12/78	AR 00526	Petrol	1570	4	8	18
Giulia (105_)	01/74→12/78	AR 00530	Petrol	1290	4	8	7
Giulia (105_)	02/76→03/79	AR 00515	Petrol	1962	4	8	42
Giulia GT	01/62→12/64	AR 00112	Petrol	1570	4	8	18
Giulia GT	01/63→12/65	AR 00121	Petrol	1570	4	8	19
Giulia GT	01/74→12/78	AR 00526	Petrol	1570	4	8	18
Giulia GT	01/74→12/78	AR 00530	Petrol	1290	4	8	7
Giulia Spider (101_)	03/62→02/69	AR 00112	Petrol	1570	4	8	18
Giulia Spider (101_)	03/62→02/69	AR 00121	Petrol	1570	4	8	19
Giulia Spider (101_)	03/62→02/69	AR 00516	Petrol	1570	4	8	18
Giulietta (116_)	10/77→06/83	AR 01644	Petrol	1357	4	8	7
Giulietta (116_)	10/77→05/85	AR 01600	Petrol	1570	4	8	18
Giulietta (116_)	04/79→07/85	AR 01678	Petrol	1779	4	8	30
Giulietta (116_)	06/80→04/85	AR 01655	Petrol	1962	4	8	42
Giulietta (116_)	06/80→04/85	AR 11671	Petrol	1962	4	8	42
Giulietta (116_)	07/83→06/84	AR 01699	Petrol	1962	4	8	42
Giulietta (116_)	01/84→12/85	AR 01354	Petrol	1779	4	8	30
Giulietta (940_)	04/10→	198 A4.000	Petrol	1368	4	16	9
Giulietta (940_)	04/10→	940 A1.000	Petrol	1742	4	16	29
Giulietta (940_)	04/10→	940 A2.000	Petrol	1368	4	16	11
Giulietta (940_)	04/10→	940 A3.000	Diesel	1598	4	16	17
Giulietta (940_)	04/10→	940 A4.000	Diesel	1956	4	16	39
Giulietta (940_)	04/10→	940 A5.000	Diesel	1956	4	16	39
Giulietta (940_)	04/10→	940 A6.000	Petrol	1368	4	16	9
Giulietta (940_)	04/10→	940 A7.000	Diesel	1956	4	16	39
Giulietta (940_)	04/10→	940 A8.000	Diesel	1956	4	16	39
Giulietta (940_)	04/10→	940 B4.000	Diesel	1956	4	16	39
Giulietta (940_)	04/10→	940 B6.000	Diesel	1956	4	16	39
Giulietta (940_)	04/10→	940 B7.000	Petrol	1368	4	16	9
Giulietta (940_)	04/10→	940 B9.000	Diesel	1956	4	16	41
Giulietta (940_)	04/10→	940 C3.000	Diesel	1956	4	16	41
Giulietta (940_)	04/10→	940 C4.000	Diesel	1956	4	16	41
Giulietta (940_)	04/10→	955 A8.000	Petrol	1368	4	16	11
Giulietta (940_)	04/11→	940 B1.000	Petrol	1368	4	16	9
Giulietta (940_)	04/11→	940 B8.000	Petrol	1368	4	16	9
Giulietta (940_)	08/13→	940 B5.000	Diesel	1956	4	16	39
Giulietta (940_)	09/13→	940 B2.000	Petrol	1742	4	16	29
Giulietta (940_)	09/13→	960 A1.000	Petrol	1742	4	16	29
Giulietta (940_)	09/14→	940 C2.000	Petrol	1368	4	16	11
Giulietta (940_)	02/15→	940 C1.000	Diesel	1598	4	16	17
Giulietta (940_)	02/15→	940 C5.000	Diesel	1598	4	16	17
Giulietta Berlina	01/55→12/57	AR 00500	Petrol	1290	4	8	7
Giulietta Berlina	01/57→12/62	AR 00502	Petrol	1290	4	8	7
Giulietta Berlina	01/58→12/60	AR 00504	Petrol	1290	4	8	7
Giulietta Coupe	01/58→12/61	AR 00514	Petrol	1290	4	8	7
Giulietta Estate	01/57→12/62	AR 00500	Petrol	1290	4	8	7
Giulietta Estate	01/59→12/62	AR 00504	Petrol	1290	4	8	7
Giulietta Spider	01/55→12/62	AR 00501	Petrol	1290	4	8	7
Giulietta Spider	01/56→12/62	AR 00510	Petrol	1290	4	8	7
Giulietta Spider	01/61→12/62	AR 00508	Petrol	1290	4	8	7
Giulietta Sprint	01/54→12/62	AR 00501	Petrol	1290	4	8	7
Giulietta Sprint	01/56→12/62	AR 00510	Petrol	1290	4	8	7
Giulietta Sprint	01/58→12/62	AR 00508	Petrol	1290	4	8	7
Giulietta Sprint Speciale	01/58→12/61	AR 00514	Petrol	1290	4	8	7
GT (105_)	03/63→12/77	AR 00526 S	Petrol	1570	4	8	18



CC



9

GT (105_)	01/65→12/70	AR 10538	Petrol	1570	4	8	18
GT (105_)	01/66→12/77	AR 00530	Petrol	1290	4	8	7
GT (105_)	01/66→12/77	AR 00536	Petrol	1570	4	8	18
GT (105_)	01/67→12/72	AR 00548	Petrol	1779	4	8	30
GT (105_)	01/71→12/77	AR 10527	Petrol	1962	4	8	37
GT (937_)	11/03→09/10	932 A2.000	Petrol	1970	4	16	40
GT (937_)	11/03→09/10	936 A.000	Petrol	3179	6	24	72
GT (937_)	11/03→09/10	937 A1.000	Petrol	1970	4	16	40
GT (937_)	11/03→09/10	937 A5.000	Diesel	1910	4	16	35
GT (937_)	11/03→09/10	AR 32205	Petrol	1747	4	16	31
GT (937_)	05/08→09/10	937 A6.000	Diesel	1910	4	16	35
GTA Coupe	05/68→12/76	AR 10531	Petrol	1290	4	8	7
GTA Coupe	05/68→12/76	AR 10534	Petrol	1290	4	8	7
GTV (116_)	01/78→12/80	AR 11642	Petrol	1962	4	8	42
GTV (116_)	07/78→01/86	AR 01655	Petrol	1962	4	8	42
GTV (116_)	07/78→01/86	AR 06212	Petrol	1962	4	8	42
GTV (116_)	11/80→02/87	AR 01646	Petrol	2492	6	12	57
GTV (916_)	06/95→09/98	AR 16202	Petrol	1996	6	12	43
GTV (916_)	06/95→10/05	AR 16201	Petrol	1970	4	16	40
GTV (916_)	06/95→10/05	AR 32310	Petrol	1970	4	16	46
GTV (916_)	10/96→10/00	AR 16102	Petrol	2959	6	24	66
GTV (916_)	05/98→08/00	AR 32301	Petrol	1970	4	16	46
GTV (916_)	05/98→10/05	AR 32201	Petrol	1747	4	16	25
GTV (916_)	10/00→10/05	AR 16105	Petrol	2959	6	24	66
GTV (916_)	04/03→10/05	936 A6.000	Petrol	3179	6	24	72
GTV (916_)	04/03→10/05	937 A1.000	Petrol	1970	4	16	40
Mito (955_)	09/08→	198 A1.000	Petrol	1368	4	16	9
Mito (955_)	09/08→	198 A2.000	Diesel	1598	4	16	17
Mito (955_)	09/08→	198 A4.000	Petrol	1368	4	16	9
Mito (955_)	09/08→	199 A3.000	Diesel	1248	4	16	6
Mito (955_)	09/08→	199 A6.000	Petrol	1368	4	16	9
Mito (955_)	09/08→	199 A8.000	Petrol	1368	4	16	9
Mito (955_)	09/08→	955 A1.000	Petrol	1368	4	16	9
Mito (955_)	09/08→	955 A3.000	Diesel	1598	4	16	17
Mito (955_)	09/08→	955 A4.000	Diesel	1598	4	16	17
Mito (955_)	09/08→	955 B2.000	Diesel	1248	4	16	6
Mito (955_)	10/09→	199 B1.000	Diesel	1248	4	16	6
Mito (955_)	10/09→	330 A1.000	Diesel	1248	4	16	6
Mito (955_)	10/09→	940 A2.000	Petrol	1368	4	16	11
Mito (955_)	10/09→	955 A2.000	Petrol	1368	4	16	11
Mito (955_)	10/09→	955 A7.000	Petrol	1368	4	16	11
Mito (955_)	10/09→	955 A8.000	Petrol	1368	4	16	11
Mito (955_)	08/10→	955 A6.000	Petrol	1368	4	16	11
Mito (955_)	01/11→	199 B4.000	Diesel	1248	4	16	6
Mito (955_)	03/11→	350 A1.000	Petrol	1368	4	8	10
Mito (955_)	05/11→	955 A9.000	Petrol	1368	4	8	12
Mito (955_)	07/11→	312 A2.000	Petrol	875	2	8	1
Mito (955_)	04/13→	199 B6.000	Petrol	875	2	8	1
Mito (955_)	12/13→	199 B8.000	Diesel	1248	4	16	6
Mito (955_)	12/13→	955 B1.000	Petrol	1368	4	16	11
Romeo 2 Box	01/56→12/67	AR 00500	Petrol	1290	4	8	7
Romeo 2 Bus	01/56→12/67	AR 00500	Petrol	1290	4	8	7
RZ	01/92→12/94	AR 61501	Petrol	2959	6	12	68
Spider (105_)	03/66→12/68	AR 00526	Petrol	1570	4	8	18
Spider (105_)	03/66→12/68	AR 00536	Petrol	1570	4	8	18
Spider (105_)	03/66→12/68	AR 01600	Petrol	1570	4	8	18
Spider (105_)	01/67→12/71	AR 00548	Petrol	1779	4	8	30
Spider (105_)	01/68→12/77	AR 00530	Petrol	1290	4	8	7
Spider (105_)	01/71→12/77	AR 00512	Petrol	1962	4	8	42
Spider (115_)	03/71→12/79	AR 00536	Petrol	1570	4	8	18
Spider (115)	01/74→12/84	AR 01615	Petrol	1962	4	8	42
Spider (115_)	03/76→12/90	AR 00526	Petrol	1570	4	8	18
Spider (115_)	01/77→12/93	AR 00515	Petrol	1962	4	8	42
Spider (115_)	01/77→12/93	AR 01590	Petrol	1962	4	8	42
Spider (115_)	08/86→12/90	AR 01544	Petrol	1962	4	8	42
Spider (115_)	01/90→12/93	AR 01563	Petrol	1570	4	8	18
Spider (115_)	01/90→12/93	AR 01588	Petrol	1962	4	8	42
Spider (916_)	09/94→04/05	AR 16105	Petrol	2959	6	24	66
Spider (916_)	04/95→04/98	AR 16199	Petrol	2959	6	12	65
Spider (916_)	06/95→04/05	AR 16101	Petrol	2959	6	12	65
Spider (916_)	06/95→04/05	AR 16201	Petrol	1970	4	16	40
Spider (916_)	06/95→04/05	AR 32310	Petrol	1970	4	16	46
Spider (916_)	05/98→08/00	AR 32301	Petrol	1970	4	16	46
Spider (916_)	05/98→04/05	AR 16202	Petrol	1996	6	12	43
Spider (916_)	05/98→04/05	AR 32201	Petrol	1747	4	16	25
Spider (916_)	01/99→10/03	AR 16102	Petrol	2959	6	24	66
Spider (916_)	04/03→04/05	936 A6.000	Petrol	3179	6	24	72
Spider (916_)	04/03→04/05	937 A1.000	Petrol	1970	4	16	40



















CC



9

Model	Period	Engine	Fuel	CC	Gears	Speed	Index
Spider (939_)	03/06→06/10	939 A5.000	Petrol	2198	4	16	50
Spider (939_)	04/07→06/10	939 A3.000	Diesel	2387	5	20	52
Spider (939_)	04/09→06/10	844 A2.000	Diesel	1956	4	16	39
Spider (939_)	05/09→06/10	939 B1.000	Petrol	1742	4	16	29
Spider (939_)	05/09→06/10	939 B3.000	Diesel	1956	4	16	39
Sport Saloon	09/77→12/79	AR 01623	Petrol	1962	4	8	42
Sprint Coupe	09/76→12/79	AR 11634	Petrol	1962	4	8	42
SZ	09/88→08/94	AR 61501	Petrol	2959	6	12	68

	CC				9		CC				9
160 D100	1929	4	8	Diesel	33	955 A6.000	1368	4	16	Petrol	11
182 B9.000	1910	4	8	Diesel	34	955 A7.000	1368	4	16	Petrol	11
192 A5.000	1910	4	16	Diesel	35	955 A8.000	1368	4	16	Petrol	11
192 B1.000	1910	4	16	Diesel	35	955 A9.000	1368	4	8	Petrol	12
198 A1.000	1368	4	16	Petrol	9	955 B1.000	1368	4	16	Petrol	11
198 A2.000	1598	4	16	Diesel	17	955 B2.000	1248	4	16	Diesel	6
198 A4.000	1368	4	16	Petrol	9	960 A1.000	1742	4	16	Petrol	29
198 A5.000	1956	4	16	Diesel	39	8140.21.200 D.I.	2445	4	8	Diesel	53
198 A7.000	1368	4	16	Petrol	9	8140.61.200	2445	4	8	Diesel	54
199 A3.000	1248	4	16	Diesel	6	8144.21.220	2445	4	8	Diesel	53
199 A6.000	1368	4	16	Petrol	9	8144.61.200	2445	4	8	Diesel	54
199 A8.000	1368	4	16	Petrol	9	8144.67.220	2499	4	8	Diesel	56
199 B1.000	1248	4	16	Diesel	6	AR 00112	1570	4	8	Petrol	18
199 B4.000	1248	4	16	Diesel	6	AR 00121	1570	4	8	Petrol	19
199 B6.000	875	2	8	Petrol	1	AR 00500	1290	4	8	Petrol	7
199 B8.000	1248	4	16	Diesel	6	AR 00501	1290	4	8	Petrol	7
312 A2.000	875	2	8	Petrol	1	AR 00502	1290	4	8	Petrol	7
330 A1.000	1248	4	16	Diesel	6	AR 00504	1290	4	8	Petrol	7
350 A1.000	1368	4	8	Petrol	10	AR 00506	1290	4	8	Petrol	7
839 A6.000	2387	5	10	Diesel	51	AR 00508	1290	4	8	Petrol	7
841 C000	2387	5	10	Diesel	51	AR 00510	1290	4	8	Petrol	7
841 G.000	2387	5	20	Diesel	52	AR 00512	1962	4	8	Petrol	42
841 H.000	2387	5	20	Diesel	52	AR 00514	1290	4	8	Petrol	7
841 M.000	2387	5	20	Diesel	52	AR 00515	1962	4	8	Petrol	42
841 N.000	2387	5	20	Diesel	52	AR 00516	1570	4	8	Petrol	18
844 A1.000	1910	4	16	Diesel	35	AR 00526	1570	4	8	Petrol	18
844 A2.000	1956	4	16	Diesel	39	AR 00526 S	1570	4	8	Petrol	18
932 A.000	3179	6	24	Petrol	72	AR 00530	1290	4	8	Petrol	7
932 A2.000	1970	4	16	Petrol	40	AR 00536	1570	4	8	Petrol	18
936 A.000	3179	6	24	Petrol	72	AR 00548	1779	4	8	Petrol	30
936 A6.000	3179	6	24	Petrol	72	AR 01212	1962	4	8	Petrol	42
936 B.000	2387	5	20	Diesel	52	AR 01354	1779	4	8	Petrol	30
937 A1.000	1970	4	16	Petrol	40	AR 01544	1962	4	8	Petrol	42
937 A2.000	1910	4	8	Diesel	34	AR 01563	1570	4	8	Petrol	18
937 A3.000	1910	4	8	Diesel	34	AR 01588	1962	4	8	Petrol	42
937 A4.000	1910	4	16	Diesel	35	AR 01590	1962	4	8	Petrol	42
937 A5.000	1910	4	16	Diesel	35	AR 01600	1570	4	8	Petrol	18
937 A6.000	1910	4	16	Diesel	35	AR 01608	1779	4	8	Petrol	30
937 A7.000	1910	4	8	Diesel	34	AR 01608 X	1779	4	8	Petrol	30
937 A8.000	1910	4	16	Diesel	35	AR 01615	1962	4	8	Petrol	42
939 A1.000	1910	4	8	Diesel	34	AR 01623	1962	4	8	Petrol	42
939 A2.000	1910	4	16	Diesel	35	AR 01629	1962	4	8	Petrol	42
939 A3.000	2387	5	20	Diesel	52	AR 01644	1357	4	8	Petrol	7
939 A4.000	1796	4	16	Petrol	28	AR 01646	2492	6	12	Petrol	57
939 A5.000	2198	4	16	Petrol	50	AR 01648	2492	6	12	Petrol	57
939 A6.000	1859	4	16	Petrol	36	AR 01655	1962	4	8	Petrol	42
939 A7.000	1910	4	8	Diesel	34	AR 01678	1779	4	8	Petrol	30
939 A8.000	1910	4	16	Diesel	35	AR 01699	1962	4	8	Petrol	42
939 A9.000	2387	5	20	Diesel	52	AR 01713	1962	4	8	Petrol	42
939 B1.000	1742	4	16	Petrol	29	AR 01911	2492	6	12	Petrol	58
939 B3.000	1956	4	16	Diesel	39	AR 01913	2492	6	12	Petrol	59
939 B4.000	1956	4	16	Diesel	39	AR 01928	2492	6	12	Petrol	59
939 B5.000	1956	4	16	Diesel	39	AR 06100	1567	4	8	Petrol	18
940 A1.000	1742	4	16	Petrol	29	AR 06120	2959	6	12	Petrol	64
940 A2.000	1368	4	16	Petrol	11	AR 06124	2959	6	12	Petrol	64
940 A3.000	1598	4	16	Diesel	17	AR 06134	1779	4	8	Petrol	30
940 A4.000	1956	4	16	Diesel	39	AR 06158	1779	4	8	Petrol	30
940 A5.000	1956	4	16	Diesel	39	AR 06166	1962	4	8	Petrol	42
940 A6.000	1368	4	16	Petrol	9	AR 06168	1779	4	8	Petrol	30
940 A7.000	1956	4	16	Diesel	39	AR 06202	1779	4	8	Petrol	30
940 A8.000	1956	4	16	Diesel	39	AR 06210	1997	6	12	Petrol	43
940 B1.000	1368	4	16	Petrol	9	AR 06212	1962	4	8	Petrol	42
940 B2.000	1742	4	16	Petrol	29	AR 06224	1962	4	8	Petrol	42
940 B4.000	1956	4	16	Diesel	39	AR 06410	2959	6	12	Petrol	64
940 B5.000	1956	4	16	Diesel	39	AR 06412	2959	6	12	Petrol	64
940 B6.000	1956	4	16	Diesel	39	AR 06416	1962	4	8	Petrol	44
940 B7.000	1368	4	16	Petrol	9	AR 06420	1962	4	8	Petrol	44
940 B8.000	1368	4	16	Petrol	9	AR 06430	2959	6	12	Petrol	64
940 B9.000	1956	4	16	Diesel	41	AR 06476	1995	4	8	Petrol	45
940 C1.000	1598	4	16	Diesel	17	AR 10502	1570	4	8	Petrol	18
940 C2.000	1368	4	16	Petrol	11	AR 10512	1962	4	8	Petrol	42
940 C3.000	1956	4	16	Diesel	41	AR 10520	1962	4	8	Petrol	42
940 C4.000	1956	4	16	Diesel	41	AR 10527	1962	4	8	Petrol	37
940 C5.000	1598	4	16	Diesel	17	AR 10531	1290	4	8	Petrol	7
955 A1.000	1368	4	16	Petrol	9	AR 10534	1290	4	8	Petrol	7
955 A2.000	1368	4	16	Petrol	11	AR 10538	1570	4	8	Petrol	18
955 A3.000	1598	4	16	Diesel	17	AR 10548	1779	4	8	Petrol	30
955 A4.000	1598	4	16	Diesel	17	AR 11633	1962	4	8	Petrol	42

	CC				9		CC				9
AR 11634	1962	4	8	Petrol	42	AR 34102	1996	6	12	Petrol	43
AR 11642	1962	4	8	Petrol	42	AR 34103	1970	4	16	Petrol	46
AR 11644	1357	4	8	Petrol	7	AR 34201	2492	6	24	Petrol	60
AR 11650	1570	4	8	Petrol	18	AR 34202	2387	5	10	Diesel	51
AR 11655	1962	4	8	Petrol	42	AR 34301	2959	6	24	Petrol	66
AR 11671	1962	4	8	Petrol	42	AR 34302	2959	6	24	Petrol	67
AR 16101	2959	6	12	Petrol	65	AR 36101	2959	6	24	Petrol	66
AR 16102	2959	6	24	Petrol	66	AR 36201	2492	6	24	Petrol	60
AR 16105	2959	6	24	Petrol	66	AR 36202	2387	5	10	Diesel	51
AR 16199	2959	6	12	Petrol	65	AR 36301	1970	4	16	Petrol	47
AR 16201	1970	4	16	Petrol	40	AR 37101	1910	4	8	Diesel	34
AR 16202	1996	6	12	Petrol	43	AR 37203	1598	4	16	Petrol	21
AR 19510	1962	4	8	Petrol	42	AR 38201	1598	4	16	Petrol	21
AR 19520	2959	6	12	Petrol	65	AR 38401	1747	4	16	Petrol	25
AR 30100	1351	4	8	Petrol	8	AR 38501	1370	4	16	Petrol	14
AR 30102	1186	4	8	Petrol	2	AR 61101	1567	4	8	Petrol	18
AR 30102 S	1186	4	8	Petrol	3	AR 61102	1779	4	8	Petrol	30
AR 30104	1186	4	8	Petrol	2	AR 61201	1779	4	8	Petrol	30
AR 30124	1490	4	8	Petrol	15	AR 61202	1779	4	8	Petrol	30
AR 30128	1490	4	8	Petrol	15	AR 61203	1779	4	8	Petrol	30
AR 30143	1490	4	8	Petrol	15	AR 61501	2959	6	12	Petrol	68
AR 30146	1490	4	8	Petrol	15	AR 61503	2959	6	12	Petrol	64
AR 30160	1351	4	8	Petrol	8	AR 64101	1996	6	12	Petrol	43
AR 30164	1351	4	8	Petrol	8	AR 64102	1996	6	12	Petrol	43
AR 30168	1351	4	8	Petrol	8	AR 64103	1995	4	8	Petrol	48
AR 30180	1286	4	8	Petrol	8	AR 64301	2959	6	12	Petrol	64
AR 30182	1490	4	8	Petrol	15	AR 64303	2959	6	12	Petrol	69
AR 30184	1286	4	8	Petrol	8	AR 64304	2959	6	24	Petrol	66
AR 30198	1490	4	8	Petrol	15	AR 64305	2959	6	12	Petrol	65
AR 30500	1186	4	8	Petrol	4	AR 64306	2959	6	24	Petrol	64
AR 30502	1351	4	8	Petrol	8	AR 64307	2959	6	24	Petrol	66
AR 30504	1490	4	8	Petrol	15	AR 64308	2959	6	24	Petrol	66
AR 30508	1490	4	8	Petrol	15	AR 64399	2959	6	12	Petrol	68
AR 30514	1490	4	8	Petrol	15	AR 66201	2492	6	12	Petrol	57
AR 30520	1490	4	8	Petrol	15	AR 66301	2959	6	24	Petrol	66
AR 30550	1712	4	8	Petrol	23	AR 66302	2959	6	24	Petrol	66
AR 30558	1712	4	8	Petrol	23	AR 66303	2959	6	12	Petrol	65
AR 30578	1712	4	8	Petrol	23	AR 66304	2959	6	12	Petrol	70
AR 30585	1186	4	8	Petrol	2	AR 66306	2959	6	24	Petrol	71
AR 30586	1351	4	8	Petrol	8	AR 67101	1773	4	8	Petrol	32
AR 30587	1351	4	8	Petrol	8	AR 67102	1773	4	8	Petrol	32
AR 30588	1490	4	8	Petrol	15	AR 67103	1748	4	8	Petrol	27
AR 30732	1351	4	8	Petrol	13	AR 67105	1748	4	8	Petrol	27
AR 30734	1490	4	8	Petrol	15	AR 67106	1747	4	16	Petrol	25
AR 30736	1712	4	8	Petrol	23	AR 67199	1747	4	16	Petrol	25
AR 30737	1712	4	8	Petrol	23	AR 67201	1995	4	8	Petrol	48
AR 30737 A	1712	4	8	Petrol	23	AR 67202	1995	4	8	Petrol	48
AR 30738	1490	4	8	Petrol	15	AR 67203	1995	4	16	Petrol	49
AR 30740	1712	4	8	Petrol	23	AR 67204	1970	4	16	Petrol	40
AR 30743	1186	4	8	Petrol	5	AR 67299	1970	4	16	Petrol	47
AR 30746	1712	4	16	Petrol	24	AR 67301	2492	6	12	Petrol	61
AR 30747	1712	4	16	Petrol	24	AR 67302	2492	6	12	Petrol	62
AR 30750	1490	4	8	Petrol	15	AR 67303	2492	6	12	Petrol	61
AR 30751	1490	4	8	Petrol	15	AR 67402	1756	4	8	Petrol	32
AR 30753	1351	4	8	Petrol	13	AR 67501	1929	4	8	Diesel	33
AR 30755	1351	4	8	Petrol	13	AR 67502	1929	4	8	Diesel	38
AR 31000	1186	4	8	Petrol	2	AR 67601	1598	4	16	Petrol	21
AR 31010	1351	4	8	Petrol	8	M 722 BT 24.T	2387	5	10	Diesel	55
AR 31016	1490	4	8	Petrol	16	VM 07 B	2499	4	8	Diesel	63
AR 32101	1598	4	16	Petrol	20	VM 08 B	2499	4	8	Diesel	63
AR 32102	1598	4	16	Petrol	21	VM 31 B	2499	4	8	Diesel	63
AR 32103	1598	4	16	Petrol	21	VM 32 B	2499	4	8	Diesel	63
AR 32104	1598	4	16	Petrol	21	VM 84 A	2499	4	8	Diesel	63
AR 32201	1747	4	16	Petrol	25	VM-425 CHIEA 08 B	2499	4	8	Diesel	63
AR 32205	1747	4	16	Petrol	31						
AR 32301	1970	4	16	Petrol	46						
AR 32302	1910	4	8	Diesel	34						
AR 32303	1970	4	16	Petrol	46						
AR 32310	1970	4	16	Petrol	46						
AR 32401	2492	6	24	Petrol	60						
AR 32402	2492	6	24	Petrol	60						
AR 32405	2492	6	24	Petrol	60						
AR 32501	2387	5	10	Diesel	51						
AR 33201	1596	4	8	Petrol	22						
AR 33401	1712	4	16	Petrol	26						
AR 33501	1351	4	8	Petrol	13						
AR 33503	1370	4	16	Petrol	14						
AR 33601	1929	4	8	Diesel	33						

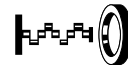
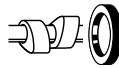

1 0.9L Petrol

199 B6.000	2 Cyl.	8 Valves	875cc	TD27856
312 A2.000	2 Cyl.	8 Valves	875cc	TD26187

NA5070
31.00 x 41.00 x 7.00mm, FPM
NF857
85.00 x 105.00 x 9.00mm, FPM/ACM

2 1.2L Petrol

AR 30102	4 Cyl.	8 Valves	1186cc	TD5335
AR 30104	4 Cyl.	8 Valves	1186cc	TD77
AR 30585	4 Cyl.	8 Valves	1186cc	TD10129
AR 31000	4 Cyl.	8 Valves	1186cc	TD99

HR602

NA5064
35.00 x 58.00 x 10.00mm, ACM

NA5063
40.00 x 56.00 x 10.00mm, ACM
NA5065
62.00 x 80.00 x 12.00mm, ACM

3 1.2L Petrol

AR 30102 S	4 Cyl.	8 Valves	1186cc	TD5336
------------	--------	----------	--------	--------

HR569

NA5064
35.00 x 58.00 x 10.00mm, ACM

NA5063
40.00 x 56.00 x 10.00mm, ACM
NA5065
62.00 x 80.00 x 12.00mm, ACM

4 1.2L Petrol

AR 30500	4 Cyl.	8 Valves	1186cc	TD87
----------	--------	----------	--------	------

HR569

NA5064
35.00 x 58.00 x 10.00mm, ACM

NB307
40.00 x 56.00 x 7.0mm, ACM

5 1.2L Petrol

AR 30743	4 Cyl.	8 Valves	1186cc	TD113
----------	--------	----------	--------	-------

HR569

NA5064
35.00 x 58.00 x 10.00mm, ACM

NA5051
40.00 x 56.00 x 7.00mm, FPM

6 1.3L Diesel

199 A3.000	4 Cyl.	16 Valves	1248cc	TD23450
199 B1.000	4 Cyl.	16 Valves	1248cc	TD24590
199 B4.000	4 Cyl.	16 Valves	1248cc	TD24938
199 B8.000	4 Cyl.	16 Valves	1248cc	TD29692
330 A1.000	4 Cyl.	16 Valves	1248cc	TD33158
955 B2.000	4 Cyl.	16 Valves	1248cc	TD33155

HR5088

NA5223
40.00 x 52.00 x 7.00mm, FPM
NA5230
78.00 x 100.00 x 9.00mm, PTFE

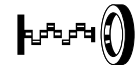
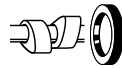

7	1.3L	Petrol			
AR 00500		4 Cyl.	8 Valves	1290cc	TD21701
AR 00501		4 Cyl.	8 Valves	1290cc	TD21702
AR 00502		4 Cyl.	8 Valves	1290cc	TD21704
AR 00504		4 Cyl.	8 Valves	1290cc	TD21705
AR 00506		4 Cyl.	8 Valves	1290cc	TD26425
AR 00508		4 Cyl.	8 Valves	1290cc	TD21709
AR 00510		4 Cyl.	8 Valves	1290cc	TD21711
AR 00514		4 Cyl.	8 Valves	1290cc	TD21712
AR 00530		4 Cyl.	8 Valves	1290cc	TD23
AR 01644		4 Cyl.	8 Valves	1357cc	TD35
AR 10531		4 Cyl.	8 Valves	1290cc	TD21724
AR 10534		4 Cyl.	8 Valves	1290cc	TD21725
AR 11644		4 Cyl.	8 Valves	1357cc	TD22399

NA5066
35.00 x 50.00 x 10.00mm, ACM

8	1.3L	Petrol			
AR 30100		4 Cyl.	8 Valves	1351cc	TD76
AR 30160		4 Cyl.	8 Valves	1351cc	TD81
AR 30164		4 Cyl.	8 Valves	1351cc	TD82
AR 30168		4 Cyl.	8 Valves	1351cc	TD83
AR 30180		4 Cyl.	8 Valves	1286cc	TD84
AR 30184		4 Cyl.	8 Valves	1286cc	TD85
AR 30502		4 Cyl.	8 Valves	1351cc	TD88
AR 30586		4 Cyl.	8 Valves	1351cc	TD96
AR 30587		4 Cyl.	8 Valves	1351cc	TD97
AR 31010		4 Cyl.	8 Valves	1351cc	TD100

HR602

NA5064
35.00 x 58.00 x 10.00mm, ACM

NA5063
40.00 x 56.00 x 10.00mm, ACM

NA5065
62.00 x 80.00 x 12.00mm, ACM

9	1.4L	Petrol			
198 A1.000		4 Cyl.	16 Valves	1368cc	TD23452
198 A4.000		4 Cyl.	16 Valves	1368cc	TD23921
198 A7.000		4 Cyl.	16 Valves	1368cc	TD24646
199 A6.000		4 Cyl.	16 Valves	1368cc	TD23447
199 A8.000		4 Cyl.	16 Valves	1368cc	TD21700
940 A6.000		4 Cyl.	16 Valves	1368cc	TD24794
940 B1.000		4 Cyl.	16 Valves	1368cc	TD26994
940 B7.000		4 Cyl.	16 Valves	1368cc	TD28632
940 B8.000		4 Cyl.	16 Valves	1368cc	TD28633
955 A1.000		4 Cyl.	16 Valves	1368cc	TD23448

HR814

NA5058
40.00 x 55.00 x 7.00mm, FPM

NA5057
27.00 x 37.00 x 7.00mm, FPM

LK5001
74.00 x 187.50 x 17.00mm, FPM

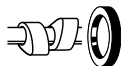

10 1.4L

Petrol

350 A1.000	4 Cyl.	8 Valves	1368cc	TD26416
PA5025 (x8) HR5048	NA5058 40.00 x 55.00 x 7.00mm, FPM	NA5057 27.00 x 37.00 x 7.00mm, FPM NA5061 74.00 x 88.00 x 8.00mm, FPM		

11 1.4L

Petrol

940 A2.000	4 Cyl.	16 Valves	1368cc	TD23920
940 C2.000	4 Cyl.	16 Valves	1368cc	TD33078
955 A2.000	4 Cyl.	16 Valves	1368cc	TD24588
955 A6.000	4 Cyl.	16 Valves	1368cc	TD24587
955 A7.000	4 Cyl.	16 Valves	1368cc	TD24940
955 A8.000	4 Cyl.	16 Valves	1368cc	TD24589
955 B1.000	4 Cyl.	16 Valves	1368cc	TD28716
HR814	NA5321 31.00 x 55.00 x 7.00mm, FPM	NA5057 27.00 x 37.00 x 7.00mm, FPM LK5001 74.00 x 187.50 x 17.00mm, FPM		

12 1.4L

Petrol

955 A9.000	4 Cyl.	8 Valves	1368cc	TD26417
PA5025 (x8) HR5048	NA5058 40.00 x 55.00 x 7.00mm, FPM	NA5057 27.00 x 37.00 x 7.00mm, FPM LK5001 74.00 x 187.50 x 17.00mm, FPM		

13 1.4L

Petrol

AR 30732	4 Cyl.	8 Valves	1351cc	TD107
AR 30753	4 Cyl.	8 Valves	1351cc	TD119
AR 30755	4 Cyl.	8 Valves	1351cc	TD120
AR 33501	4 Cyl.	8 Valves	1351cc	TD123
HR569	NA5064 35.00 x 58.00 x 10.00mm, ACM	NA5063 40.00 x 56.00 x 10.00mm, ACM NA5065 62.00 x 80.00 x 12.00mm, ACM		

14 1.4L

Petrol

AR 33503	4 Cyl.	16 Valves	1370cc	TD9752
AR 38501	4 Cyl.	16 Valves	1370cc	TD9753
HR816 (x2)	NA5053 30.00 x 42.00 x 7.00mm, FPM NA5069 55.00 x 68.00 x 8.00mm, FPM	NA5070 31.00 x 41.00 x 7.00mm, FPM NF888 93.00 x 139.70;172.00 x 12.00mm, FPM		

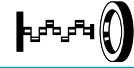

15 1.5L		Petrol			
AR 30124	4 Cyl.	8 Valves	1490cc		TD78
AR 30128	4 Cyl.	8 Valves	1490cc		TD79
AR 30143	4 Cyl.	8 Valves	1490cc		TD10131
AR 30146	4 Cyl.	8 Valves	1490cc		TD80
AR 30182	4 Cyl.	8 Valves	1490cc		TD10128
AR 30198	4 Cyl.	8 Valves	1490cc		TD86
AR 30504	4 Cyl.	8 Valves	1490cc		TD89
AR 30508	4 Cyl.	8 Valves	1490cc		TD90
AR 30514	4 Cyl.	8 Valves	1490cc		TD6373
AR 30520	4 Cyl.	8 Valves	1490cc		TD91
AR 30588	4 Cyl.	8 Valves	1490cc		TD98
AR 30734	4 Cyl.	8 Valves	1490cc		TD108
AR 30738	4 Cyl.	8 Valves	1490cc		TD23346
AR 30750	4 Cyl.	8 Valves	1490cc		TD116
AR 30751	4 Cyl.	8 Valves	1490cc		TD117
HR569	NA5064 35.00 x 58.00 x 10.00mm, ACM		NA5063 40.00 x 56.00 x 10.00mm, ACM NA5065 62.00 x 80.00 x 12.00mm, ACM		

16 1.5L		Petrol			
AR 31016	4 Cyl.	8 Valves	1490cc		TD101
	NA5064 35.00 x 58.00 x 10.00mm, ACM				

17 1.6L		Diesel			
198 A2.000	4 Cyl.	16 Valves	1598cc		TD21698
940 A3.000	4 Cyl.	16 Valves	1598cc		TD23923
940 C1.000	4 Cyl.	16 Valves	1598cc		TD32099
940 C5.000	4 Cyl.	16 Valves	1598cc		TD32093
955 A3.000	4 Cyl.	16 Valves	1598cc		TD24591
955 A4.000	4 Cyl.	16 Valves	1598cc		TD23451
HR5119	NA5347 30.0 x 45.0 x 7.00mm, FPM		NA5070 31.00 x 41.00 x 7.00mm, FPM NF888 93.00 x 139.70;172.00 x 12.00mm, FPM		

18 1.6L		Petrol			
AR 00112	4 Cyl.	8 Valves	1570cc		TD26422
AR 00516	4 Cyl.	8 Valves	1570cc		TD26424
AR 00526	4 Cyl.	8 Valves	1570cc		TD22
AR 00526 S	4 Cyl.	8 Valves	1570cc		TD5344
AR 00536	4 Cyl.	8 Valves	1570cc		TD24
AR 01563	4 Cyl.	8 Valves	1570cc		TD29
AR 01600	4 Cyl.	8 Valves	1570cc		TD32
AR 06100	4 Cyl.	8 Valves	1567cc		TD47
AR 10502	4 Cyl.	8 Valves	1570cc		TD29615
AR 10538	4 Cyl.	8 Valves	1570cc		TD21726
AR 11650	4 Cyl.	8 Valves	1570cc		TD23341
AR 61101	4 Cyl.	8 Valves	1567cc		TD102
	NA5066 35.00 x 50.00 x 10.00mm, ACM				

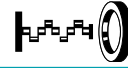

19 1.6L

Petrol

AR 00121	4 Cyl.	8 Valves	1570cc	TD26423
				NB959 35.00 x 50.00 x 7.00mm, FPM

20 1.6L

Petrol

AR 32101	4 Cyl.	16 Valves	1598cc	TD9461
		NA5053 30.00 x 42.00 x 7.00mm, FPM	NA5070 31.00 x 41.00 x 7.00mm, FPM	
		NA5069 55.00 x 68.00 x 8.00mm, FPM	NF888 93.00 x 139.70;172.00 x 12.00mm, FPM	

21 1.6L

Petrol

AR 32102	4 Cyl.	16 Valves	1598cc	TD14369
AR 32103	4 Cyl.	16 Valves	1598cc	TD15389
AR 32104	4 Cyl.	16 Valves	1598cc	TD15388
AR 37203	4 Cyl.	16 Valves	1598cc	TD15508
AR 38201	4 Cyl.	16 Valves	1598cc	TD9754
AR 67601	4 Cyl.	16 Valves	1598cc	TD19
HR816 (x2)	NA5053 30.00 x 42.00 x 7.00mm, FPM		NA5070 31.00 x 41.00 x 7.00mm, FPM	
		NA5069 55.00 x 68.00 x 8.00mm, FPM	NF888 93.00 x 139.70;172.00 x 12.00mm, FPM	

22 1.6L

Petrol

AR 33201	4 Cyl.	8 Valves	1596cc	TD121
HR569	NA5064 (x2) 35.00 x 58.00 x 10.00mm, ACM		NA5051 40.00 x 56.00 x 7.00mm, FPM	
			NA5065 62.00 x 80.00 x 12.00mm, ACM	

23 1.7L

Petrol



AR 30550	4 Cyl.	8 Valves	1712cc	TD4186
AR 30558	4 Cyl.	8 Valves	1712cc	TD93
AR 30578	4 Cyl.	8 Valves	1712cc	TD95
AR 30736	4 Cyl.	8 Valves	1712cc	TD109
AR 30737	4 Cyl.	8 Valves	1712cc	TD110
AR 30737 A	4 Cyl.	8 Valves	1712cc	TD111
AR 30740	4 Cyl.	8 Valves	1712cc	TD112
HR569	NA5064 35.00 x 58.00 x 10.00mm, ACM		NA5063 40.00 x 56.00 x 10.00mm, ACM	
			NA5065 62.00 x 80.00 x 12.00mm, ACM	

24 1.7L

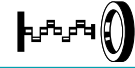

Petrol

AR 30746	4 Cyl.	16 Valves	1712cc	TD114
AR 30747	4 Cyl.	16 Valves	1712cc	TD115
HR5060	NA5064 35.00 x 58.00 x 10.00mm, ACM		NA5063 40.00 x 56.00 x 10.00mm, ACM	
			NA5065 62.00 x 80.00 x 12.00mm, ACM	





25 1.7L		Petrol			
AR 32201	4 Cyl.	16 Valves	1747cc		TD9462
AR 38401	4 Cyl.	16 Valves	1747cc		TD9755
AR 67106	4 Cyl.	16 Valves	1747cc		TD5070
AR 67199	4 Cyl.	16 Valves	1747cc		TD23350
HR816  (x2)	NA5053 30.00 x 42.00 x 7.00mm, FPM NA5069 55.00 x 68.00 x 8.00mm, FPM		NA5070  31.00 x 41.00 x 7.00mm, FPM NF888  93.00 x 139.70; 172.00 x 12.00mm, FPM		

26 1.7L		Petrol			
AR 33401	4 Cyl.	16 Valves	1712cc		TD122
HR5060 			NA5063  40.00 x 56.00 x 10.00mm, ACM NA5065  62.00 x 80.00 x 12.00mm, ACM		

27 1.7L		Petrol			
AR 67103	4 Cyl.	8 Valves	1748cc		TD134
AR 67105	4 Cyl.	8 Valves	1748cc		TD135
HR569 			NB959  35.00 x 50.00 x 7.00mm, FPM →Eng no. 0006645; 0014245 NA5051  40.00 x 56.00 x 7.00mm, FPM Eng no. 0006645; 0014245→		

28 1.8L		Petrol			
939 A4.000	4 Cyl.	16 Valves	1796cc		TD20270
HR5087 	NC006 (x2) 35.00 x 48.00 x 7.00mm, MVQ		NA5174  31.50 x 42.00 x 7.00mm, FPM NA5350  80.00 x 98.00 x 17.70mm, PTFE/ACM		

29 1.8L		Petrol			
939 B1.000	4 Cyl.	16 Valves	1742cc		TD22716
940 A1.000	4 Cyl.	16 Valves	1742cc		TD23922
940 B2.000	4 Cyl.	16 Valves	1742cc		TD33069
960 A1.000	4 Cyl.	16 Valves	1742cc		TD28240
	NA5058 (x2) 40.00 x 55.00 x 7.00mm, FPM		NA5070  31.00 x 41.00 x 7.00mm, FPM NF888  93.00 x 139.70; 172.00 x 12.00mm, FPM		

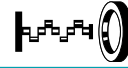
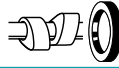

30 1.8L

Petrol

AR 00548	4 Cyl.	8 Valves	1779cc	TD18
AR 01354	4 Cyl.	8 Valves	1779cc	TD5343
AR 01608	4 Cyl.	8 Valves	1779cc	TD5340
AR 01608 X	4 Cyl.	8 Valves	1779cc	TD33
AR 01678	4 Cyl.	8 Valves	1779cc	TD38
AR 06134	4 Cyl.	8 Valves	1779cc	TD50
AR 06158	4 Cyl.	8 Valves	1779cc	TD52
AR 06168	4 Cyl.	8 Valves	1779cc	TD54
AR 06202	4 Cyl.	8 Valves	1779cc	TD55
AR 10548	4 Cyl.	8 Valves	1779cc	TD5350
AR 61102	4 Cyl.	8 Valves	1779cc	TD10149
AR 61201	4 Cyl.	8 Valves	1779cc	TD103
AR 61202	4 Cyl.	8 Valves	1779cc	TD5333
AR 61203	4 Cyl.	8 Valves	1779cc	TD23349

NA5066
35.00 x 50.00 x 10.00mm, ACM

31 1.8L

Petrol

AR 32205	4 Cyl.	16 Valves	1747cc	TD15390
HR816 (x2)	NA5053 30.00 x 42.00 x 7.00mm, FPM	NA5070 31.00 x 41.00 x 7.00mm, FPM	NA5069 55.00 x 68.00 x 8.00mm, FPM	NF888 93.00 x 139.70; 172.00 x 12.00mm, FPM

32 1.8L

Petrol

AR 67101	4 Cyl.	8 Valves	1773cc	TD133
AR 67102	4 Cyl.	8 Valves	1773cc	TD5311
AR 67402	4 Cyl.	8 Valves	1756cc	TD5071
HR569		NB959 35.00 x 50.00 x 7.00mm, FPM →Eng no. 0006645; 0014245	NA5051 40.00 x 56.00 x 7.00mm, FPM Eng no. 0006645; 0014245→	

33 1.9L

Diesel

160 D100	4 Cyl.	8 Valves	1929cc	TD10307
AR 33601	4 Cyl.	8 Valves	1929cc	TD5069
AR 67501	4 Cyl.	8 Valves	1929cc	TD140
HR569	NA5187 30.00 x 52.00 x 7.00mm, ACM	NB742 30.00 x 43.00 x 8.00mm, ACM	NB732 74.00 x 90.00 x 10.00mm, FPM	

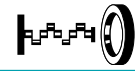
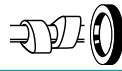
**34 1.9L****Diesel**

182 B9.000	4 Cyl.	8 Valves	1910cc	TD18312
937 A2.000	4 Cyl.	8 Valves	1910cc	TD16382
937 A3.000	4 Cyl.	8 Valves	1910cc	TD20727
937 A7.000	4 Cyl.	8 Valves	1910cc	TD20933
939 A1.000	4 Cyl.	8 Valves	1910cc	TD18915
939 A7.000	4 Cyl.	8 Valves	1910cc	TD18916
AR 32302	4 Cyl.	8 Valves	1910cc	TD9769
AR 37101	4 Cyl.	8 Valves	1910cc	TD15510

HR569

NA5053

30.00 x 42.00 x 7.00mm, FPM

NA5070

31.00 x 41.00 x 7.00mm, FPM

NF888

93.00 x 139.70;172.00 x 12.00mm, FPM

35 1.9L**Diesel**

192 A5.000	4 Cyl.	16 Valves	1910cc	TD17981
192 B1.000	4 Cyl.	16 Valves	1910cc	TD19061
844 A1.000	4 Cyl.	16 Valves	1910cc	TD24649
937 A4.000	4 Cyl.	16 Valves	1910cc	TD18844
937 A5.000	4 Cyl.	16 Valves	1910cc	TD18078
937 A6.000	4 Cyl.	16 Valves	1910cc	TD24643
937 A8.000	4 Cyl.	16 Valves	1910cc	TD20271
939 A2.000	4 Cyl.	16 Valves	1910cc	TD18473
939 A8.000	4 Cyl.	16 Valves	1910cc	TD18925

HR5095

→Eng no. 5192515

HR5119

Eng no. 5192516 →

NA5347 (x2)

30.0 x 45.0 x 7.00mm, FPM

NA5070

31.00 x 41.00 x 7.00mm, FPM

NF888

93.00 x 139.70;172.00 x 12.00mm, FPM

36 1.9L**Petrol**

939 A6.000	4 Cyl.	16 Valves	1859cc	TD18475
------------	--------	-----------	--------	---------

HR5127

NA5108

42.00 x 55.00 x 7.00mm, FPM/ACM

NB806

90.00 x 104.00 x 11.00mm, FPM

37 1.9L**Petrol**

AR 10527	4 Cyl.	8 Valves	1962cc	TD10127
----------	--------	----------	--------	---------

HR569

NA5066

35.00 x 50.00 x 10.00mm, ACM

38 1.9L**Diesel**

AR 67502	4 Cyl.	8 Valves	1929cc	TD21140
----------	--------	----------	--------	---------

HR569

NA5187

30.00 x 52.00 x 7.00mm, ACM

NB825

30.00 x 43.00 x 8.00mm, FPM

NB732

74.00 x 90.00 x 10.00mm, FPM

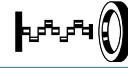

39 2.0L

Diesel

198 A5.000	4 Cyl.	16 Valves	1956cc	TD24647
844 A2.000	4 Cyl.	16 Valves	1956cc	TD24594
939 B3.000	4 Cyl.	16 Valves	1956cc	TD23107
939 B4.000	4 Cyl.	16 Valves	1956cc	TD24644
939 B5.000	4 Cyl.	16 Valves	1956cc	TD24645
940 A4.000	4 Cyl.	16 Valves	1956cc	TD23924
940 A5.000	4 Cyl.	16 Valves	1956cc	TD24578
940 A7.000	4 Cyl.	16 Valves	1956cc	TD24793
940 A8.000	4 Cyl.	16 Valves	1956cc	TD25424
940 B4.000	4 Cyl.	16 Valves	1956cc	TD28715
940 B5.000	4 Cyl.	16 Valves	1956cc	TD28630
940 B6.000	4 Cyl.	16 Valves	1956cc	TD28631

HR5119

NA5347 (x2)
30.0 x 45.0 x 7.00mm, FPM

NA5070
31.00 x 41.00 x 7.00mm, FPM
NF888
93.00 x 139.70;172.00 x 12.00mm, FPM

40 2.0L

Petrol

932 A2.000	4 Cyl.	16 Valves	1970cc	TD18076
937 A1.000	4 Cyl.	16 Valves	1970cc	TD16381
AR 16201	4 Cyl.	16 Valves	1970cc	TD4188
AR 67204	4 Cyl.	16 Valves	1970cc	TD4190

HR5060

NA5053
30.00 x 42.00 x 7.00mm, FPM
NA5069
55.00 x 68.00 x 8.00mm, FPM

NA5070
31.00 x 41.00 x 7.00mm, FPM
NF888
93.00 x 139.70;172.00 x 12.00mm, FPM

41 2.0L

Diesel

940 B9.000	4 Cyl.	16 Valves	1956cc	TD33073
940 C3.000	4 Cyl.	16 Valves	1956cc	TD33074
940 C4.000	4 Cyl.	16 Valves	1956cc	TD33077

HR5119

NA5347
30.0 x 45.0 x 7.00mm, FPM

NA5070
31.00 x 41.00 x 7.00mm, FPM
NF888
93.00 x 139.70;172.00 x 12.00mm, FPM

42 2.0L

Petrol

AR 00512	4 Cyl.	8 Valves	1962cc	TD75
AR 00515	4 Cyl.	8 Valves	1962cc	TD21
AR 01212	4 Cyl.	8 Valves	1962cc	TD27
AR 01544	4 Cyl.	8 Valves	1962cc	TD28
AR 01588	4 Cyl.	8 Valves	1962cc	TD30
AR 01590	4 Cyl.	8 Valves	1962cc	TD31
AR 01615	4 Cyl.	8 Valves	1962cc	TD21716
AR 01623	4 Cyl.	8 Valves	1962cc	TD34
AR 01629	4 Cyl.	8 Valves	1962cc	TD31951
AR 01655	4 Cyl.	8 Valves	1962cc	TD37
AR 01699	4 Cyl.	8 Valves	1962cc	TD40
AR 01713	4 Cyl.	8 Valves	1962cc	TD41
AR 06166	4 Cyl.	8 Valves	1962cc	TD53
AR 06212	4 Cyl.	8 Valves	1962cc	TD57
AR 06224	4 Cyl.	8 Valves	1962cc	TD58

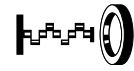
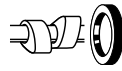

AR 10512	4 Cyl.	8 Valves	1962cc	TD5351
AR 10520	4 Cyl.	8 Valves	1962cc	TD10270
AR 11633	4 Cyl.	8 Valves	1962cc	TD22398
AR 11634	4 Cyl.	8 Valves	1962cc	TD68
AR 11642	4 Cyl.	8 Valves	1962cc	TD69
AR 11655	4 Cyl.	8 Valves	1962cc	TD23342
AR 11671	4 Cyl.	8 Valves	1962cc	TD70
AR 19510	4 Cyl.	8 Valves	1962cc	TD23344
HR569				NA5066 35.00 x 50.00 x 10.00mm, ACM

43 2.0L

Petrol

AR 06210	6 Cyl.	12 Valves	1997cc	TD56
AR 16202	6 Cyl.	12 Valves	1996cc	TD4189
AR 34102	6 Cyl.	12 Valves	1996cc	TD11600
AR 64101	6 Cyl.	12 Valves	1996cc	TD5072
AR 64102	6 Cyl.	12 Valves	1996cc	TD105
HR569	NA5001 (x2) 32.00 x 47.00 x 10.00mm, FPM			NF637 48.00 x 65.00 x 10.00mm, FPM

44 2.0L

Petrol

AR 06416	4 Cyl.	8 Valves	1962cc	TD62
AR 06420	4 Cyl.	8 Valves	1962cc	TD63
HR569				NB959 35.00 x 50.00 x 7.00mm, FPM

45 2.0L

Petrol

AR 06476	4 Cyl.	8 Valves	1995cc	TD65
HR569	NA5187 (x2) 30.00 x 52.00 x 7.00mm, ACM			NB742 30.00 x 43.00 x 8.00mm, ACM NB732 74.00 x 90.00 x 10.00mm, FPM

46 2.0L

Petrol

AR 32301	4 Cyl.	16 Valves	1970cc	TD9463
AR 32303	4 Cyl.	16 Valves	1970cc	TD19055
AR 32310	4 Cyl.	16 Valves	1970cc	TD15391
AR 34103	4 Cyl.	16 Valves	1970cc	TD11599
HR816 (x2)	NA5053 30.00 x 42.00 x 7.00mm, FPM NA5163 32.00 x 47.00 x 10.00mm, FPM			NA5070 31.00 x 41.00 x 7.00mm, FPM NF888 93.00 x 139.70;172.00 x 12.00mm, FPM

47 2.0L

Petrol

AR 36301	4 Cyl.	16 Valves	1970cc	TD15392
AR 67299	4 Cyl.	16 Valves	1970cc	TD23351
HR816 (x2)	NA5053 30.00 x 42.00 x 7.00mm, FPM NA5069 55.00 x 68.00 x 8.00mm, FPM			NA5070 31.00 x 41.00 x 7.00mm, FPM NF888 93.00 x 139.70;172.00 x 12.00mm, FPM



48 2.0L

Petrol

AR 64103	4 Cyl.	8 Valves	1995cc	TD129
AR 67201	4 Cyl.	8 Valves	1995cc	TD136
AR 67202	4 Cyl.	8 Valves	1995cc	TD137

HR569

NA5163 (x2)
32.00 x 47.00 x 10.00mm, FPM

NA5066
35.00 x 50.00 x 10.00mm, ACM

NA5065
62.00 x 80.00 x 12.00mm, ACM

49 2.0L

Petrol

AR 67203	4 Cyl.	16 Valves	1995cc	TD138
----------	--------	-----------	--------	-------

HR816 (x2)

NA5053 (x2)
30.00 x 42.00 x 7.00mm, FPM

NB825
30.00 x 43.00 x 8.00mm, FPM

NB732
74.00 x 90.00 x 10.00mm, FPM

50 2.2L

Petrol

939 A5.000	4 Cyl.	16 Valves	2198cc	TD18913
------------	--------	-----------	--------	---------

HR5127

NA5108
42.00 x 55.00 x 7.00mm, FPM/ACM

NB806
90.00 x 104.00 x 11.00mm, FPM

51 2.4L

Diesel

839 A6.000	5 Cyl.	10 Valves	2387cc	TD18819
841 C000	5 Cyl.	10 Valves	2387cc	TD16383
AR 32501	5 Cyl.	10 Valves	2387cc	TD9770
AR 34202	5 Cyl.	10 Valves	2387cc	TD11604
AR 36202	5 Cyl.	10 Valves	2387cc	TD15636

HR615

NA5053
30.00 x 42.00 x 7.00mm, FPM

NA5070
31.00 x 41.00 x 7.00mm, FPM

NF888
93.00 x 139.70;172.00 x 12.00mm, FPM

52 2.4L

Diesel

841 G.000	5 Cyl.	20 Valves	2387cc	TD18292
841 H.000	5 Cyl.	20 Valves	2387cc	TD18293
841 M.000	5 Cyl.	20 Valves	2387cc	TD20934
841 N.000	5 Cyl.	20 Valves	2387cc	TD22510
936 B.000	5 Cyl.	20 Valves	2387cc	TD20761
939 A3.000	5 Cyl.	20 Valves	2387cc	TD18474
939 A9.000	5 Cyl.	20 Valves	2387cc	TD20935

NA5347 (x2)
30.0 x 45.0 x 7.00mm, FPM

NA5070
31.00 x 41.00 x 7.00mm, FPM

NF888
93.00 x 139.70;172.00 x 12.00mm, FPM

53 2.4L

Diesel

8140.21.200 D.I.	4 Cyl.	8 Valves	2445cc	TD143
8144.21.220	4 Cyl.	8 Valves	2445cc	TD145

HR602

NP068
55.00 x 70.00 x 8.00mm, FPM

NB946
70.00 x 90.00 x 10.00mm, FPM

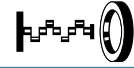

54 2.4L		Diesel			
8140.61.200		4 Cyl.	8 Valves	2445cc	TD144
8144.61.200		4 Cyl.	8 Valves	2445cc	TD146
HR602		NP068 55.00 x 70.00 x 8.00mm, FPM		NB946 70.00 x 90.00 x 10.00mm, FPM NF833 90.00 x 115.00 x 13.00mm, FPM	
55 2.4L		Diesel			
M 722 BT 24.T		5 Cyl.	10 Valves	2387cc	TD22434
HR615		NA5347 30.0 x 45.0 x 7.00mm, FPM		NA5070 31.00 x 41.00 x 7.00mm, FPM NF888 93.00 x 139.70;172.00 x 12.00mm, FPM	
56 2.5L		Diesel			
8144.67.220		4 Cyl.	8 Valves	2499cc	TD147
HR602		NP068 55.00 x 70.00 x 8.00mm, FPM		NB946 70.00 x 90.00 x 10.00mm, FPM NF833 90.00 x 115.00 x 13.00mm, FPM	
57 2.5L		Petrol			
AR 01646		6 Cyl.	12 Valves	2492cc	TD36
AR 01648		6 Cyl.	12 Valves	2492cc	TD10150
AR 66201		6 Cyl.	12 Valves	2492cc	TD132
		NA5163 (x2) 32.00 x 47.00 x 10.00mm, FPM		NF637 48.00 x 65.00 x 10.00mm, FPM	
58 2.5L		Petrol			
AR 01911		6 Cyl.	12 Valves	2492cc	TD42
		NA5163 32.00 x 47.00 x 10.00mm, FPM		NF637 48.00 x 65.00 x 10.00mm, FPM	
59 2.5L		Petrol			
AR 01913		6 Cyl.	12 Valves	2492cc	TD43
AR 01928		6 Cyl.	12 Valves	2492cc	TD44
		NA5001 (x2) 32.00 x 47.00 x 10.00mm, FPM		NF637 48.00 x 65.00 x 10.00mm, FPM	
60 2.5L		Petrol			
AR 32401		6 Cyl.	24 Valves	2492cc	TD9464
AR 32402		6 Cyl.	24 Valves	2492cc	TD19056
AR 32405		6 Cyl.	24 Valves	2492cc	TD15634
AR 34201		6 Cyl.	24 Valves	2492cc	TD11601
AR 36201		6 Cyl.	24 Valves	2492cc	TD15635
HR800		NA5163 (x2) 32.00 x 47.00 x 10.00mm, FPM			
61 2.5L		Petrol			
AR 67301		6 Cyl.	12 Valves	2492cc	TD139
AR 67303		6 Cyl.	12 Valves	2492cc	TD9767
				NF637 48.00 x 65.00 x 10.00mm, FPM	

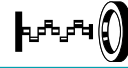

62 2.5L

Petrol

AR 67302	6 Cyl.	12 Valves	2492cc	TD9468
	NA5163 32.00 x 47.00 x 10.00mm, FPM		NF637	
	NJ951 32.00 x 50.00 x 8.00mm, FPM		48.00 x 65.00 x 10.00mm, FPM	

63 2.5L

Diesel

VM 07 B	4 Cyl.	8 Valves	2499cc	TD149
VM 08 B	4 Cyl.	8 Valves	2499cc	TD9771
VM 31 B	4 Cyl.	8 Valves	2499cc	TD9768
VM 32 B	4 Cyl.	8 Valves	2499cc	TD127
VM 84 A	4 Cyl.	8 Valves	2499cc	TD154
VM-425 CHIEA 08 B	4 Cyl.	8 Valves	2499cc	TD156
HR660				

64 3.0L

Petrol

AR 06120	6 Cyl.	12 Valves	2959cc	TD48
AR 06124	6 Cyl.	12 Valves	2959cc	TD49
AR 06410	6 Cyl.	12 Valves	2959cc	TD59
AR 06412	6 Cyl.	12 Valves	2959cc	TD61
AR 06430	6 Cyl.	12 Valves	2959cc	TD64
AR 61503	6 Cyl.	12 Valves	2959cc	TD51
AR 64301	6 Cyl.	12 Valves	2959cc	TD106
AR 64306	6 Cyl.	24 Valves	2959cc	TD25829
	NA5163 (x2) 32.00 x 47.00 x 10.00mm, FPM		NF637	
			48.00 x 65.00 x 10.00mm, FPM	

65 3.0L

Petrol

AR 16101	6 Cyl.	12 Valves	2959cc	TD4187
AR 16199	6 Cyl.	12 Valves	2959cc	TD23347
AR 19520	6 Cyl.	12 Valves	2959cc	TD23345
AR 64305	6 Cyl.	12 Valves	2959cc	TD125
AR 66303	6 Cyl.	12 Valves	2959cc	TD92
HR815	NJ951 (x2) 32.00 x 50.00 x 8.00mm, FPM		NF637	
			48.00 x 65.00 x 10.00mm, FPM	

66 3.0L

Petrol

AR 16102	6 Cyl.	24 Valves	2959cc	TD5495
AR 16105	6 Cyl.	24 Valves	2959cc	TD15970
AR 34301	6 Cyl.	24 Valves	2959cc	TD11603
AR 36101	6 Cyl.	24 Valves	2959cc	TD15393
AR 64304	6 Cyl.	24 Valves	2959cc	TD124
AR 64307	6 Cyl.	24 Valves	2959cc	TD148
AR 64308	6 Cyl.	24 Valves	2959cc	TD126
AR 66301	6 Cyl.	24 Valves	2959cc	TD130
AR 66302	6 Cyl.	24 Valves	2959cc	TD131
HR800	NA5163 (x4) 32.00 x 47.00 x 10.00mm, FPM		NF637	
			48.00 x 65.00 x 10.00mm, FPM	

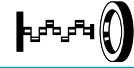
**67 3.0L****Petrol**

AR 34302	6 Cyl.	24 Valves	2959cc	TD23348
HR800	NA5258 (x4) 27.00 x 47.00 x 7.00mm, PTFE		NF637	48.00 x 65.00 x 10.00mm, FPM

68 3.0L**Petrol**

AR 61501	6 Cyl.	12 Valves	2959cc	TD104
AR 64399	6 Cyl.	12 Valves	2959cc	TD21728
HR815	NA5001 (x2) 32.00 x 47.00 x 10.00mm, FPM		NF637	48.00 x 65.00 x 10.00mm, FPM

69 3.0L**Petrol**

AR 64303	6 Cyl.	12 Valves	2959cc	TD29541
	NA5163 32.00 x 47.00 x 10.00mm, FPM		NF637	48.00 x 65.00 x 10.00mm, FPM

70 3.0L**Petrol**

AR 66304	6 Cyl.	12 Valves	2959cc	TD22624
HR662	NA5001 (x4) 32.00 x 47.00 x 10.00mm, FPM		NF637	48.00 x 65.00 x 10.00mm, FPM

71 3.0L**Petrol**









AR 66306	6 Cyl.	24 Valves	2959cc	TD21729
HR662 (x2)	NA5001 (x4) 32.00 x 47.00 x 10.00mm, FPM		NF637	48.00 x 65.00 x 10.00mm, FPM

72 3.2L**Petrol**

932 A.000	6 Cyl.	24 Valves	3179cc	TD16380
936 A.000	6 Cyl.	24 Valves	3179cc	TD18077
936 A6.000	6 Cyl.	24 Valves	3179cc	TD18311
HR662 (x2)	NA5001 (x2) 32.00 x 47.00 x 10.00mm, FPM			



50 (86)	08/74→07/77	HC	Petrol	1093	4	8	2
50 (86)	08/74→07/78	HB	Petrol	1093	4	8	2
50 (86)	01/77→07/78	HJ	Petrol	1272	4	8	8
50 (86)	08/77→07/78	HH	Petrol	1272	4	8	8
60	09/68→08/72	10	Petrol	1496	4	8	16
60	09/68→08/72	8910	Petrol	1496	4	8	16
60 Variant	09/68→08/72	10	Petrol	1496	4	8	16
60 Variant	09/68→08/72	8910	Petrol	1496	4	8	16
80	09/66→08/68	8920	Petrol	1695	4	8	33
80 (8C2, B4)	09/91→07/92	6A	Petrol	1984	4	16	68
80 (8C2, B4)	09/91→12/94	1Z	Diesel	1896	4	8	54
80 (8C2, B4)	09/91→12/94	AAH	Petrol	2771	6	12	108
80 (8C2, B4)	09/91→12/94	AAZ	Diesel	1896	4	8	55
80 (8C2, B4)	09/91→12/94	ABK	Petrol	1984	4	8	69
80 (8C2, B4)	09/91→12/94	ABM	Petrol	1595	4	8	18
80 (8C2, B4)	09/91→12/94	ABT	Petrol	1984	4	8	71
80 (8C2, B4)	09/91→12/94	AFC	Petrol	2771	6	12	110
80 (8C2, B4)	09/91→12/94	NG	Petrol	2309	5	10	94
80 (8C2, B4)	04/92→12/94	ACE	Petrol	1984	4	16	68
80 (8C2, B4)	06/92→12/94	ABC	Petrol	2598	6	12	103
80 (8C2, B4)	02/93→12/94	ABY	Petrol	2226	5	20	92
80 (8C2, B4)	06/93→12/94	ADA	Petrol	1595	4	8	19
80 (8C2, B4)	11/93→07/94	ADW	Petrol	1984	4	8	69
80 (80, 82, B1)	05/72→08/75	YJ	Petrol	1471	4	8	17
80 (80, 82, B1)	05/72→08/75	ZB	Petrol	1471	4	8	17
80 (80, 82, B1)	05/72→07/76	ZC	Petrol	1471	4	8	17
80 (80, 82, B1)	05/72→07/78	ZA	Petrol	1297	4	8	8
80 (80, 82, B1)	05/72→07/78	ZF	Petrol	1297	4	8	9
80 (80, 82, B1)	09/73→07/76	XX	Petrol	1584	4	8	32
80 (80, 82, B1)	09/74→07/78	YG	Petrol	1588	4	8	31
80 (80, 82, B1)	09/74→07/78	YH	Petrol	1588	4	8	31
80 (80, 82, B1)	09/75→12/76	YK	Petrol	1588	4	8	18
80 (80, 82, B1)	09/75→07/78	YN	Petrol	1588	4	8	18
80 (80, 82, B1)	09/75→07/78	YP	Petrol	1588	4	8	18
80 (80, 82, B1)	01/76→07/78	FS	Petrol	1588	4	8	18
80 (80, 82, B1)	01/76→07/78	YS	Petrol	1588	4	8	31
80 (81, 85, B2)	08/78→07/81	YT	Petrol	1588	4	8	31
80 (81, 85, B2)	08/78→07/81	YY	Petrol	1588	4	8	31
80 (81, 85, B2)	08/78→07/82	YZ	Petrol	1588	4	8	31
80 (81, 85, B2)	08/78→02/83	YP	Petrol	1588	4	8	18
80 (81, 85, B2)	08/78→07/86	DT	Petrol	1595	4	8	18
80 (81, 85, B2)	08/78→07/86	WV	Petrol	1588	4	8	31
80 (81, 85, B2)	08/78→07/86	YN	Petrol	1588	4	8	18
80 (81, 85, B2)	09/78→07/81	FY	Petrol	1272	4	8	8
80 (81, 85, B2)	09/78→07/81	FZ	Petrol	1272	4	8	8
80 (81, 85, B2)	09/78→07/86	EP	Petrol	1297	4	8	7
80 (81, 85, B2)	09/79→12/80	YG	Petrol	1588	4	8	31
80 (81, 85, B2)	09/79→12/80	YH	Petrol	1588	4	8	31
80 (81, 85, B2)	09/79→12/84	WE	Petrol	2144	5	10	89
80 (81, 85, B2)	08/80→08/86	CR	Diesel	1588	4	8	29
80 (81, 85, B2)	08/80→08/86	JK	Diesel	1588	4	8	29
80 (81, 85, B2)	09/80→12/83	WT	Petrol	1715	4	8	34
80 (81, 85, B2)	08/81→05/86	CY	Diesel	1588	4	8	29
80 (81, 85, B2)	09/81→07/83	WN	Petrol	1921	5	10	65
80 (81, 85, B2)	08/82→07/84	HY	Petrol	2226	5	10	91
80 (81, 85, B2)	08/82→07/84	KK	Petrol	2144	5	10	91
80 (81, 85, B2)	08/82→07/84	KL	Petrol	2144	5	10	91
80 (81, 85, B2)	01/83→08/86	DS	Petrol	1781	4	8	35
80 (81, 85, B2)	01/83→08/86	JV	Petrol	1781	4	8	52
80 (81, 85, B2)	08/83→08/86	JN	Petrol	1781	4	8	35
80 (81, 85, B2)	09/83→12/86	JT	Petrol	2226	5	10	91
80 (81, 85, B2)	10/83→09/84	HP	Petrol	1994	5	10	85
80 (81, 85, B2)	10/83→09/84	JS	Petrol	1994	5	10	86
80 (81, 85, B2)	08/84→08/86	DZ	Petrol	1781	4	8	35
80 (81, 85, B2)	08/84→08/86	NE	Petrol	1781	4	8	35
80 (81, 85, B2)	09/84→12/86	KX	Petrol	2226	5	10	91
80 (81, 85, B2)	03/85→08/86	PV	Petrol	1781	4	8	35
80 (81, 85, B2)	02/86→07/86	SA	Petrol	1595	4	8	18
80 (81, 85, B2)	02/86→07/86	SF	Petrol	1781	4	8	35
80 (89, 89Q, 8A, B3)	06/86→08/91	DZ	Petrol	1781	4	8	35
80 (89, 89Q, 8A, B3)	08/86→07/90	SF	Petrol	1781	4	8	35
80 (89, 89Q, 8A, B3)	09/86→08/90	SD	Petrol	1847	4	8	35
80 (89, 89Q, 8A, B3)	09/86→08/91	RA	Diesel	1588	4	8	29
80 (89, 89Q, 8A, B3)	09/86→08/91	RN	Petrol	1595	4	8	18
80 (89, 89Q, 8A, B3)	09/86→08/91	SB	Diesel	1588	4	8	29
80 (89, 89Q, 8A, B3)	09/86→10/91	JN	Petrol	1781	4	8	35
80 (89, 89Q, 8A, B3)	09/86→10/91	JV	Petrol	1781	4	8	52
80 (89, 89Q, 8A, B3)	09/86→10/91	NE	Petrol	1781	4	8	35

							
80 (89, 89Q, 8A, B3)	09/86→10/91	PM	Petrol	1781	4	8	35
80 (89, 89Q, 8A, B3)	10/86→01/90	RU	Petrol	1781	4	8	35
80 (89, 89Q, 8A, B3)	02/87→07/89	JK	Diesel	1588	4	8	29
80 (89, 89Q, 8A, B3)	08/87→09/91	PP	Petrol	1595	4	8	18
80 (89, 89Q, 8A, B3)	09/87→12/90	3A	Petrol	1984	4	8	67
80 (89, 89Q, 8A, B3)	10/87→10/91	NG	Petrol	2309	5	10	94
80 (89, 89Q, 8A, B3)	08/89→08/91	1Y	Diesel	1896	4	8	53
80 (89, 89Q, 8A, B3)	03/90→09/91	6A	Petrol	1984	4	16	68
80 (89, 89Q, 8A, B3)	08/90→10/91	ABB	Petrol	1595	4	8	18
80 (89, 89Q, 8A, B3)	10/90→08/91	AAD	Petrol	1984	4	8	69
80 Avant (8C5, B4)	09/91→12/94	AAZ	Diesel	1896	4	8	55
80 Avant (8C5, B4)	09/91→01/96	AAH	Petrol	2771	6	12	108
80 Avant (8C5, B4)	09/91→01/96	NG	Petrol	2309	5	10	94
80 Avant (8C5, B4)	07/92→01/96	1Z	Diesel	1896	4	8	54
80 Avant (8C5, B4)	07/92→01/96	ABC	Petrol	2598	6	12	103
80 Avant (8C5, B4)	07/92→01/96	ABK	Petrol	1984	4	8	69
80 Avant (8C5, B4)	07/92→01/96	ABT	Petrol	1984	4	8	71
80 Avant (8C5, B4)	12/92→01/96	ACE	Petrol	1984	4	16	68
80 Avant (8C5, B4)	02/93→07/95	ABY	Petrol	2226	5	20	92
80 Avant (8C5, B4)	06/93→01/96	ADA	Petrol	1595	4	8	19
80 Avant (8C5, B4)	11/93→01/96	ADW	Petrol	1984	4	8	69
80 Avant (8C5, B4)	03/94→05/95	ADU	Petrol	2226	5	20	92
80 Avant (33, B1)	09/75→12/76	YK	Petrol	1588	4	8	18
80 Variant	09/66→08/68	8920	Petrol	1695	4	8	33
90 (81, 85, B2)	08/84→03/87	JS	Petrol	1994	5	10	86
90 (81, 85, B2)	10/84→03/87	HP	Petrol	1994	5	10	85
90 (81, 85, B2)	10/84→03/87	HY	Petrol	2226	5	10	91
90 (81, 85, B2)	10/84→03/87	KV	Petrol	2226	5	10	91
90 (81, 85, B2)	01/85→03/87	KX	Petrol	2226	5	10	91
90 (81, 85, B2)	08/85→03/87	JT	Petrol	2226	5	10	91
90 (81, 85, B2)	10/85→01/87	CY	Diesel	1588	4	8	29
90 (81, 85, B2)	03/86→03/87	SK	Petrol	1994	5	10	86
90 (89, 89Q, 8A, B3)	04/87→09/91	KV	Petrol	2226	5	10	91
90 (89, 89Q, 8A, B3)	04/87→09/91	NG	Petrol	2309	5	10	94
90 (89, 89Q, 8A, B3)	04/87→09/91	RA	Diesel	1588	4	8	29
90 (89, 89Q, 8A, B3)	04/87→09/91	SB	Diesel	1588	4	8	29
90 (89, 89Q, 8A, B3)	09/87→12/88	3A	Petrol	1984	4	8	67
90 (89, 89Q, 8A, B3)	06/88→09/91	7A	Petrol	2309	5	20	93
90 (89, 89Q, 8A, B3)	07/88→09/91	PS	Petrol	1994	5	10	85
90 (89, 89Q, 8A, B3)	08/88→09/91	NM	Petrol	1994	5	20	87
90 (89, 89Q, 8A, B3)	08/89→07/90	6A	Petrol	1984	4	16	68
100 (4A2, C4)	12/90→07/94	AAD	Petrol	1984	4	8	69
100 (4A2, C4)	12/90→07/94	AAE	Petrol	1984	4	8	70
100 (4A2, C4)	12/90→07/94	AAH	Petrol	2771	6	12	108
100 (4A2, C4)	12/90→07/94	AAR	Petrol	2309	5	10	94
100 (4A2, C4)	12/90→07/94	AAS	Diesel	2370	5	10	95
100 (4A2, C4)	12/90→07/94	AAT	Diesel	2461	5	10	99
100 (4A2, C4)	12/90→07/94	ABK	Petrol	1984	4	8	69
100 (4A2, C4)	12/90→07/94	ABP	Diesel	2461	5	10	99
100 (4A2, C4)	08/91→07/94	AAN	Petrol	2226	5	20	92
100 (4A2, C4)	01/92→07/94	ACE	Petrol	1984	4	16	68
100 (4A2, C4)	03/92→07/94	ABC	Petrol	2598	6	12	103
100 (4A2, C4)	10/92→07/94	ABH	Petrol	4172	8	32	131
100 (4A, C4)	07/93→06/94	ACZ	Petrol	2598	6	12	103
100 (43, C2)	06/76→12/77	YD	Petrol	1871	4	8	66
100 (43, C2)	06/76→08/78	WA	Petrol	1984	4	8	88
100 (43, C2)	08/76→07/82	YV	Petrol	1588	4	8	31
100 (43, C2)	03/77→07/82	WC	Petrol	2144	5	10	89
100 (43, C2)	03/77→07/82	WG	Petrol	2144	5	10	89
100 (43, C2)	09/77→07/82	WD	Petrol	2144	5	10	89
100 (43, C2)	09/77→07/82	WE	Petrol	2144	5	10	89
100 (43, C2)	10/77→07/82	WB	Petrol	2144	5	10	89
100 (43, C2)	08/78→07/82	CN	Diesel	1986	5	10	83
100 (43, C2)	08/80→07/82	WH	Petrol	1921	5	10	65
100 (44, 44Q, C3)	08/82→07/84	KF	Petrol	2144	5	10	89
100 (44, 44Q, C3)	08/82→07/84	WC	Petrol	2144	5	10	89
100 (44, 44Q, C3)	08/82→07/84	WH	Petrol	1921	5	10	65
100 (44, 44Q, C3)	08/82→07/84	WU	Petrol	2144	5	10	91
100 (44, 44Q, C3)	08/82→12/84	WD	Petrol	2144	5	10	89
100 (44, 44Q, C3)	08/82→12/84	WE	Petrol	2144	5	10	89
100 (44, 44Q, C3)	08/82→12/87	DR	Petrol	1781	4	8	35
100 (44, 44Q, C3)	08/82→12/87	RS	Petrol	1781	4	8	35
100 (44, 44Q, C3)	08/82→02/88	DE	Diesel	1986	5	10	83
100 (44, 44Q, C3)	08/82→07/88	CN	Diesel	1986	5	10	83
100 (44, 44Q, C3)	08/83→07/89	DS	Petrol	1781	4	8	35
100 (44, 44Q, C3)	08/83→07/89	JW	Petrol	1781	4	8	35
100 (44, 44Q, C3)	08/83→07/89	NP	Petrol	1781	4	8	52
100 (44, 44Q, C3)	09/83→12/85	KH	Petrol	2144	5	10	91



CC



9

100 (44, 44Q, C3)	08/84→12/87	KP	Petrol	1994	5	10	85
100 (44, 44Q, C3)	08/84→11/90	KU	Petrol	2226	5	10	91
100 (44, 44Q, C3)	09/84→12/85	WX	Petrol	2144	5	10	89
100 (44, 44Q, C3)	10/84→12/87	KZ	Petrol	2226	5	10	91
100 (44, 44Q, C3)	03/85→11/90	4B	Petrol	1781	4	8	35
100 (44, 44Q, C3)	03/85→11/90	PH	Petrol	1781	4	8	35
100 (44, 44Q, C3)	08/85→07/86	PX	Petrol	2226	5	10	91
100 (44, 44Q, C3)	09/85→11/90	MC	Petrol	2226	5	10	91
100 (44, 44Q, C3)	02/86→07/90	SH	Petrol	1781	4	8	35
100 (44, 44Q, C3)	08/86→11/87	SL	Petrol	1994	5	10	85
100 (44, 44Q, C3)	08/86→11/90	NF	Petrol	2309	5	10	94
100 (44, 44Q, C3)	01/88→11/90	RT	Petrol	1994	5	10	85
100 (44, 44Q, C3)	03/88→11/90	NC	Diesel	1986	5	10	83
100 (44, 44Q, C3)	06/89→11/90	HX	Petrol	2226	5	10	91
100 (44, 44Q, C3)	08/89→07/91	3D	Diesel	2370	5	10	95
100 (44, 44Q, C3)	01/90→11/90	IT	Diesel	2461	5	10	99
100 (C1)	11/68→11/71	ZV	Petrol	1716	4	8	33
100 (C1)	11/68→11/71	ZX	Petrol	1760	4	8	36
100 (C1)	10/70→07/76	ZZ	Petrol	1760	4	8	36
100 (C1)	09/74→07/76	YD	Petrol	1871	4	8	66
100 Avant (4A5, C4)	12/90→07/94	AAD	Petrol	1984	4	8	69
100 Avant (4A5, C4)	12/90→07/94	AAS	Diesel	2370	5	10	95
100 Avant (4A5, C4)	12/90→07/94	AAT	Diesel	2461	5	10	99
100 Avant (4A5, C4)	12/90→07/94	ABP	Diesel	2461	5	10	99
100 Avant (4A5, C4)	09/91→07/94	AAE	Petrol	1984	4	8	70
100 Avant (4A5, C4)	09/91→07/94	AAH	Petrol	2771	6	12	108
100 Avant (4A5, C4)	09/91→07/94	AAN	Petrol	2226	5	20	92
100 Avant (4A5, C4)	09/91→07/94	AAR	Petrol	2309	5	10	94
100 Avant (4A5, C4)	09/91→07/94	ABK	Petrol	1984	4	8	69
100 Avant (4A5, C4)	03/92→07/94	ABC	Petrol	2598	6	12	103
100 Avant (4A5, C4)	07/92→07/94	ACE	Petrol	1984	4	16	68
100 Avant (4A5, C4)	10/92→07/94	ABH	Petrol	4172	8	32	131
100 Avant (4A5, C4)	08/93→07/94	ACZ	Petrol	2598	6	12	103
100 Avant (4A, C4)	07/93→06/94	ACZ	Petrol	2598	6	12	103
100 Avant (43, C2)	07/77→02/83	WB	Petrol	2144	5	10	89
100 Avant (43, C2)	07/77→02/83	WC	Petrol	2144	5	10	89
100 Avant (43, C2)	07/77→02/83	WE	Petrol	2144	5	10	89
100 Avant (43, C2)	07/77→02/83	WG	Petrol	2144	5	10	89
100 Avant (43, C2)	07/77→02/83	YV	Petrol	1588	4	8	31
100 Avant (43, C2)	08/77→07/80	WA	Petrol	1984	4	8	88
100 Avant (43, C2)	08/78→02/83	CN	Diesel	1986	5	10	83
100 Avant (43, C2)	08/80→07/82	WH	Petrol	1921	5	10	65
100 Avant (44, 44Q, C3)	08/82→07/84	KF	Petrol	2144	5	10	89
100 Avant (44, 44Q, C3)	08/82→07/84	WC	Petrol	2144	5	10	89
100 Avant (44, 44Q, C3)	08/82→12/87	DR	Petrol	1781	4	8	35
100 Avant (44, 44Q, C3)	08/82→12/87	RS	Petrol	1781	4	8	35
100 Avant (44, 44Q, C3)	02/83→07/84	WH	Petrol	1921	5	10	65
100 Avant (44, 44Q, C3)	03/83→10/87	DE	Diesel	1986	5	10	83
100 Avant (44, 44Q, C3)	03/83→11/90	CN	Diesel	1986	5	10	83
100 Avant (44, 44Q, C3)	08/83→07/89	DS	Petrol	1781	4	8	35
100 Avant (44, 44Q, C3)	08/83→07/89	JW	Petrol	1781	4	8	35
100 Avant (44, 44Q, C3)	08/83→07/89	NP	Petrol	1781	4	8	52
100 Avant (44, 44Q, C3)	09/83→12/84	WU	Petrol	2144	5	10	91
100 Avant (44, 44Q, C3)	08/84→11/90	KU	Petrol	2226	5	10	91
100 Avant (44, 44Q, C3)	10/84→12/87	KZ	Petrol	2226	5	10	91
100 Avant (44, 44Q, C3)	01/85→12/87	KP	Petrol	1994	5	10	85
100 Avant (44, 44Q, C3)	03/85→11/90	4B	Petrol	1781	4	8	35
100 Avant (44, 44Q, C3)	03/85→11/90	PH	Petrol	1781	4	8	35
100 Avant (44, 44Q, C3)	08/85→07/86	PX	Petrol	2226	5	10	91
100 Avant (44, 44Q, C3)	09/85→11/90	MC	Petrol	2226	5	10	91
100 Avant (44, 44Q, C3)	02/86→07/90	SH	Petrol	1781	4	8	35
100 Avant (44, 44Q, C3)	08/86→11/90	NF	Petrol	2309	5	10	94
100 Avant (44, 44Q, C3)	09/86→11/87	SL	Petrol	1994	5	10	85
100 Avant (44, 44Q, C3)	01/88→11/90	RT	Petrol	1994	5	10	85
100 Avant (44, 44Q, C3)	03/88→11/90	NC	Diesel	1986	5	10	83
100 Avant (44, 44Q, C3)	06/89→11/90	HX	Petrol	2226	5	10	91
100 Avant (44, 44Q, C3)	08/89→11/90	3D	Diesel	2370	5	10	95
100 Avant (44, 44Q, C3)	01/90→11/90	IT	Diesel	2461	5	10	99
200 (43)	10/79→08/82	WJ	Petrol	2144	5	10	89
200 (43)	10/79→09/82	WC	Petrol	2144	5	10	89
200 (43)	10/79→09/82	WK	Petrol	2144	5	10	89
200 (44, 44Q)	08/83→07/84	WC	Petrol	2144	5	10	89
200 (44, 44Q)	08/83→01/88	KG	Petrol	2144	5	10	89
200 (44, 44Q)	08/84→07/85	KU	Petrol	2226	5	10	91
200 (44, 44Q)	01/85→12/91	MC	Petrol	2226	5	10	91
200 (44, 44Q)	11/86→09/91	NF	Petrol	2309	5	10	94
200 (44, 44Q)	02/88→12/90	IB	Petrol	2226	5	10	91
200 (44, 44Q)	02/88→12/90	2B	Petrol	2226	5	10	91



200 (44, 44Q)	03/89→12/90	3B	Petrol	2226	5	20	92
200 Avant (44, 44Q)	09/83→01/88	JY	Petrol	2144	5	10	89
200 Avant (44, 44Q)	09/83→01/88	KG	Petrol	2144	5	10	89
200 Avant (44, 44Q)	09/83→12/91	MC	Petrol	2226	5	10	91
200 Avant (44, 44Q)	11/86→09/91	NF	Petrol	2309	5	10	94
200 Avant (44, 44Q)	02/88→12/91	1B	Petrol	2226	5	10	91
200 Avant (44, 44Q)	07/89→12/90	3B	Petrol	2226	5	20	92
A1 (8X1, 8XK)	05/10→	CAXA	Petrol	1390	4	16	12
A1 (8X1, 8XK)	05/10→	CAYC	Diesel	1598	4	16	27
A1 (8X1, 8XK)	05/10→	CBZA	Petrol	1197	4	8	4
A1 (8X1, 8XK)	05/10→	CNVA	Petrol	1390	4	16	12
A1 (8X1, 8XK)	01/11→	CAVG	Petrol	1390	4	16	12
A1 (8X1, 8XK)	01/11→	CTHG	Petrol	1390	4	16	12
A1 (8X1, 8XK)	01/11→	CTJA	Petrol	1390	4	16	12
A1 (8X1, 8XK)	03/11→	CAYB	Diesel	1598	4	16	27
A1 (8X1, 8XK)	09/11→	CFHD	Diesel	1968	4	16	82
A1 (8X1, 8XK)	03/12→	CDLH	Petrol	1984	4	16	75
A1 (8X1, 8XK)	04/12→	CPTA	Petrol	1395	4	16	14
A1 (8X1, 8XK)	05/12→	CFHB	Diesel	1968	4	16	82
A1 (8X1, 8XK)	03/14→	CWZA	Petrol	1984	4	16	79
A1 (8X1, 8XK)	11/14→	CUSB	Diesel	1422	3	12	15
A1 (8X1, 8XK)	11/14→	CXMA	Diesel	1598	4	16	28
A1 (8X1, 8XK)	11/14→	CZCA	Petrol	1395	4	16	13
A1 (8X1, 8XK)	11/14→	CZDB	Petrol	1395	4	16	13
A1 (8X1, 8XK)	11/14→	CZEA	Petrol	1395	4	16	14
A1 (8X1, 8XK)	02/15→	DAJB	Petrol	1798	4	16	50
A1 (8X1, 8XK)	03/15→	CHZB	Petrol	999	3	12	1
A1 (8X1, 8XK)	01/16→	CHZE	Petrol	999	3	12	1
A1 Sportback (8XA, 8XF)	09/11→	CFHD	Diesel	1968	4	16	82
A1 Sportback (8XA, 8XF)	11/11→	CAVG	Petrol	1390	4	16	12
A1 Sportback (8XA, 8XF)	11/11→	CAXA	Petrol	1390	4	16	12
A1 Sportback (8XA, 8XF)	11/11→	CAYB	Diesel	1598	4	16	27
A1 Sportback (8XA, 8XF)	11/11→	CAYC	Diesel	1598	4	16	27
A1 Sportback (8XA, 8XF)	11/11→	CNVA	Petrol	1390	4	16	12
A1 Sportback (8XA, 8XF)	11/11→	CTHG	Petrol	1390	4	16	12
A1 Sportback (8XA, 8XF)	11/11→	CTJA	Petrol	1390	4	16	12
A1 Sportback (8XA, 8XF)	01/12→	CBZA	Petrol	1197	4	8	4
A1 Sportback (8XA, 8XF)	04/12→	CPTA	Petrol	1395	4	16	14
A1 Sportback (8XA, 8XF)	05/12→	CFHB	Diesel	1968	4	16	82
A1 Sportback (8XA, 8XF)	03/14→	CWZA	Petrol	1984	4	16	79
A1 Sportback (8XA, 8XF)	11/14→	CUSB	Diesel	1422	3	12	15
A1 Sportback (8XA, 8XF)	11/14→	CXMA	Diesel	1598	4	16	28
A1 Sportback (8XA, 8XF)	11/14→	CZCA	Petrol	1395	4	16	13
A1 Sportback (8XA, 8XF)	11/14→	CZEA	Petrol	1395	4	16	14
A1 Sportback (8XA, 8XF)	02/15→	DAJB	Petrol	1798	4	16	50
A1 Sportback (8XA, 8XF)	03/15→	CHZB	Petrol	999	3	12	1
A1 Sportback (8XA, 8XF)	01/16→	CHZE	Petrol	999	3	12	1
A2 (8Z0)	02/00→08/05	AMF	Diesel	1422	3	6	10
A2 (8Z0)	02/00→08/05	AUA	Petrol	1390	4	16	11
A2 (8Z0)	02/00→08/05	BBY	Petrol	1390	4	16	11
A2 (8Z0)	02/00→08/05	BHC	Diesel	1422	3	6	10
A2 (8Z0)	03/01→08/05	ANY	Diesel	1191	3	6	3
A2 (8Z0)	05/02→08/05	BAD	Petrol	1598	4	16	24
A2 (8Z0)	11/03→08/05	ATL	Diesel	1422	3	6	10
A3 (8L1)	09/96→07/01	AGR	Diesel	1896	4	8	58
A3 (8L1)	09/96→07/01	ALH	Diesel	1896	4	8	59
A3 (8L1)	09/96→05/03	AEH	Petrol	1595	4	8	21
A3 (8L1)	09/96→05/03	AGN	Petrol	1781	4	20	39
A3 (8L1)	09/96→05/03	AKL	Petrol	1595	4	8	21
A3 (8L1)	09/96→05/03	APF	Petrol	1595	4	8	21
A3 (8L1)	09/96→05/03	APG	Petrol	1781	4	20	44
A3 (8L1)	12/96→05/03	AGU	Petrol	1781	4	20	40
A3 (8L1)	12/96→05/03	AQA	Petrol	1781	4	20	44
A3 (8L1)	12/96→05/03	ARX	Petrol	1781	4	20	44
A3 (8L1)	12/96→05/03	ARZ	Petrol	1781	4	20	44
A3 (8L1)	12/96→05/03	AUM	Petrol	1781	4	20	44
A3 (8L1)	08/97→07/01	AHF	Diesel	1896	4	8	59
A3 (8L1)	08/97→07/01	ASV	Diesel	1896	4	8	58
A3 (8L1)	10/98→05/03	AJQ	Petrol	1781	4	20	43
A3 (8L1)	10/98→05/03	ARY	Petrol	1781	4	20	43
A3 (8L1)	12/98→05/03	APP	Petrol	1781	4	20	44
A3 (8L1)	12/98→05/03	AUQ	Petrol	1781	4	20	44
A3 (8L1)	03/99→04/02	AMK	Petrol	1781	4	20	44
A3 (8L1)	03/99→04/02	APY	Petrol	1781	4	20	47
A3 (8L1)	03/99→04/02	AUL	Petrol	1781	4	20	44
A3 (8L1)	08/00→05/03	ASZ	Diesel	1896	4	8	63
A3 (8L1)	08/00→05/03	AVU	Petrol	1595	4	8	23
A3 (8L1)	08/00→05/03	BFQ	Petrol	1595	4	8	23



A3 (8L1)	10/00→05/03	ATD	Diesel	1896	4	8	63
A3 (8L1)	10/00→05/03	AXR	Diesel	1896	4	8	63
A3 (8L1)	10/01→05/03	BAM	Petrol	1781	4	20	44
A3 (8P1)	05/03→06/08	AXW	Petrol	1984	4	16	73
A3 (8P1)	05/03→06/08	BLR	Petrol	1984	4	16	73
A3 (8P1)	05/03→06/08	BLX	Petrol	1984	4	16	73
A3 (8P1)	05/03→06/08	BLY	Petrol	1984	4	16	73
A3 (8P1)	05/03→06/08	BMB	Petrol	1984	4	16	73
A3 (8P1)	05/03→06/08	BVY	Petrol	1984	4	16	73
A3 (8P1)	05/03→06/08	BVZ	Petrol	1984	4	16	73
A3 (8P1)	05/03→05/10	BKC	Diesel	1896	4	8	64
A3 (8P1)	05/03→05/10	BLS	Diesel	1896	4	8	64
A3 (8P1)	05/03→05/10	BXE	Diesel	1896	4	8	64
A3 (8P1)	05/03→08/12	AZV	Diesel	1968	4	16	76
A3 (8P1)	05/03→08/12	BGU	Petrol	1595	4	8	23
A3 (8P1)	05/03→08/12	BKD	Diesel	1968	4	16	76
A3 (8P1)	05/03→08/12	BSE	Petrol	1595	4	8	23
A3 (8P1)	05/03→08/12	BSF	Petrol	1595	4	8	23
A3 (8P1)	05/03→08/12	CBAA	Diesel	1968	4	16	82
A3 (8P1)	05/03→08/12	CBAB	Diesel	1968	4	16	82
A3 (8P1)	05/03→08/12	CFFA	Diesel	1968	4	16	82
A3 (8P1)	05/03→08/12	CFFB	Diesel	1968	4	16	82
A3 (8P1)	05/03→08/12	CLJA	Diesel	1968	4	16	82
A3 (8P1)	07/03→05/09	BDB	Petrol	3189	6	24	120
A3 (8P1)	07/03→05/09	BMJ	Petrol	3189	6	24	121
A3 (8P1)	07/03→12/09	BUB	Petrol	3189	6	24	121
A3 (8P1)	08/03→09/07	BAG	Petrol	1598	4	16	25
A3 (8P1)	08/03→09/07	BLF	Petrol	1598	4	16	25
A3 (8P1)	08/03→09/07	BLP	Petrol	1598	4	16	25
A3 (8P1)	09/04→08/12	AXX	Petrol	1984	4	16	75
A3 (8P1)	09/04→08/12	BWA	Petrol	1984	4	16	75
A3 (8P1)	09/04→08/12	CAWB	Petrol	1984	4	16	81
A3 (8P1)	09/04→08/12	CCTA	Petrol	1984	4	16	81
A3 (8P1)	09/04→08/12	CCZA	Petrol	1984	4	16	81
A3 (8P1)	06/05→06/08	BMM	Diesel	1968	4	8	78
A3 (8P1)	03/06→08/12	BMN	Diesel	1968	4	16	76
A3 (8P1)	03/06→08/12	CBBB	Diesel	1968	4	16	82
A3 (8P1)	03/06→08/12	CFGB	Diesel	1968	4	16	82
A3 (8P1)	06/06→06/08	BUY	Diesel	1968	4	16	76
A3 (8P1)	08/06→08/12	BPU	Petrol	1781	4	20	49
A3 (8P1)	11/06→08/12	BHZ	Petrol	1984	4	16	75
A3 (8P1)	11/06→08/12	BYT	Petrol	1798	4	16	50
A3 (8P1)	11/06→08/12	BZB	Petrol	1798	4	16	50
A3 (8P1)	11/06→08/12	CDA A	Petrol	1798	4	16	50
A3 (8P1)	11/06→08/12	CDLA	Petrol	1984	4	16	75
A3 (8P1)	02/07→08/12	BZC	Petrol	1984	4	16	75
A3 (8P1)	02/07→08/12	CDLC	Petrol	1984	4	16	75
A3 (8P1)	09/07→08/12	CAXC	Petrol	1390	4	16	12
A3 (8P1)	09/07→08/12	CMSA	Petrol	1390	4	16	12
A3 (8P1)	05/09→08/12	CAYB	Diesel	1598	4	16	27
A3 (8P1)	05/09→08/12	CAYC	Diesel	1598	4	16	27
A3 (8P1)	04/10→08/12	CBZB	Petrol	1197	4	8	5
A3 (8P1)	01/11→08/12	CCSA	Petrol	1595	4	8	23
A3 (8P1)	01/11→08/12	CMXA	Petrol	1595	4	8	23
A3 (8V1, 8VK)	04/12→	CJSA	Petrol	1798	4	16	51
A3 (8V1, 8VK)	04/12→	CMBA	Petrol	1395	4	16	13
A3 (8V1, 8VK)	04/12→	CRBC	Diesel	1968	4	16	84
A3 (8V1, 8VK)	04/12→	CRLB	Diesel	1968	4	16	84
A3 (8V1, 8VK)	04/12→	CRUA	Diesel	1968	4	16	84
A3 (8V1, 8VK)	04/12→	CXSA	Petrol	1395	4	16	13
A3 (8V1, 8VK)	04/12→	DBG A	Diesel	1968	4	16	84
A3 (8V1, 8VK)	04/12→	DEJA	Diesel	1968	4	16	84
A3 (8V1, 8VK)	08/12→	CJSB	Petrol	1798	4	16	51
A3 (8V1, 8VK)	09/12→	CRFC	Diesel	1968	4	16	84
A3 (8V1, 8VK)	10/12→	CLHA	Diesel	1598	4	16	28
A3 (8V1, 8VK)	11/12→	CJXC	Petrol	1984	4	16	79
A3 (8V1, 8VK)	12/12→	CUNA	Diesel	1968	4	16	84
A3 (8V1, 8VK)	01/13→	CRFA	Diesel	1968	4	16	84
A3 (8V1, 8VK)	02/13→	CJXB	Petrol	1984	4	16	79
A3 (8V1, 8VK)	02/13→	CJZA	Petrol	1197	4	16	6
A3 (8V1, 8VK)	03/13→	CPTA	Petrol	1395	4	16	14
A3 (8V1, 8VK)	05/13→	CRBD	Diesel	1968	4	16	84
A3 (8V1, 8VK)	05/13→	CRLC	Diesel	1968	4	16	84
A3 (8V1, 8VK)	09/13→	CRKB	Diesel	1598	4	16	28
A3 (8V1, 8VK)	09/13→	CXXB	Diesel	1598	4	16	28
A3 (8V1, 8VK)	09/13→	DBKA	Diesel	1598	4	16	28
A3 (8V1, 8VK)	05/14→	CJXF	Petrol	1984	4	16	79
A3 (8V1, 8VK)	05/14→	CXSB	Petrol	1395	4	16	13



CC



9

A3 (8V1, 8VK)	05/14→	CYVB	Petrol	1197	4	16	6
A3 (8V1, 8VK)	05/14→	CZCA	Petrol	1395	4	16	13
A3 (8V1, 8VK)	05/14→	CZEA	Petrol	1395	4	16	14
A3 (8V1, 8VK)	05/16→	CZPB	Petrol	1984	4	16	79
A3 (8V1, 8VK)	06/16→	CJXG	Petrol	1984	4	16	79
A3 (8V1, 8VK)	06/16→	DJHA	Petrol	1984	4	16	79
A3 (8V1, 8VK)	07/16→	CHZD	Petrol	999	3	12	1
A3 (8V1, 8VK)	07/16→	CJXD	Petrol	1984	4	16	79
A3 (8V1, 8VK)	07/16→	DJHB	Petrol	1984	4	16	79
A3 (8V1, 8VK)	02/17→	DDYA	Diesel	1598	4	16	28
A3 (8VS)	09/14→	CSS	Petrol	1395	4	16	13
A3 Convertible (8P7)	04/08→10/09	BLS	Diesel	1896	4	8	64
A3 Convertible (8P7)	04/08→05/13	BZB	Petrol	1798	4	16	50
A3 Convertible (8P7)	04/08→05/13	CAWB	Petrol	1984	4	16	81
A3 Convertible (8P7)	04/08→05/13	CBAA	Diesel	1968	4	16	82
A3 Convertible (8P7)	04/08→05/13	CBAB	Diesel	1968	4	16	82
A3 Convertible (8P7)	04/08→05/13	CCZA	Petrol	1984	4	16	81
A3 Convertible (8P7)	04/08→05/13	CDAА	Petrol	1798	4	16	50
A3 Convertible (8P7)	04/08→05/13	CFFA	Diesel	1968	4	16	82
A3 Convertible (8P7)	04/08→05/13	CFFB	Diesel	1968	4	16	82
A3 Convertible (8P7)	09/08→05/10	BSE	Petrol	1595	4	8	23
A3 Convertible (8P7)	05/09→05/13	CAYC	Diesel	1598	4	16	27
A3 Convertible (8P7)	03/10→05/13	CBZB	Petrol	1197	4	8	5
A3 Convertible (8P7)	02/11→05/13	CAXC	Petrol	1390	4	16	12
A3 Convertible (8V7, 8VE)	10/13→	CADA	Petrol	1984	4	16	81
A3 Convertible (8V7, 8VE)	10/13→	CDNC	Petrol	1984	4	16	81
A3 Convertible (8V7, 8VE)	10/13→	CJSA	Petrol	1798	4	16	51
A3 Convertible (8V7, 8VE)	10/13→	CJSB	Petrol	1798	4	16	51
A3 Convertible (8V7, 8VE)	10/13→	CPTA	Petrol	1395	4	16	14
A3 Convertible (8V7, 8VE)	10/13→	CRLB	Diesel	1968	4	16	84
A3 Convertible (8V7, 8VE)	10/13→	CRLC	Diesel	1968	4	16	84
A3 Convertible (8V7, 8VE)	02/14→	CRKB	Diesel	1598	4	16	28
A3 Convertible (8V7, 8VE)	02/14→	CXSB	Petrol	1395	4	16	13
A3 Convertible (8V7, 8VE)	02/14→	CXXB	Diesel	1598	4	16	28
A3 Convertible (8V7, 8VE)	02/14→	CZCA	Petrol	1395	4	16	13
A3 Convertible (8V7, 8VE)	03/14→	CJXF	Petrol	1984	4	16	79
A3 Convertible (8V7, 8VE)	04/14→	CJXC	Petrol	1984	4	16	79
A3 Convertible (8V7, 8VE)	05/14→	CNSB	Petrol	1798	4	16	50
A3 Convertible (8V7, 8VE)	05/14→	CNTC	Petrol	1984	4	16	79
A3 Convertible (8V7, 8VE)	05/14→	CUNA	Diesel	1968	4	16	84
A3 Convertible (8V7, 8VE)	05/14→	CZEA	Petrol	1395	4	16	14
A3 Convertible (8V7, 8VE)	02/16→	CZCC	Petrol	1395	4	16	13
A3 Convertible (8V7, 8VE)	05/16→	CZPB	Petrol	1984	4	16	79
A3 Convertible (8V7, 8VE)	07/16→	DJHA	Petrol	1984	4	16	79
A3 Convertible (8V7, 8VE)	07/16→	DJHB	Petrol	1984	4	16	79
A3 Convertible (8V7, 8VE)	04/17→	DDYA	Diesel	1598	4	16	28
A3 Limousine (8VS, 8VM)	05/13→	CJSA	Petrol	1798	4	16	51
A3 Limousine (8VS, 8VM)	05/13→	CJSB	Petrol	1798	4	16	51
A3 Limousine (8VS, 8VM)	05/13→	CPTA	Petrol	1395	4	16	14
A3 Limousine (8VS, 8VM)	05/13→	CRBC	Diesel	1968	4	16	84
A3 Limousine (8VS, 8VM)	05/13→	CRFA	Diesel	1968	4	16	84
A3 Limousine (8VS, 8VM)	05/13→	CRLB	Diesel	1968	4	16	84
A3 Limousine (8VS, 8VM)	05/13→	CRUA	Diesel	1968	4	16	84
A3 Limousine (8VS, 8VM)	05/13→	DBGА	Diesel	1968	4	16	84
A3 Limousine (8VS, 8VM)	05/13→	DCYA	Diesel	1968	4	16	84
A3 Limousine (8VS, 8VM)	05/13→	DEJA	Diesel	1968	4	16	84
A3 Limousine (8VS, 8VM)	05/13→	DEJB	Diesel	1968	4	16	84
A3 Limousine (8VS, 8VM)	09/13→	CLHA	Diesel	1598	4	16	28
A3 Limousine (8VS, 8VM)	09/13→	CMBA	Petrol	1395	4	16	13
A3 Limousine (8VS, 8VM)	09/13→	CRBD	Diesel	1968	4	16	84
A3 Limousine (8VS, 8VM)	09/13→	CRLC	Diesel	1968	4	16	84
A3 Limousine (8VS, 8VM)	09/13→	CXSA	Petrol	1395	4	16	13
A3 Limousine (8VS, 8VM)	09/13→	CXSB	Petrol	1395	4	16	13
A3 Limousine (8VS, 8VM)	09/13→	CZCA	Petrol	1395	4	16	13
A3 Limousine (8VS, 8VM)	10/13→	CJXB	Petrol	1984	4	16	79
A3 Limousine (8VS, 8VM)	10/13→	CJXC	Petrol	1984	4	16	79
A3 Limousine (8VS, 8VM)	10/13→	CJZA	Petrol	1197	4	16	6
A3 Limousine (8VS, 8VM)	10/13→	CRFC	Diesel	1968	4	16	84
A3 Limousine (8VS, 8VM)	11/13→	CNSB	Petrol	1798	4	16	50
A3 Limousine (8VS, 8VM)	11/13→	CNTC	Petrol	1984	4	16	79
A3 Limousine (8VS, 8VM)	05/14→	CJXF	Petrol	1984	4	16	79
A3 Limousine (8VS, 8VM)	05/14→	CRKB	Diesel	1598	4	16	28
A3 Limousine (8VS, 8VM)	05/14→	CUNA	Diesel	1968	4	16	84
A3 Limousine (8VS, 8VM)	05/14→	CXXB	Diesel	1598	4	16	28
A3 Limousine (8VS, 8VM)	05/14→	CYFB	Petrol	1984	4	16	79
A3 Limousine (8VS, 8VM)	05/14→	CYVB	Petrol	1197	4	16	6
A3 Limousine (8VS, 8VM)	05/14→	CZEA	Petrol	1395	4	16	14
A3 Limousine (8VS, 8VM)	05/14→	DBKA	Diesel	1598	4	16	28



CC



9

A3 Limousine (8VS, 8VM)	11/15→	CHHB	Petrol	1984	4	16	79
A3 Limousine (8VS, 8VM)	05/16→	CZPB	Petrol	1984	4	16	79
A3 Limousine (8VS, 8VM)	06/16→	CJXG	Petrol	1984	4	16	79
A3 Limousine (8VS, 8VM)	06/16→	DJHA	Petrol	1984	4	16	79
A3 Limousine (8VS, 8VM)	07/16→	CHZD	Petrol	999	3	12	1
A3 Limousine (8VS, 8VM)	08/16→	CJXD	Petrol	1984	4	16	79
A3 Limousine (8VS, 8VM)	08/16→	DJHB	Petrol	1984	4	16	79
A3 Limousine (8VS, 8VM)	03/17→	DDYA	Diesel	1598	4	16	28
A3 Limousine (8VS, 8VM)	04/17→	DAZA	Petrol	2480	5	20	101
A3 Sportback (8PA)	09/04→09/07	BLF	Petrol	1598	4	16	25
A3 Sportback (8PA)	09/04→09/07	BLP	Petrol	1598	4	16	25
A3 Sportback (8PA)	09/04→06/08	AXW	Petrol	1984	4	16	73
A3 Sportback (8PA)	09/04→06/08	BLR	Petrol	1984	4	16	73
A3 Sportback (8PA)	09/04→06/08	BLX	Petrol	1984	4	16	73
A3 Sportback (8PA)	09/04→06/08	BLY	Petrol	1984	4	16	73
A3 Sportback (8PA)	09/04→06/08	BMB	Petrol	1984	4	16	73
A3 Sportback (8PA)	09/04→06/08	BVY	Petrol	1984	4	16	73
A3 Sportback (8PA)	09/04→06/08	BVZ	Petrol	1984	4	16	73
A3 Sportback (8PA)	09/04→05/09	BDB	Petrol	3189	6	24	120
A3 Sportback (8PA)	09/04→05/09	BMJ	Petrol	3189	6	24	121
A3 Sportback (8PA)	09/04→05/09	BUB	Petrol	3189	6	24	121
A3 Sportback (8PA)	09/04→05/10	BKC	Diesel	1896	4	8	64
A3 Sportback (8PA)	09/04→05/10	BLS	Diesel	1896	4	8	64
A3 Sportback (8PA)	09/04→05/10	BXE	Diesel	1896	4	8	64
A3 Sportback (8PA)	09/04→03/13	AXX	Petrol	1984	4	16	75
A3 Sportback (8PA)	09/04→03/13	AZV	Diesel	1968	4	16	76
A3 Sportback (8PA)	09/04→03/13	BGU	Petrol	1595	4	8	23
A3 Sportback (8PA)	09/04→03/13	BKD	Diesel	1968	4	16	76
A3 Sportback (8PA)	09/04→03/13	BPY	Petrol	1984	4	16	75
A3 Sportback (8PA)	09/04→03/13	BSE	Petrol	1595	4	8	23
A3 Sportback (8PA)	09/04→03/13	BSF	Petrol	1595	4	8	23
A3 Sportback (8PA)	09/04→03/13	BWA	Petrol	1984	4	16	75
A3 Sportback (8PA)	09/04→03/13	CAWB	Petrol	1984	4	16	81
A3 Sportback (8PA)	09/04→03/13	CBAA	Diesel	1968	4	16	82
A3 Sportback (8PA)	09/04→03/13	CBAB	Diesel	1968	4	16	82
A3 Sportback (8PA)	09/04→03/13	CBFA	Petrol	1984	4	16	81
A3 Sportback (8PA)	09/04→03/13	CCTA	Petrol	1984	4	16	81
A3 Sportback (8PA)	09/04→03/13	CCZA	Petrol	1984	4	16	81
A3 Sportback (8PA)	09/04→03/13	CFFA	Diesel	1968	4	16	82
A3 Sportback (8PA)	09/04→03/13	CFFB	Diesel	1968	4	16	82
A3 Sportback (8PA)	09/04→03/13	CLJA	Diesel	1968	4	16	82
A3 Sportback (8PA)	06/05→06/08	BMM	Diesel	1968	4	8	78
A3 Sportback (8PA)	03/06→03/13	BMN	Diesel	1968	4	16	76
A3 Sportback (8PA)	03/06→03/13	CBBB	Diesel	1968	4	16	82
A3 Sportback (8PA)	03/06→03/13	CFGB	Diesel	1968	4	16	82
A3 Sportback (8PA)	06/06→06/08	BUY	Diesel	1968	4	16	76
A3 Sportback (8PA)	11/06→03/13	BYT	Petrol	1798	4	16	50
A3 Sportback (8PA)	11/06→03/13	BZB	Petrol	1798	4	16	50
A3 Sportback (8PA)	11/06→03/13	CDA A	Petrol	1798	4	16	50
A3 Sportback (8PA)	09/07→03/13	CAXC	Petrol	1390	4	16	12
A3 Sportback (8PA)	09/07→03/13	CMSA	Petrol	1390	4	16	12
A3 Sportback (8PA)	06/08→03/13	BHZ	Petrol	1984	4	16	75
A3 Sportback (8PA)	06/08→03/13	CDLA	Petrol	1984	4	16	75
A3 Sportback (8PA)	07/08→03/13	CDLC	Petrol	1984	4	16	75
A3 Sportback (8PA)	05/09→03/13	CAYB	Diesel	1598	4	16	27
A3 Sportback (8PA)	05/09→03/13	CAYC	Diesel	1598	4	16	27
A3 Sportback (8PA)	04/10→03/13	CBZB	Petrol	1197	4	8	5
A3 Sportback (8PA)	01/11→12/12	CEPA	Petrol	2480	5	20	101
A3 Sportback (8PA)	01/11→03/13	CCSA	Petrol	1595	4	8	23
A3 Sportback (8PA)	01/11→03/13	CMXA	Petrol	1595	4	8	23
A3 Sportback (8VA)	09/14→	CSSA	Petrol	1395	4	16	13
A3 Sportback (8VA, 8VF)	09/12→	CJSA	Petrol	1798	4	16	51
A3 Sportback (8VA, 8VF)	09/12→	CJSB	Petrol	1798	4	16	51
A3 Sportback (8VA, 8VF)	09/12→	CMBA	Petrol	1395	4	16	13
A3 Sportback (8VA, 8VF)	09/12→	CRBC	Diesel	1968	4	16	84
A3 Sportback (8VA, 8VF)	09/12→	CRLB	Diesel	1968	4	16	84
A3 Sportback (8VA, 8VF)	09/12→	CRUA	Diesel	1968	4	16	84
A3 Sportback (8VA, 8VF)	09/12→	CXSA	Petrol	1395	4	16	13
A3 Sportback (8VA, 8VF)	09/12→	DBG A	Diesel	1968	4	16	84
A3 Sportback (8VA, 8VF)	09/12→	DCYA	Diesel	1968	4	16	84
A3 Sportback (8VA, 8VF)	09/12→	DEJA	Diesel	1968	4	16	84
A3 Sportback (8VA, 8VF)	10/12→	CLHA	Diesel	1598	4	16	28
A3 Sportback (8VA, 8VF)	11/12→	CJXC	Petrol	1984	4	16	79
A3 Sportback (8VA, 8VF)	03/13→	CPTA	Petrol	1395	4	16	14
A3 Sportback (8VA, 8VF)	03/13→	CRFC	Diesel	1968	4	16	84
A3 Sportback (8VA, 8VF)	05/13→	CJXB	Petrol	1984	4	16	79
A3 Sportback (8VA, 8VF)	05/13→	CJZA	Petrol	1197	4	16	6
A3 Sportback (8VA, 8VF)	05/13→	CRBD	Diesel	1968	4	16	84



A3 Sportback (8VA, 8VF)	05/13→	CRFA	Diesel	1968	4	16	84
A3 Sportback (8VA, 8VF)	05/13→	CRLC	Diesel	1968	4	16	84
A3 Sportback (8VA, 8VF)	05/13→	CUNA	Diesel	1968	4	16	84
A3 Sportback (8VA, 8VF)	05/13→	DEJB	Diesel	1968	4	16	84
A3 Sportback (8VA, 8VF)	09/13→	CRKB	Diesel	1598	4	16	28
A3 Sportback (8VA, 8VF)	09/13→	CXXB	Diesel	1598	4	16	28
A3 Sportback (8VA, 8VF)	09/13→	DBKA	Diesel	1598	4	16	28
A3 Sportback (8VA, 8VF)	11/13→	CPWA	Petrol	1395	4	16	13
A3 Sportback (8VA, 8VF)	05/14→	CJXF	Petrol	1984	4	16	79
A3 Sportback (8VA, 8VF)	05/14→	CUKB	Petrol	1395	4	16	13
A3 Sportback (8VA, 8VF)	05/14→	CXSB	Petrol	1395	4	16	13
A3 Sportback (8VA, 8VF)	05/14→	CXUA	Petrol	1395	4	16	13
A3 Sportback (8VA, 8VF)	05/14→	CYVB	Petrol	1197	4	16	6
A3 Sportback (8VA, 8VF)	05/14→	CZCA	Petrol	1395	4	16	13
A3 Sportback (8VA, 8VF)	05/14→	CZEA	Petrol	1395	4	16	14
A3 Sportback (8VA, 8VF)	02/15→	CHHB	Petrol	1984	4	16	79
A3 Sportback (8VA, 8VF)	03/15→	CZGB	Petrol	2480	5	20	101
A3 Sportback (8VA, 8VF)	05/16→	CZPB	Petrol	1984	4	16	79
A3 Sportback (8VA, 8VF)	06/16→	CJXG	Petrol	1984	4	16	79
A3 Sportback (8VA, 8VF)	06/16→	DJHA	Petrol	1984	4	16	79
A3 Sportback (8VA, 8VF)	07/16→	CHZD	Petrol	999	3	12	1
A3 Sportback (8VA, 8VF)	07/16→	CJXD	Petrol	1984	4	16	79
A3 Sportback (8VA, 8VF)	07/16→	DJHB	Petrol	1984	4	16	79
A3 Sportback (8VA, 8VF)	02/17→	DDYA	Diesel	1598	4	16	28
A3 Sportback (8VA, 8VF)	04/17→	DAZA	Petrol	2480	5	20	101
A4 (8D2, B5)	11/94→10/00	ADP	Petrol	1595	4	8	20
A4 (8D2, B5)	11/94→10/00	AHL	Petrol	1595	4	8	22
A4 (8D2, B5)	11/94→10/00	ANA	Petrol	1595	4	8	21
A4 (8D2, B5)	11/94→10/00	ARM	Petrol	1595	4	8	21
A4 (8D2, B5)	11/94→11/00	ADR	Petrol	1781	4	20	37
A4 (8D2, B5)	11/94→11/00	APT	Petrol	1781	4	20	45
A4 (8D2, B5)	11/94→11/00	ARG	Petrol	1781	4	20	45
A4 (8D2, B5)	11/94→11/00	AVV	Petrol	1781	4	20	45
A4 (8D2, B5)	01/95→07/97	AAH	Petrol	2771	6	12	108
A4 (8D2, B5)	01/95→11/00	IZ	Diesel	1896	4	8	54
A4 (8D2, B5)	01/95→11/00	ABC	Petrol	2598	6	12	103
A4 (8D2, B5)	01/95→11/00	AEB	Petrol	1781	4	20	37
A4 (8D2, B5)	01/95→11/00	AHH	Diesel	1896	4	8	60
A4 (8D2, B5)	01/95→11/00	AHU	Diesel	1896	4	8	61
A4 (8D2, B5)	01/95→11/00	ANB	Petrol	1781	4	20	45
A4 (8D2, B5)	01/95→11/00	APU	Petrol	1781	4	20	45
A4 (8D2, B5)	01/95→11/00	ARK	Petrol	1781	4	20	45
A4 (8D2, B5)	01/95→11/00	AWM	Petrol	1781	4	20	44
A4 (8D2, B5)	01/95→11/00	AWT	Petrol	1781	4	20	44
A4 (8D2, B5)	04/95→11/00	AFY	Petrol	1781	4	20	38
A4 (8D2, B5)	07/95→07/97	AFM	Petrol	2393	6	12	96
A4 (8D2, B5)	10/95→11/00	AFN	Diesel	1896	4	8	57
A4 (8D2, B5)	10/95→11/00	AVG	Diesel	1896	4	8	60
A4 (8D2, B5)	12/95→11/00	AFF	Diesel	1896	4	8	57
A4 (8D2, B5)	01/96→07/97	ACZ	Petrol	2598	6	12	103
A4 (8D2, B5)	10/96→08/01	ACK	Petrol	2771	6	30	109
A4 (8D2, B5)	10/96→08/01	AHA	Petrol	2771	6	30	111
A4 (8D2, B5)	10/96→08/01	ALG	Petrol	2771	6	30	112
A4 (8D2, B5)	10/96→08/01	AMX	Petrol	2771	6	30	111
A4 (8D2, B5)	10/96→08/01	APR	Petrol	2771	6	30	112
A4 (8D2, B5)	10/96→08/01	AQD	Petrol	2771	6	30	112
A4 (8D2, B5)	03/97→11/00	AGA	Petrol	2393	6	30	97
A4 (8D2, B5)	03/97→11/00	ALF	Petrol	2393	6	30	97
A4 (8D2, B5)	03/97→11/00	AML	Petrol	2393	6	30	97
A4 (8D2, B5)	03/97→11/00	APS	Petrol	2393	6	30	97
A4 (8D2, B5)	03/97→11/00	ARJ	Petrol	2393	6	30	97
A4 (8D2, B5)	08/97→11/00	AJG	Petrol	2393	6	30	97
A4 (8D2, B5)	08/97→11/00	AMM	Petrol	2393	6	30	97
A4 (8D2, B5)	08/97→11/00	APZ	Petrol	2393	6	30	97
A4 (8D2, B5)	09/97→11/00	AFB	Diesel	2496	6	24	100
A4 (8D2, B5)	09/97→11/00	AKN	Diesel	2496	6	24	100
A4 (8D2, B5)	09/97→09/01	AGB	Petrol	2671	6	30	104
A4 (8D2, B5)	09/97→09/01	AZB	Petrol	2671	6	30	104
A4 (8D2, B5)	12/97→11/00	AJL	Petrol	1781	4	20	41
A4 (8D2, B5)	08/98→12/98	APB	Petrol	2671	6	30	104
A4 (8D2, B5)	02/99→09/00	AJK	Petrol	2671	6	30	104
A4 (8D2, B5)	09/99→10/00	ATX	Petrol	2771	6	30	111
A4 (8D2, B5)	03/00→11/00	AJM	Diesel	1896	4	8	62
A4 (8D2, B5)	03/00→11/00	ATJ	Diesel	1896	4	8	63
A4 (8D2, B5)	05/00→09/00	AMB	Petrol	1781	4	20	44
A4 (8D2, B5)	07/00→11/00	ALZ	Petrol	1595	4	8	23
A4 (8E2, B6)	11/00→07/02	AVJ	Petrol	1781	4	20	44
A4 (8E2, B6)	11/00→12/02	APB	Petrol	2671	6	30	104



CC



9

A4 (8E2, B6)	11/00→12/04	AKE	Diesel	2496	6	24	100
A4 (8E2, B6)	11/00→12/04	ALT	Petrol	1984	4	20	72
A4 (8E2, B6)	11/00→12/04	ALZ	Petrol	1595	4	8	23
A4 (8E2, B6)	11/00→12/04	ASN	Petrol	2976	6	30	116
A4 (8E2, B6)	11/00→12/04	AVF	Diesel	1896	4	8	63
A4 (8E2, B6)	11/00→12/04	AVK	Petrol	2976	6	30	116
A4 (8E2, B6)	11/00→12/04	AWX	Diesel	1896	4	8	63
A4 (8E2, B6)	11/00→12/04	BAU	Diesel	2496	6	24	100
A4 (8E2, B6)	11/00→12/04	BDH	Diesel	2496	6	24	100
A4 (8E2, B6)	04/01→12/04	BBJ	Petrol	2976	6	30	116
A4 (8E2, B6)	05/01→12/04	AVB	Diesel	1896	4	8	63
A4 (8E2, B6)	07/01→12/04	AMB	Petrol	1781	4	20	44
A4 (8E2, B6)	08/01→07/02	AYM	Diesel	2496	6	24	100
A4 (8E2, B6)	09/01→12/04	AMM	Petrol	2393	6	30	97
A4 (8E2, B6)	09/01→12/04	BDV	Petrol	2393	6	30	97
A4 (8E2, B6)	07/02→12/04	AWA	Petrol	1984	4	16	73
A4 (8E2, B6)	07/02→12/04	BCZ	Diesel	2496	6	24	100
A4 (8E2, B6)	07/02→12/04	BDG	Diesel	2496	6	24	100
A4 (8E2, B6)	07/02→12/04	BFB	Petrol	1781	4	20	44
A4 (8E2, B6)	07/02→12/04	BFC	Diesel	2496	6	24	100
A4 (8E2, B6)	11/02→12/04	BEX	Petrol	1781	4	20	44
A4 (8E2, B6)	03/03→12/04	BBK	Petrol	4163	8	40	137
A4 (8E2, B6)	06/04→12/04	BKE	Diesel	1896	4	8	63
A4 (8EC, B7)	11/04→05/06	BDG	Diesel	2496	6	24	100
A4 (8EC, B7)	11/04→07/06	BBJ	Petrol	2976	6	30	116
A4 (8EC, B7)	11/04→06/08	ALT	Petrol	1984	4	20	72
A4 (8EC, B7)	11/04→06/08	ALZ	Petrol	1595	4	8	23
A4 (8EC, B7)	11/04→06/08	BBK	Petrol	4163	8	40	137
A4 (8EC, B7)	11/04→06/08	BFB	Petrol	1781	4	20	44
A4 (8EC, B7)	11/04→06/08	BGB	Petrol	1984	4	16	75
A4 (8EC, B7)	11/04→06/08	BHF	Petrol	4163	8	40	137
A4 (8EC, B7)	11/04→06/08	BKE	Diesel	1896	4	8	63
A4 (8EC, B7)	11/04→06/08	BKN	Diesel	2967	6	24	115
A4 (8EC, B7)	11/04→06/08	BLB	Diesel	1968	4	16	76
A4 (8EC, B7)	11/04→06/08	BNA	Diesel	1968	4	16	76
A4 (8EC, B7)	11/04→06/08	BPG	Petrol	1984	4	16	75
A4 (8EC, B7)	11/04→06/08	BPW	Diesel	1968	4	8	80
A4 (8EC, B7)	11/04→06/08	BRB	Diesel	1896	4	8	63
A4 (8EC, B7)	11/04→06/08	BRE	Diesel	1968	4	16	76
A4 (8EC, B7)	11/04→06/08	BRF	Diesel	1968	4	16	76
A4 (8EC, B7)	11/04→06/08	BWE	Petrol	1984	4	16	75
A4 (8EC, B7)	11/04→06/08	BWT	Petrol	1984	4	16	75
A4 (8EC, B7)	01/05→06/08	AUK	Petrol	3123	6	24	119
A4 (8EC, B7)	01/05→06/08	BKH	Petrol	3123	6	24	119
A4 (8EC, B7)	06/05→06/08	BUL	Petrol	1984	4	16	75
A4 (8EC, B7)	09/05→09/06	BVG	Diesel	1968	4	16	76
A4 (8EC, B7)	09/05→06/08	BNS	Petrol	4163	8	32	136
A4 (8EC, B7)	11/05→11/06	BVF	Diesel	1968	4	16	76
A4 (8EC, B7)	11/05→06/08	BSG	Diesel	2698	6	24	106
A4 (8EC, B7)	01/06→06/08	ASB	Diesel	2967	6	24	115
A4 (8EC, B7)	01/06→06/08	BPP	Diesel	2698	6	24	106
A4 (8EC, B7)	06/06→06/08	BRD	Diesel	1968	4	16	76
A4 (8EC, B7)	06/06→06/08	BVA	Diesel	1968	4	16	76
A4 (8EC, B7)	10/06→06/08	BPJ	Petrol	1984	4	16	75
A4 (8EC, B7)	10/06→06/08	BYK	Petrol	1984	4	16	75
A4 (8K2, B8)	11/07→03/12	CABB	Petrol	1798	4	16	50
A4 (8K2, B8)	11/07→03/12	CALA	Petrol	3197	6	24	119
A4 (8K2, B8)	11/07→03/12	CAMA	Diesel	2698	6	24	106
A4 (8K2, B8)	11/07→03/12	CAMB	Diesel	2698	6	24	106
A4 (8K2, B8)	11/07→03/12	CAPA	Diesel	2967	6	24	115
A4 (8K2, B8)	11/07→03/12	CCLA	Diesel	2967	6	24	115
A4 (8K2, B8)	11/07→03/12	CCWA	Diesel	2967	6	24	115
A4 (8K2, B8)	11/07→03/12	CDHB	Petrol	1798	4	16	50
A4 (8K2, B8)	11/07→03/12	CGKA	Diesel	2698	6	24	106
A4 (8K2, B8)	11/07→03/12	CGKB	Diesel	2698	6	24	106
A4 (8K2, B8)	11/07→12/15	CAGA	Diesel	1968	4	16	82
A4 (8K2, B8)	11/07→12/15	CAGB	Diesel	1968	4	16	82
A4 (8K2, B8)	11/07→12/15	CJCA	Diesel	1968	4	16	82
A4 (8K2, B8)	11/07→12/15	CJCB	Diesel	1968	4	16	82
A4 (8K2, B8)	11/07→12/15	CMEA	Diesel	1968	4	16	82
A4 (8K2, B8)	11/07→12/15	CMFA	Diesel	1968	4	16	82
A4 (8K2, B8)	11/07→12/15	CSUB	Diesel	1968	4	16	84
A4 (8K2, B8)	01/08→03/12	CAHA	Diesel	1968	4	16	82
A4 (8K2, B8)	01/08→12/15	CABA	Petrol	1798	4	16	50
A4 (8K2, B8)	01/08→12/15	CDHA	Petrol	1798	4	16	50
A4 (8K2, B8)	06/08→05/10	CCWB	Diesel	2967	6	24	115
A4 (8K2, B8)	06/08→12/15	CAEA	Petrol	1984	4	16	81
A4 (8K2, B8)	06/08→12/15	CAEB	Petrol	1984	4	16	81



CC



9

A4 (8K2, B8)	06/08→12/15	CAGC	Diesel	1968	4	16	82
A4 (8K2, B8)	06/08→12/15	CDNB	Petrol	1984	4	16	81
A4 (8K2, B8)	06/08→12/15	CDNC	Petrol	1984	4	16	81
A4 (8K2, B8)	06/08→12/15	CFKA	Petrol	1984	4	16	81
A4 (8K2, B8)	06/08→12/15	CJCC	Diesel	1968	4	16	82
A4 (8K2, B8)	06/08→12/15	CPMA	Petrol	1984	4	16	81
A4 (8K2, B8)	07/08→05/10	AWT	Petrol	1781	4	20	44
A4 (8K2, B8)	07/08→	BRE	Diesel	1968	4	16	76
A4 (8K2, B8)	08/08→12/15	CAHB	Diesel	1968	4	16	82
A4 (8K2, B8)	08/08→12/15	CGLD	Diesel	1968	4	16	82
A4 (8K2, B8)	08/08→12/15	CNHC	Diesel	1968	4	16	84
A4 (8K2, B8)	11/08→12/15	CAKA	Petrol	2995	6	24	117
A4 (8K2, B8)	11/08→12/15	CCBA	Petrol	2995	6	24	117
A4 (8K2, B8)	11/08→12/15	CGWC	Petrol	2995	6	24	117
A4 (8K2, B8)	11/08→12/15	CGXC	Petrol	2995	6	24	117
A4 (8K2, B8)	11/08→12/15	CREC	Petrol	2995	6	24	117
A4 (8K2, B8)	11/08→12/15	CTUB	Petrol	2995	6	24	117
A4 (8K2, B8)	04/09→	ASB	Diesel	2967	6	24	115
A4 (8K2, B8)	11/11→12/15	CDUC	Diesel	2967	6	24	118
A4 (8K2, B8)	11/11→12/15	CGLC	Diesel	1968	4	16	82
A4 (8K2, B8)	11/11→12/15	CJEB	Petrol	1798	4	16	51
A4 (8K2, B8)	11/11→12/15	CKVB	Diesel	2967	6	24	118
A4 (8K2, B8)	11/11→12/15	CKVC	Diesel	2967	6	24	118
A4 (8K2, B8)	11/11→12/15	CLAB	Diesel	2967	6	24	118
A4 (8K2, B8)	11/11→12/15	CMGB	Diesel	1968	4	16	82
A4 (8K2, B8)	02/12→12/15	CMUA	Petrol	2995	6	24	117
A4 (8K2, B8)	02/12→12/15	CRED	Petrol	2995	6	24	117
A4 (8K2, B8)	05/13→12/15	CAED	Petrol	1984	4	16	81
A4 (8K2, B8)	05/13→12/15	CJCD	Diesel	1968	4	16	82
A4 (8K2, B8)	05/13→12/15	CMFB	Diesel	1968	4	16	82
A4 (8K2, B8)	05/13→12/15	CNCD	Petrol	1984	4	16	79
A4 (8K2, B8)	05/13→12/15	CPMB	Petrol	1984	4	16	81
A4 (8K2, B8)	05/13→12/15	CSUA	Diesel	1968	4	16	84
A4 (8K2, B8)	09/13→12/15	CNHA	Diesel	1968	4	16	84
A4 (8W2, B9)	05/15→	CRTC	Diesel	2967	6	24	118
A4 (8W2, B9)	05/15→	CVKB	Petrol	1984	4	16	79
A4 (8W2, B9)	05/15→	CYMC	Petrol	1984	4	16	79
A4 (8W2, B9)	05/15→	CYRB	Petrol	1984	4	16	79
A4 (8W2, B9)	05/15→	CZHA	Diesel	1968	4	16	84
A4 (8W2, B9)	05/15→	DBPA	Petrol	1984	4	16	79
A4 (8W2, B9)	05/15→	DESA	Diesel	1968	4	16	84
A4 (8W2, B9)	05/15→	DETA	Diesel	1968	4	16	84
A4 (8W2, B9)	05/15→	DEUA	Diesel	1968	4	16	84
A4 (8W2, B9)	05/15→	DEUB	Diesel	1968	4	16	84
A4 (8W2, B9)	05/15→	DFVA	Diesel	1968	4	16	84
A4 (8W2, B9)	08/15→	CVNA	Petrol	1395	4	16	13
A4 (8W2, B9)	09/15→	CSWB	Diesel	2967	6	24	118
A4 (8W2, B9)	11/15→	CYRC	Petrol	1984	4	16	79
A4 (8W2, B9)	05/16→	CWGD	Petrol	2995	6	24	117
A4 (8W2, B9)	05/16→	DEUC	Diesel	1968	4	16	84
A4 (8W2, B9)	09/16→	DETB	Diesel	1968	4	16	84
A4 Allroad (8KH, B8)	04/09→01/12	CCWA	Diesel	2967	6	24	115
A4 Allroad (8KH, B8)	04/09→05/16	CAHA	Diesel	1968	4	16	82
A4 Allroad (8KH, B8)	04/09→05/16	CAHB	Diesel	1968	4	16	82
A4 Allroad (8KH, B8)	04/09→05/16	CDNC	Petrol	1984	4	16	81
A4 Allroad (8KH, B8)	04/09→05/16	CGLD	Diesel	1968	4	16	82
A4 Allroad (8KH, B8)	04/09→05/16	CNHC	Diesel	1968	4	16	84
A4 Allroad (8KH, B8)	04/09→05/16	CPMA	Petrol	1984	4	16	81
A4 Allroad (8KH, B8)	09/09→05/16	CAGA	Diesel	1968	4	16	82
A4 Allroad (8KH, B8)	09/09→05/16	CAGB	Diesel	1968	4	16	82
A4 Allroad (8KH, B8)	09/09→05/16	CJCA	Diesel	1968	4	16	82
A4 Allroad (8KH, B8)	09/09→05/16	CJCB	Diesel	1968	4	16	82
A4 Allroad (8KH, B8)	09/09→05/16	CSUB	Diesel	1968	4	16	84
A4 Allroad (8KH, B8)	11/11→05/16	CGLC	Diesel	1968	4	16	82
A4 Allroad (8KH, B8)	01/12→05/16	CDUC	Diesel	2967	6	24	118
A4 Allroad (8KH, B8)	01/12→05/16	CKVB	Diesel	2967	6	24	118
A4 Allroad (8KH, B8)	01/12→05/16	CKVC	Diesel	2967	6	24	118
A4 Allroad (8KH, B8)	05/13→05/16	CJCD	Diesel	1968	4	16	82
A4 Allroad (8KH, B8)	05/13→05/16	CNCD	Petrol	1984	4	16	79
A4 Allroad (8KH, B8)	05/13→05/16	CPMB	Petrol	1984	4	16	81
A4 Allroad (8KH, B8)	05/13→05/16	CSUA	Diesel	1968	4	16	84
A4 Allroad (8KH, B8)	09/13→05/16	CNHA	Diesel	1968	4	16	84
A4 Allroad (8WH, B9)	01/16→	CRTC	Diesel	2967	6	24	118
A4 Allroad (8WH, B9)	01/16→	CSWB	Diesel	2967	6	24	118
A4 Allroad (8WH, B9)	01/16→	CYMC	Petrol	1984	4	16	79
A4 Allroad (8WH, B9)	01/16→	CYRB	Petrol	1984	4	16	79
A4 Allroad (8WH, B9)	01/16→	DESA	Diesel	1968	4	16	84
A4 Allroad (8WH, B9)	01/16→	DETA	Diesel	1968	4	16	84



CC



9

A4 Allroad (8WH, B9)	01/16→	DFVA	Diesel	1968	4	16	84
A4 Allroad (8WH, B9)	05/16→	CYRC	Petrol	1984	4	16	79
A4 Allroad (8WH, B9)	05/16→	DETB	Diesel	1968	4	16	84
A4 Allroad (8WH, B9)	11/16→	DEUA	Diesel	1968	4	16	84
A4 Allroad (8WH, B9)	11/16→	DEUB	Diesel	1968	4	16	84
A4 Avant (8D5, B5)	11/94→09/01	ADP	Petrol	1595	4	8	20
A4 Avant (8D5, B5)	11/94→09/01	AHL	Petrol	1595	4	8	22
A4 Avant (8D5, B5)	11/94→09/01	ANA	Petrol	1595	4	8	21
A4 Avant (8D5, B5)	11/94→09/01	ARM	Petrol	1595	4	8	21
A4 Avant (8D5, B5)	07/95→07/97	AFM	Petrol	2393	6	12	96
A4 Avant (8D5, B5)	07/95→09/01	AFY	Petrol	1781	4	20	38
A4 Avant (8D5, B5)	01/96→09/96	AAH	Petrol	2771	6	12	108
A4 Avant (8D5, B5)	01/96→09/01	ABC	Petrol	2598	6	12	103
A4 Avant (8D5, B5)	01/96→09/01	ADR	Petrol	1781	4	20	37
A4 Avant (8D5, B5)	01/96→09/01	AEB	Petrol	1781	4	20	37
A4 Avant (8D5, B5)	01/96→09/01	ANB	Petrol	1781	4	20	45
A4 Avant (8D5, B5)	01/96→09/01	APT	Petrol	1781	4	20	45
A4 Avant (8D5, B5)	01/96→09/01	APU	Petrol	1781	4	20	45
A4 Avant (8D5, B5)	01/96→09/01	ARG	Petrol	1781	4	20	45
A4 Avant (8D5, B5)	01/96→09/01	ARK	Petrol	1781	4	20	45
A4 Avant (8D5, B5)	01/96→09/01	AWT	Petrol	1781	4	20	44
A4 Avant (8D5, B5)	02/96→09/01	IZ	Diesel	1896	4	8	54
A4 Avant (8D5, B5)	02/96→09/01	AFN	Diesel	1896	4	8	57
A4 Avant (8D5, B5)	02/96→09/01	AHH	Diesel	1896	4	8	60
A4 Avant (8D5, B5)	02/96→09/01	AHU	Diesel	1896	4	8	61
A4 Avant (8D5, B5)	02/96→09/01	AVG	Diesel	1896	4	8	60
A4 Avant (8D5, B5)	02/96→09/01	AVV	Petrol	1781	4	20	45
A4 Avant (8D5, B5)	03/96→09/01	AFF	Diesel	1896	4	8	57
A4 Avant (8D5, B5)	10/96→09/01	ACK	Petrol	2771	6	30	109
A4 Avant (8D5, B5)	10/96→09/01	AHA	Petrol	2771	6	30	111
A4 Avant (8D5, B5)	10/96→09/01	ALG	Petrol	2771	6	30	112
A4 Avant (8D5, B5)	10/96→09/01	AMX	Petrol	2771	6	30	111
A4 Avant (8D5, B5)	10/96→09/01	APR	Petrol	2771	6	30	112
A4 Avant (8D5, B5)	10/96→09/01	AQD	Petrol	2771	6	30	112
A4 Avant (8D5, B5)	03/97→09/01	AGA	Petrol	2393	6	30	97
A4 Avant (8D5, B5)	03/97→09/01	ALF	Petrol	2393	6	30	97
A4 Avant (8D5, B5)	03/97→09/01	AML	Petrol	2393	6	30	97
A4 Avant (8D5, B5)	03/97→09/01	APS	Petrol	2393	6	30	97
A4 Avant (8D5, B5)	03/97→09/01	ARJ	Petrol	2393	6	30	97
A4 Avant (8D5, B5)	08/97→09/01	AJG	Petrol	2393	6	30	97
A4 Avant (8D5, B5)	08/97→09/01	AMM	Petrol	2393	6	30	97
A4 Avant (8D5, B5)	08/97→09/01	APZ	Petrol	2393	6	30	97
A4 Avant (8D5, B5)	09/97→09/01	AFB	Diesel	2496	6	24	100
A4 Avant (8D5, B5)	09/97→09/01	AGB	Petrol	2671	6	30	104
A4 Avant (8D5, B5)	09/97→09/01	AKN	Diesel	2496	6	24	100
A4 Avant (8D5, B5)	09/97→09/01	AZB	Petrol	2671	6	30	104
A4 Avant (8D5, B5)	12/97→09/01	AJL	Petrol	1781	4	20	41
A4 Avant (8D5, B5)	03/99→09/00	ATX	Petrol	2771	6	30	111
A4 Avant (8D5, B5)	03/00→09/01	AJM	Diesel	1896	4	8	62
A4 Avant (8D5, B5)	03/00→09/01	ATJ	Diesel	1896	4	8	63
A4 Avant (8D5, B5)	05/00→09/01	ASJ	Petrol	2671	6	30	105
A4 Avant (8D5, B5)	05/00→09/01	AZR	Petrol	2671	6	30	105
A4 Avant (8D5, B5)	07/00→09/01	ALZ	Petrol	1595	4	8	23
A4 Avant (8E5, B6)	04/01→12/02	APB	Petrol	2671	6	30	104
A4 Avant (8E5, B6)	04/01→12/04	BBJ	Petrol	2976	6	30	116
A4 Avant (8E5, B6)	09/01→07/02	AVJ	Petrol	1781	4	20	44
A4 Avant (8E5, B6)	09/01→07/02	AYM	Diesel	2496	6	24	100
A4 Avant (8E5, B6)	09/01→12/04	AKE	Diesel	2496	6	24	100
A4 Avant (8E5, B6)	09/01→12/04	ALT	Petrol	1984	4	20	72
A4 Avant (8E5, B6)	09/01→12/04	ALZ	Petrol	1595	4	8	23
A4 Avant (8E5, B6)	09/01→12/04	AMB	Petrol	1781	4	20	44
A4 Avant (8E5, B6)	09/01→12/04	AMM	Petrol	2393	6	30	97
A4 Avant (8E5, B6)	09/01→12/04	ASN	Petrol	2976	6	30	116
A4 Avant (8E5, B6)	09/01→12/04	AVF	Diesel	1896	4	8	63
A4 Avant (8E5, B6)	09/01→12/04	AVK	Petrol	2976	6	30	116
A4 Avant (8E5, B6)	09/01→12/04	AWX	Diesel	1896	4	8	63
A4 Avant (8E5, B6)	09/01→12/04	BAU	Diesel	2496	6	24	100
A4 Avant (8E5, B6)	09/01→12/04	BDH	Diesel	2496	6	24	100
A4 Avant (8E5, B6)	09/01→12/04	BDV	Petrol	2393	6	30	97
A4 Avant (8E5, B6)	11/01→12/04	AVB	Diesel	1896	4	8	63
A4 Avant (8E5, B6)	07/02→12/04	AWA	Petrol	1984	4	16	73
A4 Avant (8E5, B6)	07/02→12/04	BCZ	Diesel	2496	6	24	100
A4 Avant (8E5, B6)	07/02→12/04	BDG	Diesel	2496	6	24	100
A4 Avant (8E5, B6)	07/02→12/04	BFB	Petrol	1781	4	20	44
A4 Avant (8E5, B6)	07/02→12/04	BFC	Diesel	2496	6	24	100
A4 Avant (8E5, B6)	11/02→12/04	BEX	Petrol	1781	4	20	44
A4 Avant (8E5, B6)	03/03→12/04	BBK	Petrol	4163	8	40	137
A4 Avant (8E5, B6)	06/04→12/04	BKE	Diesel	1896	4	8	63



A4 Avant (8ED, B7)	11/04→05/06	BDG	Diesel	2496	6	24	100
A4 Avant (8ED, B7)	11/04→07/06	BBJ	Petrol	2976	6	30	116
A4 Avant (8ED, B7)	11/04→06/08	ALT	Petrol	1984	4	20	72
A4 Avant (8ED, B7)	11/04→06/08	ALZ	Petrol	1595	4	8	23
A4 Avant (8ED, B7)	11/04→06/08	BBK	Petrol	4163	8	40	137
A4 Avant (8ED, B7)	11/04→06/08	BFB	Petrol	1781	4	20	44
A4 Avant (8ED, B7)	11/04→06/08	BGB	Petrol	1984	4	16	75
A4 Avant (8ED, B7)	11/04→06/08	BKE	Diesel	1896	4	8	63
A4 Avant (8ED, B7)	11/04→06/08	BKN	Diesel	2967	6	24	115
A4 Avant (8ED, B7)	11/04→06/08	BLB	Diesel	1968	4	16	76
A4 Avant (8ED, B7)	11/04→06/08	BNA	Diesel	1968	4	16	76
A4 Avant (8ED, B7)	11/04→06/08	BPW	Diesel	1968	4	8	80
A4 Avant (8ED, B7)	11/04→06/08	BRB	Diesel	1896	4	8	63
A4 Avant (8ED, B7)	11/04→06/08	BRE	Diesel	1968	4	16	76
A4 Avant (8ED, B7)	11/04→06/08	BRF	Diesel	1968	4	16	76
A4 Avant (8ED, B7)	11/04→06/08	BWE	Petrol	1984	4	16	75
A4 Avant (8ED, B7)	11/04→06/08	BWT	Petrol	1984	4	16	75
A4 Avant (8ED, B7)	01/05→06/08	AUK	Petrol	3123	6	24	119
A4 Avant (8ED, B7)	06/05→06/08	BUL	Petrol	1984	4	16	75
A4 Avant (8ED, B7)	09/05→09/06	BVG	Diesel	1968	4	16	76
A4 Avant (8ED, B7)	09/05→06/08	BNS	Petrol	4163	8	32	136
A4 Avant (8ED, B7)	11/05→11/06	BVF	Diesel	1968	4	16	76
A4 Avant (8ED, B7)	11/05→03/08	BSG	Diesel	2698	6	24	106
A4 Avant (8ED, B7)	01/06→06/08	ASB	Diesel	2967	6	24	115
A4 Avant (8ED, B7)	01/06→06/08	BPP	Diesel	2698	6	24	106
A4 Avant (8ED, B7)	06/06→06/08	BRD	Diesel	1968	4	16	76
A4 Avant (8ED, B7)	06/06→06/08	BVA	Diesel	1968	4	16	76
A4 Avant (8ED, B7)	10/06→06/08	BPJ	Petrol	1984	4	16	75
A4 Avant (8ED, B7)	10/06→06/08	BYK	Petrol	1984	4	16	75
A4 Avant (8K5, B8)	11/07→03/12	CABB	Petrol	1798	4	16	50
A4 Avant (8K5, B8)	11/07→03/12	CDHB	Petrol	1798	4	16	50
A4 Avant (8K5, B8)	04/08→03/12	CAHA	Diesel	1968	4	16	82
A4 Avant (8K5, B8)	04/08→03/12	CALA	Petrol	3197	6	24	119
A4 Avant (8K5, B8)	04/08→03/12	CAMA	Diesel	2698	6	24	106
A4 Avant (8K5, B8)	04/08→03/12	CAPA	Diesel	2967	6	24	115
A4 Avant (8K5, B8)	04/08→03/12	CCLA	Diesel	2967	6	24	115
A4 Avant (8K5, B8)	04/08→03/12	CCWA	Diesel	2967	6	24	115
A4 Avant (8K5, B8)	04/08→03/12	CGKA	Diesel	2698	6	24	106
A4 Avant (8K5, B8)	04/08→12/15	CAGA	Diesel	1968	4	16	82
A4 Avant (8K5, B8)	04/08→12/15	CAGB	Diesel	1968	4	16	82
A4 Avant (8K5, B8)	04/08→12/15	CDHA	Petrol	1798	4	16	50
A4 Avant (8K5, B8)	04/08→12/15	CJCA	Diesel	1968	4	16	82
A4 Avant (8K5, B8)	04/08→12/15	CJCB	Diesel	1968	4	16	82
A4 Avant (8K5, B8)	04/08→12/15	CMEA	Diesel	1968	4	16	82
A4 Avant (8K5, B8)	04/08→12/15	CMFA	Diesel	1968	4	16	82
A4 Avant (8K5, B8)	04/08→12/15	CSUB	Diesel	1968	4	16	84
A4 Avant (8K5, B8)	06/08→05/10	CCWB	Diesel	2967	6	24	115
A4 Avant (8K5, B8)	06/08→03/12	CAMB	Diesel	2698	6	24	106
A4 Avant (8K5, B8)	06/08→03/12	CGKB	Diesel	2698	6	24	106
A4 Avant (8K5, B8)	06/08→12/15	CAEA	Petrol	1984	4	16	81
A4 Avant (8K5, B8)	06/08→12/15	CAEB	Petrol	1984	4	16	81
A4 Avant (8K5, B8)	06/08→12/15	CAGC	Diesel	1968	4	16	82
A4 Avant (8K5, B8)	06/08→12/15	CDNB	Petrol	1984	4	16	81
A4 Avant (8K5, B8)	06/08→12/15	CDNC	Petrol	1984	4	16	81
A4 Avant (8K5, B8)	06/08→12/15	CFKA	Petrol	1984	4	16	81
A4 Avant (8K5, B8)	06/08→12/15	CJCC	Diesel	1968	4	16	82
A4 Avant (8K5, B8)	07/08→	BRE	Diesel	1968	4	16	76
A4 Avant (8K5, B8)	08/08→12/15	CAHB	Diesel	1968	4	16	82
A4 Avant (8K5, B8)	08/08→12/15	CGLD	Diesel	1968	4	16	82
A4 Avant (8K5, B8)	08/08→12/15	CNHC	Diesel	1968	4	16	84
A4 Avant (8K5, B8)	11/08→12/15	CAKA	Petrol	2995	6	24	117
A4 Avant (8K5, B8)	11/08→12/15	CCBA	Petrol	2995	6	24	117
A4 Avant (8K5, B8)	11/08→12/15	CGWC	Petrol	2995	6	24	117
A4 Avant (8K5, B8)	11/08→12/15	CGXC	Petrol	2995	6	24	117
A4 Avant (8K5, B8)	11/08→12/15	CREC	Petrol	2995	6	24	117
A4 Avant (8K5, B8)	11/08→12/15	CTUB	Petrol	2995	6	24	117
A4 Avant (8K5, B8)	11/11→12/15	CDUC	Diesel	2967	6	24	118
A4 Avant (8K5, B8)	11/11→12/15	CGLC	Diesel	1968	4	16	82
A4 Avant (8K5, B8)	11/11→12/15	CJEB	Petrol	1798	4	16	51
A4 Avant (8K5, B8)	11/11→12/15	CKVB	Diesel	2967	6	24	118
A4 Avant (8K5, B8)	11/11→12/15	CKVC	Diesel	2967	6	24	118
A4 Avant (8K5, B8)	11/11→12/15	CLAB	Diesel	2967	6	24	118
A4 Avant (8K5, B8)	02/12→12/15	CMUA	Petrol	2995	6	24	117
A4 Avant (8K5, B8)	02/12→12/15	CRED	Petrol	2995	6	24	117
A4 Avant (8K5, B8)	05/12→08/15	CFSA	Petrol	4163	8	32	136
A4 Avant (8K5, B8)	05/13→12/15	CJCD	Diesel	1968	4	16	82
A4 Avant (8K5, B8)	05/13→12/15	CMFB	Diesel	1968	4	16	82
A4 Avant (8K5, B8)	05/13→12/15	CNCD	Petrol	1984	4	16	79



CC



9

A4 Avant (8K5, B8)	05/13→12/15	CSUA	Diesel	1968	4	16	84
A4 Avant (8K5, B8)	09/13→12/15	CNHA	Diesel	1968	4	16	84
A4 Avant (8W5, B9)	08/15→	CRTC	Diesel	2967	6	24	118
A4 Avant (8W5, B9)	08/15→	CVKB	Petrol	1984	4	16	79
A4 Avant (8W5, B9)	08/15→	CYRB	Petrol	1984	4	16	79
A4 Avant (8W5, B9)	08/15→	CZHA	Diesel	1968	4	16	84
A4 Avant (8W5, B9)	08/15→	DESA	Diesel	1968	4	16	84
A4 Avant (8W5, B9)	08/15→	DETA	Diesel	1968	4	16	84
A4 Avant (8W5, B9)	08/15→	DEUA	Diesel	1968	4	16	84
A4 Avant (8W5, B9)	08/15→	DEUB	Diesel	1968	4	16	84
A4 Avant (8W5, B9)	08/15→	DFVA	Diesel	1968	4	16	84
A4 Avant (8W5, B9)	10/15→	CSWB	Diesel	2967	6	24	118
A4 Avant (8W5, B9)	11/15→	CYRC	Petrol	1984	4	16	79
A4 Avant (8W5, B9)	02/16→	CVNA	Petrol	1395	4	16	13
A4 Avant (8W5, B9)	04/16→	DEUC	Diesel	1968	4	16	84
A4 Avant (8W5, B9)	05/16→	CWGD	Petrol	2995	6	24	117
A4 Avant (8W5, B9)	09/16→	DETB	Diesel	1968	4	16	84
A4 Avant (8W5, B9)	11/16→	CVLA	Petrol	1984	4	16	79
A4 Convertible (8H7, B6, 8HE, B7)	04/02→12/05	AMM	Petrol	2393	6	30	97
A4 Convertible (8H7, B6, 8HE, B7)	04/02→12/05	ASN	Petrol	2976	6	30	116
A4 Convertible (8H7, B6, 8HE, B7)	04/02→12/05	BBJ	Petrol	2976	6	30	116
A4 Convertible (8H7, B6, 8HE, B7)	04/02→12/05	BDV	Petrol	2393	6	30	97
A4 Convertible (8H7, B6, 8HE, B7)	07/02→03/09	BFB	Petrol	1781	4	20	44
A4 Convertible (8H7, B6, 8HE, B7)	08/02→12/05	BCZ	Diesel	2496	6	24	100
A4 Convertible (8H7, B6, 8HE, B7)	08/02→12/05	BDG	Diesel	2496	6	24	100
A4 Convertible (8H7, B6, 8HE, B7)	08/02→12/05	BFC	Diesel	2496	6	24	100
A4 Convertible (8H7, B6, 8HE, B7)	10/02→10/05	AMB	Petrol	1781	4	20	44
A4 Convertible (8H7, B6, 8HE, B7)	03/04→03/09	BBK	Petrol	4163	8	40	137
A4 Convertible (8H7, B6, 8HE, B7)	09/04→12/05	ALT	Petrol	1984	4	20	72
A4 Convertible (8H7, B6, 8HE, B7)	11/05→03/09	BWT	Petrol	1984	4	16	75
A4 Convertible (8H7, B6, 8HE, B7)	01/06→03/09	ASB	Diesel	2967	6	24	115
A4 Convertible (8H7, B6, 8HE, B7)	01/06→03/09	AUK	Petrol	3123	6	24	119
A4 Convertible (8H7, B6, 8HE, B7)	01/06→03/09	BKN	Diesel	2967	6	24	115
A4 Convertible (8H7, B6, 8HE, B7)	01/06→03/09	BPW	Diesel	1968	4	8	80
A4 Convertible (8H7, B6, 8HE, B7)	01/06→03/09	BRC	Diesel	1968	4	8	80
A4 Convertible (8H7, B6, 8HE, B7)	01/06→03/09	BWE	Petrol	1984	4	16	75
A4 Convertible (8H7, B6, 8HE, B7)	06/06→03/09	BNS	Petrol	4163	8	32	136
A4 Convertible (8H7, B6, 8HE, B7)	06/06→03/09	BPP	Diesel	2698	6	24	106
A4L Saloon (8K2, B8)	08/09→	CCUA	Petrol	1798	4	16	50
A4 Saloon (8E2, B6)	02/03→07/05	BBJ	Petrol	2976	6	30	116
A4 Saloon (8E2, B6)	02/03→07/05	BFB	Petrol	1781	4	20	44
A4 Saloon (8E2, B6)	02/03→07/05	BKB	Petrol	1781	4	20	44
A4 Saloon (8E2, B6)	01/04→07/05	BDV	Petrol	2393	6	30	97
A4 Saloon (8EC, B7)	04/03→09/08	BKB	Petrol	1781	4	20	44
A4 Saloon (8EC, B7)	07/05→09/08	BBJ	Petrol	2976	6	30	116
A4 Saloon (8EC, B7)	07/05→09/08	BGB	Petrol	1984	4	16	75
A4 Saloon (8EC, B7)	07/05→09/08	BWE	Petrol	1984	4	16	75
A5 (8T3)	06/07→03/12	CALA	Petrol	3197	6	24	119
A5 (8T3)	06/07→03/12	CAMA	Diesel	2698	6	24	106
A5 (8T3)	06/07→03/12	CAPA	Diesel	2967	6	24	115
A5 (8T3)	06/07→03/12	CCWA	Diesel	2967	6	24	115
A5 (8T3)	06/07→03/12	CGKA	Diesel	2698	6	24	106
A5 (8T3)	06/07→12/12	CAUA	Petrol	4163	8	32	136
A5 (8T3)	09/07→03/12	CAMB	Diesel	2698	6	24	106
A5 (8T3)	09/07→03/12	CGKB	Diesel	2698	6	24	106
A5 (8T3)	10/07→01/17	CABD	Petrol	1798	4	16	50
A5 (8T3)	10/07→01/17	CJEB	Petrol	1798	4	16	51
A5 (8T3)	03/08→05/10	CCWB	Diesel	2967	6	24	115
A5 (8T3)	06/08→01/17	CAEB	Petrol	1984	4	16	81
A5 (8T3)	06/08→01/17	CDNC	Petrol	1984	4	16	81
A5 (8T3)	08/08→03/12	CAHA	Diesel	1968	4	16	82
A5 (8T3)	08/08→01/17	CAHB	Diesel	1968	4	16	82
A5 (8T3)	08/08→01/17	CGLD	Diesel	1968	4	16	82
A5 (8T3)	08/08→01/17	CNHC	Diesel	1968	4	16	84
A5 (8T3)	11/08→03/12	CDNB	Petrol	1984	4	16	81
A5 (8T3)	05/09→09/11	CDHB	Petrol	1798	4	16	50
A5 (8T3)	03/10→08/15	CFSA	Petrol	4163	8	32	136
A5 (8T3)	10/11→01/17	CAKA	Petrol	2995	6	24	117
A5 (8T3)	10/11→01/17	CDUC	Diesel	2967	6	24	118
A5 (8T3)	10/11→01/17	CGLC	Diesel	1968	4	16	82
A5 (8T3)	10/11→01/17	CGWC	Petrol	2995	6	24	117
A5 (8T3)	10/11→01/17	CGXC	Petrol	2995	6	24	117
A5 (8T3)	10/11→01/17	CKVB	Diesel	2967	6	24	118
A5 (8T3)	10/11→01/17	CKVC	Diesel	2967	6	24	118
A5 (8T3)	10/11→01/17	CLAB	Diesel	2967	6	24	118
A5 (8T3)	10/11→01/17	CREC	Petrol	2995	6	24	117
A5 (8T3)	10/11→01/17	CTDA	Petrol	2995	6	24	117
A5 (8T3)	10/11→01/17	CTUB	Petrol	2995	6	24	117



A5 (8T3)	12/11→01/17	CMUA	Petrol	2995	6	24	117
A5 (8T3)	12/11→01/17	CREG	Petrol	2995	6	24	117
A5 (8T3)	03/12→01/17	CAED	Petrol	1984	4	16	81
A5 (8T3)	03/12→01/17	CPMB	Petrol	1984	4	16	81
A5 (8T3)	05/13→05/16	CNCD	Petrol	1984	4	16	79
A5 (8T3)	09/13→01/17	CNHA	Diesel	1968	4	16	84
A5 (8T3)	05/15→01/17	CJEE	Petrol	1798	4	16	51
A5 (8T3)	05/15→01/17	CKVD	Diesel	2967	6	24	118
A5 (8T3)	08/15→01/17	CNCE	Petrol	1984	4	16	79
A5 (F53)	06/16→	CYMC	Petrol	1984	4	16	79
A5 (F53)	06/16→	CYRB	Petrol	1984	4	16	79
A5 (F53)	06/16→	CYRC	Petrol	1984	4	16	79
A5 (F53)	07/16→	CSWB	Diesel	2967	6	24	118
A5 (F53)	07/16→	CWGD	Petrol	2995	6	24	117
A5 (F53)	07/16→	DESA	Diesel	1968	4	16	84
A5 (F53)	07/16→	DETA	Diesel	1968	4	16	84
A5 (F53)	09/16→	CVKB	Petrol	1984	4	16	79
A5 (F53)	10/16→	DFVA	Diesel	1968	4	16	84
A5 (F53)	11/16→	CVNA	Petrol	1395	4	16	13
A5 (F53)	01/17→	DCPC	Diesel	2967	6	24	118
A5 (F53)	02/17→	CRTC	Diesel	2967	6	24	118
A5 (F53)	05/17→	CZHA	Diesel	1968	4	16	84
A5 (F53)	05/17→	DEUA	Diesel	1968	4	16	84
A5 Convertible (8F7)	03/09→03/12	CAEA	Petrol	1984	4	16	81
A5 Convertible (8F7)	03/09→03/12	CALA	Petrol	3197	6	24	119
A5 Convertible (8F7)	03/09→03/12	CCWA	Diesel	2967	6	24	115
A5 Convertible (8F7)	03/09→03/12	CDNB	Petrol	1984	4	16	81
A5 Convertible (8F7)	03/09→03/12	CGKA	Diesel	2698	6	24	106
A5 Convertible (8F7)	03/09→01/17	CAEB	Petrol	1984	4	16	81
A5 Convertible (8F7)	03/09→01/17	CDNC	Petrol	1984	4	16	81
A5 Convertible (8F7)	03/09→01/17	CPMA	Petrol	1984	4	16	81
A5 Convertible (8F7)	05/09→03/12	CAHA	Diesel	1968	4	16	82
A5 Convertible (8F7)	05/09→03/12	CGKB	Diesel	2698	6	24	106
A5 Convertible (8F7)	05/09→06/14	CAHB	Diesel	1968	4	16	82
A5 Convertible (8F7)	05/09→06/14	CGLD	Diesel	1968	4	16	82
A5 Convertible (8F7)	06/09→01/17	CAKA	Petrol	2995	6	24	117
A5 Convertible (8F7)	06/09→01/17	CCBA	Petrol	2995	6	24	117
A5 Convertible (8F7)	06/09→01/17	CGWC	Petrol	2995	6	24	117
A5 Convertible (8F7)	06/09→01/17	CGXC	Petrol	2995	6	24	117
A5 Convertible (8F7)	06/09→01/17	CREC	Petrol	2995	6	24	117
A5 Convertible (8F7)	06/09→01/17	CTDA	Petrol	2995	6	24	117
A5 Convertible (8F7)	06/09→01/17	CTUB	Petrol	2995	6	24	117
A5 Convertible (8F7)	09/09→03/12	CDHB	Petrol	1798	4	16	50
A5 Convertible (8F7)	10/11→05/15	CJCA	Diesel	1968	4	16	82
A5 Convertible (8F7)	10/11→03/16	CABD	Petrol	1798	4	16	50
A5 Convertible (8F7)	10/11→03/16	CJEB	Petrol	1798	4	16	51
A5 Convertible (8F7)	10/11→01/17	CDUC	Diesel	2967	6	24	118
A5 Convertible (8F7)	10/11→01/17	CGLC	Diesel	1968	4	16	82
A5 Convertible (8F7)	10/11→01/17	CKVC	Diesel	2967	6	24	118
A5 Convertible (8F7)	10/11→01/17	CLAB	Diesel	2967	6	24	118
A5 Convertible (8F7)	11/11→01/17	CMUA	Petrol	2995	6	24	117
A5 Convertible (8F7)	11/11→01/17	CREG	Petrol	2995	6	24	117
A5 Convertible (8F7)	03/12→01/17	CPMB	Petrol	1984	4	16	81
A5 Convertible (8F7)	11/12→08/15	CFSA	Petrol	4133	8	32	136
A5 Convertible (8F7)	05/13→12/14	CAED	Petrol	1984	4	16	81
A5 Convertible (8F7)	05/13→05/16	CNCD	Petrol	1984	4	16	79
A5 Convertible (8F7)	05/13→01/17	CJCD	Diesel	1968	4	16	82
A5 Convertible (8F7)	05/13→01/17	CSUA	Diesel	1968	4	16	84
A5 Convertible (8F7)	09/13→01/17	CNHA	Diesel	1968	4	16	84
A5 Convertible (8F7)	05/15→01/17	CJEE	Petrol	1798	4	16	51
A5 Convertible (8F7)	05/15→01/17	CKVD	Diesel	2967	6	24	118
A5 Convertible (8F7)	08/15→01/17	CNCE	Petrol	1984	4	16	79
A5 Convertible (F57)	11/16→	CYMC	Petrol	1984	4	16	79
A5 Convertible (F57)	11/16→	CYRB	Petrol	1984	4	16	79
A5 Convertible (F57)	11/16→	DCPC	Diesel	2967	6	24	118
A5 Convertible (F57)	11/16→	DETA	Diesel	1968	4	16	84
A5 Convertible (F57)	12/16→	CSWB	Diesel	2967	6	24	118
A5 Convertible (F57)	03/17→	CVKB	Petrol	1984	4	16	79
A5 Convertible (F57)	03/17→	CWGD	Petrol	2995	6	24	117
A5 Convertible (F57)	08/17→	DEUA	Diesel	1968	4	16	84
A5 Sportback (8TA)	09/09→03/12	CAHA	Diesel	1968	4	16	82
A5 Sportback (8TA)	09/09→03/12	CALA	Petrol	3197	6	24	119
A5 Sportback (8TA)	09/09→03/12	CAMA	Diesel	2698	6	24	106
A5 Sportback (8TA)	09/09→03/12	CAPA	Diesel	2967	6	24	115
A5 Sportback (8TA)	09/09→03/12	CCWA	Diesel	2967	6	24	115
A5 Sportback (8TA)	09/09→03/12	CGKA	Diesel	2698	6	24	106
A5 Sportback (8TA)	09/09→06/14	CDNB	Petrol	1984	4	16	81
A5 Sportback (8TA)	09/09→01/17	CAEB	Petrol	1984	4	16	81



CC



9

A5 Sportback (8TA)	09/09→01/17	CAGA	Diesel	1968	4	16	82
A5 Sportback (8TA)	09/09→01/17	CAGB	Diesel	1968	4	16	82
A5 Sportback (8TA)	09/09→01/17	CAHB	Diesel	1968	4	16	82
A5 Sportback (8TA)	09/09→01/17	CAMB	Diesel	2698	6	24	106
A5 Sportback (8TA)	09/09→01/17	CDNC	Petrol	1984	4	16	81
A5 Sportback (8TA)	09/09→01/17	CGKB	Diesel	2698	6	24	106
A5 Sportback (8TA)	09/09→01/17	CGLD	Diesel	1968	4	16	82
A5 Sportback (8TA)	09/09→01/17	CJCA	Diesel	1968	4	16	82
A5 Sportback (8TA)	09/09→01/17	CJCB	Diesel	1968	4	16	82
A5 Sportback (8TA)	09/09→01/17	CMEA	Diesel	1968	4	16	82
A5 Sportback (8TA)	09/09→01/17	CMFA	Diesel	1968	4	16	82
A5 Sportback (8TA)	09/09→01/17	CNHC	Diesel	1968	4	16	84
A5 Sportback (8TA)	09/09→01/17	CSUB	Diesel	1968	4	16	84
A5 Sportback (8TA)	11/09→09/11	CDHB	Petrol	1798	4	16	50
A5 Sportback (8TA)	01/10→01/17	CAKA	Petrol	2995	6	24	117
A5 Sportback (8TA)	01/10→01/17	CGWC	Petrol	2995	6	24	117
A5 Sportback (8TA)	01/10→01/17	CGXC	Petrol	2995	6	24	117
A5 Sportback (8TA)	01/10→01/17	CREC	Petrol	2995	6	24	117
A5 Sportback (8TA)	01/10→01/17	CTDA	Petrol	2995	6	24	117
A5 Sportback (8TA)	01/10→01/17	CTUB	Petrol	2995	6	24	117
A5 Sportback (8TA)	08/11→01/17	CJEB	Petrol	1798	4	16	51
A5 Sportback (8TA)	10/11→01/17	CDUC	Diesel	2967	6	24	118
A5 Sportback (8TA)	10/11→01/17	CGLC	Diesel	1968	4	16	82
A5 Sportback (8TA)	10/11→01/17	CKVB	Diesel	2967	6	24	118
A5 Sportback (8TA)	10/11→01/17	CKVC	Diesel	2967	6	24	118
A5 Sportback (8TA)	10/11→01/17	CLAB	Diesel	2967	6	24	118
A5 Sportback (8TA)	12/11→01/17	CMUA	Petrol	2995	6	24	117
A5 Sportback (8TA)	12/11→01/17	CRED	Petrol	2995	6	24	117
A5 Sportback (8TA)	05/13→05/16	CNCD	Petrol	1984	4	16	79
A5 Sportback (8TA)	05/13→01/17	CJCD	Diesel	1968	4	16	82
A5 Sportback (8TA)	05/13→01/17	CMFB	Diesel	1968	4	16	82
A5 Sportback (8TA)	05/13→01/17	CSUA	Diesel	1968	4	16	84
A5 Sportback (8TA)	09/13→01/17	CNHA	Diesel	1968	4	16	84
A5 Sportback (8TA)	09/14→01/17	CJED	Petrol	1798	4	16	51
A5 Sportback (8TA)	05/15→01/17	CJEE	Petrol	1798	4	16	51
A5 Sportback (8TA)	05/15→01/17	CKVD	Diesel	2967	6	24	118
A5 Sportback (8TA)	08/15→01/17	CNCE	Petrol	1984	4	16	79
A5 Sportback (F5A)	09/16→	CSWB	Diesel	2967	6	24	118
A5 Sportback (F5A)	09/16→	CWGD	Petrol	2995	6	24	117
A5 Sportback (F5A)	09/16→	CYMC	Petrol	1984	4	16	79
A5 Sportback (F5A)	09/16→	CYRB	Petrol	1984	4	16	79
A5 Sportback (F5A)	09/16→	CYRC	Petrol	1984	4	16	79
A5 Sportback (F5A)	09/16→	DESA	Diesel	1968	4	16	84
A5 Sportback (F5A)	09/16→	DETA	Diesel	1968	4	16	84
A5 Sportback (F5A)	10/16→	DFVA	Diesel	1968	4	16	84
A5 Sportback (F5A)	01/17→	CVKB	Petrol	1984	4	16	79
A5 Sportback (F5A)	01/17→	CVNA	Petrol	1395	4	16	13
A5 Sportback (F5A)	01/17→	CZHA	Diesel	1968	4	16	84
A5 Sportback (F5A)	01/17→	DCPC	Diesel	2967	6	24	118
A5 Sportback (F5A)	01/17→	DEUA	Diesel	1968	4	16	84
A5 Sportback (F5A)	02/17→	CRTC	Diesel	2967	6	24	118
A5 Sportback (F5A)	02/17→	CVLA	Petrol	1984	4	16	79
A5 Sportback (F5A)	05/17→	DEUB	Diesel	1968	4	16	84
A6 (4A2, C4)	06/94→12/95	AAR	Petrol	2309	5	10	94
A6 (4A2, C4)	06/94→10/97	IZ	Diesel	1896	4	8	54
A6 (4A2, C4)	06/94→10/97	AAE	Petrol	1984	4	8	70
A6 (4A2, C4)	06/94→10/97	AAH	Petrol	2771	6	12	108
A6 (4A2, C4)	06/94→10/97	AAN	Petrol	2226	5	20	92
A6 (4A2, C4)	06/94→10/97	AAT	Diesel	2461	5	10	99
A6 (4A2, C4)	06/94→10/97	ABC	Petrol	2598	6	12	103
A6 (4A2, C4)	06/94→10/97	ABK	Petrol	1984	4	8	69
A6 (4A2, C4)	06/94→10/97	ACE	Petrol	1984	4	16	68
A6 (4A2, C4)	06/94→10/97	AEC	Petrol	4172	8	32	132
A6 (4A2, C4)	06/94→10/97	AEJ	Petrol	2771	6	12	108
A6 (4A2, C4)	06/94→10/97	AFC	Petrol	2771	6	12	110
A6 (4A2, C4)	06/94→10/97	AHU	Diesel	1896	4	8	61
A6 (4A2, C4)	08/94→10/97	AEL	Diesel	2461	5	10	99
A6 (4A2, C4)	07/95→06/96	AFM	Petrol	2393	6	12	96
A6 (4A2, C4)	12/95→10/97	ACK	Petrol	2771	6	30	109
A6 (4A2, C4)	12/95→10/97	ADR	Petrol	1781	4	20	37
A6 (4A2, C4)	04/96→10/97	AHK	Petrol	4172	8	32	132
A6 (4A, C4)	06/94→10/97	ACZ	Petrol	2598	6	12	103
A6 (4A, C4)	08/95→07/96	ADW	Petrol	1984	4	8	69
A6 (4A, C4)	08/95→07/96	AEJ	Petrol	2771	6	12	108
A6 (4B2, C5)	01/97→01/05	AEB	Petrol	1781	4	20	37
A6 (4B2, C5)	01/97→01/05	ANB	Petrol	1781	4	20	45
A6 (4B2, C5)	01/97→01/05	APU	Petrol	1781	4	20	45
A6 (4B2, C5)	01/97→01/05	ARK	Petrol	1781	4	20	45



A6 (4B2, C5)	01/97→01/05	AWL	Petrol	1781	4	20	44
A6 (4B2, C5)	01/97→01/05	AWT	Petrol	1781	4	20	44
A6 (4B2, C5)	02/97→01/05	ACK	Petrol	2771	6	30	109
A6 (4B2, C5)	02/97→01/05	AGA	Petrol	2393	6	30	97
A6 (4B2, C5)	02/97→01/05	AHA	Petrol	2771	6	30	111
A6 (4B2, C5)	02/97→01/05	AJG	Petrol	2393	6	30	97
A6 (4B2, C5)	02/97→01/05	ALF	Petrol	2393	6	30	97
A6 (4B2, C5)	02/97→01/05	ALG	Petrol	2771	6	30	112
A6 (4B2, C5)	02/97→01/05	AML	Petrol	2393	6	30	97
A6 (4B2, C5)	02/97→01/05	AMM	Petrol	2393	6	30	97
A6 (4B2, C5)	02/97→01/05	AMX	Petrol	2771	6	30	111
A6 (4B2, C5)	02/97→01/05	APC	Petrol	2393	6	30	97
A6 (4B2, C5)	02/97→01/05	APR	Petrol	2771	6	30	112
A6 (4B2, C5)	02/97→01/05	APS	Petrol	2393	6	30	97
A6 (4B2, C5)	02/97→01/05	APZ	Petrol	2393	6	30	97
A6 (4B2, C5)	02/97→01/05	AQD	Petrol	2771	6	30	112
A6 (4B2, C5)	02/97→01/05	ARJ	Petrol	2393	6	30	97
A6 (4B2, C5)	04/97→10/00	AFN	Diesel	1896	4	8	57
A6 (4B2, C5)	04/97→10/00	AVG	Diesel	1896	4	8	60
A6 (4B2, C5)	05/97→01/05	AFY	Petrol	1781	4	20	38
A6 (4B2, C5)	07/97→01/05	AFB	Diesel	2496	6	24	100
A6 (4B2, C5)	07/97→01/05	AJP	Petrol	1781	4	20	42
A6 (4B2, C5)	07/97→01/05	AKN	Diesel	2496	6	24	100
A6 (4B2, C5)	07/97→01/05	ANQ	Petrol	1781	4	20	46
A6 (4B2, C5)	07/97→01/05	AQE	Petrol	1781	4	20	42
A6 (4B2, C5)	07/97→01/05	ARH	Petrol	1781	4	20	42
A6 (4B2, C5)	10/97→05/00	AGE	Petrol	2771	6	30	111
A6 (4B2, C5)	12/97→01/05	AJK	Petrol	2671	6	30	104
A6 (4B2, C5)	12/97→01/05	AJL	Petrol	1781	4	20	41
A6 (4B2, C5)	12/97→01/05	AZA	Petrol	2671	6	30	104
A6 (4B2, C5)	07/98→01/05	ALW	Petrol	2393	6	30	97
A6 (4B2, C5)	07/98→01/05	ARN	Petrol	2393	6	30	97
A6 (4B2, C5)	07/98→01/05	ASM	Petrol	2393	6	30	97
A6 (4B2, C5)	11/98→01/05	ARS	Petrol	4172	8	40	133
A6 (4B2, C5)	11/98→01/05	ASG	Petrol	4172	8	40	133
A6 (4B2, C5)	11/98→01/05	AWN	Petrol	4172	8	40	135
A6 (4B2, C5)	03/99→01/05	AQG	Petrol	3697	8	40	126
A6 (4B2, C5)	07/99→01/05	ATX	Petrol	2771	6	30	111
A6 (4B2, C5)	07/99→01/05	BBG	Petrol	2771	6	30	111
A6 (4B2, C5)	09/99→01/05	ANK	Petrol	4172	8	40	133
A6 (4B2, C5)	09/99→01/05	AQJ	Petrol	4172	8	40	133
A6 (4B2, C5)	02/00→01/05	AKE	Diesel	2496	6	24	100
A6 (4B2, C5)	02/00→01/05	BAU	Diesel	2496	6	24	100
A6 (4B2, C5)	02/00→01/05	BDH	Diesel	2496	6	24	100
A6 (4B2, C5)	02/00→01/05	BND	Diesel	2496	6	24	100
A6 (4B2, C5)	07/00→01/05	AJM	Diesel	1896	4	8	62
A6 (4B2, C5)	09/00→12/04	BBD	Petrol	4172	8	40	133
A6 (4B2, C5)	05/01→07/04	APB	Petrol	2671	6	30	104
A6 (4B2, C5)	05/01→07/04	BEL	Petrol	2671	6	30	104
A6 (4B2, C5)	06/01→01/05	BBJ	Petrol	2976	6	30	116
A6 (4B2, C5)	08/01→01/05	ALT	Petrol	1984	4	20	72
A6 (4B2, C5)	08/01→01/05	ARE	Petrol	2671	6	30	104
A6 (4B2, C5)	08/01→01/05	ASN	Petrol	2976	6	30	116
A6 (4B2, C5)	08/01→01/05	AVF	Diesel	1896	4	8	63
A6 (4B2, C5)	08/01→01/05	AWX	Diesel	1896	4	8	63
A6 (4B2, C5)	08/01→01/05	AYM	Diesel	2496	6	24	100
A6 (4B2, C5)	08/01→01/05	BDV	Petrol	2393	6	30	97
A6 (4B2, C5)	08/01→01/05	BES	Petrol	2671	6	30	104
A6 (4B2, C5)	07/02→01/05	BCY	Petrol	4172	8	40	133
A6 (4B2, C5)	07/02→01/05	BCZ	Diesel	2496	6	24	100
A6 (4B2, C5)	07/02→01/05	BDG	Diesel	2496	6	24	100
A6 (4B2, C5)	07/02→01/05	BFC	Diesel	2496	6	24	100
A6 (4B, C5)	05/01→07/04	APB	Petrol	2671	6	30	104
A6 (4B, C5)	05/01→07/04	BEL	Petrol	2671	6	30	104
A6 (4F2, C6)	05/04→05/06	BAT	Petrol	4163	8	40	137
A6 (4F2, C6)	05/04→05/06	BBJ	Petrol	2976	6	30	116
A6 (4F2, C6)	05/04→05/06	BMK	Diesel	2967	6	24	115
A6 (4F2, C6)	05/04→10/08	BDW	Petrol	2393	6	24	98
A6 (4F2, C6)	05/04→05/09	AUK	Petrol	3123	6	24	119
A6 (4F2, C6)	05/04→05/09	BKH	Petrol	3123	6	24	119
A6 (4F2, C6)	05/04→03/11	BNG	Diesel	2967	6	24	115
A6 (4F2, C6)	05/04→03/11	CDYB	Diesel	2967	6	24	115
A6 (4F2, C6)	07/04→10/08	BLB	Diesel	1968	4	16	76
A6 (4F2, C6)	07/04→10/08	BRE	Diesel	1968	4	16	76
A6 (4F2, C6)	07/04→03/11	BNA	Diesel	1968	4	16	76
A6 (4F2, C6)	07/04→03/11	BRF	Diesel	1968	4	16	76
A6 (4F2, C6)	07/04→03/11	CAGB	Diesel	1968	4	16	82
A6 (4F2, C6)	11/04→10/08	BPP	Diesel	2698	6	24	106



CC



9

A6 (4F2, C6)	11/04→03/11	BSG	Diesel	2698	6	24	106
A6 (4F2, C6)	11/04→03/11	CANB	Diesel	2698	6	24	106
A6 (4F2, C6)	06/05→03/11	BPJ	Petrol	1984	4	16	75
A6 (4F2, C6)	06/05→03/11	BYK	Petrol	1984	4	16	75
A6 (4F2, C6)	06/05→03/11	CAND	Diesel	2698	6	24	106
A6 (4F2, C6)	09/05→06/06	BVG	Diesel	1968	4	16	76
A6 (4F2, C6)	03/06→03/11	BXA	Petrol	5204	10	40	142
A6 (4F2, C6)	06/06→10/08	ASB	Diesel	2967	6	24	115
A6 (4F2, C6)	06/06→03/11	BVJ	Petrol	4163	8	32	136
A6 (4F2, C6)	09/06→10/08	BYU	Petrol	3123	6	24	119
A6 (4F2, C6)	11/06→10/08	BDX	Petrol	2773	6	24	114
A6 (4F2, C6)	07/08→10/08	AHA	Petrol	2771	6	30	111
A6 (4F2, C6)	09/08→08/10	BUH	Petrol	4991	10	40	141
A6 (4F2, C6)	10/08→03/11	CAJA	Petrol	2995	6	24	117
A6 (4F2, C6)	10/08→03/11	CANA	Diesel	2698	6	24	106
A6 (4F2, C6)	10/08→03/11	CANC	Diesel	2698	6	24	106
A6 (4F2, C6)	10/08→03/11	CCAA	Petrol	2995	6	24	117
A6 (4F2, C6)	10/08→03/11	CCDA	Petrol	2773	6	24	114
A6 (4F2, C6)	10/08→03/11	CCEA	Petrol	2773	6	24	114
A6 (4F2, C6)	10/08→03/11	CDYA	Diesel	2967	6	24	115
A6 (4F2, C6)	10/08→03/11	CDYC	Diesel	2967	6	24	115
A6 (4F2, C6)	11/08→03/11	CAHA	Diesel	1968	4	16	82
A6 (4F2, C6)	04/09→03/11	CAHB	Diesel	1968	4	16	82
A6 (4F2, C6)	05/09→03/11	CALA	Petrol	3197	6	24	119
A6 (4G2, 4GC, C7)	11/10→05/12	CGWB	Petrol	2995	6	24	117
A6 (4G2, 4GC, C7)	11/10→04/15	CHVA	Petrol	2773	6	24	114
A6 (4G2, 4GC, C7)	11/10→	CLAB	Diesel	2967	6	24	118
A6 (4G2, 4GC, C7)	03/11→05/13	CAEB	Petrol	1984	4	16	81
A6 (4G2, 4GC, C7)	03/11→	CDUC	Diesel	2967	6	24	118
A6 (4G2, 4GC, C7)	03/11→	CDUD	Diesel	2967	6	24	118
A6 (4G2, 4GC, C7)	03/11→	CGLC	Diesel	1968	4	16	82
A6 (4G2, 4GC, C7)	03/11→	CGLD	Diesel	1968	4	16	82
A6 (4G2, 4GC, C7)	03/11→	CGWD	Petrol	2995	6	24	117
A6 (4G2, 4GC, C7)	03/11→	CGXB	Petrol	2995	6	24	117
A6 (4G2, 4GC, C7)	03/11→	CKVB	Diesel	2967	6	24	118
A6 (4G2, 4GC, C7)	03/11→	CKVC	Diesel	2967	6	24	118
A6 (4G2, 4GC, C7)	03/11→	CLAA	Diesel	2967	6	24	118
A6 (4G2, 4GC, C7)	03/11→	CMGB	Diesel	1968	4	16	82
A6 (4G2, 4GC, C7)	03/11→	CTUA	Petrol	2995	6	24	117
A6 (4G2, 4GC, C7)	05/11→	CDNB	Petrol	1984	4	16	81
A6 (4G2, 4GC, C7)	11/11→	CGQB	Diesel	2967	6	24	118
A6 (4G2, 4GC, C7)	11/11→	CHJA	Petrol	1984	4	16	81
A6 (4G2, 4GC, C7)	01/12→	CGLE	Diesel	1968	4	16	82
A6 (4G2, 4GC, C7)	01/12→	CSUE	Diesel	1968	4	16	84
A6 (4G2, 4GC, C7)	02/12→	CEUC	Petrol	3993	8	32	129
A6 (4G2, 4GC, C7)	05/13→	CAED	Petrol	1984	4	16	81
A6 (4G2, 4GC, C7)	05/13→	CPNB	Diesel	2967	6	24	118
A6 (4G2, 4GC, C7)	11/13→	CNHA	Diesel	1968	4	16	84
A6 (4G2, 4GC, C7)	11/13→	CZJA	Diesel	1968	4	16	84
A6 (4G2, 4GC, C7)	11/13→	DDDA	Diesel	1968	4	16	84
A6 (4G2, 4GC, C7)	05/14→	CYNB	Petrol	1984	4	16	79
A6 (4G2, 4GC, C7)	05/14→	CYPA	Petrol	1984	4	16	79
A6 (4G2, 4GC, C7)	09/14→	CREC	Petrol	2995	6	24	117
A6 (4G2, 4GC, C7)	09/14→	CRTD	Diesel	2967	6	24	118
A6 (4G2, 4GC, C7)	09/14→	CRTE	Diesel	2967	6	24	118
A6 (4G2, 4GC, C7)	09/14→	CRTF	Diesel	2967	6	24	118
A6 (4G2, 4GC, C7)	09/14→	CSUD	Diesel	1968	4	16	84
A6 (4G2, 4GC, C7)	09/14→	CTCB	Diesel	2967	6	24	118
A6 (4G2, 4GC, C7)	09/14→	CTCC	Diesel	2967	6	24	118
A6 (4G2, 4GC, C7)	09/14→	CVPA	Petrol	2773	6	24	114
A6 (4G2, 4GC, C7)	09/14→	CVUA	Diesel	2967	6	24	118
A6 (4G2, 4GC, C7)	09/14→	CVUB	Diesel	2967	6	24	118
A6 (4G2, 4GC, C7)	09/14→	CYGA	Petrol	1798	4	16	51
A6 (4G2, 4GC, C7)	09/14→	CZVA	Diesel	2967	6	24	118
A6 (4G2, 4GC, C7)	09/14→	CZVB	Diesel	2967	6	24	118
A6 (4G2, 4GC, C7)	09/14→	CZVC	Diesel	2967	6	24	118
A6 (4G2, 4GC, C7)	09/14→	CZVD	Diesel	2967	6	24	118
A6 (4G2, 4GC, C7)	09/14→	DDCB	Diesel	1968	4	16	84
A6 (4G2, 4GC, C7)	10/14→	CTGE	Petrol	3993	8	32	129
A6 (4G2, 4GC, C7)	05/15→	CYPB	Petrol	1984	4	16	79
A6 Allroad (4FH, C6)	05/06→10/08	ASB	Diesel	2967	6	24	115
A6 Allroad (4FH, C6)	05/06→10/08	AUK	Petrol	3123	6	24	119
A6 Allroad (4FH, C6)	05/06→10/08	BPP	Diesel	2698	6	24	106
A6 Allroad (4FH, C6)	05/06→12/10	BVJ	Petrol	4163	8	32	136
A6 Allroad (4FH, C6)	05/06→08/11	BNG	Diesel	2967	6	24	115
A6 Allroad (4FH, C6)	05/06→08/11	BSG	Diesel	2698	6	24	106
A6 Allroad (4FH, C6)	05/06→08/11	CAND	Diesel	2698	6	24	106
A6 Allroad (4FH, C6)	05/06→08/11	CDYB	Diesel	2967	6	24	115



A6 Allroad (4FH, C6)	10/08→08/11	CAJA	Petrol	2995	6	24	117
A6 Allroad (4FH, C6)	10/08→08/11	CANC	Diesel	2698	6	24	106
A6 Allroad (4FH, C6)	10/08→08/11	CDYA	Diesel	2967	6	24	115
A6 Allroad (4FH, C6)	10/08→08/11	CDYC	Diesel	2967	6	24	115
A6 Allroad (4GH, 4GJ)	01/12→	CDUD	Diesel	2967	6	24	118
A6 Allroad (4GH, 4GJ)	01/12→	CGQB	Diesel	2967	6	24	118
A6 Allroad (4GH, 4GJ)	01/12→	CGWD	Petrol	2995	6	24	117
A6 Allroad (4GH, 4GJ)	01/12→	CKVC	Diesel	2967	6	24	118
A6 Allroad (4GH, 4GJ)	01/12→	CLAA	Diesel	2967	6	24	118
A6 Allroad (4GH, 4GJ)	01/12→	CVUA	Diesel	2967	6	24	118
A6 Allroad (4GH, 4GJ)	09/14→	CREC	Petrol	2995	6	24	117
A6 Allroad (4GH, 4GJ)	09/14→	CRTD	Diesel	2967	6	24	118
A6 Allroad (4GH, 4GJ)	09/14→	CRTE	Diesel	2967	6	24	118
A6 Allroad (4GH, 4GJ)	09/14→	CRTF	Diesel	2967	6	24	118
A6 Allroad (4GH, 4GJ)	09/14→	CZVA	Diesel	2967	6	24	118
A6 Allroad (4GH, 4GJ)	09/14→	CZVC	Diesel	2967	6	24	118
A6 Allroad (4GH, 4GJ)	11/15→	CZVF	Diesel	2967	6	24	118
A6 Avant (4A5, C4)	06/94→07/95	ADW	Petrol	1984	4	8	69
A6 Avant (4A5, C4)	06/94→12/95	AAR	Petrol	2309	5	10	94
A6 Avant (4A5, C4)	06/94→12/97	IZ	Diesel	1896	4	8	54
A6 Avant (4A5, C4)	06/94→12/97	AAE	Petrol	1984	4	8	70
A6 Avant (4A5, C4)	06/94→12/97	AAH	Petrol	2771	6	12	108
A6 Avant (4A5, C4)	06/94→12/97	AAN	Petrol	2226	5	20	92
A6 Avant (4A5, C4)	06/94→12/97	AAT	Diesel	2461	5	10	99
A6 Avant (4A5, C4)	06/94→12/97	ABC	Petrol	2598	6	12	103
A6 Avant (4A5, C4)	06/94→12/97	ABK	Petrol	1984	4	8	69
A6 Avant (4A5, C4)	06/94→12/97	ACE	Petrol	1984	4	16	68
A6 Avant (4A5, C4)	06/94→12/97	AEC	Petrol	4172	8	32	132
A6 Avant (4A5, C4)	06/94→12/97	AEJ	Petrol	2771	6	12	108
A6 Avant (4A5, C4)	06/94→12/97	AFC	Petrol	2771	6	12	110
A6 Avant (4A5, C4)	06/94→12/97	AHU	Diesel	1896	4	8	61
A6 Avant (4A5, C4)	08/94→12/97	AEL	Diesel	2461	5	10	99
A6 Avant (4A5, C4)	12/95→12/97	ACK	Petrol	2771	6	30	109
A6 Avant (4A5, C4)	12/95→12/97	ADR	Petrol	1781	4	20	37
A6 Avant (4A5, C4)	04/96→12/97	AHK	Petrol	4172	8	32	132
A6 Avant (4A5, C4)	07/96→12/97	AFM	Petrol	2393	6	12	96
A6 Avant (4A, C4)	06/94→02/97	ACZ	Petrol	2598	6	12	103
A6 Avant (4B5, C5)	12/97→05/00	AGE	Petrol	2771	6	30	111
A6 Avant (4B5, C5)	12/97→01/05	ACK	Petrol	2771	6	30	109
A6 Avant (4B5, C5)	12/97→01/05	AEB	Petrol	1781	4	20	37
A6 Avant (4B5, C5)	12/97→01/05	AFB	Diesel	2496	6	24	100
A6 Avant (4B5, C5)	12/97→01/05	AGA	Petrol	2393	6	30	97
A6 Avant (4B5, C5)	12/97→01/05	AHA	Petrol	2771	6	30	111
A6 Avant (4B5, C5)	12/97→01/05	AJG	Petrol	2393	6	30	97
A6 Avant (4B5, C5)	12/97→01/05	AJK	Petrol	2671	6	30	104
A6 Avant (4B5, C5)	12/97→01/05	AJL	Petrol	1781	4	20	41
A6 Avant (4B5, C5)	12/97→01/05	AJP	Petrol	1781	4	20	42
A6 Avant (4B5, C5)	12/97→01/05	AKN	Diesel	2496	6	24	100
A6 Avant (4B5, C5)	12/97→01/05	ALF	Petrol	2393	6	30	97
A6 Avant (4B5, C5)	12/97→01/05	ALG	Petrol	2771	6	30	112
A6 Avant (4B5, C5)	12/97→01/05	AML	Petrol	2393	6	30	97
A6 Avant (4B5, C5)	12/97→01/05	AMM	Petrol	2393	6	30	97
A6 Avant (4B5, C5)	12/97→01/05	AMX	Petrol	2771	6	30	111
A6 Avant (4B5, C5)	12/97→01/05	ANB	Petrol	1781	4	20	45
A6 Avant (4B5, C5)	12/97→01/05	APC	Petrol	2393	6	30	97
A6 Avant (4B5, C5)	12/97→01/05	APR	Petrol	2771	6	30	112
A6 Avant (4B5, C5)	12/97→01/05	APS	Petrol	2393	6	30	97
A6 Avant (4B5, C5)	12/97→01/05	APU	Petrol	1781	4	20	45
A6 Avant (4B5, C5)	12/97→01/05	APZ	Petrol	2393	6	30	97
A6 Avant (4B5, C5)	12/97→01/05	AQD	Petrol	2771	6	30	112
A6 Avant (4B5, C5)	12/97→01/05	AQE	Petrol	1781	4	20	42
A6 Avant (4B5, C5)	12/97→01/05	ARH	Petrol	1781	4	20	42
A6 Avant (4B5, C5)	12/97→01/05	ARJ	Petrol	2393	6	30	97
A6 Avant (4B5, C5)	12/97→01/05	ARK	Petrol	1781	4	20	45
A6 Avant (4B5, C5)	12/97→01/05	AWT	Petrol	1781	4	20	44
A6 Avant (4B5, C5)	12/97→01/05	AZA	Petrol	2671	6	30	104
A6 Avant (4B5, C5)	02/98→04/01	AFN	Diesel	1896	4	8	57
A6 Avant (4B5, C5)	02/98→01/05	AFY	Petrol	1781	4	20	38
A6 Avant (4B5, C5)	07/98→01/05	ALW	Petrol	2393	6	30	97
A6 Avant (4B5, C5)	07/98→01/05	ARN	Petrol	2393	6	30	97
A6 Avant (4B5, C5)	07/98→01/05	ASM	Petrol	2393	6	30	97
A6 Avant (4B5, C5)	11/98→01/05	ARS	Petrol	4172	8	40	133
A6 Avant (4B5, C5)	11/98→01/05	ASG	Petrol	4172	8	40	133
A6 Avant (4B5, C5)	11/98→01/05	AWN	Petrol	4172	8	40	135
A6 Avant (4B5, C5)	03/99→01/05	AQG	Petrol	3697	8	40	126
A6 Avant (4B5, C5)	07/99→01/05	ATX	Petrol	2771	6	30	111
A6 Avant (4B5, C5)	09/99→01/05	ANK	Petrol	4172	8	40	133
A6 Avant (4B5, C5)	09/99→01/05	AQJ	Petrol	4172	8	40	133



CC



9

A6 Avant (4B5, C5)	02/00→01/05	AKE	Diesel	2496	6	24	100
A6 Avant (4B5, C5)	02/00→01/05	BAU	Diesel	2496	6	24	100
A6 Avant (4B5, C5)	02/00→01/05	BDH	Diesel	2496	6	24	100
A6 Avant (4B5, C5)	07/00→01/05	AJM	Diesel	1896	4	8	62
A6 Avant (4B5, C5)	06/01→01/05	BBJ	Petrol	2976	6	30	116
A6 Avant (4B5, C5)	08/01→01/05	ALT	Petrol	1984	4	20	72
A6 Avant (4B5, C5)	08/01→01/05	ARE	Petrol	2671	6	30	104
A6 Avant (4B5, C5)	08/01→01/05	ASN	Petrol	2976	6	30	116
A6 Avant (4B5, C5)	08/01→01/05	AVF	Diesel	1896	4	8	63
A6 Avant (4B5, C5)	08/01→01/05	AWX	Diesel	1896	4	8	63
A6 Avant (4B5, C5)	08/01→01/05	AYM	Diesel	2496	6	24	100
A6 Avant (4B5, C5)	08/01→01/05	BDV	Petrol	2393	6	30	97
A6 Avant (4B5, C5)	08/01→01/05	BES	Petrol	2671	6	30	104
A6 Avant (4B5, C5)	09/01→12/03	BBD	Petrol	4172	8	40	133
A6 Avant (4B5, C5)	09/01→12/04	AVK	Petrol	2976	6	30	116
A6 Avant (4B5, C5)	07/02→01/05	BCY	Petrol	4172	8	40	133
A6 Avant (4B5, C5)	07/02→01/05	BCZ	Diesel	2496	6	24	100
A6 Avant (4B5, C5)	07/02→01/05	BDG	Diesel	2496	6	24	100
A6 Avant (4B5, C5)	07/02→01/05	BFC	Diesel	2496	6	24	100
A6 Avant (4B5, C5)	04/04→01/05	BRV	Petrol	4172	8	40	133
A6 Avant (4F5, C6)	03/05→05/06	BAT	Petrol	4163	8	40	137
A6 Avant (4F5, C6)	03/05→05/06	BBJ	Petrol	2976	6	30	116
A6 Avant (4F5, C6)	03/05→05/06	BMK	Diesel	2967	6	24	115
A6 Avant (4F5, C6)	03/05→10/08	AUK	Petrol	3123	6	24	119
A6 Avant (4F5, C6)	03/05→10/08	BDW	Petrol	2393	6	24	98
A6 Avant (4F5, C6)	03/05→10/08	BPP	Diesel	2698	6	24	106
A6 Avant (4F5, C6)	03/05→08/11	BNG	Diesel	2967	6	24	115
A6 Avant (4F5, C6)	03/05→08/11	BSG	Diesel	2698	6	24	106
A6 Avant (4F5, C6)	03/05→08/11	CANB	Diesel	2698	6	24	106
A6 Avant (4F5, C6)	03/05→08/11	CDYB	Diesel	2967	6	24	115
A6 Avant (4F5, C6)	06/05→10/08	BLB	Diesel	1968	4	16	76
A6 Avant (4F5, C6)	06/05→10/08	BRE	Diesel	1968	4	16	76
A6 Avant (4F5, C6)	06/05→08/11	BNA	Diesel	1968	4	16	76
A6 Avant (4F5, C6)	06/05→08/11	BPJ	Petrol	1984	4	16	75
A6 Avant (4F5, C6)	06/05→08/11	BRF	Diesel	1968	4	16	76
A6 Avant (4F5, C6)	06/05→08/11	CAGB	Diesel	1968	4	16	82
A6 Avant (4F5, C6)	06/05→08/11	CAND	Diesel	2698	6	24	106
A6 Avant (4F5, C6)	09/05→06/06	BVG	Diesel	1968	4	16	76
A6 Avant (4F5, C6)	03/06→08/11	BXA	Petrol	5204	10	40	142
A6 Avant (4F5, C6)	06/06→08/11	ASB	Diesel	2967	6	24	115
A6 Avant (4F5, C6)	06/06→08/11	BVJ	Petrol	4163	8	32	136
A6 Avant (4F5, C6)	11/06→10/08	BDX	Petrol	2773	6	24	114
A6 Avant (4F5, C6)	04/08→08/10	BUH	Petrol	4991	10	40	141
A6 Avant (4F5, C6)	10/08→08/11	CAHA	Diesel	1968	4	16	82
A6 Avant (4F5, C6)	10/08→08/11	CAJA	Petrol	2995	6	24	117
A6 Avant (4F5, C6)	10/08→08/11	CANA	Diesel	2698	6	24	106
A6 Avant (4F5, C6)	10/08→08/11	CANC	Diesel	2698	6	24	106
A6 Avant (4F5, C6)	10/08→08/11	CCAA	Petrol	2995	6	24	117
A6 Avant (4F5, C6)	10/08→08/11	CCDA	Petrol	2773	6	24	114
A6 Avant (4F5, C6)	10/08→08/11	CCEA	Petrol	2773	6	24	114
A6 Avant (4F5, C6)	10/08→08/11	CDYA	Diesel	2967	6	24	115
A6 Avant (4F5, C6)	10/08→08/11	CDYC	Diesel	2967	6	24	115
A6 Avant (4F5, C6)	04/09→08/11	CAHB	Diesel	1968	4	16	82
A6 Avant (4G5, 4GD, C7)	05/11→05/12	CGWB	Petrol	2995	6	24	117
A6 Avant (4G5, 4GD, C7)	05/11→04/15	CHVA	Petrol	2773	6	24	114
A6 Avant (4G5, 4GD, C7)	05/11→	CDUC	Diesel	2967	6	24	118
A6 Avant (4G5, 4GD, C7)	05/11→	CDUD	Diesel	2967	6	24	118
A6 Avant (4G5, 4GD, C7)	05/11→	CGLC	Diesel	1968	4	16	82
A6 Avant (4G5, 4GD, C7)	05/11→	CGLD	Diesel	1968	4	16	82
A6 Avant (4G5, 4GD, C7)	05/11→	CKVB	Diesel	2967	6	24	118
A6 Avant (4G5, 4GD, C7)	05/11→	CKVC	Diesel	2967	6	24	118
A6 Avant (4G5, 4GD, C7)	05/11→	CLAA	Diesel	2967	6	24	118
A6 Avant (4G5, 4GD, C7)	05/11→	CLAB	Diesel	2967	6	24	118
A6 Avant (4G5, 4GD, C7)	05/11→	CMGB	Diesel	1968	4	16	82
A6 Avant (4G5, 4GD, C7)	06/11→	CDNB	Petrol	1984	4	16	81
A6 Avant (4G5, 4GD, C7)	11/11→	CGQB	Diesel	2967	6	24	118
A6 Avant (4G5, 4GD, C7)	11/11→	CGWD	Petrol	2995	6	24	117
A6 Avant (4G5, 4GD, C7)	01/12→	CGLE	Diesel	1968	4	16	82
A6 Avant (4G5, 4GD, C7)	01/12→	CSUE	Diesel	1968	4	16	84
A6 Avant (4G5, 4GD, C7)	02/12→	CEUC	Petrol	3993	8	32	129
A6 Avant (4G5, 4GD, C7)	01/13→	CRDB	Petrol	3993	8	32	129
A6 Avant (4G5, 4GD, C7)	01/13→	CWUB	Petrol	3993	8	32	129
A6 Avant (4G5, 4GD, C7)	11/13→	CNHA	Diesel	1968	4	16	84
A6 Avant (4G5, 4GD, C7)	11/13→	CZJA	Diesel	1968	4	16	84
A6 Avant (4G5, 4GD, C7)	11/13→	DDDA	Diesel	1968	4	16	84
A6 Avant (4G5, 4GD, C7)	09/14→	CREC	Petrol	2995	6	24	117
A6 Avant (4G5, 4GD, C7)	09/14→	CRTD	Diesel	2967	6	24	118
A6 Avant (4G5, 4GD, C7)	09/14→	CRTE	Diesel	2967	6	24	118



CC



9

A6 Avant (4G5, 4GD, C7)	09/14→	CRTF	Diesel	2967	6	24	118
A6 Avant (4G5, 4GD, C7)	09/14→	CSUD	Diesel	1968	4	16	84
A6 Avant (4G5, 4GD, C7)	09/14→	CTCB	Diesel	2967	6	24	118
A6 Avant (4G5, 4GD, C7)	09/14→	CTCC	Diesel	2967	6	24	118
A6 Avant (4G5, 4GD, C7)	09/14→	CVPA	Petrol	2773	6	24	114
A6 Avant (4G5, 4GD, C7)	09/14→	CVUA	Diesel	2967	6	24	118
A6 Avant (4G5, 4GD, C7)	09/14→	CVUB	Diesel	2967	6	24	118
A6 Avant (4G5, 4GD, C7)	09/14→	CYGA	Petrol	1798	4	16	51
A6 Avant (4G5, 4GD, C7)	09/14→	CYNB	Petrol	1984	4	16	79
A6 Avant (4G5, 4GD, C7)	09/14→	CYPA	Petrol	1984	4	16	79
A6 Avant (4G5, 4GD, C7)	09/14→	CZVA	Diesel	2967	6	24	118
A6 Avant (4G5, 4GD, C7)	09/14→	CZVB	Diesel	2967	6	24	118
A6 Avant (4G5, 4GD, C7)	09/14→	CZVC	Diesel	2967	6	24	118
A6 Avant (4G5, 4GD, C7)	09/14→	CZVD	Diesel	2967	6	24	118
A6 Avant (4G5, 4GD, C7)	09/14→	DDCB	Diesel	1968	4	16	84
A6 Avant (4G5, 4GD, C7)	10/14→	CTGE	Petrol	3993	8	32	129
A6 Avant (4G5, 4GD, C7)	05/15→	CYPB	Petrol	1984	4	16	79
A6 Avant (4G5, 4GD, C7)	11/15→	CWUC	Petrol	3993	8	32	129
A6L Saloon (4F2, C6)	03/05→12/06	BBJ	Petrol	2976	6	30	116
A6L Saloon (4F2, C6)	03/05→12/12	BDW	Petrol	2393	6	24	98
A6L Saloon (4F2, C6)	09/05→12/12	BPJ	Petrol	1984	4	16	79
A6 Saloon (C5, 4B2)	01/00→12/05	ADR	Petrol	1781	4	20	37
A6 Saloon (C5, 4B2)	01/00→12/05	ANQ	Petrol	1781	4	20	46
A6 Saloon (C5, 4B2)	01/00→12/05	AWL	Petrol	1781	4	20	48
A6 Saloon (C5, 4B2)	09/00→07/05	ATX	Petrol	2771	6	30	113
A6 Saloon (C5, 4B2)	09/00→07/05	BBG	Petrol	2771	6	30	111
A6 Saloon (C5, 4B2)	06/02→12/05	BDV	Petrol	2393	6	30	97
A6 Saloon (C5, 4B2)	08/04→12/05	BAU	Diesel	2496	6	24	100
A6 Saloon (C5, 4B2)	08/04→12/05	BND	Diesel	2496	6	24	100
A7 Sportback (4GA, 4GF)	10/10→	CDUC	Diesel	2967	6	24	118
A7 Sportback (4GA, 4GF)	10/10→	CDUD	Diesel	2967	6	24	118
A7 Sportback (4GA, 4GF)	10/10→	CGWB	Petrol	2995	6	24	117
A7 Sportback (4GA, 4GF)	10/10→	CHMA	Petrol	2995	6	24	117
A7 Sportback (4GA, 4GF)	10/10→	CHVA	Petrol	2773	6	24	114
A7 Sportback (4GA, 4GF)	10/10→	CKVB	Diesel	2967	6	24	118
A7 Sportback (4GA, 4GF)	10/10→	CKVC	Diesel	2967	6	24	118
A7 Sportback (4GA, 4GF)	10/10→	CNYA	Petrol	2773	6	24	114
A7 Sportback (4GA, 4GF)	11/10→	CLAB	Diesel	2967	6	24	118
A7 Sportback (4GA, 4GF)	12/10→	CLAA	Diesel	2967	6	24	118
A7 Sportback (4GA, 4GF)	01/11→	CGWD	Petrol	2995	6	24	117
A7 Sportback (4GA, 4GF)	01/11→	CGXB	Petrol	2995	6	24	117
A7 Sportback (4GA, 4GF)	01/11→	CTTA	Petrol	2995	6	24	117
A7 Sportback (4GA, 4GF)	01/11→	CTUA	Petrol	2995	6	24	117
A7 Sportback (4GA, 4GF)	11/11→	CGQB	Diesel	2967	6	24	118
A7 Sportback (4GA, 4GF)	02/12→	CEUC	Petrol	3993	8	32	129
A7 Sportback (4GA, 4GF)	05/13→	CPNB	Diesel	2967	6	24	118
A7 Sportback (4GA, 4GF)	10/13→	CRDB	Petrol	3993	8	32	129
A7 Sportback (4GA, 4GF)	10/13→	CWUB	Petrol	3993	8	32	129
A7 Sportback (4GA, 4GF)	02/14→	CLXB	Petrol	2498	6	24	102
A7 Sportback (4GA, 4GF)	05/14→	CREC	Petrol	2995	6	24	117
A7 Sportback (4GA, 4GF)	05/14→	CRTD	Diesel	2967	6	24	118
A7 Sportback (4GA, 4GF)	05/14→	CVUA	Diesel	2967	6	24	118
A7 Sportback (4GA, 4GF)	07/14→	CRTE	Diesel	2967	6	24	118
A7 Sportback (4GA, 4GF)	07/14→	CRTF	Diesel	2967	6	24	118
A7 Sportback (4GA, 4GF)	07/14→	CTCB	Diesel	2967	6	24	118
A7 Sportback (4GA, 4GF)	07/14→	CTCC	Diesel	2967	6	24	118
A7 Sportback (4GA, 4GF)	07/14→	CTGE	Petrol	3993	8	32	129
A7 Sportback (4GA, 4GF)	07/14→	CZVA	Diesel	2967	6	24	118
A7 Sportback (4GA, 4GF)	07/14→	CZVB	Diesel	2967	6	24	118
A7 Sportback (4GA, 4GF)	07/14→	CZVC	Diesel	2967	6	24	118
A7 Sportback (4GA, 4GF)	09/14→	CVPA	Petrol	2773	6	24	114
A7 Sportback (4GA, 4GF)	09/14→	CVUB	Diesel	2967	6	24	118
A7 Sportback (4GA, 4GF)	09/14→	CYPA	Petrol	1984	4	16	79
A7 Sportback (4GA, 4GF)	04/15→	CYGA	Petrol	1798	4	16	51
A7 Sportback (4GA, 4GF)	05/15→	CYNB	Petrol	1984	4	16	79
A7 Sportback (4GA, 4GF)	05/15→	CYPB	Petrol	1984	4	16	79
A7 Sportback (4GA, 4GF)	11/15→	CWUC	Petrol	3993	8	32	129
A7 Sportback (4GA, 4GF)	11/15→	CZVD	Diesel	2967	6	24	118
A7 Sportback (4GA, 4GF)	11/15→	CZVE	Diesel	2967	6	24	118
A7 Sportback (4GA, 4GF)	11/15→	CZVF	Diesel	2967	6	24	118
A8 (4D2, 4D8)	03/94→03/96	AAH	Petrol	2771	6	12	108
A8 (4D2, 4D8)	03/94→07/96	AEM	Petrol	4172	8	32	132
A8 (4D2, 4D8)	03/94→11/98	AKG	Petrol	4172	8	32	132
A8 (4D2, 4D8)	03/94→12/99	ABZ	Petrol	4172	8	32	132
A8 (4D2, 4D8)	07/95→03/96	AEJ	Petrol	2771	6	12	108
A8 (4D2, 4D8)	07/95→09/98	AGH	Petrol	4172	8	32	132
A8 (4D2, 4D8)	07/95→11/98	AKJ	Petrol	3697	8	32	127
A8 (4D2, 4D8)	07/95→12/98	AEW	Petrol	3697	8	32	125











CC



9

A8 (4D2, 4D8)	04/96→09/02	ACK	Petrol	2771	6	30	109
A8 (4D2, 4D8)	04/96→09/02	ALG	Petrol	2771	6	30	112
A8 (4D2, 4D8)	04/96→09/02	AMX	Petrol	2771	6	30	111
A8 (4D2, 4D8)	04/96→09/02	APR	Petrol	2771	6	30	112
A8 (4D2, 4D8)	04/96→09/02	AQD	Petrol	2771	6	30	112
A8 (4D2, 4D8)	07/96→06/99	AHC	Petrol	4172	8	32	132
A8 (4D2, 4D8)	07/96→06/99	AKH	Petrol	4172	8	32	132
A8 (4D2, 4D8)	01/97→04/00	AFB	Diesel	2496	6	24	100
A8 (4D2, 4D8)	01/97→04/00	AKN	Diesel	2496	6	24	100
A8 (4D2, 4D8)	11/98→09/02	AKC	Petrol	3697	8	40	126
A8 (4D2, 4D8)	11/98→09/02	AQF	Petrol	4172	8	40	133
A8 (4D2, 4D8)	11/98→09/02	AQG	Petrol	3697	8	40	126
A8 (4D2, 4D8)	11/98→09/02	AUW	Petrol	4172	8	40	133
A8 (4D2, 4D8)	11/98→12/02	AUX	Petrol	4172	8	40	135
A8 (4D2, 4D8)	02/99→04/00	ARU	Petrol	4172	8	32	134
A8 (4D2, 4D8)	06/99→09/02	AQH	Petrol	4172	8	40	133
A8 (4D2, 4D8)	06/99→09/02	AVP	Petrol	4172	8	40	133
A8 (4D2, 4D8)	06/00→09/02	AKF	Diesel	3328	8	40	122
A8 (4D2, 4D8)	09/00→09/02	AKE	Diesel	2496	6	24	100
A8 (4D2, 4D8)	01/01→09/02	AZC	Petrol	5998	12	48	144
A8 (4E2, 4E8)	10/02→12/03	AUX	Petrol	4172	8	40	135
A8 (4E2, 4E8)	10/02→05/06	BFL	Petrol	3697	8	40	126
A8 (4E2, 4E8)	10/02→07/10	BFM	Petrol	4172	8	40	133
A8 (4E2, 4E8)	05/03→07/05	ASE	Diesel	3936	8	32	128
A8 (4E2, 4E8)	07/03→05/05	ASN	Petrol	2976	6	30	116
A8 (4E2, 4E8)	07/03→05/06	BBJ	Petrol	2976	6	30	116
A8 (4E2, 4E8)	08/03→07/10	ASB	Diesel	2967	6	24	115
A8 (4E2, 4E8)	09/03→12/04	AYS	Petrol	4172	8	40	133
A8 (4E2, 4E8)	11/03→07/10	BNG	Diesel	2967	6	24	115
A8 (4E2, 4E8)	12/03→07/10	BHT	Petrol	5998	12	48	145
A8 (4E2, 4E8)	12/03→07/10	BSB	Petrol	5998	12	48	145
A8 (4E2, 4E8)	12/03→07/10	BTE	Petrol	5998	12	48	145
A8 (4E2, 4E8)	01/05→06/05	BMC	Diesel	4134	8	32	138
A8 (4E2, 4E8)	06/05→07/10	BPK	Petrol	3123	6	24	119
A8 (4E2, 4E8)	07/05→07/10	BVN	Diesel	4134	8	32	138
A8 (4E2, 4E8)	06/06→07/10	BSM	Petrol	5204	10	40	142
A8 (4E2, 4E8)	06/06→07/10	BJV	Petrol	4163	8	32	136
A8 (4E2, 4E8)	08/07→07/10	BDX	Petrol	2773	6	24	114
A8 (4E2, 4E8)	01/09→07/10	CJBA	Petrol	2773	6	24	114
A8 (4H2, 4H8, 4HC, 4HL)	11/09→	CDRA	Petrol	4163	8	32	136
A8 (4H2, 4H8, 4HC, 4HL)	11/09→	CDSB	Diesel	4134	8	32	139
A8 (4H2, 4H8, 4HC, 4HL)	06/10→	CGXC	Petrol	2995	6	24	117
A8 (4H2, 4H8, 4HC, 4HL)	06/10→	CMDA	Petrol	2995	6	24	117
A8 (4H2, 4H8, 4HC, 4HL)	06/10→	CREC	Petrol	2995	6	24	117
A8 (4H2, 4H8, 4HC, 4HL)	06/10→	CTDA	Petrol	2995	6	24	117
A8 (4H2, 4H8, 4HC, 4HL)	06/10→	CTUB	Petrol	2995	6	24	117
A8 (4H2, 4H8, 4HC, 4HL)	07/10→	CDTA	Diesel	2967	6	24	118
A8 (4H2, 4H8, 4HC, 4HL)	07/10→	CDTC	Diesel	2967	6	24	118
A8 (4H2, 4H8, 4HC, 4HL)	07/10→	CGWA	Petrol	2995	6	24	117
A8 (4H2, 4H8, 4HC, 4HL)	07/10→	CGXA	Petrol	2995	6	24	117
A8 (4H2, 4H8, 4HC, 4HL)	07/10→	CMHA	Diesel	2967	6	24	118
A8 (4H2, 4H8, 4HC, 4HL)	07/10→	CREG	Petrol	2995	6	24	117
A8 (4H2, 4H8, 4HC, 4HL)	08/10→	CDTB	Diesel	2967	6	24	118
A8 (4H2, 4H8, 4HC, 4HL)	08/10→	CTBB	Diesel	2967	6	24	118
A8 (4H2, 4H8, 4HC, 4HL)	01/11→	CEJA	Petrol	6299	12	48	147
A8 (4H2, 4H8, 4HC, 4HL)	01/11→	CTNA	Petrol	6299	12	48	147
A8 (4H2, 4H8, 4HC, 4HL)	09/11→	CLAB	Diesel	2967	6	24	118
A8 (4H2, 4H8, 4HC, 4HL)	11/11→	CGWD	Petrol	2995	6	24	117
A8 (4H2, 4H8, 4HC, 4HL)	11/11→	CREA	Petrol	2995	6	24	117
A8 (4H2, 4H8, 4HC, 4HL)	02/12→	CHJA	Petrol	1984	4	16	81
A8 (4H2, 4H8, 4HC, 4HL)	03/12→	CEUA	Petrol	3993	8	32	129
A8 (4H2, 4H8, 4HC, 4HL)	04/12→	CGTA	Petrol	3993	8	32	129
A8 (4H2, 4H8, 4HC, 4HL)	04/12→	CTFA	Petrol	3993	8	32	129
A8 (4H2, 4H8, 4HC, 4HL)	07/12→	CPAA	Petrol	2498	6	24	102
A8 (4H2, 4H8, 4HC, 4HL)	07/12→	CVBA	Petrol	2498	6	24	102
A8 (4H2, 4H8, 4HC, 4HL)	11/12→	CPNA	Diesel	2967	6	24	118
A8 (4H2, 4H8, 4HC, 4HL)	10/13→	CTBA	Diesel	2967	6	24	118
A8 (4H2, 4H8, 4HC, 4HL)	10/13→	CTEC	Diesel	4134	8	32	140
A8 (4H2, 4H8, 4HC, 4HL)	10/13→	CTGA	Petrol	3993	8	32	129
A8 (4H2, 4H8, 4HC, 4HL)	05/15→	CTBD	Diesel	2967	6	24	118
A8 (4H2, 4H8, 4HC, 4HL)	11/15→	DDTA	Petrol	3993	8	32	129
A8 (4H2, 4H8, 4HC, 4HL)	09/16→	CYPA	Petrol	1984	4	16	79
Allroad (4BH, C5)	05/00→08/05	AKE	Diesel	2496	6	24	100
Allroad (4BH, C5)	05/00→08/05	ARE	Petrol	2671	6	30	104
Allroad (4BH, C5)	05/00→08/05	BAU	Diesel	2496	6	24	100
Allroad (4BH, C5)	05/00→08/05	BES	Petrol	2671	6	30	104
Allroad (4BH, C5)	09/00→08/05	APB	Petrol	2671	6	30	104
Allroad (4BH, C5)	09/00→08/05	BEL	Petrol	2671	6	30	104

							
Allroad (4BH, C5)	07/02→08/05	BAS	Petrol	4163	8	40	137
Allroad (4BH, C5)	05/03→08/05	BCZ	Diesel	2496	6	24	100
Cabriolet (8G7, B4)	05/91→07/94	NG	Petrol	2309	5	10	94
Cabriolet (8G7, B4)	11/92→08/00	AAH	Petrol	2771	6	12	108
Cabriolet (8G7, B4)	01/93→07/98	ABK	Petrol	1984	4	8	69
Cabriolet (8G7, B4)	06/93→08/00	ABC	Petrol	2598	6	12	103
Cabriolet (8G7, B4)	05/95→08/00	ACZ	Petrol	2598	6	12	103
Cabriolet (8G7, B4)	06/95→07/96	ACE	Petrol	1984	4	16	68
Cabriolet (8G7, B4)	06/95→08/00	1Z	Diesel	1896	4	8	54
Cabriolet (8G7, B4)	06/95→08/00	AHU	Diesel	1896	4	8	61
Cabriolet (8G7, B4)	01/97→08/00	ADR	Petrol	1781	4	20	37
Coupe (81, 85)	07/80→08/81	YN	Petrol	1588	4	8	18
Coupe (81, 85)	08/80→07/83	WN	Petrol	1921	5	10	65
Coupe (81, 85)	09/80→12/84	WE	Petrol	2144	5	10	89
Coupe (81, 85)	07/81→12/87	KX	Petrol	2226	5	10	91
Coupe (81, 85)	08/81→07/83	DD	Petrol	1781	4	8	35
Coupe (81, 85)	09/82→10/87	KE	Petrol	2144	5	10	89
Coupe (81, 85)	09/82→10/87	KL	Petrol	2144	5	10	91
Coupe (81, 85)	09/82→10/88	DS	Petrol	1781	4	8	35
Coupe (81, 85)	09/82→10/88	JV	Petrol	1781	4	8	52
Coupe (81, 85)	09/83→07/86	HP	Petrol	1994	5	10	85
Coupe (81, 85)	09/83→07/86	JS	Petrol	1994	5	10	86
Coupe (81, 85)	09/84→10/88	HY	Petrol	2226	5	10	91
Coupe (81, 85)	09/84→10/88	KV	Petrol	2226	5	10	91
Coupe (81, 85)	12/84→10/88	DZ	Petrol	1781	4	8	35
Coupe (81, 85)	01/85→07/88	JN	Petrol	1781	4	8	35
Coupe (81, 85)	08/85→10/88	JT	Petrol	2226	5	10	91
Coupe (81, 85)	03/86→04/88	SK	Petrol	1994	5	10	86
Coupe (81, 85)	04/86→10/88	SF	Petrol	1781	4	8	35
Coupe (81, 85)	08/86→10/87	PV	Petrol	1781	4	8	35
Coupe (81, 85)	09/86→10/88	NG	Petrol	2309	5	10	94
Coupe (89, 88)	10/88→12/96	NG	Petrol	2309	5	10	94
Coupe (89, 88)	11/88→07/91	KV	Petrol	2226	5	10	91
Coupe (89, 88)	11/88→12/96	7A	Petrol	2309	5	20	93
Coupe (89, 88)	05/89→07/90	3A	Petrol	1984	4	8	67
Coupe (89, 88)	05/89→12/96	AAD	Petrol	1984	4	8	69
Coupe (89, 88)	05/89→12/96	ABK	Petrol	1984	4	8	69
Coupe (89, 88)	08/89→07/91	DZ	Petrol	1781	4	8	35
Coupe (89, 88)	08/89→07/91	NM	Petrol	1994	5	20	87
Coupe (89, 88)	09/90→09/92	3B	Petrol	2226	5	20	92
Coupe (89, 88)	08/91→12/96	AAH	Petrol	2771	6	12	108
Coupe (89, 88)	01/92→07/92	6A	Petrol	1984	4	16	68
Coupe (89, 88)	08/92→12/96	ABC	Petrol	2598	6	12	103
Coupe (89, 88)	08/92→12/96	ACE	Petrol	1984	4	16	68
Coupe (89, 88)	10/92→12/96	ABY	Petrol	2226	5	20	92
F103	08/65→08/68	8920	Petrol	1695	4	8	33
F103 Variant	04/66→08/68	8920	Petrol	1695	4	8	33
Q2 (GAB)	06/16→	CZEA	Petrol	1395	4	16	14
Q2 (GAB)	06/16→	DDYA	Diesel	1598	4	16	28
Q2 (GAB)	07/16→	DFHA	Diesel	1968	4	16	84
Q2 (GAB)	09/16→	DFGA	Diesel	1968	4	16	84
Q2 (GAB)	10/16→	CHZJ	Petrol	999	3	12	1
Q2 (GAB)	05/17→	CZPB	Petrol	1984	4	16	79
Q3 (8UB, 8UG)	06/11→	CCZC	Petrol	1984	4	16	81
Q3 (8UB, 8UG)	06/11→	CFGC	Diesel	1968	4	16	82
Q3 (8UB, 8UG)	06/11→	CFGD	Diesel	1968	4	16	82
Q3 (8UB, 8UG)	06/11→	CLLB	Diesel	1968	4	16	82
Q3 (8UB, 8UG)	06/11→	CPSA	Petrol	1984	4	16	81
Q3 (8UB, 8UG)	09/11→	CFFA	Diesel	1968	4	16	82
Q3 (8UB, 8UG)	09/11→	CFFB	Diesel	1968	4	16	82
Q3 (8UB, 8UG)	09/11→	CLJA	Diesel	1968	4	16	82
Q3 (8UB, 8UG)	05/13→	CZGA	Petrol	2480	5	20	101
Q3 (8UB, 8UG)	10/13→	CHPB	Petrol	1395	4	16	13
Q3 (8UB, 8UG)	10/13→	CTSA	Petrol	2480	5	20	101
Q3 (8UB, 8UG)	10/13→	CZDA	Petrol	1395	4	16	13
Q3 (8UB, 8UG)	10/13→	CZEA	Petrol	1395	4	16	14
Q3 (8UB, 8UG)	09/14→	CCTA	Petrol	1984	4	16	81
Q3 (8UB, 8UG)	11/14→	CULB	Petrol	1984	4	16	79
Q3 (8UB, 8UG)	11/14→	CULC	Petrol	1984	4	16	79
Q3 (8UB, 8UG)	11/14→	CUVC	Diesel	1968	4	16	84
Q3 (8UB, 8UG)	11/14→	CUWA	Diesel	1968	4	16	84
Q3 (8UB, 8UG)	11/14→	CYLA	Diesel	1968	4	16	84
Q3 (8UB, 8UG)	11/14→	DBBA	Diesel	1968	4	16	84
Q3 (8UB, 8UG)	11/14→	DFTA	Diesel	1968	4	16	84
Q3 (8UB, 8UG)	11/14→	DFUA	Diesel	1968	4	16	84
Q3 (8UB, 8UG)	01/15→	CZGB	Petrol	2480	5	20	101
Q3 (8UB, 8UG)	03/15→	CUVD	Diesel	1968	4	16	84
Q3 (8UB, 8UG)	03/15→	DFTC	Diesel	1968	4	16	84



CC



9

Q3 (8UB, 8UG)	07/16→	CZDB	Petrol	1395	4	16	13
Q3 Closed Off-Road Vehicle (8U)	04/14→	CSS	Petrol	1395	4	16	13
Q5 (8RB)	11/08→	CAEB	Petrol	1984	4	16	81
Q5 (8RB)	11/08→	CAHA	Diesel	1968	4	16	82
Q5 (8RB)	11/08→	CAHB	Diesel	1968	4	16	82
Q5 (8RB)	11/08→	CALB	Petrol	3197	6	24	119
Q5 (8RB)	11/08→	CCWA	Diesel	2967	6	24	115
Q5 (8RB)	11/08→	CCWB	Diesel	2967	6	24	115
Q5 (8RB)	11/08→	CDNC	Petrol	1984	4	16	81
Q5 (8RB)	11/08→	CGLA	Diesel	1968	4	16	82
Q5 (8RB)	11/08→	CGLB	Diesel	1968	4	16	82
Q5 (8RB)	11/08→	CGLD	Diesel	1968	4	16	82
Q5 (8RB)	11/08→	CMGA	Diesel	1968	4	16	82
Q5 (8RB)	11/08→	CNHC	Diesel	1968	4	16	84
Q5 (8RB)	11/08→	CPMA	Petrol	1984	4	16	81
Q5 (8RB)	11/08→	CPNB	Diesel	2967	6	24	118
Q5 (8RB)	08/09→	CAGA	Diesel	1968	4	16	82
Q5 (8RB)	08/09→	CAGB	Diesel	1968	4	16	82
Q5 (8RB)	08/09→	CDNB	Petrol	1984	4	16	81
Q5 (8RB)	08/09→	CJCA	Diesel	1968	4	16	82
Q5 (8RB)	08/09→	CJCB	Diesel	1968	4	16	82
Q5 (8RB)	08/09→	CNCB	Petrol	1984	4	16	79
Q5 (8RB)	08/09→	CSUB	Diesel	1968	4	16	84
Q5 (8RB)	06/11→	CHJA	Petrol	1984	4	16	81
Q5 (8RB)	06/12→	CDUD	Diesel	2967	6	24	118
Q5 (8RB)	06/12→	CGLC	Diesel	1968	4	16	82
Q5 (8RB)	06/12→	CMGB	Diesel	1968	4	16	82
Q5 (8RB)	06/12→	CNCD	Petrol	1984	4	16	79
Q5 (8RB)	06/12→	CTBC	Diesel	2967	6	24	118
Q5 (8RB)	06/12→	CTUC	Petrol	2995	6	24	117
Q5 (8RB)	06/12→	CTVA	Petrol	2995	6	24	117
Q5 (8RB)	12/12→	CGQB	Diesel	2967	6	24	118
Q5 (8RB)	12/12→	CVUC	Diesel	2967	6	24	118
Q5 (8RB)	05/13→	CJCD	Diesel	1968	4	16	82
Q5 (8RB)	05/13→	CPMB	Petrol	1984	4	16	81
Q5 (8RB)	05/13→	CSUA	Diesel	1968	4	16	84
Q5 (8RB)	05/13→	CTUD	Petrol	2995	6	24	117
Q5 (8RB)	05/13→	CTXA	Petrol	2995	6	24	117
Q5 (8RB)	11/13→	CNHA	Diesel	1968	4	16	84
Q5 (8RB)	11/13→	CTBA	Diesel	2967	6	24	118
Q5 (8RB)	04/15→	CVUB	Diesel	2967	6	24	118
Q5 (8RB)	08/15→	CNCE	Petrol	1984	4	16	79
Q5 (8RB)	11/15→	DEHA	Diesel	2967	6	24	118
Q5 (FYB)	06/16→	DAXB	Petrol	1984	4	16	79
Q5 (FYB)	06/16→	DAYB	Petrol	1984	4	16	79
Q5 (FYB)	06/16→	DESA	Diesel	1968	4	16	84
Q5 (FYB)	06/16→	DETA	Diesel	1968	4	16	84
Q5 (FYB)	06/16→	DETB	Diesel	1968	4	16	84
Q5 (FYB)	11/16→	CWGD	Petrol	2995	6	24	117
Q5 (FYB)	01/17→	DAXC	Petrol	1984	4	16	79
Q5 (FYB)	01/17→	DEUA	Diesel	1968	4	16	84
Q5 (FYB)	01/17→	DEUB	Diesel	1968	4	16	84
Q5 (FYB)	07/17→	DCPC	Diesel	2967	6	24	118
Q7 (4LB)	03/06→05/08	BUG	Diesel	2967	6	24	115
Q7 (4LB)	03/06→05/10	BUN	Diesel	2967	6	24	115
Q7 (4LB)	03/06→05/10	CASB	Diesel	2967	6	24	115
Q7 (4LB)	03/06→12/10	BAR	Petrol	4163	8	32	136
Q7 (4LB)	08/06→05/10	BHK	Petrol	3597	6	24	123
Q7 (4LB)	03/07→06/09	BTR	Diesel	4134	8	32	138
Q7 (4LB)	11/07→08/15	CASA	Diesel	2967	6	24	115
Q7 (4LB)	11/07→08/15	CCMA	Diesel	2967	6	24	115
Q7 (4LB)	11/07→08/15	CJGA	Diesel	2967	6	24	118
Q7 (4LB)	11/07→08/15	CNRB	Diesel	2967	6	24	118
Q7 (4LB)	09/08→05/14	CCGA	Diesel	5934	12	48	146
Q7 (4LB)	05/09→08/15	CCFA	Diesel	4134	8	32	139
Q7 (4LB)	05/09→08/15	CCFC	Diesel	4134	8	32	139
Q7 (4LB)	06/09→05/12	CATA	Diesel	2967	6	24	115
Q7 (4LB)	05/10→08/15	CJGC	Diesel	2967	6	24	118
Q7 (4LB)	05/10→08/15	CJMA	Diesel	2967	6	24	118
Q7 (4LB)	05/10→08/15	CJTB	Petrol	2995	6	24	117
Q7 (4LB)	05/10→08/15	CJTC	Petrol	2995	6	24	117
Q7 (4LB)	05/10→08/15	CJWB	Petrol	2995	6	24	117
Q7 (4LB)	05/10→08/15	CJWC	Petrol	2995	6	24	117
Q7 (4LB)	05/10→08/15	CNAA	Petrol	2995	6	24	117
Q7 (4LB)	05/10→08/15	CTWA	Petrol	2995	6	24	117
Q7 (4LB)	05/11→08/15	CJGD	Diesel	2967	6	24	118
Q7 (4LB)	05/11→08/15	CJWE	Petrol	2995	6	24	117
Q7 (4LB)	05/11→08/15	CLZB	Diesel	2967	6	24	118



Q7 (4LB)	05/11→08/15	CRCA	Diesel	2967	6	24	118
Q7 (4LB)	05/11→08/15	CTWB	Petrol	2995	6	24	117
Q7 (4MB)	01/15→	CREC	Petrol	2995	6	24	117
Q7 (4MB)	05/15→	CRTE	Diesel	2967	6	24	118
Q7 (4MB)	05/15→	CZZA	Diesel	2967	6	24	118
Q7 (4MB)	06/15→	CRTC	Diesel	2967	6	24	118
Q7 (4MB)	06/15→	CVMD	Diesel	2967	6	24	118
Q7 (4MB)	08/15→	CUEA	Diesel	2967	6	24	118
Q7 (4MB)	08/15→	CVZA	Diesel	2967	6	24	118
Q7 (4MB)	08/15→	CYRB	Petrol	1984	4	16	79
Q7 (4MB)	08/15→	CZZB	Diesel	2967	6	24	118
Q7 (4MB)	04/16→	CZAC	Diesel	3956	8	32	130
Quattro (85)	07/80→07/87	GV	Petrol	2144	5	10	89
Quattro (85)	07/80→07/87	WR	Petrol	2144	5	10	89
Quattro (85)	02/82→07/89	WX	Petrol	2144	5	10	89
Quattro (85)	05/84→07/87	KW	Petrol	2144	5	20	90
Quattro (85)	12/84→07/87	HY	Petrol	2226	5	10	91
Quattro (85)	12/84→07/87	JT	Petrol	2226	5	10	91
Quattro (85)	12/84→07/87	KV	Petrol	2226	5	10	91
Quattro (85)	08/87→07/89	MB	Petrol	2226	5	10	91
Quattro (85)	08/89→07/91	RR	Petrol	2226	5	20	92
R8 (4S3)	07/15→	CSPA	Petrol	5204	10	40	142
R8 (4S3)	07/15→	CSPB	Petrol	5204	10	40	143
R8 (422, 423)	04/07→09/10	BYH	Petrol	4163	8	32	136
R8 (422, 423)	04/09→07/15	BUJ	Petrol	5204	10	40	142
R8 (422, 423)	04/09→07/15	CTYA	Petrol	5204	10	40	142
R8 (422, 423)	07/10→07/15	CNDA	Petrol	4163	8	32	136
R8 (422, 423)	11/10→07/15	CMPA	Petrol	5204	10	40	142
R8 (422, 423)	05/12→07/15	CTPA	Petrol	5204	10	40	142
R8 (422, 423)	07/14→07/15	CTPB	Petrol	5204	10	40	142
R8 Spyder (4S9)	05/16→	CSPB	Petrol	5204	10	40	143
R8 Spyder (4S9)	05/17→	CSPA	Petrol	5204	10	40	142
R8 Spyder (427, 429)	02/10→07/15	BUJ	Petrol	5204	10	40	142
R8 Spyder (427, 429)	02/10→07/15	CTYA	Petrol	5204	10	40	142
R8 Spyder (427, 429)	09/10→07/15	CNDA	Petrol	4163	8	32	136
R8 Spyder (427, 429)	11/11→07/15	CMPA	Petrol	5204	10	40	142
Super 90	09/66→08/71	21	Petrol	1770	4	8	36
Super 90	09/66→08/71	8921	Petrol	1770	4	8	36
TT (8J3)	08/06→06/10	BPY	Petrol	1984	4	16	75
TT (8J3)	08/06→06/10	BUB	Petrol	3189	6	24	121
TT (8J3)	08/06→06/10	BWA	Petrol	1984	4	16	75
TT (8J3)	08/06→06/10	CCTA	Petrol	1984	4	16	81
TT (8J3)	05/08→06/14	CDLA	Petrol	1984	4	16	75
TT (8J3)	05/08→06/14	CDLB	Petrol	1984	4	16	75
TT (8J3)	05/08→06/14	CDMA	Petrol	1984	4	16	75
TT (8J3)	06/08→06/10	CCZA	Petrol	1984	4	16	81
TT (8J3)	06/08→06/14	CBBB	Diesel	1968	4	16	82
TT (8J3)	06/08→06/14	CDA A	Petrol	1798	4	16	50
TT (8J3)	06/08→06/14	CFGB	Diesel	1968	4	16	82
TT (8J3)	07/09→06/14	CEPA	Petrol	2480	5	20	101
TT (8J3)	05/10→06/14	CESA	Petrol	1984	4	16	81
TT (8J3)	05/10→06/14	CETA	Petrol	1984	4	16	81
TT (8J3)	05/11→06/14	CEPB	Petrol	2480	5	20	101
TT (8N3)	10/98→06/06	AJQ	Petrol	1781	4	20	43
TT (8N3)	10/98→06/06	APP	Petrol	1781	4	20	44
TT (8N3)	10/98→06/06	APX	Petrol	1781	4	20	44
TT (8N3)	10/98→06/06	ARY	Petrol	1781	4	20	43
TT (8N3)	10/98→06/06	ATC	Petrol	1781	4	20	44
TT (8N3)	10/98→06/06	AUQ	Petrol	1781	4	20	44
TT (8N3)	10/98→06/06	BAM	Petrol	1781	4	20	44
TT (8N3)	09/99→06/06	AMU	Petrol	1781	4	20	44
TT (8N3)	09/99→06/06	BEA	Petrol	1781	4	20	44
TT (8N3)	09/02→06/06	AUM	Petrol	1781	4	20	44
TT (8N3)	07/03→06/06	BHE	Petrol	3189	6	24	121
TT (8N3)	07/03→06/06	BPF	Petrol	3189	6	24	121
TT (8N3)	03/05→06/06	BFV	Petrol	1781	4	20	44
TT (8N3)	09/05→06/06	BVP	Petrol	1781	4	20	44
TT (8N3)	09/05→06/06	BVR	Petrol	1781	4	20	44
TT (FV3)	07/14→	CHHC	Petrol	1984	4	16	79
TT (FV3)	07/14→	CUNA	Diesel	1968	4	16	84
TT (FV3)	11/14→	CJXG	Petrol	1984	4	16	79
TT (FV3)	02/15→	CJXF	Petrol	1984	4	16	79
TT (FV3)	04/15→	CNTC	Petrol	1984	4	16	79
TT (FV3)	07/15→	CYFB	Petrol	1984	4	16	79
TT (FV3)	08/15→	CJSA	Petrol	1798	4	16	51
TT (FV3)	08/15→	CJSB	Petrol	1798	4	16	51
TT (FV3)	10/16→	DAZA	Petrol	2480	5	20	101
TT Roadster (8J9)	03/07→06/10	BPY	Petrol	1984	4	16	75



















CC



















9









TT Roadster (8J9)	03/07→06/10	BUB	Petrol	3189	6	24	121
TT Roadster (8J9)	03/07→06/10	BWA	Petrol	1984	4	16	75
TT Roadster (8J9)	03/07→06/10	CCTA	Petrol	1984	4	16	81
TT Roadster (8J9)	05/08→06/14	CDLA	Petrol	1984	4	16	75
TT Roadster (8J9)	05/08→06/14	CDLB	Petrol	1984	4	16	75
TT Roadster (8J9)	05/08→06/14	CDMA	Petrol	1984	4	16	75
TT Roadster (8J9)	06/08→06/10	CCZA	Petrol	1984	4	16	81
TT Roadster (8J9)	06/08→06/14	CBBB	Diesel	1968	4	16	82
TT Roadster (8J9)	06/08→06/14	CDA A	Petrol	1798	4	16	50
TT Roadster (8J9)	06/08→06/14	CFG B	Diesel	1968	4	16	82
TT Roadster (8J9)	07/09→06/14	CEPA	Petrol	2480	5	20	101
TT Roadster (8J9)	05/10→06/14	CESA	Petrol	1984	4	16	81
TT Roadster (8J9)	05/10→06/14	CETA	Petrol	1984	4	16	81
TT Roadster (8J9)	03/12→06/14	CEPB	Petrol	2480	5	20	101
TT Roadster (8N9)	10/99→08/02	AWP	Petrol	1781	4	20	44
TT Roadster (8N9)	10/99→06/06	AJQ	Petrol	1781	4	20	43
TT Roadster (8N9)	10/99→06/06	APP	Petrol	1781	4	20	44
TT Roadster (8N9)	10/99→06/06	APX	Petrol	1781	4	20	44
TT Roadster (8N9)	10/99→06/06	ATC	Petrol	1781	4	20	44
TT Roadster (8N9)	10/99→06/06	AUQ	Petrol	1781	4	20	44
TT Roadster (8N9)	10/99→06/06	BAM	Petrol	1781	4	20	44
TT Roadster (8N9)	02/00→06/06	ARY	Petrol	1781	4	20	43
TT Roadster (8N9)	09/00→06/06	AMU	Petrol	1781	4	20	44
TT Roadster (8N9)	09/00→06/06	BEA	Petrol	1781	4	20	44
TT Roadster (8N9)	01/01→06/06	AUM	Petrol	1781	4	20	44
TT Roadster (8N9)	07/03→06/06	BHE	Petrol	3189	6	24	121
TT Roadster (8N9)	07/03→06/06	BPF	Petrol	3189	6	24	121
TT Roadster (8N9)	09/05→06/06	BVP	Petrol	1781	4	20	44
TT Roadster (8N9)	09/05→06/06	BVR	Petrol	1781	4	20	44
TT Roadster (FV9)	11/14→	CHHC	Petrol	1984	4	16	79
TT Roadster (FV9)	11/14→	CJXG	Petrol	1984	4	16	79
TT Roadster (FV9)	11/14→	CUNA	Diesel	1968	4	16	84
TT Roadster (FV9)	02/15→	CJXF	Petrol	1984	4	16	79
TT Roadster (FV9)	04/15→	CNTC	Petrol	1984	4	16	79
TT Roadster (FV9)	08/15→	CJSA	Petrol	1798	4	16	51
TT Roadster (FV9)	08/15→	CJSB	Petrol	1798	4	16	51
TT Roadster (FV9)	10/16→	DAZA	Petrol	2480	5	20	101
V8 (441, 442, 4C2, 4C8)	10/88→02/94	PT	Petrol	3562	8	32	124
V8 (441, 442, 4C2, 4C8)	10/91→02/94	ABH	Petrol	4172	8	32	131









	CC				9		CC				9
1B	2226	5	10	Petrol	91	AKC	3697	8	40	Petrol	126
1T	2461	5	10	Diesel	99	AKE	2496	6	24	Diesel	100
1Y	1896	4	8	Diesel	53	AKF	3328	8	40	Diesel	122
1Z	1896	4	8	Diesel	54	AKG	4172	8	32	Petrol	132
2B	2226	5	10	Petrol	91	AKH	4172	8	32	Petrol	132
3A	1984	4	8	Petrol	67	AKJ	3697	8	32	Petrol	127
3B	2226	5	20	Petrol	92	AKL	1595	4	8	Petrol	21
3D	2370	5	10	Diesel	95	AKN	2496	6	24	Diesel	100
4B	1781	4	8	Petrol	35	ALF	2393	6	30	Petrol	97
6A	1984	4	16	Petrol	68	ALG	2771	6	30	Petrol	112
7A	2309	5	20	Petrol	93	ALH	1896	4	8	Diesel	59
10	1496	4	8	Petrol	16	ALT	1984	4	20	Petrol	72
21	1770	4	8	Petrol	36	ALW	2393	6	30	Petrol	97
8910	1496	4	8	Petrol	16	ALZ	1595	4	8	Petrol	23
8920	1695	4	8	Petrol	33	AMB	1781	4	20	Petrol	44
8921	1770	4	8	Petrol	36	AMF	1422	3	6	Diesel	10
AAD	1984	4	8	Petrol	69	AMK	1781	4	20	Petrol	44
AAE	1984	4	8	Petrol	70	AML	2393	6	30	Petrol	97
AAH	2771	6	12	Petrol	108	AMM	2393	6	30	Petrol	97
AAN	2226	5	20	Petrol	92	AMU	1781	4	20	Petrol	44
AAR	2309	5	10	Petrol	94	AMX	2771	6	30	Petrol	111
AAS	2370	5	10	Diesel	95	AMX	2771	6	30	Petrol	112
AAT	2461	5	10	Diesel	99	ANA	1595	4	8	Petrol	21
AAZ	1896	4	8	Diesel	55	ANB	1781	4	20	Petrol	45
ABB	1595	4	8	Petrol	18	ANK	4172	8	40	Petrol	133
ABC	2598	6	12	Petrol	103	ANQ	1781	4	20	Petrol	46
ABH	4172	8	32	Petrol	131	ANQ	1781	4	20	Petrol	46
ABK	1984	4	8	Petrol	69	ANU	1896	4	8	Diesel	63
ABM	1595	4	8	Petrol	18	ANY	1191	3	6	Diesel	3
ABP	2461	5	10	Diesel	99	APB	2671	6	30	Petrol	104
ABT	1984	4	8	Petrol	71	APC	2393	6	30	Petrol	97
ABY	2226	5	20	Petrol	92	APF	1595	4	8	Petrol	21
ABZ	4172	8	32	Petrol	132	APG	1781	4	20	Petrol	44
ACE	1984	4	16	Petrol	68	APP	1781	4	20	Petrol	44
ACK	2771	6	30	Petrol	109	APR	2771	6	30	Petrol	112
ACZ	2598	6	12	Petrol	103	APS	2393	6	30	Petrol	97
ADA	1595	4	8	Petrol	19	APS	2393	6	30	Petrol	97
ADE	1896	4	8	Diesel	56	APT	1781	4	20	Petrol	45
ADP	1595	4	8	Petrol	20	APU	1781	4	20	Petrol	45
ADR	1781	4	20	Petrol	37	APX	1781	4	20	Petrol	44
ADR	1781	4	20	Petrol	37	APY	1781	4	20	Petrol	47
ADU	2226	5	20	Petrol	92	APZ	2393	6	30	Petrol	97
ADW	1984	4	8	Petrol	69	AQA	1781	4	20	Petrol	44
AEB	1781	4	20	Petrol	37	AQD	2771	6	30	Petrol	112
AEC	4172	8	32	Petrol	132	AQE	1781	4	20	Petrol	42
AEH	1595	4	8	Petrol	21	AQF	4172	8	40	Petrol	133
AEJ	2771	6	12	Petrol	108	AQG	3697	8	40	Petrol	126
AEL	2461	5	10	Diesel	99	AQH	4172	8	40	Petrol	133
AEM	4172	8	32	Petrol	132	AQJ	4172	8	40	Petrol	133
AEW	3697	8	32	Petrol	125	ARE	2671	6	30	Petrol	104
AFB	2496	6	24	Diesel	100	ARG	1781	4	20	Petrol	45
AFC	2771	6	12	Petrol	110	ARH	1781	4	20	Petrol	42
AFC	2771	6	12	Petrol	110	ARJ	2393	6	30	Petrol	97
AFF	1896	4	8	Diesel	57	ARK	1781	4	20	Petrol	45
AFM	2393	6	12	Petrol	96	ARM	1595	4	8	Petrol	21
AFN	1896	4	8	Diesel	57	ARN	2393	6	30	Petrol	97
AFY	1781	4	20	Petrol	38	ARS	4172	8	40	Petrol	133
AGA	2393	6	30	Petrol	97	ARU	4172	8	32	Petrol	134
AGB	2671	6	30	Petrol	104	ARX	1781	4	20	Petrol	44
AGE	2771	6	30	Petrol	111	ARY	1781	4	20	Petrol	43
AGH	4172	8	32	Petrol	132	ARZ	1781	4	20	Petrol	44
AGH	4172	8	32	Petrol	132	ASB	2967	6	24	Diesel	115
AGN	1781	4	20	Petrol	39	ASE	3936	8	32	Diesel	128
AGR	1896	4	8	Diesel	58	ASG	4172	8	40	Petrol	133
AGU	1781	4	20	Petrol	40	ASJ	2671	6	30	Petrol	105
AHA	2771	6	30	Petrol	111	ASM	2393	6	30	Petrol	97
AHC	4172	8	32	Petrol	132	ASN	2976	6	30	Petrol	116
AHF	1896	4	8	Diesel	59	ASV	1896	4	8	Diesel	58
AHH	1896	4	8	Diesel	60	ASZ	1896	4	8	Diesel	63
AHK	4172	8	32	Petrol	132	ATC	1781	4	20	Petrol	44
AHL	1595	4	8	Petrol	22	ATD	1896	4	8	Diesel	63
AHU	1896	4	8	Diesel	61	ATJ	1896	4	8	Diesel	63
AJG	2393	6	30	Petrol	97	ATL	1422	3	6	Diesel	10
AJK	2671	6	30	Petrol	104	ATX	2771	6	30	Petrol	111
AJL	1781	4	20	Petrol	41	ATX	2771	6	30	Petrol	113
AJM	1896	4	8	Diesel	62	AUA	1390	4	16	Petrol	11
AJP	1781	4	20	Petrol	42	AUK	3123	6	24	Petrol	119
AJQ	1781	4	20	Petrol	43	AUL	1781	4	20	Petrol	44

	CC				9		CC				9
AUM	1781	4	20	Petrol	44	BJZ	1984	4	16	Petrol	77
AUQ	1781	4	20	Petrol	44	BKB	1781	4	20	Petrol	44
AUW	4172	8	40	Petrol	133	BKB	1781	4	20	Petrol	44
AUX	4172	8	40	Petrol	135	BKC	1896	4	8	Diesel	64
AVB	1896	4	8	Diesel	63	BKD	1968	4	16	Diesel	76
AVF	1896	4	8	Diesel	63	BKE	1896	4	8	Diesel	63
AVG	1896	4	8	Diesel	60	BKH	3123	6	24	Petrol	119
AVJ	1781	4	20	Petrol	44	BKN	2967	6	24	Diesel	115
AVK	2976	6	30	Petrol	116	BLB	1968	4	16	Diesel	76
AVP	4172	8	40	Petrol	133	BLF	1598	4	16	Petrol	25
AVU	1595	4	8	Petrol	23	BLP	1598	4	16	Petrol	25
AVV	1781	4	20	Petrol	45	BLR	1984	4	16	Petrol	73
AWA	1984	4	16	Petrol	73	BLS	1896	4	8	Diesel	64
AWL	1781	4	20	Petrol	44	BLX	1984	4	16	Petrol	73
AWL	1781	4	20	Petrol	48	BLY	1984	4	16	Petrol	73
AWM	1781	4	20	Petrol	44	BMB	1984	4	16	Petrol	73
AWN	4172	8	40	Petrol	135	BMC	4134	8	32	Diesel	138
AWP	1781	4	20	Petrol	44	BMJ	3189	6	24	Petrol	121
AWT	1781	4	20	Petrol	44	BMK	2967	6	24	Diesel	115
AWX	1896	4	8	Diesel	63	BMM	1968	4	8	Diesel	78
AXA	1984	4	8	Petrol	74	BMN	1968	4	16	Diesel	76
AXR	1896	4	8	Diesel	63	BNA	1968	4	16	Diesel	76
AXW	1984	4	16	Petrol	73	BND	2496	6	24	Diesel	100
AXX	1984	4	16	Petrol	75	BND	2496	6	24	Diesel	100
AYM	2496	6	24	Diesel	100	BNG	2967	6	24	Diesel	115
AYS	4172	8	40	Petrol	133	BNS	4163	8	32	Petrol	136
AZA	2671	6	30	Petrol	104	BPF	3189	6	24	Petrol	121
AZB	2671	6	30	Petrol	104	BPG	1984	4	16	Petrol	75
AZC	5998	12	48	Petrol	144	BPJ	1984	4	16	Petrol	75
AZR	2671	6	30	Petrol	105	BPJ	1984	4	16	Petrol	79
AZV	1968	4	16	Diesel	76	BPK	3123	6	24	Petrol	119
BAD	1598	4	16	Petrol	24	BPP	2698	6	24	Diesel	106
BAG	1598	4	16	Petrol	25	BPU	1781	4	20	Petrol	49
BAH	1598	4	8	Petrol	26	BPW	1968	4	8	Diesel	80
BAM	1781	4	20	Petrol	44	BPY	1984	4	16	Petrol	75
BAR	4163	8	32	Petrol	136	BRB	1896	4	8	Diesel	63
BAS	4163	8	40	Petrol	137	BRC	1968	4	8	Diesel	80
BAT	4163	8	40	Petrol	137	BRD	1968	4	16	Diesel	76
BAU	2496	6	24	Diesel	100	BRE	1968	4	16	Diesel	76
BAU	2496	6	24	Diesel	100	BRF	1968	4	16	Diesel	76
BBB	4172	8	40	Petrol	133	BRV	4172	8	40	Petrol	133
BBG	2771	6	30	Petrol	111	BRV	1595	4	8	Petrol	23
BBG	2771	6	30	Petrol	111	BSB	5998	12	48	Petrol	145
BBJ	2976	6	30	Petrol	116	BSE	1595	4	8	Petrol	23
BBJ	2976	6	30	Petrol	116	BSF	1595	4	8	Petrol	23
BBK	4163	8	40	Petrol	137	BSG	2698	6	24	Diesel	106
BBY	1390	4	16	Petrol	11	BSM	5204	10	40	Petrol	142
BCS	4172	8	40	Petrol	135	BTE	5998	12	48	Petrol	145
BCY	4172	8	40	Petrol	133	BTE	5998	12	48	Petrol	145
BCZ	2496	6	24	Diesel	100	BTR	4134	8	32	Diesel	138
BDB	3189	6	24	Petrol	120	BUB	3189	6	24	Petrol	121
BDG	2496	6	24	Diesel	100	BUG	2967	6	24	Diesel	115
BDH	2496	6	24	Diesel	100	BUH	4991	10	40	Petrol	141
BDV	2393	6	30	Petrol	97	BUJ	5204	10	40	Petrol	142
BDV	2393	6	30	Petrol	97	BUL	1984	4	16	Petrol	75
BDW	2393	6	24	Petrol	98	BUN	2967	6	24	Diesel	115
BDW	2393	6	24	Petrol	98	BUY	1968	4	16	Diesel	76
BDX	2773	6	24	Petrol	114	BVA	1968	4	16	Diesel	76
BEA	1781	4	20	Petrol	44	BVF	1968	4	16	Diesel	76
BEL	2671	6	30	Petrol	104	BVG	1968	4	16	Diesel	76
BES	2671	6	30	Petrol	104	BVJ	4163	8	32	Petrol	136
BEX	1781	4	20	Petrol	44	BVN	4134	8	32	Diesel	138
BFB	1781	4	20	Petrol	44	BVP	1781	4	20	Petrol	44
BFB	1781	4	20	Petrol	44	BVR	1781	4	20	Petrol	44
BFC	2496	6	24	Diesel	100	BVY	1984	4	16	Petrol	73
BFL	3697	8	40	Petrol	126	BVZ	1984	4	16	Petrol	73
BFM	4172	8	40	Petrol	133	BWA	1984	4	16	Petrol	75
BFQ	1595	4	8	Petrol	23	BWE	1984	4	16	Petrol	75
BFV	1781	4	20	Petrol	44	BWE	1984	4	16	Petrol	75
BGB	1984	4	16	Petrol	75	BWT	1984	4	16	Petrol	75
BGB	1984	4	16	Petrol	75	BXA	5204	10	40	Petrol	142
BGU	1595	4	8	Petrol	23	BXE	1896	4	8	Diesel	64
BHC	1422	3	6	Diesel	10	BYH	4163	8	32	Petrol	136
BHE	3189	6	24	Petrol	121	BYK	1984	4	16	Petrol	75
BHF	4163	8	40	Petrol	137	BYT	1798	4	16	Petrol	50
BHK	3597	6	24	Petrol	123	BYU	3123	6	24	Petrol	119
BHT	5998	12	48	Petrol	145	BZB	1798	4	16	Petrol	50
BHZ	1984	4	16	Petrol	75	BZC	1984	4	16	Petrol	75

	CC				9		CC				9
CABA	1798	4	16	Petrol	50	CDTC	2967	6	24	Diesel	118
CABB	1798	4	16	Petrol	50	CDUC	2967	6	24	Diesel	118
CABD	1798	4	16	Petrol	50	CDUD	2967	6	24	Diesel	118
CADA	1984	4	16	Petrol	81	CDYA	2967	6	24	Diesel	115
CADA	1984	4	16	Petrol	81	CDYB	2967	6	24	Diesel	115
CAEA	1984	4	16	Petrol	81	CDYC	2967	6	24	Diesel	115
CAEB	1984	4	16	Petrol	81	CDZA	1984	4	16	Petrol	81
CAEB	1984	4	16	Petrol	81	CDZA	1984	4	16	Petrol	81
CAED	1984	4	16	Petrol	81	CEJA	6299	12	48	Petrol	147
CAGA	1968	4	16	Diesel	82	CEPA	2480	5	20	Petrol	101
CAGB	1968	4	16	Diesel	82	CEPB	2480	5	20	Petrol	101
CAGC	1968	4	16	Diesel	82	CESA	1984	4	16	Petrol	81
CAHA	1968	4	16	Diesel	82	CETA	1984	4	16	Petrol	81
CAHB	1968	4	16	Diesel	82	CEUA	3993	8	32	Petrol	129
CAJA	2995	6	24	Petrol	117	CEUC	3993	8	32	Petrol	129
CAJA	2995	6	24	Petrol	117	CFFA	1968	4	16	Diesel	82
CAKA	2995	6	24	Petrol	117	CFFB	1968	4	16	Diesel	82
CALA	3197	6	24	Petrol	119	CFGB	1968	4	16	Diesel	82
CALA	3197	6	24	Petrol	119	CFGC	1968	4	16	Diesel	82
CALB	3197	6	24	Petrol	119	CFGD	1968	4	16	Diesel	82
CAMA	2698	6	24	Diesel	106	CFHB	1968	4	16	Diesel	82
CAMB	2698	6	24	Diesel	106	CFHD	1968	4	16	Diesel	82
CANA	2698	6	24	Diesel	106	CFKA	1984	4	16	Petrol	81
CANA	2698	6	24	Diesel	107	CFSA	4163	8	32	Petrol	136
CANB	2698	6	24	Diesel	106	CGKA	2698	6	24	Diesel	106
CANC	2698	6	24	Diesel	106	CGKB	2698	6	24	Diesel	106
CAND	2698	6	24	Diesel	106	CGLA	1968	4	16	Diesel	82
CAPA	2967	6	24	Diesel	115	CGLB	1968	4	16	Diesel	82
CASA	2967	6	24	Diesel	115	CGLC	1968	4	16	Diesel	82
CASB	2967	6	24	Diesel	115	CGLD	1968	4	16	Diesel	82
CATA	2967	6	24	Diesel	115	CGLE	1968	4	16	Diesel	82
CAUA	4163	8	32	Petrol	136	CGMA	1984	4	16	Petrol	81
CAVG	1390	4	16	Petrol	12	CGQB	2967	6	24	Diesel	118
CAWB	1984	4	16	Petrol	81	CGTA	3993	8	32	Petrol	129
CAXA	1390	4	16	Petrol	12	CGWA	2995	6	24	Petrol	117
CAXC	1390	4	16	Petrol	12	CGWB	2995	6	24	Petrol	117
CAYB	1598	4	16	Diesel	27	CGWC	2995	6	24	Petrol	117
CAYC	1598	4	16	Diesel	27	CGWD	2995	6	24	Petrol	117
CBA A	1968	4	16	Diesel	82	CGXA	2995	6	24	Petrol	117
CBAB	1968	4	16	Diesel	82	CGXB	2995	6	24	Petrol	117
CBBB	1968	4	16	Diesel	82	CGXC	2995	6	24	Petrol	117
CBFA	1984	4	16	Petrol	81	CHHB	1984	4	16	Petrol	79
CBZA	1197	4	8	Petrol	4	CHHC	1984	4	16	Petrol	79
CBZB	1197	4	8	Petrol	5	CHJA	1984	4	16	Petrol	81
CCAA	2995	6	24	Petrol	117	CHMA	2995	6	24	Petrol	117
CCBA	2995	6	24	Petrol	117	CHPB	1395	4	16	Petrol	13
CCDA	2773	6	24	Petrol	114	CHVA	2773	6	24	Petrol	114
CCEA	2773	6	24	Petrol	114	CHZB	999	3	12	Petrol	1
CCEA	2773	6	24	Petrol	114	CHZD	999	3	12	Petrol	1
CCFA	4134	8	32	Diesel	139	CHZE	999	3	12	Petrol	1
CCFC	4134	8	32	Diesel	139	CHZJ	999	3	12	Petrol	1
CCGA	5934	12	48	Diesel	146	CJBA	2773	6	24	Petrol	114
CCLA	2967	6	24	Diesel	115	CJCA	1968	4	16	Diesel	82
CCMA	2967	6	24	Diesel	115	CJCB	1968	4	16	Diesel	82
CCSA	1595	4	8	Petrol	23	CJCC	1968	4	16	Diesel	82
CCTA	1984	4	16	Petrol	81	CJCD	1968	4	16	Diesel	82
CCUA	1798	4	16	Petrol	50	CJEB	1798	4	16	Petrol	51
CCUA	1798	4	16	Petrol	50	CJED	1798	4	16	Petrol	51
CCWA	2967	6	24	Diesel	115	CJEE	1798	4	16	Petrol	51
CCWB	2967	6	24	Diesel	115	CJGA	2967	6	24	Diesel	118
CCZA	1984	4	16	Petrol	81	CJGC	2967	6	24	Diesel	118
CCZC	1984	4	16	Petrol	81	CJGD	2967	6	24	Diesel	118
CDAA	1798	4	16	Petrol	50	CJMA	2967	6	24	Diesel	118
CDHA	1798	4	16	Petrol	50	CJSA	1798	4	16	Petrol	51
CDHB	1798	4	16	Petrol	50	CJSB	1798	4	16	Petrol	51
CDLA	1984	4	16	Petrol	75	CJTB	2995	6	24	Petrol	117
CDLB	1984	4	16	Petrol	75	CJTC	2995	6	24	Petrol	117
CDLC	1984	4	16	Petrol	75	CJWB	2995	6	24	Petrol	117
CDLH	1984	4	16	Petrol	75	CJWC	2995	6	24	Petrol	117
CDMA	1984	4	16	Petrol	75	CJWE	2995	6	24	Petrol	117
CDNA	1984	4	16	Petrol	81	CJXB	1984	4	16	Petrol	79
CDNB	1984	4	16	Petrol	81	CJXC	1984	4	16	Petrol	79
CDNC	1984	4	16	Petrol	81	CJXD	1984	4	16	Petrol	79
CDNC	1984	4	16	Petrol	81	CJXF	1984	4	16	Petrol	79
CDRA	4163	8	32	Petrol	136	CJXG	1984	4	16	Petrol	79
CDSB	4134	8	32	Diesel	139	CJZA	1197	4	16	Petrol	6
CDTA	2967	6	24	Diesel	118	CJZB	1197	4	16	Petrol	6
CDTB	2967	6	24	Diesel	118	CKVB	2967	6	24	Diesel	118

	CC				9		CC				9
CKVC	2967	6	24	Diesel	118	CTBB	2967	6	24	Diesel	118
CKVD	2967	6	24	Diesel	118	CTBC	2967	6	24	Diesel	118
CLAA	2967	6	24	Diesel	118	CTBD	2967	6	24	Diesel	118
CLAB	2967	6	24	Diesel	118	CTCB	2967	6	24	Diesel	118
CLHA	1598	4	16	Diesel	28	CTCC	2967	6	24	Diesel	118
CLJA	1968	4	16	Diesel	82	CTDA	2995	6	24	Petrol	117
CLLB	1968	4	16	Diesel	82	CTEC	4134	8	32	Diesel	140
CLXA	2498	6	24	Petrol	102	CTFA	3993	8	32	Petrol	129
CLXB	2498	6	24	Petrol	102	CTGA	3993	8	32	Petrol	129
CLZB	2967	6	24	Diesel	118	CTGF	3993	8	32	Petrol	129
CMBA	1395	4	16	Petrol	13	CTGG	3993	8	32	Petrol	129
CMDA	2995	6	24	Petrol	117	CTHG	1390	4	16	Petrol	12
CMEA	1968	4	16	Diesel	82	CTJA	1390	4	16	Petrol	12
CMFA	1968	4	16	Diesel	82	CTNA	6299	12	48	Petrol	147
CMFB	1968	4	16	Diesel	82	CTPA	5204	10	40	Petrol	142
CMGA	1968	4	16	Diesel	82	CTPB	5204	10	40	Petrol	142
CMGB	1968	4	16	Diesel	82	CTSA	2480	5	20	Petrol	101
CMHA	2967	6	24	Diesel	118	CTTA	2995	6	24	Petrol	117
CMPA	5204	10	40	Petrol	142	CTUA	2995	6	24	Petrol	117
CMSA	1390	4	16	Petrol	12	CTUB	2995	6	24	Petrol	117
CMUA	2995	6	24	Petrol	117	CTUC	2995	6	24	Petrol	117
CMXA	1595	4	8	Petrol	23	CTUD	2995	6	24	Petrol	117
CN	1986	5	10	Diesel	83	CTVA	2995	6	24	Petrol	117
CNA	2995	6	24	Petrol	117	CTWA	2995	6	24	Petrol	117
CNCB	1984	4	16	Petrol	79	CTWB	2995	6	24	Petrol	117
CNCD	1984	4	16	Petrol	79	CTXA	2995	6	24	Petrol	117
CNCE	1984	4	16	Petrol	79	CTYA	5204	10	40	Petrol	142
CNDA	4163	8	32	Petrol	136	CUCA	1598	4	16	Gas	30
CNHA	1968	4	16	Diesel	84	CUEA	2967	6	24	Diesel	118
CNHC	1968	4	16	Diesel	84	CUKB	1395	4	16	Petrol	13
CNRB	2967	6	24	Diesel	118	CULB	1984	4	16	Petrol	79
CNSB	1798	4	16	Petrol	50	CULC	1984	4	16	Petrol	79
CNTC	1984	4	16	Petrol	79	CUNA	1968	4	16	Diesel	84
CNUA	1390	4	16	Petrol	12	CUPA	1968	4	16	Diesel	84
CNVA	1390	4	16	Petrol	12	CUSB	1422	3	12	Diesel	15
CNYA	2773	6	24	Petrol	114	CUVB	1968	4	16	Diesel	84
CNYB	2773	6	24	Petrol	114	CUVC	1968	4	16	Diesel	84
CPAA	2498	6	24	Petrol	102	CUVD	1968	4	16	Diesel	84
CPMA	1984	4	16	Petrol	81	CUWA	1968	4	16	Diesel	84
CPMB	1984	4	16	Petrol	81	CVBA	2498	6	24	Petrol	102
CPNA	2967	6	24	Diesel	118	CVKB	1984	4	16	Petrol	79
CPNB	2967	6	24	Diesel	118	CVLA	1984	4	16	Petrol	79
CPSA	1984	4	16	Petrol	81	CVMD	2967	6	24	Diesel	118
CPTA	1395	4	16	Petrol	14	CVNA	1395	4	16	Petrol	13
CPWA	1395	4	16	Petrol	13	CVPA	2773	6	24	Petrol	114
CR	1588	4	8	Diesel	29	CVUA	2967	6	24	Diesel	118
CRBC	1968	4	16	Diesel	84	CVUB	2967	6	24	Diesel	118
CRBD	1968	4	16	Diesel	84	CVUC	2967	6	24	Diesel	118
CRCA	2967	6	24	Diesel	118	CVZA	2967	6	24	Diesel	118
CRDB	3993	8	32	Petrol	129	CWGD	2995	6	24	Petrol	117
CREA	2995	6	24	Petrol	117	CWUB	3993	8	32	Petrol	129
CREC	2995	6	24	Petrol	117	CWUC	3993	8	32	Petrol	129
CRED	2995	6	24	Petrol	117	CWZA	1984	4	16	Petrol	79
CREG	2995	6	24	Petrol	117	CXMA	1598	4	16	Diesel	28
CREH	2995	6	24	Petrol	117	CXSA	1395	4	16	Petrol	13
CRFA	1968	4	16	Diesel	84	CXSB	1395	4	16	Petrol	13
CRFC	1968	4	16	Diesel	84	CXUA	1395	4	16	Petrol	13
CRHA	1984	4	16	Petrol	81	CXXB	1598	4	16	Diesel	28
CRHA	1984	4	16	Petrol	81	CY	1588	4	8	Diesel	29
CRKB	1598	4	16	Diesel	28	CYFB	1984	4	16	Petrol	79
CRLB	1968	4	16	Diesel	84	CYGA	1798	4	16	Petrol	51
CRLC	1968	4	16	Diesel	84	CYLA	1968	4	16	Diesel	84
CRTC	2967	6	24	Diesel	118	CYMC	1984	4	16	Petrol	79
CRTD	2967	6	24	Diesel	118	CYNB	1984	4	16	Petrol	79
CRTE	2967	6	24	Diesel	118	CYPA	1984	4	16	Petrol	79
CRTF	2967	6	24	Diesel	118	CYPB	1984	4	16	Petrol	79
CRUA	1968	4	16	Diesel	84	CYRB	1984	4	16	Petrol	79
CSPA	5204	10	40	Petrol	142	CYRC	1984	4	16	Petrol	79
CSPB	5204	10	40	Petrol	143	CYVB	1197	4	16	Petrol	6
CSS	1395	4	16	Petrol	13	CZAC	3956	8	32	Diesel	130
CSSA	1395	4	16	Petrol	13	CZCA	1395	4	16	Petrol	13
CSUA	1968	4	16	Diesel	84	CZCC	1395	4	16	Petrol	13
CSUB	1968	4	16	Diesel	84	CZDA	1395	4	16	Petrol	13
CSUD	1968	4	16	Diesel	84	CZDB	1395	4	16	Petrol	13
CSUE	1968	4	16	Diesel	84	CZEA	1395	4	16	Petrol	14
CSWB	2967	6	24	Diesel	118	CZGA	2480	5	20	Petrol	101
CTBA	2967	6	24	Diesel	118	CZGB	2480	5	20	Petrol	101
						CZHA	1968	4	16	Diesel	84

	CC				9		CC				9
CZJA	1968	4	16	Diesel	84	KG	2144	5	10	Petrol	89
CZPB	1984	4	16	Petrol	79	KH	2144	5	10	Petrol	91
CZVA	2967	6	24	Diesel	118	KJ	2144	5	10	Petrol	89
CZVB	2967	6	24	Diesel	118	KK	2144	5	10	Petrol	91
CZVC	2967	6	24	Diesel	118	KL	2144	5	10	Petrol	91
CZVD	2967	6	24	Diesel	118	KP	1994	5	10	Petrol	85
CZVE	2967	6	24	Diesel	118	KU	2226	5	10	Petrol	91
CZVF	2967	6	24	Diesel	118	KV	2226	5	10	Petrol	91
CZZA	2967	6	24	Diesel	118	KW	2144	5	20	Petrol	90
CZZB	2967	6	24	Diesel	118	KX	2226	5	10	Petrol	91
DAJB	1798	4	16	Petrol	50	KZ	2226	5	10	Petrol	91
DAXB	1984	4	16	Petrol	79	MB	2226	5	10	Petrol	91
DAXC	1984	4	16	Petrol	79	MC	2226	5	10	Petrol	91
DAYB	1984	4	16	Petrol	79	MC	2226	5	10	Petrol	91
DAZA	2480	5	20	Petrol	101	MU	1781	4	8	Petrol	35
DBBA	1968	4	16	Diesel	84	NC	1986	5	10	Diesel	83
DBGA	1968	4	16	Diesel	84	NE	1781	4	8	Petrol	35
DBKA	1598	4	16	Diesel	28	NF	2309	5	10	Petrol	94
DBPA	1984	4	16	Petrol	79	NG	2309	5	10	Petrol	94
DCPC	2967	6	24	Diesel	118	NM	1994	5	20	Petrol	87
DCYA	1968	4	16	Diesel	84	NP	1781	4	8	Petrol	52
DD	1781	4	8	Petrol	35	PH	1781	4	8	Petrol	35
DDCA	1968	4	16	Diesel	84	PM	1781	4	8	Petrol	35
DDCB	1968	4	16	Diesel	84	PP	1595	4	8	Petrol	18
DDDA	1968	4	16	Diesel	84	PR	2226	5	10	Petrol	91
DDTA	3993	8	32	Petrol	129	PS	1994	5	10	Petrol	85
DDYA	1598	4	16	Diesel	28	PT	3562	8	32	Petrol	124
DDYB	1598	4	16	Diesel	28	PV	1781	4	8	Petrol	35
DE	1986	5	10	Diesel	83	PX	2226	5	10	Petrol	91
DEHA	2967	6	24	Diesel	118	RA	1588	4	8	Diesel	29
DEJA	1968	4	16	Diesel	84	RN	1595	4	8	Petrol	18
DEJB	1968	4	16	Diesel	84	RNA	1595	4	8	Petrol	18
DESA	1968	4	16	Diesel	84	RR	2226	5	20	Petrol	92
DETA	1968	4	16	Diesel	84	RS	1781	4	8	Petrol	35
DETB	1968	4	16	Diesel	84	RT	1994	5	10	Petrol	85
DEUA	1968	4	16	Diesel	84	RU	1781	4	8	Petrol	35
DEUB	1968	4	16	Diesel	84	SA	1595	4	8	Petrol	18
DEUC	1968	4	16	Diesel	84	SB	1588	4	8	Diesel	29
DFGA	1968	4	16	Diesel	84	SD	1847	4	8	Petrol	35
DFHA	1968	4	16	Diesel	84	SF	1781	4	8	Petrol	35
DFTA	1968	4	16	Diesel	84	SH	1781	4	8	Petrol	35
DFTB	1968	4	16	Diesel	84	SK	1994	5	10	Petrol	86
DFTC	1968	4	16	Diesel	84	SL	1994	5	10	Petrol	85
DFUA	1968	4	16	Diesel	84	WA	1984	4	8	Petrol	88
DFVA	1968	4	16	Diesel	84	WB	2144	5	10	Petrol	89
DGCA	1968	4	16	Diesel	84	WC	2144	5	10	Petrol	89
DJHA	1984	4	16	Petrol	79	WD	2144	5	10	Petrol	89
DJHB	1984	4	16	Petrol	79	WE	2144	5	10	Petrol	89
DR	1781	4	8	Petrol	35	WF	1984	4	8	Petrol	88
DS	1781	4	8	Petrol	35	WG	2144	5	10	Petrol	89
DT	1595	4	8	Petrol	18	WH	1921	5	10	Petrol	65
DTA	1595	4	8	Petrol	18	WJ	2144	5	10	Petrol	89
DZ	1781	4	8	Petrol	35	WK	2144	5	10	Petrol	89
EP	1297	4	8	Petrol	7	WN	1921	5	10	Petrol	65
FS	1588	4	8	Petrol	18	WP	1588	4	8	Petrol	18
FY	1272	4	8	Petrol	8	WR	2144	5	10	Petrol	89
FZ	1272	4	8	Petrol	8	WS	2144	5	10	Petrol	89
GV	2144	5	10	Petrol	89	WT	1715	4	8	Petrol	34
HB	1093	4	8	Petrol	2	WU	2144	5	10	Petrol	91
HC	1093	4	8	Petrol	2	WV	1588	4	8	Petrol	31
HD	1093	4	8	Petrol	2	WX	2144	5	10	Petrol	89
HH	1272	4	8	Petrol	8	WY	1588	4	8	Petrol	18
HJ	1272	4	8	Petrol	8	WZ	1588	4	8	Petrol	18
HP	1994	5	10	Petrol	85	XX	1584	4	8	Petrol	32
HX	2226	5	10	Petrol	91	YD	1871	4	8	Petrol	66
HY	2226	5	10	Petrol	91	YG	1588	4	8	Petrol	31
JK	1588	4	8	Diesel	29	YH	1588	4	8	Petrol	31
JL	1994	5	10	Petrol	85	YJ	1471	4	8	Petrol	17
JN	1781	4	8	Petrol	35	YK	1588	4	8	Petrol	18
JS	1994	5	10	Petrol	86	YN	1588	4	8	Petrol	18
JT	2226	5	10	Petrol	91	YP	1588	4	8	Petrol	18
JU	1595	4	8	Petrol	18	YS	1588	4	8	Petrol	31
JV	1781	4	8	Petrol	52	YT	1588	4	8	Petrol	31
JW	1781	4	8	Petrol	35	YV	1588	4	8	Petrol	31
JW	1781	4	8	Petrol	52	YY	1588	4	8	Petrol	31
JY	2144	5	10	Petrol	89	YZ	1588	4	8	Petrol	31
KE	2144	5	10	Petrol	89	ZA	1297	4	8	Petrol	8
KF	2144	5	10	Petrol	89	ZB	1471	4	8	Petrol	17

	CC				9		CC				9
ZC	1471	4	8	Petrol	17						
ZF	1297	4	8	Petrol	9						
ZV	1716	4	8	Petrol	33						
ZX	1760	4	8	Petrol	36						
ZZ	1760	4	8	Petrol	36						

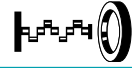

1 1.0L		Petrol		
CHZB	3 Cyl.	12 Valves	999cc	TD30928
CHZD	3 Cyl.	12 Valves	999cc	TD33426
CHZE	3 Cyl.	12 Valves	999cc	TD32545
CHZJ	3 Cyl.	12 Valves	999cc	TD33893
		NA5456 (x2) 36.00 x 46.00 x 7.00mm, PTFE/ACM NA5458 24.00 x 39.00 x 8.00mm, PTFE/ACM		

2 1.1L		Petrol		
HB	4 Cyl.	8 Valves	1093cc	TD4207
HC	4 Cyl.	8 Valves	1093cc	TD263
HD	4 Cyl.	8 Valves	1093cc	TD264
HR569	NA5001 32.00 x 47.00 x 10.00mm, FPM		NA5001 32.00 x 47.00 x 10.00mm, FPM NA5133 85.00 x 105.00 x 11.00mm, FPM	

3 1.2L		Diesel		
ANY	3 Cyl.	6 Valves	1191cc	TD17157
HR5068	NA5124 32.00 x 47.00 x 10.00mm, PTFE/ACM		NA5106 35.00 x 48.00 x 10.00mm, PTFE LK5003 85.00 x 131.00 x 15.700mm, PTFE	

4 1.2L		Petrol		
CBZA	4 Cyl.	8 Valves	1197cc	TD24385
PA5041 (x8) HR817	NA5124 32.00 x 47.00 x 10.00mm, PTFE/ACM		NA5124 32.00 x 47.00 x 10.00mm, PTFE/ACM	

5 1.2L		Petrol		
CBZB	4 Cyl.	8 Valves	1197cc	TD23907
PA5041 (x8) HR817			NA5124 32.00 x 47.00 x 10.00mm, PTFE/ACM	

6 1.2L		Petrol		
CIZA	4 Cyl.	16 Valves	1197cc	TD27151
CJZB	4 Cyl.	16 Valves	1197cc	TD27188
CYVB	4 Cyl.	16 Valves	1197cc	TD29301
		NA5456 (x2) 36.00 x 46.00 x 7.00mm, PTFE/ACM NA5458 24.00 x 39.00 x 8.00mm, PTFE/ACM		

7 1.3L		Petrol		
EP	4 Cyl.	8 Valves	1297cc	TD257
HR569	NA5001 32.00 x 47.00 x 10.00mm, FPM →07/83		NA5001 32.00 x 47.00 x 10.00mm, FPM NA5133 85.00 x 105.00 x 11.00mm, FPM	

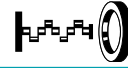

8 1.3L Petrol

FY	4 Cyl.	8 Valves	1272cc	TD259
FZ	4 Cyl.	8 Valves	1272cc	TD260
HH	4 Cyl.	8 Valves	1272cc	TD265
HJ	4 Cyl.	8 Valves	1272cc	TD16547
ZA	4 Cyl.	8 Valves	1297cc	TD4214
HR569	NA5001 32.00 x 47.00 x 10.00mm, FPM		NA5001 32.00 x 47.00 x 10.00mm, FPM NA5133 85.00 x 105.00 x 11.00mm, FPM	

9 1.3L Petrol

ZF	4 Cyl.	8 Valves	1297cc	TD368
HR569	NA5001 32.00 x 47.00 x 10.00mm, FPM		NA5133 85.00 x 105.00 x 11.00mm, FPM	

10 1.4L Diesel

AMF	3 Cyl.	6 Valves	1422cc	TD17156
ATL	3 Cyl.	6 Valves	1422cc	TD17071
BHC	3 Cyl.	6 Valves	1422cc	TD18133
HR5068	NA5124 32.00 x 47.00 x 10.00mm, PTFE/ACM		NA5106 35.00 x 48.00 x 10.00mm, PTFE LK5003 85.00 x 131.00 x 15.700mm, PTFE	

11 1.4L Petrol

AUA	4 Cyl.	16 Valves	1390cc	TD15248
BBY	4 Cyl.	16 Valves	1390cc	TD16414
PA5041 (x16) HR791	NA5180 (x2) 27.00 x 42.00 x 8.00mm, FPM		NA5185 32.00 x 42.00 x 6.00mm, FPM	

12 1.4L Petrol

CAVG	4 Cyl.	16 Valves	1390cc	TD24937
CAXA	4 Cyl.	16 Valves	1390cc	TD24386
CAXC	4 Cyl.	16 Valves	1390cc	TD20715
CMSA	4 Cyl.	16 Valves	1390cc	TD23936
CNUA	4 Cyl.	16 Valves	1390cc	TD33128
CNVA	4 Cyl.	16 Valves	1390cc	TD24951
CTHG	4 Cyl.	16 Valves	1390cc	TD25659
CTJA	4 Cyl.	16 Valves	1390cc	TD25660
PA5041 (x16) HR791			NA5106 35.00 x 48.00 x 10.00mm, PTFE	



13 1.4L Petrol

CHPB	4 Cyl.	16 Valves	1395cc	TD28307
CMBA	4 Cyl.	16 Valves	1395cc	TD26718
CPWA	4 Cyl.	16 Valves	1395cc	TD28359
CSS	4 Cyl.	16 Valves	1395cc	TD33351
CSSA	4 Cyl.	16 Valves	1395cc	TD30850
CUKB	4 Cyl.	16 Valves	1395cc	TD29356
CVNA	4 Cyl.	16 Valves	1395cc	TD32025
CXSA	4 Cyl.	16 Valves	1395cc	TD28200
CXSB	4 Cyl.	16 Valves	1395cc	TD28201
CXUA	4 Cyl.	16 Valves	1395cc	TD31336
CZCA	4 Cyl.	16 Valves	1395cc	TD29303
CZCC	4 Cyl.	16 Valves	1395cc	TD32546
CZDA	4 Cyl.	16 Valves	1395cc	TD30786
CZDB	4 Cyl.	16 Valves	1395cc	TD29748

NA5456 (x2)
36.00 x 46.00 x 7.00mm, PTFE/ACM
NA5458
24.00 x 39.00 x 8.00mm, PTFE/ACM

14 1.4L Petrol

CPTA	4 Cyl.	16 Valves	1395cc	TD25658
CZEA	4 Cyl.	16 Valves	1395cc	TD29280

NA5456 (x2)
36.00 x 46.00 x 7.00mm, PTFE/ACM
NA5454
28.00 x 39.00 x 7.00mm, PTFE/ACM

15 1.4L Diesel

CUSB	3 Cyl.	12 Valves	1422cc	TD29750
PA5041 (x12) HR280	NA5361 32.00 x 47.00 x 10.00mm, PTFE	NA5106 35.00 x 48.00 x 10.00mm, PTFE		

16 1.5L Petrol

T0	4 Cyl.	8 Valves	1496cc	TD29168
8910	4 Cyl.	8 Valves	1496cc	TD29167
PB394 (x8)				

17 1.5L Petrol

YJ	4 Cyl.	8 Valves	1471cc	TD4213
ZB	4 Cyl.	8 Valves	1471cc	TD366
ZC	4 Cyl.	8 Valves	1471cc	TD367

HR569 **NA5001**
32.00 x 47.00 x 10.00mm, FPM

NA5001
32.00 x 47.00 x 10.00mm, FPM
NA5133
85.00 x 105.00 x 11.00mm, FPM
Ch no. 825 2000 099 →

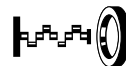
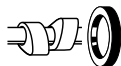

18 1.6L

Petrol

ABB	4 Cyl.	8 Valves	1595cc	TD230
ABM	4 Cyl.	8 Valves	1595cc	TD234
DT	4 Cyl.	8 Valves	1595cc	TD4206
DTA	4 Cyl.	8 Valves	1595cc	TD255
FS	4 Cyl.	8 Valves	1588cc	TD258
JU	4 Cyl.	8 Valves	1595cc	TD277
PP	4 Cyl.	8 Valves	1595cc	TD307
RN	4 Cyl.	8 Valves	1595cc	TD314
RNA	4 Cyl.	8 Valves	1595cc	TD315
SA	4 Cyl.	8 Valves	1595cc	TD321
WP	4 Cyl.	8 Valves	1588cc	TD340
WY	4 Cyl.	8 Valves	1588cc	TD348
WZ	4 Cyl.	8 Valves	1588cc	TD17147
YK	4 Cyl.	8 Valves	1588cc	TD356
YN	4 Cyl.	8 Valves	1588cc	TD358
YP	4 Cyl.	8 Valves	1588cc	TD359

HR569

NA5001
32.00 x 47.00 x 10.00mm, FPM

NA5001
32.00 x 47.00 x 10.00mm, FPM
NA5133
85.00 x 105.00 x 11.00mm, FPM
LK5006
85.00 x 131.00 x 16.000mm, PTFE

19 1.6L

Petrol

ADA	4 Cyl.	8 Valves	1595cc	TD240
-----	--------	----------	--------	-------

HR569
→Eng no. 034 669
HR816
Eng no. 034 670→

NA5001
32.00 x 47.00 x 10.00mm, FPM

NA5001
32.00 x 47.00 x 10.00mm, FPM
NA5133
85.00 x 105.00 x 11.00mm, FPM
LK5006
85.00 x 131.00 x 16.000mm, PTFE

20 1.6L

Petrol

ADP	4 Cyl.	8 Valves	1595cc	TD4198
-----	--------	----------	--------	--------

HR816

NA5001
32.00 x 47.00 x 10.00mm, FPM

NA5001
32.00 x 47.00 x 10.00mm, FPM
NA5133
85.00 x 105.00 x 11.00mm, FPM
LK5006
85.00 x 131.00 x 16.000mm, PTFE

21 1.6L

Petrol

AEH	4 Cyl.	8 Valves	1595cc	TD5074
AKL	4 Cyl.	8 Valves	1595cc	TD9990
ANA	4 Cyl.	8 Valves	1595cc	TD14128
APF	4 Cyl.	8 Valves	1595cc	TD11588
ARM	4 Cyl.	8 Valves	1595cc	TD14148

HR816

NA5124
32.00 x 47.00 x 10.00mm, PTFE/ACM

NA5106
35.00 x 48.00 x 10.00mm, PTFE
LK5008
85.00 x 131.00 x 15.700mm, PTFE

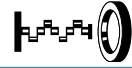

22 1.6L Petrol

AHL	4 Cyl.	8 Valves	1595cc	TD10816
HR816	NA5001 32.00 x 47.00 x 10.00mm, FPM	NA5106	35.00 x 48.00 x 10.00mm, PTFE	
	NA5124 32.00 x 47.00 x 10.00mm, PTFE/ACM	LK5008	85.00 x 131.00 x 15.700mm, PTFE	

23 1.6L Petrol

ALZ	4 Cyl.	8 Valves	1595cc	TD15748
AVU	4 Cyl.	8 Valves	1595cc	TD15350
BFQ	4 Cyl.	8 Valves	1595cc	TD17166
BGU	4 Cyl.	8 Valves	1595cc	TD16871
BRY	4 Cyl.	8 Valves	1595cc	TD19139
BSE	4 Cyl.	8 Valves	1595cc	TD20711
BSF	4 Cyl.	8 Valves	1595cc	TD20712
CCSA	4 Cyl.	8 Valves	1595cc	TD22665
CMXA	4 Cyl.	8 Valves	1595cc	TD23937
PA5041 (x8) HR817	NA5124 32.00 x 47.00 x 10.00mm, PTFE/ACM	NA5106	35.00 x 48.00 x 10.00mm, PTFE	
		LK5008	85.00 x 131.00 x 15.700mm, PTFE	

24 1.6L Petrol

BAD	4 Cyl.	16 Valves	1598cc	TD16415
PA5041 (x16) HR791	NA5180	NA5185	32.00 x 42.00 x 6.00mm, FPM	
	27.00 x 42.00 x 8.00mm, FPM			

25 1.6L Petrol

BAG	4 Cyl.	16 Valves	1598cc	TD17069
BLF	4 Cyl.	16 Valves	1598cc	TD20713
BLP	4 Cyl.	16 Valves	1598cc	TD17401
PA5041 (x16) HR791		NA5106	35.00 x 48.00 x 10.00mm, PTFE	
		LK5013	85.00 x 111.00 x 15.50mm, PTFE	
			Ch no. 8P4103001; 8P58000001 →	

26 1.6L Petrol

BAH	4 Cyl.	8 Valves	1598cc	TD26492
PA5041 (x8) HR817	NA5185	NA5185	32.00 x 42.00 x 6.00mm, FPM	
	32.00 x 42.00 x 6.00mm, FPM			

27 1.6L Diesel

CAYB	4 Cyl.	16 Valves	1598cc	TD22661
CAYC	4 Cyl.	16 Valves	1598cc	TD22662
PA5041 (x16) HR791	NA5124 (x2) 32.00 x 47.00 x 10.00mm, PTFE/ACM →09/09	NA5106	35.00 x 48.00 x 10.00mm, PTFE	
	NA5361 (x2) 32.00 x 47.00 x 10.00mm, PTFE 10/09 →	LK5019	85.00 x 131.00 x 17.25mm, PTFE/ACM	

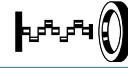

28 1.6L

Diesel

CLHA	4 Cyl.	16 Valves	1598cc	TD26721
CRKB	4 Cyl.	16 Valves	1598cc	TD28311
CXMA	4 Cyl.	16 Valves	1598cc	TD29749
CXXB	4 Cyl.	16 Valves	1598cc	TD31334
DBKA	4 Cyl.	16 Valves	1598cc	TD31335
DDYA	4 Cyl.	16 Valves	1598cc	TD33135
DDYB	4 Cyl.	16 Valves	1598cc	TD33134

PA5041 (x16)
HR791

NA5361
32.00 x 47.00 x 10.00mm, PTFE

LK5017 R
85.00 x 130.90 x 15.75mm, PTFE

29 1.6L

Diesel

CR	4 Cyl.	8 Valves	1588cc	TD248
CY	4 Cyl.	8 Valves	1588cc	TD4205
JK	4 Cyl.	8 Valves	1588cc	TD269
RA	4 Cyl.	8 Valves	1588cc	TD313
SB	4 Cyl.	8 Valves	1588cc	TD4211

HR569

NA5001
32.00 x 47.00 x 10.00mm, FPM

NA5001 F
32.00 x 47.00 x 10.00mm, FPM
NA5133 R
85.00 x 105.00 x 11.00mm, FPM

30 1.6L

Gas

CUCA	4 Cyl.	16 Valves	1598cc	TD31389
------	--------	-----------	--------	---------

NA5456 F (x2)
36.00 x 46.00 x 7.00mm, PTFE/ACM
NA5458 R (x2)
24.00 x 39.00 x 8.00mm, PTFE/ACM

31 1.6L

Petrol

WV	4 Cyl.	8 Valves	1588cc	TD345
YG	4 Cyl.	8 Valves	1588cc	TD353
YH	4 Cyl.	8 Valves	1588cc	TD354
YS	4 Cyl.	8 Valves	1588cc	TD360
YT	4 Cyl.	8 Valves	1588cc	TD361
YV	4 Cyl.	8 Valves	1588cc	TD362
YY	4 Cyl.	8 Valves	1588cc	TD363
YZ	4 Cyl.	8 Valves	1588cc	TD364

HR569

NA5001
32.00 x 47.00 x 10.00mm, FPM

NA5001 F
32.00 x 47.00 x 10.00mm, FPM
NA5133 R
85.00 x 105.00 x 11.00mm, FPM

32 1.6L

Petrol

XX	4 Cyl.	8 Valves	1584cc	TD351
----	--------	----------	--------	-------

HR569

NA5001
32.00 x 47.00 x 10.00mm, FPM

NA5001 F
32.00 x 47.00 x 10.00mm, FPM
NA5133 R
85.00 x 105.00 x 11.00mm, FPM
Ch no. 825-2074-887→

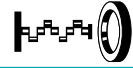

33 1.7L Petrol

8920	4 Cyl.	8 Valves	1695cc	TD29169
ZV	4 Cyl.	8 Valves	1716cc	TD377
PB394 (x8)				

34 1.7L Petrol

WT	4 Cyl.	8 Valves	1715cc	TD343
HR569	NA5001 32.00 x 47.00 x 10.00mm, FPM		NA5001 32.00 x 47.00 x 10.00mm, FPM NA5133 85.00 x 105.00 x 11.00mm, FPM	

35 1.8L Petrol

4B	4 Cyl.	8 Valves	1781cc	TD219
DD	4 Cyl.	8 Valves	1781cc	TD250
DR	4 Cyl.	8 Valves	1781cc	TD252
DS	4 Cyl.	8 Valves	1781cc	TD253
DZ	4 Cyl.	8 Valves	1781cc	TD256
JN	4 Cyl.	8 Valves	1781cc	TD4208
JW	4 Cyl.	8 Valves	1781cc	TD279
MU	4 Cyl.	8 Valves	1781cc	TD298
NE	4 Cyl.	8 Valves	1781cc	TD4210
PH	4 Cyl.	8 Valves	1781cc	TD305
PM	4 Cyl.	8 Valves	1781cc	TD306
PV	4 Cyl.	8 Valves	1781cc	TD311
RS	4 Cyl.	8 Valves	1781cc	TD317
RU	4 Cyl.	8 Valves	1781cc	TD320
SD	4 Cyl.	8 Valves	1847cc	TD323
SF	4 Cyl.	8 Valves	1781cc	TD325
SH	4 Cyl.	8 Valves	1781cc	TD326
HR569	NA5001 32.00 x 47.00 x 10.00mm, FPM		NA5001 32.00 x 47.00 x 10.00mm, FPM NA5133 85.00 x 105.00 x 11.00mm, FPM	

36 1.8L Petrol

21	4 Cyl.	8 Valves	1770cc	TD29166
8921	4 Cyl.	8 Valves	1770cc	TD29165
ZX	4 Cyl.	8 Valves	1760cc	TD378
ZZ	4 Cyl.	8 Valves	1760cc	TD380
PB394 (x8)				

37 1.8L Petrol

ADR	4 Cyl.	20 Valves	1781cc	TD19523
ADR	4 Cyl.	20 Valves	1781cc	TD241
AEB	4 Cyl.	20 Valves	1781cc	TD4199
PA5041 (x20) HR822	NA5001 (x2) 32.00 x 47.00 x 10.00mm, FPM		NA5001 32.00 x 47.00 x 10.00mm, FPM NA5133 85.00 x 105.00 x 11.00mm, FPM LK5006 85.00 x 131.00 x 16.00mm, PTFE	



38 1.8L

Petrol

AFY	4 Cyl.	20 Valves	1781cc	TD13948
PA5041 (x20) HR822	NA5001 (x2) 32.00 x 47.00 x 10.00mm, FPM	NA5001 32.00 x 47.00 x 10.00mm, FPM LK5006 85.00 x 131.00 x 16.000mm, PTFE		

39 1.8L

Petrol

AGN	4 Cyl.	20 Valves	1781cc	TD5073
PA5041 (x20) HR822	NA5001 (x2) 32.00 x 47.00 x 10.00mm, FPM	NA5106 35.00 x 48.00 x 10.00mm, PTFE LK5003 85.00 x 131.00 x 15.700mm, PTFE		

40 1.8L

Petrol

AGU	4 Cyl.	20 Valves	1781cc	TD5075
PA5041 (x20) HR822	NA5001 (x2) 32.00 x 47.00 x 10.00mm, FPM NA5124 (x2) 32.00 x 47.00 x 10.00mm, PTFE/ACM	NB716 35.00 x 48.00 x 10.00mm, FPM NA5106 35.00 x 48.00 x 10.00mm, PTFE LK5003 85.00 x 131.00 x 15.700mm, PTFE		

41 1.8L

Petrol

AJL	4 Cyl.	20 Valves	1781cc	TD9470
PA5041 (x20) HR822	NA5001 (x2) 32.00 x 47.00 x 10.00mm, FPM NA5124 (x2) 32.00 x 47.00 x 10.00mm, PTFE/ACM	NA5001 32.00 x 47.00 x 10.00mm, FPM NA5133 85.00 x 105.00 x 11.00mm, FPM LK5006 85.00 x 131.00 x 16.000mm, PTFE		

42 1.8L

Petrol

AJP	4 Cyl.	20 Valves	1781cc	TD9518
AQE	4 Cyl.	20 Valves	1781cc	TD14029
ARH	4 Cyl.	20 Valves	1781cc	TD15329
PA5041 (x20) HR822	NA5124 (x2) 32.00 x 47.00 x 10.00mm, PTFE/ACM	NA5106 35.00 x 48.00 x 10.00mm, PTFE LK5008 85.00 x 131.00 x 15.700mm, PTFE		

43 1.8L

Petrol

AJQ	4 Cyl.	20 Valves	1781cc	TD11347
ARY	4 Cyl.	20 Valves	1781cc	TD15352
PA5041 (x20) HR822	NA5124 (x2) 32.00 x 47.00 x 10.00mm, PTFE/ACM	NB716 35.00 x 48.00 x 10.00mm, FPM LK5003 85.00 x 131.00 x 15.700mm, PTFE		

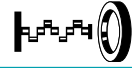

44 1.8L Petrol

AMB	4 Cyl.	20 Valves	1781cc	TD17864
AMK	4 Cyl.	20 Valves	1781cc	TD12648
AMU	4 Cyl.	20 Valves	1781cc	TD15358
APG	4 Cyl.	20 Valves	1781cc	TD11589
APP	4 Cyl.	20 Valves	1781cc	TD11591
APX	4 Cyl.	20 Valves	1781cc	TD11349
AQA	4 Cyl.	20 Valves	1781cc	TD11592
ARX	4 Cyl.	20 Valves	1781cc	TD15988
ARZ	4 Cyl.	20 Valves	1781cc	TD11593
ATC	4 Cyl.	20 Valves	1781cc	TD15357
AUL	4 Cyl.	20 Valves	1781cc	TD15355
AUM	4 Cyl.	20 Valves	1781cc	TD15629
AUQ	4 Cyl.	20 Valves	1781cc	TD15353
AVJ	4 Cyl.	20 Valves	1781cc	TD15349
AWL	4 Cyl.	20 Valves	1781cc	TD19192
AWM	4 Cyl.	20 Valves	1781cc	TD29751
AWP	4 Cyl.	20 Valves	1781cc	TD15356
AWT	4 Cyl.	20 Valves	1781cc	TD15335
BAM	4 Cyl.	20 Valves	1781cc	TD16331
BEA	4 Cyl.	20 Valves	1781cc	TD20630
BEX	4 Cyl.	20 Valves	1781cc	TD16730
BFB	4 Cyl.	20 Valves	1781cc	TD20638
BFB	4 Cyl.	20 Valves	1781cc	TD16728
BFV	4 Cyl.	20 Valves	1781cc	TD20399
BKB	4 Cyl.	20 Valves	1781cc	TD20640
BKB	4 Cyl.	20 Valves	1781cc	TD19135
BVP	4 Cyl.	20 Valves	1781cc	TD18490
BVR	4 Cyl.	20 Valves	1781cc	TD18493

PA5041 (x20)
HR822

NA5124 (x2)
32.00 x 47.00 x 10.00mm, PTFE/ACM

NA5106
35.00 x 48.00 x 10.00mm, PTFE
LK5003
85.00 x 131.00 x 15.700mm, PTFE

45 1.8L Petrol

ANB	4 Cyl.	20 Valves	1781cc	TD13949
APT	4 Cyl.	20 Valves	1781cc	TD13775
APU	4 Cyl.	20 Valves	1781cc	TD13950
ARG	4 Cyl.	20 Valves	1781cc	TD13776
ARK	4 Cyl.	20 Valves	1781cc	TD13929
AVV	4 Cyl.	20 Valves	1781cc	TD16412

PA5041 (x20)
HR822

NA5124 (x2)
32.00 x 47.00 x 10.00mm, PTFE/ACM

NA5001
32.00 x 47.00 x 10.00mm, FPM
NA5124
32.00 x 47.00 x 10.00mm, PTFE/ACM
LK5006
85.00 x 131.00 x 16.000mm, PTFE



46 1.8L

Petrol

ANQ 4 Cyl. 20 Valves 1781cc TD19190

ANQ 4 Cyl. 20 Valves 1781cc TD23398

PA5041 (x20)
HR822

NA5124 (x2)
32.00 x 47.00 x 10.00mm, PTFE/ACM

NB716
35.00 x 48.00 x 10.00mm, FPM
NA5106
35.00 x 48.00 x 10.00mm, PTFE
LK5008
85.00 x 131.00 x 15.700mm, PTFE

47 1.8L

Petrol

APY 4 Cyl. 20 Valves 1781cc TD11594

PA5041 (x20)
HR822

NA5124 (x2)
32.00 x 47.00 x 10.00mm, PTFE/ACM

NB716
35.00 x 48.00 x 10.00mm, FPM
NA5106
35.00 x 48.00 x 10.00mm, PTFE
NA5349
85.00 x 105.00 x 12.00mm, PTFE/ACM

48 1.8L

Petrol

AWL 4 Cyl. 20 Valves 1781cc TD20634

PA5041 (x20)
HR822

NA5124
32.00 x 47.00 x 10.00mm, PTFE/ACM

NB716
35.00 x 48.00 x 10.00mm, FPM
NA5106
35.00 x 48.00 x 10.00mm, PTFE
LK5008
85.00 x 131.00 x 15.700mm, PTFE

49 1.8L

Petrol

BPU 4 Cyl. 20 Valves 1781cc TD21732

NA5106
35.00 x 48.00 x 10.00mm, PTFE

50 1.8L

Petrol

BYT 4 Cyl. 16 Valves 1798cc TD20089

BZB 4 Cyl. 16 Valves 1798cc TD20090

CABA 4 Cyl. 16 Valves 1798cc TD20590

CABB 4 Cyl. 16 Valves 1798cc TD20594

CABD 4 Cyl. 16 Valves 1798cc TD20113

CCUA 4 Cyl. 16 Valves 1798cc TD30492

CCUA 4 Cyl. 16 Valves 1798cc TD23989

CDA A 4 Cyl. 16 Valves 1798cc TD20938

CDHA 4 Cyl. 16 Valves 1798cc TD21113

CDHB 4 Cyl. 16 Valves 1798cc TD21114

CNSB 4 Cyl. 16 Valves 1798cc TD29216

DAJB 4 Cyl. 16 Valves 1798cc TD30257

PA5041 (x16)
HR791

LK5016
85.00 x 164.00 x 11.00mm, PTFE

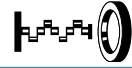

51 1.8L Petrol				
CJEB	4 Cyl.	16 Valves	1798cc	TD26326
CJED	4 Cyl.	16 Valves	1798cc	TD29687
CJEE	4 Cyl.	16 Valves	1798cc	TD31343
CJSA	4 Cyl.	16 Valves	1798cc	TD26719
CJSB	4 Cyl.	16 Valves	1798cc	TD26720
CYGA	4 Cyl.	16 Valves	1798cc	TD29834
PA5041 (x16) HR791				

52 1.8L Petrol				
JV	4 Cyl.	8 Valves	1781cc	TD278
JW	4 Cyl.	8 Valves	1781cc	TD19518
NP	4 Cyl.	8 Valves	1781cc	TD304
HR569	NA5001 (x2) 32.00 x 47.00 x 10.00mm, FPM		NA5001 32.00 x 47.00 x 10.00mm, FPM NA5133 85.00 x 105.00 x 11.00mm, FPM	

53 1.9L Diesel				
1Y	4 Cyl.	8 Valves	1896cc	TD213
HR569 →Eng no. 580 000 HR816 Eng no. 580 001→	NA5001 32.00 x 47.00 x 10.00mm, FPM		NA5133 85.00 x 105.00 x 11.00mm, FPM LK5006 85.00 x 131.00 x 16.000mm, PTFE	

54 1.9L Diesel				
1Z	4 Cyl.	8 Valves	1896cc	TD214
HR569 →Eng no. 1Z-720 000 HR816 Eng no. 1Z-720 001→	NA5001 32.00 x 47.00 x 10.00mm, FPM		NA5001 32.00 x 47.00 x 10.00mm, FPM NA5133 85.00 x 105.00 x 11.00mm, FPM	

55 1.9L Diesel				
AAZ	4 Cyl.	8 Valves	1896cc	TD229
HR569	NA5001 32.00 x 47.00 x 10.00mm, FPM		NA5001 32.00 x 47.00 x 10.00mm, FPM NA5133 85.00 x 105.00 x 11.00mm, FPM	

56 1.9L Diesel				
ADE	4 Cyl.	8 Valves	1896cc	TD22656
HR816 →Eng no. ADE 003 235 HR569 Eng no. ADE 003 236→	NA5001 32.00 x 47.00 x 10.00mm, FPM		NA5001 32.00 x 47.00 x 10.00mm, FPM NA5133 85.00 x 105.00 x 11.00mm, FPM →Eng no. ADE 004 200 LK5006 85.00 x 131.00 x 16.000mm, PTFE Eng no. ADE 004 201→	



57 1.9L

Diesel

AFF 4 Cyl. 8 Valves 1896cc **TD11597**

AFN 4 Cyl. 8 Valves 1896cc **TD4202**

HR569
→Eng no. 002 000
HR816
Eng no. 002 001→

NA5001
32.00 x 47.00 x 10.00mm, FPM

NA5001
32.00 x 47.00 x 10.00mm, FPM
NA5133
85.00 x 105.00 x 11.00mm, FPM
→12/97
LK5006
85.00 x 131.00 x 16.000mm, PTFE
01/98→

58 1.9L

Diesel

AGR 4 Cyl. 8 Valves 1896cc **TD5076**

ASV 4 Cyl. 8 Valves 1896cc **TD15354**

HR816

NA5001
32.00 x 47.00 x 10.00mm, FPM

NB716
35.00 x 48.00 x 10.00mm, FPM
NA5106
35.00 x 48.00 x 10.00mm, PTFE
LK5003
85.00 x 131.00 x 15.700mm, PTFE

59 1.9L

Diesel

AHF 4 Cyl. 8 Valves 1896cc **TD9371**

ALH 4 Cyl. 8 Valves 1896cc **TD11595**

HR816

NA5001
32.00 x 47.00 x 10.00mm, FPM

NB716
35.00 x 48.00 x 10.00mm, FPM
LK5003
85.00 x 131.00 x 15.700mm, PTFE

60 1.9L

Diesel

AHH 4 Cyl. 8 Valves 1896cc **TD16413**

AVG 4 Cyl. 8 Valves 1896cc **TD13774**

HR816

NA5001
32.00 x 47.00 x 10.00mm, FPM

NA5001
32.00 x 47.00 x 10.00mm, FPM
LK5006
85.00 x 131.00 x 16.000mm, PTFE

61 1.9L

Diesel

AHU 4 Cyl. 8 Valves 1896cc **TD10814**

HR569
→Eng no. 720 000
HR816
Eng no. 720 001→

NA5001
32.00 x 47.00 x 10.00mm, FPM

NA5001
32.00 x 47.00 x 10.00mm, FPM
NA5133
85.00 x 105.00 x 11.00mm, FPM
→Eng no. AHU 390 000
LK5006
85.00 x 131.00 x 16.000mm, PTFE
Eng no. AHU 390 001→

62 1.9L

Diesel

AJM 4 Cyl. 8 Valves 1896cc **TD11527**

HR816

NA5124
32.00 x 47.00 x 10.00mm, PTFE/ACM

NB716
35.00 x 48.00 x 10.00mm, FPM
NA5106
35.00 x 48.00 x 10.00mm, PTFE
LK5003
85.00 x 131.00 x 15.700mm, PTFE

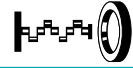

63 1.9L Diesel

ANU	4 Cyl.	8 Valves	1896cc	TD11596
ASZ	4 Cyl.	8 Valves	1896cc	TD15351
ATD	4 Cyl.	8 Valves	1896cc	TD16028
ATJ	4 Cyl.	8 Valves	1896cc	TD15989
AVB	4 Cyl.	8 Valves	1896cc	TD16518
AVF	4 Cyl.	8 Valves	1896cc	TD15348
AWX	4 Cyl.	8 Valves	1896cc	TD16133
AXR	4 Cyl.	8 Valves	1896cc	TD16416
BKE	4 Cyl.	8 Valves	1896cc	TD17596
BRB	4 Cyl.	8 Valves	1896cc	TD20492

HR816

NA5124
32.00 x 47.00 x 10.00mm, PTFE/ACM

NA5106
35.00 x 48.00 x 10.00mm, PTFE
LK5003
85.00 x 131.00 x 15.700mm, PTFE

64 1.9L Diesel

BKC	4 Cyl.	8 Valves	1896cc	TD17026
BLS	4 Cyl.	8 Valves	1896cc	TD20823
BXE	4 Cyl.	8 Valves	1896cc	TD22657

HR816

NA5124
32.00 x 47.00 x 10.00mm, PTFE/ACM

NA5106
35.00 x 48.00 x 10.00mm, PTFE
LK5012
85.00 x 132.00 x 15.70mm, PTFE

65 1.9L Petrol

WH	5 Cyl.	10 Valves	1921cc	TD336
WN	5 Cyl.	10 Valves	1921cc	TD339

HR615

NA5001
32.00 x 47.00 x 10.00mm, FPM

NB716
35.00 x 48.00 x 10.00mm, FPM
NA5133
85.00 x 105.00 x 11.00mm, FPM

66 1.9L Petrol

YD	4 Cyl.	8 Valves	1871cc	TD29377
----	--------	----------	--------	---------

PB394 (x8)

NF637
48.00 x 65.00 x 10.00mm, FPM

67 2.0L Petrol

3A	4 Cyl.	8 Valves	1984cc	TD4191
----	--------	----------	--------	--------

HR569

NA5001
32.00 x 47.00 x 10.00mm, FPM

NA5001
32.00 x 47.00 x 10.00mm, FPM
NA5133
85.00 x 105.00 x 11.00mm, FPM
LK5006
85.00 x 131.00 x 16.000mm, PTFE

68 2.0L Petrol

6A	4 Cyl.	16 Valves	1984cc	TD4193
ACE	4 Cyl.	16 Valves	1984cc	TD238

HR816 (x2)

NA5001
32.00 x 47.00 x 10.00mm, FPM

NA5001
32.00 x 47.00 x 10.00mm, FPM
NA5133
85.00 x 105.00 x 11.00mm, FPM

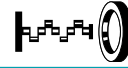

69 2.0L

Petrol

AAD	4 Cyl.	8 Valves	1984cc	TD222
ABK	4 Cyl.	8 Valves	1984cc	TD233
ADW	4 Cyl.	8 Valves	1984cc	TD243
HR816	NA5001 32.00 x 47.00 x 10.00mm, FPM		NA5001 32.00 x 47.00 x 10.00mm, FPM NA5133 85.00 x 105.00 x 11.00mm, FPM LK5006 85.00 x 131.00 x 16.000mm, PTFE	

70 2.0L

Petrol

AAE	4 Cyl.	8 Valves	1984cc	TD223
HR569 →Eng no. 032 209 HR816 Eng no. 032 210→	NA5001 32.00 x 47.00 x 10.00mm, FPM		NA5001 32.00 x 47.00 x 10.00mm, FPM NA5133 85.00 x 105.00 x 11.00mm, FPM →Eng no. AEE 630 000 LK5006 85.00 x 131.00 x 16.000mm, PTFE Eng no. AEE 630 001→	

71 2.0L

Petrol

ABT	4 Cyl.	8 Valves	1984cc	TD236
HR569 →Eng no. 246 861 HR816 Eng no. 246 862→	NA5001 32.00 x 47.00 x 10.00mm, FPM		NA5001 32.00 x 47.00 x 10.00mm, FPM NA5133 85.00 x 105.00 x 11.00mm, FPM LK5006 85.00 x 131.00 x 16.000mm, PTFE	

72 2.0L

Petrol

ALT	4 Cyl.	20 Valves	1984cc	TD15345
PA5041 (x20) HR822	NA5124 (x2) 32.00 x 47.00 x 10.00mm, PTFE/ACM		NA5106 35.00 x 48.00 x 10.00mm, PTFE LK5008 85.00 x 131.00 x 15.700mm, PTFE	

73 2.0L

Petrol

AWA	4 Cyl.	16 Valves	1984cc	TD17035
AXW	4 Cyl.	16 Valves	1984cc	TD16872
BLR	4 Cyl.	16 Valves	1984cc	TD18199
BLX	4 Cyl.	16 Valves	1984cc	TD17404
BLY	4 Cyl.	16 Valves	1984cc	TD17405
BMB	4 Cyl.	16 Valves	1984cc	TD17406
BVY	4 Cyl.	16 Valves	1984cc	TD18200
BVZ	4 Cyl.	16 Valves	1984cc	TD18201
PA5041 (x16) HR791	NA5124 (x2) 32.00 x 47.00 x 10.00mm, PTFE/ACM		NA5106 35.00 x 48.00 x 10.00mm, PTFE LK5008 85.00 x 131.00 x 15.700mm, PTFE	

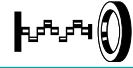

74 2.0L Petrol

AXA	4 Cyl.	8 Valves	1984cc	TD16865
HR816	NA5124 32.00 x 47.00 x 10.00mm, PTFE/ACM		NA5106 35.00 x 48.00 x 10.00mm, PTFE LK5003 85.00 x 131.00 x 15.700mm, PTFE	

75 2.0L Petrol

AXX	4 Cyl.	16 Valves	1984cc	TD17450
BGB	4 Cyl.	16 Valves	1984cc	TD18008
BGB	4 Cyl.	16 Valves	1984cc	TD20639
BHZ	4 Cyl.	16 Valves	1984cc	TD19821
BPG	4 Cyl.	16 Valves	1984cc	TD20530
BPJ	4 Cyl.	16 Valves	1984cc	TD18486
BPY	4 Cyl.	16 Valves	1984cc	TD20704
BUL	4 Cyl.	16 Valves	1984cc	TD18484
BWA	4 Cyl.	16 Valves	1984cc	TD19199
BWE	4 Cyl.	16 Valves	1984cc	TD18968
BWE	4 Cyl.	16 Valves	1984cc	TD20646
BWT	4 Cyl.	16 Valves	1984cc	TD19705
BYK	4 Cyl.	16 Valves	1984cc	TD20404
BZC	4 Cyl.	16 Valves	1984cc	TD20842
CDLA	4 Cyl.	16 Valves	1984cc	TD21734
CDLB	4 Cyl.	16 Valves	1984cc	TD21735
CDLC	4 Cyl.	16 Valves	1984cc	TD22470
CDLH	4 Cyl.	16 Valves	1984cc	TD26515
CDMA	4 Cyl.	16 Valves	1984cc	TD24962
PA5041 (x16) HR791	NA5124 (x2) 32.00 x 47.00 x 10.00mm, PTFE/ACM		NA5106 35.00 x 48.00 x 10.00mm, PTFE LK5003 85.00 x 131.00 x 15.700mm, PTFE	

76 2.0L Diesel

AZV	4 Cyl.	16 Valves	1968cc	TD17027
BKD	4 Cyl.	16 Valves	1968cc	TD17025
BLB	4 Cyl.	16 Valves	1968cc	TD17377
BMN	4 Cyl.	16 Valves	1968cc	TD18991
BNA	4 Cyl.	16 Valves	1968cc	TD18009
BRD	4 Cyl.	16 Valves	1968cc	TD20402
BRE	4 Cyl.	16 Valves	1968cc	TD18029
BRF	4 Cyl.	16 Valves	1968cc	TD18748
BUY	4 Cyl.	16 Valves	1968cc	TD20403
BVA	4 Cyl.	16 Valves	1968cc	TD20529
BVF	4 Cyl.	16 Valves	1968cc	TD20497
BVG	4 Cyl.	16 Valves	1968cc	TD20496
PA5041 (x16) HR791	NA5124 (x2) 32.00 x 47.00 x 10.00mm, PTFE/ACM		NA5106 35.00 x 48.00 x 10.00mm, PTFE LK5012 85.00 x 132.00 x 15.70mm, PTFE	

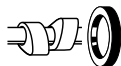

77 2.0L

Petrol

BJZ	4 Cyl.	16 Valves	1984cc	TD19137
HR816 (x2)	NA5124 (x2) 32.00 x 47.00 x 10.00mm, PTFE/ACM		NA5106 35.00 x 48.00 x 10.00mm, PTFE LK5003 85.00 x 131.00 x 15.700mm, PTFE	

78 2.0L

Diesel

BMM	4 Cyl.	8 Valves	1968cc	TD18203
HR816	NA5124 32.00 x 47.00 x 10.00mm, PTFE/ACM		NA5106 35.00 x 48.00 x 10.00mm, PTFE LK5012 85.00 x 132.00 x 15.70mm, PTFE	

79 2.0L

Petrol

BPJ	4 Cyl.	16 Valves	1984cc	TD20643
CHHB	4 Cyl.	16 Valves	1984cc	TD30801
CHHC	4 Cyl.	16 Valves	1984cc	TD29803
CJXB	4 Cyl.	16 Valves	1984cc	TD27153
CJXC	4 Cyl.	16 Valves	1984cc	TD27152
CJXD	4 Cyl.	16 Valves	1984cc	TD33635
CJXF	4 Cyl.	16 Valves	1984cc	TD29304
CJXG	4 Cyl.	16 Valves	1984cc	TD29804
CNCB	4 Cyl.	16 Valves	1984cc	TD26727
CNCD	4 Cyl.	16 Valves	1984cc	TD26888
CNCE	4 Cyl.	16 Valves	1984cc	TD31491
CNTC	4 Cyl.	16 Valves	1984cc	TD29744
CULB	4 Cyl.	16 Valves	1984cc	TD30604
CULC	4 Cyl.	16 Valves	1984cc	TD33121
CVKB	4 Cyl.	16 Valves	1984cc	TD32026
CVLA	4 Cyl.	16 Valves	1984cc	TD34439
CWZA	4 Cyl.	16 Valves	1984cc	TD29231
CYFB	4 Cyl.	16 Valves	1984cc	TD29777
CYMC	4 Cyl.	16 Valves	1984cc	TD32027
CYNB	4 Cyl.	16 Valves	1984cc	TD29835
CYPA	4 Cyl.	16 Valves	1984cc	TD29688
CYPB	4 Cyl.	16 Valves	1984cc	TD31347
CYRB	4 Cyl.	16 Valves	1984cc	TD31667
CYRC	4 Cyl.	16 Valves	1984cc	TD32036
CZPB	4 Cyl.	16 Valves	1984cc	TD33138
DAXB	4 Cyl.	16 Valves	1984cc	TD33904
DAXC	4 Cyl.	16 Valves	1984cc	TD33903
DAYB	4 Cyl.	16 Valves	1984cc	TD34203
DBPA	4 Cyl.	16 Valves	1984cc	TD33106
DJHA	4 Cyl.	16 Valves	1984cc	TD33427
DJHB	4 Cyl.	16 Valves	1984cc	TD33636
PA5041 (x16) HR791				

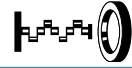

80 2.0L Diesel

BPW	4 Cyl.	8 Valves	1968cc	TD18010
BRC	4 Cyl.	8 Valves	1968cc	TD20672
HR816	NA5124 32.00 x 47.00 x 10.00mm, PTFE/ACM		NA5106 35.00 x 48.00 x 10.00mm, PTFE LK5003 85.00 x 131.00 x 15.700mm, PTFE	

81 2.0L Petrol

CADA	4 Cyl.	16 Valves	1984cc	TD23991
CADA	4 Cyl.	16 Valves	1984cc	TD26737
CAEA	4 Cyl.	16 Valves	1984cc	TD21115
CAEB	4 Cyl.	16 Valves	1984cc	TD21116
CAEB	4 Cyl.	16 Valves	1984cc	TD27664
CAED	4 Cyl.	16 Valves	1984cc	TD28001
CAWB	4 Cyl.	16 Valves	1984cc	TD20714
CBFA	4 Cyl.	16 Valves	1984cc	TD22663
CCTA	4 Cyl.	16 Valves	1984cc	TD22666
CCZA	4 Cyl.	16 Valves	1984cc	TD22170
CCZC	4 Cyl.	16 Valves	1984cc	TD25726
CDNA	4 Cyl.	16 Valves	1984cc	TD23860
CDNB	4 Cyl.	16 Valves	1984cc	TD20936
CDNC	4 Cyl.	16 Valves	1984cc	TD20937
CDNC	4 Cyl.	16 Valves	1984cc	TD27663
CDZA	4 Cyl.	16 Valves	1984cc	TD23990
CDZA	4 Cyl.	16 Valves	1984cc	TD22289
CESA	4 Cyl.	16 Valves	1984cc	TD24753
CETA	4 Cyl.	16 Valves	1984cc	TD24754
CFKA	4 Cyl.	16 Valves	1984cc	TD23856
CGMA	4 Cyl.	16 Valves	1984cc	TD31243
CHJA	4 Cyl.	16 Valves	1984cc	TD25428
CPMA	4 Cyl.	16 Valves	1984cc	TD26715
CPMA	4 Cyl.	16 Valves	1984cc	TD27665
CPMB	4 Cyl.	16 Valves	1984cc	TD26891
CPSA	4 Cyl.	16 Valves	1984cc	TD25730
CRHA	4 Cyl.	16 Valves	1984cc	TD30504
CRHA	4 Cyl.	16 Valves	1984cc	TD31396
PA5041 (x16) HR791			LK5016 85.00 x 164.00 x 11.00mm, PTFE	



82 2.0L

Diesel

CAGA	4 Cyl.	16 Valves	1968cc	TD20597
CAGB	4 Cyl.	16 Valves	1968cc	TD20598
CAGC	4 Cyl.	16 Valves	1968cc	TD21118
CAHA	4 Cyl.	16 Valves	1968cc	TD20602
CAHB	4 Cyl.	16 Valves	1968cc	TD20864
CBA A	4 Cyl.	16 Valves	1968cc	TD20825
CBAB	4 Cyl.	16 Valves	1968cc	TD20828
CBBB	4 Cyl.	16 Valves	1968cc	TD20939
CFFA	4 Cyl.	16 Valves	1968cc	TD23858
CFFB	4 Cyl.	16 Valves	1968cc	TD23859
CFGB	4 Cyl.	16 Valves	1968cc	TD23857
CFGC	4 Cyl.	16 Valves	1968cc	TD25727
CFGD	4 Cyl.	16 Valves	1968cc	TD25728
CFHB	4 Cyl.	16 Valves	1968cc	TD25662
CFHD	4 Cyl.	16 Valves	1968cc	TD24939
CGLA	4 Cyl.	16 Valves	1968cc	TD24406
CGLB	4 Cyl.	16 Valves	1968cc	TD24948
CGLC	4 Cyl.	16 Valves	1968cc	TD24870
CGLD	4 Cyl.	16 Valves	1968cc	TD24943
CGLE	4 Cyl.	16 Valves	1968cc	TD26329
CJCA	4 Cyl.	16 Valves	1968cc	TD24949
CJCB	4 Cyl.	16 Valves	1968cc	TD24941
CJCC	4 Cyl.	16 Valves	1968cc	TD26713
CJCD	4 Cyl.	16 Valves	1968cc	TD27985
CLJA	4 Cyl.	16 Valves	1968cc	TD23938
CLLB	4 Cyl.	16 Valves	1968cc	TD25729
CMEA	4 Cyl.	16 Valves	1968cc	TD23939
CMFA	4 Cyl.	16 Valves	1968cc	TD26714
CMFB	4 Cyl.	16 Valves	1968cc	TD28002
CMGA	4 Cyl.	16 Valves	1968cc	TD25767
CMGB	4 Cyl.	16 Valves	1968cc	TD24871

PA5041 (x16)
HR791

NA5361
32.00 x 47.00 x 10.00mm, PTFE

NA5106
35.00 x 48.00 x 10.00mm, PTFE
LK5019
85.00 x 131.00 x 17.25mm, PTFE/ACM

83 2.0L

Diesel

CN	5 Cyl.	10 Valves	1986cc	TD247
DE	5 Cyl.	10 Valves	1986cc	TD251
NC	5 Cyl.	10 Valves	1986cc	TD299

HR615

NA5001
32.00 x 47.00 x 10.00mm, FPM

NB716
35.00 x 48.00 x 10.00mm, FPM
NA5133
85.00 x 105.00 x 11.00mm, FPM

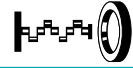
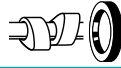

84 2.0L

Diesel

CNHA	4 Cyl.	16 Valves	1968cc	TD28003
CNHC	4 Cyl.	16 Valves	1968cc	TD30652
CRBC	4 Cyl.	16 Valves	1968cc	TD26724
CRBD	4 Cyl.	16 Valves	1968cc	TD28036
CRFA	4 Cyl.	16 Valves	1968cc	TD26722
CRFC	4 Cyl.	16 Valves	1968cc	TD26723
CRLB	4 Cyl.	16 Valves	1968cc	TD26725
CRLC	4 Cyl.	16 Valves	1968cc	TD29305
CRUA	4 Cyl.	16 Valves	1968cc	TD29213
CSUA	4 Cyl.	16 Valves	1968cc	TD30651
CSUB	4 Cyl.	16 Valves	1968cc	TD30650
CSUD	4 Cyl.	16 Valves	1968cc	TD29836
CSUE	4 Cyl.	16 Valves	1968cc	TD30797
CUNA	4 Cyl.	16 Valves	1968cc	TD28035
CUPA	4 Cyl.	16 Valves	1968cc	TD26726
CUVB	4 Cyl.	16 Valves	1968cc	TD33122
CUVC	4 Cyl.	16 Valves	1968cc	TD30258
CUVD	4 Cyl.	16 Valves	1968cc	TD30929
CUWA	4 Cyl.	16 Valves	1968cc	TD30259
CYLA	4 Cyl.	16 Valves	1968cc	TD31341
CZHA	4 Cyl.	16 Valves	1968cc	TD32031
CZJA	4 Cyl.	16 Valves	1968cc	TD32597
DBBA	4 Cyl.	16 Valves	1968cc	TD33116
DBGA	4 Cyl.	16 Valves	1968cc	TD33137
DCYA	4 Cyl.	16 Valves	1968cc	TD33136
DDCA	4 Cyl.	16 Valves	1968cc	TD33108
DDCB	4 Cyl.	16 Valves	1968cc	TD33109
DDDA	4 Cyl.	16 Valves	1968cc	TD33110
DEJA	4 Cyl.	16 Valves	1968cc	TD33133
DEJB	4 Cyl.	16 Valves	1968cc	TD33132
DESA	4 Cyl.	16 Valves	1968cc	TD32028
DETA	4 Cyl.	16 Valves	1968cc	TD32029
DETB	4 Cyl.	16 Valves	1968cc	TD32990
DEUA	4 Cyl.	16 Valves	1968cc	TD32032
DEUB	4 Cyl.	16 Valves	1968cc	TD32035
DEUC	4 Cyl.	16 Valves	1968cc	TD32838
DFGA	4 Cyl.	16 Valves	1968cc	TD33895
DFHA	4 Cyl.	16 Valves	1968cc	TD33894
DFTA	4 Cyl.	16 Valves	1968cc	TD33117
DFTB	4 Cyl.	16 Valves	1968cc	TD33118
DFTC	4 Cyl.	16 Valves	1968cc	TD33119
DFUA	4 Cyl.	16 Valves	1968cc	TD33120
DFVA	4 Cyl.	16 Valves	1968cc	TD32030
DGCA	4 Cyl.	16 Valves	1968cc	TD33131

PA5041 (x16)
HR791

NA5361
32.00 x 47.00 x 10.00mm, PTFE

LK5017
85.00 x 130.90 x 15.75mm, PTFE

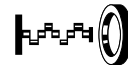
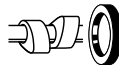

85 2.0L

Petrol

HP	5 Cyl.	10 Valves	1994cc	TD266
JL	5 Cyl.	10 Valves	1994cc	TD271
KP	5 Cyl.	10 Valves	1994cc	TD289
PS	5 Cyl.	10 Valves	1994cc	TD308
RT	5 Cyl.	10 Valves	1994cc	TD318
SL	5 Cyl.	10 Valves	1994cc	TD328
HR615	NA5001 32.00 x 47.00 x 10.00mm, FPM		NB716 35.00 x 48.00 x 10.00mm, FPM NA5133 85.00 x 105.00 x 11.00mm, FPM	

86 2.0L

Petrol

JS	5 Cyl.	10 Valves	1994cc	TD274
SK	5 Cyl.	10 Valves	1994cc	TD327
HR615	NA5001 32.00 x 47.00 x 10.00mm, FPM		NB716 35.00 x 48.00 x 10.00mm, FPM NA5133 85.00 x 105.00 x 11.00mm, FPM LK5006 85.00 x 131.00 x 16.000mm, PTFE	

87 2.0L

Petrol

NM	5 Cyl.	20 Valves	1994cc	TD303
HR5085 (x5)	NA5001 32.00 x 47.00 x 10.00mm, FPM		NB716 35.00 x 48.00 x 10.00mm, FPM NA5133 85.00 x 105.00 x 11.00mm, FPM	

88 2.0L

Petrol

WA	4 Cyl.	8 Valves	1984cc	TD329
WF	4 Cyl.	8 Valves	1984cc	TD334
PB394 (x8)	NA5001 32.00 x 47.00 x 10.00mm, FPM			

89 2.1L

Petrol

GV	5 Cyl.	10 Valves	2144cc	TD261
JY	5 Cyl.	10 Valves	2144cc	TD280
KE	5 Cyl.	10 Valves	2144cc	TD281
KF	5 Cyl.	10 Valves	2144cc	TD282
KG	5 Cyl.	10 Valves	2144cc	TD283
KJ	5 Cyl.	10 Valves	2144cc	TD285
WB	5 Cyl.	10 Valves	2144cc	TD330
WC	5 Cyl.	10 Valves	2144cc	TD331
WD	5 Cyl.	10 Valves	2144cc	TD332
WE	5 Cyl.	10 Valves	2144cc	TD333
WG	5 Cyl.	10 Valves	2144cc	TD335
WJ	5 Cyl.	10 Valves	2144cc	TD337

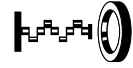
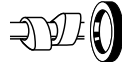

WK	5 Cyl.	10 Valves	2144cc	TD338
WR	5 Cyl.	10 Valves	2144cc	TD341
WS	5 Cyl.	10 Valves	2144cc	TD342
WX	5 Cyl.	10 Valves	2144cc	TD347
HR615	NA5001 32.00 x 47.00 x 10.00mm, FPM		NB716 35.00 x 48.00 x 10.00mm, FPM NA5133 85.00 x 105.00 x 11.00mm, FPM	

90 2.1L

Petrol

KW	5 Cyl.	20 Valves	2144cc	TD292
HR615	NA5001 32.00 x 47.00 x 10.00mm, FPM		NB716 35.00 x 48.00 x 10.00mm, FPM NA5133 85.00 x 105.00 x 11.00mm, FPM	

91 2.2L

Petrol

1B	5 Cyl.	10 Valves	2226cc	TD211
2B	5 Cyl.	10 Valves	2226cc	TD215
HX	5 Cyl.	10 Valves	2226cc	TD267
HY	5 Cyl.	10 Valves	2226cc	TD268
JT	5 Cyl.	10 Valves	2226cc	TD276
KH	5 Cyl.	10 Valves	2144cc	TD284
KK	5 Cyl.	10 Valves	2144cc	TD286
KL	5 Cyl.	10 Valves	2144cc	TD288
KU	5 Cyl.	10 Valves	2226cc	TD9375
KV	5 Cyl.	10 Valves	2226cc	TD4209
KX	5 Cyl.	10 Valves	2226cc	TD293
KZ	5 Cyl.	10 Valves	2226cc	TD294
MB	5 Cyl.	10 Valves	2226cc	TD295
MC	5 Cyl.	10 Valves	2226cc	TD19545
MC	5 Cyl.	10 Valves	2226cc	TD296
PR	5 Cyl.	10 Valves	2226cc	TD26493
PX	5 Cyl.	10 Valves	2226cc	TD312
WU	5 Cyl.	10 Valves	2144cc	TD344
HR615	NA5001 32.00 x 47.00 x 10.00mm, FPM		NB716 35.00 x 48.00 x 10.00mm, FPM NA5133 85.00 x 105.00 x 11.00mm, FPM	

92 2.2L

Petrol

3B	5 Cyl.	20 Valves	2226cc	TD4192
AAN	5 Cyl.	20 Valves	2226cc	TD225
ABY	5 Cyl.	20 Valves	2226cc	TD237
ADU	5 Cyl.	20 Valves	2226cc	TD242
RR	5 Cyl.	20 Valves	2226cc	TD316
HR615	NA5001 (x2) 32.00 x 47.00 x 10.00mm, FPM		NB716 35.00 x 48.00 x 10.00mm, FPM NA5133 85.00 x 105.00 x 11.00mm, FPM	

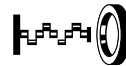
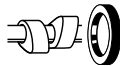

93 2.3L

Petrol

7A	5 Cyl.	20 Valves	2309cc	TD221
	NA5001 (x2) 32.00 x 47.00 x 10.00mm, FPM		NB716 35.00 x 48.00 x 10.00mm, FPM NA5133 85.00 x 105.00 x 11.00mm, FPM	

94 2.3L

Petrol

AAR	5 Cyl.	10 Valves	2309cc	TD4194
NF	5 Cyl.	10 Valves	2309cc	TD301
NG	5 Cyl.	10 Valves	2309cc	TD302
HR615	NA5001 32.00 x 47.00 x 10.00mm, FPM		NB716 35.00 x 48.00 x 10.00mm, FPM NA5133 85.00 x 105.00 x 11.00mm, FPM	

95 2.4L

Diesel

3D	5 Cyl.	10 Valves	2370cc	TD218
AAS	5 Cyl.	10 Valves	2370cc	TD227
HR615	NA5001 32.00 x 47.00 x 10.00mm, FPM		NB716 35.00 x 48.00 x 10.00mm, FPM NA5133 85.00 x 105.00 x 11.00mm, FPM	

96 2.4L

Petrol

AFM	6 Cyl.	12 Valves	2393cc	TD17146
HR662	NA5001 (x4) 32.00 x 47.00 x 10.00mm, FPM		NB716 35.00 x 48.00 x 10.00mm, FPM NA5133 85.00 x 105.00 x 11.00mm, FPM	

97 2.4L

Petrol

AGA	6 Cyl.	30 Valves	2393cc	TD9515
AJG	6 Cyl.	30 Valves	2393cc	TD13928
ALF	6 Cyl.	30 Valves	2393cc	TD11359
ALW	6 Cyl.	30 Valves	2393cc	TD11088
AML	6 Cyl.	30 Valves	2393cc	TD13951
AMM	6 Cyl.	30 Valves	2393cc	TD15331
APC	6 Cyl.	30 Valves	2393cc	TD11360
APS	6 Cyl.	30 Valves	2393cc	TD13952
APS	6 Cyl.	30 Valves	2393cc	TD19542
APZ	6 Cyl.	30 Valves	2393cc	TD13954
ARJ	6 Cyl.	30 Valves	2393cc	TD13953
ARN	6 Cyl.	30 Valves	2393cc	TD14028
ASM	6 Cyl.	30 Valves	2393cc	TD15330
BDV	6 Cyl.	30 Valves	2393cc	TD16410
BDV	6 Cyl.	30 Valves	2393cc	TD20636
PA5041 (x30)	NA5001 (x4) 32.00 x 47.00 x 10.00mm, FPM		NA5106 35.00 x 48.00 x 10.00mm, PTFE NA5349 85.00 x 105.00 x 12.00mm, PTFE/ACM	

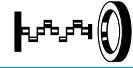

98 2.4L Petrol

BDW	6 Cyl.	24 Valves	2393cc	TD20637
BDW	6 Cyl.	24 Valves	2393cc	TD17374
PA5041 (x24) HR5062			NA5325 85.00 x 105.00 x 8.80mm, PTFE	

99 2.5L Diesel

1T	5 Cyl.	10 Valves	2461cc	TD212
AAT	5 Cyl.	10 Valves	2461cc	TD228
ABP	5 Cyl.	10 Valves	2461cc	TD235
AEL	5 Cyl.	10 Valves	2461cc	TD245
HR615	NA5001 (x2) 32.00 x 47.00 x 10.00mm, FPM	NB716 35.00 x 48.00 x 10.00mm, FPM		NA5133 85.00 x 105.00 x 11.00mm, FPM

100 2.5L Diesel

AFB	6 Cyl.	24 Valves	2496cc	TD9517
AKE	6 Cyl.	24 Valves	2496cc	TD15312
AKN	6 Cyl.	24 Valves	2496cc	TD11356
AYM	6 Cyl.	24 Valves	2496cc	TD16384
BAU	6 Cyl.	24 Valves	2496cc	TD17033
BAU	6 Cyl.	24 Valves	2496cc	TD33296
BCZ	6 Cyl.	24 Valves	2496cc	TD16859
BDG	6 Cyl.	24 Valves	2496cc	TD16860
BDH	6 Cyl.	24 Valves	2496cc	TD17034
BFC	6 Cyl.	24 Valves	2496cc	TD16858
BND	6 Cyl.	24 Valves	2496cc	TD19131
BND	6 Cyl.	24 Valves	2496cc	TD20642
PA5041 (x24) HR5062	NA5001 (x2) 32.00 x 47.00 x 10.00mm, FPM	NB716 35.00 x 48.00 x 10.00mm, FPM		NA5349 85.00 x 105.00 x 12.00mm, PTFE/ACM

101 2.5L Petrol

CEPA	5 Cyl.	20 Valves	2480cc	TD23089
CEPB	5 Cyl.	20 Valves	2480cc	TD25430
CTSA	5 Cyl.	20 Valves	2480cc	TD29520
CZGA	5 Cyl.	20 Valves	2480cc	TD30615
CZGB	5 Cyl.	20 Valves	2480cc	TD32806
DAZA	5 Cyl.	20 Valves	2480cc	TD33679
PA5041 (x20) HR822			NA5349 85.00 x 105.00 x 12.00mm, PTFE/ACM	

102 2.5L Petrol

CLXA	6 Cyl.	24 Valves	2498cc	TD33140
CLXB	6 Cyl.	24 Valves	2498cc	TD29214
CPAA	6 Cyl.	24 Valves	2498cc	TD27966
CVBA	6 Cyl.	24 Valves	2498cc	TD31388
PA5041 (x24) HR5062			NA5325 85.00 x 105.00 x 8.80mm, PTFE	

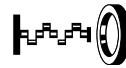
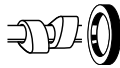

103 2.6L

Petrol

ABC	6 Cyl.	12 Valves	2598cc	TD231
ACZ	6 Cyl.	12 Valves	2598cc	TD239
HR805	NA5001 (x3) 32.00 x 47.00 x 10.00mm, FPM			NB716 35.00 x 48.00 x 10.00mm, FPM
HR662	Ch no. 8C-S-025-820; 08-G-S-001 302			NA5133 85.00 x 105.00 x 11.00mm, FPM
Ch no. 8C-S-025 821; 8G-S-001 303→				

104 2.7L

Petrol

AGB	6 Cyl.	30 Valves	2671cc	TD11888
AJK	6 Cyl.	30 Valves	2671cc	TD10813
APB	6 Cyl.	30 Valves	2671cc	TD17865
ARE	6 Cyl.	30 Valves	2671cc	TD15328
AZA	6 Cyl.	30 Valves	2671cc	TD17164
AZB	6 Cyl.	30 Valves	2671cc	TD20534
BEL	6 Cyl.	30 Valves	2671cc	TD20674
BES	6 Cyl.	30 Valves	2671cc	TD16432
PA5041 (x30)	NA5001 (x4) 32.00 x 47.00 x 10.00mm, FPM			NB716 35.00 x 48.00 x 10.00mm, FPM
				NA5106 35.00 x 48.00 x 10.00mm, PTFE
				NA5349 85.00 x 105.00 x 12.00mm, PTFE/ACM

105 2.7L

Petrol

ASJ	6 Cyl.	30 Valves	2671cc	TD14150
AZR	6 Cyl.	30 Valves	2671cc	TD16417
PA5041 (x30)	NA5001 32.00 x 47.00 x 10.00mm, FPM			NA5106 35.00 x 48.00 x 10.00mm, PTFE
				NA5124 (x3) 32.00 x 47.00 x 10.00mm, PTFE/ACM

106 2.7L

Diesel

BPP	6 Cyl.	24 Valves	2698cc	TD18926
BSG	6 Cyl.	24 Valves	2698cc	TD18030
CAMA	6 Cyl.	24 Valves	2698cc	TD20006
CAMB	6 Cyl.	24 Valves	2698cc	TD20599
CANA	6 Cyl.	24 Valves	2698cc	TD21172
CANB	6 Cyl.	24 Valves	2698cc	TD22658
CANC	6 Cyl.	24 Valves	2698cc	TD22659
CAND	6 Cyl.	24 Valves	2698cc	TD23099
CGKA	6 Cyl.	24 Valves	2698cc	TD21065
CGKB	6 Cyl.	24 Valves	2698cc	TD21064
PA5041 (x24) HR5062	NA5001 (x2) 32.00 x 47.00 x 10.00mm, FPM			NA5329 55.00 x 70.00 x 8.00mm, PTFE
				NA5325 85.00 x 105.00 x 8.80mm, PTFE

107 2.7L

Diesel

CANA	6 Cyl.	24 Valves	2698cc	TD26739
PA5041 (x24) HR5062	NA5001 32.00 x 47.00 x 10.00mm, FPM			NA5329 55.00 x 70.00 x 8.00mm, PTFE
				NA5325 85.00 x 105.00 x 8.80mm, PTFE

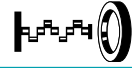

108 2.8L		Petrol		
AAH	6 Cyl.	12 Valves	2771cc	TD224
AEJ	6 Cyl.	12 Valves	2771cc	TD9541
HR805	→Ch no. 8C-S-025-820; 08-G-S-001 302		NA5001 (x3) 32.00 x 47.00 x 10.00mm, FPM	NB716 35.00 x 48.00 x 10.00mm, FPM
HR662	Ch no. 8C-S-025 821; 8G-S-001 303→			NA5133 85.00 x 105.00 x 11.00mm, FPM

109 2.8L		Petrol		
ACK	6 Cyl.	30 Valves	2771cc	TD4197
PA5041 (x30)			NA5001 (x4) 32.00 x 47.00 x 10.00mm, FPM	NB716 35.00 x 48.00 x 10.00mm, FPM
				NA5349 85.00 x 105.00 x 12.00mm, PTFE/ACM

110 2.8L		Petrol		
AFC	6 Cyl.	12 Valves	2771cc	TD21916
AFC	6 Cyl.	12 Valves	2771cc	TD246
HR805	→Ch no. 8C-S-025-820; 08-G-S-001 302		NA5001 32.00 x 47.00 x 10.00mm, FPM	NB716 35.00 x 48.00 x 10.00mm, FPM
HR662	Ch no. 8C-S-025 821; 8G-S-001 303→			NA5133 85.00 x 105.00 x 11.00mm, FPM

111 2.8L		Petrol		
AGE	6 Cyl.	30 Valves	2771cc	TD15616
AHA	6 Cyl.	30 Valves	2771cc	TD26491
AMX	6 Cyl.	30 Valves	2771cc	TD13930
ATX	6 Cyl.	30 Valves	2771cc	TD15617
BBG	6 Cyl.	30 Valves	2771cc	TD21600
BBG	6 Cyl.	30 Valves	2771cc	TD19142
PA5041 (x30)			NA5001 (x2) 32.00 x 47.00 x 10.00mm, FPM	NA5106 35.00 x 48.00 x 10.00mm, PTFE
				NA5349 85.00 x 105.00 x 12.00mm, PTFE/ACM

112 2.8L		Petrol		
ALG	6 Cyl.	30 Valves	2771cc	TD9516
AMX	6 Cyl.	30 Valves	2771cc	TD19541
APR	6 Cyl.	30 Valves	2771cc	TD13931
AQD	6 Cyl.	30 Valves	2771cc	TD13932
PA5041 (x30)			NA5001 (x4) 32.00 x 47.00 x 10.00mm, FPM	NA5106 35.00 x 48.00 x 10.00mm, PTFE
				NA5349 85.00 x 105.00 x 12.00mm, PTFE/ACM

113 2.8L		Petrol		
ATX	6 Cyl.	30 Valves	2771cc	TD19544
PA5041 (x30)			NA5163 (x2) 32.00 x 47.00 x 10.00mm, FPM	NA5106 35.00 x 48.00 x 10.00mm, PTFE
			NA5001 (x4) 32.00 x 47.00 x 10.00mm, FPM	NA5349 85.00 x 105.00 x 12.00mm, PTFE/ACM

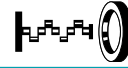

114 2.8L

Petrol

BDX	6 Cyl.	24 Valves	2773cc	TD20108
CCDA	6 Cyl.	24 Valves	2773cc	TD21174
CCEA	6 Cyl.	24 Valves	2773cc	TD21175
CCEA	6 Cyl.	24 Valves	2773cc	TD26740
CHVA	6 Cyl.	24 Valves	2773cc	TD24758
CJBA	6 Cyl.	24 Valves	2773cc	TD25768
CNYA	6 Cyl.	24 Valves	2773cc	TD24757
CNYB	6 Cyl.	24 Valves	2773cc	TD31387
CVPA	6 Cyl.	24 Valves	2773cc	TD32594

PA5041 (x24)
HR5062

NA5325
85.00 x 105.00 x 8.80mm, PTFE

115 3.0L

Diesel

ASB	6 Cyl.	24 Valves	2967cc	TD17336
BKN	6 Cyl.	24 Valves	2967cc	TD18027
BMK	6 Cyl.	24 Valves	2967cc	TD17845
BNG	6 Cyl.	24 Valves	2967cc	TD17337
BUG	6 Cyl.	24 Valves	2967cc	TD18996
BUN	6 Cyl.	24 Valves	2967cc	TD19881
CAPA	6 Cyl.	24 Valves	2967cc	TD20007
CASA	6 Cyl.	24 Valves	2967cc	TD20709
CASB	6 Cyl.	24 Valves	2967cc	TD21315
CATA	6 Cyl.	24 Valves	2967cc	TD22660
CCLA	6 Cyl.	24 Valves	2967cc	TD23861
CCMA	6 Cyl.	24 Valves	2967cc	TD21316
CCWA	6 Cyl.	24 Valves	2967cc	TD20600
CCWB	6 Cyl.	24 Valves	2967cc	TD21029
CDYA	6 Cyl.	24 Valves	2967cc	TD21177
CDYB	6 Cyl.	24 Valves	2967cc	TD22955
CDYC	6 Cyl.	24 Valves	2967cc	TD22973

PA5041 (x24)
HR5062

NA5001
32.00 x 47.00 x 10.00mm, FPM

NA5329
55.00 x 70.00 x 8.00mm, PTFE

NA5325
85.00 x 105.00 x 8.80mm, PTFE

116 3.0L

Petrol

ASN	6 Cyl.	30 Valves	2976cc	TD15346
AVK	6 Cyl.	30 Valves	2976cc	TD17863
BBJ	6 Cyl.	30 Valves	2976cc	TD16516
BBJ	6 Cyl.	30 Valves	2976cc	TD20635

PA5041 (x30)

NA5106
35.00 x 48.00 x 10.00mm, PTFE

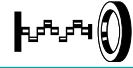

117 3.0L Petrol

CAJA	6 Cyl.	24 Valves	2995cc	TD21178
CAJA	6 Cyl.	24 Valves	2995cc	TD26738
CAKA	6 Cyl.	24 Valves	2995cc	TD21117
CCAA	6 Cyl.	24 Valves	2995cc	TD22664
CCBA	6 Cyl.	24 Valves	2995cc	TD23862
CGWA	6 Cyl.	24 Valves	2995cc	TD23971
CGWB	6 Cyl.	24 Valves	2995cc	TD24759
CGWC	6 Cyl.	24 Valves	2995cc	TD26472
CGWD	6 Cyl.	24 Valves	2995cc	TD25667
CGXA	6 Cyl.	24 Valves	2995cc	TD23970
CGXB	6 Cyl.	24 Valves	2995cc	TD24960
CGXC	6 Cyl.	24 Valves	2995cc	TD25721
CHMA	6 Cyl.	24 Valves	2995cc	TD27525
CJTB	6 Cyl.	24 Valves	2995cc	TD24387
CJTC	6 Cyl.	24 Valves	2995cc	TD24394
CJWB	6 Cyl.	24 Valves	2995cc	TD24388
CJWC	6 Cyl.	24 Valves	2995cc	TD24395
CJWE	6 Cyl.	24 Valves	2995cc	TD25737
CMDA	6 Cyl.	24 Valves	2995cc	TD24957
CMUA	6 Cyl.	24 Valves	2995cc	TD26327
CNAA	6 Cyl.	24 Valves	2995cc	TD24389
CREA	6 Cyl.	24 Valves	2995cc	TD29540
CREC	6 Cyl.	24 Valves	2995cc	TD29439
CRED	6 Cyl.	24 Valves	2995cc	TD30796
CREG	6 Cyl.	24 Valves	2995cc	TD29539
CREH	6 Cyl.	24 Valves	2995cc	TD33114
CTDA	6 Cyl.	24 Valves	2995cc	TD29440
CTTA	6 Cyl.	24 Valves	2995cc	TD25665
CTUA	6 Cyl.	24 Valves	2995cc	TD25666
CTUB	6 Cyl.	24 Valves	2995cc	TD25722
CTUC	6 Cyl.	24 Valves	2995cc	TD26889
CTUD	6 Cyl.	24 Valves	2995cc	TD28421
CTVA	6 Cyl.	24 Valves	2995cc	TD26890
CTWA	6 Cyl.	24 Valves	2995cc	TD26227
CTWB	6 Cyl.	24 Valves	2995cc	TD25738
CTXA	6 Cyl.	24 Valves	2995cc	TD28422
CWGD	6 Cyl.	24 Valves	2995cc	TD33107

PA5041 (x24)
HR5062

NA5325
85.00 x 105.00 x 8.80mm, PTFE

118 3.0L Diesel

CDTA	6 Cyl.	24 Valves	2967cc	TD23973
CDTB	6 Cyl.	24 Valves	2967cc	TD25770
CDTC	6 Cyl.	24 Valves	2967cc	TD31395
CDUC	6 Cyl.	24 Valves	2967cc	TD24761
CDUD	6 Cyl.	24 Valves	2967cc	TD25669
CGQB	6 Cyl.	24 Valves	2967cc	TD24944
CIGA	6 Cyl.	24 Valves	2967cc	TD24959
CJGC	6 Cyl.	24 Valves	2967cc	TD24396

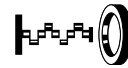
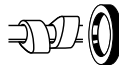

CJGD	6 Cyl.	24 Valves	2967cc	TD25215
CJMA	6 Cyl.	24 Valves	2967cc	TD24397
CKVB	6 Cyl.	24 Valves	2967cc	TD24762
CKVC	6 Cyl.	24 Valves	2967cc	TD25668
CKVD	6 Cyl.	24 Valves	2967cc	TD31344
CLAA	6 Cyl.	24 Valves	2967cc	TD24873
CLAB	6 Cyl.	24 Valves	2967cc	TD24760
CLZB	6 Cyl.	24 Valves	2967cc	TD25402
CMHA	6 Cyl.	24 Valves	2967cc	TD25723
CNRB	6 Cyl.	24 Valves	2967cc	TD26228
CPNA	6 Cyl.	24 Valves	2967cc	TD27956
CPNB	6 Cyl.	24 Valves	2967cc	TD27526
CRCA	6 Cyl.	24 Valves	2967cc	TD25216
CRTC	6 Cyl.	24 Valves	2967cc	TD31032
CRTD	6 Cyl.	24 Valves	2967cc	TD29595
CRTE	6 Cyl.	24 Valves	2967cc	TD29594
CRTF	6 Cyl.	24 Valves	2967cc	TD29599
CSWB	6 Cyl.	24 Valves	2967cc	TD32033
CTBA	6 Cyl.	24 Valves	2967cc	TD28254
CTBB	6 Cyl.	24 Valves	2967cc	TD31397
CTBC	6 Cyl.	24 Valves	2967cc	TD29239
CTBD	6 Cyl.	24 Valves	2967cc	TD31348
CTCB	6 Cyl.	24 Valves	2967cc	TD29600
CTCC	6 Cyl.	24 Valves	2967cc	TD29593
CUEA	6 Cyl.	24 Valves	2967cc	TD32399
CVMD	6 Cyl.	24 Valves	2967cc	TD31033
CVUA	6 Cyl.	24 Valves	2967cc	TD29596
CVUB	6 Cyl.	24 Valves	2967cc	TD29689
CVUC	6 Cyl.	24 Valves	2967cc	TD32438
CVZA	6 Cyl.	24 Valves	2967cc	TD32228
CZVA	6 Cyl.	24 Valves	2967cc	TD32600
CZVB	6 Cyl.	24 Valves	2967cc	TD32599
CZVC	6 Cyl.	24 Valves	2967cc	TD32598
CZVD	6 Cyl.	24 Valves	2967cc	TD32526
CZVE	6 Cyl.	24 Valves	2967cc	TD32232
CZVF	6 Cyl.	24 Valves	2967cc	TD32233
CZZA	6 Cyl.	24 Valves	2967cc	TD31559
CZZB	6 Cyl.	24 Valves	2967cc	TD31561
DCPC	6 Cyl.	24 Valves	2967cc	TD34505
DEHA	6 Cyl.	24 Valves	2967cc	TD32166

PA5041 (x24)
HR5062

NA5329
55.00 x 70.00 x 8.00mm, PTFE

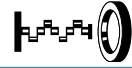

119 3.2L		Petrol		
AUK	6 Cyl.	24 Valves	3123cc	TD17376
BKH	6 Cyl.	24 Valves	3123cc	TD19706
BPK	6 Cyl.	24 Valves	3123cc	TD18191
BYU	6 Cyl.	24 Valves	3123cc	TD19711
CALA	6 Cyl.	24 Valves	3197cc	TD26741
CALA	6 Cyl.	24 Valves	3197cc	TD20005
CALB	6 Cyl.	24 Valves	3197cc	TD21357
PA5041 (x24) HR5062				NA5325 85.00 x 105.00 x 8.80mm, PTFE

120 3.2L		Petrol		
BDB	6 Cyl.	24 Valves	3189cc	TD17068
PA5041 (x24) HR5062				NA5106 35.00 x 48.00 x 10.00mm, PTFE NA5305 85.00 x 105.00 x 11.00mm, PTFE 01/01→

121 3.2L		Petrol		
BHE	6 Cyl.	24 Valves	3189cc	TD17029
BMJ	6 Cyl.	24 Valves	3189cc	TD17407
BPF	6 Cyl.	24 Valves	3189cc	TD20705
BUB	6 Cyl.	24 Valves	3189cc	TD19200
PA5041 (x24) HR5062				NA5106 35.00 x 48.00 x 10.00mm, PTFE NA5305 85.00 x 105.00 x 11.00mm, PTFE

122 3.3L		Diesel		
AKF	8 Cyl.	40 Valves	3328cc	TD15344
PA5041 (x40) HR822 (x2)			NA5001 (x4) 32.00 x 47.00 x 10.00mm, FPM	

123 3.6L		Petrol		
BHK	6 Cyl.	24 Valves	3597cc	TD19880
PA5041 (x24) HR5062				NA5305 85.00 x 105.00 x 11.00mm, PTFE

124 3.6L		Petrol		
PT	8 Cyl.	32 Valves	3562cc	TD310
HR816 (x4)			NA5001 (x2) 32.00 x 47.00 x 10.00mm, FPM	

125 3.7L		Petrol		
AEW	8 Cyl.	32 Valves	3697cc	TD4201
PA5041 (x32) HR791 (x2)			NA5001 (x2) 32.00 x 47.00 x 10.00mm, FPM	NB716 35.00 x 48.00 x 10.00mm, FPM

126 3.7L		Petrol		
AKC	8 Cyl.	40 Valves	3697cc	TD15343
AQG	8 Cyl.	40 Valves	3697cc	TD11358
BFL	8 Cyl.	40 Valves	3697cc	TD17031
PA5041 (x40) HR822 (x2)			NA5001 (x2) 32.00 x 47.00 x 10.00mm, FPM	



127 3.7L

Petrol

AKJ	8 Cyl.	32 Valves	3697cc	TD17154
PA5041 (x32) HR791  (x2)	NA5001 32.00 x 47.00 x 10.00mm, FPM	NB716 	35.00 x 48.00 x 10.00mm, FPM	



128 4.0L

Diesel

ASE	8 Cyl.	32 Valves	3936cc	TD17030
PA5041 (x32) HR791  (x2)	NA5307 (x2) 32.00 x 47.00 x 10.00mm, PTFE	NA5325 	85.00 x 105.00 x 8.80mm, PTFE	

129 4.0L

Petrol

CEUA	8 Cyl.	32 Valves	3993cc	TD25720
CEUC	8 Cyl.	32 Valves	3993cc	TD25634
CGTA	8 Cyl.	32 Valves	3993cc	TD25685
CRDB	8 Cyl.	32 Valves	3993cc	TD27986
CTFA	8 Cyl.	32 Valves	3993cc	TD31001
CTGA	8 Cyl.	32 Valves	3993cc	TD28255
CTGE	8 Cyl.	32 Valves	3993cc	TD29592
CTGF	8 Cyl.	32 Valves	3993cc	TD33112
CWUB	8 Cyl.	32 Valves	3993cc	TD30822
CWUC	8 Cyl.	32 Valves	3993cc	TD32248
DDTA	8 Cyl.	32 Valves	3993cc	TD32252
PA5041 (x32) HR791  (x2)		NA5325 	85.00 x 105.00 x 8.80mm, PTFE	



130 4.0L

Diesel

CZAC	8 Cyl.	32 Valves	3956cc	TD33418
PA5041 (x32) HR791  (x2)		NA5329 	55.00 x 70.00 x 8.00mm, PTFE	



131 4.2L

Petrol

ABH	8 Cyl.	32 Valves	4172cc	TD4195
HR816  (x4)	NA5001 (x2) 32.00 x 47.00 x 10.00mm, FPM	NB716 	35.00 x 48.00 x 10.00mm, FPM	

132 4.2L

Petrol

ABZ	8 Cyl.	32 Valves	4172cc	TD4196
AEC	8 Cyl.	32 Valves	4172cc	TD244
AEM	8 Cyl.	32 Valves	4172cc	TD4200
AGH	8 Cyl.	32 Valves	4172cc	TD21917
AGH	8 Cyl.	32 Valves	4172cc	TD17149
AHC	8 Cyl.	32 Valves	4172cc	TD4203
AHK	8 Cyl.	32 Valves	4172cc	TD4204
AKG	8 Cyl.	32 Valves	4172cc	TD17152
AKH	8 Cyl.	32 Valves	4172cc	TD17153
PA5041 (x32) HR791  (x2)	NA5001 (x2) 32.00 x 47.00 x 10.00mm, FPM	NB716 	35.00 x 48.00 x 10.00mm, FPM	

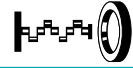

133 4.2L Petrol

ANK	8 Cyl.	40 Valves	4172cc	TD15338
AQF	8 Cyl.	40 Valves	4172cc	TD11357
AQH	8 Cyl.	40 Valves	4172cc	TD13439
AQJ	8 Cyl.	40 Valves	4172cc	TD15339
ARS	8 Cyl.	40 Valves	4172cc	TD12107
ASG	8 Cyl.	40 Valves	4172cc	TD15337
AUW	8 Cyl.	40 Valves	4172cc	TD15342
AVP	8 Cyl.	40 Valves	4172cc	TD15340
AYS	8 Cyl.	40 Valves	4172cc	TD17163
BBD	8 Cyl.	40 Valves	4172cc	TD29481
BCY	8 Cyl.	40 Valves	4172cc	TD16411
BFM	8 Cyl.	40 Valves	4172cc	TD17032
BRV	8 Cyl.	40 Valves	4172cc	TD20401

PA5041 (x40)
HR822 (x2)

NA5001 (x4)
32.00 x 47.00 x 10.00mm, FPM

134 4.2L Petrol

ARU	8 Cyl.	32 Valves	4172cc	TD13440
-----	--------	-----------	--------	---------

PA5041 (x40)
HR791 (x2)

NA5001 (x4)
32.00 x 47.00 x 10.00mm, FPM

135 4.2L Petrol

AUX	8 Cyl.	40 Valves	4172cc	TD15341
AWN	8 Cyl.	40 Valves	4172cc	TD15336
BCS	8 Cyl.	40 Valves	4172cc	TD17165

PA5041 (x40)
HR822

NA5001 (x4)
32.00 x 47.00 x 10.00mm, FPM

136 4.2L Petrol

BAR	8 Cyl.	32 Valves	4163cc	TD18995
BNS	8 Cyl.	32 Valves	4163cc	TD20400
BVJ	8 Cyl.	32 Valves	4163cc	TD18927
BYH	8 Cyl.	32 Valves	4163cc	TD19876
CAUA	8 Cyl.	32 Valves	4163cc	TD20601
CDRA	8 Cyl.	32 Valves	4163cc	TD23972
CFSA	8 Cyl.	32 Valves	4163cc	TD24942
CNDA	8 Cyl.	32 Valves	4163cc	TD24142

PA5041 (x32)
HR791 (x2)

NA5325
85.00 x 105.00 x 8.80mm, PTFE

137 4.2L Petrol

BAS	8 Cyl.	40 Valves	4163cc	TD16433
BAT	8 Cyl.	40 Valves	4163cc	TD17378
BBK	8 Cyl.	40 Valves	4163cc	TD16729
BHF	8 Cyl.	40 Valves	4163cc	TD19707

PA5041 (x40)
HR822 (x2)

NA5325
85.00 x 105.00 x 8.80mm, PTFE



138 4.2L

Diesel

BMC	8 Cyl.	32 Valves	4134cc	TD18192
BTR	8 Cyl.	32 Valves	4134cc	TD19883
BVN	8 Cyl.	32 Valves	4134cc	TD18992

PA5041 (x32)
HR791  (x2)

NA5307 (x2)
32.00 x 47.00 x 10.00mm, PTFE

NA5329 
55.00 x 70.00 x 8.00mm, PTFE
NA5325 
85.00 x 105.00 x 8.80mm, PTFE

139 4.2L

Diesel

CCFA	8 Cyl.	32 Valves	4134cc	TD23106
CCFC	8 Cyl.	32 Valves	4134cc	TD24958
CDSB	8 Cyl.	32 Valves	4134cc	TD23974

PA5041 (x32)
HR791  (x2)

NA5307 (x2)
32.00 x 47.00 x 10.00mm, PTFE

NF850 
85.00 x 105.00 x 8.80mm, FPM

140 4.2L

Diesel

CTEC	8 Cyl.	32 Valves	4134cc	TD28253
------	--------	-----------	--------	---------

PA5041 (x32)
HR791  (x2)

NA5307 (x2)
32.00 x 47.00 x 10.00mm, PTFE

141 5.0L

Petrol

BUH	10 Cyl.	40 Valves	4991cc	TD20940
-----	---------	-----------	--------	---------

PA5041 (x40)
HR822  (x2)

NA5325 
85.00 x 105.00 x 8.80mm, PTFE

142 5.2L

Petrol

BSM	10 Cyl.	40 Valves	5204cc	TD18905
BUJ	10 Cyl.	40 Valves	5204cc	TD23311
BXA	10 Cyl.	40 Valves	5204cc	TD18928
CMPA	10 Cyl.	40 Valves	5204cc	TD25429
CSPA	10 Cyl.	40 Valves	5204cc	TD32514
CTPA	10 Cyl.	40 Valves	5204cc	TD26226
CTPB	10 Cyl.	40 Valves	5204cc	TD29309
CTYA	10 Cyl.	40 Valves	5204cc	TD27763

PA5041 (x40)
HR822  (x2)

NA5325 
85.00 x 105.00 x 8.80mm, PTFE

143 5.2L

Petrol

CSPB	10 Cyl.	40 Valves	5204cc	TD32515
------	---------	-----------	--------	---------

PA5041 (x40)
HR822  (x2)

NA5361 (x2)
32.00 x 47.00 x 10.00mm, PTFE

NA5325 
85.00 x 105.00 x 8.80mm, PTFE

144 6.0L

Petrol

AZC	12 Cyl.	48 Valves	5998cc	TD16418
-----	---------	-----------	--------	---------

PA5041 (x48)
HR5062  (x2)

NA5305 
85.00 x 105.00 x 11.00mm, PTFE
01/01 →

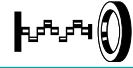

145 6.0L Petrol

BHT	12 Cyl.	48 Valves	5998cc	TD17284
BSB	12 Cyl.	48 Valves	5998cc	TD19709
BTE	12 Cyl.	48 Valves	5998cc	TD21918
BTE	12 Cyl.	48 Valves	5998cc	TD18242

PA5041 (x48) HR5062  (x2)	NA5305  85.00 x 105.00 x 11.00mm, PTFE
---	--

146 6.0L Diesel

CCGA	12 Cyl.	48 Valves	5934cc	TD21318
------	---------	-----------	--------	---------

PA5041 (x48) HR5062  (x2)	NA5329  55.00 x 70.00 x 8.00mm, PTFE
---	--

147 6.3L Petrol

CEJA	12 Cyl.	48 Valves	6299cc	TD24956
CTNA	12 Cyl.	48 Valves	6299cc	TD29441

PA5041 (x48) HR5062  (x2)	NA5305  85.00 x 105.00 x 11.00mm, PTFE
---	--











CC



9

1000-Series MK II	03/67→04/69	12 H	Petrol	1275	4	8	4
Allegro Estate (ADO 67)	08/75→03/82	14 H	Petrol	1485	4	8	6
Allegro Estate (ADO 67)	01/81→12/83	12 H	Petrol	1275	4	8	4
Allegro Hatchback (ADO 67)	05/73→10/81	10 H	Petrol	1098	4	8	3
Allegro Hatchback (ADO 67)	05/73→03/82	14 H	Petrol	1485	4	8	6
Allegro Hatchback (ADO 67)	05/73→10/83	12 H	Petrol	1275	4	8	4
Allegro Hatchback (ADO 67)	01/80→10/83	99 H	Petrol	999	4	8	2
Allegro Saloon	02/73→12/84	12 H	Petrol	1275	4	8	4
Allegro Saloon	12/79→12/81	14 H	Petrol	1485	4	8	6
Ambassador	03/82→10/84	20 H	Petrol	1994	4	8	9
America	09/67→12/72	12 H	Petrol	1275	4	8	4
Maestro (XC)	03/83→08/85	16 HA03AL	Petrol	1598	4	8	7
Maestro (XC)	03/83→08/90	16 HA35AL	Petrol	1598	4	8	7
Maestro (XC)	03/83→08/90	16 HC37	Petrol	1598	4	8	7
Maestro (XC)	03/83→09/92	12 H	Petrol	1275	4	8	4
Maestro (XC)	10/84→08/90	20 HC51AA	Petrol	1994	4	8	9
Maestro (XC)	01/86→09/92	12 HE	Petrol	1275	4	8	5
Maxi	04/69→07/80	14 H	Petrol	1485	4	8	6
Metro	10/80→12/83	12 HL	Petrol	1275	4	8	5
Metro	10/80→12/85	12 H996AA	Petrol	1275	4	8	4
Metro	10/80→04/90	12 H	Petrol	1275	4	8	4
Metro	10/80→04/90	12 HA83AA	Petrol	1275	4	8	4
Metro	10/80→04/90	99 H	Petrol	999	4	8	2
Metro	10/80→04/90	99 HA65P	Petrol	999	4	8	2
Metro	10/83→04/90	12 HA85AA	Petrol	1275	4	8	4
Metro	11/85→04/90	12 HC21AA	Petrol	1273	4	8	4
Mini	01/61→09/84	99 H	Petrol	999	4	8	2
Mini	01/67→08/79	BMC Serie A	Petrol	848	4	8	1
Mini	09/69→09/80	12 HC	Petrol	1275	4	8	4
Mini	10/69→09/80	12 H	Petrol	1275	4	8	4
Mini	01/76→08/81	10 H	Petrol	1098	4	8	3
Mini	08/82→06/93	99 H997P	Petrol	998	4	8	2
Mini	08/82→06/93	99 HA53P	Petrol	998	4	8	2
Mini	08/82→06/93	99 HC20P	Petrol	998	4	8	2
Mini	09/88→06/93	99 HD81	Petrol	999	4	8	2
Mini Box Body / Estate	01/69→12/80	99 H	Petrol	999	4	8	2
Mini Estate	01/76→08/81	10 H	Petrol	1098	4	8	3
Montego (XE)	04/84→08/88	12 HL	Petrol	1275	4	8	5
Montego (XE)	04/84→08/88	16 HC37	Petrol	1598	4	8	7
Montego (XE)	04/84→08/88	20 H	Petrol	1994	4	8	9
Montego (XE)	04/84→08/88	20 H(EFI)	Petrol	1994	4	8	9
Montego (XE)	04/84→08/88	20 HC85	Petrol	1994	4	8	9
Montego (XE)	04/84→08/88	20 HSC	Petrol	1994	4	8	9
Montego Estate (XE)	10/84→08/88	16 HC37	Petrol	1598	4	8	7
Montego Estate (XE)	10/84→10/88	12 HL	Petrol	1275	4	8	5
Montego Estate (XE)	10/84→08/91	20 HSC	Petrol	1994	4	8	9
Montego Estate (XE)	10/84→09/92	20 H	Petrol	1994	4	8	9
Princess	04/76→09/78	18 H	Petrol	1798	4	8	8
Princess 2	10/78→10/82	20 H	Petrol	1994	4	8	9

	CC				9		CC				9
10 H	1098	4	8	Petrol	3						
12 H	1275	4	8	Petrol	4						
12 H996AA	1275	4	8	Petrol	4						
12 HA83AA	1275	4	8	Petrol	4						
12 HA85AA	1275	4	8	Petrol	4						
12 HC	1275	4	8	Petrol	4						
12 HC21AA	1273	4	8	Petrol	4						
12 HE	1275	4	8	Petrol	5						
12 HL	1275	4	8	Petrol	5						
14 H	1485	4	8	Petrol	6						
16 H	1598	4	8	Petrol	7						
16 HA03AL	1598	4	8	Petrol	7						
16 HA35AL	1598	4	8	Petrol	7						
16 HC37	1598	4	8	Petrol	7						
18 H	1798	4	8	Petrol	8						
20 H	1994	4	8	Petrol	9						
20 H(EFI)	1994	4	8	Petrol	9						
20 HC51AA	1994	4	8	Petrol	9						
20 HC85	1994	4	8	Petrol	9						
20 HSC	1994	4	8	Petrol	9						
99 H	999	4	8	Petrol	2						
99 H997P	998	4	8	Petrol	2						
99 HA53P	998	4	8	Petrol	2						
99 HA65P	999	4	8	Petrol	2						
99 HC20P	998	4	8	Petrol	2						
99 HD81	999	4	8	Petrol	2						
BMC Serie A	848	4	8	Petrol	1						

AUSTIN

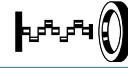

1 0.8L Petrol

BMC Serie A	4 Cyl.	8 Valves	848cc	TD13428
HR619				
				NA473 39.70 x 59.00 x 9.50mm, NBR NA584 55.00 x 70.00 x 10.00mm, MVQ

2 1.0L Petrol

99 H	4 Cyl.	8 Valves	999cc	TD4215
99 H997P	4 Cyl.	8 Valves	998cc	TD5473
99 HA53P	4 Cyl.	8 Valves	998cc	TD5472
99 HA65P	4 Cyl.	8 Valves	999cc	TD383
99 HC20P	4 Cyl.	8 Valves	998cc	TD5474
99 HD81	4 Cyl.	8 Valves	999cc	TD5471
HR339				
				NA473 39.70 x 59.00 x 9.50mm, NBR NA584 55.00 x 70.00 x 10.00mm, MVQ

3 1.1L Petrol

10 H	4 Cyl.	8 Valves	1098cc	TD384
HR339				
				NA473 39.70 x 59.00 x 9.50mm, NBR NA584 55.00 x 70.00 x 10.00mm, MVQ

4 1.3L Petrol

12 H	4 Cyl.	8 Valves	1275cc	TD381
12 H996AA	4 Cyl.	8 Valves	1275cc	TD13429
12 HA83AA	4 Cyl.	8 Valves	1275cc	TD5468
12 HA85AA	4 Cyl.	8 Valves	1275cc	TD5469
12 HC	4 Cyl.	8 Valves	1275cc	TD22493
12 HC21AA	4 Cyl.	8 Valves	1273cc	TD5470
HR339				
				NA473 39.70 x 59.00 x 9.50mm, NBR NA584 55.00 x 70.00 x 10.00mm, MVQ

5 1.3L Petrol

12 HE	4 Cyl.	8 Valves	1275cc	TD22435
12 HL	4 Cyl.	8 Valves	1275cc	TD16446
HR339				
				NA473 39.70 x 59.00 x 9.50mm, NBR NB291 82.60 x 98.70 x 12.70mm, MVQ

6 1.5L Petrol

14 H	4 Cyl.	8 Valves	1485cc	TD387
HR618				

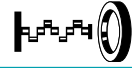
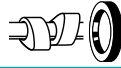

7 1.6L		Petrol			
16 H		4 Cyl.	8 Valves	1598cc	TD382
16 HA03AL		4 Cyl.	8 Valves	1598cc	TD5461
16 HA35AL		4 Cyl.	8 Valves	1598cc	TD5462
16 HC37		4 Cyl.	8 Valves	1598cc	TD389
		NB775 40.00 x 52.00 x 7.00mm, FPM		NB586 F 30.00 x 40.00 x 7.00mm, MVQ NB772 R 88.90 x 104.80 x 9.52mm, MVQ	

8 1.8L		Petrol			
18 H		4 Cyl.	8 Valves	1798cc	TD5478
HR618 S					NA473 F 39.70 x 59.00 x 9.50mm, NBR NB772 R 88.90 x 104.80 x 9.52mm, MVQ

9 2.0L		Petrol			
20 H		4 Cyl.	8 Valves	1994cc	TD5475
20 H(EFI)		4 Cyl.	8 Valves	1994cc	TD385
20 HC51AA		4 Cyl.	8 Valves	1994cc	TD5465
20 HC85		4 Cyl.	8 Valves	1994cc	TD5476
20 HSC		4 Cyl.	8 Valves	1994cc	TD4216
		NB775 40.00 x 52.00 x 7.00mm, FPM 12/85→ NB773 46.00 x 60.00 x 7.00mm, FPM 12/85→		NB586 F 30.00 x 40.00 x 7.00mm, MVQ →12/85 NB774 F 35.00 x 45.00 x 7.00mm, FPM 12/85→ NB772 R 88.90 x 104.80 x 9.52mm, MVQ	











CC



9

Astramax Estate	09/85→08/88	16 D	Diesel	1598	4	8	6
Astramax Estate	09/85→08/88	16 DA	Diesel	1598	4	8	6
Astramax Estate	09/85→06/90	13 NB	Petrol	1297	4	8	4
Astramax Estate	12/86→06/90	13 S	Petrol	1297	4	8	4
Astramax Estate	09/88→06/90	17 D	Diesel	1699	4	8	9
Astramax Estate	09/89→06/90	14 NV	Petrol	1389	4	8	5
Astra Van Estate	07/82→08/88	16 D	Diesel	1598	4	8	6
Astra Van Estate	09/84→09/89	13 N	Petrol	1297	4	8	4
Astra Van Estate	09/84→09/89	13 NB	Petrol	1297	4	8	4
Astra Van Estate	09/84→09/89	13 S	Petrol	1297	4	8	4
Astra Van Estate	09/84→08/91	16 SV	Petrol	1598	4	8	7
Astra Van Estate	09/87→08/89	16 DA	Diesel	1598	4	8	6
Astra Van Estate	09/88→08/91	17 D	Diesel	1699	4	8	9
Astra Van Estate	09/89→08/91	14 NV	Petrol	1389	4	8	5
Blitz (CF97)	01/73→10/87	23D	Diesel	2260	4	8	19
Blitz (CF97)	09/81→10/87	21D	Diesel	2068	4	8	15
Blitz (CF97)	02/85→10/87	20 N	Petrol	1979	4	8	12
Brava	12/88→02/90	C223	Diesel	2238	4	8	18
Brava	02/90→07/90	4JA1	Diesel	2499	4	8	20
CF Box	08/69→12/88	23D	Diesel	2260	4	8	19
CF Box	10/69→04/84	21D	Diesel	2068	4	8	15
CF Box	05/84→12/88	20 NZ	Petrol	1979	4	8	13
CF Bus	08/69→12/88	23D	Diesel	2260	4	8	19
CF Bus	10/69→04/84	21D	Diesel	2068	4	8	15
CF Bus	05/84→12/88	20 NZ	Petrol	1979	4	8	13
CF Platform/Chassis	08/69→12/88	23D	Diesel	2260	4	8	19
CF Platform/Chassis	10/69→04/84	21D	Diesel	2068	4	8	15
CF Platform/Chassis	05/84→12/88	20 NZ	Petrol	1979	4	8	13
KB	05/72→12/88	G161	Petrol	1584	4	8	8
KB	01/83→12/88	4JA1	Diesel	2499	4	8	20
KB	01/85→12/88	G200Z	Petrol	1950	4	8	14
Midi Box	09/84→05/88	4ZB1	Petrol	1817	4	8	10
Midi Box	07/86→10/88	CB	Petrol	993	3	6	2
Midi Box	07/86→06/90	CD	Petrol	843	3	6	1
Midi Box	06/88→08/92	4FD1	Diesel	2189	4	8	16
Midi Box	06/88→08/92	4ZC1	Petrol	1994	4	8	11
Midi Bus	09/84→07/90	4ZB1	Petrol	1817	4	8	10
Midi Bus	09/84→08/92	4FD1	Diesel	2189	4	8	16
Midi Bus	09/84→08/92	4ZC1	Petrol	1994	4	8	11
Midi Bus	09/84→08/92	22DIE	Diesel	2189	4	8	17
Rascal Box	07/86→06/90	CB	Petrol	993	3	6	2
Rascal Box	07/86→06/90	CD	Petrol	843	3	6	1
Rascal Box	07/86→06/90	FA10A	Petrol	970	4	8	3
Rascal Bus	07/86→06/90	CB	Petrol	993	3	6	2
Rascal Bus	07/86→06/90	FA10A	Petrol	970	4	8	3
Rascal Pickup	06/86→06/90	FA10A	Petrol	970	4	8	3
Rascal Pickup	07/86→06/90	CB	Petrol	993	3	6	2
Rascal Pickup	07/86→06/90	CD	Petrol	843	3	6	1
Rascal Platform/Chassis	06/86→06/90	FA10A	Petrol	970	4	8	3
Rascal Platform/Chassis	07/86→06/90	CB	Petrol	993	3	6	2
Rascal Platform/Chassis	07/86→06/90	CD	Petrol	843	3	6	1

	CC				9		CC				9
4FD1	2189	4	8	Diesel	16						
4JA1	2499	4	8	Diesel	20						
4ZB1	1817	4	8	Petrol	10						
4ZC1	1994	4	8	Petrol	11						
13 N	1297	4	8	Petrol	4						
13 NB	1297	4	8	Petrol	4						
13 S	1297	4	8	Petrol	4						
14 NV	1389	4	8	Petrol	5						
16 D	1598	4	8	Diesel	6						
16 DA	1598	4	8	Diesel	6						
16 SV	1598	4	8	Petrol	7						
17 D	1699	4	8	Diesel	9						
20 N	1979	4	8	Petrol	12						
20 NZ	1979	4	8	Petrol	13						
20PET	1994	4	8	Petrol	11						
21D	2068	4	8	Diesel	15						
22DIE	2189	4	8	Diesel	17						
23D	2260	4	8	Diesel	19						
220	3614	4	8	Diesel	21						
330	5420	6	12	Diesel	22						
380 CID	6221	6	12	Diesel	23						
C223	2238	4	8	Diesel	18						
CB	993	3	6	Petrol	2						
CD	843	3	6	Petrol	1						
FA10A	970	4	8	Petrol	3						
G161	1584	4	8	Petrol	8						
G200Z	1950	4	8	Petrol	14						

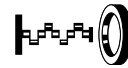
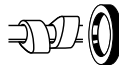

1 0.9L Petrol

CD	3 Cyl.	6 Valves	843cc	TD26853
PA387 (x6)	NJ324 34.00 x 48.00 x 7.00mm, ACM	NJ324 34.00 x 48.00 x 7.00mm, ACM	NJ269 58.00 x 74.00 x 10.00mm, ACM	

2 1.0L Petrol

CB	3 Cyl.	6 Valves	993cc	TD26849
PA387 (x6)	NJ268 32.00 x 48.00 x 7.00mm, NBR	NJ324 34.00 x 48.00 x 7.00mm, ACM	NJ269 58.00 x 74.00 x 10.00mm, ACM	

3 1.0L Petrol

FA10A	4 Cyl.	8 Valves	970cc	TD9933
PA305 (x8)	NJ336 32.00 x 47.00 x 8.00mm, NBR	NJ336 32.00 x 47.00 x 8.00mm, NBR	NJ337 60.00 x 80.00 x 8.00mm, NBR	

4 1.3L Petrol

13 N	4 Cyl.	8 Valves	1297cc	TD29217
13 NB	4 Cyl.	8 Valves	1297cc	TD26852
13 S	4 Cyl.	8 Valves	1297cc	TD410
PA565 (x8) HR342	NC006 35.00 x 48.00 x 7.00mm, MVQ	NB697 26.00 x 42.00 x 8.00mm, FPM	NB698 80.00 x 98.00 x 10.00mm, FPM	

5 1.4L Petrol

14 NV	4 Cyl.	8 Valves	1389cc	TD411
PA565 (x8) HR342	NC006 35.00 x 48.00 x 7.00mm, MVQ	NB697 26.00 x 42.00 x 8.00mm, FPM	NB698 80.00 x 98.00 x 10.00mm, FPM	

6 1.6L Diesel

16 D	4 Cyl.	8 Valves	1598cc	TD412
16 DA	4 Cyl.	8 Valves	1598cc	TD26851
HR343	NC006 35.00 x 48.00 x 7.00mm, MVQ	NB734 35.00 x 50.00 x 8.00mm, FPM	NB701 86.00 x 104.00 x 11.00mm, FPM →11/86	
		NB806 90.00 x 104.00 x 11.00mm, FPM 12/86→		

7 1.6L Petrol

16 SV	4 Cyl.	8 Valves	1598cc	TD413
PA565 (x8) HR342	NC006 35.00 x 48.00 x 7.00mm, MVQ	NB697 26.00 x 42.00 x 8.00mm, FPM	NB698 80.00 x 98.00 x 10.00mm, FPM	



8 1.6L Petrol

G161	4 Cyl.	8 Valves	1584cc	TD32777
PA933 (x8)				
			NJ014 50.00 x 68.00 x 9.00mm, NBR NJ060 82.00 x 105.00 x 13.00mm, MVQ	

9 1.7L Diesel

17 D	4 Cyl.	8 Valves	1699cc	TD26850
HR343				
			NC006 35.00 x 48.00 x 7.00mm, MVQ NB734 35.00 x 50.00 x 8.00mm, FPM NB806 90.00 x 104.00 x 11.00mm, FPM	

10 1.8L Petrol

4ZB1	4 Cyl.	8 Valves	1817cc	TD9929
PA933 (x8)				
			NA5347 30.0 x 45.0 x 7.00mm, FPM NJ323 40.00 x 56.00 x 7.00mm, NBR NJ322 95.00 x 118.00 x 10.00mm, NBR	

11 2.0L Petrol

4ZC1	4 Cyl.	8 Valves	1994cc	TD27097
20PET	4 Cyl.	8 Valves	1994cc	TD9931
PA933 (x8)				
			NA5347 30.0 x 45.0 x 7.00mm, FPM NJ323 40.00 x 56.00 x 7.00mm, NBR NJ322 95.00 x 118.00 x 10.00mm, NBR	

12 2.0L Petrol

20 N	4 Cyl.	8 Valves	1979cc	TD13433
PA619 (x8)				
HR336 (x2)				
			NB628 45.00 x 60.00 x 9.00mm, ACM NB469 77.00 x 100.00 x 11.50mm, FPM	

13 2.0L Petrol

20 NZ	4 Cyl.	8 Valves	1979cc	TD34446
			NB628 45.00 x 60.00 x 9.00mm, ACM NB469 77.00 x 100.00 x 11.50mm, FPM	

14 2.0L Petrol

G200Z	4 Cyl.	8 Valves	1950cc	TD33833
PA933 (x8)				
			NF843 50.00 x 68.00 x 10.00mm, FPM/ACM	

15 2.1L Diesel

21D	4 Cyl.	8 Valves	2068cc	TD9935
HR336 (x2)				
			NB628 45.00 x 60.00 x 9.00mm, ACM NB690 81.00 x 100.10 x 11.50mm, FPM	



16 2.2L

Diesel

4FD1 4 Cyl. 8 Valves 2189cc TD27095

PA933 (x8) NJ321 28.00 x 47.00 x 8.00mm, NBR NJ158 95.00 x 118.00 x 10.00mm, ACM

17 2.2L

Diesel

22DIE 4 Cyl. 8 Valves 2189cc TD9932

PA933 (x8) NJ323 40.00 x 56.00 x 7.00mm, NBR
NJ322 95.00 x 118.00 x 10.00mm, NBR

18 2.2L

Diesel

C223 4 Cyl. 8 Valves 2238cc TD34465

PA418 (x8) NJ265 82.00 x 105.00 x 13.00mm, MVQ

19 2.3L

Diesel

23D 4 Cyl. 8 Valves 2260cc TD418

HR336 (x2) →12/79 NB628 45.00 x 60.00 x 9.00mm, ACM
NB690 81.00 x 100.10 x 11.50mm, FPM

20 2.5L

Diesel

4JA1 4 Cyl. 8 Valves 2499cc TD33834

PA418 (x8) NA5051 40.00 x 56.00 x 7.00mm, FPM
NJ014 50.00 x 68.00 x 9.00mm, NBR
NJ322 95.00 x 118.00 x 10.00mm, NBR

21 3.6L

Diesel

220 4 Cyl. 8 Valves 3614cc TD6483

KT632 (x2)

22 5.4L

Diesel

330 6 Cyl. 12 Valves 5420cc TD6485

KT632 (x2)

23 6.2L

Diesel

380 CID 6 Cyl. 12 Valves 6221cc TD6467

NB688 66.70 x 89.60 x 9.52mm, MVQ
KT638



CC



9

1 (E81)	09/06→10/11	N46 B20 C	Petrol	1995	4	16	28
1 (E81)	09/06→12/11	N43 B20 A	Petrol	1995	4	16	28
1 (E81)	09/06→12/11	N46 B20 B	Petrol	1995	4	16	28
1 (E81)	09/06→12/11	N47 D20 A	Diesel	1995	4	16	19
1 (E81)	09/06→12/11	N47 D20 C	Diesel	1995	4	16	19
1 (E81)	03/07→11/11	N43 B16 A	Petrol	1599	4	16	8
1 (E81)	03/07→11/11	N43 B16 AA	Petrol	1599	4	16	8
1 (E81)	03/07→12/11	N47 D20 B	Diesel	1995	4	16	19
1 (E81)	03/07→12/11	N47 D20 D	Diesel	1995	4	16	19
1 (E81)	04/07→12/11	N45 B16 A	Petrol	1596	4	16	8
1 (E81)	09/07→12/11	N54 B30 A	Petrol	2979	6	24	56
1 (E87)	03/03→06/11	M47 D20 (204D4)	Diesel	1995	4	16	24
1 (E87)	03/03→09/12	N47 D20 A	Diesel	1995	4	16	19
1 (E87)	03/03→09/12	N47 D20 C	Diesel	1995	4	16	19
1 (E87)	11/03→06/11	N45 B16 A	Petrol	1596	4	16	8
1 (E87)	11/03→06/11	N46 B20 A	Petrol	1995	4	16	28
1 (E87)	11/03→06/11	N46 B20 B	Petrol	1995	4	16	28
1 (E87)	11/03→06/11	N46 B20 BD	Petrol	1995	4	16	28
1 (E87)	11/03→06/11	N46 B20 C	Petrol	1995	4	16	28
1 (E87)	11/03→06/11	N46 B20 CC	Petrol	1995	4	16	28
1 (E87)	09/06→06/11	N43 B20 A	Petrol	1995	4	16	28
1 (E87)	03/07→06/11	N43 B16 A	Petrol	1599	4	16	8
1 (E87)	03/07→09/12	N47 D20 B	Diesel	1995	4	16	19
1 (E87)	03/07→09/12	N47 D20 D	Diesel	1995	4	16	19
1 (F20)	11/10→	N13 B16 A	Petrol	1598	4	16	7
1 (F20)	12/10→	N47 D20 C	Diesel	1995	4	16	19
1 (F20)	08/11→	N47 D20 D	Diesel	1995	4	16	19
1 (F20)	10/12→	N47 D16 A	Diesel	1598	4	16	9
1 (F20)	03/15→	B37 D15 A	Diesel	1496	3	12	1
1 (F20)	03/15→	B38 B15 A	Petrol	1499	3	12	2
1 (F20)	03/15→	B47 D20 A	Diesel	1995	4	16	19
1 (F20)	03/15→	B47 D20 B	Diesel	1995	4	16	19
1 (F21)	12/11→	N13 B16 A	Petrol	1598	4	16	7
1 (F21)	12/11→	N46 B20 A	Petrol	1995	4	16	28
1 (F21)	12/11→	N47 D16 A	Diesel	1598	4	16	9
1 (F21)	12/11→	N47 D20 C	Diesel	1995	4	16	19
1 (F21)	12/11→	N47 D20 D	Diesel	1995	4	16	19
1 (F21)	03/15→	B37 D15 A	Diesel	1496	3	12	1
1 (F21)	03/15→	B38 B15 A	Petrol	1499	3	12	2
1 (F21)	03/15→	B47 D20 A	Diesel	1995	4	16	19
1 (F21)	03/15→	B47 D20 B	Diesel	1995	4	16	19
1 Convertible (E88)	03/08→12/13	N43 B20 A	Petrol	1995	4	16	28
1 Convertible (E88)	03/08→12/13	N46 B20 B	Petrol	1995	4	16	28
1 Convertible (E88)	03/08→12/13	N46 B20 C	Petrol	1995	4	16	28
1 Convertible (E88)	03/08→12/13	N46 B20 E	Petrol	1995	4	16	28
1 Convertible (E88)	03/08→12/13	N47 D20 A	Diesel	1995	4	16	19
1 Convertible (E88)	03/08→12/13	N47 D20 C	Diesel	1995	4	16	19
1 Convertible (E88)	03/08→12/13	N54 B30 A	Petrol	2979	6	24	56
1 Convertible (E88)	09/08→12/13	N47 D20 B	Diesel	1995	4	16	19
1 Convertible (E88)	09/08→12/13	N47 D20 D	Diesel	1995	4	16	19
1 Coupe (E82)	10/06→10/13	N47 D20 A	Diesel	1995	4	16	19
1 Coupe (E82)	10/06→10/13	N47 D20 C	Diesel	1995	4	16	19
1 Coupe (E82)	10/07→10/13	N43 B20 A	Petrol	1995	4	16	28
1 Coupe (E82)	10/07→10/13	N47 D20 B	Diesel	1995	4	16	19
1 Coupe (E82)	10/07→10/13	N47 D20 D	Diesel	1995	4	16	19
1 Coupe (E82)	10/07→10/13	N54 B30 A	Petrol	2979	6	24	56
1 Coupe (E82)	09/09→10/13	N46 B20 B	Petrol	1995	4	16	28
02 (E10)	09/67→07/75	M10 B20	Petrol	1990	4	8	21
02 (E10)	09/67→07/77	M10 B16	Petrol	1573	4	8	4
02 (E10)	09/70→07/75	M10 B18	Petrol	1766	4	8	11
02 (E10)	01/74→07/75	M10 B20 (22T A)	Petrol	1990	4	8	21
2 Active Tourer (F45)	11/13→	B38 A15 A	Petrol	1499	3	12	2
2 Active Tourer (F45)	11/13→	B47 C20 A	Diesel	1995	4	16	19
2 Active Tourer (F45)	11/13→	B48 A20 B	Petrol	1998	4	16	20
2 Active Tourer (F45)	03/14→	B37 C15 A	Diesel	1496	3	12	1
2 Active Tourer (F45)	03/14→	B47 D20 A	Diesel	1995	4	16	19
2 Active Tourer (F45)	03/14→	B48 A20 A	Petrol	1998	4	16	20
02 Convertible (E10)	12/67→10/71	M10 B16	Petrol	1573	4	8	4
02 Convertible (E10)	05/71→07/75	M10 B20	Petrol	1990	4	8	21
2 Convertible (F23)	03/14→	B47 D20 A	Diesel	1995	4	16	19
2 Convertible (F23)	03/15→	B38 B15 A	Petrol	1499	3	12	2
2 Convertible (F23)	07/15→	B47 D20 B	Diesel	1995	4	16	19
2 Coupe (F22, F87)	10/12→	N47 D20 C	Diesel	1995	4	16	19
2 Coupe (F22, F87)	01/14→	N47 D20 D	Diesel	1995	4	16	19
2 Coupe (F22, F87)	03/14→	B47 D20 A	Diesel	1995	4	16	19
2 Coupe (F22, F87)	03/15→	B38 B15 A	Petrol	1499	3	12	2
2 Coupe (F22, F87)	07/15→	B47 D20 B	Diesel	1995	4	16	19
2 Gran Tourer (F46)	07/14→	B38 A15 A	Petrol	1499	3	12	2



2 Gran Tourer (F46)	07/14→	B47 C20 A	Diesel	1995	4	16	19
2 Gran Tourer (F46)	07/14→	B48 A20 A	Petrol	1998	4	16	20
2 Gran Tourer (F46)	08/14→	B37 C15 A	Diesel	1496	3	12	1
02 Touring (E6)	01/71→07/75	M10 B20	Petrol	1990	4	8	21
02 Touring (E6)	05/71→04/73	M10 B16	Petrol	1573	4	8	4
02 Touring (E6)	05/71→07/75	M10 B18	Petrol	1766	4	8	11
3 (E21)	06/75→08/82	M10 B20	Petrol	1990	4	8	21
3 (E21)	08/75→08/80	M10 B16 (164VA)	Petrol	1573	4	8	4
3 (E21)	08/75→08/82	M10 B18 (184VA)	Petrol	1766	4	8	11
3 (E21)	09/77→08/82	M20 B20 (206VA)	Petrol	1990	6	12	22
3 (E21)	01/78→08/82	M20 B23 (236EA)	Petrol	2316	6	12	32
3 (E21)	09/79→12/83	M10 B18 (184EA)	Petrol	1766	4	8	11
3 (E21)	09/80→08/82	M10 B18 (184VC)	Petrol	1766	4	8	11
3 (E21)	03/81→03/84	M10 B16 (164VB)	Petrol	1573	4	8	4
3 (E30)	09/82→08/86	M20 B23 (236EC)	Petrol	2316	6	12	32
3 (E30)	09/82→08/87	M10 B18 (184EA)	Petrol	1766	4	8	11
3 (E30)	09/82→12/87	M10 B18 (184VC)	Petrol	1766	4	8	11
3 (E30)	09/82→12/91	M10 B16	Petrol	1573	4	8	4
3 (E30)	09/82→12/91	M20 B20 (206EB)	Petrol	1990	6	12	22
3 (E30)	09/83→12/90	M10 B18 (184VD)	Petrol	1766	4	8	11
3 (E30)	09/83→08/91	M20 B25 (256E2)	Petrol	2494	6	12	35
3 (E30)	10/83→12/88	M20 B27 (276KA)	Petrol	2693	6	12	46
3 (E30)	10/83→12/88	M20 B27 (276KB)	Petrol	2693	6	12	46
3 (E30)	12/84→08/88	M10 B18 (184KA)	Petrol	1766	4	8	11
3 (E30)	07/85→06/91	S14 B23 (234EA)	Petrol	2303	4	16	33
3 (E30)	09/85→08/91	M21 D24 (246DA)	Diesel	2443	6	12	34
3 (E30)	12/85→06/91	M20 B20 (206KA)	Petrol	1990	6	12	22
3 (E30)	03/86→08/91	M20 B25 (256E1)	Petrol	2494	6	12	35
3 (E30)	03/86→08/91	M20 B25 (256EX)	Petrol	2494	6	12	35
3 (E30)	03/86→08/91	M20 B25 (256K1)	Petrol	2494	6	12	35
3 (E30)	07/86→06/91	S14 B23 (234S1)	Petrol	2303	4	16	33
3 (E30)	07/86→06/91	S14 B23 (234S2)	Petrol	2303	4	16	33
3 (E30)	09/87→06/91	M40 B16 (164E1)	Petrol	1596	4	8	5
3 (E30)	09/87→06/91	M40 B18 (184E1)	Petrol	1796	4	8	12
3 (E30)	09/87→08/91	M21 D24 (246TB)	Diesel	2443	6	12	34
3 (E30)	05/88→12/90	S14 B20 (204EA)	Petrol	1990	4	16	30
3 (E30)	09/89→08/91	M42 B18 (184S1)	Petrol	1796	4	16	13
3 (E30)	01/90→01/92	S14 B25 (254S1)	Petrol	2467	4	16	45
3 (E36)	09/90→09/93	M40 B16 (164E1)	Petrol	1596	4	8	5
3 (E36)	09/90→09/95	M50 B25 (256S1)	Petrol	2494	6	24	37
3 (E36)	09/90→09/95	M50 B25 (256S2)	Petrol	2494	6	24	37
3 (E36)	09/90→02/98	M42 B18 (184S1)	Petrol	1796	4	16	13
3 (E36)	09/90→02/98	M43 B16 (164E2)	Petrol	1596	4	8	6
3 (E36)	09/90→02/98	M50 B20 (206S1)	Petrol	1991	6	24	26
3 (E36)	09/90→02/98	M50 B20 (206S2)	Petrol	1991	6	24	25
3 (E36)	09/90→02/98	M52 B20 (206S3)	Petrol	1991	6	24	27
3 (E36)	12/90→10/93	M40 B18 (184E1)	Petrol	1796	4	8	12
3 (E36)	09/91→02/98	M51 D25 (256T1)	Diesel	2497	6	12	39
3 (E36)	10/93→02/98	M43 B18 (184E2)	Petrol	1796	4	8	14
3 (E36)	08/94→09/95	S50 B30 (306S1)	Petrol	2990	6	24	52
3 (E36)	01/95→02/98	M41 D17 (174T1)	Diesel	1665	4	8	10
3 (E36)	01/95→02/98	M52 B28 (286S1)	Petrol	2793	6	24	49
3 (E36)	03/95→02/98	M52 B25 (256S3)	Petrol	2494	6	24	41
3 (E36)	09/95→02/98	M44 B19 (194S1)	Petrol	1895	4	16	18
3 (E36)	09/95→02/98	S50 B32 (326S1)	Petrol	3201	6	24	59
3 (E36)	09/95→02/98	S52 B32 (326S2)	Petrol	3152	6	24	59
3 (E46)	02/98→12/00	M52 B28 (286S2)	Petrol	2793	6	24	49
3 (E46)	02/98→02/05	M43 B19 (194E1)	Petrol	1895	4	8	17
3 (E46)	02/98→04/05	M47 D20 (204D1)	Diesel	1951	4	16	23
3 (E46)	03/98→09/00	M52 B20 (206S4)	Petrol	1991	6	24	27
3 (E46)	03/98→09/00	M52 B25 (256S4)	Petrol	2494	6	24	41
3 (E46)	10/99→02/05	M57 D30 (306D1)	Diesel	2926	6	24	53
3 (E46)	04/00→02/05	M43 B16 (164E3)	Petrol	1596	4	8	6
3 (E46)	06/00→04/05	M54 B30 (306S3)	Petrol	2979	6	24	52
3 (E46)	09/00→02/05	M54 B22 (226S1)	Petrol	2171	6	24	31
3 (E46)	09/00→04/05	M54 B25 (256S5)	Petrol	2494	6	24	42
3 (E46)	09/01→02/05	M47 D20 (204D4)	Diesel	1995	4	16	24
3 (E46)	09/01→02/05	N42 B20 A	Petrol	1995	4	16	28
3 (E46)	09/01→02/05	N46 B20 A	Petrol	1995	4	16	28
3 (E46)	02/02→02/05	N42 B18 A	Petrol	1796	4	16	16
3 (E46)	02/02→02/05	N46 B18 A	Petrol	1796	4	16	16
3 (E46)	06/02→02/05	N40 B16 A	Petrol	1596	4	16	8
3 (E46)	06/02→02/05	N45 B16 A	Petrol	1596	4	16	8
3 (E46)	09/02→02/05	M57 D30 (306D2)	Diesel	2993	6	24	54
3 (E90)	02/04→12/11	M47 D20 (204D4)	Diesel	1995	4	16	24
3 (E90)	02/04→12/11	N47 D20 C	Diesel	1995	4	16	19
3 (E90)	06/04→03/07	N46 B20 A	Petrol	1995	4	16	28
3 (E90)	06/04→12/11	N46 B20 B	Petrol	1995	4	16	28



CC



9

3 (E90)	06/04→12/11	N46 B20 C	Petrol	1995	4	16	28
3 (E90)	09/04→12/11	M57 D30 (306D3)	Diesel	2993	6	24	54
3 (E90)	09/04→12/11	N57 D30 A	Diesel	2993	6	24	50
3 (E90)	01/05→12/08	M47N 204 D4	Diesel	1995	4	16	24
3 (E90)	03/05→10/11	N45 B16 A	Petrol	1596	4	16	8
3 (E90)	09/05→08/06	N45 B20 A	Petrol	1997	4	16	29
3 (E90)	03/06→12/11	N54 B30 A	Petrol	2979	6	24	56
3 (E90)	09/06→12/11	M57 D30 (306D5)	Diesel	2993	6	24	53
3 (E90)	09/06→12/11	N46 B20 CC	Petrol	1995	4	16	28
3 (E90)	09/06→12/11	N46 B20 CD	Petrol	1995	4	16	28
3 (E90)	09/06→12/11	N46 B20 E	Petrol	1995	4	16	28
3 (E90)	02/07→10/11	N43 B16 A	Petrol	1599	4	16	8
3 (E90)	02/07→12/11	N43 B20 A	Petrol	1995	4	16	28
3 (E90)	02/07→12/11	N47 D20 A	Diesel	1995	4	16	19
3 (E90)	03/07→12/11	S65 B40 A	Petrol	3999	8	32	70
3 (E90)	09/08→12/11	M57 D30 (306D4)	Diesel	2993	6	24	53
3 (E90)	03/11→12/11	S65 B44 A	Petrol	4361	8	32	75
3 (F30, F80)	03/11→	N47 D20 C	Diesel	1995	4	16	19
3 (F30, F80)	04/11→	B47 D20 A	Diesel	1995	4	16	19
3 (F30, F80)	01/12→	N57 D30 A	Diesel	2993	6	24	50
3 (F30, F80)	04/12→08/16	N13 B16 A	Petrol	1598	4	16	7
3 (F30, F80)	07/12→02/16	N47 D20 D	Diesel	1995	4	16	19
3 (F30, F80)	11/12→	N57 D30 B	Diesel	2993	6	24	50
3 (F30, F80)	03/15→	B38 B15 A	Petrol	1499	3	12	2
3 (F30, F80)	04/15→	B47 D20 B	Diesel	1995	4	16	19
3 Compact (E36)	03/94→08/00	M43 B16 (164E2)	Petrol	1596	4	8	6
3 Compact (E36)	09/94→12/95	M42 B18 (184S1)	Petrol	1796	4	16	13
3 Compact (E36)	01/95→08/00	M41 D17 (174T1)	Diesel	1665	4	8	10
3 Compact (E36)	07/95→08/00	M44 B19 (194S1)	Petrol	1895	4	16	18
3 Compact (E36)	08/97→08/00	M52 B25 (256S3)	Petrol	2494	6	24	41
3 Compact (E36)	12/98→08/00	M43 B19 (194E1)	Petrol	1895	4	8	17
3 Compact (E46)	03/01→12/04	N42 B20 A	Petrol	1995	4	16	28
3 Compact (E46)	03/01→12/04	N46 B20 A	Petrol	1995	4	16	28
3 Compact (E46)	06/01→02/05	M54 B25 (256S5)	Petrol	2494	6	24	42
3 Compact (E46)	06/01→02/05	N42 B18 A	Petrol	1796	4	16	16
3 Compact (E46)	06/01→02/05	N46 B18 A	Petrol	1796	4	16	16
3 Compact (E46)	09/01→02/05	M47 D20 (204D4)	Diesel	1995	4	16	24
3 Compact (E46)	10/01→12/02	M47 D20 (204D1)	Diesel	1951	4	16	23
3 Compact (E46)	06/02→02/05	N40 B16 A	Petrol	1596	4	16	8
3 Compact (E46)	06/02→02/05	N45 B16 A	Petrol	1596	4	16	8
3 Convertible (E30)	12/85→10/93	M20 B25 (256E2)	Petrol	2494	6	12	35
3 Convertible (E30)	04/86→10/93	M20 B20	Petrol	1990	6	12	22
3 Convertible (E30)	04/86→10/93	M20 B20 (206KA)	Petrol	1990	6	12	22
3 Convertible (E30)	09/87→12/89	M40 B16 (164E1)	Petrol	1596	4	8	5
3 Convertible (E30)	09/87→10/93	M20 B25 (256EX)	Petrol	2494	6	12	35
3 Convertible (E30)	09/87→10/93	M20 B25 (256K1)	Petrol	2494	6	12	35
3 Convertible (E30)	06/88→06/91	S14 B23 (234EA)	Petrol	2303	4	16	33
3 Convertible (E30)	06/88→02/92	M40 B18 C	Petrol	1796	4	8	12
3 Convertible (E30)	09/90→12/92	M42 B18 (184S1)	Petrol	1796	4	16	13
3 Convertible (E30)	09/90→10/93	M40 B18 (184E1)	Petrol	1796	4	8	12
3 Convertible (E36)	03/93→03/95	M50 B25 (256S2)	Petrol	2494	6	24	37
3 Convertible (E36)	03/93→12/95	M42 B18	Petrol	1796	4	16	13
3 Convertible (E36)	12/93→04/99	M50 B20 (206S2)	Petrol	1991	6	24	25
3 Convertible (E36)	12/93→04/99	M52 B20 (206S3)	Petrol	1991	6	24	27
3 Convertible (E36)	01/94→10/95	S50 B30 (306S1)	Petrol	2990	6	24	52
3 Convertible (E36)	01/94→04/99	M43 B18 (184E2)	Petrol	1796	4	8	14
3 Convertible (E36)	03/95→04/99	M52 B28 (286S1)	Petrol	2793	6	24	49
3 Convertible (E36)	06/95→04/99	M52 B25 (256S3)	Petrol	2494	6	24	41
3 Convertible (E36)	09/95→04/99	M44 B19 (194S1)	Petrol	1895	4	16	18
3 Convertible (E36)	10/95→04/99	S50 B32 (326S1)	Petrol	3201	6	24	59
3 Convertible (E36)	09/97→04/99	S52 B32 (326S2)	Petrol	3152	6	24	59
3 Convertible (E46)	04/00→09/00	M52 B25 (256S4)	Petrol	2494	6	24	41
3 Convertible (E46)	06/00→12/07	M54 B30 (306S3)	Petrol	2979	6	24	52
3 Convertible (E46)	09/00→12/07	M54 B22 (226S1)	Petrol	2171	6	24	31
3 Convertible (E46)	09/00→12/07	M54 B25 (256S5)	Petrol	2494	6	24	42
3 Convertible (E46)	09/00→12/07	S54 B32 (326S4)	Petrol	3246	6	24	59
3 Convertible (E46)	12/00→12/07	N42 B20 A	Petrol	1995	4	16	28
3 Convertible (E46)	12/00→12/07	N46 B20 A	Petrol	1995	4	16	28
3 Convertible (E46)	02/05→12/07	M47 D20 (204D4)	Diesel	1995	4	16	24
3 Convertible (E46)	02/05→12/07	N46 B20 B	Petrol	1995	4	16	28
3 Convertible (E46)	08/05→12/07	M57 D30 (306D2)	Diesel	2993	6	24	54
3 Convertible (E93)	05/06→10/13	N54 B30 A	Petrol	2979	6	24	56
3 Convertible (E93)	09/06→12/13	N43 B20 A	Petrol	1995	4	16	28
3 Convertible (E93)	01/07→08/13	N46 B20 A	Petrol	1995	4	16	28
3 Convertible (E93)	01/07→12/13	N46 B20 B	Petrol	1995	4	16	28
3 Convertible (E93)	03/07→10/13	S65 B40 A	Petrol	3999	8	32	70
3 Convertible (E93)	03/07→12/13	M57 D30 (306D3)	Diesel	2993	6	24	54
3 Convertible (E93)	09/07→02/10	N47 D20 A	Diesel	1995	4	16	19



3 Convertible (E93)	09/07→12/13	N47 D20 C	Diesel	1995	4	16	19
3 Convertible (E93)	01/09→12/13	N57 D30 A	Diesel	2993	6	24	50
3 Convertible (E93)	01/10→12/13	N46 B20 CC	Petrol	1995	4	16	28
3 Convertible (E93)	01/10→12/13	N46 B20 CD	Petrol	1995	4	16	28
3 Convertible (E93)	01/10→12/13	N46 B20 E	Petrol	1995	4	16	28
3 Coupe (E36)	03/92→06/94	M40 B18 (184E1)	Petrol	1796	4	8	12
3 Coupe (E36)	03/92→12/95	M42 B18 (184S1)	Petrol	1796	4	16	13
3 Coupe (E36)	03/92→04/99	M50 B20 (206S1)	Petrol	1991	6	24	26
3 Coupe (E36)	03/92→04/99	M50 B20 (206S2)	Petrol	1991	6	24	25
3 Coupe (E36)	03/92→04/99	M50 B25 (256S1)	Petrol	2494	6	24	37
3 Coupe (E36)	03/92→04/99	M50 B25 (256S2)	Petrol	2494	6	24	37
3 Coupe (E36)	03/92→04/99	M52 B20 (206S3)	Petrol	1991	6	24	27
3 Coupe (E36)	10/92→12/95	S50 B30 (306S1)	Petrol	2990	6	24	52
3 Coupe (E36)	09/93→04/99	M43 B16 (164E2)	Petrol	1596	4	8	6
3 Coupe (E36)	01/95→04/99	M52 B28 (286S1)	Petrol	2793	6	24	49
3 Coupe (E36)	03/95→04/99	M52 B25 (256S3)	Petrol	2494	6	24	41
3 Coupe (E36)	09/95→04/99	M44 B19 (194S1)	Petrol	1895	4	16	18
3 Coupe (E36)	09/95→04/99	S52 B32 (326S2)	Petrol	3152	6	24	59
3 Coupe (E36)	10/95→04/99	S50 B32 (326S1)	Petrol	3201	6	24	59
3 Coupe (E46)	02/99→08/01	M52 B20 (206S4)	Petrol	1991	6	24	27
3 Coupe (E46)	04/99→06/00	M52 B28 (286S2)	Petrol	2793	6	24	49
3 Coupe (E46)	04/99→12/00	M52 B25 (256S4)	Petrol	2494	6	24	41
3 Coupe (E46)	11/99→09/01	M43 B19 (194E1)	Petrol	1895	4	8	17
3 Coupe (E46)	01/00→05/06	M54 B22 (226S1)	Petrol	2171	6	24	31
3 Coupe (E46)	04/00→07/06	M43 B16 (164E3)	Petrol	1596	4	8	6
3 Coupe (E46)	06/00→07/06	M54 B30 (306S3)	Petrol	2979	6	24	52
3 Coupe (E46)	06/00→07/06	S54 B32 (326S4)	Petrol	3246	6	24	59
3 Coupe (E46)	09/00→07/06	M54 B25 (256S5)	Petrol	2494	6	24	42
3 Coupe (E46)	12/00→05/06	N42 B20 A	Petrol	1995	4	16	28
3 Coupe (E46)	12/00→05/06	N46 B20 C	Petrol	1995	4	16	28
3 Coupe (E46)	12/00→07/06	N46 B20 A	Petrol	1995	4	16	28
3 Coupe (E46)	06/02→07/06	N45 B16 A	Petrol	1596	4	16	8
3 Coupe (E46)	03/03→07/06	M57 D30 (306D2)	Diesel	2993	6	24	54
3 Coupe (E46)	11/03→07/06	M47 D20 (204D4)	Diesel	1995	4	16	24
3 Coupe (E92)	11/05→12/13	N54 B30 A	Petrol	2979	6	24	56
3 Coupe (E92)	09/06→06/13	N47 D20 A	Diesel	1995	4	16	19
3 Coupe (E92)	09/06→06/13	N47 D20 C	Diesel	1995	4	16	19
3 Coupe (E92)	09/06→12/13	M57 D30 (306D3)	Diesel	2993	6	24	54
3 Coupe (E92)	09/06→12/13	M57 D30 (306D5)	Diesel	2993	6	24	53
3 Coupe (E92)	11/06→06/07	N46 B20 A	Petrol	1995	4	16	28
3 Coupe (E92)	01/07→12/13	N43 B20 A	Petrol	1995	4	16	28
3 Coupe (E92)	03/07→12/13	S65 B40 A	Petrol	3999	8	32	70
3 Coupe (E92)	03/07→12/13	S65 B44 A	Petrol	4361	8	32	75
3 Coupe (E92)	06/07→12/13	N46 B20 B	Petrol	1995	4	16	28
3 Coupe (E92)	09/07→12/13	N43 B16 A	Petrol	1599	4	16	8
3 Coupe (E92)	01/09→12/13	N57 D30 A	Diesel	2993	6	24	50
3 Coupe (E92)	01/10→12/13	N46 B20 CC	Petrol	1995	4	16	28
3 Coupe (E92)	01/10→12/13	N46 B20 CD	Petrol	1995	4	16	28
3 Coupe (E92)	01/10→12/13	N46 B20 E	Petrol	1995	4	16	28
3 Gran Turismo (F34)	03/13→	B47 D20 A	Diesel	1995	4	16	19
3 Gran Turismo (F34)	03/13→	N47 D20 C	Diesel	1995	4	16	19
3 Gran Turismo (F34)	03/13→	N47 D20 D	Diesel	1995	4	16	19
3 Gran Turismo (F34)	01/14→	N54 B30 A	Petrol	2979	6	24	56
3 Gran Turismo (F34)	01/14→	N57 D30 A	Diesel	2993	6	24	50
3 Gran Turismo (F34)	01/14→	N57 D30 B	Diesel	2993	6	24	50
3 Gran Turismo (F34)	07/16→	B47 D20 B	Diesel	1995	4	16	19
3 Touring (E30)	07/87→10/93	M20 B25 (256K1)	Petrol	2494	6	12	35
3 Touring (E30)	09/87→06/94	M40 B18 (184E1)	Petrol	1796	4	8	12
3 Touring (E30)	01/88→12/91	M20 B20 (206KA)	Petrol	1990	6	12	22
3 Touring (E30)	01/88→06/93	M21 D24 (246TB)	Diesel	2443	6	12	34
3 Touring (E30)	09/91→06/94	M40 B16 (164E1)	Petrol	1596	4	8	5
3 Touring (E36)	01/95→10/99	M41 D17 (174T1)	Diesel	1665	4	8	10
3 Touring (E36)	01/95→10/99	M51 D25 (256T1)	Diesel	2497	6	12	39
3 Touring (E36)	01/95→10/99	M52 B20 (206S3)	Petrol	1991	6	24	27
3 Touring (E36)	01/95→10/99	M52 B28 (286S1)	Petrol	2793	6	24	49
3 Touring (E36)	07/95→10/99	M43 B18 (184E2)	Petrol	1796	4	8	14
3 Touring (E36)	09/95→10/99	M52 B25 (256S3)	Petrol	2494	6	24	41
3 Touring (E36)	01/96→10/99	M43 B16 (164E2)	Petrol	1596	4	8	6
3 Touring (E46)	10/99→06/00	M52 B28 (286S2)	Petrol	2793	6	24	49
3 Touring (E46)	10/99→09/00	M52 B20 (206S4)	Petrol	1991	6	24	27
3 Touring (E46)	10/99→12/00	M52 B25 (256S3)	Petrol	2494	6	24	41
3 Touring (E46)	10/99→09/01	M43 B19 (194E1)	Petrol	1895	4	8	17
3 Touring (E46)	10/99→02/05	M57 D30 (306D1)	Diesel	2926	6	24	53
3 Touring (E46)	03/00→03/03	M47 D20 (204D1)	Diesel	1951	4	16	23
3 Touring (E46)	06/00→02/05	M54 B30 (306S3)	Petrol	2979	6	24	52
3 Touring (E46)	09/00→02/05	M54 B22 (226S1)	Petrol	2171	6	24	31
3 Touring (E46)	09/00→02/05	M54 B25 (256S5)	Petrol	2494	6	24	42
3 Touring (E46)	09/01→02/05	M47 D20 (204D4)	Diesel	1995	4	16	24



CC









9

3 Touring (E46)	09/01→02/05	N42 B20 A	Petrol	1995	4	16	28
3 Touring (E46)	09/01→02/05	N46 B20 A	Petrol	1995	4	16	28
3 Touring (E46)	03/02→02/05	N42 B18 A	Petrol	1796	4	16	16
3 Touring (E46)	03/02→02/05	N46 B18 A	Petrol	1796	4	16	16
3 Touring (E46)	06/02→02/05	N45 B16 A	Petrol	1596	4	16	8
3 Touring (E46)	08/02→05/05	M57 D30 (306D2)	Diesel	2993	6	24	54
3 Touring (E91)	12/04→06/12	M47 D20 (204D4)	Diesel	1995	4	16	24
3 Touring (E91)	12/04→06/12	M57 D30 (306D3)	Diesel	2993	6	24	54
3 Touring (E91)	12/04→06/12	N57 D30 A	Diesel	2993	6	24	50
3 Touring (E91)	09/05→06/12	N46 B20 B	Petrol	1995	4	16	28
3 Touring (E91)	09/05→06/12	N46 B20 BD	Petrol	1995	4	16	28
3 Touring (E91)	09/05→06/12	N46 B20 C	Petrol	1995	4	16	28
3 Touring (E91)	03/06→05/12	N54 B30 A	Petrol	2979	6	24	56
3 Touring (E91)	09/06→06/12	M57 D30 (306D5)	Diesel	2993	6	24	53
3 Touring (E91)	02/07→05/12	N43 B20 A	Petrol	1995	4	16	28
3 Touring (E91)	02/07→06/12	N47 D20 A	Diesel	1995	4	16	19
3 Touring (E91)	02/07→06/12	N47 D20 C	Diesel	1995	4	16	19
3 Touring (E91)	05/08→05/12	N43 B16 A	Petrol	1599	4	16	8
3 Touring (F31)	07/11→	B47 D20 A	Diesel	1995	4	16	19
3 Touring (F31)	07/11→	N47 D20 C	Diesel	1995	4	16	19
3 Touring (F31)	01/12→	N57 D30 A	Diesel	2993	6	24	50
3 Touring (F31)	03/12→08/16	N13 B16 A	Petrol	1598	4	16	7
3 Touring (F31)	09/12→02/16	N47 D20 D	Diesel	1995	4	16	19
3 Touring (F31)	04/13→	N57 D30 B	Diesel	2993	6	24	50
3 Touring (F31)	01/15→	B38 B15 A	Petrol	1499	3	12	2
3 Touring (F31)	04/15→	B47 D20 B	Diesel	1995	4	16	19
4 Convertible (F33, F83)	10/13→	B47 D20 A	Diesel	1995	4	16	19
4 Convertible (F33, F83)	10/13→	N47 D20 C	Diesel	1995	4	16	19
4 Convertible (F33, F83)	10/13→	N57 D30 A	Diesel	2993	6	24	50
4 Convertible (F33, F83)	07/14→	N47 D20 D	Diesel	1995	4	16	19
4 Convertible (F33, F83)	07/14→	N57 D30 B	Diesel	2993	6	24	50
4 Convertible (F33, F83)	03/16→	B47 D20 B	Diesel	1995	4	16	19
4 Coupe (F32, F82)	07/13→	B47 D20 A	Diesel	1995	4	16	19
4 Coupe (F32, F82)	07/13→	N47 D20 C	Diesel	1995	4	16	19
4 Coupe (F32, F82)	11/13→	N57 D30 A	Diesel	2993	6	24	50
4 Coupe (F32, F82)	11/13→	N57 D30 B	Diesel	2993	6	24	50
4 Coupe (F32, F82)	01/14→	N47 D20 D	Diesel	1995	4	16	19
4 Coupe (F32, F82)	02/16→	B38 B15 A	Petrol	1499	3	12	2
4 Coupe (F32, F82)	03/16→	B47 D20 B	Diesel	1995	4	16	19
4 Gran Coupe (F36)	03/14→	B47 D20 A	Diesel	1995	4	16	19
4 Gran Coupe (F36)	03/14→	N47 D20 C	Diesel	1995	4	16	19
4 Gran Coupe (F36)	07/14→	N57 D30 A	Diesel	2993	6	24	50
4 Gran Coupe (F36)	07/14→	N57 D30 B	Diesel	2993	6	24	50
4 Gran Coupe (F36)	07/15→	B38 B15 A	Petrol	1499	3	12	2
4 Gran Coupe (F36)	03/16→	B47 D20 B	Diesel	1995	4	16	19
5 (E12)	03/72→07/79	M10 B20	Petrol	1990	4	8	21
5 (E12)	06/73→06/81	M30 B25	Petrol	2494	6	12	36
5 (E12)	07/74→05/81	M10 B18 (184VB)	Petrol	1766	4	8	11
5 (E12)	09/74→12/78	M30 B30	Petrol	2986	6	12	51
5 (E12)	01/75→06/81	M30 B28	Petrol	2788	6	12	47
5 (E12)	08/76→05/81	M30 B25 (256VA)	Petrol	2494	6	12	36
5 (E12)	09/77→05/81	M20 B20 (206VA)	Petrol	1990	6	12	22
5 (E12)	06/79→06/81	M10 B18 (184EB)	Petrol	1766	4	8	11
5 (E12)	06/80→08/81	M30 B35 (Motronic,9.3:1)	Petrol	3453	6	12	61
5 (E28)	05/81→12/87	M10 B18 (184EB)	Petrol	1766	4	8	11
5 (E28)	06/81→08/84	M10 B18 (184VC)	Petrol	1766	4	8	11
5 (E28)	06/81→08/84	M10 B18 (184VD)	Petrol	1766	4	8	11
5 (E28)	06/81→12/87	M20 B20 (206EA)	Petrol	1990	6	12	22
5 (E28)	06/81→12/87	M30 B25 (256EA)	Petrol	2494	6	12	36
5 (E28)	06/81→12/87	M30 B28 (286EA)	Petrol	2788	6	12	47
5 (E28)	09/81→12/87	M20 B27 (276EB)	Petrol	2693	6	12	46
5 (E28)	09/81→12/87	M20 B27 (276KA)	Petrol	2693	6	12	46
5 (E28)	09/81→12/87	M20 B27 (276KB)	Petrol	2693	6	12	46
5 (E28)	09/82→12/84	M30 B32	Petrol	3210	6	12	58
5 (E28)	05/83→12/87	M20 B27 (276EA)	Petrol	2693	6	12	46
5 (E28)	09/83→12/87	M21 D24 (246TA)	Diesel	2443	6	12	34
5 (E28)	01/85→12/87	M30 B34 (346EC)	Petrol	3430	6	12	61
5 (E28)	01/85→12/87	M30 B34 (346KA)	Petrol	3430	6	12	61
5 (E28)	01/85→12/87	M30 B35 (Motronic)	Petrol	3430	6	12	61
5 (E28)	08/85→12/87	M20 B20 (206KA)	Petrol	1990	6	12	22
5 (E28)	08/85→12/87	S38 B35 (356ED)	Petrol	3453	6	24	63
5 (E28)	03/86→12/87	M21 D24 (246DA)	Diesel	2443	6	12	34
5 (E34)	12/87→12/88	S38 B35 (356ED)	Petrol	3453	6	24	63
5 (E34)	12/87→12/88	S38 B36	Petrol	3535	6	24	64
5 (E34)	12/87→09/95	M30 B34 (346KB)	Petrol	3430	6	12	61
5 (E34)	01/88→08/91	M20 B20 (206KA)	Petrol	1990	6	12	22
5 (E34)	01/88→08/91	M20 B25 (256K1)	Petrol	2494	6	12	35
5 (E34)	01/88→08/91	M30 B30 (306KA)	Petrol	2986	6	12	51









5 (E34)	03/88→09/95	M21 D24 (246TB)	Diesel	2443	6	12	34
5 (E34)	10/88→12/93	S38 B36 (366S1)	Petrol	3535	6	24	64
5 (E34)	08/89→09/95	M40 B18 (184E1)	Petrol	1796	4	8	12
5 (E34)	08/89→09/95	M43 B18 (184E2)	Petrol	1796	4	8	14
5 (E34)	09/89→09/95	M50 B20 (206S1)	Petrol	1991	6	24	26
5 (E34)	09/89→09/95	M50 B20 (206S2)	Petrol	1991	6	24	25
5 (E34)	09/89→09/95	M50 B25 (256S2)	Petrol	2494	6	24	37
5 (E34)	09/91→09/95	M51 D25 (256T1)	Diesel	2497	6	12	39
5 (E34)	10/91→09/95	M50 B25 (256S1)	Petrol	2494	6	24	37
5 (E34)	03/92→09/95	S38 B38 (386S1)	Petrol	3795	6	24	66
5 (E34)	09/92→09/95	M60 B40 (408S1)	Petrol	3982	8	32	68
5 (E34)	09/92→11/95	M60 B30 (308S1)	Petrol	2997	8	32	55
5 (E39)	11/95→09/00	M52 B25 (256S3)	Petrol	2494	6	24	41
5 (E39)	11/95→09/00	M52 B28 (286S1)	Petrol	2793	6	24	49
5 (E39)	11/95→09/00	M52 B28 (286S2)	Petrol	2793	6	24	49
5 (E39)	01/96→06/03	M51 D25 (256T1)	Diesel	2497	6	12	39
5 (E39)	01/96→06/03	M52 B20 (206S3)	Petrol	1991	6	24	27
5 (E39)	04/96→03/99	M62 B35 (358S1)	Petrol	3498	8	32	62
5 (E39)	04/96→06/03	M62 B35 (358S2)	Petrol	3498	8	32	62
5 (E39)	04/96→06/03	M62 B44 (448S1)	Petrol	4398	8	32	72
5 (E39)	04/96→06/03	M62 B44 (448S2)	Petrol	4398	8	32	72
5 (E39)	08/98→06/03	M57 D30 (306D1)	Diesel	2926	6	24	53
5 (E39)	10/98→06/03	S62 B50 (508S1)	Petrol	4941	8	32	79
5 (E39)	02/00→06/03	M47 D20 (204D1)	Diesel	1951	4	16	23
5 (E39)	02/00→06/03	M57 D25 (256D1)	Diesel	2497	6	24	43
5 (E39)	09/00→06/03	M54 B22 (226S1)	Petrol	2171	6	24	31
5 (E39)	09/00→06/03	M54 B25 (256S5)	Petrol	2494	6	24	42
5 (E39)	09/00→06/03	M54 B30 (306S3)	Petrol	2979	6	24	52
5 (E60)	12/01→12/05	M54 B30 (306S3)	Petrol	2979	6	24	52
5 (E60)	02/02→12/09	M57 D30 (306D2)	Diesel	2993	6	24	54
5 (E60)	02/02→03/10	M57 D30 (306D3)	Diesel	2993	6	24	54
5 (E60)	07/03→03/10	M54 B22 (226S1)	Petrol	2171	6	24	31
5 (E60)	07/03→03/10	M54 B25 (256S5)	Petrol	2494	6	24	42
5 (E60)	09/03→03/10	N62 B44 A	Petrol	4398	8	32	71
5 (E60)	06/04→03/10	M57 D25 (256D2)	Diesel	2497	6	24	44
5 (E60)	09/04→03/10	M57 D30 (306D4)	Diesel	2993	6	24	53
5 (E60)	09/04→03/10	S85 B50 A	Petrol	4999	10	40	81
5 (E60)	12/04→03/10	M57 D25 (256D1)	Diesel	2497	6	24	43
5 (E60)	02/05→02/08	M47 D20 (204D4)	Diesel	1995	4	16	24
5 (E60)	07/05→03/10	N62 B40 A	Petrol	4000	8	32	69
5 (E60)	07/05→03/10	N62 B48 A	Petrol	4799	8	32	78
5 (E60)	07/05→03/10	N62 B48 B	Petrol	4799	8	32	78
5 (E60)	04/06→12/09	N46 B20 B	Petrol	1995	4	16	28
5 (E60)	04/06→12/09	N47 D20 A	Diesel	1995	4	16	19
5 (E60)	04/06→12/09	N47 D20 C	Diesel	1995	4	16	19
5 (E60)	04/06→03/10	N54 B30 A	Petrol	2979	6	24	56
5 (E60)	12/06→03/10	N43 B20 A	Petrol	1995	4	16	28
5 (E60)	01/07→03/10	M57 D30 (306D5)	Diesel	2993	6	24	53
5 (F10)	01/09→06/13	N63 B44 A	Petrol	4395	8	32	71
5 (F10)	01/09→10/16	B47 D20 A	Diesel	1995	4	16	19
5 (F10)	01/09→10/16	N47 D20 C	Diesel	1995	4	16	19
5 (F10)	01/09→10/16	N57 D30 A	Diesel	2993	6	24	50
5 (F10)	03/10→10/16	N57 D30 B	Diesel	2993	6	24	50
5 (F10)	10/10→10/16	S63 B44 B	Petrol	4395	8	32	71
5 (F10)	01/11→10/16	N47 D20 D	Diesel	1995	4	16	19
5 (F10)	07/11→10/16	N57 D30 C	Diesel	2993	6	24	50
5 (F10)	08/12→10/16	N63 B44 B	Petrol	4395	8	32	71
5 (G30, F90)	09/16→	B47 D20 A	Diesel	1995	4	16	19
5 (G30, F90)	09/16→	B57 D30 A	Diesel	2993	6	24	50
5 (G30, F90)	03/17→	N63 B44 C	Petrol	4395	8	32	71
5 (G30, F90)	06/17→	B57 D30 C	Diesel	2993	6	24	50
5 (G30, F90)	07/17→	B47 D20 B	Diesel	1995	4	16	19
5 (G30, F90)	07/17→	B57 D30 B	Diesel	2993	6	24	50
5 Gran Turismo (F07)	01/09→07/16	N63 B44 A	Petrol	4395	8	32	71
5 Gran Turismo (F07)	01/09→	N57 D30 A	Diesel	2993	6	24	50
5 Gran Turismo (F07)	05/09→	N57 D30 B	Diesel	2993	6	24	50
5 Gran Turismo (F07)	04/11→03/14	N63 B40 A	Petrol	3982	8	32	69
5 Gran Turismo (F07)	04/11→	N47 D20 C	Diesel	1995	4	16	19
5 Gran Turismo (F07)	04/11→	N63 B44 B	Petrol	4395	8	32	71
5 Touring (E34)	11/91→01/97	M50 B20 (206S1)	Petrol	1991	6	24	26
5 Touring (E34)	11/91→01/97	M50 B20 (206S2)	Petrol	1991	6	24	25
5 Touring (E34)	11/91→01/97	M50 B25 (256S1)	Petrol	2494	6	24	37
5 Touring (E34)	11/91→01/97	M50 B25 (256S2)	Petrol	2494	6	24	37
5 Touring (E34)	12/91→01/97	M51 D25 (256T1)	Diesel	2497	6	12	39
5 Touring (E34)	09/92→01/97	M60 B30 (308S1)	Petrol	2997	8	32	55
5 Touring (E34)	03/93→01/97	M43 B18 (184E2)	Petrol	1796	4	8	14
5 Touring (E34)	09/93→01/97	M60 B40 (408S1)	Petrol	3982	8	32	68
5 Touring (E34)	09/94→01/97	S38 B38 (386S1)	Petrol	3795	6	24	66

							
5 Touring (E39)	09/96→09/98	M52 B25 (256S3)	Petrol	2494	6	24	41
5 Touring (E39)	01/97→09/00	M52 B28 (286S1)	Petrol	2793	6	24	49
5 Touring (E39)	01/97→09/00	M52 B28 (286S2)	Petrol	2793	6	24	49
5 Touring (E39)	01/97→05/04	M52 B20 (206S3)	Petrol	1991	6	24	27
5 Touring (E39)	01/97→05/04	M62 B44 (448S1)	Petrol	4398	8	32	72
5 Touring (E39)	01/97→05/04	M62 B44 (448S2)	Petrol	4398	8	32	72
5 Touring (E39)	03/97→05/04	M51 D25 (256T1)	Diesel	2497	6	12	39
5 Touring (E39)	08/98→05/04	M57 D30 (306D1)	Diesel	2926	6	24	53
5 Touring (E39)	09/98→08/00	M52 B25 (256S4)	Petrol	2494	6	24	41
5 Touring (E39)	02/00→09/03	M47 D20 (204D1)	Diesel	1951	4	16	23
5 Touring (E39)	02/00→05/04	M57 D25 (256D1)	Diesel	2497	6	24	43
5 Touring (E39)	09/00→05/04	M54 B22 (226S1)	Petrol	2171	6	24	31
5 Touring (E39)	09/00→05/04	M54 B25 (256S5)	Petrol	2494	6	24	42
5 Touring (E39)	09/00→05/04	M54 B30 (306S3)	Petrol	2979	6	24	52
5 Touring (E61)	06/04→12/10	M54 B25 (256S5)	Petrol	2494	6	24	42
5 Touring (E61)	06/04→12/10	M57 D25 (256D2)	Diesel	2497	6	24	44
5 Touring (E61)	06/04→12/10	M57 D30 (306D2)	Diesel	2993	6	24	54
5 Touring (E61)	06/04→12/10	N62 B44 A	Petrol	4398	8	32	71
5 Touring (E61)	09/04→12/10	M57 D30 (306D4)	Diesel	2993	6	24	53
5 Touring (E61)	12/04→12/10	M57N 256 D4	Diesel	2497	6	24	44
5 Touring (E61)	04/05→02/08	M47 D20 (204D4)	Diesel	1995	4	16	24
5 Touring (E61)	07/05→12/10	M57 D30 (306D3)	Diesel	2993	6	24	54
5 Touring (E61)	07/05→12/10	N62 B48 A	Petrol	4799	8	32	78
5 Touring (E61)	07/05→12/10	N62 B48 B	Petrol	4799	8	32	78
5 Touring (E61)	01/07→12/10	M57 D30 (306D5)	Diesel	2993	6	24	53
5 Touring (E61)	02/07→12/10	S85 B50 A	Petrol	4999	10	40	81
5 Touring (E61)	03/07→05/10	N47 D20 A	Diesel	1995	4	16	19
5 Touring (E61)	03/07→05/10	N47 D20 C	Diesel	1995	4	16	19
5 Touring (E61)	07/07→12/10	N43 B20 A	Petrol	1995	4	16	28
5 Touring (E61)	09/07→12/10	N54 B30 A	Petrol	2979	6	24	56
5 Touring (F11)	11/09→	B47 D20 A	Diesel	1995	4	16	19
5 Touring (F11)	11/09→	N47 D20 C	Diesel	1995	4	16	19
5 Touring (F11)	11/09→	N57 D30 A	Diesel	2993	6	24	50
5 Touring (F11)	03/10→	N57 D30 B	Diesel	2993	6	24	50
5 Touring (F11)	09/10→06/13	N63 B44 A	Petrol	4395	8	32	71
5 Touring (F11)	10/10→	N57 D30 C	Diesel	2993	6	24	50
5 Touring (F11)	02/11→	N47 D20 D	Diesel	1995	4	16	19
5 Touring (F11)	08/12→	N63 B44 B	Petrol	4395	8	32	71
5 Touring (G31)	03/17→	B47 D20 A	Diesel	1995	4	16	19
5 Touring (G31)	03/17→	B57 D30 A	Diesel	2993	6	24	50
5 Touring (G31)	07/17→	B47 D20 B	Diesel	1995	4	16	19
5 Touring (G31)	07/17→	B57 D30 B	Diesel	2993	6	24	50
5 Touring (G31)	07/17→	B57 D30 C	Diesel	2993	6	24	50
6 (E24)	10/75→12/84	M30 B32	Petrol	3210	6	12	58
6 (E24)	04/76→08/79	M30 B30	Petrol	2986	6	12	51
6 (E24)	12/77→04/89	M30 B34 (346EC)	Petrol	3430	6	12	61
6 (E24)	12/77→04/89	M30 B34 (346KA)	Petrol	3430	6	12	61
6 (E24)	12/77→04/89	M30 B34 (346KB)	Petrol	3430	6	12	61
6 (E24)	06/78→08/88	M30 B35 (L-Jetronic,10:1)	Petrol	3453	6	12	61
6 (E24)	06/78→08/88	M30 B35 (Motronic,9.3:1)	Petrol	3453	6	12	61
6 (E24)	06/78→10/89	M30 B35 (Motronic,10:1)	Petrol	3430	6	12	61
6 (E24)	09/79→08/87	M30 B28	Petrol	2788	6	12	47
6 (E24)	04/84→12/88	M88 B35	Petrol	3453	6	24	63
6 (E24)	04/86→02/89	S38 B35 (356ED)	Petrol	3453	6	24	63
6 (E63)	01/04→12/05	N62 B44 A	Petrol	4398	8	32	71
6 (E63)	07/05→12/10	N62 B48 B	Petrol	4799	8	32	78
6 (E63)	09/05→07/10	S85 B50 A	Petrol	4999	10	40	81
6 (E63)	09/05→12/10	N62 B48 A	Petrol	4799	8	32	78
6 (E63)	07/07→07/10	M57 D30 (306D5)	Diesel	2993	6	24	53
6 Convertible (E64)	04/04→12/05	N62 B44 A	Petrol	4398	8	32	71
6 Convertible (E64)	07/05→12/10	N62 B48 B	Petrol	4799	8	32	78
6 Convertible (E64)	07/06→07/10	S85 B50 A	Petrol	4999	10	40	81
6 Convertible (E64)	07/07→07/10	M57 D30 (306D5)	Diesel	2993	6	24	53
6 Convertible (F12)	03/11→	N63 B44 A	Petrol	4395	8	32	71
6 Convertible (F12)	09/11→	N57 D30 B	Diesel	2993	6	24	50
6 Convertible (F12)	10/11→	N63 B44 B	Petrol	4395	8	32	71
6 Convertible (F12)	01/12→	N63 B40 A	Petrol	3982	8	32	69
6 Convertible (F12)	01/12→	S63 B44 B	Petrol	4395	8	32	71
6 Coupe (F13)	11/10→	N57 D30 B	Diesel	2993	6	24	50
6 Coupe (F13)	11/10→	N63 B44 A	Petrol	4395	8	32	71
6 Coupe (F13)	01/11→	N63 B40 A	Petrol	3982	8	32	69
6 Coupe (F13)	10/11→	N63 B44 B	Petrol	4395	8	32	71
6 Coupe (F13)	01/12→	S63 B44 B	Petrol	4395	8	32	71
6 Gran Coupe (F06)	09/11→	N57 D30 B	Diesel	2993	6	24	50
6 Gran Coupe (F06)	11/11→	N63 B44 B	Petrol	4395	8	32	71
6 Gran Coupe (F06)	12/12→	S63 B44 B	Petrol	4395	8	32	71
6 Gran Coupe (F06)	05/13→	N63 B40 A	Petrol	3982	8	32	69
6 Gran Turismo (G32)	06/17→	B57 D30 A	Diesel	2993	6	24	50



6 Gran Turismo (G32)	11/17→	B57 D30 B	Diesel	2993	6	24	50
7 (E23)	05/77→08/79	M30 B30	Petrol	2986	6	12	51
7 (E23)	05/77→08/86	M30 B28	Petrol	2788	6	12	47
7 (E23)	05/77→08/86	M30 B32	Petrol	3210	6	12	58
7 (E23)	07/77→06/86	M30 B25	Petrol	2494	6	12	36
7 (E23)	09/79→08/86	M30 B35 (Motronic,10:1)	Petrol	3430	6	12	61
7 (E23)	09/79→08/86	M30 B35 (Motronic,9.3:1)	Petrol	3453	6	12	61
7 (E23)	04/80→04/83	M30 B32 (326TA)	Petrol	3210	6	12	58
7 (E23)	06/82→06/86	M30 B34 (346EC)	Petrol	3430	6	12	61
7 (E23)	05/83→08/86	M30 B35	Petrol	3430	6	12	61
7 (E23)	01/85→08/86	M30 B34 (346KA)	Petrol	3430	6	12	61
7 (E23)	04/85→08/86	M30 B35 (Motronic)	Petrol	3430	6	12	61
7 (E32)	09/86→12/87	M30 B35 (Motronic,9.2:1)	Petrol	3430	6	12	61
7 (E32)	09/86→12/92	M30 B34 (346EC)	Petrol	3430	6	12	61
7 (E32)	09/86→12/92	M30 B34 (346KB)	Petrol	3430	6	12	61
7 (E32)	12/86→09/94	M30 B30 (306EA)	Petrol	2986	6	12	51
7 (E32)	12/86→09/94	M30 B30 (306KA)	Petrol	2986	6	12	51
7 (E32)	09/87→09/94	M70 B50 (5012A)	Petrol	4988	12	24	80
7 (E32)	04/92→09/94	M60 B30 (308S1)	Petrol	2997	8	32	55
7 (E32)	04/92→09/94	M60 B40 (408S1)	Petrol	3982	8	32	68
7 (E38)	10/94→11/01	M60 B30 (308S1)	Petrol	2997	8	32	55
7 (E38)	10/94→11/01	M60 B40 (408S1)	Petrol	3982	8	32	68
7 (E38)	12/94→11/01	M73 B54 (54121)	Petrol	5379	12	24	82
7 (E38)	12/94→11/01	M73 B54 (54122)	Petrol	5379	12	24	82
7 (E38)	08/95→11/01	M52 B28 (286S1)	Petrol	2793	6	24	49
7 (E38)	08/95→11/01	M52 B28 (286S2)	Petrol	2793	6	24	49
7 (E38)	01/96→12/98	M62 B35 (358S1)	Petrol	3498	8	32	62
7 (E38)	01/96→11/01	M62 B44 (448S1)	Petrol	4398	8	32	72
7 (E38)	01/96→11/01	M62 B44 (448S2)	Petrol	4398	8	32	72
7 (E38)	04/96→11/01	M51 D25 (256T1)	Diesel	2497	6	12	39
7 (E38)	08/98→11/01	M57 D30 (306D1)	Diesel	2926	6	24	53
7 (E38)	09/98→07/01	M62 B35 (358S2)	Petrol	3498	8	32	62
7 (E38)	05/99→11/01	M67 D39 (398D1)	Diesel	3901	8	32	67
7 (E65, E66, E67)	11/01→02/05	N62 B36 A	Petrol	3600	8	32	65
7 (E65, E66, E67)	11/01→07/08	N62 B44 A	Petrol	4398	8	32	71
7 (E65, E66, E67)	11/01→12/09	N73 B60 A	Petrol	5972	12	48	84
7 (E65, E66, E67)	10/02→02/05	M67 D39 (398D1)	Diesel	3901	8	32	67
7 (E65, E66, E67)	10/02→07/08	M57 D30 (306D2)	Diesel	2993	6	24	54
7 (E65, E66, E67)	10/02→12/09	M57 D30 (306D3)	Diesel	2993	6	24	54
7 (E65, E66, E67)	03/03→07/08	M54 B30 (306S3)	Petrol	2979	6	24	52
7 (E65, E66, E67)	03/05→07/08	M67 D44 (448D1)	Diesel	4423	8	32	73
7 (E65, E66, E67)	03/05→12/09	N62 B40 A	Petrol	4000	8	32	69
7 (E65, E66, E67)	07/05→12/08	N62 B48 B	Petrol	4799	8	32	78
7 (F01, F02, F03, F04)	02/08→05/15	N57 D30 A	Diesel	2993	6	24	50
7 (F01, F02, F03, F04)	09/08→12/15	N63 B44 A	Petrol	4395	8	32	71
7 (F01, F02, F03, F04)	10/08→12/15	N54 B30 A	Petrol	2979	6	24	56
7 (F01, F02, F03, F04)	09/09→12/15	N57 D30 B	Diesel	2993	6	24	50
7 (F01, F02, F03, F04)	09/09→12/15	N63 B44 B	Petrol	4395	8	32	71
7 (F01, F02, F03, F04)	07/12→12/15	N57 D30 C	Diesel	2993	6	24	50
7 (F01, F02, F03, F04)	07/13→03/15	N63 B40 A	Petrol	3982	8	32	69
7 (G11, G12)	10/14→	N63 B40 B	Petrol	3982	8	32	69
7 (G11, G12)	09/15→	B47 D20 B	Diesel	1995	4	16	19
7 (G11, G12)	09/15→	B57 D30 A	Diesel	2993	6	24	50
7 (G11, G12)	09/15→	N63 B44 C	Petrol	4395	8	32	71
7 (G11, G12)	11/15→	B57 D30 B	Diesel	2993	6	24	50
7 (G11, G12)	07/16→	B57 D30 C	Diesel	2993	6	24	50
8 (E31)	04/90→10/94	M70 B50 (5012A)	Petrol	4988	12	24	80
8 (E31)	02/93→02/96	M60 B40 (408S1)	Petrol	3982	8	32	68
8 (E31)	04/93→12/96	S70 B56 (56121)	Petrol	5576	12	24	83
8 (E31)	09/94→12/99	M73 B54 (54121)	Petrol	5379	12	24	82
8 (E31)	01/96→12/99	M62 B44 (448S1)	Petrol	4398	8	32	72
1500-2000 (115, 116, 118, 121)	10/62→07/66	M10 B15	Petrol	1499	4	8	3
1500-2000 (115, 116, 118, 121)	08/63→09/69	M118	Petrol	1773	4	8	15
1500-2000 (115, 116, 118, 121)	09/63→12/71	M10 B16	Petrol	1573	4	8	4
1500-2000 (115, 116, 118, 121)	09/65→11/72	M10 B18	Petrol	1766	4	8	11
1500-2000 (115, 116, 118, 121)	09/65→11/72	M10 B20	Petrol	1990	4	8	21
1600 GT Coupe	10/67→05/69	M10 B16	Petrol	1573	4	8	4
2000-3.2 Coupe (E9)	10/65→06/70	M10 B20	Petrol	1990	4	8	21
2000-3.2 Coupe (E9)	09/67→12/74	M30 B28	Petrol	2788	6	12	47
2000-3.2 Coupe (E9)	09/70→03/76	M30 B30	Petrol	2986	6	12	51
2000-3.2 Coupe (E9)	01/74→11/75	M30 B32 (L-Jetronic)	Petrol	3153	6	12	58
2000-3.2 Coupe (E9)	09/74→03/76	M30 B25	Petrol	2494	6	12	36
2500-3.3 (E3)	10/68→04/77	M30 B25	Petrol	2494	6	12	36
2500-3.3 (E3)	10/68→04/77	M30 B28	Petrol	2788	6	12	47
2500-3.3 (E3)	05/71→04/77	M30 B30	Petrol	2986	6	12	51
2500-3.3 (E3)	01/74→09/76	M30 B33 (35/40 INAT)	Petrol	3295	6	12	60
2500-3.3 (E3)	10/75→04/77	M30 B32	Petrol	3210	6	12	58
2500-3.3 (E3)	10/75→04/77	M30 B32 (330EL)	Petrol	3210	6	12	58

				CC			9
B3 (E90)	09/07→05/13	N54 B30 A	Petrol	2979	6	24	56
B3 Convertible (E93)	09/07→03/10	N54 B30 A	Petrol	2979	6	24	56
B3 Coupe (E92)	09/07→12/13	N54 B30 A	Petrol	2979	6	24	56
B3 Estate (E91)	09/07→05/13	N54 B30 A	Petrol	2979	6	24	56
B5 (F10)	01/12→12/16	N63 B44 A	Petrol	4395	8	32	71
B5 (G30)	03/17→	N63 B44 C	Petrol	4395	8	32	71
B5 Estate (F11)	01/12→12/16	N63 B44 A	Petrol	4395	8	32	71
B5 Touring (G31)	03/17→	N63 B44 C	Petrol	4395	8	32	71
B6 Convertible (E64)	04/06→08/10	N62 B44 A	Petrol	4398	8	32	71
B6 Convertible (F12)	09/11→09/14	N63 B44 A	Petrol	4395	8	32	71
B6 Convertible (F12)	01/15→	N63 B44 B	Petrol	4395	8	32	71
B6 Coupe (E63)	04/06→08/10	N62 B44 A	Petrol	4398	8	32	71
B6 Coupe (F06)	04/14→12/14	N63 B44 A	Petrol	4395	8	32	71
B6 Coupe (F06)	03/15→	N63 B44 B	Petrol	4395	8	32	71
B6 Coupe (F13)	09/11→09/14	N63 B44 A	Petrol	4395	8	32	71
B6 Coupe (F13)	01/15→	N63 B44 B	Petrol	4395	8	32	71
B7 (F01, F02)	07/12→07/15	N63 B44 B	Petrol	4395	8	32	71
B7 (G12)	02/16→	N63 B44 C	Petrol	4395	8	32	71
D3 (E90)	07/08→05/13	N47 D20 D	Diesel	1995	4	16	19
D3 (F30)	03/14→	N57 D30 B	Diesel	2993	6	24	57
D3 Coupe (E92)	07/08→05/13	N47 D20 D	Diesel	1995	4	16	19
D3 Estate (E91)	07/08→05/13	N47 D20 D	Diesel	1995	4	16	19
D3 Estate (F31)	03/14→	N57 D30 B	Diesel	2993	6	24	57
D4 Convertible (F33)	09/14→	N57 D30 B	Diesel	2993	6	24	57
D4 Coupe (F32)	09/14→	N57 D30 B	Diesel	2993	6	24	57
D5 (F10)	09/11→12/16	N57 D30 B	Diesel	2993	6	24	57
D5 Touring (F11)	09/11→12/16	N57 D30 B	Diesel	2993	6	24	57
i8 (I12)	03/14→	B38 K15 A	Petrol	1499	3	12	2
M1 (E26)	05/79→05/83	M88 B35	Petrol	3453	6	24	63
X1 (E84)	03/09→06/15	N46 B20 B	Petrol	1995	4	16	28
X1 (E84)	03/09→06/15	N47 D20 C	Diesel	1995	4	16	19
X1 (E84)	10/09→06/15	N47 D20 D	Diesel	1995	4	16	19
X1 (E84)	10/09→06/15	N47S D20 D	Diesel	1995	4	16	19
X1 (F48)	11/14→	B37 C15 A	Diesel	1496	3	12	1
X1 (F48)	11/14→	B38 A15 A	Petrol	1499	3	12	2
X1 (F48)	11/14→	B47 C20 A	Diesel	1995	4	16	19
X1 (F48)	11/14→	B47 C20 B	Diesel	1995	4	16	19
X1 (F48)	11/14→	B48 A20 A	Petrol	1998	4	16	20
X1 (F48)	11/14→	B48 A20 B	Petrol	1998	4	16	20
X3 (E83)	01/03→08/05	M57 D30 (306D2)	Diesel	2993	6	24	54
X3 (E83)	11/03→08/07	M47 D20 (204D4)	Diesel	1995	4	16	24
X3 (E83)	01/04→12/06	M54 B25 (256S5)	Petrol	2494	6	24	42
X3 (E83)	01/04→12/06	M54 B30 (306S3)	Petrol	2979	6	24	52
X3 (E83)	10/04→08/10	M57 D30 (306D3)	Diesel	2993	6	24	54
X3 (E83)	07/05→08/11	N46 B20 B	Petrol	1995	4	16	28
X3 (E83)	09/06→08/11	M57 D30 (306D5)	Diesel	2993	6	24	53
X3 (E83)	03/07→08/07	N47 D20 A	Diesel	1995	4	16	19
X3 (E83)	03/07→12/11	N47 D20 C	Diesel	1995	4	16	19
X3 (F25)	09/10→	N47 D20 C	Diesel	1995	4	16	19
X3 (F25)	05/11→	N57 D30 A	Diesel	2993	6	24	50
X3 (F25)	09/11→	N57 D30 B	Diesel	2993	6	24	50
X3 (F25)	02/14→	B47 D20 A	Diesel	1995	4	16	19
X3 (G01)	10/17→	B47 D20 A	Diesel	1995	4	16	19
X3 (G01)	10/17→	B57 D30 A	Diesel	2993	6	24	50
X4 (F26)	05/13→	N57 D30 B	Diesel	2993	6	24	50
X4 (F26)	06/13→	N57 D30 A	Diesel	2993	6	24	50
X4 (F26)	07/13→	B47 D20 A	Diesel	1995	4	16	19
X5 (E53)	05/00→12/03	M62 B44 (448S2)	Petrol	4398	8	32	72
X5 (E53)	05/00→12/06	M54 B30 (306S3)	Petrol	2979	6	24	52
X5 (E53)	05/01→12/03	M57 D30 (306D1)	Diesel	2926	6	24	53
X5 (E53)	09/01→12/03	M62 B46 (468S1)	Petrol	4619	8	32	76
X5 (E53)	09/03→12/06	M57 D30 (306D2)	Diesel	2993	6	24	54
X5 (E53)	12/03→09/06	N62 B44	Petrol	4398	8	32	71
X5 (E53)	12/03→09/06	N62 B44 A	Petrol	4398	8	32	71
X5 (E53)	04/04→09/06	N62 B48 A	Petrol	4799	8	32	78
X5 (E70)	02/07→06/13	M57 D30 (306D1)	Diesel	2926	6	24	53
X5 (E70)	02/07→06/13	M57 D30 (306D3)	Diesel	2993	6	24	54
X5 (E70)	02/07→06/13	N62 B48 B	Petrol	4799	8	32	78
X5 (E70)	09/07→06/13	M57 D30 (306D5)	Diesel	2993	6	24	53
X5 (E70)	09/08→12/12	M57 D30 (306D4)	Diesel	2993	6	24	53
X5 (E70)	09/08→06/13	N57 D30 A	Diesel	2993	6	24	50
X5 (E70)	09/09→06/13	N63 B44 A	Petrol	4395	8	32	71
X5 (E70)	09/09→06/13	S63 B44 A	Petrol	4395	8	32	71
X5 (E70)	09/10→06/13	N57 D30 B	Diesel	2993	6	24	50
X5 (E70)	08/11→06/13	N57 D30 C	Diesel	2993	6	24	50
X5 (F15, F85)	07/13→	N57 D30 A	Diesel	2993	6	24	50
X5 (F15, F85)	07/13→	N57 D30 C	Diesel	2993	6	24	50
X5 (F15, F85)	07/13→	N63 B44 B	Petrol	4395	8	32	71











CC



9

X5 (F15, F85)	11/13→	N47 D20 D	Diesel	1995	4	16	19
X5 (F15, F85)	12/13→	N57 D30 B	Diesel	2993	6	24	50
X5 (F15, F85)	02/14→	N63 B40 A	Petrol	3982	8	32	69
X5 (F15, F85)	12/14→	S63 B44 B	Petrol	4395	8	32	71
X5 (F15, F85)	07/15→	B47 D20 B	Diesel	1995	4	16	19
X6 (E71, E72)	06/07→03/10	M57 D30 (306D5)	Diesel	2993	6	24	53
X6 (E71, E72)	06/07→06/14	N54 B30 A	Petrol	2979	6	24	56
X6 (E71, E72)	09/07→03/10	M57 D30 (306D3)	Diesel	2993	6	24	54
X6 (E71, E72)	10/07→06/14	N63 B44 A	Petrol	4395	8	32	71
X6 (E71, E72)	07/08→06/14	S63 B44 A	Petrol	4395	8	32	71
X6 (E71, E72)	04/09→06/14	N57 D30 A	Diesel	2993	6	24	50
X6 (E71, E72)	07/09→06/14	N57 D30 B	Diesel	2993	6	24	50
X6 (E71, E72)	08/11→06/14	N57 D30 C	Diesel	2993	6	24	50
X6 (F16, F86)	08/14→	N57 D30 A	Diesel	2993	6	24	50
X6 (F16, F86)	08/14→	N57 D30 C	Diesel	2993	6	24	50
X6 (F16, F86)	08/14→	N63 B44 B	Petrol	4395	8	32	71
X6 (F16, F86)	11/14→	N63 B40 A	Petrol	3982	8	32	69
X6 (F16, F86)	12/14→	N57 D30 B	Diesel	2993	6	24	50
X6 (F16, F86)	12/14→	S63 B44 B	Petrol	4395	8	32	71
XD3 (F25)	04/13→	N57 D30 B	Diesel	2993	6	24	57
Z1 Roadster	06/88→06/91	M20 B25 (256K1)	Petrol	2494	6	12	35
Z3 Coupe (E36)	07/97→06/00	M52 B28 (286S1)	Petrol	2793	6	24	49
Z3 Coupe (E36)	02/98→06/01	S50 B32 (326S1)	Petrol	3201	6	24	59
Z3 Coupe (E36)	09/98→12/00	S52 B32 (326S2)	Petrol	3152	6	24	59
Z3 Coupe (E36)	06/00→06/03	M54 B30 (306S3)	Petrol	2979	6	24	52
Z3 Coupe (E36)	09/00→06/03	S54 B32 (326S4)	Petrol	3246	6	24	59
Z3 Roadster (E36)	10/95→10/98	M43 B18 (184E2)	Petrol	1796	4	8	14
Z3 Roadster (E36)	10/95→03/99	M44 B19 (194S1)	Petrol	1895	4	16	18
Z3 Roadster (E36)	01/96→07/00	M52 B28 (286S1)	Petrol	2793	6	24	49
Z3 Roadster (E36)	01/96→07/00	M52 B28 (286S2)	Petrol	2793	6	24	49
Z3 Roadster (E36)	03/97→06/01	S50 B32 (326S1)	Petrol	3201	6	24	59
Z3 Roadster (E36)	09/97→12/00	S52 B32 (326S2)	Petrol	3152	6	24	59
Z3 Roadster (E36)	07/98→01/03	M43 B19 (194E1)	Petrol	1895	4	8	17
Z3 Roadster (E36)	09/98→12/00	M52 B25 TU	Petrol	2494	6	24	42
Z3 Roadster (E36)	04/99→01/03	M52 B20 (206S4)	Petrol	1991	6	24	27
Z3 Roadster (E36)	06/00→01/03	M54 B30 (306S3)	Petrol	2979	6	24	52
Z3 Roadster (E36)	08/00→01/03	M54 B22 (226S1)	Petrol	2171	6	24	31
Z3 Roadster (E36)	09/00→12/02	M54 B25 (256S5)	Petrol	2494	6	24	42
Z3 Roadster (E36)	09/00→01/03	S54 B32 (326S4)	Petrol	3246	6	24	59
Z4 Coupe (E86)	03/06→01/09	S54 B32 (326S4)	Petrol	3246	6	24	59
Z4 Coupe (E86)	11/06→04/08	M54 B25 (256S5)	Petrol	2494	6	24	42
Z4 Coupe (E86)	11/06→04/08	M54 256 S5	Petrol	2494	6	24	42
Z4 Roadster (E85)	02/03→12/05	M54 B25 (256S5)	Petrol	2494	6	24	42
Z4 Roadster (E85)	02/03→12/05	M54 B30 (306S3)	Petrol	2979	6	24	52
Z4 Roadster (E85)	10/03→10/05	M54 B22 (226S1)	Petrol	2171	6	24	31
Z4 Roadster (E85)	03/05→02/09	N46 B20 A	Petrol	1995	4	16	28
Z4 Roadster (E85)	03/05→02/09	N46 B20 B	Petrol	1995	4	16	28
Z4 Roadster (E85)	09/05→02/09	S54 B32 (326S4)	Petrol	3246	6	24	59
Z4 Roadster (E89)	05/09→	N54 B30 A	Petrol	2979	6	24	56
Z8 Roadster (E52)	06/00→06/03	S62 B50 (508S1)	Petrol	4941	8	32	79

	CC				9		CC				9
B37 C15 A	1496	3	12	Diesel	1	M30 B32 (633EL)	3210	6	12	Petrol	58
B37 D15 A	1496	3	12	Diesel	1	M30 B32 (732EL)	3210	6	12	Petrol	58
B38 A15 A	1499	3	12	Petrol	2	M30 B32 (733EL)	3210	6	12	Petrol	58
B38 B15 A	1499	3	12	Petrol	2	M30 B32 (L-Jetronic)	3153	6	12	Petrol	58
B38 K15 A	1499	3	12	Petrol	2	M30 B33 (35/40 INAT)	3295	6	12	Petrol	60
B47 C20 A	1995	4	16	Diesel	19	M30 B34 (346EC)	3430	6	12	Petrol	61
B47 C20 B	1995	4	16	Diesel	19	M30 B34 (346KA)	3430	6	12	Petrol	61
B47 D20 A	1995	4	16	Diesel	19	M30 B34 (346KB)	3430	6	12	Petrol	61
B47 D20 B	1995	4	16	Diesel	19	M30 B35	3430	6	12	Petrol	61
B48 A20 A	1998	4	16	Petrol	20	M30 B35 (L-Jetronic,10:1)	3453	6	12	Petrol	61
B48 A20 B	1998	4	16	Petrol	20	M30 B35 (Motronic)	3430	6	12	Petrol	61
B57 D30 A	2993	6	24	Diesel	50	M30 B35 (Motronic,10:1)	3430	6	12	Petrol	61
B57 D30 B	2993	6	24	Diesel	50	M30 B35 (Motronic,9.2:1)	3430	6	12	Petrol	61
B57 D30 C	2993	6	24	Diesel	50	M30 B35 (Motronic,9.3:1)	3453	6	12	Petrol	61
M10 B15	1499	4	8	Petrol	3	M40 B16	1596	4	8	Petrol	5
M10 B16	1573	4	8	Petrol	4	M40 B16 (164E1)	1596	4	8	Petrol	5
M10 B16 (164VA)	1573	4	8	Petrol	4	M40 B16 C	1596	4	8	Petrol	5
M10 B16 (164VB)	1573	4	8	Petrol	4	M40 B18 (184E1)	1796	4	8	Petrol	12
M10 B18	1766	4	8	Petrol	11	M40 B18 C	1796	4	8	Petrol	12
M10 B18 (184EA)	1766	4	8	Petrol	11	M41 D17 (174T1)	1665	4	8	Diesel	10
M10 B18 (184EB)	1766	4	8	Petrol	11	M42 B18	1796	4	16	Petrol	13
M10 B18 (184EW)	1766	4	8	Petrol	11	M42 B18 (184S1)	1796	4	16	Petrol	13
M10 B18 (184EY)	1766	4	8	Petrol	11	M43 B16 (164E2)	1596	4	8	Petrol	6
M10 B18 (184EZ)	1766	4	8	Petrol	11	M43 B16 (164E3)	1596	4	8	Petrol	6
M10 B18 (184KA)	1766	4	8	Petrol	11	M43 B18 (184E2)	1796	4	8	Petrol	14
M10 B18 (184VA)	1766	4	8	Petrol	11	M43 B19 (194E1)	1895	4	8	Petrol	17
M10 B18 (184VB)	1766	4	8	Petrol	11	M44 B19 (194S1)	1895	4	16	Petrol	18
M10 B18 (184VC)	1766	4	8	Petrol	11	M47 D20	1951	4	16	Diesel	23
M10 B18 (184VD)	1766	4	8	Petrol	11	M47 D20 (204D1)	1951	4	16	Diesel	23
M10 B18 (184VU)	1766	4	8	Petrol	11	M47 D20 (204D4)	1995	4	16	Diesel	24
M10 B18 (320US)	1766	4	8	Petrol	11	M47 D20 TU	1951	4	16	Diesel	24
M10 B20	1990	4	8	Petrol	21	M47N 204 D4	1995	4	16	Diesel	24
M10 B20 (22T A)	1990	4	8	Petrol	21	M47N 204 D5	1995	4	16	Diesel	24
M10 B20 (22TIU)	1990	4	8	Petrol	21	M50 B(20 6 S1)	1991	6	24	Petrol	25
M10 B20 (320EK)	1990	4	8	Petrol	21	M50 B(20 6 S2) Vanos	1991	6	24	Petrol	25
M10 B20 (320US)	1990	4	8	Petrol	21	M50 B20	1991	6	24	Petrol	25
M10 B20 (Turbo)	1990	4	8	Petrol	21	M50 B20 (206S1)	1991	6	24	Petrol	26
M20 B20	1990	6	12	Petrol	22	M50 B20 (206S2)	1991	6	24	Petrol	25
M20 B20 (206EA)	1990	6	12	Petrol	22	M50 B20 TU	1991	6	24	Petrol	25
M20 B20 (206EB)	1990	6	12	Petrol	22	M50 B25 (256S1)	2494	6	24	Petrol	37
M20 B20 (206EC)	1990	6	12	Petrol	22	M50 B25 (256S2)	2494	6	24	Petrol	37
M20 B20 (206EE)	1990	6	12	Petrol	22	M50 B25 (Vanos)	2494	6	24	Petrol	37
M20 B20 (206EY)	1990	6	12	Petrol	22	M50 B25 TU	2494	6	24	Petrol	38
M20 B20 (206EZ)	1990	6	12	Petrol	22	M51 D25 (256T1)	2497	6	12	Diesel	39
M20 B20 (206KA)	1990	6	12	Petrol	22	M51 D25 (Inter.)	2503	6	12	Diesel	40
M20 B20 (206VA)	1990	6	12	Petrol	22	M52 B(20 6 S3) Vanos	1991	6	24	Petrol	27
M20 B23 (236EA)	2316	6	12	Petrol	32	M52 B20	1991	6	24	Petrol	27
M20 B23 (236EB)	2316	6	12	Petrol	32	M52 B20 (206S3)	1991	6	24	Petrol	27
M20 B23 (236EC)	2316	6	12	Petrol	32	M52 B20 (206S4)	1991	6	24	Petrol	27
M20 B23 (236EW)	2316	6	12	Petrol	32	M52 B25 (256S3)	2494	6	24	Petrol	41
M20 B25 (256E1)	2494	6	12	Petrol	35	M52 B25 (256S4)	2494	6	24	Petrol	41
M20 B25 (256E2)	2494	6	12	Petrol	35	M52 B25 (Vanos)	2494	6	24	Petrol	42
M20 B25 (256EX)	2494	6	12	Petrol	35	M52 B25 TU	2494	6	24	Petrol	42
M20 B25 (256K1)	2494	6	12	Petrol	35	M52 B28	2793	6	24	Petrol	48
M20 B27 (276EA)	2693	6	12	Petrol	46	M52 B28 (286S1)	2793	6	24	Petrol	49
M20 B27 (276EB)	2693	6	12	Petrol	46	M52 B28 (286S2)	2793	6	24	Petrol	49
M20 B27 (276KA)	2693	6	12	Petrol	46	M52 B28 GG	2793	6	24	Petrol	49
M20 B27 (276KB)	2693	6	12	Petrol	46	M52 B28 TU	2793	6	24	Petrol	48
M21 D24 (246DA)	2443	6	12	Diesel	34	M54 B22 (226S1)	2171	6	24	Petrol	31
M21 D24 (246TA)	2443	6	12	Diesel	34	M54 B25 (256S3)	2494	6	24	Petrol	42
M21 D24 (246TB)	2443	6	12	Diesel	34	M54 B25 (256S5)	2494	6	24	Petrol	42
M21 D24 W	2443	6	12	Diesel	34	M54 B30 (306S3)	2979	6	24	Petrol	52
M30 B25	2494	6	12	Petrol	36	M57 D25 (256D1)	2497	6	24	Diesel	43
M30 B25 (256EA)	2494	6	12	Petrol	36	M57 D25 (256D2)	2497	6	24	Diesel	44
M30 B25 (256VA)	2494	6	12	Petrol	36	M57 D25 TU	2497	6	24	Diesel	44
M30 B28	2788	6	12	Petrol	47	M57 D30 (306D1)	2926	6	24	Diesel	53
M30 B28 (286EA)	2788	6	12	Petrol	47	M57 D30 (306D2)	2993	6	24	Diesel	54
M30 B28 (528EL)	2788	6	12	Petrol	47	M57 D30 (306D3)	2993	6	24	Diesel	54
M30 B28 (528TR)	2788	6	12	Petrol	47	M57 D30 (306D4)	2993	6	24	Diesel	53
M30 B28 (628EL)	2788	6	12	Petrol	47	M57 D30 (306D5)	2993	6	24	Diesel	53
M30 B28 (728EL)	2788	6	12	Petrol	47	M57 D30 TU2	2993	6	24	Diesel	54
M30 B28 (728TR)	2788	6	12	Petrol	47	M57N2 306 D2	2993	6	24	Diesel	54
M30 B30	2986	6	12	Petrol	51	M57N2 306 D3	2993	6	24	Diesel	53
M30 B30 (306EA)	2986	6	12	Petrol	51	M57N 256 D4	2497	6	24	Diesel	44
M30 B30 (306KA)	2986	6	12	Petrol	51	M57N 306 D2	2993	6	24	Diesel	54
M30 B32	3210	6	12	Petrol	58	M57N 306 D4	2993	6	24	Diesel	54
M30 B32 (326TA)	3210	6	12	Petrol	58	M57N 306 D5	2993	6	24	Diesel	53
M30 B32 (330EL)	3210	6	12	Petrol	58	M60 B30	2997	8	32	Petrol	55

	CC				9		CC				9
M60 B30 (308S1)	2997	8	32	Petrol	55	N63 B44 C	4395	8	32	Petrol	71
M60 B40 (408S1)	3982	8	32	Petrol	68	N63 B44 C	4395	8	32	Petrol	71
M62 B35 (358S1)	3498	8	32	Petrol	62	N67N 448 D1	4423	8	32	Diesel	74
M62 B35 (358S2)	3498	8	32	Petrol	62	N67N 448 D2	4423	8	32	Diesel	74
M62 B35 TU	3498	8	32	Petrol	62	N73 B60 A	5972	12	48	Petrol	84
M62 B44	4398	8	32	Petrol	71	N57 306 D2	2993	6	24	Diesel	54
M62 B44 (448S1)	4398	8	32	Petrol	72	N57 306 D3	2993	6	24	Diesel	54
M62 B44 (448S2)	4398	8	32	Petrol	72	N67 398 D1	3901	8	32	Diesel	67
M62 B44 TU	4398	8	32	Petrol	72	S14 B20 (204EA)	1990	4	16	Petrol	30
M62 B46 (468S1)	4619	8	32	Petrol	76	S14 B23 (234EA)	2303	4	16	Petrol	33
M67 D39 (398D1)	3901	8	32	Diesel	67	S14 B23 (234S1)	2303	4	16	Petrol	33
M67 D44 (448D1)	4423	8	32	Diesel	73	S14 B23 (234S2)	2303	4	16	Petrol	33
M70 B50 (5012A)	4988	12	24	Petrol	80	S14 B23 (EVO I)	2302	4	16	Petrol	33
M70 B56	5576	12	24	Petrol	83	S14 B25 (254S1)	2467	4	16	Petrol	45
M73 B54	5379	12	24	Petrol	82	S14 B25 (EVO II)	2467	4	16	Petrol	45
M73 B54 (54121)	5379	12	24	Petrol	82	S38 B35 (356EB)	3453	6	24	Petrol	63
M73 B54 (54122)	5379	12	24	Petrol	82	S38 B35 (356ED)	3453	6	24	Petrol	63
M88 B35	3453	6	24	Petrol	63	S38 B35 (356EE)	3453	6	24	Petrol	63
M118	1773	4	8	Petrol	15	S38 B35 (356EY)	3453	6	24	Petrol	63
M47 204 D1	1951	4	16	Diesel	23	S38 B36	3535	6	24	Petrol	64
M54 226 S1	2171	6	24	Petrol	31	S38 B36 (366S1)	3535	6	24	Petrol	64
M54 256 S5	2494	6	24	Petrol	42	S38 B36 (366S2)	3535	6	24	Petrol	64
M54 306 S3	2979	6	24	Petrol	52	S38 B38 (386S1)	3795	6	24	Petrol	66
M57 306 D3	2993	6	24	Diesel	53	S38 B49	4941	8	32	Petrol	79
M67 468 S1	4619	8	32	Petrol	77	S50 B30 (306S1)	2990	6	24	Petrol	52
N13 B16 A	1598	4	16	Petrol	7	S50 B30 (306S2)	2990	6	24	Petrol	52
N40 B16 A	1596	4	16	Petrol	8	S50 B32	3201	6	24	Petrol	59
N42 B18 A	1796	4	16	Petrol	16	S50 B32 (326S1)	3201	6	24	Petrol	59
N42 B20	1995	4	16	Petrol	28	S50 B32 (326S3)	3201	6	24	Petrol	59
N42 B20 A	1995	4	16	Petrol	28	S50 B32 (326S4)	3201	6	24	Petrol	59
N42 B20 B	1995	4	16	Petrol	28	S52 B32	3152	6	24	Petrol	59
N43 B16 A	1599	4	16	Petrol	8	S52 B32 (326S2)	3152	6	24	Petrol	59
N43 B16 AA	1599	4	16	Petrol	8	S54 B32	3246	6	24	Petrol	59
N43 B20 A	1995	4	16	Petrol	28	S54 B32 (326S4)	3246	6	24	Petrol	59
N45 B16	1596	4	16	Petrol	8	S54N 326 S4	3246	6	24	Petrol	59
N45 B16 A	1596	4	16	Petrol	8	S62 B50 (508S1)	4941	8	32	Petrol	79
N45 B16 TU2	1596	4	16	Petrol	8	S63 B44 A	4395	8	32	Petrol	71
N45 B20 A	1997	4	16	Petrol	29	S63 B44 B	4395	8	32	Petrol	71
N46 B18 A	1796	4	16	Petrol	16	S65 B40 A	3999	8	32	Petrol	70
N46 B20 A	1995	4	16	Petrol	28	S65 B44 A	4361	8	32	Petrol	75
N46 B20 B	1995	4	16	Petrol	28	S70 B56 (56121)	5576	12	24	Petrol	83
N46 B20 BD	1995	4	16	Petrol	28	S85 B50 A	4999	10	40	Petrol	81
N46 B20 C	1995	4	16	Petrol	28	S14 204 EA	1990	4	16	Petrol	30
N46 B20 CD	1995	4	16	Petrol	28	S50 326 S4	3201	6	24	Petrol	59
N46 B20 E	1995	4	16	Petrol	28	S54 326 S4	3246	6	24	Petrol	59
N47 D16 A	1598	4	16	Diesel	9						
N47 D20 A	1995	4	16	Diesel	19						
N47 D20 B	1995	4	16	Diesel	19						
N47 D20 C	1995	4	16	Diesel	19						
N47 D20 C	1995	4	16	Diesel	19						
N47 D20 D	1995	4	16	Diesel	19						
N47 D20 D	1995	4	16	Diesel	19						
N47S D20 D	1995	4	16	Diesel	19						
N54 B30 A	2979	6	24	Petrol	56						
N54 B30 A	2979	6	24	Petrol	56						
N57 D30 A	2993	6	24	Diesel	50						
N57 D30 B	2993	6	24	Diesel	50						
N57 D30 B	2993	6	24	Diesel	57						
N57 D30 C	2993	6	24	Diesel	50						
N57N 306 D2	2993	6	24	Diesel	54						
N57N 306 D3	2993	6	24	Diesel	53						
N57N 306 D5	2993	6	24	Diesel	53						
N57S D30 B	2993	6	24	Diesel	50						
N62 B36	3600	8	32	Petrol	65						
N62 B36 A	3600	8	32	Petrol	65						
N62 B40 A	4000	8	32	Petrol	69						
N62 B44	4398	8	32	Petrol	71						
N62 B44 A	4398	8	32	Petrol	71						
N62 B44 A	4398	8	32	Petrol	71						
N62 B48 A	4799	8	32	Petrol	78						
N62 B48 B	4799	8	32	Petrol	78						
N63 B40 A	3982	8	32	Petrol	69						
N63 B40 B	3982	8	32	Petrol	69						
N63 B44 A	4395	8	32	Petrol	71						
N63 B44 A	4395	8	32	Petrol	71						
N63 B44 B	4395	8	32	Petrol	71						
N63 B44 B	4395	8	32	Petrol	71						



1 1.5L Diesel

B37 C15 A	3 Cyl.	12 Valves	1496cc	TD29839
B37 D15 A	3 Cyl.	12 Valves	1496cc	TD30399
HR5110				
			NA5298	
			90.00 x 104.00 x 9.00mm, FPM	

2 1.5L Petrol

B38 A15 A	3 Cyl.	12 Valves	1499cc	TD29579
B38 B15 A	3 Cyl.	12 Valves	1499cc	TD30362
B38 K15 A	3 Cyl.	12 Valves	1499cc	TD31516
			NA5298	
			90.00 x 104.00 x 9.00mm, FPM	

3 1.5L Petrol

M10 B15	4 Cyl.	8 Valves	1499cc	TD5168
HR569				
			NB432	
			35.00 x 55.00 x 12.00mm, ACM	
			NB431	
			90.00 x 110.00 x 12.00mm, FPM	
			NF634	
			80.00 x 100.00 x 13.00mm, MVQ	

4 1.6L Petrol

M10 B16	4 Cyl.	8 Valves	1573cc	TD5170
M10 B16 (164VA)	4 Cyl.	8 Valves	1573cc	TD28312
M10 B16 (164VB)	4 Cyl.	8 Valves	1573cc	TD28313
HR569				
			NB432	
			35.00 x 55.00 x 12.00mm, ACM	
			NB431	
			90.00 x 110.00 x 12.00mm, FPM	
			NF634	
			80.00 x 100.00 x 13.00mm, MVQ	

5 1.6L Petrol

M40 B16	4 Cyl.	8 Valves	1596cc	TD5255
M40 B16 (164E1)	4 Cyl.	8 Valves	1596cc	TD28367
M40 B16 C	4 Cyl.	8 Valves	1596cc	TD21160
HR816				
			NB799	
			38.00 x 50.00 x 7.00mm, FPM	
			NB980	
			42.00 x 52.00 x 7.50mm, FPM	
			NB431	
			90.00 x 110.00 x 12.00mm, FPM	

6 1.6L Petrol

M43 B16 (164E2)	4 Cyl.	8 Valves	1596cc	TD28371
M43 B16 (164E3)	4 Cyl.	8 Valves	1596cc	TD17055
HR816				
			NA5099	
			44.00 x 60.00 x 10.00mm, PTFE	
			NA5104	
			90.00 x 110.00 x 12.00mm, PTFE	

7 1.6L Petrol

N13 B16 A	4 Cyl.	16 Valves	1598cc	TD26581
			NA5363	
			61.00 x 75.00 x 8.00mm, PTFE/ACM	
			NA5362	
			85.00 x 105.00 x 8.00mm, PTFE/ACM	



8 1.6L		Petrol		
N40 B16 A	4 Cyl.	16 Valves	1596cc	TD18037
N43 B16 A	4 Cyl.	16 Valves	1599cc	TD20844
N43 B16 AA	4 Cyl.	16 Valves	1599cc	TD34117
N45 B16	4 Cyl.	16 Valves	1596cc	TD21404
N45 B16 A	4 Cyl.	16 Valves	1596cc	TD18358
N45 B16 TU2	4 Cyl.	16 Valves	1596cc	TD21221
				NA5104 90.00 x 110.00 x 12.00mm, PTFE

9 1.6L		Diesel		
N47 D16 A	4 Cyl.	16 Valves	1598cc	TD26346
HR5110				NA5299 55.0 x 68.0 x 8.0mm, FPM NA5298 90.00 x 104.00 x 9.00mm, FPM

10 1.7L		Diesel		
M41 D17 (174T1)	4 Cyl.	8 Valves	1665cc	TD28369
PA5041 (x8) HR817				NF637 48.00 x 65.00 x 10.00mm, FPM NB431 90.00 x 110.00 x 12.00mm, FPM

11 1.8L		Petrol		
M10 B18	4 Cyl.	8 Valves	1766cc	TD5174
M10 B18 (184EA)	4 Cyl.	8 Valves	1766cc	TD28314
M10 B18 (184EB)	4 Cyl.	8 Valves	1766cc	TD28315
M10 B18 (184EW)	4 Cyl.	8 Valves	1766cc	TD28316
M10 B18 (184EY)	4 Cyl.	8 Valves	1766cc	TD28317
M10 B18 (184EZ)	4 Cyl.	8 Valves	1766cc	TD28318
M10 B18 (184KA)	4 Cyl.	8 Valves	1766cc	TD28319
M10 B18 (184VA)	4 Cyl.	8 Valves	1766cc	TD28320
M10 B18 (184VB)	4 Cyl.	8 Valves	1766cc	TD28321
M10 B18 (184VC)	4 Cyl.	8 Valves	1766cc	TD28322
M10 B18 (184VD)	4 Cyl.	8 Valves	1766cc	TD28323
M10 B18 (184VU)	4 Cyl.	8 Valves	1766cc	TD28324
M10 B18 (320US)	4 Cyl.	8 Valves	1766cc	TD28326
HR569				NB432 35.00 x 55.00 x 12.00mm, ACM NB431 90.00 x 110.00 x 12.00mm, FPM

12 1.8L		Petrol		
M40 B18 (184E1)	4 Cyl.	8 Valves	1796cc	TD28368
M40 B18 C	4 Cyl.	8 Valves	1796cc	TD19662
HR816	NB799 38.00 x 50.00 x 7.00mm, FPM			NB980 42.00 x 52.00 x 7.50mm, FPM NB431 90.00 x 110.00 x 12.00mm, FPM



13 1.8L Petrol

M42 B18	4 Cyl.	16 Valves	1796cc	TD454
M42 B18 (184S1)	4 Cyl.	16 Valves	1796cc	TD28370
PA5041 (x16) 09/92→				
HR816 (x2) →09/92				
HR817 (x2) 09/92→				
			NC015 44.00 x 60.00 x 10.00mm, FPM NA5099 44.00 x 60.00 x 10.00mm, PTFE NB431 90.00 x 110.00 x 12.00mm, FPM NA5104 90.00 x 110.00 x 12.00mm, PTFE	

14 1.8L Petrol

M43 B18 (184E2)	4 Cyl.	8 Valves	1796cc	TD28372
HR816				
			NC015 44.00 x 60.00 x 10.00mm, FPM NA5099 44.00 x 60.00 x 10.00mm, PTFE NB431 90.00 x 110.00 x 12.00mm, FPM NA5104 90.00 x 110.00 x 12.00mm, PTFE	

15 1.8L Petrol

M118	4 Cyl.	8 Valves	1773cc	TD33079
HR569				
			NB432 35.00 x 55.00 x 12.00mm, ACM NB431 90.00 x 110.00 x 12.00mm, FPM NF634 80.00 x 100.00 x 13.00mm, MVQ	

16 1.8L Petrol

N42 B18 A	4 Cyl.	16 Valves	1796cc	TD30334
N46 B18 A	4 Cyl.	16 Valves	1796cc	TD20538
			NA5104 90.00 x 110.00 x 12.00mm, PTFE	

17 1.9L Petrol

M43 B19 (194E1)	4 Cyl.	8 Valves	1895cc	TD27701
HR816				
			NA5099 44.00 x 60.00 x 10.00mm, PTFE NA5104 90.00 x 110.00 x 12.00mm, PTFE	

18 1.9L Petrol

M44 B19 (194S1)	4 Cyl.	16 Valves	1895cc	TD28373
PA5041 (x16) HR791				
			NC015 44.00 x 60.00 x 10.00mm, FPM NB431 90.00 x 110.00 x 12.00mm, FPM	

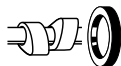

19 2.0L

Diesel

B47 C20 A	4 Cyl.	16 Valves	1995cc	TD29580
B47 C20 B	4 Cyl.	16 Valves	1995cc	TD31366
B47 D20 A	4 Cyl.	16 Valves	1995cc	TD29233
B47 D20 B	4 Cyl.	16 Valves	1995cc	TD30401
N47 D20 A	4 Cyl.	16 Valves	1995cc	TD19922
N47 D20 B	4 Cyl.	16 Valves	1995cc	TD20845
N47 D20 C	4 Cyl.	16 Valves	1995cc	TD31127
N47 D20 C	4 Cyl.	16 Valves	1995cc	TD24405
N47 D20 D	4 Cyl.	16 Valves	1995cc	TD26347
N47 D20 D	4 Cyl.	16 Valves	1995cc	TD33815
N47S D20 D	4 Cyl.	16 Valves	1995cc	TD24642

HR5110

NA5299

55.00 x 68.00 x 8.00mm, FPM

NA5298

90.00 x 104.00 x 9.00mm, FPM

20 2.0L

Petrol

B48 A20 A	4 Cyl.	16 Valves	1998cc	TD29840
B48 A20 B	4 Cyl.	16 Valves	1998cc	TD29581

NA5103

55.00 x 68.00 x 8.00mm, PTFE

NA5298

90.00 x 104.00 x 9.00mm, FPM

21 2.0L

Petrol

M10 B20	4 Cyl.	8 Valves	1990cc	TD432
M10 B20 (22T A)	4 Cyl.	8 Valves	1990cc	TD34690
M10 B20 (22TIU)	4 Cyl.	8 Valves	1990cc	TD28327
M10 B20 (320EK)	4 Cyl.	8 Valves	1990cc	TD28325
M10 B20 (320US)	4 Cyl.	8 Valves	1990cc	TD28328
M10 B20 (Turbo)	4 Cyl.	8 Valves	1990cc	TD5198

HR569

NB432

35.00 x 55.00 x 12.00mm, ACM

NB431

90.00 x 110.00 x 12.00mm, FPM

22 2.0L

Petrol

M20 B20	6 Cyl.	12 Valves	1990cc	TD5117
M20 B20 (206EA)	6 Cyl.	12 Valves	1990cc	TD28329
M20 B20 (206EB)	6 Cyl.	12 Valves	1990cc	TD28330
M20 B20 (206EC)	6 Cyl.	12 Valves	1990cc	TD28331
M20 B20 (206EE)	6 Cyl.	12 Valves	1990cc	TD28332
M20 B20 (206EY)	6 Cyl.	12 Valves	1990cc	TD28333
M20 B20 (206EZ)	6 Cyl.	12 Valves	1990cc	TD28334
M20 B20 (206KA)	6 Cyl.	12 Valves	1990cc	TD28335
M20 B20 (206VA)	6 Cyl.	12 Valves	1990cc	TD28336

HR662

NB799

38.00 x 50.00 x 7.00mm, FPM

NF637

48.00 x 65.00 x 10.00mm, FPM

NB431

90.00 x 110.00 x 12.00mm, FPM



23 2.0L		Diesel			
M47 204 D1	4 Cyl.	16 Valves	1951cc		TD18305
M47 D20	4 Cyl.	16 Valves	1951cc		TD9521
M47 D20 (204D1)	4 Cyl.	16 Valves	1951cc		TD28374
PA5016 (x16) HR5045				NA5105 48.00 x 65.00 x 10.00mm, PTFE NA5104 90.00 x 110.00 x 12.00mm, PTFE	

24 2.0L		Diesel			
M47 D20 (204D4)	4 Cyl.	16 Valves	1995cc		TD27472
M47 D20 TU	4 Cyl.	16 Valves	1951cc		TD21236
M47N 204 D4	4 Cyl.	16 Valves	1995cc		TD17523
M47N 204 D5	4 Cyl.	16 Valves	1995cc		TD18171
PA5016 (x16) HR5045				NA5103 55.00 x 68.00 x 8.00mm, PTFE LK5007 90.00 x 173.00 x 24.00mm, PTFE	

25 2.0L		Petrol			
M50 B(20 6 S1)	6 Cyl.	24 Valves	1991cc		TD4227
M50 B(20 6 S2) Vanos	6 Cyl.	24 Valves	1991cc		TD10027
M50 B20	6 Cyl.	24 Valves	1991cc		TD21402
M50 B20 (206S2)	6 Cyl.	24 Valves	1991cc		TD28376
M50 B20 TU	6 Cyl.	24 Valves	1991cc		TD21239
PA5041 (x24) 09/92→ HR662 (x2) →09/92 HR280 (x2) 09/92→				NF637 48.00 x 65.00 x 10.00mm, FPM NB431 90.00 x 110.00 x 12.00mm, FPM	

26 2.0L		Petrol			
M50 B20 (206S1)	6 Cyl.	24 Valves	1991cc		TD28375
PA5041 (x24) 10/92→ HR662 (x2) →09/92 HR5062 10/92→				NF637 48.00 x 65.00 x 10.00mm, FPM NB431 90.00 x 110.00 x 12.00mm, FPM	

27 2.0L		Petrol			
M52 B(20 6 S3) Vanos	6 Cyl.	24 Valves	1991cc		TD460
M52 B20	6 Cyl.	24 Valves	1991cc		TD21403
M52 B20 (206S3)	6 Cyl.	24 Valves	1991cc		TD28380
M52 B20 (206S4)	6 Cyl.	24 Valves	1991cc		TD28381
PA5041 (x24) HR5062				NF637 48.00 x 65.00 x 10.00mm, FPM NB431 90.00 x 110.00 x 12.00mm, FPM	

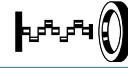

28 2.0L

Petrol

N42 B20	4 Cyl.	16 Valves	1995cc	TD17052
N42 B20 A	4 Cyl.	16 Valves	1995cc	TD18038
N42 B20 B	4 Cyl.	16 Valves	1995cc	TD18304
N43 B20 A	4 Cyl.	16 Valves	1995cc	TD20584
N46 B20 A	4 Cyl.	16 Valves	1995cc	TD18167
N46 B20 B	4 Cyl.	16 Valves	1995cc	TD18945
N46 B20 BD	4 Cyl.	16 Valves	1995cc	TD27479
N46 B20 C	4 Cyl.	16 Valves	1995cc	TD18168
N46 B20 CC	4 Cyl.	16 Valves	1995cc	TD27476
N46 B20 CD	4 Cyl.	16 Valves	1995cc	TD27477
N46 B20 E	4 Cyl.	16 Valves	1995cc	TD27478

NA5104
90.00 x 110.00 x 12.00mm, PTFE

29 2.0L

Petrol

N45 B20 A	4 Cyl.	16 Valves	1997cc	TD20580
PA5025 (x16) HR5048				

NA5104
90.00 x 110.00 x 12.00mm, PTFE

30 2.0L

Petrol

S14 204 EA	4 Cyl.	16 Valves	1990cc	TD18440
S14 B20 (204EA)	4 Cyl.	16 Valves	1990cc	TD28399
HR816 (x2)				

NC015
44.00 x 60.00 x 10.00mm, FPM
NB431
90.00 x 110.00 x 12.00mm, FPM

31 2.2L

Petrol

M54 226 S1	6 Cyl.	24 Valves	2171cc	TD17522
M54 B22 (226S1)	6 Cyl.	24 Valves	2171cc	TD28215
PA5041 (x24) HR5062				

NA5105
48.00 x 65.00 x 10.00mm, PTFE
NA5104
90.00 x 110.00 x 12.00mm, PTFE

32 2.3L

Petrol

M20 B23 (236EA)	6 Cyl.	12 Valves	2316cc	TD28337
M20 B23 (236EB)	6 Cyl.	12 Valves	2316cc	TD28338
M20 B23 (236EC)	6 Cyl.	12 Valves	2316cc	TD28339
M20 B23 (236EW)	6 Cyl.	12 Valves	2316cc	TD28340
HR662				

NB799
38.00 x 50.00 x 7.00mm, FPM

NF637
48.00 x 65.00 x 10.00mm, FPM
NB431
90.00 x 110.00 x 12.00mm, FPM

33 2.3L

Petrol

S14 B23 (234EA)	4 Cyl.	16 Valves	2303cc	TD28400
S14 B23 (234S1)	4 Cyl.	16 Valves	2303cc	TD28401
S14 B23 (234S2)	4 Cyl.	16 Valves	2303cc	TD28402
S14 B23 (EVO I)	4 Cyl.	16 Valves	2302cc	TD5265
HR816 (x2)				

NC015
44.00 x 60.00 x 10.00mm, FPM
NB431
90.00 x 110.00 x 12.00mm, FPM



34 2.4L

Diesel

M21 D24 (246DA)	6 Cyl.	12 Valves	2443cc	TD28349
M21 D24 (246TA)	6 Cyl.	12 Valves	2443cc	TD28350
M21 D24 (246TB)	6 Cyl.	12 Valves	2443cc	TD28351
M21 D24 W	6 Cyl.	12 Valves	2443cc	TD5165

HR662

NB799
38.00 x 50.00 x 7.00mm, FPM

NF637
48.00 x 65.00 x 10.00mm, FPM
NB431
90.00 x 110.00 x 12.00mm, FPM

35 2.5L

Petrol

M20 B25 (256E1)	6 Cyl.	12 Valves	2494cc	TD28341
M20 B25 (256E2)	6 Cyl.	12 Valves	2494cc	TD28342
M20 B25 (256EX)	6 Cyl.	12 Valves	2494cc	TD28343
M20 B25 (256K1)	6 Cyl.	12 Valves	2494cc	TD28344

HR662

NB799
38.00 x 50.00 x 7.00mm, FPM

NF637
48.00 x 65.00 x 10.00mm, FPM
NB431
90.00 x 110.00 x 12.00mm, FPM

36 2.5L

Petrol

M30 B25	6 Cyl.	12 Valves	2494cc	TD5204
M30 B25 (256EA)	6 Cyl.	12 Valves	2494cc	TD28352
M30 B25 (256VA)	6 Cyl.	12 Valves	2494cc	TD28353

NB792
42.00 x 62.00 x 12.00mm, FPM
NB431
90.00 x 110.00 x 12.00mm, FPM

37 2.5L

Petrol

M50 B25 (256S1)	6 Cyl.	24 Valves	2494cc	TD28377
M50 B25 (256S2)	6 Cyl.	24 Valves	2494cc	TD28378
M50 B25 (Vanos)	6 Cyl.	24 Valves	2494cc	TD18476

PA5041 (x24)
10/92→
HR662 (x2)
→09/92
HR5062
10/92→

NF637
48.00 x 65.00 x 10.00mm, FPM
NB431
90.00 x 110.00 x 12.00mm, FPM

38 2.5L

Petrol

M50 B25 TU	6 Cyl.	24 Valves	2494cc	TD21240
------------	--------	-----------	--------	---------

PA5041 (x24)
10/92→
HR662
→09/92
HR5062
10/92→

NF637
48.00 x 65.00 x 10.00mm, FPM
NB431
90.00 x 110.00 x 12.00mm, FPM

39 2.5L

Diesel

M51 D25 (256T1)	6 Cyl.	12 Valves	2497cc	TD28379
-----------------	--------	-----------	--------	---------

PA5041 (x12)
09/92→
HR662
→08/92
HR280
09/92→

NF637
48.00 x 65.00 x 10.00mm, FPM
NB431
90.00 x 110.00 x 12.00mm, FPM

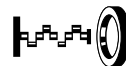
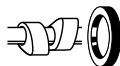

40 2.5L

Diesel

M51 D25 (Inter.)	6 Cyl.	12 Valves	2503cc	TD5285
PA5041 (x12) 09/92→ HR280				NF637 48.00 x 65.00 x 10.00mm, FPM NB431 90.00 x 110.00 x 12.00mm, FPM

41 2.5L

Petrol

M52 B25 (256S3)	6 Cyl.	24 Valves	2494cc	TD28382
M52 B25 (256S4)	6 Cyl.	24 Valves	2494cc	TD28383
PA5041 (x24) HR5062				NF637 48.00 x 65.00 x 10.00mm, FPM NB431 90.00 x 110.00 x 12.00mm, FPM

42 2.5L

Petrol

M52 B25 (Vanos)	6 Cyl.	24 Valves	2494cc	TD4230
M52 B25 TU	6 Cyl.	24 Valves	2494cc	TD21241
M54 256 S5	6 Cyl.	24 Valves	2494cc	TD17516
M54 B25 (256S3)	6 Cyl.	24 Valves	2494cc	TD28216
M54 B25 (256S5)	6 Cyl.	24 Valves	2494cc	TD28217
PA5041 (x24) HR5062				NA5105 48.00 x 65.00 x 10.00mm, PTFE NA5104 90.00 x 110.00 x 12.00mm, PTFE

43 2.5L

Diesel

M57 D25 (256D1)	6 Cyl.	24 Valves	2497cc	TD27988
PA5016 (x24) HR5121				NA5103 55.00 x 68.00 x 8.00mm, PTFE NA5104 90.00 x 110.00 x 12.00mm, PTFE

44 2.5L

Diesel

M57 D25 (256D2)	6 Cyl.	24 Valves	2497cc	TD30331
M57 D25 TU	6 Cyl.	24 Valves	2497cc	TD21234
M57N 256 D4	6 Cyl.	24 Valves	2497cc	TD18033
PA5016 (x24) HR5121				NA5103 55.00 x 68.00 x 8.00mm, PTFE LK5007 90.00 x 173.00 x 24.00mm, PTFE

45 2.5L

Petrol

S14 B25 (254S1)	4 Cyl.	16 Valves	2467cc	TD28403
S14 B25 (EVO II)	4 Cyl.	16 Valves	2467cc	TD471
HR816 (x2)				NC015 44.00 x 60.00 x 10.00mm, FPM



46 2.7L

Petrol

M20 B27 (276EA)	6 Cyl.	12 Valves	2693cc	TD28345
M20 B27 (276EB)	6 Cyl.	12 Valves	2693cc	TD28346
M20 B27 (276KA)	6 Cyl.	12 Valves	2693cc	TD28347
M20 B27 (276KB)	6 Cyl.	12 Valves	2693cc	TD28348

HR662

NB799
38.00 x 50.00 x 7.00mm, FPM

NF637
48.00 x 65.00 x 10.00mm, FPM
NB431
90.00 x 110.00 x 12.00mm, FPM

47 2.8L

Petrol

M30 B28	6 Cyl.	12 Valves	2788cc	TD5215
M30 B28 (286EA)	6 Cyl.	12 Valves	2788cc	TD30327
M30 B28 (528EL)	6 Cyl.	12 Valves	2788cc	TD28354
M30 B28 (528TR)	6 Cyl.	12 Valves	2788cc	TD28355
M30 B28 (628EL)	6 Cyl.	12 Valves	2788cc	TD28356
M30 B28 (728EL)	6 Cyl.	12 Valves	2788cc	TD28357
M30 B28 (728TR)	6 Cyl.	12 Valves	2788cc	TD28358

NB792
42.00 x 62.00 x 12.00mm, FPM
NB431
90.00 x 110.00 x 12.00mm, FPM

48 2.8L

Petrol

M52 B28	6 Cyl.	24 Valves	2793cc	TD4231
M52 B28 TU	6 Cyl.	24 Valves	2793cc	TD21242

PA5041 (x24)
HR5062

NA5105
48.00 x 65.00 x 10.00mm, PTFE
NA5104
90.00 x 110.00 x 12.00mm, PTFE

49 2.8L

Petrol

M52 B28 (286S1)	6 Cyl.	24 Valves	2793cc	TD28384
M52 B28 (286S2)	6 Cyl.	24 Valves	2793cc	TD28385
M52 B28 GG	6 Cyl.	24 Valves	2793cc	TD26671

PA5041 (x24)
HR5062

NF637
48.00 x 65.00 x 10.00mm, FPM
NB431
90.00 x 110.00 x 12.00mm, FPM

50 3.0L

Diesel

B57 D30 A	6 Cyl.	24 Valves	2993cc	TD31362
B57 D30 B	6 Cyl.	24 Valves	2993cc	TD32088
B57 D30 C	6 Cyl.	24 Valves	2993cc	TD33183
N57 D30 A	6 Cyl.	24 Valves	2993cc	TD24613
N57 D30 B	6 Cyl.	24 Valves	2993cc	TD26305
N57 D30 C	6 Cyl.	24 Valves	2993cc	TD26349
N57S D30 B	6 Cyl.	24 Valves	2993cc	TD24635

HR5107

NA5299
55.0 x 68.0 x 8.0mm, FPM
NA5298
90.00 x 104.00 x 9.00mm, FPM

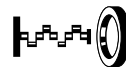
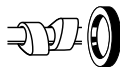

51 3.0L

Petrol

M30 B30	6 Cyl.	12 Valves	2986cc	TD5276
M30 B30 (306EA)	6 Cyl.	12 Valves	2986cc	TD28360
M30 B30 (306KA)	6 Cyl.	12 Valves	2986cc	TD28361

HR569 (x2)

NB792

42.00 x 62.00 x 12.00mm, FPM

NB431

90.00 x 110.00 x 12.00mm, FPM

52 3.0L

Petrol

M54 306 S3	6 Cyl.	24 Valves	2979cc	TD17517
M54 B30 (306S3)	6 Cyl.	24 Valves	2979cc	TD28218
S50 B30 (306S1)	6 Cyl.	24 Valves	2990cc	TD28411
S50 B30 (306S2)	6 Cyl.	24 Valves	2990cc	TD28412

PA5041 (x24)

HR5062

NA5105

48.00 x 65.00 x 10.00mm, PTFE

NA5104

90.00 x 110.00 x 12.00mm, PTFE

53 3.0L

Diesel

M57 306 D3	6 Cyl.	24 Valves	2993cc	TD18985
M57 D30 (306D1)	6 Cyl.	24 Valves	2926cc	TD27992
M57 D30 (306D4)	6 Cyl.	24 Valves	2993cc	TD28386
M57 D30 (306D5)	6 Cyl.	24 Valves	2993cc	TD28387
M57N2 306 D3	6 Cyl.	24 Valves	2993cc	TD24615
M57N 306 D5	6 Cyl.	24 Valves	2993cc	TD20581
N57N 306 D3	6 Cyl.	24 Valves	2993cc	TD20583
N57N 306 D5	6 Cyl.	24 Valves	2993cc	TD20595

PA5016 (x24)

HR5121

NA5103

55.00 x 68.00 x 8.00mm, PTFE

NA5104

90.00 x 110.00 x 12.00mm, PTFE

54 3.0L

Diesel

M57 D30 (306D2)	6 Cyl.	24 Valves	2993cc	TD27248
M57 D30 (306D3)	6 Cyl.	24 Valves	2993cc	TD27267
M57 D30 TU2	6 Cyl.	24 Valves	2993cc	TD20843
M57N2 306 D2	6 Cyl.	24 Valves	2993cc	TD20589
M57N 306 D2	6 Cyl.	24 Valves	2993cc	TD17525
M57N 306 D4	6 Cyl.	24 Valves	2993cc	TD18306
N57 306 D2	6 Cyl.	24 Valves	2993cc	TD18307
N57 306 D3	6 Cyl.	24 Valves	2993cc	TD20587
N57N 306 D2	6 Cyl.	24 Valves	2993cc	TD20592

PA5016 (x24)

HR5121

NA5103

55.00 x 68.00 x 8.00mm, PTFE

LK5007

90.00 x 173.00 x 24.00mm, PTFE

55 3.0L

Petrol

M60 B30	8 Cyl.	32 Valves	2997cc	TD4232
M60 B30 (308S1)	8 Cyl.	32 Valves	2997cc	TD28388

PA5041 (x32)

HR791 (x2)

NF637

48.00 x 65.00 x 10.00mm, FPM

NA5132

100.00 x 125.00 x 13.00mm, FPM



56 3.0L Petrol

N54 B30 A	6 Cyl.	24 Valves	2979cc	TD20342
N54 B30 A	6 Cyl.	24 Valves	2979cc	TD31119

NA5104
90.00 x 110.00 x 12.00mm, PTFE

57 3.0L Diesel

N57 D30 B	6 Cyl.	24 Valves	2993cc	TD31125
-----------	--------	-----------	--------	---------

HR5107

58 3.2L Petrol

M30 B32	6 Cyl.	12 Valves	3210cc	TD4220
M30 B32 (326TA)	6 Cyl.	12 Valves	3210cc	TD28362
M30 B32 (330EL)	6 Cyl.	12 Valves	3210cc	TD28363
M30 B32 (633EL)	6 Cyl.	12 Valves	3210cc	TD28364
M30 B32 (732EL)	6 Cyl.	12 Valves	3210cc	TD28365
M30 B32 (733EL)	6 Cyl.	12 Valves	3210cc	TD28366
M30 B32 (L-Jetronic)	6 Cyl.	12 Valves	3153cc	TD5208

NB792
42.00 x 62.00 x 12.00mm, FPM
NB431
90.00 x 110.00 x 12.00mm, FPM

59 3.2L Petrol

S50 326 S4	6 Cyl.	24 Valves	3201cc	TD20596
S50 B32	6 Cyl.	24 Valves	3201cc	TD4242
S50 B32 (326S1)	6 Cyl.	24 Valves	3201cc	TD28413
S50 B32 (326S3)	6 Cyl.	24 Valves	3201cc	TD28414
S50 B32 (326S4)	6 Cyl.	24 Valves	3201cc	TD30332
S52 B32	6 Cyl.	24 Valves	3152cc	TD29482
S52 B32 (326S2)	6 Cyl.	24 Valves	3152cc	TD30329
S54 326 S4	6 Cyl.	24 Valves	3246cc	TD17518
S54 B32	6 Cyl.	24 Valves	3246cc	TD21412
S54 B32 (326S4)	6 Cyl.	24 Valves	3246cc	TD17051
S54N 326 S4	6 Cyl.	24 Valves	3246cc	TD18402

PA5041 (x24)
HR5062

NA5105
48.00 x 65.00 x 10.00mm, PTFE
NA5104
90.00 x 110.00 x 12.00mm, PTFE

60 3.3L Petrol

M30 B33 (35/40 INAT)	6 Cyl.	12 Valves	3295cc	TD5213
----------------------	--------	-----------	--------	--------

NB792
42.00 x 62.00 x 12.00mm, FPM
NB431
90.00 x 110.00 x 12.00mm, FPM



61 3.4L

Petrol

M30 B34 (346EC)	6 Cyl.	12 Valves	3430cc	TD28417
M30 B34 (346KA)	6 Cyl.	12 Valves	3430cc	TD28419
M30 B34 (346KB)	6 Cyl.	12 Valves	3430cc	TD28420
M30 B35	6 Cyl.	12 Valves	3430cc	TD4221
M30 B35 (L-Jetronic,10:1)	6 Cyl.	12 Valves	3453cc	TD5245
M30 B35 (Motronic)	6 Cyl.	12 Valves	3430cc	TD5272
M30 B35 (Motronic,9.2:1)	6 Cyl.	12 Valves	3430cc	TD5278
M30 B35 (Motronic,9.3:1)	6 Cyl.	12 Valves	3453cc	TD447
M30 B35 (Motronic,10:1)	6 Cyl.	12 Valves	3430cc	TD5246

HR569 (x2)

NB792

42.00 x 62.00 x 12.00mm, FPM

NB431

90.00 x 110.00 x 12.00mm, FPM

62 3.5L

Petrol

M62 B35 (358S1)	8 Cyl.	32 Valves	3498cc	TD28390
M62 B35 (358S2)	8 Cyl.	32 Valves	3498cc	TD28391
M62 B35 TU	8 Cyl.	32 Valves	3498cc	TD21244

PA5041 (x32)

HR791 (x2)

NF637

48.00 x 65.00 x 10.00mm, FPM

NA5132

100.00 x 125.00 x 13.00mm, FPM

63 3.5L

Petrol

M88 B35	6 Cyl.	24 Valves	3453cc	TD468
S38 B35 (356EB)	6 Cyl.	24 Valves	3453cc	TD28404
S38 B35 (356ED)	6 Cyl.	24 Valves	3453cc	TD28405
S38 B35 (356EE)	6 Cyl.	24 Valves	3453cc	TD28406
S38 B35 (356EY)	6 Cyl.	24 Valves	3453cc	TD28407

HR662 (x2)

NB792

42.00 x 62.00 x 12.00mm, FPM

NB431

90.00 x 110.00 x 12.00mm, FPM

64 3.5L

Petrol

S38 B36	6 Cyl.	24 Valves	3535cc	TD5283
S38 B36 (366S1)	6 Cyl.	24 Valves	3535cc	TD28408
S38 B36 (366S2)	6 Cyl.	24 Valves	3535cc	TD28409

HR662 (x2)

NF637

48.00 x 65.00 x 10.00mm, FPM

NB431

90.00 x 110.00 x 12.00mm, FPM

65 3.6L

Petrol

N62 B36	8 Cyl.	32 Valves	3600cc	TD16267
N62 B36 A	8 Cyl.	32 Valves	3600cc	TD30330

PA5041 (x32)

HR791 (x2)



66 3.8L

Petrol

S38 B38 (386S1)	6 Cyl.	24 Valves	3795cc	TD28410
HR662 (x2)				
			NB792 42.00 x 62.00 x 12.00mm, FPM NB431 90.00 x 110.00 x 12.00mm, FPM	

67 3.9L

Diesel

M67 D39 (398D1)	8 Cyl.	32 Valves	3901cc	TD28394
N67 398 D1	8 Cyl.	32 Valves	3901cc	TD17546
PA5016 (x32) HR5045 (x2)				
			NF637 48.00 x 65.00 x 10.00mm, FPM NA5132 100.00 x 125.00 x 13.00mm, FPM	

68 4.0L

Petrol

M60 B40 (408S1)	8 Cyl.	32 Valves	3982cc	TD28389
PA5041 (x32) HR791 (x2)				
			NF637 48.00 x 65.00 x 10.00mm, FPM NA5132 100.00 x 125.00 x 13.00mm, FPM	

69 4.0L

Petrol

N62 B40 A	8 Cyl.	32 Valves	4000cc	TD18516
N63 B40 A	8 Cyl.	32 Valves	3982cc	TD31165
N63 B40 B	8 Cyl.	32 Valves	3982cc	TD33065
PA5041 (x32) HR791 (x2)				

70 4.0L

Petrol

S65 B40 A	8 Cyl.	32 Valves	3999cc	TD25631
PA5025 (x32) HR5048 (x2)				
			NF637 48.00 x 65.00 x 10.00mm, FPM NA5132 100.00 x 125.00 x 13.00mm, FPM	

71 4.4L

Petrol

M62 B44	8 Cyl.	32 Valves	4398cc	TD4235
N62 B44	8 Cyl.	32 Valves	4398cc	TD16268
N62 B44 A	8 Cyl.	32 Valves	4398cc	TD18546
N62 B44 A	8 Cyl.	32 Valves	4398cc	TD31124
N63 B44 A	8 Cyl.	32 Valves	4395cc	TD31122
N63 B44 A	8 Cyl.	32 Valves	4395cc	TD24607
N63 B44 B	8 Cyl.	32 Valves	4395cc	TD31121
N63 B44 B	8 Cyl.	32 Valves	4395cc	TD26582
N63 B44 C	8 Cyl.	32 Valves	4395cc	TD31363
N63 B44 C	8 Cyl.	32 Valves	4395cc	TD32880
S63 B44 A	8 Cyl.	32 Valves	4395cc	TD24606
S63 B44 B	8 Cyl.	32 Valves	4395cc	TD26348
PA5041 (x32) HR791 (x2)				

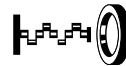
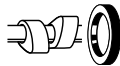

72 4.4L

Petrol

M62 B44 (448S1)	8 Cyl.	32 Valves	4398cc	TD28392
M62 B44 (448S2)	8 Cyl.	32 Valves	4398cc	TD28393
M62 B44 TU	8 Cyl.	32 Valves	4398cc	TD21245
PA5041 (x32) HR791 (x2)				NF637 48.00 x 65.00 x 10.00mm, FPM NA5132 100.00 x 125.00 x 13.00mm, FPM

73 4.4L

Diesel

M67 D44 (448D1)	8 Cyl.	32 Valves	4423cc	TD28395
				NF637 48.00 x 65.00 x 10.00mm, FPM NA5132 100.00 x 125.00 x 13.00mm, FPM

74 4.4L

Diesel

N67N 448 D1	8 Cyl.	32 Valves	4423cc	TD20591
N67N 448 D2	8 Cyl.	32 Valves	4423cc	TD20593
PA5041 (x32) HR791 (x2)				NF637 48.00 x 65.00 x 10.00mm, FPM NA5132 100.00 x 125.00 x 13.00mm, FPM

75 4.4L

Petrol

S65 B44 A	8 Cyl.	32 Valves	4361cc	TD27245
PA5025 (x32) HR5048 (x2)				NF637 48.00 x 65.00 x 10.00mm, FPM NA5132 100.00 x 125.00 x 13.00mm, FPM

76 4.6L

Petrol

M62 B46 (468S1)	8 Cyl.	32 Valves	4619cc	TD28423
PA5041 (x32) HR791 (x2)				NA5103 55.00 x 68.00 x 8.00mm, PTFE NA5132 100.00 x 125.00 x 13.00mm, FPM

77 4.6L

Petrol

M67 468 S1	8 Cyl.	32 Valves	4619cc	TD18401
PA5041 (x32) HR791 (x2)				NF637 48.00 x 65.00 x 10.00mm, FPM NA5132 100.00 x 125.00 x 13.00mm, FPM

78 4.8L

Petrol

N62 B48 A	8 Cyl.	32 Valves	4799cc	TD18034
N62 B48 B	8 Cyl.	32 Valves	4799cc	TD18515
PA5041 (x32) HR791 (x2)				



79 4.9L Petrol

S38 B49	8 Cyl.	32 Valves	4941cc	TD13568
S62 B50 (508S1)	8 Cyl.	32 Valves	4941cc	TD28415
PA5041 (x32) HR791 (x2)				NF637 (x2) 48.00 x 65.00 x 10.00mm, FPM NA5132 (x2) 100.00 x 125.00 x 13.00mm, FPM

80 5.0L Petrol

M70 B50 (5012A)	12 Cyl.	24 Valves	4988cc	TD28396
HR662 (x2)				NA5267 (x2) 55.00 x 72.00 x 10.00mm, FPM NA5132 (x2) 100.00 x 125.00 x 13.00mm, FPM

81 5.0L Petrol

S85 B50 A	10 Cyl.	40 Valves	4999cc	TD18036
PA5025 (x40)				NA5105 (x40) 48.00 x 65.00 x 10.00mm, PTFE NA5132 (x40) 100.00 x 125.00 x 13.00mm, FPM

82 5.4L Petrol

M73 B54	12 Cyl.	24 Valves	5379cc	TD466
M73 B54 (54121)	12 Cyl.	24 Valves	5379cc	TD28397
M73 B54 (54122)	12 Cyl.	24 Valves	5379cc	TD28398
HR662 (x2)				NA5267 (x2) 55.00 x 72.00 x 10.00mm, FPM NA5132 (x2) 100.00 x 125.00 x 13.00mm, FPM

83 5.6L Petrol

M70 B56	12 Cyl.	24 Valves	5576cc	TD4237
S70 B56 (56121)	12 Cyl.	24 Valves	5576cc	TD28416
HR662 (x2)				NA5267 (x2) 55.00 x 72.00 x 10.00mm, FPM NA5132 (x2) 100.00 x 125.00 x 13.00mm, FPM

84 6.0L Petrol

N73 B60 A	12 Cyl.	48 Valves	5972cc	TD21152
PA5041 (x48) HR791 (x2)				











CC



9

Model	Year Range	Engine	Fuel	CC	Doors	Seats	Power Windows
Century Coupe (4A_)	09/81→12/85	LK9	Petrol	2966	6	12	12
Century Estate (4_35)	10/81→08/83	LK9	Petrol	2966	6	12	12
Century Saloon	10/81→09/86	LK9	Petrol	2966	6	12	12
Electra	10/84→09/85	LK9	Petrol	2966	6	12	12
Encore Closed Off-Road Vehicle	09/12→	LUV	Petrol	1364	4	16	1
Envision	03/16→	LTG	Petrol	1998	4	16	10
Excele	04/03→	F16D3	Petrol	1598	4	16	3
Excele Estate	01/04→12/13	T18SED	Petrol	1796	4	16	6
Excele GT	06/10→12/15	2H0	Petrol	1796	4	16	5
Excele GT	06/10→12/15	LDE	Petrol	1598	4	16	4
Excele Saloon	05/08→12/10	T18SED	Petrol	1796	4	16	6
Excele XT	01/10→12/12	2H0	Petrol	1796	4	16	5
Excele XT	01/10→12/15	LDE	Petrol	1598	4	16	4
GL8 II MPV	11/11→12/16	LE5	Petrol	2384	4	16	11
GL8 II MPV	01/13→12/16	LAF	Petrol	2384	4	16	11
Lacrosse	03/06→12/12	LE5	Petrol	2384	4	16	11
Lacrosse	01/11→	LAF	Petrol	2384	4	16	11
Lacrosse	08/11→	LUK	Petrol	2384	4	16	11
La Crosse Saloon	09/09→	LAF	Petrol	2384	4	16	11
La Crosse Saloon	09/09→	LE5	Petrol	2384	4	16	11
La Crosse Saloon	09/11→	LUK	Petrol	2384	4	16	11
Regal II	12/08→12/11	LE5	Petrol	2384	4	16	11
Regal II	01/11→	LAF	Petrol	2384	4	16	11
Regal Saloon	09/10→	LAF	Petrol	2384	4	16	11
Regal Saloon	09/10→	LHU	Petrol	1998	4	16	8
Regal Saloon	09/11→	LEA	Petrol	2384	4	16	11
Regal Saloon	09/11→	LUK	Petrol	2384	4	16	11
Regal Saloon	07/13→	LTG	Petrol	1998	4	16	10
Skyhawk Coupe	09/81→12/86	LQ5	Petrol	1998	4	8	9
Skyhawk Estate	09/82→12/89	LQ5	Petrol	1998	4	8	9
Skyhawk Saloon	09/83→12/86	LQ5	Petrol	1998	4	8	9
Verano Saloon	09/12→	LEA	Petrol	2384	4	16	11
Verano Saloon	09/12→	LHU	Petrol	1998	4	16	8

	CC				9		CC				9
2H0	1796	4	16	Petrol	5						
A155MS	1498	4	8	Petrol	2						
F16D3	1598	4	16	Petrol	3						
L34	1998	4	16	Petrol	7						
LAF	2384	4	16	Petrol	11						
LAF	2384	4	16	Petrol	11						
LDE	1598	4	16	Petrol	4						
LE5	2384	4	16	Petrol	11						
LE5	2384	4	16	Petrol	11						
LEA	2384	4	16	Petrol	11						
LHU	1998	4	16	Petrol	8						
LK9	2966	6	12	Petrol	12						
LQ5	1998	4	8	Petrol	9						
LTG	1998	4	16	Petrol	10						
LUK	2384	4	16	Petrol	11						
LUV	1364	4	16	Petrol	1						
T18SED	1796	4	16	Petrol	6						

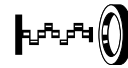
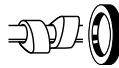

1 1.4L Petrol				
LUV	4 Cyl.	16 Valves	1364cc	TD28520
PA5025 (x16) HR5048				NA5108 42.00 x 55.00 x 7.00mm, FPM/ACM NB698 80.00 x 98.00 x 10.00mm, FPM
2 1.5L Petrol				
A15SMS	4 Cyl.	8 Valves	1498cc	TD32712
PA565 (x8) HR342				NC006 35.00 x 48.00 x 7.00mm, MVQ NA5053 30.00 x 42.00 x 7.00mm, FPM NB698 80.00 x 98.00 x 10.00mm, FPM
3 1.6L Petrol				
F16D3	4 Cyl.	16 Valves	1598cc	TD22484
NA5164 (x16) HR5092				NA5190 (x2) 42.00 x 56.00 x 7.00mm, FPM NA5190 42.00 x 56.00 x 7.00mm, FPM NB698 80.00 x 98.00 x 10.00mm, FPM
4 1.6L Petrol				
LDE	4 Cyl.	16 Valves	1598cc	TD23426
HR5087				NC006 (x2) 35.00 x 48.00 x 7.00mm, MVQ NA5174 31.50 x 42.00 x 7.00mm, FPM NA5350 80.00 x 98.00 x 17.70mm, PTFE/ACM
5 1.8L Petrol				
2H0	4 Cyl.	16 Valves	1796cc	TD25233
HR5087				NC006 (x2) 35.00 x 48.00 x 7.00mm, MVQ NA5174 31.50 x 42.00 x 7.00mm, FPM NA5350 80.00 x 98.00 x 17.70mm, PTFE/ACM
6 1.8L Petrol				
T18SED	4 Cyl.	16 Valves	1796cc	TD22339
PA5041 (x16) HR791				NC006 (x2) 35.00 x 48.00 x 7.00mm, MVQ NA5174 31.50 x 42.00 x 7.00mm, FPM NB806 90.00 x 104.00 x 11.00mm, FPM
7 2.0L Petrol				
L34	4 Cyl.	16 Valves	1998cc	TD33423
PA5041 (x16) HR791				NB700 31.00 x 50.00 x 8.00mm, MVQ NB806 90.00 x 104.00 x 11.00mm, FPM
8 2.0L Petrol				
LHU	4 Cyl.	16 Valves	1998cc	TD28522
				NA5108 42.00 x 55.00 x 7.00mm, FPM/ACM NB806 90.00 x 104.00 x 11.00mm, FPM

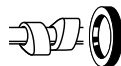

9	2.0L	Petrol		
----------	-------------	---------------	--	--

LQ5	4 Cyl.	8 Valves	1998cc	TD32814
PA928 (x8)				NJ377 32.00 x 47.00 x 6.00mm, ACM NJ337 60.00 x 80.00 x 8.00mm, NBR

10	2.0L	Petrol		
-----------	-------------	---------------	--	--

L7G	4 Cyl.	16 Valves	1998cc	TD28524
HR5127				NA5108 42.00 x 55.00 x 7.00mm, FPM/ACM

11	2.4L	Petrol		
-----------	-------------	---------------	--	--

LAF	4 Cyl.	16 Valves	2384cc	TD26034
LAF	4 Cyl.	16 Valves	2384cc	TD23638
LE5	4 Cyl.	16 Valves	2384cc	TD21793
LE5	4 Cyl.	16 Valves	2384cc	TD20657
LEA	4 Cyl.	16 Valves	2384cc	TD28529
LUK	4 Cyl.	16 Valves	2384cc	TD28525
LUK	4 Cyl.	16 Valves	2384cc	TD30034
HR5127				NA5108 42.00 x 55.00 x 7.00mm, FPM/ACM

12	3.0L	Petrol		
-----------	-------------	---------------	--	--

LK9	6 Cyl.	12 Valves	2966cc	TD21800
HR5127				NA5108 42.00 x 55.00 x 7.00mm, FPM/ACM NB806 90.00 x 104.00 x 11.00mm, FPM











CC



9

Model	Year Range	Engine	Fuel	Year	CC	Power (kW)	Power (hp)
ATS	02/13→	LTG	Petrol	1998	4	16	5
ATS Coupe	02/13→	LTG	Petrol	1998	4	16	5
BLS	04/06→	B207L	Petrol	1998	4	16	4
BLS	04/06→	B207R	Petrol	1998	4	16	4
BLS	04/06→	LK9	Petrol	1998	4	16	4
BLS	04/06→	Z19DTH	Diesel	1910	4	16	2
BLS	12/07→	Z 19 DTR	Diesel	1910	4	16	3
BLS	12/07→	Z 20 LER	Petrol	1998	4	16	7
BLS Wagon	12/07→	B207R	Petrol	1998	4	16	4
BLS Wagon	12/07→	Z19DTH	Diesel	1910	4	16	2
BLS Wagon	12/07→	Z 19 DTR	Diesel	1910	4	16	3
BLS Wagon	12/07→	Z 20 LER	Petrol	1998	4	16	7
BLS Wagon	12/07→	Z 20 NER	Petrol	1998	4	16	4
BLS Wagon	12/07→	Z 20 NET	Petrol	1998	4	16	4
Cimarron Saloon	09/84→12/86	LQ5	Petrol	1991	4	8	6
CT6	11/15→	LTG	Petrol	1998	4	16	5
CTS	09/13→	LTG	Petrol	1998	4	16	5
CTS Coupe	07/14→	LTG	Petrol	1998	4	16	5
CTS Sport Wagon	07/14→	LTG	Petrol	1998	4	16	5
ELR	09/13→	LUU	Petrol	1398	4	16	1
SLS	12/10→12/13	LNF	Petrol	1998	4	16	5

	CC				9		CC				9
B207L	1998	4	16	Petrol	4						
B207R	1998	4	16	Petrol	4						
LK9	1998	4	16	Petrol	4						
LNF	1998	4	16	Petrol	5						
LQ5	1991	4	8	Petrol	6						
LTG	1998	4	16	Petrol	5						
LUU	1398	4	16	Petrol	1						
Z19DTH	1910	4	16	Diesel	2						
Z 19 DTR	1910	4	16	Diesel	3						
Z 20 LER	1998	4	16	Petrol	7						
Z 20 NER	1998	4	16	Petrol	4						
Z 20 NET	1998	4	16	Petrol	4						

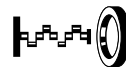
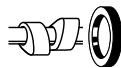

1 1.4L Petrol

LUU 4 Cyl. 16 Valves 1398cc TD28518

PA5025 (x16)
HR5048

NA5108 42.00 x 55.00 x 7.00mm, FPM/ACM
NB698 80.00 x 98.00 x 10.00mm, FPM

2 1.9L Diesel

Z19DTH 4 Cyl. 16 Valves 1910cc TD20109

HR5095
→Eng no. 17180894

NA5347 (x2)
30.0 x 45.0 x 7.00mm, FPM

NA5070 31.00 x 41.00 x 7.00mm, FPM
NF888 93.00 x 139.70;172.00 x 12.00mm, FPM

3 1.9L Diesel

Z 19 DTR 4 Cyl. 16 Valves 1910cc TD21835

HR5119

NA5347 (x2)
30.0 x 45.0 x 7.00mm, FPM

NA5070 31.00 x 41.00 x 7.00mm, FPM
NF888 93.00 x 139.70;172.00 x 12.00mm, FPM

4 2.0L Petrol

B207L 4 Cyl. 16 Valves 1998cc TD20110

B207R 4 Cyl. 16 Valves 1998cc TD20111

LK9 4 Cyl. 16 Valves 1998cc TD26659

Z 20 NER 4 Cyl. 16 Valves 1998cc TD22481

Z 20 NET 4 Cyl. 16 Valves 1998cc TD21837

HR5127

NA5108 42.00 x 55.00 x 7.00mm, FPM/ACM
NB806 90.00 x 104.00 x 11.00mm, FPM

5 2.0L Petrol

LNF 4 Cyl. 16 Valves 1998cc TD30966

LTG 4 Cyl. 16 Valves 1998cc TD27821

HR5127

NA5108 42.00 x 55.00 x 7.00mm, FPM/ACM

6 2.0L Petrol

LQ5 4 Cyl. 8 Valves 1991cc TD32878

PA928 (x8)

NJ377
32.00 x 47.00 x 6.00mm, ACM

NJ377 32.00 x 47.00 x 6.00mm, ACM
NJ337 60.00 x 80.00 x 8.00mm, NBR

7 2.0L Petrol

Z 20 LER 4 Cyl. 16 Valves 1998cc TD21836

PA5041 (x16)
HR791

NC006 (x2)
35.00 x 48.00 x 7.00mm, MVQ

NB700 31.00 x 50.00 x 8.00mm, MVQ
NB806 90.00 x 104.00 x 11.00mm, FPM



CC



9

Agile	10/09→	N 14 YF	Petrol	1389	4	8	19
Agile	10/09→	X 14 YEH	Petrol	1389	4	8	21
Alero	12/01→09/04	L61	Petrol	2198	4	16	72
Astra Estate	02/96→06/98	X 17 DT	Diesel	1686	4	8	38
Astra Estate	02/96→12/11	C 20 NE	Petrol	1998	4	8	54
Astra Estate	10/99→07/02	X 20 XEV	Petrol	1998	4	16	56
Astra Estate	08/00→08/04	Z 22 SE	Petrol	2198	4	16	72
Astra Estate	08/02→06/05	Z 18 XE	Petrol	1796	4	16	52
Astra Estate	08/02→07/05	C 20 SEL	Petrol	1998	4	16	56
Astra Hatchback	02/96→06/98	X 17 DT	Diesel	1686	4	8	38
Astra Hatchback	09/98→12/11	C 18 NE	Petrol	1796	4	8	43
Astra Hatchback	09/98→12/11	C 18 YE	Petrol	1796	4	8	43
Astra Hatchback	03/99→07/02	C 20 SEJ	Petrol	1998	4	8	53
Astra Hatchback	03/99→07/02	X 20 XEV	Petrol	1998	4	16	56
Astra Hatchback	08/00→08/03	Y 17 DT	Diesel	1686	4	16	39
Astra Hatchback	08/00→08/04	Z 22 SE	Petrol	2198	4	16	72
Astra Hatchback	08/02→06/05	Z 18 XE	Petrol	1796	4	16	52
Astra Hatchback	08/02→12/11	C 20 NE	Petrol	1998	4	8	54
Astra Hatchback	08/02→12/11	C 20 SEL	Petrol	1998	4	16	56
Astra Hatchback	08/02→12/11	Y 20 DTH	Diesel	1995	4	16	68
Astra Hatchback	04/04→02/09	X 20 XE	Petrol	1998	4	8	64
Astra Hatchback	08/05→12/11	N 24 XF	Petrol	2405	4	8	80
Astra Hatchback	08/06→03/09	2HO	Petrol	1796	4	16	41
Astra Hatchback	04/09→12/11	N 20 XF	Petrol	1998	4	8	64
Astra Saloon	01/99→07/03	X 20 DTL	Diesel	1995	4	16	68
Astra Saloon	03/99→07/02	X 20 XEV	Petrol	1998	4	16	56
Astra Saloon	03/99→12/11	C 18 NE	Petrol	1796	4	8	43
Astra Saloon	03/99→12/11	C 18 YE	Petrol	1796	4	8	43
Astra Saloon	09/99→12/03	Z 18 XEL	Petrol	1796	4	16	51
Astra Saloon	08/02→06/05	Z 18 XE	Petrol	1796	4	16	52
Astra Saloon	08/02→12/11	C 20 SEL	Petrol	1998	4	16	56
Astra Saloon	08/02→12/11	Y 20 DTH	Diesel	1995	4	16	68
Astra Saloon	09/03→12/08	L34	Petrol	1998	4	16	56
Astra Saloon	04/04→02/09	X 20 XE	Petrol	1998	4	8	64
Astra Saloon	08/06→03/09	Z 18 XER	Petrol	1796	4	16	41
Astra Saloon	09/07→12/08	2HO	Petrol	1796	4	16	41
Astra Saloon	04/09→12/11	N 20 XF	Petrol	1998	4	8	64
Aveo Hatchback (T200)	09/03→12/07	A16DMS	Petrol	1598	4	16	29
Aveo Hatchback (T200)	09/03→12/07	LXT	Petrol	1598	4	16	32
Aveo Hatchback (T200)	01/04→05/08	F12S3	Petrol	1150	4	8	10
Aveo Hatchback (T200)	01/05→05/08	F15S3	Petrol	1498	4	8	24
Aveo Hatchback (T250, T255)	01/07→	B12S1	Petrol	1150	4	8	10
Aveo Hatchback (T250, T255)	01/07→	LY4	Petrol	1150	4	8	10
Aveo Hatchback (T250, T255)	01/08→	LXV	Petrol	1598	4	16	33
Aveo Hatchback (T250, T255)	04/08→	B12D1	Petrol	1206	4	16	9
Aveo Hatchback (T250, T255)	04/08→	F14D4	Petrol	1399	4	16	17
Aveo Hatchback (T250, T255)	04/08→	LDT	Petrol	1399	4	16	17
Aveo Hatchback (T250, T255)	04/08→	LMU	Petrol	1206	4	16	9
Aveo Hatchback (T250, T255)	10/08→	F12S3	Petrol	1150	4	8	10
Aveo Hatchback (T250, T255)	09/09→12/11	LXT	Petrol	1598	4	16	32
Aveo Hatchback (T300)	03/11→	A 12 XEL	Petrol	1229	4	16	8
Aveo Hatchback (T300)	03/11→	A 12 XER	Petrol	1229	4	16	8
Aveo Hatchback (T300)	03/11→	A 14 XER	Petrol	1398	4	16	14
Aveo Hatchback (T300)	03/11→	F16D4	Petrol	1598	4	16	33
Aveo Hatchback (T300)	05/11→	LDE	Petrol	1598	4	16	33
Aveo Hatchback (T300)	07/11→	LDV	Diesel	1248	4	16	11
Aveo Hatchback (T300)	07/11→	LSF	Diesel	1248	4	16	11
Aveo Hatchback (T300)	09/11→	LUW	Petrol	1796	4	16	47
Aveo Hatchback (T300)	08/13→	LUJ	Petrol	1364	4	16	14
Aveo Hatchback (T300)	08/13→	LUV	Petrol	1364	4	16	14
Aveo Saloon (T200)	05/03→01/07	F14D3	Petrol	1399	4	16	16
Aveo Saloon (T200)	09/03→12/08	A16DMS	Petrol	1598	4	16	29
Aveo Saloon (T200)	09/03→12/08	LXT	Petrol	1598	4	16	32
Aveo Saloon (T250, T255)	05/05→	F15S3	Petrol	1498	4	8	24
Aveo Saloon (T250, T255)	05/05→	F16D3	Petrol	1598	4	16	32
Aveo Saloon (T250, T255)	05/05→	LX6	Petrol	1498	4	8	25
Aveo Saloon (T250, T255)	05/05→	LXT	Petrol	1598	4	16	32
Aveo Saloon (T250, T255)	05/05→	LXV	Petrol	1598	4	16	33
Aveo Saloon (T250, T255)	03/06→12/07	F12S3	Petrol	1150	4	8	10
Aveo Saloon (T250, T255)	03/06→12/07	F14D3	Petrol	1399	4	16	16
Aveo Saloon (T250, T255)	03/06→12/07	L14	Petrol	1399	4	16	16
Aveo Saloon (T250, T255)	03/06→	B12S1	Petrol	1150	4	8	10
Aveo Saloon (T250, T255)	03/06→	LY4	Petrol	1150	4	8	10
Aveo Saloon (T250, T255)	01/08→	A16DMS	Petrol	1598	4	16	29
Aveo Saloon (T250, T255)	01/08→	B12D1	Petrol	1206	4	16	9
Aveo Saloon (T250, T255)	01/08→	L95	Petrol	1399	4	16	16
Aveo Saloon (T250, T255)	01/08→	LMU	Petrol	1206	4	16	9
Aveo Saloon (T250, T255)	09/08→	F14D4	Petrol	1399	4	16	17



CC



9

Aveo Saloon (T300)	03/11→	A 12 XEL	Petrol	1229	4	16	8
Aveo Saloon (T300)	03/11→	A 12 XER	Petrol	1229	4	16	8
Aveo Saloon (T300)	03/11→	F16D4	Petrol	1598	4	16	33
Aveo Saloon (T300)	03/11→	LXT	Petrol	1598	4	16	32
Aveo Saloon (T300)	05/11→	LDE	Petrol	1598	4	16	33
Aveo Saloon (T300)	07/11→	A 14 XER	Petrol	1398	4	16	14
Aveo Saloon (T300)	07/11→	LDV	Diesel	1248	4	16	11
Aveo Saloon (T300)	07/11→	LSF	Diesel	1248	4	16	11
Aveo Saloon (T300)	09/11→	LUV	Petrol	1364	4	16	14
Aveo Saloon (T300)	09/11→	Luw	Petrol	1796	4	16	47
Blazer S10	10/94→05/05	4JA1	Diesel	2499	4	8	82
Blazer S10	10/94→05/05	L43	Petrol	2198	4	8	70
Blazer S10	08/96→10/98	B 22 NZ	Petrol	2198	4	8	70
Blazer S10	08/96→10/03	C 43 NE	Petrol	4299	6	12	93
Blazer S10	05/00→01/07	C 24 SE	Petrol	2405	4	8	77
Blazer S10	02/07→12/09	X 24 XF	Petrol	2405	4	8	77
Calibra	10/93→03/96	C 20 XE	Petrol	1998	4	16	57
Camaro	09/15→	LTG	Petrol	1998	4	16	61
Camaro Convertible	09/15→	LTG	Petrol	1998	4	16	61
Captiva (C100, C140)	06/06→	Z 24 SED	Petrol	2405	4	16	81
Captiva (C100, C140)	10/06→	Z 20 DMH	Diesel	1991	4	16	60
Captiva (C100, C140)	10/06→	Z 20 S	Diesel	1991	4	16	60
Captiva (C100, C140)	01/11→	LE9	Petrol	2384	4	16	75
Captiva (C100, C140)	01/11→	LEA	Petrol	2384	4	16	75
Captiva (C100, C140)	03/11→	A 22 DMH	Diesel	2231	4	16	69
Captiva (C100, C140)	03/11→	A 24 XE	Petrol	2384	4	16	75
Captiva (C100, C140)	03/11→	LE5	Petrol	2384	4	16	75
Captiva (C100, C140)	03/11→	Z 22 D1	Diesel	2231	4	16	69
Captiva Closed Off-Road Vehicle	12/11→	LE5	Petrol	2384	4	16	78
Captiva Closed Off-Road Vehicle	12/11→	LE9	Petrol	2384	4	16	78
Captiva Sport	12/09→	LE5	Petrol	2384	4	16	75
Captiva Sport	12/09→	LE9	Petrol	2384	4	16	75
Captiva Sport	09/11→	LEA	Petrol	2384	4	16	75
Captiva Sport	01/12→	LAF	Petrol	2384	4	16	75
Cavalier Convertible	09/83→12/87	LQ5	Petrol	1998	4	8	63
Cavalier Convertible	10/01→09/03	L61	Petrol	2198	4	16	72
Cavalier Coupe	09/82→12/87	LQ5	Petrol	1998	4	8	63
Cavalier Coupe	10/01→08/05	L61	Petrol	2198	4	16	72
Cavalier Estate	09/82→12/87	LQ5	Petrol	1998	4	8	63
Cavalier Hatchback	09/82→12/87	LQ5	Petrol	1998	4	8	63
Cavalier Saloon	09/82→12/87	LQ5	Petrol	1998	4	8	63
Cavalier Saloon	01/94→08/05	L61	Petrol	2198	4	16	72
Celta	08/99→02/02	C 10 NE	Petrol	999	4	8	4
Celta	08/02→	C 10 YEH	Petrol	999	4	8	6
Celta	04/06→12/06	C 14 SE	Petrol	1389	4	8	15
Chevy	08/95→07/02	C 16 SEI	Petrol	1598	4	8	30
Chevy	12/95→07/06	C 14 NZ	Petrol	1389	4	8	15
Chevy	05/06→	A16DMS	Petrol	1598	4	16	29
Chevy Estate	08/95→07/02	C 16 SEI	Petrol	1598	4	8	30
Chevy Estate	08/02→09/06	Z 14 XE	Petrol	1389	4	16	22
Chevy Estate	08/02→09/06	Z 16 XE	Petrol	1598	4	16	31
Chevy Saloon	08/95→07/02	C 16 SEI	Petrol	1598	4	8	30
Chevy Saloon	09/00→12/00	C 14 NZ	Petrol	1389	4	8	15
Chevy Saloon	08/02→09/06	Z 14 XE	Petrol	1389	4	16	22
Chevy Saloon	08/02→	Z 16 XE	Petrol	1598	4	16	31
Classic	01/03→12/05	C 10 YEH	Petrol	999	4	8	6
Classic	09/03→12/05	L61	Petrol	2198	4	16	72
Classic	01/10→	X 14 XE	Petrol	1389	4	16	20
Classic Estate	01/02→	X 14 XE	Petrol	1389	4	16	20
Classic Hatchback	01/10→10/12	X 14 XE	Petrol	1389	4	16	20
Cobalt	04/04→	L61	Petrol	2198	4	16	72
Cobalt	07/04→	LE5	Petrol	2384	4	16	75
Cobalt	09/08→12/09	LNF	Petrol	1998	4	16	61
Cobalt	09/08→12/10	LAP	Petrol	2198	4	16	73
Cobalt	01/11→	N18XFH	Petrol	1796	4	8	48
Cobalt	01/11→	X 14 YFL	Petrol	1389	4	8	19
Cobalt	03/13→	N 14 YF	Petrol	1389	4	8	19
Cobalt	03/13→	X 14 YF	Petrol	1389	4	8	19
Cobalt	03/13→	Z 13 DT	Diesel	1248	4	16	11
Cobalt Coupe	04/04→12/08	L61	Petrol	2198	4	16	72
Cobalt Coupe	07/04→12/08	LE5	Petrol	2384	4	16	75
Cobalt Coupe	09/08→12/10	LAP	Petrol	2198	4	16	73
Cobalt Coupe	09/08→12/10	LNF	Petrol	1998	4	16	61
Colorado	04/03→01/07	C 24 SE	Petrol	2405	4	8	77
Colorado	01/07→01/12	X 24 XF	Petrol	2405	4	8	77
Colorado	01/11→	LWH	Diesel	2776	4	16	87
Colorado Crew Cab Pickup	08/15→	4J11-TC	Diesel	2999	4	16	89
Colorado Crew Cab Pickup	09/15→	LWN	Diesel	2776	4	16	88



CC



9

Colorado Extended Cab Pickup	09/15→	LWN	Diesel	2776	4	16	88
Combo	04/01→	Y 17 DTL	Diesel	1686	4	8	40
Combo	04/01→	Z 16 SE	Petrol	1598	4	8	30
Corsa Estate	08/97→07/02	C 16 NE	Petrol	1598	4	8	30
Corsa Estate	08/97→07/02	X 16 XE	Petrol	1598	4	16	31
Corsa Estate	08/00→07/02	Y 17 DTL	Diesel	1686	4	8	40
Corsa Estate	01/09→	X 14 YEH	Petrol	1389	4	8	21
Corsa Hatchback	03/94→07/00	C 10 NE	Petrol	999	4	8	4
Corsa Hatchback	03/94→07/00	X 10 E	Petrol	999	4	8	4
Corsa Hatchback	08/94→07/97	C 14 NZ	Petrol	1389	4	8	15
Corsa Hatchback	08/94→07/97	C 16 XE	Petrol	1598	4	16	31
Corsa Hatchback	08/94→07/02	C 16 NE	Petrol	1598	4	8	30
Corsa Hatchback	08/94→07/02	X 16 XE	Petrol	1598	4	16	31
Corsa Hatchback	03/00→12/05	C 10 YE	Petrol	999	4	8	5
Corsa Hatchback	08/00→03/09	Y 17 DTL	Diesel	1686	4	8	40
Corsa Hatchback	09/01→07/02	Z 14 XE	Petrol	1389	4	16	22
Corsa Hatchback	02/02→08/05	C 10 YEH	Petrol	999	4	8	6
Corsa Hatchback	08/02→08/05	C 18 NE	Petrol	1796	4	8	43
Corsa Hatchback	08/02→08/05	X 18 XE	Petrol	1799	4	16	50
Corsa Hatchback	09/05→12/10	B 16 NE	Petrol	1598	4	8	30
Corsa Hatchback	06/07→	X 14 YEH	Petrol	1389	4	8	21
Corsa Hatchback	06/07→	X 14 YFH	Petrol	1389	4	8	21
Corsa Pickup	08/94→07/97	C 14 NZ	Petrol	1389	4	8	15
Corsa Pickup	08/94→07/02	C 16 NE	Petrol	1598	4	8	30
Corsa Pickup	08/97→07/00	X 10 E	Petrol	999	4	8	4
Corsa Pickup	08/00→07/02	Y 17 DTL	Diesel	1686	4	8	40
Corsa Pickup	08/01→	Y 17 DT	Diesel	1686	4	16	39
Corsa Pickup	08/01→	Z 16 SE	Petrol	1598	4	8	30
Corsa Saloon	03/94→07/00	C 10 NE	Petrol	999	4	8	4
Corsa Saloon	03/94→07/00	X 10 E	Petrol	999	4	8	4
Corsa Saloon	08/94→07/97	C 14 NZ	Petrol	1389	4	8	15
Corsa Saloon	08/94→12/10	B 16 NE	Petrol	1598	4	8	30
Corsa Saloon	08/97→07/02	X 16 XE	Petrol	1598	4	16	31
Corsa Saloon	08/99→12/05	C 10 YE	Petrol	999	4	8	5
Corsa Saloon	08/00→03/09	Y 17 DTL	Diesel	1686	4	8	40
Corsa Saloon	02/02→08/05	C 10 YEH	Petrol	999	4	8	6
Corsa Saloon	08/02→	C 18 NE	Petrol	1796	4	8	43
Corsa Saloon	06/07→	X 14 YEH	Petrol	1389	4	8	21
Corsa Saloon	06/07→	X 14 YFH	Petrol	1389	4	8	21
Cruze	07/00→09/08	M13A	Petrol	1328	4	16	12
Cruze	08/03→09/08	M15A	Petrol	1490	4	16	26
Cruze (J300)	05/09→	2H0	Petrol	1796	4	16	41
Cruze (J300)	05/09→	F16D3	Petrol	1598	4	16	32
Cruze (J300)	05/09→	F16D4	Petrol	1598	4	16	33
Cruze (J300)	05/09→	F18D4	Petrol	1796	4	16	46
Cruze (J300)	05/09→	LDE	Petrol	1598	4	16	33
Cruze (J300)	05/09→	LUV	Petrol	1796	4	16	47
Cruze (J300)	05/09→	LXT	Petrol	1598	4	16	32
Cruze (J300)	05/09→	LXV	Petrol	1598	4	16	33
Cruze (J300)	05/09→	Z 20 DMH	Diesel	1991	4	16	60
Cruze (J300)	05/09→	Z 20 SI	Diesel	1991	4	16	60
Cruze (J300)	08/10→	LNP	Diesel	1998	4	16	62
Cruze (J300)	08/10→	Z 20 D1	Diesel	1998	4	16	62
Cruze (J300)	09/10→	A 14 NET	Petrol	1364	4	16	14
Cruze (J300)	09/10→	LUJ	Petrol	1364	4	16	14
Cruze (J300)	09/10→	LUV	Petrol	1364	4	16	14
Cruze (J300)	01/12→	LUD	Diesel	1686	4	16	37
Cruze (J300)	07/13→	A 14 XER	Petrol	1398	4	16	14
Cruze (J300)	07/13→	LDD	Petrol	1398	4	16	14
Cruze (J300)	11/13→	A 17 DTE	Diesel	1686	4	16	36
Cruze Hatchback	09/13→	LDE	Petrol	1598	4	16	33
Cruze Hatchback (J305)	12/10→	Z 20 DMH	Diesel	1991	4	16	60
Cruze Hatchback (J305)	06/11→	F16D4	Petrol	1598	4	16	33
Cruze Hatchback (J305)	06/11→	F18D4	Petrol	1796	4	16	46
Cruze Hatchback (J305)	06/11→	Z 20 D1	Diesel	1998	4	16	62
Cruze Hatchback (J305)	01/12→	LUD	Diesel	1686	4	16	37
Cruze Hatchback (J305)	01/12→	LXT	Petrol	1598	4	16	32
Cruze Hatchback (J305)	06/12→	LUJ	Petrol	1364	4	16	14
Cruze Hatchback (J305)	10/12→	LUV	Petrol	1796	4	16	47
Cruze Hatchback (J305)	07/13→	A 14 XER	Petrol	1398	4	16	14
Cruze Hatchback (J305)	07/13→	LDD	Petrol	1398	4	16	14
Cruze Hatchback (J305)	08/13→	A 17 DTE	Diesel	1686	4	16	36
Cruze Saloon	04/09→12/11	2H0	Petrol	1796	4	16	41
Cruze Saloon	04/09→06/14	LDE	Petrol	1598	4	16	33
Cruze Station Wagon (J308)	08/12→	2H0	Petrol	1796	4	16	41
Cruze Station Wagon (J308)	08/12→	LDE	Petrol	1598	4	16	33
Cruze Station Wagon (J308)	08/12→	LNP	Diesel	1998	4	16	62
Cruze Station Wagon (J308)	08/12→	LUD	Diesel	1686	4	16	37







CC



9

Cruze Station Wagon (J308)	08/12→	LUJ	Petrol	1364	4	16	14
Cruze Station Wagon (J308)	12/12→	F16D4	Petrol	1598	4	16	33
Cruze Station Wagon (J308)	07/13→	A 14 XER	Petrol	1398	4	16	14
Cruze Station Wagon (J308)	07/13→	LDD	Petrol	1398	4	16	14
Cruze Station Wagon (J308)	11/13→	A 17 DTE	Diesel	1686	4	16	36
Epica	04/06→09/09	L34	Petrol	1998	4	16	56
Epica	04/06→09/09	T20SED	Petrol	1998	4	16	56
Epica	10/09→12/15	2H0	Petrol	1796	4	16	41
Epica (KL1_)	01/05→12/06	C 20 SED	Petrol	1998	4	16	55
Epica (KL1_)	01/05→12/06	T20SED	Petrol	1998	4	16	56
Epica (KL1_)	06/06→	LF4	Petrol	2492	6	24	85
Epica (KL1_)	06/06→	X 20 D1	Petrol	1993	6	24	67
Epica (KL1_)	08/06→	X 20 SE	Petrol	1998	4	8	53
Epica (KL1_)	01/07→	Z 20 S	Diesel	1991	4	16	60
Epica Saloon	09/03→12/06	LF4	Petrol	2492	6	24	85
Equinox	09/09→	LAF	Petrol	2384	4	16	75
Equinox	09/09→	LEA	Petrol	2384	4	16	75
Evanda	03/05→	X 20 SED	Petrol	1998	4	16	56
Grand Vitara	09/99→08/03	RF	Diesel	1998	4	8	65
Grand Vitara	09/99→08/03	RHZ	Diesel	1997	4	8	66
Grand Vitara	09/99→12/06	J20A	Petrol	1995	4	16	58
Grand Vitara	02/01→	G16B	Petrol	1590	4	16	35
Hhr	09/05→12/11	L61	Petrol	2198	4	16	72
Hhr	01/06→12/11	LE5	Petrol	2384	4	16	75
Hhr	08/07→12/10	LNF	Petrol	1998	4	16	61
Hhr	09/08→12/11	LE8 (2.2L I-4)	Petrol	2198	4	16	73
Hhr	09/08→12/11	LE9	Petrol	2384	4	16	75
Impala Saloon	07/13→	LUK	Petrol	2384	4	16	75
Ipanema	03/91→12/97	C 20 NE	Petrol	1998	4	8	54
Kadett	03/91→12/98	C 20 NE	Petrol	1998	4	8	54
Kalos	03/05→	B12S1	Petrol	1150	4	8	10
Kalos	03/05→	F14D3	Petrol	1399	4	16	16
Kalos	03/05→	F14S3	Petrol	1399	4	8	18
Kalos Saloon	03/05→	F12S3	Petrol	1150	4	8	10
Kalos Saloon	03/05→	F14D3	Petrol	1399	4	16	16
Kalos Saloon	03/05→	F14S3	Petrol	1399	4	8	18
Lacetti (J200)	03/05→12/09	F18D2	Petrol	1796	4	8	45
Lacetti (J200)	03/05→	F14D3	Petrol	1399	4	16	16
Lacetti (J200)	03/05→	F16D3	Petrol	1598	4	16	32
Lacetti (J200)	03/05→	T18SED	Petrol	1799	4	16	49
Lacetti (J200)	08/05→	F18D3	Petrol	1796	4	16	44
Lacetti (J200)	01/07→	Z 20 DM	Diesel	1991	4	16	60
Lacetti Estate (J200)	03/05→	F14D3	Petrol	1399	4	16	16
Lacetti Estate (J200)	03/05→	F16D3	Petrol	1598	4	16	32
Lacetti Estate (J200)	08/05→	F18D3	Petrol	1796	4	16	44
Lacetti Estate (J200)	08/05→	T18SED	Petrol	1799	4	16	49
Lacetti Saloon	03/05→03/13	F14D3	Petrol	1399	4	16	16
Lacetti Saloon	03/05→03/13	F16D3	Petrol	1598	4	16	32
Lanos Saloon	11/05→	A 13 SM	Petrol	1349	4	8	13
Lanos Saloon	11/05→	A15SMS	Petrol	1498	4	8	24
Lanos Saloon	11/05→	A16DMS	Petrol	1598	4	16	29
LUV	02/92→11/99	4 ZD1	Petrol	2255	4	8	74
LUV	02/92→08/01	4JA1-T	Diesel	2499	4	8	82
LUV	09/96→12/05	C 22 NE	Petrol	2198	4	8	70
LUV	10/02→09/05	6 VE1	Petrol	3494	6	24	92
LUV	01/04→12/06	L43	Petrol	2198	4	8	70
Malibu	10/01→12/08	L61	Petrol	2198	4	16	72
Malibu	01/08→12/10	LAT	Petrol	2384	4	16	79
Malibu	01/08→	LE5	Petrol	2384	4	16	75
Malibu	09/09→12/12	LE9	Petrol	2384	4	16	75
Malibu	02/12→	LAF	Petrol	2384	4	16	78
Malibu	09/12→	LTG	Petrol	1998	4	16	61
Malibu (V300)	01/12→12/15	LTG	Petrol	1998	4	16	61
Malibu (V300)	01/12→	LE9	Petrol	2384	4	16	75
Malibu (V300)	01/12→	LUK	Petrol	2384	4	16	75
Malibu (V300)	04/12→	LBS	Diesel	1956	4	16	59
Malibu Hatchback	10/03→12/08	L61	Petrol	2198	4	16	72
Matiz (M200, M250)	03/05→	B10S	Petrol	995	4	8	3
Matiz (M200, M250)	03/05→	B10S1	Petrol	995	4	8	3
Matiz (M200, M250)	03/05→	F8CV	Petrol	796	3	6	1
Matiz (M200, M250)	01/07→	LA2	Petrol	995	4	8	3
Meriva	02/02→07/12	C 18 NE	Petrol	1796	4	8	43
Meriva	05/03→05/08	Z 18 XE	Petrol	1796	4	16	52
Meriva	07/07→07/12	X 14 YEH	Petrol	1389	4	8	21
Metro Hatchback	09/97→12/00	LP2	Petrol	993	3	6	7
Metro Saloon	09/97→12/00	LP2	Petrol	993	3	6	7
Montana Pickup	07/07→	X 14 YFH	Petrol	1389	4	8	21
Montana Pickup	01/11→	LDP	Diesel	1248	4	16	11

				CC			9
Montana Pickup	01/11→	X 14 YEH	Petrol	1389	4	8	21
Monza	01/86→12/96	20 E	Petrol	1979	4	8	53
Monza	12/95→09/02	C 14 NZ	Petrol	1389	4	8	15
Monza Hatchback	01/87→12/88	20 E	Petrol	1979	4	8	53
MW	01/00→12/10	M13A	Petrol	1328	4	16	12
Niva	01/07→12/09	Z 18 XE	Petrol	1796	4	16	52
Nova Hatchback	09/85→12/88	4A-LC	Petrol	1587	4	8	27
Nova Saloon	08/85→07/89	4A-LC	Petrol	1587	4	8	27
Nubira Estate	03/05→	F16D3	Petrol	1598	4	16	32
Nubira Estate	03/05→	T18SED	Petrol	1799	4	16	49
Nubira Estate	08/05→	F18D3	Petrol	1796	4	16	44
Nubira Estate	01/07→	Z 20 DM	Diesel	1991	4	16	60
Nubira Estate	01/07→	Z 20 S	Diesel	1991	4	16	60
Nubira Saloon	01/05→	F14D3	Petrol	1399	4	16	16
Nubira Saloon	01/05→	Z 20 S	Diesel	1991	4	16	60
Nubira Saloon	03/05→	F16D3	Petrol	1598	4	16	32
Nubira Saloon	03/05→	T18SED	Petrol	1799	4	16	49
Nubira Saloon	01/06→	F18D3	Petrol	1796	4	16	44
Nubira Saloon	01/10→	LXT	Petrol	1598	4	16	32
Omega	01/92→12/95	C 20 NE	Petrol	1998	4	8	54
Omega	09/92→12/94	C 30 NE	Petrol	2969	6	12	90
Omega	04/94→09/00	C 22 NE	Petrol	2198	4	8	70
Omega Suprema	04/93→12/94	C 30 NE	Petrol	2969	6	12	90
Omega Suprema	04/93→05/96	C 20 NE	Petrol	1998	4	8	54
Omega Suprema	10/94→09/00	C 22 NE	Petrol	2198	4	8	70
Onix	10/12→	N 14 YF	Petrol	1389	4	8	19
Optra	06/99→07/03	X 20 SED	Petrol	1998	4	16	56
Optra (1J_)	08/03→12/08	F16D3	Petrol	1598	4	16	32
Optra (1J_)	08/03→12/08	LXT	Petrol	1598	4	16	32
Optra (1J_)	08/03→12/08	T18SED	Petrol	1799	4	16	49
Optra (1J_)	09/03→12/10	L34	Petrol	1998	4	16	56
Optra (1J_)	08/06→12/08	LMN	Diesel	1991	4	16	60
Optra (1J_)	01/07→	Z 20 S1	Diesel	1991	4	16	60
Optra Estate	09/05→12/07	C 20 XE	Petrol	1998	4	16	57
Optra Estate	06/06→12/08	F16D3	Petrol	1598	4	16	32
Optra Estate	06/06→12/08	LXT	Petrol	1598	4	16	32
Optra Hatchback	08/03→11/12	LXT	Petrol	1598	4	16	32
Optra Hatchback	06/06→	F16D3	Petrol	1598	4	16	32
Optra Hatchback	06/06→	T18SED	Petrol	1799	4	16	49
Optra Hatchback	09/06→12/07	C 20 XE	Petrol	1998	4	16	57
Orlando (J309)	02/11→	2H0	Petrol	1796	4	16	41
Orlando (J309)	02/11→	F18D4	Petrol	1796	4	16	46
Orlando (J309)	02/11→	Z 20 D1	Diesel	1998	4	16	62
Orlando (J309)	09/11→12/12	LAF	Petrol	2384	4	16	75
Orlando (J309)	06/12→	LUJ	Petrol	1364	4	16	14
Orlando (J309)	07/13→	LEA	Petrol	2384	4	16	75
Prisma	10/06→11/13	X 14 YFL	Petrol	1389	4	8	19
Prisma	10/06→	N 14 YF	Petrol	1389	4	8	19
Rezzo	03/05→	A16DMS	Petrol	1598	4	16	29
Rezzo	03/05→	T20SED	Petrol	1998	4	16	56
S10 Pickup	10/94→12/04	L43	Petrol	2198	4	8	70
S10 Pick Up	10/94→05/05	L43	Petrol	2198	4	8	70
S10 Pickup	03/95→10/98	B 22 NZ	Petrol	2198	4	8	70
S10 Pickup	08/96→10/03	C 43 NE	Petrol	4299	6	12	93
S10 Pickup	05/00→12/04	C 24 SE	Petrol	2405	4	8	77
S10 Pickup	02/12→	X 24 XF	Petrol	2405	4	8	77
S10 Pickup	02/12→	XLD28	Diesel	2776	4	16	88
S10 Pickup	08/15→	4JA1-L	Diesel	2499	4	8	83
Sail Hatchback	01/12→	LDP	Diesel	1248	4	16	11
Sail Hatchback	01/13→	LDV	Diesel	1248	4	16	11
Sail Hatchback	01/13→	Z 12 XE	Petrol	1199	4	16	8
Sail Saloon	01/13→	LDV	Diesel	1248	4	16	11
Sail Saloon	01/13→	Z 12 XE	Petrol	1199	4	16	8
Spark	09/00→	F8CV	Petrol	796	3	6	1
Spark	12/03→03/09	F8CV	Petrol	796	3	6	1
Spark	12/03→03/09	F8CVC	Petrol	796	3	6	1
Spark	12/04→04/10	B10S1	Petrol	995	4	8	3
Spark	12/04→04/10	B10S1C	Petrol	995	4	8	3
Spark	05/05→	B10S	Petrol	995	4	8	3
Spark	05/05→	B10S1	Petrol	995	4	8	3
Spark	05/05→	LA2	Petrol	995	4	8	3
Spark (M300)	12/09→	Z 12 XE	Petrol	1199	4	16	8
Spark (M300)	03/10→	B10D1	Petrol	995	4	16	2
Spark (M300)	03/10→	B12D1	Petrol	1206	4	16	9
Spark (M300)	03/10→	LMU	Petrol	1206	4	16	9
Spectrum Hatchback	09/84→12/88	4XC1U	Petrol	1471	4	8	23
Spectrum Hatchback	09/87→12/88	4XC1UT	Petrol	1471	4	8	23
Spectrum Saloon	09/84→12/88	4XC1U	Petrol	1471	4	8	23



















CC



9

Spin	01/12→	Z 13 DTJ	Diesel	1248	4	16	11
Spin	07/12→	N18XFH	Petrol	1796	4	8	48
Sprint Convertible	09/89→12/92	LP2	Petrol	993	3	6	7
Sprint Hatchback	09/88→12/92	LP2	Petrol	993	3	6	7
Tavera	05/04→	4JA1-T	Diesel	2499	4	8	82
Tornado Standard Cab Pickup	09/03→12/10	N18XFH	Petrol	1796	4	8	48
Tracker	09/88→12/91	G16A	Petrol	1590	4	8	34
Tracker	05/98→07/04	G16B	Petrol	1590	4	16	35
Tracker	05/98→12/08	L34	Petrol	1998	4	16	56
Tracker	09/98→10/08	J20A	Petrol	1995	4	16	58
Trailblazer (31UX)	08/12→	LVN	Diesel	2499	4	16	86
Trailblazer (31UX)	08/12→	LWH	Diesel	2776	4	16	87
Trailblazer (31UX)	07/14→	XLD28	Diesel	2776	4	16	88
Traverse	07/17→	LTG	Petrol	1998	4	16	61
Trax	12/12→	A 14 NET	Petrol	1364	4	16	14
Trax	12/12→	F16D4	Petrol	1598	4	16	33
Trax	12/12→	LDE	Petrol	1598	4	16	33
Trax	12/12→	LUD	Diesel	1686	4	16	37
Trax	12/12→	LUJ	Petrol	1364	4	16	14
Trax	12/12→	LUV	Petrol	1364	4	16	14
Trax	03/13→	2H0	Petrol	1796	4	16	41
Trax	03/13→	F18D4	Petrol	1796	4	16	46
Trax	04/13→	B 14 NET	Petrol	1364	4	16	14
Vectra	10/93→03/96	C 20 XE	Petrol	1998	4	16	57
Vectra	03/96→12/05	20 NEJ	Petrol	1998	4	8	53
Vectra	03/96→12/05	C 20 NE	Petrol	1998	4	8	54
Vectra	03/96→02/12	C 20 SEL	Petrol	1998	4	16	56
Vectra	09/96→12/05	16 LZ2	Petrol	1598	4	8	28
Vectra	12/97→12/05	C 22 SEL	Petrol	2198	4	16	71
Vectra	02/98→06/03	X 20 DTH	Diesel	1995	4	16	68
Vectra	05/98→07/04	C 22 NE	Petrol	2198	4	8	70
Vectra	09/01→07/04	Z 32 SE	Petrol	3175	6	24	91
Vectra	04/02→04/04	Z 22 SE	Petrol	2198	4	16	72
Vectra	01/05→07/06	Z 22 YH	Petrol	2198	4	16	72
Vectra	11/05→06/11	X 20 XE	Petrol	1998	4	8	64
Vectra	07/08→	X 20 SED	Petrol	1998	4	16	56
Vectra Hatchback	01/07→06/10	X 20 XE	Petrol	1998	4	8	64
Vectra Hatchback	07/08→02/12	C 20 SEL	Petrol	1998	4	16	56
Viva	09/03→03/08	Z 18 XE	Petrol	1796	4	16	52
Vivant	08/00→	X 20 SED	Petrol	1998	4	16	56
Vivant	08/01→	A16DMS	Petrol	1598	4	16	29
Vivant	01/05→	T20SED	Petrol	1998	4	16	56
Volt	11/11→	LUU	Petrol	1398	4	16	14
Zafira	07/05→	Z 22 YH	Petrol	2198	4	16	72
Zafira	08/05→01/09	X 20 XE	Petrol	1998	4	8	64
Zafira	02/09→	N 20 XF	Petrol	1998	4	8	64
Zafira (F75)	02/99→07/01	C 18 YE	Petrol	1796	4	8	43
Zafira (F75)	07/00→06/05	Z 18 XE	Petrol	1796	4	16	52
Zafira (F75)	04/01→07/04	C 20 NE	Petrol	1998	4	8	54
Zafira (F75)	04/01→07/12	C 20 SEL	Petrol	1998	4	16	56
Zafira (F75)	09/01→12/05	Z 22 SE	Petrol	2198	4	16	72
Zafira (F75)	03/04→07/12	X 20 XE	Petrol	1998	4	8	64
Zafira (F75)	09/05→12/06	Z 22 YH	Petrol	2198	4	16	72

	CC				9		CC				9
2H0	1796	4	16	Petrol	41	L14	1399	4	16	Petrol	16
2H0	1796	4	16	Petrol	41	L34	1998	4	16	Petrol	56
4A-LC	1587	4	8	Petrol	27	L34	1998	4	16	Petrol	56
4JA1	2499	4	8	Diesel	82	L43	2198	4	8	Petrol	70
4JA1-L	2499	4	8	Diesel	83	L61	2198	4	16	Petrol	72
4JA1-T	2499	4	8	Diesel	82	L95	1399	4	16	Petrol	16
4JJ1-TC	2999	4	16	Diesel	89	LA2	995	4	8	Petrol	3
4JK1-TC	2499	4	16	Diesel	84	LAF	2384	4	16	Petrol	75
4XC1U	1471	4	8	Petrol	23	LAF	2384	4	16	Petrol	78
4XC1UT	1471	4	8	Petrol	23	LAP	2198	4	16	Petrol	73
4 ZD1	2255	4	8	Petrol	74	LAT	2384	4	16	Petrol	79
6 VE1	3494	6	24	Petrol	92	LBS	1956	4	16	Diesel	59
7A-FE	1762	4	16	Petrol	42	LDC	1229	4	16	Petrol	8
16 L22	1598	4	8	Petrol	28	LDD	1398	4	16	Petrol	14
20 E	1979	4	8	Petrol	53	LDE	1598	4	16	Petrol	33
20 NEJ	1998	4	8	Petrol	53	LDE	1598	4	16	Petrol	33
A 12 XEL	1229	4	16	Petrol	8	LDP	1248	4	16	Diesel	11
A 12 XER	1229	4	16	Petrol	8	LDT	1399	4	16	Petrol	17
A 13 SM	1349	4	8	Petrol	13	LDV	1248	4	16	Diesel	11
A 14 NET	1364	4	16	Petrol	14	LE5	2384	4	16	Petrol	75
A 14 XER	1398	4	16	Petrol	14	LE5	2384	4	16	Petrol	78
A15SMS	1498	4	8	Petrol	24	LE8 (2.2L I-4)	2198	4	16	Petrol	73
A16DMS	1598	4	16	Petrol	29	LE9	2384	4	16	Petrol	75
A 17 DTE	1686	4	16	Diesel	36	LE9	2384	4	16	Petrol	78
A 22 DMH	2231	4	16	Diesel	69	LEA	2384	4	16	Petrol	75
A 24 XE	2384	4	16	Petrol	75	LF4	2492	6	24	Petrol	85
B10D1	995	4	16	Petrol	2	LLU	1598	4	16	Petrol	33
B10S	995	4	8	Petrol	3	LLW	1991	4	16	Diesel	60
B10S	995	4	8	Petrol	3	LMN	1991	4	16	Diesel	60
B10S1	995	4	8	Petrol	3	LMU	1206	4	16	Petrol	9
B10S1	995	4	8	Petrol	3	LNF	1998	4	16	Petrol	61
B10S1C	995	4	8	Petrol	3	LNF	1998	4	16	Petrol	61
B12D1	1206	4	16	Petrol	9	LNP	1998	4	16	Diesel	62
B12S1	1150	4	8	Petrol	10	LP2	993	3	6	Petrol	7
B 14 NET	1364	4	16	Petrol	14	LQ5	1998	4	8	Petrol	63
B 16 NE	1598	4	8	Petrol	30	LSF	1248	4	16	Diesel	11
B 22 NZ	2198	4	8	Petrol	70	LTG	1998	4	16	Petrol	61
C 10 NE	999	4	8	Petrol	4	LUD	1686	4	16	Diesel	37
C 10 YE	999	4	8	Petrol	5	LUJ	1364	4	16	Petrol	14
C 10 YEH	999	4	8	Petrol	6	LUK	2384	4	16	Petrol	75
C 14 NZ	1389	4	8	Petrol	15	LUU	1398	4	16	Petrol	14
C 14 SE	1389	4	8	Petrol	15	LUV	1364	4	16	Petrol	14
C 16 NE	1598	4	8	Petrol	30	LWU	1796	4	16	Petrol	47
C 16 SE	1598	4	8	Petrol	30	LVN	2499	4	16	Diesel	86
C 16 SEI	1598	4	8	Petrol	30	LWH	2776	4	16	Diesel	87
C 16 XE	1598	4	16	Petrol	31	LWN	2776	4	16	Diesel	88
C 18 NE	1796	4	8	Petrol	43	LX6	1498	4	8	Petrol	25
C 18 SEL	1796	4	16	Petrol	44	LXT	1598	4	16	Petrol	32
C 18 YE	1796	4	8	Petrol	43	LXV	1598	4	16	Petrol	33
C 20 NE	1998	4	8	Petrol	54	LY4	1150	4	8	Petrol	10
C 20 SED	1998	4	16	Petrol	55	M13A	1328	4	16	Petrol	12
C 20 SEJ	1998	4	8	Petrol	53	M15A	1490	4	16	Petrol	26
C 20 SEL	1998	4	16	Petrol	56	N 14 YF	1389	4	8	Petrol	19
C 20 XE	1998	4	16	Petrol	57	N18XFH	1796	4	8	Petrol	48
C 22 NE	2198	4	8	Petrol	70	N 20 XF	1998	4	8	Petrol	64
C 22 SEL	2198	4	16	Petrol	71	N 24 XF	2405	4	8	Petrol	80
C 24 NE	2410	4	8	Petrol	76	RF	1998	4	8	Diesel	65
C 24 SE	2405	4	8	Petrol	77	RHZ	1997	4	8	Diesel	66
C 30 NE	2969	6	12	Petrol	90	T18SED	1799	4	16	Petrol	49
C 43 NE	4299	6	12	Petrol	93	T20SED	1998	4	16	Petrol	56
F8CV	796	3	6	Petrol	1	T20SED	1998	4	16	Petrol	56
F8CV	796	3	6	Petrol	1	X 10 E	999	4	8	Petrol	4
F8CVC	796	3	6	Petrol	1	X 14 XE	1389	4	16	Petrol	20
F12S3	1150	4	8	Petrol	10	X 14 YEH	1389	4	8	Petrol	21
F14D3	1399	4	16	Petrol	16	X 14 YF	1389	4	8	Petrol	19
F14D4	1399	4	16	Petrol	17	X 14 YFH	1389	4	8	Petrol	21
F14S3	1399	4	8	Petrol	18	X 14 YFL	1389	4	8	Petrol	19
F15S3	1498	4	8	Petrol	24	X 16 XE	1598	4	16	Petrol	31
F16D3	1598	4	16	Petrol	32	X 17 DT	1686	4	8	Diesel	38
F16D4	1598	4	16	Petrol	33	X 18 XE	1799	4	16	Petrol	50
F18D2	1796	4	8	Petrol	45	X 18 XE1	1796	4	16	Petrol	51
F18D3	1796	4	16	Petrol	44	X 20 D1	1993	6	24	Petrol	67
F18D4	1796	4	16	Petrol	46	X 20 DTH	1995	4	16	Diesel	68
F18S2	1761	4	8	Petrol	45	X 20 DTL	1995	4	16	Diesel	68
G 10 CV	993	4	8	Petrol	3	X 20 SE	1998	4	8	Petrol	53
G16A	1590	4	8	Petrol	34	X 20 SED	1998	4	16	Petrol	56
G16B	1590	4	16	Petrol	35	X 20 XE	1998	4	8	Petrol	64
J20A	1995	4	16	Petrol	58	X 20 XEV	1998	4	16	Petrol	56

	CC				9		CC				9
X 22 XE	2198	4	16	Petrol	71						
X 24 XF	2405	4	8	Petrol	77						
XLD28	2776	4	16	Diesel	88						
Y 17 DT	1686	4	16	Diesel	39						
Y 17 DTL	1686	4	8	Diesel	40						
Y 20 DTH	1995	4	16	Diesel	68						
Z 12 XE	1199	4	16	Petrol	8						
Z 13 DT	1248	4	16	Diesel	11						
Z 13 DTJ	1248	4	16	Diesel	11						
Z 14 XE	1389	4	16	Petrol	22						
Z 16 SE	1598	4	8	Petrol	30						
Z 16 XE	1598	4	16	Petrol	31						
Z 18 XE	1796	4	16	Petrol	52						
Z 18 XEL	1796	4	16	Petrol	51						
Z 18 XER	1796	4	16	Petrol	41						
Z 20 D1	1998	4	16	Diesel	62						
Z 20 DM	1991	4	16	Diesel	60						
Z 20 DMH	1991	4	16	Diesel	60						
Z 20 S	1991	4	16	Diesel	60						
Z 20 S1	1991	4	16	Diesel	60						
Z 22 D1	2231	4	16	Diesel	69						
Z 22 SE	2198	4	16	Petrol	72						
Z 22 YH	2198	4	16	Petrol	72						
Z 24 SED	2405	4	16	Petrol	81						
Z 32 SE	3175	6	24	Petrol	91						

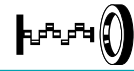
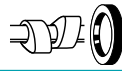

1 0.8L		Petrol		
F8CV	3 Cyl.	6 Valves	796cc	TD18521
F8CV	3 Cyl.	6 Valves	796cc	TD26041
F8CVC	3 Cyl.	6 Valves	796cc	TD33517
PA928 (x6) HR5075	NJ377 32.00 x 47.00 x 6.00mm, ACM		NJ377 32.00 x 47.00 x 6.00mm, ACM NJ337 60.00 x 80.00 x 8.00mm, NBR	

2 1.0L		Petrol		
B10D1	4 Cyl.	16 Valves	995cc	TD24815
HR5125			NA5351 36.00 x 50.00 x 6.00mm, FPM NA5478 60.00 x 80.00 x 8.00mm, FPM	

3 1.0L		Petrol		
B10S	4 Cyl.	8 Valves	995cc	TD18523
B10S	4 Cyl.	8 Valves	995cc	TD32687
B10S1	4 Cyl.	8 Valves	995cc	TD26040
B10S1	4 Cyl.	8 Valves	995cc	TD18522
B10S1C	4 Cyl.	8 Valves	995cc	TD33519
G 10 CV	4 Cyl.	8 Valves	993cc	TD22567
LA2	4 Cyl.	8 Valves	995cc	TD26658
PA928 (x8)	NJ377 32.00 x 47.00 x 6.00mm, ACM		NJ377 32.00 x 47.00 x 6.00mm, ACM NJ337 60.00 x 80.00 x 8.00mm, NBR	

4 1.0L		Petrol		
C 10 NE	4 Cyl.	8 Valves	999cc	TD29515
X 10 E	4 Cyl.	8 Valves	999cc	TD22482
PA565 (x8) HR342	NC006 35.00 x 48.00 x 7.00mm, MVQ			

5 1.0L		Petrol		
C 10 YE	4 Cyl.	8 Valves	999cc	TD29528
	NC006 35.00 x 48.00 x 7.00mm, MVQ		NB697 26.00 x 42.00 x 8.00mm, FPM NB698 80.00 x 98.00 x 10.00mm, FPM	

6 1.0L		Petrol		
C 10 YEH	4 Cyl.	8 Valves	999cc	TD29523
			NB697 26.00 x 42.00 x 8.00mm, FPM NB698 80.00 x 98.00 x 10.00mm, FPM	

7 1.0L		Petrol		
LP2	3 Cyl.	6 Valves	993cc	TD32042
	NA5190 42.00 x 56.00 x 7.00mm, FPM			

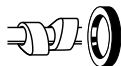

8 1.2L Petrol				
A 12 XEL	4 Cyl.	16 Valves	1229cc	TD25432
A 12 XER	4 Cyl.	16 Valves	1229cc	TD26084
LDC	4 Cyl.	16 Valves	1229cc	TD26191
Z 12 XE	4 Cyl.	16 Valves	1199cc	TD26428
PA5025 (x16) HR5048				NA5108 42.00 x 55.00 x 7.00mm, FPM/ACM NB698 80.00 x 98.00 x 10.00mm, FPM

9 1.2L Petrol				
B12D1	4 Cyl.	16 Valves	1206cc	TD24816
LMU	4 Cyl.	16 Valves	1206cc	TD28037
HR5125				NA5351 36.00 x 50.00 x 6.00mm, FPM NA5478 60.00 x 80.00 x 8.00mm, FPM

10 1.2L Petrol				
B12S1	4 Cyl.	8 Valves	1150cc	TD18524
F12S3	4 Cyl.	8 Valves	1150cc	TD22566
LY4	4 Cyl.	8 Valves	1150cc	TD28022
PA928 (x8)				NJ377 32.00 x 47.00 x 6.00mm, ACM NJ377 32.00 x 47.00 x 6.00mm, ACM NJ337 60.00 x 80.00 x 8.00mm, NBR

11 1.3L Diesel				
LDP	4 Cyl.	16 Valves	1248cc	TD26870
LDV	4 Cyl.	16 Valves	1248cc	TD26193
LSF	4 Cyl.	16 Valves	1248cc	TD26189
Z 13 DT	4 Cyl.	16 Valves	1248cc	TD32912
Z 13 DTJ	4 Cyl.	16 Valves	1248cc	TD29414
HR5088				NA5223 40.00 x 52.00 x 7.00mm, FPM NA5230 78.00 x 100.00 x 9.00mm, PTFE

12 1.3L Petrol				
M13A	4 Cyl.	16 Valves	1328cc	TD19864
PA928 (x16)				NJ377 32.00 x 47.00 x 6.00mm, ACM NJ337 60.00 x 80.00 x 8.00mm, NBR

13 1.4L Petrol				
A 13 SM	4 Cyl.	8 Valves	1349cc	TD32253
PA565 (x8) HR342				NC006 35.00 x 48.00 x 7.00mm, MVQ NB698 80.00 x 98.00 x 10.00mm, FPM

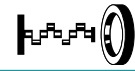

14 1.4L		Petrol			
A 14 NET	4 Cyl.	16 Valves	1364cc		TD29268
A 14 XER	4 Cyl.	16 Valves	1398cc		TD25431
B 14 NET	4 Cyl.	16 Valves	1364cc		TD29269
LDD	4 Cyl.	16 Valves	1398cc		TD26192
LUJ	4 Cyl.	16 Valves	1364cc		TD26818
LUU	4 Cyl.	16 Valves	1398cc		TD26216
LUV	4 Cyl.	16 Valves	1364cc		TD28519
PA5025 (x16) HR5048				NA5108 42.00 x 55.00 x 7.00mm, FPM/ACM NB698 80.00 x 98.00 x 10.00mm, FPM	

15 1.4L		Petrol			
C 14 NZ	4 Cyl.	8 Valves	1389cc		TD19861
C 14 SE	4 Cyl.	8 Valves	1389cc		TD32909
PA565 (x8) HR342		NC006 35.00 x 48.00 x 7.00mm, MVQ		NB697 26.00 x 42.00 x 8.00mm, FPM NB698 80.00 x 98.00 x 10.00mm, FPM	

16 1.4L		Petrol			
F14D3	4 Cyl.	16 Valves	1399cc		TD18525
L14	4 Cyl.	16 Valves	1399cc		TD28024
L95	4 Cyl.	16 Valves	1399cc		TD26429
NA5164 (x16) HR5092		NA5190 (x2) 42.00 x 56.00 x 7.00mm, FPM		NA5190 42.00 x 56.00 x 7.00mm, FPM NB698 80.00 x 98.00 x 10.00mm, FPM	

17 1.4L		Petrol			
F14D4	4 Cyl.	16 Valves	1399cc		TD24611
LDT	4 Cyl.	16 Valves	1399cc		TD28038
HR5087		NC006 (x2) 35.00 x 48.00 x 7.00mm, MVQ		NA5174 31.50 x 42.00 x 7.00mm, FPM NA5350 80.00 x 98.00 x 17.70mm, PTFE/ACM	

18 1.4L		Petrol			
F14S3	4 Cyl.	8 Valves	1399cc		TD18526
PA565 (x8) HR342		NC006 (x2) 35.00 x 48.00 x 7.00mm, MVQ		NF812 30.00 x 42.00 x 8.00mm, ACM NB698 80.00 x 98.00 x 10.00mm, FPM	

19 1.4L		Petrol			
N 14 YF	4 Cyl.	8 Valves	1389cc		TD29524
X 14 YF	4 Cyl.	8 Valves	1389cc		TD28236
X 14 YFL	4 Cyl.	8 Valves	1389cc		TD27390
PA565 (x8) HR342		NC006 (x2) 35.00 x 48.00 x 7.00mm, MVQ			

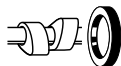

20 1.4L

Petrol

X 14 XE	4 Cyl.	16 Valves	1389cc	TD32220
PA5041 (x16) HR791				NB697 26.00 x 42.00 x 8.00mm, FPM NB698 80.00 x 98.00 x 10.00mm, FPM

21 1.4L

Petrol

X 14 YEH	4 Cyl.	8 Valves	1389cc	TD26868
X 14 YFH	4 Cyl.	8 Valves	1389cc	TD28237
PA565 (x8) HR342				NC006 35.00 x 48.00 x 7.00mm, MVQ

22 1.4L

Petrol

Z 14 XE	4 Cyl.	16 Valves	1389cc	TD28086
PA5041 (x16) HR791				NC006 (x2) 35.00 x 48.00 x 7.00mm, MVQ NB697 26.00 x 42.00 x 8.00mm, FPM NB698 80.00 x 98.00 x 10.00mm, FPM

23 1.5L

Petrol

4XC1U	4 Cyl.	8 Valves	1471cc	TD32411
4XC1UT	4 Cyl.	8 Valves	1471cc	TD32412
PA658 (x8)				NJ449 40.00 x 52.00 x 6.00mm, NBR NA5322 32.00 x 44.00 x 6.00mm, ACM NJ446 87.00 x 100.00 x 8.00mm, MVQ

24 1.5L

Petrol

A15SMS	4 Cyl.	8 Valves	1498cc	TD26129
F15S3	4 Cyl.	8 Valves	1498cc	TD22565
PA565 (x8) HR342				NC006 35.00 x 48.00 x 7.00mm, MVQ NA5053 30.00 x 42.00 x 7.00mm, FPM NB698 80.00 x 98.00 x 10.00mm, FPM

25 1.5L

Petrol

LX6	4 Cyl.	8 Valves	1498cc	TD28025
PA565 (x8) HR342				NC006 35.00 x 48.00 x 7.00mm, MVQ NB698 80.00 x 98.00 x 10.00mm, FPM

26 1.5L

Petrol

M15A	4 Cyl.	16 Valves	1490cc	TD19865
PA928 (x16)				

27 1.6L

Petrol

4A-LC	4 Cyl.	8 Valves	1587cc	TD32394
KJ722 (x8)				NJ353 35.00 x 49.00 x 6.00mm, NBR NJ349 32.50 x 46.00 x 6.00mm, NBR NJ001 70.00 x 92.00 x 8.50mm, MVQ

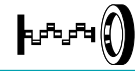
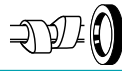

28 1.6L

Petrol

16 LZ2	4 Cyl.	8 Valves	1598cc	TD32251
PA565 (x8) HR342	NC006 35.00 x 48.00 x 7.00mm, MVQ		NB700	
			31.00 x 50.00 x 8.00mm, MVQ	
			NB806	
			90.00 x 104.00 x 11.00mm, FPM	

29 1.6L

Petrol

A16DMS	4 Cyl.	16 Valves	1598cc	TD18529
NA5164 (x16) HR5092	NA5190 (x2) 42.00 x 56.00 x 7.00mm, FPM		NF812	
			30.00 x 42.00 x 8.00mm, ACM	
			NB698	
			80.00 x 98.00 x 10.00mm, FPM	

30 1.6L

Petrol

B 16 NE	4 Cyl.	8 Valves	1598cc	TD29513
C 16 NE	4 Cyl.	8 Valves	1598cc	TD29516
C 16 SE	4 Cyl.	8 Valves	1598cc	TD28280
C 16 SEI	4 Cyl.	8 Valves	1598cc	TD27249
Z 16 SE	4 Cyl.	8 Valves	1598cc	TD19869
PA565 (x8) HR342	NC006 35.00 x 48.00 x 7.00mm, MVQ		NB697	
			26.00 x 42.00 x 8.00mm, FPM	
			NB698	
			80.00 x 98.00 x 10.00mm, FPM	

31 1.6L

Petrol

C 16 XE	4 Cyl.	16 Valves	1598cc	TD23209
X 16 XE	4 Cyl.	16 Valves	1598cc	TD19866
Z 16 XE	4 Cyl.	16 Valves	1598cc	TD27250
PA5041 (x16) HR791	NC006 (x2) 35.00 x 48.00 x 7.00mm, MVQ		NB697	
			26.00 x 42.00 x 8.00mm, FPM	
			NB698	
			80.00 x 98.00 x 10.00mm, FPM	

32 1.6L

Petrol

F16D3	4 Cyl.	16 Valves	1598cc	TD18527
LXT	4 Cyl.	16 Valves	1598cc	TD25572
NA5164 (x16) HR5092	NA5190 (x2) 42.00 x 56.00 x 7.00mm, FPM		NA5190	
			42.00 x 56.00 x 7.00mm, FPM	
			NB698	
			80.00 x 98.00 x 10.00mm, FPM	

33 1.6L

Petrol

F16D4	4 Cyl.	16 Valves	1598cc	TD24612
LDE	4 Cyl.	16 Valves	1598cc	TD26188
LDE	4 Cyl.	16 Valves	1598cc	TD24199
LLU	4 Cyl.	16 Valves	1598cc	TD33424
LXV	4 Cyl.	16 Valves	1598cc	TD23637
HR5087	NC006 (x2) 35.00 x 48.00 x 7.00mm, MVQ		NA5174	
			31.50 x 42.00 x 7.00mm, FPM	
			NA5350	
			80.00 x 98.00 x 17.70mm, PTFE/ACM	

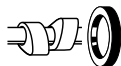

34 1.6L

Petrol

G16A	4 Cyl.	8 Valves	1590cc	TD29302
	NJ336 32.00 x 47.00 x 8.00mm, NBR		NJ377 32.00 x 47.00 x 6.00mm, ACM NJ378 68.00 x 86.00 x 8.00mm, ACM	

35 1.6L

Petrol

G16B PA928 (x16)	4 Cyl.	16 Valves	1590cc	TD26114
	NJ336 32.00 x 47.00 x 8.00mm, NBR		NJ377 32.00 x 47.00 x 6.00mm, ACM NJ337 60.00 x 80.00 x 8.00mm, NBR	

36 1.7L

Diesel

A 17 DTE PA5041 (x16) HR791	4 Cyl.	16 Valves	1686cc	TD31419
	NB884 (x2) 38.00 x 50.00 x 5.50mm, FPM		NJ449 40.00 x 52.00 x 6.00mm, NBR NK103 87.00 x 100.00 x 8.50mm, FPM	

37 1.7L

Diesel

LUD PA5041 (x16) HR791	4 Cyl.	16 Valves	1686cc	TD26178
			NJ449 40.00 x 52.00 x 6.00mm, NBR NK103 87.00 x 100.00 x 8.50mm, FPM	

38 1.7L

Diesel

X 17 DT	4 Cyl.	8 Valves	1686cc	TD32906
			NJ449 40.00 x 52.00 x 6.00mm, NBR NK103 87.00 x 100.00 x 8.50mm, FPM	

39 1.7L

Diesel

Y 17 DT PA5041 (x16) HR791	4 Cyl.	16 Valves	1686cc	TD19867
	NC006 35.00 x 48.00 x 7.00mm, MVQ		NJ449 40.00 x 52.00 x 6.00mm, NBR NK103 87.00 x 100.00 x 8.50mm, FPM	

40 1.7L

Diesel

Y 17 DTL PA5041 (x8) HR791	4 Cyl.	8 Valves	1686cc	TD32256
			NJ449 40.00 x 52.00 x 6.00mm, NBR NK103 87.00 x 100.00 x 8.50mm, FPM	

41 1.8L

Petrol

2H0	4 Cyl.	16 Valves	1796cc	TD24814
2H0	4 Cyl.	16 Valves	1796cc	TD25232
Z 18 XER HR5087	4 Cyl.	16 Valves	1796cc	TD32222
	NC006 (x2) 35.00 x 48.00 x 7.00mm, MVQ		NA5174 31.50 x 42.00 x 7.00mm, FPM NA5350 80.00 x 98.00 x 17.70mm, PTFE/ACM	

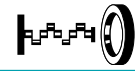
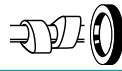

42 1.8L

Petrol

7A-FE	4 Cyl.	16 Valves	1762cc	TD21849
PA425 (x16)	NJ353 35.00 x 49.00 x 6.00mm, NBR		NJ349 32.50 x 46.00 x 6.00mm, NBR NJ001 70.00 x 92.00 x 8.50mm, MVQ	

43 1.8L

Petrol

C 18 NE	4 Cyl.	8 Valves	1796cc	TD28275
C 18 YE	4 Cyl.	8 Valves	1796cc	TD32211
PA565 (x8) HR342	NC006 35.00 x 48.00 x 7.00mm, MVQ		NB700 31.00 x 50.00 x 8.00mm, MVQ NB806 90.00 x 104.00 x 11.00mm, FPM	

44 1.8L

Petrol

C 18 SEL	4 Cyl.	16 Valves	1796cc	TD32919
F18D3	4 Cyl.	16 Valves	1796cc	TD23579
PA5041 (x16) HR791	NC006 (x2) 35.00 x 48.00 x 7.00mm, MVQ		NB700 31.00 x 50.00 x 8.00mm, MVQ NB806 90.00 x 104.00 x 11.00mm, FPM	

45 1.8L

Petrol

F18D2	4 Cyl.	8 Valves	1796cc	TD32266
F18S2	4 Cyl.	8 Valves	1761cc	TD29412
	NC006 35.00 x 48.00 x 7.00mm, MVQ		NF812 30.00 x 42.00 x 8.00mm, ACM NB698 80.00 x 98.00 x 10.00mm, FPM	

46 1.8L

Petrol

F18D4	4 Cyl.	16 Valves	1796cc	TD24824
HR5087	NC006 35.00 x 48.00 x 7.00mm, MVQ		NA5174 31.50 x 42.00 x 7.00mm, FPM NA5350 80.00 x 98.00 x 17.70mm, PTFE/ACM	

47 1.8L

Petrol

LUW	4 Cyl.	16 Valves	1796cc	TD28214
			NA5174 31.50 x 42.00 x 7.00mm, FPM NA5350 80.00 x 98.00 x 17.70mm, PTFE/ACM	

48 1.8L

Petrol

N18XFH	4 Cyl.	8 Valves	1796cc	TD28032
PA565 (x8) HR342	NC006 35.00 x 48.00 x 7.00mm, MVQ			

49 1.8L

Petrol

T18SED	4 Cyl.	16 Valves	1799cc	TD18528
PA5041 (x16) HR791	NC006 (x2) 35.00 x 48.00 x 7.00mm, MVQ		NA5174 31.50 x 42.00 x 7.00mm, FPM	



50 1.8L

Petrol

X 18 XE	4 Cyl.	16 Valves	1799cc	TD32242
PA5041 (x16) HR791	NC006 35.00 x 48.00 x 7.00mm, MVQ		NB700 31.00 x 50.00 x 8.00mm, MVQ NB806 90.00 x 104.00 x 11.00mm, FPM	

51 1.8L

Petrol

X 18 XE1	4 Cyl.	16 Valves	1796cc	TD32954
Z 18 XEL	4 Cyl.	16 Valves	1796cc	TD32261
PA5025 (x16) HR5048			NC065 30.00 x 40.00 x 7.00mm, FPM →07/02 NA5174 31.50 x 42.00 x 7.00mm, FPM 08/02→ NB698 80.00 x 98.00 x 10.00mm, FPM	

52 1.8L

Petrol

Z 18 XE	4 Cyl.	16 Valves	1796cc	TD21857
PA5025 (x16) HR5048	NC006 (x2) 35.00 x 48.00 x 7.00mm, MVQ		NA5174 31.50 x 42.00 x 7.00mm, FPM NB698 80.00 x 98.00 x 10.00mm, FPM NA5327 80.00 x 98.00 x 14.50mm, PTFE	

53 2.0L

Petrol

20 E	4 Cyl.	8 Valves	1979cc	TD32210
20 NEJ	4 Cyl.	8 Valves	1998cc	TD26438
C 20 SEJ	4 Cyl.	8 Valves	1998cc	TD32238
X 20 SE	4 Cyl.	8 Valves	1998cc	TD32713
PA565 (x8) HR342	NC006 35.00 x 48.00 x 7.00mm, MVQ		NB700 31.00 x 50.00 x 8.00mm, MVQ NB806 90.00 x 104.00 x 11.00mm, FPM	

54 2.0L

Petrol

C 20 NE	4 Cyl.	8 Valves	1998cc	TD28278
PA565 (x8) HR342	NB807 55.00 x 70.10 x 8.00mm, FPM NC006 35.00 x 48.00 x 7.00mm, MVQ		NB700 31.00 x 50.00 x 8.00mm, MVQ NB806 90.00 x 104.00 x 11.00mm, FPM	

55 2.0L

Petrol

C 20 SED	4 Cyl.	16 Valves	1998cc	TD26433
PA5041 (x16) HR791	NC006 35.00 x 48.00 x 7.00mm, MVQ		NB700 31.00 x 50.00 x 8.00mm, MVQ NB806 90.00 x 104.00 x 11.00mm, FPM	



56 2.0L		Petrol		
C 20 SEL	4 Cyl.	16 Valves	1998cc	TD19856
L34	4 Cyl.	16 Valves	1998cc	TD26038
L34	4 Cyl.	16 Valves	1998cc	TD29299
T20SED	4 Cyl.	16 Valves	1998cc	TD18623
T20SED	4 Cyl.	16 Valves	1998cc	TD26039
X 20 SED	4 Cyl.	16 Valves	1998cc	TD18531
X 20 XEV	4 Cyl.	16 Valves	1998cc	TD26430
PA5041 (x16) HR791	NC006 (x2) 35.00 x 48.00 x 7.00mm, MVQ		NB700 31.00 x 50.00 x 8.00mm, MVQ NB806 90.00 x 104.00 x 11.00mm, FPM	

57 2.0L		Petrol		
C 20 XE	4 Cyl.	16 Valves	1998cc	TD28273
PA565 (x16) HR342 (x2)	NC006 (x2) 35.00 x 48.00 x 7.00mm, MVQ		NB700 31.00 x 50.00 x 8.00mm, MVQ NB806 90.00 x 104.00 x 11.00mm, FPM	

58 2.0L		Petrol		
J20A	4 Cyl.	16 Valves	1995cc	TD27269
PB314 (x16)	NJ377 (x2) 32.00 x 47.00 x 6.00mm, ACM			

59 2.0L		Diesel		
LBS	4 Cyl.	16 Valves	1956cc	TD26514
HR5119	NA5347 (x2) 30.0 x 45.0 x 7.00mm, FPM		NA5070 31.00 x 41.00 x 7.00mm, FPM NF888 93.00 x 139.70;172.00 x 12.00mm, FPM	

60 2.0L		Diesel		
LLW	4 Cyl.	16 Valves	1991cc	TD26179
LMN	4 Cyl.	16 Valves	1991cc	TD26195
Z 20 DM	4 Cyl.	16 Valves	1991cc	TD21856
Z 20 DMH	4 Cyl.	16 Valves	1991cc	TD28118
Z 20 S	4 Cyl.	16 Valves	1991cc	TD21855
Z 20 S1	4 Cyl.	16 Valves	1991cc	TD24614
	NF817 (x2) 36.00 x 50.00 x 7.00mm, FPM		NA5139 32.00 x 45.00 x 6.00mm, FPM	

61 2.0L		Petrol		
LNF	4 Cyl.	16 Valves	1998cc	TD20540
LNF	4 Cyl.	16 Valves	1998cc	TD30029
LTG	4 Cyl.	16 Valves	1998cc	TD28523
HR5127			NA5108 42.00 x 55.00 x 7.00mm, FPM/ACM	

62 2.0L		Diesel		
LNP	4 Cyl.	16 Valves	1998cc	TD26819
Z 20 D1	4 Cyl.	16 Valves	1998cc	TD25208
HR5119				



63 2.0L

Petrol

LQ5	4 Cyl.	8 Valves	1998cc	TD28021
PA928 (x8)	NJ377 32.00 x 47.00 x 6.00mm, ACM	NJ377 32.00 x 47.00 x 6.00mm, ACM	NJ337 60.00 x 80.00 x 8.00mm, NBR	

64 2.0L

Petrol

N 20 XF	4 Cyl.	8 Valves	1998cc	TD32209
X 20 XE	4 Cyl.	8 Valves	1998cc	TD28219
	NC006 35.00 x 48.00 x 7.00mm, MVQ	NB700 31.00 x 50.00 x 8.00mm, MVQ	NB806 90.00 x 104.00 x 11.00mm, FPM	

65 2.0L

Diesel

RF	4 Cyl.	8 Valves	1998cc	TD32914
KJ710 (x8)			NJ324 34.00 x 48.00 x 7.00mm, ACM	
			NJ325 90.00 x 110.00 x 9.00mm, MVQ	

66 2.0L

Diesel

RHZ	4 Cyl.	8 Valves	1997cc	TD32916
HR5046			NA5191 42.00 x 62.00 x 7.00mm, PTFE	
			NA5192 90.00 x 110.00 x 7.00mm, PTFE	

67 2.0L

Petrol

X 20 D1	6 Cyl.	24 Valves	1993cc	TD24075
			NF850 85.00 x 105.00 x 8.00mm, FPM	

68 2.0L

Diesel

X 20 DTH	4 Cyl.	16 Valves	1995cc	TD32922
X 20 DTL	4 Cyl.	16 Valves	1995cc	TD32905
Y 20 DTH	4 Cyl.	16 Valves	1995cc	TD19868
PA5041 (x16) HR791			NA5069 55.00 x 68.00 x 8.00mm, FPM	
			NA5209 99.00 x 114.00 x 11.00mm, FPM	

69 2.2L

Diesel

A 22 DMH	4 Cyl.	16 Valves	2231cc	TD24987
Z 22 D1	4 Cyl.	16 Valves	2231cc	TD26078
HR5119				

70 2.2L

Petrol

B 22 NZ	4 Cyl.	8 Valves	2198cc	TD29514
C 22 NE	4 Cyl.	8 Valves	2198cc	TD22564
L43	4 Cyl.	8 Valves	2198cc	TD22571
PA565 (x8) HR342	NC006 35.00 x 48.00 x 7.00mm, MVQ	NB700 31.00 x 50.00 x 8.00mm, MVQ	NB806 90.00 x 104.00 x 11.00mm, FPM	

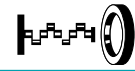

71 2.2L Petrol

C 22 SEL	4 Cyl.	16 Valves	2198cc	TD22563
X 22 XE	4 Cyl.	16 Valves	2198cc	TD27421
PA5041 (x16) HR791	NC006 (x2) 35.00 x 48.00 x 7.00mm, MVQ		NB700 31.00 x 50.00 x 8.00mm, MVQ NB806 90.00 x 104.00 x 11.00mm, FPM	

72 2.2L Petrol

L61	4 Cyl.	16 Valves	2198cc	TD17292
Z 22 SE	4 Cyl.	16 Valves	2198cc	TD21854
Z 22 YH	4 Cyl.	16 Valves	2198cc	TD21853
HR5127			NA5108 42.00 x 55.00 x 7.00mm, FPM/ACM NB806 90.00 x 104.00 x 11.00mm, FPM	

73 2.2L Petrol

LAP	4 Cyl.	16 Valves	2198cc	TD23636
LE8 (2.2L I-4)	4 Cyl.	16 Valves	2198cc	TD23975
HR5127			NA5108 42.00 x 55.00 x 7.00mm, FPM/ACM	

74 2.3L Petrol

4 ZD1	4 Cyl.	8 Valves	2255cc	TD32918
PA933 (x8)	NA5347 30.0 x 45.0 x 7.00mm, FPM		NJ323 40.00 x 56.00 x 7.00mm, NBR NJ322 95.00 x 118.00 x 10.00mm, NBR	

75 2.4L Petrol

A 24 XE	4 Cyl.	16 Valves	2384cc	TD24988
LAF	4 Cyl.	16 Valves	2384cc	TD23639
LE5	4 Cyl.	16 Valves	2384cc	TD18604
LE9	4 Cyl.	16 Valves	2384cc	TD23642
LEA	4 Cyl.	16 Valves	2384cc	TD28527
LUK	4 Cyl.	16 Valves	2384cc	TD28526
HR5127			NA5108 42.00 x 55.00 x 7.00mm, FPM/ACM	

76 2.4L Petrol

C 24 NE	4 Cyl.	8 Valves	2410cc	TD28227
			NB628 45.00 x 60.00 x 9.00mm, ACM NB469 77.00 x 100.00 x 11.50mm, FPM	

77 2.4L Petrol

C 24 SE	4 Cyl.	8 Valves	2405cc	TD31887
X 24 XF	4 Cyl.	8 Valves	2405cc	TD29525
PA565 (x8) HR342	NC006 35.00 x 48.00 x 7.00mm, MVQ		NB700 31.00 x 50.00 x 8.00mm, MVQ NB806 90.00 x 104.00 x 11.00mm, FPM	

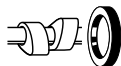

78 2.4L

Petrol

LAF	4 Cyl.	16 Valves	2384cc	TD30967
LE5	4 Cyl.	16 Valves	2384cc	TD24181
LE9	4 Cyl.	16 Valves	2384cc	TD32674
HR5127				

79 2.4L

Petrol

LAT	4 Cyl.	16 Valves	2384cc	TD20070
HR5127				NA5190 42.00 x 56.00 x 7.00mm, FPM NB788 79.40 x 95.30 x 11.10mm, PTFE

80 2.4L

Petrol

N 24 XF	4 Cyl.	8 Valves	2405cc	TD32255
				NB700 31.00 x 50.00 x 8.00mm, MVQ NB806 90.00 x 104.00 x 11.00mm, FPM

81 2.4L

Petrol

Z 24 SED	4 Cyl.	16 Valves	2405cc	TD20750
PA5041 (x16) HR791	NC006 (x2) 35.00 x 48.00 x 7.00mm, MVQ			NB700 31.00 x 50.00 x 8.00mm, MVQ NB806 90.00 x 104.00 x 11.00mm, FPM

82 2.5L

Diesel

4JA1	4 Cyl.	8 Valves	2499cc	TD26440
4JA1-T	4 Cyl.	8 Valves	2499cc	TD23998
PA418 (x8)	NA5051 40.00 x 56.00 x 7.00mm, FPM			NJ014 50.00 x 68.00 x 9.00mm, NBR NJ322 95.00 x 118.00 x 10.00mm, NBR

83 2.5L

Diesel

4JA1-L	4 Cyl.	8 Valves	2499cc	TD34256
PA418 (x8)	NA5051 40.00 x 56.00 x 7.00mm, FPM			NA5051 40.00 x 56.00 x 7.00mm, FPM NF843 50.00 x 68.00 x 10.00mm, FPM/ACM

84 2.5L

Diesel

4JK1-TC	4 Cyl.	16 Valves	2499cc	TD28668
				NF843 50.00 x 68.00 x 10.00mm, FPM/ACM NJ158 95.00 x 118.00 x 10.00mm, ACM

85 2.5L

Petrol

LF4	6 Cyl.	24 Valves	2492cc	TD26274
				NF850 85.00 x 105.00 x 8.00mm, FPM



86 2.5L Diesel				
LVN	4 Cyl.	16 Valves	2499cc	TD27220
	NA5136 (x2)			
	30.00 x 47.00 x 7.00mm, FPM			
87 2.8L Diesel				
LWH	4 Cyl.	16 Valves	2776cc	TD27221
	NA5136 (x2)			
	30.00 x 47.00 x 7.00mm, FPM			
88 2.8L Diesel				
LWN	4 Cyl.	16 Valves	2776cc	TD31572
XLD28	4 Cyl.	16 Valves	2776cc	TD32265
	PA5041 (x16)			
	HR791			
89 3.0L Diesel				
4JJ1-TC	4 Cyl.	16 Valves	2999cc	TD28670
	PA418 (x16)			
90 3.0L Petrol				
C 30 NE	6 Cyl.	12 Valves	2969cc	TD28279
	PA619 (x12)			
	HR336 (x3)			
			NB628	
			45.00 x 60.00 x 9.00mm, ACM	
			NB469	
			77.00 x 100.00 x 11.50mm, FPM	
91 3.2L Petrol				
Z 32 SE	6 Cyl.	24 Valves	3175cc	TD21851
	PA5041 (x12)			
	HR5062			
	NC006 (x2)			
	35.00 x 48.00 x 7.00mm, MVQ			
			NB884	
			38.00 x 50.00 x 5.50mm, FPM	
			NB806	
			90.00 x 104.00 x 11.00mm, FPM	
92 3.5L Petrol				
6 VE1	6 Cyl.	24 Valves	3494cc	TD21848
	NA5347			
	30.0 x 45.0 x 7.00mm, FPM			
			NA5108	
			42.00 x 55.00 x 7.00mm, FPM/ACM	
93 4.3L Petrol				
C 43 NE	6 Cyl.	12 Valves	4299cc	TD29529
	NC006			
	35.00 x 48.00 x 7.00mm, MVQ			













CC



9

200 Convertible	09/10→	ERB	Petrol	3604	6	24	34
200 Convertible	01/11→	ED3	Petrol	2360	4	16	21
200 Convertible	01/11→	EDG	Petrol	2360	4	16	21
200 Saloon	09/10→	ERB	Petrol	3604	6	24	34
200 Saloon	01/11→12/13	ED3	Petrol	2360	4	16	21
200 Saloon	01/11→	EDG	Petrol	2360	4	16	21
200 Saloon	06/14→	ED6	Petrol	2360	4	16	21
300C	09/10→	ERB	Petrol	3604	6	24	34
300C	09/11→	EXF	Diesel	2987	6	24	30
300 C (LX)	09/05→11/12	EXL	Diesel	2987	6	24	30
300 C Touring (LX)	09/05→12/10	EXL	Diesel	2987	6	24	30
Acclaim	01/89→09/95	EFA	Petrol	2972	6	12	29
Aspen (HG)	09/07→12/09	EVD	Petrol	4701	8	16	36
Aspen (HG)	09/07→	EVE	Petrol	4701	8	16	36
Caravan	01/95→11/00	EGA	Petrol	3301	6	12	32
Caravan	01/95→12/00	EDZ	Petrol	2429	4	16	20
Centura Saloon (KB)	04/75→03/77	7T2	Petrol	1981	4	8	11
Chrysler R/T Coupe	09/96→12/97	EDZ	Petrol	2429	4	16	20
Cirrus	05/94→09/00	ECB	Petrol	1996	4	16	13
Cirrus	05/94→04/07	EDZ	Petrol	2429	4	16	20
Cirrus	09/94→09/00	EEB	Petrol	2497	6	24	22
Cirrus	09/00→04/07	ECC	Petrol	1996	4	16	14
Cirrus	01/01→12/06	EDV	Petrol	2429	4	16	20
Cirrus Saloon	09/06→12/10	ED3	Petrol	2360	4	16	21
Concorde	09/92→12/95	EGA	Petrol	3301	6	12	32
Concorde	09/92→09/97	EGE	Petrol	3518	6	24	33
Concorde	10/92→09/97	EGB	Petrol	3301	6	12	32
Concorde	10/97→09/03	EWZ	Petrol	3518	6	24	33
Crossfire	07/03→12/08	EGX	Petrol	3199	6	18	31
Crossfire	09/04→12/07	EGZ	Petrol	3199	6	18	31
Crossfire Roadster	05/04→12/08	EGX	Petrol	3199	6	18	31
Crossfire Roadster	09/04→12/06	EGZ	Petrol	3199	6	18	31
Daytona Coupe	10/84→12/90	EDR	Petrol	2213	4	8	18
Daytona Coupe	01/89→10/92	EDT	Petrol	2501	4	8	24
Daytona Hatchback	01/84→12/91	EDR	Petrol	2213	4	8	18
Delta	08/11→	198 A2.000	Diesel	1598	4	16	8
Delta	08/11→	198 A4.000	Petrol	1368	4	16	7
Delta	08/11→	198 A5.000	Diesel	1956	4	16	12
Delta	08/11→	198 A7.000	Petrol	1368	4	16	7
Dynasty Saloon	09/87→12/92	EDM	Petrol	2501	4	8	24
Dynasty Saloon	09/90→12/93	EGA	Petrol	3301	6	12	32
ES	10/88→09/90	EDM	Petrol	2501	4	8	24
Grand Caravan	01/96→11/07	EGM	Petrol	3301	6	12	32
Grand Caravan	04/03→12/07	EDZ	Petrol	2429	4	16	20
Grand Caravan	02/06→05/07	ENC	Diesel	2499	4	8	25
Grand Voyager V (RT)	10/07→	ENS	Diesel	2777	4	16	28
Grand Voyager V (RT)	01/08→	EGV	Petrol	3301	6	12	32
Grand Voyager V (RT)	02/11→	ERB	Petrol	3604	6	24	34
Imperial	09/89→12/91	EGA	Petrol	3301	6	12	32
Intrepid Saloon	09/92→12/97	EDZ	Petrol	2429	4	16	20
Intrepid Saloon	09/92→12/97	EGA	Petrol	3301	6	12	32
Intrepid Saloon	09/92→12/97	EGE	Petrol	3518	6	24	33
Laser Hatchback	09/85→12/86	EDM	Petrol	2501	4	8	24
Le Baron Convertible	09/86→12/89	EDF	Petrol	2213	4	8	18
Le Baron Convertible	09/86→12/90	EDR	Petrol	2213	4	8	18
Le Baron Convertible	09/86→12/93	EDM	Petrol	2501	4	8	24
Le Baron Convertible	01/89→12/93	EDT	Petrol	2501	4	8	24
Le Baron Convertible	01/90→12/96	6G72	Petrol	2972	6	12	29
Le Baron Coupe	01/86→12/88	EDF	Petrol	2213	4	8	18
Le Baron Coupe	01/86→12/93	EDM	Petrol	2501	4	8	24
Le Baron Coupe	01/90→12/93	EFA	Petrol	2972	6	12	29
Le Baron Hatchback	09/84→12/89	EDR	Petrol	2213	4	8	18
Le Baron Saloon	09/85→12/88	EDF	Petrol	2213	4	8	18
Le Baron Saloon	01/89→12/94	EDM	Petrol	2501	4	8	24
Le Baron Saloon	01/89→12/94	EDT	Petrol	2501	4	8	24
Le Baron Saloon	09/89→01/91	EDR	Petrol	2213	4	8	18
Le Baron Saloon	01/90→12/94	EFA	Petrol	2972	6	12	29
LHS Saloon	09/93→12/97	EGE	Petrol	3518	6	24	33
Neon (PL)	05/94→08/99	420H	Petrol	1996	4	16	13
Neon (PL)	06/94→09/00	ECC	Petrol	1996	4	16	14
Neon (PL)	04/96→08/99	420T	Petrol	1996	4	16	14
Neon (PL)	09/97→08/99	EBD	Petrol	1796	4	16	10
Neon II	08/99→12/06	420H	Petrol	1996	4	16	13
Neon II	08/99→12/06	ECB	Petrol	1996	4	16	13
Neon II	01/00→12/01	EBD	Petrol	1796	4	16	10
Neon II	10/01→09/05	EDV	Petrol	2429	4	16	20
Neon II	10/01→12/06	ECH	Petrol	1996	4	16	14
Neon II	11/01→12/06	EJD	Petrol	1598	4	16	9

							
New Yorker	10/89→12/93	EGA	Petrol	3301	6	12	32
New Yorker	04/93→09/98	F01	Petrol	3518	6	24	33
New Yorker	03/95→09/98	EGE	Petrol	3518	6	24	33
Pacifica	02/16→	ERB	Petrol	3604	6	24	34
Phantom	09/86→11/93	EDM	Petrol	2501	4	8	24
PT Cruiser (PT_)	06/00→12/10	ECC	Petrol	1996	4	16	14
PT Cruiser (PT_)	06/00→12/10	EDZ	Petrol	2429	4	16	20
PT Cruiser (PT_)	11/01→12/10	EJD	Petrol	1598	4	16	9
PT Cruiser (PT_)	03/02→12/10	EDJ	Diesel	2148	4	16	19
PT Cruiser (PT_)	08/03→12/10	EDV	Petrol	2429	4	16	20
PT Cruiser Convertible	06/00→12/10	EDZ	Petrol	2429	4	16	20
PT Cruiser Convertible	03/04→12/08	EDV	Petrol	2429	4	16	20
Saratoga	09/89→12/95	6G72	Petrol	2972	6	12	29
Saratoga	10/89→09/91	EDM	Petrol	2501	4	8	24
Sebring (JR)	04/01→06/07	ECC	Petrol	1996	4	16	14
Sebring (JR)	04/01→06/07	EDZ	Petrol	2429	4	16	20
Sebring (JR)	09/01→06/07	EDV	Petrol	2429	4	16	20
Sebring (JS)	09/06→12/10	EDG	Petrol	2360	4	16	21
Sebring (JS)	07/07→12/10	ECD	Diesel	1968	4	16	15
Sebring (JS)	07/07→12/10	ECN	Petrol	1998	4	16	16
Sebring (JS)	07/07→12/10	ED3	Petrol	2360	4	16	21
Sebring Convertible	09/95→12/98	EDZ	Petrol	2429	4	16	20
Sebring Convertible	09/95→09/00	EEB	Petrol	2497	6	24	22
Sebring Convertible (JR)	04/01→06/07	ECC	Petrol	1996	4	16	14
Sebring Convertible (JR)	04/01→06/07	EDZ	Petrol	2429	4	16	20
Sebring Convertible (JR)	09/01→06/07	EDV	Petrol	2429	4	16	20
Sebring Convertible (JS)	05/07→12/10	EDG	Petrol	2360	4	16	21
Sebring Convertible (JS)	07/07→12/10	ECD	Diesel	1968	4	16	15
Sebring Convertible (JS)	07/07→12/10	ED3	Petrol	2360	4	16	21
Sebring Coupe (FJ)	05/95→12/99	ECF	Petrol	1996	4	16	14
Sebring Coupe (FJ)	05/95→09/00	EEB	Petrol	2497	6	24	22
Sebring Coupe (JR)	01/01→12/05	EDZ	Petrol	2429	4	16	20
Sebring Saloon (FJ)	05/95→09/00	ECB	Petrol	1996	4	16	13
Stratus	01/01→10/06	EDV	Petrol	2429	4	16	20
Stratus	01/01→10/06	EDZ	Petrol	2429	4	16	20
Stratus (JA)	12/95→04/01	COO	Petrol	1995	4	16	13
Stratus (JA)	12/95→04/01	ECB	Petrol	1996	4	16	13
Stratus (JA)	12/95→04/01	EDZ	Petrol	2429	4	16	20
Stratus (JA)	12/95→04/01	EEB	Petrol	2497	6	24	22
Stratus (JA)	12/95→04/01	H00	Petrol	2497	6	24	22
Stratus (JA)	01/96→12/97	EDV	Petrol	2429	4	16	20
Stratus Convertible (JX)	04/96→04/01	625H	Petrol	2499	6	24	22
Stratus Convertible (JX)	06/96→04/01	420X	Petrol	1996	4	16	13
Vision	09/93→12/97	EGE	Petrol	3518	6	24	33
Vision	09/93→12/97	F00	Petrol	3518	6	24	33
Vision	09/93→12/97	F01	Petrol	3518	6	24	33
Voyager / Grand III (GS)	01/95→03/01	B00	Petrol	2429	4	16	20
Voyager / Grand III (GS)	01/95→03/01	COO	Petrol	1995	4	16	13
Voyager / Grand III (GS)	01/95→03/01	EFA	Petrol	2972	6	12	29
Voyager / Grand III (GS)	01/95→03/01	EGA	Petrol	3301	6	12	32
Voyager / Grand III (GS)	01/95→03/01	ENC	Diesel	2499	4	8	25
Voyager / Grand III (GS)	01/95→03/01	L00	Petrol	3778	6	12	35
Voyager / Grand III (GS)	02/97→03/01	EDZ	Petrol	2429	4	16	20
Voyager / Grand III (GS)	09/97→12/00	EGM	Petrol	3301	6	12	32
Voyager I (AS)	10/87→09/90	EFA	Petrol	2972	6	12	29
Voyager I (AS)	10/88→09/90	EDM	Petrol	2501	4	8	24
Voyager I (AS)	10/89→09/90	EGA	Petrol	3301	6	12	32
Voyager II (ES)	08/90→09/95	EGA	Petrol	3301	6	12	32
Voyager II (ES)	08/90→09/95	K	Petrol	2501	4	8	24
Voyager II (ES)	10/90→09/95	EFA	Petrol	2972	6	12	29
Voyager II (ES)	01/91→09/95	6G72	Petrol	2972	6	12	29
Voyager II (ES)	01/91→09/95	300	Petrol	2972	6	12	29
Voyager II (ES)	01/91→09/95	K00	Petrol	2501	4	8	24
Voyager IV (RG, RS)	09/99→12/08	EGA	Petrol	3301	6	12	32
Voyager IV (RG, RS)	09/99→12/08	EGM	Petrol	3301	6	12	32
Voyager IV (RG, RS)	02/00→12/08	EDZ	Petrol	2429	4	16	20
Voyager IV (RG, RS)	02/00→12/08	ENJ	Diesel	2499	4	16	26
Voyager IV (RG, RS)	06/04→12/08	ENR	Diesel	2776	4	16	28
Voyager IV (RG, RS)	08/05→12/08	EDK	Diesel	2499	4	16	23
Ypsilon	05/11→	169 A4.000	Petrol	1242	4	8	3
Ypsilon	05/11→	199 B1.000	Diesel	1248	4	16	5
Ypsilon	05/11→	312 A2.000	Petrol	875	2	8	1

	CC				9
3E1	1118	4	8	Petrol	2
3G1A	1294	4	8	Petrol	4
3Y2	1442	4	8	Petrol	6
6G72	2972	6	12	Petrol	29
6Y2	1442	4	8	Petrol	6
7T2	1981	4	8	Petrol	11
169 A4.000	1242	4	8	Petrol	3
198 A2.000	1598	4	16	Diesel	8
198 A4.000	1368	4	16	Petrol	7
198 A5.000	1956	4	16	Diesel	12
198 A7.000	1368	4	16	Petrol	7
199 B1.000	1248	4	16	Diesel	5
300	2972	6	12	Petrol	29
312 A2.000	875	2	8	Petrol	1
420H	1996	4	16	Petrol	13
420T	1996	4	16	Petrol	14
420X	1996	4	16	Petrol	13
625H	2499	6	24	Petrol	22
B00	2429	4	16	Petrol	20
C00	1995	4	16	Petrol	13
EBD	1796	4	16	Petrol	10
ECB	1996	4	16	Petrol	13
ECC	1996	4	16	Petrol	14
ECD	1968	4	16	Diesel	15
ECF	1996	4	16	Petrol	14
ECH	1996	4	16	Petrol	14
ECN	1998	4	16	Petrol	16
ED3	2360	4	16	Petrol	21
ED6	2360	4	16	Petrol	21
EDF	2213	4	8	Petrol	18
EDG	2360	4	16	Petrol	21
EDJ	2148	4	16	Diesel	19
EDK	2499	4	16	Diesel	23
EDM	2501	4	8	Petrol	24
EDR	2213	4	8	Petrol	18
EDT	2501	4	8	Petrol	24
EDV	2429	4	16	Petrol	20
EDZ	2429	4	16	Petrol	20
EEB	2497	6	24	Petrol	22
EFA	2972	6	12	Petrol	29
EGA	3301	6	12	Petrol	32
EGB	3301	6	12	Petrol	32
EGE	3518	6	24	Petrol	33
EGM	3301	6	12	Petrol	32
EGV	3301	6	12	Petrol	32
EGX	3199	6	18	Petrol	31
EGZ	3199	6	18	Petrol	31
EJD	1598	4	16	Petrol	9
ENC	2499	4	8	Diesel	25
ENJ	2499	4	16	Diesel	26
ENR	2776	4	16	Diesel	28
ENS	2777	4	16	Diesel	28
EPE	2464	4	8	Petrol	27
ERB	3604	6	24	Petrol	34
EVA	4701	8	16	Petrol	36
EVD	4701	8	16	Petrol	36
EVE	4701	8	16	Petrol	36
EWZ	3518	6	24	Petrol	33
EXF	2987	6	24	Diesel	30
EXL	2987	6	24	Diesel	30
F00	3518	6	24	Petrol	33
F01	3518	6	24	Petrol	33
H00	2497	6	24	Petrol	22
J8S	2068	4	8	Diesel	17
J8S 890	2068	4	8	Diesel	17
K	2501	4	8	Petrol	24
K00	2501	4	8	Petrol	24
L00	3778	6	12	Petrol	35
M51	2499	4	8	Diesel	25
M52	2499	4	8	Diesel	25
M664	2987	6	24	Diesel	30
Y2	1442	4	8	Petrol	6

	CC				9
---	----	---	---	---	---



1 0.9L Petrol

312 A2.000	2 Cyl.	8 Valves	875cc	TD26554
			NA5070 31.00 x 41.00 x 7.00mm, FPM NF857 85.00 x 105.00 x 9.00mm, FPM/ACM	

2 1.1L Petrol

3E1	4 Cyl.	8 Valves	1118cc	TD536
HR569			NA5016 35.00 x 47.00 x 7.00mm, FPM/ACM NF843 50.00 x 68.00 x 10.00mm, FPM/ACM NF648 50.00 x 68.00 x 10.00mm, MVQ	

3 1.2L Petrol

169 A4.000	4 Cyl.	8 Valves	1242cc	TD26555
PA5025 (x8) HR5048			NA5058 40.00 x 55.00 x 7.00mm, FPM NA5057 27.00 x 37.00 x 7.00mm, FPM NA5061 74.00 x 88.00 x 8.00mm, FPM	

4 1.3L Petrol

3G1A	4 Cyl.	8 Valves	1294cc	TD538
HR569			NA5016 35.00 x 47.00 x 7.00mm, FPM/ACM NF843 50.00 x 68.00 x 10.00mm, FPM/ACM NF648 50.00 x 68.00 x 10.00mm, MVQ	

5 1.3L Diesel

199 B1.000	4 Cyl.	16 Valves	1248cc	TD26556
HR5088			NA5223 40.00 x 52.00 x 7.00mm, FPM NA5230 78.00 x 100.00 x 9.00mm, PTFE	

6 1.4L Petrol

3Y2	4 Cyl.	8 Valves	1442cc	TD540
6Y2	4 Cyl.	8 Valves	1442cc	TD545
Y2	4 Cyl.	8 Valves	1442cc	TD557
HR569			NA5058 40.00 x 55.00 x 7.00mm, FPM NA5057 27.00 x 37.00 x 7.00mm, FPM LK5001 74.00 x 187.50 x 17.00mm, FPM	

7 1.4L Petrol

198 A4.000	4 Cyl.	16 Valves	1368cc	TD26558
198 A7.000	4 Cyl.	16 Valves	1368cc	TD26559
HR814			NA5058 (x2) 40.00 x 55.00 x 7.00mm, FPM NA5057 27.00 x 37.00 x 7.00mm, FPM LK5001 74.00 x 187.50 x 17.00mm, FPM	

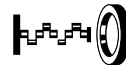
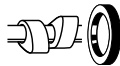

8 1.6L Diesel

198 A2.000 4 Cyl. 16 Valves 1598cc TD26557

HR5119	NA5347 30.0 x 45.0 x 7.00mm, FPM	NA5070 31.00 x 41.00 x 7.00mm, FPM NF888 93.00 x 139.70;172.00 x 12.00mm, FPM
--------	-------------------------------------	--

9 1.6L Petrol

EJD 4 Cyl. 16 Valves 1598cc TD18383

HR5061		NA5139 32.00 x 45.00 x 6.00mm, FPM NA5140 91.00 x 111.00 x 10.00mm, FPM
--------	--	--

10 1.8L Petrol

EBD 4 Cyl. 16 Valves 1796cc TD21946

HR5061	NC006 35.00 x 48.00 x 7.00mm, MVQ	NA5139 32.00 x 45.00 x 6.00mm, FPM NA5140 91.00 x 111.00 x 10.00mm, FPM
--------	--------------------------------------	--

11 2.0L Petrol

7T2 4 Cyl. 8 Valves 1981cc TD547

		NF694 40.00 x 58.00 x 8.00mm, ACM
--	--	--------------------------------------

12 2.0L Diesel

198 A5.000 4 Cyl. 16 Valves 1956cc TD26560

HR5119	NA5347 (x2) 30.0 x 45.0 x 7.00mm, FPM	NA5070 31.00 x 41.00 x 7.00mm, FPM NF888 93.00 x 139.70;172.00 x 12.00mm, FPM
--------	--	--

13 2.0L Petrol

420H 4 Cyl. 16 Valves 1996cc TD5485

420X 4 Cyl. 16 Valves 1996cc TD533

C00 4 Cyl. 16 Valves 1995cc TD5482

ECB 4 Cyl. 16 Valves 1996cc TD21947

HR5061	NC006 35.00 x 48.00 x 7.00mm, MVQ	NA5139 32.00 x 45.00 x 6.00mm, FPM NA5140 91.00 x 111.00 x 10.00mm, FPM
--------	--------------------------------------	--

14 2.0L Petrol

420T 4 Cyl. 16 Valves 1996cc TD5486

ECC 4 Cyl. 16 Valves 1996cc TD18328

ECF 4 Cyl. 16 Valves 1996cc TD23784

ECH 4 Cyl. 16 Valves 1996cc TD21948

HR5061	NC006 (x2) 35.00 x 48.00 x 7.00mm, MVQ	NA5139 32.00 x 45.00 x 6.00mm, FPM NA5140 91.00 x 111.00 x 10.00mm, FPM
--------	---	--



15 2.0L Diesel

ECD	4 Cyl.	16 Valves	1968cc	TD26121
PA5041 (x16) HR791	NA5124 32.00 x 47.00 x 10.00mm, PTFE/ACM		NA5106 35.00 x 48.00 x 10.00mm, PTFE LK5012 85.00 x 132.00 x 15.70mm, PTFE	

16 2.0L Petrol

ECN	4 Cyl.	16 Valves	1998cc	TD26120
	NC006 (x2) 35.00 x 48.00 x 7.00mm, MVQ		NA5108 42.00 x 55.00 x 7.00mm, FPM/ACM NK143 85.00 x 103.00 x 8.00mm, FPM	

17 2.1L Diesel

J8S	4 Cyl.	8 Valves	2068cc	TD4254
J8S 890 HR569	4 Cyl.	8 Valves	2068cc	TD4255
	NA5016 35.00 x 47.00 x 7.00mm, FPM/ACM		NF843 50.00 x 68.00 x 10.00mm, FPM/ACM NF844 90.00 x 110.00 x 11.00mm, FPM/ACM	

18 2.2L Petrol

EDF	4 Cyl.	8 Valves	2213cc	TD30840
EDR	4 Cyl.	8 Valves	2213cc	TD550
			NA5140 91.00 x 111.00 x 10.00mm, FPM	

19 2.2L Diesel

EDJ	4 Cyl.	16 Valves	2148cc	TD18404
HR5085 (x4)			NA5131 45.00 x 67.00 x 8.00mm, PTFE NA5074 93.00 x 133.50 x 15.50mm, PTFE	

20 2.4L Petrol

B00	4 Cyl.	16 Valves	2429cc	TD5484
EDV	4 Cyl.	16 Valves	2429cc	TD18407
EDZ HR5061	4 Cyl.	16 Valves	2429cc	TD18326
	NC006 (x2) 35.00 x 48.00 x 7.00mm, MVQ		NA5139 32.00 x 45.00 x 6.00mm, FPM NA5140 91.00 x 111.00 x 10.00mm, FPM	

21 2.4L Petrol

ED3	4 Cyl.	16 Valves	2360cc	TD25573
ED6	4 Cyl.	16 Valves	2360cc	TD29566
EDG	4 Cyl.	16 Valves	2360cc	TD21949
			NA5108 42.00 x 55.00 x 7.00mm, FPM/ACM NK143 85.00 x 103.00 x 8.00mm, FPM	

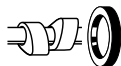

22 2.5L

Petrol

625H	6 Cyl.	24 Valves	2499cc	TD534
EEB	6 Cyl.	24 Valves	2497cc	TD18382
H00	6 Cyl.	24 Valves	2497cc	TD4249

NF841 (x2)
35.00 x 50.00 x 8.00mm, FPM

NJ874
37.00 x 50.00 x 6.00mm, ACM

NA5140
91.00 x 111.00 x 10.00mm, FPM

23 2.5L

Diesel

EDK	4 Cyl.	16 Valves	2499cc	TD21953
-----	--------	-----------	--------	---------

NA5136 (x2)
30.00 x 47.00 x 7.00mm, FPM

24 2.5L

Petrol

EDM	4 Cyl.	8 Valves	2501cc	TD18374
EDT	4 Cyl.	8 Valves	2501cc	TD9561
K	4 Cyl.	8 Valves	2501cc	TD539
K00	4 Cyl.	8 Valves	2501cc	TD4251

NA5140
91.00 x 111.00 x 10.00mm, FPM

25 2.5L

Diesel

ENC	4 Cyl.	8 Valves	2499cc	TD18322
M51	4 Cyl.	8 Valves	2499cc	TD4257
M52	4 Cyl.	8 Valves	2499cc	TD535

HR801

26 2.5L

Diesel

ENJ	4 Cyl.	16 Valves	2499cc	TD18323
-----	--------	-----------	--------	---------

HR660 (x2)

NA5136 (x2)
30.00 x 47.00 x 7.00mm, FPM

27 2.5L

Petrol

EPE	4 Cyl.	8 Valves	2464cc	TD4244
-----	--------	----------	--------	--------

NA5133
85.00 x 105.00 x 11.00mm, FPM

28 2.8L

Diesel

ENR	4 Cyl.	16 Valves	2776cc	TD18329
ENS	4 Cyl.	16 Valves	2777cc	TD24902

PA5041 (x16)
HR791

NA5136 (x2)
30.00 x 47.00 x 7.00mm, FPM

29 3.0L

Petrol

6672	6 Cyl.	12 Valves	2972cc	TD542
300	6 Cyl.	12 Valves	2972cc	TD4247
EFA	6 Cyl.	12 Valves	2972cc	TD21954

KJ211 (x12)

NF841
35.00 x 50.00 x 8.00mm, FPM

NJ874
37.00 x 50.00 x 6.00mm, ACM

NA5140
91.00 x 111.00 x 10.00mm, FPM



30 3.0L

Diesel

EXF	6 Cyl.	24 Valves	2987cc	TD27226
EXL	6 Cyl.	24 Valves	2987cc	TD26077
M664	6 Cyl.	24 Valves	2987cc	TD21964

HR5062

NA5131

45.00 x 67.00 x 8.00mm, PTFE

31 3.2L

Petrol

EGX	6 Cyl.	18 Valves	3199cc	TD18986
EGZ	6 Cyl.	18 Valves	3199cc	TD18406

HR5055

NA5131

45.00 x 67.00 x 8.00mm, PTFE

NA5168

93.00 x 114.00 x 11.50mm, PTFE

32 3.3L

Petrol

EGA	6 Cyl.	12 Valves	3301cc	TD18321
EGB	6 Cyl.	12 Valves	3301cc	TD21955
EGM	6 Cyl.	12 Valves	3301cc	TD21957
EGV	6 Cyl.	12 Valves	3301cc	TD23785

NJ874

37.00 x 50.00 x 6.00mm, ACM

NA5140

91.00 x 111.00 x 10.00mm, FPM

33 3.5L

Petrol

EGE	6 Cyl.	24 Valves	3518cc	TD21956
EWZ	6 Cyl.	24 Valves	3518cc	TD21963
F00	6 Cyl.	24 Valves	3518cc	TD551
F01	6 Cyl.	24 Valves	3518cc	TD4248

NA5140

91.00 x 111.00 x 10.00mm, FPM

34 3.6L

Petrol

ERB	6 Cyl.	24 Valves	3604cc	TD25243
-----	--------	-----------	--------	---------

HR5062

NA5131

45.00 x 67.00 x 8.00mm, PTFE

35 3.8L

Petrol

L00	6 Cyl.	12 Valves	3778cc	TD530
-----	--------	-----------	--------	-------

NA5140

91.00 x 111.00 x 10.00mm, FPM

36 4.7L

Petrol

EVA	8 Cyl.	16 Valves	4701cc	TD23811
EVD	8 Cyl.	16 Valves	4701cc	TD32610
EVE	8 Cyl.	16 Valves	4701cc	TD28059

HR5077

NA5173

100.00 x 120.00 x 9.50mm, FPM











CC



9

2 CV	03/63→02/70	A 53	Petrol	425	2	4	1
2 CV	01/70→12/75	A79/1 (AYA2)	Petrol	435	2	4	1
2 CV	02/70→10/85	A06/635	Petrol	602	2	4	2
2 CV	02/70→07/90	A06/664	Petrol	602	2	4	2
2 CV	09/75→06/81	M28/1 (AK2)	Petrol	602	2	4	3
Acadiane	08/78→10/88	M28 (AM2)	Petrol	602	2	4	3
AMI	01/63→05/68	M4 (AM)	Petrol	602	2	4	3
AMI	05/68→12/77	M28 (AM2)	Petrol	602	2	4	3
AMI	03/73→12/77	G10	Petrol	1015	4	8	8
AMI Break	05/68→12/77	M28 (AM2)	Petrol	602	2	4	3
AMI Break	03/73→12/77	G10	Petrol	1015	4	8	8
Ax (ZA-)	07/86→12/98	CDY (TU9M)	Petrol	954	4	8	7
Ax (ZA-)	09/86→06/92	C1A	Petrol	954	4	8	7
Ax (ZA-)	09/86→12/92	K2A	Petrol	1360	4	8	26
Ax (ZA-)	09/86→12/97	H1B	Petrol	1124	4	8	13
Ax (ZA-)	09/86→12/97	HDZ (TU1M)	Petrol	1124	4	8	13
Ax (ZA-)	12/86→12/88	C3A	Petrol	954	4	8	7
Ax (ZA-)	12/86→12/88	KAY (TU3CP)	Petrol	1360	4	8	7
Ax (ZA-)	12/86→04/94	H1A	Petrol	1124	4	8	13
Ax (ZA-)	02/87→12/98	CDZ (TU9M)	Petrol	954	4	8	7
Ax (ZA-)	04/87→12/88	M4A	Petrol	1294	4	8	20
Ax (ZA-)	04/87→04/97	KDX (TU3M/Z)	Petrol	1360	4	8	26
Ax (ZA-)	04/87→04/97	KDY (TU3FM)	Petrol	1360	4	8	26
Ax (ZA-)	04/87→04/97	KDY (TU3M)	Petrol	1360	4	8	26
Ax (ZA-)	04/87→04/97	KDZ (TU3M/Z)	Petrol	1360	4	8	26
Ax (ZA-)	01/88→12/92	K2B	Petrol	1360	4	8	26
Ax (ZA-)	06/88→04/94	K1F	Petrol	1360	4	8	26
Ax (ZA-)	09/88→12/89	HAZ (TU1CP)	Petrol	1124	4	8	13
Ax (ZA-)	09/88→07/92	K9A (TUD3)	Diesel	1360	4	8	27
Ax (ZA-)	01/89→12/91	K1G	Petrol	1360	4	8	26
Ax (ZA-)	06/91→12/96	KFZ (TU3FJ2)	Petrol	1360	4	8	26
Ax (ZA-)	08/91→12/96	KFY (TU3FJ2)	Petrol	1360	4	8	26
Ax (ZA-)	08/91→12/97	K9Y (TUD3Y)	Diesel	1360	4	8	27
Ax (ZA-)	08/94→12/97	VJY (TUD5)	Diesel	1527	4	8	32
Ax (ZA-)	08/94→12/97	VJZ (TUD5)	Diesel	1527	4	8	32
Axel	10/81→03/91	V06 644	Petrol	652	2	4	4
Berlingo (B9)	04/08→	9HN (DV6ETED)	Diesel	1560	4	8	35
Berlingo (B9)	04/08→	9HT (DV6BTED4)	Diesel	1560	4	16	37
Berlingo (B9)	04/08→	9HX (DV6ATED4)	Diesel	1560	4	16	37
Berlingo (B9)	04/08→	9HZ (DV6TED4)	Diesel	1560	4	16	37
Berlingo (B9)	04/08→	BHW (DV6FE)	Diesel	1560	4	8	35
Berlingo (B9)	04/08→	NFR (TU5JP4B)	Petrol	1587	4	16	45
Berlingo (B9)	04/08→	NFU (TU5JP4)	Petrol	1587	4	16	48
Berlingo (B9)	11/09→	SFS (EP6C)	Petrol	1598	4	16	34
Berlingo (B9)	07/10→	5FK (EP6CB)	Petrol	1598	4	16	34
Berlingo (B9)	07/10→	9HL (DV6C)	Diesel	1560	4	8	35
Berlingo (B9)	07/10→	9HP (DV6DTED)	Diesel	1560	4	8	35
Berlingo (B9)	07/10→	9HR (DV6C)	Diesel	1560	4	8	35
Berlingo (B9)	07/11→	KFX (TU3A)	Petrol	1360	4	8	31
Berlingo (B9)	02/12→	9HF (DV6DTED)	Diesel	1560	4	8	35
Berlingo (B9)	12/14→	BHY (DV6FD)	Diesel	1560	4	8	35
Berlingo (B9)	12/14→	BHZ (DV6FC)	Diesel	1560	4	8	35
Berlingo (MF)	07/96→12/03	D9B (XUD9A/L)	Diesel	1905	4	8	59
Berlingo (MF)	07/96→12/03	DJY (XUD9A)	Diesel	1905	4	8	57
Berlingo (MF)	07/96→05/08	HDZ (TU1M)	Petrol	1124	4	8	13
Berlingo (MF)	07/96→05/08	HFX (TU1JP)	Petrol	1124	4	8	14
Berlingo (MF)	07/96→10/08	KFX (TU3JP)	Petrol	1360	4	8	30
Berlingo (MF)	07/96→12/11	KFW (TU3JP)	Petrol	1360	4	8	30
Berlingo (MF)	11/96→10/02	A9A (XUD7)	Diesel	1769	4	8	52
Berlingo (MF)	04/97→10/02	LFX (XU7JB)	Petrol	1761	4	8	54
Berlingo (MF)	07/98→10/05	WJY (DW8B)	Diesel	1868	4	8	59
Berlingo (MF)	07/98→10/05	WJZ (DW8)	Diesel	1868	4	8	59
Berlingo (MF)	12/99→10/05	RHY (DW10TD)	Diesel	1997	4	8	79
Berlingo (MF)	10/00→12/11	NFU (TU5JP4)	Petrol	1587	4	16	48
Berlingo (MF)	07/05→05/08	9HX (DV6ATED4)	Diesel	1560	4	16	37
Berlingo (MF)	07/05→12/11	9HW (DV6BTED4)	Diesel	1560	4	16	37
Berlingo (MF)	07/05→12/11	DV6B	Diesel	1560	4	16	37
Berlingo Box (B9)	04/08→	9HS (DV6TED4BU)	Diesel	1560	4	16	37
Berlingo Box (B9)	04/08→	9HT (DV6BTED4)	Diesel	1560	4	16	37
Berlingo Box (B9)	04/08→	9HT (DV6BUTED4)	Diesel	1560	4	16	37
Berlingo Box (B9)	04/08→	9HX (DV6ATED4)	Diesel	1560	4	16	37
Berlingo Box (B9)	04/08→	9HX (DV6AUTED4)	Diesel	1560	4	16	37
Berlingo Box (B9)	04/08→	9HZ (DV6TED4)	Diesel	1560	4	16	37
Berlingo Box (B9)	04/08→	NFR (TU5JP4B)	Petrol	1587	4	16	45
Berlingo Box (B9)	04/08→	NFU (TU5JP4)	Petrol	1587	4	16	48
Berlingo Box (B9)	11/09→	SFS (EP6C)	Petrol	1598	4	16	34
Berlingo Box (B9)	07/10→	5FK (EP6CB)	Petrol	1598	4	16	34
Berlingo Box (B9)	07/10→	9HE (DV6DBM)	Diesel	1560	4	8	35

							
Berlingo Box (B9)	07/10→	9HF (DV6DTE)	Diesel	1560	4	8	35
Berlingo Box (B9)	07/10→	9HL (DV6C)	Diesel	1560	4	8	35
Berlingo Box (B9)	07/10→	9HN (DV6ETED)	Diesel	1560	4	8	35
Berlingo Box (B9)	07/10→	9HP (DV6DTE)	Diesel	1560	4	8	35
Berlingo Box (B9)	07/10→	9HR (DV6C)	Diesel	1560	4	8	35
Berlingo Box (B9)	07/10→	BHW (DV6FE)	Diesel	1560	4	8	35
Berlingo Box (B9)	12/14→	BHY (DV6FD)	Diesel	1560	4	8	35
Berlingo Box (B9)	12/14→	BHZ (DV6FC)	Diesel	1560	4	8	35
Berlingo Box (M_)	07/96→10/02	A9A (XUD7)	Diesel	1769	4	8	52
Berlingo Box (M_)	07/96→12/03	DJY (XUD9A)	Diesel	1905	4	8	57
Berlingo Box (M_)	07/96→03/08	HDZ (TU1M)	Petrol	1124	4	8	13
Berlingo Box (M_)	07/96→03/08	HFX (TU1JP)	Petrol	1124	4	8	14
Berlingo Box (M_)	07/96→12/11	KFW (TU3JP)	Petrol	1360	4	8	30
Berlingo Box (M_)	07/96→12/11	KFX (TU3JP)	Petrol	1360	4	8	30
Berlingo Box (M_)	07/98→12/11	WJY (DW8B)	Diesel	1868	4	8	59
Berlingo Box (M_)	07/98→12/11	WJZ (DW8)	Diesel	1868	4	8	59
Berlingo Box (M_)	08/99→10/02	LFX (XU7JB)	Petrol	1761	4	8	54
Berlingo Box (M_)	12/99→12/11	RHY (DW10TD)	Diesel	1997	4	8	79
Berlingo Box (M_)	10/00→03/08	NFU (TU5JP4)	Petrol	1587	4	16	48
Berlingo Box (M_)	07/05→12/11	9HW (DV6BTED4)	Diesel	1560	4	16	37
Berlingo Box (M_)	07/05→12/11	9HX (DV6ATED4)	Diesel	1560	4	16	37
Berlingo Box (M_)	07/05→12/11	DV6B	Diesel	1560	4	16	37
Berlingo Platform/Chassis (B9)	04/08→	9HX (DV6ATED4)	Diesel	1560	4	16	37
Berlingo Platform/Chassis (B9)	07/10→	9HJ (DV6DTE)	Diesel	1560	4	8	35
Berlingo Platform/Chassis (B9)	12/14→	BHY (DV6FD)	Diesel	1560	4	8	35
BX (XB-)	10/82→06/88	150A	Petrol	1360	4	8	24
BX (XB-)	10/82→06/88	171A	Petrol	1580	4	8	39
BX (XB-)	10/82→06/88	171C	Petrol	1580	4	8	39
BX (XB-)	10/82→12/92	XU52C	Petrol	1580	4	8	39
BX (XB-)	10/82→06/94	171B	Petrol	1580	4	8	39
BX (XB-)	04/83→07/89	K1G	Petrol	1360	4	8	26
BX (XB-)	04/83→02/93	150C	Petrol	1360	4	8	24
BX (XB-)	09/83→09/93	162 (XUD9)	Diesel	1905	4	8	57
BX (XB-)	09/83→09/93	D9A (XUD9)	Diesel	1905	4	8	57
BX (XB-)	09/83→09/93	DJZ (XUD9Y)	Diesel	1905	4	8	61
BX (XB-)	09/84→01/92	D2E	Petrol	1905	4	8	56
BX (XB-)	10/84→06/94	D6A (XU9J2)	Petrol	1905	4	8	56
BX (XB-)	07/85→02/93	171D	Petrol	1580	4	8	39
BX (XB-)	09/85→02/93	150F	Petrol	1360	4	8	24
BX (XB-)	10/85→09/93	161 (XUD7)	Diesel	1769	4	8	52
BX (XB-)	03/86→02/93	180Z	Petrol	1580	4	8	39
BX (XB-)	07/86→05/89	159A	Petrol	1905	4	8	56
BX (XB-)	07/86→01/92	D2A (XU92C)	Petrol	1905	4	8	56
BX (XB-)	09/86→11/89	D2C (XU92C)	Petrol	1905	4	8	56
BX (XB-)	10/86→06/92	H1A	Petrol	1124	4	8	13
BX (XB-)	01/87→01/92	B6D	Petrol	1580	4	8	39
BX (XB-)	01/87→01/92	B6E	Petrol	1580	4	8	41
BX (XB-)	01/87→02/93	B1E (XU51C)	Petrol	1580	4	8	39
BX (XB-)	03/87→10/93	D9B (XUD9A/U)	Diesel	1905	4	8	59
BX (XB-)	09/87→12/88	D6C (XU9J4)	Petrol	1905	4	16	58
BX (XB-)	09/87→02/93	B1A (XU51C/K)	Petrol	1580	4	8	39
BX (XB-)	03/88→02/93	A8A (XUD7TE)	Diesel	1769	4	8	52
BX (XB-)	03/88→02/93	AJZ (XUD7TE)	Diesel	1769	4	8	52
BX (XB-)	03/88→02/93	DFW (XU9J4)	Petrol	1905	4	16	58
BX (XB-)	06/88→02/93	DDZ (XU9M)	Petrol	1905	4	8	56
BX (XB-)	06/88→02/93	DKZ (XU9JA)	Petrol	1905	4	8	56
BX (XB-)	09/88→02/93	BAY (XU5CP)	Petrol	1580	4	8	39
BX (XB-)	09/88→02/93	BAZ (XU5CP)	Petrol	1580	4	8	39
BX (XB-)	10/88→06/92	HDZ (TU1M)	Petrol	1124	4	8	13
BX (XB-)	01/89→12/89	K1H (TU3A)	Petrol	1360	4	8	26
BX (XB-)	01/89→02/93	KDY (TU3M)	Petrol	1360	4	8	26
BX (XB-)	01/89→02/93	KDZ (TU3M/Z)	Petrol	1360	4	8	26
BX (XB-)	04/89→02/93	D2F	Petrol	1905	4	8	56
BX (XB-)	05/89→02/93	BDY (XU5M)	Petrol	1580	4	8	39
BX (XB-)	05/89→02/93	BDZ (XU5M)	Petrol	1580	4	8	39
BX Break (XB-)	04/83→01/92	171C	Petrol	1580	4	8	39
BX Break (XB-)	09/83→11/94	162 (XUD9)	Diesel	1905	4	8	57
BX Break (XB-)	09/83→11/94	D9A (XUD9)	Diesel	1905	4	8	57
BX Break (XB-)	09/83→11/94	DJZ (XUD9Y)	Diesel	1905	4	8	61
BX Break (XB-)	06/85→06/88	171A	Petrol	1580	4	8	39
BX Break (XB-)	06/85→06/88	171B	Petrol	1580	4	8	39
BX Break (XB-)	07/85→12/94	171D	Petrol	1580	4	8	39
BX Break (XB-)	10/85→09/93	161A (XUD7)	Diesel	1769	4	8	52
BX Break (XB-)	01/86→02/93	150C	Petrol	1360	4	8	24
BX Break (XB-)	03/86→12/94	180Z	Petrol	1580	4	8	39
BX Break (XB-)	07/86→12/94	D2A (XU92C)	Petrol	1905	4	8	56
BX Break (XB-)	07/86→12/94	D6A (XU9J2)	Petrol	1905	4	8	56
BX Break (XB-)	07/86→12/94	DFZ (XU9J1)	Petrol	1905	4	8	56









CC



9

BX Break (XB-)	01/87→01/92	B6D	Petrol	1580	4	8	39
BX Break (XB-)	01/87→01/92	B6E	Petrol	1580	4	8	41
BX Break (XB-)	01/87→01/92	D2E	Petrol	1905	4	8	56
BX Break (XB-)	01/87→01/92	D9B (XUD9A/L)	Diesel	1905	4	8	59
BX Break (XB-)	01/87→01/92	K1F	Petrol	1360	4	8	26
BX Break (XB-)	01/87→12/94	B1E (XU51C)	Petrol	1580	4	8	39
BX Break (XB-)	03/87→12/94	D9B (XUD9A/U)	Diesel	1905	4	8	59
BX Break (XB-)	12/87→12/89	D2C (XU92C)	Petrol	1905	4	8	56
BX Break (XB-)	03/88→12/94	A8A (XUD7TE)	Diesel	1769	4	8	52
BX Break (XB-)	03/88→12/94	AJZ (XUD7TE)	Diesel	1769	4	8	52
BX Break (XB-)	06/88→12/94	DDZ (XU9M)	Petrol	1905	4	8	56
BX Break (XB-)	06/88→12/94	DKZ (XU9JA)	Petrol	1905	4	8	56
BX Break (XB-)	09/88→12/94	BAY (XU5CP)	Petrol	1580	4	8	39
BX Break (XB-)	09/88→12/94	BAZ (XU5CP)	Petrol	1580	4	8	39
BX Break (XB-)	01/89→12/89	K1H (TU3A)	Petrol	1360	4	8	26
BX Break (XB-)	01/89→02/93	KDY (TU3M)	Petrol	1360	4	8	26
BX Break (XB-)	05/89→12/94	BDY (XU5M)	Petrol	1580	4	8	39
BX Break (XB-)	05/89→12/94	BDZ (XU5M)	Petrol	1580	4	8	39
C1 (PM_, PN_)	06/05→09/14	1KR-FE	Petrol	998	3	12	5
C1 (PM_, PN_)	06/05→09/14	8HT (DV4TD)	Diesel	1398	4	8	22
C1 II	04/14→	1KR-FE	Petrol	998	3	12	5
C1 II	04/14→	HMT (EB2D)	Petrol	1199	3	12	18
C2 (JM_)	09/03→	8HX (DV4TD)	Diesel	1398	4	8	22
C2 (JM_)	09/03→	8HZ (DV4TD)	Diesel	1398	4	8	22
C2 (JM_)	09/03→	HFX (TU1JP)	Petrol	1124	4	8	14
C2 (JM_)	09/03→	KFV (TU3JP)	Petrol	1360	4	8	30
C2 (JM_)	09/03→	NFU (TU5JP4)	Petrol	1587	4	16	48
C2 (JM_)	01/05→	NFS (TU5JP4S)	Petrol	1587	4	16	46
C2 (JM_)	09/05→	9HZ (DV6TED4)	Diesel	1560	4	16	37
C2 (JM_)	06/06→	KFU (ET3J4)	Petrol	1360	4	16	29
C2 (T11)	10/06→12/14	TU5JP4	Petrol	1587	4	16	43
C2 Enterprise	04/09→	8HX (DV4TD)	Diesel	1398	4	8	22
C3 (FC_)	06/05→	NFU (TU5JP4)	Petrol	1587	4	16	48
C3 (FC_)	01/09→	KFV (TU3JP)	Petrol	1360	4	8	30
C3 Aircross	06/13→	NFU (TU5JP4)	Petrol	1587	4	16	48
C3 I (FC_)	02/02→	8HX (DV4TD)	Diesel	1398	4	8	22
C3 I (FC_)	02/02→	8HY (DV4TED4)	Diesel	1398	4	16	23
C3 I (FC_)	02/02→	8HZ (DV4TD)	Diesel	1398	4	8	22
C3 I (FC_)	02/02→	HFX (TU1A)	Petrol	1124	4	8	14
C3 I (FC_)	02/02→	HFX (TU1JP)	Petrol	1124	4	8	14
C3 I (FC_)	02/02→	KFV (TU3A)	Petrol	1360	4	8	28
C3 I (FC_)	02/02→	KFV (TU3JP)	Petrol	1360	4	8	30
C3 I (FC_)	02/02→	NFU (TU5JP4)	Petrol	1587	4	16	48
C3 I (FC_)	12/03→	KFU (ET3J4)	Petrol	1360	4	16	29
C3 I (FC_)	09/05→	9HZ (DV6TED4)	Diesel	1560	4	16	37
C3 I (FC_)	10/05→	9HX (DV6ATED4)	Diesel	1560	4	16	37
C3 II	11/09→	5FS (EP6C)	Petrol	1598	4	16	34
C3 II	11/09→	8FP (EP3)	Petrol	1397	4	16	21
C3 II	11/09→	8FR (EP3)	Petrol	1397	4	16	21
C3 II	11/09→	8HR (DV4C)	Diesel	1398	4	8	22
C3 II	11/09→	8HZ (DV4TD)	Diesel	1398	4	8	22
C3 II	11/09→	9HP (DV6DTE)	Diesel	1560	4	8	35
C3 II	11/09→	9HR (DV6C)	Diesel	1560	4	8	35
C3 II	11/09→	9HX (DV6ATED4)	Diesel	1560	4	16	37
C3 II	11/09→	HFX (TU1JP)	Petrol	1124	4	8	14
C3 II	11/09→	KFT (TU3A)	Petrol	1360	4	8	28
C3 II	11/09→	KFV (TU3A)	Petrol	1360	4	8	28
C3 II	11/10→	HFX (TU1A)	Petrol	1124	4	8	14
C3 II	06/12→	HMZ (EB2F)	Petrol	1199	3	12	18
C3 II	08/12→	ZMZ (E80)	Petrol	999	3	12	10
C3 II	09/12→	9HD (DV6C)	Diesel	1560	4	8	35
C3 II	06/13→	8FN (EP3)	Petrol	1397	4	16	21
C3 II	07/14→	BHY (DV6FD)	Diesel	1560	4	8	35
C3 II	10/14→	HNZ (EB2DT)	Petrol	1199	3	12	18
C3 II	04/15→	BHW (DV6FE)	Diesel	1560	4	8	35
C3 III (SX)	07/16→	BHW (DV6FE)	Diesel	1560	4	8	35
C3 III (SX)	07/16→	BHY (DV6FD)	Diesel	1560	4	8	35
C3 III (SX)	07/16→	HMZ (EB2F)	Petrol	1199	3	12	18
C3 III (SX)	07/16→	HNZ (EB2DT)	Petrol	1199	3	12	18
C3 III (SX)	01/17→	NFP (EC5)	Petrol	1587	4	16	44
C3 Picasso	02/09→	5FS (EP6C)	Petrol	1598	4	16	34
C3 Picasso	02/09→	5FW (EP6)	Petrol	1598	4	16	34
C3 Picasso	02/09→	8FN (EP3)	Petrol	1397	4	16	21
C3 Picasso	02/09→	8FP (EP3)	Petrol	1397	4	16	21
C3 Picasso	02/09→	8FS (EP3)	Petrol	1397	4	16	21
C3 Picasso	02/09→	9HX (DV6ATED4)	Diesel	1560	4	16	37
C3 Picasso	02/09→	9HZ (DV6TED4)	Diesel	1560	4	16	37
C3 Picasso	05/10→	9HR (DV6C)	Diesel	1560	4	8	35

				CC			9
C3 Picasso	07/10→	9HP (DV6DTEd)	Diesel	1560	4	8	35
C3 Picasso	04/11→	NFX (TU5JP4)	Petrol	1587	4	16	43
C3 Picasso	07/12→	NFU (TU5JP4)	Petrol	1587	4	16	48
C3 Picasso	01/13→	9HD (DV6C)	Diesel	1560	4	8	35
C3 Picasso	06/13→	NFP (EC5)	Petrol	1587	4	16	44
C3 Picasso	01/15→	BHY (DV6FD)	Diesel	1560	4	8	35
C3 Picasso	01/15→	HNZ (EB2DT)	Petrol	1199	3	12	18
C3 Picasso	10/16→	5FP (EP6)	Petrol	1598	4	16	33
C3 Pluriel (HB_)	05/03→	KFV (TU3JP)	Petrol	1360	4	8	30
C3 Pluriel (HB_)	05/03→	NFU (TU5JP4)	Petrol	1587	4	16	48
C3 Pluriel (HB_)	07/03→	KFV (TU3A)	Petrol	1360	4	8	28
C3 Pluriel (HB_)	04/04→	8HX (DV4TD)	Diesel	1398	4	8	22
C4 Aircross	08/10→	NFX (TU5JP4)	Petrol	1587	4	16	43
C4 Aircross	04/12→	4B11	Petrol	1998	4	16	63
C4 Aircross	04/12→	9HD (DV6C)	Diesel	1560	4	8	35
C4 Aircross	05/12→	9HL (DV6C)	Diesel	1560	4	8	35
C4 Cactus	09/14→	9HP (DV6DTEd)	Diesel	1560	4	8	35
C4 Cactus	09/14→	BHY (DV6FD)	Diesel	1560	4	8	35
C4 Cactus	09/14→	HMU (EB2D)	Petrol	1199	3	12	18
C4 Cactus	09/14→	HMZ (EB2F)	Petrol	1199	3	12	18
C4 Cactus	09/14→	HNZ (EB2DT)	Petrol	1199	3	12	18
C4 Coupe (LA_)	11/04→07/07	RFN (EW10J4)	Petrol	1997	4	16	73
C4 Coupe (LA_)	11/04→12/10	RFK (EW10J4S)	Petrol	1997	4	16	70
C4 Coupe (LA_)	11/04→12/10	RHR (DW10BTEd4)	Diesel	1997	4	16	78
C4 Coupe (LA_)	11/04→07/11	9HX (DV6ATEd4)	Diesel	1560	4	16	37
C4 Coupe (LA_)	11/04→07/11	9HY (DV6TEd4)	Diesel	1560	4	16	37
C4 Coupe (LA_)	11/04→07/11	9HZ (DV6TEd4)	Diesel	1560	4	16	37
C4 Coupe (LA_)	11/04→07/11	KFU (ET3J4)	Petrol	1360	4	16	29
C4 Coupe (LA_)	11/04→07/11	NFU (TU5JP4)	Petrol	1587	4	16	48
C4 Coupe (LA_)	10/06→12/07	RFJ (EW10A)	Petrol	1997	4	16	73
C4 Coupe (LA_)	07/08→07/11	5FW (EP6)	Petrol	1598	4	16	34
C4 Coupe (LA_)	07/08→07/11	5FX (EP6DT)	Petrol	1598	4	16	34
C4 Coupe (LA_)	07/08→07/11	RHF (DW10BTEd4)	Diesel	1997	4	16	78
C4 Grand Picasso I (UA_)	10/06→	6FY (EW7A)	Petrol	1749	4	16	51
C4 Grand Picasso I (UA_)	10/06→	9HY (DV6TEd4)	Diesel	1560	4	16	37
C4 Grand Picasso I (UA_)	10/06→	9HZ (DV6TEd4)	Diesel	1560	4	16	37
C4 Grand Picasso I (UA_)	10/06→	RFJ (EW10A)	Petrol	1997	4	16	73
C4 Grand Picasso I (UA_)	10/06→	RHJ (DW10BTEd4)	Diesel	1997	4	16	78
C4 Grand Picasso I (UA_)	10/06→	RHR (DW10BTEd4)	Diesel	1997	4	16	78
C4 Grand Picasso I (UA_)	07/08→	5FT (EP6DT)	Petrol	1598	4	16	34
C4 Grand Picasso I (UA_)	07/08→	5FW (EP6)	Petrol	1598	4	16	34
C4 Grand Picasso I (UA_)	10/08→	5FX (EP6DT)	Petrol	1598	4	16	34
C4 Grand Picasso I (UA_)	07/09→	RHE (DW10CTEd4)	Diesel	1997	4	16	68
C4 Grand Picasso I (UA_)	09/10→	5FV (EP6CDT)	Petrol	1598	4	16	34
C4 Grand Picasso I (UA_)	09/10→	9HL (DV6C)	Diesel	1560	4	8	35
C4 Grand Picasso I (UA_)	09/10→	9HR (DV6C)	Diesel	1560	4	8	35
C4 Grand Picasso I (UA_)	09/10→	RHH (DW10CTEd4)	Diesel	1997	4	16	68
C4 Grand Picasso II	09/13→	5FS (EP6C)	Petrol	1598	4	16	34
C4 Grand Picasso II	09/13→	5FV (EP6CDT)	Petrol	1598	4	16	34
C4 Grand Picasso II	09/13→	9HC (DV6C)	Diesel	1560	4	8	35
C4 Grand Picasso II	09/13→	9HP (DV6DTEd)	Diesel	1560	4	8	35
C4 Grand Picasso II	09/13→	AHS (DW10FD)	Diesel	1997	4	16	67
C4 Grand Picasso II	09/13→	AHV (DW10FD)	Diesel	1997	4	16	68
C4 Grand Picasso II	09/13→	AHX (DW10FD)	Diesel	1997	4	16	68
C4 Grand Picasso II	09/13→	BHX (DV6FC)	Diesel	1560	4	8	35
C4 Grand Picasso II	04/14→	HNY (EB2DTS)	Petrol	1199	3	12	18
C4 Grand Picasso II	07/14→	5GZ (EP6FDT)	Petrol	1598	4	16	34
C4 Grand Picasso II	07/14→	BHZ (DV6FC)	Diesel	1560	4	8	35
C4 Grand Picasso II	09/14→	5FX (EP6DT)	Petrol	1598	4	16	34
C4 Grand Picasso II	01/15→	BHY (DV6FD)	Diesel	1560	4	8	35
C4 I (LC_)	11/04→07/07	RFN (EW10J4)	Petrol	1997	4	16	73
C4 I (LC_)	11/04→07/08	RFK (EW10J4S)	Petrol	1997	4	16	70
C4 I (LC_)	11/04→07/11	9HX (DV6ATEd4)	Diesel	1560	4	16	37
C4 I (LC_)	11/04→07/11	9HY (DV6TEd4)	Diesel	1560	4	16	37
C4 I (LC_)	11/04→07/11	9HZ (DV6TEd4)	Diesel	1560	4	16	37
C4 I (LC_)	11/04→07/11	KFU (ET3J4)	Petrol	1360	4	16	29
C4 I (LC_)	11/04→07/11	NFU (TU5JP4)	Petrol	1587	4	16	48
C4 I (LC_)	11/04→07/11	RFJ (EW10A)	Petrol	1997	4	16	73
C4 I (LC_)	11/04→07/11	RHR (DW10BTEd4)	Diesel	1997	4	16	78
C4 I (LC_)	04/07→07/08	RHZ (DW10ATEd)	Diesel	1997	4	8	79
C4 I (LC_)	07/08→07/11	5FT (EP6DT)	Petrol	1598	4	16	34
C4 I (LC_)	07/08→07/11	5FW (EP6)	Petrol	1598	4	16	34
C4 I (LC_)	07/08→07/11	5FX (EP6DT)	Petrol	1598	4	16	34
C4 I (LC_)	07/08→07/11	RHF (DW10BTEd4)	Diesel	1997	4	16	78
C4 II (B7)	11/09→	5FS (EP6C)	Petrol	1598	4	16	34
C4 II (B7)	11/09→	5FV (EP6CDT)	Petrol	1598	4	16	34
C4 II (B7)	11/09→	8FP (EP3)	Petrol	1397	4	16	21
C4 II (B7)	11/09→	9HP (DV6DTEd)	Diesel	1560	4	8	35



CC



9

C4 II (B7)	11/09→	9HR (DV6C)	Diesel	1560	4	8	35
C4 II (B7)	11/09→	AHR (DW10FD)	Diesel	1997	4	16	68
C4 II (B7)	11/09→	NFX (TU5JP4)	Petrol	1587	4	16	43
C4 II (B7)	11/09→	RHE (DW10CTED4)	Diesel	1997	4	16	68
C4 II (B7)	07/12→	9HD (DV6C)	Diesel	1560	4	8	35
C4 II (B7)	04/14→	HNY (EB2DTS)	Petrol	1199	3	12	18
C4 II (B7)	07/14→	BHY (DV6FD)	Diesel	1560	4	8	35
C4 II (B7)	08/14→	BHX (DV6FC)	Diesel	1560	4	8	35
C4 II (B7)	02/15→	BHZ (DV6FC)	Diesel	1560	4	8	35
C4 II (B7)	02/15→	HNZ (EB2DT)	Petrol	1199	3	12	18
C4 Picasso I (UD_)	10/06→08/13	RHJ (DW10BTED4)	Diesel	1997	4	16	78
C4 Picasso I (UD_)	10/06→08/13	RHR (DW10BTED4)	Diesel	1997	4	16	78
C4 Picasso I (UD_)	02/07→10/12	6FY (EW7A)	Petrol	1749	4	16	51
C4 Picasso I (UD_)	02/07→08/13	9HY (DV6TED4)	Diesel	1560	4	16	37
C4 Picasso I (UD_)	02/07→08/13	9HZ (DV6TED4)	Diesel	1560	4	16	37
C4 Picasso I (UD_)	02/07→08/13	RFJ (EW10A)	Petrol	1997	4	16	73
C4 Picasso I (UD_)	05/08→05/13	RFN (EW10J4)	Petrol	1997	4	16	73
C4 Picasso I (UD_)	07/08→08/13	5FT (EP6DT)	Petrol	1598	4	16	34
C4 Picasso I (UD_)	07/08→08/13	5FW (EP6)	Petrol	1598	4	16	34
C4 Picasso I (UD_)	07/08→08/13	5FX (EP6DT)	Petrol	1598	4	16	34
C4 Picasso I (UD_)	07/09→08/13	RHE (DW10CTED4)	Diesel	1997	4	16	68
C4 Picasso I (UD_)	09/10→08/13	5FV (EP6CDT)	Petrol	1598	4	16	34
C4 Picasso I (UD_)	09/10→08/13	9HR (DV6C)	Diesel	1560	4	8	35
C4 Picasso I (UD_)	09/10→08/13	RHH (DW10CTED4)	Diesel	1997	4	16	68
C4 Picasso II	02/13→	5FS (EP6C)	Petrol	1598	4	16	34
C4 Picasso II	02/13→	5FV (EP6CDT)	Petrol	1598	4	16	34
C4 Picasso II	02/13→	9HC (DV6C)	Diesel	1560	4	8	35
C4 Picasso II	02/13→	9HP (DV6DTE4)	Diesel	1560	4	8	35
C4 Picasso II	02/13→	BHX (DV6FC)	Diesel	1560	4	8	35
C4 Picasso II	09/13→	AHS (DW10FD)	Diesel	1997	4	16	67
C4 Picasso II	09/13→	AHV (DW10FD)	Diesel	1997	4	16	68
C4 Picasso II	09/13→	AHX (DW10FD)	Diesel	1997	4	16	68
C4 Picasso II	04/14→	HNY (EB2DTS)	Petrol	1199	3	12	18
C4 Picasso II	07/14→	5GZ (EP6FDT)	Petrol	1598	4	16	34
C4 Picasso II	07/14→	BHZ (DV6FC)	Diesel	1560	4	8	35
C4 Picasso II	09/14→	5FX (EP6DT)	Petrol	1598	4	16	34
C4 Picasso II	12/14→	BHY (DV6FD)	Diesel	1560	4	8	35
C4 Picasso II	04/16→	HNZ (EB2DT)	Petrol	1199	3	12	18
C4 Saloon	07/06→07/11	9HY (DV6TED4)	Diesel	1560	4	16	37
C4 Saloon	07/06→07/11	9HZ (DV6TED4)	Diesel	1560	4	16	37
C4 Saloon	07/06→	NFU (TU5JP4)	Petrol	1587	4	16	48
C4 Saloon	07/06→	RFJ (EW10A)	Petrol	1997	4	16	73
C4 Saloon	04/07→12/11	RHZ (DW10ATED)	Diesel	1997	4	8	79
C4 Saloon	06/07→12/10	RHF (DW10BTED4)	Diesel	1997	4	16	78
C4 Saloon	07/07→12/08	RFN (EW10J4)	Petrol	1997	4	16	73
C4 Saloon	09/13→	5FM (EP6DT)	Petrol	1598	4	16	34
C5	01/13→	PSA RFN 10LH3X	Petrol	1997	4	16	70
C5 I (DC_)	03/01→08/04	4HX (DW12TED4/FAP)	Diesel	2179	4	16	85
C5 I (DC_)	03/01→08/04	6FZ (EW7J4)	Petrol	1749	4	16	51
C5 I (DC_)	03/01→08/04	RFN (EW10J4)	Petrol	1997	4	16	73
C5 I (DC_)	03/01→08/04	RHS (DW10ATED)	Diesel	1997	4	8	79
C5 I (DC_)	03/01→08/04	RHY (DW10TD)	Diesel	1997	4	8	79
C5 I (DC_)	03/01→08/04	RHZ (DW10ATED)	Diesel	1997	4	8	79
C5 I (DC_)	03/01→08/04	RLZ (EW10D)	Petrol	1997	4	16	70
C5 I (DC_)	03/01→08/04	XFX (ES9J4S)	Petrol	2946	6	24	108
C5 I (DC_)	08/02→03/05	XFX (ES9A)	Petrol	2946	6	24	108
C5 I Break (DE_)	06/01→08/04	4HX (DW12TED4/FAP)	Diesel	2179	4	16	85
C5 I Break (DE_)	06/01→08/04	6FZ (EW7J4)	Petrol	1749	4	16	51
C5 I Break (DE_)	06/01→08/04	RFN (EW10J4)	Petrol	1997	4	16	73
C5 I Break (DE_)	06/01→08/04	RHS (DW10ATED)	Diesel	1997	4	8	79
C5 I Break (DE_)	06/01→08/04	RHY (DW10TD)	Diesel	1997	4	8	79
C5 I Break (DE_)	06/01→08/04	RHZ (DW10ATED)	Diesel	1997	4	8	79
C5 I Break (DE_)	06/01→08/04	RLZ (EW10D)	Petrol	1997	4	16	70
C5 I Break (DE_)	06/01→08/04	XFX (ES9J4S)	Petrol	2946	6	24	108
C5 II (RC_)	09/04→	4HX (DW12TED4/FAP)	Diesel	2179	4	16	85
C5 II (RC_)	09/04→	6FZ (EW7J4)	Petrol	1749	4	16	51
C5 II (RC_)	09/04→	9HY (DV6TED4)	Diesel	1560	4	16	37
C5 II (RC_)	09/04→	9HZ (DV6TED4)	Diesel	1560	4	16	37
C5 II (RC_)	09/04→	RFJ (EW10A)	Petrol	1997	4	16	73
C5 II (RC_)	09/04→	RHR (DW10BTED4)	Diesel	1997	4	16	78
C5 II (RC_)	09/04→	XFU (ES9A)	Petrol	2946	6	24	104
C5 II (RC_)	09/04→	XFX (ES9J4S)	Petrol	2946	6	24	108
C5 II (RC_)	10/04→04/07	XFV (ES9A)	Petrol	2946	6	24	104
C5 II (RC_)	09/05→	6FY (EW7A)	Petrol	1749	4	16	51
C5 II (RC_)	04/06→	4HT (DW12BTED4)	Diesel	2179	4	16	84
C5 II (RC_)	05/06→	4HP (DW12BTED4)	Diesel	2179	4	16	84
C5 II (RC_)	05/06→	4HR (DW12BTED4)	Diesel	2179	4	16	84
C5 II Break (RE_)	09/04→	4HX (DW12TED4/FAP)	Diesel	2179	4	16	85



CC



9

C5 II Break (RE_)	09/04 →	6FZ (EW7J4)	Petrol	1749	4	16	51
C5 II Break (RE_)	09/04 →	9HY (DV6TED4)	Diesel	1560	4	16	37
C5 II Break (RE_)	09/04 →	9HZ (DV6TED4)	Diesel	1560	4	16	37
C5 II Break (RE_)	09/04 →	RFJ (EW10A)	Petrol	1997	4	16	73
C5 II Break (RE_)	09/04 →	RHR (DW10BTE4)	Diesel	1997	4	16	78
C5 II Break (RE_)	09/04 →	XFU (ES9A)	Petrol	2946	6	24	104
C5 II Break (RE_)	09/04 →	XFX (ES9J4S)	Petrol	2946	6	24	108
C5 II Break (RE_)	09/05 →	6FY (EW7A)	Petrol	1749	4	16	51
C5 II Break (RE_)	04/06 →	4HT (DW12BTE4)	Diesel	2179	4	16	84
C5 II Break (RE_)	05/06 →	4HP (DW12BTE4)	Diesel	2179	4	16	84
C5 II Break (RE_)	05/06 →	4HR (DW12BTE4)	Diesel	2179	4	16	84
C5 III (RD_)	02/08 →	4HT (DW12BTE4)	Diesel	2179	4	16	84
C5 III (RD_)	02/08 →	6FY (EW7A)	Petrol	1749	4	16	51
C5 III (RD_)	02/08 →	9HZ (DV6TED4)	Diesel	1560	4	16	37
C5 III (RD_)	02/08 →	DT17ED4	Diesel	2720	6	24	102
C5 III (RD_)	02/08 →	RFJ (EW10A)	Petrol	1997	4	16	73
C5 III (RD_)	02/08 →	RHF (DW10BTE4)	Diesel	1997	4	16	78
C5 III (RD_)	02/08 →	RHR (DW10BTE4)	Diesel	1997	4	16	78
C5 III (RD_)	02/08 →	XFU (ES9A)	Petrol	2946	6	24	104
C5 III (RD_)	02/08 →	XFV (ES9A)	Petrol	2946	6	24	104
C5 III (RD_)	04/09 →	5FV (EP6CDT)	Petrol	1598	4	16	34
C5 III (RD_)	04/09 →	AHR (DW10FDF)	Diesel	1997	4	16	68
C5 III (RD_)	04/09 →	DT20C	Diesel	2993	6	24	105
C5 III (RD_)	04/09 →	RHE (DW10CTED4)	Diesel	1997	4	16	68
C5 III (RD_)	04/09 →	RHH (DW10CTED4)	Diesel	1997	4	16	68
C5 III (RD_)	07/10 →	4HL (DW12C)	Diesel	2179	4	16	84
C5 III (RD_)	07/10 →	5FN (EP6CDT)	Petrol	1598	4	16	34
C5 III (RD_)	07/10 →	5FS (EP6C)	Petrol	1598	4	16	34
C5 III (RD_)	07/10 →	9HL (DV6C)	Diesel	1560	4	8	35
C5 III (RD_)	07/10 →	9HR (DV6C)	Diesel	1560	4	8	35
C5 III (RD_)	03/11 →	5FM (EP6DT)	Petrol	1598	4	16	34
C5 III (RD_)	03/15 →	AHW (DW10FC)	Diesel	1997	4	16	68
C5 III Break (TD_)	02/08 →	4HP (DW12BTE4)	Diesel	2179	4	16	84
C5 III Break (TD_)	02/08 →	4HT (DW12BTE4)	Diesel	2179	4	16	84
C5 III Break (TD_)	02/08 →	6FY (EW7A)	Petrol	1749	4	16	51
C5 III Break (TD_)	02/08 →	9HZ (DV6TED4)	Diesel	1560	4	16	37
C5 III Break (TD_)	02/08 →	DT17ED4	Diesel	2720	6	24	102
C5 III Break (TD_)	02/08 →	RFJ (EW10A)	Petrol	1997	4	16	73
C5 III Break (TD_)	02/08 →	RHR (DW10BTE4)	Diesel	1997	4	16	78
C5 III Break (TD_)	02/08 →	UHZ (DT17BTE4)	Diesel	2720	6	24	102
C5 III Break (TD_)	02/08 →	XFU (ES9A)	Petrol	2946	6	24	104
C5 III Break (TD_)	02/08 →	XFV (ES9A)	Petrol	2946	6	24	104
C5 III Break (TD_)	02/08 →	XFX (ES9J4S)	Petrol	2946	6	24	108
C5 III Break (TD_)	04/09 →	5FN (EP6CDT)	Petrol	1598	4	16	34
C5 III Break (TD_)	04/09 →	5FV (EP6CDT)	Petrol	1598	4	16	34
C5 III Break (TD_)	04/09 →	AHR (DW10FDF)	Diesel	1997	4	16	68
C5 III Break (TD_)	04/09 →	DT20C	Diesel	2993	6	24	105
C5 III Break (TD_)	04/09 →	RHE (DW10CTED4)	Diesel	1997	4	16	68
C5 III Break (TD_)	04/09 →	RHF (DW10BTE4)	Diesel	1997	4	16	78
C5 III Break (TD_)	04/09 →	RHH (DW10CTED4)	Diesel	1997	4	16	68
C5 III Break (TD_)	07/10 →	4HL (DW12C)	Diesel	2179	4	16	84
C5 III Break (TD_)	07/10 →	5FS (EP6C)	Petrol	1598	4	16	34
C5 III Break (TD_)	07/10 →	9HL (DV6C)	Diesel	1560	4	8	35
C5 III Break (TD_)	07/10 →	9HR (DV6C)	Diesel	1560	4	8	35
C5 III Break (TD_)	03/15 →	AHW (DW10FC)	Diesel	1997	4	16	68
C6 (TD_)	09/05 →	DT17ED4	Diesel	2720	6	24	102
C6 (TD_)	09/05 →	UHZ (DT17BTE4)	Diesel	2720	6	24	102
C6 (TD_)	09/05 →	XFV (ES9A)	Petrol	2946	6	24	104
C6 (TD_)	09/05 →	XFX (ES9J4S)	Petrol	2946	6	24	108
C6 (TD_)	06/06 →	4HP (DW12BTE4)	Diesel	2179	4	16	84
C6 (TD_)	06/06 →	4HT (DW12BTE4)	Diesel	2179	4	16	84
C6 (TD_)	04/09 →	DT20C	Diesel	2993	6	24	105
C8 (EA_, EB_)	07/02 →	3FZ (EW12J4)	Petrol	2230	4	16	82
C8 (EA_, EB_)	07/02 →	4HW (DW12TED4)	Diesel	2179	4	16	85
C8 (EA_, EB_)	07/02 →	RFN (EW10J4)	Petrol	1997	4	16	73
C8 (EA_, EB_)	07/02 →	RHM (DW10ATED4)	Diesel	1997	4	16	78
C8 (EA_, EB_)	07/02 →	RHT (DW10ATED4)	Diesel	1997	4	16	78
C8 (EA_, EB_)	07/02 →	RHW (DW10ATED4)	Diesel	1997	4	16	78
C8 (EA_, EB_)	07/02 →	XFX (ES9J4S)	Petrol	2946	6	24	108
C8 (EA_, EB_)	09/05 →	RFJ (EW10A)	Petrol	1997	4	16	73
C8 (EA_, EB_)	03/06 →	RHD (DW10CB)	Diesel	1997	4	16	68
C8 (EA_, EB_)	03/06 →	RHD (DW10CTED4)	Diesel	1997	4	16	68
C8 (EA_, EB_)	03/06 →	RHE (DW10CTED4)	Diesel	1997	4	16	68
C8 (EA_, EB_)	03/06 →	RHH (DW10CTED4)	Diesel	1997	4	16	68
C8 (EA_, EB_)	03/06 →	RHR (DW10BTE4)	Diesel	1997	4	16	78
C8 (EA_, EB_)	06/06 →	4HT (DW12BTE4)	Diesel	2179	4	16	84
C8 (EA_, EB_)	07/06 →	RHK (DW10UTED4)	Diesel	1997	4	16	78
C8 (EA_, EB_)	06/07 →	4HP (DW12BTE4)	Diesel	2179	4	16	84



CC



9

C8 (EA_, EB_)	06/07→	4HR (DW12BTD4)	Diesel	2179	4	16	84
C15 (VD-)	10/84→12/96	109K	Petrol	1124	4	8	11
C15 (VD-)	10/84→12/96	E1A	Petrol	1124	4	8	12
C15 (VD-)	10/84→12/97	TU9	Petrol	954	4	8	7
C15 (VD-)	10/84→12/97	XV8	Petrol	954	4	8	9
C15 (VD-)	07/86→12/00	161A (XUD7)	Diesel	1769	4	8	52
C15 (VD-)	05/87→12/96	150D (XY7)	Petrol	1360	4	8	25
C15 (VD-)	07/87→05/88	G1A	Petrol	1294	4	8	19
C15 (VD-)	07/87→12/96	K1H (TU3A)	Petrol	1360	4	8	26
C15 (VD-)	07/87→12/96	K3A	Petrol	1360	4	8	26
C15 (VD-)	07/88→12/96	HDZ (TU1M)	Petrol	1124	4	8	13
C15 (VD-)	11/88→07/96	H1A	Petrol	1124	4	8	13
C15 (VD-)	05/91→12/96	KDY (TU3FM)	Petrol	1360	4	8	26
C15 (VD-)	05/91→12/96	KDY (TU3M)	Petrol	1360	4	8	26
C15 (VD-)	11/92→07/96	TU9K	Petrol	954	4	8	7
C15 (VD-)	10/00→10/02	WJY (DW8B)	Diesel	1868	4	8	59
C15 (VD-)	12/00→12/05	WJX (DW8B)	Diesel	1868	4	8	59
C15 Estate	04/87→08/00	161A (XUD7)	Diesel	1769	4	8	52
C15 Estate	05/87→09/92	KAZ	Petrol	1360	4	8	26
C15 Estate	05/87→10/92	150D (XY7)	Petrol	1360	4	8	25
C15 Estate	08/88→07/96	HDZ (TU1M)	Petrol	1124	4	8	13
C15 Estate	05/91→07/96	KDY (TU3M)	Petrol	1360	4	8	26
C25 Box (280_, 290_)	09/81→03/94	170A (XNIT)	Petrol	1971	4	8	64
C25 Box (280_, 290_)	09/81→03/94	170B (XNIT)	Petrol	1971	4	8	64
C25 Box (280_, 290_)	11/81→01/94	169 (XM7T)	Petrol	1796	4	8	53
C25 Box (280_, 290_)	11/81→01/94	CRD93L (U25-661)	Diesel	2500	4	8	98
C25 Box (280_, 290_)	01/88→01/94	DJY (XUD9A)	Diesel	1905	4	8	57
C25 Box (280_, 290_)	01/90→03/94	170C (XNIT)	Petrol	1971	4	8	64
C25 Box (280_, 290_)	08/91→01/94	CRD93LS (U25-673)	Diesel	2500	4	8	98
C25 Bus (280_, 290_)	09/81→02/94	170A (XNIT)	Petrol	1971	4	8	64
C25 Bus (280_, 290_)	09/81→02/94	170B (XNIT)	Petrol	1971	4	8	64
C25 Bus (280_, 290_)	11/81→02/94	169 (XM7T)	Petrol	1796	4	8	53
C25 Bus (280_, 290_)	11/81→02/94	CRD93L (U25-661)	Diesel	2500	4	8	98
C25 Bus (280_, 290_)	07/87→02/94	D9B (XUD9A/U)	Diesel	1905	4	8	59
C25 Bus (280_, 290_)	08/87→02/94	CRD93LS (U25-673)	Diesel	2500	4	8	98
C25 Bus (280_, 290_)	02/91→02/94	170C (XNIT)	Petrol	1971	4	8	64
C25 Bus (280_, 290_)	04/92→02/94	M705	Diesel	1930	4	8	62
C25 Platform/Chassis (280_, 290_)	11/81→12/86	170A (XNIT)	Petrol	1971	4	8	64
C25 Platform/Chassis (280_, 290_)	11/83→01/94	CRD93L (U25-661)	Diesel	2500	4	8	98
C25 Platform/Chassis (280_, 290_)	01/87→01/94	CRD93LS (U25-673)	Diesel	2500	4	8	98
C25 Platform/Chassis (280_, 290_)	01/87→03/94	170C (XNIT)	Petrol	1971	4	8	64
C25 Platform/Chassis (280_, 290_)	07/87→02/94	169 (XM7T)	Petrol	1796	4	8	53
C25 Platform/Chassis (280_, 290_)	10/91→01/94	M705	Diesel	1930	4	8	62
C35 Box	11/73→01/80	B22615	Diesel	2175	4	8	87
C35 Box	11/73→01/94	B20614	Petrol	1985	4	8	69
C35 Box	02/80→01/94	B25637	Diesel	2498	4	8	96
C35 Bus	11/73→01/80	B22615	Diesel	2175	4	8	87
C35 Bus	11/73→01/94	B20614	Petrol	1985	4	8	69
C35 Bus	02/80→01/94	B25637	Diesel	2498	4	8	96
C35 Pickup	11/73→01/80	B22615	Diesel	2175	4	8	87
C35 Pickup	11/73→01/94	B20614	Petrol	1985	4	8	69
C35 Pickup	02/80→01/94	B25637	Diesel	2498	4	8	96
C-Crosser (EP_)	02/07→	4HN (DW12MTED4)	Diesel	2179	4	16	84
C-Crosser (EP_)	08/08→	SFZ (4B12-MMC)	Petrol	2360	4	16	94
C-Crosser (EP_)	11/10→	4B11	Petrol	1998	4	16	63
C-Crosser Enterprise	01/09→	4B12	Petrol	2360	4	16	93
C-Crosser Enterprise	01/09→	4HN (DW12MTED4)	Diesel	2179	4	16	84
C-Elysee	11/12→	9HJ (DV6DTEDM)	Diesel	1560	4	8	35
C-Elysee	11/12→	9HP (DV6DTED)	Diesel	1560	4	8	35
C-Elysee	11/12→	HMY (EB2M)	Petrol	1199	3	12	18
C-Elysee	11/12→	NFP (EC5)	Petrol	1587	4	16	44
C-Elysee	11/14→	BHY (DV6FD)	Diesel	1560	4	8	35
C-Quatre - SHI JIA	10/08→12/13	RFN	Petrol	1997	4	16	70
C-Quatre - SHI JIA Saloon	06/09→12/15	RFN	Petrol	1997	4	16	70
CX I (MA)	09/74→07/76	M22-617	Petrol	2175	4	8	89
CX I (MA)	10/75→02/79	M22-621	Diesel	2175	4	8	90
CX I (MA)	08/76→06/80	M23-623	Petrol	2347	4	8	92
CX I (MA)	06/77→06/82	M23-622	Petrol	2347	4	8	92
CX I (MA)	02/78→06/82	M25-629	Diesel	2500	4	8	96
CX I (MA)	06/79→08/85	829 A5	Petrol	1995	4	8	65
CX I (MA)	05/80→05/82	M23-639	Petrol	2347	4	8	92
CX I (MA)	06/81→08/85	J6T A500	Petrol	2165	4	8	88
CX I (MA)	04/83→08/85	M25-648	Diesel	2500	4	8	97
CX I (MA)	07/83→08/85	M25-659	Petrol	2500	4	8	99
CX I (MA)	06/84→08/85	M25-662	Petrol	2500	4	8	99
CX I Break (MA)	08/76→02/79	M22-621	Diesel	2175	4	8	90
CX I Break (MA)	08/76→06/80	M23-623	Petrol	2347	4	8	92
CX I Break (MA)	02/78→08/85	M25-629	Diesel	2500	4	8	96



CC



9

CX I Break (MA)	06/79→08/85	829 A5	Petrol	1995	4	8	65
CX I Break (MA)	05/80→05/82	M23-639	Petrol	2347	4	8	92
CX I Break (MA)	06/81→08/85	J6T A500	Petrol	2165	4	8	88
CX I Break (MA)	07/82→06/83	M23-622	Petrol	2347	4	8	92
CX I Break (MA)	04/83→08/85	M25-648	Diesel	2500	4	8	97
CX I Break (MA)	07/83→08/85	M25-659	Petrol	2500	4	8	99
CX II	07/85→12/92	J6T A500	Petrol	2165	4	8	88
CX II	08/85→12/86	M25-648	Diesel	2500	4	8	97
CX II	08/85→12/92	829 A5	Petrol	1995	4	8	65
CX II	08/85→12/92	M25-659	Petrol	2500	4	8	99
CX II	08/85→12/92	M25-660	Diesel	2500	4	8	97
CX II	08/85→12/92	M25-662	Petrol	2500	4	8	99
CX II	05/86→12/92	M25-668	Petrol	2498	4	8	99
CX II	09/86→12/92	M25-667	Petrol	2498	4	8	99
CX II	01/87→12/92	M25-669	Diesel	2500	4	8	97
CX II Break	07/85→12/92	J6T A500	Petrol	2165	4	8	88
CX II Break	08/85→08/86	829 A5	Petrol	1995	4	8	65
CX II Break	08/85→12/86	M25-648	Diesel	2500	4	8	97
CX II Break	08/85→12/92	M25-659	Petrol	2500	4	8	99
CX II Break	05/86→12/92	M25-660	Diesel	2500	4	8	97
CX II Break	05/86→12/92	M25-668	Petrol	2498	4	8	99
CX II Break	01/87→12/92	M25-669	Diesel	2500	4	8	97
DS	09/72→07/75	M23-623	Petrol	2347	4	8	92
DS	09/72→07/75	M23-627	Petrol	2348	4	8	92
DS3	11/09→07/15	8FR (EP3)	Petrol	1397	4	16	21
DS3	11/09→07/15	9HP (DV6DTE)	Diesel	1560	4	8	35
DS3	11/09→07/15	9HR (DV6C)	Diesel	1560	4	8	35
DS3	01/10→07/15	5FN (EP6CDT)	Petrol	1598	4	16	34
DS3	01/10→07/15	5FX (EP6DT)	Petrol	1598	4	16	34
DS3	04/10→07/15	5FR (EP6DT)	Petrol	1598	4	16	34
DS3	04/10→07/15	5FS (EP6C)	Petrol	1598	4	16	34
DS3	04/10→07/15	5FV (EP6CDT)	Petrol	1598	4	16	34
DS3	04/10→07/15	8FP (EP3)	Petrol	1397	4	16	21
DS3	04/10→07/15	8HR (DV4C)	Diesel	1398	4	8	22
DS3	02/11→07/15	5FD (EP6DTS)	Petrol	1598	4	16	34
DS3	02/11→07/15	5FU (EP6CTX)	Petrol	1598	4	16	34
DS3	01/12→07/15	5FM (EP6DT)	Petrol	1598	4	16	34
DS3	08/12→07/15	8FN (EP3)	Petrol	1397	4	16	21
DS3	08/12→07/15	9HD (DV6C)	Diesel	1560	4	8	35
DS3	08/12→07/15	9HL (DV6C)	Diesel	1560	4	8	35
DS3	01/13→03/15	HMZ (EB2F)	Petrol	1199	3	12	18
DS3	10/13→07/15	BHX (DV6FC)	Diesel	1560	4	8	35
DS3	10/13→07/15	BHZ (DV6FC)	Diesel	1560	4	8	35
DS3	07/14→07/15	BHY (DV6FD)	Diesel	1560	4	8	35
DS3	10/14→03/15	HNZ (EB2DT)	Petrol	1199	3	12	18
DS3	10/14→06/15	5GZ (EP6FDT)	Petrol	1598	4	16	34
DS3	03/15→07/15	BHW (DV6FE)	Diesel	1560	4	8	35
DS3 Convertible	01/13→07/15	5FN (EP6CDT)	Petrol	1598	4	16	34
DS3 Convertible	01/13→07/15	5FS (EP6C)	Petrol	1598	4	16	34
DS3 Convertible	01/13→07/15	5FV (EP6CDT)	Petrol	1598	4	16	34
DS3 Convertible	01/13→07/15	9HP (DV6DTE)	Diesel	1560	4	8	35
DS3 Convertible	01/13→07/15	HMZ (EB2F)	Petrol	1199	3	12	18
DS3 Convertible	10/13→07/15	BHX (DV6FC)	Diesel	1560	4	8	35
DS3 Convertible	03/14→07/15	5FD (EP6DTS)	Petrol	1598	4	16	34
DS3 Convertible	07/14→07/15	BHY (DV6FD)	Diesel	1560	4	8	35
DS3 Convertible	07/14→07/15	BHZ (DV6FC)	Diesel	1560	4	8	35
DS3 Convertible	10/14→07/15	5GZ (EP6FDT)	Petrol	1598	4	16	34
DS3 Convertible	10/14→07/15	HNZ (EB2DT)	Petrol	1199	3	12	18
DS4	04/11→07/15	5FE (EP6CTMD)	Petrol	1598	4	16	34
DS4	04/11→07/15	5FS (EP6C)	Petrol	1598	4	16	34
DS4	04/11→07/15	5FU (EP6CTX)	Petrol	1598	4	16	34
DS4	04/11→07/15	5FV (EP6CDT)	Petrol	1598	4	16	34
DS4	04/11→07/15	9HR (DV6C)	Diesel	1560	4	8	35
DS4	04/11→07/15	RHH (DW10CTED4)	Diesel	1997	4	16	68
DS4	05/11→07/15	9HP (DV6DTE)	Diesel	1560	4	8	35
DS4	09/11→07/15	AHS (DW10FD)	Diesel	1997	4	16	67
DS4	09/11→07/15	AHV (DW10FD)	Diesel	1997	4	16	68
DS4	09/11→07/15	RHD (DW10CB)	Diesel	1997	4	16	68
DS4	09/11→07/15	RHD (DW10CTED4)	Diesel	1997	4	16	68
DS4	01/12→07/15	5FM (EP6DT)	Petrol	1598	4	16	34
DS4	01/12→07/15	5GZ (EP6FDT)	Petrol	1598	4	16	34
DS4	08/12→07/15	9HD (DV6C)	Diesel	1560	4	8	35
DS4	08/12→07/15	9HL (DV6C)	Diesel	1560	4	8	35
DS4	07/14→07/15	AHW (DW10FC)	Diesel	1997	4	16	68
DS4	07/14→07/15	AHX (DW10FD)	Diesel	1997	4	16	68
DS4	07/14→07/15	BHZ (DV6FC)	Diesel	1560	4	8	35
DS4	07/14→07/15	HNY (EB2DTS)	Petrol	1199	3	12	18
DS4	08/14→07/15	BHX (DV6FC)	Diesel	1560	4	8	35











CC



9

D55	11/11→07/15	5FE (EP6CDTMD)	Petrol	1598	4	16	34
D55	11/11→07/15	5FU (EP6DTX)	Petrol	1598	4	16	34
D55	11/11→07/15	5FV (EP6CDT)	Petrol	1598	4	16	34
D55	11/11→07/15	9HR (DV6C)	Diesel	1560	4	8	35
D55	11/11→07/15	AHX (DW10FD)	Diesel	1997	4	16	68
D55	11/11→07/15	RHD (DW10CB)	Diesel	1997	4	16	68
D55	11/11→07/15	RHH (DW10CTED4)	Diesel	1997	4	16	68
D55	12/11→07/15	RHC (DW10CTED4)	Diesel	1997	4	16	68
D55	01/12→07/15	5FM (EP6DT)	Petrol	1598	4	16	34
D55	01/12→07/15	5GZ (EP6FDT)	Petrol	1598	4	16	34
D55	06/12→07/15	9HD (DV6C)	Diesel	1560	4	8	35
D55	08/13→07/15	AHW (DW10FC)	Diesel	1997	4	16	68
D55	11/13→07/15	BHX (DV6FC)	Diesel	1560	4	8	35
D55	07/14→07/15	BHZ (DV6FC)	Diesel	1560	4	8	35
D55	11/14→07/15	5GM (EP6FDTX)	Petrol	1598	4	16	34
DS Break	07/72→06/74	M23-627	Petrol	2348	4	8	92
DS Break	09/72→07/75	M23-623	Petrol	2347	4	8	92
Dyane	08/67→03/68	A79/0 (AYA)	Petrol	425	2	4	1
Dyane	04/68→07/75	A79/1 (AYA2)	Petrol	435	2	4	1
Dyane	12/68→10/84	M28 (AM2)	Petrol	602	2	4	3
Dyane	05/72→12/80	M28/1 (AK2)	Petrol	602	2	4	3
Elysee (7B)	06/02→04/08	TU5JPK	Petrol	1587	4	8	50
Elysee (R31)	01/08→12/09	TU5JPK	Petrol	1587	4	8	50
Evasion (22, U6)	06/94→07/02	RFU (XU10J2/C)	Petrol	1998	4	8	71
Evasion (22, U6)	06/94→07/02	RGX (XU10J2TE)	Petrol	1998	4	8	71
Evasion (22, U6)	11/94→07/02	D8B (XUD9TF)	Diesel	1905	4	8	57
Evasion (22, U6)	11/94→07/02	DXH (XUD9TF/BTF)	Diesel	1905	4	8	60
Evasion (22, U6)	05/96→07/02	P8C (XUD11BTE)	Diesel	2088	4	12	81
Evasion (22, U6)	05/97→07/02	LFZ (XU7JP)	Petrol	1761	4	8	54
Evasion (22, U6)	05/98→04/00	RFV (XU10J4R)	Petrol	1998	4	16	77
Evasion (22, U6)	08/99→07/02	RHZ (DW10ATED)	Diesel	1997	4	8	79
Evasion (22, U6)	09/99→07/02	RHW (DW10ATED4)	Diesel	1997	4	16	78
Evasion (22, U6)	05/00→07/02	RFN (EW10J4)	Petrol	1997	4	16	73
Fukang Hatchback	02/97→12/08	TU5JP4	Petrol	1587	4	16	43
Fukang Hatchback	02/97→12/08	TU5JPK	Petrol	1587	4	8	50
Fukang Saloon	09/98→08/01	TU5JPK	Petrol	1587	4	8	50
GS	09/70→09/77	G10/612	Petrol	1015	4	8	8
GS	04/73→06/79	G12/611	Petrol	1222	4	8	17
GS	04/73→06/79	G12/612	Petrol	1222	4	8	17
GS	09/75→07/79	G12/619	Petrol	1222	4	8	17
GS Break	07/71→09/77	G10	Petrol	1015	4	8	8
GS Break	04/73→06/79	G12/611	Petrol	1222	4	8	17
GS Break	04/73→06/79	G12/612	Petrol	1222	4	8	17
Jumper Box	04/06→	4HU (P22DTE)	Diesel	2198	4	16	83
Jumper Box	04/06→	4HV (P22DTE)	Diesel	2198	4	16	83
Jumper Box	10/09→	F1AEQ48N	Diesel	2287	4	16	91
Jumper Box	07/11→	4HG (P22DTE)	Diesel	2198	4	16	83
Jumper Box	07/11→	4HH (P22DTE)	Diesel	2198	4	16	83
Jumper Box	07/11→	4HJ (P22DTE)	Diesel	2198	4	16	83
Jumper Box	04/16→	AHM (DW10FUE)	Diesel	1997	4	16	67
Jumper Box	04/16→	AHN (DW10FUD)	Diesel	1997	4	16	68
Jumper Box	04/16→	AHP (DW10FUC)	Diesel	1997	4	16	68
Jumper Box (230L)	02/94→04/02	D9B (XUD9A/U)	Diesel	1905	4	8	59
Jumper Box (230L)	03/94→04/02	D8C (XUD9UTF)	Diesel	1905	4	8	57
Jumper Box (230L)	03/94→04/02	DXH (XUD9TF/BTF)	Diesel	1905	4	8	60
Jumper Box (230L)	03/94→04/02	RFW (XU10J2U)	Petrol	1998	4	8	71
Jumper Box (230L)	03/94→04/02	T8A (DJ5T)	Diesel	2446	4	12	100
Jumper Box (230L)	03/94→04/02	T9A (DJ5)	Diesel	2446	4	12	100
Jumper Box (230L)	10/96→08/97	THZ (DJ5T)	Diesel	2446	4	12	101
Jumper Box (230L)	12/96→11/00	THX (DJ5TED)	Diesel	2446	4	8	95
Jumper Box (230L)	01/99→02/02	8140.63 (F28D)	Diesel	2798	4	8	103
Jumper Box (230L)	07/99→04/02	DJY (XUD9A)	Diesel	1905	4	8	57
Jumper Box (230L)	09/00→04/02	8140.43S	Diesel	2798	4	8	103
Jumper Box (230L)	11/01→04/02	RHV (DW10UTD)	Diesel	1997	4	8	79
Jumper Box (244)	04/02→	4HY (DW12UTED)	Diesel	2179	4	8	86
Jumper Box (244)	04/02→	8140.43S	Diesel	2798	4	8	103
Jumper Box (244)	04/02→	RHV (DW10TD)	Diesel	1997	4	8	79
Jumper Box (244)	04/02→	RHV (DW10UTD)	Diesel	1997	4	8	79
Jumper Box (244)	04/02→	XU10J2	Petrol	1998	4	8	71
Jumper Box (244)	05/04→	8140.43N	Diesel	2798	4	8	103
Jumper Bus	04/06→	4HU (P22DTE)	Diesel	2198	4	16	83
Jumper Bus	04/06→	4HV (P22DTE)	Diesel	2198	4	16	83
Jumper Bus	07/11→	4HG (P22DTE)	Diesel	2198	4	16	83
Jumper Bus	07/11→	4HH (P22DTE)	Diesel	2198	4	16	83
Jumper Bus	07/11→	4HJ (P22DTE)	Diesel	2198	4	16	83
Jumper Bus	07/15→	AHN (DW10FUD)	Diesel	1997	4	16	68
Jumper Bus	07/15→	AHP (DW10FUC)	Diesel	1997	4	16	68
Jumper Bus (230P)	02/94→04/02	D8C (XUD9UTF)	Diesel	1905	4	8	57

							
Jumper Bus (230P)	02/94→04/02	RFW (XU10J2U)	Petrol	1998	4	8	71
Jumper Bus (230P)	08/94→04/02	T8A (DJ5T)	Diesel	2446	4	12	100
Jumper Bus (230P)	08/94→04/02	T9A (DJ5)	Diesel	2446	4	12	100
Jumper Bus (230P)	12/96→11/00	THX (DJ5TED)	Diesel	2446	4	8	95
Jumper Bus (230P)	01/99→02/02	8140.63 (F28D)	Diesel	2798	4	8	103
Jumper Bus (230P)	01/99→04/02	D9B (XUD9A/U)	Diesel	1905	4	8	59
Jumper Bus (230P)	09/00→04/02	8140.43S	Diesel	2798	4	8	103
Jumper Bus (244, Z_)	04/02→	4HY (DW12UTED)	Diesel	2179	4	8	86
Jumper Bus (244, Z_)	04/02→	8140.43S	Diesel	2798	4	8	103
Jumper Bus (244, Z_)	04/02→	RHV (DW10UTD)	Diesel	1997	4	8	79
Jumper Bus (244, Z_)	04/02→	XU10J2	Petrol	1998	4	8	71
Jumper Platform/Chassis	04/06→	4HU (P22DTE)	Diesel	2198	4	16	83
Jumper Platform/Chassis	04/06→	4HV (P22DTE)	Diesel	2198	4	16	83
Jumper Platform/Chassis	07/11→	4HG (P22DTE)	Diesel	2198	4	16	83
Jumper Platform/Chassis	07/11→	4HH (P22DTE)	Diesel	2198	4	16	83
Jumper Platform/Chassis	07/11→	4HJ (P22DTE)	Diesel	2198	4	16	83
Jumper Platform/Chassis	04/16→	AHM (DW10FUE)	Diesel	1997	4	16	67
Jumper Platform/Chassis	04/16→	AHN (DW10FUD)	Diesel	1997	4	16	68
Jumper Platform/Chassis	04/16→	AHP (DW10FUC)	Diesel	1997	4	16	68
Jumper Platform/Chassis (230)	03/94→04/02	D8C (XUD9UTF)	Diesel	1905	4	8	57
Jumper Platform/Chassis (230)	03/94→04/02	DHX (XUD9TF/BTF)	Diesel	1905	4	8	60
Jumper Platform/Chassis (230)	03/94→04/02	RFW (XU10J2U)	Petrol	1998	4	8	71
Jumper Platform/Chassis (230)	03/94→04/02	T8A (DJ5T)	Diesel	2446	4	12	100
Jumper Platform/Chassis (230)	03/94→04/02	T9A (DJ5)	Diesel	2446	4	12	100
Jumper Platform/Chassis (230)	12/96→04/02	THX (DJ5TED)	Diesel	2446	4	8	95
Jumper Platform/Chassis (230)	01/99→02/02	8140.63 (F28D)	Diesel	2798	4	8	103
Jumper Platform/Chassis (230)	09/00→04/02	8140.43S	Diesel	2798	4	8	103
Jumper Platform/Chassis (244)	02/02→06/06	F28TDCR	Diesel	2798	4	8	103
Jumper Platform/Chassis (244)	02/02→	4HY (DW12UTED)	Diesel	2179	4	8	86
Jumper Platform/Chassis (244)	04/02→	8140.43S	Diesel	2798	4	8	103
Jumper Platform/Chassis (244)	04/02→	RHV (DW10UTD)	Diesel	1997	4	8	79
Jumper Platform/Chassis (244)	05/04→	8140.43N	Diesel	2798	4	8	103
Jumpy	01/07→	9HH (DV6DUM)	Diesel	1560	4	8	35
Jumpy	01/07→	9HM (DV6UC)	Diesel	1560	4	8	35
Jumpy	01/07→	9HU (DV6UTED4)	Diesel	1560	4	16	37
Jumpy	01/07→	RFH (EW10A)	Petrol	1997	4	16	72
Jumpy	01/07→	RHK (DW10UTED4)	Diesel	1997	4	16	78
Jumpy	01/07→	RHR (DW10BTED4)	Diesel	1997	4	16	78
Jumpy	07/10→	RHH (DW10CTED4)	Diesel	1997	4	16	68
Jumpy	07/11→	AHY (DW10CE)	Diesel	1997	4	16	68
Jumpy	07/11→	AHZ (DW10CD)	Diesel	1997	4	16	68
Jumpy	04/16→	AHJ (DW10FE)	Diesel	1997	4	16	67
Jumpy	04/16→	AHK (DW10FE)	Diesel	1997	4	16	67
Jumpy	04/16→	AHR (DW10FD)	Diesel	1997	4	16	68
Jumpy	04/16→	AHX (DW10FD)	Diesel	1997	4	16	68
Jumpy	04/16→	BHS (DV6FDU)	Diesel	1560	4	8	35
Jumpy	04/16→	BHV (DV6FDU)	Diesel	1560	4	8	35
Jumpy	04/16→	BHX (DV6FCU)	Diesel	1560	4	8	42
Jumpy (U6U)	10/95→08/98	D9B (XUD9A/U)	Diesel	1905	4	8	59
Jumpy (U6U)	10/95→08/00	220 A2.000	Petrol	1581	4	8	40
Jumpy (U6U)	10/95→08/00	1580 SPI	Petrol	1581	4	8	40
Jumpy (U6U)	10/95→08/00	DHX (XUD9TF/BTF)	Diesel	1905	4	8	60
Jumpy (U6U)	04/96→11/03	D8B (XUD9TF)	Diesel	1905	4	8	57
Jumpy (U6U)	04/98→11/03	WJY (DW8B)	Diesel	1868	4	8	59
Jumpy (U6U)	04/98→11/03	WJZ (DW8)	Diesel	1868	4	8	59
Jumpy (U6U)	10/99→10/06	RHX (DW10BTED)	Diesel	1997	4	8	79
Jumpy (U6U)	03/00→10/06	RHW (DW10ATED4)	Diesel	1997	4	16	78
Jumpy (U6U)	03/00→10/06	RHZ (DW10ATED)	Diesel	1997	4	8	79
Jumpy (U6U)	03/00→10/06	RHZ (DW10BTED)	Diesel	1997	4	8	80
Jumpy (U6U)	03/00→10/06	RHZ (DW10BTED+)	Diesel	1997	4	8	80
Jumpy (U6U)	03/00→10/06	RHZ (DW10CTED)	Diesel	1997	4	8	80
Jumpy (U6U)	03/00→12/06	RFN (EW10J4)	Petrol	1997	4	16	73
Jumpy Box	01/07→	9HH (DV6DUM)	Diesel	1560	4	8	35
Jumpy Box	01/07→	9HM (DV6UC)	Diesel	1560	4	8	35
Jumpy Box	01/07→	9HU (DV6UTED4)	Diesel	1560	4	16	37
Jumpy Box	01/07→	RFH (EW10A)	Petrol	1997	4	16	72
Jumpy Box	01/07→	RHK (DW10UTED4)	Diesel	1997	4	16	78
Jumpy Box	01/07→	RHR (DW10BTED4)	Diesel	1997	4	16	78
Jumpy Box	07/10→	RHH (DW10CTED4)	Diesel	1997	4	16	68
Jumpy Box	07/11→	AHY (DW10CE)	Diesel	1997	4	16	68
Jumpy Box	07/11→	AHZ (DW10CD)	Diesel	1997	4	16	68
Jumpy Box	04/16→	AHJ (DW10FE)	Diesel	1997	4	16	67
Jumpy Box	04/16→	AHK (DW10FE)	Diesel	1997	4	16	67
Jumpy Box	04/16→	AHR (DW10FD)	Diesel	1997	4	16	68
Jumpy Box	04/16→	AHX (DW10FD)	Diesel	1997	4	16	68
Jumpy Box	04/16→	BHS (DV6FDU)	Diesel	1560	4	8	35
Jumpy Box	04/16→	BHV (DV6FDU)	Diesel	1560	4	8	35
Jumpy Box	04/16→	BHX (DV6FCU)	Diesel	1560	4	8	42



CC



9

Jumpy Box (BS_, BT_, BY_, BZ_)	10/95→08/98	D9B (XUD9A/U)	Diesel	1905	4	8	59
Jumpy Box (BS_, BT_, BY_, BZ_)	10/95→08/00	220 A2.000	Petrol	1581	4	8	40
Jumpy Box (BS_, BT_, BY_, BZ_)	10/95→08/00	1580 SPI	Petrol	1581	4	8	40
Jumpy Box (BS_, BT_, BY_, BZ_)	10/95→08/00	DXH (XUD9TF/BTF)	Diesel	1905	4	8	60
Jumpy Box (BS_, BT_, BY_, BZ_)	04/98→10/06	WJY (DW8B)	Diesel	1868	4	8	59
Jumpy Box (BS_, BT_, BY_, BZ_)	04/98→10/06	WJZ (DW8)	Diesel	1868	4	8	59
Jumpy Box (BS_, BT_, BY_, BZ_)	10/99→10/06	RHX (DW10BTD)	Diesel	1997	4	8	79
Jumpy Box (BS_, BT_, BY_, BZ_)	03/00→10/06	RFN (EW10J4)	Petrol	1997	4	16	73
Jumpy Box (BS_, BT_, BY_, BZ_)	10/01→10/06	RHZ (DW10ATED)	Diesel	1997	4	8	79
Jumpy Box (BS_, BT_, BY_, BZ_)	10/01→10/06	RHZ (DW10BTD)	Diesel	1997	4	8	80
Jumpy Box (BS_, BT_, BY_, BZ_)	10/01→10/06	RHZ (DW10BTD+)	Diesel	1997	4	8	80
Jumpy Box (BS_, BT_, BY_, BZ_)	10/01→10/06	RHZ (DW10CTED)	Diesel	1997	4	8	80
Jumpy Box (BS_, BT_, BY_, BZ_)	01/02→10/06	RHW (DW10ATED4)	Diesel	1997	4	16	78
Jumpy Platform/Chassis	07/11→	AHZ (DW10CD)	Diesel	1997	4	16	68
Jumpy Platform/Chassis	09/16→	AHK (DW10FE)	Diesel	1997	4	16	67
Jumpy Platform/Chassis	09/16→	AHX (DW10FD)	Diesel	1997	4	16	68
Jumpy Platform/Chassis	09/16→	BHS (DV6FDU)	Diesel	1560	4	8	35
Jumpy Platform/Chassis	09/16→	BHV (DV6FDU)	Diesel	1560	4	8	35
Jumpy Platform/Chassis (BU_, BV_, BW_, BX_)	10/99→10/06	D8B (XUD9TF)	Diesel	1905	4	8	57
Jumpy Platform/Chassis (BU_, BV_, BW_, BX_)	10/99→10/06	RHX (DW10BTD)	Diesel	1997	4	8	79
Jumpy Platform/Chassis (BU_, BV_, BW_, BX_)	12/03→10/06	RFN (EW10J4)	Petrol	1997	4	16	73
Jumpy Platform/Chassis (BU_, BV_, BW_, BX_)	12/03→10/06	RHW (DW10ATED4)	Diesel	1997	4	16	78
Jumpy Platform/Chassis (BU_, BV_, BW_, BX_)	12/03→10/06	RHZ (DW10ATED)	Diesel	1997	4	8	79
Jumpy Platform/Chassis (BU_, BV_, BW_, BX_)	12/03→10/06	RHZ (DW10BTD)	Diesel	1997	4	8	80
Jumpy Platform/Chassis (BU_, BV_, BW_, BX_)	12/03→10/06	RHZ (DW10BTD+)	Diesel	1997	4	8	80
Jumpy Platform/Chassis (BU_, BV_, BW_, BX_)	12/03→10/06	RHZ (DW10CTED)	Diesel	1997	4	8	80
LNA	11/76→07/79	RO6 627	Petrol	602	2	4	2
LNA	11/78→07/86	V06 630	Petrol	652	2	4	4
LNA	11/78→07/86	V06 644	Petrol	652	2	4	4
LNA	07/82→04/85	109/5E	Petrol	1124	4	8	11
LNA	07/84→10/86	108C	Petrol	954	4	8	6
Mehari	05/68→10/87	M28/1 (AK2)	Petrol	602	2	4	3
Mehari	10/79→10/87	A06/635	Petrol	602	2	4	2
Nemo Box (AA_)	02/08→	8HS (DV4TED)	Diesel	1398	4	8	22
Nemo Box (AA_)	02/08→	KFV (TU3A)	Petrol	1360	4	8	28
Nemo Box (AA_)	10/10→	FHZ (F13DTE5)	Diesel	1248	4	16	16
Nemo Box (AA_)	02/16→	FHY (F13DTE6)	Diesel	1248	4	16	16
Nemo Estate	04/09→	8HS (DV4TED)	Diesel	1398	4	8	22
Nemo Estate	04/09→	KFT (TU3A)	Petrol	1360	4	8	28
Nemo Estate	04/09→	KFV (TU3A)	Petrol	1360	4	8	28
Nemo Estate	10/10→	FHZ (F13DTE5)	Diesel	1248	4	16	16
Nemo Estate	10/15→	FHY (F13DTE6)	Diesel	1248	4	16	16
Saxo (S0, S1)	02/96→06/03	NFZ (TU5JP)	Petrol	1587	4	8	49
Saxo (S0, S1)	02/96→04/04	NFX (TU5JP4)	Petrol	1587	4	16	43
Saxo (S0, S1)	05/96→06/03	CDZ (TU9M)	Petrol	954	4	8	7
Saxo (S0, S1)	05/96→06/03	KFW (TU3JP)	Petrol	1360	4	8	30
Saxo (S0, S1)	05/96→06/03	KFX (TU3JP)	Petrol	1360	4	8	30
Saxo (S0, S1)	05/96→09/03	HDZ (TU1M)	Petrol	1124	4	8	13
Saxo (S0, S1)	05/96→09/03	HFX (TU1JP)	Petrol	1124	4	8	14
Saxo (S0, S1)	09/96→09/03	VJY (TUD5)	Diesel	1527	4	8	32
Saxo (S0, S1)	09/96→04/04	VJZ (TUD5)	Diesel	1527	4	8	32
Saxo (S0, S1)	09/00→04/04	NFT (TU5JP)	Petrol	1587	4	8	47
Spacetourer	04/16→	AHH (DW10FC)	Diesel	1997	4	16	68
Spacetourer	04/16→	AHX (DW10FD)	Diesel	1997	4	16	68
Spacetourer	04/16→	BHV (DV6FDU)	Diesel	1560	4	8	35
Spacetourer	04/16→	BHX (DV6FCU)	Diesel	1560	4	8	42
Visa	09/78→06/88	109K	Petrol	1124	4	8	11
Visa	09/78→06/88	V06 630	Petrol	652	2	4	4
Visa	09/78→06/88	V06 644	Petrol	652	2	4	4
Visa	09/78→03/91	109/5	Petrol	1124	4	8	11
Visa	09/78→03/91	109/5F	Petrol	1124	4	8	11
Visa	07/80→06/82	129/5	Petrol	1219	4	8	15
Visa	03/82→03/91	150B (XY8)	Petrol	1360	4	8	24
Visa	07/82→03/91	V06/665	Petrol	652	2	4	4
Visa	04/84→03/91	161A (XUD7)	Diesel	1769	4	8	52
Visa	07/84→03/91	150D (XY7)	Petrol	1360	4	8	25
Visa	09/84→06/88	XV8	Petrol	954	4	8	9
Visa	01/85→06/86	180A (XU5J)	Petrol	1580	4	8	39
Visa	06/86→03/91	B6D	Petrol	1580	4	8	39
Visa Convertible	03/83→10/88	109/5F	Petrol	1124	4	8	11
Xantia (X1)	03/93→05/95	RFX XU10J2C/Z L3	Petrol	1998	4	8	71
Xantia (X1)	03/93→01/98	BFZ (XU5JP)	Petrol	1580	4	8	39
Xantia (X1)	03/93→01/98	LFZ (XU7JP)	Petrol	1761	4	8	54
Xantia (X1)	03/93→01/98	RFX (XU10J2C)	Petrol	1998	4	8	71
Xantia (X1)	03/93→01/98	RFY (XU10J4/Z)	Petrol	1998	4	16	76
Xantia (X1)	06/94→01/98	D9B (XUD9A/L)	Diesel	1905	4	8	59
Xantia (X1)	06/94→01/98	DJZ (XUD9Y)	Diesel	1905	4	8	61
Xantia (X1)	06/94→01/98	RFT (XU10J4/Z)	Petrol	1998	4	16	76



CC



9

Xantia (X1)	10/94→01/98	DHX (XUD9TE/BTF)	Diesel	1905	4	8	60
Xantia (X1)	10/94→01/98	DHY (XUD9TE/Y)	Diesel	1905	4	8	57
Xantia (X1)	06/95→01/98	LFY (XU7JP4)	Petrol	1762	4	16	55
Xantia (X1)	06/95→01/98	P8C (XUD11BTE)	Diesel	2088	4	12	81
Xantia (X1)	06/95→01/98	RFV (XU10J4R)	Petrol	1998	4	16	77
Xantia (X1)	06/95→01/98	RGX (XU10J2TE)	Petrol	1998	4	8	71
Xantia (X1)	02/96→01/98	DHW (XUD9SD)	Diesel	1905	4	8	57
Xantia (X1)	01/97→01/98	XFZ (ES9J4)	Petrol	2946	6	24	104
Xantia (X1)	04/97→01/98	LFX (XU7JB)	Petrol	1761	4	8	54
Xantia (X2)	01/98→02/99	P8C (XUD11BTE)	Diesel	2088	4	12	81
Xantia (X2)	01/98→03/01	BFZ (XU5JP)	Petrol	1580	4	8	39
Xantia (X2)	01/98→04/03	DHW (XUD9SD)	Diesel	1905	4	8	57
Xantia (X2)	01/98→04/03	DHX (XUD9TE/BTF)	Diesel	1905	4	8	60
Xantia (X2)	01/98→04/03	DHY (XUD9TE/Y)	Diesel	1905	4	8	57
Xantia (X2)	01/98→04/03	LFX (XU7JB)	Petrol	1761	4	8	54
Xantia (X2)	01/98→04/03	LFY (XU7JP4)	Petrol	1762	4	16	55
Xantia (X2)	01/98→04/03	RFV (XU10J4R)	Petrol	1998	4	16	77
Xantia (X2)	01/98→04/03	RFX (XU10J2C)	Petrol	1998	4	8	71
Xantia (X2)	01/98→04/03	RGX (XU10J2TE)	Petrol	1998	4	8	71
Xantia (X2)	01/98→04/03	XFZ (ES9J4)	Petrol	2946	6	24	104
Xantia (X2)	02/99→04/03	RHZ (DW10ATED)	Diesel	1997	4	8	79
Xantia (X2)	03/99→04/03	RHY (DW10TD)	Diesel	1997	4	8	79
Xantia Break (X1)	06/95→01/98	D8B (XUD9TF)	Diesel	1905	4	8	57
Xantia Break (X1)	06/95→01/98	DHX (XUD9TE/BTF)	Diesel	1905	4	8	60
Xantia Break (X1)	06/95→01/98	DHY (XUD9TE/Y)	Diesel	1905	4	8	57
Xantia Break (X1)	06/95→01/98	LFY (XU7JP4)	Petrol	1762	4	16	55
Xantia Break (X1)	06/95→01/98	LFZ (XU7JP)	Petrol	1761	4	8	54
Xantia Break (X1)	06/95→01/98	RFV (XU10J4R)	Petrol	1998	4	16	77
Xantia Break (X1)	06/95→01/98	RFX (XU10J2C)	Petrol	1998	4	8	71
Xantia Break (X1)	06/95→01/98	RGX (XU10J2TE)	Petrol	1998	4	8	71
Xantia Break (X1)	06/96→01/98	P8C (XUD11BTE)	Diesel	2088	4	12	81
Xantia Break (X1)	04/97→01/98	DHW (XUD9SD)	Diesel	1905	4	8	57
Xantia Break (X1)	04/97→01/98	LFX (XU7JB)	Petrol	1761	4	8	54
Xantia Break (X2)	01/98→02/99	P8C (XUD11BTE)	Diesel	2088	4	12	81
Xantia Break (X2)	01/98→04/03	D8B (XUD9TF)	Diesel	1905	4	8	57
Xantia Break (X2)	01/98→04/03	DHW (XUD9SD)	Diesel	1905	4	8	57
Xantia Break (X2)	01/98→04/03	DHX (XUD9TE/BTF)	Diesel	1905	4	8	60
Xantia Break (X2)	01/98→04/03	LFX (XU7JB)	Petrol	1761	4	8	54
Xantia Break (X2)	01/98→04/03	LFY (XU7JP4)	Petrol	1762	4	16	55
Xantia Break (X2)	01/98→04/03	RFV (XU10J4R)	Petrol	1998	4	16	77
Xantia Break (X2)	01/98→04/03	RFX (XU10J2C)	Petrol	1998	4	8	71
Xantia Break (X2)	01/98→04/03	RGX (XU10J2TE)	Petrol	1998	4	8	71
Xantia Break (X2)	01/98→04/03	XFZ (ES9J4)	Petrol	2946	6	24	104
Xantia Break (X2)	02/99→04/03	RHZ (DW10ATED)	Diesel	1997	4	8	79
Xantia Break (X2)	03/99→04/03	RHY (DW10TD)	Diesel	1997	4	8	79
XM (Y3)	05/89→04/94	RDZ (XU10MZ)	Petrol	1998	4	8	71
XM (Y3)	05/89→05/94	SFZ (ZPJ/Z)	Petrol	2975	6	12	106
XM (Y3)	05/89→06/94	P8A (XUD11ATE)	Diesel	2088	4	12	81
XM (Y3)	05/89→06/94	P9A (XUD11A)	Diesel	2138	4	12	81
XM (Y3)	05/89→06/94	PHZ (XUD11ATE)	Diesel	2088	4	12	81
XM (Y3)	05/89→06/94	PJZ (XUD11ATE)	Diesel	2088	4	12	81
XM (Y3)	05/89→06/94	R6A	Petrol	1998	4	8	71
XM (Y3)	05/89→06/94	RFV (XU10J4R)	Petrol	1998	4	16	77
XM (Y3)	05/89→06/94	RFZ (XU10J2)	Petrol	1998	4	8	71
XM (Y3)	05/89→06/94	UFZ (ZPJ/Z)	Petrol	2963	6	12	106
XM (Y3)	07/90→06/94	SKZ (ZPJ4/Z)	Petrol	2963	6	24	107
XM (Y3)	07/90→06/94	UKZ (ZPJ4/Z)	Petrol	2963	6	24	107
XM (Y3)	09/92→06/94	RGY (XU10J2TE/Z)	Petrol	1998	4	8	71
XM (Y4)	05/94→10/00	P8A (XUD11ATE)	Diesel	2088	4	12	81
XM (Y4)	05/94→10/00	P8C (XUD11BTE)	Diesel	2088	4	12	81
XM (Y4)	05/94→10/00	PHZ (XUD11ATE)	Diesel	2088	4	12	81
XM (Y4)	05/94→10/00	PJZ (XUD11ATE)	Diesel	2088	4	12	81
XM (Y4)	05/94→10/00	RFV (XU10J4R)	Petrol	1998	4	16	77
XM (Y4)	05/94→10/00	RGX (XU10J2TE)	Petrol	1998	4	8	71
XM (Y4)	05/94→10/00	SKZ (ZPJ4/Z)	Petrol	2963	6	24	107
XM (Y4)	05/94→10/00	THY (DK5ATE)	Diesel	2446	4	12	101
XM (Y4)	05/94→10/00	UFZ (ZPJ/Z)	Petrol	2963	6	12	106
XM (Y4)	05/94→10/00	UKZ (ZPJ4/Z)	Petrol	2963	6	24	107
XM (Y4)	07/94→12/97	SFZ (ZPJ/Z)	Petrol	2975	6	12	106
XM (Y4)	03/96→08/96	P9A (XUD11A)	Diesel	2138	4	12	81
XM (Y4)	04/97→10/00	XFZ (ES9J4)	Petrol	2946	6	24	104
XM Break (Y3)	05/89→06/94	R6A	Petrol	1998	4	8	71
XM Break (Y3)	05/89→07/94	SFZ (ZPJ/Z)	Petrol	2975	6	12	106
XM Break (Y3)	01/90→07/94	UKZ (ZPJ4/Z)	Petrol	2963	6	24	107
XM Break (Y3)	11/91→04/94	P8A (XUD11ATE)	Diesel	2088	4	12	81
XM Break (Y3)	11/91→04/94	P8C (XUD11BTE)	Diesel	2088	4	12	81
XM Break (Y3)	11/91→04/94	P9A (XUD11A)	Diesel	2138	4	12	81
XM Break (Y3)	11/91→04/94	PHZ (XUD11ATE)	Diesel	2088	4	12	81



















CC











9

XM Break (Y3)	11/91→04/94	PJZ (XUD11ATE)	Diesel	2088	4	12	81
XM Break (Y3)	11/91→04/94	RDZ (XU10MZ)	Petrol	1998	4	8	71
XM Break (Y3)	11/91→04/94	RFZ (XU10J2)	Petrol	1998	4	8	71
XM Break (Y3)	11/91→04/94	XU102C	Petrol	1998	4	8	71
XM Break (Y3)	11/91→07/94	UFZ (ZPJ/Z)	Petrol	2963	6	12	106
XM Break (Y3)	09/92→04/94	RGY (XU10J2TE/Z)	Petrol	1998	4	8	71
XM Break (Y4)	05/94→10/00	P8C (XUD11BTE)	Diesel	2088	4	12	81
XM Break (Y4)	05/94→10/00	PHZ (XUD11ATE)	Diesel	2088	4	12	81
XM Break (Y4)	05/94→10/00	PJZ (XUD11ATE)	Diesel	2088	4	12	81
XM Break (Y4)	05/94→10/00	RFV (XU10J4R)	Petrol	1998	4	16	77
XM Break (Y4)	05/94→10/00	RGX (XU10J2TE)	Petrol	1998	4	8	71
XM Break (Y4)	05/94→10/00	RGY (XU10J2TE/Z)	Petrol	1998	4	8	71
XM Break (Y4)	05/94→10/00	THY (DK5ATE)	Diesel	2446	4	12	101
XM Break (Y4)	05/94→10/00	UFZ (ZPJ/Z)	Petrol	2963	6	12	106
XM Break (Y4)	07/94→06/96	P9A (XUD11A)	Diesel	2138	4	12	81
XM Break (Y4)	04/97→10/00	XFZ (ES9J4)	Petrol	2946	6	24	104
Xsara (N1)	04/97→09/00	161A (XUD7)	Diesel	1769	4	8	52
Xsara (N1)	04/97→09/00	A9A (XUD7)	Diesel	1769	4	8	52
Xsara (N1)	04/97→09/00	DHY (XUD9TE/Y)	Diesel	1905	4	8	57
Xsara (N1)	04/97→09/00	DJY (XUD9A)	Diesel	1905	4	8	57
Xsara (N1)	04/97→09/00	LFX (XU7JB)	Petrol	1761	4	8	54
Xsara (N1)	04/97→09/00	LFY (XU7JP4)	Petrol	1762	4	16	55
Xsara (N1)	04/97→09/00	LFZ (XU7JP)	Petrol	1761	4	8	54
Xsara (N1)	04/97→09/00	NFZ (TU5JP)	Petrol	1587	4	8	49
Xsara (N1)	04/97→09/00	RFS (XU10J4RS)	Petrol	1998	4	16	75
Xsara (N1)	04/97→09/00	VJZ (TUD5)	Diesel	1527	4	8	32
Xsara (N1)	04/97→03/05	KFW (TU3JP)	Petrol	1360	4	8	30
Xsara (N1)	04/97→03/05	KFX (TU3JP)	Petrol	1360	4	8	30
Xsara (N1)	01/98→09/00	DHV (XUD9BSD)	Diesel	1905	4	8	59
Xsara (N1)	07/98→09/00	RFV (XU10J4R)	Petrol	1998	4	16	77
Xsara (N1)	07/98→03/05	WJZ (DW8)	Diesel	1868	4	8	59
Xsara (N1)	07/98→04/05	WJY (DW8B)	Diesel	1868	4	8	59
Xsara (N1)	02/99→03/05	RHY (DW10TD)	Diesel	1997	4	8	79
Xsara (N1)	09/00→10/04	6FZ (EW7J4)	Petrol	1749	4	16	51
Xsara (N1)	09/00→03/05	NFU (TU5JP4)	Petrol	1587	4	16	48
Xsara (N1)	09/00→03/05	RFN (EW10J4)	Petrol	1997	4	16	73
Xsara (N1)	05/01→03/05	RHZ (DW10ATED)	Diesel	1997	4	8	79
Xsara (N1)	01/03→03/05	8HX (DV4TD)	Diesel	1398	4	8	22
Xsara Box Body / Estate	05/98→05/99	A9A (XUD7)	Diesel	1769	4	8	52
Xsara Box Body / Estate	05/98→08/00	VJZ (TUD5)	Diesel	1527	4	8	32
Xsara Box Body / Estate	06/99→08/05	WJZ (DW8)	Diesel	1868	4	8	59
Xsara Box Body / Estate	09/00→03/05	KFX (TU3JP)	Petrol	1360	4	8	30
Xsara Box Body / Estate	09/00→03/05	RHY (DW10TD)	Diesel	1997	4	8	79
Xsara Box Body / Hatchback	05/98→05/99	A9A (XUD7)	Diesel	1769	4	8	52
Xsara Box Body / Hatchback	05/98→08/00	DHY (XUD9TE/Y)	Diesel	1905	4	8	57
Xsara Box Body / Hatchback	05/98→08/00	VJZ (TUD5)	Diesel	1527	4	8	32
Xsara Box Body / Hatchback	05/98→10/04	KFX (TU3JP)	Petrol	1360	4	8	30
Xsara Box Body / Hatchback	06/99→03/05	WJZ (DW8)	Diesel	1868	4	8	59
Xsara Box Body / Hatchback	09/00→03/05	RHY (DW10TD)	Diesel	1997	4	8	79
Xsara Break (N2)	10/97→09/00	A9A (XUD7)	Diesel	1769	4	8	52
Xsara Break (N2)	10/97→09/00	DHY (XUD9TE/Y)	Diesel	1905	4	8	57
Xsara Break (N2)	10/97→09/00	DJY (XUD9A)	Diesel	1905	4	8	57
Xsara Break (N2)	10/97→09/00	LFX (XU7JB)	Petrol	1761	4	8	54
Xsara Break (N2)	10/97→09/00	LFY (XU7JP4)	Petrol	1762	4	16	55
Xsara Break (N2)	10/97→09/00	LFZ (XU7JP)	Petrol	1761	4	8	54
Xsara Break (N2)	10/97→09/00	NFZ (TU5JP)	Petrol	1587	4	8	49
Xsara Break (N2)	10/97→09/00	VJZ (TUD5)	Diesel	1527	4	8	32
Xsara Break (N2)	10/97→08/05	KFW (TU3JP)	Petrol	1360	4	8	30
Xsara Break (N2)	10/97→08/05	KFX (TU3JP)	Petrol	1360	4	8	30
Xsara Break (N2)	01/98→09/00	DHV (XUD9BSD)	Diesel	1905	4	8	59
Xsara Break (N2)	07/98→09/00	RFV (XU10J4R)	Petrol	1998	4	16	77
Xsara Break (N2)	07/98→08/05	WJY (DW8B)	Diesel	1868	4	8	59
Xsara Break (N2)	07/98→08/05	WJZ (DW8)	Diesel	1868	4	8	59
Xsara Break (N2)	02/99→08/05	RHY (DW10TD)	Diesel	1997	4	8	79
Xsara Break (N2)	09/00→08/05	NFU (TU5JP4)	Petrol	1587	4	16	48
Xsara Break (N2)	09/00→08/05	RFN (EW10J4)	Petrol	1997	4	16	73
Xsara Break (N2)	05/01→08/05	RHZ (DW10ATED)	Diesel	1997	4	8	79
Xsara Break (N2)	01/03→08/05	8HX (DV4TD)	Diesel	1398	4	8	22
Xsara Coupe (N0)	01/98→09/00	LFY (XU7JP4)	Petrol	1762	4	16	55
Xsara Coupe (N0)	02/98→05/99	DHV (XUD9BSD)	Diesel	1905	4	8	59
Xsara Coupe (N0)	02/98→09/00	DHY (XUD9TE/Y)	Diesel	1905	4	8	57
Xsara Coupe (N0)	02/98→09/00	DJY (XUD9A)	Diesel	1905	4	8	57
Xsara Coupe (N0)	02/98→09/00	LFX (XU7JB)	Petrol	1761	4	8	54
Xsara Coupe (N0)	02/98→09/00	LFZ (XU7JP)	Petrol	1761	4	8	54
Xsara Coupe (N0)	02/98→09/00	NFZ (TU5JP)	Petrol	1587	4	8	49
Xsara Coupe (N0)	02/98→03/05	RFS (XU10J4RS)	Petrol	1998	4	16	75
Xsara Coupe (N0)	03/98→03/05	KFW (TU3JP)	Petrol	1360	4	8	30
Xsara Coupe (N0)	03/98→03/05	KFX (TU3JP)	Petrol	1360	4	8	30

							
Xsara Coupe (N0)	08/98→08/00	RFV (XU10J4R)	Petrol	1998	4	16	77
Xsara Coupe (N0)	02/99→03/05	RHY (DW10TD)	Diesel	1997	4	8	79
Xsara Coupe (N0)	02/99→03/05	WJY (DW88B)	Diesel	1868	4	8	59
Xsara Coupe (N0)	02/99→03/05	WJZ (DW8)	Diesel	1868	4	8	59
Xsara Coupe (N0)	09/00→03/05	NFU (TU5JP4)	Petrol	1587	4	16	48
Xsara Coupe (N0)	09/00→03/05	RFN (EW10J4)	Petrol	1997	4	16	73
Xsara Coupe (N0)	05/01→03/05	RHZ (DW10ATED)	Diesel	1997	4	8	79
Xsara Coupe (N0)	01/03→03/05	8HX (DV4TD)	Diesel	1398	4	8	22
Xsara Picasso (N68)	12/99→	NFV (TU5JP)	Petrol	1587	4	8	49
Xsara Picasso (N68)	12/99→	NFZ (TU5JP)	Petrol	1587	4	8	49
Xsara Picasso (N68)	12/99→	RFN (EW10J4)	Petrol	1997	4	16	73
Xsara Picasso (N68)	12/99→	RHY (DW10TD)	Diesel	1997	4	8	79
Xsara Picasso (N68)	12/99→	RHZ (DW10ATED)	Diesel	1997	4	8	79
Xsara Picasso (N68)	02/00→	6FZ (EW7J4)	Petrol	1749	4	16	51
Xsara Picasso (N68)	05/04→	9HY (DV6TED4)	Diesel	1560	4	16	37
Xsara Picasso (N68)	05/04→	9HZ (DV6TED4)	Diesel	1560	4	16	37
Xsara Picasso (N68)	06/05→	NFU (TU5JP4)	Petrol	1587	4	16	48
Xsara Picasso (N68)	09/05→	9HX (DV6ATED4)	Diesel	1560	4	16	37
Xsara Picasso MPV (N68)	03/04→03/07	EW10J4	Petrol	1997	4	16	70
ZX (N2)	03/91→08/93	H1A	Petrol	1124	4	8	13
ZX (N2)	03/91→08/93	H1B	Petrol	1124	4	8	13
ZX (N2)	03/91→06/97	D6E (XU9JA)	Petrol	1905	4	8	56
ZX (N2)	03/91→06/97	DJZ (XUD9Y)	Diesel	1905	4	8	61
ZX (N2)	03/91→06/97	DKZ (XU9JA)	Petrol	1905	4	8	56
ZX (N2)	03/91→06/97	HDZ (TU1M)	Petrol	1124	4	8	13
ZX (N2)	03/91→06/97	KDX (TU3M/Z)	Petrol	1360	4	8	26
ZX (N2)	03/91→06/97	KDZ (TU3M/Z)	Petrol	1360	4	8	26
ZX (N2)	03/91→06/97	KFX (TU3JP)	Petrol	1360	4	8	30
ZX (N2)	03/91→10/97	BDY (XU5M)	Petrol	1580	4	8	39
ZX (N2)	03/91→10/97	BFZ (XU5JP)	Petrol	1580	4	8	39
ZX (N2)	06/92→10/97	DHY (XUD9TE/Y)	Diesel	1905	4	8	57
ZX (N2)	07/92→10/97	LFZ (XU7JP)	Petrol	1761	4	8	54
ZX (N2)	07/92→10/97	RFT (XU10J4/Z)	Petrol	1998	4	16	76
ZX (N2)	07/92→10/97	RFX (XU10J2C)	Petrol	1998	4	8	71
ZX (N2)	07/92→10/97	RFY (XU10J4/Z)	Petrol	1998	4	16	76
ZX (N2)	06/93→06/97	161A (XUD7)	Diesel	1769	4	8	52
ZX (N2)	07/93→06/97	D9B (XUD9A/U)	Diesel	1905	4	8	59
ZX (N2)	07/93→06/97	DJY (XUD9A)	Diesel	1905	4	8	57
ZX (N2)	10/93→07/99	D9B (XUD9A/L)	Diesel	1905	4	8	59
ZX (N2)	07/94→10/97	K9Y (TUD3Y)	Diesel	1360	4	8	27
ZX (N2)	01/96→10/97	LFY (XU7JP4)	Petrol	1762	4	16	55
ZX (N2)	05/96→10/97	RFS (XU10J4RS)	Petrol	1998	4	16	75
ZX Break (N2)	10/93→11/95	RFX XU10J2C/Z L3	Petrol	1998	4	8	71
ZX Break (N2)	10/93→10/97	161A (XUD7)	Diesel	1769	4	8	52
ZX Break (N2)	10/93→10/97	BDY (XU5M)	Petrol	1580	4	8	39
ZX Break (N2)	10/93→10/97	BFZ (XU5JP)	Petrol	1580	4	8	39
ZX Break (N2)	10/93→10/97	DHY (XUD9TE/Y)	Diesel	1905	4	8	57
ZX Break (N2)	10/93→10/97	DJZ (XUD9Y)	Diesel	1905	4	8	61
ZX Break (N2)	10/93→10/97	KDX (TU3M/Z)	Petrol	1360	4	8	26
ZX Break (N2)	10/93→10/97	KDY (TU3M)	Petrol	1360	4	8	26
ZX Break (N2)	10/93→10/97	KFX (TU3JP)	Petrol	1360	4	8	30
ZX Break (N2)	10/93→10/97	LFZ (XU7JP)	Petrol	1761	4	8	54
ZX Break (N2)	10/93→07/99	D9B (XUD9A/L)	Diesel	1905	4	8	59
ZX Break (N2)	06/94→10/97	D9B (XUD9A/U)	Diesel	1905	4	8	59
ZX Break (N2)	01/96→02/98	LFY (XU7JP4)	Petrol	1762	4	16	55
ZX Break (N2)	06/96→02/98	VJY (TUD5)	Diesel	1527	4	8	32

	CC				9		CC				9
1KR-FE	998	3	12	Petrol	5	9HZ (DV6TED4)	1560	4	16	Diesel	37
3FY (EW12J4)	2230	4	16	Petrol	82	108C	954	4	8	Petrol	6
3FZ (EW12J4)	2230	4	16	Petrol	82	109/5	1124	4	8	Petrol	11
4B11	1998	4	16	Petrol	63	109/5E	1124	4	8	Petrol	11
4B12	2360	4	16	Petrol	93	109/5F	1124	4	8	Petrol	11
4HG (P22DTE)	2198	4	16	Diesel	83	109K	1124	4	8	Petrol	11
4HH (P22DTE)	2198	4	16	Diesel	83	129/5	1219	4	8	Petrol	15
4HJ (P22DTE)	2198	4	16	Diesel	83	150A	1360	4	8	Petrol	24
4HL (DW12C)	2179	4	16	Diesel	84	150B (XY8)	1360	4	8	Petrol	24
4HN (DW12MTED4)	2179	4	16	Diesel	84	150C	1360	4	8	Petrol	24
4HP (DW12BTED4)	2179	4	16	Diesel	84	150D	1360	4	8	Petrol	24
4HR (DW12BTED4)	2179	4	16	Diesel	84	150D (XY7)	1360	4	8	Petrol	25
4HT (DW12BTED4)	2179	4	16	Diesel	84	150F	1360	4	8	Petrol	24
4HU (P22DTE)	2198	4	16	Diesel	83	159A	1905	4	8	Petrol	56
4HV (P22DTE)	2198	4	16	Diesel	83	159B	1905	4	8	Petrol	56
4HW (DW12TED4)	2179	4	16	Diesel	85	161 (XUD7)	1769	4	8	Diesel	52
4HX (DW12TED4/FAP)	2179	4	16	Diesel	85	161A (XUD7)	1769	4	8	Diesel	52
4HY (DW12UTED)	2179	4	8	Diesel	86	162 (XUD9)	1905	4	8	Diesel	57
5F4 (EP6DT)	1598	4	16	Petrol	33	169 (XM7T)	1796	4	8	Petrol	53
5FA (EP6CDT)	1598	4	16	Petrol	33	169B	1796	4	8	Petrol	53
5FA (EP6CDTD)	1598	4	16	Petrol	33	170A (XNIT)	1971	4	8	Petrol	64
5FC (EP6CDTM)	1598	4	16	Petrol	33	170B (XNIT)	1971	4	8	Petrol	64
5FD (EP6DTS)	1598	4	16	Petrol	34	170C (XNIT)	1971	4	8	Petrol	64
5FE (EP6CDTMD)	1598	4	16	Petrol	34	171A	1580	4	8	Petrol	39
5FF (EP6DTS)	1598	4	16	Petrol	34	171B	1580	4	8	Petrol	39
5FK (EP6CB)	1598	4	16	Petrol	34	171C	1580	4	8	Petrol	39
5FM (EP6DT)	1598	4	16	Petrol	34	171D	1580	4	8	Petrol	39
5FN (EP6CDT)	1598	4	16	Petrol	34	180A (XU5J)	1580	4	8	Petrol	39
5FN (EP6DT)	1598	4	16	Petrol	34	180Z	1580	4	8	Petrol	39
5FP (EP6)	1598	4	16	Petrol	33	220 A2.000	1581	4	8	Petrol	40
5FR (EP6DT)	1598	4	16	Petrol	34	829 A5	1995	4	8	Petrol	65
5FS (EP6C)	1598	4	16	Petrol	34	1580 SPI	1581	4	8	Petrol	40
5FT (EP6DT)	1598	4	16	Petrol	34	8140.43N	2798	4	8	Diesel	103
5FU (EP6CDTX)	1598	4	16	Petrol	34	8140.43S	2798	4	8	Diesel	103
5FU (EP6DTX)	1598	4	16	Petrol	34	8140.63 (F28D)	2798	4	8	Diesel	103
5FV (EP6CDT)	1598	4	16	Petrol	34	A06/635	602	2	4	Petrol	2
5FW (EP6)	1598	4	16	Petrol	34	A06/664	602	2	4	Petrol	2
5FX (EP6DT)	1598	4	16	Petrol	34	A8A (XUD7TE)	1769	4	8	Diesel	52
5FY (EP6CDTX)	1598	4	16	Petrol	34	A9A (XUD7)	1769	4	8	Diesel	52
5FY (EP6DT)	1598	4	16	Petrol	34	A 53	425	2	4	Petrol	1
5FY (EP6DTS)	1598	4	16	Petrol	34	A79/0 (AYA)	425	2	4	Petrol	1
5GM (EP6FDTX)	1598	4	16	Petrol	34	A79/1 (AYA2)	435	2	4	Petrol	1
5GZ (EP6FDT)	1598	4	16	Petrol	34	AHE (DW10FD)	1997	4	16	Diesel	66
6FY (EW7A)	1749	4	16	Petrol	51	AHF (DW10FD)	1997	4	16	Diesel	67
6FZ (EW7A)	1749	4	16	Petrol	51	AHG (DW10FD)	1997	4	16	Diesel	67
6FZ (EW7J4)	1749	4	16	Petrol	51	AHH (DW10FC)	1997	4	16	Diesel	68
8FN (EP3)	1397	4	16	Petrol	21	AHJ (DW10FE)	1997	4	16	Diesel	67
8FP (EP3)	1397	4	16	Petrol	21	AHK (DW10FE)	1997	4	16	Diesel	67
8FR (EP3)	1397	4	16	Petrol	21	AHM (DW10FUE)	1997	4	16	Diesel	67
8FS (EP3)	1397	4	16	Petrol	21	AHN (DW10FUD)	1997	4	16	Diesel	68
8HR (DV4C)	1398	4	8	Diesel	22	AHP (DW10FUC)	1997	4	16	Diesel	68
8HS (DV4TED)	1398	4	8	Diesel	22	AHR (DW10FD)	1997	4	16	Diesel	68
8HT (DV4TD)	1398	4	8	Diesel	22	AHS (DW10FD)	1997	4	16	Diesel	67
8HX (DV4TD)	1398	4	8	Diesel	22	AHT (DW10FC)	1997	4	16	Diesel	67
8HY (DV4TED4)	1398	4	16	Diesel	23	AHU (DW10FD)	1997	4	16	Diesel	67
8HZ (DV4TD)	1398	4	8	Diesel	22	AHV (DW10FD)	1997	4	16	Diesel	68
9HC (DV6C)	1560	4	8	Diesel	35	AHW (DW10FC)	1997	4	16	Diesel	68
9HD (DV6C)	1560	4	8	Diesel	35	AHX (DW10FCD)	1997	4	16	Diesel	67
9HE (DV6DBM)	1560	4	8	Diesel	35	AHX (DW10FD)	1997	4	16	Diesel	68
9HF (DV6DTE)	1560	4	8	Diesel	35	AHY (DW10CE)	1997	4	16	Diesel	68
9HH (DV6DUM)	1560	4	8	Diesel	35	AHZ (DW10CD)	1997	4	16	Diesel	68
9HJ (DV6DTE)	1560	4	8	Diesel	35	AJZ (XUD7TE)	1769	4	8	Diesel	52
9HK (DV6ETEDM)	1560	4	8	Diesel	35	B1A (XU51C/K)	1580	4	8	Petrol	39
9HL (DV6C)	1560	4	8	Diesel	35	B1E (XU51C)	1580	4	8	Petrol	39
9HM (DV6UC)	1560	4	8	Diesel	35	B6D	1580	4	8	Petrol	39
9HN (DV6ETED)	1560	4	8	Diesel	35	B6E	1580	4	8	Petrol	41
9HN (DV6ETED4)	1560	4	16	Diesel	36	B20	1985	4	8	Petrol	69
9HP (DV6DTE)	1560	4	8	Diesel	35	B20614	1985	4	8	Petrol	69
9HR (DV6C)	1560	4	8	Diesel	35	B22615	2175	4	8	Diesel	87
9HS (DV6TED4BU)	1560	4	16	Diesel	37	B25637	2498	4	8	Diesel	96
9HT (DV6BTED4)	1560	4	16	Diesel	37	BAY (XU5CP)	1580	4	8	Petrol	39
9HT (DV6BUTED4)	1560	4	16	Diesel	37	BAZ (XU5CP)	1580	4	8	Petrol	39
9HU (DV6UTED4)	1560	4	16	Diesel	37	BDY (XU5M)	1580	4	8	Petrol	39
9HW (DV6BTED4)	1560	4	16	Diesel	37	BDZ (XU5M)	1580	4	8	Petrol	39
9HW (DV6ETED)	1560	4	8	Diesel	38	BFZ (XU51P)	1580	4	8	Petrol	39
9HX (DV6ATED4)	1560	4	16	Diesel	37	BHS (DV6FUD)	1560	4	8	Diesel	35
9HX (DV6AUTED4)	1560	4	16	Diesel	37	BHT (DV6FC)	1560	4	8	Diesel	35
9HY (DV6TED4)	1560	4	16	Diesel	37	BHU (DV6FC)	1560	4	8	Diesel	35

	CC				9		CC				9
BHV (DV6FDU)	1560	4	8	Diesel	35	KAZ	1360	4	8	Petrol	26
BHW (DV6FE)	1560	4	8	Diesel	35	KDX (TU3M/Z)	1360	4	8	Petrol	26
BHX (DV6FC)	1560	4	8	Diesel	35	KDY (TU3FM)	1360	4	8	Petrol	26
BHX (DV6FCU)	1560	4	8	Diesel	42	KDY (TU3M)	1360	4	8	Petrol	26
BHY (DV6FD)	1560	4	8	Diesel	35	KDZ (TU3M/Z)	1360	4	8	Petrol	26
BHZ (DV6FC)	1560	4	8	Diesel	35	KFT (TU3A)	1360	4	8	Petrol	28
C1A	954	4	8	Petrol	7	KFU (ET3J4)	1360	4	16	Petrol	29
C3A	954	4	8	Petrol	7	KFV (TU3A)	1360	4	8	Petrol	28
CDY (TU9M)	954	4	8	Petrol	7	KFV (TU3JP)	1360	4	8	Petrol	30
CDZ (TU9M)	954	4	8	Petrol	7	KFW (TU3A)	1360	4	8	Petrol	28
CFA (384F)	998	3	12	Petrol	5	KFW (TU3JP)	1360	4	8	Petrol	30
CFB (1KR)	998	3	12	Petrol	5	KFX (TU3A)	1360	4	8	Petrol	31
CRD93B	2499	4	8	Diesel	97	KFX (TU3JP)	1360	4	8	Petrol	30
CRD93L (U25-661)	2500	4	8	Diesel	98	KFY (TU3FJ2)	1360	4	8	Petrol	26
CRD93LS (U25-673)	2500	4	8	Diesel	98	KFZ (TU3FJ2)	1360	4	8	Petrol	26
D2A (XU92C)	1905	4	8	Petrol	56	LFX (XU7JB)	1761	4	8	Petrol	54
D2C (XU92C)	1905	4	8	Petrol	56	LFY (XU7JP4)	1762	4	16	Petrol	55
D2E	1905	4	8	Petrol	56	LFZ (XU7JP)	1761	4	8	Petrol	54
D2F	1905	4	8	Petrol	56	M4 (AM)	602	2	4	Petrol	3
D6A (XU9J2)	1905	4	8	Petrol	56	M4A	1294	4	8	Petrol	20
D6C (XU9J4)	1905	4	16	Petrol	58	M22-617	2175	4	8	Petrol	89
D6E (XU9JA)	1905	4	8	Petrol	56	M22-621	2175	4	8	Diesel	90
D8B (XUD9TF)	1905	4	8	Diesel	57	M23-622	2347	4	8	Petrol	92
D8C (XUD9UTF)	1905	4	8	Diesel	57	M23-623	2347	4	8	Petrol	92
D9A (XUD9)	1905	4	8	Diesel	57	M23-627	2348	4	8	Petrol	92
D9B (XUD9A/L)	1905	4	8	Diesel	59	M23-639	2347	4	8	Petrol	92
D9B (XUD9A/U)	1905	4	8	Diesel	59	M25-629	2500	4	8	Diesel	96
DDZ (XU9M)	1905	4	8	Petrol	56	M25-648	2500	4	8	Diesel	97
DFW (XU9J4)	1905	4	16	Petrol	58	M25-659	2500	4	8	Petrol	99
DFZ (XU9J1)	1905	4	8	Petrol	56	M25-660	2500	4	8	Diesel	97
DHV (XUD9BSD)	1905	4	8	Diesel	59	M25-662	2500	4	8	Petrol	99
DHW (XUD9SD)	1905	4	8	Diesel	57	M25-667	2498	4	8	Petrol	99
DHX (XUD9TF/BTF)	1905	4	8	Diesel	60	M25-668	2498	4	8	Petrol	99
DHY (XUD9TE/Y)	1905	4	8	Diesel	57	M25-669	2500	4	8	Diesel	97
DJY (XUD9A)	1905	4	8	Diesel	57	M28 (AM2)	602	2	4	Petrol	3
DJZ (XUD9Y)	1905	4	8	Diesel	61	M28/1 (AK2)	602	2	4	Petrol	3
DKZ (XU9JA)	1905	4	8	Petrol	56	M705	1930	4	8	Diesel	62
DT17ED4	2720	6	24	Diesel	102	N6A (TU5JP4)	1587	4	16	Petrol	43
DT20C	2993	6	24	Diesel	105	NFP (EC5)	1587	4	16	Petrol	44
DV4D	1398	4	8	Diesel	22	NFR (TU5JP4B)	1587	4	16	Petrol	45
DV6B	1560	4	16	Diesel	37	NFS (TU5JP4S)	1587	4	16	Petrol	46
E1A	1124	4	8	Petrol	12	NFT (TU5JP)	1587	4	8	Petrol	47
EW10J4	1997	4	16	Petrol	70	NFU (TU5JP4)	1587	4	16	Petrol	48
F1AEO48N	2287	4	16	Diesel	91	NFV (TU5JP)	1587	4	8	Petrol	49
F28TDCR	2798	4	8	Diesel	103	NFX (TU5JP4)	1587	4	16	Petrol	43
FHY (F13DTE6)	1248	4	16	Diesel	16	NFZ (TU5JP)	1587	4	8	Petrol	49
FHZ (F13DTE5)	1248	4	16	Diesel	16	P8A (XUD11ATE)	2088	4	12	Diesel	81
G1A	1294	4	8	Petrol	19	P8C (XUD11BTE)	2088	4	12	Diesel	81
G10	1015	4	8	Petrol	8	P9A (XUD11A)	2138	4	12	Diesel	81
G10/612	1015	4	8	Petrol	8	PHZ (XUD11ATE)	2088	4	12	Diesel	81
G12/611	1222	4	8	Petrol	17	PJZ (XUD11ATE)	2088	4	12	Diesel	81
G12/612	1222	4	8	Petrol	17	PSA RFN 10LH3X	1997	4	16	Petrol	70
G12/619	1222	4	8	Petrol	17	R6A	1998	4	8	Petrol	71
H1A	1124	4	8	Petrol	13	RO6 627	602	2	4	Petrol	2
H1B	1124	4	8	Petrol	13	RDZ (XU10MZ)	1998	4	8	Petrol	71
HAZ (TU1CP)	1124	4	8	Petrol	13	RFH (EW10A)	1997	4	16	Petrol	72
HDY (TU1M+)	1124	4	8	Petrol	13	RFJ (EW10A)	1997	4	16	Petrol	73
HDZ (TU1M)	1124	4	8	Petrol	13	RFK (EW10A)	1997	4	16	Petrol	73
HFX (TU1A)	1124	4	8	Petrol	14	RFK (EW10J4S)	1997	4	16	Petrol	70
HFX (TU1JP)	1124	4	8	Petrol	14	RFM	1997	4	16	Petrol	74
HMT (EB2D)	1199	3	12	Petrol	18	RFN (EW10A)	1997	4	16	Petrol	73
HMU (EB2D)	1199	3	12	Petrol	18	RFN (EW10J4)	1997	4	16	Petrol	73
HMY (EB2M)	1199	3	12	Petrol	18	RFN	1997	4	16	Petrol	70
HMZ (EB2F)	1199	3	12	Petrol	18	RFR (EW10A)	1997	4	16	Petrol	73
HNY (EB2DTS)	1199	3	12	Petrol	18	RFS (XU10J4RS)	1998	4	16	Petrol	75
HNZ (EB2DT)	1199	3	12	Petrol	18	RFT (XU10J4/Z)	1998	4	16	Petrol	76
J6T A500	2165	4	8	Petrol	88	RFU (XU10J2/C)	1998	4	8	Petrol	71
K1B	1360	4	8	Petrol	26	RFV (XU10J4R)	1998	4	16	Petrol	77
K1F	1360	4	8	Petrol	26	RFW (XU10J2U)	1998	4	8	Petrol	71
K1G	1360	4	8	Petrol	26	RFX (XU10J2C)	1998	4	8	Petrol	71
K1H (TU3A)	1360	4	8	Petrol	26	RFX XU10J2C/Z L3	1998	4	8	Petrol	71
K2A	1360	4	8	Petrol	26	RFY (XU10J4/Z)	1998	4	16	Petrol	76
K2B	1360	4	8	Petrol	26	RFZ (XU10J2)	1998	4	8	Petrol	71
K2D	1360	4	8	Petrol	26	RGX (XU10J2TE)	1998	4	8	Petrol	71
K3A	1360	4	8	Petrol	26	RGY (XU10J2TE/Z)	1998	4	8	Petrol	71
K9A (TUD3)	1360	4	8	Diesel	27	RHC (DW10CTED4)	1997	4	16	Diesel	68
K9Y (TUD3Y)	1360	4	8	Diesel	27	RHD (DW10CB)	1997	4	16	Diesel	68
KAY (TU3CP)	1360	4	8	Petrol	7	RHD (DW10CTED4)	1997	4	16	Diesel	68



CC



9



CC



9

RHE (DW10CTED4)	1997	4	16	Diesel	68
RHF (DW10BTED4)	1997	4	16	Diesel	78
RHH (DW10CTED4)	1997	4	16	Diesel	68
RHJ (DW10BTED4)	1997	4	16	Diesel	78
RHK (DW10UTED4)	1997	4	16	Diesel	78
RHM (DW10ATED4)	1997	4	16	Diesel	78
RHR (DW10BTED4)	1997	4	16	Diesel	78
RHS (DW10ATED)	1997	4	8	Diesel	79
RHT (DW10ATED4)	1997	4	16	Diesel	78
RHV (DW10TD)	1997	4	8	Diesel	79
RHV (DW10UTD)	1997	4	8	Diesel	79
RHW (DW10ATED4)	1997	4	16	Diesel	78
RHX (DW10BTED)	1997	4	8	Diesel	79
RHY (DW10TD)	1997	4	8	Diesel	79
RHZ (DW10ATED)	1997	4	8	Diesel	79
RHZ (DW10BTED)	1997	4	8	Diesel	80
RHZ (DW10BTED+)	1997	4	8	Diesel	80
RHZ (DW10CTED)	1997	4	8	Diesel	80
RLZ (EW10D)	1997	4	16	Petrol	70
SFZ (4B12-MMC)	2360	4	16	Petrol	94
SFZ (ZPJ/Z)	2975	6	12	Petrol	106
SKZ (ZPJ4/Z)	2963	6	24	Petrol	107
T8A (DJ5T)	2446	4	12	Diesel	100
T9A (DJ5)	2446	4	12	Diesel	100
THX (DJ5TED)	2446	4	8	Diesel	95
THY (DK5ATE)	2446	4	12	Diesel	101
THZ (DJ5T)	2446	4	12	Diesel	101
TU5JP4	1587	4	16	Petrol	43
TU5JPK	1587	4	8	Petrol	50
TU9	954	4	8	Petrol	7
TU9K	954	4	8	Petrol	7
UFZ (ZPJ/Z)	2963	6	12	Petrol	106
UHZ (DT17BTED4)	2720	6	24	Diesel	102
UHZ (DT17TED4)	2720	6	24	Diesel	102
UKZ (ZPJ4/Z)	2963	6	24	Petrol	107
V06 630	652	2	4	Petrol	4
V06 644	652	2	4	Petrol	4
V06/665	652	2	4	Petrol	4
VJY (TUD5)	1527	4	8	Diesel	32
VJZ (TUD5)	1527	4	8	Diesel	32
WJX (DW8B)	1868	4	8	Diesel	59
WJY (DW8B)	1868	4	8	Diesel	59
WJZ (DW8)	1868	4	8	Diesel	59
X8C (DT20C)	2993	6	24	Diesel	105
XFU (ES9A)	2946	6	24	Petrol	104
XFV (ES9A)	2946	6	24	Petrol	104
XFW (ES9A)	2946	6	24	Petrol	104
XFW (ES9J4S)	2946	6	24	Petrol	104
AFX (ES9A)	2946	6	24	Petrol	108
AFX (ES9J4S)	2946	6	24	Petrol	108
XFZ (ES9J4)	2946	6	24	Petrol	104
XU10J2	1998	4	8	Petrol	71
XU52C	1580	4	8	Petrol	39
XU102C	1998	4	8	Petrol	71
XV8	954	4	8	Petrol	9
ZMZ (EBO)	999	3	12	Petrol	10
ZMZ (EBOF)	999	3	12	Petrol	10



1 0.4L Petrol

A 53	2 Cyl.	4 Valves	425cc	TD5088
A79/0 (AYA)	2 Cyl.	4 Valves	425cc	TD5085
A79/1 (AYA2)	2 Cyl.	4 Valves	435cc	TD601

NF812
30.00 x 42.00 x 8.00mm, ACM

2 0.6L Petrol

A06/635	2 Cyl.	4 Valves	602cc	TD599
A06/664	2 Cyl.	4 Valves	602cc	TD600
R06 627	2 Cyl.	4 Valves	602cc	TD5090

NF812
30.00 x 42.00 x 8.00mm, ACM
NF809
56.00 x 69.00 x 10.00mm, FPM

3 0.6L Petrol

M4 (AM)	2 Cyl.	4 Valves	602cc	TD5180
M28 (AM2)	2 Cyl.	4 Valves	602cc	TD5084
M28/1 (AK2)	2 Cyl.	4 Valves	602cc	TD705

NF812
30.00 x 42.00 x 8.00mm, ACM

4 0.7L Petrol

V06 630	2 Cyl.	4 Valves	652cc	TD737
V06 644	2 Cyl.	4 Valves	652cc	TD738
V06/665	2 Cyl.	4 Valves	652cc	TD741

NF812
30.00 x 42.00 x 8.00mm, ACM

5 1.0L Petrol

1KR-FE	3 Cyl.	12 Valves	998cc	TD18548
CFA (384F)	3 Cyl.	12 Valves	998cc	TD25073
CFB (1KR)	3 Cyl.	12 Valves	998cc	TD34180

NA5260
38.00 x 50.00 x 6.00mm, FPM
NA5324
74.00 x 89.00 x 8.50mm, FPM

6 1.0L Petrol

108C	4 Cyl.	8 Valves	954cc	TD6560
------	--------	----------	-------	--------

HR300

NF817
36.00 x 50.00 x 7.00mm, FPM

NJ242
35.00 x 50.00 x 8.00mm, NBR
NF641
78.00 x 100.00 x 10.00mm, MVQ

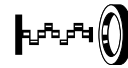
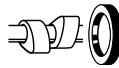

7 1.0L Petrol

C1A	4 Cyl.	8 Valves	954cc	TD6559
C3A	4 Cyl.	8 Valves	954cc	TD619
CDY (TU9M)	4 Cyl.	8 Valves	954cc	TD5095
CDZ (TU9M)	4 Cyl.	8 Valves	954cc	TD10787
KAY (TU3CP)	4 Cyl.	8 Valves	1360cc	TD9546
TU9	4 Cyl.	8 Valves	954cc	TD18545
TU9K	4 Cyl.	8 Valves	954cc	TD26984

HR816

NF817
36.00 x 50.00 x 7.00mm, FPM

NF870
42.00 x 66.00 x 6.00mm, FPM/ACM
NF850
85.00 x 105.00 x 8.00mm, FPM
NF857
85.00 x 105.00 x 9.00mm, FPM/ACM

8 1.0L Petrol

G10	4 Cyl.	8 Valves	1015cc	TD649
G10/612	4 Cyl.	8 Valves	1015cc	TD5094

NF812
30.00 x 42.00 x 8.00mm, ACM

9 1.0L Petrol

XV8	4 Cyl.	8 Valves	954cc	TD18544
-----	--------	----------	-------	---------

HR569

NJ242
35.00 x 50.00 x 8.00mm, NBR
NF641
78.00 x 100.00 x 10.00mm, MVQ

10 1.0L Petrol

ZMZ (EBO)	3 Cyl.	12 Valves	999cc	TD32360
ZMZ (EBOF)	3 Cyl.	12 Valves	999cc	TD34183

NA5363
61.00 x 75.00 x 8.00mm, PTFE/ACM
LK5020
85.00 x 154.00 x 9.50mm, PTFE/ACM

11 1.1L Petrol

109/5	4 Cyl.	8 Valves	1124cc	TD564
109/5E	4 Cyl.	8 Valves	1124cc	TD565
109/5F	4 Cyl.	8 Valves	1124cc	TD566
109K	4 Cyl.	8 Valves	1124cc	TD563

HR300

NJ242
35.00 x 50.00 x 8.00mm, NBR
NF641
78.00 x 100.00 x 10.00mm, MVQ

12 1.1L Petrol

E1A	4 Cyl.	8 Valves	1124cc	TD648
-----	--------	----------	--------	-------

HR300

NF812
30.00 x 42.00 x 8.00mm, ACM



13 1.1L Petrol

H1A	4 Cyl.	8 Valves	1124cc	TD6562
H1B	4 Cyl.	8 Valves	1124cc	TD658
HAZ (TU1CP)	4 Cyl.	8 Valves	1124cc	TD5083
HDY (TU1M+)	4 Cyl.	8 Valves	1124cc	TD26411
HDZ (TU1M)	4 Cyl.	8 Valves	1124cc	TD661
HR816	NF817 36.00 x 50.00 x 7.00mm, FPM		NF870 42.00 x 66.00 x 6.00mm, FPM/ACM NF850 85.00 x 105.00 x 8.00mm, FPM	

14 1.1L Petrol

HFX (TU1A)	4 Cyl.	8 Valves	1124cc	TD30658
HFX (TU1JP)	4 Cyl.	8 Valves	1124cc	TD14730
HR816	NF817 36.00 x 50.00 x 7.00mm, FPM		NA5363 61.00 x 75.00 x 8.00mm, PTFE/ACM NA5362 85.00 x 105.00 x 8.00mm, PTFE/ACM	

15 1.2L Petrol

129/5	4 Cyl.	8 Valves	1219cc	TD574
HR300			NJ242 35.00 x 50.00 x 8.00mm, NBR NF641 78.00 x 100.00 x 10.00mm, MVQ	

16 1.2L Diesel

FHY (F13DTE6)	4 Cyl.	16 Valves	1248cc	TD32882
FHZ (F13DTE5)	4 Cyl.	16 Valves	1248cc	TD25689
HR5088			NA5223 40.00 x 52.00 x 7.00mm, FPM NA5230 78.00 x 100.00 x 9.00mm, PTFE	

17 1.2L Petrol

G12/611	4 Cyl.	8 Valves	1222cc	TD5100
G12/612	4 Cyl.	8 Valves	1222cc	TD5099
G12/619	4 Cyl.	8 Valves	1222cc	TD5098
			NF812 30.00 x 42.00 x 8.00mm, ACM	

18 1.2L Petrol

HMT (EB2D)	3 Cyl.	12 Valves	1199cc	TD32498
HMU (EB2D)	3 Cyl.	12 Valves	1199cc	TD32429
HMY (EB2M)	3 Cyl.	12 Valves	1199cc	TD32339
HMZ (EB2F)	3 Cyl.	12 Valves	1199cc	TD32341
HNY (EB2DTS)	3 Cyl.	12 Valves	1199cc	TD32357
HNZ (EB2DT)	3 Cyl.	12 Valves	1199cc	TD29366
			NA5363 61.00 x 75.00 x 8.00mm, PTFE/ACM LK5020 85.00 x 154.00 x 9.50mm, PTFE/ACM	

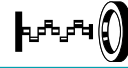

19 1.3L

Petrol

G1A	4 Cyl.	8 Valves	1294cc	TD6565
HR569	NF817 36.00 x 50.00 x 7.00mm, FPM	NF694 40.00 x 58.00 x 8.00mm, ACM	NF692 71.00 x 88.00 x 8.00mm, MVQ	

20 1.3L

Petrol

M4A	4 Cyl.	8 Valves	1294cc	TD706
HR569	NF817 36.00 x 50.00 x 7.00mm, FPM	NF870 42.00 x 66.00 x 6.00mm, FPM/ACM	NF850 85.00 x 105.00 x 8.00mm, FPM	

21 1.4L

Petrol

8FN (EP3)	4 Cyl.	16 Valves	1397cc	TD29266
8FP (EP3)	4 Cyl.	16 Valves	1397cc	TD25076
8FR (EP3)	4 Cyl.	16 Valves	1397cc	TD25077
8FS (EP3)	4 Cyl.	16 Valves	1397cc	TD24725
HR5110		NA5363 61.00 x 75.00 x 8.00mm, PTFE/ACM	NA5362 85.00 x 105.00 x 8.00mm, PTFE/ACM	

22 1.4L

Diesel

8HR (DV4C)	4 Cyl.	8 Valves	1398cc	TD25061
8HS (DV4TED)	4 Cyl.	8 Valves	1398cc	TD25063
8HT (DV4TD)	4 Cyl.	8 Valves	1398cc	TD25062
8HX (DV4TD)	4 Cyl.	8 Valves	1398cc	TD16425
8HZ (DV4TD)	4 Cyl.	8 Valves	1398cc	TD23773
DV4D	4 Cyl.	8 Valves	1398cc	TD18550
PA5068 (x8) HR5120	NA5258 27.00 x 47.00 x 7.00mm, PTFE	NA5259 40.00 x 55.00 x 6.40mm, PTFE	NA5325 85.00 x 105.00 x 8.80mm, PTFE	

23 1.4L

Diesel

8HY (DV4TED4)	4 Cyl.	16 Valves	1398cc	TD16426
PA6072 (x16) HR5124	NA5258 (x2) 27.00 x 47.00 x 7.00mm, PTFE	NA5259 40.00 x 55.00 x 6.40mm, PTFE	NA5325 85.00 x 105.00 x 8.80mm, PTFE	

24 1.4L

Petrol

150A	4 Cyl.	8 Valves	1360cc	TD576
150B (XY8)	4 Cyl.	8 Valves	1360cc	TD577
150C	4 Cyl.	8 Valves	1360cc	TD582
150D	4 Cyl.	8 Valves	1360cc	TD6570
150F	4 Cyl.	8 Valves	1360cc	TD578
HR300		NJ242 35.00 x 50.00 x 8.00mm, NBR	NF641 78.00 x 100.00 x 10.00mm, MVQ	

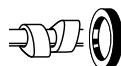

25 1.4L

Petrol

150D (XY7)	4 Cyl.	8 Valves	1360cc	TD5091
HR569				
			NJ242 35.00 x 50.00 x 8.00mm, NBR NF641 78.00 x 100.00 x 10.00mm, MVQ	

26 1.4L

Petrol

K1B	4 Cyl.	8 Valves	1360cc	TD665
K1F	4 Cyl.	8 Valves	1360cc	TD666
K1G	4 Cyl.	8 Valves	1360cc	TD6567
K1H (TU3A)	4 Cyl.	8 Valves	1360cc	TD4272
K2A	4 Cyl.	8 Valves	1360cc	TD668
K2B	4 Cyl.	8 Valves	1360cc	TD669
K2D	4 Cyl.	8 Valves	1360cc	TD6568
K3A	4 Cyl.	8 Valves	1360cc	TD6569
KAZ	4 Cyl.	8 Valves	1360cc	TD6566
KDX (TU3M/Z)	4 Cyl.	8 Valves	1360cc	TD5080
KDY (TU3FM)	4 Cyl.	8 Valves	1360cc	TD4277
KDY (TU3M)	4 Cyl.	8 Valves	1360cc	TD5160
KDZ (TU3M/Z)	4 Cyl.	8 Valves	1360cc	TD683
KFY (TU3FJ2)	4 Cyl.	8 Valves	1360cc	TD5078
KFZ (TU3FJ2)	4 Cyl.	8 Valves	1360cc	TD5096
HR816			NF817 36.00 x 50.00 x 7.00mm, FPM	NF870 42.00 x 66.00 x 6.00mm, FPM/ACM NF850 85.00 x 105.00 x 8.00mm, FPM

27 1.4L

Diesel

K9A (TUD3)	4 Cyl.	8 Valves	1360cc	TD5079
K9Y (TUD3Y)	4 Cyl.	8 Valves	1360cc	TD5092
HR816			NF746 36.00 x 50.00 x 7.00mm, ACM	NF870 42.00 x 66.00 x 6.00mm, FPM/ACM NF850 85.00 x 105.00 x 8.00mm, FPM

28 1.4L

Petrol

KFT (TU3A)	4 Cyl.	8 Valves	1360cc	TD25070
KFV (TU3A)	4 Cyl.	8 Valves	1360cc	TD23774
KFW (TU3A)	4 Cyl.	8 Valves	1360cc	TD25066
HR816			NA5364 36.00 x 50.00 x 8.00mm, ACM	NA5331 42.00 x 66.00 x 7.00mm, PTFE NA5362 85.00 x 105.00 x 8.00mm, PTFE/ACM

29 1.4L

Petrol

KFU (ET3J4)	4 Cyl.	16 Valves	1360cc	TD17977
			NA5364 36.00 x 50.00 x 8.00mm, ACM NA5453 24.00 x 50.00 x 8.00mm, PTFE/ACM	NA5331 42.00 x 66.00 x 7.00mm, PTFE NF850 85.00 x 105.00 x 8.00mm, FPM

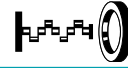

30 1.4L

Petrol

KFV (TU3JP)	4 Cyl.	8 Valves	1360cc	TD16464
KFW (TU3JP)	4 Cyl.	8 Valves	1360cc	TD14731
KFX (TU3JP)	4 Cyl.	8 Valves	1360cc	TD6554
HR816	NF817 36.00 x 50.00 x 7.00mm, FPM		NA5331 42.00 x 66.00 x 7.00mm, PTFE NF850 85.00 x 105.00 x 8.00mm, FPM	

31 1.4L

Petrol

KFX (TU3A)	4 Cyl.	8 Valves	1360cc	TD25074
	NA5364 36.00 x 50.00 x 8.00mm, ACM		NA5331 42.00 x 66.00 x 7.00mm, PTFE NA5362 85.00 x 105.00 x 8.00mm, PTFE/ACM	

32 1.5L

Diesel

VJY (TUD5)	4 Cyl.	8 Valves	1527cc	TD11890
VJZ (TUD5)	4 Cyl.	8 Valves	1527cc	TD4296
HR816	NF817 36.00 x 50.00 x 7.00mm, FPM		NF870 42.00 x 66.00 x 6.00mm, FPM/ACM NF850 85.00 x 105.00 x 8.00mm, FPM	

33 1.6L

Petrol

SF4 (EP6DT)	4 Cyl.	16 Valves	1598cc	TD25080
SFA (EP6CDT)	4 Cyl.	16 Valves	1598cc	TD34192
SFA (EP6CDTD)	4 Cyl.	16 Valves	1598cc	TD34193
SFC (EP6CDTM)	4 Cyl.	16 Valves	1598cc	TD34194
SFP (EP6)	4 Cyl.	16 Valves	1598cc	TD33800
			NA5363 61.00 x 75.00 x 8.00mm, PTFE/ACM NA5362 85.00 x 105.00 x 8.00mm, PTFE/ACM	

34 1.6L

Petrol

SFD (EP6DTS)	4 Cyl.	16 Valves	1598cc	TD27050
SFE (EP6CDTMD)	4 Cyl.	16 Valves	1598cc	TD28090
SFF (EP6DTS)	4 Cyl.	16 Valves	1598cc	TD28251
SFK (EP6CB)	4 Cyl.	16 Valves	1598cc	TD25065
SFM (EP6DT)	4 Cyl.	16 Valves	1598cc	TD25081
SFN (EP6CDT)	4 Cyl.	16 Valves	1598cc	TD28249
SFN (EP6DT)	4 Cyl.	16 Valves	1598cc	TD25079
SFR (EP6DT)	4 Cyl.	16 Valves	1598cc	TD24933
SFS (EP6C)	4 Cyl.	16 Valves	1598cc	TD24934
SFT (EP6DT)	4 Cyl.	16 Valves	1598cc	TD24694
SFU (EP6CDTX)	4 Cyl.	16 Valves	1598cc	TD27048
SFU (EP6DTX)	4 Cyl.	16 Valves	1598cc	TD25084
SFV (EP6CDT)	4 Cyl.	16 Valves	1598cc	TD24936
SFW (EP6)	4 Cyl.	16 Valves	1598cc	TD24724
SFX (EP6DT)	4 Cyl.	16 Valves	1598cc	TD23516
SFY (EP6CDTX)	4 Cyl.	16 Valves	1598cc	TD27049



5FY (EP6DT)	4 Cyl.	16 Valves	1598cc	TD25082
5FY (EP6DTS)	4 Cyl.	16 Valves	1598cc	TD28250
5GM (EP6FDTX)	4 Cyl.	16 Valves	1598cc	TD32493
5GZ (EP6FDT)	4 Cyl.	16 Valves	1598cc	TD31763

HR5110

NA5363

61.00 x 75.00 x 8.00mm, PTFE/ACM

NA5362

85.00 x 105.00 x 8.00mm, PTFE/ACM

35 1.6L

Diesel

9HC (DV6C)	4 Cyl.	8 Valves	1560cc	TD31490
9HD (DV6C)	4 Cyl.	8 Valves	1560cc	TD29578
9HE (DV6DBM)	4 Cyl.	8 Valves	1560cc	TD25095
9HF (DV6DTED)	4 Cyl.	8 Valves	1560cc	TD25094
9HH (DV6DUM)	4 Cyl.	8 Valves	1560cc	TD29698
9HJ (DV6DTEDM)	4 Cyl.	8 Valves	1560cc	TD25093
9HK (DV6ETEDM)	4 Cyl.	8 Valves	1560cc	TD25097
9HL (DV6C)	4 Cyl.	8 Valves	1560cc	TD26985
9HM (DV6UC)	4 Cyl.	8 Valves	1560cc	TD28622
9HN (DV6ETED)	4 Cyl.	8 Valves	1560cc	TD25096
9HP (DV6DTED)	4 Cyl.	8 Valves	1560cc	TD25092
9HR (DV6C)	4 Cyl.	8 Valves	1560cc	TD25690
BHS (DV6FDU)	4 Cyl.	8 Valves	1560cc	TD33791
BHT (DV6FC)	4 Cyl.	8 Valves	1560cc	TD33790
BHU (DV6FC)	4 Cyl.	8 Valves	1560cc	TD33788
BHV (DV6FDU)	4 Cyl.	8 Valves	1560cc	TD33703
BHW (DV6FE)	4 Cyl.	8 Valves	1560cc	TD31068
BHX (DV6FC)	4 Cyl.	8 Valves	1560cc	TD28551
BHY (DV6FD)	4 Cyl.	8 Valves	1560cc	TD31067
BHZ (DV6FC)	4 Cyl.	8 Valves	1560cc	TD28612

PA5068 (x8)

HR5120

NA5258

27.00 x 47.00 x 7.00mm, PTFE

NA5259

40.00 x 55.00 x 6.40mm, PTFE

NA5325

85.00 x 105.00 x 8.80mm, PTFE

36 1.6L

Diesel

9HN (DV6ETED4)	4 Cyl.	16 Valves	1560cc	TD29850
----------------	--------	-----------	--------	---------

PA5068 (x16)

HR5120

NA5258

27.00 x 47.00 x 7.00mm, PTFE

NA5259

40.00 x 55.00 x 6.40mm, PTFE

NA5325

85.00 x 105.00 x 8.80mm, PTFE

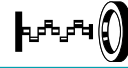

37 1.6L

Diesel

9HS (DV6TED4BU)	4 Cyl.	16 Valves	1560cc	TD29161
9HT (DV6BTED4)	4 Cyl.	16 Valves	1560cc	TD21321
9HT (DV6BUTED4)	4 Cyl.	16 Valves	1560cc	TD21322
9HU (DV6UTED4)	4 Cyl.	16 Valves	1560cc	TD24692
9HW (DV6BTED4)	4 Cyl.	16 Valves	1560cc	TD27840
9HX (DV6ATED4)	4 Cyl.	16 Valves	1560cc	TD19913
9HX (DV6AUTED4)	4 Cyl.	16 Valves	1560cc	TD25064
9HY (DV6TED4)	4 Cyl.	16 Valves	1560cc	TD19911
9HZ (DV6TED4)	4 Cyl.	16 Valves	1560cc	TD19824
DV6B	4 Cyl.	16 Valves	1560cc	TD18832

PA6072 (x16)
HR5124

NA5258
27.00 x 47.00 x 7.00mm, PTFE

NA5259
40.00 x 55.00 x 6.40mm, PTFE
NA5325
85.00 x 105.00 x 8.80mm, PTFE

38 1.6L

Diesel

9HW (DV6ETED)	4 Cyl.	8 Valves	1560cc	TD25632
---------------	--------	----------	--------	---------

PA5068 (x8)
HR5120

NA5258 (x2)
27.00 x 47.00 x 7.00mm, PTFE

NA5259
40.00 x 55.00 x 6.40mm, PTFE
NA5325
85.00 x 105.00 x 8.80mm, PTFE

39 1.6L

Petrol

171A	4 Cyl.	8 Valves	1580cc	TD591
171B	4 Cyl.	8 Valves	1580cc	TD592
171C	4 Cyl.	8 Valves	1580cc	TD593
171D	4 Cyl.	8 Valves	1580cc	TD594
180A (XU5J)	4 Cyl.	8 Valves	1580cc	TD596
180Z	4 Cyl.	8 Valves	1580cc	TD597
B1A (XU51C/K)	4 Cyl.	8 Valves	1580cc	TD12428
B1E (XU51C)	4 Cyl.	8 Valves	1580cc	TD607
B6D	4 Cyl.	8 Valves	1580cc	TD4262
BAY (XU5CP)	4 Cyl.	8 Valves	1580cc	TD9550
BAZ (XU5CP)	4 Cyl.	8 Valves	1580cc	TD9551
BDY (XU5M)	4 Cyl.	8 Valves	1580cc	TD5097
BDZ (XU5M)	4 Cyl.	8 Valves	1580cc	TD615
BFZ (XU5JP)	4 Cyl.	8 Valves	1580cc	TD5101
XU52C	4 Cyl.	8 Valves	1580cc	TD14648

HR569

NF817
36.00 x 50.00 x 7.00mm, FPM

NA5191
42.00 x 62.00 x 7.00mm, PTFE
NA5192
90.00 x 110.00 x 7.00mm, PTFE

40 1.6L

Petrol

220 A2.000	4 Cyl.	8 Valves	1581cc	TD6587
1580 SPI	4 Cyl.	8 Valves	1581cc	TD12808

HR569

NA5187
30.00 x 52.00 x 7.00mm, ACM

NA5051
40.00 x 56.00 x 7.00mm, FPM
NB808
64.00 x 80.00 x 8.00mm, FPM



41 1.6L Petrol

B6E	4 Cyl.	8 Valves	1580cc	TD21866
HR569	NF746 36.00 x 50.00 x 7.00mm, ACM		NA5191 42.00 x 62.00 x 7.00mm, PTFE NA5192 90.00 x 110.00 x 7.00mm, PTFE	

42 1.6L Diesel

BHX (DV6FCU)	4 Cyl.	8 Valves	1560cc	TD33789
			NA5259 40.00 x 55.00 x 6.40mm, PTFE NA5325 85.00 x 105.00 x 8.80mm, PTFE	

43 1.6L Petrol

N6A (TU5JP4)	4 Cyl.	16 Valves	1587cc	TD21504
NFX (TU5JP4)	4 Cyl.	16 Valves	1587cc	TD10788
TU5JP4	4 Cyl.	16 Valves	1587cc	TD21154
PA5041 (x16) HR791	NA5260 (x2) 38.00 x 50.00 x 6.00mm, FPM		NF870 42.00 x 66.00 x 6.00mm, FPM/ACM NA5331 42.00 x 66.00 x 7.00mm, PTFE NF850 85.00 x 105.00 x 8.00mm, FPM	

44 1.6L Petrol

NFP (EC5)	4 Cyl.	16 Valves	1587cc	TD28573
PA5041 (x16) HR791	NA5260 (x2) 38.00 x 50.00 x 6.00mm, FPM		NA5331 42.00 x 66.00 x 7.00mm, PTFE NA5362 85.00 x 105.00 x 8.00mm, PTFE/ACM	

45 1.6L Petrol

NFR (TU5JP4B)	4 Cyl.	16 Valves	1587cc	TD21320
PA5041 (x16) HR791	NF817 (x2) 36.00 x 50.00 x 7.00mm, FPM		NF870 42.00 x 66.00 x 6.00mm, FPM/ACM NF850 85.00 x 105.00 x 8.00mm, FPM	

46 1.6L Petrol

NFS (TU5JP4S)	4 Cyl.	16 Valves	1587cc	TD18551
PA5041 (x16) HR791	NA5260 38.00 x 50.00 x 6.00mm, FPM		NA5331 42.00 x 66.00 x 7.00mm, PTFE NA5362 85.00 x 105.00 x 8.00mm, PTFE/ACM	

47 1.6L Petrol

NFT (TU5JP)	4 Cyl.	8 Valves	1587cc	TD32684
HR816	NF817 36.00 x 50.00 x 7.00mm, FPM		NF870 42.00 x 66.00 x 6.00mm, FPM/ACM NF850 85.00 x 105.00 x 8.00mm, FPM NF857 85.00 x 105.00 x 9.00mm, FPM/ACM	

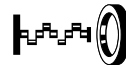
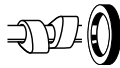

48 1.6L

Petrol

NFU (TU5JP4)	4 Cyl.	16 Valves	1587cc	TD15308
PA5041 (x16) HR791	NA5260 (x2) 38.00 x 50.00 x 6.00mm, FPM		NA5260 38.00 x 50.00 x 6.00mm, FPM NA5331 42.00 x 66.00 x 7.00mm, PTFE NF850 85.00 x 105.00 x 8.00mm, FPM	

49 1.6L

Petrol

NFV (TU5JP)	4 Cyl.	8 Valves	1587cc	TD23392
NFZ (TU5JP)	4 Cyl.	8 Valves	1587cc	TD9458
HR816	NF817 36.00 x 50.00 x 7.00mm, FPM		NF870 42.00 x 66.00 x 6.00mm, FPM/ACM NF850 85.00 x 105.00 x 8.00mm, FPM	

50 1.6L

Petrol

TU5JPK	4 Cyl.	8 Valves	1587cc	TD19609
	NF817 36.00 x 50.00 x 7.00mm, FPM		NF870 42.00 x 66.00 x 6.00mm, FPM/ACM NF850 85.00 x 105.00 x 8.00mm, FPM	

51 1.8L

Petrol

6FY (EW7A)	4 Cyl.	16 Valves	1749cc	TD19822
6FZ (EW7A)	4 Cyl.	16 Valves	1749cc	TD25085
6FZ (EW7J4)	4 Cyl.	16 Valves	1749cc	TD13548
HR5126	NA5455 39.00 x 50.00 x 7.00mm, PTFE/ACM NF817 36.00 x 50.00 x 7.00mm, FPM		NA5259 40.00 x 55.00 x 6.40mm, PTFE NF844 90.00 x 110.00 x 11.00mm, FPM/ACM	

52 1.8L

Diesel

161 (XUD7)	4 Cyl.	8 Valves	1769cc	TD586
161A (XUD7)	4 Cyl.	8 Valves	1769cc	TD4258
A8A (XUD7TE)	4 Cyl.	8 Valves	1769cc	TD602
A9A (XUD7)	4 Cyl.	8 Valves	1769cc	TD6555
AJZ (XUD7TE)	4 Cyl.	8 Valves	1769cc	TD604
HR569	NF841 35.00 x 50.00 x 8.00mm, FPM		NA5191 42.00 x 62.00 x 7.00mm, PTFE NA5192 90.00 x 110.00 x 7.00mm, PTFE	

53 1.8L

Petrol

169 (XM7T)	4 Cyl.	8 Valves	1796cc	TD588
169B	4 Cyl.	8 Valves	1796cc	TD6575
HR300			NA5191 42.00 x 62.00 x 7.00mm, PTFE NA5192 90.00 x 110.00 x 7.00mm, PTFE	

54 1.8L Petrol

LFX (XU7JB)	4 Cyl.	8 Valves	1761cc	TD9457
LFX (XU7JP)	4 Cyl.	8 Valves	1761cc	TD5116
HR569	NF817 36.00 x 50.00 x 7.00mm, FPM		NA5191 42.00 x 62.00 x 7.00mm, PTFE NA5192 90.00 x 110.00 x 7.00mm, PTFE	

55 1.8L Petrol

LFY (XU7JP4)	4 Cyl.	16 Valves	1762cc	TD4279
HR5080	NF817 (x2) 36.00 x 50.00 x 7.00mm, FPM		NA5191 42.00 x 62.00 x 7.00mm, PTFE NA5192 90.00 x 110.00 x 7.00mm, PTFE	
→12/96 →Eng no. 07359				
HR5081				
01/97→08/98 Eng no. 07360→07965				
HR5126				
05/98→				

56 1.9L Petrol

159A	4 Cyl.	8 Valves	1905cc	TD584
159B	4 Cyl.	8 Valves	1905cc	TD21529
D2A (XU92C)	4 Cyl.	8 Valves	1905cc	TD628
D2C (XU92C)	4 Cyl.	8 Valves	1905cc	TD629
D2E	4 Cyl.	8 Valves	1905cc	TD22449
D2F	4 Cyl.	8 Valves	1905cc	TD630
D6A (XU9J2)	4 Cyl.	8 Valves	1905cc	TD631
D6E (XU9JA)	4 Cyl.	8 Valves	1905cc	TD22622
DDZ (XU9M)	4 Cyl.	8 Valves	1905cc	TD639
DFZ (XU9J1)	4 Cyl.	8 Valves	1905cc	TD9548
DKZ (XU9JA)	4 Cyl.	8 Valves	1905cc	TD647
HR569	NF817 36.00 x 50.00 x 7.00mm, FPM		NA5191 42.00 x 62.00 x 7.00mm, PTFE NA5192 90.00 x 110.00 x 7.00mm, PTFE	

57 1.9L Diesel

162 (XUD9)	4 Cyl.	8 Valves	1905cc	TD587
D8B (XUD9TF)	4 Cyl.	8 Valves	1905cc	TD5046
D8C (XUD9UTF)	4 Cyl.	8 Valves	1905cc	TD4264
D9A (XUD9)	4 Cyl.	8 Valves	1905cc	TD4265
DHW (XUD9SD)	4 Cyl.	8 Valves	1905cc	TD10689
DHY (XUD9TE/Y)	4 Cyl.	8 Valves	1905cc	TD4269
DJY (XUD9A)	4 Cyl.	8 Valves	1905cc	TD6556
HR569	NF841 35.00 x 50.00 x 8.00mm, FPM		NA5191 42.00 x 62.00 x 7.00mm, PTFE NA5192 90.00 x 110.00 x 7.00mm, PTFE	

58 1.9L Petrol

D6C (XU9J4)	4 Cyl.	16 Valves	1905cc	TD632
DFW (XU9J4)	4 Cyl.	16 Valves	1905cc	TD640
HR816 (x2)	NF869 (x2) 32.00 x 45.00 x 8.00mm, FPM NF817 (x2) 36.00 x 50.00 x 7.00mm, FPM		NA5191 42.00 x 62.00 x 7.00mm, PTFE NA5192 90.00 x 110.00 x 7.00mm, PTFE	



59 1.9L

Diesel

D9B (XUD9A/L)	4 Cyl.	8 Valves	1905cc	TD4267
D9B (XUD9A/U)	4 Cyl.	8 Valves	1905cc	TD4266
DHV (XUD9BSD)	4 Cyl.	8 Valves	1905cc	TD22991
WJX (DW8B)	4 Cyl.	8 Valves	1868cc	TD26981
WJY (DW8B)	4 Cyl.	8 Valves	1868cc	TD15310
WJZ (DW8)	4 Cyl.	8 Valves	1868cc	TD10708

HR569

NB959
35.00 x 50.00 x 7.00mm, FPM
NF841
35.00 x 50.00 x 8.00mm, FPM

NA5191
42.00 x 62.00 x 7.00mm, PTFE
NA5192
90.00 x 110.00 x 7.00mm, PTFE

60 1.9L

Diesel

DHX (XUD9TF/BTF)	4 Cyl.	8 Valves	1905cc	TD4268
------------------	--------	----------	--------	--------

HR569

NF841
35.00 x 50.00 x 8.00mm, FPM
NB959
35.00 x 50.00 x 7.00mm, FPM
Eng no. 06265 →

NA5191
42.00 x 62.00 x 7.00mm, PTFE
NA5192
90.00 x 110.00 x 7.00mm, PTFE

61 1.9L

Diesel

DJZ (XUD9Y)	4 Cyl.	8 Valves	1905cc	TD646
-------------	--------	----------	--------	-------

HR569

NF841
35.00 x 50.00 x 8.00mm, FPM
NB959
35.00 x 50.00 x 7.00mm, FPM
Eng no. 07265 →

NA5191
42.00 x 62.00 x 7.00mm, PTFE
NA5192
90.00 x 110.00 x 7.00mm, PTFE

62 1.9L

Diesel

M705	4 Cyl.	8 Valves	1930cc	TD6574
------	--------	----------	--------	--------

HR569

NA5187
30.00 x 52.00 x 7.00mm, ACM

NB742
30.00 x 43.00 x 8.00mm, ACM
NB732
74.00 x 90.00 x 10.00mm, FPM

63 2.0L

Petrol

4B11	4 Cyl.	16 Valves	1998cc	TD26063
------	--------	-----------	--------	---------

NA5108
42.00 x 55.00 x 7.00mm, FPM/ACM
NK143
85.00 x 103.00 x 8.00mm, FPM

64 2.0L

Petrol

170A (XN1T)	4 Cyl.	8 Valves	1971cc	TD5164
170B (XN1T)	4 Cyl.	8 Valves	1971cc	TD589
170C (XN1T)	4 Cyl.	8 Valves	1971cc	TD590

HR569

NA5191
42.00 x 62.00 x 7.00mm, PTFE
NA5192
90.00 x 110.00 x 7.00mm, PTFE

65 2.0L

Petrol

829 A5	4 Cyl.	8 Valves	1995cc	TD4259
--------	--------	----------	--------	--------

HR569

NF687
35.00 x 47.00 x 7.00mm, FPM

NF843
50.00 x 68.00 x 10.00mm, FPM/ACM
NF844
90.00 x 110.00 x 11.00mm, FPM/ACM

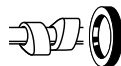

66 2.0L Diesel

AHE (DW10FD)	4 Cyl.	16 Valves	1997cc	TD33778
	NA5035 27.00 x 47.00 x 7.00mm, FPM		NA5191 42.00 x 62.00 x 7.00mm, PTFE NA5192 90.00 x 110.00 x 7.00mm, PTFE	

67 2.0L Diesel

AHF (DW10FD)	4 Cyl.	16 Valves	1997cc	TD33779
AHG (DW10FD)	4 Cyl.	16 Valves	1997cc	TD33781
AHJ (DW10FE)	4 Cyl.	16 Valves	1997cc	TD33771
AHK (DW10FE)	4 Cyl.	16 Valves	1997cc	TD33770
AHM (DW10FUE)	4 Cyl.	16 Valves	1997cc	TD33763
AHS (DW10FD)	4 Cyl.	16 Valves	1997cc	TD32492
AHT (DW10FC)	4 Cyl.	16 Valves	1997cc	TD33784
AHU (DW10FD)	4 Cyl.	16 Valves	1997cc	TD33776
AHX (DW10FCD)	4 Cyl.	16 Valves	1997cc	TD33782
	NA5035 27.00 x 47.00 x 7.00mm, FPM		NA5191 42.00 x 62.00 x 7.00mm, PTFE NA5192 90.00 x 110.00 x 7.00mm, PTFE	

68 2.0L Diesel

AHH (DW10FC)	4 Cyl.	16 Valves	1997cc	TD33704
AHN (DW10FUD)	4 Cyl.	16 Valves	1997cc	TD32331
AHP (DW10FUC)	4 Cyl.	16 Valves	1997cc	TD32332
AHR (DW10FD)	4 Cyl.	16 Valves	1997cc	TD31846
AHV (DW10FD)	4 Cyl.	16 Valves	1997cc	TD28617
AHW (DW10FC)	4 Cyl.	16 Valves	1997cc	TD28616
AHX (DW10FD)	4 Cyl.	16 Valves	1997cc	TD28615
AHY (DW10CE)	4 Cyl.	16 Valves	1997cc	TD29730
AHZ (DW10CD)	4 Cyl.	16 Valves	1997cc	TD29729
RHC (DW10CTED4)	4 Cyl.	16 Valves	1997cc	TD28242
RHD (DW10CB)	4 Cyl.	16 Valves	1997cc	TD29779
RHD (DW10CTED4)	4 Cyl.	16 Valves	1997cc	TD29706
RHE (DW10CTED4)	4 Cyl.	16 Valves	1997cc	TD24935
RHH (DW10CTED4)	4 Cyl.	16 Valves	1997cc	TD23770
HR5122	NA5035 27.00 x 47.00 x 7.00mm, FPM		NA5191 42.00 x 62.00 x 7.00mm, PTFE NA5192 90.00 x 110.00 x 7.00mm, PTFE	

69 2.0L Petrol

B20	4 Cyl.	8 Valves	1985cc	TD5572
B20614	4 Cyl.	8 Valves	1985cc	TD16437
			NF637 48.00 x 65.00 x 10.00mm, FPM	

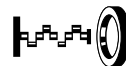

70 2.0L

Petrol

EW10J4	4 Cyl.	16 Valves	1997cc	TD21428
PSA RFN 10LH3X	4 Cyl.	16 Valves	1997cc	TD33521
RFK (EW10J4S)	4 Cyl.	16 Valves	1997cc	TD19910
RFN	4 Cyl.	16 Valves	1997cc	TD21578
RLZ (EW10D)	4 Cyl.	16 Valves	1997cc	TD16233

HR5126

NF817 (x2)
36.00 x 50.00 x 7.00mm, FPM

NA5256
40.00 x 55.00 x 6.50mm, FPM
NF844
90.00 x 110.00 x 11.00mm, FPM/ACM

71 2.0L

Petrol

R6A	4 Cyl.	8 Valves	1998cc	TD22606
RDZ (XU10MZ)	4 Cyl.	8 Valves	1998cc	TD9552
RFU (XU10J2/C)	4 Cyl.	8 Valves	1998cc	TD4284
RFW (XU10J2U)	4 Cyl.	8 Valves	1998cc	TD4285
RFX (XU10J2C)	4 Cyl.	8 Valves	1998cc	TD727
RFX XU10J2C/Z L3	4 Cyl.	8 Valves	1998cc	TD4286
RFZ (XU10J2)	4 Cyl.	8 Valves	1998cc	TD729
RGX (XU10J2TE)	4 Cyl.	8 Valves	1998cc	TD4290
RGY (XU10J2TE/Z)	4 Cyl.	8 Valves	1998cc	TD4291
XU10J2	4 Cyl.	8 Valves	1998cc	TD16738
XU102C	4 Cyl.	8 Valves	1998cc	TD12830

HR569

NF817
36.00 x 50.00 x 7.00mm, FPM

NA5191
42.00 x 62.00 x 7.00mm, PTFE
NA5192
90.00 x 110.00 x 7.00mm, PTFE

72 2.0L

Petrol

RFH (EW10A)	4 Cyl.	16 Valves	1997cc	TD24145
-------------	--------	-----------	--------	---------

HR5126

NA5455
39.00 x 50.00 x 7.00mm, PTFE/ACM
NF817
36.00 x 50.00 x 7.00mm, FPM

NA5259
40.00 x 55.00 x 6.40mm, PTFE
NF844
90.00 x 110.00 x 11.00mm, FPM/ACM

73 2.0L

Petrol

RFJ (EW10A)	4 Cyl.	16 Valves	1997cc	TD19823
RFK (EW10A)	4 Cyl.	16 Valves	1997cc	TD25086
RFN (EW10A)	4 Cyl.	16 Valves	1997cc	TD25087
RFN (EW10J4)	4 Cyl.	16 Valves	1997cc	TD15309
RFR (EW10A)	4 Cyl.	16 Valves	1997cc	TD25088

HR5126

NA5455
39.00 x 50.00 x 7.00mm, PTFE/ACM
NF817
36.00 x 50.00 x 7.00mm, FPM

NA5256
40.00 x 55.00 x 6.50mm, FPM
NF844
90.00 x 110.00 x 11.00mm, FPM/ACM

74 2.0L

Petrol

RFM	4 Cyl.	16 Valves	1997cc	TD22283
-----	--------	-----------	--------	---------

NF817 (x2)
36.00 x 50.00 x 7.00mm, FPM

NA5256
40.00 x 55.00 x 6.50mm, FPM
NA5192
90.00 x 110.00 x 7.00mm, PTFE



75 2.0L Petrol

RFS (XU10J4RS)	4 Cyl.	16 Valves	1998cc	TD10668
PA5041 (x16) HR791	NF817 (x2) 36.00 x 50.00 x 7.00mm, FPM	NA5191 42.00 x 62.00 x 7.00mm, PTFE NA5192 90.00 x 110.00 x 7.00mm, PTFE		

76 2.0L Petrol

RFT (XU10J4/Z)	4 Cyl.	16 Valves	1998cc	TD5066
RFY (XU10J4/Z)	4 Cyl.	16 Valves	1998cc	TD4288
HR816 (x2)	NF817 (x2) 36.00 x 50.00 x 7.00mm, FPM	NA5191 42.00 x 62.00 x 7.00mm, PTFE NA5192 90.00 x 110.00 x 7.00mm, PTFE		

77 2.0L Petrol

RJV (XU10J4R)	4 Cyl.	16 Valves	1998cc	TD11667
HR5080 →12/96 →Eng no. 07359 HR5081 01/97→08/98 Eng no. 07360→07965 HR5126 05/98→	NF817 (x2) 36.00 x 50.00 x 7.00mm, FPM	NA5191 42.00 x 62.00 x 7.00mm, PTFE NA5192 90.00 x 110.00 x 7.00mm, PTFE		

78 2.0L Diesel

RHF (DW10BTED4)	4 Cyl.	16 Valves	1997cc	TD26795
RHJ (DW10BTED4)	4 Cyl.	16 Valves	1997cc	TD19825
RHK (DW10UTED4)	4 Cyl.	16 Valves	1997cc	TD20787
RHM (DW10ATED4)	4 Cyl.	16 Valves	1997cc	TD20786
RHR (DW10BTED4)	4 Cyl.	16 Valves	1997cc	TD19912
RHT (DW10ATED4)	4 Cyl.	16 Valves	1997cc	TD20785
RHW (DW10ATED4)	4 Cyl.	16 Valves	1997cc	TD20784
HR5046 (x2)	NA5035 27.00 x 47.00 x 7.00mm, FPM	NA5191 42.00 x 62.00 x 7.00mm, PTFE NA5192 90.00 x 110.00 x 7.00mm, PTFE		

79 2.0L Diesel

RHS (DW10ATED)	4 Cyl.	8 Valves	1997cc	TD20782
RHV (DW10TD)	4 Cyl.	8 Valves	1997cc	TD24877
RHV (DW10UTD)	4 Cyl.	8 Valves	1997cc	TD16739
RHX (DW10BTED)	4 Cyl.	8 Valves	1997cc	TD21039
RHY (DW10TD)	4 Cyl.	8 Valves	1997cc	TD15311
RHZ (DW10ATED)	4 Cyl.	8 Valves	1997cc	TD12829
HR5046	NA5035 27.00 x 47.00 x 7.00mm, FPM	NA5191 42.00 x 62.00 x 7.00mm, PTFE NA5192 90.00 x 110.00 x 7.00mm, PTFE		

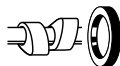

80 2.0L

Diesel

RHZ (DW10BTEd)	4 Cyl.	8 Valves	1997cc	TD33718
RHZ (DW10BTEd+)	4 Cyl.	8 Valves	1997cc	TD33720
RHZ (DW10CTEd)	4 Cyl.	8 Valves	1997cc	TD33717

HR5046

NA5191
42.00 x 62.00 x 7.00mm, PTFE

NA5192
90.00 x 110.00 x 7.00mm, PTFE

81 2.1L

Diesel

P8A (XUD11ATE)	4 Cyl.	12 Valves	2088cc	TD711
P8C (XUD11BTE)	4 Cyl.	12 Valves	2088cc	TD4281
P9A (XUD11A)	4 Cyl.	12 Valves	2138cc	TD713
PHZ (XUD11ATE)	4 Cyl.	12 Valves	2088cc	TD717
PJZ (XUD11ATE)	4 Cyl.	12 Valves	2088cc	TD718

HR805

NF841
35.00 x 50.00 x 8.00mm, FPM

NA5191
42.00 x 62.00 x 7.00mm, PTFE

NA5192
90.00 x 110.00 x 7.00mm, PTFE

82 2.2L

Petrol

3FY (EW12J4)	4 Cyl.	16 Valves	2230cc	TD25089
3FZ (EW12J4)	4 Cyl.	16 Valves	2230cc	TD16485

HR5126

NF817
36.00 x 50.00 x 7.00mm, FPM

NA5256
40.00 x 55.00 x 6.50mm, FPM

NF844
90.00 x 110.00 x 11.00mm, FPM/ACM

83 2.2L

Diesel

4HG (P22DTE)	4 Cyl.	16 Valves	2198cc	TD32329
4HH (P22DTE)	4 Cyl.	16 Valves	2198cc	TD30660
4HJ (P22DTE)	4 Cyl.	16 Valves	2198cc	TD32330
4HU (P22DTE)	4 Cyl.	16 Valves	2198cc	TD24538
4HV (P22DTE)	4 Cyl.	16 Valves	2198cc	TD24537

HR5082

NA5031
50.00 x 86.50 x 13.70mm, PTFE

NA5030
106.00 x 190.00 x 15.20mm, PTFE/FPM

84 2.2L

Diesel

4HL (DW12C)	4 Cyl.	16 Valves	2179cc	TD26899
4HN (DW12MTED4)	4 Cyl.	16 Valves	2179cc	TD24713
4HP (DW12BTED4)	4 Cyl.	16 Valves	2179cc	TD29271
4HR (DW12BTED4)	4 Cyl.	16 Valves	2179cc	TD29272
4HT (DW12BTED4)	4 Cyl.	16 Valves	2179cc	TD20812

HR5122



NA5035
27.00 x 47.00 x 7.00mm, FPM

NA5191
42.00 x 62.00 x 7.00mm, PTFE

NA5192
90.00 x 110.00 x 7.00mm, PTFE



85 2.2L Diesel

4HW (DW12TED4)	4 Cyl.	16 Valves	2179cc	TD20024
4HX (DW12TED4/FAP)	4 Cyl.	16 Valves	2179cc	TD16165
HR5046  (x2)	NA5035 27.00 x 47.00 x 7.00mm, FPM		NA5191  42.00 x 62.00 x 7.00mm, PTFE NA5192  90.00 x 110.00 x 7.00mm, PTFE	

86 2.2L Diesel

4HY (DW12UTED)	4 Cyl.	8 Valves	2179cc	TD24468
HR5046 	NA5035 27.00 x 47.00 x 7.00mm, FPM		NA5191  42.00 x 62.00 x 7.00mm, PTFE NA5192  90.00 x 110.00 x 7.00mm, PTFE	



87 2.2L Diesel

B22615	4 Cyl.	8 Valves	2175cc	TD6897
HR340 			NF637  48.00 x 65.00 x 10.00mm, FPM	

88 2.2L Petrol

J6T A500	4 Cyl.	8 Valves	2165cc	TD663
HR569 	NF687 35.00 x 47.00 x 7.00mm, FPM		NF843  50.00 x 68.00 x 10.00mm, FPM/ACM NF844  90.00 x 110.00 x 11.00mm, FPM/ACM	

89 2.2L Petrol

M22-617	4 Cyl.	8 Valves	2175cc	TD688
HR340 	NF741 29.00 x 46.00 x 10.00mm, ACM		NF637  48.00 x 65.00 x 10.00mm, FPM	

90 2.2L Diesel

M22-621	4 Cyl.	8 Valves	2175cc	TD689
HR340 	NF741 29.00 x 46.00 x 10.00mm, ACM		NF637  48.00 x 65.00 x 10.00mm, FPM	

91 2.3L Diesel

F1AEO48N	4 Cyl.	16 Valves	2287cc	TD34298
				NA5202  50.0 x 80.0 x 14.0mm, FPM

92 2.3L Petrol

M23-622	4 Cyl.	8 Valves	2347cc	TD690
M23-623	4 Cyl.	8 Valves	2347cc	TD691
M23-627	4 Cyl.	8 Valves	2348cc	TD34324
M23-639	4 Cyl.	8 Valves	2347cc	TD692
HR340 			NF637  48.00 x 65.00 x 10.00mm, FPM	

93 2.4L Petrol

4B12	4 Cyl.	16 Valves	2360cc	TD26763
HR340 			NA5108  42.00 x 55.00 x 7.00mm, FPM/ACM NK143  85.00 x 103.00 x 8.00mm, FPM	

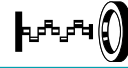

94 2.4L

Petrol

SFZ (4B12-MMC) 4 Cyl. 16 Valves 2360cc TD25075

NA5108 42.00 x 55.00 x 7.00mm, FPM/ACM
NK143 85.00 x 103.00 x 8.00mm, FPM

95 2.4L

Diesel

THX (DJSTED) 4 Cyl. 8 Valves 2446cc TD11889

HR816

NB959
35.00 x 50.00 x 7.00mm, FPM

NF866 64.00 x 88.00 x 6.00mm, FPM/ACM
NF867 98.00 x 120.00 x 7.00mm, FPM/ACM

96 2.5L

Diesel

B25637 4 Cyl. 8 Valves 2498cc TD6895

M25-629 4 Cyl. 8 Valves 2500cc TD693

HR340

NF637 48.00 x 65.00 x 10.00mm, FPM

97 2.5L

Diesel

CRD93B 4 Cyl. 8 Valves 2499cc TD6577

M25-648 4 Cyl. 8 Valves 2500cc TD694

M25-660 4 Cyl. 8 Valves 2500cc TD696

M25-669 4 Cyl. 8 Valves 2500cc TD702

HR340

NF776 75.00 x 90.00 x 11.50mm, FPM/ACM

98 2.5L

Diesel

CRD93L (U25-661) 4 Cyl. 8 Valves 2500cc TD625

CRD93LS (U25-673) 4 Cyl. 8 Valves 2500cc TD626

HR340

NF741
29.00 x 46.00 x 10.00mm, ACM

NF776 75.00 x 90.00 x 11.50mm, FPM/ACM

99 2.5L

Petrol

M25-659 4 Cyl. 8 Valves 2500cc TD695

M25-662 4 Cyl. 8 Valves 2500cc TD697

M25-667 4 Cyl. 8 Valves 2498cc TD700

M25-668 4 Cyl. 8 Valves 2498cc TD701

HR340

NA5108 42.00 x 55.00 x 7.00mm, FPM/ACM
NK143 85.00 x 103.00 x 8.00mm, FPM

100 2.5L

Diesel

T8A (DJST) 4 Cyl. 12 Valves 2446cc TD4292

T9A (DJ5) 4 Cyl. 12 Valves 2446cc TD4293

HR662

NB959
35.00 x 50.00 x 7.00mm, FPM

NF860 93.00 x 108.00 x 7.00mm, FPM/ACM
NF867 98.00 x 120.00 x 7.00mm, FPM/ACM



101 2.5L		Diesel		
THY (DK5ATE)	4 Cyl.	12 Valves	2446cc	TD4294
THZ (DJ5T)	4 Cyl.	12 Valves	2446cc	TD6585
HR662	NB959 35.00 x 50.00 x 7.00mm, FPM		NF866 64.00 x 88.00 x 6.00mm, FPM/ACM NF867 98.00 x 120.00 x 7.00mm, FPM/ACM	

102 2.7L		Diesel		
DT17ED4	6 Cyl.	24 Valves	2720cc	TD19827
UHZ (DT17BTED4)	6 Cyl.	24 Valves	2720cc	TD21319
UHZ (DT17TED4)	6 Cyl.	24 Valves	2720cc	TD24868
HR5111	NA5318 (x2) 26.0 x 45.0 x 8.00mm, FPM		NA5323 35.00 x 50.00 x 7.00mm, PTFE LK5021 92.00 x 220.00 x 22.00mm, PTFE/ACM	

103 2.8L		Diesel		
8140.43N	4 Cyl.	8 Valves	2798cc	TD18297
8140.43S	4 Cyl.	8 Valves	2798cc	TD17849
8140.63 (F28D)	4 Cyl.	8 Valves	2798cc	TD24977
F28TDCR	4 Cyl.	8 Valves	2798cc	TD16741
HR602	NP068 55.00 x 70.00 x 8.00mm, FPM		NF885 70.00 x 159.00 ; 179.00 x 16.00mm, FPM NF883 114.00 x 171.00 x 13.00mm, FPM	

104 2.9L		Petrol		
XFU (ES9A)	6 Cyl.	24 Valves	2946cc	TD21314
XFV (ES9A)	6 Cyl.	24 Valves	2946cc	TD18962
XFW (ES9A)	6 Cyl.	24 Valves	2946cc	TD25091
XFW (ES9J4S)	6 Cyl.	24 Valves	2946cc	TD26409
XFZ (ES9J4)	6 Cyl.	24 Valves	2946cc	TD5487
PA5041 (x24) HR5062	NA5260 (x4) 38.00 x 50.00 x 6.00mm, FPM		NA5190 42.00 x 56.00 x 7.00mm, FPM NF867 98.00 x 120.00 x 7.00mm, FPM/ACM	

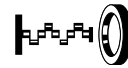
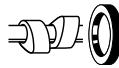

105 3.0L		Diesel		
DT20C	6 Cyl.	24 Valves	2993cc	TD23526
X8C (DT20C)	6 Cyl.	24 Valves	2993cc	TD24869
HR5111	NA5318 (x2) 26.0 x 45.0 x 8.00mm, FPM		NA5323 35.00 x 50.00 x 7.00mm, PTFE LK5021 92.00 x 220.00 x 22.00mm, PTFE/ACM	

106 3.0L		Petrol		
SFZ (ZPJ/Z)	6 Cyl.	12 Valves	2975cc	TD731
UFZ (ZPJ/Z)	6 Cyl.	12 Valves	2963cc	TD735
HR805	NF869 32.00 x 45.00 x 8.00mm, FPM		NA5191 42.00 x 62.00 x 7.00mm, PTFE NF634 80.00 x 100.00 x 13.00mm, MVQ	





107 3.0L









Petrol

SKZ (ZPJ4/Z)	6 Cyl.	24 Valves	2963cc	TD732
UKZ (ZPJ4/Z)	6 Cyl.	24 Valves	2963cc	TD736
HR662  (x2)	NF869 (x2) 32.00 x 45.00 x 8.00mm, FPM		NA5191  42.00 x 62.00 x 7.00mm, PTFE NF634  80.00 x 100.00 x 13.00mm, MVQ	

108 3.0L

Petrol

AFX (ES9A)	6 Cyl.	24 Valves	2946cc	TD25090
AFX (ES9J4S)	6 Cyl.	24 Valves	2946cc	TD16164
PA5041 (x24) HR5062 	NA5260 (x4) 38.00 x 50.00 x 6.00mm, FPM		NA5190  42.00 x 56.00 x 7.00mm, FPM →Eng no. 10086 NF867  98.00 x 120.00 x 7.00mm, FPM/ACM →Eng no. 10086	

	CC				9		CC				9
ISBe 135	3922	4	16	Diesel	2						
ISBe 150	3922	4	16	Diesel	2						
ISBe 170	3922	4	16	Diesel	2						
ISBe 205	6728	6	24	Diesel	5						
ISBe 220	5883	6	24	Diesel	4						
ISBe 225	6728	6	24	Diesel	5						
ISBe 250	5883	6	24	Diesel	4						
ISBe 275	5883	6	24	Diesel	4						
ISDe 140-30	4460	4	8	Diesel	3						
ISDe 160-30	4460	4	8	Diesel	3						
ISDe 180-30	6690	6	12	Diesel	5						
ISDe 200-30	6690	6	12	Diesel	5						
ISDe 210-30	6744	6	12	Diesel	5						
ISDe 230-30	6744	6	12	Diesel	5						
ISDe 245-30	6744	6	12	Diesel	5						
ISDe 270-30	6744	6	12	Diesel	5						
ISDe 285-30	6744	6	12	Diesel	5						
ISF 3.8S3141	3759	4		Diesel	1						
ISF 3.8S3154	3759	4		Diesel	1						
ISF 3.8S3168	3759	4	8	Diesel	1						
ISF 3.8S4154	3759	4		Diesel	1						
ISF 3.8S4168	3759	4		Diesel	1						
NT 855	14040	6	24	Diesel	6						

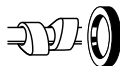

1 3.8L Diesel

ISF 3.8S3141	4 Cyl.		3759cc	TD27546
ISF 3.8S3154	4 Cyl.		3759cc	TD27547
ISF 3.8S3168	4 Cyl.	8 Valves	3759cc	TD27555
ISF 3.8S4154	4 Cyl.		3759cc	TD27554
ISF 3.8S4168	4 Cyl.		3759cc	TD27557

NA5293 70.00 x 100.00 x 12.50mm, PTFE
NA5294 130.00 x 155.00 x 12.50mm, PTFE

2 3.9L Diesel

ISBe 135	4 Cyl.	16 Valves	3922cc	TD18969
ISBe 150	4 Cyl.	16 Valves	3922cc	TD18970
ISBe 170	4 Cyl.	16 Valves	3922cc	TD18971

NA5293 70.00 x 100.00 x 12.50mm, PTFE
NA5294 130.00 x 155.00 x 12.50mm, PTFE

3 4.5L Diesel

ISDe 140-30	4 Cyl.	8 Valves	4460cc	TD27586
ISDe 160-30	4 Cyl.	8 Valves	4460cc	TD27585

NA5293 70.00 x 100.00 x 12.50mm, PTFE
NA5294 130.00 x 155.00 x 12.50mm, PTFE

4 5.9L Diesel

ISBe 220	6 Cyl.	24 Valves	5883cc	TD24028
ISBe 250	6 Cyl.	24 Valves	5883cc	TD20459
ISBe 275	6 Cyl.	24 Valves	5883cc	TD20462

NA5293 70.00 x 100.00 x 12.50mm, PTFE
NA5294 130.00 x 155.00 x 12.50mm, PTFE

5 6.7L Diesel

ISBe 205	6 Cyl.	24 Valves	6728cc	TD20867
ISBe 225	6 Cyl.	24 Valves	6728cc	TD20868
ISDe 180-30	6 Cyl.	12 Valves	6690cc	TD27584
ISDe 200-30	6 Cyl.	12 Valves	6690cc	TD27583
ISDe 210-30	6 Cyl.	12 Valves	6744cc	TD27510
ISDe 230-30	6 Cyl.	12 Valves	6744cc	TD27553
ISDe 245-30	6 Cyl.	12 Valves	6744cc	TD27552
ISDe 270-30	6 Cyl.	12 Valves	6744cc	TD27524
ISDe 285-30	6 Cyl.	12 Valves	6744cc	TD27551

NA5293 70.00 x 100.00 x 12.50mm, PTFE
NA5294 130.00 x 155.00 x 12.50mm, PTFE

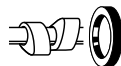

6 14.0L

Diesel

NT 855

6 Cyl.

24 Valves









14040cc









TD33213

NA5464 
152.50 x 171.50 x 11.00mm, PTFE



1300	12/72→05/83	810-02/-99	Petrol	1289	4	8	5
1300 Estate	12/72→05/83	810-02/-99	Petrol	1289	4	8	5
1304 Pickup	06/83→08/90	810-02/-99	Petrol	1289	4	8	5
1310 Estate	05/83→07/04	810-02/-99	Petrol	1289	4	8	5
1310 Saloon (U, X)	05/83→07/04	810-02/-99	Petrol	1289	4	8	5
1410 Estate	09/85→12/98	102-00	Petrol	1397	4	8	6
1410 Saloon	09/85→12/98	102-00	Petrol	1397	4	8	6
Dokker	11/12→	H5F 402	Petrol	1198	4	16	4
Dokker	11/12→	K7M 812	Petrol	1598	4	8	12
Dokker	11/12→	K7M 828	Petrol	1598	4	8	12
Dokker	11/12→	K9K 612	Diesel	1461	4	8	9
Dokker Express	12/12→	H5F 402	Petrol	1198	4	16	4
Dokker Express	12/12→	K7M 812	Petrol	1598	4	8	12
Dokker Express	12/12→	K7M 828	Petrol	1598	4	8	12
Dokker Express	12/12→	K9K 612	Diesel	1461	4	8	9
Duster	04/10→	K4M 690	Petrol	1598	4	16	11
Duster	04/10→	K4M 696	Petrol	1598	4	16	11
Duster	04/10→	K9K 796	Diesel	1461	4	8	9
Duster	04/10→	K9K 830	Diesel	1461	4	8	9
Duster	06/10→	K4M 606	Petrol	1598	4	16	10
Duster	06/10→	K9K 896	Diesel	1461	4	8	9
Duster	06/10→	K9K 898	Diesel	1461	4	8	9
Duster	10/10→	K9K 884	Diesel	1461	4	8	9
Duster	10/10→	K9K 892	Diesel	1461	4	8	9
Duster	10/10→	K9K 894	Diesel	1461	4	8	9
Duster	08/13→	K9K 658	Diesel	1461	4	8	9
Duster	08/13→	K9K 856	Diesel	1461	4	8	9
Duster	08/13→	K9K 858	Diesel	1461	4	8	9
Duster	10/13→	H5F 404	Petrol	1197	4	16	4
Duster	06/15→	H5F 410	Petrol	1197	4	16	4
Duster Box	04/11→	K4M 606	Petrol	1598	4	16	10
Duster Box	04/11→	K4M 696	Petrol	1598	4	16	11
Duster Box	04/11→	K9K 884	Diesel	1461	4	8	9
Duster Box	04/11→	K9K 892	Diesel	1461	4	8	9
Duster Box	04/13→	K9K 658	Diesel	1461	4	8	9
Duster Box	04/13→	K9K 666	Diesel	1461	4	8	9
Duster Box	04/13→	K9K 856	Diesel	1461	4	8	9
Duster Box	04/13→	K9K 858	Diesel	1461	4	8	9
Duster Box	10/13→	H5F 404	Petrol	1197	4	16	4
Lodgy	03/12→	H5F 402	Petrol	1198	4	16	4
Lodgy	03/12→	K7M 812	Petrol	1598	4	8	12
Lodgy	03/12→	K7M 828	Petrol	1598	4	8	12
Lodgy	03/12→	K9K 612	Diesel	1461	4	8	9
Lodgy	03/12→	K9K 846	Diesel	1461	4	8	9
Lodgy	06/15→	K9K 666	Diesel	1461	4	8	9
Logan (LS_)	09/04→	K7J 710	Petrol	1390	4	8	8
Logan (LS_)	09/04→	K7M 710	Petrol	1598	4	8	12
Logan (LS_)	09/05→	K9K 790	Diesel	1461	4	8	9
Logan (LS_)	01/06→	K9K 792	Diesel	1461	4	8	9
Logan (LS_)	02/06→	D4F 732	Petrol	1149	4	16	3
Logan (LS_)	02/06→	D4F 734	Petrol	1149	4	16	3
Logan (LS_)	02/06→	K4M 690	Petrol	1598	4	16	11
Logan (LS_)	02/06→	K4M 696	Petrol	1598	4	16	11
Logan (LS_)	02/06→	K7J 714	Petrol	1390	4	8	8
Logan (LS_)	09/07→	K9K 796	Diesel	1461	4	8	9
Logan (LS_)	05/10→	K7M 718	Petrol	1598	4	8	12
Logan (LS_)	05/10→	K7M 800	Petrol	1598	4	8	12
Logan (LS_)	05/10→	K9K 892	Diesel	1461	4	8	9
Logan (LS_)	01/11→10/12	D4D 760	Petrol	999	4	16	2
Logan EXPRESS (FS_)	03/09→	K7J 710	Petrol	1390	4	8	8
Logan EXPRESS (FS_)	03/09→	K7M 710	Petrol	1598	4	8	12
Logan EXPRESS (FS_)	03/09→	K9K 792	Diesel	1461	4	8	9
Logan EXPRESS (FS_)	03/09→	K9K 796	Diesel	1461	4	8	9
Logan EXPRESS (FS_)	05/10→	K7M 800	Petrol	1598	4	8	12
Logan EXPRESS (FS_)	05/10→	K9K 892	Diesel	1461	4	8	9
Logan II	10/12→	D4F 732	Petrol	1149	4	16	3
Logan II	10/12→	D4F 734	Petrol	1149	4	16	3
Logan II	10/12→	H4B 400	Petrol	898	3	12	1
Logan II	10/12→	K9K 612	Diesel	1461	4	8	9
Logan II	10/12→	K9K 626	Diesel	1461	4	8	9
Logan II	01/13→	K4M 842	Petrol	1598	4	16	11
Logan II	01/13→	K9K 830	Diesel	1461	4	8	9
Logan II	09/15→	H4B 410	Petrol	898	3	12	1
Logan II	09/16→	K7M 812	Petrol	1598	4	8	12
Logan MCV (KS_)	02/07→	K4M 690	Petrol	1598	4	16	11
Logan MCV (KS_)	02/07→	K4M 696	Petrol	1598	4	16	11
Logan MCV (KS_)	02/07→	K7J 710	Petrol	1390	4	8	8
Logan MCV (KS_)	02/07→	K7M 710	Petrol	1598	4	8	12

							
Logan MCV (KS_)	02/07→	K9K 792	Diesel	1461	4	8	9
Logan MCV (KS_)	09/07→	K9K 796	Diesel	1461	4	8	9
Logan MCV (KS_)	05/10→	K7M 718	Petrol	1598	4	8	12
Logan MCV (KS_)	05/10→	K7M 800	Petrol	1598	4	8	12
Logan MCV (KS_)	05/10→	K9K 892	Diesel	1461	4	8	9
Logan MCV II	02/13→	D4F 732	Petrol	1149	4	16	3
Logan MCV II	02/13→	D4F 734	Petrol	1149	4	16	3
Logan MCV II	02/13→	H4B 400	Petrol	898	3	12	1
Logan MCV II	02/13→	K9K 612	Diesel	1461	4	8	9
Logan MCV II	02/13→	K9K 626	Diesel	1461	4	8	9
Logan MCV II	02/13→	K9K 830	Diesel	1461	4	8	9
Logan MCV II	06/13→	K7M 812	Petrol	1598	4	8	12
Logan MCV II	09/15→	H4B 410	Petrol	898	3	12	1
Logan Pickup (US_)	03/08→	K7M 710	Petrol	1598	4	8	12
Logan Pickup (US_)	03/08→	K9K 792	Diesel	1461	4	8	9
Logan Pickup (US_)	03/08→	K9K 796	Diesel	1461	4	8	9
Logan Pickup (US_)	04/08→12/12	K9K 794	Diesel	1461	4	8	9
Logan Pickup (US_)	01/09→	K7J 710	Petrol	1390	4	8	8
Logan Pickup (US_)	01/10→08/13	K4M 690	Petrol	1598	4	16	11
Logan Pickup (US_)	05/10→	K7M 800	Petrol	1598	4	8	12
Logan Pickup (US_)	05/10→	K9K 892	Diesel	1461	4	8	9
Nova	04/96→03/01	C2J	Petrol	1397	4	8	7
Sandero	06/08→12/12	K7M 732	Petrol	1598	4	8	12
Sandero	06/08→	K7J 710	Petrol	1390	4	8	8
Sandero	06/08→	K7M 710	Petrol	1598	4	8	12
Sandero	11/08→	D4F 732	Petrol	1149	4	16	3
Sandero	11/08→	K9K 790	Diesel	1461	4	8	9
Sandero	11/08→	K9K 792	Diesel	1461	4	8	9
Sandero	11/08→	K9K 796	Diesel	1461	4	8	9
Sandero	01/09→	K7J 714	Petrol	1390	4	8	8
Sandero	05/10→12/12	K7M 818	Petrol	1598	4	8	12
Sandero	05/10→	K7M 800	Petrol	1598	4	8	12
Sandero	05/10→	K9K 892	Diesel	1461	4	8	9
Sandero	01/11→12/12	D4D 760	Petrol	999	4	16	2
Sandero	01/11→	K4M 690	Petrol	1598	4	16	11
Sandero	01/11→	K4M 694	Petrol	1598	4	16	11
Sandero	01/11→	K4M 696	Petrol	1598	4	16	11
Sandero II	10/12→	D4F 732	Petrol	1149	4	16	3
Sandero II	10/12→	H4B 400	Petrol	898	3	12	1
Sandero II	10/12→	K9K 612	Diesel	1461	4	8	9
Sandero II	10/12→	K9K 626	Diesel	1461	4	8	9
Sandero II	11/12→	K7M 812	Petrol	1598	4	8	12
Sandero II	01/13→	K9K 830	Diesel	1461	4	8	9
Solenza (B41_)	02/03→	E7J 262	Petrol	1390	4	8	8
Solenza (B41_)	02/03→	F8Q 636	Diesel	1870	4	8	14
Supernova	04/00→03/03	E7J 262	Petrol	1390	4	8	8

	CC				9		CC				9
102-00	1397	4	8	Petrol	6						
810-02/-99	1289	4	8	Petrol	5						
810-99	1289	4	8	Petrol	5						
C2J	1397	4	8	Petrol	7						
D4D 760	999	4	16	Petrol	2						
D4F 732	1149	4	16	Petrol	3						
D4F 734	1149	4	16	Petrol	3						
E7J 262	1390	4	8	Petrol	8						
F8Q 600	1870	4	8	Diesel	13						
F8Q 630	1870	4	8	Diesel	13						
F8Q 636	1870	4	8	Diesel	14						
H4B 400	898	3	12	Petrol	1						
H4B 410	898	3	12	Petrol	1						
H5F 402	1198	4	16	Petrol	4						
H5F 404	1197	4	16	Petrol	4						
H5F 410	1197	4	16	Petrol	4						
K4M 606	1598	4	16	Petrol	10						
K4M 690	1598	4	16	Petrol	11						
K4M 694	1598	4	16	Petrol	11						
K4M 696	1598	4	16	Petrol	11						
K4M 842	1598	4	16	Petrol	11						
K4M 845	1598	4	16	Petrol	11						
K7J 710	1390	4	8	Petrol	8						
K7J 714	1390	4	8	Petrol	8						
K7M 690	1598	4	8	Petrol	12						
K7M 710	1598	4	8	Petrol	12						
K7M 718	1598	4	8	Petrol	12						
K7M 732	1598	4	8	Petrol	12						
K7M 800	1598	4	8	Petrol	12						
K7M 812	1598	4	8	Petrol	12						
K7M 818	1598	4	8	Petrol	12						
K7M 828	1598	4	8	Petrol	12						
K7MA8	1598	4	8	Petrol	12						
K9K 612	1461	4	8	Diesel	9						
K9K 626	1461	4	8	Diesel	9						
K9K 658	1461	4	8	Diesel	9						
K9K 666	1461	4	8	Diesel	9						
K9K 790	1461	4	8	Diesel	9						
K9K 792	1461	4	8	Diesel	9						
K9K 794	1461	4	8	Diesel	9						
K9K 796	1461	4	8	Diesel	9						
K9K 830	1461	4	8	Diesel	9						
K9K 846	1461	4	8	Diesel	9						
K9K 856	1461	4	8	Diesel	9						
K9K 858	1461	4	8	Diesel	9						
K9K 884	1461	4	8	Diesel	9						
K9K 892	1461	4	8	Diesel	9						
K9K 894	1461	4	8	Diesel	9						
K9K 896	1461	4	8	Diesel	9						
K9K 898	1461	4	8	Diesel	9						



1 0.9L Petrol

H4B 400	3 Cyl.	12 Valves	898cc	TD31427
H4B 410	3 Cyl.	12 Valves	898cc	TD34151
PB681 (x12)				NB734 35.00 x 50.00 x 8.00mm, FPM

2 1.0L Petrol

D4D 760	4 Cyl.	16 Valves	999cc	TD34112
	NA5261 28.00 x 47.00 x 8.00mm, PTFE/ACM			NA5322 32.00 x 44.00 x 6.00mm, ACM NA5326 32.00 x 44.00 x 6.00mm, PTFE NA5348 70.00 x 86.00 x 7.00mm, PTFE

3 1.2L Petrol

D4F 732	4 Cyl.	16 Valves	1149cc	TD23529
D4F 734	4 Cyl.	16 Valves	1149cc	TD28221
	NA5261 28.00 x 47.00 x 8.00mm, PTFE/ACM			NA5326 32.00 x 44.00 x 6.00mm, PTFE NA5348 70.00 x 86.00 x 7.00mm, PTFE

4 1.2L Petrol

H5F 402	4 Cyl.	16 Valves	1198cc	TD27174
H5F 404	4 Cyl.	16 Valves	1197cc	TD31424
H5F 410	4 Cyl.	16 Valves	1197cc	TD33469
PB681 (x16)				

5 1.3L Petrol

810-02/-99	4 Cyl.	8 Valves	1289cc	TD13436
810-99	4 Cyl.	8 Valves	1289cc	TD32509
	NF535 30.00 x 42.00 x 8.00mm, NBR			NF722 35.00 x 50.00 x 10.00mm, MVQ NF634 80.00 x 100.00 x 13.00mm, MVQ

6 1.4L Petrol

102-00	4 Cyl.	8 Valves	1397cc	TD32505
HR816				NF722 35.00 x 50.00 x 10.00mm, MVQ NF634 80.00 x 100.00 x 13.00mm, MVQ

7 1.4L Petrol

C2J	4 Cyl.	8 Valves	1397cc	TD24574
HR816	NF834 35.00 x 50.00 x 8.00mm, FPM			NF722 35.00 x 50.00 x 10.00mm, MVQ NF634 80.00 x 100.00 x 13.00mm, MVQ



8 1.4L Petrol

E7J 262	4 Cyl.	8 Valves	1390cc	TD33025
K7J 710	4 Cyl.	8 Valves	1390cc	TD18140
K7J 714	4 Cyl.	8 Valves	1390cc	TD23531
HR816	NA5053 30.00 x 42.00 x 7.00mm, FPM		NA5016 35.00 x 47.00 x 7.00mm, FPM/ACM	
			NF835 80.00 x 100.00 x 8.00mm, FPM/ACM	

9 1.5L Diesel

K9K 612	4 Cyl.	8 Valves	1461cc	TD28005
K9K 626	4 Cyl.	8 Valves	1461cc	TD34129
K9K 658	4 Cyl.	8 Valves	1461cc	TD33762
K9K 666	4 Cyl.	8 Valves	1461cc	TD33761
K9K 790	4 Cyl.	8 Valves	1461cc	TD18514
K9K 792	4 Cyl.	8 Valves	1461cc	TD19223
K9K 794	4 Cyl.	8 Valves	1461cc	TD34236
K9K 796	4 Cyl.	8 Valves	1461cc	TD22403
K9K 830	4 Cyl.	8 Valves	1461cc	TD31047
K9K 846	4 Cyl.	8 Valves	1461cc	TD31425
K9K 856	4 Cyl.	8 Valves	1461cc	TD28611
K9K 858	4 Cyl.	8 Valves	1461cc	TD28610
K9K 884	4 Cyl.	8 Valves	1461cc	TD31046
K9K 892	4 Cyl.	8 Valves	1461cc	TD24780
K9K 894	4 Cyl.	8 Valves	1461cc	TD24783
K9K 896	4 Cyl.	8 Valves	1461cc	TD24784
K9K 898	4 Cyl.	8 Valves	1461cc	TD24785
PA5041 (x8) HR817	NA5215 28.00 x 42.00 x 5.00mm, FPM →Eng no. 061106		NA5255 35.00 x 47.00 x 7.00mm, PTFE/ACM	
	NA5328 28.00 x 42.00 x 6.00mm, PTFE/ACM Eng no. 061106→		NA5118 80.00 x 100.00 x 9.00mm, PTFE	

10 1.6L Petrol

K4M 606	4 Cyl.	16 Valves	1598cc	TD24782
PA5013 (x16)	NA5328 28.00 x 42.00 x 6.00mm, PTFE/ACM		NA5016 35.00 x 47.00 x 7.00mm, FPM/ACM	
	NA5457 33.00 x 42.00 x 6.00mm, PTFE/ACM		NF835 80.00 x 100.00 x 8.00mm, FPM/ACM	

11 1.6L Petrol

K4M 690	4 Cyl.	16 Valves	1598cc	TD20941
K4M 694	4 Cyl.	16 Valves	1598cc	TD24876
K4M 696	4 Cyl.	16 Valves	1598cc	TD24781
K4M 842	4 Cyl.	16 Valves	1598cc	TD32333
K4M 845	4 Cyl.	16 Valves	1598cc	TD32497
PA5013 (x16)	NA5215 (x2) 28.00 x 42.00 x 5.00mm, FPM		NA5016 35.00 x 47.00 x 7.00mm, FPM/ACM	
			NF835 80.00 x 100.00 x 8.00mm, FPM/ACM	



12 1.6L Petrol

K7M 690	4 Cyl.	8 Valves	1598cc	TD22402
K7M 710	4 Cyl.	8 Valves	1598cc	TD18141
K7M 718	4 Cyl.	8 Valves	1598cc	TD23535
K7M 732	4 Cyl.	8 Valves	1598cc	TD23533
K7M 800	4 Cyl.	8 Valves	1598cc	TD24779
K7M 812	4 Cyl.	8 Valves	1598cc	TD29265
K7M 818	4 Cyl.	8 Valves	1598cc	TD32788
K7M 828	4 Cyl.	8 Valves	1598cc	TD31423
K7MA8	4 Cyl.	8 Valves	1598cc	TD26980

HR816

NA5053
30.00 x 42.00 x 7.00mm, FPM

NA5016
35.00 x 47.00 x 7.00mm, FPM/ACM
NF835
80.00 x 100.00 x 8.00mm, FPM/ACM

13 1.9L Diesel

F8Q 600	4 Cyl.	8 Valves	1870cc	TD22200
F8Q 630	4 Cyl.	8 Valves	1870cc	TD22401

HR569

NF846
25.00 x 42.00 x 7.00mm, FPM/ACM

NA5036
42.00 x 54.00 x 6.00mm, FPM
NA5037
85.00 x 105.00 x 11.00mm, ACM

14 1.9L Diesel

F8Q 636	4 Cyl.	8 Valves	1870cc	TD33024
---------	--------	----------	--------	---------









HR569









NF846
25.00 x 42.00 x 7.00mm, FPM/ACM

NA5036
42.00 x 54.00 x 6.00mm, FPM
NA5037
85.00 x 105.00 x 11.00mm, ACM
NF850
85.00 x 105.00 x 8.00mm, FPM



1.5i (1C4)	07/94→10/95	G15MF	Petrol	1498	4	8	14
1.5i Saloon (1C4)	07/94→10/95	G15MF	Petrol	1498	4	8	14
Aranos	01/95→11/97	C20LE	Petrol	1998	4	8	21
Aranos	01/95→11/97	V15L	Petrol	1498	4	16	12
Aranos	01/95→11/97	Y18L	Petrol	1796	4	8	20
Brougham	09/91→12/95	C20LE	Petrol	1998	4	8	21
Brougham	08/94→12/97	X 20 XEV	Petrol	1998	4	16	22
Cielo	06/94→03/95	A15MF	Petrol	1498	4	16	12
Cielo	06/94→07/98	V15L	Petrol	1498	4	16	12
Cielo	01/95→11/00	G15MF	Petrol	1498	4	8	14
Cielo	04/95→07/97	Y15L	Petrol	1498	4	8	13
Cielo Load Runner	02/96→08/97	G15MF	Petrol	1498	4	8	14
Damas Box	10/91→07/98	F8A	Petrol	797	4	8	2
Damas Box	03/95→07/98	F8B	Petrol	796	3	6	3
Damas Bus	03/95→07/98	F8B	Petrol	796	3	6	3
Espero (KLEJ)	10/91→09/93	C20LZ	Petrol	1998	4	8	21
Espero (KLEJ)	10/93→06/99	A15MF	Petrol	1498	4	16	12
Espero (KLEJ)	10/93→06/99	C20LE	Petrol	1998	4	8	21
Espero (KLEJ)	02/95→09/99	C18LE	Petrol	1796	4	8	17
Espero (KLEJ)	10/97→08/99	A15F	Petrol	1498	4	8	11
Evanda (KLAL)	08/02→	L88	Petrol	1998	4	16	23
Evanda (KLAL)	08/02→	X 20 SED	Petrol	1998	4	16	22
Genra Hatchback	05/05→	F14D3	Petrol	1399	4	16	8
Genra Hatchback	05/05→	F16D3	Petrol	1598	4	16	15
Genra Saloon	05/03→	F14D3	Petrol	1399	4	16	8
Genra Saloon	05/05→	F16D3	Petrol	1598	4	16	15
Kalos (KLAS)	09/02→	F14S3	Petrol	1399	4	8	9
Kalos (KLAS)	11/02→12/04	F15S	Petrol	1498	4	8	13
Kalos (KLAS)	04/03→	B12S1	Petrol	1150	4	8	6
Kalos (KLAS)	04/03→	F12S3	Petrol	1150	4	8	6
Kalos (KLAS)	04/03→	F14D3	Petrol	1399	4	16	8
Kalos Saloon (KLAS)	11/02→12/04	F14S3	Petrol	1399	4	8	9
Kalos Saloon (KLAS)	11/02→12/04	F15S	Petrol	1498	4	8	13
Kalos Saloon (KLAS)	05/03→12/04	F14D3	Petrol	1399	4	16	8
Korando (KJ)	01/99→	M 104.995	Petrol	3199	6	24	36
Korando (KJ)	01/99→	M 161.970	Petrol	2295	4	16	31
Korando (KJ)	01/99→	MB-OM 662	Diesel	2874	5	10	34
Korando (KJ)	01/99→	MB-OM 601 29TD	Diesel	2874	5	10	34
Korando Cabrio (KJ)	02/99→	M 161.950	Petrol	1998	4	16	24
Korando Cabrio (KJ)	02/99→	M 161.970	Petrol	2295	4	16	31
Korando Cabrio (KJ)	02/99→	MB-OM 662	Diesel	2874	5	10	34
Korando Cabrio (KJ)	02/99→	MB-OM 601 29TD	Diesel	2874	5	10	34
Labo Box	03/95→07/98	F8A	Petrol	797	4	8	2
Labo Pickup	03/95→07/98	F8A	Petrol	797	4	8	2
Lacetti Hatchback (KLAN)	06/02→	F14D3	Petrol	1399	4	16	8
Lacetti Hatchback (KLAN)	02/04→	F16D3	Petrol	1598	4	16	15
Lacetti Hatchback (KLAN)	02/04→	T18SED	Petrol	1799	4	16	19
Lacetti Premiere Saloon (J300)	02/09→02/11	LXV	Petrol	1598	4	16	16
Lacetti Saloon	06/99→07/03	A16DMS	Petrol	1598	4	16	15
Lacetti Saloon	06/99→07/03	C20SED	Petrol	1998	4	16	22
Lacetti Saloon	06/99→07/03	X 20 SED	Petrol	1998	4	16	22
Lacetti Saloon (J200)	06/02→12/04	T18SED	Petrol	1799	4	16	19
Lacetti Saloon (J200)	08/03→12/04	A15SMS	Petrol	1498	4	8	13
Lacetti Saloon (J200)	08/03→12/04	F18D2	Petrol	1761	4	8	18
Lanos (KLAT)	05/97→	A14SMS	Petrol	1349	4	8	7
Lanos (KLAT)	05/97→	A15SMS	Petrol	1498	4	8	13
Lanos (KLAT)	05/97→	A16DMS	Petrol	1598	4	16	15
Lanos (KLAT)	10/97→06/99	A15DMS	Petrol	1498	4	16	10
Lanos Saloon (KLAT)	02/97→	A16DMS	Petrol	1598	4	16	15
Lanos Saloon (KLAT)	05/97→	A13SMS	Petrol	1349	4	8	7
Lanos Saloon (KLAT)	05/97→	A14SMS	Petrol	1349	4	8	7
Lanos Saloon (KLAT)	05/97→	A15SMS	Petrol	1498	4	8	13
Lanos Saloon (KLAT)	10/97→06/99	A15DMS	Petrol	1498	4	16	10
Leganza (KLAV)	06/97→12/02	X 20 SED	Petrol	1998	4	16	22
Leganza (KLAV)	06/97→07/03	C18LE	Petrol	1796	4	8	17
Leganza (KLAV)	09/98→12/02	X 22 SE	Petrol	2198	4	16	30
Leganza (KLAV)	04/99→12/02	T22SED	Petrol	2198	4	16	30
Leganza (KLAV)	07/00→04/04	T20SED	Petrol	1998	4	16	22
Lemans	09/90→07/93	C20LE	Petrol	1998	4	8	21
Lublin II Box	04/97→	4C90	Diesel	2417	4	8	32
Lublin II Box	04/97→	4CT90-1	Diesel	2417	4	8	32
Lublin II Bus	04/97→02/02	4CT90-1	Diesel	2417	4	8	32
Lublin II Platform/Chassis	04/97→	4C90	Diesel	2417	4	8	32
Lublin II Platform/Chassis	04/97→	4CT90-1	Diesel	2417	4	8	32
Magnus	07/99→	X 20 SED	Petrol	1998	4	16	22
Matiz (KLYA)	01/03→	B10S	Petrol	995	4	8	5
Musso (FJ)	01/99→09/99	MB-OM 662	Diesel	2874	5	10	34
Musso (FJ)	01/99→	M 104.992	Petrol	3199	6	24	36

							
Musso (FJ)	01/99→	M 111.970	Petrol	2295	4	16	31
Musso (FJ)	01/99→	MB-OM 601 29TD	Diesel	2874	5	10	34
Musso (FJ)	09/99→	MB OM 601	Diesel	2299	4	8	29
Nexia (KLETN)	02/95→08/97	A15MF	Petrol	1498	4	16	12
Nexia (KLETN)	02/95→08/97	G15MF	Petrol	1498	4	8	14
Nexia Saloon	07/08→	F16D3	Petrol	1598	4	16	15
Nexia Saloon	07/08→	Y15L	Petrol	1498	4	8	13
Nexia Saloon (KLETN)	02/95→08/97	A15MF	Petrol	1498	4	16	12
Nexia Saloon (KLETN)	02/95→06/08	C18LE	Petrol	1796	4	8	17
Nexia Saloon (KLETN)	02/95→06/08	G15MF	Petrol	1498	4	8	14
Nexia Saloon (KLETN)	08/97→06/08	LXV	Petrol	1598	4	16	16
Nubira (KLAJ)	05/97→	A16DMS	Petrol	1598	4	16	15
Nubira (KLAJ)	05/97→	X 20 SED	Petrol	1998	4	16	22
Nubira (KLAJ)	05/97→	Z20L	Petrol	1998	4	16	22
Nubira (KLAJ)	08/02→07/03	T20SED	Petrol	1998	4	16	22
Nubira Saloon (KLAJ)	05/97→	A16DMS	Petrol	1598	4	16	15
Nubira Saloon (KLAJ)	05/97→	X 20 SED	Petrol	1998	4	16	22
Nubira Saloon (KLAJ)	09/98→12/02	X 20 SE	Petrol	1998	4	8	26
Nubira Saloon (KLAJ)	06/99→07/03	A15DMS	Petrol	1498	4	16	10
Nubira Saloon (KLAJ)	06/99→07/03	C20SED	Petrol	1998	4	16	22
Nubira Saloon (KLAJ)	12/00→	T20SED	Petrol	1998	4	16	22
Nubira Saloon (KLAN)	07/03→	F16D3	Petrol	1598	4	16	15
Nubira Saloon (KLAN)	07/03→	T18SED	Petrol	1799	4	16	19
Nubira Saloon (KLAN)	10/03→12/04	F14D3	Petrol	1399	4	16	8
Nubira Wagon (KLAJ)	05/97→	A16DMS	Petrol	1598	4	16	15
Nubira Wagon (KLAJ)	05/97→	X 20 SED	Petrol	1998	4	16	22
Nubira Wagon (KLAJ)	09/98→12/02	X 20 SE	Petrol	1998	4	8	26
Nubira Wagon (KLAJ)	12/00→	T20SED	Petrol	1998	4	16	22
Nubira Wagon (KLAN)	07/03→	F16D3	Petrol	1598	4	16	15
Nubira Wagon (KLAN)	07/03→	T18SED	Petrol	1799	4	16	19
Nubira Wagon (KLAN)	06/04→	C18LE	Petrol	1796	4	8	17
Prince (J19)	08/90→08/97	S 18 NV	Petrol	1796	4	8	17
Prince (J19)	08/92→07/95	C20LZ	Petrol	1998	4	8	21
Prince (J19)	08/93→08/98	C18LE	Petrol	1796	4	8	17
Prince (J19)	08/94→07/97	C 30 NE	Petrol	2969	6	12	35
Prince (J19)	08/94→12/98	C20LE	Petrol	1998	4	8	21
Prince (J19)	08/94→12/98	C 20 NED	Petrol	1998	4	8	21
Prince (J19)	08/97→08/99	X 22 XE	Petrol	2198	4	16	30
Racer Hatchback	03/95→12/97	G15MF	Petrol	1498	4	8	14
Rexton (GAB_)	04/02→	M 162.992	Petrol	3199	6	24	36
Rexton (GAB_)	04/02→	OM 662.983	Diesel	2874	5	10	34
Rexton (GAB_)	05/02→	M 161.974	Petrol	2295	4	16	31
Rezzo (KLAU)	09/00→	A16DMS	Petrol	1598	4	16	15
Rezzo (KLAU)	09/00→	F18D2	Petrol	1761	4	8	18
Rezzo (KLAU)	09/00→	F18S2	Petrol	1761	4	8	18
Rezzo (KLAU)	09/00→	T20SED	Petrol	1998	4	16	22
Rezzo (KLAU)	09/01→	X 20 SED	Petrol	1998	4	16	22
Royale	04/89→08/93	C 20 NED	Petrol	1998	4	8	21
Royale	04/89→08/93	C 30 NE	Petrol	2969	6	12	35
Super Saloon	04/89→08/95	C 20 NED	Petrol	1998	4	8	21
Super Saloon	08/92→08/95	S 18 NV	Petrol	1796	4	8	17
Super Saloon	08/94→08/95	C 30 NE	Petrol	2969	6	12	35
Tico (KLY3)	02/95→12/00	FBC	Petrol	796	3	6	4
Tosca	02/06→	T18SED	Petrol	1799	4	16	19
Tosca	02/06→	X 20 DT	Petrol	1993	6	24	25
Tosca	02/06→	Z 20 DMH	Diesel	1991	4	16	27
Winstorm	12/06→	Z 24 XED	Petrol	2405	4	16	33
Winstorm	12/06→	Z 32 SEE	Petrol	3195	6	24	37

	CC				9		CC				9
4C90	2417	4	8	Diesel	32						
4CT90-1	2417	4	8	Diesel	32						
A13SMS	1349	4	8	Petrol	7						
A14SMS	1349	4	8	Petrol	7						
A15DMS	1498	4	16	Petrol	10						
A15F	1498	4	8	Petrol	11						
A15MF	1498	4	16	Petrol	12						
A15SMS	1498	4	8	Petrol	13						
A16DMS	1598	4	16	Petrol	15						
B10S	995	4	8	Petrol	5						
B12S1	1150	4	8	Petrol	6						
C18LE	1796	4	8	Petrol	17						
C20LE	1998	4	8	Petrol	21						
C20LZ	1998	4	8	Petrol	21						
C 20 NE	1998	4	8	Petrol	21						
C 20 NED	1998	4	8	Petrol	21						
C20SED	1998	4	16	Petrol	22						
C 22 SED	2198	4	16	Petrol	28						
C 30 NE	2969	6	12	Petrol	35						
F5A	543	3	6	Petrol	1						
F8A	797	4	8	Petrol	2						
F8B	796	3	6	Petrol	3						
F8C	796	3	6	Petrol	4						
F12S3	1150	4	8	Petrol	6						
F14D3	1399	4	16	Petrol	8						
F14S3	1399	4	8	Petrol	9						
F15S	1498	4	8	Petrol	13						
F16D3	1598	4	16	Petrol	15						
F18D2	1761	4	8	Petrol	18						
F18S2	1761	4	8	Petrol	18						
G15MF	1498	4	8	Petrol	14						
L88	1998	4	16	Petrol	23						
LXV	1598	4	16	Petrol	16						
M 104.992	3199	6	24	Petrol	36						
M 104.995	3199	6	24	Petrol	36						
M 111.970	2295	4	16	Petrol	31						
M 161.950	1998	4	16	Petrol	24						
M 161.970	2295	4	16	Petrol	31						
M 161.974	2295	4	16	Petrol	31						
M 162.992	3199	6	24	Petrol	36						
MB OM 601	2299	4	8	Diesel	29						
MB-OM 662	2874	5	10	Diesel	34						
MB-OM 601 29TD	2874	5	10	Diesel	34						
OM 662.983	2874	5	10	Diesel	34						
S 18 NV	1796	4	8	Petrol	17						
T18SED	1799	4	16	Petrol	19						
T20SED	1998	4	16	Petrol	22						
T22SED	2198	4	16	Petrol	30						
V15L	1498	4	16	Petrol	12						
X 20 D1	1993	6	24	Petrol	25						
X 20 SE	1998	4	8	Petrol	26						
X 20 SED	1998	4	16	Petrol	22						
X 20 XEV	1998	4	16	Petrol	22						
X 22 SE	2198	4	16	Petrol	30						
X 22 XE	2198	4	16	Petrol	30						
Y15L	1498	4	8	Petrol	13						
Y15LS	1498	4	8	Petrol	13						
Y18L	1796	4	8	Petrol	20						
Z 20 DMH	1991	4	16	Diesel	27						
Z20L	1998	4	16	Petrol	22						
Z 24 XED	2405	4	16	Petrol	33						
Z 32 SEE	3195	6	24	Petrol	37						



1 0.5L Petrol

F5A	3 Cyl.	6 Valves	543cc	TD26682
PA305 (x6)	NJ336 32.00 x 47.00 x 8.00mm, NBR		NJ377 32.00 x 47.00 x 6.00mm, ACM NJ337 60.00 x 80.00 x 8.00mm, NBR	

2 0.8L Petrol

F8A	4 Cyl.	8 Valves	797cc	TD26686
PA305 (x8)	NJ336 32.00 x 47.00 x 8.00mm, NBR		NJ377 32.00 x 47.00 x 6.00mm, ACM NJ337 60.00 x 80.00 x 8.00mm, NBR	

3 0.8L Petrol

F8B	3 Cyl.	6 Valves	796cc	TD18849
PA305 (x6)	NJ336 32.00 x 47.00 x 8.00mm, NBR		NJ377 32.00 x 47.00 x 6.00mm, ACM NJ337 60.00 x 80.00 x 8.00mm, NBR	

4 0.8L Petrol

F8C	3 Cyl.	6 Valves	796cc	TD4298
PA928 (x6) HR5075	NJ336 32.00 x 47.00 x 8.00mm, NBR		NJ377 32.00 x 47.00 x 6.00mm, ACM NJ337 60.00 x 80.00 x 8.00mm, NBR	

5 1.0L Petrol

B10S	4 Cyl.	8 Valves	995cc	TD26101
PA928 (x8)	NJ336 32.00 x 47.00 x 8.00mm, NBR		NJ377 32.00 x 47.00 x 6.00mm, ACM NJ337 60.00 x 80.00 x 8.00mm, NBR	

6 1.2L Petrol

B12S1	4 Cyl.	8 Valves	1150cc	TD24878
F12S3	4 Cyl.	8 Valves	1150cc	TD30841
PA928 (x8)	NJ336 32.00 x 47.00 x 8.00mm, NBR		NJ377 32.00 x 47.00 x 6.00mm, ACM NJ337 60.00 x 80.00 x 8.00mm, NBR	

7 1.3L Petrol

A13SMS	4 Cyl.	8 Valves	1349cc	TD33581
A14SMS	4 Cyl.	8 Valves	1349cc	TD9506
PA565 (x8) HR342	NC006 35.00 x 48.00 x 7.00mm, MVQ		NA5053 30.00 x 42.00 x 7.00mm, FPM NB698 80.00 x 98.00 x 10.00mm, FPM	

8 1.4L Petrol

F14D3	4 Cyl.	16 Valves	1399cc	TD19854
NA5164 (x16) HR5092	NA5190 (x2) 42.00 x 56.00 x 7.00mm, FPM		NF812 30.00 x 42.00 x 8.00mm, ACM NB698 80.00 x 98.00 x 10.00mm, FPM	



9 1.4L Petrol

F14S3	4 Cyl.	8 Valves	1399cc	TD24879
PA565 (x8) HR342	NC006 (x2) 35.00 x 48.00 x 7.00mm, MVQ		NF812 30.00 x 42.00 x 8.00mm, ACM NB698 80.00 x 98.00 x 10.00mm, FPM	

10 1.5L Petrol

A15DMS	4 Cyl.	16 Valves	1498cc	TD19847
PA565 (x16) HR342 (x2)	NC006 (x2) 35.00 x 48.00 x 7.00mm, MVQ		NB698 80.00 x 98.00 x 10.00mm, FPM	

11 1.5L Petrol

A15F	4 Cyl.	8 Valves	1498cc	TD32386
PA565 (x16) HR342	NC006 35.00 x 48.00 x 7.00mm, MVQ		NB698 80.00 x 98.00 x 10.00mm, FPM	

12 1.5L Petrol

A15MF	4 Cyl.	16 Valves	1498cc	TD742
V15L	4 Cyl.	16 Valves	1498cc	TD18934
NA5164 (x16) HR5092	NA5190 (x2) 42.00 x 56.00 x 7.00mm, FPM		NB697 26.00 x 42.00 x 8.00mm, FPM NB698 80.00 x 98.00 x 10.00mm, FPM	

13 1.5L Petrol

A15SMS	4 Cyl.	8 Valves	1498cc	TD9507
F15S	4 Cyl.	8 Valves	1498cc	TD25314
Y15L	4 Cyl.	8 Valves	1498cc	TD18933
Y15LS	4 Cyl.	8 Valves	1498cc	TD32271
PA565 (x8) HR342	NC006 35.00 x 48.00 x 7.00mm, MVQ		NA5053 30.00 x 42.00 x 7.00mm, FPM NB698 80.00 x 98.00 x 10.00mm, FPM	

14 1.5L Petrol

G15MF	4 Cyl.	8 Valves	1498cc	TD5490
PA565 (x8) HR342	NC006 35.00 x 48.00 x 7.00mm, MVQ		NB697 26.00 x 42.00 x 8.00mm, FPM NB698 80.00 x 98.00 x 10.00mm, FPM	

15 1.6L Petrol

A16DMS	4 Cyl.	16 Valves	1598cc	TD9505
F16D3	4 Cyl.	16 Valves	1598cc	TD19853
NA5164 (x16) HR5092	NA5190 (x2) 42.00 x 56.00 x 7.00mm, FPM		NF812 30.00 x 42.00 x 8.00mm, ACM NB698 80.00 x 98.00 x 10.00mm, FPM	

16 1.6L Petrol

LXV	4 Cyl.	16 Valves	1598cc	TD26685
HR5087	NC006 (x2) 35.00 x 48.00 x 7.00mm, MVQ		NA5174 31.50 x 42.00 x 7.00mm, FPM NA5350 80.00 x 98.00 x 17.70mm, PTFE/ACM	



17 1.8L Petrol

C18LE	4 Cyl.	8 Valves	1796cc	TD4301
S 18 NV	4 Cyl.	8 Valves	1796cc	TD19851
PA565 (x8) HR342	NC006	35.00 x 48.00 x 7.00mm, MVQ	NB700	31.00 x 50.00 x 8.00mm, MVQ
	NB807	55.00 x 70.10 x 8.00mm, FPM	NB806	90.00 x 104.00 x 11.00mm, FPM

18 1.8L Petrol

F18D2	4 Cyl.	8 Valves	1761cc	TD18901
F18S2	4 Cyl.	8 Valves	1761cc	TD26684
	NC006	35.00 x 48.00 x 7.00mm, MVQ	NF812	30.00 x 42.00 x 8.00mm, ACM
			NB698	80.00 x 98.00 x 10.00mm, FPM

19 1.8L Petrol

T18SED	4 Cyl.	16 Valves	1799cc	TD19850
PA5041 (x16) HR791	NC006 (x2)	35.00 x 48.00 x 7.00mm, MVQ	NB700	31.00 x 50.00 x 8.00mm, MVQ
			NB806	90.00 x 104.00 x 11.00mm, FPM

20 1.8L Petrol

Y18L	4 Cyl.	8 Valves	1796cc	TD22508
PA565 (x8) HR342	NC006	35.00 x 48.00 x 7.00mm, MVQ	NB700	31.00 x 50.00 x 8.00mm, MVQ
			NB806	90.00 x 104.00 x 11.00mm, FPM

21 2.0L Petrol

C20LE	4 Cyl.	8 Valves	1998cc	TD4300
C20LZ	4 Cyl.	8 Valves	1998cc	TD22052
C 20 NE	4 Cyl.	8 Valves	1998cc	TD21445
C 20 NED	4 Cyl.	8 Valves	1998cc	TD21444
PA565 (x8) HR342	NC006	35.00 x 48.00 x 7.00mm, MVQ	NB700	31.00 x 50.00 x 8.00mm, MVQ
	NB807	55.00 x 70.10 x 8.00mm, FPM	NB806	90.00 x 104.00 x 11.00mm, FPM

22 2.0L Petrol

C20SED	4 Cyl.	16 Valves	1998cc	TD18847
T20SED	4 Cyl.	16 Valves	1998cc	TD18900
X 20 SED	4 Cyl.	16 Valves	1998cc	TD9504
X 20 XEV	4 Cyl.	16 Valves	1998cc	TD26693
Z20L	4 Cyl.	16 Valves	1998cc	TD20011
PA5041 (x16) HR791	NC006 (x2)	35.00 x 48.00 x 7.00mm, MVQ	NB700	31.00 x 50.00 x 8.00mm, MVQ
			NB806	90.00 x 104.00 x 11.00mm, FPM

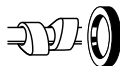

23 2.0L

Petrol

L88	4 Cyl.	16 Valves	1998cc	TD22106
PA565 (x16) HR342 (x2)	NC006 (x2) 35.00 x 48.00 x 7.00mm, MVQ	NB700 (x2) 31.00 x 50.00 x 8.00mm, MVQ NB806 (x2) 90.00 x 104.00 x 11.00mm, FPM		

24 2.0L

Petrol

M 161.950	4 Cyl.	16 Valves	1998cc	TD26691
HR5085 (x4)		NB973 (x2) 45.00 x 67.00 x 8.00mm, FPM NB974 (x2) 93.00 x 114.00 x 13.00mm, FPM		

25 2.0L

Petrol

X 20 D1	6 Cyl.	24 Valves	1993cc	TD24076
		NF850 (x2) 85.00 x 105.00 x 8.00mm, FPM		

26 2.0L

Petrol

X 20 SE	4 Cyl.	8 Valves	1998cc	TD29518
PA565 (x8) HR342		NB700 (x2) 31.00 x 50.00 x 8.00mm, MVQ NB806 (x2) 90.00 x 104.00 x 11.00mm, FPM		

27 2.0L

Diesel

Z 20 DMH	4 Cyl.	16 Valves	1991cc	TD26675
		NF817 36.00 x 50.00 x 7.00mm, FPM NA5139 (x2) 32.00 x 45.00 x 6.00mm, FPM		

28 2.2L

Petrol

C 22 SED	4 Cyl.	16 Valves	2198cc	TD22201
		NC006 35.00 x 48.00 x 7.00mm, MVQ NB700 (x2) 31.00 x 50.00 x 8.00mm, MVQ NB806 (x2) 90.00 x 104.00 x 11.00mm, FPM		

29 2.2L

Diesel

MB OM 601	4 Cyl.	8 Valves	2299cc	TD22985
PB394 (x4) HR757		NA5131 (x2) 45.00 x 67.00 x 8.00mm, PTFE NA5074 (x2) 93.00 x 133.50 x 15.50mm, PTFE		

30 2.2L

Petrol

T22SED	4 Cyl.	16 Valves	2198cc	TD18177
X 22 SE	4 Cyl.	16 Valves	2198cc	TD21443
X 22 XE	4 Cyl.	16 Valves	2198cc	TD22506
PA5041 (x16) HR791	NC006 (x2) 35.00 x 48.00 x 7.00mm, MVQ	NB700 (x2) 31.00 x 50.00 x 8.00mm, MVQ NB806 (x2) 90.00 x 104.00 x 11.00mm, FPM		



31 2.3L		Petrol			
M 111.970	4 Cyl.	16 Valves	2295cc		TD22989
M 161.970	4 Cyl.	16 Valves	2295cc		TD26690
M 161.974	4 Cyl.	16 Valves	2295cc		TD26679
HR5055				NB973 45.00 x 67.00 x 8.00mm, FPM NB974 93.00 x 114.00 x 13.00mm, FPM	

32 2.4L		Diesel			
4C90	4 Cyl.	8 Valves	2417cc		TD10687
4CT90-1	4 Cyl.	8 Valves	2417cc		TD10688
PB180 (x8) HR801 	NA5058 40.00 x 55.00 x 7.00mm, FPM			NA5016 35.00 x 47.00 x 7.00mm, FPM/ACM	

33 2.4L		Petrol			
Z 24 XED	4 Cyl.	16 Valves	2405cc		TD19849
PA5041 (x16) HR791 	NC006 (x2) 35.00 x 48.00 x 7.00mm, MVQ			NB700 31.00 x 50.00 x 8.00mm, MVQ NB806 90.00 x 104.00 x 11.00mm, FPM	

34 2.9L		Diesel			
MB-OM 601 29TD	5 Cyl.	10 Valves	2874cc		TD22986
MB-OM 662	5 Cyl.	10 Valves	2874cc		TD22987
OM 662.983	5 Cyl.	10 Valves	2874cc		TD26681
PB394 (x5) HR758 				NA5131 45.00 x 67.00 x 8.00mm, PTFE NA5074 93.00 x 133.50 x 15.50mm, PTFE	

35 3.0L		Petrol			
C 30 NE	6 Cyl.	12 Valves	2969cc		TD19855
PA619 (x12) HR336 (x3)				NB628 45.00 x 60.00 x 9.00mm, ACM NB469 77.00 x 100.00 x 11.50mm, FPM	

36 3.2L		Petrol			
M 104.992	6 Cyl.	24 Valves	3199cc		TD22988
M 104.995	6 Cyl.	24 Valves	3199cc		TD22990
M 162.992	6 Cyl.	24 Valves	3199cc		TD26680
HR5055				NB973 45.00 x 67.00 x 8.00mm, FPM NB974 93.00 x 114.00 x 13.00mm, FPM	

37 3.2L		Petrol			
Z 32 SEE	6 Cyl.	24 Valves	3195cc		TD19848
PA5041 (x24) HR5062 	NC006 (x4) 35.00 x 48.00 x 7.00mm, MVQ			NB700 31.00 x 50.00 x 8.00mm, MVQ NB806 90.00 x 104.00 x 11.00mm, FPM	



















CC



9

55	10/67→09/72	DBB 110E	Petrol	1108	4	8	1	
55 Coupe	05/68→09/72	DBB 110E	Petrol	1108	4	8	1	
55 Estate	10/68→09/72	DBB 110E	Petrol	1108	4	8	1	
400 Platform/Chassis	04/89→12/94	EN 55	Diesel	2498	4	8	3	
400 Platform/Chassis	04/89→01/97	ET 70	Diesel	2498	4	8	3	
400-Serie Box	04/89→08/93	EN 55	Diesel	2498	4	8	3	
400-Serie Box	04/89→08/93	ET 70	Diesel	2498	4	8	3	
400-Serie Bus	04/89→12/94	EN 55	Diesel	2498	4	8	3	
400-Serie Bus	04/89→01/97	ET 70	Diesel	2498	4	8	3	

	CC				9		CC				9
BE 99 C	3920	4	16	Diesel	5	PE 212 C	9200	6	24	Diesel	12
BE 110 C	3920	4	16	Diesel	5	PE 228 C	9200	6	24	Diesel	12
BE 123 C	3920	4	16	Diesel	5	PE 235 C	9200	6	24	Diesel	12
CE 136 C	5880	6	24	Diesel	7	PE 250 C	9200	6	24	Diesel	12
CE 162 C	5880	6	24	Diesel	7	PE 265 C	9200	6	24	Diesel	12
CE 184 C	5880	6	24	Diesel	7	PE 310 C	9200	6	24	Diesel	12
DBB 110E	1108	4	8	Petrol	1	PE 360 C	9200	6	24	Diesel	12
DH 825	8250	6	12	Diesel	10	PF 183 M	9200	6	24	Diesel	12
DHB 825	8250	6	12	Diesel	10	PF 212 M	9200	6	24	Diesel	12
DHR 825	8250	6	12	Diesel	10	PF 235 M	9200	6	24	Diesel	12
DHS 825	8250	6	12	Diesel	10	PR 183 S	9200	6	24	Diesel	12
DHS 825SM	8250	6	12	Diesel	10	PR 228 S	9200	6	24	Diesel	12
DHT 825	8250	6	12	Diesel	10	PR 265 S	9200	6	24	Diesel	12
DHTD 825	8250	6	12	Diesel	10	PX-5 112	4460	4	16	Diesel	6
DHU 825	8250	6	12	Diesel	10	PX-5 135	4460	4	16	Diesel	6
DJST	2446	4	12	Diesel	2	PX-5 157	4460	4	16	Diesel	6
DK 1160	11630	6	12	Diesel	13	PX-7 164	6690	6	24	Diesel	9
DKA 1160	11600	6	12	Diesel	13	PX-7 172	6690	6	24	Diesel	9
DKB 1160	11600	6	12	Diesel	13	PX-7 186	6690	6	24	Diesel	9
DKCL 1160	11630	6	12	Diesel	13	PX-7 194	6690	6	24	Diesel	9
DKD 1160	11630	6	12	Diesel	13	PX-7 208	6690	6	24	Diesel	9
DKDL 1160	11630	6	12	Diesel	13	PX-7 231	6690	6	24	Diesel	9
DKFL 1160	11630	6	12	Diesel	13	PX-7 239	6690	6	24	Diesel	9
DKL 1160	11630	6	12	Diesel	13	RS 180	8650	6	12	Diesel	11
DKS 1160	11600	6	12	Diesel	13	RS 180 L	8650	6	12	Diesel	11
DKS 1160 E	11600	6	12	Diesel	13	RS 180 M	8650	6	12	Diesel	11
DKSB 1160	11630	6	12	Diesel	13	RS 200	8650	6	12	Diesel	11
DKSE 1160	11630	6	12	Diesel	13	RS 200 L	8650	6	12	Diesel	11
DKT 1160	11600	6	12	Diesel	13	RS 200 M	8650	6	12	Diesel	11
DKTD 1160	11600	6	12	Diesel	13	RS 222	8650	6	12	Diesel	11
DKTL 1160	11600	6	12	Diesel	13	RS 222 L	8650	6	12	Diesel	11
DKV 1160	11600	6	12	Diesel	13	RS 222 M	8650	6	12	Diesel	11
DKVL 1160	11600	6	12	Diesel	13	VF 373 M	14000	6	24	Diesel	17
DKX 1160	11600	6	12	Diesel	13	VF 390 M	14000	6	24	Diesel	17
DKX 1160 ATi	11600	6	12	Diesel	13	WS 222 G	11630	6	12	Diesel	14
DKXE 1160	11600	6	12	Diesel	13	WS 222 L	11630	6	12	Diesel	14
DKXE 1160 ATi	11630	6	12	Diesel	13	WS 222 M	11630	6	12	Diesel	14
DKZ 1160 ATi	11600	6	12	Diesel	13	WS 225	11600	6	12	Diesel	14
DKZE 1160	11600	6	12	Diesel	13	WS 225 ATi	11630	6	12	Diesel	14
DNS 620	6240	6	12	Diesel	8	WS 242	11600	6	12	Diesel	14
DNT 620	6240	6	12	Diesel	8	WS 242 G	11630	6	12	Diesel	14
DNTD 620	6240	6	12	Diesel	8	WS 242 L	11600	6	12	Diesel	14
DT 825	8250	6	12	Diesel	10	WS 242 M	11600	6	12	Diesel	14
DU 825	8250	6	12	Diesel	10	WS 259	11600	6	12	Diesel	14
EN 55	2498	4	8	Diesel	3	WS 259 ATi	11630	6	12	Diesel	14
ET 70	2498	4	8	Diesel	3	WS 268	11600	6	12	Diesel	14
FR 103 S1	4461	4	16	Diesel	6	WS 268 G	11600	6	12	Diesel	14
FR 118 S1	4461	4	16	Diesel	6	WS 268 L	11600	6	12	Diesel	14
FR 136 S1	4461	4	16	Diesel	6	WS 268 M	11600	6	12	Diesel	14
FR 152	4461	4	16	Diesel	6	WS 270	11630	6	12	Diesel	14
GR 165 S1	6691	6	12	Diesel	9	WS 282	11600	6	12	Diesel	14
GR 184 S1	6691	6	24	Diesel	9	WS 282 ATi	11630	6	12	Diesel	14
GR 210 S1	6691	6	24	Diesel	9	WS 282 L	11630	6	12	Diesel	14
GR 220	6691	6	24	Diesel	9	WS 295	11600	6	12	Diesel	14
HS 825	8250	6	12	Diesel	10	WS 295 G	11600	6	12	Diesel	14
HT 825	8250	6	12	Diesel	10	WS 295 L	11600	6	12	Diesel	14
KS 1160	11600	6	12	Diesel	13	WS 295 M	11600	6	12	Diesel	14
KV 1160	11600	6	12	Diesel	13	WS 295 M Ati	11627	6	12	Diesel	14
LT 160	11630	6	12	Diesel	13	WS 315	11600	6	12	Diesel	14
LT 210	11630	6	12	Diesel	13	WS 315 G	11627	6	12	Diesel	14
MX 265	12900	6	24	Diesel	16	WS 315 L	11600	6	12	Diesel	14
MX 300	12900	6	24	Diesel	16	WS 315 M	11600	6	12	Diesel	14
MX 340	12900	6	24	Diesel	16	XD3P	2497	4	8	Diesel	4
MX 375	12900	6	24	Diesel	16	XD3T	2497	4	8	Diesel	4
MX-13 265	12900	6	24	Diesel	16	XE 250 C	12580	6	24	Diesel	15
MX-13 303	12900	6	24	Diesel	16	XE 280 C	12580	6	24	Diesel	15
MX-13 340	12900	6	24	Diesel	16	XE 280 CI	12580	6	24	Diesel	15
MX-13 375	12900	6	24	Diesel	16	XE 315 C	12580	6	24	Diesel	15
NS 133 L	6240	6	12	Diesel	8	XE 315 CI	12580	6	24	Diesel	15
NS 133 M	6240	6	12	Diesel	8	XE 340 C	12580	6	24	Diesel	15
NS 156	6240	6	12	Diesel	8	XE 355 C	12580	6	24	Diesel	15
NS 156G	6239	6	12	Diesel	8	XE 355 CI	12580	6	24	Diesel	15
NS 156 L	6240	6	12	Diesel	8	XE 380 C	12580	6	24	Diesel	15
NS 156 M	6240	6	12	Diesel	8	XE 390 C	12580	6	24	Diesel	15
NS 177 M	6240	6	12	Diesel	8	XE 390 CI	12580	6	24	Diesel	15
NT 116	6240	6	12	Diesel	8	XE 430 C	12580	6	24	Diesel	15
NT 133	6240	6	12	Diesel	8	XF 250 M	12580	6	24	Diesel	15
PE 183 C	9200	6	24	Diesel	12	XF 280 M	12580	6	24	Diesel	15

	CC				9		CC				9
XF 315 M	12580	6	24	Diesel	15						
XF 355 M	12580	6	24	Diesel	15						



1 1.1L Petrol

DBB 110E 4 Cyl. 8 Valves 1108cc TD5225

NF835
80.00 x 100.00 x 8.00mm, FPM/ACM

2 2.5L Diesel

DJ5T 4 Cyl. 12 Valves 2446cc TD22210

HR662
NB959
35.00 x 50.00 x 7.00mm, FPM

NF866
64.00 x 88.00 x 6.00mm, FPM/ACM
NF867
98.00 x 120.00 x 7.00mm, FPM/ACM

3 2.5L Diesel

EN 55 4 Cyl. 8 Valves 2498cc TD763

ET 70 4 Cyl. 8 Valves 2498cc TD764

PA229 (x8)

NF780
45.00 x 60.00 x 7.00mm, ACM
KS696 (x2)

4 2.5L Diesel

XD3P 4 Cyl. 8 Valves 2497cc TD22215

XD3T 4 Cyl. 8 Valves 2497cc TD22216

PA229 (x8)

NF387
42.00 x 60.00 x 10.00mm, NBR
→09/85
NF780
45.00 x 60.00 x 7.00mm, ACM
09/85→
KS696 (x2)

5 3.9L Diesel

BE 99 C 4 Cyl. 16 Valves 3920cc TD16709

BE 110 C 4 Cyl. 16 Valves 3920cc TD16714

BE 123 C 4 Cyl. 16 Valves 3920cc TD16715

NA5293
70.00 x 100.00 x 12.50mm, PTFE
NA5294
130.00 x 155.00 x 12.50mm, PTFE

6 4.5L Diesel

FR 103 S1 4 Cyl. 16 Valves 4461cc TD18957

FR 118 S1 4 Cyl. 16 Valves 4461cc TD18958

FR 136 S1 4 Cyl. 16 Valves 4461cc TD18959

FR 152 4 Cyl. 16 Valves 4461cc TD26696

PX-5 112 4 Cyl. 16 Valves 4460cc TD28886

PX-5 135 4 Cyl. 16 Valves 4460cc TD28887

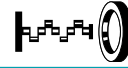

PX-5 157 4 Cyl. 16 Valves 4460cc TD28888

NA5293
70.00 x 100.00 x 12.50mm, PTFE
NA5465
130.00 x 150.00 x 14.80mm, PTFE



7 5.9L Diesel

CE 136 C	6 Cyl.	24 Valves	5880cc	TD16712
CE 162 C	6 Cyl.	24 Valves	5880cc	TD16711
CE 184 C	6 Cyl.	24 Valves	5880cc	TD16710

NA5293 
70.00 x 100.00 x 12.50mm, PTFE
NA5294 
130.00 x 155.00 x 12.50mm, PTFE



8 6.2L Diesel

DNS 620	6 Cyl.	12 Valves	6240cc	TD6617
DNT 620	6 Cyl.	12 Valves	6240cc	TD6615
DNTD 620	6 Cyl.	12 Valves	6240cc	TD6614
NS 133 L	6 Cyl.	12 Valves	6240cc	TD6650
NS 133 M	6 Cyl.	12 Valves	6240cc	TD6651
NS 156	6 Cyl.	12 Valves	6240cc	TD12928
NS 156G	6 Cyl.	12 Valves	6239cc	TD6526
NS 156 L	6 Cyl.	12 Valves	6240cc	TD6652
NS 156 M	6 Cyl.	12 Valves	6240cc	TD6653
NS 177 M	6 Cyl.	12 Valves	6240cc	TD12552
NT 116	6 Cyl.	12 Valves	6240cc	TD12908
NT 133	6 Cyl.	12 Valves	6240cc	TD12909

NB618 
80.00 x 100.40 x 13.00mm, PTFE

9 6.7L Diesel

GR 165 S1	6 Cyl.	12 Valves	6691cc	TD18960
GR 184 S1	6 Cyl.	24 Valves	6691cc	TD19699
GR 210 S1	6 Cyl.	24 Valves	6691cc	TD19700
GR 220	6 Cyl.	24 Valves	6691cc	TD26630
PX-7 164	6 Cyl.	24 Valves	6690cc	TD28889
PX-7 172	6 Cyl.	24 Valves	6690cc	TD33807
PX-7 186	6 Cyl.	24 Valves	6690cc	TD28890
PX-7 194	6 Cyl.	24 Valves	6690cc	TD33808
PX-7 208	6 Cyl.	24 Valves	6690cc	TD28891
PX-7 231	6 Cyl.	24 Valves	6690cc	TD28892
PX-7 239	6 Cyl.	24 Valves	6690cc	TD33810

NA5293 
70.00 x 100.00 x 12.50mm, PTFE
NA5465 
130.00 x 150.00 x 14.80mm, PTFE



10	8.3L	Diesel			
DH 825		6 Cyl.	12 Valves	8250cc	TD6603
DHB 825		6 Cyl.	12 Valves	8250cc	TD13229
DHR 825		6 Cyl.	12 Valves	8250cc	TD6619
DHS 825		6 Cyl.	12 Valves	8250cc	TD6625
DHS 825SM		6 Cyl.	12 Valves	8250cc	TD6626
DHT 825		6 Cyl.	12 Valves	8250cc	TD6620
DHTD 825		6 Cyl.	12 Valves	8250cc	TD6621
DHU 825		6 Cyl.	12 Valves	8250cc	TD6623
DT 825		6 Cyl.	12 Valves	8250cc	TD22801
DU 825		6 Cyl.	12 Valves	8250cc	TD6618
HS 825		6 Cyl.	12 Valves	8250cc	TD12890
HT 825		6 Cyl.	12 Valves	8250cc	TD12891
					NB946 F 70.00 x 90.00 x 10.00mm, FPM NB954 R 125.00 x 150.00 x 12.00mm, FPM

11	8.7L	Diesel			
RS 180		6 Cyl.	12 Valves	8650cc	TD12553
RS 180 L		6 Cyl.	12 Valves	8650cc	TD6654
RS 180 M		6 Cyl.	12 Valves	8650cc	TD6655
RS 200		6 Cyl.	12 Valves	8650cc	TD12554
RS 200 L		6 Cyl.	12 Valves	8650cc	TD6656
RS 200 M		6 Cyl.	12 Valves	8650cc	TD6657
RS 222		6 Cyl.	12 Valves	8650cc	TD12555
RS 222 L		6 Cyl.	12 Valves	8650cc	TD6658
RS 222 M		6 Cyl.	12 Valves	8650cc	TD6659
					NB954 R 125.00 x 150.00 x 12.00mm, FPM

12	9.2L	Diesel			
PE 183 C		6 Cyl.	24 Valves	9200cc	TD13328
PE 212 C		6 Cyl.	24 Valves	9200cc	TD13329
PE 228 C		6 Cyl.	24 Valves	9200cc	TD16701
PE 235 C		6 Cyl.	24 Valves	9200cc	TD13330
PE 250 C		6 Cyl.	24 Valves	9200cc	TD22813
PE 265 C		6 Cyl.	24 Valves	9200cc	TD16700
PE 310 C		6 Cyl.	24 Valves	9200cc	TD22814
PE 360 C		6 Cyl.	24 Valves	9200cc	TD22815
PF 183 M		6 Cyl.	24 Valves	9200cc	TD11909
PF 212 M		6 Cyl.	24 Valves	9200cc	TD11910
PF 235 M		6 Cyl.	24 Valves	9200cc	TD11911
PR 183 S		6 Cyl.	24 Valves	9200cc	TD20053
PR 228 S		6 Cyl.	24 Valves	9200cc	TD20054
PR 265 S		6 Cyl.	24 Valves	9200cc	TD20055
					NB954 R 125.00 x 150.00 x 12.00mm, FPM

**13 11.6L****Diesel**

DK 1160	6 Cyl.	12 Valves	11630cc	TD6606
DKA 1160	6 Cyl.	12 Valves	11600cc	TD6608
DKB 1160	6 Cyl.	12 Valves	11600cc	TD6627
DKCL 1160	6 Cyl.	12 Valves	11630cc	TD20105
DKD 1160	6 Cyl.	12 Valves	11630cc	TD6605
DKDL 1160	6 Cyl.	12 Valves	11630cc	TD6640
DKFL 1160	6 Cyl.	12 Valves	11630cc	TD20107
DKL 1160	6 Cyl.	12 Valves	11630cc	TD6641
DKS 1160	6 Cyl.	12 Valves	11600cc	TD6629
DKS 1160 E	6 Cyl.	12 Valves	11600cc	TD6630
DKSB 1160	6 Cyl.	12 Valves	11630cc	TD20106
DKSE 1160	6 Cyl.	12 Valves	11630cc	TD22211
DKT 1160	6 Cyl.	12 Valves	11600cc	TD6631
DKTD 1160	6 Cyl.	12 Valves	11600cc	TD6632
DKTL 1160	6 Cyl.	12 Valves	11600cc	TD6642
DKV 1160	6 Cyl.	12 Valves	11600cc	TD6633
DKVL 1160	6 Cyl.	12 Valves	11600cc	TD13288
DKX 1160	6 Cyl.	12 Valves	11600cc	TD6637
DKX 1160 ATi	6 Cyl.	12 Valves	11600cc	TD6638
DKXE 1160	6 Cyl.	12 Valves	11600cc	TD6634
DKXE 1160 ATi	6 Cyl.	12 Valves	11630cc	TD22212
DKZ 1160 ATi	6 Cyl.	12 Valves	11600cc	TD6639
DKZE 1160	6 Cyl.	12 Valves	11600cc	TD12828
KS 1160	6 Cyl.	12 Valves	11600cc	TD12889
KV 1160	6 Cyl.	12 Valves	11600cc	TD12888
LT 160	6 Cyl.	12 Valves	11630cc	TD24104
LT 210	6 Cyl.	12 Valves	11630cc	TD7173

NB946

70.00 x 90.00 x 10.00mm, FPM

NB947

154.00 x 180.00 x 12.00mm, FPM



14 11.6L	Diesel			
WS 222 G	6 Cyl.	12 Valves	11630cc	TD6667
WS 222 L	6 Cyl.	12 Valves	11630cc	TD6660
WS 222 M	6 Cyl.	12 Valves	11630cc	TD6661
WS 225	6 Cyl.	12 Valves	11600cc	TD6668
WS 225 ATi	6 Cyl.	12 Valves	11630cc	TD7517
WS 242	6 Cyl.	12 Valves	11600cc	TD6669
WS 242 G	6 Cyl.	12 Valves	11630cc	TD22214
WS 242 L	6 Cyl.	12 Valves	11600cc	TD6662
WS 242 M	6 Cyl.	12 Valves	11600cc	TD6663
WS 259	6 Cyl.	12 Valves	11600cc	TD6670
WS 259 ATi	6 Cyl.	12 Valves	11630cc	TD7518
WS 268	6 Cyl.	12 Valves	11600cc	TD6671
WS 268 G	6 Cyl.	12 Valves	11600cc	TD6672
WS 268 L	6 Cyl.	12 Valves	11600cc	TD6664
WS 268 M	6 Cyl.	12 Valves	11600cc	TD6665
WS 270	6 Cyl.	12 Valves	11630cc	TD6673
WS 282	6 Cyl.	12 Valves	11600cc	TD11907
WS 282 ATi	6 Cyl.	12 Valves	11630cc	TD7519
WS 282 L	6 Cyl.	12 Valves	11630cc	TD6674
WS 295	6 Cyl.	12 Valves	11600cc	TD6675
WS 295 G	6 Cyl.	12 Valves	11600cc	TD6676
WS 295 L	6 Cyl.	12 Valves	11600cc	TD6677
WS 295 M	6 Cyl.	12 Valves	11600cc	TD6678
WS 295 M Ati	6 Cyl.	12 Valves	11627cc	TD6666
WS 315	6 Cyl.	12 Valves	11600cc	TD11908
WS 315 G	6 Cyl.	12 Valves	11627cc	TD6679
WS 315 L	6 Cyl.	12 Valves	11600cc	TD6680
WS 315 M	6 Cyl.	12 Valves	11600cc	TD6681

NB956 
100.00 x 124.00 x 12.00mm, FPM

NB947 
154.00 x 180.00 x 12.00mm, FPM

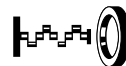
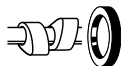
**15 12.6L****Diesel**

XE 250 C	6 Cyl.	24 Valves	12580cc	TD13331
XE 280 C	6 Cyl.	24 Valves	12580cc	TD13332
XE 280 C1	6 Cyl.	24 Valves	12580cc	TD22217
XE 315 C	6 Cyl.	24 Valves	12580cc	TD13333
XE 315 C1	6 Cyl.	24 Valves	12580cc	TD22218
XE 340 C	6 Cyl.	24 Valves	12580cc	TD22780
XE 355 C	6 Cyl.	24 Valves	12580cc	TD13334
XE 355 C1	6 Cyl.	24 Valves	12580cc	TD22219
XE 380 C	6 Cyl.	24 Valves	12580cc	TD22781
XE 390 C	6 Cyl.	24 Valves	12580cc	TD13335
XE 390 C1	6 Cyl.	24 Valves	12580cc	TD22220
XE 430 C	6 Cyl.	24 Valves	12580cc	TD22782
XF 250 M	6 Cyl.	24 Valves	12580cc	TD11912
XF 280 M	6 Cyl.	24 Valves	12580cc	TD11913
XF 315 M	6 Cyl.	24 Valves	12580cc	TD11914
XF 355 M	6 Cyl.	24 Valves	12580cc	TD11915

NB956 F

100.00 x 124.00 x 12.00mm, FPM

NB947 R

154.00 x 180.00 x 12.00mm, FPM

16 12.9L**Diesel**

MX-13 265	6 Cyl.	24 Valves	12900cc	TD28894
MX-13 303	6 Cyl.	24 Valves	12900cc	TD28147
MX-13 340	6 Cyl.	24 Valves	12900cc	TD28148
MX-13 375	6 Cyl.	24 Valves	12900cc	TD28149
MX 265	6 Cyl.	24 Valves	12900cc	TD20056
MX 300	6 Cyl.	24 Valves	12900cc	TD18902
MX 340	6 Cyl.	24 Valves	12900cc	TD18903
MX 375	6 Cyl.	24 Valves	12900cc	TD18904

NA5460 F

134.00 x 161.00 x 16.00mm, NBR

NA5462 R









165.00 x 191.00 x 16.00mm, PTFE/ACM

17 14.0L**Diesel**

VF 373 M	6 Cyl.	24 Valves	14000cc	TD11916
VF 390 M	6 Cyl.	24 Valves	14000cc	TD11917

NA5464 R

152.50 x 171.50 x 11.00mm, PTFE

							
1000 Box	07/86→10/97	CB 10	Petrol	993	3	6	7
1000 Bus	06/92→10/97	CB 10	Petrol	993	3	6	7
1000 Pickup	06/92→10/97	CB 10	Petrol	993	3	6	7
1300 Box	06/98→	HCE	Petrol	1296	4	16	16
1300 Bus	06/98→	HCE	Petrol	1296	4	16	16
1300 Pickup	06/98→	HCE	Petrol	1296	4	16	16
Altis	10/96→07/01	5S-FE	Petrol	2164	4	16	29
Altis	08/01→12/10	2AZ-FE	Petrol	2362	4	16	30
Altis Hatchback	10/96→07/01	5S-FE	Petrol	2164	4	16	29
Altis Saloon	01/08→04/10	2AZ-FE	Petrol	2362	4	16	30
Altis Saloon	05/12→	2AR-FXE	Petrol	2493	4	16	31
Applause I (A101, A111)	06/89→07/97	HD	Petrol	1590	4	16	24
Applause I (A101, A111)	06/89→07/97	HD-E	Petrol	1590	4	16	24
Applause II (A101)	07/97→05/00	HD-E	Petrol	1590	4	16	24
Atrai Box	06/92→07/99	EF-RS	Petrol	659	3	12	3
Atrai Box	08/99→	EF-VE	Petrol	659	3	12	3
Atrai Wagon (S320_, S330_)	04/05→	EF-DET	Petrol	659	3	12	3
Atrai Wagon Bus	06/92→07/99	EF-RS	Petrol	659	3	12	3
Atrai Wagon Bus (S220_, S230_)	08/99→04/05	EF-DET	Petrol	659	3	12	3
Atrai Wagon Bus (S220_, S230_)	07/00→09/03	K3-VE	Petrol	1298	4	16	17
Atria Wagon Bus	06/92→04/05	EF-DET	Petrol	659	3	12	3
Atria Wagon Bus	08/99→04/05	EF-VE	Petrol	659	3	12	3
Bego	11/05→	K3-VE	Petrol	1298	4	16	17
Boon	01/10→	1KR-FE	Petrol	998	3	12	6
Boon Luminas	12/08→02/12	3SZ-VE	Petrol	1495	4	16	18
Charade	05/11→	1NR-FE	Petrol	1329	4	16	13
Charade (L2_)	03/03→	1KR-FE	Petrol	998	3	12	6
Charade (L2_)	03/03→	EJ-VE	Petrol	989	3	12	11
Charade I (G10)	10/77→02/83	CB 20	Petrol	993	3	6	7
Charade I (G10)	02/81→02/83	CB 22	Petrol	993	3	6	7
Charade II (G11, G30)	10/83→03/87	CB 20	Petrol	993	3	6	7
Charade II (G11, G30)	10/83→03/87	CB 22	Petrol	993	3	6	7
Charade II (G11, G30)	10/83→03/87	CB 60	Petrol	993	3	6	7
Charade II (G11, G30)	10/83→03/87	CL 10	Diesel	993	3	6	9
Charade II (G11, G30)	02/85→03/87	CL 60	Diesel	993	3	6	9
Charade II Box (G11)	04/83→05/87	CB 22	Petrol	993	3	6	7
Charade III (G100, G101, G102)	03/87→10/90	CB 61	Petrol	993	3	6	7
Charade III (G100, G101, G102)	03/87→12/92	CB 23	Petrol	993	3	6	7
Charade III (G100, G101, G102)	03/87→12/92	CB 80 T	Petrol	993	3	12	8
Charade III (G100, G101, G102)	03/87→12/92	CL	Diesel	993	3	6	9
Charade III (G100, G101, G102)	03/87→12/92	CL 11	Diesel	993	3	6	9
Charade III (G100, G101, G102)	03/87→12/92	CL 61	Diesel	993	3	6	9
Charade III (G100, G101, G102)	06/88→01/93	HCE	Petrol	1296	4	16	16
Charade III (G100, G101, G102)	09/88→01/92	HC-C	Petrol	1295	4	16	16
Charade III (G100, G101, G102)	09/88→12/92	HC	Petrol	1296	4	16	15
Charade III (G100, G101, G102)	04/89→12/92	CB 90	Petrol	993	3	6	7
Charade III Saloon (G102)	09/89→12/92	HC	Petrol	1296	4	16	15
Charade III Saloon (G102)	11/90→02/93	HCE	Petrol	1296	4	16	16
Charade IV (G200, G202)	01/93→09/00	HC	Petrol	1296	4	16	15
Charade IV (G200, G202)	01/93→09/00	HCE	Petrol	1296	4	16	16
Charade IV (G200, G202)	03/93→03/96	CB 20	Petrol	993	3	6	7
Charade IV (G200, G202)	03/93→11/99	HD-E	Petrol	1590	4	16	24
Charade IV (G200, G202)	06/94→11/99	HEE	Petrol	1499	4	16	19
Charade IV (G200, G202)	06/94→11/99	HEEG	Petrol	1499	4	16	19
Charade IV (G200, G202)	09/94→03/96	CB 22	Petrol	993	3	6	7
Charade IV Saloon (G203)	03/93→03/96	HD-E	Petrol	1590	4	16	24
Charade IV Saloon (G203)	06/94→01/01	HEE	Petrol	1499	4	16	19
Charmant (A)	11/81→07/87	4K	Petrol	1290	4	8	14
Charmant (A)	12/81→09/84	2T	Petrol	1588	4	8	21
Charmant (A)	08/83→07/87	4A	Petrol	1587	4	8	22
Coo	10/06→	3SZ-VE	Petrol	1495	4	16	18
Coo	10/06→	EJ-DE	Petrol	989	3	12	10
Coo	10/06→	EJ-VE	Petrol	989	3	12	11
Coo	10/06→	K3-VE	Petrol	1298	4	16	17
Coo	10/06→	K3-VET	Petrol	1298	4	16	17
Coo (M411S)	10/06→11/12	K3-VE	Petrol	1298	4	16	17
Copen (L880_, L881_)	03/06→09/12	K3-VE	Petrol	1298	4	16	17
Cuore I (L55, L60)	08/82→09/85	AD 10	Petrol	617	2	4	1
Cuore II (L80, L81)	09/85→12/90	ED 10	Petrol	847	3	6	5
Cuore III (L201)	08/90→09/94	EF-CL	Petrol	659	3	6	2
Cuore III (L201)	08/90→09/94	EF-HL	Petrol	659	3	12	2
Cuore III (L201)	08/90→09/94	EF-XL	Petrol	659	3	6	2
Cuore III (L201)	08/90→11/94	EF-EL	Petrol	659	3	12	2
Cuore III (L201)	08/90→12/94	EF-JL	Petrol	659	3	12	2
Cuore III (L201)	10/90→09/94	ED	Petrol	847	3	6	5
Cuore III (L201)	10/90→12/94	ED 10 K	Petrol	847	3	6	5
Cuore IV (L501)	12/94→10/98	EF-SE	Petrol	659	3	6	2
Cuore IV (L501)	01/95→10/98	ED 20	Petrol	847	3	6	5



CC



9

Cuore V (L7_)	10/98→09/00	EF-SE	Petrol	659	3	6	2
Cuore V (L7_)	10/98→05/03	EJ-DE	Petrol	989	3	12	10
Cuore V (L7_)	10/98→05/03	EJ-VE	Petrol	989	3	12	11
Cuore VI (L251, L250_, L260_)	05/03→	EJ-VE	Petrol	989	3	12	11
Cuore VII (L251)	03/03→	EF-DET	Petrol	659	3	12	3
Cuore VII (L251)	03/03→	EF-JL	Petrol	659	3	12	2
Cuore VII (L251)	03/03→	EF-SE	Petrol	659	3	6	2
Cuore VII (L251)	03/03→	EF-VE	Petrol	659	3	12	3
Cuore VII (L275_, L285_, L276_)	04/07→	TKR-FE	Petrol	998	3	12	6
Delta Box (V1_, V2_, V5_, YB_)	09/91→04/99	4Y	Petrol	2237	4	8	28
Delta Bus	09/87→04/94	DL	Diesel	2765	4	8	33
Delta Bus	09/91→04/99	4Y	Petrol	2237	4	8	28
Delta WIDE Box (YB_)	09/84→09/91	4KJ	Petrol	1290	4	8	14
Delta WIDE Box (YB_)	04/85→09/99	3Y	Petrol	1998	4	8	27
Delta WIDE Platform/Chassis (YB_)	04/85→09/99	3Y	Petrol	1998	4	8	27
Delta WIDE Platform/Chassis (YB_)	09/91→04/99	4Y	Petrol	2237	4	8	28
Extol Box	07/00→	K3-VE	Petrol	1298	4	16	17
Extol Bus (S22_, S23_)	07/00→11/11	K3-VE	Petrol	1298	4	16	17
F50	05/84→12/91	DG	Diesel	2530	4	8	32
Feroza Hard Top (F300)	10/88→12/99	HDC	Petrol	1590	4	16	24
Feroza Hard Top (F300)	10/88→12/99	HD-E	Petrol	1590	4	16	24
Feroza Soft Top (F300)	10/88→12/99	HDC	Petrol	1590	4	16	24
Feroza Soft Top (F300)	10/88→12/99	HD-E	Petrol	1590	4	16	24
Gran Move (G3)	10/96→08/98	HEE	Petrol	1499	4	16	19
Gran Move (G3)	10/96→08/98	HEEG	Petrol	1499	4	16	19
Gran Move (G3)	05/98→	HDEP	Petrol	1590	4	16	24
Handi Box (L5_, L7_)	03/95→06/98	EF-EL	Petrol	659	3	12	2
Handi Box (L5_, L7_)	07/98→09/00	EJ-DE	Petrol	989	3	12	10
Handivan I (_L_)	01/82→01/86	AD	Petrol	617	2	4	1
Handivan II Box (_L_)	03/86→06/90	ED 10 K	Petrol	847	3	6	5
Hijet Box	05/05→12/10	EF-SE	Petrol	659	3	6	2
Hijet Box (S8_)	06/86→12/89	CB	Petrol	993	3	6	7
Hijet Box (S8_)	06/86→12/89	CD	Petrol	843	3	6	4
Hijet Box (S8_)	07/86→10/90	CB 10	Petrol	993	3	6	7
Hijet Box (S85)	12/92→05/98	CB41	Petrol	993	3	6	7
Hijet Box (S85)	07/94→05/98	CB42	Petrol	993	3	6	7
Hijet Box (S85)	10/94→12/95	HDC	Petrol	1590	4	16	24
Hijet Box (S85)	05/98→	HCE	Petrol	1296	4	16	16
Hijet Bus	06/86→12/89	CB	Petrol	993	3	6	7
Hijet Bus	06/86→12/89	CD	Petrol	843	3	6	4
Hijet Bus (S20_, S21_)	06/98→10/05	HCE	Petrol	1296	4	16	16
Hijet Bus (S32_V, S33_V)	05/05→12/10	EF-SE	Petrol	659	3	6	2
Hijet Bus (S85)	07/94→05/98	CB42	Petrol	993	3	6	7
Hijet Bus (S85)	08/98→	HCE	Petrol	1296	4	16	16
Hijet Pickup	06/98→	HCE	Petrol	1296	4	16	16
Hijet Pickup (_U20)	07/86→10/90	CB 10	Petrol	993	3	6	7
Hijet Pickup (_U20)	07/86→10/90	CD	Petrol	843	3	6	4
Hijet Pickup (_U60)	12/92→09/94	CB41	Petrol	993	3	6	7
Hijet Pickup (_U60)	10/94→05/98	CB42	Petrol	993	3	6	7
Hijet Platform/Chassis	06/86→12/89	CB 10	Petrol	993	3	6	7
Hijet Platform/Chassis (S7_)	09/83→05/86	CB	Petrol	993	3	6	7
Leeza	08/90→08/94	EF-HL	Petrol	659	3	12	2
Leeza Coupe	08/90→08/94	EF-JL	Petrol	659	3	12	2
Luxio	03/09→	3SZ-VE	Petrol	1495	4	16	18
Materia (M4_)	10/06→	3SZ-VE	Petrol	1495	4	16	18
Materia (M4_)	10/06→	EJ-DE	Petrol	989	3	12	10
Materia (M4_)	10/06→	EJ-VE	Petrol	989	3	12	11
Materia (M4_)	10/06→	K3-VE	Petrol	1298	4	16	17
Materia (M4_)	10/06→	K3-VET	Petrol	1298	4	16	17
Max	06/00→12/06	EF-VE	Petrol	659	3	12	3
Max	09/02→12/06	EF-DET	Petrol	659	3	12	3
Mebius MPV	04/13→	2ZR-FXE	Petrol	1797	4	16	25
Midget	02/93→12/02	EF-CL	Petrol	659	3	6	2
Mira Gino	08/98→08/03	EF-DET	Petrol	659	3	12	3
Mira Gino	08/98→06/06	EF-VE	Petrol	659	3	12	3
Mira Gino I	08/98→09/03	ED 20	Petrol	847	3	6	5
Move (L6_)	06/94→08/98	EF-GL	Petrol	659	3	12	3
Move (L6_)	06/94→08/98	EF-ZL	Petrol	659	3	6	3
Move (L6_)	01/97→11/99	ED 20	Petrol	847	3	6	5
Move (L9_)	04/97→09/02	EF-DET	Petrol	659	3	12	3
Move (L9_)	05/97→09/02	EJ-DE	Petrol	989	3	12	10
Move (L9_)	09/98→09/02	EF-SE	Petrol	659	3	6	2
Move (L9_)	09/98→09/02	EF-VE	Petrol	659	3	12	3
Move (L150_, L160_)	10/02→10/06	EF-VE	Petrol	659	3	12	3
Naked	11/99→02/05	EF-DET	Petrol	659	3	12	3
Naked	11/99→02/05	EF-VE	Petrol	659	3	12	3
Opti	05/92→02/03	EF-SE	Petrol	659	3	6	2
Opti	11/98→02/03	EF-DET	Petrol	659	3	12	3











CC



9

Opti I (L300, L310)	05/92→10/98	EF-ZL	Petrol	659	3	6	3
Opti II Saloon	11/98→02/03	EF-ZL	Petrol	659	3	6	3
Rocky Hard Top (F7, F8)	02/85→04/93	3Y	Petrol	1998	4	8	27
Rocky Hard Top (F7, F8)	02/85→12/98	DL	Diesel	2765	4	8	33
Rocky Hard Top (F7, F8)	12/87→04/93	DL 51	Diesel	2765	4	8	33
Rocky Hard Top (F7, F8)	09/89→12/92	HD-E	Petrol	1590	4	16	24
Rocky Hard Top (F7, F8)	09/91→04/93	4Y	Petrol	2237	4	8	28
Rocky Hard Top (F7, F8)	09/91→12/98	DL 52	Diesel	2765	4	8	33
Rocky Hard Top (F7, F8)	09/91→12/98	DLT	Diesel	2765	4	8	33
Rocky Hard Top (F7, F8)	05/93→12/98	DLT-C	Diesel	2765	4	8	33
Rocky Hard Top (F7, F8)	09/93→12/97	HDC	Petrol	1590	4	16	24
Rocky Soft Top (F7, F8)	02/85→04/93	3Y	Petrol	1998	4	8	27
Rocky Soft Top (F7, F8)	02/85→12/98	DL	Diesel	2765	4	8	33
Rocky Soft Top (F7, F8)	12/87→04/93	DL 51	Diesel	2765	4	8	33
Rocky Soft Top (F7, F8)	09/91→12/98	DL 52	Diesel	2765	4	8	33
Rugger	04/84→10/88	3Y	Petrol	1998	4	8	27
Rugger	04/84→09/94	DL	Diesel	2765	4	8	33
Rugger	04/84→12/99	DLT	Diesel	2765	4	8	33
Rugger	09/91→05/94	4Y	Petrol	2237	4	8	28
Rush	11/05→	3S2-VE	Petrol	1495	4	16	18
Rush	11/05→	K3-VE	Petrol	1298	4	16	17
Sirion (M1)	04/98→10/00	EJ-DE	Petrol	989	3	12	10
Sirion (M1)	08/00→03/05	K3-VE2	Petrol	1298	4	16	17
Sirion (M1)	09/00→01/05	EJ-VE	Petrol	989	3	12	11
Sirion (M3_)	01/05→	1KR-FE	Petrol	998	3	12	6
Sirion (M3_)	01/05→	K3-VE	Petrol	1298	4	16	17
Sirion (M3_)	05/06→	3S2-VE	Petrol	1495	4	16	18
Sirion (M6_)	02/10→	1NR-FE	Petrol	1329	4	16	13
Sirion (M7_)	04/16→	1KR-FE	Petrol	998	3	12	6
Skywing	02/87→10/90	CB 80 T	Petrol	993	3	12	8
Skywing	02/87→02/93	CB 22	Petrol	993	3	6	7
Skywing	02/87→02/93	CB 23	Petrol	993	3	6	7
Skywing	11/90→02/93	CB 90	Petrol	993	3	6	7
Social	05/89→06/92	HDC	Petrol	1590	4	16	24
Social	05/89→08/97	HD-E	Petrol	1590	4	16	24
Sparcar Box (S7_)	09/83→05/86	CB	Petrol	993	3	6	7
Sparcar Box (S7_)	09/83→05/86	CD	Petrol	843	3	6	4
Sparcar Bus (S7_)	09/83→05/86	CB	Petrol	993	3	6	7
Sparcar Bus (S7_)	09/83→05/86	CD	Petrol	843	3	6	4
Taft	08/78→08/82	DG	Diesel	2530	4	8	32
Taft	08/82→11/95	DL	Diesel	2765	4	8	33
Taft	04/84→04/93	3Y	Petrol	1998	4	8	27
Taft	07/96→06/01	DL 52	Diesel	2765	4	8	33
Tanto	09/02→11/07	EF-DET	Petrol	659	3	12	3
Tanto	09/02→11/07	EF-VE	Petrol	659	3	12	3
Terios (J1_)	05/97→10/00	HC-EJ	Petrol	1296	4	16	16
Terios (J1)	05/97→05/12	EF-DET	Petrol	659	3	12	3
Terios (J1)	05/99→10/05	HDC	Petrol	1590	4	16	24
Terios (J1_)	10/00→10/05	K3-VE	Petrol	1298	4	16	17
Terios (J1)	10/02→10/05	K3-VET	Petrol	1298	4	16	17
Terios (J2_)	11/05→	3S2-VE	Petrol	1495	4	16	18
Terios (J2_)	11/05→	K3-VE	Petrol	1298	4	16	17
Terios Kid (J11_, J13_)	10/98→10/05	EF-DEM	Petrol	659	3	12	3
Thor (M900S, M910S)	11/16→	1KR-FE	Petrol	998	3	12	6
Trevis	06/06→	EJ-VE	Petrol	989	3	12	11
Wildcat/Rocky (F70)	02/85→03/87	DL	Diesel	2765	4	8	33
Wildcat/Rocky (F70)	09/85→04/87	DL 50	Diesel	2765	4	8	33
Wildcat/Rocky (F75)	02/85→03/87	DL	Diesel	2765	4	8	33
Wildcat/Rocky (F75)	09/85→04/87	DL 50	Diesel	2765	4	8	33
Xenia	05/07→	EJ-DE	Petrol	989	3	12	10
Xenia	05/07→	K3-VE	Petrol	1298	4	16	17
Xenia	06/07→	3S2-VE	Petrol	1495	4	16	18
YRV (M2)	02/01→	EJ-VE	Petrol	989	3	12	11
YRV (M2)	02/01→	K3-VE	Petrol	1298	4	16	17
YRV (M2)	07/02→	K3-VET	Petrol	1298	4	16	17

	CC				9
1KR-FE	998	3	12	Petrol	6
1NR-FE	1329	4	16	Petrol	13
1Y	1626	4	8	Petrol	20
2AR-FXE	2493	4	16	Petrol	31
2AZ-FE	2362	4	16	Petrol	30
2T	1588	4	8	Petrol	21
2ZR-FXE	1797	4	16	Petrol	25
3K	1166	4	8	Petrol	12
3KJ	1166	4	8	Petrol	12
3S-FE	1998	4	16	Petrol	26
3SZ-VE	1495	4	16	Petrol	18
3Y	1998	4	8	Petrol	27
4A	1587	4	8	Petrol	22
4K	1290	4	8	Petrol	14
4KC	1290	4	8	Petrol	14
4KJ	1290	4	8	Petrol	14
4Y	2237	4	8	Petrol	28
5S-FE	2164	4	16	Petrol	29
11B	2977	4	8	Diesel	34
12R	1587	4	8	Diesel	23
13B	3431	4	8	Diesel	35
AD	617	2	4	Petrol	1
AD 10	617	2	4	Petrol	1
B	2977	4	8	Diesel	34
CB	993	3	6	Petrol	7
CB 10	993	3	6	Petrol	7
CB 20	993	3	6	Petrol	7
CB 22	993	3	6	Petrol	7
CB 23	993	3	6	Petrol	7
CB41	993	3	6	Petrol	7
CB42	993	3	6	Petrol	7
CB 51	993	3	6	Petrol	7
CB 60	993	3	6	Petrol	7
CB 61	993	3	6	Petrol	7
CB 80 T	993	3	12	Petrol	8
CB 90	993	3	6	Petrol	7
CD	843	3	6	Petrol	4
CL	993	3	6	Diesel	9
CL 10	993	3	6	Diesel	9
CL 11	993	3	6	Diesel	9
CL 50	993	3	6	Diesel	9
CL 60	993	3	6	Diesel	9
CL 61	993	3	6	Diesel	9
DG	2530	4	8	Diesel	32
DL	2765	4	8	Diesel	33
DL 50	2765	4	8	Diesel	33
DL 51	2765	4	8	Diesel	33
DL 52	2765	4	8	Diesel	33
DLT	2765	4	8	Diesel	33
DLT-C	2765	4	8	Diesel	33
ED	847	3	6	Petrol	5
ED 10	847	3	6	Petrol	5
ED 10 K	847	3	6	Petrol	5
ED 20	847	3	6	Petrol	5
EF-CL	659	3	6	Petrol	2
EF-DEM	659	3	12	Petrol	3
EF-DET	659	3	12	Petrol	3
EF-EL	659	3	12	Petrol	2
EF-GL	659	3	12	Petrol	3
EF-HL	659	3	12	Petrol	2
EF-JL	659	3	12	Petrol	2
EF-RS	659	3	12	Petrol	3
EF-SE	659	3	6	Petrol	2
EF-VE	659	3	12	Petrol	3
EF-XL	659	3	6	Petrol	2
EF-ZL	659	3	6	Petrol	3
EF-ZN	659	3	6	Petrol	2
EF-ZS	659	3	6	Petrol	2
EJ	989	3	12	Petrol	10
EJ-DE	989	3	12	Petrol	10
EJ-VE	989	3	12	Petrol	11
HC	1296	4	16	Petrol	15
HC-C	1295	4	16	Petrol	16
HCE	1296	4	16	Petrol	16
HC-EJ	1296	4	16	Petrol	16
HD	1590	4	16	Petrol	24
HDC	1590	4	16	Petrol	24
HD-E	1590	4	16	Petrol	24

	CC				9
HDEP	1590	4	16	Petrol	24
HEE	1499	4	16	Petrol	19
HEEG	1499	4	16	Petrol	19
K3-VE	1298	4	16	Petrol	17
K3-VE2	1298	4	16	Petrol	17
K3-VET	1298	4	16	Petrol	17



1 0.6L Petrol

AD	2 Cyl.	4 Valves	617cc	TD25246
AD 10	2 Cyl.	4 Valves	617cc	TD4307
PA387 (x4)	NJ268 32.00 x 48.00 x 7.00mm, NBR		NJ268 32.00 x 48.00 x 7.00mm, NBR NJ269 58.00 x 74.00 x 10.00mm, ACM	

2 0.7L Petrol

EF-CL	3 Cyl.	6 Valves	659cc	TD20454
EF-EL	3 Cyl.	12 Valves	659cc	TD5450
EF-HL	3 Cyl.	12 Valves	659cc	TD20456
EF-JL	3 Cyl.	12 Valves	659cc	TD19704
EF-SE	3 Cyl.	6 Valves	659cc	TD20013
EF-XL	3 Cyl.	6 Valves	659cc	TD20458
EF-ZN	3 Cyl.	6 Valves	659cc	TD27092
EF-ZS	3 Cyl.	6 Valves	659cc	TD22514
	NC048 38.00 x 52.00 x 6.00mm, FPM		NJ349 32.50 x 46.00 x 6.00mm, NBR NJ269 58.00 x 74.00 x 10.00mm, ACM	

3 0.7L Petrol

EF-DEM	3 Cyl.	12 Valves	659cc	TD32593
EF-DET	3 Cyl.	12 Valves	659cc	TD20378
EF-GL	3 Cyl.	12 Valves	659cc	TD20455
EF-RS	3 Cyl.	12 Valves	659cc	TD20457
EF-VE	3 Cyl.	12 Valves	659cc	TD20012
EF-ZL	3 Cyl.	6 Valves	659cc	TD22513
	NC048 38.00 x 52.00 x 6.00mm, FPM		NJ349 32.50 x 46.00 x 6.00mm, NBR NJ269 58.00 x 74.00 x 10.00mm, ACM	

4 0.8L Petrol

CD	3 Cyl.	6 Valves	843cc	TD6699
PA387 (x6)	NJ268 32.00 x 48.00 x 7.00mm, NBR		NJ324 34.00 x 48.00 x 7.00mm, ACM NJ269 58.00 x 74.00 x 10.00mm, ACM	

5 0.8L Petrol

ED	3 Cyl.	6 Valves	847cc	TD800
ED 10	3 Cyl.	6 Valves	847cc	TD4324
ED 10 K	3 Cyl.	6 Valves	847cc	TD801
ED 20	3 Cyl.	6 Valves	847cc	TD4325
PA387 (x6)	NC048 38.00 x 52.00 x 6.00mm, FPM		NJ349 32.50 x 46.00 x 6.00mm, NBR NJ269 58.00 x 74.00 x 10.00mm, ACM	

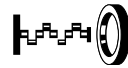
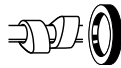

6 1.0L Petrol

1KR-FE	3 Cyl.	12 Valves	998cc	TD20287
				NA5260 38.00 x 50.00 x 6.00mm, FPM NA5324 74.00 x 89.00 x 8.50mm, FPM

7 1.0L Petrol

CB	3 Cyl.	6 Valves	993cc	TD782
CB 10	3 Cyl.	6 Valves	993cc	TD18852
CB 20	3 Cyl.	6 Valves	993cc	TD4308
CB 22	3 Cyl.	6 Valves	993cc	TD4309
CB 23	3 Cyl.	6 Valves	993cc	TD4310
CB41	3 Cyl.	6 Valves	993cc	TD789
CB42	3 Cyl.	6 Valves	993cc	TD9601
CB 51	3 Cyl.	6 Valves	993cc	TD4311
CB 60	3 Cyl.	6 Valves	993cc	TD783
CB 61	3 Cyl.	6 Valves	993cc	TD4312
CB 90	3 Cyl.	6 Valves	993cc	TD4314
PA387 (x6)	NJ268			NJ324 34.00 x 48.00 x 7.00mm, ACM NJ269 58.00 x 74.00 x 10.00mm, ACM

8 1.0L Petrol

CB 80 T	3 Cyl.	12 Valves	993cc	TD4313
PA387 (x12)	NJ268 (x2)			NJ324 34.00 x 48.00 x 7.00mm, ACM NJ269 58.00 x 74.00 x 10.00mm, ACM

9 1.0L Diesel

CL	3 Cyl.	6 Valves	993cc	TD4316
CL 10	3 Cyl.	6 Valves	993cc	TD4317
CL 11	3 Cyl.	6 Valves	993cc	TD5440
CL 50	3 Cyl.	6 Valves	993cc	TD4318
CL 60	3 Cyl.	6 Valves	993cc	TD5439
CL 61	3 Cyl.	6 Valves	993cc	TD4319
PA387 (x6)	NJ270			NJ324 34.00 x 48.00 x 7.00mm, ACM NJ269 58.00 x 74.00 x 10.00mm, ACM

10 1.0L Petrol

EJ	3 Cyl.	12 Valves	989cc	TD12350
EJ-DE	3 Cyl.	12 Valves	989cc	TD10267
	NC048 (x2)			NJ349 32.50 x 46.00 x 6.00mm, NBR NJ269 58.00 x 74.00 x 10.00mm, ACM



11 1.0L Petrol

EJ-VE	3 Cyl.	12 Valves	989cc	TD16468
	NC048 38.00 x 52.00 x 6.00mm, FPM		NJ349 32.50 x 46.00 x 6.00mm, NBR NJ269 58.00 x 74.00 x 10.00mm, ACM	

12 1.2L Petrol

3K	4 Cyl.	8 Valves	1166cc	TD770
3KJ	4 Cyl.	8 Valves	1166cc	TD6689
KH066 (x8) →07/74 PA136 (x8) 08/74→			NJ102 38.50 x 58.00 x 11.00mm, NBR NJ001 70.00 x 92.00 x 8.50mm, MVQ	

13 1.3L Petrol

1NR-FE	4 Cyl.	16 Valves	1329cc	TD26206
			NA5088 75.00 x 107.00 x 8.00mm, FPM	

14 1.3L Petrol

4K	4 Cyl.	8 Valves	1290cc	TD774
4KC	4 Cyl.	8 Valves	1290cc	TD775
4KJ	4 Cyl.	8 Valves	1290cc	TD6690
PA136 (x8)			NJ102 38.50 x 58.00 x 11.00mm, NBR NJ001 70.00 x 92.00 x 8.50mm, MVQ	

15 1.3L Petrol

HC	4 Cyl.	16 Valves	1296cc	TD5441
PA952 (x16)	NB884 38.00 x 50.00 x 5.50mm, FPM		NK209 33.80 x 48.00 x 6.00mm, MVQ NJ360 80.00 x 100.00 x 8.50mm, MVQ	

16 1.3L Petrol

HC-C	4 Cyl.	16 Valves	1295cc	TD22423
HCE	4 Cyl.	16 Valves	1296cc	TD4326
HC-EJ	4 Cyl.	16 Valves	1296cc	TD23812
PA305 (x16)	NB884 38.00 x 50.00 x 5.50mm, FPM		NK209 33.80 x 48.00 x 6.00mm, MVQ	

17 1.3L Petrol

K3-VE	4 Cyl.	16 Valves	1298cc	TD16469
K3-VE2	4 Cyl.	16 Valves	1298cc	TD16471
K3-VET	4 Cyl.	16 Valves	1298cc	TD16515
			NJ353 35.00 x 49.00 x 6.00mm, NBR NA5324 74.00 x 89.00 x 8.50mm, FPM	

18 1.5L Petrol

3SZ-VE	4 Cyl.	16 Valves	1495cc	TD19816
			NA5324 74.00 x 89.00 x 8.50mm, FPM	

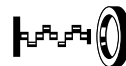

19 1.5L Petrol

HEE	4 Cyl.	16 Valves	1499cc	TD4328
HEEG	4 Cyl.	16 Valves	1499cc	TD12348
PA305 (x16)	NJ347 38.00 x 50.00 x 8.00mm, NBR	NK209 33.80 x 48.00 x 6.00mm, MVQ	NJ360 80.00 x 100.00 x 8.50mm, MVQ	

20 1.6L Petrol

1Y	4 Cyl.	8 Valves	1626cc	TD22451
PA136 (x8)		NJ344 42.00 x 60.00 x 7.00mm, NBR	NJ360 80.00 x 100.00 x 8.50mm, MVQ	

21 1.6L Petrol

2T	4 Cyl.	8 Valves	1588cc	TD4302
KH066 (x8) →09/75		NJ102 38.50 x 58.00 x 11.00mm, NBR	NJ044 75.00 x 100.00 x 13.00mm, MVQ	
PA136 (x8) 10/75→				

22 1.6L Petrol

4A	4 Cyl.	8 Valves	1587cc	TD4305
		NJ353 35.00 x 49.00 x 6.00mm, NBR	NJ349 32.50 x 46.00 x 6.00mm, NBR	NJ001 70.00 x 92.00 x 8.50mm, MVQ

23 1.6L Diesel

12R	4 Cyl.	8 Valves	1587cc	TD767
KH066 (x8) →01/77			NJ102 38.50 x 58.00 x 11.00mm, NBR	KV412
PA021 (x8) 01/77→				

24 1.6L Petrol

HD	4 Cyl.	16 Valves	1590cc	TD810
HDC	4 Cyl.	16 Valves	1590cc	TD809
HD-E	4 Cyl.	16 Valves	1590cc	TD811
HDEP	4 Cyl.	16 Valves	1590cc	TD12349
PA952 (x16)	NJ347 38.00 x 50.00 x 8.00mm, NBR	NK209 33.80 x 48.00 x 6.00mm, MVQ	NJ360 80.00 x 100.00 x 8.50mm, MVQ	

25 1.8L Petrol

2ZR-FXE	4 Cyl.	16 Valves	1797cc	TD32061
			NA5260 38.00 x 50.00 x 6.00mm, FPM	

26 2.0L Petrol

3S-FE	4 Cyl.	16 Valves	1998cc	TD22221
PA425 (x16)	NB799 38.00 x 50.00 x 7.00mm, FPM	NK214 35.00 x 63.00 x 10.00mm, ACM		



27 2.0L		Petrol			
3Y	PA136 (x8)	4 Cyl.	8 Valves	1998cc	TD4303
					NJ344 42.00 x 60.00 x 7.00mm, NBR NJ360 80.00 x 100.00 x 8.50mm, MVQ
28 2.2L		Petrol			
4Y	PA136 (x8)	4 Cyl.	8 Valves	2237cc	TD776
					NJ344 42.00 x 60.00 x 7.00mm, NBR NJ360 80.00 x 100.00 x 8.50mm, MVQ
29 2.2L		Petrol			
5S-FE	PA425 (x16)	4 Cyl.	16 Valves	2164cc	TD19916
		NJ347 (x2) 38.00 x 50.00 x 8.00mm, NBR			NJ344 42.00 x 60.00 x 7.00mm, NBR NJ215 85.00 x 105.00 x 10.00mm, FPM NJ354 85.00 x 105.00 x 10.00mm, MVQ
30 2.4L		Petrol			
2AZ-FE	PA5020 (x8)	4 Cyl.	16 Valves	2362cc	TD19915
		NJ347 (x2) 38.00 x 50.00 x 8.00mm, NBR			NA5089 38.00 x 50.00 x 8.00mm, NBR NK169 89.00 x 105.00 x 10.00mm, MVQ
31 2.5L		Petrol			
2AR-FXE		4 Cyl.	16 Valves	2493cc	TD32059
					NA5036 42.00 x 54.00 x 6.00mm, FPM NK169 89.00 x 105.00 x 10.00mm, MVQ
32 2.5L		Diesel			
DG		4 Cyl.	8 Valves	2530cc	TD6693
					NJ276 45.00 x 62.00 x 9.00mm, NBR NJ098 95.00 x 110.00 x 11.00mm, MVQ
33 2.8L		Diesel			
DL		4 Cyl.	8 Valves	2765cc	TD6694
DL 50		4 Cyl.	8 Valves	2765cc	TD4321
DL 51		4 Cyl.	8 Valves	2765cc	TD4322
DL 52		4 Cyl.	8 Valves	2765cc	TD4323
DLT		4 Cyl.	8 Valves	2765cc	TD17639
DLT-C	PA260 (x8)	4 Cyl.	8 Valves	2765cc	TD25840
					NJ276 45.00 x 62.00 x 9.00mm, NBR NJ098 95.00 x 110.00 x 11.00mm, MVQ



34 3.0L









Diesel

11B	4 Cyl.	8 Valves	2977cc	TD6696
B	4 Cyl.	8 Valves	2977cc	TD6695
PA260 (x8)				NJ239 50.00 x 72.00 x 12.00mm, NBR NJ240 95.00 x 115.00 x 12.00mm, MVQ

35 3.4L

Diesel

13B	4 Cyl.	8 Valves	3431cc	TD6697
PA260 (x8)				NJ239 50.00 x 72.00 x 12.00mm, NBR NJ240 95.00 x 115.00 x 12.00mm, MVQ

	CC				9		CC				9
BF 3L 1011 FL	2185	3	6	Diesel	5	BF 12L 513 C	19144	12	24	Diesel	48
BF 3L 2011	2332	3	6	Diesel	6	BF 12L 513 F	19144	12	24	Diesel	48
BF 3L 914	3236	3	6	Diesel	13	D 914 L3	3235	3	6	Diesel	13
BF 3M 1011	2184	3	6	Diesel	5	D 914 L4	4314	4	8	Diesel	20
BF 3M 1011 F	2184	3	6	Diesel	5	D 914 L5	5393	5	10	Diesel	26
BF 3M 2011	2332	3	6	Diesel	6	D 914 L6	6472	6	12	Diesel	32
BF 4 L 1011	2731	4	8	Diesel	8	D 2011 L2	1554	2	4	Diesel	2
BF 4 L 1011 F	2731	4	8	Diesel	8	D 2011 L3	2331	3	6	Diesel	6
BF 4L 1011 F	2731	4	8	Diesel	8	D 2011 L4	3619	4	8	Diesel	15
BF 4L 1011 FT	2732	4	8	Diesel	8	F 2L 1011	1366	2	4	Diesel	1
BF 4L 2011	3110	4	8	Diesel	11	F 2L 1011 F	1366	2	4	Diesel	1
BF 4 L 913	4086	4	8	Diesel	19	F 2L 2011	1554	2	4	Diesel	2
BF 4L 913	4086	4	8	Diesel	19	F 2L 912	1885	2	4	Diesel	3
BF 4 L 913 T	4086	4	8	Diesel	19	F 2M 1011	1366	2	4	Diesel	1
BF 4L 913 T	4086	4	8	Diesel	19	F 2M 1011 F	1366	2	4	Diesel	1
BF 4L 914	4314	4	8	Diesel	20	F 2M 2011	1555	2	4	Diesel	2
BF 4M 1011 F	2912	4	8	Diesel	10	F 3L 1011	2049	3	6	Diesel	4
BF 4M 1013	4764	4	8	Diesel	21	F 3L 1011 F	2049	3	6	Diesel	4
BF 4M 1013 C	4764	4	8	Diesel	23	F 3L 2011	2332	3	6	Diesel	6
BF 4M 1013 E	4764	4	8	Diesel	23	F 3L 712	2552	3	6	Diesel	7
BF 4M 1013E C	4764	4	8	Diesel	23	F 3L 812	2552	3	6	Diesel	7
BF 4M 1013 ECW	4764	4	8	Diesel	23	F 3L 912	2827	3	6	Diesel	9
BF 4M 1013 EW	4764	4	8	Diesel	23	F 3L 912 D	2826	3	6	Diesel	9
BF 4M 1013 FC	4764	4	8	Diesel	23	F 3L 912 W	2826	3	6	Diesel	9
BF 4M 2011	3110	4	8	Diesel	11	F 3L 913	3064	3	6	Diesel	12
BF 4M 2011 M	3110	4	8	Diesel	11	F 3L 914	3236	3	6	Diesel	13
BF 4M 2012	4038	4	8	Diesel	18	F 3M 1011	2185	3	6	Diesel	5
BF 4M 2012 B	4038	4	8	Diesel	18	F 3M 1011 F	2185	3	6	Diesel	5
BF 4M 2012 C	4038	4	8	Diesel	18	F 3M 2011	2332	3	6	Diesel	6
BF 4M 2012 C*	4038	4	8	Diesel	18	F 4 L 1011	2731	4	8	Diesel	8
BF 4M 2013	3802	4	16	Diesel	16	F 4L 1011 F	2732	4	8	Diesel	8
BF 4M 2013 C	3802	4	16	Diesel	16	F 4L 1011 FL	2914	4	8	Diesel	10
BF 4M 2013 EC	3802	4	16	Diesel	16	F 4L 2011	3110	4	8	Diesel	11
BF 6L 413	8478	6	12	Diesel	35	F 4L 413 F	6381	4	8	Diesel	31
BF 6L 413 F	9572	6	12	Diesel	37	F 4L 413 FR	6381	4	8	Diesel	31
BF 6L 413 FR	9572	6	12	Diesel	37	F 4L 712	3400	4	8	Diesel	14
BF 6L 413 FRC	9572	6	12	Diesel	37	F 4L 812	3400	4	8	Diesel	14
BF 6L 513	9572	6	12	Diesel	37	F 4 L 912	3770	4	8	Diesel	17
BF 6 L 912	5655	6	12	Diesel	27	F 4L 912	3770	4	8	Diesel	17
BF 6L 912	5655	6	12	Diesel	27	F 4L 912 D	3770	4	8	Diesel	17
BF 6 L 913	6128	6	12	Diesel	29	F 4L 912 W	3770	4	8	Diesel	17
BF 6L 913	6128	6	12	Diesel	29	F 4 L 913	4086	4	8	Diesel	19
BF 6L 913 C	6128	6	12	Diesel	29	F 4L 913	4086	4	8	Diesel	19
BF 6 L 913 T	6128	6	12	Diesel	29	F 4L 914	4314	4	8	Diesel	20
BF 6L 913 T	6128	6	12	Diesel	29	F 4M 1011 F	2732	4	8	Diesel	8
BF 6L 914	6472	6	12	Diesel	32	F 4M 2011	3110	4	8	Diesel	11
BF 6L 914 C	6472	6	12	Diesel	32	F 5L 912	4712	5	10	Diesel	22
BF 6M 1013	7146	6	12	Diesel	33	F 5L 912 D	4712	5	10	Diesel	22
BF 6M 1013 C	7146	6	12	Diesel	33	F 5L 914	5393	5	10	Diesel	26
BF 6M 1013 CP	7146	6	12	Diesel	33	F 6 L 413	8478	6	12	Diesel	35
BF 6M 1013 E	7146	6	12	Diesel	33	F 6L 413	8478	6	12	Diesel	35
BF 6M 1013 EC	7146	6	12	Diesel	33	F 6 L 413 F	9572	6	12	Diesel	37
BF 6M 1013E CP	7146	6	12	Diesel	33	F 6L 413 F	9572	6	12	Diesel	37
BF 6M 1013 ECW	7146	6	12	Diesel	33	F 6L 413 FW	9572	6	12	Diesel	37
BF 6M 1013 EW	7146	6	12	Diesel	33	F 6 L 413 V	8822	6	12	Diesel	36
BF 6M 1013 FC	7146	6	12	Diesel	33	F 6 L 712	5100	6	12	Diesel	25
BF 6M 2012 C	6057	6	12	Diesel	30	F 6L 712	5104	6	12	Diesel	25
BF 6M 2012 C*	6057	6	12	Diesel	30	F 6 L 812	5104	6	12	Diesel	25
BF 6M 2013	5702	6	24	Diesel	28	F 6 L 812	5104	6	12	Diesel	25
BF 6M 2013 C	5702	6	24	Diesel	28	F 6 L 812 D	5100	6	12	Diesel	25
BF 8L 413	11310	8	16	Diesel	38	F 6L 912	5655	6	12	Diesel	27
BF 8 L 413 F	12763	8	16	Diesel	40	F 6 L 912	5660	6	12	Diesel	27
BF 8L 413 F	12763	8	16	Diesel	40	F 6L 912 D	5655	6	12	Diesel	27
BF 8L 513	12763	8	16	Diesel	40	F 6L 912 W	5655	6	12	Diesel	27
BF 8 L 513-225	12763	8	16	Diesel	40	F 6 L 913	6128	6	12	Diesel	29
BF 8 L 513-243	12763	8	16	Diesel	40	F 6L 913	6128	6	12	Diesel	29
BF 8 L 513 LC	13745	8	16	Diesel	42	F 6L 914	6472	6	12	Diesel	32
BF 10 L 413 F	15953	10	20	Diesel	45	F 8 L 413	11310	8	16	Diesel	38
BF 10L 413 F	15953	10	20	Diesel	45	F 8L 413	11310	8	16	Diesel	38
BF 10L 513	15954	10	20	Diesel	45	F 8 L 413 F	12763	8	16	Diesel	40
BF 10L 513 F	15945	10	20	Diesel	45	F 8L 413 F	12763	8	16	Diesel	40
BF 12 L 413	16964	12	24	Diesel	47	F 8L 413 FW	12763	8	16	Diesel	40
BF 12L 413	16964	12	24	Diesel	47	F 8 L 413 W	11310	8	16	Diesel	38
BF 12 L 413 F	19144	12	24	Diesel	48	F 8L 513	13382	8	16	Diesel	41
BF 12L 413 F	19144	12	24	Diesel	48	F 8 L 513	13383	8	16	Diesel	41
BF 12 L 413 FC	19144	12	24	Diesel	48	F 8 L 914	12667	8	16	Diesel	39
BF 12 L 413 FW	19144	12	24	Diesel	48	F 10 L 413	14140	10	20	Diesel	43
BF 12L 513	19144	12	24	Diesel	48	F 10L 413	14140	10	20	Diesel	43



CC



9



CC



9

F 10 L 413 F	15953	10	20	Diesel	45
F 10L 413 F	15953	10	20	Diesel	45
F 10L 413 FW	15953	10	20	Diesel	45
F 10L 413 FZ	15953	10	20	Diesel	45
F 10L 413 L	14700	10	20	Diesel	44
F 10L 513	16728	10	20	Diesel	46
F 10L 513 F	15953	10	20	Diesel	45
F 10L 513 L	16728	10	20	Diesel	46
F 10L 513 T	16728	10	20	Diesel	46
F 12 L 413	16960	12	24	Diesel	47
F 12L 413	16960	12	24	Diesel	47
F 12 L 413 F	19144	12	24	Diesel	48
F 12L 413 F	19144	12	24	Diesel	48
F 12L 413 FW	19144	12	24	Diesel	48
F 12 L 513	20074	12	24	Diesel	49
F 12L 513	20074	12	24	Diesel	49
F 12L 513 F	19144	12	24	Diesel	48
TCD 2012 L4 2V	4038	4	8	Diesel	18
TCD 2012 L6 2V	6057	6	12	Diesel	30
TCD 2013 L06 4V	7146	6	24	Diesel	34
TCD 2013 L4 4V	4764	4	16	Diesel	24
TCD 2013 L6 4V	7146	6	24	Diesel	34
TD 2011 L4	3619	4	8	Diesel	15

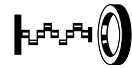
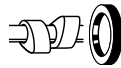

1 1.4L Diesel

F 2L 1011	2 Cyl.	4 Valves	1366cc	TD29643
F 2L 1011 F	2 Cyl.	4 Valves	1366cc	TD17224
F 2M 1011	2 Cyl.	4 Valves	1366cc	TD17231
F 2M 1011 F	2 Cyl.	4 Valves	1366cc	TD29644
PB180 (x4)				

2 1.6L Diesel

D 2011 L2	2 Cyl.	4 Valves	1554cc	TD19991
F 2L 2011	2 Cyl.	4 Valves	1554cc	TD17387
F 2M 2011	2 Cyl.	4 Valves	1555cc	TD17382
PB180 (x4)				

3 1.9L Diesel

F 2L 912	2 Cyl.	4 Valves	1885cc	TD18128
NB938 F 65.00 x 85.00 x 13.00mm, FPM NB939 R 115.00 x 140.00 x 16.00mm, FPM				

4 2.1L Diesel

F 3L 1011	3 Cyl.	6 Valves	2049cc	TD29645
F 3L 1011 F	3 Cyl.	6 Valves	2049cc	TD17225
PB180 (x6)				

5 2.2L Diesel

BF 3L 1011 FL	3 Cyl.	6 Valves	2185cc	TD17226
BF 3M 1011	3 Cyl.	6 Valves	2184cc	TD29617
BF 3M 1011 F	3 Cyl.	6 Valves	2184cc	TD18487
F 3M 1011	3 Cyl.	6 Valves	2185cc	TD29647
F 3M 1011 F	3 Cyl.	6 Valves	2185cc	TD17232
PB180 (x6)				

6 2.3L Diesel

BF 3L 2011	3 Cyl.	6 Valves	2332cc	TD17389
BF 3M 2011	3 Cyl.	6 Valves	2332cc	TD17384
D 2011 L3	3 Cyl.	6 Valves	2331cc	TD19992
F 3L 2011	3 Cyl.	6 Valves	2332cc	TD17388
F 3M 2011	3 Cyl.	6 Valves	2332cc	TD17383
PB180 (x6)				

7 2.6L Diesel

F 3L 712	3 Cyl.	6 Valves	2552cc	TD17877
F 3L 812	3 Cyl.	6 Valves	2552cc	TD17878
NB938 F 65.00 x 85.00 x 13.00mm, FPM NB939 R 115.00 x 140.00 x 16.00mm, FPM				

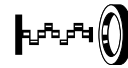
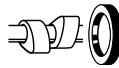

8 2.7L		Diesel		
BF 4 L 1011	4 Cyl.	8 Valves	2731cc	TD26015
BF 4 L 1011 F	4 Cyl.	8 Valves	2731cc	TD26016
BF 4L 1011 F	4 Cyl.	8 Valves	2731cc	TD17230
BF 4L 1011 FT	4 Cyl.	8 Valves	2732cc	TD17228
F 4 L 1011	4 Cyl.	8 Valves	2731cc	TD26022
F 4L 1011 F	4 Cyl.	8 Valves	2732cc	TD17227
F 4M 1011 F	4 Cyl.	8 Valves	2732cc	TD18488
PB180 (x8) HR801				

9 2.8L		Diesel		
F 3L 912	3 Cyl.	6 Valves	2827cc	TD17207
F 3L 912 D	3 Cyl.	6 Valves	2826cc	TD19020
F 3L 912 W	3 Cyl.	6 Valves	2826cc	TD19019
NB938 65.00 x 85.00 x 13.00mm, FPM NB939 115.00 x 140.00 x 16.00mm, FPM				

10 2.9L		Diesel		
BF 4M 1011 F	4 Cyl.	8 Valves	2912cc	TD18489
F 4L 1011 FL	4 Cyl.	8 Valves	2914cc	TD17229
PB180 (x8) HR801				

11 3.1L		Diesel		
BF 4L 2011	4 Cyl.	8 Valves	3110cc	TD17391
BF 4M 2011	4 Cyl.	8 Valves	3110cc	TD17386
BF 4M 2011 M	4 Cyl.	8 Valves	3110cc	TD29620
F 4L 2011	4 Cyl.	8 Valves	3110cc	TD17390
F 4M 2011	4 Cyl.	8 Valves	3110cc	TD17385
PB180 (x8) HR801				

12 3.1L		Diesel		
F 3L 913	3 Cyl.	6 Valves	3064cc	TD17201
NB938 65.00 x 85.00 x 13.00mm, FPM NB939 115.00 x 140.00 x 16.00mm, FPM				

13 3.2L		Diesel		
BF 3L 914	3 Cyl.	6 Valves	3236cc	TD17215
D 914 L3	3 Cyl.	6 Valves	3235cc	TD24300
F 3L 914	3 Cyl.	6 Valves	3236cc	TD17211
PB180 (x6) NB938 65.00 x 85.00 x 13.00mm, FPM NB939 115.00 x 140.00 x 16.00mm, FPM				

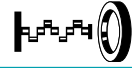

14 3.4L Diesel

F 4L 712	4 Cyl.	8 Valves	3400cc	TD17879
F 4L 812	4 Cyl.	8 Valves	3400cc	TD17880

NB938 F
65.00 x 85.00 x 13.00mm, FPM
NB939 R
115.00 x 140.00 x 16.00mm, FPM

15 3.6L Diesel

D 2011 L4	4 Cyl.	8 Valves	3619cc	TD19993
TD 2011 L4	4 Cyl.	8 Valves	3619cc	TD19994

PB180 (x8)
HR801 R

16 3.8L Diesel

BF 4M 2013	4 Cyl.	16 Valves	3802cc	TD18491
BF 4M 2013 C	4 Cyl.	16 Valves	3802cc	TD17316
BF 4M 2013 EC	4 Cyl.	16 Valves	3802cc	TD29622

PB180 (x16)
HR801 R (x2)

17 3.8L Diesel

F 4 L 912	4 Cyl.	8 Valves	3770cc	TD7445
F 4L 912	4 Cyl.	8 Valves	3770cc	TD17208
F 4L 912 D	4 Cyl.	8 Valves	3770cc	TD19021
F 4L 912 W	4 Cyl.	8 Valves	3770cc	TD19022

NB938 F
65.00 x 85.00 x 13.00mm, FPM
NB939 R
115.00 x 140.00 x 16.00mm, FPM

18 4.0L Diesel

BF 4M 2012	4 Cyl.	8 Valves	4038cc	TD17258
BF 4M 2012 B	4 Cyl.	8 Valves	4038cc	TD29621
BF 4M 2012 C	4 Cyl.	8 Valves	4038cc	TD17259
BF 4M 2012 C*	4 Cyl.	8 Valves	4038cc	TD17260
TCD 2012 L4 2V	4 Cyl.	8 Valves	4038cc	TD19989

PB180 (x8)
HR801 R

19 4.1L Diesel

BF 4L 913	4 Cyl.	8 Valves	4086cc	TD17203
BF 4 L 913	4 Cyl.	8 Valves	4086cc	TD9020
BF 4 L 913 T	4 Cyl.	8 Valves	4086cc	TD7270
BF 4L 913 T	4 Cyl.	8 Valves	4086cc	TD18347
F 4 L 913	4 Cyl.	8 Valves	4086cc	TD7277
F 4L 913	4 Cyl.	8 Valves	4086cc	TD17202

NB938 F
65.00 x 85.00 x 13.00mm, FPM
NB939 R
115.00 x 140.00 x 16.00mm, FPM

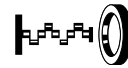
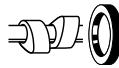

20 4.3L

Diesel

BF 4L 914	4 Cyl.	8 Valves	4314cc	TD17216
D 914 L4	4 Cyl.	8 Valves	4314cc	TD24301
F 4L 914	4 Cyl.	8 Valves	4314cc	TD17212

PB180 (x8)
HR801

NB938
65.00 x 85.00 x 13.00mm, FPM
NB939
115.00 x 140.00 x 16.00mm, FPM

21 4.7L

Diesel

BF 4M 1013	4 Cyl.	8 Valves	4764cc	TD17246
------------	--------	----------	--------	---------

NA5459
81.00 x 104.00 x 11.00mm, FPM
NA5475
130.00 x 150.00 x 12.00mm, FPM

22 4.7L

Diesel

F 5L 912	5 Cyl.	10 Valves	4712cc	TD17209
F 5L 912 D	5 Cyl.	10 Valves	4712cc	TD19023

NB938
65.00 x 85.00 x 13.00mm, FPM
NB939
115.00 x 140.00 x 16.00mm, FPM

23 4.8L

Diesel

BF 4M 1013 C	4 Cyl.	8 Valves	4764cc	TD17247
BF 4M 1013 E	4 Cyl.	8 Valves	4764cc	TD17244
BF 4M 1013 E C	4 Cyl.	8 Valves	4764cc	TD17241
BF 4M 1013 ECW	4 Cyl.	8 Valves	4764cc	TD29618
BF 4M 1013 EW	4 Cyl.	8 Valves	4764cc	TD29619
BF 4M 1013 FC	4 Cyl.	8 Valves	4764cc	TD20767

NA5459
81.00 x 104.00 x 11.00mm, FPM
NA5475
130.00 x 150.00 x 12.00mm, FPM

24 4.8L

Diesel

TCD 2013 L4 4V	4 Cyl.	16 Valves	4764cc	TD20769
----------------	--------	-----------	--------	---------

PB180 (x16)
HR801 (x2)

NA5459
81.00 x 104.00 x 11.00mm, FPM
NA5475
130.00 x 150.00 x 12.00mm, FPM

25 5.1L

Diesel

F 6 L 712	6 Cyl.	12 Valves	5100cc	TD7471
F 6L 712	6 Cyl.	12 Valves	5104cc	TD19239
F 6 L 812	6 Cyl.	12 Valves	5104cc	TD26418
F 6 L 812	6 Cyl.	12 Valves	5104cc	TD7447
F 6 L 812 D	6 Cyl.	12 Valves	5100cc	TD7448

NB938
65.00 x 85.00 x 13.00mm, FPM
NB939
115.00 x 140.00 x 16.00mm, FPM

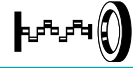

26 5.4L Diesel

D 914 L5	5 Cyl.	10 Valves	5393cc	TD24302
F 5L 914	5 Cyl.	10 Valves	5393cc	TD17213
PB180 (x10)				NB938 F 65.00 x 85.00 x 13.00mm, FPM NB939 R 115.00 x 140.00 x 16.00mm, FPM

27 5.7L Diesel

BF 6L 912	6 Cyl.	12 Valves	5655cc	TD18348
BF 6 L 912	6 Cyl.	12 Valves	5655cc	TD7053
F 6L 912	6 Cyl.	12 Valves	5655cc	TD17210
F 6 L 912	6 Cyl.	12 Valves	5660cc	TD7449
F 6L 912 D	6 Cyl.	12 Valves	5655cc	TD19030
F 6L 912 W	6 Cyl.	12 Valves	5655cc	TD19024
				NB938 F 65.00 x 85.00 x 13.00mm, FPM NB939 R 115.00 x 140.00 x 16.00mm, FPM

28 5.7L Diesel

BF 6M 2013	6 Cyl.	24 Valves	5702cc	TD17318
BF 6M 2013 C	6 Cyl.	24 Valves	5702cc	TD17317
PB180 (x24) HR801 R (x3)				

29 6.1L Diesel

BF 6 L 913	6 Cyl.	12 Valves	6128cc	TD7289
BF 6L 913	6 Cyl.	12 Valves	6128cc	TD17205
BF 6L 913 C	6 Cyl.	12 Valves	6128cc	TD17206
BF 6 L 913 T	6 Cyl.	12 Valves	6128cc	TD7286
BF 6L 913 T	6 Cyl.	12 Valves	6128cc	TD18350
F 6 L 913	6 Cyl.	12 Valves	6128cc	TD7451
F 6L 913	6 Cyl.	12 Valves	6128cc	TD17204
				NB938 F 65.00 x 85.00 x 13.00mm, FPM NB939 R 115.00 x 140.00 x 16.00mm, FPM

30 6.1L Diesel

BF 6M 2012 C	6 Cyl.	12 Valves	6057cc	TD17261
BF 6M 2012 C*	6 Cyl.	12 Valves	6057cc	TD17262
TCD 2012 L6 2V	6 Cyl.	12 Valves	6057cc	TD19990
PB180 (x12) HR801 R (x2)				

31 6.4L Diesel

F 4L 413 F	4 Cyl.	8 Valves	6381cc	TD29649
F 4L 413 FR	4 Cyl.	8 Valves	6381cc	TD18340
				NB934 F 100.00 x 120.00 x 15.00mm, FPM NB935 R 105.00 x 130.00 x 15.00mm, FPM

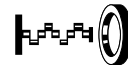
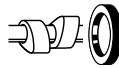

32 6.5L

Diesel

BF 6L 914	6 Cyl.	12 Valves	6472cc	TD17217
BF 6L 914 C	6 Cyl.	12 Valves	6472cc	TD17218
D 914 L6	6 Cyl.	12 Valves	6472cc	TD24303
F 6L 914	6 Cyl.	12 Valves	6472cc	TD17214

PB180 (x12)
HR801 (x2)

NB938
65.00 x 85.00 x 13.00mm, FPM
NB939
115.00 x 140.00 x 16.00mm, FPM

33 7.1L

Diesel

BF 6M 1013	6 Cyl.	12 Valves	7146cc	TD17248
BF 6M 1013 C	6 Cyl.	12 Valves	7146cc	TD17249
BF 6M 1013 CP	6 Cyl.	12 Valves	7146cc	TD17250
BF 6M 1013 E	6 Cyl.	12 Valves	7146cc	TD17245
BF 6M 1013 EC	6 Cyl.	12 Valves	7146cc	TD17242
BF 6M 1013E CP	6 Cyl.	12 Valves	7146cc	TD17243
BF 6M 1013 ECW	6 Cyl.	12 Valves	7146cc	TD29625
BF 6M 1013 EW	6 Cyl.	12 Valves	7146cc	TD29626
BF 6M 1013 FC	6 Cyl.	12 Valves	7146cc	TD20768

NA5459
81.00 x 104.00 x 11.00mm, FPM
NA5475
130.00 x 150.00 x 12.00mm, FPM

34 7.1L

Diesel

TCD 2013 L06 4V	6 Cyl.	24 Valves	7146cc	TD29652
TCD 2013 L6 4V	6 Cyl.	24 Valves	7146cc	TD20765

PB180 (x24)
HR801 (x3)

NA5459
81.00 x 104.00 x 11.00mm, FPM
NA5475
130.00 x 150.00 x 12.00mm, FPM

35 8.5L

Diesel

BF 6L 413	6 Cyl.	12 Valves	8478cc	TD19027
F 6 L 413	6 Cyl.	12 Valves	8478cc	TD7444
F 6L 413	6 Cyl.	12 Valves	8478cc	TD18362

NB934
100.00 x 120.00 x 15.00mm, FPM
NB935
105.00 x 130.00 x 15.00mm, FPM

36 8.8L

Diesel

F 6 L 413 V	6 Cyl.	12 Valves	8822cc	TD7458
-------------	--------	-----------	--------	--------

NB934
100.00 x 120.00 x 15.00mm, FPM
NB935
105.00 x 130.00 x 15.00mm, FPM

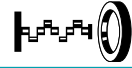

37 9.6L		Diesel			
BF 6L 413 F	6 Cyl.	12 Valves	9572cc		TD29623
BF 6L 413 FR	6 Cyl.	12 Valves	9572cc		TD19028
BF 6L 413 FRC	6 Cyl.	12 Valves	9572cc		TD29624
BF 6L 513	6 Cyl.	12 Valves	9572cc		TD19240
F 6L 413 F	6 Cyl.	12 Valves	9572cc		TD18341
F 6 L 413 F	6 Cyl.	12 Valves	9572cc		TD6960
F 6L 413 FW	6 Cyl.	12 Valves	9572cc		TD17883
					NB934 F 100.00 x 120.00 x 15.00mm, FPM NB935 R 105.00 x 130.00 x 15.00mm, FPM

38 11.3L		Diesel			
BF 8L 413	8 Cyl.	16 Valves	11310cc		TD19025
F 8 L 413	8 Cyl.	16 Valves	11310cc		TD7459
F 8L 413	8 Cyl.	16 Valves	11310cc		TD18363
F 8 L 413 W	8 Cyl.	16 Valves	11310cc		TD7462
					NB934 F 100.00 x 120.00 x 15.00mm, FPM NB935 R 105.00 x 130.00 x 15.00mm, FPM

39 12.7L		Diesel			
F 8 L 914	8 Cyl.	16 Valves	12667cc		TD7464
PB180 (x16)					
HR801 R (x2)					
					NB934 F 100.00 x 120.00 x 15.00mm, FPM NB935 R 105.00 x 130.00 x 15.00mm, FPM

40 12.8L		Diesel			
BF 8L 413 F	8 Cyl.	16 Valves	12763cc		TD18351
BF 8 L 413 F	8 Cyl.	16 Valves	12763cc		TD7329
BF 8L 513	8 Cyl.	16 Valves	12763cc		TD18495
BF 8 L 513-225	8 Cyl.	16 Valves	12763cc		TD16483
BF 8 L 513-243	8 Cyl.	16 Valves	12763cc		TD7313
F 8 L 413 F	8 Cyl.	16 Valves	12763cc		TD7256
F 8L 413 F	8 Cyl.	16 Valves	12763cc		TD18342
F 8L 413 FW	8 Cyl.	16 Valves	12763cc		TD17885
					NB934 F 100.00 x 120.00 x 15.00mm, FPM NB935 R 105.00 x 130.00 x 15.00mm, FPM

41 13.4L		Diesel			
F 8L 513	8 Cyl.	16 Valves	13382cc		TD18343
F 8 L 513	8 Cyl.	16 Valves	13383cc		TD7314
					NB934 F 100.00 x 120.00 x 15.00mm, FPM NB935 R 105.00 x 130.00 x 15.00mm, FPM

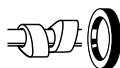

42 13.7L

Diesel

BF 8 L 513 LC 8 Cyl. 16 Valves 13745cc TD9035

NB934 100.00 x 120.00 x 15.00mm, FPM
NB935 105.00 x 130.00 x 15.00mm, FPM

43 14.1L

Diesel

F 10 L 413 10 Cyl. 20 Valves 14140cc TD7468

F 10 L 413 10 Cyl. 20 Valves 14140cc TD18352

NB934 100.00 x 120.00 x 15.00mm, FPM
NB935 105.00 x 130.00 x 15.00mm, FPM

44 14.7L

Diesel

F 10 L 413 L 10 Cyl. 20 Valves 14700cc TD29640

NB934 100.00 x 120.00 x 15.00mm, FPM
NB935 105.00 x 130.00 x 15.00mm, FPM

45 16.0L

Diesel

BF 10 L 413 F 10 Cyl. 20 Valves 15953cc TD7355

BF 10 L 413 F 10 Cyl. 20 Valves 15953cc TD18344

BF 10 L 513 10 Cyl. 20 Valves 15954cc TD18127

BF 10 L 513 F 10 Cyl. 20 Valves 15945cc TD19241

F 10 L 413 F 10 Cyl. 20 Valves 15953cc TD7331

F 10 L 413 F 10 Cyl. 20 Valves 15953cc TD18353

F 10 L 413 FW 10 Cyl. 20 Valves 15953cc TD17886

F 10 L 413 FZ 10 Cyl. 20 Valves 15953cc TD29639

F 10 L 513 F 10 Cyl. 20 Valves 15953cc TD19242

NB934 100.00 x 120.00 x 15.00mm, FPM
NB935 105.00 x 130.00 x 15.00mm, FPM

46 16.7L

Diesel

F 10 L 513 10 Cyl. 20 Valves 16728cc TD17887

F 10 L 513 L 10 Cyl. 20 Valves 16728cc TD29642

F 10 L 513 T 10 Cyl. 20 Valves 16728cc TD29641

NB934 100.00 x 120.00 x 15.00mm, FPM
NB935 105.00 x 130.00 x 15.00mm, FPM

47 17.0L

Diesel

BF 12 L 413 12 Cyl. 24 Valves 16964cc TD6771

BF 12 L 413 12 Cyl. 24 Valves 16964cc TD18345

F 12 L 413 12 Cyl. 24 Valves 16960cc TD18354

F 12 L 413 12 Cyl. 24 Valves 16960cc TD7469

NB934 100.00 x 120.00 x 15.00mm, FPM
NB935 105.00 x 130.00 x 15.00mm, FPM

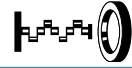

48 19.1L

Diesel

BF 12L 413 F	12 Cyl.	24 Valves	19144cc	TD18346
BF 12 L 413 F	12 Cyl.	24 Valves	19144cc	TD6772
BF 12 L 413 FC	12 Cyl.	24 Valves	19144cc	TD26011
BF 12 L 413 FW	12 Cyl.	24 Valves	19144cc	TD26012
BF 12L 513	12 Cyl.	24 Valves	19144cc	TD18496
BF 12L 513 C	12 Cyl.	24 Valves	19144cc	TD18498
BF 12L 513 F	12 Cyl.	24 Valves	19144cc	TD19029
F 12L 413 F	12 Cyl.	24 Valves	19144cc	TD18355
F 12 L 413 F	12 Cyl.	24 Valves	19144cc	TD6770
F 12L 413 FW	12 Cyl.	24 Valves	19144cc	TD17888
F 12L 513 F	12 Cyl.	24 Valves	19144cc	TD21062

NB934 F
100.00 x 120.00 x 15.00mm, FPM
NB935 R
105.00 x 130.00 x 15.00mm, FPM

49 20.0L

Diesel

F 12 L 513	12 Cyl.	24 Valves	20074cc	TD26017
F 12L 513	12 Cyl.	24 Valves	20074cc	TD18492

NB934 F
100.00 x 120.00 x 15.00mm, FPM
NB935 R
105.00 x 130.00 x 15.00mm, FPM



400 Convertible	01/82→12/83	EDF	Petrol	2213	4	8	8
400 Coupe	01/82→12/83	EDF	Petrol	2213	4	8	8
400 Saloon	09/81→12/83	EDF	Petrol	2213	4	8	8
600 Convertible	09/85→12/86	EDF	Petrol	2213	4	8	8
600 Coupe	09/83→12/86	EDF	Petrol	2213	4	8	8
600 Saloon	09/85→12/88	EDF	Petrol	2213	4	8	8
Aries Coupe	09/85→12/89	EDM	Petrol	2501	4	8	13
Aries Coupe	09/88→12/89	EDF	Petrol	2213	4	8	8
Aries Estate	09/85→12/88	EDM	Petrol	2501	4	8	13
Aries Estate	10/85→12/88	EDF	Petrol	2213	4	8	8
Aries Saloon	09/80→12/89	EDF	Petrol	2213	4	8	8
Aries Saloon	09/85→12/89	EDM	Petrol	2501	4	8	13
Avenger	06/07→	ECD	Diesel	1968	4	16	5
Avenger	06/07→	ECN	Petrol	1998	4	16	6
Avenger	06/07→	ED3	Petrol	2359	4	16	10
Avenger	06/07→	EDG	Petrol	2360	4	16	10
Avenger	09/10→	ERB	Petrol	3604	6	24	21
Avenger Coupe	09/94→12/99	ECF	Petrol	1996	4	16	4
Avenger Coupe	09/94→12/00	EEB	Petrol	2497	6	24	14
Caliber	06/06→12/09	EBA	Petrol	1798	4	16	2
Caliber	06/06→	ECD	Diesel	1968	4	16	5
Caliber	06/06→	ECE	Diesel	1968	4	16	5
Caliber	06/06→	ECN	Petrol	1998	4	16	6
Caliber	10/06→	ED3	Petrol	2359	4	16	10
Caliber	10/06→	ED4	Petrol	2360	4	16	10
Caliber	09/07→12/12	EDG	Petrol	2360	4	16	10
Caliber	07/10→	ENE	Diesel	2143	4	16	7
Caravan	09/88→12/95	EDM	Petrol	2501	4	8	13
Caravan	10/88→03/01	EFA	Petrol	2972	6	12	18
Caravan	10/89→12/00	EGA	Petrol	3301	6	12	19
Caravan	10/90→03/01	EGP	Petrol	3301	6	12	19
Caravan	01/95→03/01	EDZ	Petrol	2429	4	16	11
Caravan	01/95→03/01	ENC	Diesel	2499	4	8	15
Caravan	09/97→12/00	EGM	Petrol	3301	6	12	19
Caravan	01/09→	ENS	Diesel	2777	4	16	17
Caravan (RG_)	02/00→05/07	EGM	Petrol	3301	6	12	19
Caravan (RG_)	02/00→12/07	EDZ	Petrol	2429	4	16	11
Caravan (RG_)	02/00→12/07	EGA	Petrol	3301	6	12	19
Caravan (RG_)	09/06→12/07	EGV	Petrol	3301	6	12	19
Caravan Mini Cargo Van	01/91→12/95	EGP	Petrol	3301	6	12	19
Caravan Mini Cargo Van	09/02→12/07	EGA	Petrol	3301	6	12	19
Caravan Mini Cargo Van	09/02→12/07	EGV	Petrol	3301	6	12	19
Challenger Coupe	09/10→	ERB	Petrol	3604	6	24	21
Charger	06/05→12/08	EZA	Petrol	5654	8	16	24
Charger	01/11→	ERB	Petrol	3604	6	24	21
Dakota	10/89→09/03	EDM	Petrol	2501	4	8	13
Dakota	10/00→	EVA	Petrol	4701	8	16	23
Dakota	10/03→	EKG	Petrol	3700	6	12	22
Dakota	10/04→	EVC	Petrol	4701	8	16	23
Dakota Crew Cab Pickup	09/99→12/10	EVC	Petrol	4701	8	16	23
Dakota Crew Cab Pickup	09/03→12/10	EKG	Petrol	3700	6	12	22
Dakota Crew Cab Pickup	09/06→12/07	EVA	Petrol	4701	8	16	23
Dakota Extended Cab Pickup	09/96→12/02	EDM	Petrol	2501	4	8	13
Dakota Extended Cab Pickup	09/99→12/08	EVC	Petrol	4701	8	16	23
Dakota Extended Cab Pickup	09/04→12/10	EKG	Petrol	3700	6	12	22
Dakota Standard Cab Pickup	09/99→12/04	EVC	Petrol	4701	8	16	23
Dakota Standard Cab Pickup	09/03→12/04	EKG	Petrol	3700	6	12	22
Dart	04/12→	EAF	Petrol	1368	4	16	1
Dart	04/12→	ECN	Petrol	1998	4	16	6
Dart	04/12→	ED6	Petrol	2360	4	16	10
Daytona Hatchback	09/85→12/93	EDM	Petrol	2501	4	8	13
Durango	11/03→12/10	EKG	Petrol	3700	6	12	22
Durango (DN)	09/97→12/03	EVA	Petrol	4701	8	16	23
Durango (HB)	09/03→12/10	EZA	Petrol	5654	8	16	24
Durango (HB)	11/03→12/09	EVA	Petrol	4701	8	16	23
Durango (HB)	09/07→12/09	EVC	Petrol	4701	8	16	23
Durango (WD)	12/10→	ERB	Petrol	3604	6	24	21
Dynasty Saloon	09/87→12/93	EDM	Petrol	2501	4	8	13
Grand Caravan	06/07→12/10	EGV	Petrol	3301	6	12	19
Grand Caravan	06/07→	EGM	Petrol	3301	6	12	19
Grand Caravan	09/10→	ERB	Petrol	3604	6	24	21
Grand Caravan Mini Cargo Van	09/03→12/07	EGA	Petrol	3301	6	12	19
Grand Caravan Mini Cargo Van	09/07→12/08	EGV	Petrol	3301	6	12	19
Grand Caravan Mini Cargo Van	01/11→12/11	ERB	Petrol	3604	6	24	21
Grand Caravan Mini Passenger Van	09/86→12/90	EDM	Petrol	2501	4	8	13
Grand Caravan Mini Passenger Van	09/86→12/00	EFA	Petrol	2972	6	12	18
Grand Caravan Mini Passenger Van	09/89→12/07	EGA	Petrol	3301	6	12	19
Grand Caravan Mini Passenger Van	09/94→12/03	EGM	Petrol	3301	6	12	19



CC



9

H 100 Box	09/10→	4D56 T	Diesel	2477	4	8	12
H 100 Bus	09/10→	4D56 T	Diesel	2477	4	8	12
H 100 Platform/Chassis	01/07→	4D56 T	Diesel	2477	4	8	12
Intrepid	10/92→12/93	EGA	Petrol	3301	6	12	19
Intrepid	10/92→12/95	EGB	Petrol	3301	6	12	19
Intrepid	10/92→12/98	EGE	Petrol	3518	6	24	20
Intrepid	01/95→12/98	EGD	Petrol	3301	6	12	19
Journey	06/08→	ECE	Diesel	1968	4	16	5
Journey	09/08→	ED3	Petrol	2359	4	16	10
Journey	09/08→	EDG	Petrol	2360	4	16	10
Journey	09/10→	ERB	Petrol	3604	6	24	21
Lancer Hatchback	09/84→12/88	EDF	Petrol	2213	4	8	8
Neon	05/94→08/99	ECB	Petrol	1996	4	16	3
Neon	06/94→08/99	ECC	Petrol	1996	4	16	4
Neon Coupe	01/94→09/99	ECB	Petrol	1996	4	16	3
Neon Coupe	01/94→09/99	ECC	Petrol	1996	4	16	4
Neon II	08/99→	ECB	Petrol	1996	4	16	3
Neon II	08/99→	ECH	Petrol	1996	4	16	4
Neon II	09/03→12/05	EDV	Petrol	2429	4	16	11
Nitro	09/06→12/12	EKG	Petrol	3700	6	12	22
Nitro	06/07→12/12	ENR	Diesel	2777	4	16	17
Nitro	06/07→12/12	ENS	Diesel	2777	4	16	17
Omni Hatchback	10/80→09/82	EDF	Petrol	2213	4	8	8
Ram 1500 Crew Cab Pickup	09/01→12/07	EVA	Petrol	4701	8	16	23
Ram 1500 Crew Cab Pickup	09/01→12/10	EKG	Petrol	3700	6	12	22
Ram 1500 Crew Cab Pickup	09/07→12/10	EVC	Petrol	4701	8	16	23
Ram 1500 Extended Cab Pickup	09/08→12/10	EKG	Petrol	3700	6	12	22
Ram 1500 Extended Cab Pickup	09/08→12/10	EVC	Petrol	4701	8	16	23
Ram 1500 Extended Crew Cab Pickup	09/05→12/07	EVA	Petrol	4701	8	16	23
Ram 1500 Extended Crew Cab Pickup	09/07→12/08	EKG	Petrol	3700	6	12	22
Ram 1500 Extended Crew Cab Pickup	09/07→12/08	EVC	Petrol	4701	8	16	23
Ram 1500 Pickup (D1, DC, DH, DM, DR)	06/01→09/08	EKG	Petrol	3700	6	12	22
Ram 1500 Pickup (D1, DC, DH, DM, DR)	06/01→09/08	EVA	Petrol	4701	8	16	23
Ram 1500 Pickup (D1, DC, DH, DM, DR)	06/01→09/08	EZA	Petrol	5654	8	16	24
Ram 1500 Pickup (D1, DC, DH, DM, DR)	08/01→09/08	EVC	Petrol	4701	8	16	23
Ram 1500 Pickup (DJ, DS)	10/08→	EVC	Petrol	4701	8	16	23
Ram 1500 Standard Cab Pickup	09/01→12/07	EVA	Petrol	4701	8	16	23
Ram 1500 Standard Cab Pickup	09/01→12/10	EKG	Petrol	3700	6	12	22
Ram 1500 Standard Cab Pickup	09/03→12/10	EVC	Petrol	4701	8	16	23
Ram 2500 Cab & Chassis	09/02→12/05	EZA	Petrol	5654	8	16	24
Ram 2500 Crew Cab Pickup	09/02→12/08	EZA	Petrol	5654	8	16	24
Ram 2500 Extended Crew Cab Pickup	09/05→12/08	EZA	Petrol	5654	8	16	24
Ram 2500 Pickup (D1, DC, DH, DM, DR)	01/02→12/09	EZA	Petrol	5654	8	16	24
Ram 2500 Standard Cab Pickup	09/02→12/08	EZA	Petrol	5654	8	16	24
Ram 3500 Cab & Chassis	09/02→12/08	EZA	Petrol	5654	8	16	24
Ram 3500 Crew Cab Pickup	09/02→12/08	EZA	Petrol	5654	8	16	24
Ram 3500 Extended Crew Cab Pickup	09/05→12/08	EZA	Petrol	5654	8	16	24
Ram 3500 Pickup (DR, DH, D1, DC, DM)	01/02→09/08	EZA	Petrol	5654	8	16	24
Ram 3500 Standard Cab Pickup	09/02→12/08	EZA	Petrol	5654	8	16	24
Ram 4000 Standard Cab Pickup	09/01→12/05	EZA	Petrol	5654	8	16	24
Ram Van	06/95→10/02	ENC	Diesel	2499	4	8	15
Ram Van	03/02→12/05	ENJ	Diesel	2499	4	16	16
Ram Van	06/04→12/05	ENR	Diesel	2777	4	16	17
Shadow	09/86→12/88	EDF	Petrol	2213	4	8	8
Shadow	09/87→12/94	EDM	Petrol	2501	4	8	13
Shadow Convertible	09/90→12/93	EDF	Petrol	2213	4	8	8
Shadow Convertible	09/90→12/93	EDM	Petrol	2501	4	8	13
Stratus	12/95→04/01	ECB	Petrol	1996	4	16	3
Stratus	12/95→04/01	EDZ	Petrol	2429	4	16	11
Stratus	12/95→04/01	EEB	Petrol	2497	6	24	14
Stratus Coupe	09/00→12/05	EDZ	Petrol	2429	4	16	11
Stratus II	10/00→10/06	EDZ	Petrol	2429	4	16	11
Stratus II	01/01→10/06	EDV	Petrol	2429	4	16	11
SX 2.0 Saloon	09/02→12/05	ECB	Petrol	1996	4	16	3



CC



9



CC



9

4D56 T	2477	4	8	Diesel	12
EAF	1368	4	16	Petrol	1
EBA	1798	4	16	Petrol	2
ECB	1996	4	16	Petrol	3
ECC	1996	4	16	Petrol	4
ECD	1968	4	16	Diesel	5
ECE	1968	4	16	Diesel	5
ECF	1996	4	16	Petrol	4
ECH	1996	4	16	Petrol	4
ECN	1998	4	16	Petrol	6
ED3	2359	4	16	Petrol	10
ED4	2360	4	16	Petrol	10
ED6	2360	4	16	Petrol	10
EDF	2213	4	8	Petrol	8
EDG	2360	4	16	Petrol	10
EDM	2501	4	8	Petrol	13
EDV	2429	4	16	Petrol	11
EDZ	2429	4	16	Petrol	11
EEB	2497	6	24	Petrol	14
EFA	2972	6	12	Petrol	18
EGA	3301	6	12	Petrol	19
EGB	3301	6	12	Petrol	19
EGD	3301	6	12	Petrol	19
EGE	3518	6	24	Petrol	20
EGM	3301	6	12	Petrol	19
EGP	3301	6	12	Petrol	19
EGV	3301	6	12	Petrol	19
EKG	3700	6	12	Petrol	22
ENC	2499	4	8	Diesel	15
ENE	2143	4	16	Diesel	7
ENJ	2499	4	16	Diesel	16
ENR	2777	4	16	Diesel	17
ENS	2777	4	16	Diesel	17
ERB	3604	6	24	Petrol	21
EVA	4701	8	16	Petrol	23
EVC	4701	8	16	Petrol	23
EVE	4701	8	16	Petrol	23
EZA	5654	8	16	Petrol	24
FPT	2287	4	16	Diesel	9



1 1.4L Petrol

EAF	4 Cyl.	16 Valves	1368cc	TD29563
HR814				
			NA5057 27.00 x 37.00 x 7.00mm, FPM LK5001 74.00 x 187.50 x 17.000mm, FPM	

2 1.8L Petrol

EBA	4 Cyl.	16 Valves	1798cc	TD21868
			NA5108 42.00 x 55.00 x 7.00mm, FPM/ACM NK143 85.00 x 103.00 x 8.00mm, FPM	

3 2.0L Petrol

ECB	4 Cyl.	16 Valves	1996cc	TD20383
HR5061			NC006 35.00 x 48.00 x 7.00mm, MVQ NA5139 32.00 x 45.00 x 6.00mm, FPM NA5140 91.00 x 111.00 x 10.00mm, FPM	

4 2.0L Petrol

ECC	4 Cyl.	16 Valves	1996cc	TD20384
ECF	4 Cyl.	16 Valves	1996cc	TD20385
ECH	4 Cyl.	16 Valves	1996cc	TD21872
HR5061			NC006 (x2) 35.00 x 48.00 x 7.00mm, MVQ NA5139 32.00 x 45.00 x 6.00mm, FPM NA5140 91.00 x 111.00 x 10.00mm, FPM	

5 2.0L Diesel

ECD	4 Cyl.	16 Valves	1968cc	TD21869
ECE	4 Cyl.	16 Valves	1968cc	TD21870
PA5041 (x16) HR791			NA5124 (x2) 32.00 x 47.00 x 10.00mm, PTFE/ACM NA5106 35.00 x 48.00 x 10.00mm, PTFE LK5012 85.00 x 132.00 x 15.70mm, PTFE	

6 2.0L Petrol

ECN	4 Cyl.	16 Valves	1998cc	TD21874
			NC006 (x2) 35.00 x 48.00 x 7.00mm, MVQ NA5108 42.00 x 55.00 x 7.00mm, FPM/ACM NK143 85.00 x 103.00 x 8.00mm, FPM	

7 2.1L Diesel

ENE	4 Cyl.	16 Valves	2143cc	TD26130
PA5041 (x16) HR791			NA5479 60.00 x 75.00 x 8.00mm, FPM	

8 2.2L Petrol

EDF	4 Cyl.	8 Valves	2213cc	TD29436
			NA5140 91.00 x 111.00 x 10.00mm, FPM	



9 2.3L Diesel

FPT	4 Cyl.	16 Valves	2287cc	TD31436
	NA5201 34.00 x 60.00 x 10.00mm, FPM		NA5202 50.0 x 80.0 x 14.0mm, FPM	

10 2.4L Petrol

ED3	4 Cyl.	16 Valves	2359cc	TD23318
ED4	4 Cyl.	16 Valves	2360cc	TD23551
ED6	4 Cyl.	16 Valves	2360cc	TD29564
EDG	4 Cyl.	16 Valves	2360cc	TD23571
			NA5108 42.00 x 55.00 x 7.00mm, FPM/ACM NK143 85.00 x 103.00 x 8.00mm, FPM	

11 2.4L Petrol

EDV	4 Cyl.	16 Valves	2429cc	TD21877
EDZ	4 Cyl.	16 Valves	2429cc	TD18405
HR5061	NC006 (x2) 35.00 x 48.00 x 7.00mm, MVQ		NA5139 32.00 x 45.00 x 6.00mm, FPM NA5140 91.00 x 111.00 x 10.00mm, FPM	

12 2.5L Diesel

4D56 T	4 Cyl.	8 Valves	2477cc	TD27389
KJ211 (x8)	NJ933 35.00 x 50.00 x 8.00mm, FPM NJ242 35.00 x 50.00 x 8.00mm, NBR		NJ005 44.00 x 60.00 x 7.00mm, NBR NJ251 80.00 x 96.00 x 9.00mm, MVQ	

13 2.5L Petrol

EDM	4 Cyl.	8 Valves	2501cc	TD21876
			NA5140 91.00 x 111.00 x 10.00mm, FPM	

14 2.5L Petrol

EEB	6 Cyl.	24 Valves	2497cc	TD20386
	NF841 (x2) 35.00 x 50.00 x 8.00mm, FPM		NJ874 37.00 x 50.00 x 6.00mm, ACM NA5140 91.00 x 111.00 x 10.00mm, FPM	

15 2.5L Diesel

ENC	4 Cyl.	8 Valves	2499cc	TD21897
HR801				

16 2.5L Diesel

ENJ	4 Cyl.	16 Valves	2499cc	TD31417
HR660	NA5136 (x2) 30.00 x 47.00 x 7.00mm, FPM			



17 2.8L Diesel

ENR	4 Cyl.	16 Valves	2777cc	TD23715
ENS	4 Cyl.	16 Valves	2777cc	TD23716
PA5041 (x16) HR791	NA5136 (x2) 30.00 x 47.00 x 7.00mm, FPM			

18 3.0L Petrol

EFA	6 Cyl.	12 Valves	2972cc	TD21187
KJ211 (x12)	NF841 35.00 x 50.00 x 8.00mm, FPM		NJ874 37.00 x 50.00 x 6.00mm, ACM NA5140 91.00 x 111.00 x 10.00mm, FPM	

19 3.3L Petrol

EGA	6 Cyl.	12 Valves	3301cc	TD21878
EGB	6 Cyl.	12 Valves	3301cc	TD21879
EGD	6 Cyl.	12 Valves	3301cc	TD21881
EGM	6 Cyl.	12 Valves	3301cc	TD21886
EGP	6 Cyl.	12 Valves	3301cc	TD21188
EGV	6 Cyl.	12 Valves	3301cc	TD29433
			NJ874 37.00 x 50.00 x 6.00mm, ACM NA5140 91.00 x 111.00 x 10.00mm, FPM	

20 3.5L Petrol

EGE	6 Cyl.	24 Valves	3518cc	TD21882
			NA5140 91.00 x 111.00 x 10.00mm, FPM	

21 3.6L Petrol

ERB	6 Cyl.	24 Valves	3604cc	TD28432
HR5062			NA5131 45.00 x 67.00 x 8.00mm, PTFE	

22 3.7L Petrol

EKG	6 Cyl.	12 Valves	3700cc	TD21888
			NA5173 100.00 x 120.00 x 9.50mm, FPM	

23 4.7L Petrol









EVA	8 Cyl.	16 Valves	4701cc	TD21189
EVC	8 Cyl.	16 Valves	4701cc	TD21901
EVE	8 Cyl.	16 Valves	4701cc	TD33746
HR5077			NA5173 100.00 x 120.00 x 9.50mm, FPM	

24 5.7L Petrol

EZA	8 Cyl.	16 Valves	5654cc	TD21902
			NA5001 32.00 x 47.00 x 10.00mm, FPM NA5133 85.00 x 105.00 x 11.00mm, FPM	



10 (188)	10/05→	188 A4.000	Petrol	1242	4	8	39
45-65	03/83→12/91	11A	Petrol	1116	4	8	24
45-65	03/83→12/91	128A4	Petrol	1116	4	8	26
45-65	03/83→12/91	164A0	Petrol	903	4	8	15
101 (1100)	06/73→01/90	128 A.000	Petrol	1116	4	8	26
101 (1100)	05/75→12/93	128 A.064	Petrol	1116	4	8	27
101 (1100)	07/79→09/81	128 AC5.000	Petrol	1116	4	8	26
101 (1100)	10/81→12/93	128 AR.000	Petrol	1290	4	8	42
124 (124_)	07/66→07/75	124 A.000	Petrol	1197	4	8	32
124 (124_)	09/67→07/75	124 B2.000	Petrol	1438	4	8	49
124 (124_)	01/71→07/75	124 AC.000	Petrol	1438	4	8	49
124 (124_)	01/73→07/75	124 A9.000	Petrol	1592	4	8	76
124 (124_)	01/73→07/75	132 AC.000	Petrol	1592	4	8	79
124 Coupe (124_)	06/67→10/72	124 AC.000	Petrol	1438	4	8	49
124 Coupe (124_)	04/70→10/73	125 B.000	Petrol	1608	4	8	77
124 Coupe (124_)	08/72→12/75	132 AC.000	Petrol	1592	4	8	79
124 Familiare (124_)	04/67→03/75	124 A.000	Petrol	1197	4	8	32
124 Familiare (124_)	09/67→05/71	124 B.000	Petrol	1438	4	8	49
124 Spider (124_)	01/66→12/72	124 AC.000	Petrol	1438	4	8	49
124 Spider (124_)	01/69→12/74	125 B.000	Petrol	1608	4	8	77
124 Spider (124_)	09/70→07/75	132 AC.000	Petrol	1592	4	8	79
124 Spider (124_)	01/72→12/77	132 AC1.000	Petrol	1756	4	8	108
124 Spider (124_)	04/72→11/85	132 C3.031	Petrol	1995	4	8	133
124 Spider (348_)	03/16→	55253268	Petrol	1368	4	16	61
124 Spider (348_)	08/16→	EAM	Petrol	1368	4	16	61
125 (125_)	07/67→03/74	125 A.000	Petrol	1608	4	8	77
125 (125_)	06/68→03/74	131 A.000	Petrol	1297	4	8	45
125 (125_)	05/69→10/73	125 B.000	Petrol	1608	4	8	77
126 (126_)	09/72→06/77	126 A.000	Petrol	594	2	4	2
126 (126_)	07/77→09/87	126 A1.000	Petrol	652	2	4	2
126 (126_)	07/77→09/00	126 A1.048	Petrol	652	2	4	2
126 (126_)	09/87→06/96	126 A2.000	Petrol	704	2	4	3
126 (126_)	09/87→06/96	126 A2.048	Petrol	704	2	4	3
127 (127_)	06/71→05/83	100 GL.048	Petrol	903	4	8	13
127 (127_)	06/71→12/86	100 GL.000	Petrol	903	4	8	13
127 (127_)	04/77→12/86	127 A.000	Petrol	1049	4	8	17
127 (127_)	07/78→02/82	127 A1.000	Petrol	1049	4	8	17
127 (127_)	04/81→05/96	127 A5.000	Diesel	1302	4	8	43
127 (127_)	12/81→05/83	127 A3.000	Petrol	1301	4	8	42
127 Panorama (127_)	01/77→12/86	127 A.000	Petrol	1049	4	8	17
127 Panorama (127_)	06/81→12/86	127 A5.000	Diesel	1302	4	8	43
128 (128_)	03/69→12/84	128 A.000	Petrol	1116	4	8	27
128 (128_)	09/71→12/79	128 AR.000	Petrol	1290	4	8	42
128 (128_)	08/74→12/84	128 A1.000	Petrol	1290	4	8	44
128 (128_)	02/75→09/81	128 A.048	Petrol	1116	4	8	27
128 Coupe (128_)	03/72→12/79	128 A1.000	Petrol	1290	4	8	44
128 Coupe (128_)	03/72→12/79	128 AC.000	Petrol	1290	4	8	44
128 Coupe (128_)	03/72→02/81	128 AC5.000	Petrol	1116	4	8	26
128 Familiare (128_)	10/69→10/82	128 A.000	Petrol	1116	4	8	27
128 Familiare (128_)	09/73→10/82	128 A1.000	Petrol	1290	4	8	44
128 Familiare (128_)	02/75→02/81	128 A.048	Petrol	1116	4	8	27
128 Saloon	03/83→09/91	128 A1.000	Petrol	1290	4	8	44
131 (131_)	10/74→09/81	131 A1.000	Petrol	1585	4	8	77
131 (131_)	10/74→09/81	131 A6.000	Petrol	1297	4	8	45
131 (131_)	10/74→12/82	131 A.000	Petrol	1297	4	8	45
131 (131_)	01/76→12/81	131 B2.000	Petrol	1995	4	8	130
131 (131_)	11/76→12/84	131 C2.000	Petrol	1585	4	8	78
131 (131_)	03/78→12/80	131 B.000	Petrol	1297	4	8	45
131 (131_)	03/78→01/84	131 C3.000	Petrol	1585	4	8	77
131 (131_)	06/78→02/84	8144.61	Diesel	2428	4	8	173
131 (131_)	03/79→03/82	131 B1.000	Petrol	1585	4	8	78
131 (131_)	11/80→01/84	131 C.000	Petrol	1367	4	8	50
131 (131_)	11/80→01/84	131 C1.000	Petrol	1367	4	8	50
131 (131_)	01/81→12/84	131 C4.000	Petrol	1995	4	8	131
131 Familiare/Panorama (131_)	03/75→12/78	131 A1.000	Petrol	1585	4	8	77
131 Familiare/Panorama (131_)	03/75→12/78	131 A6.000	Petrol	1297	4	8	45
131 Familiare/Panorama (131_)	03/75→03/82	131 A.000	Petrol	1297	4	8	45
131 Familiare/Panorama (131_)	03/79→12/84	8144.61	Diesel	2428	4	8	173
131 Familiare/Panorama (131_)	12/79→12/81	131 C3.000	Petrol	1585	4	8	77
131 Familiare/Panorama (131_)	11/80→12/84	131 C2.000	Petrol	1585	4	8	78
131 Familiare/Panorama (131_)	01/81→12/84	131 C4.000	Petrol	1995	4	8	131
131 Familiare/Panorama (131_)	11/81→01/84	131 C.000	Petrol	1367	4	8	50
131 Familiare/Panorama (131_)	11/81→01/84	131 C1.000	Petrol	1367	4	8	50
132 (132_)	04/72→01/76	132 BB OA 0	Petrol	1592	4	8	79
132 (132_)	04/72→01/77	132 B1.000	Petrol	1756	4	8	102
132 (132_)	01/76→06/81	132 C2.000	Petrol	1995	4	8	133
132 (132_)	01/76→12/82	132 C.000	Petrol	1585	4	8	80
132 (132_)	03/77→12/81	132 C6.000	Petrol	1585	4	8	80

							
132 (132_)	07/78→07/82	8144.61	Diesel	2428	4	8	173
132 (132_)	01/80→12/82	132 C3.000	Petrol	1995	4	8	133
133	06/74→12/76	126 A1.048	Petrol	652	2	4	2
133	06/75→04/81	127 A1.024	Petrol	843	4	8	8
147	10/76→12/95	127 A.000	Petrol	1049	4	8	17
147	11/76→02/87	156 A.000	Petrol	1049	4	8	17
147	04/77→12/81	100 GL.000	Petrol	903	4	8	13
147	10/78→02/87	127 A2.011	Petrol	1297	4	8	42
147	10/80→10/95	127 A5.000	Diesel	1302	4	8	43
147	10/84→11/92	128 A011	Petrol	1116	4	8	27
147	10/84→11/92	128 A 064	Petrol	1116	4	8	27
242-Serie Box (242_)	10/75→08/80	B22615	Diesel	2175	4	8	167
242-Serie Box (242_)	10/75→07/82	124 B3.000	Petrol	1585	4	8	77
242-Serie Box (242_)	10/75→07/82	132 AZ2.000	Petrol	1995	4	8	122
242-Serie Box (242_)	08/80→07/82	B 25.637	Diesel	2498	4	8	185
242-Serie Bus (242_)	10/75→07/82	124 B3.000	Petrol	1585	4	8	77
242-Serie Bus (242_)	10/75→07/82	132 AZ2.000	Petrol	1995	4	8	122
311 / 411	04/83→04/91	128A4	Petrol	1116	4	8	26
500	01/65→01/76	110 F.000	Petrol	499	2	4	1
500	01/65→01/76	120.000	Petrol	499	2	4	1
500 (312_)	10/07→	169 A1.000	Diesel	1248	4	16	33
500 (312_)	10/07→	169 A3.000	Petrol	1368	4	16	53
500 (312_)	10/07→	169 A4.000	Petrol	1242	4	8	34
500 (312_)	12/09→	199 B1.000	Diesel	1248	4	16	47
500 (312_)	12/09→	312 B1.000	Diesel	1248	4	16	47
500 (312_)	07/10→	312 A2.000	Petrol	875	2	8	16
500 (312_)	08/11→	327 A.011	Petrol	1368	4	8	59
500 (312_)	09/11→	310 A2.011	Petrol	1368	4	8	55
500 (312_)	09/12→	312 A4.000	Petrol	964	2	8	16
500 (312_)	09/13→	EAF	Petrol	1368	4	16	63
500 (312_)	10/13→	199 B6.000	Petrol	875	2	8	16
500 (312_)	12/13→	312 A5.000	Petrol	875	2	8	16
500 (312_)	12/13→	312 A6.000	Petrol	964	2	8	16
500 (312_)	11/14→	312 A1.000	Petrol	1368	4	16	53
500 (312_)	11/14→	312 A3.000	Petrol	1368	4	16	53
500 (312_)	06/16→	312 B5.000	Diesel	1248	4	16	47
500 / 595 / 695 (312_)	08/08→	312 A1.000	Petrol	1368	4	16	53
500 / 595 / 695 (312_)	08/08→	312 A3.000	Petrol	1368	4	16	53
500 C (312_)	09/09→	169 A1.000	Diesel	1248	4	16	33
500 C (312_)	09/09→	169 A3.000	Petrol	1368	4	16	53
500 C (312_)	09/09→	169 A4.000	Petrol	1242	4	8	34
500 C (312_)	09/09→	199 B1.000	Diesel	1248	4	16	47
500 C (312_)	09/09→	312 A2.000	Petrol	875	2	8	16
500 C (312_)	09/09→	312 B1.000	Diesel	1248	4	16	47
500 C (312_)	09/12→	312 A4.000	Petrol	964	2	8	16
500 C (312_)	12/13→	199 B6.000	Petrol	875	2	8	16
500 C (312_)	12/13→	312 A5.000	Petrol	875	2	8	16
500 C (312_)	12/13→	312 A6.000	Petrol	964	2	8	16
500 C (312_)	07/14→	327 A.011	Petrol	1368	4	8	59
500C / 595C / 695C (312_)	09/09→	312 A3.000	Petrol	1368	4	16	53
500C / 595C / 695C (312_)	01/11→	312 A1.000	Petrol	1368	4	16	53
500 Estate	01/60→12/66	120.000	Petrol	499	2	4	1
500L (351_, 352_)	09/12→	199 B4.000	Diesel	1248	4	16	47
500L (351_, 352_)	09/12→	199 B5.000	Diesel	1598	4	16	92
500L (351_, 352_)	09/12→	199 B6.000	Petrol	875	2	8	16
500L (351_, 352_)	09/12→	843 A1.000	Petrol	1368	4	16	53
500L (351_, 352_)	03/13→	312 A2.000	Petrol	875	2	8	16
500L (351_, 352_)	09/13→	312 A1.000	Petrol	1368	4	16	53
500L (351_, 352_)	09/13→	940 C1.000	Diesel	1598	4	16	92
500L (351_, 352_)	09/13→	955 A3.000	Diesel	1598	4	16	92
500L (351_, 352_)	10/13→	940 B7.000	Petrol	1368	4	16	53
500L (351_, 352_)	06/14→	330 A1.000	Diesel	1248	4	16	47
500X (334_)	09/14→	55260384	Diesel	1598	4	16	92
500X (334_)	09/14→	55263087	Diesel	1956	4	16	144
500X (334_)	09/14→	55263088	Diesel	1956	4	16	144
500X (334_)	09/14→	55263624	Petrol	1368	4	16	61
500X (334_)	11/14→	55263842	Petrol	1598	4	16	94
500X (334_)	02/15→	55263623	Petrol	1368	4	16	61
500X (334_)	05/15→	ED6	Petrol	2360	4	16	175
500X (334_)	06/15→	55266963	Diesel	1248	4	16	47
511 / 513	04/83→04/91	128A4	Petrol	1116	4	8	26
695	01/11→	312 A1.000	Petrol	1368	4	16	53
750	03/80→11/85	126G100	Petrol	843	4	8	14
850	07/64→10/72	100 G.000	Petrol	843	4	8	6
850	07/64→10/72	100 G.002	Petrol	843	4	8	6
850	03/68→10/72	100 GB.000	Petrol	843	4	8	6
850 Coupe (100_)	02/68→10/72	100 GL.040	Petrol	903	4	8	13
850 Spider	10/65→10/68	126G100	Petrol	843	4	8	7











Model	Year Range	Engine	Fuel	CC	Power (kW)	Power (hp)	Transmission
850 Spider	03/68→12/73	100 GL.040	Petrol	903	4	8	13
900T/E Panorama (200_)	01/78→01/86	100 GF 000	Petrol	903	4	8	12
900T/E Pulmino (200_)	01/78→01/86	100 GF 000	Petrol	903	4	8	12
A 112	10/69→12/85	A112A 5.000	Petrol	903	4	8	13
A 112	07/75→12/85	A112B2.000	Petrol	903	4	8	13
A 112	11/77→12/85	A112B1.000	Petrol	965	4	8	18
Aero 8	10/00→	M62448S2	Petrol	4398	8	32	202
Aero 8	10/08→	N62 B48 B	Petrol	4799	8	32	205
Aero Coupe	10/12→	N62 B48 B	Petrol	4799	8	32	205
Aero Supersports	03/10→	N62 B48 B	Petrol	4799	8	32	205
Argenta (132_)	06/78→12/85	132 C2.000	Petrol	1995	4	8	133
Argenta (132_)	06/78→12/85	132 D1.000	Petrol	1995	4	8	133
Argenta (132_)	04/81→12/85	132 D.000	Petrol	1585	4	8	78
Argenta (132_)	06/81→11/85	8144.61	Diesel	2428	4	8	173
Argenta (132_)	06/81→07/86	132 C3.000	Petrol	1995	4	8	133
Argenta (132_)	07/83→08/85	8144.61.500.81	Diesel	2445	4	8	173
Argo (358_)	04/17→	370 A0.011	Petrol	1747	4	16	113
Aria	10/10→	DW12DD	Diesel	2179	4	16	164
Barchetta (183_)	04/95→05/05	183 A1.000	Petrol	1747	4	16	113
Barchetta (183_)	04/95→05/05	188 A6.000	Petrol	1747	4	16	113
Bolt	01/15→	169 A1.000	Diesel	1248	4	16	33
Brava (182_)	10/95→08/98	182 A3.000	Petrol	1370	4	12	56
Brava (182_)	10/95→10/01	160 A7.000	Diesel	1929	4	8	123
Brava (182_)	10/95→10/01	182 A2.000	Petrol	1747	4	16	113
Brava (182_)	10/95→10/01	182 A5.000	Petrol	1370	4	12	56
Brava (182_)	10/95→10/01	182 A6.000	Petrol	1581	4	16	88
Brava (182_)	02/96→10/01	182 A4.000	Petrol	1581	4	16	88
Brava (182_)	03/96→10/01	182 A7.000	Diesel	1910	4	8	125
Brava (182_)	03/96→10/01	182 A8.000	Diesel	1910	4	8	125
Brava (182_)	09/98→08/00	182 B7.000	Petrol	1998	5	20	142
Brava (182_)	12/98→12/02	182 B2.000	Petrol	1242	4	16	36
Brava (182_)	12/98→12/02	182 B4.000	Diesel	1910	4	8	125
Brava (182_)	01/99→12/02	182 B6.000	Petrol	1596	4	16	88
Brava (182_)	02/00→06/03	183 A1.000	Petrol	1747	4	16	113
Brava (182_)	09/00→10/01	182 B9.000	Diesel	1910	4	8	125
Brava (182_)	10/00→10/01	188 A5.000	Petrol	1242	4	16	40
Bravo I (182_)	10/95→07/98	182 A1.000	Petrol	1998	5	20	142
Bravo I (182_)	10/95→10/01	160 A7.000	Diesel	1929	4	8	123
Bravo I (182_)	10/95→10/01	182 A2.000	Petrol	1747	4	16	113
Bravo I (182_)	10/95→10/01	182 A3.000	Petrol	1370	4	12	56
Bravo I (182_)	10/95→10/01	182 A5.000	Petrol	1370	4	12	56
Bravo I (182_)	10/95→10/01	182 A6.000	Petrol	1581	4	16	88
Bravo I (182_)	03/96→10/01	182 A4.000	Petrol	1581	4	16	88
Bravo I (182_)	03/96→10/01	182 A7.000	Diesel	1910	4	8	125
Bravo I (182_)	03/96→10/01	182 A8.000	Diesel	1910	4	8	125
Bravo I (182_)	07/98→10/01	182 B7.000	Petrol	1998	5	20	142
Bravo I (182_)	12/98→10/01	182 B2.000	Petrol	1242	4	16	36
Bravo I (182_)	12/98→10/01	182 B4.000	Diesel	1910	4	8	125
Bravo I (182_)	09/00→10/01	182 B6.000	Petrol	1596	4	16	88
Bravo I (182_)	09/00→10/01	182 B9.000	Diesel	1910	4	8	125
Bravo I (182_)	10/00→10/01	188 A5.000	Petrol	1242	4	16	40
Bravo II (198_)	11/06→	192 A1.000	Diesel	1910	4	8	125
Bravo II (198_)	11/06→	192 B4.000	Diesel	1910	4	8	125
Bravo II (198_)	04/07→12/08	192 B5.000	Diesel	1910	4	8	125
Bravo II (198_)	04/07→	192 A8.000	Diesel	1910	4	8	125
Bravo II (198_)	04/07→	192 B2.000	Petrol	1368	4	16	57
Bravo II (198_)	04/07→	937 A5.000	Diesel	1910	4	16	128
Bravo II (198_)	09/07→	198 A1.000	Petrol	1368	4	16	53
Bravo II (198_)	09/07→	198 A3.000	Diesel	1598	4	16	92
Bravo II (198_)	09/07→	198 A4.000	Petrol	1368	4	16	53
Bravo II (198_)	09/07→	844 A3.000	Diesel	1598	4	16	92
Bravo II (198_)	03/08→	198 A2.000	Diesel	1598	4	16	92
Bravo II (198_)	03/08→	198 A6.000	Diesel	1598	4	16	92
Bravo II (198_)	03/08→	198 A7.000	Petrol	1368	4	16	53
Bravo II (198_)	09/08→	198 A5.000	Diesel	1956	4	16	144
Bravo II (198_)	09/08→	198 A8.000	Diesel	1956	4	16	144
Bravo II (198_)	09/08→	370 A0.011	Petrol	1747	4	16	113
Bravo II (198_)	09/08→	844 A2.000	Diesel	1956	4	16	144
Bravo II (198_)	11/08→	955 A4.000	Diesel	1598	4	16	92
Campagnola	06/74→10/89	6132 AZ 2.000	Petrol	1995	4	8	149
Campagnola	06/74→10/89	8144.61.200	Diesel	2445	4	8	173
Cinquecento (170_)	07/91→12/93	170 A1.000	Petrol	903	4	8	12
Cinquecento (170_)	07/91→12/93	170 A1.046	Petrol	903	4	8	12
Cinquecento (170_)	07/91→07/99	1170 A1.000	Petrol	899	4	8	14
Cinquecento (170_)	07/91→07/99	1170 A1.046	Petrol	899	4	8	14
Cinquecento (170_)	12/91→01/96	170 A.000	Petrol	704	2	4	3
Cinquecento (170_)	07/94→01/98	170 A.046	Petrol	704	2	4	3
Cinquecento (170_)	10/94→01/98	176 B2.000	Petrol	1108	4	8	29

				CC			9
Coupe (175_)	11/93→08/96	175 A1.000	Petrol	1995	4	16	141
Coupe (175_)	11/93→08/96	836 A3.000	Petrol	1995	4	16	147
Coupe (175_)	03/96→08/00	183 A1.000	Petrol	1747	4	16	113
Coupe (175_)	08/96→04/98	182 A1.000	Petrol	1998	5	20	142
Coupe (175_)	08/96→08/00	175 A3.000	Petrol	1998	5	20	142
Coupe (175_)	04/98→08/00	182 B3.000	Petrol	1998	5	20	142
Croma (154_)	12/85→08/89	8144.91.2000	Diesel	2445	4	8	174
Croma (154_)	12/85→12/89	8144.67	Diesel	2500	4	8	183
Croma (154_)	12/85→06/90	154 A2.000	Petrol	1995	4	8	136
Croma (154_)	12/85→12/90	154 A.048	Petrol	1585	4	8	84
Croma (154_)	12/85→09/92	154 A1.000	Petrol	1995	4	8	136
Croma (154_)	03/86→09/90	834 B.048	Petrol	1995	4	8	136
Croma (154_)	11/86→08/96	834 C.146	Petrol	1995	4	8	136
Croma (154_)	03/87→09/92	154 C3.000	Petrol	1995	4	8	136
Croma (154_)	03/87→09/92	834 B.000	Petrol	1995	4	8	146
Croma (154_)	06/87→08/96	154 C4.046	Petrol	1995	4	8	137
Croma (154_)	10/87→08/96	154 C3.046	Petrol	1995	4	8	136
Croma (154_)	10/87→08/96	834 B.146	Petrol	1995	4	8	136
Croma (154_)	05/89→10/92	154 C6.000	Diesel	1929	4	8	124
Croma (154_)	05/89→08/96	8144.97	Diesel	2499	4	8	184
Croma (154_)	05/89→08/96	8144.97.2400	Diesel	2499	4	8	184
Croma (154_)	05/89→08/96	8144.97 Y	Diesel	2500	4	8	184
Croma (154_)	01/91→09/92	154 C5.000	Petrol	1995	4	8	136
Croma (154_)	12/91→08/96	8144.97 S	Diesel	2500	4	8	184
Croma (154_)	08/92→08/96	154 E1.000	Petrol	1995	4	16	138
Croma (154_)	11/92→12/96	154 D1.000	Diesel	1929	4	8	124
Croma (154_)	06/93→08/96	834 G.000	Petrol	2492	6	12	177
Croma (194_)	06/05→	194 A1.000	Petrol	2198	4	16	166
Croma (194_)	06/05→	939 A1.000	Diesel	1910	4	8	125
Croma (194_)	06/05→	939 A2.000	Diesel	1910	4	16	128
Croma (194_)	06/05→	939 A3.000	Diesel	2387	5	20	172
Croma (194_)	06/05→	939 A7.000	Diesel	1910	4	8	125
Croma (194_)	12/05→	939 A4.000	Petrol	1796	4	16	115
Croma (194_)	12/05→	939 A8.000	Diesel	1910	4	16	128
Doblo (119)	09/02→	182 B6.000	Petrol	1596	4	16	88
Doblo Box Body / Estate (263_)	02/10→	198 A3.000	Diesel	1598	4	16	92
Doblo Box Body / Estate (263_)	02/10→	199 A3.000	Diesel	1248	4	16	47
Doblo Box Body / Estate (263_)	02/10→	263 A1.000	Diesel	1956	4	16	144
Doblo Box Body / Estate (263_)	02/10→	263 A2.000	Diesel	1248	4	16	47
Doblo Box Body / Estate (263_)	02/10→	263 A3.000	Diesel	1598	4	16	92
Doblo Box Body / Estate (263_)	02/10→	263 A4.000	Diesel	1598	4	16	92
Doblo Box Body / Estate (263_)	02/10→	263 A5.000	Diesel	1598	4	16	92
Doblo Box Body / Estate (263_)	02/10→	263 A8.000	Diesel	1598	4	16	92
Doblo Box Body / Estate (263_)	02/10→	263 A9.000	Diesel	1598	4	16	92
Doblo Box Body / Estate (263_)	02/10→	843 A1.000	Petrol	1368	4	16	53
Doblo Box Body / Estate (263_)	06/10→	198 A4.000	Petrol	1368	4	16	53
Doblo Box Body / Estate (263_)	11/13→	263 A6.000	Diesel	1248	4	16	47
Doblo Box Body / Estate (263_)	01/14→	310 A2.011	Petrol	1368	4	8	55
Doblo Box Body / Estate (263_)	08/14→	370 A0.011	Petrol	1747	4	16	113
Doblo Box Body / Estate (263_)	02/16→	940 C1.000	Diesel	1598	4	16	92
Doblo Box Body / Estate (263_)	03/16→	225 A2.000	Diesel	1248	4	16	47
Doblo Box Body / Estate (263_)	03/16→	330 A1.000	Diesel	1248	4	16	47
Doblo Cargo (223_)	11/00→01/06	PN93327668	Petrol	1796	4	8	117
Doblo Cargo (223_)	03/01→	223 A5.000	Petrol	1242	4	8	35
Doblo Cargo (223_)	03/01→	223 A6.000	Diesel	1910	4	8	125
Doblo Cargo (223_)	10/01→	182 B6.000	Petrol	1596	4	16	88
Doblo Cargo (223_)	10/01→	182 B9.000	Diesel	1910	4	8	125
Doblo Cargo (223_)	11/01→	223 A3.011	Petrol	1242	4	16	40
Doblo Cargo (223_)	02/02→	93313090-7U	Petrol	1796	4	8	117
Doblo Cargo (223_)	07/03→	223 A7.000	Diesel	1910	4	8	125
Doblo Cargo (223_)	07/03→	223 B1.000	Diesel	1910	4	8	125
Doblo Cargo (223_)	05/04→12/06	188 A8.000	Diesel	1248	4	16	47
Doblo Cargo (223_)	05/04→12/06	188 A9.000	Diesel	1248	4	16	47
Doblo Cargo (223_)	10/05→01/10	199 A2.000	Diesel	1248	4	16	47
Doblo Cargo (223_)	10/05→	350 A1.000	Petrol	1368	4	8	58
Doblo Cargo (223_)	08/06→	223 A9.000	Diesel	1248	4	16	47
Doblo Cargo (223_)	12/06→	186 A9.000	Diesel	1910	4	8	125
Doblo Cargo (223_)	08/09→	310 A2.011	Petrol	1368	4	8	55
Doblo Cargo (223_)	08/10→	370 A0.011	Petrol	1747	4	16	113
Doblo MPV (119_, 223_)	03/01→	223 A5.000	Petrol	1242	4	8	35
Doblo MPV (119_, 223_)	03/01→	223 A6.000	Diesel	1910	4	8	125
Doblo MPV (119_, 223_)	10/01→	182 B6.000	Petrol	1596	4	16	88
Doblo MPV (119_, 223_)	10/01→	182 B9.000	Diesel	1910	4	8	125
Doblo MPV (119_, 223_)	10/01→	223 B2.000	Diesel	1910	4	8	125
Doblo MPV (119_, 223_)	07/03→	223 A7.000	Diesel	1910	4	8	125
Doblo MPV (119_, 223_)	07/03→	223 B1.000	Diesel	1910	4	8	125
Doblo MPV (119_, 223_)	09/03→01/06	PN93327668	Petrol	1796	4	8	117
Doblo MPV (119_, 223_)	12/04→05/05	188 A9.000	Diesel	1248	4	16	47









Doblo MPV (119_, 223_)	05/05→	199 A2.000	Diesel	1248	4	16	47
Doblo MPV (119_, 223_)	09/05→	223 A3.011	Petrol	1242	4	16	40
Doblo MPV (119_, 223_)	10/05→	186 A9.000	Diesel	1910	4	8	125
Doblo MPV (119_, 223_)	10/05→	223 A9.000	Diesel	1248	4	16	47
Doblo MPV (119_, 223_)	10/05→	350 A1.000	Petrol	1368	4	8	58
Doblo MPV (119_, 223_)	02/06→12/12	93313090-7U	Petrol	1796	4	8	117
Doblo MPV (119_, 223_)	08/09→	310 A2.011	Petrol	1368	4	8	55
Doblo MPV (263_)	11/09→	310 A2.011	Petrol	1368	4	8	55
Doblo MPV (263_)	02/10→	198 A3.000	Diesel	1598	4	16	92
Doblo MPV (263_)	02/10→	198 A4.000	Petrol	1368	4	16	53
Doblo MPV (263_)	02/10→	199 A3.000	Diesel	1248	4	16	47
Doblo MPV (263_)	02/10→	263 A1.000	Diesel	1956	4	16	144
Doblo MPV (263_)	02/10→	263 A2.000	Diesel	1248	4	16	47
Doblo MPV (263_)	02/10→	263 A4.000	Diesel	1598	4	16	92
Doblo MPV (263_)	02/10→	263 A8.000	Diesel	1598	4	16	92
Doblo MPV (263_)	02/10→	843 A1.000	Petrol	1368	4	16	53
Doblo MPV (263_)	08/10→	370 A0.011	Petrol	1747	4	16	113
Doblo MPV (263_)	03/15→	263 A6.000	Diesel	1248	4	16	47
Doblo MPV (263_)	03/15→	263 A7.000	Diesel	1598	4	16	92
Doblo MPV (263_)	03/15→	940 C1.000	Diesel	1598	4	16	92
Doblo MPV (263_)	03/16→	263 A3.000	Diesel	1598	4	16	92
Doblo MPV (263_)	03/16→	330 A1.000	Diesel	1248	4	16	47
Doblo Platform/Chassis (263_)	02/10→	198 A3.000	Diesel	1598	4	16	92
Doblo Platform/Chassis (263_)	02/10→	199 A3.000	Diesel	1248	4	16	47
Doblo Platform/Chassis (263_)	02/10→	263 A1.000	Diesel	1956	4	16	144
Doblo Platform/Chassis (263_)	02/10→	263 A2.000	Diesel	1248	4	16	47
Doblo Platform/Chassis (263_)	02/10→	263 A4.000	Diesel	1598	4	16	92
Doblo Platform/Chassis (263_)	02/10→	263 A5.000	Diesel	1598	4	16	92
Doblo Platform/Chassis (263_)	02/10→	263 A8.000	Diesel	1598	4	16	92
Doblo Platform/Chassis (263_)	04/10→	843 A1.000	Petrol	1368	4	16	53
Doblo Platform/Chassis (263_)	06/10→	198 A4.000	Petrol	1368	4	16	53
Doblo Platform/Chassis (263_)	02/11→	263 A3.000	Diesel	1598	4	16	92
Doblo Platform/Chassis (263_)	02/11→	263 A9.000	Diesel	1598	4	16	92
Doblo Platform/Chassis (263_)	11/13→	263 A6.000	Diesel	1248	4	16	47
Doblo Platform/Chassis (263_)	02/16→	940 C1.000	Diesel	1598	4	16	92
Doblo Platform/Chassis (263_)	03/16→	225 A2.000	Diesel	1248	4	16	47
Doblo Platform/Chassis (263_)	03/16→	330 A1.000	Diesel	1248	4	16	47
Ducato Box (230_)	03/94→04/02	230 A2.000	Diesel	1929	4	8	123
Ducato Box (230_)	03/94→04/02	230 A3.000	Diesel	1929	4	8	123
Ducato Box (230_)	03/94→04/02	8140.47	Diesel	2500	4	8	180
Ducato Box (230_)	03/94→04/02	8140.47R	Diesel	2500	4	8	180
Ducato Box (230_)	03/94→04/02	8140.67	Diesel	2500	4	8	180
Ducato Box (230_)	03/94→04/02	RFW	Petrol	1998	4	8	155
Ducato Box (230_)	08/94→04/02	230 A4.000	Diesel	1929	4	8	123
Ducato Box (230_)	10/97→04/02	8140.43	Diesel	2800	4	8	190
Ducato Box (230_)	11/97→05/05	8140.43S	Diesel	2798	4	8	190
Ducato Box (230_)	04/98→04/02	DHX (XUD9TF/L)	Diesel	1905	4	8	129
Ducato Box (230_)	04/98→04/02	DJY	Diesel	1905	4	8	129
Ducato Box (230_)	05/98→11/01	DHX	Diesel	1905	4	8	129
Ducato Box (230_)	05/98→04/02	8140.63	Diesel	2800	4	8	190
Ducato Box (230_)	10/01→04/02	RHV (DW10)	Diesel	1997	4	8	158
Ducato Box (230L)	06/94→08/98	8140.47	Diesel	2500	4	8	180
Ducato Box (244_)	04/02→07/06	8140.43	Diesel	2800	4	8	190
Ducato Box (244_)	04/02→	8140.43S	Diesel	2798	4	8	190
Ducato Box (244_)	04/02→	F1AE0481C	Diesel	2286	4	16	168
Ducato Box (244_)	04/02→	RFL	Petrol	1998	4	16	153
Ducato Box (244_)	04/02→	RHV (DW10)	Diesel	1997	4	8	158
Ducato Box (244_)	05/04→	8140.43N	Diesel	2798	4	8	190
Ducato Box (244_)	04/05→	8140.23.2200	Diesel	2800	4	8	190
Ducato Box (244_)	12/09→	F1AE0481T	Diesel	2286	4	16	168
Ducato Box (250_, 290_)	07/06→	4HV	Diesel	2198	4	16	163
Ducato Box (250_, 290_)	07/06→	F1AE0481D	Diesel	2287	4	16	168
Ducato Box (250_, 290_)	07/06→	FPT	Diesel	2287	4	16	168
Ducato Box (250_, 290_)	08/06→	F1AE0481T	Diesel	2286	4	16	168
Ducato Box (250_, 290_)	01/11→	F1AE0481N	Diesel	2287	4	16	168
Ducato Box (250_, 290_)	01/11→	F1AE3481D	Diesel	2287	4	16	168
Ducato Box (250_, 290_)	01/11→	F1AGL411D	Diesel	2287	4	16	168
Ducato Box (250_, 290_)	06/11→	250 A1.000	Diesel	1956	4	16	144
Ducato Box (250_, 290_)	06/11→	250 A2.000	Diesel	1956	4	16	145
Ducato Box (250_, 290_)	06/11→	F1AE3481E	Diesel	2287	4	16	168
Ducato Box (250_, 290_)	10/11→	F1AE3481G	Diesel	2287	4	16	168
Ducato Box (250_, 290_)	12/15→	F1AGL411A	Diesel	2287	4	16	168
Ducato Box (250_, 290_)	12/15→	F1AGL411B	Diesel	2287	4	16	168
Ducato Box (250_, 290_)	12/15→	F1AGL411C	Diesel	2287	4	16	168
Ducato Box (280_)	01/82→10/88	169 B	Petrol	1796	4	8	112
Ducato Box (280_)	01/82→08/90	8144.61	Diesel	2428	4	8	173
Ducato Box (280_)	01/82→08/90	8144.67	Diesel	2500	4	8	183
Ducato Box (280_)	01/82→08/90	CRD93L (U25-661)	Diesel	2500	4	8	186

							
Ducato Box (280_)	01/82→08/90	XN 1T	Petrol	1971	4	8	160
Ducato Box (280_)	07/82→12/88	XM7T	Petrol	1796	4	8	112
Ducato Box (280_)	07/85→08/90	170 B	Petrol	1971	4	8	140
Ducato Box (280_)	09/86→05/90	8140.27	Diesel	2500	4	8	178
Ducato Box (280)	09/86→05/90	8140.27	Diesel	2500	4	8	178
Ducato Box (280_)	09/86→05/90	8140.61	Diesel	2445	4	8	181
Ducato Box (280_)	09/86→09/90	8144.21	Diesel	2445	4	8	181
Ducato Box (280_)	01/88→08/90	149 B1.000	Diesel	1929	4	8	123
Ducato Box (280_)	03/89→08/90	170 D	Petrol	1971	4	8	140
Ducato Box (280_)	03/89→08/90	280 A1.000	Diesel	1929	4	8	123
Ducato Box (290_)	03/89→03/94	280 A1.000	Diesel	1929	4	8	123
Ducato Box (290_)	06/90→05/94	170 D	Petrol	1971	4	8	140
Ducato Box (290_)	06/90→05/94	8144.67	Diesel	2500	4	8	183
Ducato Box (290_)	07/90→03/94	149 B1.000	Diesel	1929	4	8	123
Ducato Box (290_)	07/90→03/94	8140.27	Diesel	2500	4	8	178
Ducato Bus (230_)	03/94→04/02	230 A3.000	Diesel	1929	4	8	123
Ducato Bus (230_)	03/94→04/02	8140.27	Diesel	2500	4	8	178
Ducato Bus (230_)	03/94→04/02	8140.47	Diesel	2500	4	8	180
Ducato Bus (230_)	03/94→04/02	8140.67	Diesel	2500	4	8	180
Ducato Bus (230_)	03/94→04/02	RFW	Petrol	1998	4	8	155
Ducato Bus (230)	06/94→08/98	8140.47	Diesel	2500	4	8	180
Ducato Bus (230_)	07/94→04/02	8140.47R	Diesel	2500	4	8	180
Ducato Bus (230_)	08/94→04/02	230 A4.000	Diesel	1929	4	8	123
Ducato Bus (230_)	06/95→04/02	230 A2.000	Diesel	1929	4	8	123
Ducato Bus (230_)	10/97→04/02	8140.43	Diesel	2800	4	8	190
Ducato Bus (230_)	02/98→04/02	8140.63	Diesel	2800	4	8	190
Ducato Bus (230_)	04/98→04/02	D9B	Diesel	1905	4	8	129
Ducato Bus (230_)	04/98→04/02	D9B (XUD9A)	Diesel	1905	4	8	129
Ducato Bus (230_)	04/98→04/02	DHX (XUD9TF/L)	Diesel	1905	4	8	129
Ducato Bus (230_)	04/98→04/02	DJY	Diesel	1905	4	8	129
Ducato Bus (230_)	05/98→11/01	DHX	Diesel	1905	4	8	129
Ducato Bus (230_)	11/00→04/02	8140.43S	Diesel	2798	4	8	190
Ducato Bus (230_)	10/01→04/02	RHV (DW10)	Diesel	1997	4	8	158
Ducato Bus (244_)	04/02→	8140.43S	Diesel	2798	4	8	190
Ducato Bus (244_)	04/02→	FIAE0481C	Diesel	2286	4	16	168
Ducato Bus (244_)	04/02→	RFL	Petrol	1998	4	16	153
Ducato Bus (244_)	04/02→	RHV (DW10)	Diesel	1997	4	8	158
Ducato Bus (244_)	11/03→07/06	8140.43	Diesel	2800	4	8	190
Ducato Bus (244_)	04/04→07/06	8140.43N	Diesel	2798	4	8	190
Ducato Bus (244_)	04/05→	8140.23.2200	Diesel	2800	4	8	190
Ducato Bus (244_)	12/09→	FIAE0481T	Diesel	2286	4	16	168
Ducato Bus (250_, 290_)	07/06→	4HV	Diesel	2198	4	16	163
Ducato Bus (250_, 290_)	07/06→	FIAE0481D	Diesel	2287	4	16	168
Ducato Bus (250_, 290_)	01/10→	FIAE0481T	Diesel	2286	4	16	168
Ducato Bus (250_, 290_)	01/11→	FIAE0481N	Diesel	2287	4	16	168
Ducato Bus (250_, 290_)	01/11→	FIAE3481D	Diesel	2287	4	16	168
Ducato Bus (250_, 290_)	01/11→	FIAGL411D	Diesel	2287	4	16	168
Ducato Bus (250_, 290_)	01/11→	FIAGL411M	Diesel	2287	4	16	168
Ducato Bus (250_, 290_)	06/11→	250 A1.000	Diesel	1956	4	16	144
Ducato Bus (250_, 290_)	06/11→	250 A2.000	Diesel	1956	4	16	145
Ducato Bus (250_, 290_)	06/11→	FIAE3481E	Diesel	2287	4	16	168
Ducato Bus (250_, 290_)	10/11→	FIAE3481G	Diesel	2287	4	16	168
Ducato Bus (250_, 290_)	04/15→	FIAGL411A	Diesel	2287	4	16	168
Ducato Bus (250_, 290_)	04/15→	FIAGL411C	Diesel	2287	4	16	168
Ducato Bus (250_, 290_)	12/15→	FIAGL411B	Diesel	2287	4	16	168
Ducato Panorama (280_)	07/82→05/85	XN 1T	Petrol	1971	4	8	160
Ducato Panorama (280_)	07/82→12/85	8144.61	Diesel	2428	4	8	173
Ducato Panorama (280_)	07/82→12/88	XM7T	Petrol	1796	4	8	112
Ducato Panorama (280_)	01/86→08/90	170 B	Petrol	1971	4	8	140
Ducato Panorama (280_)	01/86→08/90	8144.21	Diesel	2445	4	8	181
Ducato Panorama (280_)	01/86→08/90	8144.67	Diesel	2500	4	8	183
Ducato Panorama (280_)	01/86→08/90	CRD93L (U25-661)	Diesel	2500	4	8	186
Ducato Panorama (280_)	09/86→05/90	8140.27	Diesel	2500	4	8	178
Ducato Panorama (280_)	01/87→08/90	8144.21.220	Diesel	2445	4	8	182
Ducato Panorama (280_)	02/87→08/90	149 B1.000	Diesel	1929	4	8	123
Ducato Panorama (280_)	09/88→08/90	170 D	Petrol	1971	4	8	140
Ducato Panorama (280_)	03/89→08/90	280 A1.000	Diesel	1929	4	8	123
Ducato Panorama (290_)	06/90→05/94	170 D	Petrol	1971	4	8	140
Ducato Panorama (290_)	06/90→05/94	8140.27	Diesel	2500	4	8	178
Ducato Panorama (290_)	07/90→03/94	149 B1.000	Diesel	1929	4	8	123
Ducato Panorama (290_)	07/90→03/94	280 A1.000	Diesel	1929	4	8	123
Ducato Panorama (290_)	07/90→03/94	8144.67	Diesel	2500	4	8	183
Ducato Platform/Chassis (230_)	03/94→04/02	230 A2.000	Diesel	1929	4	8	123
Ducato Platform/Chassis (230_)	03/94→04/02	230 A3.000	Diesel	1929	4	8	123
Ducato Platform/Chassis (230_)	03/94→04/02	8140.47	Diesel	2500	4	8	180
Ducato Platform/Chassis (230_)	03/94→04/02	8140.47R	Diesel	2500	4	8	180
Ducato Platform/Chassis (230_)	03/94→04/02	8140.67	Diesel	2500	4	8	180
Ducato Platform/Chassis (230_)	03/94→04/02	RFW	Petrol	1998	4	8	155











Ducato Platform/Chassis (230)	06/94→08/98	8140.47	Diesel	2500	4	8	180
Ducato Platform/Chassis (230_)	08/94→04/02	230 A4.000	Diesel	1929	4	8	123
Ducato Platform/Chassis (230_)	02/98→04/02	8140.63	Diesel	2800	4	8	190
Ducato Platform/Chassis (230_)	04/98→04/02	DXH (XUD9TF/L)	Diesel	1905	4	8	129
Ducato Platform/Chassis (230_)	04/98→04/02	DJY	Diesel	1905	4	8	129
Ducato Platform/Chassis (230_)	05/98→11/01	DXH	Diesel	1905	4	8	129
Ducato Platform/Chassis (230_)	05/98→04/02	8140.43	Diesel	2800	4	8	190
Ducato Platform/Chassis (230_)	11/00→04/02	8140.43S	Diesel	2798	4	8	190
Ducato Platform/Chassis (230_)	07/01→04/02	RHV (DW10)	Diesel	1997	4	8	158
Ducato Platform/Chassis (244_)	04/02→07/06	8140.43S	Diesel	2798	4	8	190
Ducato Platform/Chassis (244_)	04/02→07/06	F1AE0481C	Diesel	2286	4	16	168
Ducato Platform/Chassis (244_)	04/02→07/06	RFL	Petrol	1998	4	16	153
Ducato Platform/Chassis (244_)	04/02→07/06	RHV (DW10)	Diesel	1997	4	8	158
Ducato Platform/Chassis (244_)	11/03→07/06	8140.43	Diesel	2800	4	8	190
Ducato Platform/Chassis (244_)	05/04→07/06	8140.43N	Diesel	2798	4	8	190
Ducato Platform/Chassis (244_)	04/05→07/06	8140.23.2200	Diesel	2800	4	8	190
Ducato Platform/Chassis (244_)	12/09→	F1AE0481T	Diesel	2286	4	16	168
Ducato Platform/Chassis (250_ , 290_)	07/06→	4HV	Diesel	2198	4	16	163
Ducato Platform/Chassis (250_ , 290_)	07/06→	F1AE0481D	Diesel	2287	4	16	168
Ducato Platform/Chassis (250_ , 290_)	07/06→	F1AE0481N	Diesel	2287	4	16	168
Ducato Platform/Chassis (250_ , 290_)	07/06→	F1AE3481D	Diesel	2287	4	16	168
Ducato Platform/Chassis (250_ , 290_)	07/06→	F1AGL411D	Diesel	2287	4	16	168
Ducato Platform/Chassis (250_ , 290_)	08/06→	F1AE0481T	Diesel	2286	4	16	168
Ducato Platform/Chassis (250_ , 290_)	06/11→	250 A1.000	Diesel	1956	4	16	144
Ducato Platform/Chassis (250_ , 290_)	06/11→	250 A2.000	Diesel	1956	4	16	145
Ducato Platform/Chassis (250_ , 290_)	06/11→	F1AE3481E	Diesel	2287	4	16	168
Ducato Platform/Chassis (250_ , 290_)	10/11→	F1AE3481G	Diesel	2287	4	16	168
Ducato Platform/Chassis (250_ , 290_)	12/15→	F1AGL411B	Diesel	2287	4	16	168
Ducato Platform/Chassis (250_ , 290_)	12/15→	F1AGL411C	Diesel	2287	4	16	168
Ducato Platform/Chassis (280_)	07/82→08/90	8144.67	Diesel	2500	4	8	183
Ducato Platform/Chassis (280_)	07/82→08/90	CRD93L (U25-661)	Diesel	2500	4	8	186
Ducato Platform/Chassis (280_)	07/85→08/90	170 B	Petrol	1971	4	8	140
Ducato Platform/Chassis (280_)	07/85→08/90	XN IT	Petrol	1971	4	8	160
Ducato Platform/Chassis (280_)	01/86→08/90	8144.21	Diesel	2445	4	8	181
Ducato Platform/Chassis (280_)	09/86→05/90	8140.27	Diesel	2500	4	8	178
Ducato Platform/Chassis (280_)	01/88→08/90	149 B1.000	Diesel	1929	4	8	123
Ducato Platform/Chassis (280_)	08/88→08/90	170 D	Petrol	1971	4	8	140
Ducato Platform/Chassis (280_)	03/89→08/90	280 A1.000	Diesel	1929	4	8	123
Ducato Platform/Chassis (290_)	03/89→03/94	280 A1.000	Diesel	1929	4	8	123
Ducato Platform/Chassis (290_)	03/89→03/94	8144.67	Diesel	2500	4	8	183
Ducato Platform/Chassis (290_)	06/90→05/94	149 B1.000	Diesel	1929	4	8	123
Ducato Platform/Chassis (290_)	06/90→05/94	170 D	Petrol	1971	4	8	140
Ducato Platform/Chassis (290_)	07/90→03/94	8140.27	Diesel	2500	4	8	178
Duna (146_)	01/87→12/91	146 A5.000	Petrol	1301	4	8	46
Duna (146_)	01/87→12/91	146 A6.000	Petrol	1116	4	8	27
Duna (146_)	01/87→12/91	149 B3.000	Diesel	1698	4	8	106
Duna Saloon	07/91→10/95	146 A.048	Petrol	903	4	8	12
Duna Saloon	07/91→07/96	146 A4.048	Petrol	1116	4	8	27
Duna Saloon	07/91→07/96	160 A1.046	Petrol	1372	4	8	48
Duna Saloon	02/96→09/00	159 A3.000	Petrol	1581	4	8	85
Duna Weekend (146_)	01/87→12/91	146 A5.000	Petrol	1301	4	8	46
Duna Weekend (146_)	01/87→12/91	146 A6.000	Petrol	1116	4	8	27
Duna Weekend (146_)	01/87→12/91	146 B2.000	Diesel	1698	4	8	106
Duna Weekend (146_)	01/87→12/91	149 B3.000	Diesel	1698	4	8	106
Elba (146_)	10/85→09/93	146 A3.011	Petrol	1497	4	8	69
Elba (146_)	10/85→12/93	127 A2.011	Petrol	1297	4	8	42
Elba (146_)	04/86→10/92	127 A5.000	Diesel	1302	4	8	43
Elba (146_)	04/86→12/96	149 C1.000	Petrol	1499	4	8	67
Elba (146_)	03/88→02/97	146 B7.011	Petrol	1581	4	8	82
Elba (146_)	04/89→12/93	159 A3.000	Petrol	1581	4	8	85
Elba (146_)	04/89→10/97	146 B2.000	Diesel	1698	4	8	106
Elba (146_)	11/89→12/97	146 B6.011	Petrol	1581	4	8	82
Elba (146_)	04/91→02/95	146 A5.000	Petrol	1301	4	8	46
Elba (146_)	01/92→12/96	146 D1.011	Petrol	1497	4	8	69
Elba (146_)	10/93→02/95	146 D5.000	Petrol	1372	4	8	48
Elba (146_)	01/94→12/96	146 C6.000	Petrol	1581	4	8	82
Elba (146_)	01/94→12/96	146 D6.000	Petrol	1581	4	8	82
Eva	03/12→	N54 B30 A	Petrol	2979	6	24	193
Fiorino (127_)	10/77→10/86	100 GL.000	Petrol	903	4	8	13
Fiorino (127_)	01/80→12/87	127 A.000	Petrol	1049	4	8	17
Fiorino (147_)	01/80→12/87	127 A.000	Petrol	1049	4	8	17
Fiorino (147_)	03/82→01/88	127 A5.000	Diesel	1302	4	8	43
Fiorino (147_)	11/86→04/88	146 A9.000	Petrol	1116	4	8	27
Fiorino (147_)	12/86→04/88	156 A.000	Petrol	1049	4	8	17
Fiorino (147_)	12/87→08/93	146 A5.000	Petrol	1301	4	8	46
Fiorino Box	11/13→	327 A.011	Petrol	1368	4	8	59
Fiorino Box (146_)	01/88→12/94	146 A5.000	Petrol	1301	4	8	46
Fiorino Box (146_)	01/88→10/99	146 B2.000	Diesel	1698	4	8	106

				CC			9
Fiorino Box (146_)	05/88→12/93	146 A9.000	Petrol	1116	4	8	27
Fiorino Box (146_)	05/88→09/96	149 C1.000	Petrol	1499	4	8	67
Fiorino Box (146_)	05/88→05/00	149 B3.000	Diesel	1698	4	8	106
Fiorino Box (146_)	05/88→12/04	146 A3.011	Petrol	1497	4	8	69
Fiorino Box (146_)	01/89→05/01	146 C5.000	Petrol	1372	4	8	48
Fiorino Box (146_)	01/89→05/01	146 D5.000	Petrol	1372	4	8	48
Fiorino Box (146_)	11/92→04/96	156 A2.246	Petrol	999	4	8	18
Fiorino Box (146_)	11/92→10/96	146 C5.000	Petrol	1372	4	8	48
Fiorino Box (146_)	10/93→05/01	146 C6.000	Petrol	1581	4	8	82
Fiorino Box (146_)	10/93→05/01	146 D6.000	Petrol	1581	4	8	82
Fiorino Box (146_)	01/95→12/96	146 A7.011	Petrol	994	4	8	19
Fiorino Box (146_)	09/96→12/04	178 A6.011	Petrol	1497	4	8	70
Fiorino Box (146_)	11/96→05/01	146 D7.000	Diesel	1698	4	8	106
Fiorino Box (146_)	01/04→08/06	176 A3.000	Diesel	1698	4	8	106
Fiorino Box (146_)	01/04→	178 B5.000	Petrol	1242	4	8	37
Fiorino Box Body / Estate (225_)	01/07→	178 E9.011	Petrol	1242	4	8	38
Fiorino Box Body / Estate (225_)	11/07→	199 A2.000	Diesel	1248	4	16	47
Fiorino Box Body / Estate (225_)	11/07→	199 A9.000	Diesel	1248	4	16	47
Fiorino Box Body / Estate (225_)	11/07→	KFT	Petrol	1360	4	8	66
Fiorino Box Body / Estate (225_)	11/07→	KFV	Petrol	1360	4	8	66
Fiorino Box Body / Estate (225_)	06/08→	350 A1.000	Petrol	1368	4	8	58
Fiorino Box Body / Estate (225_)	07/09→	199 B1.000	Diesel	1248	4	16	47
Fiorino Box Body / Estate (225_)	07/09→	330 A1.000	Diesel	1248	4	16	47
Fiorino Box Body / Estate (225_)	03/15→	225 A2.000	Diesel	1248	4	16	47
Fiorino Pick up (146_)	01/88→10/92	149 C1.000	Petrol	1499	4	8	67
Fiorino Pick up (146_)	01/88→12/94	146 A5.000	Petrol	1301	4	8	46
Fiorino Pick up (146_)	01/88→05/01	146 C6.000	Petrol	1581	4	8	82
Fiorino Pick up (146_)	01/88→05/01	146 D6.000	Petrol	1581	4	8	82
Fiorino Pick up (146_)	05/88→09/96	146 D1.011	Petrol	1497	4	8	69
Fiorino Pick up (146_)	05/88→10/99	149 B3.000	Diesel	1698	4	8	106
Fiorino Pick up (146_)	01/89→03/00	146 C5.000	Petrol	1372	4	8	48
Fiorino Pick up (146_)	01/89→05/01	146 D5.000	Petrol	1372	4	8	48
Fiorino Pick up (146_)	05/91→10/96	146 B7.011	Petrol	1581	4	8	82
Fiorino Pick up (146_)	05/91→10/96	160 A2.011	Petrol	1581	4	8	85
Fiorino Pick up (146_)	10/93→10/99	146 B2.000	Diesel	1698	4	8	106
Fiorino Pick up (146_)	01/94→11/95	146 A7.011	Petrol	994	4	8	19
Fiorino Pick up (146_)	01/97→05/01	146 D7.000	Diesel	1698	4	8	106
Fiorino Pick up (147_)	12/78→06/88	127 A2.011	Petrol	1297	4	8	42
Fiorino Pick up (147_)	06/82→10/87	127 A.000	Petrol	1049	4	8	17
Fiorino Pick up (147_)	06/82→10/87	127A.046	Petrol	1049	4	8	17
Fiorino Pick up (147_)	05/84→12/88	127 A5.000	Diesel	1302	4	8	43
Fiorino Pick up (147_)	12/86→10/89	156 A.000	Petrol	1049	4	8	17
Four Four	01/80→06/85	132 C1.000	Petrol	1756	4	8	103
Four Four	08/82→09/91	LUA	Petrol	1597	4	8	96
Four Four	08/91→12/93	LJA	Petrol	1597	4	8	96
Four Four	01/06→04/08	CHBA	Petrol	1798	4	16	118
Four Four	03/08→	RHBA	Petrol	1596	4	16	99
Four Four	01/09→	ZSG416	Petrol	1595	4	16	100
Freemont (345_)	08/11→	939 B5.000	Diesel	1956	4	16	144
Freemont (345_)	08/11→	940 A5.000	Diesel	1956	4	16	144
Freemont (345_)	08/11→	ED3	Petrol	2360	4	16	175
Freemont (345_)	08/11→	EDG	Petrol	2360	4	16	175
Freemont (345_)	08/11→	ERB	Petrol	3604	6	24	199
Fullback Pickup (502_ , 503_)	01/16→	4D56	Diesel	2477	4	16	176
Fullback Pickup (502_ , 503_)	01/16→	4G64	Petrol	2351	4	16	169
Grande Punto (199_)	10/05→	199 A2.000	Diesel	1248	4	16	47
Grande Punto (199_)	10/05→	199 A3.000	Diesel	1248	4	16	47
Grande Punto (199_)	10/05→	199 A4.000	Petrol	1242	4	8	41
Grande Punto (199_)	10/05→	199 A5.000	Diesel	1910	4	8	125
Grande Punto (199_)	10/05→	199 A6.000	Petrol	1368	4	16	53
Grande Punto (199_)	10/05→	350 A1.000	Petrol	1368	4	8	58
Grande Punto (199_)	10/05→	939 A1.000	Diesel	1910	4	8	125
Grande Punto (199_)	06/06→12/09	939 A7.000	Diesel	1910	4	8	125
Grande Punto (199_)	06/06→	199 A7.000	Petrol	1368	4	8	58
Grande Punto (199_)	09/06→	323 B6.600	Petrol	1368	4	16	53
Grande Punto (199_)	08/07→06/10	310 A2.011	Petrol	1368	4	8	55
Grande Punto (199_)	08/07→06/10	J2	Petrol	1796	4	8	117
Grande Punto (199_)	08/07→06/10	Y2	Petrol	1796	4	8	117
Grande Punto (199_)	09/07→07/12	198 A1.000	Petrol	1368	4	16	53
Grande Punto (199_)	09/07→	198 A4.000	Petrol	1368	4	16	53
Grande Punto (199_)	12/07→12/12	199 A8.000	Petrol	1368	4	16	53
Grande Punto (199_)	12/07→12/12	955 A8.000	Petrol	1368	4	16	61
Grande Punto (199_)	07/08→	199 B2.000	Diesel	1248	4	16	47
Grande Punto (199_)	07/08→	955 A3.000	Diesel	1598	4	16	92
Grande Punto (199_)	09/08→	310 A5.011	Petrol	1598	4	16	93
Grande Punto (199_)	04/10→	199 B4.000	Diesel	1248	4	16	47
Grande Punto (199_)	04/10→	223 A9.000	Diesel	1248	4	16	47
Grande Punto (199_)	07/10→07/12	370 A0.011	Petrol	1747	4	16	113



Model	Year	Engine	Fuel	CC	Wrench	Screwdriver	Box 9
Grande Punto (199_)	09/10→	169 A4.000	Petrol	1242	4	8	34
Grand Siena (372_)	01/12→	310 A1.011	Petrol	999	4	8	21
Grand Siena (372_)	01/12→	310 A5.011	Petrol	1598	4	16	93
Grand Siena (372_)	01/12→	327 A.011	Petrol	1368	4	8	59
Grand Siena (372_)	06/12→	370 A0.011	Petrol	1747	4	16	113
GV Hatchback	09/85→12/89	11A	Petrol	1116	4	8	24
GVL Hatchback	09/87→12/89	11A	Petrol	1116	4	8	24
GVS Hatchback	09/87→12/88	11A	Petrol	1116	4	8	24
Hexa	06/17→	DW12DD	Diesel	2179	4	16	164
Idea (350_)	12/03→	192 B2.000	Petrol	1368	4	16	57
Idea (350_)	01/04→	188 A5.000	Petrol	1242	4	16	40
Idea (350_)	01/04→	188 A9.000	Diesel	1248	4	16	47
Idea (350_)	01/04→	188 B2.000	Diesel	1910	4	8	125
Idea (350_)	01/04→	843 A1.000	Petrol	1368	4	16	53
Idea (350_)	09/05→	178 F3.011	Petrol	1368	4	8	55
Idea (350_)	09/05→	93313090-7U	Petrol	1796	4	8	117
Idea (350_)	10/05→	199 A3.000	Diesel	1248	4	16	47
Idea (350_)	10/05→	350 A1.000	Petrol	1368	4	8	58
Idea (350_)	05/08→12/12	199 B1.000	Diesel	1248	4	16	47
Idea (350_)	05/08→	350 A2.000	Diesel	1598	4	16	92
Idea (350_)	11/08→12/10	350 A3.000	Diesel	1598	4	16	92
Idea (350_)	08/10→	310 A5.011	Petrol	1598	4	16	93
Idea (350_)	08/10→	370 A0.011	Petrol	1747	4	16	113
Indica Vista	08/08→	169 A2.000	Diesel	1248	4	16	33
Indica Vista	10/10→	192 B2.000	Petrol	1368	4	16	57
Indica Vista	10/10→	199 A7.000	Petrol	1368	4	8	58
Indigo Manza	08/09→	169 A1.000	Diesel	1248	4	16	33
Indigo Manza	08/09→	350 A1.000	Petrol	1368	4	8	58
Koral	10/02→11/08	128 A.064	Petrol	1116	4	8	27
Koral	10/02→11/08	TU1JP	Petrol	1124	4	8	31
Lanos Hatchback	10/04→	A13SM	Petrol	1349	4	8	62
Lanos Hatchback	10/04→	A15SM	Petrol	1498	4	8	72
Lanos Hatchback	10/04→	A16DMS	Petrol	1598	4	16	95
Lanos Hatchback	01/11→	F14D4	Petrol	1399	4	16	65
Lanos Pick-Up	10/04→	A13SM	Petrol	1349	4	8	62
Lanos Pick-Up	10/04→	A15SM	Petrol	1498	4	8	72
Lanos Saloon	10/04→	A13SM	Petrol	1349	4	8	62
Lanos Saloon	10/04→	A15SM	Petrol	1498	4	8	72
Lanos Saloon	10/04→	A16DMS	Petrol	1598	4	16	95
Lanos Saloon	01/11→	F14D4	Petrol	1399	4	16	65
Linea (323_)	06/07→	199 A3.000	Diesel	1248	4	16	47
Linea (323_)	06/07→	350 A1.000	Petrol	1368	4	8	58
Linea (323_)	09/07→	198 A4.000	Petrol	1368	4	16	53
Linea (323_)	09/07→	323 B6.600	Petrol	1368	4	16	53
Linea (323_)	01/08→	199 A2.000	Diesel	1248	4	16	47
Linea (323_)	10/08→	198 A1.000	Petrol	1368	4	16	53
Linea (323_)	10/08→	310 A3.011	Petrol	1839	4	16	127
Linea (323_)	01/09→	370 A0.011	Petrol	1747	4	16	113
Linea (323_)	06/09→	198 A3.000	Diesel	1598	4	16	92
Marea (185_)	09/96→04/99	182 A1.000	Petrol	1998	5	20	142
Marea (185_)	09/96→04/99	185 A2.000	Diesel	2387	5	10	170
Marea (185_)	09/96→05/02	182 A2.000	Petrol	1747	4	16	113
Marea (185_)	09/96→05/02	182 A3.000	Petrol	1370	4	12	56
Marea (185_)	09/96→05/02	182 A4.000	Petrol	1581	4	16	88
Marea (185_)	09/96→05/02	182 A7.000	Diesel	1910	4	8	125
Marea (185_)	09/96→05/02	182 A8.000	Diesel	1910	4	8	125
Marea (185_)	09/96→12/07	183 A1.000	Petrol	1747	4	16	113
Marea (185_)	04/97→05/02	185 A3.000	Petrol	1581	4	16	89
Marea (185_)	05/98→09/00	185 A5.011	Petrol	1998	5	20	143
Marea (185_)	10/98→05/02	182 B2.000	Petrol	1242	4	16	36
Marea (185)	03/99→08/00	185 A3.000	Petrol	1581	4	16	89
Marea (185_)	04/99→01/01	182 B7.000	Petrol	1998	5	20	142
Marea (185_)	04/99→05/02	185 A6.000	Diesel	2387	5	10	170
Marea (185_)	04/99→05/02	186 A4.000	Petrol	1581	4	16	89
Marea (185_)	04/99→05/02	839 A5.000	Diesel	2387	5	10	170
Marea (185_)	04/99→12/07	182 B4.000	Diesel	1910	4	8	125
Marea (185_)	08/00→12/07	185 A7.011	Petrol	2446	5	20	171
Marea (185_)	09/00→08/02	182 B5.098	Petrol	1581	4	16	89
Marea (185_)	09/00→06/06	192 A2.000	Petrol	2446	5	20	171
Marea (185_)	09/00→12/07	182 B6.000	Petrol	1596	4	16	88
Marea (185_)	01/01→05/02	185 A8.000	Petrol	1998	5	20	142
Marea (185_)	01/01→05/02	186 A6.000	Diesel	1910	4	8	125
Marea (185_)	01/01→12/07	182 B9.000	Diesel	1910	4	8	125
Marea (185_)	08/05→12/07	185 A4.011	Petrol	1998	5	20	142
Marea Weekend (185_)	09/96→04/99	182 A1.000	Petrol	1998	5	20	142
Marea Weekend (185_)	09/96→04/99	185 A2.000	Diesel	2387	5	10	170
Marea Weekend (185_)	09/96→05/02	182 A2.000	Petrol	1747	4	16	113
Marea Weekend (185_)	09/96→05/02	182 A3.000	Petrol	1370	4	12	56

							
Marea Weekend (185_)	09/96→05/02	182 A4.000	Petrol	1581	4	16	88
Marea Weekend (185_)	09/96→05/02	182 A7.000	Diesel	1910	4	8	125
Marea Weekend (185_)	09/96→05/02	182 A8.000	Diesel	1910	4	8	125
Marea Weekend (185_)	09/96→12/07	182 B9.000	Diesel	1910	4	8	125
Marea Weekend (185_)	05/98→09/00	185 A5.011	Petrol	1998	5	20	143
Marea Weekend (185_)	10/98→05/02	182 B2.000	Petrol	1242	4	16	36
Marea Weekend (185_)	12/98→12/07	185 A4.011	Petrol	1998	5	20	142
Marea Weekend (185_)	04/99→05/02	185 A6.000	Diesel	2387	5	10	170
Marea Weekend (185_)	04/99→05/02	839 A5.000	Diesel	2387	5	10	170
Marea Weekend (185_)	04/99→02/03	182 B7.000	Petrol	1998	5	20	142
Marea Weekend (185_)	04/99→12/07	182 B4.000	Diesel	1910	4	8	125
Marea Weekend (185_)	08/99→12/07	183 A1.000	Petrol	1747	4	16	113
Marea Weekend (185_)	07/00→12/07	185 A7.011	Petrol	2446	5	20	171
Marea Weekend (185_)	09/00→06/06	192 A2.000	Petrol	2446	5	20	171
Marea Weekend (185_)	09/00→12/07	182 B6.000	Petrol	1596	4	16	88
Marea Weekend (185_)	01/01→05/02	185 A8.000	Petrol	1998	5	20	142
Marea Weekend (185_)	01/01→05/02	186 A6.000	Diesel	1910	4	8	125
Mille	12/13→	146 E1.011	Petrol	999	4	8	21
Movus	05/14→	DW12DD	Diesel	2179	4	16	164
Multipla (186_)	04/99→06/10	182 A4.000	Petrol	1581	4	16	88
Multipla (186_)	04/99→06/10	182 B4.000	Diesel	1910	4	8	125
Multipla (186_)	04/99→06/10	186 A3.000	Petrol	1581	4	16	89
Multipla (186_)	04/99→06/10	186 A4.000	Petrol	1581	4	16	89
Multipla (186_)	09/00→06/10	182 B6.000	Petrol	1596	4	16	88
Multipla (186_)	03/01→07/02	186 A6.000	Diesel	1910	4	8	125
Multipla (186_)	04/02→06/10	186 A9.000	Diesel	1910	4	8	125
Multipla (186_)	07/02→06/10	186 A8.000	Diesel	1910	4	8	125
Oggi Saloon	02/83→12/85	127 A2.011	Petrol	1297	4	8	42
Palio (26_, 27_, 28_)	11/11→	146 E1.011	Petrol	999	4	8	21
Palio (26_, 27_, 28_)	11/11→	310 A1.011	Petrol	999	4	8	21
Palio (26_, 27_, 28_)	11/11→	310 A2.011	Petrol	1368	4	8	55
Palio (26_, 27_, 28_)	11/11→	310 A5.011	Petrol	1598	4	16	93
Palio (26_, 27_, 28_)	11/11→	327 A.011	Petrol	1368	4	8	59
Palio (178BX)	04/96→11/99	178 A6.011	Petrol	1497	4	8	70
Palio (178BX)	04/96→08/01	178 B2.016	Petrol	1372	4	8	48
Palio (178BX)	04/96→09/02	176 B3.000	Diesel	1698	4	8	106
Palio (178BX)	04/96→10/02	178 B2.000	Petrol	1372	4	8	48
Palio (178BX)	04/96→02/03	178 B3.000	Petrol	1581	4	16	88
Palio (178BX)	04/96→10/03	178 A1.000	Petrol	994	4	8	19
Palio (178BX)	04/96→	178 D2.011	Petrol	1581	4	16	89
Palio (178BX)	06/96→	182 B6.000	Petrol	1596	4	16	88
Palio (178BX)	02/97→	176 A3.000	Diesel	1698	4	8	106
Palio (178BX)	02/97→	176 A5.000	Diesel	1698	4	8	106
Palio (178BX)	07/97→10/00	178 C7.098	Petrol	1581	4	16	88
Palio (178BX)	07/97→08/02	188 A4.000	Petrol	1242	4	8	39
Palio (178BX)	07/97→10/03	178 B7.045	Petrol	1242	4	8	37
Palio (178BX)	07/97→10/03	178 B9.033	Petrol	1108	4	8	29
Palio (178BX)	07/97→	178 C4.066	Petrol	1242	4	8	37
Palio (178BX)	06/98→	176 A8.000	Petrol	1242	4	8	35
Palio (178BX)	06/98→	178 B5.000	Petrol	1242	4	8	37
Palio (178BX)	06/98→	178 E2.000	Petrol	1242	4	8	35
Palio (178BX)	03/00→	178 D9.011	Petrol	999	4	8	21
Palio (178BX)	08/00→02/03	178D8.011	Petrol	999	4	16	22
Palio (178BX)	09/00→	223 A6.000	Diesel	1910	4	8	125
Palio (178BX)	06/01→	188 A5.000	Petrol	1242	4	16	40
Palio (178BX)	02/03→	93313090-7U	Petrol	1796	4	8	117
Palio (178BX)	06/03→	188 A9.000	Diesel	1248	4	16	47
Palio (178BX)	06/03→	834 A1.000	Petrol	1368	4	16	60
Palio (178BX)	10/03→	178 F1.011	Petrol	999	4	8	21
Palio (178BX)	10/03→	93313090-H2	Petrol	1796	4	8	117
Palio (178BX)	11/03→	178 E9.011	Petrol	1242	4	8	38
Palio (178BX)	06/04→	178 E5.022	Petrol	1461	4	8	71
Palio (178BX)	04/05→	178 F3.011	Petrol	1368	4	8	55
Palio (178BX)	10/05→	350 A1.000	Petrol	1368	4	8	58
Palio (178BX)	06/06→	178 E7.000	Petrol	1596	4	16	90
Palio (178BX)	06/06→	187 A1.000	Petrol	1108	4	8	30
Palio (178BX)	01/09→	310 A1.011	Petrol	999	4	8	21
Palio (178BX)	01/09→	310 A2.011	Petrol	1368	4	8	55
Palio (178BX)	08/10→	310 A5.011	Petrol	1598	4	16	93
Palio Fire	01/14→	146 E1.011	Petrol	999	4	8	21
Palio Hatchback	01/02→	188 A4.000	Petrol	1242	4	8	39
Palio Hatchback	01/02→	188 A5.000	Petrol	1242	4	16	40
Palio Weekend (178_)	04/96→02/01	178 B5.000	Petrol	1242	4	8	37
Palio Weekend (178_)	04/96→03/01	176 A3.000	Diesel	1698	4	8	106
Palio Weekend (178_)	04/96→	178 B3.000	Petrol	1581	4	16	88
Palio Weekend (178_)	02/97→02/04	178 A6.011	Petrol	1497	4	8	70
Palio Weekend (178_)	07/97→08/01	178 C9.066	Diesel	1698	4	8	106
Palio Weekend (178_)	07/97→12/07	178 D2.011	Petrol	1581	4	16	89











CC



9

Palió Weekend (178_)	07/97→	176 A5.000	Diesel	1698	4	8	106
Palió Weekend (178_)	07/97→	178 C7.098	Petrol	1581	4	16	88
Palió Weekend (178_)	07/97→	188 A4.000	Petrol	1242	4	8	39
Palió Weekend (178_)	07/98→10/03	178 A1.000	Petrol	994	4	8	19
Palió Weekend (178_)	06/99→10/02	178 E2.000	Petrol	1242	4	8	35
Palió Weekend (178_)	09/00→	310 A1.011	Petrol	999	4	8	21
Palió Weekend (178_)	02/01→	178 C4.066	Petrol	1242	4	8	37
Palió Weekend (178_)	02/01→	182 B6.000	Petrol	1596	4	16	88
Palió Weekend (178_)	03/01→	223 A6.000	Diesel	1910	4	8	125
Palió Weekend (178_)	09/01→	188 A2.000	Diesel	1910	4	8	125
Palió Weekend (178_)	09/01→	188 A5.000	Petrol	1242	4	16	40
Palió Weekend (178_)	02/02→	178 E5.022	Petrol	1461	4	8	71
Palió Weekend (178_)	09/02→02/04	178 B7.045	Petrol	1242	4	8	37
Palió Weekend (178_)	03/04→	93313090-7U	Petrol	1796	4	8	117
Palió Weekend (178_)	04/05→	178 F3.011	Petrol	1368	4	8	55
Palió Weekend (178_)	05/06→	93313090-H2	Petrol	1796	4	8	117
Palió Weekend (178_)	01/10→	370 A0.011	Petrol	1747	4	16	113
Palió Weekend (178_)	08/10→	310 A5.011	Petrol	1598	4	16	93
Palió Weekend (178DX)	07/97→08/01	178 B2.000	Petrol	1372	4	8	48
Palió Weekend (178DX)	10/01→10/04	178 A6.011	Petrol	1497	4	8	70
Palió Weekend (178DX)	01/04→	178 E9.011	Petrol	1242	4	8	38
Palió Weekend (178DX)	02/05→	310 A2.011	Petrol	1368	4	8	55
Palió Weekend (178DX)	10/05→	178 F3.011	Petrol	1368	4	8	55
Palió Weekend (373_)	06/12→	310 A2.011	Petrol	1368	4	8	55
Palió Weekend (373_)	06/12→	310 A5.011	Petrol	1598	4	16	93
Palió Weekend (373_)	06/12→	327 A.011	Petrol	1368	4	8	59
Palió Weekend (373_)	06/12→	370 A0.011	Petrol	1747	4	16	113
Panda (141_)	10/80→06/94	100 GL3.000	Petrol	903	4	8	13
Panda (141_)	10/80→06/94	146 A.000	Petrol	903	4	8	13
Panda (141_)	02/81→12/85	100 GL6.000	Petrol	843	4	8	7
Panda (141_)	01/82→07/04	141 A.000	Petrol	652	2	4	4
Panda (141_)	09/82→12/86	A 112 B1.054	Petrol	965	4	8	13
Panda (141_)	01/85→12/92	156 A3.000	Petrol	999	4	8	18
Panda (141_)	01/86→07/89	156 A3.100	Petrol	999	4	8	18
Panda (141_)	01/86→04/92	156 A2.100	Petrol	999	4	8	18
Panda (141_)	01/86→10/03	156 A4.000	Petrol	770	4	8	5
Panda (141_)	04/86→12/92	156 A5.000	Diesel	1302	4	8	43
Panda (141_)	05/86→08/98	141 C2.000	Petrol	999	4	8	18
Panda (141_)	05/86→08/98	156 A2.246	Petrol	999	4	8	18
Panda (141_)	05/91→07/04	156 C.046	Petrol	1108	4	8	29
Panda (141_)	04/92→12/96	1170 A1.046	Petrol	899	4	8	14
Panda (141_)	02/95→09/03	187 A1.000	Petrol	1108	4	8	30
Panda (141_)	02/95→07/04	176 B2.000	Petrol	1108	4	8	29
Panda (141A_)	10/80→04/86	146 A.048	Petrol	903	4	8	12
Panda (169_)	09/03→	187 A1.000	Petrol	1108	4	8	30
Panda (169_)	09/03→	188 A4.000	Petrol	1242	4	8	39
Panda (169_)	09/03→	188 A8.000	Diesel	1248	4	16	47
Panda (169_)	09/03→	188 A9.000	Diesel	1248	4	16	47
Panda (169_)	06/06→	169 A1.000	Diesel	1248	4	16	33
Panda (169_)	06/06→	169 A5.000	Diesel	1248	4	16	33
Panda (169_)	10/06→	169 A3.000	Petrol	1368	4	16	53
Panda (169_)	11/09→	169 A4.000	Petrol	1242	4	8	34
Panda (169_)	01/10→	350 A1.000	Petrol	1368	4	8	58
Panda (312_, 319_)	02/12→	169 A4.000	Petrol	1242	4	8	34
Panda (312_, 319_)	02/12→	199 A1.000	Diesel	1248	4	16	47
Panda (312_, 319_)	02/12→	199 A9.000	Diesel	1248	4	16	47
Panda (312_, 319_)	02/12→	312 A2.000	Petrol	875	2	8	16
Panda (312_, 319_)	02/12→	312 A4.000	Petrol	964	2	8	16
Panda (312_, 319_)	02/12→	312 A7.000	Petrol	875	2	8	16
Panda (312_, 319_)	12/13→	312 A5.000	Petrol	875	2	8	16
Panda (312_, 319_)	12/13→	312 A6.000	Petrol	964	2	8	16
Panda (312_, 319_)	06/14→	225 A2.000	Diesel	1248	4	16	47
Panda (312_, 319_)	06/14→	312 A8.000	Diesel	1248	4	16	47
Panda (312_, 319_)	06/14→	312 B2.000	Diesel	1248	4	16	47
Panda (312_, 319_)	04/15→	199 B1.000	Diesel	1248	4	16	47
Panda (312_, 319_)	04/15→	312 B1.000	Diesel	1248	4	16	47
Panda (312_, 319_)	04/15→	330 A1.000	Diesel	1248	4	16	47
Panda Van (141_)	01/86→02/92	156 A2.100	Petrol	999	4	8	18
Panda Van (141_)	01/86→02/92	156 A3.100	Petrol	999	4	8	18
Panda Van (141_)	01/86→07/92	141 B.000	Petrol	769	4	8	9
Panda Van (141_)	05/86→04/91	156 A5.000	Diesel	1302	4	8	43
Panda Van (141_)	05/91→03/95	156 C.046	Petrol	1108	4	8	29
Panda Van (141_)	08/92→02/04	156 A2.246	Petrol	999	4	8	18
Panda Van (141_)	09/00→02/04	187 A1.000	Petrol	1108	4	8	30
Panda Van (169_)	03/04→	188 A8.000	Diesel	1248	4	16	47
Panda Van (169_)	03/04→	188 A9.000	Diesel	1248	4	16	47
Panda Van (169_)	09/04→	187 A1.000	Petrol	1108	4	8	30
Panda Van (169_)	09/04→	188 A4.000	Petrol	1242	4	8	39

							
Panda Van (169_)	01/06 →	169 A1.000	Diesel	1248	4	16	33
Panda Van (169_)	10/09 →	350 A1.000	Petrol	1368	4	8	58
Panda Van (169_)	09/10 →	169 A4.000	Petrol	1242	4	8	34
Panda Van (312_, 519_)	02/12 →	169 A4.000	Petrol	1242	4	8	34
Panda Van (312_, 519_)	02/12 →	199 A9.000	Diesel	1248	4	16	47
Panda Van (312_, 519_)	02/12 →	312 A2.000	Petrol	875	2	8	16
Panda Van (312_, 519_)	02/12 →	312 A4.000	Petrol	964	2	8	16
Panda Van (312_, 519_)	12/13 →	312 A5.000	Petrol	875	2	8	16
Panda Van (312_, 519_)	06/14 →	225 A2.000	Diesel	1248	4	16	47
Panda Van (312_, 519_)	12/15 →	312 B2.000	Diesel	1248	4	16	47
Panorama	03/80 →11/86	127 A2.011	Petrol	1297	4	8	42
Penny Van (257_)	01/86 →12/90	146 A5.000	Petrol	1301	4	8	46
Penny Van (257_)	01/86 →12/90	146 A6.000	Petrol	1116	4	8	27
Penny Van (257_)	01/86 →12/90	149 B3.000	Diesel	1698	4	8	106
Penny Van (257_)	04/86 →12/88	146 B1.000	Diesel	1301	4	8	43
Plus Eight	01/84 →08/90	30 A	Petrol	3528	8	16	196
Plus Eight	01/96 →10/01	46 D	Petrol	4553	8	16	203
Plus Eight	03/10 →	N62 B48 B	Petrol	4799	8	32	205
Plus Four	01/85 →08/88	132 C3.000	Petrol	1995	4	8	133
Plus Four	01/93 →06/99	RQB	Petrol	1796	4	16	121
Plus Four	01/04 →06/14	AODA	Petrol	1999	4	16	150
Plus Four	06/14 →	XQDA	Petrol	1999	4	16	150
Premio	03/85 →09/92	127 A2.011	Petrol	1297	4	8	42
Premio	03/85 →12/96	146 D1.011	Petrol	1497	4	8	69
Premio	03/85 →12/96	159 A3.000	Petrol	1581	4	8	85
Premio	10/85 →12/96	138 B3.011	Petrol	1498	4	8	69
Premio	11/89 →06/94	146 B6.011	Petrol	1581	4	8	82
Premio	08/93 →12/96	146 B7.011	Petrol	1581	4	8	82
Premio	08/93 →12/96	160 A2.011	Petrol	1581	4	8	85
Punto (176_)	09/93 →09/99	176 A6.000	Petrol	1108	4	8	29
Punto (176_)	09/93 →09/99	176 B1.000	Petrol	1242	4	8	35
Punto (176_)	09/93 →09/99	176 B2.000	Petrol	1108	4	8	29
Punto (176_)	09/93 →09/99	176 B4.000	Petrol	1242	4	8	35
Punto (176_)	10/93 →09/99	176 A8.000	Petrol	1242	4	8	35
Punto (176_)	01/94 →09/96	176 A4.000	Petrol	1372	4	8	54
Punto (176_)	01/94 →04/97	176 A9.000	Petrol	1581	4	8	87
Punto (176_)	01/94 →09/99	176 A3.000	Diesel	1698	4	8	106
Punto (176_)	01/94 →09/99	176 A5.000	Diesel	1698	4	8	106
Punto (176_)	01/94 →09/99	176 A7.000	Petrol	1242	4	8	35
Punto (176_)	04/94 →09/97	176 B3.000	Diesel	1698	4	8	106
Punto (176_)	09/96 →09/99	176 B6.000	Petrol	1372	4	8	54
Punto (176_)	09/96 →09/99	176 B7.000	Diesel	1698	4	8	106
Punto (176_)	04/97 →09/99	176 B9.000	Petrol	1242	4	16	36
Punto (188_)	09/99 →12/06	188 A5.000	Petrol	1242	4	16	40
Punto (188_)	09/99 →03/12	183 A1.000	Petrol	1747	4	16	113
Punto (188_)	09/99 →03/12	188 A2.000	Diesel	1910	4	8	125
Punto (188_)	09/99 →03/12	188 A3.000	Diesel	1910	4	8	125
Punto (188_)	09/99 →03/12	188 A4.000	Petrol	1242	4	8	39
Punto (188_)	09/99 →03/12	188 A6.000	Petrol	1747	4	16	113
Punto (188_)	10/01 →03/12	188 A7.000	Diesel	1910	4	8	125
Punto (188_)	06/03 →03/12	188 A9.000	Diesel	1248	4	16	47
Punto (188_)	06/03 →03/12	188 B2.000	Diesel	1910	4	8	125
Punto (188_)	09/03 →03/12	843 A1.000	Petrol	1368	4	16	53
Punto (188_)	11/05 →03/12	199 A6.000	Petrol	1368	4	16	53
Punto (188_)	01/07 →03/12	J2	Petrol	1796	4	8	117
Punto (188_)	07/07 →03/12	310 A2.011	Petrol	1368	4	8	55
Punto (188_)	07/10 →07/12	370 A0.011	Petrol	1747	4	16	113
Punto (199_)	05/08 →	199 A8.000	Petrol	1368	4	16	53
Punto (199_)	05/08 →	955 A8.000	Petrol	1368	4	16	61
Punto (199_)	03/12 →	169 A4.000	Petrol	1242	4	8	34
Punto (199_)	03/12 →	199 A2.000	Diesel	1248	4	16	47
Punto (199_)	03/12 →	199 A7.000	Petrol	1368	4	8	58
Punto (199_)	03/12 →	199 A9.000	Diesel	1248	4	16	47
Punto (199_)	03/12 →	199 B1.000	Diesel	1248	4	16	47
Punto (199_)	03/12 →	199 B4.000	Diesel	1248	4	16	47
Punto (199_)	03/12 →	310 A2.011	Petrol	1368	4	8	55
Punto (199_)	03/12 →	312 A2.000	Petrol	875	2	8	16
Punto (199_)	03/12 →	327 A.011	Petrol	1368	4	8	59
Punto (199_)	03/12 →	330 A1.000	Diesel	1248	4	16	47
Punto (199_)	03/12 →	350 A1.000	Petrol	1368	4	8	58
Punto (199_)	03/12 →	955 A2.000	Petrol	1368	4	16	61
Punto (199_)	03/12 →	955 A6.000	Petrol	1368	4	16	61
Punto (199_)	07/13 →	199 B6.000	Petrol	875	2	8	16
Punto (199_)	07/13 →	370 A0.011	Petrol	1747	4	16	113
Punto (199_)	12/13 →	199 B7.000	Petrol	875	2	8	16
Punto (199_)	12/13 →	199 B8.000	Diesel	1248	4	16	47
Punto (199_)	02/14 →	199 B9.000	Petrol	1242	4	8	41
Punto (199_)	10/14 →	310 A5.011	Petrol	1598	4	16	93



Punto (199_)	05/16→	955 B2.000	Diesel	1248	4	16	47
Punto Convertible (176_)	04/94→04/97	176 A9.000	Petrol	1581	4	8	87
Punto Convertible (176_)	04/94→06/00	176 A7.000	Petrol	1242	4	8	35
Punto Convertible (176_)	05/95→06/00	176 B1.000	Petrol	1242	4	8	35
Punto Convertible (176_)	05/95→06/00	176 B4.000	Petrol	1242	4	8	35
Punto Convertible (176_)	04/97→06/00	176 B9.000	Petrol	1242	4	16	36
Punto Evo (199_)	07/08→02/12	199 B2.000	Diesel	1248	4	16	47
Punto Evo (199_)	06/09→02/12	350 A1.000	Petrol	1368	4	8	58
Punto Evo (199_)	07/09→02/12	199 A7.000	Petrol	1368	4	8	58
Punto Evo (199_)	10/09→02/12	169 A4.000	Petrol	1242	4	8	34
Punto Evo (199_)	10/09→02/12	199 A4.000	Petrol	1242	4	8	41
Punto Evo (199_)	10/09→02/12	199 B1.000	Diesel	1248	4	16	47
Punto Evo (199_)	10/09→02/12	199 B4.000	Diesel	1248	4	16	47
Punto Evo (199_)	10/09→02/12	223 A9.000	Diesel	1248	4	16	47
Punto Evo (199_)	10/09→02/12	955 A2.000	Petrol	1368	4	16	61
Punto Evo (199_)	10/09→02/12	955 A3.000	Diesel	1598	4	16	92
Punto Evo (199_)	10/09→02/12	955 A6.000	Petrol	1368	4	16	61
Punto Evo (199_)	10/09→	199 A2.000	Diesel	1248	4	16	47
Punto Evo (199_)	10/09→	199 A3.000	Diesel	1248	4	16	47
Punto Evo (199_)	10/09→	199 A9.000	Diesel	1248	4	16	47
Punto Van (176_)	04/96→02/00	176 A5.000	Diesel	1698	4	8	106
Punto Van (176_)	04/96→02/00	176 B2.000	Petrol	1108	4	8	29
Punto Van (176_)	04/96→02/00	176 B3.000	Diesel	1698	4	8	106
Punto Van (176_)	09/96→09/99	176 B7.000	Diesel	1698	4	8	106
Punto Van (188_)	02/00→10/09	188 A3.000	Diesel	1910	4	8	125
Punto Van (188_)	02/00→10/09	188 A4.000	Petrol	1242	4	8	39
Punto Van (188_)	02/00→10/09	188 A7.000	Diesel	1910	4	8	125
Punto Van (188_)	06/03→10/09	188 A9.000	Diesel	1248	4	16	47
Punto Van (199_)	02/06→	350 A1.000	Petrol	1368	4	8	58
Punto Van (199_)	04/08→	199 A2.000	Diesel	1248	4	16	47
Punto Van (199_)	04/08→	199 A9.000	Diesel	1248	4	16	47
Punto Van (199_)	03/09→	199 B1.000	Diesel	1248	4	16	47
Punto Van (199_)	01/10→02/12	199 A3.000	Diesel	1248	4	16	47
Punto Van (199_)	03/12→	199 B4.000	Diesel	1248	4	16	47
Punto Van (199_)	03/12→	312 A2.000	Petrol	875	2	8	16
Qubo (225_)	02/08→	199 A2.000	Diesel	1248	4	16	47
Qubo (225_)	02/08→	199 A9.000	Diesel	1248	4	16	47
Qubo (225_)	02/08→	KFT	Petrol	1360	4	8	66
Qubo (225_)	02/08→	KFV	Petrol	1360	4	8	66
Qubo (225_)	10/09→	350 A1.000	Petrol	1368	4	8	58
Qubo (225_)	07/10→	199 B1.000	Diesel	1248	4	16	47
Qubo (225_)	03/15→	225 A2.000	Diesel	1248	4	16	47
Regata (138_)	09/83→07/86	138 B2.000	Petrol	1302	4	8	46
Regata (138_)	09/83→08/86	138 B3.000	Petrol	1498	4	8	67
Regata (138_)	09/83→12/86	138 B6.000	Diesel	1714	4	8	105
Regata (138_)	09/83→07/89	149 A3.000	Petrol	1301	4	8	46
Regata (138_)	09/83→07/89	149 A7.000	Petrol	1302	4	8	46
Regata (138_)	10/83→07/89	149 C3.000	Petrol	1585	4	8	77
Regata (138_)	10/83→06/90	149 A.000	Petrol	1585	4	8	77
Regata (138_)	10/83→12/90	149 A2.000	Petrol	1585	4	8	77
Regata (138_)	10/83→12/90	149 A4.000	Petrol	1585	4	8	77
Regata (138_)	12/83→07/89	138 B3.048	Petrol	1498	4	8	67
Regata (138_)	12/83→07/89	138 C2.048	Petrol	1498	4	8	67
Regata (138_)	12/83→07/89	138 C3.048	Petrol	1498	4	8	67
Regata (138_)	12/83→07/89	149 C1.000	Petrol	1499	4	8	67
Regata (138_)	04/84→07/89	149 A1.000	Diesel	1929	4	8	123
Regata (138_)	05/85→12/87	149 A5.000	Petrol	1498	4	8	67
Regata (138_)	05/85→03/89	149 B3.000	Diesel	1698	4	8	106
Regata (138_)	05/86→07/89	831 D1.000	Diesel	1929	4	8	123
Regata (138_)	01/87→07/89	149 C2.000	Petrol	1595	4	8	83
Regata Weekend (138_)	06/83→04/89	138 B3.000	Petrol	1498	4	8	67
Regata Weekend (138_)	09/83→08/86	138 AR.000	Petrol	1585	4	8	81
Regata Weekend (138_)	01/84→07/89	138 B2.000	Petrol	1302	4	8	46
Regata Weekend (138_)	01/84→12/89	149 B3.000	Diesel	1698	4	8	106
Regata Weekend (138_)	04/84→07/89	149 A1.000	Diesel	1929	4	8	123
Regata Weekend (138_)	09/84→07/89	138 B3.048	Petrol	1498	4	8	67
Regata Weekend (138_)	09/84→07/89	138 C2.048	Petrol	1498	4	8	67
Regata Weekend (138_)	09/84→07/89	138 C3.048	Petrol	1498	4	8	67
Regata Weekend (138_)	09/84→12/90	149 A4.000	Petrol	1585	4	8	77
Regata Weekend (138_)	09/84→12/90	149 C3.000	Petrol	1585	4	8	77
Regata Weekend (138_)	10/84→06/89	149 A.000	Petrol	1585	4	8	77
Regata Weekend (138_)	05/86→07/89	831 D1.000	Diesel	1929	4	8	123
Regata Weekend (138_)	01/87→07/89	149 C2.000	Petrol	1595	4	8	83
Ritmo (138_)	01/78→08/85	138 A1.000	Petrol	1301	4	8	46
Ritmo (138_)	01/78→08/85	149 A3.000	Petrol	1301	4	8	46
Ritmo (138_)	01/78→08/85	149 A7.000	Petrol	1302	4	8	46
Ritmo (138_)	01/78→12/88	138 A2.000	Petrol	1498	4	8	67
Ritmo (138_)	01/78→12/88	138 C2.048	Petrol	1498	4	8	67



CC











9

Ritmo (138_)	01/78→12/88	138 C3.048	Petrol	1498	4	8	67
Ritmo (138_)	01/78→12/88	149 C1.000	Petrol	1499	4	8	67
Ritmo (138_)	09/78→09/82	127 A6.000	Petrol	1049	4	8	17
Ritmo (138_)	10/79→09/82	138 A5.000	Diesel	1714	4	8	104
Ritmo (138_)	08/80→08/88	138 B.000	Petrol	1116	4	8	27
Ritmo (138_)	08/80→08/88	146 A4.000	Petrol	1116	4	8	27
Ritmo (138_)	01/81→09/82	138 A3.000	Petrol	1301	4	8	46
Ritmo (138_)	01/81→05/87	138 A4.000	Petrol	1498	4	8	67
Ritmo (138_)	05/81→12/87	138 AR.000	Petrol	1585	4	8	81
Ritmo (138_)	10/82→12/87	138 B1.000	Petrol	1116	4	8	27
Ritmo (138_)	10/82→12/87	138 C1.000	Petrol	1116	4	8	27
Ritmo (138_)	01/83→04/85	138 B2.000	Petrol	1302	4	8	46
Ritmo (138_)	01/83→12/87	138 B3.000	Petrol	1498	4	8	67
Ritmo (138_)	01/83→12/87	149 A4.000	Petrol	1585	4	8	77
Ritmo (138_)	04/85→12/87	146 A4.048	Petrol	1116	4	8	27
Ritmo (138_)	05/85→12/87	138 C.000	Diesel	1698	4	8	106
Ritmo (138_)	05/85→12/87	149 B3.000	Diesel	1698	4	8	106
Ritmo (138_)	08/85→05/87	149 A5.000	Petrol	1498	4	8	67
Ritmo (138_)	09/85→12/87	149 C2.000	Petrol	1595	4	8	83
Ritmo (138_)	12/85→12/87	831 D1.000	Diesel	1929	4	8	123
Ritmo (138A_)	11/81→12/87	138 AR1.000	Petrol	1995	4	8	134
Ritmo (138A_)	04/83→12/87	138 AR2.000	Petrol	1995	4	8	134
Ritmo Convertible (138_)	10/79→09/83	138 A1.000	Petrol	1301	4	8	46
Ritmo Convertible (138_)	01/80→07/89	138 A4.000	Petrol	1498	4	8	67
Ritmo Convertible (138_)	03/83→12/86	138 B3.000	Petrol	1498	4	8	67
Ritmo Convertible (138_)	10/85→12/87	138 AR.000	Petrol	1585	4	8	81
Ritmo Convertible (138_)	10/85→12/87	138 AR.048	Petrol	1585	4	8	80
Ritmo Convertible (138_)	10/85→12/87	138 B2.000	Petrol	1302	4	8	46
Roadster Convertible	01/04→	AODA	Petrol	1999	4	16	150
Roadster Convertible	01/04→	MEBA	Petrol	2967	6	24	192
Roadster Convertible	01/04→	ZSG416	Petrol	1595	4	16	100
Safari (42_FD)	07/06→	DW12DD	Diesel	2179	4	16	164
Sana	10/89→10/93	14FE	Petrol	1372	4	8	48
Scudo (270_, 272_)	01/07→	9HU	Diesel	1560	4	16	75
Scudo (270_, 272_)	01/07→	RHK	Diesel	1997	4	16	151
Scudo (270_, 272_)	01/07→	RHR	Diesel	1997	4	16	151
Scudo (270_, 272_)	07/10→	RH02	Diesel	1997	4	16	157
Scudo (270_, 272_)	07/10→	RHH	Diesel	1997	4	16	157
Scudo (270_, 272_)	02/11→	9H07 (DV6UC)	Diesel	1560	4	8	73
Scudo (270_, 272_)	02/11→	9HM (DV6UC)	Diesel	1560	4	8	74
Scudo Box (220_)	02/96→12/06	220 A 2.000	Petrol	1581	4	8	85
Scudo Box (220_)	02/96→12/06	D9B	Diesel	1905	4	8	129
Scudo Box (220_)	02/96→12/06	DXH (XUD9TF/L)	Diesel	1905	4	8	129
Scudo Box (220_)	02/98→12/06	D8B	Diesel	1905	4	8	129
Scudo Box (220_)	04/98→12/06	WJY (DW8B)	Diesel	1868	4	8	129
Scudo Box (220_)	04/98→12/06	WJZ (DW8)	Diesel	1868	4	8	129
Scudo Box (220_)	05/99→12/06	RHK (DW10ATED4)	Diesel	1997	4	16	151
Scudo Box (220_)	05/99→12/06	RHM (DW10ATED4)	Diesel	1997	4	16	151
Scudo Box (220_)	05/99→12/06	RHW (DW10ATED4)	Diesel	1997	4	16	151
Scudo Box (220_)	10/99→12/06	RHX	Diesel	1997	4	8	159
Scudo Box (220_)	05/00→12/06	RFN (EW10J4)	Petrol	1997	4	16	154
Scudo Box (220_)	12/02→12/06	RHZ	Diesel	1997	4	8	159
Scudo Box (270_, 272_)	01/07→	9HU	Diesel	1560	4	16	75
Scudo Box (270_, 272_)	01/07→	RHK	Diesel	1997	4	16	151
Scudo Box (270_, 272_)	01/07→	RHR	Diesel	1997	4	16	151
Scudo Box (270_, 272_)	07/10→	RH02	Diesel	1997	4	16	157
Scudo Box (270_, 272_)	07/10→	RHH	Diesel	1997	4	16	157
Scudo Box (270_, 272_)	02/11→	9H07 (DV6UC)	Diesel	1560	4	8	73
Scudo Box (270_, 272_)	02/11→	9HM (DV6UC)	Diesel	1560	4	8	74
Scudo Combinato (220_)	02/96→04/98	D9B	Diesel	1905	4	8	129
Scudo Combinato (220_)	02/96→12/06	220 A 2.000	Petrol	1581	4	8	85
Scudo Combinato (220_)	02/96→12/06	D8B	Diesel	1905	4	8	129
Scudo Combinato (220_)	02/96→12/06	DXH (XUD9TF/L)	Diesel	1905	4	8	129
Scudo Combinato (220_)	04/98→12/06	WJZ (DW8)	Diesel	1868	4	8	129
Scudo Combinato (220_)	05/99→12/06	RHW (DW10ATED4)	Diesel	1997	4	16	151
Scudo Combinato (220_)	12/99→12/06	RHZ	Diesel	1997	4	8	159
Scudo Combinato (220_)	06/00→12/06	RFN (EW10J4)	Petrol	1997	4	16	154
Scudo Combinato (220_)	01/04→12/06	RHX	Diesel	1997	4	8	159
Scudo Platform/Chassis (220_)	09/96→12/06	220 A 2.000	Petrol	1581	4	8	85
Scudo Platform/Chassis (220_)	09/96→12/06	D8B	Diesel	1905	4	8	129
Scudo Platform/Chassis (220_)	09/96→12/06	DXH (XUD9TF/L)	Diesel	1905	4	8	129
Scudo Platform/Chassis (220_)	04/98→12/06	WJY (DW8)	Diesel	1868	4	8	129
Scudo Platform/Chassis (220_)	05/99→12/06	RHK (DW10ATED4)	Diesel	1997	4	16	151
Scudo Platform/Chassis (220_)	05/99→12/06	RHM (DW10ATED4)	Diesel	1997	4	16	151
Scudo Platform/Chassis (220_)	05/99→12/06	RHW (DW10ATED4)	Diesel	1997	4	16	151
Scudo Platform/Chassis (220_)	10/99→12/06	RHX	Diesel	1997	4	8	159
Scudo Platform/Chassis (220_)	12/02→12/06	RHZ	Diesel	1997	4	8	159
Scudo Platform/Chassis (270_, 272_)	01/07→	9H07 (DV6UC)	Diesel	1560	4	8	73



Scudo Platform/Chassis (270_, 272_)	01/07→	9HM (DV6UC)	Diesel	1560	4	8	74
Scudo Platform/Chassis (270_, 272_)	01/07→	9HU	Diesel	1560	4	16	75
Scudo Platform/Chassis (270_, 272_)	01/07→	DW10BTD4	Diesel	1997	4	16	151
Scudo Platform/Chassis (270_, 272_)	01/07→	RHK	Diesel	1997	4	16	151
Scudo Platform/Chassis (270_, 272_)	01/07→	RHR	Diesel	1997	4	16	151
Scudo Platform/Chassis (270_, 272_)	07/10→	RH02	Diesel	1997	4	16	157
Scudo Platform/Chassis (270_, 272_)	07/10→	RHH	Diesel	1997	4	16	157
Sedici (FY_)	06/06→10/14	D19AA	Diesel	1910	4	8	125
Sedici (FY_)	06/06→10/14	D20AA	Diesel	1956	4	16	144
Sedici (FY_)	06/06→10/14	M16A	Petrol	1586	4	16	97
Seicento / 600 (187_)	01/98→01/10	176 B2.000	Petrol	1108	4	8	29
Seicento / 600 (187_)	01/98→01/10	187 A1.000	Petrol	1108	4	8	30
Seicento / 600 (187_)	01/98→01/10	1170 A1.046	Petrol	899	4	8	14
Seicento / 600 Van (287_)	01/98→01/10	176 B2.000	Petrol	1108	4	8	29
Seicento / 600 Van (287_)	01/98→01/10	1170 A1.046	Petrol	899	4	8	14
Siena	01/03→	188 A4.000	Petrol	1242	4	8	39
Siena (172_)	08/06→12/12	310 A2.011	Petrol	1368	4	8	55
Siena (172_)	11/07→12/11	93313090-7U	Petrol	1796	4	8	117
Siena (172_)	11/07→10/13	178 F1.011	Petrol	999	4	8	21
Siena (172_)	11/07→10/13	310 A1.011	Petrol	999	4	8	21
Siena (172_)	11/07→	178 F3.011	Petrol	1368	4	8	55
Siena (172_)	11/07→	188 A9.000	Diesel	1248	4	16	47
Siena (172_)	08/10→	310 A5.011	Petrol	1598	4	16	93
Siena (172_)	11/10→	370 A0.011	Petrol	1747	4	16	113
Siena (178_)	04/96→12/09	178 B2.000	Petrol	1372	4	8	48
Siena (178_)	04/96→12/09	178 B2.016	Petrol	1372	4	8	48
Siena (178_)	09/97→10/98	146 C6.000	Petrol	1581	4	8	82
Siena (178_)	09/97→03/00	146 D6.000	Petrol	1581	4	8	82
Siena (178_)	09/98→12/09	178 B3.000	Petrol	1581	4	16	88
Siena (178_)	09/98→12/09	178 B5.000	Petrol	1242	4	8	37
Siena (178_)	09/98→12/09	182 B6.000	Petrol	1596	4	16	88
Siena (178_)	05/99→12/09	176 B7.000	Diesel	1698	4	8	106
Siena (178_)	05/99→12/09	178 C9.066	Diesel	1698	4	8	106
Siena (178_)	09/00→12/09	178 D9.011	Petrol	999	4	8	21
Siena (178_)	09/00→12/09	178 F1.011	Petrol	999	4	8	21
Siena (178_)	11/00→12/09	223 A6.000	Diesel	1910	4	8	125
Siena (178_)	06/01→12/09	188 A5.000	Petrol	1242	4	16	40
Siena (178_)	06/01→12/09	93313090-7U	Petrol	1796	4	8	117
Siena (178_)	09/01→12/09	178 C4.066	Petrol	1242	4	8	37
Siena (178_)	09/01→12/09	188 A4.000	Petrol	1242	4	8	39
Siena (178_)	03/02→12/09	176 A3.000	Diesel	1698	4	8	106
Siena (178_)	09/02→02/04	178 E8.011	Petrol	1242	4	8	38
Siena (178_)	09/02→12/05	178 A6.011	Petrol	1497	4	8	70
Siena (178_)	09/03→12/09	188 A9.000	Diesel	1248	4	16	47
Siena (178_)	03/04→12/09	178 E9.011	Petrol	1242	4	8	38
Siena (178_)	06/04→12/09	178 E5.022	Petrol	1461	4	8	71
Siena (178_)	06/04→12/09	178 F3.011	Petrol	1368	4	8	55
Siena (178_)	07/05→12/09	310 A2.011	Petrol	1368	4	8	55
Siena (178_)	05/06→12/09	93313090-H2	Petrol	1796	4	8	117
Siena (178_)	01/07→12/09	350 A1.000	Petrol	1368	4	8	58
Stilo (192_)	10/01→11/06	182 B6.000	Petrol	1596	4	16	88
Stilo (192_)	10/01→11/06	192 A1.000	Diesel	1910	4	8	125
Stilo (192_)	10/01→11/06	192 A2.000	Petrol	2446	5	20	171
Stilo (192_)	10/01→11/06	192 A4.000	Petrol	1747	4	16	113
Stilo (192_)	10/01→11/06	937 A7.000	Diesel	1910	4	8	125
Stilo (192_)	02/02→11/06	188 A5.000	Petrol	1242	4	16	40
Stilo (192_)	02/02→11/06	192 A3.000	Diesel	1910	4	8	125
Stilo (192_)	09/03→11/06	937 A4.000	Diesel	1910	4	16	126
Stilo (192_)	01/04→11/06	192 A5.000	Diesel	1910	4	16	126
Stilo (192_)	01/04→11/06	192 A7.011	Petrol	2446	5	20	171
Stilo (192_)	01/04→11/06	843 A1.000	Petrol	1368	4	16	53
Stilo (192_)	01/04→11/06	PN93327668	Petrol	1796	4	8	117
Stilo (192_)	01/04→11/06	PN93327669	Petrol	1796	4	16	120
Stilo (192_)	04/04→11/06	192 B1.000	Diesel	1910	4	16	126
Stilo (192_)	09/04→11/06	192 B5.000	Diesel	1910	4	8	125
Stilo (192_)	03/05→11/06	192 B2.000	Petrol	1368	4	16	57
Stilo (192_)	05/05→11/06	192 B3.000	Petrol	1598	4	16	91
Stilo (192_)	09/05→11/06	192 A8.000	Diesel	1910	4	8	125
Stilo (192_)	09/05→11/06	192 A9.000	Diesel	1910	4	8	125
Stilo (192_)	09/05→11/06	937 A5.000	Diesel	1910	4	16	128
Stilo (192_)	09/05→11/10	93337154-J1	Petrol	1796	4	8	117
Stilo Multi Wagon (192_)	01/03→08/08	182 B6.000	Petrol	1596	4	16	88
Stilo Multi Wagon (192_)	01/03→08/08	192 A1.000	Diesel	1910	4	8	125
Stilo Multi Wagon (192_)	01/03→08/08	192 A3.000	Diesel	1910	4	8	125
Stilo Multi Wagon (192_)	01/03→08/08	192 A4.000	Petrol	1747	4	16	113
Stilo Multi Wagon (192_)	01/03→08/08	937 A7.000	Diesel	1910	4	8	125
Stilo Multi Wagon (192_)	09/03→08/08	937 A4.000	Diesel	1910	4	16	126
Stilo Multi Wagon (192_)	01/04→08/08	192 A5.000	Diesel	1910	4	16	126

							
Stilo Multi Wagon (192_)	01/04→08/08	192 A7.011	Petrol	2446	5	20	171
Stilo Multi Wagon (192_)	01/04→08/08	843 A1.000	Petrol	1368	4	16	53
Stilo Multi Wagon (192_)	01/04→08/08	PN93327669	Petrol	1796	4	16	120
Stilo Multi Wagon (192_)	04/04→08/08	192 B1.000	Diesel	1910	4	16	126
Stilo Multi Wagon (192_)	09/04→08/08	192 B5.000	Diesel	1910	4	8	125
Stilo Multi Wagon (192_)	03/05→12/07	192 B3.000	Petrol	1598	4	16	91
Stilo Multi Wagon (192_)	03/05→08/08	192 B2.000	Petrol	1368	4	16	57
Stilo Multi Wagon (192_)	09/05→08/08	192 A8.000	Diesel	1910	4	8	125
Stilo Multi Wagon (192_)	09/05→08/08	192 A9.000	Diesel	1910	4	8	125
Stilo Multi Wagon (192_)	09/05→08/08	937 A5.000	Diesel	1910	4	16	128
Stilo Multi Wagon (192_)	09/05→08/08	93337154-J1	Petrol	1796	4	8	117
Strada Pickup	06/12→	192 A4.000	Petrol	1747	4	16	113
Strada Pickup	06/12→	310 A2.011	Petrol	1368	4	8	55
Strada Pickup (178_)	02/98→	178 D2.011	Petrol	1581	4	16	89
Strada Pickup (178_)	06/99→12/06	178 B5.000	Petrol	1242	4	8	37
Strada Pickup (178_)	06/99→01/10	176 A3.000	Diesel	1698	4	8	106
Strada Pickup (178_)	12/00→	223 A6.000	Diesel	1910	4	8	125
Strada Pickup (178_)	01/03→	93313090-7U	Petrol	1796	4	8	117
Strada Pickup (178_)	04/03→	188 A2.000	Diesel	1910	4	8	125
Strada Pickup (178_)	04/03→	188 A4.000	Petrol	1242	4	8	39
Strada Pickup (178_)	06/04→	178 E8.011	Petrol	1242	4	8	38
Strada Pickup (178_)	06/05→	178 F3.011	Petrol	1368	4	8	55
Strada Pickup (178_)	06/05→	310 A2.011	Petrol	1368	4	8	55
Strada Pickup (178_)	08/05→07/10	93313090-H2	Petrol	1796	4	8	117
Strada Pickup (178_)	11/05→	178 B7.045	Petrol	1242	4	8	37
Strada Pickup (178_)	05/06→	223 A9.000	Diesel	1248	4	16	47
Strada Pickup (278_)	02/09→	310 A2.011	Petrol	1368	4	8	55
Strada Pickup (278_)	09/09→	310 A5.011	Petrol	1598	4	16	93
Strada Pickup (278_)	08/10→	370 A0.011	Petrol	1747	4	16	113
Strada Pickup (278_)	10/10→	199 B1.000	Diesel	1248	4	16	47
Sumo Grande	01/08→	DW12DD	Diesel	2179	4	16	164
Sumo Victa	05/04→12/07	DW12DD	Diesel	2179	4	16	164
Talento Box (290_)	03/89→03/94	149 B1.000	Diesel	1929	4	8	123
Talento Box (290_)	03/89→03/94	170 B	Petrol	1971	4	8	140
Talento Box (296_)	06/16→	R9M 408	Diesel	1598	4	16	98
Talento Box (296_)	06/16→	R9M 413	Diesel	1598	4	16	98
Talento Box (296_)	06/16→	R9M 450	Diesel	1598	4	16	98
Talento Box (296_)	06/16→	R9M 452	Diesel	1598	4	16	98
Talento Box Body / Estate (296_)	06/16→	R9M 408	Diesel	1598	4	16	98
Talento Box Body / Estate (296_)	06/16→	R9M 413	Diesel	1598	4	16	98
Talento Box Body / Estate (296_)	06/16→	R9M 450	Diesel	1598	4	16	98
Talento Box Body / Estate (296_)	06/16→	R9M 452	Diesel	1598	4	16	98
Talento Bus (290_)	03/89→03/94	149 B1.000	Diesel	1929	4	8	123
Talento Bus (290_)	03/89→03/94	170 B	Petrol	1971	4	8	140
Talento Bus (296_)	06/16→	R9M 408	Diesel	1598	4	16	98
Talento Bus (296_)	06/16→	R9M 413	Diesel	1598	4	16	98
Talento Bus (296_)	06/16→	R9M 450	Diesel	1598	4	16	98
Talento Bus (296_)	06/16→	R9M 452	Diesel	1598	4	16	98
Talento Platform/Chassis (290_)	03/89→03/94	149 B1.000	Diesel	1929	4	8	123
Talento Platform/Chassis (290_)	03/89→03/94	170 B	Petrol	1971	4	8	140
Talento Platform/Chassis (296_)	06/16→	R9M 413	Diesel	1598	4	16	98
Talento Platform/Chassis (296_)	06/16→	R9M 450	Diesel	1598	4	16	98
Talento Platform/Chassis (296_)	06/16→	R9M 452	Diesel	1598	4	16	98
Tempo	06/85→07/93	11A	Petrol	1116	4	8	24
Tempo	06/85→07/93	128A4	Petrol	1116	4	8	26
Tempo	05/91→12/93	164A0	Petrol	903	4	8	15
Tempra (159_)	03/90→08/96	159 A3.000	Petrol	1581	4	8	85
Tempra (159_)	03/90→08/96	159 A4.000	Petrol	1756	4	8	110
Tempra (159_)	03/90→08/96	159 B9.000	Petrol	1581	4	8	85
Tempra (159)	04/90→06/93	159 A3.048	Petrol	1581	4	8	86
Tempra (159_)	04/90→08/96	159 A2.000	Petrol	1372	4	8	52
Tempra (159_)	04/90→08/96	160 A1.046	Petrol	1372	4	8	48
Tempra (159_)	04/90→08/96	836 A4.000	Petrol	1372	4	8	48
Tempra (159_)	04/90→12/98	159 A6.046	Petrol	1995	4	8	139
Tempra (159_)	05/90→08/96	160 A6.000	Diesel	1929	4	8	123
Tempra (159_)	05/90→08/96	160 D1.000	Diesel	1929	4	8	123
Tempra (159_)	06/90→07/92	159 A3.046	Petrol	1581	4	8	85
Tempra (159_)	07/91→08/96	149 A1.000	Diesel	1929	4	8	123
Tempra (159_)	07/91→08/96	160 A7.000	Diesel	1929	4	8	123
Tempra (159_)	03/92→08/96	159 A4.046	Petrol	1756	4	8	110
Tempra (159_)	06/92→08/96	159 A3.048	Petrol	1581	4	8	86
Tempra (159_)	06/92→08/96	835 C1.000	Petrol	1581	4	8	85
Tempra (159_)	07/92→08/96	160 B6.046	Diesel	1929	4	8	123
Tempra (159_)	11/92→04/94	149 E1.011	Petrol	1995	4	8	135
Tempra (159_)	09/93→08/96	835 C2.000	Petrol	1756	4	8	114
Tempra (159_)	09/93→08/96	835 C4.000	Petrol	1756	4	8	114
Tempra (159_)	05/94→12/98	159 B2.011	Petrol	1995	4	8	136
Tempra (159_)	10/94→08/96	836 A5.000	Petrol	1756	4	8	114



Tempra (159_)	11/94→05/98	154 C4.000	Petrol	1995	4	8	136
Tempra (159_)	10/95→12/98	154 E1.000	Petrol	1995	4	16	138
Tempra S.W. (159_)	03/90→08/96	159 A4.000	Petrol	1756	4	8	110
Tempra S.W. (159_)	10/90→08/96	159 A3.046	Petrol	1581	4	8	85
Tempra S.W. (159_)	10/90→08/96	835 C1.000	Petrol	1581	4	8	85
Tempra S.W. (159_)	12/90→04/93	159 A3.000	Petrol	1581	4	8	85
Tempra S.W. (159_)	01/91→12/96	159 A6.046	Petrol	1995	4	8	139
Tempra S.W. (159_)	03/91→08/96	159 A2.000	Petrol	1372	4	8	52
Tempra S.W. (159_)	07/91→02/95	160 A6.000	Diesel	1929	4	8	123
Tempra S.W. (159_)	07/91→02/95	160 D1.000	Diesel	1929	4	8	123
Tempra S.W. (159_)	07/91→08/96	149 A1.000	Diesel	1929	4	8	123
Tempra S.W. (159_)	07/91→08/96	160 A7.000	Diesel	1929	4	8	123
Tempra S.W. (159_)	03/92→06/93	160 B6.046	Diesel	1929	4	8	123
Tempra S.W. (159_)	03/92→12/93	159 A4.046	Petrol	1756	4	8	110
Tempra S.W. (159_)	10/92→08/96	159 A3.048	Petrol	1581	4	8	86
Tempra S.W. (159_)	10/92→08/96	160 A1.046	Petrol	1372	4	8	48
Tempra S.W. (159_)	10/92→08/96	836 A4.000	Petrol	1372	4	8	48
Tempra S.W. (159_)	09/93→08/96	835 C2.000	Petrol	1756	4	8	114
Tempra S.W. (159_)	09/93→08/96	835 C4.000	Petrol	1756	4	8	114
Tempra S.W. (159_)	06/94→08/96	159 B9.000	Petrol	1581	4	8	85
Tempra S.W. (159_)	10/94→08/96	836 A5.000	Petrol	1756	4	8	114
Tipo (160_)	07/87→12/89	160 A1.000	Petrol	1372	4	8	52
Tipo (160_)	07/87→04/95	160 A1.048	Petrol	1372	4	8	48
Tipo (160_)	01/88→10/91	160 A3.000	Petrol	1108	4	8	29
Tipo (160_)	01/88→10/92	160 A2.000	Petrol	1581	4	8	85
Tipo (160_)	01/88→10/95	149 B4.000	Diesel	1697	4	8	106
Tipo (160_)	02/88→05/91	149 C2.046	Petrol	1595	4	8	82
Tipo (160_)	05/89→04/95	159 A2.000	Petrol	1372	4	8	52
Tipo (160_)	05/89→04/95	160 A1.046	Petrol	1372	4	8	48
Tipo (160_)	05/89→04/95	836 A4.000	Petrol	1372	4	8	48
Tipo (160_)	05/89→10/95	159 A3.000	Petrol	1581	4	8	85
Tipo (160_)	11/89→06/92	160 A5.000	Petrol	1756	4	16	111
Tipo (160_)	03/90→04/95	159 A6.046	Petrol	1995	4	8	139
Tipo (160_)	06/90→10/92	159 A5.046	Petrol	1995	4	8	136
Tipo (160_)	07/90→10/95	159 A3.046	Petrol	1581	4	8	85
Tipo (160_)	09/90→04/95	160 A6.000	Diesel	1929	4	8	123
Tipo (160_)	09/90→04/95	160 A6.046	Diesel	1929	4	8	123
Tipo (160_)	09/90→04/95	160 D1.000	Diesel	1929	4	8	123
Tipo (160_)	10/90→06/93	159 A4.046	Petrol	1756	4	8	110
Tipo (160_)	10/90→10/95	159 A4.000	Petrol	1756	4	8	110
Tipo (160_)	07/91→04/95	160 A8.046	Petrol	1995	4	16	138
Tipo (160_)	07/91→08/95	149 A1.000	Diesel	1929	4	8	123
Tipo (160_)	07/91→08/95	160 A7.000	Diesel	1929	4	8	123
Tipo (160_)	03/92→06/93	160 B6.046	Diesel	1929	4	8	123
Tipo (160_)	10/92→10/95	159 A3.048	Petrol	1581	4	8	86
Tipo (160_)	10/92→10/95	835 C1.000	Petrol	1581	4	8	85
Tipo (160_)	03/93→04/95	836 A3.000	Petrol	1995	4	16	147
Tipo (160_)	03/93→04/95	836 A3.011	Petrol	1995	4	16	148
Tipo (160_)	03/93→10/95	836 A5.000	Petrol	1756	4	8	114
Tipo (160_)	04/93→04/95	835 C2.000	Petrol	1756	4	8	114
Tipo (160_)	09/93→04/95	835 C4.000	Petrol	1756	4	8	114
Tipo Estate (357_)	03/16→	843 A1.000	Petrol	1368	4	16	53
Tipo Estate (357_)	03/16→	940 B7.000	Petrol	1368	4	16	53
Tipo Estate (357_)	03/16→	55260384	Diesel	1598	4	16	92
Tipo Estate (357_)	03/16→	55266963	Diesel	1248	4	16	47
Tipo Estate (357_)	07/16→	55268036	Petrol	1598	4	16	93
Tipo Hatchback (357_)	03/16→	843 A1.000	Petrol	1368	4	16	53
Tipo Hatchback (357_)	03/16→	940 B7.000	Petrol	1368	4	16	53
Tipo Hatchback (357_)	03/16→	55260384	Diesel	1598	4	16	92
Tipo Hatchback (357_)	03/16→	55266963	Diesel	1248	4	16	47
Tipo Hatchback (357_)	07/16→	55268036	Petrol	1598	4	16	93
Tipo Saloon (356_)	10/15→	199 B1.000	Diesel	1248	4	16	47
Tipo Saloon (356_)	10/15→	843 A1.000	Petrol	1368	4	16	53
Tipo Saloon (356_)	10/15→	940 C1.000	Diesel	1598	4	16	92
Tipo Saloon (356_)	10/15→	55260384	Diesel	1598	4	16	92
Tipo Saloon (356_)	10/15→	55266963	Diesel	1248	4	16	47
Tipo Saloon (356_)	10/15→	55268036	Petrol	1598	4	16	93
Tipo Saloon (356_)	05/16→	940 B7.000	Petrol	1368	4	16	53
Ulysse (179_)	08/02→08/06	4HW (DW12ATED4)	Diesel	2179	4	16	164
Ulysse (179_)	08/02→08/06	RHW (DW10ATED4)	Diesel	1997	4	16	151
Ulysse (179_)	08/02→06/11	RFN (EW10J4)	Petrol	1997	4	16	154
Ulysse (179_)	08/02→06/11	XFW	Petrol	2946	6	24	194
Ulysse (179_)	05/03→08/06	RHM (DW10ATED4)	Diesel	1997	4	16	151
Ulysse (179_)	05/06→06/11	RHK	Diesel	1997	4	16	151
Ulysse (179_)	05/06→06/11	RHR	Diesel	1997	4	16	151
Ulysse (179_)	03/08→06/11	4HP	Diesel	2179	4	16	162
Ulysse (179_)	03/08→06/11	4HR	Diesel	2179	4	16	162
Ulysse (179_)	03/08→06/11	4HS	Diesel	2179	4	16	162



CC



9

Ulysse (179_)	03/08→06/11	4HT (DW128TED4)	Diesel	2179	4	16	162
Ulysse (220_)	06/94→08/02	RFU (XU10J2C)	Petrol	1998	4	8	155
Ulysse (220_)	06/94→08/02	RGX (XU10J2CTE)	Petrol	1998	4	8	153
Ulysse (220_)	02/95→08/02	DHX (XUD9TF/L)	Diesel	1905	4	8	129
Ulysse (220_)	03/96→10/99	P8C	Diesel	2088	4	12	161
Ulysse (220_)	05/97→08/02	LFW	Petrol	1761	4	8	119
Ulysse (220_)	05/98→09/00	RFV	Petrol	1998	4	16	156
Ulysse (220_)	05/99→08/02	RHW (DW10ATED4)	Diesel	1997	4	16	151
Ulysse (220_)	10/99→08/02	RHZ	Diesel	1997	4	8	159
Ulysse (220_)	09/00→08/02	RFN (EW10J4)	Petrol	1997	4	16	154
Uno (146_)	01/83→04/85	138 B2.000	Petrol	1302	4	8	46
Uno (146_)	01/83→08/89	138 B.000	Petrol	1116	4	8	27
Uno (146_)	03/83→09/92	146 A.000	Petrol	903	4	8	13
Uno (146_)	03/83→09/92	146 A1.000	Petrol	903	4	8	13
Uno (146_)	06/83→03/92	127 A5.000	Diesel	1302	4	8	43
Uno (146_)	06/83→03/92	146 B1.000	Diesel	1301	4	8	43
Uno (146_)	02/84→08/89	100 GL.000	Petrol	903	4	8	13
Uno (146_)	04/84→12/03	156 A2.246	Petrol	999	4	8	18
Uno (146_)	06/84→10/05	127 A2.011	Petrol	1297	4	8	42
Uno (146_)	04/85→08/89	146 A2.000	Petrol	1301	4	8	46
Uno (146_)	05/85→08/89	149 A7.000	Petrol	1302	4	8	46
Uno (146_)	05/85→06/06	146 A4.048	Petrol	1116	4	8	27
Uno (146_)	10/85→12/93	138 C2.048	Petrol	1498	4	8	67
Uno (146_)	10/85→01/96	149 C1.000	Petrol	1499	4	8	67
Uno (146_)	01/86→12/89	146 A4.044	Petrol	1116	4	8	27
Uno (146_)	04/86→06/06	160 A3.000	Petrol	1108	4	8	29
Uno (146_)	06/86→12/93	156 A2.048	Petrol	999	4	8	18
Uno (146_)	06/86→12/93	156 A2.100	Petrol	999	4	8	18
Uno (146_)	07/86→08/89	149 B3.000	Diesel	1698	4	8	106
Uno (146_)	10/86→10/90	146 B.000	Diesel	1367	4	8	51
Uno (146_)	10/86→10/90	146 B3.000	Diesel	1367	4	8	51
Uno (146_)	01/87→12/87	146 A2.146	Petrol	1301	4	8	42
Uno (146_)	03/87→09/93	138 B3.011	Petrol	1498	4	8	69
Uno (146_)	10/88→08/00	146 A8.000	Petrol	1372	4	8	48
Uno (146_)	10/88→06/06	160 A1.046	Petrol	1372	4	8	48
Uno (146_)	10/88→06/06	160 A1.048	Petrol	1372	4	8	48
Uno (146_)	06/89→02/92	156 A2.000	Petrol	999	4	8	18
Uno (146_)	09/89→03/91	146 A2.246	Petrol	1301	4	8	46
Uno (146_)	09/89→09/93	146 A8.046	Petrol	1372	4	8	48
Uno (146_)	09/89→12/93	146 C1.000	Petrol	1372	4	8	48
Uno (146_)	09/89→03/94	149 B5.046	Diesel	1929	4	8	123
Uno (146_)	09/89→08/00	146 B2.000	Diesel	1698	4	8	106
Uno (146_)	11/89→04/93	160 A2.011	Petrol	1581	4	8	85
Uno (146_)	12/89→04/93	159 A3.046	Petrol	1581	4	8	85
Uno (146_)	01/90→12/93	156 C.046	Petrol	1108	4	8	29
Uno (146_)	08/90→06/01	146 A2.166	Petrol	994	4	8	19
Uno (146_)	06/92→12/93	146 C3.000	Petrol	1116	4	8	28
Uno (146_)	12/92→12/95	159 A3.048	Petrol	1581	4	8	86
Uno (146_)	05/93→06/01	146 A7.011	Petrol	994	4	8	19
Uno (146_)	09/98→04/10	178 D9.011	Petrol	999	4	8	21
Uno (146_)	08/00→04/10	188 A4.000	Petrol	1242	4	8	39
Uno (146_)	01/04→04/10	178 A6.011	Petrol	1497	4	8	70
Uno (146_)	01/04→04/10	178 E8.011	Petrol	1242	4	8	38
Uno (146_)	11/04→08/09	93313090-7U	Petrol	1796	4	8	117
Uno (146_)	03/05→12/08	146 E1.011	Petrol	999	4	8	21
Uno (146_)	03/05→12/08	178 F1.011	Petrol	999	4	8	21
Uno (146_)	11/05→04/10	178 E9.011	Petrol	1242	4	8	38
Uno (146A/E)	01/89→12/91	146 A8.000	Petrol	1372	4	8	48
Uno (195_)	05/10→	146 E4.1011	Petrol	999	4	8	21
Uno (195_)	05/10→	310 A1.011	Petrol	999	4	8	21
Uno (195_)	05/10→	327 A.011	Petrol	1368	4	8	59
Uno Box (146_)	02/88→02/92	146 A4.048	Petrol	1116	4	8	27
Uno Box (146_)	02/88→02/92	146 A6.000	Petrol	1116	4	8	27
Uno Box (146_)	02/88→02/92	146 B2.000	Diesel	1698	4	8	106
Uno Box (146_)	02/88→02/92	149 B4.046	Diesel	1697	4	8	106
Uno Box (146_)	02/88→07/96	146 A.000	Petrol	903	4	8	13
Uno Box (146_)	02/88→07/96	146 A1.000	Petrol	903	4	8	13
Uno Cargo	03/00→12/04	178 A6.011	Petrol	1497	4	8	70
Uno Cargo	01/04→12/09	178 D9.011	Petrol	999	4	8	21
Uno Cargo	11/05→	178 E9.011	Petrol	1242	4	8	38
Uno Cargo	03/06→12/09	146 E1.011	Petrol	999	4	8	21
Vida Hatchback	01/12→	F14D3	Petrol	1399	4	16	64
Vida Saloon	01/12→	F14D3	Petrol	1399	4	16	64
Vida Saloon	01/12→	F15S3	Petrol	1498	4	8	72
X 1/9 (128_)	05/73→12/79	128 AS.000	Petrol	1290	4	8	42
X 1/9 (128_)	11/78→12/89	138 AS.000	Petrol	1499	4	8	68
Xenon Pickup	01/09→	DW12DD	Diesel	2179	4	16	164
Y10	03/85→10/95	156A.000	Petrol	1049	4	8	17



















CC



















9









Y10	03/85→10/95	156A1.000	Petrol	1049	4	8	17	
Y10	03/85→10/95	156A2.000	Petrol	999	4	8	18	
Y10	12/86→10/95	156A3.000	Petrol	999	4	8	18	
Y10	10/87→10/95	156A2.246	Petrol	999	4	8	18	
Y10	06/89→10/95	146A5.046	Petrol	1297	4	8	46	
Y10	06/89→10/95	156B.000	Petrol	1301	4	8	46	
Y10	06/89→10/95	156C.000	Petrol	1108	4	8	29	
Y10	09/90→10/95	156C.046	Petrol	1108	4	8	29	
Yugo	04/80→06/95	128 A.000	Petrol	1116	4	8	26	
Yugo	08/91→06/95	100 GL. 0.64	Petrol	1116	4	8	25	
Yugo Florida	10/88→11/08	160 A1.000	Petrol	1372	4	8	52	
Yugo Florida	08/89→06/95	149 A.000	Petrol	1585	4	8	77	
Yugo Florida	08/89→11/08	138 B.0000	Petrol	1116	4	8	24	
Zest Saloon	08/14→	169 A1.000	Diesel	1248	4	16	33	









	CC				9		CC				9
4D56	2477	4	16	Diesel	176	128 BB.0A0	1116	4	8	Petrol	27
4G64	2351	4	16	Petrol	169	131 A.000	1297	4	8	Petrol	45
4HP	2179	4	16	Diesel	162	131 A1.000	1585	4	8	Petrol	77
4HR	2179	4	16	Diesel	162	131 A6.000	1297	4	8	Petrol	45
4HS	2179	4	16	Diesel	162	131 AB.1A.0	1585	4	8	Petrol	77
4HT (DW12BTED4)	2179	4	16	Diesel	162	131 B.000	1297	4	8	Petrol	45
4HU	2198	4	16	Diesel	163	131 B1.000	1585	4	8	Petrol	78
4HV	2198	4	16	Diesel	163	131 B2.000	1995	4	8	Petrol	130
4HW (DW12ATED4)	2179	4	16	Diesel	164	131 C.000	1367	4	8	Petrol	50
4HX (DW12TED4)	2179	4	16	Diesel	165	131 C1.000	1367	4	8	Petrol	50
9H07 (DV6UC)	1560	4	8	Diesel	73	131 C2.000	1585	4	8	Petrol	78
9HM (DV6UC)	1560	4	8	Diesel	74	131 C3.000	1585	4	8	Petrol	77
9HU	1560	4	16	Diesel	75	131 C4.000	1995	4	8	Petrol	131
11A	1116	4	8	Petrol	24	132 A.000	1592	4	8	Petrol	79
14FE	1372	4	8	Petrol	48	132 A.9000	1592	4	8	Petrol	79
30 A	3528	8	16	Petrol	196	132 A1.000	1756	4	8	Petrol	101
46 D	4553	8	16	Petrol	203	132 AB.000	1756	4	8	Petrol	107
100 G.000	843	4	8	Petrol	6	132 AB.OA.0	1592	4	8	Petrol	79
100 G.002	843	4	8	Petrol	6	132 AB.1A.0	1756	4	8	Petrol	107
100 GB.000	843	4	8	Petrol	6	132 AC.000	1592	4	8	Petrol	79
100 GBC.000	903	4	8	Petrol	12	132 AC1.000	1756	4	8	Petrol	108
100 GBC.040	903	4	8	Petrol	12	132 AZ2.000	1995	4	8	Petrol	122
100 GBS.000	903	4	8	Petrol	12	132 B.000	1756	4	8	Petrol	102
100 GC.000	843	4	8	Petrol	6	132 B1.000	1756	4	8	Petrol	102
100 GF 000	903	4	8	Petrol	12	132 B1.000	1756	4	8	Petrol	102
100 GL. 0.64	1116	4	8	Petrol	25	132 B2.000	1995	4	8	Petrol	132
100 GL.000	903	4	8	Petrol	13	132 BB.1A 0	1756	4	8	Petrol	109
100 GL.040	903	4	8	Petrol	13	132 BB OA 0	1592	4	8	Petrol	79
100 GL.048	903	4	8	Petrol	13	132 C.000	1585	4	8	Petrol	80
100 GL.064	903	4	8	Petrol	12	132 C1.000	1756	4	8	Petrol	102
100 GL3.000	903	4	8	Petrol	13	132 C1.000	1756	4	8	Petrol	103
100 GL6.000	843	4	8	Petrol	7	132 C2.000	1995	4	8	Petrol	133
110 D.000	499	2	4	Petrol	1	132 C2.031	1995	4	8	Petrol	132
110 F.000	499	2	4	Petrol	1	132 C2.040	1995	4	8	Petrol	132
120.000	499	2	4	Petrol	1	132 C3.000	1995	4	8	Petrol	133
124 A.000	1197	4	8	Petrol	32	132 C3.000	1995	4	8	Petrol	133
124 A.000	1197	4	8	Petrol	32	132 C3.031	1995	4	8	Petrol	133
124 A9.000	1592	4	8	Petrol	76	132 C3.040	1995	4	8	Petrol	132
124 AC.000	1438	4	8	Petrol	49	132 C6.000	1585	4	8	Petrol	80
124 B.000	1438	4	8	Petrol	49	132 CB.1A	1756	4	8	Petrol	109
124 B2.000	1438	4	8	Petrol	49	132 D.000	1585	4	8	Petrol	77
124 B3.000	1585	4	8	Petrol	77	132 D.000	1585	4	8	Petrol	78
124 BL.016	1197	4	8	Petrol	32	132 D1.000	1995	4	8	Petrol	133
124 BL 1.016	1438	4	8	Petrol	49	138 A.000	1302	4	8	Petrol	46
125 A.000	1608	4	8	Petrol	77	138 A1.000	1301	4	8	Petrol	46
125 B.000	1608	4	8	Petrol	77	138 A2.000	1498	4	8	Petrol	67
126 A.000	594	2	4	Petrol	2	138 A3.000	1301	4	8	Petrol	46
126 A1.000	652	2	4	Petrol	2	138 A4.000	1498	4	8	Petrol	67
126 A1.048	652	2	4	Petrol	2	138 A5.000	1714	4	8	Diesel	104
126 A2.000	704	2	4	Petrol	3	138 AE OA.0	1116	4	8	Petrol	27
126 A2.048	704	2	4	Petrol	3	138 AR.000	1585	4	8	Petrol	81
126 AB.0C.0	594	2	4	Petrol	2	138 AR.048	1585	4	8	Petrol	80
126 AB.5C.0	594	2	4	Petrol	2	138 AR1.000	1995	4	8	Petrol	134
126G100	843	4	8	Petrol	7	138 AR1.000	1995	4	8	Petrol	134
126G100	843	4	8	Petrol	14	138 AR2.000	1995	4	8	Petrol	134
127 A.000	1049	4	8	Petrol	17	138 AR2.000	1995	4	8	Petrol	134
127A.046	1049	4	8	Petrol	17	138 AS.000	1499	4	8	Petrol	68
127 A1.000	1049	4	8	Petrol	17	138 B.000	1116	4	8	Petrol	27
127 A1.024	843	4	8	Petrol	8	138 B.0000	1116	4	8	Petrol	24
127 A2.011	1297	4	8	Petrol	42	138 B1.000	1116	4	8	Petrol	27
127 A3.000	1301	4	8	Petrol	42	138 B2.000	1302	4	8	Petrol	46
127 A5.000	1302	4	8	Diesel	43	138 B3.000	1498	4	8	Petrol	67
127 A6.000	1049	4	8	Petrol	17	138 B3.011	1498	4	8	Petrol	69
128 A.000	1116	4	8	Petrol	26	138 B3.048	1498	4	8	Petrol	67
128 A.000	1116	4	8	Petrol	27	138 B5.000	1714	4	8	Diesel	105
128 A.048	1116	4	8	Petrol	27	138 B6.000	1714	4	8	Diesel	105
128 A.064	1116	4	8	Petrol	27	138 C.000	1698	4	8	Diesel	106
128 A011	1116	4	8	Petrol	27	138 C1.000	1116	4	8	Petrol	27
128 A 064	1116	4	8	Petrol	27	138 C2.048	1498	4	8	Petrol	67
128 A1.000	1290	4	8	Petrol	44	138 C3.048	1498	4	8	Petrol	67
128A4	1116	4	8	Petrol	26	141 A.000	652	2	4	Petrol	4
128 A5.000	1499	4	8	Petrol	42	141 A4.000	769	4	8	Petrol	9
128 AC.000	1290	4	8	Petrol	44	141 A4.048	770	4	8	Petrol	10
128 AC5.000	1116	4	8	Petrol	26	141 B.000	769	4	8	Petrol	9
128 AC5.000	1116	4	8	Petrol	26	141 C2.000	999	4	8	Petrol	18
128 AR.000	1290	4	8	Petrol	42	146 A.000	903	4	8	Petrol	13
128 AR.000	1290	4	8	Petrol	42	146 A.048	903	4	8	Petrol	12
128 AS.000	1290	4	8	Petrol	42	146 A1.000	903	4	8	Petrol	13









	CC				9		CC				9
146 A2.000	1301	4	8	Petrol	46	156A2.146	999	4	8	Petrol	18
146 A2.146	1301	4	8	Petrol	42	156 A2.246	999	4	8	Petrol	18
146 A2.166	994	4	8	Petrol	19	156A2.246	999	4	8	Petrol	18
146 A2.246	1301	4	8	Petrol	46	156A2.256	999	4	8	Petrol	18
146 A3.011	1497	4	8	Petrol	69	156 A3.000	999	4	8	Petrol	18
146 A4.000	1116	4	8	Petrol	27	156A3.000	999	4	8	Petrol	18
146 A4.044	1116	4	8	Petrol	27	156 A3.100	999	4	8	Petrol	18
146 A4.048	1116	4	8	Petrol	27	156 A4.000	770	4	8	Petrol	5
146 A5.000	1301	4	8	Petrol	46	156 A4.048	770	4	8	Petrol	11
146A5.046	1297	4	8	Petrol	46	156 A5.000	1302	4	8	Diesel	43
146 A6.000	1116	4	8	Petrol	27	156B.000	1301	4	8	Petrol	46
146 A7.011	994	4	8	Petrol	19	156C.000	1108	4	8	Petrol	29
146 A8.000	1372	4	8	Petrol	48	156 C.046	1108	4	8	Petrol	29
146 A8.046	1372	4	8	Petrol	48	156C.046	1108	4	8	Petrol	29
146 A9.000	1116	4	8	Petrol	27	159 A2.000	1372	4	8	Petrol	52
146 B.000	1367	4	8	Diesel	51	159 A3.000	1581	4	8	Petrol	85
146 B1.000	1301	4	8	Diesel	43	159 A3.046	1581	4	8	Petrol	85
146 B2.000	1698	4	8	Diesel	106	159 A3.048	1581	4	8	Petrol	86
146 B3.000	1367	4	8	Diesel	51	159 A4.000	1756	4	8	Petrol	110
146 B4.000	999	4	8	Petrol	20	159 A4.046	1756	4	8	Petrol	110
146 B6.011	1581	4	8	Petrol	82	159 A5.046	1995	4	8	Petrol	136
146 B7.011	1581	4	8	Petrol	82	159 A6.046	1995	4	8	Petrol	139
146 C1.000	1372	4	8	Petrol	48	159 B2.011	1995	4	8	Petrol	136
146 C3.000	1116	4	8	Petrol	28	159 B9.000	1581	4	8	Petrol	85
146 C4.011	994	4	8	Petrol	19	160 A1.000	1372	4	8	Petrol	52
146 C5.000	1372	4	8	Petrol	48	160 A1.000	1372	4	8	Petrol	52
146 C6.000	1581	4	8	Petrol	82	160 A1.046	1372	4	8	Petrol	48
146 D1.011	1497	4	8	Petrol	69	160 A1.048	1372	4	8	Petrol	48
146 D5.000	1372	4	8	Petrol	48	160 A2.000	1581	4	8	Petrol	85
146 D6.000	1581	4	8	Petrol	82	160 A2.011	1581	4	8	Petrol	85
146 D7.000	1698	4	8	Diesel	106	160 A3.000	1108	4	8	Petrol	29
146 E1.011	999	4	8	Petrol	21	160 A5.000	1756	4	16	Petrol	111
146 E4.1011	999	4	8	Petrol	21	160 A6.000	1929	4	8	Diesel	123
149 A.000	1585	4	8	Petrol	77	160 A6.046	1929	4	8	Diesel	123
149 A.000	1585	4	8	Petrol	77	160 A7.000	1929	4	8	Diesel	123
149 A1.000	1929	4	8	Diesel	123	160 A8.046	1995	4	16	Petrol	138
149 A2.000	1585	4	8	Petrol	77	160 B6.046	1929	4	8	Diesel	123
149 A3.000	1301	4	8	Petrol	46	160 D1.000	1929	4	8	Diesel	123
149 A4.000	1585	4	8	Petrol	77	164A0	903	4	8	Petrol	15
149 A5.000	1498	4	8	Petrol	67	169 A1.000	1248	4	16	Diesel	33
149 A5.046	1498	4	8	Petrol	67	169 A1.000	1248	4	16	Diesel	33
149 A7.000	1302	4	8	Petrol	46	169 A2.000	1248	4	16	Diesel	33
149 A7.003	1301	4	8	Petrol	46	169 A3.000	1368	4	16	Petrol	53
149 A7.046	1302	4	8	Petrol	46	169 A4.000	1242	4	8	Petrol	34
149 B1.000	1929	4	8	Diesel	123	169 A5.000	1248	4	16	Diesel	33
149 B2.000	1697	4	8	Diesel	106	169 B	1796	4	8	Petrol	112
149 B3.000	1698	4	8	Diesel	106	170 A.000	704	2	4	Petrol	3
149 B4.000	1697	4	8	Diesel	106	170 A.046	704	2	4	Petrol	3
149 B4.046	1697	4	8	Diesel	106	170 A1.000	903	4	8	Petrol	12
149 B5.046	1929	4	8	Diesel	123	170 A1.046	903	4	8	Petrol	12
149 C1.000	1499	4	8	Petrol	67	170 B	1971	4	8	Petrol	140
149 C2.000	1595	4	8	Petrol	83	170 D	1971	4	8	Petrol	140
149 C2.046	1595	4	8	Petrol	82	175 A1.000	1995	4	16	Petrol	141
149 C3.000	1585	4	8	Petrol	77	175 A3.000	1998	5	20	Petrol	142
149 E1.011	1995	4	8	Petrol	135	176 A3.000	1698	4	8	Diesel	106
154 A.048	1585	4	8	Petrol	84	176 A4.000	1372	4	8	Petrol	54
154 A1.000	1995	4	8	Petrol	136	176 A5.000	1698	4	8	Diesel	106
154 A2.000	1995	4	8	Petrol	136	176 A6.000	1108	4	8	Petrol	29
154 B.000	1929	4	8	Diesel	124	176 A7.000	1242	4	8	Petrol	35
154 C3.000	1995	4	8	Petrol	136	176 A8.000	1242	4	8	Petrol	35
154 C3.046	1995	4	8	Petrol	136	176 A9.000	1581	4	8	Petrol	87
154 C4.000	1995	4	8	Petrol	136	176 B1.000	1242	4	8	Petrol	35
154 C4.046	1995	4	8	Petrol	137	176 B2.000	1108	4	8	Petrol	29
154 C5.000	1995	4	8	Petrol	136	176 B3.000	1698	4	8	Diesel	106
154 C6.000	1929	4	8	Diesel	124	176 B4.000	1242	4	8	Petrol	35
154 D1.000	1929	4	8	Diesel	124	176 B6.000	1372	4	8	Petrol	54
154 E1.000	1995	4	16	Petrol	138	176 B7.000	1698	4	8	Diesel	106
156 A.000	1049	4	8	Petrol	17	176 B9.000	1242	4	16	Petrol	36
156A.000	1049	4	8	Petrol	17	178 A1.000	994	4	8	Petrol	19
156A1.000	1049	4	8	Petrol	17	178 A6.011	1497	4	8	Petrol	70
156 A2.000	999	4	8	Petrol	18	178 B2.000	1372	4	8	Petrol	48
156A2.000	999	4	8	Petrol	18	178 B2.016	1372	4	8	Petrol	48
156 A2.0157	999	4	8	Petrol	18	178 B3.000	1581	4	16	Petrol	88
156 A2.048	999	4	8	Petrol	18	178 B5.000	1242	4	8	Petrol	37
156 A2.050	999	4	8	Petrol	18	178 B7.045	1242	4	8	Petrol	37
156 A2.100	999	4	8	Petrol	18	178 B9.033	1108	4	8	Petrol	29
156 A2.100	999	4	8	Petrol	18	178 C4.066	1242	4	8	Petrol	37
156 A2.146	999	4	8	Petrol	18	178 C7.098	1581	4	16	Petrol	88

	CC				9		CC				9
178 C9.066	1698	4	8	Diesel	106	199 A4.000	1242	4	8	Petrol	41
178 D2.011	1581	4	16	Petrol	89	199 A5.000	1910	4	8	Diesel	125
178D8.011	999	4	16	Petrol	22	199 A6.000	1368	4	16	Petrol	53
178 D9.011	999	4	8	Petrol	21	199 A7.000	1368	4	8	Petrol	58
178 E2.000	1242	4	8	Petrol	35	199 A7.000	1368	4	8	Petrol	58
178 E5.022	1461	4	8	Petrol	71	199 A8.000	1368	4	16	Petrol	53
178 E7.000	1596	4	16	Petrol	90	199 A8.000	1368	4	16	Petrol	53
178 E8.011	1242	4	8	Petrol	38	199 A9.000	1248	4	16	Diesel	47
178 E9.011	1242	4	8	Petrol	38	199 B1.000	1248	4	16	Diesel	47
178 F1.011	999	4	8	Petrol	21	199 B2.000	1248	4	16	Diesel	47
178 F3.011	1368	4	8	Petrol	55	199 B4.000	1248	4	16	Diesel	47
182 A1.000	1998	5	20	Petrol	142	199 B5.000	1598	4	16	Diesel	92
182 A2.000	1747	4	16	Petrol	113	199 B6.000	875	2	8	Petrol	16
182 A3.000	1370	4	12	Petrol	56	199 B7.000	875	2	8	Petrol	16
182 A4.000	1581	4	16	Petrol	88	199 B8.000	1248	4	16	Diesel	47
182 A5.000	1370	4	12	Petrol	56	199 B9.000	1242	4	8	Petrol	41
182 A6.000	1581	4	16	Petrol	88	220 A 2.000	1581	4	8	Petrol	85
182 A7.000	1910	4	8	Diesel	125	223 A3.011	1242	4	16	Petrol	40
182 A8.000	1910	4	8	Diesel	125	223 A5.000	1242	4	8	Petrol	35
182 B2.000	1242	4	16	Petrol	36	223 A6.000	1910	4	8	Diesel	125
182 B3.000	1998	5	20	Petrol	142	223 A7.000	1910	4	8	Diesel	125
182 B4.000	1910	4	8	Diesel	125	223 A9.000	1248	4	16	Diesel	47
182 B5.098	1581	4	16	Petrol	89	223 B1.000	1910	4	8	Diesel	125
182 B6.000	1596	4	16	Petrol	88	223 B2.000	1910	4	8	Diesel	125
182 B7.000	1998	5	20	Petrol	142	225 A2.000	1248	4	16	Diesel	47
182 B9.000	1910	4	8	Diesel	125	230 A2.000	1929	4	8	Diesel	123
183 A1.000	1747	4	16	Petrol	113	230 A3.000	1929	4	8	Diesel	123
185 A2.000	2387	5	10	Diesel	170	230 A4.000	1929	4	8	Diesel	123
185 A3.000	1581	4	16	Petrol	89	250 A1.000	1956	4	16	Diesel	144
185 A4.011	1998	5	20	Petrol	142	250 A2.000	1956	4	16	Diesel	145
185 A5.011	1998	5	20	Petrol	143	263 A1.000	1956	4	16	Diesel	144
185 A6.000	2387	5	10	Diesel	170	263 A2.000	1248	4	16	Diesel	47
185 A7.011	2446	5	20	Petrol	171	263 A3.000	1598	4	16	Diesel	92
185 A8.000	1998	5	20	Petrol	142	263 A4.000	1598	4	16	Diesel	92
186 A3.000	1581	4	16	Petrol	89	263 A5.000	1598	4	16	Diesel	92
186 A4.000	1581	4	16	Petrol	89	263 A6.000	1248	4	16	Diesel	47
186 A6.000	1910	4	8	Diesel	125	263 A7.000	1598	4	16	Diesel	92
186 A8.000	1910	4	8	Diesel	125	263 A8.000	1598	4	16	Diesel	92
186 A9.000	1910	4	8	Diesel	125	263 A9.000	1598	4	16	Diesel	92
187 A1.000	1108	4	8	Petrol	30	280 A1.000	1929	4	8	Diesel	123
188 A2.000	1910	4	8	Diesel	125	310 A1.011	999	4	8	Petrol	21
188 A3.000	1910	4	8	Diesel	125	310 A2.011	1368	4	8	Petrol	55
188 A4.000	1242	4	8	Petrol	39	310 A3.011	1839	4	16	Petrol	127
188 A4.000	1242	4	8	Petrol	39	310 A5.011	1598	4	16	Petrol	93
188 A4.000	1242	4	8	Petrol	39	312 A1.000	1368	4	16	Petrol	53
188 A5.000	1242	4	16	Petrol	40	312 A1.000	1368	4	16	Petrol	53
188 A5.000	1242	4	16	Petrol	40	312 A2.000	875	2	8	Petrol	16
188 A6.000	1747	4	16	Petrol	113	312 A3.000	1368	4	16	Petrol	53
188 A7.000	1910	4	8	Diesel	125	312 A3.000	1368	4	16	Petrol	53
188 A8.000	1248	4	16	Diesel	47	312 A4.000	964	2	8	Petrol	16
188 A9.000	1248	4	16	Diesel	47	312 A5.000	875	2	8	Petrol	16
188 B2.000	1910	4	8	Diesel	125	312 A6.000	964	2	8	Petrol	16
192 A1.000	1910	4	8	Diesel	125	312 A7.000	875	2	8	Petrol	16
192 A2.000	2446	5	20	Petrol	171	312 A8.000	1248	4	16	Diesel	47
192 A3.000	1910	4	8	Diesel	125	312 B1.000	1248	4	16	Diesel	47
192 A4.000	1747	4	16	Petrol	113	312 B2.000	1248	4	16	Diesel	47
192 A5.000	1910	4	16	Diesel	126	312 B5.000	1248	4	16	Diesel	47
192 A7.011	2446	5	20	Petrol	171	323 B6.600	1368	4	16	Petrol	53
192 A8.000	1910	4	8	Diesel	125	327 A.011	1368	4	8	Petrol	59
192 A9.000	1910	4	8	Diesel	125	330 A1.000	1248	4	16	Diesel	47
192 B1.000	1910	4	16	Diesel	126	350 A1.000	1368	4	8	Petrol	58
192 B2.000	1368	4	16	Petrol	57	350 A1.000	1368	4	8	Petrol	58
192 B2.000	1368	4	16	Petrol	57	350 A2.000	1598	4	16	Diesel	92
192 B3.000	1598	4	16	Petrol	91	350 A3.000	1598	4	16	Diesel	92
192 B4.000	1910	4	8	Diesel	125	370 A0.011	1747	4	16	Petrol	113
192 B5.000	1910	4	8	Diesel	125	831 D1.000	1929	4	8	Diesel	123
194 A1.000	2198	4	16	Petrol	166	834 A1.000	1368	4	16	Petrol	60
198 A1.000	1368	4	16	Petrol	53	834 B.000	1995	4	8	Petrol	146
198 A2.000	1598	4	16	Diesel	92	834 B.048	1995	4	8	Petrol	136
198 A3.000	1598	4	16	Diesel	92	834 B.146	1995	4	8	Petrol	136
198 A4.000	1368	4	16	Petrol	53	834 C.146	1995	4	8	Petrol	136
198 A5.000	1956	4	16	Diesel	144	834 G.000	2492	6	12	Petrol	177
198 A6.000	1598	4	16	Diesel	92	835 C1.000	1581	4	8	Petrol	85
198 A7.000	1368	4	16	Petrol	53	835 C2.000	1756	4	8	Petrol	114
198 A8.000	1956	4	16	Diesel	144	835 C4.000	1756	4	8	Petrol	114
199 A1.000	1248	4	16	Diesel	47	836 A3.000	1995	4	16	Petrol	147
199 A2.000	1248	4	16	Diesel	47	836 A3.011	1995	4	16	Petrol	148
199 A3.000	1248	4	16	Diesel	47	836 A4.000	1372	4	8	Petrol	48

	CC				9		CC				9
836 A5.000	1756	4	8	Petrol	114	8040.45.271	3908	4	8	Diesel	201
836 A6.000	1756	4	8	Petrol	114	8040.45.4000 (TCA)	3908	4	8	Diesel	201
839 A5.000	2387	5	10	Diesel	170	8040.45.4180 (TCA)	3908	4	8	Diesel	201
843 A1.000	1368	4	16	Petrol	53	8040.45.5200	3908	4	8	Diesel	201
844 A2.000	1956	4	16	Diesel	144	8040.45.5281	3908	4	8	Diesel	201
844 A3.000	1598	4	16	Diesel	92	8040.45D.5100	3908	4	8	Diesel	201
937 A4.000	1910	4	16	Diesel	126	8040.45D.5103	3908	4	8	Diesel	201
937 A5.000	1910	4	16	Diesel	128	8045.02	3456	4	8	Diesel	197
937 A7.000	1910	4	8	Diesel	125	8045.04.189	3666	4	8	Diesel	200
939 A1.000	1910	4	8	Diesel	125	8045.04.270	3666	4	8	Diesel	200
939 A2.000	1910	4	16	Diesel	128	8045.04.275	3666	4	8	Diesel	200
939 A3.000	2387	5	20	Diesel	172	8045.04.276	3666	4	8	Diesel	200
939 A4.000	1796	4	16	Petrol	115	8045.04.277	3666	4	8	Diesel	200
939 A7.000	1910	4	8	Diesel	125	8045.04.293	3666	4	8	Diesel	200
939 A8.000	1910	4	16	Diesel	128	8045.04.300	3666	4	8	Diesel	200
939 B5.000	1956	4	16	Diesel	144	8045.04.359	3666	4	8	Diesel	200
940 A5.000	1956	4	16	Diesel	144	8045.04.370	3666	4	8	Diesel	200
940 B7.000	1368	4	16	Petrol	53	8045.04.376	3666	4	8	Diesel	200
940 C1.000	1598	4	16	Diesel	92	8045.04.377	3666	4	8	Diesel	200
955 A2.000	1368	4	16	Petrol	61	8045.05.000	3908	4	8	Diesel	201
955 A3.000	1598	4	16	Diesel	92	8045.05.200	3908	4	8	Diesel	201
955 A4.000	1598	4	16	Diesel	92	8045.05.204	3908	4	8	Diesel	201
955 A6.000	1368	4	16	Petrol	61	8045.05.213	3908	4	8	Diesel	201
955 A8.000	1368	4	16	Petrol	61	8045.05.215	3908	4	8	Diesel	201
955 A8.000	1368	4	16	Petrol	61	8045.05.216	3908	4	8	Diesel	201
955 B2.000	1248	4	16	Diesel	47	8045.05.217	3908	4	8	Diesel	201
960 A1.000	1742	4	16	Petrol	116	8045.05.300	3908	4	8	Diesel	201
1170 A1.000	899	4	8	Petrol	14	8045.05.304	3908	4	8	Diesel	201
1170 A1.046	899	4	8	Petrol	14	8045.05.308	3908	4	8	Diesel	201
6132 AZ 2.000	1995	4	8	Petrol	149	8045.05.317	3908	4	8	Diesel	201
8030.02	2592	3	6	Diesel	188	8045.05.359	3908	4	8	Diesel	201
8035.02	2592	3	6	Diesel	188	8045.05.370	3908	4	8	Diesel	201
8035.04.265	2749	3	6	Diesel	189	8045.05.376	3908	4	8	Diesel	201
8035.04.270	2749	3	6	Diesel	189	8045.05.389	3908	4	8	Diesel	201
8035.04.272	2749	3	6	Diesel	189	8045.05.393	3908	4	8	Diesel	201
8035.04.300	2749	3	6	Diesel	189	8045.05.395	3908	4	8	Diesel	201
8035.04.359	2749	3	6	Diesel	189	8045.06.200	3613	4	8	Diesel	198
8035.04.370	2749	3	6	Diesel	189	8045.06.208	3613	4	8	Diesel	198
8035.04.376	2749	3	6	Diesel	189	8045.06.213	3613	4	8	Diesel	198
8035.04.377	2749	3	6	Diesel	189	8045.06.214	3613	4	8	Diesel	198
8035.04.378	2749	3	6	Diesel	189	8045.06.215	3613	4	8	Diesel	198
8035.05.214	2931	3	6	Diesel	191	8045.06.225	3613	4	8	Diesel	198
8035.05.215	2931	3	6	Diesel	191	8045.06.319	3613	4	8	Diesel	198
8035.06.200	2708	3	6	Diesel	189	8045.06.326	3613	4	8	Diesel	198
8035.06.206	2708	3	6	Diesel	189	8045.25.210	3908	4	8	Diesel	201
8035.06.208	2708	3	6	Diesel	189	8045.25.310	3908	4	8	Diesel	201
8035.06.216	2708	3	6	Diesel	189	8045.25.370	3908	4	8	Diesel	201
8035.06.220	2708	3	6	Diesel	189	8045.25.375	3908	4	8	Diesel	201
8035.06.222	2708	3	6	Diesel	189	8045.25.376	3908	4	8	Diesel	201
8035.06.223	2708	3	6	Diesel	189	8045.25.380	3908	4	8	Diesel	201
8035.06.306	2708	3	6	Diesel	189	8045.25.381	3908	4	8	Diesel	201
8035.06.307	2708	3	6	Diesel	189	8045.25.382	3908	4	8	Diesel	201
8035.06.308	2708	3	6	Diesel	189	8045.25.385	3908	4	8	Diesel	201
8035.06.309	2708	3	6	Diesel	189	8045.25.395	3908	4	8	Diesel	201
8035.06.317	2708	3	6	Diesel	189	8055.04.200	4583	5	10	Diesel	204
8035.06.320	2708	3	6	Diesel	189	8055.04.205	4583	5	10	Diesel	204
8035.06.321	2708	3	6	Diesel	189	8055.04.250	4583	5	10	Diesel	204
8035.06.322	2708	3	6	Diesel	189	8055.05.000	4885	5	10	Diesel	206
8035.06.323	2708	3	6	Diesel	189	8060.02.000	5184	6	12	Diesel	207
8040.00	3120	4	8	Diesel	195	8060.02.001	5184	6	12	Diesel	208
8040.02	3456	4	8	Diesel	197	8060.02.003	5184	6	12	Diesel	208
8040.02.041	3456	4	8	Diesel	197	8060.02.070	5184	6	12	Diesel	207
8040.02.267	3456	4	8	Diesel	197	8060.04.000	5499	6	12	Diesel	210
8040.02.300	3455	4	8	Diesel	197	8060.04.051	5499	6	12	Diesel	210
8040.02.360	3456	4	8	Diesel	197	8060.04.052	5499	6	12	Diesel	210
8040.02.367	3456	4	8	Diesel	197	8060.04.055	5499	6	12	Diesel	210
8040.04.200	3666	4	8	Diesel	200	8060.04.060	5499	6	12	Diesel	210
8040.04.280	3666	4	8	Diesel	200	8060.04.070	5499	6	12	Diesel	210
8040.05.200	3908	4	8	Diesel	201	8060.04.620	5499	6	12	Diesel	210
8040.05.230	3908	4	8	Diesel	201	8060.04.621	5499	6	12	Diesel	210
8040.05.4990	3908	4	8	Diesel	201	8060.04.630	5499	6	12	Diesel	210
8040.25.000	3908	4	8	Diesel	201	8060.04.639	5499	6	12	Diesel	210
8040.25.200	3908	4	8	Diesel	201	8060.04.658	5499	6	12	Diesel	210
8040.25.220	3908	4	8	Diesel	201	8060.04.660	5499	6	12	Diesel	210
8040.25.230	3908	4	8	Diesel	201	8060.04.661	5499	6	12	Diesel	210
8040.25B.4200 (LTC)	3908	4	8	Diesel	201	8060.04.662	5499	6	12	Diesel	210
8040.25X.4000	3908	4	8	Diesel	201	8060.04.669	5499	6	12	Diesel	210
8040.45.261	3908	4	8	Diesel	201	8060.04.670	5499	6	12	Diesel	210

	CC				9		CC				9
8060.04.672	5499	6	12	Diesel	210	8065.06.300	5418	6	12	Diesel	209
8060.04.675	5499	6	12	Diesel	210	8065.24.000	5499	6	12	Diesel	210
8060.04.689	5499	6	12	Diesel	210	8065.24.091	5499	6	12	Diesel	210
8060.05.000	5861	6	12	Diesel	211	8065.24.092	5499	6	12	Diesel	210
8060.05.200	5861	6	12	Diesel	211	8065.24.098	5499	6	12	Diesel	210
8060.05.246	5861	6	12	Diesel	211	8065.24.300	5499	6	12	Diesel	210
8060.05.270	5861	6	12	Diesel	211	8065.25.000	5863	6	12	Diesel	211
8060.05.280	5861	6	12	Diesel	211	8065.25.010	5863	6	12	Diesel	211
8060.05.285	5861	6	12	Diesel	211	8065.25.080	5863	6	12	Diesel	211
8060.05.289	5861	6	12	Diesel	211	8065.25.320	5863	6	12	Diesel	211
8060.05.661	5861	6	12	Diesel	211	8140.23.2200	2800	4	8	Diesel	190
8060.05.662	5861	6	12	Diesel	211	8140.27	2500	4	8	Diesel	178
8060.05.663	5861	6	12	Diesel	211	8140.27.2100	2500	4	8	Diesel	178
8060.05.673	5861	6	12	Diesel	211	8140.27S.3700	2499	4	8	Diesel	179
8060.12	5184	6	12	Diesel	207	8140.43	2800	4	8	Diesel	190
8060.12.031	5184	6	12	Diesel	207	8140.43N	2798	4	8	Diesel	190
8060.24.601	5499	6	12	Diesel	210	8140.43S	2798	4	8	Diesel	190
8060.24.643	5499	6	12	Diesel	210	8140.47	2500	4	8	Diesel	180
8060.24.652	5499	6	12	Diesel	210	8140.47.3700	2499	4	8	Diesel	180
8060.24.661	5500	6	12	Diesel	210	8140.47R	2500	4	8	Diesel	180
8060.24.662	5499	6	12	Diesel	210	8140.47R.2210	2499	4	8	Diesel	180
8060.24.664	5499	6	12	Diesel	210	8140.61	2445	4	8	Diesel	181
8060.24.670	5499	6	12	Diesel	210	8140.61.204	2445	4	8	Diesel	173
8060.24.671	5499	6	12	Diesel	210	8140.63	2800	4	8	Diesel	190
8060.24.673	5499	6	12	Diesel	210	8140.67	2500	4	8	Diesel	180
8060.24.678	5500	6	12	Diesel	210	8140.67.2700	2499	4	8	Diesel	180
8060.25.221	5861	6	12	Diesel	211	8142.61	2445	4	8	Diesel	173
8060.25.241	5861	6	12	Diesel	211	8144.21	2445	4	8	Diesel	181
8060.25.243	5861	6	12	Diesel	211	8144.21.220	2445	4	8	Diesel	182
8060.25.246	5861	6	12	Diesel	211	8144.61	2428	4	8	Diesel	173
8060.25.4600	5499	6	12	Diesel	210	8144.61.200	2445	4	8	Diesel	173
8060.25.600	5861	6	12	Diesel	212	8144.61.500.81	2445	4	8	Diesel	173
8060.25.621	5861	6	12	Diesel	211	8144.67	2500	4	8	Diesel	183
8060.25.630	5861	6	12	Diesel	211	8144.67.220	2499	4	8	Diesel	181
8060.25.631	5861	6	12	Diesel	211	8144.81.2000	2445	4	8	Diesel	174
8060.25.641	5861	6	12	Diesel	211	8144.91.2000	2445	4	8	Diesel	174
8060.25.661	5861	6	12	Diesel	211	8144.97	2499	4	8	Diesel	184
8060.25.662	5861	6	12	Diesel	211	8144.97.2200	2499	4	8	Diesel	184
8060.25.663	5861	6	12	Diesel	211	8144.97.2400	2499	4	8	Diesel	184
8060.25.669	5861	6	12	Diesel	213	8144.97.2500	2500	4	8	Diesel	184
8060.25.670	5861	6	12	Diesel	213	8144.97 S	2500	4	8	Diesel	184
8060.25.673	5861	6	12	Diesel	211	8144.97 Y	2500	4	8	Diesel	184
8060.25.678	5861	6	12	Diesel	213	8210.02.000	13798	6	12	Diesel	217
8060.25.679	5861	6	12	Diesel	213	8210.02.020	13798	6	12	Diesel	217
8060.25R.4200	5861	6	12	Diesel	213	8210.02.022	13798	6	12	Diesel	217
8060.25R.4280	5861	6	12	Diesel	213	8210.02.032	13798	6	12	Diesel	217
8060.25V.4000	5861	6	12	Diesel	212	8210.02.033	13798	6	12	Diesel	217
8060.25V.4080	5861	6	12	Diesel	213	8210.02.053	13798	6	12	Diesel	217
8060.45.4100	5861	6	12	Diesel	213	8210.02.067	13798	6	12	Diesel	217
8060.45.4180	5861	6	12	Diesel	213	8210.02.069	13798	6	12	Diesel	217
8060.45.600	5861	6	12	Diesel	211	8210.02.081	13798	6	12	Diesel	217
8060.45.6090	5861	6	12	Diesel	213	8210.02.266	13798	6	12	Diesel	217
8060.45S.6000	5861	6	12	Diesel	213	8210.02.267	13798	6	12	Diesel	217
8060.45S.6700	5861	6	12	Diesel	213	8210.02.290	13798	6	12	Diesel	217
8060.45S.6800	5861	6	12	Diesel	213	8210.02.371	13798	6	12	Diesel	217
8062.24.070	5499	6	12	Diesel	210	8210.02.373	13798	6	12	Diesel	217
8065.02.007	5184	6	12	Diesel	207	8210.02.377	13798	6	12	Diesel	217
8065.02.200	5184	6	12	Diesel	207	8210.02.385	13798	6	12	Diesel	217
8065.02.207	5184	6	12	Diesel	207	8210.02.393	13798	6	12	Diesel	217
8065.02.217	5184	6	12	Diesel	207	8210.02.405	13798	6	12	Diesel	217
8065.04.089	5499	6	12	Diesel	210	8210.02.426	13798	6	12	Diesel	217
8065.04.095	5499	6	12	Diesel	210	8210.02.440	13798	6	12	Diesel	217
8065.04.097	5499	6	12	Diesel	210	8210.02.441	13798	6	12	Diesel	217
8065.04.200	5499	6	12	Diesel	210	8210.02.731	13798	6	12	Diesel	217
8065.04.217	5499	6	12	Diesel	210	8210.02.791	13798	6	12	Diesel	217
8065.04.270	5499	6	12	Diesel	210	8210.02.793	13798	6	12	Diesel	217
8065.05.000	5863	6	12	Diesel	211	8210.22.000	13798	6	12	Diesel	217
8065.05.210	5863	6	12	Diesel	211	8210.22.069	13798	6	12	Diesel	217
8065.05.220	5863	6	12	Diesel	211	8210.22.101	13798	6	12	Diesel	217
8065.05.290	5863	6	12	Diesel	211	8210.22.105	13798	6	12	Diesel	217
8065.05.295	5863	6	12	Diesel	211	8210.22.171	13798	6	12	Diesel	217
8065.05.297	5863	6	12	Diesel	211	8210.22.175	13798	6	12	Diesel	217
8065.05.300	5863	6	12	Diesel	211	8210.22.183	13798	6	12	Diesel	217
8065.05.330	5863	6	12	Diesel	211	8210.22.235	13798	6	12	Diesel	217
8065.06.000	5418	6	12	Diesel	209	8210.22.269	13798	6	12	Diesel	217
8065.06.200	5418	6	12	Diesel	209	8210.22.290	13798	6	12	Diesel	217
8065.06.220	5418	6	12	Diesel	209	8210.22.317	13798	6	12	Diesel	217
8065.06.230	5418	6	12	Diesel	209	8210.22.327	13798	6	12	Diesel	217

	CC				9		CC				9
8210.22.373	13798	6	12	Diesel	217	CRD93L (U25-661)	2500	4	8	Diesel	186
8210.22.385	13798	6	12	Diesel	217	D8B	1905	4	8	Diesel	129
8210.22.406	13798	6	12	Diesel	217	D8B (XUD9TE)	1905	4	8	Diesel	129
8210.22.569	13798	6	12	Diesel	217	D9B	1905	4	8	Diesel	129
8210.22.869	13798	6	12	Diesel	217	D9B (XUD9A)	1905	4	8	Diesel	129
8210.22X.069	13798	6	12	Diesel	217	D19AA	1910	4	8	Diesel	125
8210.22X.235	13798	6	12	Diesel	217	D20AA	1956	4	16	Diesel	144
8210.22X.523	13798	6	12	Diesel	217	DHX (XUD9TE)	1905	4	8	Diesel	129
8210.22X.575	13798	6	12	Diesel	217	DHX (XUD9TF/L)	1905	4	8	Diesel	129
8210.42(TCA)	13798	6	12	Diesel	217	DHX	1905	4	8	Diesel	129
8210.42.061	13798	6	12	Diesel	217	DJY (XUD9)	1905	4	8	Diesel	129
8210.42.073	13798	6	12	Diesel	217	DJY	1905	4	8	Diesel	129
8210.42.101	13798	6	12	Diesel	217	DW10BTE4	1997	4	16	Diesel	151
8210.42.115	13798	6	12	Diesel	217	DW12DD	2179	4	16	Diesel	164
8210.42.151	13798	6	12	Diesel	217	EAF	1368	4	16	Petrol	63
8210.42.152	13798	6	12	Diesel	217	EAM	1368	4	16	Petrol	61
8210.42.154	13798	6	12	Diesel	217	ED3	2360	4	16	Petrol	175
8210.42.155	13798	6	12	Diesel	217	ED6	2360	4	16	Petrol	175
8210.42.161	13798	6	12	Diesel	217	EDG	2360	4	16	Petrol	175
8210.42.162	13798	6	12	Diesel	217	ERB	3604	6	24	Petrol	199
8210.42.165	13798	6	12	Diesel	217	F1AE0481C	2286	4	16	Diesel	168
8210.42.171	13798	6	12	Diesel	217	F1AE0481D	2287	4	16	Diesel	168
8210.42.172	13798	6	12	Diesel	217	F1AE0481N	2287	4	16	Diesel	168
8210.42.175	13798	6	12	Diesel	217	F1AE0481T	2286	4	16	Diesel	168
8210.42.181	13798	6	12	Diesel	217	F1AE3481D	2287	4	16	Diesel	168
8210.42.182	13798	6	12	Diesel	217	F1AE3481E	2287	4	16	Diesel	168
8210.42.185	13798	6	12	Diesel	217	F1AE3481G	2287	4	16	Diesel	168
8210.42.186	13798	6	12	Diesel	217	F1AGL411A	2287	4	16	Diesel	168
8210.42.191	13798	6	12	Diesel	217	F1AGL411B	2287	4	16	Diesel	168
8210.42.195	13798	6	12	Diesel	217	F1AGL411C	2287	4	16	Diesel	168
8210.42L.400	13798	6	12	Diesel	217	F1AGL411D	2287	4	16	Diesel	168
8220.02.701	9572	6	12	Diesel	215	F1AGL411M	2287	4	16	Diesel	168
8220.02.834	9572	6	12	Diesel	215	F14D3	1399	4	16	Petrol	64
8220.02.842	9570	6	12	Diesel	216	F14D4	1399	4	16	Petrol	65
8220.02.847	9572	6	12	Diesel	215	F15S3	1498	4	8	Petrol	72
8220.02.856	9572	6	12	Diesel	215	FPT	2287	4	16	Diesel	168
8220.02.870	9572	6	12	Diesel	215	J2	1796	4	8	Petrol	117
8220.12.001	9570	6	12	Diesel	216	KFT	1360	4	8	Petrol	66
8220.12.709	9572	6	12	Diesel	215	KFV	1360	4	8	Petrol	66
8220.22.002	9572	6	12	Diesel	215	LFW	1761	4	8	Petrol	119
8220.22.102	9572	6	12	Diesel	215	LJA	1597	4	8	Petrol	96
8220.22.104	9572	6	12	Diesel	215	LUA	1597	4	8	Petrol	96
8220.22.106	9572	6	12	Diesel	215	M16A	1586	4	16	Petrol	97
8220.22.708	9570	6	12	Diesel	216	MO20 AA.09.0	903	4	8	Petrol	14
8220.22.709	9570	6	12	Diesel	216	M62448S2	4398	8	32	Petrol	202
8220.32.701	9572	6	12	Diesel	215	MEBA	2967	6	24	Petrol	192
8220.32.721	9570	6	12	Diesel	216	N54 B30 A	2979	6	24	Petrol	193
8220.32.723	9570	6	12	Diesel	216	N62 B48 B	4799	8	32	Petrol	205
8460.21.002	9498	6	12	Diesel	214	P8C	2088	4	12	Diesel	161
8460.41R.723	9498	6	12	Diesel	214	PN93327668	1796	4	8	Petrol	117
8460.41S.733	9498	6	12	Diesel	214	PN93327669	1796	4	16	Petrol	120
55253268	1368	4	16	Petrol	61	R9M 408	1598	4	16	Diesel	98
55260384	1598	4	16	Diesel	92	R9M 413	1598	4	16	Diesel	98
55263087	1956	4	16	Diesel	144	R9M 450	1598	4	16	Diesel	98
55263088	1956	4	16	Diesel	144	R9M 452	1598	4	16	Diesel	98
55263623	1368	4	16	Petrol	61	RFH (EW10A)	1997	4	16	Petrol	152
55263624	1368	4	16	Petrol	61	RFL	1998	4	16	Petrol	153
55263842	1598	4	16	Petrol	94	RFN (EW10J4)	1997	4	16	Petrol	154
55266963	1248	4	16	Diesel	47	RFU (XU10J2C)	1998	4	8	Petrol	155
55268036	1598	4	16	Petrol	93	RFV	1998	4	16	Petrol	156
93313090-7U	1796	4	8	Petrol	117	RFW	1998	4	8	Petrol	155
93313090-H2	1796	4	8	Petrol	117	RGX (XU10J2CTE)	1998	4	8	Petrol	153
93337154-J1	1796	4	8	Petrol	117	RH02	1997	4	16	Diesel	157
A13SM	1349	4	8	Petrol	62	RHBA	1596	4	16	Petrol	99
A15SM	1498	4	8	Petrol	72	RHH	1997	4	16	Diesel	157
A16DMS	1598	4	16	Petrol	95	RHK (DW10UTED4)	1997	4	16	Diesel	151
A112	903	4	8	Petrol	13	RHK	1997	4	16	Diesel	151
A112A	1049	4	8	Petrol	23	RHM (DW10ATED4)	1997	4	16	Diesel	151
A112A 5.000	903	4	8	Petrol	13	RHR	1997	4	16	Diesel	151
A 112 AB.2C.0	1050	4	8	Petrol	25	RHV (DW10)	1997	4	8	Diesel	158
A112B1.000	965	4	8	Petrol	18	RHW (DW10ATED4)	1997	4	16	Diesel	151
A 112 B1.054	965	4	8	Petrol	13	RHX	1997	4	8	Diesel	159
A112B1.054	965	4	8	Petrol	18	RHZ	1997	4	8	Diesel	159
A112B2.000	903	4	8	Petrol	13	RQB	1796	4	16	Petrol	121
AODA	1999	4	16	Petrol	150	THY (DK5ATE)	2446	4	12	Diesel	187
B 25.637	2498	4	8	Diesel	185	TUIJP	1124	4	8	Petrol	31
B22615	2175	4	8	Diesel	167	WJY (DW8)	1868	4	8	Diesel	129
CHBA	1798	4	16	Petrol	118	WJY (DW8B)	1868	4	8	Diesel	129

	CC				9		CC				9
WJZ (DW8)	1868	4	8	Diesel	129						
XFW	2946	6	24	Petrol	194						
XM7T	1796	4	8	Petrol	112						
XN 1T	1971	4	8	Petrol	160						
XQDA	1999	4	16	Petrol	150						
Y2	1796	4	8	Petrol	117						
ZSG416	1595	4	16	Petrol	100						

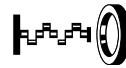
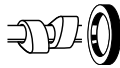

1 0.5L Petrol				
110 D.000	2 Cyl.	4 Valves	499cc	TD23456
110 F.000	2 Cyl.	4 Valves	499cc	TD871
120.000	2 Cyl.	4 Valves	499cc	TD873
KG393 (x4)				NA5045 53.00 x 68.00 x 10.00mm, ACM

2 0.6L Petrol				
126 A.000	2 Cyl.	4 Valves	594cc	TD880
126 A1.000	2 Cyl.	4 Valves	652cc	TD4343
126 A1.048	2 Cyl.	4 Valves	652cc	TD881
126 AB.0C.0	2 Cyl.	4 Valves	594cc	TD22224
126 AB.5C.0	2 Cyl.	4 Valves	594cc	TD22225
KG393 (x4)				NA5045 53.00 x 68.00 x 10.00mm, ACM

3 0.7L Petrol				
126 A2.000	2 Cyl.	4 Valves	704cc	TD4342
126 A2.048	2 Cyl.	4 Valves	704cc	TD4344
170 A.000	2 Cyl.	4 Valves	704cc	TD1028
170 A.046	2 Cyl.	4 Valves	704cc	TD15809
HR569				NA5045 53.00 x 68.00 x 10.00mm, ACM

4 0.7L Petrol				
141 A.000	2 Cyl.	4 Valves	652cc	TD9385
KG393 (x4)				NB728 53.00 x 68.00 x 10.00mm, ACM NA5049 64.00 x 80.00 x 8.00mm, ACM
HR569				

5 0.7L Petrol				
156 A4.000	4 Cyl.	8 Valves	770cc	TD11307
HR816	NA5053 30.00 x 42.00 x 7.00mm, FPM			NB815 23.00 x 35.00 x 7.00mm, FPM NB814 70.00 x 88.00 x 8.00mm, FPM

6 0.8L Petrol				
100 G.000	4 Cyl.	8 Valves	843cc	TD863
100 G.002	4 Cyl.	8 Valves	843cc	TD864
100 GB.000	4 Cyl.	8 Valves	843cc	TD865
100 GC.000	4 Cyl.	8 Valves	843cc	TD868
HR816				NB808 64.00 x 80.00 x 8.00mm, FPM

7 0.8L Petrol				
100 GL6.000	4 Cyl.	8 Valves	843cc	TD21449
126G100	4 Cyl.	8 Valves	843cc	TD32749
HR816				NA5190 42.00 x 56.00 x 7.00mm, FPM NB808 64.00 x 80.00 x 8.00mm, FPM

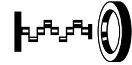
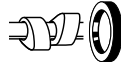

8 0.8L Petrol

127 A1.024	4 Cyl.	8 Valves	843cc	TD27357
HR569				
			NA5190 42.00 x 56.00 x 7.00mm, FPM NB808 64.00 x 80.00 x 8.00mm, FPM	

9 0.8L Petrol

141 A4.000	4 Cyl.	8 Valves	769cc	TD931
141 B.000	4 Cyl.	8 Valves	769cc	TD4370
HR816				
			NA5049 64.00 x 80.00 x 8.00mm, ACM	

10 0.8L Petrol

141 A4.048	4 Cyl.	8 Valves	770cc	TD930
HR816				
			NA5053 30.00 x 42.00 x 7.00mm, FPM	NA5049 64.00 x 80.00 x 8.00mm, ACM

11 0.8L Petrol

156 A4.048	4 Cyl.	8 Valves	770cc	TD11308
HR816				
			NA5053 30.00 x 42.00 x 7.00mm, FPM	NB815 23.00 x 35.00 x 7.00mm, FPM NB814 70.00 x 88.00 x 8.00mm, FPM

12 0.9L Petrol

100 GBC.000	4 Cyl.	8 Valves	903cc	TD866
100 GBC.040	4 Cyl.	8 Valves	903cc	TD23115
100 GBS.000	4 Cyl.	8 Valves	903cc	TD867
100 GF 000	4 Cyl.	8 Valves	903cc	TD6939
100 GL.064	4 Cyl.	8 Valves	903cc	TD23116
146 A.048	4 Cyl.	8 Valves	903cc	TD934
170 A1.000	4 Cyl.	8 Valves	903cc	TD15810
170 A1.046	4 Cyl.	8 Valves	903cc	TD15811
HR816				
			NC048 38.00 x 52.00 x 6.00mm, FPM	NA5190 42.00 x 56.00 x 7.00mm, FPM NB808 64.00 x 80.00 x 8.00mm, FPM

13 0.9L Petrol

100 GL.000	4 Cyl.	8 Valves	903cc	TD870
100 GL3.000	4 Cyl.	8 Valves	903cc	TD869
100 GL.040	4 Cyl.	8 Valves	903cc	TD22509
100 GL.048	4 Cyl.	8 Valves	903cc	TD4413
146 A.000	4 Cyl.	8 Valves	903cc	TD4371
146 A1.000	4 Cyl.	8 Valves	903cc	TD4372
A112	4 Cyl.	8 Valves	903cc	TD402
A112A 5.000	4 Cyl.	8 Valves	903cc	TD5111
A 112 B1.054	4 Cyl.	8 Valves	965cc	TD4412
A112B2.000	4 Cyl.	8 Valves	903cc	TD13430
HR816				
			NC048 38.00 x 52.00 x 6.00mm, FPM	NA5049 64.00 x 80.00 x 8.00mm, ACM NB808 64.00 x 80.00 x 8.00mm, FPM

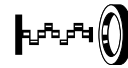
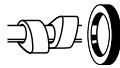

14 0.9L

Petrol

126G100	4 Cyl.	8 Valves	843cc	TD31689
1170 A1.000	4 Cyl.	8 Valves	899cc	TD1030
1170 A1.046	4 Cyl.	8 Valves	899cc	TD872
M020 AA.09.0	4 Cyl.	8 Valves	903cc	TD22241

HR816

NA5190

42.00 x 56.00 x 7.00mm, FPM

NB808

64.00 x 80.00 x 8.00mm, FPM

15 0.9L

Petrol

164A0	4 Cyl.	8 Valves	903cc	TD21690
-------	--------	----------	-------	---------

NC048

38.00 x 52.00 x 6.00mm, FPM

NA5049

64.00 x 80.00 x 8.00mm, ACM

NB808

64.00 x 80.00 x 8.00mm, FPM

16 0.9L

Petrol

199 B6.000	2 Cyl.	8 Valves	875cc	TD26735
199 B7.000	2 Cyl.	8 Valves	875cc	TD33886
312 A2.000	2 Cyl.	8 Valves	875cc	TD24763
312 A4.000	2 Cyl.	8 Valves	964cc	TD26432
312 A5.000	2 Cyl.	8 Valves	875cc	TD29234
312 A6.000	2 Cyl.	8 Valves	964cc	TD31245
312 A7.000	2 Cyl.	8 Valves	875cc	TD29719

NA5070

31.00 x 41.00 x 7.00mm, FPM

NF857

85.00 x 105.00 x 9.00mm, FPM/ACM

17 1.0L

Petrol

127 A.000	4 Cyl.	8 Valves	1049cc	TD887
127 A1.000	4 Cyl.	8 Valves	1049cc	TD4345
127 A6.000	4 Cyl.	8 Valves	1049cc	TD4347
127A.046	4 Cyl.	8 Valves	1049cc	TD33031
156A.000	4 Cyl.	8 Valves	1049cc	TD391
156 A.000	4 Cyl.	8 Valves	1049cc	TD4411
156A1.000	4 Cyl.	8 Valves	1049cc	TD392

HR569

NA5187

30.00 x 52.00 x 7.00mm, ACM

NB307

40.00 x 56.00 x 7.00mm, ACM

NB808

64.00 x 80.00 x 8.00mm, FPM

18 1.0L

Petrol

141 C2.000	4 Cyl.	8 Valves	999cc	TD1070
156 A2.000	4 Cyl.	8 Valves	999cc	TD16230
156A2.000	4 Cyl.	8 Valves	999cc	TD393
156 A2.048	4 Cyl.	8 Valves	999cc	TD992
156 A2.050	4 Cyl.	8 Valves	999cc	TD22228
156 A2.100	4 Cyl.	8 Valves	999cc	TD394
156 A2.100	4 Cyl.	8 Valves	999cc	TD4387
156 A2.146	4 Cyl.	8 Valves	999cc	TD993
156A2.146	4 Cyl.	8 Valves	999cc	TD395
156 A2.0157	4 Cyl.	8 Valves	999cc	TD22227

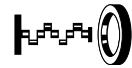
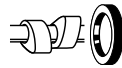

156A2.246	4 Cyl.	8 Valves	999cc	TD16210
156 A2.246	4 Cyl.	8 Valves	999cc	TD994
156A2.256	4 Cyl.	8 Valves	999cc	TD396
156A3.000	4 Cyl.	8 Valves	999cc	TD397
156 A3.000	4 Cyl.	8 Valves	999cc	TD16209
156 A3.100	4 Cyl.	8 Valves	999cc	TD4386
A112B1.000	4 Cyl.	8 Valves	965cc	TD5113
A112B1.054	4 Cyl.	8 Valves	965cc	TD404
HR816	NA5053 30.00 x 42.00 x 7.00mm, FPM		NB815 23.00 x 35.00 x 7.00mm, FPM NB814 70.00 x 88.00 x 8.00mm, FPM	

19 1.0L

Petrol

146 A2.166	4 Cyl.	8 Valves	994cc	TD19059
146 A7.011	4 Cyl.	8 Valves	994cc	TD29509
146 C4.011	4 Cyl.	8 Valves	994cc	TD29388
178 A1.000	4 Cyl.	8 Valves	994cc	TD34057
HR569	NA5187 30.00 x 52.00 x 7.00mm, ACM		NA5051 40.00 x 56.00 x 7.00mm, FPM	

20 1.0L

Petrol

146 B4.000	4 Cyl.	8 Valves	999cc	TD18820
HR816			NB307 40.00 x 56.00 x 7.0mm, ACM	

21 1.0L

Petrol

146 E1.011	4 Cyl.	8 Valves	999cc	TD25023
146 E4.1011	4 Cyl.	8 Valves	999cc	TD24629
178 D9.011	4 Cyl.	8 Valves	999cc	TD25000
178 F1.011	4 Cyl.	8 Valves	999cc	TD25003
310 A1.011	4 Cyl.	8 Valves	999cc	TD24640
HR816	NA5053 30.00 x 42.00 x 7.00mm, FPM		NA5057 27.00 x 37.00 x 7.00mm, FPM NA5061 74.00 x 88.00 x 8.00mm, FPM	

22 1.0L

Petrol

178D8.011	4 Cyl.	16 Valves	999cc	TD34239
				NA5057 27.00 x 37.00 x 7.00mm, FPM LK5001 74.00 x 187.50 x 17.000mm, FPM

23 1.0L

Petrol

A112A	4 Cyl.	8 Valves	1049cc	TD403
HR816			NA5049 64.00 x 80.00 x 8.00mm, ACM	

24 1.1L

Petrol

11A	4 Cyl.	8 Valves	1116cc	TD21707
138 B.0000	4 Cyl.	8 Valves	1116cc	TD21703
HR569	NA5187 30.00 x 52.00 x 7.00mm, ACM		NA5051 40.00 x 56.00 x 7.00mm, FPM NA5049 64.00 x 80.00 x 8.00mm, ACM	



25 1.1L

Petrol

100 GL. 0.64	4 Cyl.	8 Valves	1116cc	TD9410
A 112 AB.2C.0	4 Cyl.	8 Valves	1050cc	TD22319
HR816				

NA5049
64.00 x 80.00 x 8.00mm, ACM

26 1.1L

Petrol

128 A.000	4 Cyl.	8 Valves	1116cc	TD4183
128A4	4 Cyl.	8 Valves	1116cc	TD21706
128 AC5.000	4 Cyl.	8 Valves	1116cc	TD5045
128 AC5.000	4 Cyl.	8 Valves	1116cc	TD891
HR569				

NA5187
30.00 x 52.00 x 7.00mm, ACM

NB307
40.00 x 56.00 x 7.00mm, ACM
NA5049
64.00 x 80.00 x 8.00mm, ACM

27 1.1L

Petrol

128 A.000	4 Cyl.	8 Valves	1116cc	TD888
128 A011	4 Cyl.	8 Valves	1116cc	TD32943
128 A.048	4 Cyl.	8 Valves	1116cc	TD5378
128 A 064	4 Cyl.	8 Valves	1116cc	TD23118
128 A.064	4 Cyl.	8 Valves	1116cc	TD9409
128 BB.OA0	4 Cyl.	8 Valves	1116cc	TD23459
138 AE OA.0	4 Cyl.	8 Valves	1116cc	TD23461
138 B.000	4 Cyl.	8 Valves	1116cc	TD923
138 B1.000	4 Cyl.	8 Valves	1116cc	TD924
138 C1.000	4 Cyl.	8 Valves	1116cc	TD18371
146 A4.000	4 Cyl.	8 Valves	1116cc	TD22226
146 A4.044	4 Cyl.	8 Valves	1116cc	TD9469
146 A4.048	4 Cyl.	8 Valves	1116cc	TD4375
146 A6.000	4 Cyl.	8 Valves	1116cc	TD9493
146 A9.000	4 Cyl.	8 Valves	1116cc	TD945
HR569				

NA5187
30.00 x 52.00 x 7.00mm, ACM

NB818
40.00 x 56.00 x 7.00mm, ACM
NA5049
64.00 x 80.00 x 8.00mm, ACM

28 1.1L

Petrol

146 C3.000	4 Cyl.	8 Valves	1116cc	TD4348
HR816				

NA5053
30.00 x 42.00 x 7.00mm, FPM

NB815
23.00 x 35.00 x 7.00mm, FPM
NA5061
74.00 x 88.00 x 8.00mm, FPM

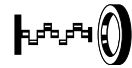
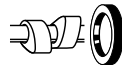

29 1.1L		Petrol		
156C.000	4 Cyl.	8 Valves	1108cc	TD398
156C.046	4 Cyl.	8 Valves	1108cc	TD399
156 C.046	4 Cyl.	8 Valves	1108cc	TD4389
160 A3.000	4 Cyl.	8 Valves	1108cc	TD10189
176 A6.000	4 Cyl.	8 Valves	1108cc	TD1036
176 B2.000	4 Cyl.	8 Valves	1108cc	TD4396
178 B9.033	4 Cyl.	8 Valves	1108cc	TD26111
HR816	NA5053 30.00 x 42.00 x 7.00mm, FPM		NB815 23.00 x 35.00 x 7.00mm, FPM NB814 70.00 x 88.00 x 8.00mm, FPM →Eng no. 6315750 NA5061 74.00 x 88.00 x 8.00mm, FPM Eng no. 6315751 →	

30 1.1L		Petrol		
187 A1.000	4 Cyl.	8 Valves	1108cc	TD17847
PA5025 (x8) Eng no. 2533528 → HR816 →Eng no. 2533527 HR5048 Eng no. 2533528 →	NA5053 30.00 x 42.00 x 7.00mm, FPM NA5321 31.00 x 55.00 x 7.00mm, FPM Eng no. 2939661 →		NB815 23.00 x 35.00 x 7.00mm, FPM →Eng no. 2888158 NA5057 27.00 x 37.00 x 7.00mm, FPM Eng no. 2888158 → NA5061 74.00 x 88.00 x 8.00mm, FPM	

31 1.1L		Petrol		
TU1JP	4 Cyl.	8 Valves	1124cc	TD26420
	NF817 36.00 x 50.00 x 7.00mm, FPM		NF870 42.00 x 66.00 x 6.00mm, FPM/ACM NF850 85.00 x 105.00 x 8.00mm, FPM	

32 1.2L		Petrol		
124 A.000	4 Cyl.	8 Valves	1197cc	TD874
124 A.000	4 Cyl.	8 Valves	1197cc	TD18845
124 BL.016	4 Cyl.	8 Valves	1197cc	TD21452
HR569			NB818 40.00 x 56.00 x 7.00mm, ACM NA5050 70.00 x 90.00 x 10.00mm, ACM	

33 1.2L		Diesel		
169 A1.000	4 Cyl.	16 Valves	1248cc	TD20236
169 A1.000	4 Cyl.	16 Valves	1248cc	TD24228
169 A2.000	4 Cyl.	16 Valves	1248cc	TD26445
169 A5.000	4 Cyl.	16 Valves	1248cc	TD24711
HR5088	NA5058 40.00 x 55.00 x 7.00mm, FPM		NA5223 40.00 x 52.00 x 7.00mm, FPM NA5230 78.00 x 100.00 x 9.00mm, PTFE	

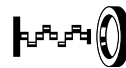
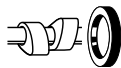

34 1.2L

Petrol

169 A4.000	4 Cyl.	8 Valves	1242cc	TD20928
PA5025 (x8) HR5048	NA5058 40.00 x 55.00 x 7.00mm, FPM		NA5057 27.00 x 37.00 x 7.00mm, FPM NA5061 74.00 x 88.00 x 8.00mm, FPM	

35 1.2L

Petrol

176 A7.000	4 Cyl.	8 Valves	1242cc	TD1037
176 A8.000	4 Cyl.	8 Valves	1242cc	TD1038
176 B1.000	4 Cyl.	8 Valves	1242cc	TD1032
176 B4.000	4 Cyl.	8 Valves	1242cc	TD1076
178 E2.000	4 Cyl.	8 Valves	1242cc	TD16737
223 A5.000	4 Cyl.	8 Valves	1242cc	TD15828
PA5025 (x8) Eng no. 2533528 → HR816 →Eng no. 2533527 HR5048 Eng no. 2533528 →	NA5053 30.00 x 42.00 x 7.00mm, FPM		NB815 23.00 x 35.00 x 7.00mm, FPM NA5061 74.00 x 88.00 x 8.00mm, FPM	

36 1.2L

Petrol

176 B9.000	4 Cyl.	16 Valves	1242cc	TD9727
182 B2.000	4 Cyl.	16 Valves	1242cc	TD11807
HR814	NA5058 40.00 x 55.00 x 7.00mm, FPM		NA5057 27.00 x 37.00 x 7.00mm, FPM NA5061 74.00 x 88.00 x 8.00mm, FPM	

37 1.2L

Petrol

178 B5.000	4 Cyl.	8 Valves	1242cc	TD10188
178 B7.045	4 Cyl.	8 Valves	1242cc	TD18895
178 C4.066	4 Cyl.	8 Valves	1242cc	TD20237
PA5025 (x8) Eng no. 2533528 → HR816 →Eng no. 2533527 HR5048 Eng no. 2533528 →	NA5053 30.00 x 42.00 x 7.00mm, FPM		NB815 23.00 x 35.00 x 7.00mm, FPM →Eng no. 2935743 NA5057 27.00 x 37.00 x 7.00mm, FPM Eng no. 2935744 → NA5061 74.00 x 88.00 x 8.00mm, FPM	

38 1.2L

Petrol

178 E8.011	4 Cyl.	8 Valves	1242cc	TD25005
178 E9.011	4 Cyl.	8 Valves	1242cc	TD24630
HR816	NA5053 30.00 x 42.00 x 7.00mm, FPM		NA5057 27.00 x 37.00 x 7.00mm, FPM NA5061 74.00 x 88.00 x 8.00mm, FPM	

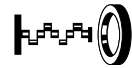
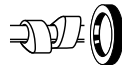

39 1.2L		Petrol			
188 A4.000	4 Cyl.	8 Valves	1242cc		TD12790
188 A4.000	4 Cyl.	8 Valves	1242cc		TD20664
188 A4.000	4 Cyl.	8 Valves	1242cc		TD24580
PA5025 (x8) Eng no. 2533528 →					
HR816					
→Eng no. 2533527					
HR5048					
Eng no. 2533528 →					
	NA5053 30.00 x 42.00 x 7.00mm, FPM →Eng no. 2939600			NB815 23.00 x 35.00 x 7.00mm, FPM →Eng no. 2939600	
	NA5321 31.00 x 55.00 x 7.00mm, FPM Eng no. 2939661 →			NA5057 27.00 x 37.00 x 7.00mm, FPM →Eng no. 2939661	
				NA5061 74.00 x 88.00 x 8.00mm, FPM	

40 1.2L		Petrol			
188 A5.000	4 Cyl.	16 Valves	1242cc		TD20665
188 A5.000	4 Cyl.	16 Valves	1242cc		TD12791
223 A3.011	4 Cyl.	16 Valves	1242cc		TD24997
HR814					
	NA5058 40.00 x 55.00 x 7.00mm, FPM			NA5057 27.00 x 37.00 x 7.00mm, FPM	
				LK5001 74.00 x 187.50 x 17.000mm, FPM	

41 1.2L		Petrol			
199 A4.000	4 Cyl.	8 Valves	1242cc		TD20242
199 B9.000	4 Cyl.	8 Valves	1242cc		TD29691
PA5025 (x8) HR5048					
	NA5321 31.00 x 55.00 x 7.00mm, FPM			NA5057 27.00 x 37.00 x 7.00mm, FPM	
				NA5061 74.00 x 88.00 x 8.00mm, FPM	

42 1.3L		Petrol			
127 A2.011	4 Cyl.	8 Valves	1297cc		TD29350
127 A3.000	4 Cyl.	8 Valves	1301cc		TD4415
128 A5.000	4 Cyl.	8 Valves	1499cc		TD21447
128 AR.000	4 Cyl.	8 Valves	1290cc		TD21448
128 AR.000	4 Cyl.	8 Valves	1290cc		TD18319
128 AS.000	4 Cyl.	8 Valves	1290cc		TD995
146 A2.146	4 Cyl.	8 Valves	1301cc		TD938
HR569					
	NA5187 30.00 x 52.00 x 7.00mm, ACM			NB307 40.00 x 56.00 x 7.0mm, ACM	

43 1.3L		Diesel			
127 A5.000	4 Cyl.	8 Valves	1302cc		TD4346
146 B1.000	4 Cyl.	8 Valves	1301cc		TD948
156 A5.000	4 Cyl.	8 Valves	1302cc		TD999
HR569					
	NA5187 30.00 x 52.00 x 7.00mm, ACM			NA5051 40.00 x 56.00 x 7.00mm, FPM	
				NA5052 70.00 x 85.00 x 8.00mm, FPM	



44 1.3L

Petrol

128 A1.000	4 Cyl.	8 Valves	1290cc	TD889
128 AC.000	4 Cyl.	8 Valves	1290cc	TD890
HR569	NA5187 30.00 x 52.00 x 7.00mm, ACM		NA5051 40.00 x 56.00 x 7.00mm, FPM NA5049 64.00 x 80.00 x 8.00mm, ACM	

45 1.3L

Petrol

131 A.000	4 Cyl.	8 Valves	1297cc	TD26093
131 A6.000	4 Cyl.	8 Valves	1297cc	TD897
131 B.000	4 Cyl.	8 Valves	1297cc	TD899
HR569	NA5187 30.00 x 52.00 x 7.00mm, ACM		NB307 40.00 x 56.00 x 7.00mm, ACM NA5050 70.00 x 90.00 x 10.00mm, ACM	

46 1.3L

Petrol

138 A.000	4 Cyl.	8 Valves	1302cc	TD18855
138 A1.000	4 Cyl.	8 Valves	1301cc	TD4368
138 A3.000	4 Cyl.	8 Valves	1301cc	TD4362
138 B2.000	4 Cyl.	8 Valves	1302cc	TD4363
146 A2.000	4 Cyl.	8 Valves	1301cc	TD4373
146 A2.246	4 Cyl.	8 Valves	1301cc	TD932
146 A5.000	4 Cyl.	8 Valves	1301cc	TD4376
146A5.046	4 Cyl.	8 Valves	1297cc	TD390
149 A3.000	4 Cyl.	8 Valves	1301cc	TD958
149 A7.000	4 Cyl.	8 Valves	1302cc	TD4382
149 A7.003	4 Cyl.	8 Valves	1301cc	TD23357
149 A7.046	4 Cyl.	8 Valves	1302cc	TD23864
156B.000	4 Cyl.	8 Valves	1301cc	TD16212
HR569	NA5187 30.00 x 52.00 x 7.00mm, ACM		NB818 40.00 x 56.00 x 7.00mm, ACM NA5049 64.00 x 80.00 x 8.00mm, ACM	

47 1.3L

Diesel

188 A8.000	4 Cyl.	16 Valves	1248cc	TD23866
188 A9.000	4 Cyl.	16 Valves	1248cc	TD17456
199 A1.000	4 Cyl.	16 Valves	1248cc	TD29726
199 A2.000	4 Cyl.	16 Valves	1248cc	TD20240
199 A3.000	4 Cyl.	16 Valves	1248cc	TD20241
199 A9.000	4 Cyl.	16 Valves	1248cc	TD23573
199 B1.000	4 Cyl.	16 Valves	1248cc	TD23574
199 B2.000	4 Cyl.	16 Valves	1248cc	TD23578
199 B4.000	4 Cyl.	16 Valves	1248cc	TD24898
199 B8.000	4 Cyl.	16 Valves	1248cc	TD29432
223 A9.000	4 Cyl.	16 Valves	1248cc	TD20243
225 A2.000	4 Cyl.	16 Valves	1248cc	TD31853
263 A2.000	4 Cyl.	16 Valves	1248cc	TD24796
263 A6.000	4 Cyl.	16 Valves	1248cc	TD31011
312 A8.000	4 Cyl.	16 Valves	1248cc	TD29720
312 B1.000	4 Cyl.	16 Valves	1248cc	TD31858

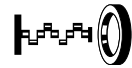
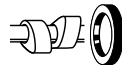

312 B2.000	4 Cyl.	16 Valves	1248cc	TD32630
312 B5.000	4 Cyl.	16 Valves	1248cc	TD33596
330 A1.000	4 Cyl.	16 Valves	1248cc	TD31856
955 B2.000	4 Cyl.	16 Valves	1248cc	TD33440
55266963	4 Cyl.	16 Valves	1248cc	TD31788

HR5088

NA5223

40.00 x 52.00 x 7.00mm, FPM

NA5230

78.00 x 100.00 x 9.00mm, PTFE

48 1.4L

Petrol

14FE	4 Cyl.	8 Valves	1372cc	TD21696
146 A8.000	4 Cyl.	8 Valves	1372cc	TD18372
146 A8.046	4 Cyl.	8 Valves	1372cc	TD944
146 C1.000	4 Cyl.	8 Valves	1372cc	TD18821
146 C5.000	4 Cyl.	8 Valves	1372cc	TD6816
146 D5.000	4 Cyl.	8 Valves	1372cc	TD6817
160 A1.046	4 Cyl.	8 Valves	1372cc	TD1016
160 A1.048	4 Cyl.	8 Valves	1372cc	TD4393
178 B2.000	4 Cyl.	8 Valves	1372cc	TD16173
178 B2.016	4 Cyl.	8 Valves	1372cc	TD16174
836 A4.000	4 Cyl.	8 Valves	1372cc	TD893

HR569

NA5187

30.00 x 52.00 x 7.00mm, ACM

NB818

40.00 x 56.00 x 7.00mm, ACM

NA5051

40.00 x 56.00 x 7.00mm, FPM

NB808

64.00 x 80.00 x 8.00mm, FPM

49 1.4L

Petrol

124 AC.000	4 Cyl.	8 Valves	1438cc	TD13413
124 B.000	4 Cyl.	8 Valves	1438cc	TD18853
124 B2.000	4 Cyl.	8 Valves	1438cc	TD13412
124 BL 1.016	4 Cyl.	8 Valves	1438cc	TD6890

HR569

NB818

40.00 x 56.00 x 7.00mm, ACM

NB307

40.00 x 56.00 x 7.0mm, ACM

NA5050

70.00 x 90.00 x 10.00mm, ACM

50 1.4L

Petrol

131 C.000	4 Cyl.	8 Valves	1367cc	TD902
131 C1.000	4 Cyl.	8 Valves	1367cc	TD903

HR569

NA5187

30.00 x 52.00 x 7.00mm, ACM

NB307

40.00 x 56.00 x 7.0mm, ACM

NA5050

70.00 x 90.00 x 10.00mm, ACM

51 1.4L

Diesel

146 B.000	4 Cyl.	8 Valves	1367cc	TD947
146 B3.000	4 Cyl.	8 Valves	1367cc	TD950

HR569

NA5187

30.00 x 52.00 x 7.00mm, ACM

NB742

30.00 x 43.00 x 8.00mm, ACM

NA5050

70.00 x 90.00 x 10.00mm, ACM



52 1.4L

Petrol

159 A2.000	4 Cyl.	8 Valves	1372cc	TD9728
160 A1.000	4 Cyl.	8 Valves	1372cc	TD1015
160 A1.000	4 Cyl.	8 Valves	1372cc	TD21694

HR569

NA5187
30.00 x 52.00 x 7.00mm, ACM

NB818
40.00 x 56.00 x 7.00mm, ACM

NA5049
64.00 x 80.00 x 8.00mm, ACM

53 1.4L

Petrol

169 A3.000	4 Cyl.	16 Valves	1368cc	TD20277
198 A1.000	4 Cyl.	16 Valves	1368cc	TD21045
198 A4.000	4 Cyl.	16 Valves	1368cc	TD21046
198 A7.000	4 Cyl.	16 Valves	1368cc	TD24595
199 A6.000	4 Cyl.	16 Valves	1368cc	TD20929
199 A8.000	4 Cyl.	16 Valves	1368cc	TD24567
199 A8.000	4 Cyl.	16 Valves	1368cc	TD31897
312 A1.000	4 Cyl.	16 Valves	1368cc	TD21036
312 A1.000	4 Cyl.	16 Valves	1368cc	TD31895
312 A3.000	4 Cyl.	16 Valves	1368cc	TD31896
312 A3.000	4 Cyl.	16 Valves	1368cc	TD24772
323 B6.600	4 Cyl.	16 Valves	1368cc	TD24955
843 A1.000	4 Cyl.	16 Valves	1368cc	TD17978
940 B7.000	4 Cyl.	16 Valves	1368cc	TD28883

HR814

NA5058 (x2)
40.00 x 55.00 x 7.00mm, FPM

NA5057
27.00 x 37.00 x 7.00mm, FPM

LK5001
74.00 x 187.50 x 17.00mm, FPM

54 1.4L

Petrol

176 A4.000	4 Cyl.	8 Valves	1372cc	TD1034
176 B6.000	4 Cyl.	8 Valves	1372cc	TD5492

HR569

NA5187
30.00 x 52.00 x 7.00mm, ACM

NB818
40.00 x 56.00 x 7.00mm, ACM

NF887
64.00 x 112.50 x 20.00mm, FPM

55 1.4L

Petrol

178 F3.011	4 Cyl.	8 Valves	1368cc	TD24633
310 A2.011	4 Cyl.	8 Valves	1368cc	TD24631

PA5025 (x8)
HR5048

NA5053
30.00 x 42.00 x 7.00mm, FPM

NA5057
27.00 x 37.00 x 7.00mm, FPM

LK5001
74.00 x 187.50 x 17.00mm, FPM

56 1.4L

Petrol

182 A3.000	4 Cyl.	12 Valves	1370cc	TD4399
182 A5.000	4 Cyl.	12 Valves	1370cc	TD4401

HR662

NA5053
30.00 x 42.00 x 7.00mm, FPM

NA5070
31.00 x 41.00 x 7.00mm, FPM

NF888
93.00 x 139.70;172.00 x 12.00mm, FPM

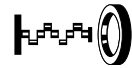
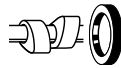

57 1.4L Petrol

192 B2.000	4 Cyl.	16 Valves	1368cc	TD18571
192 B2.000	4 Cyl.	16 Valves	1368cc	TD26443
HR814	NA5058 (x2) 40.00 x 55.00 x 7.00mm, FPM		NA5057 27.00 x 37.00 x 7.00mm, FPM	
→04/06			LK5001 74.00 x 187.50 x 17.000mm, FPM	
HR816 (x2)				
05/06→				

58 1.4L Petrol

199 A7.000	4 Cyl.	8 Valves	1368cc	TD23572
199 A7.000	4 Cyl.	8 Valves	1368cc	TD26903
350 A1.000	4 Cyl.	8 Valves	1368cc	TD20248
350 A1.000	4 Cyl.	8 Valves	1368cc	TD24229
PA5025 (x8)	NA5058 40.00 x 55.00 x 7.00mm, FPM		NA5057 27.00 x 37.00 x 7.00mm, FPM	
HR5048			NA5061 74.00 x 88.00 x 8.00mm, FPM	

59 1.4L Petrol

327 A.011	4 Cyl.	8 Valves	1368cc	TD24641
PA5025 (x8)	NA5053 30.00 x 42.00 x 7.00mm, FPM		NA5057 27.00 x 37.00 x 7.00mm, FPM	
HR5048			NA5061 74.00 x 88.00 x 8.00mm, FPM	

60 1.4L Petrol

834 A1.000	4 Cyl.	16 Valves	1368cc	TD23867
HR814	NA5058 40.00 x 55.00 x 7.00mm, FPM		NB815 23.00 x 35.00 x 7.00mm, FPM	
			LK5001 74.00 x 187.50 x 17.000mm, FPM	

61 1.4L Petrol

955 A2.000	4 Cyl.	16 Valves	1368cc	TD23576
955 A6.000	4 Cyl.	16 Valves	1368cc	TD23577
955 A8.000	4 Cyl.	16 Valves	1368cc	TD31898
955 A8.000	4 Cyl.	16 Valves	1368cc	TD24767
55253268	4 Cyl.	16 Valves	1368cc	TD33164
55263623	4 Cyl.	16 Valves	1368cc	TD31786
55263624	4 Cyl.	16 Valves	1368cc	TD31785
EAM	4 Cyl.	16 Valves	1368cc	TD33530
HR814	NA5321 31.00 x 55.00 x 7.00mm, FPM		NA5057 27.00 x 37.00 x 7.00mm, FPM	
			LK5001 74.00 x 187.50 x 17.000mm, FPM	
			→06/16	

62 1.4L Petrol

A13SM	4 Cyl.	8 Valves	1349cc	TD31722
PA565 (x8)	NC006 35.00 x 48.00 x 7.00mm, MVQ		NA5053 30.00 x 42.00 x 7.00mm, FPM	
HR342			NB698 80.00 x 98.00 x 10.00mm, FPM	

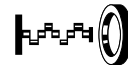
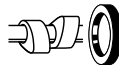

63 1.4L

Petrol

NA5164 (x16) HR814	NA5190 (x2) 42.00 x 56.00 x 7.00mm, FPM	NA5057 27.00 x 37.00 x 7.00mm, FPM LK5001 74.00 x 187.50 x 17.000mm, FPM	4 Cyl. 16 Valves 1368cc TD29570
-------------------------------------	---	---	--

64 1.4L

Petrol

NA5164 (x16) HR5092	NA5190 (x2) 42.00 x 56.00 x 7.00mm, FPM	NA5053 30.00 x 42.00 x 7.00mm, FPM NB698 80.00 x 98.00 x 10.00mm, FPM	4 Cyl. 16 Valves 1399cc TD31716
--------------------------------------	---	--	--

65 1.4L

Petrol

HR5087	NC006 35.00 x 48.00 x 7.00mm, MVQ	NA5174 31.50 x 42.00 x 7.00mm, FPM NA5350 80.00 x 98.00 x 17.70mm, PTFE/ACM	4 Cyl. 16 Valves 1399cc TD31147
---------------	---	--	--

66 1.4L

Petrol

HR816	NF817 36.00 x 50.00 x 7.00mm, FPM	NF870 42.00 x 66.00 x 6.00mm, FPM/ACM NA5362 85.00 x 105.00 x 8.00mm, PTFE/ACM	4 Cyl. 8 Valves 1360cc TD24950 4 Cyl. 8 Valves 1360cc TD24771
--------------	---	---	--

67 1.5L

Petrol

138 A2.000	4 Cyl.	8 Valves	1498cc	TD916
138 A4.000	4 Cyl.	8 Valves	1498cc	TD4357
138 B3.000	4 Cyl.	8 Valves	1498cc	TD4365
138 B3.048	4 Cyl.	8 Valves	1498cc	TD4364
138 C2.048	4 Cyl.	8 Valves	1498cc	TD926
138 C3.048	4 Cyl.	8 Valves	1498cc	TD4366
149 A5.000	4 Cyl.	8 Valves	1498cc	TD4381
149 A5.046	4 Cyl.	8 Valves	1498cc	TD23863
149 C1.000	4 Cyl.	8 Valves	1499cc	TD973
HR569	NA5187 30.00 x 52.00 x 7.00mm, ACM	NB818 40.00 x 56.00 x 7.00mm, ACM NA5049 64.00 x 80.00 x 8.00mm, ACM		

68 1.5L

Petrol

HR569	NA5187 30.00 x 52.00 x 7.00mm, ACM	NA5051 40.00 x 56.00 x 7.00mm, FPM NA5049 64.00 x 80.00 x 8.00mm, ACM	4 Cyl. 8 Valves 1499cc TD4359
--------------	--	--	--

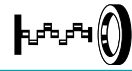

69 1.5L Petrol

138 B3.011	4 Cyl.	8 Valves	1498cc	TD29352
146 A3.011	4 Cyl.	8 Valves	1497cc	TD29510
146 D1.011	4 Cyl.	8 Valves	1497cc	TD29389
HR569				NA5051 40.00 x 56.00 x 7.00mm, FPM

70 1.5L Petrol

178 A6.011	4 Cyl.	8 Valves	1497cc	TD25022
HR569	NA5187 30.00 x 52.00 x 7.00mm, ACM			NA5051 40.00 x 56.00 x 7.00mm, FPM

71 1.5L Petrol

178 E5.022	4 Cyl.	8 Valves	1461cc	TD20448
HR816	NB866 28.00 x 42.00 x 7.00mm, FPM			NA5055 70.00 x 90.00 x 10.00mm, FPM

72 1.5L Petrol

A15SM	4 Cyl.	8 Valves	1498cc	TD25168
F15S3	4 Cyl.	8 Valves	1498cc	TD31724
PA565 (x8) HR342	NC006 35.00 x 48.00 x 7.00mm, MVQ			NA5053 30.00 x 42.00 x 7.00mm, FPM NB698 80.00 x 98.00 x 10.00mm, FPM

73 1.6L Diesel

9H07 (DV6UC)	4 Cyl.	8 Valves	1560cc	TD32530
	NA5258 27.00 x 47.00 x 7.00mm, PTFE			NA5259 40.00 x 55.00 x 6.40mm, PTFE NA5325 85.00 x 105.00 x 8.80mm, PTFE

74 1.6L Diesel

9HM (DV6UC)	4 Cyl.	8 Valves	1560cc	TD32529
PA5068 (x8) HR5120	NA5258 27.00 x 47.00 x 7.00mm, PTFE			NA5259 40.00 x 55.00 x 6.40mm, PTFE NA5325 85.00 x 105.00 x 8.80mm, PTFE

75 1.6L Diesel

9HU	4 Cyl.	16 Valves	1560cc	TD24776
PA6072 (x16) HR5124	NA5258 27.00 x 47.00 x 7.00mm, PTFE			NA5259 40.00 x 55.00 x 6.40mm, PTFE NA5325 85.00 x 105.00 x 8.80mm, PTFE

76 1.6L Petrol

124 A9.000	4 Cyl.	8 Valves	1592cc	TD32752
HR569				NB307 40.00 x 56.00 x 7.0mm, ACM NA784 70.00 x 90.00 x 10.00mm, ACM



77 1.6L

Petrol

124 B3.000	4 Cyl.	8 Valves	1585cc	TD6898
125 A.000	4 Cyl.	8 Valves	1608cc	TD878
125 B.000	4 Cyl.	8 Valves	1608cc	TD879
131 A1.000	4 Cyl.	8 Valves	1585cc	TD896
131 AB.1A.0	4 Cyl.	8 Valves	1585cc	TD21454
131 C3.000	4 Cyl.	8 Valves	1585cc	TD904
132 D.000	4 Cyl.	8 Valves	1585cc	TD2375
149 A.000	4 Cyl.	8 Valves	1585cc	TD21697
149 A.000	4 Cyl.	8 Valves	1585cc	TD962
149 A2.000	4 Cyl.	8 Valves	1585cc	TD4379
149 A4.000	4 Cyl.	8 Valves	1585cc	TD4380
149 C3.000	4 Cyl.	8 Valves	1585cc	TD18856

HR569

NA5187
30.00 x 52.00 x 7.00mm, ACM

NB307
40.00 x 56.00 x 7.00mm, ACM
NA5050
70.00 x 90.00 x 10.00mm, ACM

78 1.6L

Petrol

131 B1.000	4 Cyl.	8 Valves	1585cc	TD901
131 C2.000	4 Cyl.	8 Valves	1585cc	TD4351
132 D.000	4 Cyl.	8 Valves	1585cc	TD911

HR569

NA5187
30.00 x 52.00 x 7.00mm, ACM

NB818
40.00 x 56.00 x 7.00mm, ACM
NA5050
70.00 x 90.00 x 10.00mm, ACM

79 1.6L

Petrol

132 A.000	4 Cyl.	8 Valves	1592cc	TD19053
132 A.9000	4 Cyl.	8 Valves	1592cc	TD21277
132 AB.0A.0	4 Cyl.	8 Valves	1592cc	TD21455
132 AC.000	4 Cyl.	8 Valves	1592cc	TD907
132 BB OA 0	4 Cyl.	8 Valves	1592cc	TD6825

HR569

NA5187 (x2)
30.00 x 52.00 x 7.00mm, ACM

NB307
40.00 x 56.00 x 7.00mm, ACM
NA784
70.00 x 90.00 x 10.00mm, ACM

80 1.6L

Petrol

132 C.000	4 Cyl.	8 Valves	1585cc	TD909
132 C6.000	4 Cyl.	8 Valves	1585cc	TD912
138 AR.048	4 Cyl.	8 Valves	1585cc	TD920

HR569

NA5187 (x2)
30.00 x 52.00 x 7.00mm, ACM

NB307
40.00 x 56.00 x 7.00mm, ACM
NA5050
70.00 x 90.00 x 10.00mm, ACM

81 1.6L

Petrol

138 AR.000	4 Cyl.	8 Valves	1585cc	TD919
------------	--------	----------	--------	-------

HR569

NA5187 (x2)
30.00 x 52.00 x 7.00mm, ACM

NB818
40.00 x 56.00 x 7.00mm, ACM
NA5050
70.00 x 90.00 x 10.00mm, ACM

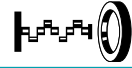

82 1.6L		Petrol		
146 B6.011	4 Cyl.	8 Valves	1581cc	TD29387
146 B7.011	4 Cyl.	8 Valves	1581cc	TD29351
146 C6.000	4 Cyl.	8 Valves	1581cc	TD954
146 D6.000	4 Cyl.	8 Valves	1581cc	TD959
149 C2.046	4 Cyl.	8 Valves	1595cc	TD978
HR569	NA5187 30.00 x 52.00 x 7.00mm, ACM	NA5051 40.00 x 56.00 x 7.00mm, FPM	NB808 64.00 x 80.00 x 8.00mm, FPM	

83 1.6L		Petrol		
149 C2.000	4 Cyl.	8 Valves	1595cc	TD4384
HR569	NA5187 30.00 x 52.00 x 7.00mm, ACM			

84 1.6L		Petrol		
154 A.048	4 Cyl.	8 Valves	1585cc	TD11754
HR569	NA5187 30.00 x 52.00 x 7.00mm, ACM	NB742 30.00 x 43.00 x 8.00mm, ACM	NA5050 70.00 x 90.00 x 10.00mm, ACM	

85 1.6L		Petrol		
159 A3.000	4 Cyl.	8 Valves	1581cc	TD9787
159 A3.046	4 Cyl.	8 Valves	1581cc	TD1006
159 B9.000	4 Cyl.	8 Valves	1581cc	TD965
160 A2.000	4 Cyl.	8 Valves	1581cc	TD1019
160 A2.011	4 Cyl.	8 Valves	1581cc	TD29508
220 A 2.000	4 Cyl.	8 Valves	1581cc	TD6826
835 C1.000	4 Cyl.	8 Valves	1581cc	TD1067
HR569	NA5187 30.00 x 52.00 x 7.00mm, ACM	NA5051 40.00 x 56.00 x 7.00mm, FPM	NA5049 64.00 x 80.00 x 8.00mm, ACM	

86 1.6L		Petrol		
159 A3.048	4 Cyl.	8 Valves	1581cc	TD1007
HR569	NA5187 30.00 x 52.00 x 7.00mm, ACM	NB818 40.00 x 56.00 x 7.00mm, ACM	NA5051 40.00 x 56.00 x 7.00mm, FPM	

87 1.6L		Petrol		
176 A9.000	4 Cyl.	8 Valves	1581cc	TD1039
HR569	NA5187 30.00 x 52.00 x 7.00mm, ACM	NB818 40.00 x 56.00 x 7.00mm, ACM	NF887 64.00 x 112.50 x 20.00mm, FPM	

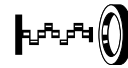
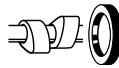

88 1.6L

Petrol

178 B3.000	4 Cyl.	16 Valves	1581cc	TD10187
178 C7.098	4 Cyl.	16 Valves	1581cc	TD18896
182 A4.000	4 Cyl.	16 Valves	1581cc	TD4400
182 A6.000	4 Cyl.	16 Valves	1581cc	TD4402
182 B6.000	4 Cyl.	16 Valves	1596cc	TD16166
HR5060	NA5187 (x2) 30.00 x 52.00 x 7.00mm, ACM		NB818 40.00 x 56.00 x 7.00mm, ACM NF887 64.00 x 112.50 x 20.00mm, FPM	

89 1.6L

Petrol

178 D2.011	4 Cyl.	16 Valves	1581cc	TD18897
182 B5.098	4 Cyl.	16 Valves	1581cc	TD19060
185 A3.000	4 Cyl.	16 Valves	1581cc	TD15650
186 A3.000	4 Cyl.	16 Valves	1581cc	TD11787
186 A4.000	4 Cyl.	16 Valves	1581cc	TD11788
HR816 (x2)	NA5187 (x2) 30.00 x 52.00 x 7.00mm, ACM		NB818 40.00 x 56.00 x 7.00mm, ACM NF887 64.00 x 112.50 x 20.00mm, FPM	

90 1.6L

Petrol

178 E7.000	4 Cyl.	16 Valves	1596cc	TD25965
HR800	NA5187 (x2) 30.00 x 52.00 x 7.00mm, ACM		NA5051 40.00 x 56.00 x 7.00mm, FPM NF887 64.00 x 112.50 x 20.00mm, FPM	

91 1.6L

Petrol

192 B3.000	4 Cyl.	16 Valves	1598cc	TD22147
HR5087	NC006 (x2) 35.00 x 48.00 x 7.00mm, MVQ		NA5174 31.50 x 42.00 x 7.00mm, FPM NB698 80.00 x 98.00 x 10.00mm, FPM	

92 1.6L

Diesel

198 A2.000	4 Cyl.	16 Valves	1598cc	TD21047
198 A3.000	4 Cyl.	16 Valves	1598cc	TD24568
198 A6.000	4 Cyl.	16 Valves	1598cc	TD24596
199 B5.000	4 Cyl.	16 Valves	1598cc	TD27727
263 A3.000	4 Cyl.	16 Valves	1598cc	TD24768
263 A4.000	4 Cyl.	16 Valves	1598cc	TD24769
263 A5.000	4 Cyl.	16 Valves	1598cc	TD31012
263 A7.000	4 Cyl.	16 Valves	1598cc	TD31013
263 A8.000	4 Cyl.	16 Valves	1598cc	TD33008
263 A9.000	4 Cyl.	16 Valves	1598cc	TD33009
350 A2.000	4 Cyl.	16 Valves	1598cc	TD24899
350 A3.000	4 Cyl.	16 Valves	1598cc	TD24973
844 A3.000	4 Cyl.	16 Valves	1598cc	TD31284
940 C1.000	4 Cyl.	16 Valves	1598cc	TD31014

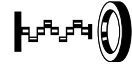
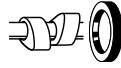

955 A3.000	4 Cyl.	16 Valves	1598cc	TD23575
955 A4.000	4 Cyl.	16 Valves	1598cc	TD25735
55260384	4 Cyl.	16 Valves	1598cc	TD31789
HR5119	NA5347 30.0 x 45.0 x 7.00mm, FPM		NA5070 31.00 x 41.00 x 7.00mm, FPM NF888 93.00 x 139.70;172.00 x 12.00mm, FPM	

93 1.6L

Petrol

310 A5.011	4 Cyl.	16 Valves	1598cc	TD24634
55268036	4 Cyl.	16 Valves	1598cc	TD32524
HR5061	NA5139 32.00 x 45.00 x 6.00mm, FPM NA5140 91.00 x 111.00 x 10.00mm, FPM			

94 1.6L

Petrol

55263842	4 Cyl.	16 Valves	1598cc	TD31787
HR5061	NA5347 30.0 x 45.0 x 7.00mm, FPM		NA5139 32.00 x 45.00 x 6.00mm, FPM NA5140 91.00 x 111.00 x 10.00mm, FPM	

95 1.6L

Petrol

A16DMS	4 Cyl.	16 Valves	1598cc	TD25169
NA5164 (x16) HR5092	NA5190 (x2) 42.00 x 56.00 x 7.00mm, FPM		NF812 30.00 x 42.00 x 8.00mm, ACM NB698 80.00 x 98.00 x 10.00mm, FPM	

96 1.6L

Petrol

LJA	4 Cyl.	8 Valves	1597cc	TD27756
LUA	4 Cyl.	8 Valves	1597cc	TD27755
HR661	NA5190 42.00 x 56.00 x 7.00mm, FPM		NB959 35.00 x 50.00 x 7.00mm, FPM NB847 88.00 x 108.00 x 11.00mm, FPM	

97 1.6L

Petrol

M16A	4 Cyl.	16 Valves	1586cc	TD20932
PA928 (x16) HR5075	NJ377 32.00 x 47.00 x 6.00mm, ACM NJ337 60.00 x 80.00 x 8.00mm, NBR			

98 1.6L

Diesel

R9M 408	4 Cyl.	16 Valves	1598cc	TD33447
R9M 413	4 Cyl.	16 Valves	1598cc	TD33830
R9M 450	4 Cyl.	16 Valves	1598cc	TD33829
R9M 452	4 Cyl.	16 Valves	1598cc	TD33831
PA5041 (x16) HR791	NA5333 48.00 x 81.00 x 11.5mm, FPM/ACM			



99 1.6L

Petrol

RHBA	4 Cyl.	16 Valves	1596cc	TD34058
HR808				
HR809				
			NA5137	
			33.00 x 47.00 x 5.00mm, FPM	
			LK5004	
			80.00 x 182.00 x 19.400mm, PTFE	

100 1.6L

Petrol

ZSG416	4 Cyl.	16 Valves	1595cc	TD27469
HR809 (x2)				
			NA5310	
			46.00 x 56.40 x 7.00mm, FPM	
			LK5004	
			80.00 x 182.00 x 19.400mm, PTFE	

101 1.7L

Petrol

132 A1.000	4 Cyl.	8 Valves	1756cc	TD21453
HR569				
			NA5187	
			30.00 x 52.00 x 7.00mm, ACM	
			NB818	
			40.00 x 56.00 x 7.00mm, ACM	
			NA5050	
			70.00 x 90.00 x 10.00mm, ACM	

102 1.7L

Petrol

132 B.000	4 Cyl.	8 Valves	1756cc	TD18854
132 B1.000	4 Cyl.	8 Valves	1756cc	TD21377
132 B1.000	4 Cyl.	8 Valves	1756cc	TD906
132 C1.000	4 Cyl.	8 Valves	1756cc	TD19054
HR569				
			NA5187	
			30.00 x 52.00 x 7.00mm, ACM	
			NB307	
			40.00 x 56.00 x 7.0mm, ACM	

103 1.7L

Petrol

132 C1.000	4 Cyl.	8 Valves	1756cc	TD32786
HR569				
			NA5187	
			30.00 x 52.00 x 7.00mm, ACM	
			NB307	
			40.00 x 56.00 x 7.0mm, ACM	
			NA5050	
			70.00 x 90.00 x 10.00mm, ACM	

104 1.7L

Diesel

138 A5.000	4 Cyl.	8 Valves	1714cc	TD4358
HR569				
			NA5187	
			30.00 x 52.00 x 7.00mm, ACM	
			NB307	
			40.00 x 56.00 x 7.0mm, ACM	
			NB808	
			64.00 x 80.00 x 8.00mm, FPM	

105 1.7L

Diesel

138 B5.000	4 Cyl.	8 Valves	1714cc	TD23462
138 B6.000	4 Cyl.	8 Valves	1714cc	TD922
HR569				
			NA5187	
			30.00 x 52.00 x 7.00mm, ACM	
			NB818	
			40.00 x 56.00 x 7.00mm, ACM	
			NA5062	
			74.00 x 90.00 x 10.00mm, ACM	

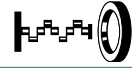

106 1.7L		Diesel		
138 C.000	4 Cyl.	8 Valves	1698cc	TD925
146 B2.000	4 Cyl.	8 Valves	1698cc	TD949
146 D7.000	4 Cyl.	8 Valves	1698cc	TD9472
149 B2.000	4 Cyl.	8 Valves	1697cc	TD16864
149 B3.000	4 Cyl.	8 Valves	1698cc	TD967
149 B4.000	4 Cyl.	8 Valves	1697cc	TD968
149 B4.046	4 Cyl.	8 Valves	1697cc	TD969
176 A3.000	4 Cyl.	8 Valves	1698cc	TD1033
176 A5.000	4 Cyl.	8 Valves	1698cc	TD1035
176 B3.000	4 Cyl.	8 Valves	1698cc	TD9477
176 B7.000	4 Cyl.	8 Valves	1698cc	TD5493
178 C9.066	4 Cyl.	8 Valves	1698cc	TD23865
HR569	NA5187 30.00 x 52.00 x 7.00mm, ACM		NB742 30.00 x 43.00 x 8.00mm, ACM NA5062 74.00 x 90.00 x 10.00mm, ACM	

107 1.8L		Petrol		
132 AB.000	4 Cyl.	8 Valves	1756cc	TD23120
132 AB.1A.0	4 Cyl.	8 Valves	1756cc	TD21456
HR569	NA5187 30.00 x 52.00 x 7.00mm, ACM		NB818 40.00 x 56.00 x 7.00mm, ACM NA5050 70.00 x 90.00 x 10.00mm, ACM	

108 1.8L		Petrol		
132 AC1.000	4 Cyl.	8 Valves	1756cc	TD23121
	NA5187 (x2) 30.00 x 52.00 x 7.00mm, ACM		NB818 40.00 x 56.00 x 7.00mm, ACM NA5050 70.00 x 90.00 x 10.00mm, ACM	

109 1.8L		Petrol		
132 BB.1A 0	4 Cyl.	8 Valves	1756cc	TD21457
132 CB.1A	4 Cyl.	8 Valves	1756cc	TD21459
HR569	NA5187 30.00 x 52.00 x 7.00mm, ACM		NB307 40.00 x 56.00 x 7.0mm, ACM	

110 1.8L		Petrol		
159 A4.000	4 Cyl.	8 Valves	1756cc	TD1008
159 A4.046	4 Cyl.	8 Valves	1756cc	TD1009
HR569	NA5187 30.00 x 52.00 x 7.00mm, ACM		NB742 30.00 x 43.00 x 8.00mm, ACM NA5062 74.00 x 90.00 x 10.00mm, ACM	

111 1.8L		Petrol		
160 A5.000	4 Cyl.	16 Valves	1756cc	TD13669
HR816 (x2)	NA5053 (x2) 30.00 x 42.00 x 7.00mm, FPM		NB742 30.00 x 43.00 x 8.00mm, ACM NA5062 74.00 x 90.00 x 10.00mm, ACM	

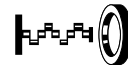
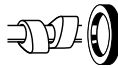

112 1.8L

Petrol

169 B	4 Cyl.	8 Valves	1796cc	TD12750
XM7T	4 Cyl.	8 Valves	1796cc	TD28853
HR569				NA5191 42.00 x 62.00 x 7.00mm, PTFE

113 1.8L

Petrol

182 A2.000	4 Cyl.	16 Valves	1747cc	TD4398
183 A1.000	4 Cyl.	16 Valves	1747cc	TD4405
188 A6.000	4 Cyl.	16 Valves	1747cc	TD16408
192 A4.000	4 Cyl.	16 Valves	1747cc	TD16395
370 A0.011	4 Cyl.	16 Valves	1747cc	TD24636
HR5060	NA5053 30.00 x 42.00 x 7.00mm, FPM	NA5070 31.00 x 41.00 x 7.00mm, FPM		
	NA5069 55.00 x 68.00 x 8.00mm, FPM	NF888 93.00 x 139.70;172.00 x 12.00mm, FPM		

114 1.8L

Petrol

835 C2.000	4 Cyl.	8 Valves	1756cc	TD1068
835 C4.000	4 Cyl.	8 Valves	1756cc	TD1069
836 A5.000	4 Cyl.	8 Valves	1756cc	TD892
836 A6.000	4 Cyl.	8 Valves	1756cc	TD18890
HR569	NA5187 (x2) 30.00 x 52.00 x 7.00mm, ACM	NB742 30.00 x 43.00 x 8.00mm, ACM		
		NB732 74.00 x 90.00 x 10.00mm, FPM		

115 1.8L

Petrol

939 A4.000	4 Cyl.	16 Valves	1796cc	TD20262
HR5087	NC006 (x2) 35.00 x 48.00 x 7.00mm, MVQ	NA5174 31.50 x 42.00 x 7.00mm, FPM		
		NA5350 80.00 x 98.00 x 17.70mm, PTFE/ACM		

116 1.8L

Petrol

960 A1.000	4 Cyl.	16 Valves	1742cc	TD28239
	NA5058 (x2) 40.00 x 55.00 x 7.00mm, FPM	NA5070 31.00 x 41.00 x 7.00mm, FPM		
		NF888 93.00 x 139.70;172.00 x 12.00mm, FPM		

117 1.8L

Petrol

93313090-7U	4 Cyl.	8 Valves	1796cc	TD24992
93313090-H2	4 Cyl.	8 Valves	1796cc	TD25004
93337154-J1	4 Cyl.	8 Valves	1796cc	TD25021
J2	4 Cyl.	8 Valves	1796cc	TD25017
PN93327668	4 Cyl.	8 Valves	1796cc	TD24998
Y2	4 Cyl.	8 Valves	1796cc	TD25019
PA565 (x8) HR342	NC006 35.00 x 48.00 x 7.00mm, MVQ	NB697 26.00 x 42.00 x 8.00mm, FPM		
		NB698 80.00 x 98.00 x 10.00mm, FPM		

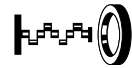
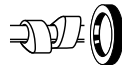

118 1.8L Petrol

CHBA	4 Cyl.	16 Valves	1798cc	TD34438
HR5063				
			NA5157 37.00 x 50.00 x 8.00mm, PTFE LK5005 88.00 x 188.00 x 15.000mm, PTFE	

119 1.8L Petrol

LFW	4 Cyl.	8 Valves	1761cc	TD10167
HR569				
			NF817 36.00 x 50.00 x 7.00mm, FPM NA5191 42.00 x 62.00 x 7.00mm, PTFE NA5192 90.00 x 110.00 x 7.00mm, PTFE	

120 1.8L Petrol

PN93327669	4 Cyl.	16 Valves	1796cc	TD25025
PA5041 (x16) HR791				
			NC006 35.00 x 48.00 x 7.00mm, MVQ NB697 26.00 x 42.00 x 8.00mm, FPM NB698 80.00 x 98.00 x 10.00mm, FPM	

121 1.8L Petrol

RQB	4 Cyl.	16 Valves	1796cc	TD26933
HR5033				
			NB958 (x2) 42.00 x 53.00 x 7.00mm, FPM NB959 35.00 x 50.00 x 7.00mm, FPM NA5323 35.00 x 50.00 x 7.00mm, PTFE NB847 88.00 x 108.00 x 11.00mm, FPM	

122 1.9L Petrol

132 AZ2.000	4 Cyl.	8 Valves	1995cc	TD13028
HR569				
			NA5187 30.00 x 52.00 x 7.00mm, ACM NB307 40.00 x 56.00 x 7.0mm, ACM NA5050 70.00 x 90.00 x 10.00mm, ACM	

123 1.9L Diesel

149 A1.000	4 Cyl.	8 Valves	1929cc	TD4378
149 B1.000	4 Cyl.	8 Valves	1929cc	TD963
149 B5.046	4 Cyl.	8 Valves	1929cc	TD9602
160 A6.000	4 Cyl.	8 Valves	1929cc	TD4394
160 A6.046	4 Cyl.	8 Valves	1929cc	TD1022
160 A7.000	4 Cyl.	8 Valves	1929cc	TD1023
160 B6.046	4 Cyl.	8 Valves	1929cc	TD1025
160 D1.000	4 Cyl.	8 Valves	1929cc	TD1026
230 A2.000	4 Cyl.	8 Valves	1929cc	TD862
230 A3.000	4 Cyl.	8 Valves	1929cc	TD5481
230 A4.000	4 Cyl.	8 Valves	1929cc	TD4407
280 A1.000	4 Cyl.	8 Valves	1929cc	TD1043
831 D1.000	4 Cyl.	8 Valves	1929cc	TD4410
HR569			NA5187 30.00 x 52.00 x 7.00mm, ACM NB742 30.00 x 43.00 x 8.00mm, ACM NB732 74.00 x 90.00 x 10.00mm, FPM	



124 1.9L

Diesel

154 B.000	4 Cyl.	8 Valves	1929cc	TD21460
154 C6.000	4 Cyl.	8 Valves	1929cc	TD9621
154 D1.000	4 Cyl.	8 Valves	1929cc	TD9622
HR569	NA5053 30.00 x 42.00 x 7.00mm, FPM		NB742 30.00 x 43.00 x 8.00mm, ACM NB732 74.00 x 90.00 x 10.00mm, FPM	

125 1.9L

Diesel

182 A7.000	4 Cyl.	8 Valves	1910cc	TD4403
182 A8.000	4 Cyl.	8 Valves	1910cc	TD4404
182 B4.000	4 Cyl.	8 Valves	1910cc	TD11168
182 B9.000	4 Cyl.	8 Valves	1910cc	TD16399
186 A6.000	4 Cyl.	8 Valves	1910cc	TD15831
186 A8.000	4 Cyl.	8 Valves	1910cc	TD18309
186 A9.000	4 Cyl.	8 Valves	1910cc	TD19306
188 A2.000	4 Cyl.	8 Valves	1910cc	TD12788
188 A3.000	4 Cyl.	8 Valves	1910cc	TD12789
188 A7.000	4 Cyl.	8 Valves	1910cc	TD16409
188 B2.000	4 Cyl.	8 Valves	1910cc	TD18291
192 A1.000	4 Cyl.	8 Valves	1910cc	TD16398
192 A3.000	4 Cyl.	8 Valves	1910cc	TD16397
192 A8.000	4 Cyl.	8 Valves	1910cc	TD20238
192 A9.000	4 Cyl.	8 Valves	1910cc	TD18451
192 B4.000	4 Cyl.	8 Valves	1910cc	TD24592
192 B5.000	4 Cyl.	8 Valves	1910cc	TD19308
199 A5.000	4 Cyl.	8 Valves	1910cc	TD20762
223 A6.000	4 Cyl.	8 Valves	1910cc	TD15829
223 A7.000	4 Cyl.	8 Valves	1910cc	TD18318
223 B1.000	4 Cyl.	8 Valves	1910cc	TD20245
223 B2.000	4 Cyl.	8 Valves	1910cc	TD20246
937 A7.000	4 Cyl.	8 Valves	1910cc	TD19307
939 A1.000	4 Cyl.	8 Valves	1910cc	TD18448
939 A7.000	4 Cyl.	8 Valves	1910cc	TD20263
D19AA	4 Cyl.	8 Valves	1910cc	TD20930

HR569	NA5053 30.00 x 42.00 x 7.00mm, FPM		NA5070 31.00 x 41.00 x 7.00mm, FPM NF888 93.00 x 139.70;172.00 x 12.00mm, FPM	
-------	--	--	--	--

126 1.9L

Diesel

192 A5.000	4 Cyl.	16 Valves	1910cc	TD17980
192 B1.000	4 Cyl.	16 Valves	1910cc	TD18944
937 A4.000	4 Cyl.	16 Valves	1910cc	TD18943
HR5095 →Eng no. 5192515 HR5119 Eng no. 5192516→	NA5347 (x2) 30.0 x 45.0 x 7.00mm, FPM		NA5070 31.00 x 41.00 x 7.00mm, FPM NF888 93.00 x 139.70;172.00 x 12.00mm, FPM	

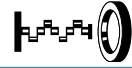

127 1.9L

Petrol

310 A3.011 4 Cyl. 16 Valves 1839cc TD24637

NB818 40.00 x 56.00 x 7.00mm, ACM
NF887 64.00 x 112.50 x 20.00mm, FPM

128 1.9L

Diesel

937 A5.000 4 Cyl. 16 Valves 1910cc TD18929

939 A2.000 4 Cyl. 16 Valves 1910cc TD18449

939 A8.000 4 Cyl. 16 Valves 1910cc TD25733

HR5095
 →Eng no. 5192515
HR5119
 Eng no. 5192516→

NA5347
 30.0 x 45.0 x 7.00mm, FPM

NA5070 31.00 x 41.00 x 7.00mm, FPM
NF888 93.00 x 139.70;172.00 x 12.00mm, FPM

129 1.9L

Diesel

D8B 4 Cyl. 8 Valves 1905cc TD6828

D8B (XUD9TE) 4 Cyl. 8 Valves 1905cc TD21263

D9B 4 Cyl. 8 Valves 1905cc TD6827

D9B (XUD9A) 4 Cyl. 8 Valves 1905cc TD21265

DHX 4 Cyl. 8 Valves 1905cc TD24799

DHX (XUD9TE) 4 Cyl. 8 Valves 1905cc TD21264

DHX (XUD9TF/L) 4 Cyl. 8 Valves 1905cc TD4352

DJY 4 Cyl. 8 Valves 1905cc TD12748

DJY (XUD9) 4 Cyl. 8 Valves 1905cc TD21267

WJY (DW8) 4 Cyl. 8 Valves 1868cc TD21266

WJY (DW8B) 4 Cyl. 8 Valves 1868cc TD22240

WJZ (DW8) 4 Cyl. 8 Valves 1868cc TD16300

HR569 **NF841**
 35.00 x 50.00 x 8.00mm, FPM

NA5191 42.00 x 62.00 x 7.00mm, PTFE
NA5192 90.00 x 110.00 x 7.00mm, PTFE

130 2.0L

Petrol

131 B2.000 4 Cyl. 8 Valves 1995cc TD900

HR569 **NA5187**
 30.00 x 52.00 x 7.00mm, ACM

NB818 40.00 x 56.00 x 7.00mm, ACM
NB732 74.00 x 90.00 x 10.00mm, FPM

131 2.0L

Petrol

131 C4.000 4 Cyl. 8 Valves 1995cc TD4350

HR569 **NA5187** (x2)
 30.00 x 52.00 x 7.00mm, ACM

NB307 40.00 x 56.00 x 7.0mm, ACM
NA5050 70.00 x 90.00 x 10.00mm, ACM

132 2.0L

Petrol

132 B2.000 4 Cyl. 8 Valves 1995cc TD23356

132 C2.031 4 Cyl. 8 Valves 1995cc TD20757

132 C2.040 4 Cyl. 8 Valves 1995cc TD20756

132 C3.040 4 Cyl. 8 Valves 1995cc TD20758

NB307 40.00 x 56.00 x 7.0mm, ACM

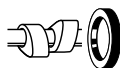

133 2.0L

Petrol

132 C2.000	4 Cyl.	8 Valves	1995cc	TD910
132 C3.000	4 Cyl.	8 Valves	1995cc	TD4353
132 C3.000	4 Cyl.	8 Valves	1995cc	TD2374
132 C3.031	4 Cyl.	8 Valves	1995cc	TD908
132 D1.000	4 Cyl.	8 Valves	1995cc	TD4354
HR300	NA5187 (x2) 30.00 x 52.00 x 7.00mm, ACM		NB307 40.00 x 56.00 x 7.00mm, ACM	

134 2.0L

Petrol

138 AR1.000	4 Cyl.	8 Valves	1995cc	TD31899
138 AR1.000	4 Cyl.	8 Valves	1995cc	TD4360
138 AR2.000	4 Cyl.	8 Valves	1995cc	TD31901
138 AR2.000	4 Cyl.	8 Valves	1995cc	TD4361
HR569	NA5187 (x2) 30.00 x 52.00 x 7.00mm, ACM		NB307 40.00 x 56.00 x 7.00mm, ACM	

135 2.0L

Petrol

149 E1.011	4 Cyl.	8 Valves	1995cc	TD29390
HR569			NB825 30.00 x 43.00 x 8.00mm, FPM	

136 2.0L

Petrol

154 A1.000	4 Cyl.	8 Valves	1995cc	TD1077
154 A2.000	4 Cyl.	8 Valves	1995cc	TD1083
154 C3.000	4 Cyl.	8 Valves	1995cc	TD18822
154 C3.046	4 Cyl.	8 Valves	1995cc	TD984
154 C4.000	4 Cyl.	8 Valves	1995cc	TD18823
154 C5.000	4 Cyl.	8 Valves	1995cc	TD23358
159 A5.046	4 Cyl.	8 Valves	1995cc	TD1011
159 B2.011	4 Cyl.	8 Valves	1995cc	TD29391
834 B.048	4 Cyl.	8 Valves	1995cc	TD1085
834 B.146	4 Cyl.	8 Valves	1995cc	TD11707
834 C.146	4 Cyl.	8 Valves	1995cc	TD1064
HR569	NA5187 (x2) 30.00 x 52.00 x 7.00mm, ACM		NB742 30.00 x 43.00 x 8.00mm, ACM NB732 74.00 x 90.00 x 10.00mm, FPM	

137 2.0L

Petrol

154 C4.046	4 Cyl.	8 Valves	1995cc	TD986
HR569	NA5187 (x2) 30.00 x 52.00 x 7.00mm, ACM		NB742 30.00 x 43.00 x 8.00mm, ACM NA5062 74.00 x 90.00 x 10.00mm, ACM	

138 2.0L

Petrol

154 E1.000	4 Cyl.	16 Valves	1995cc	TD989
160 A8.046	4 Cyl.	16 Valves	1995cc	TD1024
HR816 (x2)	NA5053 (x2) 30.00 x 42.00 x 7.00mm, FPM		NB742 30.00 x 43.00 x 8.00mm, ACM NB732 74.00 x 90.00 x 10.00mm, FPM	

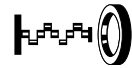
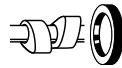

139 2.0L

Petrol

159 A6.046	4 Cyl.	8 Valves	1995cc	TD1012
HR569	NA5187 (x2) 30.00 x 52.00 x 7.00mm, ACM		NB742 30.00 x 43.00 x 8.00mm, ACM	
			NB825 30.00 x 43.00 x 8.00mm, FPM	
			NB644 74.00 x 90.00 x 10.00mm, NBR	

140 2.0L

Petrol

170 B	4 Cyl.	8 Valves	1971cc	TD4417
170 D	4 Cyl.	8 Valves	1971cc	TD5102
HR569			NA5191 42.00 x 62.00 x 7.00mm, PTFE	

141 2.0L

Petrol

175 A1.000	4 Cyl.	16 Valves	1995cc	TD4395
HR816 (x2)	NA5053 (x2) 30.00 x 42.00 x 7.00mm, FPM		NB825 30.00 x 43.00 x 8.00mm, FPM	
			NB732 74.00 x 90.00 x 10.00mm, FPM	

142 2.0L

Petrol

175 A3.000	5 Cyl.	20 Valves	1998cc	TD5491
182 A1.000	5 Cyl.	20 Valves	1998cc	TD4397
182 B3.000	5 Cyl.	20 Valves	1998cc	TD11789
182 B7.000	5 Cyl.	20 Valves	1998cc	TD15498
185 A4.011	5 Cyl.	20 Valves	1998cc	TD24639
185 A8.000	5 Cyl.	20 Valves	1998cc	TD15830
HR800	NA5053 30.00 x 42.00 x 7.00mm, FPM		NA5070 31.00 x 41.00 x 7.00mm, FPM	
	NA5069 55.00 x 68.00 x 8.00mm, FPM		NF888 93.00 x 139.70;172.00 x 12.00mm, FPM	

143 2.0L

Petrol

185 A5.011	5 Cyl.	20 Valves	1998cc	TD34240
			NA5070 31.00 x 41.00 x 7.00mm, FPM	
			NF888 93.00 x 139.70;172.00 x 12.00mm, FPM	

144 2.0L

Diesel

198 A5.000	4 Cyl.	16 Valves	1956cc	TD24569
198 A8.000	4 Cyl.	16 Valves	1956cc	TD31286
250 A1.000	4 Cyl.	16 Valves	1956cc	TD25173
263 A1.000	4 Cyl.	16 Valves	1956cc	TD24764
844 A2.000	4 Cyl.	16 Valves	1956cc	TD24593
939 B5.000	4 Cyl.	16 Valves	1956cc	TD26620
940 A5.000	4 Cyl.	16 Valves	1956cc	TD26672
55263087	4 Cyl.	16 Valves	1956cc	TD31790
55263088	4 Cyl.	16 Valves	1956cc	TD31791
D20AA	4 Cyl.	16 Valves	1956cc	TD24670
HR5119	NA5347 (x2) 30.0 x 45.0 x 7.00mm, FPM		NA5070 31.00 x 41.00 x 7.00mm, FPM	
			NF888 93.00 x 139.70;172.00 x 12.00mm, FPM	

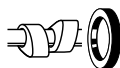

145 2.0L

Diesel

250 A2.000	4 Cyl.	16 Valves	1956cc	TD32948
HR5119	NA5347	30.0 x 45.0 x 7.00mm, FPM		NA5070
				NF888
				93.00 x 139.70; 172.00 x 12.00mm, FPM

146 2.0L

Petrol

834 B.000	4 Cyl.	8 Valves	1995cc	TD1084
HR569	NA5187	30.00 x 52.00 x 7.00mm, ACM		NB742
				30.00 x 43.00 x 8.00mm, ACM
				NB732
				74.00 x 90.00 x 10.00mm, FPM

147 2.0L

Petrol

836 A3.000	4 Cyl.	16 Valves	1995cc	TD1071
HR5060	NA5053 (x2)	30.00 x 42.00 x 7.00mm, FPM		NB742
				30.00 x 43.00 x 8.00mm, ACM
				NB732
				74.00 x 90.00 x 10.00mm, FPM

148 2.0L

Petrol

836 A3.011	4 Cyl.	16 Valves	1995cc	TD26168
HR800	NA5053 (x2)	30.00 x 42.00 x 7.00mm, FPM		NB742
				30.00 x 43.00 x 8.00mm, ACM
				NB732
				74.00 x 90.00 x 10.00mm, FPM

149 2.0L

Petrol

6132 AZ 2.000	4 Cyl.	8 Valves	1995cc	TD13508
HR569	NA5187	30.00 x 52.00 x 7.00mm, ACM		NB307
				40.00 x 56.00 x 7.0mm, ACM
				NA5050
				70.00 x 90.00 x 10.00mm, ACM

150 2.0L

Petrol

AODA	4 Cyl.	16 Valves	1999cc	TD26929
XQDA	4 Cyl.	16 Valves	1999cc	TD32473
HR5063	NA5157	37.00 x 50.00 x 8.00mm, PTFE		
	LK5005	88.00 x 188.00 x 15.000mm, PTFE		

151 2.0L

Diesel

DW10BTED4	4 Cyl.	16 Valves	1997cc	TD25755
RHK	4 Cyl.	16 Valves	1997cc	TD20267
RHK (DW10UTED4)	4 Cyl.	16 Valves	1997cc	TD32639
RHM (DW10ATED4)	4 Cyl.	16 Valves	1997cc	TD18906
RHR	4 Cyl.	16 Valves	1997cc	TD20268
RHW (DW10ATED4)	4 Cyl.	16 Valves	1997cc	TD16789
HR5046 (x2)	NA5035	27.00 x 47.00 x 7.00mm, FPM		NA5191
				42.00 x 62.00 x 7.00mm, PTFE
				NA5192
				90.00 x 110.00 x 7.00mm, PTFE

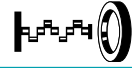

152 2.0L Petrol

RFH (EW10A)	4 Cyl.	16 Valves	1997cc	TD25732
HR5126	NA5455		NA5259	
	39.00 x 50.00 x 7.00mm, PTFE/ACM		40.00 x 55.00 x 6.40mm, PTFE	
	NF817		NF844	
	36.00 x 50.00 x 7.00mm, FPM		90.00 x 110.00 x 11.00mm, FPM/ACM	

153 2.0L Petrol

RFL	4 Cyl.	16 Valves	1998cc	TD16405
RGX (XU10J2CTE)	4 Cyl.	8 Valves	1998cc	TD4355
HR569	NF817		NA5191	
	36.00 x 50.00 x 7.00mm, FPM		42.00 x 62.00 x 7.00mm, PTFE	
			NA5192	
			90.00 x 110.00 x 7.00mm, PTFE	

154 2.0L Petrol

RFN (EW10J4)	4 Cyl.	16 Valves	1997cc	TD16788
HR5126	NF817 (x2)		NA5256	
	36.00 x 50.00 x 7.00mm, FPM		40.00 x 55.00 x 6.50mm, FPM	
			NA5192	
			90.00 x 110.00 x 7.00mm, PTFE	

155 2.0L Petrol

RFU (XU10J2C)	4 Cyl.	8 Valves	1998cc	TD4349
RFW	4 Cyl.	8 Valves	1998cc	TD6808
HR569	NF817		NA5191	
	36.00 x 50.00 x 7.00mm, FPM		42.00 x 62.00 x 7.00mm, PTFE	
			NA5192	
			90.00 x 110.00 x 7.00mm, PTFE	

156 2.0L Petrol

RFV	4 Cyl.	16 Valves	1998cc	TD18824
HR5126	NF817 (x2)		NA5191	
08/98 →	36.00 x 50.00 x 7.00mm, FPM		42.00 x 62.00 x 7.00mm, PTFE	
			NA5192	
			90.00 x 110.00 x 7.00mm, PTFE	

157 2.0L Diesel

RH02	4 Cyl.	16 Valves	1997cc	TD26194
RHH	4 Cyl.	16 Valves	1997cc	TD24777
HR5122	NA5035		NA5191	
	27.00 x 47.00 x 7.00mm, FPM		42.00 x 62.00 x 7.00mm, PTFE	
			NA5192	
			90.00 x 110.00 x 7.00mm, PTFE	

158 2.0L Diesel

RHV (DW10)	4 Cyl.	8 Valves	1997cc	TD16406
HR5046	NA5035		NA5191	
	27.00 x 47.00 x 7.00mm, FPM		42.00 x 62.00 x 7.00mm, PTFE	
			NA5192	
			90.00 x 110.00 x 7.00mm, PTFE	

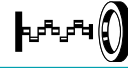

159 2.0L

Diesel

RHX	4 Cyl.	8 Valves	1997cc	TD16299
RHZ	4 Cyl.	8 Valves	1997cc	TD16324
HR817	NA5035 27.00 x 47.00 x 7.00mm, FPM			NA5191 42.00 x 62.00 x 7.00mm, PTFE
→Eng no. 08331				NA5192 90.00 x 110.00 x 7.00mm, PTFE
HR5046				
Eng no. 08332→				

160 2.0L

Petrol

XN 1T	4 Cyl.	8 Valves	1971cc	TD4418
HR569				NA5191 42.00 x 62.00 x 7.00mm, PTFE
				NA5192 90.00 x 110.00 x 7.00mm, PTFE

161 2.1L

Diesel

P8C	4 Cyl.	12 Valves	2088cc	TD960
HR805	NF841 35.00 x 50.00 x 8.00mm, FPM			NA5191 42.00 x 62.00 x 7.00mm, PTFE
				NA5192 90.00 x 110.00 x 7.00mm, PTFE

162 2.2L

Diesel

4HP	4 Cyl.	16 Valves	2179cc	TD24945
4HR	4 Cyl.	16 Valves	2179cc	TD24946
4HS	4 Cyl.	16 Valves	2179cc	TD24775
4HT (DW12BTD4)	4 Cyl.	16 Valves	2179cc	TD25656
HR5122	NA5035 (x2) 27.00 x 47.00 x 7.00mm, FPM			NA5191 42.00 x 62.00 x 7.00mm, PTFE
				NA5192 90.00 x 110.00 x 7.00mm, PTFE

163 2.2L

Diesel

4HU	4 Cyl.	16 Valves	2198cc	TD25655
4HV	4 Cyl.	16 Valves	2198cc	TD20266
HR5082				NA5031 50.00 x 86.50 x 13.70mm, PTFE
				NA5030 106.00 x 190.00 x 15.20mm, PTFE/FPM

164 2.2L

Diesel

4HW (DW12ATED4)	4 Cyl.	16 Valves	2179cc	TD16790
DW12DD	4 Cyl.	16 Valves	2179cc	TD26444
HR5046 (x2)	NA5035 (x2) 27.00 x 47.00 x 7.00mm, FPM			NA5191 42.00 x 62.00 x 7.00mm, PTFE
				NA5192 90.00 x 110.00 x 7.00mm, PTFE

165 2.2L

Diesel

4HX (DW12TED4)	4 Cyl.	16 Valves	2179cc	TD22230
HR5046 (x2)	NA5035 27.00 x 47.00 x 7.00mm, FPM			NA5191 42.00 x 62.00 x 7.00mm, PTFE
				NA5192 90.00 x 110.00 x 7.00mm, PTFE

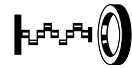
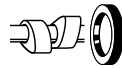

166 2.2L Petrol

194 A1.000	4 Cyl.	16 Valves	2198cc	TD18447
HR5127				NA5108 42.00 x 55.00 x 7.00mm, FPM/ACM NB806 90.00 x 104.00 x 11.00mm, FPM

167 2.2L Diesel

B22615	4 Cyl.	8 Valves	2175cc	TD32740
HR340				NF637 48.00 x 65.00 x 10.00mm, FPM

168 2.3L Diesel

F1AE0481C	4 Cyl.	16 Valves	2286cc	TD16407
F1AE0481D	4 Cyl.	16 Valves	2287cc	TD20264
F1AE0481N	4 Cyl.	16 Valves	2287cc	TD24778
F1AE0481T	4 Cyl.	16 Valves	2286cc	TD24632
F1AE3481D	4 Cyl.	16 Valves	2287cc	TD25174
F1AE3481E	4 Cyl.	16 Valves	2287cc	TD25175
F1AE3481G	4 Cyl.	16 Valves	2287cc	TD26313
FIAGL411A	4 Cyl.	16 Valves	2287cc	TD32614
FIAGL411B	4 Cyl.	16 Valves	2287cc	TD32949
FIAGL411C	4 Cyl.	16 Valves	2287cc	TD32950
FIAGL411D	4 Cyl.	16 Valves	2287cc	TD32951
FIAGL411M	4 Cyl.	16 Valves	2287cc	TD34128
FPT	4 Cyl.	16 Valves	2287cc	TD31437
			NA5201 34.00 x 60.00 x 10.00mm, FPM	NA5202 50.0 x 80.0 x 14.0mm, FPM

169 2.4L Petrol

4G64	4 Cyl.	16 Valves	2351cc	TD33686
			NJ933 35.00 x 50.00 x 8.00mm, FPM	NJ005 44.00 x 60.00 x 7.00mm, NBR NK143 85.00 x 103.00 x 8.00mm, FPM

170 2.4L Diesel

185 A2.000	5 Cyl.	10 Valves	2387cc	TD4406	
185 A6.000	5 Cyl.	10 Valves	2387cc	TD18145	
839 A5.000	5 Cyl.	10 Valves	2387cc	TD14408	
HR615				NA5053 30.00 x 42.00 x 7.00mm, FPM	NA5070 31.00 x 41.00 x 7.00mm, FPM NF888 93.00 x 139.70;172.00 x 12.00mm, FPM

171 2.4L Petrol

185 A7.011	5 Cyl.	20 Valves	2446cc	TD24638	
192 A2.000	5 Cyl.	20 Valves	2446cc	TD16396	
192 A7.011	5 Cyl.	20 Valves	2446cc	TD25020	
HR800				NA5053 30.00 x 42.00 x 7.00mm, FPM NA5069 55.00 x 68.00 x 8.00mm, FPM	NA5070 31.00 x 41.00 x 7.00mm, FPM NF888 93.00 x 139.70;172.00 x 12.00mm, FPM



172 2.4L

Diesel

939 A3.000	5 Cyl.	20 Valves	2387cc	TD18450
	NA5347 30.0 x 45.0 x 7.00mm, FPM		NA5070 31.00 x 41.00 x 7.00mm, FPM NF888 93.00 x 139.70; 172.00 x 12.00mm, FPM	

173 2.4L

Diesel

8140.61.204	4 Cyl.	8 Valves	2445cc	TD1051
8142.61	4 Cyl.	8 Valves	2445cc	TD1053
8144.61	4 Cyl.	8 Valves	2428cc	TD4408
8144.61.200	4 Cyl.	8 Valves	2445cc	TD6796
8144.61.500.81	4 Cyl.	8 Valves	2445cc	TD1054
HR602	NP068 55.00 x 70.00 x 8.00mm, FPM		NB946 70.00 x 90.00 x 10.00mm, FPM NF833 90.00 x 115.00 x 13.00mm, FPM	

174 2.4L

Diesel

8144.81.2000	4 Cyl.	8 Valves	2445cc	TD1057
8144.91.2000	4 Cyl.	8 Valves	2445cc	TD1058
HR602	NP068 55.00 x 70.00 x 8.00mm, FPM		NP068 55.00 x 70.00 x 8.00mm, FPM NF853 100.00 x 118.00 x 10.00mm, FPM	

175 2.4L

Petrol

ED3	4 Cyl.	16 Valves	2360cc	TD31848
ED6	4 Cyl.	16 Valves	2360cc	TD33062
EDG	4 Cyl.	16 Valves	2360cc	TD31849
			NA5108 42.00 x 55.00 x 7.00mm, FPM/ACM NK143 85.00 x 103.00 x 8.00mm, FPM	

176 2.5L

Diesel

4D56	4 Cyl.	16 Valves	2477cc	TD33689
	NJ933 35.00 x 50.00 x 8.00mm, FPM NJ242 35.00 x 50.00 x 8.00mm, NBR			

177 2.5L

Petrol

834 G.000	6 Cyl.	12 Valves	2492cc	TD1066
			NA5163 32.00 x 47.00 x 10.00mm, FPM	

178 2.5L

Diesel

8140.27	4 Cyl.	8 Valves	2500cc	TD1047
8140.27.2100	4 Cyl.	8 Valves	2500cc	TD6800
HR602	NP068 55.00 x 70.00 x 8.00mm, FPM		NB946 70.00 x 90.00 x 10.00mm, FPM NF853 100.00 x 118.00 x 10.00mm, FPM	

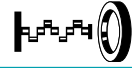

179 2.5L		Diesel		
8140.27S.3700	4 Cyl.	8 Valves	2499cc	TD20152
HR602	NP068 55.00 x 70.00 x 8.00mm, FPM NP067 50.00 x 70.00 x 10.00mm, FPM		NP068 55.00 x 70.00 x 8.00mm, FPM NB946 70.00 x 90.00 x 10.00mm, FPM NF853 100.00 x 118.00 x 10.00mm, FPM NF886 100.00 x 179.00 x 15.80mm, FPM	

180 2.5L		Diesel		
8140.47	4 Cyl.	8 Valves	2500cc	TD1048
8140.47.3700	4 Cyl.	8 Valves	2499cc	TD6809
8140.47R	4 Cyl.	8 Valves	2500cc	TD1049
8140.47R.2210	4 Cyl.	8 Valves	2499cc	TD6811
8140.67	4 Cyl.	8 Valves	2500cc	TD1052
8140.67.2700	4 Cyl.	8 Valves	2499cc	TD6810
HR602	NP068 55.00 x 70.00 x 8.00mm, FPM		NB946 70.00 x 90.00 x 10.00mm, FPM NF885 70.00 x 159.00 ; 179.00 x 16.00mm, FPM Eng no. 2263444 → NF853 100.00 x 118.00 x 10.00mm, FPM NF883 114.00 x 171.00 x 13.00mm, FPM Eng no. 1884196 →	

181 2.5L		Diesel		
8140.61	4 Cyl.	8 Valves	2445cc	TD1050
8144.21	4 Cyl.	8 Valves	2445cc	TD4419
8144.67.220	4 Cyl.	8 Valves	2499cc	TD6797
HR602	NP068 55.00 x 70.00 x 8.00mm, FPM		NB946 70.00 x 90.00 x 10.00mm, FPM NF833 90.00 x 115.00 x 13.00mm, FPM	

182 2.5L		Diesel		
8144.21.220	4 Cyl.	8 Valves	2445cc	TD6803
HR602	NP068 55.00 x 70.00 x 8.00mm, FPM		NP067 50.00 x 70.00 x 10.00mm, FPM NF833 90.00 x 115.00 x 13.00mm, FPM	

183 2.5L		Diesel		
8144.67	4 Cyl.	8 Valves	2500cc	TD1056
HR602	NP068 55.00 x 70.00 x 8.00mm, FPM		NB946 70.00 x 90.00 x 10.00mm, FPM NF853 100.00 x 118.00 x 10.00mm, FPM NF833 90.00 x 115.00 x 13.00mm, FPM →Eng no. 1050633	



184 2.5L

Diesel

8144.97	4 Cyl.	8 Valves	2499cc	TD1061
8144.97.2200	4 Cyl.	8 Valves	2499cc	TD1062
8144.97.2400	4 Cyl.	8 Valves	2499cc	TD22316
8144.97.2500	4 Cyl.	8 Valves	2500cc	TD1063
8144.97 S	4 Cyl.	8 Valves	2500cc	TD1059
8144.97 Y	4 Cyl.	8 Valves	2500cc	TD1060
HR602	NP068 55.00 x 70.00 x 8.00mm, FPM		NP068 55.00 x 70.00 x 8.00mm, FPM	
	NF841 35.00 x 50.00 x 8.00mm, FPM		NF853 100.00 x 118.00 x 10.00mm, FPM	

185 2.5L

Diesel

B 25.637	4 Cyl.	8 Valves	2498cc	TD21463
HR340				NF637 48.00 x 65.00 x 10.00mm, FPM

186 2.5L

Diesel

CRD93L (U25-661)	4 Cyl.	8 Valves	2500cc	TD22981
HR340	NP068 55.00 x 70.00 x 8.00mm, FPM		NB946 70.00 x 90.00 x 10.00mm, FPM	
			NF853 100.00 x 118.00 x 10.00mm, FPM	

187 2.5L

Diesel

THY (DKSATE)	4 Cyl.	12 Valves	2446cc	TD22239
HR662				NF866 64.00 x 88.00 x 6.00mm, FPM/ACM
			NF867 98.00 x 120.00 x 7.00mm, FPM/ACM	

188 2.6L

Diesel

8030.02	3 Cyl.	6 Valves	2592cc	TD6922
8035.02	3 Cyl.	6 Valves	2592cc	TD25194
				NA5040 110.00 x 135.00 x 13.00mm, FPM

189 2.7L

Diesel

8035.04.265	3 Cyl.	6 Valves	2749cc	TD25325
8035.04.270	3 Cyl.	6 Valves	2749cc	TD25326
8035.04.272	3 Cyl.	6 Valves	2749cc	TD25327
8035.04.300	3 Cyl.	6 Valves	2749cc	TD25328
8035.04.359	3 Cyl.	6 Valves	2749cc	TD25329
8035.04.370	3 Cyl.	6 Valves	2749cc	TD25330
8035.04.376	3 Cyl.	6 Valves	2749cc	TD25331
8035.04.377	3 Cyl.	6 Valves	2749cc	TD25332
8035.04.378	3 Cyl.	6 Valves	2749cc	TD25333
8035.06.200	3 Cyl.	6 Valves	2708cc	TD25535
8035.06.206	3 Cyl.	6 Valves	2708cc	TD25536
8035.06.208	3 Cyl.	6 Valves	2708cc	TD25537
8035.06.216	3 Cyl.	6 Valves	2708cc	TD25538
8035.06.220	3 Cyl.	6 Valves	2708cc	TD25539
8035.06.222	3 Cyl.	6 Valves	2708cc	TD25540
8035.06.223	3 Cyl.	6 Valves	2708cc	TD25541

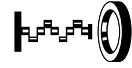
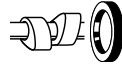

8035.06.306	3 Cyl.	6 Valves	2708cc	TD25542
8035.06.307	3 Cyl.	6 Valves	2708cc	TD25543
8035.06.308	3 Cyl.	6 Valves	2708cc	TD25544
8035.06.309	3 Cyl.	6 Valves	2708cc	TD25545
8035.06.317	3 Cyl.	6 Valves	2708cc	TD25546
8035.06.320	3 Cyl.	6 Valves	2708cc	TD25547
8035.06.321	3 Cyl.	6 Valves	2708cc	TD25548
8035.06.322	3 Cyl.	6 Valves	2708cc	TD25549
8035.06.323	3 Cyl.	6 Valves	2708cc	TD25550

NA5040
110.00 x 135.00 x 13.00mm, FPM

190 2.8L

Diesel

8140.23.2200	4 Cyl.	8 Valves	2800cc	TD24996
8140.43	4 Cyl.	8 Valves	2800cc	TD11769
8140.43N	4 Cyl.	8 Valves	2798cc	TD20450
8140.43S	4 Cyl.	8 Valves	2798cc	TD16196
8140.63	4 Cyl.	8 Valves	2800cc	TD12749

HR602

NP068
55.00 x 70.00 x 8.00mm, FPM

NF885
70.00 x 159.00 ; 179.00 x 16.00mm, FPM
NF883
114.00 x 171.00 x 13.00mm, FPM

191 2.9L

Diesel

8035.05.214	3 Cyl.	6 Valves	2931cc	TD22233
8035.05.215	3 Cyl.	6 Valves	2931cc	TD22234

NA5040
110.00 x 135.00 x 13.00mm, FPM

192 3.0L

Petrol

MEBA	6 Cyl.	24 Valves	2967cc	TD26930
------	--------	-----------	--------	---------

NA5175
91.00 x 108.00 x 9.50mm, NBR

193 3.0L

Petrol

N54 B30 A	6 Cyl.	24 Valves	2979cc	TD24989
-----------	--------	-----------	--------	---------

NA5104
90.00 x 110.00 x 12.00mm, PTFE

194 3.0L

Petrol

XFW	6 Cyl.	24 Valves	2946cc	TD18310
-----	--------	-----------	--------	---------

PA5041 (x24)
HR5062

NA5260 (x2)
38.00 x 50.00 x 6.00mm, FPM

NA5190
42.00 x 56.00 x 7.00mm, FPM
NF867
98.00 x 120.00 x 7.00mm, FPM/ACM

195 3.2L

Diesel

8040.00	4 Cyl.	8 Valves	3120cc	TD24575
---------	--------	----------	--------	---------

NA5040
110.00 x 135.00 x 13.00mm, FPM



196 3.5L

Petrol

30 A	8 Cyl.	16 Valves	3528cc	TD32480
HR5052 (x2)				NB849 48.70 x 63.50 x 8.00mm, FPM NB291 82.60 x 98.70 x 12.70mm, MVQ

197 3.5L

Diesel

8040.02	4 Cyl.	8 Valves	3456cc	TD6840
8040.02.041	4 Cyl.	8 Valves	3456cc	TD6925
8040.02.267	4 Cyl.	8 Valves	3456cc	TD5606
8040.02.300	4 Cyl.	8 Valves	3455cc	TD5605
8040.02.360	4 Cyl.	8 Valves	3456cc	TD5944
8040.02.367	4 Cyl.	8 Valves	3456cc	TD5945
8045.02	4 Cyl.	8 Valves	3456cc	TD25195
			NA5041 42.00 x 65.00 x 12.00mm, ACM NA5039 95.00 x 120.00 x 13.00mm, FPM	NA5040 110.00 x 135.00 x 13.00mm, FPM

198 3.6L

Diesel

8045.06.200	4 Cyl.	8 Valves	3613cc	TD25521
8045.06.208	4 Cyl.	8 Valves	3613cc	TD25522
8045.06.213	4 Cyl.	8 Valves	3613cc	TD25523
8045.06.214	4 Cyl.	8 Valves	3613cc	TD25524
8045.06.215	4 Cyl.	8 Valves	3613cc	TD25525
8045.06.225	4 Cyl.	8 Valves	3613cc	TD25526
8045.06.319	4 Cyl.	8 Valves	3613cc	TD25527
8045.06.326	4 Cyl.	8 Valves	3613cc	TD25528
				NA5040 110.00 x 135.00 x 13.00mm, FPM

199 3.6L

Petrol

ERB	6 Cyl.	24 Valves	3604cc	TD26197
HR5062				NA5131 45.00 x 67.00 x 8.00mm, PTFE

200 3.7L

Diesel

8040.04.200	4 Cyl.	8 Valves	3666cc	TD7263
8040.04.280	4 Cyl.	8 Valves	3666cc	TD6841
8045.04.189	4 Cyl.	8 Valves	3666cc	TD25334
8045.04.270	4 Cyl.	8 Valves	3666cc	TD25335
8045.04.275	4 Cyl.	8 Valves	3666cc	TD25336
8045.04.276	4 Cyl.	8 Valves	3666cc	TD25337
8045.04.277	4 Cyl.	8 Valves	3666cc	TD25338
8045.04.293	4 Cyl.	8 Valves	3666cc	TD25339
8045.04.300	4 Cyl.	8 Valves	3666cc	TD25340
8045.04.359	4 Cyl.	8 Valves	3666cc	TD25341
8045.04.370	4 Cyl.	8 Valves	3666cc	TD25342
8045.04.376	4 Cyl.	8 Valves	3666cc	TD25343
8045.04.377	4 Cyl.	8 Valves	3666cc	TD25344
				NA5040 110.00 x 135.00 x 13.00mm, FPM

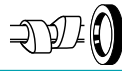

201 3.9L Diesel

8040.05.200	4 Cyl.	8 Valves	3908cc	TD7265
8040.05.230	4 Cyl.	8 Valves	3908cc	TD7264
8040.05.4990	4 Cyl.	8 Valves	3908cc	TD22235
8040.25.000	4 Cyl.	8 Valves	3908cc	TD21461
8040.25.200	4 Cyl.	8 Valves	3908cc	TD7272
8040.25.220	4 Cyl.	8 Valves	3908cc	TD7280
8040.25.230	4 Cyl.	8 Valves	3908cc	TD7271
8040.25B.4200 (LTC)	4 Cyl.	8 Valves	3908cc	TD7267
8040.25X.4000	4 Cyl.	8 Valves	3908cc	TD7268
8040.45.261	4 Cyl.	8 Valves	3908cc	TD7245
8040.45.271	4 Cyl.	8 Valves	3908cc	TD7246
8040.45.4000 (TCA)	4 Cyl.	8 Valves	3908cc	TD7269
8040.45.4180 (TCA)	4 Cyl.	8 Valves	3908cc	TD7275
8040.45.5200	4 Cyl.	8 Valves	3908cc	TD21462
8040.45.5281	4 Cyl.	8 Valves	3908cc	TD22236
8040.45D.5100	4 Cyl.	8 Valves	3908cc	TD22237
8040.45D.5103	4 Cyl.	8 Valves	3908cc	TD22238
8045.05.000	4 Cyl.	8 Valves	3908cc	TD25496
8045.05.200	4 Cyl.	8 Valves	3908cc	TD25497
8045.05.204	4 Cyl.	8 Valves	3908cc	TD25498
8045.05.213	4 Cyl.	8 Valves	3908cc	TD25500
8045.05.215	4 Cyl.	8 Valves	3908cc	TD25501
8045.05.216	4 Cyl.	8 Valves	3908cc	TD25502
8045.05.217	4 Cyl.	8 Valves	3908cc	TD25503
8045.05.300	4 Cyl.	8 Valves	3908cc	TD25504
8045.05.304	4 Cyl.	8 Valves	3908cc	TD25505
8045.05.308	4 Cyl.	8 Valves	3908cc	TD25506
8045.05.317	4 Cyl.	8 Valves	3908cc	TD25507
8045.05.359	4 Cyl.	8 Valves	3908cc	TD25508
8045.05.370	4 Cyl.	8 Valves	3908cc	TD25509
8045.05.376	4 Cyl.	8 Valves	3908cc	TD25510
8045.05.389	4 Cyl.	8 Valves	3908cc	TD25511
8045.05.393	4 Cyl.	8 Valves	3908cc	TD25512
8045.05.395	4 Cyl.	8 Valves	3908cc	TD25513
8045.25.210	4 Cyl.	8 Valves	3908cc	TD25363
8045.25.310	4 Cyl.	8 Valves	3908cc	TD25364
8045.25.370	4 Cyl.	8 Valves	3908cc	TD25365
8045.25.375	4 Cyl.	8 Valves	3908cc	TD25366
8045.25.376	4 Cyl.	8 Valves	3908cc	TD25367
8045.25.380	4 Cyl.	8 Valves	3908cc	TD25368
8045.25.381	4 Cyl.	8 Valves	3908cc	TD25369
8045.25.382	4 Cyl.	8 Valves	3908cc	TD25370
8045.25.385	4 Cyl.	8 Valves	3908cc	TD25371
8045.25.395	4 Cyl.	8 Valves	3908cc	TD25372

NA5041
42.00 x 65.00 x 12.00mm, ACM

NA5040
110.00 x 135.00 x 13.00mm, FPM



202 4.4L

Petrol

M62448S2	8 Cyl.	32 Valves	4398cc	TD21094
PA5041 (x32) HR791 (x2)				NA5105 48.00 x 65.00 x 10.00mm, PTFE NA5132 100.00 x 125.00 x 13.00mm, FPM

203 4.6L

Petrol

46 D	8 Cyl.	16 Valves	4553cc	TD26932
HR5053				NB849 48.70 x 63.50 x 8.00mm, FPM NB291 82.60 x 98.70 x 12.70mm, MVQ

204 4.6L

Diesel

8055.04.200	5 Cyl.	10 Valves	4583cc	TD25345
8055.04.205	5 Cyl.	10 Valves	4583cc	TD25346
8055.04.250	5 Cyl.	10 Valves	4583cc	TD25347
				NA5040 110.00 x 135.00 x 13.00mm, FPM

205 4.8L

Petrol

N62 B48 B	8 Cyl.	32 Valves	4799cc	TD26931
PA5041 (x32) HR791 (x2)				

206 4.9L

Diesel

8055.05.000	5 Cyl.	10 Valves	4885cc	TD25384
				NA5040 110.00 x 135.00 x 13.00mm, FPM

207 5.2L

Diesel

8060.02.000	6 Cyl.	12 Valves	5184cc	TD6852
8060.02.070	6 Cyl.	12 Valves	5184cc	TD6843
8060.12	6 Cyl.	12 Valves	5184cc	TD6908
8060.12.031	6 Cyl.	12 Valves	5184cc	TD6909
8065.02.007	6 Cyl.	12 Valves	5184cc	TD25315
8065.02.200	6 Cyl.	12 Valves	5184cc	TD25316
8065.02.207	6 Cyl.	12 Valves	5184cc	TD25317
8065.02.217	6 Cyl.	12 Valves	5184cc	TD25318
				NA5040 110.00 x 135.00 x 13.00mm, FPM

208 5.2L

Diesel

8060.02.001	6 Cyl.	12 Valves	5184cc	TD5614
8060.02.003	6 Cyl.	12 Valves	5184cc	TD5953
			NA5039 95.00 x 120.00 x 13.00mm, FPM	NA5040 110.00 x 135.00 x 13.00mm, FPM

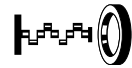
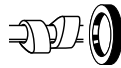

209 5.4L

Diesel

8065.06.000	6 Cyl.	12 Valves	5418cc	TD25390
8065.06.200	6 Cyl.	12 Valves	5418cc	TD25392
8065.06.220	6 Cyl.	12 Valves	5418cc	TD25393
8065.06.230	6 Cyl.	12 Valves	5418cc	TD25395
8065.06.300	6 Cyl.	12 Valves	5418cc	TD25397

NA5040 
110.00 x 135.00 x 13.00mm, FPM

210 5.5L

Diesel

8060.04.000	6 Cyl.	12 Valves	5499cc	TD6853
8060.04.051	6 Cyl.	12 Valves	5499cc	TD7349
8060.04.052	6 Cyl.	12 Valves	5499cc	TD7351
8060.04.055	6 Cyl.	12 Valves	5499cc	TD5612
8060.04.060	6 Cyl.	12 Valves	5499cc	TD5916
8060.04.070	6 Cyl.	12 Valves	5499cc	TD7279
8060.04.620	6 Cyl.	12 Valves	5499cc	TD5608
8060.04.621	6 Cyl.	12 Valves	5499cc	TD5948
8060.04.630	6 Cyl.	12 Valves	5499cc	TD7298
8060.04.639	6 Cyl.	12 Valves	5499cc	TD5615
8060.04.658	6 Cyl.	12 Valves	5499cc	TD7261
8060.04.660	6 Cyl.	12 Valves	5499cc	TD6255
8060.04.661	6 Cyl.	12 Valves	5499cc	TD7257
8060.04.662	6 Cyl.	12 Valves	5499cc	TD7258
8060.04.669	6 Cyl.	12 Valves	5499cc	TD7292
8060.04.670	6 Cyl.	12 Valves	5499cc	TD5610
8060.04.672	6 Cyl.	12 Valves	5499cc	TD5950
8060.04.675	6 Cyl.	12 Valves	5499cc	TD5954
8060.04.689	6 Cyl.	12 Valves	5499cc	TD7296
8060.24.601	6 Cyl.	12 Valves	5499cc	TD7300
8060.24.643	6 Cyl.	12 Valves	5499cc	TD7259
8060.24.652	6 Cyl.	12 Valves	5499cc	TD7251
8060.24.661	6 Cyl.	12 Valves	5500cc	TD6832
8060.24.662	6 Cyl.	12 Valves	5499cc	TD5603
8060.24.664	6 Cyl.	12 Valves	5499cc	TD5941
8060.24.670	6 Cyl.	12 Valves	5499cc	TD5611
8060.24.671	6 Cyl.	12 Valves	5499cc	TD5951
8060.24.673	6 Cyl.	12 Valves	5499cc	TD5942
8060.24.678	6 Cyl.	12 Valves	5500cc	TD7297
8060.25.4600	6 Cyl.	12 Valves	5499cc	TD7350
8062.24.070	6 Cyl.	12 Valves	5499cc	TD7291
8065.04.089	6 Cyl.	12 Valves	5499cc	TD25319
8065.04.095	6 Cyl.	12 Valves	5499cc	TD25320
8065.04.097	6 Cyl.	12 Valves	5499cc	TD25321
8065.04.200	6 Cyl.	12 Valves	5499cc	TD25322
8065.04.217	6 Cyl.	12 Valves	5499cc	TD25323
8065.04.270	6 Cyl.	12 Valves	5499cc	TD25324
8065.24.000	6 Cyl.	12 Valves	5499cc	TD25348
8065.24.091	6 Cyl.	12 Valves	5499cc	TD25349

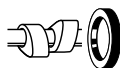

8065.24.092	6 Cyl.	12 Valves	5499cc	TD25350
8065.24.098	6 Cyl.	12 Valves	5499cc	TD25351
8065.24.300	6 Cyl.	12 Valves	5499cc	TD25352

NA5040 R
110.00 x 135.00 x 13.00mm, FPM

211 5.9L

Diesel

8060.05.000	6 Cyl.	12 Valves	5861cc	TD7282
8060.05.200	6 Cyl.	12 Valves	5861cc	TD7299
8060.05.246	6 Cyl.	12 Valves	5861cc	TD7262
8060.05.270	6 Cyl.	12 Valves	5861cc	TD7278
8060.05.280	6 Cyl.	12 Valves	5861cc	TD7281
8060.05.285	6 Cyl.	12 Valves	5861cc	TD7274
8060.05.289	6 Cyl.	12 Valves	5861cc	TD7293
8060.05.661	6 Cyl.	12 Valves	5861cc	TD5596
8060.05.662	6 Cyl.	12 Valves	5861cc	TD5598
8060.05.663	6 Cyl.	12 Valves	5861cc	TD5935
8060.05.673	6 Cyl.	12 Valves	5861cc	TD5937
8060.25.221	6 Cyl.	12 Valves	5861cc	TD7247
8060.25.241	6 Cyl.	12 Valves	5861cc	TD5600
8060.25.243	6 Cyl.	12 Valves	5861cc	TD7244
8060.25.246	6 Cyl.	12 Valves	5861cc	TD5939
8060.25.621	6 Cyl.	12 Valves	5861cc	TD7243
8060.25.630	6 Cyl.	12 Valves	5861cc	TD5604
8060.25.631	6 Cyl.	12 Valves	5861cc	TD5943
8060.25.641	6 Cyl.	12 Valves	5861cc	TD7242
8060.25.661	6 Cyl.	12 Valves	5861cc	TD5597
8060.25.662	6 Cyl.	12 Valves	5861cc	TD5599
8060.25.663	6 Cyl.	12 Valves	5861cc	TD5936
8060.25.673	6 Cyl.	12 Valves	5861cc	TD5938
8060.45.600	6 Cyl.	12 Valves	5861cc	TD7295
8065.05.000	6 Cyl.	12 Valves	5863cc	TD25488
8065.05.210	6 Cyl.	12 Valves	5863cc	TD25489
8065.05.220	6 Cyl.	12 Valves	5863cc	TD25491
8065.05.290	6 Cyl.	12 Valves	5863cc	TD25490
8065.05.295	6 Cyl.	12 Valves	5863cc	TD25492
8065.05.297	6 Cyl.	12 Valves	5863cc	TD25493
8065.05.300	6 Cyl.	12 Valves	5863cc	TD25494
8065.05.330	6 Cyl.	12 Valves	5863cc	TD25495
8065.25.000	6 Cyl.	12 Valves	5863cc	TD25473
8065.25.010	6 Cyl.	12 Valves	5863cc	TD25474
8065.25.080	6 Cyl.	12 Valves	5863cc	TD25475
8065.25.320	6 Cyl.	12 Valves	5863cc	TD25477

NA5040 R
110.00 x 135.00 x 13.00mm, FPM

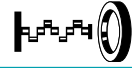

212 5.9L Diesel

8060.25.600	6 Cyl.	12 Valves	5861cc	TD7301
8060.25V.4000	6 Cyl.	12 Valves	5861cc	TD7283
		NA5041 42.00 x 65.00 x 12.00mm, ACM		NA5040 110.00 x 135.00 x 13.00mm, FPM
				NA5042 114.00 x 135.00 x 13.00mm, FPM

213 5.9L Diesel

8060.25.669	6 Cyl.	12 Valves	5861cc	TD5613
8060.25.670	6 Cyl.	12 Valves	5861cc	TD5952
8060.25.678	6 Cyl.	12 Valves	5861cc	TD5616
8060.25.679	6 Cyl.	12 Valves	5861cc	TD5955
8060.25R.4200	6 Cyl.	12 Valves	5861cc	TD7276
8060.25R.4280	6 Cyl.	12 Valves	5861cc	TD7302
8060.25V.4080	6 Cyl.	12 Valves	5861cc	TD7303
8060.45.4100	6 Cyl.	12 Valves	5861cc	TD7284
8060.45.4180	6 Cyl.	12 Valves	5861cc	TD7285
8060.45.6090	6 Cyl.	12 Valves	5861cc	TD7304
8060.45S.6000	6 Cyl.	12 Valves	5861cc	TD7307
8060.45S.6700	6 Cyl.	12 Valves	5861cc	TD7343
8060.45S.6800	6 Cyl.	12 Valves	5861cc	TD7305
		NA5041 42.00 x 65.00 x 12.00mm, ACM		NA5040 110.00 x 135.00 x 13.00mm, FPM

214 9.5L Diesel

8460.21.002	6 Cyl.	12 Valves	9498cc	TD24863
8460.41R.723	6 Cyl.	12 Valves	9498cc	TD24864
8460.41S.733	6 Cyl.	12 Valves	9498cc	TD24865
				NB939 115.00 x 140.00 x 16.00mm, FPM

215 9.6L Diesel

8220.02.701	6 Cyl.	12 Valves	9572cc	TD7252
8220.02.834	6 Cyl.	12 Valves	9572cc	TD7361
8220.02.847	6 Cyl.	12 Valves	9572cc	TD6866
8220.02.856	6 Cyl.	12 Valves	9572cc	TD6867
8220.02.870	6 Cyl.	12 Valves	9572cc	TD7327
8220.12.709	6 Cyl.	12 Valves	9572cc	TD7370
8220.22.002	6 Cyl.	12 Valves	9572cc	TD5618
8220.22.102	6 Cyl.	12 Valves	9572cc	TD5601
8220.22.104	6 Cyl.	12 Valves	9572cc	TD5940
8220.22.106	6 Cyl.	12 Valves	9572cc	TD6258
8220.32.701	6 Cyl.	12 Valves	9572cc	TD7379
				NB928 105.00 x 130.00 x 12.00mm, FPM
				NB939 115.00 x 140.00 x 16.00mm, FPM



216 9.6L

Diesel

8220.02.842	6 Cyl.	12 Valves	9570cc	TD6887
8220.12.001	6 Cyl.	12 Valves	9570cc	TD6917
8220.22.708	6 Cyl.	12 Valves	9570cc	TD5640
8220.22.709	6 Cyl.	12 Valves	9570cc	TD5981
8220.32.721	6 Cyl.	12 Valves	9570cc	TD7380
8220.32.723	6 Cyl.	12 Valves	9570cc	TD7373

NB928

105.00 x 130.00 x 12.00mm, FPM

217 13.8L

Diesel

8210.02.000	6 Cyl.	12 Valves	13798cc	TD6868
8210.02.020	6 Cyl.	12 Valves	13798cc	TD6864
8210.02.022	6 Cyl.	12 Valves	13798cc	TD6877
8210.02.032	6 Cyl.	12 Valves	13798cc	TD6923
8210.02.033	6 Cyl.	12 Valves	13798cc	TD5975
8210.02.053	6 Cyl.	12 Valves	13798cc	TD6266
8210.02.067	6 Cyl.	12 Valves	13798cc	TD5622
8210.02.069	6 Cyl.	12 Valves	13798cc	TD5959
8210.02.081	6 Cyl.	12 Valves	13798cc	TD6865
8210.02.266	6 Cyl.	12 Valves	13798cc	TD5635
8210.02.267	6 Cyl.	12 Valves	13798cc	TD5976
8210.02.290	6 Cyl.	12 Valves	13798cc	TD6384
8210.02.371	6 Cyl.	12 Valves	13798cc	TD5619
8210.02.373	6 Cyl.	12 Valves	13798cc	TD5621
8210.02.377	6 Cyl.	12 Valves	13798cc	TD5958
8210.02.385	6 Cyl.	12 Valves	13798cc	TD6899
8210.02.393	6 Cyl.	12 Valves	13798cc	TD6259
8210.02.405	6 Cyl.	12 Valves	13798cc	TD7254
8210.02.426	6 Cyl.	12 Valves	13798cc	TD7359
8210.02.440	6 Cyl.	12 Valves	13798cc	TD5617
8210.02.441	6 Cyl.	12 Valves	13798cc	TD5956
8210.02.731	6 Cyl.	12 Valves	13798cc	TD5973
8210.02.791	6 Cyl.	12 Valves	13798cc	TD6380
8210.02.793	6 Cyl.	12 Valves	13798cc	TD6381
8210.22.000	6 Cyl.	12 Valves	13798cc	TD22223
8210.22.069	6 Cyl.	12 Valves	13798cc	TD6885
8210.22.101	6 Cyl.	12 Valves	13798cc	TD6881
8210.22.105	6 Cyl.	12 Valves	13798cc	TD7335
8210.22.171	6 Cyl.	12 Valves	13798cc	TD5623
8210.22.175	6 Cyl.	12 Valves	13798cc	TD5960
8210.22.183	6 Cyl.	12 Valves	13798cc	TD7340
8210.22.235	6 Cyl.	12 Valves	13798cc	TD7352
8210.22.269	6 Cyl.	12 Valves	13798cc	TD5630
8210.22.290	6 Cyl.	12 Valves	13798cc	TD6385
8210.22.317	6 Cyl.	12 Valves	13798cc	TD6260
8210.22.327	6 Cyl.	12 Valves	13798cc	TD5968
8210.22.373	6 Cyl.	12 Valves	13798cc	TD6878
8210.22.385	6 Cyl.	12 Valves	13798cc	TD6264
8210.22.406	6 Cyl.	12 Valves	13798cc	TD7255

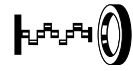
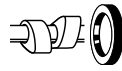

8210.22.569	6 Cyl.	12 Valves	13798cc	TD7330
8210.22.869	6 Cyl.	12 Valves	13798cc	TD7333
8210.22X.069	6 Cyl.	12 Valves	13798cc	TD5637
8210.22X.235	6 Cyl.	12 Valves	13798cc	TD5636
8210.22X.523	6 Cyl.	12 Valves	13798cc	TD5977
8210.22X.575	6 Cyl.	12 Valves	13798cc	TD5978
8210.42(TCA)	6 Cyl.	12 Valves	13798cc	TD7322
8210.42.061	6 Cyl.	12 Valves	13798cc	TD5627
8210.42.073	6 Cyl.	12 Valves	13798cc	TD5964
8210.42.101	6 Cyl.	12 Valves	13798cc	TD7336
8210.42.115	6 Cyl.	12 Valves	13798cc	TD7341
8210.42.151	6 Cyl.	12 Valves	13798cc	TD5624
8210.42.152	6 Cyl.	12 Valves	13798cc	TD5625
8210.42.154	6 Cyl.	12 Valves	13798cc	TD5962
8210.42.155	6 Cyl.	12 Valves	13798cc	TD5631
8210.42.161	6 Cyl.	12 Valves	13798cc	TD5961
8210.42.162	6 Cyl.	12 Valves	13798cc	TD6262
8210.42.165	6 Cyl.	12 Valves	13798cc	TD5970
8210.42.171	6 Cyl.	12 Valves	13798cc	TD6261
8210.42.172	6 Cyl.	12 Valves	13798cc	TD5969
8210.42.175	6 Cyl.	12 Valves	13798cc	TD5974
8210.42.181	6 Cyl.	12 Valves	13798cc	TD5626
8210.42.182	6 Cyl.	12 Valves	13798cc	TD5963
8210.42.185	6 Cyl.	12 Valves	13798cc	TD5632
8210.42.186	6 Cyl.	12 Valves	13798cc	TD5971
8210.42.191	6 Cyl.	12 Valves	13798cc	TD6263
8210.42.195	6 Cyl.	12 Valves	13798cc	TD6265
8210.42L.400	6 Cyl.	12 Valves	13798cc	TD7320

NB946 
70.00 x 90.00 x 10.00mm, FPM



CC



9

Bantam Pickup	03/86→08/90	LUG	Petrol	1597	4	8	63
Bantam Pickup	09/90→09/94	JBE	Petrol	1299	4	8	22
Bantam Pickup	09/90→10/94	LJF	Petrol	1598	4	8	63
Bantam Pickup	09/90→10/94	LUJ	Petrol	1598	4	8	63
Bantam Pickup	11/94→08/01	B6	Petrol	1598	4	16	47
Bantam Pickup	11/94→08/01	F6	Petrol	1587	4	8	55
Bantam Pickup	09/01→08/06	A9JA	Petrol	1299	4	8	15
Bantam Pickup	09/01→08/06	RTP	Diesel	1753	4	8	73
Bantam Pickup	09/06→	A9JD	Petrol	1299	4	8	15
Belina II	01/79→12/86	CHT 1600	Petrol	1555	4	8	54
B-Max (JK)	10/12→	IQJA	Petrol	1596	4	16	58
B-Max (JK)	10/12→	MIJA	Petrol	998	3	12	3
B-Max (JK)	10/12→	MIJE	Petrol	998	3	12	3
B-Max (JK)	10/12→	SFJA	Petrol	998	3	12	3
B-Max (JK)	10/12→	SFJB	Petrol	998	3	12	3
B-Max (JK)	10/12→	SFJC	Petrol	998	3	12	3
B-Max (JK)	10/12→	SFJD	Petrol	998	3	12	3
B-Max (JK)	10/12→	SPJD	Petrol	1388	4	16	30
B-Max (JK)	10/12→	T3JB	Diesel	1560	4	8	68
B-Max (JK)	10/12→	UGJC	Diesel	1499	4	8	36
B-Max (JK)	08/13→	RTJC	Petrol	1388	4	16	30
B-Max (JK)	04/15→	XVJA	Diesel	1499	4	8	36
B-Max (JK)	04/15→	XVJC	Diesel	1499	4	8	36
B-Max (JK)	02/16→	YVJC	Petrol	998	3	12	3
B-Max Van	10/12→	IQJA	Petrol	1596	4	16	58
B-Max Van	10/12→	MIJE	Petrol	998	3	12	3
B-Max Van	10/12→	SFJA	Petrol	998	3	12	3
B-Max Van	10/12→	SFJB	Petrol	998	3	12	3
B-Max Van	10/12→	SFJC	Petrol	998	3	12	3
B-Max Van	10/12→	SFJD	Petrol	998	3	12	3
B-Max Van	10/12→	SPJD	Petrol	1388	4	16	30
B-Max Van	10/12→	T3JB	Diesel	1560	4	8	68
B-Max Van	10/12→	UGJC	Diesel	1499	4	8	36
B-Max Van	04/15→	XVJA	Diesel	1499	4	8	36
B-Max Van	04/15→	XVJC	Diesel	1499	4	8	36
Capri (ECJ)	12/68→08/72	TV 17 H	Petrol	1699	4	8	71
Capri (ECJ)	12/68→12/72	EV 13 L	Petrol	1305	4	8	19
Capri (ECJ)	12/68→02/74	EV 15 H	Petrol	1488	4	8	41
Capri (ECJ)	12/68→02/74	EX	Petrol	1498	4	8	42
Capri (ECJ)	01/69→12/70	KL 13 H	Petrol	1298	4	8	19
Capri (ECJ)	01/69→12/73	KL 13 L	Petrol	1298	4	8	19
Capri (ECJ)	02/69→06/71	NX	Petrol	1998	6	12	126
Capri (ECJ)	02/69→02/74	NY	Petrol	1998	6	12	126
Capri (ECJ)	02/69→02/74	TV 23 H	Petrol	2293	6	12	145
Capri (ECJ)	08/69→02/74	YY	Petrol	2294	6	12	147
Capri (ECJ)	08/70→02/74	OZ	Petrol	2638	6	12	173
Capri (ECJ)	08/70→02/74	UY	Petrol	2550	6	12	168
Capri (ECJ)	01/72→12/72	KL 13 HC	Petrol	1298	4	8	19
Capri (ECJ)	08/72→02/74	LE	Petrol	1593	4	8	64
Capri (ECJ)	08/72→02/74	OHC TL 16 H	Petrol	1593	4	8	69
Capri Convertible (SA II, SC, SE, SA I)	09/89→07/94	B6 (DOHC 16 V)	Petrol	1598	4	16	49
Capri Convertible (SA II, SC, SE, SA I)	09/89→07/94	B6T	Petrol	1598	4	16	51
Capri Convertible (SA, SB, SC, SE)	09/89→10/90	B6 (8 V)	Petrol	1598	4	8	48
Capri II (GCEP)	02/74→08/77	JIE	Petrol	1298	4	8	19
Capri II (GCEP)	02/74→12/77	HYF	Petrol	2993	6	12	184
Capri II (GCEP)	02/74→12/77	LCE	Petrol	1593	4	8	64
Capri II (GCEP)	02/74→12/77	LEC	Petrol	1593	4	8	45
Capri II (GCEP)	02/74→12/77	YYE	Petrol	2294	6	12	145
Capri II (GCEP)	04/74→12/77	OHC TL 20 H	Petrol	1993	4	8	122
Capri II (GCEP)	09/74→12/77	LAC	Petrol	1593	4	8	64
Capri II (GCEP)	04/76→12/77	NWN	Petrol	1999	6	12	126
Capri II (GCEP)	04/76→12/77	NYL	Petrol	1999	6	12	126
Capri III (GCEP)	01/78→12/81	HYF	Petrol	2993	6	12	184
Capri III (GCEP)	01/78→12/82	NYL	Petrol	1999	6	12	126
Capri III (GCEP)	01/78→06/85	JIE	Petrol	1298	4	8	19
Capri III (GCEP)	01/78→12/85	NEN	Petrol	1993	4	8	122
Capri III (GCEP)	01/78→12/85	OHC TL 20 H	Petrol	1993	4	8	122
Capri III (GCEP)	01/78→04/87	LCN	Petrol	1593	4	8	64
Capri III (GCEP)	06/79→12/85	YYN	Petrol	2294	6	12	145
Capri III (GCEP)	01/81→04/87	PRN	Petrol	2792	6	12	180
Capri III (GCEP)	01/82→04/87	PYN	Petrol	2792	6	12	180
C-Max (DM2)	02/07→09/10	AODA	Petrol	1999	4	16	105
C-Max (DM2)	02/07→09/10	AODB	Petrol	1999	4	16	105
C-Max (DM2)	02/07→09/10	AODE	Petrol	1999	4	16	105
C-Max (DM2)	02/07→09/10	G6DA	Diesel	1997	4	16	106
C-Max (DM2)	02/07→09/10	G6DB	Diesel	1997	4	16	106
C-Max (DM2)	02/07→09/10	G6DC	Diesel	1997	4	16	106
C-Max (DM2)	02/07→09/10	G6DD	Diesel	1997	4	16	106



CC



9

C-Max (DM2)	02/07→09/10	G6DE	Diesel	1997	4	16	106
C-Max (DM2)	02/07→09/10	G6DF	Diesel	1997	4	16	106
C-Max (DM2)	02/07→09/10	G6DG	Diesel	1997	4	16	106
C-Max (DM2)	02/07→09/10	G8DA	Diesel	1560	4	16	57
C-Max (DM2)	02/07→09/10	G8DB	Diesel	1560	4	16	57
C-Max (DM2)	02/07→09/10	G8DC	Diesel	1560	4	16	57
C-Max (DM2)	02/07→09/10	G8DD	Diesel	1560	4	16	57
C-Max (DM2)	02/07→09/10	GPDA	Diesel	1560	4	16	57
C-Max (DM2)	02/07→09/10	HHDA	Diesel	1560	4	16	57
C-Max (DM2)	02/07→09/10	HHDB	Diesel	1560	4	16	57
C-Max (DM2)	02/07→09/10	HWDA	Petrol	1596	4	16	56
C-Max (DM2)	02/07→09/10	HWDB	Petrol	1596	4	16	56
C-Max (DM2)	02/07→09/10	KKDA	Diesel	1753	4	8	81
C-Max (DM2)	02/07→09/10	MTDA	Diesel	1560	4	16	57
C-Max (DM2)	02/07→09/10	Q7DA	Petrol	1798	4	16	77
C-Max (DM2)	02/07→09/10	QQDA	Petrol	1798	4	16	77
C-Max (DM2)	02/07→09/10	QQDB	Petrol	1798	4	16	77
C-Max (DM2)	02/07→09/10	QQDC	Petrol	1798	4	16	77
C-Max (DM2)	02/07→09/10	SHDA	Petrol	1596	4	16	56
C-Max (DM2)	02/07→09/10	SHDB	Petrol	1596	4	16	56
C-Max (DM2)	02/07→09/10	SHDC	Petrol	1596	4	16	56
C-Max (DM2)	02/07→09/10	SYDA	Petrol	1999	4	16	105
C-Max (DM2)	04/07→09/10	HXDA	Petrol	1596	4	16	58
C-Max (DM2)	04/07→09/10	HXDB	Petrol	1596	4	16	58
C-Max (DM2)	04/07→09/10	SIDA	Petrol	1596	4	16	58
C-Max (DM2)	02/08→09/10	IXDA	Diesel	1997	4	16	106
C-Max II (DXA/CB7, DXA/CEU)	12/10→	IQDA	Petrol	1596	4	16	58
C-Max II (DXA/CB7, DXA/CEU)	12/10→	IQDB	Petrol	1596	4	16	58
C-Max II (DXA/CB7, DXA/CEU)	12/10→	JQDA	Petrol	1596	4	16	59
C-Max II (DXA/CB7, DXA/CEU)	12/10→	JQDB	Petrol	1596	4	16	59
C-Max II (DXA/CB7, DXA/CEU)	12/10→	JTDA	Petrol	1596	4	16	59
C-Max II (DXA/CB7, DXA/CEU)	12/10→	JTDB	Petrol	1596	4	16	59
C-Max II (DXA/CB7, DXA/CEU)	12/10→	PNDA	Petrol	1596	4	16	58
C-Max II (DXA/CB7, DXA/CEU)	12/10→	T1DA	Diesel	1560	4	8	68
C-Max II (DXA/CB7, DXA/CEU)	12/10→	T1DB	Diesel	1560	4	8	68
C-Max II (DXA/CB7, DXA/CEU)	12/10→	T3DA	Diesel	1560	4	8	68
C-Max II (DXA/CB7, DXA/CEU)	12/10→	T3DB	Diesel	1560	4	8	68
C-Max II (DXA/CB7, DXA/CEU)	12/10→	TXDB	Diesel	1997	4	16	129
C-Max II (DXA/CB7, DXA/CEU)	12/10→	XTDA	Petrol	1596	4	16	58
C-Max II (DXA/CB7, DXA/CEU)	02/11→	MUDA	Petrol	1596	4	16	58
C-Max II (DXA/CB7, DXA/CEU)	02/11→	TYDA	Diesel	1997	4	16	129
C-Max II (DXA/CB7, DXA/CEU)	02/11→	UFDB	Diesel	1997	4	16	129
C-Max II (DXA/CB7, DXA/CEU)	02/11→	UKDB	Diesel	1997	4	16	129
C-Max II (DXA/CB7, DXA/CEU)	10/12→	M1DA	Petrol	998	3	12	3
C-Max II (DXA/CB7, DXA/CEU)	10/12→	M2DA	Petrol	998	3	12	3
C-Max II (DXA/CB7, DXA/CEU)	10/12→	SFDA	Petrol	998	3	12	3
C-Max II (DXA/CB7, DXA/CEU)	03/15→	AEDA	Diesel	1499	4	8	36
C-Max II (DXA/CB7, DXA/CEU)	03/15→	M8DB	Petrol	1498	4	16	43
C-Max II (DXA/CB7, DXA/CEU)	03/15→	M9DB	Petrol	1498	4	16	43
C-Max II (DXA/CB7, DXA/CEU)	03/15→	T7DB	Diesel	1997	4	16	129
C-Max II (DXA/CB7, DXA/CEU)	03/15→	T8DE	Diesel	1997	4	16	129
C-Max II (DXA/CB7, DXA/CEU)	03/15→	XWDA	Diesel	1499	4	8	36
C-Max II (DXA/CB7, DXA/CEU)	03/15→	XWDB	Diesel	1499	4	8	36
C-Max II (DXA/CB7, DXA/CEU)	03/15→	XWDC	Diesel	1499	4	8	36
C-Max II (DXA/CB7, DXA/CEU)	03/15→	XWDD	Diesel	1499	4	8	36
C-Max II (DXA/CB7, DXA/CEU)	03/15→	XXDA	Diesel	1499	4	8	36
C-Max II Van	12/10→	JQDA	Petrol	1596	4	16	59
C-Max II Van	12/10→	JQDB	Petrol	1596	4	16	59
C-Max II Van	12/10→	T1DA	Diesel	1560	4	8	68
C-Max II Van	12/10→	T1DB	Diesel	1560	4	8	68
C-Max II Van	12/10→	T3DA	Diesel	1560	4	8	68
C-Max II Van	12/10→	T3DB	Diesel	1560	4	8	68
C-Max II Van	12/10→	TXDB	Diesel	1997	4	16	129
C-Max II Van	02/11→	TYDA	Diesel	1997	4	16	129
C-Max II Van	02/11→	UFDB	Diesel	1997	4	16	129
C-Max II Van	10/12→	M1DA	Petrol	998	3	12	3
C-Max II Van	10/12→	M2DA	Petrol	998	3	12	3
C-Max II Van	10/12→	SFDA	Petrol	998	3	12	3
C-Max II Van	03/15→	AEDA	Diesel	1499	4	8	36
C-Max II Van	03/15→	M8DB	Petrol	1498	4	16	43
C-Max II Van	03/15→	M9DB	Petrol	1498	4	16	43
C-Max II Van	03/15→	T7DB	Diesel	1997	4	16	129
C-Max II Van	03/15→	T8DE	Diesel	1997	4	16	129
C-Max II Van	03/15→	XWDA	Diesel	1499	4	8	36
C-Max II Van	03/15→	XWDB	Diesel	1499	4	8	36
Consul (GGFL)	01/72→12/74	EV 25 HRB	Petrol	2495	6	12	157
Consul (GGFL)	01/72→12/74	EV 30 H	Petrol	2994	6	12	184
Consul (GGFL)	01/72→12/75	NE	Petrol	1993	4	8	101



CC



9

Consul (GGFL)	01/72→12/75	TV 17 HC	Petrol	1699	4	8	71
Consul (GGFL)	01/72→12/75	TV 17 L	Petrol	1699	4	8	71
Consul (GGFL)	01/72→12/75	YY	Petrol	2294	6	12	147
Consul (GGFL)	09/74→12/75	NY	Petrol	1998	6	12	126
Consul Coupe (GGCL)	01/72→12/74	EV 30 H	Petrol	2994	6	12	184
Consul Coupe (GGCL)	01/72→12/75	NE	Petrol	1993	4	8	101
Consul Coupe (GGCL)	01/72→12/75	TV 17 HC	Petrol	1699	4	8	71
Consul Coupe (GGCL)	01/72→12/75	TV 17 L	Petrol	1699	4	8	71
Consul Coupe (GGCL)	01/72→12/75	YY	Petrol	2294	6	12	147
Consul Turnier (GGNL)	01/72→12/74	EV 25 HRB	Petrol	2495	6	12	157
Consul Turnier (GGNL)	01/72→12/75	EV 30 H	Petrol	2994	6	12	184
Consul Turnier (GGNL)	01/72→12/75	NE	Petrol	1993	4	8	101
Consul Turnier (GGNL)	01/72→12/75	TV 17 HC	Petrol	1699	4	8	71
Consul Turnier (GGNL)	01/72→12/75	TV 17 L	Petrol	1699	4	8	71
Consul Turnier (GGNL)	01/72→12/75	YY	Petrol	2294	6	12	147
Corcel II	01/79→12/86	CHT 1600	Petrol	1555	4	8	54
Corsair Hatchback (UA)	10/89→09/92	KA24E	Petrol	2389	4	12	152
Corsair Hatchback (UA)	10/89→12/92	CA20E	Petrol	1974	4	8	108
Corsair Saloon (UA)	10/89→09/92	KA24E	Petrol	2389	4	12	152
Corsair Saloon (UA)	10/89→12/92	CA20E	Petrol	1974	4	8	108
Cortina	10/66→03/72	KL 13 H	Petrol	1298	4	8	19
Cortina	10/66→03/72	KL 13 L	Petrol	1298	4	8	19
Cortina	10/67→12/69	KL 16 L	Petrol	1598	4	8	60
Cortina	10/70→03/72	LCJ	Petrol	1593	4	8	64
Cortina Coupe	10/66→03/72	KL 13 H	Petrol	1298	4	8	19
Cortina Coupe	10/66→03/72	KL 13 L	Petrol	1298	4	8	19
Cortina Coupe	10/67→12/69	KL 16 L	Petrol	1598	4	8	60
Cortina Coupe	10/70→03/72	LCJ	Petrol	1593	4	8	64
Cortina Estate	10/66→03/72	KL 13 H	Petrol	1298	4	8	19
Cortina Estate	10/66→03/72	KL 13 L	Petrol	1298	4	8	19
Cortina Estate	10/67→12/69	KL 16 L	Petrol	1598	4	8	60
Cougar (EC_)	08/98→12/01	EDBA	Petrol	1988	4	16	110
Cougar (EC_)	08/98→12/01	EDBB	Petrol	1988	4	16	110
Cougar (EC_)	08/98→12/01	EDBC	Petrol	1988	4	16	110
Cougar (EC_)	08/98→12/01	EDBD	Petrol	1988	4	16	110
Cougar (EC_)	08/98→12/01	LCBA	Petrol	2544	6	24	163
Cougar (EC_)	01/00→12/01	SGA	Petrol	2495	6	24	163
Cougar (EC_)	06/00→12/01	LCBB	Petrol	2495	6	24	163
Cougar (EC_)	06/00→12/01	LCBC	Petrol	2495	6	24	163
Cougar (EC_)	06/00→12/01	LCBE	Petrol	2495	6	24	163
Cougar Coupe (SW, SX)	10/99→03/03	LCBC	Petrol	2495	6	24	163
Courier Pickup	11/78→02/82	VC	Petrol	1769	4	8	93
Courier Pickup	11/82→12/85	MA	Petrol	1970	4	8	119
Courier Pickup	01/88→01/99	R263	Diesel	2184	4	8	138
Courier Pickup	03/98→02/02	RKA	Petrol	1796	4	16	78
Courier Pickup	03/98→09/05	WL-T	Diesel	2500	4	12	169
Courier Pickup	06/99→02/02	RTK	Diesel	1753	4	8	91
Courier Pickup (PC)	06/85→12/92	FE	Petrol	1998	4	8	113
Courier Pickup (PC)	06/85→04/96	R2	Diesel	2184	4	8	138
Courier Pickup (PC)	05/87→11/92	4G54	Petrol	2555	4	8	172
Courier Pickup (PC)	01/89→06/93	F2 (12 V)	Petrol	2184	4	12	134
Courier Pickup (PD)	05/96→02/99	WL	Diesel	2500	4	12	169
Courier Pickup (PE)	02/99→11/02	WLAT (12 V)	Diesel	2500	4	12	169
Courier Pickup (PG)	11/02→07/04	WLAT (12 V)	Diesel	2500	4	12	169
Courier Pickup (PH)	08/04→12/06	WLAT (12 V)	Diesel	2500	4	12	169
Courier Platform/Chassis (PC)	01/88→12/92	FE	Petrol	1998	4	8	113
Courier Platform/Chassis (PC)	01/88→04/96	R2	Diesel	2184	4	8	138
Courier Platform/Chassis (PC)	01/89→06/93	F2 (12 V)	Petrol	2184	4	12	134
Courier Platform/Chassis (PD)	05/96→02/99	WL	Diesel	2500	4	12	169
Courier Platform/Chassis (PE)	02/99→11/02	WLAT (12 V)	Diesel	2500	4	12	169
Courier Platform/Chassis (PG)	11/02→07/04	WLAT (12 V)	Diesel	2500	4	12	169
Courier Platform/Chassis (PH)	08/04→12/06	WLAT (12 V)	Diesel	2500	4	12	169
Del Rey	01/81→12/89	CHT 1600	Petrol	1555	4	8	54
Del Rey Turnier	01/79→12/89	CHT 1600	Petrol	1555	4	8	54
Econovan (KBA, KCA)	03/86→03/92	RF	Diesel	1998	4	8	128
Econovan (KBA, KCA)	03/86→03/92	UC	Petrol	1416	4	8	35
Econovan Box	06/79→04/84	NA	Petrol	1586	4	8	67
Econovan Box	01/84→05/85	U	Petrol	1415	4	8	34
Econovan Box	04/84→05/97	F8 (8 V)	Petrol	1789	4	8	79
Econovan Box	04/84→05/97	R2	Diesel	2184	4	8	138
Econovan Box	04/85→05/97	FE	Petrol	1998	4	8	113
Econovan Box	06/97→	FEY9	Petrol	1998	4	12	115
Econovan Box (JG)	06/97→01/00	FE	Petrol	1998	4	8	113
Econovan Box (JH)	01/00→07/06	FE	Petrol	1998	4	8	113
Econovan Box (JH)	03/03→07/06	F8 (8 V)	Petrol	1789	4	8	79
Econovan Box (KAA)	03/86→03/92	RF	Diesel	1998	4	8	128
Econovan Box (KAA)	03/86→03/92	UC	Petrol	1416	4	8	35
Econovan Bus	09/89→05/97	FEY9	Petrol	1998	4	12	115



CC



9

Econovan Platform/Chassis	04/85→12/93	FE	Petrol	1998	4	8	113
Econovan Platform/Chassis	01/90→05/97	R2	Diesel	2184	4	8	138
Econovan Platform/Chassis (JG)	06/97→01/00	FE	Petrol	1998	4	8	113
Ecosport	01/12→	AOJB	Petrol	1999	4	16	105
Ecosport	08/12→	HXJD	Petrol	1596	4	16	58
Ecosport	08/12→	IQJB	Petrol	1596	4	16	58
Ecosport	10/12→	MVJA	Petrol	1596	4	16	58
Ecosport	10/13→	M1JC	Petrol	998	3	12	3
Ecosport	10/13→	UEJB	Petrol	1498	4	16	44
Ecosport	10/13→	UGJE	Diesel	1499	4	8	36
Ecosport	05/15→	XVJD	Diesel	1499	4	8	36
Ecosport	03/16→	YYJD	Petrol	998	3	12	3
Ecosport (BK)	12/13→	M1JC	Petrol	998	3	12	3
Ecosport (BK)	12/13→	UEJB	Petrol	1498	4	16	44
Edge	08/15→	T8CC	Diesel	1997	4	16	129
Edge	08/15→	T8CM	Diesel	1997	4	16	130
Edge	08/15→	T9CE	Diesel	1997	4	16	130
Edge	08/15→	T9CF	Diesel	1997	4	16	130
Escape (BA, ZA, ZB, ZC, ZD)	03/01→12/08	AJ	Petrol	2967	6	24	183
Escape (BA, ZA, ZB, ZC, ZD)	01/04→12/12	L3	Petrol	2261	4	16	143
Escape (ZG)	09/16→	M9MA	Petrol	1499	4	16	39
Escort '81 Express (AVA)	03/81→02/86	GLB	Petrol	1117	4	8	10
Escort '81 Express (AVA)	03/81→02/86	JPA	Petrol	1296	4	8	27
Escort '81 Express (AVA)	02/84→02/86	LTA	Diesel	1608	4	8	66
Escort '86 Express (AVF)	02/86→07/90	F6B	Petrol	1392	4	8	31
Escort '86 Express (AVF)	02/86→07/90	F6D	Petrol	1392	4	8	31
Escort '86 Express (AVF)	02/86→07/90	FUC	Petrol	1392	4	8	31
Escort '86 Express (AVF)	02/86→07/90	JBB	Petrol	1297	4	8	24
Escort '86 Express (AVF)	02/86→07/90	JLA	Petrol	1297	4	8	22
Escort '86 Express (AVF)	02/86→07/90	JLB	Petrol	1297	4	8	25
Escort '86 Express (AVF)	02/86→07/90	LTA	Diesel	1608	4	8	66
Escort '86 Express (AVF)	02/86→07/90	LUC	Petrol	1597	4	8	63
Escort '86 Express (AVF)	05/86→07/90	GSG	Petrol	1117	4	8	11
Escort '86 Express (AVF)	07/88→07/90	JBA	Petrol	1297	4	8	22
Escort '86 Express (AVF)	07/88→07/90	RTA	Diesel	1753	4	8	88
Escort '86 Express (AVF)	07/88→07/90	RTB	Diesel	1753	4	8	88
Escort '91 Express (AVL)	07/90→12/94	F6F	Petrol	1392	4	8	31
Escort '91 Express (AVL)	07/90→12/94	F6G	Petrol	1392	4	8	31
Escort '91 Express (AVL)	07/90→12/94	JBD	Petrol	1297	4	8	22
Escort '91 Express (AVL)	07/90→12/94	RTH	Diesel	1753	4	8	90
Escort '95 Box (AVL)	01/95→08/00	F4B	Petrol	1392	4	8	31
Escort '95 Box (AVL)	01/95→08/00	RFD	Diesel	1753	4	8	87
Escort '95 Box (AVL)	01/95→08/00	RFK	Diesel	1753	4	8	87
Escort '95 Box (AVL)	01/95→08/00	RFS	Diesel	1753	4	8	87
Escort '95 Box (AVL)	01/95→08/00	RTF	Diesel	1753	4	8	89
Escort '95 Box (AVL)	01/95→08/00	RTH	Diesel	1753	4	8	90
Escort '95 Box (AVL)	12/95→06/01	RVA	Diesel	1753	4	8	92
Escort Classic (AAL, ABL)	10/98→07/00	L1E	Petrol	1597	4	16	62
Escort Classic (AAL, ABL)	10/98→07/00	RFD	Diesel	1753	4	8	87
Escort Classic (AAL, ABL)	10/98→07/00	RFK	Diesel	1753	4	8	87
Escort Classic Turnier (ANL)	02/99→07/00	L1E	Petrol	1597	4	16	62
Escort Classic Turnier (ANL)	02/99→07/00	RFD	Diesel	1753	4	8	87
Escort Classic Turnier (ANL)	02/99→07/00	RFK	Diesel	1753	4	8	87
Escort Estate	01/01→08/02	L1K	Petrol	1597	4	16	62
Escort Hatchback	01/81→12/85	LPI	Petrol	1597	4	8	63
Escort I (AFH, ATH)	01/68→12/74	G1	Petrol	1098	4	8	7
Escort I (AFH, ATH)	06/68→06/71	KL11	Petrol	1098	4	8	7
Escort I (AFH, ATH)	06/68→06/71	KL 13 H	Petrol	1298	4	8	19
Escort I (AFH, ATH)	06/68→06/71	KL 13 L	Petrol	1298	4	8	19
Escort I (AFH, ATH)	06/68→02/76	J2	Petrol	1298	4	8	19
Escort I (AFH, ATH)	08/69→11/74	TL 16M	Petrol	1593	4	8	45
Escort I (AFH, ATH)	01/70→10/75	KL 16 R	Petrol	1601	4	8	61
Escort I (AFH, ATH)	06/70→02/76	G2	Petrol	1098	4	8	7
Escort I (AFH, ATH)	06/70→02/76	J3D	Petrol	1298	4	8	19
Escort I (AFH, ATH)	09/73→02/76	J1F	Petrol	1298	4	8	19
Escort I Turnier (ADH)	06/68→06/71	KL11	Petrol	1098	4	8	7
Escort I Turnier (ADH)	12/68→02/76	J2	Petrol	1298	4	8	19
Escort I Turnier (ADH)	06/70→02/76	G1	Petrol	1098	4	8	7
Escort I Turnier (ADH)	06/70→02/76	G2	Petrol	1098	4	8	7
Escort II (ATH)	03/73→08/80	NE	Petrol	1993	4	8	101
Escort II (ATH)	12/74→08/80	G1	Petrol	1098	4	8	7
Escort II (ATH)	12/74→08/80	G2	Petrol	1098	4	8	7
Escort II (ATH)	12/74→08/80	J1F	Petrol	1298	4	8	19
Escort II (ATH)	12/74→08/80	J2	Petrol	1298	4	8	19
Escort II (ATH)	12/74→08/80	J3	Petrol	1298	4	8	19
Escort II (ATH)	12/74→08/80	LC	Petrol	1598	4	8	61
Escort II Turnier	04/75→01/79	KL 13 H	Petrol	1298	4	8	19
Escort II Turnier	04/75→08/80	G1	Petrol	1098	4	8	7



CC



9

Escort II Turnier	04/75→08/80	G2	Petrol	1098	4	8	7
Escort II Turnier	04/75→08/80	J2	Petrol	1298	4	8	19
Escort III (GAA)	09/80→10/82	LUA	Petrol	1597	4	8	63
Escort III (GAA)	09/80→08/83	GLB	Petrol	1117	4	8	10
Escort III (GAA)	09/80→08/83	GMA	Petrol	1117	4	8	12
Escort III (GAA)	09/80→08/83	GPA	Petrol	1117	4	8	12
Escort III (GAA)	09/80→12/85	JPA	Petrol	1296	4	8	27
Escort III (GAA)	09/80→12/85	LP1	Petrol	1597	4	8	63
Escort III (GAA)	09/80→12/85	LPA	Petrol	1597	4	8	63
Escort III (GAA)	05/82→12/85	LUAE	Petrol	1597	4	8	63
Escort III (GAA)	10/82→12/85	LRI	Petrol	1597	4	8	63
Escort III (GAA)	10/82→12/85	LRA	Petrol	1597	4	8	63
Escort III (GAA)	05/83→07/86	CHT 1600	Petrol	1555	4	8	54
Escort III (GAA)	08/83→12/85	GSE	Petrol	1117	4	8	13
Escort III (GAA)	01/84→12/85	JGA	Petrol	1341	4	8	26
Escort III (GAA)	02/84→12/85	LTA	Diesel	1608	4	8	66
Escort III (GAA)	11/84→12/85	LNA	Petrol	1597	4	8	63
Escort III (GAA)	07/85→12/85	L4B	Petrol	1598	4	8	63
Escort III Convertible (ALD)	09/83→12/85	CHT 1600	Petrol	1555	4	8	54
Escort III Convertible (ALD)	09/83→12/85	JPA	Petrol	1296	4	8	27
Escort III Convertible (ALD)	09/83→12/85	LP1	Petrol	1597	4	8	63
Escort III Convertible (ALD)	09/83→12/85	LPA	Petrol	1597	4	8	63
Escort III Convertible (ALD)	09/83→12/85	LRI	Petrol	1597	4	8	63
Escort III Convertible (ALD)	09/83→12/85	LRA	Petrol	1597	4	8	63
Escort III Turnier (AWA)	09/80→08/83	GLB	Petrol	1117	4	8	10
Escort III Turnier (AWA)	09/80→08/83	GMA	Petrol	1117	4	8	12
Escort III Turnier (AWA)	09/80→12/85	LP1	Petrol	1597	4	8	63
Escort III Turnier (AWA)	09/80→12/85	LPA	Petrol	1597	4	8	63
Escort III Turnier (AWA)	03/81→12/85	JPA	Petrol	1296	4	8	27
Escort III Turnier (AWA)	08/83→12/85	GSE	Petrol	1117	4	8	13
Escort III Turnier (AWA)	02/84→12/85	LTA	Diesel	1608	4	8	66
Escort IV (GAF, AWF, ABFT)	03/83→12/89	CHT 1600	Petrol	1555	4	8	54
Escort IV (GAF, AWF, ABFT)	10/85→10/90	FUAA	Petrol	1392	4	8	31
Escort IV (GAF, AWF, ABFT)	12/85→07/90	GSG	Petrol	1117	4	8	11
Escort IV (GAF, AWF, ABFT)	01/86→12/88	LP2	Petrol	1597	4	8	63
Escort IV (GAF, AWF, ABFT)	01/86→01/89	LTC	Diesel	1608	4	8	66
Escort IV (GAF, AWF, ABFT)	01/86→08/89	LR2	Petrol	1597	4	8	63
Escort IV (GAF, AWF, ABFT)	01/86→08/89	LRB	Petrol	1597	4	8	63
Escort IV (GAF, AWF, ABFT)	01/86→05/90	L4B	Petrol	1598	4	8	63
Escort IV (GAF, AWF, ABFT)	01/86→07/90	F6B	Petrol	1392	4	8	31
Escort IV (GAF, AWF, ABFT)	01/86→07/90	F6D	Petrol	1392	4	8	31
Escort IV (GAF, AWF, ABFT)	01/86→07/90	FUA	Petrol	1392	4	8	31
Escort IV (GAF, AWF, ABFT)	01/86→07/90	FUC	Petrol	1392	4	8	31
Escort IV (GAF, AWF, ABFT)	01/86→07/90	JBB	Petrol	1297	4	8	24
Escort IV (GAF, AWF, ABFT)	01/86→07/90	JLA	Petrol	1297	4	8	22
Escort IV (GAF, AWF, ABFT)	01/86→07/90	JLB	Petrol	1297	4	8	25
Escort IV (GAF, AWF, ABFT)	01/86→07/90	LNB	Petrol	1597	4	8	63
Escort IV (GAF, AWF, ABFT)	11/86→07/88	JPA	Petrol	1296	4	8	27
Escort IV (GAF, AWF, ABFT)	07/88→10/90	JBA	Petrol	1297	4	8	22
Escort IV (GAF, AWF, ABFT)	01/89→07/90	RTA	Diesel	1753	4	8	88
Escort IV (GAF, AWF, ABFT)	01/89→07/90	RTB	Diesel	1753	4	8	88
Escort IV (GAF, AWF, ABFT)	04/89→07/90	LUG	Petrol	1597	4	8	63
Escort IV (GAF, AWF, ABFT)	08/89→07/90	LJB	Petrol	1597	4	8	63
Escort IV Convertible (ALF)	01/86→12/87	LP2	Petrol	1597	4	8	63
Escort IV Convertible (ALF)	01/86→12/87	LPA	Petrol	1597	4	8	63
Escort IV Convertible (ALF)	01/86→07/90	FUA	Petrol	1392	4	8	31
Escort IV Convertible (ALF)	01/86→07/90	L4B	Petrol	1598	4	8	63
Escort IV Convertible (ALF)	01/86→07/90	LR2	Petrol	1597	4	8	63
Escort IV Convertible (ALF)	01/86→07/90	LRB	Petrol	1597	4	8	63
Escort IV Convertible (ALF)	02/87→07/90	F6B	Petrol	1392	4	8	31
Escort IV Convertible (ALF)	02/87→07/90	F6D	Petrol	1392	4	8	31
Escort IV Convertible (ALF)	02/87→07/90	FUC	Petrol	1392	4	8	31
Escort IV Convertible (ALF)	08/89→07/90	LJB	Petrol	1597	4	8	63
Escort IV Turnier (AWF, AVF)	10/85→09/90	GSG	Petrol	1117	4	8	11
Escort IV Turnier (AWF, AVF)	10/85→10/90	FUAA	Petrol	1392	4	8	31
Escort IV Turnier (AWF, AVF)	01/86→01/89	LTC	Diesel	1608	4	8	66
Escort IV Turnier (AWF, AVF)	01/86→07/90	F6B	Petrol	1392	4	8	31
Escort IV Turnier (AWF, AVF)	01/86→07/90	F6D	Petrol	1392	4	8	31
Escort IV Turnier (AWF, AVF)	01/86→07/90	FUA	Petrol	1392	4	8	31
Escort IV Turnier (AWF, AVF)	01/86→07/90	FUC	Petrol	1392	4	8	31
Escort IV Turnier (AWF, AVF)	01/86→07/90	JBB	Petrol	1297	4	8	24
Escort IV Turnier (AWF, AVF)	01/86→07/90	JLA	Petrol	1297	4	8	22
Escort IV Turnier (AWF, AVF)	01/86→07/90	JLB	Petrol	1297	4	8	25
Escort IV Turnier (AWF, AVF)	01/86→07/90	L4B	Petrol	1598	4	8	63
Escort IV Turnier (AWF, AVF)	01/86→07/90	LP2	Petrol	1597	4	8	63
Escort IV Turnier (AWF, AVF)	11/86→07/88	JPA	Petrol	1296	4	8	27
Escort IV Turnier (AWF, AVF)	01/89→07/90	RTA	Diesel	1753	4	8	88
Escort IV Turnier (AWF, AVF)	01/89→07/90	RTB	Diesel	1753	4	8	88



CC



9

Escort V (GAL)	07/90→08/92	LUJ	Petrol	1598	4	8	63
Escort V (GAL)	07/90→08/92	LUK	Petrol	1598	4	8	63
Escort V (GAL)	07/90→09/92	F6F	Petrol	1392	4	8	31
Escort V (GAL)	07/90→09/92	F6G	Petrol	1392	4	8	31
Escort V (GAL)	07/90→09/92	J4B	Petrol	1299	4	8	22
Escort V (GAL)	07/90→09/92	J6A	Petrol	1299	4	8	22
Escort V (GAL)	07/90→12/92	LJF	Petrol	1598	4	8	63
Escort V (GAL)	07/90→12/92	RTE	Diesel	1753	4	8	89
Escort V (GAL)	07/90→12/92	RTF	Diesel	1753	4	8	89
Escort V (GAL)	07/90→12/92	RTH	Diesel	1753	4	8	90
Escort V (GAL)	05/91→12/92	N7A	Petrol	1998	4	16	121
Escort V (GAL)	02/92→12/92	RDA	Petrol	1796	4	16	78
Escort V (GAL)	02/92→12/92	RQB	Petrol	1796	4	16	78
Escort V Convertible (ALL)	07/90→12/92	F6F	Petrol	1392	4	8	31
Escort V Convertible (ALL)	07/90→12/92	F6G	Petrol	1392	4	8	31
Escort V Convertible (ALL)	07/90→12/92	LJF	Petrol	1598	4	8	63
Escort V Convertible (ALL)	02/92→12/92	RDA	Petrol	1796	4	16	78
Escort V Convertible (ALL)	02/92→12/92	RQB	Petrol	1796	4	16	78
Escort V Turnier (GAL, AVL)	07/90→08/92	LUJ	Petrol	1598	4	8	63
Escort V Turnier (GAL, AVL)	07/90→08/92	LUK	Petrol	1598	4	8	63
Escort V Turnier (GAL, AVL)	07/90→09/92	F6F	Petrol	1392	4	8	31
Escort V Turnier (GAL, AVL)	07/90→09/92	F6G	Petrol	1392	4	8	31
Escort V Turnier (GAL, AVL)	07/90→09/92	LJF	Petrol	1598	4	8	63
Escort V Turnier (GAL, AVL)	07/90→12/92	RTE	Diesel	1753	4	8	89
Escort V Turnier (GAL, AVL)	07/90→12/92	RTF	Diesel	1753	4	8	89
Escort V Turnier (GAL, AVL)	07/90→12/92	RTH	Diesel	1753	4	8	90
Escort V Turnier (GAL, AVL)	09/91→09/92	J4B	Petrol	1299	4	8	22
Escort V Turnier (GAL, AVL)	09/91→09/92	J6A	Petrol	1299	4	8	22
Escort V Turnier (GAL, AVL)	02/92→12/92	RDA	Petrol	1796	4	16	78
Escort VI (GAL)	09/92→01/95	F6F	Petrol	1392	4	8	31
Escort VI (GAL)	09/92→01/95	F6G	Petrol	1392	4	8	31
Escort VI (GAL)	09/92→01/95	J4B	Petrol	1299	4	8	22
Escort VI (GAL)	09/92→01/95	J6A	Petrol	1299	4	8	22
Escort VI (GAL)	09/92→01/95	L1E	Petrol	1597	4	16	62
Escort VI (GAL)	09/92→01/95	N7A	Petrol	1998	4	16	121
Escort VI (GAL)	09/92→01/95	RDA	Petrol	1796	4	16	78
Escort VI (GAL)	09/92→01/95	RQB	Petrol	1796	4	16	78
Escort VI (GAL)	09/92→01/95	RTE	Diesel	1753	4	8	89
Escort VI (GAL)	09/92→01/95	RTF	Diesel	1753	4	8	89
Escort VI (GAL)	09/92→01/95	RTH	Diesel	1753	4	8	90
Escort VI (GAL)	02/93→01/95	RFD	Diesel	1753	4	8	87
Escort VI (GAL)	02/93→01/95	RFK	Diesel	1753	4	8	87
Escort VI (GAL)	02/93→01/95	RFS	Diesel	1753	4	8	87
Escort VI (GAL)	01/94→01/95	F4B	Petrol	1392	4	8	31
Escort VI (GAL)	01/94→01/95	FUH	Petrol	1392	4	8	31
Escort VI (GAL)	01/94→01/95	L1H	Petrol	1597	4	16	62
Escort VI Convertible (ALL)	12/92→04/94	F6F	Petrol	1392	4	8	31
Escort VI Convertible (ALL)	12/92→04/94	F6G	Petrol	1392	4	8	31
Escort VI Convertible (ALL)	12/92→01/95	L1E	Petrol	1597	4	16	62
Escort VI Convertible (ALL)	12/92→01/95	RDA	Petrol	1796	4	16	78
Escort VI Convertible (ALL)	12/92→01/95	RQB	Petrol	1796	4	16	78
Escort VI Convertible (ALL)	07/93→01/95	F4B	Petrol	1392	4	8	31
Escort VI Convertible (ALL)	02/94→01/95	L1H	Petrol	1597	4	16	62
Escort VI Saloon (GAL)	08/93→04/94	F6F	Petrol	1392	4	8	31
Escort VI Saloon (GAL)	08/93→04/94	F6G	Petrol	1392	4	8	31
Escort VI Saloon (GAL)	08/93→01/95	F4B	Petrol	1392	4	8	31
Escort VI Saloon (GAL)	08/93→01/95	FUH	Petrol	1392	4	8	31
Escort VI Saloon (GAL)	08/93→01/95	J4B	Petrol	1299	4	8	22
Escort VI Saloon (GAL)	08/93→01/95	J6A	Petrol	1299	4	8	22
Escort VI Saloon (GAL)	08/93→01/95	L1E	Petrol	1597	4	16	62
Escort VI Saloon (GAL)	08/93→01/95	L1K	Petrol	1597	4	16	62
Escort VI Saloon (GAL)	08/93→01/95	RDA	Petrol	1796	4	16	78
Escort VI Saloon (GAL)	08/93→01/95	RFD	Diesel	1753	4	8	87
Escort VI Saloon (GAL)	08/93→01/95	RFK	Diesel	1753	4	8	87
Escort VI Saloon (GAL)	08/93→01/95	RTE	Diesel	1753	4	8	89
Escort VI Saloon (GAL)	08/93→01/95	RTF	Diesel	1753	4	8	89
Escort VI Saloon (GAL)	08/93→01/95	RTH	Diesel	1753	4	8	90
Escort VI Saloon (GAL)	01/94→01/95	L1H	Petrol	1597	4	16	62
Escort VI Turnier (GAL)	09/92→01/95	F6F	Petrol	1392	4	8	31
Escort VI Turnier (GAL)	09/92→01/95	F6G	Petrol	1392	4	8	31
Escort VI Turnier (GAL)	09/92→01/95	J4B	Petrol	1299	4	8	22
Escort VI Turnier (GAL)	09/92→01/95	J6A	Petrol	1299	4	8	22
Escort VI Turnier (GAL)	09/92→01/95	L1E	Petrol	1597	4	16	62
Escort VI Turnier (GAL)	09/92→01/95	RTH	Diesel	1753	4	8	90
Escort VI Turnier (GAL)	01/93→01/95	RDA	Petrol	1796	4	16	78
Escort VI Turnier (GAL)	02/93→01/95	RFD	Diesel	1753	4	8	87
Escort VI Turnier (GAL)	02/93→01/95	RFK	Diesel	1753	4	8	87
Escort VI Turnier (GAL)	02/93→01/95	RQB	Petrol	1796	4	16	78







CC



9

Escort VI Turnier (GAL)	01/94→01/95	F4B	Petrol	1392	4	8	31
Escort VI Turnier (GAL)	01/94→01/95	FUH	Petrol	1392	4	8	31
Escort VI Turnier (GAL)	01/94→01/95	L1H	Petrol	1597	4	16	62
Escort VII (GAL, AAL, ABL)	01/95→08/95	L1H	Petrol	1597	4	16	62
Escort VII (GAL, AAL, ABL)	01/95→08/95	RDA	Petrol	1796	4	16	78
Escort VII (GAL, AAL, ABL)	01/95→12/96	RTE	Diesel	1753	4	8	89
Escort VII (GAL, AAL, ABL)	01/95→12/96	RTF	Diesel	1753	4	8	89
Escort VII (GAL, AAL, ABL)	01/95→12/96	RTH	Diesel	1753	4	8	90
Escort VII (GAL, AAL, ABL)	01/95→10/98	J4B	Petrol	1299	4	8	22
Escort VII (GAL, AAL, ABL)	01/95→10/98	J6A	Petrol	1299	4	8	22
Escort VII (GAL, AAL, ABL)	01/95→10/98	L1E	Petrol	1597	4	16	62
Escort VII (GAL, AAL, ABL)	01/95→10/98	RFD	Diesel	1753	4	8	87
Escort VII (GAL, AAL, ABL)	01/95→10/98	RFK	Diesel	1753	4	8	87
Escort VII (GAL, AAL, ABL)	01/95→10/98	RKC	Petrol	1796	4	16	78
Escort VII (GAL, AAL, ABL)	01/95→12/99	F4B	Petrol	1392	4	8	31
Escort VII (GAL, AAL, ABL)	02/95→10/98	N7A	Petrol	1998	4	16	121
Escort VII (GAL, AAL, ABL)	12/95→10/98	RVA	Diesel	1753	4	8	92
Escort VII Convertible (ALL)	02/95→12/96	L1H	Petrol	1597	4	16	62
Escort VII Convertible (ALL)	02/95→08/98	F4B	Petrol	1392	4	8	31
Escort VII Convertible (ALL)	02/95→08/98	RDA	Petrol	1796	4	16	78
Escort VII Convertible (ALL)	02/95→09/99	L1E	Petrol	1597	4	16	62
Escort VII Convertible (ALL)	02/95→08/00	RQB	Petrol	1796	4	16	78
Escort VII Convertible (ALL)	09/95→08/98	RFD	Diesel	1753	4	8	87
Escort VII Convertible (ALL)	09/95→08/98	RFK	Diesel	1753	4	8	87
Escort VII Convertible (ALL)	10/95→08/98	RKC	Petrol	1796	4	16	78
Escort VII Convertible (ALL)	10/96→08/99	RVA	Diesel	1753	4	8	92
Escort VII Saloon (GAL, AFL)	01/95→08/95	L1H	Petrol	1597	4	16	62
Escort VII Saloon (GAL, AFL)	01/95→08/95	RDA	Petrol	1796	4	16	78
Escort VII Saloon (GAL, AFL)	01/95→12/96	RTE	Diesel	1753	4	8	89
Escort VII Saloon (GAL, AFL)	01/95→12/96	RTF	Diesel	1753	4	8	89
Escort VII Saloon (GAL, AFL)	01/95→12/96	RTH	Diesel	1753	4	8	90
Escort VII Saloon (GAL, AFL)	01/95→02/99	F4B	Petrol	1392	4	8	31
Escort VII Saloon (GAL, AFL)	01/95→02/99	FUH	Petrol	1392	4	8	31
Escort VII Saloon (GAL, AFL)	01/95→02/99	J4B	Petrol	1299	4	8	22
Escort VII Saloon (GAL, AFL)	01/95→02/99	J6A	Petrol	1299	4	8	22
Escort VII Saloon (GAL, AFL)	01/95→02/99	L1E	Petrol	1597	4	16	62
Escort VII Saloon (GAL, AFL)	01/95→02/99	RFD	Diesel	1753	4	8	87
Escort VII Saloon (GAL, AFL)	01/95→02/99	RFK	Diesel	1753	4	8	87
Escort VII Saloon (GAL, AFL)	01/95→02/99	RKC	Petrol	1796	4	16	78
Escort VII Saloon (GAL, AFL)	01/95→08/02	L1K	Petrol	1597	4	16	62
Escort VII Saloon (GAL, AFL)	12/95→02/99	RVA	Diesel	1753	4	8	92
Escort VII Turnier (GAL, ANL)	01/95→08/95	L1H	Petrol	1597	4	16	62
Escort VII Turnier (GAL, ANL)	01/95→08/95	RDA	Petrol	1796	4	16	78
Escort VII Turnier (GAL, ANL)	01/95→01/99	J4B	Petrol	1299	4	8	22
Escort VII Turnier (GAL, ANL)	01/95→01/99	J6A	Petrol	1299	4	8	22
Escort VII Turnier (GAL, ANL)	01/95→02/99	F4B	Petrol	1392	4	8	31
Escort VII Turnier (GAL, ANL)	01/95→02/99	FUH	Petrol	1392	4	8	31
Escort VII Turnier (GAL, ANL)	01/95→02/99	L1E	Petrol	1597	4	16	62
Escort VII Turnier (GAL, ANL)	01/95→02/99	RFD	Diesel	1753	4	8	87
Escort VII Turnier (GAL, ANL)	01/95→02/99	RFK	Diesel	1753	4	8	87
Escort VII Turnier (GAL, ANL)	01/95→02/99	RKC	Petrol	1796	4	16	78
Escort VII Turnier (GAL, ANL)	01/95→02/99	RTE	Diesel	1753	4	8	89
Escort VII Turnier (GAL, ANL)	01/95→02/99	RTF	Diesel	1753	4	8	89
Escort VII Turnier (GAL, ANL)	01/95→02/99	RTH	Diesel	1753	4	8	90
Escort VII Turnier (GAL, ANL)	12/95→02/99	RVA	Diesel	1753	4	8	92
Escort Saloon	01/68→12/74	G1	Petrol	1098	4	8	7
Escort Saloon	06/70→02/76	J2	Petrol	1298	4	8	19
Escort Saloon	12/74→08/80	J1F	Petrol	1298	4	8	19
Escort Saloon	12/74→08/80	LC	Petrol	1599	4	8	61
Escort Saloon	08/75→08/80	NE	Petrol	1993	4	8	122
Escort Saloon	01/01→08/02	L1K	Petrol	1597	4	16	62
Festiva (WA)	10/91→03/94	B3	Petrol	1324	4	8	16
Festiva (WB)	04/94→12/97	B3	Petrol	1324	4	8	16
Festiva (WD)	01/97→12/97	B3	Petrol	1324	4	8	16
Festiva (WD)	01/97→12/97	B5 (16 V)	Petrol	1498	4	16	38
Festiva (WF)	01/98→04/01	B3	Petrol	1324	4	8	16
Festiva (WF)	01/98→12/01	B5 (8 V)	Petrol	1498	4	8	37
Fiesta (WS)	10/08→12/10	HXJA	Petrol	1596	4	16	58
Fiesta (WS)	01/09→12/10	HHJD	Diesel	1560	4	16	57
Fiesta (WS)	10/09→12/10	SPJA	Petrol	1388	4	16	30
Fiesta Box (F3L, F5L)	09/91→02/96	J6B	Petrol	1299	4	8	22
Fiesta Box (F3L, F5L)	09/91→02/96	RTC	Diesel	1753	4	8	89
Fiesta Box (F3L, F5L)	09/91→02/96	RTD	Diesel	1753	4	8	89
Fiesta Box (F3L, F5L)	09/91→02/96	RTG	Diesel	1753	4	8	89
Fiesta Box (FVD)	08/83→11/89	TKB	Petrol	957	4	8	4
Fiesta Box (FVD)	09/83→09/89	LTB	Diesel	1608	4	8	66
Fiesta Box (FVD)	09/86→09/89	F6A	Petrol	1393	4	8	31
Fiesta Box (FVD)	03/89→12/95	RTC	Diesel	1753	4	8	89

				CC			9
Fiesta Box (FVD)	03/89→12/95	RTD	Diesel	1753	4	8	89
Fiesta Box (FVD)	03/89→12/95	RTG	Diesel	1753	4	8	89
Fiesta Box (J5_, J3_)	02/96→04/02	RTK	Diesel	1753	4	8	91
Fiesta Box (J5_, J3_)	02/96→08/03	J4C	Petrol	1299	4	8	22
Fiesta Box (J5_, J3_)	04/96→10/99	FHA	Petrol	1388	4	16	30
Fiesta Box (J5_, J3_)	09/00→08/03	RTN	Diesel	1753	4	8	73
Fiesta Box (J5_, J3_)	09/00→08/03	RTP	Diesel	1753	4	8	73
Fiesta Box (JV_)	05/98→04/02	RTJ	Diesel	1753	4	8	91
Fiesta Box (JV_)	05/98→04/02	RTK	Diesel	1753	4	8	91
Fiesta Box (JV_)	03/00→08/03	RTN	Diesel	1753	4	8	73
Fiesta Box (JV_)	03/00→08/03	RTP	Diesel	1753	4	8	73
Fiesta Box (JV_)	03/00→08/03	RTQ	Diesel	1753	4	8	73
Fiesta Box (WFVT)	10/77→11/86	GLI	Petrol	1117	4	8	9
Fiesta Box (WFVT)	10/77→11/86	GLA	Petrol	1117	4	8	9
Fiesta Box (WFVT)	10/77→11/86	TKA	Petrol	957	4	8	4
Fiesta Hatchback (WP, WQ)	04/04→12/08	FYJA	Petrol	1596	4	16	56
Fiesta Hatchback (WP, WQ)	04/04→12/08	FYJB	Petrol	1596	4	16	56
Fiesta Hatchback (WP, WQ)	06/07→03/09	N4JB	Petrol	1999	4	16	105
Fiesta Hatchback (WT)	10/10→12/12	HHJC	Diesel	1560	4	16	57
Fiesta Hatchback (WT)	10/10→	HXJA	Petrol	1596	4	16	58
Fiesta Hatchback (WT)	01/16→	JTJA	Petrol	1596	4	16	59
Fiesta Hatchback (WZ)	09/13→	JTJA	Petrol	1596	4	16	59
Fiesta Hatchback (WZ)	09/13→	MIJE	Petrol	998	3	12	3
Fiesta I (GFBT)	05/76→08/83	GLA	Petrol	1117	4	8	9
Fiesta I (GFBT)	05/76→08/83	TKA	Petrol	957	4	8	4
Fiesta I (GFBT)	05/76→08/83	TKW	Petrol	957	4	8	1
Fiesta I (GFBT)	05/76→08/83	TLA	Petrol	957	4	8	4
Fiesta I (GFBT)	08/77→08/83	J3E	Petrol	1297	4	8	19
Fiesta I (GFBT)	02/81→08/83	GLW	Petrol	1117	4	8	11
Fiesta I (GFBT)	08/81→08/83	L3E	Petrol	1598	4	8	60
Fiesta II (FBD)	09/83→01/87	FUBA	Petrol	1392	4	8	33
Fiesta II (FBD)	09/83→02/89	GLC	Petrol	1117	4	8	11
Fiesta II (FBD)	09/83→02/89	GSF	Petrol	1117	4	8	11
Fiesta II (FBD)	09/83→02/89	TKB	Petrol	957	4	8	4
Fiesta II (FBD)	09/83→09/89	JPC	Petrol	1297	4	8	28
Fiesta II (FBD)	09/83→11/89	TLB	Petrol	999	4	8	5
Fiesta II (FBD)	03/84→02/89	LUD	Petrol	1597	4	8	63
Fiesta II (FBD)	04/84→02/89	LTB	Diesel	1608	4	8	66
Fiesta II (FBD)	04/84→02/89	LUB	Petrol	1597	4	8	63
Fiesta II (FBD)	01/85→11/89	LP3	Petrol	1597	4	8	63
Fiesta II (FBD)	10/85→11/89	FUB	Petrol	1392	4	8	31
Fiesta II (FBD)	05/86→02/89	GSH	Petrol	1117	4	8	11
Fiesta II (FBD)	10/86→02/89	F6A	Petrol	1393	4	8	31
Fiesta II (FBD)	10/86→02/89	F6C	Petrol	1392	4	8	31
Fiesta II (FBD)	02/87→02/89	FUD	Petrol	1392	4	8	31
Fiesta III (GFJ)	01/89→01/94	LUH	Petrol	1597	4	8	63
Fiesta III (GFJ)	03/89→03/93	LJD	Petrol	1598	4	8	63
Fiesta III (GFJ)	03/89→01/94	LJC	Petrol	1597	4	8	63
Fiesta III (GFJ)	03/89→12/95	F4A	Petrol	1391	4	8	31
Fiesta III (GFJ)	03/89→12/95	F6E	Petrol	1392	4	8	31
Fiesta III (GFJ)	03/89→12/95	FUG	Petrol	1392	4	8	31
Fiesta III (GFJ)	03/89→12/95	FUJ	Petrol	1392	4	8	33
Fiesta III (GFJ)	03/89→12/95	G6A	Petrol	1119	4	8	8
Fiesta III (GFJ)	03/89→12/95	GUD	Petrol	1119	4	8	8
Fiesta III (GFJ)	03/89→12/95	GUE	Petrol	1119	4	8	8
Fiesta III (GFJ)	03/89→12/95	JBB	Petrol	1297	4	8	24
Fiesta III (GFJ)	03/89→12/95	JBC	Petrol	1299	4	8	22
Fiesta III (GFJ)	03/89→12/95	RTC	Diesel	1753	4	8	89
Fiesta III (GFJ)	03/89→12/95	RTD	Diesel	1753	4	8	89
Fiesta III (GFJ)	03/89→12/95	RTG	Diesel	1753	4	8	89
Fiesta III (GFJ)	03/89→12/95	TLB	Petrol	999	4	8	5
Fiesta III (GFJ)	03/90→10/92	LHA	Petrol	1598	4	8	63
Fiesta III (GFJ)	05/91→01/97	J6B	Petrol	1299	4	8	22
Fiesta III (GFJ)	02/92→12/95	RDB	Petrol	1796	4	16	78
Fiesta III (GFJ)	02/92→12/95	RQC	Petrol	1796	4	16	78
Fiesta III (GFJ)	11/92→12/96	FUF	Petrol	1392	4	8	33
Fiesta III (GFJ)	03/93→12/95	RFL	Diesel	1753	4	8	86
Fiesta III (GFJ)	01/94→12/95	LIG	Petrol	1597	4	16	62
Fiesta IV (JA_, JB_)	08/95→04/00	RTJ	Diesel	1753	4	8	91
Fiesta IV (JA_, JB_)	08/95→04/00	RTK	Diesel	1753	4	8	91
Fiesta IV (JA_, JB_)	08/95→01/02	DHA	Petrol	1242	4	16	17
Fiesta IV (JA_, JB_)	08/95→01/02	DHB	Petrol	1242	4	16	17
Fiesta IV (JA_, JB_)	08/95→01/02	DHC	Petrol	1242	4	16	17
Fiesta IV (JA_, JB_)	08/95→01/02	DHD	Petrol	1242	4	16	17
Fiesta IV (JA_, JB_)	08/95→01/02	DHE	Petrol	1242	4	16	17
Fiesta IV (JA_, JB_)	08/95→01/02	DHF	Petrol	1242	4	16	17
Fiesta IV (JA_, JB_)	08/95→01/02	DHG	Petrol	1242	4	16	17
Fiesta IV (JA_, JB_)	08/95→01/02	J4C	Petrol	1299	4	8	22



CC



9

Fiesta IV (JA, JB)	08/95→01/02	J4J	Petrol	1299	4	8	22
Fiesta IV (JA, JB)	08/95→01/02	J4L	Petrol	1299	4	8	22
Fiesta IV (JA, JB)	08/95→01/02	J4Q	Petrol	1299	4	8	22
Fiesta IV (JA, JB)	08/95→01/02	J4R	Petrol	1299	4	8	22
Fiesta IV (JA, JB)	08/95→01/02	J4T	Petrol	1299	4	8	22
Fiesta IV (JA, JB)	08/95→01/02	JBC	Petrol	1299	4	8	22
Fiesta IV (JA, JB)	08/95→01/02	JJA	Petrol	1299	4	8	22
Fiesta IV (JA, JB)	08/95→01/02	JJC	Petrol	1299	4	8	22
Fiesta IV (JA, JB)	08/95→01/02	JJE	Petrol	1299	4	8	22
Fiesta IV (JA, JB)	08/95→01/02	JJJ	Petrol	1299	4	8	22
Fiesta IV (JA, JB)	08/95→01/02	JJK	Petrol	1299	4	8	22
Fiesta IV (JA, JB)	08/95→01/02	JJM	Petrol	1299	4	8	22
Fiesta IV (JA, JB)	04/96→01/02	FHA	Petrol	1388	4	16	30
Fiesta IV (JA, JB)	04/96→01/02	FHE	Petrol	1388	4	16	30
Fiesta IV (JA, JB)	02/97→09/99	ZH10JRB	Petrol	999	4	8	6
Fiesta IV (JA, JB)	02/00→01/02	LIT	Petrol	1596	4	16	56
Fiesta IV (JA, JB)	02/00→01/02	LIV	Petrol	1596	4	16	56
Fiesta IV (JA, JB)	04/00→01/02	RTN	Diesel	1753	4	8	73
Fiesta IV (JA, JB)	04/00→01/02	RTP	Diesel	1753	4	8	73
Fiesta IV (JA, JB)	04/00→01/02	RTQ	Diesel	1753	4	8	73
Fiesta V (JH, JD)	11/01→06/08	A9JA	Petrol	1299	4	8	15
Fiesta V (JH, JD)	11/01→06/08	A9JB	Petrol	1299	4	8	15
Fiesta V (JH, JD)	11/01→06/08	BAJA	Petrol	1299	4	8	15
Fiesta V (JH, JD)	11/01→06/08	F6JA	Diesel	1399	4	8	32
Fiesta V (JH, JD)	11/01→06/08	F6JB	Diesel	1399	4	8	32
Fiesta V (JH, JD)	11/01→06/08	FXJA	Petrol	1388	4	16	30
Fiesta V (JH, JD)	11/01→06/08	FXJB	Petrol	1388	4	16	30
Fiesta V (JH, JD)	11/01→06/08	FYJA	Petrol	1596	4	16	56
Fiesta V (JH, JD)	11/01→06/08	FYJB	Petrol	1596	4	16	56
Fiesta V (JH, JD)	05/02→06/08	FUJA	Petrol	1242	4	16	17
Fiesta V (JH, JD)	05/02→06/08	FUJB	Petrol	1242	4	16	17
Fiesta V (JH, JD)	03/03→06/08	M7JA	Petrol	1242	4	16	17
Fiesta V (JH, JD)	03/03→06/08	M7JB	Petrol	1242	4	16	17
Fiesta V (JH, JD)	11/04→06/08	HHJA	Diesel	1560	4	16	57
Fiesta V (JH, JD)	11/04→06/08	HHJB	Diesel	1560	4	16	57
Fiesta V (JH, JD)	03/05→06/08	N4JB	Petrol	1999	4	16	105
Fiesta V Van	10/03→07/05	A9JA	Petrol	1299	4	8	15
Fiesta V Van	10/03→07/05	A9JB	Petrol	1299	4	8	15
Fiesta V Van	10/03→12/10	F6JA	Diesel	1399	4	8	32
Fiesta V Van	10/03→12/10	F6JB	Diesel	1399	4	8	32
Fiesta V Van	04/07→09/09	HHJA	Diesel	1560	4	16	57
Fiesta V Van	04/07→09/09	HHJB	Diesel	1560	4	16	57
Fiesta VI	06/08→	HHJC	Diesel	1560	4	16	57
Fiesta VI	06/08→	HHJD	Diesel	1560	4	16	57
Fiesta VI	06/08→	HHJE	Diesel	1560	4	16	57
Fiesta VI	06/08→	HHJF	Diesel	1560	4	16	57
Fiesta VI	06/08→	HXJA	Petrol	1596	4	16	58
Fiesta VI	06/08→	HXJB	Petrol	1596	4	16	58
Fiesta VI	06/08→	SNJA	Petrol	1242	4	16	17
Fiesta VI	06/08→	SNJB	Petrol	1242	4	16	17
Fiesta VI	06/08→	SNJC	Petrol	1242	4	16	17
Fiesta VI	06/08→	SNJD	Petrol	1242	4	16	17
Fiesta VI	06/08→	SPJA	Petrol	1388	4	16	30
Fiesta VI	06/08→	SPJC	Petrol	1388	4	16	30
Fiesta VI	06/08→	STJA	Petrol	1242	4	16	17
Fiesta VI	06/08→	STJB	Petrol	1242	4	16	17
Fiesta VI	06/08→	STJC	Petrol	1242	4	16	17
Fiesta VI	06/08→	UBJA	Diesel	1560	4	16	57
Fiesta VI	01/09→	F6JB	Diesel	1399	4	8	32
Fiesta VI	01/09→	F6JD	Diesel	1399	4	8	32
Fiesta VI	01/09→	RTJA	Petrol	1388	4	16	30
Fiesta VI	01/09→	RTJB	Petrol	1388	4	16	30
Fiesta VI	02/10→	T3JA	Diesel	1560	4	8	68
Fiesta VI	02/10→	TZJA	Diesel	1560	4	8	68
Fiesta VI	02/10→	TZJB	Diesel	1560	4	8	68
Fiesta VI	07/10→	KVJA	Diesel	1399	4	8	32
Fiesta VI	12/10→	U5JA	Petrol	1596	4	16	58
Fiesta VI	09/12→	IQJA	Petrol	1596	4	16	58
Fiesta VI	09/12→	M1JE	Petrol	998	3	12	3
Fiesta VI	09/12→	M1JH	Petrol	998	3	12	3
Fiesta VI	09/12→	UGJC	Diesel	1499	4	8	36
Fiesta VI	09/12→	XUJA	Diesel	1499	4	8	36
Fiesta VI	09/12→	XUJB	Diesel	1499	4	8	36
Fiesta VI	10/12→	P4JA	Petrol	998	3	12	3
Fiesta VI	10/12→	P4JB	Petrol	998	3	12	3
Fiesta VI	10/12→	P4JC	Petrol	998	3	12	3
Fiesta VI	10/12→	P4JD	Petrol	998	3	12	3
Fiesta VI	01/13→	SFJA	Petrol	998	3	12	3



CC



9

Fiesta VI	01/13→	SFJB	Petrol	998	3	12	3
Fiesta VI	01/13→	SFJC	Petrol	998	3	12	3
Fiesta VI	01/13→	SFJD	Petrol	998	3	12	3
Fiesta VI	01/13→	XMJA	Petrol	998	3	12	3
Fiesta VI	01/13→	XMJB	Petrol	998	3	12	3
Fiesta VI	03/13→	JTJA	Petrol	1596	4	16	59
Fiesta VI	03/13→	JTJB	Petrol	1596	4	16	59
Fiesta VI	05/14→	YYJA	Petrol	998	3	12	3
Fiesta VI	05/14→	YYJB	Petrol	998	3	12	3
Fiesta VI	05/15→	XVJB	Diesel	1499	4	8	36
Fiesta VI	05/15→	XVJC	Diesel	1499	4	8	36
Fiesta VI	04/16→	JTJC	Petrol	1596	4	16	59
Fiesta VI Van	01/09→	F6JB	Diesel	1399	4	8	32
Fiesta VI Van	01/09→	F6JD	Diesel	1399	4	8	32
Fiesta VI Van	01/09→	HHJC	Diesel	1560	4	16	57
Fiesta VI Van	01/09→	HHJD	Diesel	1560	4	16	57
Fiesta VI Van	01/09→	HHJE	Diesel	1560	4	16	57
Fiesta VI Van	01/09→	SNJA	Petrol	1242	4	16	17
Fiesta VI Van	01/09→	SNJB	Petrol	1242	4	16	17
Fiesta VI Van	02/10→	T3JA	Diesel	1560	4	8	68
Fiesta VI Van	02/10→	TZJA	Diesel	1560	4	8	68
Fiesta VI Van	02/10→	TZJB	Diesel	1560	4	8	68
Fiesta VI Van	07/10→	KVJA	Diesel	1399	4	8	32
Fiesta VI Van	09/12→	M1JE	Petrol	998	3	12	3
Fiesta VI Van	10/12→	P4JA	Petrol	998	3	12	3
Fiesta VI Van	10/12→	P4JB	Petrol	998	3	12	3
Fiesta VI Van	10/12→	P4JC	Petrol	998	3	12	3
Fiesta VI Van	10/12→	P4JD	Petrol	998	3	12	3
Fiesta VI Van	10/12→	UGJC	Diesel	1499	4	8	36
Fiesta VI Van	10/12→	XUJA	Diesel	1499	4	8	36
Fiesta VI Van	10/12→	XUJB	Diesel	1499	4	8	36
Fiesta VI Van	01/13→	SFJA	Petrol	998	3	12	3
Fiesta VI Van	01/13→	SFJB	Petrol	998	3	12	3
Fiesta VI Van	01/13→	SFJC	Petrol	998	3	12	3
Fiesta VI Van	01/13→	SFJD	Petrol	998	3	12	3
Fiesta VI Van	01/13→	XMJA	Petrol	998	3	12	3
Fiesta VI Van	01/13→	XMJB	Petrol	998	3	12	3
Fiesta VI Van	03/13→	JTJA	Petrol	1596	4	16	59
Fiesta VI Van	03/13→	JTJB	Petrol	1596	4	16	59
Fiesta VI Van	05/14→	YYJA	Petrol	998	3	12	3
Fiesta VI Van	05/14→	YYJB	Petrol	998	3	12	3
Fiesta VI Van	05/15→	XVJB	Diesel	1499	4	8	36
Fiesta VI Van	05/15→	XVJC	Diesel	1499	4	8	36
Fiesta Saloon	05/02→11/11	F6JC	Diesel	1399	4	8	32
Fiesta Saloon	12/05→	F6JA	Diesel	1399	4	8	32
Fiesta Saloon	04/10→	HXJA	Petrol	1596	4	16	58
Fiesta Saloon	04/10→	HXJB	Petrol	1596	4	16	58
Fiesta Saloon	10/10→	HHJC	Diesel	1560	4	16	57
Fiesta Saloon	10/10→	M6JA	Petrol	1388	4	16	30
Fiesta Saloon	10/12→	STJB	Petrol	1242	4	16	17
Fiesta Saloon	09/13→	M1JE	Petrol	998	3	12	3
Fiesta Saloon	09/13→	M1JH	Petrol	998	3	12	3
Fiesta Saloon (WT)	10/10→12/12	HHJC	Diesel	1560	4	16	57
Fiesta Saloon (WT)	10/10→	HXJA	Petrol	1596	4	16	58
Figo	01/10→	F6JA	Diesel	1399	4	8	32
Focus (DAW, DBW)	10/98→11/04	C9DA	Diesel	1753	4	8	73
Focus (DAW, DBW)	10/98→11/04	C9DB	Diesel	1753	4	8	73
Focus (DAW, DBW)	10/98→11/04	C9DC	Diesel	1753	4	8	73
Focus (DAW, DBW)	10/98→11/04	EDDB	Petrol	1988	4	16	111
Focus (DAW, DBW)	10/98→11/04	EDDC	Petrol	1988	4	16	111
Focus (DAW, DBW)	10/98→11/04	EDDD	Petrol	1988	4	16	111
Focus (DAW, DBW)	10/98→11/04	EDDF	Petrol	1988	4	16	111
Focus (DAW, DBW)	10/98→11/04	EYDB	Petrol	1796	4	16	78
Focus (DAW, DBW)	10/98→11/04	EYDC	Petrol	1796	4	16	78
Focus (DAW, DBW)	10/98→11/04	EYDD	Petrol	1796	4	16	78
Focus (DAW, DBW)	10/98→11/04	EYDE	Petrol	1796	4	16	78
Focus (DAW, DBW)	10/98→11/04	EYDF	Petrol	1796	4	16	78
Focus (DAW, DBW)	10/98→11/04	EYDG	Petrol	1796	4	16	78
Focus (DAW, DBW)	10/98→11/04	EYDI	Petrol	1796	4	16	78
Focus (DAW, DBW)	10/98→11/04	EYDJ	Petrol	1796	4	16	78
Focus (DAW, DBW)	10/98→11/04	EYDL	Petrol	1796	4	16	78
Focus (DAW, DBW)	10/98→11/04	FXDA	Petrol	1388	4	16	30
Focus (DAW, DBW)	10/98→11/04	FXDB	Petrol	1388	4	16	30
Focus (DAW, DBW)	10/98→11/04	FXDC	Petrol	1388	4	16	30
Focus (DAW, DBW)	10/98→11/04	FXDD	Petrol	1388	4	16	30
Focus (DAW, DBW)	10/98→11/04	FYDB	Petrol	1596	4	16	56
Focus (DAW, DBW)	10/98→11/04	FYDC	Petrol	1596	4	16	56
Focus (DAW, DBW)	10/98→11/04	FYDD	Petrol	1596	4	16	56



CC



9

Focus (DAW, DBW)	10/98→11/04	FYDH	Petrol	1596	4	16	56
Focus (DAW, DBW)	10/98→03/07	FYDA	Petrol	1596	4	16	56
Focus (DAW, DBW)	08/99→11/04	BHDA	Diesel	1753	4	8	73
Focus (DAW, DBW)	08/99→11/04	BHDB	Diesel	1753	4	8	73
Focus (DAW, DBW)	03/01→11/04	F9DA	Diesel	1753	4	8	73
Focus (DAW, DBW)	03/01→11/04	F9DB	Diesel	1753	4	8	73
Focus (DAW, DBW)	03/02→11/04	ALDA	Petrol	1988	4	16	103
Focus (DAW, DBW)	08/02→11/04	FFDA	Diesel	1753	4	8	73
Focus (DAW, DBW)	10/02→11/04	HMDA	Petrol	1988	4	16	117
Focus C-Max	10/03→03/07	CSDA	Petrol	1798	4	16	77
Focus C-Max	10/03→03/07	CSDB	Petrol	1798	4	16	77
Focus C-Max	10/03→03/07	G6DA	Diesel	1997	4	16	106
Focus C-Max	10/03→03/07	G6DB	Diesel	1997	4	16	106
Focus C-Max	10/03→03/07	G6DC	Diesel	1997	4	16	106
Focus C-Max	10/03→03/07	G6DD	Diesel	1997	4	16	106
Focus C-Max	10/03→03/07	G6DE	Diesel	1997	4	16	106
Focus C-Max	10/03→03/07	G6DF	Diesel	1997	4	16	106
Focus C-Max	10/03→03/07	G6DG	Diesel	1997	4	16	106
Focus C-Max	10/03→03/07	G8DA	Diesel	1560	4	16	57
Focus C-Max	10/03→03/07	G8DB	Diesel	1560	4	16	57
Focus C-Max	10/03→03/07	HWDA	Petrol	1596	4	16	56
Focus C-Max	10/03→03/07	HWDB	Petrol	1596	4	16	56
Focus C-Max	03/04→03/07	AODA	Petrol	1999	4	16	105
Focus C-Max	03/04→03/07	AODB	Petrol	1999	4	16	105
Focus C-Max	03/04→03/07	SYDA	Petrol	1999	4	16	105
Focus C-Max	04/04→03/07	Q7DA	Petrol	1798	4	16	77
Focus C-Max	04/04→03/07	QQDA	Petrol	1798	4	16	77
Focus C-Max	04/04→03/07	QQDB	Petrol	1798	4	16	77
Focus C-Max	08/04→03/07	HXDA	Petrol	1596	4	16	58
Focus C-Max	08/04→03/07	SIDA	Petrol	1596	4	16	58
Focus C-Max	01/05→03/07	KKDA	Diesel	1753	4	8	81
Focus C-Max	02/05→03/07	HHDA	Diesel	1560	4	16	57
Focus C-Max	02/05→03/07	HHDB	Diesel	1560	4	16	57
Focus C-Max	09/05→03/07	QQDC	Petrol	1798	4	16	77
Focus Coupe (LT)	12/07→03/09	AODB	Petrol	1999	4	16	105
Focus Coupe (LT)	12/07→03/09	AODE	Petrol	1999	4	16	105
Focus Hatchback (LR)	09/02→04/05	EDDB	Petrol	1988	4	16	112
Focus Hatchback (LR)	09/02→04/05	EYDE	Petrol	1796	4	16	78
Focus Hatchback (LR)	04/03→04/05	ALDA	Petrol	1988	4	16	104
Focus Hatchback (LT)	05/05→03/09	AODB	Petrol	1999	4	16	105
Focus Hatchback (LT)	05/05→03/09	AODE	Petrol	1999	4	16	105
Focus Hatchback (LT)	04/06→05/08	HYDA	Petrol	2522	5	20	159
Focus Hatchback (LT)	04/07→03/09	G6DA	Diesel	1997	4	16	106
Focus Hatchback (LV)	03/09→08/11	AODB	Petrol	1999	4	16	105
Focus Hatchback (LV)	03/09→08/11	AODE	Petrol	1999	4	16	105
Focus Hatchback (LV)	03/09→08/11	G6DA	Diesel	1997	4	16	106
Focus Hatchback (LV)	03/09→08/11	HYDA	Petrol	2522	5	20	159
Focus Hatchback (LV)	01/10→12/10	JZDA	Petrol	2521	5	20	160
Focus Hatchback (LW)	08/11→07/15	MGDA	Petrol	1999	4	16	120
Focus Hatchback (LW)	08/11→07/15	PNDA	Petrol	1596	4	16	58
Focus Hatchback (LW)	08/11→07/15	TXDB	Diesel	1997	4	16	129
Focus Hatchback (LW)	08/12→07/15	R9DA	Petrol	1999	4	16	105
Focus Hatchback (LZ)	05/15→	R9DA	Petrol	1999	4	16	105
Focus Hatchback (LZ)	11/15→	YVDA	Petrol	2261	4	16	143
Focus II (DA_)	12/05→01/08	QQDD	Petrol	1798	4	16	77
Focus II (DA_, HCP)	07/04→01/08	G6DE	Diesel	1997	4	16	106
Focus II (DA_, HCP)	07/04→01/08	G6DF	Diesel	1997	4	16	106
Focus II (DA_, HCP)	07/04→09/12	AODA	Petrol	1999	4	16	105
Focus II (DA_, HCP)	07/04→09/12	AODB	Petrol	1999	4	16	105
Focus II (DA_, HCP)	07/04→09/12	AODE	Petrol	1999	4	16	105
Focus II (DA_, HCP)	07/04→09/12	ASDA	Petrol	1388	4	16	30
Focus II (DA_, HCP)	07/04→09/12	ASDB	Petrol	1388	4	16	30
Focus II (DA_, HCP)	07/04→09/12	G6DA	Diesel	1997	4	16	106
Focus II (DA_, HCP)	07/04→09/12	G6DB	Diesel	1997	4	16	106
Focus II (DA_, HCP)	07/04→09/12	G6DD	Diesel	1997	4	16	106
Focus II (DA_, HCP)	07/04→09/12	G8DA	Diesel	1560	4	16	57
Focus II (DA_, HCP)	07/04→09/12	G8DB	Diesel	1560	4	16	57
Focus II (DA_, HCP)	07/04→09/12	G8DC	Diesel	1560	4	16	57
Focus II (DA_, HCP)	07/04→09/12	G8DD	Diesel	1560	4	16	57
Focus II (DA_, HCP)	07/04→09/12	G8DE	Diesel	1560	4	16	57
Focus II (DA_, HCP)	07/04→09/12	G8DF	Diesel	1560	4	16	57
Focus II (DA_, HCP)	07/04→09/12	HWDA	Petrol	1596	4	16	56
Focus II (DA_, HCP)	07/04→09/12	HWDB	Petrol	1596	4	16	56
Focus II (DA_, HCP)	07/04→09/12	HXDA	Petrol	1596	4	16	58
Focus II (DA_, HCP)	07/04→09/12	HXDB	Petrol	1596	4	16	58
Focus II (DA_, HCP)	07/04→09/12	MTDA	Diesel	1560	4	16	57
Focus II (DA_, HCP)	07/04→09/12	SHDA	Petrol	1596	4	16	56
Focus II (DA_, HCP)	07/04→09/12	SHDB	Petrol	1596	4	16	56



CC



9

Focus II (DA, HCP)	07/04→09/12	SHDC	Petrol	1596	4	16	56
Focus II (DA, HCP)	07/04→09/12	SIDA	Petrol	1596	4	16	58
Focus II (DA, HCP)	01/05→09/12	GPDA	Diesel	1560	4	16	57
Focus II (DA, HCP)	01/05→09/12	GPDB	Diesel	1560	4	16	57
Focus II (DA, HCP)	01/05→09/12	GPDC	Diesel	1560	4	16	57
Focus II (DA, HCP)	01/05→09/12	HHDA	Diesel	1560	4	16	57
Focus II (DA, HCP)	01/05→09/12	HHDB	Diesel	1560	4	16	57
Focus II (DA, HCP)	01/05→09/12	KKDA	Diesel	1753	4	8	81
Focus II (DA, HCP)	01/05→09/12	KKDB	Diesel	1753	4	8	81
Focus II (DA, HCP)	10/05→09/12	HYDA	Petrol	2522	5	20	159
Focus II (DA, HCP)	01/06→09/12	Q7DA	Petrol	1798	4	16	77
Focus II (DA, HCP)	03/06→09/12	QQDA	Petrol	1798	4	16	77
Focus II (DA, HCP)	03/06→09/12	QQDB	Petrol	1798	4	16	77
Focus II (DA, HCP)	02/08→07/11	IXDA	Diesel	1997	4	16	106
Focus II (DA, HCP)	06/08→09/12	SYDA	Petrol	1999	4	16	105
Focus II (DA, HCP)	01/09→07/11	JZDA	Petrol	2521	5	20	160
Focus II Convertible	10/06→09/10	AODA	Petrol	1999	4	16	105
Focus II Convertible	10/06→09/10	AODB	Petrol	1999	4	16	105
Focus II Convertible	10/06→09/10	G6DA	Diesel	1997	4	16	106
Focus II Convertible	10/06→09/10	G6DB	Diesel	1997	4	16	106
Focus II Convertible	10/06→09/10	G6DD	Diesel	1997	4	16	106
Focus II Convertible	10/06→09/10	HWDA	Petrol	1596	4	16	56
Focus II Convertible	10/06→09/10	HWDB	Petrol	1596	4	16	56
Focus II Convertible	10/06→09/10	SHDA	Petrol	1596	4	16	56
Focus II Convertible	10/06→09/10	SHDB	Petrol	1596	4	16	56
Focus II Convertible	10/06→09/10	SHDC	Petrol	1596	4	16	56
Focus II Saloon (DB)	04/05→07/11	AODA	Petrol	1999	4	16	105
Focus II Saloon (DB)	04/05→07/11	AODB	Petrol	1999	4	16	105
Focus II Saloon (DB)	04/05→09/12	ASDA	Petrol	1388	4	16	30
Focus II Saloon (DB)	04/05→09/12	ASDB	Petrol	1388	4	16	30
Focus II Saloon (DB)	04/05→09/12	G6DA	Diesel	1997	4	16	106
Focus II Saloon (DB)	04/05→09/12	G6DB	Diesel	1997	4	16	106
Focus II Saloon (DB)	04/05→09/12	G6DD	Diesel	1997	4	16	106
Focus II Saloon (DB)	04/05→09/12	G8DA	Diesel	1560	4	16	57
Focus II Saloon (DB)	04/05→09/12	G8DB	Diesel	1560	4	16	57
Focus II Saloon (DB)	04/05→09/12	G8DC	Diesel	1560	4	16	57
Focus II Saloon (DB)	04/05→09/12	G8DD	Diesel	1560	4	16	57
Focus II Saloon (DB)	04/05→09/12	G8DE	Diesel	1560	4	16	57
Focus II Saloon (DB)	04/05→09/12	G8DF	Diesel	1560	4	16	57
Focus II Saloon (DB)	04/05→09/12	HHDA	Diesel	1560	4	16	57
Focus II Saloon (DB)	04/05→09/12	HHDB	Diesel	1560	4	16	57
Focus II Saloon (DB)	04/05→09/12	HWDA	Petrol	1596	4	16	56
Focus II Saloon (DB)	04/05→09/12	HWDB	Petrol	1596	4	16	56
Focus II Saloon (DB)	04/05→09/12	HXDA	Petrol	1596	4	16	58
Focus II Saloon (DB)	04/05→09/12	HXDB	Petrol	1596	4	16	58
Focus II Saloon (DB)	04/05→09/12	KKDA	Diesel	1753	4	8	81
Focus II Saloon (DB)	04/05→09/12	KKDB	Diesel	1753	4	8	81
Focus II Saloon (DB)	04/05→09/12	MTDA	Diesel	1560	4	16	57
Focus II Saloon (DB)	04/05→09/12	SHDA	Petrol	1596	4	16	56
Focus II Saloon (DB)	04/05→09/12	SHDB	Petrol	1596	4	16	56
Focus II Saloon (DB)	04/05→09/12	SHDC	Petrol	1596	4	16	56
Focus II Saloon (DB)	03/06→09/12	Q7DA	Petrol	1798	4	16	77
Focus II Saloon (DB)	03/06→09/12	QQDA	Petrol	1798	4	16	77
Focus II Saloon (DB)	03/06→09/12	QQDB	Petrol	1798	4	16	77
Focus II Saloon (DB)	02/08→07/11	IXDA	Diesel	1997	4	16	106
Focus II Turnier (DA)	07/04→01/08	G6DE	Diesel	1997	4	16	106
Focus II Turnier (DA)	07/04→01/08	G6DF	Diesel	1997	4	16	106
Focus II Turnier (DA)	07/04→07/11	HWDA	Petrol	1596	4	16	56
Focus II Turnier (DA)	07/04→07/11	HWDB	Petrol	1596	4	16	56
Focus II Turnier (DA)	07/04→07/11	SHDA	Petrol	1596	4	16	56
Focus II Turnier (DA)	07/04→07/11	SHDB	Petrol	1596	4	16	56
Focus II Turnier (DA)	07/04→07/11	SHDC	Petrol	1596	4	16	56
Focus II Turnier (DA)	07/04→09/12	AODA	Petrol	1999	4	16	105
Focus II Turnier (DA)	07/04→09/12	AODB	Petrol	1999	4	16	105
Focus II Turnier (DA)	07/04→09/12	AODE	Petrol	1999	4	16	105
Focus II Turnier (DA)	07/04→09/12	ASDA	Petrol	1388	4	16	30
Focus II Turnier (DA)	07/04→09/12	ASDB	Petrol	1388	4	16	30
Focus II Turnier (DA)	07/04→09/12	G6DA	Diesel	1997	4	16	106
Focus II Turnier (DA)	07/04→09/12	G6DB	Diesel	1997	4	16	106
Focus II Turnier (DA)	07/04→09/12	G6DD	Diesel	1997	4	16	106
Focus II Turnier (DA)	07/04→09/12	G8DA	Diesel	1560	4	16	57
Focus II Turnier (DA)	07/04→09/12	G8DB	Diesel	1560	4	16	57
Focus II Turnier (DA)	07/04→09/12	G8DC	Diesel	1560	4	16	57
Focus II Turnier (DA)	07/04→09/12	G8DD	Diesel	1560	4	16	57
Focus II Turnier (DA)	07/04→09/12	G8DE	Diesel	1560	4	16	57
Focus II Turnier (DA)	07/04→09/12	G8DF	Diesel	1560	4	16	57
Focus II Turnier (DA)	07/04→09/12	GPDA	Diesel	1560	4	16	57
Focus II Turnier (DA)	07/04→09/12	GPDC	Diesel	1560	4	16	57



CC



9

Focus II Turnier (DA_)	07/04→09/12	HHDA	Diesel	1560	4	16	57
Focus II Turnier (DA_)	07/04→09/12	HHDB	Diesel	1560	4	16	57
Focus II Turnier (DA_)	07/04→09/12	HXDA	Petrol	1596	4	16	58
Focus II Turnier (DA_)	07/04→09/12	HXDB	Petrol	1596	4	16	58
Focus II Turnier (DA_)	07/04→09/12	KKDA	Diesel	1753	4	8	81
Focus II Turnier (DA_)	07/04→09/12	KKDB	Diesel	1753	4	8	81
Focus II Turnier (DA_)	07/04→09/12	MTDA	Diesel	1560	4	16	57
Focus II Turnier (DA_)	01/06→09/12	Q7DA	Petrol	1798	4	16	77
Focus II Turnier (DA_)	03/06→09/12	QQDA	Petrol	1798	4	16	77
Focus II Turnier (DA_)	03/06→09/12	QQDB	Petrol	1798	4	16	77
Focus II Turnier (DA_)	02/08→07/11	IXDA	Diesel	1997	4	16	106
Focus II Turnier (DA_)	06/08→07/11	SYDA	Petrol	1999	4	16	105
Focus II Turnier (DA_)	10/09→09/12	SIDA	Petrol	1596	4	16	58
Focus III	07/10→	IQDB	Petrol	1596	4	16	58
Focus III	07/10→	JQDA	Petrol	1596	4	16	59
Focus III	07/10→	JQDB	Petrol	1596	4	16	59
Focus III	07/10→	JTDA	Petrol	1596	4	16	59
Focus III	07/10→	JTDB	Petrol	1596	4	16	59
Focus III	07/10→	MUDA	Petrol	1596	4	16	58
Focus III	07/10→	PNDA	Petrol	1596	4	16	58
Focus III	07/10→	T1DA	Diesel	1560	4	8	68
Focus III	07/10→	T1DB	Diesel	1560	4	8	68
Focus III	07/10→	T3DA	Diesel	1560	4	8	68
Focus III	07/10→	T3DB	Diesel	1560	4	8	68
Focus III	07/10→	TXDB	Diesel	1997	4	16	129
Focus III	07/10→	TYDA	Diesel	1997	4	16	129
Focus III	07/10→	UFDB	Diesel	1997	4	16	129
Focus III	07/10→	UKDB	Diesel	1997	4	16	129
Focus III	07/10→	YUDA	Petrol	1596	4	16	59
Focus III	08/11→	MGDA	Petrol	1999	4	16	105
Focus III	08/11→	XTDA	Petrol	1596	4	16	58
Focus III	02/12→	M1DA	Petrol	998	3	12	3
Focus III	02/12→	M2DA	Petrol	998	3	12	3
Focus III	05/12→	NGDA	Diesel	1560	4	8	68
Focus III	05/12→	NGDB	Diesel	1560	4	8	68
Focus III	07/12→	R9DA	Petrol	1999	4	16	105
Focus III	10/13→	XQDA	Petrol	1999	4	16	105
Focus III	09/14→	M8DA	Petrol	1498	4	16	43
Focus III	09/14→	M8DB	Petrol	1498	4	16	43
Focus III	09/14→	M9DA	Petrol	1498	4	16	43
Focus III	09/14→	M9DB	Petrol	1498	4	16	43
Focus III	09/14→	XWDA	Diesel	1499	4	8	36
Focus III	09/14→	XWDB	Diesel	1499	4	8	36
Focus III	09/14→	XWDC	Diesel	1499	4	8	36
Focus III	09/14→	XWDD	Diesel	1499	4	8	36
Focus III	09/14→	XXDA	Diesel	1499	4	8	36
Focus III	09/14→	XXDB	Diesel	1499	4	8	36
Focus III	09/14→	XXDC	Diesel	1499	4	8	36
Focus III	11/14→	T7DB	Diesel	1997	4	16	129
Focus III	11/14→	T8DA	Diesel	1997	4	16	129
Focus III	07/15→	YVDA	Petrol	2261	4	16	143
Focus III Box Body / Estate	02/12→	M1DA	Petrol	998	3	12	3
Focus III Box Body / Estate	02/12→	M2DA	Petrol	998	3	12	3
Focus III Box Body / Estate	09/14→	M8DA	Petrol	1498	4	16	43
Focus III Box Body / Estate	09/14→	M8DB	Petrol	1498	4	16	43
Focus III Box Body / Estate	09/14→	M9DA	Petrol	1498	4	16	43
Focus III Box Body / Estate	09/14→	M9DB	Petrol	1498	4	16	43
Focus III Box Body / Estate	09/14→	XWDA	Diesel	1499	4	8	36
Focus III Box Body / Estate	09/14→	XWDB	Diesel	1499	4	8	36
Focus III Box Body / Estate	09/14→	XWDC	Diesel	1499	4	8	36
Focus III Box Body / Estate	09/14→	XWDD	Diesel	1499	4	8	36
Focus III Box Body / Estate	09/14→	XXDA	Diesel	1499	4	8	36
Focus III Box Body / Estate	09/14→	XXDB	Diesel	1499	4	8	36
Focus III Box Body / Estate	09/14→	XXDC	Diesel	1499	4	8	36
Focus III Box Body / Estate	11/14→	T7DB	Diesel	1997	4	16	129
Focus III Box Body / Hatchback	01/11→06/14	TYDA	Diesel	1997	4	16	129
Focus III Box Body / Hatchback	01/11→06/14	UFDB	Diesel	1997	4	16	129
Focus III Box Body / Hatchback	01/11→	IQDB	Petrol	1596	4	16	58
Focus III Box Body / Hatchback	11/11→06/14	JQDA	Petrol	1596	4	16	59
Focus III Box Body / Hatchback	11/11→06/14	JQDB	Petrol	1596	4	16	59
Focus III Box Body / Hatchback	11/11→06/14	JTDA	Petrol	1596	4	16	59
Focus III Box Body / Hatchback	11/11→06/14	JTDB	Petrol	1596	4	16	59
Focus III Box Body / Hatchback	11/11→06/14	YUDA	Petrol	1596	4	16	59
Focus III Box Body / Hatchback	02/12→	M1DA	Petrol	998	3	12	3
Focus III Box Body / Hatchback	02/12→	M2DA	Petrol	998	3	12	3
Focus III Box Body / Hatchback	02/12→	T1DA	Diesel	1560	4	8	68
Focus III Box Body / Hatchback	02/12→	T1DB	Diesel	1560	4	8	68
Focus III Box Body / Hatchback	09/14→	M8DA	Petrol	1498	4	16	43



CC



9

Focus III Box Body / Hatchback	09/14 →	M8DB	Petrol	1498	4	16	43
Focus III Box Body / Hatchback	09/14 →	M9DA	Petrol	1498	4	16	43
Focus III Box Body / Hatchback	09/14 →	M9DB	Petrol	1498	4	16	43
Focus III Box Body / Hatchback	09/14 →	XWDA	Diesel	1499	4	8	36
Focus III Box Body / Hatchback	09/14 →	XWDB	Diesel	1499	4	8	36
Focus III Box Body / Hatchback	09/14 →	XWDC	Diesel	1499	4	8	36
Focus III Box Body / Hatchback	09/14 →	XWDD	Diesel	1499	4	8	36
Focus III Box Body / Hatchback	09/14 →	XXDA	Diesel	1499	4	8	36
Focus III Box Body / Hatchback	09/14 →	XXDB	Diesel	1499	4	8	36
Focus III Box Body / Hatchback	09/14 →	XXDC	Diesel	1499	4	8	36
Focus III Box Body / Hatchback	11/14 →	T7DB	Diesel	1997	4	16	129
Focus III Saloon	07/10 →	IQDB	Petrol	1596	4	16	58
Focus III Saloon	07/10 →	JQDA	Petrol	1596	4	16	59
Focus III Saloon	07/10 →	JQDB	Petrol	1596	4	16	59
Focus III Saloon	07/10 →	JTDA	Petrol	1596	4	16	59
Focus III Saloon	07/10 →	JTDB	Petrol	1596	4	16	59
Focus III Saloon	07/10 →	MUDA	Petrol	1596	4	16	58
Focus III Saloon	07/10 →	PNDA	Petrol	1596	4	16	58
Focus III Saloon	07/10 →	PNDD	Petrol	1596	4	16	58
Focus III Saloon	07/10 →	T1DA	Diesel	1560	4	8	68
Focus III Saloon	07/10 →	T1DB	Diesel	1560	4	8	68
Focus III Saloon	07/10 →	T3DA	Diesel	1560	4	8	68
Focus III Saloon	07/10 →	T3DB	Diesel	1560	4	8	68
Focus III Saloon	07/10 →	TXDB	Diesel	1997	4	16	129
Focus III Saloon	07/10 →	TYDA	Diesel	1997	4	16	129
Focus III Saloon	07/10 →	UFDB	Diesel	1997	4	16	129
Focus III Saloon	07/10 →	UKDB	Diesel	1997	4	16	129
Focus III Saloon	07/10 →	YUDA	Petrol	1596	4	16	59
Focus III Saloon	08/11 →	MGDA	Petrol	1999	4	16	105
Focus III Saloon	08/11 →	XTDA	Petrol	1596	4	16	58
Focus III Saloon	02/12 →	M1DA	Petrol	998	3	12	3
Focus III Saloon	02/12 →	M2DA	Petrol	998	3	12	3
Focus III Saloon	05/12 →	NGDA	Diesel	1560	4	8	68
Focus III Saloon	05/12 →	NGDB	Diesel	1560	4	8	68
Focus III Saloon	10/13 →	XQDA	Petrol	1999	4	16	105
Focus III Saloon	11/14 →	M8DA	Petrol	1498	4	16	43
Focus III Saloon	11/14 →	M8DB	Petrol	1498	4	16	43
Focus III Saloon	11/14 →	M9DA	Petrol	1498	4	16	43
Focus III Saloon	11/14 →	M9DB	Petrol	1498	4	16	43
Focus III Saloon	11/14 →	T7DB	Diesel	1997	4	16	129
Focus III Saloon	11/14 →	XWDA	Diesel	1499	4	8	36
Focus III Saloon	11/14 →	XWDB	Diesel	1499	4	8	36
Focus III Saloon	11/14 →	XWDC	Diesel	1499	4	8	36
Focus III Saloon	11/14 →	XWDD	Diesel	1499	4	8	36
Focus III Saloon	11/14 →	XXDA	Diesel	1499	4	8	36
Focus III Saloon	11/14 →	XXDB	Diesel	1499	4	8	36
Focus III Saloon	11/14 →	XXDC	Diesel	1499	4	8	36
Focus III Turnier	07/10 →	IQDB	Petrol	1596	4	16	58
Focus III Turnier	07/10 →	JQDA	Petrol	1596	4	16	59
Focus III Turnier	07/10 →	JQDB	Petrol	1596	4	16	59
Focus III Turnier	07/10 →	JTDA	Petrol	1596	4	16	59
Focus III Turnier	07/10 →	JTDB	Petrol	1596	4	16	59
Focus III Turnier	07/10 →	MGDA	Petrol	1999	4	16	105
Focus III Turnier	07/10 →	MUDA	Petrol	1596	4	16	58
Focus III Turnier	07/10 →	PNDA	Petrol	1596	4	16	58
Focus III Turnier	07/10 →	T1DA	Diesel	1560	4	8	68
Focus III Turnier	07/10 →	T1DB	Diesel	1560	4	8	68
Focus III Turnier	07/10 →	T3DA	Diesel	1560	4	8	68
Focus III Turnier	07/10 →	T3DB	Diesel	1560	4	8	68
Focus III Turnier	07/10 →	TXDB	Diesel	1997	4	16	129
Focus III Turnier	07/10 →	TYDA	Diesel	1997	4	16	129
Focus III Turnier	07/10 →	UFDB	Diesel	1997	4	16	129
Focus III Turnier	07/10 →	UKDB	Diesel	1997	4	16	129
Focus III Turnier	07/10 →	YUDA	Petrol	1596	4	16	59
Focus III Turnier	08/11 →	XTDA	Petrol	1596	4	16	58
Focus III Turnier	02/12 →	M1DA	Petrol	998	3	12	3
Focus III Turnier	02/12 →	M2DA	Petrol	998	3	12	3
Focus III Turnier	05/12 →	NGDA	Diesel	1560	4	8	68
Focus III Turnier	05/12 →	NGDB	Diesel	1560	4	8	68
Focus III Turnier	07/12 →	R9DA	Petrol	1999	4	16	105
Focus III Turnier	10/13 →	XQDA	Petrol	1999	4	16	105
Focus III Turnier	09/14 →	M8DA	Petrol	1498	4	16	43
Focus III Turnier	09/14 →	M8DB	Petrol	1498	4	16	43
Focus III Turnier	09/14 →	M9DA	Petrol	1498	4	16	43
Focus III Turnier	09/14 →	M9DB	Petrol	1498	4	16	43
Focus III Turnier	09/14 →	XWDA	Diesel	1499	4	8	36
Focus III Turnier	09/14 →	XWDB	Diesel	1499	4	8	36
Focus III Turnier	09/14 →	XWDC	Diesel	1499	4	8	36



CC



9

Focus III Turnier	09/14→	XWDD	Diesel	1499	4	8	36
Focus III Turnier	09/14→	XXDA	Diesel	1499	4	8	36
Focus III Turnier	09/14→	XXDB	Diesel	1499	4	8	36
Focus III Turnier	09/14→	XXDC	Diesel	1499	4	8	36
Focus III Turnier	11/14→	T7DB	Diesel	1997	4	16	129
Focus III Turnier	11/14→	T8DA	Diesel	1997	4	16	129
Focus Saloon (DFW)	02/99→11/04	C9DA	Diesel	1753	4	8	73
Focus Saloon (DFW)	02/99→11/04	C9DB	Diesel	1753	4	8	73
Focus Saloon (DFW)	02/99→11/04	C9DC	Diesel	1753	4	8	73
Focus Saloon (DFW)	02/99→11/04	EDDB	Petrol	1988	4	16	111
Focus Saloon (DFW)	02/99→11/04	EDDC	Petrol	1988	4	16	111
Focus Saloon (DFW)	02/99→11/04	EDDD	Petrol	1988	4	16	111
Focus Saloon (DFW)	02/99→11/04	EDDF	Petrol	1988	4	16	111
Focus Saloon (DFW)	02/99→11/04	EYDB	Petrol	1796	4	16	78
Focus Saloon (DFW)	02/99→11/04	EYDC	Petrol	1796	4	16	78
Focus Saloon (DFW)	02/99→11/04	EYDD	Petrol	1796	4	16	78
Focus Saloon (DFW)	02/99→11/04	EYDE	Petrol	1796	4	16	78
Focus Saloon (DFW)	02/99→11/04	EYDF	Petrol	1796	4	16	78
Focus Saloon (DFW)	02/99→11/04	EYDG	Petrol	1796	4	16	78
Focus Saloon (DFW)	02/99→11/04	EYDI	Petrol	1796	4	16	78
Focus Saloon (DFW)	02/99→11/04	EYDJ	Petrol	1796	4	16	78
Focus Saloon (DFW)	02/99→11/04	EYDL	Petrol	1796	4	16	78
Focus Saloon (DFW)	02/99→11/04	FXDA	Petrol	1388	4	16	30
Focus Saloon (DFW)	02/99→11/04	FXDB	Petrol	1388	4	16	30
Focus Saloon (DFW)	02/99→11/04	FXDC	Petrol	1388	4	16	30
Focus Saloon (DFW)	02/99→11/04	FXDD	Petrol	1388	4	16	30
Focus Saloon (DFW)	02/99→11/04	FYDA	Petrol	1596	4	16	56
Focus Saloon (DFW)	02/99→11/04	FYDB	Petrol	1596	4	16	56
Focus Saloon (DFW)	02/99→11/04	FYDC	Petrol	1596	4	16	56
Focus Saloon (DFW)	02/99→11/04	FYDD	Petrol	1596	4	16	56
Focus Saloon (DFW)	02/99→11/04	FYDH	Petrol	1596	4	16	56
Focus Saloon (DFW)	03/01→11/04	F9DA	Diesel	1753	4	8	73
Focus Saloon (DFW)	03/01→11/04	F9DB	Diesel	1753	4	8	73
Focus Saloon (DFW)	08/01→03/05	BHDA	Diesel	1753	4	8	73
Focus Saloon (DFW)	08/01→03/05	BHDB	Diesel	1753	4	8	73
Focus Saloon (DFW)	08/02→11/04	FFDA	Diesel	1753	4	8	73
Focus Saloon (LR)	09/02→04/05	EDDB	Petrol	1988	4	16	112
Focus Saloon (LR)	09/02→04/05	EYDE	Petrol	1796	4	16	78
Focus Saloon (LS, LT)	05/05→03/09	AODB	Petrol	1999	4	16	105
Focus Saloon (LS, LT)	05/05→03/09	AODE	Petrol	1999	4	16	105
Focus Saloon (LV)	03/09→08/11	AODB	Petrol	1999	4	16	105
Focus Saloon (LV)	03/09→08/11	AODE	Petrol	1999	4	16	105
Focus Saloon (LV)	03/09→08/11	G6DA	Diesel	1997	4	16	106
Focus Saloon (LW)	08/11→07/15	MGDA	Petrol	1999	4	16	120
Focus Saloon (LW)	08/11→07/15	PNDA	Petrol	1596	4	16	58
Focus Saloon (LW)	08/11→07/15	TXDB	Diesel	1997	4	16	129
Focus Turnier (DNW)	02/99→11/04	C9DA	Diesel	1753	4	8	73
Focus Turnier (DNW)	02/99→11/04	C9DB	Diesel	1753	4	8	73
Focus Turnier (DNW)	02/99→11/04	C9DC	Diesel	1753	4	8	73
Focus Turnier (DNW)	02/99→11/04	EDDB	Petrol	1988	4	16	111
Focus Turnier (DNW)	02/99→11/04	EDDC	Petrol	1988	4	16	111
Focus Turnier (DNW)	02/99→11/04	EDDD	Petrol	1988	4	16	111
Focus Turnier (DNW)	02/99→11/04	EDDF	Petrol	1988	4	16	111
Focus Turnier (DNW)	02/99→11/04	EYDB	Petrol	1796	4	16	78
Focus Turnier (DNW)	02/99→11/04	EYDC	Petrol	1796	4	16	78
Focus Turnier (DNW)	02/99→11/04	EYDD	Petrol	1796	4	16	78
Focus Turnier (DNW)	02/99→11/04	EYDE	Petrol	1796	4	16	78
Focus Turnier (DNW)	02/99→11/04	EYDF	Petrol	1796	4	16	78
Focus Turnier (DNW)	02/99→11/04	EYDG	Petrol	1796	4	16	78
Focus Turnier (DNW)	02/99→11/04	EYDI	Petrol	1796	4	16	78
Focus Turnier (DNW)	02/99→11/04	EYDJ	Petrol	1796	4	16	78
Focus Turnier (DNW)	02/99→11/04	FXDA	Petrol	1388	4	16	30
Focus Turnier (DNW)	02/99→11/04	FXDB	Petrol	1388	4	16	30
Focus Turnier (DNW)	02/99→11/04	FXDC	Petrol	1388	4	16	30
Focus Turnier (DNW)	02/99→11/04	FXDD	Petrol	1388	4	16	30
Focus Turnier (DNW)	02/99→11/04	FYDA	Petrol	1596	4	16	56
Focus Turnier (DNW)	02/99→11/04	FYDB	Petrol	1596	4	16	56
Focus Turnier (DNW)	02/99→11/04	FYDC	Petrol	1596	4	16	56
Focus Turnier (DNW)	02/99→11/04	FYDD	Petrol	1596	4	16	56
Focus Turnier (DNW)	02/99→11/04	FYDH	Petrol	1596	4	16	56
Focus Turnier (DNW)	02/99→01/05	EYDL	Petrol	1796	4	16	78
Focus Turnier (DNW)	08/99→11/04	BHDA	Diesel	1753	4	8	73
Focus Turnier (DNW)	08/99→11/04	BHDB	Diesel	1753	4	8	73
Focus Turnier (DNW)	03/01→11/04	F9DA	Diesel	1753	4	8	73
Focus Turnier (DNW)	03/01→11/04	F9DB	Diesel	1753	4	8	73
Focus Turnier (DNW)	08/02→11/04	ALDA	Petrol	1988	4	16	103
Focus Turnier (DNW)	08/02→11/04	FFDA	Diesel	1753	4	8	73
Freda Box (FSR1)	02/92→11/97	FEY9	Petrol	1998	4	12	115



CC



9

Fusion (JU_)	08/02→11/08	FYJA	Petrol	1596	4	16	56
Fusion (JU_)	08/02→11/08	FYJB	Petrol	1596	4	16	56
Fusion (JU_)	08/02→11/08	FYJC	Petrol	1596	4	16	56
Fusion (JU_)	08/02→12/12	F6JA	Diesel	1399	4	8	32
Fusion (JU_)	08/02→12/12	F6JB	Diesel	1399	4	8	32
Fusion (JU_)	08/02→12/12	FXJA	Petrol	1388	4	16	30
Fusion (JU_)	08/02→12/12	FXJB	Petrol	1388	4	16	30
Fusion (JU_)	08/02→12/12	FXJC	Petrol	1388	4	16	30
Fusion (JU_)	11/02→07/05	BAJA	Petrol	1299	4	8	15
Fusion (JU_)	08/04→12/12	FUJA	Petrol	1242	4	16	17
Fusion (JU_)	08/04→12/12	FUJB	Petrol	1242	4	16	17
Fusion (JU_)	11/04→12/12	HHJA	Diesel	1560	4	16	57
Fusion (JU_)	11/04→12/12	HHJB	Diesel	1560	4	16	57
Fusion (JU_)	01/10→12/12	UTJA	Petrol	1388	4	16	30
Galaxy	01/15→	R9CD	Petrol	1999	4	16	105
Galaxy	01/15→	R9CI	Petrol	1999	4	16	105
Galaxy	01/15→	T7CI	Diesel	1997	4	16	129
Galaxy	01/15→	T7CJ	Diesel	1997	4	16	129
Galaxy	01/15→	T7CK	Diesel	1997	4	16	129
Galaxy	01/15→	T7CL	Diesel	1997	4	16	129
Galaxy	01/15→	T8CG	Diesel	1997	4	16	129
Galaxy	01/15→	T8CH	Diesel	1997	4	16	129
Galaxy	01/15→	T8CI	Diesel	1997	4	16	129
Galaxy	01/15→	T8CJ	Diesel	1997	4	16	129
Galaxy	01/15→	T9CB	Diesel	1997	4	16	129
Galaxy	01/15→	T9CC	Diesel	1997	4	16	129
Galaxy	01/15→	UFCA	Diesel	1997	4	16	129
Galaxy	01/15→	UFCB	Diesel	1997	4	16	129
Galaxy	01/15→	UNCI	Petrol	1499	4	16	39
Galaxy	01/15→	UNCJ	Petrol	1499	4	16	39
Galaxy (WA6)	05/06→06/15	AOWA	Petrol	1999	4	16	105
Galaxy (WA6)	05/06→06/15	AOWB	Petrol	1999	4	16	105
Galaxy (WA6)	05/06→06/15	AZWA	Diesel	1997	4	16	106
Galaxy (WA6)	05/06→06/15	AZWC	Diesel	1997	4	16	106
Galaxy (WA6)	05/06→06/15	FFWA	Diesel	1753	4	8	73
Galaxy (WA6)	05/06→06/15	QXWA	Diesel	1997	4	16	106
Galaxy (WA6)	05/06→06/15	QXWB	Diesel	1997	4	16	106
Galaxy (WA6)	05/06→06/15	QXWC	Diesel	1997	4	16	106
Galaxy (WA6)	05/06→06/15	QYWA	Diesel	1753	4	8	73
Galaxy (WA6)	05/06→06/15	TBWA	Petrol	1999	4	16	105
Galaxy (WA6)	05/06→06/15	TBWB	Petrol	1999	4	16	105
Galaxy (WA6)	05/06→06/15	UFWA	Diesel	1997	4	16	129
Galaxy (WA6)	05/06→06/15	UKWA	Diesel	1997	4	16	129
Galaxy (WA6)	09/07→06/15	SEWA	Petrol	2261	4	16	143
Galaxy (WA6)	11/07→06/15	KLWA	Diesel	1997	4	16	106
Galaxy (WA6)	11/07→06/15	TYWA	Diesel	1997	4	16	129
Galaxy (WA6)	03/08→12/12	Q4BA	Diesel	2179	4	16	136
Galaxy (WA6)	03/08→12/12	Q4WA	Diesel	2179	4	16	136
Galaxy (WA6)	03/10→06/15	TNWA	Petrol	1999	4	16	105
Galaxy (WA6)	03/10→06/15	TXWA	Diesel	1997	4	16	129
Galaxy (WA6)	07/10→06/15	TNWB	Petrol	1999	4	16	105
Galaxy (WA6)	11/10→06/15	JTWA	Petrol	1596	4	16	59
Galaxy (WA6)	11/10→06/15	JTWB	Petrol	1596	4	16	59
Galaxy (WA6)	11/10→06/15	KNWA	Diesel	2179	4	16	136
Galaxy (WA6)	02/11→06/15	TIWA	Diesel	1560	4	8	68
Galaxy (WA6)	02/11→06/15	TIWB	Diesel	1560	4	8	68
Galaxy (WGR)	03/95→05/06	IZ	Diesel	1896	4	8	94
Galaxy (WGR)	03/95→05/06	AHU	Diesel	1896	4	8	95
Galaxy (WGR)	03/95→05/06	ANU	Diesel	1896	4	8	97
Galaxy (WGR)	11/95→04/00	AAA	Petrol	2792	6	12	176
Galaxy (WGR)	11/95→04/00	AMY	Petrol	2792	6	12	176
Galaxy (WGR)	11/95→05/06	NSE	Petrol	1998	4	8	123
Galaxy (WGR)	11/95→05/06	ZVSA	Petrol	1998	4	8	124
Galaxy (WGR)	09/96→05/06	Y5B	Petrol	2295	4	16	141
Galaxy (WGR)	01/97→05/06	E5SA	Petrol	2295	4	16	141
Galaxy (WGR)	08/97→04/00	AFN	Diesel	1896	4	8	94
Galaxy (WGR)	08/97→04/00	AVG	Diesel	1896	4	8	99
Galaxy (WGR)	04/00→05/06	AUY	Diesel	1896	4	8	96
Galaxy (WGR)	04/00→05/06	AYL	Petrol	2792	6	24	177
Galaxy (WGR)	09/01→05/06	E5SB	Petrol	2295	4	16	141
Galaxy (WGR)	02/03→05/06	ASZ	Diesel	1896	4	8	98
Galaxy (WGR)	05/05→05/06	BTB	Diesel	1896	4	8	98
Granada (GGTL, GGFL)	01/72→02/76	EV 30 H	Petrol	2994	6	12	184
Granada (GGTL, GGFL)	01/72→02/76	UY	Petrol	2550	6	12	168
Granada (GGTL, GGFL)	01/72→02/76	YY	Petrol	2294	6	12	147
Granada (GGTL, GGFL)	03/72→02/75	TV 17 H	Petrol	1699	4	8	71
Granada (GGTL, GGFL)	03/72→02/75	TV 17 HC	Petrol	1699	4	8	71
Granada (GGTL, GGFL)	12/74→08/77	MWB	Petrol	1699	4	8	71









CC



9

Granada (GGTL, GGFL)	01/75→07/77	TL 20 LC	Petrol	1994	4	8	122
Granada (GGTL, GGFL)	01/75→08/77	NY	Petrol	1998	6	12	126
Granada (GGTL, GGFL)	01/75→08/77	YYH	Petrol	2294	6	12	145
Granada (GGTL, GGFL)	12/75→08/77	TV 26 L	Petrol	2551	6	12	173
Granada (GGTL, GGFL)	01/76→08/77	OHC LC	Petrol	1994	4	8	122
Granada (GU)	08/77→06/79	YYH	Petrol	2294	6	12	145
Granada (GU)	08/77→07/79	TL 20 LC	Petrol	1994	4	8	122
Granada (GU)	08/77→07/81	MY	Petrol	1699	4	8	71
Granada (GU)	08/77→08/81	PRB	Petrol	2792	6	12	180
Granada (GU)	08/77→05/82	TV 17 LC	Petrol	1699	4	8	71
Granada (GU)	08/77→08/82	WTA	Diesel	2112	4	8	132
Granada (GU)	08/77→08/85	NYP	Petrol	1998	6	12	126
Granada (GU)	08/77→08/85	PRD	Petrol	2792	6	12	180
Granada (GU)	08/77→08/85	PYA	Petrol	2792	6	12	180
Granada (GU)	06/79→08/85	YYP	Petrol	2294	6	12	145
Granada (GU)	08/79→08/85	NEP	Petrol	1993	4	8	101
Granada (GU)	06/81→08/85	PYU	Petrol	2792	6	12	180
Granada (GU)	06/81→08/85	YU	Petrol	2294	6	12	145
Granada (GU)	07/81→08/85	LCK	Petrol	1593	4	8	64
Granada (GU)	08/81→08/85	NEK	Petrol	1993	4	8	101
Granada (GU)	08/82→08/85	STP	Diesel	2499	4	8	166
Granada (GU)	10/82→08/85	PRC	Petrol	2792	6	12	180
Granada Coupe (GGCL)	01/72→02/76	EV 30 H	Petrol	2994	6	12	184
Granada Coupe (GGCL)	01/72→02/76	UY	Petrol	2550	6	12	168
Granada Coupe (GGCL)	01/72→02/76	YY	Petrol	2294	6	12	147
Granada Coupe (GGCL)	03/72→02/75	TV 17 LC	Petrol	1699	4	8	71
Granada Turnier (GGNL)	01/72→02/76	EV 30 H	Petrol	2994	6	12	184
Granada Turnier (GGNL)	01/72→02/76	UY	Petrol	2550	6	12	168
Granada Turnier (GGNL)	01/72→02/76	YY	Petrol	2294	6	12	147
Granada Turnier (GGNL)	03/72→02/75	TV 17 HC	Petrol	1699	4	8	71
Granada Turnier (GGNL)	12/74→08/77	MWB	Petrol	1699	4	8	71
Granada Turnier (GGNL)	01/75→07/77	TL 20 LC	Petrol	1994	4	8	122
Granada Turnier (GGNL)	01/75→08/77	NY	Petrol	1998	6	12	126
Granada Turnier (GGNL)	01/76→08/77	TV 26 L	Petrol	2551	6	12	173
Granada Turnier (GNU)	08/77→06/79	YYH	Petrol	2294	6	12	145
Granada Turnier (GNU)	08/77→07/79	OHC LC	Petrol	1994	4	8	122
Granada Turnier (GNU)	08/77→07/81	MYE	Petrol	1699	4	8	71
Granada Turnier (GNU)	08/77→08/81	PRB	Petrol	2792	6	12	180
Granada Turnier (GNU)	08/77→06/85	NYP	Petrol	1998	6	12	126
Granada Turnier (GNU)	08/77→08/85	PRD	Petrol	2792	6	12	180
Granada Turnier (GNU)	08/77→08/85	PYA	Petrol	2792	6	12	180
Granada Turnier (GNU)	06/79→08/85	YYP	Petrol	2294	6	12	145
Granada Turnier (GNU)	08/79→08/85	NEP	Petrol	1993	4	8	101
Granada Turnier (GNU)	06/81→06/85	YU	Petrol	2294	6	12	145
Granada Turnier (GNU)	06/81→08/85	PYU	Petrol	2792	6	12	180
Granada Turnier (GNU)	08/81→08/85	NEK	Petrol	1993	4	8	101
Granada Turnier (GNU)	08/82→08/85	STP	Diesel	2499	4	8	166
Granada Turnier (GNU)	10/82→08/85	PRC	Petrol	2792	6	12	180
Grand C-Max (DXA/CB7, DXA/CEU)	12/10→	IQDA	Petrol	1596	4	16	58
Grand C-Max (DXA/CB7, DXA/CEU)	12/10→	IQDB	Petrol	1596	4	16	58
Grand C-Max (DXA/CB7, DXA/CEU)	12/10→	JQDA	Petrol	1596	4	16	59
Grand C-Max (DXA/CB7, DXA/CEU)	12/10→	JQDB	Petrol	1596	4	16	59
Grand C-Max (DXA/CB7, DXA/CEU)	12/10→	JTDA	Petrol	1596	4	16	59
Grand C-Max (DXA/CB7, DXA/CEU)	12/10→	JTDB	Petrol	1596	4	16	59
Grand C-Max (DXA/CB7, DXA/CEU)	12/10→	PNDA	Petrol	1596	4	16	58
Grand C-Max (DXA/CB7, DXA/CEU)	12/10→	T1DA	Diesel	1560	4	8	68
Grand C-Max (DXA/CB7, DXA/CEU)	12/10→	T1DB	Diesel	1560	4	8	68
Grand C-Max (DXA/CB7, DXA/CEU)	12/10→	T3DA	Diesel	1560	4	8	68
Grand C-Max (DXA/CB7, DXA/CEU)	12/10→	T3DB	Diesel	1560	4	8	68
Grand C-Max (DXA/CB7, DXA/CEU)	12/10→	TXDB	Diesel	1997	4	16	129
Grand C-Max (DXA/CB7, DXA/CEU)	02/11→	TYDA	Diesel	1997	4	16	129
Grand C-Max (DXA/CB7, DXA/CEU)	02/11→	UFDB	Diesel	1997	4	16	129
Grand C-Max (DXA/CB7, DXA/CEU)	02/11→	UKDB	Diesel	1997	4	16	129
Grand C-Max (DXA/CB7, DXA/CEU)	10/12→	M1DA	Petrol	998	3	12	3
Grand C-Max (DXA/CB7, DXA/CEU)	10/12→	M2DA	Petrol	998	3	12	3
Grand C-Max (DXA/CB7, DXA/CEU)	10/12→	SFDA	Petrol	998	3	12	3
Grand C-Max (DXA/CB7, DXA/CEU)	03/15→	M8DB	Petrol	1498	4	16	43
Grand C-Max (DXA/CB7, DXA/CEU)	03/15→	M9DB	Petrol	1498	4	16	43
Grand C-Max (DXA/CB7, DXA/CEU)	03/15→	T7DB	Diesel	1997	4	16	129
Grand C-Max (DXA/CB7, DXA/CEU)	03/15→	T8DE	Diesel	1997	4	16	129
Grand C-Max (DXA/CB7, DXA/CEU)	03/15→	XWDA	Diesel	1499	4	8	36
Grand C-Max (DXA/CB7, DXA/CEU)	03/15→	XWDB	Diesel	1499	4	8	36
Grand C-Max (DXA/CB7, DXA/CEU)	03/15→	XXDA	Diesel	1499	4	8	36
Grand C-Max (DXA/CB7, DXA/CEU)	03/15→	XXDC	Diesel	1499	4	8	36
Grand C-Max Van	12/10→	JQDA	Petrol	1596	4	16	59
Grand C-Max Van	12/10→	JQDB	Petrol	1596	4	16	59
Grand C-Max Van	12/10→	T1DA	Diesel	1560	4	8	68
Grand C-Max Van	12/10→	T1DB	Diesel	1560	4	8	68

							
Grand C-Max Van	12/10→	T3DA	Diesel	1560	4	8	68
Grand C-Max Van	12/10→	T3DB	Diesel	1560	4	8	68
Grand C-Max Van	12/10→	TXDB	Diesel	1997	4	16	129
Grand C-Max Van	12/10→	UFDB	Diesel	1997	4	16	129
Grand C-Max Van	02/11→	TYDA	Diesel	1997	4	16	129
Grand C-Max Van	10/12→	M1DA	Petrol	998	3	12	3
Grand C-Max Van	10/12→	M2DA	Petrol	998	3	12	3
Grand C-Max Van	10/12→	SFDA	Petrol	998	3	12	3
Grand C-Max Van	03/15→	M8DB	Petrol	1498	4	16	43
Grand C-Max Van	03/15→	T7DB	Diesel	1997	4	16	129
Grand C-Max Van	03/15→	T8DE	Diesel	1997	4	16	129
Grand C-Max Van	03/15→	XWDA	Diesel	1499	4	8	36
Grand C-Max Van	03/15→	XWDB	Diesel	1499	4	8	36
Husky Box	01/86→12/90	4G63	Petrol	1997	4	8	100
Husky Bus	01/86→08/98	4G63	Petrol	1997	4	8	100
Husky Pickup	01/86→08/98	4G63	Petrol	1997	4	8	100
Ikon (L)	06/99→	ZH13J4J	Petrol	1299	4	8	15
Ikon (L)	02/09→	F6JA	Diesel	1399	4	8	32
KA	02/08→	CDB	Petrol	1597	4	8	53
KA	02/08→	CDC	Petrol	1597	4	8	53
KA (RB_)	09/96→10/02	JJB	Petrol	1299	4	8	22
KA (RB_)	09/96→11/08	BAA	Petrol	1299	4	8	15
KA (RB_)	09/96→11/08	J4D	Petrol	1299	4	8	22
KA (RB_)	09/96→11/08	J4K	Petrol	1299	4	8	22
KA (RB_)	09/96→11/08	J4M	Petrol	1299	4	8	22
KA (RB_)	09/96→11/08	J4N	Petrol	1299	4	8	22
KA (RB_)	09/96→11/08	J4P	Petrol	1299	4	8	22
KA (RB_)	09/96→11/08	J4S	Petrol	1299	4	8	22
KA (RB_)	07/97→09/99	ZH10JRB	Petrol	999	4	8	6
KA (RB_)	06/98→11/08	JJD	Petrol	1299	4	8	22
KA (RB_)	06/98→11/08	JJF	Petrol	1299	4	8	22
KA (RB_)	06/98→11/08	JJG	Petrol	1299	4	8	22
KA (RB_)	06/98→11/08	JJH	Petrol	1299	4	8	22
KA (RB_)	06/98→11/08	JJL	Petrol	1299	4	8	22
KA (RB_)	09/00→11/08	CDB	Petrol	1597	4	8	53
KA (RB_)	09/00→11/08	CDC	Petrol	1597	4	8	53
KA (RB_)	08/02→11/08	A9A	Petrol	1299	4	8	15
KA (RB_)	08/02→11/08	A9B	Petrol	1299	4	8	15
KA (RU8)	10/08→	FD4	Diesel	1248	4	16	20
KA (RU8)	10/08→	FP4	Petrol	1242	4	8	14
KA Hatchback (TA, TB)	11/99→12/03	J4D	Petrol	1299	4	8	22
KA Hatchback (TA, TB)	11/99→12/03	J4F	Petrol	1299	4	8	22
Ka Van (RB)	05/02→05/05	BAA	Petrol	1299	4	8	15
Ka Van (RB)	05/02→05/05	J4D	Petrol	1299	4	8	22
Ka Van (RB)	05/02→05/05	J4K	Petrol	1299	4	8	22
Ka Van (RB)	05/02→05/05	J4M	Petrol	1299	4	8	22
Ka Van (RB)	05/02→05/05	J4N	Petrol	1299	4	8	22
Ka Van (RB)	05/02→05/05	J4P	Petrol	1299	4	8	22
Ka Van (RB)	05/02→05/05	J4S	Petrol	1299	4	8	22
Kuga (TE)	01/11→11/14	HYDB	Petrol	2522	5	20	160
Kuga (TE)	04/13→11/14	JQMA	Petrol	1596	4	16	59
Kuga (TE)	04/13→11/14	JQMB	Petrol	1596	4	16	59
Kuga (TE)	04/13→11/14	JTMA	Petrol	1596	4	16	59
Kuga (TE)	04/13→11/14	TXMA	Diesel	1997	4	16	129
Kuga (TF)	09/15→08/16	M9MA	Petrol	1499	4	16	39
Kuga I	03/08→11/12	G6DG	Diesel	1997	4	16	106
Kuga I	03/08→11/12	UKDA	Diesel	1997	4	16	129
Kuga I	03/09→11/12	HYDC	Petrol	2522	5	20	159
Kuga I	03/09→	HYDB	Petrol	2522	5	20	159
Kuga I	03/10→11/12	TXDA	Diesel	1997	4	16	129
Kuga I	03/10→11/12	UFDA	Diesel	1997	4	16	129
Kuga II (DM2)	03/13→	JQMA	Petrol	1596	4	16	59
Kuga II (DM2)	03/13→	JQMB	Petrol	1596	4	16	59
Kuga II (DM2)	03/13→	JTMA	Petrol	1596	4	16	59
Kuga II (DM2)	03/13→	TXDA	Diesel	1997	4	16	129
Kuga II (DM2)	03/13→	TXMA	Diesel	1997	4	16	129
Kuga II (DM2)	03/13→	TYMA	Diesel	1997	4	16	129
Kuga II (DM2)	03/13→	UFMA	Diesel	1997	4	16	129
Kuga II (DM2)	03/13→	UKMA	Diesel	1997	4	16	129
Kuga II (DM2)	09/14→	M8MA	Petrol	1499	4	16	43
Kuga II (DM2)	09/14→	M9MA	Petrol	1499	4	16	43
Kuga II (DM2)	09/14→	T7MA	Diesel	1997	4	16	129
Kuga II (DM2)	09/14→	T7MB	Diesel	1997	4	16	129
Kuga II (DM2)	09/14→	T8MA	Diesel	1997	4	16	129
Kuga II (DM2)	09/14→	T8MB	Diesel	1997	4	16	129
Kuga II (DM2)	09/14→	XRMA	Diesel	1997	4	16	129
Kuga II (DM2)	09/14→	XRMB	Diesel	1997	4	16	129
Kuga II (DM2)	01/16→	BNMA	Petrol	1499	4	16	39











CC



9

Kuga II Van	09/14→	M8MA	Petrol	1499	4	16	43
Kuga II Van	09/14→	M9MA	Petrol	1499	4	16	43
Kuga II Van	09/14→	T7MA	Diesel	1997	4	16	129
Kuga II Van	09/14→	T7MB	Diesel	1997	4	16	129
Kuga II Van	09/14→	T8MA	Diesel	1997	4	16	129
Kuga II Van	09/14→	T8MB	Diesel	1997	4	16	129
Laser Estate (KE)	03/87→12/94	B6 (8 V)	Petrol	1598	4	8	48
Laser Hatchback	01/91→12/95	B3	Petrol	1324	4	8	16
Laser Hatchback	01/91→12/95	B6	Petrol	1598	4	16	47
Laser Hatchback (KA)	03/81→02/83	E3	Petrol	1296	4	8	18
Laser Hatchback (KA)	03/81→02/83	E5	Petrol	1490	4	8	40
Laser Hatchback (KB)	03/83→09/85	E3	Petrol	1296	4	8	18
Laser Hatchback (KB)	03/83→09/85	E5	Petrol	1490	4	8	40
Laser Hatchback (KB)	06/85→12/85	EST	Petrol	1490	4	8	40
Laser Hatchback (KC)	10/85→09/87	B6 (8 V)	Petrol	1598	4	8	48
Laser Hatchback (KC)	10/85→09/87	E3	Petrol	1296	4	8	18
Laser Hatchback (KE)	10/87→03/89	E3	Petrol	1296	4	8	18
Laser Hatchback (KE)	10/87→04/90	B6 (8 V)	Petrol	1598	4	8	48
Laser Hatchback (KE)	10/87→04/90	B6T	Petrol	1598	4	16	51
Laser Hatchback (KF)	03/90→09/91	B6 (SOHC 16 V)	Petrol	1598	4	16	50
Laser Hatchback (KF)	03/90→09/91	BP (DOHC)	Petrol	1840	4	16	74
Laser Hatchback (KF)	06/90→09/91	BPT	Petrol	1840	4	16	76
Laser Hatchback (KH)	10/91→07/93	BPT	Petrol	1840	4	16	76
Laser Hatchback (KH)	10/91→10/94	B6 (SOHC 16 V)	Petrol	1598	4	16	50
Laser Hatchback (KH)	10/91→10/94	BP (DOHC)	Petrol	1840	4	16	74
Laser Hatchback (KJ)	10/94→03/99	B6 (DOHC 16 V)	Petrol	1598	4	16	49
Laser Hatchback (KJ)	10/94→03/99	BP (DOHC)	Petrol	1840	4	16	74
Laser Hatchback (KN)	03/99→04/01	B6 (DOHC 16 V)	Petrol	1598	4	16	49
Laser Hatchback (KN)	03/99→04/01	BP (DOHC)	Petrol	1840	4	16	74
Laser Hatchback (KN)	02/00→02/01	ZM	Petrol	1598	4	16	70
Laser Hatchback (KQ)	04/01→09/02	FP	Petrol	1840	4	16	82
Laser Hatchback (KQ)	04/01→09/02	FS	Petrol	1991	4	16	116
Laser Hatchback (KQ)	04/01→09/02	ZM	Petrol	1598	4	16	70
Laser Saloon (KE)	10/87→04/90	B6 (8 V)	Petrol	1598	4	8	48
Laser Saloon (KF)	03/90→09/91	B6 (SOHC 16 V)	Petrol	1598	4	16	50
Laser Saloon (KF)	03/90→09/91	BP (DOHC)	Petrol	1840	4	16	74
Laser Saloon (KH)	10/91→10/94	B6 (SOHC 16 V)	Petrol	1598	4	16	50
Laser Saloon (KH)	10/91→10/94	BP (DOHC)	Petrol	1840	4	16	74
Laser Saloon (KJ)	10/94→03/99	B6 (DOHC 16 V)	Petrol	1598	4	16	49
Laser Saloon (KJ)	10/94→03/99	BP (DOHC)	Petrol	1840	4	16	74
Laser Saloon (KN)	03/99→04/01	B6 (DOHC 16 V)	Petrol	1598	4	16	49
Laser Saloon (KN)	03/99→04/01	BP (DOHC)	Petrol	1840	4	16	74
Laser Saloon (KQ)	04/01→09/02	FP	Petrol	1840	4	16	82
Laser Saloon (KQ)	04/01→09/02	ZM	Petrol	1598	4	16	70
Liata (BJ_2, BN_2)	05/94→06/97	FS83	Petrol	1991	4	16	116
Liata Hatchback	05/94→06/97	FS83	Petrol	1991	4	16	116
Maverick	02/01→	AJ	Petrol	2967	6	24	183
Maverick	02/01→	YF	Petrol	1989	4	16	131
Maverick	03/04→	GZ	Petrol	2261	4	16	143
Maverick (UDS, UNS)	02/93→08/96	KA24-E	Petrol	2389	4	12	152
Maverick (UDS, UNS)	02/93→08/96	TD27	Diesel	2663	4	8	175
Maverick (UDS, UNS)	09/96→04/98	KA-24	Petrol	2389	4	12	152
Maverick (UDS, UNS)	09/96→04/98	TD27E	Diesel	2664	4	8	175
Maverick Closed Off-Road Vehicle (DA)	02/88→03/94	TB42	Petrol	4169	6	12	187
Maverick Closed Off-Road Vehicle (DA)	02/88→03/94	TD42	Diesel	4169	6	12	188
Maverick Pickup (DA)	02/88→03/94	TD42	Diesel	4169	6	12	188
Maverick Platform/Chassis (DA)	02/88→03/94	TD42	Diesel	4169	6	12	188
Maverick Van	06/96→04/98	TD27	Diesel	2663	4	8	175
Maverick Van	06/96→04/98	TD27E	Diesel	2664	4	8	175
Meteor	03/83→08/90	LUG	Petrol	1597	4	8	63
Meteor	09/90→11/93	LJF	Petrol	1598	4	8	63
Meteor Estate (GC)	03/86→09/87	B6 (8 V)	Petrol	1598	4	8	48
Meteor Saloon (GA, GB)	04/82→09/85	E5	Petrol	1490	4	8	40
Meteor Saloon (GC)	10/85→09/87	B6 (8 V)	Petrol	1598	4	8	48
Metrostar	10/00→02/07	LCBD	Petrol	2495	6	24	163
Mondeo Estate (HB, HC, HD)	07/95→12/99	NGA	Petrol	1988	4	16	125
Mondeo Estate (MB)	06/09→01/15	SEBA	Petrol	2261	4	16	143
Mondeo Estate (MB, MC)	03/12→01/15	QXBA	Diesel	1997	4	16	127
Mondeo Estate (MB, MC)	03/12→01/15	QXBB	Diesel	1997	4	16	127
Mondeo Estate (MB, MC)	03/12→01/15	TXBA	Diesel	1997	4	16	129
Mondeo Estate (MB, MC)	03/12→01/15	TXBB	Diesel	1997	4	16	129
Mondeo Estate (MB, MC)	03/12→01/15	UFBA	Diesel	1997	4	16	129
Mondeo Estate (MB, MC)	03/12→01/15	UFBB	Diesel	1997	4	16	129
Mondeo Estate (MD)	09/14→	R9CB	Petrol	1999	4	16	105
Mondeo Estate (MD)	09/14→	R9CF	Petrol	1999	4	16	105
Mondeo Estate (MD)	09/14→	R9CH	Petrol	1999	4	16	105
Mondeo Estate (MD)	09/14→	T8CC	Diesel	1997	4	16	129
Mondeo Estate (MD)	09/14→	TNCD	Petrol	1999	4	16	105

							
Mondeo Estate (MD)	09/14→	TNCF	Petrol	1999	4	16	105
Mondeo Hatchback (HA, HB, HC)	07/95→02/00	NGA	Petrol	1988	4	16	125
Mondeo Hatchback (MA, MB)	03/07→07/10	SEBA	Petrol	2261	4	16	143
Mondeo Hatchback (MA, MB)	03/07→01/15	AZBA	Diesel	1997	4	16	106
Mondeo Hatchback (MA, MB)	03/07→01/15	HUBA	Petrol	2521	5	20	159
Mondeo Hatchback (MA, MB, MC)	07/09→01/15	TXBB	Diesel	1997	4	16	129
Mondeo Hatchback (MA, MB, MC)	07/09→01/15	TXDB	Diesel	1997	4	16	129
Mondeo Hatchback (MA, MB, MC)	03/12→01/15	TNBA	Petrol	1999	4	16	120
Mondeo Hatchback (MD)	09/14→	R9CB	Petrol	1999	4	16	105
Mondeo Hatchback (MD)	09/14→	R9CF	Petrol	1999	4	16	105
Mondeo Hatchback (MD)	09/14→	R9CH	Petrol	1999	4	16	105
Mondeo Hatchback (MD)	09/14→	T8CC	Diesel	1997	4	16	129
Mondeo Hatchback (MD)	09/14→	TNCD	Petrol	1999	4	16	105
Mondeo Hatchback (MD)	09/14→	TNCF	Petrol	1999	4	16	105
Mondeo I (GBP)	02/93→08/96	LIF	Petrol	1597	4	16	62
Mondeo I (GBP)	02/93→08/96	NGA	Petrol	1988	4	16	125
Mondeo I (GBP)	02/93→08/96	RKA	Petrol	1796	4	16	78
Mondeo I (GBP)	06/93→08/96	RFM	Diesel	1753	4	8	87
Mondeo I (GBP)	06/93→08/96	RFN	Diesel	1753	4	8	87
Mondeo I (GBP)	07/94→08/96	LIJ	Petrol	1597	4	16	62
Mondeo I (GBP)	07/94→08/96	RKB	Petrol	1796	4	16	78
Mondeo I (GBP)	07/94→08/96	SEA	Petrol	2544	6	24	163
Mondeo I Saloon (GBP)	02/93→08/96	LIF	Petrol	1597	4	16	62
Mondeo I Saloon (GBP)	02/93→08/96	NGA	Petrol	1988	4	16	125
Mondeo I Saloon (GBP)	02/93→08/96	RKA	Petrol	1796	4	16	78
Mondeo I Saloon (GBP)	06/93→08/96	RFM	Diesel	1753	4	8	87
Mondeo I Saloon (GBP)	06/93→08/96	RFN	Diesel	1753	4	8	87
Mondeo I Saloon (GBP)	01/94→08/96	RKB	Petrol	1796	4	16	78
Mondeo I Saloon (GBP)	07/94→08/96	LIJ	Petrol	1597	4	16	62
Mondeo I Saloon (GBP)	07/94→08/96	SEA	Petrol	2544	6	24	163
Mondeo I Turnier (BNP)	01/93→08/96	NGA	Petrol	1988	4	16	125
Mondeo I Turnier (BNP)	04/93→08/96	LIF	Petrol	1597	4	16	62
Mondeo I Turnier (BNP)	04/93→08/96	RKA	Petrol	1796	4	16	78
Mondeo I Turnier (BNP)	06/93→08/96	RFM	Diesel	1753	4	8	87
Mondeo I Turnier (BNP)	06/93→08/96	RFN	Diesel	1753	4	8	87
Mondeo I Turnier (BNP)	07/94→08/96	LIJ	Petrol	1597	4	16	62
Mondeo I Turnier (BNP)	07/94→08/96	RKB	Petrol	1796	4	16	78
Mondeo I Turnier (BNP)	07/94→08/96	SEA	Petrol	2544	6	24	163
Mondeo II (BAP)	08/96→09/00	LIJ	Petrol	1597	4	16	62
Mondeo II (BAP)	08/96→09/00	NGA	Petrol	1988	4	16	125
Mondeo II (BAP)	08/96→09/00	NGB	Petrol	1988	4	16	125
Mondeo II (BAP)	08/96→09/00	NGC	Petrol	1988	4	16	125
Mondeo II (BAP)	08/96→09/00	NGD	Petrol	1988	4	16	125
Mondeo II (BAP)	08/96→09/00	RFN	Diesel	1753	4	8	87
Mondeo II (BAP)	08/96→09/00	RKB	Petrol	1796	4	16	78
Mondeo II (BAP)	08/96→09/00	RKF	Petrol	1796	4	16	78
Mondeo II (BAP)	08/96→09/00	RKH	Petrol	1796	4	16	78
Mondeo II (BAP)	08/96→09/00	RKJ	Petrol	1796	4	16	78
Mondeo II (BAP)	08/96→09/00	RKK	Petrol	1796	4	16	78
Mondeo II (BAP)	08/96→09/00	SEA	Petrol	2544	6	24	163
Mondeo II (BAP)	05/98→09/00	LIL	Petrol	1597	4	16	62
Mondeo II (BAP)	05/98→09/00	LIN	Petrol	1597	4	16	62
Mondeo II (BAP)	05/98→09/00	LIQ	Petrol	1597	4	16	62
Mondeo II (BAP)	05/99→09/00	SGA	Petrol	2495	6	24	163
Mondeo II (BAP)	06/00→09/00	SEB	Petrol	2495	6	24	163
Mondeo II (BAP)	06/00→09/00	SEC	Petrol	2495	6	24	163
Mondeo II Saloon (BFP)	08/96→09/00	LIJ	Petrol	1597	4	16	62
Mondeo II Saloon (BFP)	08/96→09/00	NGA	Petrol	1988	4	16	125
Mondeo II Saloon (BFP)	08/96→09/00	NGB	Petrol	1988	4	16	125
Mondeo II Saloon (BFP)	08/96→09/00	NGC	Petrol	1988	4	16	125
Mondeo II Saloon (BFP)	08/96→09/00	NGD	Petrol	1988	4	16	125
Mondeo II Saloon (BFP)	08/96→09/00	RFN	Diesel	1753	4	8	87
Mondeo II Saloon (BFP)	08/96→09/00	RKB	Petrol	1796	4	16	78
Mondeo II Saloon (BFP)	08/96→09/00	RKF	Petrol	1796	4	16	78
Mondeo II Saloon (BFP)	08/96→09/00	RKH	Petrol	1796	4	16	78
Mondeo II Saloon (BFP)	08/96→09/00	RKJ	Petrol	1796	4	16	78
Mondeo II Saloon (BFP)	08/96→09/00	RKK	Petrol	1796	4	16	78
Mondeo II Saloon (BFP)	08/96→09/00	SEA	Petrol	2544	6	24	163
Mondeo II Saloon (BFP)	05/98→09/00	LIL	Petrol	1597	4	16	62
Mondeo II Saloon (BFP)	05/98→09/00	LIN	Petrol	1597	4	16	62
Mondeo II Saloon (BFP)	05/98→09/00	LIQ	Petrol	1597	4	16	62
Mondeo II Saloon (BFP)	05/99→09/00	SGA	Petrol	2495	6	24	163
Mondeo II Saloon (BFP)	06/00→09/00	LCBD	Petrol	2495	6	24	163
Mondeo II Saloon (BFP)	06/00→09/00	SEB	Petrol	2495	6	24	163
Mondeo II Saloon (BFP)	06/00→09/00	SEC	Petrol	2495	6	24	163
Mondeo II Turnier (BNP)	08/96→09/00	LIJ	Petrol	1597	4	16	62
Mondeo II Turnier (BNP)	08/96→09/00	NGA	Petrol	1988	4	16	125
Mondeo II Turnier (BNP)	08/96→09/00	NGB	Petrol	1988	4	16	125



CC



9

Mondeo II Turnier (BNP)	08/96→09/00	NGC	Petrol	1988	4	16	125
Mondeo II Turnier (BNP)	08/96→09/00	NGD	Petrol	1988	4	16	125
Mondeo II Turnier (BNP)	08/96→09/00	RFN	Diesel	1753	4	8	87
Mondeo II Turnier (BNP)	08/96→09/00	RKB	Petrol	1796	4	16	78
Mondeo II Turnier (BNP)	08/96→09/00	RKF	Petrol	1796	4	16	78
Mondeo II Turnier (BNP)	08/96→09/00	RKH	Petrol	1796	4	16	78
Mondeo II Turnier (BNP)	08/96→09/00	RKJ	Petrol	1796	4	16	78
Mondeo II Turnier (BNP)	08/96→09/00	RKK	Petrol	1796	4	16	78
Mondeo II Turnier (BNP)	08/96→09/00	SEA	Petrol	2544	6	24	163
Mondeo II Turnier (BNP)	05/98→09/00	LTL	Petrol	1597	4	16	62
Mondeo II Turnier (BNP)	05/98→09/00	LIN	Petrol	1597	4	16	62
Mondeo II Turnier (BNP)	05/98→09/00	LIQ	Petrol	1597	4	16	62
Mondeo II Turnier (BNP)	05/99→09/00	SGA	Petrol	2495	6	24	163
Mondeo II Turnier (BNP)	10/99→09/00	SEB	Petrol	2495	6	24	163
Mondeo II Turnier (BNP)	10/99→09/00	SEC	Petrol	2495	6	24	163
Mondeo III (B5Y)	10/00→03/07	CGBA	Petrol	1798	4	16	77
Mondeo III (B5Y)	10/00→03/07	CGBB	Petrol	1798	4	16	77
Mondeo III (B5Y)	10/00→03/07	CHBA	Petrol	1798	4	16	77
Mondeo III (B5Y)	10/00→03/07	CHBB	Petrol	1798	4	16	77
Mondeo III (B5Y)	10/00→03/07	CJBA	Petrol	1999	4	16	105
Mondeo III (B5Y)	10/00→03/07	CJBB	Petrol	1999	4	16	105
Mondeo III (B5Y)	10/00→03/07	D5BA	Diesel	1998	4	16	102
Mondeo III (B5Y)	10/00→03/07	D6BA	Diesel	1998	4	16	102
Mondeo III (B5Y)	10/00→03/07	HJBA	Diesel	1998	4	16	102
Mondeo III (B5Y)	10/00→03/07	HJBB	Diesel	1998	4	16	102
Mondeo III (B5Y)	10/00→03/07	HJBC	Diesel	1998	4	16	102
Mondeo III (B5Y)	10/00→03/07	LCBD	Petrol	2495	6	24	163
Mondeo III (B5Y)	10/00→03/07	SDBA	Diesel	1998	4	16	102
Mondeo III (B5Y)	10/01→03/07	FMBA	Diesel	1998	4	16	102
Mondeo III (B5Y)	10/01→03/07	N7BA	Diesel	1998	4	16	102
Mondeo III (B5Y)	04/02→03/07	MEBA	Petrol	2967	6	24	183
Mondeo III (B5Y)	06/03→03/07	CFBA	Petrol	1798	4	16	77
Mondeo III (B5Y)	09/04→03/07	QJBA	Diesel	2198	4	16	137
Mondeo III (B5Y)	09/04→03/07	QJBB	Diesel	2198	4	16	137
Mondeo III (B5Y)	09/04→03/07	QJBC	Diesel	2198	4	16	137
Mondeo III (B5Y)	09/04→03/07	QJBD	Diesel	2198	4	16	137
Mondeo III (B5Y)	09/04→03/07	REBA	Petrol	2967	6	24	183
Mondeo III Saloon (B4Y)	10/00→03/07	CGBA	Petrol	1798	4	16	77
Mondeo III Saloon (B4Y)	10/00→03/07	CGBB	Petrol	1798	4	16	77
Mondeo III Saloon (B4Y)	10/00→03/07	CHBA	Petrol	1798	4	16	77
Mondeo III Saloon (B4Y)	10/00→03/07	CHBB	Petrol	1798	4	16	77
Mondeo III Saloon (B4Y)	10/00→03/07	CJBA	Petrol	1999	4	16	105
Mondeo III Saloon (B4Y)	10/00→03/07	CJBB	Petrol	1999	4	16	105
Mondeo III Saloon (B4Y)	10/00→03/07	D5BA	Diesel	1998	4	16	102
Mondeo III Saloon (B4Y)	10/00→03/07	D6BA	Diesel	1998	4	16	102
Mondeo III Saloon (B4Y)	10/00→03/07	HJBA	Diesel	1998	4	16	102
Mondeo III Saloon (B4Y)	10/00→03/07	HJBB	Diesel	1998	4	16	102
Mondeo III Saloon (B4Y)	10/00→03/07	HJBC	Diesel	1998	4	16	102
Mondeo III Saloon (B4Y)	10/00→03/07	LCBD	Petrol	2495	6	24	163
Mondeo III Saloon (B4Y)	10/00→03/07	SDBA	Diesel	1998	4	16	102
Mondeo III Saloon (B4Y)	10/01→03/07	FMBA	Diesel	1998	4	16	102
Mondeo III Saloon (B4Y)	10/01→03/07	N7BA	Diesel	1998	4	16	102
Mondeo III Saloon (B4Y)	04/02→03/07	MEBA	Petrol	2967	6	24	183
Mondeo III Saloon (B4Y)	06/03→03/07	CFBA	Petrol	1798	4	16	77
Mondeo III Saloon (B4Y)	09/04→03/07	QJBA	Diesel	2198	4	16	137
Mondeo III Saloon (B4Y)	09/04→03/07	QJBB	Diesel	2198	4	16	137
Mondeo III Saloon (B4Y)	09/04→03/07	QJBC	Diesel	2198	4	16	137
Mondeo III Saloon (B4Y)	09/04→03/07	QJBD	Diesel	2198	4	16	137
Mondeo III Saloon (B4Y)	09/04→03/07	REBA	Petrol	2967	6	24	183
Mondeo III Turnier (BWY)	10/00→03/07	CGBA	Petrol	1798	4	16	77
Mondeo III Turnier (BWY)	10/00→03/07	CGBB	Petrol	1798	4	16	77
Mondeo III Turnier (BWY)	10/00→03/07	CHBA	Petrol	1798	4	16	77
Mondeo III Turnier (BWY)	10/00→03/07	CHBB	Petrol	1798	4	16	77
Mondeo III Turnier (BWY)	10/00→03/07	CJBA	Petrol	1999	4	16	105
Mondeo III Turnier (BWY)	10/00→03/07	CJBB	Petrol	1999	4	16	105
Mondeo III Turnier (BWY)	10/00→03/07	D5BA	Diesel	1998	4	16	102
Mondeo III Turnier (BWY)	10/00→03/07	D6BA	Diesel	1998	4	16	102
Mondeo III Turnier (BWY)	10/00→03/07	HJBA	Diesel	1998	4	16	102
Mondeo III Turnier (BWY)	10/00→03/07	HJBB	Diesel	1998	4	16	102
Mondeo III Turnier (BWY)	10/00→03/07	HJBC	Diesel	1998	4	16	102
Mondeo III Turnier (BWY)	10/00→03/07	LCBD	Petrol	2495	6	24	163
Mondeo III Turnier (BWY)	10/00→03/07	SDBA	Diesel	1998	4	16	102
Mondeo III Turnier (BWY)	10/01→03/07	FMBA	Diesel	1998	4	16	102
Mondeo III Turnier (BWY)	10/01→03/07	N7BA	Diesel	1998	4	16	102
Mondeo III Turnier (BWY)	04/02→03/07	MEBA	Petrol	2967	6	24	183
Mondeo III Turnier (BWY)	06/03→03/07	CFBA	Petrol	1798	4	16	77
Mondeo III Turnier (BWY)	09/04→03/07	QJBA	Diesel	2198	4	16	137
Mondeo III Turnier (BWY)	09/04→03/07	QJBB	Diesel	2198	4	16	137



CC



9

Mondeo III Turnier (BWY)	09/04→03/07	QJBC	Diesel	2198	4	16	137
Mondeo III Turnier (BWY)	09/04→03/07	QJBD	Diesel	2198	4	16	137
Mondeo III Turnier (BWY)	09/04→03/07	REBA	Petrol	2967	6	24	183
Mondeo IV (BA7)	03/07→01/15	AOBA	Petrol	1999	4	16	105
Mondeo IV (BA7)	03/07→01/15	AOBC	Petrol	1999	4	16	105
Mondeo IV (BA7)	03/07→01/15	AZBA	Diesel	1997	4	16	106
Mondeo IV (BA7)	03/07→01/15	AZBC	Diesel	1997	4	16	106
Mondeo IV (BA7)	03/07→01/15	FFBA	Diesel	1753	4	8	81
Mondeo IV (BA7)	03/07→01/15	HUBA	Petrol	2521	5	20	159
Mondeo IV (BA7)	03/07→01/15	PNBA	Petrol	1596	4	16	58
Mondeo IV (BA7)	03/07→01/15	QXBA	Diesel	1997	4	16	106
Mondeo IV (BA7)	03/07→01/15	QXBB	Diesel	1997	4	16	106
Mondeo IV (BA7)	03/07→01/15	RHBA	Petrol	1596	4	16	58
Mondeo IV (BA7)	03/07→01/15	TBBA	Petrol	1999	4	16	105
Mondeo IV (BA7)	03/07→01/15	UFBA	Diesel	1997	4	16	129
Mondeo IV (BA7)	03/07→01/15	UFBB	Diesel	1997	4	16	129
Mondeo IV (BA7)	03/07→01/15	UKBA	Diesel	1997	4	16	129
Mondeo IV (BA7)	03/07→01/15	UKBB	Diesel	1997	4	16	129
Mondeo IV (BA7)	06/07→01/15	KHBA	Diesel	1753	4	8	81
Mondeo IV (BA7)	06/07→01/15	QYBA	Diesel	1753	4	8	73
Mondeo IV (BA7)	07/07→01/15	SEBA	Petrol	2261	4	16	143
Mondeo IV (BA7)	11/07→01/15	KLBA	Diesel	1997	4	16	106
Mondeo IV (BA7)	11/07→01/15	LPBA	Diesel	1997	4	16	106
Mondeo IV (BA7)	11/07→01/15	TYBA	Diesel	1997	4	16	129
Mondeo IV (BA7)	03/08→10/10	Q4BA	Diesel	2179	4	16	136
Mondeo IV (BA7)	03/09→01/15	TBBB	Petrol	1999	4	16	105
Mondeo IV (BA7)	03/10→01/15	TNBA	Petrol	1999	4	16	105
Mondeo IV (BA7)	03/10→01/15	TXBA	Diesel	1997	4	16	129
Mondeo IV (BA7)	03/10→01/15	TXBB	Diesel	1997	4	16	129
Mondeo IV (BA7)	07/10→01/15	KGBA	Petrol	1596	4	16	58
Mondeo IV (BA7)	07/10→01/15	KNBA	Diesel	2179	4	16	136
Mondeo IV (BA7)	07/10→01/15	TPBA	Petrol	1999	4	16	105
Mondeo IV (BA7)	02/11→01/15	JTBA	Petrol	1596	4	16	59
Mondeo IV (BA7)	02/11→01/15	JTBB	Petrol	1596	4	16	59
Mondeo IV (BA7)	02/11→01/15	T1BA	Diesel	1560	4	8	68
Mondeo IV (BA7)	02/11→01/15	T1BB	Diesel	1560	4	8	68
Mondeo IV (BA7)	02/11→01/15	T1BC	Diesel	1560	4	8	68
Mondeo IV Saloon (BA7)	03/07→01/15	AOBA	Petrol	1999	4	16	105
Mondeo IV Saloon (BA7)	03/07→01/15	AOBC	Petrol	1999	4	16	105
Mondeo IV Saloon (BA7)	03/07→01/15	AZBA	Diesel	1997	4	16	106
Mondeo IV Saloon (BA7)	03/07→01/15	FFBA	Diesel	1753	4	8	81
Mondeo IV Saloon (BA7)	03/07→01/15	HUBA	Petrol	2521	5	20	159
Mondeo IV Saloon (BA7)	03/07→01/15	PNBA	Petrol	1596	4	16	58
Mondeo IV Saloon (BA7)	03/07→01/15	QXBA	Diesel	1997	4	16	106
Mondeo IV Saloon (BA7)	03/07→01/15	QXBB	Diesel	1997	4	16	106
Mondeo IV Saloon (BA7)	03/07→01/15	RHBA	Petrol	1596	4	16	58
Mondeo IV Saloon (BA7)	03/07→01/15	TBBA	Petrol	1999	4	16	105
Mondeo IV Saloon (BA7)	03/07→01/15	UFBA	Diesel	1997	4	16	129
Mondeo IV Saloon (BA7)	03/07→01/15	UFBB	Diesel	1997	4	16	129
Mondeo IV Saloon (BA7)	06/07→01/15	KHBA	Diesel	1753	4	8	81
Mondeo IV Saloon (BA7)	06/07→01/15	QYBA	Diesel	1753	4	8	73
Mondeo IV Saloon (BA7)	07/07→01/15	SEBA	Petrol	2261	4	16	143
Mondeo IV Saloon (BA7)	11/07→01/15	KLBA	Diesel	1997	4	16	106
Mondeo IV Saloon (BA7)	11/07→01/15	LPBA	Diesel	1997	4	16	106
Mondeo IV Saloon (BA7)	11/07→01/15	TYBA	Diesel	1997	4	16	129
Mondeo IV Saloon (BA7)	03/08→10/10	Q4BA	Diesel	2179	4	16	136
Mondeo IV Saloon (BA7)	08/08→01/15	AZBC	Diesel	1997	4	16	106
Mondeo IV Saloon (BA7)	08/08→01/15	UKBA	Diesel	1997	4	16	129
Mondeo IV Saloon (BA7)	08/08→01/15	UKBB	Diesel	1997	4	16	129
Mondeo IV Saloon (BA7)	03/09→01/15	TBBB	Petrol	1999	4	16	105
Mondeo IV Saloon (BA7)	03/10→01/15	KGBA	Petrol	1596	4	16	58
Mondeo IV Saloon (BA7)	03/10→01/15	TXBA	Diesel	1997	4	16	129
Mondeo IV Saloon (BA7)	03/10→01/15	TXBB	Diesel	1997	4	16	129
Mondeo IV Saloon (BA7)	10/10→01/15	KNBA	Diesel	2179	4	16	136
Mondeo IV Saloon (BA7)	11/10→01/15	JTBA	Petrol	1596	4	16	59
Mondeo IV Saloon (BA7)	11/10→01/15	JTBB	Petrol	1596	4	16	59
Mondeo IV Saloon (BA7)	12/10→01/15	T1BA	Diesel	1560	4	8	68
Mondeo IV Saloon (BA7)	12/10→01/15	T1BB	Diesel	1560	4	8	68
Mondeo IV Saloon (BA7)	12/10→01/15	T1BC	Diesel	1560	4	8	68
Mondeo IV Turnier (BA7)	03/07→12/10	PNBA	Petrol	1596	4	16	58
Mondeo IV Turnier (BA7)	03/07→12/12	AZBA	Diesel	1997	4	16	106
Mondeo IV Turnier (BA7)	03/07→12/12	FFBA	Diesel	1753	4	8	81
Mondeo IV Turnier (BA7)	03/07→12/12	HUBA	Petrol	2521	5	20	159
Mondeo IV Turnier (BA7)	03/07→12/12	RHBA	Petrol	1596	4	16	58
Mondeo IV Turnier (BA7)	03/07→01/15	AOBA	Petrol	1999	4	16	105
Mondeo IV Turnier (BA7)	03/07→01/15	AOBC	Petrol	1999	4	16	105
Mondeo IV Turnier (BA7)	03/07→01/15	AZBC	Diesel	1997	4	16	106
Mondeo IV Turnier (BA7)	03/07→01/15	QXBA	Diesel	1997	4	16	106



CC



9

Mondeo IV Turnier (BA7)	03/07→01/15	QXBB	Diesel	1997	4	16	106
Mondeo IV Turnier (BA7)	03/07→01/15	TBBA	Petrol	1999	4	16	105
Mondeo IV Turnier (BA7)	03/07→01/15	UFBA	Diesel	1997	4	16	129
Mondeo IV Turnier (BA7)	03/07→01/15	UFBB	Diesel	1997	4	16	129
Mondeo IV Turnier (BA7)	03/07→01/15	UKBA	Diesel	1997	4	16	129
Mondeo IV Turnier (BA7)	03/07→01/15	UKBB	Diesel	1997	4	16	129
Mondeo IV Turnier (BA7)	06/07→12/12	KHBA	Diesel	1753	4	8	81
Mondeo IV Turnier (BA7)	06/07→12/12	QYBA	Diesel	1753	4	8	73
Mondeo IV Turnier (BA7)	07/07→01/15	SEBA	Petrol	2261	4	16	143
Mondeo IV Turnier (BA7)	11/07→01/15	KLBA	Diesel	1997	4	16	106
Mondeo IV Turnier (BA7)	11/07→01/15	LPBA	Diesel	1997	4	16	106
Mondeo IV Turnier (BA7)	11/07→01/15	TYBA	Diesel	1997	4	16	129
Mondeo IV Turnier (BA7)	03/08→10/10	Q4BA	Diesel	2179	4	16	136
Mondeo IV Turnier (BA7)	03/09→01/15	TBBB	Petrol	1999	4	16	105
Mondeo IV Turnier (BA7)	03/10→01/15	TNBA	Petrol	1999	4	16	105
Mondeo IV Turnier (BA7)	03/10→01/15	TXBA	Diesel	1997	4	16	129
Mondeo IV Turnier (BA7)	03/10→01/15	TXBB	Diesel	1997	4	16	129
Mondeo IV Turnier (BA7)	07/10→01/15	KGBA	Petrol	1596	4	16	58
Mondeo IV Turnier (BA7)	07/10→01/15	KNBA	Diesel	2179	4	16	136
Mondeo IV Turnier (BA7)	07/10→01/15	TPBA	Petrol	1999	4	16	105
Mondeo IV Turnier (BA7)	02/11→01/15	JTBA	Petrol	1596	4	16	59
Mondeo IV Turnier (BA7)	02/11→01/15	JTBB	Petrol	1596	4	16	59
Mondeo IV Turnier (BA7)	02/11→01/15	T1BA	Diesel	1560	4	8	68
Mondeo IV Turnier (BA7)	02/11→01/15	T1BB	Diesel	1560	4	8	68
Mondeo IV Turnier (BA7)	02/11→01/15	T1BC	Diesel	1560	4	8	68
Mondeo V Hatchback	09/14→	NGCA	Diesel	1560	4	8	68
Mondeo V Hatchback	09/14→	R9CB	Petrol	1999	4	16	105
Mondeo V Hatchback	09/14→	R9CF	Petrol	1999	4	16	105
Mondeo V Hatchback	09/14→	R9CH	Petrol	1999	4	16	105
Mondeo V Hatchback	09/14→	T7CE	Diesel	1997	4	16	129
Mondeo V Hatchback	09/14→	T8CC	Diesel	1997	4	16	129
Mondeo V Hatchback	09/14→	TNCD	Petrol	1999	4	16	105
Mondeo V Hatchback	09/14→	TNCF	Petrol	1999	4	16	105
Mondeo V Hatchback	09/14→	U3CA	Diesel	1560	4	8	68
Mondeo V Hatchback	09/14→	UNCA	Petrol	1499	4	16	43
Mondeo V Hatchback	09/14→	UNCB	Petrol	1499	4	16	43
Mondeo V Hatchback	09/14→	UNCE	Petrol	1499	4	16	43
Mondeo V Hatchback	09/14→	UNCF	Petrol	1499	4	16	43
Mondeo V Hatchback	02/15→	M1CA	Petrol	998	3	12	3
Mondeo V Hatchback	02/15→	M1CB	Petrol	998	3	12	3
Mondeo V Hatchback	03/15→	T9CA	Diesel	1997	4	16	129
Mondeo V Hatchback	03/15→	UGCC	Diesel	1499	4	8	36
Mondeo V Hatchback	03/15→	XUCA	Diesel	1499	4	8	36
Mondeo V Saloon	01/13→	R9CB	Petrol	1999	4	16	105
Mondeo V Saloon	01/13→	R9CF	Petrol	1999	4	16	105
Mondeo V Saloon	01/13→	R9CH	Petrol	1999	4	16	105
Mondeo V Saloon	09/14→	T7CE	Diesel	1997	4	16	129
Mondeo V Saloon	09/14→	UNCA	Petrol	1499	4	16	43
Mondeo V Saloon	09/14→	UNCB	Petrol	1499	4	16	43
Mondeo V Saloon	09/14→	UNCE	Petrol	1499	4	16	43
Mondeo V Saloon	09/14→	UNCF	Petrol	1499	4	16	43
Mondeo V Saloon	10/14→	UACA	Petrol	1999	4	16	105
Mondeo V Saloon	02/15→	M1CA	Petrol	998	3	12	3
Mondeo V Saloon	02/15→	M1CB	Petrol	998	3	12	3
Mondeo V Saloon	03/15→	UGCC	Diesel	1499	4	8	36
Mondeo V Saloon	03/15→	XUCA	Diesel	1499	4	8	36
Mondeo V Saloon	05/15→	S7CB	Petrol	2489	4	16	164
Mondeo V Saloon	05/15→	T8CC	Diesel	1997	4	16	129
Mondeo V Saloon	05/15→	T9CA	Diesel	1997	4	16	129
Mondeo V Saloon	05/15→	TNCC	Petrol	1999	4	16	105
Mondeo V Saloon	05/15→	TNCD	Petrol	1999	4	16	105
Mondeo V Saloon	05/15→	TNCF	Petrol	1999	4	16	105
Mondeo V Turnier	09/14→	NGCA	Diesel	1560	4	8	68
Mondeo V Turnier	09/14→	R9CB	Petrol	1999	4	16	105
Mondeo V Turnier	09/14→	R9CF	Petrol	1999	4	16	105
Mondeo V Turnier	09/14→	R9CH	Petrol	1999	4	16	105
Mondeo V Turnier	09/14→	T7CE	Diesel	1997	4	16	129
Mondeo V Turnier	09/14→	T8CC	Diesel	1997	4	16	129
Mondeo V Turnier	09/14→	TNCD	Petrol	1999	4	16	105
Mondeo V Turnier	09/14→	TNCF	Petrol	1999	4	16	105
Mondeo V Turnier	09/14→	U3CA	Diesel	1560	4	8	68
Mondeo V Turnier	09/14→	UNCA	Petrol	1499	4	16	43
Mondeo V Turnier	09/14→	UNCB	Petrol	1499	4	16	43
Mondeo V Turnier	09/14→	UNCE	Petrol	1499	4	16	43
Mondeo V Turnier	09/14→	UNCF	Petrol	1499	4	16	43
Mondeo V Turnier	02/15→	M1CA	Petrol	998	3	12	3
Mondeo V Turnier	02/15→	M1CB	Petrol	998	3	12	3
Mondeo V Turnier	03/15→	T9CA	Diesel	1997	4	16	129



CC



9

Mondeo V Turnier	03/15→	UGCC	Diesel	1499	4	8	36
Mondeo V Turnier	03/15→	XUCA	Diesel	1499	4	8	36
Mondeo Saloon (HA, HB)	07/95→02/00	NGA	Petrol	1988	4	16	125
Mondeo Saloon (HE)	02/00→04/01	SEA	Petrol	2544	6	24	163
Mondeo Saloon (MA, MB)	03/07→01/15	AZBA	Diesel	1997	4	16	106
Mondeo Saloon (MA, MB)	03/07→01/15	SEBA	Petrol	2261	4	16	143
Mustang Coupe	01/15→	N38H	Petrol	2261	4	16	144
Mustang Coupe	01/15→	N48H	Petrol	2261	4	16	144
Orion I (AFD)	07/83→03/86	JPA	Petrol	1296	4	8	27
Orion I (AFD)	07/83→03/86	LP1	Petrol	1597	4	8	63
Orion I (AFD)	07/83→03/86	LPA	Petrol	1597	4	8	63
Orion I (AFD)	07/83→03/86	LRI	Petrol	1597	4	8	63
Orion I (AFD)	07/83→03/86	LRA	Petrol	1597	4	8	63
Orion I (AFD)	02/84→03/86	LTA	Diesel	1608	4	8	66
Orion I (AFF)	12/85→01/89	LTC	Diesel	1608	4	8	66
Orion II (AFF)	12/85→07/90	FUA	Petrol	1392	4	8	31
Orion II (AFF)	12/85→07/90	JBB	Petrol	1297	4	8	24
Orion II (AFF)	12/85→07/90	JLA	Petrol	1297	4	8	22
Orion II (AFF)	12/85→07/90	JLB	Petrol	1297	4	8	25
Orion II (AFF)	12/85→07/90	LUC	Petrol	1597	4	8	63
Orion II (AFF)	01/86→07/90	FUC	Petrol	1392	4	8	31
Orion II (AFF)	03/86→07/90	FUAA	Petrol	1392	4	8	31
Orion II (AFF)	03/86→07/90	L4B	Petrol	1598	4	8	63
Orion II (AFF)	03/86→07/90	LRB	Petrol	1597	4	8	63
Orion II (AFF)	03/86→07/90	LUG	Petrol	1597	4	8	63
Orion II (AFF)	04/86→12/88	LP2	Petrol	1597	4	8	63
Orion II (AFF)	11/86→07/88	JPA	Petrol	1296	4	8	27
Orion II (AFF)	02/87→07/90	F6B	Petrol	1392	4	8	31
Orion II (AFF)	02/87→07/90	F6D	Petrol	1392	4	8	31
Orion II (AFF)	01/89→07/90	RTA	Diesel	1753	4	8	88
Orion II (AFF)	01/89→07/90	RTB	Diesel	1753	4	8	88
Orion II (AFF)	08/89→07/90	LJB	Petrol	1597	4	8	63
Orion III (GAL)	07/90→09/92	LJF	Petrol	1598	4	8	63
Orion III (GAL)	07/90→12/92	LUJ	Petrol	1598	4	8	63
Orion III (GAL)	07/90→12/92	LUK	Petrol	1598	4	8	63
Orion III (GAL)	07/90→12/93	F6F	Petrol	1392	4	8	31
Orion III (GAL)	07/90→12/93	F6G	Petrol	1392	4	8	31
Orion III (GAL)	07/90→12/93	FUH	Petrol	1392	4	8	31
Orion III (GAL)	07/90→12/93	J4B	Petrol	1299	4	8	22
Orion III (GAL)	07/90→12/93	J6A	Petrol	1299	4	8	22
Orion III (GAL)	07/90→10/94	CHT 1600	Petrol	1555	4	8	54
Orion III (GAL)	11/90→12/93	RTE	Diesel	1753	4	8	89
Orion III (GAL)	11/90→12/93	RTF	Diesel	1753	4	8	89
Orion III (GAL)	11/90→12/93	RTH	Diesel	1753	4	8	90
Orion III (GAL)	01/92→12/93	RQB	Petrol	1796	4	16	78
Orion III (GAL)	02/92→12/93	RDA	Petrol	1796	4	16	78
Orion III (GAL)	03/92→12/93	RFD	Diesel	1753	4	8	87
Orion III (GAL)	03/92→12/93	RFK	Diesel	1753	4	8	87
Orion III (GAL)	07/92→12/93	LIE	Petrol	1597	4	16	62
Orion III (GAL)	07/92→12/93	LIK	Petrol	1597	4	16	62
P 100 I	04/82→09/87	LCR	Petrol	1598	4	8	64
P 100 II	10/87→12/92	NAE	Petrol	1993	4	8	122
P 100 II	10/87→12/92	RFA	Diesel	1753	4	8	86
Pampa	07/83→12/93	CHT 1600	Petrol	1555	4	8	54
Probe (ST, SU, SV)	07/94→01/98	KL-ZE	Petrol	2497	6	24	162
Probe II (ECP)	10/93→03/98	FS	Petrol	1991	4	16	116
Probe II (ECP)	10/93→03/98	KL	Petrol	2497	6	24	161
Puma (EC_)	03/97→06/02	MHA	Petrol	1679	4	16	72
Puma (EC_)	03/97→06/02	MHB	Petrol	1679	4	16	72
Puma (EC_)	11/97→10/00	FHD	Petrol	1388	4	16	30
Puma (EC_)	11/97→10/00	FHF	Petrol	1388	4	16	30
Puma (EC_)	08/00→06/02	LIW	Petrol	1596	4	16	56
Ranger	11/11→	GBVAF	Petrol	2488	4	16	158
Ranger	11/11→	GBVAK	Petrol	2488	4	16	158
Ranger	11/11→	GBVAL	Petrol	2488	4	16	158
Ranger (ER, EQ)	06/99→02/02	RKA	Petrol	1796	4	16	78
Ranger (ER, EQ)	10/99→04/02	WL	Diesel	2500	4	12	169
Ranger (ER, EQ)	10/99→06/06	WL-T	Diesel	2500	4	12	169
Ranger (TKE)	04/11→	GBVAJPF	Diesel	2198	4	16	133
Ranger (TKE)	04/11→	GBVAJQJ	Diesel	2198	4	16	133
Ranger (TKE)	04/11→	GBVAJQW	Diesel	2198	4	16	133
Ranger (TKE)	04/11→	SAFA	Diesel	3198	5	20	185
Ranger (TKE)	11/11→	GBVAF	Petrol	2488	4	16	158
Ranger (TKE)	11/11→	GBVAK	Petrol	2488	4	16	158
Ranger (TKE)	11/11→	GBVAL	Petrol	2488	4	16	158
Ranger (TU_)	04/02→09/05	WL	Diesel	2500	4	12	169
Ranger Pickup (PJ)	11/06→03/09	WLAT (16 V)	Diesel	2500	4	16	170
Ranger Pickup (PK)	03/09→11/11	WLAT (16 V)	Diesel	2500	4	16	170











CC



9

Ranger Pickup (PX)	11/11→	GBVAF	Petrol	2488	4	16	158
Ranger Pickup (PX)	11/11→	GBVAJQJ	Diesel	2198	4	16	133
Ranger Pickup (PX)	11/11→	GBVAK	Petrol	2488	4	16	158
Ranger Pickup (PX)	11/11→	GBVAL	Petrol	2488	4	16	158
Ranger Pickup (PX)	11/11→	P5-AT	Diesel	3198	5	20	185
Ranger Pickup (PX)	11/11→	SAFA	Diesel	3198	5	20	185
Ranger Platform/Chassis (PJ)	11/06→03/09	WLAT (16 V)	Diesel	2500	4	16	170
Ranger Platform/Chassis (PK)	03/09→11/11	WLAT (16 V)	Diesel	2500	4	16	170
Ranger Platform/Chassis (PX)	11/11→	GBVAF	Petrol	2488	4	16	158
Ranger Platform/Chassis (PX)	11/11→	GBVAJQJ	Diesel	2198	4	16	133
Ranger Platform/Chassis (PX)	11/11→	GBVAK	Petrol	2488	4	16	158
Ranger Platform/Chassis (PX)	11/11→	GBVAL	Petrol	2488	4	16	158
Ranger Platform/Chassis (PX)	11/11→	SAFA	Diesel	3198	5	20	185
Scorpio I (GAE, GGE)	04/85→11/86	PRE	Petrol	2792	6	12	180
Scorpio I (GAE, GGE)	04/85→08/89	N8D	Petrol	1993	4	8	124
Scorpio I (GAE, GGE)	04/85→08/89	NEL	Petrol	1993	4	8	122
Scorpio I (GAE, GGE)	04/85→02/92	REC	Petrol	1796	4	8	85
Scorpio I (GAE, GGE)	04/85→09/94	NRA	Petrol	1993	4	8	122
Scorpio I (GAE, GGE)	04/85→09/94	NRI	Petrol	1993	4	8	122
Scorpio I (GAE, GGE)	10/85→12/90	NRC	Petrol	1993	4	8	122
Scorpio I (GAE, GGE)	12/85→02/92	STR	Diesel	2498	4	8	166
Scorpio I (GAE, GGE)	09/86→09/88	ARC	Petrol	2394	6	12	150
Scorpio I (GAE, GGE)	09/86→09/94	BRC	Petrol	2933	6	12	181
Scorpio I (GAE, GGE)	09/86→09/94	BRD	Petrol	2933	6	12	181
Scorpio I (GAE, GGE)	09/86→09/94	BRE	Petrol	2933	6	12	181
Scorpio I (GAE, GGE)	09/86→09/94	BRF	Petrol	2933	6	12	181
Scorpio I (GAE, GGE)	06/88→07/93	SFA	Diesel	2498	4	8	165
Scorpio I (GAE, GGE)	06/88→07/93	SFB	Diesel	2498	4	8	165
Scorpio I (GAE, GGE)	10/88→09/94	ARD	Petrol	2394	6	12	150
Scorpio I (GAE, GGE)	11/88→10/92	N8A	Petrol	1998	4	8	123
Scorpio I (GAE, GGE)	05/89→09/94	N9D	Petrol	1998	4	8	123
Scorpio I (GAE, GGE)	04/91→09/94	BOA	Petrol	2933	6	24	182
Scorpio I (GAE, GGE)	11/92→09/94	N9F	Petrol	1998	4	8	123
Scorpio I Saloon (GGE)	01/86→10/88	REC	Petrol	1796	4	8	85
Scorpio I Saloon (GGE)	09/86→12/94	BRD	Petrol	2933	6	12	181
Scorpio I Saloon (GGE)	09/86→12/94	BRE	Petrol	2933	6	12	181
Scorpio I Saloon (GGE)	09/86→12/94	BRF	Petrol	2933	6	12	181
Scorpio I Saloon (GGE)	06/88→07/93	SFA	Diesel	2498	4	8	165
Scorpio I Saloon (GGE)	06/88→07/93	SFB	Diesel	2498	4	8	165
Scorpio I Saloon (GGE)	10/88→10/94	ARD	Petrol	2394	6	12	150
Scorpio I Saloon (GGE)	05/89→02/92	N9B	Petrol	1998	4	8	123
Scorpio I Saloon (GGE)	05/89→09/94	N9D	Petrol	1998	4	8	123
Scorpio I Saloon (GGE)	06/89→03/93	N8B	Petrol	1998	4	8	123
Scorpio I Saloon (GGE)	12/89→12/94	STR	Diesel	2498	4	8	166
Scorpio I Saloon (GGE)	04/91→09/94	BOA	Petrol	2933	6	24	182
Scorpio I Saloon (GGE)	02/92→09/94	N9F	Petrol	1998	4	8	123
Scorpio I Saloon (GGE)	11/92→09/93	NRA	Petrol	1993	4	8	122
Scorpio I Turnier (GGE)	05/88→09/94	BRD	Petrol	2933	6	12	181
Scorpio I Turnier (GGE)	05/88→09/94	BRE	Petrol	2933	6	12	181
Scorpio I Turnier (GGE)	05/88→09/94	BRF	Petrol	2933	6	12	181
Scorpio I Turnier (GGE)	10/90→08/92	STR	Diesel	2498	4	8	166
Scorpio I Turnier (GGE)	10/90→10/92	N9A	Petrol	1998	4	8	124
Scorpio I Turnier (GGE)	09/91→07/93	SFA	Diesel	2498	4	8	165
Scorpio I Turnier (GGE)	09/91→07/93	SFB	Diesel	2498	4	8	165
Scorpio I Turnier (GGE)	09/91→09/94	ARD	Petrol	2394	6	12	150
Scorpio I Turnier (GGE)	09/91→09/94	N9D	Petrol	1998	4	8	123
Scorpio I Turnier (GGE)	09/91→09/94	N9F	Petrol	1998	4	8	123
Scorpio I Turnier (GGE)	08/93→09/94	BOA	Petrol	2933	6	24	182
Scorpio II (GFR, GGR)	10/94→08/98	BOB	Petrol	2933	6	24	182
Scorpio II (GFR, GGR)	10/94→08/98	N3A	Petrol	1998	4	16	121
Scorpio II (GFR, GGR)	10/94→08/98	NSD	Petrol	1998	4	8	123
Scorpio II (GFR, GGR)	02/95→08/98	BRG	Petrol	2933	6	12	181
Scorpio II (GFR, GGR)	06/96→08/98	Y5A	Petrol	2295	4	16	141
Scorpio II Turnier (GNR, GGR)	10/94→08/98	BOB	Petrol	2933	6	24	182
Scorpio II Turnier (GNR, GGR)	10/94→08/98	N3A	Petrol	1998	4	16	121
Scorpio II Turnier (GNR, GGR)	10/94→08/98	NSD	Petrol	1998	4	8	123
Scorpio II Turnier (GNR, GGR)	02/95→08/98	BRG	Petrol	2933	6	12	181
Scorpio II Turnier (GNR, GGR)	06/96→08/98	Y5A	Petrol	2295	4	16	141
Sierra (GBG, GB4)	01/87→05/88	R2A	Petrol	1796	4	8	83
Sierra (GBG, GB4)	01/87→09/89	RED	Petrol	1796	4	8	85
Sierra (GBG, GB4)	01/87→09/89	YTR	Diesel	2304	4	8	146
Sierra (GBG, GB4)	01/87→09/89	YTT	Diesel	2304	4	8	146
Sierra (GBG, GB4)	01/87→12/89	NE5	Petrol	1993	4	8	122
Sierra (GBG, GB4)	01/87→12/89	NEJ	Petrol	1993	4	8	122
Sierra (GBG, GB4)	01/87→02/93	EV 30 H	Petrol	2994	6	12	184
Sierra (GBG, GB4)	01/87→02/93	LSE	Petrol	1597	4	8	64
Sierra (GBG, GB4)	01/87→02/93	N4A	Petrol	1993	4	8	122
Sierra (GBG, GB4)	01/87→02/93	N4B	Petrol	1993	4	8	122

							
Sierra (GBG, GB4)	01/87→02/93	N4I	Petrol	1993	4	8	122
Sierra (GBG, GB4)	01/87→02/93	N8C	Petrol	1993	4	8	123
Sierra (GBG, GB4)	01/87→02/93	NES	Petrol	1993	4	8	101
Sierra (GBG, GB4)	08/87→02/93	PR8	Petrol	2792	6	12	180
Sierra (GBG, GB4)	10/87→09/89	REF	Petrol	1796	4	8	85
Sierra (GBG, GB4)	01/88→02/93	LSF	Petrol	1597	4	8	64
Sierra (GBG, GB4)	05/88→02/93	R2C	Petrol	1769	4	8	84
Sierra (GBG, GB4)	05/88→02/93	R6A	Petrol	1769	4	8	84
Sierra (GBG, GB4)	08/88→02/93	B4B	Petrol	2936	6	12	181
Sierra (GBG, GB4)	08/88→02/93	B4C	Petrol	2936	6	12	181
Sierra (GBG, GB4)	08/88→02/93	RFA	Diesel	1753	4	8	86
Sierra (GBG, GB4)	08/88→02/93	RFB	Diesel	1753	4	8	86
Sierra (GBG, GB4)	08/88→02/93	RFL	Diesel	1753	4	8	86
Sierra (GBG, GB4)	07/89→12/92	N8A	Petrol	1998	4	8	123
Sierra (GBG, GB4)	10/89→02/93	L6B	Petrol	1598	4	8	63
Sierra (GBG, GB4)	01/90→02/93	N9A	Petrol	1998	4	8	124
Sierra (GBG, GB4)	01/90→02/93	N9C	Petrol	1998	4	8	123
Sierra (GBG, GB4)	12/91→02/93	N9E	Petrol	1998	4	8	123
Sierra Hatchback (GBC)	08/82→10/84	NYT	Petrol	1999	6	12	126
Sierra Hatchback (GBC)	08/82→12/86	JCT	Petrol	1294	4	8	25
Sierra Hatchback (GBC)	08/82→12/86	LCS	Petrol	1593	4	8	65
Sierra Hatchback (GBC)	08/82→12/86	LCT	Petrol	1593	4	8	65
Sierra Hatchback (GBC)	08/82→12/86	LSD	Petrol	1597	4	8	65
Sierra Hatchback (GBC)	08/82→12/86	NET	Petrol	1993	4	8	101
Sierra Hatchback (GBC)	08/82→12/86	PR5	Petrol	2792	6	12	180
Sierra Hatchback (GBC)	08/82→12/86	PR6	Petrol	2792	6	12	180
Sierra Hatchback (GBC)	08/82→12/86	PRT	Petrol	2792	6	12	180
Sierra Hatchback (GBC)	08/82→12/86	YTT	Diesel	2304	4	8	146
Sierra Hatchback (GBC)	08/82→12/86	YYT	Petrol	2294	6	12	145
Sierra Hatchback (GBC)	10/82→02/87	LSDA	Petrol	1597	4	8	60
Sierra Hatchback (GBC)	10/84→12/86	REB	Petrol	1796	4	8	85
Sierra Hatchback (GBC)	03/85→12/86	NR2	Petrol	1993	4	8	122
Sierra Hatchback (GBC)	03/85→12/86	NRB	Petrol	1993	4	8	122
Sierra Hatchback (GBC)	10/85→12/86	NRD	Petrol	1993	4	8	122
Sierra Hatchback (GBC, GBG)	01/87→05/88	R2A	Petrol	1796	4	8	83
Sierra Hatchback (GBC, GBG)	01/87→05/88	RED	Petrol	1796	4	8	85
Sierra Hatchback (GBC, GBG)	01/87→09/89	PRG	Petrol	2792	6	12	180
Sierra Hatchback (GBC, GBG)	01/87→09/89	YTR	Diesel	2304	4	8	146
Sierra Hatchback (GBC, GBG)	01/87→02/93	LSE	Petrol	1597	4	8	64
Sierra Hatchback (GBC, GBG)	01/87→02/93	N4A	Petrol	1993	4	8	122
Sierra Hatchback (GBC, GBG)	01/87→02/93	N4B	Petrol	1993	4	8	122
Sierra Hatchback (GBC, GBG)	01/87→02/93	N4I	Petrol	1993	4	8	122
Sierra Hatchback (GBC, GBG)	01/87→02/93	N8C	Petrol	1993	4	8	123
Sierra Hatchback (GBC, GBG)	01/87→02/93	NES	Petrol	1993	4	8	122
Sierra Hatchback (GBC, GBG)	01/87→02/93	NEJ	Petrol	1993	4	8	122
Sierra Hatchback (GBC, GBG)	01/87→02/93	NES	Petrol	1993	4	8	101
Sierra Hatchback (GBC, GBG)	01/87→02/93	PR7	Petrol	2792	6	12	180
Sierra Hatchback (GBC, GBG)	01/87→02/93	PR8	Petrol	2792	6	12	180
Sierra Hatchback (GBC, GBG)	10/87→05/88	REF	Petrol	1796	4	8	85
Sierra Hatchback (GBC, GBG)	01/88→02/93	LSF	Petrol	1597	4	8	64
Sierra Hatchback (GBC, GBG)	05/88→02/93	R2C	Petrol	1769	4	8	84
Sierra Hatchback (GBC, GBG)	05/88→02/93	R6A	Petrol	1769	4	8	84
Sierra Hatchback (GBC, GBG)	08/88→02/93	B4A	Petrol	2936	6	12	181
Sierra Hatchback (GBC, GBG)	08/88→02/93	B4B	Petrol	2936	6	12	181
Sierra Hatchback (GBC, GBG)	08/88→02/93	B4C	Petrol	2936	6	12	181
Sierra Hatchback (GBC, GBG)	08/88→02/93	RFA	Diesel	1753	4	8	86
Sierra Hatchback (GBC, GBG)	08/88→02/93	RFB	Diesel	1753	4	8	86
Sierra Hatchback (GBC, GBG)	08/88→02/93	RFL	Diesel	1753	4	8	86
Sierra Hatchback (GBC, GBG)	06/89→02/93	N8A	Petrol	1998	4	8	123
Sierra Hatchback (GBC, GBG)	06/89→02/93	N9B	Petrol	1998	4	8	123
Sierra Hatchback (GBC, GBG)	06/89→03/93	N9C	Petrol	1998	4	8	123
Sierra Hatchback (GBC, GBG)	10/89→02/93	L6B	Petrol	1598	4	8	63
Sierra Hatchback (GBC, GBG)	12/91→02/93	N9E	Petrol	1998	4	8	123
Sierra Turnier (BNC)	08/82→10/84	NYT	Petrol	1999	6	12	126
Sierra Turnier (BNC)	08/82→12/86	LCS	Petrol	1593	4	8	65
Sierra Turnier (BNC)	08/82→12/86	LCT	Petrol	1593	4	8	65
Sierra Turnier (BNC)	08/82→12/86	LSD	Petrol	1597	4	8	65
Sierra Turnier (BNC)	08/82→12/86	NET	Petrol	1993	4	8	101
Sierra Turnier (BNC)	08/82→12/86	PR5	Petrol	2792	6	12	180
Sierra Turnier (BNC)	08/82→12/86	PR6	Petrol	2792	6	12	180
Sierra Turnier (BNC)	08/82→12/86	YTT	Diesel	2304	4	8	146
Sierra Turnier (BNC)	08/82→12/86	YYT	Petrol	2294	6	12	145
Sierra Turnier (BNC)	10/84→12/86	REB	Petrol	1796	4	8	85
Sierra Turnier (BNC)	03/85→12/86	NR2	Petrol	1993	4	8	122
Sierra Turnier (BNC)	03/85→12/86	NRB	Petrol	1993	4	8	122
Sierra Turnier (BNC)	10/85→12/86	NRD	Petrol	1993	4	8	122
Sierra Turnier (BNG)	01/87→05/88	R2A	Petrol	1796	4	8	83
Sierra Turnier (BNG)	01/87→05/88	RED	Petrol	1796	4	8	85



CC



9

Sierra Turnier (BNG)	01/87→08/88	PRG	Petrol	2792	6	12	180
Sierra Turnier (BNG)	01/87→02/93	LSE	Petrol	1597	4	8	64
Sierra Turnier (BNG)	01/87→02/93	N4A	Petrol	1993	4	8	122
Sierra Turnier (BNG)	01/87→02/93	N4B	Petrol	1993	4	8	122
Sierra Turnier (BNG)	01/87→02/93	N4I	Petrol	1993	4	8	122
Sierra Turnier (BNG)	01/87→02/93	N8C	Petrol	1993	4	8	123
Sierra Turnier (BNG)	01/87→02/93	NE5	Petrol	1993	4	8	122
Sierra Turnier (BNG)	01/87→02/93	NEJ	Petrol	1993	4	8	122
Sierra Turnier (BNG)	01/87→02/93	NES	Petrol	1993	4	8	101
Sierra Turnier (BNG)	01/87→02/93	PR7	Petrol	2792	6	12	180
Sierra Turnier (BNG)	01/87→02/93	PR8	Petrol	2792	6	12	180
Sierra Turnier (BNG)	01/87→02/93	YTR	Diesel	2304	4	8	146
Sierra Turnier (BNG)	10/87→05/88	REF	Petrol	1796	4	8	85
Sierra Turnier (BNG)	01/88→02/93	LSF	Petrol	1597	4	8	64
Sierra Turnier (BNG)	05/88→02/93	R2C	Petrol	1769	4	8	84
Sierra Turnier (BNG)	05/88→02/93	R6A	Petrol	1769	4	8	84
Sierra Turnier (BNG)	08/88→02/93	B4B	Petrol	2936	6	12	181
Sierra Turnier (BNG)	08/88→02/93	B4C	Petrol	2936	6	12	181
Sierra Turnier (BNG)	08/88→02/93	RFA	Diesel	1753	4	8	86
Sierra Turnier (BNG)	08/88→02/93	RFB	Diesel	1753	4	8	86
Sierra Turnier (BNG)	08/88→02/93	RFL	Diesel	1753	4	8	86
Sierra Turnier (BNG)	10/88→09/91	N8A	Petrol	1998	4	8	123
Sierra Turnier (BNG)	05/89→02/93	N9C	Petrol	1998	4	8	123
Sierra Turnier (BNG)	10/89→02/93	L6B	Petrol	1598	4	8	63
Sierra Turnier (BNG)	12/91→02/93	N9E	Petrol	1998	4	8	123
S-Max	01/15→	R9CD	Petrol	1999	4	16	105
S-Max	01/15→	R9CI	Petrol	1999	4	16	105
S-Max	01/15→	T7CI	Diesel	1997	4	16	129
S-Max	01/15→	T7CJ	Diesel	1997	4	16	129
S-Max	01/15→	T7CK	Diesel	1997	4	16	129
S-Max	01/15→	T7CL	Diesel	1997	4	16	129
S-Max	01/15→	T8CG	Diesel	1997	4	16	129
S-Max	01/15→	T8CH	Diesel	1997	4	16	129
S-Max	01/15→	T8CI	Diesel	1997	4	16	129
S-Max	01/15→	T8CJ	Diesel	1997	4	16	129
S-Max	01/15→	T9CB	Diesel	1997	4	16	129
S-Max	01/15→	T9CC	Diesel	1997	4	16	129
S-Max	01/15→	UFCA	Diesel	1997	4	16	129
S-Max	01/15→	UFCB	Diesel	1997	4	16	129
S-Max	01/15→	UNCI	Petrol	1499	4	16	39
S-Max	01/15→	UNCJ	Petrol	1499	4	16	39
S-Max	01/15→	UNCK	Petrol	1498	4	16	39
S-Max (WA6)	05/06→12/14	AOWA	Petrol	1999	4	16	105
S-Max (WA6)	05/06→12/14	AOWB	Petrol	1999	4	16	105
S-Max (WA6)	05/06→12/14	AZWA	Diesel	1997	4	16	106
S-Max (WA6)	05/06→12/14	AZWC	Diesel	1997	4	16	106
S-Max (WA6)	05/06→12/14	HUWA	Petrol	2521	5	20	159
S-Max (WA6)	05/06→12/14	QXWA	Diesel	1997	4	16	106
S-Max (WA6)	05/06→12/14	QXWB	Diesel	1997	4	16	106
S-Max (WA6)	05/06→12/14	QXWC	Diesel	1997	4	16	106
S-Max (WA6)	05/06→12/14	QYWA	Diesel	1753	4	8	73
S-Max (WA6)	05/06→12/14	TBWA	Petrol	1999	4	16	105
S-Max (WA6)	05/06→12/14	TBWB	Petrol	1999	4	16	105
S-Max (WA6)	05/06→12/14	UFWA	Diesel	1997	4	16	129
S-Max (WA6)	05/06→12/14	UKWA	Diesel	1997	4	16	129
S-Max (WA6)	01/07→12/10	FFWA	Diesel	1753	4	8	73
S-Max (WA6)	07/07→12/14	SEWA	Petrol	2261	4	16	143
S-Max (WA6)	11/07→12/14	KLWA	Diesel	1997	4	16	106
S-Max (WA6)	11/07→12/14	TYWA	Diesel	1997	4	16	129
S-Max (WA6)	03/08→12/12	Q4WA	Diesel	2179	4	16	136
S-Max (WA6)	03/10→12/14	TNWA	Petrol	1999	4	16	105
S-Max (WA6)	03/10→12/14	TXWA	Diesel	1997	4	16	129
S-Max (WA6)	07/10→12/14	KNWA	Diesel	2179	4	16	136
S-Max (WA6)	07/10→12/14	TNWB	Petrol	1999	4	16	105
S-Max (WA6)	07/10→12/14	TPWA	Petrol	1999	4	16	105
S-Max (WA6)	02/11→12/14	JTWA	Petrol	1596	4	16	59
S-Max (WA6)	02/11→12/14	JTWB	Petrol	1596	4	16	59
S-Max (WA6)	02/11→12/14	TIWA	Diesel	1560	4	8	68
S-Max (WA6)	02/11→12/14	TIWB	Diesel	1560	4	8	68
Spectron Box	01/83→05/84	NA	Petrol	1586	4	8	67
Spectron Box	05/84→12/89	FB (12 V)	Petrol	1789	4	12	80
Spectron Box	03/86→04/90	FE	Petrol	1998	4	8	113
Spectron Pickup (SD_)	09/89→05/97	FEY9	Petrol	1998	4	12	115
Street Ka (RL2)	05/03→07/05	CDRA	Petrol	1599	4	8	53
Street Ka (RL2)	05/03→07/05	CDRB	Petrol	1599	4	8	53
Taurus	01/89→10/94	NER	Petrol	1993	4	8	122
Taurus (GBFK)	08/70→02/76	LCJ	Petrol	1593	4	8	64
Taurus (GBFK)	08/70→02/76	LE	Petrol	1593	4	8	64



CC



9

Taunus (GBFK)	08/70→02/76	NY	Petrol	1998	6	12	126
Taunus (GBFK)	01/74→05/75	LAD	Petrol	1593	4	8	45
Taunus (GBTK)	01/70→05/75	JAC	Petrol	1297	4	8	23
Taunus (GBTK)	01/70→05/75	LCJ	Petrol	1593	4	8	64
Taunus (GBTK)	08/70→02/76	LE	Petrol	1593	4	8	64
Taunus (GBTK)	08/70→02/76	NY	Petrol	1998	6	12	126
Taunus (GBTK)	08/73→02/76	NEG	Petrol	1993	4	8	122
Taunus (GBTK)	01/74→05/75	LAD	Petrol	1593	4	8	45
Taunus (GBTS, GBFS, CBTS)	05/75→07/79	JAC	Petrol	1297	4	8	23
Taunus (GBTS, GBFS, CBTS)	05/75→07/79	LAD	Petrol	1593	4	8	45
Taunus (GBTS, GBFS, CBTS)	05/75→07/79	LCJ	Petrol	1593	4	8	64
Taunus (GBTS, GBFS, CBTS)	05/75→07/79	NYR	Petrol	1999	6	12	126
Taunus (GBTS, GBFS, CBTS)	05/75→07/79	YYF	Petrol	2294	6	12	145
Taunus (GBTS, GBFS, CBTS)	12/75→07/76	OHC LC	Petrol	1994	4	8	122
Taunus (GBTS, GBFS, CBTS)	01/76→07/79	JCC	Petrol	1294	4	8	25
Taunus (GBTS, GBFS, CBTS)	08/76→07/79	LE	Petrol	1593	4	8	64
Taunus (GBTS, GBFS, CBTS)	08/76→07/79	NEG	Petrol	1993	4	8	122
Taunus (GBTS, GBFS, CBTS)	08/76→07/79	OHC TL 20 H	Petrol	1993	4	8	122
Taunus '80 Turnier (GBNS)	07/79→07/82	LAR	Petrol	1593	4	8	65
Taunus '80 Turnier (GBNS)	07/79→07/82	LCJ	Petrol	1593	4	8	64
Taunus '80 Turnier (GBNS)	07/79→07/82	NER	Petrol	1993	4	8	101
Taunus '80 Turnier (GBNS)	07/79→07/82	NWR	Petrol	1999	6	12	126
Taunus '80 Turnier (GBNS)	07/79→07/82	YYR	Petrol	2294	6	12	145
Taunus 12M (11G)	08/66→06/71	TV 15 H	Petrol	1498	4	8	41
Taunus 12M (12G)	08/66→06/71	KL 13 L	Petrol	1298	4	8	19
Taunus 15M (21G)	08/66→06/71	TV 15 H	Petrol	1498	4	8	41
Taunus 15M (22G)	08/66→06/71	TV 15 H	Petrol	1498	4	8	41
Taunus 15M (28G)	08/66→06/71	TV 15 HC	Petrol	1498	4	8	41
Taunus 15M (28G)	01/68→06/71	TV 15 H	Petrol	1498	4	8	41
Taunus 15M (28G)	01/68→06/71	TV 17 H	Petrol	1699	4	8	71
Taunus 15M (28G)	07/68→06/71	TV 17 HC	Petrol	1699	4	8	71
Taunus 15M (29G)	08/66→06/71	TV 15 HC	Petrol	1498	4	8	41
Taunus 15M (29G)	01/68→06/71	TV 15 H	Petrol	1498	4	8	41
Taunus 15M Coupe (23G)	08/66→06/71	TV 15 HC	Petrol	1498	4	8	41
Taunus 15M Coupe (23G)	01/68→06/71	TV 15 H	Petrol	1498	4	8	41
Taunus 15M Coupe (23G)	01/68→06/71	TV 17 H	Petrol	1699	4	8	71
Taunus 15M Coupe (23G)	07/68→06/71	TV 17 HC	Petrol	1699	4	8	71
Taunus 15M Turnier (25G)	09/66→07/71	TV 15 H	Petrol	1498	4	8	41
Taunus 17M (31F)	07/67→04/74	EX	Petrol	1498	4	8	42
Taunus 17M (31F)	07/67→04/74	MY	Petrol	1699	4	8	71
Taunus 17M (31F)	12/67→04/74	NX	Petrol	1998	6	12	126
Taunus 17M (31F)	12/67→04/74	NY	Petrol	1998	6	12	126
Taunus 17M (32F)	07/67→04/74	EX	Petrol	1498	4	8	42
Taunus 17M (32F)	07/67→04/74	MY	Petrol	1699	4	8	71
Taunus 17M (32F)	12/67→04/74	NY	Petrol	1998	6	12	126
Taunus 17M Coupe (33F)	07/67→04/74	MY	Petrol	1699	4	8	71
Taunus 17M Coupe (33F)	12/67→04/74	NY	Petrol	1998	6	12	126
Taunus 17M Turnier (35F)	09/67→04/74	EX	Petrol	1498	4	8	42
Taunus 17M Turnier (35F)	01/68→04/74	MY	Petrol	1699	4	8	71
Taunus 17M Turnier (36F)	01/68→04/74	NY	Petrol	1998	6	12	126
Taunus 17M Turnier (36F)	08/68→04/74	MY	Petrol	1699	4	8	71
Taunus 20M (41F)	07/67→04/74	NX	Petrol	1998	6	12	126
Taunus 20M (41F)	07/67→04/74	NY	Petrol	1998	6	12	126
Taunus 20M (41F)	07/67→04/74	YY	Petrol	2294	6	12	147
Taunus 20M (41F)	09/67→08/71	TV 26 H	Petrol	2523	6	12	167
Taunus 20M (42F)	07/67→04/74	NX	Petrol	1998	6	12	126
Taunus 20M (42F)	07/67→04/74	NY	Petrol	1998	6	12	126
Taunus 20M (42F)	07/67→04/74	YY	Petrol	2294	6	12	147
Taunus 20M (42F)	09/67→08/71	TV 26 H	Petrol	2523	6	12	167
Taunus 20M Coupe (43F)	07/67→04/74	YY	Petrol	2294	6	12	147
Taunus 20M Coupe (43F)	09/67→08/71	TV 26 H	Petrol	2523	6	12	167
Taunus 20M Turnier	11/64→10/68	NX	Petrol	1998	6	12	126
Taunus 20M Turnier (46F)	07/67→04/74	NY	Petrol	1998	6	12	126
Taunus 20M Turnier (46F)	09/67→04/74	NX	Petrol	1998	6	12	126
Taunus 20M Turnier (46F)	01/68→04/74	YY	Petrol	2294	6	12	147
Taunus 20M XL (51F)	07/67→04/74	NY	Petrol	1998	6	12	126
Taunus 20M XL (51F)	07/67→04/74	YY	Petrol	2294	6	12	147
Taunus 20M XL (51F)	01/68→04/74	NX	Petrol	1998	6	12	126
Taunus 20M XL (52F)	07/67→04/74	NY	Petrol	1998	6	12	126
Taunus 20M XL (52F)	07/67→04/74	YY	Petrol	2294	6	12	147
Taunus 20M XL (52F)	01/68→04/74	NX	Petrol	1998	6	12	126
Taunus 20M XL Coupe (53F)	07/67→04/74	NY	Petrol	1998	6	12	126
Taunus 20M XL Coupe (53F)	07/67→04/74	YY	Petrol	2294	6	12	147
Taunus 26M XL (52F)	10/69→04/74	TV 26 H	Petrol	2523	6	12	167
Taunus 26M XL Coupe (53F)	10/69→04/74	TV 26 H	Petrol	2523	6	12	167
Taunus '80 (GBS, GBNS)	07/79→07/82	JCC	Petrol	1294	4	8	25
Taunus '80 (GBS, GBNS)	07/79→07/82	LAR	Petrol	1593	4	8	65
Taunus '80 (GBS, GBNS)	07/79→07/82	LCJ	Petrol	1593	4	8	64



CC



9

Taunus '80 (GBS, GBNS)	07/79→07/82	LE	Petrol	1593	4	8	64
Taunus '80 (GBS, GBNS)	07/79→07/82	NER	Petrol	1993	4	8	101
Taunus '80 (GBS, GBNS)	07/79→07/82	NWR	Petrol	1999	6	12	126
Taunus '80 (GBS, GBNS)	07/79→07/82	YJR	Petrol	2294	6	12	145
Taunus Coupe	01/76→07/79	JAC	Petrol	1297	4	8	23
Taunus Coupe	01/76→08/79	JCC	Petrol	1294	4	8	25
Taunus Coupe	09/76→08/79	LAD	Petrol	1593	4	8	45
Taunus Coupe	09/76→08/79	YJF	Petrol	2294	6	12	145
Taunus Coupe (GBCK)	08/70→02/76	LE	Petrol	1593	4	8	64
Taunus Coupe (GBCK)	08/70→02/76	NY	Petrol	1998	6	12	126
Taunus Coupe (GBCK)	08/71→02/76	YY	Petrol	2294	6	12	147
Taunus Coupe (GBCK)	08/73→02/76	NEE	Petrol	1993	4	8	122
Taunus Turnier (GBNK)	08/70→02/76	LCJ	Petrol	1593	4	8	64
Taunus Turnier (GBNK)	01/74→05/75	LAD	Petrol	1593	4	8	45
Taunus Turnier (GBNS)	05/75→07/79	JAC	Petrol	1297	4	8	23
Taunus Turnier (GBNS)	05/75→07/79	LAD	Petrol	1593	4	8	45
Taunus Turnier (GBNS)	05/75→07/79	LCJ	Petrol	1593	4	8	64
Taunus Turnier (GBNS)	05/75→07/79	NYR	Petrol	1999	6	12	126
Taunus Turnier (GBNS)	05/75→07/79	YJF	Petrol	2294	6	12	145
Taunus Turnier (GBNS)	12/75→07/76	OHC LC	Petrol	1994	4	8	122
Taunus Turnier (GBNS)	08/76→07/79	NEG	Petrol	1993	4	8	122
Taunus Turnier (GBNS)	08/76→07/79	OHC TL 20 H	Petrol	1993	4	8	122
Taunus Turnier (GBNS)	09/76→08/79	LE	Petrol	1593	4	8	64
Telstar	01/93→12/96	KF	Petrol	1995	6	24	118
Telstar	08/93→05/00	FS83	Petrol	1991	4	16	116
Telstar Coupe (GE_)	08/91→10/95	FS83	Petrol	1991	4	16	116
Telstar Hatchback	08/91→07/93	FS83	Petrol	1991	4	16	116
Telstar Hatchback (AR)	05/83→08/85	FE	Petrol	1998	4	8	113
Telstar Hatchback (AS)	09/85→10/87	FE	Petrol	1998	4	8	113
Telstar Hatchback (AS)	02/86→10/87	FET	Petrol	1998	4	8	114
Telstar Hatchback (AT)	11/87→09/89	F2 (12 V)	Petrol	2184	4	12	134
Telstar Hatchback (AT)	11/87→09/89	F2T	Petrol	2184	4	12	135
Telstar Hatchback (AT)	11/87→09/89	FE	Petrol	1998	4	8	113
Telstar Hatchback (AV)	01/90→01/92	F2 (12 V)	Petrol	2184	4	12	134
Telstar Hatchback (AV)	01/90→01/92	F2T	Petrol	2184	4	12	135
Telstar Hatchback (AX)	01/92→08/94	FS	Petrol	1991	4	16	116
Telstar Hatchback (AX)	01/92→08/94	KL-ZE	Petrol	2497	6	24	162
Telstar Hatchback (AY)	10/94→11/96	FS	Petrol	1991	4	16	116
Telstar Hatchback (AY)	10/94→11/96	KL-ZE	Petrol	2497	6	24	162
Telstar Saloon	08/91→10/98	FS83	Petrol	1991	4	16	116
Telstar Saloon (AR)	05/83→08/85	FE	Petrol	1998	4	8	113
Telstar Saloon (AS)	09/85→10/87	FE	Petrol	1998	4	8	113
Telstar Saloon (AT)	11/87→09/89	F2 (12 V)	Petrol	2184	4	12	134
Telstar Saloon (AT)	11/87→09/89	FE	Petrol	1998	4	8	113
Telstar Saloon (AT)	11/87→07/91	F8 (8 V)	Petrol	1789	4	8	79
Telstar Saloon (AX)	01/92→08/94	FS	Petrol	1991	4	16	116
Telstar Saloon (AX)	01/92→10/95	KL-ZE	Petrol	2497	6	24	162
Telstar Saloon (AY)	10/94→11/96	FS	Petrol	1991	4	16	116
Territory (SZ)	05/11→	276DT	Diesel	2720	6	24	174
Tierra (CA_)	05/98→09/03	FS2C	Petrol	1991	4	16	116
Tourneo Connect	06/02→12/13	BHPA	Diesel	1753	4	8	73
Tourneo Connect	06/02→12/13	EYPA	Petrol	1796	4	16	78
Tourneo Connect	06/02→12/13	EYPC	Petrol	1796	4	16	78
Tourneo Connect	06/02→12/13	EYPD	Petrol	1796	4	16	78
Tourneo Connect	06/02→12/13	HCPA	Diesel	1753	4	8	73
Tourneo Connect	06/02→12/13	HCPB	Diesel	1753	4	8	73
Tourneo Connect	06/02→12/13	P7PA	Diesel	1753	4	8	73
Tourneo Connect	06/02→12/13	P7PB	Diesel	1753	4	8	73
Tourneo Connect	06/02→12/13	P9PA	Diesel	1753	4	8	73
Tourneo Connect	06/02→12/13	P9PB	Diesel	1753	4	8	73
Tourneo Connect	06/02→12/13	P9PC	Diesel	1753	4	8	73
Tourneo Connect	06/02→12/13	P9PD	Diesel	1753	4	8	73
Tourneo Connect	06/02→12/13	R2PA	Diesel	1753	4	8	73
Tourneo Connect	06/02→12/13	R3PA	Diesel	1753	4	8	73
Tourneo Connect	06/02→12/13	RWPE	Diesel	1753	4	8	73
Tourneo Connect	06/02→12/13	RWPF	Diesel	1753	4	8	73
Tourneo Connect	08/06→12/13	RWPA	Diesel	1753	4	8	73
Tourneo Connect	08/06→12/13	RWPC	Diesel	1753	4	8	73
Tourneo Connect	08/06→12/13	RWPD	Diesel	1753	4	8	73
Tourneo Connect / Grand Tourneo Connect Kombi	09/13→	T1GA	Diesel	1560	4	8	68
Tourneo Connect / Grand Tourneo Connect Kombi	09/13→	TZGA	Diesel	1560	4	8	68
Tourneo Connect / Grand Tourneo Connect Kombi	09/13→	TZGB	Diesel	1560	4	8	68
Tourneo Connect / Grand Tourneo Connect Kombi	09/13→	UBGA	Diesel	1560	4	8	68
Tourneo Connect / Grand Tourneo Connect Kombi	11/13→	JQGA	Petrol	1596	4	16	59
Tourneo Connect / Grand Tourneo Connect Kombi	11/13→	M2GA	Petrol	998	3	12	3
Tourneo Connect / Grand Tourneo Connect Kombi	11/13→	M2GB	Petrol	998	3	12	3
Tourneo Connect / Grand Tourneo Connect Kombi	05/15→	XUGA	Diesel	1499	4	8	36
Tourneo Connect / Grand Tourneo Connect Kombi	05/15→	XVGA	Diesel	1499	4	8	36



CC



9

Tourneo Connect / Grand Tourneo Connect Kombi	05/15→	XVGB	Diesel	1499	4	8	36
Tourneo Connect / Grand Tourneo Connect Kombi	05/15→	XVGC	Diesel	1499	4	8	36
Tourneo Connect / Grand Tourneo Connect Kombi	05/15→	XWGA	Diesel	1499	4	8	36
Tourneo Connect / Grand Tourneo Connect Kombi	05/15→	XWGB	Diesel	1499	4	8	36
Tourneo Courier Kombi	02/14→	SFCA	Petrol	998	3	12	3
Tourneo Courier Kombi	02/14→	SFCB	Petrol	998	3	12	3
Tourneo Courier Kombi	02/14→	SFCC	Petrol	998	3	12	3
Tourneo Courier Kombi	02/14→	SFCD	Petrol	998	3	12	3
Tourneo Courier Kombi	02/14→	T3CA	Diesel	1560	4	8	68
Tourneo Courier Kombi	02/14→	T3CB	Diesel	1560	4	8	68
Tourneo Courier Kombi	02/14→	T3CC	Diesel	1560	4	8	68
Tourneo Courier Kombi	02/14→	UGCA	Diesel	1499	4	8	36
Tourneo Courier Kombi	02/14→	UGCB	Diesel	1499	4	8	36
Tourneo Courier Kombi	02/14→	XUCC	Diesel	1499	4	8	36
Tourneo Courier Kombi	02/14→	XUCD	Diesel	1499	4	8	36
Tourneo Courier Kombi	05/15→	XVCA	Diesel	1499	4	8	36
Tourneo Courier Kombi	05/15→	XVCB	Diesel	1499	4	8	36
Tourneo Courier Kombi	05/15→	XVCC	Diesel	1499	4	8	36
Tourneo Custom Bus	04/12→	CVFF	Diesel	2198	4	16	133
Tourneo Custom Bus	04/12→	CYFA	Diesel	2198	4	16	133
Tourneo Custom Bus	04/12→	CYFF	Diesel	2198	4	16	133
Tourneo Custom Bus	04/12→	DRFA	Diesel	2198	4	16	133
Tourneo Custom Bus	04/12→	DRFF	Diesel	2198	4	16	133
Tourneo Custom Bus	04/12→	DRFG	Diesel	2198	4	16	133
Tourneo Custom Bus	05/14→	CVFF	Diesel	2198	4	16	133
Tracer	06/94→05/00	B6GP	Petrol	1598	4	16	47
Transit Box	04/06→08/14	GZFA	Petrol	2261	4	16	143
Transit Box	04/06→08/14	GZFB	Petrol	2261	4	16	143
Transit Box	04/06→08/14	GZFC	Petrol	2261	4	16	143
Transit Box	04/06→08/14	H9FD	Diesel	2402	4	16	151
Transit Box	04/06→08/14	JXFA	Diesel	2402	4	16	151
Transit Box	04/06→08/14	JXFC	Diesel	2402	4	16	151
Transit Box	04/06→08/14	P8FA	Diesel	2198	4	16	133
Transit Box	04/06→08/14	P8FB	Diesel	2198	4	16	133
Transit Box	04/06→08/14	PHFA	Diesel	2402	4	16	151
Transit Box	04/06→08/14	PHFC	Diesel	2402	4	16	151
Transit Box	04/06→08/14	QVFA	Diesel	2198	4	16	133
Transit Box	04/06→08/14	QWFA	Diesel	2198	4	16	133
Transit Box	11/06→08/14	H9FB	Diesel	2402	4	16	151
Transit Box	09/07→08/14	SAFA	Diesel	3198	5	20	185
Transit Box	09/07→08/14	SAFB	Diesel	3199	5	20	185
Transit Box	10/07→08/14	PGFA	Diesel	2198	4	16	133
Transit Box	10/07→08/14	PGFB	Diesel	2198	4	16	133
Transit Box	10/07→08/14	UHFA	Diesel	2198	4	16	133
Transit Box	10/07→08/14	UHFB	Diesel	2198	4	16	133
Transit Box	10/07→08/14	UHFC	Diesel	2198	4	16	133
Transit Box	10/08→08/14	SRFA	Diesel	2198	4	16	133
Transit Box	10/08→08/14	SRFB	Diesel	2198	4	16	133
Transit Box	10/08→08/14	SRFC	Diesel	2198	4	16	133
Transit Box	10/08→08/14	SRFD	Diesel	2198	4	16	133
Transit Box	10/08→08/14	SRFE	Diesel	2198	4	16	133
Transit Box	10/11→08/14	CYFA	Diesel	2198	4	16	133
Transit Box	10/11→08/14	CYFB	Diesel	2198	4	16	133
Transit Box	10/11→08/14	CYFC	Diesel	2198	4	16	133
Transit Box	10/11→08/14	CYFD	Diesel	2198	4	16	133
Transit Box	10/11→08/14	CYRA	Diesel	2198	4	16	133
Transit Box	10/11→08/14	CYRB	Diesel	2198	4	16	133
Transit Box	10/11→08/14	CYRC	Diesel	2198	4	16	133
Transit Box	10/11→08/14	DRFA	Diesel	2198	4	16	133
Transit Box	10/11→08/14	DRFB	Diesel	2198	4	16	133
Transit Box	10/11→08/14	DRFC	Diesel	2198	4	16	133
Transit Box	10/11→08/14	DRFD	Diesel	2198	4	16	133
Transit Box	10/11→08/14	DRFE	Diesel	2198	4	16	133
Transit Box	10/11→08/14	DRRA	Diesel	2198	4	16	133
Transit Box	10/11→08/14	DRRB	Diesel	2198	4	16	133
Transit Box	10/11→08/14	DRRC	Diesel	2198	4	16	133
Transit Box	10/11→08/14	USRA	Diesel	2198	4	16	133
Transit Box	10/11→08/14	USRB	Diesel	2198	4	16	133
Transit Box	10/11→	CVRA	Diesel	2198	4	16	133
Transit Box	10/11→	CVRB	Diesel	2198	4	16	133
Transit Box	10/11→	CVRC	Diesel	2198	4	16	133
Transit Box	08/13→	CV24	Diesel	2198	4	16	133
Transit Box	08/13→	CVF5	Diesel	2198	4	16	133
Transit Box	08/13→	CVR5	Diesel	2198	4	16	133
Transit Box	08/13→	CY14	Diesel	2198	4	16	133
Transit Box	08/13→	CY24	Diesel	2198	4	16	133
Transit Box	08/13→	CYF5	Diesel	2198	4	16	133
Transit Box	08/13→	CYFG	Diesel	2198	4	16	133









CC



9

Transit Box	08/13→	CYR5	Diesel	2198	4	16	133
Transit Box	08/13→	DRF5	Diesel	2198	4	16	133
Transit Box	08/13→	DRFF	Diesel	2198	4	16	133
Transit Box	08/13→	DRFG	Diesel	2198	4	16	133
Transit Box	08/13→	DRR5	Diesel	2198	4	16	133
Transit Box	08/13→	UHR5	Diesel	2198	4	16	133
Transit Box	08/13→	USF6	Diesel	2198	4	16	133
Transit Box	08/13→	USR6	Diesel	2198	4	16	133
Transit Box	08/13→	UYR6	Diesel	2198	4	16	133
Transit Box (72E, 71E)	01/71→05/73	EX	Petrol	1498	4	8	42
Transit Box (72E, 71E)	04/71→03/78	EY	Petrol	1699	4	8	71
Transit Box (81E)	11/65→07/73	EY	Petrol	1699	4	8	71
Transit Box (E_)	05/91→06/94	4BC	Diesel	2496	4	8	154
Transit Box (E_)	05/91→06/94	4CC	Diesel	2496	4	8	154
Transit Box (E_)	05/91→06/94	4DA	Diesel	2496	4	8	154
Transit Box (E_)	05/91→06/94	4EA	Diesel	2496	4	8	154
Transit Box (E_)	05/91→03/00	4FA	Diesel	2496	4	8	154
Transit Box (E_)	09/91→06/94	NBA	Petrol	1993	4	8	122
Transit Box (E_)	09/91→06/94	NCA	Petrol	1994	4	8	122
Transit Box (E_)	10/92→03/00	4GA	Diesel	2496	4	8	154
Transit Box (E_)	06/94→03/00	4EB	Diesel	2496	4	8	154
Transit Box (E_)	06/94→03/00	4EC	Diesel	2496	4	8	154
Transit Box (E_)	06/94→03/00	4FB	Diesel	2496	4	8	154
Transit Box (E_)	06/94→03/00	4FC	Diesel	2496	4	8	154
Transit Box (E_)	06/94→03/00	4FD	Diesel	2496	4	8	154
Transit Box (E_)	06/94→03/00	4GB	Diesel	2496	4	8	154
Transit Box (E_)	06/94→03/00	4GC	Diesel	2496	4	8	154
Transit Box (E_)	06/94→03/00	4GD	Diesel	2496	4	8	154
Transit Box (E_)	06/94→03/00	4GE	Diesel	2496	4	8	154
Transit Box (E_)	06/94→03/00	4GF	Diesel	2496	4	8	154
Transit Box (E_)	06/94→03/00	4HB	Diesel	2496	4	8	154
Transit Box (E_)	06/94→03/00	4HC	Diesel	2496	4	8	154
Transit Box (E_)	06/94→03/00	NSF	Petrol	1998	4	8	123
Transit Box (E_)	06/94→03/00	NSG	Petrol	1998	4	8	123
Transit Box (E_)	10/98→03/00	4HA	Diesel	2496	4	8	154
Transit Box (E_)	10/98→03/00	4HD	Diesel	2496	4	8	154
Transit Box (E_)	05/99→03/00	4ED	Diesel	2496	4	8	154
Transit Box (FA_)	01/00→05/06	D2FA	Diesel	2402	4	16	151
Transit Box (FA_)	01/00→05/06	D2FB	Diesel	2402	4	16	151
Transit Box (FA_)	01/00→05/06	D2FE	Diesel	2402	4	16	151
Transit Box (FA_)	01/00→05/06	D4FA	Diesel	2402	4	16	151
Transit Box (FA_)	01/00→05/06	F4FA	Diesel	2402	4	16	151
Transit Box (FA_)	08/00→05/06	ABFA	Diesel	1998	4	16	102
Transit Box (FA_)	08/00→05/06	D3FA	Diesel	1998	4	16	102
Transit Box (FA_)	08/00→05/06	F3FA	Diesel	1998	4	16	102
Transit Box (FA_)	09/00→03/06	NSF	Petrol	1998	4	8	123
Transit Box (FA_)	03/01→05/06	E5FA	Petrol	2295	4	16	141
Transit Box (FA_)	03/01→05/06	E5FC	Petrol	2295	4	16	141
Transit Box (FA_)	07/01→05/06	DOFA	Diesel	2402	4	16	151
Transit Box (FA_)	08/02→05/06	FIFA	Diesel	1998	4	16	102
Transit Box (FA_)	03/04→05/06	FXFA	Diesel	2402	4	16	151
Transit Box (FA_)	03/04→05/06	H9FA	Diesel	2402	4	16	151
Transit Box (T_)	09/85→09/92	LAT	Petrol	1593	4	8	64
Transit Box (T_)	09/85→09/92	NAT	Petrol	1994	4	8	122
Transit Box (T_)	09/85→09/92	NAV	Petrol	1994	4	8	122
Transit Box (T_)	10/85→03/91	4AE	Diesel	2496	4	8	154
Transit Box (T_)	10/85→03/91	N6TS	Petrol	1993	4	8	122
Transit Box (T_)	10/85→03/91	NAW	Petrol	1993	4	8	122
Transit Box (T_)	01/86→09/91	4AB	Diesel	2496	4	8	153
Transit Box (T_)	10/88→09/91	4BA	Diesel	2496	4	8	155
Transit Box (T_)	10/88→09/91	4CA	Diesel	2496	4	8	155
Transit Box (V_)	11/77→10/86	4AA	Diesel	2358	4	8	148
Transit Box (V_)	11/77→10/86	4RB	Petrol	1593	4	8	45
Transit Box (V_)	11/77→10/86	4RC	Petrol	1993	4	8	101
Transit Box (V_)	10/83→10/86	4AB	Diesel	2496	4	8	153
Transit Box (VF)	06/94→03/00	NSF	Petrol	1998	4	8	123
Transit Box (VF)	06/94→03/00	NSG	Petrol	1998	4	8	123
Transit Box (VH, VJ)	01/00→09/06	D2FA	Diesel	2402	4	16	151
Transit Box (VH, VJ)	01/00→09/06	D4FA	Diesel	2402	4	16	151
Transit Box (VH, VJ)	08/00→09/06	E5FA	Petrol	2295	4	16	140
Transit Box (VH, VJ)	07/01→09/06	DOFA	Diesel	2402	4	16	151
Transit Box (VM)	07/06→12/14	FXFA	Diesel	2402	4	16	151
Transit Box (VM)	07/06→12/14	H9FB	Diesel	2402	4	16	151
Transit Box (VM)	07/06→12/14	PHFC	Diesel	2402	4	16	151
Transit Box (VM)	09/06→03/08	GZFA	Petrol	2261	4	16	143
Transit Box (VM)	09/06→12/14	QVFA	Diesel	2198	4	16	133
Transit Box (VM)	01/10→12/14	SRFA	Diesel	2198	4	16	133
Transit Box (VM)	01/10→12/14	SRFB	Diesel	2198	4	16	133

				CC			9
Transit Box (VM)	01/10→12/14	SRFC	Diesel	2198	4	16	133
Transit Box (VM)	01/10→12/14	SRFD	Diesel	2198	4	16	133
Transit Box (VM)	01/10→12/14	SRFE	Diesel	2198	4	16	133
Transit Box (VM)	10/11→12/14	CVRA	Diesel	2198	4	16	133
Transit Box (VM)	10/11→12/14	CVRB	Diesel	2198	4	16	133
Transit Box (VM)	10/11→12/14	CVRC	Diesel	2198	4	16	133
Transit Box (VM)	01/12→12/14	CYFA	Diesel	2198	4	16	133
Transit Box (VM)	01/12→12/14	CYFB	Diesel	2198	4	16	133
Transit Box (VM)	01/12→12/14	CYFC	Diesel	2198	4	16	133
Transit Box (VO)	09/14→	CV24	Diesel	2198	4	16	133
Transit Box (VO)	09/14→	CVR5	Diesel	2198	4	16	133
Transit Box (VO)	09/14→	UYR6	Diesel	2198	4	16	133
Transit Bus	04/06→08/14	JXFA	Diesel	2402	4	16	151
Transit Bus	04/06→08/14	JXFC	Diesel	2402	4	16	151
Transit Bus	04/06→08/14	P8FA	Diesel	2198	4	16	133
Transit Bus	04/06→08/14	P8FB	Diesel	2198	4	16	133
Transit Bus	04/06→08/14	PHFA	Diesel	2402	4	16	151
Transit Bus	04/06→08/14	PHFC	Diesel	2402	4	16	151
Transit Bus	04/06→08/14	QVFA	Diesel	2198	4	16	133
Transit Bus	04/06→08/14	QWFA	Diesel	2198	4	16	133
Transit Bus	04/06→	H9FD	Diesel	2402	4	16	151
Transit Bus	11/06→08/14	H9FB	Diesel	2402	4	16	151
Transit Bus	10/07→08/14	PGFA	Diesel	2198	4	16	133
Transit Bus	10/07→08/14	PGFB	Diesel	2198	4	16	133
Transit Bus	10/07→08/14	UHFA	Diesel	2198	4	16	133
Transit Bus	10/07→08/14	UHFB	Diesel	2198	4	16	133
Transit Bus	10/07→08/14	UHFC	Diesel	2198	4	16	133
Transit Bus	02/08→08/14	SAFA	Diesel	3198	5	20	185
Transit Bus	02/08→08/14	SAFB	Diesel	3199	5	20	185
Transit Bus	10/08→08/14	SRFA	Diesel	2198	4	16	133
Transit Bus	10/08→08/14	SRFB	Diesel	2198	4	16	133
Transit Bus	10/08→08/14	SRFC	Diesel	2198	4	16	133
Transit Bus	10/08→08/14	SRFD	Diesel	2198	4	16	133
Transit Bus	10/08→08/14	SRFE	Diesel	2198	4	16	133
Transit Bus	09/11→08/14	USRA	Diesel	2198	4	16	133
Transit Bus	09/11→08/14	USRB	Diesel	2198	4	16	133
Transit Bus	10/11→08/14	CYFA	Diesel	2198	4	16	133
Transit Bus	10/11→08/14	CYFB	Diesel	2198	4	16	133
Transit Bus	10/11→08/14	CYFC	Diesel	2198	4	16	133
Transit Bus	10/11→08/14	CYFD	Diesel	2198	4	16	133
Transit Bus	10/11→08/14	CYRA	Diesel	2198	4	16	133
Transit Bus	10/11→08/14	CYRB	Diesel	2198	4	16	133
Transit Bus	10/11→08/14	DRFA	Diesel	2198	4	16	133
Transit Bus	10/11→08/14	DRFB	Diesel	2198	4	16	133
Transit Bus	10/11→08/14	DRFC	Diesel	2198	4	16	133
Transit Bus	10/11→08/14	DRFD	Diesel	2198	4	16	133
Transit Bus	10/11→08/14	DRFE	Diesel	2198	4	16	133
Transit Bus	10/11→08/14	DRRA	Diesel	2198	4	16	133
Transit Bus	10/11→08/14	DRRB	Diesel	2198	4	16	133
Transit Bus	10/11→08/14	DRRC	Diesel	2198	4	16	133
Transit Bus	08/13→	CV24	Diesel	2198	4	16	133
Transit Bus	08/13→	CVR5	Diesel	2198	4	16	133
Transit Bus	08/13→	CY14	Diesel	2198	4	16	133
Transit Bus	08/13→	CY24	Diesel	2198	4	16	133
Transit Bus	08/13→	CYF5	Diesel	2198	4	16	133
Transit Bus	08/13→	CYFG	Diesel	2198	4	16	133
Transit Bus	08/13→	CYR5	Diesel	2198	4	16	133
Transit Bus	08/13→	DRF5	Diesel	2198	4	16	133
Transit Bus	08/13→	DRFF	Diesel	2198	4	16	133
Transit Bus	08/13→	DRFG	Diesel	2198	4	16	133
Transit Bus	08/13→	DRR5	Diesel	2198	4	16	133
Transit Bus	08/13→	USR6	Diesel	2198	4	16	133
Transit Bus	08/13→	UYR6	Diesel	2198	4	16	133
Transit Bus	12/14→	CVF5	Diesel	2198	4	16	133
Transit Bus (72E, 73E)	11/65→05/73	EX	Petrol	1498	4	8	42
Transit Bus (72E, 73E)	01/66→03/78	EY	Petrol	1699	4	8	71
Transit Bus (72E, 73E)	11/71→09/78	4AA	Diesel	2358	4	8	148
Transit Bus (E_)	01/91→09/94	BRT	Petrol	2935	6	12	181
Transit Bus (E_)	08/91→07/94	4BC	Diesel	2496	4	8	154
Transit Bus (E_)	08/91→07/94	4CC	Diesel	2496	4	8	154
Transit Bus (E_)	08/91→03/00	4FA	Diesel	2496	4	8	154
Transit Bus (E_)	09/91→07/94	4DA	Diesel	2496	4	8	154
Transit Bus (E_)	09/91→07/94	4EA	Diesel	2496	4	8	154
Transit Bus (E_)	09/91→07/94	NCA	Petrol	1994	4	8	122
Transit Bus (E_)	09/91→09/94	NBA	Petrol	1993	4	8	122
Transit Bus (E_)	10/92→03/00	4GA	Diesel	2496	4	8	154
Transit Bus (E_)	10/92→03/00	4GB	Diesel	2496	4	8	154
Transit Bus (E_)	10/92→03/00	4GC	Diesel	2496	4	8	154



CC



9

Transit Bus (E_)	06/94→03/00	NSH	Petrol	1998	4	8	123
Transit Bus (E_)	07/94→03/00	4EB	Diesel	2496	4	8	154
Transit Bus (E_)	07/94→03/00	4EC	Diesel	2496	4	8	154
Transit Bus (E_)	07/94→03/00	4HB	Diesel	2496	4	8	154
Transit Bus (E_)	07/94→03/00	4HC	Diesel	2496	4	8	154
Transit Bus (E_)	08/94→03/00	4FB	Diesel	2496	4	8	154
Transit Bus (E_)	08/94→03/00	4FC	Diesel	2496	4	8	154
Transit Bus (E_)	08/94→03/00	4FD	Diesel	2496	4	8	154
Transit Bus (E_)	08/94→06/00	4HA	Diesel	2496	4	8	154
Transit Bus (E_)	08/94→06/00	4HD	Diesel	2496	4	8	154
Transit Bus (E_)	01/95→03/00	4GD	Diesel	2496	4	8	154
Transit Bus (E_)	01/95→03/00	4GE	Diesel	2496	4	8	154
Transit Bus (E_)	01/95→03/00	4GF	Diesel	2496	4	8	154
Transit Bus (E_)	09/95→03/00	NSF	Petrol	1998	4	8	123
Transit Bus (E_)	09/95→03/00	NSG	Petrol	1998	4	8	123
Transit Bus (E_)	08/97→03/00	4ED	Diesel	2496	4	8	154
Transit Bus (FD_, FB_, FS_, FZ_, FC_)	01/00→05/06	D2FA	Diesel	2402	4	16	151
Transit Bus (FD_, FB_, FS_, FZ_, FC_)	01/00→05/06	D2FB	Diesel	2402	4	16	151
Transit Bus (FD_, FB_, FS_, FZ_, FC_)	01/00→05/06	D2FE	Diesel	2402	4	16	151
Transit Bus (FD_, FB_, FS_, FZ_, FC_)	01/00→05/06	D4FA	Diesel	2402	4	16	151
Transit Bus (FD_, FB_, FS_, FZ_, FC_)	01/00→05/06	F4FA	Diesel	2402	4	16	151
Transit Bus (FD_, FB_, FS_, FZ_, FC_)	08/00→05/06	ABFA	Diesel	1998	4	16	102
Transit Bus (FD_, FB_, FS_, FZ_, FC_)	08/00→05/06	D3FA	Diesel	1998	4	16	102
Transit Bus (FD_, FB_, FS_, FZ_, FC_)	08/00→05/06	E5FA	Petrol	2295	4	16	141
Transit Bus (FD_, FB_, FS_, FZ_, FC_)	08/00→05/06	E5FC	Petrol	2295	4	16	141
Transit Bus (FD_, FB_, FS_, FZ_, FC_)	08/00→05/06	F3FA	Diesel	1998	4	16	102
Transit Bus (FD_, FB_, FS_, FZ_, FC_)	09/00→03/06	NSF	Petrol	1998	4	8	123
Transit Bus (FD_, FB_, FS_, FZ_, FC_)	07/01→05/06	DOFA	Diesel	2402	4	16	151
Transit Bus (FD_, FB_, FS_, FZ_, FC_)	08/02→05/06	F1FA	Diesel	1998	4	16	102
Transit Bus (FD_, FB_, FS_, FZ_, FC_)	03/04→05/06	FXFA	Diesel	2402	4	16	151
Transit Bus (FD_, FB_, FS_, FZ_, FC_)	03/04→05/06	H9FA	Diesel	2402	4	16	151
Transit Bus (T_)	10/85→03/91	N6TS	Petrol	1993	4	8	122
Transit Bus (T_)	10/85→03/91	NAW	Petrol	1993	4	8	122
Transit Bus (T_)	10/85→03/91	NAX	Petrol	1993	4	8	122
Transit Bus (T_)	11/85→09/92	NAT	Petrol	1994	4	8	122
Transit Bus (T_)	11/85→09/92	NAV	Petrol	1994	4	8	122
Transit Bus (T_)	12/85→01/89	4AE	Diesel	2496	4	8	154
Transit Bus (T_)	12/85→01/89	LAT	Petrol	1593	4	8	64
Transit Bus (T_)	12/85→09/92	4AB	Diesel	2496	4	8	153
Transit Bus (T_)	12/85→09/92	N6T	Petrol	1993	4	8	122
Transit Bus (T_)	09/88→09/92	4BA	Diesel	2496	4	8	155
Transit Bus (T_)	09/88→09/92	4CA	Diesel	2496	4	8	155
Transit Bus (V_)	11/77→10/86	4RC	Petrol	1993	4	8	101
Transit Bus (V_)	12/77→10/86	4AA	Diesel	2358	4	8	148
Transit Bus (V_)	12/77→10/86	4RB	Petrol	1593	4	8	45
Transit Bus (V_)	10/83→10/86	4AB	Diesel	2496	4	8	153
Transit Bus (VF, VG)	06/94→03/00	NSF	Petrol	1998	4	8	123
Transit Bus (VF, VG)	07/94→03/00	4EB	Diesel	2496	4	8	154
Transit Bus (VF, VG)	08/94→06/00	4HC	Diesel	2496	4	8	154
Transit Bus (VF, VG)	01/95→03/00	4GF	Diesel	2496	4	8	154
Transit Bus (VF, VG)	09/95→03/00	NSG	Petrol	1998	4	8	123
Transit Bus (VF, VG)	08/97→03/00	4ED	Diesel	2496	4	8	154
Transit Bus (VH, VJ)	01/00→09/06	D2FA	Diesel	2402	4	16	151
Transit Bus (VH, VJ)	01/00→09/06	D4FA	Diesel	2402	4	16	151
Transit Bus (VH, VJ)	01/00→09/06	F4FA	Diesel	2402	4	16	151
Transit Bus (VH, VJ)	08/00→09/06	E5FA	Petrol	2295	4	16	140
Transit Bus (VH, VJ)	08/00→09/06	E5FC	Petrol	2295	4	16	142
Transit Bus (VH, VJ)	07/01→09/06	DOFA	Diesel	2402	4	16	151
Transit Bus (VH, VJ)	03/04→09/06	FXFA	Diesel	2402	4	16	151
Transit Bus (VH, VJ)	03/04→09/06	H9FA	Diesel	2402	4	16	151
Transit Bus (VM)	07/06→	H9FB	Diesel	2402	4	16	151
Transit Bus (VM)	07/06→	JXFA	Diesel	2402	4	16	151
Transit Bus (VM)	07/06→	PHFC	Diesel	2402	4	16	151
Transit Bus (VM)	10/11→12/14	CVRA	Diesel	2198	4	16	133
Transit Bus (VM)	10/11→12/14	CVRB	Diesel	2198	4	16	133
Transit Bus (VM)	10/11→12/14	CVRC	Diesel	2198	4	16	133
Transit Classic Bus	01/02→01/05	JX493ZQ-3	Diesel	2771	4	8	178
Transit Classic Bus	01/02→01/05	JX493ZQ-4	Diesel	2771	4	8	178
Transit Classic Bus	08/11→	JX493ZLQ-3	Diesel	2771	4	8	178
Transit Classic Bus	08/11→	JX493ZLQ-3A	Diesel	2771	4	8	178
Transit Classic Bus	08/11→	JX493ZXQ-3	Diesel	2771	4	8	178
Transit Classic Bus	02/13→	JX493ZLQ	Diesel	2771	4	8	178
Transit Classic Bus	02/13→	JX493ZLQ-4	Diesel	2771	4	8	178
Transit Connect (P65_, P70_, P80_)	06/02→12/13	BHPA	Diesel	1753	4	8	73
Transit Connect (P65_, P70_, P80_)	06/02→12/13	EYPA	Petrol	1796	4	16	78
Transit Connect (P65_, P70_, P80_)	06/02→12/13	EYPC	Petrol	1796	4	16	78
Transit Connect (P65_, P70_, P80_)	06/02→12/13	EYPD	Petrol	1796	4	16	78
Transit Connect (P65_, P70_, P80_)	06/02→12/13	HCPA	Diesel	1753	4	8	73



CC



9

Transit Connect (P65_, P70_, P80_)	06/02→12/13	HCPB	Diesel	1753	4	8	73
Transit Connect (P65_, P70_, P80_)	06/02→12/13	P7PA	Diesel	1753	4	8	73
Transit Connect (P65_, P70_, P80_)	06/02→12/13	P7PB	Diesel	1753	4	8	73
Transit Connect (P65_, P70_, P80_)	06/02→12/13	P9PA	Diesel	1753	4	8	73
Transit Connect (P65_, P70_, P80_)	06/02→12/13	P9PB	Diesel	1753	4	8	73
Transit Connect (P65_, P70_, P80_)	06/02→12/13	P9PC	Diesel	1753	4	8	73
Transit Connect (P65_, P70_, P80_)	06/02→12/13	P9PD	Diesel	1753	4	8	73
Transit Connect (P65_, P70_, P80_)	06/02→12/13	R2PA	Diesel	1753	4	8	73
Transit Connect (P65_, P70_, P80_)	06/02→12/13	R3PA	Diesel	1753	4	8	73
Transit Connect (P65_, P70_, P80_)	06/02→12/13	RWPF	Diesel	1753	4	8	73
Transit Connect (P65_, P70_, P80_)	06/02→12/13	RWPF	Diesel	1753	4	8	73
Transit Connect (P65_, P70_, P80_)	08/06→12/13	RWPA	Diesel	1753	4	8	73
Transit Connect (P65_, P70_, P80_)	08/06→12/13	RWPC	Diesel	1753	4	8	73
Transit Connect (P65_, P70_, P80_)	08/06→12/13	RWPD	Diesel	1753	4	8	73
Transit Connect Box	02/13→	M2GA	Petrol	998	3	12	3
Transit Connect Box	02/13→	T1GA	Diesel	1560	4	8	68
Transit Connect Box	02/13→	TZGA	Diesel	1560	4	8	68
Transit Connect Box	02/13→	TZGB	Diesel	1560	4	8	68
Transit Connect Box	02/13→	UBGA	Diesel	1560	4	8	68
Transit Connect Box	11/13→	JQGA	Petrol	1596	4	16	59
Transit Connect Box	05/15→	XVGA	Diesel	1499	4	8	36
Transit Connect Box	05/15→	XVGB	Diesel	1499	4	8	36
Transit Connect Box	05/15→	XVGC	Diesel	1499	4	8	36
Transit Connect Box	05/15→	XWGA	Diesel	1499	4	8	36
Transit Connect Box	05/15→	XWGB	Diesel	1499	4	8	36
Transit Connect Box	08/15→	XUGA	Diesel	1499	4	8	36
Transit Connect Kombi	02/13→	JQGA	Petrol	1596	4	16	59
Transit Connect Kombi	02/13→	T1GA	Diesel	1560	4	8	68
Transit Connect Kombi	02/13→	TZGA	Diesel	1560	4	8	68
Transit Connect Kombi	02/13→	TZGB	Diesel	1560	4	8	68
Transit Connect Kombi	02/13→	UBGA	Diesel	1560	4	8	68
Transit Connect Kombi	05/15→	XVGA	Diesel	1499	4	8	36
Transit Connect Kombi	05/15→	XVGB	Diesel	1499	4	8	36
Transit Connect Kombi	05/15→	XVGC	Diesel	1499	4	8	36
Transit Connect Kombi	05/15→	XWGA	Diesel	1499	4	8	36
Transit Connect Kombi	05/15→	XWGB	Diesel	1499	4	8	36
Transit Connect Kombi	08/15→	XUGA	Diesel	1499	4	8	36
Transit Courier Box	02/14→	SFCA	Petrol	998	3	12	3
Transit Courier Box	02/14→	SFCB	Petrol	998	3	12	3
Transit Courier Box	02/14→	SFCC	Petrol	998	3	12	3
Transit Courier Box	02/14→	SFCD	Petrol	998	3	12	3
Transit Courier Box	02/14→	T3CA	Diesel	1560	4	8	68
Transit Courier Box	02/14→	T3CB	Diesel	1560	4	8	68
Transit Courier Box	02/14→	T3CC	Diesel	1560	4	8	68
Transit Courier Box	02/14→	UGCA	Diesel	1499	4	8	36
Transit Courier Box	02/14→	UGCB	Diesel	1499	4	8	36
Transit Courier Box	02/14→	XUCC	Diesel	1499	4	8	36
Transit Courier Box	02/14→	XUCD	Diesel	1499	4	8	36
Transit Courier Box	05/15→	XVCA	Diesel	1499	4	8	36
Transit Courier Box	05/15→	XVCB	Diesel	1499	4	8	36
Transit Courier Box	05/15→	XVCC	Diesel	1499	4	8	36
Transit Courier Kombi	02/14→	SFCA	Petrol	998	3	12	3
Transit Courier Kombi	02/14→	SFCB	Petrol	998	3	12	3
Transit Courier Kombi	02/14→	SFCC	Petrol	998	3	12	3
Transit Courier Kombi	02/14→	SFCD	Petrol	998	3	12	3
Transit Courier Kombi	02/14→	T3CA	Diesel	1560	4	8	68
Transit Courier Kombi	02/14→	T3CB	Diesel	1560	4	8	68
Transit Courier Kombi	02/14→	T3CC	Diesel	1560	4	8	68
Transit Courier Kombi	02/14→	UGCA	Diesel	1499	4	8	36
Transit Courier Kombi	02/14→	UGCB	Diesel	1499	4	8	36
Transit Courier Kombi	02/14→	XUCC	Diesel	1499	4	8	36
Transit Courier Kombi	02/14→	XUCD	Diesel	1499	4	8	36
Transit Courier Kombi	05/15→	XVCA	Diesel	1499	4	8	36
Transit Courier Kombi	05/15→	XVCB	Diesel	1499	4	8	36
Transit Courier Kombi	05/15→	XVCC	Diesel	1499	4	8	36
Transit Custom Box	04/12→	CVFF	Diesel	2198	4	16	133
Transit Custom Box	04/12→	CYF4	Diesel	2198	4	16	133
Transit Custom Box	04/12→	CYFF	Diesel	2198	4	16	133
Transit Custom Box	04/12→	DRF4	Diesel	2198	4	16	133
Transit Custom Box	04/12→	DRFF	Diesel	2198	4	16	133
Transit Custom Box	04/12→	DRFG	Diesel	2198	4	16	133
Transit Custom Box (VN)	09/13→	CYF4	Diesel	2198	4	16	133
Transit Custom Box (VN)	09/13→	CYFF	Diesel	2198	4	16	133
Transit Custom Bus	04/12→	CVFF	Diesel	2198	4	16	133
Transit Custom Bus	04/12→	CYF4	Diesel	2198	4	16	133
Transit Custom Bus	04/12→	CYFF	Diesel	2198	4	16	133
Transit Custom Bus	04/12→	DRF4	Diesel	2198	4	16	133
Transit Custom Bus	04/12→	DRFF	Diesel	2198	4	16	133



CC



9

Transit Custom Bus	04/12→	DRFG	Diesel	2198	4	16	133
Transit Platform/Chassis	04/06→08/14	GZFA	Petrol	2261	4	16	143
Transit Platform/Chassis	04/06→08/14	GZFB	Petrol	2261	4	16	143
Transit Platform/Chassis	04/06→08/14	GZFC	Petrol	2261	4	16	143
Transit Platform/Chassis	04/06→08/14	H9FB	Diesel	2402	4	16	151
Transit Platform/Chassis	04/06→08/14	H9FD	Diesel	2402	4	16	151
Transit Platform/Chassis	04/06→08/14	JXFA	Diesel	2402	4	16	151
Transit Platform/Chassis	04/06→08/14	JXFC	Diesel	2402	4	16	151
Transit Platform/Chassis	04/06→08/14	P8FA	Diesel	2198	4	16	133
Transit Platform/Chassis	04/06→08/14	P8FB	Diesel	2198	4	16	133
Transit Platform/Chassis	04/06→08/14	PHFA	Diesel	2402	4	16	151
Transit Platform/Chassis	04/06→08/14	PHFC	Diesel	2402	4	16	151
Transit Platform/Chassis	04/06→08/14	QVFA	Diesel	2198	4	16	133
Transit Platform/Chassis	04/06→08/14	QWFA	Diesel	2198	4	16	133
Transit Platform/Chassis	09/07→08/14	SAFA	Diesel	3198	5	20	185
Transit Platform/Chassis	09/07→08/14	SAFB	Diesel	3199	5	20	185
Transit Platform/Chassis	10/07→09/11	PGFA	Diesel	2198	4	16	133
Transit Platform/Chassis	10/07→09/11	PGFB	Diesel	2198	4	16	133
Transit Platform/Chassis	10/07→09/11	UHFA	Diesel	2198	4	16	133
Transit Platform/Chassis	10/07→09/11	UHFB	Diesel	2198	4	16	133
Transit Platform/Chassis	10/07→09/11	UHFC	Diesel	2198	4	16	133
Transit Platform/Chassis	10/08→08/14	SRFA	Diesel	2198	4	16	133
Transit Platform/Chassis	10/08→08/14	SRFB	Diesel	2198	4	16	133
Transit Platform/Chassis	10/08→08/14	SRFC	Diesel	2198	4	16	133
Transit Platform/Chassis	10/08→08/14	SRFD	Diesel	2198	4	16	133
Transit Platform/Chassis	10/08→08/14	SRFE	Diesel	2198	4	16	133
Transit Platform/Chassis	10/11→08/14	CVRA	Diesel	2198	4	16	133
Transit Platform/Chassis	10/11→08/14	CVRB	Diesel	2198	4	16	133
Transit Platform/Chassis	10/11→08/14	CVRC	Diesel	2198	4	16	133
Transit Platform/Chassis	10/11→08/14	CYFA	Diesel	2198	4	16	133
Transit Platform/Chassis	10/11→08/14	CYFB	Diesel	2198	4	16	133
Transit Platform/Chassis	10/11→08/14	CYFC	Diesel	2198	4	16	133
Transit Platform/Chassis	10/11→08/14	CYFD	Diesel	2198	4	16	133
Transit Platform/Chassis	10/11→08/14	CYRA	Diesel	2198	4	16	133
Transit Platform/Chassis	10/11→08/14	CYRB	Diesel	2198	4	16	133
Transit Platform/Chassis	10/11→08/14	CYRC	Diesel	2198	4	16	133
Transit Platform/Chassis	10/11→08/14	DRFA	Diesel	2198	4	16	133
Transit Platform/Chassis	10/11→08/14	DRFB	Diesel	2198	4	16	133
Transit Platform/Chassis	10/11→08/14	DRFC	Diesel	2198	4	16	133
Transit Platform/Chassis	10/11→08/14	DRFD	Diesel	2198	4	16	133
Transit Platform/Chassis	10/11→08/14	DRFE	Diesel	2198	4	16	133
Transit Platform/Chassis	10/11→08/14	DRRA	Diesel	2198	4	16	133
Transit Platform/Chassis	10/11→08/14	DRRB	Diesel	2198	4	16	133
Transit Platform/Chassis	10/11→08/14	DRRC	Diesel	2198	4	16	133
Transit Platform/Chassis	08/13→	CV24	Diesel	2198	4	16	133
Transit Platform/Chassis	08/13→	CVF5	Diesel	2198	4	16	133
Transit Platform/Chassis	08/13→	CVR5	Diesel	2198	4	16	133
Transit Platform/Chassis	08/13→	CY24	Diesel	2198	4	16	133
Transit Platform/Chassis	08/13→	CYF5	Diesel	2198	4	16	133
Transit Platform/Chassis	08/13→	CYR5	Diesel	2198	4	16	133
Transit Platform/Chassis	08/13→	DRF5	Diesel	2198	4	16	133
Transit Platform/Chassis	08/13→	DRFF	Diesel	2198	4	16	133
Transit Platform/Chassis	08/13→	DRFG	Diesel	2198	4	16	133
Transit Platform/Chassis	08/13→	DRR5	Diesel	2198	4	16	133
Transit Platform/Chassis	08/13→	UHR5	Diesel	2198	4	16	133
Transit Platform/Chassis	08/13→	USR6	Diesel	2198	4	16	133
Transit Platform/Chassis	08/13→	UYR6	Diesel	2198	4	16	133
Transit Platform/Chassis (74E)	01/71→05/73	EX	Petrol	1498	4	8	42
Transit Platform/Chassis (74E)	04/71→03/78	EY	Petrol	1699	4	8	71
Transit Platform/Chassis (E_)	04/91→07/94	NBA	Petrol	1993	4	8	122
Transit Platform/Chassis (E_)	09/91→08/94	4AB	Diesel	2496	4	8	153
Transit Platform/Chassis (E_)	09/91→08/94	4BC	Diesel	2496	4	8	154
Transit Platform/Chassis (E_)	09/91→08/94	4CC	Diesel	2496	4	8	154
Transit Platform/Chassis (E_)	09/91→08/94	4DA	Diesel	2496	4	8	154
Transit Platform/Chassis (E_)	09/91→08/94	4EA	Diesel	2496	4	8	154
Transit Platform/Chassis (E_)	09/91→08/94	NCA	Petrol	1994	4	8	122
Transit Platform/Chassis (E_)	09/91→03/00	4FA	Diesel	2496	4	8	154
Transit Platform/Chassis (E_)	11/92→03/00	4GA	Diesel	2496	4	8	154
Transit Platform/Chassis (E_)	11/92→03/00	4GB	Diesel	2496	4	8	154
Transit Platform/Chassis (E_)	11/92→03/00	4GC	Diesel	2496	4	8	154
Transit Platform/Chassis (E_)	08/94→03/00	4EB	Diesel	2496	4	8	154
Transit Platform/Chassis (E_)	08/94→03/00	4EC	Diesel	2496	4	8	154
Transit Platform/Chassis (E_)	08/94→03/00	4FB	Diesel	2496	4	8	154
Transit Platform/Chassis (E_)	08/94→03/00	4FC	Diesel	2496	4	8	154
Transit Platform/Chassis (E_)	08/94→03/00	4FD	Diesel	2496	4	8	154
Transit Platform/Chassis (E_)	08/94→03/00	4GD	Diesel	2496	4	8	154
Transit Platform/Chassis (E_)	08/94→03/00	4GE	Diesel	2496	4	8	154
Transit Platform/Chassis (E_)	08/94→03/00	4GF	Diesel	2496	4	8	154



CC



9

Transit Platform/Chassis (E_ _)	08/94→03/00	4HB	Diesel	2496	4	8	154
Transit Platform/Chassis (E_ _)	08/94→03/00	4HC	Diesel	2496	4	8	154
Transit Platform/Chassis (E_ _)	08/94→03/00	NSF	Petrol	1998	4	8	123
Transit Platform/Chassis (E_ _)	08/94→03/00	NSG	Petrol	1998	4	8	123
Transit Platform/Chassis (E_ _)	10/98→07/00	4HA	Diesel	2496	4	8	154
Transit Platform/Chassis (E_ _)	10/98→07/00	4HD	Diesel	2496	4	8	154
Transit Platform/Chassis (E_ _)	05/99→03/00	4ED	Diesel	2496	4	8	154
Transit Platform/Chassis (FM_ _ , FN_ _)	01/00→05/06	D2FA	Diesel	2402	4	16	151
Transit Platform/Chassis (FM_ _ , FN_ _)	01/00→05/06	D2FB	Diesel	2402	4	16	151
Transit Platform/Chassis (FM_ _ , FN_ _)	01/00→05/06	D2FE	Diesel	2402	4	16	151
Transit Platform/Chassis (FM_ _ , FN_ _)	01/00→05/06	D4FA	Diesel	2402	4	16	151
Transit Platform/Chassis (FM_ _ , FN_ _)	01/00→05/06	F4FA	Diesel	2402	4	16	151
Transit Platform/Chassis (FM_ _ , FN_ _)	08/00→05/06	ABFA	Diesel	1998	4	16	102
Transit Platform/Chassis (FM_ _ , FN_ _)	08/00→05/06	D3FA	Diesel	1998	4	16	102
Transit Platform/Chassis (FM_ _ , FN_ _)	08/00→05/06	F3FA	Diesel	1998	4	16	102
Transit Platform/Chassis (FM_ _ , FN_ _)	03/01→05/06	E5FC	Petrol	2295	4	16	141
Transit Platform/Chassis (FM_ _ , FN_ _)	04/01→05/06	E5FA	Petrol	2295	4	16	141
Transit Platform/Chassis (FM_ _ , FN_ _)	07/01→05/06	DOFA	Diesel	2402	4	16	151
Transit Platform/Chassis (FM_ _ , FN_ _)	08/02→05/06	F1FA	Diesel	1998	4	16	102
Transit Platform/Chassis (FM_ _ , FN_ _)	03/04→05/06	FXFA	Diesel	2402	4	16	151
Transit Platform/Chassis (FM_ _ , FN_ _)	03/04→05/06	H9FA	Diesel	2402	4	16	151
Transit Platform/Chassis (T_ _)	10/85→03/91	N6TS	Petrol	1993	4	8	122
Transit Platform/Chassis (T_ _)	11/85→09/92	N6T	Petrol	1993	4	8	122
Transit Platform/Chassis (T_ _)	01/86→01/89	4AB	Diesel	2496	4	8	153
Transit Platform/Chassis (T_ _)	01/86→09/92	NAT	Petrol	1994	4	8	122
Transit Platform/Chassis (T_ _)	01/86→09/92	NAV	Petrol	1994	4	8	122
Transit Platform/Chassis (T_ _)	09/88→09/92	4BA	Diesel	2496	4	8	155
Transit Platform/Chassis (T_ _)	09/88→09/92	4CA	Diesel	2496	4	8	155
Transit Platform/Chassis (V_ _)	11/77→09/85	4AA	Diesel	2358	4	8	148
Transit Platform/Chassis (V_ _)	11/77→10/86	4RC	Petrol	1993	4	8	101
Transit Platform/Chassis (V_ _)	11/77→10/86	B	Petrol	1593	4	8	46
Transit Platform/Chassis (V_ _)	10/83→10/86	4AB	Diesel	2496	4	8	153
Transit Platform/Chassis (VF, VG)	01/86→01/89	4AB	Diesel	2496	4	8	154
Transit Platform/Chassis (VF, VG)	09/88→09/92	4BA	Diesel	2496	4	8	154
Transit Platform/Chassis (VF, VG)	09/91→08/94	4BC	Diesel	2496	4	8	154
Transit Platform/Chassis (VF, VG)	09/91→08/94	4DA	Diesel	2496	4	8	154
Transit Platform/Chassis (VF, VG)	09/91→08/94	4EA	Diesel	2496	4	8	154
Transit Platform/Chassis (VF, VG)	11/92→03/00	4GF	Diesel	2496	4	8	154
Transit Platform/Chassis (VF, VG)	08/94→03/00	4EB	Diesel	2496	4	8	154
Transit Platform/Chassis (VF, VG)	08/94→03/00	4FB	Diesel	2496	4	8	154
Transit Platform/Chassis (VF, VG)	08/94→03/00	4HB	Diesel	2496	4	8	154
Transit Platform/Chassis (VF, VG)	08/94→03/00	NSF	Petrol	1998	4	8	123
Transit Platform/Chassis (VF, VG)	08/94→03/00	NSG	Petrol	1998	4	8	123
Transit Platform/Chassis (VF, VG)	10/98→03/00	4HC	Diesel	2496	4	8	154
Transit Platform/Chassis (VF, VG)	05/99→03/00	4ED	Diesel	2496	4	8	154
Transit Platform/Chassis (VH, VJ)	01/00→09/06	D2FA	Diesel	2402	4	16	151
Transit Platform/Chassis (VH, VJ)	01/00→09/06	D4FA	Diesel	2402	4	16	151
Transit Platform/Chassis (VH, VJ)	01/00→09/06	F4FA	Diesel	2402	4	16	151
Transit Platform/Chassis (VH, VJ)	08/00→09/06	E5FA	Petrol	2295	4	16	140
Transit Platform/Chassis (VH, VJ)	07/01→09/06	DOFA	Diesel	2402	4	16	151
Transit Platform/Chassis (VH, VJ)	03/04→07/06	FXFA	Diesel	2402	4	16	151
Transit Platform/Chassis (VH, VJ)	03/04→09/06	H9FA	Diesel	2402	4	16	151
Transit Platform/Chassis (VM)	07/06→12/14	H9FB	Diesel	2402	4	16	151
Transit Platform/Chassis (VM)	07/06→12/14	JXFA	Diesel	2402	4	16	151
Transit Platform/Chassis (VM)	07/06→12/14	PHFC	Diesel	2402	4	16	151
Transit Platform/Chassis (VM)	10/11→12/14	CVRA	Diesel	2198	4	16	133
Transit Platform/Chassis (VM)	10/11→12/14	CVRB	Diesel	2198	4	16	133
Transit Platform/Chassis (VM)	10/11→12/14	CVRC	Diesel	2198	4	16	133
Transit Platform/Chassis (VO)	09/14→	CV24	Diesel	2198	4	16	133
Transit Platform/Chassis (VO)	09/14→	CVR5	Diesel	2198	4	16	133
Transit Platform/Chassis (VO)	09/14→	UYR6	Diesel	2198	4	16	133
Transit Tourneo	08/94→12/00	4HA	Diesel	2496	4	8	154
Transit Tourneo	11/94→12/00	4FA	Diesel	2496	4	8	154
Transit Tourneo	11/94→12/00	4FB	Diesel	2496	4	8	154
Transit Tourneo	11/94→12/00	4FC	Diesel	2496	4	8	154
Transit Tourneo	11/94→12/00	4FD	Diesel	2496	4	8	154
Transit Tourneo	11/94→12/00	4GA	Diesel	2496	4	8	154
Transit Tourneo	11/94→12/00	4GB	Diesel	2496	4	8	154
Transit Tourneo	11/94→12/00	4GC	Diesel	2496	4	8	154
Transit Tourneo	11/94→12/00	4HB	Diesel	2496	4	8	154
Transit Tourneo	11/94→12/00	4HC	Diesel	2496	4	8	154
Transit Tourneo	11/94→12/00	NSH	Petrol	1998	4	8	123
Transit Tourneo	04/98→12/00	4EB	Diesel	2496	4	8	154
Transit Tourneo	04/98→12/00	4EC	Diesel	2496	4	8	154
Transit Tourneo	07/06→08/14	QVFA	Diesel	2198	4	16	133
Transit Tourneo	07/06→08/14	QWFA	Diesel	2198	4	16	133
Transit Tourneo	10/07→08/14	PGFA	Diesel	2198	4	16	133
Transit Tourneo	10/07→08/14	PGFB	Diesel	2198	4	16	133



















CC



















9









Model	Year Range	Engine Code	Fuel Type	CC	Cylinders	Power (kW)	Power (HP)
Transit Tourneo	10/07→08/14	UHFA	Diesel	2198	4	16	133
Transit Tourneo	10/07→08/14	UHFB	Diesel	2198	4	16	133
Transit Tourneo	10/08→08/14	SRFA	Diesel	2198	4	16	133
Transit Tourneo	10/08→08/14	SRFB	Diesel	2198	4	16	133
Transit Tourneo	10/08→08/14	SRFC	Diesel	2198	4	16	133
Transit Tourneo	10/08→08/14	SRFD	Diesel	2198	4	16	133
Transit Tourneo	10/08→08/14	SRFE	Diesel	2198	4	16	133
Triton Box	06/86→12/96	4D56 (8V)	Diesel	2477	4	8	156
Triton Box	11/94→05/97	G54B	Petrol	2555	4	8	172
Triton Box	01/95→12/97	4D56 T	Diesel	2477	4	8	156
Triton Box	11/95→07/99	4G64	Petrol	2351	4	8	149
Verona	12/92→10/94	CHT 1600	Petrol	1555	4	8	54
Zephyr IV	03/68→10/72	EV 25 B	Petrol	2495	6	12	157
Zephyr IV	03/68→10/72	EV 25 L	Petrol	2495	6	12	157
Zephyr IV	03/68→10/72	EV 30 A	Petrol	2994	6	12	184
Zephyr IV	03/68→10/72	EV30B	Petrol	2994	6	12	184
Zephyr IV Station Wagon	03/68→10/72	EV 25 B	Petrol	2495	6	12	157
Zephyr IV Station Wagon	03/68→10/72	EV 25 L	Petrol	2495	6	12	157
Zephyr IV Station Wagon	03/68→10/72	EV 30 A	Petrol	2994	6	12	184
Zephyr IV Station Wagon	03/68→10/72	EV30B	Petrol	2994	6	12	184
Zodiac	11/66→02/72	EV 25 L	Petrol	2495	6	12	157
Zodiac	03/67→10/72	EV 30 A	Petrol	2994	6	12	184
Zodiac	03/67→10/72	EV30B	Petrol	2994	6	12	184
Zodiac Station Wagon	03/67→10/72	EV 30 A	Petrol	2994	6	12	184
Zodiac Station Wagon	03/67→10/72	EV30B	Petrol	2994	6	12	184









	CC				9		CC				9
1Z	1896	4	8	Diesel	94	AODE	1999	4	16	Petrol	105
4AA	2358	4	8	Diesel	148	AOJA	1999	4	16	Petrol	105
4AB	2496	4	8	Diesel	153	AOJB	1999	4	16	Petrol	105
4AB	2496	4	8	Diesel	154	AOWA	1999	4	16	Petrol	105
4AE	2496	4	8	Diesel	154	AOWB	1999	4	16	Petrol	105
4BA	2496	4	8	Diesel	154	ARC	2394	6	12	Petrol	150
4BA	2496	4	8	Diesel	155	ARD	2394	6	12	Petrol	150
4BC	2496	4	8	Diesel	154	ASDA	1388	4	16	Petrol	30
4BC	2496	4	8	Diesel	154	ASDB	1388	4	16	Petrol	30
4CA	2496	4	8	Diesel	155	ASZ	1896	4	8	Diesel	98
4CC	2496	4	8	Diesel	154	AUY	1896	4	8	Diesel	96
4 D 55 T	2347	4	8	Diesel	139	AVG	1896	4	8	Diesel	99
4D56 (8V)	2477	4	8	Diesel	156	AYL	2792	6	24	Petrol	177
4D56 T	2477	4	8	Diesel	156	AZBA	1997	4	16	Diesel	106
4DA	2496	4	8	Diesel	154	AZBA	1997	4	16	Diesel	106
4DA	2496	4	8	Diesel	154	AZBC	1997	4	16	Diesel	106
4EA	2496	4	8	Diesel	154	AZWA	1997	4	16	Diesel	106
4EA	2496	4	8	Diesel	154	AZWC	1997	4	16	Diesel	106
4EB	2496	4	8	Diesel	154	B	1593	4	8	Petrol	46
4EB	2496	4	8	Diesel	154	B3	1324	4	8	Petrol	16
4EC	2496	4	8	Diesel	154	B3	1324	4	8	Petrol	16
4ED	2496	4	8	Diesel	154	B4A	2936	6	12	Petrol	181
4ED	2496	4	8	Diesel	154	B4B	2936	6	12	Petrol	181
4FA	2496	4	8	Diesel	154	B4C	2936	6	12	Petrol	181
4FA	2496	4	8	Diesel	154	B4T	2935	6	12	Petrol	181
4FB	2496	4	8	Diesel	154	B5 (16 V)	1498	4	16	Petrol	38
4FB	2496	4	8	Diesel	154	B5 (8 V)	1498	4	8	Petrol	37
4FC	2496	4	8	Diesel	154	B6	1598	4	16	Petrol	47
4FD	2496	4	8	Diesel	154	B6	1598	4	16	Petrol	47
4G54	2555	4	8	Petrol	172	B6 (8 V)	1598	4	8	Petrol	48
4G63	1997	4	8	Petrol	100	B6 (DOHC 16 V)	1598	4	16	Petrol	49
4G64	2351	4	8	Petrol	149	B6 (SOHC 16 V)	1598	4	16	Petrol	50
4GA	2496	4	8	Diesel	154	B6GP	1598	4	16	Petrol	47
4GB	2496	4	8	Diesel	154	B6T	1598	4	16	Petrol	51
4GC	2496	4	8	Diesel	154	BAA	1299	4	8	Petrol	15
4GD	2496	4	8	Diesel	154	BAJA	1299	4	8	Petrol	15
4GE	2496	4	8	Diesel	154	BHDA	1753	4	8	Diesel	73
4GF	2496	4	8	Diesel	154	BHDB	1753	4	8	Diesel	73
4GF	2496	4	8	Diesel	154	BHPA	1753	4	8	Diesel	73
4HA	2496	4	8	Diesel	154	BNMA	1499	4	16	Petrol	39
4HB	2496	4	8	Diesel	154	BOA	2933	6	24	Petrol	182
4HB	2496	4	8	Diesel	154	BOB	2933	6	24	Petrol	182
4HC	2496	4	8	Diesel	154	BP (DOHC)	1840	4	16	Petrol	74
4HC	2496	4	8	Diesel	154	BP (SOHC)	1840	4	16	Petrol	75
4HD	2496	4	8	Diesel	154	BPT	1840	4	16	Petrol	76
4RB	1593	4	8	Petrol	45	BRC	2933	6	12	Petrol	181
4RC	1993	4	8	Petrol	101	BRD	2933	6	12	Petrol	181
5 AA/254 CID	4160	4	8	Diesel	186	BRE	2933	6	12	Petrol	181
90/5 AA-Dover	4162	4	8	Diesel	186	BRF	2933	6	12	Petrol	181
110/6 AA-Dover	5944	6	12	Diesel	189	BRG	2933	6	12	Petrol	181
130/7 AA-Dover	6223	6	12	Diesel	191	BRT	2935	6	12	Petrol	181
150/6 CA-Dover	5944	6	12	Diesel	190	BTB	1896	4	8	Diesel	98
276DT	2720	6	24	Diesel	174	C	1993	4	8	Petrol	107
380 CID	6223	6	12	Diesel	191	C9DA	1753	4	8	Diesel	73
A9A	1299	4	8	Petrol	15	C9DB	1753	4	8	Diesel	73
A9B	1299	4	8	Petrol	15	C9DC	1753	4	8	Diesel	73
A9JA	1299	4	8	Petrol	15	CA20E	1974	4	8	Petrol	108
A9JB	1299	4	8	Petrol	15	CCA	1599	4	8	Petrol	52
A9JD	1299	4	8	Petrol	15	CDB	1597	4	8	Petrol	53
AAA	2792	6	12	Petrol	176	CDC	1597	4	8	Petrol	53
ABFA	1998	4	16	Diesel	102	CDRA	1599	4	8	Petrol	53
AEDA	1499	4	8	Diesel	36	CDRB	1599	4	8	Petrol	53
AFN	1896	4	8	Diesel	94	CFBA	1798	4	16	Petrol	77
AHU	1896	4	8	Diesel	95	CGBA	1798	4	16	Petrol	77
AJ	2967	6	24	Petrol	183	CGBB	1798	4	16	Petrol	77
AJ	2967	6	24	Petrol	183	CHBA	1798	4	16	Petrol	77
AJM	1896	4	8	Diesel	96	CHBB	1798	4	16	Petrol	77
ALDA	1988	4	16	Petrol	103	CHT 1600	1555	4	8	Petrol	54
ALDA	1988	4	16	Petrol	104	CHT 1600	1555	4	8	Petrol	54
AMY	2792	6	12	Petrol	176	CJBA	1999	4	16	Petrol	105
ANU	1896	4	8	Diesel	97	CJBB	1999	4	16	Petrol	105
AOBA	1999	4	16	Petrol	105	CSDA	1798	4	16	Petrol	77
AOBC	1999	4	16	Petrol	105	CSDB	1798	4	16	Petrol	77
AODA	1999	4	16	Petrol	105	CV24	2198	4	16	Diesel	133
AODA	1999	4	16	Petrol	105	CV24	2198	4	16	Diesel	133
AODB	1999	4	16	Petrol	105	CVF5	2198	4	16	Diesel	133
AODB	1999	4	16	Petrol	105	CVFF	2198	4	16	Diesel	133
AODE	1999	4	16	Petrol	105	CVFF	2198	4	16	Diesel	133









	CC				9		CC				9
CVR5	2198	4	16	Diesel	133	EV 13 L	1305	4	8	Petrol	19
CVR5	2198	4	16	Diesel	133	EV 15 H	1488	4	8	Petrol	41
CVRA	2198	4	16	Diesel	133	EV 15 L	1488	4	8	Petrol	41
CVRA	2198	4	16	Diesel	133	EV 25 B	2495	6	12	Petrol	157
CVRB	2198	4	16	Diesel	133	EV 25 H	2495	6	12	Petrol	157
CVRB	2198	4	16	Diesel	133	EV 25 HRB	2495	6	12	Petrol	157
CVRC	2198	4	16	Diesel	133	EV 25 L	2495	6	12	Petrol	157
CVRC	2198	4	16	Diesel	133	EV 30 A	2994	6	12	Petrol	184
CY14	2198	4	16	Diesel	133	EV30B	2994	6	12	Petrol	184
CY24	2198	4	16	Diesel	133	EV 30 H	2994	6	12	Petrol	184
CYF4	2198	4	16	Diesel	133	EX	1498	4	8	Petrol	42
CYF4	2198	4	16	Diesel	133	EY	1699	4	8	Petrol	71
CYF5	2198	4	16	Diesel	133	EYDB	1796	4	16	Petrol	78
CYFA	2198	4	16	Diesel	133	EYDC	1796	4	16	Petrol	78
CYFA	2198	4	16	Diesel	133	EYDD	1796	4	16	Petrol	78
CYFB	2198	4	16	Diesel	133	EYDE	1796	4	16	Petrol	78
CYFB	2198	4	16	Diesel	133	EYDE	1796	4	16	Petrol	78
CYFC	2198	4	16	Diesel	133	EYDF	1796	4	16	Petrol	78
CYFC	2198	4	16	Diesel	133	EYDG	1796	4	16	Petrol	78
CYFD	2198	4	16	Diesel	133	EYDI	1796	4	16	Petrol	78
CYFF	2198	4	16	Diesel	133	EYDJ	1796	4	16	Petrol	78
CYFF	2198	4	16	Diesel	133	EYDL	1796	4	16	Petrol	78
CYFG	2198	4	16	Diesel	133	EYPA	1796	4	16	Petrol	78
CYR5	2198	4	16	Diesel	133	EYPC	1796	4	16	Petrol	78
CYRA	2198	4	16	Diesel	133	EYPD	1796	4	16	Petrol	78
CYRB	2198	4	16	Diesel	133	F2 (12 V)	2184	4	12	Petrol	134
CYRC	2198	4	16	Diesel	133	F2T	2184	4	12	Petrol	135
D2FA	2402	4	16	Diesel	151	F3FA	1998	4	16	Diesel	102
D2FA	2402	4	16	Diesel	151	F4A	1391	4	8	Petrol	31
D2FB	2402	4	16	Diesel	151	F4B	1392	4	8	Petrol	31
D2FE	2402	4	16	Diesel	151	F4FA	2402	4	16	Diesel	151
D3FA	1998	4	16	Diesel	102	F4FA	2402	4	16	Diesel	151
D4FA	2402	4	16	Diesel	151	F6	1587	4	8	Petrol	55
D4FA	2402	4	16	Diesel	151	F6A	1393	4	8	Petrol	31
D5BA	1998	4	16	Diesel	102	F6B	1392	4	8	Petrol	31
D6BA	1998	4	16	Diesel	102	F6C	1392	4	8	Petrol	31
D 4204 T	1997	4	16	Diesel	109	F6D	1392	4	8	Petrol	31
DHA	1242	4	16	Petrol	17	F6E	1392	4	8	Petrol	31
DHB	1242	4	16	Petrol	17	F6F	1392	4	8	Petrol	31
DHC	1242	4	16	Petrol	17	F6G	1392	4	8	Petrol	31
DHD	1242	4	16	Petrol	17	F6JA	1399	4	8	Diesel	32
DHE	1242	4	16	Petrol	17	F6JA	1399	4	8	Diesel	32
DHF	1242	4	16	Petrol	17	F6JB	1399	4	8	Diesel	32
DHG	1242	4	16	Petrol	17	F6JC	1399	4	8	Diesel	32
DOFA	2402	4	16	Diesel	151	F6JD	1399	4	8	Diesel	32
DOFA	2402	4	16	Diesel	151	F8 (12 V)	1789	4	12	Petrol	80
DRF4	2198	4	16	Diesel	133	F8 (8 V)	1789	4	8	Petrol	79
DRF5	2198	4	16	Diesel	133	F9DA	1753	4	8	Diesel	73
DRFA	2198	4	16	Diesel	133	F9DB	1753	4	8	Diesel	73
DRFB	2198	4	16	Diesel	133	FD4	1248	4	16	Diesel	20
DRFC	2198	4	16	Diesel	133	FE	1998	4	8	Petrol	113
DRFD	2198	4	16	Diesel	133	FET	1998	4	8	Petrol	114
DRFE	2198	4	16	Diesel	133	FEY9	1998	4	12	Petrol	115
DRFF	2198	4	16	Diesel	133	FFBA	1753	4	8	Diesel	81
DRFG	2198	4	16	Diesel	133	FFDA	1753	4	8	Diesel	73
DRR5	2198	4	16	Diesel	133	FFWA	1753	4	8	Diesel	73
DRRA	2198	4	16	Diesel	133	FHA	1388	4	16	Petrol	30
DRRB	2198	4	16	Diesel	133	FHD	1388	4	16	Petrol	30
DRRC	2198	4	16	Diesel	133	FHE	1388	4	16	Petrol	30
E3	1296	4	8	Petrol	18	FHF	1388	4	16	Petrol	30
E5	1490	4	8	Petrol	40	FIFA	1998	4	16	Diesel	102
E5FA	2295	4	16	Petrol	140	FMBA	1998	4	16	Diesel	102
E5FA	2295	4	16	Petrol	141	FP	1840	4	16	Petrol	82
E5FC	2295	4	16	Petrol	141	FP4	1242	4	8	Petrol	14
E5FC	2295	4	16	Petrol	142	FS	1991	4	16	Petrol	116
E5SA	2295	4	16	Petrol	141	FS	1991	4	16	Petrol	116
E5SB	2295	4	16	Petrol	141	FS	1991	4	16	Petrol	116
EST	1490	4	8	Petrol	40	FS2C	1991	4	16	Petrol	116
EDBA	1988	4	16	Petrol	110	FS83	1991	4	16	Petrol	116
EDBB	1988	4	16	Petrol	110	FUA	1392	4	8	Petrol	31
EDBC	1988	4	16	Petrol	110	FUAA	1392	4	8	Petrol	31
EDBD	1988	4	16	Petrol	110	FUB	1392	4	8	Petrol	31
EDDB	1988	4	16	Petrol	111	FUBA	1392	4	8	Petrol	33
EDDB	1988	4	16	Petrol	112	FUC	1392	4	8	Petrol	31
EDDC	1988	4	16	Petrol	111	FUD	1392	4	8	Petrol	31
EDDD	1988	4	16	Petrol	111	FUF	1392	4	8	Petrol	33
EDDF	1988	4	16	Petrol	111	FUG	1392	4	8	Petrol	31
ENUG	1499	4	8	Diesel	36	FUH	1392	4	8	Petrol	31





	CC				9		CC				9
FUJ	1392	4	8	Petrol	33	H9FA	2402	4	16	Diesel	151
FUJA	1242	4	16	Petrol	17	H9FB	2402	4	16	Diesel	151
FUJA	1242	4	16	Petrol	17	H9FB	2402	4	16	Diesel	151
FUJB	1242	4	16	Petrol	17	H9FD	2402	4	16	Diesel	151
FXDA	1388	4	16	Petrol	30	HCPA	1753	4	8	Diesel	73
FXDB	1388	4	16	Petrol	30	HCPB	1753	4	8	Diesel	73
FXDC	1388	4	16	Petrol	30	HHDA	1560	4	16	Diesel	57
FXDD	1388	4	16	Petrol	30	HHDB	1560	4	16	Diesel	57
FXFA	2402	4	16	Diesel	151	HHJA	1560	4	16	Diesel	57
FXFA	2402	4	16	Diesel	151	HHJB	1560	4	16	Diesel	57
FXJA	1388	4	16	Petrol	30	HHJC	1560	4	16	Diesel	57
FXJB	1388	4	16	Petrol	30	HHJC	1560	4	16	Diesel	57
FXJC	1388	4	16	Petrol	30	HHJD	1560	4	16	Diesel	57
FYDA	1596	4	16	Petrol	56	HHJD	1560	4	16	Diesel	57
FYDB	1596	4	16	Petrol	56	HHJE	1560	4	16	Diesel	57
FYDC	1596	4	16	Petrol	56	HHJF	1560	4	16	Diesel	57
FYDD	1596	4	16	Petrol	56	HJBA	1998	4	16	Diesel	102
FYDH	1596	4	16	Petrol	56	HJBB	1998	4	16	Diesel	102
FYJA	1596	4	16	Petrol	56	HJBC	1998	4	16	Diesel	102
FYJA	1596	4	16	Petrol	56	HMDA	1988	4	16	Petrol	117
FYJB	1596	4	16	Petrol	56	HUBA	2521	5	20	Petrol	159
FYJB	1596	4	16	Petrol	56	HUBA	2521	5	20	Petrol	159
FYJC	1596	4	16	Petrol	56	HUWA	2521	5	20	Petrol	159
G1	1098	4	8	Petrol	7	HWDA	1596	4	16	Petrol	56
G1	1098	4	8	Petrol	7	HWDB	1596	4	16	Petrol	56
G2	1098	4	8	Petrol	7	HXDA	1596	4	16	Petrol	58
G6A	1119	4	8	Petrol	8	HXDB	1596	4	16	Petrol	58
G6DA	1997	4	16	Diesel	106	HXJA	1596	4	16	Petrol	58
G6DA	1997	4	16	Diesel	106	HXJA	1596	4	16	Petrol	58
G6DB	1997	4	16	Diesel	106	HXJB	1596	4	16	Petrol	58
G6DC	1997	4	16	Diesel	106	HXJD	1596	4	16	Petrol	58
G6DD	1997	4	16	Diesel	106	HYDA	2522	5	20	Petrol	159
G6DE	1997	4	16	Diesel	106	HYDA	2522	5	20	Petrol	159
G6DF	1997	4	16	Diesel	106	HYDB	2522	5	20	Petrol	159
G6DG	1997	4	16	Diesel	106	HYDB	2522	5	20	Petrol	160
G8DA	1560	4	16	Diesel	57	HYDC	2522	5	20	Petrol	159
G8DB	1560	4	16	Diesel	57	HYF	2993	6	12	Petrol	184
G8DC	1560	4	16	Diesel	57	IQDA	1596	4	16	Petrol	58
G8DD	1560	4	16	Diesel	57	IQDB	1596	4	16	Petrol	58
G8DE	1560	4	16	Diesel	57	IQDC	1596	4	16	Petrol	56
G8DF	1560	4	16	Diesel	57	IQJA	1596	4	16	Petrol	58
G54B	2555	4	8	Petrol	172	IQJB	1596	4	16	Petrol	58
GBVAF	2488	4	16	Petrol	158	IQJC	1596	4	16	Petrol	58
GBVAF	2488	4	16	Petrol	158	IQJE	1596	4	16	Petrol	58
GBVAJPF	2198	4	16	Diesel	133	IXDA	1997	4	16	Diesel	106
GBVAJQJ	2198	4	16	Diesel	133	J1E	1298	4	8	Petrol	19
GBVAJQJ	2198	4	16	Diesel	133	J1F	1298	4	8	Petrol	19
GBVAJQW	2198	4	16	Diesel	133	J1F	1298	4	8	Petrol	19
GBVAK	2488	4	16	Petrol	158	J2	1298	4	8	Petrol	19
GBVAK	2488	4	16	Petrol	158	J2	1298	4	8	Petrol	19
GBVAL	2488	4	16	Petrol	158	J2F	1298	4	8	Petrol	21
GBVAL	2488	4	16	Petrol	158	J2N	1298	4	8	Petrol	21
GL	1043	4	8	Petrol	2	J3	1298	4	8	Petrol	19
GL1	1117	4	8	Petrol	9	J3C	1298	4	8	Petrol	21
GLA	1117	4	8	Petrol	9	J3D	1298	4	8	Petrol	19
GLB	1117	4	8	Petrol	10	J3E	1297	4	8	Petrol	19
GLC	1117	4	8	Petrol	11	J3N	1298	4	8	Petrol	21
GLW	1117	4	8	Petrol	11	J4B	1299	4	8	Petrol	22
GMA	1117	4	8	Petrol	12	J4C	1299	4	8	Petrol	22
GPA	1117	4	8	Petrol	12	J4D	1299	4	8	Petrol	22
GPDA	1560	4	16	Diesel	57	J4D	1299	4	8	Petrol	22
GPDB	1560	4	16	Diesel	57	J4F	1299	4	8	Petrol	22
GPDC	1560	4	16	Diesel	57	J4J	1299	4	8	Petrol	22
GSE	1117	4	8	Petrol	13	J4K	1299	4	8	Petrol	22
GSF	1117	4	8	Petrol	11	J4L	1299	4	8	Petrol	22
GSG	1117	4	8	Petrol	11	J4M	1299	4	8	Petrol	22
GSH	1117	4	8	Petrol	11	J4N	1299	4	8	Petrol	22
GUB	1117	4	8	Petrol	8	J4P	1299	4	8	Petrol	22
GUC	1119	4	8	Petrol	8	J4Q	1299	4	8	Petrol	22
GUD	1119	4	8	Petrol	8	J4R	1299	4	8	Petrol	22
GUE	1119	4	8	Petrol	8	J4S	1299	4	8	Petrol	22
GUF	1118	4	8	Petrol	8	J4T	1299	4	8	Petrol	22
GZ	2261	4	16	Petrol	143	J6A	1299	4	8	Petrol	22
GZFA	2261	4	16	Petrol	143	J6B	1299	4	8	Petrol	22
GZFA	2261	4	16	Petrol	143	JAC	1297	4	8	Petrol	23
GZFB	2261	4	16	Petrol	143	JBA	1297	4	8	Petrol	22
GZFC	2261	4	16	Petrol	143	JBB	1297	4	8	Petrol	24
H9FA	2402	4	16	Diesel	151	JBC	1299	4	8	Petrol	22

	CC				9		CC				9
JBD	1297	4	8	Petrol	22	LTF	1597	4	16	Petrol	62
JBE	1299	4	8	Petrol	22	L1G	1597	4	16	Petrol	62
JCC	1294	4	8	Petrol	25	L1H	1597	4	16	Petrol	62
JCT	1294	4	8	Petrol	25	L1J	1597	4	16	Petrol	62
JGA	1341	4	8	Petrol	26	L1K	1597	4	16	Petrol	62
JJA	1299	4	8	Petrol	22	L1L	1597	4	16	Petrol	62
JJB	1299	4	8	Petrol	22	L1M	1597	4	16	Petrol	62
JJC	1299	4	8	Petrol	22	L1N	1597	4	16	Petrol	62
JJD	1299	4	8	Petrol	22	L1Q	1597	4	16	Petrol	62
JJE	1299	4	8	Petrol	22	L1T	1596	4	16	Petrol	56
JJF	1299	4	8	Petrol	22	L1V	1596	4	16	Petrol	56
JJG	1299	4	8	Petrol	22	L1W	1596	4	16	Petrol	56
JJH	1299	4	8	Petrol	22	L3	2261	4	16	Petrol	143
JJJ	1299	4	8	Petrol	22	L3E	1598	4	8	Petrol	60
JJK	1299	4	8	Petrol	22	L4B	1598	4	8	Petrol	63
JJL	1299	4	8	Petrol	22	L6B	1598	4	8	Petrol	63
JJM	1299	4	8	Petrol	22	LAC	1593	4	8	Petrol	64
JLA	1297	4	8	Petrol	22	LAD	1593	4	8	Petrol	45
JLB	1297	4	8	Petrol	25	LAN	1593	4	8	Petrol	60
JPA	1296	4	8	Petrol	27	LAR	1593	4	8	Petrol	65
JPC	1297	4	8	Petrol	28	LAT	1593	4	8	Petrol	64
JQDA	1596	4	16	Petrol	59	LC	1598	4	8	Petrol	61
JQDB	1596	4	16	Petrol	59	LC	1599	4	8	Petrol	61
JQGA	1596	4	16	Petrol	59	LCBA	2544	6	24	Petrol	163
JQMA	1596	4	16	Petrol	59	LCBB	2495	6	24	Petrol	163
JQMA	1596	4	16	Petrol	59	LCBB	2495	6	24	Petrol	163
JQMB	1596	4	16	Petrol	59	LCBC	2495	6	24	Petrol	163
JQMB	1596	4	16	Petrol	59	LCBC	2495	6	24	Petrol	163
JSD	1298	4	8	Petrol	21	LCBD	2495	6	24	Petrol	163
JTBA	1596	4	16	Petrol	59	LCBE	2495	6	24	Petrol	163
JTBB	1596	4	16	Petrol	59	LCE	2495	6	24	Petrol	163
JTDA	1596	4	16	Petrol	59	LCE	1593	4	8	Petrol	64
JTDB	1596	4	16	Petrol	59	LCJ	1593	4	8	Petrol	64
JTJA	1596	4	16	Petrol	59	LCK	1593	4	8	Petrol	64
JTJA	1596	4	16	Petrol	59	LCN	1593	4	8	Petrol	64
JTJB	1596	4	16	Petrol	59	LCR	1598	4	8	Petrol	64
JTJC	1596	4	16	Petrol	59	LCS	1593	4	8	Petrol	65
JTMA	1596	4	16	Petrol	59	LCT	1593	4	8	Petrol	65
JTMA	1596	4	16	Petrol	59	LE	1593	4	8	Petrol	64
JTWA	1596	4	16	Petrol	59	LEC	1593	4	8	Petrol	45
JTWB	1596	4	16	Petrol	59	LEN	1593	4	8	Petrol	60
JX493ZLQ	2771	4	8	Diesel	178	LHA	1598	4	8	Petrol	63
JX493ZLQ-3	2771	4	8	Diesel	178	LJA	1598	4	8	Petrol	63
JX493ZLQ-3A	2771	4	8	Diesel	178	LJB	1597	4	8	Petrol	63
JX493ZLQ-4	2771	4	8	Diesel	178	LJC	1597	4	8	Petrol	63
JX493ZQ-3	2771	4	8	Diesel	178	LJD	1598	4	8	Petrol	63
JX493ZQ-4	2771	4	8	Diesel	178	LJE	1598	4	8	Petrol	63
JX493ZXQ-3	2771	4	8	Diesel	178	LJF	1598	4	8	Petrol	63
JXFA	2402	4	16	Diesel	151	LNA	1597	4	8	Petrol	63
JXFA	2402	4	16	Diesel	151	LNB	1597	4	8	Petrol	63
JXFC	2402	4	16	Diesel	151	LP1	1597	4	8	Petrol	63
JZDA	2521	5	20	Petrol	160	LP1	1597	4	8	Petrol	63
JZDA	2521	5	20	Petrol	160	LP2	1597	4	8	Petrol	63
KA-24	2389	4	12	Petrol	152	LP3	1597	4	8	Petrol	63
KA24E	2389	4	12	Petrol	152	LPA	1597	4	8	Petrol	63
KA24-E	2389	4	12	Petrol	152	LPBA	1997	4	16	Diesel	106
KF	1995	6	24	Petrol	118	LR1	1597	4	8	Petrol	63
KGBA	1596	4	16	Petrol	58	LR2	1597	4	8	Petrol	63
KHBA	1753	4	8	Diesel	81	LRA	1597	4	8	Petrol	63
KKDA	1753	4	8	Diesel	81	LRB	1597	4	8	Petrol	63
KKDB	1753	4	8	Diesel	81	LSD	1597	4	8	Petrol	65
KL	2497	6	24	Petrol	161	LSDA	1597	4	8	Petrol	60
KL	2497	6	24	Petrol	161	LSE	1597	4	8	Petrol	64
KL11	1098	4	8	Petrol	7	LSF	1597	4	8	Petrol	64
KL 13 H	1298	4	8	Petrol	19	LTA	1608	4	8	Diesel	66
KL 13 HC	1298	4	8	Petrol	19	LTB	1608	4	8	Diesel	66
KL 13 L	1298	4	8	Petrol	19	LTC	1608	4	8	Diesel	66
KL 16 L	1598	4	8	Petrol	60	LUA	1597	4	8	Petrol	63
KL 16 R	1601	4	8	Petrol	61	LUAE	1597	4	8	Petrol	63
KLBA	1997	4	16	Diesel	106	LUB	1597	4	8	Petrol	63
KLWA	1997	4	16	Diesel	106	LUC	1597	4	8	Petrol	63
KL-ZE	2497	6	24	Petrol	162	LUD	1597	4	8	Petrol	63
KNBA	2179	4	16	Diesel	136	LUG	1597	4	8	Petrol	63
KNBB	2179	4	16	Diesel	136	LUH	1597	4	8	Petrol	63
KNWA	2179	4	16	Diesel	136	LUJ	1598	4	8	Petrol	63
KNWB	2179	4	16	Diesel	136	LUK	1598	4	8	Petrol	63
KVJA	1399	4	8	Diesel	32	M1CA	998	3	12	Petrol	3
LIE	1597	4	16	Petrol	62	M1CB	998	3	12	Petrol	3

	CC				9		CC				9
M1DA	998	3	12	Petrol	3	NEJ	1993	4	8	Petrol	122
M1DC	998	3	12	Petrol	3	NEK	1993	4	8	Petrol	101
M1DD	998	3	12	Petrol	3	NEL	1993	4	8	Petrol	122
M1JA	998	3	12	Petrol	3	NEN	1993	4	8	Petrol	122
M1JC	998	3	12	Petrol	3	NEP	1993	4	8	Petrol	101
M1JC	998	3	12	Petrol	3	NER	1993	4	8	Petrol	101
M1JE	998	3	12	Petrol	3	NER	1993	4	8	Petrol	122
M1JE	998	3	12	Petrol	3	NES	1993	4	8	Petrol	101
M1JH	998	3	12	Petrol	3	NET	1993	4	8	Petrol	101
M1JJ	998	3	12	Petrol	3	NGA	1988	4	16	Petrol	125
M2DA	998	3	12	Petrol	3	NGA	1988	4	16	Petrol	125
M2DB	998	3	12	Petrol	3	NGB	1988	4	16	Petrol	125
M2DC	998	3	12	Petrol	3	NGB	1988	4	16	Petrol	125
M2GA	998	3	12	Petrol	3	NGC	1988	4	16	Petrol	125
M2GB	998	3	12	Petrol	3	NGC	1988	4	16	Petrol	125
M6JA	1388	4	16	Petrol	30	NGCA	1560	4	8	Diesel	68
M7JA	1242	4	16	Petrol	17	NGD	1988	4	16	Petrol	125
M7JB	1242	4	16	Petrol	17	NGD	1988	4	16	Petrol	125
M8DA	1498	4	16	Petrol	43	NGDA	1560	4	8	Diesel	68
M8DB	1498	4	16	Petrol	43	NGDB	1560	4	8	Diesel	68
M8MA	1499	4	16	Petrol	43	NR2	1993	4	8	Petrol	122
M9DA	1498	4	16	Petrol	43	NRA	1993	4	8	Petrol	122
M9DB	1498	4	16	Petrol	43	NRB	1993	4	8	Petrol	122
M9MA	1499	4	16	Petrol	39	NRC	1993	4	8	Petrol	122
M9MA	1499	4	16	Petrol	43	NRD	1993	4	8	Petrol	122
M9MC	1499	4	16	Petrol	39	NRI	1993	4	8	Petrol	122
MA	1970	4	8	Petrol	119	NSD	1998	4	8	Petrol	123
MEBA	2967	6	24	Petrol	183	NSE	1998	4	8	Petrol	123
MGDA	1999	4	16	Petrol	105	NSF	1998	4	8	Petrol	123
MGDA	1999	4	16	Petrol	120	NSF	1998	4	8	Petrol	123
MHA	1679	4	16	Petrol	72	NSG	1998	4	8	Petrol	123
MHB	1679	4	16	Petrol	72	NSG	1998	4	8	Petrol	123
MTDA	1560	4	16	Diesel	57	NSH	1998	4	8	Petrol	123
MUDA	1596	4	16	Petrol	58	NWN	1999	6	12	Petrol	126
MUDD	1596	4	16	Petrol	58	NWP	1998	6	12	Petrol	126
MVJA	1596	4	16	Petrol	58	NWR	1999	6	12	Petrol	126
MWB	1699	4	8	Petrol	71	NX	1998	6	12	Petrol	126
MY	1699	4	8	Petrol	71	NY	1998	6	12	Petrol	126
MYE	1699	4	8	Petrol	71	NYL	1999	6	12	Petrol	126
N3A	1998	4	16	Petrol	121	NYP	1998	6	12	Petrol	126
N4A	1993	4	8	Petrol	122	NYR	1999	6	12	Petrol	126
N4B	1993	4	8	Petrol	122	NYT	1999	6	12	Petrol	126
N4I	1993	4	8	Petrol	122	NYU	1999	6	12	Petrol	126
N4JB	1999	4	16	Petrol	105	OHC LC	1994	4	8	Petrol	122
N4JB	1999	4	16	Petrol	105	OHC TL 13 H	1295	4	8	Petrol	21
N6T	1993	4	8	Petrol	122	OHC TL 13 L	1295	4	8	Petrol	21
N6TS	1993	4	8	Petrol	122	OHC TL 16	1595	4	8	Petrol	60
N7A	1998	4	16	Petrol	121	OHC TL 16 G	1593	4	8	Petrol	60
N7BA	1998	4	16	Diesel	102	OHC TL 16 H	1593	4	8	Petrol	69
N8A	1998	4	8	Petrol	123	OHC TL 16 L	1593	4	8	Petrol	45
N8B	1998	4	8	Petrol	123	OHC TL 20	1993	4	8	Petrol	122
N8C	1993	4	8	Petrol	123	OHC TL 20 H	1993	4	8	Petrol	122
N8D	1993	4	8	Petrol	124	OHC TL 20 L	1993	4	8	Petrol	122
N9A	1998	4	8	Petrol	124	OHV KL 13 G	1298	4	8	Petrol	29
N9B	1998	4	8	Petrol	123	OHV KL 13 H	1298	4	8	Petrol	29
N9C	1998	4	8	Petrol	123	OHV KL 13 L	1298	4	8	Petrol	29
N9D	1998	4	8	Petrol	123	OHV KL 16 G	1599	4	8	Petrol	61
N9E	1998	4	8	Petrol	123	OHV KL 16 H	1599	4	8	Petrol	61
N9F	1998	4	8	Petrol	123	OHV KL 16 L	1599	4	8	Petrol	61
N38H	2261	4	16	Petrol	144	OZ	2638	6	12	Petrol	173
N48H	2261	4	16	Petrol	144	P4JA	998	3	12	Petrol	3
NA	1586	4	8	Petrol	67	P4JB	998	3	12	Petrol	3
NAE	1993	4	8	Petrol	122	P4JC	998	3	12	Petrol	3
NAT	1994	4	8	Petrol	122	P4JD	998	3	12	Petrol	3
NAV	1994	4	8	Petrol	122	P5-AT	3198	5	20	Diesel	185
NAW	1993	4	8	Petrol	122	P7PA	1753	4	8	Diesel	73
NAX	1993	4	8	Petrol	122	P7PB	1753	4	8	Diesel	73
NBA	1993	4	8	Petrol	122	P8FA	2198	4	16	Diesel	133
NCA	1994	4	8	Petrol	122	P8FB	2198	4	16	Diesel	133
NE	1993	4	8	Petrol	101	P9PA	1753	4	8	Diesel	73
NE	1993	4	8	Petrol	122	P9PB	1753	4	8	Diesel	73
NE1	1993	4	8	Petrol	122	P9PC	1753	4	8	Diesel	73
NE2	1993	4	8	Petrol	122	P9PD	1753	4	8	Diesel	73
NE3	1993	4	8	Petrol	122	PGFA	2198	4	16	Diesel	133
NE4	1993	4	8	Petrol	122	PGFB	2198	4	16	Diesel	133
NE5	1993	4	8	Petrol	122	PHFA	2402	4	16	Diesel	151
NEE	1993	4	8	Petrol	122	PHFC	2402	4	16	Diesel	151
NEG	1993	4	8	Petrol	122	PHFC	2402	4	16	Diesel	151

	CC				9		CC				9
PNBA	1596	4	16	Petrol	58	RFM	1753	4	8	Diesel	87
PNDA	1596	4	16	Petrol	58	RFN	1753	4	8	Diesel	87
PNDA	1596	4	16	Petrol	58	RFS	1753	4	8	Diesel	87
PNDD	1596	4	16	Petrol	58	RFU	1753	4	8	Diesel	87
PR	2792	6	12	Petrol	179	RHBA	1596	4	16	Petrol	58
PR3	2792	6	12	Petrol	179	RKA	1796	4	16	Petrol	78
PR4	2792	6	12	Petrol	179	RKB	1796	4	16	Petrol	78
PR5	2792	6	12	Petrol	180	RKC	1796	4	16	Petrol	78
PR6	2792	6	12	Petrol	180	RKF	1796	4	16	Petrol	78
PR7	2792	6	12	Petrol	180	RKH	1796	4	16	Petrol	78
PR8	2792	6	12	Petrol	180	RKJ	1796	4	16	Petrol	78
PRB	2792	6	12	Petrol	180	RKK	1796	4	16	Petrol	78
PRC	2792	6	12	Petrol	180	ROB	1796	4	16	Petrol	78
PRD	2792	6	12	Petrol	180	RQC	1796	4	16	Petrol	78
PRE	2792	6	12	Petrol	180	RTA	1753	4	8	Diesel	88
PRG	2792	6	12	Petrol	180	RTB	1753	4	8	Diesel	88
PRI	2792	6	12	Petrol	179	RTC	1753	4	8	Diesel	89
PRN	2792	6	12	Petrol	180	RTD	1753	4	8	Diesel	89
PRT	2792	6	12	Petrol	180	RTE	1753	4	8	Diesel	89
PYA	2792	6	12	Petrol	180	RTF	1753	4	8	Diesel	89
PYN	2792	6	12	Petrol	180	RTG	1753	4	8	Diesel	89
PYU	2792	6	12	Petrol	180	RTH	1753	4	8	Diesel	90
Q4BA	2179	4	16	Diesel	136	RTJ	1753	4	8	Diesel	91
Q4WA	2179	4	16	Diesel	136	RTJA	1388	4	16	Petrol	30
Q7DA	1798	4	16	Petrol	77	RTJB	1388	4	16	Petrol	30
QJBA	2198	4	16	Diesel	137	RTJC	1388	4	16	Petrol	30
QJBB	2198	4	16	Diesel	137	RTK	1753	4	8	Diesel	91
QJBC	2198	4	16	Diesel	137	RTN	1753	4	8	Diesel	73
QJBD	2198	4	16	Diesel	137	RTP	1753	4	8	Diesel	73
QQDA	1798	4	16	Petrol	77	RTQ	1753	4	8	Diesel	73
QQDB	1798	4	16	Petrol	77	RVA	1753	4	8	Diesel	92
QQDC	1798	4	16	Petrol	77	RWPA	1753	4	8	Diesel	73
QQDD	1798	4	16	Petrol	77	RWPC	1753	4	8	Diesel	73
QVFA	2198	4	16	Diesel	133	RWPD	1753	4	8	Diesel	73
QVFA	2198	4	16	Diesel	133	RWPE	1753	4	8	Diesel	73
QWFA	2198	4	16	Diesel	133	RWPF	1753	4	8	Diesel	73
QXBA	1997	4	16	Diesel	106	S7CB	2489	4	16	Petrol	164
QXBA	1997	4	16	Diesel	127	SAFA	3198	5	20	Diesel	185
QXBB	1997	4	16	Diesel	106	SAFA	3198	5	20	Diesel	185
QXBB	1997	4	16	Diesel	127	SAFB	3199	5	20	Diesel	185
QXWA	1997	4	16	Diesel	106	SDBA	1998	4	16	Diesel	102
QXWB	1997	4	16	Diesel	106	SEA	2544	6	24	Petrol	163
QXWC	1997	4	16	Diesel	106	SEA	2544	6	24	Petrol	163
QYBA	1753	4	8	Diesel	73	SEB	2495	6	24	Petrol	163
QYWA	1753	4	8	Diesel	73	SEBA	2261	4	16	Petrol	143
R2	2184	4	8	Diesel	138	SEBA	2261	4	16	Petrol	143
R2A	1796	4	8	Petrol	83	SEC	2495	6	24	Petrol	163
R2C	1769	4	8	Petrol	84	SEC	2495	6	24	Petrol	163
R2PA	1753	4	8	Diesel	73	SEWA	2261	4	16	Petrol	143
R3PA	1753	4	8	Diesel	73	SFA	2498	4	8	Diesel	165
R6A	1769	4	8	Petrol	84	SFB	2498	4	8	Diesel	165
R9CB	1999	4	16	Petrol	105	SFCA	998	3	12	Petrol	3
R9CB	1999	4	16	Petrol	105	SFCB	998	3	12	Petrol	3
R9CD	1999	4	16	Petrol	105	SFCC	998	3	12	Petrol	3
R9CF	1999	4	16	Petrol	105	SFCD	998	3	12	Petrol	3
R9CF	1999	4	16	Petrol	105	SFDA	998	3	12	Petrol	3
R9CH	1999	4	16	Petrol	105	SFDB	998	3	12	Petrol	3
R9CH	1999	4	16	Petrol	105	SFJA	998	3	12	Petrol	3
R9CI	1999	4	16	Petrol	105	SFJB	998	3	12	Petrol	3
R9DA	1999	4	16	Petrol	105	SFJC	998	3	12	Petrol	3
R9DA	1999	4	16	Petrol	105	SFJD	998	3	12	Petrol	3
R9DB	1999	4	16	Petrol	120	SGA	2495	6	24	Petrol	163
R9DC	1999	4	16	Petrol	120	SHDA	1596	4	16	Petrol	56
R263	2184	4	8	Diesel	138	SHDB	1596	4	16	Petrol	56
RDA	1796	4	16	Petrol	78	SHDC	1596	4	16	Petrol	56
RDB	1796	4	16	Petrol	78	SIDA	1596	4	16	Petrol	58
REB	1796	4	8	Petrol	85	SNJA	1242	4	16	Petrol	17
REBA	2967	6	24	Petrol	183	SNJB	1242	4	16	Petrol	17
REC	1796	4	8	Petrol	85	SNJC	1242	4	16	Petrol	17
RED	1796	4	8	Petrol	85	SNJD	1242	4	16	Petrol	17
REF	1796	4	8	Petrol	85	SPJA	1388	4	16	Petrol	30
RF	1998	4	8	Diesel	128	SPJA	1388	4	16	Petrol	30
RF1G	1998	4	8	Diesel	128	SPJC	1388	4	16	Petrol	30
RFA	1753	4	8	Diesel	86	SPJD	1388	4	16	Petrol	30
RFB	1753	4	8	Diesel	86	SRFA	2198	4	16	Diesel	133
RFD	1753	4	8	Diesel	87	SRFA	2198	4	16	Diesel	133
RFK	1753	4	8	Diesel	87	SRFB	2198	4	16	Diesel	133
RFL	1753	4	8	Diesel	86	SRFB	2198	4	16	Diesel	133

	CC				9		CC				9
SRFC	2198	4	16	Diesel	133	TNWB	1999	4	16	Petrol	105
SRFC	2198	4	16	Diesel	133	TPBA	1999	4	16	Petrol	105
SRFD	2198	4	16	Diesel	133	TPWA	1999	4	16	Petrol	105
SRFD	2198	4	16	Diesel	133	TV 15 H	1498	4	8	Petrol	41
SRFE	2198	4	16	Diesel	133	TV 15 HC	1498	4	8	Petrol	41
SRFE	2198	4	16	Diesel	133	TV 17 H	1699	4	8	Petrol	71
STJA	1242	4	16	Petrol	17	TV 17 HC	1699	4	8	Petrol	71
STJB	1242	4	16	Petrol	17	TV 17 L	1699	4	8	Petrol	71
STJC	1242	4	16	Petrol	17	TV 17 LC	1699	4	8	Petrol	71
STJD	1242	4	16	Petrol	17	TV 20 H	1998	6	12	Petrol	126
STP	2499	4	8	Diesel	166	TV 20 L	1998	6	12	Petrol	126
STR	2498	4	8	Diesel	166	TV 23 H	2293	6	12	Petrol	145
SYDA	1999	4	16	Petrol	105	TV 26 H	2523	6	12	Petrol	167
T1BA	1560	4	8	Diesel	68	TV 26 L	2551	6	12	Petrol	173
T1BB	1560	4	8	Diesel	68	TXBA	1997	4	16	Diesel	129
T1BC	1560	4	8	Diesel	68	TXBA	1997	4	16	Diesel	129
T1DA	1560	4	8	Diesel	68	TXBB	1997	4	16	Diesel	129
T1DB	1560	4	8	Diesel	68	TXBB	1997	4	16	Diesel	129
T1GA	1560	4	8	Diesel	68	TXDA	1997	4	16	Diesel	129
T1WA	1560	4	8	Diesel	68	TXDB	1997	4	16	Diesel	129
T1WB	1560	4	8	Diesel	68	TXDB	1997	4	16	Diesel	129
T3CA	1560	4	8	Diesel	68	TXMA	1997	4	16	Diesel	129
T3CB	1560	4	8	Diesel	68	TXMA	1997	4	16	Diesel	129
T3CC	1560	4	8	Diesel	68	TXWA	1997	4	16	Diesel	129
T3DA	1560	4	8	Diesel	68	TYBA	1997	4	16	Diesel	129
T3DB	1560	4	8	Diesel	68	TYDA	1997	4	16	Diesel	129
T3JA	1560	4	8	Diesel	68	TYMA	1997	4	16	Diesel	129
T3JB	1560	4	8	Diesel	68	TYWA	1997	4	16	Diesel	129
T7CE	1997	4	16	Diesel	129	TZGA	1560	4	8	Diesel	68
T7CI	1997	4	16	Diesel	129	TZGB	1560	4	8	Diesel	68
T7CJ	1997	4	16	Diesel	129	TZJA	1560	4	8	Diesel	68
T7CK	1997	4	16	Diesel	129	TZJB	1560	4	8	Diesel	68
T7CL	1997	4	16	Diesel	129	U	1415	4	8	Petrol	34
T7DB	1997	4	16	Diesel	129	U3CA	1560	4	8	Diesel	68
T7MA	1997	4	16	Diesel	129	U5JA	1596	4	16	Petrol	58
T7MB	1997	4	16	Diesel	129	UACA	1999	4	16	Petrol	105
T8CC	1997	4	16	Diesel	129	UBGA	1560	4	8	Diesel	68
T8CC	1997	4	16	Diesel	129	UBJA	1560	4	16	Diesel	57
T8CC	1997	4	16	Diesel	129	UC	1416	4	8	Petrol	35
T8CG	1997	4	16	Diesel	129	UEJB	1498	4	16	Petrol	44
T8CH	1997	4	16	Diesel	129	UEJB	1498	4	16	Petrol	44
T8CI	1997	4	16	Diesel	129	UFBA	1997	4	16	Diesel	129
T8CJ	1997	4	16	Diesel	129	UFBA	1997	4	16	Diesel	129
T8CM	1997	4	16	Diesel	130	UFBB	1997	4	16	Diesel	129
T8DA	1997	4	16	Diesel	129	UFBB	1997	4	16	Diesel	129
T8DE	1997	4	16	Diesel	129	UFCA	1997	4	16	Diesel	129
T8MA	1997	4	16	Diesel	129	UFCB	1997	4	16	Diesel	129
T8MB	1997	4	16	Diesel	129	UFDA	1997	4	16	Diesel	129
T9CA	1997	4	16	Diesel	129	UFDB	1997	4	16	Diesel	129
T9CB	1997	4	16	Diesel	129	UFMA	1997	4	16	Diesel	129
T9CC	1997	4	16	Diesel	129	UFWA	1997	4	16	Diesel	129
T9CE	1997	4	16	Diesel	130	UGCA	1499	4	8	Diesel	36
T9CF	1997	4	16	Diesel	130	UGCB	1499	4	8	Diesel	36
TB42	4169	6	12	Petrol	187	UGCC	1499	4	8	Diesel	36
TBBA	1999	4	16	Petrol	105	UGJC	1499	4	8	Diesel	36
TBBB	1999	4	16	Petrol	105	UGJE	1499	4	8	Diesel	36
TBWA	1999	4	16	Petrol	105	UHFA	2198	4	16	Diesel	133
TBWB	1999	4	16	Petrol	105	UHFB	2198	4	16	Diesel	133
TD27	2663	4	8	Diesel	175	UHFC	2198	4	16	Diesel	133
TD27E	2664	4	8	Diesel	175	UHR5	2198	4	16	Diesel	133
TD 27 T	2664	4	8	Diesel	175	UKBA	1997	4	16	Diesel	129
TD42	4169	6	12	Diesel	188	UKBB	1997	4	16	Diesel	129
TKA	957	4	8	Petrol	4	UKDA	1997	4	16	Diesel	129
TKB	957	4	8	Petrol	4	UKDB	1997	4	16	Diesel	129
TKW	957	4	8	Petrol	1	UKMA	1997	4	16	Diesel	129
TL 16M	1593	4	8	Petrol	45	UKWA	1997	4	16	Diesel	129
TL 20 LC	1994	4	8	Petrol	122	UNCA	1499	4	16	Petrol	43
TLA	957	4	8	Petrol	4	UNCB	1499	4	16	Petrol	43
TLB	999	4	8	Petrol	5	UNCC	1499	4	16	Petrol	39
TNBA	1999	4	16	Petrol	105	UNCD	1499	4	16	Petrol	39
TNBA	1999	4	16	Petrol	120	UNCE	1499	4	16	Petrol	43
TNBB	1999	4	16	Petrol	105	UNCF	1499	4	16	Petrol	43
TNCC	1999	4	16	Petrol	105	UNCG	1499	4	16	Petrol	39
TNCD	1999	4	16	Petrol	105	UNCH	1499	4	16	Petrol	39
TNCD	1999	4	16	Petrol	105	UNCI	1499	4	16	Petrol	39
TNCF	1999	4	16	Petrol	105	UNCJ	1499	4	16	Petrol	39
TNCF	1999	4	16	Petrol	105	UNCK	1498	4	16	Petrol	39
TNWA	1999	4	16	Petrol	105	UNCM	1498	4	16	Petrol	39

	CC				9
USF6	2198	4	16	Diesel	133
USR6	2198	4	16	Diesel	133
USRA	2198	4	16	Diesel	133
USRB	2198	4	16	Diesel	133
UTJA	1388	4	16	Petrol	30
UY	2550	6	12	Petrol	168
UYR6	2198	4	16	Diesel	133
UYR6	2198	4	16	Diesel	133
VC	1769	4	8	Petrol	93
WL	2500	4	12	Diesel	169
WL	2500	4	12	Diesel	169
WLAT (12 V)	2500	4	12	Diesel	169
WLAT (16 V)	2500	4	16	Diesel	170
WL-T	2500	4	12	Diesel	169
WTA	2112	4	8	Diesel	132
XD3P	2497	4	8	Diesel	171
XD3T	2497	4	8	Diesel	171
XMJA	998	3	12	Petrol	3
XMJB	998	3	12	Petrol	3
XMJC	998	3	12	Petrol	3
XMJD	998	3	12	Petrol	3
XQDA	1999	4	16	Petrol	105
XRMA	1997	4	16	Diesel	129
XRMB	1997	4	16	Diesel	129
XTDA	1596	4	16	Petrol	58
XTDB	1596	4	16	Petrol	58
XUCA	1499	4	8	Diesel	36
XUCC	1499	4	8	Diesel	36
XUCD	1499	4	8	Diesel	36
XUGA	1499	4	8	Diesel	36
XUJA	1499	4	8	Diesel	36
XUJB	1499	4	8	Diesel	36
XVCA	1499	4	8	Diesel	36
XVCB	1499	4	8	Diesel	36
XVCC	1499	4	8	Diesel	36
XVGA	1499	4	8	Diesel	36
XVGB	1499	4	8	Diesel	36
XVGC	1499	4	8	Diesel	36
XVJA	1499	4	8	Diesel	36
XVJB	1499	4	8	Diesel	36
XVJC	1499	4	8	Diesel	36
XVJD	1499	4	8	Diesel	36
XWDA	1499	4	8	Diesel	36
XWDB	1499	4	8	Diesel	36
XWDC	1499	4	8	Diesel	36
XWDD	1499	4	8	Diesel	36
XWGA	1499	4	8	Diesel	36
XWGB	1499	4	8	Diesel	36
XXDA	1499	4	8	Diesel	36
XXDB	1499	4	8	Diesel	36
XXDC	1499	4	8	Diesel	36
XXGA	1499	4	8	Diesel	36
Y5A	2295	4	16	Petrol	141
Y5B	2295	4	16	Petrol	141
YF	1989	4	16	Petrol	131
YTR	2304	4	8	Diesel	146
YTT	2304	4	8	Diesel	146
YUDA	1596	4	16	Petrol	59
YVDA	2261	4	16	Petrol	143
YVDA	2261	4	16	Petrol	143
YY	2294	6	12	Petrol	147
YYE	2294	6	12	Petrol	145
YYF	2294	6	12	Petrol	145
YYH	2294	6	12	Petrol	145
YYJA	998	3	12	Petrol	3
YYJB	998	3	12	Petrol	3
YYJC	998	3	12	Petrol	3
YYJD	998	3	12	Petrol	3
YYN	2294	6	12	Petrol	145
YYP	2294	6	12	Petrol	145
YYR	2294	6	12	Petrol	145
YYT	2294	6	12	Petrol	145
YYU	2294	6	12	Petrol	145
ZH10JRB	999	4	8	Petrol	6
ZH13J4J	1299	4	8	Petrol	15
ZM	1598	4	16	Petrol	70
ZVSA	1998	4	8	Petrol	124

	CC				9
---	----	---	---	---	---



1 0.9L Petrol

TKW	4 Cyl.	8 Valves	957cc	TD4496
PB180 (x8) HR631				NA576 36.50 x 52.30 x 8.00mm, MVQ NB564 60.45 x 76.18 x 10.00mm, FPM

2 1.0L Petrol

GL	4 Cyl.	8 Valves	1043cc	TD1194
	NA5001 32.00 x 47.00 x 10.00mm, FPM			

3 1.0L Petrol

M1CA	3 Cyl.	12 Valves	998cc	TD30757
M1CB	3 Cyl.	12 Valves	998cc	TD30758
M1DA	3 Cyl.	12 Valves	998cc	TD26478
M1DC	3 Cyl.	12 Valves	998cc	TD33181
M1DD	3 Cyl.	12 Valves	998cc	TD33182
M1JA	3 Cyl.	12 Valves	998cc	TD28068
M1JC	3 Cyl.	12 Valves	998cc	TD29434
M1JC	3 Cyl.	12 Valves	998cc	TD32387
M1JE	3 Cyl.	12 Valves	998cc	TD27831
M1JE	3 Cyl.	12 Valves	998cc	TD32392
M1JH	3 Cyl.	12 Valves	998cc	TD32762
M1JJ	3 Cyl.	12 Valves	998cc	TD33165
M2DA	3 Cyl.	12 Valves	998cc	TD26479
M2DB	3 Cyl.	12 Valves	998cc	TD33179
M2DC	3 Cyl.	12 Valves	998cc	TD33180
M2GA	3 Cyl.	12 Valves	998cc	TD28261
M2GB	3 Cyl.	12 Valves	998cc	TD31109
P4JA	3 Cyl.	12 Valves	998cc	TD27837
P4JB	3 Cyl.	12 Valves	998cc	TD27838
P4JC	3 Cyl.	12 Valves	998cc	TD31511
P4JD	3 Cyl.	12 Valves	998cc	TD31512
SFCA	3 Cyl.	12 Valves	998cc	TD29694
SFCB	3 Cyl.	12 Valves	998cc	TD29695
SFCC	3 Cyl.	12 Valves	998cc	TD31101
SFCD	3 Cyl.	12 Valves	998cc	TD31102
SFDA	3 Cyl.	12 Valves	998cc	TD30309
SFDB	3 Cyl.	12 Valves	998cc	TD33178
SFJA	3 Cyl.	12 Valves	998cc	TD27833
SFJB	3 Cyl.	12 Valves	998cc	TD27834
SFJC	3 Cyl.	12 Valves	998cc	TD31015
SFJD	3 Cyl.	12 Valves	998cc	TD31016
XMJA	3 Cyl.	12 Valves	998cc	TD27835
XMJB	3 Cyl.	12 Valves	998cc	TD27836
XMJC	3 Cyl.	12 Valves	998cc	TD33188
XMJD	3 Cyl.	12 Valves	998cc	TD33189
YYJA	3 Cyl.	12 Valves	998cc	TD31077

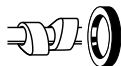

YYJB	3 Cyl.	12 Valves	998cc	TD31078
YYJC	3 Cyl.	12 Valves	998cc	TD32680
YYJD	3 Cyl.	12 Valves	998cc	TD32681
PA6070 (x12) HR5123				

4 1.0L Petrol

TKA	4 Cyl.	8 Valves	957cc	TD4495
TKB	4 Cyl.	8 Valves	957cc	TD1452
TLA	4 Cyl.	8 Valves	957cc	TD1453
PB180 (x8) HR631				NA576 36.50 x 52.30 x 8.00mm, MVQ NB564 60.45 x 76.18 x 10.00mm, FPM

5 1.0L Petrol

TLB	4 Cyl.	8 Valves	999cc	TD1454
HR655				NA576 36.50 x 52.30 x 8.00mm, MVQ NB564 60.45 x 76.18 x 10.00mm, FPM

6 1.0L Petrol

ZH10JRB	4 Cyl.	8 Valves	999cc	TD24108
HR655				NA576 36.50 x 52.30 x 8.00mm, MVQ NB788 79.40 x 95.30 x 11.10mm, PTFE

7 1.1L Petrol

G1	4 Cyl.	8 Valves	1098cc	TD26388
G1	4 Cyl.	8 Valves	1098cc	TD4454
G2	4 Cyl.	8 Valves	1098cc	TD1191
KL11	4 Cyl.	8 Valves	1098cc	TD22407
HR632				NA576 36.50 x 52.30 x 8.00mm, MVQ NB788 79.40 x 95.30 x 11.10mm, PTFE

8 1.1L Petrol

G6A	4 Cyl.	8 Valves	1119cc	TD4455
GUB	4 Cyl.	8 Valves	1117cc	TD1207
GUC	4 Cyl.	8 Valves	1119cc	TD1208
GUD	4 Cyl.	8 Valves	1119cc	TD1209
GUE	4 Cyl.	8 Valves	1119cc	TD1210
GUF	4 Cyl.	8 Valves	1118cc	TD1211
HR655				NA576 36.50 x 52.30 x 8.00mm, MVQ NB564 60.45 x 76.18 x 10.00mm, FPM →03/92 NB788 79.40 x 95.30 x 11.10mm, PTFE 04/92→



9 1.1L Petrol

GLI	4 Cyl.	8 Valves	1117cc	TD1195
GLA	4 Cyl.	8 Valves	1117cc	TD1196
PB180 (x8) HR631	NA5190 42.00 x 56.00 x 7.00mm, FPM	NB959 35.00 x 50.00 x 7.00mm, FPM NA576 36.50 x 52.30 x 8.00mm, MVQ NB564 60.45 x 76.18 x 10.00mm, FPM NB847 88.00 x 108.00 x 11.00mm, FPM		

10 1.1L Petrol

GLB	4 Cyl.	8 Valves	1117cc	TD1197
PB180 (x8) HR631	NA5190 42.00 x 56.00 x 7.00mm, FPM	NB959 35.00 x 50.00 x 7.00mm, FPM NA576 36.50 x 52.30 x 8.00mm, MVQ NB847 88.00 x 108.00 x 11.00mm, FPM NB848 100.00 x 120.00 x 11.00mm, PTFE		

11 1.1L Petrol

GLC	4 Cyl.	8 Valves	1117cc	TD1198
GLW	4 Cyl.	8 Valves	1117cc	TD1199
GSF	4 Cyl.	8 Valves	1117cc	TD1204
GSG	4 Cyl.	8 Valves	1117cc	TD1205
GSH	4 Cyl.	8 Valves	1117cc	TD1206
PB180 (x8) HR631		NA576 36.50 x 52.30 x 8.00mm, MVQ NB564 60.45 x 76.18 x 10.00mm, FPM		

12 1.1L Petrol

GMA	4 Cyl.	8 Valves	1117cc	TD1200
GPA	4 Cyl.	8 Valves	1117cc	TD1201
HR661	NA5190 42.00 x 56.00 x 7.00mm, FPM	NB959 35.00 x 50.00 x 7.00mm, FPM NA576 36.50 x 52.30 x 8.00mm, MVQ NB847 88.00 x 108.00 x 11.00mm, FPM NB848 100.00 x 120.00 x 11.00mm, PTFE		

13 1.1L Petrol

GSE	4 Cyl.	8 Valves	1117cc	TD1203
PB180 (x8) HR631	NA5190 42.00 x 56.00 x 7.00mm, FPM	NB959 35.00 x 50.00 x 7.00mm, FPM NA576 36.50 x 52.30 x 8.00mm, MVQ NB847 88.00 x 108.00 x 11.00mm, FPM		

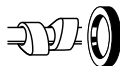

14 1.2L

Petrol

FP4	4 Cyl.	8 Valves	1242cc	TD24408
PA5025 (x8) HR5048	NA5058 40.00 x 55.00 x 7.00mm, FPM	NA5057 27.00 x 37.00 x 7.00mm, FPM NA5061 74.00 x 88.00 x 8.00mm, FPM		

15 1.3L

Petrol

A9A	4 Cyl.	8 Valves	1299cc	TD18764
A9B	4 Cyl.	8 Valves	1299cc	TD18765
A9JA	4 Cyl.	8 Valves	1299cc	TD17302
A9JB	4 Cyl.	8 Valves	1299cc	TD17303
A9JD	4 Cyl.	8 Valves	1299cc	TD26814
BAA	4 Cyl.	8 Valves	1299cc	TD17169
BAJA	4 Cyl.	8 Valves	1299cc	TD17301
ZH13J4J	4 Cyl.	8 Valves	1299cc	TD19638
PA5033 (x8)		NA5147 40.00 x 62.00 x 7.40mm, PTFE NA5130 79.00 x 196.00 x 21.50mm, PTFE		

16 1.3L

Petrol

B3	4 Cyl.	8 Valves	1324cc	TD24355
B3	4 Cyl.	8 Valves	1324cc	TD27820
PA883 (x8)	NJ448 30.00 x 44.00 x 7.00mm, NBR	NJ448 30.00 x 44.00 x 7.00mm, NBR NJ650 83.00 x 100.00 x 9.00mm, ACM		

17 1.3L

Petrol

DHA	4 Cyl.	16 Valves	1242cc	TD12069
DHB	4 Cyl.	16 Valves	1242cc	TD12070
DHC	4 Cyl.	16 Valves	1242cc	TD15921
DHD	4 Cyl.	16 Valves	1242cc	TD15922
DHE	4 Cyl.	16 Valves	1242cc	TD15923
DHF	4 Cyl.	16 Valves	1242cc	TD15924
DHG	4 Cyl.	16 Valves	1242cc	TD15925
FUJA	4 Cyl.	16 Valves	1242cc	TD17159
FUJA	4 Cyl.	16 Valves	1242cc	TD22562
FUJB	4 Cyl.	16 Valves	1242cc	TD17160
M7JA	4 Cyl.	16 Valves	1242cc	TD17161
M7JB	4 Cyl.	16 Valves	1242cc	TD17162
SNJA	4 Cyl.	16 Valves	1242cc	TD23540
SNJB	4 Cyl.	16 Valves	1242cc	TD24411
SNJC	4 Cyl.	16 Valves	1242cc	TD32760
SNJD	4 Cyl.	16 Valves	1242cc	TD32761
STJA	4 Cyl.	16 Valves	1242cc	TD23539
STJB	4 Cyl.	16 Valves	1242cc	TD24410
STJC	4 Cyl.	16 Valves	1242cc	TD33190
STJD	4 Cyl.	16 Valves	1242cc	TD33191
HR808 HR809	NC048 (x2) 38.00 x 52.00 x 6.00mm, FPM	NA5137 33.00 x 47.00 x 5.00mm, FPM LK5004 80.00 x 182.00 x 19.400mm, PTFE		



18 1.3L Petrol

E3	4 Cyl.	8 Valves	1296cc	TD25129
KJ710 (x8)				
			NB384 40.00 x 55.00 x 8.00mm, NBR NJ099 70.00 x 88.00 x 12.00mm, MVQ	

19 1.3L Petrol

EV 13 L	4 Cyl.	8 Valves	1305cc	TD22521
J1E	4 Cyl.	8 Valves	1298cc	TD1216
J1F	4 Cyl.	8 Valves	1298cc	TD4457
J1F	4 Cyl.	8 Valves	1298cc	TD26390
J2	4 Cyl.	8 Valves	1298cc	TD1217
J2	4 Cyl.	8 Valves	1298cc	TD26393
J3	4 Cyl.	8 Valves	1298cc	TD1219
J3D	4 Cyl.	8 Valves	1298cc	TD5480
J3E	4 Cyl.	8 Valves	1297cc	TD1221
KL 13 H	4 Cyl.	8 Valves	1298cc	TD22533
KL 13 HC	4 Cyl.	8 Valves	1298cc	TD22534
KL 13 L	4 Cyl.	8 Valves	1298cc	TD22535
HR632			NA576 36.50 x 52.30 x 8.00mm, MVQ NB788 79.40 x 95.30 x 11.10mm, PTFE	

20 1.3L Diesel

FD4	4 Cyl.	16 Valves	1248cc	TD24409
HR5088			NA5223 40.00 x 52.00 x 7.00mm, FPM NA5230 78.00 x 100.00 x 9.00mm, PTFE	

21 1.3L Petrol

J2F	4 Cyl.	8 Valves	1298cc	TD1218
J2N	4 Cyl.	8 Valves	1298cc	TD1110
J3C	4 Cyl.	8 Valves	1298cc	TD1220
J3N	4 Cyl.	8 Valves	1298cc	TD1222
JSD	4 Cyl.	8 Valves	1298cc	TD1240
OHC TL 13 H	4 Cyl.	8 Valves	1295cc	TD1384
OHC TL 13 L	4 Cyl.	8 Valves	1295cc	TD1385
			NB788 79.40 x 95.30 x 11.10mm, PTFE	

22 1.3L Petrol

J4B	4 Cyl.	8 Valves	1299cc	TD4458
J4C	4 Cyl.	8 Valves	1299cc	TD11087
J4D	4 Cyl.	8 Valves	1299cc	TD12084
J4D	4 Cyl.	8 Valves	1299cc	TD24358
J4F	4 Cyl.	8 Valves	1299cc	TD24359
J4J	4 Cyl.	8 Valves	1299cc	TD12073
J4K	4 Cyl.	8 Valves	1299cc	TD12085
J4L	4 Cyl.	8 Valves	1299cc	TD15930
J4M	4 Cyl.	8 Valves	1299cc	TD15952

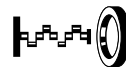
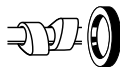

J4N	4 Cyl.	8 Valves	1299cc	TD15953
J4P	4 Cyl.	8 Valves	1299cc	TD15954
J4Q	4 Cyl.	8 Valves	1299cc	TD15931
J4R	4 Cyl.	8 Valves	1299cc	TD15932
J4S	4 Cyl.	8 Valves	1299cc	TD15955
J4T	4 Cyl.	8 Valves	1299cc	TD15933
J6A	4 Cyl.	8 Valves	1299cc	TD1223
J6B	4 Cyl.	8 Valves	1299cc	TD1224
JBA	4 Cyl.	8 Valves	1297cc	TD1227
JBC	4 Cyl.	8 Valves	1299cc	TD1229
JBD	4 Cyl.	8 Valves	1297cc	TD1230
JBE	4 Cyl.	8 Valves	1299cc	TD1231
JJA	4 Cyl.	8 Valves	1299cc	TD12071
JJB	4 Cyl.	8 Valves	1299cc	TD12083
JJC	4 Cyl.	8 Valves	1299cc	TD12072
JJD	4 Cyl.	8 Valves	1299cc	TD12082
JJE	4 Cyl.	8 Valves	1299cc	TD15926
JJF	4 Cyl.	8 Valves	1299cc	TD15948
JJG	4 Cyl.	8 Valves	1299cc	TD15949
JJH	4 Cyl.	8 Valves	1299cc	TD15950
JJJ	4 Cyl.	8 Valves	1299cc	TD15927
JJK	4 Cyl.	8 Valves	1299cc	TD15928
JJL	4 Cyl.	8 Valves	1299cc	TD15951
JJM	4 Cyl.	8 Valves	1299cc	TD15929
JLA	4 Cyl.	8 Valves	1297cc	TD1236

HR655

NA576

36.50 x 52.30 x 8.00mm, MVQ

NB788

79.40 x 95.30 x 11.10mm, PTFE

23 1.3L

Petrol

JAC	4 Cyl.	8 Valves	1297cc	TD1226
PB180 (x8)	NA5190	NA576		
HR631	42.00 x 56.00 x 7.00mm, FPM	36.50 x 52.30 x 8.00mm, MVQ		
01/86→08/88		NB788		
HR661		79.40 x 95.30 x 11.10mm, PTFE		

24 1.3L

Petrol

JBB	4 Cyl.	8 Valves	1297cc	TD4459
PB180 (x8)	NA5190	NA576		
HR631	42.00 x 56.00 x 7.00mm, FPM	36.50 x 52.30 x 8.00mm, MVQ		
01/86→08/88		NB788		
HR661		79.40 x 95.30 x 11.10mm, PTFE		

25 1.3L

Petrol

JCC	4 Cyl.	8 Valves	1294cc	TD1232
JCT	4 Cyl.	8 Valves	1294cc	TD1233
JLB	4 Cyl.	8 Valves	1297cc	TD1237
PB180 (x8)	NA5190	NA5190		
HR631	42.00 x 56.00 x 7.00mm, FPM	42.00 x 56.00 x 7.00mm, FPM		
01/86→08/88		NB788		
HR661		79.40 x 95.30 x 11.10mm, PTFE		



26 1.3L Petrol

JGA	4 Cyl.	8 Valves	1341cc	TD1234
				NA5066 35.00 x 50.00 x 10.00mm, ACM

27 1.3L Petrol

JPA	4 Cyl.	8 Valves	1296cc	TD1238
HR661	NA5190 42.00 x 56.00 x 7.00mm, FPM		NB959 35.00 x 50.00 x 7.00mm, FPM NB847 88.00 x 108.00 x 11.00mm, FPM	

28 1.3L Petrol

JPC	4 Cyl.	8 Valves	1297cc	TD1239
HR661	NA5190 42.00 x 56.00 x 7.00mm, FPM		NB959 35.00 x 50.00 x 7.00mm, FPM NB847 88.00 x 108.00 x 11.00mm, FPM NB848 100.00 x 120.00 x 11.00mm, PTFE	

29 1.3L Petrol

OHV KL 13 G	4 Cyl.	8 Valves	1298cc	TD1393
OHV KL 13 H	4 Cyl.	8 Valves	1298cc	TD1394
OHV KL 13 L	4 Cyl.	8 Valves	1298cc	TD1395
HR632	NA576 36.50 x 52.30 x 8.00mm, MVQ		NA576 36.50 x 52.30 x 8.00mm, MVQ NB788 79.40 x 95.30 x 11.10mm, PTFE	

30 1.4L Petrol

ASDA	4 Cyl.	16 Valves	1388cc	TD18501
ASDB	4 Cyl.	16 Valves	1388cc	TD18502
FHA	4 Cyl.	16 Valves	1388cc	TD12074
FHD	4 Cyl.	16 Valves	1388cc	TD11327
FHE	4 Cyl.	16 Valves	1388cc	TD15934
FHF	4 Cyl.	16 Valves	1388cc	TD15919
FXDA	4 Cyl.	16 Valves	1388cc	TD12075
FXDB	4 Cyl.	16 Valves	1388cc	TD15892
FXDC	4 Cyl.	16 Valves	1388cc	TD12076
FXDD	4 Cyl.	16 Valves	1388cc	TD15893
FXJA	4 Cyl.	16 Valves	1388cc	TD17304
FXJB	4 Cyl.	16 Valves	1388cc	TD17305
FXJC	4 Cyl.	16 Valves	1388cc	TD26945
M6JA	4 Cyl.	16 Valves	1388cc	TD31048
RTJA	4 Cyl.	16 Valves	1388cc	TD24413
RTJB	4 Cyl.	16 Valves	1388cc	TD24414
RTJC	4 Cyl.	16 Valves	1388cc	TD29223
SPJA	4 Cyl.	16 Valves	1388cc	TD23538
SPJA	4 Cyl.	16 Valves	1388cc	TD24101



SPJC	4 Cyl.	16 Valves	1388cc	TD24412
SPJD	4 Cyl.	16 Valves	1388cc	TD29297
UTJA	4 Cyl.	16 Valves	1388cc	TD26946
HR808	NC048 (x2) 38.00 x 52.00 x 6.00mm, FPM		NA5137 33.00 x 47.00 x 5.00mm, FPM	
HR809			LK5004 80.00 x 182.00 x 19.400mm, PTFE	

31 1.4L

Petrol

F4A	4 Cyl.	8 Valves	1391cc	TD10007
F4B	4 Cyl.	8 Valves	1392cc	TD4447
F6A	4 Cyl.	8 Valves	1393cc	TD4448
F6B	4 Cyl.	8 Valves	1392cc	TD1171
F6C	4 Cyl.	8 Valves	1392cc	TD4450
F6D	4 Cyl.	8 Valves	1392cc	TD1174
F6E	4 Cyl.	8 Valves	1392cc	TD4451
F6F	4 Cyl.	8 Valves	1392cc	TD1177
F6G	4 Cyl.	8 Valves	1392cc	TD1178
FUA	4 Cyl.	8 Valves	1392cc	TD4453
FUAA	4 Cyl.	8 Valves	1392cc	TD1181
FUB	4 Cyl.	8 Valves	1392cc	TD1182
FUC	4 Cyl.	8 Valves	1392cc	TD1184
FUD	4 Cyl.	8 Valves	1392cc	TD1185
FUG	4 Cyl.	8 Valves	1392cc	TD1187
FUH	4 Cyl.	8 Valves	1392cc	TD1188
HR661	NA5190 42.00 x 56.00 x 7.00mm, FPM		NB959 35.00 x 50.00 x 7.00mm, FPM	
			NB847 88.00 x 108.00 x 11.00mm, FPM	

32 1.4L

Diesel

F6JA	4 Cyl.	8 Valves	1399cc	TD17307
F6JA	4 Cyl.	8 Valves	1399cc	TD23996
F6JB	4 Cyl.	8 Valves	1399cc	TD17346
F6JC	4 Cyl.	8 Valves	1399cc	TD26167
F6JD	4 Cyl.	8 Valves	1399cc	TD23542
KVJA	4 Cyl.	8 Valves	1399cc	TD26332
PA5068 (x8) HR5120	NA5258 27.00 x 47.00 x 7.00mm, PTFE		NA5259 40.00 x 55.00 x 6.40mm, PTFE	
			NA5325 85.00 x 105.00 x 8.80mm, PTFE	

33 1.4L

Petrol

FUBA	4 Cyl.	8 Valves	1392cc	TD1183
FUF	4 Cyl.	8 Valves	1392cc	TD1186
FUJ	4 Cyl.	8 Valves	1392cc	TD1189
HR661	NA5190 42.00 x 56.00 x 7.00mm, FPM		NB847 88.00 x 108.00 x 11.00mm, FPM	

34 1.4L

Petrol

U	4 Cyl.	8 Valves	1415cc	TD25123
KJ710 (x8)				



35 1.4L

Petrol

UC	4 Cyl.	8 Valves	1416cc	TD1469
KJ710 (x8)				NB384 40.00 x 55.00 x 8.00mm, NBR

36 1.5L

Diesel

AEDA	4 Cyl.	8 Valves	1499cc	TD31018
ENUG	4 Cyl.	8 Valves	1499cc	TD33167
UGCA	4 Cyl.	8 Valves	1499cc	TD30776
UGCB	4 Cyl.	8 Valves	1499cc	TD30777
UGCC	4 Cyl.	8 Valves	1499cc	TD31062
UGJC	4 Cyl.	8 Valves	1499cc	TD27839
UGJE	4 Cyl.	8 Valves	1499cc	TD29437
XUCA	4 Cyl.	8 Valves	1499cc	TD31063
XUCC	4 Cyl.	8 Valves	1499cc	TD31103
XUCD	4 Cyl.	8 Valves	1499cc	TD31104
XUGA	4 Cyl.	8 Valves	1499cc	TD31506
XUJA	4 Cyl.	8 Valves	1499cc	TD33196
XUJB	4 Cyl.	8 Valves	1499cc	TD33197
XVCA	4 Cyl.	8 Valves	1499cc	TD31105
XVCB	4 Cyl.	8 Valves	1499cc	TD31106
XVCC	4 Cyl.	8 Valves	1499cc	TD31107
XVGA	4 Cyl.	8 Valves	1499cc	TD31503
XVGB	4 Cyl.	8 Valves	1499cc	TD31504
XVGC	4 Cyl.	8 Valves	1499cc	TD31505
XVJA	4 Cyl.	8 Valves	1499cc	TD31073
XVJB	4 Cyl.	8 Valves	1499cc	TD31079
XVJC	4 Cyl.	8 Valves	1499cc	TD31074
XVJD	4 Cyl.	8 Valves	1499cc	TD31333
XWDA	4 Cyl.	8 Valves	1499cc	TD29877
XWDB	4 Cyl.	8 Valves	1499cc	TD29878
XWDC	4 Cyl.	8 Valves	1499cc	TD29879
XWDD	4 Cyl.	8 Valves	1499cc	TD29880
XWGA	4 Cyl.	8 Valves	1499cc	TD31507
XWGB	4 Cyl.	8 Valves	1499cc	TD31508
XXDA	4 Cyl.	8 Valves	1499cc	TD29874
XXDB	4 Cyl.	8 Valves	1499cc	TD29876
XXDC	4 Cyl.	8 Valves	1499cc	TD29875
XXGA	4 Cyl.	8 Valves	1499cc	TD33184

PA5068 (x8)
HR5120

NA5258
27.00 x 47.00 x 7.00mm, PTFE

NA5259
40.00 x 55.00 x 6.40mm, PTFE
NA5325
85.00 x 105.00 x 8.80mm, PTFE

37 1.5L

Petrol

B5 (8 V)	4 Cyl.	8 Valves	1498cc	TD24357
PA883 (x8)				NJ448 30.00 x 44.00 x 7.00mm, NBR NJ650 83.00 x 100.00 x 9.00mm, ACM



38 1.5L

Petrol

B5 (16 V)	4 Cyl.	16 Valves	1498cc	TD24356
PB314 (x16)	NJ448 30.00 x 44.00 x 7.00mm, NBR	NK158 37.00 x 50.50 x 7.00mm, ACM	NJ650 83.00 x 100.00 x 9.00mm, ACM	

39 1.5L

Petrol

BNMA	4 Cyl.	16 Valves	1499cc	TD33187
M9MA	4 Cyl.	16 Valves	1499cc	TD34490
M9MC	4 Cyl.	16 Valves	1499cc	TD33186
UNCC	4 Cyl.	16 Valves	1499cc	TD30534
UNCD	4 Cyl.	16 Valves	1499cc	TD30535
UNCG	4 Cyl.	16 Valves	1499cc	TD33198
UNCH	4 Cyl.	16 Valves	1499cc	TD33199
UNCI	4 Cyl.	16 Valves	1499cc	TD31082
UNCJ	4 Cyl.	16 Valves	1499cc	TD31083
UNCK	4 Cyl.	16 Valves	1498cc	TD31084
UNCM	4 Cyl.	16 Valves	1498cc	TD33200
			NA5137 33.00 x 47.00 x 5.00mm, FPM	
			LK5004 80.00 x 182.00 x 19.400mm, PTFE	

40 1.5L

Petrol

E5	4 Cyl.	8 Valves	1490cc	TD25128
EST	4 Cyl.	8 Valves	1490cc	TD23740
KJ710 (x8)			NB384 40.00 x 55.00 x 8.00mm, NBR	
			NJ099 70.00 x 88.00 x 12.00mm, MVQ	

41 1.5L

Petrol

EV 15 H	4 Cyl.	8 Valves	1488cc	TD32353
EV 15 L	4 Cyl.	8 Valves	1488cc	TD32354
TV 15 H	4 Cyl.	8 Valves	1498cc	TD1457
TV 15 HC	4 Cyl.	8 Valves	1498cc	TD22541
			NB564 60.45 x 76.18 x 10.00mm, FPM	

42 1.5L

Petrol

EX	4 Cyl.	8 Valves	1498cc	TD1168
HR632			NA576 36.50 x 52.30 x 8.00mm, MVQ	
			NB564 60.45 x 76.18 x 10.00mm, FPM	



43 1.5L Petrol

M8DA	4 Cyl.	16 Valves	1498cc	TD29721
M8DB	4 Cyl.	16 Valves	1498cc	TD29722
M8MA	4 Cyl.	16 Valves	1499cc	TD31331
M9DA	4 Cyl.	16 Valves	1498cc	TD29723
M9DB	4 Cyl.	16 Valves	1498cc	TD29724
M9MA	4 Cyl.	16 Valves	1499cc	TD31332
UNCA	4 Cyl.	16 Valves	1499cc	TD30530
UNCB	4 Cyl.	16 Valves	1499cc	TD30531
UNCE	4 Cyl.	16 Valves	1499cc	TD30532
UNCF	4 Cyl.	16 Valves	1499cc	TD30533

NA5310 (x2)
46.00 x 56.40 x 7.00mm, FPM

NA5137
33.00 x 47.00 x 5.00mm, FPM
LK5004
80.00 x 182.00 x 19.400mm, PTFE

44 1.5L Petrol

UEJB	4 Cyl.	16 Valves	1498cc	TD29435
UEJB	4 Cyl.	16 Valves	1498cc	TD32388

HR808
HR809

NA5310 (x2)
46.00 x 56.40 x 7.00mm, FPM

NA5137
33.00 x 47.00 x 5.00mm, FPM
LK5004
80.00 x 182.00 x 19.400mm, PTFE

45 1.6L Petrol

4RB	4 Cyl.	8 Valves	1593cc	TD9440
LAD	4 Cyl.	8 Valves	1593cc	TD1258
LEC	4 Cyl.	8 Valves	1593cc	TD11229
OHC TL 16 L	4 Cyl.	8 Valves	1593cc	TD1389
TL 16M	4 Cyl.	8 Valves	1593cc	TD24561

PB180 (x8)
HR631

NA5190
42.00 x 56.00 x 7.00mm, FPM

NA5190
42.00 x 56.00 x 7.00mm, FPM
NB788
79.40 x 95.30 x 11.10mm, PTFE

46 1.6L Petrol

B	4 Cyl.	8 Valves	1593cc	TD4439
HR631				

NA5190
42.00 x 56.00 x 7.00mm, FPM

NA5190
42.00 x 56.00 x 7.00mm, FPM
NB788
79.40 x 95.30 x 11.10mm, PTFE

47 1.6L Petrol

B6	4 Cyl.	16 Valves	1598cc	TD30975
B6	4 Cyl.	16 Valves	1598cc	TD27818
B6GP	4 Cyl.	16 Valves	1598cc	TD32254

PB313 (x8)
PB314 (x8)

NJ324 (x2)
34.00 x 48.00 x 7.00mm, ACM

NJ448
30.00 x 44.00 x 7.00mm, NBR
NJ650
83.00 x 100.00 x 9.00mm, ACM

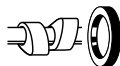

48 1.6L

Petrol

B6 (8 V) 4 Cyl. 8 Valves 1598cc TD24339

NJ448
30.00 x 44.00 x 7.00mm, NBR

NJ448
30.00 x 44.00 x 7.00mm, NBR
NJ650
83.00 x 100.00 x 9.00mm, ACM

49 1.6L

Petrol

B6 (DOHC 16 V) 4 Cyl. 16 Valves 1598cc TD24340

PB313 (x8)
PB314 (x8)

NJ448 (x2)
30.00 x 44.00 x 7.00mm, NBR

NJ448
30.00 x 44.00 x 7.00mm, NBR
NJ650
83.00 x 100.00 x 9.00mm, ACM

50 1.6L

Petrol

B6 (SOHC 16 V) 4 Cyl. 16 Valves 1598cc TD25312

PB314 (x16)

NJ324
34.00 x 48.00 x 7.00mm, ACM

NJ448
30.00 x 44.00 x 7.00mm, NBR
NJ650
83.00 x 100.00 x 9.00mm, ACM

51 1.6L

Petrol

B6T 4 Cyl. 16 Valves 1598cc TD23739

PB314 (x16)

NJ324 (x2)
34.00 x 48.00 x 7.00mm, ACM

NJ448
30.00 x 44.00 x 7.00mm, NBR
NJ650
83.00 x 100.00 x 9.00mm, ACM

52 1.6L

Petrol

CCA 4 Cyl. 8 Valves 1599cc TD29531

NA5147
40.00 x 62.00 x 7.40mm, PTFE
NA5130
79.00 x 196.00 x 21.50mm, PTFE

53 1.6L

Petrol

CDB 4 Cyl. 8 Valves 1597cc TD18766

CDC 4 Cyl. 8 Valves 1597cc TD18767

CDRA 4 Cyl. 8 Valves 1599cc TD18768

CDRB 4 Cyl. 8 Valves 1599cc TD18769

PA5033 (x8)

NA5147
40.00 x 62.00 x 7.40mm, PTFE
NA5130
79.00 x 196.00 x 21.50mm, PTFE

54 1.6L

Petrol

CHT 1600 4 Cyl. 8 Valves 1555cc TD1157

CHT 1600 4 Cyl. 8 Valves 1555cc TD25413

HR569

NB959
35.00 x 50.00 x 7.00mm, FPM

55 1.6L

Petrol

F6 4 Cyl. 8 Valves 1587cc TD27819

KJ710 (x8)

NJ324
34.00 x 48.00 x 7.00mm, ACM

NJ324
34.00 x 48.00 x 7.00mm, ACM
NJ325
90.00 x 110.00 x 9.00mm, MVQ



56 1.6L Petrol

FYDA	4 Cyl.	16 Valves	1596cc	TD12077
FYDB	4 Cyl.	16 Valves	1596cc	TD15894
FYDC	4 Cyl.	16 Valves	1596cc	TD12078
FYDD	4 Cyl.	16 Valves	1596cc	TD15895
FYDH	4 Cyl.	16 Valves	1596cc	TD18776
FYJA	4 Cyl.	16 Valves	1596cc	TD17306
FYJA	4 Cyl.	16 Valves	1596cc	TD23730
FYJB	4 Cyl.	16 Valves	1596cc	TD18778
FYJB	4 Cyl.	16 Valves	1596cc	TD23731
FYJC	4 Cyl.	16 Valves	1596cc	TD31039
HWDA	4 Cyl.	16 Valves	1596cc	TD18503
HWDB	4 Cyl.	16 Valves	1596cc	TD18504
IQDC	4 Cyl.	16 Valves	1596cc	TD33175
LIT	4 Cyl.	16 Valves	1596cc	TD15935
LIV	4 Cyl.	16 Valves	1596cc	TD15936
LIW	4 Cyl.	16 Valves	1596cc	TD18770
SHDA	4 Cyl.	16 Valves	1596cc	TD21247
SHDB	4 Cyl.	16 Valves	1596cc	TD24345
SHDC	4 Cyl.	16 Valves	1596cc	TD24346

HR808
HR809

NC048 (x2)
38.00 x 52.00 x 6.00mm, FPM

NA5137
33.00 x 47.00 x 5.00mm, FPM
LK5004
80.00 x 182.00 x 19.400mm, PTFE

57 1.6L Diesel

G8DA	4 Cyl.	16 Valves	1560cc	TD18508
G8DB	4 Cyl.	16 Valves	1560cc	TD18509
G8DC	4 Cyl.	16 Valves	1560cc	TD25205
G8DD	4 Cyl.	16 Valves	1560cc	TD24351
G8DE	4 Cyl.	16 Valves	1560cc	TD25790
G8DF	4 Cyl.	16 Valves	1560cc	TD25791
GPDA	4 Cyl.	16 Valves	1560cc	TD24348
GPDB	4 Cyl.	16 Valves	1560cc	TD31040
GPDC	4 Cyl.	16 Valves	1560cc	TD24660
HHDA	4 Cyl.	16 Valves	1560cc	TD18478
HHDB	4 Cyl.	16 Valves	1560cc	TD18479
HHJA	4 Cyl.	16 Valves	1560cc	TD17988
HHJB	4 Cyl.	16 Valves	1560cc	TD17989
HHJC	4 Cyl.	16 Valves	1560cc	TD24416
HHJC	4 Cyl.	16 Valves	1560cc	TD25011
HHJD	4 Cyl.	16 Valves	1560cc	TD25635
HHJD	4 Cyl.	16 Valves	1560cc	TD23543
HHJE	4 Cyl.	16 Valves	1560cc	TD24417
HHJF	4 Cyl.	16 Valves	1560cc	TD24418
MTDA	4 Cyl.	16 Valves	1560cc	TD25206
UBJA	4 Cyl.	16 Valves	1560cc	TD24419

PA6072 (x16)
HR5124

NA5258 (x2)
27.00 x 47.00 x 7.00mm, PTFE

NA5259
40.00 x 55.00 x 6.40mm, PTFE
NA5325
85.00 x 105.00 x 8.80mm, PTFE

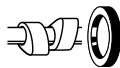

58 1.6L

Petrol

HXDA	4 Cyl.	16 Valves	1596cc	TD18505
HXDB	4 Cyl.	16 Valves	1596cc	TD23365
HXJA	4 Cyl.	16 Valves	1596cc	TD24096
HXJA	4 Cyl.	16 Valves	1596cc	TD23541
HXJB	4 Cyl.	16 Valves	1596cc	TD24415
HXJD	4 Cyl.	16 Valves	1596cc	TD31022
IQDA	4 Cyl.	16 Valves	1596cc	TD25873
IQDB	4 Cyl.	16 Valves	1596cc	TD25874
IQJA	4 Cyl.	16 Valves	1596cc	TD27832
IQJB	4 Cyl.	16 Valves	1596cc	TD31023
IQJC	4 Cyl.	16 Valves	1596cc	TD33192
IQJE	4 Cyl.	16 Valves	1596cc	TD33193
KGBA	4 Cyl.	16 Valves	1596cc	TD28067
MUDA	4 Cyl.	16 Valves	1596cc	TD25876
MUDD	4 Cyl.	16 Valves	1596cc	TD33176
MVJA	4 Cyl.	16 Valves	1596cc	TD32925
PNBA	4 Cyl.	16 Valves	1596cc	TD23302
PNDA	4 Cyl.	16 Valves	1596cc	TD32198
PNDA	4 Cyl.	16 Valves	1596cc	TD25875
PNDD	4 Cyl.	16 Valves	1596cc	TD33177
RHBA	4 Cyl.	16 Valves	1596cc	TD23301
SIDA	4 Cyl.	16 Valves	1596cc	TD23366
USJA	4 Cyl.	16 Valves	1596cc	TD28071
XTDA	4 Cyl.	16 Valves	1596cc	TD26480
XTDB	4 Cyl.	16 Valves	1596cc	TD33174

HR808
HR809

NA5310 (x2)
46.00 x 56.40 x 7.00mm, FPM

NA5137
33.00 x 47.00 x 5.00mm, FPM
LK5004
80.00 x 182.00 x 19.400mm, PTFE

59 1.6L

Petrol

JQDA	4 Cyl.	16 Valves	1596cc	TD25877
JQDB	4 Cyl.	16 Valves	1596cc	TD25878
JQGA	4 Cyl.	16 Valves	1596cc	TD28260
JQMA	4 Cyl.	16 Valves	1596cc	TD29490
JQMA	4 Cyl.	16 Valves	1596cc	TD32375
JQMB	4 Cyl.	16 Valves	1596cc	TD32376
JQMB	4 Cyl.	16 Valves	1596cc	TD29491
JTBA	4 Cyl.	16 Valves	1596cc	TD26474
JTBB	4 Cyl.	16 Valves	1596cc	TD25701
JTDA	4 Cyl.	16 Valves	1596cc	TD25879
JTDB	4 Cyl.	16 Valves	1596cc	TD25880
JTJA	4 Cyl.	16 Valves	1596cc	TD27997
JTJA	4 Cyl.	16 Valves	1596cc	TD32393
JTJB	4 Cyl.	16 Valves	1596cc	TD33194
JTJC	4 Cyl.	16 Valves	1596cc	TD33195
JTMA	4 Cyl.	16 Valves	1596cc	TD29492
JTMA	4 Cyl.	16 Valves	1596cc	TD32390



JTWA	4 Cyl.	16 Valves	1596cc	TD28065
JTWB	4 Cyl.	16 Valves	1596cc	TD28066
YUDA	4 Cyl.	16 Valves	1596cc	TD31050
PA6070 (x16) HR5123	NA5310 (x2) 46.00 x 56.40 x 7.00mm, FPM	NA5137 33.00 x 47.00 x 5.00mm, FPM LK5004 80.00 x 182.00 x 19.400mm, PTFE		

60 1.6L

Petrol

KL 16 L	4 Cyl.	8 Valves	1598cc	TD22536
L3E	4 Cyl.	8 Valves	1598cc	TD1251
LAN	4 Cyl.	8 Valves	1593cc	TD1259
LEN	4 Cyl.	8 Valves	1593cc	TD1271
LSDA	4 Cyl.	8 Valves	1597cc	TD1292
OHC TL 16	4 Cyl.	8 Valves	1595cc	TD1386
OHC TL 16 G HR632	4 Cyl.	8 Valves	1593cc	TD1387
		NA576 36.50 x 52.30 x 8.00mm, MVQ NB788 79.40 x 95.30 x 11.10mm, PTFE		

61 1.6L

Petrol

KL 16 R	4 Cyl.	8 Valves	1601cc	TD22537
LC	4 Cyl.	8 Valves	1598cc	TD1261
LC	4 Cyl.	8 Valves	1599cc	TD26391
OHV KL 16 G	4 Cyl.	8 Valves	1599cc	TD1396
OHV KL 16 H	4 Cyl.	8 Valves	1599cc	TD1397
OHV KL 16 L HR632	4 Cyl.	8 Valves	1599cc	TD1398
		NA576 36.50 x 52.30 x 8.00mm, MVQ NB788 79.40 x 95.30 x 11.10mm, PTFE		

62 1.6L

Petrol

L1E	4 Cyl.	16 Valves	1597cc	TD1249
L1F	4 Cyl.	16 Valves	1597cc	TD10069
L1G	4 Cyl.	16 Valves	1597cc	TD9467
L1H	4 Cyl.	16 Valves	1597cc	TD5105
L1J	4 Cyl.	16 Valves	1597cc	TD4464
L1K	4 Cyl.	16 Valves	1597cc	TD10849
L1K	4 Cyl.	16 Valves	1597cc	TD25414
L1L	4 Cyl.	16 Valves	1597cc	TD12087
L1N	4 Cyl.	16 Valves	1597cc	TD15990
L1Q HR5033	4 Cyl.	16 Valves	1597cc	TD16010
		NB958 (x2) 42.00 x 53.00 x 7.00mm, FPM NB959 35.00 x 50.00 x 7.00mm, FPM NA5323 35.00 x 50.00 x 7.00mm, PTFE NB847 88.00 x 108.00 x 11.00mm, FPM		

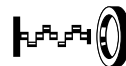
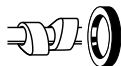

63 1.6L

Petrol

L4B	4 Cyl.	8 Valves	1598cc	TD1252
L6B	4 Cyl.	8 Valves	1598cc	TD1254
LHA	4 Cyl.	8 Valves	1598cc	TD1273
LJA	4 Cyl.	8 Valves	1598cc	TD1274
LJB	4 Cyl.	8 Valves	1597cc	TD1275
LJC	4 Cyl.	8 Valves	1597cc	TD1277
LJD	4 Cyl.	8 Valves	1598cc	TD4465
LJE	4 Cyl.	8 Valves	1598cc	TD1279
LJF	4 Cyl.	8 Valves	1598cc	TD4466
LNA	4 Cyl.	8 Valves	1597cc	TD1281
LNB	4 Cyl.	8 Valves	1597cc	TD1282
LP1	4 Cyl.	8 Valves	1597cc	TD1283
LP1	4 Cyl.	8 Valves	1597cc	TD30842
LP2	4 Cyl.	8 Valves	1597cc	TD1284
LP3	4 Cyl.	8 Valves	1597cc	TD1285
LPA	4 Cyl.	8 Valves	1597cc	TD1286
LR1	4 Cyl.	8 Valves	1597cc	TD1287
LR2	4 Cyl.	8 Valves	1597cc	TD1288
LRA	4 Cyl.	8 Valves	1597cc	TD1289
LRB	4 Cyl.	8 Valves	1597cc	TD1290
LUA	4 Cyl.	8 Valves	1597cc	TD1298
LUAE	4 Cyl.	8 Valves	1597cc	TD1299
LUB	4 Cyl.	8 Valves	1597cc	TD1300
LUC	4 Cyl.	8 Valves	1597cc	TD1301
LUD	4 Cyl.	8 Valves	1597cc	TD1302
LUG	4 Cyl.	8 Valves	1597cc	TD1304
LUH	4 Cyl.	8 Valves	1597cc	TD1305
LUJ	4 Cyl.	8 Valves	1598cc	TD1306
LUK	4 Cyl.	8 Valves	1598cc	TD1308

HR661

NA5190
42.00 x 56.00 x 7.00mm, FPM

NB959
35.00 x 50.00 x 7.00mm, FPM
NB847
88.00 x 108.00 x 11.00mm, FPM

64 1.6L

Petrol

LAC	4 Cyl.	8 Valves	1593cc	TD1256
LAT	4 Cyl.	8 Valves	1593cc	TD17086
LCE	4 Cyl.	8 Valves	1593cc	TD1263
LCJ	4 Cyl.	8 Valves	1593cc	TD1264
LCK	4 Cyl.	8 Valves	1593cc	TD1265
LCN	4 Cyl.	8 Valves	1593cc	TD1266
LCR	4 Cyl.	8 Valves	1598cc	TD1267
LE	4 Cyl.	8 Valves	1593cc	TD1270
LSE	4 Cyl.	8 Valves	1597cc	TD1293
LSF	4 Cyl.	8 Valves	1597cc	TD1294

PB180 (x8)
HR631

NA5190
42.00 x 56.00 x 7.00mm, FPM

NA5190
42.00 x 56.00 x 7.00mm, FPM
NB788
79.40 x 95.30 x 11.10mm, PTFE



65 1.6L Petrol

LAR	4 Cyl.	8 Valves	1593cc	TD11328
LCS	4 Cyl.	8 Valves	1593cc	TD1268
LCT	4 Cyl.	8 Valves	1593cc	TD1269
LSD	4 Cyl.	8 Valves	1597cc	TD1291

PB180 (x8)
HR631

NA5190
42.00 x 56.00 x 7.00mm, FPM
NA5190
42.00 x 56.00 x 7.00mm, FPM

NA5190
42.00 x 56.00 x 7.00mm, FPM
NB792
42.00 x 62.00 x 12.00mm, FPM
NB788
79.40 x 95.30 x 11.10mm, PTFE

66 1.6L Diesel

LTA	4 Cyl.	8 Valves	1608cc	TD1295
LTB	4 Cyl.	8 Valves	1608cc	TD1296
LTC	4 Cyl.	8 Valves	1608cc	TD1297

HR659

NB785
28.00 x 38.00 x 7.00mm, FPM

NB786
42.00 x 58.00 x 11.00mm, FPM
NB788
79.40 x 95.30 x 11.10mm, PTFE

67 1.6L Petrol

NA	4 Cyl.	8 Valves	1586cc	TD25122
----	--------	----------	--------	---------

KJ710 (x8)

NJ042
48.00 x 70.00 x 12.00mm, NBR

68 1.6L Diesel

NGCA	4 Cyl.	8 Valves	1560cc	TD30545
NGDA	4 Cyl.	8 Valves	1560cc	TD26481
NGDB	4 Cyl.	8 Valves	1560cc	TD31042
T1BA	4 Cyl.	8 Valves	1560cc	TD26475
T1BB	4 Cyl.	8 Valves	1560cc	TD26476
T1BC	4 Cyl.	8 Valves	1560cc	TD26477
T1DA	4 Cyl.	8 Valves	1560cc	TD25883
T1DB	4 Cyl.	8 Valves	1560cc	TD25884
T1GA	4 Cyl.	8 Valves	1560cc	TD28257
T1WA	4 Cyl.	8 Valves	1560cc	TD29369
T1WB	4 Cyl.	8 Valves	1560cc	TD29370
T3CA	4 Cyl.	8 Valves	1560cc	TD29696
T3CB	4 Cyl.	8 Valves	1560cc	TD29697
T3CC	4 Cyl.	8 Valves	1560cc	TD31108
T3DA	4 Cyl.	8 Valves	1560cc	TD25881
T3DB	4 Cyl.	8 Valves	1560cc	TD25882
T3JA	4 Cyl.	8 Valves	1560cc	TD26473
T3JB	4 Cyl.	8 Valves	1560cc	TD28069
TZGA	4 Cyl.	8 Valves	1560cc	TD28258
TZGB	4 Cyl.	8 Valves	1560cc	TD28281
TZJA	4 Cyl.	8 Valves	1560cc	TD24420

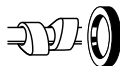

TZJB	4 Cyl.	8 Valves	1560cc	TD24421
U3CA	4 Cyl.	8 Valves	1560cc	TD30544
UBGA	4 Cyl.	8 Valves	1560cc	TD28259
HR5120	NA5258 27.00 x 47.00 x 7.00mm, PTFE	NA5259 40.00 x 55.00 x 6.40mm, PTFE	NA5325 85.00 x 105.00 x 8.80mm, PTFE	

69 1.6L

Petrol

OHC TL 16 H	4 Cyl.	8 Valves	1593cc	TD1388
HR632	NA5190 42.00 x 56.00 x 7.00mm, FPM	NA576 36.50 x 52.30 x 8.00mm, MVQ	NB788 79.40 x 95.30 x 11.10mm, PTFE	

70 1.6L

Petrol

ZM	4 Cyl.	16 Valves	1598cc	TD25269
PB313 (x8) PB314 (x8)	NJ324 (x2) 34.00 x 48.00 x 7.00mm, ACM	NK158 37.00 x 50.50 x 7.00mm, ACM	NJ650 83.00 x 100.00 x 9.00mm, ACM	

71 1.7L

Petrol

EY	4 Cyl.	8 Valves	1699cc	TD4446
MWB	4 Cyl.	8 Valves	1699cc	TD11687
MY	4 Cyl.	8 Valves	1699cc	TD4469
MYE	4 Cyl.	8 Valves	1699cc	TD1317
TV 17 H	4 Cyl.	8 Valves	1699cc	TD1459
TV 17 HC	4 Cyl.	8 Valves	1699cc	TD22543
TV 17 L	4 Cyl.	8 Valves	1699cc	TD1460
TV 17 LC	4 Cyl.	8 Valves	1699cc	TD22544
			NB564 60.45 x 76.18 x 10.00mm, FPM	

72 1.7L

Petrol

MHA	4 Cyl.	16 Valves	1679cc	TD5498
MHB	4 Cyl.	16 Valves	1679cc	TD15920
PB313 (x8) PB314 (x8)	NC048 (x2) 38.00 x 52.00 x 6.00mm, FPM	NA5137 33.00 x 47.00 x 5.00mm, FPM	LK5004 80.00 x 182.00 x 19.400mm, PTFE	

73 1.8L

Diesel

BHDA	4 Cyl.	8 Valves	1753cc	TD15903
BHDB	4 Cyl.	8 Valves	1753cc	TD15904
BHPA	4 Cyl.	8 Valves	1753cc	TD20062
C9DA	4 Cyl.	8 Valves	1753cc	TD15905
C9DB	4 Cyl.	8 Valves	1753cc	TD15906
C9DC	4 Cyl.	8 Valves	1753cc	TD12081
F9DA	4 Cyl.	8 Valves	1753cc	TD17524
F9DB	4 Cyl.	8 Valves	1753cc	TD17526
FFDA	4 Cyl.	8 Valves	1753cc	TD17521
FFWA	4 Cyl.	8 Valves	1753cc	TD20047
HCPA	4 Cyl.	8 Valves	1753cc	TD18779
HCPB	4 Cyl.	8 Valves	1753cc	TD18780



P7PA	4 Cyl.	8 Valves	1753cc	TD24465
P7PB	4 Cyl.	8 Valves	1753cc	TD24466
P9PA	4 Cyl.	8 Valves	1753cc	TD25795
P9PB	4 Cyl.	8 Valves	1753cc	TD25796
P9PC	4 Cyl.	8 Valves	1753cc	TD25797
P9PD	4 Cyl.	8 Valves	1753cc	TD25798
QYBA	4 Cyl.	8 Valves	1753cc	TD23371
QYWA	4 Cyl.	8 Valves	1753cc	TD19112
R2PA	4 Cyl.	8 Valves	1753cc	TD24467
R3PA	4 Cyl.	8 Valves	1753cc	TD25799
RTN	4 Cyl.	8 Valves	1753cc	TD15937
RTP	4 Cyl.	8 Valves	1753cc	TD15938
RTQ	4 Cyl.	8 Valves	1753cc	TD15939
RWPA	4 Cyl.	8 Valves	1753cc	TD20063
RWPC	4 Cyl.	8 Valves	1753cc	TD25793
RWPD	4 Cyl.	8 Valves	1753cc	TD25794
RWPE	4 Cyl.	8 Valves	1753cc	TD25800
RWPF	4 Cyl.	8 Valves	1753cc	TD25801

PB180 (x8)
HR801

NB785
28.00 x 38.00 x 7.00mm, FPM

NA5013
30.00 x 50.00 x 7.50mm, PTFE
NC086
79.80 x 184.00 x 18.80mm, PTFE

74 1.8L

Petrol

BP (DOHC)	4 Cyl.	16 Valves	1840cc	TD25126
PA425 (x16)	NJ324 (x2) 34.00 x 48.00 x 7.00mm, ACM	NJ448 30.00 x 44.00 x 7.00mm, NBR NJ650 83.00 x 100.00 x 9.00mm, ACM		

75 1.8L

Petrol

BP (SOHC)	4 Cyl.	16 Valves	1840cc	TD25313
	NJ324 34.00 x 48.00 x 7.00mm, ACM			

76 1.8L

Petrol

BPT	4 Cyl.	16 Valves	1840cc	TD23738
	NJ324 (x2) 34.00 x 48.00 x 7.00mm, ACM	NK158 37.00 x 50.50 x 7.00mm, ACM NJ650 83.00 x 100.00 x 9.00mm, ACM		

77 1.8L

Petrol

CFBA	4 Cyl.	16 Valves	1798cc	TD18758
CGBA	4 Cyl.	16 Valves	1798cc	TD15907
CGBB	4 Cyl.	16 Valves	1798cc	TD15908
CHBA	4 Cyl.	16 Valves	1798cc	TD15909
CHBB	4 Cyl.	16 Valves	1798cc	TD15910
CSDA	4 Cyl.	16 Valves	1798cc	TD18975
CSDB	4 Cyl.	16 Valves	1798cc	TD18976
Q7DA	4 Cyl.	16 Valves	1798cc	TD18974
QQDA	4 Cyl.	16 Valves	1798cc	TD18788



QQDB	4 Cyl.	16 Valves	1798cc	TD18787
QQDC	4 Cyl.	16 Valves	1798cc	TD18789
QQDD	4 Cyl.	16 Valves	1798cc	TD25792
HR5063				NA5157 37.00 x 50.00 x 8.00mm, PTFE LK5005 88.00 x 188.00 x 15.000mm, PTFE

78 1.8L

Petrol

EYDB	4 Cyl.	16 Valves	1796cc	TD15896
EYDC	4 Cyl.	16 Valves	1796cc	TD12079
EYDD	4 Cyl.	16 Valves	1796cc	TD15897
EYDE	4 Cyl.	16 Valves	1796cc	TD15898
EYDE	4 Cyl.	16 Valves	1796cc	TD24091
EYDF	4 Cyl.	16 Valves	1796cc	TD15899
EYDG	4 Cyl.	16 Valves	1796cc	TD18772
EYDI	4 Cyl.	16 Valves	1796cc	TD18774
EYDJ	4 Cyl.	16 Valves	1796cc	TD18775
EYDL	4 Cyl.	16 Valves	1796cc	TD18784
EYPA	4 Cyl.	16 Valves	1796cc	TD18773
EYPC	4 Cyl.	16 Valves	1796cc	TD18843
EYPD	4 Cyl.	16 Valves	1796cc	TD24464
RDA	4 Cyl.	16 Valves	1796cc	TD1419
RDB	4 Cyl.	16 Valves	1796cc	TD1420
RKA	4 Cyl.	16 Valves	1796cc	TD4487
RKB	4 Cyl.	16 Valves	1796cc	TD12091
RKC	4 Cyl.	16 Valves	1796cc	TD5107
RKF	4 Cyl.	16 Valves	1796cc	TD12088
RKH	4 Cyl.	16 Valves	1796cc	TD15991
RKJ	4 Cyl.	16 Valves	1796cc	TD12089
RKK	4 Cyl.	16 Valves	1796cc	TD16011
RQB	4 Cyl.	16 Valves	1796cc	TD1431
RQC	4 Cyl.	16 Valves	1796cc	TD1432

HR5033

NB958 (x2)
42.00 x 53.00 x 7.00mm, FPM

NB959
35.00 x 50.00 x 7.00mm, FPM
NA5323
35.00 x 50.00 x 7.00mm, PTFE
NB847
88.00 x 108.00 x 11.00mm, FPM

79 1.8L

Petrol

F8 (8 V)	4 Cyl.	8 Valves	1789cc	TD25121
KJ710 (x8)				NJ324 34.00 x 48.00 x 7.00mm, ACM NJ325 90.00 x 110.00 x 9.00mm, MVQ

80 1.8L

Petrol

F8 (12 V)	4 Cyl.	12 Valves	1789cc	TD25275
PA883 (x12)				NJ324 34.00 x 48.00 x 7.00mm, ACM NJ325 90.00 x 110.00 x 9.00mm, MVQ



81 1.8L Diesel				
FFBA	4 Cyl.	8 Valves	1753cc	TD23304
KHBA	4 Cyl.	8 Valves	1753cc	TD23372
KKDA	4 Cyl.	8 Valves	1753cc	TD18480
KKDB	4 Cyl.	8 Valves	1753cc	TD23303
PB180 (x8) HR801	NB785 (x2) 28.00 x 38.00 x 7.00mm, FPM		NA5013 30.00 x 50.00 x 7.50mm, PTFE NC086 79.80 x 184.00 x 18.80mm, PTFE	

82 1.8L Petrol				
FP	4 Cyl.	16 Valves	1840cc	TD25127
PB313 (x8) PB314 (x8)	NJ324 (x2) 34.00 x 48.00 x 7.00mm, ACM		NA5246 42.50 x 54.50 x 6.00mm, MVQ NK205 89.00 x 109.00 x 9.00mm, MVQ	

83 1.8L Petrol				
R2A	4 Cyl.	8 Valves	1796cc	TD4483
PB180 (x8) HR631	NA5190 42.00 x 56.00 x 7.00mm, FPM		NB959 35.00 x 50.00 x 7.00mm, FPM NB847 88.00 x 108.00 x 11.00mm, FPM	

84 1.8L Petrol				
R2C	4 Cyl.	8 Valves	1769cc	TD1418
R6A	4 Cyl.	8 Valves	1769cc	TD17422
HR661	NA5190 42.00 x 56.00 x 7.00mm, FPM		NB959 35.00 x 50.00 x 7.00mm, FPM NB847 88.00 x 108.00 x 11.00mm, FPM	

85 1.8L Petrol				
REB	4 Cyl.	8 Valves	1796cc	TD1421
REC	4 Cyl.	8 Valves	1796cc	TD1422
RED	4 Cyl.	8 Valves	1796cc	TD1423
REF	4 Cyl.	8 Valves	1796cc	TD1424
PB180 (x8) HR631	NA5190 42.00 x 56.00 x 7.00mm, FPM		NA5190 42.00 x 56.00 x 7.00mm, FPM NB788 79.40 x 95.30 x 11.10mm, PTFE	

86 1.8L Diesel				
RFA	4 Cyl.	8 Valves	1753cc	TD1426
RFB	4 Cyl.	8 Valves	1753cc	TD1427
RFL	4 Cyl.	8 Valves	1753cc	TD4486
PB180 (x8) 09/92→ HR659 →08/92 HR801 09/92→	NB785 28.00 x 38.00 x 7.00mm, FPM		NB984 66.67 x 89.30 x 10.00mm, FPM NB788 79.40 x 95.30 x 11.10mm, PTFE NC086 79.80 x 184.00 x 18.80mm, PTFE	



87 1.8L

Diesel

RFD	4 Cyl.	8 Valves	1753cc	TD4484
RFK	4 Cyl.	8 Valves	1753cc	TD4485
RFM	4 Cyl.	8 Valves	1753cc	TD1428
RFN	4 Cyl.	8 Valves	1753cc	TD1429
RFS	4 Cyl.	8 Valves	1753cc	TD16143
RFU	4 Cyl.	8 Valves	1753cc	TD23181

PB180 (x8)
HR801

NB785
28.00 x 38.00 x 7.00mm, FPM

NB984
66.67 x 89.30 x 10.00mm, FPM
NB788
79.40 x 95.30 x 11.10mm, PTFE
NC086
79.80 x 184.00 x 18.80mm, PTFE

88 1.8L

Diesel

RTA	4 Cyl.	8 Valves	1753cc	TD1434
RTB	4 Cyl.	8 Valves	1753cc	TD1435

PB180 (x8)
09/92→
HR659
01/88→07/92
HR801
08/92→10/93

NB785
28.00 x 38.00 x 7.00mm, FPM

NB984
66.67 x 89.30 x 10.00mm, FPM
NB788
79.40 x 95.30 x 11.10mm, PTFE

89 1.8L

Diesel

RTC	4 Cyl.	8 Valves	1753cc	TD4489
RTD	4 Cyl.	8 Valves	1753cc	TD1437
RTE	4 Cyl.	8 Valves	1753cc	TD1438
RTF	4 Cyl.	8 Valves	1753cc	TD1439
RTG	4 Cyl.	8 Valves	1753cc	TD1440

PB180 (x8)
09/92→
HR659
08/88→08/92
HR801
09/92→

NB785
28.00 x 38.00 x 7.00mm, FPM

NB984
66.67 x 89.30 x 10.00mm, FPM
NB788
79.40 x 95.30 x 11.10mm, PTFE

90 1.8L

Diesel

RTH	4 Cyl.	8 Valves	1753cc	TD1441
-----	--------	----------	--------	--------

PB180 (x8)
09/92→
HR659
→08/92
HR801
09/92→

NB785
28.00 x 38.00 x 7.00mm, FPM

NB984
66.67 x 89.30 x 10.00mm, FPM
NB788
79.40 x 95.30 x 11.10mm, PTFE

91 1.8L

Diesel

RTJ	4 Cyl.	8 Valves	1753cc	TD10068
RTK	4 Cyl.	8 Valves	1753cc	TD10067

PB180 (x8)
HR801

NB785
28.00 x 38.00 x 7.00mm, FPM

NB984
66.67 x 89.30 x 10.00mm, FPM
NB788
79.40 x 95.30 x 11.10mm, PTFE



92 1.8L Diesel

RVA	4 Cyl.	8 Valves	1753cc	TD5104
PB180 (x8) 09/92→	NB785 28.00 x 38.00 x 7.00mm, FPM		NB984 66.67 x 89.30 x 10.00mm, FPM	
HR659 04/89→08/92			NB788 79.40 x 95.30 x 11.10mm, PTFE	
HR801 09/92→				

93 1.8L Petrol

VC	4 Cyl.	8 Valves	1769cc	TD25120
HR661	NA5190 42.00 x 56.00 x 7.00mm, FPM		NB847 88.00 x 108.00 x 11.00mm, FPM	

94 1.9L Diesel

1Z	4 Cyl.	8 Valves	1896cc	TD11370
AFN	4 Cyl.	8 Valves	1896cc	TD11368
HR569 →04/96	NA5001 32.00 x 47.00 x 10.00mm, FPM		NA5001 32.00 x 47.00 x 10.00mm, FPM	
HR816 05/96→			NA5133 85.00 x 105.00 x 11.00mm, FPM	
			LK5006 85.00 x 131.00 x 16.000mm, PTFE	

95 1.9L Diesel

AHU	4 Cyl.	8 Valves	1896cc	TD11369
HR816	NA5001 32.00 x 47.00 x 10.00mm, FPM		NA5001 32.00 x 47.00 x 10.00mm, FPM	
			NA5133 85.00 x 105.00 x 11.00mm, FPM	
			LK5006 85.00 x 131.00 x 16.000mm, PTFE	

96 1.9L Diesel

AJM	4 Cyl.	8 Valves	1896cc	TD14108
AUY	4 Cyl.	8 Valves	1896cc	TD14918
HR816	NA5124 32.00 x 47.00 x 10.00mm, PTFE/ACM		NA5106 35.00 x 48.00 x 10.00mm, PTFE	
			LK5003 85.00 x 131.00 x 15.700mm, PTFE	

97 1.9L Diesel

ANU	4 Cyl.	8 Valves	1896cc	TD14917
HR569 →04/96	NA5124 32.00 x 47.00 x 10.00mm, PTFE/ACM		NA5106 35.00 x 48.00 x 10.00mm, PTFE	
HR816 05/96→			LK5003 85.00 x 131.00 x 15.700mm, PTFE	

98 1.9L Diesel

ASZ	4 Cyl.	8 Valves	1896cc	TD17167
BTB	4 Cyl.	8 Valves	1896cc	TD18795
PB180 (x8) HR816	NA5124 32.00 x 47.00 x 10.00mm, PTFE/ACM		NA5106 35.00 x 48.00 x 10.00mm, PTFE	
			LK5003 85.00 x 131.00 x 15.700mm, PTFE	



99 1.9L

Diesel

AVG	4 Cyl.	8 Valves	1896cc	TD17557
HR816	NA5001 32.00 x 47.00 x 10.00mm, FPM		NA5001 32.00 x 47.00 x 10.00mm, FPM LK5006 85.00 x 131.00 x 16.000mm, PTFE	

100 2.0L

Petrol

4G63	4 Cyl.	8 Valves	1997cc	TD26856
KJ211 (x8)	NJ933 35.00 x 50.00 x 8.00mm, FPM		NJ005 44.00 x 60.00 x 7.00mm, NBR NJ058 80.00 x 96.00 x 9.00mm, NBR	

101 2.0L

Petrol

4RC	4 Cyl.	8 Valves	1993cc	TD9441
NE	4 Cyl.	8 Valves	1993cc	TD4473
NEK	4 Cyl.	8 Valves	1993cc	TD1356
NEP	4 Cyl.	8 Valves	1993cc	TD1359
NER	4 Cyl.	8 Valves	1993cc	TD4474
NES	4 Cyl.	8 Valves	1993cc	TD1361
NET	4 Cyl.	8 Valves	1993cc	TD1362
PB180 (x8) HR631	NA5190 42.00 x 56.00 x 7.00mm, FPM NA5190 42.00 x 56.00 x 7.00mm, FPM		NA5190 42.00 x 56.00 x 7.00mm, FPM NB788 79.40 x 95.30 x 11.10mm, PTFE	

102 2.0L

Diesel

ABFA	4 Cyl.	16 Valves	1998cc	TD15888
D3FA	4 Cyl.	16 Valves	1998cc	TD15551
D5BA	4 Cyl.	16 Valves	1998cc	TD15914
D6BA	4 Cyl.	16 Valves	1998cc	TD15915
F3FA	4 Cyl.	16 Valves	1998cc	TD18777
FIFA	4 Cyl.	16 Valves	1998cc	TD18839
FMBA	4 Cyl.	16 Valves	1998cc	TD18761
HJBA	4 Cyl.	16 Valves	1998cc	TD17547
HJBB	4 Cyl.	16 Valves	1998cc	TD17548
HJBC	4 Cyl.	16 Valves	1998cc	TD17549
N7BA	4 Cyl.	16 Valves	1998cc	TD18762
SDBA	4 Cyl.	16 Valves	1998cc	TD18763
HR5082	NA5028 (x2) 36.00 x 50.00 x 7.00mm, PTFE		NA5031 50.00 x 86.50 x 13.70mm, PTFE NA5030 106.00 x 190.00 x 15.20mm, PTFE/FPM	

103 2.0L

Petrol

ALDA	4 Cyl.	16 Valves	1988cc	TD18785
HR5033	NB958 (x2) 42.00 x 53.00 x 7.00mm, FPM		NB959 35.00 x 50.00 x 7.00mm, FPM NA5323 35.00 x 50.00 x 7.00mm, PTFE NB847 88.00 x 108.00 x 11.00mm, FPM	



104 2.0L		Petrol		
ALDA	4 Cyl.	16 Valves	1988cc	TD24089
HR5033	NB958	42.00 x 53.00 x 7.00mm, FPM		NB959 35.00 x 50.00 x 7.00mm, FPM NA5323 35.00 x 50.00 x 7.00mm, PTFE NB847 88.00 x 108.00 x 11.00mm, FPM

105 2.0L		Petrol		
AOBA	4 Cyl.	16 Valves	1999cc	TD23308
AOBC	4 Cyl.	16 Valves	1999cc	TD24422
AODA	4 Cyl.	16 Valves	1999cc	TD23733
AODA	4 Cyl.	16 Valves	1999cc	TD18506
AODB	4 Cyl.	16 Valves	1999cc	TD18507
AODB	4 Cyl.	16 Valves	1999cc	TD23734
AODE	4 Cyl.	16 Valves	1999cc	TD24347
AODE	4 Cyl.	16 Valves	1999cc	TD34038
AOJA	4 Cyl.	16 Valves	1999cc	TD32927
AOJB	4 Cyl.	16 Valves	1999cc	TD32929
AOWA	4 Cyl.	16 Valves	1999cc	TD20039
AOWB	4 Cyl.	16 Valves	1999cc	TD24430
CJBA	4 Cyl.	16 Valves	1999cc	TD15911
CJBB	4 Cyl.	16 Valves	1999cc	TD15912
MGDA	4 Cyl.	16 Valves	1999cc	TD28248
N4JB	4 Cyl.	16 Valves	1999cc	TD18781
N4JB	4 Cyl.	16 Valves	1999cc	TD23732
R9CB	4 Cyl.	16 Valves	1999cc	TD30713
R9CB	4 Cyl.	16 Valves	1999cc	TD30539
R9CD	4 Cyl.	16 Valves	1999cc	TD31085
R9CF	4 Cyl.	16 Valves	1999cc	TD30714
R9CF	4 Cyl.	16 Valves	1999cc	TD30540
R9CH	4 Cyl.	16 Valves	1999cc	TD30541
R9CH	4 Cyl.	16 Valves	1999cc	TD30717
R9CI	4 Cyl.	16 Valves	1999cc	TD31086
R9DA	4 Cyl.	16 Valves	1999cc	TD28070
R9DA	4 Cyl.	16 Valves	1999cc	TD32391
SYDA	4 Cyl.	16 Valves	1999cc	TD23368
TBBA	4 Cyl.	16 Valves	1999cc	TD23309
TBBB	4 Cyl.	16 Valves	1999cc	TD24423
TBWA	4 Cyl.	16 Valves	1999cc	TD24431
TBWB	4 Cyl.	16 Valves	1999cc	TD24432
TNBA	4 Cyl.	16 Valves	1999cc	TD24424
TNBB	4 Cyl.	16 Valves	1999cc	TD26701
TNCC	4 Cyl.	16 Valves	1999cc	TD30538
TNCD	4 Cyl.	16 Valves	1999cc	TD30710
TNCD	4 Cyl.	16 Valves	1999cc	TD30536
TNCF	4 Cyl.	16 Valves	1999cc	TD30537
TNCF	4 Cyl.	16 Valves	1999cc	TD30711
TNWA	4 Cyl.	16 Valves	1999cc	TD24433
TNWB	4 Cyl.	16 Valves	1999cc	TD27998

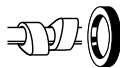

TPBA	4 Cyl.	16 Valves	1999cc	TD26072
TPWA	4 Cyl.	16 Valves	1999cc	TD28181
UACA	4 Cyl.	16 Valves	1999cc	TD33010
XQDA	4 Cyl.	16 Valves	1999cc	TD29690

HR5063				NA5157 37.00 x 50.00 x 8.00mm, PTFE LK5005 88.00 x 188.00 x 15.000mm, PTFE
--------	--	--	--	---

106 2.0L Diesel

AZBA	4 Cyl.	16 Valves	1997cc	TD23367
AZBA	4 Cyl.	16 Valves	1997cc	TD24360
AZBC	4 Cyl.	16 Valves	1997cc	TD24653
AZWA	4 Cyl.	16 Valves	1997cc	TD20040
AZWC	4 Cyl.	16 Valves	1997cc	TD24655
G6DA	4 Cyl.	16 Valves	1997cc	TD18510
G6DA	4 Cyl.	16 Valves	1997cc	TD25250
G6DB	4 Cyl.	16 Valves	1997cc	TD18511
G6DC	4 Cyl.	16 Valves	1997cc	TD18791
G6DD	4 Cyl.	16 Valves	1997cc	TD18790
G6DE	4 Cyl.	16 Valves	1997cc	TD18792
G6DF	4 Cyl.	16 Valves	1997cc	TD18793
G6DG	4 Cyl.	16 Valves	1997cc	TD24352
IXDA	4 Cyl.	16 Valves	1997cc	TD24353
KLBA	4 Cyl.	16 Valves	1997cc	TD23305
KLWA	4 Cyl.	16 Valves	1997cc	TD24436
LPBA	4 Cyl.	16 Valves	1997cc	TD23354
QXBA	4 Cyl.	16 Valves	1997cc	TD23306
QXBB	4 Cyl.	16 Valves	1997cc	TD23307
QXWA	4 Cyl.	16 Valves	1997cc	TD20041
QXWB	4 Cyl.	16 Valves	1997cc	TD20046
QXWC	4 Cyl.	16 Valves	1997cc	TD24437

HR5046 (x2)	NA5035 (x2) 27.00 x 47.00 x 7.00mm, FPM	NA5191 42.00 x 62.00 x 7.00mm, PTFE NA5192 90.00 x 110.00 x 7.00mm, PTFE
--------------	---	---

107 2.0L Petrol

C	4 Cyl.	8 Valves	1993cc	TD4445
PB180 (x8) HR631				NA5190 42.00 x 56.00 x 7.00mm, FPM NB788 79.40 x 95.30 x 11.10mm, PTFE

108 2.0L Petrol

CA20E	4 Cyl.	8 Valves	1974cc	TD23729
PA079 (x8) HR5112	NJ285 34.00 x 48.00 x 8.00mm, NBR	NJ280 33.00 x 47.00 x 8.00mm, NBR NJ284 84.00 x 104.00 x 11.00mm, MVQ		



109 2.0L Diesel

D 4204 T	4 Cyl.	16 Valves	1997cc	TD23737
HR5046 (x2)	NA5035 27.00 x 47.00 x 7.00mm, FPM		NA5191 42.00 x 62.00 x 7.00mm, PTFE NA5192 90.00 x 110.00 x 7.00mm, PTFE	

110 2.0L Petrol

EDBA	4 Cyl.	16 Valves	1988cc	TD12068
EDBB	4 Cyl.	16 Valves	1988cc	TD15916
EDBC	4 Cyl.	16 Valves	1988cc	TD15917
EDBD	4 Cyl.	16 Valves	1988cc	TD15918
HR5033	NB958 (x2) 42.00 x 53.00 x 7.00mm, FPM		NA5323 35.00 x 50.00 x 7.00mm, PTFE 01/99→ NA5066 35.00 x 50.00 x 10.00mm, ACM NB959 35.00 x 50.00 x 7.00mm, FPM NB847 88.00 x 108.00 x 11.00mm, FPM	

111 2.0L Petrol

EDDB	4 Cyl.	16 Valves	1988cc	TD15900
EDDC	4 Cyl.	16 Valves	1988cc	TD12080
EDDD	4 Cyl.	16 Valves	1988cc	TD15901
EDDF	4 Cyl.	16 Valves	1988cc	TD15902
HR5033	NB958 (x2) 42.00 x 53.00 x 7.00mm, FPM		NA5066 35.00 x 50.00 x 10.00mm, ACM NB959 35.00 x 50.00 x 7.00mm, FPM NB847 88.00 x 108.00 x 11.00mm, FPM	

112 2.0L Petrol

EDDB	4 Cyl.	16 Valves	1988cc	TD25249
HR5033	NB958 42.00 x 53.00 x 7.00mm, FPM		NA5066 35.00 x 50.00 x 10.00mm, ACM NB959 35.00 x 50.00 x 7.00mm, FPM NB847 88.00 x 108.00 x 11.00mm, FPM	

113 2.0L Petrol

FE	4 Cyl.	8 Valves	1998cc	TD24354
			NJ324 34.00 x 48.00 x 7.00mm, ACM NJ325 90.00 x 110.00 x 9.00mm, MVQ	

114 2.0L Petrol

FET	4 Cyl.	8 Valves	1998cc	TD25136
KJ710 (x8)	NJ324 34.00 x 48.00 x 7.00mm, ACM		NJ324 34.00 x 48.00 x 7.00mm, ACM NJ325 90.00 x 110.00 x 9.00mm, MVQ	

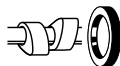

115 2.0L

Petrol

FEY9	4 Cyl.	12 Valves	1998cc	TD19550
PA883 (x12)	NJ324	34.00 x 48.00 x 7.00mm, ACM	NJ324	34.00 x 48.00 x 7.00mm, ACM
			NJ325	90.00 x 110.00 x 9.00mm, MVQ

116 2.0L

Petrol

FS	4 Cyl.	16 Valves	1991cc	TD25125
FS	4 Cyl.	16 Valves	1991cc	TD22977
FS	4 Cyl.	16 Valves	1991cc	TD4452
FS2C	4 Cyl.	16 Valves	1991cc	TD19588
FS83	4 Cyl.	16 Valves	1991cc	TD19551
PB313 (x8)	NJ324 (x2)	34.00 x 48.00 x 7.00mm, ACM	NA5246	42.50 x 54.50 x 6.00mm, MVQ
PB314 (x8)			NK205	89.00 x 109.00 x 9.00mm, MVQ

117 2.0L

Petrol

HMDA	4 Cyl.	16 Valves	1988cc	TD18786
HR5033	NB958 (x2)	42.00 x 53.00 x 7.00mm, FPM	NB959	35.00 x 50.00 x 7.00mm, FPM
			NA5323	35.00 x 50.00 x 7.00mm, PTFE
			NB847	88.00 x 108.00 x 11.00mm, FPM

118 2.0L

Petrol

KF	6 Cyl.	24 Valves	1995cc	TD27823
PB313 (x12)	NJ448 (x2)	30.00 x 44.00 x 7.00mm, NBR	NA5246	42.50 x 54.50 x 6.00mm, MVQ
PB314 (x12)				

119 2.0L

Petrol

MA	4 Cyl.	8 Valves	1970cc	TD25119
KJ710 (x8)				

120 2.0L

Petrol

MGDA	4 Cyl.	16 Valves	1999cc	TD32197
R9DB	4 Cyl.	16 Valves	1999cc	TD33168
R9DC	4 Cyl.	16 Valves	1999cc	TD33169
TNBA	4 Cyl.	16 Valves	1999cc	TD30270
HR5063				

121 2.0L

Petrol

N3A	4 Cyl.	16 Valves	1998cc	TD4470
N7A	4 Cyl.	16 Valves	1998cc	TD1328
HR655 (x2)	NA5190 (x2)	42.00 x 56.00 x 7.00mm, FPM	NA5190	42.00 x 56.00 x 7.00mm, FPM
			NB847	88.00 x 108.00 x 11.00mm, FPM



122 2.0L Petrol

N4A	4 Cyl.	8 Valves	1993cc	TD1318
N4B	4 Cyl.	8 Valves	1993cc	TD1319
N4I	4 Cyl.	8 Valves	1993cc	TD1320
N6T	4 Cyl.	8 Valves	1993cc	TD1327
N6TS	4 Cyl.	8 Valves	1993cc	TD22540
NAE	4 Cyl.	8 Valves	1993cc	TD1342
NAT	4 Cyl.	8 Valves	1994cc	TD4472
NAV	4 Cyl.	8 Valves	1994cc	TD1344
NAW	4 Cyl.	8 Valves	1993cc	TD17074
NAX	4 Cyl.	8 Valves	1993cc	TD17075
NBA	4 Cyl.	8 Valves	1993cc	TD1345
NCA	4 Cyl.	8 Valves	1994cc	TD1346
NE	4 Cyl.	8 Valves	1993cc	TD26392
NE1	4 Cyl.	8 Valves	1993cc	TD1347
NE2	4 Cyl.	8 Valves	1993cc	TD1348
NE3	4 Cyl.	8 Valves	1993cc	TD1349
NE4	4 Cyl.	8 Valves	1993cc	TD1350
NE5	4 Cyl.	8 Valves	1993cc	TD1351
NEE	4 Cyl.	8 Valves	1993cc	TD1353
NEG	4 Cyl.	8 Valves	1993cc	TD1354
NEJ	4 Cyl.	8 Valves	1993cc	TD1355
NEL	4 Cyl.	8 Valves	1993cc	TD1357
NEN	4 Cyl.	8 Valves	1993cc	TD1358
NER	4 Cyl.	8 Valves	1993cc	TD22410
NR2	4 Cyl.	8 Valves	1993cc	TD1364
NRA	4 Cyl.	8 Valves	1993cc	TD1365
NRB	4 Cyl.	8 Valves	1993cc	TD1367
NRC	4 Cyl.	8 Valves	1993cc	TD1368
NRD	4 Cyl.	8 Valves	1993cc	TD1369
NRI	4 Cyl.	8 Valves	1993cc	TD1370
OHC LC	4 Cyl.	8 Valves	1994cc	TD16538
OHC TL 20	4 Cyl.	8 Valves	1993cc	TD1390
OHC TL 20 H	4 Cyl.	8 Valves	1993cc	TD1391
OHC TL 20 L	4 Cyl.	8 Valves	1993cc	TD1392
TL 20 LC	4 Cyl.	8 Valves	1994cc	TD19004

PB180 (x8)
HR631

NA5190
42.00 x 56.00 x 7.00mm, FPM

NA5190
42.00 x 56.00 x 7.00mm, FPM
NB788
79.40 x 95.30 x 11.10mm, PTFE

123 2.0L Petrol

N8A	4 Cyl.	8 Valves	1998cc	TD1329
N8B	4 Cyl.	8 Valves	1998cc	TD1330
N8C	4 Cyl.	8 Valves	1993cc	TD1332
N9B	4 Cyl.	8 Valves	1998cc	TD1336
N9C	4 Cyl.	8 Valves	1998cc	TD1337
N9D	4 Cyl.	8 Valves	1998cc	TD1338
N9E	4 Cyl.	8 Valves	1998cc	TD4471
N9F	4 Cyl.	8 Valves	1998cc	TD1339
NSD	4 Cyl.	8 Valves	1998cc	TD4476

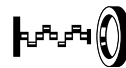
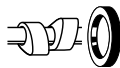

NSE	4 Cyl.	8 Valves	1998cc	TD5109
NSF	4 Cyl.	8 Valves	1998cc	TD26377
NSF	4 Cyl.	8 Valves	1998cc	TD4477
NSG	4 Cyl.	8 Valves	1998cc	TD26379
NSG	4 Cyl.	8 Valves	1998cc	TD4478
NSH	4 Cyl.	8 Valves	1998cc	TD16364

HR655

NB959 (x2)
35.00 x 50.00 x 7.00mm, FPM

NA5190
42.00 x 56.00 x 7.00mm, FPM
NB847
88.00 x 108.00 x 11.00mm, FPM

124 2.0L

Petrol

N8D	4 Cyl.	8 Valves	1993cc	TD1334
N9A	4 Cyl.	8 Valves	1998cc	TD1335
ZVSA	4 Cyl.	8 Valves	1998cc	TD17158

HR655

NB959
35.00 x 50.00 x 7.00mm, FPM

NA5190
42.00 x 56.00 x 7.00mm, FPM
NB847
88.00 x 108.00 x 11.00mm, FPM

125 2.0L

Petrol

NGA	4 Cyl.	16 Valves	1988cc	TD4475
NGA	4 Cyl.	16 Valves	1988cc	TD25132
NGB	4 Cyl.	16 Valves	1988cc	TD25133
NGB	4 Cyl.	16 Valves	1988cc	TD12090
NGC	4 Cyl.	16 Valves	1988cc	TD15994
NGC	4 Cyl.	16 Valves	1988cc	TD25134
NGD	4 Cyl.	16 Valves	1988cc	TD16012
NGD	4 Cyl.	16 Valves	1988cc	TD25135

HR5033

NB958 (x2)
42.00 x 53.00 x 7.00mm, FPM

NB959
35.00 x 50.00 x 7.00mm, FPM
NB847
88.00 x 108.00 x 11.00mm, FPM

126 2.0L

Petrol

NWN	6 Cyl.	12 Valves	1999cc	TD1372
NWP	6 Cyl.	12 Valves	1998cc	TD1373
NWR	6 Cyl.	12 Valves	1999cc	TD1374
NX	6 Cyl.	12 Valves	1998cc	TD1375
NY	6 Cyl.	12 Valves	1998cc	TD4479
NYL	6 Cyl.	12 Valves	1999cc	TD1377
NYP	6 Cyl.	12 Valves	1998cc	TD4480
NYR	6 Cyl.	12 Valves	1999cc	TD1379
NYT	6 Cyl.	12 Valves	1999cc	TD1380
NYU	6 Cyl.	12 Valves	1999cc	TD1381
TV 20 H	6 Cyl.	12 Valves	1998cc	TD1461
TV 20 L	6 Cyl.	12 Valves	1998cc	TD1462

PB180 (x12)
HR630 (x2)

NB564
60.45 x 76.18 x 10.00mm, FPM



127 2.0L Diesel

QXBA	4 Cyl.	16 Valves	1997cc	TD32381
QXBB	4 Cyl.	16 Valves	1997cc	TD32378
HR5046				NA5191 42.00 x 62.00 x 7.00mm, PTFE NA5192 90.00 x 110.00 x 7.00mm, PTFE

128 2.0L Diesel

RF	4 Cyl.	8 Valves	1998cc	TD1425
RFIG	4 Cyl.	8 Valves	1998cc	TD19629
KJ710 (x8)	NJ448	30.00 x 44.00 x 7.00mm, NBR		NJ324 34.00 x 48.00 x 7.00mm, ACM

129 2.0L Diesel

T7CE	4 Cyl.	16 Valves	1997cc	TD30546
T7CI	4 Cyl.	16 Valves	1997cc	TD31089
T7CJ	4 Cyl.	16 Valves	1997cc	TD31090
T7CK	4 Cyl.	16 Valves	1997cc	TD31092
T7CL	4 Cyl.	16 Valves	1997cc	TD31091
T7DB	4 Cyl.	16 Valves	1997cc	TD31019
T7MA	4 Cyl.	16 Valves	1997cc	TD30562
T7MB	4 Cyl.	16 Valves	1997cc	TD30554
T8CC	4 Cyl.	16 Valves	1997cc	TD30548
T8CC	4 Cyl.	16 Valves	1997cc	TD30719
T8CC	4 Cyl.	16 Valves	1997cc	TD32595
T8CG	4 Cyl.	16 Valves	1997cc	TD31097
T8CH	4 Cyl.	16 Valves	1997cc	TD31094
T8CI	4 Cyl.	16 Valves	1997cc	TD31096
T8CJ	4 Cyl.	16 Valves	1997cc	TD31095
T8DA	4 Cyl.	16 Valves	1997cc	TD31080
T8DE	4 Cyl.	16 Valves	1997cc	TD31020
T8MA	4 Cyl.	16 Valves	1997cc	TD30563
T8MB	4 Cyl.	16 Valves	1997cc	TD30557
T9CA	4 Cyl.	16 Valves	1997cc	TD31064
T9CB	4 Cyl.	16 Valves	1997cc	TD31098
T9CC	4 Cyl.	16 Valves	1997cc	TD31099
TXBA	4 Cyl.	16 Valves	1997cc	TD34018
TXBA	4 Cyl.	16 Valves	1997cc	TD25804
TXBB	4 Cyl.	16 Valves	1997cc	TD31045
TXBB	4 Cyl.	16 Valves	1997cc	TD34019
TXDA	4 Cyl.	16 Valves	1997cc	TD25805
TXDB	4 Cyl.	16 Valves	1997cc	TD25803
TXDB	4 Cyl.	16 Valves	1997cc	TD32199
TXMA	4 Cyl.	16 Valves	1997cc	TD32389
TXMA	4 Cyl.	16 Valves	1997cc	TD30566
TXWA	4 Cyl.	16 Valves	1997cc	TD25806
TYBA	4 Cyl.	16 Valves	1997cc	TD24425
TYDA	4 Cyl.	16 Valves	1997cc	TD25885
TYMA	4 Cyl.	16 Valves	1997cc	TD31053
TYWA	4 Cyl.	16 Valves	1997cc	TD24435



UFBA	4 Cyl.	16 Valves	1997cc	TD24426
UFBA	4 Cyl.	16 Valves	1997cc	TD32380
UFBB	4 Cyl.	16 Valves	1997cc	TD32382
UFBB	4 Cyl.	16 Valves	1997cc	TD31049
UFCA	4 Cyl.	16 Valves	1997cc	TD31087
UFCB	4 Cyl.	16 Valves	1997cc	TD31088
UFDA	4 Cyl.	16 Valves	1997cc	TD24429
UFDB	4 Cyl.	16 Valves	1997cc	TD25886
UFMA	4 Cyl.	16 Valves	1997cc	TD29483
UFWA	4 Cyl.	16 Valves	1997cc	TD24438
UKBA	4 Cyl.	16 Valves	1997cc	TD25802
UKBB	4 Cyl.	16 Valves	1997cc	TD31051
UKDA	4 Cyl.	16 Valves	1997cc	TD24428
UKDB	4 Cyl.	16 Valves	1997cc	TD25887
UKMA	4 Cyl.	16 Valves	1997cc	TD29484
UKWA	4 Cyl.	16 Valves	1997cc	TD24654
XRMA	4 Cyl.	16 Valves	1997cc	TD30560
XRMB	4 Cyl.	16 Valves	1997cc	TD30550

HR5122

NA5035 (x2)
27.00 x 47.00 x 7.00mm, FPM

NA5191
42.00 x 62.00 x 7.00mm, PTFE

NA5192
90.00 x 110.00 x 7.00mm, PTFE

130 2.0L

Diesel

T8CM	4 Cyl.	16 Valves	1997cc	TD33263
T9CE	4 Cyl.	16 Valves	1997cc	TD32596
T9CF	4 Cyl.	16 Valves	1997cc	TD33264

NA5191
42.00 x 62.00 x 7.00mm, PTFE

NA5192
90.00 x 110.00 x 7.00mm, PTFE

131 2.0L

Petrol

YF	4 Cyl.	16 Valves	1989cc	TD18794
----	--------	-----------	--------	---------

HR5033

NB958 (x2)
42.00 x 53.00 x 7.00mm, FPM

NB959
35.00 x 50.00 x 7.00mm, FPM

NA5323
35.00 x 50.00 x 7.00mm, PTFE

132 2.1L

Diesel

WTA	4 Cyl.	8 Valves	2112cc	TD1478
-----	--------	----------	--------	--------

PA229 (x8)

NF387
42.00 x 60.00 x 10.00mm, NBR

133 2.2L

Diesel

CV24	4 Cyl.	16 Valves	2198cc	TD29669
CV24	4 Cyl.	16 Valves	2198cc	TD32371
CVF5	4 Cyl.	16 Valves	2198cc	TD29676
CVFF	4 Cyl.	16 Valves	2198cc	TD29681
CVFF	4 Cyl.	16 Valves	2198cc	TD30729
CVR5	4 Cyl.	16 Valves	2198cc	TD29667
CVR5	4 Cyl.	16 Valves	2198cc	TD32373
CVRA	4 Cyl.	16 Valves	2198cc	TD32367
CVRA	4 Cyl.	16 Valves	2198cc	TD26453



CVRB	4 Cyl.	16 Valves	2198cc	TD26454
CVRB	4 Cyl.	16 Valves	2198cc	TD32368
CVRC	4 Cyl.	16 Valves	2198cc	TD26455
CVRC	4 Cyl.	16 Valves	2198cc	TD32370
CY14	4 Cyl.	16 Valves	2198cc	TD29674
CY24	4 Cyl.	16 Valves	2198cc	TD29672
CYF4	4 Cyl.	16 Valves	2198cc	TD30728
CYF4	4 Cyl.	16 Valves	2198cc	TD29679
CYF5	4 Cyl.	16 Valves	2198cc	TD29666
CYFA	4 Cyl.	16 Valves	2198cc	TD26461
CYFA	4 Cyl.	16 Valves	2198cc	TD30792
CYFB	4 Cyl.	16 Valves	2198cc	TD26462
CYFB	4 Cyl.	16 Valves	2198cc	TD30794
CYFC	4 Cyl.	16 Valves	2198cc	TD30795
CYFC	4 Cyl.	16 Valves	2198cc	TD26463
CYFD	4 Cyl.	16 Valves	2198cc	TD26464
CYFF	4 Cyl.	16 Valves	2198cc	TD30727
CYFF	4 Cyl.	16 Valves	2198cc	TD29680
CYFG	4 Cyl.	16 Valves	2198cc	TD29673
CYR5	4 Cyl.	16 Valves	2198cc	TD29671
CYRA	4 Cyl.	16 Valves	2198cc	TD26716
CYRB	4 Cyl.	16 Valves	2198cc	TD26465
CYRC	4 Cyl.	16 Valves	2198cc	TD26466
DRF4	4 Cyl.	16 Valves	2198cc	TD29678
DRF5	4 Cyl.	16 Valves	2198cc	TD29442
DRFA	4 Cyl.	16 Valves	2198cc	TD26456
DRFB	4 Cyl.	16 Valves	2198cc	TD26457
DRFC	4 Cyl.	16 Valves	2198cc	TD26458
DRFD	4 Cyl.	16 Valves	2198cc	TD26459
DRFE	4 Cyl.	16 Valves	2198cc	TD26460
DRFF	4 Cyl.	16 Valves	2198cc	TD29677
DRFG	4 Cyl.	16 Valves	2198cc	TD29656
DRR5	4 Cyl.	16 Valves	2198cc	TD29655
DRRA	4 Cyl.	16 Valves	2198cc	TD26450
DRRB	4 Cyl.	16 Valves	2198cc	TD26451
DRRC	4 Cyl.	16 Valves	2198cc	TD26452
GBVAJPF	4 Cyl.	16 Valves	2198cc	TD26487
GBVAJQJ	4 Cyl.	16 Valves	2198cc	TD26483
GBVAJQJ	4 Cyl.	16 Valves	2198cc	TD32200
GBVAJQW	4 Cyl.	16 Valves	2198cc	TD26486
P8FA	4 Cyl.	16 Valves	2198cc	TD20042
P8FB	4 Cyl.	16 Valves	2198cc	TD21066
PGFA	4 Cyl.	16 Valves	2198cc	TD21067
PGFB	4 Cyl.	16 Valves	2198cc	TD24463
QVFA	4 Cyl.	16 Valves	2198cc	TD20043
QVFA	4 Cyl.	16 Valves	2198cc	TD24099
QWFA	4 Cyl.	16 Valves	2198cc	TD20044
SRFA	4 Cyl.	16 Valves	2198cc	TD24458
SRFA	4 Cyl.	16 Valves	2198cc	TD33017
SRFB	4 Cyl.	16 Valves	2198cc	TD33018

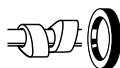

SRFB	4 Cyl.	16 Valves	2198cc	TD24459
SRFC	4 Cyl.	16 Valves	2198cc	TD24460
SRFC	4 Cyl.	16 Valves	2198cc	TD33019
SRFD	4 Cyl.	16 Valves	2198cc	TD24461
SRFD	4 Cyl.	16 Valves	2198cc	TD33020
SRFE	4 Cyl.	16 Valves	2198cc	TD24462
SRFE	4 Cyl.	16 Valves	2198cc	TD33021
UHFA	4 Cyl.	16 Valves	2198cc	TD26467
UHFB	4 Cyl.	16 Valves	2198cc	TD26468
UHFC	4 Cyl.	16 Valves	2198cc	TD26469
UHR5	4 Cyl.	16 Valves	2198cc	TD31052
USF6	4 Cyl.	16 Valves	2198cc	TD29675
USR6	4 Cyl.	16 Valves	2198cc	TD29670
USRA	4 Cyl.	16 Valves	2198cc	TD26470
USRB	4 Cyl.	16 Valves	2198cc	TD26471
UYR6	4 Cyl.	16 Valves	2198cc	TD29668
UYR6	4 Cyl.	16 Valves	2198cc	TD32374

HR5082

NA5031

50.00 x 86.50 x 13.70mm, PTFE

NA5030

106.00 x 190.00 x 15.20mm, PTFE/FPM

134 2.2L

Petrol

F2 (12 V)	4 Cyl.	12 Valves	2184cc	TD25117
-----------	--------	-----------	--------	---------

NJ324

34.00 x 48.00 x 7.00mm, ACM

NJ324

34.00 x 48.00 x 7.00mm, ACM

135 2.2L

Petrol

F2T	4 Cyl.	12 Valves	2184cc	TD25273
-----	--------	-----------	--------	---------

PA883 (x12)

NJ324

34.00 x 48.00 x 7.00mm, ACM

NJ324

34.00 x 48.00 x 7.00mm, ACM

NJ325

90.00 x 110.00 x 9.00mm, MVQ

136 2.2L

Diesel

KNBA	4 Cyl.	16 Valves	2179cc	TD26808
------	--------	-----------	--------	---------

KNBB	4 Cyl.	16 Valves	2179cc	TD26809
------	--------	-----------	--------	---------

KNWA	4 Cyl.	16 Valves	2179cc	TD26488
------	--------	-----------	--------	---------

KNWB	4 Cyl.	16 Valves	2179cc	TD26489
------	--------	-----------	--------	---------

Q4BA	4 Cyl.	16 Valves	2179cc	TD20838
------	--------	-----------	--------	---------

Q4WA	4 Cyl.	16 Valves	2179cc	TD24439
------	--------	-----------	--------	---------

HR5122

NA5035 (x2)

27.00 x 47.00 x 7.00mm, FPM

NA5191

42.00 x 62.00 x 7.00mm, PTFE

NA5192

90.00 x 110.00 x 7.00mm, PTFE

137 2.2L

Diesel

QJBA	4 Cyl.	16 Valves	2198cc	TD18756
------	--------	-----------	--------	---------

QJBB	4 Cyl.	16 Valves	2198cc	TD18757
------	--------	-----------	--------	---------

QJBC	4 Cyl.	16 Valves	2198cc	TD18782
------	--------	-----------	--------	---------

QJBD	4 Cyl.	16 Valves	2198cc	TD18783
------	--------	-----------	--------	---------

HR5082

NA5028 (x2)

36.00 x 50.00 x 7.00mm, PTFE

NA5031

50.00 x 86.50 x 13.70mm, PTFE

NA5030

106.00 x 190.00 x 15.20mm, PTFE/FPM



138 2.2L Diesel

R2	4 Cyl.	8 Valves	2184cc	TD25116
R263	4 Cyl.	8 Valves	2184cc	TD26834
KJ710 (x8)	NJ448 30.00 x 44.00 x 7.00mm, NBR		NJ324 34.00 x 48.00 x 7.00mm, ACM NJ325 90.00 x 110.00 x 9.00mm, MVQ	

139 2.3L Diesel

4 D 55 T	4 Cyl.	8 Valves	2347cc	TD21262
KJ211 (x8)	NJ933 35.00 x 50.00 x 8.00mm, FPM		NJ058 80.00 x 96.00 x 9.00mm, NBR	

140 2.3L Petrol

ESFA	4 Cyl.	16 Valves	2295cc	TD26381
HR655 (x2)	NA5190 (x2) 42.00 x 56.00 x 7.00mm, FPM		NA5190 42.00 x 56.00 x 7.00mm, FPM NA5323 35.00 x 50.00 x 7.00mm, PTFE	

141 2.3L Petrol

ESFA	4 Cyl.	16 Valves	2295cc	TD16167
ESFC	4 Cyl.	16 Valves	2295cc	TD20058
ESSA	4 Cyl.	16 Valves	2295cc	TD15889
ESSB	4 Cyl.	16 Valves	2295cc	TD17168
Y5A	4 Cyl.	16 Valves	2295cc	TD12092
Y5B	4 Cyl.	16 Valves	2295cc	TD5497
HR655 (x2)	NA5190 (x2) 42.00 x 56.00 x 7.00mm, FPM		NA5190 42.00 x 56.00 x 7.00mm, FPM NA5323 35.00 x 50.00 x 7.00mm, PTFE NB847 88.00 x 108.00 x 11.00mm, FPM	

142 2.3L Petrol

ESFC	4 Cyl.	16 Valves	2295cc	TD26382
HR655 (x2)	NA5190 (x2) 42.00 x 56.00 x 7.00mm, FPM		NA5190 42.00 x 56.00 x 7.00mm, FPM NB847 88.00 x 108.00 x 11.00mm, FPM	

143 2.3L Petrol

GZ	4 Cyl.	16 Valves	2261cc	TD20057
GZFA	4 Cyl.	16 Valves	2261cc	TD20045
GZFA	4 Cyl.	16 Valves	2261cc	TD28031
GZFB	4 Cyl.	16 Valves	2261cc	TD30734
GZFC	4 Cyl.	16 Valves	2261cc	TD23370
L3	4 Cyl.	16 Valves	2261cc	TD34020
SEBA	4 Cyl.	16 Valves	2261cc	TD23352
SEBA	4 Cyl.	16 Valves	2261cc	TD24361

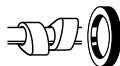

SEWA	4 Cyl.	16 Valves	2261cc	TD24434
YVDA	4 Cyl.	16 Valves	2261cc	TD33173
YVDA	4 Cyl.	16 Valves	2261cc	TD34489
HR5063				NA5157 37.00 x 50.00 x 8.00mm, PTFE LK5005 88.00 x 188.00 x 15.000mm, PTFE

144 2.3L

Petrol

N38H	4 Cyl.	16 Valves	2261cc	TD33261
N48H	4 Cyl.	16 Valves	2261cc	TD33262
				LK5005 88.00 x 188.00 x 15.000mm, PTFE

145 2.3L

Petrol

TV 23 H	6 Cyl.	12 Valves	2293cc	TD1463
YYE	6 Cyl.	12 Valves	2294cc	TD1484
YYF	6 Cyl.	12 Valves	2294cc	TD1485
YYH	6 Cyl.	12 Valves	2294cc	TD4497
YYN	6 Cyl.	12 Valves	2294cc	TD1487
YYP	6 Cyl.	12 Valves	2294cc	TD1488
YYR	6 Cyl.	12 Valves	2294cc	TD1489
YYT	6 Cyl.	12 Valves	2294cc	TD1490
YYU	6 Cyl.	12 Valves	2294cc	TD1491
PB180 (x12) HR630 (x2)				NA5190 42.00 x 56.00 x 7.00mm, FPM NB564 60.45 x 76.18 x 10.00mm, FPM

146 2.3L

Diesel

YTR	4 Cyl.	8 Valves	2304cc	TD1482
YTT	4 Cyl.	8 Valves	2304cc	TD1483
PA229 (x8)				NF387 42.00 x 60.00 x 10.00mm, NBR KS696 (x2)

147 2.3L

Petrol

YY	6 Cyl.	12 Valves	2294cc	TD34329
				NA5190 42.00 x 56.00 x 7.00mm, FPM NB564 60.45 x 76.18 x 10.00mm, FPM

148 2.4L

Diesel

4AA	4 Cyl.	8 Valves	2358cc	TD17094
				NB453 47.60 x 67.00 x 11.10mm, MVQ NB452 66.70 x 85.70 x 9.52mm, MVQ NB788 79.40 x 95.30 x 11.10mm, PTFE

149 2.4L

Petrol

4G64	4 Cyl.	8 Valves	2351cc	TD26869
KJ211 (x8)				NJ933 35.00 x 50.00 x 8.00mm, FPM NJ058 80.00 x 96.00 x 9.00mm, NBR



150 2.4L Petrol

ARC	6 Cyl.	12 Valves	2394cc	TD1144
ARD	6 Cyl.	12 Valves	2394cc	TD1145
PB180 (x12) HR660	NA5190 42.00 x 56.00 x 7.00mm, FPM		NA5190 42.00 x 56.00 x 7.00mm, FPM NB564 60.45 x 76.18 x 10.00mm, FPM	

151 2.4L Diesel

D2FA	4 Cyl.	16 Valves	2402cc	TD15549
D2FA	4 Cyl.	16 Valves	2402cc	TD24102
D2FB	4 Cyl.	16 Valves	2402cc	TD20037
D2FE	4 Cyl.	16 Valves	2402cc	TD15552
D4FA	4 Cyl.	16 Valves	2402cc	TD15550
D4FA	4 Cyl.	16 Valves	2402cc	TD25530
DOFA	4 Cyl.	16 Valves	2402cc	TD20038
DOFA	4 Cyl.	16 Valves	2402cc	TD24090
F4FA	4 Cyl.	16 Valves	2402cc	TD24092
F4FA	4 Cyl.	16 Valves	2402cc	TD15548
FXFA	4 Cyl.	16 Valves	2402cc	TD18798
FXFA	4 Cyl.	16 Valves	2402cc	TD24093
H9FA	4 Cyl.	16 Valves	2402cc	TD20036
H9FA	4 Cyl.	16 Valves	2402cc	TD24094
H9FB	4 Cyl.	16 Valves	2402cc	TD20033
H9FB	4 Cyl.	16 Valves	2402cc	TD24095
H9FD	4 Cyl.	16 Valves	2402cc	TD24457
JXFA	4 Cyl.	16 Valves	2402cc	TD24097
JXFA	4 Cyl.	16 Valves	2402cc	TD20034
JXFC	4 Cyl.	16 Valves	2402cc	TD24456
PHFA	4 Cyl.	16 Valves	2402cc	TD20035
PHFC	4 Cyl.	16 Valves	2402cc	TD21068
PHFC	4 Cyl.	16 Valves	2402cc	TD24098
HR5082			NA5031 50.00 x 86.50 x 13.70mm, PTFE NA5030 106.00 x 190.00 x 15.20mm, PTFE/FPM	

152 2.4L Petrol

KA-24	4 Cyl.	12 Valves	2389cc	TD12086
KA24E	4 Cyl.	12 Valves	2389cc	TD23762
KA24-E	4 Cyl.	12 Valves	2389cc	TD4460
PA079 (x8) PA933 (x4)			NK106 46.00 x 58.00 x 7.00mm, ACM NJ287 80.00 x 100.00 x 10.00mm, MVQ	



153 2.5L

Diesel

4AB	4 Cyl.	8 Valves	2496cc	TD1113
HR5064	NB856 47.62 x 66.50 x 11.00mm, PTFE			NB855 67.00 x 86.00 x 9.50mm, PTFE 10/88→ NB788 79.40 x 95.30 x 11.10mm, PTFE →09/88 NB854 79.00 x 99.00 x 9.50mm, PTFE 10/88→

154 2.5L

Diesel

4AB	4 Cyl.	8 Valves	2496cc	TD26375
4AE	4 Cyl.	8 Valves	2496cc	TD32686
4BA	4 Cyl.	8 Valves	2496cc	TD26376
4BC	4 Cyl.	8 Valves	2496cc	TD1115
4BC	4 Cyl.	8 Valves	2496cc	TD24079
4CC	4 Cyl.	8 Valves	2496cc	TD1117
4DA	4 Cyl.	8 Valves	2496cc	TD1118
4DA	4 Cyl.	8 Valves	2496cc	TD25270
4EA	4 Cyl.	8 Valves	2496cc	TD1119
4EA	4 Cyl.	8 Valves	2496cc	TD24080
4EB	4 Cyl.	8 Valves	2496cc	TD24081
4EB	4 Cyl.	8 Valves	2496cc	TD4424
4EC	4 Cyl.	8 Valves	2496cc	TD15214
4ED	4 Cyl.	8 Valves	2496cc	TD12093
4ED	4 Cyl.	8 Valves	2496cc	TD24082
4FA	4 Cyl.	8 Valves	2496cc	TD1120
4FA	4 Cyl.	8 Valves	2496cc	TD25271
4FB	4 Cyl.	8 Valves	2496cc	TD24083
4FB	4 Cyl.	8 Valves	2496cc	TD4426
4FC	4 Cyl.	8 Valves	2496cc	TD4428
4FD	4 Cyl.	8 Valves	2496cc	TD15209
4GA	4 Cyl.	8 Valves	2496cc	TD4430
4GB	4 Cyl.	8 Valves	2496cc	TD4432
4GC	4 Cyl.	8 Valves	2496cc	TD4433
4GD	4 Cyl.	8 Valves	2496cc	TD15211
4GE	4 Cyl.	8 Valves	2496cc	TD15212
4GF	4 Cyl.	8 Valves	2496cc	TD15213
4GF	4 Cyl.	8 Valves	2496cc	TD24086
4HA	4 Cyl.	8 Valves	2496cc	TD4434
4HB	4 Cyl.	8 Valves	2496cc	TD4436
4HB	4 Cyl.	8 Valves	2496cc	TD25272
4HC	4 Cyl.	8 Valves	2496cc	TD15210
4HC	4 Cyl.	8 Valves	2496cc	TD24103
4HD	4 Cyl.	8 Valves	2496cc	TD16250

HR5064	NB856 47.62 x 66.50 x 11.00mm, PTFE			NB855 67.00 x 86.00 x 9.50mm, PTFE NB854 79.00 x 99.00 x 9.50mm, PTFE
---------------	---	--	--	--



155 2.5L		Diesel		
4BA	4 Cyl.	8 Valves	2496cc	TD1114
4CA	4 Cyl.	8 Valves	2496cc	TD1116
HR5064	NB856 47.62 x 66.50 x 11.00mm, PTFE		NB855 67.00 x 86.00 x 9.50mm, PTFE 10/88→ NB854 79.00 x 99.00 x 9.50mm, PTFE 10/88→	

156 2.5L		Diesel		
4D56 (8V)	4 Cyl.	8 Valves	2477cc	TD28196
4D56 T	4 Cyl.	8 Valves	2477cc	TD28195
KJ211 (x8)	NJ933 35.00 x 50.00 x 8.00mm, FPM NJ242 35.00 x 50.00 x 8.00mm, NBR		NJ005 44.00 x 60.00 x 7.00mm, NBR NJ251 80.00 x 96.00 x 9.00mm, MVQ	

157 2.5L		Petrol		
EV 25 B	6 Cyl.	12 Valves	2495cc	TD22529
EV 25 H	6 Cyl.	12 Valves	2495cc	TD1166
EV 25 HRB	6 Cyl.	12 Valves	2495cc	TD22530
EV 25 L	6 Cyl.	12 Valves	2495cc	TD22531
PB180 (x12) HR630 (x2)			NB788 79.40 x 95.30 x 11.10mm, PTFE	

158 2.5L		Petrol		
GBVAF	4 Cyl.	16 Valves	2488cc	TD26502
GBVAF	4 Cyl.	16 Valves	2488cc	TD26578
GBVAK	4 Cyl.	16 Valves	2488cc	TD26504
GBVAK	4 Cyl.	16 Valves	2488cc	TD26580
GBVAL	4 Cyl.	16 Valves	2488cc	TD26579
GBVAL	4 Cyl.	16 Valves	2488cc	TD26503
HR5063				

159 2.5L		Petrol		
HUBA	5 Cyl.	20 Valves	2521cc	TD24362
HUBA	5 Cyl.	20 Valves	2521cc	TD23310
HUWA	5 Cyl.	20 Valves	2521cc	TD20032
HYDA	5 Cyl.	20 Valves	2522cc	TD20031
HYDA	5 Cyl.	20 Valves	2522cc	TD23763
HYDB	5 Cyl.	20 Valves	2522cc	TD24427
HYDC	5 Cyl.	20 Valves	2522cc	TD31041
HR5113	NA5178 (x2) 45.00 x 65.00 x 7.00mm, FPM/ACM		NA5018 35.00 x 47.00 x 5.60mm, FPM NA5017 98.00 x 110.00 x 8.50mm, FPM	

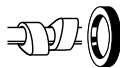

160 2.5L

Petrol

HYDB	5 Cyl.	20 Valves	2522cc	TD28027
JZDA	5 Cyl.	20 Valves	2521cc	TD33022
JZDA	5 Cyl.	20 Valves	2521cc	TD24658

HR5113

NA5178
45.00 x 65.00 x 7.00mm, FPM/ACM

NA5018
35.00 x 47.00 x 5.60mm, FPM
NA5017
98.00 x 110.00 x 8.50mm, FPM

161 2.5L

Petrol

KL	6 Cyl.	24 Valves	2497cc	TD22976
KL	6 Cyl.	24 Valves	2497cc	TD4461

PB313 (x12)
PB314 (x12)

NJ448 (x2)
30.00 x 44.00 x 7.00mm, NBR

NA5246
42.50 x 54.50 x 6.00mm, MVQ

162 2.5L

Petrol

KL-ZE	6 Cyl.	24 Valves	2497cc	TD25252
-------	--------	-----------	--------	---------

PB313 (x12)
PB314 (x12)

NA5246
42.50 x 54.50 x 6.00mm, MVQ

163 2.5L

Petrol

LCBA	6 Cyl.	24 Valves	2544cc	TD12067
LCBB	6 Cyl.	24 Valves	2495cc	TD16009
LCBB	6 Cyl.	24 Valves	2495cc	TD25108
LCBC	6 Cyl.	24 Valves	2495cc	TD15956
LCBC	6 Cyl.	24 Valves	2495cc	TD25109
LCBD	6 Cyl.	24 Valves	2495cc	TD15913
LCBE	6 Cyl.	24 Valves	2495cc	TD16008
LCBE	6 Cyl.	24 Valves	2495cc	TD25110
SEA	6 Cyl.	24 Valves	2544cc	TD25131
SEA	6 Cyl.	24 Valves	2544cc	TD4491
SEB	6 Cyl.	24 Valves	2495cc	TD20095
SEC	6 Cyl.	24 Valves	2495cc	TD20096
SEC	6 Cyl.	24 Valves	2495cc	TD24100
SGA	6 Cyl.	24 Valves	2495cc	TD13528

NA5175
91.00 x 108.00 x 9.50mm, NBR

164 2.5L

Petrol

S7CB	4 Cyl.	16 Valves	2489cc	TD31219
------	--------	-----------	--------	---------

HR5063

NA5157
37.00 x 50.00 x 8.00mm, PTFE
LK5005
88.00 x 188.00 x 15.00mm, PTFE

165 2.5L

Diesel

SFA	4 Cyl.	8 Valves	2498cc	TD4492
SFB	4 Cyl.	8 Valves	2498cc	TD4493

PA229 (x8)

NF780
45.00 x 60.00 x 7.00mm, ACM
KS696 (x2)



166 2.5L Diesel

STP	4 Cyl.	8 Valves	2499cc	TD1448
STR	4 Cyl.	8 Valves	2498cc	TD1449
PA229 (x8)				NF387 42.00 x 60.00 x 10.00mm, NBR KS696 (x2)

167 2.5L Petrol

TV 26 H	6 Cyl.	12 Valves	2523cc	TD1465
				NB564 60.45 x 76.18 x 10.00mm, FPM

168 2.5L Petrol

UY	6 Cyl.	12 Valves	2550cc	TD1470
PB180 (x12) HR630 (x2)				NB564 60.45 x 76.18 x 10.00mm, FPM

169 2.5L Diesel

WL	4 Cyl.	12 Valves	2500cc	TD15890
WL	4 Cyl.	12 Valves	2500cc	TD25115
WLAT (12 V)	4 Cyl.	12 Valves	2500cc	TD25111
WL-T	4 Cyl.	12 Valves	2500cc	TD15891
				NA5197 53.00 x 70.00 x 11.00mm, MVQ

170 2.5L Diesel

WLAT (16 V)	4 Cyl.	16 Valves	2500cc	TD25251
PB314 (x16)				

171 2.5L Diesel

XD3P	4 Cyl.	8 Valves	2497cc	TD22249
XD3T	4 Cyl.	8 Valves	2497cc	TD22250
PA229 (x8)				NF387 42.00 x 60.00 x 10.00mm, NBR →09/85 NF780 45.00 x 60.00 x 7.00mm, ACM 09/85→ KS696 (x2)

172 2.6L Petrol

4G54	4 Cyl.	8 Valves	2555cc	TD24084
G54B	4 Cyl.	8 Valves	2555cc	TD26871
KJ211 (x8)				NJ251 80.00 x 96.00 x 9.00mm, MVQ

173 2.6L Petrol

OZ	6 Cyl.	12 Valves	2638cc	TD11227
TV 26 L	6 Cyl.	12 Valves	2551cc	TD1466
				NB564 60.45 x 76.18 x 10.00mm, FPM

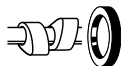

174 2.7L

Diesel

276DT	6 Cyl.	24 Valves	2720cc	TD32944
HR5111	NA5318 26.0 x 45.0 x 8.00mm, FPM	NA5323 35.00 x 50.00 x 7.00mm, PTFE	LK5021 92.00 x 220.00 x 22.00mm, PTFE/ACM	

175 2.7L

Diesel

TD27	4 Cyl.	8 Valves	2663cc	TD4494
TD27E	4 Cyl.	8 Valves	2664cc	TD9466
TD 27 T	4 Cyl.	8 Valves	2664cc	TD1450
PA378 (x8)			NJ831 58.00 x 80.00 x 10.00mm, NBR	
			NJ829 86.00 x 100.00 x 10.00mm, MVQ	

176 2.8L

Petrol

AAA	6 Cyl.	12 Valves	2792cc	TD5106
AMY	6 Cyl.	12 Valves	2792cc	TD17559
HR662			NB716 35.00 x 48.00 x 10.00mm, FPM	
			NA5133 85.00 x 105.00 x 11.00mm, FPM	

177 2.8L

Petrol

AYL	6 Cyl.	24 Valves	2792cc	TD14919
PA5041 (x24)			NA5106 35.00 x 48.00 x 10.00mm, PTFE	
HR5062			NA5305 85.00 x 105.00 x 11.00mm, PTFE	

178 2.8L

Diesel

JX493ZLQ	4 Cyl.	8 Valves	2771cc	TD33251
JX493ZLQ-3	4 Cyl.	8 Valves	2771cc	TD32018
JX493ZLQ-3A	4 Cyl.	8 Valves	2771cc	TD33613
JX493ZLQ-4	4 Cyl.	8 Valves	2771cc	TD32019
JX493ZQ-3	4 Cyl.	8 Valves	2771cc	TD33674
JX493ZQ-4	4 Cyl.	8 Valves	2771cc	TD33675
JX493ZXQ-3	4 Cyl.	8 Valves	2771cc	TD32017
			NA5051 40.00 x 56.00 x 7.00mm, FPM	

179 2.8L

Petrol

PR	6 Cyl.	12 Valves	2792cc	TD1401
PR3	6 Cyl.	12 Valves	2792cc	TD1402
PR4	6 Cyl.	12 Valves	2792cc	TD1403
PRI	6 Cyl.	12 Valves	2792cc	TD1413
PB180 (x12)			NA5191 42.00 x 62.00 x 7.00mm, PTFE	
HR630 (x2)			NB564 60.45 x 76.18 x 10.00mm, FPM	



180 2.8L Petrol

PR5	6 Cyl.	12 Valves	2792cc	TD1404
PR6	6 Cyl.	12 Valves	2792cc	TD1405
PR7	6 Cyl.	12 Valves	2792cc	TD1406
PR8	6 Cyl.	12 Valves	2792cc	TD1407
PRB	6 Cyl.	12 Valves	2792cc	TD4481
PRC	6 Cyl.	12 Valves	2792cc	TD1408
PRD	6 Cyl.	12 Valves	2792cc	TD1410
PRE	6 Cyl.	12 Valves	2792cc	TD1411
PRG	6 Cyl.	12 Valves	2792cc	TD1412
PRN	6 Cyl.	12 Valves	2792cc	TD4482
PRT	6 Cyl.	12 Valves	2792cc	TD1414
PYA	6 Cyl.	12 Valves	2792cc	TD1415
PYN	6 Cyl.	12 Valves	2792cc	TD1416
PYU	6 Cyl.	12 Valves	2792cc	TD1417

PB180 (x12)
HR630 (x2)

NA5190
42.00 x 56.00 x 7.00mm, FPM
NB564
60.45 x 76.18 x 10.00mm, FPM

181 2.9L Petrol

B4A	6 Cyl.	12 Valves	2936cc	TD5108
B4B	6 Cyl.	12 Valves	2936cc	TD1147
B4C	6 Cyl.	12 Valves	2936cc	TD4440
B4T	6 Cyl.	12 Valves	2935cc	TD1148
BRC	6 Cyl.	12 Valves	2933cc	TD4442
BRD	6 Cyl.	12 Valves	2933cc	TD4443
BRE	6 Cyl.	12 Valves	2933cc	TD1153
BRF	6 Cyl.	12 Valves	2933cc	TD1154
BRG	6 Cyl.	12 Valves	2933cc	TD4444
BRT	6 Cyl.	12 Valves	2935cc	TD1155

PB180 (x12)
HR660

NA5190
42.00 x 56.00 x 7.00mm, FPM

NA5190
42.00 x 56.00 x 7.00mm, FPM
NB564
60.45 x 76.18 x 10.00mm, FPM

182 2.9L Petrol

BOA	6 Cyl.	24 Valves	2933cc	TD1151
BOB	6 Cyl.	24 Valves	2933cc	TD4441

PB180 (x12)
HR660 (x2)

NA5190 (x2)
42.00 x 56.00 x 7.00mm, FPM

NA5190
42.00 x 56.00 x 7.00mm, FPM
NB564
60.45 x 76.18 x 10.00mm, FPM

183 3.0L Petrol

AJ	6 Cyl.	24 Valves	2967cc	TD20030
AJ	6 Cyl.	24 Valves	2967cc	TD24088
MEBA	6 Cyl.	24 Valves	2967cc	TD18760
REBA	6 Cyl.	24 Valves	2967cc	TD18759

NA5175
91.00 x 108.00 x 9.50mm, NBR

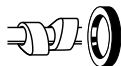

184 3.0L Petrol

EV 30 A	6 Cyl.	12 Valves	2994cc	TD22532
EV30B	6 Cyl.	12 Valves	2994cc	TD32351
EV 30 H	6 Cyl.	12 Valves	2994cc	TD1167
HYF	6 Cyl.	12 Valves	2993cc	TD1214

PB180 (x12)
HR630 (x2)

NB788 (x2)
79.40 x 95.30 x 11.10mm, PTFE

185 3.2L Diesel

PS-AT	5 Cyl.	20 Valves	3198cc	TD32201
SAFA	5 Cyl.	20 Valves	3198cc	TD32202
SAFA	5 Cyl.	20 Valves	3198cc	TD21069
SAFB	5 Cyl.	20 Valves	3199cc	TD23369

HR5082 (x2)

NA5030 (x2)
106.00 x 190.00 x 15.20mm, PTFE/FPM

186 4.2L Diesel

5 AA/254 CID	4 Cyl.	8 Valves	4160cc	TD6950
90/5 AA-Dover	4 Cyl.	8 Valves	4162cc	TD6954

NB688 (x2)
66.70 x 89.60 x 9.52mm, MVQ
KT638 (x2)

187 4.2L Petrol

TB42	6 Cyl.	12 Valves	4169cc	TD24368
------	--------	-----------	--------	---------

PA378 (x12)

188 4.2L Diesel

TD42	6 Cyl.	12 Valves	4169cc	TD25130
------	--------	-----------	--------	---------

PA378 (x12)

189 5.9L Diesel

110/6 AA-Dover	6 Cyl.	12 Valves	5944cc	TD22248
----------------	--------	-----------	--------	---------

NB688 (x2)
66.70 x 89.60 x 9.52mm, MVQ
KT638 (x2)

190 6.0L Diesel

150/6 CA-Dover	6 Cyl.	12 Valves	5944cc	TD6957
----------------	--------	-----------	--------	--------

NB688 (x2)
66.70 x 89.60 x 9.52mm, MVQ
KT638 (x2)

191 6.2L Diesel

130/7 AA-Dover	6 Cyl.	12 Valves	6223cc	TD6956
----------------	--------	-----------	--------	--------

380 CID	6 Cyl.	12 Valves	6223cc	TD6985
---------	--------	-----------	--------	--------

HR629 (x2)

NB688 (x2)
66.70 x 89.60 x 9.52mm, MVQ
KT638 (x2)



CC



9

Accord Coupe	07/03→12/08	J30A4	Petrol	2997	6	24	84
Accord Coupe	04/06→	J30A5	Petrol	2997	6	24	84
Accord Coupe (CM)	07/03→03/06	K24A4	Petrol	2354	4	16	78
Accord Coupe (CM)	09/05→12/07	J30A5	Petrol	2997	6	24	84
Accord Coupe (CM)	04/06→07/08	K24A8	Petrol	2354	4	16	78
Accord Coupe (CM)	09/07→12/12	J35Z2	Petrol	3471	6	24	93
Accord Coupe (CM)	09/07→	K24Z3	Petrol	2354	4	16	78
Accord Hatchback	09/75→12/78	EF1	Petrol	1599	4	12	38
Accord I (SJ, SY)	01/78→09/83	EG	Petrol	1602	4	8	38
Accord I (SJ, SY)	01/78→09/83	EL	Petrol	1602	4	8	39
Accord I (SJ, SY)	09/78→12/80	EK1	Petrol	1751	4	12	52
Accord I Hatchback (SJ, SY)	01/79→09/83	EK1	Petrol	1751	4	12	52
Accord I Hatchback (SJ, SY)	01/79→09/83	EL	Petrol	1602	4	8	39
Accord II (AC, AD)	09/83→10/85	ES2	Petrol	1829	4	12	53
Accord II (AC, AD)	09/83→10/85	ET1	Petrol	1829	4	12	54
Accord II (AC, AD)	09/83→10/85	EZ	Petrol	1598	4	12	41
Accord II Hatchback (AC, AD)	09/83→10/85	ES2	Petrol	1829	4	12	53
Accord II Hatchback (AC, AD)	09/83→10/85	ET1	Petrol	1829	4	12	54
Accord II Hatchback (AC, AD)	09/83→10/85	EZ	Petrol	1598	4	12	41
Accord III (CA)	11/85→12/87	A20A4	Petrol	1955	4	12	60
Accord III (CA)	11/85→05/89	A20A2	Petrol	1955	4	12	60
Accord III (CA)	11/85→12/89	A16A1	Petrol	1598	4	12	31
Accord III (CA)	11/85→12/89	A20A1	Petrol	1955	4	12	60
Accord III (CA)	11/85→12/89	A20A3	Petrol	1955	4	12	60
Accord III (CA)	01/87→12/87	B20A2	Petrol	1958	4	16	61
Accord III (CA)	10/87→12/89	B20A8	Petrol	1958	4	16	64
Accord III (CA4, CA5)	01/86→03/88	A20A1	Petrol	1955	4	12	60
Accord III (CA4, CA5)	01/87→12/89	A20A3	Petrol	1955	4	12	60
Accord III Aerodeck (CA)	11/85→12/87	A20A4	Petrol	1955	4	12	60
Accord III Aerodeck (CA)	11/85→05/89	A20A2	Petrol	1955	4	12	60
Accord III Aerodeck (CA)	11/85→12/89	A16A1	Petrol	1598	4	12	31
Accord III Aerodeck (CA)	10/87→12/89	A20A1	Petrol	1955	4	12	60
Accord III Aerodeck (CA)	10/87→12/89	A20A3	Petrol	1955	4	12	60
Accord III Coupe	03/85→12/89	A20A3	Petrol	1955	4	12	60
Accord III Coupe	01/88→12/89	A20A1	Petrol	1955	4	12	60
Accord IV (CB)	01/90→12/91	F22A4	Petrol	2156	4	16	70
Accord IV (CB)	01/90→03/93	F20A2	Petrol	1997	4	16	67
Accord IV (CB)	01/90→03/93	F20A3	Petrol	1997	4	16	67
Accord IV (CB)	01/90→03/93	F20A4	Petrol	1997	4	16	67
Accord IV (CB)	01/90→03/93	F20A6	Petrol	1997	4	16	67
Accord IV (CB)	01/90→03/93	F20A8	Petrol	1997	4	16	67
Accord IV (CB)	01/90→03/93	F22A3	Petrol	2156	4	16	70
Accord IV (CB)	01/90→12/93	F22A1	Petrol	2156	4	16	70
Accord IV (CB)	09/90→04/93	F20A5	Petrol	1997	4	16	67
Accord IV (CB)	01/91→12/93	F22A6	Petrol	2156	4	16	70
Accord IV (CB)	10/91→10/93	F22A9	Petrol	2156	4	16	70
Accord IV Aerodeck (CB)	09/90→04/93	F20A5	Petrol	1997	4	16	67
Accord IV Aerodeck (CB)	01/91→12/91	F22A4	Petrol	2156	4	16	70
Accord IV Aerodeck (CB)	01/91→12/93	F22A1	Petrol	2156	4	16	70
Accord IV Aerodeck (CB)	01/91→12/93	F22A6	Petrol	2156	4	16	70
Accord IV Aerodeck (CB)	01/91→12/93	F22A7	Petrol	2156	4	16	70
Accord IV Aerodeck (CB)	01/91→12/93	F22A8	Petrol	2156	4	16	70
Accord IV Aerodeck (CB)	03/93→12/93	F20Z3	Petrol	1997	4	16	67
Accord IV Coupe (CB, CC)	09/89→12/91	F22A4	Petrol	2156	4	16	70
Accord IV Coupe (CB, CC)	09/89→12/93	F22A1	Petrol	2156	4	16	70
Accord IV Coupe (CB, CC)	09/90→04/93	F20A5	Petrol	1997	4	16	67
Accord IV Coupe (CB, CC)	09/91→12/93	F22A6	Petrol	2156	4	16	70
Accord IV Coupe (CB, CC)	01/92→09/93	F20A7	Petrol	1997	4	16	67
Accord V (CC, CD)	06/92→06/96	C27A1	Petrol	2675	6	24	82
Accord V (CC, CD)	03/93→01/96	F20Z1	Petrol	1997	4	16	67
Accord V (CC, CD)	03/93→01/96	F20Z2	Petrol	1997	4	16	67
Accord V (CC, CD)	03/93→01/96	H23A3	Petrol	2259	4	16	76
Accord V (CC, CD)	04/93→06/97	F20B3	Petrol	1997	4	16	67
Accord V (CC, CD)	04/93→06/97	F22B5	Petrol	2156	4	16	70
Accord V (CC, CD)	10/93→12/97	F22B1	Petrol	2156	4	16	70
Accord V (CC, CD)	10/93→12/97	F22B3	Petrol	2156	4	16	70
Accord V (CC, CD)	01/94→12/97	F22B2	Petrol	2156	4	16	70
Accord V (CE, CF)	09/95→06/96	F22B1	Petrol	2156	4	16	70
Accord V (CE, CF)	09/95→12/97	C27A4	Petrol	2675	6	24	83
Accord V (CE, CF)	09/95→12/97	F22B2	Petrol	2156	4	16	70
Accord V (CE, CF)	02/96→10/98	F18A3	Petrol	1850	4	16	58
Accord V (CE, CF)	02/96→10/98	F20Z1	Petrol	1997	4	16	67
Accord V (CE, CF)	02/96→10/98	F22Z2	Petrol	2156	4	16	70
Accord V (CE, CF)	04/96→12/97	F22Z2	Petrol	2156	4	16	70
Accord V (CE, CF)	04/96→10/98	20T2N	Diesel	1994	4	8	59
Accord V Aerodeck (CE)	09/93→12/97	F22B1	Petrol	2156	4	16	70
Accord V Aerodeck (CE)	09/93→12/97	F22B2	Petrol	2156	4	16	70
Accord V Aerodeck (CE)	09/93→02/98	F20B3	Petrol	1997	4	16	67











CC



9

Accord V Aerodeck (CE)	09/93→02/98	F22B5	Petrol	2156	4	16	70
Accord V Aerodeck (CE)	09/94→12/97	C27A4	Petrol	2675	6	24	83
Accord V Coupe (CD)	09/93→12/97	F20B3	Petrol	1997	4	16	67
Accord V Coupe (CD)	09/93→12/97	F22B2	Petrol	2156	4	16	70
Accord V Coupe (CD)	09/93→02/98	F22B5	Petrol	2156	4	16	70
Accord V Coupe (CD)	01/95→12/98	C27A4	Petrol	2675	6	24	83
Accord VI (CG, CK)	10/98→12/02	J30A1	Petrol	2997	6	24	84
Accord VI (CK, CG, CH, CF8)	03/97→06/03	F23A1	Petrol	2254	4	16	74
Accord VI (CK, CG, CH, CF8)	03/97→06/03	F23Z5	Petrol	2254	4	16	74
Accord VI (CK, CG, CH, CF8)	09/97→05/00	F20B	Petrol	1997	4	16	67
Accord VI (CK, CG, CH, CF8)	09/97→12/00	F23A5	Petrol	2254	4	16	74
Accord VI (CK, CG, CH, CF8)	10/98→01/01	F20B6	Petrol	1997	4	16	67
Accord VI (CK, CG, CH, CF8)	10/98→12/02	D16B6	Petrol	1590	4	16	33
Accord VI (CK, CG, CH, CF8)	10/98→12/02	D16B7	Petrol	1590	4	16	33
Accord VI (CK, CG, CH, CF8)	10/98→12/02	F18B2	Petrol	1850	4	16	55
Accord VI (CK, CG, CH, CF8)	02/99→12/02	20T2N	Diesel	1994	4	8	59
Accord VI (CK, CG, CH, CF8)	02/99→12/02	H22A7	Petrol	2157	4	16	72
Accord VI Aerodeck (CF)	07/97→12/02	F23A	Petrol	2254	4	16	74
Accord VI Aerodeck (CM)	02/98→12/02	F23A7	Petrol	2254	4	16	75
Accord VI Aerodeck (CM)	10/98→12/02	A16A5	Petrol	1598	4	12	31
Accord VI Aerodeck (CM)	09/03→09/05	K24A2	Petrol	2354	4	16	78
Accord VI Coupe (CG)	12/97→12/02	F23A1	Petrol	2254	4	16	74
Accord VI Coupe (CG)	02/98→10/02	F23A3	Petrol	2254	4	16	74
Accord VI Coupe (CG)	02/98→06/03	F20B5	Petrol	1997	4	16	67
Accord VI Coupe (CG)	02/98→06/03	F20B7	Petrol	1997	4	16	67
Accord VI Coupe (CG)	02/98→06/03	J30A1	Petrol	2997	6	24	84
Accord VI Coupe (CG)	10/01→06/03	J30A2	Petrol	2997	6	24	84
Accord VI Hatchback (CH, CL)	12/99→10/00	20T2N	Diesel	1994	4	8	59
Accord VI Hatchback (CH, CL)	12/99→12/02	D16B6	Petrol	1590	4	16	33
Accord VI Hatchback (CH, CL)	12/99→12/02	F18B2	Petrol	1850	4	16	55
Accord VI Hatchback (CH, CL)	12/99→12/02	F20B6	Petrol	1997	4	16	67
Accord VI Hatchback (CH, CL)	11/00→12/02	F23Z5	Petrol	2254	4	16	74
Accord VII (CL)	04/06→05/08	J30A5	Petrol	2997	6	24	84
Accord VII (CL, CN)	01/03→12/05	K24A4	Petrol	2354	4	16	78
Accord VII (CL, CN)	02/03→05/08	K20A6	Petrol	1998	4	16	68
Accord VII (CL, CN)	02/03→05/08	K24A3	Petrol	2354	4	16	78
Accord VII (CL, CN)	02/03→09/12	K24A	Petrol	2354	4	16	78
Accord VII (CL, CN)	10/03→12/08	J30A1	Petrol	2997	6	24	84
Accord VII (CL, CN)	01/04→05/08	N22A1	Diesel	2204	4	16	73
Accord VII (CL, CN)	01/06→05/08	F20B	Petrol	1997	4	16	67
Accord VII (CL, CN)	01/06→07/08	K24A8	Petrol	2354	4	16	78
Accord VII (CL, CN)	09/06→05/08	J30A5	Petrol	2997	6	24	84
Accord VII (CM)	09/02→12/05	J30A4	Petrol	2997	6	24	84
Accord VII (CM)	09/02→12/05	K24A2	Petrol	2354	4	16	78
Accord VII (CM)	09/02→01/08	K24A4	Petrol	2354	4	16	78
Accord VII (CM)	09/05→12/07	J30A5	Petrol	2997	6	24	84
Accord VII (CP)	02/08→09/12	J35Z2	Petrol	3471	6	24	93
Accord VII Tourer (CM)	09/03→09/05	K24A2	Petrol	2354	4	16	78
Accord VII Tourer (CM, CN)	04/03→05/08	K20A6	Petrol	1998	4	16	68
Accord VII Tourer (CM, CN)	04/03→05/08	K24A	Petrol	2354	4	16	78
Accord VII Tourer (CM, CN)	09/03→05/08	K24A1	Petrol	2354	4	16	78
Accord VII Tourer (CM, CN)	01/04→05/08	N22A1	Diesel	2204	4	16	73
Accord VIII (CP)	09/07→12/08	J35Z2	Petrol	3471	6	24	93
Accord VIII (CP)	09/07→	K24Z2	Petrol	2354	4	16	78
Accord VIII (CP)	09/07→	K24Z3	Petrol	2354	4	16	78
Accord VIII (CP)	12/07→09/12	J35A	Petrol	3471	6	24	93
Accord VIII (CP)	07/08→09/12	R20A3	Petrol	1997	4	16	68
Accord VIII (CU)	06/08→06/15	R20A3	Petrol	1997	4	16	68
Accord VIII (CU)	07/08→06/15	K24Z3	Petrol	2354	4	16	78
Accord VIII (CU)	07/08→06/15	N22B1	Diesel	2199	4	16	73
Accord VIII (CU)	07/08→06/15	N22B2	Diesel	2199	4	16	73
Accord VIII (CU)	07/08→	J35A8	Petrol	3471	6	24	93
Accord VIII (CU)	07/08→	J35Z2	Petrol	3471	6	24	93
Accord VIII (CU)	07/08→	K24Z5	Petrol	2354	4	16	78
Accord VIII Estate (CW)	07/08→	K24Z3	Petrol	2354	4	16	78
Accord VIII Estate (CW)	07/08→	N22B1	Diesel	2199	4	16	73
Accord VIII Estate (CW)	07/08→	N22B2	Diesel	2199	4	16	73
Accord VIII Estate (CW)	07/08→	R20A3	Petrol	1997	4	16	68
Accord VIII Estate (CW)	07/08→	R20A4	Petrol	1997	4	16	68
Accord IX Coupe	09/12→	J35Y1	Petrol	3471	6	24	93
Accord IX Coupe	09/12→	K24Z3	Petrol	2354	4	16	78
Accord IX Saloon (CR)	09/12→	J35Y1	Petrol	3471	6	24	93
Accord IX Saloon (CR)	09/12→	K24Z3	Petrol	2354	4	16	78
Accord IX Saloon (CR)	01/13→	K24A3	Petrol	2354	4	16	78
Accord IX Saloon (CR)	05/13→	J35Z2	Petrol	3471	6	24	93
Acty (TN)	08/79→06/86	EH	Petrol	545	2	4	1
Airwave	06/04→	L15A	Petrol	1497	4	16	29
Amaze	04/13→	L12B1	Petrol	1198	4	16	8

							
Ascot	11/90→10/96	F22A7	Petrol	2156	4	16	70
Ascot	11/90→10/96	F22A8	Petrol	2156	4	16	70
Avancier	09/99→09/03	F23A	Petrol	2254	4	16	74
Avancier	09/99→09/03	J30A	Petrol	2997	6	24	84
Brio (DD)	01/11→	L12B1	Petrol	1198	4	16	8
Capa	01/98→09/02	B16A	Petrol	1595	4	16	32
Capa	01/98→09/02	D15B	Petrol	1493	4	16	22
City	04/06→12/08	L13A3	Petrol	1339	4	8	16
City	04/06→12/08	L15A1	Petrol	1497	4	16	29
City (GM)	12/08→12/15	L15A7	Petrol	1497	4	16	29
City Box (VF)	01/84→10/86	ER4	Petrol	1231	4	8	6
City Hatchback	11/80→08/84	ER1	Petrol	1231	4	8	6
City Saloon	12/99→09/03	D13B4	Petrol	1343	4	16	10
City Saloon	12/99→09/03	D15B	Petrol	1493	4	16	22
City Saloon	12/99→09/03	D15B7	Petrol	1493	4	16	22
City Saloon	08/00→09/03	L15A4	Petrol	1497	4	16	29
City Saloon	09/01→09/05	L13A1	Petrol	1339	4	8	15
City Saloon	09/01→09/05	L13A8	Petrol	1339	4	8	20
City Saloon	09/01→07/08	L15AV	Petrol	1497	4	16	29
City Saloon	05/03→09/05	L12A2	Petrol	1243	4	8	7
City Saloon	09/04→07/08	L15A1	Petrol	1497	4	16	29
City Saloon	09/04→07/08	L15A2	Petrol	1497	4	8	30
City Saloon	10/05→07/08	L12A3	Petrol	1243	4	8	7
City Saloon	10/05→07/08	L13A3	Petrol	1339	4	8	15
City Saloon (CG_)	02/97→11/99	D13B2	Petrol	1343	4	16	10
City Saloon (CG_)	02/97→11/99	D13B4	Petrol	1343	4	16	10
City Saloon (CG_)	02/97→11/99	D15B7	Petrol	1493	4	16	22
City Saloon (CG_)	02/97→11/99	XUD7T	Diesel	1769	4	8	57
City Saloon (GE4)	09/04→09/05	L15A1	Petrol	1497	4	16	29
City Saloon (GE4)	01/05→03/09	L15AV	Petrol	1497	4	16	29
City Saloon (GM2, GM3)	09/08→	L13Z1	Petrol	1339	4	16	16
City Saloon (GM2, GM3)	02/09→	L15A7	Petrol	1497	4	16	29
City Saloon (GM2, GM3)	08/09→	L15A	Petrol	1497	4	16	29
City Saloon (GM4, GM5, GM6, GM9)	01/14→	L15A7	Petrol	1497	4	16	29
City Saloon (GM4, GM5, GM6, GM9)	06/15→	L13A	Petrol	1339	4	16	19
Civic Coupe	09/05→12/11	K20Z4	Petrol	1998	4	16	68
Civic Coupe	09/05→12/11	R18A1	Petrol	1799	4	16	56
Civic Coupe	01/12→	K24Z7	Petrol	2354	4	16	78
Civic Coupe	11/14→	R20A2	Petrol	1997	4	16	68
Civic Estate	09/74→12/75	ED1	Petrol	1488	4	12	26
Civic Estate	09/75→12/79	ED4	Petrol	1488	4	12	26
Civic I Hatchback (SB)	07/72→02/77	EB1	Petrol	1169	4	8	5
Civic I Hatchback (SB)	09/75→12/80	EB2	Petrol	1238	4	8	5
Civic I Hatchback (SB)	09/77→12/80	EB3	Petrol	1238	4	8	5
Civic I Saloon (SF)	10/79→12/84	EN4	Petrol	1335	4	8	13
Civic I Saloon (SF)	09/80→09/83	EN1	Petrol	1335	4	8	13
Civic I Saloon (SF)	09/80→09/83	EN2	Petrol	1335	4	8	13
Civic I Saloon (SF)	09/80→12/83	EM1	Petrol	1487	4	8	26
Civic I Shuttle (AN, AR)	08/83→12/87	EV2	Petrol	1342	4	12	14
Civic I Shuttle (AN, AR)	09/83→10/87	EW2	Petrol	1488	4	8	28
Civic I Shuttle (AN, AR)	09/84→12/87	EV1	Petrol	1342	4	12	14
Civic I Shuttle (AN, AR)	09/84→12/87	EW1	Petrol	1488	4	12	27
Civic II Estate (WC)	09/79→12/81	EM1	Petrol	1487	4	8	26
Civic II Estate (WC)	09/79→09/83	EN1	Petrol	1335	4	8	13
Civic II Hatchback (SS, SL)	09/79→09/83	EN1	Petrol	1335	4	8	13
Civic II Hatchback (SS, SL)	09/79→12/83	EM1	Petrol	1487	4	8	26
Civic II Shuttle (EE)	01/88→12/89	D15B4	Petrol	1493	4	16	22
Civic II Shuttle (EE)	01/88→11/91	D15B2	Petrol	1493	4	16	22
Civic II Shuttle (EE)	01/88→12/92	D14A1	Petrol	1396	4	16	17
Civic II Shuttle (EE)	01/88→12/92	D16A	Petrol	1590	4	16	33
Civic II Shuttle (EE)	01/88→12/92	D16A7	Petrol	1590	4	16	33
Civic II Shuttle (EE)	01/88→02/95	B18B6	Petrol	1834	4	16	47
Civic II Shuttle (EE)	01/88→02/95	D16A6	Petrol	1590	4	16	33
Civic III Hatchback (AL, AJ, AG, AH)	10/83→10/87	EV1	Petrol	1342	4	12	14
Civic III Hatchback (AL, AJ, AG, AH)	10/83→10/87	EV2	Petrol	1342	4	12	14
Civic III Hatchback (AL, AJ, AG, AH)	10/83→10/87	EW1	Petrol	1488	4	12	27
Civic III Hatchback (AL, AJ, AG, AH)	10/83→10/87	EW2	Petrol	1488	4	8	28
Civic III Hatchback (AL, AJ, AG, AH)	01/84→10/87	D12B1	Petrol	1187	4	8	4
Civic III Hatchback (AL, AJ, AG, AH)	01/84→10/87	EW4	Petrol	1488	4	8	28
Civic III Hatchback (AL, AJ, AG, AH)	01/84→10/87	ZA2	Petrol	1187	4	8	9
Civic III Hatchback (AL, AJ, AG, AH)	01/85→10/87	EW3	Petrol	1488	4	12	27
Civic III Saloon (AM, AK, AU)	10/83→10/87	EV2	Petrol	1342	4	12	14
Civic III Saloon (AM, AK, AU)	10/83→10/87	EW1	Petrol	1488	4	12	27
Civic III Saloon (AM, AK, AU)	10/83→10/87	EW2	Petrol	1488	4	8	28
Civic III Saloon (AM, AK, AU)	09/84→10/87	EV1	Petrol	1342	4	12	14
Civic III Saloon (AM, AK, AU)	01/85→10/87	D12B1	Petrol	1187	4	8	4
Civic III Saloon (AM, AK, AU)	01/85→10/87	EW3	Petrol	1488	4	12	27
Civic III Saloon (AM, AK, AU)	01/85→10/87	ZA2	Petrol	1187	4	8	9







Model	Year Range	Engine	Fuel	CC	Doors	Seats	Power
Civic III Saloon (AM, AK, AU)	03/86→10/87	EW4	Petrol	1488	4	8	28
Civic IV Hatchback (EC, ED, EE)	09/87→09/91	D16A9	Petrol	1590	4	16	34
Civic IV Hatchback (EC, ED, EE)	09/87→12/91	D16A7	Petrol	1590	4	16	33
Civic IV Hatchback (EC, ED, EE)	09/87→10/93	D15B1	Petrol	1493	4	16	22
Civic IV Hatchback (EC, ED, EE)	10/87→12/89	D13B1	Petrol	1343	4	16	10
Civic IV Hatchback (EC, ED, EE)	10/87→12/89	D14A1	Petrol	1396	4	16	17
Civic IV Hatchback (EC, ED, EE)	10/87→09/91	D16A6	Petrol	1590	4	16	33
Civic IV Hatchback (EC, ED, EE)	10/87→09/91	D1622	Petrol	1590	4	16	33
Civic IV Hatchback (EC, ED, EE)	10/87→10/93	D15B4	Petrol	1493	4	16	22
Civic IV Hatchback (EC, ED, EE)	10/88→09/91	D15B2	Petrol	1493	4	16	22
Civic IV Hatchback (EC, ED, EE)	09/89→09/91	D13B2	Petrol	1343	4	16	10
Civic IV Hatchback (EC, ED, EE)	10/89→09/91	B16A1	Petrol	1595	4	16	32
Civic IV Saloon (ED)	09/87→12/87	EW1	Petrol	1488	4	12	27
Civic IV Saloon (ED)	09/87→09/91	D16A7	Petrol	1590	4	16	33
Civic IV Saloon (ED)	10/87→12/89	D13B1	Petrol	1343	4	16	10
Civic IV Saloon (ED)	10/87→12/89	D14A1	Petrol	1396	4	16	17
Civic IV Saloon (ED)	10/87→09/91	D15B2	Petrol	1493	4	16	22
Civic IV Saloon (ED)	10/87→12/91	D1622	Petrol	1590	4	16	33
Civic IV Saloon (ED)	10/87→10/93	D15B4	Petrol	1493	4	16	22
Civic IV Saloon (ED)	11/87→09/91	D16A6	Petrol	1590	4	16	33
Civic IV Saloon (ED)	01/88→08/88	EW3	Petrol	1488	4	12	27
Civic IV Saloon (ED)	01/88→12/89	D15B1	Petrol	1493	4	16	22
Civic IV Saloon (ED)	01/88→12/89	D16Z5	Petrol	1590	4	16	36
Civic IV Saloon (ED)	01/88→12/91	D12B1	Petrol	1187	4	8	4
Civic V Coupe (EJ)	08/93→12/95	D15B7	Petrol	1493	4	16	22
Civic V Coupe (EJ)	01/94→11/95	B16A2	Petrol	1595	4	16	32
Civic V Coupe (EJ)	01/94→11/95	D16Y7	Petrol	1590	4	16	33
Civic V Coupe (EJ)	01/94→03/96	D16Y6	Petrol	1590	4	16	33
Civic V Coupe (EJ)	01/94→03/96	D16Z9	Petrol	1590	4	16	33
Civic V Hatchback (EG)	10/91→10/93	D16A8	Petrol	1590	4	16	34
Civic V Hatchback (EG)	10/91→05/95	B16A1	Petrol	1595	4	16	32
Civic V Hatchback (EG)	10/91→09/95	D16A9	Petrol	1590	4	16	34
Civic V Hatchback (EG)	10/91→09/95	D16Y1	Petrol	1590	4	16	33
Civic V Hatchback (EG)	10/91→09/95	D1622	Petrol	1590	4	16	33
Civic V Hatchback (EG)	10/91→11/95	B16A2	Petrol	1595	4	16	32
Civic V Hatchback (EG)	10/91→11/95	D13B2	Petrol	1343	4	16	10
Civic V Hatchback (EG)	10/91→11/95	D15B2	Petrol	1493	4	16	22
Civic V Hatchback (EG)	10/91→11/95	D15B7	Petrol	1493	4	16	22
Civic V Hatchback (EG)	10/91→11/95	D15B8	Petrol	1493	4	8	23
Civic V Hatchback (EG)	10/91→11/95	D15Z1	Petrol	1493	4	16	22
Civic V Hatchback (EG)	10/91→11/95	D15Z2	Petrol	1493	4	16	22
Civic V Hatchback (EG)	10/91→11/95	D16Z6	Petrol	1590	4	16	37
Civic V Saloon (EG, EH)	10/91→10/93	D16A8	Petrol	1590	4	16	34
Civic V Saloon (EG, EH)	10/91→10/93	D16Y1	Petrol	1590	4	16	33
Civic V Saloon (EG, EH)	10/91→05/95	B16A1	Petrol	1595	4	16	32
Civic V Saloon (EG, EH)	10/91→11/95	B16A2	Petrol	1595	4	16	32
Civic V Saloon (EG, EH)	10/91→11/95	D16Z6	Petrol	1590	4	16	37
Civic V Saloon (EG, EH)	10/91→11/95	D16Z7	Petrol	1590	4	16	33
Civic V Saloon (EG, EH)	10/91→12/95	D15B2	Petrol	1493	4	16	22
Civic V Saloon (EG, EH)	10/91→12/95	D15Z1	Petrol	1493	4	16	22
Civic V Saloon (EG, EH)	01/92→12/92	D13B2	Petrol	1343	4	16	10
Civic V Saloon (EG, EH)	08/93→10/95	D16A7	Petrol	1590	4	16	33
Civic V Saloon (EG, EH)	10/93→12/95	D15B7	Petrol	1493	4	16	22
Civic VI Aerodeck (MB, MC)	04/98→02/01	20T2N	Diesel	1994	4	8	59
Civic VI Aerodeck (MB, MC)	04/98→02/01	B18C4	Petrol	1797	4	16	50
Civic VI Aerodeck (MB, MC)	04/98→02/01	D14A7	Petrol	1396	4	16	17
Civic VI Aerodeck (MB, MC)	04/98→02/01	D14A8	Petrol	1396	4	16	17
Civic VI Aerodeck (MB, MC)	04/98→02/01	D15Z8	Petrol	1493	4	16	22
Civic VI Aerodeck (MB, MC)	04/98→02/01	D16B2	Petrol	1590	4	16	33
Civic VI Aerodeck (MB, MC)	04/98→02/01	D16W4	Petrol	1590	4	16	33
Civic VI Coupe (EJ, EM1)	03/96→03/00	D16Y7	Petrol	1590	4	16	33
Civic VI Coupe (EJ, EM1)	03/96→03/00	D16Y8	Petrol	1590	4	16	33
Civic VI Coupe (EJ, EM1)	09/97→12/99	D16Y5	Petrol	1590	4	16	33
Civic VI Coupe (EJ, EM1)	04/99→12/00	B16A2	Petrol	1595	4	16	32
Civic VI Fastback (MA, MB)	09/94→01/97	D15Z3	Petrol	1493	4	16	24
Civic VI Fastback (MA, MB)	09/94→01/97	D16Y2	Petrol	1590	4	16	33
Civic VI Fastback (MA, MB)	09/94→01/97	D16Y3	Petrol	1590	4	16	33
Civic VI Fastback (MA, MB)	09/94→02/01	D14A2	Petrol	1396	4	16	17
Civic VI Fastback (MA, MB)	09/94→02/01	D14A6	Petrol	1396	4	16	17
Civic VI Fastback (MA, MB)	09/94→02/01	D14A8	Petrol	1396	4	16	17
Civic VI Fastback (MA, MB)	09/94→02/01	D14Z4	Petrol	1396	4	16	17
Civic VI Fastback (MA, MB)	09/95→02/01	D14A5	Petrol	1396	4	16	17
Civic VI Fastback (MA, MB)	09/95→02/01	D14A7	Petrol	1396	4	16	17
Civic VI Fastback (MA, MB)	09/95→02/01	D14Z3	Petrol	1396	4	16	17
Civic VI Fastback (MA, MB)	01/97→02/01	20T2R	Diesel	1994	4	8	59
Civic VI Fastback (MA, MB)	01/97→02/01	B16A2	Petrol	1595	4	16	32
Civic VI Fastback (MA, MB)	01/97→02/01	B18C4	Petrol	1797	4	16	50
Civic VI Fastback (MA, MB)	01/97→02/01	D15Z8	Petrol	1493	4	16	22

				CC			9
Civic VI Fastback (MA, MB)	01/97→02/01	D16B2	Petrol	1590	4	16	33
Civic VI Fastback (MA, MB)	11/98→10/00	20T2N	Diesel	1994	4	8	59
Civic VI Fastback (MA, MB)	11/98→10/00	D16W4	Petrol	1590	4	16	33
Civic VI Hatchback (EJ, EK)	10/95→09/00	D16A7	Petrol	1590	4	16	33
Civic VI Hatchback (EJ, EK)	10/95→09/00	D16Y2	Petrol	1590	4	16	33
Civic VI Hatchback (EJ, EK)	10/95→12/00	D16Y7	Petrol	1590	4	16	33
Civic VI Hatchback (EJ, EK)	11/95→12/96	D15Z3	Petrol	1493	4	16	24
Civic VI Hatchback (EJ, EK)	11/95→02/01	B16A2	Petrol	1595	4	16	32
Civic VI Hatchback (EJ, EK)	11/95→02/01	D14A3	Petrol	1396	4	16	17
Civic VI Hatchback (EJ, EK)	11/95→02/01	D14A4	Petrol	1396	4	16	17
Civic VI Hatchback (EJ, EK)	11/95→02/01	D14Z1	Petrol	1396	4	16	17
Civic VI Hatchback (EJ, EK)	11/95→02/01	D14Z2	Petrol	1396	4	16	17
Civic VI Hatchback (EJ, EK)	11/95→02/01	D14Z4	Petrol	1396	4	16	17
Civic VI Hatchback (EJ, EK)	11/95→02/01	D15Z6	Petrol	1493	4	16	22
Civic VI Hatchback (EJ, EK)	11/95→02/01	D16Y5	Petrol	1590	4	16	33
Civic VI Hatchback (EJ, EK)	11/98→10/00	20T2N	Diesel	1994	4	8	59
Civic VI Hatchback (EJ, EK)	11/98→10/00	D16W4	Petrol	1590	4	16	33
Civic VI Saloon (EJ, EK)	06/95→10/99	F20B3	Petrol	1997	4	16	67
Civic VI Saloon (EJ, EK)	09/95→12/00	D16Y7	Petrol	1590	4	16	33
Civic VI Saloon (EJ, EK)	09/95→02/01	D16Y8	Petrol	1590	4	16	33
Civic VI Saloon (EJ, EK)	10/95→12/00	D16Y2	Petrol	1590	4	16	33
Civic VI Saloon (EJ, EK)	10/95→03/01	D15B2	Petrol	1493	4	16	22
Civic VI Saloon (EJ, EK)	11/95→02/01	B16A2	Petrol	1595	4	16	32
Civic VI Saloon (EJ, EK)	11/95→02/01	D14A4	Petrol	1396	4	16	17
Civic VI Saloon (EJ, EK)	11/95→02/01	D14Z2	Petrol	1396	4	16	17
Civic VI Saloon (EJ, EK)	11/95→02/01	D14Z4	Petrol	1396	4	16	17
Civic VI Saloon (EJ, EK)	11/95→02/01	D15Z6	Petrol	1493	4	16	22
Civic VI Saloon (EJ, EK)	11/95→02/01	D16Y6	Petrol	1590	4	16	33
Civic VI Saloon (EJ, EK)	11/95→02/01	D16Z7	Petrol	1590	4	16	33
Civic VI Saloon (EJ, EK)	01/97→03/01	B18C4	Petrol	1797	4	16	50
Civic VI Saloon (EJ, EK)	09/97→12/00	D16B5	Petrol	1590	4	16	33
Civic VI Saloon (EJ, EK)	11/97→03/01	D17A6	Petrol	1668	4	16	46
Civic VII Coupe (EM2)	02/01→12/05	D16V1	Petrol	1590	4	16	35
Civic VII Coupe (EM2)	02/01→12/05	D17A6	Petrol	1668	4	16	46
Civic VII Coupe (EM2)	05/01→12/05	D17A5	Petrol	1668	4	16	46
Civic VII Coupe (EM2)	05/01→12/05	D17A8	Petrol	1668	4	16	46
Civic VII Coupe (EM2)	05/01→12/05	D17A9	Petrol	1668	4	16	46
Civic VII Coupe (EM2)	09/01→12/05	D17A1	Petrol	1668	4	16	46
Civic VII Coupe (EM2)	09/01→12/05	D17A2	Petrol	1668	4	16	46
Civic VII Hatchback (EU, EP, EV)	01/00→08/05	D17A6	Petrol	1668	4	16	46
Civic VII Hatchback (EU, EP, EV)	02/01→09/05	D14Z5	Petrol	1396	4	16	18
Civic VII Hatchback (EU, EP, EV)	02/01→09/05	D14Z6	Petrol	1396	4	16	18
Civic VII Hatchback (EU, EP, EV)	02/01→09/05	D16V1	Petrol	1590	4	16	35
Civic VII Hatchback (EU, EP, EV)	09/01→09/05	K20A2	Petrol	1998	4	16	68
Civic VII Hatchback (EU, EP, EV)	09/01→12/05	K20A3	Petrol	1998	4	16	68
Civic VII Hatchback (EU, EP, EV)	01/02→09/05	4EE-2	Diesel	1686	4	16	44
Civic VII Saloon (ES)	02/01→09/05	R16A1	Petrol	1595	4	16	42
Civic VII Saloon (ES)	04/01→10/04	L12A1	Petrol	1243	4	8	7
Civic VII Saloon (ES)	07/03→08/05	F18A2	Petrol	1849	4	16	55
Civic VII Saloon (ES)	10/03→09/05	K20A3	Petrol	1998	4	16	68
Civic VII Saloon (ES, ET)	12/00→09/05	D14Z5	Petrol	1396	4	16	18
Civic VII Saloon (ES, ET)	12/00→09/05	D17A5	Petrol	1668	4	16	46
Civic VII Saloon (ES, ET)	12/00→12/05	D17A1	Petrol	1668	4	16	46
Civic VII Saloon (ES, ET)	12/00→12/05	D17A7	Petrol	1668	4	16	46
Civic VII Saloon (ES, ET)	02/01→09/05	D16V1	Petrol	1590	4	16	35
Civic VII Saloon (ES, ET)	02/01→09/05	D17A6	Petrol	1668	4	16	46
Civic VII Saloon (ES, ET)	09/02→12/05	LDA1	Petrol	1339	4	16	16
Civic VII Saloon (ES, ET)	02/03→09/05	D15Y3	Petrol	1493	4	16	22
Civic VIII	01/09→12/13	LDA2	Petrol	1339	4	8	16
Civic VIII Hatchback (FN, FK)	09/05→	L13A7	Petrol	1339	4	8	15
Civic VIII Hatchback (FN, FK)	09/05→	N22A2	Diesel	2204	4	16	73
Civic VIII Hatchback (FN, FK)	09/05→	R16A1	Petrol	1595	4	16	42
Civic VIII Hatchback (FN, FK)	09/05→	R18A2	Petrol	1799	4	16	56
Civic VIII Hatchback (FN, FK)	09/06→	K20Z4	Petrol	1998	4	16	68
Civic VIII Hatchback (FN, FK)	10/08→	L13Z1	Petrol	1339	4	16	16
Civic VIII Saloon (FD, FA)	09/05→12/11	R18A4	Petrol	1799	4	16	56
Civic VIII Saloon (FD, FA)	09/05→02/12	R18A2	Petrol	1799	4	16	56
Civic VIII Saloon (FD, FA)	09/05→	D17A6	Petrol	1668	4	16	46
Civic VIII Saloon (FD, FA)	09/05→	LDA2	Petrol	1339	4	8	15
Civic VIII Saloon (FD, FA)	09/05→	R16A1	Petrol	1595	4	16	42
Civic VIII Saloon (FD, FA)	09/05→	R18A1	Petrol	1799	4	16	56
Civic VIII Saloon (FD, FA)	02/06→02/12	K20A3	Petrol	1998	4	16	68
Civic VIII Saloon (FD, FA)	02/06→02/12	K20Z2	Petrol	1997	4	16	68
Civic VIII Saloon (FD, FA)	02/06→	L13A6	Petrol	1339	4	8	15
Civic VIII Saloon (FD, FA)	01/07→12/11	K20Z3	Petrol	1998	4	16	68
Civic VIII Saloon (FD, FA)	01/08→	K20Z4	Petrol	1998	4	16	68
Civic VIII Saloon (FD, FA)	03/11→	L15A7	Petrol	1497	4	16	29
Civic IX (FK)	02/12→	N22B4	Diesel	2199	4	16	73











Civic IX Saloon (FB, FG)	09/11→12/12	R18A9	Petrol	1799	4	16	56
Civic IX Saloon (FB, FG)	09/11→	K24Z7	Petrol	2354	4	16	78
Civic IX Saloon (FB, FG)	09/11→	LEA2	Petrol	1497	4	16	29
Civic IX Saloon (FB, FG)	09/11→	R18A1	Petrol	1799	4	16	56
Civic IX Saloon (FB, FG)	06/12→	R20A5	Petrol	1997	4	16	68
Civic IX Saloon (FB, FG)	01/13→	R20A	Petrol	1997	4	16	68
Civic Saloon	09/74→12/79	EB2	Petrol	1238	4	8	5
Civic Saloon	09/74→12/79	ED3	Petrol	1488	4	12	26
CL Coupe	10/96→09/97	F22B2	Petrol	2156	4	16	70
CL Coupe	10/96→09/00	J30A1	Petrol	2997	6	24	84
CL Coupe	10/98→09/00	F23A7	Petrol	2254	4	16	74
CL Coupe	09/00→09/03	J32A1	Petrol	3210	6	24	90
CL Coupe	06/01→09/03	J32A4	Petrol	3210	6	24	89
Concerto (HW, MA)	08/89→10/91	D14A8	Petrol	1396	4	16	17
Concerto (HW, MA)	08/89→10/92	D14A1	Petrol	1396	4	16	17
Concerto (HW, MA)	08/89→03/95	D15B2	Petrol	1493	4	16	22
Concerto (HW, MA)	08/89→03/95	D16A8	Petrol	1590	4	16	34
Concerto (HW, MA)	08/89→03/95	D16Z2	Petrol	1590	4	16	33
Concerto (HW, MA)	10/89→10/92	D16A9	Petrol	1590	4	16	34
Concerto Saloon (HWW)	08/89→10/91	D14A8	Petrol	1396	4	16	17
Concerto Saloon (HWW)	08/89→10/92	D14A1	Petrol	1396	4	16	17
Concerto Saloon (HWW)	08/89→03/95	D16A8	Petrol	1590	4	16	34
Concerto Saloon (HWW)	08/89→03/95	D16Z2	Petrol	1590	4	16	33
Concerto Saloon (HWW)	08/89→05/95	D15B2	Petrol	1493	4	16	22
Concerto Saloon (HWW)	10/89→10/92	D16A9	Petrol	1590	4	16	34
Crossroad	02/07→08/10	R18A2	Petrol	1799	4	16	56
Crossroad (RT_)	02/07→08/10	R18A2	Petrol	1799	4	16	56
Crossroad (RT_)	02/07→08/10	R20A	Petrol	1997	4	16	68
Crosstour	09/09→	J35Z2	Petrol	3471	6	24	93
Crosstour	09/12→	J35Y1	Petrol	3471	6	24	93
CR-V I (RD)	10/95→12/01	B20B	Petrol	1972	4	16	65
CR-V I (RD)	09/96→12/98	B20B4	Petrol	1973	4	16	65
CR-V I (RD)	09/98→12/01	B20Z2	Petrol	1973	4	16	65
CR-V I (RD)	01/99→02/02	B20Z1	Petrol	1973	4	16	65
CR-V II (RD_)	09/01→09/06	K24A1	Petrol	2354	4	16	78
CR-V II (RD_)	09/01→03/07	K20A4	Petrol	1998	4	16	68
CR-V II (RD_)	03/02→09/06	K20A5	Petrol	1998	4	16	68
CR-V II (RD_)	02/05→09/06	N22A2	Diesel	2204	4	16	73
CR-V III (RE_)	06/06→06/12	K24Z6	Petrol	2354	4	16	78
CR-V III (RE_)	06/06→	K24A	Petrol	2354	4	16	78
CR-V III (RE_)	06/06→	K24Z1	Petrol	2354	4	16	78
CR-V III (RE_)	10/06→	K24A1	Petrol	2354	4	16	78
CR-V III (RE_)	01/07→	N22A2	Diesel	2204	4	16	73
CR-V III (RE_)	01/07→	N22B3	Diesel	2199	4	16	73
CR-V III (RE_)	01/07→	R20A2	Petrol	1997	4	16	68
CR-V III (RE_)	09/09→	K24Z4	Petrol	2354	4	16	78
CR-V III (RE_)	09/11→12/12	K24Z7	Petrol	2354	4	16	78
CR-V IV (RM_)	01/12→	K24A1	Petrol	2354	4	16	78
CR-V IV (RM_)	01/12→	K24Z6	Petrol	2354	4	16	78
CR-V IV (RM_)	01/12→	K24Z7	Petrol	2354	4	16	78
CR-V IV (RM_)	01/12→	K24Z9	Petrol	2354	4	16	78
CR-V IV (RM_)	01/12→	R20A	Petrol	1997	4	16	68
CR-V IV (RM_)	09/12→	K24A	Petrol	2354	4	16	78
CR-V IV (RM_)	10/12→	N22B4	Diesel	2199	4	16	73
CR-V IV (RM_)	10/12→	R20A9	Petrol	1997	4	16	68
CR-V IV (RM_)	01/13→	R20A1	Petrol	1997	4	16	68
CRX I (AF, AS)	10/83→11/86	EW3	Petrol	1488	4	12	27
CRX I (AF, AS)	10/83→10/87	EV2	Petrol	1342	4	12	14
CRX I (AF, AS)	09/84→10/87	EW1	Petrol	1488	4	12	27
CRX I (AF, AS)	03/86→10/87	ZC1	Petrol	1590	4	16	43
CRX II (ED, EE)	10/87→05/88	D16A	Petrol	1590	4	16	33
CRX II (ED, EE)	10/87→12/89	D16A8	Petrol	1590	4	16	34
CRX II (ED, EE)	10/87→12/89	D16A9	Petrol	1590	4	16	34
CRX II (ED, EE)	10/87→12/91	D15B2	Petrol	1493	4	16	22
CRX II (ED, EE)	10/87→12/91	D16A6	Petrol	1590	4	16	33
CRX II (ED, EE)	10/87→02/92	D16Z5	Petrol	1590	4	16	36
CRX II (ED, EE)	09/89→12/91	D15B6	Petrol	1493	4	8	23
CRX II (ED, EE)	10/89→02/92	B16A1	Petrol	1595	4	16	32
CRX II (ED, EE)	01/90→12/91	D14A1	Petrol	1396	4	16	17
CRX III (EH, EG)	03/92→12/98	B16A2	Petrol	1595	4	16	32
CRX III (EH, EG)	03/92→12/98	D16Y8	Petrol	1590	4	16	33
CRX III (EH, EG)	03/92→12/98	D16Z6	Petrol	1590	4	16	37
CRX III (EH, EG)	08/93→04/98	D15B7	Petrol	1493	4	16	22
CRX III (EH, EG)	09/95→03/96	D16Y7	Petrol	1590	4	16	33
CR-Z (ZF)	06/10→	LEA1	Petrol	1497	4	16	29
CR-Z (ZF)	09/10→	LEA3	Petrol	1497	4	16	29
CSX Saloon	09/05→12/10	K20Z2	Petrol	1997	4	16	68
Domani	11/88→12/97	D16Z2	Petrol	1590	4	16	33

				CC			9
Domani	10/92→09/00	D15B3	Petrol	1493	4	16	22
Domani	10/94→09/00	B18B6	Petrol	1834	4	16	47
Domani	10/95→09/99	D16A	Petrol	1590	4	16	33
Element (YH)	07/02→12/06	K24A4	Petrol	2354	4	16	78
Element (YH)	07/02→12/11	K24A6	Petrol	2354	4	16	78
Element (YH)	09/06→12/11	K24A8	Petrol	2354	4	16	78
EL Saloon	09/96→12/00	D16Y8	Petrol	1590	4	16	33
EL Saloon	09/00→12/05	D17A2	Petrol	1668	4	16	46
Elysion	05/04→	J30A4	Petrol	2997	6	24	84
Elysion	05/04→	K24A1	Petrol	2354	4	16	78
Elysion	04/07→10/13	J35A4	Petrol	3471	6	24	93
Everus	04/11→	L13A3	Petrol	1339	4	8	16
Everus	04/11→	L15A1	Petrol	1497	4	16	29
Fit Hatchback	09/04→07/08	L13A3	Petrol	1339	4	8	16
Fit Hatchback	09/04→07/08	L15A1	Petrol	1497	4	16	29
Fit Hatchback	07/08→12/14	L15A7	Petrol	1497	4	16	29
Fit Hatchback	07/08→	L13Z1	Petrol	1339	4	16	16
Fit Saloon	09/03→04/06	L13A3	Petrol	1339	4	8	16
Fit Saloon	06/04→04/06	L15A1	Petrol	1497	4	16	29
Freed I (GB3, GB4, GP3)	10/10→	L15A	Petrol	1497	4	16	29
Freed Spike (GB3, GB4, GP3)	07/10→05/15	L15A	Petrol	1497	4	16	29
FR-V (BE)	08/04→	D17A2	Petrol	1668	4	16	46
FR-V (BE)	08/04→	K20A9	Petrol	1998	4	16	68
FR-V (BE)	07/05→	N22A1	Diesel	2204	4	16	73
FR-V (BE)	01/07→	R18A1	Petrol	1799	4	16	56
FR-V (BE)	01/08→12/11	K24A3	Petrol	2354	4	16	78
HR-V (GH)	03/99→	D16W1	Petrol	1590	4	16	33
HR-V (GH)	10/99→	D16W5	Petrol	1590	4	16	33
HR-V (RU)	06/15→	R18A1	Petrol	1799	4	16	56
ILX Saloon	09/12→12/15	K24Z7	Petrol	2354	4	16	78
ILX Saloon	09/12→	LEA2	Petrol	1497	4	16	29
ILX Saloon	09/12→	R20A5	Petrol	1997	4	16	68
Insight (ZE)	04/00→12/06	ECA1	Petrol	995	3	12	2
Insight (ZE_)	04/09→	LDA3	Petrol	1339	4	8	15
Inspire	06/95→08/98	C32A	Petrol	3206	6	24	88
Inspire (UA4, UA5)	09/98→08/03	J32A	Petrol	3210	6	24	90
Inspire (UA4, UA5)	06/03→	J30A	Petrol	2997	6	24	84
Integra (DA)	09/89→08/93	B16A	Petrol	1595	4	16	32
Integra Coupe	01/85→12/90	D15A1	Petrol	1488	4	8	21
Integra Coupe	01/85→12/90	D16A3	Petrol	1590	4	16	34
Integra Coupe	01/85→12/90	D16A8	Petrol	1590	4	16	34
Integra Coupe	10/93→09/01	F18C1	Petrol	1797	4	16	51
Integra Coupe	10/93→09/01	F18C2	Petrol	1797	4	16	51
Integra Coupe	03/98→09/01	B18C6	Petrol	1797	4	16	50
Integra Coupe (DC2, DC4)	07/93→11/99	B18C1	Petrol	1797	4	16	49
Integra Coupe (DC2, DC4)	07/93→11/99	B18C2	Petrol	1797	4	16	50
Integra Coupe (DC2, DC4)	07/93→11/01	B18B1	Petrol	1834	4	16	47
Integra Coupe (DC2, DC4)	07/93→11/01	B18B2	Petrol	1834	4	16	47
Integra Coupe (DC2, DC4)	09/93→08/01	B18C	Petrol	1797	4	16	49
Integra Coupe (DC2, DC4)	09/93→08/01	ZC1	Petrol	1590	4	16	43
Integra Coupe (DC2, DC4)	09/95→08/99	D15B	Petrol	1493	4	16	22
Integra Coupe (DC2, DC4)	11/97→10/01	B18C6	Petrol	1797	4	16	50
Integra Coupe (DC5)	02/02→	K20A3	Petrol	1998	4	16	68
Integra Coupe (DC5)	02/02→	K20Z1	Petrol	1998	4	16	68
Integra Coupe (DC5)	10/04→	K20A2	Petrol	1998	4	16	68
Integra Hatchback	01/85→12/90	D15A1	Petrol	1488	4	8	21
Integra Hatchback	01/85→12/90	D16A1	Petrol	1590	4	16	34
Integra Hatchback	01/85→12/90	D16A8	Petrol	1590	4	16	34
Integra Hatchback	10/90→09/93	B18A1	Petrol	1834	4	16	48
Integra Hatchback	10/90→09/93	F18A2	Petrol	1849	4	16	55
Integra Hatchback	09/91→09/93	B17A1	Petrol	1678	4	16	45
Integra Hatchback	10/93→09/01	B18B1	Petrol	1834	4	16	48
Integra Hatchback	10/93→09/01	F18C1	Petrol	1797	4	16	51
Integra Hatchback	09/96→09/01	B18C5	Petrol	1797	4	16	51
Integra Hatchback (DA)	10/85→08/89	D15A1	Petrol	1488	4	8	21
Integra Hatchback (DA)	03/86→08/89	D16A3	Petrol	1590	4	16	34
Integra Hatchback (DA)	06/89→07/93	B18A1	Petrol	1834	4	16	47
Integra Saloon	01/85→12/90	D15A1	Petrol	1488	4	8	21
Integra Saloon	01/85→12/90	D16A3	Petrol	1590	4	16	34
Integra Saloon	01/85→12/90	D16A8	Petrol	1590	4	16	34
Integra Saloon	03/88→09/89	D16A2	Petrol	1590	4	16	34
Integra Saloon	09/89→08/93	B16A	Petrol	1595	4	16	32
Integra Saloon	09/89→08/93	F18A2	Petrol	1849	4	16	55
Integra Saloon	10/90→09/93	F18A2	Petrol	1849	4	16	55
Integra Saloon	10/90→12/93	B18A1	Petrol	1834	4	16	48
Integra Saloon	10/93→09/01	B18B1	Petrol	1834	4	16	48
Integra Saloon	10/93→09/01	F18C1	Petrol	1797	4	16	51
Integra Saloon	10/93→09/01	F18C2	Petrol	1797	4	16	51



Integra Saloon (DB6, DB7, DB8, DB9)	09/93→08/01	B18B2	Petrol	1834	4	16	47
Integra Saloon (DB6, DB7, DB8, DB9)	09/93→08/01	B18C	Petrol	1797	4	16	49
Integra Saloon (DB6, DB7, DB8, DB9)	09/93→08/01	ZC1	Petrol	1590	4	16	43
Jazz I (AA)	10/83→10/86	ER1	Petrol	1231	4	8	6
Jazz I (AA)	02/84→10/86	ER2	Petrol	1231	4	8	6
Jazz I (AA)	09/84→10/86	ER4	Petrol	1231	4	8	6
Jazz II (GD)	03/02→09/07	L13A1	Petrol	1339	4	8	15
Jazz II (GD)	03/02→09/07	L15A1	Petrol	1497	4	16	29
Jazz II (GD, GE3, GE2)	03/02→07/08	L12A1	Petrol	1243	4	8	7
Jazz II (GD, GE3, GE2)	03/02→07/08	L12A4	Petrol	1243	4	8	7
Jazz II (GD, GE3, GE2)	03/02→10/08	L13A1	Petrol	1339	4	8	15
Jazz II (GD, GE3, GE2)	04/02→12/08	L15A	Petrol	1497	4	16	29
Jazz II (GD, GE3, GE2)	10/03→09/07	D17A2	Petrol	1668	4	16	46
Jazz II (GD, GE3, GE2)	02/05→12/08	L15A1	Petrol	1497	4	16	29
Jazz II (GD, GE3, GE2)	12/06→10/08	L13A6	Petrol	1339	4	8	15
Jazz III (GE, GG, GP)	10/07→	L15A	Petrol	1497	4	16	29
Jazz III (GE, GG, GP)	10/07→	L15A3	Petrol	1497	4	16	29
Jazz III (GE, GG, GP)	07/08→	L12B1	Petrol	1198	4	16	8
Jazz III (GE, GG, GP)	07/08→	L13Z1	Petrol	1339	4	16	16
Jazz III (GE, GG, GP)	07/08→	L15A7	Petrol	1497	4	16	29
Jazz III (GE, GG, GP)	11/08→	L13A	Petrol	1339	4	16	19
Jazz III (GE, GG, GP)	04/11→	LDA3	Petrol	1339	4	8	15
Jazz IV (GK)	09/14→	L15A	Petrol	1497	4	16	29
Jazz Saloon (GD)	05/03→06/06	L15A1	Petrol	1497	4	16	29
Jazz Saloon (GD)	05/03→07/08	L13A1	Petrol	1339	4	8	15
Jazz Saloon (GD)	10/04→07/08	L15A2	Petrol	1497	4	8	30
Jazz Shuttle (GG8, GG7, GP2)	03/11→03/14	L15A	Petrol	1497	4	16	29
Jazz Shuttle (GG8, GG7, GP2)	03/11→03/14	LDA3	Petrol	1339	4	8	15
Lagreat	11/98→08/04	J35A	Petrol	3471	6	24	93
Lagreat	07/02→09/03	F23A	Petrol	2254	4	16	74
Lagreat	09/04→08/05	J35A5	Petrol	3471	6	24	93
Lagreat	09/05→	J35A8	Petrol	3471	6	24	93
Legend	01/86→12/87	C25A1	Petrol	2494	6	24	80
Legend	09/86→08/91	C27A1	Petrol	2675	6	24	82
Legend	01/88→08/91	C20A	Petrol	1996	6	12	66
Legend Coupe	01/87→12/87	C25A1	Petrol	2494	6	24	80
Legend Coupe	01/87→08/91	C27A1	Petrol	2675	6	24	82
Legend I (HS, KA)	01/86→12/87	C25A1	Petrol	2494	6	24	80
Legend I (HS, KA)	02/87→06/88	C25A2	Petrol	2494	6	24	80
Legend I (HS, KA)	01/88→12/90	C27A1	Petrol	2675	6	24	82
Legend I Coupe (KA)	10/87→12/90	C27A1	Petrol	2675	6	24	82
Legend I Coupe (KA)	10/87→12/90	C27A2	Petrol	2675	6	24	83
Legend II	08/91→08/96	C32A	Petrol	3206	6	24	88
Legend II	09/91→12/95	C32A6	Petrol	3206	6	24	89
Legend II	09/93→12/95	C32A1	Petrol	3206	6	24	89
Legend II (KA)	01/91→02/96	C32A2	Petrol	3206	6	24	88
Legend II Coupe	08/91→08/96	C32A2	Petrol	3206	6	24	88
Legend II Coupe	09/92→12/95	C32A1	Petrol	3206	6	24	89
Legend II Coupe (KA)	01/91→02/96	C32A2	Petrol	3206	6	24	88
Legend III (KA)	02/96→09/04	C35A2	Petrol	3474	6	24	92
Legend III (KA9)	10/04→06/09	C35A8	Petrol	3471	6	24	92
Legend IV (KB)	05/06→12/12	C35A8	Petrol	3471	6	24	92
Legend IV (KB)	05/06→12/12	J35A8	Petrol	3471	6	24	93
Legend IV (KB)	07/08→12/12	J37A3	Petrol	3664	6	24	94
Legend IV (KB)	07/08→12/13	J37A2	Petrol	3664	6	24	94
Logo (GA)	03/99→03/02	D13B7	Petrol	1343	4	8	11
MDX (YD)	04/03→04/07	J35A5	Petrol	3471	6	24	93
MDX (YD1)	08/00→04/06	J35A5	Petrol	3471	6	24	93
MDX (YD1)	08/00→09/06	J35A4	Petrol	3471	6	24	93
MDX (YD1)	03/01→12/05	J35A3	Petrol	3471	6	24	93
MDX (YD2)	10/06→	J37A1	Petrol	3664	6	24	94
MDX (YD2)	10/06→	J37A2	Petrol	3664	6	24	94
MDX (YD2)	11/13→	J35Y5	Petrol	3471	6	24	93
MDX (YD3)	11/13→	J35Y4	Petrol	3471	6	24	93
MDX (YD3)	01/14→	J35Y5	Petrol	3471	6	24	93
Mobilio (GB)	12/01→10/08	L15A	Petrol	1497	4	16	29
Mobilio (GB)	12/01→10/08	L15A1	Petrol	1497	4	16	29
NSX	01/90→08/97	C30A3	Petrol	2977	6	24	84
NSX	01/92→08/97	C30A4	Petrol	2977	6	24	84
NSX	08/97→12/05	C32B2	Petrol	3179	6	24	90
NSX	09/97→12/05	C32B1	Petrol	3179	6	24	89
NSX Convertible (NA)	03/95→09/05	C30A3	Petrol	2977	6	24	84
NSX Convertible (NA)	03/95→09/05	C30A4	Petrol	2977	6	24	85
NSX Convertible (NA)	01/97→09/05	C32B2	Petrol	3179	6	24	90
NSX Coupe (NA)	06/90→09/05	C30A3	Petrol	2977	6	24	84
NSX Coupe (NA)	06/90→09/05	C30A4	Petrol	2977	6	24	85
NSX Coupe (NA)	01/97→09/05	C32B2	Petrol	3179	6	24	90
NSX Targa (NA1)	01/95→12/96	C30A3	Petrol	2977	6	24	84

							
NSX Targa (NA1)	01/95→12/97	C30A4	Petrol	2977	6	24	84
NSX Targa (NA1)	09/96→12/05	C32B1	Petrol	3179	6	24	89
Odyssey (RA_)	10/95→12/99	F22B6	Petrol	2156	4	16	70
Odyssey (RA_)	10/97→12/99	F23A	Petrol	2254	4	16	74
Odyssey (RA_)	10/97→12/99	F23A7	Petrol	2254	4	16	75
Odyssey (RB_)	09/98→12/01	J35A1	Petrol	3474	6	24	93
Odyssey (RB_)	09/01→12/04	J35A4	Petrol	3471	6	24	93
Odyssey (RB_)	07/02→09/03	F23A	Petrol	2254	4	16	74
Odyssey (RB_)	07/02→08/04	J35A	Petrol	3471	6	24	93
Odyssey (RB_)	10/03→	K24A5	Petrol	2354	4	16	78
Odyssey (RB_)	09/04→09/05	J35A5	Petrol	3471	6	24	93
Odyssey (RB_)	09/05→	J35A8	Petrol	3471	6	24	93
Odyssey (RB_)	10/05→	K24A4	Petrol	2354	4	16	78
Odyssey (RB_)	09/08→	K24A	Petrol	2354	4	16	78
Odyssey (RL3, RL4)	09/04→12/05	J35A6	Petrol	3471	6	24	93
Odyssey (RL3, RL4)	09/04→08/08	K24A3	Petrol	2354	4	16	78
Odyssey (RL3, RL4)	09/04→12/10	J35A7	Petrol	3471	6	24	93
Odyssey (RL5)	08/10→	J35A8	Petrol	3471	6	24	93
Orthia / Partner (EL_, EY_)	10/95→09/96	D16A	Petrol	1590	4	16	33
Orthia / Partner (EL_, EY_)	10/95→09/01	B18B6	Petrol	1834	4	16	47
Orthia / Partner (EL_, EY_)	10/95→09/01	B20B	Petrol	1972	4	16	65
Orthia / Partner (EL_, EY_)	10/95→09/02	D15B	Petrol	1493	4	16	22
Passport Closed Off-Road Vehicle	09/93→12/96	4ZE1	Petrol	2559	4	8	81
Passport Closed Off-Road Vehicle	09/93→12/02	6VD1	Petrol	3165	6	24	87
Pilot	09/02→12/04	J35A4	Petrol	3471	6	24	93
Pilot	09/04→12/05	J35A6	Petrol	3471	6	24	93
Pilot	09/05→07/08	J35A9	Petrol	3471	6	24	93
Pilot	09/08→	J35Z4	Petrol	3471	6	24	93
Pilot	07/15→	J35Y6	Petrol	3471	6	24	93
Prelude I Coupe (SN)	11/78→10/82	EK1	Petrol	1751	4	12	52
Prelude I Coupe (SN)	11/78→10/82	EL	Petrol	1602	4	8	39
Prelude I Coupe (SN)	11/78→10/82	EL14	Petrol	1602	4	8	39
Prelude II (AB)	11/83→04/87	ET2	Petrol	1829	4	8	54
Prelude II (AB)	11/83→04/87	ET3	Petrol	1829	4	8	54
Prelude II (AB)	11/85→04/87	ET4	Petrol	1829	4	8	54
Prelude II (AB)	01/86→09/87	A20A4	Petrol	1955	4	12	60
Prelude III (BA)	04/86→12/87	B20A1	Petrol	1958	4	16	61
Prelude III (BA)	04/87→01/92	B20A3	Petrol	1958	4	12	62
Prelude III (BA)	04/87→01/92	B20A5	Petrol	1958	4	16	63
Prelude III (BA)	08/87→01/92	B20A4	Petrol	1958	4	12	62
Prelude III (BA)	10/87→12/90	B20A7	Petrol	1958	4	16	64
Prelude III (BA)	10/87→12/91	B20A6	Petrol	1958	4	16	64
Prelude III (BA)	10/87→01/92	B20A9	Petrol	1958	4	16	64
Prelude III (BA)	09/89→12/91	B21A1	Petrol	2056	4	16	69
Prelude IV (BB_)	12/91→12/96	F22A1	Petrol	2156	4	16	70
Prelude IV (BB_)	02/92→09/96	F20A4	Petrol	1997	4	16	67
Prelude IV (BB_)	02/92→09/96	H23A2	Petrol	2259	4	16	76
Prelude IV (BB_)	02/93→09/96	H22A2	Petrol	2157	4	16	72
Prelude IV (BB_)	02/94→02/97	H22A1	Petrol	2157	4	16	72
Prelude V (BB_)	10/96→10/00	F20A4	Petrol	1997	4	16	67
Prelude V (BB_)	10/96→10/00	H22A2	Petrol	2157	4	16	72
Prelude V (BB_)	10/96→10/00	H22A5	Petrol	2157	4	16	72
Prelude V (BB_)	10/96→04/01	H22A4	Petrol	2157	4	16	72
Prelude V (BB_)	03/97→04/01	F22Z6	Petrol	2156	4	16	70
Quintet (SU)	02/80→12/84	EL	Petrol	1602	4	8	39
RDX	04/06→12/12	K23A1	Petrol	2300	4	16	77
RDX	01/12→	J35Z2	Petrol	3471	6	24	93
RDX	06/13→	J30Y1	Petrol	2997	6	24	86
Ridgeline	07/16→	J35Y6	Petrol	3471	6	24	93
Ridgeline (YK)	03/05→12/14	J35A9	Petrol	3471	6	24	93
Ridgeline (YK)	09/07→12/14	J35Z5	Petrol	3471	6	24	93
RL	10/95→09/00	C35A2	Petrol	3474	6	24	92
RL	10/95→09/04	C35A1	Petrol	3475	6	24	92
RL	10/00→09/04	C35A5	Petrol	3474	6	24	92
RL	10/04→	J35A1	Petrol	3471	6	24	93
RL	08/05→12/08	J35A6	Petrol	3471	6	24	93
RL	10/06→	J35A8	Petrol	3471	6	24	93
RL	09/08→	J37A2	Petrol	3664	6	24	94
RLX	06/13→	J35Y4	Petrol	3471	6	24	93
RSX Coupe (DC_)	10/01→12/06	K20A2	Petrol	1998	4	16	68
RSX Coupe (DC_)	10/01→	K20A	Petrol	1998	4	16	68
RSX Coupe (DC_)	10/01→	K20A3	Petrol	1998	4	16	68
S2000 (AP)	03/99→12/03	F20C1	Petrol	1997	4	16	68
S2000 (AP)	06/99→	F20C VTEC	Petrol	1997	4	16	68
S2000 (AP)	09/03→	F22C1	Petrol	2157	4	16	71
S2000 (AP)	10/03→	F20C3	Petrol	1997	4	16	68
Shuttle (RA)	06/94→09/97	F22B9	Petrol	2156	4	16	70
Shuttle (RA)	10/94→02/98	F22B8	Petrol	2156	4	16	70



















CC











9

Shuttle (RA)	10/97→06/02	F23A	Petrol	2254	4	16	74
Shuttle (RA)	10/97→06/04	F23A7	Petrol	2254	4	16	75
Shuttle (RA)	10/97→06/04	J30A	Petrol	2997	6	24	84
Shuttle (RA)	09/00→06/02	J35A	Petrol	3471	6	24	93
SLX	11/95→09/99	6VD1	Petrol	3165	6	24	87
SLX	09/97→09/99	6 VE1	Petrol	3494	6	24	91
SLX	11/97→09/99	C35A5	Petrol	3474	6	24	92
SMX	01/96→12/01	B20B	Petrol	1972	4	16	65
Stepwagon	10/00→09/09	K24A3	Petrol	2354	4	16	78
Stepwagon	10/05→09/09	K20A6	Petrol	1998	4	16	68
Stepwagon	10/09→03/15	R20A1	Petrol	1997	4	16	68
Stepwgn (DBA-RG_)	10/05→09/09	K20A6	Petrol	1998	4	16	68
Stepwgn (DBA-RG_)	10/05→09/09	K24A3	Petrol	2354	4	16	78
Stepwgn (DBA-RK_)	10/09→12/15	R20A	Petrol	1997	4	16	68
Stepwgn (E-RF_, GF-RF_)	05/96→09/00	B20B	Petrol	1972	4	16	65
Stepwgn (LA-RF_, UA-RF_)	10/00→09/05	K20A9	Petrol	1998	4	16	68
Stream	10/05→	R18A2	Petrol	1799	4	16	56
Stream	10/05→	R20A4	Petrol	1997	4	16	68
Stream (RN)	05/01→	D17A2	Petrol	1668	4	16	46
Stream (RN)	05/01→	K20A1	Petrol	1998	4	16	68
TL	06/95→09/98	C32A	Petrol	3206	6	24	88
TL	06/95→09/98	C32A6	Petrol	3206	6	24	89
TL	10/98→09/03	J32A1	Petrol	3210	6	24	90
TL	06/01→09/03	J32A4	Petrol	3210	6	24	89
TL	09/01→09/03	J32A2	Petrol	3210	6	24	89
TL (UA8, UA9)	01/09→	J35Z6	Petrol	3471	6	24	93
TL (UA8, UA9)	01/09→	J37A4	Petrol	3664	6	24	94
TL (UC_)	10/03→12/08	J32A5	Petrol	3210	6	24	90
TL (UC_)	11/06→11/12	C35A8	Petrol	3471	6	24	92
TLX	07/14→	J35Y6	Petrol	3471	6	24	93
TLX	07/14→	K24W7	Petrol	2356	4	16	78
Today	09/85→09/88	EH	Petrol	545	2	4	1
Torneo Estate	10/99→09/02	D16B6	Petrol	1590	4	16	33
Torneo Estate	10/99→09/03	F22A2	Petrol	2156	4	16	70
Torneo Saloon	04/94→12/97	F20Z2	Petrol	1997	4	16	67
Torneo Saloon	01/98→09/03	F20B1	Petrol	1997	4	16	67
Torneo Saloon	10/99→09/02	D16B6	Petrol	1590	4	16	33
Torneo Saloon	10/99→09/03	F20B	Petrol	1997	4	16	67
Torneo Saloon	10/99→09/03	F22A2	Petrol	2156	4	16	70
TSX (CL_)	10/03→12/08	K24A2	Petrol	2354	4	16	78
TSX (CU_)	09/10→	K24Z3	Petrol	2354	4	16	78
TSX (CU_)	01/12→	J35Z6	Petrol	3471	6	24	93
TSX Estate (CW_)	09/10→	K24Z3	Petrol	2354	4	16	78
ZDX	01/10→	J37A5	Petrol	3664	6	24	94

	CC				9		CC				9
4EE-2	1686	4	16	Diesel	44	D13B4	1343	4	16	Petrol	10
4JA1	2499	4	8	Diesel	79	D13B7	1343	4	8	Petrol	11
4ZE1	2559	4	8	Petrol	81	D13C	1296	4	8	Petrol	12
6VD1	3165	6	24	Petrol	87	D14A	1396	4	16	Petrol	17
6VD1	3165	6	24	Petrol	87	D14A1	1396	4	16	Petrol	17
6 VE1	3494	6	24	Petrol	91	D14A2	1396	4	16	Petrol	17
20T2N	1994	4	8	Diesel	59	D14A3	1396	4	16	Petrol	17
20T2R	1994	4	8	Diesel	59	D14A4	1396	4	16	Petrol	17
A16A1	1598	4	12	Petrol	31	D14A5	1396	4	16	Petrol	17
A16A5	1598	4	12	Petrol	31	D14A6	1396	4	16	Petrol	17
A20A1	1955	4	12	Petrol	60	D14A7	1396	4	16	Petrol	17
A20A2	1955	4	12	Petrol	60	D14A8	1396	4	16	Petrol	17
A20A3	1955	4	12	Petrol	60	D14Z1	1396	4	16	Petrol	17
A20A4	1955	4	12	Petrol	60	D14Z2	1396	4	16	Petrol	17
B16A	1595	4	16	Petrol	32	D14Z3	1396	4	16	Petrol	17
B16A1	1595	4	16	Petrol	32	D14Z4	1396	4	16	Petrol	17
B16A2	1595	4	16	Petrol	32	D14Z5	1396	4	16	Petrol	18
B17A1	1678	4	16	Petrol	45	D14Z6	1396	4	16	Petrol	18
B18A1	1834	4	16	Petrol	47	D15A1	1488	4	8	Petrol	21
B18A1	1834	4	16	Petrol	48	D15A1	1488	4	8	Petrol	21
B18B1	1834	4	16	Petrol	47	D15B	1493	4	16	Petrol	22
B18B1	1834	4	16	Petrol	48	D15B1	1493	4	16	Petrol	22
B18B2	1834	4	16	Petrol	47	D15B2	1493	4	16	Petrol	22
B18B6	1834	4	16	Petrol	47	D15B3	1493	4	16	Petrol	22
B18C	1797	4	16	Petrol	49	D15B4	1493	4	16	Petrol	22
B18C1	1797	4	16	Petrol	49	D15B6	1493	4	8	Petrol	23
B18C2	1797	4	16	Petrol	50	D15B7	1493	4	16	Petrol	22
B18C4	1797	4	16	Petrol	50	D15B8	1493	4	8	Petrol	23
B18C5	1797	4	16	Petrol	51	D15Y3	1493	4	16	Petrol	22
B18C6	1797	4	16	Petrol	50	D15Z1	1493	4	16	Petrol	22
B18C6	1797	4	16	Petrol	50	D15Z2	1493	4	16	Petrol	22
B20A1	1958	4	16	Petrol	61	D15Z3	1493	4	16	Petrol	24
B20A2	1958	4	16	Petrol	61	D15Z6	1493	4	16	Petrol	22
B20A3	1958	4	12	Petrol	62	D15Z8	1493	4	16	Petrol	22
B20A4	1958	4	12	Petrol	62	D16A	1590	4	16	Petrol	33
B20A5	1958	4	16	Petrol	63	D16A1	1590	4	16	Petrol	34
B20A6	1958	4	16	Petrol	64	D16A2	1590	4	16	Petrol	34
B20A7	1958	4	16	Petrol	64	D16A3	1590	4	16	Petrol	34
B20A8	1958	4	16	Petrol	64	D16A3	1590	4	16	Petrol	34
B20A9	1958	4	16	Petrol	64	D16A6	1590	4	16	Petrol	33
B20B	1972	4	16	Petrol	65	D16A7	1590	4	16	Petrol	33
B20B3	1973	4	16	Petrol	65	D16A8	1590	4	16	Petrol	34
B20B4	1973	4	16	Petrol	65	D16A8	1590	4	16	Petrol	34
B20Z1	1973	4	16	Petrol	65	D16A9	1590	4	16	Petrol	34
B20Z2	1973	4	16	Petrol	65	D16B2	1590	4	16	Petrol	33
B21A1	2056	4	16	Petrol	69	D16B5	1590	4	16	Petrol	33
C20A	1996	6	12	Petrol	66	D16B6	1590	4	16	Petrol	33
C25A1	2494	6	24	Petrol	80	D16B7	1590	4	16	Petrol	33
C25A1	2494	6	24	Petrol	80	D16V1	1590	4	16	Petrol	35
C25A2	2494	6	24	Petrol	80	D16W1	1590	4	16	Petrol	33
C27A1	2675	6	24	Petrol	82	D16W4	1590	4	16	Petrol	33
C27A1	2675	6	24	Petrol	82	D16W5	1590	4	16	Petrol	33
C27A2	2675	6	24	Petrol	83	D16Y1	1590	4	16	Petrol	33
C27A4	2675	6	24	Petrol	83	D16Y2	1590	4	16	Petrol	33
C30A3	2977	6	24	Petrol	84	D16Y3	1590	4	16	Petrol	33
C30A3	2977	6	24	Petrol	84	D16Y5	1590	4	16	Petrol	33
C30A4	2977	6	24	Petrol	84	D16Y6	1590	4	16	Petrol	33
C30A4	2977	6	24	Petrol	85	D16Y7	1590	4	16	Petrol	33
C32A	3206	6	24	Petrol	88	D16Y8	1590	4	16	Petrol	33
C32A	3206	6	24	Petrol	88	D16Y8	1590	4	16	Petrol	33
C32A1	3206	6	24	Petrol	89	D16Z	1590	4	16	Petrol	31
C32A2	3206	6	24	Petrol	88	D16Z1	1590	4	16	Petrol	33
C32A2	3206	6	24	Petrol	88	D16Z2	1590	4	16	Petrol	33
C32A6	3206	6	24	Petrol	89	D16Z5	1590	4	16	Petrol	36
C32B1	3179	6	24	Petrol	89	D16Z6	1590	4	16	Petrol	37
C32B2	3179	6	24	Petrol	90	D16Z7	1590	4	16	Petrol	33
C32B2	3179	6	24	Petrol	90	D16Z9	1590	4	16	Petrol	33
C35A1	3475	6	24	Petrol	92	D17A1	1668	4	16	Petrol	46
C35A2	3474	6	24	Petrol	92	D17A2	1668	4	16	Petrol	46
C35A2	3474	6	24	Petrol	92	D17A2	1668	4	16	Petrol	46
C35A5	3474	6	24	Petrol	92	D17A5	1668	4	16	Petrol	46
C35A8	3471	6	24	Petrol	92	D17A6	1668	4	16	Petrol	46
C35A8	3471	6	24	Petrol	92	D17A7	1668	4	16	Petrol	46
D12A	1238	4	16	Petrol	3	D17A8	1668	4	16	Petrol	46
D12B1	1187	4	8	Petrol	4	D17A9	1668	4	16	Petrol	46
D13B	1343	4	16	Petrol	10	D17Z1	1668	4	16	Petrol	46
D13B1	1343	4	16	Petrol	10	EB1	1169	4	8	Petrol	5
D13B2	1343	4	16	Petrol	10	EB2	1238	4	8	Petrol	5

	CC				9		CC				9
EB3	1238	4	8	Petrol	5	F22Z6	2156	4	16	Petrol	70
EC	1488	4	8	Petrol	25	F23A	2254	4	16	Petrol	74
ECA1	995	3	12	Petrol	2	F23A1	2254	4	16	Petrol	74
ED1	1488	4	12	Petrol	26	F23A3	2254	4	16	Petrol	74
ED3	1488	4	12	Petrol	26	F23A4	2254	4	16	Petrol	74
ED4	1488	4	12	Petrol	26	F23A5	2254	4	16	Petrol	74
EF1	1599	4	12	Petrol	38	F23A7	2254	4	16	Petrol	74
EG	1602	4	8	Petrol	38	F23A7	2254	4	16	Petrol	75
EH	545	2	4	Petrol	1	F23B	2254	4	16	Petrol	74
EK1	1751	4	12	Petrol	52	F23Z2	2254	4	16	Petrol	74
EL	1602	4	8	Petrol	39	F23Z5	2254	4	16	Petrol	74
EL14	1602	4	8	Petrol	39	G32A	3206	6	12	Petrol	89
EM1	1487	4	8	Petrol	26	H22A1	2157	4	16	Petrol	72
EN1	1335	4	8	Petrol	13	H22A2	2157	4	16	Petrol	72
EN2	1335	4	8	Petrol	13	H22A4	2157	4	16	Petrol	72
EN4	1335	4	8	Petrol	13	H22A5	2157	4	16	Petrol	72
ER1	1231	4	8	Petrol	6	H22A7	2157	4	16	Petrol	72
ER2	1231	4	8	Petrol	6	H23A1	2259	4	16	Petrol	76
ER4	1231	4	8	Petrol	6	H23A2	2259	4	16	Petrol	76
ES2	1829	4	12	Petrol	53	H23A3	2259	4	16	Petrol	76
ET1	1829	4	12	Petrol	54	J30A	2997	6	24	Petrol	84
ET2	1829	4	8	Petrol	54	J30A1	2997	6	24	Petrol	84
ET3	1829	4	8	Petrol	54	J30A1	2997	6	24	Petrol	84
ET4	1829	4	8	Petrol	54	J30A2	2997	6	24	Petrol	84
EV1	1342	4	12	Petrol	14	J30A4	2997	6	24	Petrol	84
EV2	1342	4	12	Petrol	14	J30A5	2997	6	24	Petrol	84
EW	1595	4	8	Petrol	40	J30Y1	2997	6	24	Petrol	86
EW1	1488	4	12	Petrol	27	J32A	3210	6	24	Petrol	90
EW2	1488	4	8	Petrol	28	J32A1	3210	6	24	Petrol	90
EW3	1488	4	12	Petrol	27	J32A2	3210	6	24	Petrol	89
EW4	1488	4	8	Petrol	28	J32A4	3210	6	24	Petrol	89
EZ	1598	4	12	Petrol	41	J32A5	3210	6	24	Petrol	90
F18A2	1849	4	16	Petrol	55	J35A	3471	6	24	Petrol	93
F18A2	1849	4	16	Petrol	55	J35A1	3471	6	24	Petrol	93
F18A3	1850	4	16	Petrol	58	J35A1	3474	6	24	Petrol	93
F18B2	1850	4	16	Petrol	55	J35A3	3471	6	24	Petrol	93
F18C1	1797	4	16	Petrol	51	J35A4	3471	6	24	Petrol	93
F18C2	1797	4	16	Petrol	51	J35A4	3471	6	24	Petrol	93
F20A2	1997	4	16	Petrol	67	J35A5	3471	6	24	Petrol	93
F20A3	1997	4	16	Petrol	67	J35A5	3471	6	24	Petrol	93
F20A4	1997	4	16	Petrol	67	J35A6	3471	6	24	Petrol	93
F20A5	1997	4	16	Petrol	67	J35A6	3471	6	24	Petrol	93
F20A6	1997	4	16	Petrol	67	J35A7	3471	6	24	Petrol	93
F20A7	1997	4	16	Petrol	67	J35A8	3471	6	24	Petrol	93
F20A8	1997	4	16	Petrol	67	J35A8	3471	6	24	Petrol	93
F20B	1997	4	16	Petrol	67	J35A9	3471	6	24	Petrol	93
F20B1	1997	4	16	Petrol	67	J35Y1	3471	6	24	Petrol	93
F20B2	1997	4	16	Petrol	67	J35Y4	3471	6	24	Petrol	93
F20B2	1997	4	16	Petrol	67	J35Y5	3471	6	24	Petrol	93
F20B3	1997	4	16	Petrol	67	J35Y6	3471	6	24	Petrol	93
F20B5	1997	4	16	Petrol	67	J35Y6	3471	6	24	Petrol	93
F20B6	1997	4	16	Petrol	67	J35Z1	3471	6	24	Petrol	93
F20B7	1997	4	16	Petrol	67	J35Z2	3471	6	24	Petrol	93
F20C1	1997	4	16	Petrol	68	J35Z2	3471	6	24	Petrol	93
F20C3	1997	4	16	Petrol	68	J35Z4	3471	6	24	Petrol	93
F20C VTEC	1997	4	16	Petrol	68	J35Z5	3471	6	24	Petrol	93
F20Z1	1997	4	16	Petrol	67	J35Z6	3471	6	24	Petrol	93
F20Z2	1997	4	16	Petrol	67	J37A1	3664	6	24	Petrol	94
F20Z3	1997	4	16	Petrol	67	J37A2	3664	6	24	Petrol	94
F22A1	2156	4	16	Petrol	70	J37A2	3664	6	24	Petrol	94
F22A2	2156	4	16	Petrol	70	J37A3	3664	6	24	Petrol	94
F22A3	2156	4	16	Petrol	70	J37A4	3664	6	24	Petrol	94
F22A4	2156	4	16	Petrol	70	J37A5	3664	6	24	Petrol	94
F22A6	2156	4	16	Petrol	70	K20A	1998	4	16	Petrol	68
F22A7	2156	4	16	Petrol	70	K20A	1998	4	16	Petrol	68
F22A8	2156	4	16	Petrol	70	K20A1	1998	4	16	Petrol	68
F22A9	2156	4	16	Petrol	70	K20A2	1998	4	16	Petrol	68
F22B1	2156	4	16	Petrol	70	K20A2	1998	4	16	Petrol	68
F22B1	2156	4	16	Petrol	70	K20A3	1998	4	16	Petrol	68
F22B2	2156	4	16	Petrol	70	K20A3	1998	4	16	Petrol	68
F22B2	2156	4	16	Petrol	70	K20A4	1998	4	16	Petrol	68
F22B3	2156	4	16	Petrol	70	K20A5	1998	4	16	Petrol	68
F22B5	2156	4	16	Petrol	70	K20A6	1998	4	16	Petrol	68
F22B6	2156	4	16	Petrol	70	K20A7	1998	4	16	Petrol	68
F22B8	2156	4	16	Petrol	70	K20A9	1998	4	16	Petrol	68
F22B9	2156	4	16	Petrol	70	K20Z1	1998	4	16	Petrol	68
F22C1	2157	4	16	Petrol	71	K20Z2	1997	4	16	Petrol	68
F22Z2	2156	4	16	Petrol	70	K20Z2	1997	4	16	Petrol	68

	CC				9		CC				9
K20Z3	1998	4	16	Petrol	68						
K20Z4	1998	4	16	Petrol	68						
K23A1	2300	4	16	Petrol	77						
K24A	2354	4	16	Petrol	78						
K24A1	2354	4	16	Petrol	78						
K24A2	2354	4	16	Petrol	78						
K24A2	2354	4	16	Petrol	78						
K24A3	2354	4	16	Petrol	78						
K24A4	2354	4	16	Petrol	78						
K24A5	2354	4	16	Petrol	78						
K24A6	2354	4	16	Petrol	78						
K24A8	2354	4	16	Petrol	78						
K24W7	2356	4	16	Petrol	78						
K24Z1	2354	4	16	Petrol	78						
K24Z2	2354	4	16	Petrol	78						
K24Z3	2354	4	16	Petrol	78						
K24Z3	2354	4	16	Petrol	78						
K24Z4	2354	4	16	Petrol	78						
K24Z5	2354	4	16	Petrol	78						
K24Z6	2354	4	16	Petrol	78						
K24Z7	2354	4	16	Petrol	78						
K24Z7	2354	4	16	Petrol	78						
K24Z9	2354	4	16	Petrol	78						
L12A	1243	4	8	Petrol	7						
L12A1	1243	4	8	Petrol	7						
L12A2	1243	4	8	Petrol	7						
L12A3	1243	4	8	Petrol	7						
L12A4	1243	4	8	Petrol	7						
L12B1	1198	4	16	Petrol	8						
L13A	1339	4	16	Petrol	19						
L13A1	1339	4	8	Petrol	15						
L13A3	1339	4	8	Petrol	15						
L13A3	1339	4	8	Petrol	16						
L13A5	1339	4	8	Petrol	15						
L13A6	1339	4	8	Petrol	15						
L13A7	1339	4	8	Petrol	15						
L13A8	1339	4	8	Petrol	20						
L13Z1	1339	4	16	Petrol	16						
L13Z1	1339	4	16	Petrol	16						
L15A	1497	4	16	Petrol	29						
L15A1	1497	4	16	Petrol	29						
L15A1	1497	4	16	Petrol	29						
L15A2	1497	4	8	Petrol	30						
L15A3	1497	4	16	Petrol	29						
L15A4	1497	4	16	Petrol	29						
L15A7	1497	4	16	Petrol	29						
L15A7	1497	4	16	Petrol	29						
L15AV	1497	4	16	Petrol	29						
LDA1	1339	4	16	Petrol	16						
LDA2	1339	4	8	Petrol	15						
LDA2	1339	4	8	Petrol	16						
LDA3	1339	4	8	Petrol	15						
LEA1	1497	4	16	Petrol	29						
LEA2	1497	4	16	Petrol	29						
LEA2	1497	4	16	Petrol	29						
LEA3	1497	4	16	Petrol	29						
N22A1	2204	4	16	Diesel	73						
N22A2	2204	4	16	Diesel	73						
N22B1	2199	4	16	Diesel	73						
N22B2	2199	4	16	Diesel	73						
N22B3	2199	4	16	Diesel	73						
N22B4	2199	4	16	Diesel	73						
R16A1	1595	4	16	Petrol	42						
R18A1	1799	4	16	Petrol	56						
R18A2	1799	4	16	Petrol	56						
R18A4	1799	4	16	Petrol	56						
R18A9	1799	4	16	Petrol	56						
R20A	1997	4	16	Petrol	68						
R20A1	1997	4	16	Petrol	68						
R20A2	1997	4	16	Petrol	68						
R20A3	1997	4	16	Petrol	68						
R20A4	1997	4	16	Petrol	68						
R20A5	1997	4	16	Petrol	68						
R20A5	1997	4	16	Petrol	68						
R20A9	1997	4	16	Petrol	68						
XUD7T	1769	4	8	Diesel	57						
ZA2	1187	4	8	Petrol	9						
ZC1	1590	4	16	Petrol	43						

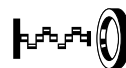

1 0.5L Petrol

EH	2 Cyl.	4 Valves	545cc	TD1572
	NJ254 27.00 x 43.00 x 9.00mm, NBR		NK102 65.00 x 88.00 x 12.00mm, MVQ	

2 1.0L Petrol

ECA1	3 Cyl.	12 Valves	995cc	TD18263
			NA5058 40.00 x 55.00 x 7.00mm, FPM	

3 1.2L Petrol

D12A	4 Cyl.	16 Valves	1238cc	TD1536
	PB355 (x8) PB356 (x8)		NJ313 29.00 x 45.00 x 8.00mm, ACM	

4 1.2L Petrol

D12B1	4 Cyl.	8 Valves	1187cc	TD1537
			NJ312 80.00 x 100.00 x 10.00mm, MVQ	

5 1.2L Petrol

EB1	4 Cyl.	8 Valves	1169cc	TD4526
EB2	4 Cyl.	8 Valves	1238cc	TD5391
EB3	4 Cyl.	8 Valves	1238cc	TD1569
	NJ254 27.00 x 43.00 x 9.00mm, NBR		NJ072 35.00 x 50.00 x 8.00mm, NBR	

6 1.2L Petrol

ER1	4 Cyl.	8 Valves	1231cc	TD4532
ER2	4 Cyl.	8 Valves	1231cc	TD4533
ER4	4 Cyl.	8 Valves	1231cc	TD4534
	PA286 (x4)		NJ254 27.00 x 43.00 x 9.00mm, NBR	
			NJ072 35.00 x 50.00 x 8.00mm, NBR	

7 1.2L Petrol

L12A	4 Cyl.	8 Valves	1243cc	TD22057
L12A1	4 Cyl.	8 Valves	1243cc	TD18261
L12A2	4 Cyl.	8 Valves	1243cc	TD22058
L12A3	4 Cyl.	8 Valves	1243cc	TD22060
L12A4	4 Cyl.	8 Valves	1243cc	TD34312
	PB355 (x4) PB356 (x4)		NA5058 40.00 x 55.00 x 7.00mm, FPM NB698 80.00 x 98.00 x 10.00mm, FPM	

8 1.2L Petrol

L12B1	4 Cyl.	16 Valves	1198cc	TD24324
	PB355 (x8) PB356 (x8)		NA5058 40.00 x 55.00 x 7.00mm, FPM NB698 80.00 x 98.00 x 10.00mm, FPM	



9 1.2L Petrol

ZA2	4 Cyl.	8 Valves	1187cc	TD4555
	NJ313 29.00 x 45.00 x 8.00mm, ACM		NJ312 80.00 x 100.00 x 10.00mm, MVQ	

10 1.3L Petrol

D13B	4 Cyl.	16 Valves	1343cc	TD4509
D13B1	4 Cyl.	16 Valves	1343cc	TD1538
D13B2	4 Cyl.	16 Valves	1343cc	TD4510
D13B4	4 Cyl.	16 Valves	1343cc	TD26663
PB355 (x8) PB356 (x8)	NJ313 29.00 x 45.00 x 8.00mm, ACM		NJ381 31.00 x 46.00 x 8.00mm, NBR NJ312 80.00 x 100.00 x 10.00mm, MVQ	

11 1.3L Petrol

D13B7	4 Cyl.	8 Valves	1343cc	TD13188
PB355 (x4) PB356 (x4)	NJ313 29.00 x 45.00 x 8.00mm, ACM		NJ381 31.00 x 46.00 x 8.00mm, NBR NJ312 80.00 x 100.00 x 10.00mm, MVQ	

12 1.3L Petrol

D13C	4 Cyl.	8 Valves	1296cc	TD1540
	NJ313 29.00 x 45.00 x 8.00mm, ACM			

13 1.3L Petrol

EN1	4 Cyl.	8 Valves	1335cc	TD4529
EN2	4 Cyl.	8 Valves	1335cc	TD4530
EN4	4 Cyl.	8 Valves	1335cc	TD4531
PA286 (x4)	NJ254 27.00 x 43.00 x 9.00mm, NBR		NJ072 35.00 x 50.00 x 8.00mm, NBR	

14 1.3L Petrol

EV1	4 Cyl.	12 Valves	1342cc	TD32832
EV2	4 Cyl.	12 Valves	1342cc	TD4538
PA528 (x8) PA531 (x4)	NJ313 29.00 x 45.00 x 8.00mm, ACM		NJ381 31.00 x 46.00 x 8.00mm, NBR NJ312 80.00 x 100.00 x 10.00mm, MVQ	

15 1.3L Petrol

L13A1	4 Cyl.	8 Valves	1339cc	TD18259
L13A3	4 Cyl.	8 Valves	1339cc	TD22061
L13A5	4 Cyl.	8 Valves	1339cc	TD22062
L13A6	4 Cyl.	8 Valves	1339cc	TD26664
L13A7	4 Cyl.	8 Valves	1339cc	TD20328
LDA2	4 Cyl.	8 Valves	1339cc	TD20325
LDA3	4 Cyl.	8 Valves	1339cc	TD24571
PB355 (x4) PB356 (x4)			NA5058 40.00 x 55.00 x 7.00mm, FPM NB698 80.00 x 98.00 x 10.00mm, FPM	

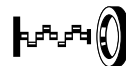
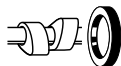

16 1.3L

Petrol

L13A3	4 Cyl.	8 Valves	1339cc	TD20682
L13Z1	4 Cyl.	16 Valves	1339cc	TD32662
L13Z1	4 Cyl.	16 Valves	1339cc	TD23844
LDA1	4 Cyl.	16 Valves	1339cc	TD18254
LDA2	4 Cyl.	8 Valves	1339cc	TD29964

PB355 ■ (x8)
PB356 ■ (x8)

NA5058 ■
40.00 x 55.00 x 7.00mm, FPM
NB698 ■
80.00 x 98.00 x 10.00mm, FPM

17 1.4L

Petrol

D14A	4 Cyl.	16 Valves	1396cc	TD1542
D14A1	4 Cyl.	16 Valves	1396cc	TD1544
D14A2	4 Cyl.	16 Valves	1396cc	TD4511
D14A3	4 Cyl.	16 Valves	1396cc	TD4512
D14A4	4 Cyl.	16 Valves	1396cc	TD4513
D14A5	4 Cyl.	16 Valves	1396cc	TD1543
D14A6	4 Cyl.	16 Valves	1396cc	TD28609
D14A7	4 Cyl.	16 Valves	1396cc	TD9807
D14A8	4 Cyl.	16 Valves	1396cc	TD9808
D14Z1	4 Cyl.	16 Valves	1396cc	TD20029
D14Z2	4 Cyl.	16 Valves	1396cc	TD21246
D14Z3	4 Cyl.	16 Valves	1396cc	TD18857
D14Z4	4 Cyl.	16 Valves	1396cc	TD18858

PB355 ■ (x8)
PB356 ■ (x8)

NJ313
29.00 x 45.00 x 8.00mm, ACM

NJ381 ■
31.00 x 46.00 x 8.00mm, NBR
NJ312 ■
80.00 x 100.00 x 10.00mm, MVQ

18 1.4L

Petrol

D14Z5	4 Cyl.	16 Valves	1396cc	TD18255
D14Z6	4 Cyl.	16 Valves	1396cc	TD18747

PB355 ■ (x8)
PB356 ■ (x8)

NJ313
29.00 x 45.00 x 8.00mm, ACM

NJ312 ■
80.00 x 100.00 x 10.00mm, MVQ

19 1.4L

Petrol

L13A	4 Cyl.	16 Valves	1339cc	TD28182
------	--------	-----------	--------	---------

PB355 ■ (x8)
PB356 ■ (x8)

NA5058 ■
40.00 x 55.00 x 7.00mm, FPM
NB698 ■
80.00 x 98.00 x 10.00mm, FPM

20 1.4L

Petrol

L13A8	4 Cyl.	8 Valves	1339cc	TD22063
-------	--------	----------	--------	---------

PB355 ■ (x4)
PB356 ■ (x4)

NA5058 ■
40.00 x 55.00 x 7.00mm, FPM
NB698 ■
80.00 x 98.00 x 10.00mm, FPM

21 1.5L

Petrol

D15A1	4 Cyl.	8 Valves	1488cc	TD17263
D15A1	4 Cyl.	8 Valves	1488cc	TD21680

PB355 ■ (x4)
PB356 ■ (x4)



NJ313
29.00 x 45.00 x 8.00mm, ACM

NJ312 ■
80.00 x 100.00 x 10.00mm, MVQ





22 1.5L Petrol

D15B	4 Cyl.	16 Valves	1493cc	TD4514
D15B1	4 Cyl.	16 Valves	1493cc	TD18859
D15B2	4 Cyl.	16 Valves	1493cc	TD4516
D15B3	4 Cyl.	16 Valves	1493cc	TD22044
D15B4	4 Cyl.	16 Valves	1493cc	TD23848
D15B7	4 Cyl.	16 Valves	1493cc	TD1550
D15Y3	4 Cyl.	16 Valves	1493cc	TD32401
D15Z1	4 Cyl.	16 Valves	1493cc	TD1551
D15Z2	4 Cyl.	16 Valves	1493cc	TD23834
D15Z6	4 Cyl.	16 Valves	1493cc	TD5392
D15Z8	4 Cyl.	16 Valves	1493cc	TD9809



PB355  (x8)
PB356  (x8)

NJ313
29.00 x 45.00 x 8.00mm, ACM



NJ381 
31.00 x 46.00 x 8.00mm, NBR
NJ312 
80.00 x 100.00 x 10.00mm, MVQ

23 1.5L Petrol

D15B6	4 Cyl.	8 Valves	1493cc	TD32830
D15B8	4 Cyl.	8 Valves	1493cc	TD32837



PB355  (x4)
PB356  (x4)

NJ313
29.00 x 45.00 x 8.00mm, ACM

NJ381 
31.00 x 46.00 x 8.00mm, NBR
NJ312 
80.00 x 100.00 x 10.00mm, MVQ

24 1.5L Petrol

D15Z3	4 Cyl.	16 Valves	1493cc	TD4517
-------	--------	-----------	--------	--------

PB355  (x8)
PB356  (x8)

NJ313
29.00 x 45.00 x 8.00mm, ACM

NJ312 
80.00 x 100.00 x 10.00mm, MVQ

25 1.5L Petrol

EC	4 Cyl.	8 Valves	1488cc	TD1570
----	--------	----------	--------	--------

NJ254
27.00 x 43.00 x 9.00mm, NBR

NJ072 
35.00 x 50.00 x 8.00mm, NBR

26 1.5L Petrol

ED1	4 Cyl.	12 Valves	1488cc	TD32835
ED3	4 Cyl.	12 Valves	1488cc	TD33047
ED4	4 Cyl.	12 Valves	1488cc	TD32834
EM1	4 Cyl.	8 Valves	1487cc	TD33044



NJ254
27.00 x 43.00 x 9.00mm, NBR

27 1.5L Petrol

EW1	4 Cyl.	12 Valves	1488cc	TD32780
EW3	4 Cyl.	12 Valves	1488cc	TD4540

PA528  (x8)
PA531  (x4)

NJ313
29.00 x 45.00 x 8.00mm, ACM

NJ381 
31.00 x 46.00 x 8.00mm, NBR
NJ312 
80.00 x 100.00 x 10.00mm, MVQ

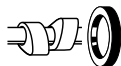

28 1.5L

Petrol

EW2	4 Cyl.	8 Valves	1488cc	TD4539
EW4	4 Cyl.	8 Valves	1488cc	TD1589
PA528 (x4) PA531 (x4)	NJ313 29.00 x 45.00 x 8.00mm, ACM		NJ381 31.00 x 46.00 x 8.00mm, NBR NJ312 80.00 x 100.00 x 10.00mm, MVQ	

29 1.5L

Petrol

L15A	4 Cyl.	16 Valves	1497cc	TD22064
L15A1	4 Cyl.	16 Valves	1497cc	TD19286
L15A1	4 Cyl.	16 Valves	1497cc	TD20669
L15A3	4 Cyl.	16 Valves	1497cc	TD23847
L15A4	4 Cyl.	16 Valves	1497cc	TD26987
L15A7	4 Cyl.	16 Valves	1497cc	TD21609
L15A7	4 Cyl.	16 Valves	1497cc	TD24274
L15AV	4 Cyl.	16 Valves	1497cc	TD24323
LEA1	4 Cyl.	16 Valves	1497cc	TD26132
LEA2	4 Cyl.	16 Valves	1497cc	TD30781
LEA2	4 Cyl.	16 Valves	1497cc	TD29485
LEA3	4 Cyl.	16 Valves	1497cc	TD27984
PB355 (x8) PB356 (x8)	NA5058 40.00 x 55.00 x 7.00mm, FPM NB698 80.00 x 98.00 x 10.00mm, FPM			

30 1.5L

Petrol

L15A2	4 Cyl.	8 Valves	1497cc	TD22065
PB355 (x4) PB356 (x4)	NA5058 40.00 x 55.00 x 7.00mm, FPM NB698 80.00 x 98.00 x 10.00mm, FPM			

31 1.6L

Petrol

A16A1	4 Cyl.	12 Valves	1598cc	TD1513
A16A5	4 Cyl.	12 Valves	1598cc	TD22036
D16Z	4 Cyl.	16 Valves	1590cc	TD4522
	NJ313 29.00 x 45.00 x 8.00mm, ACM			

32 1.6L

Petrol

B16A	4 Cyl.	16 Valves	1595cc	TD22039
B16A1	4 Cyl.	16 Valves	1595cc	TD4500
B16A2	4 Cyl.	16 Valves	1595cc	TD1520
PB355 (x8) PB356 (x8)	NJ254 (x2) 27.00 x 43.00 x 9.00mm, NBR			



33 1.6L

Petrol

D16A	4 Cyl.	16 Valves	1590cc	TD17638
D16A6	4 Cyl.	16 Valves	1590cc	TD4518
D16A7	4 Cyl.	16 Valves	1590cc	TD1558
D16B2	4 Cyl.	16 Valves	1590cc	TD9810
D16B5	4 Cyl.	16 Valves	1590cc	TD32885
D16B6	4 Cyl.	16 Valves	1590cc	TD14254
D16B7	4 Cyl.	16 Valves	1590cc	TD22045
D16W1	4 Cyl.	16 Valves	1590cc	TD14248
D16W4	4 Cyl.	16 Valves	1590cc	TD19664
D16W5	4 Cyl.	16 Valves	1590cc	TD18262
D16Y1	4 Cyl.	16 Valves	1590cc	TD23849
D16Y2	4 Cyl.	16 Valves	1590cc	TD4519
D16Y3	4 Cyl.	16 Valves	1590cc	TD4520
D16Y5	4 Cyl.	16 Valves	1590cc	TD14488
D16Y6	4 Cyl.	16 Valves	1590cc	TD14268
D16Y7	4 Cyl.	16 Valves	1590cc	TD11128
D16Y8	4 Cyl.	16 Valves	1590cc	TD4521
D16Y8	4 Cyl.	16 Valves	1590cc	TD29456
D16Z1	4 Cyl.	16 Valves	1590cc	TD23122
D16Z2	4 Cyl.	16 Valves	1590cc	TD1561
D16Z7	4 Cyl.	16 Valves	1590cc	TD1564
D16Z9	4 Cyl.	16 Valves	1590cc	TD1565

PB355 (x8)
PB356 (x8)

NJ313
29.00 x 45.00 x 8.00mm, ACM

NJ381
31.00 x 46.00 x 8.00mm, NBR
NJ312
80.00 x 100.00 x 10.00mm, MVQ

34 1.6L

Petrol

D16A1	4 Cyl.	16 Valves	1590cc	TD25567
D16A2	4 Cyl.	16 Valves	1590cc	TD33644
D16A3	4 Cyl.	16 Valves	1590cc	TD17264
D16A3	4 Cyl.	16 Valves	1590cc	TD22424
D16A8	4 Cyl.	16 Valves	1590cc	TD1552
D16A8	4 Cyl.	16 Valves	1590cc	TD21682
D16A9	4 Cyl.	16 Valves	1590cc	TD1553

PB156 (x8)

NJ254 (x2)
27.00 x 43.00 x 9.00mm, NBR

NJ381
31.00 x 46.00 x 8.00mm, NBR
NJ312
80.00 x 100.00 x 10.00mm, MVQ

35 1.6L

Petrol

D16V1	4 Cyl.	16 Valves	1590cc	TD18257
-------	--------	-----------	--------	---------

PB355 (x8)
PB356 (x8)

NJ313
29.00 x 45.00 x 8.00mm, ACM

NB884
38.00 x 50.00 x 5.50mm, FPM
NJ312
80.00 x 100.00 x 10.00mm, MVQ

36 1.6L

Petrol

D16Z5	4 Cyl.	16 Valves	1590cc	TD4524
-------	--------	-----------	--------	--------

PB156 (x8)
PB354 (x8)



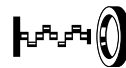
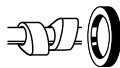

NJ254 (x2)
27.00 x 43.00 x 9.00mm, NBR

NJ381
31.00 x 46.00 x 8.00mm, NBR
NJ312
80.00 x 100.00 x 10.00mm, MVQ



37 1.6L

Petrol

D16Z6	4 Cyl.	16 Valves	1590cc	TD4525
PB355  (x8)	NJ313 		NJ312 	
PB356  (x8)	29.00 x 45.00 x 8.00mm, ACM		80.00 x 100.00 x 10.00mm, MVQ	

38 1.6L

Petrol

EF1	4 Cyl.	12 Valves	1599cc	TD33045
EG	4 Cyl.	8 Valves	1602cc	TD4527
	NJ254		NJ072 	
	27.00 x 43.00 x 9.00mm, NBR		35.00 x 50.00 x 8.00mm, NBR	



39 1.6L

Petrol

EL	4 Cyl.	8 Valves	1602cc	TD1573
EL14	4 Cyl.	8 Valves	1602cc	TD1574
PA313  (x4)	NJ254		NJ072 	
	27.00 x 43.00 x 9.00mm, NBR		35.00 x 50.00 x 8.00mm, NBR	

40 1.6L

Petrol

EW	4 Cyl.	8 Valves	1595cc	TD1588
PA528  (x4)	NJ313			
PA531  (x4)	29.00 x 45.00 x 8.00mm, ACM			

41 1.6L

Petrol

EZ	4 Cyl.	12 Valves	1598cc	TD5048
	NJ313		NJ312 	
	29.00 x 45.00 x 8.00mm, ACM		80.00 x 100.00 x 10.00mm, MVQ	

42 1.6L

Petrol

R16A1	4 Cyl.	16 Valves	1595cc	TD22070
PB355  (x8)			NA5320 	
PB356  (x8)			43.00 x 58.00 x 7.00mm, ACM	
			NB698 	
			80.00 x 98.00 x 10.00mm, FPM	



43 1.6L

Petrol

ZC1	4 Cyl.	16 Valves	1590cc	TD4556
PA528  (x8)	NJ254 (x2)		NJ381 	
PA531  (x8)	27.00 x 43.00 x 9.00mm, NBR		31.00 x 46.00 x 8.00mm, NBR	
			NJ312 	
			80.00 x 100.00 x 10.00mm, MVQ	

44 1.7L

Diesel

4EE-2	4 Cyl.	16 Valves	1686cc	TD18735
PA5041 (x16)	NB884		NJ449 	
HR791 	38.00 x 50.00 x 5.50mm, FPM		40.00 x 52.00 x 6.00mm, NBR	
			NK103 	
			87.00 x 100.00 x 8.50mm, FPM	

45 1.7L

Petrol

B17A1	4 Cyl.	16 Valves	1678cc	TD31949
			NA5089 	
			38.00 x 50.00 x 8.00mm, NBR	



46 1.7L Petrol

D17A1	4 Cyl.	16 Valves	1668cc	TD19273
D17A2	4 Cyl.	16 Valves	1668cc	TD18253
D17A2	4 Cyl.	16 Valves	1668cc	TD29457
D17A5	4 Cyl.	16 Valves	1668cc	TD22046
D17A6	4 Cyl.	16 Valves	1668cc	TD19274
D17A7	4 Cyl.	16 Valves	1668cc	TD19275
D17A8	4 Cyl.	16 Valves	1668cc	TD22047
D17A9	4 Cyl.	16 Valves	1668cc	TD22048
D17Z1	4 Cyl.	16 Valves	1668cc	TD34243

PB355 ■ (x8)
PB356 ■ (x8)

NJ313
29.00 x 45.00 x 8.00mm, ACM

NB884 ■
38.00 x 50.00 x 5.50mm, FPM
NJ312 ■
80.00 x 100.00 x 10.00mm, MVQ

47 1.8L Petrol

B18A1	4 Cyl.	16 Valves	1834cc	TD25282
B18B1	4 Cyl.	16 Valves	1834cc	TD25283
B18B2	4 Cyl.	16 Valves	1834cc	TD25284
B18B6	4 Cyl.	16 Valves	1834cc	TD22040

PB156 ■ (x8)

NJ254 (x2)
27.00 x 43.00 x 9.00mm, NBR

NJ312 ■
80.00 x 100.00 x 10.00mm, MVQ

48 1.8L Petrol

B18A1	4 Cyl.	16 Valves	1834cc	TD29458
B18B1	4 Cyl.	16 Valves	1834cc	TD20343

PB156 (x16)

NJ254
27.00 x 43.00 x 9.00mm, NBR

NJ312 ■
80.00 x 100.00 x 10.00mm, MVQ

49 1.8L Petrol

B18C	4 Cyl.	16 Valves	1797cc	TD27234
B18C1	4 Cyl.	16 Valves	1797cc	TD27052

PB355 ■ (x8)
PB356 ■ (x8)

NB799 (x2)
38.00 x 50.00 x 7.00mm, FPM

NA5089 ■
38.00 x 50.00 x 8.00mm, NBR

50 1.8L Petrol

B18C2	4 Cyl.	16 Valves	1797cc	TD23851
B18C4	4 Cyl.	16 Valves	1797cc	TD14489
B18C6	4 Cyl.	16 Valves	1797cc	TD13192
B18C6	4 Cyl.	16 Valves	1797cc	TD33645

PB355 ■ (x8)
PB356 ■ (x8)

NA5089 ■
38.00 x 50.00 x 8.00mm, NBR

51 1.8L Petrol

B18C5	4 Cyl.	16 Valves	1797cc	TD31962
F18C1	4 Cyl.	16 Valves	1797cc	TD19791
F18C2	4 Cyl.	16 Valves	1797cc	TD19792

NA5089 ■
38.00 x 50.00 x 8.00mm, NBR

52 1.8L Petrol

EK1	4 Cyl.	12 Valves	1751cc	TD33043
-----	--------	-----------	--------	---------

NJ254
27.00 x 43.00 x 9.00mm, NBR

NJ072 ■
35.00 x 50.00 x 8.00mm, NBR



53 1.8L

Petrol

ES2	4 Cyl.	12 Valves	1829cc	TD33046
	NJ313 29.00 x 45.00 x 8.00mm, ACM			

54 1.8L

Petrol

ET1	4 Cyl.	12 Valves	1829cc	TD4535
ET2	4 Cyl.	8 Valves	1829cc	TD4536
ET3	4 Cyl.	8 Valves	1829cc	TD1583
ET4	4 Cyl.	8 Valves	1829cc	TD4537
PA528 (x8)	NJ313 29.00 x 45.00 x 8.00mm, ACM			NJ311 (x) 35.00 x 54.00 x 8.00mm, NBR NJ312 (x) 80.00 x 100.00 x 10.00mm, MVQ

55 1.8L

Petrol

F18A2	4 Cyl.	16 Valves	1849cc	TD1595
F18A2	4 Cyl.	16 Valves	1849cc	TD19790
F18B2	4 Cyl.	16 Valves	1850cc	TD14251
PB355 (x8) PB356 (x8)	NJ134 28.00 x 42.00 x 8.00mm, MVQ			NJ312 (x) 80.00 x 100.00 x 10.00mm, MVQ

56 1.8L

Petrol

R18A1	4 Cyl.	16 Valves	1799cc	TD19281
R18A2	4 Cyl.	16 Valves	1799cc	TD20326
R18A4	4 Cyl.	16 Valves	1799cc	TD31954
R18A9	4 Cyl.	16 Valves	1799cc	TD29772
PB355 (x8) PB356 (x8)				NA5320 (x) 43.00 x 58.00 x 7.00mm, ACM NB698 (x) 80.00 x 98.00 x 10.00mm, FPM

57 1.8L

Diesel

XUD7T	4 Cyl.	8 Valves	1769cc	TD18393
HR569 (x)	NF841 35.00 x 50.00 x 8.00mm, FPM			NA5191 (x) 42.00 x 62.00 x 7.00mm, PTFE NA5192 (x) 90.00 x 110.00 x 7.00mm, PTFE

58 1.9L

Petrol

F18A3	4 Cyl.	16 Valves	1850cc	TD4542
PB355 (x8) PB356 (x8)	NJ134 28.00 x 42.00 x 8.00mm, MVQ			NA5242 (x) 40.00 x 52.00 x 7.00mm, ACM NJ312 (x) 80.00 x 100.00 x 10.00mm, MVQ

59 2.0L

Diesel

20T2N	4 Cyl.	8 Valves	1994cc	TD5390
20T2R	4 Cyl.	8 Valves	1994cc	TD22035
PB354 (x8) HR5051 (x)	NB775 (x2) 40.00 x 52.00 x 7.00mm, FPM			NB774 (x) 35.00 x 45.00 x 7.00mm, FPM



60 2.0L		Petrol			
A20A1	4 Cyl.	12 Valves	1955cc		TD4498
A20A2	4 Cyl.	12 Valves	1955cc		TD1515
A20A3	4 Cyl.	12 Valves	1955cc		TD4499
A20A4	4 Cyl.	12 Valves	1955cc		TD1517
PA528 (x8)	NJ313		NJ311		
PA313 (x4)	29.00 x 45.00 x 8.00mm, ACM		35.00 x 54.00 x 8.00mm, NBR		
			NJ312		
			80.00 x 100.00 x 10.00mm, MVQ		

61 2.0L		Petrol			
B20A1	4 Cyl.	16 Valves	1958cc		TD4502
B20A2	4 Cyl.	16 Valves	1958cc		TD4503
	NJ254 (x2)		NJ312		
	27.00 x 43.00 x 9.00mm, NBR		80.00 x 100.00 x 10.00mm, MVQ		

62 2.0L		Petrol			
B20A3	4 Cyl.	12 Valves	1958cc		TD4504
B20A4	4 Cyl.	12 Valves	1958cc		TD1526
	NJ313		NJ312		
	29.00 x 45.00 x 8.00mm, ACM		80.00 x 100.00 x 10.00mm, MVQ		

63 2.0L		Petrol			
B20A5	4 Cyl.	16 Valves	1958cc		TD1524
PA528 (x8)	NJ254 (x2)		NJ982		
PA531 (x8)	27.00 x 43.00 x 9.00mm, NBR		38.00 x 53.00 x 7.00mm, FPM		
	→12/87		NJ312		
			80.00 x 100.00 x 10.00mm, MVQ		

64 2.0L		Petrol			
B20A6	4 Cyl.	16 Valves	1958cc		TD23853
B20A7	4 Cyl.	16 Valves	1958cc		TD10967
B20A8	4 Cyl.	16 Valves	1958cc		TD4505
B20A9	4 Cyl.	16 Valves	1958cc		TD1525
PA528 (x8)	NJ254 (x2)		NJ982		
PA531 (x8)	27.00 x 43.00 x 9.00mm, NBR		38.00 x 53.00 x 7.00mm, FPM		
			NJ312		
			80.00 x 100.00 x 10.00mm, MVQ		

65 2.0L		Petrol			
B20B	4 Cyl.	16 Valves	1972cc		TD9398
B20B3	4 Cyl.	16 Valves	1973cc		TD25830
B20B4	4 Cyl.	16 Valves	1973cc		TD25582
B20Z1	4 Cyl.	16 Valves	1973cc		TD18256
B20Z2	4 Cyl.	16 Valves	1973cc		TD25583
PB156 (x8)	NJ254 (x2)				
PB354 (x8)	27.00 x 43.00 x 9.00mm, NBR				

66 2.0L		Petrol			
C20A	6 Cyl.	12 Valves	1996cc		TD26090
	NJ933		NB698		
	35.00 x 50.00 x 8.00mm, FPM		80.00 x 98.00 x 10.00mm, FPM		

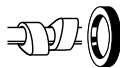

67 2.0L

Petrol

F20A2	4 Cyl.	16 Valves	1997cc	TD1596
F20A3	4 Cyl.	16 Valves	1997cc	TD22266
F20A4	4 Cyl.	16 Valves	1997cc	TD1597
F20A5	4 Cyl.	16 Valves	1997cc	TD25832
F20A6	4 Cyl.	16 Valves	1997cc	TD1599
F20A7	4 Cyl.	16 Valves	1997cc	TD4543
F20A8	4 Cyl.	16 Valves	1997cc	TD1598
F20B	4 Cyl.	16 Valves	1997cc	TD22083
F20B1	4 Cyl.	16 Valves	1997cc	TD22084
F20B2	4 Cyl.	16 Valves	1997cc	TD22975
F20B2	4 Cyl.	16 Valves	1997cc	TD20677
F20B3	4 Cyl.	16 Valves	1997cc	TD4544
F20B5	4 Cyl.	16 Valves	1997cc	TD14249
F20B6	4 Cyl.	16 Valves	1997cc	TD14252
F20B7	4 Cyl.	16 Valves	1997cc	TD18737
F20Z1	4 Cyl.	16 Valves	1997cc	TD4545
F20Z2	4 Cyl.	16 Valves	1997cc	TD4546
F20Z3	4 Cyl.	16 Valves	1997cc	TD1601

PB355 (x8)
PB356 (x8)

NJ134
28.00 x 42.00 x 8.00mm, MVQ



NA5242
40.00 x 52.00 x 7.00mm, ACM
NJ312
80.00 x 100.00 x 10.00mm, MVQ

68 2.0L

Petrol

F20C1	4 Cyl.	16 Valves	1997cc	TD22089
F20C3	4 Cyl.	16 Valves	1997cc	TD22090
F20C VTEC	4 Cyl.	16 Valves	1997cc	TD12448
K20A	4 Cyl.	16 Valves	1998cc	TD19803
K20A	4 Cyl.	16 Valves	1998cc	TD17179
K20A1	4 Cyl.	16 Valves	1998cc	TD22056
K20A2	4 Cyl.	16 Valves	1998cc	TD19246
K20A2	4 Cyl.	16 Valves	1998cc	TD31141
K20A3	4 Cyl.	16 Valves	1998cc	TD18369
K20A3	4 Cyl.	16 Valves	1998cc	TD19804
K20A4	4 Cyl.	16 Valves	1998cc	TD20678
K20A5	4 Cyl.	16 Valves	1998cc	TD26854
K20A6	4 Cyl.	16 Valves	1998cc	TD22073
K20A7	4 Cyl.	16 Valves	1998cc	TD33766
K20A9	4 Cyl.	16 Valves	1998cc	TD18736
K20Z1	4 Cyl.	16 Valves	1998cc	TD23852
K20Z2	4 Cyl.	16 Valves	1997cc	TD27700
K20Z2	4 Cyl.	16 Valves	1997cc	TD29455
K20Z3	4 Cyl.	16 Valves	1998cc	TD19282
K20Z4	4 Cyl.	16 Valves	1998cc	TD22072
R20A	4 Cyl.	16 Valves	1997cc	TD29535
R20A1	4 Cyl.	16 Valves	1997cc	TD23845
R20A2	4 Cyl.	16 Valves	1997cc	TD20329
R20A3	4 Cyl.	16 Valves	1997cc	TD23846
R20A4	4 Cyl.	16 Valves	1997cc	TD22071



R20A5	4 Cyl.	16 Valves	1997cc	TD27690
R20A5	4 Cyl.	16 Valves	1997cc	TD29461
R20A9	4 Cyl.	16 Valves	1997cc	TD27802
PB355  (x8) PB356  (x8)			NA5320  43.00 x 58.00 x 7.00mm, ACM NB698  80.00 x 98.00 x 10.00mm, FPM	





69 2.1L

Petrol

B21A1	4 Cyl.	16 Valves	2056cc	TD1528
PB156  (x8) PB354  (x8)	NJ254 (x2) 27.00 x 43.00 x 9.00mm, NBR		NJ982  38.00 x 53.00 x 7.00mm, FPM NJ312  80.00 x 100.00 x 10.00mm, MVQ	

70 2.2L

Petrol

F22A1	4 Cyl.	16 Valves	2156cc	TD20743
F22A2	4 Cyl.	16 Valves	2156cc	TD22091
F22A3	4 Cyl.	16 Valves	2156cc	TD1604
F22A4	4 Cyl.	16 Valves	2156cc	TD20744
F22A6	4 Cyl.	16 Valves	2156cc	TD20745
F22A7	4 Cyl.	16 Valves	2156cc	TD4547
F22A8	4 Cyl.	16 Valves	2156cc	TD4548
F22A9	4 Cyl.	16 Valves	2156cc	TD33016
F22B1	4 Cyl.	16 Valves	2156cc	TD20746
F22B1	4 Cyl.	16 Valves	2156cc	TD25568
F22B2	4 Cyl.	16 Valves	2156cc	TD20747
F22B2	4 Cyl.	16 Valves	2156cc	TD19793
F22B3	4 Cyl.	16 Valves	2156cc	TD24287
F22B5	4 Cyl.	16 Valves	2156cc	TD4549
F22B6	4 Cyl.	16 Valves	2156cc	TD25584
F22B8	4 Cyl.	16 Valves	2156cc	TD4550
F22B9	4 Cyl.	16 Valves	2156cc	TD26666
F22Z2	4 Cyl.	16 Valves	2156cc	TD4551
F22Z6	4 Cyl.	16 Valves	2156cc	TD24285
PB355  (x8) PB356  (x8)	NJ134 28.00 x 42.00 x 8.00mm, MVQ		NA5242  40.00 x 52.00 x 7.00mm, ACM NJ312  80.00 x 100.00 x 10.00mm, MVQ	



71 2.2L

Petrol

F22C1	4 Cyl.	16 Valves	2157cc	TD19276
PB355  (x8) PB356  (x8)			NA5320  43.00 x 58.00 x 7.00mm, ACM	

72 2.2L

Petrol

H22A1	4 Cyl.	16 Valves	2157cc	TD24263
H22A2	4 Cyl.	16 Valves	2157cc	TD4552
H22A4	4 Cyl.	16 Valves	2157cc	TD24286
H22A5	4 Cyl.	16 Valves	2157cc	TD5499
H22A7	4 Cyl.	16 Valves	2157cc	TD14253
PB355  (x8) PB356  (x8)	NA5245 (x2) 29.00 x 43.00 x 8.00mm		NA5242  40.00 x 52.00 x 7.00mm, ACM NJ312  80.00 x 100.00 x 10.00mm, MVQ	



73 2.2L

Diesel

N22A1	4 Cyl.	16 Valves	2204cc	TD18260
N22A2	4 Cyl.	16 Valves	2204cc	TD20327
N22B1	4 Cyl.	16 Valves	2199cc	TD22066
N22B2	4 Cyl.	16 Valves	2199cc	TD26137
N22B3	4 Cyl.	16 Valves	2199cc	TD24821
N22B4	4 Cyl.	16 Valves	2199cc	TD26225
PB355 (x8) PB356 (x8)				NA5320 43.00 x 58.00 x 7.00mm, ACM

74 2.3L

Petrol

F23A	4 Cyl.	16 Valves	2254cc	TD22080
F23A1	4 Cyl.	16 Valves	2254cc	TD19270
F23A3	4 Cyl.	16 Valves	2254cc	TD22081
F23A4	4 Cyl.	16 Valves	2254cc	TD19272
F23A5	4 Cyl.	16 Valves	2254cc	TD19271
F23A7	4 Cyl.	16 Valves	2254cc	TD19794
F23B	4 Cyl.	16 Valves	2254cc	TD21606
F23Z2	4 Cyl.	16 Valves	2254cc	TD25695
F23Z5	4 Cyl.	16 Valves	2254cc	TD20754
PB355 (x8) PB356 (x8)	NJ134 28.00 x 42.00 x 8.00mm, MVQ			NA5242 40.00 x 52.00 x 7.00mm, ACM NJ312 80.00 x 100.00 x 10.00mm, MVQ

75 2.3L

Petrol

F23A7	4 Cyl.	16 Valves	2254cc	TD12007
PB355 (x8) PB356 (x8)	NJ134 28.00 x 42.00 x 8.00mm, MVQ			NA5242 40.00 x 52.00 x 7.00mm, ACM NJ312 80.00 x 100.00 x 10.00mm, MVQ

76 2.3L

Petrol

H23A1	4 Cyl.	16 Valves	2259cc	TD25585
H23A2	4 Cyl.	16 Valves	2259cc	TD4554
H23A3	4 Cyl.	16 Valves	2259cc	TD4553
PB156 (x8) PB354 (x8)	NJ134 (x2) 28.00 x 42.00 x 8.00mm, MVQ			NA5242 40.00 x 52.00 x 7.00mm, ACM NJ312 80.00 x 100.00 x 10.00mm, MVQ

77 2.3L

Petrol

K23A1	4 Cyl.	16 Valves	2300cc	TD31137
PB355 (x8) PB356 (x8)				



78 2.4L		Petrol			
K24A	4 Cyl.	16 Valves	2354cc		TD17180
K24A1	4 Cyl.	16 Valves	2354cc		TD22049
K24A2	4 Cyl.	16 Valves	2354cc		TD19247
K24A2	4 Cyl.	16 Valves	2354cc		TD19805
K24A3	4 Cyl.	16 Valves	2354cc		TD22051
K24A4	4 Cyl.	16 Valves	2354cc		TD19248
K24A5	4 Cyl.	16 Valves	2354cc		TD22053
K24A6	4 Cyl.	16 Valves	2354cc		TD22054
K24A8	4 Cyl.	16 Valves	2354cc		TD19249
K24W7	4 Cyl.	16 Valves	2356cc		TD29739
K24Z1	4 Cyl.	16 Valves	2354cc		TD25586
K24Z2	4 Cyl.	16 Valves	2354cc		TD24288
K24Z3	4 Cyl.	16 Valves	2354cc		TD22055
K24Z3	4 Cyl.	16 Valves	2354cc		TD26561
K24Z4	4 Cyl.	16 Valves	2354cc		TD24820
K24Z5	4 Cyl.	16 Valves	2354cc		TD26196
K24Z6	4 Cyl.	16 Valves	2354cc		TD28074
K24Z7	4 Cyl.	16 Valves	2354cc		TD29486
K24Z7	4 Cyl.	16 Valves	2354cc		TD29517
K24Z9	4 Cyl.	16 Valves	2354cc		TD32395
PB355 (x8)				NA5320	
PB356 (x8)				43.00 x 58.00 x 7.00mm, ACM	
				NB698	
				80.00 x 98.00 x 10.00mm, FPM	

79 2.5L		Diesel			
4JA1	4 Cyl.	8 Valves	2499cc		TD32048
PA418 (x8)				NA5051	
				40.00 x 56.00 x 7.00mm, FPM	
				NJ014	
				50.00 x 68.00 x 9.00mm, NBR	
				NJ322	
				95.00 x 118.00 x 10.00mm, NBR	

80 2.5L		Petrol			
C25A1	6 Cyl.	24 Valves	2494cc		TD25565
C25A1	6 Cyl.	24 Valves	2494cc		TD4506
C25A2	6 Cyl.	24 Valves	2494cc		TD5393
PA528 (x12)				NJ933 (x2)	
				35.00 x 50.00 x 8.00mm, FPM	
				NB698	
				80.00 x 98.00 x 10.00mm, FPM	

81 2.6L		Petrol			
4ZE1	4 Cyl.	8 Valves	2559cc		TD25581
PA933 (x8)				NA5347	
				30.0 x 45.0 x 7.00mm, FPM	
				NJ323	
				40.00 x 56.00 x 7.00mm, NBR	
				NJ322	
				95.00 x 118.00 x 10.00mm, NBR	

82 2.7L		Petrol			
C27A1	6 Cyl.	24 Valves	2675cc		TD1531
C27A1	6 Cyl.	24 Valves	2675cc		TD4
PA528 (x12)				NJ933 (x2)	
PB156 (x12)				35.00 x 50.00 x 8.00mm, FPM	
				NB698	
				80.00 x 98.00 x 10.00mm, FPM	

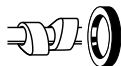

83 2.7L

Petrol

C27A2	6 Cyl.	24 Valves	2675cc	TD25831
C27A4	6 Cyl.	24 Valves	2675cc	TD30252
	NJ933 (x2) 35.00 x 50.00 x 8.00mm, FPM		NB698 80.00 x 98.00 x 10.00mm, FPM	

84 3.0L

Petrol

C30A3	6 Cyl.	24 Valves	2977cc	TD1534
C30A3	6 Cyl.	24 Valves	2977cc	TD20485
C30A4	6 Cyl.	24 Valves	2977cc	TD20486
J30A	6 Cyl.	24 Valves	2997cc	TD22077
J30A1	6 Cyl.	24 Valves	2997cc	TD10710
J30A1	6 Cyl.	24 Valves	2997cc	TD19797
J30A2	6 Cyl.	24 Valves	2997cc	TD20014
J30A4	6 Cyl.	24 Valves	2997cc	TD19243
J30A5	6 Cyl.	24 Valves	2997cc	TD22076
	PB355 (x12) PB356 (x12)		NB698 80.00 x 98.00 x 10.00mm, FPM	

85 3.0L

Petrol

C30A4	6 Cyl.	24 Valves	2977cc	TD4507
	PB355 (x12) PB356 (x12)		NB698 80.00 x 98.00 x 10.00mm, FPM	

86 3.0L

Petrol

J30Y1	6 Cyl.	24 Valves	2997cc	TD31475
			NB698 80.00 x 98.00 x 10.00mm, FPM	

87 3.2L

Petrol

6VD1	6 Cyl.	24 Valves	3165cc	TD19787
6VD1	6 Cyl.	24 Valves	3165cc	TD29452
	HR5094		NA5108 42.00 x 55.00 x 7.00mm, FPM/ACM NJ158 95.00 x 118.00 x 10.00mm, ACM	
	NA5347 30.0 x 45.0 x 7.00mm, FPM			

88 3.2L

Petrol

C32A	6 Cyl.	24 Valves	3206cc	TD5
C32A	6 Cyl.	24 Valves	3206cc	TD22042
C32A2	6 Cyl.	24 Valves	3206cc	TD21677
C32A2	6 Cyl.	24 Valves	3206cc	TD4508
	PB355 (x12) PB356 (x12)		NJ933 (x2) 35.00 x 50.00 x 8.00mm, FPM NB698 80.00 x 98.00 x 10.00mm, FPM	

89 3.2L

Petrol

C32A1	6 Cyl.	24 Valves	3206cc	TD31963
C32A6	6 Cyl.	24 Valves	3206cc	TD25566
C32B1	6 Cyl.	24 Valves	3179cc	TD31950
G32A	6 Cyl.	12 Valves	3206cc	TD19796
J32A2	6 Cyl.	24 Valves	3210cc	TD25569
J32A4	6 Cyl.	24 Valves	3210cc	TD19799
			NB698 80.00 x 98.00 x 10.00mm, FPM	



90 3.2L		Petrol		
C32B2	6 Cyl.	24 Valves	3179cc	TD18258
C32B2	6 Cyl.	24 Valves	3179cc	TD20487
J32A	6 Cyl.	24 Valves	3210cc	TD22075
J32A1	6 Cyl.	24 Valves	3210cc	TD19798
J32A5	6 Cyl.	24 Valves	3210cc	TD19800
PB355 (x12)				NB698
PB356 (x12)				80.00 x 98.00 x 10.00mm, FPM

91 3.5L		Petrol		
6 VE1	6 Cyl.	24 Valves	3494cc	TD29459
		NA5347		NB5108
		30.0 x 45.0 x 7.00mm, FPM		42.00 x 55.00 x 7.00mm, FPM/ACM

92 3.5L		Petrol		
C35A1	6 Cyl.	24 Valves	3475cc	TD31139
C35A2	6 Cyl.	24 Valves	3474cc	TD19788
C35A2	6 Cyl.	24 Valves	3474cc	TD5394
C35A5	6 Cyl.	24 Valves	3474cc	TD19789
C35A8	6 Cyl.	24 Valves	3471cc	TD22043
C35A8	6 Cyl.	24 Valves	3471cc	TD21151
PB355 (x12)		NJ933 (x2)		NB698
PB356 (x12)		35.00 x 50.00 x 8.00mm, FPM		80.00 x 98.00 x 10.00mm, FPM

93 3.5L		Petrol		
J35A	6 Cyl.	24 Valves	3471cc	TD22074
J35A1	6 Cyl.	24 Valves	3471cc	TD19801
J35A1	6 Cyl.	24 Valves	3474cc	TD31955
J35A3	6 Cyl.	24 Valves	3471cc	TD26660
J35A4	6 Cyl.	24 Valves	3471cc	TD19802
J35A4	6 Cyl.	24 Valves	3471cc	TD19244
J35A5	6 Cyl.	24 Valves	3471cc	TD19245
J35A5	6 Cyl.	24 Valves	3471cc	TD25570
J35A6	6 Cyl.	24 Valves	3471cc	TD19277
J35A6	6 Cyl.	24 Valves	3471cc	TD21686
J35A7	6 Cyl.	24 Valves	3471cc	TD19278
J35A8	6 Cyl.	24 Valves	3471cc	TD29235
J35A8	6 Cyl.	24 Valves	3471cc	TD19279
J35A9	6 Cyl.	24 Valves	3471cc	TD19280
J35Y1	6 Cyl.	24 Valves	3471cc	TD29488
J35Y4	6 Cyl.	24 Valves	3471cc	TD29562
J35Y5	6 Cyl.	24 Valves	3471cc	TD31472
J35Y6	6 Cyl.	24 Valves	3471cc	TD31320
J35Y6	6 Cyl.	24 Valves	3471cc	TD31845
J35Z1	6 Cyl.	24 Valves	3471cc	TD19283
J35Z2	6 Cyl.	24 Valves	3471cc	TD29460
J35Z2	6 Cyl.	24 Valves	3471cc	TD23850
J35Z4	6 Cyl.	24 Valves	3471cc	TD26649
J35Z5	6 Cyl.	24 Valves	3471cc	TD27448
J35Z6	6 Cyl.	24 Valves	3471cc	TD26562
PB355 (x12)				NB698
PB356 (x12)				80.00 x 98.00 x 10.00mm, FPM

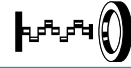

94 3.7L

Petrol

J37A1	6 Cyl.	24 Valves	3664cc	TD31483
J37A2	6 Cyl.	24 Valves	3664cc	TD26340
J37A2	6 Cyl.	24 Valves	3664cc	TD21687
J37A3	6 Cyl.	24 Valves	3664cc	TD23546
J37A4	6 Cyl.	24 Valves	3664cc	TD29616
J37A5	6 Cyl.	24 Valves	3664cc	TD31476

PB355 ■ (x12)
PB356 ■ (x12)

NB698 ■
 80.00 x 98.00 x 10.00mm, FPM



CC



9

Accent	02/06→12/10	G4ED	Petrol	1599	4	16	22
Accent	02/06→12/13	G4EE	Petrol	1399	4	16	12
Accent Box (X-2)	10/91→11/94	G4DJ	Petrol	1468	4	8	15
Accent I (X-3)	10/94→01/00	G4EH	Petrol	1341	4	12	8
Accent I (X-3)	10/94→01/00	G4EK	Petrol	1495	4	12	16
Accent I (X-3)	10/94→01/00	G4FK	Petrol	1495	4	16	17
Accent I (X-3)	12/95→01/00	G4ER	Petrol	1495	4	16	17
Accent II (LC)	09/99→10/02	G4EK	Petrol	1495	4	12	16
Accent II (LC)	09/99→10/02	G4FK	Petrol	1495	4	16	17
Accent II (LC)	01/00→11/05	G4EA	Petrol	1341	4	12	8
Accent II (LC)	01/00→11/05	G4EB	Petrol	1495	4	12	16
Accent II (LC)	01/00→11/05	G4ED	Petrol	1599	4	16	22
Accent II (LC)	09/00→11/05	G4EC-G	Petrol	1495	4	16	17
Accent II (LC)	04/02→11/05	D3EA	Diesel	1493	3	12	13
Accent II (LC)	08/02→11/05	G4EH	Petrol	1341	4	12	8
Accent II (LC)	12/02→11/05	G4ED-G	Petrol	1599	4	16	22
Accent II Saloon (LC)	09/99→10/02	G4FK	Petrol	1495	4	16	17
Accent II Saloon (LC)	01/00→11/05	G4EA	Petrol	1341	4	12	8
Accent II Saloon (LC)	01/00→11/05	G4EB	Petrol	1495	4	12	16
Accent II Saloon (LC)	01/00→12/06	G4EK	Petrol	1495	4	12	16
Accent II Saloon (LC)	09/00→12/05	G4ED	Petrol	1599	4	16	22
Accent II Saloon (LC)	01/02→11/05	D3EA	Diesel	1493	3	12	13
Accent II Saloon (LC)	12/02→11/05	G4ED-G	Petrol	1599	4	16	22
Accent III (MC)	11/05→11/10	D4FA	Diesel	1493	4	16	14
Accent III (MC)	11/05→11/10	G4ED	Petrol	1599	4	16	22
Accent III (MC)	11/05→11/10	G4EE	Petrol	1399	4	16	12
Accent III Saloon (MC)	11/05→12/09	G4GR	Petrol	1599	4	16	23
Accent III Saloon (MC)	11/05→11/10	D4FA	Diesel	1493	4	16	14
Accent III Saloon (MC)	11/05→11/10	G4ED	Petrol	1599	4	16	22
Accent III Saloon (MC)	11/05→11/10	G4EE	Petrol	1399	4	16	12
Accent III Saloon (MC)	01/08→11/10	G4EK	Petrol	1495	4	12	16
Accent IV (RB)	12/10→	D4FC	Diesel	1396	4	16	11
Accent IV (RB)	07/11→	D4FB	Diesel	1582	4	16	20
Accent IV Saloon (RB)	08/10→	D4FA	Diesel	1493	4	16	14
Accent IV Saloon (RB)	08/10→	G4ED	Petrol	1599	4	16	22
Accent IV Saloon (RB)	11/10→	D4FB	Diesel	1582	4	16	20
Accent IV Saloon (RB)	11/10→	D4FC	Diesel	1396	4	16	11
Accent Saloon (LC)	09/99→10/02	G4FK	Petrol	1495	4	16	17
Accent Saloon (X-3)	10/94→01/00	G4EH	Petrol	1341	4	12	8
Accent Saloon (X-3)	10/94→01/00	G4EK	Petrol	1495	4	12	16
Accent Saloon (X-3)	10/95→01/00	G4ER	Petrol	1495	4	16	17
Aslan	06/14→	G6DG	Petrol	2999	6	24	55
Aslan	06/14→	G6DH	Petrol	3342	6	24	56
Atos (MX)	01/97→	G4HG	Petrol	1086	4	12	4
Atos (MX)	02/98→08/08	G4HC	Petrol	999	4	12	2
Atos (MX)	03/01→07/03	G4HC-E	Petrol	999	4	12	2
Atos (MX)	08/03→05/05	G4HD	Petrol	1086	4	12	4
Atos Prime (MX)	01/97→12/08	G4HG	Petrol	1086	4	12	4
Atos Prime (MX)	08/99→	G4HC	Petrol	999	4	12	2
Atos Prime (MX)	03/01→07/03	G4HC-E	Petrol	999	4	12	2
Atos Prime (MX)	08/03→05/05	G4HD	Petrol	1086	4	12	4
Coupe (GK)	01/01→08/09	G6BA-G	Petrol	2656	6	24	50
Coupe (GK)	08/01→08/09	G4GC-G	Petrol	1975	4	16	38
Coupe (GK)	03/02→08/09	G4ED-G	Petrol	1599	4	16	22
Coupe (RD)	07/96→04/02	G4GM	Petrol	1795	4	16	28
Coupe (RD)	08/96→04/02	G4GF	Petrol	1975	4	16	38
Coupe (RD)	12/96→04/02	G4GR	Petrol	1599	4	16	23
Coupe (RD)	08/99→04/02	G4DF	Petrol	1975	4	16	38
Coupe (RD)	08/00→01/02	G4ED-G	Petrol	1599	4	16	22
Creta	01/16→	D4FB	Diesel	1582	4	16	20
Creta	01/16→	D4FC	Diesel	1396	4	16	11
Dynasty	05/96→05/05	G67A	Petrol	3497	6	24	57
Dynasty	05/96→05/05	G6AV	Petrol	2497	6	24	48
Elantra (XD)	06/00→07/06	G4BB	Petrol	1795	4	16	28
Elantra (XD)	06/00→07/06	G4ED-G	Petrol	1599	4	16	22
Elantra (XD)	06/00→07/06	G4GB	Petrol	1795	4	16	31
Elantra (XD)	06/00→07/06	G4GC	Petrol	1975	4	16	38
Elantra (XD)	06/00→07/06	G4GC-G	Petrol	1975	4	16	38
Elantra (XD)	06/00→07/06	G4GR	Petrol	1599	4	16	23
Elantra (XD)	04/01→07/06	D4EA	Diesel	1991	4	16	35
Elantra (XD)	09/03→07/06	G4GA	Petrol	1599	4	16	22
Elantra Estate	03/98→06/02	G4GB	Petrol	1795	4	16	31
Elantra Estate	09/08→	G4GC	Petrol	1975	4	16	38
Elantra Saloon	12/03→12/14	G4ED-G	Petrol	1599	4	16	22
Elantra Saloon (AD)	02/16→	D4FB	Diesel	1582	4	16	20
Elantra Saloon (HD)	11/05→12/11	D4FB	Diesel	1582	4	16	20
Elantra Saloon (HD)	06/06→06/11	G4GC	Petrol	1975	4	16	38
Elantra Saloon (MD, UD)	02/11→	D4FB	Diesel	1582	4	16	20







CC



9

Elantra Saloon (MD, UD)	09/13→	G4NC	Petrol	1999	4	16	40
Elantra Saloon (XD)	06/00→07/06	D4FA	Diesel	1493	4	16	14
Elantra Saloon (XD)	06/00→07/06	G4BB	Petrol	1795	4	16	28
Elantra Saloon (XD)	06/00→07/06	G4ED-G	Petrol	1599	4	16	22
Elantra Saloon (XD)	06/00→07/06	G4GB	Petrol	1795	4	16	31
Elantra Saloon (XD)	06/00→07/06	G4GC	Petrol	1975	4	16	38
Elantra Saloon (XD)	06/00→07/06	G4GC-G	Petrol	1975	4	16	38
Elantra Saloon (XD)	06/00→07/06	G4GR	Petrol	1599	4	16	23
Elantra Saloon (XD)	09/00→07/06	G4EC-G	Petrol	1495	4	16	17
Elantra Saloon (XD)	04/01→07/06	D4EA	Diesel	1991	4	16	35
Elantra Saloon (XD)	09/02→12/03	G4DF	Petrol	1975	4	16	38
Entourage Mini Passenger Van	09/06→12/08	G6DA	Petrol	3778	6	24	60
Equus / Centennial	03/09→	G6DA	Petrol	3778	6	24	60
Equus / Centennial	03/09→	G6DJ	Petrol	3778	6	24	61
Equus / Centennial (JS)	10/99→03/09	G6CU	Petrol	3497	6	24	58
Equus / Centennial (JS)	10/04→03/09	G6DB	Petrol	3342	6	24	56
Excel Hatchback	01/92→11/95	G4AJ	Petrol	1468	4	8	15
Excel Saloon	01/92→11/95	G4AJ	Petrol	1468	4	8	15
Galloper I	08/91→07/98	4D56T	Diesel	2477	4	8	46
Galloper I	08/91→07/98	G672	Petrol	2972	6	12	52
Galloper II (JK-01)	08/98→06/03	D4BB	Diesel	2607	4	8	49
Galloper II (JK-01)	08/98→12/03	D4BA	Diesel	2477	4	8	46
Galloper II (JK-01)	08/98→12/03	D4BF	Diesel	2476	4	8	46
Galloper II (JK-01)	08/98→12/03	D4BH	Diesel	2476	4	8	46
Galloper II (JK-01)	08/98→12/03	G6AT	Petrol	2972	6	12	54
Genesis (BH)	01/08→12/14	G6DA	Petrol	3778	6	24	60
Genesis (BH)	01/08→12/14	G6DB	Petrol	3342	6	24	56
Genesis (BH)	01/08→12/14	G6DH	Petrol	3342	6	24	56
Genesis (BH)	01/08→12/14	G6DJ	Petrol	3778	6	24	61
Genesis (BH)	01/12→12/15	G6DG	Petrol	2999	6	24	55
Genesis (DH)	06/14→	G6DG	Petrol	2999	6	24	55
Genesis (DH)	06/14→	G6DJ	Petrol	3778	6	24	61
Genesis (DH)	08/14→	G6DH	Petrol	3342	6	24	56
Genesis Coupe	01/08→12/14	G4KF	Petrol	1998	4	16	39
Genesis Coupe	01/08→	G6DA	Petrol	3778	6	24	60
Genesis Coupe	11/11→	G6DJ	Petrol	3778	6	24	61
Getz (TB)	09/02→12/06	G4ED-G	Petrol	1599	4	16	22
Getz (TB)	09/02→06/09	G4EA	Petrol	1341	4	12	8
Getz (TB)	09/02→06/09	G4HD	Petrol	1086	4	12	4
Getz (TB)	03/03→09/05	D3EA	Diesel	1493	3	12	13
Getz (TB)	03/03→09/05	G4EC-G	Petrol	1495	4	16	17
Getz (TB)	03/03→09/05	G4ER	Petrol	1495	4	16	17
Getz (TB)	07/04→06/09	D4FA	Diesel	1493	4	16	14
Getz (TB)	08/05→12/10	G4EE	Petrol	1399	4	16	12
Getz (TB)	09/05→06/09	G4HG	Petrol	1086	4	12	4
Grace Box	07/93→12/04	G4CS	Petrol	2351	4	8	43
Grace Bus	07/93→06/94	D4BA	Diesel	2477	4	8	46
Grace Bus	06/98→10/01	D4BF	Diesel	2476	4	8	46
Grace Bus	10/99→10/04	D4BB	Diesel	2607	4	8	49
Grandeur	09/89→07/92	G672 (DOHC 24V)	Petrol	2972	6	24	53
Grandeur (HG)	01/11→	G4KJ	Petrol	2359	4	16	45
Grandeur (HG)	01/11→	G6DG	Petrol	2999	6	24	55
Grandeur (HG)	01/11→	G6DJ	Petrol	3778	6	24	61
Grandeur (HG)	02/11→	G6DH	Petrol	3342	6	24	56
Grandeur (HG)	06/11→	G6BA	Petrol	2656	6	24	50
Grandeur (HG)	07/11→	G4KE	Petrol	2359	4	16	45
Grandeur (IG)	11/16→	G4KJ	Petrol	2359	4	16	45
Grandeur (IG)	11/16→	G6DH	Petrol	3342	6	24	56
Grandeur (TG)	04/05→	G6DB	Petrol	3342	6	24	56
Grandeur (TG)	06/05→12/11	G6DA	Petrol	3778	6	24	60
Grandeur (TG)	05/06→10/10	G6BA	Petrol	2656	6	24	50
Grandeur (TG)	06/06→12/11	D4EB	Diesel	2188	4	16	41
Grandeur (TG)	09/06→12/09	G4KC	Petrol	2359	4	16	45
Grandeur (TG)	01/09→12/10	G6EA	Petrol	2656	6	24	50
Grandeur II	08/94→05/99	G673	Petrol	2497	6	24	47
Grand Santa Fé	01/13→	G6DF	Petrol	3342	6	24	56
Grand Santa Fé	07/13→	G6DG	Petrol	2999	6	24	55
Grand Santa Fé	07/13→	G6DH	Petrol	3342	6	24	56
Grand Santa Fé	08/15→	G4KH	Petrol	1998	4	16	39
H-1 Box	10/97→04/04	D4BA	Diesel	2477	4	8	46
H-1 Box	10/97→12/07	D4BB	Diesel	2607	4	8	49
H-1 Box	10/98→04/08	D4BF	Diesel	2476	4	8	46
H-1 Box	03/00→04/04	G4CS	Petrol	2351	4	8	43
H-1 Box	03/00→08/07	D4BH	Diesel	2476	4	8	46
H-1 Cargo (TQ)	02/08→	G4KC	Petrol	2359	4	16	45
H-1 Cargo (TQ)	08/15→	G4KE	Petrol	2359	4	16	45
H-1 Platform/Chassis	06/00→04/04	D4BA	Diesel	2477	4	8	46
H-1 Platform/Chassis	06/00→10/05	D4BH	Diesel	2476	4	8	46

				CC			9
H-1 / Starex	10/97→04/04	D4BB	Diesel	2607	4	8	49
H-1 / Starex	10/97→04/04	D4BF	Diesel	2476	4	8	46
H-1 / Starex	02/03→04/04	G4JS	Petrol	2351	4	16	42
H-1 / Starex MPV	06/97→04/04	D4BF	Diesel	2476	4	8	46
H-1 / Starex MPV	06/97→04/04	G4CS	Petrol	2351	4	8	43
H-1 / Starex MPV	10/97→12/07	D4BH	Diesel	2476	4	8	46
H-1 / Starex MPV	06/01→04/04	G4JS	Petrol	2351	4	16	42
H-1 Travel (TQ)	02/08→	G4CS	Petrol	2351	4	8	43
H-1 Travel (TQ)	02/08→	G4KC	Petrol	2359	4	16	45
H100 Box	07/93→12/94	D4BX	Diesel	2477	4	8	46
H100 Box	07/93→03/00	D4BA	Diesel	2477	4	8	46
H100 Box	07/93→12/04	D4BB	Diesel	2607	4	8	49
H100 Box	07/93→12/04	G4CS	Petrol	2351	4	8	43
H100 Box	06/98→10/03	D4BF	Diesel	2476	4	8	46
H100 Bus (P)	07/93→12/94	D4BX	Diesel	2477	4	8	46
H100 Bus (P)	07/93→03/00	D4BA	Diesel	2477	4	8	46
H100 Bus (P)	07/93→03/00	D4BF	Diesel	2476	4	8	46
H100 Bus (P)	07/93→03/00	G4CS	Petrol	2351	4	8	43
H100 Bus (P)	10/99→10/04	D4BB	Diesel	2607	4	8	49
H100 Pickup	05/96→12/97	D4BB	Diesel	2607	4	8	49
H100 Pickup	05/96→10/01	D4BA	Diesel	2477	4	8	46
H100 Platform/Chassis	07/93→12/97	D4BA	Diesel	2477	4	8	46
H100 Platform/Chassis	09/94→08/98	D4BF	Diesel	2476	4	8	46
H100 Platform/Chassis	03/96→08/98	D4BH	Diesel	2476	4	8	46
H100 Platform/Chassis	04/96→10/06	D4BB	Diesel	2607	4	8	49
H100 Platform/Chassis	05/96→12/97	G4CS	Petrol	2351	4	8	43
H100 Platform/Chassis	11/06→	4D56T	Diesel	2477	4	8	46
Highway Van	03/00→03/04	G4JP	Petrol	1997	4	16	36
Highway Van	03/00→03/04	G6BA	Petrol	2656	6	24	50
Highway Van	03/01→03/04	D4EA	Diesel	1991	4	16	35
Highway Van	11/03→03/04	G4GC	Petrol	1975	4	16	38
i10 (BA, IA)	12/13→	D3FA	Diesel	1120	3	12	3
i10 (BA, IA)	12/13→	G4LA	Petrol	1248	4	16	5
i10 (PA)	12/07→12/13	G4HG	Petrol	1086	4	12	4
i10 (PA)	01/08→12/11	D3FA	Diesel	1120	3	12	3
i10 (PA)	11/08→12/13	G4LA	Petrol	1248	4	16	5
i10 Saloon	12/13→	G4LA	Petrol	1248	4	16	5
i10 Saloon	03/14→	D3FA	Diesel	1120	3	12	3
i20 (GB)	11/14→	D3FA	Diesel	1120	3	12	3
i20 (GB)	11/14→	D4FC	Diesel	1396	4	16	11
i20 (GB)	11/14→	G4LA	Petrol	1248	4	16	5
i20 (PB, PBT)	08/08→12/15	D4FC	Diesel	1396	4	16	11
i20 (PB, PBT)	09/08→12/12	D4FB	Diesel	1582	4	16	20
i20 (PB, PBT)	09/08→12/15	G4LA	Petrol	1248	4	16	5
i20 (PB, PBT)	03/12→12/15	D3FA	Diesel	1120	3	12	3
i20 ACTIVE (GB)	09/15→	D4FC	Diesel	1396	4	16	11
i20 Coupe (GB)	05/15→	D3FA	Diesel	1120	3	12	3
i20 Coupe (GB)	05/15→	D4FC	Diesel	1396	4	16	11
i20 Coupe (GB)	05/15→	G4LA	Petrol	1248	4	16	5
i30 (FD)	10/07→11/11	D4EA-F	Diesel	1991	4	16	35
i30 (FD)	10/07→11/11	D4FB	Diesel	1582	4	16	20
i30 (FD)	10/07→11/11	G4GC	Petrol	1975	4	16	38
i30 (FD)	10/07→11/11	G4GC-G	Petrol	1975	4	16	38
i30 (GD)	11/11→12/16	D4FB	Diesel	1582	4	16	20
i30 (GD)	12/11→12/16	D4FC	Diesel	1396	4	16	11
i30 (GD)	09/13→	G4NC	Petrol	1999	4	16	40
i30 (PDE, PD)	11/16→	D4FB	Diesel	1582	4	16	20
i30 (PDE, PD)	07/17→	G4KH	Petrol	1998	4	16	39
i30 Coupe	05/13→	D4FB	Diesel	1582	4	16	20
i30 Coupe	05/13→	D4FC	Diesel	1396	4	16	11
i30 Estate	03/17→	D4FB	Diesel	1582	4	16	20
i30 Estate (FD)	02/08→06/12	D4EA-F	Diesel	1991	4	16	35
i30 Estate (FD)	02/08→06/12	D4FB	Diesel	1582	4	16	20
i30 Estate (FD)	02/08→06/12	G4GC	Petrol	1975	4	16	38
i30 Estate (FD)	02/08→06/12	G4GC-G	Petrol	1975	4	16	38
i30 Estate (GD)	06/12→12/15	D4FB-5P	Diesel	1582	4	16	20
i30 Estate (GD)	06/12→	D4FB	Diesel	1582	4	16	20
i30 Estate (GD)	06/12→	D4FC	Diesel	1396	4	16	11
i40 (VF)	03/12→	D4FD	Diesel	1685	4	16	25
i40 (VF)	03/12→	G4NC	Petrol	1999	4	16	40
i40 CW (VF)	07/11→	D4FD	Diesel	1685	4	16	25
i40 CW (VF)	07/11→	G4NC	Petrol	1999	4	16	40
ix20 (JC)	11/10→	D4FC	Diesel	1396	4	16	11
ix20 (JC)	06/11→	D4FB	Diesel	1582	4	16	20
ix20 (JC)	06/11→	D4FC-M	Diesel	1396	4	16	11
ix35	04/10→12/12	G4KD	Petrol	1998	4	16	39
ix35 (LM, EL)	08/09→	G4KD	Petrol	1998	4	16	39
ix35 (LM, EL, ELH)	08/09→	G4KD	Petrol	1998	4	16	39







CC



9

ix35 (LM, EL, ELH)	01/10→	G4KE	Petrol	2359	4	16	45
ix35 (LM, EL, ELH)	11/10→	D4FD	Diesel	1685	4	16	25
ix35 (LM, EL, ELH)	01/13→	G4KJ	Petrol	2359	4	16	45
ix35 (LM, EL, ELH)	08/13→	G4NC	Petrol	1999	4	16	40
ix35 (LM, EL, ELH)	07/14→	G4GC	Petrol	1975	4	16	38
ix55	01/07→	G6DA	Petrol	3778	6	24	60
Kona (OS)	07/17→	D4FB	Diesel	1582	4	16	20
Lantra I (J-1)	10/90→11/95	G4CN	Petrol	1836	4	16	30
Lantra I (J-1)	10/90→11/95	G4CR	Petrol	1596	4	16	21
Lantra I (J-1)	10/90→11/95	G4DJ	Petrol	1468	4	8	15
Lantra I (J-1)	10/90→11/95	G15B	Petrol	1468	4	8	18
Lantra II (J-2)	09/95→12/97	G4BB	Petrol	1795	4	16	28
Lantra II (J-2)	09/95→09/00	G4GM	Petrol	1795	4	16	28
Lantra II (J-2)	11/95→10/00	G4FK	Petrol	1495	4	16	17
Lantra II (J-2)	11/95→10/00	G4GR	Petrol	1599	4	16	23
Lantra II (J-2)	08/96→09/00	G4GF	Petrol	1975	4	16	38
Lantra II (J-2)	12/96→09/00	G4EK	Petrol	1495	4	12	16
Lantra II (J-2)	04/97→05/00	G4JP	Petrol	1997	4	16	36
Lantra II (J-2)	09/97→12/98	G4CN	Petrol	1836	4	16	30
Lantra II (J-2)	03/98→09/00	DJY	Diesel	1905	4	8	33
Lantra II Wagon (J-2)	02/96→12/97	G4BB	Petrol	1795	4	16	28
Lantra II Wagon (J-2)	02/96→10/00	G4GM	Petrol	1795	4	16	28
Lantra II Wagon (J-2)	02/96→10/00	G4GR	Petrol	1599	4	16	23
Lantra II Wagon (J-2)	12/96→10/00	G4GF	Petrol	1975	4	16	38
Lantra II Wagon (J-2)	04/97→05/00	G4JP	Petrol	1997	4	16	36
Lantra II Wagon (J-2)	04/97→10/00	G4EK	Petrol	1495	4	12	16
Lantra II Wagon (J-2)	03/98→10/00	DJY	Diesel	1905	4	8	33
Marcia	05/93→05/96	G62B	Petrol	1796	4	8	32
Marcia	05/93→05/98	G4CP	Petrol	1997	4	8	34
Marcia	05/93→05/98	G6AT	Petrol	2972	6	12	54
Marcia	07/96→05/98	G4CP-D	Petrol	1997	4	16	37
Marcia	07/96→05/98	G4JP	Petrol	1997	4	16	36
Matrix (FC)	06/01→08/10	G4EC-G	Petrol	1495	4	16	17
Matrix (FC)	06/01→08/10	G4ED-G	Petrol	1599	4	16	22
Matrix (FC)	06/01→08/10	G4GB-G	Petrol	1795	4	16	28
Matrix (FC)	10/01→08/10	D3EA	Diesel	1493	3	12	13
Matrix (FC)	01/02→12/05	G4ED-L	Petrol	1599	4	16	22
Matrix (FC)	12/04→08/10	D4FA	Diesel	1493	4	16	14
Pony	06/74→12/82	J12G	Petrol	1238	4	8	6
Pony	08/77→12/85	4G33	Petrol	1439	4	8	10
Pony (X-1)	09/85→12/89	G4DJ	Petrol	1468	4	8	15
Pony (X-1)	10/85→09/89	G4AJ	Petrol	1468	4	8	15
Pony (X-1)	10/85→09/89	G13B	Petrol	1299	4	8	9
Pony (X-1)	10/85→09/89	G15B	Petrol	1468	4	8	18
Pony (X-2)	10/89→01/95	G4DG	Petrol	1299	4	8	7
Pony (X-2)	10/89→01/95	G4DJ	Petrol	1468	4	8	15
Pony (X-2)	10/89→01/95	G15B	Petrol	1468	4	8	18
Pony / Excel Saloon (X-2)	09/89→01/95	G4DG	Petrol	1299	4	8	7
Pony / Excel Saloon (X-2)	01/90→01/95	G4DJ	Petrol	1468	4	8	15
Pony / Excel Saloon (X-2)	01/90→01/95	G15B	Petrol	1468	4	8	18
Pony Saloon (X-1)	10/85→09/89	G4DJ	Petrol	1468	4	8	15
Pony Saloon (X-1)	10/85→09/89	G13B	Petrol	1299	4	8	9
Pony Saloon (X-1)	10/85→09/89	G15B	Petrol	1468	4	8	18
Pony Wagon	02/78→06/86	4G33	Petrol	1439	4	8	10
Pony Wagon	02/78→06/86	J12G	Petrol	1238	4	8	6
Porter Box	07/94→04/04	D4BA	Diesel	2477	4	8	46
Porter Box	07/94→04/04	D4BB	Diesel	2607	4	8	49
Porter Box	07/94→	D4BH	Diesel	2476	4	8	46
Porter Box	03/96→04/04	G4CS	Petrol	2351	4	8	43
Porter Bus	07/94→04/04	D4BA	Diesel	2477	4	8	46
Porter Bus	03/96→04/04	G4CS	Petrol	2351	4	8	43
Porter Pickup	07/94→04/04	D4BA	Diesel	2477	4	8	46
Porter Pickup	07/94→04/04	D4BH	Diesel	2476	4	8	46
Porter Pickup	07/94→12/04	D4BB	Diesel	2607	4	8	49
Porter Pickup	03/96→04/04	G4CS	Petrol	2351	4	8	43
Porter Platform/Chassis	01/05→	D4BA	Diesel	2477	4	8	46
Porter Platform/Chassis	04/07→	D4BH	Diesel	2476	4	8	46
Santa Fé Closed Off-Road Vehicle	10/16→	D4EA	Diesel	1991	4	16	35
Santa Fé I (SM)	11/00→03/06	G4JS	Petrol	2351	4	16	42
Santa Fé I (SM)	11/00→03/06	G6EA	Petrol	2656	6	24	50
Santa Fé I (SM)	02/01→03/06	G4JS-G	Petrol	2351	4	16	44
Santa Fé I (SM)	02/01→03/06	G6BA-G	Petrol	2656	6	24	50
Santa Fé I (SM)	04/01→03/06	D4EA	Diesel	1991	4	16	35
Santa Fé I (SM)	08/01→03/06	G4BP	Petrol	1997	4	16	36
Santa Fé I (SM)	09/02→03/06	G6CU	Petrol	3497	6	24	58
Santa Fé I (SM)	08/03→03/06	D4EA-V	Diesel	1991	4	16	35
Santa Fé I (SM)	11/03→02/06	D4EA-F	Diesel	1991	4	16	35
Santa Fé I (SM)	09/04→12/05	G6BA	Petrol	2656	6	24	50

				CC			9
Santa Fé II (CM)	03/06→12/09	G6EA	Petrol	2656	6	24	50
Santa Fé II (CM)	03/06→12/12	D4EA	Diesel	1991	4	16	35
Santa Fé II (CM)	03/06→12/12	D4EB	Diesel	2188	4	16	41
Santa Fé II (CM)	03/06→12/12	G6BA	Petrol	2656	6	24	50
Santa Fé II (CM)	03/06→12/12	G6DB	Petrol	3342	6	24	56
Santa Fé II (CM)	09/09→12/12	G4KE	Petrol	2359	4	16	45
Santa Fé II (CM)	09/09→12/12	G6DC	Petrol	3470	6	24	59
Santa Fé III (DM)	09/12→	G4KE	Petrol	2359	4	16	45
Santa Fé III (DM)	09/12→	G4KJ	Petrol	2359	4	16	45
Santa Fé III (DM)	09/12→	G6DH	Petrol	3342	6	24	56
Santa Fé III (DM)	01/13→	G4KH	Petrol	1998	4	16	39
Santa Fé III (DM)	01/13→	G6DG	Petrol	2999	6	24	55
Santa Fé III (DM)	01/14→	G6DF	Petrol	3342	6	24	56
Santamo	10/98→10/02	G4CP	Petrol	1997	4	8	34
Santamo	05/99→12/02	G4CP-D	Petrol	1997	4	16	37
Santamo	05/99→12/02	G4JP	Petrol	1997	4	16	36
S Coupe (SLC)	02/90→05/96	G4DJ	Petrol	1468	4	8	15
S Coupe (SLC)	02/90→05/96	G15B	Petrol	1468	4	8	18
S Coupe (SLC)	04/91→05/96	G4EK-TC	Petrol	1495	4	12	16
S Coupe (SLC)	04/92→05/96	G4EK	Petrol	1495	4	12	16
Solaris Saloon	01/17→	D4FB	Diesel	1582	4	16	20
Sonata (NFC)	12/08→12/12	G4KD	Petrol	1998	4	16	39
Sonata (YF)	04/11→	G4KD	Petrol	1998	4	16	39
Sonata II (Y-2)	09/88→08/91	G4CP	Petrol	1997	4	8	34
Sonata II (Y-2)	09/88→12/91	G4CS	Petrol	2351	4	8	43
Sonata II (Y-2)	09/88→10/93	4G62	Petrol	1796	4	8	27
Sonata II (Y-2)	01/91→10/93	G4CP-D	Petrol	1997	4	16	37
Sonata II (Y-2)	01/91→10/93	G4CP-U	Petrol	1997	4	8	34
Sonata II (Y-2)	01/91→10/93	G6AT	Petrol	2972	6	12	54
Sonata III (Y-3)	05/93→08/96	G4CP	Petrol	1997	4	8	34
Sonata III (Y-3)	05/93→06/98	G4CM	Petrol	1796	4	8	29
Sonata III (Y-3)	05/93→06/98	G4CP-D	Petrol	1997	4	16	37
Sonata III (Y-3)	05/93→06/98	G6AT	Petrol	2972	6	12	54
Sonata III (Y-3)	06/96→06/98	G4CP-DM	Petrol	1997	4	16	37
Sonata III (Y-3)	07/96→05/98	G4DM	Petrol	1795	4	16	28
Sonata IV (EF)	03/98→12/05	G4BS	Petrol	2351	4	16	42
Sonata IV (EF)	06/98→10/01	G4JP-G	Petrol	1997	4	16	36
Sonata IV (EF)	06/98→10/01	G6BV-G	Petrol	2493	6	24	48
Sonata IV (EF)	07/98→04/01	G4CN	Petrol	1836	4	16	30
Sonata IV (EF)	08/98→09/01	G6BV	Petrol	2493	6	24	48
Sonata IV (EF)	04/01→11/04	G4JP	Petrol	1997	4	16	36
Sonata IV (EF)	09/01→05/05	G6BA-Y	Petrol	2656	6	24	50
Sonata IV (EF)	10/01→11/04	D4EA-F	Diesel	1991	4	16	35
Sonata IV (EF)	10/01→11/04	G4JP-EG	Petrol	1997	4	16	36
Sonata IV (EF)	10/01→11/04	G6BA-G	Petrol	2656	6	24	50
Sonata IV (EF)	10/01→05/05	G4JS	Petrol	2351	4	16	42
Sonata IV (EF)	06/02→11/04	D4EB	Diesel	2188	4	16	41
Sonata IV (EF)	11/02→11/04	G6BA	Petrol	2656	6	24	50
Sonata V (NF)	01/05→12/10	G4KC	Petrol	2359	4	16	45
Sonata V (NF)	01/05→12/10	G6DB	Petrol	3342	6	24	56
Sonata V (NF)	05/05→12/10	G4KA	Petrol	1998	4	16	39
Sonata V (NF)	02/06→12/10	D4EA-F	Diesel	1991	4	16	35
Sonata V (NF)	01/08→12/10	G4KD	Petrol	1998	4	16	39
Sonata V (NF)	06/08→12/10	G4KE	Petrol	2359	4	16	45
Sonata VI (YF)	01/09→06/14	G4KD	Petrol	1998	4	16	39
Sonata VI (YF)	01/09→12/15	G4KC	Petrol	2359	4	16	45
Sonata VI (YF)	09/10→12/14	G4KH	Petrol	1998	4	16	39
Sonata VI (YF)	09/11→12/14	G4KJ	Petrol	2359	4	16	45
Sonata VII (LF)	09/14→	G4KH	Petrol	1998	4	16	39
Sonata VII (LF)	09/14→	G4KJ	Petrol	2359	4	16	45
Sonata VII (LF)	06/16→	G4NG	Petrol	1999	4	16	40
Stellar (F31_, SF2_)	10/83→08/86	4G33	Petrol	1439	4	8	10
Stellar (F31_, SF2_)	10/83→12/91	G32B	Petrol	1597	4	8	24
Stellar (F31_, SF2_)	05/84→12/89	4G63	Petrol	1997	4	8	34
Terracan (HP)	06/01→12/06	D4BH	Diesel	2476	4	8	46
Terracan (HP)	11/01→12/06	J3	Diesel	2902	4	16	51
Terracan (HP)	12/01→12/06	G6CU	Petrol	3497	6	24	58
Terracan Closed Off-Road Vehicle	03/03→12/08	D4BH	Diesel	2476	4	8	46
Tiburon Coupe	01/96→12/08	G4GC	Petrol	1975	4	16	38
Tiburon Coupe	09/96→12/97	G4GM	Petrol	1795	4	16	28
Tiburon Coupe	09/97→12/01	G4CP-D	Petrol	1997	4	16	37
Tiburon Coupe	09/02→12/08	G6BA	Petrol	2656	6	24	50
Tiburon Coupe	09/03→12/08	G4DF	Petrol	1975	4	16	38
Tiburon Coupe	10/06→12/08	G4ED-G	Petrol	1599	4	16	22
Trajét (FO)	03/00→06/07	G6BA	Petrol	2656	6	24	50
Trajét (FO)	03/00→07/08	G4JP-G	Petrol	1997	4	16	36
Trajét (FO)	09/00→07/08	G6BA-G	Petrol	2656	6	24	50
Trajét (FO)	03/01→10/03	G4CP-D	Petrol	1997	4	16	37











CC



9

Trajat (FO)	04/01→07/08	D4EA	Diesel	1991	4	16	35
Trajat (FO)	11/03→07/08	G4GC	Petrol	1975	4	16	38
Trajat (FO)	01/04→07/08	G4GC-G	Petrol	1975	4	16	38
Trajat (FO)	08/05→07/08	D4EA-V	Diesel	1991	4	16	35
Tucson (JM)	08/04→12/09	G6BA	Petrol	2656	6	24	50
Tucson (JM)	08/04→03/10	D4EA	Diesel	1991	4	16	35
Tucson (JM)	08/04→03/10	G6BA-G	Petrol	2656	6	24	50
Tucson (JM)	08/04→11/10	G4GC	Petrol	1975	4	16	38
Tucson (JM)	01/05→03/10	D4EA-F	Diesel	1991	4	16	35
Tucson (JM)	09/09→03/10	G4KC	Petrol	2359	4	16	45
Tucson (TL)	05/15→	G4NC	Petrol	1999	4	16	40
Tucson (TL)	06/15→	D4FD	Diesel	1685	4	16	25
Tucson (TL)	01/17→	G4GC	Petrol	1975	4	16	38
Visto	11/97→10/00	F8CN	Petrol	796	3	6	1
Xcent	03/14→	D3FA	Diesel	1120	3	12	3
XG (XG)	12/98→12/05	G6BV	Petrol	2493	6	24	48
XG (XG)	09/99→05/05	G6CT	Petrol	2972	6	24	53
XG (XG)	10/02→12/05	G6CU	Petrol	3497	6	24	58
XG Saloon	09/00→12/01	G6CT	Petrol	2972	6	24	53
XG Saloon	10/03→09/05	G6BV	Petrol	2493	6	24	48
Yue Dong	04/08→12/09	G4ED	Petrol	1599	4	16	22

	CC				9		CC				9
2ZZ-GE	1796	4	16	Petrol	26	G4JS	2351	4	16	Petrol	42
4D56T	2477	4	8	Diesel	46	G4JS-G	2351	4	16	Petrol	44
4G33	1439	4	8	Petrol	10	G4KA	1998	4	16	Petrol	39
4G61	1599	4	16	Petrol	19	G4KC	2359	4	16	Petrol	45
4G62	1796	4	8	Petrol	27	G4KD	1998	4	16	Petrol	39
4G63	1997	4	8	Petrol	34	G4KE	1998	4	16	Petrol	39
6G72	2972	6	12	Petrol	52	G4KE	2359	4	16	Petrol	45
6G72 (DOHC 24V)	2972	6	24	Petrol	53	G4KF	1998	4	16	Petrol	39
6G73	2497	6	24	Petrol	47	G4KH	1998	4	16	Petrol	39
6G74	3497	6	24	Petrol	57	G4KJ	2359	4	16	Petrol	45
D3EA	1493	3	12	Diesel	13	G4LA	1248	4	16	Petrol	5
D3FA	1120	3	12	Diesel	3	G4NC	1999	4	16	Petrol	40
D4BA	2477	4	8	Diesel	46	G4NG	1999	4	16	Petrol	40
D4BB	2607	4	8	Diesel	49	G6AT	2972	6	12	Petrol	54
D4BF	2476	4	8	Diesel	46	G6AV	2497	6	24	Petrol	48
D4BH	2476	4	8	Diesel	46	G6BA	2656	6	24	Petrol	50
D4BH	2476	4	8	Diesel	46	G6BA-G	2656	6	24	Petrol	50
D4BX	2477	4	8	Diesel	46	G6BA-Y	2656	6	24	Petrol	50
D4EA	1991	4	16	Diesel	35	G6BV	2493	6	24	Petrol	48
D4EA	1991	4	16	Diesel	35	G6BV-G	2493	6	24	Petrol	48
D4EA-F	1991	4	16	Diesel	35	G6CT	2972	6	24	Petrol	53
D4EA-V	1991	4	16	Diesel	35	G6CU	3497	6	24	Petrol	58
D4EB	2188	4	16	Diesel	41	G6DA	3778	6	24	Petrol	60
D4FA	1493	4	16	Diesel	14	G6DB	3342	6	24	Petrol	56
D4FB	1582	4	16	Diesel	20	G6DC	3470	6	24	Petrol	59
D4FB-5P	1582	4	16	Diesel	20	G6DF	3342	6	24	Petrol	56
D4FB-L	1582	4	16	Diesel	20	G6DG	2999	6	24	Petrol	55
D4FC	1396	4	16	Diesel	11	G6DH	3342	6	24	Petrol	56
D4FC-M	1396	4	16	Diesel	11	G6DH	3342	6	24	Petrol	56
D4FD	1685	4	16	Diesel	25	G6DJ	3778	6	24	Petrol	61
DJY	1905	4	8	Diesel	33	G6EA	2656	6	24	Petrol	50
F8CN	796	3	6	Petrol	1	G13B	1299	4	8	Petrol	9
G4AJ	1468	4	8	Petrol	15	G15B	1468	4	8	Petrol	18
G4BB	1795	4	16	Petrol	28	G32B	1597	4	8	Petrol	24
G4BP	1997	4	16	Petrol	36	G62B	1796	4	8	Petrol	32
G4BS	2351	4	16	Petrol	42	J3	2902	4	16	Diesel	51
G4CM	1796	4	8	Petrol	29	J12G	1238	4	8	Petrol	6
G4CN	1836	4	16	Petrol	30						
G4CP	1997	4	8	Petrol	34						
G4CP-D	1997	4	16	Petrol	37						
G4CP-DM	1997	4	16	Petrol	37						
G4CP-U	1997	4	8	Petrol	34						
G4CR	1596	4	16	Petrol	21						
G4CS	2351	4	8	Petrol	43						
G4DF	1975	4	16	Petrol	38						
G4DG	1299	4	8	Petrol	7						
G4DJ	1468	4	8	Petrol	15						
G4DM	1795	4	16	Petrol	28						
G4EA	1341	4	12	Petrol	8						
G4EB	1495	4	12	Petrol	16						
G4EC-G	1495	4	16	Petrol	17						
G4ED	1599	4	16	Petrol	22						
G4ED	1599	4	16	Petrol	22						
G4ED-G	1599	4	16	Petrol	22						
G4ED-G	1599	4	16	Petrol	22						
G4ED-L	1599	4	16	Petrol	22						
G4EE	1399	4	16	Petrol	12						
G4EE	1399	4	16	Petrol	12						
G4EH	1341	4	12	Petrol	8						
G4EK	1495	4	12	Petrol	16						
G4EK-TC	1495	4	12	Petrol	16						
G4ER	1495	4	16	Petrol	17						
G4FK	1495	4	16	Petrol	17						
G4GA	1599	4	16	Petrol	22						
G4GB	1795	4	16	Petrol	31						
G4GB-G	1795	4	16	Petrol	28						
G4GC	1975	4	16	Petrol	38						
G4GC-G	1975	4	16	Petrol	38						
G4GF	1975	4	16	Petrol	38						
G4GM	1795	4	16	Petrol	28						
G4GR	1599	4	16	Petrol	23						
G4HC	999	4	12	Petrol	2						
G4HC-E	999	4	12	Petrol	2						
G4HD	1086	4	12	Petrol	4						
G4HG	1086	4	12	Petrol	4						
G4JP	1997	4	16	Petrol	36						
G4JP-EG	1997	4	16	Petrol	36						
G4JP-G	1997	4	16	Petrol	36						

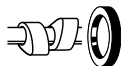

1 0.8L Petrol

F8CN	3 Cyl.	6 Valves	796cc	TD31685
PA928 (x6) HR5075	NJ336 32.00 x 47.00 x 8.00mm, NBR		NJ377 32.00 x 47.00 x 6.00mm, ACM NJ337 60.00 x 80.00 x 8.00mm, NBR	

2 1.0L Petrol

G4HC	4 Cyl.	12 Valves	999cc	TD16145
G4HC-E	4 Cyl.	12 Valves	999cc	TD18218
	NJ933 35.00 x 50.00 x 8.00mm, FPM		NJ252 30.00 x 46.00 x 7.00mm, NBR	

3 1.1L Diesel

D3FA	3 Cyl.	12 Valves	1120cc	TD21020
				NA5140 91.00 x 111.00 x 10.00mm, FPM

4 1.1L Petrol

G4HD	4 Cyl.	12 Valves	1086cc	TD18219
G4HG	4 Cyl.	12 Valves	1086cc	TD20724
	NJ933 35.00 x 50.00 x 8.00mm, FPM		NJ252 30.00 x 46.00 x 7.00mm, NBR	

5 1.2L Petrol

G4LA	4 Cyl.	16 Valves	1248cc	TD24880
				NJ324 34.00 x 48.00 x 7.00mm, ACM

6 1.2L Petrol

J12G	4 Cyl.	8 Valves	1238cc	TD31679
KJ570 (x8)	NJ933 35.00 x 50.00 x 8.00mm, FPM		NJ005 44.00 x 60.00 x 7.00mm, NBR NJ006 72.00 x 96.00 x 9.00mm, MVQ	

7 1.3L Petrol

G4DG	4 Cyl.	8 Valves	1299cc	TD4565
KJ570 (x8)	NJ933 35.00 x 50.00 x 8.00mm, FPM		NJ252 30.00 x 46.00 x 7.00mm, NBR NJ006 72.00 x 96.00 x 9.00mm, MVQ	

8 1.3L Petrol

G4EA	4 Cyl.	12 Valves	1341cc	TD16149
G4EH	4 Cyl.	12 Valves	1341cc	TD4568
PA425 (x12)	NJ933 35.00 x 50.00 x 8.00mm, FPM		NC006 35.00 x 48.00 x 7.00mm, MVQ NJ006 72.00 x 96.00 x 9.00mm, MVQ	



9 1.3L Petrol

G13B	4 Cyl.	8 Valves	1299cc	TD12988
KJ570 (x8)	NJ933 35.00 x 50.00 x 8.00mm, FPM	NJ252 30.00 x 46.00 x 7.00mm, NBR	NJ242 35.00 x 50.00 x 8.00mm, NBR	NJ006 72.00 x 96.00 x 9.00mm, MVQ

10 1.4L Petrol

4G33	4 Cyl.	8 Valves	1439cc	TD25028
KJ211 (x8)	NJ933 35.00 x 50.00 x 8.00mm, FPM	NJ005 44.00 x 60.00 x 7.00mm, NBR	NJ242 35.00 x 50.00 x 8.00mm, NBR	NJ006 72.00 x 96.00 x 9.00mm, MVQ

11 1.4L Diesel

D4FC	4 Cyl.	16 Valves	1396cc	TD24883
D4FC-M	4 Cyl.	16 Valves	1396cc	TD25434
			NA5140 91.00 x 111.00 x 10.00mm, FPM	

12 1.4L Petrol

G4EE	4 Cyl.	16 Valves	1399cc	TD20684
G4EE	4 Cyl.	16 Valves	1399cc	TD20722
PA425 (x16)	NJ933 35.00 x 50.00 x 8.00mm, FPM	NC006 35.00 x 48.00 x 7.00mm, MVQ		NJ006 72.00 x 96.00 x 9.00mm, MVQ

13 1.5L Diesel

D3EA	3 Cyl.	12 Valves	1493cc	TD16283
	NF817 36.00 x 50.00 x 7.00mm, FPM	NA5139 32.00 x 45.00 x 6.00mm, FPM		NA5140 91.00 x 111.00 x 10.00mm, FPM

14 1.5L Diesel

D4FA	4 Cyl.	16 Valves	1493cc	TD18229
			NA5140 91.00 x 111.00 x 10.00mm, FPM	

15 1.5L Petrol

G4AJ	4 Cyl.	8 Valves	1468cc	TD33653
G4DJ	4 Cyl.	8 Valves	1468cc	TD9400
KJ570 (x8)	NJ933 35.00 x 50.00 x 8.00mm, FPM	NJ252 30.00 x 46.00 x 7.00mm, NBR		NJ006 72.00 x 96.00 x 9.00mm, MVQ

16 1.5L Petrol

G4EB	4 Cyl.	12 Valves	1495cc	TD16371
G4EK	4 Cyl.	12 Valves	1495cc	TD4569
G4EK-TC	4 Cyl.	12 Valves	1495cc	TD4570
PA425 (x12)	NJ933 35.00 x 50.00 x 8.00mm, FPM	NC006 35.00 x 48.00 x 7.00mm, MVQ		NJ006 72.00 x 96.00 x 9.00mm, MVQ



17 1.5L

Petrol

G4EC-G	4 Cyl.	16 Valves	1495cc	TD16148
G4ER	4 Cyl.	16 Valves	1495cc	TD18938
G4FK	4 Cyl.	16 Valves	1495cc	TD23961
PA425 (x16)	NJ933 35.00 x 50.00 x 8.00mm, FPM		NC006 35.00 x 48.00 x 7.00mm, MVQ NJ006 72.00 x 96.00 x 9.00mm, MVQ	

18 1.5L

Petrol

G15B	4 Cyl.	8 Valves	1468cc	TD1636
KJ570 (x8)	NJ933 35.00 x 50.00 x 8.00mm, FPM NJ242 35.00 x 50.00 x 8.00mm, NBR		NJ252 30.00 x 46.00 x 7.00mm, NBR NJ006 72.00 x 96.00 x 9.00mm, MVQ	

19 1.6L

Petrol

4G61	4 Cyl.	16 Valves	1599cc	TD9399
KJ570 (x16)	NJ933 35.00 x 50.00 x 8.00mm, FPM		NJ252 30.00 x 46.00 x 7.00mm, NBR NJ006 72.00 x 96.00 x 9.00mm, MVQ	

20 1.6L

Diesel

D4FB	4 Cyl.	16 Valves	1582cc	TD20726
D4FB-5P	4 Cyl.	16 Valves	1582cc	TD26998
D4FB-L	4 Cyl.	16 Valves	1582cc	TD27228
			NA5140 91.00 x 111.00 x 10.00mm, FPM	

21 1.6L

Petrol

G4CR	4 Cyl.	16 Valves	1596cc	TD4564
KJ570 (x16)	NJ933 (x2) 35.00 x 50.00 x 8.00mm, FPM		NJ005 44.00 x 60.00 x 7.00mm, NBR NJ058 80.00 x 96.00 x 9.00mm, NBR	

22 1.6L

Petrol

G4ED	4 Cyl.	16 Valves	1599cc	TD20671
G4ED	4 Cyl.	16 Valves	1599cc	TD20721
G4ED-G	4 Cyl.	16 Valves	1599cc	TD16146
G4ED-G	4 Cyl.	16 Valves	1599cc	TD32643
G4ED-L	4 Cyl.	16 Valves	1599cc	TD22586
G4GA	4 Cyl.	16 Valves	1599cc	TD19136
PA425 (x16)	NJ933 35.00 x 50.00 x 8.00mm, FPM		NC006 35.00 x 48.00 x 7.00mm, MVQ NJ006 72.00 x 96.00 x 9.00mm, MVQ	

23 1.6L

Petrol

G4GR	4 Cyl.	16 Valves	1599cc	TD4572
PA425 (x16)	NJ933 35.00 x 50.00 x 8.00mm, FPM		NJ251 80.00 x 96.00 x 9.00mm, MVQ	



24 1.6L Petrol

G32B	4 Cyl.	8 Valves	1597cc	TD1637
KJ211 (x8)	NJ933 35.00 x 50.00 x 8.00mm, FPM	NJ005	44.00 x 60.00 x 7.00mm, NBR	
	NJ242 35.00 x 50.00 x 8.00mm, NBR	NJ006	72.00 x 96.00 x 9.00mm, MVQ	

25 1.7L Diesel

D4FD	4 Cyl.	16 Valves	1685cc	TD26344
			NA5140	91.00 x 111.00 x 10.00mm, FPM

26 1.8L Petrol

2ZZ-GE	4 Cyl.	16 Valves	1796cc	TD30844
	NB799 38.00 x 50.00 x 7.00mm, FPM	NA5089	38.00 x 50.00 x 8.00mm, NBR	
		NJ215	85.00 x 105.00 x 10.00mm, FPM	

27 1.8L Petrol

4G62	4 Cyl.	8 Valves	1796cc	TD26092
KJ211 (x8)	NJ933 35.00 x 50.00 x 8.00mm, FPM	NJ005	44.00 x 60.00 x 7.00mm, NBR	
	NJ242 35.00 x 50.00 x 8.00mm, NBR	NJ251	80.00 x 96.00 x 9.00mm, MVQ	

28 1.8L Petrol

G4BB	4 Cyl.	16 Valves	1795cc	TD18320
G4DM	4 Cyl.	16 Valves	1795cc	TD26110
G4GB-G	4 Cyl.	16 Valves	1795cc	TD16282
G4GM	4 Cyl.	16 Valves	1795cc	TD4571
PA425 (x16)	NJ933 35.00 x 50.00 x 8.00mm, FPM	NJ251	80.00 x 96.00 x 9.00mm, MVQ	

29 1.8L Petrol

G4CM	4 Cyl.	8 Valves	1796cc	TD26091
KJ211 (x8)	NJ933 35.00 x 50.00 x 8.00mm, FPM	NJ005	44.00 x 60.00 x 7.00mm, NBR	
		NJ058	80.00 x 96.00 x 9.00mm, NBR	

30 1.8L Petrol

G4CN	4 Cyl.	16 Valves	1836cc	TD4561
KJ570 (x16)	NJ933 35.00 x 50.00 x 8.00mm, FPM	NJ005	44.00 x 60.00 x 7.00mm, NBR	
		NJ058	80.00 x 96.00 x 9.00mm, NBR	

31 1.8L Petrol

G4GB	4 Cyl.	16 Valves	1795cc	TD19154
PA425 (x16)	NJ933 35.00 x 50.00 x 8.00mm, FPM	NK158	37.00 x 50.50 x 7.00mm, ACM	
		NJ251	80.00 x 96.00 x 9.00mm, MVQ	



32 1.8L

Petrol

G62B	4 Cyl.	8 Valves	1796cc	TD1638
	NJ933 35.00 x 50.00 x 8.00mm, FPM NJ242 35.00 x 50.00 x 8.00mm, NBR			

33 1.9L

Diesel

DJY HR569	4 Cyl.	8 Valves	1905cc	TD22267
	NF841 35.00 x 50.00 x 8.00mm, FPM		NA5191 42.00 x 62.00 x 7.00mm, PTFE NA5192 90.00 x 110.00 x 7.00mm, PTFE	

34 2.0L

Petrol

4G63	4 Cyl.	8 Valves	1997cc	TD26745
G4CP	4 Cyl.	8 Valves	1997cc	TD4562
G4CP-U	4 Cyl.	8 Valves	1997cc	TD1616
KJ211 (x8)	NJ933 35.00 x 50.00 x 8.00mm, FPM		NJ005 44.00 x 60.00 x 7.00mm, NBR NJ058 80.00 x 96.00 x 9.00mm, NBR	

35 2.0L

Diesel

D4EA	4 Cyl.	16 Valves	1991cc	TD21615
D4EA	4 Cyl.	16 Valves	1991cc	TD16321
D4EA-F	4 Cyl.	16 Valves	1991cc	TD20720
D4EA-V	4 Cyl.	16 Valves	1991cc	TD20719
	NF817 36.00 x 50.00 x 7.00mm, FPM		NA5140 91.00 x 111.00 x 10.00mm, FPM	

36 2.0L

Petrol

G4BP	4 Cyl.	16 Valves	1997cc	TD17366
G4JP	4 Cyl.	16 Valves	1997cc	TD31392
G4JP-EG	4 Cyl.	16 Valves	1997cc	TD16281
G4JP-G	4 Cyl.	16 Valves	1997cc	TD16150
KJ570 (x16)	NJ933 (x2) 35.00 x 50.00 x 8.00mm, FPM		NJ005 44.00 x 60.00 x 7.00mm, NBR NK143 85.00 x 103.00 x 8.00mm, FPM	

37 2.0L

Petrol

G4CP-D	4 Cyl.	16 Valves	1997cc	TD4563
G4CP-DM	4 Cyl.	16 Valves	1997cc	TD4559
KJ570 (x16)	NJ933 (x2) 35.00 x 50.00 x 8.00mm, FPM		NJ005 44.00 x 60.00 x 7.00mm, NBR NJ058 80.00 x 96.00 x 9.00mm, NBR	



38 2.0L Petrol

G4DF	4 Cyl.	16 Valves	1975cc	TD18937
G4GC	4 Cyl.	16 Valves	1975cc	TD20723
G4GC-G	4 Cyl.	16 Valves	1975cc	TD16147
G4GF	4 Cyl.	16 Valves	1975cc	TD5500

PA425 (x16)

NJ933
35.00 x 50.00 x 8.00mm, FPM

NJ005
44.00 x 60.00 x 7.00mm, NBR
NJ058
80.00 x 96.00 x 9.00mm, NBR

39 2.0L Petrol

G4KA	4 Cyl.	16 Valves	1998cc	TD29276
G4KD	4 Cyl.	16 Valves	1998cc	TD21538
G4KD	4 Cyl.	16 Valves	1998cc	TD26118
G4KF	4 Cyl.	16 Valves	1998cc	TD26603
G4KH	4 Cyl.	16 Valves	1998cc	TD31868

HR816 (x2)

NA5108
42.00 x 55.00 x 7.00mm, FPM/ACM
NK143
85.00 x 103.00 x 8.00mm, FPM

40 2.0L Petrol

G4NC	4 Cyl.	16 Valves	1999cc	TD26342
G4NG	4 Cyl.	16 Valves	1999cc	TD33438

PA425 (x16)

41 2.2L Diesel

D4EB	4 Cyl.	16 Valves	2188cc	TD20717
-------------	--------	-----------	--------	----------------

NF817
36.00 x 50.00 x 7.00mm, FPM

NA5139
32.00 x 45.00 x 6.00mm, FPM
NA5140
91.00 x 111.00 x 10.00mm, FPM

42 2.4L Petrol

G4BS	4 Cyl.	16 Valves	2351cc	TD18936
G4JS	4 Cyl.	16 Valves	2351cc	TD26626

KJ570 (x16)

NJ933 (x2)
35.00 x 50.00 x 8.00mm, FPM

NJ005
44.00 x 60.00 x 7.00mm, NBR
NK143
85.00 x 103.00 x 8.00mm, FPM

43 2.4L Petrol

G4CS	4 Cyl.	8 Valves	2351cc	TD16109
-------------	--------	----------	--------	----------------

KJ211 (x8)

NJ933
35.00 x 50.00 x 8.00mm, FPM

NJ005
44.00 x 60.00 x 7.00mm, NBR
NJ058
80.00 x 96.00 x 9.00mm, NBR

44 2.4L Petrol

G4JS-G	4 Cyl.	16 Valves	2351cc	TD16153
---------------	--------	-----------	--------	----------------

NJ933 (x2)
35.00 x 50.00 x 8.00mm, FPM

NJ005
44.00 x 60.00 x 7.00mm, NBR
NK143
85.00 x 103.00 x 8.00mm, FPM

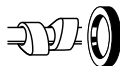

45 2.4L

Petrol

G4KC	4 Cyl.	16 Valves	2359cc	TD25636
G4KE	4 Cyl.	16 Valves	2359cc	TD24885
G4KJ	4 Cyl.	16 Valves	2359cc	TD27222

HR816 (x2)

NA5108
42.00 x 55.00 x 7.00mm, FPM/ACM

NK143
85.00 x 103.00 x 8.00mm, FPM

46 2.5L

Diesel

4D56T	4 Cyl.	8 Valves	2477cc	TD18860
D4BA	4 Cyl.	8 Valves	2477cc	TD7147
D4BF	4 Cyl.	8 Valves	2476cc	TD16108
D4BH	4 Cyl.	8 Valves	2476cc	TD11429
D4BH	4 Cyl.	8 Valves	2476cc	TD21614
D4BX	4 Cyl.	8 Valves	2477cc	TD7148

KJ211 (x8)

NJ933
35.00 x 50.00 x 8.00mm, FPM

NJ005
44.00 x 60.00 x 7.00mm, NBR

NJ058
80.00 x 96.00 x 9.00mm, NBR

47 2.5L

Petrol

6G73	6 Cyl.	24 Valves	2497cc	TD34491
------	--------	-----------	--------	---------

KJ570 (x24)

NA5053 (x4)
30.00 x 42.00 x 7.00mm, FPM

NJ874
37.00 x 50.00 x 6.00mm, ACM

NA5140
91.00 x 111.00 x 10.00mm, FPM

48 2.5L

Petrol

G6AV	6 Cyl.	24 Valves	2497cc	TD26753
G6BV	6 Cyl.	24 Valves	2493cc	TD31867
G6BV-G	6 Cyl.	24 Valves	2493cc	TD16151

HR5094

NF535 (x4)
30.00 x 42.00 x 8.00mm, NBR

NA5140
91.00 x 111.00 x 10.00mm, FPM

49 2.6L

Diesel

D4BB	4 Cyl.	8 Valves	2607cc	TD16110
------	--------	----------	--------	---------

KJ211 (x8)

NJ933
35.00 x 50.00 x 8.00mm, FPM

NJ005
44.00 x 60.00 x 7.00mm, NBR

NJ058
80.00 x 96.00 x 9.00mm, NBR

50 2.7L

Petrol

G6BA	6 Cyl.	24 Valves	2656cc	TD19133
G6BA-G	6 Cyl.	24 Valves	2656cc	TD16154
G6BA-Y	6 Cyl.	24 Valves	2656cc	TD24507
G6EA	6 Cyl.	24 Valves	2656cc	TD20718

NF535
30.00 x 42.00 x 8.00mm, NBR

NA5140
91.00 x 111.00 x 10.00mm, FPM

51 2.9L

Diesel

J3	4 Cyl.	16 Valves	2902cc	TD18360
----	--------	-----------	--------	---------

NC048 (x2)
38.00 x 52.00 x 6.00mm, FPM

NK251
50.00 x 68.00 x 9.00mm, NBR

NA5196
90.00 x 110.00 x 9.00mm, ACM



52 3.0L Petrol

6G72	6 Cyl.	12 Valves	2972cc	TD18862
KJ211 (x12)	NF841 (x2) 35.00 x 50.00 x 8.00mm, FPM		NJ874 37.00 x 50.00 x 6.00mm, ACM NA5140 91.00 x 111.00 x 10.00mm, FPM	

53 3.0L Petrol

6G72 (DOHC 24V)	6 Cyl.	24 Valves	2972cc	TD32989
G6CT	6 Cyl.	24 Valves	2972cc	TD26858
KJ570 (x24)	NA5053 (x4) 30.00 x 42.00 x 7.00mm, FPM		NJ874 37.00 x 50.00 x 6.00mm, ACM NA5140 91.00 x 111.00 x 10.00mm, FPM	

54 3.0L Petrol

G6AT	6 Cyl.	12 Valves	2972cc	TD4573
KJ211 (x12)	NJ933 35.00 x 50.00 x 8.00mm, FPM NJ242 35.00 x 50.00 x 8.00mm, NBR		NJ874 37.00 x 50.00 x 6.00mm, ACM NA5140 91.00 x 111.00 x 10.00mm, FPM	

55 3.0L Petrol

G6DG	6 Cyl.	24 Valves	2999cc	TD30838
			NA5140 91.00 x 111.00 x 10.00mm, FPM	

56 3.3L Petrol

G6DB	6 Cyl.	24 Valves	3342cc	TD20716
G6DF	6 Cyl.	24 Valves	3342cc	TD30529
G6DH	6 Cyl.	24 Valves	3342cc	TD30835
G6DH	6 Cyl.	24 Valves	3342cc	TD32843
			NA5140 91.00 x 111.00 x 10.00mm, FPM	

57 3.5L Petrol

6G74	6 Cyl.	24 Valves	3497cc	TD31674
KJ570 (x24)	NA5053 (x4) 30.00 x 42.00 x 7.00mm, FPM		NJ874 37.00 x 50.00 x 6.00mm, ACM NA5140 91.00 x 111.00 x 10.00mm, FPM	

58 3.5L Petrol

G6CU	6 Cyl.	24 Valves	3497cc	TD18359
	NA5053 30.00 x 42.00 x 7.00mm, FPM NF535 30.00 x 42.00 x 8.00mm, NBR		NA5140 91.00 x 111.00 x 10.00mm, FPM	

59 3.5L Petrol

G6DC	6 Cyl.	24 Valves	3470cc	TD31391
			NA5140 91.00 x 111.00 x 10.00mm, FPM	

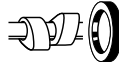

60 3.8L

Petrol

G6DA 6 Cyl. 24 Valves 3778cc **TD26074**

NA5053
 30.00 x 42.00 x 7.00mm, FPM
NF535
 30.00 x 42.00 x 8.00mm, NBR









NA5140
 91.00 x 111.00 x 10.00mm, FPM

61 3.8L

Petrol

G6DJ 6 Cyl. 24 Valves 3778cc **TD28045**

NA5140
 91.00 x 111.00 x 10.00mm, FPM

							
117	06/70→06/78	G180-SZ	Petrol	1817	4	8	15
117	06/71→02/76	G180	Petrol	1817	4	8	15
117	11/72→02/76	G180-Z	Petrol	1817	4	8	16
117	06/73→06/75	G180-W	Petrol	1817	4	8	16
117	06/73→06/78	G180-WE	Petrol	1817	4	8	16
117	06/79→06/81	C223	Diesel	2238	4	8	29
Amigo Closed Off-Road Vehicle	09/88→12/93	4ZD1	Petrol	2254	4	8	27
Amigo Closed Off-Road Vehicle	09/88→12/94	4ZE1	Petrol	2259	4	8	38
Amigo Closed Off-Road Vehicle	09/97→12/00	X 22 SE	Petrol	2198	4	16	30
Amigo Closed Off-Road Vehicle	06/98→12/00	6VD1	Petrol	3165	6	24	46
Aska	04/83→06/89	4FC1	Diesel	1995	4	8	18
Aska	10/87→06/89	4FC1T	Diesel	1995	4	8	18
Aska	07/89→09/95	4ZB1	Petrol	1817	4	8	14
Aska	07/89→09/95	4ZC1-T	Petrol	1995	4	8	20
Aska	10/95→09/01	F20B	Petrol	1997	4	16	24
Aska	10/97→09/01	4ZD1	Petrol	2254	4	8	27
Axiom Closed Off-Road Vehicle	09/01→12/04	6VE1	Petrol	3494	6	24	48
Campo (KB)	04/77→12/82	C220	Diesel	2238	4	8	28
Campo (KB)	01/83→03/88	4ZC1	Petrol	1994	4	8	19
Campo (KB)	01/83→12/90	4JA1	Diesel	2499	4	8	35
Campo (KB)	01/83→12/91	C223	Diesel	2238	4	8	29
Campo (KB)	06/85→12/88	G200Z	Petrol	1950	4	8	25
Campo (KB)	01/89→12/90	4ZD1	Petrol	2254	4	8	27
D-Max I (TFR, TFS)	10/06→06/12	4JK1-TC	Diesel	2499	4	16	36
D-Max I (TFR, TFS)	01/07→06/12	4JJ1-TC	Diesel	2999	4	16	42
D-Max I Platform/Chassis (TFR, TFS)	01/07→06/12	4JJ1-TC	Diesel	2999	4	16	42
D-Max II (TFR, TFS)	06/12→	4JA1-L	Diesel	2499	4	8	35
D-Max II (TFR, TFS)	06/12→	4JJ1-TC	Diesel	2999	4	16	42
D-Max II (TFR, TFS)	06/12→	4JK1-TC	Diesel	2499	4	16	36
D-Max II Platform/Chassis (TFR, TFS)	06/12→	4JJ1-TC	Diesel	2999	4	16	42
Elf Box (NHR5_)	10/85→09/92	4JB1-T	Diesel	2771	4	8	40
Elf Box (NHR5_)	10/85→09/03	4JB1	Diesel	2771	4	8	40
Elf Box (NHR6_, NKR6_, NKR7_, NKS7_)	09/93→09/01	4JG2	Diesel	3059	4	8	45
Elf Box (NKR8_)	10/03→	4JB1-TC	Diesel	2771	4	8	40
Elf Platform/Chassis (NHR5_)	10/85→09/92	4JB1-T	Diesel	2771	4	8	40
Elf Platform/Chassis (NHR5_)	10/85→09/03	4JB1	Diesel	2771	4	8	40
Elf Platform/Chassis (NHR5_)	09/93→09/01	4JG2	Diesel	3059	4	8	45
Elf Platform/Chassis (NHR6_, NKR6_, NKR7_, NKS7_)	09/93→09/01	4JG2	Diesel	3059	4	8	45
Elf Platform/Chassis (NHR6_, NKR6_, NKR7_, NKS7_)	09/94→09/99	4BD1T	Diesel	3856	4	8	50
Elf Platform/Chassis (NKR7_, NKS7_, NHR6_, NKR6_, NPR_6)	09/93→09/99	TD25II	Diesel	2494	4	8	37
Elf Platform/Chassis (NKR7_, NKS7_, NHR6_, NKR6_, NPR_6)	09/94→09/99	4BD1T	Diesel	3856	4	8	50
Elf Platform/Chassis (NKR7_, NKS7_, NHR6_, NKR6_, NPR_6)	01/98→12/01	4JG2	Diesel	3059	4	8	45
Elf Platform/Chassis (NKR7_, NKS7_, NHR6_, NKR6_, NPR_6)	10/99→09/01	TD27	Diesel	2663	4	8	39
Elf Platform/Chassis (NKR8_, NKQ8_)	10/03→	4JB1-TC	Diesel	2771	4	8	40
Fargo Box	08/82→03/88	4ZC1	Petrol	1994	4	8	19
Fargo Bus	08/82→12/88	4ZC1	Petrol	1994	4	8	19
Fargo Bus	01/83→12/86	4ZB1	Petrol	1817	4	8	14
Fargo Bus	01/83→01/88	4FD1	Diesel	2189	4	8	26
Filly	01/00→12/02	VQ35DE	Petrol	3498	6	24	49
Filly	01/00→12/02	ZD30DDTi	Diesel	2953	4	16	44
Florian	04/67→12/75	G161-A	Petrol	1584	4	8	10
Florian	01/76→03/83	G161-D	Petrol	1584	4	8	10
Florian Estate	04/67→12/75	G161-A	Petrol	1584	4	8	10
Frontier	08/97→07/02	6VD1	Petrol	3165	6	24	46
Frontier	11/97→08/03	4JB1	Diesel	2771	4	8	40
Gemini	01/90→12/93	4EE1	Diesel	1686	4	8	11
Gemini	01/90→12/93	4XC1	Petrol	1471	4	12	2
Gemini	01/90→12/93	4XE1-WU	Petrol	1588	4	16	7
Gemini	01/90→12/93	4XE1-WUT	Petrol	1588	4	16	7
Gemini	01/90→12/93	4XF1	Petrol	1809	4	16	13
Gemini (JT)	01/85→12/87	4XC1U	Petrol	1471	4	8	3
Gemini (JT)	02/88→06/90	4XC1UT	Petrol	1471	4	8	3
Gemini (JT)	02/88→12/90	4EC1	Diesel	1488	4	8	1
Gemini (JT)	02/88→12/90	4EC1T	Diesel	1488	4	8	1
Gemini (JT)	02/88→12/90	4XC1U Kat.	Petrol	1481	4	8	3
Gemini (JT)	03/88→12/90	4XE1	Petrol	1588	4	16	4
Gemini Saloon	06/74→09/84	4EC1	Diesel	1488	4	8	1
Gemini Saloon	09/77→12/85	G180-Z	Petrol	1817	4	8	16
Gemini Saloon	09/80→12/84	4FB1	Diesel	1817	4	8	12
Gemini Saloon	01/90→12/93	4EE1	Diesel	1686	4	8	11
Gemini Saloon	01/90→12/93	4XC1	Petrol	1471	4	12	2
Gemini Saloon	01/90→12/93	4XE1-V	Petrol	1588	4	12	6
Gemini Saloon	01/90→12/93	4XE1-WU	Petrol	1588	4	16	7
Gemini Saloon	01/90→12/93	4XE1-WUT	Petrol	1588	4	16	7
Gemini Saloon	01/90→12/93	4XF1	Petrol	1809	4	16	13
Gemini Saloon (JT)	09/84→06/90	4XC1U	Petrol	1471	4	8	3
Gemini Saloon (JT)	02/88→12/89	4EC1	Diesel	1488	4	8	1
Gemini Saloon (JT)	02/88→12/89	4EC1T	Diesel	1488	4	8	1



Gemini Saloon (JT)	02/88→12/89	4XCIU Kat.	Petrol	1481	4	8	3
Gemini Saloon (JT)	09/88→12/89	4XE1	Petrol	1588	4	16	4
I-Mark Coupe	09/80→12/84	4FB1	Diesel	1817	4	8	12
Impulse	09/84→12/87	G200Z	Petrol	1950	4	8	25
Impulse	09/84→12/89	4ZC1-T	Petrol	1995	4	8	20
Impulse	09/87→12/89	4ZD1	Petrol	2254	4	8	27
Impulse	01/90→11/93	4XE1	Petrol	1588	4	16	4
Impulse	01/90→12/93	4XE1-V	Petrol	1588	4	12	6
Impulse	01/90→12/93	4XE1-XUT	Petrol	1588	4	16	7
Impulse	09/91→12/92	4XF1	Petrol	1809	4	16	13
Jing Ji ZHE	09/09→	4JB1-TCT	Diesel	2771	4	8	41
KB	04/77→12/80	G161	Petrol	1584	4	8	9
KB	01/83→03/88	4ZC1	Petrol	1994	4	8	19
KB	01/83→03/88	C223	Diesel	2238	4	8	29
KB	01/83→03/88	G200Z	Petrol	1950	4	8	25
KB	01/83→09/08	4JA1	Diesel	2499	4	8	35
KB	04/88→09/03	4ZD1	Petrol	2254	4	8	27
KB	12/90→09/03	4JB1-TC	Diesel	2771	4	8	40
KB	12/90→	4JA1T	Diesel	2499	4	8	35
KB	12/94→09/03	4JG2	Diesel	3059	4	8	45
KB	11/97→09/03	4ZE1	Petrol	2559	4	8	38
KB	01/98→09/03	6VD1	Petrol	3165	6	24	46
KB	01/98→09/03	X 22 SE	Petrol	2198	4	16	30
KB	07/02→06/04	C 20 NE	Petrol	1998	4	8	21
KB	07/02→	4JJ1-TC	Diesel	2999	4	16	42
KB	10/02→12/08	6VE1	Petrol	3494	6	24	48
KB	06/04→	C 24 SE	Petrol	2405	4	8	33
KB	10/08→	4JK1-TC	Diesel	2499	4	16	36
LUV	10/93→09/05	4ZD1	Petrol	2254	4	8	27
Mairui Pickup	07/16→	JE493ZLQ-4CA	Diesel	2771	4	8	41
Midi Box (9800N)	06/88→08/92	4FD1	Diesel	2189	4	8	26
Midi Box (9800N)	06/88→08/92	4ZC1	Petrol	1994	4	8	19
Midi Box (9800N)	09/92→07/96	4FG1T	Diesel	2380	4	8	32
Midi Bus (94000, 98000)	06/88→08/92	4FD1	Diesel	2189	4	8	26
Midi Bus (94000, 98000)	06/88→08/92	4ZC1	Petrol	1994	4	8	19
Midi Bus (94000, 98000)	01/89→08/92	4FC1T	Diesel	1995	4	8	18
Midi Bus (94000, 98000)	01/94→07/96	4FG1T	Diesel	2380	4	8	32
Midi Van (94000, 98000)	06/88→08/92	4FD1	Diesel	2189	4	8	26
Midi Van (94000, 98000)	06/88→08/92	4ZC1	Petrol	1994	4	8	19
Midi Van (94000, 98000)	01/89→08/92	4FC1T	Diesel	1995	4	8	18
Midi Van (94000, 98000)	01/94→07/96	4FG1T	Diesel	2380	4	8	32
MU (_ U _)	02/89→07/94	4ZE1	Petrol	2559	4	8	38
MU (_ U _)	05/90→07/93	4JB1-T	Diesel	2771	4	8	40
MU (_ U _)	08/93→05/98	4JG2 TC	Diesel	3059	4	8	45
MU (_ U _)	06/98→08/02	6VD1	Petrol	3165	6	24	46
MU 7 Closed Off-Road Vehicle	01/13→	4JJ1-TC	Diesel	2999	4	16	42
MU Box (_ U _)	05/89→10/93	4ZE1	Petrol	2559	4	8	38
MU-X Closed Off-Road Vehicle (UCS/UCR)	11/13→	4JJ1-TC	Diesel	2999	4	16	42
Oasis Mini Passenger Van	09/97→12/99	F23A7	Petrol	2254	4	16	31
Panther	03/91→08/00	4JA1T	Diesel	2499	4	8	35
Piazza (JR _)	06/81→02/89	G200W	Petrol	1950	4	8	25
Piazza (JR _)	06/85→12/90	4ZC1-T	Petrol	1995	4	8	20
Pickup	08/79→07/82	4ZB1	Petrol	1817	4	8	14
Pickup	08/80→09/87	C223-T	Diesel	2238	4	8	29
Pickup	08/82→09/87	G200Z	Petrol	1950	4	8	25
Pickup	08/85→08/96	4ZD1	Petrol	2254	4	8	27
Pickup	10/87→08/96	4ZE1	Petrol	2559	4	8	38
Pickup	06/92→08/96	4JA1T	Diesel	2499	4	8	35
Pickup (TF)	07/96→12/02	4JA1T	Diesel	2499	4	8	35
Pickup (TF)	07/96→06/05	4JB1-T	Diesel	2771	4	8	40
Pickup (TF)	05/97→06/05	4JG2 T	Diesel	3059	4	8	45
Pickup Standard Cab Pickup	10/93→04/99	4JA1T	Diesel	2499	4	8	35
Rodeo Closed Off-Road Vehicle	09/90→12/97	4ZE1	Petrol	2559	4	8	38
Rodeo Closed Off-Road Vehicle	09/92→08/04	6VD1	Petrol	3165	6	24	46
Rodeo Closed Off-Road Vehicle	09/97→12/03	X 22 SE	Petrol	2198	4	16	30
Rodeo Closed Off-Road Vehicle	09/03→08/04	6VE1	Petrol	3494	6	24	48
Rodeo Pickup	08/06→04/07	4JA1	Diesel	2499	4	8	35
Rodeo Sport	09/00→12/03	6VD1	Petrol	3165	6	24	46
Rodeo Sport	09/00→12/03	X 22 SE	Petrol	2198	4	16	30
TF Pickup	05/00→09/03	4JB1-T	Diesel	2771	4	8	40
TF Pickup	05/00→09/03	4ZD1	Petrol	2254	4	8	27
TFR/TFS Pickup (TF _)	09/88→08/91	4JA1T	Diesel	2499	4	8	35
TFR/TFS Pickup (TF _)	09/91→08/99	4JB1	Diesel	2771	4	8	40
TFR/TFS Pickup (TF _)	09/94→08/99	F23A7	Petrol	2254	4	16	31
TFR/TFS Pickup (TF _)	09/95→12/02	6VE1	Petrol	3494	6	24	48
Trooper I (UBS)	05/84→12/89	C223	Diesel	2238	4	8	29
Trooper I (UBS)	09/84→12/91	4ZD1	Petrol	2254	4	8	27
Trooper I (UBS)	11/86→12/91	4ZE1	Petrol	2559	4	8	38







CC



9

Trooper I (UBS)	10/87→12/91	4JB1-T	Diesel	2771	4	8	40
Trooper I (UBS)	10/88→12/91	4JB1-TC	Diesel	2771	4	8	40
Trooper I Open Off-Road Vehicle (UBS)	01/83→12/85	G200Z	Petrol	1950	4	8	25
Trooper I Open Off-Road Vehicle (UBS)	01/83→12/91	C223-T	Diesel	2238	4	8	29
Trooper I Open Off-Road Vehicle (UBS)	05/84→07/89	C223	Diesel	2238	4	8	29
Trooper I Open Off-Road Vehicle (UBS)	11/85→12/91	4ZD1	Petrol	2254	4	8	27
Trooper I Open Off-Road Vehicle (UBS)	10/87→12/91	4ZE1	Petrol	2559	4	8	38
Trooper II (UB)	08/91→04/96	4ZE1	Petrol	2559	4	8	38
Trooper II (UB)	08/91→07/98	4JG2 T	Diesel	3059	4	8	45
Trooper II (UB)	08/91→07/98	6VD1	Petrol	3165	6	24	46
Trooper II Open Off-Road Vehicle (UB)	08/91→04/96	4ZE1	Petrol	2559	4	8	38
Trooper II Open Off-Road Vehicle (UB)	08/91→07/98	4JG2 T	Diesel	3059	4	8	45
Trooper II Open Off-Road Vehicle (UB)	08/91→07/98	6VD1	Petrol	3165	6	24	46
Trooper III	05/98→08/04	4JX1	Diesel	2999	4	16	43
Trooper III	05/98→08/04	6VE1	Petrol	3494	6	24	48
Trooper III Open Off-Road Vehicle	04/00→08/04	6VE1	Petrol	3494	6	24	48
Vehicross (_U_)	04/97→12/00	6VD1	Petrol	3165	6	24	46
Vehicross (_U_)	09/98→12/01	6VE1	Petrol	3494	6	24	48
Wizard (_U_)	09/97→05/00	4JG2 TC	Diesel	3059	4	8	45
Wizard (_U_)	06/98→08/02	6VD1	Petrol	3165	6	24	46

	CC				9
4BC2	3268	4	8	Diesel	47
4BD1	3856	4	8	Diesel	50
4BD1T	3856	4	8	Diesel	50
4EC1	1488	4	8	Diesel	1
4EC1T	1488	4	8	Diesel	1
4EE1	1686	4	8	Diesel	11
4FB1	1817	4	8	Diesel	12
4FB1T	1817	4	8	Diesel	12
4FC1	1995	4	8	Diesel	18
4FC1T	1995	4	8	Diesel	18
4FD1	2189	4	8	Diesel	26
4FG1T	2380	4	8	Diesel	32
4JA1	2499	4	8	Diesel	35
4JA1-AG	2499	4	8	Diesel	35
4JA1-L	2499	4	8	Diesel	35
4JA1T	2499	4	8	Diesel	35
4JB1	2771	4	8	Diesel	40
4JB1-T	2771	4	8	Diesel	40
4JB1-TC	2771	4	8	Diesel	40
4JB1-TCT	2771	4	8	Diesel	41
4JG2	3059	4	8	Diesel	45
4JG2 T	3059	4	8	Diesel	45
4JG2 TC	3059	4	8	Diesel	45
4JJ1-TC	2999	4	16	Diesel	42
4JK1-TC	2499	4	16	Diesel	36
4JX1	2999	4	16	Diesel	43
4XC1	1471	4	12	Petrol	2
4XC1U	1471	4	8	Petrol	3
4XC1U Kat.	1481	4	8	Petrol	3
4XC1UT	1471	4	8	Petrol	3
4XE1	1588	4	16	Petrol	4
4XE1-UW	1588	4	16	Petrol	5
4XE1-V	1588	4	12	Petrol	6
4XE1-WU	1588	4	16	Petrol	7
4XE1-WUT	1588	4	16	Petrol	7
4XE1-XUT	1588	4	16	Petrol	7
4XF1	1809	4	16	Petrol	13
4ZA1	1584	4	8	Petrol	8
4ZB1	1817	4	8	Petrol	14
4ZC1	1994	4	8	Petrol	19
4ZC1-T	1995	4	8	Petrol	20
4ZD1	2254	4	8	Petrol	27
4ZE1	2559	4	8	Petrol	38
6BD1	5785	6	12	Diesel	51
6BD1T	5785	6	12	Diesel	51
6BG1	6494	6	12	Diesel	52
6SA1	8413	6	12	Diesel	53
6VD1	3165	6	24	Petrol	46
6VE1	3494	6	24	Petrol	48
17 D 4EE1 OHC	1699	4	8	Diesel	11
C 20 NE	1998	4	8	Petrol	21
C 24 SE	2405	4	8	Petrol	33
C190	1951	4	8	Diesel	17
C220	2038	4	8	Diesel	22
C220	2238	4	8	Diesel	28
C223	2238	4	8	Diesel	29
C223-T	2238	4	8	Diesel	29
C240	2369	4	8	Diesel	34
EJ20	1994	4	16	Petrol	23
F20B	1997	4	16	Petrol	24
F23A7	2254	4	16	Petrol	31
G161	1584	4	8	Petrol	9
G161-A	1584	4	8	Petrol	10
G161-D	1584	4	8	Petrol	10
G161-Z	1584	4	8	Petrol	9
G180	1817	4	8	Petrol	15
G180-SZ	1817	4	8	Petrol	15
G180-W	1817	4	8	Petrol	16
G180-WE	1817	4	8	Petrol	16
G180-Z	1817	4	8	Petrol	16
G200W	1950	4	8	Petrol	25
G200Z	1950	4	8	Petrol	25
JE493ZLQ-4CA	2771	4	8	Diesel	41
TD25II	2494	4	8	Diesel	37
TD27	2663	4	8	Diesel	39
VQ35DE	3498	6	24	Petrol	49
X 1.7 D 4EE1 OHC	1686	4	8	Diesel	11
X 22 SE	2198	4	16	Petrol	30

	CC				9
ZD30DDTi	2953	4	16	Diesel	44

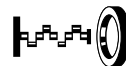
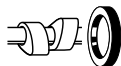

1 1.5L Diesel					
4EC1	4 Cyl.	8 Valves	1488cc		TD4575
4EC1T	4 Cyl.	8 Valves	1488cc		TD4576
PA658 (x8)	NJ449 40.00 x 52.00 x 6.00mm, NBR		NJ449 40.00 x 52.00 x 6.00mm, NBR NK103 87.00 x 100.00 x 8.50mm, FPM		
2 1.5L Petrol					
4XC1	4 Cyl.	12 Valves	1471cc		TD1673
PA658 (x12)	NJ449 40.00 x 52.00 x 6.00mm, NBR		NA5322 32.00 x 44.00 x 6.00mm, ACM NJ446 87.00 x 100.00 x 8.00mm, MVQ		
3 1.5L Petrol					
4XC1U	4 Cyl.	8 Valves	1471cc		TD1674
4XC1U Kat.	4 Cyl.	8 Valves	1481cc		TD1675
4XC1UT	4 Cyl.	8 Valves	1471cc		TD1676
PA658 (x8)	NJ449 40.00 x 52.00 x 6.00mm, NBR		NA5322 32.00 x 44.00 x 6.00mm, ACM NJ446 87.00 x 100.00 x 8.00mm, MVQ		
4 1.6L Petrol					
4XE1	4 Cyl.	16 Valves	1588cc		TD1677
	NJ449 (x2) 40.00 x 52.00 x 6.00mm, NBR		NA5322 32.00 x 44.00 x 6.00mm, ACM NJ446 87.00 x 100.00 x 8.00mm, MVQ		
5 1.6L Petrol					
4XE1-UW	4 Cyl.	16 Valves	1588cc		TD1678
	NJ454 30.00 x 45.00 x 8.00mm, NBR		NA5322 32.00 x 44.00 x 6.00mm, ACM NK103 87.00 x 100.00 x 8.50mm, FPM		
6 1.6L Petrol					
4XE1-V	4 Cyl.	12 Valves	1588cc		TD26231
			NA5322 32.00 x 44.00 x 6.00mm, ACM NK103 87.00 x 100.00 x 8.50mm, FPM		
7 1.6L Petrol					
4XE1-WU	4 Cyl.	16 Valves	1588cc		TD26229
4XE1-WUT	4 Cyl.	16 Valves	1588cc		TD26230
4XE1-XUT	4 Cyl.	16 Valves	1588cc		TD26235
	NA5347 (x2) 30.0 x 45.0 x 7.00mm, FPM		NA5322 32.00 x 44.00 x 6.00mm, ACM NK103 87.00 x 100.00 x 8.50mm, FPM		

**8 1.6L****Petrol**

4ZA1	4 Cyl.	8 Valves	1584cc	TD21261
PA933 (x8)	NA5347 30.0 x 45.0 x 7.00mm, FPM		NJ323 40.00 x 56.00 x 7.00mm, NBR	

9 1.6L**Petrol**

G161	4 Cyl.	8 Valves	1584cc	TD1688
G161-Z	4 Cyl.	8 Valves	1584cc	TD1689
PA933 (x8)			NJ014 50.00 x 68.00 x 9.00mm, NBR NJ060 82.00 x 105.00 x 13.00mm, MVQ	

10 1.6L**Petrol**

G161-A	4 Cyl.	8 Valves	1584cc	TD34322
G161-D	4 Cyl.	8 Valves	1584cc	TD34321
			NJ014 50.00 x 68.00 x 9.00mm, NBR NJ060 82.00 x 105.00 x 13.00mm, MVQ	

11 1.7L**Diesel**

4EE1	4 Cyl.	8 Valves	1686cc	TD26233
17 D 4EE1 OHC	4 Cyl.	8 Valves	1699cc	TD8408
X 1.7 D 4EE1 OHC	4 Cyl.	8 Valves	1686cc	TD8407
PA658 (x8)	NJ449 40.00 x 52.00 x 6.00mm, NBR		NJ449 40.00 x 52.00 x 6.00mm, NBR NK103 87.00 x 100.00 x 8.50mm, FPM	

12 1.8L**Diesel**

4FB1	4 Cyl.	8 Valves	1817cc	TD22269
4FB1T	4 Cyl.	8 Valves	1817cc	TD22271
PA933 (x8)	NJ321 28.00 x 47.00 x 8.00mm, NBR		NJ323 40.00 x 56.00 x 7.00mm, NBR NJ322 95.00 x 118.00 x 10.00mm, NBR	

13 1.8L**Petrol**

4XF1	4 Cyl.	16 Valves	1809cc	TD26232
	NA5347 (x2) 30.0 x 45.0 x 7.00mm, FPM		NA5322 32.00 x 44.00 x 6.00mm, ACM NJ446 87.00 x 100.00 x 8.00mm, MVQ	

14 1.8L**Petrol**

4ZB1	4 Cyl.	8 Valves	1817cc	TD1679
PA933 (x8)	NA5347 30.0 x 45.0 x 7.00mm, FPM		NJ323 40.00 x 56.00 x 7.00mm, NBR NJ322 95.00 x 118.00 x 10.00mm, NBR	



15 1.8L		Petrol		
G180	4 Cyl.	8 Valves	1817cc	TD1690
G180-SZ	4 Cyl.	8 Valves	1817cc	TD1691
PA933 (x8)				NF843 50.00 x 68.00 x 10.00mm, FPM/ACM NJ014 50.00 x 68.00 x 9.00mm, NBR NJ060 82.00 x 105.00 x 13.00mm, MVQ →09/82 NJ943 82.00 x 105.00 x 10.00mm, MVQ 10/82→

16 1.8L		Petrol		
G180-W	4 Cyl.	8 Valves	1817cc	TD1692
G180-WE	4 Cyl.	8 Valves	1817cc	TD1693
G180-Z	4 Cyl.	8 Valves	1817cc	TD1694
PA933 (x8)				NF843 50.00 x 68.00 x 10.00mm, FPM/ACM NJ060 82.00 x 105.00 x 13.00mm, MVQ →09/82 NJ943 82.00 x 105.00 x 10.00mm, MVQ 10/82→

17 1.9L		Diesel		
C190	4 Cyl.	8 Valves	1951cc	TD1685
PA658 (x8)				NJ014 50.00 x 68.00 x 9.00mm, NBR 01/82→ NF843 50.00 x 68.00 x 10.00mm, FPM/ACM NJ060 82.00 x 105.00 x 13.00mm, MVQ 01/75→12/79 NJ265 82.00 x 105.00 x 13.00mm, MVQ 01/82→

18 2.0L		Diesel		
4FC1	4 Cyl.	8 Valves	1995cc	TD1664
4FC1T	4 Cyl.	8 Valves	1995cc	TD1666
PA933 (x8)		NJ321 28.00 x 47.00 x 8.00mm, NBR		NJ323 40.00 x 56.00 x 7.00mm, NBR NJ158 95.00 x 118.00 x 10.00mm, ACM NJ322 95.00 x 118.00 x 10.00mm, NBR

19 2.0L		Petrol		
4ZC1	4 Cyl.	8 Valves	1994cc	TD7221
PA933 (x8)		NA5347 30.0 x 45.0 x 7.00mm, FPM		NJ323 40.00 x 56.00 x 7.00mm, NBR NJ158 95.00 x 118.00 x 10.00mm, ACM

**20 2.0L****Petrol**

4ZC1-T	4 Cyl.	8 Valves	1995cc	TD1681
PA933 (x8)	NA5347 30.0 x 45.0 x 7.00mm, FPM	NJ323 40.00 x 56.00 x 7.00mm, NBR	NJ322 95.00 x 118.00 x 10.00mm, NBR	

21 2.0L**Petrol**

C 20 NE	4 Cyl.	8 Valves	1998cc	TD26802
PA565 (x8) HR342	NC006 35.00 x 48.00 x 7.00mm, MVQ NB807 55.00 x 70.10 x 8.00mm, FPM	NB700 31.00 x 50.00 x 8.00mm, MVQ NB806 90.00 x 104.00 x 11.00mm, FPM		

22 2.0L**Diesel**

C220	4 Cyl.	8 Valves	2038cc	TD16440
		NJ014 50.00 x 68.00 x 9.00mm, NBR NJ060 82.00 x 105.00 x 13.00mm, MVQ		

23 2.0L**Petrol**

EJ20	4 Cyl.	16 Valves	1994cc	TD29416
PA425 (x16)	NK117 32.00 x 45.00 x 8.00mm, ACM	NA5226 33.0 x 49.0 x 8.0mm, FPM NK139 86.00 x 103.00 x 10.00mm, FPM		

24 2.0L**Petrol**

F20B	4 Cyl.	16 Valves	1997cc	TD22130
PB355 (x8) PB356 (x8)	NJ134 28.00 x 42.00 x 8.00mm, MVQ	NA5242 40.00 x 52.00 x 7.00mm, ACM NJ312 80.00 x 100.00 x 10.00mm, MVQ		

25 2.0L**Petrol**

G200W	4 Cyl.	8 Valves	1950cc	TD1695
G200Z	4 Cyl.	8 Valves	1950cc	TD1696
PA933 (x8)		NF843 50.00 x 68.00 x 10.00mm, FPM/ACM NJ265 82.00 x 105.00 x 13.00mm, MVQ		

26 2.2L**Diesel**

4FD1	4 Cyl.	8 Valves	2189cc	TD1667
PA933 (x8)	NJ321 28.00 x 47.00 x 8.00mm, NBR	NJ323 40.00 x 56.00 x 7.00mm, NBR NJ322 95.00 x 118.00 x 10.00mm, NBR		

27 2.2L**Petrol**

4ZD1	4 Cyl.	8 Valves	2254cc	TD1683
PA933 (x8)	NA5347 30.0 x 45.0 x 7.00mm, FPM	NJ323 40.00 x 56.00 x 7.00mm, NBR NJ322 95.00 x 118.00 x 10.00mm, NBR		

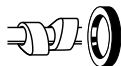

28 2.2L Diesel					
C220	4 Cyl.	8 Valves	2238cc		TD34687
				NJ014 50.00 x 68.00 x 9.00mm, NBR NJ060 82.00 x 105.00 x 13.00mm, MVQ	
29 2.2L Diesel					
C223	4 Cyl.	8 Valves	2238cc		TD1686
C223-T	4 Cyl.	8 Valves	2238cc		TD1687
PA418 (x8)				NJ267 42.00 x 55.00 x 9.00mm, NBR NJ265 82.00 x 105.00 x 13.00mm, MVQ	
30 2.2L Petrol					
X 22 SE	4 Cyl.	16 Valves	2198cc		TD25588
PA5041 (x16) HR791				NC006 (x2) 35.00 x 48.00 x 7.00mm, MVQ NB700 31.00 x 50.00 x 8.00mm, MVQ NB806 90.00 x 104.00 x 11.00mm, FPM	
31 2.3L Petrol					
F23A7	4 Cyl.	16 Valves	2254cc		TD29472
PB355 (x8) PB356 (x8)				NJ134 28.00 x 42.00 x 8.00mm, MVQ NA5242 40.00 x 52.00 x 7.00mm, ACM NJ312 80.00 x 100.00 x 10.00mm, MVQ	
32 2.4L Diesel					
4FG1T	4 Cyl.	8 Valves	2380cc		TD4577
PA933 (x8)				NJ321 28.00 x 47.00 x 8.00mm, NBR NJ323 40.00 x 56.00 x 7.00mm, NBR	
33 2.4L Petrol					
C 24 SE	4 Cyl.	8 Valves	2405cc		TD23594
PA565 (x8) HR342				NC006 35.00 x 48.00 x 7.00mm, MVQ NB700 31.00 x 50.00 x 8.00mm, MVQ NB806 90.00 x 104.00 x 11.00mm, FPM	
34 2.4L Diesel					
C240	4 Cyl.	8 Valves	2369cc		TD26269
PA418 (x8)				NJ014 50.00 x 68.00 x 9.00mm, NBR NJ265 82.00 x 105.00 x 13.00mm, MVQ	
35 2.5L Diesel					
4JA1	4 Cyl.	8 Valves	2499cc		TD1668
4JA1-AG	4 Cyl.	8 Valves	2499cc		TD1669
4JA1-L	4 Cyl.	8 Valves	2499cc		TD23595
4JA1T	4 Cyl.	8 Valves	2499cc		TD8401
PA418 (x8)				NA5051 40.00 x 56.00 x 7.00mm, FPM NA5051 40.00 x 56.00 x 7.00mm, FPM NF843 50.00 x 68.00 x 10.00mm, FPM/ACM	

**36 2.5L****Diesel**

4JK1-TC 4 Cyl. 16 Valves 2499cc TD19385

NF843 50.00 x 68.00 x 10.00mm, FPM/ACM
NJ158 95.00 x 118.00 x 10.00mm, ACM

37 2.5L**Diesel**

TD25II 4 Cyl. 8 Valves 2494cc TD29418

PA378 (x8)

NJ831 58.00 x 80.00 x 10.00mm, NBR
NJ829 86.00 x 100.00 x 10.00mm, MVQ

38 2.6L**Petrol**

4ZE1 4 Cyl. 8 Valves 2559cc TD1684

PA933 (x8)

NA5347
30.0 x 45.0 x 7.00mm, FPM

NJ323 40.00 x 56.00 x 7.00mm, NBR
NJ322 95.00 x 118.00 x 10.00mm, NBR

39 2.7L**Diesel**

TD27 4 Cyl. 8 Valves 2663cc TD21156

PA378 (x8)

NJ831 58.00 x 80.00 x 10.00mm, NBR
NJ829 86.00 x 100.00 x 10.00mm, MVQ

40 2.8L**Diesel**

4JB1 4 Cyl. 8 Valves 2771cc TD1670

4JB1-T 4 Cyl. 8 Valves 2771cc TD1671

4JB1-TC 4 Cyl. 8 Valves 2771cc TD1672

PA418 (x8)

NA5051
40.00 x 56.00 x 7.00mm, FPM

NJ014 50.00 x 68.00 x 9.00mm, NBR
NJ322 95.00 x 118.00 x 10.00mm, NBR

41 2.8L**Diesel**

4JB1-TCT 4 Cyl. 8 Valves 2771cc TD33992

JE493ZLQ-4CA 4 Cyl. 8 Valves 2771cc TD33585

NA5051
40.00 x 56.00 x 7.00mm, FPM

NJ014 50.00 x 68.00 x 9.00mm, NBR
NJ322 95.00 x 118.00 x 10.00mm, NBR

42 3.0L**Diesel**

4JJ1-TC 4 Cyl. 16 Valves 2999cc TD19386

PA418 (x16)

43 3.0L**Diesel**

4JX1 4 Cyl. 16 Valves 2999cc TD22857

NJ321
28.00 x 47.00 x 8.00mm, NBR

NJ014 50.00 x 68.00 x 9.00mm, NBR
NJ322 95.00 x 118.00 x 10.00mm, NBR

**44 3.0L****Diesel**

ZD30DDTi	4 Cyl.	16 Valves	2953cc	TD29793
PA079 (x16)				

45 3.1L**Diesel**

4JG2	4 Cyl.	8 Valves	3059cc	TD21157
4JG2 T	4 Cyl.	8 Valves	3059cc	TD8402
4JG2 TC	4 Cyl.	8 Valves	3059cc	TD21081

NA5051
40.00 x 56.00 x 7.00mm, FPM

NF843
50.00 x 68.00 x 10.00mm, FPM/ACM
NJ322
95.00 x 118.00 x 10.00mm, NBR

46 3.2L**Petrol**

6VD1	6 Cyl.	24 Valves	3165cc	TD21399
HR5094				

NA5347 (x2)
30.0 x 45.0 x 7.00mm, FPM

NA5108
42.00 x 55.00 x 7.00mm, FPM/ACM
NJ158
95.00 x 118.00 x 10.00mm, ACM

47 3.3L**Diesel**

4BC2	4 Cyl.	8 Valves	3268cc	TD1659
------	--------	----------	--------	--------

NJ232
100.00 x 135.00 x 15.00mm, MVQ

48 3.5L**Petrol**

6VE1	6 Cyl.	24 Valves	3494cc	TD22863
PB313 (x12)				
PB314 (x12)				

NA5347 (x2)
30.0 x 45.0 x 7.00mm, FPM

NA5108
42.00 x 55.00 x 7.00mm, FPM/ACM
NJ158
95.00 x 118.00 x 10.00mm, ACM

49 3.5L**Petrol**

VQ35DE	6 Cyl.	24 Valves	3498cc	TD29794
PA874 (x24)				

50 3.9L**Diesel**

4BD1	4 Cyl.	8 Valves	3856cc	TD1660
4BD1T	4 Cyl.	8 Valves	3856cc	TD1661
PA208 (x8)				

NJ232
100.00 x 135.00 x 15.00mm, MVQ

51 5.8L**Diesel**

6BD1	6 Cyl.	12 Valves	5785cc	TD7208
6BD1T	6 Cyl.	12 Valves	5785cc	TD7209
PA208 (x12)				

NJ232
100.00 x 135.00 x 15.00mm, MVQ
01/76 → 11/81
NJ596
105.00 x 135.00 x 14.00mm, MVQ
09/86 → 11/86

52 6.5L**Diesel**

6BG1	6 Cyl.	12 Valves	6494cc	TD7210
------	--------	-----------	--------	--------

NJ596
105.00 x 135.00 x 14.00mm, MVQ

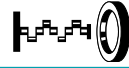

53 8.4L

Diesel

6SA1

6 Cyl.





12 Valves

8413cc

TD7211

NJ790 

120.00 x 153.00 x 15.00mm, MVQ

				CC			9
Daily I Box Body / Estate	01/78→12/89	8140.61.200	Diesel	2445	4	8	6
Daily I Box Body / Estate	01/85→12/89	8140.21.200	Diesel	2445	4	8	3
Daily I Box Body / Estate	01/85→12/89	8140.27 S	Diesel	2445	4	8	15
Daily I Platform/Chassis	01/78→12/89	8140.61.200	Diesel	2445	4	8	6
Daily I Platform/Chassis	01/85→12/89	8140.21.200	Diesel	2445	4	8	3
Daily I Platform/Chassis	01/85→12/89	8140.27 S	Diesel	2445	4	8	15
Daily II Box Body / Estate	01/89→04/96	8140.27.2720	Diesel	2499	4	8	16
Daily II Box Body / Estate	01/89→05/96	8140.27.2700	Diesel	2499	4	8	15
Daily II Box Body / Estate	01/89→08/98	8140.07.2700	Diesel	2499	4	8	9
Daily II Box Body / Estate	01/89→08/98	8140.07.2712	Diesel	2499	4	8	12
Daily II Box Body / Estate	01/89→08/98	8140.47R	Diesel	2499	4	8	9
Daily II Box Body / Estate	01/89→08/98	8140.47R.2790	Diesel	2499	4	8	20
Daily II Box Body / Estate	01/89→08/98	8140.67F.	Diesel	2499	4	8	20
Daily II Box Body / Estate	01/89→08/98	8140.67F.3710	Diesel	2499	4	8	24
Daily II Box Body / Estate	01/89→08/98	8140.67F.3711	Diesel	2499	4	8	24
Daily II Box Body / Estate	01/89→08/98	8140.67F.3713	Diesel	2499	4	8	24
Daily II Box Body / Estate	01/89→08/98	8140.67F.3721	Diesel	2499	4	8	24
Daily II Box Body / Estate	01/90→04/96	8140.47.2700	Diesel	2499	4	8	9
Daily II Box Body / Estate	01/90→04/96	8140.47S	Diesel	2499	4	8	22
Daily II Box Body / Estate	06/90→04/96	8140.47.2711	Diesel	2499	4	8	8
Daily II Box Body / Estate	06/90→04/96	8140.47.2721	Diesel	2499	4	8	8
Daily II Box Body / Estate	01/91→08/98	8140.67F.3701	Diesel	2499	4	8	24
Daily II Box Body / Estate	02/95→05/99	8140.43.	Diesel	2798	4	8	25
Daily II Box Body / Estate	01/96→05/99	8140.23.	Diesel	2798	4	8	25
Daily II Box Body / Estate	09/96→08/98	8140.97.2781	Diesel	2499	4	8	19
Daily II Box Body / Estate	09/98→05/99	8140.63.	Diesel	2798	4	8	25
Daily II Bus	06/90→04/96	8140.47.2711	Diesel	2499	4	8	8
Daily II Bus	06/90→04/96	8140.47.2721	Diesel	2499	4	8	8
Daily II Bus	01/91→12/96	8140.27.2720	Diesel	2499	4	8	16
Daily II Bus	05/96→05/99	8140.23.	Diesel	2798	4	8	25
Daily II Bus	05/96→05/99	8140.43.	Diesel	2798	4	8	25
Daily II Dumptruck	01/89→04/96	8140.27.2700	Diesel	2499	4	8	15
Daily II Dumptruck	01/89→04/96	8140.47R.2790	Diesel	2499	4	8	20
Daily II Dumptruck	06/90→04/96	8140.47.2711	Diesel	2499	4	8	8
Daily II Dumptruck	06/90→04/96	8140.47.2721	Diesel	2499	4	8	8
Daily II Dumptruck	05/91→04/96	8140.47.2700	Diesel	2499	4	8	9
Daily II Dumptruck	01/92→04/96	8140.27.2720	Diesel	2499	4	8	16
Daily II Dumptruck	05/96→05/99	8140.23.	Diesel	2798	4	8	25
Daily II Dumptruck	05/96→05/99	8140.43.	Diesel	2798	4	8	25
Daily II Dumptruck	09/98→05/99	8140.63.	Diesel	2798	4	8	25
Daily II Platform/Chassis	01/89→04/96	8140.27.2700	Diesel	2499	4	8	15
Daily II Platform/Chassis	01/89→04/96	8140.27.2720	Diesel	2499	4	8	16
Daily II Platform/Chassis	01/89→12/96	8140.47R	Diesel	2499	4	8	9
Daily II Platform/Chassis	01/89→12/96	8140.47R.2790	Diesel	2499	4	8	20
Daily II Platform/Chassis	01/89→12/96	8140.97.2781	Diesel	2499	4	8	19
Daily II Platform/Chassis	01/89→08/98	8140.07.2700	Diesel	2499	4	8	9
Daily II Platform/Chassis	01/89→08/98	8140.07.2712	Diesel	2499	4	8	12
Daily II Platform/Chassis	01/89→08/98	8140.67F.	Diesel	2499	4	8	20
Daily II Platform/Chassis	01/90→04/96	8140.47.2700	Diesel	2499	4	8	9
Daily II Platform/Chassis	06/90→04/96	8140.47.2711	Diesel	2499	4	8	8
Daily II Platform/Chassis	06/90→04/96	8140.47.2721	Diesel	2499	4	8	8
Daily II Platform/Chassis	01/92→08/98	8140.67F.3710	Diesel	2499	4	8	24
Daily II Platform/Chassis	01/92→08/98	8140.67F.3711	Diesel	2499	4	8	24
Daily II Platform/Chassis	01/92→08/98	8140.67F.3713	Diesel	2499	4	8	24
Daily II Platform/Chassis	01/92→08/98	8140.67F.3721	Diesel	2499	4	8	24
Daily II Platform/Chassis	02/95→05/99	8140.43.	Diesel	2798	4	8	25
Daily II Platform/Chassis	01/96→05/99	8140.23.	Diesel	2798	4	8	25
Daily II Platform/Chassis	09/98→05/99	8140.63.	Diesel	2798	4	8	25
Daily III Box Body / Estate	11/97→07/07	8140.23.	Diesel	2798	4	8	25
Daily III Box Body / Estate	11/97→07/07	8140.43.	Diesel	2798	4	8	25
Daily III Box Body / Estate	05/99→07/07	8140.43C	Diesel	2798	4	8	32
Daily III Box Body / Estate	05/99→07/07	8140.43S	Diesel	2798	4	8	28
Daily III Box Body / Estate	05/99→07/07	8140.63.	Diesel	2798	4	8	25
Daily III Box Body / Estate	05/99→07/07	8149.03	Gas	2798	4	8	34
Daily III Box Body / Estate	01/01→07/07	8140.43N	Diesel	2798	4	8	25
Daily III Box Body / Estate	11/01→04/06	8140.43R	Diesel	2798	4	8	25
Daily III Box Body / Estate	09/02→07/07	F1AE0481A	Diesel	2287	4	16	1
Daily III Box Body / Estate	09/02→07/07	F1AE0481B	Diesel	2287	4	16	1
Daily III Box Body / Estate	01/05→04/06	F1AE0481M	Diesel	2287	4	16	1
Daily III Bus	05/99→05/06	8140.43B	Diesel	2798	4	8	28
Daily III Bus	05/99→05/06	8140.43C	Diesel	2798	4	8	32
Daily III Bus	05/99→05/06	8140.43N	Diesel	2798	4	8	25
Daily III Bus	05/99→05/06	8140.43S	Diesel	2798	4	8	28
Daily III Bus	05/02→05/06	8149.03	Gas	2798	4	8	34
Daily III Bus	01/03→05/06	F1AE0481B	Diesel	2287	4	16	1
Daily III Platform/Chassis	05/99→04/06	8140.43B	Diesel	2798	4	8	28
Daily III Platform/Chassis	05/99→04/06	8140.43C	Diesel	2798	4	8	32
Daily III Platform/Chassis	05/99→04/06	8140.43S	Diesel	2798	4	8	28



















CC



















9









Daily III Platform/Chassis	05/99→04/06	8140.63.	Diesel	2798	4	8	25
Daily III Platform/Chassis	05/99→04/06	8149.03	Gas	2798	4	8	34
Daily III Platform/Chassis	07/99→04/06	8140.43.K	Diesel	2798	4	8	30
Daily III Platform/Chassis	01/01→04/06	8140.43N	Diesel	2798	4	8	25
Daily III Platform/Chassis	11/01→04/06	8140.43R	Diesel	2798	4	8	25
Daily III Platform/Chassis	09/02→04/06	F1AE0481A	Diesel	2287	4	16	1
Daily III Platform/Chassis	09/02→04/06	F1AE0481B	Diesel	2287	4	16	1
Daily III Platform/Chassis	01/05→04/06	F1AE0481M	Diesel	2287	4	16	1
Daily IV Box Body / Estate	05/06→08/11	F1AE0481FA	Diesel	2287	4	16	1
Daily IV Box Body / Estate	05/06→08/11	F1AE0481GA	Diesel	2287	4	16	1
Daily IV Box Body / Estate	05/06→08/11	F1AE0481HA	Diesel	2287	4	16	1
Daily IV Bus	05/06→08/11	F1AE0481HA	Diesel	2287	4	16	1
Daily IV Dumptruck	05/06→08/11	F1AE0481FA	Diesel	2287	4	16	1
Daily IV Dumptruck	05/06→08/11	F1AE0481GA	Diesel	2287	4	16	1
Daily IV Dumptruck	07/07→08/11	F1AE0481HA	Diesel	2287	4	16	1
Daily IV Platform/Chassis	05/06→08/11	F1AE0481FA	Diesel	2287	4	16	1
Daily IV Platform/Chassis	05/06→08/11	F1AE0481GA	Diesel	2287	4	16	1
Daily IV Platform/Chassis	05/06→08/11	F1AE0481HA	Diesel	2287	4	16	1
Daily V Box Body / Estate	09/11→02/14	F1AE3481A	Diesel	2287	4	16	1
Daily V Box Body / Estate	09/11→02/14	F1AE3481B	Diesel	2287	4	16	1
Daily V Box Body / Estate	09/11→02/14	F1AE3481C	Diesel	2287	4	16	1
Daily V Dumptruck	09/11→02/14	F1AE3481A	Diesel	2287	4	16	1
Daily V Dumptruck	09/11→02/14	F1AE3481B	Diesel	2287	4	16	1
Daily V Platform/Chassis	09/11→02/14	F1AE3481A	Diesel	2287	4	16	1
Daily V Platform/Chassis	09/11→02/14	F1AE3481B	Diesel	2287	4	16	1
Daily V Platform/Chassis	09/11→02/14	F1AE3481C	Diesel	2287	4	16	1
Daily VI Box	03/14→04/16	F1AE3481A	Diesel	2287	4	16	1
Daily VI Box	03/14→04/16	F1AE3481C	Diesel	2287	4	16	1
Daily VI Box	03/14→04/16	F1AFL411A	Diesel	2287	4	16	1
Daily VI Box	03/14→04/16	F1AFL411B	Diesel	2287	4	16	1
Daily VI Box	03/14→04/16	F1AFL411C	Diesel	2287	4	16	1
Daily VI Platform/Chassis	03/14→04/16	F1AE3481A	Diesel	2287	4	16	1
Daily VI Platform/Chassis	03/14→04/16	F1AE3481B	Diesel	2287	4	16	1
Daily VI Platform/Chassis	03/14→04/16	F1AE3481C	Diesel	2287	4	16	1
Daily VI Platform/Chassis	03/14→04/16	F1AFL411A	Diesel	2287	4	16	1
Daily VI Platform/Chassis	03/14→04/16	F1AFL411B	Diesel	2287	4	16	1
Daily VI Platform/Chassis	03/14→04/16	F1AFL411C	Diesel	2287	4	16	1
Duling V Bus	08/04→12/08	4G64-S4M	Petrol	2351	4	16	2

	CC				9		CC				9
4G64-S4M	2351	4	16	Petrol	2	8060.05.270	5861	6	12	Diesel	45
8040.04.200	3666	4	8	Diesel	36	8060.05.280	5861	6	12	Diesel	45
8040.05.200	3908	4	8	Diesel	39	8060.05.284	5861	6	12	Diesel	45
8040.05.203	3908	4	8	Diesel	39	8060.05.285	5861	6	12	Diesel	45
8040.05.230	3908	4	8	Diesel	39	8060.05.286	5861	6	12	Diesel	45
8040.05.232	3908	4	8	Diesel	39	8060.05.288	5861	6	12	Diesel	45
8040.05.233	3908	4	8	Diesel	39	8060.05.289	5861	6	12	Diesel	45
8040.05.235	3908	4	8	Diesel	39	8060.24.601	5500	6	12	Diesel	43
8040.05.4990	3908	4	8	Diesel	37	8060.24.670	5499	6	12	Diesel	43
8040.25.200	3908	4	8	Diesel	39	8060.24.671	5499	6	12	Diesel	43
8040.25.201	3908	4	8	Diesel	39	8060.24.678	5500	6	12	Diesel	43
8040.25.202	3908	4	8	Diesel	39	8060.25.600	5861	6	12	Diesel	46
8040.25.203	3908	4	8	Diesel	39	8060.25.601	5861	6	12	Diesel	47
8040.25.207	3908	4	8	Diesel	39	8060.25.602	5861	6	12	Diesel	47
8040.25.208	3908	4	8	Diesel	39	8060.25.603	5861	6	12	Diesel	47
8040.25.220	3908	4	8	Diesel	37	8060.25.604	5861	6	12	Diesel	47
8040.25.222	3908	4	8	Diesel	39	8060.25.669	5861	6	12	Diesel	47
8040.25.223	3908	4	8	Diesel	39	8060.25.670	5861	6	12	Diesel	47
8040.25.225	3908	4	8	Diesel	39	8060.25.678	5861	6	12	Diesel	47
8040.25.229	3908	4	8	Diesel	39	8060.25.679	5861	6	12	Diesel	47
8040.25.230 R	3908	4	8	Diesel	39	8060.25R.4200	5861	6	12	Diesel	47
8040.25.231	3908	4	8	Diesel	39	8060.25R.4200 LTC	5861	6	12	Diesel	47
8040.25.233	3908	4	8	Diesel	39	8060.25R.4210	5861	6	12	Diesel	47
8040.25.234	3908	4	8	Diesel	39	8060.25R.4220	5861	6	12	Diesel	47
8040.25B.4200	3908	4	8	Diesel	39	8060.25R.4225	5861	6	12	Diesel	47
8040.25B.4220	3908	4	8	Diesel	39	8060.25R.4230	5861	6	12	Diesel	47
8040.25X.4000	3908	4	8	Diesel	39	8060.25R.4240	5861	6	12	Diesel	47
8040.25X.4010	3908	4	8	Diesel	39	8060.25R.4250	5861	6	12	Diesel	47
8040.25X.4020	3908	4	8	Diesel	39	8060.25R.4280	5861	6	12	Diesel	47
8040.25X.4030	3908	4	8	Diesel	39	8060.25R.4285	5861	6	12	Diesel	47
8040.25X.4035	3908	4	8	Diesel	39	8060.25R.4290	5861	6	12	Diesel	47
8040.25X.4040	3908	4	8	Diesel	39	8060.25R.4295	5861	6	12	Diesel	47
8040.25X.4045	3908	4	8	Diesel	39	8060.25R.4300	5861	6	12	Diesel	47
8040.45	3908	4	8	Diesel	39	8060.25R.4360	5861	6	12	Diesel	47
8040.45.4000	3908	4	8	Diesel	39	8060.25R.4362	5861	6	12	Diesel	47
8040.45.4010	3908	4	8	Diesel	39	8060.25R.4750	5861	6	12	Diesel	47
8040.45.4020	3908	4	8	Diesel	39	8060.25R.4755	5861	6	12	Diesel	47
8040.45.4030	3908	4	8	Diesel	39	8060.25R.4760	5861	6	12	Diesel	47
8040.45.4035	3908	4	8	Diesel	39	8060.25R.4764	5861	6	12	Diesel	47
8040.45.4050	3908	4	8	Diesel	39	8060.25R.4960	5861	6	12	Diesel	47
8040.45.4180	3908	4	8	Diesel	37	8060.25R.4967	5861	6	12	Diesel	47
8040.45.4303	3908	4	8	Diesel	39	8060.25R.4968	5861	6	12	Diesel	47
8040.45.4380	3908	4	8	Diesel	37	8060.25R.4970	5861	6	12	Diesel	47
8040.45.5200	3908	4	8	Diesel	37	8060.25R.4973	5861	6	12	Diesel	47
8040.45.5201	3908	4	8	Diesel	39	8060.25R.4980	5861	6	12	Diesel	47
8040.45.5203	3908	4	8	Diesel	39	8060.25V.4000	5861	6	12	Diesel	46
8040.45.5205	3908	4	8	Diesel	37	8060.25V.4010	5861	6	12	Diesel	47
8040.45.5280	3908	4	8	Diesel	37	8060.25V.4020	5861	6	12	Diesel	47
8040.45.5281	3908	4	8	Diesel	37	8060.25V.4025	5861	6	12	Diesel	47
8040.45D.5100	3908	4	8	Diesel	37	8060.25V.4030	5861	6	12	Diesel	47
8040.45D.5101	3908	4	8	Diesel	37	8060.25V.4040	5861	6	12	Diesel	47
8040.45D.5103	3908	4	8	Diesel	37	8060.25V.4050	5861	6	12	Diesel	47
8040.45D.5105	3908	4	8	Diesel	37	8060.25V.4060	5861	6	12	Diesel	47
8040.45X.4180	3908	4	8	Diesel	37	8060.25V.4080	5861	6	12	Diesel	47
8045.05	3908	4		Diesel	37	8060.25V.4090	5861	6	12	Diesel	47
8045.06	3613	4		Diesel	35	8060.25V.4100	5861	6	12	Diesel	47
8060.02.001	5184	6	12	Diesel	42	8060.25V.4105	5861	6	12	Diesel	47
8060.02.003	5184	6	12	Diesel	42	8060.25V.4110	5861	6	12	Diesel	47
8060.04.051	5499	6	12	Diesel	43	8060.25V.4160	5861	6	12	Diesel	47
8060.04.055	5499	6	12	Diesel	43	8060.25V.4165	5861	6	12	Diesel	47
8060.04.060	5500	6	12	Diesel	43	8060.25V.4170	5861	6	12	Diesel	47
8060.04.070	5499	6	12	Diesel	43	8060.25V.4175	5861	6	12	Diesel	47
8060.04.620	5499	6	12	Diesel	43	8060.25V.4720	5861	6	12	Diesel	47
8060.04.621	5499	6	12	Diesel	43	8060.25V.4722	5861	6	12	Diesel	47
8060.04.630	5500	6	12	Diesel	43	8060.25V.4724	5861	6	12	Diesel	47
8060.04.639	5500	6	12	Diesel	43	8060.25V.4725	5861	6	12	Diesel	47
8060.04.658	5499	6	12	Diesel	43	8060.25V.4800	5861	6	12	Diesel	47
8060.04.660	5500	6	12	Diesel	43	8060.25V.4900	5861	6	12	Diesel	47
8060.04.669	5500	6	12	Diesel	43	8060.25V.4920	5861	6	12	Diesel	47
8060.04.670	5500	6	12	Diesel	43	8060.25V.4925	5861	6	12	Diesel	47
8060.04.672	5500	6	12	Diesel	43	8060.25V.4950	5861	6	12	Diesel	47
8060.04.675	5500	6	12	Diesel	43	8060.25V.4952	5861	6	12	Diesel	47
8060.04.689	5500	6	12	Diesel	43	8060.25V.4953	5861	6	12	Diesel	47
8060.05.000	5861	6	12	Diesel	45	8060.45	5861	6	12	Diesel	47
8060.05.200	5861	6	12	Diesel	45	8060.45.4100	5861	6	12	Diesel	47
8060.05.201	5861	6	12	Diesel	45	8060.45.4100 TCA	5861	6	12	Diesel	47
8060.05.203	5861	6	12	Diesel	45	8060.45.4110	5861	6	12	Diesel	47
8060.05.246	5861	6	12	Diesel	45	8060.45.4120	5861	6	12	Diesel	47

	CC				9		CC				9
8060.45.4130	5861	6	12	Diesel	47	8060.455.6130	5861	6	12	Diesel	47
8060.45.4150	5861	6	12	Diesel	47	8060.455.6140	5861	6	12	Diesel	47
8060.45.4180	5861	6	12	Diesel	47	8060.455.6150	5861	6	12	Diesel	47
8060.45.4403	5861	6	12	Diesel	47	8060.455.6203	5861	6	12	Diesel	47
8060.45.4700	5861	6	12	Diesel	47	8060.455.6700	5861	6	12	Diesel	47
8060.45.4702	5861	6	12	Diesel	47	8060.455.6705	5861	6	12	Diesel	47
8060.45.4704	5861	6	12	Diesel	47	8060.455.6706	5861	6	12	Diesel	47
8060.45.4706	5861	6	12	Diesel	47	8060.455.6707	5861	6	12	Diesel	47
8060.45.4708	5861	6	12	Diesel	47	8060.455.6710	5861	6	12	Diesel	47
8060.45.5200	5861	6	12	Diesel	47	8060.455.6711	5861	6	12	Diesel	47
8060.45.5201	5861	6	12	Diesel	47	8060.455.6800	5861	6	12	Diesel	47
8060.45.5203	5861	6	12	Diesel	47	8060.455.6912	5861	6	12	Diesel	47
8060.45.5205	5861	6	12	Diesel	47	8060.455.7200	5861	6	12	Diesel	47
8060.45.5210	5861	6	12	Diesel	47	8060.455.7201	5861	6	12	Diesel	47
8060.45.5211	5861	6	12	Diesel	47	8060.455.7203	5861	6	12	Diesel	47
8060.45.5220	5861	6	12	Diesel	47	8060.455.7205	5861	6	12	Diesel	47
8060.45.5221	5861	6	12	Diesel	47	8060.455.7210	5861	6	12	Diesel	47
8060.45.5223	5861	6	12	Diesel	47	8060.455.7211	5861	6	12	Diesel	47
8060.45.5232	5861	6	12	Diesel	47	8060.455.7213	5861	6	12	Diesel	47
8060.45.5233	5861	6	12	Diesel	47	8060.455.7215	5861	6	12	Diesel	47
8060.45.5234	5861	6	12	Diesel	47	8060.455.7250	5861	6	12	Diesel	47
8060.45.5235	5861	6	12	Diesel	47	8060.455.7251	5861	6	12	Diesel	47
8060.45.5250	5861	6	12	Diesel	47	8060.455.7253	5861	6	12	Diesel	47
8060.45.5251	5861	6	12	Diesel	47	8060.455.7255	5861	6	12	Diesel	47
8060.45.5255	5861	6	12	Diesel	47	8060.455 TCA	5861	6	12	Diesel	44
8060.45.6090	5861	6	12	Diesel	47	8060.45X.4180	5861	6	12	Diesel	47
8060.45A.4100	5861	6	12	Diesel	47	8061.05	5861	6	12	Diesel	47
8060.45B	5861	6	12	Diesel	47	8062.24.070	5499	6	12	Diesel	43
8060.45B.4385	5861	6	12	Diesel	47	8065.E	5861	6	12	Diesel	47
8060.45B.4386	5861	6	12	Diesel	47	8140.07.2585	2500	4	8	Diesel	8
8060.45B.5100	5861	6	12	Diesel	47	8140.07.2700	2499	4	8	Diesel	9
8060.45B.5101	5861	6	12	Diesel	47	8140.07.2701	2499	4	8	Diesel	10
8060.45B.5103	5861	6	12	Diesel	47	8140.07.2710	2499	4	8	Diesel	11
8060.45B.5105	5861	6	12	Diesel	47	8140.07.2711	2499	4	8	Diesel	11
8060.45B.5110	5861	6	12	Diesel	47	8140.07.2712	2499	4	8	Diesel	12
8060.45B.5111	5861	6	12	Diesel	47	8140.07.2713	2499	4	8	Diesel	11
8060.45B.5112	5861	6	12	Diesel	47	8140.07.3700	2499	4	8	Diesel	13
8060.45B.5113	5861	6	12	Diesel	47	8140.07.3710	2499	4	8	Diesel	14
8060.45B.5120	5861	6	12	Diesel	47	8140.07.3711	2499	4	8	Diesel	11
8060.45B.5121	5861	6	12	Diesel	47	8140.07.3712	2499	4	8	Diesel	11
8060.45B.5123	5861	6	12	Diesel	47	8140.07.3713	2499	4	8	Diesel	11
8060.45B.5124	5861	6	12	Diesel	47	8140.21.200	2445	4	8	Diesel	3
8060.45B.5145	5861	6	12	Diesel	47	8140.21.201	2445	4	8	Diesel	4
8060.45B.5146	5861	6	12	Diesel	47	8140.21.202	2445	4	8	Diesel	4
8060.45B.5150	5861	6	12	Diesel	47	8140.21.203	2445	4	8	Diesel	4
8060.45B.5151	5861	6	12	Diesel	47	8140.21.212	2445	4	8	Diesel	4
8060.45B.5153	5861	6	12	Diesel	47	8140.21.214	2445	4	8	Diesel	5
8060.45B.5155	5861	6	12	Diesel	47	8140.21.290	2445	4	8	Diesel	4
8060.45B.5185	5861	6	12	Diesel	47	8140.23.	2798	4	8	Diesel	25
8060.45B.5186	5861	6	12	Diesel	47	8140.23.2585	2799	4	8	Diesel	26
8060.45K.6090	5861	6	12	Diesel	47	8140.23.3700	2798	4	8	Diesel	27
8060.45L	5861	6	12	Diesel	47	8140.23.3701	2798	4	8	Diesel	28
8060.45L.4485	5861	6	12	Diesel	47	8140.23.3710	2798	4	8	Diesel	28
8060.45L.4486	5861	6	12	Diesel	47	8140.23.3711	2798	4	8	Diesel	28
8060.45M	5861	6	12	Diesel	47	8140.23.3713	2798	4	8	Diesel	28
8060.45M.7281	5861	6	12	Diesel	47	8140.23.3720	2798	4	8	Diesel	28
8060.45M.7285	5861	6	12	Diesel	47	8140.23.3721	2798	4	8	Diesel	28
8060.45M.7286	5861	6	12	Diesel	47	8140.23.3730	2798	4	8	Diesel	28
8060.45R.4245	5861	6	12	Diesel	47	8140.23.3731	2798	4	8	Diesel	28
8060.45R.5000	5861	6	12	Diesel	47	8140.23.3750	2798	4	8	Diesel	28
8060.45R.5001	5861	6	12	Diesel	47	8140.23.3751	2798	4	8	Diesel	28
8060.45R.5003	5861	6	12	Diesel	47	8140.23.3760	2798	4	8	Diesel	28
8060.45R.5005	5861	6	12	Diesel	47	8140.23.3801	2798	4	8	Diesel	28
8060.45R.5010	5861	6	12	Diesel	47	8140.23.3811	2798	4	8	Diesel	28
8060.45R.5011	5861	6	12	Diesel	47	8140.23.3821	2798	4	8	Diesel	28
8060.45R.5013	5861	6	12	Diesel	47	8140.27.215	2499	4	8	Diesel	13
8060.45R.5015	5861	6	12	Diesel	47	8140.27.218	2499	4	8	Diesel	13
8060.45R.5050	5861	6	12	Diesel	47	8140.27.2582	2499	4	8	Diesel	13
8060.45R.5051	5861	6	12	Diesel	47	8140.27.2700	2499	4	8	Diesel	15
8060.45S.6000	5861	6	12	Diesel	47	8140.27.2720	2499	4	8	Diesel	16
8060.45S.6010	5861	6	12	Diesel	47	8140.27.2811	2499	4	8	Diesel	13
8060.45S.6020	5861	6	12	Diesel	47	8140.27R.2700	2499	4	8	Diesel	13
8060.45S.6030	5861	6	12	Diesel	47	8140.27R.2780	2499	4	8	Diesel	11
8060.45S.6040	5861	6	12	Diesel	47	8140.27R.2782	2499	4	8	Diesel	14
8060.45S.6045	5861	6	12	Diesel	47	8140.27R.2786	2499	4	8	Diesel	14
8060.45S.6052	5861	6	12	Diesel	47	8140.27R.2787	2499	4	8	Diesel	11
8060.45S.6110	5861	6	12	Diesel	47	8140.27 S	2445	4	8	Diesel	15
8060.45S.6120	5861	6	12	Diesel	47	8140.27S.2700	2499	4	8	Diesel	17

	CC				9		CC				9
8140.27S.2701	2499	4	8	Diesel	18	8140.43R.4400	2798	4	8	Diesel	28
8140.27S.2710	2499	4	8	Diesel	18	8140.43R.4420	2798	4	8	Diesel	28
8140.27S.2711	2499	4	8	Diesel	18	8140.43R.4430	2798	4	8	Diesel	28
8140.27S.2720	2499	4	8	Diesel	18	8140.43S	2798	4	8	Diesel	28
8140.27S.2721	2499	4	8	Diesel	18	8140.43S.4000	2798	4	8	Diesel	28
8140.27S.2730	2499	4	8	Diesel	18	8140.43S.4020	2798	4	8	Diesel	28
8140.27S.2731	2499	4	8	Diesel	18	8140.43S.4030	2798	4	8	Diesel	28
8140.27S.2750	2499	4	8	Diesel	18	8140.43S.4140	2798	4	8	Diesel	28
8140.27S.2751	2499	4	8	Diesel	18	8140.43S.4300	2798	4	8	Diesel	28
8140.27S.2760	2499	4	8	Diesel	19	8140.43S.4320	2798	4	8	Diesel	28
8140.27S.2761	2499	4	8	Diesel	19	8140.43S.4330	2798	4	8	Diesel	28
8140.27S.2770	2499	4	8	Diesel	18	8140.43S.4400	2798	4	8	Diesel	28
8140.27S.2771	2499	4	8	Diesel	18	8140.43S.4420	2798	4	8	Diesel	28
8140.27S.2801	2499	4	8	Diesel	19	8140.43S.4430	2798	4	8	Diesel	28
8140.27S.2811	2499	4	8	Diesel	18	8140.47.2700	2499	4	8	Diesel	9
8140.27S.2885	2499	4	8	Diesel	19	8140.47.2711	2499	4	8	Diesel	8
8140.27S.3700	2499	4	8	Diesel	18	8140.47.2721	2499	4	8	Diesel	8
8140.27S.3701	2499	4	8	Diesel	18	8140.47.2785	2499	4	8	Diesel	18
8140.27S.3711	2499	4	8	Diesel	18	8140.47.3700	2499	4	8	Diesel	18
8140.27S.3720	2499	4	8	Diesel	18	8140.47.3711	2499	4	8	Diesel	19
8140.27S.3721	2499	4	8	Diesel	18	8140.47.3721	2499	4	8	Diesel	18
8140.27S.3750	2499	4	8	Diesel	18	8140.47.3731	2499	4	8	Diesel	18
8140.27S.3751	2499	4	8	Diesel	18	8140.47B.3790	2499	4	8	Diesel	18
8140.27S.3760	2499	4	8	Diesel	18	8140.47B.3795	2499	4	8	Diesel	18
8140.27S.3761	2499	4	8	Diesel	18	8140.47R	2499	4	8	Diesel	9
8140.27S.3770	2499	4	8	Diesel	19	8140.47R.2790	2499	4	8	Diesel	20
8140.27S.3771	2499	4	8	Diesel	18	8140.47R.2795	2499	4	8	Diesel	21
8140.27S.3780	2499	4	8	Diesel	18	8140.47S	2499	4	8	Diesel	22
8140.27S.3781	2499	4	8	Diesel	18	8140.61.200	2445	4	8	Diesel	6
8140.27S.3811	2499	4	8	Diesel	19	8140.61.300	2445	4	8	Diesel	7
8140.43.	2798	4	8	Diesel	25	8140.63.	2798	4	8	Diesel	25
8140.43.2585	2798	4	8	Diesel	29	8140.63.4000	2798	4	8	Diesel	31
8140.43.3700	2798	4	8	Diesel	29	8140.67.2585	2500	4	8	Diesel	23
8140.43.3711	2798	4	8	Diesel	30	8140.67F.	2499	4	8	Diesel	20
8140.43.3713	2798	4	8	Diesel	30	8140.67F.3700	2499	4	8	Diesel	24
8140.43.3718	2798	4	8	Diesel	30	8140.67F.3701	2499	4	8	Diesel	24
8140.43.3721	2798	4	8	Diesel	30	8140.67F.3710	2499	4	8	Diesel	24
8140.43.3723	2798	4	8	Diesel	30	8140.67F.3711	2499	4	8	Diesel	24
8140.43.3728	2798	4	8	Diesel	30	8140.67F.3713	2499	4	8	Diesel	24
8140.43.3731	2798	4	8	Diesel	30	8140.67F.3721	2499	4	8	Diesel	24
8140.43.3900	2798	4	8	Diesel	31	8140.97.2781	2499	4	8	Diesel	19
8140.43.3911	2798	4	8	Diesel	30	8140 SC 27.02	2500	4	8	Diesel	8
8140.43.3921	2798	4	8	Diesel	30	8144.61.200	2445	4	8	Diesel	7
8140.43.3931	2798	4	8	Diesel	30	8149.03	2798	4	8	Gas	34
8140.43.K	2798	4	8	Diesel	30	8210.02.	13800	6	12	Diesel	61
8140.43B	2798	4	8	Diesel	28	8210.02.067	13798	6	12	Diesel	61
8140.43B.4300	2798	4	8	Diesel	28	8210.02.069	13798	6	12	Diesel	61
8140.43B.4305	2798	4	8	Diesel	28	8210.02.371	13798	6	12	Diesel	61
8140.43B.4320	2798	4	8	Diesel	28	8210.02.373	13798	6	12	Diesel	61
8140.43B.4325	2798	4	8	Diesel	28	8210.02.377	13798	6	12	Diesel	61
8140.43B.4330	2798	4	8	Diesel	28	8210.02.393	13798	6	12	Diesel	61
8140.43B.4335	2798	4	8	Diesel	28	8210.02.440	13798	6	12	Diesel	61
8140.43C	2798	4	8	Diesel	32	8210.02.441	13798	6	12	Diesel	61
8140.43C	2798	4	8	Diesel	33	8210.02.731	13798	6	12	Diesel	61
8140.43C.4000	2798	4	8	Diesel	28	8210.22.105	13798	6	12	Diesel	61
8140.43C.4005	2798	4	8	Diesel	28	8210.22.171	13798	6	12	Diesel	61
8140.43C.4020	2798	4	8	Diesel	28	8210.22.175	13798	6	12	Diesel	61
8140.43C.4021	2798	4	8	Diesel	28	8210.22.183	13798	6	12	Diesel	61
8140.43C.4025	2798	4	8	Diesel	28	8210.22.210	13798	6	12	Diesel	61
8140.43C.4026	2798	4	8	Diesel	28	8210.22.236	13798	6	12	Diesel	61
8140.43C.4030	2798	4	8	Diesel	28	8210.22.269	13798	6	12	Diesel	61
8140.43C.4031	2798	4	8	Diesel	28	8210.22.317	13798	6	12	Diesel	61
8140.43C.4035	2798	4	8	Diesel	28	8210.22.327	13798	6	12	Diesel	61
8140.43C.4036	2798	4	8	Diesel	28	8210.22.385	13798	6	12	Diesel	61
8140.43K.4000	2798	4	8	Diesel	25	8210.22.511	13798	6	12	Diesel	61
8140.43K.4020	2798	4	8	Diesel	28	8210.22.521	13798	6	12	Diesel	61
8140.43K.4030	2798	4	8	Diesel	30	8210.22.523	13798	6	12	Diesel	61
8140.43N	2798	4	8	Diesel	25	8210.22.525	13798	6	12	Diesel	61
8140.43N.4300	2798	4	8	Diesel	28	8210.22.535	13798	6	12	Diesel	61
8140.43N.4320	2798	4	8	Diesel	28	8210.22.537	13798	6	12	Diesel	61
8140.43N.4330	2798	4	8	Diesel	28	8210.22.569	13798	6	12	Diesel	61
8140.43N.4400	2798	4	8	Diesel	28	8210.22.869	13798	6	12	Diesel	61
8140.43N.4430	2798	4	8	Diesel	28	8210.22X.069	13798	6	12	Diesel	61
8140.43P	2798	4	8	Diesel	28	8210.22X.235	13798	6	12	Diesel	61
8140.43R	2798	4	8	Diesel	25	8210.22X.523	13798	6	12	Diesel	61
8140.43R.4300	2798	4	8	Diesel	28	8210.22X.575	13798	6	12	Diesel	61
8140.43R.4320	2798	4	8	Diesel	28	8210.42.	13798	6	12	Diesel	61
8140.43R.4330	2798	4	8	Diesel	28	8210.42.061	13798	6	12	Diesel	61

	CC				9		CC				9
8210.42.073	13798	6	12	Diesel	61	F1AE0481U	2287	4	16	Diesel	1
8210.42.101	13798	6	12	Diesel	61	F1AE0481V	2287	4	16	Diesel	1
8210.42.115	13798	6	12	Diesel	61	F1AE3481A	2287	4	16	Diesel	1
8210.42.151	13798	6	12	Diesel	61	F1AE3481B	2287	4	16	Diesel	1
8210.42.152	13798	6	12	Diesel	61	F1AE3481C	2287	4	16	Diesel	1
8210.42.154	13798	6	12	Diesel	61	F1AFL411A	2287	4	16	Diesel	1
8210.42.155	13798	6	12	Diesel	61	F1AFL411B	2287	4	16	Diesel	1
8210.42.161	13798	6	12	Diesel	61	F1AFL411C	2287	4	16	Diesel	1
8210.42.162	13798	6	12	Diesel	61	F3AE0681B	10300	6	24	Diesel	56
8210.42.165	13798	6	12	Diesel	61	F3AE0681D	10300	6	24	Diesel	56
8210.42.171	13798	6	12	Diesel	61	F3AE0681E	10300	6	24	Diesel	56
8210.42.172	13798	6	12	Diesel	61	F3AE0681H	10300	6	24	Diesel	56
8210.42.175	13798	6	12	Diesel	61	F3AE3681A	10300	6	24	Diesel	56
8210.42.181	13798	6	12	Diesel	61	F3AE3681B	10300	6	24	Diesel	56
8210.42.182	13798	6	12	Diesel	61	F3AE3681D	10300	6	24	Diesel	56
8210.42.185	13798	6	12	Diesel	61	F3AE3681Y	10300	6	24	Diesel	56
8210.42.186	13798	6	12	Diesel	61	F3B3681A	12880	6	24	Diesel	58
8210.42.191	13798	6	12	Diesel	61	F3B3681B	12882	6	24	Diesel	58
8210.42.195	13798	6	12	Diesel	61	F3B3681C	12880	6	24	Diesel	58
8210.42.210	13798	6	12	Diesel	61	F3B3681D	12880	6	24	Diesel	58
8210.42.235	13798	6	12	Diesel	61	F3B3681E	12880	6	24	Diesel	59
8210.42.237	13798	6	12	Diesel	61	F3B3681F	12882	6	24	Diesel	59
8210.42.269	13798	6	12	Diesel	61	F3B3681G	12880	6	24	Diesel	59
8210.42.270	13798	6	12	Diesel	61	F3BE0681A	12880	6	24	Diesel	59
8210.42.271	13798	6	12	Diesel	61	F3BE0681B	12880	6	24	Diesel	59
8210.42.500	13798	6	12	Diesel	61	F3BE0681C	12880	6	24	Diesel	59
8210.42K(TCA)	13798	6	12	Diesel	61	F3BE0681D	12882	6	24	Diesel	58
8210.42K.	13798	6	12	Diesel	61	F3BE0681E	12880	6	24	Diesel	59
8210.42L(TCA)	13798	6	12	Diesel	61	F3BE0681F	12882	6	24	Diesel	58
8210.42L.	13798	6	12	Diesel	61	F3BE0681G	12880	6	24	Diesel	59
8210.42L.400	13798	6	12	Diesel	61	F3BE0681H	12882	6	24	Diesel	58
8210.42M	13798	6	12	Diesel	61	F3BE0681J	12882	6	24	Diesel	58
8210.42M. TCA	13798	6	12	Diesel	61	F3BE0681K	12882	6	24	Diesel	58
8210.42 TCA	13798	6	12	Diesel	61	F3BE0681V	12880	6	24	Diesel	59
8220.02.870	9572	6	12	Diesel	54	F3BE3681A	12882	6	24	Diesel	58
8220.22.002	9572	6	12	Diesel	54	F3BE3681B	12880	6	24	Diesel	58
8220.22.102	9572	6	12	Diesel	54	F3BE3681C	12880	6	24	Diesel	58
8460.21.002	9500	6	12	Diesel	53	F3BE3681D	12882	6	24	Diesel	58
8460.21.010	9500	6	12	Diesel	53	F3BE3681E	12882	6	24	Diesel	59
8460.21.102	9500	6	12	Diesel	53	F3BE3681F	12882	6	24	Diesel	59
8460.21.202	9498	6	12	Diesel	53	F3BE3681G	12882	6	24	Diesel	59
8460.21.206	9498	6	12	Diesel	53	F3HFE611/410	12882	6	24	Diesel	58
8460.21.601	9498	6	12	Diesel	53	F3HFE611/450	12882	6	24	Diesel	58
8460.21.611	9498	6	12	Diesel	53	F3HFE611/500	12882	6	24	Diesel	58
8460.41.102	9500	6	12	Diesel	53	F3HFE611/560	12882	6	24	Diesel	58
8460.41.124	9500	6	12	Diesel	53	F3HFE611A	12882	6	24	Diesel	58
8460.41.160	9500	6	12	Diesel	53	F3HFE611B	12882	6	24	Diesel	58
8460.41 B	9500	6	12	Diesel	53	F3HFE611C	12882	6	24	Diesel	58
8460.41C.	9500	6	12	Diesel	53	F3HFE611D	12882	6	24	Diesel	58
8460.41C.320	9500	6	12	Diesel	53	F4AE0481A	3920	4	16	Diesel	38
8460.41C. TCA	9500	6	12	Diesel	53	F4AE0481C	3920	4	16	Diesel	38
8460.41K.	9500	6	12	Diesel	53	F4AE0481D	3920	4	16	Diesel	38
8460.41K.406	9500	6	12	Diesel	53	F4AE0681A	5880	6	24	Diesel	48
8460.41K.410	9500	6	12	Diesel	53	F4AE0681B	5880	6	24	Diesel	48
8460.41K. TCA	9500	6	12	Diesel	53	F4AE0681C	5880	6	24	Diesel	48
8460.41L.5020	9500	6	12	Diesel	53	F4AE0681D	5880	6	24	Diesel	48
8460.41L TCA	9500	6	12	Diesel	53	F4AE0681E	5880	6	24	Diesel	48
8460.41 M	9500	6	12	Diesel	53	F4AE3481A	3920	4	16	Diesel	38
8460.41N	9500	6	12	Diesel	53	F4AE3481B	3920	4	16	Diesel	38
8460.41 R	9500	6	12	Diesel	53	F4AE3481C	3920	4	16	Diesel	38
8460.41 S	9500	6	12	Diesel	53	F4AE3481D	3920	4	16	Diesel	38
8460.41 T	9500	6	12	Diesel	53	F4AE3681A	5880	6	24	Diesel	48
BF4L 913 T	4086	4	8	Diesel	40	F4AE3681B	5880	6	24	Diesel	48
BF6L 913	6128	6	12	Diesel	50	F4AE3681C	5880	6	24	Diesel	48
BF6L 913 /U	6128	6	12	Diesel	50	F4AE3681D	5880	6	24	Diesel	48
BF6L 913 T	6128	6	12	Diesel	50	F4AE3681E	5880	6	24	Diesel	48
BF8L 413 F	12763	8	16	Diesel	57	F4AFE411A	4485	4	8	Diesel	41
BF8L 513	12763	8	16	Diesel	57	F4AFE411B	4485	4	8	Diesel	41
F1AE0481A	2287	4	16	Diesel	1	F4AFE411C	4485	4	8	Diesel	41
F1AE0481B	2287	4	16	Diesel	1	F4AFE411E	4485	4	8	Diesel	41
F1AE0481F	2287	4	16	Diesel	1	F4AFE411F	4485	4	8	Diesel	41
F1AE0481FA	2287	4	16	Diesel	1	F4AFE611A	6728	6	12	Diesel	51
F1AE0481G	2287	4	16	Diesel	1	F4AFE611B	6728	6	12	Diesel	51
F1AE0481GA	2287	4	16	Diesel	1	F4AFE611C	6728	6	12	Diesel	51
F1AE0481H	2287	4	16	Diesel	1	F4AFE611D	6728	6	12	Diesel	51
F1AE0481HA	2287	4	16	Diesel	1	F4AFE611E	6728	6	12	Diesel	51
F1AE0481M	2287	4	16	Diesel	1	F4BE0611A	5880	6	24	Gas	49
F1AE0481R	2287	4	16	Diesel	1	F4GE0404A	4485	4	8	Diesel	41

	CC				9		CC				9
F4GE0454A	4485	4	8	Diesel	41						
F4GE0484C	4485	4	8	Diesel	41						
F4GE0484G	4485	4	8	Diesel	41						
F4GE0604A	6728	6	12	Diesel	51						
F4GE0684C	6728	6	12	Diesel	51						
F4GE0684E	6728	6	12	Diesel	51						
F4GFE601A	5880	6	24	Gas	49						
F4L 913	4086	4	8	Diesel	40						
F6L 413	8478	6	12	Diesel	52						
F6L 413 F	9570	6	12	Diesel	55						
F6L 913	6128	6	12	Diesel	50						
F8L 413 F	12763	8	16	Diesel	57						
F8L 513	13383	8	16	Diesel	60						
F10L 413 F	15953	10	20	Diesel	62						

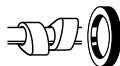

1 2.3L Diesel

F1AE0481A	4 Cyl.	16 Valves	2287cc	TD17144
F1AE0481B	4 Cyl.	16 Valves	2287cc	TD17145
F1AE0481F	4 Cyl.	16 Valves	2287cc	TD28231
F1AE0481FA	4 Cyl.	16 Valves	2287cc	TD19231
F1AE0481G	4 Cyl.	16 Valves	2287cc	TD28232
F1AE0481GA	4 Cyl.	16 Valves	2287cc	TD19232
F1AE0481H	4 Cyl.	16 Valves	2287cc	TD28233
F1AE0481HA	4 Cyl.	16 Valves	2287cc	TD19233
F1AE0481M	4 Cyl.	16 Valves	2287cc	TD19156
F1AE0481R	4 Cyl.	16 Valves	2287cc	TD28234
F1AE0481U	4 Cyl.	16 Valves	2287cc	TD26638
F1AE0481V	4 Cyl.	16 Valves	2287cc	TD26637
F1AE3481A	4 Cyl.	16 Valves	2287cc	TD26934
F1AE3481B	4 Cyl.	16 Valves	2287cc	TD26935
F1AE3481C	4 Cyl.	16 Valves	2287cc	TD26943
F1AFL411A	4 Cyl.	16 Valves	2287cc	TD29628
F1AFL411B	4 Cyl.	16 Valves	2287cc	TD29629
F1AFL411C	4 Cyl.	16 Valves	2287cc	TD29630

NA5201 (x2)
34.00 x 60.00 x 10.00mm, FPM

NA5202
50.0 x 80.0 x 14.0mm, FPM

2 2.4L Petrol

4G64-S4M	4 Cyl.	16 Valves	2351cc	TD34265
----------	--------	-----------	--------	---------

NJ933
35.00 x 50.00 x 8.00mm, FPM

NJ005
44.00 x 60.00 x 7.00mm, NBR
NK143
85.00 x 103.00 x 8.00mm, FPM

3 2.4L Diesel

8140.21.200	4 Cyl.	8 Valves	2445cc	TD1703
-------------	--------	----------	--------	--------

HR602

NP067
50.00 x 70.00 x 10.00mm, FPM
NP068
55.00 x 70.00 x 8.00mm, FPM

NP067
50.00 x 70.00 x 10.00mm, FPM
NF885
70.00 x 159.00 ; 179.00 x 16.00mm, FPM
NF853
100.00 x 118.00 x 10.00mm, FPM
NF886
100.00 x 179.00 x 15.80mm, FPM
NF883
114.00 x 171.00 x 13.00mm, FPM

4 2.4L Diesel

8140.21.201	4 Cyl.	8 Valves	2445cc	TD27368
8140.21.202	4 Cyl.	8 Valves	2445cc	TD27369
8140.21.203	4 Cyl.	8 Valves	2445cc	TD27370
8140.21.212	4 Cyl.	8 Valves	2445cc	TD27371
8140.21.290	4 Cyl.	8 Valves	2445cc	TD27372

HR602

NP067
50.00 x 70.00 x 10.00mm, FPM
NP068
55.00 x 70.00 x 8.00mm, FPM

NP068
55.00 x 70.00 x 8.00mm, FPM
NB946
70.00 x 90.00 x 10.00mm, FPM
NF833
90.00 x 115.00 x 13.00mm, FPM



5 2.4L Diesel

8140.21.214	4 Cyl.	8 Valves	2445cc	TD1704
HR602	NP067 50.00 x 70.00 x 10.00mm, FPM	NP067 50.00 x 70.00 x 10.00mm, FPM	NB946 70.00 x 90.00 x 10.00mm, FPM	NF853 100.00 x 118.00 x 10.00mm, FPM
	NP068 55.00 x 70.00 x 8.00mm, FPM	NF833 90.00 x 115.00 x 13.00mm, FPM		

6 2.4L Diesel

8140.61.200	4 Cyl.	8 Valves	2445cc	TD7225
HR602	NP068 55.00 x 70.00 x 8.00mm, FPM	NP067 50.00 x 70.00 x 10.00mm, FPM	NF833 90.00 x 115.00 x 13.00mm, FPM	
	NP067 50.00 x 70.00 x 10.00mm, FPM			

7 2.4L Diesel

8140.61.300	4 Cyl.	8 Valves	2445cc	TD20426
8144.61.200	4 Cyl.	8 Valves	2445cc	TD20429
HR602	NP067 50.00 x 70.00 x 10.00mm, FPM	NP067 50.00 x 70.00 x 10.00mm, FPM	NB946 70.00 x 90.00 x 10.00mm, FPM	NF833 90.00 x 115.00 x 13.00mm, FPM
	NP068 55.00 x 70.00 x 8.00mm, FPM			

8 2.5L Diesel

8140.07.2585	4 Cyl.	8 Valves	2500cc	TD20437
8140.47.2711	4 Cyl.	8 Valves	2499cc	TD1712
8140.47.2721	4 Cyl.	8 Valves	2499cc	TD1713
8140 SC 27.02	4 Cyl.	8 Valves	2500cc	TD16182
HR602	NP067 50.00 x 70.00 x 10.00mm, FPM	NB946 70.00 x 90.00 x 10.00mm, FPM	NF853 100.00 x 118.00 x 10.00mm, FPM	
	NP068 55.00 x 70.00 x 8.00mm, FPM			

9 2.5L Diesel

8140.07.2700	4 Cyl.	8 Valves	2499cc	TD1700
8140.47.2700	4 Cyl.	8 Valves	2499cc	TD1711
8140.47R	4 Cyl.	8 Valves	2499cc	TD7234
HR602	NP067 50.00 x 70.00 x 10.00mm, FPM	NP067 50.00 x 70.00 x 10.00mm, FPM	NF885 70.00 x 159.00 ; 179.00 x 16.00mm, FPM	NF886 100.00 x 179.00 x 15.80mm, FPM
	NP068 55.00 x 70.00 x 8.00mm, FPM	NF883 114.00 x 171.00 x 13.00mm, FPM		

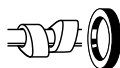

10 2.5L

Diesel

8140.07.2701	4 Cyl.	8 Valves	2499cc	TD1701
HR602	NP067 50.00 x 70.00 x 10.00mm, FPM NP068 55.00 x 70.00 x 8.00mm, FPM			NF885 70.00 x 159.00 ; 179.00 x 16.00mm, FPM NB946 70.00 x 90.00 x 10.00mm, FPM NF853 100.00 x 118.00 x 10.00mm, FPM NF886 100.00 x 179.00 x 15.80mm, FPM NF883 114.00 x 171.00 x 13.00mm, FPM NF833 90.00 x 115.00 x 13.00mm, FPM

11 2.5L

Diesel

8140.07.2710	4 Cyl.	8 Valves	2499cc	TD27358
8140.07.2711	4 Cyl.	8 Valves	2499cc	TD27359
8140.07.2713	4 Cyl.	8 Valves	2499cc	TD27360
8140.07.3711	4 Cyl.	8 Valves	2499cc	TD27365
8140.07.3712	4 Cyl.	8 Valves	2499cc	TD27366
8140.07.3713	4 Cyl.	8 Valves	2499cc	TD27367
8140.27R.2780	4 Cyl.	8 Valves	2499cc	TD27393
8140.27R.2787	4 Cyl.	8 Valves	2499cc	TD27395
HR602	NP067 50.00 x 70.00 x 10.00mm, FPM NP068 55.00 x 70.00 x 8.00mm, FPM			NP068 55.00 x 70.00 x 8.00mm, FPM NB946 70.00 x 90.00 x 10.00mm, FPM NF853 100.00 x 118.00 x 10.00mm, FPM NF886 100.00 x 179.00 x 15.80mm, FPM NF833 90.00 x 115.00 x 13.00mm, FPM

12 2.5L

Diesel

8140.07.2712	4 Cyl.	8 Valves	2499cc	TD1702
HR602	NP067 50.00 x 70.00 x 10.00mm, FPM NP068 55.00 x 70.00 x 8.00mm, FPM			NP067 50.00 x 70.00 x 10.00mm, FPM NB946 70.00 x 90.00 x 10.00mm, FPM NA5305 85.00 x 105.00 x 11.00mm, PTFE 01/01→ NF853 100.00 x 118.00 x 10.00mm, FPM



13 2.5L		Diesel		
8140.07.3700	4 Cyl.	8 Valves	2499cc	TD27364
8140.27.215	4 Cyl.	8 Valves	2499cc	TD27387
8140.27.218	4 Cyl.	8 Valves	2499cc	TD26268
8140.27.2582	4 Cyl.	8 Valves	2499cc	TD7260
8140.27.2811	4 Cyl.	8 Valves	2499cc	TD1708
8140.27R.2700	4 Cyl.	8 Valves	2499cc	TD20420
HR602	NP067 50.00 x 70.00 x 10.00mm, FPM		NP068 55.00 x 70.00 x 8.00mm, FPM	
	NP068 55.00 x 70.00 x 8.00mm, FPM		NP068 55.00 x 70.00 x 8.00mm, FPM	
			NB946 70.00 x 90.00 x 10.00mm, FPM	
			NF853 100.00 x 118.00 x 10.00mm, FPM	
			NF833 90.00 x 115.00 x 13.00mm, FPM	

14 2.5L		Diesel		
8140.07.3710	4 Cyl.	8 Valves	2499cc	TD20418
8140.27R.2782	4 Cyl.	8 Valves	2499cc	TD1710
8140.27R.2786	4 Cyl.	8 Valves	2499cc	TD27394
HR602	NP067 50.00 x 70.00 x 10.00mm, FPM		NB946 70.00 x 90.00 x 10.00mm, FPM	
	NP068 55.00 x 70.00 x 8.00mm, FPM		NF853 100.00 x 118.00 x 10.00mm, FPM	
			NF886 100.00 x 179.00 x 15.80mm, FPM	
			NF833 90.00 x 115.00 x 13.00mm, FPM	

15 2.5L		Diesel		
8140.27.2700	4 Cyl.	8 Valves	2499cc	TD1706
8140.27 S	4 Cyl.	8 Valves	2445cc	TD1705
HR602	NP067 50.00 x 70.00 x 10.00mm, FPM		NB946 70.00 x 90.00 x 10.00mm, FPM	
	NP068 55.00 x 70.00 x 8.00mm, FPM		NF853 100.00 x 118.00 x 10.00mm, FPM	
			NF833 90.00 x 115.00 x 13.00mm, FPM	

16 2.5L		Diesel		
8140.27.2720	4 Cyl.	8 Valves	2499cc	TD1707
HR602	NP067 50.00 x 70.00 x 10.00mm, FPM		NP067 50.00 x 70.00 x 10.00mm, FPM	
	NP068 55.00 x 70.00 x 8.00mm, FPM		NF885 70.00 x 159.00 ; 179.00 x 16.00mm, FPM	
			NF886 100.00 x 179.00 x 15.80mm, FPM	
			NF833 90.00 x 115.00 x 13.00mm, FPM	

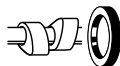

17 2.5L

Diesel

8140.27S.2700	4 Cyl.	8 Valves	2499cc	TD20421
HR602	NP068 55.00 x 70.00 x 8.00mm, FPM NP067 50.00 x 70.00 x 10.00mm, FPM			NP067 50.00 x 70.00 x 10.00mm, FPM NB946 70.00 x 90.00 x 10.00mm, FPM NF853 100.00 x 118.00 x 10.00mm, FPM NF883 114.00 x 171.00 x 13.00mm, FPM

18 2.5L

Diesel

8140.27S.2701	4 Cyl.	8 Valves	2499cc	TD27396
8140.27S.2710	4 Cyl.	8 Valves	2499cc	TD27397
8140.27S.2711	4 Cyl.	8 Valves	2499cc	TD27398
8140.27S.2720	4 Cyl.	8 Valves	2499cc	TD27399
8140.27S.2721	4 Cyl.	8 Valves	2499cc	TD27400
8140.27S.2730	4 Cyl.	8 Valves	2499cc	TD27401
8140.27S.2731	4 Cyl.	8 Valves	2499cc	TD27402
8140.27S.2750	4 Cyl.	8 Valves	2499cc	TD27403
8140.27S.2751	4 Cyl.	8 Valves	2499cc	TD27404
8140.27S.2770	4 Cyl.	8 Valves	2499cc	TD27407
8140.27S.2771	4 Cyl.	8 Valves	2499cc	TD27408
8140.27S.2811	4 Cyl.	8 Valves	2499cc	TD27409
8140.27S.3700	4 Cyl.	8 Valves	2499cc	TD27410
8140.27S.3701	4 Cyl.	8 Valves	2499cc	TD27411
8140.27S.3711	4 Cyl.	8 Valves	2499cc	TD27412
8140.27S.3720	4 Cyl.	8 Valves	2499cc	TD27413
8140.27S.3721	4 Cyl.	8 Valves	2499cc	TD27414
8140.27S.3750	4 Cyl.	8 Valves	2499cc	TD27415
8140.27S.3751	4 Cyl.	8 Valves	2499cc	TD27416
8140.27S.3760	4 Cyl.	8 Valves	2499cc	TD27419
8140.27S.3761	4 Cyl.	8 Valves	2499cc	TD27420
8140.27S.3771	4 Cyl.	8 Valves	2499cc	TD27423
8140.27S.3780	4 Cyl.	8 Valves	2499cc	TD27424
8140.27S.3781	4 Cyl.	8 Valves	2499cc	TD27425
8140.47.2785	4 Cyl.	8 Valves	2499cc	TD1715
8140.47.3700	4 Cyl.	8 Valves	2499cc	TD20477
8140.47.3721	4 Cyl.	8 Valves	2499cc	TD26006
8140.47.3731	4 Cyl.	8 Valves	2499cc	TD26007
8140.47B.3790	4 Cyl.	8 Valves	2499cc	TD26008
8140.47B.3795	4 Cyl.	8 Valves	2499cc	TD26009

HR602	NP067 50.00 x 70.00 x 10.00mm, FPM NP068 55.00 x 70.00 x 8.00mm, FPM			NP068 55.00 x 70.00 x 8.00mm, FPM NB946 70.00 x 90.00 x 10.00mm, FPM NF853 100.00 x 118.00 x 10.00mm, FPM NF886 100.00 x 179.00 x 15.80mm, FPM
--------------	---	--	--	---

**19 2.5L****Diesel**

8140.27S.2760	4 Cyl.	8 Valves	2499cc	TD27405
8140.27S.2761	4 Cyl.	8 Valves	2499cc	TD27406
8140.27S.2801	4 Cyl.	8 Valves	2499cc	TD20419
8140.27S.2885	4 Cyl.	8 Valves	2499cc	TD20422
8140.27S.3770	4 Cyl.	8 Valves	2499cc	TD27422
8140.27S.3811	4 Cyl.	8 Valves	2499cc	TD27426
8140.47.3711	4 Cyl.	8 Valves	2499cc	TD26005
8140.97.2781	4 Cyl.	8 Valves	2499cc	TD1717

HR602

NP067

50.00 x 70.00 x 10.00mm, FPM

NP068

55.00 x 70.00 x 8.00mm, FPM

NB946

70.00 x 90.00 x 10.00mm, FPM

NF853

100.00 x 118.00 x 10.00mm, FPM

NF886

100.00 x 179.00 x 15.80mm, FPM

20 2.5L**Diesel**

8140.47R.2790	4 Cyl.	8 Valves	2499cc	TD1716
8140.67F.	4 Cyl.	8 Valves	2499cc	TD7226

HR602

NP067

50.00 x 70.00 x 10.00mm, FPM

NP068

55.00 x 70.00 x 8.00mm, FPM

NP067

50.00 x 70.00 x 10.00mm, FPM

NF885

70.00 x 159.00 ; 179.00 x 16.00mm, FPM

NF883

114.00 x 171.00 x 13.00mm, FPM

21 2.5L**Diesel**

8140.47R.2795	4 Cyl.	8 Valves	2499cc	TD26010
---------------	--------	----------	--------	---------

HR602

NP067

50.00 x 70.00 x 10.00mm, FPM

NP068

55.00 x 70.00 x 8.00mm, FPM

NP068

55.00 x 70.00 x 8.00mm, FPM

NF885

70.00 x 159.00 ; 179.00 x 16.00mm, FPM

NB946

70.00 x 90.00 x 10.00mm, FPM

NF853

100.00 x 118.00 x 10.00mm, FPM

NF886

100.00 x 179.00 x 15.80mm, FPM

NF883

114.00 x 171.00 x 13.00mm, FPM

22 2.5L**Diesel**

8140.47S	4 Cyl.	8 Valves	2499cc	TD20453
----------	--------	----------	--------	---------

HR602

NP067

50.00 x 70.00 x 10.00mm, FPM

NP068

55.00 x 70.00 x 8.00mm, FPM

NP068

55.00 x 70.00 x 8.00mm, FPM

NF885

70.00 x 159.00 ; 179.00 x 16.00mm, FPM

NB946

70.00 x 90.00 x 10.00mm, FPM

NF853

100.00 x 118.00 x 10.00mm, FPM

NF883

114.00 x 171.00 x 13.00mm, FPM

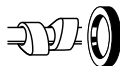

23 2.5L

Diesel

8140.67.2585	4 Cyl.	8 Valves	2500cc	TD20427
HR602	NP067 50.00 x 70.00 x 10.00mm, FPM NP068 55.00 x 70.00 x 8.00mm, FPM		NF885 70.00 x 159.00 ; 179.00 x 16.00mm, FPM NA5055 70.00 x 90.00 x 10.00mm, FPM NF883 114.00 x 171.00 x 13.00mm, FPM	

24 2.5L

Diesel

8140.67F.3700	4 Cyl.	8 Valves	2499cc	TD20428
8140.67F.3701	4 Cyl.	8 Valves	2499cc	TD26292
8140.67F.3710	4 Cyl.	8 Valves	2499cc	TD26293
8140.67F.3711	4 Cyl.	8 Valves	2499cc	TD26294
8140.67F.3713	4 Cyl.	8 Valves	2499cc	TD26295
8140.67F.3721	4 Cyl.	8 Valves	2499cc	TD26296
HR602	NP067 50.00 x 70.00 x 10.00mm, FPM NP068 55.00 x 70.00 x 8.00mm, FPM		NP067 50.00 x 70.00 x 10.00mm, FPM NP068 55.00 x 70.00 x 8.00mm, FPM NF885 70.00 x 159.00 ; 179.00 x 16.00mm, FPM NB946 70.00 x 90.00 x 10.00mm, FPM NF883 114.00 x 171.00 x 13.00mm, FPM	

25 2.8L

Diesel

8140.23.	4 Cyl.	8 Valves	2798cc	TD7229
8140.43.	4 Cyl.	8 Valves	2798cc	TD7235
8140.43K.4000	4 Cyl.	8 Valves	2798cc	TD17143
8140.43N	4 Cyl.	8 Valves	2798cc	TD16873
8140.43R	4 Cyl.	8 Valves	2798cc	TD18570
8140.63.	4 Cyl.	8 Valves	2798cc	TD10389
HR602	NP067 50.00 x 70.00 x 10.00mm, FPM NP068 55.00 x 70.00 x 8.00mm, FPM		NP067 50.00 x 70.00 x 10.00mm, FPM NF885 70.00 x 159.00 ; 179.00 x 16.00mm, FPM NF883 114.00 x 171.00 x 13.00mm, FPM	

26 2.8L

Diesel

8140.23.2585	4 Cyl.	8 Valves	2799cc	TD16183
HR602	NP067 50.00 x 70.00 x 10.00mm, FPM NP068 55.00 x 70.00 x 8.00mm, FPM		NP067 50.00 x 70.00 x 10.00mm, FPM NF885 70.00 x 159.00 ; 179.00 x 16.00mm, FPM NF886 100.00 x 179.00 x 15.80mm, FPM NF883 114.00 x 171.00 x 13.00mm, FPM	

**27 2.8L****Diesel**

8140.23.3700	4 Cyl.	8 Valves	2798cc	TD10387	
HR602					
	NP067 50.00 x 70.00 x 10.00mm, FPM NP068 55.00 x 70.00 x 8.00mm, FPM			NP067 50.00 x 70.00 x 10.00mm, FPM NF885 70.00 x 159.00 ; 179.00 x 16.00mm, FPM NB946 70.00 x 90.00 x 10.00mm, FPM NF853 100.00 x 118.00 x 10.00mm, FPM NF886 100.00 x 179.00 x 15.80mm, FPM NF883 114.00 x 171.00 x 13.00mm, FPM	

28 2.8L**Diesel**

8140.23.3701	4 Cyl.	8 Valves	2798cc	TD27373
8140.23.3710	4 Cyl.	8 Valves	2798cc	TD27374
8140.23.3711	4 Cyl.	8 Valves	2798cc	TD27375
8140.23.3713	4 Cyl.	8 Valves	2798cc	TD27376
8140.23.3720	4 Cyl.	8 Valves	2798cc	TD27377
8140.23.3721	4 Cyl.	8 Valves	2798cc	TD27378
8140.23.3730	4 Cyl.	8 Valves	2798cc	TD27379
8140.23.3731	4 Cyl.	8 Valves	2798cc	TD27380
8140.23.3750	4 Cyl.	8 Valves	2798cc	TD27381
8140.23.3751	4 Cyl.	8 Valves	2798cc	TD27382
8140.23.3760	4 Cyl.	8 Valves	2798cc	TD27383
8140.23.3801	4 Cyl.	8 Valves	2798cc	TD27384
8140.23.3811	4 Cyl.	8 Valves	2798cc	TD27385
8140.23.3821	4 Cyl.	8 Valves	2798cc	TD27386
8140.43B	4 Cyl.	8 Valves	2798cc	TD16514
8140.43B.4300	4 Cyl.	8 Valves	2798cc	TD25968
8140.43B.4305	4 Cyl.	8 Valves	2798cc	TD25966
8140.43B.4320	4 Cyl.	8 Valves	2798cc	TD25967
8140.43B.4325	4 Cyl.	8 Valves	2798cc	TD25969
8140.43B.4330	4 Cyl.	8 Valves	2798cc	TD25970
8140.43B.4335	4 Cyl.	8 Valves	2798cc	TD25971
8140.43C.4000	4 Cyl.	8 Valves	2798cc	TD25972
8140.43C.4005	4 Cyl.	8 Valves	2798cc	TD25973
8140.43C.4020	4 Cyl.	8 Valves	2798cc	TD25974
8140.43C.4021	4 Cyl.	8 Valves	2798cc	TD25975
8140.43C.4025	4 Cyl.	8 Valves	2798cc	TD25976
8140.43C.4026	4 Cyl.	8 Valves	2798cc	TD25977
8140.43C.4030	4 Cyl.	8 Valves	2798cc	TD25978
8140.43C.4031	4 Cyl.	8 Valves	2798cc	TD25979
8140.43C.4035	4 Cyl.	8 Valves	2798cc	TD25980
8140.43C.4036	4 Cyl.	8 Valves	2798cc	TD25981
8140.43K.4020	4 Cyl.	8 Valves	2798cc	TD25982
8140.43N.4300	4 Cyl.	8 Valves	2798cc	TD25984
8140.43N.4320	4 Cyl.	8 Valves	2798cc	TD25985
8140.43N.4330	4 Cyl.	8 Valves	2798cc	TD25986
8140.43N.4400	4 Cyl.	8 Valves	2798cc	TD25987
8140.43N.4430	4 Cyl.	8 Valves	2798cc	TD25988



8140.43P	4 Cyl.	8 Valves	2798cc	TD22680
8140.43R.4300	4 Cyl.	8 Valves	2798cc	TD25989
8140.43R.4320	4 Cyl.	8 Valves	2798cc	TD25990
8140.43R.4330	4 Cyl.	8 Valves	2798cc	TD25991
8140.43R.4400	4 Cyl.	8 Valves	2798cc	TD25992
8140.43R.4420	4 Cyl.	8 Valves	2798cc	TD25993
8140.43R.4430	4 Cyl.	8 Valves	2798cc	TD25994
8140.43S	4 Cyl.	8 Valves	2798cc	TD16874
8140.43S.4000	4 Cyl.	8 Valves	2798cc	TD25995
8140.43S.4020	4 Cyl.	8 Valves	2798cc	TD25996
8140.43S.4030	4 Cyl.	8 Valves	2798cc	TD25997
8140.43S.4140	4 Cyl.	8 Valves	2798cc	TD25998
8140.43S.4300	4 Cyl.	8 Valves	2798cc	TD25999
8140.43S.4320	4 Cyl.	8 Valves	2798cc	TD26000
8140.43S.4330	4 Cyl.	8 Valves	2798cc	TD26001
8140.43S.4400	4 Cyl.	8 Valves	2798cc	TD26002
8140.43S.4420	4 Cyl.	8 Valves	2798cc	TD26003
8140.43S.4430	4 Cyl.	8 Valves	2798cc	TD26004

HR602

NP067
50.00 x 70.00 x 10.00mm, FPM
NP068
55.00 x 70.00 x 8.00mm, FPM

NF885
70.00 x 159.00 ; 179.00 x 16.00mm, FPM
NF883
114.00 x 171.00 x 13.00mm, FPM

29 2.8L

Diesel

8140.43.2585	4 Cyl.	8 Valves	2798cc	TD20423
8140.43.3700	4 Cyl.	8 Valves	2798cc	TD20424

HR602

NP067
50.00 x 70.00 x 10.00mm, FPM
NP068
55.00 x 70.00 x 8.00mm, FPM

NB946
70.00 x 90.00 x 10.00mm, FPM
NF853
100.00 x 118.00 x 10.00mm, FPM

30 2.8L

Diesel

8140.43.3711	4 Cyl.	8 Valves	2798cc	TD27427
8140.43.3713	4 Cyl.	8 Valves	2798cc	TD27428
8140.43.3718	4 Cyl.	8 Valves	2798cc	TD27429
8140.43.3721	4 Cyl.	8 Valves	2798cc	TD27430
8140.43.3723	4 Cyl.	8 Valves	2798cc	TD27431
8140.43.3728	4 Cyl.	8 Valves	2798cc	TD27432
8140.43.3731	4 Cyl.	8 Valves	2798cc	TD27433
8140.43.3911	4 Cyl.	8 Valves	2798cc	TD27434
8140.43.3921	4 Cyl.	8 Valves	2798cc	TD27435
8140.43.3931	4 Cyl.	8 Valves	2798cc	TD27436
8140.43.K	4 Cyl.	8 Valves	2798cc	TD28051
8140.43K.4030	4 Cyl.	8 Valves	2798cc	TD25983

HR602

NP067
50.00 x 70.00 x 10.00mm, FPM
NP068
55.00 x 70.00 x 8.00mm, FPM

NP068
55.00 x 70.00 x 8.00mm, FPM
NF885
70.00 x 159.00 ; 179.00 x 16.00mm, FPM
NF883
114.00 x 171.00 x 13.00mm, FPM



31 2.8L		Diesel		
8140.43.3900	4 Cyl.	8 Valves	2798cc	TD20425
8140.63.4000	4 Cyl.	8 Valves	2798cc	TD20478
HR602		NP067 50.00 x 70.00 x 10.00mm, FPM NP068 55.00 x 70.00 x 8.00mm, FPM	NP067 50.00 x 70.00 x 10.00mm, FPM NP068 55.00 x 70.00 x 8.00mm, FPM NF885 70.00 x 159.00 ; 179.00 x 16.00mm, FPM NF883 114.00 x 171.00 x 13.00mm, FPM	

32 2.8L		Diesel		
8140.43C	4 Cyl.	8 Valves	2798cc	TD14449
HR602		NP068 55.00 x 70.00 x 8.00mm, FPM NP067 50.00 x 70.00 x 10.00mm, FPM	NP067 50.00 x 70.00 x 10.00mm, FPM NF885 70.00 x 159.00 ; 179.00 x 16.00mm, FPM NF883 114.00 x 171.00 x 13.00mm, FPM	

33 2.8L		Diesel		
8140.43C	4 Cyl.	8 Valves	2798cc	TD31460
HR602		NP068 55.00 x 70.00 x 8.00mm, FPM	NP067 50.00 x 70.00 x 10.00mm, FPM NF885 70.00 x 159.00 ; 179.00 x 16.00mm, FPM NF883 114.00 x 171.00 x 13.00mm, FPM	

34 2.8L		Gas		
8149.03	4 Cyl.	8 Valves	2798cc	TD31263
HR602		NP067 50.00 x 70.00 x 10.00mm, FPM NP068 55.00 x 70.00 x 8.00mm, FPM	NF885 70.00 x 159.00 ; 179.00 x 16.00mm, FPM NF883 114.00 x 171.00 x 13.00mm, FPM	

35 3.6L		Diesel		
8045.06	4 Cyl.		3613cc	TD28623
				NA5040 110.00 x 135.00 x 13.00mm, FPM

36 3.7L		Diesel		
8040.04.200	4 Cyl.	8 Valves	3666cc	TD10397
				NA5040 110.00 x 135.00 x 13.00mm, FPM

37 3.9L		Diesel		
8040.05.4990	4 Cyl.	8 Valves	3908cc	TD16725
8040.25.220	4 Cyl.	8 Valves	3908cc	TD10416
8040.45.4180	4 Cyl.	8 Valves	3908cc	TD10406
8040.45.4380	4 Cyl.	8 Valves	3908cc	TD20438
8040.45.5200	4 Cyl.	8 Valves	3908cc	TD20439
8040.45.5205	4 Cyl.	8 Valves	3908cc	TD27292
8040.45.5280	4 Cyl.	8 Valves	3908cc	TD27293
8040.45.5281	4 Cyl.	8 Valves	3908cc	TD27294

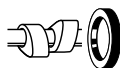

8040.45D.5100	4 Cyl.	8 Valves	3908cc	TD20440
8040.45D.5101	4 Cyl.	8 Valves	3908cc	TD27295
8040.45D.5103	4 Cyl.	8 Valves	3908cc	TD27296
8040.45D.5105	4 Cyl.	8 Valves	3908cc	TD27297
8040.45X.4180	4 Cyl.	8 Valves	3908cc	TD20441
8045.05	4 Cyl.		3908cc	TD28624

NA5041
42.00 x 65.00 x 12.00mm, ACM

NA5040
110.00 x 135.00 x 13.00mm, FPM

38 3.9L

Diesel

F4AE0481A	4 Cyl.	16 Valves	3920cc	TD16294
F4AE0481C	4 Cyl.	16 Valves	3920cc	TD16293
F4AE0481D	4 Cyl.	16 Valves	3920cc	TD16292
F4AE3481A	4 Cyl.	16 Valves	3920cc	TD21097
F4AE3481B	4 Cyl.	16 Valves	3920cc	TD21096
F4AE3481C	4 Cyl.	16 Valves	3920cc	TD21092
F4AE3481D	4 Cyl.	16 Valves	3920cc	TD21095

NA5293
70.00 x 100.00 x 12.50mm, PTFE

NA5294
130.00 x 155.00 x 12.50mm, PTFE

39 4.0L

Diesel

8040.05.200	4 Cyl.	8 Valves	3908cc	TD10399
8040.05.203	4 Cyl.	8 Valves	3908cc	TD16721
8040.05.230	4 Cyl.	8 Valves	3908cc	TD10398
8040.05.232	4 Cyl.	8 Valves	3908cc	TD16722
8040.05.233	4 Cyl.	8 Valves	3908cc	TD16723
8040.05.235	4 Cyl.	8 Valves	3908cc	TD16724
8040.25.200	4 Cyl.	8 Valves	3908cc	TD10407
8040.25.201	4 Cyl.	8 Valves	3908cc	TD27212
8040.25.202	4 Cyl.	8 Valves	3908cc	TD27213
8040.25.203	4 Cyl.	8 Valves	3908cc	TD27214
8040.25.207	4 Cyl.	8 Valves	3908cc	TD27215
8040.25.208	4 Cyl.	8 Valves	3908cc	TD27216
8040.25.222	4 Cyl.	8 Valves	3908cc	TD27217
8040.25.223	4 Cyl.	8 Valves	3908cc	TD27218
8040.25.225	4 Cyl.	8 Valves	3908cc	TD27219
8040.25.229	4 Cyl.	8 Valves	3908cc	TD27230
8040.25.230 R	4 Cyl.	8 Valves	3908cc	TD10401
8040.25.231	4 Cyl.	8 Valves	3908cc	TD27231
8040.25.233	4 Cyl.	8 Valves	3908cc	TD27233
8040.25.234	4 Cyl.	8 Valves	3908cc	TD27232
8040.25B.4200	4 Cyl.	8 Valves	3908cc	TD10403
8040.25B.4220	4 Cyl.	8 Valves	3908cc	TD23360
8040.25X.4000	4 Cyl.	8 Valves	3908cc	TD10404
8040.25X.4010	4 Cyl.	8 Valves	3908cc	TD27277
8040.25X.4020	4 Cyl.	8 Valves	3908cc	TD27278
8040.25X.4030	4 Cyl.	8 Valves	3908cc	TD27279
8040.25X.4035	4 Cyl.	8 Valves	3908cc	TD27280
8040.25X.4040	4 Cyl.	8 Valves	3908cc	TD27281
8040.25X.4045	4 Cyl.	8 Valves	3908cc	TD27282



8040.45	4 Cyl.	8 Valves	3908cc	TD27447
8040.45.4000	4 Cyl.	8 Valves	3908cc	TD10405
8040.45.4010	4 Cyl.	8 Valves	3908cc	TD27284
8040.45.4020	4 Cyl.	8 Valves	3908cc	TD27285
8040.45.4030	4 Cyl.	8 Valves	3908cc	TD27286
8040.45.4035	4 Cyl.	8 Valves	3908cc	TD27287
8040.45.4050	4 Cyl.	8 Valves	3908cc	TD27288
8040.45.4303	4 Cyl.	8 Valves	3908cc	TD27289
8040.45.5201	4 Cyl.	8 Valves	3908cc	TD27290
8040.45.5203	4 Cyl.	8 Valves	3908cc	TD27291

NA5041
42.00 x 65.00 x 12.00mm, ACM

NA5040
110.00 x 135.00 x 13.00mm, FPM

40 4.1L

Diesel

BF4L 913 T	4 Cyl.	8 Valves	4086cc	TD10402
F4L 913	4 Cyl.	8 Valves	4086cc	TD10414

NB938
65.00 x 85.00 x 13.00mm, FPM
NB939
115.00 x 140.00 x 16.00mm, FPM

41 4.5L

Diesel

F4AFE411A	4 Cyl.	8 Valves	4485cc	TD29824
F4AFE411B	4 Cyl.	8 Valves	4485cc	TD29825
F4AFE411C	4 Cyl.	8 Valves	4485cc	TD29826
F4AFE411E	4 Cyl.	8 Valves	4485cc	TD33066
F4AFE411F	4 Cyl.	8 Valves	4485cc	TD33104
F4GE0404A	4 Cyl.	8 Valves	4485cc	TD27631
F4GE0454A	4 Cyl.	8 Valves	4485cc	TD27632
F4GE0484C	4 Cyl.	8 Valves	4485cc	TD27633
F4GE0484G	4 Cyl.	8 Valves	4485cc	TD27634

NA5293
70.00 x 100.00 x 12.50mm, PTFE
NA5294
130.00 x 155.00 x 12.50mm, PTFE

42 5.2L

Diesel

8060.02.001	6 Cyl.	12 Valves	5184cc	TD10468
8060.02.003	6 Cyl.	12 Valves	5184cc	TD10469

NA5039
95.00 x 120.00 x 13.00mm, FPM

NA5040
110.00 x 135.00 x 13.00mm, FPM

43 5.5L

Diesel

8060.04.051	6 Cyl.	12 Valves	5499cc	TD10457
8060.04.055	6 Cyl.	12 Valves	5499cc	TD10420
8060.04.060	6 Cyl.	12 Valves	5500cc	TD10417
8060.04.070	6 Cyl.	12 Valves	5499cc	TD10413
8060.04.620	6 Cyl.	12 Valves	5499cc	TD10408
8060.04.621	6 Cyl.	12 Valves	5499cc	TD10409
8060.04.630	6 Cyl.	12 Valves	5500cc	TD10470
8060.04.639	6 Cyl.	12 Valves	5500cc	TD10463
8060.04.658	6 Cyl.	12 Valves	5499cc	TD10390
8060.04.660	6 Cyl.	12 Valves	5500cc	TD10421



8060.04.669	6 Cyl.	12 Valves	5500cc	TD10460
8060.04.670	6 Cyl.	12 Valves	5500cc	TD10449
8060.04.672	6 Cyl.	12 Valves	5500cc	TD10450
8060.04.675	6 Cyl.	12 Valves	5500cc	TD10464
8060.04.689	6 Cyl.	12 Valves	5500cc	TD10462
8060.24.601	6 Cyl.	12 Valves	5500cc	TD10472
8060.24.670	6 Cyl.	12 Valves	5499cc	TD10447
8060.24.671	6 Cyl.	12 Valves	5499cc	TD10448
8060.24.678	6 Cyl.	12 Valves	5500cc	TD10465
8062.24.070	6 Cyl.	12 Valves	5499cc	TD10458

NA5040 R
110.00 x 135.00 x 13.00mm, FPM

44 5.8L

Diesel

8060.45S TCA	6 Cyl.	12 Valves	5861cc	TD10482
--------------	--------	-----------	--------	---------

NA5041
42.00 x 65.00 x 12.00mm, ACM

NA5040 R
110.00 x 135.00 x 13.00mm, FPM

45 5.9L

Diesel

8060.05.000	6 Cyl.	12 Valves	5861cc	TD10424
8060.05.200	6 Cyl.	12 Valves	5861cc	TD10471
8060.05.201	6 Cyl.	12 Valves	5861cc	TD27298
8060.05.203	6 Cyl.	12 Valves	5861cc	TD27299
8060.05.246	6 Cyl.	12 Valves	5861cc	TD10391
8060.05.270	6 Cyl.	12 Valves	5861cc	TD10412
8060.05.280	6 Cyl.	12 Valves	5861cc	TD10423
8060.05.284	6 Cyl.	12 Valves	5861cc	TD27300
8060.05.285	6 Cyl.	12 Valves	5861cc	TD10411
8060.05.286	6 Cyl.	12 Valves	5861cc	TD27301
8060.05.288	6 Cyl.	12 Valves	5861cc	TD27302
8060.05.289	6 Cyl.	12 Valves	5861cc	TD10461

NA5040 R
110.00 x 135.00 x 13.00mm, FPM

46 5.9L

Diesel

8060.25.600	6 Cyl.	12 Valves	5861cc	TD10473
8060.25V.4000	6 Cyl.	12 Valves	5861cc	TD10454

NA5041
42.00 x 65.00 x 12.00mm, ACM

NA5040 R
110.00 x 135.00 x 13.00mm, FPM

NA5042 R
114.00 x 135.00 x 13.00mm, FPM

47 5.9L

Diesel

8060.25.601	6 Cyl.	12 Valves	5861cc	TD27303
8060.25.602	6 Cyl.	12 Valves	5861cc	TD27304
8060.25.603	6 Cyl.	12 Valves	5861cc	TD27305
8060.25.604	6 Cyl.	12 Valves	5861cc	TD27306
8060.25.669	6 Cyl.	12 Valves	5861cc	TD10459
8060.25.670	6 Cyl.	12 Valves	5861cc	TD10453
8060.25.678	6 Cyl.	12 Valves	5861cc	TD10466
8060.25.679	6 Cyl.	12 Valves	5861cc	TD10467
8060.25R.4200	6 Cyl.	12 Valves	5861cc	TD10479
8060.25R.4200 LTC	6 Cyl.	12 Valves	5861cc	TD10415



8060.25R.4210	6 Cyl.	12 Valves	586lcc	TD27309
8060.25R.4220	6 Cyl.	12 Valves	586lcc	TD27310
8060.25R.4225	6 Cyl.	12 Valves	586lcc	TD27311
8060.25R.4230	6 Cyl.	12 Valves	586lcc	TD27312
8060.25R.4240	6 Cyl.	12 Valves	586lcc	TD27313
8060.25R.4250	6 Cyl.	12 Valves	586lcc	TD27314
8060.25R.4280	6 Cyl.	12 Valves	586lcc	TD10475
8060.25R.4285	6 Cyl.	12 Valves	586lcc	TD27315
8060.25R.4290	6 Cyl.	12 Valves	586lcc	TD27316
8060.25R.4295	6 Cyl.	12 Valves	586lcc	TD27317
8060.25R.4300	6 Cyl.	12 Valves	586lcc	TD20414
8060.25R.4360	6 Cyl.	12 Valves	586lcc	TD27318
8060.25R.4362	6 Cyl.	12 Valves	586lcc	TD27319
8060.25R.4750	6 Cyl.	12 Valves	586lcc	TD10907
8060.25R.4755	6 Cyl.	12 Valves	586lcc	TD10908
8060.25R.4760	6 Cyl.	12 Valves	586lcc	TD10909
8060.25R.4764	6 Cyl.	12 Valves	586lcc	TD10910
8060.25R.4960	6 Cyl.	12 Valves	586lcc	TD27321
8060.25R.4967	6 Cyl.	12 Valves	586lcc	TD27322
8060.25R.4968	6 Cyl.	12 Valves	586lcc	TD27323
8060.25R.4970	6 Cyl.	12 Valves	586lcc	TD27324
8060.25R.4973	6 Cyl.	12 Valves	586lcc	TD27325
8060.25R.4980	6 Cyl.	12 Valves	586lcc	TD27326
8060.25V.4010	6 Cyl.	12 Valves	586lcc	TD27330
8060.25V.4020	6 Cyl.	12 Valves	586lcc	TD27331
8060.25V.4025	6 Cyl.	12 Valves	586lcc	TD27332
8060.25V.4030	6 Cyl.	12 Valves	586lcc	TD27333
8060.25V.4040	6 Cyl.	12 Valves	586lcc	TD27334
8060.25V.4050	6 Cyl.	12 Valves	586lcc	TD27336
8060.25V.4060	6 Cyl.	12 Valves	586lcc	TD27335
8060.25V.4080	6 Cyl.	12 Valves	586lcc	TD10476
8060.25V.4090	6 Cyl.	12 Valves	586lcc	TD27337
8060.25V.4100	6 Cyl.	12 Valves	586lcc	TD27338
8060.25V.4105	6 Cyl.	12 Valves	586lcc	TD27339
8060.25V.4110	6 Cyl.	12 Valves	586lcc	TD27340
8060.25V.4160	6 Cyl.	12 Valves	586lcc	TD27341
8060.25V.4165	6 Cyl.	12 Valves	586lcc	TD27342
8060.25V.4170	6 Cyl.	12 Valves	586lcc	TD27343
8060.25V.4175	6 Cyl.	12 Valves	586lcc	TD27344
8060.25V.4720	6 Cyl.	12 Valves	586lcc	TD27345
8060.25V.4722	6 Cyl.	12 Valves	586lcc	TD27346
8060.25V.4724	6 Cyl.	12 Valves	586lcc	TD27347
8060.25V.4725	6 Cyl.	12 Valves	586lcc	TD27348
8060.25V.4800	6 Cyl.	12 Valves	586lcc	TD10481
8060.25V.4900	6 Cyl.	12 Valves	586lcc	TD27349
8060.25V.4920	6 Cyl.	12 Valves	586lcc	TD27350
8060.25V.4925	6 Cyl.	12 Valves	586lcc	TD27351
8060.25V.4950	6 Cyl.	12 Valves	586lcc	TD27352
8060.25V.4952	6 Cyl.	12 Valves	586lcc	TD27353
8060.25V.4953	6 Cyl.	12 Valves	586lcc	TD27354

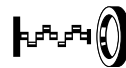
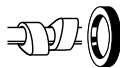

8060.45	6 Cyl.	12 Valves	5861cc	TD27439
8060.45.4100	6 Cyl.	12 Valves	5861cc	TD10497
8060.45.4100 TCA	6 Cyl.	12 Valves	5861cc	TD10455
8060.45.4110	6 Cyl.	12 Valves	5861cc	TD27101
8060.45.4120	6 Cyl.	12 Valves	5861cc	TD27102
8060.45.4130	6 Cyl.	12 Valves	5861cc	TD27103
8060.45.4150	6 Cyl.	12 Valves	5861cc	TD27104
8060.45.4180	6 Cyl.	12 Valves	5861cc	TD10456
8060.45.4403	6 Cyl.	12 Valves	5861cc	TD27105
8060.45.4700	6 Cyl.	12 Valves	5861cc	TD10913
8060.45.4702	6 Cyl.	12 Valves	5861cc	TD10914
8060.45.4704	6 Cyl.	12 Valves	5861cc	TD10915
8060.45.4706	6 Cyl.	12 Valves	5861cc	TD10916
8060.45.4708	6 Cyl.	12 Valves	5861cc	TD10917
8060.45.5200	6 Cyl.	12 Valves	5861cc	TD27106
8060.45.5201	6 Cyl.	12 Valves	5861cc	TD27107
8060.45.5203	6 Cyl.	12 Valves	5861cc	TD27108
8060.45.5205	6 Cyl.	12 Valves	5861cc	TD27109
8060.45.5210	6 Cyl.	12 Valves	5861cc	TD27110
8060.45.5211	6 Cyl.	12 Valves	5861cc	TD27111
8060.45.5220	6 Cyl.	12 Valves	5861cc	TD27112
8060.45.5221	6 Cyl.	12 Valves	5861cc	TD27113
8060.45.5223	6 Cyl.	12 Valves	5861cc	TD27114
8060.45.5232	6 Cyl.	12 Valves	5861cc	TD27115
8060.45.5233	6 Cyl.	12 Valves	5861cc	TD27116
8060.45.5234	6 Cyl.	12 Valves	5861cc	TD27117
8060.45.5235	6 Cyl.	12 Valves	5861cc	TD27118
8060.45.5250	6 Cyl.	12 Valves	5861cc	TD10918
8060.45.5251	6 Cyl.	12 Valves	5861cc	TD10919
8060.45.5255	6 Cyl.	12 Valves	5861cc	TD10920
8060.45.6090	6 Cyl.	12 Valves	5861cc	TD10477
8060.45A.4100	6 Cyl.	12 Valves	5861cc	TD10498
8060.45B	6 Cyl.	12 Valves	5861cc	TD27442
8060.45B.4385	6 Cyl.	12 Valves	5861cc	TD27119
8060.45B.4386	6 Cyl.	12 Valves	5861cc	TD27120
8060.45B.5100	6 Cyl.	12 Valves	5861cc	TD20415
8060.45B.5101	6 Cyl.	12 Valves	5861cc	TD27121
8060.45B.5103	6 Cyl.	12 Valves	5861cc	TD27122
8060.45B.5105	6 Cyl.	12 Valves	5861cc	TD27123
8060.45B.5110	6 Cyl.	12 Valves	5861cc	TD27124
8060.45B.5111	6 Cyl.	12 Valves	5861cc	TD27125
8060.45B.5112	6 Cyl.	12 Valves	5861cc	TD27126
8060.45B.5113	6 Cyl.	12 Valves	5861cc	TD27127
8060.45B.5120	6 Cyl.	12 Valves	5861cc	TD27128
8060.45B.5121	6 Cyl.	12 Valves	5861cc	TD27129
8060.45B.5123	6 Cyl.	12 Valves	5861cc	TD27130
8060.45B.5124	6 Cyl.	12 Valves	5861cc	TD27131
8060.45B.5145	6 Cyl.	12 Valves	5861cc	TD27132
8060.45B.5146	6 Cyl.	12 Valves	5861cc	TD27133
8060.45B.5150	6 Cyl.	12 Valves	5861cc	TD27134



8060.45B.5151	6 Cyl.	12 Valves	5861cc	TD27136
8060.45B.5153	6 Cyl.	12 Valves	5861cc	TD27137
8060.45B.5155	6 Cyl.	12 Valves	5861cc	TD27138
8060.45B.5185	6 Cyl.	12 Valves	5861cc	TD27139
8060.45B.5186	6 Cyl.	12 Valves	5861cc	TD27140
8060.45K.6090	6 Cyl.	12 Valves	5861cc	TD20471
8060.45L	6 Cyl.	12 Valves	5861cc	TD27451
8060.45L.4485	6 Cyl.	12 Valves	5861cc	TD27141
8060.45L.4486	6 Cyl.	12 Valves	5861cc	TD27142
8060.45M	6 Cyl.	12 Valves	5861cc	TD27450
8060.45M.7281	6 Cyl.	12 Valves	5861cc	TD27143
8060.45M.7285	6 Cyl.	12 Valves	5861cc	TD27144
8060.45M.7286	6 Cyl.	12 Valves	5861cc	TD27145
8060.45R.4245	6 Cyl.	12 Valves	5861cc	TD27146
8060.45R.5000	6 Cyl.	12 Valves	5861cc	TD16717
8060.45R.5001	6 Cyl.	12 Valves	5861cc	TD16718
8060.45R.5003	6 Cyl.	12 Valves	5861cc	TD16719
8060.45R.5005	6 Cyl.	12 Valves	5861cc	TD16720
8060.45R.5010	6 Cyl.	12 Valves	5861cc	TD27147
8060.45R.5011	6 Cyl.	12 Valves	5861cc	TD27148
8060.45R.5013	6 Cyl.	12 Valves	5861cc	TD27149
8060.45R.5015	6 Cyl.	12 Valves	5861cc	TD27150
8060.45R.5050	6 Cyl.	12 Valves	5861cc	TD10911
8060.45R.5051	6 Cyl.	12 Valves	5861cc	TD10912
8060.45S.6000	6 Cyl.	12 Valves	5861cc	TD10480
8060.45S.6010	6 Cyl.	12 Valves	5861cc	TD27154
8060.45S.6020	6 Cyl.	12 Valves	5861cc	TD27155
8060.45S.6030	6 Cyl.	12 Valves	5861cc	TD27156
8060.45S.6040	6 Cyl.	12 Valves	5861cc	TD27157
8060.45S.6045	6 Cyl.	12 Valves	5861cc	TD27158
8060.45S.6052	6 Cyl.	12 Valves	5861cc	TD27159
8060.45S.6110	6 Cyl.	12 Valves	5861cc	TD27160
8060.45S.6120	6 Cyl.	12 Valves	5861cc	TD27161
8060.45S.6130	6 Cyl.	12 Valves	5861cc	TD27162
8060.45S.6140	6 Cyl.	12 Valves	5861cc	TD27163
8060.45S.6150	6 Cyl.	12 Valves	5861cc	TD27164
8060.45S.6203	6 Cyl.	12 Valves	5861cc	TD27165
8060.45S.6700	6 Cyl.	12 Valves	5861cc	TD27166
8060.45S.6705	6 Cyl.	12 Valves	5861cc	TD27167
8060.45S.6706	6 Cyl.	12 Valves	5861cc	TD27168
8060.45S.6707	6 Cyl.	12 Valves	5861cc	TD27169
8060.45S.6710	6 Cyl.	12 Valves	5861cc	TD27170
8060.45S.6711	6 Cyl.	12 Valves	5861cc	TD27171
8060.45S.6800	6 Cyl.	12 Valves	5861cc	TD10478
8060.45S.6912	6 Cyl.	12 Valves	5861cc	TD27172
8060.45S.7200	6 Cyl.	12 Valves	5861cc	TD20472
8060.45S.7201	6 Cyl.	12 Valves	5861cc	TD27176
8060.45S.7203	6 Cyl.	12 Valves	5861cc	TD27177
8060.45S.7205	6 Cyl.	12 Valves	5861cc	TD27178
8060.45S.7210	6 Cyl.	12 Valves	5861cc	TD27179

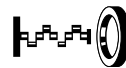
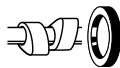

8060.45S.7211	6 Cyl.	12 Valves	5861cc	TD27180
8060.45S.7213	6 Cyl.	12 Valves	5861cc	TD27181
8060.45S.7215	6 Cyl.	12 Valves	5861cc	TD27182
8060.45S.7250	6 Cyl.	12 Valves	5861cc	TD27183
8060.45S.7251	6 Cyl.	12 Valves	5861cc	TD27184
8060.45S.7253	6 Cyl.	12 Valves	5861cc	TD27185
8060.45S.7255	6 Cyl.	12 Valves	5861cc	TD27186
8060.45X.4180	6 Cyl.	12 Valves	5861cc	TD27187
8061.05	6 Cyl.		5861cc	TD28429
8065.E	6 Cyl.		5861cc	TD28430

NA5041
42.00 x 65.00 x 12.00mm, ACM

NA5040
110.00 x 135.00 x 13.00mm, FPM

48 5.9L

Diesel

F4AE0681A	6 Cyl.	24 Valves	5880cc	TD16520
F4AE0681B	6 Cyl.	24 Valves	5880cc	TD16519
F4AE0681C	6 Cyl.	24 Valves	5880cc	TD24238
F4AE0681D	6 Cyl.	24 Valves	5880cc	TD16296
F4AE0681E	6 Cyl.	24 Valves	5880cc	TD16295
F4AE3681A	6 Cyl.	24 Valves	5880cc	TD22585
F4AE3681B	6 Cyl.	24 Valves	5880cc	TD21098
F4AE3681C	6 Cyl.	24 Valves	5880cc	TD22602
F4AE3681D	6 Cyl.	24 Valves	5880cc	TD21099
F4AE3681E	6 Cyl.	24 Valves	5880cc	TD21100

NA5293
70.00 x 100.00 x 12.50mm, PTFE

NA5294
130.00 x 155.00 x 12.50mm, PTFE

49 5.9L

Gas

F4BE0611A	6 Cyl.	24 Valves	5880cc	TD28557
F4GFE601A	6 Cyl.	24 Valves	5880cc	TD33212

NA5293
70.00 x 100.00 x 12.50mm, PTFE

NA5294
130.00 x 155.00 x 12.50mm, PTFE

50 6.1L

Diesel

BF6L 913	6 Cyl.	12 Valves	6128cc	TD10451
BF6L 913 T	6 Cyl.	12 Valves	6128cc	TD10425
BF6L 913 /U	6 Cyl.	12 Valves	6128cc	TD10474
F6L 913	6 Cyl.	12 Valves	6128cc	TD10427

NB938
65.00 x 85.00 x 13.00mm, FPM

NB939
115.00 x 140.00 x 16.00mm, FPM

**51 6.7L****Diesel**

F4AFE611A	6 Cyl.	12 Valves	6728cc	TD29827
F4AFE611B	6 Cyl.	12 Valves	6728cc	TD29828
F4AFE611C	6 Cyl.	12 Valves	6728cc	TD29829
F4AFE611D	6 Cyl.	12 Valves	6728cc	TD29830
F4AFE611E	6 Cyl.	12 Valves	6728cc	TD33123
F4GE0604A	6 Cyl.	12 Valves	6728cc	TD27630
F4GE0684C	6 Cyl.	12 Valves	6728cc	TD27629
F4GE0684E	6 Cyl.	12 Valves	6728cc	TD27627

NA5293

70.00 x 100.00 x 12.50mm, PTFE

NA5294

130.00 x 155.00 x 12.50mm, PTFE

52 8.5L**Diesel**

F6L 413	6 Cyl.	12 Valves	8478cc	TD10485
---------	--------	-----------	--------	---------

NB934

100.00 x 120.00 x 15.00mm, FPM

NB935

105.00 x 130.00 x 15.00mm, FPM

53 9.5L**Diesel**

8460.21.002	6 Cyl.	12 Valves	9500cc	TD10502
8460.21.010	6 Cyl.	12 Valves	9500cc	TD10503
8460.21.102	6 Cyl.	12 Valves	9500cc	TD10521
8460.21.202	6 Cyl.	12 Valves	9498cc	TD10518
8460.21.206	6 Cyl.	12 Valves	9498cc	TD10519
8460.21.601	6 Cyl.	12 Valves	9498cc	TD20435
8460.21.611	6 Cyl.	12 Valves	9498cc	TD20436
8460.41.102	6 Cyl.	12 Valves	9500cc	TD10548
8460.41.124	6 Cyl.	12 Valves	9500cc	TD10599
8460.41.160	6 Cyl.	12 Valves	9500cc	TD10547
8460.41 B	6 Cyl.	12 Valves	9500cc	TD29814
8460.41C.	6 Cyl.	12 Valves	9500cc	TD10807
8460.41C.320	6 Cyl.	12 Valves	9500cc	TD10512
8460.41C. TCA	6 Cyl.	12 Valves	9500cc	TD10595
8460.41K.	6 Cyl.	12 Valves	9500cc	TD10808
8460.41K.406	6 Cyl.	12 Valves	9500cc	TD10513
8460.41K.410	6 Cyl.	12 Valves	9500cc	TD10709
8460.41K. TCA	6 Cyl.	12 Valves	9500cc	TD7342
8460.41L.5020	6 Cyl.	12 Valves	9500cc	TD10514
8460.41L TCA	6 Cyl.	12 Valves	9500cc	TD10573
8460.41 M	6 Cyl.	12 Valves	9500cc	TD7250
8460.41N	6 Cyl.	12 Valves	9500cc	TD10707
8460.41 R	6 Cyl.	12 Valves	9500cc	TD7248
8460.41 S	6 Cyl.	12 Valves	9500cc	TD7249
8460.41 T	6 Cyl.	12 Valves	9500cc	TD24262

NB946

70.00 x 90.00 x 10.00mm, FPM

NB882

70.00 x 90.00 x 15.00mm, FPM

NB939

115.00 x 140.00 x 16.00mm, FPM

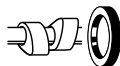

54 9.6L

Diesel

8220.02.870	6 Cyl.	12 Valves	9572cc	TD10517
8220.22.002	6 Cyl.	12 Valves	9572cc	TD10495
8220.22.102	6 Cyl.	12 Valves	9572cc	TD10496

NB928
105.00 x 130.00 x 12.00mm, FPM
NB939
115.00 x 140.00 x 16.00mm, FPM

55 9.6L

Diesel

F6L 413 F	6 Cyl.	12 Valves	9570cc	TD10483
-----------	--------	-----------	--------	---------

NB934
100.00 x 120.00 x 15.00mm, FPM
NB935
105.00 x 130.00 x 15.00mm, FPM

56 10.3L

Diesel

F3AE0681B	6 Cyl.	24 Valves	10300cc	TD16551
F3AE0681D	6 Cyl.	24 Valves	10300cc	TD14970
F3AE0681E	6 Cyl.	24 Valves	10300cc	TD14968
F3AE0681H	6 Cyl.	24 Valves	10300cc	TD24541
F3AE3681A	6 Cyl.	24 Valves	10300cc	TD20468
F3AE3681B	6 Cyl.	24 Valves	10300cc	TD20467
F3AE3681D	6 Cyl.	24 Valves	10300cc	TD24603
F3AE3681Y	6 Cyl.	24 Valves	10300cc	TD20469

NA5354
130.00 x 160.00 x 13.00mm, MVQ

57 12.8L

Diesel

BF8L 413 F	8 Cyl.	16 Valves	12763cc	TD10578
BF8L 513	8 Cyl.	16 Valves	12763cc	TD10501
F8L 413 F	8 Cyl.	16 Valves	12763cc	TD10522

NB934
100.00 x 120.00 x 15.00mm, FPM
NB935
105.00 x 130.00 x 15.00mm, FPM

58 12.9L

Diesel

F3B3681A	6 Cyl.	24 Valves	12880cc	TD20481
F3B3681B	6 Cyl.	24 Valves	12882cc	TD20480
F3B3681C	6 Cyl.	24 Valves	12880cc	TD20474
F3B3681D	6 Cyl.	24 Valves	12880cc	TD20470
F3BE0681D	6 Cyl.	24 Valves	12882cc	TD20620
F3BE0681F	6 Cyl.	24 Valves	12882cc	TD20622
F3BE0681H	6 Cyl.	24 Valves	12882cc	TD20619
F3BE0681J	6 Cyl.	24 Valves	12882cc	TD20618
F3BE0681K	6 Cyl.	24 Valves	12882cc	TD20626
F3BE3681A	6 Cyl.	24 Valves	12882cc	TD20645
F3BE3681B	6 Cyl.	24 Valves	12880cc	TD21089
F3BE3681C	6 Cyl.	24 Valves	12880cc	TD21057
F3BE3681D	6 Cyl.	24 Valves	12882cc	TD20632
F3HFE611/410	6 Cyl.	24 Valves	12882cc	TD28298
F3HFE611/450	6 Cyl.	24 Valves	12882cc	TD28300



F3HFE611/500	6 Cyl.	24 Valves	12882cc	TD28295
F3HFE611/560	6 Cyl.	24 Valves	12882cc	TD28296
F3HFE611A	6 Cyl.	24 Valves	12882cc	TD32124
F3HFE611B	6 Cyl.	24 Valves	12882cc	TD32123
F3HFE611C	6 Cyl.	24 Valves	12882cc	TD32122
F3HFE611D	6 Cyl.	24 Valves	12882cc	TD32121

NA5354 R
130.00 x 160.00 x 13.00mm, MVQ

59 13.0L

Diesel

F3B3681E	6 Cyl.	24 Valves	12880cc	TD20479
F3B3681F	6 Cyl.	24 Valves	12882cc	TD28286
F3B3681G	6 Cyl.	24 Valves	12880cc	TD20473
F3BE0681A	6 Cyl.	24 Valves	12880cc	TD16505
F3BE0681B	6 Cyl.	24 Valves	12880cc	TD16550
F3BE0681C	6 Cyl.	24 Valves	12880cc	TD16507
F3BE0681E	6 Cyl.	24 Valves	12880cc	TD16506
F3BE0681G	6 Cyl.	24 Valves	12880cc	TD16591
F3BE0681V	6 Cyl.	24 Valves	12880cc	TD24331
F3BE3681E	6 Cyl.	24 Valves	12882cc	TD20644
F3BE3681F	6 Cyl.	24 Valves	12882cc	TD20641
F3BE3681G	6 Cyl.	24 Valves	12882cc	TD20633

NA5354 R
130.00 x 160.00 x 13.00mm, MVQ

60 13.4L

Diesel

F8L 513	8 Cyl.	16 Valves	13383cc	TD10499
---------	--------	-----------	---------	---------

NB934 F
100.00 x 120.00 x 15.00mm, FPM
NB935 R
105.00 x 130.00 x 15.00mm, FPM

61 13.8L

Diesel

8210.02.	6 Cyl.	12 Valves	13800cc	TD10598
8210.02.067	6 Cyl.	12 Valves	13798cc	TD10523
8210.02.069	6 Cyl.	12 Valves	13798cc	TD10525
8210.02.371	6 Cyl.	12 Valves	13798cc	TD10507
8210.02.373	6 Cyl.	12 Valves	13798cc	TD10508
8210.02.377	6 Cyl.	12 Valves	13798cc	TD10509
8210.02.393	6 Cyl.	12 Valves	13798cc	TD10510
8210.02.440	6 Cyl.	12 Valves	13798cc	TD10491
8210.02.441	6 Cyl.	12 Valves	13798cc	TD10492
8210.02.731	6 Cyl.	12 Valves	13798cc	TD10524
8210.22.105	6 Cyl.	12 Valves	13798cc	TD10550
8210.22.171	6 Cyl.	12 Valves	13798cc	TD10530
8210.22.175	6 Cyl.	12 Valves	13798cc	TD10528
8210.22.183	6 Cyl.	12 Valves	13798cc	TD10579
8210.22.210	6 Cyl.	12 Valves	13798cc	TD11387
8210.22.236	6 Cyl.	12 Valves	13798cc	TD11388
8210.22.269	6 Cyl.	12 Valves	13798cc	TD10584
8210.22.317	6 Cyl.	12 Valves	13798cc	TD10531
8210.22.327	6 Cyl.	12 Valves	13798cc	TD10585

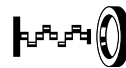
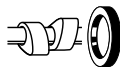

8210.22.385	6 Cyl.	12 Valves	13798cc	TD10586
8210.22.511	6 Cyl.	12 Valves	13798cc	TD11389
8210.22.521	6 Cyl.	12 Valves	13798cc	TD11390
8210.22.523	6 Cyl.	12 Valves	13798cc	TD11391
8210.22.525	6 Cyl.	12 Valves	13798cc	TD11392
8210.22.535	6 Cyl.	12 Valves	13798cc	TD11393
8210.22.537	6 Cyl.	12 Valves	13798cc	TD11394
8210.22.569	6 Cyl.	12 Valves	13798cc	TD10529
8210.22.869	6 Cyl.	12 Valves	13798cc	TD10549
8210.22X.069	6 Cyl.	12 Valves	13798cc	TD11329
8210.22X.235	6 Cyl.	12 Valves	13798cc	TD11407
8210.22X.523	6 Cyl.	12 Valves	13798cc	TD11408
8210.22X.575	6 Cyl.	12 Valves	13798cc	TD11330
8210.42.	6 Cyl.	12 Valves	13798cc	TD10564
8210.42.061	6 Cyl.	12 Valves	13798cc	TD10561
8210.42.073	6 Cyl.	12 Valves	13798cc	TD10562
8210.42.101	6 Cyl.	12 Valves	13798cc	TD10563
8210.42.115	6 Cyl.	12 Valves	13798cc	TD10582
8210.42.151	6 Cyl.	12 Valves	13798cc	TD10552
8210.42.152	6 Cyl.	12 Valves	13798cc	TD10555
8210.42.154	6 Cyl.	12 Valves	13798cc	TD10556
8210.42.155	6 Cyl.	12 Valves	13798cc	TD10580
8210.42.161	6 Cyl.	12 Valves	13798cc	TD10553
8210.42.162	6 Cyl.	12 Valves	13798cc	TD10557
8210.42.165	6 Cyl.	12 Valves	13798cc	TD10588
8210.42.171	6 Cyl.	12 Valves	13798cc	TD10554
8210.42.172	6 Cyl.	12 Valves	13798cc	TD10581
8210.42.175	6 Cyl.	12 Valves	13798cc	TD10590
8210.42.181	6 Cyl.	12 Valves	13798cc	TD10558
8210.42.182	6 Cyl.	12 Valves	13798cc	TD10559
8210.42.185	6 Cyl.	12 Valves	13798cc	TD10591
8210.42.186	6 Cyl.	12 Valves	13798cc	TD10592
8210.42.191	6 Cyl.	12 Valves	13798cc	TD10560
8210.42.195	6 Cyl.	12 Valves	13798cc	TD10593
8210.42.210	6 Cyl.	12 Valves	13798cc	TD11512
8210.42.235	6 Cyl.	12 Valves	13798cc	TD11511
8210.42.237	6 Cyl.	12 Valves	13798cc	TD11510
8210.42.269	6 Cyl.	12 Valves	13798cc	TD11507
8210.42.270	6 Cyl.	12 Valves	13798cc	TD11508
8210.42.271	6 Cyl.	12 Valves	13798cc	TD11509
8210.42.500	6 Cyl.	12 Valves	13798cc	TD18332
8210.42K.	6 Cyl.	12 Valves	13798cc	TD10809
8210.42K(TCA)	6 Cyl.	12 Valves	13798cc	TD7377
8210.42L.	6 Cyl.	12 Valves	13798cc	TD10812
8210.42L(TCA)	6 Cyl.	12 Valves	13798cc	TD7378
8210.42L.400	6 Cyl.	12 Valves	13798cc	TD10515
8210.42M	6 Cyl.	12 Valves	13798cc	TD20617
8210.42M. TCA	6 Cyl.	12 Valves	13798cc	TD10576
8210.42 TCA	6 Cyl.	12 Valves	13798cc	TD10574

NB946 
70.00 x 90.00 x 10.00mm, FPM

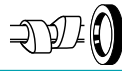
**62 16.0L****Diesel**

F10L 413 F

10 Cyl.

20 Valves

15953cc

TD10527

NB934

100.00 x 120.00 x 15.00mm, FPM

NB935

105.00 x 130.00 x 15.00mm, FPM











CC



9

D-Type Saloon	09/53→12/56	XK 3.4 (82-86)	Petrol	3442	6	12	9
E-Type	05/64→05/71	XK 4.2 (82-87)	Petrol	4235	6	12	13
E-Type Convertible	05/64→05/71	XK 4.2 (82-87)	Petrol	4235	6	12	13
E-Type Convertible	03/71→04/75	8L (85-87)	Petrol	4235	6	12	13
F-Pace (X761)	09/15→	306DT	Diesel	2993	6	24	6
S-Type (X200)	06/04→10/07	AJD	Diesel	2720	6	24	5
XF (X250)	03/08→04/15	AJD	Diesel	2720	6	24	5
XF (X250)	03/09→04/15	306DT	Diesel	2993	6	24	6
XF (X250)	03/09→04/15	AJV6D	Diesel	2993	6	24	6
XF (X250)	04/11→04/15	224DT	Diesel	2179	4	16	3
XF (X260)	05/15→	306DT	Diesel	2993	6	24	6
XF Sportbrake (X250)	09/12→04/14	224DT	Diesel	2179	4	16	3
XF Sportbrake (X250)	09/12→04/14	306DT	Diesel	2993	6	24	6
XF Sportbrake (X250)	09/12→04/14	AJV6D	Diesel	2993	6	24	6
XF Sportbrake (X260)	07/17→	306DT	Diesel	2993	6	24	6
XJ	10/69→01/80	XK 4.2 (-79)	Petrol	4235	6	12	13
XJ	06/72→12/92	7P	Petrol	5343	12	24	14
XJ	01/75→12/86	8L (85-87)	Petrol	4235	6	12	13
XJ	05/75→10/86	XK 3.4 (82-86)	Petrol	3442	6	12	9
XJ	05/75→02/93	V 12 (75-79)	Petrol	5343	12	24	14
XJ	09/79→12/87	XK 4.2 (82-87)	Petrol	4235	6	12	13
XJ	05/81→12/92	V 12 (82-90)	Petrol	5343	12	24	14
XJ	07/85→12/92	V 12 (90-93, 197KW)	Petrol	5343	12	24	14
XJ (X300, X330)	11/94→07/97	9JPGRB	Petrol	3239	6	24	8
XJ (X300, X330)	11/94→07/97	9KPDRB	Petrol	3980	6	24	12
XJ (X350)	10/05→03/09	AJD	Diesel	2720	6	24	5
XJ (X351)	10/09→12/15	AJV6D	Diesel	2993	6	24	6
XJ (X351)	04/15→	306DT	Diesel	2993	6	24	6
XJ (XJ40, XJ81)	10/86→08/89	9DPANA	Petrol	3590	6	12	10
XJ (XJ40, XJ81)	10/86→08/89	AJ 6 (3.6, 156KW)	Petrol	3590	6	12	10
XJ (XJ40, XJ81)	09/89→11/94	9EPCNA	Petrol	3980	6	24	11
XJ (XJ40, XJ81)	09/90→11/94	9BPMNA	Petrol	3239	6	24	7
XJ (XJ40, XJ81)	03/93→11/94	8C (92-94)	Petrol	5993	12	48	16
XJ Coupe	09/73→05/92	V 12 (90-93, 211KW)	Petrol	5344	12	24	14
XJ Coupe	07/81→12/87	V 12 (82-90)	Petrol	5343	12	24	14
XJ Coupe	10/83→12/89	AJ 6 (3.6, 156KW)	Petrol	3590	6	12	10
XJ Coupe	09/85→09/92	8S (86-88)	Petrol	5343	12	24	14
XJ Coupe	01/86→12/89	V 12 (90-93, 197KW)	Petrol	5343	12	24	14
XJ Coupe	10/87→03/96	9EPCNA	Petrol	3980	6	24	11
XJ Coupe	01/88→06/91	8C (88-92)	Petrol	5344	12	24	14
XJ Coupe	01/88→05/92	9DPANA	Petrol	3590	6	12	10
XJ Coupe	09/89→12/93	8C (92-94)	Petrol	5993	12	48	16
XJ Coupe	05/91→08/93	8S (92-93)	Petrol	5344	12	48	15
XJ Coupe	09/92→03/96	8D	Petrol	5993	12	48	16
XJSC Convertible (X27)	07/85→05/92	8S (86-88)	Petrol	5343	12	24	14
XJSC Convertible (X27)	09/85→12/90	V 12 (82-90)	Petrol	5343	12	24	14
XJSC Convertible (X27)	01/86→05/88	V 12 (90-93, 197KW)	Petrol	5343	12	24	14
XJSC Convertible (X27)	07/86→05/88	7P	Petrol	5343	12	24	14
XJSC Convertible (X27)	08/87→05/91	9DPANA	Petrol	3590	6	12	10
XJSC Convertible (X27)	08/87→05/91	AJ 6 (3.6, 156KW)	Petrol	3590	6	12	10
XJSC Convertible (X27)	01/88→09/91	8C (88-92)	Petrol	5344	12	24	14
XJSC Convertible (X27)	01/88→05/92	V 12 (90-93, 211KW)	Petrol	5344	12	24	14
XJSC Convertible (X27)	05/91→08/93	8S (92-93)	Petrol	5344	12	48	15
XJSC Convertible (X27)	05/91→09/94	9EPCNA	Petrol	3980	6	24	11
XJSC Convertible (X27)	09/92→03/96	8D	Petrol	5993	12	48	16
X-Type (X400)	07/03→11/09	FMBA	Diesel	1998	4	16	1
X-Type (X400)	07/03→11/09	FMBB	Diesel	1998	4	16	1
X-Type (X400)	07/03→11/09	R4-X404	Diesel	1998	4	16	2
X-Type (X400)	10/05→11/09	LJ46G	Diesel	2198	4	16	4
X-Type Estate (X400)	02/04→12/09	FMBA	Diesel	1998	4	16	1
X-Type Estate (X400)	02/04→12/09	FMBB	Diesel	1998	4	16	1
X-Type Estate (X400)	02/04→12/09	R4-X404	Diesel	1998	4	16	2
X-Type Estate (X400)	10/05→12/09	LJ46G	Diesel	2198	4	16	4

	CC				9		CC				9
7P	5343	12	24	Petrol	14						
8C (88-92)	5344	12	24	Petrol	14						
8C (92-94)	5993	12	48	Petrol	16						
8D	5993	12	48	Petrol	16						
8L (85-87)	4235	6	12	Petrol	13						
8S (86-88)	5343	12	24	Petrol	14						
8S (88-91)	5343	12	24	Petrol	14						
8S (92-93)	5344	12	48	Petrol	15						
9BPMNA	3239	6	24	Petrol	7						
9DPANA	3590	6	12	Petrol	10						
9EPCNA	3980	6	24	Petrol	11						
9JPGRB	3239	6	24	Petrol	8						
9KPDRB	3980	6	24	Petrol	12						
224DT	2179	4	16	Diesel	3						
306DT	2993	6	24	Diesel	6						
AJ 6 (3.6, 156KW)	3590	6	12	Petrol	10						
AJD	2720	6	24	Diesel	5						
AJV6D	2993	6	24	Diesel	6						
FMBA	1998	4	16	Diesel	1						
FMBB	1998	4	16	Diesel	1						
LJ46G	2198	4	16	Diesel	4						
QJBA	2198	4	16	Diesel	4						
R4-X404	1998	4	16	Diesel	2						
V 12 (75-79)	5343	12	24	Petrol	14						
V 12 (78-82)	5343	12	24	Petrol	14						
V 12 (82-90)	5343	12	24	Petrol	14						
V 12 (90-93, 197KW)	5343	12	24	Petrol	14						
V 12 (90-93, 211KW)	5344	12	24	Petrol	14						
XK 3.4 (82-86)	3442	6	12	Petrol	9						
XK 4.2 (-79)	4235	6	12	Petrol	13						
XK 4.2 (82-87)	4235	6	12	Petrol	13						



1 2.0L Diesel

FMBA	4 Cyl.	16 Valves	1998cc	TD24398
FMBB	4 Cyl.	16 Valves	1998cc	TD24399
HR5082	NA5028 (x2) 36.00 x 50.00 x 7.00mm, PTFE		NA5031 50.00 x 86.50 x 13.70mm, PTFE NA5030 106.00 x 190.00 x 15.20mm, PTFE/FPM	

2 2.0L Diesel

R4-X404	4 Cyl.	16 Valves	1998cc	TD22085
HR5082	NA5028 36.00 x 50.00 x 7.00mm, PTFE		NA5031 50.00 x 86.50 x 13.70mm, PTFE NA5030 106.00 x 190.00 x 15.20mm, PTFE/FPM	

3 2.2L Diesel

224DT	4 Cyl.	16 Valves	2179cc	TD26822
HR5122	NA5035 (x2) 27.00 x 47.00 x 7.00mm, FPM		NA5191 42.00 x 62.00 x 7.00mm, PTFE NA5192 90.00 x 110.00 x 7.00mm, PTFE	

4 2.2L Diesel

LJ46G	4 Cyl.	16 Valves	2198cc	TD24454
QJBA	4 Cyl.	16 Valves	2198cc	TD24400
HR5082	NA5028 (x2) 36.00 x 50.00 x 7.00mm, PTFE		NA5031 50.00 x 86.50 x 13.70mm, PTFE NA5030 106.00 x 190.00 x 15.20mm, PTFE/FPM	

5 2.7L Diesel

AJD	6 Cyl.	24 Valves	2720cc	TD25810
HR5111	NA5318 (x2) 26.0 x 45.0 x 8.00mm, FPM		NA5323 35.00 x 50.00 x 7.00mm, PTFE LK5021 92.00 x 220.00 x 22.00mm, PTFE/ACM	

6 3.0L Diesel

306DT	6 Cyl.	24 Valves	2993cc	TD27175
AJV6D	6 Cyl.	24 Valves	2993cc	TD25809
HR5111	NA5318 (x2) 26.0 x 45.0 x 8.00mm, FPM		NA5323 35.00 x 50.00 x 7.00mm, PTFE LK5021 92.00 x 220.00 x 22.00mm, PTFE/ACM	

7 3.2L Petrol

9BPMNA	6 Cyl.	24 Valves	3239cc	TD1730
HR299 (x4)			NB720 99.30 x 120.00 x 12.00mm, PTFE	

8 3.2L Petrol

9JPGRB	6 Cyl.	24 Valves	3239cc	TD4580
HR5050			NB720 99.30 x 120.00 x 12.00mm, PTFE	



9 3.4L Petrol

XK 3.4 (82-86)	6 Cyl.	12 Valves	3442cc	TD4587
HR299 (x2)				NA422 50.80 x 69.90 x 12.70mm, NBR

10 3.6L Petrol

9DPANA	6 Cyl.	12 Valves	3590cc	TD1725
AJ 6 (3.6, 156KW)	6 Cyl.	12 Valves	3590cc	TD1723
HR299 (x2)				NB720 99.30 x 120.00 x 12.00mm, PTFE

11 4.0L Petrol

9EPCNA	6 Cyl.	24 Valves	3980cc	TD1724
HR299 (x4)				NB720 99.30 x 120.00 x 12.00mm, PTFE

12 4.0L Petrol

9KPDRB	6 Cyl.	24 Valves	3980cc	TD4581
HR5050				NB720 99.30 x 120.00 x 12.00mm, PTFE

13 4.2L Petrol

8L (85-87)	6 Cyl.	12 Valves	4235cc	TD5202
XK 4.2 (-79)	6 Cyl.	12 Valves	4235cc	TD1737
XK 4.2 (82-87)	6 Cyl.	12 Valves	4235cc	TD5199
HR299 (x2)				NA422 50.80 x 69.90 x 12.70mm, NBR

14 5.3L Petrol

7P	12 Cyl.	24 Valves	5343cc	TD5203
8C (88-92)	12 Cyl.	24 Valves	5344cc	TD1736
8S (86-88)	12 Cyl.	24 Valves	5343cc	TD5216
8S (88-91)	12 Cyl.	24 Valves	5343cc	TD5217
V 12 (75-79)	12 Cyl.	24 Valves	5343cc	TD1731
V 12 (78-82)	12 Cyl.	24 Valves	5343cc	TD1728
V 12 (82-90)	12 Cyl.	24 Valves	5343cc	TD1732
V 12 (90-93, 197KW)	12 Cyl.	24 Valves	5343cc	TD4583
V 12 (90-93, 211KW)	12 Cyl.	24 Valves	5344cc	TD4585
HR299 (x4)				NB584 54.00 x 73.00 x 12.40mm, NBR

15 5.3L Petrol

8S (92-93)	12 Cyl.	48 Valves	5344cc	TD1735
HR299 (x8)				NB584 54.00 x 73.00 x 12.40mm, NBR

16 6.0L Petrol

8C (92-94)	12 Cyl.	48 Valves	5993cc	TD4584
8D	12 Cyl.	48 Valves	5993cc	TD4586
HR299 (x8)				NB584 54.00 x 73.00 x 12.40mm, NBR











CC



9

Cherokee (KJ)	03/01→01/08	EKG	Petrol	3700	6	12	23
Cherokee (KJ)	09/01→01/08	ED1	Petrol	2429	4	16	11
Cherokee (KJ)	09/01→01/08	R 425 DOHC	Diesel	2499	4	16	16
Cherokee (KJ)	11/02→01/08	ENR	Diesel	2777	4	16	18
Cherokee (KK)	01/08→	EKG	Petrol	3700	6	12	23
Cherokee (KK)	05/08→	ENS	Diesel	2777	4	16	18
Cherokee (KL)	11/13→	ED6	Petrol	2360	4	16	12
Cherokee (KL)	11/13→	EHB	Petrol	3239	6	24	21
Cherokee (KL)	04/14→	EBT	Diesel	1956	4	16	5
Cherokee (XJ)	10/84→09/01	EPE	Petrol	2464	4	8	15
Cherokee (XJ)	10/84→09/01	J8S	Diesel	2068	4	8	10
Cherokee (XJ)	10/86→09/92	J8S 742	Diesel	2068	4	8	10
Cherokee (XJ)	01/88→09/01	ENC	Diesel	2499	4	8	13
CJ5 - CJ8	01/83→12/87	J5R-800	Petrol	1995	4	8	8
CJ5 - CJ8	01/83→12/87	J8S-800	Diesel	2068	4	8	10
Comanche (MJ)	01/86→09/90	J8S-814	Diesel	2068	4	8	10
Comanche (MJ)	10/86→09/90	EPE	Petrol	2464	4	8	15
Commander (XK, XH)	09/05→12/10	EKG	Petrol	3700	6	12	23
Commander (XK, XH)	09/05→12/10	EVA	Petrol	4701	8	16	24
Commander (XK, XH)	04/06→12/10	EXL	Diesel	2987	6	24	19
Commander (XK, XH)	09/07→12/10	EVE	Petrol	4701	8	16	24
Compass (MK49)	08/06→	ECD	Diesel	1968	4	16	6
Compass (MK49)	08/06→	ECE	Diesel	1968	4	16	6
Compass (MK49)	08/06→	ECN	Petrol	1998	4	16	7
Compass (MK49)	08/06→	ED3	Petrol	2360	4	16	12
Compass (MK49)	12/10→	OM 651.925	Diesel	2143	4	16	9
Compass (MK49)	05/11→	ENE	Diesel	2143	4	16	9
Grand Cherokee I (ZJ)	10/95→04/99	M51	Diesel	2499	4	8	13
Grand Cherokee I (ZJ)	10/95→04/99	M52	Diesel	2499	4	8	13
Grand Cherokee II (WJ, WG)	09/98→09/05	EVA	Petrol	4701	8	16	24
Grand Cherokee II (WJ, WG)	09/98→09/05	EVC	Petrol	4701	8	16	24
Grand Cherokee II (WJ, WG)	04/99→12/01	EXA	Diesel	3125	5	10	20
Grand Cherokee II (WJ, WG)	10/01→09/05	ENF	Diesel	2685	5	20	17
Grand Cherokee III (WH, WK)	10/04→12/10	EVA	Petrol	4701	8	16	24
Grand Cherokee III (WH, WK)	10/04→12/10	EVD	Petrol	4701	8	16	24
Grand Cherokee III (WH, WK)	10/04→12/10	EVE	Petrol	4701	8	16	24
Grand Cherokee III (WH, WK)	06/05→12/10	EKG	Petrol	3700	6	12	23
Grand Cherokee III (WH, WK)	06/05→12/10	EXL	Diesel	2987	6	24	19
Grand Cherokee IV (WK, WK2)	06/10→12/11	EKG	Petrol	3700	6	12	23
Grand Cherokee IV (WK, WK2)	09/10→	ERB	Petrol	3604	6	24	22
Grand Cherokee IV (WK, WK2)	02/11→	EXF	Diesel	2987	6	24	19
Patriot (MK74)	02/07→	ECD	Diesel	1968	4	16	6
Patriot (MK74)	02/07→	ECE	Diesel	1968	4	16	6
Patriot (MK74)	02/07→	ECN	Petrol	1998	4	16	7
Patriot (MK74)	02/07→	ED3	Petrol	2360	4	16	12
Patriot (MK74)	01/11→	ENE	Diesel	2143	4	16	9
Renegade Closed Off-Road Vehicle (BU)	07/14→	EAM	Petrol	1368	4	16	1
Renegade Closed Off-Road Vehicle (BU)	07/14→	EBT	Diesel	1956	4	16	5
Renegade Closed Off-Road Vehicle (BU)	07/14→	ED6	Petrol	2360	4	16	12
Renegade Closed Off-Road Vehicle (BU)	07/14→	EJH	Petrol	1598	4	16	2
Renegade Closed Off-Road Vehicle (BU)	07/14→	EJK	Diesel	1598	4	16	3
Wrangler I (YJ, SJ_)	12/91→08/96	EPE	Petrol	2464	4	8	15
Wrangler II (TJ)	09/96→12/02	EPE	Petrol	2464	4	8	15
Wrangler II (TJ)	09/02→04/07	ED1	Petrol	2429	4	16	11
Wrangler III (JK)	04/07→	ENS	Diesel	2777	4	16	18
Wrangler III (JK)	09/11→	ERB	Petrol	3604	6	24	22

	CC				9		CC				9
BMM	1968	4	8	Diesel	4						
EAM	1368	4	16	Petrol	1						
EBT	1956	4	16	Diesel	5						
ECD	1968	4	16	Diesel	6						
ECE	1968	4	16	Diesel	6						
ECN	1998	4	16	Petrol	7						
ED1	2429	4	16	Petrol	11						
ED3	2360	4	16	Petrol	12						
ED6	2360	4	16	Petrol	12						
EDG	2360	4	16	Petrol	12						
EDO	2429	4	16	Petrol	11						
EHB	3239	6	24	Petrol	21						
EJH	1598	4	16	Petrol	2						
EJK	1598	4	16	Diesel	3						
EKG	3700	6	12	Petrol	23						
ENC	2499	4	8	Diesel	13						
ENE	2143	4	16	Diesel	9						
ENF	2685	5	20	Diesel	17						
ENO	2499	4	16	Diesel	14						
ENR	2777	4	16	Diesel	18						
ENS	2777	4	16	Diesel	18						
EPE	2464	4	8	Petrol	15						
ERB	3604	6	24	Petrol	22						
ERZ	2359	4	16	Petrol	12						
EVA	4701	8	16	Petrol	24						
EVC	4701	8	16	Petrol	24						
EVD	4701	8	16	Petrol	24						
EVE	4701	8	16	Petrol	24						
EXA	3125	5	10	Diesel	20						
EXF	2987	6	24	Diesel	19						
EXL	2987	6	24	Diesel	19						
J5R-800	1995	4	8	Petrol	8						
J8S	2068	4	8	Diesel	10						
J8S 742	2068	4	8	Diesel	10						
J8S-800	2068	4	8	Diesel	10						
J8S-814	2068	4	8	Diesel	10						
J8S-890	2068	4	8	Diesel	10						
M51	2499	4	8	Diesel	13						
M52	2499	4	8	Diesel	13						
OM 651.925	2143	4	16	Diesel	9						
R 425 DOHC	2499	4	16	Diesel	16						

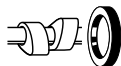

1 1.4L Petrol

EAM	4 Cyl.	16 Valves	1368cc	TD31580
HR814	NA5321 (x2) 31.00 x 55.00 x 7.00mm, FPM		NA5057 27.00 x 37.00 x 7.00mm, FPM LK5001 74.00 x 187.50 x 17.00mm, FPM	

2 1.6L Petrol

EJH	4 Cyl.	16 Valves	1598cc	TD32606
			NA5139 32.00 x 45.00 x 6.00mm, FPM NA5140 91.00 x 111.00 x 10.00mm, FPM	

3 1.6L Diesel

EJK	4 Cyl.	16 Valves	1598cc	TD32609
	NA5347 (x2) 30.0 x 45.0 x 7.00mm, FPM		NA5070 31.00 x 41.00 x 7.00mm, FPM NF888 93.00 x 139.70;172.00 x 12.00mm, FPM	

4 2.0L Diesel

BMM	4 Cyl.	8 Valves	1968cc	TD24007
HR816	NA5124 32.00 x 47.00 x 10.00mm, PTFE/ACM		NA5106 35.00 x 48.00 x 10.00mm, PTFE LK5012 85.00 x 132.00 x 15.70mm, PTFE	

5 2.0L Diesel

EBT	4 Cyl.	16 Valves	1956cc	TD32605
	NA5347 (x2) 30.0 x 45.0 x 7.00mm, FPM		NA5070 31.00 x 41.00 x 7.00mm, FPM NF888 93.00 x 139.70;172.00 x 12.00mm, FPM	

6 2.0L Diesel

ECD	4 Cyl.	16 Valves	1968cc	TD24008
ECE	4 Cyl.	16 Valves	1968cc	TD24009
PA5041 (x16) HR791	NA5124 (x2) 32.00 x 47.00 x 10.00mm, PTFE/ACM		NA5106 35.00 x 48.00 x 10.00mm, PTFE LK5012 85.00 x 132.00 x 15.70mm, PTFE	

7 2.0L Petrol

ECN	4 Cyl.	16 Valves	1998cc	TD25589
	NC006 (x2) 35.00 x 48.00 x 7.00mm, MVQ		NA5108 42.00 x 55.00 x 7.00mm, FPM/ACM NK143 85.00 x 103.00 x 8.00mm, FPM	

8 2.0L Petrol

JSR-800	4 Cyl.	8 Valves	1995cc	TD1747
HR569	NA5016 35.00 x 47.00 x 7.00mm, FPM/ACM		NF843 50.00 x 68.00 x 10.00mm, FPM/ACM NF844 90.00 x 110.00 x 11.00mm, FPM/ACM	

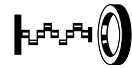
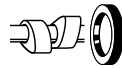

9 2.1L Diesel

ENE	4 Cyl.	16 Valves	2143cc	TD26754
OM 651.925	4 Cyl.	16 Valves	2143cc	TD25244
PA5041 (x16) HR791				NA5479 60.00 x 75.00 x 8.00mm, FPM

10 2.1L Diesel

J8S	4 Cyl.	8 Valves	2068cc	TD22946
J8S 742	4 Cyl.	8 Valves	2068cc	TD22464
J8S-800	4 Cyl.	8 Valves	2068cc	TD1750
J8S-814	4 Cyl.	8 Valves	2068cc	TD1745
J8S-890	4 Cyl.	8 Valves	2068cc	TD1749
HR569	NA5016 35.00 x 47.00 x 7.00mm, FPM/ACM			NF843 50.00 x 68.00 x 10.00mm, FPM/ACM NF648 50.00 x 68.00 x 10.00mm, MVQ NF844 90.00 x 110.00 x 11.00mm, FPM/ACM

11 2.4L Petrol

ED1	4 Cyl.	16 Valves	2429cc	TD22458
EDO	4 Cyl.	16 Valves	2429cc	TD22109
HR5061	NC006 (x2) 35.00 x 48.00 x 7.00mm, MVQ			NA5139 32.00 x 45.00 x 6.00mm, FPM NA5140 91.00 x 111.00 x 10.00mm, FPM

12 2.4L Petrol

ED3	4 Cyl.	16 Valves	2360cc	TD25590
ED6	4 Cyl.	16 Valves	2360cc	TD29575
EDG	4 Cyl.	16 Valves	2360cc	TD24010
ERZ	4 Cyl.	16 Valves	2359cc	TD22463
				NA5108 42.00 x 55.00 x 7.00mm, FPM/ACM NK143 85.00 x 103.00 x 8.00mm, FPM

13 2.5L Diesel

ENC	4 Cyl.	8 Valves	2499cc	TD26068
M51	4 Cyl.	8 Valves	2499cc	TD22949
M52	4 Cyl.	8 Valves	2499cc	TD22950
HR801				

14 2.5L Diesel

ENO	4 Cyl.	16 Valves	2499cc	TD22110
				NA5136 30.00 x 47.00 x 7.00mm, FPM

15 2.5L Petrol

EPE	4 Cyl.	8 Valves	2464cc	TD22461
				NA5133 85.00 x 105.00 x 11.00mm, FPM

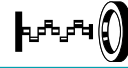

16 2.5L

Diesel

R 425 DOHC	4 Cyl.	16 Valves	2499cc	TD22945
	NA5136 (x2) 30.00 x 47.00 x 7.00mm, FPM			

17 2.7L

Diesel

ENF	5 Cyl.	20 Valves	2685cc	TD26098
	NA5131 45.00 x 67.00 x 8.00mm, PTFE			
	NA5074 93.00 x 133.50 x 15.50mm, PTFE			

18 2.8L

Diesel

ENR	4 Cyl.	16 Valves	2777cc	TD24005
ENS	4 Cyl.	16 Valves	2777cc	TD24001
PA5041 (x16) HR791	NA5136 (x2) 30.00 x 47.00 x 7.00mm, FPM			

19 3.0L

Diesel

EXF	6 Cyl.	24 Valves	2987cc	TD26755
EXL	6 Cyl.	24 Valves	2987cc	TD26069
HR5062	NA5131 45.00 x 67.00 x 8.00mm, PTFE			

20 3.1L

Diesel

EXA	5 Cyl.	10 Valves	3125cc	TD26736
HR660				

21 3.2L

Petrol

EHB	6 Cyl.	24 Valves	3239cc	TD29576
HR5062	NA5131 45.00 x 67.00 x 8.00mm, PTFE			

22 3.6L

Petrol

ERB	6 Cyl.	24 Valves	3604cc	TD25591
HR5062	NA5131 45.00 x 67.00 x 8.00mm, PTFE			

23 3.7L







Petrol

EKG	6 Cyl.	12 Valves	3700cc	TD22479
	NA5173 100.00 x 120.00 x 9.50mm, FPM			

24 4.7L





Petrol

EVA	8 Cyl.	16 Valves	4701cc	TD22111
EVC	8 Cyl.	16 Valves	4701cc	TD22480
EVD	8 Cyl.	16 Valves	4701cc	TD28047
EVE	8 Cyl.	16 Valves	4701cc	TD23786
HR5077	NA5173 100.00 x 120.00 x 9.50mm, FPM			

							
Avella	11/95→12/01	B3	Petrol	1324	4	16	6
Avella Hatchback	11/95→12/01	B3	Petrol	1324	4	16	6
Avella Hatchback	02/98→10/01	B5	Petrol	1498	4	8	13
Besta Box	01/93→07/99	J2	Diesel	2665	4	8	45
Besta Box	07/93→12/03	4C90	Diesel	2417	4	8	36
Besta Box	02/96→12/03	R2	Diesel	2184	4	8	34
Besta Bus	07/92→10/97	R2	Diesel	2184	4	8	34
Bongo Box	10/03→	D48H	Diesel	2477	4	8	39
Bongo Bus	10/03→	D48H	Diesel	2477	4	8	39
Bongo Bus	10/03→	J2	Diesel	2665	4	8	45
Bongo MPV	10/03→	D48H	Diesel	2477	4	8	39
Bongo MPV	10/03→	J2	Diesel	2665	4	8	45
Bongo Platform/Chassis	04/85→09/99	4C90	Diesel	2417	4	8	36
Bongo Platform/Chassis	03/97→09/03	J2	Diesel	2665	4	8	45
Bongo Platform/Chassis	10/03→	D48H	Diesel	2477	4	8	39
Borrego	06/08→	G6DA	Petrol	3778	6	24	54
Cadenza	01/10→	G4KC	Petrol	2359	4	16	38
Cadenza	01/10→	G6BA	Petrol	2656	6	24	44
Cadenza	01/10→	G6DC	Petrol	3470	6	24	53
Cadenza	01/10→	G6DG	Petrol	2999	6	24	47
Cadenza	01/10→	G6DH	Petrol	3342	6	24	51
Cadenza	01/10→	G6HA	Petrol	2656	6	24	44
Cadenza I (VG)	06/13→	G4KE	Petrol	2359	4	16	38
Cadenza I (VG)	09/13→	G6DH	Petrol	3342	6	24	51
Cadenza I (VG)	01/16→	G6DF	Petrol	3342	6	24	51
Cadenza II (YG)	01/16→	G4KJ	Petrol	2359	4	16	38
Cadenza II (YG)	01/16→	G6DF	Petrol	3342	6	24	51
Carens I (FC)	03/00→05/02	TB	Petrol	1793	4	16	24
Carens I (FC)	11/00→07/02	T8	Petrol	1793	4	16	24
Carens II (FJ)	07/02→	D4EA	Diesel	1991	4	16	25
Carens II (FJ)	07/02→	GA6D	Petrol	1594	4	16	20
Carens II (FJ)	07/02→	TB	Petrol	1793	4	16	24
Carens II (FJ)	08/04→	G4GC	Petrol	1975	4	16	29
Carens II (FJ)	11/05→	D4EA-F	Diesel	1991	4	16	25
Carens III (UN)	09/06→12/10	G6EA	Petrol	2656	6	24	44
Carens III (UN)	09/06→12/12	G4KC	Petrol	2359	4	16	38
Carens III (UN)	09/06→	D4EA-F	Diesel	1991	4	16	25
Carens III (UN)	09/06→	G4KA	Petrol	1998	4	16	31
Carens III (UN)	05/07→	D4EA	Diesel	1991	4	16	25
Carens III (UN)	10/10→	D4FB	Diesel	1582	4	16	18
Carens IV	03/13→	D4FD-L	Diesel	1685	4	16	21
Carens IV	03/13→	G4NC	Petrol	1999	4	16	32
Carens IV	01/14→	G4NA	Petrol	1999	4	16	32
Carnival / Grand Carnival III (VQ)	09/05→	G6DA	Petrol	3778	6	24	54
Carnival / Grand Carnival III (VQ)	06/06→	G6EA	Petrol	2656	6	24	44
Carnival / Grand Carnival III (VQ)	06/06→	J3	Diesel	2902	4	16	46
Carnival / Grand Carnival III (VQ)	06/10→	G6DC	Petrol	3470	6	24	53
Carnival I (UP)	08/99→10/01	J3	Diesel	2902	4	16	46
Carnival I (UP)	08/99→10/01	KRV6	Petrol	2497	6	24	43
Carnival I (UP)	10/00→10/01	KV6	Petrol	2497	6	24	43
Carnival II (GQ)	01/99→09/07	J3	Diesel	2902	4	16	46
Carnival II (GQ)	10/01→06/06	K5	Petrol	2497	6	24	43
Carnival II (GQ)	10/01→06/06	KV6	Petrol	2497	6	24	43
Carnival II (GQ)	07/02→04/06	G6CU	Petrol	3497	6	24	52
Carnival MPV	07/04→12/10	G6CU	Petrol	3497	6	24	52
Cee'd (JD)	05/12→	D4FB	Diesel	1582	4	16	18
Cee'd (JD)	05/12→	D4FB-L	Diesel	1582	4	16	18
Cee'd (JD)	05/12→	D4FC	Diesel	1396	4	16	10
Cee'd Hatchback (ED)	12/06→12/12	D4FB	Diesel	1582	4	16	18
Cee'd Hatchback (ED)	12/06→12/12	D4FB-L	Diesel	1582	4	16	18
Cee'd Hatchback (ED)	12/06→12/12	G4GC	Petrol	1975	4	16	29
Cee'd Hatchback (ED)	06/07→12/12	D4EA	Diesel	1991	4	16	25
Cee'd Hatchback (ED)	09/07→12/12	D4EA-F	Diesel	1991	4	16	25
Cee'd Sportswagon (JD)	09/12→	D4FB	Diesel	1582	4	16	18
Cee'd Sportswagon (JD)	09/12→	D4FC	Diesel	1396	4	16	10
Cee'd SW (ED)	09/07→12/12	D4EA-F	Diesel	1991	4	16	25
Cee'd SW (ED)	09/07→12/12	D4FB	Diesel	1582	4	16	18
Cee'd SW (ED)	09/07→12/12	D4FB-L	Diesel	1582	4	16	18
Cee'd SW (ED)	09/07→12/12	G4GC	Petrol	1975	4	16	29
Cerato	05/05→	G4ED	Petrol	1599	4	16	19
Cerato (LD)	04/04→	D4EA	Diesel	1991	4	16	25
Cerato (LD)	04/04→	G4GC	Petrol	1975	4	16	29
Cerato (LD)	07/04→	G4ED	Petrol	1599	4	16	19
Cerato (LD)	06/05→	D4FB	Diesel	1582	4	16	18
Cerato (LD)	07/05→	D4FA	Diesel	1493	4	16	15
Cerato (LD)	08/05→	G4GB	Petrol	1795	4	16	23
Cerato Hatchback	12/07→12/14	G4ED	Petrol	1599	4	16	19
Cerato II (TD)	01/09→	G4KD	Petrol	1998	4	16	31



Cerato II (TD)	09/10→12/13	G4KC	Petrol	2359	4	16	38
Cerato II Saloon (TD)	01/09→	G4KD	Petrol	1998	4	16	31
Cerato II Saloon (TD)	09/09→	G4KE	Petrol	2359	4	16	38
Cerato Koup (TD)	01/09→	G4KD	Petrol	1998	4	16	31
Cerato Koup (TD)	09/10→12/13	G4KE	Petrol	2359	4	16	38
Cerato Saloon	10/01→07/04	T8	Petrol	1793	4	16	24
Cerato Saloon	09/12→	D4FB	Diesel	1582	4	16	18
Cerato Saloon	06/13→	G4KD	Petrol	1998	4	16	31
Cerato Saloon	06/13→	G4NC	Petrol	1999	4	16	32
Cerato Saloon	12/14→	G4NA	Petrol	1999	4	16	32
Cerato Saloon (LD)	04/04→	D4EA	Diesel	1991	4	16	25
Cerato Saloon (LD)	04/04→	G4ED	Petrol	1599	4	16	19
Cerato Saloon (LD)	04/04→	G4GC	Petrol	1975	4	16	29
Cerato Saloon (LD)	06/05→	D4FB	Diesel	1582	4	16	18
Cerato Saloon (LD)	07/05→	D4FA	Diesel	1493	4	16	15
Ceres	06/92→01/97	S2	Diesel	2209	4	8	35
Clarus (K9A)	05/96→11/01	FE (16V)	Petrol	1998	4	16	27
Clarus (K9A)	07/96→08/01	T8	Petrol	1793	4	16	24
Clarus Estate (GC)	05/98→	FE (16V)	Petrol	1998	4	16	27
Clarus Estate (GC)	05/98→	T8	Petrol	1793	4	16	24
Enterprise	01/98→12/02	J5DE	Petrol	2494	6	24	42
Enterprise	01/98→12/02	JE	Petrol	2954	6	18	48
Enterprise	01/98→12/02	JEZE	Petrol	2954	6	24	49
Joice	02/00→	G4CP	Petrol	1997	4	16	28
K2500 (SD)	01/03→	D4BH	Diesel	2477	4	8	39
K2700	01/06→	J2	Diesel	2665	4	8	45
K2700 (K62W)	03/97→09/99	J2	Diesel	2665	4	8	45
K2700 (SD)	10/99→	J2	Diesel	2665	4	8	45
K2900	01/08→	J3	Diesel	2902	4	16	46
Magentis (GD)	04/04→	G6BA	Petrol	2656	6	24	44
Magentis (GD, MS)	05/01→12/01	G6BW	Petrol	2493	6	24	41
Magentis (GD, MS)	05/01→09/05	G4JP	Petrol	1997	4	16	30
Magentis (GD, MS)	05/01→12/05	G4JS	Petrol	2351	4	16	37
Magentis (GD, MS)	05/01→	G6BV	Petrol	2493	6	24	40
Magentis (GD, MS)	09/01→12/05	G6BA	Petrol	2656	6	24	44
Magentis (MG)	11/05→12/06	G6BA	Petrol	2656	6	24	44
Magentis (MG)	11/05→12/08	D4EA	Diesel	1991	4	16	25
Magentis (MG)	11/05→12/09	G4KC	Petrol	2359	4	16	38
Magentis (MG)	11/05→	G4KA	Petrol	1998	4	16	31
Magentis (MG)	11/05→	G6EA	Petrol	2656	6	24	44
Magentis (MG)	04/06→	D4EA-F	Diesel	1991	4	16	25
Magentis (MG)	07/09→	G4KD	Petrol	1998	4	16	31
Magentis (MG)	09/09→12/10	G4KE	Petrol	2359	4	16	38
Opirus (GH)	09/03→	G6CU	Petrol	3497	6	24	52
Opirus (GH)	10/03→02/12	G6BA	Petrol	2656	6	24	44
Opirus (GH)	10/06→	G6DA	Petrol	3778	6	24	54
Opirus (GH)	10/06→	G6EA	Petrol	2656	6	24	44
Optima	04/10→	G4KD	Petrol	1998	4	16	31
Optima	09/11→	G4KC	Petrol	2359	4	16	38
Optima	03/12→	D4FD-L	Diesel	1685	4	16	21
Optima	03/12→	G4KH	Petrol	1998	4	16	31
Optima	03/12→	G4KJ	Petrol	2359	4	16	38
Optima	03/12→	G4NA	Petrol	1999	4	16	32
Optima	03/12→	G4NE	Petrol	1999	4	16	32
Optima	09/16→	G4NG	Petrol	1999	4	16	32
Optima Sportswagon (JF)	09/16→	D4FD-L	Diesel	1685	4	16	21
Optima Sportswagon (JF)	09/16→	G4KH	Petrol	1998	4	16	31
Optima Sportswagon (JF)	04/17→	G4NG	Petrol	1999	4	16	32
Picanto (BA)	04/04→04/11	G4HC	Petrol	999	4	12	1
Picanto (BA)	04/04→	G4HE	Petrol	999	4	12	1
Picanto (BA)	04/04→	G4HG	Petrol	1086	4	12	4
Picanto (BA)	11/05→	D3FA	Diesel	1120	3	12	3
Picanto (JA)	03/17→	G4LA	Petrol	1248	4	16	9
Picanto (TA)	09/11→	G4LA	Petrol	1248	4	16	9
Pregio Box (TB)	10/97→	J2	Diesel	2665	4	8	45
Pregio Box (TB)	09/02→	D4BH	Diesel	2477	4	8	39
Pregio Bus	08/95→09/04	D4BH	Diesel	2477	4	8	39
Pride (DA)	01/90→09/01	B3	Petrol	1324	4	16	6
Pride (DA)	01/91→10/00	B1	Petrol	1139	4	8	2
Pride (DA)	03/05→12/11	D4FA	Diesel	1493	4	16	15
Pride (DA)	03/05→12/11	G4ED	Petrol	1599	4	16	19
Pride (DA)	03/05→12/11	G4EE	Petrol	1399	4	16	11
Pride Estate	08/99→05/01	B3A5	Petrol	1324	4	8	7
Pride Hatchback	05/05→	G4EE	Petrol	1399	4	16	11
Pride Van (DA)	04/92→06/99	B3	Petrol	1324	4	16	6
Pro Cee'd (JD)	03/13→	D4FB	Diesel	1582	4	16	18
Pro Cee'd (JD)	03/13→	D4FC	Diesel	1396	4	16	10
Pro Cee'd (ED)	02/08→09/12	D4EA-F	Diesel	1991	4	16	25

				CC			9
Pro Cee'd (ED)	02/08→09/12	D4FB	Diesel	1582	4	16	18
Pro Cee'd (ED)	02/08→09/12	D4FB-L	Diesel	1582	4	16	18
Pro Cee'd (ED)	02/08→09/12	G4GC	Petrol	1975	4	16	29
Qianlima	12/02→04/07	G4EA	Petrol	1341	4	12	8
Qianlima	12/02→04/07	G4ED	Petrol	1599	4	16	19
Retona (CE)	06/99→	RF	Diesel	1998	4	8	33
Retona (CE)	05/00→	FE (16V)	Petrol	1998	4	16	27
Rio	01/07→12/14	G4ED	Petrol	1599	4	16	19
Rio	01/07→12/14	G4EE	Petrol	1399	4	16	11
Rio Estate (DC)	08/00→02/05	A3E	Petrol	1343	4	8	5
Rio Estate (DC)	08/00→02/05	A5D	Petrol	1493	4	16	12
Rio II (JB)	03/05→	D4FA	Diesel	1493	4	16	15
Rio II (JB)	03/05→	G4ED	Petrol	1599	4	16	19
Rio II (JB)	03/05→	G4EE	Petrol	1399	4	16	11
Rio II Saloon (JB)	03/05→	D4FA	Diesel	1493	4	16	15
Rio II Saloon (JB)	03/05→	G4ED	Petrol	1599	4	16	19
Rio II Saloon (JB)	03/05→	G4EE	Petrol	1399	4	16	11
Rio III (UB)	09/11→	D3FA	Diesel	1120	3	12	3
Rio III (UB)	09/11→	D4FC	Diesel	1396	4	16	10
Rio III (UB)	09/11→	G4LA	Petrol	1248	4	16	9
Rio III Saloon (UB)	06/11→	G4LA	Petrol	1248	4	16	9
Rio IV (YB)	01/17→	D4FC	Diesel	1396	4	16	10
Rio Saloon (DC_)	09/00→02/05	A3E	Petrol	1343	4	8	5
Rio Saloon (DC_)	09/00→02/05	A5D	Petrol	1493	4	16	12
Sedona	09/14→	G6DH	Petrol	3342	6	24	51
Sedona	01/15→	G6DF	Petrol	3342	6	24	51
Sephia (FA)	01/95→10/97	B6	Petrol	1598	4	8	17
Sephia (FA)	01/95→10/97	OK24N	Petrol	1793	4	16	24
Sephia (FA)	01/95→10/97	OK26Y	Petrol	1793	4	16	24
Sephia (FA)	02/96→10/97	B5	Petrol	1498	4	8	13
Sephia Saloon (FA)	01/92→10/97	B5	Petrol	1498	4	8	13
Sephia Saloon (FA)	09/93→10/97	B6	Petrol	1598	4	8	17
Sephia Saloon (FA)	01/95→10/97	OK24N	Petrol	1793	4	16	24
Sephia Saloon (FA)	01/95→10/97	OK26Y	Petrol	1793	4	16	24
Sephia Saloon (FA)	10/00→09/01	BFD	Petrol	1498	4	16	14
Shuma (FB)	10/97→03/01	BFD	Petrol	1498	4	16	14
Shuma (FB)	10/97→03/01	T8	Petrol	1793	4	16	24
Shuma (FB)	10/97→03/01	ZYVE	Petrol	1498	4	16	16
Shuma (FB)	01/01→12/01	GA6D	Petrol	1594	4	16	20
Shuma Coupe	01/10→12/14	G4KD	Petrol	1998	4	16	31
Shuma Coupe	02/14→	G4NA	Petrol	1999	4	16	32
Shuma II (FB)	05/01→08/04	GA6D	Petrol	1594	4	16	20
Shuma II (FB)	05/01→08/04	T8	Petrol	1793	4	16	24
Shuma II Saloon (FB)	05/01→05/04	GA6D	Petrol	1594	4	16	20
Shuma Saloon (FB)	03/96→12/98	OK280	Petrol	1498	4	8	13
Shuma Saloon (FB)	10/97→10/01	BFD	Petrol	1498	4	16	14
Shuma Saloon (FB)	10/97→10/01	ZYVE	Petrol	1498	4	16	16
Sorento I (JC)	08/02→	G4JS	Petrol	2351	4	16	37
Sorento I (JC)	08/02→	G6CU	Petrol	3497	6	24	52
Sorento I (JC)	07/06→	G6DA	Petrol	3778	6	24	54
Sorento I (JC)	02/07→	G6DB	Petrol	3342	6	24	50
Sorento II (XM)	11/09→12/15	G6HA	Petrol	2656	6	24	44
Sorento II (XM)	11/09→	G4KE	Petrol	2359	4	16	38
Sorento II (XM)	11/09→	G6DC	Petrol	3470	6	24	53
Sorento II (XM)	10/12→	G4KJ	Petrol	2359	4	16	38
Sorento II (XM)	09/13→	G6DH	Petrol	3342	6	24	51
Sorento III (UM)	01/15→	G4KE	Petrol	2359	4	16	38
Sorento III (UM)	01/15→	G4KH	Petrol	1998	4	16	31
Sorento III (UM)	01/15→	G4KJ	Petrol	2359	4	16	38
Soul (AM)	02/09→	D4FB	Diesel	1582	4	16	18
Soul (AM)	02/09→	G4KD	Petrol	1998	4	16	31
Soul (AM)	09/09→12/11	G4GC	Petrol	1975	4	16	29
Soul II (PS)	02/14→	D4FB	Diesel	1582	4	16	18
Soul II (PS)	02/14→	G4NA	Petrol	1999	4	16	32
Soul II (PS)	07/16→	G4KD	Petrol	1998	4	16	31
Sportage (JE_, KM_)	09/04→	D4EA	Diesel	1991	4	16	25
Sportage (JE_, KM_)	09/04→	G4GC	Petrol	1975	4	16	29
Sportage (JE_, KM_)	09/04→	G6BA	Petrol	2656	6	24	44
Sportage (JE_, KM_)	03/05→07/10	FE (16V)	Petrol	1998	4	16	27
Sportage (JE_, KM_)	01/06→	D4EA-F	Diesel	1991	4	16	25
Sportage (K00)	04/94→08/99	FE (8V)	Petrol	1998	4	8	26
Sportage (K00)	04/94→10/03	RF	Diesel	1998	4	8	33
Sportage (K00)	04/94→08/04	FE (16V)	Petrol	1998	4	16	27
Sportage (QL)	09/15→	D4FD-L	Diesel	1685	4	16	21
Sportage (QL)	12/15→	G4NA	Petrol	1999	4	16	32
Sportage (SL)	06/10→	G4KD	Petrol	1998	4	16	31
Sportage (SL)	08/10→	G4KE	Petrol	2359	4	16	38
Sportage (SL)	09/10→	G4KH	Petrol	1998	4	16	31











CC



9

Model	Year Range	Engine Code	Fuel Type	CC	Cylinders	Power (kW)	Power (hp)
Sportage (SL)	12/10→	D4FD-L	Diesel	1685	4	16	21
Sportage (SL)	09/13→05/16	G4KJ	Petrol	2359	4	16	38
Sportage (SL)	02/14→	G4NC	Petrol	1999	4	16	32
Sonic (YB)	07/17→	D4FB	Diesel	1582	4	16	18
Venga (YN)	02/10→	D4FB	Diesel	1582	4	16	18
Venga (YN)	02/10→	D4FC	Diesel	1396	4	16	10

	CC				9		CC				9
4C90	2417	4	8	Diesel	36						
A3E	1343	4	8	Petrol	5						
A5D	1493	4	16	Petrol	12						
B1	1139	4	8	Petrol	2						
B3	1324	4	16	Petrol	6						
B3A5	1324	4	8	Petrol	7						
B5	1498	4	8	Petrol	13						
B6	1598	4	8	Petrol	17						
BFD	1498	4	16	Petrol	14						
D3FA	1120	3	12	Diesel	3						
D4BH	2477	4	8	Diesel	39						
D4EA	1991	4	16	Diesel	25						
D4EA-F	1991	4	16	Diesel	25						
D4FA	1493	4	16	Diesel	15						
D4FB	1582	4	16	Diesel	18						
D4FB-L	1582	4	16	Diesel	18						
D4FC	1396	4	16	Diesel	10						
D4FD-L	1685	4	16	Diesel	21						
F8	1789	4	12	Petrol	22						
FE (8V)	1998	4	8	Petrol	26						
FE (16V)	1998	4	16	Petrol	27						
G4CP	1997	4	16	Petrol	28						
G4EA	1341	4	12	Petrol	8						
G4ED	1599	4	16	Petrol	19						
G4ED	1599	4	16	Petrol	19						
G4EE	1399	4	16	Petrol	11						
G4EE	1399	4	16	Petrol	11						
G4GB	1795	4	16	Petrol	23						
G4GC	1975	4	16	Petrol	29						
G4HC	999	4	12	Petrol	1						
G4HD	1086	4	12	Petrol	4						
G4HE	999	4	12	Petrol	1						
G4HG	1086	4	12	Petrol	4						
G4JP	1997	4	16	Petrol	30						
G4JS	2351	4	16	Petrol	37						
G4KA	1998	4	16	Petrol	31						
G4KC	2359	4	16	Petrol	38						
G4KD	1998	4	16	Petrol	31						
G4KE	2359	4	16	Petrol	38						
G4KH	1998	4	16	Petrol	31						
G4KJ	2359	4	16	Petrol	38						
G4LA	1248	4	16	Petrol	9						
G4NA	1999	4	16	Petrol	32						
G4NC	1999	4	16	Petrol	32						
G4NE	1999	4	16	Petrol	32						
G4NG	1999	4	16	Petrol	32						
G6BA	2656	6	24	Petrol	44						
G6BV	2493	6	24	Petrol	40						
G6BW	2493	6	24	Petrol	41						
G6CU	3497	6	24	Petrol	52						
G6CU	3497	6	24	Petrol	52						
G6DA	3778	6	24	Petrol	54						
G6DB	3342	6	24	Petrol	50						
G6DC	3470	6	24	Petrol	53						
G6DF	3342	6	24	Petrol	51						
G6DG	2999	6	24	Petrol	47						
G6DH	3342	6	24	Petrol	51						
G6EA	2656	6	24	Petrol	44						
G6HA	2656	6	24	Petrol	44						
GA6D	1594	4	16	Petrol	20						
J2	2665	4	8	Diesel	45						
J3	2902	4	16	Diesel	46						
J5DE	2494	6	24	Petrol	42						
JE	2954	6	18	Petrol	48						
JEZE	2954	6	24	Petrol	49						
K5	2497	6	24	Petrol	43						
KRV6	2497	6	24	Petrol	43						
KV6	2497	6	24	Petrol	43						
OK24N	1793	4	16	Petrol	24						
OK26Y	1793	4	16	Petrol	24						
OK280	1498	4	8	Petrol	13						
R2	2184	4	8	Diesel	34						
RF	1998	4	8	Diesel	33						
S2	2209	4	8	Diesel	35						
T8	1793	4	16	Petrol	24						
TB	1793	4	16	Petrol	24						
ZYVE	1498	4	16	Petrol	16						

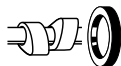
**1 1.0L****Petrol**

G4HC	4 Cyl.	12 Valves	999cc	TD33759
G4HE	4 Cyl.	12 Valves	999cc	TD20755
	NJ933 35.00 x 50.00 x 8.00mm, FPM		NJ252 30.00 x 46.00 x 7.00mm, NBR	

2 1.1L**Petrol**

B1	4 Cyl.	8 Valves	1139cc	TD1762
PA883 (x8)	NJ448 30.00 x 44.00 x 7.00mm, NBR		NJ448 30.00 x 44.00 x 7.00mm, NBR NJ650 83.00 x 100.00 x 9.00mm, ACM	

3 1.1L**Diesel**

D3FA	3 Cyl.	12 Valves	1120cc	TD19960
			NA5140 91.00 x 111.00 x 10.00mm, FPM	

4 1.1L**Petrol**

G4HD	4 Cyl.	12 Valves	1086cc	TD24833
G4HG	4 Cyl.	12 Valves	1086cc	TD17408
	NJ933 35.00 x 50.00 x 8.00mm, FPM		NJ252 30.00 x 46.00 x 7.00mm, NBR	

5 1.3L**Petrol**

A3E	4 Cyl.	8 Valves	1343cc	TD29360
			NK158 37.00 x 50.50 x 7.00mm, ACM NJ650 83.00 x 100.00 x 9.00mm, ACM	

6 1.3L**Petrol**

B3	4 Cyl.	16 Valves	1324cc	TD5503
PA425 (x16)	NJ448 30.00 x 44.00 x 7.00mm, NBR		NJ448 30.00 x 44.00 x 7.00mm, NBR NJ650 83.00 x 100.00 x 9.00mm, ACM	

7 1.3L**Petrol**

B3A5	4 Cyl.	8 Valves	1324cc	TD32503
PA883 (x8)	NJ448 30.00 x 44.00 x 7.00mm, NBR		NJ448 30.00 x 44.00 x 7.00mm, NBR NJ650 83.00 x 100.00 x 9.00mm, ACM	

8 1.3L**Petrol**

G4EA	4 Cyl.	12 Valves	1341cc	TD20690
PA425 (x12)	NJ933 35.00 x 50.00 x 8.00mm, FPM		NC006 35.00 x 48.00 x 7.00mm, MVQ NJ006 72.00 x 96.00 x 9.00mm, MVQ	

9 1.3L**Petrol**

G4LA	4 Cyl.	16 Valves	1248cc	TD26878
			NJ324 34.00 x 48.00 x 7.00mm, ACM	

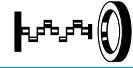

10 1.4L Diesel					
D4FC	4 Cyl.	16 Valves	1396cc		TD25027
				NA5140	91.00 x 111.00 x 10.00mm, FPM
11 1.4L Petrol					
G4EE	4 Cyl.	16 Valves	1399cc		TD20692
G4EE	4 Cyl.	16 Valves	1399cc		TD19959
PA425 (x16)	NJ933			NK006	35.00 x 48.00 x 7.00mm, MVQ
	35.00 x 50.00 x 8.00mm, FPM			NJ006	72.00 x 96.00 x 9.00mm, MVQ
12 1.5L Petrol					
A5D	4 Cyl.	16 Valves	1493cc		TD28073
				NK158	37.00 x 50.50 x 7.00mm, ACM
				NJ650	83.00 x 100.00 x 9.00mm, ACM
13 1.5L Petrol					
B5	4 Cyl.	8 Valves	1498cc		TD1763
OK280	4 Cyl.	8 Valves	1498cc		TD18946
PA883 (x8)	NJ448			NK158	37.00 x 50.50 x 7.00mm, ACM
	30.00 x 44.00 x 7.00mm, NBR			NJ650	83.00 x 100.00 x 9.00mm, ACM
14 1.5L Petrol					
BFD	4 Cyl.	16 Valves	1498cc		TD32936
PB313 (x8)	NJ324			NK158	37.00 x 50.50 x 7.00mm, ACM
PB314 (x8)	34.00 x 48.00 x 7.00mm, ACM			NJ650	83.00 x 100.00 x 9.00mm, ACM
15 1.5L Diesel					
D4FA	4 Cyl.	16 Valves	1493cc		TD18454
				NA5140	91.00 x 111.00 x 10.00mm, FPM
16 1.5L Petrol					
ZYVE	4 Cyl.	16 Valves	1498cc		TD32501
HR5063					
17 1.6L Petrol					
B6	4 Cyl.	8 Valves	1598cc		TD4588
PA883 (x8)	NJ448			NK158	37.00 x 50.50 x 7.00mm, ACM
	30.00 x 44.00 x 7.00mm, NBR			NJ650	83.00 x 100.00 x 9.00mm, ACM
18 1.6L Diesel					
D4FB	4 Cyl.	16 Valves	1582cc		TD19228
D4FB-L	4 Cyl.	16 Valves	1582cc		TD19229
				NA5140	91.00 x 111.00 x 10.00mm, FPM

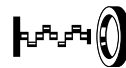
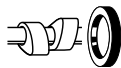
**19 1.6L****Petrol**

G4ED	4 Cyl.	16 Valves	1599cc	TD18452
G4ED	4 Cyl.	16 Valves	1599cc	TD20691
PA425 (x16)	NJ933 35.00 x 50.00 x 8.00mm, FPM	NC006 35.00 x 48.00 x 7.00mm, MVQ	NJ006 72.00 x 96.00 x 9.00mm, MVQ	

20 1.6L**Petrol**

GA6D	4 Cyl.	16 Valves	1594cc	TD26096
			NK158 37.00 x 50.50 x 7.00mm, ACM	
			NJ650 83.00 x 100.00 x 9.00mm, ACM	

21 1.7L**Diesel**

D4FD-L	4 Cyl.	16 Valves	1685cc	TD25026
			NA5140 91.00 x 111.00 x 10.00mm, FPM	

22 1.8L**Petrol**

F8	4 Cyl.	12 Valves	1789cc	TD1764
			NJ324 34.00 x 48.00 x 7.00mm, ACM	
			NJ325 90.00 x 110.00 x 9.00mm, MVQ	

23 1.8L**Petrol**

G4GB	4 Cyl.	16 Valves	1795cc	TD26116
PA425 (x16)	NJ933 35.00 x 50.00 x 8.00mm, FPM	NK158 37.00 x 50.50 x 7.00mm, ACM	NJ251 80.00 x 96.00 x 9.00mm, MVQ	

24 1.8L**Petrol**

OK24N	4 Cyl.	16 Valves	1793cc	TD18941
OK26Y	4 Cyl.	16 Valves	1793cc	TD18942
T8	4 Cyl.	16 Valves	1793cc	TD1767
TB	4 Cyl.	16 Valves	1793cc	TD30821
PB313 (x8)	NJ324 34.00 x 48.00 x 7.00mm, ACM	NK158 37.00 x 50.50 x 7.00mm, ACM	NJ650 83.00 x 100.00 x 9.00mm, ACM	
PB314 (x8)				

25 2.0L**Diesel**

D4EA	4 Cyl.	16 Valves	1991cc	TD18131
D4EA-F	4 Cyl.	16 Valves	1991cc	TD20226
	NF817 36.00 x 50.00 x 7.00mm, FPM	NA5140 91.00 x 111.00 x 10.00mm, FPM		

26 2.0L**Petrol**

FE (8V)	4 Cyl.	8 Valves	1998cc	TD9379
KJ710 (x8) →05/94	NJ324 34.00 x 48.00 x 7.00mm, ACM	NJ324 34.00 x 48.00 x 7.00mm, ACM	NJ325 90.00 x 110.00 x 9.00mm, MVQ	
PA425 (x8) 05/94→				

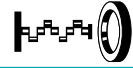
**27 2.0L****Petrol**

FE (16V)	4 Cyl.	16 Valves	1998cc	TD1766
PA425 (x16)	NJ324 (x2) 34.00 x 48.00 x 7.00mm, ACM	NJ324 34.00 x 48.00 x 7.00mm, ACM	NJ325 90.00 x 110.00 x 9.00mm, MVQ	

28 2.0L**Petrol**

G4CP	4 Cyl.	16 Valves	1997cc	TD26094
KJ570 (x16)	NJ933 (x2) 35.00 x 50.00 x 8.00mm, FPM	NJ005 44.00 x 60.00 x 7.00mm, NBR	NJ058 80.00 x 96.00 x 9.00mm, NBR	

29 2.0L**Petrol**

G4GC	4 Cyl.	16 Valves	1975cc	TD18130
PA425 (x16)	NJ933 35.00 x 50.00 x 8.00mm, FPM	NJ058 80.00 x 96.00 x 9.00mm, NBR		

30 2.0L**Petrol**

G4JP	4 Cyl.	16 Valves	1997cc	TD24736
KJ570 (x16)	NJ933 35.00 x 50.00 x 8.00mm, FPM	NJ005 44.00 x 60.00 x 7.00mm, NBR	NK143 85.00 x 103.00 x 8.00mm, FPM	

31 2.0L**Petrol**

G4KA	4 Cyl.	16 Valves	1998cc	TD19198
G4KD	4 Cyl.	16 Valves	1998cc	TD24735
G4KH	4 Cyl.	16 Valves	1998cc	TD33050
HR816 (x2)		NA5108 42.00 x 55.00 x 7.00mm, FPM/ACM	NK143 85.00 x 103.00 x 8.00mm, FPM	

32 2.0L**Petrol**

G4NA	4 Cyl.	16 Valves	1999cc	TD32420
G4NC	4 Cyl.	16 Valves	1999cc	TD27987
G4NE	4 Cyl.	16 Valves	1999cc	TD29358
G4NG	4 Cyl.	16 Valves	1999cc	TD33821
PA425 (x16)				

33 2.0L**Diesel**

RF	4 Cyl.	8 Valves	1998cc	TD11135
KJ710 (x8)	NJ448 30.00 x 44.00 x 7.00mm, NBR	NJ324 34.00 x 48.00 x 7.00mm, ACM	NJ325 90.00 x 110.00 x 9.00mm, MVQ	

34 2.2L**Diesel**

R2	4 Cyl.	8 Valves	2184cc	TD11132
KJ710 (x8)	NJ448 30.00 x 44.00 x 7.00mm, NBR	NJ324 34.00 x 48.00 x 7.00mm, ACM	NJ325 90.00 x 110.00 x 9.00mm, MVQ	

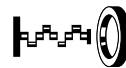
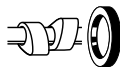
**35 2.2L****Diesel**

S2 4 Cyl. 8 Valves 2209cc TD25285

NJ330
101.60 x 125.00 x 13.00mm, MVQ**36 2.4L****Diesel**

4C90 4 Cyl. 8 Valves 2417cc TD27265

PB180 (x8)
HR801 **NA5058**
40.00 x 55.00 x 7.00mm, FPM**NA5016**
35.00 x 47.00 x 7.00mm, FPM/ACM**37 2.4L****Petrol**

G4JS 4 Cyl. 16 Valves 2351cc TD22115

KJ570 (x16)**NJ933** (x2)
35.00 x 50.00 x 8.00mm, FPM**NJ005**
44.00 x 60.00 x 7.00mm, NBR
NK143
85.00 x 103.00 x 8.00mm, FPM**38 2.4L****Petrol**

G4KC 4 Cyl. 16 Valves 2359cc TD25637

G4KE 4 Cyl. 16 Valves 2359cc TD24734

G4KJ 4 Cyl. 16 Valves 2359cc TD26879

HR816 (x2)**NA5108**
42.00 x 55.00 x 7.00mm, FPM/ACM
NK143
85.00 x 103.00 x 8.00mm, FPM**39 2.5L****Diesel**

D4BH 4 Cyl. 8 Valves 2477cc TD17409

KJ211 (x8)**NJ933**
35.00 x 50.00 x 8.00mm, FPM**NJ005**
44.00 x 60.00 x 7.00mm, NBR
NJ058
80.00 x 96.00 x 9.00mm, NBR**40 2.5L****Petrol**

G6BV 6 Cyl. 24 Valves 2493cc TD24733

HR5094 **NF535** (x4)
30.00 x 42.00 x 8.00mm, NBR**NA5140**
91.00 x 111.00 x 10.00mm, FPM**41 2.5L****Petrol**

G6BW 6 Cyl. 24 Valves 2493cc TD32858

HR5094 **NA5140**
91.00 x 111.00 x 10.00mm, FPM**42 2.5L****Petrol**

J5DE 6 Cyl. 24 Valves 2494cc TD30241

PB313 (x12)
PB314 (x12)**43 2.5L****Petrol**

K5 6 Cyl. 24 Valves 2497cc TD22116

KRV6 6 Cyl. 24 Valves 2497cc TD25833

KV6 6 Cyl. 24 Valves 2497cc TD25287

NC065 (x2)
30.00 x 40.00 x 7.00mm, FPM
NB998 (x4)
30.00 x 40.00 x 7.00mm, FPM**NA5083**
32.50 x 45.00 x 7.70mm, FPM
LK5000
89.00 x 116.00 x 10.20mm, FPM

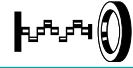

44 2.7L Petrol				
G6BA	6 Cyl.	24 Valves	2656cc	TD18132
G6EA	6 Cyl.	24 Valves	2656cc	TD19953
G6HA	6 Cyl.	24 Valves	2656cc	TD26784
	NF535 30.00 x 42.00 x 8.00mm, NBR		NA5140 91.00 x 111.00 x 10.00mm, FPM	
45 2.7L Diesel				
J2	4 Cyl.	8 Valves	2665cc	TD22112
			NA5197 53.00 x 70.00 x 11.00mm, MVQ NA5196 90.00 x 110.00 x 9.00mm, ACM	
46 2.9L Diesel				
J3	4 Cyl.	16 Valves	2902cc	TD19954
	NC048 (x2) 38.00 x 52.00 x 6.00mm, FPM		NK251 50.00 x 68.00 x 9.00mm, NBR NA5196 90.00 x 110.00 x 9.00mm, ACM	
47 3.0L Petrol				
G6DG	6 Cyl.	24 Valves	2999cc	TD26786
			NA5140 91.00 x 111.00 x 10.00mm, FPM	
48 3.0L Petrol				
JE	6 Cyl.	18 Valves	2954cc	TD30242
PA883 (x12) KJ710 (x6)	NJ985 35.00 x 49.60 x 11.00mm, NBR		NJ978 46.00 x 60.00 x 7.00mm, MVQ NK035 75.00 x 93.00 x 9.00mm, MVQ	
49 3.0L Petrol				
JEZE	6 Cyl.	24 Valves	2954cc	TD30240
PB314 (x24)				
50 3.3L Petrol				
G6DB	6 Cyl.	24 Valves	3342cc	TD19956
	NA5053 30.00 x 42.00 x 7.00mm, FPM NF535 30.00 x 42.00 x 8.00mm, NBR		NA5140 91.00 x 111.00 x 10.00mm, FPM	
51 3.3L Petrol				
G6DF	6 Cyl.	24 Valves	3342cc	TD34275
G6DH	6 Cyl.	24 Valves	3342cc	TD26788
			NA5140 91.00 x 111.00 x 10.00mm, FPM	



52 3.5L

Petrol

G6CU	6 Cyl.	24 Valves	3497cc	TD20696
G6CU	6 Cyl.	24 Valves	3497cc	TD24887
	NA5053 30.00 x 42.00 x 7.00mm, FPM NF535 30.00 x 42.00 x 8.00mm, NBR		NA5140 91.00 x 111.00 x 10.00mm, FPM	

53 3.5L









Petrol









G6DC	6 Cyl.	24 Valves	3470cc	TD26789
				NA5140 91.00 x 111.00 x 10.00mm, FPM

54 3.8L

Petrol

G6DA	6 Cyl.	24 Valves	3778cc	TD19958
	NA5053 30.00 x 42.00 x 7.00mm, FPM NF535 30.00 x 42.00 x 8.00mm, NBR		NA5140 91.00 x 111.00 x 10.00mm, FPM	

							
110 (2110)	01/95→12/05	BA3 2111	Petrol	1499	4	8	6
110 (2110)	01/95→12/05	VAZ-2111	Petrol	1499	4	8	6
110 (2110)	01/95→12/10	VAZ-2112	Petrol	1499	4	16	7
110 (2110)	08/96→07/00	C 20 XE	Petrol	1998	4	16	11
111 (2111)	01/95→12/05	VAZ-2112	Petrol	1499	4	16	7
111 (2111)	01/96→12/05	VAZ-2111	Petrol	1499	4	8	6
111 (2111)	01/97→12/03	BA3 2111	Petrol	1499	4	8	6
112 (2112)	01/95→12/05	VAZ-2111	Petrol	1499	4	8	6
112 (2112)	01/95→12/05	VAZ-2112	Petrol	1499	4	16	7
1200-1500 Estate	09/73→08/84	BA3 2101	Petrol	1198	4	8	2
1200-1500 Estate	09/73→06/85	BA3 2103	Petrol	1452	4	8	5
1200-1500 Estate	01/81→12/82	BA3 2105	Petrol	1294	4	8	3
1200-1600	01/70→06/86	BA3 2101	Petrol	1198	4	8	2
1200-1600	09/72→10/86	BA3 2103	Petrol	1452	4	8	5
1200-1600	09/72→12/05	BA3 2106	Petrol	1570	4	8	8
1200-1600	08/74→08/84	BA3 2105	Petrol	1294	4	8	3
1200-1600	05/78→01/87	BA3 21011	Petrol	1285	4	8	3
1922 Marsz (21213)	05/95→05/13	VAZ-2121.3	Petrol	1690	4	8	9
Nadeschda (2120)	12/97→12/06	BA3 21214	Petrol	1690	4	8	9
Nadeschda (2120)	12/97→12/06	VAZ-2121.3	Petrol	1690	4	8	9
Niva Closed Off-Road Vehicle (2121)	12/76→03/95	BA3 2121	Petrol	1569	4	8	8
Niva Closed Off-Road Vehicle (2121)	01/93→08/99	XUD9A	Diesel	1905	4	8	10
Niva Closed Off-Road Vehicle (2121)	06/96→12/06	VAZ-2121.3	Petrol	1690	4	8	9
Niva Closed Off-Road Vehicle (2121)	06/96→	BA3 21214	Petrol	1690	4	8	9
Niva Closed Off-Road Vehicle (2121)	01/99→12/06	XUD9SD	Diesel	1905	4	8	10
Niva II (2123)	09/02→	BA3 21214	Petrol	1690	4	8	9
Nova (2105)	05/81→04/12	BA3 2105	Petrol	1294	4	8	3
Nova (2105)	09/81→04/12	BA3 2101	Petrol	1198	4	8	2
Nova (2105)	03/85→04/12	BA3 2103	Petrol	1452	4	8	5
Nova (2105)	09/87→12/88	BA3 2103 (KAT)	Petrol	1451	4	8	5
Nova (2105)	01/88→10/01	BA3 2106	Petrol	1570	4	8	8
Nova (2105)	06/89→04/12	BA3 21083	Petrol	1499	4	8	6
Nova Estate (2104)	09/81→02/85	BA3 2101	Petrol	1198	4	8	2
Nova Estate (2104)	09/85→12/91	BA3 2105	Petrol	1294	4	8	3
Nova Estate (2104)	09/85→04/12	BA3 2103	Petrol	1452	4	8	5
Nova Estate (2104)	02/93→04/12	BA3 2106	Petrol	1570	4	8	8
Samara (2108, 2109, 2115, 2113, 2114)	01/86→12/96	BA3 21083	Petrol	1499	4	8	6
Samara (2108, 2109, 2115, 2113, 2114)	01/86→08/99	BA3 2108	Petrol	1288	4	8	4
Samara (2108, 2109, 2115, 2113, 2114)	02/88→08/99	BA3 21081	Petrol	1100	4	8	1
Samara (2108, 2109, 2115, 2113, 2114)	02/95→12/06	BA3 2111	Petrol	1499	4	8	6
Samara (2108, 2109, 2115, 2113, 2114)	02/96→12/96	BA3 21115	Petrol	1288	4	8	4
Samara (2108, 2109, 2115, 2113, 2114)	04/96→12/06	VAZ-2111	Petrol	1499	4	8	6
Samara Hatchback (2113, 2114, 2115)	08/03→12/13	BA3 21083	Petrol	1499	4	8	6
Samara Saloon (21099, 2115)	05/89→08/99	BA3 2108	Petrol	1288	4	8	4
Samara Saloon (21099, 2115)	07/91→12/96	BA3 21083	Petrol	1499	4	8	6
Samara Saloon (21099, 2115)	07/91→08/99	BA3 21081	Petrol	1100	4	8	1
Samara Saloon (21099, 2115)	11/94→12/06	BA3 2111	Petrol	1499	4	8	6
Samara Saloon (21099, 2115)	02/96→12/06	BA3 21115	Petrol	1288	4	8	4
Samara Saloon (21099, 2115)	01/00→12/06	VAZ-2111	Petrol	1499	4	8	6
Toscana (2107)	05/82→05/12	BA3 2106	Petrol	1570	4	8	8
Toscana (2107)	05/82→05/12	VAZ-2121.3	Petrol	1690	4	8	9
Toscana (2107)	09/83→02/93	BA3 2103	Petrol	1452	4	8	5
Toscana (2107)	12/85→05/12	BA3 2105	Petrol	1294	4	8	3

	CC				9		CC				9
BA3 2101	1198	4	8	Petrol	2						
BA3 2103	1452	4	8	Petrol	5						
BA3 2103 (KAT)	1451	4	8	Petrol	5						
BA3 2105	1294	4	8	Petrol	3						
BA3 2106	1570	4	8	Petrol	8						
BA3 2108	1288	4	8	Petrol	4						
BA3 2108 (KAT)	1288	4	8	Petrol	4						
BA3 2111	1499	4	8	Petrol	6						
BA3 2121	1569	4	8	Petrol	8						
BA3 2121 (KAT)	1569	4	8	Petrol	8						
BA3 21011	1285	4	8	Petrol	3						
BA3 21081	1100	4	8	Petrol	1						
BA3 21081 (KAT)	1099	4	8	Petrol	1						
BA3 21083	1499	4	8	Petrol	6						
BA3 21083 (KAT)	1500	4	8	Petrol	6						
BA3 21115	1288	4	8	Petrol	4						
BA3 21214	1690	4	8	Petrol	9						
C 20 XE	1998	4	16	Petrol	11						
VAZ-2111	1499	4	8	Petrol	6						
VAZ-2112	1499	4	16	Petrol	7						
VAZ-2121.3	1690	4	8	Petrol	9						
XUD9A	1905	4	8	Diesel	10						
XUD9SD	1905	4	8	Diesel	10						



1 1.1L Petrol

BA3 21081	4 Cyl.	8 Valves	1100cc	TD5185
BA3 21081 (KAT)	4 Cyl.	8 Valves	1099cc	TD5384
HR569				NJ287 80.00 x 100.00 x 10.00mm, MVQ

2 1.2L Petrol

BA3 2101	4 Cyl.	8 Valves	1198cc	TD5182
HR569				NB307 40.00 x 56.00 x 7.0mm, ACM NA5050 70.00 x 90.00 x 10.00mm, ACM

3 1.3L Petrol

BA3 2105	4 Cyl.	8 Valves	1294cc	TD5183
BA3 21011	4 Cyl.	8 Valves	1285cc	TD5189
HR569				NB307 40.00 x 56.00 x 7.0mm, ACM NA5050 70.00 x 90.00 x 10.00mm, ACM

4 1.3L Petrol

BA3 2108	4 Cyl.	8 Valves	1288cc	TD5186
BA3 2108 (KAT)	4 Cyl.	8 Valves	1288cc	TD5387
BA3 21115	4 Cyl.	8 Valves	1288cc	TD13352
HR569				NJ287 80.00 x 100.00 x 10.00mm, MVQ

5 1.5L Petrol

BA3 2103	4 Cyl.	8 Valves	1452cc	TD5181
BA3 2103 (KAT)	4 Cyl.	8 Valves	1451cc	TD5389
HR569				NB307 40.00 x 56.00 x 7.0mm, ACM NA5050 70.00 x 90.00 x 10.00mm, ACM

6 1.5L Petrol

BA3 2111	4 Cyl.	8 Valves	1499cc	TD13353
BA3 21083	4 Cyl.	8 Valves	1499cc	TD5188
BA3 21083 (KAT)	4 Cyl.	8 Valves	1500cc	TD5386
VAZ-2111	4 Cyl.	8 Valves	1499cc	TD11748
HR569				NJ287 80.00 x 100.00 x 10.00mm, MVQ

7 1.5L Petrol

VAZ-2112	4 Cyl.	16 Valves	1499cc	TD11749
HR816 (x2)				NJ287 80.00 x 100.00 x 10.00mm, MVQ

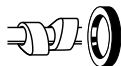

8 1.6L Petrol

BA3 2106	4 Cyl.	8 Valves	1570cc	TD5190
BA3 2121	4 Cyl.	8 Valves	1569cc	TD5184
BA3 2121 (KAT)	4 Cyl.	8 Valves	1569cc	TD5388

HR569

NB307
40.00 x 56.00 x 7.0mm, ACM
NA5050
70.00 x 90.00 x 10.00mm, ACM

9 1.7L Petrol

BA3 21214	4 Cyl.	8 Valves	1690cc	TD13351
VAZ-2121.3	4 Cyl.	8 Valves	1690cc	TD11750

HR569

NB307
40.00 x 56.00 x 7.0mm, ACM
NA5050
70.00 x 90.00 x 10.00mm, ACM

10 1.9L Diesel

XUD9A	4 Cyl.	8 Valves	1905cc	TD13350
XUD9SD	4 Cyl.	8 Valves	1905cc	TD17345

HR569

NF841
35.00 x 50.00 x 8.00mm, FPM

NA5191
42.00 x 62.00 x 7.00mm, PTFE
NA5192
90.00 x 110.00 x 7.00mm, PTFE

11 2.0L Petrol

C 20 XE	4 Cyl.	16 Valves	1998cc	TD22868
---------	--------	-----------	--------	---------

PA565 (x16)
HR342 (x2)

NC006 (x2)
35.00 x 48.00 x 7.00mm, MVQ

NB884
38.00 x 50.00 x 5.50mm, FPM
NB806
90.00 x 104.00 x 11.00mm, FPM



A 112	03/78→02/84	A112 A2.000	Petrol	1050	4	8	6
A 112	03/81→06/86	A112 A.000	Petrol	903	4	8	3
A 112	03/81→06/86	A112 A5.000	Petrol	903	4	8	3
A 112	03/81→06/86	A112 B2.000	Petrol	903	4	8	3
A 112	03/84→12/86	A112 B1.000	Petrol	965	4	8	5
Ardea Berlina	12/39→11/49	100	Petrol	903	4	8	1
Ardea Berlina	12/39→11/49	100A	Petrol	903	4	8	1
Ardea Berlina	11/49→12/52	100B	Petrol	903	4	8	1
Beta (828_)	08/73→07/76	828 A1.000	Petrol	1756	4	8	41
Beta (828_)	08/73→07/76	828 A2.000	Petrol	1438	4	8	23
Beta (828_)	08/73→07/82	828 B.000	Petrol	1585	4	8	33
Beta (828_)	04/76→07/82	828 B1.000	Petrol	1995	4	8	55
Beta Coupe (828_)	09/74→12/76	828 A1.000	Petrol	1756	4	8	41
Beta Coupe (828_)	04/76→12/84	828 B.000	Petrol	1585	4	8	33
Beta Coupe (828_)	04/76→12/84	828 B1.000	Petrol	1995	4	8	55
Beta Coupe (828_)	12/81→12/84	828 B4.000	Petrol	1995	4	8	55
Beta Coupe (828_)	12/81→12/84	828 D3.000	Petrol	1367	4	8	24
Beta Coupe (828_)	07/83→12/84	828 B7.000	Petrol	1995	4	8	55
Betah.P.E. (828_)	05/76→09/84	828 B1.000	Petrol	1995	4	8	55
Betah.P.E. (828_)	08/80→09/84	828 B.000	Petrol	1585	4	8	33
Betah.P.E. (828_)	05/81→09/84	828 B4.000	Petrol	1995	4	8	55
Betah.P.E. (828_)	07/83→09/84	828 B7.000	Petrol	1995	4	8	55
Beta Monte Carlo (137_)	09/75→05/81	134 A5.000	Petrol	1995	4	8	51
Beta Saloon (828_)	01/81→10/86	828 B.000	Petrol	1585	4	8	33
Beta Spider (828_)	05/76→10/86	828 B.000	Petrol	1585	4	8	33
Beta Spider (828_)	05/76→10/86	828 B1.000	Petrol	1995	4	8	55
Dedra (835_)	04/89→07/99	160 D1.000	Diesel	1929	4	8	46
Dedra (835_)	04/89→07/99	835 A4.000	Diesel	1929	4	8	46
Dedra (835_)	04/89→07/99	835 A4.046	Diesel	1929	4	8	46
Dedra (835_)	08/89→03/93	835 A1.046	Petrol	1581	4	8	30
Dedra (835_)	08/89→06/94	835 A1.000	Petrol	1581	4	8	30
Dedra (835_)	09/89→07/92	835 A5.000	Petrol	1995	4	8	56
Dedra (835_)	09/89→06/94	835 A2.000	Petrol	1756	4	8	42
Dedra (835_)	09/89→07/99	835 A2.046	Petrol	1756	4	8	42
Dedra (835_)	09/89→07/99	835 A5.046	Petrol	1995	4	8	60
Dedra (835_)	05/90→07/94	835 A7.000	Petrol	1995	4	8	56
Dedra (835_)	11/90→06/94	835 A8.000	Petrol	1995	4	8	56
Dedra (835_)	11/90→07/94	835 A7.046	Petrol	1995	4	8	56
Dedra (835_)	04/91→07/99	835 A8.046	Petrol	1995	4	8	57
Dedra (835_)	04/93→07/99	835 C1.000	Petrol	1581	4	8	30
Dedra (835_)	08/93→07/99	835 C5.000	Petrol	1756	4	8	43
Dedra (835_)	07/94→07/99	159 B9.000	Petrol	1581	4	8	30
Dedra (835_)	07/94→07/99	836 A3.000	Petrol	1995	4	16	53
Dedra (835_)	07/94→07/99	836 A5.000	Petrol	1756	4	8	42
Dedra (835_)	01/96→07/99	182 A4.000	Petrol	1581	4	16	31
Dedra (835_)	03/96→07/99	182 A2.000	Petrol	1747	4	16	40
Dedra (835_)	03/96→07/99	183 A1.000	Petrol	1747	4	16	40
Dedra SW (835_)	07/94→07/99	160 D1.000	Diesel	1929	4	8	46
Dedra SW (835_)	07/94→07/99	835 A4.000	Diesel	1929	4	8	46
Dedra SW (835_)	07/94→07/99	836 A3.000	Petrol	1995	4	16	53
Dedra SW (835_)	07/94→07/99	836 A5.000	Petrol	1756	4	8	42
Dedra SW (835_)	10/94→07/99	159 B9.000	Petrol	1581	4	8	30
Dedra SW (835_)	01/96→07/99	182 A4.000	Petrol	1581	4	16	31
Dedra SW (835_)	03/96→07/99	182 A2.000	Petrol	1747	4	16	40
Dedra SW (835_)	03/96→07/99	183 A1.000	Petrol	1747	4	16	40
Delta I (831_)	09/79→08/92	831 A2.000	Petrol	1301	4	8	17
Delta I (831_)	09/79→08/92	831 B.000	Petrol	1301	4	8	18
Delta I (831_)	09/79→12/92	831 A1.000	Petrol	1498	4	8	27
Delta I (831_)	09/79→12/92	831 B1.000	Petrol	1498	4	8	27
Delta I (831_)	11/82→04/86	831 A4.000	Petrol	1585	4	8	34
Delta I (831_)	10/83→12/86	831 A7.000	Petrol	1585	4	8	35
Delta I (831_)	08/86→08/88	831 B3.000	Petrol	1585	4	8	36
Delta I (831_)	08/86→08/88	831 B7.000	Petrol	1585	4	8	37
Delta I (831_)	10/86→12/89	831 D1.000	Diesel	1929	4	8	46
Delta I (831_)	11/86→08/88	831 B5.000	Petrol	1995	4	8	56
Delta I (831_)	12/86→12/92	831 C5.046	Petrol	1995	4	8	57
Delta I (831_)	04/87→03/89	831 B7.046	Petrol	1585	4	8	37
Delta I (831_)	05/87→08/92	149 C2.000	Petrol	1585	4	8	29
Delta I (831_)	10/87→12/91	831 C5.000	Petrol	1995	4	8	56
Delta I (831_)	03/89→09/91	831 D5.000	Petrol	1995	4	16	58
Delta I (831_)	06/93→01/94	831 E5.000	Petrol	1995	4	16	58
Delta I (831_)	06/93→01/94	831 E5.046	Petrol	1995	4	16	58
Delta II (836_)	06/93→08/99	835 C1.000	Petrol	1581	4	8	30
Delta II (836_)	06/93→08/99	835 C2.000	Petrol	1756	4	8	42
Delta II (836_)	06/93→08/99	836 A2.000	Petrol	1995	4	16	58
Delta II (836_)	06/93→08/99	836 A3.000	Petrol	1995	4	16	53
Delta II (836_)	07/94→08/99	835 C4.000	Petrol	1756	4	8	42
Delta II (836_)	07/94→08/99	836 A6.000	Petrol	1756	4	8	42







CC



9

Delta II (836_)	07/94→08/99	836 C4.000	Petrol	1756	4	8	43
Delta II (836_)	10/94→08/99	160 A1.046	Petrol	1372	4	8	19
Delta II (836_)	10/94→08/99	160 D1.000	Diesel	1929	4	8	46
Delta II (836_)	10/94→08/99	835 A4.000	Diesel	1929	4	8	46
Delta II (836_)	10/94→08/99	836 A4.000	Petrol	1372	4	8	25
Delta II (836_)	01/96→08/99	182 A4.000	Petrol	1581	4	16	31
Delta II (836_)	03/96→08/99	182 A2.000	Petrol	1747	4	16	40
Delta II (836_)	03/96→08/99	182 A6.000	Petrol	1581	4	16	31
Delta II (836_)	03/96→08/99	183 A1.000	Petrol	1747	4	16	40
Delta II (836_)	07/96→08/99	175 A4.000	Petrol	1995	4	16	53
Delta III (844_)	08/08→08/14	955 A4.000	Diesel	1598	4	16	32
Delta III (844_)	09/08→08/14	198 A1.000	Petrol	1368	4	16	21
Delta III (844_)	09/08→08/14	198 A2.000	Diesel	1598	4	16	32
Delta III (844_)	09/08→08/14	198 A4.000	Petrol	1368	4	16	21
Delta III (844_)	09/08→08/14	198 A5.000	Diesel	1956	4	16	54
Delta III (844_)	09/08→08/14	198 A8.000	Diesel	1956	4	16	54
Delta III (844_)	09/08→08/14	844 A2.000	Diesel	1956	4	16	54
Delta III (844_)	01/09→08/14	844 A1.000	Diesel	1910	4	16	49
Delta III (844_)	01/09→08/14	939 B1.000	Petrol	1742	4	16	45
Delta III (844_)	07/10→08/14	198 A7.000	Petrol	1368	4	16	21
Delta III (844_)	04/11→08/14	944 A 3.000	Diesel	1598	4	16	32
Flavia Convertible (JS_)	03/12→12/14	EDG	Petrol	2360	4	16	75
Kappa (838_)	08/94→10/01	838 A2.000	Petrol	2446	5	20	70
Kappa (838_)	08/94→10/01	838 A2.027	Petrol	2446	5	20	70
Kappa (838_)	08/94→10/01	838 A3.000	Diesel	2387	5	10	71
Kappa (838_)	08/94→10/01	838 A7.000	Diesel	2387	5	10	71
Kappa (838_)	08/94→10/01	838 B.000	Petrol	2959	6	24	80
Kappa (838_)	10/94→10/01	838 A1.000	Petrol	1998	5	20	52
Kappa (838_)	02/95→10/01	838 A4.000	Petrol	1995	4	16	53
Kappa (838_)	07/96→10/01	838 A6.000	Petrol	1998	5	20	52
Kappa (838_)	06/98→10/01	175 A3.000	Petrol	1998	5	20	52
Kappa (838_)	06/98→10/01	838 A8.000	Diesel	2387	5	10	71
Kappa Coupe (838_)	07/96→03/01	838 A6.000	Petrol	1998	5	20	52
Kappa Coupe (838_)	11/96→03/01	838 A2.000	Petrol	2446	5	20	70
Kappa Coupe (838_)	11/96→03/01	838 A4.000	Petrol	1995	4	16	53
Kappa Coupe (838_)	11/96→03/01	838 B.000	Petrol	2959	6	24	80
Kappa Coupe (838_)	06/98→03/01	175 A3.000	Petrol	1998	5	20	52
Kappa SW (838_)	07/96→10/01	838 A2.000	Petrol	2446	5	20	70
Kappa SW (838_)	07/96→10/01	838 A3.000	Diesel	2387	5	10	71
Kappa SW (838_)	07/96→10/01	838 A4.000	Petrol	1995	4	16	53
Kappa SW (838_)	07/96→10/01	838 A6.000	Petrol	1998	5	20	52
Kappa SW (838_)	07/96→10/01	838 A7.000	Diesel	2387	5	10	71
Kappa SW (838_)	07/96→10/01	838 B.000	Petrol	2959	6	24	80
Kappa SW (838_)	06/98→10/01	175 A3.000	Petrol	1998	5	20	52
Kappa SW (838_)	06/98→10/01	838 A8.000	Diesel	2387	5	10	71
Lybra (839_)	07/99→09/00	182 B7.000	Petrol	1998	5	20	52
Lybra (839_)	07/99→09/00	AR 32302	Diesel	1910	4	8	47
Lybra (839_)	07/99→02/01	839 A5.000	Diesel	2387	5	10	71
Lybra (839_)	07/99→02/01	AR 32501	Diesel	2387	5	10	71
Lybra (839_)	07/99→10/05	182 A4.000	Petrol	1581	4	16	31
Lybra (839_)	07/99→10/05	839 A4.000	Petrol	1747	4	16	44
Lybra (839_)	07/99→10/05	839 A7.000	Petrol	1747	4	16	44
Lybra (839_)	07/99→10/05	839 A9.000	Petrol	1747	4	16	44
Lybra (839_)	09/00→05/01	AR 37101	Diesel	1910	4	8	47
Lybra (839_)	09/00→05/02	839 A6.000	Diesel	2387	5	10	71
Lybra (839_)	09/00→10/05	185 A8.000	Petrol	1998	5	20	52
Lybra (839_)	10/00→10/05	182 B6.000	Petrol	1596	4	16	31
Lybra (839_)	05/01→10/05	937 A2.000	Diesel	1910	4	8	47
Lybra (839_)	10/01→10/05	192 A2.000	Petrol	2446	5	20	69
Lybra (839_)	05/02→10/05	841 C.000	Diesel	2387	5	10	71
Lybra SW (839_)	07/99→09/00	182 B7.000	Petrol	1998	5	20	52
Lybra SW (839_)	07/99→09/00	AR 32302	Diesel	1910	4	8	47
Lybra SW (839_)	07/99→10/05	182 A4.000	Petrol	1581	4	16	31
Lybra SW (839_)	07/99→10/05	839 A4.000	Petrol	1747	4	16	44
Lybra SW (839_)	07/99→10/05	839 A7.000	Petrol	1747	4	16	44
Lybra SW (839_)	10/99→09/00	839 A5.000	Diesel	2387	5	10	71
Lybra SW (839_)	10/99→09/00	AR 32501	Diesel	2387	5	10	71
Lybra SW (839_)	09/00→05/01	AR 37101	Diesel	1910	4	8	47
Lybra SW (839_)	09/00→10/05	185 A8.000	Petrol	1998	5	20	52
Lybra SW (839_)	09/00→10/05	839 A6.000	Diesel	2387	5	10	71
Lybra SW (839_)	10/00→10/05	182 B6.000	Petrol	1596	4	16	31
Lybra SW (839_)	05/01→10/05	937 A2.000	Diesel	1910	4	8	47
Lybra SW (839_)	05/02→10/05	841 C.000	Diesel	2387	5	10	71
Musa (350_)	10/04→09/12	188 A9.000	Diesel	1248	4	16	16
Musa (350_)	10/04→09/12	188 B2.000	Diesel	1910	4	8	47
Musa (350_)	10/04→09/12	843 A 1.000	Petrol	1368	4	16	21
Musa (350_)	09/05→09/12	350 A1.000	Petrol	1368	4	8	22
Musa (350_)	09/06→09/12	199 A3.000	Diesel	1248	4	16	16

				CC			9
Musa (350_)	10/07→09/12	192 B2.000	Petrol	1368	4	16	20
Musa (350_)	07/08→09/12	350 A2.000	Diesel	1598	4	16	32
Musa (350_)	07/08→09/12	350 A3.000	Diesel	1598	4	16	32
Musa (350_)	03/09→09/12	199 B1.000	Diesel	1248	4	16	16
Phedra (179_)	09/02→11/10	4HW (DW12ATED4)	Diesel	2179	4	16	68
Phedra (179_)	09/02→11/10	ES9 J4S	Petrol	2946	6	24	82
Phedra (179_)	09/02→11/10	RFN (EW10J4)	Petrol	1997	4	16	61
Phedra (179_)	09/02→11/10	RHW (DW10ATED4)	Diesel	1997	4	16	64
Phedra (179_)	07/03→11/10	RHM (DW10ATED4)	Diesel	1997	4	16	64
Phedra (179_)	04/06→11/10	4HP	Diesel	2179	4	16	67
Phedra (179_)	04/06→11/10	4HR	Diesel	2179	4	16	67
Phedra (179_)	06/06→11/10	RHK (DW10UTED4)	Diesel	1997	4	16	64
Phedra (179_)	07/06→11/10	RHR (DW10BTED4)	Diesel	1997	4	16	64
Phedra (179_)	03/08→11/10	4HS	Diesel	2179	4	16	67
Phedra (179_)	03/08→11/10	4HT	Diesel	2179	4	16	67
Prisma (831_)	01/83→04/86	831 A1.000	Petrol	1498	4	8	27
Prisma (831_)	01/83→04/86	831 A4.000	Petrol	1585	4	8	34
Prisma (831_)	01/83→02/92	831 A2.000	Petrol	1301	4	8	17
Prisma (831_)	01/83→02/92	831 D.000	Diesel	1911	4	8	48
Prisma (831_)	05/85→12/89	831 D1.000	Diesel	1929	4	8	46
Prisma (831_)	09/85→02/92	138 C2.048	Petrol	1498	4	8	27
Prisma (831_)	09/85→02/92	831 B1.048	Petrol	1498	4	8	28
Prisma (831_)	04/86→12/89	831 B4.000	Petrol	1995	4	8	56
Prisma (831_)	05/86→12/89	831 B7.000	Petrol	1585	4	8	37
Prisma (831_)	08/86→02/92	831 B1.000	Petrol	1498	4	8	27
Prisma (831_)	08/86→02/92	831 B6.000	Petrol	1585	4	8	36
Prisma (831_)	05/87→12/89	149 C2.000	Petrol	1585	4	8	29
Thema (834_)	11/84→09/88	834 B.000	Petrol	1995	4	8	57
Thema (834_)	11/84→09/88	8144.91	Diesel	2445	4	8	74
Thema (834_)	11/84→12/89	834 C.000	Petrol	1995	4	8	56
Thema (834_)	03/86→09/88	834 B.048	Petrol	1995	4	8	57
Thema (834_)	07/86→05/90	834 C.146	Petrol	1995	4	8	56
Thema (834_)	09/87→05/92	834 B.146	Petrol	1995	4	8	56
Thema (834_)	05/88→07/92	8144.97S	Diesel	2500	4	8	76
Thema (834_)	05/88→08/92	834 B2.000	Petrol	1995	4	16	58
Thema (834_)	06/88→05/92	8144.97	Diesel	2499	4	8	76
Thema (834_)	09/88→05/92	834 B1.000	Petrol	1995	4	8	57
Thema (834_)	12/88→06/90	834 C1.000	Petrol	1995	4	16	59
Thema (834_)	02/89→05/92	834 B2.246	Petrol	1995	4	16	59
Thema (834_)	04/89→05/92	834 C1.246	Petrol	1995	4	16	59
Thema (834_)	05/92→07/94	8144.97 Y	Diesel	2500	4	8	76
Thema (834_)	08/92→12/93	834 F1.000	Petrol	1995	4	16	59
Thema (834_)	08/92→07/94	834 F.000	Petrol	2959	6	12	79
Thema (834_)	10/92→07/94	834 F2.000	Petrol	1995	4	16	59
Thema (LX_)	09/11→	ERB	Petrol	3604	6	24	86
Thema (LX_)	09/11→	EXF	Diesel	2987	6	24	83
Thema SW (834_)	03/87→09/90	8144.91	Diesel	2445	4	8	74
Thema SW (834_)	06/87→07/94	834 C.000	Petrol	1995	4	8	56
Thema SW (834_)	05/88→07/92	8144.97S	Diesel	2500	4	8	76
Thema SW (834_)	06/88→05/92	8144.97	Diesel	2499	4	8	76
Thema SW (834_)	12/88→06/90	834 C1.000	Petrol	1995	4	16	59
Thema SW (834_)	12/88→03/92	834 C.146	Petrol	1995	4	8	56
Thema SW (834_)	02/89→05/92	834 B2.246	Petrol	1995	4	16	59
Thema SW (834_)	04/89→03/93	834 C1.246	Petrol	1995	4	16	59
Thema SW (834_)	05/89→08/92	834 B2.000	Petrol	1995	4	16	58
Thema SW (834_)	05/92→07/94	834 F1.000	Petrol	1995	4	16	59
Thema SW (834_)	09/92→07/94	834 F.000	Petrol	2959	6	12	79
Thema SW (834_)	09/92→07/94	8144.97 Y	Diesel	2500	4	8	76
Thema SW (834_)	11/92→07/94	834 F2.000	Petrol	1995	4	16	59
Thesis (841_)	07/02→07/09	841 A.000	Petrol	2959	6	24	81
Thesis (841_)	07/02→07/09	841 C.000	Diesel	2387	5	10	71
Thesis (841_)	07/02→07/09	841 D.000	Petrol	2446	5	20	72
Thesis (841_)	07/02→07/09	841 E.000	Petrol	1998	5	20	52
Thesis (841_)	05/03→07/09	841 G.000	Diesel	2387	5	20	73
Thesis (841_)	05/03→07/09	841 L.000	Petrol	3179	6	24	85
Thesis (841_)	09/03→07/09	841 M.000	Diesel	2387	5	20	73
Thesis (841_)	09/03→07/09	841 N.000	Diesel	2387	5	20	73
Thesis (841_)	04/06→07/09	841 P.000	Diesel	2387	5	20	73
Trevi (828_)	05/80→10/84	828 B1.000	Petrol	1995	4	8	55
Trevi (828_)	05/80→01/87	828 B.000	Petrol	1585	4	8	33
Trevi (828_)	05/80→01/87	828 B4.000	Petrol	1995	4	8	55
Trevi (828_)	08/83→05/85	828 B7.000	Petrol	1995	4	8	55
Voyager MPV (404_)	09/11→12/14	ENS	Diesel	2776	4	16	78
Voyager MPV (404_)	09/11→12/14	ERB	Petrol	3604	6	24	86
Y (840_)	11/95→09/03	176 B2.000	Petrol	1108	4	8	7
Y (840_)	03/96→09/03	188 A4.000	Petrol	1242	4	8	12
Y (840_)	03/96→09/03	840 A3.000	Petrol	1242	4	8	14
Y (840_)	03/96→09/03	840 A4.000	Petrol	1370	4	12	26











CC



9

Y (840_)	10/96→09/03	840 A2.000	Petrol	1370	4	12	26
Y (840_)	04/97→09/03	176 B9.000	Petrol	1242	4	16	11
Y (840_)	10/00→09/03	188 A5.000	Petrol	1242	4	16	13
Y10 (156_)	03/85→02/89	156 A1.000	Petrol	1049	4	8	4
Y10 (156_)	03/85→07/89	156 A.000	Petrol	1049	4	8	4
Y10 (156_)	03/85→02/92	156 A2.000	Petrol	999	4	8	5
Y10 (156_)	06/85→06/91	156 A2.100	Petrol	999	4	8	5
Y10 (156_)	10/87→02/92	156 A2.246	Petrol	999	4	8	5
Y10 (156_)	11/87→12/95	156 B.000	Petrol	1301	4	8	15
Y10 (156_)	02/89→12/95	146 A 5.046	Petrol	1297	4	8	15
Y10 (156_)	07/89→12/95	156 C.046	Petrol	1108	4	8	7
Y10 (156_)	08/89→06/92	156 C.000	Petrol	1108	4	8	7
Y10 (156_)	01/95→12/95	176 B2.000	Petrol	1108	4	8	7
Ypsilon (312_)	05/11→	169 A4.000	Petrol	1242	4	8	9
Ypsilon (312_)	05/11→	199 B1.000	Diesel	1248	4	16	16
Ypsilon (312_)	05/11→	312 A2.000	Petrol	875	2	8	2
Ypsilon (312_)	05/11→	312 B1.000	Diesel	1248	4	16	16
Ypsilon (312_)	12/13→	312 A5.000	Petrol	875	2	8	2
Ypsilon (312_)	06/16→	312 B5.000	Diesel	1248	4	16	16
Ypsilon (843_)	10/03→12/11	188 A4.000	Petrol	1242	4	8	12
Ypsilon (843_)	10/03→12/11	188 A5.000	Petrol	1242	4	16	13
Ypsilon (843_)	10/03→12/11	188 A9.000	Diesel	1248	4	16	16
Ypsilon (843_)	10/03→12/11	843 A 1.000	Petrol	1368	4	16	21
Ypsilon (843_)	02/06→12/11	350 A1.000	Petrol	1368	4	8	22
Ypsilon (843_)	09/06→12/11	199 A2.000	Diesel	1248	4	16	16
Ypsilon (843_)	09/06→12/11	199 A3.000	Diesel	1248	4	16	16
Ypsilon (843_)	08/10→12/11	169 A4.000	Petrol	1242	4	8	9
Zeta (22_)	05/95→09/02	RGX (XU10J2TE)	Petrol	1998	4	8	63
Zeta (22_)	05/96→09/99	P 8 C	Diesel	2088	4	12	66
Zeta (22_)	05/98→07/00	RFV (XU10J4R)	Petrol	1998	4	16	62
Zeta (22_)	09/99→09/02	RHW (DW10ATED4)	Diesel	1997	4	16	64
Zeta (22_)	04/00→09/02	RHZ (DW10ATED)	Diesel	1997	4	8	65
Zeta (22_)	07/00→09/02	RFN	Petrol	1997	4	16	61

	CC				9		CC				9
4HP	2179	4	16	Diesel	67	831 B3.000	1585	4	8	Petrol	36
4HR	2179	4	16	Diesel	67	831 B4.000	1995	4	8	Petrol	56
4HS	2179	4	16	Diesel	67	831 B5.000	1995	4	8	Petrol	56
4HT	2179	4	16	Diesel	67	831 B6.000	1585	4	8	Petrol	36
4HW (DW12ATED4)	2179	4	16	Diesel	68	831 B7.000	1585	4	8	Petrol	37
100	903	4	8	Petrol	1	831 B7.046	1585	4	8	Petrol	37
100A	903	4	8	Petrol	1	831 C5.000	1995	4	8	Petrol	56
100B	903	4	8	Petrol	1	831 C5.046	1995	4	8	Petrol	57
132 B1.000	1756	4	8	Petrol	38	831 D.000	1911	4	8	Diesel	48
132 BB.1A 0	1756	4	8	Petrol	39	831 D1.000	1929	4	8	Diesel	46
134 A5.000	1995	4	8	Petrol	51	831 D5.000	1995	4	16	Petrol	58
138 C2.048	1498	4	8	Petrol	27	831 E5.000	1995	4	16	Petrol	58
146 A 5.046	1297	4	8	Petrol	15	831 E5.046	1995	4	16	Petrol	58
149 C2.000	1585	4	8	Petrol	29	834 A4.000	1995	4	16	Petrol	58
156 A.000	1049	4	8	Petrol	4	834 B.000	1995	4	8	Petrol	57
156 A1.000	1049	4	8	Petrol	4	834 B.048	1995	4	8	Petrol	57
156 A2.000	999	4	8	Petrol	5	834 B.146	1995	4	8	Petrol	56
156 A2.048	999	4	8	Petrol	5	834 B1.000	1995	4	8	Petrol	57
156 A2.100	999	4	8	Petrol	5	834 B2.000	1995	4	16	Petrol	58
156 A2.146	999	4	8	Petrol	5	834 B2.246	1995	4	16	Petrol	59
156 A2.246	999	4	8	Petrol	5	834 C.000	1995	4	8	Petrol	56
156 A2.256	999	4	8	Petrol	5	834 C.146	1995	4	8	Petrol	56
156 B.000	1301	4	8	Petrol	15	834 C1.000	1995	4	16	Petrol	59
156 C.000	1108	4	8	Petrol	7	834 C1.246	1995	4	16	Petrol	59
156 C.046	1108	4	8	Petrol	7	834 F.000	2959	6	12	Petrol	79
159 B9.000	1581	4	8	Petrol	30	834 F1.000	1995	4	16	Petrol	59
160 A1.046	1372	4	8	Petrol	19	834 F2.000	1995	4	16	Petrol	59
160 D1.000	1929	4	8	Diesel	46	835 A1.000	1581	4	8	Petrol	30
169 A4.000	1242	4	8	Petrol	9	835 A1.046	1581	4	8	Petrol	30
169 A5.000	1248	4	16	Diesel	10	835 A2.000	1756	4	8	Petrol	42
175 A3.000	1998	5	20	Petrol	52	835 A2.046	1756	4	8	Petrol	42
175 A4.000	1995	4	16	Petrol	53	835 A4.000	1929	4	8	Diesel	46
176 B2.000	1108	4	8	Petrol	7	835 A4.046	1929	4	8	Diesel	46
176 B9.000	1242	4	16	Petrol	11	835 A5.000	1995	4	8	Petrol	56
182 A2.000	1747	4	16	Petrol	40	835 A5.046	1995	4	8	Petrol	60
182 A4.000	1581	4	16	Petrol	31	835 A7.000	1995	4	8	Petrol	56
182 A6.000	1581	4	16	Petrol	31	835 A7.046	1995	4	8	Petrol	56
182 B6.000	1596	4	16	Petrol	31	835 A8.000	1995	4	8	Petrol	56
182 B7.000	1998	5	20	Petrol	52	835 A8.046	1995	4	8	Petrol	57
183 A1.000	1747	4	16	Petrol	40	835 C1.000	1581	4	8	Petrol	30
185 A8.000	1998	5	20	Petrol	52	835 C2.000	1756	4	8	Petrol	42
188 A4.000	1242	4	8	Petrol	12	835 C4.000	1756	4	8	Petrol	42
188 A5.000	1242	4	16	Petrol	13	835 C5.000	1756	4	8	Petrol	43
188 A9.000	1248	4	16	Diesel	16	836 A2.000	1995	4	16	Petrol	58
188 B2.000	1910	4	8	Diesel	47	836 A2.046	1756	4	8	Petrol	41
192 A2.000	2446	5	20	Petrol	69	836 A3.000	1995	4	16	Petrol	53
192 B2.000	1368	4	16	Petrol	20	836 A4.000	1372	4	8	Petrol	25
198 A1.000	1368	4	16	Petrol	21	836 A5.000	1756	4	8	Petrol	42
198 A2.000	1598	4	16	Diesel	32	836 A6.000	1756	4	8	Petrol	42
198 A4.000	1368	4	16	Petrol	21	836 C4.000	1756	4	8	Petrol	43
198 A5.000	1956	4	16	Diesel	54	838 A1.000	1998	5	20	Petrol	52
198 A7.000	1368	4	16	Petrol	21	838 A2.000	2446	5	20	Petrol	70
198 A8.000	1956	4	16	Diesel	54	838 A2.027	2446	5	20	Petrol	70
198 A9.000	1956	4	16	Diesel	54	838 A3.000	2387	5	10	Diesel	71
199 A2.000	1248	4	16	Diesel	16	838 A4.000	1995	4	16	Petrol	53
199 A3.000	1248	4	16	Diesel	16	838 A6.000	1998	5	20	Petrol	52
199 B1.000	1248	4	16	Diesel	16	838 A7.000	2387	5	10	Diesel	71
312 A2.000	875	2	8	Petrol	2	838 A8.000	2387	5	10	Diesel	71
312 A5.000	875	2	8	Petrol	2	838 B.000	2959	6	24	Petrol	80
312 B1.000	1248	4	16	Diesel	16	838 B2.000	2446	5	20	Petrol	70
312 B5.000	1248	4	16	Diesel	16	839 A4.000	1747	4	16	Petrol	44
350 A1.000	1368	4	8	Petrol	22	839 A5.000	2387	5	10	Diesel	71
350 A2.000	1598	4	16	Diesel	32	839 A6.000	2387	5	10	Diesel	71
350 A3.000	1598	4	16	Diesel	32	839 A7.000	1747	4	16	Petrol	44
828 A1.000	1756	4	8	Petrol	41	839 A9.000	1747	4	16	Petrol	44
828 A2.000	1438	4	8	Petrol	23	840 A2.000	1370	4	12	Petrol	26
828 B.000	1585	4	8	Petrol	33	840 A3.000	1242	4	8	Petrol	14
828 B1.000	1995	4	8	Petrol	55	840 A4.000	1370	4	12	Petrol	26
828 B4.000	1995	4	8	Petrol	55	841 A.000	2959	6	24	Petrol	81
828 B7.000	1995	4	8	Petrol	55	841 C.000	2387	5	10	Diesel	71
828 D3.000	1367	4	8	Petrol	24	841 D.000	2446	5	20	Petrol	72
831 A1.000	1498	4	8	Petrol	27	841 E.000	1998	5	20	Petrol	52
831 A2.000	1301	4	8	Petrol	17	841 G.000	2387	5	20	Diesel	73
831 A4.000	1585	4	8	Petrol	34	841 H.000	2387	5	20	Diesel	73
831 A7.000	1585	4	8	Petrol	35	841 L.000	3179	6	24	Petrol	85
831 B.000	1301	4	8	Petrol	18	841 M.000	2387	5	20	Diesel	73
831 B1.000	1498	4	8	Petrol	27	841 N.000	2387	5	20	Diesel	73
831 B1.048	1498	4	8	Petrol	28	841 P.000	2387	5	20	Diesel	73



CC



9



CC



9

843 A 1.000	1368	4	16	Petrol	21
844 A1.000	1910	4	16	Diesel	49
844 A2.000	1956	4	16	Diesel	54
844 A3.000	1598	4	16	Diesel	32
937 A2.000	1910	4	8	Diesel	47
937 A5.000	1910	4	16	Diesel	50
939 B1.000	1742	4	16	Petrol	45
944 A 3.000	1598	4	16	Diesel	32
955 A4.000	1598	4	16	Diesel	32
8144.91	2445	4	8	Diesel	74
8144.97	2499	4	8	Diesel	76
8144.97.2200	2499	4	8	Diesel	76
8144.97.2400	2499	4	8	Diesel	77
8144. 97S	2500	4	8	Diesel	76
8144.97 Y	2500	4	8	Diesel	76
A112 A.000	903	4	8	Petrol	3
A112 A2.000	1050	4	8	Petrol	6
A112 A5.000	903	4	8	Petrol	3
A 112 AB.2C.0	1050	4	8	Petrol	8
A112 B1.000	965	4	8	Petrol	5
A112 B2.000	903	4	8	Petrol	3
AR 32302	1910	4	8	Diesel	47
AR 32501	2387	5	10	Diesel	71
AR 37101	1910	4	8	Diesel	47
EDG	2360	4	16	Petrol	75
ENS	2776	4	16	Diesel	78
ERB	3604	6	24	Petrol	86
ES9 J4S	2946	6	24	Petrol	82
EXF	2987	6	24	Diesel	83
P 8 C	2088	4	12	Diesel	66
RFN (EW10J4)	1997	4	16	Petrol	61
RFN	1997	4	16	Petrol	61
RFV (XU10J4R)	1998	4	16	Petrol	62
RGX (XU10J2TE)	1998	4	8	Petrol	63
RHK (DW10UTED4)	1997	4	16	Diesel	64
RHM (DW10ATED4)	1997	4	16	Diesel	64
RHR (DW10BTED4)	1997	4	16	Diesel	64
RHW (DW10ATED4)	1997	4	16	Diesel	64
RHZ (DW10ATED)	1997	4	8	Diesel	65
XFW	2946	6	24	Petrol	84

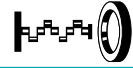

1 0.9L		Petrol			
100		4 Cyl.	8 Valves	903cc	TD31979
100A		4 Cyl.	8 Valves	903cc	TD31980
100B		4 Cyl.	8 Valves	903cc	TD31981
HR816					

2 0.9L		Petrol			
312 A2.000		2 Cyl.	8 Valves	875cc	TD25191
312 A5.000		2 Cyl.	8 Valves	875cc	TD31269
NA5070 31.00 x 41.00 x 7.00mm, FPM NF857 85.00 x 105.00 x 9.00mm, FPM/ACM					

3 0.9L		Petrol			
A112 A.000		4 Cyl.	8 Valves	903cc	TD1856
A112 A5.000		4 Cyl.	8 Valves	903cc	TD1803
A112 B2.000		4 Cyl.	8 Valves	903cc	TD4622
HR816 NC048 38.00 x 52.00 x 6.00mm, FPM NA5049 64.00 x 80.00 x 8.00mm, ACM NB808 64.00 x 80.00 x 8.00mm, FPM					

4 1.0L		Petrol			
156 A.000		4 Cyl.	8 Valves	1049cc	TD21222
156 A1.000		4 Cyl.	8 Valves	1049cc	TD1783
HR569 NA5187 30.00 x 52.00 x 7.00mm, ACM NB307 40.00 x 56.00 x 7.0mm, ACM NB808 64.00 x 80.00 x 8.00mm, FPM					

5 1.0L		Petrol			
156 A2.000		4 Cyl.	8 Valves	999cc	TD4592
156 A2.048		4 Cyl.	8 Valves	999cc	TD1782
156 A2.100		4 Cyl.	8 Valves	999cc	TD4593
156 A2.146		4 Cyl.	8 Valves	999cc	TD4594
156 A2.246		4 Cyl.	8 Valves	999cc	TD5423
156 A2.256		4 Cyl.	8 Valves	999cc	TD4595
A112 B1.000		4 Cyl.	8 Valves	965cc	TD1824
HR816 NA5053 30.00 x 42.00 x 7.00mm, FPM NB815 23.00 x 35.00 x 7.00mm, FPM NB814 70.00 x 88.00 x 8.00mm, FPM					

6 1.0L		Petrol			
A112 A2.000		4 Cyl.	8 Valves	1050cc	TD4621
HR816 NA5049 64.00 x 80.00 x 8.00mm, ACM					



7 1.1L

Petrol

156 C.000	4 Cyl.	8 Valves	1108cc	TD1854
156 C.046	4 Cyl.	8 Valves	1108cc	TD4597
176 B2.000	4 Cyl.	8 Valves	1108cc	TD11847

HR816	NA5053 30.00 x 42.00 x 7.00mm, FPM	NB815 23.00 x 35.00 x 7.00mm, FPM NB814 70.00 x 88.00 x 8.00mm, FPM →Eng no. 6315750 NA5061 74.00 x 88.00 x 8.00mm, FPM Eng no. 6315751 →
-------	---------------------------------------	--

8 1.1L

Petrol

A 112 AB.2C.0	4 Cyl.	8 Valves	1050cc	TD22321
---------------	--------	----------	--------	---------

HR816	NA5049 64.00 x 80.00 x 8.00mm, ACM
-------	---------------------------------------

9 1.2L

Petrol

169 A4.000	4 Cyl.	8 Valves	1242cc	TD25192
------------	--------	----------	--------	---------

PA5025 (x8) HR5048	NA5058 40.00 x 55.00 x 7.00mm, FPM	NA5057 27.00 x 37.00 x 7.00mm, FPM NA5061 74.00 x 88.00 x 8.00mm, FPM
-----------------------	---------------------------------------	--

10 1.2L

Diesel

169 A5.000	4 Cyl.	16 Valves	1248cc	TD24712
------------	--------	-----------	--------	---------

HR5088	NA5058 40.00 x 55.00 x 7.00mm, FPM	NA5223 40.00 x 52.00 x 7.00mm, FPM NA5230 78.00 x 100.00 x 9.00mm, PTFE
--------	---------------------------------------	--

11 1.2L

Petrol

176 B9.000	4 Cyl.	16 Valves	1242cc	TD11849
------------	--------	-----------	--------	---------

HR814	NA5058 40.00 x 55.00 x 7.00mm, FPM	NA5057 27.00 x 37.00 x 7.00mm, FPM NA5061 74.00 x 88.00 x 8.00mm, FPM
-------	---------------------------------------	--

12 1.2L

Petrol

188 A4.000	4 Cyl.	8 Valves	1242cc	TD15501
------------	--------	----------	--------	---------

PA5025 (x8) Eng no. 2533528 → HR816 →Eng no. 2533527 HR5048 Eng no. 2533528 →	NA5053 30.00 x 42.00 x 7.00mm, FPM →Eng no. 2939661 NA5321 31.00 x 55.00 x 7.00mm, FPM Eng no. 2939662 →	NB815 23.00 x 35.00 x 7.00mm, FPM →Eng no. 2939661 NA5057 27.00 x 37.00 x 7.00mm, FPM Eng no. 2939662 → NA5061 74.00 x 88.00 x 8.00mm, FPM
--	---	---

13 1.2L

Petrol

188 A5.000	4 Cyl.	16 Valves	1242cc	TD15500
------------	--------	-----------	--------	---------

HR814	NA5058 40.00 x 55.00 x 7.00mm, FPM	NA5057 27.00 x 37.00 x 7.00mm, FPM LK5001 74.00 x 187.50 x 17.000mm, FPM
-------	---------------------------------------	---

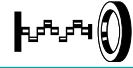

14 1.2L Petrol

840 A3.000	4 Cyl.	8 Valves	1242cc	TD1839
HR816	NA5053 30.00 x 42.00 x 7.00mm, FPM		NB815 23.00 x 35.00 x 7.00mm, FPM NA5061 74.00 x 88.00 x 8.00mm, FPM	

15 1.3L Petrol

146 A 5.046	4 Cyl.	8 Valves	1297cc	TD4591
156 B.000	4 Cyl.	8 Valves	1301cc	TD1853
HR569	NA5187 30.00 x 52.00 x 7.00mm, ACM		NA5051 40.00 x 56.00 x 7.00mm, FPM	

16 1.3L Diesel

188 A9.000	4 Cyl.	16 Valves	1248cc	TD18314
199 A2.000	4 Cyl.	16 Valves	1248cc	TD20272
199 A3.000	4 Cyl.	16 Valves	1248cc	TD20273
199 B1.000	4 Cyl.	16 Valves	1248cc	TD24672
312 B1.000	4 Cyl.	16 Valves	1248cc	TD33594
312 B5.000	4 Cyl.	16 Valves	1248cc	TD33595
HR5088			NA5223 40.00 x 52.00 x 7.00mm, FPM NA5230 78.00 x 100.00 x 9.00mm, PTFE	

17 1.3L Petrol

831 A2.000	4 Cyl.	8 Valves	1301cc	TD4605
HR569	NA5187 30.00 x 52.00 x 7.00mm, ACM		NA5051 40.00 x 56.00 x 7.00mm, FPM NA5049 64.00 x 80.00 x 8.00mm, ACM	

18 1.3L Petrol

831 B.000	4 Cyl.	8 Valves	1301cc	TD1809
HR569	NA5187 30.00 x 52.00 x 7.00mm, ACM		NB818 40.00 x 56.00 x 7.00mm, ACM NA5049 64.00 x 80.00 x 8.00mm, ACM	

19 1.4L Petrol

160 A1.046	4 Cyl.	8 Valves	1372cc	TD4599
HR569	NA5187 30.00 x 52.00 x 7.00mm, ACM		NB818 40.00 x 56.00 x 7.00mm, ACM NA5049 64.00 x 80.00 x 8.00mm, ACM	

20 1.4L Petrol

192 B2.000	4 Cyl.	16 Valves	1368cc	TD20952
HR814 →04/06	NA5058 40.00 x 55.00 x 7.00mm, FPM		NA5057 27.00 x 37.00 x 7.00mm, FPM	
HR816 (x2) 05/06→			LK5001 74.00 x 187.50 x 17.00mm, FPM	

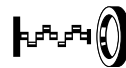
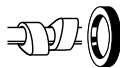

21 1.4L

Petrol

198 A1.000	4 Cyl.	16 Valves	1368cc	TD21041
198 A4.000	4 Cyl.	16 Valves	1368cc	TD21040
198 A7.000	4 Cyl.	16 Valves	1368cc	TD24650
843 A 1.000	4 Cyl.	16 Valves	1368cc	TD17979

HR814	NA5058 40.00 x 55.00 x 7.00mm, FPM	NA5057 27.00 x 37.00 x 7.00mm, FPM LK5001 74.00 x 187.50 x 17.000mm, FPM
-------	---------------------------------------	---

22 1.4L

Petrol

350 A1.000	4 Cyl.	8 Valves	1368cc	TD20274
PA5025 (x8) HR5048	NA5058 40.00 x 55.00 x 7.00mm, FPM	NA5057 27.00 x 37.00 x 7.00mm, FPM NA5061 74.00 x 88.00 x 8.00mm, FPM		

23 1.4L

Petrol

828 A2.000	4 Cyl.	8 Valves	1438cc	TD1793
HR569		NB307 40.00 x 56.00 x 7.0mm, ACM NA5050 70.00 x 90.00 x 10.00mm, ACM		

24 1.4L

Petrol

828 D3.000	4 Cyl.	8 Valves	1367cc	TD1798
HR569		NB307 40.00 x 56.00 x 7.0mm, ACM NB946 70.00 x 90.00 x 10.00mm, FPM		

25 1.4L

Petrol

836 A4.000	4 Cyl.	8 Valves	1372cc	TD14568
HR569	NA5187 30.00 x 52.00 x 7.00mm, ACM	NA5051 40.00 x 56.00 x 7.00mm, FPM NB808 64.00 x 80.00 x 8.00mm, FPM NF887 64.00 x 112.50 x 20.00mm, FPM Eng no. 9528124 →		

26 1.4L

Petrol

840 A2.000	4 Cyl.	12 Valves	1370cc	TD1858
840 A4.000	4 Cyl.	12 Valves	1370cc	TD4596

HR662	NA5053 30.00 x 42.00 x 7.00mm, FPM	NA5070 31.00 x 41.00 x 7.00mm, FPM NF888 93.00 x 139.70;172.00 x 12.00mm, FPM
-------	---------------------------------------	--

27 1.5L

Petrol

138 C2.048	4 Cyl.	8 Valves	1498cc	TD5424
831 A1.000	4 Cyl.	8 Valves	1498cc	TD1805
831 B1.000	4 Cyl.	8 Valves	1498cc	TD1811

HR569	NA5187 30.00 x 52.00 x 7.00mm, ACM	NB818 40.00 x 56.00 x 7.00mm, ACM NA5049 64.00 x 80.00 x 8.00mm, ACM
-------	---------------------------------------	---

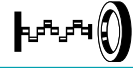
**28 1.5L****Petrol**

831 B1.048 HR816	4 Cyl.	8 Valves	1498cc	TD1810
	NA5187 30.00 x 52.00 x 7.00mm, ACM		NB818 40.00 x 56.00 x 7.00mm, ACM NA5049 64.00 x 80.00 x 8.00mm, ACM	

29 1.6L**Petrol**

149 C2.000 HR569	4 Cyl.	8 Valves	1585cc	TD5432
	NA5187 (x2) 30.00 x 52.00 x 7.00mm, ACM		NB742 30.00 x 43.00 x 8.00mm, ACM	

30 1.6L**Petrol**

159 B9.000	4 Cyl.	8 Valves	1581cc	TD4598
835 A1.000	4 Cyl.	8 Valves	1581cc	TD1842
835 A1.046	4 Cyl.	8 Valves	1581cc	TD1843
835 C1.000 HR569	4 Cyl.	8 Valves	1581cc	TD4611
	NA5187 (x2) 30.00 x 52.00 x 7.00mm, ACM		NA5051 40.00 x 56.00 x 7.00mm, FPM NA5049 64.00 x 80.00 x 8.00mm, ACM	

31 1.6L**Petrol**

182 A4.000	4 Cyl.	16 Valves	1581cc	TD9476
182 A6.000	4 Cyl.	16 Valves	1581cc	TD9475
182 B6.000 HR5060	4 Cyl.	16 Valves	1596cc	TD15632
	NA5187 (x2) 30.00 x 52.00 x 7.00mm, ACM		NB818 40.00 x 56.00 x 7.00mm, ACM NF887 64.00 x 112.50 x 20.00mm, FPM	

32 1.6L**Diesel**

198 A2.000	4 Cyl.	16 Valves	1598cc	TD21042
350 A2.000	4 Cyl.	16 Valves	1598cc	TD22138
350 A3.000	4 Cyl.	16 Valves	1598cc	TD24974
844 A3.000	4 Cyl.	16 Valves	1598cc	TD25652
944 A 3.000	4 Cyl.	16 Valves	1598cc	TD25422
955 A4.000 HR5119	4 Cyl.	16 Valves	1598cc	TD24651
	NA5347 30.0 x 45.0 x 7.00mm, FPM		NA5070 31.00 x 41.00 x 7.00mm, FPM NF888 93.00 x 139.70;172.00 x 12.00mm, FPM	

33 1.6L**Petrol**

828 B.000 HR569	4 Cyl.	8 Valves	1585cc	TD1796
	NA5187 (x2) 30.00 x 52.00 x 7.00mm, ACM		NA5051 40.00 x 56.00 x 7.00mm, FPM NA5050 70.00 x 90.00 x 10.00mm, ACM	

34 1.6L**Petrol**

831 A4.000 HR569	4 Cyl.	8 Valves	1585cc	TD4604
	NA5187 (x2) 30.00 x 52.00 x 7.00mm, ACM		NA5051 40.00 x 56.00 x 7.00mm, FPM NB732 74.00 x 90.00 x 10.00mm, FPM	

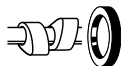

35 1.6L

Petrol

831 A7.000	4 Cyl.	8 Valves	1585cc	TD1808
HR569	NA5187 (x2) 30.00 x 52.00 x 7.00mm, ACM		NB825 30.00 x 43.00 x 8.00mm, FPM NA5050 70.00 x 90.00 x 10.00mm, ACM	

36 1.6L

Petrol

831 B3.000	4 Cyl.	8 Valves	1585cc	TD1807
831 B6.000	4 Cyl.	8 Valves	1585cc	TD1815
HR569	NA5187 (x2) 30.00 x 52.00 x 7.00mm, ACM		NB742 30.00 x 43.00 x 8.00mm, ACM NA5050 70.00 x 90.00 x 10.00mm, ACM	

37 1.6L

Petrol

831 B7.000	4 Cyl.	8 Valves	1585cc	TD1817
831 B7.046	4 Cyl.	8 Valves	1585cc	TD4606
HR569	NA5187 (x2) 30.00 x 52.00 x 7.00mm, ACM		NB742 30.00 x 43.00 x 8.00mm, ACM NB825 30.00 x 43.00 x 8.00mm, FPM	

38 1.7L

Petrol

132 B1.000	4 Cyl.	8 Valves	1756cc	TD21378
HR569	NA5187 30.00 x 52.00 x 7.00mm, ACM		NB307 40.00 x 56.00 x 7.00mm, ACM	

39 1.8L

Petrol

132 BB.1A 0	4 Cyl.	8 Valves	1756cc	TD22281
HR569	NA5187 30.00 x 52.00 x 7.00mm, ACM		NB307 40.00 x 56.00 x 7.00mm, ACM	

40 1.8L

Petrol

182 A2.000	4 Cyl.	16 Valves	1747cc	TD9473
183 A1.000	4 Cyl.	16 Valves	1747cc	TD9474
HR5060	NA5053 30.00 x 42.00 x 7.00mm, FPM NA5069 55.00 x 68.00 x 8.00mm, FPM		NA5070 31.00 x 41.00 x 7.00mm, FPM NF888 93.00 x 139.70;172.00 x 12.00mm, FPM	

41 1.8L

Petrol

828 A1.000	4 Cyl.	8 Valves	1756cc	TD1792
836 A2.046	4 Cyl.	8 Valves	1756cc	TD4613
HR569	NA5187 30.00 x 52.00 x 7.00mm, ACM			



42 1.8L		Petrol			
835 A2.000	4 Cyl.	8 Valves	1756cc		TD1845
835 A2.046	4 Cyl.	8 Valves	1756cc		TD1844
835 C2.000	4 Cyl.	8 Valves	1756cc		TD4612
835 C4.000	4 Cyl.	8 Valves	1756cc		TD5433
836 A5.000	4 Cyl.	8 Valves	1756cc		TD4615
836 A6.000	4 Cyl.	8 Valves	1756cc		TD11918
HR569	NA5187 (x2) 30.00 x 52.00 x 7.00mm, ACM		NB742 30.00 x 43.00 x 8.00mm, ACM NB732 74.00 x 90.00 x 10.00mm, FPM		

43 1.8L		Petrol			
835 C5.000	4 Cyl.	8 Valves	1756cc		TD1847
836 C4.000	4 Cyl.	8 Valves	1756cc		TD5434
HR569	NA5187 (x2) 30.00 x 52.00 x 7.00mm, ACM		NB825 30.00 x 43.00 x 8.00mm, FPM NB732 74.00 x 90.00 x 10.00mm, FPM		

44 1.8L		Petrol			
839 A4.000	4 Cyl.	16 Valves	1747cc		TD14468
839 A7.000	4 Cyl.	16 Valves	1747cc		TD15633
839 A9.000	4 Cyl.	16 Valves	1747cc		TD17508
HR816 (x2)	NA5053 30.00 x 42.00 x 7.00mm, FPM NA5069 55.00 x 68.00 x 8.00mm, FPM		NA5070 31.00 x 41.00 x 7.00mm, FPM NF888 93.00 x 139.70;172.00 x 12.00mm, FPM		

45 1.8L		Petrol			
939 B1.000	4 Cyl.	16 Valves	1742cc		TD24691
	NA5058 (x2) 40.00 x 55.00 x 7.00mm, FPM		NA5070 31.00 x 41.00 x 7.00mm, FPM NF888 93.00 x 139.70;172.00 x 12.00mm, FPM		

46 1.9L		Diesel			
160 D1.000	4 Cyl.	8 Valves	1929cc		TD4610
831 D1.000	4 Cyl.	8 Valves	1929cc		TD4607
835 A4.000	4 Cyl.	8 Valves	1929cc		TD1846
835 A4.046	4 Cyl.	8 Valves	1929cc		TD5425
HR569	NA5187 30.00 x 52.00 x 7.00mm, ACM		NB742 30.00 x 43.00 x 8.00mm, ACM NB732 74.00 x 90.00 x 10.00mm, FPM		

47 1.9L		Diesel			
188 B2.000	4 Cyl.	8 Valves	1910cc		TD18316
937 A2.000	4 Cyl.	8 Valves	1910cc		TD18313
AR 32302	4 Cyl.	8 Valves	1910cc		TD17398
AR 37101	4 Cyl.	8 Valves	1910cc		TD17890
HR569	NA5053 30.00 x 42.00 x 7.00mm, FPM		NA5070 31.00 x 41.00 x 7.00mm, FPM NF888 93.00 x 139.70;172.00 x 12.00mm, FPM		

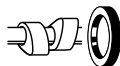

48 1.9L

Diesel

831 D.000	4 Cyl.	8 Valves	1911cc	TD1813
HR569	NA5187 (x2) 30.00 x 52.00 x 7.00mm, ACM		NB742 30.00 x 43.00 x 8.00mm, ACM NB732 74.00 x 90.00 x 10.00mm, FPM	

49 1.9L

Diesel

844 A1.000	4 Cyl.	16 Valves	1910cc	TD21044
HR5119	NA5347 30.0 x 45.0 x 7.00mm, FPM		NA5070 31.00 x 41.00 x 7.00mm, FPM NF888 93.00 x 139.70;172.00 x 12.00mm, FPM	

50 1.9L

Diesel

937 A5.000	4 Cyl.	16 Valves	1910cc	TD21086
HR5095 →Eng no. 5192515 HR5119 Eng no. 5192516→	NA5347 30.0 x 45.0 x 7.00mm, FPM		NA5070 31.00 x 41.00 x 7.00mm, FPM NF888 93.00 x 139.70;172.00 x 12.00mm, FPM	

51 2.0L

Petrol

134 A5.000	4 Cyl.	8 Valves	1995cc	TD1781
HR569	NA5187 30.00 x 52.00 x 7.00mm, ACM			

52 2.0L

Petrol

175 A3.000	5 Cyl.	20 Valves	1998cc	TD11550
182 B7.000	5 Cyl.	20 Valves	1998cc	TD14389
185 A8.000	5 Cyl.	20 Valves	1998cc	TD15630
838 A1.000	5 Cyl.	20 Valves	1998cc	TD4616
838 A6.000	5 Cyl.	20 Valves	1998cc	TD5436
841 E.000	5 Cyl.	20 Valves	1998cc	TD16731
HR800	NA5053 30.00 x 42.00 x 7.00mm, FPM NA5069 55.00 x 68.00 x 8.00mm, FPM		NA5070 31.00 x 41.00 x 7.00mm, FPM NF888 93.00 x 139.70;172.00 x 12.00mm, FPM	

53 2.0L

Petrol

175 A4.000	4 Cyl.	16 Valves	1995cc	TD11827
836 A3.000	4 Cyl.	16 Valves	1995cc	TD4614
838 A4.000	4 Cyl.	16 Valves	1995cc	TD4619
HR5060	NA5053 (x2) 30.00 x 42.00 x 7.00mm, FPM		NB742 30.00 x 43.00 x 8.00mm, ACM NB732 74.00 x 90.00 x 10.00mm, FPM	

54 2.0L

Diesel

198 A5.000	4 Cyl.	16 Valves	1956cc	TD21043
198 A8.000	4 Cyl.	16 Valves	1956cc	TD25650
198 A9.000	4 Cyl.	16 Valves	1956cc	TD25651
844 A2.000	4 Cyl.	16 Valves	1956cc	TD24652
HR5119	NA5347 30.0 x 45.0 x 7.00mm, FPM		NA5070 31.00 x 41.00 x 7.00mm, FPM NF888 93.00 x 139.70;172.00 x 12.00mm, FPM	

**55 2.0L****Petrol**

828 B1.000	4 Cyl.	8 Valves	1995cc	TD1797
828 B4.000	4 Cyl.	8 Valves	1995cc	TD4602
828 B7.000	4 Cyl.	8 Valves	1995cc	TD1800
HR569	NA5187 30.00 x 52.00 x 7.00mm, ACM		NB307 40.00 x 56.00 x 7.0mm, ACM NB732 74.00 x 90.00 x 10.00mm, FPM	

56 2.0L**Petrol**

831 B4.000	4 Cyl.	8 Valves	1995cc	TD1812
831 B5.000	4 Cyl.	8 Valves	1995cc	TD1823
831 C5.000	4 Cyl.	8 Valves	1995cc	TD1821
834 B.146	4 Cyl.	8 Valves	1995cc	TD1818
834 C.000	4 Cyl.	8 Valves	1995cc	TD1834
834 C.146	4 Cyl.	8 Valves	1995cc	TD1837
835 A5.000	4 Cyl.	8 Valves	1995cc	TD14589
835 A7.000	4 Cyl.	8 Valves	1995cc	TD1849
835 A7.046	4 Cyl.	8 Valves	1995cc	TD1850
835 A8.000	4 Cyl.	8 Valves	1995cc	TD14588
HR569	NA5187 (x2) 30.00 x 52.00 x 7.00mm, ACM		NB742 30.00 x 43.00 x 8.00mm, ACM NB732 74.00 x 90.00 x 10.00mm, FPM	

57 2.0L**Petrol**

831 C5.046	4 Cyl.	8 Valves	1995cc	TD1822
834 B.000	4 Cyl.	8 Valves	1995cc	TD1833
834 B1.000	4 Cyl.	8 Valves	1995cc	TD1830
834 B.048	4 Cyl.	8 Valves	1995cc	TD1829
835 A8.046	4 Cyl.	8 Valves	1995cc	TD1852
HR569	NA5187 (x2) 30.00 x 52.00 x 7.00mm, ACM		NB825 30.00 x 43.00 x 8.00mm, FPM NB732 74.00 x 90.00 x 10.00mm, FPM	

58 2.0L**Petrol**

831 D5.000	4 Cyl.	16 Valves	1995cc	TD1825
831 E5.000	4 Cyl.	16 Valves	1995cc	TD1827
831 E5.046	4 Cyl.	16 Valves	1995cc	TD1826
834 A4.000	4 Cyl.	16 Valves	1995cc	TD25828
834 B2.000	4 Cyl.	16 Valves	1995cc	TD14549
836 A2.000	4 Cyl.	16 Valves	1995cc	TD5435
HR816 (x2)	NA5053 (x2) 30.00 x 42.00 x 7.00mm, FPM		NB825 30.00 x 43.00 x 8.00mm, FPM NB732 74.00 x 90.00 x 10.00mm, FPM	

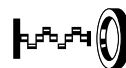

59 2.0L

Petrol

834 B2.246	4 Cyl.	16 Valves	1995cc	TD1832
834 C1.000	4 Cyl.	16 Valves	1995cc	TD1835
834 C1.246	4 Cyl.	16 Valves	1995cc	TD1836
834 F1.000	4 Cyl.	16 Valves	1995cc	TD1831
834 F2.000	4 Cyl.	16 Valves	1995cc	TD1840

HR816 (x2)

NA5053 (x2)
30.00 x 42.00 x 7.00mm, FPM

NB742
30.00 x 43.00 x 8.00mm, ACM
NB732
74.00 x 90.00 x 10.00mm, FPM

60 2.0L

Petrol

835 A5.046	4 Cyl.	8 Valves	1995cc	TD1848
------------	--------	----------	--------	--------

HR569

NP068 (x2)
55.00 x 70.00 x 8.00mm, FPM

NP067
50.00 x 70.00 x 10.00mm, FPM
NB644
74.00 x 90.00 x 10.00mm, NBR

61 2.0L

Petrol

RFN	4 Cyl.	16 Valves	1997cc	TD16322
RFN (EW10J4)	4 Cyl.	16 Valves	1997cc	TD16734

HR5126

NF817 (x2)
36.00 x 50.00 x 7.00mm, FPM

NA5256
40.00 x 55.00 x 6.50mm, FPM
NA5192
90.00 x 110.00 x 7.00mm, PTFE

62 2.0L

Petrol

RFV (XU10J4R)	4 Cyl.	16 Valves	1998cc	TD26959
---------------	--------	-----------	--------	---------

HR5081
→08/98

HR5126
09/98→

NF817 (x2)
36.00 x 50.00 x 7.00mm, FPM

NA5191
42.00 x 62.00 x 7.00mm, PTFE
NA5192
90.00 x 110.00 x 7.00mm, PTFE

63 2.0L

Petrol

RGX (XU10J2TE)	4 Cyl.	8 Valves	1998cc	TD26958
----------------	--------	----------	--------	---------

HR569

NF817
36.00 x 50.00 x 7.00mm, FPM

NA5191
42.00 x 62.00 x 7.00mm, PTFE
NA5192
90.00 x 110.00 x 7.00mm, PTFE

64 2.0L

Diesel

RHK (DW10UTED4)	4 Cyl.	16 Valves	1997cc	TD26952
RHM (DW10ATED4)	4 Cyl.	16 Valves	1997cc	TD26957
RHR (DW10BTED4)	4 Cyl.	16 Valves	1997cc	TD26955
RHW (DW10ATED4)	4 Cyl.	16 Valves	1997cc	TD16735

HR5046 (x2)

NA5035
27.00 x 47.00 x 7.00mm, FPM

NA5191
42.00 x 62.00 x 7.00mm, PTFE
NA5192
90.00 x 110.00 x 7.00mm, PTFE

65 2.0L

Diesel

RHZ (DW10ATED)	4 Cyl.	8 Valves	1997cc	TD26954
----------------	--------	----------	--------	---------

HR817
→Eng no. 08331

HR5046
Eng no. 08332→

NA5035
27.00 x 47.00 x 7.00mm, FPM

NA5191
42.00 x 62.00 x 7.00mm, PTFE
NA5192
90.00 x 110.00 x 7.00mm, PTFE

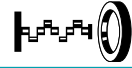

66 2.1L Diesel

P 8 C	4 Cyl.	12 Valves	2088cc	TD1859
HR805	NF841 35.00 x 50.00 x 8.00mm, FPM		NA5191 42.00 x 62.00 x 7.00mm, PTFE NA5192 90.00 x 110.00 x 7.00mm, PTFE	

67 2.2L Diesel

4HP	4 Cyl.	16 Valves	2179cc	TD24689
4HR	4 Cyl.	16 Valves	2179cc	TD24690
4HS	4 Cyl.	16 Valves	2179cc	TD24688
4HT	4 Cyl.	16 Valves	2179cc	TD24686
HR5122	NA5035 (x2) 27.00 x 47.00 x 7.00mm, FPM		NA5191 42.00 x 62.00 x 7.00mm, PTFE NA5192 90.00 x 110.00 x 7.00mm, PTFE	

68 2.2L Diesel

4HW (DW12ATED4)	4 Cyl.	16 Valves	2179cc	TD16736
HR5046 (x2)	NA5035 27.00 x 47.00 x 7.00mm, FPM		NA5191 42.00 x 62.00 x 7.00mm, PTFE NA5192 90.00 x 110.00 x 7.00mm, PTFE	

69 2.4L Petrol

192 A2.000	5 Cyl.	20 Valves	2446cc	TD28274
HR800	NA5053 30.00 x 42.00 x 7.00mm, FPM NA5069 55.00 x 68.00 x 8.00mm, FPM		NA5070 31.00 x 41.00 x 7.00mm, FPM NF888 93.00 x 139.70;172.00 x 12.00mm, FPM	

70 2.4L Petrol

838 A2.000	5 Cyl.	20 Valves	2446cc	TD4617
838 A2.027	5 Cyl.	20 Valves	2446cc	TD14528
838 B2.000	5 Cyl.	20 Valves	2446cc	TD18864
HR800	NA5053 30.00 x 42.00 x 7.00mm, FPM		NA5070 31.00 x 41.00 x 7.00mm, FPM NF888 93.00 x 139.70;172.00 x 12.00mm, FPM	

71 2.4L Diesel

838 A3.000	5 Cyl.	10 Valves	2387cc	TD4618
838 A7.000	5 Cyl.	10 Valves	2387cc	TD5437
838 A8.000	5 Cyl.	10 Valves	2387cc	TD11551
839 A5.000	5 Cyl.	10 Valves	2387cc	TD17399
839 A6.000	5 Cyl.	10 Valves	2387cc	TD15631
841 C.000	5 Cyl.	10 Valves	2387cc	TD16472
AR 32501	5 Cyl.	10 Valves	2387cc	TD17400
HR615	NA5053 30.00 x 42.00 x 7.00mm, FPM		NA5070 31.00 x 41.00 x 7.00mm, FPM NF888 93.00 x 139.70;172.00 x 12.00mm, FPM	

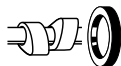

72 2.4L

Petrol

841 D.000	5 Cyl.	20 Valves	2446cc	TD16732
HR816 (x3)	NA5053 30.00 x 42.00 x 7.00mm, FPM	NA5070 31.00 x 41.00 x 7.00mm, FPM		
	NA5069 55.00 x 68.00 x 8.00mm, FPM	NF888 93.00 x 139.70;172.00 x 12.00mm, FPM		

73 2.4L

Diesel

841 G.000	5 Cyl.	20 Valves	2387cc	TD18317
841 H.000	5 Cyl.	20 Valves	2387cc	TD20953
841 M.000	5 Cyl.	20 Valves	2387cc	TD19057
841 N.000	5 Cyl.	20 Valves	2387cc	TD19058
841 P.000	5 Cyl.	20 Valves	2387cc	TD20954
	NA5347 (x2) 30.0 x 45.0 x 7.00mm, FPM	NA5070 31.00 x 41.00 x 7.00mm, FPM		
		NF888 93.00 x 139.70;172.00 x 12.00mm, FPM		

74 2.4L

Diesel

8144.91	4 Cyl.	8 Valves	2445cc	TD4600
HR602	NP068 55.00 x 70.00 x 8.00mm, FPM	NP068 55.00 x 70.00 x 8.00mm, FPM		
	NF841 35.00 x 50.00 x 8.00mm, FPM	NF853 100.00 x 118.00 x 10.00mm, FPM		

75 2.4L

Petrol

EDG	4 Cyl.	16 Valves	2360cc	TD29582
		NA5108 42.00 x 55.00 x 7.00mm, FPM/ACM		
		NK143 85.00 x 103.00 x 8.00mm, FPM		

76 2.5L

Diesel

8144.97	4 Cyl.	8 Valves	2499cc	TD4601
8144.97.2200	4 Cyl.	8 Valves	2499cc	TD19036
8144. 97S	4 Cyl.	8 Valves	2500cc	TD1785
8144.97 Y	4 Cyl.	8 Valves	2500cc	TD1786
HR602	NF841 35.00 x 50.00 x 8.00mm, FPM	NP068 55.00 x 70.00 x 8.00mm, FPM		
	NP068 55.00 x 70.00 x 8.00mm, FPM	NF853 100.00 x 118.00 x 10.00mm, FPM		

77 2.5L

Diesel

8144.97.2400	4 Cyl.	8 Valves	2499cc	TD22318
HR602		NP068 55.00 x 70.00 x 8.00mm, FPM		
		NF853 100.00 x 118.00 x 10.00mm, FPM		

78 2.8L

Diesel

ENS	4 Cyl.	16 Valves	2776cc	TD26317
PA5041 (x16)	NA5136 (x2) 30.00 x 47.00 x 7.00mm, FPM			
HR791				

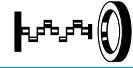

79 3.0L		Petrol		
834 F.000	6 Cyl.	12 Valves	2959cc	TD1841
	NA5163 32.00 x 47.00 x 10.00mm, FPM		NF637 48.00 x 65.00 x 10.00mm, FPM	
80 3.0L		Petrol		
838 B.000	6 Cyl.	24 Valves	2959cc	TD4620
HR662 (x2)	NA5001 (x4) 32.00 x 47.00 x 10.00mm, FPM		NF637 48.00 x 65.00 x 10.00mm, FPM	
81 3.0L		Petrol		
841 A.000	6 Cyl.	24 Valves	2959cc	TD16733
HR662 (x2)	NA5163 (x4) 32.00 x 47.00 x 10.00mm, FPM		NF637 48.00 x 65.00 x 10.00mm, FPM	
82 3.0L		Petrol		
ES9 J4S	6 Cyl.	24 Valves	2946cc	TD17397
HR5062	NA5260 (x4) 38.00 x 50.00 x 6.00mm, FPM		NA5190 42.00 x 56.00 x 7.00mm, FPM NF867 98.00 x 120.00 x 7.00mm, FPM/ACM	
83 3.0L		Diesel		
EXF	6 Cyl.	24 Valves	2987cc	TD26319
HR5062			NA5131 45.00 x 67.00 x 8.00mm, PTFE	
84 3.0L		Petrol		
XFW	6 Cyl.	24 Valves	2946cc	TD18825
PA5041 (x24) HR5062	NA5260 (x4) 38.00 x 50.00 x 6.00mm, FPM		NA5190 42.00 x 56.00 x 7.00mm, FPM NF867 98.00 x 120.00 x 7.00mm, FPM/ACM	
85 3.2L		Petrol		
841 L.000	6 Cyl.	24 Valves	3179cc	TD22139
HR662 (x2)	NA5001 (x4) 32.00 x 47.00 x 10.00mm, FPM			
86 3.6L		Petrol		
ERB	6 Cyl.	24 Valves	3604cc	TD26316
HR5062			NA5131 45.00 x 67.00 x 8.00mm, PTFE	



CC









9

88/109 (LR)	09/63→12/86	10 J	Diesel	2286	4	8	9
88/109 (LR)	11/79→05/84	12 J	Diesel	2495	4	8	13
88/109 Hardtop (LR)	09/63→12/86	10 J	Diesel	2286	4	8	9
88/109 Hardtop (LR)	03/83→05/84	12 J	Diesel	2495	4	8	13
90/110 (DHMC)	09/83→07/90	12 J	Diesel	2495	4	8	13
90/110 (DHMC)	06/84→08/87	10 J	Diesel	2286	4	8	9
90/110 (DHMC)	09/85→07/90	17 H	Petrol	2495	4	8	17
90/110 (DHMC)	09/86→07/90	19 J	Diesel	2495	4	8	13
Defender Cabrio (L316)	09/90→12/98	22 D	Petrol	3531	8	16	27
Defender Cabrio (L316)	09/90→09/01	12 J	Diesel	2495	4	8	13
Defender Cabrio (L316)	09/90→12/01	11 L	Diesel	2495	4	8	12
Defender Cabrio (L316)	09/90→12/01	16 L	Diesel	2495	4	8	16
Defender Cabrio (L316)	09/90→12/01	23 L	Diesel	2495	4	8	19
Defender Cabrio (L316)	06/98→02/16	10 P	Diesel	2495	5	10	11
Defender Cabrio (L316)	06/98→02/16	14 P	Diesel	2495	5	10	11
Defender Cabrio (L316)	06/98→02/16	15 P	Diesel	2495	5	10	11
Defender Cabrio (L316)	05/07→02/16	ZSD-424	Diesel	2402	4	16	10
Defender Cabrio (L316)	08/11→02/16	ZSD-422	Diesel	2198	4	16	8
Defender Pickup (L316)	06/98→02/16	10 P	Diesel	2495	5	10	11
Defender Pickup (L316)	11/98→09/03	M52 B28	Petrol	2793	6	24	23
Defender Pickup (L316)	05/07→02/16	ZSD-424	Diesel	2402	4	16	10
Defender Pickup (L316)	08/11→02/16	ZSD-422	Diesel	2198	4	16	8
Defender Platform/Chassis (L316)	01/07→02/16	ZSD-424	Diesel	2402	4	16	10
Defender Platform/Chassis (L316)	08/11→02/16	ZSD-422	Diesel	2198	4	16	8
Defender Station Wagon (L316)	09/90→08/93	11 D	Petrol	3528	8	16	27
Defender Station Wagon (L316)	09/90→12/94	17 H	Petrol	2495	4	8	17
Defender Station Wagon (L316)	09/90→12/98	16 L	Diesel	2495	4	8	16
Defender Station Wagon (L316)	09/90→12/98	22 D	Petrol	3531	8	16	27
Defender Station Wagon (L316)	09/90→09/01	12 J	Diesel	2495	4	8	13
Defender Station Wagon (L316)	09/90→12/05	11 L	Diesel	2495	4	8	12
Defender Station Wagon (L316)	09/90→12/05	23 L	Diesel	2495	4	8	19
Defender Station Wagon (L316)	06/98→02/16	10 P	Diesel	2495	5	10	11
Defender Station Wagon (L316)	06/98→02/16	14 P	Diesel	2495	5	10	11
Defender Station Wagon (L316)	06/98→02/16	15 P	Diesel	2495	5	10	11
Defender Station Wagon (L316)	11/98→09/03	M52 B28	Petrol	2793	6	24	23
Defender Station Wagon (L316)	05/07→02/16	ZSD-424	Diesel	2402	4	16	10
Defender Station Wagon (L316)	08/11→02/16	ZSD-422	Diesel	2198	4	16	8
Discovery I (LJ)	06/89→06/94	22 D	Petrol	3531	8	16	27
Discovery I (LJ)	06/89→10/98	20 T4H	Petrol	1994	4	16	3
Discovery I (LJ)	10/89→10/98	12 L	Diesel	2496	4	8	14
Discovery I (LJ)	10/89→10/98	17 L	Diesel	2495	4	8	16
Discovery I (LJ)	10/89→10/98	19 L	Diesel	2496	4	8	18
Discovery I (LJ)	10/89→10/98	21 L	Diesel	2495	4	8	19
Discovery I (LJ)	06/93→10/98	22 L	Diesel	2496	4	8	16
Discovery I (LJ)	09/93→10/98	35 D	Petrol	3947	8	16	28
Discovery I (LJ)	09/93→10/98	36 D	Petrol	3947	8	16	28
Discovery II (L318)	11/98→06/04	35 D	Petrol	3947	8	16	28
Discovery II (L318)	11/98→06/04	56 D	Petrol	3947	8	16	30
Discovery II (L318)	01/99→06/04	10 P	Diesel	2495	5	10	11
Discovery II (L318)	01/99→06/04	15 P	Diesel	2495	5	10	11
Discovery II (L318)	09/99→12/02	46 D	Petrol	4553	8	16	33
Discovery II (LJ, LT)	11/98→06/04	10 P	Diesel	2495	5	10	11
Discovery II (LJ, LT)	11/98→06/04	15 P	Diesel	2495	5	10	11
Discovery III (L319)	07/04→09/09	276DT	Diesel	2720	6	24	22
Discovery IV (L319)	09/09→	276DT	Diesel	2720	6	24	22
Discovery IV (L319)	09/09→	306DT	Diesel	2993	6	24	24
Discovery V (L462)	09/16→	306DT	Diesel	2993	6	24	24
Discovery SPORT (L550)	12/14→	204PT	Petrol	1999	4	16	5
Discovery SPORT (L550)	12/14→	224DT	Diesel	2179	4	16	7
Freelander (L314)	02/98→11/00	20 T2N	Diesel	1994	4	8	2
Freelander (L314)	02/98→10/06	18 K4F	Petrol	1796	4	16	1
Freelander (L314)	11/00→10/06	25 K4F	Petrol	2497	6	24	21
Freelander (L314)	11/00→10/06	204D3	Diesel	1951	4	16	4
Freelander (L314)	11/00→10/06	M 47	Diesel	1951	4	16	4
Freelander 2 (L359)	10/06→10/14	224DT	Diesel	2179	4	16	7
Freelander 2 (L359)	10/06→10/14	DW128TED4	Diesel	2179	4	16	7
Freelander 2 (L359)	10/11→10/14	204PT	Petrol	1999	4	16	5
Freelander Soft Top (L359)	02/98→10/06	18 K4F	Petrol	1796	4	16	1
Freelander Soft Top (L359)	02/98→10/06	20 T2N	Diesel	1994	4	8	2
Freelander Soft Top (L359)	10/00→10/06	204D3	Diesel	1951	4	16	4
Range Rover Evoque (L538)	06/11→	204PT	Petrol	1999	4	16	5
Range Rover Evoque (L538)	06/11→	224DT	Diesel	2179	4	16	7
Range Rover Evoque Convertible (L538)	02/16→	204PT	Petrol	1999	4	16	5
Range Rover I	10/69→08/91	11 D	Petrol	3528	8	16	27
Range Rover I	10/85→09/90	24 D	Petrol	3528	8	16	27
Range Rover I	10/85→09/90	25 D	Petrol	3528	8	16	27
Range Rover I	01/87→09/90	31 D	Petrol	3528	8	16	27
Range Rover I	11/88→07/94	35 D	Petrol	3947	8	16	28



Range Rover I	11/88→07/94	36 D	Petrol	3947	8	16	28	
Range Rover I	11/88→07/94	37 D	Petrol	3947	8	16	28	
Range Rover I	11/88→07/94	38 D	Petrol	3947	8	16	28	
Range Rover I	10/89→04/94	14 L	Diesel	2495	4	8	15	
Range Rover I	10/89→04/94	21 L	Diesel	2495	4	8	19	
Range Rover I	09/92→12/95	42 D	Petrol	3947	8	16	29	
Range Rover I	09/92→04/96	40 D	Petrol	4275	8	16	31	
Range Rover II (P38A)	07/94→03/02	42 D	Petrol	3947	8	16	29	
Range Rover II (P38A)	07/94→03/02	46 D	Petrol	4553	8	16	33	
Range Rover II (P38A)	07/94→03/02	25 6T (BMW)	Diesel	2497	6	12	20	
Range Rover II (P38A)	08/94→03/02	19 L	Diesel	2496	4	8	18	
Range Rover II (P38A)	08/94→03/02	22 L	Diesel	2496	4	8	16	
Range Rover II (P38A)	06/98→03/02	60 D	Petrol	4554	8	16	34	
Range Rover III (L322)	03/02→12/05	M62 B44	Petrol	4398	8	32	32	
Range Rover III (L322)	03/02→08/12	306D1	Diesel	2926	6	24	25	
Range Rover IV (L322)	08/12→	306DT	Diesel	2993	6	24	24	
Range Rover Sport (L320)	02/05→03/13	276DT	Diesel	2720	6	24	22	
Range Rover Sport (L320)	09/09→03/13	30DDTX	Diesel	2993	6	24	24	
Range Rover Sport (L320)	08/12→03/13	306DT	Diesel	2993	6	24	24	
Range Rover Sport (L494)	04/13→	30DDTX	Diesel	2993	6	24	24	
Range Rover Sport (L494)	04/13→	306DT	Diesel	2993	6	24	24	
Range Rover Velar (L560)	03/17→	306DT	Diesel	2993	6	24	24	
Serie II	04/58→12/61	21 D	Diesel	2068	4	8	6	

	CC				9		CC				9
10 J	2286	4	8	Diesel	9						
10 P	2495	5	10	Diesel	11						
11 D	3528	8	16	Petrol	27						
11 L	2495	4	8	Diesel	12						
12 J	2495	4	8	Diesel	13						
12 L	2496	4	8	Diesel	14						
14 L	2495	4	8	Diesel	15						
14 P	2495	5	10	Diesel	11						
15 P	2495	5	10	Diesel	11						
16 L	2495	4	8	Diesel	16						
17 H	2495	4	8	Petrol	17						
17 L	2495	4	8	Diesel	16						
18 K4F	1796	4	16	Petrol	1						
19 J	2495	4	8	Diesel	13						
19 L	2496	4	8	Diesel	18						
20 T2N	1994	4	8	Diesel	2						
20 T4H	1994	4	16	Petrol	3						
21 D	2068	4	8	Diesel	6						
21 L	2495	4	8	Diesel	19						
22 D	3531	8	16	Petrol	27						
22 L	2496	4	8	Diesel	16						
23 L	2495	4	8	Diesel	19						
24 D	3528	8	16	Petrol	27						
25 D	3528	8	16	Petrol	27						
25 K4F	2497	6	24	Petrol	21						
30DDTX	2993	6	24	Diesel	24						
31 D	3528	8	16	Petrol	27						
35 D	3947	8	16	Petrol	28						
36 D	3947	8	16	Petrol	28						
37 D	3947	8	16	Petrol	28						
38 D	3947	8	16	Petrol	28						
40 D	4275	8	16	Petrol	31						
42 D	3947	8	16	Petrol	29						
46 D	4553	8	16	Petrol	33						
56 D	3947	8	16	Petrol	30						
60 D	4554	8	16	Petrol	34						
204D3	1951	4	16	Diesel	4						
204PT	1999	4	16	Petrol	5						
224DT	2179	4	16	Diesel	7						
25 6T (BMW)	2497	6	12	Diesel	20						
276DT	2720	6	24	Diesel	22						
306D1	2926	6	24	Diesel	25						
306DT	2993	6	24	Diesel	24						
DW12BTED4	2179	4	16	Diesel	7						
M 47	1951	4	16	Diesel	4						
M 47 R	1950	4	16	Diesel	4						
M52 B28	2793	6	24	Petrol	23						
M 57 D 30	2926	6	12	Diesel	26						
M62 B44	4398	8	32	Petrol	32						
ZSD-422	2198	4	16	Diesel	8						
ZSD-424	2402	4	16	Diesel	10						

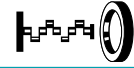

1 1.8L		Petrol		
18 K4F	4 Cyl.	16 Valves	1796cc	TD20740
HR752	NC065 (x2) 30.00 x 40.00 x 7.00mm, FPM NB998 (x2) 30.00 x 40.00 x 7.00mm, FPM		NB828 27.50 x 39.50 x 7.00mm, FPM NB829 79.95 x 116.00; 126.00 x 11.50mm, FPM	
2 2.0L		Diesel		
20 T2N	4 Cyl.	8 Valves	1994cc	TD26632
HR5051	NB775 (x2) 40.00 x 52.00 x 7.00mm, FPM		NB774 35.00 x 45.00 x 7.00mm, FPM LK5002 136.00 x 153.00 x 21.000mm, PTFE	
3 2.0L		Petrol		
20 T4H	4 Cyl.	16 Valves	1994cc	TD32496
HR802 →12/94 HR656 (x2) 01/95→			NB774 35.00 x 45.00 x 7.00mm, FPM NB843 128.00 x 145.00 x 28.00mm, FPM	
4 2.0L		Diesel		
204D3	4 Cyl.	16 Valves	1951cc	TD26631
M 47	4 Cyl.	16 Valves	1951cc	TD26848
M 47 R	4 Cyl.	16 Valves	1950cc	TD24392
PA5016 (x16) HR5045			NA5103 55.00 x 68.00 x 8.00mm, PTFE NB431 90.00 x 110.00 x 12.00mm, FPM NA5104 90.00 x 110.00 x 12.00mm, PTFE	
5 2.0L		Petrol		
204PT	4 Cyl.	16 Valves	1999cc	TD26312
HR5063			NA5157 37.00 x 50.00 x 8.00mm, PTFE LK5005 88.00 x 188.00 x 15.000mm, PTFE	
6 2.1L		Diesel		
21 D	4 Cyl.	8 Valves	2068cc	TD32489
PA619 (x8) HR336 (x2)			NB628 45.00 x 60.00 x 9.00mm, ACM NB690 81.00 x 100.10 x 11.50mm, FPM	
7 2.2L		Diesel		
224DT	4 Cyl.	16 Valves	2179cc	TD24922
DW12BTED4	4 Cyl.	16 Valves	2179cc	TD26064
HR5122	NA5035 (x2) 27.00 x 47.00 x 7.00mm, FPM		NA5191 42.00 x 62.00 x 7.00mm, PTFE NA5192 90.00 x 110.00 x 7.00mm, PTFE	

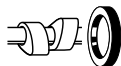

8 2.2L Diesel

ZSD-422 4 Cyl. 16 Valves 2198cc TD31976

NA5031 50.00 x 86.50 x 13.70mm, PTFE
NA5030 106.00 x 190.00 x 15.20mm, PTFE/FPM

9 2.3L Diesel

10 J 4 Cyl. 8 Valves 2286cc TD25822

HR635

NB849 48.70 x 63.50 x 8.00mm, FPM
NB848 100.00 x 120.00 x 11.00mm, PTFE

10 2.4L Diesel

ZSD-424 4 Cyl. 16 Valves 2402cc TD31977

NA5031 50.00 x 86.50 x 13.70mm, PTFE
NA5030 106.00 x 190.00 x 15.20mm, PTFE/FPM

11 2.5L Diesel

10 P 5 Cyl. 10 Valves 2495cc TD25823

14 P 5 Cyl. 10 Valves 2495cc TD25825

15 P 5 Cyl. 10 Valves 2495cc TD28552

HR5044

NA5023 50.00 x 65.00 x 8.00mm, FPM
LK5002 136.00 x 153.00 x 21.00mm, PTFE

12 2.5L Diesel

11 L 4 Cyl. 8 Valves 2495cc TD20407

HR801

NB775 40.00 x 52.00 x 7.00mm, FPM
 →02/94

NB848 100.00 x 120.00 x 11.00mm, PTFE
 →02/94

13 2.5L Diesel

12 J 4 Cyl. 8 Valves 2495cc TD24370

19 J 4 Cyl. 8 Valves 2495cc TD24369

HR635

NB775 40.00 x 52.00 x 7.00mm, FPM

NB849 48.70 x 63.50 x 8.00mm, FPM
NB848 100.00 x 120.00 x 11.00mm, PTFE

14 2.5L Diesel

12 L 4 Cyl. 8 Valves 2496cc TD20408

HR801

NB775 40.00 x 52.00 x 7.00mm, FPM

NB849 48.70 x 63.50 x 8.00mm, FPM
 →02/94
NB848 100.00 x 120.00 x 11.00mm, PTFE
 →02/94

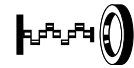
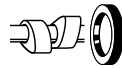

15 2.5L

Diesel

14 L	4 Cyl.	8 Valves	2495cc	TD19655
HR801	NB775 40.00 x 52.00 x 7.00mm, FPM		NB849 48.70 x 63.50 x 8.00mm, FPM NB848 100.00 x 120.00 x 11.00mm, PTFE	

16 2.5L

Diesel

16 L	4 Cyl.	8 Valves	2495cc	TD20411
17 L	4 Cyl.	8 Valves	2495cc	TD20412
22 L	4 Cyl.	8 Valves	2496cc	TD20413
HR801	NB775 40.00 x 52.00 x 7.00mm, FPM →02/94 NC008 47.00 x 62.00 x 10.00mm, FPM 03/94→		NB849 48.70 x 63.50 x 8.00mm, FPM →02/94 NC007 57.00 x 71.00 x 9.50mm, FPM 03/94→ NC009 57.20 x 74.00 x 9.70mm, NBR 03/94→ NB848 100.00 x 120.00 x 11.00mm, PTFE →02/94 LK5009 99.00 x 118.00 x 16.50mm, PTFE 03/94→	

17 2.5L

Petrol

17 H	4 Cyl.	8 Valves	2495cc	TD19656
HR635			NB849 48.70 x 63.50 x 8.00mm, FPM NB848 100.00 x 120.00 x 11.00mm, PTFE	

18 2.5L

Diesel

19 L	4 Cyl.	8 Valves	2496cc	TD20409
HR343	NB775 40.00 x 52.00 x 7.00mm, FPM →02/94 NC008 47.00 x 62.00 x 10.00mm, FPM 03/94→		NB849 48.70 x 63.50 x 8.00mm, FPM →02/94 NC009 57.20 x 74.00 x 9.70mm, NBR 03/94→ NB848 100.00 x 120.00 x 11.00mm, PTFE →02/94 LK5009 99.00 x 118.00 x 16.50mm, PTFE 03/94→	

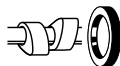

19 2.5L

Diesel

21 L 4 Cyl. 8 Valves 2495cc TD20410

23 L 4 Cyl. 8 Valves 2495cc TD20406

HR343

NB775
40.00 x 52.00 x 7.00mm, FPM
→02/94

NC008
47.00 x 62.00 x 10.00mm, FPM
03/94→

NB849
48.70 x 63.50 x 8.00mm, FPM
→02/94

NC007
57.00 x 71.00 x 9.50mm, FPM
03/94→

NC009
57.20 x 74.00 x 9.70mm, NBR
03/94→

NB848
100.00 x 120.00 x 11.00mm, PTFE
→02/94

LK5009
99.00 x 118.00 x 16.50mm, PTFE
03/94→

20 2.5L

Diesel

25 6T (BMW) 6 Cyl. 12 Valves 2497cc TD22933

PA5041 (x12)
HR280

NF637
48.00 x 65.00 x 10.00mm, FPM
NA5104
90.00 x 110.00 x 12.00mm, PTFE

21 2.5L

Petrol

25 K4F 6 Cyl. 24 Valves 2497cc TD19716

HR5031 (x2)

NC065 (x2)
30.00 x 40.00 x 7.00mm, FPM
NB998 (x4)
30.00 x 40.00 x 7.00mm, FPM

NA5083
32.50 x 45.00 x 7.70mm, FPM
LK5000
89.00 x 116.00 x 10.20mm, FPM

22 2.7L

Diesel

276DT 6 Cyl. 24 Valves 2720cc TD24908

HR5111

NA5318 (x2)
26.0 x 45.0 x 8.00mm, FPM

NA5323
35.00 x 50.00 x 7.00mm, PTFE
LK5021
92.00 x 220.00 x 22.00mm, PTFE/ACM

23 2.8L

Petrol

M52 B28 6 Cyl. 24 Valves 2793cc TD32495

PA5041 (x24)
HR5062

NA5318 (x2)
26.0 x 45.0 x 8.00mm, FPM

NA5105
48.00 x 65.00 x 10.00mm, PTFE
NA5104
90.00 x 110.00 x 12.00mm, PTFE

24 3.0L

Diesel

30DDTX 6 Cyl. 24 Valves 2993cc TD25818

306DT 6 Cyl. 24 Valves 2993cc TD24909

HR5111

NA5318 (x2)
26.0 x 45.0 x 8.00mm, FPM

NA5323
35.00 x 50.00 x 7.00mm, PTFE
LK5021
92.00 x 220.00 x 22.00mm, PTFE/ACM

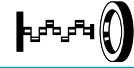

25 3.0L

Diesel

306D1	6 Cyl.	24 Valves	2926cc	TD29267
PA5016 (x24) HR5121				NA5103 55.00 x 68.00 x 8.00mm, PTFE NA5104 90.00 x 110.00 x 12.00mm, PTFE

26 3.0L

Diesel

M 57 D 30	6 Cyl.	12 Valves	2926cc	TD22322
PA5016 (x12)				NA5103 55.00 x 68.00 x 8.00mm, PTFE NA5104 90.00 x 110.00 x 12.00mm, PTFE

27 3.5L

Petrol

11 D	8 Cyl.	16 Valves	3528cc	TD22941
22 D	8 Cyl.	16 Valves	3531cc	TD22934
24 D	8 Cyl.	16 Valves	3528cc	TD22939
25 D	8 Cyl.	16 Valves	3528cc	TD22940
31 D	8 Cyl.	16 Valves	3528cc	TD22942
HR5052 (x2)				NB849 48.70 x 63.50 x 8.00mm, FPM NB291 82.60 x 98.70 x 12.70mm, MVQ

28 3.9L

Petrol

35 D	8 Cyl.	16 Valves	3947cc	TD22930
36 D	8 Cyl.	16 Valves	3947cc	TD22929
37 D	8 Cyl.	16 Valves	3947cc	TD22937
38 D	8 Cyl.	16 Valves	3947cc	TD22938
HR5054 (x2)				NB849 48.70 x 63.50 x 8.00mm, FPM 10/98 → NB291 82.60 x 98.70 x 12.70mm, MVQ 10/98 →

29 3.9L

Petrol

42 D	8 Cyl.	16 Valves	3947cc	TD22932
HR5053				NB849 48.70 x 63.50 x 8.00mm, FPM NB291 82.60 x 98.70 x 12.70mm, MVQ

30 4.0L

Petrol

56 D	8 Cyl.	16 Valves	3947cc	TD26647
HR5054 (x2)				

31 4.3L

Petrol

40 D	8 Cyl.	16 Valves	4275cc	TD22935
HR5054 (x2)				NB849 48.70 x 63.50 x 8.00mm, FPM NB291 82.60 x 98.70 x 12.70mm, MVQ

LAND ROVER

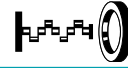

32 4.4L

Petrol

M62 B44 8 Cyl. 32 Valves 4398cc TD29227

PA5041 (x32)
HR791 (x2)

NF637 (F)
48.00 x 65.00 x 10.00mm, FPM
NA5132 (R)
100.00 x 125.00 x 13.00mm, FPM

33 4.6L

Petrol

46 D 8 Cyl. 16 Valves 4553cc TD22931

HR5053 (F)

NB849 (F)
48.70 x 63.50 x 8.00mm, FPM
NB291 (R)
82.60 x 98.70 x 12.70mm, MVQ

34 4.6L

Petrol

60 D 8 Cyl. 16 Valves 4554cc TD26648

HR5045 (F)

NA5103 (F)
55.00 x 68.00 x 8.00mm, PTFE
NB431 (R)
90.00 x 110.00 x 12.00mm, FPM
NA5104 (R)
90.00 x 110.00 x 12.00mm, PTFE











CC



9

200 Box	10/94→03/96	XUD9	Diesel	1905	4	8	3
200 Pickup	10/94→03/96	XUD9	Diesel	1905	4	8	3
400 Box	04/89→03/96	EN 55	Diesel	2498	4	8	9
400 Box	04/89→03/96	ET 70	Diesel	2496	4	8	9
400 Bus	04/89→03/96	EN 55	Diesel	2498	4	8	9
400 Bus	11/95→10/98	ET 70	Diesel	2496	4	8	9
400 Platform/Chassis	04/89→10/96	EN 55	Diesel	2498	4	8	9
400 Platform/Chassis	11/95→04/96	ET 70	Diesel	2496	4	8	9
Convoy Box	04/96→04/09	EN 55	Diesel	2498	4	8	9
Convoy Box	04/96→04/09	ET 70	Diesel	2496	4	8	9
Convoy Box	03/02→04/09	D2FA	Diesel	2402	4	16	6
Convoy Box	03/02→04/09	F4FA	Diesel	2402	4	16	6
Convoy Bus	04/96→02/02	EN 55	Diesel	2498	4	8	9
Convoy Bus	04/96→02/02	ET 70	Diesel	2496	4	8	9
Convoy Bus	10/97→04/09	4EB	Diesel	2496	4	8	7
Convoy Bus	10/97→04/09	4HB	Diesel	2496	4	8	7
Convoy Bus	03/02→04/09	D2FA	Diesel	2402	4	16	6
Convoy Platform/Chassis	04/96→04/09	EN 55	Diesel	2498	4	8	9
Convoy Platform/Chassis	04/96→04/09	ET 70	Diesel	2496	4	8	9
Convoy Platform/Chassis	03/02→04/06	F4FA	Diesel	2402	4	16	6
Cub	08/98→09/01	LD23	Diesel	2283	4	8	5
Maxus Box	02/05→12/08	VM39C	Diesel	2499	4	16	10
Maxus Box	10/05→12/09	BS580VM	Diesel	2499	4	16	8
Maxus Box	02/06→12/09	BS582VM	Diesel	2499	4	16	8
Maxus Bus	02/05→12/09	VM39C	Diesel	2499	4	16	10
Maxus Bus	02/06→12/09	BS582VM	Diesel	2499	4	16	8
Maxus Platform/Chassis	02/05→12/08	VM39C	Diesel	2499	4	16	10
Maxus Platform/Chassis	10/05→12/09	BS580VM	Diesel	2499	4	16	8
Maxus Platform/Chassis	02/06→12/09	BS582VM	Diesel	2499	4	16	8
Pilot Box	04/96→02/02	XUD9	Diesel	1905	4	8	3
Pilot Box	03/02→10/05	DW8	Diesel	1868	4	8	3
Pilot Bus	04/96→10/05	XUD9	Diesel	1905	4	8	3
Pilot Bus	06/01→10/05	DW8	Diesel	1868	4	8	3
Pilot Platform/Chassis	04/96→02/02	XUD9	Diesel	1905	4	8	3
Pilot Platform/Chassis	06/01→10/05	DW8	Diesel	1868	4	8	3
Sherpa Box	04/85→03/89	G20A	Petrol	1994	4	8	4
Sherpa Bus (AS)	03/74→12/82	KD18	Diesel	1798	4	8	2
Sherpa Bus (FR)	01/83→09/88	G16A	Petrol	1598	4	8	1
Sherpa Bus (FR)	01/83→09/88	G20A	Petrol	1994	4	8	4
Sherpa Bus (FR)	01/83→09/88	K25D	Diesel	2594	6	12	11
Sherpa Pickup	04/85→03/89	G20A	Petrol	1994	4	8	4
V80 Box	02/13→	SC25R136Q4	Diesel	2499	4	16	8
V80 Bus	01/15→	SC25R136Q4	Diesel	2499	4	16	8
V80 Platform/Chassis	07/15→	SC25R136Q4	Diesel	2499	4	16	8

	CC				9		CC				9
4.98 NV	3771	4	8	Diesel	12						
4EB	2496	4	8	Diesel	7						
4HB	2496	4	8	Diesel	7						
6.98 DV	5655	6	12	Diesel	13						
6.98 NV	5655	6	12	Diesel	13						
B5580VM	2499	4	16	Diesel	8						
B5582VM	2499	4	16	Diesel	8						
D2FA	2402	4	16	Diesel	6						
DW8	1868	4	8	Diesel	3						
EN 55	2498	4	8	Diesel	9						
ET 70	2496	4	8	Diesel	9						
F4FA	2402	4	16	Diesel	6						
G16A	1598	4	8	Petrol	1						
G20A	1994	4	8	Petrol	4						
K25D	2594	6	12	Diesel	11						
KD18	1798	4	8	Diesel	2						
LD23	2283	4	8	Diesel	5						
SC25R136Q4	2499	4	16	Diesel	8						
VM39C	2499	4	16	Diesel	10						
XUD9	1905	4	8	Diesel	3						

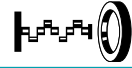

1 1.6L Petrol

G16A	4 Cyl.	8 Valves	1598cc	TD16453
	NJ336 32.00 x 47.00 x 8.00mm, NBR			

2 1.8L Diesel

KD18	4 Cyl.	8 Valves	1798cc	TD16449
HR621  (x2)				NA473  39.70 x 59.00 x 9.50mm, NBR
				NB772  88.90 x 104.80 x 9.52mm, MVQ

3 1.9L Diesel

DW8	4 Cyl.	8 Valves	1868cc	TD33222
XUD9	4 Cyl.	8 Valves	1905cc	TD26905
HR569 	NF841 35.00 x 50.00 x 8.00mm, FPM			NA5191  42.00 x 62.00 x 7.00mm, PTFE
				NA5192  90.00 x 110.00 x 7.00mm, PTFE



4 2.0L Petrol

G20A	4 Cyl.	8 Valves	1994cc	TD16455
HR775  (x2)				NB967  66.00 x 90.00 x 12.00mm, FPM
				NA5181  110.00 x 130.00 x 13.00mm, PTFE



5 2.3L Diesel

LD23	4 Cyl.	8 Valves	2283cc	TD26910
PA933 (x8)				

6 2.4L Diesel

D2FA	4 Cyl.	16 Valves	2402cc	TD26906
F4FA	4 Cyl.	16 Valves	2402cc	TD26909
HR5082 				NA5031  50.00 x 86.50 x 13.70mm, PTFE
				NA5030  106.00 x 190.00 x 15.20mm, PTFE/FPM

7 2.5L Diesel

4EB	4 Cyl.	8 Valves	2496cc	TD26911
4HB	4 Cyl.	8 Valves	2496cc	TD26914
HR5064 	NB856 47.62 x 66.50 x 11.00mm, PTFE			NB855  67.00 x 86.00 x 9.50mm, PTFE
				NB854  79.00 x 99.00 x 9.50mm, PTFE

8 2.5L Diesel

BS580VM	4 Cyl.	16 Valves	2499cc	TD33224
BS582VM	4 Cyl.	16 Valves	2499cc	TD33223
SC25R136Q4	4 Cyl.	16 Valves	2499cc	TD32070
	NA5136 (x2) 30.00 x 47.00 x 7.00mm, FPM			

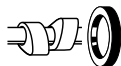

9 2.5L Diesel

EN 55	4 Cyl.	8 Valves	2498cc	TD22927
ET 70	4 Cyl.	8 Valves	2496cc	TD22928
PA229 (x8)	NB856 47.62 x 66.50 x 11.00mm, PTFE		NF780 45.00 x 60.00 x 7.00mm, ACM KS696	

10 2.5L Diesel

VM39C	4 Cyl.	16 Valves	2499cc	TD26107
	NA5136 30.00 x 47.00 x 7.00mm, FPM			

11 2.6L Diesel

K25D	6 Cyl.	12 Valves	2594cc	TD16456
HR775 (x3)			NB967 66.00 x 90.00 x 12.00mm, FPM NA5181 110.00 x 130.00 x 13.00mm, PTFE	

12 3.8L Diesel

4.98 NV	4 Cyl.	8 Valves	3771cc	TD7513
			NA773 55.50 x 73.00 x 12.70mm, NBR NA933 127.00 x 146.10 x 11.10mm, ACM	

13 5.7L Diesel

6.98 DV	6 Cyl.	12 Valves	5655cc	TD7488
6.98 NV	6 Cyl.	12 Valves	5655cc	TD7490
			NA773 55.50 x 73.00 x 12.70mm, NBR NA933 127.00 x 146.10 x 11.10mm, ACM	



















CC



















9









TGE Box (UY_)	02/17→	DAUA	Diesel	1968	4	16	1
TGE Box (UY_)	02/17→	DAUB	Diesel	1968	4	16	1
TGE Box (UY_)	02/17→	DAVA	Diesel	1968	4	16	1
TGE Platform/Chassis (UZ_)	11/16→	DAUA	Diesel	1968	4	16	1
TGE Platform/Chassis (UZ_)	11/16→	DAUB	Diesel	1968	4	16	1
TGE Platform/Chassis (UZ_)	11/16→	DAVA	Diesel	1968	4	16	1









	CC				9		CC				9
D 0224 M	3790	4	8	Diesel	2	D 0826 GFA 02	6871	6	12	Diesel	12
D 0224 ME	3790	4	8	Diesel	2	D 0826 GFA 03	6871	6	12	Diesel	12
D 0224 MF	3790	4	8	Diesel	2	D 0826 GFA 04	6871	6	12	Diesel	12
D 0226 M	5687	6	12	Diesel	9	D 0826 LE 51	6871	6	12	Diesel	12
D 0226 MC	5687	6	12	Diesel	9	D 0826 LE 52	6871	6	12	Diesel	12
D 0226 MCFO/170	5687	6	12	Diesel	9	D 0826 LE 521	6871	6	12	Diesel	12
D 0226 ME	5687	6	12	Diesel	9	D 0826 LE 522	6871	6	12	Diesel	12
D 0226 MF	5687	6	12	Diesel	9	D 0826 LE 523	6871	6	12	Diesel	12
D 0226 MFA	5687	6	12	Diesel	9	D 0826 LE 524	6871	6	12	Diesel	12
D 0226 MFM	5687	6	12	Diesel	9	D 0826 LE 527	6871	6	12	Diesel	12
D 0226 MFO	5687	6	12	Diesel	9	D 0826 LE 530	6871	6	12	Diesel	12
D 0226 MH	5687	6	12	Diesel	9	D 0826 LE 531	6871	6	12	Diesel	12
D 0226 MK	5687	6	12	Diesel	9	D 0826 LF/217/Silent	6870	6	12	Diesel	12
D 0226 MKF	5687	6	12	Diesel	9	D 0826 LF01	6871	6	12	Diesel	12
D 0226 MKF/170	5687	6	12	Diesel	9	D 0826 LF02	6871	6	12	Diesel	12
D 0226 MKFA	5687	6	12	Diesel	9	D 0826 LF04	6871	6	12	Diesel	12
D 0226 MKFO	5687	6	12	Diesel	9	D 0826 LF05	6871	6	12	Diesel	12
D 0226 MKH	5687	6	12	Diesel	9	D 0826 LF06	6871	6	12	Diesel	12
D 0226 ML	5687	6	12	Diesel	9	D 0826 LF07	6871	6	12	Diesel	12
D 0226 MLE	5687	6	12	Diesel	9	D 0826 LF08	6871	6	12	Diesel	12
D 0226 MT	5687	6	12	Diesel	9	D 0826 LF09	6871	6	12	Diesel	12
D 0226 MTE	5687	6	12	Diesel	9	D 0826 LF10	6871	6	12	Diesel	12
D 0824 FL 01	4580	4	8	Diesel	3	D 0826 LF11	6871	6	12	Diesel	12
D 0824 GF	4580	4	8	Diesel	3	D 0826 LF12	6871	6	12	Diesel	12
D 0824 GF01	4580	4	8	Diesel	3	D 0826 LF13	6871	6	12	Diesel	12
D 0824 GF02	4580	4	8	Diesel	3	D 0826 LF15	6871	6	12	Diesel	12
D 0824 GF03	4580	4	8	Diesel	3	D 0826 LF17	6871	6	12	Diesel	12
D 0824 GF04	4580	4	8	Diesel	3	D 0826 LF18	6871	6	12	Diesel	12
D 0824 LF 01	4580	4	8	Diesel	3	D 0826 LFG 01	6871	6	12	Diesel	12
D 0824 LF 02	4580	4	8	Diesel	3	D 0826 LFG 02	6871	6	12	Diesel	12
D 0824 LF 03	4580	4	8	Diesel	3	D 0826 LFG 06	6871	6	12	Diesel	12
D 0824 LF 04	4580	4	8	Diesel	3	D 0826 LFG 15	6871	6	12	Diesel	12
D 0824 LF 05	4580	4	8	Diesel	3	D 0826 LFG 16	6871	6	12	Diesel	12
D 0824 LF 06	4580	4	8	Diesel	3	D 0826 LFL	6871	6	12	Diesel	12
D 0824 LF 07	4580	4	8	Diesel	3	D 0826 LFL01	6871	6	12	Diesel	12
D 0824 LF 08	4580	4	8	Diesel	3	D 0826 LFL02	6871	6	12	Diesel	12
D 0824 LF 09	4580	4	8	Diesel	3	D 0826 LFL03	6871	6	12	Diesel	12
D 0824 LF 10	4580	4	8	Diesel	3	D 0826 LFL05	6871	6	12	Diesel	12
D 0824 LFG 01	4580	4	8	Diesel	3	D 0826 LFL06	6871	6	12	Diesel	12
D 0824 LFL 01	4580	4	8	Diesel	3	D 0826 LFL07	6871	6	12	Diesel	12
D 0824 LFL 02	4580	4	8	Diesel	3	D 0826 LFL08	6871	6	12	Diesel	12
D 0824 LFL 03	4580	4	8	Diesel	3	D 0826 LFL09	6871	6	12	Diesel	12
D 0824 LFL 04	4580	4	8	Diesel	3	D 0826 LFL10	6871	6	12	Diesel	12
D 0824 LFL 05	4580	4	8	Diesel	3	D 0826 LOH 01	6871	6	12	Diesel	12
D 0824 LFL 06	4580	4	8	Diesel	3	D 0826 LOH 02	6871	6	12	Diesel	12
D 0824 LFL 07	4580	4	8	Diesel	3	D 0826 LOH 03	6871	6	12	Diesel	12
D 0824 LFL 08	4580	4	12	Diesel	4	D 0826 LOH 04	6871	6	12	Diesel	12
D 0824 LFL 09	4580	4	8	Diesel	3	D 0826 LOH 05	6871	6	12	Diesel	12
D 0824 LFL 10	4580	4	8	Diesel	3	D 0826 LOH 06	6871	6	12	Diesel	12
D 0824 LFO	4580	4	8	Diesel	3	D 0826 LOH 07	6871	6	12	Diesel	12
D 0824 LFO 01	4580	4	8	Diesel	3	D 0826 LOH 08	6871	6	12	Diesel	12
D 0824 LFO 02	4580	4	8	Diesel	3	D 0826 LOH 09	6871	6	12	Diesel	12
D 0824 LOH 01	4580	4	8	Diesel	3	D 0826 LOH 10	6871	6	12	Diesel	12
D 0824 LOH 02	4580	4	8	Diesel	3	D 0826 LOH 11	6871	6	12	Diesel	12
D 0824 LOH 03	4580	4	8	Diesel	3	D 0826 LOH 12	6871	6	12	Diesel	12
D 0824 LOH 04	4580	4	8	Diesel	3	D 0826 LOH 13	6871	6	12	Diesel	12
D 0824 LOH 05	4580	4	8	Diesel	3	D 0826 LOH 15	6871	6	12	Diesel	12
D 0824 LUE 521	4580	4	8	Diesel	3	D 0826 LOH 17	6871	6	12	Diesel	12
D 0824 LUE 522	4580	4	8	Diesel	3	D 0826 LOH 18	6871	6	12	Diesel	12
D 0824 LUE 523	4580	4	8	Diesel	3	D 0826 LOH 19	6871	6	12	Diesel	12
D 0824 LUE 524	4580	4	8	Diesel	3	D 0826 LUE 51	6870	6	12	Diesel	12
D 0826 F01	6871	6	12	Diesel	12	D 0826 LUH	6870	6	12	Diesel	12
D 0826 F02	6871	6	12	Diesel	12	D 0826 LUH/213	6871	6	12	Diesel	12
D 0826 FG001	6871	6	12	Diesel	12	D 0826 LUH 01	6871	6	12	Diesel	12
D 0826 FG002	6871	6	12	Diesel	12	D 0826 LUH 02	6871	6	12	Diesel	12
D 0826 FO	6871	6	12	Diesel	12	D 0826 LUH 03	6871	6	12	Diesel	12
D 0826 FO 01	6871	6	12	Diesel	12	D 0826 LUH 04	6871	6	12	Diesel	12
D 0826 FO 02	6871	6	12	Diesel	12	D 0826 LUH 05	6871	6	12	Diesel	12
D 0826 FO 03	6871	6	12	Diesel	12	D 0826 LUH 06	6871	6	12	Diesel	12
D 0826 FR	6871	6	12	Diesel	12	D 0826 LUH 08	6871	6	12	Diesel	12
D 0826 FR 01	6871	6	12	Diesel	12	D 0826 LUH 09	6871	6	12	Diesel	12
D 0826 GF	6871	6	12	Diesel	12	D 0826 LUH 10	6871	6	12	Diesel	12
D 0826 GF01	6871	6	12	Diesel	12	D 0826 LUH 11	6871	6	12	Diesel	12
D 0826 GF02	6871	6	12	Diesel	12	D 0826 LUH 12	6870	6	12	Diesel	12
D 0826 GF03	6871	6	12	Diesel	12	D 0826 LUH 13	6871	6	12	Diesel	12
D 0826 GF04	6871	6	12	Diesel	12	D 0826 OH	6871	6	12	Diesel	12
D 0826 GFA	6871	6	12	Diesel	12	D 0826 OH01	6871	6	12	Diesel	12
D 0826 GFA 01	6871	6	12	Diesel	12	D 0826 OH02	6871	6	12	Diesel	12

	CC				9		CC				9
D 0826 OH03	6871	6	12	Diesel	12	D 0836 LFL 06	6871	6	12	Diesel	12
D 0826 TE 520	6596	6	12	Diesel	10	D 0836 LFL 07	6871	6	12	Diesel	12
D 0826 TF	6596	6	12	Diesel	10	D 0836 LFL 08	6871	6	12	Diesel	12
D 0826 TOH	6596	6	12	Diesel	10	D 0836 LFL 10	6871	6	12	Diesel	12
D 0826 TOH 01	6596	6	12	Diesel	10	D 0836 LFL 40	6871	6	24	Diesel	14
D 0826 TUE 51	6871	6	12	Diesel	12	D 0836 LFL 41	6871	6	24	Diesel	14
D 0834 LE 121	4580	4	8	Diesel	6	D 0836 LFL 44	6871	6	24	Diesel	14
D 0834 LE 122	4580	4	8	Diesel	6	D 0836 LFL 50	6871	6	24	Diesel	14
D 0834 LE 123	4580	4	8	Diesel	6	D 0836 LFL 51	6871	6	24	Diesel	14
D 0834 LFL 01	4580	4	8	Diesel	3	D 0836 LFL 52	6871	6	24	Diesel	14
D 0834 LFL 02	4580	4	8	Diesel	3	D 0836 LFL 53	6871	6	24	Diesel	14
D 0834 LFL 03	4580	4	8	Diesel	3	D 0836 LFL 54	6871	6	24	Diesel	14
D 0834 LFL 04	4580	4	8	Diesel	3	D 0836 LFL 55	6871	6	24	Diesel	14
D 0834 LFL 07	4580	4	8	Diesel	3	D 0836 LFL 60	6871	6	24	Diesel	14
D 0834 LFL 10	4580	4	8	Diesel	3	D 0836 LFL 61	6871	6	24	Diesel	14
D 0834 LFL 11	4580	4	8	Diesel	3	D 0836 LFL 62	6871	6	24	Diesel	14
D 0834 LFL 20	4580	4	8	Diesel	3	D 0836 LFL 63	6871	6	24	Diesel	14
D 0834 LFL 40	4580	4	16	Diesel	5	D 0836 LFL 64	6871	6	24	Diesel	14
D 0834 LFL 41	4580	4	16	Diesel	5	D 0836 LFL 65	6871	6	24	Diesel	14
D 0834 LFL 42	4580	4	16	Diesel	5	D 0836 LFL 66	6871	6	24	Diesel	14
D 0834 LFL 50	4580	4	16	Diesel	5	D 0836 LFL 67	6871	6	24	Diesel	14
D 0834 LFL 51	4580	4	16	Diesel	5	D 0836 LFL 68	6871	6	24	Diesel	14
D 0834 LFL 52	4580	4	16	Diesel	5	D 0836 LFL 69	6871	6	24	Diesel	14
D 0834 LFL 53	4580	4	16	Diesel	5	D 0836 LFL 70	6871	6	24	Diesel	14
D 0834 LFL 54	4580	4	16	Diesel	5	D 0836 LFL 71	6871	6	24	Diesel	14
D 0834 LFL 55	4580	4	16	Diesel	5	D 0836 LFL 75	6871	6	24	Diesel	14
D 0834 LFL 57	4580	4	16	Diesel	5	D 0836 LFL 76	6871	6	24	Diesel	14
D 0834 LFL 60	4580	4	16	Diesel	5	D 0836 LFL 77	6871	6	24	Diesel	14
D 0834 LFL 61	4580	4	16	Diesel	5	D 0836 LOH 01	6871	6	12	Diesel	12
D 0834 LFL 62	4580	4	16	Diesel	5	D 0836 LOH 02	6871	6	12	Diesel	12
D 0834 LFL 63	4580	4	16	Diesel	5	D 0836 LOH 03	6871	6	12	Diesel	12
D 0834 LFL 64	4580	4	16	Diesel	5	D 0836 LOH 40	6871	6	24	Diesel	14
D 0834 LFL 65	4580	4	16	Diesel	5	D 0836 LOH 41	6871	6	24	Diesel	14
D 0834 LFL 66	4580	4	16	Diesel	5	D 0836 LOH 51	6871	6	24	Diesel	14
D 0834 LFL 67	4580	4	16	Diesel	5	D 0836 LOH 52	6871	6	24	Diesel	14
D 0834 LFL 68	4580	4	16	Diesel	5	D 0836 LOH 55	6871	6	24	Diesel	14
D 0834 LFL 75	4580	4	16	Diesel	5	D 0836 LOH 56	6871	6	24	Diesel	14
D 0834 LFL 76	4580	4	16	Diesel	5	D 0836 LOH 60	6871	6	24	Diesel	14
D 0834 LOH 01	4580	4	16	Diesel	7	D 0836 LOH 61	6871	6	24	Diesel	14
D 0834 LOH 02	4580	4	16	Diesel	7	D 0836 LOH 62	6871	6	24	Diesel	14
D 0834 LOH 03	4580	4	16	Diesel	7	D 0836 LOH 63	6871	6	24	Diesel	14
D 0834 LOH 40	4580	4	16	Diesel	5	D 0836 LOH 64	6871	6	24	Diesel	14
D 0834 LOH 50	4580	4	16	Diesel	5	D 0836 LOH 65	6871	6	24	Diesel	14
D 0834 LOH 51	4580	4	16	Diesel	5	D 0836 LOH 66	6871	6	24	Diesel	14
D 0834 LOH 52	4580	4	16	Diesel	5	D 0836 LOH 67	6871	6	24	Diesel	14
D 0834 LOH 53	4580	4	16	Diesel	5	D 0836 LOH 69	6871	6	24	Diesel	13
D 0834 LOH 60	4580	4	16	Diesel	5	D 0836 LOH 70	6871	6	24	Diesel	14
D 0834 LOH 61	4580	4	16	Diesel	5	D 0836 LOH 71	6871	6	24	Diesel	14
D 0834 LOH 63	4580	4	16	Diesel	5	D 0836 LOH 72	6871	6	24	Diesel	14
D 0834 LOH 64	4580	4	16	Diesel	5	D 0836 LOH 73	6871	6	24	Diesel	14
D 0836 HM 4	7030	6	12	Diesel	17	D 0836 LOH 74	6871	6	24	Diesel	14
D 0836 HM 7	7030	6	12	Diesel	17	D 0836 LOH 75	6871	6	24	Diesel	14
D 0836 HM 70	7030	6	12	Diesel	17	D 0836 LOH 76	6871	6	24	Diesel	14
D 0836 HM 71	7030	6	12	Diesel	17	D 0836 LOH 77	6871	6	24	Diesel	14
D 0836 HM 7 U	7030	6	12	Diesel	17	D 0836 LUH 01	6871	6	24	Diesel	15
D 0836 HM 9 H	7030	6	12	Diesel	17	D 0836 LUH 02	6871	6	24	Diesel	15
D 0836 HM 9 U	7030	6	12	Diesel	17	D 0836 LUH 40	6871	6	24	Diesel	14
D 0836 HMN 70	7030	6	12	Diesel	17	D 0836 LUH 41	6871	6	24	Diesel	14
D 0836 LE 501	6871	6	12	Diesel	12	D 0836 LUH 50	6871	6	24	Diesel	14
D 0836 LE 502	6871	6	12	Diesel	12	D 0836 LUH 51	6871	6	24	Diesel	14
D 0836 LE 503	6871	6	12	Diesel	12	D 0846 HM 2	7250	6	12	Diesel	18
D 0836 LE 504	6871	6	12	Diesel	12	D 0846 HMN	7252	6	12	Diesel	18
D 0836 LE 510	6871	6	12	Diesel	12	D 2066 LE 621	10518	6	24	Diesel	22
D 0836 LF 01	6871	6	12	Diesel	12	D 2066 LF 01	10518	6	24	Diesel	23
D 0836 LF 02	6871	6	12	Diesel	12	D 2066 LF 02	10518	6	24	Diesel	23
D 0836 LF 03	6871	6	12	Diesel	12	D 2066 LF 03	10518	6	24	Diesel	23
D 0836 LF 04	6871	6	12	Diesel	12	D 2066 LF 04	10518	6	24	Diesel	23
D 0836 LF 05	6871	6	12	Diesel	12	D 2066 LF 06	10518	6	24	Diesel	23
D 0836 LF 06	6871	6	12	Diesel	12	D 2066 LF 07	10518	6	24	Diesel	23
D 0836 LF 10	6871	6	12	Diesel	12	D 2066 LF 11	10518	6	24	Diesel	23
D 0836 LF 41	6871	6	24	Diesel	14	D 2066 LF 12	10518	6	24	Diesel	23
D 0836 LF 44	6871	6	24	Diesel	14	D 2066 LF 13	10518	6	24	Diesel	23
D 0836 LFG 50	6871	6	24	Diesel	14	D 2066 LF 14	10518	6	24	Diesel	23
D 0836 LFL 01	6871	6	12	Diesel	12	D 2066 LF 17	10518	6	24	Diesel	24
D 0836 LFL 02	6871	6	12	Diesel	12	D 2066 LF 18	10518	6	24	Diesel	24
D 0836 LFL 03	6871	6	12	Diesel	12	D 2066 LF 19	10518	6	24	Diesel	24
D 0836 LFL 04	6871	6	12	Diesel	12	D 2066 LF 20	10518	6	24	Diesel	24
D 0836 LFL 05	6871	6	12	Diesel	12	D 2066 LF 21	10518	6	24	Diesel	24

	CC				9		CC				9
D 2066 LF 22	10518	6	24	Diesel	24	D 2066 LOH 36	10518	6	24	Diesel	24
D 2066 LF 23	10518	6	24	Diesel	24	D 2066 LOH 37	10518	6	24	Diesel	24
D 2066 LF 24	10518	6	24	Diesel	24	D 2066 LOH 38	10518	6	24	Diesel	24
D 2066 LF 25	10518	6	24	Diesel	24	D 2066 LOH 39	10518	6	24	Diesel	24
D 2066 LF 26	10518	6	24	Diesel	24	D 2066 LOH 40	10518	6	24	Diesel	24
D 2066 LF 27	10518	6	24	Diesel	24	D 2066 LUH 01	10520	6	24	Diesel	24
D 2066 LF 28	10518	6	24	Diesel	24	D 2066 LUH 02	10520	6	24	Diesel	24
D 2066 LF 29	10518	6	24	Diesel	24	D 2066 LUH 03	10520	6	24	Diesel	24
D 2066 LF 30	10518	6	24	Diesel	24	D 2066 LUH 04	10520	6	24	Diesel	24
D 2066 LF 31	10518	6	24	Diesel	23	D 2066 LUH 05	10520	6	24	Diesel	24
D 2066 LF 32	10518	6	24	Diesel	23	D 2066 LUH 07	10520	6	24	Diesel	24
D 2066 LF 33	10518	6	24	Diesel	23	D 2066 LUH 08	10520	6	24	Diesel	24
D 2066 LF 34	10518	6	24	Diesel	23	D 2066 LUH 09	10520	6	24	Diesel	24
D 2066 LF 35	10518	6	24	Diesel	23	D 2066 LUH 11	10520	6	24	Diesel	24
D 2066 LF 36	10518	6	24	Diesel	23	D 2066 LUH 12	10520	6	24	Diesel	24
D 2066 LF 37	10518	6	24	Diesel	23	D 2066 LUH 13	10520	6	24	Diesel	24
D 2066 LF 38	10518	6	24	Diesel	23	D 2066 LUH 14	10520	6	24	Diesel	24
D 2066 LF 39	10518	6	24	Diesel	23	D 2066 LUH 15	10520	6	24	Diesel	24
D 2066 LF 40	10518	6	24	Diesel	24	D 2066 LUH 21	10518	6	24	Diesel	24
D 2066 LF 41	10518	6	24	Diesel	24	D 2066 LUH 22	10518	6	24	Diesel	24
D 2066 LF 42	10518	6	24	Diesel	24	D 2066 LUH 23	10518	6	24	Diesel	24
D 2066 LF 43	10518	6	24	Diesel	24	D 2066 LUH 24	10518	6	24	Diesel	24
D 2066 LF 44	10518	6	24	Diesel	24	D 2066 LUH 32	10518	6	24	Diesel	24
D 2066 LF 45	10518	6	24	Diesel	24	D 2066 LUH 33	10518	6	24	Diesel	24
D 2066 LF 46	10518	6	24	Diesel	24	D 2066 LUH 34	10518	6	24	Diesel	24
D 2066 LF 47	10518	6	24	Diesel	24	D 2066 LUH 41	10518	6	24	Diesel	24
D 2066 LF 48	10518	6	24	Diesel	24	D 2066 LUH 42	10518	6	24	Diesel	24
D 2066 LF 49	10518	6	24	Diesel	24	D 2066 LUH 43	10518	6	24	Diesel	24
D 2066 LF 50	10518	6	24	Diesel	24	D 2066 LUH 46	10518	6	24	Diesel	24
D 2066 LF 51	10518	6	24	Diesel	24	D 2066 LUH 47	10518	6	24	Diesel	24
D 2066 LF 52	10518	6	24	Diesel	24	D 2066 LUH 48	10518	6	24	Diesel	24
D 2066 LF 53	10518	6	24	Diesel	24	D 2066 LUH 50	10518	6	24	Diesel	24
D 2066 LF 54	10518	6	24	Diesel	24	D 2066 LUH 51	10518	6	24	Diesel	24
D 2066 LF 55	10518	6	24	Diesel	24	D 2066 LUH 52	10518	6	24	Diesel	24
D 2066 LF 56	10518	6	24	Diesel	24	D 2066 LUH 53	10518	6	24	Diesel	24
D 2066 LF 57	10518	6	24	Diesel	24	D 2066 LUH 55	10518	6	24	Diesel	24
D 2066 LF 58	10518	6	24	Diesel	24	D 2066 LUH 56	10518	6	24	Diesel	24
D 2066 LF 59	10518	6	24	Diesel	24	D 2530 ME	15945	10	20	Diesel	42
D 2066 LF 60	10518	6	24	Diesel	24	D 2530 MF	15945	10	20	Diesel	42
D 2066 LF 61	10518	6	24	Diesel	24	D 2530 MTE	15953	10	20	Diesel	42
D 2066 LF 62	10518	6	24	Diesel	24	D 2530 MTXF	15953	10	20	Diesel	42
D 2066 LF 63	10518	6	24	Diesel	24	D 2530 MTXF/360	15900	10	20	Diesel	42
D 2066 LF 64	10518	6	24	Diesel	24	D 2530 MXF	15945	10	20	Diesel	42
D 2066 LF 65	10518	6	24	Diesel	24	D 2538 M	12763	8	16	Diesel	35
D 2066 LF 67	10518	6	24	Diesel	24	D 2538 ME	12763	8	16	Diesel	35
D 2066 LF 68	10518	6	24	Diesel	24	D 2538 MF	12763	8	16	Diesel	35
D 2066 LF 69	10518	6	24	Diesel	24	D 2538 MT	12763	8	16	Diesel	35
D 2066 LF 70	10518	6	24	Diesel	24	D 2538 MTE	12763	8	16	Diesel	35
D 2066 LF 71	10518	6	24	Diesel	24	D 2540 MT	17426	10	20	Diesel	44
D 2066 LF 72	10518	6	24	Diesel	24	D 2540 MTF	17426	10	20	Diesel	44
D 2066 LF 76	10518	6	24	Diesel	24	D 2540 MTF/390	17426	10	20	Diesel	44
D 2066 LF 77	10518	6	24	Diesel	24	D 2542 MLE	20911	12	24	Diesel	47
D 2066 LF 78	10518	6	24	Diesel	24	D 2542 MTE	20911	12	24	Diesel	47
D 2066 LF 80	10518	6	24	Diesel	24	D 2555 M	9200	5	10	Diesel	19
D 2066 LF 81	10518	6	24	Diesel	24	D 2555 MF	9200	5	10	Diesel	19
D 2066 LF 83	10518	6	24	Diesel	24	D 2555 MX	9200	5	10	Diesel	19
D 2066 LF 84	10518	6	24	Diesel	24	D 2555 MXF	9200	5	10	Diesel	19
D 2066 LOH 01	10520	6	24	Diesel	23	D 2555 MXUL	9200	5	10	Diesel	19
D 2066 LOH 02	10518	6	24	Diesel	23	D 2556 M	11045	6	12	Diesel	25
D 2066 LOH 03	10518	6	24	Diesel	23	D 2556 MF	11045	6	12	Diesel	25
D 2066 LOH 04	10518	6	24	Diesel	23	D 2556 MTE	11045	6	12	Diesel	25
D 2066 LOH 05	10518	6	24	Diesel	23	D 2556 MX	11045	6	12	Diesel	25
D 2066 LOH 06	10518	6	24	Diesel	23	D 2556 MXF	11045	6	12	Diesel	25
D 2066 LOH 07	10518	6	24	Diesel	23	D 2556 MXUH/175	11045	6	12	Diesel	25
D 2066 LOH 08	10518	6	24	Diesel	23	D 2556 MXUH/192	11045	6	12	Diesel	25
D 2066 LOH 10	10518	6	24	Diesel	23	D 2556 MXUH/240	11045	6	12	Diesel	25
D 2066 LOH 11	10518	6	24	Diesel	23	D 2556 MXUM	11045	6	12	Diesel	25
D 2066 LOH 12	10518	6	24	Diesel	23	D 2565 HM	9510	5	10	Diesel	20
D 2066 LOH 13	10518	6	24	Diesel	24	D 2565 M	9510	5	10	Diesel	20
D 2066 LOH 26	10518	6	24	Diesel	24	D 2565 M/168	9510	5	10	Diesel	20
D 2066 LOH 27	10518	6	24	Diesel	24	D 2565 ME	9510	5	10	Diesel	20
D 2066 LOH 28	10518	6	24	Diesel	24	D 2565 MF	9510	5	10	Diesel	20
D 2066 LOH 30	10518	6	24	Diesel	24	D 2565 MF/168	9510	5	10	Diesel	20
D 2066 LOH 31	10518	6	24	Diesel	24	D 2565 MFR	9510	5	10	Diesel	20
D 2066 LOH 32	10518	6	24	Diesel	24	D 2565 MH	9510	5	10	Diesel	20
D 2066 LOH 33	10518	6	24	Diesel	24	D 2565 MK	9510	5	10	Diesel	20
D 2066 LOH 34	10518	6	24	Diesel	24	D 2565 MKUL	9510	5	10	Diesel	20
D 2066 LOH 35	10518	6	24	Diesel	24	D 2565 MR	9510	5	10	Diesel	20

	CC				9		CC				9
D 2565 MSFV	9510	5	10	Diesel	20	D 2676 LF 35	12419	6	24	Diesel	33
D 2565 MT	9510	5	10	Diesel	20	D 2676 LF 36	12419	6	24	Diesel	33
D 2565 MUE	9510	5	10	Diesel	20	D 2676 LF 45	12419	6	24	Diesel	33
D 2565 MUH	9510	5	10	Diesel	20	D 2676 LF 46	12419	6	24	Diesel	33
D 2565 MUL	9510	5	10	Diesel	20	D 2676 LF 47	12419	6	24	Diesel	33
D 2566	11413	6	12	Diesel	26	D 2676 LF 48	12419	6	24	Diesel	33
D 2566 M	11413	6	12	Diesel	26	D 2676 LF 49	12419	6	24	Diesel	33
D 2566 ME	11413	6	12	Diesel	26	D 2676 LF 50	12419	6	24	Diesel	33
D 2566 MF	11413	6	12	Diesel	26	D 2676 LF 54	12419	6	24	Diesel	33
D 2566 MF/220	11413	6	12	Diesel	26	D 2676 LF 55	12419	6	24	Diesel	33
D 2566 MFO	11413	6	12	Diesel	26	D 2676 LF 56	12419	6	24	Diesel	33
D 2566 MH	11413	6	12	Diesel	26	D 2676 LF 57	12419	6	24	Diesel	33
D 2566 MHO	11413	6	12	Diesel	26	D 2676 LF 58	12419	6	24	Diesel	33
D 2566 MK	11413	6	12	Diesel	26	D 2676 LOH 01	12419	6	24	Diesel	33
D 2566 MK/280	11413	6	12	Diesel	26	D 2676 LOH 02	12419	6	24	Diesel	33
D 2566 MKF	11413	6	12	Diesel	26	D 2676 LOH 03	12419	6	24	Diesel	33
D 2566 MKF/280	11413	6	12	Diesel	26	D 2676 LOH 04	12419	6	24	Diesel	33
D 2566 MKUH/320	11413	6	12	Diesel	26	D 2676 LOH 10	12419	6	24	Diesel	33
D 2566 MKUL	11413	6	12	Diesel	26	D 2676 LOH 18	12419	6	24	Diesel	33
D 2566 MLUH	11413	6	12	Diesel	26	D 2676 LOH 26	12419	6	24	Diesel	33
D 2566 MLUM	11413	6	12	Diesel	26	D 2676 LOH 27	12419	6	24	Diesel	33
D 2566 MLUM/US	11413	6	12	Diesel	26	D 2676 LOH 28	12419	6	24	Diesel	33
D 2566 MSFV	11413	6	12	Diesel	26	D 2676 LOH 30	12419	6	24	Diesel	33
D 2566 MT	11413	6	12	Diesel	26	D 2676 LOH 31	12419	6	24	Diesel	33
D 2566 MTE	11413	6	12	Diesel	26	D 2676 LOH 32	12419	6	24	Diesel	33
D 2566 MTF	11413	6	12	Diesel	26	D 2676 LOH 33	12419	6	24	Diesel	33
D 2566 MTFG	11413	6	12	Diesel	26	D 2676 LOH 34	12419	6	24	Diesel	33
D 2566 MTH	11413	6	12	Diesel	26	D 2840 LE	18273	10	20	Diesel	45
D 2566 MTHO	11413	6	12	Diesel	26	D 2840 LE 403	18273	10	20	Diesel	45
D 2566 MTSF	11413	6	12	Diesel	26	D 2840 LE 423	18270	10	40	Diesel	45
D 2566 MTUH	11413	6	12	Diesel	26	D 2840 LFO1	18273	10	20	Diesel	45
D 2566 MUE	11413	6	12	Diesel	26	D 2840 LFO3	18273	10	20	Diesel	45
D 2566 MUH	11413	6	12	Diesel	26	D 2840 LFO4	18273	10	20	Diesel	45
D 2566 MUH/175	11413	6	12	Diesel	26	D 2840 LFO6	18273	10	20	Diesel	45
D 2566 MUH/192	11413	6	12	Diesel	26	D 2840 LF20	18273	10	20	Diesel	45
D 2566 MUH/200	11413	6	12	Diesel	26	D 2840 LF21	18273	10	20	Diesel	45
D 2566 MUH/220	11413	6	12	Diesel	26	D 2840 LF25	18273	10	40	Diesel	45
D 2566 MUH/240	11413	6	12	Diesel	26	D 2840 LF 460	18273	10	20	Diesel	45
D 2566 MUL	11413	6	12	Diesel	26	D 2840 LXE	18273	10	20	Diesel	46
D 2566 MUM	11413	6	12	Diesel	26	D 2840 LXF	18273	10	20	Diesel	46
D 2566 MUM/200	11413	6	12	Diesel	26	D 2840 LYE	18273	10	20	Diesel	46
D 2566 MUM/220	11413	6	12	Diesel	26	D 2840 ME	18273	10	20	Diesel	46
D 2566 MUM/240	11413	6	12	Diesel	26	D 2840 MF	18273	10	20	Diesel	46
D 2566 MXF	11413	6	12	Diesel	26	D 2840 MFG	18273	10	20	Diesel	46
D 2566 UH	11413	6	12	Diesel	26	D 2840 MFR	18273	10	20	Diesel	46
D 2566 UH/205	11413	6	12	Diesel	26	D 2840 MH	18273	10	20	Diesel	46
D 2676 LE 621	12412	6	24	Diesel	34	D 2842 LE 202	21930	12	24	Diesel	48
D 2676 LE 622	12412	6	24	Diesel	34	D 2842 LE 211	21930	12	24	Diesel	48
D 2676 LF 01	12419	6	24	Diesel	33	D 2842 LE 401	21930	12	24	Diesel	48
D 2676 LF 02	12419	6	24	Diesel	33	D 2842 LE 402	21930	12	24	Diesel	48
D 2676 LF 03	12419	6	24	Diesel	33	D 2842 LE 403	21930	12	24	Diesel	48
D 2676 LF 04	12419	6	24	Diesel	33	D 2842 LE 404	21930	12	24	Diesel	48
D 2676 LF 05	12419	6	24	Diesel	33	D 2842 LE 405	21930	12	24	Diesel	48
D 2676 LF 06	12419	6	24	Diesel	33	D 2842 LE 406	21930	12	24	Diesel	48
D 2676 LF 07	12419	6	24	Diesel	33	D 2842 LE 407	21930	12	24	Diesel	48
D 2676 LF 08	12419	6	24	Diesel	33	D 2842 LE 408	21930	12	24	Diesel	48
D 2676 LF 09	12419	6	24	Diesel	33	D 2842 LE 409	21930	12	24	Diesel	48
D 2676 LF 10	12419	6	24	Diesel	33	D 2842 LE 410	21930	12	24	Diesel	48
D 2676 LF 11	12419	6	24	Diesel	33	D 2842 LE 412	21930	12	24	Diesel	48
D 2676 LF 12	12419	6	24	Diesel	33	D 2842 LE 413	21930	12	24	Diesel	48
D 2676 LF 13	12419	6	24	Diesel	33	D 2842 LE 419	21930	12	24	Diesel	48
D 2676 LF 14	12419	6	24	Diesel	33	D 2842 LE 423	21930	12	24	Diesel	48
D 2676 LF 15	12419	6	24	Diesel	33	D 2842 LE 433	21930	12	24	Diesel	48
D 2676 LF 16	12419	6	24	Diesel	33	D 2842 LE 443	21930	12	24	Diesel	48
D 2676 LF 17	12419	6	24	Diesel	33	D 2842 LE 602	21930	12	24	Diesel	48
D 2676 LF 18	12419	6	24	Diesel	33	D 2842 LE 604	21930	12	24	Diesel	48
D 2676 LF 19	12419	6	24	Diesel	33	D 2842 LE 606	21930	12	24	Diesel	48
D 2676 LF 20	12419	6	24	Diesel	33	D 2842 LE 607	21930	12	24	Diesel	48
D 2676 LF 21	12419	6	24	Diesel	33	D 2842 LE 620	21927	12	24	Diesel	48
D 2676 LF 22	12419	6	24	Diesel	33	D 2842 LE 622	21927	12	24	Diesel	48
D 2676 LF 23	12419	6	24	Diesel	33	D 2842 LF10	21927	12	24	Diesel	48
D 2676 LF 24	12419	6	24	Diesel	33	D 2842 LXE	21927	12	24	Diesel	48
D 2676 LF 25	12419	6	24	Diesel	33	D 2842 LYE	21927	12	24	Diesel	48
D 2676 LF 26	12419	6	24	Diesel	33	D 2842 LZE	21927	12	24	Diesel	48
D 2676 LF 28	12419	6	24	Diesel	33	D 2842 ME	21927	12	24	Diesel	48
D 2676 LF 31	12419	6	24	Diesel	33	D 2848 LE 422	14618	8	32	Diesel	39
D 2676 LF 32	12419	6	24	Diesel	33	D 2848 LE 423	14618	8	16	Diesel	39
D 2676 LF 33	12419	6	24	Diesel	33	D 2848 LXE	14618	8	16	Diesel	40

	CC				9		CC				9
D 2848 LYE	14618	8	16	Diesel	40	D 2866 LF23	11967	6	12	Diesel	27
D 2848 M	14618	8	16	Diesel	40	D 2866 LF24	11967	6	12	Diesel	27
D 2848 MH	14618	8	16	Diesel	40	D 2866 LF25	11967	6	24	Diesel	28
D 2862 LE 421	24243	12	48	Diesel	50	D 2866 LF26	11967	6	24	Diesel	28
D 2862 LE 422	24243	12	48	Diesel	50	D 2866 LF27	11967	6	24	Diesel	28
D 2862 LE 431	24243	12	48	Diesel	50	D 2866 LF28	11967	6	24	Diesel	28
D 2862 LE 432	24243	12	48	Diesel	50	D 2866 LF29	11967	6	12	Diesel	27
D 2862 LE 463	24243	12	48	Diesel	50	D 2866 LF30	11967	6	24	Diesel	28
D 2862 LE 631	24243	12	48	Diesel	50	D 2866 LF31	11967	6	24	Diesel	28
D 2862 LE 632	24243	12	48	Diesel	50	D 2866 LF32	11967	6	24	Diesel	28
D 2862 LE 633	24243	12	48	Diesel	50	D 2866 LF34	11967	6	12	Diesel	27
D 2865 LF/260	9973	5	10	Diesel	21	D 2866 LF35	11967	6	12	Diesel	27
D 2865 LF01	9973	5	10	Diesel	21	D 2866 LF36	11967	6	24	Diesel	28
D 2865 LF02	9973	5	10	Diesel	21	D 2866 LF37	11967	6	24	Diesel	28
D 2865 LF03	9973	5	10	Diesel	21	D 2866 LF39	11967	6	24	Diesel	28
D 2865 LF05	9973	5	10	Diesel	21	D 2866 LF40	11967	6	24	Diesel	28
D 2865 LF06	9973	5	10	Diesel	21	D 2866 LF41	11967	6	24	Diesel	28
D 2865 LF09	9973	5	10	Diesel	21	D 2866 LF43	11967	6	24	Diesel	28
D 2865 LF10	9973	5	10	Diesel	21	D 2866 LFG	11967	6	12	Diesel	27
D 2865 LF20	9973	5	10	Diesel	21	D 2866 LFG 03	11967	6	12	Diesel	27
D 2865 LF21	9973	5	10	Diesel	21	D 2866 LFG 04	11967	6	12	Diesel	27
D 2865 LF22	9973	5	10	Diesel	21	D 2866 LFG 05	11967	6	12	Diesel	27
D 2865 LF23	9973	5	10	Diesel	21	D 2866 LFG 06	11967	6	12	Diesel	29
D 2865 LF24	9973	5	10	Diesel	21	D 2866 LFG 07	11967	6	12	Diesel	30
D 2865 LFR	9973	5	10	Diesel	21	D 2866 LFZ/290	11967	6	12	Diesel	27
D 2865 LFR 01	9973	5	10	Diesel	21	D 2866 LFZ/330	11967	6	12	Diesel	27
D 2865 LOH 01	9973	5	10	Diesel	21	D 2866 LH 01	11967	6	12	Diesel	29
D 2865 LOH 02	9973	5	10	Diesel	21	D 2866 LOH	11967	6	12	Diesel	27
D 2865 LOH 05	9973	5	10	Diesel	21	D 2866 LOH 02	11967	6	12	Diesel	27
D 2865 LOH 06	9973	5	10	Diesel	21	D 2866 LOH 03	11967	6	12	Diesel	27
D 2865 LOH 07	9973	5	10	Diesel	21	D 2866 LOH 06	11967	6	24	Diesel	28
D 2865 LOH 08	9973	5	10	Diesel	21	D 2866 LOH 07	11967	6	12	Diesel	27
D 2865 LOH 09	9973	5	10	Diesel	21	D 2866 LOH 09	11967	6	12	Diesel	27
D 2865 LOH 10	9973	5	10	Diesel	21	D 2866 LOH 20	11967	6	12	Diesel	27
D 2865 LU 01	9973	5	10	Diesel	21	D 2866 LOH 21	11967	6	12	Diesel	27
D 2865 LU 02	9973	5	10	Diesel	21	D 2866 LOH 22	11967	6	12	Diesel	27
D 2865 LU 03	9973	5	10	Diesel	21	D 2866 LOH 23	11967	6	12	Diesel	27
D 2865 LU 04	9973	5	10	Diesel	21	D 2866 LOH 24	11970	6	12	Diesel	27
D 2865 LU 05	9973	5	10	Diesel	21	D 2866 LOH 25	11967	6	12	Diesel	27
D 2865 LU 06	9973	5	10	Diesel	21	D 2866 LOH 26	11967	6	12	Diesel	27
D 2865 LUH 02	9973	5	10	Diesel	21	D 2866 LOH 27	11967	6	24	Diesel	28
D 2865 LUH 03	9973	5	10	Diesel	21	D 2866 LOH 28	11967	6	24	Diesel	28
D 2865 LUH 05	9973	5	10	Diesel	21	D 2866 LOH 29	11967	6	24	Diesel	28
D 2865 LUH 06	9973	5	10	Diesel	21	D 2866 LOH 31	11967	6	12	Diesel	27
D 2865 LUH 07	9973	5	10	Diesel	21	D 2866 LOH 32	11967	6	24	Diesel	28
D 2865 LUH 08	9973	5	10	Diesel	21	D 2866 LOH 33	11967	6	24	Diesel	28
D 2865 LUH 09	9973	5	10	Diesel	21	D 2866 LOH 34	11967	6	24	Diesel	28
D 2865 LXF	9973	5	10	Diesel	21	D 2866 LOH 35	11967	6	24	Diesel	28
D 2865 LXFR	9973	5	10	Diesel	21	D 2866 LOH 36	11967	6	24	Diesel	28
D 2866 F/240	11967	6	12	Diesel	27	D 2866 LU	11967	6	12	Diesel	27
D 2866 FG	11967	6	12	Diesel	27	D 2866 LU/330	11967	6	12	Diesel	27
D 2866 FR	11967	6	12	Diesel	27	D 2866 LU 01	11967	6	12	Diesel	27
D 2866 KF	11967	6	12	Diesel	27	D 2866 LU 02	11967	6	12	Diesel	27
D 2866 KFZ	11967	6	12	Diesel	27	D 2866 LU 03	11967	6	12	Diesel	27
D 2866 KOH/360	11967	6	12	Diesel	27	D 2866 LU 04	11967	6	12	Diesel	27
D 2866 KOH/373	11967	6	12	Diesel	27	D 2866 LU 07	11967	6	12	Diesel	27
D 2866 KUH/360	11967	6	12	Diesel	27	D 2866 LU 08	11967	6	12	Diesel	27
D 2866 KUL	11967	6	12	Diesel	27	D 2866 LUH	11967	6	12	Diesel	27
D 2866 LF	11967	6	12	Diesel	27	D 2866 LUH/330	11967	6	24	Diesel	28
D 2866 LF/290	11967	6	12	Diesel	27	D 2866 LUH 04	11967	6	12	Diesel	27
D 2866 LF/330	11967	6	12	Diesel	27	D 2866 LUH 05	11967	6	12	Diesel	27
D 2866 LF01	11967	6	12	Diesel	27	D 2866 LUH 20	11967	6	12	Diesel	27
D 2866 LF02	11967	6	12	Diesel	27	D 2866 LUH 21	11967	6	12	Diesel	27
D 2866 LF03	11967	6	12	Diesel	27	D 2866 LUH 22	11967	6	12	Diesel	27
D 2866 LF04	11967	6	12	Diesel	27	D 2866 LUH 23	11967	6	24	Diesel	28
D 2866 LF05	11967	6	12	Diesel	27	D 2866 LUH 24	11967	6	24	Diesel	28
D 2866 LF06	11967	6	12	Diesel	27	D 2866 LUH 25	11967	6	24	Diesel	28
D 2866 LF07	11967	6	12	Diesel	27	D 2866 LUH 26	11967	6	12	Diesel	27
D 2866 LF08	11967	6	12	Diesel	27	D 2866 LUH 27	11967	6	24	Diesel	28
D 2866 LF09	11967	6	12	Diesel	27	D 2866 LUH 28	11967	6	24	Diesel	28
D 2866 LF10	11967	6	12	Diesel	27	D 2866 LUH 29	11967	6	24	Diesel	28
D 2866 LF14	11967	6	12	Diesel	27	D 2866 LUH 30	11967	6	24	Diesel	28
D 2866 LF15	11967	6	12	Diesel	27	D 2866 LUH 34	11967	6	24	Diesel	28
D 2866 LF16	11967	6	12	Diesel	27	D 2866 LUH 35	11967	6	24	Diesel	28
D 2866 LF17	11967	6	12	Diesel	27	D 2866 LUH 36	11967	6	24	Diesel	28
D 2866 LF20	11967	6	12	Diesel	27	D 2866 LUH 37	11967	6	24	Diesel	28
D 2866 LF21	11967	6	12	Diesel	27	D 2866 LUH 50	11967	6	24	Diesel	28
D 2866 LF22	11967	6	12	Diesel	27	D 2866 LUH 51	11967	6	24	Diesel	28

	CC				9		CC				9
D 2866 LUH 52	11967	6	24	Diesel	28	DAUB	1968	4	16	Diesel	1
D 2866 LUL/330	11967	6	12	Diesel	27	DAVA	1968	4	16	Diesel	1
D 2866 LX	11967	6	12	Diesel	27	E 0824 E 301	4580	4	8	Gas	8
D 2866 LXE 40	11967	6	12	Diesel	27	E 0826 E 301	6596	6	12	Gas	11
D 2866 LXE 47	11967	6	12	Diesel	27	E 0834 E 302	4580	4	8	Gas	8
D 2866 LXF	11967	6	12	Diesel	27	E 0834 E 312	4580	4	8	Gas	8
D 2866 LXFG	11967	6	12	Diesel	27	E 0834 LE 302	4580	4	8	Gas	8
D 2866 LXOH	11967	6	12	Diesel	27	E 0836 E 302	6871	6	12	Gas	16
D 2866 LXU	11967	6	12	Diesel	27	E 0836 E 312	6871	6	12	Gas	16
D 2866 LXUH	11967	6	12	Diesel	27	E 0836 LE 202	6871	6	12	Gas	16
D 2866 OH	11967	6	12	Diesel	27	E 0836 LE 302	6871	6	12	Gas	16
D 2866 T	11967	6	12	Diesel	27	E 0836 LOH 01	6871	6	12	Gas	16
D 2866 TOH	11967	6	12	Diesel	27	E 0836 LOH 02	6871	6	12	Gas	16
D 2866 TOH/290	11967	6	12	Diesel	27	E 0836 LOH 03	6871	6	12	Gas	16
D 2866 TOH/310	11967	6	12	Diesel	27	E 0836 LOH 04	6871	6	12	Gas	16
D 2866 TUH	11967	6	12	Diesel	27	E 0836 LOH 05	6871	6	12	Gas	16
D 2866 TUH/290	11967	6	12	Diesel	27	E 0836 LOH 06	6871	6	12	Gas	16
D 2866 TUH 01	11967	6	12	Diesel	27	E 2842 E 312	21927	12	24	Gas	49
D 2866 U	11967	6	12	Diesel	29	E 2842 LE 312	21927	12	24	Gas	49
D 2866 UH	11967	6	12	Diesel	27	E 2842 LE 322	21927	12	24	Gas	49
D 2866 UH/240	11967	6	12	Diesel	27	E 2842 LE 332	21927	12	24	Gas	49
D 2866 UM	11967	6	12	Diesel	27	E 2848 LE 322	14618	8	16	Gas	41
D 2868 LE 421	16200	8	32	Diesel	43	E 2866	11967	6	12	Gas	31
D 2868 LE 422	16200	8	32	Diesel	43	E 2866 DE	11967	6	12	Gas	31
D 2868 LF02	16200	8	32	Diesel	43	E 2866 DF 01	11967	6	12	Gas	31
D 2868 LF03	16200	8	32	Diesel	43	E 2866 DF 02	11967	6	12	Gas	31
D 2868 LF04	16200	8	32	Diesel	43	E 2866 DF 03	11967	6	12	Gas	31
D 2868 LF05	16200	8	32	Diesel	43	E 2866 DF 04	11967	6	12	Gas	31
D 2868 LF06	16200	8	32	Diesel	43	E 2866 DOH 01	11967	6	12	Gas	31
D 2868 LF07	16200	8	32	Diesel	43	E 2866 DOH 02	11967	6	12	Gas	31
D 2876 LE 121	12816	6	24	Diesel	36	E 2866 DOH 03	11967	6	12	Gas	31
D 2876 LE 122	12816	6	24	Diesel	36	E 2866 DOH 04	11967	6	12	Gas	31
D 2876 LE 123	12816	6	24	Diesel	36	E 2866 DUH	11970	6	12	Gas	31
D 2876 LE 124	12816	6	24	Diesel	36	E 2866 DUH 01	11967	6	12	Gas	31
D 2876 LE 402	12816	6	24	Diesel	36	E 2866 DUH 02	11967	6	12	Gas	31
D 2876 LE 403	12816	6	12	Diesel	36	E 2866 DUH 03	11967	6	12	Gas	31
D 2876 LE 406	12816	6	12	Diesel	36	E 2866 DUH 04	11967	6	12	Gas	31
D 2876 LE 407	12816	6	12	Diesel	36	E 2866 LUH 01	11967	6	12	Gas	31
D 2876 LF 01	12816	6	24	Diesel	36	E 2866 LUH 02	11967	6	12	Gas	31
D 2876 LF 02	12816	6	12	Diesel	37	E 2876 E 312	12816	6	12	Gas	38
D 2876 LF 03	12816	6	24	Diesel	36	E 2876 LE 202	12816	6	12	Gas	38
D 2876 LF 04	12816	6	24	Diesel	36	E 2876 LE 302	12816	6	12	Gas	38
D 2876 LF 05	12816	6	24	Diesel	36	E 2876 LUH 01	12816	6	12	Gas	38
D 2876 LF 06	12816	6	24	Diesel	36	E 2876 LUH 02	12816	6	12	Gas	38
D 2876 LF 07	12816	6	24	Diesel	36	E 2876 LUH 03	12816	6	12	Gas	38
D 2876 LF 10	12816	6	24	Diesel	36	E 2876 LUH 04	12816	6	12	Gas	38
D 2876 LF 11	12816	6	24	Diesel	36	E 2876 LUH 07	12816	6	12	Gas	38
D 2876 LF 12	12816	6	24	Diesel	36	E 2876 LUH 08	12816	6	12	Gas	38
D 2876 LF 13	12816	6	24	Diesel	36	E 2876 TE 302	12816	6	12	Gas	38
D 2876 LF 17	12816	6	24	Diesel	36	E 3262 LE 202	25782	12	48	Gas	51
D 2876 LF 18	12816	6	24	Diesel	36	G 2866 DOH 02	11967	6	12	Gas	32
D 2876 LF 19	12816	6	24	Diesel	36	G 2866 DOH 03	11967	6	12	Gas	32
D 2876 LF 20	12816	6	24	Diesel	36	G 2866 DUH 01	11967	6	12	Gas	32
D 2876 LF 23	12816	6	24	Diesel	36	G 2866 DUH 02	11967	6	12	Gas	32
D 2876 LF 25	12816	6	24	Diesel	36	G 2866 DUH 03	11967	6	12	Gas	32
D 2876 LFG 01	12816	6	24	Diesel	36	G 2866 DUH 04	11967	6	12	Gas	32
D 2876 LOH 01	12816	6	12	Diesel	37	G 2866 DUH 05	11967	6	12	Gas	32
D 2876 LOH 02	12816	6	12	Diesel	37	G 2876 DUH 01	12816	6	12	Gas	38
D 2876 LOH 03	12816	6	24	Diesel	36	G 2876 DUH 02	12816	6	12	Gas	38
D 2876 LOH 20	12816	6	24	Diesel	36						
D 2876 LOH 21	12816	6	24	Diesel	36						
D 2876 LUE 604	12816	6	24	Diesel	36						
D 2876 LUE 605	12816	6	24	Diesel	36						
D 2876 LUE 606	12816	6	24	Diesel	36						
D 2876 LUE 621	12816	6	24	Diesel	36						
D 2876 LUE 622	12816	6	24	Diesel	36						
D 2876 LUE 623	12816	6	24	Diesel	36						
D 2876 LUE 631	12816	6	24	Diesel	36						
D 2876 LUE 632	12816	6	24	Diesel	36						
D 2876 LUE 633	12816	6	24	Diesel	36						
D 2876 LUH 01	12816	6	12	Diesel	37						
D 2876 LUH 02	12816	6	12	Diesel	37						
D 0834 190	4580	4	16	Diesel	5						
D 0834 230	4580	4	16	Diesel	5						
D 0836 260	6871	6	24	Diesel	13						
D 0836 280	6871	6	24	Diesel	13						
D 2676 440	12419	6	24	Diesel	33						
DAUA	1968	4	16	Diesel	1						

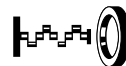
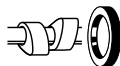

1 2.0L Diesel

DAUA	4 Cyl.	16 Valves	1968cc	TD34497
DAUB	4 Cyl.	16 Valves	1968cc	TD34496
DAVA	4 Cyl.	16 Valves	1968cc	TD34499

LK5017 R
85.00 x 130.90 x 15.75mm, PTFE

2 3.8L Diesel

D 0224 M	4 Cyl.	8 Valves	3790cc	TD19431
D 0224 ME	4 Cyl.	8 Valves	3790cc	TD19432
D 0224 MF	4 Cyl.	8 Valves	3790cc	TD7637

NA5181 R
110.00 x 130.00 x 13.00mm, PTFE

3 4.6L Diesel

D 0824 FL 01	4 Cyl.	8 Valves	4580cc	TD7655
D 0824 GF	4 Cyl.	8 Valves	4580cc	TD5648
D 0824 GF01	4 Cyl.	8 Valves	4580cc	TD5988
D 0824 GF02	4 Cyl.	8 Valves	4580cc	TD7639
D 0824 GF03	4 Cyl.	8 Valves	4580cc	TD21287
D 0824 GF04	4 Cyl.	8 Valves	4580cc	TD23126
D 0824 LF 01	4 Cyl.	8 Valves	4580cc	TD7680
D 0824 LF 02	4 Cyl.	8 Valves	4580cc	TD7683
D 0824 LF 03	4 Cyl.	8 Valves	4580cc	TD21278
D 0824 LF 04	4 Cyl.	8 Valves	4580cc	TD21279
D 0824 LF 05	4 Cyl.	8 Valves	4580cc	TD21280
D 0824 LF 06	4 Cyl.	8 Valves	4580cc	TD21281
D 0824 LF 07	4 Cyl.	8 Valves	4580cc	TD21282
D 0824 LF 08	4 Cyl.	8 Valves	4580cc	TD21283
D 0824 LF 09	4 Cyl.	8 Valves	4580cc	TD21284
D 0824 LF 10	4 Cyl.	8 Valves	4580cc	TD21285
D 0824 LFG 01	4 Cyl.	8 Valves	4580cc	TD23127
D 0824 LFL 01	4 Cyl.	8 Valves	4580cc	TD7658
D 0824 LFL 02	4 Cyl.	8 Valves	4580cc	TD7660
D 0824 LFL 03	4 Cyl.	8 Valves	4580cc	TD23128
D 0824 LFL 04	4 Cyl.	8 Valves	4580cc	TD7656
D 0824 LFL 05	4 Cyl.	8 Valves	4580cc	TD7659
D 0824 LFL 06	4 Cyl.	8 Valves	4580cc	TD7661
D 0824 LFL 07	4 Cyl.	8 Valves	4580cc	TD7662
D 0824 LFL 09	4 Cyl.	8 Valves	4580cc	TD9707
D 0824 LFL 10	4 Cyl.	8 Valves	4580cc	TD21286
D 0824 LFO	4 Cyl.	8 Valves	4580cc	TD7657
D 0824 LFO 01	4 Cyl.	8 Valves	4580cc	TD23129
D 0824 LFO 02	4 Cyl.	8 Valves	4580cc	TD16245
D 0824 LOH 01	4 Cyl.	8 Valves	4580cc	TD7598
D 0824 LOH 02	4 Cyl.	8 Valves	4580cc	TD21288
D 0824 LOH 03	4 Cyl.	8 Valves	4580cc	TD21289
D 0824 LOH 04	4 Cyl.	8 Valves	4580cc	TD21290
D 0824 LOH 05	4 Cyl.	8 Valves	4580cc	TD20537
D 0824 LUE 521	4 Cyl.	8 Valves	4580cc	TD23130
D 0824 LUE 522	4 Cyl.	8 Valves	4580cc	TD23131

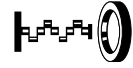
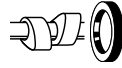

D 0824 LUE 523	4 Cyl.	8 Valves	4580cc	TD23132
D 0824 LUE 524	4 Cyl.	8 Valves	4580cc	TD23133
D 0834 LFL 01	4 Cyl.	8 Valves	4580cc	TD17044
D 0834 LFL 02	4 Cyl.	8 Valves	4580cc	TD6591
D 0834 LFL 03	4 Cyl.	8 Valves	4580cc	TD16498
D 0834 LFL 04	4 Cyl.	8 Valves	4580cc	TD18096
D 0834 LFL 07	4 Cyl.	8 Valves	4580cc	TD24975
D 0834 LFL 10	4 Cyl.	8 Valves	4580cc	TD28896
D 0834 LFL 11	4 Cyl.	8 Valves	4580cc	TD28897
D 0834 LFL 20	4 Cyl.	8 Valves	4580cc	TD16829

HR775 (x2)

NB967

66.00 x 90.00 x 12.00mm, FPM

NA5156

66.00 x 90.00 x 12.00mm, PTFE

NA5181

110.00 x 130.00 x 13.00mm, PTFE

4 4.6L

Diesel

D 0824 LFL 08	4 Cyl.	12 Valves	4580cc	TD16523
---------------	--------	-----------	--------	---------

HR775 (x3)

NB967

66.00 x 90.00 x 12.00mm, FPM

NA5156

66.00 x 90.00 x 12.00mm, PTFE

NA5181

110.00 x 130.00 x 13.00mm, PTFE

5 4.6L

Diesel

D 0834 190	4 Cyl.	16 Valves	4580cc	TD30275
D 0834 230	4 Cyl.	16 Valves	4580cc	TD30286
D 0834 LFL 40	4 Cyl.	16 Valves	4580cc	TD18179
D 0834 LFL 41	4 Cyl.	16 Valves	4580cc	TD18180
D 0834 LFL 42	4 Cyl.	16 Valves	4580cc	TD18181
D 0834 LFL 50	4 Cyl.	16 Valves	4580cc	TD18182
D 0834 LFL 51	4 Cyl.	16 Valves	4580cc	TD18183
D 0834 LFL 52	4 Cyl.	16 Valves	4580cc	TD18184
D 0834 LFL 53	4 Cyl.	16 Valves	4580cc	TD22957
D 0834 LFL 54	4 Cyl.	16 Valves	4580cc	TD22958
D 0834 LFL 55	4 Cyl.	16 Valves	4580cc	TD22969
D 0834 LFL 57	4 Cyl.	16 Valves	4580cc	TD31946
D 0834 LFL 60	4 Cyl.	16 Valves	4580cc	TD22962
D 0834 LFL 61	4 Cyl.	16 Valves	4580cc	TD22963
D 0834 LFL 62	4 Cyl.	16 Valves	4580cc	TD22965
D 0834 LFL 63	4 Cyl.	16 Valves	4580cc	TD22959
D 0834 LFL 64	4 Cyl.	16 Valves	4580cc	TD22960
D 0834 LFL 65	4 Cyl.	16 Valves	4580cc	TD22961
D 0834 LFL 66	4 Cyl.	16 Valves	4580cc	TD27703
D 0834 LFL 67	4 Cyl.	16 Valves	4580cc	TD27704
D 0834 LFL 68	4 Cyl.	16 Valves	4580cc	TD27705
D 0834 LFL 75	4 Cyl.	16 Valves	4580cc	TD31909
D 0834 LFL 76	4 Cyl.	16 Valves	4580cc	TD31908
D 0834 LOH 40	4 Cyl.	16 Valves	4580cc	TD23680
D 0834 LOH 50	4 Cyl.	16 Valves	4580cc	TD19968
D 0834 LOH 51	4 Cyl.	16 Valves	4580cc	TD19969

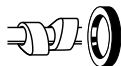

D 0834 LOH 52	4 Cyl.	16 Valves	4580cc	TD23057
D 0834 LOH 53	4 Cyl.	16 Valves	4580cc	TD23058
D 0834 LOH 60	4 Cyl.	16 Valves	4580cc	TD23669
D 0834 LOH 61	4 Cyl.	16 Valves	4580cc	TD23679
D 0834 LOH 63	4 Cyl.	16 Valves	4580cc	TD30623
D 0834 LOH 64	4 Cyl.	16 Valves	4580cc	TD31944

HR655 (x2)

NB967
66.00 x 90.00 x 12.00mm, FPM
NA5156
66.00 x 90.00 x 12.00mm, PTFE
NA5181
110.00 x 130.00 x 13.00mm, PTFE

6 4.6L Diesel

D 0834 LE 121	4 Cyl.	8 Valves	4580cc	TD30137
D 0834 LE 122	4 Cyl.	8 Valves	4580cc	TD30139
D 0834 LE 123	4 Cyl.	8 Valves	4580cc	TD30140

NB967
66.00 x 90.00 x 12.00mm, FPM
NA5156
66.00 x 90.00 x 12.00mm, PTFE
NA5181
110.00 x 130.00 x 13.00mm, PTFE

7 4.6L Diesel

D 0834 LOH 01	4 Cyl.	16 Valves	4580cc	TD16748
D 0834 LOH 02	4 Cyl.	16 Valves	4580cc	TD16749
D 0834 LOH 03	4 Cyl.	16 Valves	4580cc	TD16750

HR775 (x4)

NB967
66.00 x 90.00 x 12.00mm, FPM
NA5156
66.00 x 90.00 x 12.00mm, PTFE
NA5181
110.00 x 130.00 x 13.00mm, PTFE

8 4.6L Gas

E 0824 E 301	4 Cyl.	8 Valves	4580cc	TD25680
E 0834 E 302	4 Cyl.	8 Valves	4580cc	TD25700
E 0834 E 312	4 Cyl.	8 Valves	4580cc	TD25699
E 0834 LE 302	4 Cyl.	8 Valves	4580cc	TD28164

HR775 (x2)

NA5156
66.00 x 90.00 x 12.00mm, PTFE
NA5181
110.00 x 130.00 x 13.00mm, PTFE

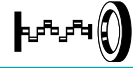

9 5.7L		Diesel			
D 0226 M	6 Cyl.	12 Valves	5687cc	TD19433	
D 0226 MC	6 Cyl.	12 Valves	5687cc	TD23123	
D 0226 MCFO/170	6 Cyl.	12 Valves	5687cc	TD7652	
D 0226 ME	6 Cyl.	12 Valves	5687cc	TD19079	
D 0226 MF	6 Cyl.	12 Valves	5687cc	TD7645	
D 0226 MFA	6 Cyl.	12 Valves	5687cc	TD19080	
D 0226 MFM	6 Cyl.	12 Valves	5687cc	TD19081	
D 0226 MFO	6 Cyl.	12 Valves	5687cc	TD19434	
D 0226 MH	6 Cyl.	12 Valves	5687cc	TD19435	
D 0226 MK	6 Cyl.	12 Valves	5687cc	TD19077	
D 0226 MKF	6 Cyl.	12 Valves	5687cc	TD7685	
D 0226 MKF/170	6 Cyl.	12 Valves	5687cc	TD7684	
D 0226 MKFA	6 Cyl.	12 Valves	5687cc	TD19436	
D 0226 MKFO	6 Cyl.	12 Valves	5687cc	TD23124	
D 0226 MKH	6 Cyl.	12 Valves	5687cc	TD19078	
D 0226 ML	6 Cyl.	12 Valves	5687cc	TD19437	
D 0226 MLE	6 Cyl.	12 Valves	5687cc	TD19438	
D 0226 MT	6 Cyl.	12 Valves	5687cc	TD19439	
D 0226 MTE	6 Cyl.	12 Valves	5687cc	TD19071	
				NA5181	
				110.00 x 130.00 x 13.00mm, PTFE	

10 6.6L		Diesel			
D 0826 TE 520	6 Cyl.	12 Valves	6596cc	TD23159	
D 0826 TF	6 Cyl.	12 Valves	6596cc	TD7689	
D 0826 TOH	6 Cyl.	12 Valves	6596cc	TD7600	
D 0826 TOH 01	6 Cyl.	12 Valves	6596cc	TD23160	
HR775 (x3)				NB967	
				66.00 x 90.00 x 12.00mm, FPM	
				NA5156	
				66.00 x 90.00 x 12.00mm, PTFE	
				NA5181	
				110.00 x 130.00 x 13.00mm, PTFE	

11 6.6L		Gas			
E 0826 E 301	6 Cyl.	12 Valves	6596cc	TD25681	
HR775 (x3)				NB967	
				66.00 x 90.00 x 12.00mm, FPM	
				NA5156	
				66.00 x 90.00 x 12.00mm, PTFE	
				NA5181	
				110.00 x 130.00 x 13.00mm, PTFE	

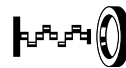
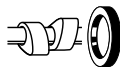

12 6.9L

Diesel

D 0826 F01	6 Cyl.	12 Valves	6871cc	TD7681
D 0826 F02	6 Cyl.	12 Valves	6871cc	TD7682
D 0826 FG001	6 Cyl.	12 Valves	6871cc	TD22324
D 0826 FG002	6 Cyl.	12 Valves	6871cc	TD22326
D 0826 FO	6 Cyl.	12 Valves	6871cc	TD25847
D 0826 FO 01	6 Cyl.	12 Valves	6871cc	TD23134
D 0826 FO 02	6 Cyl.	12 Valves	6871cc	TD23135
D 0826 FO 03	6 Cyl.	12 Valves	6871cc	TD25846
D 0826 FR	6 Cyl.	12 Valves	6871cc	TD25848
D 0826 FR 01	6 Cyl.	12 Valves	6871cc	TD25849
D 0826 GF	6 Cyl.	12 Valves	6871cc	TD7647
D 0826 GF01	6 Cyl.	12 Valves	6871cc	TD7649
D 0826 GF02	6 Cyl.	12 Valves	6871cc	TD22328
D 0826 GF03	6 Cyl.	12 Valves	6871cc	TD7648
D 0826 GF04	6 Cyl.	12 Valves	6871cc	TD19440
D 0826 GFA	6 Cyl.	12 Valves	6871cc	TD23139
D 0826 GFA 01	6 Cyl.	12 Valves	6871cc	TD23140
D 0826 GFA 02	6 Cyl.	12 Valves	6871cc	TD23141
D 0826 GFA 03	6 Cyl.	12 Valves	6871cc	TD23142
D 0826 GFA 04	6 Cyl.	12 Valves	6871cc	TD23143
D 0826 LE 51	6 Cyl.	12 Valves	6871cc	TD19441
D 0826 LE 52	6 Cyl.	12 Valves	6871cc	TD19442
D 0826 LE 521	6 Cyl.	12 Valves	6871cc	TD22331
D 0826 LE 522	6 Cyl.	12 Valves	6871cc	TD23144
D 0826 LE 523	6 Cyl.	12 Valves	6871cc	TD23146
D 0826 LE 524	6 Cyl.	12 Valves	6871cc	TD23147
D 0826 LE 527	6 Cyl.	12 Valves	6871cc	TD23148
D 0826 LE 530	6 Cyl.	12 Valves	6871cc	TD23149
D 0826 LE 531	6 Cyl.	12 Valves	6871cc	TD23150
D 0826 LF01	6 Cyl.	12 Valves	6871cc	TD7686
D 0826 LF02	6 Cyl.	12 Valves	6871cc	TD7691
D 0826 LF04	6 Cyl.	12 Valves	6871cc	TD7695
D 0826 LF05	6 Cyl.	12 Valves	6871cc	TD7687
D 0826 LF06	6 Cyl.	12 Valves	6871cc	TD7692
D 0826 LF07	6 Cyl.	12 Valves	6871cc	TD7688
D 0826 LF08	6 Cyl.	12 Valves	6871cc	TD7693
D 0826 LF09	6 Cyl.	12 Valves	6871cc	TD22332
D 0826 LF10	6 Cyl.	12 Valves	6871cc	TD22335
D 0826 LF11	6 Cyl.	12 Valves	6871cc	TD7690
D 0826 LF12	6 Cyl.	12 Valves	6871cc	TD22337
D 0826 LF13	6 Cyl.	12 Valves	6871cc	TD7694
D 0826 LF15	6 Cyl.	12 Valves	6871cc	TD7726
D 0826 LF17	6 Cyl.	12 Valves	6871cc	TD7727
D 0826 LF18	6 Cyl.	12 Valves	6871cc	TD10227
D 0826 LF/217/Silent	6 Cyl.	12 Valves	6870cc	TD7723
D 0826 LFG 01	6 Cyl.	12 Valves	6871cc	TD23151
D 0826 LFG 02	6 Cyl.	12 Valves	6871cc	TD23152
D 0826 LFG 06	6 Cyl.	12 Valves	6871cc	TD23153
D 0826 LFG 15	6 Cyl.	12 Valves	6871cc	TD23154

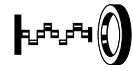
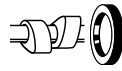

D 0826 LFG 16	6 Cyl.	12 Valves	6871cc	TD23155
D 0826 LFL	6 Cyl.	12 Valves	6871cc	TD19443
D 0826 LFL01	6 Cyl.	12 Valves	6871cc	TD28895
D 0826 LFL02	6 Cyl.	12 Valves	6871cc	TD7664
D 0826 LFL03	6 Cyl.	12 Valves	6871cc	TD7663
D 0826 LFL05	6 Cyl.	12 Valves	6871cc	TD21291
D 0826 LFL06	6 Cyl.	12 Valves	6871cc	TD7665
D 0826 LFL07	6 Cyl.	12 Valves	6871cc	TD21292
D 0826 LFL08	6 Cyl.	12 Valves	6871cc	TD21293
D 0826 LFL09	6 Cyl.	12 Valves	6871cc	TD7725
D 0826 LFL10	6 Cyl.	12 Valves	6871cc	TD10207
D 0826 LOH 01	6 Cyl.	12 Valves	6871cc	TD7601
D 0826 LOH 02	6 Cyl.	12 Valves	6871cc	TD7679
D 0826 LOH 03	6 Cyl.	12 Valves	6871cc	TD16465
D 0826 LOH 04	6 Cyl.	12 Valves	6871cc	TD16466
D 0826 LOH 05	6 Cyl.	12 Valves	6871cc	TD21295
D 0826 LOH 06	6 Cyl.	12 Valves	6871cc	TD7587
D 0826 LOH 07	6 Cyl.	12 Valves	6871cc	TD16246
D 0826 LOH 08	6 Cyl.	12 Valves	6871cc	TD21296
D 0826 LOH 09	6 Cyl.	12 Valves	6871cc	TD21297
D 0826 LOH 10	6 Cyl.	12 Valves	6871cc	TD16247
D 0826 LOH 11	6 Cyl.	12 Valves	6871cc	TD21298
D 0826 LOH 12	6 Cyl.	12 Valves	6871cc	TD21299
D 0826 LOH 13	6 Cyl.	12 Valves	6871cc	TD21300
D 0826 LOH 15	6 Cyl.	12 Valves	6871cc	TD7588
D 0826 LOH 17	6 Cyl.	12 Valves	6871cc	TD17419
D 0826 LOH 18	6 Cyl.	12 Valves	6871cc	TD17420
D 0826 LOH 19	6 Cyl.	12 Valves	6871cc	TD23156
D 0826 LUE 51	6 Cyl.	12 Valves	6870cc	TD19444
D 0826 LUH	6 Cyl.	12 Valves	6870cc	TD7583
D 0826 LUH 01	6 Cyl.	12 Valves	6871cc	TD7596
D 0826 LUH 02	6 Cyl.	12 Valves	6871cc	TD21301
D 0826 LUH 03	6 Cyl.	12 Valves	6871cc	TD7584
D 0826 LUH 04	6 Cyl.	12 Valves	6871cc	TD21302
D 0826 LUH 05	6 Cyl.	12 Valves	6871cc	TD7585
D 0826 LUH 06	6 Cyl.	12 Valves	6871cc	TD21303
D 0826 LUH 08	6 Cyl.	12 Valves	6871cc	TD21304
D 0826 LUH 09	6 Cyl.	12 Valves	6871cc	TD21305
D 0826 LUH 10	6 Cyl.	12 Valves	6871cc	TD21306
D 0826 LUH 11	6 Cyl.	12 Valves	6871cc	TD21307
D 0826 LUH 12	6 Cyl.	12 Valves	6870cc	TD7586
D 0826 LUH 13	6 Cyl.	12 Valves	6871cc	TD16248
D 0826 LUH/213	6 Cyl.	12 Valves	6871cc	TD7597
D 0826 OH	6 Cyl.	12 Valves	6871cc	TD19445
D 0826 OH01	6 Cyl.	12 Valves	6871cc	TD23157
D 0826 OH02	6 Cyl.	12 Valves	6871cc	TD7599
D 0826 OH03	6 Cyl.	12 Valves	6871cc	TD23158
D 0826 TUE 51	6 Cyl.	12 Valves	6871cc	TD23162
D 0836 LE 501	6 Cyl.	12 Valves	6871cc	TD32899
D 0836 LE 502	6 Cyl.	12 Valves	6871cc	TD32900

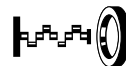

D 0836 LE 503	6 Cyl.	12 Valves	6871cc	TD32901
D 0836 LE 504	6 Cyl.	12 Valves	6871cc	TD32902
D 0836 LE 510	6 Cyl.	12 Valves	6871cc	TD32926
D 0836 LF 01	6 Cyl.	12 Valves	6871cc	TD14289
D 0836 LF 02	6 Cyl.	12 Valves	6871cc	TD17045
D 0836 LF 03	6 Cyl.	12 Valves	6871cc	TD16503
D 0836 LF 04	6 Cyl.	12 Valves	6871cc	TD16500
D 0836 LF 05	6 Cyl.	12 Valves	6871cc	TD16504
D 0836 LF 06	6 Cyl.	12 Valves	6871cc	TD28898
D 0836 LF 10	6 Cyl.	12 Valves	6871cc	TD28899
D 0836 LFL 01	6 Cyl.	12 Valves	6871cc	TD16875
D 0836 LFL 02	6 Cyl.	12 Valves	6871cc	TD16499
D 0836 LFL 03	6 Cyl.	12 Valves	6871cc	TD16502
D 0836 LFL 04	6 Cyl.	12 Valves	6871cc	TD17049
D 0836 LFL 05	6 Cyl.	12 Valves	6871cc	TD16501
D 0836 LFL 06	6 Cyl.	12 Valves	6871cc	TD23163
D 0836 LFL 07	6 Cyl.	12 Valves	6871cc	TD16830
D 0836 LFL 08	6 Cyl.	12 Valves	6871cc	TD24953
D 0836 LFL 10	6 Cyl.	12 Valves	6871cc	TD16831
D 0836 LOH 01	6 Cyl.	12 Valves	6871cc	TD16753
D 0836 LOH 02	6 Cyl.	12 Valves	6871cc	TD16752
D 0836 LOH 03	6 Cyl.	12 Valves	6871cc	TD16751

HR775 (x3)

NB967

66.00 x 90.00 x 12.00mm, FPM

NA5156

66.00 x 90.00 x 12.00mm, PTFE

NA5181

110.00 x 130.00 x 13.00mm, PTFE

13 6.9L

Diesel

D 0836 260	6 Cyl.	24 Valves	6871cc	TD31859
D 0836 280	6 Cyl.	24 Valves	6871cc	TD30276
D 0836 LOH 69	6 Cyl.	24 Valves	6871cc	TD30440

NB967

66.00 x 90.00 x 12.00mm, FPM

NA5156

66.00 x 90.00 x 12.00mm, PTFE

NA5181

110.00 x 130.00 x 13.00mm, PTFE

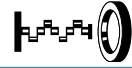

14 6.9L		Diesel			
D 0836 LF 41	6 Cyl.	24 Valves	687lcc	TD16827	
D 0836 LF 44	6 Cyl.	24 Valves	687lcc	TD16828	
D 0836 LFG 50	6 Cyl.	24 Valves	687lcc	TD20228	
D 0836 LFL 40	6 Cyl.	24 Valves	687lcc	TD18185	
D 0836 LFL 41	6 Cyl.	24 Valves	687lcc	TD18703	
D 0836 LFL 44	6 Cyl.	24 Valves	687lcc	TD18704	
D 0836 LFL 50	6 Cyl.	24 Valves	687lcc	TD18186	
D 0836 LFL 51	6 Cyl.	24 Valves	687lcc	TD19114	
D 0836 LFL 52	6 Cyl.	24 Valves	687lcc	TD19113	
D 0836 LFL 53	6 Cyl.	24 Valves	687lcc	TD22970	
D 0836 LFL 54	6 Cyl.	24 Valves	687lcc	TD22971	
D 0836 LFL 55	6 Cyl.	24 Valves	687lcc	TD22972	
D 0836 LFL 60	6 Cyl.	24 Valves	687lcc	TD22966	
D 0836 LFL 61	6 Cyl.	24 Valves	687lcc	TD23686	
D 0836 LFL 62	6 Cyl.	24 Valves	687lcc	TD23687	
D 0836 LFL 63	6 Cyl.	24 Valves	687lcc	TD22967	
D 0836 LFL 64	6 Cyl.	24 Valves	687lcc	TD22984	
D 0836 LFL 65	6 Cyl.	24 Valves	687lcc	TD22995	
D 0836 LFL 66	6 Cyl.	24 Valves	687lcc	TD27706	
D 0836 LFL 67	6 Cyl.	24 Valves	687lcc	TD27707	
D 0836 LFL 68	6 Cyl.	24 Valves	687lcc	TD27724	
D 0836 LFL 69	6 Cyl.	24 Valves	687lcc	TD27708	
D 0836 LFL 70	6 Cyl.	24 Valves	687lcc	TD27709	
D 0836 LFL 71	6 Cyl.	24 Valves	687lcc	TD27710	
D 0836 LFL 75	6 Cyl.	24 Valves	687lcc	TD31910	
D 0836 LFL 76	6 Cyl.	24 Valves	687lcc	TD31911	
D 0836 LFL 77	6 Cyl.	24 Valves	687lcc	TD31912	
D 0836 LOH 40	6 Cyl.	24 Valves	687lcc	TD16754	
D 0836 LOH 41	6 Cyl.	24 Valves	687lcc	TD16755	
D 0836 LOH 51	6 Cyl.	24 Valves	687lcc	TD19971	
D 0836 LOH 52	6 Cyl.	24 Valves	687lcc	TD19970	
D 0836 LOH 55	6 Cyl.	24 Valves	687lcc	TD23060	
D 0836 LOH 56	6 Cyl.	24 Valves	687lcc	TD23059	
D 0836 LOH 60	6 Cyl.	24 Valves	687lcc	TD23671	
D 0836 LOH 61	6 Cyl.	24 Valves	687lcc	TD23670	
D 0836 LOH 62	6 Cyl.	24 Valves	687lcc	TD23164	
D 0836 LOH 63	6 Cyl.	24 Valves	687lcc	TD23962	
D 0836 LOH 64	6 Cyl.	24 Valves	687lcc	TD23682	
D 0836 LOH 65	6 Cyl.	24 Valves	687lcc	TD23681	
D 0836 LOH 66	6 Cyl.	24 Valves	687lcc	TD30438	
D 0836 LOH 67	6 Cyl.	24 Valves	687lcc	TD30439	
D 0836 LOH 70	6 Cyl.	24 Valves	687lcc	TD30442	
D 0836 LOH 71	6 Cyl.	24 Valves	687lcc	TD30441	
D 0836 LOH 72	6 Cyl.	24 Valves	687lcc	TD31913	
D 0836 LOH 73	6 Cyl.	24 Valves	687lcc	TD31914	
D 0836 LOH 74	6 Cyl.	24 Valves	687lcc	TD31915	
D 0836 LOH 75	6 Cyl.	24 Valves	687lcc	TD31916	
D 0836 LOH 76	6 Cyl.	24 Valves	687lcc	TD31917	
D 0836 LOH 77	6 Cyl.	24 Valves	687lcc	TD31918	

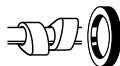

D 0836 LUH 40	6 Cyl.	24 Valves	6871cc	TD16758
D 0836 LUH 41	6 Cyl.	24 Valves	6871cc	TD16759
D 0836 LUH 50	6 Cyl.	24 Valves	6871cc	TD28161
D 0836 LUH 51	6 Cyl.	24 Valves	6871cc	TD28162

HR655 (x3)

NB967
66.00 x 90.00 x 12.00mm, FPM
NA5156
66.00 x 90.00 x 12.00mm, PTFE
NA5181
110.00 x 130.00 x 13.00mm, PTFE

15 6.9L

Diesel

D 0836 LUH 01	6 Cyl.	24 Valves	6871cc	TD16756
D 0836 LUH 02	6 Cyl.	24 Valves	6871cc	TD16757

HR775 (x6)

NB967
66.00 x 90.00 x 12.00mm, FPM
NA5156
66.00 x 90.00 x 12.00mm, PTFE
NA5181
110.00 x 130.00 x 13.00mm, PTFE

16 6.9L

Gas

E 0836 E 302	6 Cyl.	12 Valves	6871cc	TD23749
E 0836 E 312	6 Cyl.	12 Valves	6871cc	TD23748
E 0836 LE 202	6 Cyl.	12 Valves	6871cc	TD23747
E 0836 LE 302	6 Cyl.	12 Valves	6871cc	TD23750
E 0836 LOH 01	6 Cyl.	12 Valves	6871cc	TD23746
E 0836 LOH 02	6 Cyl.	12 Valves	6871cc	TD25457
E 0836 LOH 03	6 Cyl.	12 Valves	6871cc	TD25458
E 0836 LOH 04	6 Cyl.	12 Valves	6871cc	TD30451
E 0836 LOH 05	6 Cyl.	12 Valves	6871cc	TD30452
E 0836 LOH 06	6 Cyl.	12 Valves	6871cc	TD30453

HR775 (x3)

NA5156
66.00 x 90.00 x 12.00mm, PTFE
NA5181
110.00 x 130.00 x 13.00mm, PTFE

17 7.0L

Diesel

D 0836 HM 4	6 Cyl.	12 Valves	7030cc	TD5652
D 0836 HM 7	6 Cyl.	12 Valves	7030cc	TD5990
D 0836 HM 7 U	6 Cyl.	12 Valves	7030cc	TD7825
D 0836 HM 9 H	6 Cyl.	12 Valves	7030cc	TD7817
D 0836 HM 9 U	6 Cyl.	12 Valves	7030cc	TD7821
D 0836 HM 70	6 Cyl.	12 Valves	7030cc	TD6268
D 0836 HM 71	6 Cyl.	12 Valves	7030cc	TD7668
D 0836 HMN 70	6 Cyl.	12 Valves	7030cc	TD7650

HR775 (x3)

18 7.3L

Diesel

D 0846 HM 2	6 Cyl.	12 Valves	7250cc	TD7654
D 0846 HMN	6 Cyl.	12 Valves	7252cc	TD7651

HR775 (x3)

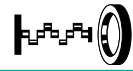
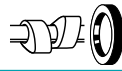

19 9.2L		Diesel		
D 2555 M	5 Cyl.	10 Valves	9200cc	TD7708
D 2555 MF	5 Cyl.	10 Valves	9200cc	TD7703
D 2555 MX	5 Cyl.	10 Valves	9200cc	TD7710
D 2555 MXF	5 Cyl.	10 Valves	9200cc	TD7705
D 2555 MXUL	5 Cyl.	10 Valves	9200cc	TD7720
PB224 (x10)				NB928 F 105.00 x 130.00 x 12.00mm, FPM NB929 R 120.00 x 140.00 x 13.00mm, FPM

20 9.5L		Diesel		
D 2565 HM	5 Cyl.	10 Valves	9510cc	TD19039
D 2565 M	5 Cyl.	10 Valves	9510cc	TD7711
D 2565 M/168	5 Cyl.	10 Valves	9510cc	TD7709
D 2565 ME	5 Cyl.	10 Valves	9510cc	TD19040
D 2565 MF	5 Cyl.	10 Valves	9510cc	TD7706
D 2565 MF/168	5 Cyl.	10 Valves	9510cc	TD7704
D 2565 MFR	5 Cyl.	10 Valves	9510cc	TD19041
D 2565 MH	5 Cyl.	10 Valves	9510cc	TD23167
D 2565 MK	5 Cyl.	10 Valves	9510cc	TD19117
D 2565 MKUL	5 Cyl.	10 Valves	9510cc	TD19072
D 2565 MR	5 Cyl.	10 Valves	9510cc	TD23168
D 2565 MSFV	5 Cyl.	10 Valves	9510cc	TD8749
D 2565 MT	5 Cyl.	10 Valves	9510cc	TD19073
D 2565 MUE	5 Cyl.	10 Valves	9510cc	TD23169
D 2565 MUH	5 Cyl.	10 Valves	9510cc	TD19042
D 2565 MUL	5 Cyl.	10 Valves	9510cc	TD7721
PB224 (x10)				NB928 F 105.00 x 130.00 x 12.00mm, FPM NB929 R 120.00 x 140.00 x 13.00mm, FPM

21 10.0L		Diesel		
D 2865 LF01	5 Cyl.	10 Valves	9973cc	TD25850
D 2865 LF02	5 Cyl.	10 Valves	9973cc	TD7696
D 2865 LF03	5 Cyl.	10 Valves	9973cc	TD7780
D 2865 LF05	5 Cyl.	10 Valves	9973cc	TD7777
D 2865 LF06	5 Cyl.	10 Valves	9973cc	TD7781
D 2865 LF09	5 Cyl.	10 Valves	9973cc	TD7784
D 2865 LF10	5 Cyl.	10 Valves	9973cc	TD28917
D 2865 LF20	5 Cyl.	10 Valves	9973cc	TD7765
D 2865 LF21	5 Cyl.	10 Valves	9973cc	TD7769
D 2865 LF22	5 Cyl.	10 Valves	9973cc	TD7764
D 2865 LF23	5 Cyl.	10 Valves	9973cc	TD7767
D 2865 LF24	5 Cyl.	10 Valves	9973cc	TD7766
D 2865 LF/260	5 Cyl.	10 Valves	9973cc	TD7776
D 2865 LFR	5 Cyl.	10 Valves	9973cc	TD25851
D 2865 LFR 01	5 Cyl.	10 Valves	9973cc	TD25852
D 2865 LOH 01	5 Cyl.	10 Valves	9973cc	TD9087
D 2865 LOH 02	5 Cyl.	10 Valves	9973cc	TD7754
D 2865 LOH 05	5 Cyl.	10 Valves	9973cc	TD25854

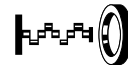
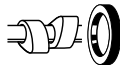

D 2865 LOH 06	5 Cyl.	10 Valves	9973cc	TD25856
D 2865 LOH 07	5 Cyl.	10 Valves	9973cc	TD25855
D 2865 LOH 08	5 Cyl.	10 Valves	9973cc	TD25857
D 2865 LOH 09	5 Cyl.	10 Valves	9973cc	TD25858
D 2865 LOH 10	5 Cyl.	10 Valves	9973cc	TD25859
D 2865 LU 01	5 Cyl.	10 Valves	9973cc	TD7724
D 2865 LU 02	5 Cyl.	10 Valves	9973cc	TD28918
D 2865 LU 03	5 Cyl.	10 Valves	9973cc	TD28919
D 2865 LU 04	5 Cyl.	10 Valves	9973cc	TD28920
D 2865 LU 05	5 Cyl.	10 Valves	9973cc	TD16484
D 2865 LU 06	5 Cyl.	10 Valves	9973cc	TD28921
D 2865 LUH 02	5 Cyl.	10 Valves	9973cc	TD7578
D 2865 LUH 03	5 Cyl.	10 Valves	9973cc	TD28922
D 2865 LUH 05	5 Cyl.	10 Valves	9973cc	TD7579
D 2865 LUH 06	5 Cyl.	10 Valves	9973cc	TD28923
D 2865 LUH 07	5 Cyl.	10 Valves	9973cc	TD7581
D 2865 LUH 08	5 Cyl.	10 Valves	9973cc	TD7612
D 2865 LUH 09	5 Cyl.	10 Valves	9973cc	TD7594
D 2865 LXF	5 Cyl.	10 Valves	9973cc	TD25860
D 2865 LXFR	5 Cyl.	10 Valves	9973cc	TD25861

PB224 (x10)

NB928
 105.00 x 130.00 x 12.00mm, FPM
NB929
 120.00 x 140.00 x 13.00mm, FPM

22 10.5L

Diesel

D 2066 LE 621	6 Cyl.	24 Valves	10518cc	TD27953
---------------	--------	-----------	---------	---------

NA5450
 100.00 x 130.00 x 12.00mm, PTFE
NB929
 120.00 x 140.00 x 13.00mm, FPM

23 10.5L

Diesel

D 2066 LF 01	6 Cyl.	24 Valves	10518cc	TD17370
D 2066 LF 02	6 Cyl.	24 Valves	10518cc	TD17371
D 2066 LF 03	6 Cyl.	24 Valves	10518cc	TD17372
D 2066 LF 04	6 Cyl.	24 Valves	10518cc	TD17373
D 2066 LF 06	6 Cyl.	24 Valves	10518cc	TD19951
D 2066 LF 07	6 Cyl.	24 Valves	10518cc	TD22899
D 2066 LF 11	6 Cyl.	24 Valves	10518cc	TD18098
D 2066 LF 12	6 Cyl.	24 Valves	10518cc	TD18097
D 2066 LF 13	6 Cyl.	24 Valves	10518cc	TD19111
D 2066 LF 14	6 Cyl.	24 Valves	10518cc	TD19109
D 2066 LF 31	6 Cyl.	24 Valves	10518cc	TD19094
D 2066 LF 32	6 Cyl.	24 Valves	10518cc	TD19095
D 2066 LF 33	6 Cyl.	24 Valves	10518cc	TD19096
D 2066 LF 34	6 Cyl.	24 Valves	10518cc	TD28904
D 2066 LF 35	6 Cyl.	24 Valves	10518cc	TD19097
D 2066 LF 36	6 Cyl.	24 Valves	10518cc	TD20368
D 2066 LF 37	6 Cyl.	24 Valves	10518cc	TD20369
D 2066 LF 38	6 Cyl.	24 Valves	10518cc	TD20370
D 2066 LF 39	6 Cyl.	24 Valves	10518cc	TD20396

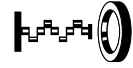
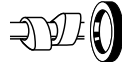

D 2066 LOH 01	6 Cyl.	24 Valves	10520cc	TD19972
D 2066 LOH 02	6 Cyl.	24 Valves	10518cc	TD19973
D 2066 LOH 03	6 Cyl.	24 Valves	10518cc	TD19974
D 2066 LOH 04	6 Cyl.	24 Valves	10518cc	TD19975
D 2066 LOH 05	6 Cyl.	24 Valves	10518cc	TD23061
D 2066 LOH 06	6 Cyl.	24 Valves	10518cc	TD23062
D 2066 LOH 07	6 Cyl.	24 Valves	10518cc	TD23063
D 2066 LOH 08	6 Cyl.	24 Valves	10518cc	TD23064
D 2066 LOH 10	6 Cyl.	24 Valves	10518cc	TD23073
D 2066 LOH 11	6 Cyl.	24 Valves	10518cc	TD23072
D 2066 LOH 12	6 Cyl.	24 Valves	10518cc	TD23070

PB394 (x24)

NA5450
 100.00 x 130.00 x 12.00mm, PTFE
NB929
 120.00 x 140.00 x 13.00mm, FPM

24 10.5L Diesel

D 2066 LF 17	6 Cyl.	24 Valves	10518cc	TD23081
D 2066 LF 18	6 Cyl.	24 Valves	10518cc	TD23083
D 2066 LF 19	6 Cyl.	24 Valves	10518cc	TD23084
D 2066 LF 20	6 Cyl.	24 Valves	10518cc	TD23085
D 2066 LF 21	6 Cyl.	24 Valves	10518cc	TD20230
D 2066 LF 22	6 Cyl.	24 Valves	10518cc	TD20229
D 2066 LF 23	6 Cyl.	24 Valves	10518cc	TD19098
D 2066 LF 24	6 Cyl.	24 Valves	10518cc	TD19099
D 2066 LF 25	6 Cyl.	24 Valves	10518cc	TD20363
D 2066 LF 26	6 Cyl.	24 Valves	10518cc	TD20364
D 2066 LF 27	6 Cyl.	24 Valves	10518cc	TD20365
D 2066 LF 28	6 Cyl.	24 Valves	10518cc	TD20366
D 2066 LF 29	6 Cyl.	24 Valves	10518cc	TD25603
D 2066 LF 30	6 Cyl.	24 Valves	10518cc	TD25604
D 2066 LF 40	6 Cyl.	24 Valves	10518cc	TD23119
D 2066 LF 41	6 Cyl.	24 Valves	10518cc	TD23104
D 2066 LF 42	6 Cyl.	24 Valves	10518cc	TD23094
D 2066 LF 43	6 Cyl.	24 Valves	10518cc	TD23003
D 2066 LF 44	6 Cyl.	24 Valves	10518cc	TD25456
D 2066 LF 45	6 Cyl.	24 Valves	10518cc	TD25455
D 2066 LF 46	6 Cyl.	24 Valves	10518cc	TD25454
D 2066 LF 47	6 Cyl.	24 Valves	10518cc	TD25453
D 2066 LF 48	6 Cyl.	24 Valves	10518cc	TD25598
D 2066 LF 49	6 Cyl.	24 Valves	10518cc	TD25599
D 2066 LF 50	6 Cyl.	24 Valves	10518cc	TD25600
D 2066 LF 51	6 Cyl.	24 Valves	10518cc	TD23436
D 2066 LF 52	6 Cyl.	24 Valves	10518cc	TD23437
D 2066 LF 53	6 Cyl.	24 Valves	10518cc	TD23438
D 2066 LF 54	6 Cyl.	24 Valves	10518cc	TD25607
D 2066 LF 55	6 Cyl.	24 Valves	10518cc	TD25606
D 2066 LF 56	6 Cyl.	24 Valves	10518cc	TD25605
D 2066 LF 57	6 Cyl.	24 Valves	10518cc	TD25452
D 2066 LF 58	6 Cyl.	24 Valves	10518cc	TD25451
D 2066 LF 59	6 Cyl.	24 Valves	10518cc	TD23688

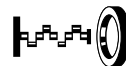
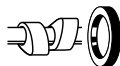

D 2066 LF 60	6 Cyl.	24 Valves	10518cc	TD23689
D 2066 LF 61	6 Cyl.	24 Valves	10518cc	TD27711
D 2066 LF 62	6 Cyl.	24 Valves	10518cc	TD25612
D 2066 LF 63	6 Cyl.	24 Valves	10518cc	TD25613
D 2066 LF 64	6 Cyl.	24 Valves	10518cc	TD25614
D 2066 LF 65	6 Cyl.	24 Valves	10518cc	TD25611
D 2066 LF 67	6 Cyl.	24 Valves	10518cc	TD27712
D 2066 LF 68	6 Cyl.	24 Valves	10518cc	TD27717
D 2066 LF 69	6 Cyl.	24 Valves	10518cc	TD25620
D 2066 LF 70	6 Cyl.	24 Valves	10518cc	TD25619
D 2066 LF 71	6 Cyl.	24 Valves	10518cc	TD25618
D 2066 LF 72	6 Cyl.	24 Valves	10518cc	TD25617
D 2066 LF 76	6 Cyl.	24 Valves	10518cc	TD31921
D 2066 LF 77	6 Cyl.	24 Valves	10518cc	TD31922
D 2066 LF 78	6 Cyl.	24 Valves	10518cc	TD31923
D 2066 LF 80	6 Cyl.	24 Valves	10518cc	TD31924
D 2066 LF 81	6 Cyl.	24 Valves	10518cc	TD31925
D 2066 LF 83	6 Cyl.	24 Valves	10518cc	TD31926
D 2066 LF 84	6 Cyl.	24 Valves	10518cc	TD31927
D 2066 LOH 13	6 Cyl.	24 Valves	10518cc	TD23979
D 2066 LOH 26	6 Cyl.	24 Valves	10518cc	TD23672
D 2066 LOH 27	6 Cyl.	24 Valves	10518cc	TD23673
D 2066 LOH 28	6 Cyl.	24 Valves	10518cc	TD23396
D 2066 LOH 30	6 Cyl.	24 Valves	10518cc	TD30598
D 2066 LOH 31	6 Cyl.	24 Valves	10518cc	TD30599
D 2066 LOH 32	6 Cyl.	24 Valves	10518cc	TD30600
D 2066 LOH 33	6 Cyl.	24 Valves	10518cc	TD30605
D 2066 LOH 34	6 Cyl.	24 Valves	10518cc	TD30606
D 2066 LOH 35	6 Cyl.	24 Valves	10518cc	TD30607
D 2066 LOH 36	6 Cyl.	24 Valves	10518cc	TD30608
D 2066 LOH 37	6 Cyl.	24 Valves	10518cc	TD30612
D 2066 LOH 38	6 Cyl.	24 Valves	10518cc	TD30613
D 2066 LOH 39	6 Cyl.	24 Valves	10518cc	TD30618
D 2066 LOH 40	6 Cyl.	24 Valves	10518cc	TD30619
D 2066 LUH 01	6 Cyl.	24 Valves	10520cc	TD28905
D 2066 LUH 02	6 Cyl.	24 Valves	10520cc	TD28906
D 2066 LUH 03	6 Cyl.	24 Valves	10520cc	TD28907
D 2066 LUH 04	6 Cyl.	24 Valves	10520cc	TD28908
D 2066 LUH 05	6 Cyl.	24 Valves	10520cc	TD28909
D 2066 LUH 07	6 Cyl.	24 Valves	10520cc	TD23074
D 2066 LUH 08	6 Cyl.	24 Valves	10520cc	TD23075
D 2066 LUH 09	6 Cyl.	24 Valves	10520cc	TD23076
D 2066 LUH 11	6 Cyl.	24 Valves	10520cc	TD19976
D 2066 LUH 12	6 Cyl.	24 Valves	10520cc	TD19977
D 2066 LUH 13	6 Cyl.	24 Valves	10520cc	TD19978
D 2066 LUH 14	6 Cyl.	24 Valves	10520cc	TD19979
D 2066 LUH 15	6 Cyl.	24 Valves	10520cc	TD19980
D 2066 LUH 21	6 Cyl.	24 Valves	10518cc	TD22860
D 2066 LUH 22	6 Cyl.	24 Valves	10518cc	TD23065
D 2066 LUH 23	6 Cyl.	24 Valves	10518cc	TD23066

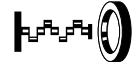
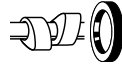

D 2066 LUH 24	6 Cyl.	24 Valves	10518cc	TD23067
D 2066 LUH 32	6 Cyl.	24 Valves	10518cc	TD23683
D 2066 LUH 33	6 Cyl.	24 Valves	10518cc	TD23684
D 2066 LUH 34	6 Cyl.	24 Valves	10518cc	TD23685
D 2066 LUH 41	6 Cyl.	24 Valves	10518cc	TD23963
D 2066 LUH 42	6 Cyl.	24 Valves	10518cc	TD23964
D 2066 LUH 43	6 Cyl.	24 Valves	10518cc	TD23965
D 2066 LUH 46	6 Cyl.	24 Valves	10518cc	TD23674
D 2066 LUH 47	6 Cyl.	24 Valves	10518cc	TD23675
D 2066 LUH 48	6 Cyl.	24 Valves	10518cc	TD23676
D 2066 LUH 50	6 Cyl.	24 Valves	10518cc	TD30513
D 2066 LUH 51	6 Cyl.	24 Valves	10518cc	TD30514
D 2066 LUH 52	6 Cyl.	24 Valves	10518cc	TD30515
D 2066 LUH 53	6 Cyl.	24 Valves	10518cc	TD30516
D 2066 LUH 55	6 Cyl.	24 Valves	10518cc	TD31930
D 2066 LUH 56	6 Cyl.	24 Valves	10518cc	TD31929

PB394 (x12)

NA5450
100.00 x 130.00 x 12.00mm, PTFE
NB929
120.00 x 140.00 x 13.00mm, FPM

25 11.0L

Diesel

D 2556 M	6 Cyl.	12 Valves	11045cc	TD7730
D 2556 MF	6 Cyl.	12 Valves	11045cc	TD7729
D 2556 MTE	6 Cyl.	12 Valves	11045cc	TD23166
D 2556 MX	6 Cyl.	12 Valves	11045cc	TD7733
D 2556 MXF	6 Cyl.	12 Valves	11045cc	TD7731
D 2556 MXUH/175	6 Cyl.	12 Valves	11045cc	TD7613
D 2556 MXUH/192	6 Cyl.	12 Valves	11045cc	TD7606
D 2556 MXUH/240	6 Cyl.	12 Valves	11045cc	TD7607
D 2556 MXUM	6 Cyl.	12 Valves	11045cc	TD7439

PB224 (x12)

NB928
105.00 x 130.00 x 12.00mm, FPM
NB929
120.00 x 140.00 x 13.00mm, FPM

26 11.4L

Diesel

D 2566	6 Cyl.	12 Valves	11413cc	TD7413
D 2566 M	6 Cyl.	12 Valves	11413cc	TD7735
D 2566 ME	6 Cyl.	12 Valves	11413cc	TD19451
D 2566 MF	6 Cyl.	12 Valves	11413cc	TD7732
D 2566 MF/220	6 Cyl.	12 Valves	11413cc	TD7722
D 2566 MFO	6 Cyl.	12 Valves	11413cc	TD28911
D 2566 MH	6 Cyl.	12 Valves	11413cc	TD7414
D 2566 MHO	6 Cyl.	12 Valves	11413cc	TD7741
D 2566 MK	6 Cyl.	12 Valves	11413cc	TD7801
D 2566 MK/280	6 Cyl.	12 Valves	11413cc	TD7800
D 2566 MKF	6 Cyl.	12 Valves	11413cc	TD7758
D 2566 MKF/280	6 Cyl.	12 Valves	11413cc	TD7756
D 2566 MKUH/320	6 Cyl.	12 Valves	11413cc	TD7633
D 2566 MKUL	6 Cyl.	12 Valves	11413cc	TD7804
D 2566 MLUH	6 Cyl.	12 Valves	11413cc	TD7632

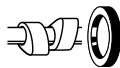

D 2566 MLUM	6 Cyl.	12 Valves	11413cc	TD7625
D 2566 MLUM/US	6 Cyl.	12 Valves	11413cc	TD7621
D 2566 MSFV	6 Cyl.	12 Valves	11413cc	TD8750
D 2566 MT	6 Cyl.	12 Valves	11413cc	TD7799
D 2566 MTE	6 Cyl.	12 Valves	11413cc	TD19074
D 2566 MTF	6 Cyl.	12 Valves	11413cc	TD7738
D 2566 MTFG	6 Cyl.	12 Valves	11413cc	TD7805
D 2566 MTH	6 Cyl.	12 Valves	11413cc	TD7418
D 2566 MTHO	6 Cyl.	12 Valves	11413cc	TD7744
D 2566 MTSF	6 Cyl.	12 Valves	11413cc	TD8756
D 2566 MTUH	6 Cyl.	12 Valves	11413cc	TD7603
D 2566 MUE	6 Cyl.	12 Valves	11413cc	TD19452
D 2566 MUH	6 Cyl.	12 Valves	11413cc	TD7407
D 2566 MUH/175	6 Cyl.	12 Valves	11413cc	TD7614
D 2566 MUH/192	6 Cyl.	12 Valves	11413cc	TD7608
D 2566 MUH/200	6 Cyl.	12 Valves	11413cc	TD7609
D 2566 MUH/220	6 Cyl.	12 Valves	11413cc	TD7615
D 2566 MUH/240	6 Cyl.	12 Valves	11413cc	TD7610
D 2566 MUL	6 Cyl.	12 Valves	11413cc	TD7803
D 2566 MUM	6 Cyl.	12 Valves	11413cc	TD7440
D 2566 MUM/200	6 Cyl.	12 Valves	11413cc	TD7622
D 2566 MUM/220	6 Cyl.	12 Valves	11413cc	TD7623
D 2566 MUM/240	6 Cyl.	12 Valves	11413cc	TD7624
D 2566 MXF	6 Cyl.	12 Valves	11413cc	TD19043
D 2566 UH	6 Cyl.	12 Valves	11413cc	TD7616
D 2566 UH/205	6 Cyl.	12 Valves	11413cc	TD7611

PB224 (x12)

NB928
 105.00 x 130.00 x 12.00mm, FPM
NB929
 120.00 x 140.00 x 13.00mm, FPM

27 12.0L

Diesel

D 2866 F/240	6 Cyl.	12 Valves	11967cc	TD7775
D 2866 FG	6 Cyl.	12 Valves	11967cc	TD28924
D 2866 FR	6 Cyl.	12 Valves	11967cc	TD19127
D 2866 KF	6 Cyl.	12 Valves	11967cc	TD5651
D 2866 KFZ	6 Cyl.	12 Valves	11967cc	TD7761
D 2866 KOH/360	6 Cyl.	12 Valves	11967cc	TD16487
D 2866 KOH/373	6 Cyl.	12 Valves	11967cc	TD7415
D 2866 KUH/360	6 Cyl.	12 Valves	11967cc	TD7591
D 2866 KUL	6 Cyl.	12 Valves	11967cc	TD7786
D 2866 LF	6 Cyl.	12 Valves	11967cc	TD28926
D 2866 LF01	6 Cyl.	12 Valves	11967cc	TD28927
D 2866 LF02	6 Cyl.	12 Valves	11967cc	TD28928
D 2866 LF03	6 Cyl.	12 Valves	11967cc	TD7787
D 2866 LF04	6 Cyl.	12 Valves	11967cc	TD7779
D 2866 LF05	6 Cyl.	12 Valves	11967cc	TD7788
D 2866 LF06	6 Cyl.	12 Valves	11967cc	TD7792
D 2866 LF07	6 Cyl.	12 Valves	11967cc	TD28929
D 2866 LF08	6 Cyl.	12 Valves	11967cc	TD28930
D 2866 LF09	6 Cyl.	12 Valves	11967cc	TD7793

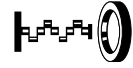
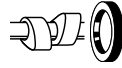

D 2866 LF10	6 Cyl.	12 Valves	11967cc	TD7794
D 2866 LF14	6 Cyl.	12 Valves	11967cc	TD21308
D 2866 LF15	6 Cyl.	12 Valves	11967cc	TD7789
D 2866 LF16	6 Cyl.	12 Valves	11967cc	TD7791
D 2866 LF17	6 Cyl.	12 Valves	11967cc	TD21309
D 2866 LF20	6 Cyl.	12 Valves	11967cc	TD7771
D 2866 LF21	6 Cyl.	12 Valves	11967cc	TD7770
D 2866 LF22	6 Cyl.	12 Valves	11967cc	TD7772
D 2866 LF23	6 Cyl.	12 Valves	11967cc	TD16521
D 2866 LF24	6 Cyl.	12 Valves	11967cc	TD16522
D 2866 LF29	6 Cyl.	12 Valves	11967cc	TD21310
D 2866 LF34	6 Cyl.	12 Valves	11967cc	TD14308
D 2866 LF35	6 Cyl.	12 Valves	11967cc	TD14311
D 2866 LF/290	6 Cyl.	12 Valves	11967cc	TD7778
D 2866 LF/330	6 Cyl.	12 Valves	11967cc	TD7782
D 2866 LFG	6 Cyl.	12 Valves	11967cc	TD28932
D 2866 LFG 03	6 Cyl.	12 Valves	11967cc	TD28933
D 2866 LFG 04	6 Cyl.	12 Valves	11967cc	TD28934
D 2866 LFG 05	6 Cyl.	12 Valves	11967cc	TD28935
D 2866 LFZ/290	6 Cyl.	12 Valves	11967cc	TD7757
D 2866 LFZ/330	6 Cyl.	12 Valves	11967cc	TD7759
D 2866 LOH	6 Cyl.	12 Valves	11967cc	TD7750
D 2866 LOH 02	6 Cyl.	12 Valves	11967cc	TD28939
D 2866 LOH 03	6 Cyl.	12 Valves	11967cc	TD7808
D 2866 LOH 07	6 Cyl.	12 Valves	11967cc	TD7602
D 2866 LOH 09	6 Cyl.	12 Valves	11967cc	TD28940
D 2866 LOH 20	6 Cyl.	12 Valves	11967cc	TD5647
D 2866 LOH 21	6 Cyl.	12 Valves	11967cc	TD28941
D 2866 LOH 22	6 Cyl.	12 Valves	11967cc	TD7420
D 2866 LOH 23	6 Cyl.	12 Valves	11967cc	TD7592
D 2866 LOH 24	6 Cyl.	12 Valves	11970cc	TD7752
D 2866 LOH 25	6 Cyl.	12 Valves	11967cc	TD7753
D 2866 LOH 26	6 Cyl.	12 Valves	11967cc	TD7590
D 2866 LOH 31	6 Cyl.	12 Valves	11967cc	TD28942
D 2866 LU	6 Cyl.	12 Valves	11967cc	TD28945
D 2866 LU 01	6 Cyl.	12 Valves	11967cc	TD21312
D 2866 LU 02	6 Cyl.	12 Valves	11967cc	TD28946
D 2866 LU 03	6 Cyl.	12 Valves	11967cc	TD21313
D 2866 LU 04	6 Cyl.	12 Valves	11967cc	TD28947
D 2866 LU 07	6 Cyl.	12 Valves	11967cc	TD28948
D 2866 LU 08	6 Cyl.	12 Valves	11967cc	TD28949
D 2866 LU/330	6 Cyl.	12 Valves	11967cc	TD7809
D 2866 LUH	6 Cyl.	12 Valves	11967cc	TD28950
D 2866 LUH 04	6 Cyl.	12 Valves	11967cc	TD28951
D 2866 LUH 05	6 Cyl.	12 Valves	11967cc	TD28952
D 2866 LUH 20	6 Cyl.	12 Valves	11967cc	TD7582
D 2866 LUH 21	6 Cyl.	12 Valves	11967cc	TD11167
D 2866 LUH 22	6 Cyl.	12 Valves	11967cc	TD11133
D 2866 LUH 26	6 Cyl.	12 Valves	11967cc	TD11134
D 2866 LUL/330	6 Cyl.	12 Valves	11967cc	TD7783

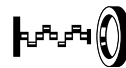
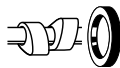

D 2866 LX	6 Cyl.	12 Valves	11967cc	TD19128
D 2866 LXE 40	6 Cyl.	12 Valves	11967cc	TD27926
D 2866 LXE 47	6 Cyl.	12 Valves	11967cc	TD27929
D 2866 LXF	6 Cyl.	12 Valves	11967cc	TD7785
D 2866 LXFG	6 Cyl.	12 Valves	11967cc	TD28961
D 2866 LXOH	6 Cyl.	12 Valves	11967cc	TD6728
D 2866 LXU	6 Cyl.	12 Valves	11967cc	TD28962
D 2866 LXUH	6 Cyl.	12 Valves	11967cc	TD28963
D 2866 OH	6 Cyl.	12 Valves	11967cc	TD23745
D 2866 T	6 Cyl.	12 Valves	11967cc	TD7580
D 2866 TOH	6 Cyl.	12 Valves	11967cc	TD7745
D 2866 TOH/290	6 Cyl.	12 Valves	11967cc	TD7746
D 2866 TOH/310	6 Cyl.	12 Valves	11967cc	TD7747
D 2866 TUH	6 Cyl.	12 Valves	11967cc	TD7186
D 2866 TUH 01	6 Cyl.	12 Valves	11967cc	TD7176
D 2866 TUH/290	6 Cyl.	12 Valves	11967cc	TD7589
D 2866 UH	6 Cyl.	12 Valves	11967cc	TD7419
D 2866 UH/240	6 Cyl.	12 Valves	11967cc	TD7577
D 2866 UM	6 Cyl.	12 Valves	11967cc	TD7174

PB224 (x12)

NB928

105.00 x 130.00 x 12.00mm, FPM

NB929

120.00 x 140.00 x 13.00mm, FPM

28 12.0L

Diesel

D 2866 LF25	6 Cyl.	24 Valves	11967cc	TD16467
D 2866 LF26	6 Cyl.	24 Valves	11967cc	TD16204
D 2866 LF27	6 Cyl.	24 Valves	11967cc	TD16205
D 2866 LF28	6 Cyl.	24 Valves	11967cc	TD15050
D 2866 LF30	6 Cyl.	24 Valves	11967cc	TD21311
D 2866 LF31	6 Cyl.	24 Valves	11967cc	TD14312
D 2866 LF32	6 Cyl.	24 Valves	11967cc	TD15048
D 2866 LF36	6 Cyl.	24 Valves	11967cc	TD16202
D 2866 LF37	6 Cyl.	24 Valves	11967cc	TD16203
D 2866 LF39	6 Cyl.	24 Valves	11967cc	TD28931
D 2866 LF40	6 Cyl.	24 Valves	11967cc	TD23662
D 2866 LF41	6 Cyl.	24 Valves	11967cc	TD23005
D 2866 LF43	6 Cyl.	24 Valves	11967cc	TD23004
D 2866 LOH 06	6 Cyl.	24 Valves	11967cc	TD7755
D 2866 LOH 27	6 Cyl.	24 Valves	11967cc	TD16760
D 2866 LOH 28	6 Cyl.	24 Valves	11967cc	TD16761
D 2866 LOH 29	6 Cyl.	24 Valves	11967cc	TD16493
D 2866 LOH 32	6 Cyl.	24 Valves	11967cc	TD16746
D 2866 LOH 33	6 Cyl.	24 Valves	11967cc	TD16747
D 2866 LOH 34	6 Cyl.	24 Valves	11967cc	TD16297
D 2866 LOH 35	6 Cyl.	24 Valves	11967cc	TD28943
D 2866 LOH 36	6 Cyl.	24 Valves	11967cc	TD28944
D 2866 LUH 23	6 Cyl.	24 Valves	11967cc	TD16764
D 2866 LUH 24	6 Cyl.	24 Valves	11967cc	TD16765
D 2866 LUH 25	6 Cyl.	24 Valves	11967cc	TD16766
D 2866 LUH 27	6 Cyl.	24 Valves	11967cc	TD28953

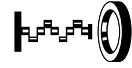
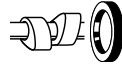

D 2866 LUH 28	6 Cyl.	24 Valves	11967cc	TD28954
D 2866 LUH 29	6 Cyl.	24 Valves	11967cc	TD18040
D 2866 LUH 30	6 Cyl.	24 Valves	11967cc	TD16767
D 2866 LUH 34	6 Cyl.	24 Valves	11967cc	TD28955
D 2866 LUH 35	6 Cyl.	24 Valves	11967cc	TD28956
D 2866 LUH 36	6 Cyl.	24 Valves	11967cc	TD28957
D 2866 LUH 37	6 Cyl.	24 Valves	11967cc	TD28958
D 2866 LUH 50	6 Cyl.	24 Valves	11967cc	TD28959
D 2866 LUH 51	6 Cyl.	24 Valves	11967cc	TD28163
D 2866 LUH 52	6 Cyl.	24 Valves	11967cc	TD28960
D 2866 LUH/330	6 Cyl.	24 Valves	11967cc	TD7593

PB394 (x24)

NB928 105.00 x 130.00 x 12.00mm, FPM
NB929 120.00 x 140.00 x 13.00mm, FPM

29 12.0L

Diesel

D 2866 LFG 06	6 Cyl.	12 Valves	11967cc	TD28936
D 2866 LH 01	6 Cyl.	12 Valves	11967cc	TD28938
D 2866 U	6 Cyl.	12 Valves	11967cc	TD28964

NB928 105.00 x 130.00 x 12.00mm, FPM
NB929 120.00 x 140.00 x 13.00mm, FPM

30 12.0L

Diesel

D 2866 LFG 07	6 Cyl.	12 Valves	11967cc	TD28937
---------------	--------	-----------	---------	---------

PB224 (x12)
 PB394 (x12)

NB928 105.00 x 130.00 x 12.00mm, FPM
NB929 120.00 x 140.00 x 13.00mm, FPM

31 12.0L

Gas

E 2866	6 Cyl.	12 Valves	11967cc	TD7768
E 2866 DE	6 Cyl.	12 Valves	11967cc	TD19457
E 2866 DF 01	6 Cyl.	12 Valves	11967cc	TD7763
E 2866 DF 02	6 Cyl.	12 Valves	11967cc	TD16777
E 2866 DF 03	6 Cyl.	12 Valves	11967cc	TD16778
E 2866 DF 04	6 Cyl.	12 Valves	11967cc	TD16779
E 2866 DOH 01	6 Cyl.	12 Valves	11967cc	TD28244
E 2866 DOH 02	6 Cyl.	12 Valves	11967cc	TD16772
E 2866 DOH 03	6 Cyl.	12 Valves	11967cc	TD16773
E 2866 DOH 04	6 Cyl.	12 Valves	11967cc	TD16774
E 2866 DUH	6 Cyl.	12 Valves	11970cc	TD7595
E 2866 DUH 01	6 Cyl.	12 Valves	11967cc	TD7626
E 2866 DUH 02	6 Cyl.	12 Valves	11967cc	TD28245
E 2866 DUH 03	6 Cyl.	12 Valves	11967cc	TD16768
E 2866 DUH 04	6 Cyl.	12 Valves	11967cc	TD22859
E 2866 LUH 01	6 Cyl.	12 Valves	11967cc	TD28246
E 2866 LUH 02	6 Cyl.	12 Valves	11967cc	TD16769

PB224 (x12)

NB928 105.00 x 130.00 x 12.00mm, FPM
NB929 120.00 x 140.00 x 13.00mm, FPM

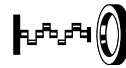
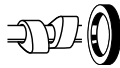

32 12.0L

Gas

G 2866 DOH 02	6 Cyl.	12 Valves	11967cc	TD16775
G 2866 DOH 03	6 Cyl.	12 Valves	11967cc	TD16776
G 2866 DUH 01	6 Cyl.	12 Valves	11967cc	TD28971
G 2866 DUH 02	6 Cyl.	12 Valves	11967cc	TD28972
G 2866 DUH 03	6 Cyl.	12 Valves	11967cc	TD28973
G 2866 DUH 04	6 Cyl.	12 Valves	11967cc	TD16770
G 2866 DUH 05	6 Cyl.	12 Valves	11967cc	TD16771

NB928
 105.00 x 130.00 x 12.00mm, FPM
NB929
 120.00 x 140.00 x 13.00mm, FPM

33 12.4L

Diesel

D 2676 440	6 Cyl.	24 Valves	12419cc	TD30292
D 2676 LF 01	6 Cyl.	24 Valves	12419cc	TD19100
D 2676 LF 02	6 Cyl.	24 Valves	12419cc	TD20542
D 2676 LF 03	6 Cyl.	24 Valves	12419cc	TD20543
D 2676 LF 04	6 Cyl.	24 Valves	12419cc	TD22906
D 2676 LF 05	6 Cyl.	24 Valves	12419cc	TD20371
D 2676 LF 06	6 Cyl.	24 Valves	12419cc	TD23145
D 2676 LF 07	6 Cyl.	24 Valves	12419cc	TD23137
D 2676 LF 08	6 Cyl.	24 Valves	12419cc	TD25462
D 2676 LF 09	6 Cyl.	24 Valves	12419cc	TD25463
D 2676 LF 10	6 Cyl.	24 Valves	12419cc	TD27718
D 2676 LF 11	6 Cyl.	24 Valves	12419cc	TD19104
D 2676 LF 12	6 Cyl.	24 Valves	12419cc	TD19103
D 2676 LF 13	6 Cyl.	24 Valves	12419cc	TD20372
D 2676 LF 14	6 Cyl.	24 Valves	12419cc	TD20373
D 2676 LF 15	6 Cyl.	24 Valves	12419cc	TD23087
D 2676 LF 16	6 Cyl.	24 Valves	12419cc	TD23088
D 2676 LF 17	6 Cyl.	24 Valves	12419cc	TD25460
D 2676 LF 18	6 Cyl.	24 Valves	12419cc	TD25461
D 2676 LF 19	6 Cyl.	24 Valves	12419cc	TD25615
D 2676 LF 20	6 Cyl.	24 Valves	12419cc	TD25616
D 2676 LF 21	6 Cyl.	24 Valves	12419cc	TD23691
D 2676 LF 22	6 Cyl.	24 Valves	12419cc	TD23692
D 2676 LF 23	6 Cyl.	24 Valves	12419cc	TD25609
D 2676 LF 24	6 Cyl.	24 Valves	12419cc	TD25608
D 2676 LF 25	6 Cyl.	24 Valves	12419cc	TD27720
D 2676 LF 26	6 Cyl.	24 Valves	12419cc	TD27722
D 2676 LF 28	6 Cyl.	24 Valves	12419cc	TD27723
D 2676 LF 31	6 Cyl.	24 Valves	12419cc	TD25610
D 2676 LF 32	6 Cyl.	24 Valves	12419cc	TD25621
D 2676 LF 33	6 Cyl.	24 Valves	12419cc	TD25623
D 2676 LF 35	6 Cyl.	24 Valves	12419cc	TD31931
D 2676 LF 36	6 Cyl.	24 Valves	12419cc	TD31932
D 2676 LF 45	6 Cyl.	24 Valves	12419cc	TD31933
D 2676 LF 46	6 Cyl.	24 Valves	12419cc	TD31934
D 2676 LF 47	6 Cyl.	24 Valves	12419cc	TD31935
D 2676 LF 48	6 Cyl.	24 Valves	12419cc	TD31936

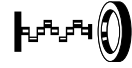
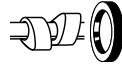

D 2676 LF 49	6 Cyl.	24 Valves	12419cc	TD31937
D 2676 LF 50	6 Cyl.	24 Valves	12419cc	TD31938
D 2676 LF 54	6 Cyl.	24 Valves	12419cc	TD31939
D 2676 LF 55	6 Cyl.	24 Valves	12419cc	TD31940
D 2676 LF 56	6 Cyl.	24 Valves	12419cc	TD31941
D 2676 LF 57	6 Cyl.	24 Valves	12419cc	TD31942
D 2676 LF 58	6 Cyl.	24 Valves	12419cc	TD31943
D 2676 LOH 01	6 Cyl.	24 Valves	12419cc	TD19102
D 2676 LOH 02	6 Cyl.	24 Valves	12419cc	TD19101
D 2676 LOH 03	6 Cyl.	24 Valves	12419cc	TD23068
D 2676 LOH 04	6 Cyl.	24 Valves	12419cc	TD23069
D 2676 LOH 10	6 Cyl.	24 Valves	12419cc	TD23077
D 2676 LOH 18	6 Cyl.	24 Valves	12419cc	TD23966
D 2676 LOH 26	6 Cyl.	24 Valves	12419cc	TD23400
D 2676 LOH 27	6 Cyl.	24 Valves	12419cc	TD23401
D 2676 LOH 28	6 Cyl.	24 Valves	12419cc	TD23678
D 2676 LOH 30	6 Cyl.	24 Valves	12419cc	TD30484
D 2676 LOH 31	6 Cyl.	24 Valves	12419cc	TD30485
D 2676 LOH 32	6 Cyl.	24 Valves	12419cc	TD30486
D 2676 LOH 33	6 Cyl.	24 Valves	12419cc	TD30487
D 2676 LOH 34	6 Cyl.	24 Valves	12419cc	TD30488

PB394 (x24)

NA5450 **F**

100.00 x 130.00 x 12.00mm, PTFE

NB929 **R**

120.00 x 140.00 x 13.00mm, FPM

34 12.4L

Diesel

D 2676 LE 621	6 Cyl.	24 Valves	12412cc	TD27946
D 2676 LE 622	6 Cyl.	24 Valves	12412cc	TD27954

NA5450 **F**

100.00 x 130.00 x 12.00mm, PTFE

NB929 **R**

120.00 x 140.00 x 13.00mm, FPM

35 12.8L

Diesel

D 2538 M	8 Cyl.	16 Valves	12763cc	TD7743
D 2538 ME	8 Cyl.	16 Valves	12763cc	TD19447
D 2538 MF	8 Cyl.	16 Valves	12763cc	TD7737
D 2538 MT	8 Cyl.	16 Valves	12763cc	TD7748
D 2538 MTE	8 Cyl.	16 Valves	12763cc	TD19064

PB224 (x16)

NB928 **F**

105.00 x 130.00 x 12.00mm, FPM

NB929 **R**

120.00 x 140.00 x 13.00mm, FPM

36 12.8L

Diesel

D 2876 LE 121	6 Cyl.	24 Valves	12816cc	TD20232
D 2876 LE 122	6 Cyl.	24 Valves	12816cc	TD20233
D 2876 LE 123	6 Cyl.	24 Valves	12816cc	TD20234
D 2876 LE 124	6 Cyl.	24 Valves	12816cc	TD20235
D 2876 LE 402	6 Cyl.	24 Valves	12816cc	TD27927
D 2876 LE 403	6 Cyl.	12 Valves	12816cc	TD27930
D 2876 LE 406	6 Cyl.	12 Valves	12816cc	TD27933

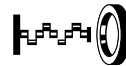
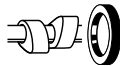

D 2876 LE 407	6 Cyl.	12 Valves	12816cc	TD27934
D 2876 LF 01	6 Cyl.	24 Valves	12816cc	TD28965
D 2876 LF 03	6 Cyl.	24 Valves	12816cc	TD17050
D 2876 LF 04	6 Cyl.	24 Valves	12816cc	TD15051
D 2876 LF 05	6 Cyl.	24 Valves	12816cc	TD16206
D 2876 LF 06	6 Cyl.	24 Valves	12816cc	TD14313
D 2876 LF 07	6 Cyl.	24 Valves	12816cc	TD15049
D 2876 LF 10	6 Cyl.	24 Valves	12816cc	TD28966
D 2876 LF 11	6 Cyl.	24 Valves	12816cc	TD20603
D 2876 LF 12	6 Cyl.	24 Valves	12816cc	TD16825
D 2876 LF 13	6 Cyl.	24 Valves	12816cc	TD16826
D 2876 LF 17	6 Cyl.	24 Valves	12816cc	TD28967
D 2876 LF 18	6 Cyl.	24 Valves	12816cc	TD23078
D 2876 LF 19	6 Cyl.	24 Valves	12816cc	TD23080
D 2876 LF 20	6 Cyl.	24 Valves	12816cc	TD23008
D 2876 LF 23	6 Cyl.	24 Valves	12816cc	TD23079
D 2876 LF 25	6 Cyl.	24 Valves	12816cc	TD19115
D 2876 LFG 01	6 Cyl.	24 Valves	12816cc	TD28968
D 2876 LOH 03	6 Cyl.	24 Valves	12816cc	TD16298
D 2876 LOH 20	6 Cyl.	24 Valves	12816cc	TD16762
D 2876 LOH 21	6 Cyl.	24 Valves	12816cc	TD18041
D 2876 LUE 604	6 Cyl.	24 Valves	12816cc	TD27939
D 2876 LUE 605	6 Cyl.	24 Valves	12816cc	TD27938
D 2876 LUE 606	6 Cyl.	24 Valves	12816cc	TD27937
D 2876 LUE 621	6 Cyl.	24 Valves	12816cc	TD27940
D 2876 LUE 622	6 Cyl.	24 Valves	12816cc	TD27941
D 2876 LUE 623	6 Cyl.	24 Valves	12816cc	TD27942
D 2876 LUE 631	6 Cyl.	24 Valves	12816cc	TD27945
D 2876 LUE 632	6 Cyl.	24 Valves	12816cc	TD27944
D 2876 LUE 633	6 Cyl.	24 Valves	12816cc	TD27943

PB394 (x24)

NB928
105.00 x 130.00 x 12.00mm, FPM
NB929
120.00 x 140.00 x 13.00mm, FPM

37 12.8L

Diesel

D 2876 LF 02	6 Cyl.	12 Valves	12816cc	TD7773
D 2876 LOH 01	6 Cyl.	12 Valves	12816cc	TD16249
D 2876 LOH 02	6 Cyl.	12 Valves	12816cc	TD16509
D 2876 LUH 01	6 Cyl.	12 Valves	12816cc	TD28969
D 2876 LUH 02	6 Cyl.	12 Valves	12816cc	TD28970

PB224 (x12)

NB928
105.00 x 130.00 x 12.00mm, FPM
NB929
120.00 x 140.00 x 13.00mm, FPM

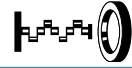

38 12.8L		Gas		
E 2876 E 312	6 Cyl.	12 Valves	12816cc	TD28167
E 2876 LE 202	6 Cyl.	12 Valves	12816cc	TD28170
E 2876 LE 302	6 Cyl.	12 Valves	12816cc	TD28168
E 2876 LUH 01	6 Cyl.	12 Valves	12816cc	TD28243
E 2876 LUH 02	6 Cyl.	12 Valves	12816cc	TD19966
E 2876 LUH 03	6 Cyl.	12 Valves	12816cc	TD23804
E 2876 LUH 04	6 Cyl.	12 Valves	12816cc	TD25459
E 2876 LUH 07	6 Cyl.	12 Valves	12816cc	TD31919
E 2876 LUH 08	6 Cyl.	12 Valves	12816cc	TD31920
E 2876 TE 302	6 Cyl.	12 Valves	12816cc	TD28169
G 2876 DUH 01	6 Cyl.	12 Valves	12816cc	TD19967
G 2876 DUH 02	6 Cyl.	12 Valves	12816cc	TD28974
PB224 (x12)				NB928 F 105.00 x 130.00 x 12.00mm, FPM NB929 R 120.00 x 140.00 x 13.00mm, FPM

39 14.6L		Diesel		
D 2848 LE 422	8 Cyl.	32 Valves	14618cc	TD27928
D 2848 LE 423	8 Cyl.	16 Valves	14618cc	TD27920
				NB928 F 105.00 x 130.00 x 12.00mm, FPM NB929 R 120.00 x 140.00 x 13.00mm, FPM

40 14.6L		Diesel		
D 2848 LXE	8 Cyl.	16 Valves	14618cc	TD19118
D 2848 LYE	8 Cyl.	16 Valves	14618cc	TD19119
D 2848 M	8 Cyl.	16 Valves	14618cc	TD19075
D 2848 MH	8 Cyl.	16 Valves	14618cc	TD19076
PB224 (x16)				NB928 F 105.00 x 130.00 x 12.00mm, FPM NB929 R 120.00 x 140.00 x 13.00mm, FPM

41 14.6L		Gas		
E 2848 LE 322	8 Cyl.	16 Valves	14618cc	TD28166
PB224 (x16)				NB928 F 105.00 x 130.00 x 12.00mm, FPM NB929 R 120.00 x 140.00 x 13.00mm, FPM

42 15.9L		Diesel		
D 2530 ME	10 Cyl.	20 Valves	15945cc	TD19446
D 2530 MF	10 Cyl.	20 Valves	15945cc	TD5650
D 2530 MTE	10 Cyl.	20 Valves	15953cc	TD19065
D 2530 MTXF	10 Cyl.	20 Valves	15953cc	TD7813
D 2530 MTXF/360	10 Cyl.	20 Valves	15900cc	TD7760
D 2530 MXF	10 Cyl.	20 Valves	15945cc	TD19038
PB224 (x20)				NB928 F 105.00 x 130.00 x 12.00mm, FPM NB929 R 120.00 x 140.00 x 13.00mm, FPM

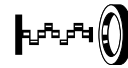
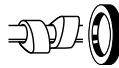

43 16.2L

Diesel

D 2868 LE 421	8 Cyl.	32 Valves	16200cc	TD27932
D 2868 LE 422	8 Cyl.	32 Valves	16200cc	TD27931
D 2868 LF02	8 Cyl.	32 Valves	16200cc	TD20374
D 2868 LF03	8 Cyl.	32 Valves	16200cc	TD20375
D 2868 LF04	8 Cyl.	32 Valves	16200cc	TD23161
D 2868 LF05	8 Cyl.	32 Valves	16200cc	TD23442
D 2868 LF06	8 Cyl.	32 Valves	16200cc	TD25464
D 2868 LF07	8 Cyl.	32 Valves	16200cc	TD25465

PB394 (x32)

NA5467

110.00 x 130.00 x 12.00mm, PTFE/ACM

NA5466

139.00 x 164.00 x 12.00mm, PTFE/ACM

44 17.4L

Diesel

D 2540 MT	10 Cyl.	20 Valves	17426cc	TD19448
D 2540 MTF	10 Cyl.	20 Valves	17426cc	TD7814
D 2540 MTF/390	10 Cyl.	20 Valves	17426cc	TD7762

PB224 (x20)

NB928

105.00 x 130.00 x 12.00mm, FPM

NB929

120.00 x 140.00 x 13.00mm, FPM

45 18.3L

Diesel

D 2840 LE	10 Cyl.	20 Valves	18273cc	TD19453
D 2840 LE 403	10 Cyl.	20 Valves	18273cc	TD27911
D 2840 LE 423	10 Cyl.	40 Valves	18270cc	TD27921
D 2840 LF01	10 Cyl.	20 Valves	18273cc	TD7796
D 2840 LF03	10 Cyl.	20 Valves	18273cc	TD28916
D 2840 LF04	10 Cyl.	20 Valves	18273cc	TD7797
D 2840 LF06	10 Cyl.	20 Valves	18273cc	TD7798
D 2840 LF20	10 Cyl.	20 Valves	18273cc	TD7774
D 2840 LF21	10 Cyl.	20 Valves	18273cc	TD18099
D 2840 LF25	10 Cyl.	40 Valves	18273cc	TD16824
D 2840 LF 460	10 Cyl.	20 Valves	18273cc	TD7795

NB928

105.00 x 130.00 x 12.00mm, FPM

NB929

120.00 x 140.00 x 13.00mm, FPM

46 18.3L

Diesel

D 2840 LXE	10 Cyl.	20 Valves	18273cc	TD19454
D 2840 LXF	10 Cyl.	20 Valves	18273cc	TD19455
D 2840 LYE	10 Cyl.	20 Valves	18273cc	TD19124
D 2840 ME	10 Cyl.	20 Valves	18273cc	TD19125
D 2840 MF	10 Cyl.	20 Valves	18273cc	TD7811
D 2840 MFG	10 Cyl.	20 Valves	18273cc	TD7812
D 2840 MFR	10 Cyl.	20 Valves	18273cc	TD19456
D 2840 MH	10 Cyl.	20 Valves	18273cc	TD19126

PB224 (x20)

NB928

105.00 x 130.00 x 12.00mm, FPM

NB929

120.00 x 140.00 x 13.00mm, FPM

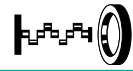
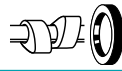

47 20.9L Diesel

D 2542 MLE	12 Cyl.	24 Valves	20911cc	TD19449
D 2542 MTE	12 Cyl.	24 Valves	20911cc	TD19450
PB224 (x24)				NB928 F 105.00 x 130.00 x 12.00mm, FPM NB929 R 120.00 x 140.00 x 13.00mm, FPM

48 21.9L Diesel

D 2842 LE 202	12 Cyl.	24 Valves	21930cc	TD25682
D 2842 LE 211	12 Cyl.	24 Valves	21930cc	TD27955
D 2842 LE 401	12 Cyl.	24 Valves	21930cc	TD27860
D 2842 LE 402	12 Cyl.	24 Valves	21930cc	TD27861
D 2842 LE 403	12 Cyl.	24 Valves	21930cc	TD27862
D 2842 LE 404	12 Cyl.	24 Valves	21930cc	TD27702
D 2842 LE 405	12 Cyl.	24 Valves	21930cc	TD27863
D 2842 LE 406	12 Cyl.	24 Valves	21930cc	TD27864
D 2842 LE 407	12 Cyl.	24 Valves	21930cc	TD27865
D 2842 LE 408	12 Cyl.	24 Valves	21930cc	TD27866
D 2842 LE 409	12 Cyl.	24 Valves	21930cc	TD27867
D 2842 LE 410	12 Cyl.	24 Valves	21930cc	TD27868
D 2842 LE 412	12 Cyl.	24 Valves	21930cc	TD27870
D 2842 LE 413	12 Cyl.	24 Valves	21930cc	TD27871
D 2842 LE 419	12 Cyl.	24 Valves	21930cc	TD27869
D 2842 LE 423	12 Cyl.	24 Valves	21930cc	TD27922
D 2842 LE 433	12 Cyl.	24 Valves	21930cc	TD27923
D 2842 LE 443	12 Cyl.	24 Valves	21930cc	TD27924
D 2842 LE 602	12 Cyl.	24 Valves	21930cc	TD25234
D 2842 LE 604	12 Cyl.	24 Valves	21930cc	TD27918
D 2842 LE 606	12 Cyl.	24 Valves	21930cc	TD27947
D 2842 LE 607	12 Cyl.	24 Valves	21930cc	TD27919
D 2842 LE 620	12 Cyl.	24 Valves	21927cc	TD27948
D 2842 LE 622	12 Cyl.	24 Valves	21927cc	TD20231
D 2842 LF10	12 Cyl.	24 Valves	21927cc	TD20177
D 2842 LXE	12 Cyl.	24 Valves	21927cc	TD19121
D 2842 LYE	12 Cyl.	24 Valves	21927cc	TD19122
D 2842 LZE	12 Cyl.	24 Valves	21927cc	TD19123
D 2842 ME	12 Cyl.	24 Valves	21927cc	TD19120
PB224 (x24)				NB928 F 105.00 x 130.00 x 12.00mm, FPM NB929 R 120.00 x 140.00 x 13.00mm, FPM

49 21.9L Gas

E 2842 E 312	12 Cyl.	24 Valves	21927cc	TD28171
E 2842 LE 312	12 Cyl.	24 Valves	21927cc	TD27925
E 2842 LE 322	12 Cyl.	24 Valves	21927cc	TD27639
E 2842 LE 332	12 Cyl.	24 Valves	21927cc	TD28172
PB224 (x24)				NB928 F 105.00 x 130.00 x 12.00mm, FPM NB929 R 120.00 x 140.00 x 13.00mm, FPM



50 24.2L

Diesel

D 2862 LE 421	12 Cyl.	48 Valves	24243cc	TD27936
D 2862 LE 422	12 Cyl.	48 Valves	24243cc	TD27623
D 2862 LE 431	12 Cyl.	48 Valves	24243cc	TD27935
D 2862 LE 432	12 Cyl.	48 Valves	24243cc	TD27624
D 2862 LE 463	12 Cyl.	48 Valves	24243cc	TD27625
D 2862 LE 631	12 Cyl.	48 Valves	24243cc	TD27949
D 2862 LE 632	12 Cyl.	48 Valves	24243cc	TD27950
D 2862 LE 633	12 Cyl.	48 Valves	24243cc	TD27951

PB394 (x48)

NA5467 F
110.00 x 130.00 x 12.00mm, PTFE/ACM

NA5466 R
139.00 x 164.00 x 12.00mm, PTFE/ACM

51 25.8L

Gas

E 3262 LE 202	12 Cyl.	48 Valves	25782cc	TD29290
---------------	---------	-----------	---------	---------

PB394 (x48)

NA5467 F
110.00 x 130.00 x 12.00mm, PTFE/ACM

NA5466 R
139.00 x 164.00 x 12.00mm, PTFE/ACM



CC



9

2 (DE)	07/07→06/15	ZJ-VE	Petrol	1349	4	16	15
2 (DE)	10/07→06/15	ZY-DE	Petrol	1498	4	16	26
2 (DE)	10/07→06/15	ZY-VE	Petrol	1498	4	16	26
2 (DE)	01/08→06/15	Y404	Diesel	1399	4	8	16
2 (DE)	10/08→06/15	Y406	Diesel	1560	4	16	36
2 (DE)	10/08→06/15	Y646	Diesel	1560	4	16	36
2 (DE)	05/11→11/14	ZJ46	Petrol	1349	4	16	15
2 (DE)	06/11→06/15	Y655	Diesel	1560	4	8	37
2 (DE)	06/11→06/15	Y661	Diesel	1560	4	8	37
2 (DE)	06/11→06/15	ZY05	Petrol	1498	4	16	26
2 (DE)	06/11→06/15	ZY66	Petrol	1498	4	16	26
2 (DE)	05/12→11/14	ZJ-VEM	Petrol	1349	4	16	15
2 (DY)	02/03→06/07	FUJA	Petrol	1242	4	16	10
2 (DY)	02/03→06/07	FXJA	Petrol	1388	4	16	17
2 (DY)	02/03→06/07	FYJA	Petrol	1596	4	16	34
2 (DY)	02/03→06/07	ZY-VE	Petrol	1498	4	16	26
2 (DY)	04/03→06/07	F6JA	Diesel	1399	4	8	16
2 (DY)	04/03→06/07	F6JB	Diesel	1399	4	8	16
2 (DY)	04/03→06/07	ZJ04	Petrol	1348	4	16	15
2 Saloon (DE)	05/10→06/15	ZY-DE	Petrol	1498	4	16	26
3 (BK)	10/03→12/06	L3-V	Petrol	2261	4	16	78
3 (BK)	10/03→03/09	ZY-VE	Petrol	1498	4	16	26
3 (BK)	10/03→06/09	B6ZE	Petrol	1598	4	16	28
3 (BK)	10/03→06/09	L3YS	Petrol	2261	4	16	78
3 (BK)	10/03→06/09	L3YT	Petrol	2261	4	16	78
3 (BK)	10/03→06/09	LF17	Petrol	1999	4	16	65
3 (BK)	10/03→06/09	ZJ-VE	Petrol	1349	4	16	15
3 (BK)	02/04→06/09	FXJA	Petrol	1388	4	16	17
3 (BK)	03/04→03/09	L3-VE	Petrol	2261	4	16	78
3 (BK)	06/04→03/09	LF-VE	Petrol	1999	4	16	65
3 (BK)	06/04→06/09	Y601	Diesel	1560	4	16	36
3 (BK)	04/06→06/09	L3-VDT	Petrol	2261	4	16	78
3 (BK)	06/06→06/09	L3YH	Petrol	2261	4	16	78
3 (BK)	06/06→12/09	Y406	Diesel	1560	4	16	36
3 (BK)	12/06→06/09	L3N9	Petrol	2261	4	16	78
3 (BK)	12/06→06/09	RF7J	Diesel	1998	4	16	67
3 (BK)	01/07→	Z6	Petrol	1598	4	16	38
3 (BL)	12/08→05/13	LF5W	Petrol	1999	4	16	65
3 (BL)	12/08→05/13	Y601	Diesel	1560	4	16	36
3 (BL)	12/08→05/13	Y642	Diesel	1560	4	16	36
3 (BL)	12/08→09/14	LF5H	Petrol	1999	4	16	65
3 (BL)	12/08→09/14	Z6	Petrol	1598	4	16	38
3 (BL)	01/09→05/13	R2AA	Diesel	2184	4	16	75
3 (BL)	01/09→09/14	LF17	Petrol	1999	4	16	65
3 (BL)	01/09→09/14	LF-DE	Petrol	1999	4	16	65
3 (BL)	03/09→09/14	L5-VE	Petrol	2488	4	16	84
3 (BL)	05/09→02/12	LF-VDS	Petrol	1998	4	16	65
3 (BL)	05/09→05/13	LF-VE	Petrol	1999	4	16	65
3 (BL)	06/09→09/14	L3KG	Petrol	2261	4	16	78
3 (BL)	06/09→09/14	L3-VDT	Petrol	2261	4	16	78
3 (BL)	09/09→12/11	L5-Y3	Petrol	2488	4	16	84
3 (BL)	09/10→05/13	Y650	Diesel	1560	4	8	37
3 (BL)	09/10→05/13	Y655	Diesel	1560	4	8	37
3 (BL)	10/12→05/13	ZY-VE	Petrol	1498	4	16	26
3 (BM, BN)	09/13→	Z6Y1	Petrol	1598	4	16	39
3 Saloon	02/06→12/14	B6	Petrol	1598	4	16	29
3 Saloon (BK)	06/00→06/09	L3-VE	Petrol	2261	4	16	78
3 Saloon (BK)	09/03→06/09	LF17	Petrol	1999	4	16	65
3 Saloon (BK)	10/03→03/09	ZJ-VE	Petrol	1349	4	16	15
3 Saloon (BK)	01/04→06/09	L3-VDT	Petrol	2261	4	16	78
3 Saloon (BK)	02/04→06/09	Z6	Petrol	1598	4	16	38
3 Saloon (BK)	06/04→06/09	Y601	Diesel	1560	4	16	36
3 Saloon (BK)	09/06→06/09	L3-V	Petrol	2261	4	16	78
3 Saloon (BK)	12/06→06/09	RF7J	Diesel	1998	4	16	67
3 Saloon (BL)	12/08→05/13	Y642	Diesel	1560	4	16	36
3 Saloon (BL)	01/09→09/14	R2AA	Diesel	2184	4	16	75
3 Saloon (BL)	02/09→05/13	LF5W	Petrol	1999	4	16	65
3 Saloon (BL)	02/09→09/14	LF5H	Petrol	1999	4	16	65
3 Saloon (BL)	02/09→09/14	Z6	Petrol	1598	4	16	38
3 Saloon (BL)	03/09→09/14	LF17	Petrol	1999	4	16	65
3 Saloon (BL)	03/09→09/14	LF-DE	Petrol	1999	4	16	65
3 Saloon (BL)	05/09→09/14	L5-VE	Petrol	2488	4	16	84
3 Saloon (BL)	01/10→12/13	L5-X	Petrol	2488	4	16	84
3 Saloon (BL)	09/10→05/13	Y650	Diesel	1560	4	8	37
3 Saloon (BL)	09/10→05/13	Y655	Diesel	1560	4	8	37
3 Saloon (BL)	10/12→05/13	LF-VE	Petrol	1999	4	16	65
3 Saloon (BL)	10/12→05/13	ZY-VE	Petrol	1498	4	16	26
3 Saloon (BM, BN)	09/13→	Z6Y1	Petrol	1598	4	16	39











CC



9

3 Saloon (BM, BN)	09/13→	Z6Y3	Petrol	1598	4	16	39
5 (CR19)	02/05→05/10	L3X	Petrol	2261	4	16	78
5 (CR19)	02/05→05/10	L823	Petrol	1798	4	16	53
5 (CR19)	02/05→05/10	LFF7	Petrol	1999	4	16	65
5 (CR19)	02/05→05/10	RF7J	Diesel	1998	4	16	67
5 (CR19)	02/05→12/10	L3-V	Petrol	2261	4	16	78
5 (CR19)	10/06→05/10	LF-VE	Petrol	1999	4	16	65
5 (CW)	09/10→	L850	Petrol	1798	4	16	53
5 (CW)	09/10→	LF5H	Petrol	1999	4	16	65
5 (CW)	09/10→	Y650	Diesel	1560	4	8	37
5 (CW)	09/10→	Y655	Diesel	1560	4	8	37
5 (CW)	01/11→	LFZB	Petrol	1999	4	16	65
5 (CW)	09/11→	L5-VE	Petrol	2488	4	16	84
5 (CW)	08/14→	LF-VE	Petrol	1999	4	16	65
6 Estate (GH)	12/07→12/10	RF7J	Diesel	1998	4	16	67
6 Estate (GH)	12/07→07/13	LF17	Petrol	1999	4	16	65
6 Estate (GH)	02/08→07/13	L5-VE	Petrol	2488	4	16	84
6 Estate (GH)	02/08→07/13	L813	Petrol	1798	4	16	53
6 Estate (GH)	08/08→07/13	R2AA	Diesel	2184	4	16	75
6 Estate (GH)	01/09→07/13	R2BF	Diesel	2184	4	16	75
6 Estate (GH)	01/10→07/13	LF-DE	Petrol	1999	4	16	65
6 Hatchback (GG)	08/02→08/07	L3C1	Petrol	2261	4	16	78
6 Hatchback (GG)	08/02→08/07	L813	Petrol	1798	4	16	53
6 Hatchback (GG)	08/02→08/07	LF17	Petrol	1999	4	16	65
6 Hatchback (GG)	08/02→08/07	LF18	Petrol	1999	4	16	65
6 Hatchback (GG)	08/02→08/07	RF5C	Diesel	1998	4	16	67
6 Hatchback (GG)	09/03→12/06	L3X	Petrol	2261	4	16	78
6 Hatchback (GG)	01/04→12/07	AJ	Petrol	2967	6	24	89
6 Hatchback (GG)	03/05→08/07	LFF7	Petrol	1999	4	16	65
6 Hatchback (GG)	06/05→08/07	RF7J	Diesel	1998	4	16	67
6 Hatchback (GH)	08/07→10/09	RF7J	Diesel	1998	4	16	67
6 Hatchback (GH)	08/07→03/13	L5-VE	Petrol	2488	4	16	84
6 Hatchback (GH)	08/07→07/13	L813	Petrol	1798	4	16	53
6 Hatchback (GH)	08/07→07/13	LF17	Petrol	1999	4	16	65
6 Hatchback (GH)	01/09→12/12	R2AA	Diesel	2184	4	16	75
6 Hatchback (GH)	01/09→12/12	R2BF	Diesel	2184	4	16	75
6 Hatchback (GH)	01/10→12/12	LF-DE	Petrol	1999	4	16	65
6 Saloon (GG)	06/02→08/07	L3C1	Petrol	2261	4	16	78
6 Saloon (GG)	06/02→08/07	LF17	Petrol	1999	4	16	65
6 Saloon (GG)	06/02→08/07	LF18	Petrol	1999	4	16	65
6 Saloon (GG)	06/02→08/07	RF5C	Diesel	1998	4	16	67
6 Saloon (GG)	08/02→08/07	L813	Petrol	1798	4	16	53
6 Saloon (GG)	08/02→08/07	L823	Petrol	1798	4	16	53
6 Saloon (GG)	08/02→08/07	L828	Petrol	1798	4	16	53
6 Saloon (GG)	07/03→12/08	L3X	Petrol	2261	4	16	78
6 Saloon (GG)	03/05→08/07	LFF7	Petrol	1999	4	16	65
6 Saloon (GG)	06/05→08/07	RF7J	Diesel	1998	4	16	67
6 Saloon (GG)	09/05→12/06	L3-VDT	Petrol	2261	4	16	78
6 Saloon (GG)	12/05→08/07	L3KG	Petrol	2261	4	16	78
6 Saloon (GG)	09/06→12/08	AJ	Petrol	2967	6	24	89
6 Saloon (GH)	08/07→10/10	RF7J	Diesel	1998	4	16	67
6 Saloon (GH)	08/07→12/12	LF17	Petrol	1999	4	16	65
6 Saloon (GH)	08/07→07/13	L5-VE	Petrol	2488	4	16	84
6 Saloon (GH)	08/07→07/13	L813	Petrol	1798	4	16	53
6 Saloon (GH)	01/09→12/12	R2BF	Diesel	2184	4	16	75
6 Saloon (GH)	01/09→07/13	R2AA	Diesel	2184	4	16	75
6 Saloon (GH)	01/10→12/12	LF-DE	Petrol	1999	4	16	65
6 Station Wagon (GY)	08/02→08/07	L3C1	Petrol	2261	4	16	78
6 Station Wagon (GY)	08/02→08/07	L813	Petrol	1798	4	16	53
6 Station Wagon (GY)	08/02→08/07	LF17	Petrol	1999	4	16	65
6 Station Wagon (GY)	08/02→08/07	LF18	Petrol	1999	4	16	65
6 Station Wagon (GY)	08/02→08/07	RF5C	Diesel	1998	4	16	67
6 Station Wagon (GY)	01/04→12/07	AJ	Petrol	2967	6	24	89
6 Station Wagon (GY)	03/05→08/07	LFF7	Petrol	1999	4	16	65
6 Station Wagon (GY)	06/05→08/07	RF7J	Diesel	1998	4	16	67
121 I (DA)	10/87→10/90	B1	Petrol	1139	4	8	5
121 I (DA)	10/87→10/90	B116	Petrol	1139	4	8	5
121 I (DA)	10/87→11/90	B3	Petrol	1324	4	8	8
121 I (DA)	11/87→03/89	B518	Petrol	1498	4	8	20
121 I (DA)	11/87→03/89	B573	Petrol	1498	4	8	20
121 I (DA)	11/87→10/90	B3A5	Petrol	1324	4	8	8
121 II (DB)	11/90→10/93	B1	Petrol	1139	4	8	5
121 II (DB)	11/90→03/96	B3 (16V)	Petrol	1324	4	16	9
121 III (JASM, JBSM)	03/96→04/03	DHF	Petrol	1242	4	16	10
121 III (JASM, JBSM)	03/96→04/03	DHG	Petrol	1242	4	16	10
121 III (JASM, JBSM)	03/96→04/03	J4R	Petrol	1299	4	8	13
121 III (JASM, JBSM)	03/96→04/03	J4T	Petrol	1299	4	8	13
121 III (JASM, JBSM)	03/96→04/03	JJK	Petrol	1299	4	8	13

							
121 III (JASM, JBSM)	03/96→04/03	JJM	Petrol	1299	4	8	13
121 III (JASM, JBSM)	03/96→04/03	RTJ	Diesel	1753	4	8	55
121 III (JASM, JBSM)	03/96→04/03	RTK	Diesel	1753	4	8	55
323 C IV (BG)	06/89→04/94	BP55	Petrol	1840	4	16	42
323 C IV (BG)	08/89→07/94	PN54	Diesel	1720	4	8	40
323 C IV (BG)	09/89→06/91	B6E	Petrol	1598	4	8	31
323 C IV (BG)	09/89→03/93	BP (DOHC)	Petrol	1840	4	16	42
323 C IV (BG)	09/89→03/93	BP22	Petrol	1840	4	16	42
323 C IV (BG)	09/89→03/93	BP31	Petrol	1840	4	16	42
323 C IV (BG)	09/89→06/93	BP21	Petrol	1840	4	16	42
323 C IV (BG)	09/89→07/94	B3 (16V)	Petrol	1324	4	16	9
323 C IV (BG)	09/89→07/94	B3E	Petrol	1324	4	8	8
323 C IV (BG)	09/90→07/94	BP Turbo	Petrol	1840	4	16	43
323 C IV (BG)	03/91→10/94	B6	Petrol	1598	4	16	29
323 C IV (BG)	11/91→12/93	BP	Petrol	1840	4	16	41
323 C IV (BG)	09/93→09/00	B67K	Petrol	1597	4	16	32
323 C V (BA)	08/94→09/98	B3 (16V)	Petrol	1324	4	16	9
323 C V (BA)	08/94→09/98	BP (DOHC)	Petrol	1840	4	16	42
323 C V (BA)	08/94→09/98	KF	Petrol	1995	6	24	64
323 C V (BA)	08/94→09/98	Z5-DE	Petrol	1489	4	16	24
323 F IV (BG)	04/87→08/93	B6 (SOHC)	Petrol	1598	4	8	31
323 F IV (BG)	04/87→08/93	B6T	Petrol	1598	4	16	29
323 F IV (BG)	08/89→07/94	BP (DOHC)	Petrol	1840	4	16	42
323 F IV (BG)	08/89→07/94	BP	Petrol	1840	4	16	41
323 F IV (BG)	09/89→06/91	B6E	Petrol	1598	4	8	31
323 F IV (BG)	09/89→03/93	BP31	Petrol	1840	4	16	42
323 F IV (BG)	01/91→04/94	BPC	Petrol	1840	4	16	45
323 F IV (BG)	03/91→10/94	B6	Petrol	1598	4	16	29
323 F IV (BG)	04/91→04/94	B67J	Petrol	1597	4	16	32
323 F IV (BG)	04/91→04/94	B67K	Petrol	1597	4	16	32
323 F IV (BG)	04/91→04/94	B67L	Petrol	1597	4	16	32
323 F V (BA)	07/94→09/98	Z5-DE	Petrol	1489	4	16	24
323 F V (BA)	08/94→09/98	BP (DOHC)	Petrol	1840	4	16	42
323 F V (BA)	08/94→09/98	KF	Petrol	1995	6	24	64
323 F VI (BJ)	09/98→01/01	B3 ME	Petrol	1324	4	16	9
323 F VI (BJ)	09/98→01/01	FP	Petrol	1840	4	16	49
323 F VI (BJ)	09/98→01/01	FP55	Petrol	1840	4	16	49
323 F VI (BJ)	09/98→01/01	ZL05	Petrol	1498	4	16	25
323 F VI (BJ)	09/98→01/01	ZL06	Petrol	1498	4	16	25
323 F VI (BJ)	09/98→05/04	B3 (16V)	Petrol	1324	4	16	9
323 F VI (BJ)	09/98→05/04	B6 (SOHC)	Petrol	1598	4	8	31
323 F VI (BJ)	09/98→05/04	BP (DOHC)	Petrol	1840	4	16	42
323 F VI (BJ)	09/98→05/04	RFTG	Diesel	1998	4	8	66
323 F VI (BJ)	02/00→05/04	FS	Petrol	1991	4	16	62
323 F VI (BJ)	01/01→05/04	FS7E	Petrol	1991	4	16	62
323 F VI (BJ)	01/01→05/04	FS7G	Petrol	1991	4	16	62
323 F VI (BJ)	01/01→05/04	RF4F	Diesel	1998	4	16	67
323 F VI (BJ)	01/01→05/04	ZM	Petrol	1598	4	16	28
323 I (FA)	01/77→05/80	T	Petrol	1272	4	8	14
323 I (FA)	01/77→05/80	TC	Petrol	1272	4	8	14
323 I (FA)	06/77→05/80	P	Petrol	985	4	8	4
323 I (FA)	06/77→05/80	PC	Petrol	985	4	8	4
323 I (FA)	05/78→05/80	U	Petrol	1415	4	8	19
323 I (FA)	05/78→05/80	UC	Petrol	1415	4	8	19
323 I Station Wagon (FA)	05/78→08/82	UC	Petrol	1415	4	8	19
323 I Station Wagon (FA)	05/78→05/86	TC	Petrol	1272	4	8	14
323 II (BD)	10/80→09/86	E5	Petrol	1490	4	8	22
323 II (BD)	11/80→10/85	E1	Petrol	1071	4	8	6
323 II (BD)	11/80→10/89	E3	Petrol	1296	4	8	11
323 II (BD)	06/86→03/87	B68	Petrol	1597	4	8	31
323 II (BD)	04/87→05/89	B335	Petrol	1324	4	8	8
323 II Hatchback (BD)	11/80→10/85	E1	Petrol	1071	4	8	6
323 II Hatchback (BD)	11/80→12/85	E5	Petrol	1490	4	8	22
323 II Hatchback (BD)	11/80→10/89	E3	Petrol	1296	4	8	11
323 III (BF)	08/85→05/89	E3	Petrol	1296	4	8	11
323 III (BF)	08/85→05/89	E5	Petrol	1490	4	8	22
323 III (BF)	08/85→05/89	E5E2	Petrol	1490	4	8	22
323 III (BF)	08/85→05/89	E5E3	Petrol	1490	4	8	22
323 III (BF)	08/85→04/90	E1	Petrol	1071	4	8	6
323 III (BF)	10/85→11/91	B6T	Petrol	1598	4	16	29
323 III (BF)	01/86→10/89	B6 (SOHC)	Petrol	1598	4	8	31
323 III (BF)	06/86→03/87	B68	Petrol	1597	4	8	31
323 III (BF)	09/86→05/89	PN27	Diesel	1720	4	8	40
323 III (BF)	01/87→05/89	PN46	Diesel	1720	4	8	40
323 III (BF)	04/87→05/89	B315	Petrol	1324	4	8	8
323 III (BF)	04/87→07/89	B3	Petrol	1324	4	8	8
323 III (BF)	09/87→10/89	B5	Petrol	1498	4	8	20
323 III Hatchback (BF)	08/85→05/89	E5	Petrol	1490	4	8	22











CC



9

323 III Hatchback (BF)	08/85→05/89	E5E2	Petrol	1490	4	8	22
323 III Hatchback (BF)	08/85→05/89	E5E3	Petrol	1490	4	8	22
323 III Hatchback (BF)	08/85→08/93	B6 (SOHC)	Petrol	1598	4	8	31
323 III Hatchback (BF)	09/85→12/87	E3	Petrol	1296	4	8	11
323 III Hatchback (BF)	09/85→08/89	B3E	Petrol	1324	4	8	8
323 III Hatchback (BF)	09/85→10/89	E1	Petrol	1071	4	8	6
323 III Hatchback (BF)	10/85→08/93	B6T	Petrol	1598	4	16	29
323 III Hatchback (BF)	04/86→05/89	PN27	Diesel	1720	4	8	40
323 III Hatchback (BF)	01/87→05/89	PN46	Diesel	1720	4	8	40
323 III Hatchback (BF)	04/87→05/89	B315	Petrol	1324	4	8	8
323 III Hatchback (BF)	08/87→10/89	B6F2	Petrol	1597	4	16	29
323 III Hatchback (BF)	09/87→10/89	B3	Petrol	1324	4	8	8
323 III Hatchback (BF)	09/87→10/89	B5	Petrol	1498	4	8	20
323 III Hatchback (BF)	09/87→10/89	B68	Petrol	1597	4	8	31
323 III Station Wagon (BW)	01/86→06/87	E391	Petrol	1324	4	8	12
323 III Station Wagon (BW)	01/86→06/87	E393	Petrol	1324	4	8	12
323 III Station Wagon (BW)	01/86→05/89	E5	Petrol	1490	4	8	22
323 III Station Wagon (BW)	05/86→05/89	B50	Petrol	1498	4	8	20
323 III Station Wagon (BW)	05/86→05/89	B53	Petrol	1498	4	8	20
323 III Station Wagon (BW)	07/86→04/90	E3	Petrol	1296	4	8	11
323 III Station Wagon (BW)	09/86→10/95	B6 (SOHC)	Petrol	1598	4	8	31
323 III Station Wagon (BW)	09/86→10/95	B6E	Petrol	1598	4	8	31
323 III Station Wagon (BW)	09/86→10/95	B65M	Petrol	1598	4	8	31
323 III Station Wagon (BW)	11/86→03/93	PN26	Diesel	1720	4	8	40
323 III Station Wagon (BW)	11/86→03/93	PN54	Diesel	1720	4	8	40
323 III Station Wagon (BW)	01/87→09/91	B5	Petrol	1498	4	8	20
323 III Station Wagon (BW)	09/87→10/89	B68	Petrol	1597	4	8	31
323 III Station Wagon (BW)	09/92→10/98	BPF1	Petrol	1840	4	16	44
323 P V (BA)	10/96→09/98	B3 (16V)	Petrol	1324	4	16	9
323 P V (BA)	10/96→09/98	RF1G	Diesel	1998	4	8	66
323 P V (BA)	10/96→09/98	Z5-DE	Petrol	1489	4	16	24
323 S IV (BG)	06/89→03/91	B61V	Petrol	1597	4	8	31
323 S IV (BG)	06/89→07/94	BP (DOHC)	Petrol	1840	4	16	42
323 S IV (BG)	06/89→10/94	B6 (SOHC)	Petrol	1598	4	8	31
323 S IV (BG)	08/89→07/94	BP52	Petrol	1840	4	16	42
323 S IV (BG)	08/89→07/94	PN46	Diesel	1720	4	8	40
323 S IV (BG)	08/89→07/94	PN54	Diesel	1720	4	8	40
323 S IV (BG)	08/89→07/94	PN62	Diesel	1720	4	8	40
323 S IV (BG)	08/89→10/94	B6	Petrol	1598	4	16	29
323 S IV (BG)	09/89→06/91	B3E	Petrol	1324	4	8	8
323 S IV (BG)	09/89→06/91	B6E	Petrol	1598	4	8	31
323 S IV (BG)	09/89→06/91	B383	Petrol	1324	4	8	8
323 S IV (BG)	01/91→07/94	BP Turbo	Petrol	1840	4	16	43
323 S IV (BG)	04/91→04/94	BP55	Petrol	1840	4	16	42
323 S IV (BG)	04/91→07/94	B3 (16V)	Petrol	1324	4	16	9
323 S V (BA)	09/92→08/00	BP21	Petrol	1840	4	16	42
323 S V (BA)	05/94→09/98	4EE1-T	Diesel	1686	4	8	27
323 S V (BA)	05/94→12/98	Z5-DE	Petrol	1489	4	16	24
323 S V (BA)	07/94→09/98	BP (DOHC)	Petrol	1840	4	16	42
323 S V (BA)	07/94→09/98	ZKF48	Petrol	1995	6	24	69
323 S V (BA)	07/94→09/98	ZKF49	Petrol	1995	6	24	69
323 S V (BA)	08/94→09/98	B3 (16V)	Petrol	1324	4	16	9
323 S V (BA)	08/94→09/98	B6 (DOHC)	Petrol	1598	4	16	30
323 S V (BA)	10/96→09/98	RF1G	Diesel	1998	4	8	66
323 S VI (BJ)	05/98→05/04	BP (DOHC)	Petrol	1840	4	16	42
323 S VI (BJ)	09/98→01/01	B3 ME	Petrol	1324	4	16	9
323 S VI (BJ)	09/98→01/01	ZL05	Petrol	1498	4	16	25
323 S VI (BJ)	09/98→01/01	ZL06	Petrol	1498	4	16	25
323 S VI (BJ)	09/98→02/01	B6 (DOHC)	Petrol	1598	4	16	30
323 S VI (BJ)	09/98→05/04	FP	Petrol	1840	4	16	49
323 S VI (BJ)	09/98→05/04	FP55	Petrol	1840	4	16	49
323 S VI (BJ)	09/98→05/04	RF1G	Diesel	1998	4	8	66
323 S VI (BJ)	09/98→05/04	RF3F	Diesel	1998	4	16	67
323 S VI (BJ)	02/00→05/04	FS	Petrol	1991	4	16	62
323 S VI (BJ)	10/00→10/02	RF4F	Diesel	1998	4	16	67
323 S VI (BJ)	01/01→05/04	B3 (16V)	Petrol	1324	4	16	9
323 S VI (BJ)	01/01→05/04	FS7E	Petrol	1991	4	16	62
323 S VI (BJ)	01/01→05/04	FS7G	Petrol	1991	4	16	62
323 S VI (BJ)	01/01→05/04	ZM	Petrol	1598	4	16	28
616	06/73→02/78	NA	Petrol	1586	4	8	35
626 I (CB)	05/79→05/82	HE3	Petrol	1970	4	8	63
626 I (CB)	05/79→05/82	M	Petrol	1970	4	8	63
626 I (CB)	05/79→05/82	MA	Petrol	1970	4	8	63
626 I (CB)	05/79→05/82	NA	Petrol	1586	4	8	35
626 I Coupe	10/78→12/82	MA	Petrol	1970	4	8	63
626 II (GC)	11/82→06/87	F6	Petrol	1587	4	8	33
626 II (GC)	11/82→06/87	RF46	Diesel	1998	4	8	66
626 II (GC)	03/83→09/87	FE (8V)	Petrol	1998	4	8	57

							
626 II (GC)	01/86→10/87	FET	Petrol	1998	4	8	61
626 II Coupe (GC)	11/82→07/87	F603	Petrol	1587	4	8	33
626 II Coupe (GC)	11/82→07/87	F658	Petrol	1587	4	8	33
626 II Coupe (GC)	11/82→10/87	FE (8V)	Petrol	1998	4	8	57
626 II Coupe (GC)	09/83→12/85	RF46	Diesel	1998	4	8	66
626 II Coupe (GC)	01/86→10/87	FET	Petrol	1998	4	8	61
626 II Hatchback (GC)	03/83→09/87	F6	Petrol	1587	4	8	33
626 II Hatchback (GC)	03/83→09/87	F603	Petrol	1587	4	8	33
626 II Hatchback (GC)	03/83→09/87	F658	Petrol	1587	4	8	33
626 II Hatchback (GC)	03/83→09/87	FE (8V)	Petrol	1998	4	8	57
626 II Hatchback (GC)	03/84→06/87	RF46	Diesel	1998	4	8	66
626 II Hatchback (GC)	01/86→10/87	FET	Petrol	1998	4	8	61
626 III (GD)	06/87→05/92	F6	Petrol	1587	4	8	33
626 III (GD)	07/87→07/91	RF-N	Diesel	1998	4	8	66
626 III (GD)	07/87→05/92	FE (16V)	Petrol	1998	4	16	59
626 III (GD)	08/87→05/92	FE (12V)	Petrol	1998	4	12	58
626 III (GD)	11/87→05/92	F2	Petrol	2184	4	12	71
626 III (GD)	11/87→05/92	F8 (12V)	Petrol	1789	4	12	48
626 III Coupe (GD)	06/87→10/90	FE (16V)	Petrol	1998	4	16	59
626 III Coupe (GD)	09/87→12/88	FE (12V)	Petrol	1998	4	12	58
626 III Coupe (GD)	09/87→10/90	FE (8V)	Petrol	1998	4	8	57
626 III Coupe (GD)	09/87→08/91	F8 (12V)	Petrol	1789	4	12	48
626 III Coupe (GD)	04/88→12/91	F2	Petrol	2184	4	12	71
626 III Hatchback (GD)	06/87→10/90	FE (16V)	Petrol	1998	4	16	59
626 III Hatchback (GD)	06/87→05/92	F6	Petrol	1587	4	8	33
626 III Hatchback (GD)	07/87→07/91	RF-N	Diesel	1998	4	8	66
626 III Hatchback (GD)	09/87→10/90	FE (8V)	Petrol	1998	4	8	57
626 III Hatchback (GD)	10/87→07/89	FE4J	Petrol	1998	4	12	58
626 III Hatchback (GD)	10/87→07/89	FE4K	Petrol	1998	4	12	60
626 III Hatchback (GD)	10/87→12/91	F2T	Petrol	2184	4	12	71
626 III Hatchback (GD)	11/87→04/92	F2	Petrol	2184	4	12	71
626 III Hatchback (GD)	11/87→05/92	F8 (12V)	Petrol	1789	4	12	48
626 III Hatchback (GD)	11/87→05/92	FE (12V)	Petrol	1998	4	12	58
626 III Station Wagon (GV)	09/87→12/92	FE (12V)	Petrol	1998	4	12	58
626 III Station Wagon (GV)	01/88→03/92	F8 (12V)	Petrol	1789	4	12	48
626 III Station Wagon (GV)	01/88→03/92	FE (16V)	Petrol	1998	4	16	59
626 III Station Wagon (GV)	09/88→07/91	RF-N	Diesel	1998	4	8	66
626 III Station Wagon (GV)	10/88→09/97	FE (8V)	Petrol	1998	4	8	57
626 III Station Wagon (GV)	03/89→11/96	F2	Petrol	2184	4	12	71
626 III Station Wagon (GV)	05/91→11/92	F2L1	Petrol	2184	4	12	71
626 III Station Wagon (GV)	04/92→02/95	FS	Petrol	1991	4	16	62
626 III Station Wagon (GV)	05/93→11/96	RF-CX	Diesel	1998	4	8	66
626 III Station Wagon (GV)	11/94→09/97	RF65	Diesel	1998	4	8	66
626 IV (GE)	08/91→08/98	F2	Petrol	2184	4	12	71
626 IV (GE)	01/92→04/97	FS	Petrol	1991	4	16	62
626 IV (GE)	01/92→04/97	KL-ZE	Petrol	2497	6	24	83
626 IV (GE)	01/92→06/97	FP	Petrol	1840	4	16	49
626 IV (GE)	10/92→06/97	RF55	Diesel	1998	4	8	66
626 IV Hatchback (GE)	08/91→04/97	FP	Petrol	1840	4	16	49
626 IV Hatchback (GE)	08/91→04/97	FS	Petrol	1991	4	16	62
626 IV Hatchback (GE)	01/92→04/97	KL	Petrol	2497	6	24	83
626 IV Hatchback (GE)	01/93→04/97	RF55	Diesel	1998	4	8	66
626 IV Hatchback (GE)	08/94→04/97	FP01LP	Petrol	1840	4	16	49
626 V (GF)	05/97→12/99	FPY3	Petrol	1840	4	16	49
626 V (GF)	05/97→10/02	FS	Petrol	1991	4	16	62
626 V (GF)	07/97→07/99	B6EW	Petrol	1598	4	16	28
626 V (GF)	04/98→10/02	FS2C	Petrol	1991	4	16	62
626 V (GF)	04/98→10/02	RF3F	Diesel	1998	4	16	67
626 V (GF)	04/98→10/02	RF4F	Diesel	1998	4	16	67
626 V (GF)	12/99→10/02	FP9A	Petrol	1840	4	16	50
626 V (GF)	09/00→10/02	KL	Petrol	2497	6	24	83
626 V Hatchback (GF)	05/97→12/99	FPY3	Petrol	1840	4	16	49
626 V Hatchback (GF)	05/97→10/02	FS	Petrol	1991	4	16	62
626 V Hatchback (GF)	02/98→10/02	FS2C	Petrol	1991	4	16	62
626 V Hatchback (GF)	04/98→10/02	RF3F	Diesel	1998	4	16	67
626 V Hatchback (GF)	04/98→10/02	RF4F	Diesel	1998	4	16	67
626 V Hatchback (GF)	12/99→10/02	FP	Petrol	1840	4	16	49
626 V Station Wagon (GW)	01/98→10/02	FS	Petrol	1991	4	16	62
626 V Station Wagon (GW)	02/98→01/00	FPY3	Petrol	1840	4	16	49
626 V Station Wagon (GW)	02/98→10/02	FS2C	Petrol	1991	4	16	62
626 V Station Wagon (GW)	04/98→10/02	RF4F	Diesel	1998	4	16	67
626 V Station Wagon (GW)	09/99→10/02	RF3F	Diesel	1998	4	16	67
626 V Station Wagon (GW)	01/00→10/02	FP9A	Petrol	1840	4	16	50
818 Estate	01/74→10/78	TC	Petrol	1272	4	8	14
818 Estate	01/77→10/78	NA	Petrol	1586	4	8	35
929 I (LA)	05/79→07/86	M	Petrol	1970	4	8	63
929 I (LA)	05/79→07/86	MA	Petrol	1970	4	8	63
929 I Estate (LA)	10/78→12/88	MA	Petrol	1970	4	8	63







CC











9









929 II (HB)	05/82→03/84	HEE	Petrol	1970	4	8	63
929 II (HB)	05/82→03/84	MA	Petrol	1970	4	8	63
929 II (HB)	03/84→07/87	FE (8V)	Petrol	1998	4	8	57
929 II Coupe (HB)	05/82→03/84	HEE	Petrol	1970	4	8	63
929 II Coupe (HB)	05/82→03/84	MA	Petrol	1970	4	8	63
929 II Coupe (HB)	03/84→07/87	FE (8V)	Petrol	1998	4	8	57
929 II Coupe (HB)	10/84→07/87	FET	Petrol	1998	4	8	61
929 II Estate (HV)	01/83→12/87	HEE	Petrol	1970	4	8	63
929 II Estate (HV)	01/83→12/87	MA	Petrol	1970	4	8	63
929 III (HC)	05/87→12/88	F2-EG1	Petrol	2184	4	12	71
929 III (HC)	06/87→12/88	FE (8V)	Petrol	1998	4	8	57
929 III (HC)	06/87→12/88	FEFA	Petrol	1998	4	8	61
929 III (HC)	06/87→06/91	JE	Petrol	2954	6	18	91
929 III (HC)	01/88→04/89	F2	Petrol	2184	4	12	71
929 III (HC)	01/88→04/89	F2E	Petrol	2184	4	12	71
929 III (HC)	01/88→04/89	F21	Petrol	2184	4	12	71
929 III (HC)	01/88→06/91	JE3	Petrol	2954	6	18	91
929 III (HC)	04/89→06/91	F2-C	Petrol	2184	4	12	71
929 IV (HD)	01/90→03/96	JEZE	Petrol	2954	6	24	92
929 IV (HD)	12/90→09/92	FEFA	Petrol	1998	4	8	61
929 IV (HD)	12/90→09/92	JE34	Petrol	2954	6	18	91
929 IV (HD)	12/90→09/92	JE35	Petrol	2954	6	18	91
929 IV (HD)	06/91→04/94	J5DE	Petrol	2494	6	24	82
929 V (HE)	06/94→10/99	JEZE	Petrol	2954	6	24	92
1000	01/75→01/77	PC	Petrol	985	4	8	4
1300	02/71→01/77	TC	Petrol	1272	4	8	14
AZ Offroad	10/98→	K6A	Petrol	658	3	12	1
AZ Wagon (MJ21_, MJ22_)	10/03→06/08	K6A	Petrol	658	3	12	1
AZ Wagon (MJ23_)	07/08→12/12	K6A	Petrol	658	3	12	1
Biante (CC_)	06/08→	L3-VE	Petrol	2261	4	16	78
Biante (CC_)	07/08→	LFVD	Petrol	1997	4	16	65
Bongo Truck Platform/Chassis (SKF_)	08/10→	L813	Petrol	1798	4	16	53
Bongo Van Box (SK_)	09/99→	L813	Petrol	1798	4	16	53
Bongo Van Bus (SK_)	09/99→	L813	Petrol	1798	4	16	53
B-Serie (PE)	02/77→09/78	NA	Petrol	1586	4	8	35
B-Serie (PE)	02/77→01/82	VC	Petrol	1769	4	8	56
B-Serie (UD)	01/81→01/82	S2	Diesel	2209	4	8	76
B-Serie (UD)	06/82→12/84	HEA1	Petrol	1998	4	8	61
B-Serie (UF)	01/85→03/96	F6	Petrol	1587	4	8	33
B-Serie (UF)	01/85→03/96	FE (8V)	Petrol	1998	4	8	57
B-Serie (UF)	01/85→03/96	R290	Diesel	2184	4	8	74
B-Serie (UF)	03/85→10/89	R2	Diesel	2184	4	8	74
B-Serie (UF)	03/85→10/91	S2	Diesel	2209	4	8	76
B-Serie (UF)	01/87→10/90	4G54	Petrol	2555	4	8	80
B-Serie (UF)	03/87→10/91	G54B	Petrol	2555	4	8	88
B-Serie (UF)	01/90→06/99	G6MPV	Petrol	2606	4	12	87
B-Serie (UF)	08/91→12/96	F2L8	Petrol	2184	4	8	72
B-Serie (UF)	02/92→10/99	WLE7	Diesel	2500	4	12	85
B-Serie (UF)	07/93→05/94	F2I8	Petrol	2184	4	8	72
B-Serie (UF)	04/94→06/99	F8 (8V)	Petrol	1789	4	8	47
B-Serie (UF)	04/96→02/99	WL-T	Diesel	2500	4	12	85
B-Serie (UF)	04/96→06/99	WL31	Diesel	2500	4	12	85
B-Serie (UN)	02/99→03/05	WLF5	Diesel	2500	4	12	85
B-Serie (UN)	02/99→03/05	WL-T (12 V)	Diesel	2499	4	12	85
B-Serie (UN)	02/99→03/05	WL-T	Diesel	2500	4	12	85
B-Serie (UN)	02/99→11/06	G6Y1	Petrol	2606	4	12	87
B-Serie (UN)	02/99→11/06	R5A2	Petrol	2184	4	12	71
B-Serie (UN)	06/99→07/06	MD25TI	Diesel	2500	4	12	85
B-Serie (UN)	06/99→11/06	JL22	Petrol	2148	4	8	72
B-Serie (UN)	06/99→11/06	MD25NA	Diesel	2500	4	12	85
B-Serie (UN)	11/99→07/02	WLE9	Diesel	2500	4	12	85
B-Serie (UN)	11/99→08/02	F2R4	Petrol	2184	4	12	71
B-Serie (UN)	11/99→11/06	WLE7	Diesel	2500	4	12	85
B-Serie (UN)	04/00→07/06	F8 (8V)	Petrol	1789	4	8	47
B-Serie (UN)	08/02→11/06	WL84	Diesel	2500	4	12	85
B-Serie Platform/Chassis (UF)	05/85→07/88	FE (8V)	Petrol	1998	4	8	57
B-Serie Platform/Chassis (UF)	01/87→10/91	4G54	Petrol	2555	4	8	80
B-Serie Platform/Chassis (UF)	01/88→03/96	R290	Diesel	2184	4	8	74
B-Serie Platform/Chassis (UF)	03/88→11/91	F2I8	Petrol	2184	4	8	72
B-Serie Platform/Chassis (UF)	03/88→11/91	F2L5	Petrol	2184	4	8	72
B-Serie Platform/Chassis (UF)	04/94→10/01	F8 (8V)	Petrol	1789	4	8	47
B-Serie Platform/Chassis (UF)	05/96→02/99	WL-T	Diesel	2500	4	12	85
B-Serie Platform/Chassis (UF)	05/96→10/01	WL84	Diesel	2500	4	12	85
B-Serie Platform/Chassis (UN)	02/99→03/05	WL-T (12 V)	Diesel	2499	4	12	85
B-Serie Platform/Chassis (UN)	02/99→03/05	WL-T	Diesel	2500	4	12	85
BT-50 Pickup (B22, B32, UP, UR)	11/11→	L5-Y3	Petrol	2488	4	16	84
BT-50 Pickup (B22, B32, UP, UR)	11/11→	P4-AT	Diesel	2198	4	16	73
BT-50 Pickup (B22, B32, UP, UR)	11/11→	P5-AT	Diesel	3198	5	20	94

				CC			9
BT-50 Pickup (CD, UN)	08/06→12/15	WLAA	Diesel	2500	4	16	86
BT-50 Pickup (CD, UN)	10/06→12/15	G6Y1	Petrol	2606	4	12	87
BT-50 Pickup (CD, UN)	10/06→12/15	WEAT	Diesel	2953	4	16	93
BT-50 Platform/Chassis (B22, B32, UP, UR)	11/11→	P4-AT	Diesel	2198	4	16	73
BT-50 Platform/Chassis (B22, B32, UP, UR)	11/11→	P5-AT	Diesel	3198	5	20	94
BT-50 Platform/Chassis (CD, UN)	10/06→	G6Y1	Petrol	2606	4	12	87
BT-50 Platform/Chassis (CD, UN)	12/06→	WEAT	Diesel	2953	4	16	93
BT-50 Platform/Chassis (CD, UN)	12/06→	WLAT (16 V)	Diesel	2500	4	16	86
Carol (HB24)	04/04→04/10	K6A	Petrol	658	3	12	1
Carol (HB25)	01/10→	K6A	Petrol	658	3	12	1
Carol (HB25)	01/10→	R06A	Petrol	658	3	12	2
Carol (HB36)	01/15→	R06A	Petrol	658	3	12	2
CX-7 (ER)	06/06→06/09	L3K7	Petrol	2261	4	16	78
CX-7 (ER)	06/06→12/14	L3-VDT	Petrol	2261	4	16	78
CX-7 (ER)	01/07→12/14	L3Y7	Petrol	2261	4	16	78
CX-7 (ER)	07/09→03/13	L5-VE	Petrol	2488	4	16	84
CX-7 (ER)	07/09→03/13	R2AA	Diesel	2184	4	16	75
Demio (DW)	01/96→07/03	B3 ME	Petrol	1324	4	16	9
Demio (DW)	08/98→04/00	B3 (16V)	Petrol	1324	4	16	9
Demio (DW)	04/00→07/03	B5 E	Petrol	1498	4	16	21
E-Serie Box	05/78→06/84	UC	Petrol	1415	4	8	19
E-Serie Box	08/80→06/84	NA	Petrol	1586	4	8	35
E-Serie Box (SG)	02/03→12/06	F8 (8V)	Petrol	1789	4	8	47
E-Serie Box (SG)	04/04→07/06	FE (8V)	Petrol	1998	4	8	57
E-Serie Box (SR2)	10/83→08/99	F8 (8V)	Petrol	1789	4	8	47
E-Serie Box (SR2)	01/84→05/03	FE (8V)	Petrol	1998	4	8	57
E-Serie Box (SR2)	02/84→01/88	F8 (12V)	Petrol	1789	4	12	48
E-Serie Box (SR2)	07/84→03/88	E5	Petrol	1490	4	8	22
E-Serie Box (SR2)	05/85→04/89	FE18	Petrol	1998	4	8	61
E-Serie Box (SR2)	05/85→04/89	FE58	Petrol	1998	4	8	61
E-Serie Box (SR2)	05/85→05/03	R203	Diesel	2184	4	8	74
E-Serie Box (SR2)	05/85→05/03	R207	Diesel	2184	4	8	74
E-Serie Box (SR2)	11/87→09/89	FEY7	Petrol	1998	4	8	61
E-Serie Box (SR2)	01/88→07/91	FECK	Petrol	1998	4	8	61
E-Serie Box (SR2)	03/91→05/94	FE60	Petrol	1998	4	8	61
E-Serie Box (SR2)	03/91→05/94	FE61	Petrol	1998	4	8	61
E-Serie Box (SR2)	02/97→05/03	R2	Diesel	2184	4	8	74
E-Serie Box (SR2)	04/97→08/99	FEY9	Petrol	1998	4	12	58
E-Serie Box (SR2)	08/97→05/03	WLE2	Diesel	2500	4	12	85
E-Serie Bus	03/91→05/03	R281	Diesel	2184	4	8	74
E-Serie Bus (SR1)	01/84→02/88	R2	Diesel	2184	4	8	74
E-Serie Bus (SR1)	01/84→02/88	R207	Diesel	2184	4	8	74
E-Serie Bus (SR1)	11/84→05/94	FE (8V)	Petrol	1998	4	8	57
E-Serie Bus (SR1)	11/84→05/94	FE18	Petrol	1998	4	8	61
E-Serie Bus (SR1)	11/84→05/94	FEV4	Petrol	1998	4	8	61
E-Serie Bus (SR1)	10/88→05/94	FE8N	Petrol	1998	4	8	61
E-Serie MPV (SG)	06/95→09/99	FE (8V)	Petrol	1998	4	8	57
E-Serie MPV (SG)	06/95→10/01	J5DE	Petrol	2494	6	24	82
E-Serie MPV (SG)	06/95→10/01	WL-T (12 V)	Diesel	2499	4	12	85
E-Serie MPV (SG)	06/95→10/01	WL-T	Diesel	2500	4	12	85
E-Serie MPV (SG)	11/97→10/01	FE (12V)	Petrol	1998	4	12	58
E-Serie Platform/Chassis	05/81→02/84	S2	Diesel	2209	4	8	76
E-Serie Platform/Chassis (SD1)	01/83→07/91	FECK	Petrol	1998	4	8	61
E-Serie Platform/Chassis (SD1)	11/88→09/89	FEY7	Petrol	1998	4	8	61
E-Serie Platform/Chassis (SD1)	11/88→03/97	R281	Diesel	2184	4	8	74
E-Serie Platform/Chassis (SD1)	10/89→05/95	FE8N	Petrol	1998	4	8	61
E-Serie Platform/Chassis (SD1)	01/91→08/98	FEY9	Petrol	1998	4	12	58
E-Serie Platform/Chassis (SD1)	04/97→07/99	R2	Diesel	2184	4	8	74
E-Serie Platform/Chassis (SD1)	08/97→07/99	WL-T	Diesel	2500	4	12	85
E-Serie Platform/Chassis (SD1, SL)	09/99→07/04	R21N	Diesel	2184	4	8	74
E-Serie Platform/Chassis (SD1, SL)	09/99→09/04	FE (12V)	Petrol	1998	4	12	58
Familia Van (Y12)	01/07→	CR12DE	Petrol	1240	4	16	7
Familia Van (Y12)	01/07→	HR15DE	Petrol	1498	4	16	23
Familia Van (Y12)	01/07→	MR18DE	Petrol	1798	4	16	54
Festiva	04/89→10/90	B115	Petrol	1138	4	8	5
Festiva	11/98→10/99	ZL05	Petrol	1498	4	16	25
Flair	07/12→	R06A	Petrol	658	3	12	2
Flair Crossover	01/14→	R06A	Petrol	658	3	12	2
Flair Wagon	07/12→	R06A	Petrol	658	3	12	2
Laputa	06/98→09/01	K6A-T	Petrol	658	3	12	2
MPV I (LV)	05/96→09/99	WL-T	Diesel	2500	4	12	85
MPV II (LW)	09/99→08/00	FS-DS	Petrol	1991	4	16	62
MPV II (LW)	09/99→03/02	GY-DE	Petrol	2495	6	24	81
MPV II (LW)	08/00→07/02	FS	Petrol	1991	4	16	62
MPV II (LW)	03/02→02/06	AJ	Petrol	2967	6	24	89
MPV II (LW)	07/02→02/06	L3	Petrol	2261	4	16	78
MPV II (LW)	07/02→02/06	RF5C	Diesel	1998	4	16	67
MPV III (LY)	02/06→	L3-VDT	Petrol	2261	4	16	78



Model	Year Range	Engine	Fuel	CC	Power (kW)	Power (hp)	0-100 (s)
MPV III (LY)	02/06→	L3-VE	Petrol	2261	4	16	78
MX-3 (EC)	07/91→10/97	B69	Petrol	1598	4	8	31
MX-3 (EC)	01/92→01/94	K819	Petrol	1845	6	24	51
MX-3 (EC)	01/94→10/97	K838	Petrol	1845	6	12	52
MX-3 (EC)	01/94→05/98	B6D	Petrol	1598	4	16	28
MX-3 (EC)	01/96→10/97	K8-ZE	Petrol	1845	6	24	51
MX-5 I (NA)	01/90→12/93	B6ZE	Petrol	1598	4	16	28
MX-5 I (NA)	05/90→01/94	B64F	Petrol	1598	4	16	30
MX-5 I (NA)	09/93→04/98	BPF1	Petrol	1840	4	16	44
MX-5 I (NA)	02/94→04/98	BP (DOHC)	Petrol	1840	4	16	42
MX-5 I (NA)	01/95→04/98	8AN1	Petrol	1598	4	16	28
MX-5 II (NB)	01/98→10/05	BPD	Petrol	1840	4	16	46
MX-5 II (NB)	05/98→10/05	B6D	Petrol	1598	4	16	28
MX-5 II (NB)	01/02→10/05	BP Turbo	Petrol	1840	4	16	43
MX-5 II (NB)	04/02→10/05	BP4W	Petrol	1840	4	16	43
MX-5 II (NB)	08/02→10/05	BP6J	Petrol	1839	4	16	44
MX-5 III (NC)	03/05→12/14	L8-DE	Petrol	1798	4	16	53
MX-5 III (NC)	03/05→12/14	L828	Petrol	1798	4	16	53
MX-5 III (NC)	07/05→12/14	LF62	Petrol	1999	4	16	65
MX-5 III (NC)	07/05→12/14	LF-DE	Petrol	1999	4	16	65
MX-6 (GD)	10/87→09/91	F2T	Petrol	2184	4	12	71
MX-6 (GD)	09/92→01/97	KL	Petrol	2497	6	24	83
MX-6 (GE)	02/92→02/97	FS	Petrol	1991	4	16	62
MX-6 (GE)	02/92→02/97	KL	Petrol	2497	6	24	83
MX-6 (GE)	12/95→02/97	FP9A	Petrol	1840	4	16	50
MX-6 (GE)	12/95→02/97	KJZM	Petrol	2255	6	24	77
Premacy (CP)	07/99→03/05	FP	Petrol	1840	4	16	49
Premacy (CP)	10/99→07/00	RF3F	Diesel	1998	4	16	67
Premacy (CP)	07/00→03/05	RF4F	Diesel	1998	4	16	67
Premacy (CP)	11/01→03/05	FS7E	Petrol	1991	4	16	62
Premacy (CP)	11/01→03/05	FS7G	Petrol	1991	4	16	62
Premacy (CP)	02/05→03/05	L333	Petrol	2261	4	16	78
Premacy (CP)	02/05→03/05	LFF7	Petrol	1999	4	16	65
Rustler	06/93→12/03	B383	Petrol	1324	4	8	8
Rustler	09/93→10/04	B65M	Petrol	1598	4	8	31
Scrum Truck (DG1_T)	01/14→	RO6A	Petrol	658	3	12	2
Scrum Truck (DG6_T)	05/09→02/15	K6A	Petrol	658	3	12	1
Scrum Van (DG1_V)	03/15→	K6A	Petrol	658	3	12	1
Scrum Van (DG1_V)	03/15→	RO6A	Petrol	658	3	12	2
Scrum Van (DG6_V)	01/05→02/15	K6A	Petrol	658	3	12	1
Spectron	08/86→10/95	FEKN	Petrol	1998	4	12	58
Spectron	08/86→10/95	R2	Diesel	2184	4	8	74
Spectron	08/86→10/95	RF46	Diesel	1998	4	8	66
Spiano (HF21)	01/02→12/08	K6A	Petrol	658	3	12	1
Tribute (EP)	03/00→05/08	AJ	Petrol	2967	6	24	89
Tribute (EP)	03/00→05/08	YF	Petrol	1989	4	16	68
Tribute (EP)	12/03→05/08	L3-VE	Petrol	2261	4	16	78
Tribute (EP)	07/06→05/08	L3	Petrol	2261	4	16	78
Verisa (ND)	07/04→03/15	ZY-VE	Petrol	1498	4	16	26
Xedos 6 (CA)	01/92→10/99	KF1	Petrol	1995	6	24	64
Xedos 6 (CA)	08/92→05/94	B69	Petrol	1598	4	16	30
Xedos 6 (CA)	04/94→10/99	FP29	Petrol	1839	4	16	49
Xedos 6 (CA)	04/94→10/99	FP30	Petrol	1839	4	16	49
Xedos 6 (CA)	06/94→10/99	B6 (DOHC)	Petrol	1598	4	16	30
Xedos 9 (TA)	07/93→09/02	KL	Petrol	2497	6	24	83
Xedos 9 (TA)	08/93→08/00	KF	Petrol	1995	6	24	64
Xedos 9 (TA)	02/95→01/00	KJ-ZEM	Petrol	2255	6	24	77
Xedos 9 (TA)	09/00→09/02	KL-ZE	Petrol	2497	6	24	83

	CC				9		CC				9
4EE1-T	1686	4	8	Diesel	27	F6JA	1399	4	8	Diesel	16
4G54	2555	4	8	Petrol	80	F6JB	1399	4	8	Diesel	16
8AN1	1598	4	16	Petrol	28	F8 (12V)	1789	4	12	Petrol	48
AJ	2967	6	24	Petrol	89	F8 (8V)	1789	4	8	Petrol	47
B1	1139	4	8	Petrol	5	F21	2184	4	12	Petrol	71
B3	1324	4	8	Petrol	8	F603	1587	4	8	Petrol	33
B3 (16V)	1324	4	16	Petrol	9	F658	1587	4	8	Petrol	33
B3A5	1324	4	8	Petrol	8	F659	1587	4	8	Petrol	33
B3E	1324	4	8	Petrol	8	FE (8V)	1998	4	8	Petrol	57
B3 ME	1324	4	16	Petrol	9	FE (12V)	1998	4	12	Petrol	58
B5	1498	4	8	Petrol	20	FE (16V)	1998	4	16	Petrol	59
B5C5	1498	4	8	Petrol	20	FE4J	1998	4	12	Petrol	58
B5 E	1498	4	16	Petrol	21	FE4K	1998	4	12	Petrol	60
B6	1598	4	16	Petrol	29	FE18	1998	4	8	Petrol	61
B6	1598	4	16	Petrol	29	FE58	1998	4	8	Petrol	61
B6 (DOHC)	1598	4	16	Petrol	30	FE60	1998	4	8	Petrol	61
B6 (SOHC)	1598	4	8	Petrol	31	FE61	1998	4	8	Petrol	61
B6D	1598	4	16	Petrol	28	FEBN	1998	4	8	Petrol	61
B6E	1598	4	8	Petrol	31	FECK	1998	4	8	Petrol	61
B6EW	1598	4	16	Petrol	28	FEFA	1998	4	8	Petrol	61
B6F2	1597	4	16	Petrol	29	FEKN	1998	4	12	Petrol	58
B6T	1598	4	16	Petrol	29	FET	1998	4	8	Petrol	61
B6ZE	1598	4	16	Petrol	28	FEV4	1998	4	8	Petrol	61
B50	1498	4	8	Petrol	20	FEY7	1998	4	8	Petrol	61
B53	1498	4	8	Petrol	20	FEY9	1998	4	12	Petrol	58
B61V	1597	4	8	Petrol	31	FP	1840	4	16	Petrol	49
B64F	1598	4	16	Petrol	30	FP01LP	1840	4	16	Petrol	49
B65L	1598	4	8	Petrol	31	FP9A	1840	4	16	Petrol	50
B65M	1598	4	8	Petrol	31	FP29	1839	4	16	Petrol	49
B67J	1597	4	16	Petrol	32	FP30	1839	4	16	Petrol	49
B67K	1597	4	16	Petrol	32	FP55	1840	4	16	Petrol	49
B67L	1597	4	16	Petrol	32	FPY3	1840	4	16	Petrol	49
B68	1597	4	8	Petrol	31	FS	1991	4	16	Petrol	62
B69	1598	4	8	Petrol	31	FS2C	1991	4	16	Petrol	62
B69	1598	4	16	Petrol	30	FS7E	1991	4	16	Petrol	62
B115	1138	4	8	Petrol	5	FS7G	1991	4	16	Petrol	62
B116	1139	4	8	Petrol	5	FS-DS	1991	4	16	Petrol	62
B315	1324	4	8	Petrol	8	FUJA	1242	4	16	Petrol	10
B335	1324	4	8	Petrol	8	FXJA	1388	4	16	Petrol	17
B383	1324	4	8	Petrol	8	FYJA	1596	4	16	Petrol	34
B518	1498	4	8	Petrol	20	G6MPV	2606	4	12	Petrol	87
B572	1498	4	8	Petrol	20	G6Y0	2606	4	12	Petrol	87
B573	1498	4	8	Petrol	20	G6Y1	2606	4	12	Petrol	87
BP (DOHC)	1840	4	16	Petrol	42	G54B	2555	4	8	Petrol	88
BP	1840	4	16	Petrol	41	GY-DE	2495	6	24	Petrol	81
BP4W	1840	4	16	Petrol	43	HA	2977	4	8	Diesel	90
BP6J	1839	4	16	Petrol	44	HE3	1970	4	8	Petrol	63
BP21	1840	4	16	Petrol	42	HEA1	1998	4	8	Petrol	61
BP22	1840	4	16	Petrol	42	HEE	1970	4	8	Petrol	63
BP31	1840	4	16	Petrol	42	HR15DE	1498	4	16	Petrol	23
BP52	1840	4	16	Petrol	42	J4R	1299	4	8	Petrol	13
BP55	1840	4	16	Petrol	42	J4T	1299	4	8	Petrol	13
BPC	1840	4	16	Petrol	45	J5DE	2494	6	24	Petrol	82
BPD	1840	4	16	Petrol	46	JE	2954	6	18	Petrol	91
BPF1	1840	4	16	Petrol	44	JE3	2954	6	18	Petrol	91
BP Turbo	1840	4	16	Petrol	43	JE34	2954	6	18	Petrol	91
CR12DE	1240	4	16	Petrol	7	JE35	2954	6	18	Petrol	91
DHF	1242	4	16	Petrol	10	JEZE	2954	6	24	Petrol	92
DHG	1242	4	16	Petrol	10	JJA	1299	4	8	Petrol	13
E1	1071	4	8	Petrol	6	JJK	1299	4	8	Petrol	13
E3	1296	4	8	Petrol	11	JJM	1299	4	8	Petrol	13
E5	1490	4	8	Petrol	22	JL22	2148	4	8	Petrol	72
E5E2	1490	4	8	Petrol	22	K6A	658	3	12	Petrol	1
E5E3	1490	4	8	Petrol	22	K6A-T	658	3	12	Petrol	2
E391	1324	4	8	Petrol	12	K8-ZE	1845	6	24	Petrol	51
E393	1324	4	8	Petrol	12	K14B	1373	4	16	Petrol	18
F2	2184	4	12	Petrol	71	K819	1845	6	24	Petrol	51
F2-C	2184	4	12	Petrol	71	K838	1845	6	12	Petrol	52
F2E	2184	4	12	Petrol	71	KF	1995	6	24	Petrol	64
F2-EG1	2184	4	12	Petrol	71	KF1	1995	6	24	Petrol	64
F2G	2184	4	12	Petrol	71	KF-VE	658	3	12	Petrol	3
F21B	2184	4	8	Petrol	72	KJ15	2255	6	24	Petrol	77
F2L1	2184	4	12	Petrol	71	KJ-ZEM	2255	6	24	Petrol	77
F2L5	2184	4	8	Petrol	72	KJZM	2255	6	24	Petrol	77
F2L8	2184	4	8	Petrol	72	KL	2497	6	24	Petrol	83
F2R4	2184	4	12	Petrol	71	KL-ZE	2497	6	24	Petrol	83
F2T	2184	4	12	Petrol	71	L3	2261	4	16	Petrol	78
F6	1587	4	8	Petrol	33	L3C1	2261	4	16	Petrol	78

	CC				9		CC				9
L3K4	2261	4	16	Petrol	79	UC	1415	4	8	Petrol	19
L3K7	2261	4	16	Petrol	78	VC	1769	4	8	Petrol	56
L3KG	2261	4	16	Petrol	78	WEAT	2953	4	16	Diesel	93
L3N9	2261	4	16	Petrol	78	WL31	2500	4	12	Diesel	85
L3-V	2261	4	16	Petrol	78	WL84	2500	4	12	Diesel	85
L3-VDT	2261	4	16	Petrol	78	WLAA	2500	4	16	Diesel	86
L3-VE	2261	4	16	Petrol	78	WLAT (16 V)	2500	4	16	Diesel	86
L3X	2261	4	16	Petrol	78	WLE2	2500	4	12	Diesel	85
L3Y7	2261	4	16	Petrol	78	WLE7	2500	4	12	Diesel	85
L3YH	2261	4	16	Petrol	78	WLE9	2500	4	12	Diesel	85
L3YS	2261	4	16	Petrol	78	WLF5	2500	4	12	Diesel	85
L3YT	2261	4	16	Petrol	78	WL-T (12 V)	2499	4	12	Diesel	85
L5-VE	2488	4	16	Petrol	84	WL-T	2500	4	12	Diesel	85
L5-X	2488	4	16	Petrol	84	Y404	1399	4	8	Diesel	16
L5-Y3	2488	4	16	Petrol	84	Y406	1560	4	16	Diesel	36
L8-DE	1798	4	16	Petrol	53	Y601	1560	4	16	Diesel	36
L333	2261	4	16	Petrol	78	Y642	1560	4	16	Diesel	36
L813	1798	4	16	Petrol	53	Y646	1560	4	16	Diesel	36
L823	1798	4	16	Petrol	53	Y650	1560	4	8	Diesel	37
L828	1798	4	16	Petrol	53	Y655	1560	4	8	Diesel	37
L850	1798	4	16	Petrol	53	Y661	1560	4	8	Diesel	37
LF5H	1999	4	16	Petrol	65	YF	1989	4	16	Petrol	68
LF5W	1999	4	16	Petrol	65	Z5-DE	1489	4	16	Petrol	24
LF17	1999	4	16	Petrol	65	Z6	1598	4	16	Petrol	38
LF18	1999	4	16	Petrol	65	Z6Y1	1598	4	16	Petrol	39
LF62	1999	4	16	Petrol	65	Z6Y3	1598	4	16	Petrol	39
LF-DE	1999	4	16	Petrol	65	ZB	4052	6	12	Diesel	96
LFF7	1999	4	16	Petrol	65	ZJ04	1348	4	16	Petrol	15
LFVD	1997	4	16	Petrol	65	ZJ46	1349	4	16	Petrol	15
LF-VDS	1998	4	16	Petrol	65	ZJ-VE	1349	4	16	Petrol	15
LF-VE	1999	4	16	Petrol	65	ZJ-VEM	1349	4	16	Petrol	15
LFZB	1999	4	16	Petrol	65	ZKF48	1995	6	24	Petrol	69
M	1970	4	8	Petrol	63	ZKF49	1995	6	24	Petrol	69
MA	1970	4	8	Petrol	63	ZL05	1498	4	16	Petrol	25
MD25NA	2500	4	12	Diesel	85	ZL06	1498	4	16	Petrol	25
MD25TI	2500	4	12	Diesel	85	ZM	1598	4	16	Petrol	28
MR18DE	1798	4	16	Petrol	54	ZY05	1498	4	16	Petrol	26
NA	1586	4	8	Petrol	35	ZY66	1498	4	16	Petrol	26
P	985	4	8	Petrol	4	ZY-DE	1498	4	16	Petrol	26
P4-AT	2198	4	16	Diesel	73	ZY-VE	1498	4	16	Petrol	26
P5-AT	3198	5	20	Diesel	94						
PC	985	4	8	Petrol	4						
PN26	1720	4	8	Diesel	40						
PN27	1720	4	8	Diesel	40						
PN46	1720	4	8	Diesel	40						
PN54	1720	4	8	Diesel	40						
PN62	1720	4	8	Diesel	40						
R2	2184	4	8	Diesel	74						
R2AA	2184	4	16	Diesel	75						
R2BF	2184	4	16	Diesel	75						
R5A2	2184	4	12	Petrol	71						
R06A	658	3	12	Petrol	2						
R21N	2184	4	8	Diesel	74						
R203	2184	4	8	Diesel	74						
R207	2184	4	8	Diesel	74						
R238	2184	4	8	Diesel	74						
R254	2184	4	8	Diesel	70						
R281	2184	4	8	Diesel	74						
R290	2184	4	8	Diesel	74						
RF1G	1998	4	8	Diesel	66						
RF3F	1998	4	16	Diesel	67						
RF4F	1998	4	16	Diesel	67						
RF5C	1998	4	16	Diesel	67						
RF7J	1998	4	16	Diesel	67						
RF46	1998	4	8	Diesel	66						
RF55	1998	4	8	Diesel	66						
RF83	1998	4	8	Diesel	66						
RF-CX	1998	4	8	Diesel	66						
RF65	1998	4	8	Diesel	66						
RFH7	1998	4	8	Diesel	66						
RF-N	1998	4	8	Diesel	66						
RTJ	1753	4	8	Diesel	55						
RTK	1753	4	8	Diesel	55						
S2	2209	4	8	Diesel	76						
SL	3455	4	8	Diesel	95						
T	1272	4	8	Petrol	14						
TC	1272	4	8	Petrol	14						
U	1415	4	8	Petrol	19						



1 0.7L Petrol

K6A 3 Cyl. 12 Valves 658cc TD31277

NA5016
35.00 x 47.00 x 7.00mm, FPM/ACM

2 0.7L Petrol

K6A-T 3 Cyl. 12 Valves 658cc TD34085

R06A 3 Cyl. 12 Valves 658cc TD31276

PA928 (x12) **NA5016**
35.00 x 47.00 x 7.00mm, FPM/ACM

3 0.7L Petrol

KF-VE 3 Cyl. 12 Valves 658cc TD34070

NA5246
42.50 x 54.50 x 6.00mm, MVQ

4 1.0L Petrol

P 4 Cyl. 8 Valves 985cc TD2022

PC 4 Cyl. 8 Valves 985cc TD2023

KJ710 (x8) **NB384**
40.00 x 55.00 x 8.00mm, NBR
NJ099
70.00 x 88.00 x 12.00mm, MVQ

5 1.1L Petrol

B1 4 Cyl. 8 Valves 1139cc TD1911

B115 4 Cyl. 8 Valves 1138cc TD31576

B116 4 Cyl. 8 Valves 1139cc TD1913

PA883 (x8) **NJ448**
30.00 x 44.00 x 7.00mm, NBR **NJ448**
30.00 x 44.00 x 7.00mm, NBR
NJ650
83.00 x 100.00 x 9.00mm, ACM

6 1.1L Petrol

E1 4 Cyl. 8 Valves 1071cc TD4640

KJ710 (x8) **NB384**
40.00 x 55.00 x 8.00mm, NBR
NJ099
70.00 x 88.00 x 12.00mm, MVQ

7 1.2L Petrol

CR12DE 4 Cyl. 16 Valves 1240cc TD30818

PB681 (x16) **NJ222**
40.00 x 52.00 x 7.00mm, FPM
NJ765
40.00 x 52.00 x 7.00mm, NBR
NJ284
84.00 x 104.00 x 11.00mm, MVQ

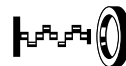

8 1.3L Petrol

B3	4 Cyl.	8 Valves	1324cc	TD4634
B3A5	4 Cyl.	8 Valves	1324cc	TD31518
B3E	4 Cyl.	8 Valves	1324cc	TD1916
B315	4 Cyl.	8 Valves	1324cc	TD31290
B335	4 Cyl.	8 Valves	1324cc	TD31575
B383	4 Cyl.	8 Valves	1324cc	TD1919
PA883 (x8)	NJ448 30.00 x 44.00 x 7.00mm, NBR		NJ448 30.00 x 44.00 x 7.00mm, NBR NJ650 83.00 x 100.00 x 9.00mm, ACM	

9 1.3L Petrol

B3 (16V)	4 Cyl.	16 Valves	1324cc	TD1918
B3 ME	4 Cyl.	16 Valves	1324cc	TD10327
PA425 (x16)	NJ448 30.00 x 44.00 x 7.00mm, NBR		NK158 37.00 x 50.50 x 7.00mm, ACM NJ650 83.00 x 100.00 x 9.00mm, ACM	

10 1.3L Petrol

DHF	4 Cyl.	16 Valves	1242cc	TD18699
DHG	4 Cyl.	16 Valves	1242cc	TD18700
FUJA	4 Cyl.	16 Valves	1242cc	TD18694
HR808 HR809	NC048 (x2) 38.00 x 52.00 x 6.00mm, FPM		NA5137 33.00 x 47.00 x 5.00mm, FPM LK5004 80.00 x 182.00 x 19.400mm, PTFE	

11 1.3L Petrol

E3	4 Cyl.	8 Valves	1296cc	TD1955
KJ710 (x8)			NB384 40.00 x 55.00 x 8.00mm, NBR NJ099 70.00 x 88.00 x 12.00mm, MVQ	

12 1.3L Petrol

E391	4 Cyl.	8 Valves	1324cc	TD31529
E393	4 Cyl.	8 Valves	1324cc	TD31528
KJ710 (x8)				

13 1.3L Petrol

J4R	4 Cyl.	8 Valves	1299cc	TD24680
J4T	4 Cyl.	8 Valves	1299cc	TD24681
JJA	4 Cyl.	8 Valves	1299cc	TD25845
JJK	4 Cyl.	8 Valves	1299cc	TD24678
JJM	4 Cyl.	8 Valves	1299cc	TD24679
HR655			NA576 36.50 x 52.30 x 8.00mm, MVQ NB788 79.40 x 95.30 x 11.10mm, PTFE	



14 1.3L Petrol

T	4 Cyl.	8 Valves	1272cc	TD4651
TC	4 Cyl.	8 Valves	1272cc	TD2048
				NB384 40.00 x 55.00 x 8.00mm, NBR NJ099 70.00 x 88.00 x 12.00mm, MVQ

15 1.3L Petrol

ZJ04	4 Cyl.	16 Valves	1348cc	TD31260
ZJ46	4 Cyl.	16 Valves	1349cc	TD28020
ZJ-VE	4 Cyl.	16 Valves	1349cc	TD24828
ZJ-VEM	4 Cyl.	16 Valves	1349cc	TD34055
				NA5246 42.50 x 54.50 x 6.00mm, MVQ NJ650 83.00 x 100.00 x 9.00mm, ACM

16 1.4L Diesel

F6JA	4 Cyl.	8 Valves	1399cc	TD18693
F6JB	4 Cyl.	8 Valves	1399cc	TD20951
Y404	4 Cyl.	8 Valves	1399cc	TD31261
PA5068 (x8) HR5120	NA5258 27.00 x 47.00 x 7.00mm, PTFE	NA5259 40.00 x 55.00 x 6.40mm, PTFE NA5325 85.00 x 105.00 x 8.80mm, PTFE		

17 1.4L Petrol

FXJA	4 Cyl.	16 Valves	1388cc	TD18695
HR808 HR809	NC048 (x2) 38.00 x 52.00 x 6.00mm, FPM	NA5137 33.00 x 47.00 x 5.00mm, FPM LK5004 80.00 x 182.00 x 19.400mm, PTFE		

18 1.4L Petrol

K14B	4 Cyl.	16 Valves	1373cc	TD31311
HR5128				

19 1.4L Petrol

U	4 Cyl.	8 Valves	1415cc	TD4652
UC	4 Cyl.	8 Valves	1415cc	TD5110
KJ710 (x8)				NB384 40.00 x 55.00 x 8.00mm, NBR



20 1.5L

Petrol

B5	4 Cyl.	8 Valves	1498cc	TD4636
B5C5	4 Cyl.	8 Valves	1498cc	TD31520
B50	4 Cyl.	8 Valves	1498cc	TD1925
B53	4 Cyl.	8 Valves	1498cc	TD1926
B518	4 Cyl.	8 Valves	1498cc	TD31524
B572	4 Cyl.	8 Valves	1498cc	TD31519
B573	4 Cyl.	8 Valves	1498cc	TD31525

PA883 (x8)

NJ448
30.00 x 44.00 x 7.00mm, NBR

NJ448
30.00 x 44.00 x 7.00mm, NBR
NJ650
83.00 x 100.00 x 9.00mm, ACM

21 1.5L

Petrol

B5 E	4 Cyl.	16 Valves	1498cc	TD24708
------	--------	-----------	--------	---------

PB314 (x16)

NJ448
30.00 x 44.00 x 7.00mm, NBR

NK158
37.00 x 50.50 x 7.00mm, ACM
NJ650
83.00 x 100.00 x 9.00mm, ACM

22 1.5L

Petrol

E5	4 Cyl.	8 Valves	1490cc	TD1956
E5E2	4 Cyl.	8 Valves	1490cc	TD18217
E5E3	4 Cyl.	8 Valves	1490cc	TD18216

KJ710 (x8)

NB384
40.00 x 55.00 x 8.00mm, NBR
NJ099
70.00 x 88.00 x 12.00mm, MVQ

23 1.5L

Petrol

HR15DE	4 Cyl.	16 Valves	1498cc	TD30811
--------	--------	-----------	--------	---------

NJ449
40.00 x 52.00 x 6.00mm, NBR

24 1.5L

Petrol

Z5-DE	4 Cyl.	16 Valves	1489cc	TD2053
-------	--------	-----------	--------	--------

NJ324 (x2)
34.00 x 48.00 x 7.00mm, ACM

NJ650
83.00 x 100.00 x 9.00mm, ACM

25 1.5L

Petrol

ZL05	4 Cyl.	16 Valves	1498cc	TD28014
ZL06	4 Cyl.	16 Valves	1498cc	TD28013

PB313 (x8)
PB314 (x8)

NJ324 (x2)
34.00 x 48.00 x 7.00mm, ACM

NK158
37.00 x 50.50 x 7.00mm, ACM
NJ650
83.00 x 100.00 x 9.00mm, ACM

26 1.5L

Petrol

ZY05	4 Cyl.	16 Valves	1498cc	TD31265
ZY66	4 Cyl.	16 Valves	1498cc	TD31266
ZY-DE	4 Cyl.	16 Valves	1498cc	TD25012
ZY-VE	4 Cyl.	16 Valves	1498cc	TD23705

HR5063

NA5246
42.50 x 54.50 x 6.00mm, MVQ
NJ650
83.00 x 100.00 x 9.00mm, ACM

27 1.6L Diesel

4EE1-T PA658 (x8)	4 Cyl. NJ449 40.00 x 52.00 x 6.00mm, NBR	8 Valves NJ449 40.00 x 52.00 x 6.00mm, NBR NK103 87.00 x 100.00 x 8.50mm, FPM	1686cc TD9465
-----------------------------	---	---	-------------------------

28 1.6L Petrol

8AN1	4 Cyl.	16 Valves	1598cc	TD31246
B6D	4 Cyl.	16 Valves	1598cc	TD4638
B6EW	4 Cyl.	16 Valves	1598cc	TD26749
B6ZE	4 Cyl.	16 Valves	1598cc	TD1943
ZM	4 Cyl.	16 Valves	1598cc	TD22096
PB313 (x8) PB314 (x8)	NJ324 (x2) 34.00 x 48.00 x 7.00mm, ACM	NK158 37.00 x 50.50 x 7.00mm, ACM NJ650 83.00 x 100.00 x 9.00mm, ACM		

29 1.6L Petrol

B6	4 Cyl.	16 Valves	1598cc	TD1930
B6	4 Cyl.	16 Valves	1598cc	TD24149
B6F2	4 Cyl.	16 Valves	1597cc	TD31291
B6T	4 Cyl.	16 Valves	1598cc	TD1932
PB314 (x16)	NJ448 30.00 x 44.00 x 7.00mm, NBR	NJ448 30.00 x 44.00 x 7.00mm, NBR NJ650 83.00 x 100.00 x 9.00mm, ACM		

30 1.6L Petrol

B6 (DOHC)	4 Cyl.	16 Valves	1598cc	TD9427
B64F	4 Cyl.	16 Valves	1598cc	TD1933
B69	4 Cyl.	16 Valves	1598cc	TD1937
PB313 (x8) PB314 (x8)	NJ324 (x2) 34.00 x 48.00 x 7.00mm, ACM	NJ448 30.00 x 44.00 x 7.00mm, NBR NJ650 83.00 x 100.00 x 9.00mm, ACM		

31 1.6L Petrol

B6 (SOHC)	4 Cyl.	8 Valves	1598cc	TD9428
B6E	4 Cyl.	8 Valves	1598cc	TD1931
B61V	4 Cyl.	8 Valves	1597cc	TD31289
B65L	4 Cyl.	8 Valves	1598cc	TD1934
B65M	4 Cyl.	8 Valves	1598cc	TD1935
B68	4 Cyl.	8 Valves	1597cc	TD1936
B69	4 Cyl.	8 Valves	1598cc	TD1938
PA883 (x8)	NJ448 30.00 x 44.00 x 7.00mm, NBR	NJ448 30.00 x 44.00 x 7.00mm, NBR NJ650 83.00 x 100.00 x 9.00mm, ACM		

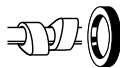

32 1.6L

Petrol

B67J	4 Cyl.	16 Valves	1597cc	TD31531
B67K	4 Cyl.	16 Valves	1597cc	TD31569
B67L	4 Cyl.	16 Valves	1597cc	TD31530

PB314 (x16)

NJ448
30.00 x 44.00 x 7.00mm, NBR

NK158
37.00 x 50.50 x 7.00mm, ACM

NJ650
83.00 x 100.00 x 9.00mm, ACM

33 1.6L

Petrol

F6	4 Cyl.	8 Valves	1587cc	TD1967
F603	4 Cyl.	8 Valves	1587cc	TD31534
F658	4 Cyl.	8 Valves	1587cc	TD31535
F659	4 Cyl.	8 Valves	1587cc	TD31324

KJ710 (x8)

NJ324
34.00 x 48.00 x 7.00mm, ACM

NJ324
34.00 x 48.00 x 7.00mm, ACM

NJ325
90.00 x 110.00 x 9.00mm, MVQ

34 1.6L

Petrol

FYJA	4 Cyl.	16 Valves	1596cc	TD18692
------	--------	-----------	--------	---------

HR808
HR809

NC048 (x2)
38.00 x 52.00 x 6.00mm, FPM

NA5137
33.00 x 47.00 x 5.00mm, FPM

LK5004
80.00 x 182.00 x 19.400mm, PTFE

35 1.6L

Petrol

NA	4 Cyl.	8 Valves	1586cc	TD2021
----	--------	----------	--------	--------

KJ710 (x8)

NJ042
48.00 x 70.00 x 12.00mm, NBR

36 1.6L

Diesel

Y406	4 Cyl.	16 Valves	1560cc	TD31264
Y601	4 Cyl.	16 Valves	1560cc	TD18512
Y642	4 Cyl.	16 Valves	1560cc	TD31288
Y646	4 Cyl.	16 Valves	1560cc	TD31262

PA6072 (x16)
HR5124

NA5258
27.00 x 47.00 x 7.00mm, PTFE

NA5259
40.00 x 55.00 x 6.40mm, PTFE

NA5325
85.00 x 105.00 x 8.80mm, PTFE

37 1.6L

Diesel

Y650	4 Cyl.	8 Valves	1560cc	TD31287
Y655	4 Cyl.	8 Valves	1560cc	TD31229
Y661	4 Cyl.	8 Valves	1560cc	TD31228

PA5068 (x8)
HR5120

NA5258
27.00 x 47.00 x 7.00mm, PTFE

NA5259
40.00 x 55.00 x 6.40mm, PTFE

NA5325
85.00 x 105.00 x 8.80mm, PTFE

38 1.6L

Petrol

Z6	4 Cyl.	16 Valves	1598cc	TD22118
----	--------	-----------	--------	---------

PB313 (x8)
PB314 (x8)

NA5246
42.50 x 54.50 x 6.00mm, MVQ

NJ650
83.00 x 100.00 x 9.00mm, ACM



39 1.6L Petrol

Z6Y1	4 Cyl.	16 Valves	1598cc	TD31235
Z6Y3	4 Cyl.	16 Valves	1598cc	TD31234
				NA5246 42.50 x 54.50 x 6.00mm, MVQ NJ650 83.00 x 100.00 x 9.00mm, ACM

40 1.7L Diesel

PN26	4 Cyl.	8 Valves	1720cc	TD2025
PN27	4 Cyl.	8 Valves	1720cc	TD2026
PN46	4 Cyl.	8 Valves	1720cc	TD2027
PN54	4 Cyl.	8 Valves	1720cc	TD2028
PN62	4 Cyl.	8 Valves	1720cc	TD2029
PA883 (x8)	NJ448 30.00 x 44.00 x 7.00mm, NBR			NJ448 30.00 x 44.00 x 7.00mm, NBR NJ650 83.00 x 100.00 x 9.00mm, ACM

41 1.8L Petrol

BP	4 Cyl.	16 Valves	1840cc	TD1947
PA425 (x16)	NJ448 30.00 x 44.00 x 7.00mm, NBR			NJ448 30.00 x 44.00 x 7.00mm, NBR NJ650 83.00 x 100.00 x 9.00mm, ACM

42 1.8L Petrol

BP (DOHC)	4 Cyl.	16 Valves	1840cc	TD1949
BP21	4 Cyl.	16 Valves	1840cc	TD26887
BP22	4 Cyl.	16 Valves	1840cc	TD18364
BP31	4 Cyl.	16 Valves	1840cc	TD18392
BP52	4 Cyl.	16 Valves	1840cc	TD1948
BP55	4 Cyl.	16 Valves	1840cc	TD26857
PA425 (x16)	NJ324 (x2) 34.00 x 48.00 x 7.00mm, ACM			NJ448 30.00 x 44.00 x 7.00mm, NBR NJ650 83.00 x 100.00 x 9.00mm, ACM

43 1.8L Petrol

BP4W	4 Cyl.	16 Valves	1840cc	TD31248
BP Turbo	4 Cyl.	16 Valves	1840cc	TD14748
NJ324 34.00 x 48.00 x 7.00mm, ACM				

44 1.8L Petrol

BP6J	4 Cyl.	16 Valves	1839cc	TD31247
BPF1	4 Cyl.	16 Valves	1840cc	TD1951
PB313 (x8) PB314 (x8)	NJ324 (x2) 34.00 x 48.00 x 7.00mm, ACM			NJ448 30.00 x 44.00 x 7.00mm, NBR NJ650 83.00 x 100.00 x 9.00mm, ACM

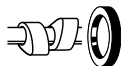

45 1.8L

Petrol

BPC	4 Cyl.	16 Valves	1840cc	TD26075
PA425 (x16)	NJ448 (x2) 30.00 x 44.00 x 7.00mm, NBR	NJ448 30.00 x 44.00 x 7.00mm, NBR	NJ650 83.00 x 100.00 x 9.00mm, ACM	

46 1.8L

Petrol

BPD	4 Cyl.	16 Valves	1840cc	TD24709
PB313 (x8) PB314 (x8)	NJ324 34.00 x 48.00 x 7.00mm, ACM	NJ448 30.00 x 44.00 x 7.00mm, NBR	NJ650 83.00 x 100.00 x 9.00mm, ACM	

47 1.8L

Petrol

F8 (8V)	4 Cyl.	8 Valves	1789cc	TD1970
KJ710 (x8)	NJ324 34.00 x 48.00 x 7.00mm, ACM	NJ324 34.00 x 48.00 x 7.00mm, ACM	NJ325 90.00 x 110.00 x 9.00mm, MVQ	

48 1.8L

Petrol

F8 (12V)	4 Cyl.	12 Valves	1789cc	TD1969
PA883 (x12)	NJ324 34.00 x 48.00 x 7.00mm, ACM	NJ324 34.00 x 48.00 x 7.00mm, ACM	NJ325 90.00 x 110.00 x 9.00mm, MVQ	

49 1.8L

Petrol

FP	4 Cyl.	16 Valves	1840cc	TD1996
FP01LP	4 Cyl.	16 Valves	1840cc	TD31532
FP29	4 Cyl.	16 Valves	1839cc	TD31567
FP30	4 Cyl.	16 Valves	1839cc	TD31568
FP55	4 Cyl.	16 Valves	1840cc	TD26760
FPY3	4 Cyl.	16 Valves	1840cc	TD26076
PB313 (x8) PB314 (x8)	NJ324 (x2) 34.00 x 48.00 x 7.00mm, ACM	NA5246 42.50 x 54.50 x 6.00mm, MVQ	NK205 89.00 x 109.00 x 9.00mm, MVQ	

50 1.8L

Petrol

FP9A	4 Cyl.	16 Valves	1840cc	TD18210
PB313 (x8) PB314 (x8)	NJ324 34.00 x 48.00 x 7.00mm, ACM	NA5246 42.50 x 54.50 x 6.00mm, MVQ	NK205 89.00 x 109.00 x 9.00mm, MVQ	

51 1.8L

Petrol

K8-ZE	6 Cyl.	24 Valves	1845cc	TD25256
K819	6 Cyl.	24 Valves	1845cc	TD4645
PB313 (x12) PB314 (x12)	NJ448 (x2) 30.00 x 44.00 x 7.00mm, NBR	NA5246 42.50 x 54.50 x 6.00mm, MVQ		



52 1.8L Petrol

K838	6 Cyl.	12 Valves	1845cc	TD2014
PB313  (x12)	NJ448		NA5246 	
PB314  (x12)	30.00 x 44.00 x 7.00mm, NBR		42.50 x 54.50 x 6.00mm, MVQ	

53 1.8L Petrol

L8-DE	4 Cyl.	16 Valves	1798cc	TD24825
L813	4 Cyl.	16 Valves	1798cc	TD18205
L823	4 Cyl.	16 Valves	1798cc	TD19204
L828	4 Cyl.	16 Valves	1798cc	TD24715
L850	4 Cyl.	16 Valves	1798cc	TD31307
HR5063 			NA5157 	
			37.00 x 50.00 x 8.00mm, PTFE	
			LK5005 	
			88.00 x 188.00 x 15.000mm, PTFE	

54 1.8L Petrol

MR18DE	4 Cyl.	16 Valves	1798cc	TD30813
PB681 (x16)			NK106 	
			46.00 x 58.00 x 7.00mm, ACM	

55 1.8L Diesel

RTJ	4 Cyl.	8 Valves	1753cc	TD18697
RTK	4 Cyl.	8 Valves	1753cc	TD18698
PB180 (x8) 08/92→	NB785		NB984 	
HR801 	28.00 x 38.00 x 7.00mm, FPM		66.67 x 89.30 x 10.00mm, FPM	
			NB788 	
			79.40 x 95.30 x 11.10mm, PTFE	

56 1.8L Petrol

VC	4 Cyl.	8 Valves	1769cc	TD2052
HR661 				



57 2.0L Petrol

FE (8V)	4 Cyl.	8 Valves	1998cc	TD1976
KJ710 (x8) →05/94	NJ324		NJ324 	
PA425 (x8) 05/94→	34.00 x 48.00 x 7.00mm, ACM		34.00 x 48.00 x 7.00mm, ACM	
			NJ325 	
			90.00 x 110.00 x 9.00mm, MVQ	

58 2.0L Petrol

FE (12V)	4 Cyl.	12 Valves	1998cc	TD9511
FE4J	4 Cyl.	12 Valves	1998cc	TD31550
FEKN	4 Cyl.	12 Valves	1998cc	TD31603
FEY9	4 Cyl.	12 Valves	1998cc	TD24549
KJ710 (x12)	NJ324		NJ324 	
	34.00 x 48.00 x 7.00mm, ACM		34.00 x 48.00 x 7.00mm, ACM	
			NJ325 	
			90.00 x 110.00 x 9.00mm, MVQ	

59 2.0L Petrol

FE (16V)	4 Cyl.	16 Valves	1998cc	TD1973
PA425 (x16)	NJ324 (x2)		NJ324 	
	34.00 x 48.00 x 7.00mm, ACM		34.00 x 48.00 x 7.00mm, ACM	
			NJ325 	
			90.00 x 110.00 x 9.00mm, MVQ	

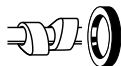

60 2.0L

Petrol

FE4K	4 Cyl.	12 Valves	1998cc	TD31549
PA883 (x12)	NJ324 (x12) 34.00 x 48.00 x 7.00mm, ACM		NJ324 34.00 x 48.00 x 7.00mm, ACM NJ325 90.00 x 110.00 x 9.00mm, MVQ	

61 2.0L

Petrol

FE18	4 Cyl.	8 Valves	1998cc	TD1977
FE58	4 Cyl.	8 Valves	1998cc	TD1978
FE60	4 Cyl.	8 Valves	1998cc	TD1979
FE61	4 Cyl.	8 Valves	1998cc	TD1980
FEBN	4 Cyl.	8 Valves	1998cc	TD1984
FECK	4 Cyl.	8 Valves	1998cc	TD26750
FEFA	4 Cyl.	8 Valves	1998cc	TD1990
FET	4 Cyl.	8 Valves	1998cc	TD25290
FEV4	4 Cyl.	8 Valves	1998cc	TD1995
FEY7	4 Cyl.	8 Valves	1998cc	TD26752
HEA1	4 Cyl.	8 Valves	1998cc	TD31539
KJ710 (x8)	NJ324 (x2) 34.00 x 48.00 x 7.00mm, ACM		NJ324 34.00 x 48.00 x 7.00mm, ACM NJ325 90.00 x 110.00 x 9.00mm, MVQ	

62 2.0L

Petrol

FS	4 Cyl.	16 Valves	1991cc	TD1997
FS2C	4 Cyl.	16 Valves	1991cc	TD18211
FS7E	4 Cyl.	16 Valves	1991cc	TD18214
FS7G	4 Cyl.	16 Valves	1991cc	TD18215
FS-DS	4 Cyl.	16 Valves	1991cc	TD13348
PB313 (x8) PB314 (x8)	NJ324 (x2) 34.00 x 48.00 x 7.00mm, ACM		NA5246 42.50 x 54.50 x 6.00mm, MVQ NK205 89.00 x 109.00 x 9.00mm, MVQ	

63 2.0L

Petrol

HE3	4 Cyl.	8 Valves	1970cc	TD2002
HEE	4 Cyl.	8 Valves	1970cc	TD2005
M	4 Cyl.	8 Valves	1970cc	TD4648
MA	4 Cyl.	8 Valves	1970cc	TD2019
KJ710 (x8)				

64 2.0L

Petrol

KF	6 Cyl.	24 Valves	1995cc	TD4646
KF1	6 Cyl.	24 Valves	1995cc	TD2016
PB313 (x12) PB314 (x12)	NJ448 (x2) 30.00 x 44.00 x 7.00mm, NBR		NA5246 42.50 x 54.50 x 6.00mm, MVQ	



65 2.0L		Petrol			
LF5H	4 Cyl.	16 Valves	1999cc		TD24832
LF5W	4 Cyl.	16 Valves	1999cc		TD24831
LF17	4 Cyl.	16 Valves	1999cc		TD18206
LF18	4 Cyl.	16 Valves	1999cc		TD18207
LF62	4 Cyl.	16 Valves	1999cc		TD24714
LF-DE	4 Cyl.	16 Valves	1999cc		TD24826
LFF7	4 Cyl.	16 Valves	1999cc		TD19205
LFVD	4 Cyl.	16 Valves	1997cc		TD31310
LF-VDS	4 Cyl.	16 Valves	1998cc		TD23704
LF-VE	4 Cyl.	16 Valves	1999cc		TD23703
LFZB	4 Cyl.	16 Valves	1999cc		TD31306
HR5063					NA5157 37.00 x 50.00 x 8.00mm, PTFE
					LK5005 88.00 x 188.00 x 15.000mm, PTFE

66 2.0L		Diesel			
RF1G	4 Cyl.	8 Valves	1998cc		TD18950
RF46	4 Cyl.	8 Valves	1998cc		TD2043
RF55	4 Cyl.	8 Valves	1998cc		TD31533
RF83	4 Cyl.	8 Valves	1998cc		TD2044
RF-CX	4 Cyl.	8 Valves	1998cc		TD4649
RFG5	4 Cyl.	8 Valves	1998cc		TD18951
RFH7	4 Cyl.	8 Valves	1998cc		TD2047
RF-N	4 Cyl.	8 Valves	1998cc		TD4650
KJ710 (x8)		NJ448 30.00 x 44.00 x 7.00mm, NBR			NJ324 34.00 x 48.00 x 7.00mm, ACM
					NJ325 90.00 x 110.00 x 9.00mm, MVQ

67 2.0L		Diesel			
RF3F	4 Cyl.	16 Valves	1998cc		TD18212
RF4F	4 Cyl.	16 Valves	1998cc		TD18213
RF5C	4 Cyl.	16 Valves	1998cc		TD18204
RF7J	4 Cyl.	16 Valves	1998cc		TD18458
PB314 (x16)		NJ448 30.00 x 44.00 x 7.00mm, NBR			NJ325 90.00 x 110.00 x 9.00mm, MVQ

68 2.0L		Petrol			
YF	4 Cyl.	16 Valves	1989cc		TD24707
HR5033		NB958 (x2) 42.00 x 53.00 x 7.00mm, FPM			NB959 35.00 x 50.00 x 7.00mm, FPM
					NA5323 35.00 x 50.00 x 7.00mm, PTFE

69 2.0L		Petrol			
ZKF48	6 Cyl.	24 Valves	1995cc		TD31526
ZKF49	6 Cyl.	24 Valves	1995cc		TD31527
PB313 (x12)		NJ448 (x2) 30.00 x 44.00 x 7.00mm, NBR			
PB314 (x12)					

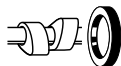

70 2.1L

Diesel

R254	4 Cyl.	8 Valves	2184cc	TD2034
KJ710 (x8)	NJ448 30.00 x 44.00 x 7.00mm, NBR		NJ324 34.00 x 48.00 x 7.00mm, ACM NJ325 90.00 x 110.00 x 9.00mm, MVQ	

71 2.2L

Petrol

F2	4 Cyl.	12 Valves	2184cc	TD1960
F2-C	4 Cyl.	12 Valves	2184cc	TD14868
F2E	4 Cyl.	12 Valves	2184cc	TD4642
F2-EGI	4 Cyl.	12 Valves	2184cc	TD4641
F2G	4 Cyl.	12 Valves	2184cc	TD1965
F2L1	4 Cyl.	12 Valves	2184cc	TD1966
F2R4	4 Cyl.	12 Valves	2184cc	TD32462
F2T	4 Cyl.	12 Valves	2184cc	TD25289
F2I	4 Cyl.	12 Valves	2184cc	TD1962
R5A2	4 Cyl.	12 Valves	2184cc	TD16445
PA883 (x12)	NJ324 34.00 x 48.00 x 7.00mm, ACM		NJ324 34.00 x 48.00 x 7.00mm, ACM NJ325 90.00 x 110.00 x 9.00mm, MVQ	

72 2.2L

Petrol

F2IB	4 Cyl.	8 Valves	2184cc	TD31547
F2L5	4 Cyl.	8 Valves	2184cc	TD31543
F2L8	4 Cyl.	8 Valves	2184cc	TD16444
JL22	4 Cyl.	8 Valves	2148cc	TD13475
KJ710 (x8)	NJ324 34.00 x 48.00 x 7.00mm, ACM		NJ324 34.00 x 48.00 x 7.00mm, ACM NJ325 90.00 x 110.00 x 9.00mm, MVQ	

73 2.2L

Diesel

P4-AT	4 Cyl.	16 Valves	2198cc	TD26844
HR5082			NA5031 50.00 x 86.50 x 13.70mm, PTFE NA5030 106.00 x 190.00 x 15.20mm, PTFE/FPM	

74 2.2L

Diesel

R2	4 Cyl.	8 Valves	2184cc	TD2030
R21N	4 Cyl.	8 Valves	2184cc	TD31552
R203	4 Cyl.	8 Valves	2184cc	TD2031
R207	4 Cyl.	8 Valves	2184cc	TD2032
R238	4 Cyl.	8 Valves	2184cc	TD2033
R281	4 Cyl.	8 Valves	2184cc	TD2035
R290	4 Cyl.	8 Valves	2184cc	TD2038
KJ710 (x8)	NJ448 30.00 x 44.00 x 7.00mm, NBR		NJ324 34.00 x 48.00 x 7.00mm, ACM NJ325 90.00 x 110.00 x 9.00mm, MVQ	



75 2.2L

Diesel

R2AA	4 Cyl.	16 Valves	2184cc	TD28009
R2BF	4 Cyl.	16 Valves	2184cc	TD28077
PB314 (x16)				NJ325 90.00 x 110.00 x 9.00mm, MVQ

76 2.2L

Diesel

S2	4 Cyl.	8 Valves	2209cc	TD7864
				NJ330 101.60 x 125.00 x 13.00mm, MVQ

77 2.3L

Petrol

KJ15	6 Cyl.	24 Valves	2255cc	TD18949
KJ-ZEM	6 Cyl.	24 Valves	2255cc	TD4647
KJZM	6 Cyl.	24 Valves	2255cc	TD31578
PB313 (x12)	NJ448 (x2) 30.00 x 44.00 x 7.00mm, NBR			NA5246 42.50 x 54.50 x 6.00mm, MVQ
PB314 (x12)				

78 2.3L

Petrol

L3	4 Cyl.	16 Valves	2261cc	TD24710
L3C1	4 Cyl.	16 Valves	2261cc	TD18208
L3K7	4 Cyl.	16 Valves	2261cc	TD31253
L3KG	4 Cyl.	16 Valves	2261cc	TD24716
L3N9	4 Cyl.	16 Valves	2261cc	TD24827
L3-V	4 Cyl.	16 Valves	2261cc	TD27275
L3-VDT	4 Cyl.	16 Valves	2261cc	TD23702
L3-VE	4 Cyl.	16 Valves	2261cc	TD24117
L3X	4 Cyl.	16 Valves	2261cc	TD29431
L3Y7	4 Cyl.	16 Valves	2261cc	TD27276
L3YH	4 Cyl.	16 Valves	2261cc	TD31312
L3YS	4 Cyl.	16 Valves	2261cc	TD31325
L3YT	4 Cyl.	16 Valves	2261cc	TD31326
L333	4 Cyl.	16 Valves	2261cc	TD31327
HR5063				NA5157 37.00 x 50.00 x 8.00mm, PTFE LK5005 88.00 x 188.00 x 15.000mm, PTFE

79 2.3L

Petrol

L3K4	4 Cyl.	16 Valves	2261cc	TD20281
HR5063				

80 2.5L

Petrol

4G54	4 Cyl.	8 Valves	2555cc	TD25291
KJ211 (x8)				NJ251 80.00 x 96.00 x 9.00mm, MVQ

81 2.5L

Petrol

GY-DE	6 Cyl.	24 Valves	2495cc	TD13349
				NA5175 91.00 x 108.00 x 9.50mm, NBR

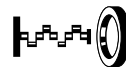
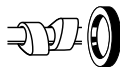

82 2.5L

Petrol

J5DE	6 Cyl.	24 Valves	2494cc	TD2006
PB313 (x12)				
PB314 (x12)				

83 2.5L

Petrol

KL	6 Cyl.	24 Valves	2497cc	TD2017
KL-ZE	6 Cyl.	24 Valves	2497cc	TD25257
PB313 (x12)	NJ448 (x2)		NA5246	
PB314 (x12)	30.00 x 44.00 x 7.00mm, NBR		42.50 x 54.50 x 6.00mm, MVQ	

84 2.5L

Petrol

L5-VE	4 Cyl.	16 Valves	2488cc	TD23706
L5-X	4 Cyl.	16 Valves	2488cc	TD28212
L5-Y3	4 Cyl.	16 Valves	2488cc	TD26845
HR5063			NA5157	
			37.00 x 50.00 x 8.00mm, PTFE	
			LK5005	
			88.00 x 188.00 x 15.000mm, PTFE	

85 2.5L

Diesel

MD25NA	4 Cyl.	12 Valves	2500cc	TD13473
MD25TI	4 Cyl.	12 Valves	2500cc	TD13474
WL31	4 Cyl.	12 Valves	2500cc	TD28007
WL84	4 Cyl.	12 Valves	2500cc	TD27027
WLE2	4 Cyl.	12 Valves	2500cc	TD31566
WLE7	4 Cyl.	12 Valves	2500cc	TD18456
WLE9	4 Cyl.	12 Valves	2500cc	TD31540
WLF5	4 Cyl.	12 Valves	2500cc	TD31542
WL-T	4 Cyl.	12 Valves	2500cc	TD21260
WL-T (12 V)	4 Cyl.	12 Valves	2499cc	TD25292
			NA5197	
			53.00 x 70.00 x 11.00mm, MVQ	

86 2.5L

Diesel

WLAA	4 Cyl.	16 Valves	2500cc	TD24718
WLAT (16 V)	4 Cyl.	16 Valves	2500cc	TD25253
PB314 (x16)				

87 2.6L

Petrol

G6MPV	4 Cyl.	12 Valves	2606cc	TD1998
G6Y0	4 Cyl.	12 Valves	2606cc	TD23932
G6Y1	4 Cyl.	12 Valves	2606cc	TD23933
PA883 (x12)			NF844	
			90.00 x 110.00 x 11.00mm, FPM/ACM	

88 2.6L

Petrol

G54B	4 Cyl.	8 Valves	2555cc	TD31546
KJ211 (x8)			NJ251	
			80.00 x 96.00 x 9.00mm, MVQ	



89 3.0L Petrol

AJ	6 Cyl.	24 Valves	2967cc	TD24706
				NA5175 91.00 x 108.00 x 9.50mm, NBR

90 3.0L Diesel

HA	4 Cyl.	8 Valves	2977cc	TD7868
				NJ330 101.60 x 125.00 x 13.00mm, MVQ

91 3.0L Petrol

JE	6 Cyl.	18 Valves	2954cc	TD2007
JE3	6 Cyl.	18 Valves	2954cc	TD2009
JE34	6 Cyl.	18 Valves	2954cc	TD31537
JE35	6 Cyl.	18 Valves	2954cc	TD31536
PA883 (x12) KJ710 (x6)	NJ985 35.00 x 49.60 x 11.00mm, NBR		NJ978 46.00 x 60.00 x 7.00mm, MVQ NK035 75.00 x 93.00 x 9.00mm, MVQ	

92 3.0L Petrol

JEZE	6 Cyl.	24 Valves	2954cc	TD2012
PB314 (x24)				

93 3.0L Diesel

WEAT	4 Cyl.	16 Valves	2953cc	TD25288
PB314 (x16)				

94 3.2L Diesel

P5-AT	5 Cyl.	20 Valves	3198cc	TD26846
HR5082 (x2)				NA5030 106.00 x 190.00 x 15.20mm, PTFE/FPM

95 3.4L Diesel

SL	4 Cyl.	8 Valves	3455cc	TD7869
PA606 (x8)				NJ330 101.60 x 125.00 x 13.00mm, MVQ

96 4.1L Diesel

ZB	6 Cyl.	12 Valves	4052cc	TD7871
				NJ330 101.60 x 125.00 x 13.00mm, MVQ



CC



9

2.8 - 5.3	05/75→07/81	V 12 (75-79)	Petrol	5344	12	24	136
2.8 - 5.3	06/76→03/79	XK 4.2 (-79)	Petrol	4235	6	12	119
2.8 - 5.3	03/79→10/86	XK 4.2 (82-87)	Petrol	4235	6	12	119
2.8 - 5.3	07/81→10/86	V 12 (82-90)	Petrol	5344	12	24	136
2.8 - 5.3	10/86→02/93	7P	Petrol	5344	12	24	135
/8 (W114)	01/68→08/72	M 114.920	Petrol	2496	6	12	63
/8 (W114)	01/68→11/76	M 180.954	Petrol	2292	6	12	53
/8 (W114)	06/72→11/76	M 110.921	Petrol	2746	6	12	71
/8 (W114)	06/72→11/76	M 110.981	Petrol	2746	6	12	71
/8 (W114)	06/72→11/76	M 130.923	Petrol	2778	6	12	71
/8 (W115)	01/68→07/73	M 115.920	Petrol	2197	4	8	41
/8 (W115)	01/68→07/73	M 115.924	Petrol	2197	4	8	41
/8 (W115)	01/68→01/77	M 115.923	Petrol	1988	4	8	28
/8 (W115)	01/68→01/77	M 115.926	Petrol	1988	4	8	28
/8 (W115)	01/68→01/77	OM 615.912	Diesel	2197	4	8	47
/8 (W115)	01/68→01/77	OM 615.913	Diesel	1988	4	8	34
/8 (W115)	08/73→12/76	M 115.951	Petrol	2307	4	8	52
/8 (W115)	08/73→01/77	OM 616.916	Diesel	2404	4	8	60
/8 (W115)	08/74→11/76	OM 617.910	Diesel	2998	5	10	92
/8 Coupe (W114)	04/69→04/72	M 114.980	Petrol	2496	6	12	63
/8 Coupe (W114)	04/69→06/72	M 114.920	Petrol	2496	6	12	63
/8 Coupe (W114)	06/72→11/76	M 130.923	Petrol	2778	6	12	71
/8 Coupe (W114)	06/72→01/77	M 110.981	Petrol	2746	6	12	71
/8 Coupe (W114)	06/72→02/77	M 110.921	Petrol	2746	6	12	71
100 Box (631)	02/88→02/96	OM 616.963	Diesel	2399	4	8	60
100 Box (631)	04/88→04/96	OM 615.970	Diesel	1988	4	8	34
100 Bus (631)	02/88→02/96	OM 616.963	Diesel	2399	4	8	60
100 Bus (631)	04/88→08/93	OM 615.963	Diesel	1988	4	8	34
100 Bus (631)	04/88→04/96	OM 615.970	Diesel	1988	4	8	34
100 Bus (631)	12/90→02/96	OM 616	Diesel	2399	4	8	60
100 Platform/Chassis (631)	02/88→02/96	OM 616.963	Diesel	2399	4	8	60
190 (W201)	10/82→10/84	M 102.921	Petrol	1996	4	8	26
190 (W201)	10/82→06/93	M 102.961	Petrol	1996	4	8	26
190 (W201)	10/82→08/93	M 102.962	Petrol	1996	4	8	26
190 (W201)	10/82→08/93	M 102.985	Petrol	2298	4	8	49
190 (W201)	10/82→08/93	M 103.942	Petrol	2597	6	12	69
190 (W201)	08/83→08/93	OM 601.911	Diesel	1997	4	8	32
190 (W201)	04/84→08/88	M 102.983	Petrol	2298	4	16	49
190 (W201)	09/84→12/85	OM 601.921	Diesel	2197	4	8	43
190 (W201)	09/84→05/90	M 102.924	Petrol	1996	4	8	26
190 (W201)	04/85→08/93	OM 602.911	Diesel	2497	5	10	66
190 (W201)	02/88→08/93	OM 602.961	Diesel	2497	5	10	66
190 (W201)	09/88→08/93	M 102.990	Petrol	2498	4	16	61
190 (W201)	03/89→08/93	M 102.991	Petrol	2498	4	16	61
190 (W201)	04/90→08/93	M 102.910	Petrol	1797	4	8	15
190 (W201)	05/90→08/93	M 102.992	Petrol	2498	4	8	61
A-Class (W168)	07/97→08/04	M 166.940	Petrol	1397	4	8	4
A-Class (W168)	07/97→08/04	M 166.960	Petrol	1598	4	8	9
A-Class (W168)	07/98→02/01	OM 668.941	Diesel	1689	4	16	14
A-Class (W168)	07/98→08/04	OM 668.940	Diesel	1689	4	16	14
A-Class (W168)	03/99→08/04	M 166.990	Petrol	1898	4	8	24
A-Class (W168)	02/01→08/04	OM 668.942	Diesel	1689	4	16	14
A-Class (W168)	03/02→08/04	M 166.995	Petrol	2084	4	8	37
A-Class (W169)	09/04→06/12	M 266.920	Petrol	1498	4	8	6
A-Class (W169)	09/04→06/12	M 266.940	Petrol	1699	4	8	13
A-Class (W169)	09/04→06/12	M 266.960	Petrol	2034	4	8	30
A-Class (W169)	09/04→06/12	OM 640.940	Diesel	1991	4	16	35
A-Class (W169)	09/04→06/12	OM 640.941	Diesel	1991	4	16	35
A-Class (W169)	09/04→06/12	OM 640.942	Diesel	1991	4	16	35
A-Class (W169)	09/05→06/12	M 266.980	Petrol	2034	4	8	30
A-Class (W176)	06/12→	M 270.910	Petrol	1595	4	16	10
A-Class (W176)	06/12→	M 270.920	Petrol	1991	4	16	31
A-Class (W176)	06/12→	OM 607.951	Diesel	1461	4	8	7
A-Class (W176)	06/12→	OM 651.901	Diesel	1796	4	16	22
A-Class (W176)	09/12→	OM 651.930	Diesel	2143	4	16	39
B-Class (W245)	03/05→11/11	M 266.920	Petrol	1498	4	8	6
B-Class (W245)	03/05→11/11	M 266.940	Petrol	1699	4	8	13
B-Class (W245)	03/05→11/11	M 266.960	Petrol	2034	4	8	30
B-Class (W245)	03/05→11/11	M 266.980	Petrol	2034	4	8	30
B-Class (W245)	03/05→11/11	OM 640.940	Diesel	1991	4	16	35
B-Class (W245)	03/05→11/11	OM 640.941	Diesel	1991	4	16	35
B-Class (W246, W242)	11/11→	M 270.910	Petrol	1595	4	16	10
B-Class (W246, W242)	11/11→	OM 651.901	Diesel	1796	4	16	22
B-Class (W246, W242)	11/11→	OM 651.930	Diesel	2143	4	16	39
B-Class (W246, W242)	05/12→	M 270.920	Petrol	1991	4	16	31
B-Class (W246, W242)	02/13→	OM 607.951	Diesel	1461	4	8	7
Cabriolet (A124)	04/92→06/93	M 104.980	Petrol	2960	6	24	86
Cabriolet (A124)	10/92→05/93	M 104.992	Petrol	3199	6	24	95



Model	Year Range	Engine Code	Fuel	CC	Power (kW)	Power (hp)	Transmission	Price
Cabriolet (W111)	01/69→12/71	M 116.980	Petrol	3500	8	16	99	
C-Class (W202)	03/93→05/00	M 111.920	Petrol	1799	4	16	16	
C-Class (W202)	03/93→05/00	M 111.921	Petrol	1799	4	16	16	
C-Class (W202)	03/93→05/00	M 111.961	Petrol	2199	4	16	40	
C-Class (W202)	03/93→05/00	OM 601.913	Diesel	1997	4	8	32	
C-Class (W202)	05/93→05/00	M 104.941	Petrol	2799	6	24	75	
C-Class (W202)	05/93→05/00	OM 605.910	Diesel	2497	5	20	67	
C-Class (W202)	08/93→05/00	OM 604.910	Diesel	2155	4	16	44	
C-Class (W202)	01/94→05/00	M 111.941	Petrol	1998	4	16	27	
C-Class (W202)	01/94→05/00	M 111.945	Petrol	1998	4	16	27	
C-Class (W202)	05/94→05/00	M 104.941 (AMG 3.6)	Petrol	3606	6	24	103	
C-Class (W202)	10/95→05/00	M 111.944	Petrol	1998	4	16	27	
C-Class (W202)	10/95→05/00	M 111.975	Petrol	2295	4	16	50	
C-Class (W202)	10/95→05/00	OM 605.960	Diesel	2497	5	20	67	
C-Class (W202)	06/96→06/97	M 111.974	Petrol	2295	4	16	50	
C-Class (W202)	10/96→05/00	OM 604.915	Diesel	1997	4	16	33	
C-Class (W202)	06/97→05/00	M 112.910	Petrol	2398	6	18	59	
C-Class (W202)	06/97→05/00	M 112.920	Petrol	2799	6	18	76	
C-Class (W202)	08/97→05/00	M 113.944	Petrol	4266	8	24	120	
C-Class (W202)	09/97→05/00	OM 611.960	Diesel	2151	4	16	38	
C-Class (W203)	05/00→06/02	M 111.955	Petrol	1998	4	16	27	
C-Class (W203)	05/00→02/07	M 112.912	Petrol	2597	6	18	70	
C-Class (W203)	05/00→02/07	M 112.946	Petrol	3199	6	18	96	
C-Class (W203)	05/00→02/07	OM 611.962	Diesel	2148	4	16	38	
C-Class (W203)	05/00→02/07	OM 646.963	Diesel	2148	4	16	46	
C-Class (W203)	10/00→05/02	M 111.951	Petrol	1998	4	16	27	
C-Class (W203)	12/00→02/07	OM 612.962	Diesel	2685	5	20	73	
C-Class (W203)	02/01→02/07	M 112.961	Petrol	3199	6	18	96	
C-Class (W203)	05/02→02/07	M 271.940	Petrol	1796	4	16	18	
C-Class (W203)	05/02→02/07	M 271.946	Petrol	1796	4	16	18	
C-Class (W203)	07/02→02/07	M 112.916	Petrol	2597	6	18	70	
C-Class (W203)	07/02→02/07	M 112.953	Petrol	3199	6	18	96	
C-Class (W203)	01/03→02/07	OM 612.990	Diesel	2950	5	20	91	
C-Class (W203)	04/03→02/07	OM 646.962	Diesel	2148	4	16	46	
C-Class (W203)	07/03→02/07	M 271.942	Petrol	1796	4	16	19	
C-Class (W203)	02/04→02/07	M 113.988	Petrol	5439	8	24	137	
C-Class (W203)	02/04→02/07	M 271.948	Petrol	1796	4	16	18	
C-Class (W203)	01/05→02/07	M 272.920	Petrol	2496	6	24	64	
C-Class (W203)	01/05→02/07	M 272.940	Petrol	2996	6	24	87	
C-Class (W203)	01/05→02/07	M 272.941	Petrol	2996	6	24	87	
C-Class (W203)	01/05→02/07	M 272.960	Petrol	3498	6	24	101	
C-Class (W203)	01/05→02/07	M 272.970	Petrol	3498	6	24	101	
C-Class (W203)	01/05→02/07	OM 642.910	Diesel	2987	6	24	94	
C-Class (W204)	01/07→12/10	OM 646.811	Diesel	2148	4	16	38	
C-Class (W204)	01/07→12/10	OM 646.812	Diesel	2148	4	16	38	
C-Class (W204)	01/07→01/14	M 271.820	Petrol	1796	4	16	17	
C-Class (W204)	01/07→01/14	M 271.860	Petrol	1796	4	16	17	
C-Class (W204)	01/07→01/14	M 271.950	Petrol	1796	4	16	20	
C-Class (W204)	01/07→01/14	M 271.952	Petrol	1796	4	16	20	
C-Class (W204)	01/07→01/14	M 272.921	Petrol	2496	6	24	64	
C-Class (W204)	01/07→01/14	M 272.947	Petrol	2996	6	24	87	
C-Class (W204)	01/07→01/14	M 272.961	Petrol	3498	6	24	101	
C-Class (W204)	01/07→01/14	OM 642.960	Diesel	2987	6	24	94	
C-Class (W204)	07/07→01/14	M 272.911	Petrol	2496	6	24	64	
C-Class (W204)	07/07→01/14	M 272.948	Petrol	2996	6	24	87	
C-Class (W204)	07/07→01/14	M 272.971	Petrol	3498	6	24	101	
C-Class (W204)	07/07→01/14	OM 642.961	Diesel	2987	6	24	94	
C-Class (W204)	01/08→01/14	M 271.910	Petrol	1597	4	16	11	
C-Class (W204)	01/08→01/14	M 274.910	Petrol	1595	4	16	10	
C-Class (W204)	02/08→01/14	M 156.985	Petrol	6208	8	32	153	
C-Class (W204)	03/08→	M 272.947	Petrol	2996	6	24	87	
C-Class (W204)	05/08→12/10	M 272.921	Petrol	2496	6	24	64	
C-Class (W204)	08/08→01/14	OM 651.911	Diesel	2143	4	16	39	
C-Class (W204)	09/08→01/14	M 272.982	Petrol	3498	6	24	101	
C-Class (W204)	10/09→01/14	OM 642.830	Diesel	2987	6	24	94	
C-Class (W204)	10/09→01/14	OM 642.832	Diesel	2987	6	24	94	
C-Class (W204)	10/09→12/14	M 271.860	Petrol	1796	4	16	17	
C-Class (W204)	07/10→12/12	M 271.910	Petrol	1597	4	16	11	
C-Class (W204)	01/11→01/14	M 276.957	Petrol	3498	6	24	101	
C-Class (W204)	01/11→01/14	OM 651.912	Diesel	2143	4	16	39	
C-Class (W204)	01/11→01/14	OM 651.913	Diesel	2143	4	16	39	
C-Class (W204)	06/11→01/14	OM 642.834	Diesel	2987	6	24	94	
C-Class (W204)	07/11→	M 272.940	Petrol	2996	6	24	87	
C-Class (W204)	11/12→	M 271.820	Petrol	1796	4	16	17	
C-Class (W205)	12/13→	M 274.920	Petrol	1991	4	16	31	
C-Class (W205)	12/13→	OM 651.921	Diesel	2143	4	16	39	
C-Class (W205)	03/14→	M 274.910	Petrol	1595	4	16	10	
C-Class (W205)	05/14→	OM 626.951	Diesel	1598	4	16	12	



CC



9

C-Class (W205)	08/14→	M 274.920	Petrol	1991	4	16	31
C-Class (W205)	10/14→	M 274.910	Petrol	1595	4	16	10
C-Class (W205)	10/14→	M 276.823	Petrol	2996	6	24	87
C-Class Convertible (A205)	06/16→	M 270.910	Petrol	1595	4	16	10
C-Class Convertible (A205)	06/16→	M 274.910	Petrol	1595	4	16	10
C-Class Convertible (A205)	06/16→	M 274.920	Petrol	1991	4	16	31
C-Class Convertible (A205)	06/16→	M 276.823	Petrol	2996	6	24	87
C-Class Convertible (A205)	06/16→	OM 651.921	Diesel	2143	4	16	39
C-Class Coupe (C204)	06/11→	M 156.985	Petrol	6208	8	32	153
C-Class Coupe (C204)	06/11→	M 271.820	Petrol	1796	4	16	17
C-Class Coupe (C204)	06/11→	M 271.860	Petrol	1796	4	16	17
C-Class Coupe (C204)	06/11→	M 276.957	Petrol	3498	6	24	101
C-Class Coupe (C204)	06/11→	OM 651.911	Diesel	2143	4	16	39
C-Class Coupe (C204)	01/13→	M 274.910	Petrol	1595	4	16	10
C-Class Coupe (C205)	10/15→	M 274.910	Petrol	1595	4	16	10
C-Class Coupe (C205)	10/15→	M 274.920	Petrol	1991	4	16	31
C-Class Coupe (C205)	10/15→	OM 651.921	Diesel	2143	4	16	39
C-Class Coupe (C205)	04/16→	M 276.823	Petrol	2996	6	24	87
C-Class Coupe (CL203)	03/01→05/02	M 111.951	Petrol	1998	4	16	27
C-Class Coupe (CL203)	03/01→05/02	M 111.955	Petrol	1998	4	16	27
C-Class Coupe (CL203)	03/01→12/02	M 111.981	Petrol	2295	4	16	50
C-Class Coupe (CL203)	03/01→01/04	OM 611.962	Diesel	2148	4	16	38
C-Class Coupe (CL203)	05/02→05/08	M 112.961	Petrol	3199	6	18	96
C-Class Coupe (CL203)	05/02→05/08	M 271.921	Petrol	1796	4	16	18
C-Class Coupe (CL203)	05/02→05/08	M 271.940	Petrol	1796	4	16	18
C-Class Coupe (CL203)	05/02→05/08	M 271.946	Petrol	1796	4	16	18
C-Class Coupe (CL203)	05/02→05/08	M 271.948	Petrol	1796	4	16	18
C-Class Coupe (CL203)	09/02→05/08	M 112.946	Petrol	3199	6	18	96
C-Class Coupe (CL203)	09/02→05/08	OM 612.990	Diesel	2950	5	20	91
C-Class Coupe (CL203)	03/03→05/08	M 271.942	Petrol	1796	4	16	19
C-Class Coupe (CL203)	03/03→05/08	OM 646.962	Diesel	2148	4	16	46
C-Class Coupe (CL203)	02/04→05/08	OM 646.963	Diesel	2148	4	16	46
C-Class Coupe (CL203)	01/05→05/08	M 272.920	Petrol	2496	6	24	64
C-Class Coupe (CL203)	01/05→05/08	M 272.960	Petrol	3498	6	24	101
C-Class T-Model (S202)	06/96→06/98	M 111.974	Petrol	2295	4	16	50
C-Class T-Model (S202)	06/96→09/00	M 111.920	Petrol	1799	4	16	16
C-Class T-Model (S202)	06/96→09/00	M 111.921	Petrol	1799	4	16	16
C-Class T-Model (S202)	06/96→03/01	M 111.941	Petrol	1998	4	16	27
C-Class T-Model (S202)	06/96→03/01	M 111.945	Petrol	1998	4	16	27
C-Class T-Model (S202)	06/96→03/01	OM 604.910	Diesel	2155	4	16	44
C-Class T-Model (S202)	06/96→03/01	OM 605.960	Diesel	2497	5	20	67
C-Class T-Model (S202)	10/96→03/01	OM 604.915	Diesel	1997	4	16	33
C-Class T-Model (S202)	11/96→03/01	M 111.944	Petrol	1998	4	16	27
C-Class T-Model (S202)	06/97→09/00	M 111.975	Petrol	2295	4	16	50
C-Class T-Model (S202)	06/97→09/00	M 112.910	Petrol	2398	6	18	59
C-Class T-Model (S202)	06/97→03/01	M 112.920	Petrol	2799	6	18	76
C-Class T-Model (S202)	08/97→03/01	M 113.944	Petrol	4266	8	24	120
C-Class T-Model (S202)	09/97→03/01	OM 611.960	Diesel	2151	4	16	38
C-Class T-Model (S202)	09/00→03/01	M 111.952	Petrol	1998	4	16	27
C-Class T-Model (S202)	09/00→03/01	M 111.956	Petrol	1998	4	16	27
C-Class T-Model (S202)	09/00→03/01	M 112.915	Petrol	2597	6	18	70
C-Class T-Model (S203)	03/01→05/02	M 111.951	Petrol	1998	4	16	27
C-Class T-Model (S203)	03/01→05/02	M 111.955	Petrol	1998	4	16	27
C-Class T-Model (S203)	03/01→08/07	M 112.912	Petrol	2597	6	18	70
C-Class T-Model (S203)	03/01→08/07	M 112.946	Petrol	3199	6	18	96
C-Class T-Model (S203)	03/01→08/07	M 112.961	Petrol	3199	6	18	96
C-Class T-Model (S203)	03/01→08/07	OM 611.962	Diesel	2148	4	16	38
C-Class T-Model (S203)	03/01→08/07	OM 612.962	Diesel	2685	5	20	73
C-Class T-Model (S203)	03/01→08/07	OM 646.962	Diesel	2148	4	16	46
C-Class T-Model (S203)	05/02→08/07	M 271.940	Petrol	1796	4	16	18
C-Class T-Model (S203)	05/02→08/07	M 271.946	Petrol	1796	4	16	18
C-Class T-Model (S203)	07/02→08/07	M 112.916	Petrol	2597	6	18	70
C-Class T-Model (S203)	07/02→08/07	M 112.953	Petrol	3199	6	18	96
C-Class T-Model (S203)	01/03→08/07	OM 612.990	Diesel	2950	5	20	91
C-Class T-Model (S203)	07/03→08/07	M 271.942	Petrol	1796	4	16	19
C-Class T-Model (S203)	02/04→08/07	M 113.988	Petrol	5439	8	24	137
C-Class T-Model (S203)	02/04→08/07	M 271.948	Petrol	1796	4	16	18
C-Class T-Model (S203)	02/04→08/07	OM 646.963	Diesel	2148	4	16	46
C-Class T-Model (S203)	01/05→08/07	M 272.920	Petrol	2496	6	24	64
C-Class T-Model (S203)	01/05→08/07	M 272.940	Petrol	2996	6	24	87
C-Class T-Model (S203)	01/05→08/07	M 272.941	Petrol	2996	6	24	87
C-Class T-Model (S203)	01/05→08/07	M 272.960	Petrol	3498	6	24	101
C-Class T-Model (S203)	01/05→08/07	M 272.970	Petrol	3498	6	24	101
C-Class T-Model (S203)	06/05→08/07	OM 642.910	Diesel	2987	6	24	94
C-Class T-Model (S204)	08/07→12/11	OM 646.811	Diesel	2148	4	16	38
C-Class T-Model (S204)	08/07→08/14	M 271.820	Petrol	1796	4	16	17
C-Class T-Model (S204)	08/07→08/14	M 271.860	Petrol	1796	4	16	17
C-Class T-Model (S204)	08/07→08/14	M 271.950	Petrol	1796	4	16	20



Model	Year Range	Price (M)	Fuel	CC	Power (kW)	Speed (km/h)	0-100 (s)
C-Class T-Model (S204)	08/07→08/14	M 271.952	Petrol	1796	4	16	20
C-Class T-Model (S204)	08/07→08/14	M 272.921	Petrol	2496	6	24	64
C-Class T-Model (S204)	08/07→08/14	M 272.947	Petrol	2996	6	24	87
C-Class T-Model (S204)	08/07→08/14	M 271.910	Petrol	3498	6	24	101
C-Class T-Model (S204)	08/07→08/14	OM 642.830	Diesel	2987	6	24	94
C-Class T-Model (S204)	08/07→08/14	OM 642.960	Diesel	2987	6	24	94
C-Class T-Model (S204)	08/07→08/14	OM 642.961	Diesel	2987	6	24	94
C1-Class T-Model (S204)	01/08→08/14	M 271.910	Petrol	1597	4	16	11
C-Class T-Model (S204)	02/08→08/14	M 156.985	Petrol	6208	8	32	153
C-Class T-Model (S204)	12/08→08/14	OM 651.911	Diesel	2143	4	16	39
C-Class T-Model (S204)	10/09→08/14	OM 642.832	Diesel	2987	6	24	94
C-Class T-Model (S204)	04/10→08/14	OM 651.912	Diesel	2143	4	16	39
C-Class T-Model (S204)	08/10→08/14	OM 651.913	Diesel	2143	4	16	39
C-Class T-Model (S204)	06/11→08/14	M 276.957	Petrol	3498	6	24	101
C-Class T-Model (S204)	06/11→08/14	OM 642.834	Diesel	2987	6	24	94
C-Class T-Model (S204)	02/12→08/14	M 274.910	Petrol	1595	4	16	10
C-Class T-Model (S204)	03/14→08/14	M 274.920	Petrol	1991	4	16	31
C-Class T-Model (S205)	09/14→	M 274.910	Petrol	1595	4	16	10
C-Class T-Model (S205)	09/14→	M 274.920	Petrol	1991	4	16	31
C-Class T-Model (S205)	09/14→	OM 626.951	Diesel	1598	4	16	12
C-Class T-Model (S205)	09/14→	OM 651.921	Diesel	2143	4	16	39
C-Class T-Model (S205)	10/14→	M 276.823	Petrol	2996	6	24	87
Citan Box (415)	11/12→	OM 607.951	Diesel	1461	4	8	7
Citan Box (415)	06/13→	M 200.711	Petrol	1197	4	16	3
Citan Combi (415)	11/12→	OM 607.951	Diesel	1461	4	8	7
Citan Combi (415)	06/13→	M 200.711	Petrol	1197	4	16	3
Citan Mixto (415)	11/12→	OM 607.951	Diesel	1461	4	8	7
CLA Coupe (C117)	01/13→	M 270.910	Petrol	1595	4	16	10
CLA Coupe (C117)	01/13→	M 270.920	Petrol	1991	4	16	31
CLA Coupe (C117)	01/13→	OM 651.930	Diesel	2143	4	16	39
CLA Coupe (C117)	06/13→	OM 651.901	Diesel	1796	4	16	22
CLA Coupe (C117)	10/13→	OM 607.951	Diesel	1461	4	8	7
CLA Shooting Brake (X117)	01/15→	M 270.910	Petrol	1595	4	16	10
CLA Shooting Brake (X117)	01/15→	M 270.920	Petrol	1991	4	16	31
CLA Shooting Brake (X117)	01/15→	OM 651.930	Diesel	2143	4	16	39
CLA Shooting Brake (X117)	07/15→	OM 607.951	Diesel	1461	4	8	7
CLC-Class (CL203)	05/08→06/11	M 271.946	Petrol	1796	4	16	18
CLC-Class (CL203)	05/08→06/11	M 271.957	Petrol	1796	4	16	20
CLC-Class (CL203)	05/08→06/11	M 272.920	Petrol	2496	6	24	64
CLC-Class (CL203)	05/08→06/11	M 272.960	Petrol	3498	6	24	101
CLC-Class (CL203)	05/08→06/11	OM 646.962	Diesel	2148	4	16	46
CLC-Class (CL203)	05/08→06/11	OM 646.963	Diesel	2148	4	16	46
CLC-Class (CL203)	02/09→06/11	M 271.911	Petrol	1597	4	16	11
CLK (C208)	06/97→06/00	M 111.944	Petrol	1998	4	16	27
CLK (C208)	06/97→06/00	M 111.973	Petrol	2295	4	16	50
CLK (C208)	06/97→06/00	M 111.975	Petrol	2295	4	16	50
CLK (C208)	06/97→06/02	M 111.945	Petrol	1998	4	16	27
CLK (C208)	06/97→06/02	M 112.940	Petrol	3199	6	18	96
CLK (C208)	07/98→06/02	M 113.943	Petrol	4266	8	24	120
CLK (C208)	10/98→07/02	M 113.984	Petrol	5439	8	24	137
CLK (C208)	08/99→06/02	M 113.981	Petrol	5439	8	24	137
CLK (C208)	06/00→06/02	M 111.956	Petrol	1998	4	16	27
CLK (C208)	06/00→06/02	M 111.982	Petrol	2295	4	16	50
CLK (C209)	06/02→05/09	M 112.912	Petrol	2597	6	18	70
CLK (C209)	06/02→05/09	M 112.955	Petrol	3199	6	18	96
CLK (C209)	06/02→05/09	M 113.968	Petrol	4966	8	24	129
CLK (C209)	09/02→05/09	M 113.987	Petrol	5439	8	24	138
CLK (C209)	09/02→05/09	M 271.940	Petrol	1796	4	16	18
CLK (C209)	10/02→05/09	OM 612.962	Diesel	2685	5	20	73
CLK (C209)	10/02→05/09	OM 612.967	Diesel	2685	5	20	73
CLK (C209)	07/03→05/09	M 271.942	Petrol	1796	4	16	19
CLK (C209)	06/04→05/09	M 113.994	Petrol	5439	8	24	137
CLK (C209)	01/05→05/09	M 272.940	Petrol	2996	6	24	87
CLK (C209)	01/05→05/09	M 272.960	Petrol	3498	6	24	101
CLK (C209)	01/05→05/09	OM 642.910	Diesel	2987	6	24	94
CLK (C209)	01/05→05/09	OM 646.966	Diesel	2148	4	16	46
CLK (C209)	04/06→05/09	M 156.982	Petrol	6208	8	32	153
CLK (C209)	06/06→05/09	M 273.965	Petrol	5461	8	32	140
CLK (C209)	10/06→05/09	M 271.955	Petrol	1796	4	16	20
CLK Convertible (A208)	03/98→06/00	M 111.944	Petrol	1998	4	16	27
CLK Convertible (A208)	03/98→06/00	M 111.973	Petrol	2295	4	16	50
CLK Convertible (A208)	03/98→06/00	M 111.975	Petrol	2295	4	16	50
CLK Convertible (A208)	03/98→03/02	M 111.941	Petrol	1998	4	16	27
CLK Convertible (A208)	03/98→03/02	M 111.945	Petrol	1998	4	16	27
CLK Convertible (A208)	03/98→03/02	M 112.940	Petrol	3199	6	18	96
CLK Convertible (A208)	09/98→03/02	M 113.943	Petrol	4266	8	24	120
CLK Convertible (A208)	01/00→03/02	M 113.981	Petrol	5439	8	24	137
CLK Convertible (A208)	01/00→03/02	M 113.984	Petrol	5439	8	24	137



CC



9

CLK Convertible (A208)	06/00→03/02	M 111.956	Petrol	1998	4	16	27
CLK Convertible (A208)	06/00→03/02	M 111.982	Petrol	2295	4	16	50
CLK Convertible (A209)	02/03→03/10	M 112.912	Petrol	2597	6	18	70
CLK Convertible (A209)	02/03→03/10	M 112.955	Petrol	3199	6	18	96
CLK Convertible (A209)	02/03→03/10	M 113.968	Petrol	4966	8	24	129
CLK Convertible (A209)	02/03→03/10	M 113.987	Petrol	5439	8	24	138
CLK Convertible (A209)	02/03→03/10	M 271.940	Petrol	1796	4	16	18
CLK Convertible (A209)	07/03→03/10	M 271.942	Petrol	1796	4	16	19
CLK Convertible (A209)	06/04→03/10	M 113.994	Petrol	5439	8	24	137
CLK Convertible (A209)	01/05→03/10	M 272.940	Petrol	2996	6	24	87
CLK Convertible (A209)	01/05→03/10	M 272.960	Petrol	3498	6	24	101
CLK Convertible (A209)	03/05→03/10	OM 642.910	Diesel	2987	6	24	94
CLK Convertible (A209)	04/06→03/10	M 156.982	Petrol	6208	8	32	153
CLK Convertible (A209)	06/06→03/10	M 273.967	Petrol	5461	8	32	140
CLK Convertible (A209)	10/06→03/10	M 271.955	Petrol	1796	4	16	20
CLS (C218)	01/11→	M 157.980	Petrol	5461	8	32	140
CLS (C218)	01/11→	M 157.981	Petrol	5461	8	32	140
CLS (C218)	01/11→	M 276.952	Petrol	3498	6	24	101
CLS (C218)	01/11→	OM 642.853	Diesel	2987	6	24	94
CLS (C218)	02/11→	M 278.922	Petrol	4663	8	32	125
CLS (C218)	04/11→	OM 651.924	Diesel	2143	4	16	39
CLS (C218)	09/11→	OM 642.854	Diesel	2987	6	24	94
CLS (C218)	10/11→	M 276.957	Petrol	3498	6	24	101
CLS (C218)	11/12→	OM 642.852	Diesel	2987	6	24	94
CLS (C218)	11/12→	OM 642.858	Diesel	2987	6	24	94
CLS (C218)	05/14→	M 276.820	Petrol	2996	6	24	87
CLS (C218)	07/14→	M 276.850	Petrol	3498	6	24	101
CLS (C218)	01/15→	M 274.920	Petrol	1991	4	16	31
CLS (C219)	10/04→12/10	M 113.967	Petrol	4966	8	24	129
CLS (C219)	10/04→12/10	M 272.964	Petrol	3498	6	24	101
CLS (C219)	01/05→12/10	M 113.990	Petrol	5439	8	24	137
CLS (C219)	01/05→12/10	OM 642.920	Diesel	2987	6	24	94
CLS (C219)	04/06→12/10	M 156.983	Petrol	6208	8	32	153
CLS (C219)	04/06→12/10	M 272.985	Petrol	3498	6	24	101
CLS (C219)	04/06→12/10	M 273.960	Petrol	5461	8	32	140
CLS (C219)	07/08→12/10	M 272.943	Petrol	2996	6	24	87
CLS Shooting Brake (X218)	10/12→	M 157.981	Petrol	5461	8	32	140
CLS Shooting Brake (X218)	10/12→	M 276.952	Petrol	3498	6	24	101
CLS Shooting Brake (X218)	10/12→	M 278.922	Petrol	4663	8	32	125
CLS Shooting Brake (X218)	10/12→	OM 642.853	Diesel	2987	6	24	94
CLS Shooting Brake (X218)	10/12→	OM 642.854	Diesel	2987	6	24	94
CLS Shooting Brake (X218)	10/12→	OM 651.924	Diesel	2143	4	16	39
CLS Shooting Brake (X218)	05/14→	M 276.820	Petrol	2996	6	24	87
CLS Shooting Brake (X218)	05/14→	OM 642.852	Diesel	2987	6	24	94
CLS Shooting Brake (X218)	05/14→	OM 642.858	Diesel	2987	6	24	94
CLS Shooting Brake (X218)	07/14→	M 276.850	Petrol	3498	6	24	101
Coupe (C123)	03/77→03/80	M 110.923	Petrol	2746	6	12	71
Coupe (C123)	03/77→11/85	M 110.988	Petrol	2746	6	12	71
Coupe (C123)	05/77→04/80	M 115.954	Petrol	2307	4	8	52
Coupe (C123)	04/80→12/85	M 102.980	Petrol	2299	4	8	49
Coupe (C123)	09/81→07/85	OM 617.952	Diesel	2998	5	10	92
Coupe (C124)	03/87→12/92	M 102.982	Petrol	2298	4	8	49
Coupe (C124)	03/87→05/93	M 103.983	Petrol	2960	6	12	85
Coupe (C124)	09/89→12/92	M 104.980	Petrol	2960	6	24	86
Coupe (C124)	10/92→05/93	M 104.992	Petrol	3199	6	24	95
Coupe (C124)	10/92→05/93	M 111.960	Petrol	2199	4	16	40
Coupe (W111)	01/61→12/65	M 127.984	Petrol	2180	6	12	42
Coupe (W111)	01/65→12/67	M 129.980	Petrol	2496	6	12	63
Coupe (W111)	01/65→12/67	M 129.981	Petrol	2496	6	12	63
Coupe (W111)	01/67→12/71	M 130.980	Petrol	2780	6	12	71
Coupe (W111)	01/67→12/71	M 130.984	Petrol	2778	6	12	71
Coupe (W111)	01/69→12/71	M 116.980	Petrol	3500	8	16	99
Daimler (XJ4_)	10/89→09/94	9EPCNA	Petrol	3980	6	24	110
E-Class (W124)	06/93→06/95	M 103.985	Petrol	2960	6	12	85
E-Class (W124)	06/93→06/95	M 104.942	Petrol	2799	6	24	75
E-Class (W124)	06/93→06/95	M 104.992	Petrol	3199	6	24	95
E-Class (W124)	06/93→06/95	M 111.940	Petrol	1998	4	16	27
E-Class (W124)	06/93→06/95	M 111.960	Petrol	2199	4	16	40
E-Class (W124)	06/93→06/95	M 119.974	Petrol	4973	8	32	132
E-Class (W124)	06/93→06/95	M 119.975	Petrol	4196	8	32	116
E-Class (W124)	06/93→06/95	OM 601.912	Diesel	1997	4	8	32
E-Class (W124)	06/93→06/95	OM 602.962	Diesel	2497	5	10	66
E-Class (W124)	06/93→06/95	OM 603.960	Diesel	2996	6	12	89
E-Class (W124)	06/93→06/95	OM 603.963	Diesel	2996	6	12	89
E-Class (W124)	07/93→06/95	OM 605.911	Diesel	2497	5	20	67
E-Class (W124)	07/93→06/95	OM 606.910	Diesel	2996	6	24	90
E-Class (W124)	07/94→01/95	M 104.992 (AMG 3.6)	Petrol	3606	6	24	103
E-Class (W210)	06/95→06/97	M 104.995	Petrol	3199	6	24	95



Model	Year Range	Engine Code	Fuel	CC	Gear	Steering	Box
E-Class (W210)	06/95→06/97	M 111.970	Petrol	2295	4	16	50
E-Class (W210)	06/95→06/97	OM 606.912	Diesel	2996	6	24	90
E-Class (W210)	06/95→07/99	OM 605.912	Diesel	2497	5	20	67
E-Class (W210)	06/95→08/00	M 111.942	Petrol	1998	4	16	27
E-Class (W210)	06/95→03/02	OM 604.912	Diesel	2155	4	16	45
E-Class (W210)	01/96→06/97	M 104.945	Petrol	2799	6	24	75
E-Class (W210)	01/96→06/97	M 119.985	Petrol	4196	8	32	117
E-Class (W210)	01/96→03/02	OM 604.917	Diesel	1997	4	16	33
E-Class (W210)	02/96→08/97	M 119.985 (AMG 5.0)	Petrol	4973	8	32	133
E-Class (W210)	03/96→07/99	OM 602.982	Diesel	2874	5	10	81
E-Class (W210)	12/96→07/99	OM 606.962	Diesel	2996	6	24	90
E-Class (W210)	12/96→03/02	M 112.921	Petrol	2799	6	18	76
E-Class (W210)	06/97→07/99	OM 605.962	Diesel	2497	5	20	68
E-Class (W210)	06/97→08/00	M 112.911	Petrol	2398	6	18	59
E-Class (W210)	06/97→03/02	M 111.947	Petrol	1998	4	16	27
E-Class (W210)	06/97→03/02	M 112.941	Petrol	3199	6	18	96
E-Class (W210)	06/97→03/02	M 113.940	Petrol	4266	8	24	120
E-Class (W210)	08/97→03/02	M 113.980	Petrol	5439	8	24	137
E-Class (W210)	06/98→03/02	OM 611.961	Diesel	2148	4	16	46
E-Class (W210)	07/99→03/02	OM 612.961	Diesel	2685	5	20	73
E-Class (W210)	07/99→03/02	OM 613.961	Diesel	3226	6	24	97
E-Class (W210)	08/00→03/02	M 111.957	Petrol	1998	4	16	27
E-Class (W210)	08/00→03/02	M 112.914	Petrol	2597	6	18	70
E-Class (W211)	03/02→12/08	M 112.913	Petrol	2597	6	18	70
E-Class (W211)	03/02→12/08	M 112.917	Petrol	2597	6	18	70
E-Class (W211)	03/02→12/08	M 112.949	Petrol	3199	6	18	96
E-Class (W211)	03/02→12/08	M 113.967	Petrol	4966	8	24	129
E-Class (W211)	03/02→12/08	OM 646.961	Diesel	2148	4	16	38
E-Class (W211)	03/02→12/08	OM 647.961	Diesel	2685	5	20	73
E-Class (W211)	07/02→12/08	OM 646.951	Diesel	2148	4	16	46
E-Class (W211)	10/02→12/08	M 113.990	Petrol	5439	8	24	137
E-Class (W211)	11/02→12/08	M 271.941	Petrol	1796	4	16	18
E-Class (W211)	11/02→12/08	OM 648.961	Diesel	3222	6	24	97
E-Class (W211)	02/03→12/08	OM 628.961	Diesel	3996	8	32	114
E-Class (W211)	03/03→12/08	M 112.954	Petrol	3199	6	18	96
E-Class (W211)	03/03→12/08	OM 646.821	Diesel	2148	4	16	38
E-Class (W211)	10/03→12/08	M 113.969	Petrol	4966	8	24	129
E-Class (W211)	03/05→12/08	M 272.943	Petrol	2996	6	24	87
E-Class (W211)	03/05→12/08	M 272.964	Petrol	3498	6	24	101
E-Class (W211)	03/05→12/08	M 272.972	Petrol	3498	6	24	101
E-Class (W211)	03/05→12/08	OM 642.910	Diesel	2987	6	24	94
E-Class (W211)	03/05→12/08	OM 642.921	Diesel	2987	6	24	94
E-Class (W211)	03/05→03/09	OM 642.920	Diesel	2987	6	24	94
E-Class (W211)	11/05→12/06	M 271.941	Petrol	1796	4	16	18
E-Class (W211)	11/05→12/09	M 272.922	Petrol	2496	6	24	64
E-Class (W211)	11/05→12/09	M 272.964	Petrol	3498	6	24	101
E-Class (W211)	11/05→09/12	M 272.943	Petrol	2996	6	24	87
E-Class (W211)	01/06→12/08	OM 629.910	Diesel	3996	8	32	114
E-Class (W211)	03/06→12/08	M 156.983	Petrol	6208	8	32	153
E-Class (W211)	04/06→12/08	M 271.956	Petrol	1796	4	16	20
E-Class (W211)	04/06→12/08	M 273.960	Petrol	5461	8	32	140
E-Class (W211)	04/06→12/08	M 273.962	Petrol	5461	8	32	140
E-Class (W211)	04/06→12/08	OM 646.820	Diesel	2148	4	16	38
E-Class (W211)	09/06→12/12	M 271.860	Petrol	1796	4	16	17
E-Class (W211)	09/06→12/12	M 271.956	Petrol	1796	4	16	21
E-Class (W211)	09/07→12/08	M 272.922	Petrol	2496	6	24	64
E-Class (W211)	09/07→12/08	M 272.985	Petrol	3498	6	24	101
E-Class (W212)	01/09→08/11	M 272.977	Petrol	3498	6	24	101
E-Class (W212)	01/09→08/11	M 272.982	Petrol	3498	6	24	101
E-Class (W212)	01/09→08/11	M 272.983	Petrol	3498	6	24	101
E-Class (W212)	01/09→	M 156.985	Petrol	6208	8	32	153
E-Class (W212)	01/09→	M 271.860	Petrol	1796	4	16	17
E-Class (W212)	01/09→	M 272.952	Petrol	2996	6	24	87
E-Class (W212)	01/09→	M 272.980	Petrol	3498	6	24	101
E-Class (W212)	01/09→	M 273.970	Petrol	5461	8	32	140
E-Class (W212)	01/09→	M 273.971	Petrol	5461	8	32	140
E-Class (W212)	01/09→	OM 642.850	Diesel	2987	6	24	94
E-Class (W212)	01/09→	OM 651.924	Diesel	2143	4	16	39
E-Class (W212)	01/09→	OM 651.925	Diesel	2143	4	16	39
E-Class (W212)	08/09→	M 271.820	Petrol	1796	4	16	17
E-Class (W212)	09/09→	OM 642.856	Diesel	2987	6	24	94
E-Class (W212)	06/10→12/14	M 271.860	Petrol	1796	4	16	17
E-Class (W212)	12/10→12/14	M 272.952	Petrol	2996	6	24	87
E-Class (W212)	02/11→	M 157.980	Petrol	5461	8	32	140
E-Class (W212)	02/11→	M 157.981	Petrol	5461	8	32	140
E-Class (W212)	03/11→	M 271.958	Petrol	1796	4	16	17
E-Class (W212)	03/11→	OM 642.852	Diesel	2987	6	24	94
E-Class (W212)	03/11→	OM 642.858	Diesel	2987	6	24	94



CC



9

E-Class (W212)	07/11→	M 276.952	Petrol	3498	6	24	101
E-Class (W212)	09/11→	M 278.922	Petrol	4663	8	32	125
E-Class (W212)	01/13→	M 274.920	Petrol	1991	4	16	31
E-Class (W212)	01/13→	M 276.820	Petrol	2996	6	24	87
E-Class (W212)	08/13→	M 276.820	Petrol	2996	6	24	87
E-Class (W212)	06/14→	M 274.920	Petrol	1991	4	16	31
E-Class (W212)	06/14→	M 276.952	Petrol	3498	6	24	101
E-Class (W212)	07/14→	M 276.850	Petrol	3498	6	24	101
E-Class (W213)	01/16→	M 274.920	Petrol	1991	4	16	31
E-Class (W213)	01/16→	OM 642.855	Diesel	2987	6	24	94
E-Class (W213)	01/16→	OM 654.920	Diesel	1950	4	16	36
E-Class (W213)	06/16→	M 276.823	Petrol	2996	6	24	87
E-Class (W213)	07/16→	M 276.853	Petrol	3498	6	24	101
E-Class (W213)	11/16→	M 276.823	Petrol	2996	6	24	87
E-Class (W213)	01/17→	M 274.910	Petrol	1595	4	16	10
E-Class (W213)	06/17→	OM 642.873	Diesel	2987	6	24	94
E-Class All-Terrain (S213)	01/17→	OM 654.920	Diesel	1950	4	16	36
E-Class All-Terrain (S213)	06/17→	OM 642.855	Diesel	2987	6	24	94
E-Class All-Terrain (S213)	06/17→	OM 642.873	Diesel	2987	6	24	94
E-Class Convertible (A124)	06/93→03/98	M 104.992	Petrol	3199	6	24	95
E-Class Convertible (A124)	06/93→03/98	M 111.940	Petrol	1998	4	16	27
E-Class Convertible (A124)	06/93→03/98	M 111.960	Petrol	2199	4	16	40
E-Class Convertible (A124)	05/94→03/98	M 104.992 (AMG 3.6)	Petrol	3606	6	24	103
E-Class Convertible (A207)	01/10→	M 271.820	Petrol	1796	4	16	17
E-Class Convertible (A207)	01/10→	M 271.860	Petrol	1796	4	16	17
E-Class Convertible (A207)	01/10→	M 272.982	Petrol	3498	6	24	101
E-Class Convertible (A207)	01/10→	M 272.984	Petrol	3498	6	24	101
E-Class Convertible (A207)	01/10→	M 273.966	Petrol	5461	8	32	140
E-Class Convertible (A207)	01/10→	OM 642.836	Diesel	2987	6	24	94
E-Class Convertible (A207)	01/10→	OM 651.911	Diesel	2143	4	16	39
E-Class Convertible (A207)	04/11→	M 276.957	Petrol	3498	6	24	101
E-Class Convertible (A207)	04/11→	OM 642.838	Diesel	2987	6	24	94
E-Class Convertible (A207)	05/11→	M 272.988	Petrol	3498	6	24	101
E-Class Convertible (A207)	09/11→	M 278.922	Petrol	4663	8	32	125
E-Class Convertible (A207)	03/13→	M 274.920	Petrol	1991	4	16	31
E-Class Convertible (A207)	06/13→	M 276.820	Petrol	2996	6	24	87
E-Class Convertible (A207)	07/14→	M 276.850	Petrol	3498	6	24	101
E-Class Convertible (A238)	06/17→	M 274.920	Petrol	1991	4	16	31
E-Class Convertible (A238)	06/17→	M 276.823	Petrol	2996	6	24	87
E-Class Convertible (A238)	06/17→	OM 642.873	Diesel	2987	6	24	94
E-Class Convertible (A238)	06/17→	OM 654.920	Diesel	1950	4	16	36
E-Class Coupe (C124)	06/93→06/97	M 104.992	Petrol	3199	6	24	95
E-Class Coupe (C124)	06/93→06/97	M 104.992 (AMG 3.6)	Petrol	3606	6	24	103
E-Class Coupe (C124)	06/93→06/97	M 111.940	Petrol	1998	4	16	27
E-Class Coupe (C124)	06/93→06/97	M 111.960	Petrol	2199	4	16	40
E-Class Coupe (C207)	01/09→	M 271.860	Petrol	1796	4	16	17
E-Class Coupe (C207)	01/09→	M 272.982	Petrol	3498	6	24	101
E-Class Coupe (C207)	01/09→	M 272.984	Petrol	3498	6	24	101
E-Class Coupe (C207)	01/09→	M 273.966	Petrol	5461	8	32	140
E-Class Coupe (C207)	01/09→	OM 642.836	Diesel	2987	6	24	94
E-Class Coupe (C207)	01/09→	OM 651.911	Diesel	2143	4	16	39
E-Class Coupe (C207)	01/10→	M 271.820	Petrol	1796	4	16	17
E-Class Coupe (C207)	04/11→	M 276.957	Petrol	3498	6	24	101
E-Class Coupe (C207)	04/11→	OM 642.838	Diesel	2987	6	24	94
E-Class Coupe (C207)	05/11→	M 272.961	Petrol	3498	6	24	101
E-Class Coupe (C207)	05/11→	M 272.988	Petrol	3498	6	24	101
E-Class Coupe (C207)	09/11→	M 278.922	Petrol	4663	8	32	125
E-Class Coupe (C207)	06/13→	M 274.920	Petrol	1991	4	16	31
E-Class Coupe (C207)	06/13→	M 276.820	Petrol	2996	6	24	87
E-Class Coupe (C207)	07/14→	M 276.850	Petrol	3498	6	24	101
E-Class Coupe (C238)	12/16→	M 274.920	Petrol	1991	4	16	31
E-Class Coupe (C238)	12/16→	M 276.823	Petrol	2996	6	24	87
E-Class Coupe (C238)	12/16→	OM 654.920	Diesel	1950	4	16	36
E-Class Coupe (C238)	06/17→	OM 642.873	Diesel	2987	6	24	94
E-Class T-Model (S124)	06/93→06/96	M 103.985	Petrol	2960	6	12	85
E-Class T-Model (S124)	06/93→06/96	M 104.942	Petrol	2799	6	24	75
E-Class T-Model (S124)	06/93→06/96	M 104.980	Petrol	2960	6	24	86
E-Class T-Model (S124)	06/93→06/96	M 104.992	Petrol	3199	6	24	95
E-Class T-Model (S124)	06/93→06/96	M 111.940	Petrol	1998	4	16	27
E-Class T-Model (S124)	06/93→06/96	M 111.960	Petrol	2199	4	16	40
E-Class T-Model (S124)	06/93→06/96	OM 602.962	Diesel	2497	5	10	66
E-Class T-Model (S124)	06/93→06/96	OM 603.912	Diesel	2996	6	12	89
E-Class T-Model (S124)	06/93→06/96	OM 603.960	Diesel	2996	6	12	89
E-Class T-Model (S124)	06/93→06/96	OM 603.963	Diesel	2996	6	12	89
E-Class T-Model (S124)	06/93→06/96	OM 605.911	Diesel	2497	5	20	67
E-Class T-Model (S124)	06/93→06/96	OM 606.910	Diesel	2996	6	24	90
E-Class T-Model (S124)	05/94→06/96	M 104.992 (AMG 3.6)	Petrol	3606	6	24	103
E-Class T-Model (S210)	06/96→06/97	M 111.970	Petrol	2295	4	16	50



CC



9

Model	Year	OM	Fuel	CC	Wrench	Screwdriver	Price
E-Class T-Model (S210)	06/96→06/97	M 119.985	Petrol	4196	8	32	117
E-Class T-Model (S210)	06/96→07/99	OM 602.982	Diesel	2874	5	10	81
E-Class T-Model (S210)	06/96→07/99	OM 605.912	Diesel	2497	5	20	67
E-Class T-Model (S210)	06/96→08/00	M 111.942	Petrol	1998	4	16	27
E-Class T-Model (S210)	12/96→07/99	OM 606.962	Diesel	2996	6	24	90
E-Class T-Model (S210)	12/96→03/03	M 112.921	Petrol	2799	6	18	76
E-Class T-Model (S210)	12/96→03/03	M 112.941	Petrol	3199	6	18	96
E-Class T-Model (S210)	06/97→07/99	OM 605.962	Diesel	2497	5	20	68
E-Class T-Model (S210)	06/97→03/03	M 111.947	Petrol	1998	4	16	27
E-Class T-Model (S210)	06/97→03/03	M 112.911	Petrol	2398	6	18	59
E-Class T-Model (S210)	06/97→03/03	M 113.940	Petrol	4266	8	24	120
E-Class T-Model (S210)	08/97→03/03	M 113.980	Petrol	5439	8	24	137
E-Class T-Model (S210)	06/98→03/03	OM 611.961	Diesel	2148	4	16	46
E-Class T-Model (S210)	07/99→03/03	OM 612.961	Diesel	2685	5	20	73
E-Class T-Model (S210)	07/99→03/03	OM 613.961	Diesel	3226	6	24	97
E-Class T-Model (S210)	08/00→03/03	M 111.957	Petrol	1998	4	16	27
E-Class T-Model (S210)	08/00→03/03	M 112.914	Petrol	2597	6	18	70
E-Class T-Model (S211)	03/03→07/09	M 112.913	Petrol	2597	6	18	70
E-Class T-Model (S211)	03/03→07/09	M 112.949	Petrol	3199	6	18	96
E-Class T-Model (S211)	03/03→07/09	M 271.941	Petrol	1796	4	16	18
E-Class T-Model (S211)	03/03→07/09	OM 646.821	Diesel	2148	4	16	38
E-Class T-Model (S211)	03/03→07/09	OM 646.961	Diesel	2148	4	16	38
E-Class T-Model (S211)	03/03→07/09	OM 647.961	Diesel	2685	5	20	73
E-Class T-Model (S211)	03/03→07/09	OM 648.961	Diesel	3222	6	24	97
E-Class T-Model (S211)	07/03→07/09	M 112.917	Petrol	2597	6	18	70
E-Class T-Model (S211)	07/03→07/09	M 112.954	Petrol	3199	6	18	96
E-Class T-Model (S211)	07/03→07/09	M 113.990	Petrol	5439	8	24	137
E-Class T-Model (S211)	10/03→07/09	M 113.967	Petrol	4966	8	24	129
E-Class T-Model (S211)	10/03→07/09	M 113.969	Petrol	4966	8	24	129
E-Class T-Model (S211)	08/04→07/09	M 272.972	Petrol	3498	6	24	101
E-Class T-Model (S211)	03/05→07/09	M 272.943	Petrol	2996	6	24	87
E-Class T-Model (S211)	03/05→07/09	M 272.964	Petrol	3498	6	24	101
E-Class T-Model (S211)	03/05→07/09	OM 642.920	Diesel	2987	6	24	94
E-Class T-Model (S211)	03/05→07/09	OM 642.921	Diesel	2987	6	24	94
E-Class T-Model (S211)	03/06→07/09	M 156.983	Petrol	6208	8	32	153
E-Class T-Model (S211)	04/06→07/09	M 271.956	Petrol	1796	4	16	20
E-Class T-Model (S211)	04/06→07/09	M 273.960	Petrol	5461	8	32	140
E-Class T-Model (S211)	04/06→07/09	M 273.962	Petrol	5461	8	32	140
E-Class T-Model (S211)	05/06→07/09	M 272.985	Petrol	3498	6	24	101
E-Class T-Model (S211)	05/07→07/09	M 272.922	Petrol	2496	6	24	64
E-Class T-Model (S212)	08/09→	M 156.985	Petrol	6208	8	32	153
E-Class T-Model (S212)	08/09→	M 272.980	Petrol	3498	6	24	101
E-Class T-Model (S212)	08/09→	OM 651.924	Diesel	2143	4	16	39
E-Class T-Model (S212)	11/09→	M 271.860	Petrol	1796	4	16	17
E-Class T-Model (S212)	11/09→	M 272.952	Petrol	2996	6	24	87
E-Class T-Model (S212)	11/09→	M 272.977	Petrol	3498	6	24	101
E-Class T-Model (S212)	11/09→	M 272.983	Petrol	3498	6	24	101
E-Class T-Model (S212)	11/09→	M 273.971	Petrol	5461	8	32	140
E-Class T-Model (S212)	11/09→	OM 642.850	Diesel	2987	6	24	94
E-Class T-Model (S212)	11/09→	OM 642.852	Diesel	2987	6	24	94
E-Class T-Model (S212)	11/09→	OM 642.856	Diesel	2987	6	24	94
E-Class T-Model (S212)	11/09→	OM 651.925	Diesel	2143	4	16	39
E-Class T-Model (S212)	02/11→	M 157.980	Petrol	5461	8	32	140
E-Class T-Model (S212)	02/11→	M 157.981	Petrol	5461	8	32	140
E-Class T-Model (S212)	07/11→	M 276.952	Petrol	3498	6	24	101
E-Class T-Model (S212)	07/11→	OM 642.858	Diesel	2987	6	24	94
E-Class T-Model (S212)	09/11→	M 278.922	Petrol	4663	8	32	125
E-Class T-Model (S212)	11/12→	M 274.920	Petrol	1991	4	16	31
E-Class T-Model (S212)	01/13→	M 276.820	Petrol	2996	6	24	87
E-Class T-Model (S212)	07/14→	M 276.850	Petrol	3498	6	24	101
E-Class T-Model (S213)	07/16→	M 274.920	Petrol	1991	4	16	31
E-Class T-Model (S213)	07/16→	OM 654.920	Diesel	1950	4	16	36
E-Class T-Model (S213)	10/16→	M 276.823	Petrol	2996	6	24	87
E-Class T-Model (S213)	10/16→	M 276.853	Petrol	3498	6	24	101
E-Class T-Model (S213)	10/16→	OM 642.855	Diesel	2987	6	24	94
E-Class T-Model (S213)	06/17→	OM 642.873	Diesel	2987	6	24	94
G-Class (W460)	03/79→08/87	OM 616.936	Diesel	2399	4	8	60
G-Class (W460)	03/79→07/93	M 115.973	Petrol	2307	4	8	52
G-Class (W460)	03/79→07/93	OM 603.912	Diesel	2996	6	12	89
G-Class (W460)	11/79→08/89	M 110.994	Petrol	2746	6	12	71
G-Class (W460)	12/79→12/91	OM 617.931	Diesel	2998	5	10	92
G-Class (W460)	04/82→08/92	M 102.981	Petrol	2299	4	8	49
G-Class (W460)	04/82→08/92	M 102.987	Petrol	2299	4	8	49
G-Class (W460)	04/82→08/92	M 102.989	Petrol	2298	4	8	49
G-Class (W460)	07/82→08/89	M 102.964	Petrol	1997	4	8	26
G-Class (W460)	05/87→08/92	M 102.979	Petrol	2299	4	8	49
G-Class (W460)	10/87→12/92	OM 602.930	Diesel	2497	5	10	66
G-Class (W461)	09/89→07/96	M 102.979	Petrol	2299	4	8	49











CC



9

G-Class (W461)	02/90→05/93	OM 602.939	Diesel	2497	5	10	66
G-Class (W461)	06/93→07/00	M 102.996	Petrol	2298	4	8	49
G-Class (W461)	06/93→07/00	M 102.997	Petrol	2299	4	8	49
G-Class (W461)	06/93→07/00	OM 602.942	Diesel	2874	5	10	81
G-Class (W461)	07/97→	OM 602.983	Diesel	2874	5	10	81
G-Class (W461)	01/03→	OM 612.966	Diesel	2685	5	20	73
G-Class (W461)	04/09→	OM 642.884	Diesel	2987	6	24	94
G-Class (W461)	04/09→	OM 642.975	Diesel	2987	6	24	94
G-Class (W463)	09/89→06/93	OM 603.931	Diesel	2996	6	12	89
G-Class (W463)	09/89→08/97	M 103.987	Petrol	2960	6	12	85
G-Class (W463)	01/90→07/93	M 102.965	Petrol	1996	4	8	26
G-Class (W463)	06/90→10/92	OM 602.931	Diesel	2497	5	10	66
G-Class (W463)	06/90→06/93	M 102.989	Petrol	2298	4	8	49
G-Class (W463)	09/91→08/99	OM 603.972	Diesel	3449	6	12	98
G-Class (W463)	09/93→12/94	M 117.965	Petrol	4973	8	16	128
G-Class (W463)	09/94→12/97	M 104.996	Petrol	3199	6	24	95
G-Class (W463)	01/95→07/98	M 104.996 (AMG 3.6)	Petrol	3606	6	24	103
G-Class (W463)	08/96→07/00	OM 606.964	Diesel	2996	6	24	90
G-Class (W463)	07/97→	M 112.945	Petrol	3199	6	18	96
G-Class (W463)	04/98→	M 113.962	Petrol	4966	8	24	129
G-Class (W463)	04/99→	M 113.982	Petrol	5439	8	24	138
G-Class (W463)	12/00→	OM 628.962	Diesel	3996	8	32	114
G-Class (W463)	10/01→	OM 612.965	Diesel	2685	5	20	73
G-Class (W463)	06/04→	M 113.993	Petrol	5439	8	24	137
G-Class (W463)	09/06→	OM 642.970	Diesel	2987	6	24	94
G-Class (W463)	05/08→	M 273.963	Petrol	5461	8	32	140
G-Class (W463)	07/11→	OM 642.886	Diesel	2987	6	24	94
G-Class (W463)	05/12→	M 157.984	Petrol	5461	8	32	140
G-Class (W463)	05/12→	M 279.982	Petrol	5980	12	36	151
G-Class (W463)	06/15→	OM 642.887	Diesel	2987	6	24	94
G-Class Cabrio (W463)	09/89→09/97	M 103.987	Petrol	2960	6	12	85
G-Class Cabrio (W463)	01/90→07/93	M 102.965	Petrol	1996	4	8	26
G-Class Cabrio (W463)	06/90→02/93	M 102.989	Petrol	2298	4	8	49
G-Class Cabrio (W463)	12/90→09/97	OM 603.931	Diesel	2996	6	12	89
G-Class Cabrio (W463)	09/91→08/99	OM 603.972	Diesel	3449	6	12	98
G-Class Cabrio (W463)	09/94→11/97	M 104.996	Petrol	3199	6	24	95
G-Class Cabrio (W463)	09/96→07/00	OM 606.964	Diesel	2996	6	24	90
G-Class Cabrio (W463)	11/97→	M 112.945	Petrol	3199	6	18	96
G-Class Cabrio (W463)	04/98→	M 113.962	Petrol	4966	8	24	129
G-Class Cabrio (W463)	12/00→	OM 628.962	Diesel	3996	8	32	114
G-Class Cabrio (W463)	09/06→	OM 642.970	Diesel	2987	6	24	94
G-Class Cabrio (W463)	12/09→	M 273.963	Petrol	5461	8	32	140
G-Class Cabrio (W463)	07/11→	OM 642.886	Diesel	2987	6	24	94
GLA (X156)	04/15→	M 270.910	Petrol	1595	4	16	10
GLA-Class (X156)	12/13→	M 270.910	Petrol	1595	4	16	10
GLA-Class (X156)	12/13→	M 270.920	Petrol	1991	4	16	31
GLA-Class (X156)	12/13→	OM 651.930	Diesel	2143	4	16	39
GLA-Class (X156)	07/14→	OM 607.951	Diesel	1461	4	8	7
GLC (X253)	06/15→	M 274.920	Petrol	1991	4	16	31
GLC (X253)	06/15→	OM 651.921	Diesel	2143	4	16	39
GLC (X253)	11/15→	M 274.920	Petrol	1991	4	16	31
GLC (X253)	04/16→	M 276.823	Petrol	2996	6	24	87
GLC (X253)	10/16→	OM 642.873	Diesel	2987	6	24	94
GLC Coupe (C253)	06/16→	M 274.920	Petrol	1991	4	16	31
GLC Coupe (C253)	06/16→	OM 651.921	Diesel	2143	4	16	39
GLC Coupe (C253)	10/16→	M 276.823	Petrol	2996	6	24	87
GLC Coupe (C253)	10/16→	OM 642.873	Diesel	2987	6	24	94
GL-Class (X164)	09/06→	M 273.923	Petrol	4663	8	32	125
GL-Class (X164)	09/06→	M 273.963	Petrol	5461	8	32	140
GL-Class (X164)	09/06→	OM 629.912	Diesel	3996	8	32	114
GL-Class (X164)	09/06→	OM 642.940	Diesel	2987	6	24	94
GL-Class (X164)	09/09→	OM 642.820	Diesel	2987	6	24	94
GL-Class (X164)	10/10→	OM 642.822	Diesel	2987	6	24	94
GL-Class (X166)	07/12→	M 157.982	Petrol	5461	8	32	140
GL-Class (X166)	07/12→	M 278.928	Petrol	4663	8	32	125
GL-Class (X166)	07/12→	OM 642.826	Diesel	2987	6	24	94
GL-Class (X166)	08/13→	M 276.821	Petrol	2996	6	24	87
GL-Class (X166)	04/15→	M 278.912	Petrol	3996	8	32	111
GLE (W166)	04/15→	M 157.982	Petrol	5461	8	32	140
GLE (W166)	04/15→	M 276.821	Petrol	2996	6	24	87
GLE (W166)	04/15→	M 278.928	Petrol	4663	8	32	125
GLE (W166)	04/15→	OM 642.826	Diesel	2987	6	24	94
GLE (W166)	04/15→	OM 651.960	Diesel	2143	4	16	39
GLE (W166)	11/15→	M 276.955	Petrol	3498	6	24	101
GLE Coupe (C292)	03/15→	M 157.982	Petrol	5461	8	32	140
GLE Coupe (C292)	03/15→	M 276.821	Petrol	2996	6	24	87
GLE Coupe (C292)	03/15→	M 276.825	Petrol	2996	6	24	87
GLE Coupe (C292)	03/15→	OM 642.826	Diesel	2987	6	24	94

							
GLE Coupe (C292)	10/15→	M 278.928	Petrol	4663	8	32	125
GLE Coupe (C292)	12/16→	M 278.912	Petrol	3996	8	32	111
GLK-Class (X204)	06/08→04/11	M 272.948	Petrol	2996	6	24	87
GLK-Class (X204)	06/08→04/11	M 272.971	Petrol	3498	6	24	101
GLK-Class (X204)	06/08→06/15	OM 642.961	Diesel	2987	6	24	94
GLK-Class (X204)	06/08→	M 276.957	Petrol	3498	6	24	101
GLK-Class (X204)	12/08→06/15	OM 651.912	Diesel	2143	4	16	39
GLK-Class (X204)	12/08→06/15	OM 651.916	Diesel	2143	4	16	39
GLK-Class (X204)	04/09→06/15	M 272.991	Petrol	3498	6	24	101
GLK-Class (X204)	07/09→05/10	OM 642.832	Diesel	2987	6	24	94
GLK-Class (X204)	07/10→06/15	OM 651.913	Diesel	2143	4	16	39
GLK-Class (X204)	07/12→06/15	OM 642.835	Diesel	2987	6	24	94
GLK-Class (X204)	08/13→06/15	M 274.920	Petrol	1991	4	16	31
GLK Closed Off-Road Vehicle (X204)	04/12→	M 272.948	Petrol	2996	6	24	87
GLK Closed Off-Road Vehicle (X204)	08/13→	M 274.920	Petrol	1991	4	16	31
GLS (X166)	11/15→	M 157.982	Petrol	5461	8	32	140
GLS (X166)	11/15→	M 276.821	Petrol	2996	6	24	87
GLS (X166)	11/15→	M 278.928	Petrol	4663	8	32	125
GLS (X166)	11/15→	OM 642.826	Diesel	2987	6	24	94
GLS (X166)	03/16→	M 278.912	Petrol	3996	8	32	111
Heckflosse (W110)	04/61→08/65	M 121.924	Petrol	1884	4	8	23
Heckflosse (W110)	06/61→08/65	OM 621.912	Diesel	1990	4	8	34
Heckflosse (W110)	07/65→02/68	M 115.926	Petrol	1988	4	8	28
Heckflosse (W110)	07/65→02/68	M 121.940	Petrol	1988	4	8	29
Heckflosse (W110)	07/65→02/68	M 180.945	Petrol	2281	6	12	55
Heckflosse (W110)	07/65→02/68	M 180.949	Petrol	2281	6	12	53
Heckflosse (W110)	07/65→02/68	OM 621.918	Diesel	1988	4	8	34
Heckflosse (W110)	06/66→12/67	M 180.950	Petrol	2281	6	12	53
Heckflosse (W111, W112)	08/59→08/65	M 127.982	Petrol	2180	6	12	42
Heckflosse (W111, W112)	08/59→08/65	M 180.940	Petrol	2180	6	12	42
Heckflosse (W111, W112)	08/59→08/65	M 180.941	Petrol	2180	6	12	42
Heckflosse (W111, W112)	07/65→01/68	M 180.947	Petrol	2281	6	12	53
Heckflosse (W111, W112)	07/65→01/68	M 180.950	Petrol	2281	6	12	53
Henschel 2-t	02/73→12/77	OM 615.917	Diesel	2197	4	8	47
Henschel 2-t	02/73→12/77	OM 615.937	Diesel	2197	4	8	47
Henschel 2-t	02/73→12/77	OM 615.939	Diesel	2197	4	8	47
Kombi Estate (S124)	06/92→05/93	OM 603.960	Diesel	2996	6	12	89
Kombi Estate (S124)	11/92→05/93	M 102.922	Petrol	1996	4	8	26
Kombi T-Model (S123)	09/77→03/80	M 115.954	Petrol	2307	4	8	52
Kombi T-Model (S123)	09/77→11/85	M 110.988	Petrol	2746	6	12	71
Kombi T-Model (S123)	09/77→11/85	OM 617.912	Diesel	2998	5	10	82
Kombi T-Model (S123)	09/77→12/85	OM 616.912	Diesel	2399	4	8	60
Kombi T-Model (S123)	05/78→08/82	M 123.921	Petrol	2525	6	12	63
Kombi T-Model (S123)	04/80→11/85	M 102.980	Petrol	2299	4	8	49
Kombi T-Model (S123)	10/80→11/85	OM 617.952	Diesel	2998	5	10	92
Kombi T-Model (S123)	11/80→11/85	M 102.920	Petrol	1997	4	8	26
Kombi T-Model (S123)	11/80→11/85	M 102.939	Petrol	1997	4	8	26
Kombi T-Model (S124)	09/85→05/90	M 102.922	Petrol	1996	4	8	26
Kombi T-Model (S124)	09/85→08/91	OM 601.912	Diesel	1997	4	8	32
Kombi T-Model (S124)	09/85→08/92	M 102.982	Petrol	2298	4	8	49
Kombi T-Model (S124)	09/85→08/92	M 103.940	Petrol	2597	6	12	69
Kombi T-Model (S124)	09/85→06/93	OM 602.912	Diesel	2497	5	10	66
Kombi T-Model (S124)	01/86→08/92	M 103.983	Petrol	2960	6	12	85
Kombi T-Model (S124)	05/86→06/93	M 111.940	Petrol	1998	4	16	27
Kombi T-Model (S124)	09/86→01/89	OM 603.963	Diesel	2996	6	12	89
Kombi T-Model (S124)	09/86→06/93	M 103.985	Petrol	2960	6	12	85
Kombi T-Model (S124)	09/86→06/93	OM 603.912	Diesel	2996	6	12	89
Kombi T-Model (S124)	09/86→06/93	OM 603.960	Diesel	2996	6	12	89
Kombi T-Model (S124)	03/88→07/93	OM 602.962	Diesel	2497	5	10	66
Kombi T-Model (S124)	09/88→12/89	M 102.962	Petrol	1996	4	8	26
Kombi T-Model (S124)	09/88→08/92	M 102.963	Petrol	1996	4	8	26
Kombi T-Model (S124)	09/89→08/92	M 104.980	Petrol	2960	6	24	86
Kombi T-Model (S124)	10/92→05/93	M 111.960	Petrol	2199	4	16	40
Kombi T-Model (S124)	10/92→06/93	M 104.942	Petrol	2799	6	24	75
Kombi T-Model (S124)	10/92→06/93	M 104.992	Petrol	3199	6	24	95
Limousine	06/68→12/91	XK 4.2 (-79)	Petrol	4235	6	12	119
Maybach (240_)	09/02→12/12	M 285.950	Petrol	5513	12	36	141
Maybach (240_)	09/05→12/12	M 285.980	Petrol	5980	12	36	151
MB100 Box (KPA)	11/99→01/03	OM 661.911	Diesel	2299	4	8	57
MB100 Box (KPA)	10/01→05/05	OM 662.911	Diesel	2874	5	10	83
MB140 Box (KPA)	10/01→05/05	OM 662.911	Diesel	2874	5	10	83
M-Class (W163)	02/98→08/02	M 112.942	Petrol	3199	6	18	96
M-Class (W163)	02/98→06/05	M 111.977	Petrol	2295	4	16	50
M-Class (W163)	02/98→06/05	M 113.942	Petrol	4266	8	24	120
M-Class (W163)	12/99→06/05	OM 612.963	Diesel	2685	5	20	73
M-Class (W163)	02/00→06/05	M 113.981	Petrol	5439	8	24	137
M-Class (W163)	09/01→06/05	M 113.964	Petrol	4966	8	24	129
M-Class (W163)	09/01→06/05	M 113.965	Petrol	4966	8	24	129











CC



9

M-Class (W163)	09/01→06/05	OM 628.963	Diesel	3996	8	32	114
M-Class (W163)	08/02→06/05	M 112.970	Petrol	3724	6	18	104
M-Class (W164)	07/05→12/11	M 113.964	Petrol	4966	8	24	129
M-Class (W164)	07/05→12/11	M 272.967	Petrol	3498	6	24	101
M-Class (W164)	07/05→12/11	OM 642.820	Diesel	2987	6	24	94
M-Class (W164)	07/05→12/11	OM 642.940	Diesel	2987	6	24	94
M-Class (W164)	01/06→12/11	M 156.980	Petrol	6208	8	32	153
M-Class (W164)	02/06→12/11	OM 629.912	Diesel	3996	8	32	114
M-Class (W164)	12/07→12/11	M 273.963	Petrol	5461	8	32	140
M-Class (W164)	09/09→12/11	M 272.973	Petrol	3498	6	24	101
M-Class (W164)	03/10→	M 272.945	Petrol	2996	6	24	87
M-Class (W164)	09/10→12/11	OM 642.822	Diesel	2987	6	24	94
M-Class (W166)	06/11→	M 276.955	Petrol	3498	6	24	101
M-Class (W166)	06/11→	OM 642.826	Diesel	2987	6	24	94
M-Class (W166)	06/11→	OM 642.940	Diesel	2987	6	24	94
M-Class (W166)	06/11→	OM 651.960	Diesel	2143	4	16	39
M-Class (W166)	11/11→	M 157.982	Petrol	5461	8	32	140
M-Class (W166)	02/12→	M 278.928	Petrol	4663	8	32	125
M-Class (W166)	08/13→	M 276.821	Petrol	2996	6	24	87
Pagode (W113)	01/63→01/67	M 127.981	Petrol	2306	6	12	53
Pagode (W113)	01/66→01/68	M 129.982	Petrol	2496	6	12	63
Pagode (W113)	01/68→03/71	M 130.983	Petrol	2778	6	12	71
Ponton (W121)	01/59→12/61	OM 621.910	Diesel	1884	4	8	25
Ponton (W121)	06/59→12/61	M 121.920	Petrol	1884	4	8	23
Ponton (W128)	01/58→08/59	M 127.980	Petrol	2180	6	12	42
Ponton (W180)	01/56→12/59	M 180.924	Petrol	2180	6	12	42
R-Class (W251, V251)	01/06→	M 113.960	Petrol	4966	8	24	129
R-Class (W251, V251)	01/06→	M 113.971	Petrol	4966	8	24	129
R-Class (W251, V251)	01/06→	M 272.967	Petrol	3498	6	24	101
R-Class (W251, V251)	01/06→	M 276.958	Petrol	3498	6	24	101
R-Class (W251, V251)	01/06→	OM 642.870	Diesel	2987	6	24	94
R-Class (W251, V251)	01/06→	OM 642.950	Diesel	2987	6	24	94
R-Class (W251, V251)	02/06→	M 156.980	Petrol	6208	8	32	153
R-Class (W251, V251)	05/06→	OM 642.872	Diesel	2987	6	24	94
R-Class (W251, V251)	01/07→	M 272.945	Petrol	2996	6	24	87
R-Class (W251, V251)	01/07→	M 273.963	Petrol	5461	8	32	140
R-Class (W251, V251)	01/14→	M 276.825	Petrol	2996	6	24	87
R-Class (W251, V251)	01/14→	M 276.826	Petrol	2996	6	24	88
Saloon (W123)	01/76→03/79	OM 615.941	Diesel	2197	4	8	47
Saloon (W123)	02/76→08/80	M 115.938	Petrol	1988	4	8	28
Saloon (W123)	02/76→08/80	M 115.939	Petrol	1988	4	8	28
Saloon (W123)	02/76→03/81	M 115.954	Petrol	2307	4	8	52
Saloon (W123)	02/76→08/81	M 110.923	Petrol	2746	6	12	71
Saloon (W123)	02/76→07/85	M 123.921	Petrol	2525	6	12	63
Saloon (W123)	02/76→11/85	M 110.984	Petrol	2746	6	12	71
Saloon (W123)	02/76→11/85	M 110.988	Petrol	2746	6	12	71
Saloon (W123)	02/76→11/85	OM 616.912	Diesel	2399	4	8	60
Saloon (W123)	02/76→11/85	OM 617.912	Diesel	2998	5	10	82
Saloon (W123)	07/76→11/85	OM 615.940	Diesel	1988	4	8	34
Saloon (W123)	04/80→12/85	M 102.980	Petrol	2299	4	8	49
Saloon (W123)	06/80→11/85	M 102.920	Petrol	1997	4	8	26
Saloon (W123)	06/80→11/85	M 102.939	Petrol	1997	4	8	26
Saloon (W123)	08/81→07/85	OM 617.952	Diesel	2998	5	10	92
Saloon (W124)	12/84→06/93	M 102.982	Petrol	2298	4	8	49
Saloon (W124)	12/84→06/93	OM 601.912	Diesel	1997	4	8	32
Saloon (W124)	12/84→06/93	OM 603.912	Diesel	2996	6	12	89
Saloon (W124)	01/85→12/85	M 103.980	Petrol	2960	6	12	85
Saloon (W124)	04/85→06/93	OM 602.912	Diesel	2497	5	10	66
Saloon (W124)	06/85→08/92	M 103.983	Petrol	2960	6	12	85
Saloon (W124)	09/85→08/92	M 103.940	Petrol	2597	6	12	69
Saloon (W124)	12/85→05/93	M 102.922	Petrol	1996	4	8	26
Saloon (W124)	09/86→08/92	M 103.943	Petrol	2597	6	12	69
Saloon (W124)	09/86→06/93	M 103.985	Petrol	2960	6	12	85
Saloon (W124)	09/86→06/93	OM 603.913	Diesel	2996	6	12	89
Saloon (W124)	09/86→06/93	OM 603.960	Diesel	2996	6	12	89
Saloon (W124)	09/86→06/93	OM 603.963	Diesel	2996	6	12	89
Saloon (W124)	09/88→08/92	M 102.963	Petrol	1996	4	8	26
Saloon (W124)	09/88→08/92	M 104.980	Petrol	2960	6	24	86
Saloon (W124)	09/88→06/93	OM 602.962	Diesel	2497	5	10	66
Saloon (W124)	01/91→06/93	M 119.974	Petrol	4973	8	32	132
Saloon (W124)	10/92→06/93	M 104.942	Petrol	2799	6	24	75
Saloon (W124)	10/92→06/93	M 104.992	Petrol	3199	6	24	95
Saloon (W124)	10/92→06/93	M 111.940	Petrol	1998	4	16	27
Saloon (W124)	10/92→06/93	M 111.960	Petrol	2199	4	16	40
Saloon (W124)	10/92→06/93	M 119.975	Petrol	4196	8	32	116
S-Class (W108, W109)	01/66→12/67	M 129.980	Petrol	2496	6	12	63
S-Class (W108, W109)	01/66→12/69	M 108.920	Petrol	2496	6	12	63
S-Class (W108, W109)	10/67→07/72	M 130.920	Petrol	2780	6	12	71

							
S-Class (W108, W109)	01/68→08/72	M 130.980	Petrol	2780	6	12	71
S-Class (W108, W109)	01/68→08/72	M 130.981	Petrol	2778	6	12	71
S-Class (W108, W109)	01/70→07/72	M 116.981	Petrol	3500	8	16	99
S-Class (W108, W109)	03/71→08/72	M 116.980	Petrol	3500	8	16	99
S-Class (W108, W109)	09/71→08/72	M 117.984	Petrol	4520	8	16	123
S-Class (W116)	08/72→02/76	M 116.983	Petrol	3499	8	16	99
S-Class (W116)	08/72→07/80	M 110.922	Petrol	2746	6	12	71
S-Class (W116)	08/72→07/80	M 110.983	Petrol	2746	6	12	71
S-Class (W116)	08/72→07/80	M 110.985	Petrol	2746	6	12	71
S-Class (W116)	08/72→07/80	M 117.983	Petrol	4520	8	16	123
S-Class (W116)	01/73→04/80	M 117.986	Petrol	4520	8	16	123
S-Class (W116)	03/76→03/80	M 116.985	Petrol	3499	8	16	99
S-Class (W126)	10/79→07/85	M 110.987	Petrol	2746	6	12	71
S-Class (W126)	10/79→07/85	M 110.989	Petrol	2746	6	12	71
S-Class (W126)	12/79→07/85	M 110.924	Petrol	2746	6	12	71
S-Class (W126)	12/79→07/85	M 110.926	Petrol	2746	6	12	71
S-Class (W126)	12/79→08/85	M 117.961	Petrol	4973	8	16	130
S-Class (W126)	12/79→08/85	M 117.963	Petrol	4973	8	16	131
S-Class (W126)	08/80→08/84	M 116.961	Petrol	3818	8	16	105
S-Class (W126)	09/80→12/85	OM 617.951	Diesel	2998	5	10	92
S-Class (W126)	10/81→08/85	M 116.963	Petrol	3839	8	16	105
S-Class (W126)	09/85→12/87	OM 603.961	Diesel	2996	6	12	89
S-Class (W126)	09/85→06/91	M 103.941	Petrol	2597	6	12	62
S-Class (W126)	09/85→06/91	M 103.981	Petrol	2960	6	12	85
S-Class (W126)	09/85→06/91	M 117.965	Petrol	4973	8	16	128
S-Class (W126)	10/85→06/91	M 116.965	Petrol	4196	8	16	115
S-Class (W126)	10/85→06/91	M 117.968	Petrol	5547	8	16	139
S-Class (W140)	02/91→10/98	M 119.970	Petrol	4973	8	32	132
S-Class (W140)	02/91→10/98	M 119.971	Petrol	4196	8	32	116
S-Class (W140)	03/91→10/98	M 104.990	Petrol	3199	6	24	95
S-Class (W140)	03/91→10/98	M 104.994	Petrol	3199	6	24	95
S-Class (W140)	04/91→10/98	M 120.980	Petrol	5987	12	48	148
S-Class (W140)	04/91→10/98	M 120.982	Petrol	5987	12	48	150
S-Class (W140)	01/93→10/98	M 104.944	Petrol	2799	6	24	75
S-Class (W140)	01/93→10/98	M 119.980	Petrol	4973	8	32	133
S-Class (W140)	01/93→10/98	OM 603.971	Diesel	3449	6	12	98
S-Class (W140)	05/96→10/98	OM 606.961	Diesel	2996	6	24	90
S-Class (W220)	10/98→08/05	M 112.922	Petrol	2799	6	18	76
S-Class (W220)	10/98→08/05	M 112.944	Petrol	3199	6	18	96
S-Class (W220)	10/98→08/05	M 113.941	Petrol	4266	8	24	120
S-Class (W220)	10/98→08/05	M 113.960	Petrol	4966	8	24	129
S-Class (W220)	10/98→08/05	M 113.966	Petrol	4966	8	24	129
S-Class (W220)	04/99→08/05	M 113.986	Petrol	5439	8	24	138
S-Class (W220)	08/99→09/02	OM 613.960	Diesel	3222	6	24	97
S-Class (W220)	01/00→08/05	M 137.970	Petrol	5786	12	36	147
S-Class (W220)	06/00→08/05	OM 628.960	Diesel	3996	8	32	114
S-Class (W220)	09/01→08/05	M 137.980	Petrol	6258	12	36	154
S-Class (W220)	06/02→08/05	M 113.991	Petrol	5439	8	24	138
S-Class (W220)	09/02→08/05	M 112.972	Petrol	3724	6	18	104
S-Class (W220)	09/02→08/05	M 113.948	Petrol	4266	8	24	120
S-Class (W220)	09/02→08/05	M 275.950	Petrol	5513	12	36	141
S-Class (W220)	09/02→08/05	OM 648.960	Diesel	3222	6	24	97
S-Class (W220)	06/03→08/05	M 112.975	Petrol	3724	6	18	104
S-Class (W220)	03/04→08/05	M 275.980	Petrol	5980	12	36	151
S-Class (W221)	10/05→12/13	M 272.965	Petrol	3498	6	24	101
S-Class (W221)	10/05→12/13	M 273.961	Petrol	5461	8	32	140
S-Class (W221)	10/05→12/13	M 273.968	Petrol	5461	8	32	140
S-Class (W221)	10/05→12/13	OM 642.930	Diesel	2987	6	24	94
S-Class (W221)	10/05→12/13	OM 642.932	Diesel	2987	6	24	94
S-Class (W221)	12/05→12/13	M 273.922	Petrol	4663	8	32	125
S-Class (W221)	12/05→12/13	M 273.924	Petrol	4663	8	32	125
S-Class (W221)	12/05→12/13	M 275.953	Petrol	5513	12	36	141
S-Class (W221)	12/05→12/13	M 275.982	Petrol	5980	12	36	151
S-Class (W221)	08/06→12/13	M 272.946	Petrol	2996	6	24	87
S-Class (W221)	10/06→12/13	M 156.984	Petrol	6208	8	32	153
S-Class (W221)	10/06→12/13	OM 629.911	Diesel	3996	8	32	114
S-Class (W221)	02/08→12/13	M 272.975	Petrol	3498	6	24	101
S-Class (W221)	01/09→12/13	M 272.974	Petrol	3498	6	24	101
S-Class (W221)	01/11→12/13	OM 651.961	Diesel	2143	4	16	48
S-Class (W221)	03/11→12/13	M 157.980	Petrol	5461	8	32	140
S-Class (W221)	03/11→12/13	M 278.932	Petrol	4663	8	32	125
S-Class (W221)	04/11→12/13	M 276.950	Petrol	3498	6	24	101
S-Class (W221)	04/11→12/13	OM 642.862	Diesel	2987	6	24	94
S-Class (W221)	04/11→12/13	OM 642.868	Diesel	2987	6	24	94
S-Class (W222, V222, X222)	05/13→	M 157.985	Petrol	5461	8	32	140
S-Class (W222, V222, X222)	05/13→	M 276.960	Petrol	3498	6	24	101
S-Class (W222, V222, X222)	05/13→	M 278.929	Petrol	4663	8	32	125
S-Class (W222, V222, X222)	05/13→	OM 642.861	Diesel	2987	6	24	94



CC



9

S-Class (W222, V222, X222)	02/14→	M 277.980	Petrol	5980	12	36	151
S-Class (W222, V222, X222)	02/14→	M 278.910	Petrol	3996	8	32	111
S-Class (W222, V222, X222)	02/14→	M 279.980	Petrol	5980	12	36	151
S-Class (W222, V222, X222)	02/14→	OM 642.867	Diesel	2987	6	24	94
S-Class (W222, V222, X222)	02/14→	OM 651.921	Diesel	2143	4	16	39
S-Class (W222, V222, X222)	03/14→	M 276.824	Petrol	2996	6	24	87
S-Class Convertible (A217)	12/15→	M 157.985	Petrol	5461	8	32	140
S-Class Convertible (A217)	12/15→	M 278.929	Petrol	4663	8	32	125
S-Class Convertible (A217)	04/16→	M 279.980	Petrol	5980	12	36	151
S-Class Coupe (C126)	08/80→12/81	M 116.961	Petrol	3818	8	16	105
S-Class Coupe (C126)	08/80→08/85	M 117.963	Petrol	4973	8	16	131
S-Class Coupe (C126)	10/81→07/85	M 116.963	Petrol	3839	8	16	105
S-Class Coupe (C126)	09/85→06/91	M 117.965	Petrol	4973	8	16	128
S-Class Coupe (C126)	10/85→06/91	M 116.965	Petrol	4196	8	16	115
S-Class Coupe (C126)	10/85→06/91	M 117.968	Petrol	5547	8	16	139
S-Class Coupe (C140)	07/92→02/99	M 120.980	Petrol	5987	12	48	148
S-Class Coupe (C140)	09/92→02/99	M 120.982	Petrol	5987	12	48	150
S-Class Coupe (C140)	10/92→02/99	M 119.970	Petrol	4973	8	32	132
S-Class Coupe (C140)	10/94→02/99	M 119.971	Petrol	4196	8	32	116
S-Class Coupe (C140)	10/94→02/99	M 119.981	Petrol	4196	8	32	117
S-Class Coupe (C215)	03/99→03/06	M 113.960	Petrol	4966	8	24	129
S-Class Coupe (C215)	03/99→03/06	M 137.970	Petrol	5786	12	36	147
S-Class Coupe (C215)	10/99→03/06	M 113.986	Petrol	5439	8	24	138
S-Class Coupe (C215)	09/01→03/06	M 137.980	Petrol	6258	12	36	154
S-Class Coupe (C215)	06/02→08/06	M 113.991	Petrol	5439	8	24	138
S-Class Coupe (C215)	09/02→03/06	M 275.950	Petrol	5513	12	36	141
S-Class Coupe (C215)	09/03→03/06	M 275.980	Petrol	5980	12	36	151
S-Class Coupe (C216)	05/06→12/13	M 275.953	Petrol	5513	12	36	141
S-Class Coupe (C216)	06/06→12/13	M 273.961	Petrol	5461	8	32	140
S-Class Coupe (C216)	10/06→12/13	M 156.984	Petrol	6208	8	32	153
S-Class Coupe (C216)	10/06→12/13	M 275.982	Petrol	5980	12	36	151
S-Class Coupe (C216)	02/08→12/13	M 273.968	Petrol	5461	8	32	140
S-Class Coupe (C216)	01/10→12/13	M 157.980	Petrol	5461	8	32	140
S-Class Coupe (C216)	02/11→12/13	M 278.920	Petrol	4663	8	32	125
S-Class Coupe (C217)	04/14→	M 157.985	Petrol	5461	8	32	140
S-Class Coupe (C217)	04/14→	M 278.929	Petrol	4663	8	32	125
S-Class Coupe (C217)	07/14→	M 279.980	Petrol	5980	12	36	151
S-Class Coupe (C217)	11/14→	M 278.910	Petrol	3996	8	32	111
S-Class Coupe (C217)	10/15→	M 276.824	Petrol	2996	6	24	87
SL (R107)	05/71→02/80	M 116.982	Petrol	3499	8	16	99
SL (R107)	05/71→02/80	M 116.984	Petrol	3499	8	16	99
SL (R107)	10/72→10/80	M 117.982	Petrol	4520	8	16	123
SL (R107)	10/72→12/80	M 117.985	Petrol	4520	8	16	123
SL (R107)	08/74→07/85	M 110.982	Petrol	2746	6	12	71
SL (R107)	08/74→07/85	M 110.986	Petrol	2746	6	12	71
SL (R107)	08/74→07/85	M 110.990	Petrol	2746	6	12	71
SL (R107)	05/80→12/85	M 117.962	Petrol	4973	8	16	131
SL (R107)	05/80→08/89	M 117.960	Petrol	4973	8	16	130
SL (R107)	09/80→08/81	M 116.960	Petrol	3818	8	16	105
SL (R107)	09/80→08/85	M 116.962	Petrol	3839	8	16	105
SL (R107)	09/85→08/89	M 103.982	Petrol	2960	6	12	80
SL (R107)	09/85→12/89	M 117.967	Petrol	5547	8	16	139
SL (R107)	01/86→08/89	M 116.964	Petrol	4196	8	16	115
SL (R107)	01/86→08/89	M 117.964	Petrol	4973	8	16	131
SL (R129)	03/89→07/93	M 104.981	Petrol	2960	6	24	86
SL (R129)	03/89→08/93	M 103.984	Petrol	2960	6	12	85
SL (R129)	09/89→08/92	M 119.960	Petrol	4973	8	32	132
SL (R129)	09/89→10/01	M 119.972	Petrol	4973	8	32	132
SL (R129)	02/92→10/01	M 120.981	Petrol	5987	12	48	149
SL (R129)	02/92→10/01	M 120.983	Petrol	5987	12	48	150
SL (R129)	09/92→10/01	M 119.982	Petrol	4973	8	32	133
SL (R129)	08/93→10/01	M 104.943	Petrol	2799	6	24	75
SL (R129)	09/93→10/01	M 104.991	Petrol	3199	6	24	95
SL (R129)	05/98→10/01	M 112.923	Petrol	2799	6	18	76
SL (R129)	05/98→10/01	M 112.943	Petrol	3199	6	18	96
SL (R129)	05/98→10/01	M 113.961	Petrol	4966	8	24	129
SL (R129)	08/99→07/01	M 113.992	Petrol	5439	8	24	138
SL (R129)	03/00→10/01	M 113.985	Petrol	5439	8	24	138
SL (R230)	10/01→01/12	M 113.963	Petrol	4966	8	24	129
SL (R230)	10/01→01/12	M 113.992	Petrol	5439	8	24	138
SL (R230)	03/03→01/12	M 112.973	Petrol	3724	6	18	104
SL (R230)	04/03→01/12	M 275.951	Petrol	5513	12	36	141
SL (R230)	03/04→01/12	M 275.981	Petrol	5980	12	36	151
SL (R230)	03/06→01/12	M 113.995	Petrol	5439	8	24	137
SL (R230)	03/06→01/12	M 272.966	Petrol	3498	6	24	101
SL (R230)	03/06→01/12	M 273.965	Petrol	5461	8	32	140
SL (R230)	03/06→01/12	M 275.954	Petrol	5513	12	36	141
SL (R230)	03/08→01/12	M 156.981	Petrol	6208	8	32	153



CC



9

Model	Year Range	Price (M)	Fuel	CC	Power (hp)	Speed (km/h)	0-100 (s)
SL (R230)	03/08→01/12	M 272.949	Petrol	2996	6	24	87
SL (R230)	04/08→01/12	M 272.968	Petrol	3498	6	24	101
SL (R230)	07/08→01/12	M 275.983	Petrol	5980	12	36	151
SL (R231)	01/12→	M 157.983	Petrol	5461	8	32	140
SL (R231)	01/12→	M 278.927	Petrol	4663	8	32	125
SL (R231)	02/12→	M 276.954	Petrol	3498	6	24	101
SL (R231)	05/12→	M 279.981	Petrol	5980	12	36	151
SL (R231)	04/14→	M 276.825	Petrol	2996	6	24	87
SL (W121)	01/55→12/63	M 121.921	Petrol	1897	4	8	23
SL (W121)	01/55→12/63	M 121.928	Petrol	1897	4	8	23
SLC (R172)	01/16→	M 270.910	Petrol	1595	4	16	10
SLC (R172)	01/16→	M 274.910	Petrol	1595	4	16	10
SLC (R172)	01/16→	M 274.920	Petrol	1991	4	16	31
SLC (R172)	01/16→	M 276.822	Petrol	2996	6	24	87
SLC (R172)	01/16→	OM 651.980	Diesel	2143	4	16	48
SL Coupe (C107)	01/72→02/80	M 116.982	Petrol	3499	8	16	99
SL Coupe (C107)	01/72→02/80	M 116.984	Petrol	3499	8	16	99
SL Coupe (C107)	01/73→08/79	M 117.982	Petrol	4520	8	16	123
SL Coupe (C107)	01/73→12/80	M 117.985	Petrol	4520	8	16	123
SL Coupe (C107)	08/74→09/81	M 110.982	Petrol	2746	6	12	71
SL Coupe (C107)	08/74→09/81	M 110.986	Petrol	2746	6	12	71
SL Coupe (C107)	08/74→09/81	M 110.990	Petrol	2746	6	12	71
SL Coupe (C107)	06/78→02/80	M 117.960	Petrol	4973	8	16	130
SL Coupe (C107)	07/80→08/81	M 116.960	Petrol	3818	8	16	105
SL Coupe (C107)	08/81→08/84	M 116.962	Petrol	3839	8	16	105
SLK (R170)	09/96→03/00	M 111.946	Petrol	1998	4	16	27
SLK (R170)	09/96→12/00	M 111.973	Petrol	2295	4	16	50
SLK (R170)	10/96→03/00	M 111.943	Petrol	1998	4	16	27
SLK (R170)	03/00→04/04	M 111.958	Petrol	1998	4	16	27
SLK (R170)	03/00→04/04	M 111.983	Petrol	2295	4	16	50
SLK (R170)	03/00→04/04	M 112.947	Petrol	3199	6	18	96
SLK (R170)	03/01→04/04	M 112.960	Petrol	3199	6	18	96
SLK (R171)	03/04→02/11	M 271.944	Petrol	1795	4	16	18
SLK (R171)	06/04→02/11	M 113.989	Petrol	5439	8	24	138
SLK (R171)	06/04→02/11	M 272.963	Petrol	3498	6	24	101
SLK (R171)	01/05→02/11	M 272.942	Petrol	2996	6	24	87
SLK (R171)	01/08→02/11	M 271.954	Petrol	1796	4	16	17
SLK (R171)	01/08→02/11	M 272.969	Petrol	3498	6	24	101
SLK (R172)	02/11→	M 271.860	Petrol	1796	4	16	17
SLK (R172)	02/11→	M 271.861	Petrol	1796	4	16	17
SLK (R172)	02/11→	M 276.956	Petrol	3498	6	24	101
SLK (R172)	01/12→	M 152.980	Petrol	5461	8	32	140
SLK (R172)	01/12→	OM 651.980	Diesel	2143	4	16	48
SLK (R172)	04/15→	M 274.920	Petrol	1991	4	16	31
SLR (R199)	04/04→	M 155.980	Petrol	5439	8	24	137
SLR Roadster (R199)	10/06→	M 155.980	Petrol	5439	8	24	137
SLS AMG (C197)	03/10→	M 159.980	Petrol	6208	8	32	153
SLS AMG Roadster (R197)	06/11→	M 159.980	Petrol	6208	8	32	153
Sprinter 2-t Box (901, 902)	02/95→04/00	OM 601.943	Diesel	2299	4	8	57
Sprinter 2-t Box (901, 902)	02/95→04/00	OM 602.980	Diesel	2874	5	10	81
Sprinter 2-t Box (901, 902)	02/95→05/06	M 111.979	Petrol	2295	4	16	50
Sprinter 2-t Box (901, 902)	02/95→05/06	M 111.984	Petrol	2295	4	16	50
Sprinter 2-t Box (901, 902)	04/00→05/06	OM 611.981	Diesel	2148	4	16	38
Sprinter 2-t Box (901, 902)	04/00→05/06	OM 611.987	Diesel	2148	4	16	38
Sprinter 2-t Box (901, 902)	04/00→05/06	OM 612.981	Diesel	2685	5	20	73
Sprinter 2-t Bus (901, 902)	02/95→04/00	OM 601.943	Diesel	2299	4	8	57
Sprinter 2-t Bus (901, 902)	02/95→04/00	OM 602.980	Diesel	2874	5	10	81
Sprinter 2-t Bus (901, 902)	02/95→05/06	M 111.979	Petrol	2295	4	16	50
Sprinter 2-t Bus (901, 902)	02/95→05/06	M 111.984	Petrol	2295	4	16	50
Sprinter 2-t Bus (901, 902)	04/00→05/06	OM 611.981	Diesel	2148	4	16	38
Sprinter 2-t Bus (901, 902)	04/00→05/06	OM 611.987	Diesel	2148	4	16	38
Sprinter 2-t Bus (901, 902)	04/00→05/06	OM 612.981	Diesel	2685	5	20	73
Sprinter 2-t Platform/Chassis (901, 902)	01/95→04/00	OM 601.943	Diesel	2299	4	8	57
Sprinter 2-t Platform/Chassis (901, 902)	02/95→04/00	OM 602.980	Diesel	2874	5	10	81
Sprinter 2-t Platform/Chassis (901, 902)	02/95→05/06	M 111.979	Petrol	2295	4	16	50
Sprinter 2-t Platform/Chassis (901, 902)	02/95→05/06	M 111.984	Petrol	2295	4	16	50
Sprinter 2-t Platform/Chassis (901, 902)	04/00→05/06	OM 611.981	Diesel	2148	4	16	38
Sprinter 2-t Platform/Chassis (901, 902)	04/00→05/06	OM 611.987	Diesel	2148	4	16	38
Sprinter 2-t Platform/Chassis (901, 902)	04/00→05/06	OM 612.981	Diesel	2685	5	20	73
Sprinter 3,5-t Box (906)	06/06→12/09	OM 642.993	Diesel	2987	6	24	94
Sprinter 3,5-t Box (906)	06/06→12/09	OM 646.984	Diesel	2148	4	16	46
Sprinter 3,5-t Box (906)	06/06→12/09	OM 646.985	Diesel	2148	4	16	38
Sprinter 3,5-t Box (906)	06/06→12/09	OM 646.989	Diesel	2148	4	16	38
Sprinter 3,5-t Box (906)	06/06→12/09	OM 646.990	Diesel	2148	4	16	38
Sprinter 3,5-t Box (906)	06/06→12/13	M 272.979	Petrol	3498	6	24	101
Sprinter 3,5-t Box (906)	06/06→	OM 642.896	Diesel	2987	6	24	94
Sprinter 3,5-t Box (906)	06/06→	OM 642.992	Diesel	2987	6	24	94
Sprinter 3,5-t Box (906)	06/06→	OM 646.986	Diesel	2148	4	16	38



CC



9

Sprinter 3,5-t Box (906)	09/08→	M 271.951	Petrol	1796	4	16	20
Sprinter 3,5-t Box (906)	03/09→	OM 642.898	Diesel	2987	6	24	94
Sprinter 3,5-t Box (906)	03/09→	OM 651.955	Diesel	2143	4	16	39
Sprinter 3,5-t Box (906)	03/09→	OM 651.957	Diesel	2143	4	16	39
Sprinter 3,5-t Box (906)	05/09→	OM 651.956	Diesel	2143	4	16	39
Sprinter 3,5-t Bus (906)	06/06→12/09	OM 646.985	Diesel	2148	4	16	38
Sprinter 3,5-t Bus (906)	06/06→12/09	OM 646.989	Diesel	2148	4	16	38
Sprinter 3,5-t Bus (906)	06/06→12/09	OM 646.990	Diesel	2148	4	16	38
Sprinter 3,5-t Bus (906)	06/06→12/13	M 272.979	Petrol	3498	6	24	101
Sprinter 3,5-t Bus (906)	02/08→12/09	OM 642.993	Diesel	2987	6	24	94
Sprinter 3,5-t Bus (906)	02/08→	OM 642.896	Diesel	2987	6	24	94
Sprinter 3,5-t Bus (906)	02/08→	OM 642.992	Diesel	2987	6	24	94
Sprinter 3,5-t Bus (906)	09/08→	M 271.951	Petrol	1796	4	16	20
Sprinter 3,5-t Bus (906)	03/09→05/16	OM 651.956	Diesel	2143	4	16	39
Sprinter 3,5-t Bus (906)	03/09→	OM 642.898	Diesel	2987	6	24	94
Sprinter 3,5-t Bus (906)	03/09→	OM 651.955	Diesel	2143	4	16	39
Sprinter 3,5-t Bus (906)	08/11→	OM 651.957	Diesel	2143	4	16	39
Sprinter 3,5-t Platform/Chassis (906)	06/06→12/09	OM 642.993	Diesel	2987	6	24	94
Sprinter 3,5-t Platform/Chassis (906)	06/06→12/09	OM 646.984	Diesel	2148	4	16	46
Sprinter 3,5-t Platform/Chassis (906)	06/06→12/09	OM 646.985	Diesel	2148	4	16	38
Sprinter 3,5-t Platform/Chassis (906)	06/06→12/09	OM 646.989	Diesel	2148	4	16	38
Sprinter 3,5-t Platform/Chassis (906)	06/06→12/09	OM 646.990	Diesel	2148	4	16	38
Sprinter 3,5-t Platform/Chassis (906)	06/06→12/13	M 272.979	Petrol	3498	6	24	101
Sprinter 3,5-t Platform/Chassis (906)	06/06→05/16	OM 646.986	Diesel	2148	4	16	38
Sprinter 3,5-t Platform/Chassis (906)	06/06→05/16	OM 651.956	Diesel	2143	4	16	39
Sprinter 3,5-t Platform/Chassis (906)	06/06→	OM 642.896	Diesel	2987	6	24	94
Sprinter 3,5-t Platform/Chassis (906)	06/06→	OM 642.992	Diesel	2987	6	24	94
Sprinter 3,5-t Platform/Chassis (906)	06/06→	OM 651.955	Diesel	2143	4	16	39
Sprinter 3,5-t Platform/Chassis (906)	09/08→	M 271.951	Petrol	1796	4	16	20
Sprinter 3,5-t Platform/Chassis (906)	03/09→	OM 642.898	Diesel	2987	6	24	94
Sprinter 3,5-t Platform/Chassis (906)	03/09→	OM 651.957	Diesel	2143	4	16	39
Sprinter 3-t Box (903)	02/95→04/00	OM 601.943	Diesel	2299	4	8	57
Sprinter 3-t Box (903)	02/95→08/02	OM 602.980	Diesel	2874	5	10	81
Sprinter 3-t Box (903)	02/95→05/06	M 111.979	Petrol	2295	4	16	50
Sprinter 3-t Box (903)	02/95→05/06	M 111.984	Petrol	2295	4	16	50
Sprinter 3-t Box (903)	04/00→05/06	OM 611.981	Diesel	2148	4	16	38
Sprinter 3-t Box (903)	04/00→05/06	OM 611.987	Diesel	2148	4	16	38
Sprinter 3-t Box (903)	04/00→05/06	OM 612.981	Diesel	2685	5	20	73
Sprinter 3-t Box (906)	06/06→12/09	OM 646.984	Diesel	2148	4	16	46
Sprinter 3-t Box (906)	06/06→12/09	OM 646.985	Diesel	2148	4	16	38
Sprinter 3-t Box (906)	06/06→12/09	OM 646.986	Diesel	2148	4	16	38
Sprinter 3-t Box (906)	06/06→12/09	OM 646.989	Diesel	2148	4	16	38
Sprinter 3-t Box (906)	06/06→12/09	OM 646.990	Diesel	2148	4	16	38
Sprinter 3-t Box (906)	06/06→	M 272.979	Petrol	3498	6	24	101
Sprinter 3-t Box (906)	06/06→	OM 642.896	Diesel	2987	6	24	94
Sprinter 3-t Box (906)	06/06→	OM 642.992	Diesel	2987	6	24	94
Sprinter 3-t Box (906)	06/06→	OM 651.955	Diesel	2143	4	16	39
Sprinter 3-t Box (906)	06/06→	OM 651.956	Diesel	2143	4	16	39
Sprinter 3-t Box (906)	09/08→	M 271.951	Petrol	1796	4	16	20
Sprinter 3-t Box (906)	03/09→	OM 651.957	Diesel	2143	4	16	39
Sprinter 3-t Bus (903)	02/95→04/00	OM 601.943	Diesel	2299	4	8	57
Sprinter 3-t Bus (903)	02/95→08/02	OM 602.980	Diesel	2874	5	10	81
Sprinter 3-t Bus (903)	02/95→05/06	M 111.979	Petrol	2295	4	16	50
Sprinter 3-t Bus (903)	02/95→05/06	M 111.984	Petrol	2295	4	16	50
Sprinter 3-t Bus (903)	04/00→05/06	OM 611.981	Diesel	2148	4	16	38
Sprinter 3-t Bus (903)	04/00→05/06	OM 611.987	Diesel	2148	4	16	38
Sprinter 3-t Bus (903)	04/00→05/06	OM 612.981	Diesel	2685	5	20	73
Sprinter 3-t Bus (906)	06/06→12/09	OM 646.985	Diesel	2148	4	16	38
Sprinter 3-t Bus (906)	06/06→12/09	OM 646.986	Diesel	2148	4	16	38
Sprinter 3-t Bus (906)	06/06→12/09	OM 646.989	Diesel	2148	4	16	38
Sprinter 3-t Bus (906)	06/06→12/09	OM 646.990	Diesel	2148	4	16	38
Sprinter 3-t Bus (906)	06/06→12/13	M 272.979	Petrol	3498	6	24	101
Sprinter 3-t Bus (906)	06/06→05/16	OM 651.956	Diesel	2143	4	16	39
Sprinter 3-t Bus (906)	06/06→	OM 651.955	Diesel	2143	4	16	39
Sprinter 3-t Bus (906)	06/06→	OM 651.957	Diesel	2143	4	16	39
Sprinter 3-t Bus (906)	09/08→	M 271.951	Petrol	1796	4	16	20
Sprinter 3-t Platform/Chassis (903)	02/95→04/00	OM 601.943	Diesel	2299	4	8	57
Sprinter 3-t Platform/Chassis (903)	02/95→09/01	OM 602.980	Diesel	2874	5	10	81
Sprinter 3-t Platform/Chassis (903)	02/95→05/06	M 111.979	Petrol	2295	4	16	50
Sprinter 3-t Platform/Chassis (903)	02/95→05/06	M 111.984	Petrol	2295	4	16	50
Sprinter 3-t Platform/Chassis (903)	04/00→05/06	OM 611.981	Diesel	2148	4	16	38
Sprinter 3-t Platform/Chassis (903)	04/00→05/06	OM 611.987	Diesel	2148	4	16	38
Sprinter 3-t Platform/Chassis (903)	04/00→05/06	OM 612.981	Diesel	2685	5	20	73
Sprinter 3-t Platform/Chassis (906)	06/06→12/09	OM 642.993	Diesel	2987	6	24	94
Sprinter 3-t Platform/Chassis (906)	06/06→12/09	OM 646.984	Diesel	2148	4	16	46
Sprinter 3-t Platform/Chassis (906)	06/06→12/09	OM 646.985	Diesel	2148	4	16	38
Sprinter 3-t Platform/Chassis (906)	06/06→12/09	OM 646.986	Diesel	2148	4	16	38
Sprinter 3-t Platform/Chassis (906)	06/06→12/09	OM 646.989	Diesel	2148	4	16	38
Sprinter 3-t Platform/Chassis (906)	06/06→12/09	OM 646.990	Diesel	2148	4	16	38



CC



9

Sprinter 3-t Platform/Chassis (906)	06/06→12/09	OM 646.990	Diesel	2148	4	16	38
Sprinter 3-t Platform/Chassis (906)	06/06→12/13	M 272.979	Petrol	3498	6	24	101
Sprinter 3-t Platform/Chassis (906)	06/06→05/16	OM 642.896	Diesel	2987	6	24	94
Sprinter 3-t Platform/Chassis (906)	06/06→05/16	OM 642.992	Diesel	2987	6	24	94
Sprinter 3-t Platform/Chassis (906)	09/08→05/16	M 271.951	Petrol	1796	4	16	20
Sprinter 3-t Platform/Chassis (906)	03/09→05/16	OM 651.956	Diesel	2143	4	16	39
Sprinter 3-t Platform/Chassis (906)	03/09→	OM 651.955	Diesel	2143	4	16	39
Sprinter 3-t Platform/Chassis (906)	03/09→	OM 651.957	Diesel	2143	4	16	39
Sprinter 4,6-t Box (906)	06/06→12/13	M 272.979	Petrol	3498	6	24	101
Sprinter 4,6-t Box (906)	06/06→05/16	OM 646.986	Diesel	2148	4	16	38
Sprinter 4,6-t Box (906)	06/06→05/16	OM 651.955	Diesel	2143	4	16	39
Sprinter 4,6-t Box (906)	06/06→05/16	OM 651.956	Diesel	2143	4	16	39
Sprinter 4,6-t Box (906)	03/09→	OM 642.992	Diesel	2987	6	24	94
Sprinter 4,6-t Box (906)	03/09→	OM 651.957	Diesel	2143	4	16	39
Sprinter 4,6-t Box (906)	06/09→12/09	OM 646.985	Diesel	2148	4	16	38
Sprinter 4,6-t Box (906)	06/09→12/09	OM 646.989	Diesel	2148	4	16	38
Sprinter 4,6-t Box (906)	06/09→12/09	OM 646.990	Diesel	2148	4	16	38
Sprinter 4,6-t Box (906)	06/09→05/16	OM 642.896	Diesel	2987	6	24	94
Sprinter 4,6-t Bus	06/06→	OM 651.957	Diesel	2143	4	16	39
Sprinter 4,6-t Platform/Chassis (906)	06/06→12/09	OM 642.993	Diesel	2987	6	24	94
Sprinter 4,6-t Platform/Chassis (906)	06/06→12/09	OM 646.989	Diesel	2148	4	16	38
Sprinter 4,6-t Platform/Chassis (906)	06/06→12/09	OM 646.990	Diesel	2148	4	16	38
Sprinter 4,6-t Platform/Chassis (906)	06/06→12/13	M 272.979	Petrol	3498	6	24	101
Sprinter 4,6-t Platform/Chassis (906)	06/06→05/16	OM 646.986	Diesel	2148	4	16	38
Sprinter 4,6-t Platform/Chassis (906)	06/06→	OM 642.896	Diesel	2987	6	24	94
Sprinter 4,6-t Platform/Chassis (906)	06/06→	OM 642.992	Diesel	2987	6	24	94
Sprinter 4,6-t Platform/Chassis (906)	03/09→	OM 642.898	Diesel	2987	6	24	94
Sprinter 4,6-t Platform/Chassis (906)	03/09→	OM 651.957	Diesel	2143	4	16	39
Sprinter 4,6-t Platform/Chassis (906)	06/09→12/09	OM 646.985	Diesel	2148	4	16	38
Sprinter 4-t Box (904)	02/96→05/06	M 111.979	Petrol	2295	4	16	50
Sprinter 4-t Box (904)	02/96→05/06	M 111.984	Petrol	2295	4	16	50
Sprinter 4-t Box (904)	02/96→05/06	OM 601.943	Diesel	2299	4	8	57
Sprinter 4-t Box (904)	02/96→05/06	OM 602.980	Diesel	2874	5	10	81
Sprinter 4-t Box (904)	04/00→05/06	OM 611.981	Diesel	2148	4	16	38
Sprinter 4-t Box (904)	04/00→05/06	OM 611.987	Diesel	2148	4	16	38
Sprinter 4-t Box (904)	04/00→05/06	OM 612.981	Diesel	2685	5	20	73
Sprinter 4-t Bus (904)	02/96→05/06	M 111.979	Petrol	2295	4	16	50
Sprinter 4-t Bus (904)	02/96→05/06	M 111.984	Petrol	2295	4	16	50
Sprinter 4-t Bus (904)	04/00→05/06	OM 611.981	Diesel	2148	4	16	38
Sprinter 4-t Bus (904)	04/00→05/06	OM 611.987	Diesel	2148	4	16	38
Sprinter 4-t Bus (904)	04/00→05/06	OM 612.981	Diesel	2685	5	20	73
Sprinter 4-t Platform/Chassis (904)	02/96→05/06	M 111.979	Petrol	2295	4	16	50
Sprinter 4-t Platform/Chassis (904)	02/96→05/06	M 111.984	Petrol	2295	4	16	50
Sprinter 4-t Platform/Chassis (904)	02/96→05/06	OM 601.943	Diesel	2299	4	8	57
Sprinter 4-t Platform/Chassis (904)	02/96→05/06	OM 602.980	Diesel	2874	5	10	81
Sprinter 4-t Platform/Chassis (904)	04/00→05/06	OM 611.981	Diesel	2148	4	16	38
Sprinter 4-t Platform/Chassis (904)	04/00→05/06	OM 611.987	Diesel	2148	4	16	38
Sprinter 4-t Platform/Chassis (904)	04/00→05/06	OM 612.981	Diesel	2685	5	20	73
Sprinter 5-t Box (906)	06/06→12/09	OM 642.993	Diesel	2987	6	24	94
Sprinter 5-t Box (906)	06/06→12/09	OM 646.984	Diesel	2148	4	16	46
Sprinter 5-t Box (906)	06/06→12/09	OM 646.985	Diesel	2148	4	16	38
Sprinter 5-t Box (906)	06/06→12/09	OM 646.989	Diesel	2148	4	16	38
Sprinter 5-t Box (906)	06/06→12/09	OM 646.990	Diesel	2148	4	16	38
Sprinter 5-t Box (906)	06/06→12/13	M 272.979	Petrol	3498	6	24	101
Sprinter 5-t Box (906)	06/06→	OM 642.896	Diesel	2987	6	24	94
Sprinter 5-t Box (906)	06/06→	OM 642.992	Diesel	2987	6	24	94
Sprinter 5-t Box (906)	06/06→	OM 646.986	Diesel	2148	4	16	38
Sprinter 5-t Box (906)	06/06→	OM 651.955	Diesel	2143	4	16	39
Sprinter 5-t Box (906)	06/06→	OM 651.956	Diesel	2143	4	16	39
Sprinter 5-t Box (906)	06/06→	OM 651.957	Diesel	2143	4	16	39
Sprinter 5-t Box (906)	03/09→	OM 642.898	Diesel	2987	6	24	94
Sprinter 5-t Bus	06/06→	OM 651.956	Diesel	2143	4	16	39
Sprinter 5-t Bus	06/06→	OM 651.957	Diesel	2143	4	16	39
Sprinter 5-t Bus	03/09→	OM 642.896	Diesel	2987	6	24	94
Sprinter 5-t Bus	03/09→	OM 642.898	Diesel	2987	6	24	94
Sprinter 5-t Bus	03/09→	OM 642.992	Diesel	2987	6	24	94
Sprinter 5-t Platform/Chassis (905)	04/01→05/06	OM 612.981	Diesel	2685	5	20	73
Sprinter 5-t Platform/Chassis (906)	06/06→12/09	OM 642.993	Diesel	2987	6	24	94
Sprinter 5-t Platform/Chassis (906)	06/06→12/09	OM 646.984	Diesel	2148	4	16	46
Sprinter 5-t Platform/Chassis (906)	06/06→12/09	OM 646.985	Diesel	2148	4	16	38
Sprinter 5-t Platform/Chassis (906)	06/06→12/09	OM 646.989	Diesel	2148	4	16	38
Sprinter 5-t Platform/Chassis (906)	06/06→12/09	OM 646.990	Diesel	2148	4	16	38
Sprinter 5-t Platform/Chassis (906)	06/06→12/13	M 272.979	Petrol	3498	6	24	101
Sprinter 5-t Platform/Chassis (906)	06/06→05/16	OM 646.986	Diesel	2148	4	16	38
Sprinter 5-t Platform/Chassis (906)	06/06→05/16	OM 651.956	Diesel	2143	4	16	39
Sprinter 5-t Platform/Chassis (906)	06/06→	OM 642.896	Diesel	2987	6	24	94
Sprinter 5-t Platform/Chassis (906)	06/06→	OM 642.992	Diesel	2987	6	24	94
Sprinter 5-t Platform/Chassis (906)	06/06→	OM 651.955	Diesel	2143	4	16	39











CC



9

Sprinter 5-t Platform/Chassis (906)	09/08→	M 271.951	Petrol	1796	4	16	20
Sprinter 5-t Platform/Chassis (906)	03/09→	OM 642.898	Diesel	2987	6	24	94
Sprinter 5-t Platform/Chassis (906)	03/09→	OM 651.957	Diesel	2143	4	16	39
Sprinter Classic 3,5-t Box (909)	09/13→	OM 646.701	Diesel	2148	4	16	38
Sprinter Classic 4,6-t Bus (909)	09/13→	OM 646.701	Diesel	2148	4	16	38
Sprinter Dumptruck (905)	04/01→	OM 612.981	Diesel	2685	5	20	73
T1 Box (601, 611)	05/77→12/82	M 115.955	Petrol	2307	4	8	52
T1 Box (601, 611)	04/81→01/90	OM 616.937	Diesel	2399	4	8	60
T1 Box (601, 611)	06/82→01/90	OM 616.939	Diesel	2399	4	8	60
T1 Box (601, 611)	07/82→02/96	M 102.942	Petrol	2298	4	8	49
T1 Box (601, 611)	07/82→02/96	M 102.946	Petrol	2298	4	8	49
T1 Box (601, 611)	12/82→01/90	OM 617.913	Diesel	2998	5	10	82
T1 Box (601, 611)	10/88→02/96	OM 601.940	Diesel	2299	4	8	57
T1 Box (601, 611)	10/88→02/96	OM 602.940	Diesel	2874	5	10	79
T1 Box (601, 611)	05/89→02/96	M 102.945	Petrol	2298	4	8	49
T1 Box (602)	10/82→01/90	OM 616.937	Diesel	2399	4	8	60
T1 Box (602)	10/82→01/90	OM 616.939	Diesel	2399	4	8	60
T1 Box (602)	10/82→01/90	OM 617.913	Diesel	2998	5	10	82
T1 Box (602)	11/88→02/96	OM 601.940	Diesel	2299	4	8	57
T1 Box (602)	01/89→12/95	M 102.945	Petrol	2298	4	8	49
T1 Box (602)	06/89→02/96	M 102.942	Petrol	2298	4	8	49
T1 Box (602)	06/89→02/96	OM 602.940	Diesel	2874	5	10	79
T1 Bus (601)	05/77→12/82	M 115.955	Petrol	2307	4	8	52
T1 Bus (601)	05/77→12/82	M 115.972	Petrol	2307	4	8	52
T1 Bus (601)	05/77→12/82	OM 616.917	Diesel	2404	4	8	60
T1 Bus (601)	05/77→12/82	OM 616.934	Diesel	2399	4	8	60
T1 Bus (601)	07/82→01/90	M 102.942	Petrol	2298	4	8	49
T1 Bus (601)	07/82→01/90	OM 616.937	Diesel	2399	4	8	60
T1 Bus (601)	07/82→01/90	OM 616.939	Diesel	2399	4	8	60
T1 Bus (601)	12/82→01/90	OM 617.913	Diesel	2998	5	10	82
T1 Bus (601)	10/88→02/96	OM 601.940	Diesel	2299	4	8	57
T1 Bus (601)	11/88→02/96	OM 602.940	Diesel	2874	5	10	79
T1 Bus (601)	05/89→02/96	M 102.945	Petrol	2298	4	8	49
T1 Bus (602)	06/89→02/96	OM 601.940	Diesel	2299	4	8	57
T1 Bus (602)	06/89→02/96	OM 602.940	Diesel	2874	5	10	79
T1 Platform/Chassis (601)	04/77→12/82	OM 616.917	Diesel	2404	4	8	60
T1 Platform/Chassis (601)	04/77→10/89	M 102.942	Petrol	2298	4	8	49
T1 Platform/Chassis (601)	04/77→10/89	M 115.955	Petrol	2307	4	8	52
T1 Platform/Chassis (601)	12/77→10/89	OM 616.937	Diesel	2399	4	8	60
T1 Platform/Chassis (601)	12/82→01/90	OM 617.913	Diesel	2998	5	10	82
T1 Platform/Chassis (601)	11/88→02/96	OM 601.940	Diesel	2299	4	8	57
T1 Platform/Chassis (601)	11/88→02/96	OM 602.940	Diesel	2874	5	10	79
T1 Platform/Chassis (602)	01/77→12/90	OM 616.917	Diesel	2404	4	8	60
T1 Platform/Chassis (602)	04/77→01/90	OM 616.937	Diesel	2399	4	8	60
T1 Platform/Chassis (602)	01/82→12/94	M 102.942	Petrol	2298	4	8	49
T1 Platform/Chassis (602)	06/82→01/90	OM 616.939	Diesel	2399	4	8	60
T1 Platform/Chassis (602)	10/82→01/90	OM 617.913	Diesel	2998	5	10	82
T1 Platform/Chassis (602)	06/89→02/96	OM 601.940	Diesel	2299	4	8	57
T1 Platform/Chassis (602)	06/89→02/96	OM 602.940	Diesel	2874	5	10	79
T1/TN Box Body / Estate	07/81→01/89	OM 616.913	Diesel	2398	4	8	60
T1/TN Box Body / Estate	07/81→01/89	OM 616.939	Diesel	2399	4	8	60
T1/TN Box Body / Estate	04/82→01/89	OM 617.913	Diesel	2998	5	10	82
T1/TN Box Body / Estate	08/82→06/95	M 102.942	Petrol	2298	4	8	49
T1/TN Box Body / Estate	08/82→06/95	M 102.945	Petrol	2298	4	8	49
T1/TN Box Body / Estate	11/88→06/95	OM 601.940	Diesel	2299	4	8	57
T1/TN Box Body / Estate	11/88→06/95	OM 602.940	Diesel	2874	5	10	79
T1/TN Platform/Chassis	07/81→01/89	OM 616.913	Diesel	2398	4	8	60
T1/TN Platform/Chassis	07/81→01/89	OM 616.939	Diesel	2399	4	8	60
T1/TN Platform/Chassis	04/82→01/89	OM 617.913	Diesel	2998	5	10	82
T1/TN Platform/Chassis	08/82→06/95	M 102.942	Petrol	2298	4	8	49
T1/TN Platform/Chassis	08/82→06/95	M 102.945	Petrol	2298	4	8	49
T1/TN Platform/Chassis	11/88→06/95	OM 601.940	Diesel	2299	4	8	57
T1/TN Platform/Chassis	11/88→06/95	OM 602.940	Diesel	2874	5	10	79
T2/L Box Body / Estate	01/68→12/74	OM 615.910	Diesel	2197	4	8	47
T2/L Box Body / Estate	01/70→12/88	OM 314.946	Diesel	3780	4	8	106
T2/L Box Body / Estate	01/70→12/88	OM 314.948	Diesel	3780	4	8	106
T2/L Box Body / Estate	01/70→12/88	OM 314.967	Diesel	3780	4	8	106
T2/L Box Body / Estate	01/72→12/80	OM 615	Diesel	2197	4	8	47
T2/L Box Body / Estate	08/72→12/74	M 115.921	Petrol	2197	4	8	41
T2/L Box Body / Estate	08/72→12/74	M 115.928	Petrol	2197	4	8	41
T2/L Box Body / Estate	01/75→08/82	M 115.952	Petrol	2307	4	8	52
T2/L Box Body / Estate	01/75→12/88	OM 616.910	Diesel	2400	4	8	60
T2/L Box Body / Estate	04/77→12/88	OM 353.963	Diesel	5675	6	12	143
T2/L Box Body / Estate	04/77→12/88	OM 353.966	Diesel	5675	6	12	143
T2/L Box Body / Estate	08/82→12/88	M 102.943	Petrol	2299	4	8	49
T2/L Dumptruck	01/68→12/74	M 115.921	Petrol	2197	4	8	41
T2/L Dumptruck	01/72→07/83	OM 352.911	Diesel	5675	6	12	143
T2/L Dumptruck	09/72→06/88	OM 314.959	Diesel	3780	4	8	106

							
T2/L Dumptruck	09/72→06/88	OM 314.962	Diesel	3780	4	8	106
T2/L Dumptruck	09/72→12/88	OM 314.946	Diesel	3780	4	8	106
T2/L Dumptruck	09/72→12/88	OM 314.948	Diesel	3780	4	8	106
T2/L Dumptruck	09/72→12/88	OM 314.961	Diesel	3780	4	8	106
T2/L Dumptruck	09/72→12/88	OM 314.963	Diesel	3780	4	8	106
T2/L Dumptruck	01/75→08/82	M 115.952	Petrol	2307	4	8	52
T2/L Dumptruck	08/82→09/83	M 102.943	Petrol	2299	4	8	49
T2/L Municipal Vehicle	06/72→02/77	OM 314.946	Diesel	3780	4	8	106
T2/L Municipal Vehicle	06/72→02/77	OM 314.948	Diesel	3780	4	8	106
T2/L Municipal Vehicle	08/72→12/74	M 115.927	Petrol	2197	4	8	41
T2/L Municipal Vehicle	08/72→12/74	M 115.929	Petrol	2197	4	8	41
T2/L Municipal Vehicle	01/75→08/82	M 115.952	Petrol	2307	4	8	52
T2/L Municipal Vehicle	01/75→08/82	M 115.970	Petrol	2307	4	8	52
T2/L Municipal Vehicle	01/75→08/82	M 115.971	Petrol	2307	4	8	52
T2/LN1 Box Body / Estate	04/86→04/89	OM 616.914	Diesel	2399	4	8	60
T2/LN1 Box Body / Estate	04/86→12/94	M 102.946	Petrol	2298	4	8	49
T2/LN1 Box Body / Estate	04/86→12/94	OM 354.901	Diesel	3972	4	8	112
T2/LN1 Box Body / Estate	04/86→12/94	OM 354.902	Diesel	3972	4	8	112
T2/LN1 Box Body / Estate	04/86→12/94	OM 354.903	Diesel	3972	4	8	112
T2/LN1 Box Body / Estate	04/86→12/94	OM 364.906	Diesel	3972	4	8	112
T2/LN1 Box Body / Estate	04/86→12/94	OM 364.911	Diesel	3972	4	8	112
T2/LN1 Box Body / Estate	04/86→12/94	OM 364.912	Diesel	3972	4	8	112
T2/LN1 Box Body / Estate	04/86→12/94	OM 364.919	Diesel	3972	4	8	112
T2/LN1 Box Body / Estate	04/86→12/94	OM 364.920	Diesel	3972	4	8	112
T2/LN1 Box Body / Estate	04/86→12/94	OM 364.921	Diesel	3972	4	8	112
T2/LN1 Box Body / Estate	04/86→12/94	OM 364.950	Diesel	3972	4	8	112
T2/LN1 Box Body / Estate	04/86→12/94	OM 364.952	Diesel	3972	4	8	112
T2/LN1 Box Body / Estate	04/86→12/94	OM 364.957	Diesel	3972	4	8	112
T2/LN1 Box Body / Estate	04/86→12/94	OM 364.958	Diesel	3972	4	8	112
T2/LN1 Box Body / Estate	11/87→12/94	OM 354.924	Diesel	3972	4	8	112
T2/LN1 Box Body / Estate	11/87→12/94	OM 354.925	Diesel	3972	4	8	112
T2/LN1 Box Body / Estate	11/87→12/94	OM 364.981	Diesel	3972	4	8	112
T2/LN1 Box Body / Estate	11/87→12/94	OM 364.984	Diesel	3972	4	8	112
T2/LN1 Box Body / Estate	11/87→12/94	OM 364.986	Diesel	3972	4	8	112
T2/LN1 Box Body / Estate	11/87→12/94	OM 364.987	Diesel	3972	4	8	112
T2/LN1 Box Body / Estate	03/89→12/94	OM 601.941	Diesel	2299	4	8	57
T2/LN1 Box Body / Estate	06/94→12/94	OM 354.923	Diesel	3972	4	8	112
T2/LN1 Bus	07/87→12/92	OM 364.913	Diesel	3972	4	8	112
T2/LN1 Bus	07/87→12/92	OM 364.952	Diesel	3972	4	8	112
T2/LN1 Bus	07/87→12/92	OM 364.954	Diesel	3972	4	8	112
T2/LN1 Bus	07/87→12/92	OM 364.980	Diesel	3972	4	8	112
T2/LN1 Bus	07/87→12/92	OM 364.981	Diesel	3972	4	8	112
T2/LN1 Cab with engine	04/86→12/94	OM 364.911	Diesel	3972	4	8	112
T2/LN1 Dumptruck	04/86→04/89	OM 616.914	Diesel	2399	4	8	60
T2/LN1 Dumptruck	04/86→12/94	OM 354.901	Diesel	3972	4	8	112
T2/LN1 Dumptruck	04/86→12/94	OM 354.903	Diesel	3972	4	8	112
T2/LN1 Dumptruck	04/86→12/94	OM 364.906	Diesel	3972	4	8	112
T2/LN1 Dumptruck	04/86→12/94	OM 364.911	Diesel	3972	4	8	112
T2/LN1 Dumptruck	04/86→12/94	OM 364.919	Diesel	3972	4	8	112
T2/LN1 Dumptruck	04/86→12/94	OM 364.920	Diesel	3972	4	8	112
T2/LN1 Dumptruck	04/86→12/94	OM 364.921	Diesel	3972	4	8	112
T2/LN1 Dumptruck	04/86→12/94	OM 364.950	Diesel	3972	4	8	112
T2/LN1 Dumptruck	04/86→12/94	OM 364.952	Diesel	3972	4	8	112
T2/LN1 Dumptruck	04/86→12/94	OM 364.958	Diesel	3972	4	8	112
T2/LN1 Dumptruck	03/89→12/94	OM 601.941	Diesel	2299	4	8	57
T2/LN1 Platform/Chassis	04/86→04/89	OM 616.914	Diesel	2399	4	8	60
T2/LN1 Platform/Chassis	04/86→12/94	M 102.946	Petrol	2298	4	8	49
T2/LN1 Platform/Chassis	04/86→12/94	OM 354.901	Diesel	3972	4	8	112
T2/LN1 Platform/Chassis	04/86→12/94	OM 354.902	Diesel	3972	4	8	112
T2/LN1 Platform/Chassis	04/86→12/94	OM 354.903	Diesel	3972	4	8	112
T2/LN1 Platform/Chassis	04/86→12/94	OM 364.906	Diesel	3972	4	8	112
T2/LN1 Platform/Chassis	04/86→12/94	OM 364.911	Diesel	3972	4	8	112
T2/LN1 Platform/Chassis	04/86→12/94	OM 364.912	Diesel	3972	4	8	112
T2/LN1 Platform/Chassis	04/86→12/94	OM 364.919	Diesel	3972	4	8	112
T2/LN1 Platform/Chassis	04/86→12/94	OM 364.920	Diesel	3972	4	8	112
T2/LN1 Platform/Chassis	04/86→12/94	OM 364.921	Diesel	3972	4	8	112
T2/LN1 Platform/Chassis	04/86→12/94	OM 364.950	Diesel	3972	4	8	112
T2/LN1 Platform/Chassis	04/86→12/94	OM 364.952	Diesel	3972	4	8	112
T2/LN1 Platform/Chassis	04/86→12/94	OM 364.957	Diesel	3972	4	8	112
T2/LN1 Platform/Chassis	04/86→12/94	OM 364.958	Diesel	3972	4	8	112
T2/LN1 Platform/Chassis	11/87→12/94	OM 354.924	Diesel	3972	4	8	112
T2/LN1 Platform/Chassis	11/87→12/94	OM 354.925	Diesel	3972	4	8	112
T2/LN1 Platform/Chassis	11/87→12/94	OM 364.981	Diesel	3972	4	8	112
T2/LN1 Platform/Chassis	11/87→12/94	OM 364.984	Diesel	3972	4	8	112
T2/LN1 Platform/Chassis	11/87→12/94	OM 364.986	Diesel	3972	4	8	112
T2/LN1 Platform/Chassis	11/87→12/94	OM 364.987	Diesel	3972	4	8	112
T2/LN1 Platform/Chassis	06/94→12/94	OM 354.923	Diesel	3972	4	8	112
T2/L Platform/Chassis	01/68→12/74	OM 615.910	Diesel	2197	4	8	47



CC



















9









T2/L Platform/Chassis	01/70→12/88	OM 314.946	Diesel	3780	4	8	106
T2/L Platform/Chassis	01/70→12/88	OM 314.948	Diesel	3780	4	8	106
T2/L Platform/Chassis	01/70→12/88	OM 314.967	Diesel	3780	4	8	106
T2/L Platform/Chassis	01/72→12/80	OM 615	Diesel	2197	4	8	47
T2/L Platform/Chassis	01/72→07/83	OM 352.906	Diesel	5675	6	12	143
T2/L Platform/Chassis	01/72→07/83	OM 352.911	Diesel	5675	6	12	143
T2/L Platform/Chassis	08/72→12/74	M 115.921	Petrol	2197	4	8	41
T2/L Platform/Chassis	08/72→12/74	M 115.928	Petrol	2197	4	8	41
T2/L Platform/Chassis	01/75→08/82	M 115.952	Petrol	2307	4	8	52
T2/L Platform/Chassis	01/75→12/88	OM 616.910	Diesel	2400	4	8	60
T2/L Platform/Chassis	01/75→12/88	OM 616.917	Diesel	2404	4	8	60
T2/L Platform/Chassis	04/77→12/88	OM 353.963	Diesel	5675	6	12	143
T2/L Platform/Chassis	04/77→12/88	OM 353.966	Diesel	5675	6	12	143
T2/L Platform/Chassis	08/82→12/88	M 102.943	Petrol	2299	4	8	49
T2/L Truck Tractor	01/72→07/83	OM 352.911	Diesel	5675	6	12	143
Vaneo (414)	02/02→07/05	M 166.961	Petrol	1598	4	8	9
Vaneo (414)	02/02→07/05	M 166.991	Petrol	1898	4	8	24
Vaneo (414)	02/02→07/05	OM 668.914	Diesel	1689	4	16	14
Vario Box Body / Estate	09/96→12/10	OM 602.984	Diesel	2874	5	10	81
Vario Box Body / Estate	09/96→12/10	OM 602.985	Diesel	2874	5	10	81
Vario Box Body / Estate	09/96→12/13	OM 900.917	Diesel	4249	4	12	121
Vario Box Body / Estate	09/96→	OM 900.918	Diesel	4249	4	12	121
Vario Box Body / Estate	09/96→	OM 904.908	Diesel	4250	4	12	118
Vario Box Body / Estate	09/96→	OM 904.923	Diesel	4250	4	12	121
Vario Box Body / Estate	09/06→	OM 900.919	Diesel	4249	4	12	121
Vario Box Body / Estate	09/06→	OM 904.964	Diesel	4249	4	12	121
Vario Bus	09/96→12/10	OM 602.984	Diesel	2874	5	10	81
Vario Bus	09/96→12/10	OM 602.985	Diesel	2874	5	10	81
Vario Bus	09/96→12/10	OM 904.904	Diesel	4250	4	12	121
Vario Bus	09/96→12/10	OM 904.908	Diesel	4250	4	12	118
Vario Bus	09/96→12/10	OM 904.923	Diesel	4250	4	12	121
Vario Bus	01/06→	OM 900.917	Diesel	4249	4	12	121
Vario Bus	01/06→	OM 900.918	Diesel	4249	4	12	121
Vario Bus	09/06→	OM 900.919	Diesel	4249	4	12	121
Vario Cab with engine	09/96→12/10	OM 904.904	Diesel	4250	4	12	121
Vario Cab with engine	09/96→12/10	OM 904.961	Diesel	4250	4	12	121
Vario Cab with engine	09/96→	OM 904.908	Diesel	4250	4	12	118
Vario Cab with engine	09/96→	OM 904.923	Diesel	4250	4	12	121
Vario Cab with engine	01/06→	OM 900.917	Diesel	4249	4	12	121
Vario Cab with engine	01/06→	OM 900.918	Diesel	4249	4	12	121
Vario Cab with engine	09/06→	OM 900.919	Diesel	4249	4	12	121
Vario Dumptruck	09/96→12/10	OM 602.984	Diesel	2874	5	10	81
Vario Dumptruck	09/96→12/10	OM 602.985	Diesel	2874	5	10	81
Vario Dumptruck	09/96→12/13	OM 900.917	Diesel	4249	4	12	121
Vario Dumptruck	09/96→12/13	OM 904.908	Diesel	4250	4	12	118
Vario Dumptruck	09/96→	OM 900.918	Diesel	4249	4	12	121
Vario Dumptruck	09/96→	OM 904.923	Diesel	4250	4	12	121
Vario Dumptruck	09/06→	OM 900.919	Diesel	4249	4	12	121
Vario Dumptruck	09/06→	OM 904.964	Diesel	4249	4	12	121
Vario Platform/Chassis	09/96→12/10	OM 602.984	Diesel	2874	5	10	81
Vario Platform/Chassis	09/96→12/10	OM 602.985	Diesel	2874	5	10	81
Vario Platform/Chassis	09/96→12/13	OM 900.917	Diesel	4249	4	12	121
Vario Platform/Chassis	09/96→12/13	OM 904.936	Diesel	4250	4	12	121
Vario Platform/Chassis	09/96→	OM 900.918	Diesel	4249	4	12	121
Vario Platform/Chassis	09/96→	OM 904.908	Diesel	4250	4	12	118
Vario Platform/Chassis	09/96→	OM 904.917	Diesel	4249	4	12	121
Vario Platform/Chassis	09/96→	OM 904.923	Diesel	4250	4	12	121
Vario Platform/Chassis	09/06→	OM 900.919	Diesel	4249	4	12	121
Vario Platform/Chassis	09/06→	OM 904.964	Diesel	4249	4	12	121
V-Class (638/2)	09/96→07/03	OM 601.970	Diesel	2299	4	8	57
V-Class (638/2)	10/96→07/03	M 111.978	Petrol	2295	4	16	50
V-Class (638/2)	02/97→07/03	M 111.948	Petrol	1998	4	16	27
V-Class (638/2)	02/97→07/03	M 111.950	Petrol	1998	4	16	27
V-Class (638/2)	08/97→07/03	M 104.900	Petrol	2792	6	12	74
V-Class (638/2)	03/99→07/03	OM 611.980	Diesel	2151	4	16	46
V-Class (W447)	03/14→	M 274.920	Petrol	1991	4	16	31
V-Class (W447)	03/14→	OM 651.950	Diesel	2143	4	16	39
Viano (W639)	09/03→	M 112.951	Petrol	3199	6	18	96
Viano (W639)	09/03→	OM 646.980	Diesel	2148	4	16	46
Viano (W639)	09/03→	OM 646.982	Diesel	2148	4	16	46
Viano (W639)	06/04→	M 112.976	Petrol	3724	6	18	104
Viano (W639)	03/06→	OM 642.990	Diesel	2987	6	24	94
Viano (W639)	09/07→	M 272.978	Petrol	3498	6	24	101
Viano (W639)	07/10→	OM 651.940	Diesel	2143	4	16	39
Viano MPV	01/10→12/12	M 272.924	Petrol	2496	6	18	65
Viano MPV	09/12→03/16	M 272.978	Petrol	3498	6	24	101
Viano MPV	04/13→03/16	M 272.939	Petrol	2996	6	24	87
Vito Box (638)	03/97→07/03	M 111.948	Petrol	1998	4	16	27



















Model	Year Range	Engine	Fuel	CC	Wrench	Screwdriver	Index
Vito Box (638)	03/97→07/03	M 111.950	Petrol	1998	4	16	27
Vito Box (638)	03/97→07/03	M 111.978	Petrol	2295	4	16	50
Vito Box (638)	03/97→07/03	OM 601.942	Diesel	2299	4	8	57
Vito Box (638)	03/97→07/03	OM 601.970	Diesel	2299	4	8	57
Vito Box (638)	03/99→07/03	OM 611.980	Diesel	2151	4	16	46
Vito Box (638)	03/99→07/03	OM 611A (60 KW CDI)	Diesel	2151	4	16	46
Vito Box (638)	03/99→07/03	OM 611LA (75 KW CDI)	Diesel	2151	4	16	46
Vito Box (W447)	10/14→	OM 622.951	Diesel	1598	4	16	12
Vito Box (W447)	10/14→	OM 651.950	Diesel	2143	4	16	39
Vito Box (W447)	09/15→	M 274.920	Petrol	1991	4	16	31
Vito Bus	01/10→03/16	M 272.924	Petrol	2496	6	18	65
Vito Bus	01/10→03/16	OM 646.980	Diesel	2148	4	16	38
Vito Bus	05/13→03/16	M 272.939	Petrol	2996	6	24	87
Vito Bus (638)	02/96→07/03	M 111.948	Petrol	1998	4	16	27
Vito Bus (638)	02/96→07/03	M 111.950	Petrol	1998	4	16	27
Vito Bus (638)	02/96→07/03	OM 601.942	Diesel	2299	4	8	57
Vito Bus (638)	02/96→07/03	OM 601.970	Diesel	2299	4	8	57
Vito Bus (638)	12/96→07/03	M 111.978	Petrol	2295	4	16	50
Vito Bus (638)	03/99→07/03	OM 611.980	Diesel	2151	4	16	46
Vito Bus (638)	03/99→07/03	OM 611A (60 KW CDI)	Diesel	2151	4	16	46
Vito Bus (638)	03/99→07/03	OM 611LA (75 KW CDI)	Diesel	2151	4	16	46
Vito Bus (W639)	09/03→	M 112.951	Petrol	3199	6	18	96
Vito Bus (W639)	09/03→	OM 646.980	Diesel	2148	4	16	46
Vito Bus (W639)	09/03→	OM 646.982	Diesel	2148	4	16	46
Vito Bus (W639)	09/03→	OM 646.983	Diesel	2148	4	16	46
Vito Bus (W639)	06/04→	M 112.976	Petrol	3724	6	18	104
Vito Bus (W639)	07/06→	OM 642.990	Diesel	2987	6	24	94
Vito Bus (W639)	09/07→	M 272.978	Petrol	3498	6	24	101
Vito Bus (W639)	09/07→	OM 646.981	Diesel	2148	4	16	38
Vito Bus (W639)	09/10→	OM 642.890	Diesel	2987	6	24	94
Vito Bus (W639)	09/10→	OM 651.940	Diesel	2143	4	16	39
Vito Mixto (W447)	10/14→	OM 622.951	Diesel	1598	4	16	12
Vito Mixto (W447)	10/14→	OM 651.950	Diesel	2143	4	16	39
Vito / Mixto Box (W639)	09/03→	M 112.951	Petrol	3199	6	18	96
Vito / Mixto Box (W639)	09/03→	OM 646.980	Diesel	2148	4	16	46
Vito / Mixto Box (W639)	09/03→	OM 646.982	Diesel	2148	4	16	46
Vito / Mixto Box (W639)	09/03→	OM 646.983	Diesel	2148	4	16	46
Vito / Mixto Box (W639)	06/04→07/08	M 112.976	Petrol	3724	6	18	104
Vito / Mixto Box (W639)	07/06→	OM 642.990	Diesel	2987	6	24	94
Vito / Mixto Box (W639)	08/06→	OM 646.981	Diesel	2148	4	16	38
Vito / Mixto Box (W639)	09/07→	M 272.978	Petrol	3498	6	24	101
Vito / Mixto Box (W639)	09/10→	OM 642.890	Diesel	2987	6	24	94
Vito / Mixto Box (W639)	09/10→	OM 651.940	Diesel	2143	4	16	39
Vito Tourer (W447)	10/14→	OM 622.951	Diesel	1598	4	16	12
Vito Tourer (W447)	10/14→	OM 651.950	Diesel	2143	4	16	39
Vito Tourer (W447)	09/15→	M 274.920	Petrol	1991	4	16	31
XJ 40, 81	10/86→07/89	9DPANA	Petrol	3590	6	12	102
XJ 40, 81	09/89→09/94	9EPCNA	Petrol	3980	6	24	110









	CC				9		CC				9
7P	5344	12	24	Petrol	135	M 110.985	2746	6	12	Petrol	71
9DPANA	3590	6	12	Petrol	102	M 110.986	2746	6	12	Petrol	71
9EPCNA	3980	6	24	Petrol	110	M 110.987	2746	6	12	Petrol	71
M 102.910	1797	4	8	Petrol	15	M 110.988	2746	6	12	Petrol	71
M 102.919	1797	4	8	Petrol	15	M 110.989	2746	6	12	Petrol	71
M 102.920	1997	4	8	Petrol	26	M 110.990	2746	6	12	Petrol	71
M 102.921	1996	4	8	Petrol	26	M 110.991	2746	6	12	Petrol	72
M 102.922	1996	4	8	Petrol	26	M 110.992	2746	6	12	Petrol	72
M 102.924	1996	4	8	Petrol	26	M 110.994	2746	6	12	Petrol	71
M 102.938	1997	4	8	Petrol	26	M 111.920	1799	4	16	Petrol	16
M 102.939	1997	4	8	Petrol	26	M 111.921	1799	4	16	Petrol	16
M 102.942	2298	4	8	Petrol	49	M 111.940	1998	4	16	Petrol	27
M 102.943	2299	4	8	Petrol	49	M 111.941	1998	4	16	Petrol	27
M 102.945	2298	4	8	Petrol	49	M 111.942	1998	4	16	Petrol	27
M 102.946	2298	4	8	Petrol	49	M 111.943	1998	4	16	Petrol	27
M 102.955	2299	4	8	Petrol	49	M 111.944	1998	4	16	Petrol	27
M 102.958	2299	4	8	Petrol	49	M 111.945	1998	4	16	Petrol	27
M 102.959	2299	4	8	Petrol	49	M 111.946	1998	4	16	Petrol	27
M 102.961	1996	4	8	Petrol	26	M 111.947	1998	4	16	Petrol	27
M 102.962	1996	4	8	Petrol	26	M 111.948	1998	4	16	Petrol	27
M 102.963	1996	4	8	Petrol	26	M 111.950	1998	4	16	Petrol	27
M 102.964	1997	4	8	Petrol	26	M 111.951	1998	4	16	Petrol	27
M 102.965	1996	4	8	Petrol	26	M 111.952	1998	4	16	Petrol	27
M 102.979	2299	4	8	Petrol	49	M 111.955	1998	4	16	Petrol	27
M 102.980	2299	4	8	Petrol	49	M 111.956	1998	4	16	Petrol	27
M 102.981	2299	4	8	Petrol	49	M 111.957	1998	4	16	Petrol	27
M 102.982	2298	4	8	Petrol	49	M 111.958	1998	4	16	Petrol	27
M 102.983	2298	4	16	Petrol	49	M 111.960	2199	4	16	Petrol	40
M 102.985	2298	4	8	Petrol	49	M 111.961	2199	4	16	Petrol	40
M 102.987	2299	4	8	Petrol	49	M 111.970	2295	4	16	Petrol	50
M 102.989	2298	4	8	Petrol	49	M 111.973	2295	4	16	Petrol	50
M 102.990	2498	4	16	Petrol	61	M 111.974	2295	4	16	Petrol	50
M 102.991	2498	4	16	Petrol	61	M 111.975	2295	4	16	Petrol	50
M 102.992	2498	4	8	Petrol	61	M 111.977	2295	4	16	Petrol	50
M 102.996	2298	4	8	Petrol	49	M 111.978	2295	4	16	Petrol	50
M 102.997	2299	4	8	Petrol	49	M 111.979	2295	4	16	Petrol	50
M 102.998	2299	4	8	Petrol	49	M 111.980	2295	4	16	Petrol	51
M 103.940	2597	6	12	Petrol	69	M 111.981	2295	4	16	Petrol	50
M 103.941	2597	6	12	Petrol	62	M 111.982	2295	4	16	Petrol	50
M 103.942	2597	6	12	Petrol	69	M 111.983	2295	4	16	Petrol	50
M 103.943	2597	6	12	Petrol	69	M 111.984	2295	4	16	Petrol	50
M 103.980	2960	6	12	Petrol	85	M 112.910	2398	6	18	Petrol	59
M 103.981	2960	6	12	Petrol	85	M 112.911	2398	6	18	Petrol	59
M 103.982	2960	6	12	Petrol	80	M 112.912	2597	6	18	Petrol	70
M 103.983	2960	6	12	Petrol	85	M 112.913	2597	6	18	Petrol	70
M 103.984	2960	6	12	Petrol	85	M 112.914	2597	6	18	Petrol	70
M 103.985	2960	6	12	Petrol	85	M 112.915	2597	6	18	Petrol	70
M 103.987	2960	6	12	Petrol	85	M 112.916	2597	6	18	Petrol	70
M 104.900	2792	6	12	Petrol	74	M 112.917	2597	6	18	Petrol	70
M 104.941	2799	6	24	Petrol	75	M 112.920	2799	6	18	Petrol	76
M 104.941 (AMG 3.6)	3606	6	24	Petrol	103	M 112.921	2799	6	18	Petrol	76
M 104.942	2799	6	24	Petrol	75	M 112.922	2799	6	18	Petrol	76
M 104.943	2799	6	24	Petrol	75	M 112.923	2799	6	18	Petrol	76
M 104.944	2799	6	24	Petrol	75	M 112.925	2799	6	18	Petrol	76
M 104.945	2799	6	24	Petrol	75	M 112.940	3199	6	18	Petrol	96
M 104.980	2960	6	24	Petrol	86	M 112.941	3199	6	18	Petrol	96
M 104.981	2960	6	24	Petrol	86	M 112.942	3199	6	18	Petrol	96
M 104.990	3199	6	24	Petrol	95	M 112.943	3199	6	18	Petrol	96
M 104.991	3199	6	24	Petrol	95	M 112.944	3199	6	18	Petrol	96
M 104.992	3199	6	24	Petrol	95	M 112.945	3199	6	18	Petrol	96
M 104.992 (AMG 3.6)	3606	6	24	Petrol	103	M 112.946	3199	6	18	Petrol	96
M 104.994	3199	6	24	Petrol	95	M 112.947	3199	6	18	Petrol	96
M 104.995	3199	6	24	Petrol	95	M 112.949	3199	6	18	Petrol	96
M 104.996	3199	6	24	Petrol	95	M 112.951	3199	6	18	Petrol	96
M 104.996 (AMG 3.6)	3606	6	24	Petrol	103	M 112.953	3199	6	18	Petrol	96
M 108.920	2496	6	12	Petrol	63	M 112.954	3199	6	18	Petrol	96
M 108.924	2496	6	12	Petrol	63	M 112.955	3199	6	18	Petrol	96
M 110.921	2746	6	12	Petrol	71	M 112.960	3199	6	18	Petrol	96
M 110.922	2746	6	12	Petrol	71	M 112.961	3199	6	18	Petrol	96
M 110.923	2746	6	12	Petrol	71	M 112.970	3724	6	18	Petrol	104
M 110.924	2746	6	12	Petrol	71	M 112.972	3724	6	18	Petrol	104
M 110.926	2746	6	12	Petrol	71	M 112.973	3724	6	18	Petrol	104
M 110.931	2746	6	12	Petrol	72	M 112.975	3724	6	18	Petrol	104
M 110.932	2746	6	12	Petrol	72	M 112.976	3724	6	18	Petrol	104
M 110.981	2746	6	12	Petrol	71	M 113.940	4266	8	24	Petrol	120
M 110.982	2746	6	12	Petrol	71	M 113.941	4266	8	24	Petrol	120
M 110.983	2746	6	12	Petrol	71	M 113.942	4266	8	24	Petrol	120
M 110.984	2746	6	12	Petrol	71	M 113.943	4266	8	24	Petrol	120









	CC				9		CC				9
M 113.944	4266	8	24	Petrol	120	M 117.967	5547	8	16	Petrol	139
M 113.948	4266	8	24	Petrol	120	M 117.968	5547	8	16	Petrol	139
M 113.960	4966	8	24	Petrol	129	M 117.981	4520	8	16	Petrol	123
M 113.961	4966	8	24	Petrol	129	M 117.982	4520	8	16	Petrol	123
M 113.962	4966	8	24	Petrol	129	M 117.983	4520	8	16	Petrol	123
M 113.963	4966	8	24	Petrol	129	M 117.984	4520	8	16	Petrol	123
M 113.964	4966	8	24	Petrol	129	M 117.985	4520	8	16	Petrol	123
M 113.965	4966	8	24	Petrol	129	M 117.986	4520	8	16	Petrol	123
M 113.966	4966	8	24	Petrol	129	M 117.992	4520	8	16	Petrol	123
M 113.967	4966	8	24	Petrol	129	M 117.993	4520	8	16	Petrol	123
M 113.968	4966	8	24	Petrol	129	M 119.960	4973	8	32	Petrol	132
M 113.969	4966	8	24	Petrol	129	M 119.970	4973	8	32	Petrol	132
M 113.971	4966	8	24	Petrol	129	M 119.971	4196	8	32	Petrol	116
M 113.980	5439	8	24	Petrol	137	M 119.972	4973	8	32	Petrol	132
M 113.981	5439	8	24	Petrol	137	M 119.974	4973	8	32	Petrol	132
M 113.982	5439	8	24	Petrol	138	M 119.975	4196	8	32	Petrol	116
M 113.984	5439	8	24	Petrol	137	M 119.980	4973	8	32	Petrol	133
M 113.985	5439	8	24	Petrol	138	M 119.981	4196	8	32	Petrol	117
M 113.986	5439	8	24	Petrol	138	M 119.982	4973	8	32	Petrol	133
M 113.987	5439	8	24	Petrol	138	M 119.985	4196	8	32	Petrol	117
M 113.988	5439	8	24	Petrol	137	M 119.985 (AMG 5.0)	4973	8	32	Petrol	133
M 113.989	5439	8	24	Petrol	138	M 120.980	5987	12	48	Petrol	148
M 113.990	5439	8	24	Petrol	137	M 120.981	5987	12	48	Petrol	149
M 113.991	5439	8	24	Petrol	138	M 120.982	5987	12	48	Petrol	150
M 113.992	5439	8	24	Petrol	138	M 120.983	5987	12	48	Petrol	150
M 113.993	5439	8	24	Petrol	137	M 121.920	1884	4	8	Petrol	23
M 113.994	5439	8	24	Petrol	137	M 121.921	1897	4	8	Petrol	23
M 113.995	5439	8	24	Petrol	137	M 121.922	1897	4	8	Petrol	23
M 114.920	2496	6	12	Petrol	63	M 121.924	1884	4	8	Petrol	23
M 114.980	2496	6	12	Petrol	63	M 121.928	1897	4	8	Petrol	23
M 114.981	2496	6	12	Petrol	63	M 121.940	1988	4	8	Petrol	29
M 115.920	2197	4	8	Petrol	41	M 121.941	1988	4	8	Petrol	29
M 115.921	2197	4	8	Petrol	41	M 121.942	1988	4	8	Petrol	29
M 115.922	2197	4	8	Petrol	41	M 121.943	1988	4	8	Petrol	29
M 115.923	1988	4	8	Petrol	28	M 121.944	1988	4	8	Petrol	29
M 115.924	2197	4	8	Petrol	41	M 123.920	2525	6	12	Petrol	63
M 115.926	1988	4	8	Petrol	28	M 123.921	2525	6	12	Petrol	63
M 115.927	2197	4	8	Petrol	41	M 127.980	2180	6	12	Petrol	42
M 115.928	2197	4	8	Petrol	41	M 127.981	2306	6	12	Petrol	53
M 115.929	2197	4	8	Petrol	41	M 127.982	2180	6	12	Petrol	42
M 115.932	2197	4	8	Petrol	41	M 127.984	2180	6	12	Petrol	42
M 115.933	2197	4	8	Petrol	41	M 129.980	2496	6	12	Petrol	63
M 115.934	2197	4	8	Petrol	41	M 129.981	2496	6	12	Petrol	63
M 115.935	2197	4	8	Petrol	41	M 129.982	2496	6	12	Petrol	63
M 115.938	1988	4	8	Petrol	28	M 130.920	2780	6	12	Petrol	71
M 115.939	1988	4	8	Petrol	28	M 130.921	2778	6	12	Petrol	77
M 115.951	2307	4	8	Petrol	52	M 130.922	2778	6	12	Petrol	77
M 115.952	2307	4	8	Petrol	52	M 130.923	2778	6	12	Petrol	71
M 115.954	2307	4	8	Petrol	52	M 130.924	2778	6	12	Petrol	78
M 115.955	2307	4	8	Petrol	52	M 130.925	2778	6	12	Petrol	72
M 115.958	2307	4	8	Petrol	52	M 130.933	2778	6	12	Petrol	77
M 115.970	2307	4	8	Petrol	52	M 130.980	2780	6	12	Petrol	71
M 115.971	2307	4	8	Petrol	52	M 130.981	2778	6	12	Petrol	71
M 115.972	2307	4	8	Petrol	52	M 130.983	2778	6	12	Petrol	71
M 115.973	2307	4	8	Petrol	52	M 130.984	2778	6	12	Petrol	71
M 115.974	2307	4	8	Petrol	52	M 135.950	1499	4	16	Petrol	5
M 116.960	3818	8	16	Petrol	105	M 137.970	5786	12	36	Petrol	147
M 116.961	3818	8	16	Petrol	105	M 137.980	6258	12	36	Petrol	154
M 116.962	3839	8	16	Petrol	105	M 152.980	5461	8	32	Petrol	140
M 116.963	3839	8	16	Petrol	105	M 155.980	5439	8	24	Petrol	137
M 116.964	4196	8	16	Petrol	115	M 156.980	6208	8	32	Petrol	153
M 116.965	4196	8	16	Petrol	115	M 156.981	6208	8	32	Petrol	153
M 116.980	3500	8	16	Petrol	99	M 156.982	6208	8	32	Petrol	153
M 116.981	3500	8	16	Petrol	99	M 156.983	6208	8	32	Petrol	153
M 116.982	3499	8	16	Petrol	99	M 156.984	6208	8	32	Petrol	153
M 116.983	3499	8	16	Petrol	99	M 156.985	6208	8	32	Petrol	153
M 116.984	3499	8	16	Petrol	99	M 157.980	5461	8	32	Petrol	140
M 116.985	3499	8	16	Petrol	99	M 157.981	5461	8	32	Petrol	140
M 116.990	3499	8	16	Petrol	100	M 157.982	5461	8	32	Petrol	140
M 116.991	3499	8	16	Petrol	100	M 157.983	5461	8	32	Petrol	140
M 116.992	3499	8	16	Petrol	100	M 157.984	5461	8	32	Petrol	140
M 116.993	3499	8	16	Petrol	100	M 157.985	5461	8	32	Petrol	140
M 117.960	4973	8	16	Petrol	130	M 159.980	6208	8	32	Petrol	153
M 117.961	4973	8	16	Petrol	130	M 160 E6AL B03	599	3	6	Petrol	1
M 117.962	4973	8	16	Petrol	131	M 160 E6AL B04	599	3	6	Petrol	1
M 117.963	4973	8	16	Petrol	131	M 160 E6AL B05	599	3	6	Petrol	1
M 117.964	4973	8	16	Petrol	131	M 161.971	2295	4	8	Petrol	54
M 117.965	4973	8	16	Petrol	128	M 166.940	1397	4	8	Petrol	4









	CC				9		CC				9
M 166.960	1598	4	8	Petrol	9	M 272.948	2996	6	24	Petrol	87
M 166.961	1598	4	8	Petrol	9	M 272.949	2996	6	24	Petrol	87
M 166.990	1898	4	8	Petrol	24	M 272.952	2996	6	24	Petrol	87
M 166.991	1898	4	8	Petrol	24	M 272.952	2996	6	24	Petrol	87
M 166.995	2084	4	8	Petrol	37	M 272.960	3498	6	24	Petrol	101
M 180.922	2195	6	12	Petrol	42	M 272.961	3498	6	24	Petrol	101
M 180.924	2180	6	12	Petrol	42	M 272.962	3498	6	24	Petrol	101
M 180.926	2195	6	12	Petrol	42	M 272.963	3498	6	24	Petrol	101
M 180.927	2195	6	12	Petrol	42	M 272.964	3498	6	24	Petrol	101
M 180.928	2195	6	12	Petrol	42	M 272.964	3498	6	24	Petrol	101
M 180.929	2195	6	12	Petrol	42	M 272.965	3498	6	24	Petrol	101
M 180.940	2180	6	12	Petrol	42	M 272.966	3498	6	24	Petrol	101
M 180.941	2180	6	12	Petrol	42	M 272.967	3498	6	24	Petrol	101
M 180.942	2195	6	12	Petrol	42	M 272.968	3498	6	24	Petrol	101
M 180.943	2195	6	12	Petrol	42	M 272.969	3498	6	24	Petrol	101
M 180.945	2281	6	12	Petrol	55	M 272.970	3498	6	24	Petrol	101
M 180.947	2281	6	12	Petrol	53	M 272.971	3498	6	24	Petrol	101
M 180.949	2281	6	12	Petrol	53	M 272.972	3498	6	24	Petrol	101
M 180.950	2281	6	12	Petrol	53	M 272.973	3498	6	24	Petrol	101
M 180.951	2306	6	12	Petrol	55	M 272.974	3498	6	24	Petrol	101
M 180.952	2195	6	12	Petrol	42	M 272.975	3498	6	24	Petrol	101
M 180.953	2195	6	12	Petrol	42	M 272.977	3498	6	24	Petrol	101
M 180.954	2292	6	12	Petrol	53	M 272.978	3498	6	24	Petrol	101
M 180.955	2292	6	12	Petrol	53	M 272.978	3498	6	24	Petrol	101
M 180.958	2196	6	24	Petrol	42	M 272.979	3498	6	24	Petrol	101
M 200.711	1197	4	16	Petrol	3	M 272.980	3498	6	24	Petrol	101
M 266.920	1498	4	8	Petrol	6	M 272.982	3498	6	24	Petrol	101
M 266.940	1699	4	8	Petrol	13	M 272.983	3498	6	24	Petrol	101
M 266.960	2034	4	8	Petrol	30	M 272.984	3498	6	24	Petrol	101
M 266.980	2034	4	8	Petrol	30	M 272.985	3498	6	24	Petrol	101
M 270.910	1595	4	16	Petrol	10	M 272.988	3498	6	24	Petrol	101
M 270.910	1595	4	16	Petrol	10	M 272.991	3498	6	24	Petrol	101
M 270.920	1991	4	16	Petrol	31	M 273.922	4663	8	32	Petrol	125
M 271.820	1796	4	16	Petrol	17	M 273.923	4663	8	32	Petrol	125
M 271.820	1796	4	16	Petrol	17	M 273.924	4663	8	32	Petrol	125
M 271.860	1796	4	16	Petrol	17	M 273.960	5461	8	32	Petrol	140
M 271.860	1796	4	16	Petrol	17	M 273.961	5461	8	32	Petrol	140
M 271.861	1796	4	16	Petrol	17	M 273.962	5461	8	32	Petrol	140
M 271.910	1597	4	16	Petrol	11	M 273.963	5461	8	32	Petrol	140
M 271.910	1597	4	16	Petrol	11	M 273.965	5461	8	32	Petrol	140
M 271.911	1597	4	16	Petrol	11	M 273.966	5461	8	32	Petrol	140
M 271.921	1796	4	16	Petrol	18	M 273.967	5461	8	32	Petrol	140
M 271.940	1796	4	16	Petrol	18	M 273.968	5461	8	32	Petrol	140
M 271.941	1796	4	16	Petrol	18	M 273.970	5461	8	32	Petrol	140
M 271.941	1796	4	16	Petrol	18	M 273.971	5461	8	32	Petrol	140
M 271.942	1796	4	16	Petrol	19	M 274.910	1595	4	16	Petrol	10
M 271.944	1795	4	16	Petrol	18	M 274.910	1595	4	16	Petrol	10
M 271.946	1796	4	16	Petrol	18	M 274.920	1991	4	16	Petrol	31
M 271.948	1796	4	16	Petrol	18	M 274.920	1991	4	16	Petrol	31
M 271.950	1796	4	16	Petrol	20	M 275.950	5513	12	36	Petrol	141
M 271.951	1796	4	16	Petrol	20	M 275.951	5513	12	36	Petrol	141
M 271.952	1796	4	16	Petrol	20	M 275.953	5513	12	36	Petrol	141
M 271.954	1796	4	16	Petrol	17	M 275.954	5513	12	36	Petrol	141
M 271.955	1796	4	16	Petrol	20	M 275.980	5980	12	36	Petrol	151
M 271.956	1796	4	16	Petrol	20	M 275.981	5980	12	36	Petrol	151
M 271.956	1796	4	16	Petrol	21	M 275.982	5980	12	36	Petrol	151
M 271.957	1796	4	16	Petrol	20	M 275.983	5980	12	36	Petrol	151
M 271.958	1796	4	16	Petrol	17	M 276.820	2996	6	24	Petrol	87
M 272.911	2496	6	24	Petrol	64	M 276.820	2996	6	24	Petrol	87
M 272.920	2496	6	24	Petrol	64	M 276.821	2996	6	24	Petrol	87
M 272.921	2496	6	24	Petrol	64	M 276.822	2996	6	24	Petrol	87
M 272.921	2496	6	24	Petrol	64	M 276.823	2996	6	24	Petrol	87
M 272.922	2496	6	24	Petrol	64	M 276.823	2996	6	24	Petrol	87
M 272.922	2496	6	24	Petrol	64	M 276.824	2996	6	24	Petrol	87
M 272.924	2496	6	18	Petrol	65	M 276.825	2996	6	24	Petrol	87
M 272.939	2996	6	24	Petrol	87	M 276.826	2996	6	24	Petrol	88
M 272.940	2996	6	24	Petrol	87	M 276.850	3498	6	24	Petrol	101
M 272.940	2996	6	24	Petrol	87	M 276.853	3498	6	24	Petrol	101
M 272.941	2996	6	24	Petrol	87	M 276.925	2996	6	24	Petrol	87
M 272.942	2996	6	24	Petrol	87	M 276.950	3498	6	24	Petrol	101
M 272.943	2996	6	24	Petrol	87	M 276.952	3498	6	24	Petrol	101
M 272.943	2996	6	24	Petrol	87	M 276.952	3498	6	24	Petrol	101
M 272.944	2996	6	24	Petrol	87	M 276.954	3498	6	24	Petrol	101
M 272.945	2996	6	24	Petrol	87	M 276.955	3498	6	24	Petrol	101
M 272.946	2996	6	24	Petrol	87	M 276.956	3498	6	24	Petrol	101
M 272.947	2996	6	24	Petrol	87	M 276.957	3498	6	24	Petrol	101
M 272.947	2996	6	24	Petrol	87	M 276.958	3498	6	24	Petrol	101
M 272.948	2996	6	24	Petrol	87	M 276.960	3498	6	24	Petrol	101









	CC				9		CC				9
M 277.980	5980	12	36	Petrol	151	OM 326.918	10809	6	24	Diesel	170
M 278.910	3996	8	32	Petrol	111	OM 326.971	10809	6	24	Diesel	170
M 278.912	3996	8	32	Petrol	111	OM 326.972	10809	6	24	Diesel	170
M 278.920	4663	8	32	Petrol	125	OM 326.973	10809	6	24	Diesel	170
M 278.922	4663	8	32	Petrol	125	OM 326.974	10809	6	24	Diesel	170
M 278.927	4663	8	32	Petrol	125	OM 326.975	10809	6	24	Diesel	170
M 278.928	4663	8	32	Petrol	125	OM 326.977	10809	6	24	Diesel	170
M 278.929	4663	8	32	Petrol	125	OM 326.980	10809	6	24	Diesel	170
M 278.932	4663	8	32	Petrol	125	OM 326.983	10809	6	24	Diesel	170
M 279.980	5980	12	36	Petrol	151	OM 326.988	10809	6	24	Diesel	170
M 279.981	5980	12	36	Petrol	151	OM 327.910	7980	6	12	Diesel	162
M 279.982	5980	12	36	Petrol	151	OM 327.914	7980	6	12	Diesel	162
M 285.950	5513	12	36	Petrol	141	OM 327.915	7980	6	12	Diesel	162
M 285.950	5513	12	36	Petrol	141	OM 327.916	7980	6	12	Diesel	162
M 285.980	5980	12	36	Petrol	151	OM 327.917	7980	6	12	Diesel	162
M 476.920	11967	6	12	Gas	176	OM 327.918	7980	6	12	Diesel	162
M 476.921	11967	6	12	Gas	176	OM 327.919	7980	6	12	Diesel	162
M 476.925	11967	6	12	Gas	176	OM 327.931	7980	6	12	Diesel	162
M 476.926	11967	6	12	Gas	176	OM 327.932	7980	6	12	Diesel	162
M 476.927	11967	6	12	Gas	176	OM 327.933	7980	6	12	Diesel	162
M 476.930	11967	6	12	Gas	176	OM 327.934	7980	6	12	Diesel	162
M 476.932	11967	6	12	Gas	176	OM 327.935	7980	6	12	Diesel	162
M 476.933	11967	6	12	Gas	176	OM 327.936	7980	6	12	Diesel	162
M 476.934	11967	6	12	Gas	176	OM 327.937	7980	6	12	Diesel	162
M 476.935	11967	6	12	Gas	176	OM 327.938	7980	6	12	Diesel	162
M 476.936	11967	6	12	Gas	176	OM 327.939	7980	6	12	Diesel	162
M 476.937	11967	6	12	Gas	176	OM 327.940	7980	6	12	Diesel	162
M 902.900	7201	6	18	Gas	158	OM 327.941	7980	6	12	Diesel	162
M 902.901	7201	6	18	Gas	158	OM 327.942	7980	6	12	Diesel	162
M 902.902	7201	6	18	Gas	158	OM 327.943	7980	6	12	Diesel	162
M 902.903	7201	6	18	Gas	158	OM 327.944	7980	6	12	Diesel	162
M 906.900	6884	6	18	Gas	157	OM 327.945	7980	6	12	Diesel	162
M 906.901	6884	6	18	Gas	157	OM 327.946	7980	6	12	Diesel	162
M 906.903	6884	6	18	Gas	157	OM 335.910	11581	6	12	Diesel	175
OM 312.954	4580	6	12	Diesel	124	OM 335.930	11581	6	12	Diesel	175
OM 314.900	3780	4	8	Diesel	106	OM 335.932	11581	6	12	Diesel	175
OM 314.910	3780	4	8	Diesel	106	OM 340.932	3780	4	8	Diesel	109
OM 314.914	3782	4	8	Diesel	106	OM 341.900	5675	6	12	Diesel	142
OM 314.915	3780	4	8	Diesel	106	OM 341.910	5675	6	12	Diesel	142
OM 314.916	3780	4	8	Diesel	106	OM 341.911	5675	6	12	Diesel	142
OM 314.917	3780	4	8	Diesel	106	OM 341.912	5675	6	12	Diesel	142
OM 314.918	3782	4	8	Diesel	106	OM 341.913	5675	6	12	Diesel	142
OM 314.919	3782	4	8	Diesel	106	OM 341.915	5675	6	12	Diesel	142
OM 314.920	3782	4	8	Diesel	107	OM 341.918	5675	6	12	Diesel	142
OM 314.921	3782	4	8	Diesel	107	OM 341.919	5675	6	12	Diesel	142
OM 314.922	3782	4	8	Diesel	107	OM 341.931	5675	6	12	Diesel	142
OM 314.940	3782	4	8	Diesel	106	OM 341.932	5675	6	12	Diesel	142
OM 314.941	3782	4	8	Diesel	106	OM 341.933	5675	6	12	Diesel	142
OM 314.942	3782	4	8	Diesel	106	OM 341.934	5675	6	12	Diesel	142
OM 314.943	3782	4	8	Diesel	106	OM 341.935	5675	6	12	Diesel	142
OM 314.944	3780	4	8	Diesel	106	OM 341.936	5675	6	12	Diesel	142
OM 314.945	3782	4	8	Diesel	106	OM 341.937	5675	6	12	Diesel	142
OM 314.946	3780	4	8	Diesel	106	OM 341.938	5675	6	12	Diesel	142
OM 314.947	3782	4	8	Diesel	106	OM 341.939	5675	6	12	Diesel	142
OM 314.948	3780	4	8	Diesel	106	OM 341.941	5675	6	12	Diesel	142
OM 314.949	3782	4	8	Diesel	106	OM 341.943	5675	6	12	Diesel	142
OM 314.950	3782	4	8	Diesel	106	OM 341.946	5675	6	12	Diesel	142
OM 314.951	3782	4	8	Diesel	106	OM 341.947	5675	6	12	Diesel	142
OM 314.953	3780	4	8	Diesel	106	OM 341.948	5675	6	12	Diesel	142
OM 314.954	3782	4	8	Diesel	106	OM 341.949	5675	6	12	Diesel	142
OM 314.956	3782	4	8	Diesel	106	OM 341.950	5675	6	12	Diesel	142
OM 314.957	3782	4	8	Diesel	106	OM 341.951	5675	6	12	Diesel	142
OM 314.958	3782	4	8	Diesel	106	OM 341.995	5675	6	12	Diesel	142
OM 314.959	3780	4	8	Diesel	106	OM 341.996	5675	6	12	Diesel	142
OM 314.960	3782	4	8	Diesel	106	OM 343.910	3780	4	8	Diesel	109
OM 314.961	3780	4	8	Diesel	106	OM 343.932	3780	4	8	Diesel	109
OM 314.962	3780	4	8	Diesel	106	OM 343.934	3780	4	8	Diesel	109
OM 314.963	3780	4	8	Diesel	106	OM 344.905	5675	6	12	Diesel	142
OM 314.964	3780	4	8	Diesel	108	OM 344.912	5675	6	12	Diesel	142
OM 314.965	3780	4	8	Diesel	108	OM 344.913	5675	6	12	Diesel	143
OM 314.967	3780	4	8	Diesel	106	OM 344.930	5675	6	12	Diesel	142
OM 314.968	3782	4	8	Diesel	106	OM 344.931	5675	6	12	Diesel	142
OM 314.970	3782	4	8	Diesel	106	OM 344.932	5675	6	12	Diesel	142
OM 326.910	10809	6	24	Diesel	170	OM 344.933	5675	6	12	Diesel	142
OM 326.911	10809	6	24	Diesel	170	OM 344.934	5675	6	12	Diesel	143
OM 326.912	10809	6	24	Diesel	170	OM 344.937	5675	6	12	Diesel	143
OM 326.914	10809	6	24	Diesel	170	OM 344.938	5675	6	12	Diesel	143
OM 326.915	10809	6	24	Diesel	170	OM 344.939	5675	6	12	Diesel	143









	CC				9		CC				9
OM 344.940	5675	6	12	Diesel	143	OM 352.934	5675	6	12	Diesel	143
OM 344.941	5675	6	12	Diesel	142	OM 352.935	5675	6	12	Diesel	143
OM 344.943	5675	6	12	Diesel	142	OM 352.936	5675	6	12	Diesel	143
OM 344.944	5675	6	12	Diesel	142	OM 352.937	5675	6	12	Diesel	143
OM 344.945	5675	6	12	Diesel	142	OM 352.938	5675	6	12	Diesel	143
OM 344.946	5675	6	12	Diesel	142	OM 352.939	5675	6	12	Diesel	143
OM 344.948	5675	6	12	Diesel	143	OM 352.942	5675	6	12	Diesel	143
OM 344.949	5675	6	12	Diesel	143	OM 352.943	5675	6	12	Diesel	143
OM 344.951	5675	6	12	Diesel	143	OM 352.944	5675	6	12	Diesel	143
OM 344.952	5675	6	12	Diesel	143	OM 352.945	5675	6	12	Diesel	143
OM 344.963	5675	6	12	Diesel	142	OM 352.946	5675	6	12	Diesel	143
OM 345.900	9651	5	10	Diesel	167	OM 352.948	5675	6	12	Diesel	143
OM 345.910	11581	6	12	Diesel	175	OM 352.949	5675	6	12	Diesel	143
OM 345.912	11581	6	12	Diesel	175	OM 352.950	5675	6	12	Diesel	143
OM 345.913	11581	6	12	Diesel	175	OM 352.953	5675	6	12	Diesel	143
OM 345.914	11581	6	12	Diesel	175	OM 352.954	5675	6	12	Diesel	143
OM 345.915	9651	5	10	Diesel	167	OM 352.955	5675	6	12	Diesel	143
OM 345.919	9651	5	10	Diesel	167	OM 352.959	5675	6	12	Diesel	143
OM 345.932	11581	6	12	Diesel	175	OM 352.963	5675	6	12	Diesel	143
OM 345.933	11581	6	12	Diesel	175	OM 352.964	5675	6	12	Diesel	143
OM 345.936	11581	6	12	Diesel	175	OM 352.965	5675	6	12	Diesel	143
OM 345.937	11581	6	12	Diesel	175	OM 352.966	5675	6	12	Diesel	143
OM 345.941	9651	5	10	Diesel	167	OM 352.967	5675	6	12	Diesel	143
OM 345.942	9651	5	10	Diesel	167	OM 352.968	5675	6	12	Diesel	143
OM 345.945	9651	5	10	Diesel	167	OM 352.969	5675	6	12	Diesel	143
OM 345.946	9651	5	10	Diesel	167	OM 352.970	5675	6	12	Diesel	143
OM 345.947	9651	5	10	Diesel	167	OM 352.971	5675	6	12	Diesel	143
OM 345.949	9651	5	10	Diesel	167	OM 352.972	5675	6	12	Diesel	143
OM 345.960	11581	6	12	Diesel	175	OM 352.973	5675	6	12	Diesel	143
OM 345.972	9651	5	10	Diesel	165	OM 352.974	5675	6	12	Diesel	143
OM 345.973	9651	5	10	Diesel	165	OM 352.975	5675	6	12	Diesel	143
OM 345.975	9651	5	10	Diesel	165	OM 352.976	5675	6	12	Diesel	143
OM 346.910	10809	6	12	Diesel	170	OM 352.978	5675	6	12	Diesel	143
OM 346.911	10809	6	12	Diesel	170	OM 352.979	5675	6	12	Diesel	143
OM 346.912	10809	6	12	Diesel	170	OM 352.980	5675	6	12	Diesel	143
OM 346.913	10809	6	12	Diesel	170	OM 352.981	5675	6	12	Diesel	143
OM 346.914	10809	6	12	Diesel	170	OM 352.982	5675	6	12	Diesel	143
OM 346.915	10809	6	12	Diesel	170	OM 352.983	5675	6	12	Diesel	143
OM 346.916	10809	6	12	Diesel	170	OM 352.984	5675	6	12	Diesel	143
OM 346.917	10809	6	12	Diesel	170	OM 352.985	5675	6	12	Diesel	143
OM 346.918	10809	6	12	Diesel	170	OM 352.986	5700	6	12	Diesel	143
OM 346.919	10809	6	12	Diesel	170	OM 352.987	5675	6	12	Diesel	143
OM 346.940	10809	6	12	Diesel	170	OM 352.988	5675	6	12	Diesel	143
OM 346.941	10809	6	12	Diesel	170	OM 352.989	5675	6	12	Diesel	143
OM 346.942	10809	6	12	Diesel	170	OM 352.990	5675	6	12	Diesel	143
OM 346.943	10809	6	12	Diesel	170	OM 352.991	5675	6	12	Diesel	143
OM 346.944	10809	6	12	Diesel	170	OM 352.992	5675	6	12	Diesel	143
OM 346.945	10809	6	12	Diesel	170	OM 352.993	5675	6	12	Diesel	143
OM 346.946	10809	6	12	Diesel	170	OM 352.994	5675	6	12	Diesel	143
OM 346.947	10809	6	12	Diesel	170	OM 352.996	5675	6	12	Diesel	143
OM 346.952	10809	6	12	Diesel	170	OM 352.997	5675	6	12	Diesel	143
OM 346.953	10809	6	12	Diesel	170	OM 352.998	5675	6	12	Diesel	143
OM 347.915	9651	5	10	Diesel	165	OM 352.999	5675	6	12	Diesel	143
OM 347.942	9651	5	10	Diesel	165	OM 353.900	5675	6	12	Diesel	143
OM 347.943	9651	5	10	Diesel	165	OM 353.901	5675	6	12	Diesel	143
OM 352.901	5675	6	12	Diesel	143	OM 353.902	5675	6	12	Diesel	143
OM 352.902	5670	6	12	Diesel	143	OM 353.903	5675	6	12	Diesel	143
OM 352.903	5675	6	12	Diesel	143	OM 353.904	5675	6	12	Diesel	143
OM 352.904	5675	6	12	Diesel	143	OM 353.905	5680	6	12	Diesel	143
OM 352.905	5680	6	12	Diesel	143	OM 353.906	5680	6	12	Diesel	144
OM 352.906	5675	6	12	Diesel	143	OM 353.907	5675	6	12	Diesel	143
OM 352.907	5700	6	12	Diesel	143	OM 353.909	5675	6	12	Diesel	143
OM 352.908	5675	6	12	Diesel	143	OM 353.910	5675	6	12	Diesel	143
OM 352.909	5675	6	12	Diesel	143	OM 353.911	5675	6	12	Diesel	143
OM 352.910	5675	6	12	Diesel	143	OM 353.912	5675	6	12	Diesel	143
OM 352.911	5675	6	12	Diesel	143	OM 353.913	5675	6	12	Diesel	143
OM 352.912	5675	6	12	Diesel	143	OM 353.914	5675	6	12	Diesel	143
OM 352.913	5675	6	12	Diesel	143	OM 353.915	5675	6	12	Diesel	143
OM 352.914	5675	6	12	Diesel	143	OM 353.916	5675	6	12	Diesel	143
OM 352.915	5675	6	12	Diesel	143	OM 353.917	5675	6	12	Diesel	143
OM 352.916	5675	6	12	Diesel	143	OM 353.920	5675	6	12	Diesel	142
OM 352.917	5675	6	12	Diesel	143	OM 353.921	5675	6	12	Diesel	144
OM 352.918	5675	6	12	Diesel	143	OM 353.922	5675	6	12	Diesel	144
OM 352.919	5675	6	12	Diesel	143	OM 353.923	5675	6	12	Diesel	144
OM 352.930	5675	6	12	Diesel	143	OM 353.930	5675	6	12	Diesel	144
OM 352.931	5675	6	12	Diesel	143	OM 353.931	5675	6	12	Diesel	142
OM 352.932	5675	6	12	Diesel	143	OM 353.932	5675	6	12	Diesel	144
OM 352.933	5675	6	12	Diesel	143	OM 353.933	5675	6	12	Diesel	142









	CC				9		CC				9
OM 353.934	5675	6	12	Diesel	142	OM 355.964	11581	6	24	Diesel	175
OM 353.935	5675	6	12	Diesel	142	OM 355.965	11581	6	12	Diesel	175
OM 353.936	5675	6	12	Diesel	144	OM 355.966	11581	6	24	Diesel	175
OM 353.937	5675	6	12	Diesel	144	OM 355.967	11581	6	24	Diesel	175
OM 353.938	5675	6	12	Diesel	142	OM 355.968	11581	6	12	Diesel	175
OM 353.939	5675	6	12	Diesel	142	OM 355.969	11581	6	24	Diesel	175
OM 353.940	5675	6	12	Diesel	143	OM 355.970	11581	6	24	Diesel	175
OM 353.941	5675	6	12	Diesel	143	OM 355.972	11581	6	24	Diesel	175
OM 353.942	5700	6	12	Diesel	143	OM 355.973	11581	6	24	Diesel	175
OM 353.943	5700	6	12	Diesel	143	OM 355.974	11581	6	24	Diesel	175
OM 353.944	5700	6	12	Diesel	143	OM 355.975	11581	6	24	Diesel	175
OM 353.945	5700	6	12	Diesel	143	OM 355.976	11581	6	24	Diesel	175
OM 353.946	5700	6	12	Diesel	143	OM 355.977	11581	6	24	Diesel	175
OM 353.949	5675	6	12	Diesel	143	OM 355.978	11581	6	24	Diesel	175
OM 353.950	5700	6	12	Diesel	143	OM 355.979	11581	6	24	Diesel	175
OM 353.951	5700	6	12	Diesel	143	OM 355.980	11581	6	24	Diesel	175
OM 353.952	5700	6	12	Diesel	143	OM 355.981	11581	6	24	Diesel	175
OM 353.953	5700	6	12	Diesel	143	OM 355.982	11581	6	24	Diesel	175
OM 353.954	5700	6	12	Diesel	143	OM 355.983	11581	6	24	Diesel	175
OM 353.957	5675	6	12	Diesel	143	OM 355.984	11581	6	24	Diesel	175
OM 353.958	5675	6	12	Diesel	143	OM 356.901	5958	6	12	Diesel	152
OM 353.959	5675	6	12	Diesel	143	OM 356.902	5958	6	12	Diesel	152
OM 353.960	5675	6	12	Diesel	143	OM 356.903	5958	6	12	Diesel	152
OM 353.961	5675	6	12	Diesel	143	OM 356.904	5958	6	12	Diesel	152
OM 353.962	5675	6	12	Diesel	143	OM 356.905	5958	6	12	Diesel	152
OM 353.963	5675	6	12	Diesel	143	OM 356.906	5958	6	12	Diesel	152
OM 353.964	5700	6	12	Diesel	143	OM 356.907	5958	6	12	Diesel	152
OM 353.965	5675	6	12	Diesel	143	OM 356.908	5958	6	12	Diesel	152
OM 353.966	5675	6	12	Diesel	143	OM 356.909	5958	6	12	Diesel	152
OM 353.967	5675	6	12	Diesel	143	OM 356.910	5958	6	12	Diesel	152
OM 353.968	5675	6	12	Diesel	143	OM 356.911	5958	6	12	Diesel	152
OM 353.969	5675	6	12	Diesel	143	OM 356.912	5958	6	12	Diesel	152
OM 353.970	5700	6	12	Diesel	143	OM 356.913	5958	6	12	Diesel	152
OM 353.971	5700	6	12	Diesel	143	OM 356.914	5958	6	12	Diesel	152
OM 353.972	5675	6	12	Diesel	143	OM 356.915	5958	6	12	Diesel	152
OM 353.973	5675	6	12	Diesel	143	OM 356.916	5958	6	12	Diesel	152
OM 353.974	5675	6	12	Diesel	143	OM 356.940	5958	6	12	Diesel	152
OM 353.975	5700	6	12	Diesel	143	OM 356.941	5958	6	12	Diesel	152
OM 353.976	5675	6	12	Diesel	143	OM 356.943	5958	6	12	Diesel	152
OM 353.977	5675	6	12	Diesel	143	OM 356.944	5958	6	12	Diesel	152
OM 353.978	5675	6	12	Diesel	143	OM 356.945	5958	6	12	Diesel	152
OM 353.980	5675	6	12	Diesel	143	OM 356.946	5958	6	12	Diesel	152
OM 353.981	5675	6	12	Diesel	143	OM 356.947	5958	6	12	Diesel	152
OM 353.982	5675	6	12	Diesel	143	OM 356.948	5958	6	12	Diesel	152
OM 353.983	5675	6	12	Diesel	143	OM 356.949	5958	6	12	Diesel	152
OM 353.984	5675	6	12	Diesel	143	OM 356.950	5958	6	12	Diesel	152
OM 353.985	5675	6	12	Diesel	143	OM 356.951	5958	6	12	Diesel	152
OM 353.988	5675	6	12	Diesel	143	OM 356.952	5958	6	12	Diesel	152
OM 353.989	5675	6	12	Diesel	143	OM 356.953	5958	6	12	Diesel	152
OM 353.991	5675	6	12	Diesel	143	OM 356.954	5958	6	12	Diesel	152
OM 353.995	5675	6	12	Diesel	143	OM 356.955	5958	6	12	Diesel	152
OM 353.997	5675	6	12	Diesel	143	OM 356.956	5958	6	12	Diesel	152
OM 353.998	5675	6	12	Diesel	143	OM 356.957	5958	6	12	Diesel	152
OM 353.999	5675	6	12	Diesel	143	OM 356.958	5958	6	12	Diesel	152
OM 354.900	3972	4	8	Diesel	112	OM 356.959	5958	6	12	Diesel	152
OM 354.901	3972	4	8	Diesel	112	OM 356.977	5958	6	12	Diesel	152
OM 354.902	3972	4	8	Diesel	112	OM 356.978	5958	6	12	Diesel	152
OM 354.903	3972	4	8	Diesel	112	OM 356.979	5958	6	12	Diesel	152
OM 354.920	3972	4	8	Diesel	112	OM 356.980	5958	6	12	Diesel	152
OM 354.921	3972	4	8	Diesel	112	OM 356.981	5958	6	12	Diesel	152
OM 354.922	3972	4	8	Diesel	112	OM 356.983	5958	6	12	Diesel	152
OM 354.923	3972	4	8	Diesel	112	OM 356.984	5958	6	12	Diesel	152
OM 354.924	3972	4	8	Diesel	112	OM 356.985	5958	6	12	Diesel	152
OM 354.925	3972	4	8	Diesel	112	OM 356.986	5958	6	12	Diesel	152
OM 354.926	3972	4	8	Diesel	112	OM 356.987	5958	6	12	Diesel	152
OM 355.910	11581	6	24	Diesel	175	OM 356.988	5958	6	12	Diesel	152
OM 355.911	11581	6	24	Diesel	175	OM 356.989	5958	6	12	Diesel	152
OM 355.912	11581	6	24	Diesel	175	OM 356.990	5958	6	12	Diesel	152
OM 355.913	11581	6	24	Diesel	175	OM 356.991	5958	6	12	Diesel	152
OM 355.914	11581	6	24	Diesel	175	OM 356.992	5958	6	12	Diesel	152
OM 355.915	11581	6	24	Diesel	175	OM 356.993	5958	6	12	Diesel	152
OM 355.916	11581	6	12	Diesel	175	OM 356.994	5958	6	12	Diesel	152
OM 355.917	11581	6	12	Diesel	175	OM 356.995	5958	6	12	Diesel	152
OM 355.918	11581	6	24	Diesel	175	OM 356.996	5958	6	12	Diesel	152
OM 355.960	11581	6	24	Diesel	175	OM 356.997	5958	6	12	Diesel	152
OM 355.961	11581	6	24	Diesel	175	OM 356.998	5958	6	12	Diesel	152
OM 355.962	11581	6	24	Diesel	175	OM 356.999	5958	6	12	Diesel	152
OM 355.963	11581	6	24	Diesel	175	OM 357.900	5958	6	12	Diesel	152









	CC				9		CC				9
OM 357.901	5958	6	12	Diesel	152	OM 360.967	8725	6	12	Diesel	163
OM 357.902	5958	6	12	Diesel	152	OM 360.968	8725	6	12	Diesel	163
OM 357.903	5958	6	12	Diesel	152	OM 360.969	8725	6	12	Diesel	163
OM 357.904	5958	6	12	Diesel	152	OM 360.970	8725	6	12	Diesel	163
OM 357.906	5958	6	12	Diesel	152	OM 360.971	8725	6	12	Diesel	163
OM 357.907	5958	6	12	Diesel	152	OM 360.972	8725	6	12	Diesel	163
OM 357.908	5958	6	12	Diesel	152	OM 360.973	8725	6	12	Diesel	163
OM 357.909	5958	6	12	Diesel	152	OM 360.975	8725	6	12	Diesel	163
OM 357.910	5958	6	12	Diesel	152	OM 360.979	8720	6	12	Diesel	163
OM 357.912	5958	6	12	Diesel	152	OM 360.980	8720	6	12	Diesel	163
OM 357.913	5958	6	12	Diesel	152	OM 360.981	8720	6	12	Diesel	163
OM 357.915	5958	6	12	Diesel	152	OM 360.982	8725	6	12	Diesel	163
OM 357.916	5958	6	12	Diesel	152	OM 360.983	8725	6	12	Diesel	163
OM 357.917	5958	6	12	Diesel	152	OM 360.984	8720	6	12	Diesel	163
OM 357.918	5958	6	12	Diesel	152	OM 360.985	8720	6	12	Diesel	163
OM 357.919	5958	6	12	Diesel	152	OM 360.986	8720	6	12	Diesel	163
OM 357.920	5958	6	12	Diesel	152	OM 362.906	5700	6	12	Diesel	145
OM 357.921	5958	6	12	Diesel	152	OM 362.909	5700	6	12	Diesel	145
OM 357.922	5958	6	12	Diesel	152	OM 362.910	5675	6	12	Diesel	146
OM 357.924	5958	6	12	Diesel	152	OM 364.900	3972	4	8	Diesel	112
OM 357.925	5958	6	12	Diesel	152	OM 364.901	3972	4	8	Diesel	112
OM 357.926	5958	6	12	Diesel	152	OM 364.905	3972	4	8	Diesel	112
OM 357.927	5958	6	12	Diesel	152	OM 364.906	3972	4	8	Diesel	112
OM 357.929	5958	6	12	Diesel	152	OM 364.907	3970	4	8	Diesel	112
OM 357.930	5958	6	12	Diesel	152	OM 364.908	3972	4	8	Diesel	112
OM 357.931	5958	6	12	Diesel	152	OM 364.909	3972	4	8	Diesel	112
OM 357.932	5958	6	12	Diesel	152	OM 364.911	3972	4	8	Diesel	112
OM 357.933	5958	6	12	Diesel	152	OM 364.912	3972	4	8	Diesel	112
OM 357.934	5958	6	12	Diesel	152	OM 364.913	3972	4	8	Diesel	112
OM 357.935	5958	6	12	Diesel	152	OM 364.914	3972	4	8	Diesel	112
OM 357.936	5958	6	12	Diesel	152	OM 364.916	3972	4	8	Diesel	112
OM 357.937	5958	6	12	Diesel	152	OM 364.917	3972	4	8	Diesel	112
OM 357.938	5958	6	12	Diesel	152	OM 364.918	3970	4	8	Diesel	112
OM 357.940	5958	6	12	Diesel	152	OM 364.919	3972	4	8	Diesel	112
OM 357.941	5958	6	12	Diesel	152	OM 364.920	3972	4	8	Diesel	112
OM 357.942	5958	6	12	Diesel	152	OM 364.921	3972	4	8	Diesel	112
OM 357.943	5958	6	12	Diesel	152	OM 364.950	3972	4	8	Diesel	112
OM 357.944	5958	6	12	Diesel	152	OM 364.951	3972	4	8	Diesel	112
OM 357.945	5958	6	12	Diesel	152	OM 364.952	3972	4	8	Diesel	112
OM 357.946	5958	6	12	Diesel	152	OM 364.953	3972	4	8	Diesel	112
OM 357.947	5958	6	12	Diesel	152	OM 364.954	3972	4	8	Diesel	112
OM 357.948	5958	6	12	Diesel	152	OM 364.955	3973	4	8	Diesel	112
OM 357.949	5958	6	12	Diesel	152	OM 364.956	3973	4	8	Diesel	112
OM 357.961	5958	6	12	Diesel	152	OM 364.957	3972	4	8	Diesel	112
OM 357.962	5958	6	12	Diesel	152	OM 364.958	3972	4	8	Diesel	112
OM 357.963	5958	6	12	Diesel	152	OM 364.959	3972	4	8	Diesel	112
OM 360.910	8720	6	12	Diesel	163	OM 364.979	3972	4	8	Diesel	112
OM 360.911	8720	6	12	Diesel	163	OM 364.980	3972	4	8	Diesel	112
OM 360.914	8720	6	12	Diesel	163	OM 364.981	3972	4	8	Diesel	112
OM 360.915	8720	6	12	Diesel	163	OM 364.982	3972	4	8	Diesel	112
OM 360.916	8720	6	12	Diesel	163	OM 364.983	3972	4	8	Diesel	112
OM 360.917	8720	6	12	Diesel	163	OM 364.984	3972	4	8	Diesel	112
OM 360.918	8720	6	12	Diesel	163	OM 364.985	3972	4	8	Diesel	112
OM 360.931	8720	6	12	Diesel	163	OM 364.986	3972	4	8	Diesel	112
OM 360.933	8720	6	12	Diesel	163	OM 364.987	3972	4	8	Diesel	112
OM 360.935	8725	6	12	Diesel	163	OM 364.989	3972	4	8	Diesel	112
OM 360.936	8725	6	12	Diesel	163	OM 366.901	5958	6	12	Diesel	152
OM 360.937	8725	6	12	Diesel	163	OM 366.905	5958	6	12	Diesel	152
OM 360.938	8725	6	12	Diesel	163	OM 366.906	5960	6	12	Diesel	152
OM 360.939	8720	6	12	Diesel	163	OM 366.907	5958	6	12	Diesel	152
OM 360.940	8725	6	12	Diesel	163	OM 366.908	5958	6	12	Diesel	152
OM 360.941	8725	6	12	Diesel	163	OM 366.909	5960	6	12	Diesel	152
OM 360.942	8725	6	12	Diesel	163	OM 366.910	5958	6	12	Diesel	152
OM 360.943	8725	6	12	Diesel	163	OM 366.911	5958	6	12	Diesel	152
OM 360.944	8725	6	12	Diesel	163	OM 366.912	5958	6	12	Diesel	152
OM 360.946	8725	6	12	Diesel	163	OM 366.913	5958	6	12	Diesel	152
OM 360.948	8725	6	12	Diesel	163	OM 366.914	5958	6	12	Diesel	152
OM 360.949	8725	6	12	Diesel	163	OM 366.915	5958	6	12	Diesel	152
OM 360.950	8725	6	12	Diesel	163	OM 366.917	5958	6	12	Diesel	152
OM 360.951	8725	6	12	Diesel	163	OM 366.918	5960	6	12	Diesel	152
OM 360.952	8725	6	12	Diesel	163	OM 366.919	5958	6	12	Diesel	152
OM 360.960	8725	6	12	Diesel	163	OM 366.930	5958	6	12	Diesel	152
OM 360.961	8725	6	12	Diesel	163	OM 366.931	5958	6	12	Diesel	152
OM 360.962	8725	6	12	Diesel	163	OM 366.932	5958	6	12	Diesel	152
OM 360.963	8725	6	12	Diesel	163	OM 366.933	5958	6	12	Diesel	152
OM 360.964	8725	6	12	Diesel	163	OM 366.935	5958	6	12	Diesel	152
OM 360.965	8725	6	12	Diesel	163	OM 366.936	5960	6	12	Diesel	152
OM 360.966	8725	6	12	Diesel	163	OM 366.937	5960	6	12	Diesel	152









	CC				9		CC				9
OM 382.919	5958	6	12	Diesel	152	OM 402.926	12800	8	16	Diesel	184
OM 382.950	5958	6	12	Diesel	152	OM 402.927	12800	8	16	Diesel	184
OM 382.970	5958	6	12	Diesel	152	OM 402.928	12800	8	16	Diesel	184
OM 382.971	5958	6	12	Diesel	152	OM 402.970	12763	8	16	Diesel	184
OM 384.906	3972	4	8	Diesel	113	OM 402.971	12763	8	16	Diesel	184
OM 384.907	3972	4	8	Diesel	113	OM 402.972	12763	8	16	Diesel	184
OM 384.908	3972	4	8	Diesel	113	OM 402.973	12763	8	16	Diesel	184
OM 386.906	5958	6	12	Diesel	152	OM 402.974	12763	8	16	Diesel	184
OM 386.950	5958	6	12	Diesel	152	OM 402.975	12763	8	16	Diesel	184
OM 386.951	5958	6	12	Diesel	152	OM 402.977	12763	8	16	Diesel	184
OM 386.952	5958	6	12	Diesel	152	OM 402.978	12763	8	16	Diesel	184
OM 386.980	5958	6	12	Diesel	152	OM 402.982	12763	8	16	Diesel	184
OM 386.981	5958	6	12	Diesel	152	OM 402.983	12763	8	16	Diesel	184
OM 386.983	5958	6	12	Diesel	152	OM 402.984	12763	8	16	Diesel	184
OM 401.900	9570	6	12	Diesel	166	OM 402.985	12763	8	16	Diesel	184
OM 401.901	9570	6	12	Diesel	166	OM 402.986	12763	8	16	Diesel	184
OM 401.905	9570	6	12	Diesel	166	OM 402.987	12763	8	16	Diesel	184
OM 401.906	9570	6	12	Diesel	166	OM 402.989	12763	8	16	Diesel	184
OM 401.907	9572	6	12	Diesel	166	OM 402.990	12763	8	16	Diesel	184
OM 401.908	9572	6	12	Diesel	166	OM 402.995	12763	8	16	Diesel	184
OM 401.909	9570	6	12	Diesel	166	OM 402.996	12763	8	16	Diesel	184
OM 401.912	9572	6	12	Diesel	166	OM 403.900	15950	10	20	Diesel	190
OM 401.913	9570	6	12	Diesel	166	OM 403.905	15950	10	20	Diesel	190
OM 401.914	9570	6	12	Diesel	166	OM 403.906	15950	10	20	Diesel	190
OM 401.915	9570	6	12	Diesel	166	OM 403.910	15950	10	20	Diesel	190
OM 401.916	9570	6	12	Diesel	166	OM 403.915	15900	10	20	Diesel	188
OM 401.917	9570	6	12	Diesel	166	OM 403.916	15900	10	20	Diesel	188
OM 401.918	9570	6	12	Diesel	166	OM 403.917	15950	10	20	Diesel	190
OM 401.919	9570	6	12	Diesel	166	OM 403.918	15900	10	20	Diesel	188
OM 401.921	9570	6	12	Diesel	166	OM 403.919	15950	10	20	Diesel	190
OM 401.922	9570	6	12	Diesel	166	OM 403.930	15950	10	20	Diesel	190
OM 401.923	9570	6	12	Diesel	166	OM 403.931	15900	10	20	Diesel	188
OM 401.924	10456	6	12	Diesel	169	OM 403.932	15900	10	20	Diesel	188
OM 401.925	9570	6	12	Diesel	166	OM 403.933	15950	10	20	Diesel	190
OM 401.926	9570	6	12	Diesel	166	OM 403.934	15950	10	20	Diesel	190
OM 401.927	9570	6	12	Diesel	166	OM 403.935	15900	10	20	Diesel	188
OM 401.928	9570	6	12	Diesel	166	OM 407.900	11040	6	12	Diesel	172
OM 401.970	9600	6	12	Diesel	166	OM 407.901	11412	6	12	Diesel	172
OM 401.972	9572	6	12	Diesel	166	OM 407.905	11000	6	12	Diesel	172
OM 401.973	9572	6	12	Diesel	166	OM 407.907	11045	6	12	Diesel	172
OM 401.974	9572	6	12	Diesel	166	OM 407.908	11000	6	12	Diesel	172
OM 401.975	9572	6	12	Diesel	166	OM 407.909	11000	6	12	Diesel	172
OM 401.976	9572	6	12	Diesel	166	OM 407.910	11000	6	12	Diesel	172
OM 401.977	9572	6	12	Diesel	166	OM 407.911	11000	6	12	Diesel	172
OM 401.978	9572	6	12	Diesel	166	OM 407.913	11413	6	12	Diesel	174
OM 401.979	9572	6	12	Diesel	166	OM 407.914	11413	6	12	Diesel	174
OM 401.980	9572	6	12	Diesel	166	OM 407.915	11413	6	12	Diesel	174
OM 401.981	9572	6	12	Diesel	166	OM 407.916	11413	6	12	Diesel	174
OM 401.982	9572	6	12	Diesel	166	OM 407.917	11413	6	12	Diesel	174
OM 401.983	9572	6	12	Diesel	166	OM 407.918	11413	6	12	Diesel	174
OM 401.984	9572	6	12	Diesel	166	OM 407.919	11413	6	12	Diesel	174
OM 401.985	9600	6	12	Diesel	166	OM 407.920	11412	6	12	Diesel	174
OM 401.986	9572	6	12	Diesel	166	OM 407.930	11412	6	12	Diesel	174
OM 401.987	9572	6	12	Diesel	166	OM 407.931	11412	6	12	Diesel	174
OM 401.989	9572	6	12	Diesel	166	OM 407.932	11412	6	12	Diesel	174
OM 401.990	9572	6	12	Diesel	166	OM 407.951	11413	6	12	Diesel	174
OM 401.991	9600	6	12	Diesel	166	OM 407.952	11412	6	12	Diesel	174
OM 401.992	9572	6	12	Diesel	166	OM 407.953	11412	6	12	Diesel	174
OM 401.993	9572	6	12	Diesel	166	OM 407.954	11412	6	12	Diesel	174
OM 401.994	9600	6	12	Diesel	166	OM 407.955	11413	6	12	Diesel	174
OM 402.900	12800	8	16	Diesel	184	OM 407.956	11412	6	12	Diesel	174
OM 402.900	12800	8	16	Diesel	184	OM 409.906	9204	5	10	Diesel	164
OM 402.901	12800	8	16	Diesel	184	OM 409.907	9204	5	10	Diesel	164
OM 402.905	12800	8	16	Diesel	184	OM 409.908	9204	5	10	Diesel	164
OM 402.906	12800	8	16	Diesel	184	OM 421.901	10964	6	12	Diesel	172
OM 402.907	12800	8	16	Diesel	184	OM 421.905	10964	6	12	Diesel	172
OM 402.910	12800	8	16	Diesel	184	OM 421.906	10964	6	12	Diesel	171
OM 402.911	12800	8	16	Diesel	184	OM 421.907	10964	6	12	Diesel	172
OM 402.912	12800	8	16	Diesel	184	OM 421.908	10964	6	12	Diesel	172
OM 402.913	12760	8	16	Diesel	184	OM 421.909	10964	6	12	Diesel	172
OM 402.914	12800	8	16	Diesel	184	OM 421.910	10964	6	12	Diesel	172
OM 402.916	12800	8	16	Diesel	184	OM 421.951	10964	6	12	Diesel	172
OM 402.917	12760	8	16	Diesel	184	OM 422.901	14618	8	16	Diesel	186
OM 402.919	12800	8	16	Diesel	184	OM 422.905	14618	8	16	Diesel	186
OM 402.921	12760	8	16	Diesel	184	OM 422.906	14618	8	16	Diesel	186
OM 402.923	12800	8	16	Diesel	184	OM 422.907	14618	8	16	Diesel	186
OM 402.924	12800	8	16	Diesel	184	OM 422.908	14618	8	16	Diesel	186
OM 402.925	12760	8	16	Diesel	184	OM 422.909	14618	8	16	Diesel	186









	CC				9		CC				9
OM 422.910	14618	8	16	Diesel	186	OM 440.984	14618	8	16	Diesel	186
OM 422.911	14618	8	16	Diesel	186	OM 440.985	14618	8	16	Diesel	186
OM 422.912	14618	8	16	Diesel	186	OM 440.986	14618	8	16	Diesel	186
OM 422.913	14618	8	16	Diesel	186	OM 440.987	14618	8	16	Diesel	186
OM 422.914	14600	8	16	Diesel	186	OM 440.988	14618	8	16	Diesel	186
OM 422.915	14618	8	16	Diesel	186	OM 440.989	14618	8	16	Diesel	186
OM 422.916	14618	8	16	Diesel	186	OM 440.990	14618	8	16	Diesel	186
OM 422.917	14618	8	16	Diesel	186	OM 440.991	14618	8	16	Diesel	186
OM 422.918	14618	8	16	Diesel	186	OM 441.901	10964	6	12	Diesel	172
OM 422.919	14618	8	16	Diesel	186	OM 441.905	10964	6	12	Diesel	172
OM 422.920	14618	8	16	Diesel	186	OM 441.906	10964	6	12	Diesel	172
OM 422.921	14618	8	16	Diesel	186	OM 441.907	10964	6	12	Diesel	172
OM 422.922	14618	8	16	Diesel	186	OM 441.908	10964	6	12	Diesel	172
OM 422.923	14618	8	16	Diesel	186	OM 441.909	10964	6	12	Diesel	172
OM 422.950	14600	8	16	Diesel	186	OM 441.910	11309	6	12	Diesel	173
OM 422.951	14600	8	16	Diesel	186	OM 441.911	10964	6	12	Diesel	172
OM 422.952	14600	8	16	Diesel	186	OM 441.912	11309	6	12	Diesel	173
OM 422.953	14618	8	16	Diesel	186	OM 441.913	10964	6	12	Diesel	172
OM 422.954	14618	8	16	Diesel	186	OM 441.914	11309	6	12	Diesel	173
OM 422.955	14618	8	16	Diesel	186	OM 441.915	10964	6	12	Diesel	172
OM 422.956	14600	8	16	Diesel	186	OM 441.916	11309	6	12	Diesel	173
OM 422.957	14620	8	16	Diesel	186	OM 441.917	10964	6	12	Diesel	172
OM 422.958	14620	8	16	Diesel	186	OM 441.918	11309	6	12	Diesel	173
OM 422.959	14618	8	16	Diesel	186	OM 441.919	11309	6	12	Diesel	173
OM 422.963	14618	8	16	Diesel	186	OM 441.920	11309	6	12	Diesel	173
OM 423.901	18273	10	20	Diesel	192	OM 441.921	11300	6	12	Diesel	173
OM 423.905	18300	10	20	Diesel	192	OM 441.922	11300	6	12	Diesel	173
OM 423.906	18273	10	20	Diesel	192	OM 441.923	10964	6	12	Diesel	172
OM 423.907	18273	10	20	Diesel	192	OM 441.924	11309	6	12	Diesel	173
OM 423.908	18300	10	20	Diesel	192	OM 441.925	10964	6	12	Diesel	172
OM 423.909	18273	10	20	Diesel	192	OM 441.926	10964	6	12	Diesel	172
OM 423.950	18273	10	20	Diesel	192	OM 441.927	10964	6	12	Diesel	172
OM 423.951	18273	10	20	Diesel	192	OM 441.932	11309	6	12	Diesel	173
OM 424.900	21930	12	24	Diesel	194	OM 441.933	11309	6	12	Diesel	173
OM 424.901	21930	12	24	Diesel	194	OM 441.950	10964	6	12	Diesel	172
OM 424.901-510	21930	12	24	Diesel	194	OM 441.951	10964	6	12	Diesel	172
OM 427.900	11967	6	12	Diesel	177	OM 441.952	10964	6	12	Diesel	172
OM 427.901	11967	6	12	Diesel	177	OM 441.953	10964	6	12	Diesel	172
OM 427.902	11967	6	12	Diesel	177	OM 441.960	10964	6	12	Diesel	172
OM 427.903	11967	6	12	Diesel	177	OM 441.961	10964	6	12	Diesel	172
OM 427.905	11967	6	12	Diesel	177	OM 441.962	10964	6	12	Diesel	172
OM 427.910	11967	6	12	Diesel	177	OM 441.980	10964	6	12	Diesel	172
OM 427.911	11967	6	12	Diesel	177	OM 441.981	10964	6	12	Diesel	172
OM 427.950	11967	6	12	Diesel	177	OM 441.982	10964	6	12	Diesel	172
OM 427.951	11967	6	12	Diesel	177	OM 441.983	10964	6	12	Diesel	172
OM 427.952	11967	6	12	Diesel	177	OM 441.985	10964	6	12	Diesel	172
OM 429.951	9970	5	10	Diesel	168	OM 441.986	10964	6	12	Diesel	172
OM 429.952	9970	5	10	Diesel	168	OM 441.987	10964	6	12	Diesel	172
OM 429.953	9970	5	10	Diesel	168	OM 441.988	10964	6	12	Diesel	172
OM 429.955	9970	5	10	Diesel	168	OM 441.989	10964	6	12	Diesel	172
OM 440.905	15080	8	16	Diesel	187	OM 441.990	10964	6	12	Diesel	172
OM 440.906	15080	8	16	Diesel	187	OM 441.991	10964	6	12	Diesel	172
OM 440.907	15080	8	16	Diesel	187	OM 441.992	10964	6	12	Diesel	172
OM 440.908	15080	8	16	Diesel	187	OM 441.993	10964	6	12	Diesel	172
OM 440.909	15080	8	16	Diesel	187	OM 441.994	10964	6	12	Diesel	172
OM 440.910	15080	8	16	Diesel	187	OM 441.995	10964	6	12	Diesel	172
OM 440.911	15080	8	16	Diesel	187	OM 441.996	10964	6	12	Diesel	172
OM 440.912	15080	8	16	Diesel	187	OM 441.997	10964	6	12	Diesel	172
OM 440.940	14618	8	16	Diesel	186	OM 441.998	10964	6	12	Diesel	172
OM 440.941	14618	8	16	Diesel	186	OM 441.999	10964	6	12	Diesel	172
OM 440.942	14618	8	16	Diesel	186	OM 442.901	14618	8	16	Diesel	186
OM 440.943	14618	8	16	Diesel	186	OM 442.905	15080	8	16	Diesel	187
OM 440.945	14618	8	16	Diesel	186	OM 442.906	15080	8	16	Diesel	187
OM 440.948	14618	8	16	Diesel	186	OM 442.907	15080	8	16	Diesel	187
OM 440.949	14618	8	16	Diesel	186	OM 442.908	15080	8	16	Diesel	187
OM 440.970	14618	8	16	Diesel	186	OM 442.909	15080	8	16	Diesel	187
OM 440.971	14618	8	16	Diesel	186	OM 442.910	15080	8	16	Diesel	187
OM 440.972	14618	8	16	Diesel	186	OM 442.911	15080	8	16	Diesel	187
OM 440.973	14618	8	16	Diesel	186	OM 442.912	15080	8	16	Diesel	187
OM 440.974	14618	8	16	Diesel	186	OM 442.913	15080	8	16	Diesel	187
OM 440.975	14618	8	16	Diesel	186	OM 442.914	15080	8	16	Diesel	187
OM 440.976	14618	8	16	Diesel	186	OM 442.915	15078	8	16	Diesel	187
OM 440.978	14618	8	16	Diesel	186	OM 442.916	15078	8	16	Diesel	187
OM 440.979	14618	8	16	Diesel	186	OM 442.917	15080	8	16	Diesel	187
OM 440.980	14618	8	16	Diesel	186	OM 442.918	15080	8	16	Diesel	187
OM 440.981	14618	8	16	Diesel	186	OM 442.919	15080	8	16	Diesel	187
OM 440.982	14618	8	16	Diesel	186	OM 442.920	15080	8	16	Diesel	187
OM 440.983	14618	8	16	Diesel	186	OM 442.921	15080	8	16	Diesel	187

	CC				9		CC				9
OM 442.922	15080	8	16	Diesel	187	OM 445.924	10960	6	12	Diesel	172
OM 442.923	15080	8	16	Diesel	187	OM 445.925	10964	6	12	Diesel	172
OM 442.924	15080	8	16	Diesel	187	OM 445.926	10964	6	12	Diesel	172
OM 442.925	15080	8	16	Diesel	187	OM 445.927	10964	6	12	Diesel	172
OM 442.926	15080	8	16	Diesel	187	OM 445.929	10964	6	12	Diesel	172
OM 442.927	15078	8	16	Diesel	187	OM 445.930	10964	6	12	Diesel	172
OM 442.928	15078	8	16	Diesel	187	OM 445.931	10964	6	12	Diesel	172
OM 442.929	15080	8	16	Diesel	187	OM 445.933	10964	6	12	Diesel	172
OM 442.930	15100	8	16	Diesel	187	OM 445.934	10964	6	12	Diesel	172
OM 442.931	15080	8	16	Diesel	187	OM 445.935	10964	6	12	Diesel	172
OM 442.932	15080	8	16	Diesel	187	OM 445.936	10964	6	12	Diesel	172
OM 442.933	15080	8	16	Diesel	187	OM 445.937	10964	6	12	Diesel	172
OM 442.934	15080	8	16	Diesel	187	OM 445.938	10960	6	12	Diesel	172
OM 442.935	15080	8	16	Diesel	187	OM 445.939	10964	6	12	Diesel	172
OM 442.939	15080	8	16	Diesel	187	OM 445.940	10964	6	12	Diesel	172
OM 442.940	14618	8	16	Diesel	186	OM 445.941	10960	6	12	Diesel	172
OM 442.941	14618	8	16	Diesel	186	OM 446.920	14618	8	16	Diesel	186
OM 442.942	14618	8	16	Diesel	186	OM 446.922	14618	8	16	Diesel	186
OM 442.943	14620	8	16	Diesel	186	OM 446.923	14618	8	16	Diesel	186
OM 442.944	14618	8	16	Diesel	186	OM 446.924	14618	8	16	Diesel	186
OM 442.945	14618	8	16	Diesel	186	OM 446.925	14618	8	16	Diesel	186
OM 442.946	14618	8	16	Diesel	186	OM 446.926	14618	8	16	Diesel	186
OM 442.950	14618	8	16	Diesel	186	OM 446.927	14618	8	16	Diesel	186
OM 442.951	14618	8	16	Diesel	186	OM 446.928	14618	8	16	Diesel	186
OM 442.952	14618	8	16	Diesel	186	OM 446.929	14618	8	16	Diesel	186
OM 442.953	14618	8	16	Diesel	186	OM 446.930	14618	8	16	Diesel	186
OM 442.954	14618	8	16	Diesel	186	OM 446.931	14618	8	16	Diesel	186
OM 442.955	14618	8	16	Diesel	186	OM 446.932	14618	8	16	Diesel	186
OM 442.957	14618	8	16	Diesel	186	OM 446.933	14618	8	16	Diesel	186
OM 442.958	14618	8	16	Diesel	186	OM 446.934	14618	8	16	Diesel	186
OM 442.959	14618	8	16	Diesel	186	OM 446.935	14618	8	16	Diesel	186
OM 442.960	14618	8	16	Diesel	186	OM 446.936	14618	8	16	Diesel	186
OM 442.961	14618	8	16	Diesel	186	OM 446.938	14618	8	16	Diesel	186
OM 442.962	14618	8	16	Diesel	186	OM 446.939	14618	8	16	Diesel	186
OM 442.963	14618	8	16	Diesel	186	OM 446.940	14618	8	16	Diesel	186
OM 442.964	14618	8	16	Diesel	186	OM 446.941	14618	8	16	Diesel	186
OM 442.965	14618	8	16	Diesel	186	OM 446.942	14618	8	16	Diesel	186
OM 442.966	14618	8	16	Diesel	186	OM 446.943	14618	8	16	Diesel	186
OM 442.967	14618	8	16	Diesel	186	OM 446.944	14618	8	16	Diesel	186
OM 442.968	14618	8	16	Diesel	186	OM 446.945	14618	8	16	Diesel	186
OM 442.969	14618	8	16	Diesel	186	OM 446.946	14618	8	16	Diesel	186
OM 442.970	14618	8	16	Diesel	186	OM 446.947	14618	8	16	Diesel	186
OM 442.971	14620	8	16	Diesel	186	OM 446.948	14618	8	16	Diesel	186
OM 442.972	14620	8	16	Diesel	186	OM 447.900	11967	6	12	Diesel	177
OM 442.973	14618	8	16	Diesel	186	OM 447.902	11967	6	12	Diesel	177
OM 442.974	14618	8	16	Diesel	186	OM 447.905	11967	6	12	Diesel	177
OM 442.975	14618	8	16	Diesel	186	OM 447.906	11967	6	12	Diesel	177
OM 442.976	14618	8	16	Diesel	186	OM 447.907	11967	6	12	Diesel	177
OM 442.977	14618	8	16	Diesel	186	OM 447.908	11967	6	12	Diesel	177
OM 442.978	14620	8	16	Diesel	186	OM 447.910	11967	6	12	Diesel	177
OM 442.979	14618	8	16	Diesel	186	OM 447.911	11967	6	12	Diesel	177
OM 442.980	14618	8	16	Diesel	186	OM 447.912	11967	6	12	Diesel	177
OM 442.982	14618	8	16	Diesel	186	OM 447.913	11967	6	12	Diesel	177
OM 442.983	14618	8	16	Diesel	186	OM 447.914	11967	6	12	Diesel	177
OM 442.984	14618	8	16	Diesel	186	OM 447.915	11967	6	12	Petrol	178
OM 442.985	14618	8	16	Diesel	186	OM 447.916	11967	6	12	Petrol	178
OM 442.989	14618	8	16	Diesel	186	OM 447.947	11967	6	12	Diesel	177
OM 442.991	14618	8	16	Diesel	186	OM 447.948	11967	6	12	Diesel	177
OM 442.992	14618	8	16	Diesel	186	OM 447.949	11967	6	12	Diesel	177
OM 442.993	14618	8	16	Diesel	186	OM 447.950	11967	6	12	Diesel	177
OM 442.994	14618	8	16	Diesel	186	OM 447.951	11967	6	12	Diesel	177
OM 442.995	14618	8	16	Diesel	186	OM 447.952	11967	6	12	Diesel	177
OM 442.996	14618	8	16	Diesel	186	OM 447.953	11967	6	12	Diesel	177
OM 442.997	14618	8	16	Diesel	186	OM 447.954	11967	6	12	Diesel	177
OM 442.998	14618	8	16	Diesel	186	OM 447.955	11967	6	12	Diesel	177
OM 442.999	14618	8	16	Diesel	186	OM 447.956	11967	6	12	Diesel	177
OM 443.900	18848	10	20	Diesel	193	OM 447.957	11967	6	12	Diesel	177
OM 443.901	18273	10	20	Diesel	192	OM 447.958	11967	6	12	Diesel	177
OM 443.905	18848	10	20	Diesel	193	OM 447.959	11967	6	12	Diesel	177
OM 443.906	18848	10	20	Diesel	193	OM 447.960	11967	6	12	Diesel	177
OM 443.908	18848	10	20	Diesel	193	OM 447.968	11967	6	12	Diesel	177
OM 443.909	18848	10	20	Diesel	193	OM 447.968	11967	6	12	Diesel	177
OM 443.940	18270	10	20	Diesel	192	OM 447.969	11967	6	12	Diesel	179
OM 443.980	18270	10	20	Diesel	192	OM 447.970	11967	6	12	Diesel	177
OM 445.920	10964	6	12	Diesel	172	OM 447.971	11967	6	12	Diesel	177
OM 445.921	10964	6	12	Diesel	172	OM 447.972	11967	6	12	Diesel	177
OM 445.922	10964	6	12	Diesel	172	OM 447.973	11967	6	12	Diesel	177
OM 445.923	10964	6	12	Diesel	172	OM 447.974	11967	6	12	Diesel	177

	CC				9		CC				9
OM 475.952	9973	5	10	Diesel	168	OM 541.971	11946	6	24	Diesel	181
OM 475.953	9973	5	10	Diesel	168	OM 541.972	11946	6	24	Diesel	181
OM 475.954	9973	5	10	Diesel	168	OM 541.973	11946	6	24	Diesel	181
OM 475.974	9973	5	10	Diesel	168	OM 541.974	11946	6	24	Diesel	181
OM 475.976	9973	5	10	Diesel	168	OM 541.975	11946	6	24	Diesel	181
OM 475.977	9973	5	10	Diesel	168	OM 541.976	11946	6	24	Diesel	181
OM 475.978	9973	5	10	Diesel	168	OM 541.977	11946	6	24	Diesel	181
OM 475.979	9973	5	10	Diesel	168	OM 541.978	11946	6	24	Diesel	181
OM 475.982	9973	5	10	Diesel	168	OM 541.979	11946	6	24	Diesel	181
OM 475.984	9973	5	10	Diesel	168	OM 541.980	11946	6	24	Diesel	181
OM 475.985	9973	5	10	Diesel	168	OM 541.981	11946	6	24	Diesel	181
OM 475.986	9973	5	10	Diesel	168	OM 541.990	11946	6	24	Diesel	181
OM 475.989	9973	5	10	Diesel	168	OM 541.991	11946	6	24	Diesel	181
OM 475.991	9973	5	10	Diesel	168	OM 541.992	11946	6	24	Diesel	181
OM 475.994	9973	5	10	Diesel	168	OM 541.993	11946	6	24	Diesel	181
OM 475.997	9973	5	10	Diesel	168	OM 541.994	11946	6	24	Diesel	181
OM 475.998	9973	5	10	Diesel	168	OM 541.995	11946	6	24	Diesel	181
OM 476.916	11967	6	12	Diesel	181	OM 541.996	11946	6	24	Diesel	181
OM 476.917	11967	6	12	Diesel	181	OM 541.997	11946	6	24	Diesel	181
OM 476.950	11967	6	12	Diesel	181	OM 541.998	11946	6	24	Diesel	181
OM 476.971	11967	6	12	Diesel	177	OM 541.999	11946	6	24	Diesel	181
OM 476.972	11967	6	12	Diesel	177	OM 542.920	15928	8	32	Diesel	191
OM 476.973	11967	6	12	Diesel	177	OM 542.921	15928	8	32	Diesel	191
OM 476.977	11967	6	12	Diesel	177	OM 542.922	15928	8	32	Diesel	191
OM 476.978	11967	6	12	Diesel	177	OM 542.923	15928	8	32	Diesel	191
OM 476.979	11967	6	12	Diesel	177	OM 542.924	15928	8	32	Diesel	191
OM 476.980	11967	6	12	Diesel	177	OM 542.925	15928	8	32	Diesel	191
OM 476.981	11967	6	12	Diesel	177	OM 542.926	15928	8	32	Diesel	191
OM 476.982	11967	6	12	Diesel	177	OM 542.940	15928	8	32	Diesel	191
OM 476.983	11967	6	12	Diesel	177	OM 542.941	15928	8	32	Diesel	191
OM 476.985	11967	6	12	Diesel	177	OM 542.942	15928	8	32	Diesel	191
OM 476.988	11967	6	12	Diesel	177	OM 542.943	15928	8	32	Diesel	191
OM 476.991	11967	6	12	Diesel	177	OM 542.944	15928	8	32	Diesel	191
OM 476.992	11967	6	12	Diesel	177	OM 542.945	15928	8	32	Diesel	191
OM 481.902	10965	6	12	Diesel	172	OM 542.947	15928	8	32	Diesel	191
OM 481.904	10964	6	12	Diesel	172	OM 542.948	15928	8	32	Diesel	191
OM 482.912	14618	8	16	Diesel	186	OM 542.956	15928	8	32	Diesel	191
OM 482.930	14618	8	16	Diesel	186	OM 542.957	15928	8	32	Diesel	191
OM 482.940	14618	8	16	Diesel	186	OM 542.958	15928	8	32	Diesel	191
OM 482.941	14618	8	16	Diesel	186	OM 542.960	15928	8	32	Diesel	191
OM 485.980	9973	5	10	Diesel	168	OM 542.961	15928	8	32	Diesel	191
OM 489.960	9973	5	10	Diesel	168	OM 542.962	15928	8	32	Diesel	191
OM 489.961	9973	5	10	Diesel	168	OM 542.963	15928	8	32	Diesel	191
OM 492.900	14618	8	16	Diesel	186	OM 542.964	15928	8	32	Diesel	191
OM 521.940	11946	6	24	Diesel	181	OM 542.965	15928	8	32	Diesel	191
OM 521.950	11946	6	24	Diesel	181	OM 542.966	15928	8	32	Diesel	191
OM 521.951	11946	6	24	Diesel	181	OM 542.968	15928	8	32	Diesel	191
OM 522.940	15928	8	32	Diesel	191	OM 542.969	15928	8	32	Diesel	191
OM 522.941	15928	8	32	Diesel	191	OM 542.970	15928	8	32	Diesel	189
OM 522.942	15928	8	32	Diesel	191	OM 542.971	15928	8	32	Diesel	189
OM 522.943	15928	8	32	Diesel	191	OM 542.972	15928	8	32	Diesel	189
OM 522.950	15928	8	32	Diesel	191	OM 542.975	15928	8	32	Diesel	189
OM 541.920	11946	6	24	Diesel	181	OM 601.900	2300	4	8	Diesel	56
OM 541.921	11946	6	24	Diesel	181	OM 601.911	1997	4	8	Diesel	32
OM 541.922	11946	6	24	Diesel	181	OM 601.912	1997	4	8	Diesel	32
OM 541.923	11946	6	24	Diesel	181	OM 601.913	1997	4	8	Diesel	32
OM 541.924	11946	6	24	Diesel	181	OM 601.915	1997	4	8	Diesel	32
OM 541.925	11946	6	24	Diesel	181	OM 601.921	2197	4	8	Diesel	43
OM 541.926	11946	6	24	Diesel	181	OM 601.940	2299	4	8	Diesel	57
OM 541.927	11946	6	24	Diesel	181	OM 601.941	2299	4	8	Diesel	57
OM 541.928	11946	6	24	Diesel	181	OM 601.942	2299	4	8	Diesel	57
OM 541.940	11946	6	24	Diesel	181	OM 601.943	2299	4	8	Diesel	57
OM 541.941	11946	6	24	Diesel	181	OM 601.970	2299	4	8	Diesel	57
OM 541.942	11946	6	24	Diesel	181	OM 602.911	2497	5	10	Diesel	66
OM 541.943	11946	6	24	Diesel	181	OM 602.912	2497	5	10	Diesel	66
OM 541.944	11946	6	24	Diesel	181	OM 602.930	2497	5	10	Diesel	66
OM 541.945	11946	6	24	Diesel	181	OM 602.931	2497	5	10	Diesel	66
OM 541.946	11946	6	24	Diesel	181	OM 602.938	2497	5	10	Diesel	66
OM 541.947	11946	6	24	Diesel	181	OM 602.939	2497	5	10	Diesel	66
OM 541.948	11946	6	24	Diesel	181	OM 602.940	2874	5	10	Diesel	79
OM 541.949	11946	6	24	Diesel	181	OM 602.941	2874	5	10	Diesel	81
OM 541.950	11946	6	24	Diesel	183	OM 602.942	2874	5	10	Diesel	81
OM 541.951	11946	6	24	Diesel	183	OM 602.946	2874	5	10	Diesel	81
OM 541.952	11946	6	24	Diesel	181	OM 602.947	2874	5	10	Diesel	81
OM 541.953	11946	6	24	Diesel	181	OM 602.948	2874	5	10	Diesel	81
OM 541.959	11946	6	24	Diesel	181	OM 602.961	2497	5	10	Diesel	66
OM 541.960	11946	6	24	Diesel	181	OM 602.962	2497	5	10	Diesel	66
OM 541.970	11946	6	24	Diesel	181	OM 602.980	2874	5	10	Diesel	81

	CC				9		CC				9
OM 602.981	2874	5	10	Diesel	81	OM 615.944	1988	4	8	Diesel	34
OM 602.982	2874	5	10	Diesel	81	OM 615.960	1988	4	8	Diesel	34
OM 602.983	2874	5	10	Diesel	81	OM 615.961	1988	4	8	Diesel	34
OM 602.984	2874	5	10	Diesel	81	OM 615.963	1988	4	8	Diesel	34
OM 602.985	2874	5	10	Diesel	81	OM 615.964	1988	4	8	Diesel	34
OM 602.986	2874	5	10	Diesel	81	OM 615.965	1988	4	8	Diesel	34
OM 602.989	2874	5	10	Diesel	81	OM 615.966	1988	4	8	Diesel	34
OM 602.990	2497	5	10	Diesel	66	OM 615.967	1988	4	8	Diesel	34
OM 602.991	2874	5	10	Diesel	81	OM 615.968	1988	4	8	Diesel	34
OM 602.993	2497	5	10	Diesel	66	OM 615.969	1988	4	8	Diesel	34
OM 602.994	2874	5	10	Diesel	81	OM 615.970	1988	4	8	Diesel	34
OM 603.912	2996	6	12	Diesel	89	OM 616	2399	4	8	Diesel	60
OM 603.913	2996	6	12	Diesel	89	OM 616.910	2400	4	8	Diesel	60
OM 603.931	2996	6	12	Diesel	89	OM 616.911	2404	4	8	Diesel	60
OM 603.950	2996	6	12	Diesel	89	OM 616.912	2399	4	8	Diesel	60
OM 603.960	2996	6	12	Diesel	89	OM 616.913	2398	4	8	Diesel	60
OM 603.961	2996	6	12	Diesel	89	OM 616.914	2399	4	8	Diesel	60
OM 603.962	2996	6	12	Diesel	89	OM 616.915	2399	4	8	Diesel	60
OM 603.963	2996	6	12	Diesel	89	OM 616.916	2404	4	8	Diesel	60
OM 603.970	3449	6	12	Diesel	98	OM 616.917	2404	4	8	Diesel	60
OM 603.971	3449	6	12	Diesel	98	OM 616.918	2399	4	8	Diesel	60
OM 603.972	3449	6	12	Diesel	98	OM 616.919	2399	4	8	Diesel	60
OM 604.910	2155	4	16	Diesel	44	OM 616.930	2399	4	8	Diesel	60
OM 604.912	2155	4	16	Diesel	45	OM 616.931	2399	4	8	Diesel	60
OM 604.915	1997	4	16	Diesel	33	OM 616.932	2404	4	8	Diesel	60
OM 604.917	1997	4	16	Diesel	33	OM 616.933	2404	4	8	Diesel	60
OM 605.910	2497	5	20	Diesel	67	OM 616.934	2399	4	8	Diesel	60
OM 605.911	2497	5	20	Diesel	67	OM 616.936	2399	4	8	Diesel	60
OM 605.912	2497	5	20	Diesel	67	OM 616.937	2399	4	8	Diesel	60
OM 605.960	2497	5	20	Diesel	67	OM 616.938	2399	4	8	Diesel	60
OM 605.962	2497	5	20	Diesel	68	OM 616.939	2399	4	8	Diesel	60
OM 606.910	2996	6	24	Diesel	90	OM 616.940	2399	4	8	Diesel	60
OM 606.912	2996	6	24	Diesel	90	OM 616.942	2399	4	8	Diesel	60
OM 606.961	2996	6	24	Diesel	90	OM 616.943	2399	4	8	Diesel	60
OM 606.962	2996	6	24	Diesel	90	OM 616.944	2404	4	8	Diesel	60
OM 606.964	2996	6	24	Diesel	90	OM 616.960	2399	4	8	Diesel	60
OM 607.951	1461	4	8	Diesel	7	OM 616.961	2399	4	8	Diesel	60
OM 611.960	2151	4	16	Diesel	38	OM 616.962	2399	4	8	Diesel	60
OM 611.961	2148	4	16	Diesel	46	OM 616.963	2399	4	8	Diesel	60
OM 611.962	2148	4	16	Diesel	38	OM 617.910	2998	5	10	Diesel	92
OM 611.980	2151	4	16	Diesel	46	OM 617.912	2998	5	10	Diesel	82
OM 611.981	2148	4	16	Diesel	38	OM 617.913	2998	5	10	Diesel	82
OM 611.987	2148	4	16	Diesel	38	OM 617.919	2998	5	10	Diesel	93
OM 611A (60 KW CDI)	2151	4	16	Diesel	46	OM 617.931	2998	5	10	Diesel	92
OM 611LA (75 KW CDI)	2151	4	16	Diesel	46	OM 617.932	2998	5	10	Diesel	92
OM 612.961	2685	5	20	Diesel	73	OM 617.933	2998	5	10	Diesel	92
OM 612.962	2685	5	20	Diesel	73	OM 617.950	2998	5	10	Diesel	92
OM 612.963	2685	5	20	Diesel	73	OM 617.951	2998	5	10	Diesel	92
OM 612.965	2685	5	20	Diesel	73	OM 617.952	2998	5	10	Diesel	92
OM 612.966	2685	5	20	Diesel	73	OM 621	1990	4	8	Diesel	34
OM 612.967	2685	5	20	Diesel	73	OM 621.910	1884	4	8	Diesel	25
OM 612.981	2685	5	20	Diesel	73	OM 621.912	1990	4	8	Diesel	34
OM 612.983	2685	5	20	Diesel	73	OM 621.913	1990	4	8	Diesel	34
OM 612.990	2950	5	20	Diesel	91	OM 621.914	1988	4	8	Diesel	34
OM 613.960	3222	6	24	Diesel	97	OM 621.915	1988	4	8	Diesel	34
OM 613.961	3226	6	24	Diesel	97	OM 621.916	1988	4	8	Diesel	34
OM 615	2197	4	8	Diesel	47	OM 621.918	1988	4	8	Diesel	34
OM 615.910	2197	4	8	Diesel	47	OM 621.919	1988	4	8	Diesel	34
OM 615.911	2197	4	8	Diesel	47	OM 621.930	1988	4	8	Diesel	34
OM 615.912	2197	4	8	Diesel	47	OM 621.931	1988	4	8	Diesel	34
OM 615.913	1988	4	8	Diesel	34	OM 621.932	1990	4	8	Diesel	34
OM 615.914	2197	4	8	Diesel	47	OM 622.951	1598	4	16	Diesel	12
OM 615.915	1988	4	8	Diesel	34	OM 626.951	1598	4	16	Diesel	12
OM 615.915	1988	4	8	Diesel	34	OM 628.960	3996	8	32	Diesel	114
OM 615.916	2197	4	8	Diesel	47	OM 628.961	3996	8	32	Diesel	114
OM 615.917	2197	4	8	Diesel	47	OM 628.962	3996	8	32	Diesel	114
OM 615.918	2197	4	8	Diesel	47	OM 628.963	3996	8	32	Diesel	114
OM 615.919	2197	4	8	Diesel	47	OM 629.910	3996	8	32	Diesel	114
OM 615.930	2197	4	8	Diesel	47	OM 629.911	3996	8	32	Diesel	114
OM 615.932	2197	4	8	Diesel	47	OM 629.912	3996	8	32	Diesel	114
OM 615.936	2197	4	8	Diesel	47	OM 639.939	1493	3	12	Diesel	8
OM 615.937	2197	4	8	Diesel	47	OM 640.940	1991	4	16	Diesel	35
OM 615.938	2197	4	8	Diesel	47	OM 640.941	1991	4	16	Diesel	35
OM 615.939	2197	4	8	Diesel	47	OM 640.942	1991	4	16	Diesel	35
OM 615.940	1988	4	8	Diesel	34	OM 642.820	2987	6	24	Diesel	94
OM 615.941	2197	4	8	Diesel	47	OM 642.822	2987	6	24	Diesel	94
OM 615.942	1988	4	8	Diesel	34	OM 642.826	2987	6	24	Diesel	94
OM 615.943	1988	4	8	Diesel	34	OM 642.830	2987	6	24	Diesel	94

	CC				9		CC				9
OM 642.832	2987	6	24	Diesel	94	OM 651.961	2143	4	16	Diesel	48
OM 642.834	2987	6	24	Diesel	94	OM 651.980	2143	4	16	Diesel	48
OM 642.835	2987	6	24	Diesel	94	OM 654.920	1950	4	16	Diesel	36
OM 642.836	2987	6	24	Diesel	94	OM 660.950	799	3	6	Diesel	2
OM 642.838	2987	6	24	Diesel	94	OM 660 DE 8LA	799	3	6	Diesel	2
OM 642.850	2987	6	24	Diesel	94	OM 661.911	2299	4	8	Diesel	57
OM 642.852	2987	6	24	Diesel	94	OM 661.940	2299	4	8	Diesel	58
OM 642.853	2987	6	24	Diesel	94	OM 662.911	2874	5	10	Diesel	83
OM 642.854	2987	6	24	Diesel	94	OM 662.940	2874	5	10	Diesel	84
OM 642.855	2987	6	24	Diesel	94	OM 662.983	2874	5	10	Diesel	84
OM 642.856	2987	6	24	Diesel	94	OM 668.914	1689	4	16	Diesel	14
OM 642.858	2987	6	24	Diesel	94	OM 668.940	1689	4	16	Diesel	14
OM 642.861	2987	6	24	Diesel	94	OM 668.941	1689	4	16	Diesel	14
OM 642.862	2987	6	24	Diesel	94	OM 668.942	1689	4	16	Diesel	14
OM 642.867	2987	6	24	Diesel	94	OM 900.910	4249	4	12	Diesel	121
OM 642.868	2987	6	24	Diesel	94	OM 900.911	4249	4	12	Diesel	121
OM 642.870	2987	6	24	Diesel	94	OM 900.912	4249	4	12	Diesel	121
OM 642.872	2987	6	24	Diesel	94	OM 900.913	4249	4	12	Diesel	121
OM 642.873	2987	6	24	Diesel	94	OM 900.915	4249	4	12	Diesel	121
OM 642.884	2987	6	24	Diesel	94	OM 900.916	4249	4	12	Diesel	122
OM 642.886	2987	6	24	Diesel	94	OM 900.917	4249	4	12	Diesel	121
OM 642.887	2987	6	24	Diesel	94	OM 900.918	4249	4	12	Diesel	121
OM 642.890	2987	6	24	Diesel	94	OM 900.919	4249	4	12	Diesel	121
OM 642.896	2987	6	24	Diesel	94	OM 900.920	4249	4	12	Diesel	121
OM 642.898	2987	6	24	Diesel	94	OM 900.921	4249	4	12	Diesel	121
OM 642.910	2987	6	24	Diesel	94	OM 900.922	4249	4	12	Diesel	121
OM 642.920	2987	6	24	Diesel	94	OM 902.910	6374	6	18	Diesel	155
OM 642.921	2987	6	24	Diesel	94	OM 902.911	6374	6	18	Diesel	155
OM 642.930	2987	6	24	Diesel	94	OM 902.912	6374	6	18	Diesel	155
OM 642.932	2987	6	24	Diesel	94	OM 902.913	6374	6	18	Diesel	155
OM 642.940	2987	6	24	Diesel	94	OM 902.914	6374	6	18	Diesel	155
OM 642.950	2987	6	24	Diesel	94	OM 902.915	6374	6	18	Diesel	155
OM 642.960	2987	6	24	Diesel	94	OM 902.916	6374	6	18	Diesel	155
OM 642.961	2987	6	24	Diesel	94	OM 902.917	6374	6	18	Diesel	155
OM 642.970	2987	6	24	Diesel	94	OM 902.918	6374	6	18	Diesel	155
OM 642.975	2987	6	24	Diesel	94	OM 902.919	6374	6	18	Diesel	155
OM 642.990	2987	6	24	Diesel	94	OM 902.920	6374	6	18	Diesel	155
OM 642.992	2987	6	24	Diesel	94	OM 902.921	6374	6	18	Diesel	155
OM 642.993	2987	6	24	Diesel	94	OM 902.922	6374	6	18	Diesel	155
OM 646.701	2148	4	16	Diesel	38	OM 902.923	6374	6	18	Diesel	155
OM 646.811	2148	4	16	Diesel	38	OM 902.924	6374	6	18	Diesel	155
OM 646.812	2148	4	16	Diesel	38	OM 902.925	6374	6	18	Diesel	155
OM 646.820	2148	4	16	Diesel	38	OM 902.926	6374	6	18	Diesel	155
OM 646.821	2148	4	16	Diesel	38	OM 902.927	6374	6	18	Diesel	155
OM 646.951	2148	4	16	Diesel	46	OM 902.930	6374	6	18	Diesel	155
OM 646.961	2148	4	16	Diesel	38	OM 902.931	6374	6	18	Diesel	155
OM 646.962	2148	4	16	Diesel	46	OM 902.932	6374	6	18	Diesel	155
OM 646.963	2148	4	16	Diesel	46	OM 902.933	6374	6	18	Diesel	155
OM 646.966	2148	4	16	Diesel	46	OM 902.934	6374	6	18	Diesel	155
OM 646.980	2148	4	16	Diesel	38	OM 902.935	6374	6	18	Diesel	155
OM 646.980	2148	4	16	Diesel	46	OM 902.936	6374	6	18	Diesel	155
OM 646.981	2148	4	16	Diesel	38	OM 904.903	4250	4	12	Diesel	121
OM 646.982	2148	4	16	Diesel	46	OM 904.904	4250	4	12	Diesel	121
OM 646.983	2148	4	16	Diesel	46	OM 904.905	4249	4	12	Diesel	118
OM 646.984	2148	4	16	Diesel	46	OM 904.906	4249	4	12	Diesel	118
OM 646.985	2148	4	16	Diesel	38	OM 904.907	4249	4	12	Diesel	118
OM 646.986	2148	4	16	Diesel	38	OM 904.908	4250	4	12	Diesel	118
OM 646.989	2148	4	16	Diesel	38	OM 904.909	4249	4	12	Diesel	121
OM 646.990	2148	4	16	Diesel	38	OM 904.910	4249	4	12	Diesel	121
OM 647.961	2685	5	20	Diesel	73	OM 904.911	4249	4	12	Diesel	121
OM 647.981	2685	5	20	Diesel	73	OM 904.912	4249	4	12	Diesel	121
OM 648.960	3222	6	24	Diesel	97	OM 904.914	4249	4	12	Diesel	121
OM 648.961	3222	6	24	Diesel	97	OM 904.915	4249	4	12	Diesel	121
OM 651.901	1796	4	16	Diesel	22	OM 904.916	4249	4	12	Diesel	121
OM 651.911	2143	4	16	Diesel	39	OM 904.917	4249	4	12	Diesel	121
OM 651.912	2143	4	16	Diesel	39	OM 904.918	4249	4	12	Diesel	121
OM 651.913	2143	4	16	Diesel	39	OM 904.919	4249	4	12	Diesel	121
OM 651.916	2143	4	16	Diesel	39	OM 904.920	4249	4	12	Diesel	121
OM 651.921	2143	4	16	Diesel	39	OM 904.921	4249	4	12	Diesel	121
OM 651.924	2143	4	16	Diesel	39	OM 904.922	4249	4	12	Diesel	121
OM 651.925	2143	4	16	Diesel	39	OM 904.923	4250	4	12	Diesel	121
OM 651.930	2143	4	16	Diesel	39	OM 904.924	4249	4	12	Diesel	121
OM 651.940	2143	4	16	Diesel	39	OM 904.925	4249	4	12	Diesel	121
OM 651.950	2143	4	16	Diesel	39	OM 904.926	4249	4	12	Diesel	121
OM 651.955	2143	4	16	Diesel	39	OM 904.927	4249	4	12	Diesel	121
OM 651.956	2143	4	16	Diesel	39	OM 904.928	4249	4	12	Diesel	121
OM 651.957	2143	4	16	Diesel	39	OM 904.929	4249	4	12	Diesel	121
OM 651.960	2143	4	16	Diesel	39	OM 904.930	4249	4	12	Diesel	121

	CC				9		CC				9
OM 924.919	4801	4	12	Diesel	126	OM 926.990	7201	6	18	Diesel	159
OM 924.920	4801	4	12	Diesel	127	OM 926.996	7201	6	18	Diesel	159
OM 924.922	4801	4	12	Diesel	127	OM 926.999	7201	6	18	Diesel	159
OM 924.923	4801	4	12	Diesel	126	OM 934.911	5132	4	16	Diesel	134
OM 924.924	4801	4	12	Diesel	126	OM 934.913	5132	4	16	Diesel	134
OM 924.925	4801	4	12	Diesel	127	OM 934.971	5132	4	16	Diesel	134
OM 924.927	4801	4	12	Diesel	127	OM 934.972	5132	4	16	Diesel	134
OM 924.928	4801	4	12	Diesel	127	OM 934.974	5132	4	16	Diesel	134
OM 924.929	4801	4	12	Diesel	127	OM 936.912	7698	6	24	Diesel	161
OM 924.930	4801	4	12	Diesel	127	OM 936.915	7698	6	24	Diesel	161
OM 924.931	4801	4	12	Diesel	127	OM 936.916	7698	6	24	Diesel	161
OM 924.932	4801	4	12	Diesel	127	OM 936.971	7698	6	24	Diesel	161
OM 924.933	4801	4	12	Diesel	127	OM 936.972	7698	6	24	Diesel	161
OM 924.934	4801	4	12	Diesel	127	OM 936.973	7698	6	24	Diesel	161
OM 924.935	4801	4	12	Diesel	127	OM 936.980	7698	6	24	Diesel	161
OM 924.936	4801	4	12	Diesel	127	OM 941.910	11946	6	24	Diesel	181
OM 924.937	4801	4	12	Diesel	127	OM 941.920	11946	6	24	Diesel	181
OM 924.985	4801	4	12	Diesel	127	OM 941.921	11946	6	24	Diesel	181
OM 924.987	4801	4	12	Diesel	127	OM 941.929	11946	6	24	Diesel	181
OM 924.988	4801	4	12	Diesel	127	OM 941.930	11946	6	24	Diesel	181
OM 924.989	4801	4	12	Diesel	127	OM 941.940	11946	6	24	Diesel	181
OM 924.990	4801	4	12	Diesel	127	OM 941.960	11946	6	24	Diesel	181
OM 924.991	4801	4	12	Diesel	127	OM 941.970	11946	6	24	Diesel	181
OM 924.993	4801	4	12	Diesel	127	OM 941.980	11946	6	24	Diesel	181
OM 924.994	4801	4	12	Diesel	127	OM 941.981	11946	6	24	Diesel	181
OM 924.995	4801	4	12	Diesel	127	OM 941.990	11946	6	24	Diesel	181
OM 924.996	4801	4	12	Diesel	127	OM 941.991	11946	6	24	Diesel	181
OM 924.997	4801	4	12	Diesel	127	OM 941.992	11946	6	24	Diesel	181
OM 924.998	4801	4	12	Diesel	127	OM 942.900	15928	8	32	Diesel	191
OM 924.999	4801	4	12	Diesel	127	OM 942.910	15928	8	32	Diesel	191
OM 925.920	7201	6	18	Diesel	159	OM 942.911	15928	8	32	Diesel	191
OM 925.960	7201	6	18	Diesel	160	OM 942.912	15928	8	32	Diesel	191
OM 926.910	7201	6	18	Diesel	159	OM 942.925	15928	8	32	Diesel	191
OM 926.911	7201	6	18	Diesel	159	OM 942.930	15928	8	32	Diesel	191
OM 926.912	7201	6	18	Diesel	159	OM 942.960	15928	8	32	Diesel	191
OM 926.913	7201	6	18	Diesel	159	OM 942.967	15928	8	32	Diesel	191
OM 926.914	7201	6	18	Diesel	159	OM 942.970	15928	8	32	Diesel	191
OM 926.915	7201	6	18	Diesel	159	OM 942.980	15928	8	32	Diesel	191
OM 926.916	7201	6	18	Diesel	159	OM 942.990	15928	8	32	Diesel	191
OM 926.917	7201	6	18	Diesel	159	V 12 (75-79)	5344	12	24	Petrol	136
OM 926.918	7201	6	18	Diesel	159	V 12 (82-90)	5344	12	24	Petrol	136
OM 926.919	7201	6	18	Diesel	159	XK 4.2 (-79)	4235	6	12	Petrol	119
OM 926.920	7201	6	18	Diesel	159	XK 4.2 (82-87)	4235	6	12	Petrol	119
OM 926.921	7201	6	18	Diesel	159						
OM 926.924	7201	6	18	Diesel	159						
OM 926.925	7201	6	18	Diesel	159						
OM 926.926	7201	6	18	Diesel	159						
OM 926.927	7201	6	18	Diesel	159						
OM 926.928	7201	6	18	Diesel	159						
OM 926.929	7201	6	18	Diesel	159						
OM 926.930	7201	6	18	Diesel	159						
OM 926.932	7201	6	18	Diesel	159						
OM 926.933	7201	6	18	Diesel	159						
OM 926.934	7201	6	18	Diesel	159						
OM 926.935	7201	6	18	Diesel	159						
OM 926.936	7201	6	18	Diesel	159						
OM 926.937	7201	6	18	Diesel	159						
OM 926.938	7201	6	18	Diesel	159						
OM 926.939	7201	6	18	Diesel	159						
OM 926.940	7201	6	18	Diesel	159						
OM 926.941	7201	6	18	Diesel	159						
OM 926.942	7201	6	18	Diesel	159						
OM 926.945	7201	6	18	Diesel	159						
OM 926.946	7201	6	18	Diesel	159						
OM 926.947	7201	6	18	Diesel	159						
OM 926.948	7201	6	18	Diesel	159						
OM 926.949	7201	6	18	Diesel	159						
OM 926.950	7201	6	18	Diesel	159						
OM 926.959	7201	6	18	Diesel	159						
OM 926.968	7201	6	18	Diesel	159						
OM 926.969	7201	6	18	Diesel	159						
OM 926.970	7201	6	18	Diesel	159						
OM 926.971	7201	6	18	Diesel	159						
OM 926.972	7201	6	18	Diesel	159						
OM 926.973	7201	6	18	Diesel	159						
OM 926.974	7201	6	18	Diesel	159						
OM 926.975	7201	6	18	Diesel	159						
OM 926.976	7201	6	18	Diesel	159						

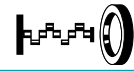

1 0.6L		Petrol		
M 160 E6AL B03	3 Cyl.	6 Valves	599cc	TD9520
M 160 E6AL B04	3 Cyl.	6 Valves	599cc	TD16490
M 160 E6AL B05	3 Cyl.	6 Valves	599cc	TD16491
PA5041 (x6) HL5002				NA5109 40.00 x 62.00 x 8.00mm, PTFE NA5118 80.00 x 100.00 x 9.00mm, PTFE
2 0.8L		Diesel		
OM 660.950	3 Cyl.	6 Valves	799cc	TD23765
OM 660 DE 8LA	3 Cyl.	6 Valves	799cc	TD16492
PA5041 (x6) HL5002				NA5332 40.00 x 62.00 x 8.00mm, FPM NA5118 80.00 x 100.00 x 9.00mm, PTFE
3 1.2L		Petrol		
M 200.711	4 Cyl.	16 Valves	1197cc	TD28454
PB681 (x16)				NJ449 40.00 x 52.00 x 6.00mm, NBR
4 1.4L		Petrol		
M 166.940	4 Cyl.	8 Valves	1397cc	TD9445
PA5041 (x4) HR5097				NA5109 40.00 x 62.00 x 8.00mm, PTFE NA5107 90.00 x 167.00 x 10.50mm, PTFE
5 1.5L		Petrol		
M 135.950	4 Cyl.	16 Valves	1499cc	TD23764
PA5025 (x16) HR5048				
6 1.5L		Petrol		
M 266.920	4 Cyl.	8 Valves	1498cc	TD18148
PA5041 (x4) HR5097				NA5332 40.00 x 62.00 x 8.00mm, FPM
7 1.5L		Diesel		
OM 607.951	4 Cyl.	8 Valves	1461cc	TD26816
PA5041 (x4) HR5097				NA5328 28.00 x 42.00 x 6.00mm, PTFE/ACM NA5255 35.00 x 47.00 x 7.00mm, PTFE/ACM NA5118 80.00 x 100.00 x 9.00mm, PTFE
8 1.5L		Diesel		
OM 639.939	3 Cyl.	12 Valves	1493cc	TD23799
PA5041 (x12) HR791				NA5332 40.00 x 62.00 x 8.00mm, FPM

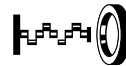
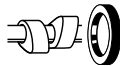

9 1.6L Petrol

M 166.960	4 Cyl.	8 Valves	1598cc	TD9446
M 166.961	4 Cyl.	8 Valves	1598cc	TD18174
PA5041 ■ (x4) HR5097 ■				NA5109 ■ 40.00 x 62.00 x 8.00mm, PTFE NA5107 ■ 90.00 x 167.00 x 10.50mm, PTFE

10 1.6L Petrol

M 270.910	4 Cyl.	16 Valves	1595cc	TD31875
M 270.910	4 Cyl.	16 Valves	1595cc	TD25820
M 274.910	4 Cyl.	16 Valves	1595cc	TD27830
M 274.910	4 Cyl.	16 Valves	1595cc	TD30890
PA5041 (x16) HR791 ■				NA5332 ■ 40.00 x 62.00 x 8.00mm, FPM

11 1.6L Petrol

M 271.910	4 Cyl.	16 Valves	1597cc	TD26056
M 271.910	4 Cyl.	16 Valves	1597cc	TD23992
M 271.911	4 Cyl.	16 Valves	1597cc	TD23993
PA5041 (x16) HR791 ■				NA5131 ■ 45.00 x 67.00 x 8.00mm, PTFE

12 1.6L Diesel

OM 622.951	4 Cyl.	16 Valves	1598cc	TD29598
OM 626.951	4 Cyl.	16 Valves	1598cc	TD29317
PA5041 (x16) HR791 ■				NA5333 ■ 48.00 x 81.00 x 11.5mm, FPM/ACM

13 1.7L Petrol

M 266.940	4 Cyl.	8 Valves	1699cc	TD18149
PA5041 ■ (x4) HR5097 ■				NA5332 ■ 40.00 x 62.00 x 8.00mm, FPM

14 1.7L Diesel

OM 668.914	4 Cyl.	16 Valves	1689cc	TD18173
OM 668.940	4 Cyl.	16 Valves	1689cc	TD10647
OM 668.941	4 Cyl.	16 Valves	1689cc	TD10648
OM 668.942	4 Cyl.	16 Valves	1689cc	TD17001
PA5041 ■ (x8) HR5056 ■				NA5109 ■ 40.00 x 62.00 x 8.00mm, PTFE NA5107 ■ 90.00 x 167.00 x 10.50mm, PTFE

15 1.8L Petrol

M 102.910	4 Cyl.	8 Valves	1797cc	TD2061
M 102.919	4 Cyl.	8 Valves	1797cc	TD2062
HR756 ■				NB973 ■ 45.00 x 67.00 x 8.00mm, FPM NB974 ■ 93.00 x 114.00 x 13.00mm, FPM

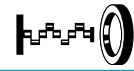
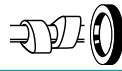



16 1.8L Petrol

M 111.920	4 Cyl.	16 Valves	1799cc	TD2131
M 111.921	4 Cyl.	16 Valves	1799cc	TD5235
HR5085  (x4)				NB973  45.00 x 67.00 x 8.00mm, FPM NB974  93.00 x 114.00 x 13.00mm, FPM



17 1.8L Petrol

M 271.820	4 Cyl.	16 Valves	1796cc	TD23776
M 271.820	4 Cyl.	16 Valves	1796cc	TD29936
M 271.860	4 Cyl.	16 Valves	1796cc	TD23724
M 271.860	4 Cyl.	16 Valves	1796cc	TD25405
M 271.861	4 Cyl.	16 Valves	1796cc	TD25100
M 271.954	4 Cyl.	16 Valves	1796cc	TD21027
M 271.958	4 Cyl.	16 Valves	1796cc	TD25260
PA5041 (x16) HR791 				NA5131  45.00 x 67.00 x 8.00mm, PTFE



18 1.8L Petrol

M 271.921	4 Cyl.	16 Valves	1796cc	TD18424
M 271.940	4 Cyl.	16 Valves	1796cc	TD16883
M 271.941	4 Cyl.	16 Valves	1796cc	TD17329
M 271.941	4 Cyl.	16 Valves	1796cc	TD25379
M 271.944	4 Cyl.	16 Valves	1795cc	TD17432
M 271.946	4 Cyl.	16 Valves	1796cc	TD17433
M 271.948	4 Cyl.	16 Valves	1796cc	TD17434
PA5041 (x16) 08/05→ HR5085  (x4) →08/05 →Eng no. 30677490 HR791  08/05→ Eng no. 30677491→				NA5131  45.00 x 67.00 x 8.00mm, PTFE

19 1.8L Petrol

M 271.942	4 Cyl.	16 Valves	1796cc	TD16392
HR5085  (x4)				NA5131  45.00 x 67.00 x 8.00mm, PTFE

20 1.8L Petrol

M 271.950	4 Cyl.	16 Valves	1796cc	TD20359
M 271.951	4 Cyl.	16 Valves	1796cc	TD23995
M 271.952	4 Cyl.	16 Valves	1796cc	TD20358
M 271.955	4 Cyl.	16 Valves	1796cc	TD20858
M 271.956	4 Cyl.	16 Valves	1796cc	TD22141
M 271.957	4 Cyl.	16 Valves	1796cc	TD23994
PA5041 (x16) 08/05→ HR5085  (x4) →08/05 HR791  08/05→				NA5131  45.00 x 67.00 x 8.00mm, PTFE

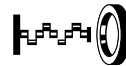
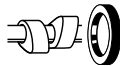

21 1.8L

Petrol

M 271.956	4 Cyl.	16 Valves	1796cc	TD25383
PA5041 (x16) 08/05→ HR5085 →08/05 HR791 08/05→				NA5131 45.00 x 67.00 x 8.00mm, PTFE

22 1.8L

Diesel

OM 651.901	4 Cyl.	16 Valves	1796cc	TD25819
PA5041 (x16) HR791				NA5479 60.00 x 75.00 x 8.00mm, FPM

23 1.9L

Petrol

M 121.920	4 Cyl.	8 Valves	1884cc	TD9957
M 121.921	4 Cyl.	8 Valves	1897cc	TD28857
M 121.922	4 Cyl.	8 Valves	1897cc	TD17787
M 121.924	4 Cyl.	8 Valves	1884cc	TD9947
M 121.928	4 Cyl.	8 Valves	1897cc	TD33067
				NB975 45.00 x 74.50 x 12.00mm, FPM PA815 78.00 x 94.00 x 8.00mm

24 1.9L

Petrol

M 166.990	4 Cyl.	8 Valves	1898cc	TD15448
M 166.991	4 Cyl.	8 Valves	1898cc	TD18176
PA5041 (x4) HR5097				NA5109 40.00 x 62.00 x 8.00mm, PTFE NA5107 90.00 x 167.00 x 10.50mm, PTFE

25 1.9L

Diesel

OM 621.910	4 Cyl.	8 Valves	1884cc	TD9961
				NB975 45.00 x 74.50 x 12.00mm, FPM PA815 78.00 x 94.00 x 8.00mm

26 2.0L

Petrol

M 102.920	4 Cyl.	8 Valves	1997cc	TD2063
M 102.921	4 Cyl.	8 Valves	1996cc	TD2064
M 102.922	4 Cyl.	8 Valves	1996cc	TD2065
M 102.924	4 Cyl.	8 Valves	1996cc	TD4653
M 102.938	4 Cyl.	8 Valves	1997cc	TD22701
M 102.939	4 Cyl.	8 Valves	1997cc	TD2069
M 102.961	4 Cyl.	8 Valves	1996cc	TD5050
M 102.962	4 Cyl.	8 Valves	1996cc	TD4655

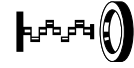
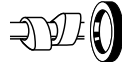

M 102.963	4 Cyl.	8 Valves	1996cc	TD2078
M 102.964	4 Cyl.	8 Valves	1997cc	TD17723
M 102.965	4 Cyl.	8 Valves	1996cc	TD2080
HR756				
				NA5264 45.00 x 67.00 x 13.00mm, FPM NB972 93.00 x 117.00 x 12.00mm, FPM →Eng no. 0-165049 NB972 93.00 x 117.00 x 12.00mm, FPM →Eng no. 2-048178 NB974 93.00 x 114.00 x 13.00mm, FPM Eng no. 0-165049→ NB974 93.00 x 114.00 x 13.00mm, FPM Eng no. 2-048178→

27 2.0L

Petrol

M 111.940	4 Cyl.	16 Valves	1998cc	TD2132
M 111.941	4 Cyl.	16 Valves	1998cc	TD2133
M 111.942	4 Cyl.	16 Valves	1998cc	TD4660
M 111.943	4 Cyl.	16 Valves	1998cc	TD4661
M 111.944	4 Cyl.	16 Valves	1998cc	TD4662
M 111.945	4 Cyl.	16 Valves	1998cc	TD5236
M 111.946	4 Cyl.	16 Valves	1998cc	TD4663
M 111.947	4 Cyl.	16 Valves	1998cc	TD9419
M 111.948	4 Cyl.	16 Valves	1998cc	TD5399
M 111.950	4 Cyl.	16 Valves	1998cc	TD22702
M 111.951	4 Cyl.	16 Valves	1998cc	TD17002
M 111.952	4 Cyl.	16 Valves	1998cc	TD17003
M 111.955	4 Cyl.	16 Valves	1998cc	TD14751
M 111.956	4 Cyl.	16 Valves	1998cc	TD16488
M 111.957	4 Cyl.	16 Valves	1998cc	TD15456
M 111.958	4 Cyl.	16 Valves	1998cc	TD14749
HR5085 (x4)				NB973 45.00 x 67.00 x 8.00mm, FPM NB974 93.00 x 114.00 x 13.00mm, FPM

28 2.0L

Petrol

M 115.923	4 Cyl.	8 Valves	1988cc	TD2141
M 115.926	4 Cyl.	8 Valves	1988cc	TD2143
M 115.938	4 Cyl.	8 Valves	1988cc	TD2147
M 115.939	4 Cyl.	8 Valves	1988cc	TD2148
PB394 (x4)				NB975 45.00 x 74.50 x 12.00mm, FPM PA815 78.00 x 94.00 x 8.00mm

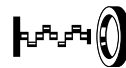
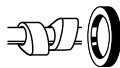

29 2.0L

Petrol

M 121.940	4 Cyl.	8 Valves	1988cc	TD9948
M 121.941	4 Cyl.	8 Valves	1988cc	TD17788
M 121.942	4 Cyl.	8 Valves	1988cc	TD17789
M 121.943	4 Cyl.	8 Valves	1988cc	TD17790
M 121.944	4 Cyl.	8 Valves	1988cc	TD17791

NB975
45.00 x 74.50 x 12.00mm, FPM
PA815
78.00 x 94.00 x 8.00mm

30 2.0L

Petrol

M 266.960	4 Cyl.	8 Valves	2034cc	TD18150
M 266.980	4 Cyl.	8 Valves	2034cc	TD18415

PA5041 (x4)
HR5097

NA5332
40.00 x 62.00 x 8.00mm, FPM

31 2.0L

Petrol

M 270.920	4 Cyl.	16 Valves	1991cc	TD26628
M 274.920	4 Cyl.	16 Valves	1991cc	TD29940
M 274.920	4 Cyl.	16 Valves	1991cc	TD28178

PA5041 (x16)
HR791

NA5332
40.00 x 62.00 x 8.00mm, FPM

32 2.0L

Diesel

OM 601.911	4 Cyl.	8 Valves	1997cc	TD2206
OM 601.912	4 Cyl.	8 Valves	1997cc	TD2207
OM 601.913	4 Cyl.	8 Valves	1997cc	TD2208
OM 601.915	4 Cyl.	8 Valves	1997cc	TD5237

PB394 (x4)
HR757

NB973
45.00 x 67.00 x 8.00mm, FPM
NB974
93.00 x 114.00 x 13.00mm, FPM

33 2.0L

Diesel

OM 604.915	4 Cyl.	16 Valves	1997cc	TD4677
OM 604.917	4 Cyl.	16 Valves	1997cc	TD9424

PA5041 (x8)
HR5056

NB973
45.00 x 67.00 x 8.00mm, FPM
NB974
93.00 x 114.00 x 13.00mm, FPM

34 2.0L

Diesel

OM 615.913	4 Cyl.	8 Valves	1988cc	TD2234
OM 615.915	4 Cyl.	8 Valves	1988cc	TD17732
OM 615.915	4 Cyl.	8 Valves	1988cc	TD1507
OM 615.940	4 Cyl.	8 Valves	1988cc	TD2238
OM 615.942	4 Cyl.	8 Valves	1988cc	TD22827
OM 615.943	4 Cyl.	8 Valves	1988cc	TD2240
OM 615.944	4 Cyl.	8 Valves	1988cc	TD2241
OM 615.960	4 Cyl.	8 Valves	1988cc	TD22828
OM 615.961	4 Cyl.	8 Valves	1988cc	TD22829
OM 615.963	4 Cyl.	8 Valves	1988cc	TD2242
OM 615.964	4 Cyl.	8 Valves	1988cc	TD22830

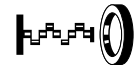
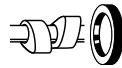

OM 615.965	4 Cyl.	8 Valves	1988cc	TD22831
OM 615.966	4 Cyl.	8 Valves	1988cc	TD22832
OM 615.967	4 Cyl.	8 Valves	1988cc	TD22833
OM 615.968	4 Cyl.	8 Valves	1988cc	TD22834
OM 615.969	4 Cyl.	8 Valves	1988cc	TD22835
OM 615.970	4 Cyl.	8 Valves	1988cc	TD2243
OM 621	4 Cyl.	8 Valves	1990cc	TD2266
OM 621.912	4 Cyl.	8 Valves	1990cc	TD2268
OM 621.913	4 Cyl.	8 Valves	1990cc	TD2269
OM 621.914	4 Cyl.	8 Valves	1988cc	TD2270
OM 621.915	4 Cyl.	8 Valves	1988cc	TD22837
OM 621.916	4 Cyl.	8 Valves	1988cc	TD7986
OM 621.918	4 Cyl.	8 Valves	1988cc	TD2271
OM 621.919	4 Cyl.	8 Valves	1988cc	TD22838
OM 621.930	4 Cyl.	8 Valves	1988cc	TD22839
OM 621.931	4 Cyl.	8 Valves	1988cc	TD7987
OM 621.932	4 Cyl.	8 Valves	1990cc	TD2272

NB975
45.00 x 74.50 x 12.00mm, FPM
PA815
78.00 x 94.00 x 8.00mm

35 2.0L Diesel

OM 640.940	4 Cyl.	16 Valves	1991cc	TD18151
OM 640.941	4 Cyl.	16 Valves	1991cc	TD18152
OM 640.942	4 Cyl.	16 Valves	1991cc	TD18153
PA5041 (x16) HR791				NA5332 40.00 x 62.00 x 8.00mm, FPM

36 2.0L Diesel

OM 654.920	4 Cyl.	16 Valves	1950cc	TD32619
PA5041 (x16) HR791				

37 2.1L Petrol

M 166.995	4 Cyl.	8 Valves	2084cc	TD16882
PA5041 (x4) HR5097				NA5109 40.00 x 62.00 x 8.00mm, PTFE NA5107 90.00 x 167.00 x 10.50mm, PTFE

38 2.1L Diesel

OM 611.960	4 Cyl.	16 Valves	2151cc	TD9529
OM 611.962	4 Cyl.	16 Valves	2148cc	TD15449
OM 611.981	4 Cyl.	16 Valves	2148cc	TD17729
OM 611.987	4 Cyl.	16 Valves	2148cc	TD17730
OM 646.701	4 Cyl.	16 Valves	2148cc	TD32464
OM 646.811	4 Cyl.	16 Valves	2148cc	TD20360
OM 646.812	4 Cyl.	16 Valves	2148cc	TD22694
OM 646.820	4 Cyl.	16 Valves	2148cc	TD20362
OM 646.821	4 Cyl.	16 Valves	2148cc	TD20334
OM 646.961	4 Cyl.	16 Valves	2148cc	TD17007
OM 646.980	4 Cyl.	16 Valves	2148cc	TD30103

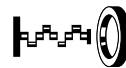
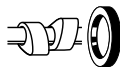

OM 646.981	4 Cyl.	16 Valves	2148cc	TD20984
OM 646.985	4 Cyl.	16 Valves	2148cc	TD20730
OM 646.986	4 Cyl.	16 Valves	2148cc	TD23620
OM 646.989	4 Cyl.	16 Valves	2148cc	TD26257
OM 646.990	4 Cyl.	16 Valves	2148cc	TD23618

HR5085 (x4)

NA5131

45.00 x 67.00 x 8.00mm, PTFE

NA5074

93.00 x 133.50 x 15.50mm, PTFE

39 2.1L

Diesel

OM 651.911	4 Cyl.	16 Valves	2143cc	TD23727
OM 651.912	4 Cyl.	16 Valves	2143cc	TD23754
OM 651.913	4 Cyl.	16 Valves	2143cc	TD24407
OM 651.916	4 Cyl.	16 Valves	2143cc	TD23755
OM 651.921	4 Cyl.	16 Valves	2143cc	TD28575
OM 651.924	4 Cyl.	16 Valves	2143cc	TD23782
OM 651.925	4 Cyl.	16 Valves	2143cc	TD23783
OM 651.930	4 Cyl.	16 Valves	2143cc	TD26817
OM 651.940	4 Cyl.	16 Valves	2143cc	TD25280
OM 651.950	4 Cyl.	16 Valves	2143cc	TD29251
OM 651.955	4 Cyl.	16 Valves	2143cc	TD24545
OM 651.956	4 Cyl.	16 Valves	2143cc	TD25279
OM 651.957	4 Cyl.	16 Valves	2143cc	TD24544
OM 651.960	4 Cyl.	16 Valves	2143cc	TD26549

PA5041 (x16)

HR791

NA5479

60.00 x 75.00 x 8.00mm, FPM

40 2.2L

Petrol

M 111.960	4 Cyl.	16 Valves	2199cc	TD2134
M 111.961	4 Cyl.	16 Valves	2199cc	TD2135

HR5085 (x4)

NB973

45.00 x 67.00 x 8.00mm, FPM

NB974

93.00 x 114.00 x 13.00mm, FPM

41 2.2L

Petrol

M 115.920	4 Cyl.	8 Valves	2197cc	TD2139
M 115.921	4 Cyl.	8 Valves	2197cc	TD2140
M 115.922	4 Cyl.	8 Valves	2197cc	TD17799
M 115.924	4 Cyl.	8 Valves	2197cc	TD2142
M 115.927	4 Cyl.	8 Valves	2197cc	TD2144
M 115.928	4 Cyl.	8 Valves	2197cc	TD2145
M 115.929	4 Cyl.	8 Valves	2197cc	TD2146
M 115.932	4 Cyl.	8 Valves	2197cc	TD17785
M 115.933	4 Cyl.	8 Valves	2197cc	TD17800
M 115.934	4 Cyl.	8 Valves	2197cc	TD17801
M 115.935	4 Cyl.	8 Valves	2197cc	TD17802

PB394 (x4)

NB975

45.00 x 74.50 x 12.00mm, FPM

PA815

78.00 x 94.00 x 8.00mm

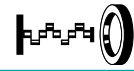

42 2.2L		Petrol			
M 127.980	6 Cyl.	12 Valves	2180cc		TD9960
M 127.982	6 Cyl.	12 Valves	2180cc		TD9951
M 127.984	6 Cyl.	12 Valves	2180cc		TD9987
M 180.922	6 Cyl.	12 Valves	2195cc		TD22718
M 180.924	6 Cyl.	12 Valves	2180cc		TD9959
M 180.926	6 Cyl.	12 Valves	2195cc		TD22719
M 180.927	6 Cyl.	12 Valves	2195cc		TD22720
M 180.928	6 Cyl.	12 Valves	2195cc		TD22721
M 180.929	6 Cyl.	12 Valves	2195cc		TD22722
M 180.940	6 Cyl.	12 Valves	2180cc		TD9949
M 180.941	6 Cyl.	12 Valves	2180cc		TD9950
M 180.942	6 Cyl.	12 Valves	2195cc		TD22724
M 180.943	6 Cyl.	12 Valves	2195cc		TD22725
M 180.952	6 Cyl.	12 Valves	2195cc		TD18356
M 180.953	6 Cyl.	12 Valves	2195cc		TD18357
M 180.958	6 Cyl.	24 Valves	2196cc		TD16997
				NA5264 45.00 x 67.00 x 13.00mm, FPM PA815 78.00 x 94.00 x 8.00mm	

43 2.2L		Diesel			
OM 601.921	4 Cyl.	8 Valves	2197cc		TD2209
PB394 (x4) HR757				NB973 45.00 x 67.00 x 8.00mm, FPM NB974 93.00 x 114.00 x 13.00mm, FPM	

44 2.2L		Diesel			
OM 604.910	4 Cyl.	16 Valves	2155cc		TD2227
PA5041 (x8) Eng no. A/031330; B/006456 → HR791 →Eng no. A/031329; B/006455 HR5056 Eng no. A/031330; B/006456 →				NB973 45.00 x 67.00 x 8.00mm, FPM NB974 93.00 x 114.00 x 13.00mm, FPM	

45 2.2L		Diesel			
OM 604.912	4 Cyl.	16 Valves	2155cc		TD4676
PA5041 (x8) HR5056				NB973 45.00 x 67.00 x 8.00mm, FPM NB974 93.00 x 114.00 x 13.00mm, FPM	

46 2.2L		Diesel			
OM 611.961	4 Cyl.	16 Valves	2148cc		TD17005
OM 611.980	4 Cyl.	16 Valves	2151cc		TD14350
OM 611A (60 KW CDI)	4 Cyl.	16 Valves	2151cc		TD14348
OM 611LA (75 KW CDI)	4 Cyl.	16 Valves	2151cc		TD14349
OM 646.951	4 Cyl.	16 Valves	2148cc		TD18129
OM 646.962	4 Cyl.	16 Valves	2148cc		TD17542
OM 646.963	4 Cyl.	16 Valves	2148cc		TD17543
OM 646.966	4 Cyl.	16 Valves	2148cc		TD22844

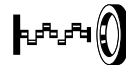
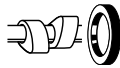

OM 646.980	4 Cyl.	16 Valves	2148cc	TD24573
OM 646.982	4 Cyl.	16 Valves	2148cc	TD18289
OM 646.983	4 Cyl.	16 Valves	2148cc	TD20921
OM 646.984	4 Cyl.	16 Valves	2148cc	TD22140

HR5085 (x4)

NA5131
45.00 x 67.00 x 8.00mm, PTFE
NA5074
93.00 x 133.50 x 15.50mm, PTFE

47 2.2L Diesel

OM 615	4 Cyl.	8 Valves	2197cc	TD2231
OM 615.910	4 Cyl.	8 Valves	2197cc	TD2232
OM 615.911	4 Cyl.	8 Valves	2197cc	TD7970
OM 615.912	4 Cyl.	8 Valves	2197cc	TD2233
OM 615.914	4 Cyl.	8 Valves	2197cc	TD7972
OM 615.916	4 Cyl.	8 Valves	2197cc	TD22823
OM 615.917	4 Cyl.	8 Valves	2197cc	TD5683
OM 615.918	4 Cyl.	8 Valves	2197cc	TD22824
OM 615.919	4 Cyl.	8 Valves	2197cc	TD28785
OM 615.930	4 Cyl.	8 Valves	2197cc	TD22825
OM 615.932	4 Cyl.	8 Valves	2197cc	TD7989
OM 615.936	4 Cyl.	8 Valves	2197cc	TD20151
OM 615.937	4 Cyl.	8 Valves	2197cc	TD2236
OM 615.938	4 Cyl.	8 Valves	2197cc	TD22826
OM 615.939	4 Cyl.	8 Valves	2197cc	TD2237
OM 615.941	4 Cyl.	8 Valves	2197cc	TD2239

NB975
45.00 x 74.50 x 12.00mm, FPM
PA815
78.00 x 94.00 x 8.00mm

48 2.2L Diesel

OM 651.961	4 Cyl.	16 Valves	2143cc	TD25277
OM 651.980	4 Cyl.	16 Valves	2143cc	TD26369

PA5041 (x16)
HR791

NA5479
60.00 x 75.00 x 8.00mm, FPM

49 2.3L Petrol

M 102.942	4 Cyl.	8 Valves	2298cc	TD2070
M 102.943	4 Cyl.	8 Valves	2299cc	TD2071
M 102.945	4 Cyl.	8 Valves	2298cc	TD2072
M 102.946	4 Cyl.	8 Valves	2298cc	TD5397
M 102.955	4 Cyl.	8 Valves	2299cc	TD5240
M 102.958	4 Cyl.	8 Valves	2299cc	TD17756
M 102.959	4 Cyl.	8 Valves	2299cc	TD17795
M 102.979	4 Cyl.	8 Valves	2299cc	TD2081
M 102.980	4 Cyl.	8 Valves	2299cc	TD2082
M 102.981	4 Cyl.	8 Valves	2299cc	TD2083
M 102.982	4 Cyl.	8 Valves	2298cc	TD4656
M 102.983	4 Cyl.	16 Valves	2298cc	TD2086
M 102.985	4 Cyl.	8 Valves	2298cc	TD4657
M 102.987	4 Cyl.	8 Valves	2299cc	TD2089
M 102.989	4 Cyl.	8 Valves	2298cc	TD2091

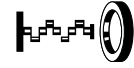
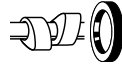

M 102.996	4 Cyl.	8 Valves	2298cc	TD11249
M 102.997	4 Cyl.	8 Valves	2299cc	TD17724
M 102.998	4 Cyl.	8 Valves	2299cc	TD17725
HR756				NB973 45.00 x 67.00 x 8.00mm, FPM NB974 93.00 x 114.00 x 13.00mm, FPM

50 2.3L

Petrol

M 111.970	4 Cyl.	16 Valves	2295cc	TD4664
M 111.973	4 Cyl.	16 Valves	2295cc	TD4665
M 111.974	4 Cyl.	16 Valves	2295cc	TD4666
M 111.975	4 Cyl.	16 Valves	2295cc	TD4667
M 111.977	4 Cyl.	16 Valves	2295cc	TD10948
M 111.978	4 Cyl.	16 Valves	2295cc	TD4668
M 111.979	4 Cyl.	16 Valves	2295cc	TD5241
M 111.981	4 Cyl.	16 Valves	2295cc	TD17177
M 111.982	4 Cyl.	16 Valves	2295cc	TD16884
M 111.983	4 Cyl.	16 Valves	2295cc	TD14750
M 111.984	4 Cyl.	16 Valves	2295cc	TD17850
HR5085 (x4)				NB973 45.00 x 67.00 x 8.00mm, FPM NB974 93.00 x 114.00 x 13.00mm, FPM

51 2.3L

Petrol

M 111.980	4 Cyl.	16 Valves	2295cc	TD22703
HR5055				NB973 45.00 x 67.00 x 8.00mm, FPM NB974 93.00 x 114.00 x 13.00mm, FPM NA5074 93.00 x 133.50 x 15.50mm, PTFE

52 2.3L

Petrol

M 115.951	4 Cyl.	8 Valves	2307cc	TD2149
M 115.952	4 Cyl.	8 Valves	2307cc	TD2150
M 115.954	4 Cyl.	8 Valves	2307cc	TD2151
M 115.955	4 Cyl.	8 Valves	2307cc	TD2152
M 115.958	4 Cyl.	8 Valves	2307cc	TD28455
M 115.970	4 Cyl.	8 Valves	2307cc	TD2153
M 115.971	4 Cyl.	8 Valves	2307cc	TD17786
M 115.972	4 Cyl.	8 Valves	2307cc	TD2154
M 115.973	4 Cyl.	8 Valves	2307cc	TD2155
M 115.974	4 Cyl.	8 Valves	2307cc	TD17727
PB394 (x4)				NB975 45.00 x 74.50 x 12.00mm, FPM PA815 78.00 x 94.00 x 8.00mm

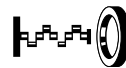
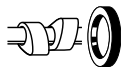

53 2.3L

Petrol

M 127.981	6 Cyl.	12 Valves	2306cc	TD9954
M 180.947	6 Cyl.	12 Valves	2281cc	TD9952
M 180.949	6 Cyl.	12 Valves	2281cc	TD9965
M 180.950	6 Cyl.	12 Valves	2281cc	TD9953
M 180.954	6 Cyl.	12 Valves	2292cc	TD2201
M 180.955	6 Cyl.	12 Valves	2292cc	TD19238

PB394 ■ (x6)

NA5264 ■
45.00 x 67.00 x 13.00mm, FPM
PA815 ■
78.00 x 94.00 x 8.00mm

54 2.3L

Petrol

M 161.971	4 Cyl.	8 Valves	2295cc	TD23184
-----------	--------	----------	--------	---------

HR5055 ■

NB973 ■
45.00 x 67.00 x 8.00mm, FPM
NB974 ■
93.00 x 114.00 x 13.00mm, FPM

55 2.3L

Petrol

M 180.945	6 Cyl.	12 Valves	2281cc	TD9964
M 180.951	6 Cyl.	12 Valves	2306cc	TD22726

NA5264 ■
45.00 x 67.00 x 13.00mm, FPM
PA815 ■
78.00 x 94.00 x 8.00mm

56 2.3L

Diesel

OM 601.900	4 Cyl.	8 Valves	2300cc	TD16185
------------	--------	----------	--------	---------

NA5131 ■
45.00 x 67.00 x 8.00mm, PTFE
NB974 ■
93.00 x 114.00 x 13.00mm, FPM
→Eng no. 710392
NA5074 ■
93.00 x 133.50 x 15.50mm, PTFE
Eng no. 710393→

57 2.3L

Diesel

OM 601.940	4 Cyl.	8 Valves	2299cc	TD2210
OM 601.941	4 Cyl.	8 Valves	2299cc	TD8041
OM 601.942	4 Cyl.	8 Valves	2299cc	TD5398
OM 601.943	4 Cyl.	8 Valves	2299cc	TD5400
OM 601.970	4 Cyl.	8 Valves	2299cc	TD4674
OM 661.911	4 Cyl.	8 Valves	2299cc	TD8942

PB394 ■ (x4)
HR757 ■

NA5131 ■
45.00 x 67.00 x 8.00mm, PTFE
NB974 ■
93.00 x 114.00 x 13.00mm, FPM
→Eng no. 710392
NA5074 ■
93.00 x 133.50 x 15.50mm, PTFE
Eng no. 710393→

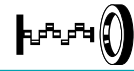
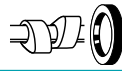

58 2.3L

Diesel

OM 661.940 PB394 (x8)	4 Cyl.	8 Valves	2299cc	TD28791
				NA5131 45.00 x 67.00 x 8.00mm, PTFE NB974 93.00 x 114.00 x 13.00mm, FPM →Eng no. 710392 NA5074 93.00 x 133.50 x 15.50mm, PTFE Eng no. 710393→

59 2.4L

Petrol

M 112.910	6 Cyl.	18 Valves	2398cc	TD9420
M 112.911 HR5055	6 Cyl.	18 Valves	2398cc	TD9887
				NA5131 45.00 x 67.00 x 8.00mm, PTFE NA5168 93.00 x 114.00 x 11.50mm, PTFE

60 2.4L

Diesel

OM 616	4 Cyl.	8 Valves	2399cc	TD2244
OM 616.910	4 Cyl.	8 Valves	2400cc	TD2245
OM 616.911	4 Cyl.	8 Valves	2404cc	TD5675
OM 616.912	4 Cyl.	8 Valves	2399cc	TD9432
OM 616.913	4 Cyl.	8 Valves	2398cc	TD2247
OM 616.914	4 Cyl.	8 Valves	2399cc	TD8040
OM 616.915	4 Cyl.	8 Valves	2399cc	TD6014
OM 616.916	4 Cyl.	8 Valves	2404cc	TD2248
OM 616.917	4 Cyl.	8 Valves	2404cc	TD2249
OM 616.918	4 Cyl.	8 Valves	2399cc	TD28786
OM 616.919	4 Cyl.	8 Valves	2399cc	TD28787
OM 616.930	4 Cyl.	8 Valves	2399cc	TD5677
OM 616.931	4 Cyl.	8 Valves	2399cc	TD5676
OM 616.932	4 Cyl.	8 Valves	2404cc	TD6015
OM 616.933	4 Cyl.	8 Valves	2404cc	TD16998
OM 616.934	4 Cyl.	8 Valves	2399cc	TD2250
OM 616.936	4 Cyl.	8 Valves	2399cc	TD2251
OM 616.937	4 Cyl.	8 Valves	2399cc	TD2252
OM 616.938	4 Cyl.	8 Valves	2399cc	TD17733
OM 616.939	4 Cyl.	8 Valves	2399cc	TD2253
OM 616.940	4 Cyl.	8 Valves	2399cc	TD22836
OM 616.942	4 Cyl.	8 Valves	2399cc	TD7991
OM 616.943	4 Cyl.	8 Valves	2399cc	TD7992
OM 616.944	4 Cyl.	8 Valves	2404cc	TD16937
OM 616.960	4 Cyl.	8 Valves	2399cc	TD2255
OM 616.961	4 Cyl.	8 Valves	2399cc	TD2256
OM 616.962	4 Cyl.	8 Valves	2399cc	TD28788
OM 616.963	4 Cyl.	8 Valves	2399cc	TD2257
				NB975 45.00 x 74.50 x 12.00mm, FPM PA815 78.00 x 94.00 x 8.00mm

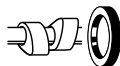

61 2.5L

Petrol

M 102.990	4 Cyl.	16 Valves	2498cc	TD2092
M 102.991	4 Cyl.	16 Valves	2498cc	TD2093
M 102.992	4 Cyl.	8 Valves	2498cc	TD2094

NB973
45.00 x 67.00 x 8.00mm, FPM
NB974
93.00 x 114.00 x 13.00mm, FPM

62 2.5L

Petrol

M 103.941	6 Cyl.	12 Valves	2597cc	TD2096
-----------	--------	-----------	--------	--------

HR759

NC065
30.00 x 40.00 x 7.00mm, FPM

NB973
45.00 x 67.00 x 8.00mm, FPM
NB974
93.00 x 114.00 x 13.00mm, FPM

63 2.5L

Petrol

M 108.920	6 Cyl.	12 Valves	2496cc	TD9962
M 108.924	6 Cyl.	12 Valves	2496cc	TD19045
M 114.920	6 Cyl.	12 Valves	2496cc	TD2136
M 114.980	6 Cyl.	12 Valves	2496cc	TD2137
M 114.981	6 Cyl.	12 Valves	2496cc	TD2138
M 123.920	6 Cyl.	12 Valves	2525cc	TD18724
M 123.921	6 Cyl.	12 Valves	2525cc	TD2194
M 129.980	6 Cyl.	12 Valves	2496cc	TD9963
M 129.981	6 Cyl.	12 Valves	2496cc	TD9988
M 129.982	6 Cyl.	12 Valves	2496cc	TD9955

PB394 (x6)

NA5264
45.00 x 67.00 x 13.00mm, FPM
PA815
78.00 x 94.00 x 8.00mm

64 2.5L

Petrol

M 272.911	6 Cyl.	24 Valves	2496cc	TD22142
M 272.920	6 Cyl.	24 Valves	2496cc	TD18425
M 272.921	6 Cyl.	24 Valves	2496cc	TD20357
M 272.921	6 Cyl.	24 Valves	2496cc	TD25382
M 272.922	6 Cyl.	24 Valves	2496cc	TD22143
M 272.922	6 Cyl.	24 Valves	2496cc	TD25377

PA5041 (x24)
HR5062

NA5131
45.00 x 67.00 x 8.00mm, PTFE

65 2.5L

Petrol

M 272.924	6 Cyl.	18 Valves	2496cc	TD29937
-----------	--------	-----------	--------	---------

PA5041 (x18)
HL5002 (x3)

NA5131
45.00 x 67.00 x 8.00mm, PTFE

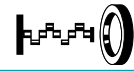

66 2.5L

Diesel

OM 602.911	5 Cyl.	10 Valves	2497cc	TD2211
OM 602.912	5 Cyl.	10 Valves	2497cc	TD2212
OM 602.930	5 Cyl.	10 Valves	2497cc	TD2213
OM 602.931	5 Cyl.	10 Valves	2497cc	TD2214
OM 602.938	5 Cyl.	10 Valves	2497cc	TD17816
OM 602.939	5 Cyl.	10 Valves	2497cc	TD9422
OM 602.961	5 Cyl.	10 Valves	2497cc	TD2216
OM 602.962	5 Cyl.	10 Valves	2497cc	TD2217
OM 602.990	5 Cyl.	10 Valves	2497cc	TD17819
OM 602.993	5 Cyl.	10 Valves	2497cc	TD17821

PB394 (x5)
HR758

NB973
45.00 x 67.00 x 8.00mm, FPM
NB974
93.00 x 114.00 x 13.00mm, FPM

67 2.5L

Diesel

OM 605.910	5 Cyl.	20 Valves	2497cc	TD2228
OM 605.911	5 Cyl.	20 Valves	2497cc	TD2229
OM 605.912	5 Cyl.	20 Valves	2497cc	TD4678
OM 605.960	5 Cyl.	20 Valves	2497cc	TD4679

PA5041 (x10)
HR822
→Eng no. 0-019351
HR822
→Eng no. 2-008689
HR804
Eng no. 0-019352→
HR804
Eng no. 2-008690→

NB973
45.00 x 67.00 x 8.00mm, FPM
→10/95
NA5131
45.00 x 67.00 x 8.00mm, PTFE
10/95→
NB974
93.00 x 114.00 x 13.00mm, FPM
→Eng no. 0-017527
NB974
93.00 x 114.00 x 13.00mm, FPM
→Eng no. 2-007819
NA5074
93.00 x 133.50 x 15.50mm, PTFE
Eng no. 0-17528→
NA5074
93.00 x 133.50 x 15.50mm, PTFE
Eng no. 2-007820→

68 2.5L

Diesel

OM 605.962	5 Cyl.	20 Valves	2497cc	TD9892
------------	--------	-----------	--------	--------

PA5041 (x10)
HR822
→Eng no. 0-019351
HR822
→Eng no. 2-008689
HR804
Eng no. 0-019352→
HR804
Eng no. 2-008690→

NA5131
45.00 x 67.00 x 8.00mm, PTFE
NB974
93.00 x 114.00 x 13.00mm, FPM
→Eng no. 0-017527
NB974
93.00 x 114.00 x 13.00mm, FPM
→Eng no. 2-007819
NA5074
93.00 x 133.50 x 15.50mm, PTFE
Eng no. 0-17528→
NA5074
93.00 x 133.50 x 15.50mm, PTFE
Eng no. 2-007820→

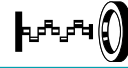

69 2.6L

Petrol

M 103.940	6 Cyl.	12 Valves	2597cc	TD9435
M 103.942	6 Cyl.	12 Valves	2597cc	TD2097
M 103.943	6 Cyl.	12 Valves	2597cc	TD2098

HR759

NC065
30.00 x 40.00 x 7.00mm, FPM

NB971
45.00 x 67.00 x 10.00mm, FPM
NB974
93.00 x 114.00 x 13.00mm, FPM

70 2.6L

Petrol

M 112.912	6 Cyl.	18 Valves	2597cc	TD15450
M 112.913	6 Cyl.	18 Valves	2597cc	TD17155
M 112.914	6 Cyl.	18 Valves	2597cc	TD15458
M 112.915	6 Cyl.	18 Valves	2597cc	TD17004
M 112.916	6 Cyl.	18 Valves	2597cc	TD17533
M 112.917	6 Cyl.	18 Valves	2597cc	TD16893

HR5055

NA5131
45.00 x 67.00 x 8.00mm, PTFE
NA5168
93.00 x 114.00 x 11.50mm, PTFE

71 2.7L

Petrol

M 110.921	6 Cyl.	12 Valves	2746cc	TD2115
M 110.922	6 Cyl.	12 Valves	2746cc	TD2116
M 110.923	6 Cyl.	12 Valves	2746cc	TD2117
M 110.924	6 Cyl.	12 Valves	2746cc	TD2118
M 110.926	6 Cyl.	12 Valves	2746cc	TD2119
M 110.981	6 Cyl.	12 Valves	2746cc	TD2120
M 110.982	6 Cyl.	12 Valves	2746cc	TD2121
M 110.983	6 Cyl.	12 Valves	2746cc	TD2122
M 110.984	6 Cyl.	12 Valves	2746cc	TD4659
M 110.985	6 Cyl.	12 Valves	2746cc	TD2124
M 110.986	6 Cyl.	12 Valves	2746cc	TD2125
M 110.987	6 Cyl.	12 Valves	2746cc	TD2126
M 110.988	6 Cyl.	12 Valves	2746cc	TD2127
M 110.989	6 Cyl.	12 Valves	2746cc	TD2128
M 110.990	6 Cyl.	12 Valves	2746cc	TD2129
M 110.994	6 Cyl.	12 Valves	2746cc	TD2130
M 130.920	6 Cyl.	12 Valves	2780cc	TD2195
M 130.923	6 Cyl.	12 Valves	2778cc	TD2196
M 130.980	6 Cyl.	12 Valves	2780cc	TD2197
M 130.981	6 Cyl.	12 Valves	2778cc	TD4673
M 130.983	6 Cyl.	12 Valves	2778cc	TD2200
M 130.984	6 Cyl.	12 Valves	2778cc	TD9989

PB394 (x6)

NA5264
45.00 x 67.00 x 13.00mm, FPM
PA815
78.00 x 94.00 x 8.00mm

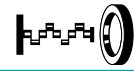
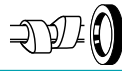

72 2.7L

Petrol

M 110.931	6 Cyl.	12 Valves	2746cc	TD17796
M 110.932	6 Cyl.	12 Valves	2746cc	TD17726
M 110.991	6 Cyl.	12 Valves	2746cc	TD17797
M 110.992	6 Cyl.	12 Valves	2746cc	TD17798
M 130.925	6 Cyl.	12 Valves	2778cc	TD16996

NA5264
45.00 x 67.00 x 13.00mm, FPM
PA815
78.00 x 94.00 x 8.00mm

73 2.7L

Diesel

OM 612.961	5 Cyl.	20 Valves	2685cc	TD15455
OM 612.962	5 Cyl.	20 Valves	2685cc	TD15451
OM 612.963	5 Cyl.	20 Valves	2685cc	TD17009
OM 612.965	5 Cyl.	20 Valves	2685cc	TD21145
OM 612.966	5 Cyl.	20 Valves	2685cc	TD16895
OM 612.967	5 Cyl.	20 Valves	2685cc	TD17323
OM 612.981	5 Cyl.	20 Valves	2685cc	TD17731
OM 612.983	5 Cyl.	20 Valves	2685cc	TD25649
OM 647.961	5 Cyl.	20 Valves	2685cc	TD17008
OM 647.981	5 Cyl.	20 Valves	2685cc	TD21142

HR5085 (x5)

NA5131
45.00 x 67.00 x 8.00mm, PTFE
NA5074
93.00 x 133.50 x 15.50mm, PTFE

74 2.8L

Petrol

M 104.900	6 Cyl.	12 Valves	2792cc	TD8023
-----------	--------	-----------	--------	--------

HR662

NB716
35.00 x 48.00 x 10.00mm, FPM
NA5133
85.00 x 105.00 x 11.00mm, FPM

75 2.8L

Petrol

M 104.941	6 Cyl.	24 Valves	2799cc	TD2106
M 104.942	6 Cyl.	24 Valves	2799cc	TD2107
M 104.943	6 Cyl.	24 Valves	2799cc	TD2108
M 104.944	6 Cyl.	24 Valves	2799cc	TD2109
M 104.945	6 Cyl.	24 Valves	2799cc	TD9423

HR5055

NB973
45.00 x 67.00 x 8.00mm, FPM
NB974
93.00 x 114.00 x 13.00mm, FPM

76 2.8L

Petrol

M 112.920	6 Cyl.	18 Valves	2799cc	TD9421
M 112.921	6 Cyl.	18 Valves	2799cc	TD9417
M 112.922	6 Cyl.	18 Valves	2799cc	TD11490
M 112.923	6 Cyl.	18 Valves	2799cc	TD10888
M 112.925	6 Cyl.	18 Valves	2799cc	TD15463

HR5055

NA5131
45.00 x 67.00 x 8.00mm, PTFE
NA5168
93.00 x 114.00 x 11.50mm, PTFE

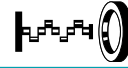
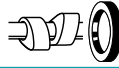

77 2.8L

Petrol

M 130.921	6 Cyl.	12 Valves	2778cc	TD17792
M 130.922	6 Cyl.	12 Valves	2778cc	TD22714
M 130.933	6 Cyl.	12 Valves	2778cc	TD17794
PB394 (x6)				NA5264 45.00 x 67.00 x 13.00mm, FPM PA815 78.00 x 94.00 x 8.00mm

78 2.8L

Petrol

M 130.924	6 Cyl.	12 Valves	2778cc	TD17793
				NA5264 45.00 x 67.00 x 13.00mm, FPM PA815 78.00 x 94.00 x 8.00mm

79 2.8L

Diesel

OM 602.940	5 Cyl.	10 Valves	2874cc	TD2215
PB394 (x5) HR758				NB973 45.00 x 67.00 x 8.00mm, FPM NB974 93.00 x 114.00 x 13.00mm, FPM

80 2.9L

Petrol

M 103.982	6 Cyl.	12 Valves	2960cc	TD9444
HR759				NC065 30.00 x 40.00 x 7.00mm, FPM NB973 45.00 x 67.00 x 8.00mm, FPM NB974 93.00 x 114.00 x 13.00mm, FPM

81 2.9L

Diesel

OM 602.941	5 Cyl.	10 Valves	2874cc	TD8013
OM 602.942	5 Cyl.	10 Valves	2874cc	TD2054
OM 602.946	5 Cyl.	10 Valves	2874cc	TD17817
OM 602.947	5 Cyl.	10 Valves	2874cc	TD17818
OM 602.948	5 Cyl.	10 Valves	2874cc	TD8014
OM 602.980	5 Cyl.	10 Valves	2874cc	TD8032
OM 602.981	5 Cyl.	10 Valves	2874cc	TD14670
OM 602.982	5 Cyl.	10 Valves	2874cc	TD4675
OM 602.983	5 Cyl.	10 Valves	2874cc	TD12910
OM 602.984	5 Cyl.	10 Valves	2874cc	TD5682
OM 602.985	5 Cyl.	10 Valves	2874cc	TD6020
OM 602.986	5 Cyl.	10 Valves	2874cc	TD9459
OM 602.989	5 Cyl.	10 Valves	2874cc	TD14672
OM 602.991	5 Cyl.	10 Valves	2874cc	TD17820
OM 602.994	5 Cyl.	10 Valves	2874cc	TD17822
PB394 (x5) HR758				NA5131 45.00 x 67.00 x 8.00mm, PTFE NA5074 93.00 x 133.50 x 15.50mm, PTFE

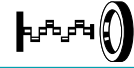

82 2.9L

Diesel

OM 617.912	5 Cyl.	10 Valves	2998cc	TD2260
OM 617.913	5 Cyl.	10 Valves	2998cc	TD2261

NB975 F
45.00 x 74.50 x 12.00mm, FPM
PA815 R
78.00 x 94.00 x 8.00mm

83 2.9L

Diesel

OM 662.911	5 Cyl.	10 Valves	2874cc	TD22700
PB394 E (x5) HR758 E				

NB973 F
45.00 x 67.00 x 8.00mm, FPM
NB974 R
93.00 x 114.00 x 13.00mm, FPM

84 2.9L

Diesel

OM 662.940	5 Cyl.	10 Valves	2874cc	TD28792
OM 662.983	5 Cyl.	10 Valves	2874cc	TD28793
PB394 (x10)				

NA5131 E
45.00 x 67.00 x 8.00mm, PTFE
NA5074 R
93.00 x 133.50 x 15.50mm, PTFE

85 3.0L

Petrol

M 103.980	6 Cyl.	12 Valves	2960cc	TD2099
M 103.981	6 Cyl.	12 Valves	2960cc	TD9436
M 103.983	6 Cyl.	12 Valves	2960cc	TD9437
M 103.984	6 Cyl.	12 Valves	2960cc	TD2103
M 103.985	6 Cyl.	12 Valves	2960cc	TD2104
M 103.987	6 Cyl.	12 Valves	2960cc	TD2105
HR759 E				

NC065
30.00 x 40.00 x 7.00mm, FPM

NB973 F
45.00 x 67.00 x 8.00mm, FPM
NB974 R
93.00 x 114.00 x 13.00mm, FPM

86 3.0L

Petrol

M 104.980	6 Cyl.	24 Valves	2960cc	TD2110
M 104.981	6 Cyl.	24 Valves	2960cc	TD2111
HR5055 E				

NC065
30.00 x 40.00 x 7.00mm, FPM

NB973 F
45.00 x 67.00 x 8.00mm, FPM
NB974 R
93.00 x 114.00 x 13.00mm, FPM

87 3.0L

Petrol

M 272.939	6 Cyl.	24 Valves	2996cc	TD29938
M 272.940	6 Cyl.	24 Valves	2996cc	TD18420
M 272.940	6 Cyl.	24 Valves	2996cc	TD26057
M 272.941	6 Cyl.	24 Valves	2996cc	TD18423
M 272.942	6 Cyl.	24 Valves	2996cc	TD18427
M 272.943	6 Cyl.	24 Valves	2996cc	TD18430
M 272.943	6 Cyl.	24 Valves	2996cc	TD25376
M 272.944	6 Cyl.	24 Valves	2996cc	TD23758
M 272.945	6 Cyl.	24 Valves	2996cc	TD20570
M 272.946	6 Cyl.	24 Valves	2996cc	TD26966
M 272.947	6 Cyl.	24 Valves	2996cc	TD25380

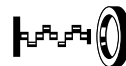
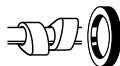

M 272.947	6 Cyl.	24 Valves	2996cc	TD20356
M 272.948	6 Cyl.	24 Valves	2996cc	TD26997
M 272.948	6 Cyl.	24 Valves	2996cc	TD22968
M 272.949	6 Cyl.	24 Valves	2996cc	TD20863
M 272.952	6 Cyl.	24 Valves	2996cc	TD25212
M 272.952	6 Cyl.	24 Valves	2996cc	TD25406
M 276.820	6 Cyl.	24 Valves	2996cc	TD29944
M 276.820	6 Cyl.	24 Valves	2996cc	TD28179
M 276.821	6 Cyl.	24 Valves	2996cc	TD28252
M 276.822	6 Cyl.	24 Valves	2996cc	TD32554
M 276.823	6 Cyl.	24 Valves	2996cc	TD34083
M 276.823	6 Cyl.	24 Valves	2996cc	TD29714
M 276.824	6 Cyl.	24 Valves	2996cc	TD29349
M 276.825	6 Cyl.	24 Valves	2996cc	TD29232
M 276.925	6 Cyl.	24 Valves	2996cc	TD31100
PA5041 (x24) HR5062				NA5131 45.00 x 67.00 x 8.00mm, PTFE

88 3.0L

Petrol

M 276.826	6 Cyl.	24 Valves	2996cc	TD34130
PA5041 (x24)				NA5131 45.00 x 67.00 x 8.00mm, PTFE

89 3.0L

Diesel

OM 603.912	6 Cyl.	12 Valves	2996cc	TD2218
OM 603.913	6 Cyl.	12 Valves	2996cc	TD2219
OM 603.931	6 Cyl.	12 Valves	2996cc	TD2220
OM 603.950	6 Cyl.	12 Valves	2996cc	TD21143
OM 603.960	6 Cyl.	12 Valves	2996cc	TD2221
OM 603.961	6 Cyl.	12 Valves	2996cc	TD2222
OM 603.962	6 Cyl.	12 Valves	2996cc	TD21144
OM 603.963	6 Cyl.	12 Valves	2996cc	TD2223
PB394 (x6) HR760				NB973 45.00 x 67.00 x 8.00mm, FPM NB974 93.00 x 114.00 x 13.00mm, FPM

90 3.0L

Diesel

OM 606.910	6 Cyl.	24 Valves	2996cc	TD2230
OM 606.912	6 Cyl.	24 Valves	2996cc	TD4680
OM 606.961	6 Cyl.	24 Valves	2996cc	TD5238
OM 606.962	6 Cyl.	24 Valves	2996cc	TD9416
OM 606.964	6 Cyl.	24 Valves	2996cc	TD9425
HR5057 Eng no. 0.007550;2.014564 →				NB973 45.00 x 67.00 x 8.00mm, FPM NB974 93.00 x 114.00 x 13.00mm, FPM

91 3.0L

Diesel

OM 612.990	5 Cyl.	20 Valves	2950cc	TD17544
				NA5131 45.00 x 67.00 x 8.00mm, PTFE NA5074 93.00 x 133.50 x 15.50mm, PTFE

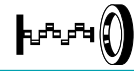
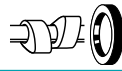

92 3.0L

Diesel

OM 617.910	5 Cyl.	10 Valves	2998cc	TD2259
OM 617.931	5 Cyl.	10 Valves	2998cc	TD2262
OM 617.932	5 Cyl.	10 Valves	2998cc	TD17743
OM 617.933	5 Cyl.	10 Valves	2998cc	TD26550
OM 617.950	5 Cyl.	10 Valves	2998cc	TD2263
OM 617.951	5 Cyl.	10 Valves	2998cc	TD2264
OM 617.952	5 Cyl.	10 Valves	2998cc	TD2265

NB975

45.00 x 74.50 x 12.00mm, FPM

PA815 (x2)

78.00 x 94.00 x 8.00mm

93 3.0L

Diesel

OM 617.919	5 Cyl.	10 Valves	2998cc	TD28789
------------	--------	-----------	--------	---------

NB975

45.00 x 74.50 x 12.00mm, FPM

PA815

78.00 x 94.00 x 8.00mm

94 3.0L

Diesel

OM 642.820	6 Cyl.	24 Valves	2987cc	TD23810
OM 642.822	6 Cyl.	24 Valves	2987cc	TD19207
OM 642.826	6 Cyl.	24 Valves	2987cc	TD26600
OM 642.830	6 Cyl.	24 Valves	2987cc	TD23772
OM 642.832	6 Cyl.	24 Valves	2987cc	TD23751
OM 642.834	6 Cyl.	24 Valves	2987cc	TD26036
OM 642.835	6 Cyl.	24 Valves	2987cc	TD26840
OM 642.836	6 Cyl.	24 Valves	2987cc	TD23723
OM 642.838	6 Cyl.	24 Valves	2987cc	TD26599
OM 642.850	6 Cyl.	24 Valves	2987cc	TD23781
OM 642.852	6 Cyl.	24 Valves	2987cc	TD23792
OM 642.853	6 Cyl.	24 Valves	2987cc	TD26065
OM 642.854	6 Cyl.	24 Valves	2987cc	TD26045
OM 642.855	6 Cyl.	24 Valves	2987cc	TD32618
OM 642.856	6 Cyl.	24 Valves	2987cc	TD23790
OM 642.858	6 Cyl.	24 Valves	2987cc	TD23791
OM 642.861	6 Cyl.	24 Valves	2987cc	TD27896
OM 642.862	6 Cyl.	24 Valves	2987cc	TD26082
OM 642.867	6 Cyl.	24 Valves	2987cc	TD28584
OM 642.868	6 Cyl.	24 Valves	2987cc	TD25099
OM 642.870	6 Cyl.	24 Valves	2987cc	TD24810
OM 642.872	6 Cyl.	24 Valves	2987cc	TD25098
OM 642.873	6 Cyl.	24 Valves	2987cc	TD33801
OM 642.884	6 Cyl.	24 Valves	2987cc	TD25842
OM 642.886	6 Cyl.	24 Valves	2987cc	TD28072
OM 642.887	6 Cyl.	24 Valves	2987cc	TD31268
OM 642.890	6 Cyl.	24 Valves	2987cc	TD27268
OM 642.896	6 Cyl.	24 Valves	2987cc	TD25841
OM 642.898	6 Cyl.	24 Valves	2987cc	TD25843
OM 642.910	6 Cyl.	24 Valves	2987cc	TD18416
OM 642.920	6 Cyl.	24 Valves	2987cc	TD18431

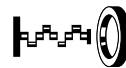
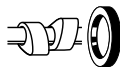

OM 642.921	6 Cyl.	24 Valves	2987cc	TD18428
OM 642.930	6 Cyl.	24 Valves	2987cc	TD19213
OM 642.932	6 Cyl.	24 Valves	2987cc	TD23761
OM 642.940	6 Cyl.	24 Valves	2987cc	TD18197
OM 642.950	6 Cyl.	24 Valves	2987cc	TD19206
OM 642.960	6 Cyl.	24 Valves	2987cc	TD20361
OM 642.961	6 Cyl.	24 Valves	2987cc	TD20986
OM 642.970	6 Cyl.	24 Valves	2987cc	TD20729
OM 642.975	6 Cyl.	24 Valves	2987cc	TD28790
OM 642.990	6 Cyl.	24 Valves	2987cc	TD22148
OM 642.992	6 Cyl.	24 Valves	2987cc	TD22149
OM 642.993	6 Cyl.	24 Valves	2987cc	TD25661

PA5041 (x24)
HR5062

NA5131
45.00 x 67.00 x 8.00mm, PTFE

95 3.2L

Petrol

M 104.990	6 Cyl.	24 Valves	3199cc	TD2112
M 104.991	6 Cyl.	24 Valves	3199cc	TD2113
M 104.992	6 Cyl.	24 Valves	3199cc	TD2114
M 104.994	6 Cyl.	24 Valves	3199cc	TD11250
M 104.995	6 Cyl.	24 Valves	3199cc	TD4658
M 104.996	6 Cyl.	24 Valves	3199cc	TD11251

HR5055
Eng no. 0-001567→
HR5055
Eng no. 2-042687→

NC065
30.00 x 40.00 x 7.00mm, FPM

NB973
45.00 x 67.00 x 8.00mm, FPM
NB974
93.00 x 114.00 x 13.00mm, FPM

96 3.2L

Petrol

M 112.940	6 Cyl.	18 Valves	3199cc	TD9407
M 112.941	6 Cyl.	18 Valves	3199cc	TD9418
M 112.942	6 Cyl.	18 Valves	3199cc	TD9898
M 112.943	6 Cyl.	18 Valves	3199cc	TD11494
M 112.944	6 Cyl.	18 Valves	3199cc	TD11491
M 112.945	6 Cyl.	18 Valves	3199cc	TD9888
M 112.946	6 Cyl.	18 Valves	3199cc	TD15452
M 112.947	6 Cyl.	18 Valves	3199cc	TD14773
M 112.949	6 Cyl.	18 Valves	3199cc	TD16894
M 112.951	6 Cyl.	18 Valves	3199cc	TD18435
M 112.953	6 Cyl.	18 Valves	3199cc	TD17535
M 112.954	6 Cyl.	18 Valves	3199cc	TD17331
M 112.955	6 Cyl.	18 Valves	3199cc	TD16885
M 112.960	6 Cyl.	18 Valves	3199cc	TD15464
M 112.961	6 Cyl.	18 Valves	3199cc	TD15453

HR5055

NA5131
45.00 x 67.00 x 8.00mm, PTFE
NA5168
93.00 x 114.00 x 11.50mm, PTFE

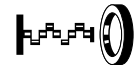
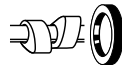

97 3.2L

Diesel

OM 613.960	6 Cyl.	24 Valves	3222cc	TD15461
OM 613.961	6 Cyl.	24 Valves	3226cc	TD15454
OM 648.960	6 Cyl.	24 Valves	3222cc	TD17187
OM 648.961	6 Cyl.	24 Valves	3222cc	TD17328

HR5055

NA5131

45.00 x 67.00 x 8.00mm, PTFE

NA5074

93.00 x 133.50 x 15.50mm, PTFE

98 3.4L

Diesel

OM 603.970	6 Cyl.	12 Valves	3449cc	TD2224
OM 603.971	6 Cyl.	12 Valves	3449cc	TD2225
OM 603.972	6 Cyl.	12 Valves	3449cc	TD2226

PB394 (x6)

HR760

NB973

45.00 x 67.00 x 8.00mm, FPM

NB974

93.00 x 114.00 x 13.00mm, FPM

99 3.5L

Petrol

M 116.980	8 Cyl.	16 Valves	3500cc	TD2164
M 116.981	8 Cyl.	16 Valves	3500cc	TD2165
M 116.982	8 Cyl.	16 Valves	3499cc	TD2166
M 116.983	8 Cyl.	16 Valves	3499cc	TD2167
M 116.984	8 Cyl.	16 Valves	3499cc	TD2168
M 116.985	8 Cyl.	16 Valves	3499cc	TD2169

NB973

45.00 x 67.00 x 8.00mm, FPM

NA5268

100.00 x 124.00 x 13.00mm, FPM

100 3.5L

Petrol

M 116.990	8 Cyl.	16 Valves	3499cc	TD22706
M 116.991	8 Cyl.	16 Valves	3499cc	TD22707
M 116.992	8 Cyl.	16 Valves	3499cc	TD22708
M 116.993	8 Cyl.	16 Valves	3499cc	TD22709

PB394 (x8)

NA5264

45.00 x 67.00 x 13.00mm, FPM

NA5268

100.00 x 124.00 x 13.00mm, FPM

101 3.5L

Petrol

M 272.960	6 Cyl.	24 Valves	3498cc	TD18417
M 272.961	6 Cyl.	24 Valves	3498cc	TD22144
M 272.962	6 Cyl.	24 Valves	3498cc	TD18195
M 272.963	6 Cyl.	24 Valves	3498cc	TD18434
M 272.964	6 Cyl.	24 Valves	3498cc	TD18429
M 272.964	6 Cyl.	24 Valves	3498cc	TD25375
M 272.965	6 Cyl.	24 Valves	3498cc	TD19146
M 272.966	6 Cyl.	24 Valves	3498cc	TD20926
M 272.967	6 Cyl.	24 Valves	3498cc	TD19148
M 272.968	6 Cyl.	24 Valves	3498cc	TD20861
M 272.969	6 Cyl.	24 Valves	3498cc	TD21028
M 272.970	6 Cyl.	24 Valves	3498cc	TD18418

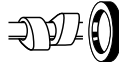

M 272.971	6 Cyl.	24 Valves	3498cc	TD22145
M 272.972	6 Cyl.	24 Valves	3498cc	TD19145
M 272.973	6 Cyl.	24 Valves	3498cc	TD33634
M 272.974	6 Cyl.	24 Valves	3498cc	TD24808
M 272.975	6 Cyl.	24 Valves	3498cc	TD23759
M 272.977	6 Cyl.	24 Valves	3498cc	TD23775
M 272.978	6 Cyl.	24 Valves	3498cc	TD29939
M 272.978	6 Cyl.	24 Valves	3498cc	TD20983
M 272.979	6 Cyl.	24 Valves	3498cc	TD23619
M 272.980	6 Cyl.	24 Valves	3498cc	TD25144
M 272.982	6 Cyl.	24 Valves	3498cc	TD23777
M 272.983	6 Cyl.	24 Valves	3498cc	TD23778
M 272.984	6 Cyl.	24 Valves	3498cc	TD23726
M 272.985	6 Cyl.	24 Valves	3498cc	TD19889
M 272.988	6 Cyl.	24 Valves	3498cc	TD25593
M 272.991	6 Cyl.	24 Valves	3498cc	TD25531
M 276.850	6 Cyl.	24 Valves	3498cc	TD29320
M 276.853	6 Cyl.	24 Valves	3498cc	TD33436
M 276.950	6 Cyl.	24 Valves	3498cc	TD26370
M 276.952	6 Cyl.	24 Valves	3498cc	TD26060
M 276.952	6 Cyl.	24 Valves	3498cc	TD29945
M 276.954	6 Cyl.	24 Valves	3498cc	TD28247
M 276.955	6 Cyl.	24 Valves	3498cc	TD26601
M 276.956	6 Cyl.	24 Valves	3498cc	TD26081
M 276.957	6 Cyl.	24 Valves	3498cc	TD25532
M 276.958	6 Cyl.	24 Valves	3498cc	TD26365
M 276.960	6 Cyl.	24 Valves	3498cc	TD27895

PA5041 (x24)
HR5062

NA5131
45.00 x 67.00 x 8.00mm, PTFE

102 3.6L

Petrol

9DPANA	6 Cyl.	12 Valves	3590cc	TD5197
--------	--------	-----------	--------	--------

HR299 (x2)

NB720
99.30 x 120.00 x 12.00mm, PTFE

103 3.6L

Petrol

M 104.941 (AMG 3.6)	6 Cyl.	24 Valves	3606cc	TD9439
M 104.992 (AMG 3.6)	6 Cyl.	24 Valves	3606cc	TD9434
M 104.996 (AMG 3.6)	6 Cyl.	24 Valves	3606cc	TD26758

HR5055

NB973
45.00 x 67.00 x 8.00mm, FPM
NB974
93.00 x 114.00 x 13.00mm, FPM

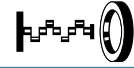

104 3.7L		Petrol			
M 112.970	6 Cyl.	18 Valves	3724cc		TD17532
M 112.972	6 Cyl.	18 Valves	3724cc		TD17189
M 112.973	6 Cyl.	18 Valves	3724cc		TD17537
M 112.975	6 Cyl.	18 Valves	3724cc		TD17190
M 112.976	6 Cyl.	18 Valves	3724cc		TD18426
HR5055				NA5131 45.00 x 67.00 x 8.00mm, PTFE NA5168 93.00 x 114.00 x 11.50mm, PTFE	

105 3.8L		Petrol			
M 116.960	8 Cyl.	16 Valves	3818cc		TD2158
M 116.961	8 Cyl.	16 Valves	3818cc		TD2159
M 116.962	8 Cyl.	16 Valves	3839cc		TD2160
M 116.963	8 Cyl.	16 Valves	3839cc		TD4669
PB394 (x16)				NB973 45.00 x 67.00 x 8.00mm, FPM NB974 93.00 x 114.00 x 13.00mm, FPM	

106 3.8L		Diesel			
OM 314.900	4 Cyl.	8 Valves	3780cc		TD22733
OM 314.910	4 Cyl.	8 Valves	3780cc		TD5691
OM 314.914	4 Cyl.	8 Valves	3782cc		TD22546
OM 314.915	4 Cyl.	8 Valves	3780cc		TD16557
OM 314.916	4 Cyl.	8 Valves	3780cc		TD7971
OM 314.917	4 Cyl.	8 Valves	3780cc		TD7973
OM 314.918	4 Cyl.	8 Valves	3782cc		TD22545
OM 314.919	4 Cyl.	8 Valves	3782cc		TD22547
OM 314.940	4 Cyl.	8 Valves	3782cc		TD22548
OM 314.941	4 Cyl.	8 Valves	3782cc		TD22549
OM 314.942	4 Cyl.	8 Valves	3782cc		TD22550
OM 314.943	4 Cyl.	8 Valves	3782cc		TD22551
OM 314.944	4 Cyl.	8 Valves	3780cc		TD6028
OM 314.945	4 Cyl.	8 Valves	3782cc		TD22552
OM 314.946	4 Cyl.	8 Valves	3780cc		TD2202
OM 314.947	4 Cyl.	8 Valves	3782cc		TD22553
OM 314.948	4 Cyl.	8 Valves	3780cc		TD2203
OM 314.949	4 Cyl.	8 Valves	3782cc		TD22554
OM 314.950	4 Cyl.	8 Valves	3782cc		TD22555
OM 314.951	4 Cyl.	8 Valves	3782cc		TD22556
OM 314.953	4 Cyl.	8 Valves	3780cc		TD7975
OM 314.954	4 Cyl.	8 Valves	3782cc		TD22557
OM 314.956	4 Cyl.	8 Valves	3782cc		TD16999
OM 314.957	4 Cyl.	8 Valves	3782cc		TD17000
OM 314.958	4 Cyl.	8 Valves	3782cc		TD22558
OM 314.959	4 Cyl.	8 Valves	3780cc		TD2204
OM 314.960	4 Cyl.	8 Valves	3782cc		TD22559
OM 314.961	4 Cyl.	8 Valves	3780cc		TD16552
OM 314.962	4 Cyl.	8 Valves	3780cc		TD16553
OM 314.963	4 Cyl.	8 Valves	3780cc		TD16554

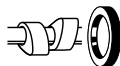

OM 314.967	4 Cyl.	8 Valves	3780cc	TD6026
OM 314.968	4 Cyl.	8 Valves	3782cc	TD8038
OM 314.970	4 Cyl.	8 Valves	3782cc	TD17852
PB177 (x4) PB172 (x4) Eng no. 468000→ HR668 →Eng no. 467 999 HR666 Eng no. 468000→				NB979 65.00 x 90.00 x 15.00mm, FPM →Eng no. 369 095 NB978 65.00 x 90.00 x 13.00mm, FPM Eng no. 369 096→ LB955 (x2) 90.00 x 107.00 x 8.00mm

107 3.8L

Diesel

OM 314.920	4 Cyl.	8 Valves	3782cc	TD28222
OM 314.921	4 Cyl.	8 Valves	3782cc	TD28223
OM 314.922	4 Cyl.	8 Valves	3782cc	TD28585
PB177 (x4) →Eng no. 467999 PB172 (x4) Eng no. 468000→ HR666 →Eng no. 467999 HR668 Eng no. 468000→				NB979 65.00 x 90.00 x 15.00mm, FPM →Eng no. 369 095 NB978 65.00 x 90.00 x 13.00mm, FPM Eng no. 369 096→ LB955 (x2) 90.00 x 107.00 x 8.00mm

108 3.8L

Diesel

OM 314.964	4 Cyl.	8 Valves	3780cc	TD16555
OM 314.965	4 Cyl.	8 Valves	3780cc	TD16556
PB177 (x4) PB177 (x4) PB172 (x4) Eng no. 468000→ HR668 →Eng no. 467 999 HR666 Eng no. 468000→				NB979 65.00 x 90.00 x 15.00mm, FPM →Eng no. 369 095 NB978 65.00 x 90.00 x 13.00mm, FPM Eng no. 369 096→ LB955 (x2) 90.00 x 107.00 x 8.00mm

109 3.8L

Diesel

OM 340.932	4 Cyl.	8 Valves	3780cc	TD28460
OM 343.910	4 Cyl.	8 Valves	3780cc	TD28491
OM 343.932	4 Cyl.	8 Valves	3780cc	TD28492
OM 343.934	4 Cyl.	8 Valves	3780cc	TD28493
				NB979 65.00 x 90.00 x 15.00mm, FPM →Eng no. 369095 NB978 65.00 x 90.00 x 13.00mm, FPM Eng no. 369096→ LB955 90.00 x 107.00 x 8.00mm

110 4.0L

Petrol

9EPCNA	6 Cyl.	24 Valves	3980cc	TD815
HR299 (x4)				

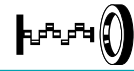
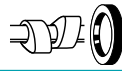

111 4.0L

Petrol

M 278.910	8 Cyl.	32 Valves	3996cc	TD31885
M 278.912	8 Cyl.	32 Valves	3996cc	TD33421
PA5041 (x32) HR791 (x2)				NA5131 (x2) 45.00 x 67.00 x 8.00mm, PTFE

112 4.0L

Diesel

OM 354.900	4 Cyl.	8 Valves	3972cc	TD8054
OM 354.901	4 Cyl.	8 Valves	3972cc	TD8084
OM 354.902	4 Cyl.	8 Valves	3972cc	TD5695
OM 354.903	4 Cyl.	8 Valves	3972cc	TD8083
OM 354.920	4 Cyl.	8 Valves	3972cc	TD8059
OM 354.921	4 Cyl.	8 Valves	3972cc	TD8066
OM 354.922	4 Cyl.	8 Valves	3972cc	TD8061
OM 354.923	4 Cyl.	8 Valves	3972cc	TD8057
OM 354.924	4 Cyl.	8 Valves	3972cc	TD8085
OM 354.925	4 Cyl.	8 Valves	3972cc	TD8087
OM 354.926	4 Cyl.	8 Valves	3972cc	TD22745
OM 364.900	4 Cyl.	8 Valves	3972cc	TD28660
OM 364.901	4 Cyl.	8 Valves	3972cc	TD21464
OM 364.905	4 Cyl.	8 Valves	3972cc	TD17099
OM 364.906	4 Cyl.	8 Valves	3972cc	TD8048
OM 364.907	4 Cyl.	8 Valves	3970cc	TD8052
OM 364.908	4 Cyl.	8 Valves	3972cc	TD17853
OM 364.909	4 Cyl.	8 Valves	3972cc	TD17854
OM 364.911	4 Cyl.	8 Valves	3972cc	TD8081
OM 364.912	4 Cyl.	8 Valves	3972cc	TD16804
OM 364.913	4 Cyl.	8 Valves	3972cc	TD8044
OM 364.914	4 Cyl.	8 Valves	3972cc	TD16805
OM 364.916	4 Cyl.	8 Valves	3972cc	TD22770
OM 364.917	4 Cyl.	8 Valves	3972cc	TD22771
OM 364.918	4 Cyl.	8 Valves	3970cc	TD8053
OM 364.919	4 Cyl.	8 Valves	3972cc	TD5692
OM 364.920	4 Cyl.	8 Valves	3972cc	TD8082
OM 364.921	4 Cyl.	8 Valves	3972cc	TD6029
OM 364.950	4 Cyl.	8 Valves	3972cc	TD5696
OM 364.951	4 Cyl.	8 Valves	3972cc	TD17855
OM 364.952	4 Cyl.	8 Valves	3972cc	TD6033
OM 364.953	4 Cyl.	8 Valves	3972cc	TD16806
OM 364.954	4 Cyl.	8 Valves	3972cc	TD8045
OM 364.955	4 Cyl.	8 Valves	3973cc	TD8015
OM 364.956	4 Cyl.	8 Valves	3973cc	TD22772
OM 364.957	4 Cyl.	8 Valves	3972cc	TD5693
OM 364.958	4 Cyl.	8 Valves	3972cc	TD6030
OM 364.959	4 Cyl.	8 Valves	3972cc	TD22773
OM 364.979	4 Cyl.	8 Valves	3972cc	TD28661
OM 364.980	4 Cyl.	8 Valves	3972cc	TD8047
OM 364.981	4 Cyl.	8 Valves	3972cc	TD8086
OM 364.982	4 Cyl.	8 Valves	3972cc	TD8016
OM 364.983	4 Cyl.	8 Valves	3972cc	TD20150

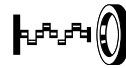
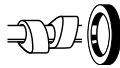

OM 364.984	4 Cyl.	8 Valves	3972cc	TD8088
OM 364.985	4 Cyl.	8 Valves	3972cc	TD8017
OM 364.986	4 Cyl.	8 Valves	3972cc	TD5694
OM 364.987	4 Cyl.	8 Valves	3972cc	TD6031
OM 364.989	4 Cyl.	8 Valves	3972cc	TD22774
OM 374.907	4 Cyl.	8 Valves	3972cc	TD8058
PB172 (x4)				NB978 65.00 x 90.00 x 13.00mm, FPM LB955 (x2) 90.00 x 107.00 x 8.00mm
PB177 (x4)				
HR666				

113 4.0L

Diesel

OM 370.905	4 Cyl.	8 Valves	3972cc	TD28664
OM 370.950	4 Cyl.	8 Valves	3972cc	TD28665
OM 370.951	4 Cyl.	8 Valves	3972cc	TD28666
OM 370.952	4 Cyl.	8 Valves	3972cc	TD28667
OM 374.900	4 Cyl.	8 Valves	3972cc	TD28688
OM 374.905	4 Cyl.	8 Valves	3972cc	TD23197
OM 374.908	4 Cyl.	8 Valves	3972cc	TD23198
OM 374.992	4 Cyl.	8 Valves	3972cc	TD25648
OM 380.940	4 Cyl.	8 Valves	3972cc	TD22776
OM 380.942	4 Cyl.	8 Valves	3972cc	TD22777
OM 380.943	4 Cyl.	8 Valves	3972cc	TD22778
OM 384.906	4 Cyl.	8 Valves	3972cc	TD23199
OM 384.907	4 Cyl.	8 Valves	3972cc	TD22788
OM 384.908	4 Cyl.	8 Valves	3972cc	TD22789
				NB978 65.00 x 90.00 x 13.00mm, FPM LB955 90.00 x 107.00 x 8.00mm

114 4.0L

Diesel

OM 628.960	8 Cyl.	32 Valves	3996cc	TD15462
OM 628.961	8 Cyl.	32 Valves	3996cc	TD17545
OM 628.962	8 Cyl.	32 Valves	3996cc	TD15459
OM 628.963	8 Cyl.	32 Valves	3996cc	TD17010
OM 629.910	8 Cyl.	32 Valves	3996cc	TD19144
OM 629.911	8 Cyl.	32 Valves	3996cc	TD20332
OM 629.912	8 Cyl.	32 Valves	3996cc	TD19208
				NA5131 45.00 x 67.00 x 8.00mm, PTFE NA5168 93.00 x 114.00 x 11.50mm, PTFE

115 4.2L

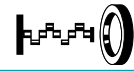

Petrol

M 116.964	8 Cyl.	16 Valves	4196cc	TD2162
M 116.965	8 Cyl.	16 Valves	4196cc	TD2163
PB394 (x16)				NB973 45.00 x 67.00 x 8.00mm, FPM NA5268 100.00 x 124.00 x 13.00mm, FPM





116 4.2L

Petrol

M 119.971	8 Cyl.	32 Valves	4196cc	TD2188
M 119.975	8 Cyl.	32 Valves	4196cc	TD2191
HR5055  (x2)	NC065 (x2) 30.00 x 40.00 x 7.00mm, FPM		NB973  45.00 x 67.00 x 8.00mm, FPM NA5268  100.00 x 124.00 x 13.00mm, FPM	



117 4.2L

Petrol

M 119.981	8 Cyl.	32 Valves	4196cc	TD19046
M 119.985	8 Cyl.	32 Valves	4196cc	TD4672
HR5055  (x2)			NB973  45.00 x 67.00 x 8.00mm, FPM NA5268  100.00 x 124.00 x 13.00mm, FPM	



118 4.2L

Diesel

OM 904.905	4 Cyl.	12 Valves	4249cc	TD8055
OM 904.906	4 Cyl.	12 Valves	4249cc	TD8060
OM 904.907	4 Cyl.	12 Valves	4249cc	TD8072
OM 904.908	4 Cyl.	12 Valves	4250cc	TD8024
PB180 (x12) Eng no. 039 740 →			NA5120  78.00 x 104.00 x 11.00mm, ACM	
HR660  Eng no. 039 740 →			NA5121  115.00 x 140.00 x 13.00mm, PTFE/ACM	



119 4.2L

Petrol

XK 4.2 (-79)	6 Cyl.	12 Valves	4235cc	TD5219
XK 4.2 (82-87)	6 Cyl.	12 Valves	4235cc	TD5220
HR299  (x2)			NA422  50.80 x 69.90 x 12.70mm, NBR	

120 4.3L

Petrol

M 113.940	8 Cyl.	24 Valves	4266cc	TD9889
M 113.941	8 Cyl.	24 Valves	4266cc	TD11492
M 113.942	8 Cyl.	24 Valves	4266cc	TD10949
M 113.943	8 Cyl.	24 Valves	4266cc	TD10947
M 113.944	8 Cyl.	24 Valves	4266cc	TD11489
M 113.948	8 Cyl.	24 Valves	4266cc	TD17188
HR5055 			NA5131  45.00 x 67.00 x 8.00mm, PTFE NA5168  93.00 x 114.00 x 11.50mm, PTFE	

121 4.3L

Diesel

OM 900.910	4 Cyl.	12 Valves	4249cc	TD22699
OM 900.911	4 Cyl.	12 Valves	4249cc	TD18918
OM 900.912	4 Cyl.	12 Valves	4249cc	TD18919
OM 900.913	4 Cyl.	12 Valves	4249cc	TD18920
OM 900.915	4 Cyl.	12 Valves	4249cc	TD23299
OM 900.917	4 Cyl.	12 Valves	4249cc	TD18921
OM 900.918	4 Cyl.	12 Valves	4249cc	TD18922
OM 900.919	4 Cyl.	12 Valves	4249cc	TD18923
OM 900.920	4 Cyl.	12 Valves	4249cc	TD22696

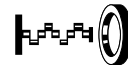
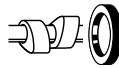

OM 900.921	4 Cyl.	12 Valves	4249cc	TD22697
OM 900.922	4 Cyl.	12 Valves	4249cc	TD22698
OM 904.903	4 Cyl.	12 Valves	4250cc	TD28795
OM 904.904	4 Cyl.	12 Valves	4250cc	TD16441
OM 904.909	4 Cyl.	12 Valves	4249cc	TD12528
OM 904.910	4 Cyl.	12 Valves	4249cc	TD12529
OM 904.911	4 Cyl.	12 Valves	4249cc	TD12530
OM 904.912	4 Cyl.	12 Valves	4249cc	TD17711
OM 904.914	4 Cyl.	12 Valves	4249cc	TD16833
OM 904.915	4 Cyl.	12 Valves	4249cc	TD16834
OM 904.916	4 Cyl.	12 Valves	4249cc	TD16835
OM 904.917	4 Cyl.	12 Valves	4249cc	TD16836
OM 904.918	4 Cyl.	12 Valves	4249cc	TD17752
OM 904.919	4 Cyl.	12 Valves	4249cc	TD17705
OM 904.920	4 Cyl.	12 Valves	4249cc	TD17706
OM 904.921	4 Cyl.	12 Valves	4249cc	TD16837
OM 904.922	4 Cyl.	12 Valves	4249cc	TD12531
OM 904.923	4 Cyl.	12 Valves	4250cc	TD16438
OM 904.924	4 Cyl.	12 Valves	4249cc	TD17707
OM 904.925	4 Cyl.	12 Valves	4249cc	TD17708
OM 904.926	4 Cyl.	12 Valves	4249cc	TD17709
OM 904.927	4 Cyl.	12 Valves	4249cc	TD17324
OM 904.928	4 Cyl.	12 Valves	4249cc	TD17325
OM 904.929	4 Cyl.	12 Valves	4249cc	TD17710
OM 904.930	4 Cyl.	12 Valves	4249cc	TD16838
OM 904.931	4 Cyl.	12 Valves	4249cc	TD16839
OM 904.932	4 Cyl.	12 Valves	4249cc	TD17712
OM 904.933	4 Cyl.	12 Valves	4249cc	TD17713
OM 904.934	4 Cyl.	12 Valves	4249cc	TD17714
OM 904.935	4 Cyl.	12 Valves	4249cc	TD17715
OM 904.936	4 Cyl.	12 Valves	4250cc	TD16916
OM 904.937	4 Cyl.	12 Valves	4249cc	TD17716
OM 904.938	4 Cyl.	12 Valves	4249cc	TD17717
OM 904.939	4 Cyl.	12 Valves	4249cc	TD17718
OM 904.940	4 Cyl.	12 Valves	4249cc	TD17719
OM 904.941	4 Cyl.	12 Valves	4249cc	TD17720
OM 904.942	4 Cyl.	12 Valves	4249cc	TD17721
OM 904.943	4 Cyl.	12 Valves	4249cc	TD17722
OM 904.944	4 Cyl.	12 Valves	4249cc	TD17734
OM 904.945	4 Cyl.	12 Valves	4249cc	TD17735
OM 904.946	4 Cyl.	12 Valves	4249cc	TD17736
OM 904.947	4 Cyl.	12 Valves	4249cc	TD17737
OM 904.948	4 Cyl.	12 Valves	4249cc	TD17738
OM 904.949	4 Cyl.	12 Valves	4249cc	TD17739
OM 904.950	4 Cyl.	12 Valves	4249cc	TD17740
OM 904.951	4 Cyl.	12 Valves	4249cc	TD17741
OM 904.952	4 Cyl.	12 Valves	4249cc	TD17183
OM 904.953	4 Cyl.	12 Valves	4249cc	TD17184
OM 904.954	4 Cyl.	12 Valves	4249cc	TD17742
OM 904.955	4 Cyl.	12 Valves	4250cc	TD16915

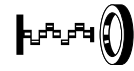
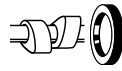

OM 904.956	4 Cyl.	12 Valves	4249cc	TD17744
OM 904.957	4 Cyl.	12 Valves	4249cc	TD17745
OM 904.959	4 Cyl.	12 Valves	4249cc	TD17746
OM 904.961	4 Cyl.	12 Valves	4250cc	TD16918
OM 904.962	4 Cyl.	12 Valves	4249cc	TD17747
OM 904.964	4 Cyl.	12 Valves	4249cc	TD16919
OM 904.965	4 Cyl.	12 Valves	4249cc	TD17748
OM 904.966	4 Cyl.	12 Valves	4249cc	TD17749
OM 904.967	4 Cyl.	12 Valves	4249cc	TD17750
OM 904.968	4 Cyl.	12 Valves	4249cc	TD17751
OM 904.970	4 Cyl.	12 Valves	4249cc	TD24856
OM 904.971	4 Cyl.	12 Valves	4249cc	TD28796
OM 904.972	4 Cyl.	12 Valves	4249cc	TD24857
OM 904.973	4 Cyl.	12 Valves	4249cc	TD24858
OM 904.974	4 Cyl.	12 Valves	4249cc	TD28797
OM 904.975	4 Cyl.	12 Valves	4249cc	TD28798
OM 904.976	4 Cyl.	12 Valves	4249cc	TD24859
OM 904.977	4 Cyl.	12 Valves	4249cc	TD28799
OM 904.978	4 Cyl.	12 Valves	4249cc	TD28800
OM 904.979	4 Cyl.	12 Valves	4249cc	TD28801
OM 904.980	4 Cyl.	12 Valves	4249cc	TD28802
OM 904.981	4 Cyl.	12 Valves	4249cc	TD28803
OM 904.983	4 Cyl.	12 Valves	4249cc	TD28804
OM 907.910	4 Cyl.	12 Valves	4250cc	TD16840
OM 907.920	4 Cyl.	12 Valves	4250cc	TD16841
OM 907.930	4 Cyl.	12 Valves	4249cc	TD17754
OM 907.940	4 Cyl.	12 Valves	4250cc	TD16842
OM 907.941	4 Cyl.	12 Valves	4249cc	TD17753
OM 907.960	4 Cyl.	12 Valves	4250cc	TD16843
OM 907.970	4 Cyl.	12 Valves	4250cc	TD16844
OM 907.980	4 Cyl.	12 Valves	4249cc	TD17755
OM 907.990	4 Cyl.	12 Valves	4250cc	TD16845

PB180 (x12)
Eng no. 039 740 →

HR660
Eng no. 039 740 →

NA5120
78.00 x 104.00 x 11.00mm, ACM

NA5121
115.00 x 140.00 x 13.00mm, PTFE/ACM

122 4.3L

Diesel

OM 900.916	4 Cyl.	12 Valves	4249cc	TD23300
------------	--------	-----------	--------	---------

NA5120
78.00 x 104.00 x 11.00mm, ACM

NA5121
115.00 x 140.00 x 13.00mm, PTFE/ACM

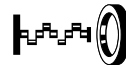
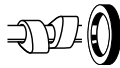

123 4.5L

Petrol

M 117.981	8 Cyl.	16 Valves	4520cc	TD2180
M 117.982	8 Cyl.	16 Valves	4520cc	TD4671
M 117.983	8 Cyl.	16 Valves	4520cc	TD2182
M 117.984	8 Cyl.	16 Valves	4520cc	TD2183
M 117.985	8 Cyl.	16 Valves	4520cc	TD5051
M 117.986	8 Cyl.	16 Valves	4520cc	TD2185
M 117.992	8 Cyl.	16 Valves	4520cc	TD22710
M 117.993	8 Cyl.	16 Valves	4520cc	TD22711

PB394 (x16)

NB973

45.00 x 67.00 x 8.00mm, FPM

NA5268

100.00 x 124.00 x 13.00mm, FPM

124 4.6L

Diesel

OM 312.954	6 Cyl.	12 Valves	4580cc	TD7983
------------	--------	-----------	--------	--------

NB979

65.00 x 90.00 x 15.00mm, FPM

125 4.7L

Petrol

M 273.922	8 Cyl.	32 Valves	4663cc	TD22146
M 273.923	8 Cyl.	32 Valves	4663cc	TD19210
M 273.924	8 Cyl.	32 Valves	4663cc	TD23760
M 278.920	8 Cyl.	32 Valves	4663cc	TD25072
M 278.922	8 Cyl.	32 Valves	4663cc	TD25516
M 278.927	8 Cyl.	32 Valves	4663cc	TD26366
M 278.928	8 Cyl.	32 Valves	4663cc	TD26364
M 278.929	8 Cyl.	32 Valves	4663cc	TD27897
M 278.932	8 Cyl.	32 Valves	4663cc	TD26083

PA5041 (x32)

HR791 (x2)

NA5131

45.00 x 67.00 x 8.00mm, PTFE

126 4.8L

Diesel

OM 924.910	4 Cyl.	12 Valves	4801cc	TD19181
OM 924.911	4 Cyl.	12 Valves	4801cc	TD19182
OM 924.912	4 Cyl.	12 Valves	4801cc	TD19183
OM 924.913	4 Cyl.	12 Valves	4801cc	TD25040
OM 924.914	4 Cyl.	12 Valves	4801cc	TD19184
OM 924.915	4 Cyl.	12 Valves	4801cc	TD19185
OM 924.916	4 Cyl.	12 Valves	4801cc	TD17185
OM 924.917	4 Cyl.	12 Valves	4801cc	TD19186
OM 924.919	4 Cyl.	12 Valves	4801cc	TD19187
OM 924.923	4 Cyl.	12 Valves	4801cc	TD19189
OM 924.924	4 Cyl.	12 Valves	4801cc	TD19191

PB180 (x12)

Eng no. 039 740→

HR660

Eng no. 039 740→

NA5120

78.00 x 104.00 x 11.00mm, ACM

NA5121

115.00 x 140.00 x 13.00mm, PTFE/ACM

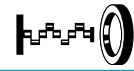
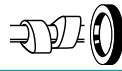

127 4.8L		Diesel			
OM 924.920	4 Cyl.	12 Valves	4801cc		TD18917
OM 924.922	4 Cyl.	12 Valves	4801cc		TD19188
OM 924.925	4 Cyl.	12 Valves	4801cc		TD28811
OM 924.927	4 Cyl.	12 Valves	4801cc		TD28812
OM 924.928	4 Cyl.	12 Valves	4801cc		TD28813
OM 924.929	4 Cyl.	12 Valves	4801cc		TD28814
OM 924.930	4 Cyl.	12 Valves	4801cc		TD25236
OM 924.931	4 Cyl.	12 Valves	4801cc		TD28815
OM 924.932	4 Cyl.	12 Valves	4801cc		TD28816
OM 924.933	4 Cyl.	12 Valves	4801cc		TD28817
OM 924.934	4 Cyl.	12 Valves	4801cc		TD28818
OM 924.935	4 Cyl.	12 Valves	4801cc		TD25237
OM 924.936	4 Cyl.	12 Valves	4801cc		TD28819
OM 924.937	4 Cyl.	12 Valves	4801cc		TD28820
OM 924.985	4 Cyl.	12 Valves	4801cc		TD28821
OM 924.987	4 Cyl.	12 Valves	4801cc		TD28822
OM 924.988	4 Cyl.	12 Valves	4801cc		TD25038
OM 924.989	4 Cyl.	12 Valves	4801cc		TD25476
OM 924.990	4 Cyl.	12 Valves	4801cc		TD28823
OM 924.991	4 Cyl.	12 Valves	4801cc		TD28824
OM 924.993	4 Cyl.	12 Valves	4801cc		TD28825
OM 924.994	4 Cyl.	12 Valves	4801cc		TD28826
OM 924.995	4 Cyl.	12 Valves	4801cc		TD28827
OM 924.996	4 Cyl.	12 Valves	4801cc		TD28828
OM 924.997	4 Cyl.	12 Valves	4801cc		TD28829
OM 924.998	4 Cyl.	12 Valves	4801cc		TD28830
OM 924.999	4 Cyl.	12 Valves	4801cc		TD28831
PB180 (x12) HR660				NA5120 78.00 x 104.00 x 11.00mm, ACM NA5121 115.00 x 140.00 x 13.00mm, PTFE/ACM	

128 4.9L		Petrol			
M 117.965	8 Cyl.	16 Valves	4973cc		TD4670
PB394 (x16)				NB973 45.00 x 67.00 x 8.00mm, FPM NA5268 100.00 x 124.00 x 13.00mm, FPM	

129 5.0L		Petrol			
M 113.960	8 Cyl.	24 Valves	4966cc		TD11493
M 113.961	8 Cyl.	24 Valves	4966cc		TD11495
M 113.962	8 Cyl.	24 Valves	4966cc		TD12027
M 113.963	8 Cyl.	24 Valves	4966cc		TD16886
M 113.964	8 Cyl.	24 Valves	4966cc		TD17011
M 113.965	8 Cyl.	24 Valves	4966cc		TD17308
M 113.966	8 Cyl.	24 Valves	4966cc		TD17191
M 113.967	8 Cyl.	24 Valves	4966cc		TD17006

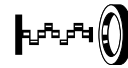
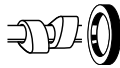

M 113.968	8 Cyl.	24 Valves	4966cc	TD16887
M 113.969	8 Cyl.	24 Valves	4966cc	TD17332
M 113.971	8 Cyl.	24 Valves	4966cc	TD18972
HR5055				NA5131 45.00 x 67.00 x 8.00mm, PTFE NA5168 93.00 x 114.00 x 11.50mm, PTFE

130 5.0L Petrol

M 117.960	8 Cyl.	16 Valves	4973cc	TD2170
M 117.961	8 Cyl.	16 Valves	4973cc	TD2172
				NB973 45.00 x 67.00 x 8.00mm, FPM NA5268 100.00 x 124.00 x 13.00mm, FPM

131 5.0L Petrol

M 117.962	8 Cyl.	16 Valves	4973cc	TD17728
M 117.963	8 Cyl.	16 Valves	4973cc	TD2174
M 117.964	8 Cyl.	16 Valves	4973cc	TD2175
PB394 (x16)				NB973 45.00 x 67.00 x 8.00mm, FPM NA5268 100.00 x 124.00 x 13.00mm, FPM

132 5.0L Petrol

M 119.960	8 Cyl.	32 Valves	4973cc	TD2186
M 119.970	8 Cyl.	32 Valves	4973cc	TD2187
M 119.972	8 Cyl.	32 Valves	4973cc	TD2189
M 119.974	8 Cyl.	32 Valves	4973cc	TD2190
HR5055 (x2)	NC065 (x2)			NB973 45.00 x 67.00 x 8.00mm, FPM NA5268 100.00 x 124.00 x 13.00mm, FPM

133 5.0L Petrol

M 119.980	8 Cyl.	32 Valves	4973cc	TD19044
M 119.982	8 Cyl.	32 Valves	4973cc	TD20346
M 119.985 (AMG 5.0)	8 Cyl.	32 Valves	4973cc	TD9891
HR5055 (x2)				NB973 45.00 x 67.00 x 8.00mm, FPM NA5268 100.00 x 124.00 x 13.00mm, FPM



134 5.1L Diesel

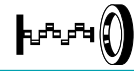
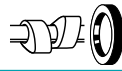

OM 934.911	4 Cyl.	16 Valves	5132cc	TD28096
OM 934.913	4 Cyl.	16 Valves	5132cc	TD28097
OM 934.971	4 Cyl.	16 Valves	5132cc	TD34251
OM 934.972	4 Cyl.	16 Valves	5132cc	TD34252
OM 934.974	4 Cyl.	16 Valves	5132cc	TD29322
				NA5120 78.00 x 104.00 x 11.00mm, ACM NA5121 115.00 x 140.00 x 13.00mm, PTFE/ACM





135 5.3L		Petrol			
7P		12 Cyl.	24 Valves	5344cc	TD5196
HR299  (x4)					NB584  54.00 x 73.00 x 12.40mm, NBR

136 5.3L		Petrol			
V 12 (75-79)		12 Cyl.	24 Valves	5344cc	TD5221
V 12 (82-90)		12 Cyl.	24 Valves	5344cc	TD816
HR299  (x4)					

137 5.4L		Petrol			
M 113.980		8 Cyl.	24 Valves	5439cc	TD9890
M 113.981		8 Cyl.	24 Valves	5439cc	TD14889
M 113.984		8 Cyl.	24 Valves	5439cc	TD15457
M 113.988		8 Cyl.	24 Valves	5439cc	TD17931
M 113.990		8 Cyl.	24 Valves	5439cc	TD17330
M 113.993		8 Cyl.	24 Valves	5439cc	TD18368
M 113.994		8 Cyl.	24 Valves	5439cc	TD18432
M 113.995		8 Cyl.	24 Valves	5439cc	TD23757
M 155.980		8 Cyl.	24 Valves	5439cc	TD17435
HR5055 					NA5131  45.00 x 67.00 x 8.00mm, PTFE NA5168  93.00 x 114.00 x 11.50mm, PTFE

138 5.5L		Petrol			
M 113.982		8 Cyl.	24 Valves	5439cc	TD16896
M 113.985		8 Cyl.	24 Valves	5439cc	TD16888
M 113.986		8 Cyl.	24 Valves	5439cc	TD16891
M 113.987		8 Cyl.	24 Valves	5439cc	TD16890
M 113.989		8 Cyl.	24 Valves	5439cc	TD18433
M 113.991		8 Cyl.	24 Valves	5439cc	TD17193
M 113.992		8 Cyl.	24 Valves	5439cc	TD16889
HR5055 					NA5131  45.00 x 67.00 x 8.00mm, PTFE NA5168  93.00 x 114.00 x 11.50mm, PTFE

139 5.5L		Petrol			
M 117.967		8 Cyl.	16 Valves	5547cc	TD2177
M 117.968		8 Cyl.	16 Valves	5547cc	TD2178
PB394  (x16)					NB973  45.00 x 67.00 x 8.00mm, FPM NA5268  100.00 x 124.00 x 13.00mm, FPM

140 5.5L		Petrol			
M 152.980		8 Cyl.	32 Valves	5461cc	TD26368
M 157.980		8 Cyl.	32 Valves	5461cc	TD25145
M 157.981		8 Cyl.	32 Valves	5461cc	TD25146
M 157.982		8 Cyl.	32 Valves	5461cc	TD27713
M 157.983		8 Cyl.	32 Valves	5461cc	TD26367
M 157.984		8 Cyl.	32 Valves	5461cc	TD29376

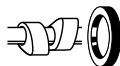

M 157.985	8 Cyl.	32 Valves	5461cc	TD28183
M 273.960	8 Cyl.	32 Valves	5461cc	TD20737
M 273.961	8 Cyl.	32 Valves	5461cc	TD19147
M 273.962	8 Cyl.	32 Valves	5461cc	TD20990
M 273.963	8 Cyl.	32 Valves	5461cc	TD19209
M 273.965	8 Cyl.	32 Valves	5461cc	TD19212
M 273.966	8 Cyl.	32 Valves	5461cc	TD23725
M 273.967	8 Cyl.	32 Valves	5461cc	TD21180
M 273.968	8 Cyl.	32 Valves	5461cc	TD20908
M 273.970	8 Cyl.	32 Valves	5461cc	TD23779
M 273.971	8 Cyl.	32 Valves	5461cc	TD23780
PA5041 (x32) HR791 (x2)				NA5131 (x2) 45.00 x 67.00 x 8.00mm, PTFE

141 5.5L

Petrol

M 275.950	12 Cyl.	36 Valves	5513cc	TD17192
M 275.951	12 Cyl.	36 Valves	5513cc	TD17538
M 275.953	12 Cyl.	36 Valves	5513cc	TD19263
M 275.954	12 Cyl.	36 Valves	5513cc	TD24809
M 285.950	12 Cyl.	36 Valves	5513cc	TD17540
M 285.950	12 Cyl.	36 Valves	5513cc	TD22727
PA5041 (x36) HR280 (x3)				NA5131 (x3) 45.00 x 67.00 x 8.00mm, PTFE NA5168 (x3) 93.00 x 114.00 x 11.50mm, PTFE

142 5.7L

Diesel

OM 341.900	6 Cyl.	12 Valves	5675cc	TD28461
OM 341.910	6 Cyl.	12 Valves	5675cc	TD28463
OM 341.911	6 Cyl.	12 Valves	5675cc	TD28464
OM 341.912	6 Cyl.	12 Valves	5675cc	TD28465
OM 341.913	6 Cyl.	12 Valves	5675cc	TD28466
OM 341.915	6 Cyl.	12 Valves	5675cc	TD28467
OM 341.918	6 Cyl.	12 Valves	5675cc	TD28468
OM 341.919	6 Cyl.	12 Valves	5675cc	TD28472
OM 341.931	6 Cyl.	12 Valves	5675cc	TD28469
OM 341.932	6 Cyl.	12 Valves	5675cc	TD28473
OM 341.933	6 Cyl.	12 Valves	5675cc	TD28474
OM 341.934	6 Cyl.	12 Valves	5675cc	TD28476
OM 341.935	6 Cyl.	12 Valves	5675cc	TD28477
OM 341.936	6 Cyl.	12 Valves	5675cc	TD28478
OM 341.937	6 Cyl.	12 Valves	5675cc	TD28479
OM 341.938	6 Cyl.	12 Valves	5675cc	TD28480
OM 341.939	6 Cyl.	12 Valves	5675cc	TD28481
OM 341.941	6 Cyl.	12 Valves	5675cc	TD28482
OM 341.943	6 Cyl.	12 Valves	5675cc	TD28483
OM 341.946	6 Cyl.	12 Valves	5675cc	TD28484
OM 341.947	6 Cyl.	12 Valves	5675cc	TD28485
OM 341.948	6 Cyl.	12 Valves	5675cc	TD28486
OM 341.949	6 Cyl.	12 Valves	5675cc	TD28487
OM 341.950	6 Cyl.	12 Valves	5675cc	TD28488
OM 341.951	6 Cyl.	12 Valves	5675cc	TD28586

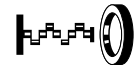
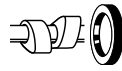

OM 341.995	6 Cyl.	12 Valves	5675cc	TD28489
OM 341.996	6 Cyl.	12 Valves	5675cc	TD28490
OM 344.905	6 Cyl.	12 Valves	5675cc	TD28587
OM 344.912	6 Cyl.	12 Valves	5675cc	TD28588
OM 344.930	6 Cyl.	12 Valves	5675cc	TD28589
OM 344.931	6 Cyl.	12 Valves	5675cc	TD28590
OM 344.932	6 Cyl.	12 Valves	5675cc	TD28591
OM 344.933	6 Cyl.	12 Valves	5675cc	TD28592
OM 344.941	6 Cyl.	12 Valves	5675cc	TD28272
OM 344.943	6 Cyl.	12 Valves	5675cc	TD28593
OM 344.944	6 Cyl.	12 Valves	5675cc	TD28594
OM 344.945	6 Cyl.	12 Valves	5675cc	TD28595
OM 344.946	6 Cyl.	12 Valves	5675cc	TD28596
OM 344.963	6 Cyl.	12 Valves	5675cc	TD28597
OM 353.920	6 Cyl.	12 Valves	5675cc	TD26350
OM 353.931	6 Cyl.	12 Valves	5675cc	TD26356
OM 353.933	6 Cyl.	12 Valves	5675cc	TD26357
OM 353.934	6 Cyl.	12 Valves	5675cc	TD26358
OM 353.935	6 Cyl.	12 Valves	5675cc	TD26359
OM 353.938	6 Cyl.	12 Valves	5675cc	TD26362
OM 353.939	6 Cyl.	12 Valves	5675cc	TD26363

PB177 (x6)
→Eng no. 467999

PB172 (x6)
Eng no. 468000→

HR667
Eng no. 794939→

NB979
65.00 x 90.00 x 15.00mm, FPM
→Eng no. 598249

NB978
65.00 x 90.00 x 13.00mm, FPM
Eng no. 598250→

LB955 (x2)
90.00 x 107.00 x 8.00mm

143 5.7L

Diesel

OM 344.913	6 Cyl.	12 Valves	5675cc	TD23170
OM 344.934	6 Cyl.	12 Valves	5675cc	TD7926
OM 344.937	6 Cyl.	12 Valves	5675cc	TD23171
OM 344.938	6 Cyl.	12 Valves	5675cc	TD23172
OM 344.939	6 Cyl.	12 Valves	5675cc	TD23173
OM 344.940	6 Cyl.	12 Valves	5675cc	TD23174
OM 344.948	6 Cyl.	12 Valves	5675cc	TD22734
OM 344.949	6 Cyl.	12 Valves	5675cc	TD22735
OM 344.951	6 Cyl.	12 Valves	5675cc	TD23176
OM 344.952	6 Cyl.	12 Valves	5675cc	TD22736
OM 352.901	6 Cyl.	12 Valves	5675cc	TD16626
OM 352.902	6 Cyl.	12 Valves	5670cc	TD7974
OM 352.903	6 Cyl.	12 Valves	5675cc	TD7977
OM 352.904	6 Cyl.	12 Valves	5675cc	TD16627
OM 352.905	6 Cyl.	12 Valves	5680cc	TD7966
OM 352.906	6 Cyl.	12 Valves	5675cc	TD5700
OM 352.907	6 Cyl.	12 Valves	5700cc	TD5702
OM 352.908	6 Cyl.	12 Valves	5675cc	TD5701
OM 352.909	6 Cyl.	12 Valves	5675cc	TD16606
OM 352.910	6 Cyl.	12 Valves	5675cc	TD16615
OM 352.911	6 Cyl.	12 Valves	5675cc	TD16607

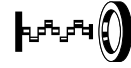
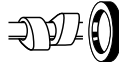

OM 352.912	6 Cyl.	12 Valves	5675cc	TD16628
OM 352.913	6 Cyl.	12 Valves	5675cc	TD16643
OM 352.914	6 Cyl.	12 Valves	5675cc	TD7921
OM 352.915	6 Cyl.	12 Valves	5675cc	TD7922
OM 352.916	6 Cyl.	12 Valves	5675cc	TD7923
OM 352.917	6 Cyl.	12 Valves	5675cc	TD16629
OM 352.918	6 Cyl.	12 Valves	5675cc	TD16641
OM 352.919	6 Cyl.	12 Valves	5675cc	TD7984
OM 352.930	6 Cyl.	12 Valves	5675cc	TD16630
OM 352.931	6 Cyl.	12 Valves	5675cc	TD16631
OM 352.932	6 Cyl.	12 Valves	5675cc	TD16608
OM 352.933	6 Cyl.	12 Valves	5675cc	TD16609
OM 352.934	6 Cyl.	12 Valves	5675cc	TD16632
OM 352.935	6 Cyl.	12 Valves	5675cc	TD16633
OM 352.936	6 Cyl.	12 Valves	5675cc	TD8158
OM 352.937	6 Cyl.	12 Valves	5675cc	TD16644
OM 352.938	6 Cyl.	12 Valves	5675cc	TD5738
OM 352.939	6 Cyl.	12 Valves	5675cc	TD16634
OM 352.942	6 Cyl.	12 Valves	5675cc	TD16616
OM 352.943	6 Cyl.	12 Valves	5675cc	TD16610
OM 352.944	6 Cyl.	12 Valves	5675cc	TD16635
OM 352.945	6 Cyl.	12 Valves	5675cc	TD16637
OM 352.946	6 Cyl.	12 Valves	5675cc	TD16645
OM 352.948	6 Cyl.	12 Valves	5675cc	TD16638
OM 352.949	6 Cyl.	12 Valves	5675cc	TD16646
OM 352.950	6 Cyl.	12 Valves	5675cc	TD16647
OM 352.953	6 Cyl.	12 Valves	5675cc	TD16639
OM 352.954	6 Cyl.	12 Valves	5675cc	TD16640
OM 352.955	6 Cyl.	12 Valves	5675cc	TD17012
OM 352.959	6 Cyl.	12 Valves	5675cc	TD22737
OM 352.963	6 Cyl.	12 Valves	5675cc	TD6071
OM 352.964	6 Cyl.	12 Valves	5675cc	TD5714
OM 352.965	6 Cyl.	12 Valves	5675cc	TD22738
OM 352.966	6 Cyl.	12 Valves	5675cc	TD22739
OM 352.967	6 Cyl.	12 Valves	5675cc	TD22740
OM 352.968	6 Cyl.	12 Valves	5675cc	TD16648
OM 352.969	6 Cyl.	12 Valves	5675cc	TD8089
OM 352.970	6 Cyl.	12 Valves	5675cc	TD16611
OM 352.971	6 Cyl.	12 Valves	5675cc	TD16617
OM 352.972	6 Cyl.	12 Valves	5675cc	TD16618
OM 352.973	6 Cyl.	12 Valves	5675cc	TD16619
OM 352.974	6 Cyl.	12 Valves	5675cc	TD16620
OM 352.975	6 Cyl.	12 Valves	5675cc	TD16621
OM 352.976	6 Cyl.	12 Valves	5675cc	TD16612
OM 352.978	6 Cyl.	12 Valves	5675cc	TD22741
OM 352.979	6 Cyl.	12 Valves	5675cc	TD16613
OM 352.980	6 Cyl.	12 Valves	5675cc	TD17015
OM 352.981	6 Cyl.	12 Valves	5675cc	TD16622
OM 352.982	6 Cyl.	12 Valves	5675cc	TD16614
OM 352.983	6 Cyl.	12 Valves	5675cc	TD16623

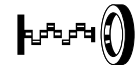
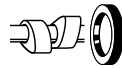

OM 352.984	6 Cyl.	12 Valves	5675cc	TD7976
OM 352.985	6 Cyl.	12 Valves	5675cc	TD16624
OM 352.986	6 Cyl.	12 Valves	5700cc	TD6037
OM 352.987	6 Cyl.	12 Valves	5675cc	TD17013
OM 352.988	6 Cyl.	12 Valves	5675cc	TD16649
OM 352.989	6 Cyl.	12 Valves	5675cc	TD16625
OM 352.990	6 Cyl.	12 Valves	5675cc	TD6036
OM 352.991	6 Cyl.	12 Valves	5675cc	TD17014
OM 352.992	6 Cyl.	12 Valves	5675cc	TD22742
OM 352.993	6 Cyl.	12 Valves	5675cc	TD7891
OM 352.994	6 Cyl.	12 Valves	5675cc	TD16650
OM 352.996	6 Cyl.	12 Valves	5675cc	TD6281
OM 352.997	6 Cyl.	12 Valves	5675cc	TD5713
OM 352.998	6 Cyl.	12 Valves	5675cc	TD6047
OM 352.999	6 Cyl.	12 Valves	5675cc	TD22743
OM 353.900	6 Cyl.	12 Valves	5675cc	TD16651
OM 353.901	6 Cyl.	12 Valves	5675cc	TD7979
OM 353.902	6 Cyl.	12 Valves	5675cc	TD5678
OM 353.903	6 Cyl.	12 Valves	5675cc	TD16652
OM 353.904	6 Cyl.	12 Valves	5675cc	TD5697
OM 353.905	6 Cyl.	12 Valves	5680cc	TD7988
OM 353.907	6 Cyl.	12 Valves	5675cc	TD7982
OM 353.909	6 Cyl.	12 Valves	5675cc	TD8091
OM 353.910	6 Cyl.	12 Valves	5675cc	TD8162
OM 353.911	6 Cyl.	12 Valves	5675cc	TD8090
OM 353.912	6 Cyl.	12 Valves	5675cc	TD8159
OM 353.913	6 Cyl.	12 Valves	5675cc	TD8097
OM 353.914	6 Cyl.	12 Valves	5675cc	TD16662
OM 353.915	6 Cyl.	12 Valves	5675cc	TD16653
OM 353.916	6 Cyl.	12 Valves	5675cc	TD16654
OM 353.917	6 Cyl.	12 Valves	5675cc	TD16655
OM 353.940	6 Cyl.	12 Valves	5675cc	TD6016
OM 353.941	6 Cyl.	12 Valves	5675cc	TD16656
OM 353.942	6 Cyl.	12 Valves	5700cc	TD5709
OM 353.943	6 Cyl.	12 Valves	5700cc	TD5727
OM 353.944	6 Cyl.	12 Valves	5700cc	TD5728
OM 353.945	6 Cyl.	12 Valves	5700cc	TD5710
OM 353.946	6 Cyl.	12 Valves	5700cc	TD6044
OM 353.949	6 Cyl.	12 Valves	5675cc	TD16994
OM 353.950	6 Cyl.	12 Valves	5700cc	TD5711
OM 353.951	6 Cyl.	12 Valves	5700cc	TD5747
OM 353.952	6 Cyl.	12 Valves	5700cc	TD6045
OM 353.953	6 Cyl.	12 Valves	5700cc	TD6092
OM 353.954	6 Cyl.	12 Valves	5700cc	TD8096
OM 353.957	6 Cyl.	12 Valves	5675cc	TD16995
OM 353.958	6 Cyl.	12 Valves	5675cc	TD7990
OM 353.959	6 Cyl.	12 Valves	5675cc	TD8009
OM 353.960	6 Cyl.	12 Valves	5675cc	TD7980
OM 353.961	6 Cyl.	12 Valves	5675cc	TD7998
OM 353.962	6 Cyl.	12 Valves	5675cc	TD7978

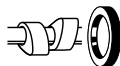

OM 353.963	6 Cyl.	12 Valves	5675cc	TD5690
OM 353.964	6 Cyl.	12 Valves	5700cc	TD6284
OM 353.965	6 Cyl.	12 Valves	5675cc	TD5715
OM 353.966	6 Cyl.	12 Valves	5675cc	TD6027
OM 353.967	6 Cyl.	12 Valves	5675cc	TD16657
OM 353.968	6 Cyl.	12 Valves	5675cc	TD16658
OM 353.969	6 Cyl.	12 Valves	5675cc	TD16659
OM 353.970	6 Cyl.	12 Valves	5700cc	TD5712
OM 353.971	6 Cyl.	12 Valves	5700cc	TD6060
OM 353.972	6 Cyl.	12 Valves	5675cc	TD16660
OM 353.973	6 Cyl.	12 Valves	5675cc	TD7981
OM 353.974	6 Cyl.	12 Valves	5675cc	TD16661
OM 353.975	6 Cyl.	12 Valves	5700cc	TD6321
OM 353.976	6 Cyl.	12 Valves	5675cc	TD17860
OM 353.977	6 Cyl.	12 Valves	5675cc	TD22744
OM 353.978	6 Cyl.	12 Valves	5675cc	TD16664
OM 353.980	6 Cyl.	12 Valves	5675cc	TD7996
OM 353.981	6 Cyl.	12 Valves	5675cc	TD6034
OM 353.982	6 Cyl.	12 Valves	5675cc	TD6048
OM 353.983	6 Cyl.	12 Valves	5675cc	TD17016
OM 353.984	6 Cyl.	12 Valves	5675cc	TD17017
OM 353.985	6 Cyl.	12 Valves	5675cc	TD17856
OM 353.988	6 Cyl.	12 Valves	5675cc	TD17178
OM 353.989	6 Cyl.	12 Valves	5675cc	TD16663
OM 353.991	6 Cyl.	12 Valves	5675cc	TD16665
OM 353.995	6 Cyl.	12 Valves	5675cc	TD7999
OM 353.997	6 Cyl.	12 Valves	5675cc	TD16666
OM 353.998	6 Cyl.	12 Valves	5675cc	TD16938
OM 353.999	6 Cyl.	12 Valves	5675cc	TD16939

PB177 (x6)
→Eng no. 794 938

PB172 (x6)
Eng no. 794 939→

HR667
Eng no. 794939→

NB979
65.00 x 90.00 x 15.00mm, FPM
→Eng no. 598249

NB978
65.00 x 90.00 x 13.00mm, FPM
Eng no. 598250→

LB955 (x2)
90.00 x 107.00 x 8.00mm

144 5.7L

Diesel

OM 353.906	6 Cyl.	12 Valves	5680cc	TD26551
OM 353.921	6 Cyl.	12 Valves	5675cc	TD26351
OM 353.922	6 Cyl.	12 Valves	5675cc	TD26352
OM 353.923	6 Cyl.	12 Valves	5675cc	TD26353
OM 353.930	6 Cyl.	12 Valves	5675cc	TD26354
OM 353.932	6 Cyl.	12 Valves	5675cc	TD26355
OM 353.936	6 Cyl.	12 Valves	5675cc	TD26360
OM 353.937	6 Cyl.	12 Valves	5675cc	TD26361

PB177 (x6)
→Eng no. 467999

PB172 (x6)
Eng no. 468000→

HR667
Eng no. 794939→

NB978
65.00 x 90.00 x 13.00mm, FPM

NB979
65.00 x 90.00 x 15.00mm, FPM

LB955 (x2)
90.00 x 107.00 x 8.00mm

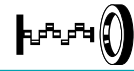
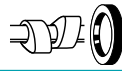

145 5.7L		Diesel		
OM 362.906	6 Cyl.	12 Valves	5700cc	TD5750
OM 362.909	6 Cyl.	12 Valves	5700cc	TD6080
PB177 (x6) →Eng no. 467 999				NB978 65.00 x 90.00 x 13.00mm, FPM
PB172 (x6) Eng no. 468 000→				LB955 (x2) 90.00 x 107.00 x 8.00mm
HR667 01/84→				
146 5.7L		Diesel		
OM 362.910	6 Cyl.	12 Valves	5675cc	TD16699
PB172 (x6)				NB978 65.00 x 90.00 x 13.00mm, FPM
PB177 (x6)				LB955 (x2) 90.00 x 107.00 x 8.00mm
HR667 →12/86				
147 5.8L		Petrol		
M 137.970	12 Cyl.	36 Valves	5786cc	TD15460
				NA5131 45.00 x 67.00 x 8.00mm, PTFE
				NA5168 93.00 x 114.00 x 11.50mm, PTFE
148 6.0L		Petrol		
M 120.980	12 Cyl.	48 Valves	5987cc	TD2192
HR5055 (x2) Eng no. 016880→	NC065 (x2) 30.00 x 40.00 x 7.00mm, FPM			NB973 45.00 x 67.00 x 8.00mm, FPM
				NA5268 100.00 x 124.00 x 13.00mm, FPM
149 6.0L		Petrol		
M 120.981	12 Cyl.	48 Valves	5987cc	TD2193
HR5055 (x2) Eng no. 000347→	NC065 (x2) 30.00 x 40.00 x 7.00mm, FPM			NB973 45.00 x 67.00 x 8.00mm, FPM
				NA5268 100.00 x 124.00 x 13.00mm, FPM
150 6.0L		Petrol		
M 120.982	12 Cyl.	48 Valves	5987cc	TD20347
M 120.983	12 Cyl.	48 Valves	5987cc	TD11496
HR5055 (x2)	NC065 (x2) 30.00 x 40.00 x 7.00mm, FPM			NB973 45.00 x 67.00 x 8.00mm, FPM
				NA5268 100.00 x 124.00 x 13.00mm, FPM
151 6.0L		Petrol		
M 275.980	12 Cyl.	36 Valves	5980cc	TD17536
M 275.981	12 Cyl.	36 Valves	5980cc	TD17832
M 275.982	12 Cyl.	36 Valves	5980cc	TD20333
M 275.983	12 Cyl.	36 Valves	5980cc	TD29273
M 277.980	12 Cyl.	36 Valves	5980cc	TD28578
M 279.980	12 Cyl.	36 Valves	5980cc	TD28577

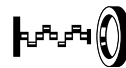
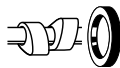

M 279.981	12 Cyl.	36 Valves	5980cc	TD27975
M 279.982	12 Cyl.	36 Valves	5980cc	TD27993
M 285.980	12 Cyl.	36 Valves	5980cc	TD25419
PA5041 ■ (x24)				NA5131 ■ 45.00 x 67.00 x 8.00mm, PTFE NA5168 ■ 93.00 x 114.00 x 11.50mm, PTFE

152 6.0L

Diesel

OM 356.901	6 Cyl.	12 Valves	5958cc	TD5704
OM 356.902	6 Cyl.	12 Valves	5958cc	TD8064
OM 356.903	6 Cyl.	12 Valves	5958cc	TD8093
OM 356.904	6 Cyl.	12 Valves	5958cc	TD8098
OM 356.905	6 Cyl.	12 Valves	5958cc	TD8062
OM 356.906	6 Cyl.	12 Valves	5958cc	TD8067
OM 356.907	6 Cyl.	12 Valves	5958cc	TD8099
OM 356.908	6 Cyl.	12 Valves	5958cc	TD8134
OM 356.909	6 Cyl.	12 Valves	5958cc	TD8133
OM 356.910	6 Cyl.	12 Valves	5958cc	TD8132
OM 356.911	6 Cyl.	12 Valves	5958cc	TD6039
OM 356.912	6 Cyl.	12 Valves	5958cc	TD16992
OM 356.913	6 Cyl.	12 Valves	5958cc	TD16810
OM 356.914	6 Cyl.	12 Valves	5958cc	TD7994
OM 356.915	6 Cyl.	12 Valves	5958cc	TD16811
OM 356.916	6 Cyl.	12 Valves	5958cc	TD17096
OM 356.940	6 Cyl.	12 Valves	5958cc	TD6098
OM 356.941	6 Cyl.	12 Valves	5958cc	TD5705
OM 356.943	6 Cyl.	12 Valves	5958cc	TD8146
OM 356.944	6 Cyl.	12 Valves	5958cc	TD8136
OM 356.945	6 Cyl.	12 Valves	5958cc	TD8137
OM 356.946	6 Cyl.	12 Valves	5958cc	TD5756
OM 356.947	6 Cyl.	12 Valves	5958cc	TD8103
OM 356.948	6 Cyl.	12 Valves	5958cc	TD8078
OM 356.949	6 Cyl.	12 Valves	5958cc	TD8105
OM 356.950	6 Cyl.	12 Valves	5958cc	TD8000
OM 356.951	6 Cyl.	12 Valves	5958cc	TD8073
OM 356.952	6 Cyl.	12 Valves	5958cc	TD16941
OM 356.953	6 Cyl.	12 Valves	5958cc	TD6089
OM 356.954	6 Cyl.	12 Valves	5958cc	TD8001
OM 356.955	6 Cyl.	12 Valves	5958cc	TD5680
OM 356.956	6 Cyl.	12 Valves	5958cc	TD6018
OM 356.957	6 Cyl.	12 Valves	5958cc	TD8010
OM 356.958	6 Cyl.	12 Valves	5958cc	TD16812
OM 356.959	6 Cyl.	12 Valves	5958cc	TD16813
OM 356.977	6 Cyl.	12 Valves	5958cc	TD16814
OM 356.978	6 Cyl.	12 Valves	5958cc	TD16815
OM 356.979	6 Cyl.	12 Valves	5958cc	TD5726
OM 356.980	6 Cyl.	12 Valves	5958cc	TD8005
OM 356.981	6 Cyl.	12 Valves	5958cc	TD8011
OM 356.983	6 Cyl.	12 Valves	5958cc	TD5724
OM 356.984	6 Cyl.	12 Valves	5958cc	TD8148

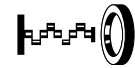
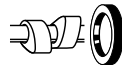

OM 356.985	6 Cyl.	12 Valves	5958cc	TD8189
OM 356.986	6 Cyl.	12 Valves	5958cc	TD8108
OM 356.987	6 Cyl.	12 Valves	5958cc	TD8149
OM 356.988	6 Cyl.	12 Valves	5958cc	TD22747
OM 356.989	6 Cyl.	12 Valves	5958cc	TD6057
OM 356.990	6 Cyl.	12 Valves	5958cc	TD8165
OM 356.991	6 Cyl.	12 Valves	5958cc	TD6282
OM 356.992	6 Cyl.	12 Valves	5958cc	TD8140
OM 356.993	6 Cyl.	12 Valves	5958cc	TD8112
OM 356.994	6 Cyl.	12 Valves	5958cc	TD5721
OM 356.995	6 Cyl.	12 Valves	5958cc	TD6054
OM 356.996	6 Cyl.	12 Valves	5958cc	TD8110
OM 356.997	6 Cyl.	12 Valves	5958cc	TD5681
OM 356.998	6 Cyl.	12 Valves	5958cc	TD6019
OM 356.999	6 Cyl.	12 Valves	5958cc	TD8124
OM 357.900	6 Cyl.	12 Valves	5958cc	TD8069
OM 357.901	6 Cyl.	12 Valves	5958cc	TD5708
OM 357.902	6 Cyl.	12 Valves	5958cc	TD5740
OM 357.903	6 Cyl.	12 Valves	5958cc	TD5742
OM 357.904	6 Cyl.	12 Valves	5958cc	TD16528
OM 357.906	6 Cyl.	12 Valves	5958cc	TD8095
OM 357.907	6 Cyl.	12 Valves	5958cc	TD8138
OM 357.908	6 Cyl.	12 Valves	5958cc	TD8074
OM 357.909	6 Cyl.	12 Valves	5958cc	TD5706
OM 357.910	6 Cyl.	12 Valves	5958cc	TD6041
OM 357.912	6 Cyl.	12 Valves	5958cc	TD14689
OM 357.913	6 Cyl.	12 Valves	5958cc	TD16993
OM 357.915	6 Cyl.	12 Valves	5958cc	TD8147
OM 357.916	6 Cyl.	12 Valves	5958cc	TD8075
OM 357.917	6 Cyl.	12 Valves	5958cc	TD8079
OM 357.918	6 Cyl.	12 Valves	5958cc	TD6043
OM 357.919	6 Cyl.	12 Valves	5958cc	TD8106
OM 357.920	6 Cyl.	12 Valves	5958cc	TD5720
OM 357.921	6 Cyl.	12 Valves	5958cc	TD5743
OM 357.922	6 Cyl.	12 Valves	5958cc	TD8166
OM 357.924	6 Cyl.	12 Valves	5958cc	TD14688
OM 357.925	6 Cyl.	12 Valves	5958cc	TD8196
OM 357.926	6 Cyl.	12 Valves	5958cc	TD16931
OM 357.927	6 Cyl.	12 Valves	5958cc	TD5723
OM 357.929	6 Cyl.	12 Valves	5958cc	TD8113
OM 357.930	6 Cyl.	12 Valves	5958cc	TD8168
OM 357.931	6 Cyl.	12 Valves	5958cc	TD16820
OM 357.932	6 Cyl.	12 Valves	5958cc	TD6056
OM 357.933	6 Cyl.	12 Valves	5958cc	TD8115
OM 357.934	6 Cyl.	12 Valves	5958cc	TD17097
OM 357.935	6 Cyl.	12 Valves	5958cc	TD17098
OM 357.936	6 Cyl.	12 Valves	5958cc	TD16821
OM 357.937	6 Cyl.	12 Valves	5958cc	TD16822
OM 357.938	6 Cyl.	12 Valves	5958cc	TD22748
OM 357.940	6 Cyl.	12 Valves	5958cc	TD5746

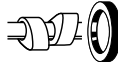

OM 357.941	6 Cyl.	12 Valves	5958cc	TD8169
OM 357.942	6 Cyl.	12 Valves	5958cc	TD8116
OM 357.943	6 Cyl.	12 Valves	5958cc	TD5725
OM 357.944	6 Cyl.	12 Valves	5958cc	TD6058
OM 357.945	6 Cyl.	12 Valves	5958cc	TD14690
OM 357.946	6 Cyl.	12 Valves	5958cc	TD8125
OM 357.947	6 Cyl.	12 Valves	5958cc	TD8170
OM 357.948	6 Cyl.	12 Valves	5958cc	TD6077
OM 357.949	6 Cyl.	12 Valves	5958cc	TD16823
OM 357.961	6 Cyl.	12 Valves	5958cc	TD6073
OM 357.962	6 Cyl.	12 Valves	5958cc	TD6074
OM 357.963	6 Cyl.	12 Valves	5958cc	TD6090
OM 366.901	6 Cyl.	12 Valves	5958cc	TD28662
OM 366.905	6 Cyl.	12 Valves	5958cc	TD5698
OM 366.906	6 Cyl.	12 Valves	5960cc	TD5748
OM 366.907	6 Cyl.	12 Valves	5958cc	TD5716
OM 366.908	6 Cyl.	12 Valves	5958cc	TD17858
OM 366.909	6 Cyl.	12 Valves	5960cc	TD6078
OM 366.910	6 Cyl.	12 Valves	5958cc	TD8065
OM 366.911	6 Cyl.	12 Valves	5958cc	TD22775
OM 366.912	6 Cyl.	12 Valves	5958cc	TD17857
OM 366.913	6 Cyl.	12 Valves	5958cc	TD17100
OM 366.914	6 Cyl.	12 Valves	5958cc	TD6049
OM 366.915	6 Cyl.	12 Valves	5958cc	TD7995
OM 366.917	6 Cyl.	12 Valves	5958cc	TD7887
OM 366.918	6 Cyl.	12 Valves	5960cc	TD5739
OM 366.919	6 Cyl.	12 Valves	5958cc	TD16808
OM 366.930	6 Cyl.	12 Valves	5958cc	TD8094
OM 366.931	6 Cyl.	12 Valves	5958cc	TD5717
OM 366.932	6 Cyl.	12 Valves	5958cc	TD8068
OM 366.933	6 Cyl.	12 Valves	5958cc	TD8100
OM 366.935	6 Cyl.	12 Valves	5958cc	TD6050
OM 366.936	6 Cyl.	12 Valves	5960cc	TD8135
OM 366.937	6 Cyl.	12 Valves	5960cc	TD6072
OM 366.938	6 Cyl.	12 Valves	5958cc	TD16809
OM 366.939	6 Cyl.	12 Valves	5958cc	TD7993
OM 366.940	6 Cyl.	12 Valves	5958cc	TD6040
OM 366.941	6 Cyl.	12 Valves	5958cc	TD8102
OM 366.942	6 Cyl.	12 Valves	5958cc	TD8076
OM 366.943	6 Cyl.	12 Valves	5958cc	TD8070
OM 366.944	6 Cyl.	12 Valves	5958cc	TD5703
OM 366.945	6 Cyl.	12 Valves	5958cc	TD5757
OM 366.946	6 Cyl.	12 Valves	5960cc	TD5741
OM 366.947	6 Cyl.	12 Valves	5958cc	TD5679
OM 366.948	6 Cyl.	12 Valves	5958cc	TD6017
OM 366.949	6 Cyl.	12 Valves	5958cc	TD6277
OM 366.951	6 Cyl.	12 Valves	5960cc	TD5749
OM 366.952	6 Cyl.	12 Valves	5958cc	TD5766
OM 366.953	6 Cyl.	12 Valves	5958cc	TD5718
OM 366.954	6 Cyl.	12 Valves	5958cc	TD17862

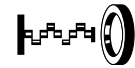
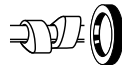

OM 366.955	6 Cyl.	12 Valves	5958cc	TD6276
OM 366.956	6 Cyl.	12 Valves	5958cc	TD6320
OM 366.957	6 Cyl.	12 Valves	5958cc	TD16816
OM 366.958	6 Cyl.	12 Valves	5958cc	TD17861
OM 366.960	6 Cyl.	12 Valves	5960cc	TD17101
OM 366.962	6 Cyl.	12 Valves	5960cc	TD5745
OM 366.963	6 Cyl.	12 Valves	5958cc	TD8006
OM 366.965	6 Cyl.	12 Valves	5958cc	TD7888
OM 366.966	6 Cyl.	12 Valves	5958cc	TD5707
OM 366.967	6 Cyl.	12 Valves	5958cc	TD5699
OM 366.968	6 Cyl.	12 Valves	5958cc	TD8077
OM 366.969	6 Cyl.	12 Valves	5958cc	TD8080
OM 366.970	6 Cyl.	12 Valves	5958cc	TD8104
OM 366.971	6 Cyl.	12 Valves	5958cc	TD8107
OM 366.972	6 Cyl.	12 Valves	5958cc	TD17112
OM 366.973	6 Cyl.	12 Valves	5958cc	TD6035
OM 366.974	6 Cyl.	12 Valves	5958cc	TD6042
OM 366.975	6 Cyl.	12 Valves	5958cc	TD5719
OM 366.976	6 Cyl.	12 Valves	5958cc	TD6052
OM 366.977	6 Cyl.	12 Valves	5958cc	TD17859
OM 366.978	6 Cyl.	12 Valves	5958cc	TD6279
OM 366.979	6 Cyl.	12 Valves	5958cc	TD6091
OM 366.980	6 Cyl.	12 Valves	5960cc	TD8141
OM 366.981	6 Cyl.	12 Valves	5958cc	TD16817
OM 366.983	6 Cyl.	12 Valves	5958cc	TD8150
OM 366.984	6 Cyl.	12 Valves	5958cc	TD8007
OM 366.988	6 Cyl.	12 Valves	5960cc	TD5744
OM 366.990	6 Cyl.	12 Valves	5958cc	TD16818
OM 366.992	6 Cyl.	12 Valves	5958cc	TD5722
OM 366.993	6 Cyl.	12 Valves	5958cc	TD8114
OM 366.994	6 Cyl.	12 Valves	5958cc	TD6055
OM 366.995	6 Cyl.	12 Valves	5958cc	TD8167
OM 366.996	6 Cyl.	12 Valves	5958cc	TD16819
OM 366.997	6 Cyl.	12 Valves	5960cc	TD6075
OM 366.999	6 Cyl.	12 Valves	5958cc	TD8126
OM 372.906	6 Cyl.	12 Valves	5958cc	TD23200
OM 372.907	6 Cyl.	12 Valves	5958cc	TD23201
OM 372.930	6 Cyl.	12 Valves	5958cc	TD23202
OM 372.950	6 Cyl.	12 Valves	5958cc	TD28669
OM 372.951	6 Cyl.	12 Valves	5958cc	TD28671
OM 372.953	6 Cyl.	12 Valves	5958cc	TD28672
OM 372.956	6 Cyl.	12 Valves	5958cc	TD28673
OM 372.958	6 Cyl.	12 Valves	5958cc	TD28674
OM 372.959	6 Cyl.	12 Valves	5958cc	TD28675
OM 372.960	6 Cyl.	12 Valves	5958cc	TD28676
OM 372.961	6 Cyl.	12 Valves	5958cc	TD28677
OM 372.962	6 Cyl.	12 Valves	5958cc	TD28678
OM 372.964	6 Cyl.	12 Valves	5958cc	TD28679
OM 372.980	6 Cyl.	12 Valves	5958cc	TD28680
OM 372.981	6 Cyl.	12 Valves	5958cc	TD28681

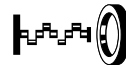
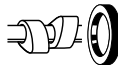

OM 372.982	6 Cyl.	12 Valves	5958cc	TD28682
OM 372.983	6 Cyl.	12 Valves	5958cc	TD28683
OM 372.984	6 Cyl.	12 Valves	5958cc	TD28684
OM 372.985	6 Cyl.	12 Valves	5958cc	TD28685
OM 372.986	6 Cyl.	12 Valves	5958cc	TD28686
OM 372.987	6 Cyl.	12 Valves	5958cc	TD28687
OM 376.905	6 Cyl.	12 Valves	5958cc	TD23006
OM 376.906	6 Cyl.	12 Valves	5958cc	TD23009
OM 376.907	6 Cyl.	12 Valves	5958cc	TD23011
OM 376.908	6 Cyl.	12 Valves	5958cc	TD23010
OM 376.909	6 Cyl.	12 Valves	5958cc	TD23012
OM 376.910	6 Cyl.	12 Valves	5958cc	TD23013
OM 376.930	6 Cyl.	12 Valves	5958cc	TD23014
OM 376.941	6 Cyl.	12 Valves	5958cc	TD23015
OM 376.945	6 Cyl.	12 Valves	5958cc	TD23016
OM 376.946	6 Cyl.	12 Valves	5958cc	TD23017
OM 376.947	6 Cyl.	12 Valves	5958cc	TD23018
OM 376.950	6 Cyl.	12 Valves	5958cc	TD23019
OM 376.951	6 Cyl.	12 Valves	5958cc	TD23020
OM 376.952	6 Cyl.	12 Valves	5958cc	TD23021
OM 376.953	6 Cyl.	12 Valves	5958cc	TD23022
OM 376.954	6 Cyl.	12 Valves	5958cc	TD23023
OM 376.955	6 Cyl.	12 Valves	5958cc	TD23024
OM 376.956	6 Cyl.	12 Valves	5958cc	TD23025
OM 376.957	6 Cyl.	12 Valves	5958cc	TD23026
OM 376.958	6 Cyl.	12 Valves	5958cc	TD23027
OM 376.961	6 Cyl.	12 Valves	5958cc	TD23028
OM 376.962	6 Cyl.	12 Valves	5958cc	TD23029
OM 376.963	6 Cyl.	12 Valves	5958cc	TD23030
OM 376.964	6 Cyl.	12 Valves	5958cc	TD23031
OM 376.967	6 Cyl.	12 Valves	5958cc	TD23032
OM 376.968	6 Cyl.	12 Valves	5958cc	TD23033
OM 376.969	6 Cyl.	12 Valves	5958cc	TD23034
OM 376.970	6 Cyl.	12 Valves	5958cc	TD23035
OM 376.972	6 Cyl.	12 Valves	5958cc	TD23036
OM 376.975	6 Cyl.	12 Valves	5958cc	TD23037
OM 376.976	6 Cyl.	12 Valves	5958cc	TD23038
OM 376.977	6 Cyl.	12 Valves	5958cc	TD23039
OM 376.980	6 Cyl.	12 Valves	5958cc	TD23040
OM 376.981	6 Cyl.	12 Valves	5958cc	TD23041
OM 376.982	6 Cyl.	12 Valves	5958cc	TD23042
OM 376.984	6 Cyl.	12 Valves	5958cc	TD23043
OM 376.986	6 Cyl.	12 Valves	5958cc	TD23044
OM 376.987	6 Cyl.	12 Valves	5958cc	TD23045
OM 376.988	6 Cyl.	12 Valves	5958cc	TD23046
OM 376.989	6 Cyl.	12 Valves	5958cc	TD23047
OM 376.993	6 Cyl.	12 Valves	5958cc	TD23050
OM 376.994	6 Cyl.	12 Valves	5958cc	TD23051
OM 376.995	6 Cyl.	12 Valves	5958cc	TD23052
OM 376.997	6 Cyl.	12 Valves	5958cc	TD23053

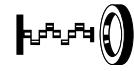
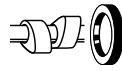

OM 376.998	6 Cyl.	12 Valves	5958cc	TD23048
OM 376.999	6 Cyl.	12 Valves	5958cc	TD23049
OM 377.940	6 Cyl.	12 Valves	5958cc	TD23203
OM 377.941	6 Cyl.	12 Valves	5958cc	TD23204
OM 377.942	6 Cyl.	12 Valves	5958cc	TD23205
OM 377.943	6 Cyl.	12 Valves	5958cc	TD23206
OM 377.944	6 Cyl.	12 Valves	5958cc	TD23207
OM 377.945	6 Cyl.	12 Valves	5958cc	TD23208
OM 377.960	6 Cyl.	12 Valves	5958cc	TD23211
OM 377.961	6 Cyl.	12 Valves	5958cc	TD23212
OM 377.962	6 Cyl.	12 Valves	5958cc	TD23213
OM 377.963	6 Cyl.	12 Valves	5958cc	TD23214
OM 377.964	6 Cyl.	12 Valves	5958cc	TD23215
OM 377.967	6 Cyl.	12 Valves	5958cc	TD23216
OM 377.968	6 Cyl.	12 Valves	5958cc	TD23217
OM 377.969	6 Cyl.	12 Valves	5958cc	TD23218
OM 377.972	6 Cyl.	12 Valves	5958cc	TD23219
OM 377.973	6 Cyl.	12 Valves	5958cc	TD23220
OM 377.980	6 Cyl.	12 Valves	5958cc	TD23221
OM 377.981	6 Cyl.	12 Valves	5958cc	TD23222
OM 377.982	6 Cyl.	12 Valves	5958cc	TD23223
OM 377.983	6 Cyl.	12 Valves	5958cc	TD23224
OM 377.984	6 Cyl.	12 Valves	5958cc	TD23225
OM 377.985	6 Cyl.	12 Valves	5958cc	TD23226
OM 382.912	6 Cyl.	12 Valves	5958cc	TD22783
OM 382.913	6 Cyl.	12 Valves	5958cc	TD22784
OM 382.916	6 Cyl.	12 Valves	5958cc	TD17174
OM 382.917	6 Cyl.	12 Valves	5958cc	TD17176
OM 382.919	6 Cyl.	12 Valves	5958cc	TD22785
OM 382.950	6 Cyl.	12 Valves	5958cc	TD17175
OM 382.970	6 Cyl.	12 Valves	5958cc	TD22786
OM 382.971	6 Cyl.	12 Valves	5958cc	TD22787
OM 386.906	6 Cyl.	12 Valves	5958cc	TD22793
OM 386.950	6 Cyl.	12 Valves	5958cc	TD22794
OM 386.951	6 Cyl.	12 Valves	5958cc	TD22795
OM 386.952	6 Cyl.	12 Valves	5958cc	TD22796
OM 386.980	6 Cyl.	12 Valves	5958cc	TD22797
OM 386.981	6 Cyl.	12 Valves	5958cc	TD22798
OM 386.983	6 Cyl.	12 Valves	5958cc	TD22799

PB172  (x6)

PB177  (x6)

HR667 

NB978 

65.00 x 90.00 x 13.00mm, FPM

LB955  (x2)

90.00 x 107.00 x 8.00mm

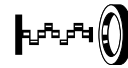
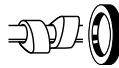

153 6.2L

Petrol

M 156.980	8 Cyl.	32 Valves	6208cc	TD19211
M 156.981	8 Cyl.	32 Valves	6208cc	TD20862
M 156.982	8 Cyl.	32 Valves	6208cc	TD20736
M 156.983	8 Cyl.	32 Valves	6208cc	TD19890
M 156.984	8 Cyl.	32 Valves	6208cc	TD20331
M 156.985	8 Cyl.	32 Valves	6208cc	TD20860
M 159.980	8 Cyl.	32 Valves	6208cc	TD25407

PA5041 (x32)
HR791 (x2)

NA5131
45.00 x 67.00 x 8.00mm, PTFE
NA5168
93.00 x 114.00 x 11.50mm, PTFE

154 6.3L

Petrol

M 137.980	12 Cyl.	36 Valves	6258cc	TD16892
-----------	---------	-----------	--------	---------

NA5131
45.00 x 67.00 x 8.00mm, PTFE
NA5168
93.00 x 114.00 x 11.50mm, PTFE

155 6.4L

Diesel

OM 902.910	6 Cyl.	18 Valves	6374cc	TD20244
OM 902.911	6 Cyl.	18 Valves	6374cc	TD20247
OM 902.912	6 Cyl.	18 Valves	6374cc	TD20249
OM 902.913	6 Cyl.	18 Valves	6374cc	TD20250
OM 902.914	6 Cyl.	18 Valves	6374cc	TD20251
OM 902.915	6 Cyl.	18 Valves	6374cc	TD20252
OM 902.916	6 Cyl.	18 Valves	6374cc	TD18924
OM 902.917	6 Cyl.	18 Valves	6374cc	TD18930
OM 902.918	6 Cyl.	18 Valves	6374cc	TD18931
OM 902.919	6 Cyl.	18 Valves	6374cc	TD20253
OM 902.920	6 Cyl.	18 Valves	6374cc	TD20254
OM 902.921	6 Cyl.	18 Valves	6374cc	TD20255
OM 902.922	6 Cyl.	18 Valves	6374cc	TD20256
OM 902.923	6 Cyl.	18 Valves	6374cc	TD23293
OM 902.924	6 Cyl.	18 Valves	6374cc	TD23294
OM 902.925	6 Cyl.	18 Valves	6374cc	TD23295
OM 902.926	6 Cyl.	18 Valves	6374cc	TD23296
OM 902.927	6 Cyl.	18 Valves	6374cc	TD20257
OM 902.930	6 Cyl.	18 Valves	6374cc	TD20258
OM 902.931	6 Cyl.	18 Valves	6374cc	TD20259
OM 902.932	6 Cyl.	18 Valves	6374cc	TD20260
OM 902.933	6 Cyl.	18 Valves	6374cc	TD20261
OM 902.934	6 Cyl.	18 Valves	6374cc	TD23297
OM 902.935	6 Cyl.	18 Valves	6374cc	TD28794
OM 902.936	6 Cyl.	18 Valves	6374cc	TD23298
OM 906.910	6 Cyl.	18 Valves	6374cc	TD11309
OM 906.911	6 Cyl.	18 Valves	6374cc	TD11310
OM 906.912	6 Cyl.	18 Valves	6374cc	TD17757
OM 906.913	6 Cyl.	18 Valves	6374cc	TD17758
OM 906.914	6 Cyl.	18 Valves	6374cc	TD17759
OM 906.915	6 Cyl.	18 Valves	6374cc	TD11311

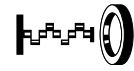
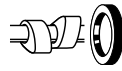

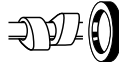

OM 906.916	6 Cyl.	18 Valves	6374cc	TD11312
OM 906.917	6 Cyl.	18 Valves	6374cc	TD17760
OM 906.918	6 Cyl.	18 Valves	6374cc	TD17761
OM 906.920	6 Cyl.	18 Valves	6374cc	TD11314
OM 906.921	6 Cyl.	18 Valves	6374cc	TD11315
OM 906.922	6 Cyl.	18 Valves	6374cc	TD11316
OM 906.923	6 Cyl.	18 Valves	6374cc	TD11317
OM 906.924	6 Cyl.	18 Valves	6374cc	TD17762
OM 906.925	6 Cyl.	18 Valves	6374cc	TD16920
OM 906.926	6 Cyl.	18 Valves	6374cc	TD16923
OM 906.927	6 Cyl.	18 Valves	6374cc	TD16921
OM 906.928	6 Cyl.	18 Valves	6374cc	TD16924
OM 906.929	6 Cyl.	18 Valves	6374cc	TD17763
OM 906.930	6 Cyl.	18 Valves	6374cc	TD11318
OM 906.931	6 Cyl.	18 Valves	6374cc	TD11319
OM 906.932	6 Cyl.	18 Valves	6374cc	TD17764
OM 906.933	6 Cyl.	18 Valves	6374cc	TD17765
OM 906.934	6 Cyl.	18 Valves	6374cc	TD17766
OM 906.935	6 Cyl.	18 Valves	6374cc	TD17326
OM 906.936	6 Cyl.	18 Valves	6374cc	TD17767
OM 906.937	6 Cyl.	18 Valves	6374cc	TD17768
OM 906.938	6 Cyl.	18 Valves	6374cc	TD17769
OM 906.939	6 Cyl.	18 Valves	6374cc	TD16926
OM 906.940	6 Cyl.	18 Valves	6374cc	TD11320
OM 906.941	6 Cyl.	18 Valves	6374cc	TD11321
OM 906.944	6 Cyl.	18 Valves	6374cc	TD17770
OM 906.945	6 Cyl.	18 Valves	6374cc	TD17771
OM 906.946	6 Cyl.	18 Valves	6374cc	TD17772
OM 906.947	6 Cyl.	18 Valves	6374cc	TD17774
OM 906.948	6 Cyl.	18 Valves	6374cc	TD17775
OM 906.949	6 Cyl.	18 Valves	6374cc	TD17776
OM 906.950	6 Cyl.	18 Valves	6374cc	TD17777
OM 906.951	6 Cyl.	18 Valves	6374cc	TD17778
OM 906.952	6 Cyl.	18 Valves	6374cc	TD16925
OM 906.953	6 Cyl.	18 Valves	6374cc	TD17779
OM 906.954	6 Cyl.	18 Valves	6374cc	TD17780
OM 906.955	6 Cyl.	18 Valves	6374cc	TD17327
OM 906.956	6 Cyl.	18 Valves	6374cc	TD17781
OM 906.957	6 Cyl.	18 Valves	6374cc	TD17782
OM 906.958	6 Cyl.	18 Valves	6374cc	TD17783
OM 906.959	6 Cyl.	18 Valves	6374cc	TD17784
OM 906.960	6 Cyl.	18 Valves	6374cc	TD17447
OM 906.961	6 Cyl.	18 Valves	6374cc	TD17459
OM 906.962	6 Cyl.	18 Valves	6374cc	TD17460
OM 906.963	6 Cyl.	18 Valves	6374cc	TD17449
OM 906.964	6 Cyl.	18 Valves	6374cc	TD17823
OM 906.965	6 Cyl.	18 Valves	6374cc	TD17824
OM 906.966	6 Cyl.	18 Valves	6374cc	TD17825
OM 906.967	6 Cyl.	18 Valves	6374cc	TD17826
OM 906.968	6 Cyl.	18 Valves	6374cc	TD17827



OM 906.970	6 Cyl.	18 Valves	6374cc	TD17828
OM 906.971	6 Cyl.	18 Valves	6374cc	TD17829
OM 906.973	6 Cyl.	24 Valves	6374cc	TD24855
OM 906.974	6 Cyl.	18 Valves	6374cc	TD17830
OM 906.975	6 Cyl.	18 Valves	6374cc	TD17831
OM 906.976	6 Cyl.	18 Valves	6374cc	TD17773
OM 906.977	6 Cyl.	18 Valves	6374cc	TD17833
OM 906.978	6 Cyl.	18 Valves	6374cc	TD17834
OM 906.979	6 Cyl.	18 Valves	6374cc	TD17835
OM 906.980	6 Cyl.	18 Valves	6374cc	TD17836
OM 906.981	6 Cyl.	18 Valves	6374cc	TD17837
OM 906.982	6 Cyl.	18 Valves	6374cc	TD17838
OM 906.983	6 Cyl.	18 Valves	6374cc	TD17839
OM 906.985	6 Cyl.	18 Valves	6374cc	TD17840
OM 906.986	6 Cyl.	18 Valves	6374cc	TD25471
OM 906.988	6 Cyl.	18 Valves	6374cc	TD17841
OM 906.990	6 Cyl.	18 Valves	6374cc	TD24860
OM 906.991	6 Cyl.	18 Valves	6374cc	TD28805
OM 906.992	6 Cyl.	18 Valves	6374cc	TD28806
OM 906.993	6 Cyl.	18 Valves	6374cc	TD28807
OM 906.995	6 Cyl.	18 Valves	6374cc	TD25657
OM 909.900	6 Cyl.	18 Valves	6374cc	TD17443
OM 909.901	6 Cyl.	18 Valves	6374cc	TD17445
OM 909.910	6 Cyl.	18 Valves	6374cc	TD16846
OM 909.911	6 Cyl.	18 Valves	6374cc	TD17444
OM 909.920	6 Cyl.	18 Valves	6374cc	TD16847
OM 909.921	6 Cyl.	18 Valves	6374cc	TD17446
OM 909.960	6 Cyl.	18 Valves	6374cc	TD16848
OM 909.970	6 Cyl.	18 Valves	6374cc	TD16849
OM 909.971	6 Cyl.	18 Valves	6374cc	TD16850

PB180 (x18)
HR660  (x2)
 Eng no. 041956→



NA5120 
 78.00 x 104.00 x 11.00mm, ACM
NA5121 
 115.00 x 140.00 x 13.00mm, PTFE/ACM

156 6.4L

Diesel

OM 906.919	6 Cyl.	18 Valves	6374cc	TD11313
OM 906.994	6 Cyl.	18 Valves	6374cc	TD28808
OM 906.998	6 Cyl.	18 Valves	6374cc	TD28809
OM 906.998	6 Cyl.	18 Valves	6374cc	TD28810
OM 906.999	6 Cyl.	18 Valves	6374cc	TD28881

PB180 (x18)
HR660  (x2)

NA5120 
 78.00 x 104.00 x 11.00mm, ACM
NA5121 
 115.00 x 140.00 x 13.00mm, PTFE/ACM

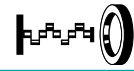

157 6.9L

Gas

M 906.900	6 Cyl.	18 Valves	6884cc	TD17842
M 906.901	6 Cyl.	18 Valves	6884cc	TD17844
M 906.903	6 Cyl.	18 Valves	6884cc	TD17843

PB180 (x18)
HR660 (x2)

NA5120 (x2)
78.00 x 104.00 x 11.00mm, ACM
NA5121 (x2)
115.00 x 140.00 x 13.00mm, PTFE/ACM

158 7.2L

Gas

M 902.900	6 Cyl.	18 Valves	7201cc	TD25515
M 902.901	6 Cyl.	18 Valves	7201cc	TD28269
M 902.902	6 Cyl.	18 Valves	7201cc	TD28270
M 902.903	6 Cyl.	18 Valves	7201cc	TD25107

PB180 (x18)
HR660 (x2)

NA5120 (x2)
78.00 x 104.00 x 11.00mm, ACM
NA5121 (x2)
115.00 x 140.00 x 13.00mm, PTFE/ACM

159 7.2L

Diesel

OM 925.920	6 Cyl.	18 Valves	7201cc	TD25238
OM 926.910	6 Cyl.	18 Valves	7201cc	TD19158
OM 926.911	6 Cyl.	18 Valves	7201cc	TD19155
OM 926.912	6 Cyl.	18 Valves	7201cc	TD19159
OM 926.913	6 Cyl.	18 Valves	7201cc	TD19160
OM 926.914	6 Cyl.	18 Valves	7201cc	TD19161
OM 926.915	6 Cyl.	18 Valves	7201cc	TD19162
OM 926.916	6 Cyl.	18 Valves	7201cc	TD19163
OM 926.917	6 Cyl.	18 Valves	7201cc	TD19164
OM 926.918	6 Cyl.	18 Valves	7201cc	TD19165
OM 926.919	6 Cyl.	18 Valves	7201cc	TD19166
OM 926.920	6 Cyl.	18 Valves	7201cc	TD19167
OM 926.921	6 Cyl.	18 Valves	7201cc	TD19168
OM 926.924	6 Cyl.	18 Valves	7201cc	TD19169
OM 926.925	6 Cyl.	18 Valves	7201cc	TD19170
OM 926.926	6 Cyl.	18 Valves	7201cc	TD19171
OM 926.927	6 Cyl.	18 Valves	7201cc	TD19172
OM 926.928	6 Cyl.	18 Valves	7201cc	TD19173
OM 926.929	6 Cyl.	18 Valves	7201cc	TD19174
OM 926.930	6 Cyl.	18 Valves	7201cc	TD19175
OM 926.932	6 Cyl.	18 Valves	7201cc	TD19176
OM 926.933	6 Cyl.	18 Valves	7201cc	TD28833
OM 926.934	6 Cyl.	18 Valves	7201cc	TD19177
OM 926.935	6 Cyl.	18 Valves	7201cc	TD21087
OM 926.936	6 Cyl.	18 Valves	7201cc	TD21088
OM 926.937	6 Cyl.	18 Valves	7201cc	TD19178
OM 926.938	6 Cyl.	18 Valves	7201cc	TD19179
OM 926.939	6 Cyl.	18 Valves	7201cc	TD19180
OM 926.940	6 Cyl.	18 Valves	7201cc	TD28834
OM 926.941	6 Cyl.	18 Valves	7201cc	TD25472
OM 926.942	6 Cyl.	18 Valves	7201cc	TD28835
OM 926.945	6 Cyl.	18 Valves	7201cc	TD25483

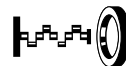
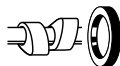

OM 926.946	6 Cyl.	18 Valves	7201cc	TD28836
OM 926.947	6 Cyl.	18 Valves	7201cc	TD24829
OM 926.948	6 Cyl.	18 Valves	7201cc	TD28837
OM 926.949	6 Cyl.	18 Valves	7201cc	TD28838
OM 926.950	6 Cyl.	18 Valves	7201cc	TD28839
OM 926.959	6 Cyl.	18 Valves	7201cc	TD28840
OM 926.968	6 Cyl.	18 Valves	7201cc	TD28841
OM 926.969	6 Cyl.	18 Valves	7201cc	TD28842
OM 926.970	6 Cyl.	18 Valves	7201cc	TD28843
OM 926.971	6 Cyl.	18 Valves	7201cc	TD28844
OM 926.972	6 Cyl.	18 Valves	7201cc	TD28845
OM 926.973	6 Cyl.	18 Valves	7201cc	TD28846
OM 926.974	6 Cyl.	18 Valves	7201cc	TD28847
OM 926.975	6 Cyl.	18 Valves	7201cc	TD28848
OM 926.976	6 Cyl.	18 Valves	7201cc	TD28849
OM 926.990	6 Cyl.	18 Valves	7201cc	TD25470
OM 926.996	6 Cyl.	18 Valves	7201cc	TD25045
OM 926.999	6 Cyl.	18 Valves	7201cc	TD28850

PB180 (x18)
HR660 (x2)

NA5120 (F)
78.00 x 104.00 x 11.00mm, ACM
NA5121 (R)
115.00 x 140.00 x 13.00mm, PTFE/ACM

160 7.2L

Diesel

OM 925.960	6 Cyl.	18 Valves	7201cc	TD28832
------------	--------	-----------	--------	---------

NA5120 (F)
78.00 x 104.00 x 11.00mm, ACM
NA5121 (R)
115.00 x 140.00 x 13.00mm, PTFE/ACM

161 7.7L

Diesel

OM 936.912	6 Cyl.	24 Valves	7698cc	TD27609
OM 936.915	6 Cyl.	24 Valves	7698cc	TD30265
OM 936.916	6 Cyl.	24 Valves	7698cc	TD27610
OM 936.971	6 Cyl.	24 Valves	7698cc	TD32230
OM 936.972	6 Cyl.	24 Valves	7698cc	TD32229
OM 936.973	6 Cyl.	24 Valves	7698cc	TD32231
OM 936.980	6 Cyl.	24 Valves	7698cc	TD34257

NA5120 (F)
78.00 x 104.00 x 11.00mm, ACM
NA5121 (R)
115.00 x 140.00 x 13.00mm, PTFE/ACM

162 8.0L

Diesel

OM 327.910	6 Cyl.	12 Valves	7980cc	TD16575
OM 327.914	6 Cyl.	12 Valves	7980cc	TD5656
OM 327.915	6 Cyl.	12 Valves	7980cc	TD5994
OM 327.916	6 Cyl.	12 Valves	7980cc	TD8117
OM 327.917	6 Cyl.	12 Valves	7980cc	TD8163
OM 327.918	6 Cyl.	12 Valves	7980cc	TD16576
OM 327.919	6 Cyl.	12 Valves	7980cc	TD16577
OM 327.931	6 Cyl.	12 Valves	7980cc	TD5657
OM 327.932	6 Cyl.	12 Valves	7980cc	TD5995

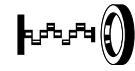
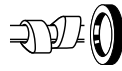

OM 327.933	6 Cyl.	12 Valves	7980cc	TD8128
OM 327.934	6 Cyl.	12 Valves	7980cc	TD16578
OM 327.935	6 Cyl.	12 Valves	7980cc	TD16579
OM 327.936	6 Cyl.	12 Valves	7980cc	TD16580
OM 327.937	6 Cyl.	12 Valves	7980cc	TD16581
OM 327.938	6 Cyl.	12 Valves	7980cc	TD16582
OM 327.939	6 Cyl.	12 Valves	7980cc	TD16583
OM 327.940	6 Cyl.	12 Valves	7980cc	TD16584
OM 327.941	6 Cyl.	12 Valves	7980cc	TD16585
OM 327.942	6 Cyl.	12 Valves	7980cc	TD8131
OM 327.943	6 Cyl.	12 Valves	7980cc	TD16586
OM 327.944	6 Cyl.	12 Valves	7980cc	TD16587
OM 327.945	6 Cyl.	12 Valves	7980cc	TD16588
OM 327.946	6 Cyl.	12 Valves	7980cc	TD16589

PB177 (x12)

NB977

75.00 x 100.00 x 12.00mm, FPM

163 8.7L

Diesel

OM 360.910	6 Cyl.	12 Valves	8720cc	TD28659
OM 360.911	6 Cyl.	12 Valves	8720cc	TD7902
OM 360.914	6 Cyl.	12 Valves	8720cc	TD5658
OM 360.915	6 Cyl.	12 Valves	8720cc	TD5996
OM 360.916	6 Cyl.	12 Valves	8720cc	TD5659
OM 360.917	6 Cyl.	12 Valves	8720cc	TD5997
OM 360.918	6 Cyl.	12 Valves	8720cc	TD7894
OM 360.931	6 Cyl.	12 Valves	8720cc	TD6269
OM 360.933	6 Cyl.	12 Valves	8720cc	TD6270
OM 360.935	6 Cyl.	12 Valves	8725cc	TD22749
OM 360.936	6 Cyl.	12 Valves	8725cc	TD16688
OM 360.937	6 Cyl.	12 Valves	8725cc	TD16689
OM 360.938	6 Cyl.	12 Valves	8725cc	TD16690
OM 360.939	6 Cyl.	12 Valves	8720cc	TD8195
OM 360.940	6 Cyl.	12 Valves	8725cc	TD16691
OM 360.941	6 Cyl.	12 Valves	8725cc	TD16698
OM 360.942	6 Cyl.	12 Valves	8725cc	TD16692
OM 360.943	6 Cyl.	12 Valves	8725cc	TD16693
OM 360.944	6 Cyl.	12 Valves	8725cc	TD16694
OM 360.946	6 Cyl.	12 Valves	8725cc	TD16695
OM 360.948	6 Cyl.	12 Valves	8725cc	TD16696
OM 360.949	6 Cyl.	12 Valves	8725cc	TD16697
OM 360.950	6 Cyl.	12 Valves	8725cc	TD22750
OM 360.951	6 Cyl.	12 Valves	8725cc	TD22751
OM 360.952	6 Cyl.	12 Valves	8725cc	TD22752
OM 360.960	6 Cyl.	12 Valves	8725cc	TD22753
OM 360.961	6 Cyl.	12 Valves	8725cc	TD22754
OM 360.962	6 Cyl.	12 Valves	8725cc	TD22755
OM 360.963	6 Cyl.	12 Valves	8725cc	TD22756
OM 360.964	6 Cyl.	12 Valves	8725cc	TD22757
OM 360.965	6 Cyl.	12 Valves	8725cc	TD22758
OM 360.966	6 Cyl.	12 Valves	8725cc	TD22759
OM 360.967	6 Cyl.	12 Valves	8725cc	TD22760

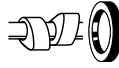

OM 360.968	6 Cyl.	12 Valves	8725cc	TD22761
OM 360.969	6 Cyl.	12 Valves	8725cc	TD22762
OM 360.970	6 Cyl.	12 Valves	8725cc	TD22763
OM 360.971	6 Cyl.	12 Valves	8725cc	TD22764
OM 360.972	6 Cyl.	12 Valves	8725cc	TD22765
OM 360.973	6 Cyl.	12 Valves	8725cc	TD22766
OM 360.975	6 Cyl.	12 Valves	8725cc	TD22767
OM 360.979	6 Cyl.	12 Valves	8720cc	TD17019
OM 360.980	6 Cyl.	12 Valves	8720cc	TD17020
OM 360.981	6 Cyl.	12 Valves	8720cc	TD17021
OM 360.982	6 Cyl.	12 Valves	8725cc	TD22768
OM 360.983	6 Cyl.	12 Valves	8725cc	TD22769
OM 360.984	6 Cyl.	12 Valves	8720cc	TD17022
OM 360.985	6 Cyl.	12 Valves	8720cc	TD17024
OM 360.986	6 Cyl.	12 Valves	8720cc	TD17023
PB177 (x12)				NB977 75.00 x 100.00 x 12.00mm, FPM

164 9.2L

Diesel

OM 409.906	5 Cyl.	10 Valves	9204cc	TD18812
OM 409.907	5 Cyl.	10 Valves	9204cc	TD18813
OM 409.908	5 Cyl.	10 Valves	9204cc	TD18814
PB224 (x10)				NB928 105.00 x 130.00 x 12.00mm, FPM NB929 120.00 x 140.00 x 13.00mm, FPM

165 9.6L

Diesel

OM 345.972	5 Cyl.	10 Valves	9651cc	TD28643
OM 345.973	5 Cyl.	10 Valves	9651cc	TD28644
OM 345.975	5 Cyl.	10 Valves	9651cc	TD28645
OM 347.915	5 Cyl.	10 Valves	9651cc	TD28652
OM 347.942	5 Cyl.	10 Valves	9651cc	TD28653
OM 347.943	5 Cyl.	10 Valves	9651cc	TD28654
				NB977 75.00 x 100.00 x 12.00mm, FPM

166 9.6L

Diesel

OM 401.900	6 Cyl.	12 Valves	9570cc	TD28691
OM 401.901	6 Cyl.	12 Valves	9570cc	TD28692
OM 401.905	6 Cyl.	12 Valves	9570cc	TD5730
OM 401.906	6 Cyl.	12 Valves	9570cc	TD6062
OM 401.907	6 Cyl.	12 Valves	9572cc	TD16942
OM 401.908	6 Cyl.	12 Valves	9572cc	TD16943
OM 401.909	6 Cyl.	12 Valves	9570cc	TD5767
OM 401.912	6 Cyl.	12 Valves	9572cc	TD7895
OM 401.913	6 Cyl.	12 Valves	9570cc	TD16944
OM 401.914	6 Cyl.	12 Valves	9570cc	TD5729
OM 401.915	6 Cyl.	12 Valves	9570cc	TD6061
OM 401.916	6 Cyl.	12 Valves	9570cc	TD6099
OM 401.917	6 Cyl.	12 Valves	9570cc	TD16949
OM 401.918	6 Cyl.	12 Valves	9570cc	TD8118

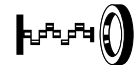
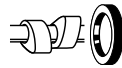

OM 401.919	6 Cyl.	12 Valves	9570cc	TD9596
OM 401.921	6 Cyl.	12 Valves	9570cc	TD16945
OM 401.922	6 Cyl.	12 Valves	9570cc	TD16946
OM 401.923	6 Cyl.	12 Valves	9570cc	TD6081
OM 401.925	6 Cyl.	12 Valves	9570cc	TD8229
OM 401.926	6 Cyl.	12 Valves	9570cc	TD9597
OM 401.927	6 Cyl.	12 Valves	9570cc	TD9598
OM 401.928	6 Cyl.	12 Valves	9570cc	TD16948
OM 401.970	6 Cyl.	12 Valves	9600cc	TD7938
OM 401.972	6 Cyl.	12 Valves	9572cc	TD5777
OM 401.973	6 Cyl.	12 Valves	9572cc	TD5733
OM 401.974	6 Cyl.	12 Valves	9572cc	TD7939
OM 401.975	6 Cyl.	12 Valves	9572cc	TD5751
OM 401.976	6 Cyl.	12 Valves	9572cc	TD17102
OM 401.977	6 Cyl.	12 Valves	9572cc	TD5801
OM 401.978	6 Cyl.	12 Valves	9572cc	TD6065
OM 401.979	6 Cyl.	12 Valves	9572cc	TD5780
OM 401.980	6 Cyl.	12 Valves	9572cc	TD6293
OM 401.981	6 Cyl.	12 Valves	9572cc	TD6162
OM 401.982	6 Cyl.	12 Valves	9572cc	TD17103
OM 401.983	6 Cyl.	12 Valves	9572cc	TD17104
OM 401.984	6 Cyl.	12 Valves	9572cc	TD8127
OM 401.985	6 Cyl.	12 Valves	9600cc	TD5753
OM 401.986	6 Cyl.	12 Valves	9572cc	TD8199
OM 401.987	6 Cyl.	12 Valves	9572cc	TD6163
OM 401.989	6 Cyl.	12 Valves	9572cc	TD6068
OM 401.990	6 Cyl.	12 Valves	9572cc	TD16950
OM 401.991	6 Cyl.	12 Valves	9600cc	TD6086
OM 401.992	6 Cyl.	12 Valves	9572cc	TD17113
OM 401.993	6 Cyl.	12 Valves	9572cc	TD6113
OM 401.994	6 Cyl.	12 Valves	9600cc	TD6084

PB224 (x12)

NB928

105.00 x 130.00 x 12.00mm, FPM

NB929

120.00 x 140.00 x 13.00mm, FPM

167 9.7L

Diesel

OM 345.900	5 Cyl.	10 Valves	9651cc	TD28598
OM 345.915	5 Cyl.	10 Valves	9651cc	TD28603
OM 345.919	5 Cyl.	10 Valves	9651cc	TD28604
OM 345.941	5 Cyl.	10 Valves	9651cc	TD28636
OM 345.942	5 Cyl.	10 Valves	9651cc	TD28637
OM 345.945	5 Cyl.	10 Valves	9651cc	TD28638
OM 345.946	5 Cyl.	10 Valves	9651cc	TD28639
OM 345.947	5 Cyl.	10 Valves	9651cc	TD28640
OM 345.949	5 Cyl.	10 Valves	9651cc	TD28641

NB977

75.00 x 100.00 x 12.00mm, FPM

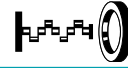

168 10.0L

Diesel

OM 429.951	5 Cyl.	10 Valves	9970cc	TD8164
OM 429.952	5 Cyl.	10 Valves	9970cc	TD18818
OM 429.953	5 Cyl.	10 Valves	9970cc	TD5755
OM 429.955	5 Cyl.	10 Valves	9970cc	TD6088
OM 475.907	5 Cyl.	10 Valves	9973cc	TD28760
OM 475.950	5 Cyl.	10 Valves	9973cc	TD23240
OM 475.951	5 Cyl.	10 Valves	9973cc	TD23241
OM 475.952	5 Cyl.	10 Valves	9973cc	TD23242
OM 475.953	5 Cyl.	10 Valves	9973cc	TD23243
OM 475.954	5 Cyl.	10 Valves	9973cc	TD23244
OM 475.974	5 Cyl.	10 Valves	9973cc	TD28761
OM 475.976	5 Cyl.	10 Valves	9973cc	TD28762
OM 475.977	5 Cyl.	10 Valves	9973cc	TD28763
OM 475.978	5 Cyl.	10 Valves	9973cc	TD28764
OM 475.979	5 Cyl.	10 Valves	9973cc	TD23245
OM 475.982	5 Cyl.	10 Valves	9973cc	TD23246
OM 475.984	5 Cyl.	10 Valves	9973cc	TD28765
OM 475.985	5 Cyl.	10 Valves	9973cc	TD28766
OM 475.986	5 Cyl.	10 Valves	9973cc	TD28767
OM 475.989	5 Cyl.	10 Valves	9973cc	TD28768
OM 475.991	5 Cyl.	10 Valves	9973cc	TD28769
OM 475.994	5 Cyl.	10 Valves	9973cc	TD28770
OM 475.997	5 Cyl.	10 Valves	9973cc	TD28771
OM 475.998	5 Cyl.	10 Valves	9973cc	TD28772
OM 485.980	5 Cyl.	10 Valves	9973cc	TD28774
OM 489.960	5 Cyl.	10 Valves	9973cc	TD22820
OM 489.961	5 Cyl.	10 Valves	9973cc	TD22821

PB224 (x10)

NB928

105.00 x 130.00 x 12.00mm, FPM

NB929

120.00 x 140.00 x 13.00mm, FPM

169 10.5L

Diesel

OM 401.924	6 Cyl.	12 Valves	10456cc	TD16947
------------	--------	-----------	---------	---------

PB224 (x12)

NB928

105.00 x 130.00 x 12.00mm, FPM

NB929

120.00 x 140.00 x 13.00mm, FPM

170 10.8L

Diesel

OM 326.910	6 Cyl.	24 Valves	10809cc	TD16558
OM 326.911	6 Cyl.	24 Valves	10809cc	TD16560
OM 326.912	6 Cyl.	24 Valves	10809cc	TD16561
OM 326.914	6 Cyl.	24 Valves	10809cc	TD16562
OM 326.915	6 Cyl.	24 Valves	10809cc	TD16563
OM 326.918	6 Cyl.	24 Valves	10809cc	TD16565
OM 326.971	6 Cyl.	24 Valves	10809cc	TD16566
OM 326.972	6 Cyl.	24 Valves	10809cc	TD16567
OM 326.973	6 Cyl.	24 Valves	10809cc	TD16568
OM 326.974	6 Cyl.	24 Valves	10809cc	TD16569
OM 326.975	6 Cyl.	24 Valves	10809cc	TD16570

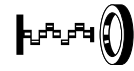
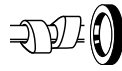

OM 326.977	6 Cyl.	24 Valves	10809cc	TD16571
OM 326.980	6 Cyl.	24 Valves	10809cc	TD16572
OM 326.983	6 Cyl.	24 Valves	10809cc	TD16573
OM 326.988	6 Cyl.	24 Valves	10809cc	TD16574
OM 346.910	6 Cyl.	12 Valves	10809cc	TD16592
OM 346.911	6 Cyl.	12 Valves	10809cc	TD7913
OM 346.912	6 Cyl.	12 Valves	10809cc	TD8178
OM 346.913	6 Cyl.	12 Valves	10809cc	TD16593
OM 346.914	6 Cyl.	12 Valves	10809cc	TD16595
OM 346.915	6 Cyl.	12 Valves	10809cc	TD16596
OM 346.916	6 Cyl.	12 Valves	10809cc	TD8160
OM 346.917	6 Cyl.	12 Valves	10809cc	TD16597
OM 346.918	6 Cyl.	12 Valves	10809cc	TD7914
OM 346.919	6 Cyl.	12 Valves	10809cc	TD28649
OM 346.940	6 Cyl.	12 Valves	10809cc	TD28650
OM 346.941	6 Cyl.	12 Valves	10809cc	TD16598
OM 346.942	6 Cyl.	12 Valves	10809cc	TD16599
OM 346.943	6 Cyl.	12 Valves	10809cc	TD16601
OM 346.944	6 Cyl.	12 Valves	10809cc	TD16602
OM 346.945	6 Cyl.	12 Valves	10809cc	TD16603
OM 346.946	6 Cyl.	12 Valves	10809cc	TD16604
OM 346.947	6 Cyl.	12 Valves	10809cc	TD28651
OM 346.952	6 Cyl.	12 Valves	10809cc	TD16605
OM 346.953	6 Cyl.	12 Valves	10809cc	TD16940

NB984 66.67 x 89.30 x 10.00mm, FPM
NB977 75.00 x 100.00 x 12.00mm, FPM

171 10.9L

Diesel

OM 421.906	6 Cyl.	12 Valves	10964cc	TD8120
PB224 (x12)				

NB928 105.00 x 130.00 x 12.00mm, FPM
NB929 120.00 x 140.00 x 13.00mm, FPM

172 11.0L

Diesel

OM 407.900	6 Cyl.	12 Valves	11040cc	TD28697
OM 407.901	6 Cyl.	12 Valves	11412cc	TD28698
OM 407.905	6 Cyl.	12 Valves	11000cc	TD5664
OM 407.907	6 Cyl.	12 Valves	11045cc	TD10767
OM 407.908	6 Cyl.	12 Valves	11000cc	TD6002
OM 407.909	6 Cyl.	12 Valves	11000cc	TD5665
OM 407.910	6 Cyl.	12 Valves	11000cc	TD6003
OM 407.911	6 Cyl.	12 Valves	11000cc	TD6273
OM 421.901	6 Cyl.	12 Valves	10964cc	TD28706
OM 421.905	6 Cyl.	12 Valves	10964cc	TD5799
OM 421.907	6 Cyl.	12 Valves	10964cc	TD6139
OM 421.908	6 Cyl.	12 Valves	10964cc	TD7898
OM 421.909	6 Cyl.	12 Valves	10964cc	TD17056
OM 421.910	6 Cyl.	12 Valves	10964cc	TD16958
OM 421.951	6 Cyl.	12 Valves	10964cc	TD7899

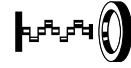
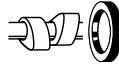

OM 441.901	6 Cyl.	12 Valves	10964cc	TD28879
OM 441.905	6 Cyl.	12 Valves	10964cc	TD5731
OM 441.906	6 Cyl.	12 Valves	10964cc	TD8184
OM 441.907	6 Cyl.	12 Valves	10964cc	TD8185
OM 441.908	6 Cyl.	12 Valves	10964cc	TD5660
OM 441.909	6 Cyl.	12 Valves	10964cc	TD5998
OM 441.911	6 Cyl.	12 Valves	10964cc	TD6271
OM 441.913	6 Cyl.	12 Valves	10964cc	TD6063
OM 441.915	6 Cyl.	12 Valves	10964cc	TD8121
OM 441.917	6 Cyl.	12 Valves	10964cc	TD8122
OM 441.923	6 Cyl.	12 Valves	10964cc	TD5732
OM 441.925	6 Cyl.	12 Valves	10964cc	TD6064
OM 441.926	6 Cyl.	12 Valves	10964cc	TD8119
OM 441.927	6 Cyl.	12 Valves	10964cc	TD8123
OM 441.950	6 Cyl.	12 Valves	10964cc	TD5661
OM 441.951	6 Cyl.	12 Valves	10964cc	TD8187
OM 441.952	6 Cyl.	12 Valves	10964cc	TD17128
OM 441.953	6 Cyl.	12 Valves	10964cc	TD5999
OM 441.960	6 Cyl.	12 Valves	10964cc	TD5772
OM 441.961	6 Cyl.	12 Valves	10964cc	TD16973
OM 441.962	6 Cyl.	12 Valves	10964cc	TD6104
OM 441.980	6 Cyl.	12 Valves	10964cc	TD7943
OM 441.981	6 Cyl.	12 Valves	10964cc	TD6103
OM 441.982	6 Cyl.	12 Valves	10964cc	TD5824
OM 441.983	6 Cyl.	12 Valves	10964cc	TD6322
OM 441.985	6 Cyl.	12 Valves	10964cc	TD6176
OM 441.986	6 Cyl.	12 Valves	10964cc	TD5779
OM 441.987	6 Cyl.	12 Valves	10964cc	TD5782
OM 441.988	6 Cyl.	12 Valves	10964cc	TD5825
OM 441.989	6 Cyl.	12 Valves	10964cc	TD5736
OM 441.990	6 Cyl.	12 Valves	10964cc	TD6177
OM 441.991	6 Cyl.	12 Valves	10964cc	TD6118
OM 441.992	6 Cyl.	12 Valves	10964cc	TD6302
OM 441.993	6 Cyl.	12 Valves	10964cc	TD6069
OM 441.994	6 Cyl.	12 Valves	10964cc	TD16974
OM 441.995	6 Cyl.	12 Valves	10964cc	TD16975
OM 441.996	6 Cyl.	12 Valves	10964cc	TD6116
OM 441.997	6 Cyl.	12 Valves	10964cc	TD16976
OM 441.998	6 Cyl.	12 Valves	10964cc	TD8222
OM 441.999	6 Cyl.	12 Valves	10964cc	TD16977
OM 445.920	6 Cyl.	12 Valves	10964cc	TD5781
OM 445.921	6 Cyl.	12 Valves	10964cc	TD8200
OM 445.922	6 Cyl.	12 Valves	10964cc	TD8252
OM 445.923	6 Cyl.	12 Valves	10964cc	TD5737
OM 445.924	6 Cyl.	12 Valves	10960cc	TD5754
OM 445.925	6 Cyl.	12 Valves	10964cc	TD8197
OM 445.926	6 Cyl.	12 Valves	10964cc	TD5776
OM 445.927	6 Cyl.	12 Valves	10964cc	TD8235
OM 445.929	6 Cyl.	12 Valves	10964cc	TD5778
OM 445.930	6 Cyl.	12 Valves	10964cc	TD6164

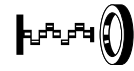
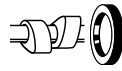

OM 445.931	6 Cyl.	12 Valves	10964cc	TD6298
OM 445.933	6 Cyl.	12 Valves	10964cc	TD6070
OM 445.934	6 Cyl.	12 Valves	10964cc	TD10969
OM 445.935	6 Cyl.	12 Valves	10964cc	TD10970
OM 445.936	6 Cyl.	12 Valves	10964cc	TD6109
OM 445.937	6 Cyl.	12 Valves	10964cc	TD6112
OM 445.938	6 Cyl.	12 Valves	10960cc	TD6087
OM 445.939	6 Cyl.	12 Valves	10964cc	TD6117
OM 445.940	6 Cyl.	12 Valves	10964cc	TD6148
OM 445.941	6 Cyl.	12 Valves	10960cc	TD6288
OM 481.902	6 Cyl.	12 Valves	10965cc	TD17814
OM 481.904	6 Cyl.	12 Valves	10964cc	TD17815
PB224 (x12)				NB928 F 105.00 x 130.00 x 12.00mm, FPM NB929 R 120.00 x 140.00 x 13.00mm, FPM

173 11.3L

Diesel

OM 441.910	6 Cyl.	12 Valves	11309cc	TD17127
OM 441.912	6 Cyl.	12 Valves	11309cc	TD6142
OM 441.914	6 Cyl.	12 Valves	11309cc	TD6101
OM 441.916	6 Cyl.	12 Valves	11309cc	TD5768
OM 441.918	6 Cyl.	12 Valves	11309cc	TD10968
OM 441.919	6 Cyl.	12 Valves	11309cc	TD16972
OM 441.920	6 Cyl.	12 Valves	11309cc	TD6100
OM 441.921	6 Cyl.	12 Valves	11300cc	TD7941
OM 441.922	6 Cyl.	12 Valves	11300cc	TD7942
OM 441.924	6 Cyl.	12 Valves	11309cc	TD6143
OM 441.932	6 Cyl.	12 Valves	11309cc	TD8190
OM 441.933	6 Cyl.	12 Valves	11309cc	TD8191
PB224 (x12)				NB928 F 105.00 x 130.00 x 12.00mm, FPM NB929 R 120.00 x 140.00 x 13.00mm, FPM

174 11.4L

Diesel

OM 407.913	6 Cyl.	12 Valves	11413cc	TD5666
OM 407.914	6 Cyl.	12 Valves	11413cc	TD6004
OM 407.915	6 Cyl.	12 Valves	11413cc	TD6274
OM 407.916	6 Cyl.	12 Valves	11413cc	TD5667
OM 407.917	6 Cyl.	12 Valves	11413cc	TD6005
OM 407.918	6 Cyl.	12 Valves	11413cc	TD6275
OM 407.919	6 Cyl.	12 Valves	11413cc	TD6006
OM 407.920	6 Cyl.	12 Valves	11412cc	TD17808
OM 407.930	6 Cyl.	12 Valves	11412cc	TD28699
OM 407.931	6 Cyl.	12 Valves	11412cc	TD28700
OM 407.932	6 Cyl.	12 Valves	11412cc	TD28701
OM 407.951	6 Cyl.	12 Valves	11413cc	TD5668
OM 407.952	6 Cyl.	12 Valves	11412cc	TD28702
OM 407.953	6 Cyl.	12 Valves	11412cc	TD28703



OM 407.954	6 Cyl.	12 Valves	11412cc	TD28704
OM 407.955	6 Cyl.	12 Valves	11413cc	TD6007
OM 407.956	6 Cyl.	12 Valves	11412cc	TD28705
PB224 (x12)				NB928 105.00 x 130.00 x 12.00mm, FPM NB929 120.00 x 140.00 x 13.00mm, FPM

175 11.6L

Diesel

OM 335.910	6 Cyl.	12 Valves	11581cc	TD28457
OM 335.930	6 Cyl.	12 Valves	11581cc	TD28458
OM 335.932	6 Cyl.	12 Valves	11581cc	TD28459
OM 345.910	6 Cyl.	12 Valves	11581cc	TD28599
OM 345.912	6 Cyl.	12 Valves	11581cc	TD28600
OM 345.913	6 Cyl.	12 Valves	11581cc	TD28601
OM 345.914	6 Cyl.	12 Valves	11581cc	TD28602
OM 345.932	6 Cyl.	12 Valves	11581cc	TD28605
OM 345.933	6 Cyl.	12 Valves	11581cc	TD28606
OM 345.936	6 Cyl.	12 Valves	11581cc	TD28607
OM 345.937	6 Cyl.	12 Valves	11581cc	TD28608
OM 345.960	6 Cyl.	12 Valves	11581cc	TD28642
OM 355.910	6 Cyl.	24 Valves	11581cc	TD16668
OM 355.911	6 Cyl.	24 Valves	11581cc	TD16669
OM 355.912	6 Cyl.	24 Valves	11581cc	TD16670
OM 355.913	6 Cyl.	24 Valves	11581cc	TD16671
OM 355.914	6 Cyl.	24 Valves	11581cc	TD16672
OM 355.915	6 Cyl.	24 Valves	11581cc	TD7892
OM 355.916	6 Cyl.	12 Valves	11581cc	TD22746
OM 355.917	6 Cyl.	12 Valves	11581cc	TD28656
OM 355.918	6 Cyl.	24 Valves	11581cc	TD16673
OM 355.960	6 Cyl.	24 Valves	11581cc	TD5813
OM 355.961	6 Cyl.	24 Valves	11581cc	TD16675
OM 355.962	6 Cyl.	24 Valves	11581cc	TD16676
OM 355.963	6 Cyl.	24 Valves	11581cc	TD5812
OM 355.964	6 Cyl.	24 Valves	11581cc	TD16677
OM 355.965	6 Cyl.	12 Valves	11581cc	TD28658
OM 355.966	6 Cyl.	24 Valves	11581cc	TD16678
OM 355.967	6 Cyl.	24 Valves	11581cc	TD7893
OM 355.968	6 Cyl.	12 Valves	11581cc	TD23185
OM 355.969	6 Cyl.	24 Valves	11581cc	TD8212
OM 355.970	6 Cyl.	24 Valves	11581cc	TD16679
OM 355.972	6 Cyl.	24 Valves	11581cc	TD16680
OM 355.973	6 Cyl.	24 Valves	11581cc	TD16681
OM 355.974	6 Cyl.	24 Valves	11581cc	TD16682
OM 355.975	6 Cyl.	24 Valves	11581cc	TD6160
OM 355.976	6 Cyl.	24 Valves	11581cc	TD6159
OM 355.977	6 Cyl.	24 Valves	11581cc	TD16683
OM 355.978	6 Cyl.	24 Valves	11581cc	TD16684
OM 355.979	6 Cyl.	24 Valves	11581cc	TD16685
OM 355.980	6 Cyl.	24 Valves	11581cc	TD16686
OM 355.981	6 Cyl.	24 Valves	11581cc	TD16687

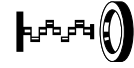
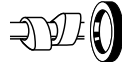

OM 355.982	6 Cyl.	24 Valves	11581cc	TD16674
OM 355.983	6 Cyl.	24 Valves	11581cc	TD5811
OM 355.984	6 Cyl.	24 Valves	11581cc	TD6158

NB977 F
75.00 x 100.00 x 12.00mm, FPM

176 12.0L

Gas

M 476.920	6 Cyl.	12 Valves	11967cc	TD22728
M 476.921	6 Cyl.	12 Valves	11967cc	TD22729
M 476.925	6 Cyl.	12 Valves	11967cc	TD22730
M 476.926	6 Cyl.	12 Valves	11967cc	TD22731
M 476.927	6 Cyl.	12 Valves	11967cc	TD22732
M 476.930	6 Cyl.	12 Valves	11967cc	TD17490
M 476.932	6 Cyl.	12 Valves	11967cc	TD17485
M 476.933	6 Cyl.	12 Valves	11967cc	TD17491
M 476.934	6 Cyl.	12 Valves	11967cc	TD17492
M 476.935	6 Cyl.	12 Valves	11967cc	TD23808
M 476.936	6 Cyl.	12 Valves	11967cc	TD28462
M 476.937	6 Cyl.	12 Valves	11967cc	TD28456

PB224 (x12)

NB928 F
105.00 x 130.00 x 12.00mm, FPM
→Eng no. 708527

NA5469 F
100.00 x 130.00 x 12.00mm, PTFE/ACM
Eng no. 708528→

NB929 F
120.00 x 140.00 x 13.00mm, FPM
→Eng no. 708527

NA5121 F
115.00 x 140.00 x 13.00mm, PTFE/ACM
Eng no. 708528→

177 12.0L

Diesel

OM 427.900	6 Cyl.	12 Valves	11967cc	TD28708
OM 427.901	6 Cyl.	12 Valves	11967cc	TD28709
OM 427.902	6 Cyl.	12 Valves	11967cc	TD28711
OM 427.903	6 Cyl.	12 Valves	11967cc	TD28712
OM 427.905	6 Cyl.	12 Valves	11967cc	TD7951
OM 427.910	6 Cyl.	12 Valves	11967cc	TD5671
OM 427.911	6 Cyl.	12 Valves	11967cc	TD6010
OM 427.950	6 Cyl.	12 Valves	11967cc	TD7946
OM 427.951	6 Cyl.	12 Valves	11967cc	TD16964
OM 427.952	6 Cyl.	12 Valves	11967cc	TD16965
OM 447.900	6 Cyl.	12 Valves	11967cc	TD28722
OM 447.902	6 Cyl.	12 Valves	11967cc	TD28723
OM 447.905	6 Cyl.	12 Valves	11967cc	TD7947
OM 447.906	6 Cyl.	12 Valves	11967cc	TD5674
OM 447.907	6 Cyl.	12 Valves	11967cc	TD5672
OM 447.908	6 Cyl.	12 Valves	11967cc	TD6011
OM 447.910	6 Cyl.	12 Valves	11967cc	TD7956
OM 447.911	6 Cyl.	12 Valves	11967cc	TD7957
OM 447.912	6 Cyl.	12 Valves	11967cc	TD7961
OM 447.913	6 Cyl.	12 Valves	11967cc	TD7948
OM 447.914	6 Cyl.	12 Valves	11967cc	TD7958

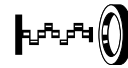
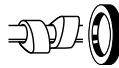

OM 447.947	6 Cyl.	12 Valves	11967cc	TD22805
OM 447.948	6 Cyl.	12 Valves	11967cc	TD22806
OM 447.949	6 Cyl.	12 Valves	11967cc	TD22807
OM 447.950	6 Cyl.	12 Valves	11967cc	TD5673
OM 447.951	6 Cyl.	12 Valves	11967cc	TD6012
OM 447.952	6 Cyl.	12 Valves	11967cc	TD16988
OM 447.953	6 Cyl.	12 Valves	11967cc	TD16989
OM 447.954	6 Cyl.	12 Valves	11967cc	TD10976
OM 447.955	6 Cyl.	12 Valves	11967cc	TD10977
OM 447.956	6 Cyl.	12 Valves	11967cc	TD7949
OM 447.957	6 Cyl.	12 Valves	11967cc	TD7959
OM 447.958	6 Cyl.	12 Valves	11967cc	TD7962
OM 447.959	6 Cyl.	12 Valves	11967cc	TD7954
OM 447.960	6 Cyl.	12 Valves	11967cc	TD22808
OM 447.968	6 Cyl.	12 Valves	11967cc	TD22809
OM 447.968	6 Cyl.	12 Valves	11967cc	TD28724
OM 447.970	6 Cyl.	12 Valves	11967cc	TD10978
OM 447.971	6 Cyl.	12 Valves	11967cc	TD10979
OM 447.972	6 Cyl.	12 Valves	11967cc	TD10980
OM 447.973	6 Cyl.	12 Valves	11967cc	TD10981
OM 447.974	6 Cyl.	12 Valves	11967cc	TD10982
OM 447.975	6 Cyl.	12 Valves	11967cc	TD11007
OM 447.976	6 Cyl.	12 Valves	11967cc	TD10983
OM 447.977	6 Cyl.	12 Valves	11967cc	TD11009
OM 447.978	6 Cyl.	12 Valves	11967cc	TD10984
OM 447.979	6 Cyl.	12 Valves	11967cc	TD10985
OM 447.980	6 Cyl.	12 Valves	11967cc	TD11008
OM 447.981	6 Cyl.	12 Valves	11967cc	TD7950
OM 447.982	6 Cyl.	12 Valves	11967cc	TD17811
OM 447.983	6 Cyl.	12 Valves	11967cc	TD17812
OM 447.984	6 Cyl.	12 Valves	11967cc	TD7955
OM 447.985	6 Cyl.	12 Valves	11967cc	TD10986
OM 447.986	6 Cyl.	12 Valves	11967cc	TD7960
OM 447.987	6 Cyl.	12 Valves	11967cc	TD7963
OM 447.988	6 Cyl.	12 Valves	11967cc	TD16990
OM 447.990	6 Cyl.	12 Valves	11967cc	TD10987
OM 447.991	6 Cyl.	12 Valves	11967cc	TD10988
OM 447.992	6 Cyl.	12 Valves	11967cc	TD10989
OM 447.993	6 Cyl.	12 Valves	11967cc	TD10990
OM 447.994	6 Cyl.	12 Valves	11967cc	TD16991
OM 447.995	6 Cyl.	12 Valves	11967cc	TD17813
OM 447.996	6 Cyl.	12 Valves	11967cc	TD22810
OM 447.998	6 Cyl.	12 Valves	11967cc	TD11010
OM 447.999	6 Cyl.	12 Valves	11967cc	TD23187
OM 466.900	6 Cyl.	12 Valves	11967cc	TD28758
OM 476.971	6 Cyl.	12 Valves	11967cc	TD23227
OM 476.972	6 Cyl.	12 Valves	11967cc	TD23228
OM 476.973	6 Cyl.	12 Valves	11967cc	TD23229
OM 476.977	6 Cyl.	12 Valves	11967cc	TD23230
OM 476.978	6 Cyl.	12 Valves	11967cc	TD23231

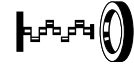
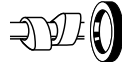

OM 476.979	6 Cyl.	12 Valves	11967cc	TD23232
OM 476.980	6 Cyl.	12 Valves	11967cc	TD23233
OM 476.981	6 Cyl.	12 Valves	11967cc	TD23234
OM 476.982	6 Cyl.	12 Valves	11967cc	TD23235
OM 476.983	6 Cyl.	12 Valves	11967cc	TD23236
OM 476.985	6 Cyl.	12 Valves	11967cc	TD23237
OM 476.988	6 Cyl.	12 Valves	11967cc	TD23238
OM 476.991	6 Cyl.	12 Valves	11967cc	TD23239
OM 476.992	6 Cyl.	12 Valves	11967cc	TD23805
PB224 (x12)				NB928 F 105.00 x 130.00 x 12.00mm, FPM NB929 R 120.00 x 140.00 x 13.00mm, FPM

178 12.0L Petrol

OM 447.915	6 Cyl.	12 Valves	11967cc	TD16986
OM 447.916	6 Cyl.	12 Valves	11967cc	TD16987
PB224 (x12)				NB928 F 105.00 x 130.00 x 12.00mm, FPM NB929 R 120.00 x 140.00 x 13.00mm, FPM

179 12.0L Diesel

OM 447.969	6 Cyl.	12 Valves	11967cc	TD28880
				NB928 F 105.00 x 130.00 x 12.00mm, FPM NB929 R 120.00 x 140.00 x 13.00mm, FPM

180 12.0L Diesel

OM 457.910	6 Cyl.	24 Valves	11967cc	TD25467
PB394 (x24)				NB928 F 105.00 x 130.00 x 12.00mm, FPM NB929 R 120.00 x 140.00 x 13.00mm, FPM NA5121 R 115.00 x 140.00 x 13.00mm, PTFE/ACM

181 12.0L Diesel

OM 457.914	6 Cyl.	24 Valves	11967cc	TD20335
OM 457.915	6 Cyl.	24 Valves	11967cc	TD20303
OM 457.916	6 Cyl.	24 Valves	11967cc	TD20304
OM 457.919	6 Cyl.	24 Valves	11967cc	TD20306
OM 457.920	6 Cyl.	24 Valves	11967cc	TD20307
OM 457.922	6 Cyl.	24 Valves	11967cc	TD20308
OM 457.923	6 Cyl.	24 Valves	11967cc	TD20309
OM 457.924	6 Cyl.	24 Valves	11967cc	TD20310
OM 457.926	6 Cyl.	24 Valves	11967cc	TD20312
OM 457.927	6 Cyl.	24 Valves	11967cc	TD20336
OM 457.928	6 Cyl.	24 Valves	11967cc	TD20313
OM 457.929	6 Cyl.	24 Valves	11967cc	TD20314
OM 457.931	6 Cyl.	24 Valves	11967cc	TD20315
OM 457.932	6 Cyl.	24 Valves	11967cc	TD20316
OM 457.933	6 Cyl.	24 Valves	11967cc	TD17662
OM 457.934	6 Cyl.	24 Valves	11967cc	TD17473

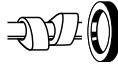

OM 457.935	6 Cyl.	24 Valves	11967cc	TD17502
OM 457.936	6 Cyl.	24 Valves	11967cc	TD17653
OM 457.938	6 Cyl.	24 Valves	11967cc	TD17645
OM 457.939	6 Cyl.	24 Valves	11967cc	TD20317
OM 457.940	6 Cyl.	24 Valves	11967cc	TD17654
OM 457.941	6 Cyl.	24 Valves	11967cc	TD17641
OM 457.942	6 Cyl.	24 Valves	11967cc	TD17448
OM 457.943	6 Cyl.	24 Valves	11967cc	TD17666
OM 457.944	6 Cyl.	24 Valves	11967cc	TD17644
OM 457.945	6 Cyl.	24 Valves	11967cc	TD20318
OM 457.946	6 Cyl.	24 Valves	11967cc	TD20319
OM 457.947	6 Cyl.	24 Valves	11967cc	TD20320
OM 457.949	6 Cyl.	24 Valves	11967cc	TD20321
OM 457.950	6 Cyl.	24 Valves	11967cc	TD20337
OM 457.951	6 Cyl.	24 Valves	11967cc	TD23250
OM 457.952	6 Cyl.	24 Valves	11967cc	TD20338
OM 457.953	6 Cyl.	24 Valves	11967cc	TD23251
OM 457.954	6 Cyl.	24 Valves	11967cc	TD20339
OM 457.955	6 Cyl.	24 Valves	11967cc	TD20323
OM 457.958	6 Cyl.	24 Valves	11967cc	TD20340
OM 457.959	6 Cyl.	24 Valves	11967cc	TD20341
OM 457.960	6 Cyl.	24 Valves	11967cc	TD20322
OM 457.961	6 Cyl.	24 Valves	11967cc	TD23252
OM 457.964	6 Cyl.	24 Valves	11967cc	TD23247
OM 457.965	6 Cyl.	24 Valves	11967cc	TD23248
OM 457.966	6 Cyl.	24 Valves	11967cc	TD23249
OM 457.967	6 Cyl.	24 Valves	11967cc	TD28150
OM 457.968	6 Cyl.	24 Valves	11967cc	TD28726
OM 457.969	6 Cyl.	24 Valves	11967cc	TD28727
OM 457.973	6 Cyl.	24 Valves	11967cc	TD27003
OM 457.974	6 Cyl.	24 Valves	11967cc	TD28728
OM 457.975	6 Cyl.	24 Valves	11967cc	TD28152
OM 457.976	6 Cyl.	24 Valves	11967cc	TD28729
OM 457.977	6 Cyl.	24 Valves	11967cc	TD28730
OM 458.960	6 Cyl.	24 Valves	11967cc	TD17668
OM 458.970	6 Cyl.	24 Valves	11967cc	TD17669
OM 458.980	6 Cyl.	24 Valves	11967cc	TD17670
OM 458.990	6 Cyl.	24 Valves	11967cc	TD28731
OM 458.991	6 Cyl.	24 Valves	11967cc	TD28732
OM 458.992	6 Cyl.	24 Valves	11967cc	TD28733
OM 476.916	6 Cyl.	12 Valves	11967cc	TD23807
OM 476.917	6 Cyl.	12 Valves	11967cc	TD23806
OM 476.950	6 Cyl.	12 Valves	11967cc	TD23809
OM 521.940	6 Cyl.	24 Valves	11946cc	TD16791
OM 521.950	6 Cyl.	24 Valves	11946cc	TD17671
OM 521.951	6 Cyl.	24 Valves	11946cc	TD28776
OM 541.920	6 Cyl.	24 Valves	11946cc	TD7872
OM 541.921	6 Cyl.	24 Valves	11946cc	TD9673
OM 541.922	6 Cyl.	24 Valves	11946cc	TD7873
OM 541.923	6 Cyl.	24 Valves	11946cc	TD7874

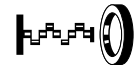
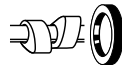

OM 541.924	6 Cyl.	24 Valves	11946cc	TD7880
OM 541.925	6 Cyl.	24 Valves	11946cc	TD7875
OM 541.926	6 Cyl.	24 Valves	11946cc	TD7879
OM 541.927	6 Cyl.	24 Valves	11946cc	TD9679
OM 541.928	6 Cyl.	24 Valves	11946cc	TD17679
OM 541.940	6 Cyl.	24 Valves	11946cc	TD16897
OM 541.941	6 Cyl.	24 Valves	11946cc	TD16898
OM 541.942	6 Cyl.	24 Valves	11946cc	TD16899
OM 541.943	6 Cyl.	24 Valves	11946cc	TD16900
OM 541.944	6 Cyl.	24 Valves	11946cc	TD16901
OM 541.945	6 Cyl.	24 Valves	11946cc	TD16902
OM 541.946	6 Cyl.	24 Valves	11946cc	TD16903
OM 541.947	6 Cyl.	24 Valves	11946cc	TD16904
OM 541.948	6 Cyl.	24 Valves	11946cc	TD16913
OM 541.949	6 Cyl.	24 Valves	11946cc	TD16914
OM 541.952	6 Cyl.	24 Valves	11946cc	TD17685
OM 541.953	6 Cyl.	24 Valves	11946cc	TD28777
OM 541.959	6 Cyl.	24 Valves	11946cc	TD28778
OM 541.960	6 Cyl.	24 Valves	11946cc	TD25520
OM 541.970	6 Cyl.	24 Valves	11946cc	TD19250
OM 541.971	6 Cyl.	24 Valves	11946cc	TD21001
OM 541.972	6 Cyl.	24 Valves	11946cc	TD19251
OM 541.973	6 Cyl.	24 Valves	11946cc	TD21022
OM 541.974	6 Cyl.	24 Valves	11946cc	TD18997
OM 541.975	6 Cyl.	24 Valves	11946cc	TD21023
OM 541.976	6 Cyl.	24 Valves	11946cc	TD19000
OM 541.977	6 Cyl.	24 Valves	11946cc	TD21024
OM 541.978	6 Cyl.	24 Valves	11946cc	TD21007
OM 541.979	6 Cyl.	24 Valves	11946cc	TD28783
OM 541.980	6 Cyl.	24 Valves	11946cc	TD21000
OM 541.981	6 Cyl.	24 Valves	11946cc	TD21003
OM 541.990	6 Cyl.	24 Valves	11946cc	TD23767
OM 541.991	6 Cyl.	24 Valves	11946cc	TD25686
OM 541.992	6 Cyl.	24 Valves	11946cc	TD23768
OM 541.993	6 Cyl.	24 Valves	11946cc	TD25687
OM 541.994	6 Cyl.	24 Valves	11946cc	TD23769
OM 541.995	6 Cyl.	24 Valves	11946cc	TD25696
OM 541.996	6 Cyl.	24 Valves	11946cc	TD25486
OM 541.997	6 Cyl.	24 Valves	11946cc	TD25697
OM 541.998	6 Cyl.	24 Valves	11946cc	TD25487
OM 541.999	6 Cyl.	24 Valves	11946cc	TD25698
OM 941.910	6 Cyl.	24 Valves	11946cc	TD17693
OM 941.920	6 Cyl.	24 Valves	11946cc	TD16793
OM 941.921	6 Cyl.	24 Valves	11946cc	TD17694
OM 941.929	6 Cyl.	24 Valves	11946cc	TD16794
OM 941.930	6 Cyl.	24 Valves	11946cc	TD16795
OM 941.940	6 Cyl.	24 Valves	11946cc	TD16796
OM 941.960	6 Cyl.	24 Valves	11946cc	TD16797
OM 941.970	6 Cyl.	24 Valves	11946cc	TD16798
OM 941.980	6 Cyl.	24 Valves	11946cc	TD17695

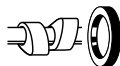

OM 941.981	6 Cyl.	24 Valves	11946cc	TD17696
OM 941.990	6 Cyl.	24 Valves	11946cc	TD16799
OM 941.991	6 Cyl.	24 Valves	11946cc	TD28855
OM 941.992	6 Cyl.	24 Valves	11946cc	TD28856

PB394 (x24)

NB928

105.00 x 130.00 x 12.00mm, FPM

NA5469

100.00 x 130.00 x 12.00mm, PTFE/ACM

NB929

120.00 x 140.00 x 13.00mm, FPM

182 12.0L

Diesel

OM 457.917	6 Cyl.	24 Valves	11967cc	TD20324
OM 457.918	6 Cyl.	24 Valves	11967cc	TD20305
OM 457.925	6 Cyl.	24 Valves	11967cc	TD20311
OM 457.937	6 Cyl.	24 Valves	11967cc	TD16489
OM 457.948	6 Cyl.	24 Valves	11967cc	TD20227
OM 457.956	6 Cyl.	24 Valves	11967cc	TD20282
OM 457.957	6 Cyl.	24 Valves	11967cc	TD20283
OM 457.962	6 Cyl.	24 Valves	11967cc	TD23253
OM 457.980	6 Cyl.	24 Valves	11967cc	TD25446
OM 457.981	6 Cyl.	24 Valves	11967cc	TD25447

PB394 (x24)

NB928

105.00 x 130.00 x 12.00mm, FPM

NA5469

100.00 x 130.00 x 12.00mm, PTFE/ACM

NB929

120.00 x 140.00 x 13.00mm, FPM

NA5121

115.00 x 140.00 x 13.00mm, PTFE/ACM

183 12.0L

Diesel

OM 541.950	6 Cyl.	24 Valves	11946cc	TD17682
OM 541.951	6 Cyl.	24 Valves	11946cc	TD17684

PB394 (x24)

NB928

105.00 x 130.00 x 12.00mm, FPM

NB815

23.00 x 35.00 x 7.00mm, FPM

NA5469

100.00 x 130.00 x 12.00mm, PTFE/ACM

NB929

120.00 x 140.00 x 13.00mm, FPM

184 12.8L

Diesel

OM 402.900	8 Cyl.	16 Valves	12800cc	TD28693
OM 402.900	8 Cyl.	16 Valves	12800cc	TD28694
OM 402.901	8 Cyl.	16 Valves	12800cc	TD28878
OM 402.905	8 Cyl.	16 Valves	12800cc	TD8179
OM 402.906	8 Cyl.	16 Valves	12800cc	TD5814
OM 402.907	8 Cyl.	16 Valves	12800cc	TD7896
OM 402.910	8 Cyl.	16 Valves	12800cc	TD5752
OM 402.911	8 Cyl.	16 Valves	12800cc	TD6085
OM 402.912	8 Cyl.	16 Valves	12800cc	TD5758
OM 402.913	8 Cyl.	16 Valves	12760cc	TD17803
OM 402.914	8 Cyl.	16 Valves	12800cc	TD8230
OM 402.916	8 Cyl.	16 Valves	12800cc	TD5798

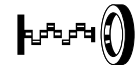
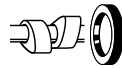

OM 402.917	8 Cyl.	16 Valves	12760cc	TD17804
OM 402.919	8 Cyl.	16 Valves	12800cc	TD8154
OM 402.921	8 Cyl.	16 Valves	12760cc	TD17805
OM 402.923	8 Cyl.	16 Valves	12800cc	TD8183
OM 402.924	8 Cyl.	16 Valves	12800cc	TD6291
OM 402.925	8 Cyl.	16 Valves	12760cc	TD17806
OM 402.926	8 Cyl.	16 Valves	12800cc	TD6296
OM 402.927	8 Cyl.	16 Valves	12800cc	TD9606
OM 402.928	8 Cyl.	16 Valves	12800cc	TD9607
OM 402.970	8 Cyl.	16 Valves	12763cc	TD7940
OM 402.971	8 Cyl.	16 Valves	12763cc	TD5783
OM 402.972	8 Cyl.	16 Valves	12763cc	TD5784
OM 402.973	8 Cyl.	16 Valves	12763cc	TD5832
OM 402.974	8 Cyl.	16 Valves	12763cc	TD17807
OM 402.975	8 Cyl.	16 Valves	12763cc	TD5818
OM 402.977	8 Cyl.	16 Valves	12763cc	TD5826
OM 402.978	8 Cyl.	16 Valves	12763cc	TD5786
OM 402.982	8 Cyl.	16 Valves	12763cc	TD5830
OM 402.983	8 Cyl.	16 Valves	12763cc	TD6182
OM 402.984	8 Cyl.	16 Valves	12763cc	TD11268
OM 402.985	8 Cyl.	16 Valves	12763cc	TD5806
OM 402.986	8 Cyl.	16 Valves	12763cc	TD6151
OM 402.987	8 Cyl.	16 Valves	12763cc	TD6178
OM 402.989	8 Cyl.	16 Valves	12763cc	TD5807
OM 402.990	8 Cyl.	16 Valves	12763cc	TD6153
OM 402.995	8 Cyl.	16 Valves	12763cc	TD11267
OM 402.996	8 Cyl.	16 Valves	12763cc	TD6121

PB224 (x16)

NB928 F

105.00 x 130.00 x 12.00mm, FPM

NB929 R

120.00 x 140.00 x 13.00mm, FPM

185 12.8L

Diesel

OM 460.900	6 Cyl.	24 Valves	12816cc	TD23255
OM 460.901	6 Cyl.	24 Valves	12816cc	TD23256
OM 460.902	6 Cyl.	24 Valves	12816cc	TD23257
OM 460.903	6 Cyl.	24 Valves	12816cc	TD23258
OM 460.904	6 Cyl.	24 Valves	12816cc	TD23259
OM 460.905	6 Cyl.	24 Valves	12816cc	TD23260
OM 460.906	6 Cyl.	24 Valves	12816cc	TD23261
OM 460.907	6 Cyl.	24 Valves	12816cc	TD23262
OM 460.908	6 Cyl.	24 Valves	12816cc	TD23263
OM 460.909	6 Cyl.	24 Valves	12816cc	TD23264
OM 460.910	6 Cyl.	24 Valves	12816cc	TD23265
OM 460.911	6 Cyl.	24 Valves	12816cc	TD23266
OM 460.912	6 Cyl.	24 Valves	12816cc	TD23267
OM 460.913	6 Cyl.	24 Valves	12816cc	TD23268
OM 460.914	6 Cyl.	24 Valves	12816cc	TD23269
OM 460.915	6 Cyl.	24 Valves	12816cc	TD23270
OM 460.916	6 Cyl.	24 Valves	12816cc	TD23271
OM 460.917	6 Cyl.	24 Valves	12816cc	TD23272

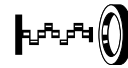
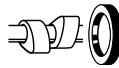

OM 460.918	6 Cyl.	24 Valves	12816cc	TD23273
OM 460.919	6 Cyl.	24 Valves	12816cc	TD23274
OM 460.920	6 Cyl.	24 Valves	12816cc	TD23275
OM 460.921	6 Cyl.	24 Valves	12816cc	TD23276
OM 460.922	6 Cyl.	24 Valves	12816cc	TD23277
OM 460.923	6 Cyl.	24 Valves	12816cc	TD23278
OM 460.925	6 Cyl.	24 Valves	12816cc	TD23279
OM 460.926	6 Cyl.	24 Valves	12816cc	TD28735
OM 460.927	6 Cyl.	24 Valves	12816cc	TD28736
OM 460.929	6 Cyl.	24 Valves	12816cc	TD23280
OM 460.931	6 Cyl.	24 Valves	12816cc	TD23281
OM 460.932	6 Cyl.	24 Valves	12816cc	TD28737
OM 460.933	6 Cyl.	24 Valves	12816cc	TD28738
OM 460.934	6 Cyl.	24 Valves	12816cc	TD28739
OM 460.935	6 Cyl.	24 Valves	12816cc	TD28740
OM 460.936	6 Cyl.	24 Valves	12816cc	TD28741
OM 460.937	6 Cyl.	24 Valves	12816cc	TD28742
OM 460.938	6 Cyl.	24 Valves	12816cc	TD28743
OM 460.939	6 Cyl.	24 Valves	12816cc	TD28744
OM 460.940	6 Cyl.	24 Valves	12816cc	TD28745
OM 460.941	6 Cyl.	24 Valves	12816cc	TD28746
OM 460.942	6 Cyl.	24 Valves	12816cc	TD28747
OM 460.943	6 Cyl.	24 Valves	12816cc	TD28748
OM 460.944	6 Cyl.	24 Valves	12816cc	TD28749
OM 460.945	6 Cyl.	24 Valves	12816cc	TD28750
OM 460.946	6 Cyl.	24 Valves	12816cc	TD28751
OM 460.947	6 Cyl.	24 Valves	12816cc	TD28752
OM 460.948	6 Cyl.	24 Valves	12816cc	TD28753
OM 460.949	6 Cyl.	24 Valves	12816cc	TD28754
OM 460.950	6 Cyl.	24 Valves	12816cc	TD22811
OM 460.951	6 Cyl.	24 Valves	12816cc	TD23254
OM 460.960	6 Cyl.	24 Valves	12816cc	TD22812
OM 460.961	6 Cyl.	24 Valves	12816cc	TD28755
OM 460.970	6 Cyl.	24 Valves	12816cc	TD23282
OM 460.971	6 Cyl.	24 Valves	12816cc	TD23283
OM 460.975	6 Cyl.	24 Valves	12816cc	TD23284
OM 460.976	6 Cyl.	24 Valves	12816cc	TD23285
OM 460.977	6 Cyl.	24 Valves	12816cc	TD23286
OM 460.978	6 Cyl.	24 Valves	12816cc	TD23287
OM 460.979	6 Cyl.	24 Valves	12816cc	TD23288
OM 460.980	6 Cyl.	24 Valves	12816cc	TD23289
OM 460.981	6 Cyl.	24 Valves	12816cc	TD23290
OM 460.982	6 Cyl.	24 Valves	12816cc	TD28756
OM 460.983	6 Cyl.	24 Valves	12816cc	TD28757

PB394 (x24)

NB928

105.00 x 130.00 x 12.00mm, FPM

NA5469

100.00 x 130.00 x 12.00mm, PTFE/ACM

NB929

120.00 x 140.00 x 13.00mm, FPM

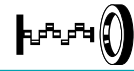
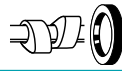

186 14.6L	Diesel			
OM 422.901	8 Cyl.	16 Valves	14618cc	TD18973
OM 422.905	8 Cyl.	16 Valves	14618cc	TD5760
OM 422.906	8 Cyl.	16 Valves	14618cc	TD6093
OM 422.907	8 Cyl.	16 Valves	14618cc	TD5805
OM 422.908	8 Cyl.	16 Valves	14618cc	TD7900
OM 422.909	8 Cyl.	16 Valves	14618cc	TD8157
OM 422.910	8 Cyl.	16 Valves	14618cc	TD6132
OM 422.911	8 Cyl.	16 Valves	14618cc	TD6140
OM 422.912	8 Cyl.	16 Valves	14618cc	TD8231
OM 422.913	8 Cyl.	16 Valves	14618cc	TD6149
OM 422.914	8 Cyl.	16 Valves	14600cc	TD5828
OM 422.915	8 Cyl.	16 Valves	14618cc	TD16959
OM 422.916	8 Cyl.	16 Valves	14618cc	TD17111
OM 422.917	8 Cyl.	16 Valves	14618cc	TD11029
OM 422.918	8 Cyl.	16 Valves	14618cc	TD16960
OM 422.919	8 Cyl.	16 Valves	14618cc	TD5821
OM 422.920	8 Cyl.	16 Valves	14618cc	TD8249
OM 422.921	8 Cyl.	16 Valves	14618cc	TD6173
OM 422.922	8 Cyl.	16 Valves	14618cc	TD16961
OM 422.923	8 Cyl.	16 Valves	14618cc	TD16962
OM 422.950	8 Cyl.	16 Valves	14600cc	TD17115
OM 422.951	8 Cyl.	16 Valves	14600cc	TD7901
OM 422.952	8 Cyl.	16 Valves	14600cc	TD5761
OM 422.953	8 Cyl.	16 Valves	14618cc	TD5763
OM 422.954	8 Cyl.	16 Valves	14618cc	TD6095
OM 422.955	8 Cyl.	16 Valves	14618cc	TD5800
OM 422.956	8 Cyl.	16 Valves	14600cc	TD6134
OM 422.957	8 Cyl.	16 Valves	14620cc	TD9613
OM 422.958	8 Cyl.	16 Valves	14620cc	TD9614
OM 422.959	8 Cyl.	16 Valves	14618cc	TD6141
OM 422.963	8 Cyl.	16 Valves	14618cc	TD11028
OM 440.940	8 Cyl.	16 Valves	14618cc	TD8194
OM 440.941	8 Cyl.	16 Valves	14618cc	TD5794
OM 440.942	8 Cyl.	16 Valves	14618cc	TD6130
OM 440.943	8 Cyl.	16 Valves	14618cc	TD17122
OM 440.945	8 Cyl.	16 Valves	14618cc	TD16967
OM 440.948	8 Cyl.	16 Valves	14618cc	TD17123
OM 440.949	8 Cyl.	16 Valves	14618cc	TD17124
OM 440.970	8 Cyl.	16 Valves	14618cc	TD5797
OM 440.971	8 Cyl.	16 Valves	14618cc	TD5788
OM 440.972	8 Cyl.	16 Valves	14618cc	TD16968
OM 440.973	8 Cyl.	16 Valves	14618cc	TD6124
OM 440.974	8 Cyl.	16 Valves	14618cc	TD17125
OM 440.975	8 Cyl.	16 Valves	14618cc	TD5833
OM 440.976	8 Cyl.	16 Valves	14618cc	TD8227
OM 440.978	8 Cyl.	16 Valves	14618cc	TD5787
OM 440.979	8 Cyl.	16 Valves	14618cc	TD6138
OM 440.980	8 Cyl.	16 Valves	14618cc	TD6179
OM 440.981	8 Cyl.	16 Valves	14618cc	TD6152

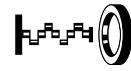
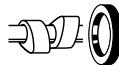

OM 440.982	8 Cyl.	16 Valves	14618cc	TD6185
OM 440.983	8 Cyl.	16 Valves	14618cc	TD6306
OM 440.984	8 Cyl.	16 Valves	14618cc	TD6305
OM 440.985	8 Cyl.	16 Valves	14618cc	TD8256
OM 440.986	8 Cyl.	16 Valves	14618cc	TD16969
OM 440.987	8 Cyl.	16 Valves	14618cc	TD16970
OM 440.988	8 Cyl.	16 Valves	14618cc	TD17126
OM 440.989	8 Cyl.	16 Valves	14618cc	TD16971
OM 440.990	8 Cyl.	16 Valves	14618cc	TD8225
OM 440.991	8 Cyl.	16 Valves	14618cc	TD6122
OM 442.901	8 Cyl.	16 Valves	14618cc	TD28718
OM 442.940	8 Cyl.	16 Valves	14618cc	TD17131
OM 442.941	8 Cyl.	16 Valves	14618cc	TD16978
OM 442.942	8 Cyl.	16 Valves	14618cc	TD5774
OM 442.943	8 Cyl.	16 Valves	14620cc	TD5793
OM 442.944	8 Cyl.	16 Valves	14618cc	TD5773
OM 442.945	8 Cyl.	16 Valves	14618cc	TD5829
OM 442.946	8 Cyl.	16 Valves	14618cc	TD5831
OM 442.950	8 Cyl.	16 Valves	14618cc	TD5764
OM 442.951	8 Cyl.	16 Valves	14618cc	TD5765
OM 442.952	8 Cyl.	16 Valves	14618cc	TD6135
OM 442.953	8 Cyl.	16 Valves	14618cc	TD5819
OM 442.954	8 Cyl.	16 Valves	14618cc	TD10972
OM 442.955	8 Cyl.	16 Valves	14618cc	TD10973
OM 442.957	8 Cyl.	16 Valves	14618cc	TD6183
OM 442.958	8 Cyl.	16 Valves	14618cc	TD6290
OM 442.959	8 Cyl.	16 Valves	14618cc	TD6161
OM 442.960	8 Cyl.	16 Valves	14618cc	TD5663
OM 442.961	8 Cyl.	16 Valves	14618cc	TD6001
OM 442.962	8 Cyl.	16 Valves	14618cc	TD8215
OM 442.963	8 Cyl.	16 Valves	14618cc	TD5802
OM 442.964	8 Cyl.	16 Valves	14618cc	TD6146
OM 442.965	8 Cyl.	16 Valves	14618cc	TD6292
OM 442.966	8 Cyl.	16 Valves	14618cc	TD6300
OM 442.967	8 Cyl.	16 Valves	14618cc	TD17809
OM 442.968	8 Cyl.	16 Valves	14618cc	TD6147
OM 442.969	8 Cyl.	16 Valves	14618cc	TD28719
OM 442.970	8 Cyl.	16 Valves	14618cc	TD17132
OM 442.971	8 Cyl.	16 Valves	14620cc	TD5795
OM 442.972	8 Cyl.	16 Valves	14620cc	TD6131
OM 442.973	8 Cyl.	16 Valves	14618cc	TD17133
OM 442.974	8 Cyl.	16 Valves	14618cc	TD17134
OM 442.975	8 Cyl.	16 Valves	14618cc	TD17135
OM 442.976	8 Cyl.	16 Valves	14618cc	TD6323
OM 442.977	8 Cyl.	16 Valves	14618cc	TD8219
OM 442.978	8 Cyl.	16 Valves	14620cc	TD8216
OM 442.979	8 Cyl.	16 Valves	14618cc	TD17136
OM 442.980	8 Cyl.	16 Valves	14618cc	TD6169
OM 442.982	8 Cyl.	16 Valves	14618cc	TD5796
OM 442.983	8 Cyl.	16 Valves	14618cc	TD8248

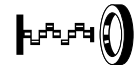
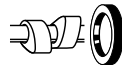

OM 442.984	8 Cyl.	16 Valves	14618cc	TD5804
OM 442.985	8 Cyl.	16 Valves	14618cc	TD5775
OM 442.989	8 Cyl.	16 Valves	14618cc	TD5817
OM 442.991	8 Cyl.	16 Valves	14618cc	TD17137
OM 442.992	8 Cyl.	16 Valves	14618cc	TD6301
OM 442.993	8 Cyl.	16 Valves	14618cc	TD8259
OM 442.994	8 Cyl.	16 Valves	14618cc	TD6165
OM 442.995	8 Cyl.	16 Valves	14618cc	TD16979
OM 442.996	8 Cyl.	16 Valves	14618cc	TD16980
OM 442.997	8 Cyl.	16 Valves	14618cc	TD5810
OM 442.998	8 Cyl.	16 Valves	14618cc	TD6157
OM 442.999	8 Cyl.	16 Valves	14618cc	TD17810
OM 446.920	8 Cyl.	16 Valves	14618cc	TD5789
OM 446.922	8 Cyl.	16 Valves	14618cc	TD8207
OM 446.923	8 Cyl.	16 Valves	14618cc	TD16935
OM 446.924	8 Cyl.	16 Valves	14618cc	TD5785
OM 446.925	8 Cyl.	16 Valves	14618cc	TD6120
OM 446.926	8 Cyl.	16 Valves	14618cc	TD5834
OM 446.927	8 Cyl.	16 Valves	14618cc	TD8203
OM 446.928	8 Cyl.	16 Valves	14618cc	TD5808
OM 446.929	8 Cyl.	16 Valves	14618cc	TD6155
OM 446.930	8 Cyl.	16 Valves	14618cc	TD6186
OM 446.931	8 Cyl.	16 Valves	14618cc	TD8257
OM 446.932	8 Cyl.	16 Valves	14618cc	TD8260
OM 446.933	8 Cyl.	16 Valves	14618cc	TD5820
OM 446.934	8 Cyl.	16 Valves	14618cc	TD10974
OM 446.935	8 Cyl.	16 Valves	14618cc	TD16982
OM 446.936	8 Cyl.	16 Valves	14618cc	TD8247
OM 446.938	8 Cyl.	16 Valves	14618cc	TD10975
OM 446.939	8 Cyl.	16 Valves	14618cc	TD5835
OM 446.940	8 Cyl.	16 Valves	14618cc	TD6187
OM 446.941	8 Cyl.	16 Valves	14618cc	TD16983
OM 446.942	8 Cyl.	16 Valves	14618cc	TD5809
OM 446.943	8 Cyl.	16 Valves	14618cc	TD8204
OM 446.944	8 Cyl.	16 Valves	14618cc	TD17141
OM 446.945	8 Cyl.	16 Valves	14618cc	TD6171
OM 446.946	8 Cyl.	16 Valves	14618cc	TD6125
OM 446.947	8 Cyl.	16 Valves	14618cc	TD17142
OM 446.948	8 Cyl.	16 Valves	14618cc	TD6156
OM 482.912	8 Cyl.	16 Valves	14618cc	TD22816
OM 482.930	8 Cyl.	16 Valves	14618cc	TD22817
OM 482.940	8 Cyl.	16 Valves	14618cc	TD22818
OM 482.941	8 Cyl.	16 Valves	14618cc	TD22819
OM 492.900	8 Cyl.	16 Valves	14618cc	TD28775

PB224 (x16)

NB928 E

105.00 x 130.00 x 12.00mm, FPM

NB929 R

120.00 x 140.00 x 13.00mm, FPM

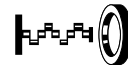
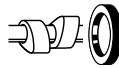

187 15.1L

Diesel

OM 440.905	8 Cyl.	16 Valves	15080cc	TD17116
OM 440.906	8 Cyl.	16 Valves	15080cc	TD17117
OM 440.907	8 Cyl.	16 Valves	15080cc	TD16966
OM 440.908	8 Cyl.	16 Valves	15080cc	TD17118
OM 440.909	8 Cyl.	16 Valves	15080cc	TD8192
OM 440.910	8 Cyl.	16 Valves	15080cc	TD17119
OM 440.911	8 Cyl.	16 Valves	15080cc	TD17120
OM 440.912	8 Cyl.	16 Valves	15080cc	TD17121
OM 442.905	8 Cyl.	16 Valves	15080cc	TD8186
OM 442.906	8 Cyl.	16 Valves	15080cc	TD5769
OM 442.907	8 Cyl.	16 Valves	15080cc	TD5771
OM 442.908	8 Cyl.	16 Valves	15080cc	TD5790
OM 442.909	8 Cyl.	16 Valves	15080cc	TD5791
OM 442.910	8 Cyl.	16 Valves	15080cc	TD5662
OM 442.911	8 Cyl.	16 Valves	15080cc	TD10971
OM 442.912	8 Cyl.	16 Valves	15080cc	TD17129
OM 442.913	8 Cyl.	16 Valves	15080cc	TD17130
OM 442.914	8 Cyl.	16 Valves	15080cc	TD5734
OM 442.915	8 Cyl.	16 Valves	15078cc	TD5822
OM 442.916	8 Cyl.	16 Valves	15078cc	TD6174
OM 442.917	8 Cyl.	16 Valves	15080cc	TD6297
OM 442.918	8 Cyl.	16 Valves	15080cc	TD6000
OM 442.919	8 Cyl.	16 Valves	15080cc	TD6272
OM 442.920	8 Cyl.	16 Valves	15080cc	TD5735
OM 442.921	8 Cyl.	16 Valves	15080cc	TD6144
OM 442.922	8 Cyl.	16 Valves	15080cc	TD5770
OM 442.923	8 Cyl.	16 Valves	15080cc	TD6127
OM 442.924	8 Cyl.	16 Valves	15080cc	TD6128
OM 442.925	8 Cyl.	16 Valves	15080cc	TD5815
OM 442.926	8 Cyl.	16 Valves	15080cc	TD5792
OM 442.927	8 Cyl.	16 Valves	15078cc	TD5823
OM 442.928	8 Cyl.	16 Valves	15078cc	TD6175
OM 442.929	8 Cyl.	16 Valves	15080cc	TD6129
OM 442.930	8 Cyl.	16 Valves	15100cc	TD7944
OM 442.931	8 Cyl.	16 Valves	15080cc	TD7945
OM 442.932	8 Cyl.	16 Valves	15080cc	TD6066
OM 442.933	8 Cyl.	16 Valves	15080cc	TD6067
OM 442.934	8 Cyl.	16 Valves	15080cc	TD6324
OM 442.935	8 Cyl.	16 Valves	15080cc	TD6102
OM 442.939	8 Cyl.	16 Valves	15080cc	TD6319

PB224 (x16)

NB928

105.00 x 130.00 x 12.00mm, FPM

NB929

120.00 x 140.00 x 13.00mm, FPM

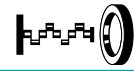
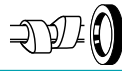

188 15.9L

Diesel

OM 403.915	10 Cyl.	20 Valves	15900cc	TD8180
OM 403.916	10 Cyl.	20 Valves	15900cc	TD5816
OM 403.918	10 Cyl.	20 Valves	15900cc	TD7897
OM 403.931	10 Cyl.	20 Valves	15900cc	TD5759
OM 403.932	10 Cyl.	20 Valves	15900cc	TD6133
OM 403.935	10 Cyl.	20 Valves	15900cc	TD6299

PB224 (x20)

NB928 F
105.00 x 130.00 x 12.00mm, FPM
NB929 R
120.00 x 140.00 x 13.00mm, FPM

189 15.9L

Diesel

OM 542.970	8 Cyl.	32 Valves	15928cc	TD28779
OM 542.971	8 Cyl.	32 Valves	15928cc	TD28780
OM 542.972	8 Cyl.	32 Valves	15928cc	TD28781
OM 542.975	8 Cyl.	32 Valves	15928cc	TD28782

PB394 (x32)

NB928 F
105.00 x 130.00 x 12.00mm, FPM
NA5469 F
100.00 x 130.00 x 12.00mm, PTFE/ACM
NB929 R
120.00 x 140.00 x 13.00mm, FPM

190 16.0L

Diesel

OM 403.900	10 Cyl.	20 Valves	15950cc	TD28695
OM 403.905	10 Cyl.	20 Valves	15950cc	TD16951
OM 403.906	10 Cyl.	20 Valves	15950cc	TD16952
OM 403.910	10 Cyl.	20 Valves	15950cc	TD28696
OM 403.917	10 Cyl.	20 Valves	15950cc	TD16953
OM 403.919	10 Cyl.	20 Valves	15950cc	TD16954
OM 403.930	10 Cyl.	20 Valves	15950cc	TD16955
OM 403.933	10 Cyl.	20 Valves	15950cc	TD16956
OM 403.934	10 Cyl.	20 Valves	15950cc	TD16957

PB224 (x20)

NB928 F
105.00 x 130.00 x 12.00mm, FPM
NB929 R
120.00 x 140.00 x 13.00mm, FPM

191 16.0L

Diesel

OM 522.940	8 Cyl.	32 Valves	15928cc	TD16800
OM 522.941	8 Cyl.	32 Valves	15928cc	TD17672
OM 522.942	8 Cyl.	32 Valves	15928cc	TD17673
OM 522.943	8 Cyl.	32 Valves	15928cc	TD17674
OM 522.950	8 Cyl.	32 Valves	15928cc	TD22822
OM 542.920	8 Cyl.	32 Valves	15928cc	TD7877
OM 542.921	8 Cyl.	32 Valves	15928cc	TD7876
OM 542.922	8 Cyl.	32 Valves	15928cc	TD7878
OM 542.923	8 Cyl.	32 Valves	15928cc	TD16905
OM 542.924	8 Cyl.	32 Valves	15928cc	TD17686
OM 542.925	8 Cyl.	32 Valves	15928cc	TD9683
OM 542.926	8 Cyl.	32 Valves	15928cc	TD17687
OM 542.940	8 Cyl.	32 Valves	15928cc	TD16909

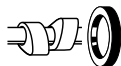

OM 542.941	8 Cyl.	32 Valves	15928cc	TD16911
OM 542.942	8 Cyl.	32 Valves	15928cc	TD16906
OM 542.943	8 Cyl.	32 Valves	15928cc	TD16907
OM 542.944	8 Cyl.	32 Valves	15928cc	TD16912
OM 542.945	8 Cyl.	32 Valves	15928cc	TD17689
OM 542.947	8 Cyl.	32 Valves	15928cc	TD17690
OM 542.948	8 Cyl.	32 Valves	15928cc	TD17655
OM 542.956	8 Cyl.	32 Valves	15928cc	TD17691
OM 542.957	8 Cyl.	32 Valves	15928cc	TD17692
OM 542.958	8 Cyl.	32 Valves	15928cc	TD24684
OM 542.960	8 Cyl.	32 Valves	15928cc	TD19999
OM 542.961	8 Cyl.	32 Valves	15928cc	TD21026
OM 542.962	8 Cyl.	32 Valves	15928cc	TD18840
OM 542.963	8 Cyl.	32 Valves	15928cc	TD21025
OM 542.964	8 Cyl.	32 Valves	15928cc	TD20000
OM 542.965	8 Cyl.	32 Valves	15928cc	TD25688
OM 542.966	8 Cyl.	32 Valves	15928cc	TD25103
OM 542.968	8 Cyl.	32 Valves	15928cc	TD25683
OM 542.969	8 Cyl.	32 Valves	15928cc	TD25684
OM 942.900	8 Cyl.	32 Valves	15928cc	TD17697
OM 942.910	8 Cyl.	32 Valves	15928cc	TD17698
OM 942.911	8 Cyl.	32 Valves	15928cc	TD16801
OM 942.912	8 Cyl.	32 Valves	15928cc	TD17699
OM 942.925	8 Cyl.	32 Valves	15928cc	TD17700
OM 942.930	8 Cyl.	32 Valves	15928cc	TD16802
OM 942.960	8 Cyl.	32 Valves	15928cc	TD17701
OM 942.967	8 Cyl.	32 Valves	15928cc	TD17702
OM 942.970	8 Cyl.	32 Valves	15928cc	TD17703
OM 942.980	8 Cyl.	32 Valves	15928cc	TD16803
OM 942.990	8 Cyl.	32 Valves	15928cc	TD17704

PB394 (x32)

NB928

105.00 x 130.00 x 12.00mm, FPM

NA5469

100.00 x 130.00 x 12.00mm, PTFE/ACM

NB929

120.00 x 140.00 x 13.00mm, FPM

192 18.3L

Diesel

OM 423.901	10 Cyl.	20 Valves	18273cc	TD28707
OM 423.905	10 Cyl.	20 Valves	18300cc	TD5762
OM 423.906	10 Cyl.	20 Valves	18273cc	TD6126
OM 423.907	10 Cyl.	20 Valves	18273cc	TD6289
OM 423.908	10 Cyl.	20 Valves	18300cc	TD6096
OM 423.909	10 Cyl.	20 Valves	18273cc	TD16963
OM 423.950	10 Cyl.	20 Valves	18273cc	TD5827
OM 423.951	10 Cyl.	20 Valves	18273cc	TD6180
OM 443.901	10 Cyl.	20 Valves	18273cc	TD28721
OM 443.940	10 Cyl.	20 Valves	18270cc	TD8214
OM 443.980	10 Cyl.	20 Valves	18270cc	TD8254

PB224 (x20)

NB928

105.00 x 130.00 x 12.00mm, FPM

NB929

120.00 x 140.00 x 13.00mm, FPM

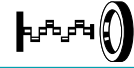

193 18.9L		Diesel			
OM 443.900	10 Cyl.	20 Valves	18848cc		TD28720
OM 443.905	10 Cyl.	20 Valves	18848cc		TD16981
OM 443.906	10 Cyl.	20 Valves	18848cc		TD17138
OM 443.908	10 Cyl.	20 Valves	18848cc		TD17139
OM 443.909	10 Cyl.	20 Valves	18848cc		TD17140
PB224 (x20)				NB928 F 105.00 x 130.00 x 12.00mm, FPM NB929 R 120.00 x 140.00 x 13.00mm, FPM	

194 21.9L		Diesel			
OM 424.900	12 Cyl.	24 Valves	21930cc		TD18815
OM 424.901	12 Cyl.	24 Valves	21930cc		TD18816
OM 424.901-510	12 Cyl.	24 Valves	21930cc		TD18817
PB224 (x24)				NB928 F 105.00 x 130.00 x 12.00mm, FPM NB929 R 120.00 x 140.00 x 13.00mm, FPM	











CC



9

Express Box	03/03→05/05	14 K4F	Petrol	1396	4	16	3
Express Box	03/03→05/05	18 K4F	Petrol	1796	4	16	7
Express Box	03/03→05/05	18 K4K	Petrol	1796	4	16	7
Express Box	03/03→05/05	20 T2N	Diesel	1994	4	8	10
Maestro	03/83→09/84	16 H	Petrol	1598	4	8	5
Maestro	10/84→09/90	20HE	Petrol	1994	4	8	8
Maestro	10/88→09/90	20HC	Petrol	1994	4	8	8
Metro	05/82→09/90	12 H	Petrol	1275	4	8	2
Metro	10/82→09/90	12 HC	Petrol	1275	4	8	2
MG 6 Hatchback	11/10→	18 K4C	Petrol	1795	4	16	7
MG 6 Saloon	11/10→	18 K4C	Petrol	1795	4	16	7
MG 7	07/07→	25V6S1	Petrol	2497	6	24	12
MGF (RD)	03/95→03/02	18 K4F	Petrol	1796	4	16	7
MGF (RD)	03/95→03/02	18 K4K	Petrol	1796	4	16	7
MGF (RD)	02/00→03/02	16 K4F	Petrol	1588	4	16	6
MG TF	03/02→12/09	16 K4F	Petrol	1588	4	16	6
MG TF	03/02→12/09	18 K4F	Petrol	1796	4	16	7
MG TF	03/02→12/09	18 K4K	Petrol	1796	4	16	7
MG ZR	06/01→04/05	14 K4F	Petrol	1396	4	16	3
MG ZR	06/01→04/05	18 K4F	Petrol	1796	4	16	7
MG ZR	06/01→04/05	18 K4K	Petrol	1796	4	16	7
MG ZR	06/01→04/05	20 T2N	Diesel	1994	4	8	10
MG ZS	07/01→04/05	18 K4F	Petrol	1796	4	16	7
MG ZS	07/01→04/05	25 K4F	Petrol	2497	6	24	12
MG ZS	07/03→04/05	16 K4F	Petrol	1588	4	16	6
MG ZS	01/04→04/05	20 T2N	Diesel	1994	4	8	10
MG ZS Hatchback	07/01→10/05	18 K4F	Petrol	1796	4	16	7
MG ZS Hatchback	07/01→10/05	25 K4F	Petrol	2497	6	24	12
MG ZS Hatchback	11/01→10/05	16 K4F	Petrol	1588	4	16	6
MG ZS Hatchback	01/04→10/05	20 T2N	Diesel	1994	4	8	10
MG ZT	06/01→07/05	25 K4F	Petrol	2497	6	24	12
MG ZT	06/02→07/05	204D2	Diesel	1951	4	16	11
MG ZT	01/03→07/05	18 K4F	Petrol	1796	4	16	7
MG ZT	01/03→07/05	18 K4G	Petrol	1795	4	16	7
MG ZT- T	10/01→07/05	25 K4F	Petrol	2497	6	24	12
MG ZT- T	06/02→07/05	204D2	Diesel	1951	4	16	11
MG ZT- T	01/03→07/05	18 K4F	Petrol	1796	4	16	7
MG ZT- T	01/03→07/05	18 K4G	Petrol	1795	4	16	7
Midget	01/64→12/66	10CG	Petrol	1098	4	8	1
Midget	01/67→09/74	12 H	Petrol	1275	4	8	2
Midget	09/74→12/79	15CE	Petrol	1493	4	8	4
Montego	04/84→09/90	20HI	Petrol	1994	4	8	8
Montego	10/84→09/90	20 HT	Petrol	1994	4	8	8

	CC				9		CC				9
10CG	1098	4	8	Petrol	1						
12 H	1275	4	8	Petrol	2						
12 HC	1275	4	8	Petrol	2						
14 K4F	1396	4	16	Petrol	3						
15CE	1493	4	8	Petrol	4						
16 H	1598	4	8	Petrol	5						
16 K4F	1588	4	16	Petrol	6						
18 K4C	1795	4	16	Petrol	7						
18 K4F	1796	4	16	Petrol	7						
18 K4G	1795	4	16	Petrol	7						
18 K4K	1796	4	16	Petrol	7						
20HC	1994	4	8	Petrol	8						
20HE	1994	4	8	Petrol	8						
20HI	1994	4	8	Petrol	8						
20 HT	1994	4	8	Petrol	8						
20 K4F	1997	6	24	Petrol	9						
20 T2N	1994	4	8	Diesel	10						
25 K4F	2497	6	24	Petrol	12						
25V6S1	2497	6	24	Petrol	12						
204D2	1951	4	16	Diesel	11						



1 1.1L Petrol

10CG	4 Cyl.	8 Valves	1098cc	TD34353
HR339			NA473 39.70 x 59.00 x 9.50mm, NBR NA584 55.00 x 70.00 x 10.00mm, MVQ	

2 1.3L Petrol

12 H	4 Cyl.	8 Valves	1275cc	TD34271
12 HC	4 Cyl.	8 Valves	1275cc	TD34355
HR339			NA473 39.70 x 59.00 x 9.50mm, NBR NA584 55.00 x 70.00 x 10.00mm, MVQ	

3 1.4L Petrol

14 K4F	4 Cyl.	16 Valves	1396cc	TD18866
HR752			NC065 (x2) 30.00 x 40.00 x 7.00mm, FPM NB998 (x2) 30.00 x 40.00 x 7.00mm, FPM NB828 27.50 x 39.50 x 7.00mm, FPM NB829 79.95 x 116.00; 126.00 x 11.50mm, FPM	

4 1.5L Petrol

15CE	4 Cyl.	8 Valves	1493cc	TD34357
			NA774 73.00 x 92.10 x 9.50mm, MVQ	

5 1.6L Petrol

16 H	4 Cyl.	8 Valves	1598cc	TD26917
			NB775 40.00 x 52.00 x 7.00mm, FPM NB586 30.00 x 40.00 x 7.00mm, MVQ NB772 88.90 x 104.80 x 9.52mm, MVQ	

6 1.6L Petrol

16 K4F	4 Cyl.	16 Valves	1588cc	TD17597
HR752			NC065 (x2) 30.00 x 40.00 x 7.00mm, FPM NB998 (x2) 30.00 x 40.00 x 7.00mm, FPM NB828 27.50 x 39.50 x 7.00mm, FPM NB829 79.95 x 116.00; 126.00 x 11.50mm, FPM	

7 1.8L Petrol

18 K4C	4 Cyl.	16 Valves	1795cc	TD25713
18 K4F	4 Cyl.	16 Valves	1796cc	TD18234
18 K4G	4 Cyl.	16 Valves	1795cc	TD25714
18 K4K	4 Cyl.	16 Valves	1796cc	TD18235
HR752			NC065 (x2) 30.00 x 40.00 x 7.00mm, FPM NB998 (x2) 30.00 x 40.00 x 7.00mm, FPM NB828 27.50 x 39.50 x 7.00mm, FPM NB829 79.95 x 116.00; 126.00 x 11.50mm, FPM	

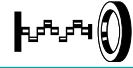

8 2.0L Petrol

20HC	4 Cyl.	8 Valves	1994cc	TD34364
20HE	4 Cyl.	8 Valves	1994cc	TD34365
20HI	4 Cyl.	8 Valves	1994cc	TD34366
20 HT	4 Cyl.	8 Valves	1994cc	TD18412

NB775
40.00 x 52.00 x 7.00mm, FPM
12/85→

NB773
46.00 x 60.00 x 7.00mm, FPM
12/85→

NB586
30.00 x 40.00 x 7.00mm, MVQ
→12/85

NB774
35.00 x 45.00 x 7.00mm, FPM
12/85→

NB772
88.90 x 104.80 x 9.52mm, MVQ

9 2.0L Petrol

20 K4F	6 Cyl.	24 Valves	1997cc	TD19047
--------	--------	-----------	--------	---------

HR5031 (x2)	NC065 (x2) 30.00 x 40.00 x 7.00mm, FPM	NB998 (x4) 30.00 x 40.00 x 7.00mm, FPM	NA5083 32.50 x 45.00 x 7.70mm, FPM	LK5000 89.00 x 116.00 x 10.20mm, FPM
--------------------	--	--	--	--

10 2.0L Diesel

20 T2N	4 Cyl.	8 Valves	1994cc	TD24113
--------	--------	----------	--------	---------

HR5051	NB775 (x2) 40.00 x 52.00 x 7.00mm, FPM	NB774 35.00 x 45.00 x 7.00mm, FPM	LK5002 136.00 x 153.00 x 21.000mm, PTFE
---------------	--	---	---

11 2.0L Diesel

204D2	4 Cyl.	16 Valves	1951cc	TD18241
-------	--------	-----------	--------	---------

PA5016 (x16) HR5045		NA5104 90.00 x 110.00 x 12.00mm, PTFE
--------------------------------------	--	---

12 2.5L Petrol

25 K4F	6 Cyl.	24 Valves	2497cc	TD18236
--------	--------	-----------	--------	---------

25V6S1	6 Cyl.	24 Valves	2497cc	TD27458
--------	--------	-----------	--------	---------

HR5031 (x2)	NC065 (x2) 30.00 x 40.00 x 7.00mm, FPM	NB998 (x4) 30.00 x 40.00 x 7.00mm, FPM	NA5083 32.50 x 45.00 x 7.70mm, FPM	LK5000 89.00 x 116.00 x 10.20mm, FPM
--------------------	--	--	--	--









CC



9

Mini (F55)	09/13→	B36 A15 A	Petrol	1499	3	12	6
Mini (F55)	09/13→	B38 A15 A	Petrol	1499	3	12	8
Mini (F55)	09/13→	B47 C20 A	Diesel	1995	4	16	13
Mini (F55)	09/13→	B48 A20 A	Petrol	1998	4	16	14
Mini (F55)	10/13→	B37 C15 A	Diesel	1496	3	12	7
Mini (F55)	02/14→	B38 A12 A	Petrol	1198	3	12	2
Mini (F56)	04/13→	B36 A15 A	Petrol	1499	3	12	6
Mini (F56)	04/13→	B38 A15 A	Petrol	1499	3	12	8
Mini (F56)	04/13→	B48 A20 A	Petrol	1998	4	16	14
Mini (F56)	06/13→	B38 A12 A	Petrol	1198	3	12	2
Mini (F56)	07/13→	B37 C15 A	Diesel	1496	3	12	7
Mini (F56)	10/13→	B47 C20 A	Diesel	1995	4	16	13
Mini (F56)	06/14→	B48 A20 B	Petrol	1998	4	16	14
Mini (R50, R53)	06/01→09/06	W10 B16 A	Petrol	1598	4	16	12
Mini (R50, R53)	03/02→09/06	W11 B16 A	Petrol	1598	4	16	12
Mini (R50, R53)	04/03→09/06	W10 B14 A	Petrol	1398	4	16	5
Mini (R50, R53)	06/03→09/06	1ND	Diesel	1364	4	8	3
Mini (R50, R53)	06/03→09/06	1ND-TV	Diesel	1364	4	8	3
Mini (R56)	10/06→02/10	N14 B16 A	Petrol	1598	4	16	10
Mini (R56)	10/06→11/13	N12 B16 A	Petrol	1598	4	16	10
Mini (R56)	11/06→03/10	N12 B14 A	Petrol	1397	4	16	4
Mini (R56)	11/06→09/10	9HZ (DV6TED4)	Diesel	1560	4	16	9
Mini (R56)	11/06→09/10	W16 D16	Diesel	1560	4	16	9
Mini (R56)	11/07→11/13	N14 B16 C	Petrol	1598	4	16	10
Mini (R56)	11/07→11/13	N18 B16 C	Petrol	1598	4	16	10
Mini (R56)	09/09→11/13	N16 B16 A	Petrol	1598	4	16	10
Mini (R56)	03/10→11/13	N18 B16 A	Petrol	1598	4	16	10
Mini (R56)	06/10→11/13	N47 C16 A	Diesel	1598	4	16	11
Mini (R56)	02/11→11/13	N47 C20 A	Diesel	1995	4	16	13
Mini Clubman (F54)	11/14→	B48 A20 A	Petrol	1998	4	16	14
Mini Clubman (F54)	12/14→	B36 A15 A	Petrol	1499	3	12	6
Mini Clubman (F54)	12/14→	B38 A15 A	Petrol	1499	3	12	8
Mini Clubman (F54)	12/14→	B47 C20 A	Diesel	1995	4	16	13
Mini Clubman (F54)	02/15→	B37 C15 A	Diesel	1496	3	12	7
Mini Clubman (F54)	11/15→	B48 A20 B	Petrol	1998	4	16	14
Mini Clubman (R55)	10/07→02/10	9HZ (DV6TED4)	Diesel	1560	4	16	9
Mini Clubman (R55)	10/07→02/10	N14 B16 A	Petrol	1598	4	16	10
Mini Clubman (R55)	10/07→12/13	N12 B16 A	Petrol	1598	4	16	10
Mini Clubman (R55)	10/07→06/14	N16 B16 A	Petrol	1598	4	16	10
Mini Clubman (R55)	11/07→06/14	N14 B16 C	Petrol	1598	4	16	10
Mini Clubman (R55)	11/07→06/14	N18 B16 C	Petrol	1598	4	16	10
Mini Clubman (R55)	03/09→02/10	N12 B14 A	Petrol	1397	4	16	4
Mini Clubman (R55)	03/10→06/14	N18 B16 A	Petrol	1598	4	16	10
Mini Clubman (R55)	03/10→06/14	N47 C16 A	Diesel	1598	4	16	11
Mini Clubman (R55)	02/11→06/14	N47 C20 A	Diesel	1995	4	16	13
Mini Clubvan (R55)	12/12→06/14	N16 B16 A	Petrol	1598	4	16	10
Mini Clubvan (R55)	12/12→06/14	N47 C16 A	Diesel	1598	4	16	11
Mini Clubvan (R55)	12/12→06/14	N47 C20 A	Diesel	1995	4	16	13
Mini Convertible (F57)	11/14→	B36 A15 A	Petrol	1499	3	12	6
Mini Convertible (F57)	11/14→	B38 A15 A	Petrol	1499	3	12	8
Mini Convertible (F57)	11/14→	B48 A20 A	Petrol	1998	4	16	14
Mini Convertible (F57)	12/14→	B37 C15 A	Diesel	1496	3	12	7
Mini Convertible (F57)	05/15→	B47 C20 A	Diesel	1995	4	16	13
Mini Convertible (F57)	05/15→	B48 A20 B	Petrol	1998	4	16	14
Mini Convertible (F57)	06/15→	B38 A12 A	Petrol	1198	3	12	2
Mini Convertible (R52)	07/04→11/07	W10 B16 A	Petrol	1598	4	16	12
Mini Convertible (R52)	07/04→11/07	W11 B16 A	Petrol	1598	4	16	12
Mini Convertible (R57)	10/07→06/15	N12 B16 A	Petrol	1598	4	16	10
Mini Convertible (R57)	10/07→06/15	N14 B16 A	Petrol	1598	4	16	10
Mini Convertible (R57)	10/07→06/15	N16 B16 A	Petrol	1598	4	16	10
Mini Convertible (R57)	10/07→06/15	N18 B16 A	Petrol	1598	4	16	10
Mini Convertible (R57)	11/07→12/08	W11 B16 A	Petrol	1598	4	16	12
Mini Convertible (R57)	08/08→05/15	N14 B16 C	Petrol	1598	4	16	10
Mini Convertible (R57)	08/08→05/15	N18 B16 C	Petrol	1598	4	16	10
Mini Convertible (R57)	05/09→11/13	N47 C16 A	Diesel	1598	4	16	11
Mini Convertible (R57)	06/09→05/15	N47 C20 A	Diesel	1995	4	16	13
Mini Countryman (F60)	10/16→	B36 A15 A	Petrol	1499	3	12	6
Mini Countryman (F60)	10/16→	B38 A15 A	Petrol	1499	3	12	8
Mini Countryman (F60)	10/16→	B47 C20 A	Diesel	1995	4	16	13
Mini Countryman (F60)	10/16→	B48 A20 A	Petrol	1998	4	16	14
Mini Countryman (F60)	01/17→	B48 A20 B	Petrol	1998	4	16	14
Mini Countryman (F60)	07/17→	B37 C15 A	Diesel	1496	3	12	7
Mini Countryman (R60)	01/10→10/16	N14 B16 A	Petrol	1598	4	16	10
Mini Countryman (R60)	01/10→10/16	N16 B16 A	Petrol	1598	4	16	10
Mini Countryman (R60)	01/10→10/16	N18 B16 A	Petrol	1598	4	16	10
Mini Countryman (R60)	01/10→10/16	N47 C16 A	Diesel	1598	4	16	11
Mini Countryman (R60)	01/10→10/16	N47 C20 A	Diesel	1995	4	16	13
Mini Countryman (R60)	09/12→09/16	N18 B16 C	Petrol	1598	4	16	10

				CC			9
Mini Coupe (R58)	12/10→04/15	N14 B16 A	Petrol	1598	4	16	10
Mini Coupe (R58)	12/10→04/15	N16 B16 A	Petrol	1598	4	16	10
Mini Coupe (R58)	12/10→04/15	N18 B16 A	Petrol	1598	4	16	10
Mini Coupe (R58)	12/10→05/15	N14 B16 C	Petrol	1598	4	16	10
Mini Coupe (R58)	12/10→05/15	N18 B16 C	Petrol	1598	4	16	10
Mini Coupe (R58)	12/10→05/15	N47 C20 A	Diesel	1995	4	16	13
Mini Paceman (R61)	03/12→09/16	N18 B16 A	Petrol	1598	4	16	10
Mini Paceman (R61)	03/12→09/16	N47 C20 A	Diesel	1995	4	16	13
Mini Paceman (R61)	04/12→09/16	N16 B16 A	Petrol	1598	4	16	10
Mini Paceman (R61)	04/12→09/16	N47 C16 A	Diesel	1598	4	16	11
Mini Paceman (R61)	09/12→09/16	N18 B16 C	Petrol	1598	4	16	10
Mini Roadster (R59)	01/11→04/15	N16 B16 A	Petrol	1598	4	16	10
Mini Roadster (R59)	01/11→04/15	N18 B16 A	Petrol	1598	4	16	10
Mini Roadster (R59)	01/11→04/15	N47 C20 A	Diesel	1995	4	16	13
Mini Roadster (R59)	05/11→04/15	N14 B16 C	Petrol	1598	4	16	10
Mini Roadster (R59)	05/11→04/15	N18 B16 C	Petrol	1598	4	16	10



CC



9



CC



9

IND	1364	4	8	Diesel	3
IND-TV	1364	4	8	Diesel	3
9HZ (DV6TED4)	1560	4	16	Diesel	9
99 H	999	4	8	Petrol	1
B36 A15 A	1499	3	12	Petrol	6
B37 C15 A	1496	3	12	Diesel	7
B38 A12 A	1198	3	12	Petrol	2
B38 A15 A	1499	3	12	Petrol	8
B47 C20 A	1995	4	16	Diesel	13
B48 A20 A	1998	4	16	Petrol	14
B48 A20 B	1998	4	16	Petrol	14
N12 B14 A	1397	4	16	Petrol	4
N12 B16 A	1598	4	16	Petrol	10
N14 B16 A	1598	4	16	Petrol	10
N14 B16 C	1598	4	16	Petrol	10
N16 B16 A	1598	4	16	Petrol	10
N18 B16 A	1598	4	16	Petrol	10
N18 B16 B	1598	4	16	Petrol	10
N18 B16 C	1598	4	16	Petrol	10
N47 C16 A	1598	4	16	Diesel	11
N47 C20 A	1995	4	16	Diesel	13
W10 B14 A	1398	4	16	Petrol	5
W10 B16 A	1598	4	16	Petrol	12
W11 B16 A	1598	4	16	Petrol	12
W16 D16	1560	4	16	Diesel	9

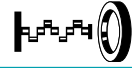

1 1.0L		Petrol			
99 H		4 Cyl.	8 Valves	999cc	TD26960
HR339					
2 1.2L		Petrol			
B38 A12 A		3 Cyl.	12 Valves	1198cc	TD28912
HR5110					NA5298 90.00 x 104.00 x 9.00mm, FPM
3 1.4L		Diesel			
1ND		4 Cyl.	8 Valves	1364cc	TD18565
1ND-TV		4 Cyl.	8 Valves	1364cc	TD22098
					NA5260 38.00 x 50.00 x 6.00mm, FPM NA5088 75.00 x 107.00 x 8.00mm, FPM
4 1.4L		Petrol			
N12 B14 A		4 Cyl.	16 Valves	1397cc	TD24547
					NA5363 61.00 x 75.00 x 8.00mm, PTFE/ACM NA5362 85.00 x 105.00 x 8.00mm, PTFE/ACM
5 1.4L		Petrol			
W10 B14 A		4 Cyl.	16 Valves	1398cc	TD31886
HR5061					NA5139 32.00 x 45.00 x 6.00mm, FPM NA5140 91.00 x 111.00 x 10.00mm, FPM
6 1.5L		Petrol			
B36 A15 A		3 Cyl.	12 Valves	1499cc	TD33433
					NA5298 90.00 x 104.00 x 9.00mm, FPM
7 1.5L		Diesel			
B37 C15 A		3 Cyl.	12 Valves	1496cc	TD28915
HR5110					NA5298 90.00 x 104.00 x 9.00mm, FPM
8 1.5L		Petrol			
B38 A15 A		3 Cyl.	12 Valves	1499cc	TD28913
HR5110					NA5298 90.00 x 104.00 x 9.00mm, FPM
9 1.6L		Diesel			
9HZ (DV6TED4)		4 Cyl.	16 Valves	1560cc	TD20982
W16 D16		4 Cyl.	16 Valves	1560cc	TD30793
PA6072 (x16)					NA5258 27.00 x 47.00 x 7.00mm, PTFE NA5259 40.00 x 55.00 x 6.40mm, PTFE NA5325 85.00 x 105.00 x 8.80mm, PTFE
HR5124					

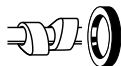

10 1.6L

Petrol

N12 B16 A	4 Cyl.	16 Valves	1598cc	TD20893
N14 B16 A	4 Cyl.	16 Valves	1598cc	TD24546
N14 B16 C	4 Cyl.	16 Valves	1598cc	TD25562
N16 B16 A	4 Cyl.	16 Valves	1598cc	TD25563
N18 B16 A	4 Cyl.	16 Valves	1598cc	TD25564
N18 B16 B	4 Cyl.	16 Valves	1598cc	TD27246
N18 B16 C	4 Cyl.	16 Valves	1598cc	TD27825

NA5363
 61.00 x 75.00 x 8.00mm, PTFE/ACM

NA5362
 85.00 x 105.00 x 8.00mm, PTFE/ACM

11 1.6L

Diesel

N47 C16 A	4 Cyl.	16 Valves	1598cc	TD26136
-----------	--------	-----------	--------	---------

HR5110

NA5299
 55.0 x 68.0 x 8.0mm, FPM

NA5298
 90.00 x 104.00 x 9.00mm, FPM

12 1.6L

Petrol

W10 B16 A	4 Cyl.	16 Valves	1598cc	TD18563
W11 B16 A	4 Cyl.	16 Valves	1598cc	TD18564

HR5061

NA5139
 32.00 x 45.00 x 6.00mm, FPM

NA5140
 91.00 x 111.00 x 10.00mm, FPM

13 2.0L

Diesel

B47 C20 A	4 Cyl.	16 Valves	1995cc	TD29493
N47 C20 A	4 Cyl.	16 Valves	1995cc	TD25060

HR5110

NA5299
 55.0 x 68.0 x 8.0mm, FPM

NA5298
 90.00 x 104.00 x 9.00mm, FPM

14 2.0L

Petrol

B48 A20 A	4 Cyl.	16 Valves	1998cc	TD28914
B48 A20 B	4 Cyl.	16 Valves	1998cc	TD30762

NA5103
 55.00 x 68.00 x 8.00mm, PTFE

NA5298
 90.00 x 104.00 x 9.00mm, FPM



CC



9

380 (DB)	04/05→04/08	6G75	Petrol	3828	6	24	80
3000GT Convertible	09/94→12/96	6G72 (DOHC 24V)	Petrol	2972	6	24	71
3000GT Convertible	09/94→12/96	6G72T	Petrol	2972	6	24	71
3000 GT Coupe (Z1_A)	06/89→08/00	6G72 (DOHC 24V)	Petrol	2972	6	24	71
3000 GT Coupe (Z1_A)	09/90→08/99	6G72T	Petrol	2972	6	24	71
3000 GT Coupe (Z1_A)	09/96→08/99	6G72 (SOHC 12V)	Petrol	2972	6	12	72
ASX (GA_W_)	01/10→	4B11	Petrol	1998	4	16	39
ASX (GA_W_)	02/10→	4B10	Petrol	1798	4	16	26
ASX (GA_W_)	09/14→	4B12	Petrol	2360	4	16	58
ASX (GA_W_)	07/15→	9HD	Diesel	1560	4	8	25
Carisma (DA_)	07/95→07/97	4G93 (DOHC 16V)	Petrol	1834	4	16	31
Carisma (DA_)	07/95→07/97	4G93 (SOHC 16V)	Petrol	1834	4	16	32
Carisma (DA_)	07/95→06/06	4G92 (SOHC 16V)	Petrol	1597	4	16	24
Carisma (DA_)	10/96→09/00	F8QT	Diesel	1870	4	8	37
Carisma (DA_)	09/97→06/06	4G93 (GDI)	Petrol	1834	4	16	31
Carisma (DA_)	09/00→06/06	F9Q1	Diesel	1870	4	8	38
Carisma (DA_)	09/00→06/06	F9Q2	Diesel	1870	4	8	38
Carisma Saloon (DA_)	09/96→09/97	4G93 (SOHC 16V)	Petrol	1834	4	16	32
Carisma Saloon (DA_)	09/96→06/06	4G92 (SOHC 16V)	Petrol	1597	4	16	24
Carisma Saloon (DA_)	10/96→09/00	F8QT	Diesel	1870	4	8	37
Carisma Saloon (DA_)	09/97→06/06	4G93 (GDI)	Petrol	1834	4	16	31
Carisma Saloon (DA_)	11/99→06/06	4G63 Turbo	Petrol	1997	4	16	48
Carisma Saloon (DA_)	09/00→10/04	4G13 (16V)	Petrol	1299	4	16	10
Carisma Saloon (DA_)	09/00→06/06	F9Q1	Diesel	1870	4	8	38
Carisma Saloon (DA_)	09/00→06/06	F9Q2	Diesel	1870	4	8	38
Colt CZC Convertible (RG)	05/06→07/09	4A91	Petrol	1499	4	16	13
Colt CZC Convertible (RG)	05/06→07/09	4G15T	Petrol	1468	4	16	17
Colt I (A15_A)	12/78→01/84	4G11	Petrol	1244	4	8	3
Colt I (A15_A)	05/79→01/84	4G12	Petrol	1410	4	8	11
Colt I (A15_A)	09/81→01/84	4G12 T	Petrol	1410	4	8	11
Colt II (C1_A)	10/82→09/86	4G32	Petrol	1597	4	8	20
Colt II (C1_A)	10/82→09/86	4G33	Petrol	1439	4	8	12
Colt II (C1_A)	02/84→04/88	4D65	Diesel	1796	4	8	27
Colt II (C1_A)	02/84→04/88	4G16	Petrol	1198	4	8	3
Colt II (C1_A)	02/84→04/88	4G32 T/C	Petrol	1597	4	8	20
Colt II (C1_A)	09/84→04/88	4G15 (8V)	Petrol	1468	4	8	14
Colt II (C1_A)	09/85→04/88	G15B	Petrol	1468	4	8	14
Colt II (C1_A)	06/86→04/88	G13B	Petrol	1299	4	8	8
Colt II (C1_A)	07/86→04/88	G32BT	Petrol	1597	4	8	20
Colt III (C5_A)	10/86→06/90	4G32	Petrol	1597	4	8	20
Colt III (C5_A)	10/86→06/90	4G33	Petrol	1439	4	8	12
Colt III (C5_A)	04/88→05/90	4G61	Petrol	1596	4	16	22
Colt III (C5_A)	04/88→05/92	4D65	Diesel	1796	4	8	27
Colt III (C5_A)	04/88→05/92	4G13 (12V)	Petrol	1299	4	12	9
Colt III (C5_A)	04/88→05/92	4G13 (8V)	Petrol	1299	4	8	8
Colt III (C5_A)	04/88→05/92	4G15 (8V)	Petrol	1468	4	8	14
Colt III (C5_A)	06/90→05/92	4G67	Petrol	1836	4	16	30
Colt III (C5_A)	07/90→05/92	4G15 (12V)	Petrol	1468	4	12	15
Colt IV (CA_A)	03/92→04/96	4G15 (8V)	Petrol	1468	4	8	14
Colt IV (CA_A)	04/92→04/96	4G13 (12V)	Petrol	1299	4	12	9
Colt IV (CA_A)	04/92→04/96	4G92 (SOHC 16V)	Petrol	1597	4	16	24
Colt IV (CA_A)	04/92→04/96	4G93 (DOHC 16V)	Petrol	1834	4	16	31
Colt V (CJ_, CP_)	09/95→09/03	4G15 (16V)	Petrol	1468	4	16	16
Colt V (CJ_, CP_)	05/96→06/00	4G13 (12V)	Petrol	1299	4	12	9
Colt V (CJ_, CP_)	05/96→09/03	4G92 (SOHC 16V)	Petrol	1597	4	16	24
Colt V (CJ_, CP_)	06/96→09/99	4G15 (12V)	Petrol	1468	4	12	15
Colt V (CJ_, CP_)	11/97→07/01	4G93 (SOHC 16V)	Petrol	1834	4	16	32
Colt V (CJ_, CP_)	06/00→09/03	4G13 (16V)	Petrol	1299	4	16	10
Colt VI (Z3_A, Z2_A)	06/04→06/12	4A90	Petrol	1332	4	16	7
Colt VI (Z3_A, Z2_A)	06/04→06/12	4A91	Petrol	1499	4	16	13
Colt VI (Z3_A, Z2_A)	08/04→06/12	OM 639.939	Diesel	1493	3	12	18
Colt VI (Z3_A, Z2_A)	09/04→02/06	4G15 (16V)	Petrol	1468	4	16	16
Colt VI (Z3_A, Z2_A)	10/04→06/12	3A91	Petrol	1124	3	12	2
Colt VI (Z3_A, Z2_A)	03/05→06/12	4G15T	Petrol	1468	4	16	17
Colt Plus VI (Z2_W)	10/04→12/12	4G15T	Petrol	1468	4	16	17
Colt Plus VI (Z2_W)	08/12→	4A91	Petrol	1499	4	16	13
Colt Plus VII (Z2_W)	08/04→	4A90	Petrol	1332	4	16	7
Colt Plus VII (Z2_W)	08/04→	4A91	Petrol	1499	4	16	13
Cordia (A21_A, AB, AC)	10/82→12/83	4G62	Petrol	1795	4	8	29
Cordia (A21_A, AB, AC)	10/82→05/85	4G32 T	Petrol	1597	4	8	20
Cordia (A21_A, AB, AC)	10/82→12/86	4G32	Petrol	1597	4	8	20
Cordia (A21_A, AB, AC)	04/83→07/89	4G62 T	Petrol	1795	4	8	29
Cordia (A21_A, AB, AC)	11/84→12/88	4G63 (SOHC 8V)	Petrol	1997	4	8	45
Cordia (A21_A, AB, AC)	11/84→07/89	4G37	Petrol	1755	4	8	28
Debonair (S1_A)	07/86→08/92	6G72 (SOHC 12V)	Petrol	2972	6	12	72
Debonair (S1_A)	09/89→08/92	6G72 (DOHC 24V)	Petrol	2972	6	24	71
Debonair (S2_A)	09/92→10/97	6G72 (SOHC 12V)	Petrol	2972	6	12	72
Debonair (S2_A)	09/92→10/97	6G74 (DOHC 24V)	Petrol	3497	6	24	76











CC



9

Delica (CV_W)	06/07→	4B11	Petrol	1998	4	16	39
Delica (CV_W)	06/07→	4B12	Petrol	2360	4	16	58
Delica (MB1_)	05/11→	K12B	Petrol	1242	4	16	6
Delica D5 (CV_W)	06/07→	4B12	Petrol	2360	4	16	58
Delica IV Bus (TG1_)	01/10→	4G64 (16V)	Petrol	2351	4	16	60
Delica IV Platform/Chassis (TG1_)	01/10→	4G64 (16V)	Petrol	2351	4	16	60
Delica / Space Gear	05/95→05/00	4G64 (16V)	Petrol	2351	4	16	60
Delica / Space Gear	09/95→10/02	4G63 (SOHC 16V)	Petrol	1997	4	16	46
Diamante Estate (F_W)	06/92→03/98	6G72 (SOHC 24V)	Petrol	2972	6	24	73
Diamante Estate (F_W)	06/92→03/98	6G74 (SOHC 24V)	Petrol	3497	6	24	77
Diamante I Estate (F_W)	09/92→12/95	6G72 (SOHC 12V)	Petrol	2972	6	12	72
Diamante I Saloon (F4_A, F3_A)	09/99→08/04	6G73	Petrol	2497	6	24	67
Diamante II Saloon (F4_A, F3_A)	09/03→11/05	6A13	Petrol	2498	6	24	66
Diamante Saloon (F2_A, F1_A)	05/90→07/96	6G73	Petrol	2497	6	24	67
Diamante Saloon (F2_A, F1_A)	10/92→07/96	6G72 (DOHC 24V)	Petrol	2972	6	24	71
Diamante Saloon (F2_A, F1_A)	10/95→07/96	6G74 (SOHC 24V)	Petrol	3497	6	24	77
Diamante Saloon (F4_A, F3_A)	06/99→08/04	6G72 (DOHC 24V)	Petrol	2972	6	24	71
Diamante Saloon (F4_A, F3_A)	06/99→11/05	6G74 (SOHC 24V)	Petrol	3497	6	24	77
Diamante Saloon (F4_A, F3_A)	09/03→11/05	6A13	Petrol	2498	6	24	66
Dion MPV (CR_W)	12/99→10/05	4G94 (GDI)	Petrol	1999	4	16	50
Dion MPV (CR_W)	12/99→12/05	4G93T (GDI)	Petrol	1834	4	16	31
Eclipse Convertible	12/89→03/94	4G37	Petrol	1755	4	8	28
Eclipse Convertible	04/94→04/99	4G93 (SOHC 16V)	Petrol	1834	4	16	32
Eclipse Convertible	09/95→04/99	4G63 T (DOHC 16V)	Petrol	1997	4	16	44
Eclipse Convertible	09/95→04/99	4G64 (16V)	Petrol	2351	4	16	60
Eclipse Convertible (D5_A)	05/99→03/05	4G64 (16V)	Petrol	2351	4	16	60
Eclipse Convertible (D5_A)	05/99→03/05	4G93 (SOHC 16V)	Petrol	1834	4	16	32
Eclipse Convertible (D5_A)	05/99→03/05	6G72 (DOHC 24V)	Petrol	2972	6	24	71
Eclipse Convertible (D5_A)	01/04→03/05	6G72 (SOHC 24V)	Petrol	2972	6	24	73
Eclipse I (D2_A)	12/89→03/94	4G37	Petrol	1755	4	8	28
Eclipse I (D2_A)	12/89→12/94	4G63 T (DOHC 16V)	Petrol	1997	4	16	44
Eclipse I (D2_A)	12/89→11/95	4G63 (DOHC 16V)	Petrol	1997	4	16	44
Eclipse II (D3_A)	04/94→04/99	4G63 T (DOHC 16V)	Petrol	1997	4	16	44
Eclipse II (D3_A)	09/95→04/99	4G63 (DOHC 16V)	Petrol	1997	4	16	44
Eclipse II (D3_A)	09/98→04/99	4G64 (16V)	Petrol	2351	4	16	60
Eclipse III (D5_A)	05/99→03/05	6G72 (DOHC 24V)	Petrol	2972	6	24	71
Eclipse III (D5_A)	05/99→12/05	4G64 (16V)	Petrol	2351	4	16	60
Eclipse IV (DK_A)	04/05→12/12	4G69	Petrol	2378	4	16	60
Eclipse IV (DK_A)	04/05→12/12	6G75	Petrol	3828	6	24	80
Eclipse IV Convertible	04/05→	6G75	Petrol	3828	6	24	80
Eclipse IV Convertible	09/06→12/12	4G69	Petrol	2378	4	16	60
eK Hatchback (B11W)	06/13→	3B20	Petrol	659	3	12	1
eK Space (B11A)	10/13→	3B20	Petrol	659	3	12	1
Endeavor (D8_W, D7_W)	01/03→08/11	6G75	Petrol	3828	6	24	80
Expo LRV Station Wagon	09/91→12/94	4G93 (SOHC 16V)	Petrol	1834	4	16	32
Expo LRV Station Wagon	09/92→12/94	4G64 (16V)	Petrol	2351	4	16	60
Expo Station Wagon	09/91→12/92	4G64 (8V)	Petrol	2351	4	8	57
Expo Station Wagon	01/92→10/96	4G64 (16V)	Petrol	2351	4	16	60
Freeca	06/98→10/10	4G63 (SOHC 16V)	Petrol	1997	4	16	46
FTO Coupe (DE_A)	09/94→07/01	4G93 (SOHC 16V)	Petrol	1834	4	16	32
Galant I (A12_)	01/77→08/80	4G32	Petrol	1597	4	8	20
Galant I (A12_)	01/77→08/80	4G52	Petrol	1995	4	8	42
Galant I Station Wagon (A12_V)	01/79→08/80	4G32	Petrol	1597	4	8	20
Galant I Station Wagon (A12_V)	01/79→08/80	4G52	Petrol	1995	4	8	42
Galant II (A16_)	09/80→05/84	4D55 T	Diesel	2347	4	8	56
Galant II (A16_)	09/80→05/84	4G32	Petrol	1597	4	8	20
Galant II (A16_)	09/80→05/84	4G63 (SOHC 8V)	Petrol	1997	4	8	45
Galant II (A16_)	05/82→05/84	4G63 T (ECI)	Petrol	1997	4	8	47
Galant II Station Wagon (A16_V)	09/80→06/83	4G63 (SOHC 8V)	Petrol	1997	4	8	45
Galant II Station Wagon (A16_V)	09/80→05/84	4G32	Petrol	1597	4	8	20
Galant II Station Wagon (A16_V)	07/83→05/84	4D55 T	Diesel	2347	4	8	56
Galant III (E1_A)	06/84→04/90	4D65 T	Diesel	1796	4	8	27
Galant III (E1_A)	06/84→04/90	4G32	Petrol	1597	4	8	20
Galant III (E1_A)	06/84→04/90	4G63 (SOHC 8V)	Petrol	1997	4	8	45
Galant III (E1_A)	06/84→04/90	4G63 T (SOHC 8V)	Petrol	1997	4	8	47
Galant III (E1_A)	09/84→04/90	4G64 (8V)	Petrol	2351	4	8	57
Galant III (E1_A)	07/85→04/90	G64B	Petrol	2351	4	8	61
Galant III (E1_A)	06/86→04/90	G63B	Petrol	1997	4	8	54
Galant III (E1_A)	09/88→04/90	6G72 (SOHC 12V)	Petrol	2972	6	12	72
Galant IV (E3_A)	11/88→10/92	4D65 T	Diesel	1796	4	8	27
Galant IV (E3_A)	11/88→10/92	4G37	Petrol	1755	4	8	28
Galant IV (E3_A)	11/88→12/92	4G63 (DOHC 16V)	Petrol	1997	4	16	44
Galant IV (E3_A)	04/89→12/92	4G63 (SOHC 8V)	Petrol	1997	4	8	45
Galant IV Saloon (E3_A)	11/87→10/92	4G37	Petrol	1755	4	8	28
Galant IV Saloon (E3_A)	11/87→10/92	4G63 (DOHC 16V)	Petrol	1997	4	16	44
Galant IV Saloon (E3_A)	11/87→03/93	4G63 (SOHC 8V)	Petrol	1997	4	8	45
Galant IV Saloon (E3_A)	12/87→10/92	4D65 T	Diesel	1796	4	8	27
Galant IV Saloon (E3_A)	01/88→10/92	4D65	Diesel	1796	4	8	27

							
Galant IV Saloon (E3_A)	01/88→10/92	4G32	Petrol	1597	4	8	20
Galant IV Saloon (E3_A)	10/90→03/93	4G63 T (DOHC 16V)	Petrol	1997	4	16	44
Galant V (E5_A, E7_A, E8_A)	11/92→08/96	4D68 T	Diesel	1998	4	8	41
Galant V (E5_A, E7_A, E8_A)	11/92→08/96	4G63 (SOHC 16V)	Petrol	1997	4	16	46
Galant V (E5_A, E7_A, E8_A)	11/92→08/96	4G93 (SOHC 16V)	Petrol	1834	4	16	32
Galant V (E5_A, E7_A, E8_A)	11/92→08/96	6A12	Petrol	1999	6	24	46
Galant V (E5_A, E7_A, E8_A)	11/92→09/96	6G73	Petrol	2497	6	24	67
Galant V Saloon (E5_A, E7_A, E8_A)	11/92→08/96	4D68 T	Diesel	1998	4	8	41
Galant V Saloon (E5_A, E7_A, E8_A)	11/92→08/96	4G63 (SOHC 16V)	Petrol	1997	4	16	46
Galant V Saloon (E5_A, E7_A, E8_A)	11/92→08/96	4G93 (SOHC 16V)	Petrol	1834	4	16	32
Galant V Saloon (E5_A, E7_A, E8_A)	11/92→08/96	6A12	Petrol	1999	6	24	46
Galant V Saloon (E5_A, E7_A, E8_A)	11/92→08/96	6G73	Petrol	2497	6	24	67
Galant V Saloon (E5_A, E7_A, E8_A)	09/93→12/98	4G64 (16V)	Petrol	2351	4	16	60
Galant VI (EA_)	09/96→10/04	4D68 T	Diesel	1998	4	8	41
Galant VI (EA_)	09/96→10/04	4G63 (SOHC 16V)	Petrol	1997	4	16	46
Galant VI (EA_)	09/96→10/04	6A13	Petrol	2498	6	24	66
Galant VI (EA_)	11/97→10/01	4G93 (GDI)	Petrol	1834	4	16	31
Galant VI (EA_)	09/98→12/99	6G72 (SOHC 24V)	Petrol	2972	6	24	73
Galant VI (EA_)	09/98→12/01	4G64 (16V)	Petrol	2351	4	16	60
Galant VI (EA_)	01/99→12/03	6G72 (DOHC 24V)	Petrol	2972	6	24	71
Galant VI (EA_)	02/99→10/04	4G64 (GDI)	Petrol	2351	4	16	60
Galant VI (EA_)	10/99→10/04	4G94 (GDI)	Petrol	1999	4	16	50
Galant VI (EA_)	10/03→10/04	4G69	Petrol	2378	4	16	60
Galant VI Estate (EA_)	09/96→10/03	4D68 T	Diesel	1998	4	8	41
Galant VI Estate (EA_)	09/96→10/03	4G63 (SOHC 16V)	Petrol	1997	4	16	46
Galant VI Estate (EA_)	09/96→10/03	6A13	Petrol	2498	6	24	66
Galant VI Estate (EA_)	10/96→07/01	4M40-T	Diesel	2835	4	8	70
Galant VI Estate (EA_)	02/99→10/03	4G64 (GDI)	Petrol	2351	4	16	60
Galant Saloon (DJ_, ED_, EF_)	10/03→	4G69	Petrol	2378	4	16	60
Galant Saloon (DJ_, ED_, EF_)	10/03→	4G94 (GDI)	Petrol	1999	4	16	50
Galant Saloon (DJ_, ED_, EF_)	10/03→	6G75	Petrol	3828	6	24	80
Galopper (JK-01)	09/98→12/03	D48F	Diesel	2476	4	8	68
Galopper (JK-01)	09/98→12/03	D48H	Diesel	2476	4	8	68
Galopper (JK-01)	09/98→12/03	G6AT	Petrol	2972	6	12	72
Grandis (N9_, N8_)	11/97→05/03	4G64 (GDI)	Petrol	2351	4	16	60
Grandis (N9_, N8_)	05/00→05/03	6G72 (DOHC 24V)	Petrol	2972	6	24	71
Grandis (NA_W)	04/04→12/11	4G69	Petrol	2378	4	16	60
Grandis (NA_W)	09/05→03/10	BSY	Diesel	1968	4	16	51
Grandis (NA_W)	02/07→03/10	BWC	Diesel	1968	4	16	53
GTO Coupe (Z1_A)	06/89→08/00	6G72 (DOHC 24V)	Petrol	2972	6	24	71
GTO Coupe (Z1_A)	06/92→09/00	6G72T	Petrol	2972	6	24	71
i (HA_)	01/10→	3B20	Petrol	659	3	12	1
Kuda (D05W)	06/98→04/03	4G37	Petrol	1755	4	8	28
L 200	03/80→10/86	4G32	Petrol	1597	4	8	20
L 200	01/81→10/86	4G52	Petrol	1995	4	8	42
L 200	09/82→12/85	4D55 T	Diesel	2347	4	8	56
L 200	09/82→12/85	4G54	Petrol	2555	4	8	65
L 200	10/82→10/86	4D55	Diesel	2347	4	8	56
L 200 (K3_T, K2_T, K1_T, KO_T)	01/86→08/96	4G63 (SOHC 8V)	Petrol	1997	4	8	45
L 200 (K3_T, K2_T, K1_T, KO_T)	01/86→10/96	4G54	Petrol	2555	4	8	65
L 200 (K3_T, K2_T, K1_T, KO_T)	10/86→10/96	4D56 (8V)	Diesel	2477	4	8	62
L 200 (K3_T, K2_T, K1_T, KO_T)	11/86→10/96	4G64 (8V)	Petrol	2351	4	8	57
L 200 (K3_T, K2_T, K1_T, KO_T)	11/86→10/96	6G72 (SOHC 12V)	Petrol	2972	6	12	72
L 200 (K3_T, K2_T, K1_T, KO_T)	04/87→10/96	4G32	Petrol	1597	4	8	20
L 200 (K3_T, K2_T, K1_T, KO_T)	11/89→05/95	G54B	Petrol	2555	4	8	69
L 200 (K3_T, K2_T, K1_T, KO_T)	09/90→10/96	4D56 T	Diesel	2477	4	8	62
L 200 (K3_T, K2_T, K1_T, KO_T)	06/92→08/96	4M40-T	Diesel	2835	4	8	70
L 200 (K7_T, K6_T)	01/96→12/07	4D56 (8V)	Diesel	2477	4	8	62
L 200 (K7_T, K6_T)	06/96→12/07	4D56 TD	Diesel	2477	4	8	62
L 200 (K7_T, K6_T)	06/96→12/07	4G63 (SOHC 16V)	Petrol	1997	4	16	46
L 200 (K7_T, K6_T)	06/96→12/07	4G64 (16V)	Petrol	2351	4	16	60
L 200 (K7_T, K6_T)	09/96→06/06	4M40-T	Diesel	2835	4	8	70
L 200 (K7_T, K6_T)	10/96→03/03	4M40-A	Diesel	2835	4	8	70
L 200 (K7_T, K6_T)	10/96→10/06	6G72 (SOHC 24V)	Petrol	2972	6	24	73
L 200 (K7_T, K6_T)	08/01→11/05	6G72 (DOHC 24V)	Petrol	2972	6	24	71
L 200 (K7_T, K6_T)	08/01→12/07	4D56 T	Diesel	2477	4	8	62
L 200 (KB_T, KA_T)	05/05→12/15	4M40-A	Diesel	2835	4	8	70
L 200 (KB_T, KA_T)	05/07→12/15	4M41	Diesel	3200	4	16	74
L 200 (KB_T, KA_T)	05/07→12/15	6G74 (SOHC 24V)	Petrol	3497	6	24	77
L 200 (KB_T, KA_T)	04/10→12/15	4D56 HP	Diesel	2477	4	16	64
L 200 (KB_T, KA_T)	04/10→12/15	4G64 (16V)	Petrol	2351	4	16	60
L 200 Platform/Chassis (K3_T, KO_T, K1_T, K2_T)	10/86→10/96	4D56 (8V)	Diesel	2477	4	8	62
L 200 Platform/Chassis (K3_T, KO_T, K1_T, K2_T)	10/86→10/96	4G54	Petrol	2555	4	8	65
L 200 Platform/Chassis (K3_T, KO_T, K1_T, K2_T)	09/90→10/96	4D56 T	Diesel	2477	4	8	62
L 200 Platform/Chassis (K3_T, KO_T, K1_T, K2_T)	09/90→10/96	6G72 (SOHC 12V)	Petrol	2972	6	12	72
L 200 Platform/Chassis (K6_T, K7_T)	10/96→03/03	4M40-A	Diesel	2835	4	8	70
L 200 Platform/Chassis (K6_T, K7_T)	10/96→12/06	4G64 (16V)	Petrol	2351	4	16	60
L 200 Platform/Chassis (K6_T, K7_T)	10/96→12/06	6G72 (SOHC 24V)	Petrol	2972	6	24	73









CC



9

L 200 PPlatform/Chassis (K6_T, K7_T)	04/03→12/06	4M40-T	Diesel	2835	4	8	70
L 200 PPlatform/Chassis (KA_T, KB_T)	12/09→12/15	4G64 (16V)	Petrol	2351	4	16	60
L 200 PPlatform/Chassis (KA_T, KB_T)	04/10→12/15	4D56 HP	Diesel	2477	4	16	64
L 200 / Triton (KA_T, KB_T)	01/04→12/12	4D56 T	Diesel	2477	4	8	62
L 200 / Triton (KA_T, KB_T)	11/05→12/15	4D56 HP	Diesel	2477	4	16	64
L 200 / Triton (KA_T, KB_T)	11/05→12/15	4G64 (16V)	Petrol	2351	4	16	60
L 200 / Triton (KA_T, KB_T)	11/05→12/15	6G74 (SOHC 24V)	Petrol	3497	6	24	77
L 200 / Triton (KA_T, KB_T)	07/06→12/15	4M41	Diesel	3200	4	16	74
L 200 / Triton (KA_T, KB_T)	04/07→12/15	4D56 (16V)	Diesel	2477	4	16	63
L 200 / Triton (KJ, KK, KL_)	11/14→	4D56 (16V)	Diesel	2477	4	16	63
L 200 / Triton (KJ, KK, KL_)	11/14→	4G64 (16V)	Petrol	2351	4	16	60
L 200 / Triton (KJ, KK, KL_)	05/15→	4M41	Diesel	3200	4	16	74
L 200 / Triton PPlatform/Chassis (KA_T, KB_T)	07/06→08/09	4M41	Diesel	3200	4	16	74
L 200 / Triton PPlatform/Chassis (KA_T, KB_T)	07/06→12/09	6G74 (SOHC 24V)	Petrol	3497	6	24	77
L 200 / Triton PPlatform/Chassis (KA_T, KB_T)	08/07→12/15	4D56 (16V)	Diesel	2477	4	16	63
L 200 / Triton PPlatform/Chassis (KA_T, KB_T)	01/08→12/15	4D56 HP	Diesel	2477	4	16	64
L 300 Box (LO3_P)	02/80→10/86	4G32	Petrol	1597	4	8	20
L 300 Box (LO3_P)	06/82→08/85	4G63 (SOHC 8V)	Petrol	1997	4	8	45
L 300 Box (LO3_P)	06/82→08/85	G63B	Petrol	1997	4	8	54
L 300 Box (PO_W, P1_W)	11/86→07/88	G63B	Petrol	1997	4	8	54
L 300 Box (PO_W, P1_W)	11/86→08/97	4G64 (8V)	Petrol	2351	4	8	57
L 300 Box (PO_W, P1_W)	11/86→08/97	G64B	Petrol	2351	4	8	61
L 300 Box (PO_W, P1_W)	04/90→05/94	4G32	Petrol	1439	4	8	12
L 300 Box (PO_W, P1_W)	09/91→09/03	4D56 (8V)	Diesel	2477	4	8	62
L 300 Box (PO_W, P1_W)	06/94→12/97	4M40-T	Diesel	2835	4	8	70
L 300 Box (PO_W, P1_W)	06/94→05/03	6G72 (DOHC 24V)	Petrol	2972	6	24	71
L 300 Box (PO_W, P1_W)	09/95→10/98	4M40	Diesel	2835	4	8	70
L 300 Box (PO_W, P1_W)	09/97→09/13	4G64 (16V)	Petrol	2351	4	16	60
L 300 Bus (LO3_P/G, LO_2P)	05/80→10/86	4G32	Petrol	1597	4	8	20
L 300 Bus (LO3_P/G, LO_2P)	06/82→08/85	4G63 (SOHC 8V)	Petrol	1997	4	8	45
L 300 Bus (LO3_P/G, LO_2P)	06/82→08/85	G63B	Petrol	1997	4	8	54
L 300 Bus (PO_W, P1_W, P2_W)	06/94→05/03	6G72 (DOHC 24V)	Petrol	2972	6	24	71
L 300 Bus (PO_W, P1_W, P2_W)	09/94→05/04	4D56 TD	Diesel	2477	4	8	62
L 300 Bus (PO_W, P1_W, P2_W)	09/97→05/03	4G64 (16V)	Petrol	2351	4	16	60
L 300 / Delica II Box (LO3_P)	05/80→10/86	4G32	Petrol	1597	4	8	20
L 300 / Delica II Box (LO3_P)	03/83→10/86	4G62	Petrol	1795	4	8	29
L 300 / Delica II Box (LO3_P)	09/83→10/86	4D55	Diesel	2347	4	8	56
L 300 / Delica II Box (LO3_P)	08/84→10/86	4G63 (SOHC 8V)	Petrol	1997	4	8	45
L 300 / Delica II Bus (LO3_P/G, LO_2P)	09/81→02/87	4G32	Petrol	1597	4	8	20
L 300 / Delica II Bus (LO3_P/G, LO_2P)	06/82→02/87	4G63 (SOHC 8V)	Petrol	1997	4	8	45
L 300 / Delica II Bus (LO3_P/G, LO_2P)	03/83→02/87	4G62	Petrol	1795	4	8	29
L 300 / Delica II Bus (LO3_P/G, LO_2P)	04/83→10/86	4D55	Diesel	2347	4	8	56
L 300 / Delica II PPlatform/Chassis (LO3_P)	03/83→10/86	4G62	Petrol	1795	4	8	29
L 300 / Delica II PPlatform/Chassis (LO3_P)	04/83→04/94	4G32	Petrol	1597	4	8	20
L 300 / Delica II PPlatform/Chassis (LO3_P)	11/86→04/94	4D56 (8V)	Diesel	2477	4	8	62
L 300 III Box (PO_V, P1_V, P_2V)	11/86→05/94	4G32	Petrol	1597	4	8	20
L 300 III Box (PO_V, P1_V, P_2V)	11/86→05/96	G63B	Petrol	1997	4	8	54
L 300 III Box (PO_V, P1_V, P_2V)	11/86→08/97	4G64 (8V)	Petrol	2351	4	8	57
L 300 III Box (PO_V, P1_V, P_2V)	11/86→08/97	G64B	Petrol	2351	4	8	61
L 300 III Box (PO_V, P1_V, P_2V)	11/86→02/06	4D56 (8V)	Diesel	2477	4	8	62
L 300 III Box (PO_V, P1_V, P_2V)	02/87→05/03	4D56 T	Diesel	2477	4	8	62
L 300 III Box (PO_V, P1_V, P_2V)	08/88→05/96	4G63 (SOHC 8V)	Petrol	1997	4	8	45
L 300 III Box (PO_V, P1_V, P_2V)	06/94→09/13	4G63 (SOHC 16V)	Petrol	1997	4	16	46
L 300 III Box (PO_V, P1_V, P_2V)	09/94→02/06	4G64 (16V)	Petrol	2351	4	16	60
L 300 III Bus (PO_W, P1_W, P2_W)	11/86→12/90	G64B	Petrol	2351	4	8	61
L 300 III Bus (PO_W, P1_W, P2_W)	11/86→05/04	4D56 (8V)	Diesel	2477	4	8	62
L 300 III Bus (PO_W, P1_W, P2_W)	11/86→05/04	4G32	Petrol	1597	4	8	20
L 300 III Bus (PO_W, P1_W, P2_W)	11/86→05/04	4G63 (SOHC 8V)	Petrol	1997	4	8	45
L 300 III Bus (PO_W, P1_W, P2_W)	11/86→05/04	G63B	Petrol	1997	4	8	54
L 300 III Bus (PO_W, P1_W, P2_W)	02/87→05/04	4D56 T	Diesel	2477	4	8	62
L 300 III Bus (PO_W, P1_W, P2_W)	11/90→05/04	4G64 (8V)	Petrol	2351	4	8	57
L 300 III Bus (PO_W, P1_W, P2_W)	06/94→05/03	4G63 (SOHC 16V)	Petrol	1997	4	16	46
L 300 III Bus (PO_W, P1_W, P2_W)	09/94→05/04	4G64 (16V)	Petrol	2351	4	16	60
L 300 III PPlatform/Chassis (P1_T)	07/94→04/00	4G63 (SOHC 16V)	Petrol	1997	4	16	46
L 300 III PPlatform/Chassis (P1_T)	11/94→04/00	4D56 T	Diesel	2477	4	8	62
L 300 PPlatform/Chassis (LO3_P)	06/82→08/85	G63B	Petrol	1997	4	8	54
L 300 PPlatform/Chassis (P1_T)	06/94→04/00	4G63 (SOHC 16V)	Petrol	1997	4	16	46
L 400 Box (PD_W, PC_W, PB_V, PA_W, PA_V)	12/94→10/02	4G63 (SOHC 16V)	Petrol	1997	4	16	46
L 400 Box (PD_W, PC_W, PB_V, PA_W, PA_V)	06/96→10/02	4G32	Petrol	1597	4	8	20
L 400 Box (PD_W, PC_W, PB_V, PA_W, PA_V)	06/96→10/02	4G64 (16V)	Petrol	2351	4	16	60
L 400 Box (PD_W, PC_W, PB_V, PA_W, PA_V)	09/96→06/05	4D56 T	Diesel	2477	4	8	62
L 400 Box (PD_W, PC_W, PA_V, PB_V, PA_W)	05/95→05/00	4D56 TD	Diesel	2477	4	8	62
L 400 Bus (PD_W, PC_W, PA_V, PB_V, PA_W)	05/95→10/02	4G63 (SOHC 16V)	Petrol	1997	4	16	46
L 400 Bus (PD_W, PC_W, PA_V, PB_V, PA_W)	05/95→06/05	4D56 T	Diesel	2477	4	8	62
L 400 Bus (PD_W, PC_W, PA_V, PB_V, PA_W)	05/95→06/05	4G64 (16V)	Petrol	2351	4	16	60
Lancer Celeste Coupe (A7_)	10/75→06/81	4G52	Petrol	1995	4	8	42
Lancer Celeste Coupe (A7_)	01/77→06/81	4G32	Petrol	1597	4	8	20
Lancer Coupe (CC)	09/92→07/96	4G93 (DOHC 16V)	Petrol	1834	4	16	31

				CC			9
Lancer Estate (CS_W)	09/03→10/08	4G64 (GDI)	Petrol	2351	4	16	60
Lancer Estate (CS_W)	09/03→10/08	4G93T (GDI)	Petrol	1834	4	16	31
Lancer Estate (CS_W)	08/05→10/08	4G94	Petrol	1999	4	16	49
Lancer Estate (CV_1)	09/08→	CR12DE	Petrol	1240	4	16	5
Lancer Estate (CV_1)	09/08→	MR18DE	Petrol	1797	4	16	34
Lancer F (A15_)	03/83→01/84	4G11	Petrol	1244	4	8	3
Lancer F (A15_)	03/83→01/84	4G12	Petrol	1410	4	8	11
Lancer F (A15_)	03/83→01/84	4G12 T	Petrol	1410	4	8	11
Lancer F (A15_)	04/84→09/86	4G32	Petrol	1597	4	8	20
Lancer F (A15_)	04/84→09/86	4G33	Petrol	1439	4	8	12
Lancer I (A7_)	11/75→09/79	4G36	Petrol	1238	4	8	4
Lancer I (A7_)	01/78→09/79	4G32 GS	Petrol	1597	4	8	21
Lancer I (A7_)	01/78→09/79	4G33	Petrol	1439	4	8	12
Lancer I Station Wagon (A7_V)	01/78→09/79	4G33	Petrol	1439	4	8	12
Lancer II (A17_)	09/79→02/83	4G12	Petrol	1410	4	8	11
Lancer II (A17_)	09/79→02/83	4G32 GS	Petrol	1597	4	8	21
Lancer II (A17_)	01/80→12/81	4G11	Petrol	1244	4	8	3
Lancer II (A17_)	03/81→02/83	4G63 T (SOHC 8V)	Petrol	1997	4	8	47
Lancer III (C1_A, C6_A)	11/83→04/88	4G15 (8V)	Petrol	1468	4	8	14
Lancer III (C1_A, C6_A)	01/84→04/88	4D65	Diesel	1796	4	8	27
Lancer III (C1_A, C6_A)	01/84→04/88	4G16	Petrol	1198	4	8	3
Lancer III (C1_A, C6_A)	06/85→04/88	G15B	Petrol	1468	4	8	14
Lancer III (C1_A, C6_A)	10/86→06/90	4G32	Petrol	1597	4	8	20
Lancer III (C1_A, C6_A)	10/86→06/90	4G33	Petrol	1439	4	8	12
Lancer III Station Wagon (C1_V, C3_V)	09/85→08/89	G15B	Petrol	1468	4	8	14
Lancer III Station Wagon (C1_V, C3_V)	09/85→12/90	4G15 (8V)	Petrol	1468	4	8	14
Lancer III Station Wagon (C1_V, C3_V)	09/85→06/92	4D65	Diesel	1796	4	8	27
Lancer III Station Wagon (C1_V, C3_V)	01/87→08/89	G37B	Petrol	1755	4	8	28
Lancer III Station Wagon (C1_V, C3_V)	01/87→06/92	4G37	Petrol	1755	4	8	28
Lancer III Station Wagon (C1_V, C3_V)	05/88→06/90	G13B	Petrol	1299	4	8	8
Lancer III Station Wagon (C1_V, C3_V)	08/89→08/92	4G15 (12V)	Petrol	1468	4	12	15
Lancer III Station Wagon (C1_V, C3_V)	07/90→08/92	4G13 (12V)	Petrol	1299	4	12	9
Lancer IV (C6_A, C7_A)	04/88→05/92	4D65	Diesel	1796	4	8	27
Lancer IV (C6_A, C7_A)	04/88→05/92	4G13 (8V)	Petrol	1299	4	8	8
Lancer IV (C6_A, C7_A)	04/88→09/92	4G15 (12V)	Petrol	1468	4	12	15
Lancer IV (C6_A, C7_A)	05/88→09/92	4G61	Petrol	1596	4	16	22
Lancer IV (C6_A, C7_A)	08/88→05/92	G13B	Petrol	1299	4	8	8
Lancer IV (C6_A, C7_A)	09/88→08/90	4G15 (8V)	Petrol	1468	4	8	14
Lancer IV (C6_A, C7_A)	07/90→06/92	4G13 (12V)	Petrol	1299	4	12	9
Lancer IV (C6_A, C7_A)	06/92→07/93	4G37	Petrol	1755	4	8	28
Lancer IV Hatchback (C6_A, C7_A)	04/88→05/92	4D65	Diesel	1796	4	8	27
Lancer IV Hatchback (C6_A, C7_A)	06/88→05/92	4G15 (8V)	Petrol	1468	4	8	14
Lancer IV Hatchback (C6_A, C7_A)	05/89→05/92	4G15 (12V)	Petrol	1468	4	12	15
Lancer IV Hatchback (C6_A, C7_A)	09/89→06/92	4G37	Petrol	1755	4	8	28
Lancer IV Hatchback (C6_A, C7_A)	11/89→05/92	4G67	Petrol	1836	4	16	30
Lancer IV Hatchback (C6_A, C7_A)	06/92→07/93	4D68	Diesel	1998	4	8	41
Lancer IV Hatchback (C6_A, C7_A)	06/92→12/93	4G93 (DOHC 16V)	Petrol	1834	4	16	31
Lancer IV Hatchback (C6_A, C7_A)	06/92→05/94	4G13 (12V)	Petrol	1299	4	12	9
Lancer IV Hatchback (C6_A, C7_A)	06/92→05/94	4G92 (SOHC 16V)	Petrol	1597	4	16	24
Lancer IV Saloon (C6_A)	05/88→06/90	G13B	Petrol	1299	4	8	8
Lancer IV Saloon (C6_A)	05/88→08/92	4G16	Petrol	1198	4	8	3
Lancer IV Saloon (C6_A)	04/89→08/90	4G15 (12V)	Petrol	1468	4	12	15
Lancer V (CB_A, CD_A, CE_A)	06/92→12/93	4G93 (DOHC 16V)	Petrol	1834	4	16	31
Lancer V (CB_A, CD_A, CE_A)	06/92→12/96	4D68	Diesel	1998	4	8	41
Lancer V (CB_A, CD_A, CE_A)	06/92→12/96	4G13 (12V)	Petrol	1299	4	12	9
Lancer V (CB_A, CD_A, CE_A)	06/92→12/96	4G92 (SOHC 16V)	Petrol	1597	4	16	24
Lancer V (CB_A, CD_A, CE_A)	09/92→07/96	4G15 (12V)	Petrol	1468	4	12	15
Lancer V (CB_A, CD_A, CE_A)	09/92→07/96	4G93 (SOHC 16V)	Petrol	1834	4	16	32
Lancer V (CB_A, CD_A, CE_A)	10/92→07/96	4G63 Turbo	Petrol	1997	4	16	48
Lancer V (CB_A, CD_A, CE_A)	11/92→07/96	4G93T	Petrol	1834	4	16	33
Lancer V (CB/D_A)	06/92→07/93	4G37	Petrol	1755	4	8	28
Lancer V (CB/D_A)	06/92→02/95	4G13 (12V)	Petrol	1299	4	12	9
Lancer V Coupe (CC)	09/92→07/96	4G15 (12V)	Petrol	1468	4	12	15
Lancer V Coupe (CC)	09/92→07/96	4G93 (SOHC 16V)	Petrol	1834	4	16	32
Lancer V Hatchback (CC)	09/92→07/96	4G15 (12V)	Petrol	1468	4	12	15
Lancer V Hatchback (CC)	09/92→07/96	4G92 (SOHC 16V)	Petrol	1597	4	16	24
Lancer V Station Wagon (CB_W, CD_W)	09/92→10/03	4G93 (SOHC 16V)	Petrol	1834	4	16	32
Lancer V Station Wagon (CB_W, CD_W)	12/92→10/03	4D68	Diesel	1998	4	8	41
Lancer V Station Wagon (CB_W, CD_W)	12/92→10/03	4G92 (SOHC 16V)	Petrol	1597	4	16	24
Lancer V Station Wagon (CB_W, CD_W)	03/95→10/03	4D68 T	Diesel	1998	4	8	41
Lancer V Station Wagon (CB_W, CD_W)	03/95→10/03	4G15 (12V)	Petrol	1468	4	12	15
Lancer V Station Wagon (CB_W, CD_W)	03/95→10/03	4G93T	Petrol	1834	4	16	33
Lancer V Station Wagon (CB_W, CD_W)	11/99→08/03	4G13 (12V)	Petrol	1299	4	12	9
Lancer VI (CJ-CP_)	09/95→08/03	4D68	Diesel	1998	4	8	41
Lancer VI (CJ-CP_)	09/95→08/03	4G15 (16V)	Petrol	1468	4	16	16
Lancer VI (CJ-CP_)	09/95→08/03	4G64 (GDI)	Petrol	2351	4	16	60
Lancer VI (CJ-CP_)	09/95→08/03	4G92 (SOHC 16V)	Petrol	1597	4	16	24
Lancer VI (CJ-CP_)	09/95→08/03	4G93 (SOHC 16V)	Petrol	1834	4	16	32











CC



9

Lancer VI (CJ-CP_)	09/95→08/03	4G93T	Petrol	1834	4	16	33
Lancer VI (CJ-CP_)	09/95→08/03	4G94 (GDI)	Petrol	1999	4	16	50
Lancer VI (CJ-CP_)	12/95→08/03	4G13 (12V)	Petrol	1299	4	12	9
Lancer VI (CJ-CP_)	07/96→08/03	4G15 (12V)	Petrol	1468	4	12	15
Lancer VI (CJ-CP_)	08/96→02/01	4G63 Turbo	Petrol	1997	4	16	48
Lancer VI (CJ-CP_)	09/99→08/03	4G64 (16V)	Petrol	2351	4	16	60
Lancer VI (CJ-CP_)	06/00→08/03	4G93 (GDI)	Petrol	1834	4	16	31
Lancer VI (CJ-CP_)	06/00→08/03	4G93T (GDI)	Petrol	1834	4	16	31
Lancer VI Convertible (CJ_A)	10/01→03/03	4G93 (SOHC 16V)	Petrol	1834	4	16	32
Lancer VI Coupe (CJ_A, CE)	07/96→09/04	4G15 (16V)	Petrol	1468	4	16	16
Lancer VI Coupe (CJ_A, CE)	07/96→09/04	4G93 (SOHC 16V)	Petrol	1834	4	16	32
Lancer VII (CS_A, CT_A)	06/00→	4G18	Petrol	1584	4	16	19
Lancer VII (CS_A, CT_A)	09/00→	4G13 (16V)	Petrol	1299	4	16	10
Lancer VII (CS_A, CT_A)	01/01→12/07	4G63 Turbo	Petrol	1997	4	16	48
Lancer VII (CS_A, CT_A)	09/01→	4G94	Petrol	1999	4	16	49
Lancer VII (CS_A, CT_A)	09/03→07/07	4G69	Petrol	2378	4	16	60
Lancer VII (CS_A, CT_A)	09/03→	4G63 (DOHC 16V)	Petrol	1997	4	16	44
Lancer VII (CS_A, CT_A)	09/03→	4G93 (SOHC 16V)	Petrol	1834	4	16	32
Lancer VII (CS_A, CT_A)	05/04→	4G15 (12V)	Petrol	1468	4	12	15
Lancer VII (CS_A, CT_A)	01/06→12/09	4G63 (SOHC 16V)	Petrol	1997	4	16	46
Lancer VII (CS_A, CT_A)	10/07→	4B11	Petrol	1998	4	16	39
Lancer VII Estate (CS_W, CT_W)	09/03→12/04	4G69	Petrol	2378	4	16	60
Lancer VII Estate (CS_W, CT_W)	09/03→12/07	4G63 (DOHC 16V)	Petrol	1997	4	16	44
Lancer VII Estate (CS_W, CT_W)	09/03→10/08	4G18	Petrol	1584	4	16	19
Lancer VII Estate (CS_W, CT_W)	09/05→03/07	4G63 Turbo	Petrol	1997	4	16	48
Lancer VIII (CY_A, CZ_A)	03/07→	4B11	Petrol	1998	4	16	39
Lancer VIII (CY_A, CZ_A)	10/07→	4B11 T/C	Petrol	1998	4	16	40
Lancer VIII (CY_A, CZ_A)	01/08→	BKD	Diesel	1968	4	16	51
Lancer VIII (CY_A, CZ_A)	01/08→	BWC	Diesel	1968	4	16	53
Lancer VIII (CY_A, CZ_A)	02/08→	4B10	Petrol	1798	4	16	26
Lancer VIII (CY_A, CZ_A)	03/08→06/15	4B11FQ30	Petrol	1998	4	16	40
Lancer VIII (CY_A, CZ_A)	03/08→06/15	4B11FQ60	Petrol	1998	4	16	40
Lancer VIII (CY_A, CZ_A)	06/08→	4A91	Petrol	1499	4	16	13
Lancer VIII (CY_A, CZ_A)	10/08→	4B12	Petrol	2360	4	16	58
Lancer VIII Estate (CV_)	09/09→12/11	4B12	Petrol	2360	4	16	58
Lancer VIII Estate (CV_)	09/10→12/11	4B11 T/C	Petrol	1998	4	16	40
Lancer VIII Sportback (CX_A)	10/07→	4B11	Petrol	1998	4	16	39
Lancer VIII Sportback (CX_A)	06/08→	4A91	Petrol	1499	4	16	13
Lancer VIII Sportback (CX_A)	06/08→	4B10	Petrol	1798	4	16	26
Lancer VIII Sportback (CX_A)	06/08→	BKD	Diesel	1968	4	16	51
Lancer VIII Sportback (CX_A)	06/08→	BWC	Diesel	1968	4	16	53
Lancer VIII Sportback (CX_A)	10/08→	4B11 T/C	Petrol	1998	4	16	40
Lancer VIII Sportback (CX_A)	10/08→	4B12	Petrol	2360	4	16	58
Lancer Saloon (CS_A)	08/03→	4G94	Petrol	1999	4	16	49
Lancer Saloon (CS_A)	09/03→03/07	4G93 (GDI)	Petrol	1834	4	16	31
Lancer Saloon (CS_A)	09/03→	4G64 (GDI)	Petrol	2351	4	16	60
Lancer Saloon (CS_A)	09/03→	4G94 (GDI)	Petrol	1999	4	16	50
Lancer Saloon (CS_A)	08/05→	4G69	Petrol	2378	4	16	60
Lancer Saloon (CY/Z_A)	01/09→	4B11	Petrol	1998	4	16	39
Lancer Sportback (CX_A)	08/11→	4B11 T/C	Petrol	1998	4	16	40
Magna Estate (TE)	04/96→06/97	4G54	Petrol	2555	4	8	65
Magna Estate (TE)	04/96→06/97	4G64 (16V)	Petrol	2351	4	16	60
Magna Estate (TE)	04/96→06/97	6G72 (SOHC 24V)	Petrol	2972	6	24	73
Magna Estate (TF)	06/97→03/99	4G64 (16V)	Petrol	2351	4	16	60
Magna Estate (TF)	06/97→03/99	6G72 (SOHC 24V)	Petrol	2972	6	24	73
Magna Estate (TH)	03/99→08/00	6G72 (SOHC 24V)	Petrol	2972	6	24	73
Magna Estate (TJ)	08/00→05/03	6G74 (SOHC 24V)	Petrol	3497	6	24	77
Magna Estate (TP)	05/89→03/91	4G54	Petrol	2555	4	8	65
Magna Estate (TP)	05/89→08/91	G54B	Petrol	2555	4	8	69
Magna Estate (TP, TN)	04/87→08/91	4G54	Petrol	2555	4	8	65
Magna Estate (TP, TN)	04/87→08/91	G54B	Petrol	2555	4	8	69
Magna Estate (TR)	03/91→02/94	6G72 (SOHC 24V)	Petrol	2972	6	24	73
Magna Estate (TR)	05/91→02/94	4G54	Petrol	2555	4	8	65
Magna Estate (TS)	02/94→04/96	4G54	Petrol	2555	4	8	65
Magna Estate (TS)	02/94→04/96	6G72 (SOHC 24V)	Petrol	2972	6	24	73
Magna Estate (TW)	06/03→07/05	6G74 (SOHC 24V)	Petrol	3497	6	24	77
Magna Estate (TW, TJ, TF, TL, TH, TE)	06/99→05/05	6G74 (SOHC 24V)	Petrol	3497	6	24	77
Magna Saloon (TF)	06/97→03/99	6G72 (SOHC 24V)	Petrol	2972	6	24	73
Magna Saloon (TH)	03/99→08/00	6G72 (SOHC 24V)	Petrol	2972	6	24	73
Magna Saloon (TJ)	08/00→05/03	6G72 (SOHC 24V)	Petrol	2972	6	24	73
Magna Saloon (TL, TJ, TH, TE, TW, TF)	04/96→03/99	4G64 (16V)	Petrol	2351	4	16	60
Magna Saloon (TL, TJ, TH, TE, TW, TF)	04/96→07/02	6G72 (SOHC 24V)	Petrol	2972	6	24	73
Magna Saloon (TL, TJ, TH, TE, TW, TF)	03/99→05/05	6G74 (SOHC 24V)	Petrol	3497	6	24	77
Magna Saloon (TM)	04/87→04/89	4G54	Petrol	2555	4	8	65
Magna Saloon (TP)	05/89→08/91	4G54	Petrol	2555	4	8	65
Magna Saloon (TP, TN, TM)	05/85→04/91	4G54	Petrol	2555	4	8	65
Magna Saloon (TS)	02/94→04/96	4G54	Petrol	2555	4	8	65
Magna Saloon (TS, TR)	04/91→06/96	4G54	Petrol	2555	4	8	65

							
Magna Saloon (TS, TR)	04/91→06/96	6G73	Petrol	2497	6	24	67
Magna Saloon (TS, TR)	05/91→03/94	G54B	Petrol	2555	4	8	69
Magna Saloon (TW)	06/03→07/05	6G74 (SOHC 24V)	Petrol	3497	6	24	77
Mirage Coupe	12/91→08/95	4G13 (12V)	Petrol	1299	4	12	9
Mirage Coupe	12/91→08/95	4G15 (12V)	Petrol	1468	4	12	15
Mirage Coupe	09/92→01/96	4G93 (SOHC 16V)	Petrol	1834	4	16	32
Mirage Coupe	09/95→08/99	4G15 (16V)	Petrol	1468	4	16	16
Mirage Coupe	09/95→08/99	4G92 (DOHC 16V)	Petrol	1597	4	16	23
Mirage Estate	02/86→01/88	G37B	Petrol	1755	4	8	28
Mirage Estate	04/86→01/88	G13B	Petrol	1299	4	8	8
Mirage Estate	08/01→07/03	4G93 (SOHC 16V)	Petrol	1834	4	16	32
Mirage Hatchback	10/83→01/88	4D65	Diesel	1796	4	8	27
Mirage Hatchback	10/83→01/88	G32BT	Petrol	1597	4	8	20
Mirage Hatchback	04/86→01/88	G13B	Petrol	1299	4	8	8
Mirage Hatchback	05/88→06/90	G15B	Petrol	1468	4	8	14
Mirage Hatchback	05/88→11/91	4G13 (12V)	Petrol	1299	4	12	9
Mirage Hatchback	05/88→11/91	4G13 (8V)	Petrol	1299	4	8	8
Mirage Hatchback	05/88→11/91	4G15 (12V)	Petrol	1468	4	12	15
Mirage Hatchback	06/88→11/91	4G61 T	Petrol	1596	4	16	22
Mirage Hatchback	07/90→11/91	4G15 (8V)	Petrol	1468	4	8	14
Mirage Hatchback	09/95→08/99	4G92 (DOHC 16V)	Petrol	1597	4	16	23
Mirage Hatchback	09/95→07/03	4D68 T	Diesel	1998	4	8	41
Mirage Hatchback (CJ_A)	09/95→08/99	4G15 (16V)	Petrol	1468	4	16	16
Mirage Hatchback (CJ_A)	09/95→07/03	4G13 (12V)	Petrol	1299	4	12	9
Mirage Hatchback (CJ_A)	09/99→07/03	4G92 (SOHC 16V)	Petrol	1597	4	16	24
Mirage Hatchback (CJ_A, CL_A)	12/91→08/95	4G13 (12V)	Petrol	1299	4	12	9
Mirage Hatchback (CJ_A, CL_A)	12/91→08/95	4G15 (12V)	Petrol	1468	4	12	15
Mirage Hatchback (CJ_A, CL_A)	12/91→07/96	4G92 (SOHC 16V)	Petrol	1597	4	16	24
Mirage II Hatchback (C10)	10/83→08/86	G15B	Petrol	1468	4	8	14
Mirage II Hatchback (C10)	10/83→01/88	4G16	Petrol	1198	4	8	3
Mirage II Hatchback (C10)	09/84→12/87	4G15 (8V)	Petrol	1468	4	8	14
Mirage II Hatchback (C10)	09/84→01/88	4G32 T	Petrol	1597	4	8	20
Mirage II Saloon (C10)	10/83→01/88	G15B	Petrol	1468	4	8	14
Mirage III Hatchback (C5 - C8_)	05/88→11/91	4G61 T	Petrol	1596	4	16	22
Mirage III Hatchback (C5 - C8_)	06/88→11/91	4G61	Petrol	1596	4	16	22
Mirage III Saloon (C5 - C8_)	09/90→06/92	4G32 T/C	Petrol	1597	4	8	20
Mirage V Coupe (CJ - CM)	09/95→08/99	4G13 (12V)	Petrol	1299	4	12	9
Mirage V Coupe (CJ - CM)	09/96→08/99	4G15 (12V)	Petrol	1468	4	12	15
Mirage V Coupe (CJ - CM)	09/96→08/02	4G93 (SOHC 16V)	Petrol	1834	4	16	32
Mirage Saloon	03/79→09/83	G11B	Petrol	1244	4	8	3
Mirage Saloon	03/79→09/83	G12B	Petrol	1410	4	8	11
Mirage Saloon	05/88→11/91	4D65	Diesel	1796	4	8	27
Mirage Saloon	05/88→11/91	4G13 (8V)	Petrol	1299	4	8	8
Mirage Saloon	05/88→11/91	4G13 P	Petrol	1298	4	12	10
Mirage Saloon	05/88→11/91	G15B	Petrol	1468	4	8	14
Mirage Saloon	05/88→08/99	4G15 (12V)	Petrol	1468	4	12	15
Mirage Saloon	07/90→11/91	4G15 (8V)	Petrol	1468	4	8	14
Mirage Saloon	07/90→08/95	4G13 (12V)	Petrol	1299	4	12	9
Mirage Saloon	12/91→08/95	4D65 T	Diesel	1796	4	8	27
Mirage Saloon	12/91→08/95	4D68	Diesel	1998	4	8	41
Mirage Saloon	12/91→08/95	4G92 (SOHC 16V)	Petrol	1597	4	16	24
Mirage Saloon	12/91→10/98	4G93 (SOHC 16V)	Petrol	1834	4	16	32
Mirage Saloon	12/91→07/03	4D68 T	Diesel	1998	4	8	41
Mirage Saloon	09/95→08/99	4G93T	Petrol	1834	4	16	33
Mirage Saloon (A15_)	03/79→09/83	4G32 GS	Petrol	1597	4	8	21
Mirage Saloon (A15_)	03/79→09/83	G32B	Petrol	1597	4	8	20
Mirage Saloon (CK_A)	09/95→12/00	4G15 (16V)	Petrol	1468	4	16	16
Mirage Saloon (CK_A)	09/96→12/00	4G15 (12V)	Petrol	1468	4	12	15
Mirage Saloon (CK_A)	09/96→12/01	4G93 (SOHC 16V)	Petrol	1834	4	16	32
Outlander	07/06→	4 G 69	Petrol	2378	4	16	60
Outlander I (CU_W)	03/01→12/06	4G69	Petrol	2378	4	16	60
Outlander I (CU_W)	01/02→10/06	4G63 Turbo	Petrol	1997	4	16	48
Outlander I (CU_W)	09/02→10/06	4G64 (16V)	Petrol	2351	4	16	60
Outlander I (CU_W)	05/03→10/06	4G63 (DOHC 16V)	Petrol	1997	4	16	44
Outlander I (CU_W)	08/03→12/06	4G64 (GDI)	Petrol	2351	4	16	60
Outlander I (CU_W)	04/04→10/06	4G63 T (DOHC 16V)	Petrol	1997	4	16	44
Outlander II (CW_W)	11/06→11/12	4B11	Petrol	1998	4	16	39
Outlander II (CW_W)	11/06→11/12	4B12	Petrol	2360	4	16	58
Outlander II (CW_W)	02/07→11/12	BSY	Diesel	1968	4	16	51
Outlander II (CW_W)	08/07→11/12	4HK	Diesel	2179	4	16	55
Outlander II (CW_W)	08/07→11/12	4HN	Diesel	2179	4	16	55
Outlander III (GG_W, GF_W)	10/12→	4B11	Petrol	1998	4	16	39
Outlander III (GG_W, GF_W)	10/12→	4B12	Petrol	2360	4	16	58
Outlander III (GG_W, GF_W, ZJ)	08/12→	4B12	Petrol	2360	4	16	58
Outlander III (GG_W, GF_W, ZJ)	10/12→	4B11	Petrol	1998	4	16	39
Pajero Classic (V2_W)	06/02→	4M40-T	Diesel	2835	4	8	70
Pajero Classic (V2_W)	06/02→	6G75	Petrol	3828	6	24	80
Pajero Classic (V2_W)	07/02→	4D56 T	Diesel	2477	4	8	62











CC



9

Pajero Classic (V2_W)	08/03→	6G72 (DOHC 24V)	Petrol	2972	6	24	71
Pajero Classic (V2_W)	09/06→	4M41	Diesel	3200	4	16	74
Pajero Classic (V2_W)	09/06→	6G72 (SOHC 24V)	Petrol	2972	6	24	73
Pajero I (L04_G, L14_G)	01/83→02/91	G63B	Petrol	1997	4	8	54
Pajero I (L04_G, L14_G)	01/83→05/91	4G54	Petrol	2555	4	8	65
Pajero I (L04_G, L14_G)	10/84→09/86	4D55	Diesel	2347	4	8	56
Pajero I (L04_G, L14_G)	10/84→02/91	4G63 T (SOHC 8V)	Petrol	1997	4	8	47
Pajero I (L04_G, L14_G)	10/86→12/91	4D56 T	Diesel	2477	4	8	62
Pajero I (L04_G, L14_G)	05/88→12/91	6G72 (SOHC 12V)	Petrol	2972	6	12	72
Pajero I Canvas Top (L04_G)	12/82→04/86	4D55 T	Diesel	2347	4	8	56
Pajero I Canvas Top (L04_G)	01/83→11/90	4G54	Petrol	2555	4	8	65
Pajero I Canvas Top (L04_G)	05/86→11/90	4D56 T	Diesel	2477	4	8	62
Pajero II (V3_W)	04/00→09/07	4M41	Diesel	3200	4	16	74
Pajero II (V3_W)	10/01→01/07	4G64 (12V)	Petrol	2351	4	12	59
Pajero II (V3_W, V2_W, V4_W)	12/90→12/95	6G72 (SOHC 12V)	Petrol	2972	6	12	72
Pajero II (V3_W, V2_W, V4_W)	12/90→10/99	4D56 TD	Diesel	2477	4	8	62
Pajero II (V3_W, V2_W, V4_W)	03/91→10/97	4G54	Petrol	2555	4	8	65
Pajero II (V3_W, V2_W, V4_W)	03/91→08/99	4D56 T	Diesel	2477	4	8	62
Pajero II (V3_W, V2_W, V4_W)	04/91→10/99	4G64 (12V)	Petrol	2351	4	12	59
Pajero II (V3_W, V2_W, V4_W)	09/93→10/99	6G72 (SOHC 24V)	Petrol	2972	6	24	73
Pajero II (V3_W, V2_W, V4_W)	09/93→10/99	6G74 (DOHC 24V)	Petrol	3497	6	24	76
Pajero II (V3_W, V2_W, V4_W)	11/93→07/97	4M40-A	Diesel	2835	4	8	70
Pajero II (V3_W, V2_W, V4_W)	11/93→10/99	4M40-T	Diesel	2835	4	8	70
Pajero II (V3_W, V2_W, V4_W)	06/94→10/99	6G74 (SOHC 24V)	Petrol	3497	6	24	77
Pajero II (V3_W, V2_W, V4_W)	11/97→08/99	4G93 (GDI)	Petrol	1834	4	16	31
Pajero II Canvas Top (V2_W, V4_W)	12/90→12/95	6G72 (SOHC 12V)	Petrol	2972	6	12	72
Pajero II Canvas Top (V2_W, V4_W)	12/90→04/00	4D56 TD	Diesel	2477	4	8	62
Pajero II Canvas Top (V2_W, V4_W)	03/91→08/99	4D56 T	Diesel	2477	4	8	62
Pajero II Canvas Top (V2_W, V4_W)	04/91→04/00	4G64 (12V)	Petrol	2351	4	12	59
Pajero II Canvas Top (V2_W, V4_W)	06/94→04/00	6G72 (DOHC 24V)	Petrol	2972	6	24	71
Pajero II Canvas Top (V2_W, V4_W)	06/94→04/00	6G72 (SOHC 24V)	Petrol	2972	6	24	73
Pajero II Canvas Top (V2_W, V4_W)	06/98→04/00	4G93 (GDI)	Petrol	1834	4	16	31
Pajero III (V7_W, V6_W)	01/99→12/06	6G72 (DOHC 24V)	Petrol	2972	6	24	71
Pajero III (V7_W, V6_W)	04/00→12/06	4D56 T	Diesel	2477	4	8	62
Pajero III (V7_W, V6_W)	04/00→01/07	4M41	Diesel	3200	4	16	74
Pajero III (V7_W, V6_W)	04/00→01/07	6G74 (DOHC 24V)	Petrol	3497	6	24	76
Pajero III (V7_W, V6_W)	10/01→01/07	4G64 (12V)	Petrol	2351	4	12	59
Pajero III (V7_W, V6_W)	09/02→01/07	6G75	Petrol	3828	6	24	80
Pajero III Canvas Top (V6_W, V7_W)	04/00→12/06	4D56 T	Diesel	2477	4	8	62
Pajero III Canvas Top (V6_W, V7_W)	04/00→12/06	4M41	Diesel	3200	4	16	74
Pajero III Canvas Top (V6_W, V7_W)	05/00→07/02	4M40-T	Diesel	2835	4	8	70
Pajero III Canvas Top (V6_W, V7_W)	05/00→10/06	6G74 (DOHC 24V)	Petrol	3497	6	24	76
Pajero III Canvas Top (V6_W, V7_W)	05/00→10/06	6G74 (SOHC 24V)	Petrol	3497	6	24	77
Pajero III Canvas Top (V6_W, V7_W)	10/01→12/06	4G64 (12V)	Petrol	2351	4	12	59
Pajero III Canvas Top (V6_W, V7_W)	10/01→12/06	6G72 (SOHC 24V)	Petrol	2972	6	24	73
Pajero III Canvas Top (V6_W, V7_W)	09/03→10/06	6G75	Petrol	3828	6	24	80
Pajero IV (V8_W, V9_W)	02/07→	4M41	Diesel	3200	4	16	74
Pajero IV (V8_W, V9_W)	02/07→	6G72 (SOHC 24V)	Petrol	2972	6	24	73
Pajero IV (V8_W, V9_W)	02/07→	6G75	Petrol	3828	6	24	80
Pajero IV (V8_W, V9_W)	08/09→	6G74 (SOHC 24V)	Petrol	3497	6	24	77
Pajero IV Van (V90, V80, V8_V)	11/06→	4M41	Diesel	3200	4	16	74
Pajero Pinin (H6_W, H7_W)	03/99→09/01	4G18	Petrol	1584	4	16	19
Pajero Pinin (H6_W, H7_W)	09/99→09/06	4M41	Diesel	3200	4	16	74
Pajero Pinin (H6_W, H7_W)	10/99→10/01	4G93 (GDI)	Petrol	1834	4	16	31
Pajero Pinin (H6_W, H7_W)	10/00→06/07	4G94 (GDI)	Petrol	1999	4	16	50
Pajero Pinin (H6_W, H7_W)	11/01→06/07	4G93 (SOHC 16V)	Petrol	1834	4	16	32
Pajero Pinin (H6_W, H7_W)	10/02→06/07	4G94	Petrol	1999	4	16	49
Pajero Sport (K90)	11/98→	4M41	Diesel	3200	4	16	74
Pajero Sport (K90)	05/99→02/01	4G93 (GDI)	Petrol	1834	4	16	31
Pajero Sport (K90)	10/01→02/05	4G94 (GDI)	Petrol	1999	4	16	50
Pajero Sport I (K7_, K9_)	09/96→12/98	4G64 (16V)	Petrol	2351	4	16	60
Pajero Sport I (K7_, K9_)	09/96→	6G72 (SOHC 24V)	Petrol	2972	6	24	73
Pajero Sport I (K7_, K9_)	11/97→	4D56 T	Diesel	2477	4	8	62
Pajero Sport I (K7_, K9_)	09/98→	6G74 (SOHC 24V)	Petrol	3497	6	24	77
Pajero Sport I (K7_, K9_)	11/98→06/08	6G74 (DOHC 24V)	Petrol	3497	6	24	76
Pajero Sport I (K7_, K9_)	11/98→	4M40-T	Diesel	2835	4	8	70
Pajero Sport I (K7_, K9_)	09/99→09/01	4G64 (12V)	Petrol	2351	4	12	59
Pajero Sport I (K7_, K9_)	03/01→02/05	4G93 (SOHC 16V)	Petrol	1834	4	16	32
Pajero Sport I (K7_, K9_)	03/03→	6G72 (DOHC 24V)	Petrol	2972	6	24	71
Pajero Sport II (KG_, KH_)	07/08→	4D56 HP	Diesel	2477	4	16	64
Pajero Sport II (KG_, KH_)	07/08→	4M41	Diesel	3200	4	16	74
Pajero Sport II (KG_, KH_)	09/08→	4D56 T	Diesel	2477	4	8	62
Pajero Sport II (KG_, KH_)	09/08→	6G74 (SOHC 24V)	Petrol	3497	6	24	77
Pajero Sport II (KH_, KG_)	07/08→	4M41	Diesel	3200	4	16	74
Pajero Sport II (KH_, KG_)	07/08→	6G74 (SOHC 24V)	Petrol	3497	6	24	77
Pajero Sport III (KS_)	08/15→	4D56 HP	Diesel	2477	4	16	64
Pajero Sport Van I (K90)	12/99→01/08	4D56 T	Diesel	2477	4	8	62
Pajero Sport Van I (K90)	12/99→01/08	6G72 (DOHC 24V)	Petrol	2972	6	24	71

							
Pajero TR4 (H7_W, H6_W)	06/07→	4G94	Petrol	1999	4	16	49
Proudia/dignity (BHGY5_, BY_5)	07/12→	VQ35HR	Petrol	3498	6	24	78
Proudia/dignity (BHGY5_, BY_5)	07/12→	VQ37VHR	Petrol	3696	6	24	79
Proudia/dignity (S4_A, S3_A)	10/99→05/01	6G74 (DOHC 24V)	Petrol	3497	6	24	76
Santamo	05/99→12/04	4G63 (DOHC 16V)	Petrol	1997	4	16	44
Sapporo I (A12_)	04/78→07/80	4G32	Petrol	1597	4	8	20
Sapporo I (A12_)	04/78→07/80	4G52	Petrol	1995	4	8	42
Sapporo II (A16_A)	08/80→09/84	4G32	Petrol	1597	4	8	20
Sapporo II (A16_A)	08/80→09/84	4G63 (SOHC 8V)	Petrol	1997	4	8	45
Sapporo II (A16_A)	08/82→08/83	4G63 T (ECI)	Petrol	1997	4	8	47
Sapporo III (E16A)	06/87→08/90	4G64 (8V)	Petrol	2351	4	8	57
Savrin	01/01→12/04	4G63 (DOHC 16V)	Petrol	1997	4	16	44
Savrin	06/04→	4G69	Petrol	2378	4	16	60
Sigma (F2_A, F1_A)	12/90→07/96	6G72 (DOHC 24V)	Petrol	2972	6	24	71
Sigma (F2_A, F1_A)	12/90→07/96	6G72 (SOHC 12V)	Petrol	2972	6	12	72
Sigma (GE)	10/77→05/80	4G32	Petrol	1597	4	8	20
Sigma (GE)	10/77→05/80	4G51	Petrol	1855	4	8	35
Sigma (GE)	10/77→12/80	4G52	Petrol	1995	4	8	42
Sigma (GH)	05/80→02/82	4G52	Petrol	1995	4	8	42
Sigma (GH)	05/80→04/82	4G54	Petrol	2555	4	8	65
Sigma (GH)	09/81→02/82	4G52-T	Petrol	1995	4	8	43
Sigma (GJ, GK, GN)	03/82→09/85	4G32	Petrol	1597	4	8	20
Sigma (GJ, GK, GN)	03/82→09/85	4G54	Petrol	2555	4	8	65
Sigma (GJ, GK, GN)	03/82→12/85	4G52	Petrol	1995	4	8	42
Sigma (GN)	07/85→12/87	4G54	Petrol	2555	4	8	65
Sigma Estate (GE)	09/78→04/80	4G51	Petrol	1855	4	8	35
Sigma Estate (GE)	09/78→12/80	4G52	Petrol	1995	4	8	42
Sigma Estate (GH)	05/80→02/82	4G52	Petrol	1995	4	8	42
Sigma Estate (GH)	05/80→04/82	4G54	Petrol	2555	4	8	65
Sigma Estate (GJ, GK, GN)	03/82→09/85	4G32	Petrol	1597	4	8	20
Sigma Estate (GJ, GK, GN)	03/82→09/85	4G54	Petrol	2555	4	8	65
Sigma Estate (GJ, GK, GN)	03/82→12/85	4G52	Petrol	1995	4	8	42
Sigma Estate (GN)	07/85→12/87	4G54	Petrol	2555	4	8	65
Sigma Scorpion Coupe (GE)	03/78→06/79	4G52	Petrol	1995	4	8	42
Sigma Scorpion Coupe (GH)	07/79→10/80	4G54	Petrol	2555	4	8	65
Sigma Station Wagon (F0_W)	06/92→10/96	6G72 (SOHC 12V)	Petrol	2972	6	12	72
Space Runner (N1_W, N2_W)	10/91→08/99	4G93 (SOHC 16V)	Petrol	1834	4	16	32
Space Runner (N1_W, N2_W)	10/92→08/99	4D68 T	Diesel	1998	4	8	41
Space Runner (N1_W, N2_W)	06/97→08/99	4G63 (DOHC 16V)	Petrol	1997	4	16	44
Space Runner (N6_W)	08/99→08/02	4G63 (SOHC 16V)	Petrol	1997	4	16	46
Space Runner (N6_W)	08/99→01/03	4G64 (GDI)	Petrol	2351	4	16	60
Space Star MPV (DG_A)	06/98→12/04	4G13 (16V)	Petrol	1299	4	16	10
Space Star MPV (DG_A)	06/98→12/04	4G93 (GDI)	Petrol	1834	4	16	31
Space Star MPV (DG_A)	01/01→12/04	4G18	Petrol	1584	4	16	19
Space Star MPV (DG_A)	02/01→12/04	F9Q1	Diesel	1870	4	8	38
Space Star MPV (DG_A)	04/01→12/04	4G92 (SOHC 16V)	Petrol	1597	4	16	24
Space Star MPV (DG_A)	10/02→12/04	4G93 (DOHC 16V)	Petrol	1834	4	16	31
Space Star MPV (DG_A)	10/02→12/04	F9Q2	Diesel	1870	4	8	38
Space Wagon (D0_V/W)	01/84→12/88	4G37	Petrol	1755	4	8	28
Space Wagon (D0_V/W)	03/85→01/92	4G63 (SOHC 8V)	Petrol	1997	4	8	45
Space Wagon (D0_V/W)	06/86→05/88	G63B	Petrol	1997	4	8	54
Space Wagon (D0_V/W)	06/86→04/91	4D65 T	Diesel	1796	4	8	27
Space Wagon (D0_V/W)	09/88→04/91	G37B	Petrol	1755	4	8	28
Space Wagon (N3_W, N4_W)	05/91→12/92	4G64 (8V)	Petrol	2351	4	8	57
Space Wagon (N3_W, N4_W)	05/91→10/97	4G63 (SOHC 8V)	Petrol	1997	4	8	45
Space Wagon (N3_W, N4_W)	10/91→10/98	4D65 T	Diesel	1796	4	8	27
Space Wagon (N3_W, N4_W)	10/91→10/98	4G64 (16V)	Petrol	2351	4	16	60
Space Wagon (N3_W, N4_W)	10/91→10/98	4G93 (SOHC 16V)	Petrol	1834	4	16	32
Space Wagon (N3_W, N4_W)	10/92→10/98	4D68 T	Diesel	1998	4	8	41
Space Wagon (N3_W, N4_W)	10/92→10/98	4G63 (SOHC 16V)	Petrol	1997	4	16	46
Space Wagon (N9_W, N8_W)	10/98→12/04	4G63 (SOHC 16V)	Petrol	1997	4	16	46
Space Wagon (N9_W, N8_W)	10/98→12/04	4G64 (GDI)	Petrol	2351	4	16	60
Space Wagon (N9_W, N8_W)	11/98→04/04	4G64 (16V)	Petrol	2351	4	16	60
Space Wagon (N9_W, N8_W)	05/00→05/03	6G72 (DOHC 24V)	Petrol	2972	6	24	71
Space Wagon (N9_W, N8_W)	05/02→08/04	4G93 (SOHC 16V)	Petrol	1834	4	16	32
Starion (A18_A)	05/82→12/87	4G54	Petrol	2555	4	8	65
Starion (A18_A)	06/82→12/85	4G63 T (ECI)	Petrol	1997	4	8	47
Starion (A18_A)	05/85→08/87	4G63 T/C	Petrol	1997	4	8	47
Starion (A18_A)	12/85→12/87	4G63 T (SOHC 8V)	Petrol	1997	4	8	47
Starion (A18_A)	09/87→06/90	G54B T/C	Petrol	2555	4	8	65
Tredia (A21_)	09/82→05/85	4G32 T	Petrol	1597	4	8	20
Tredia (A21_)	09/82→10/87	4G32	Petrol	1597	4	8	20
Tredia (A21_)	10/82→08/85	4G12	Petrol	1410	4	8	11
Tredia (A21_)	01/83→07/86	4G62	Petrol	1795	4	8	29
Tredia (A21_)	09/83→03/88	G63B	Petrol	1997	4	8	54
Tredia (A21_)	08/84→07/86	4G37	Petrol	1755	4	8	28
Tredia (A21_)	08/84→03/88	G62B	Petrol	1796	4	8	29
Tredia (A21_)	10/86→03/88	4G63 (SOHC 8V)	Petrol	1997	4	8	45











CC



9

Model	Year Range	Engine	Fuel	CC	Cylinders	Power (kW)	Power (hp)
Verada Estate (KE)	10/96→06/97	6G72 (DOHC 24V)	Petrol	2972	6	24	71
Verada Estate (KE)	10/96→06/97	6G74 (SOHC 24V)	Petrol	3497	6	24	77
Verada Estate (KF)	06/97→03/99	6G74 (SOHC 24V)	Petrol	3497	6	24	77
Verada Estate (KH)	03/99→08/00	6G74 (SOHC 24V)	Petrol	3497	6	24	77
Verada Estate (KJ)	08/00→05/03	6G74 (SOHC 24V)	Petrol	3497	6	24	77
Verada Estate (KL)	06/03→10/04	6G74 (SOHC 24V)	Petrol	3497	6	24	77
Verada Estate (KR)	08/91→02/94	6G72 (SOHC 12V)	Petrol	2972	6	12	72
Verada Estate (KR, KS)	05/91→10/92	4G54	Petrol	2555	4	8	65
Verada Estate (KS)	03/94→03/97	6G72 (SOHC 12V)	Petrol	2972	6	12	72
Verada Estate (KW)	10/04→07/05	6G74 (SOHC 24V)	Petrol	3497	6	24	77
Verada Saloon (KE)	10/96→10/97	6G74 (SOHC 24V)	Petrol	3497	6	24	77
Verada Saloon (KH)	03/99→08/00	6G74 (SOHC 24V)	Petrol	3497	6	24	77
Verada Saloon (KJ)	08/00→05/03	6G74 (SOHC 24V)	Petrol	3497	6	24	77
Verada Saloon (KL)	06/03→10/04	6G74 (SOHC 24V)	Petrol	3497	6	24	77
Verada Saloon (KR, KS)	05/91→10/92	4G54	Petrol	2555	4	8	65
Verada Saloon (KR, KS)	07/91→05/96	6G72 (SOHC 12V)	Petrol	2972	6	12	72
Verada Saloon (KR, KS)	03/94→05/96	6G72 (SOHC 24V)	Petrol	2972	6	24	73
Verada Saloon (KW)	10/04→07/05	6G74 (SOHC 24V)	Petrol	3497	6	24	77
Verada Saloon (KW, KJ, KF, KE, KL, KH)	06/97→05/05	6G74 (SOHC 24V)	Petrol	3497	6	24	77
Verada Saloon (KW, KJ, KF, KE, KL, KH)	06/99→09/02	6G72 (SOHC 12V)	Petrol	2972	6	12	72
Veryca Box Body / Estate (CA9_W, CA8_W)	10/11→	4G13 (16V)	Petrol	1299	4	16	10
Zinger MPV (KBO_A)	10/05→	4G64 (16V)	Petrol	2351	4	16	60
Zinger MPV (KBO_A)	04/08→	4G69	Petrol	2378	4	16	60

	CC				9		CC				9
3A91	1124	3	12	Petrol	2	4HK	2179	4	16	Diesel	55
3B20	659	3	12	Petrol	1	4HN	2179	4	16	Diesel	55
4A90	1332	4	16	Petrol	7	4M40	2835	4	8	Diesel	70
4A91	1499	4	16	Petrol	13	4M40-2AT	2835	4	8	Diesel	70
4B10	1798	4	16	Petrol	26	4M40-A	2835	4	8	Diesel	70
4B11	1998	4	16	Petrol	39	4M40-T	2835	4	8	Diesel	70
4B11FQ30	1998	4	16	Petrol	40	4M41	3200	4	16	Diesel	74
4B11FQ60	1998	4	16	Petrol	40	6A12	1999	6	24	Petrol	46
4B11 T	1998	4	16	Petrol	40	6A13	2498	6	24	Petrol	66
4B11 T/C	1998	4	16	Petrol	40	6D14	6557	6	12	Diesel	81
4B12	2360	4	16	Petrol	58	6D16	7545	6	12	Diesel	82
4D30	3297	4	8	Diesel	75	6G72 (DOHC 24V)	2972	6	24	Petrol	71
4D31	3298	4	8	Diesel	75	6G72 (SOHC 12V)	2972	6	12	Petrol	72
4D31T	3298	4	8	Diesel	75	6G72 (SOHC 24V)	2972	6	24	Petrol	73
4D55	2347	4	8	Diesel	56	6G72T	2972	6	24	Petrol	71
4D55 T	2347	4	8	Diesel	56	6G73	2497	6	24	Petrol	67
4D56 (16V)	2477	4	16	Diesel	63	6G74 (DOHC 24V)	3497	6	24	Petrol	76
4D56 (8V)	2477	4	8	Diesel	62	6G74 (SOHC 24V)	3497	6	24	Petrol	77
4D56 HP	2477	4	16	Diesel	64	6G75	3828	6	24	Petrol	80
4D56 T	2477	4	8	Diesel	62	9HD	1560	4	8	Diesel	25
4D56 TD	2477	4	8	Diesel	62	BKD	1968	4	16	Diesel	51
4D65	1796	4	8	Diesel	27	BMM	1968	4	8	Diesel	52
4D65 T	1796	4	8	Diesel	27	BSY	1968	4	16	Diesel	51
4D68	1998	4	8	Diesel	41	BWC	1968	4	16	Diesel	53
4D68 T	1998	4	8	Diesel	41	CR12DE	1240	4	16	Petrol	5
4G11	1244	4	8	Petrol	3	D4BF	2476	4	8	Diesel	68
4G12	1410	4	8	Petrol	11	D4BH	2476	4	8	Diesel	68
4G12 T	1410	4	8	Petrol	11	F8Q 784	1870	4	8	Diesel	36
4G13 (12V)	1299	4	12	Petrol	9	F8QT	1870	4	8	Diesel	37
4G13 (16V)	1299	4	16	Petrol	10	F9Q1	1870	4	8	Diesel	38
4G13 (8V)	1299	4	8	Petrol	8	F9Q2	1870	4	8	Diesel	38
4G13 P	1298	4	12	Petrol	10	G6AT	2972	6	12	Petrol	72
4G15 (12V)	1468	4	12	Petrol	15	G11B	1244	4	8	Petrol	3
4G15 (16V)	1468	4	16	Petrol	16	G12B	1410	4	8	Petrol	11
4G15 (8V)	1468	4	8	Petrol	14	G13B	1299	4	8	Petrol	8
4G15T	1468	4	16	Petrol	17	G15B	1468	4	8	Petrol	14
4G16	1198	4	8	Petrol	3	G32B	1597	4	8	Petrol	20
4G18	1584	4	16	Petrol	19	G32BT	1597	4	8	Petrol	20
4G32	1597	4	8	Petrol	20	G33B	1439	4	8	Petrol	12
4G32 GS	1597	4	8	Petrol	21	G37B	1755	4	8	Petrol	28
4G32 T	1597	4	8	Petrol	20	G51B	1855	4	8	Petrol	35
4G32 T/C	1597	4	8	Petrol	20	G52B	1995	4	8	Petrol	43
4G33	1439	4	8	Petrol	12	G54B	2555	4	8	Petrol	69
4G36	1238	4	8	Petrol	4	G54B T/C	2555	4	8	Petrol	65
4G37	1755	4	8	Petrol	28	G62B	1796	4	8	Petrol	29
4G51	1855	4	8	Petrol	35	G63B	1997	4	8	Petrol	54
4G52	1995	4	8	Petrol	42	G64B	2351	4	8	Petrol	61
4G52-T	1995	4	8	Petrol	43	K12B	1242	4	16	Petrol	6
4G54	2555	4	8	Petrol	65	MR18DE	1797	4	16	Petrol	34
4G61	1596	4	16	Petrol	22	OM457-T2	11967	6	24	Diesel	83
4G61 T	1596	4	16	Petrol	22	OM457-T3	11967	6	24	Diesel	83
4G62	1795	4	8	Petrol	29	OM457-T5	11967	6	24	Diesel	83
4G62 T	1795	4	8	Petrol	29	OM 639.939	1493	3	12	Diesel	18
4G63 (DOHC 16V)	1997	4	16	Petrol	44	VQ35HR	3498	6	24	Petrol	78
4G63 (SOHC 16V)	1997	4	16	Petrol	46	VQ37VHR	3696	6	24	Petrol	79
4G63 (SOHC 8V)	1997	4	8	Petrol	45						
4G63 T (DOHC 16V)	1997	4	16	Petrol	44						
4G63 T (ECI)	1997	4	8	Petrol	47						
4G63 T (SOHC 8V)	1997	4	8	Petrol	47						
4G63 T/C	1997	4	8	Petrol	47						
4G63 Turbo	1997	4	16	Petrol	48						
4G64 (12V)	2351	4	12	Petrol	59						
4G64 (16V)	2351	4	16	Petrol	60						
4G64 (8V)	2351	4	8	Petrol	57						
4G64 (GDI)	2351	4	16	Petrol	60						
4G67	1836	4	16	Petrol	30						
4 G 69	2378	4	16	Petrol	60						
4G69	2378	4	16	Petrol	60						
4G69	2378	4	16	Petrol	60						
4G92 (DOHC 16V)	1597	4	16	Petrol	23						
4G92 (SOHC 16V)	1597	4	16	Petrol	24						
4G93 (DOHC 16V)	1834	4	16	Petrol	31						
4G93 (GDI)	1834	4	16	Petrol	31						
4G93 (SOHC 16V)	1834	4	16	Petrol	32						
4G93T	1834	4	16	Petrol	33						
4G93T (GDI)	1834	4	16	Petrol	31						
4G94	1999	4	16	Petrol	49						
4G94 (GDI)	1999	4	16	Petrol	50						

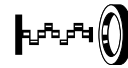
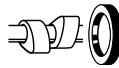

1 0.7L Petrol				
3B20	3 Cyl.	12 Valves	659cc	TD25033
HR5096				
2 1.1L Petrol				
3A91	3 Cyl.	12 Valves	1124cc	TD18553
PA5025 (x12) HR5096				
3 1.2L Petrol				
4G11	4 Cyl.	8 Valves	1244cc	TD2301
4G16	4 Cyl.	8 Valves	1198cc	TD2309
G11B	4 Cyl.	8 Valves	1244cc	TD2355
KJ570 (x8)	NJ933 35.00 x 50.00 x 8.00mm, FPM NJ242 35.00 x 50.00 x 8.00mm, NBR		NJ252 30.00 x 46.00 x 7.00mm, NBR NJ006 72.00 x 96.00 x 9.00mm, MVQ	
4 1.2L Petrol				
4G36	4 Cyl.	8 Valves	1238cc	TD2315
KJ211 (x8)	NJ933 35.00 x 50.00 x 8.00mm, FPM NJ242 35.00 x 50.00 x 8.00mm, NBR		NJ005 44.00 x 60.00 x 7.00mm, NBR NJ006 72.00 x 96.00 x 9.00mm, MVQ	
5 1.2L Petrol				
CR12DE	4 Cyl.	16 Valves	1240cc	TD27462
PB681 (x16)				
NJ222 40.00 x 52.00 x 7.00mm, FPM NJ765 40.00 x 52.00 x 7.00mm, NBR NJ284 84.00 x 104.00 x 11.00mm, MVQ				
6 1.2L Petrol				
K12B	4 Cyl.	16 Valves	1242cc	TD25235
HR5128				
7 1.3L Petrol				
4A90	4 Cyl.	16 Valves	1332cc	TD18554
PA5025 (x16) HR5048				
8 1.3L Petrol				
4G13 (8V)	4 Cyl.	8 Valves	1299cc	TD2304
G13B	4 Cyl.	8 Valves	1299cc	TD12952
KJ570 (x8)	NJ933 35.00 x 50.00 x 8.00mm, FPM NJ242 35.00 x 50.00 x 8.00mm, NBR		NJ252 30.00 x 46.00 x 7.00mm, NBR NJ006 72.00 x 96.00 x 9.00mm, MVQ	

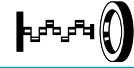

9 1.3L Petrol

4G13 (12V) KJ570 (x12)	4 Cyl.	12 Valves	1299cc	TD2305
	NJ933 35.00 x 50.00 x 8.00mm, FPM NJ242 35.00 x 50.00 x 8.00mm, NBR		NJ252 30.00 x 46.00 x 7.00mm, NBR NJ006 72.00 x 96.00 x 9.00mm, MVQ	

10 1.3L Petrol

4G13 (16V)	4 Cyl.	16 Valves	1299cc	TD11610
4G13 P	4 Cyl.	12 Valves	1298cc	TD26928
	NJ933 35.00 x 50.00 x 8.00mm, FPM NJ242 35.00 x 50.00 x 8.00mm, NBR		NJ252 30.00 x 46.00 x 7.00mm, NBR NJ006 72.00 x 96.00 x 9.00mm, MVQ	

11 1.4L Petrol

4G12	4 Cyl.	8 Valves	1410cc	TD2302
4G12 T	4 Cyl.	8 Valves	1410cc	TD2303
G12B KJ570 (x8)	4 Cyl.	8 Valves	1410cc	TD2356
	NJ933 35.00 x 50.00 x 8.00mm, FPM NJ242 35.00 x 50.00 x 8.00mm, NBR		NJ252 30.00 x 46.00 x 7.00mm, NBR NJ006 72.00 x 96.00 x 9.00mm, MVQ	

12 1.4L Petrol

4G33	4 Cyl.	8 Valves	1439cc	TD2313
G33B KJ211 (x8)	4 Cyl.	8 Valves	1439cc	TD2363
	NJ933 35.00 x 50.00 x 8.00mm, FPM NJ242 35.00 x 50.00 x 8.00mm, NBR		NJ005 44.00 x 60.00 x 7.00mm, NBR NJ006 72.00 x 96.00 x 9.00mm, MVQ	

13 1.5L Petrol

4A91 PA5025 (x16) HR5048	4 Cyl.	16 Valves	1499cc	TD18555
---	--------	-----------	--------	----------------

14 1.5L Petrol

4G15 (8V)	4 Cyl.	8 Valves	1468cc	TD2308
G15B KJ570 (x8)	4 Cyl.	8 Valves	1468cc	TD2358
	NJ933 35.00 x 50.00 x 8.00mm, FPM NJ242 35.00 x 50.00 x 8.00mm, NBR		NJ252 30.00 x 46.00 x 7.00mm, NBR NJ006 72.00 x 96.00 x 9.00mm, MVQ	

15 1.5L Petrol

4G15 (12V) KJ570 (x12)	4 Cyl.	12 Valves	1468cc	TD5327
	NJ933 35.00 x 50.00 x 8.00mm, FPM NJ242 35.00 x 50.00 x 8.00mm, NBR		NJ252 30.00 x 46.00 x 7.00mm, NBR NJ006 72.00 x 96.00 x 9.00mm, MVQ	

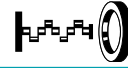

16 1.5L

Petrol

4G15 (16V)	4 Cyl.	16 Valves	1468cc	TD14208
PA425 (x16)	NJ933 (x2) 35.00 x 50.00 x 8.00mm, FPM NJ242 (x2) 35.00 x 50.00 x 8.00mm, NBR		NJ252 30.00 x 46.00 x 7.00mm, NBR NJ006 72.00 x 96.00 x 9.00mm, MVQ	

17 1.5L

Petrol

4G15T	4 Cyl.	16 Valves	1468cc	TD18562
	NF841 35.00 x 50.00 x 8.00mm, FPM		NJ252 30.00 x 46.00 x 7.00mm, NBR NJ006 72.00 x 96.00 x 9.00mm, MVQ	

18 1.5L

Diesel

OM 639.939	3 Cyl.	12 Valves	1493cc	TD27273
PA5041 (x12) HR791			NA5332 40.00 x 62.00 x 8.00mm, FPM	

19 1.6L

Petrol

4G18	4 Cyl.	16 Valves	1584cc	TD18557
	NJ933 (x2) 35.00 x 50.00 x 8.00mm, FPM NJ242 (x2) 35.00 x 50.00 x 8.00mm, NBR		NJ252 30.00 x 46.00 x 7.00mm, NBR NJ006 72.00 x 96.00 x 9.00mm, MVQ	

20 1.6L

Petrol

4G32	4 Cyl.	8 Valves	1597cc	TD5325
4G32 T	4 Cyl.	8 Valves	1597cc	TD2312
4G32 T/C	4 Cyl.	8 Valves	1597cc	TD5309
G32B	4 Cyl.	8 Valves	1597cc	TD2362
G32BT	4 Cyl.	8 Valves	1597cc	TD18868
KJ211 (x8)	NJ933 35.00 x 50.00 x 8.00mm, FPM NJ242 35.00 x 50.00 x 8.00mm, NBR		NJ005 44.00 x 60.00 x 7.00mm, NBR NJ006 72.00 x 96.00 x 9.00mm, MVQ	

21 1.6L

Petrol

4G32 GS	4 Cyl.	8 Valves	1597cc	TD5314
KJ211 (x8)			NJ005 44.00 x 60.00 x 7.00mm, NBR NJ006 72.00 x 96.00 x 9.00mm, MVQ	

22 1.6L

Petrol

4G61	4 Cyl.	16 Valves	1596cc	TD4685
4G61 T	4 Cyl.	16 Valves	1596cc	TD31588
KJ570 (x16)	NJ933 (x2) 35.00 x 50.00 x 8.00mm, FPM NJ242 (x2) 35.00 x 50.00 x 8.00mm, NBR		NJ005 44.00 x 60.00 x 7.00mm, NBR NJ251 80.00 x 96.00 x 9.00mm, MVQ	

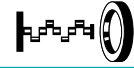

23 1.6L		Petrol		
4G92 (DOHC 16V)	4 Cyl.	16 Valves	1597cc	TD31599
	NJ933 (x2) 35.00 x 50.00 x 8.00mm, FPM		NJ874 37.00 x 50.00 x 6.00mm, ACM	
	NJ242 (x2) 35.00 x 50.00 x 8.00mm, NBR		NK143 85.00 x 103.00 x 8.00mm, FPM	
24 1.6L		Petrol		
4G92 (SOHC 16V)	4 Cyl.	16 Valves	1597cc	TD2341
	NJ933 35.00 x 50.00 x 8.00mm, FPM		NJ874 37.00 x 50.00 x 6.00mm, ACM	
	NJ242 35.00 x 50.00 x 8.00mm, NBR		NK143 85.00 x 103.00 x 8.00mm, FPM	
25 1.6L		Diesel		
9HD	4 Cyl.	8 Valves	1560cc	TD31497
			NA5325 85.00 x 105.00 x 8.80mm, PTFE	
26 1.8L		Petrol		
4B10	4 Cyl.	16 Valves	1798cc	TD23517
			NA5108 42.00 x 55.00 x 7.00mm, FPM/ACM	
27 1.8L		Diesel		
4D65	4 Cyl.	8 Valves	1796cc	TD2300
4D65 T	4 Cyl.	8 Valves	1796cc	TD2296
KJ211 (x8)	NJ933 35.00 x 50.00 x 8.00mm, FPM		NJ005 44.00 x 60.00 x 7.00mm, NBR	
	NJ242 35.00 x 50.00 x 8.00mm, NBR		NJ251 80.00 x 96.00 x 9.00mm, MVQ	
28 1.8L		Petrol		
4G37	4 Cyl.	8 Valves	1755cc	TD2316
G37B	4 Cyl.	8 Valves	1755cc	TD2365
KJ211 (x8)	NJ933 35.00 x 50.00 x 8.00mm, FPM		NJ005 44.00 x 60.00 x 7.00mm, NBR	
	NJ242 35.00 x 50.00 x 8.00mm, NBR		NJ006 72.00 x 96.00 x 9.00mm, MVQ	
29 1.8L		Petrol		
4G62	4 Cyl.	8 Valves	1795cc	TD5326
4G62 T	4 Cyl.	8 Valves	1795cc	TD2326
G62B	4 Cyl.	8 Valves	1796cc	TD2369
KJ211 (x8)	NJ933 35.00 x 50.00 x 8.00mm, FPM		NJ005 44.00 x 60.00 x 7.00mm, NBR	
	NJ242 35.00 x 50.00 x 8.00mm, NBR		NJ251 80.00 x 96.00 x 9.00mm, MVQ	
30 1.8L		Petrol		
4G67	4 Cyl.	16 Valves	1836cc	TD2337
KJ570 (x16)	NJ933 (x2) 35.00 x 50.00 x 8.00mm, FPM		NJ005 44.00 x 60.00 x 7.00mm, NBR	
	NJ242 (x2) 35.00 x 50.00 x 8.00mm, NBR		NJ251 80.00 x 96.00 x 9.00mm, MVQ	

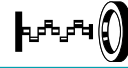

31 1.8L

Petrol

4G93 (DOHC 16V)	4 Cyl.	16 Valves	1834cc	TD32187
4G93 (GDI)	4 Cyl.	16 Valves	1834cc	TD26289
4G93T (GDI)	4 Cyl.	16 Valves	1834cc	TD26290

NJ933 (x2)
35.00 x 50.00 x 8.00mm, FPM
NJ242 (x2)
35.00 x 50.00 x 8.00mm, NBR

NJ874
37.00 x 50.00 x 6.00mm, ACM
NK143
85.00 x 103.00 x 8.00mm, FPM

32 1.8L

Petrol

4G93 (SOHC 16V)	4 Cyl.	16 Valves	1834cc	TD2346
-----------------	--------	-----------	--------	--------

NJ933
35.00 x 50.00 x 8.00mm, FPM
NJ242
35.00 x 50.00 x 8.00mm, NBR

NJ874
37.00 x 50.00 x 6.00mm, ACM
NK143
85.00 x 103.00 x 8.00mm, FPM

33 1.8L

Petrol

4G93T	4 Cyl.	16 Valves	1834cc	TD23871
-------	--------	-----------	--------	---------

NJ933 (x2)
35.00 x 50.00 x 8.00mm, FPM
NJ242 (x2)
35.00 x 50.00 x 8.00mm, NBR

NK143
85.00 x 103.00 x 8.00mm, FPM

34 1.8L

Petrol

MR18DE PB681 (x16)	4 Cyl.	16 Valves	1797cc	TD27464
-----------------------	--------	-----------	--------	---------

NK106
46.00 x 58.00 x 7.00mm, ACM

35 1.9L

Petrol

4G51	4 Cyl.	8 Valves	1855cc	TD2319
4G51B	4 Cyl.	8 Valves	1855cc	TD2366
KJ211 (x8)				

NJ251
80.00 x 96.00 x 9.00mm, MVQ

36 1.9L

Diesel

F8Q 784 HR569	4 Cyl.	8 Valves	1870cc	TD22343
------------------	--------	----------	--------	---------

NF846
25.00 x 42.00 x 7.00mm, FPM/ACM

NA5036
42.00 x 54.00 x 6.00mm, FPM
NF843
50.00 x 68.00 x 10.00mm, FPM/ACM
NF850
85.00 x 105.00 x 8.00mm, FPM

37 1.9L

Diesel

F8QT HR569	4 Cyl.	8 Valves	1870cc	TD16271
---------------	--------	----------	--------	---------

NF846
25.00 x 42.00 x 7.00mm, FPM/ACM

NF843
50.00 x 68.00 x 10.00mm, FPM/ACM
NA5037
85.00 x 105.00 x 11.00mm, ACM
NF850
85.00 x 105.00 x 8.00mm, FPM

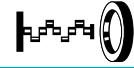

38 1.9L Diesel

F9Q1	4 Cyl.	8 Valves	1870cc	TD20725
F9Q2	4 Cyl.	8 Valves	1870cc	TD18558
HR816	NF846 25.00 x 42.00 x 7.00mm, FPM/ACM		NA5036 42.00 x 54.00 x 6.00mm, FPM NF850 85.00 x 105.00 x 8.00mm, FPM	

39 2.0L Petrol

4B11	4 Cyl.	16 Valves	1998cc	TD20775
			NA5108 42.00 x 55.00 x 7.00mm, FPM/ACM NK143 85.00 x 103.00 x 8.00mm, FPM	

40 2.0L Petrol

4B11FQ30	4 Cyl.	16 Valves	1998cc	TD26138
4B11FQ60	4 Cyl.	16 Valves	1998cc	TD25147
4B11 T	4 Cyl.	16 Valves	1998cc	TD32385
4B11 T/C	4 Cyl.	16 Valves	1998cc	TD20773
			NA5108 42.00 x 55.00 x 7.00mm, FPM/ACM	

41 2.0L Diesel

4D68	4 Cyl.	8 Valves	1998cc	TD2298
4D68 T	4 Cyl.	8 Valves	1998cc	TD4684
KJ211 (x8)	NJ933 35.00 x 50.00 x 8.00mm, FPM NJ242 35.00 x 50.00 x 8.00mm, NBR		NJ005 44.00 x 60.00 x 7.00mm, NBR NK143 85.00 x 103.00 x 8.00mm, FPM	

42 2.0L Petrol

4G52	4 Cyl.	8 Valves	1995cc	TD5319
KJ211 (x8)			NJ057 48.00 x 68.00 x 11.00mm, ACM NJ251 80.00 x 96.00 x 9.00mm, MVQ	

43 2.0L Petrol

4G52-T	4 Cyl.	8 Valves	1995cc	TD24124
G52B	4 Cyl.	8 Valves	1995cc	TD2367
KJ211 (x8)			NJ251 80.00 x 96.00 x 9.00mm, MVQ	

44 2.0L Petrol

4G63 (DOHC 16V)	4 Cyl.	16 Valves	1997cc	TD2328
4G63 T (DOHC 16V)	4 Cyl.	16 Valves	1997cc	TD23917
KJ570 (x16)	NJ933 (x2) 35.00 x 50.00 x 8.00mm, FPM NJ242 (x2) 35.00 x 50.00 x 8.00mm, NBR		NJ005 44.00 x 60.00 x 7.00mm, NBR NK143 85.00 x 103.00 x 8.00mm, FPM	

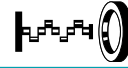
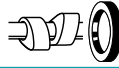

45 2.0L

Petrol

4G63 (SOHC 8V)	4 Cyl.	8 Valves	1997cc	TD4688
KJ211 (x8)	NJ933 35.00 x 50.00 x 8.00mm, FPM	NJ005 44.00 x 60.00 x 7.00mm, NBR	NK143 85.00 x 103.00 x 8.00mm, FPM	
	NJ242 35.00 x 50.00 x 8.00mm, NBR			

46 2.0L

Petrol

4G63 (SOHC 16V)	4 Cyl.	16 Valves	1997cc	TD26410
6A12	6 Cyl.	24 Valves	1999cc	TD2348
	NJ933 35.00 x 50.00 x 8.00mm, FPM	NJ005 44.00 x 60.00 x 7.00mm, NBR	NK143 85.00 x 103.00 x 8.00mm, FPM	
	NJ242 35.00 x 50.00 x 8.00mm, NBR			

47 2.0L

Petrol

4G63 T (ECI)	4 Cyl.	8 Valves	1997cc	TD5313
4G63 T (SOHC 8V)	4 Cyl.	8 Valves	1997cc	TD2333
4G63 T/C	4 Cyl.	8 Valves	1997cc	TD5323
KJ211 (x8)	NJ933 35.00 x 50.00 x 8.00mm, FPM	NJ005 44.00 x 60.00 x 7.00mm, NBR	NJ251 80.00 x 96.00 x 9.00mm, MVQ	
	NJ242 35.00 x 50.00 x 8.00mm, NBR			

48 2.0L

Petrol

4G63 Turbo	4 Cyl.	16 Valves	1997cc	TD14209
KJ570 (x16)	NF841 (x2) 35.00 x 50.00 x 8.00mm, FPM	NJ005 44.00 x 60.00 x 7.00mm, NBR	NK143 85.00 x 103.00 x 8.00mm, FPM	

49 2.0L

Petrol

4G94	4 Cyl.	16 Valves	1999cc	TD26286
	NJ933 35.00 x 50.00 x 8.00mm, FPM	NJ874 37.00 x 50.00 x 6.00mm, ACM	NK143 85.00 x 103.00 x 8.00mm, FPM	
	NJ242 35.00 x 50.00 x 8.00mm, NBR			

50 2.0L

Petrol

4G94 (GDI)	4 Cyl.	16 Valves	1999cc	TD16130
	NJ933 (x2) 35.00 x 50.00 x 8.00mm, FPM	NJ874 37.00 x 50.00 x 6.00mm, ACM	NK143 85.00 x 103.00 x 8.00mm, FPM	
	NJ242 (x2) 35.00 x 50.00 x 8.00mm, NBR			

51 2.0L

Diesel

BKD	4 Cyl.	16 Valves	1968cc	TD22162
BSY	4 Cyl.	16 Valves	1968cc	TD18560
PA5041 (x16) HR791	NA5124 (x2) 32.00 x 47.00 x 10.00mm, PTFE/ACM	NA5106 35.00 x 48.00 x 10.00mm, PTFE	LK5012 85.00 x 132.00 x 15.70mm, PTFE	

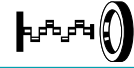

52 2.0L Diesel

BMM	4 Cyl.	8 Valves	1968cc	TD22164
HR816	NA5124 32.00 x 47.00 x 10.00mm, PTFE/ACM		NA5106 35.00 x 48.00 x 10.00mm, PTFE LK5012 85.00 x 132.00 x 15.70mm, PTFE	

53 2.0L Diesel

BWC	4 Cyl.	16 Valves	1968cc	TD24548
PA5041 (x16) HR791	NA5124 32.00 x 47.00 x 10.00mm, PTFE/ACM		NA5106 35.00 x 48.00 x 10.00mm, PTFE LK5012 85.00 x 132.00 x 15.70mm, PTFE	

54 2.0L Petrol

G63B	4 Cyl.	8 Valves	1997cc	TD4692
KJ211 (x8)	NJ933 35.00 x 50.00 x 8.00mm, FPM NJ242 35.00 x 50.00 x 8.00mm, NBR		NJ005 44.00 x 60.00 x 7.00mm, NBR NJ251 80.00 x 96.00 x 9.00mm, MVQ →04/92 NK143 85.00 x 103.00 x 8.00mm, FPM 05/92→	

55 2.2L Diesel

4HK	4 Cyl.	16 Valves	2179cc	TD24800
4HN	4 Cyl.	16 Valves	2179cc	TD24440
	NA5035 (x2) 27.00 x 47.00 x 7.00mm, FPM		NA5191 42.00 x 62.00 x 7.00mm, PTFE NA5192 90.00 x 110.00 x 7.00mm, PTFE	

56 2.3L Diesel

4D55	4 Cyl.	8 Valves	2347cc	TD5331
4D55 T	4 Cyl.	8 Valves	2347cc	TD2292
KJ211 (x8)	NJ933 35.00 x 50.00 x 8.00mm, FPM NJ242 35.00 x 50.00 x 8.00mm, NBR		NJ005 44.00 x 60.00 x 7.00mm, NBR NJ251 80.00 x 96.00 x 9.00mm, MVQ	

57 2.3L Petrol

4G64 (8V)	4 Cyl.	8 Valves	2351cc	TD2335
KJ211 (x8)	NJ933 35.00 x 50.00 x 8.00mm, FPM NJ242 35.00 x 50.00 x 8.00mm, NBR		NK143 85.00 x 103.00 x 8.00mm, FPM NJ058 80.00 x 96.00 x 9.00mm, NBR	

58 2.4L Petrol

4B12	4 Cyl.	16 Valves	2360cc	TD20774
			NA5108 42.00 x 55.00 x 7.00mm, FPM/ACM NK143 85.00 x 103.00 x 8.00mm, FPM	

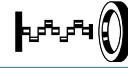

59 2.4L

Petrol

4G64 (12V)	4 Cyl.	12 Valves	2351cc	TD4689
	NJ933 (x2) 35.00 x 50.00 x 8.00mm, FPM NJ242 (x2) 35.00 x 50.00 x 8.00mm, NBR			

60 2.4L

Petrol

4G64 (16V)	4 Cyl.	16 Valves	2351cc	TD25166
4G64 (GDI)	4 Cyl.	16 Valves	2351cc	TD11611
4 G 69	4 Cyl.	16 Valves	2378cc	TD25389
4G69	4 Cyl.	16 Valves	2378cc	TD25374
4G69	4 Cyl.	16 Valves	2378cc	TD18559
	NJ933 35.00 x 50.00 x 8.00mm, FPM NJ242 35.00 x 50.00 x 8.00mm, NBR			NJ005 44.00 x 60.00 x 7.00mm, NBR NK143 85.00 x 103.00 x 8.00mm, FPM

61 2.4L

Petrol

G64B	4 Cyl.	8 Valves	2351cc	TD4693
KJ211 (x8)	NJ933 35.00 x 50.00 x 8.00mm, FPM NJ242 35.00 x 50.00 x 8.00mm, NBR			NJ005 44.00 x 60.00 x 7.00mm, NBR NJ251 80.00 x 96.00 x 9.00mm, MVQ →04/92 NK143 85.00 x 103.00 x 8.00mm, FPM 05/92→

62 2.5L

Diesel

4D56 (8V)	4 Cyl.	8 Valves	2477cc	TD2293
4D56 T	4 Cyl.	8 Valves	2477cc	TD4682
4D56 TD	4 Cyl.	8 Valves	2477cc	TD2294
KJ211 (x8)	NJ933 35.00 x 50.00 x 8.00mm, FPM NJ242 35.00 x 50.00 x 8.00mm, NBR			NJ005 44.00 x 60.00 x 7.00mm, NBR NJ251 80.00 x 96.00 x 9.00mm, MVQ

63 2.5L

Diesel

4D56 (16V)	4 Cyl.	16 Valves	2477cc	TD30760
	NJ933 35.00 x 50.00 x 8.00mm, FPM NJ242 35.00 x 50.00 x 8.00mm, NBR			

64 2.5L

Diesel

4D56 HP	4 Cyl.	16 Valves	2477cc	TD24055
PA425 (x16)	NJ933 (x2) 35.00 x 50.00 x 8.00mm, FPM NJ242 (x2) 35.00 x 50.00 x 8.00mm, NBR			

65 2.5L

Petrol

4G54	4 Cyl.	8 Valves	2555cc	TD2322
G54B T/C	4 Cyl.	8 Valves	2555cc	TD5329
KJ211 (x8)				NJ251 80.00 x 96.00 x 9.00mm, MVQ

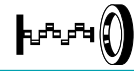
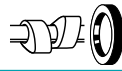

66 2.5L Petrol

6A13	6 Cyl.	24 Valves	2498cc	TD5507
	NJ933 (x2) 35.00 x 50.00 x 8.00mm, FPM NJ242 (x2) 35.00 x 50.00 x 8.00mm, NBR		NJ242 35.00 x 50.00 x 8.00mm, NBR NK143 85.00 x 103.00 x 8.00mm, FPM	

67 2.5L Petrol

6G73	6 Cyl.	24 Valves	2497cc	TD2353
KJ570 (x24)	NA5053 30.00 x 42.00 x 7.00mm, FPM		NJ242 35.00 x 50.00 x 8.00mm, NBR NK143 85.00 x 103.00 x 8.00mm, FPM	

68 2.5L Diesel

D4BF	4 Cyl.	8 Valves	2476cc	TD26100
D4BH	4 Cyl.	8 Valves	2476cc	TD29225
KJ211 (x8)	NJ933 35.00 x 50.00 x 8.00mm, FPM NJ242 35.00 x 50.00 x 8.00mm, NBR		NJ005 44.00 x 60.00 x 7.00mm, NBR NJ058 80.00 x 96.00 x 9.00mm, NBR	

69 2.6L Petrol

G54B	4 Cyl.	8 Valves	2555cc	TD2368
KJ211 (x8)				NJ251 80.00 x 96.00 x 9.00mm, MVQ

70 2.8L Diesel

4M40	4 Cyl.	8 Valves	2835cc	TD2347
4M40-2AT	4 Cyl.	8 Valves	2835cc	TD16264
4M40-A	4 Cyl.	8 Valves	2835cc	TD16265
4M40-T	4 Cyl.	8 Valves	2835cc	TD19658
KJ211 (x8)				NA5243 50.00 x 74.00 x 11.00mm, ACM NA5244 91.00 x 114.00 x 12.00mm, MVQ

71 3.0L Petrol

6G72 (DOHC 24V)	6 Cyl.	24 Valves	2972cc	TD2350
6G72T	6 Cyl.	24 Valves	2972cc	TD18867
KJ570 (x24)	NA5053 (x2) 30.00 x 42.00 x 7.00mm, FPM		NJ874 37.00 x 50.00 x 6.00mm, ACM NA5140 91.00 x 111.00 x 10.00mm, FPM	

72 3.0L Petrol

6G72 (SOHC 12V)	6 Cyl.	12 Valves	2972cc	TD8290
G6AT	6 Cyl.	12 Valves	2972cc	TD18869
KJ211 (x12)	NJ933 35.00 x 50.00 x 8.00mm, FPM NJ242 35.00 x 50.00 x 8.00mm, NBR		NJ874 37.00 x 50.00 x 6.00mm, ACM NA5140 91.00 x 111.00 x 10.00mm, FPM	

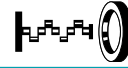

73 3.0L

Petrol

6G72 (SOHC 24V)

6 Cyl. 24 Valves 2972cc

TD25167

NF841
35.00 x 50.00 x 8.00mm, FPM

NJ874
37.00 x 50.00 x 6.00mm, ACM
NA5140
91.00 x 111.00 x 10.00mm, FPM

74 3.2L

Diesel

4M41

4 Cyl. 16 Valves 3200cc

TD18561

NA5243
50.00 x 74.00 x 11.00mm, ACM

75 3.3L

Diesel

4D30

4 Cyl. 8 Valves 3297cc

TD8268

4D31

4 Cyl. 8 Valves 3298cc

TD8293

4D31T

4 Cyl. 8 Valves 3298cc

TD8269

PA525 (x8)

NJ258
55.00 x 78.00 x 12.00mm, NBR

76 3.5L

Petrol

6G74 (DOHC 24V)

6 Cyl. 24 Valves 3497cc

TD2354

KJ570 (x24)

NA5053 (x2)
30.00 x 42.00 x 7.00mm, FPM

NJ874
37.00 x 50.00 x 6.00mm, ACM
NA5140
91.00 x 111.00 x 10.00mm, FPM

77 3.5L

Petrol

6G74 (SOHC 24V)

6 Cyl. 24 Valves 3497cc

TD25165

NF841
35.00 x 50.00 x 8.00mm, FPM

NJ874
37.00 x 50.00 x 6.00mm, ACM
NA5140
91.00 x 111.00 x 10.00mm, FPM

78 3.5L

Petrol

VQ35HR

6 Cyl. 24 Valves 3498cc

TD26606

PA874 (x24)

79 3.7L

Petrol

VQ37VHR

6 Cyl. 24 Valves 3696cc

TD26605

PA874 (x24)

80 3.8L

Petrol

6G75

6 Cyl. 24 Valves 3828cc

TD19287

NF841
35.00 x 50.00 x 8.00mm, FPM

NJ874
37.00 x 50.00 x 6.00mm, ACM
NA5140
91.00 x 111.00 x 10.00mm, FPM
NJ873
91.00 x 111.00 x 9.00mm, FPM

81 6.6L

Diesel

6D14

6 Cyl. 12 Valves 6557cc

TD8283

PA525 (x12)
01/76→12/82

NJ496
72.00 x 94.00 x 12.00mm, NBR
NJ497
100.00 x 123.00 x 12.50mm, MVQ
01/76→12/82

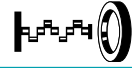

82 7.5L

Diesel

6D16	6 Cyl.	12 Valves	7545cc	TD20180
				NJ496 72.00 x 94.00 x 12.00mm, NBR

83 12.0L

Diesel

OM457-T2	6 Cyl.	24 Valves	11967cc	TD27071
OM457-T3	6 Cyl.	24 Valves	11967cc	TD27068
OM457-T5	6 Cyl.	24 Valves	11967cc	TD27070
				NB928 105.00 x 130.00 x 12.00mm, FPM NA5469 100.00 x 130.00 x 12.00mm, PTFE/ACM NB929 120.00 x 140.00 x 13.00mm, FPM



CC



9

100 NX (B13)	03/90→10/94	GA16DS	Petrol	1597	4	16	37
100 NX (B13)	09/90→10/94	GA16DE	Petrol	1597	4	16	37
100 NX (B13)	10/90→10/94	SR20DE	Petrol	1998	4	16	81
180 SX Coupe (S13)	09/88→06/92	CA18DE	Petrol	1809	4	16	50
180 SX Coupe (S13)	09/88→06/92	CA18DT	Petrol	1809	4	16	50
180 SX Coupe (S13)	04/89→06/92	CA18DET	Petrol	1809	4	16	50
180 SX Coupe (S13)	04/91→03/94	SR20DE	Petrol	1998	4	16	81
180 SX Coupe (S13)	04/91→03/94	SR20DET	Petrol	1998	4	16	81
200 SX (S13)	07/88→11/93	CA18DET	Petrol	1809	4	16	50
200 SX (S13)	07/88→11/93	SR20DE	Petrol	1998	4	16	81
200 SX (S13)	09/88→12/90	KA24E	Petrol	2389	4	12	92
200 SX (S13)	09/88→03/94	CA18DE	Petrol	1809	4	16	50
200 SX (S13)	09/90→12/93	KA24DE	Petrol	2389	4	16	91
200 SX (S13)	01/92→09/94	CA18DT	Petrol	1809	4	16	50
200 SX (S14)	10/93→12/99	SR20DE	Petrol	1998	4	16	81
200 SX (S14)	10/93→12/99	SR20DET	Petrol	1998	4	16	81
200 SX (S14)	09/94→12/99	GA16DE	Petrol	1597	4	16	37
200SX Coupe	09/76→12/79	L20B	Petrol	1952	4	8	73
200 SX Coupe	01/79→06/81	Z20E	Petrol	1952	4	8	64
200 SX Coupe	07/81→07/83	Z22E	Petrol	2188	4	8	87
200SX Coupe	09/81→12/83	Z22E	Petrol	2188	4	8	87
200SX Hatchback	09/79→12/81	Z20E	Petrol	1952	4	8	64
200SX Hatchback	09/81→12/83	Z22E	Petrol	2188	4	8	87
210 Hatchback	09/78→12/80	A14	Petrol	1397	4	8	21
210 Hatchback	09/79→12/82	A15	Petrol	1488	4	8	26
240 SX	08/88→05/93	Z24i	Petrol	2389	4	8	94
240 SX	09/88→12/90	KA24E	Petrol	2389	4	12	92
240 SX	04/93→02/01	KA24DE	Petrol	2389	4	16	91
240 SX Convertible	09/91→12/94	KA24DE	Petrol	2389	4	16	91
240 SX Hatchback	09/88→12/90	KA24E	Petrol	2389	4	12	92
240 SX Hatchback	09/90→12/93	KA24DE	Petrol	2389	4	16	91
260 Z (S30)	05/74→12/79	L26	Petrol	2565	6	12	103
280Z Coupe	09/74→12/78	L28E	Petrol	2753	6	12	105
280 ZX,ZXT (HGS130)	09/78→02/84	L28E	Petrol	2753	6	12	105
280 ZX,ZXT (HGS130)	01/83→02/84	L28ET	Petrol	2753	6	12	107
300 ZX (Z31)	01/84→12/87	VG30E	Petrol	2960	6	12	114
300 ZX (Z31)	01/84→12/88	VG30	Petrol	2959	6	12	114
300 ZX (Z31)	01/84→10/90	VG30ET	Petrol	2960	6	12	114
300 ZX (Z31)	04/84→10/90	VG30T	Petrol	2959	6	12	114
300 ZX (Z32)	09/89→12/96	VG30DE	Petrol	2960	6	24	113
300 ZX (Z32)	12/89→03/97	VQ30DE	Petrol	2988	6	24	117
300 ZX (Z32)	05/90→12/97	VG30DETT	Petrol	2960	6	24	115
300 ZX (Z32)	09/96→12/97	VG30DET	Petrol	2960	6	24	115
300 ZX Convertible (Z32)	09/92→12/96	VG30DE	Petrol	2960	6	24	113
310 Coupe	09/78→12/80	A14	Petrol	1397	4	8	21
310 Coupe	09/80→12/82	A15	Petrol	1488	4	8	26
350 Z Coupe (Z33)	09/02→12/08	VQ35DE	Petrol	3498	6	24	122
350 Z Coupe (Z33)	09/05→12/08	VQ35HR	Petrol	3498	6	24	122
350 Z Roadster (Z33)	10/03→12/07	VQ35DE	Petrol	3498	6	24	122
350 Z Roadster (Z33)	09/05→12/09	VQ35HR	Petrol	3498	6	24	122
370 Z Coupe (Z34)	04/09→	VQ37VHR	Petrol	3696	6	24	123
370 Z Coupe (Z34)	06/09→	VQ37HR	Petrol	3696	6	24	123
370 Z Roadster (Z34)	01/09→	VQ37VHR	Petrol	3696	6	24	123
510 Estate	09/77→12/81	L20B	Petrol	1952	4	8	73
510 Hatchback	09/77→12/81	L20B	Petrol	1952	4	8	73
510 Saloon	09/77→12/81	L20B	Petrol	1952	4	8	73
610 Coupe	09/74→12/76	L20B	Petrol	1952	4	8	73
610 Estate	09/74→12/76	L20B	Petrol	1952	4	8	73
610 Saloon	09/73→12/76	L20B	Petrol	1952	4	8	73
620 Pickup	09/74→12/79	L20B	Petrol	1952	4	8	73
710 Estate	09/74→12/77	L20B	Petrol	1952	4	8	73
710 Hardtop	09/74→12/77	L20B	Petrol	1952	4	8	73
720 Cab & Chassis	09/79→12/80	L20B	Petrol	1952	4	8	73
720 Cab & Chassis	09/80→12/83	SD22	Diesel	2164	4	8	85
720 Cab & Chassis	09/80→12/83	Z22	Petrol	2188	4	8	87
720 Cab & Chassis	09/83→12/86	Z24	Petrol	2388	4	8	94
720 Cab & Chassis	09/83→12/86	Z24i	Petrol	2389	4	8	94
720 Cab & Chassis	09/84→12/86	SD25	Diesel	2488	4	8	99
720 Extended Cab Pickup	09/79→12/86	L20B	Petrol	1952	4	8	73
720 Extended Cab Pickup	09/80→12/83	SD22	Diesel	2164	4	8	85
720 Extended Cab Pickup	09/80→12/83	Z22	Petrol	2188	4	8	87
720 Extended Cab Pickup	09/82→12/86	Z24	Petrol	2388	4	8	94
720 Extended Cab Pickup	09/82→12/86	Z24i	Petrol	2389	4	8	94
720 Extended Cab Pickup	09/83→12/86	SD25	Diesel	2488	4	8	99
810 Estate	09/76→12/81	L24	Petrol	2393	6	12	93
810 Estate	09/80→12/81	LD28	Diesel	2792	6	12	108
810 Hardtop	09/78→12/80	L24	Petrol	2393	6	12	93
1400 Bakkie (B140)	08/81→09/08	A14	Petrol	1397	4	8	21



CC











9

AD Van	10/81→08/88	E13S	Petrol	1269	4	8	20
AD Van	10/81→08/88	E15S	Petrol	1488	4	8	28
AD Van	10/84→12/08	CD17	Diesel	1681	4	8	47
AD Van	06/87→04/90	E16S	Petrol	1597	4	8	36
AD Van	10/94→04/99	CD20	Diesel	1974	4	8	67
AD Van	10/94→04/99	SR20DE	Petrol	1998	4	16	81
AD Van (Y12)	12/06→	CR12DE	Petrol	1240	4	16	13
AD Van (Y12)	12/06→	HR15DE	Petrol	1498	4	16	30
AD Van (Y12)	12/06→	MR18DE	Petrol	1798	4	16	56
AD Van (Y12)	12/08→	HR16DE	Petrol	1598	4	16	40
AD Wagon	10/90→08/04	CD17	Diesel	1681	4	8	47
AD Wagon	05/99→08/01	SR20DE	Petrol	1998	4	16	81
AD Wagon	05/99→08/04	QG15DE	Petrol	1498	4	16	29
AD Wagon	05/99→08/04	QG18DE	Petrol	1769	4	16	59
Almera (N17)	09/11→	HR12DE	Petrol	1198	3	12	16
Almera (N17)	01/12→	HR15DE	Petrol	1498	4	16	30
Almera Classic (B10)	03/06→	QG16DE	Petrol	1597	4	16	37
Almera I (N15)	07/95→05/00	GA15DE	Petrol	1498	4	16	29
Almera I (N15)	07/95→05/00	QG18DE	Petrol	1769	4	16	59
Almera I (N15)	07/95→07/00	GA16DE	Petrol	1597	4	16	37
Almera I (N15)	09/95→07/00	GA14DE	Petrol	1392	4	16	22
Almera I (N15)	11/95→07/00	CD20	Diesel	1974	4	8	67
Almera I Hatchback (N15)	07/95→03/00	GA15DE	Petrol	1498	4	16	29
Almera I Hatchback (N15)	07/95→07/00	GA16DE	Petrol	1597	4	16	37
Almera I Hatchback (N15)	09/95→03/00	GA14DE	Petrol	1392	4	16	22
Almera I Hatchback (N15)	11/95→03/00	CD20	Diesel	1974	4	8	67
Almera I Hatchback (N15)	07/96→03/00	SR20DE	Petrol	1998	4	16	81
Almera II (N16)	06/00→12/09	QG16DE	Petrol	1597	4	16	37
Almera II (N16)	06/00→	QG18DE	Petrol	1769	4	16	59
Almera II (N16)	07/00→02/03	GA16DE	Petrol	1597	4	16	37
Almera II (N16)	07/00→	QG15DE	Petrol	1498	4	16	29
Almera II (N16)	07/00→	YD22DDT	Diesel	2184	4	16	86
Almera II (N16)	03/01→	GA15DE	Petrol	1498	4	16	29
Almera II (N16)	08/02→	SR20DE	Petrol	1998	4	16	81
Almera II (N16)	01/03→	K9K 722	Diesel	1461	4	8	32
Almera II (N16)	09/03→	YD22DDTi	Diesel	2184	4	16	86
Almera II (N16)	08/12→	HR16DE	Petrol	1598	4	16	40
Almera II Hatchback (N16)	01/00→	QG18DE	Petrol	1769	4	16	59
Almera II Hatchback (N16)	03/00→	QG15DE	Petrol	1498	4	16	29
Almera II Hatchback (N16)	03/00→	YD22DDT	Diesel	2184	4	16	86
Almera II Hatchback (N16)	07/00→02/03	GA16DE	Petrol	1597	4	16	37
Almera II Hatchback (N16)	08/02→	SR20DE	Petrol	1998	4	16	81
Almera II Hatchback (N16)	01/03→	K9K 722	Diesel	1461	4	8	32
Almera II Hatchback (N16)	09/03→	YD22DDTi	Diesel	2184	4	16	86
Almera TINO (V10)	12/98→02/06	QG18DE	Petrol	1769	4	16	59
Almera TINO (V10)	08/00→01/03	SR20DE	Petrol	1998	4	16	81
Almera TINO (V10)	08/00→02/06	YD22DDTi	Diesel	2184	4	16	86
Almera TINO (V10)	09/03→02/06	YD22DDT	Diesel	2184	4	16	86
Altima	10/06→07/11	QR25DE	Petrol	2488	4	16	97
Altima (L30)	06/97→08/01	KA24DE	Petrol	2389	4	16	91
Altima (L31)	08/01→09/06	QR25DE	Petrol	2488	4	16	97
Altima (L31)	08/01→09/06	VQ35DE	Petrol	3498	6	24	122
Altima (L32)	10/06→07/13	QR25DE	Petrol	2488	4	16	97
Altima (L32)	10/06→07/13	VQ35DE	Petrol	3498	6	24	122
Altima (L33)	05/12→	QR25DE	Petrol	2488	4	16	97
Altima (L33)	08/12→	VQ35DE	Petrol	3498	6	24	122
Altima Coupe	10/06→06/13	QR25DE	Petrol	2488	4	16	97
Altima Coupe (CL32)	04/07→06/13	VQ35DE	Petrol	3498	6	24	122
Altima Coupe (CL32)	09/09→06/13	QR25DE	Petrol	2488	4	16	97
Altra Estate	11/97→07/01	SR20DE	Petrol	1998	4	16	81
Altra Estate	11/97→07/01	SR20DET	Petrol	1998	4	16	81
Aprio	07/08→12/10	K4M	Petrol	1598	4	16	42
Atlas	10/93→10/97	TD25	Diesel	2494	4	8	100
Atlas	10/93→10/97	Z20S	Petrol	1952	4	8	73
Atlas	10/95→10/04	KA24E	Petrol	2389	4	12	92
Atlas	07/96→10/04	TD27TI	Diesel	2664	4	8	106
Auster	06/86→10/89	CA20S	Petrol	1974	4	8	66
Auster	04/87→10/89	CA18ET	Petrol	1809	4	8	51
Auster	04/87→10/89	CA18T	Petrol	1809	4	8	51
Auster (T12)	04/87→10/89	CA18DET	Petrol	1809	4	16	50
Avenir	06/86→10/90	CA20S	Petrol	1974	4	8	66
Avenir	10/87→10/92	LD20T	Diesel	1952	4	8	74
Avenir	10/89→10/97	CA20E	Petrol	1974	4	8	66
Avenir	11/97→09/99	CD20T	Diesel	1974	4	8	67
Avenir	11/97→12/05	QG16DE	Petrol	1597	4	16	37
Avenir	09/01→12/05	QR20DE	Petrol	1998	4	16	78
Avenir (W10, PW10)	11/92→10/97	CD20T	Diesel	1974	4	8	67
Avenir (W11)	11/97→12/05	QG18DE	Petrol	1769	4	16	59



Model	Year Range	Engine Code	Fuel	CC	Power (kW)	Power (HP)	
Avenir (W11)	11/97→12/05	SR20DE	Petrol	1998	4	16	81
Avenir (W11)	08/98→12/05	SR20DET	Petrol	1998	4	16	81
B210 Coupe	09/74→12/78	A14	Petrol	1397	4	8	21
Bassara	11/99→08/02	KA24DE	Petrol	2389	4	16	91
Bassara	11/99→08/03	VQ30DE	Petrol	2988	6	24	117
Bassara	11/99→08/03	YD25DDTi	Diesel	2488	4	16	102
Bassara	06/02→08/03	QR25DE	Petrol	2488	4	16	97
Be	12/82→07/92	MA10S	Petrol	988	4	8	9
Bluebird	11/91→03/97	SR18DE	Petrol	1838	4	16	60
Bluebird	11/91→03/97	SR20DE	Petrol	1998	4	16	81
Bluebird	11/91→03/97	VG30E	Petrol	2960	6	12	114
Bluebird (910)	01/80→11/83	L16	Petrol	1595	4	8	43
Bluebird (910)	01/80→12/83	L18S	Petrol	1770	4	8	55
Bluebird (910)	01/80→12/83	LD20	Diesel	1952	4	8	63
Bluebird (910)	09/80→12/81	LD28	Diesel	2792	6	12	108
Bluebird (910)	01/82→12/83	Z20E	Petrol	1952	4	8	64
Bluebird (910)	01/83→09/83	LD20T	Diesel	1952	4	8	74
Bluebird (B610)	04/72→04/77	L16	Petrol	1595	4	8	43
Bluebird (B610)	04/72→11/79	L18	Petrol	1770	4	8	55
Bluebird (B610)	09/74→12/77	L20B	Petrol	1952	4	8	73
Bluebird (B610)	09/76→01/80	L24	Petrol	2393	6	12	93
Bluebird (T72, T12)	12/85→02/90	CA16S	Petrol	1598	4	8	34
Bluebird (T72, T12)	11/86→04/90	CA18S	Petrol	1809	4	8	49
Bluebird (T72, T12, U12)	12/85→05/90	CA18T	Petrol	1809	4	8	51
Bluebird (T72, T12, U12)	12/85→12/90	CA20E	Petrol	1974	4	8	66
Bluebird (T72, T12, U12)	12/85→12/90	CA20S	Petrol	1974	4	8	66
Bluebird (T72, T12, U12)	03/86→06/90	CA16S	Petrol	1598	4	8	34
Bluebird (T72, T12, U12)	03/86→12/90	LD20	Diesel	1952	4	8	63
Bluebird (T72, T12, U12)	05/86→09/90	CA18N	Petrol	1809	4	8	49
Bluebird (T72, T12, U12)	02/89→12/90	CA18D	Petrol	1809	4	16	50
Bluebird (U11)	11/83→12/85	LD20T	Diesel	1952	4	8	74
Bluebird (U11)	11/83→06/88	CA18S	Petrol	1809	4	8	49
Bluebird (U11)	11/83→02/90	CA16S	Petrol	1598	4	8	34
Bluebird (U11)	04/84→01/88	CA20E	Petrol	1974	4	8	66
Bluebird (U11)	04/84→01/88	LD20	Diesel	1952	4	8	63
Bluebird (U11)	04/84→05/90	CA18T	Petrol	1809	4	8	51
Bluebird (U11)	12/85→02/90	CA20S	Petrol	1974	4	8	66
Bluebird (U11)	03/88→04/90	CA18N	Petrol	1809	4	8	49
Bluebird (U13, U14)	09/91→12/95	GA16DS	Petrol	1597	4	16	37
Bluebird (U13, U14)	09/91→12/95	SR18DE	Petrol	1838	4	16	60
Bluebird (U13, U14)	09/91→12/95	SR20DE	Petrol	1998	4	16	81
Bluebird (U13, U14)	09/91→01/96	SR20DET	Petrol	1998	4	16	81
Bluebird (U13, U14)	09/91→05/02	CD20	Diesel	1974	4	8	67
Bluebird (U13, U14)	06/92→05/97	KA24DE	Petrol	2389	4	16	91
Bluebird (U14)	06/96→08/01	SR18DE	Petrol	1838	4	16	60
Bluebird (U14)	06/96→05/02	SR20DE	Petrol	1998	4	16	81
Bluebird (U14)	09/98→08/01	QG18DE	Petrol	1769	4	16	59
Bluebird Coupe (910)	01/80→10/83	L18T	Petrol	1770	4	8	55
Bluebird Coupe (910)	01/82→01/83	Z20E	Petrol	1952	4	8	64
Bluebird Coupe (910)	12/85→06/86	CA20S	Petrol	1974	4	8	66
Bluebird Estate (510)	04/71→10/72	L16	Petrol	1595	4	8	43
Bluebird Hatchback (T72, T12)	12/85→12/87	CA20S	Petrol	1974	4	8	66
Bluebird Hatchback (T72, T12)	12/85→12/90	CA20E	Petrol	1974	4	8	66
Bluebird Hatchback (T72, T12)	12/85→11/92	CA18T	Petrol	1809	4	8	51
Bluebird Hatchback (T72, T12)	03/86→12/90	LD20	Diesel	1952	4	8	63
Bluebird Hatchback (T72, T12)	03/86→06/91	CA16S	Petrol	1598	4	8	34
Bluebird Hatchback (T72, T12)	05/86→11/92	CA18N	Petrol	1809	4	8	49
Bluebird Hatchback (T72, T12)	02/89→12/90	CA18D	Petrol	1809	4	16	50
Bluebird Saloon (510)	05/68→10/72	L16	Petrol	1595	4	8	43
Bluebird Saloon (910)	01/80→05/84	L18T	Petrol	1770	4	8	55
Bluebird Saloon (910)	05/81→03/85	L20B	Petrol	1952	4	8	73
Bluebird Saloon (910)	01/82→05/84	Z20E	Petrol	1952	4	8	64
Bluebird Station Wagon (WU11)	11/83→04/90	CA18S	Petrol	1809	4	8	49
Bluebird Station Wagon (WU11)	04/84→12/90	CA20E	Petrol	1974	4	8	66
Bluebird Station Wagon (WU11)	04/84→12/90	LD20	Diesel	1952	4	8	63
Bluebird Station Wagon (WU11)	09/84→04/90	CA18ET	Petrol	1809	4	8	51
Bluebird Station Wagon (WU11)	12/85→02/90	CA16S	Petrol	1598	4	8	34
Bluebird Station Wagon (WU11)	12/85→09/90	CA20S	Petrol	1974	4	8	66
Bluebird Station Wagon (WU11)	03/88→04/90	CA18N	Petrol	1809	4	8	49
Bluebird Sylphy	08/00→08/02	SR20DE	Petrol	1998	4	16	81
Bluebird Sylphy	08/00→08/05	QG15DE	Petrol	1498	4	16	29
Bluebird Sylphy	08/00→08/05	QG16DE	Petrol	1597	4	16	37
Bluebird Sylphy	08/00→08/05	QG18DE	Petrol	1769	4	16	59
Bluebird Sylphy	09/02→08/05	QR20DD	Petrol	1998	4	16	78
Bluebird Sylphy	09/05→08/12	HR15DE	Petrol	1498	4	16	30
Bluebird Sylphy	09/05→08/12	MR20DE	Petrol	1997	4	16	77
Bluebird Sylphy (G11)	01/07→	HR16DE	Petrol	1598	4	16	40
Bluebird Sylphy I (G10, N16)	01/00→06/06	QG18DE	Petrol	1769	4	16	59

							
Bluebird Sylphy I (G10, N16)	08/02→04/13	QG16DE	Petrol	1597	4	16	37
Bluebird Sylphy II (G11)	12/12→	K4M	Petrol	1598	4	16	42
Bluebird Sylphy / Sylphy III (B17)	08/12→	MRA8DE	Petrol	1798	4	16	57
Bluebird Sylphy / Sylphy III (B17)	05/13→	HR16DE	Petrol	1598	4	16	40
Bluebird Sylphy / Sylphy III (B17)	10/13→	MR20DE	Petrol	1997	4	16	77
Bluebird Traveller (W910)	01/80→05/84	L18S	Petrol	1770	4	8	55
Bluebird Traveller (W910)	01/80→05/84	LD20	Diesel	1952	4	8	63
Bluebird Traveller (W910)	05/80→05/82	L16	Petrol	1595	4	8	43
Bluebird Traveller (W910)	05/81→03/85	L20B	Petrol	1952	4	8	73
Bluebird Traveller (W910)	04/85→06/86	CA20S	Petrol	1974	4	8	66
Bobby Box	11/87→11/94	A15S	Petrol	1488	4	8	27
Bobby Box	11/87→11/94	LD20	Diesel	1952	4	8	63
Bobby Bus	11/87→11/94	A15S	Petrol	1488	4	8	27
Bobby Bus	11/87→11/94	LD20	Diesel	1952	4	8	63
Cabstar (F22, H40)	01/82→12/87	LD20T	Diesel	1952	4	8	74
Cabstar (F22, H40)	01/82→06/92	SD23	Diesel	2289	4	8	90
Cabstar (F22, H40)	01/82→06/92	TD23	Diesel	2289	4	8	90
Cabstar (F22, H40)	01/82→06/92	Z20	Petrol	1952	4	8	73
Cabstar (F22, H40)	01/82→06/92	Z20S	Petrol	1952	4	8	73
Cabstar (F22, H40)	10/82→12/92	TD25	Diesel	2494	4	8	100
Cabstar (F22, H40)	02/83→12/90	SD25	Diesel	2488	4	8	99
Cabstar (F22, H40)	02/83→12/90	TD27	Diesel	2663	4	8	106
Cabstar (F22, H40)	10/86→06/92	Z22	Petrol	2188	4	8	87
Cabstar (F22, H40)	10/86→09/92	Z16	Petrol	1595	4	8	43
Cabstar (F23, H41, H42)	07/92→05/94	Z20S	Petrol	1952	4	8	73
Cabstar (F23, H41, H42)	07/92→12/00	TD25	Diesel	2494	4	8	100
Cabstar (F23, H41, H42)	10/97→06/10	QD32	Diesel	3153	4	8	119
Cabstar (F23, H41, H42)	10/00→04/04	TD27	Diesel	2663	4	8	106
Cabstar (F23, H41, H42)	01/04→12/06	BD-30Ti	Diesel	2953	4	8	111
Cabstar (F23, H41, H42)	10/06→09/11	YD25DDTi	Diesel	2488	4	16	102
Cabstar (F24M, F24W)	09/06→12/13	YD25DDTi	Diesel	2488	4	16	102
Cabstar (F24M, F24W)	09/06→12/13	YD25K3LD-5MI	Diesel	2488	4	16	102
Cabstar (F24M, F24W)	09/06→12/13	ZD30	Diesel	2953	4	16	118
Cabstar (F24M, F24W)	09/06→12/13	ZD30DDTi	Diesel	2953	4	16	118
Cabstar (F24M, F24W)	09/06→12/13	ZD30H HD-5	Diesel	2953	4	16	118
Cabstar E (TL_, VL_)	10/98→10/06	BD-30Ti	Diesel	2953	4	8	111
Cabstar E (TL_, VL_)	10/98→10/06	LD23	Diesel	2283	4	8	88
Cabstar E (TL_, VL_)	10/98→10/06	TD27T	Diesel	2664	4	8	106
Cabstar Platform/Chassis (F22, H40)	09/85→09/93	Z24	Petrol	2388	4	8	94
Cabstar Platform/Chassis (F22, H40)	01/92→09/93	TD25	Diesel	2494	4	8	100
Caravan	10/00→09/02	KA20DE	Petrol	1998	4	16	71
Caravan	10/00→01/12	ZD30DD	Diesel	2953	4	16	118
Caravan	05/01→01/12	KA24DE	Petrol	2389	4	16	91
Caravan	05/02→01/12	ZD30DDTi	Diesel	2953	4	16	118
Caravan Box (E25)	10/00→09/02	KA20DE	Petrol	1998	4	16	71
Caravan Box (E25)	05/01→01/12	KA24DE	Petrol	2389	4	16	91
Caravan Box (E25)	07/01→11/10	ZD30DDTi	Diesel	2953	4	16	118
Caravan Box (E25)	04/08→11/10	QR25DE	Petrol	2488	4	16	97
Caravan Bus (E25)	07/01→11/10	QR25DE	Petrol	2488	4	16	97
Caravan Bus (E25)	07/01→11/10	ZD30DDTi	Diesel	2953	4	16	118
Caravan Bus (E25)	09/01→12/07	KA24DE	Petrol	2389	4	16	91
Cedric	09/87→05/91	LD28	Diesel	2792	6	12	108
Cedric	09/87→05/91	VG20DET	Petrol	1998	6	24	79
Cedric	09/87→05/91	VG30T	Petrol	2959	6	12	114
Cedric	09/87→02/96	VG20E	Petrol	1998	6	12	72
Cedric	09/87→10/97	VG30E	Petrol	2960	6	12	114
Cedric	06/91→10/95	VQ30DE	Petrol	2988	6	24	117
Cedric	06/91→04/99	RD28T	Diesel	2826	6	12	109
Cedric	06/96→04/99	VQ25DE	Petrol	2496	6	24	101
Cedric	05/99→08/01	VQ30DD	Petrol	2987	6	24	117
Cedric (Y30)	10/83→08/87	VG30S	Petrol	2960	6	12	114
Cedric (Y30)	10/83→05/88	VG30E	Petrol	2960	6	12	114
Cedric (Y30)	01/84→12/87	LD28	Diesel	2792	6	12	108
Cedric (Y30)	05/84→08/87	CA20S	Petrol	1974	4	8	66
Cedric (Y30)	05/84→08/87	SD23	Diesel	2289	4	8	90
Cedric (Y32)	06/91→10/95	RD28	Diesel	2826	6	12	109
Cedric (Y32)	06/91→10/95	VG30T	Petrol	2959	6	12	114
Cedric (Y32)	10/92→10/95	VQ30DE	Petrol	2988	6	24	117
Cedric (Y33)	11/95→10/97	VG30E	Petrol	2960	6	12	114
Cedric (Y33)	11/95→07/98	RD28T	Diesel	2826	6	12	109
Cedric (Y33)	11/95→07/98	VG20E	Petrol	1998	6	12	72
Cedric Estate (230)	01/72→12/72	L24	Petrol	2393	6	12	93
Cedric Hardtop (230)	01/72→03/78	L24	Petrol	2393	6	12	93
Cedric Hardtop (Y31)	09/87→05/91	RD28	Diesel	2826	6	12	109
Cedric Hardtop (Y31)	09/87→05/91	VG30T	Petrol	2959	6	12	114
Cedric X (Y34)	05/99→08/04	RB25DET	Petrol	2498	6	24	98
Cedric X (Y34)	05/00→08/04	VQ25DD	Petrol	2496	6	24	101
Cedric Saloon (230)	01/72→03/78	L24	Petrol	2393	6	12	93











CC



9

Cedric Saloon (430)	03/78→02/83	L28E	Petrol	2753	6	12	105
Cedric Wagon	10/83→08/87	VG30S	Petrol	2960	6	12	114
Cedric Wagon	10/83→08/97	VG30E	Petrol	2960	6	12	114
Cedric Wagon	03/84→08/97	VG20E	Petrol	1998	6	12	72
Cefiro I Saloon (A31)	06/88→09/94	RB20DE	Petrol	1998	6	24	79
Cefiro I Saloon (A31)	06/88→09/94	RB20DET	Petrol	1998	6	24	79
Cefiro I Saloon (A31)	06/88→09/94	RB20E	Petrol	1998	6	12	80
Cefiro I Saloon (A31)	05/92→09/94	RB25DE	Petrol	2498	6	24	98
Cefiro I Saloon (J31)	01/00→09/03	VQ25DE	Petrol	2496	6	24	101
Cefiro I Saloon (J31)	01/00→09/03	VQ35DE	Petrol	3498	6	24	122
Cefiro II Saloon (A32)	10/94→12/99	VQ20DE	Petrol	1995	6	24	83
Cefiro II Saloon (A32)	10/94→12/99	VQ30DE	Petrol	2988	6	24	117
Cefiro III Saloon (A33)	01/00→09/03	VQ20DE	Petrol	1995	6	24	83
Cefiro III Saloon (A33)	01/00→09/03	VQ30DE	Petrol	2988	6	24	117
Cefiro Saloon	06/88→09/94	Z24i	Petrol	2389	4	8	94
Cefiro Saloon	10/94→12/99	VQ25DE	Petrol	2496	6	24	101
Cherry (E10) I	09/70→09/78	A10	Petrol	988	4	8	4
Cherry II Coupe (N10)	08/78→07/81	A10	Petrol	988	4	8	4
Cherry II Coupe (N10)	08/78→07/81	A12	Petrol	1171	4	8	10
Cherry II Coupe (N10)	08/80→02/81	A14	Petrol	1397	4	8	21
Cherry II Coupe (N10)	08/80→07/81	A14S	Petrol	1397	4	8	21
Cherry II Coupe (N10)	08/81→05/82	E15	Petrol	1488	4	8	28
Cherry II Coupe (N10)	08/81→09/82	E13	Petrol	1269	4	8	20
Cherry II Hatchback (N10)	08/78→07/81	A10S	Petrol	988	4	8	4
Cherry II Hatchback (N10)	08/78→07/81	A12	Petrol	1171	4	8	10
Cherry II Hatchback (N10)	08/78→07/81	A14	Petrol	1397	4	8	21
Cherry II Hatchback (N10)	08/80→07/81	A14S	Petrol	1397	4	8	21
Cherry II Hatchback (N10)	08/81→09/82	E13	Petrol	1269	4	8	20
Cherry II Hatchback (N10)	08/81→12/82	E15	Petrol	1488	4	8	28
Cherry II Traveller (VN10)	08/78→07/81	A10	Petrol	988	4	8	4
Cherry II Traveller (VN10)	10/78→07/81	A12	Petrol	1171	4	8	10
Cherry II Traveller (VN10)	08/80→07/81	A14S	Petrol	1397	4	8	21
Cherry II Traveller (VN10)	08/81→03/82	E15	Petrol	1488	4	8	28
Cherry II Traveller (VN10)	08/81→05/82	E10	Petrol	988	4	8	7
Cherry II Traveller (VN10)	09/81→12/83	E13	Petrol	1269	4	8	20
Cherry III (N12)	05/82→05/86	E10	Petrol	988	4	8	7
Cherry III (N12)	05/82→10/86	E13	Petrol	1269	4	8	20
Cherry III (N12)	10/82→12/86	CD17	Diesel	1681	4	8	47
Cherry III (N12)	01/83→12/85	E15ET	Petrol	1488	4	8	28
Cherry III (N12)	11/83→10/86	E15S	Petrol	1488	4	8	28
Cherry III (N12)	05/84→07/86	E16	Petrol	1597	4	8	36
Cherry III Saloon (N12)	11/83→06/86	E15	Petrol	1488	4	8	28
Cherry III Saloon (N12)	04/86→09/87	E16	Petrol	1597	4	8	36
Cherry IV Hatchback (N13)	07/87→09/91	18LE	Petrol	1796	4	8	48
Cherry IV Saloon (N13)	06/89→09/91	16LF	Petrol	1598	4	8	34
Cherry IV Saloon (N13)	06/89→09/91	18LE	Petrol	1796	4	8	48
Cima	01/88→08/91	VQ30DE	Petrol	2988	6	24	117
Cima	01/88→06/96	VG30DET	Petrol	2960	6	24	115
Cima	07/96→02/01	SR20DE	Petrol	1998	4	16	81
Cima	02/01→	VK45DD	Petrol	4494	8	32	130
Cima	03/01→	VK45DE	Petrol	4494	8	32	130
Crew	04/86→08/03	RD28	Diesel	2826	6	12	109
Crew	08/89→03/94	RB20E	Petrol	1998	6	12	80
Crew (_K30)	03/94→06/09	RB20E	Petrol	1998	6	12	80
Crew (_K30)	08/99→06/09	RD28E	Diesel	2826	6	12	109
Cube (Z10)	03/98→08/00	CG13DE	Petrol	1275	4	16	19
Cube (Z10)	09/00→12/02	CGA3DE	Petrol	1348	4	16	19
Cube (Z11)	01/03→09/05	CR14DE	Petrol	1386	4	16	22
Cube (Z11)	01/03→09/05	HR15DE	Petrol	1498	4	16	30
Cube (Z12)	09/08→	MR18DE	Petrol	1798	4	16	56
Cube (Z12)	11/08→	HR15DE	Petrol	1498	4	16	30
Cube (Z12)	03/10→	HR16DE	Petrol	1598	4	16	40
Cube (Z12)	03/10→	K9K	Diesel	1461	4	8	32
Cube (Z12)	03/10→	K9K 270	Diesel	1461	4	8	32
Datsun 100 A (E10, BLF10)	12/74→08/80	A10	Petrol	988	4	8	4
Datsun 100 A Estate (WBLF10)	12/75→08/80	A10	Petrol	988	4	8	4
Datsun 120	09/74→07/80	A12	Petrol	1171	4	8	10
Datsun 120 Y Coupe (KB 210)	04/62→08/80	A12	Petrol	1171	4	8	10
Datsun 140 J (710)	01/73→05/77	L14	Petrol	1428	4	8	25
Datsun 140 Y Estate (HLB310)	02/79→06/83	A14	Petrol	1397	4	8	21
Datsun 160 J (710, A10)	01/73→01/78	L16S	Petrol	1595	4	8	43
Datsun 160 J (710, A10)	01/73→02/82	L16T	Petrol	1595	4	8	43
Datsun 160 J (710, A10)	01/78→02/82	L16	Petrol	1595	4	8	43
Datsun 180 B (PL810)	05/77→01/81	L18	Petrol	1770	4	8	55
Datsun 180 B (PL810)	05/77→01/81	L18S	Petrol	1770	4	8	55
Datsun 180 B (PL810)	05/77→01/81	L18T	Petrol	1770	4	8	55
Datsun 240 Coupe (C210)	09/78→07/81	L24	Petrol	2393	6	12	93
Dayz (B21W)	06/13→	3B20	Petrol	659	3	12	1

							
Dayz Roox (B21A)	02/14→	3B20	Petrol	659	3	12	1
Elgrand (E50)	10/95→08/01	QD32ETI	Diesel	3153	4	8	119
Elgrand (E50)	04/96→04/02	VG33E	Petrol	3275	6	12	121
Elgrand (E50)	08/99→08/00	ZD30DDTi	Diesel	2953	4	16	118
Elgrand (E50)	08/00→04/02	VQ35DE	Petrol	3498	6	24	122
Elgrand (E51)	05/02→12/10	VQ35DE	Petrol	3498	6	24	122
Elgrand (E51)	04/03→12/10	ZD30	Diesel	2953	4	16	118
Elgrand (E51)	12/04→12/10	VQ25DE	Petrol	2496	6	24	101
Elgrand (E52)	09/10→	VQ35DE	Petrol	3498	6	24	122
Elgrand (E52)	11/10→	QR25DE	Petrol	2488	4	16	97
EX	09/07→	VQ35HR	Petrol	3498	6	24	122
EX	10/08→	VQ37VHR	Petrol	3696	6	24	123
EX	01/10→12/11	VQ37HR	Petrol	3696	6	24	123
Exa Coupe (N12)	04/83→07/87	E15ET	Petrol	1488	4	8	28
Exa Targa (N13)	02/87→12/87	CA16DE	Petrol	1598	4	16	35
Exa Targa (N13)	07/87→10/91	CA18DE	Petrol	1809	4	16	50
Expert	10/95→04/00	SR20DE	Petrol	1998	4	16	81
Expert	10/98→04/04	QG18DE	Petrol	1769	4	16	59
Expert	10/98→04/04	YD22D	Diesel	2184	4	16	86
F10 Estate	09/75→12/78	A14	Petrol	1397	4	8	21
F10 Hatchback	09/75→12/78	A14	Petrol	1397	4	8	21
F10 Saloon	09/75→12/78	A14	Petrol	1397	4	8	21
Fairlady Z (Z31)	01/84→12/89	VG30T	Petrol	2959	6	12	114
Figaro Coupe (FK10)	02/91→04/92	MA10ET	Petrol	988	4	8	9
Fuga I (_Y50)	10/04→11/07	VQ35DE	Petrol	3498	6	24	122
Fuga I (_Y50)	01/05→12/09	VK45DE	Petrol	4494	8	32	130
Fuga I (_Y50)	12/07→12/09	VQ35HR	Petrol	3498	6	24	122
Fuga II (_Y51)	11/09→	VQ37VHR	Petrol	3696	6	24	123
Fuga II (_Y51)	10/10→	VQ35HR	Petrol	3498	6	24	122
FX	09/02→12/08	VK45DE	Petrol	4494	8	32	130
FX	01/03→12/08	VQ35DE	Petrol	3498	6	24	122
FX	10/08→	VQ35HR	Petrol	3498	6	24	122
FX	10/08→	VQ37VHR	Petrol	3696	6	24	123
G20	01/90→12/97	SR20DE	Petrol	1998	4	16	81
G Convertible	09/10→	VQ37VHR	Petrol	3696	6	24	123
G Coupe	09/02→12/06	VQ35DE	Petrol	3498	6	24	122
G Coupe	09/07→	VQ37VHR	Petrol	3696	6	24	123
Gloria	10/83→10/97	VG30E	Petrol	2960	6	12	114
Gloria	04/84→08/04	VG30T	Petrol	2959	6	12	114
Gloria	05/84→08/87	CA20S	Petrol	1974	4	8	66
Gloria	06/85→08/87	LD28	Diesel	2792	6	12	108
Gloria	06/85→08/87	VG20ET	Petrol	1998	6	12	72
Gloria	06/85→10/95	VG20E	Petrol	1998	6	12	72
Gloria	09/87→05/91	VG20DET	Petrol	1998	6	24	79
Gloria	06/91→10/95	RD28	Diesel	2826	6	12	109
Gloria	06/91→10/95	VG30DET	Petrol	2960	6	24	115
Gloria	06/91→04/99	VQ30DE	Petrol	2988	6	24	117
Gloria	06/96→04/99	VQ25DE	Petrol	2496	6	24	101
Gloria	05/99→08/01	VQ30DD	Petrol	2987	6	24	117
Gloria	05/99→08/04	KA24DE	Petrol	2389	4	16	91
Gloria	05/99→08/04	RB25DET	Petrol	2498	6	24	98
Gloria	05/00→08/04	VQ25DD	Petrol	2496	6	24	101
Gloria	10/00→08/04	VK45DE	Petrol	4494	8	32	130
Gloria Estate	03/84→08/97	VG30E	Petrol	2960	6	12	114
Gloria Estate	06/85→08/97	VG20E	Petrol	1998	6	12	72
Gloria Estate (330)	01/75→06/78	L26	Petrol	2565	6	12	103
Gloria Hardtop (330)	01/75→06/78	L26	Petrol	2565	6	12	103
Gloria Saloon (330)	01/75→06/78	L26	Petrol	2565	6	12	103
G Saloon	09/98→12/02	SR20DE	Petrol	1998	4	16	81
G Saloon	10/02→	VQ35DE	Petrol	3498	6	24	122
G Saloon	01/07→12/08	VQ35HR	Petrol	3498	6	24	122
G Saloon	09/08→	VQ37VHR	Petrol	3696	6	24	123
Homy Box	08/82→04/92	Z20S	Petrol	1952	4	8	73
Homy Box	05/92→10/95	KA24E	Petrol	2389	4	12	92
Homy Box	05/92→10/95	TD25	Diesel	2494	4	8	100
Homy Box	05/92→10/95	VG30S	Petrol	2960	6	12	114
Homy Box	10/93→10/95	TD27TI	Diesel	2664	4	8	106
Homy Box	10/93→10/97	SD33	Diesel	3246	6	12	120
Homy Box	10/94→10/97	VG30E	Petrol	2960	6	12	114
Homy Platform/Chassis	08/82→04/92	Z20S	Petrol	1952	4	8	73
Homy Platform/Chassis	05/92→10/95	TD25	Diesel	2494	4	8	100
Homy Platform/Chassis	10/93→10/95	TD27TI	Diesel	2664	4	8	106
Homy Platform/Chassis	10/93→10/97	SD33	Diesel	3246	6	12	120
I30	01/97→	VQ30DE	Petrol	2988	6	24	117
I35 Saloon	07/01→12/04	VQ35DE	Petrol	3498	6	24	122
Ichi Box	09/90→05/01	GA16DE	Petrol	1597	4	16	37
Ichi Box	09/90→05/01	LD20	Diesel	1952	4	8	63
Ichi Bus	09/90→05/01	GA16DE	Petrol	1597	4	16	37











CC



9

Ichi Bus	09/90→05/01	LD20	Diesel	1952	4	8	63
Infiniti Q45	07/93→01/97	VH45DE	Petrol	4494	8	32	130
Interstar Box (X70)	04/02→08/06	F9Q 772	Diesel	1870	4	8	62
Interstar Box (X70)	04/02→08/06	F9Q 774	Diesel	1870	4	8	62
Interstar Box (X70)	07/02→	G9T 722	Diesel	2188	4	16	84
Interstar Box (X70)	07/02→	G9U 720	Diesel	2464	4	16	95
Interstar Box (X70)	11/03→	ZD30	Diesel	2953	4	16	118
Interstar Box (X70)	09/06→	G9U 632	Diesel	2464	4	16	95
Interstar Box (X70)	09/06→	G9U 650	Diesel	2464	4	16	95
Interstar Bus (X70)	04/02→08/06	F9Q 772	Diesel	1870	4	8	62
Interstar Bus (X70)	04/02→08/06	F9Q 774	Diesel	1870	4	8	62
Interstar Bus (X70)	07/02→	G9T 722	Diesel	2188	4	16	84
Interstar Bus (X70)	11/03→	G9U 720	Diesel	2464	4	16	95
Interstar Bus (X70)	11/03→	ZD30	Diesel	2953	4	16	118
Interstar Bus (X70)	04/06→	G9U 650	Diesel	2464	4	16	95
Interstar Bus (X70)	09/06→	G9U 632	Diesel	2464	4	16	95
Interstar Platform/Chassis	08/03→	G9U 720	Diesel	2464	4	16	95
Interstar Platform/Chassis	11/03→	ZD30	Diesel	2953	4	16	118
Interstar Platform/Chassis	08/06→	G9U 632	Diesel	2464	4	16	95
Interstar Platform/Chassis	08/06→	G9U 650	Diesel	2464	4	16	95
J30	01/92→12/97	VG30DE	Petrol	2960	6	24	115
Juke (F15)	06/10→	HR16DE	Petrol	1598	4	16	40
Juke (F15)	06/10→	K9K 636	Diesel	1461	4	8	32
Juke (F15)	06/10→	K9K 896	Diesel	1461	4	8	32
Juke (F15)	06/10→	MR16DDT	Petrol	1618	4	16	44
Juke (F15)	10/13→	HR15DE	Petrol	1498	4	16	30
Juke (F15)	05/14→	HR12DDT	Petrol	1197	4	16	17
JX Closed Off-Road Vehicle	09/12→	VQ35DE	Petrol	3498	6	24	122
Kicks (P15)	08/16→	HR16DE	Petrol	1598	4	16	40
Kubistar (X76)	08/03→10/09	D7F 764	Petrol	1149	4	8	15
Kubistar (X76)	08/03→10/09	K4M 752	Petrol	1598	4	16	42
Kubistar (X76)	08/03→10/09	K7J 700	Petrol	1390	4	8	24
Kubistar (X76)	08/03→10/09	K9K 704	Diesel	1461	4	8	32
Kubistar (X76)	08/03→10/09	K9K 710	Diesel	1461	4	8	32
Kubistar (X76)	08/03→10/09	K9K 714	Diesel	1461	4	8	32
Kubistar (X76)	08/03→10/09	K9K 722	Diesel	1461	4	8	32
Kubistar (X76)	04/06→10/09	D4F 712	Petrol	1149	4	16	14
Kubistar (X76)	04/06→10/09	K9K 276	Diesel	1461	4	8	32
Kubistar (X76)	04/06→10/09	K9K 700	Diesel	1461	4	8	32
Kubistar (X76)	04/06→10/09	K9K 716	Diesel	1461	4	8	32
Kubistar Box (X80)	08/03→	D7F 764	Petrol	1149	4	8	15
Kubistar Box (X80)	08/03→	K4M 752	Petrol	1598	4	16	42
Kubistar Box (X80)	08/03→	K9K 704	Diesel	1461	4	8	32
Kubistar Box (X80)	08/03→	K9K 722	Diesel	1461	4	8	32
Kubistar Box (X80)	08/05→	K9K 710	Diesel	1461	4	8	32
Kubistar Box (X80)	08/05→	K9K 714	Diesel	1461	4	8	32
Kubistar Box (X80)	04/06→03/10	K9K 716	Diesel	1461	4	8	32
Kubistar Box (X80)	04/06→	D4F 712	Petrol	1149	4	16	14
Lafesta	07/05→	MR20DE	Petrol	1997	4	16	77
Lafesta (B30)	08/04→10/12	MR20DE	Petrol	1997	4	16	77
Lafesta (B35)	06/11→	LF-VDS	Petrol	1999	4	16	75
Lafesta (B35)	06/11→	LF-VE	Petrol	1998	4	16	75
Lannia	10/15→	HR16DE	Petrol	1598	4	16	40
Latio Hatchback	03/07→12/10	HR18DE	Petrol	1769	4	16	53
Laurel	07/90→01/93	RB20DET	Petrol	1998	6	24	79
Laurel	07/90→06/97	RB20E	Petrol	1998	6	12	80
Laurel	07/90→10/01	RB20DE	Petrol	1998	6	24	79
Laurel	02/93→10/00	RB25DET	Petrol	2498	6	24	98
Laurel	02/93→10/02	RB25DE	Petrol	2498	6	24	98
Laurel (HLC230)	03/77→05/83	L20A	Petrol	1998	6	12	72
Laurel (HLC230)	12/77→05/83	L24	Petrol	2393	6	12	93
Laurel (HLC230)	01/78→05/83	L28	Petrol	2753	6	12	107
Laurel (JC31)	11/80→10/84	L20E	Petrol	1998	6	12	72
Laurel (JC31)	01/81→01/84	L20A	Petrol	1998	6	12	72
Laurel (JC31)	01/81→10/85	LD28	Diesel	2792	6	12	108
Laurel (JC31)	01/81→12/85	L24	Petrol	2393	6	12	93
Laurel (JC31)	04/81→10/84	LD20	Diesel	1952	4	8	63
Laurel (JC31)	11/84→12/85	CA20S	Petrol	1974	4	8	66
Laurel (JC32)	11/84→12/85	CA20S	Petrol	1974	4	8	66
Laurel (JC32)	01/85→12/87	L24E	Petrol	2393	6	12	93
Laurel (JC32)	01/85→12/87	L24S	Petrol	2393	6	12	93
Laurel (JC32)	01/85→12/87	LD28	Diesel	2792	6	12	108
Laurel (JC32)	01/85→12/89	RD28	Diesel	2826	6	12	109
Laurel (JC32)	01/86→12/87	L28E	Petrol	2753	6	12	105
Leopard	10/80→03/86	Z18	Petrol	1770	4	8	55
Leopard	06/81→09/84	L28E	Petrol	2753	6	12	105
Leopard	06/81→03/86	L20E	Petrol	1998	6	12	72
Leopard	06/81→03/86	L20ET	Petrol	1998	6	12	72

							
Leopard	06/84→03/86	VG30T	Petrol	2959	6	12	114
Leopard	10/91→09/95	VG20E	Petrol	1998	6	12	72
Leopard	10/91→08/01	VG30E	Petrol	2960	6	12	114
Leopard	10/95→08/01	KA24DE	Petrol	2389	4	16	91
Leopard	10/95→08/01	VQ30DE	Petrol	2988	6	24	117
Leopard Coupe	10/80→03/86	Z18	Petrol	1770	4	8	55
Leopard Coupe	06/81→09/84	L28E	Petrol	2753	6	12	105
Leopard Coupe	06/81→03/86	L20ET	Petrol	1998	6	12	72
Leopard Coupe	06/84→03/86	VG30T	Petrol	2959	6	12	114
Leopard Coupe	04/86→09/88	VG20ET	Petrol	1998	6	12	72
Leopard Coupe	04/86→09/91	VG20E	Petrol	1998	6	12	72
Leopard Coupe	04/86→09/91	VG30DET	Petrol	2960	6	24	115
Leopard Coupe	10/88→09/91	VG20DET	Petrol	1998	6	24	79
Leopard Estate	10/95→08/01	KA24DE	Petrol	2389	4	16	91
Leopard Estate	10/95→08/01	VQ30DE	Petrol	2988	6	24	117
Livina C-Gear	03/10→	HR16DE	Petrol	1598	4	16	40
Livina / Grand Livina (L10, L11)	02/07→	HR16DE	Petrol	1598	4	16	40
Livina / Grand Livina (L10, L11)	03/09→	HR15DE	Petrol	1498	4	16	30
Livina / Grand Livina (L10, L11)	03/09→	MR18DE	Petrol	1798	4	16	56
Livina Hatchback	04/07→	HR16DE	Petrol	1598	4	16	40
Lucino Hatchback	09/91→10/92	GA16DS	Petrol	1597	4	16	37
Lucino Hatchback	09/91→01/00	GA14DE	Petrol	1392	4	16	22
Lucino Hatchback	10/91→10/95	SR20DET	Petrol	1998	4	16	81
Lucino Hatchback	10/91→01/00	SR20DE	Petrol	1998	4	16	81
Lucino Hatchback	10/92→01/00	GA16DE	Petrol	1597	4	16	37
Lucino Hatchback	11/95→01/00	SR18DE	Petrol	1838	4	16	60
Lucino Saloon	11/95→01/00	GA14DE	Petrol	1392	4	16	22
Lucino Saloon	11/95→01/00	GA16DE	Petrol	1597	4	16	37
Lucino Saloon	11/95→01/00	SR18DE	Petrol	1838	4	16	60
Lucino Saloon	11/95→01/00	SR20DE	Petrol	1998	4	16	81
Lucino Saloon	11/96→01/00	GA13DE	Petrol	1295	4	16	19
Lucino Saloon	11/97→01/00	CD20	Diesel	1974	4	8	67
Lucino Saloon	11/97→01/00	GA15DE	Petrol	1498	4	16	29
M (Y51)	03/10→	VQ37VHR	Petrol	3696	6	24	123
M (Y51)	04/11→	VQ35HR	Petrol	3498	6	24	122
M30 Convertible	01/90→12/93	VG30E	Petrol	2960	6	12	116
M30 Coupe	01/89→12/93	VG30E	Petrol	2960	6	12	116
M35	01/05→	VQ35DE	Petrol	3498	6	24	122
M35	09/08→	VQ35HR	Petrol	3498	6	24	122
M37	01/10→	VQ37VHR	Petrol	3696	6	24	123
M45	09/02→	VK45DE	Petrol	4494	8	32	130
Maxima I Estate (G910)	09/80→12/83	LD28	Diesel	2792	6	12	108
Maxima I Estate (G910)	09/80→12/84	L24E	Petrol	2393	6	12	93
Maxima I Saloon (G910)	09/80→12/83	LD28	Diesel	2792	6	12	108
Maxima I Saloon (G910)	09/80→12/84	L24E	Petrol	2393	6	12	93
Maxima II (PU11)	09/84→12/88	VG30E	Petrol	2960	6	12	114
Maxima II Estate (PU11)	09/84→12/88	VG30E	Petrol	2960	6	12	114
Maxima III (J30)	10/88→06/94	VG30E	Petrol	2960	6	12	114
Maxima III (J30)	09/91→12/94	VQ30DE	Petrol	2988	6	24	117
Maxima VI (A34)	09/03→12/08	VQ35DE	Petrol	3498	6	24	122
Maxima VI (A34)	09/06→12/08	VG35DE	Petrol	3498	6	24	122
Maxima VII (A35)	09/08→	VQ35DE	Petrol	3498	6	24	122
Maxima VII (A35)	06/09→	VQ30DE	Petrol	2988	6	24	117
Maxima VIII (A36)	05/15→	VQ35DE	Petrol	3498	6	24	122
Maxima / Maxima QX IV (A32)	03/94→03/99	VG30DE	Petrol	2960	6	24	113
Maxima / Maxima QX IV (A32)	01/95→08/00	VQ30DE	Petrol	2988	6	24	117
Maxima / Maxima QX IV (A32)	02/95→08/00	VQ20DE	Petrol	1995	6	24	83
Maxima / Maxima QX IV (A32)	02/95→08/00	VQ25DE	Petrol	2496	6	24	101
Maxima / Maxima QX IV Station Wagon (A32)	10/97→12/00	VQ20DE	Petrol	1995	6	24	83
Maxima / Maxima QX IV Station Wagon (A32)	10/97→12/00	VQ25DE	Petrol	2496	6	24	101
Maxima / Maxima QX IV Station Wagon (A32)	10/97→12/00	VQ30DE	Petrol	2988	6	24	117
Maxima / Maxima QX V (A33)	09/99→12/01	VG30DE	Petrol	2960	6	24	113
Maxima / Maxima QX V (A33)	12/99→11/03	VQ30DE	Petrol	2988	6	24	117
Maxima / Maxima QX V (A33)	03/00→11/03	VQ20DE	Petrol	1995	6	24	83
Maxima / Maxima QX V (A33)	03/00→11/03	VQ25DE	Petrol	2496	6	24	101
Maxima / Maxima QX V (A33)	08/01→11/03	VQ35DE	Petrol	3498	6	24	122
Maxima QX (A33)	10/03→11/03	VQ35DE	Petrol	3498	6	24	122
Micra C+C III (K12)	08/05→	CR14DE	Petrol	1386	4	16	22
Micra C+C III (K12)	08/05→	HR16DE	Petrol	1598	4	16	40
Micra I (K10)	12/82→12/89	MA10S	Petrol	988	4	8	9
Micra I (K10)	12/82→10/90	MA10ET	Petrol	988	4	8	9
Micra I (K10)	07/86→07/92	MA12S	Petrol	1235	4	8	18
Micra II (K11)	01/92→04/93	MA10S	Petrol	988	4	8	9
Micra II (K11)	01/92→02/03	CG13DE	Petrol	1275	4	16	19
Micra II (K11)	08/92→02/03	CG10DE	Petrol	998	4	16	5
Micra II (K11)	02/98→02/03	TD15	Diesel	1527	4	8	33
Micra II (K11)	09/00→02/03	CGA3DE	Petrol	1348	4	16	19
Micra III (K12)	01/03→06/10	CG10DE	Petrol	998	4	16	5



CC



9

Micra III (K12)	01/03→06/10	CG12DE	Petrol	1240	4	16	12
Micra III (K12)	01/03→06/10	CR12DE	Petrol	1240	4	16	13
Micra III (K12)	01/03→06/10	CR14DE	Petrol	1386	4	16	22
Micra III (K12)	01/03→06/10	K9K 704	Diesel	1461	4	8	32
Micra III (K12)	09/03→06/10	K9K 722	Diesel	1461	4	8	32
Micra III (K12)	08/04→06/10	CGA3DE	Petrol	1348	4	16	19
Micra III (K12)	05/05→06/10	HR15DE	Petrol	1498	4	16	30
Micra III (K12)	05/05→06/10	HR16DE	Petrol	1598	4	16	40
Micra III (K12)	06/05→06/10	K9K 276	Diesel	1461	4	8	32
Micra III (K12)	06/05→06/10	K9K 708	Diesel	1461	4	8	32
Micra IV (K13)	05/10→	HR12DE	Petrol	1198	3	12	16
Micra IV (K13)	11/10→	HR15DE	Petrol	1498	4	16	30
Micra IV (K13)	11/10→	K9K 700	Diesel	1461	4	8	32
Micra IV (K13)	11/10→	K9K 704	Diesel	1461	4	8	32
Micra IV (K13)	01/11→	K9K	Diesel	1461	4	8	32
Micra IV (K13)	02/11→	D4D	Petrol	998	4	16	6
Micra IV (K13)	04/11→	HR12DDR	Petrol	1198	3	12	16
Micra IV (K13)	09/11→	HR16DE	Petrol	1598	4	16	40
Micra V (K14)	12/16→	H4B 408	Petrol	898	3	12	3
Micra V (K14)	12/16→	K9K 628	Diesel	1461	4	8	32
Moco I (MG21S)	04/02→01/06	K6A	Petrol	658	3	12	2
Moco II (MG22S)	03/06→12/10	K6A	Petrol	658	3	12	2
Moco III (MG33S)	01/11→	RO6A	Petrol	658	3	12	2
Murano (Z51)	11/07→09/14	VQ35DE	Petrol	3498	6	24	122
Murano I (Z50)	08/03→09/08	VQ35DE	Petrol	3498	6	24	122
Murano I (Z50)	11/04→10/07	QR25DE	Petrol	2488	4	16	97
Murano II	09/11→	VQ35DE	Petrol	3498	6	24	122
Murano II (Z51)	11/07→09/14	VQ35DE	Petrol	3498	6	24	122
Murano II (Z51)	09/08→09/14	QR25DE	Petrol	2488	4	16	97
Murano II (Z51)	12/09→09/14	VQ35	Petrol	3498	6	24	122
Murano II (Z51)	01/10→09/14	YD25DDTi	Diesel	2488	4	16	102
Murano II Convertible	09/10→	VQ35DE	Petrol	3498	6	24	122
Murano III	08/15→	QR25DER	Petrol	2488	4	16	97
Murano III (Z52_)	10/14→	VQ35DE	Petrol	3498	6	24	122
Murano III (Z52_)	10/14→	YD25DDTi	Diesel	2488	4	16	102
Murano III (Z52_)	01/16→	QR25DER	Petrol	2488	4	16	97
Navara (D21)	11/85→01/97	Z16	Petrol	1595	4	8	43
Navara (D21)	01/86→08/91	Z20	Petrol	1952	4	8	73
Navara (D21)	01/86→12/96	RB30S	Petrol	2962	6	12	112
Navara (D21)	01/86→12/96	VG30E	Petrol	2960	6	12	114
Navara (D21)	01/86→03/08	TD25	Diesel	2494	4	8	100
Navara (D21)	01/86→03/08	Z24	Petrol	2388	4	8	94
Navara (D21)	09/87→08/98	TD27	Diesel	2663	4	8	106
Navara (D21)	09/89→03/08	KA24E	Petrol	2389	4	12	92
Navara (D21)	01/92→12/97	Z24i	Petrol	2389	4	8	94
Navara (D22_)	01/97→08/01	SR20DE	Petrol	1998	4	16	81
Navara (D22_)	01/97→10/01	TD27	Diesel	2663	4	8	106
Navara (D22_)	01/97→03/02	QD32	Diesel	3153	4	8	119
Navara (D22_)	01/97→09/02	KA24E	Petrol	2389	4	12	92
Navara (D22_)	01/97→12/02	Z24S	Petrol	2389	4	8	94
Navara (D22_)	01/97→09/04	VG30E	Petrol	2960	6	12	114
Navara (D22_)	09/97→12/04	KA24DE	Petrol	2389	4	16	91
Navara (D22_)	02/98→10/01	TD25	Diesel	2494	4	8	100
Navara (D22_)	05/98→10/01	TD25Ti	Diesel	2494	4	8	100
Navara (D22_)	02/00→	ZD30DDT	Diesel	2953	4	16	118
Navara (D22)	05/00→	VG30E	Petrol	2960	6	12	114
Navara (D22_)	09/00→12/04	VG33ER	Petrol	3275	6	12	121
Navara (D22_)	11/01→04/07	VG33E	Petrol	3275	6	12	121
Navara (D22_)	11/01→	YD25DDTi	Diesel	2488	4	16	102
Navara (D22_)	10/04→12/11	VQ40DE	Petrol	3954	6	24	125
Navara (D22_)	01/05→	QR25DE	Petrol	2488	4	16	97
Navara Platform/Chassis (D21)	09/85→12/87	Z24	Petrol	2388	4	8	94
Navara Platform/Chassis (D21)	09/85→05/94	Z24i	Petrol	2389	4	8	94
Navara Platform/Chassis (D21)	09/85→03/97	VG30E	Petrol	2960	6	12	114
Navara Platform/Chassis (D21)	02/88→05/92	TD25	Diesel	2494	4	8	100
Navara Platform/Chassis (D21)	09/88→10/95	Z20	Petrol	1952	4	8	73
Navara Platform/Chassis (D21)	01/90→03/97	TD27	Diesel	2663	4	8	106
Navara Platform/Chassis (D21)	06/92→04/97	KA24E	Petrol	2389	4	12	92
Navara Platform/Chassis (D22)	03/97→08/99	KA24E	Petrol	2389	4	12	92
Navara Platform/Chassis (D22)	03/97→12/01	TD27T	Diesel	2664	4	8	106
Navara Platform/Chassis (D22)	04/98→12/01	QD32	Diesel	3153	4	8	119
Navara Platform/Chassis (D22)	08/99→12/05	KA24DE	Petrol	2389	4	16	91
Navara Platform/Chassis (D22)	06/00→04/04	VG30E	Petrol	2960	6	12	114
Navara Platform/Chassis (D22)	12/01→01/08	ZD30	Diesel	2953	4	16	118
Navara Platform/Chassis (D22)	02/02→	YD25DDTi	Diesel	2488	4	16	102
Navara Platform/Chassis (D23)	01/15→	YS23DDT	Diesel	2299	4	16	89
Note (E11, NE11)	01/06→12/10	HR15DE	Petrol	1498	4	16	30
Note (E11, NE11)	03/06→06/12	CR14DE	Petrol	1386	4	16	22



CC



9

Note (E11, NE11)	03/06→06/12	HR16DE	Petrol	1598	4	16	40
Note (E11, NE11)	03/06→06/12	K9K 276	Diesel	1461	4	8	32
Note (E11, NE11)	03/06→06/12	K9K 700	Diesel	1461	4	8	32
Note (E11, NE11)	07/08→06/12	K9K 292	Diesel	1461	4	8	32
Note (E12)	06/13→	HR12DDR	Petrol	1198	3	12	16
Note (E12)	06/13→	HR12DE	Petrol	1198	3	12	16
Note (E12)	06/13→	HR16DE	Petrol	1598	4	16	40
Note (E12)	06/13→	K9K 608	Diesel	1461	4	8	32
Note (E12)	06/13→	K9K 892	Diesel	1461	4	8	32
NP200	10/08→	HR16DE	Petrol	1598	4	16	40
NP200	10/08→	K9K 276	Diesel	1461	4	8	32
NP300 Navara (D40)	10/04→	KA24DE	Petrol	2389	4	16	91
NP300 Navara (D40)	10/04→	QR25DE	Petrol	2488	4	16	97
NP300 Navara (D40)	10/04→	VQ40	Petrol	3954	6	24	125
NP300 Navara (D40)	07/05→	YD25DDTi	Diesel	2488	4	16	102
NP300 Navara (D40)	09/09→12/13	KA24DEN	Petrol	2389	4	16	91
NP300 Navara (D40)	09/09→	VQ40DE	Petrol	3954	6	24	125
NP300 Navara Pickup (D23)	07/14→	YD25DDTi	Diesel	2488	4	16	102
NP300 Navara Pickup (D23)	11/14→	QR25DE	Petrol	2488	4	16	97
NP300 Navara Pickup (D23)	01/15→	YS23DDT	Diesel	2299	4	16	89
NP300 Navara Pickup (D23)	10/15→	YS23DDTT	Diesel	2299	4	16	89
NP300 Navara Platform/Chassis (D40)	08/08→	YD25DDTi	Diesel	2488	4	16	102
NP300 Navara Platform/Chassis (D40)	09/09→	KA24DEN	Petrol	2389	4	16	91
NP300 Navara Platform/Chassis (D40)	09/13→	KA24DE	Petrol	2389	4	16	91
NP300 Navara Platform/Chassis (D40)	09/13→	YD25ETI	Diesel	2488	4	16	102
NP300 Pickup (D22)	04/08→	YD25DDTi	Diesel	2488	4	16	102
NP300 Pickup (D22)	08/08→	KA20DE	Petrol	1998	4	16	71
NP300 Pickup (D22)	08/08→	KA24DE	Petrol	2389	4	16	91
NP300 Pickup (D22)	05/15→	QR25DE	Petrol	2488	4	16	97
NT100 Clipper (DR16T)	06/12→	R06A	Petrol	658	3	12	2
NT400 Cabstar (F24F)	01/14→	YD25K3LD-5HO	Diesel	2488	4	16	102
NT400 Cabstar (F24F)	01/14→	YD25K3LD-5LO	Diesel	2488	4	16	102
NT400 Cabstar (F24F)	01/14→	YD25K3LD-5MI	Diesel	2488	4	16	102
NT400 Cabstar (F24F)	09/16→	ZD30DDTi	Diesel	2953	4	16	118
NT400 Cabstar Dumpttruck (F24F)	09/16→	ZD30DDTi	Diesel	2953	4	16	118
NV100 Clipper Bus (DR17V, DR64V)	06/12→	K6A-T	Petrol	658	3	12	2
NV100 Clipper Bus (DR17V, DR64V)	06/12→	R06A	Petrol	658	3	12	2
NV100 Clipper Rio MPV (DR17W, DR64W)	03/15→	R06A	Petrol	658	3	12	2
NV200 Box Body / Estate	02/10→	HR16DE	Petrol	1598	4	16	40
NV200 Box Body / Estate	02/10→	K9K 400	Diesel	1461	4	8	32
NV200 Box Body / Estate	02/10→	K9K 608	Diesel	1461	4	8	32
NV200 Box Body / Estate	02/10→	K9K 628	Diesel	1461	4	8	32
NV200 Box Body / Estate	04/11→	K9K 636	Diesel	1461	4	8	32
NV200 Box Body / Estate	04/11→	K9K 646	Diesel	1461	4	8	32
NV200 Box Body / Estate	04/11→	K9K 892	Diesel	1461	4	8	32
NV200 Box Body / Estate	09/13→	MR20DE	Petrol	1997	4	16	77
NV200 / Evalia Bus	07/10→	HR16DE	Petrol	1598	4	16	40
NV200 / Evalia Bus	07/10→	K9K 400	Diesel	1461	4	8	32
NV200 / Evalia Bus	07/10→	K9K 608	Diesel	1461	4	8	32
NV200 / Evalia Bus	07/10→	K9K 628	Diesel	1461	4	8	32
NV200 / Evalia Bus	04/11→	K9K 636	Diesel	1461	4	8	32
NV200 / Evalia Bus	04/11→	K9K 646	Diesel	1461	4	8	32
NV200 / Evalia Bus	04/11→	K9K 892	Diesel	1461	4	8	32
NV200 / Evalia Bus	09/13→	MR20DE	Petrol	1997	4	16	77
NV200 X3 MPV	06/10→	HR16DE	Petrol	1598	4	16	40
NV300 Box (X82)	09/16→	R9M 413	Diesel	1598	4	16	46
NV300 Box (X82)	09/16→	R9M 452	Diesel	1598	4	16	46
NV300 Kombi (X82)	09/16→	R9M 413	Diesel	1598	4	16	46
NV300 Kombi (X82)	09/16→	R9M 452	Diesel	1598	4	16	46
NV300 Platform/Chassis (X82)	09/16→	R9M 452	Diesel	1598	4	16	46
NV350 Box (E26)	05/12→	QR20DE	Petrol	1998	4	16	78
NV350 Box (E26)	05/12→	QR25DE	Petrol	2488	4	16	97
NV350 Box (E26)	06/12→	YD25DDTi	Diesel	2488	4	16	102
NV350 / Caravan Bus (E26)	05/12→	QR20DE	Petrol	1998	4	16	78
NV350 / Caravan Bus (E26)	05/12→	QR25DE	Petrol	2488	4	16	97
NV350 / Caravan Bus (E26)	05/12→	YD25DDTi	Diesel	2488	4	16	102
NV400 Box	11/11→02/14	M9T 678	Diesel	2299	4	16	89
NV400 Box	11/11→02/14	M9T 680	Diesel	2299	4	16	89
NV400 Box	11/11→02/14	M9T 694	Diesel	2299	4	16	89
NV400 Box	11/11→09/16	M9T 670	Diesel	2299	4	16	89
NV400 Box	11/11→09/16	M9T 672	Diesel	2299	4	16	89
NV400 Box	11/11→09/16	M9T 676	Diesel	2299	4	16	89
NV400 Box	11/11→09/16	M9T 686	Diesel	2299	4	16	89
NV400 Box	11/11→09/16	M9T 690	Diesel	2299	4	16	89
NV400 Box	11/11→09/16	M9T 692	Diesel	2299	4	16	89
NV400 Box	11/11→09/16	M9T 696	Diesel	2299	4	16	89
NV400 Box	11/11→09/16	M9T 698	Diesel	2299	4	16	89
NV400 Box	11/11→09/16	M9T 896	Diesel	2299	4	16	89



CC



9

NV400 Box	11/11→	M9T 870	Diesel	2299	4	16	89
NV400 Box	02/14→09/16	M9T 880	Diesel	2299	4	16	89
NV400 Box	06/14→	M9T	Diesel	2299	4	16	89
NV400 Bus	11/11→02/14	M9T 678	Diesel	2299	4	16	89
NV400 Bus	11/11→02/14	M9T 680	Diesel	2299	4	16	89
NV400 Bus	11/11→09/16	M9T 670	Diesel	2299	4	16	89
NV400 Bus	11/11→09/16	M9T 672	Diesel	2299	4	16	89
NV400 Bus	11/11→09/16	M9T 676	Diesel	2299	4	16	89
NV400 Bus	02/14→09/16	M9T 880	Diesel	2299	4	16	89
NV400 Bus	06/14→09/16	M9T 696	Diesel	2299	4	16	89
NV400 Bus	06/14→09/16	M9T 698	Diesel	2299	4	16	89
NV400 Bus	06/14→09/16	M9T 870	Diesel	2299	4	16	89
NV400 Bus	06/14→	M9T	Diesel	2299	4	16	89
NV400 Platform/Chassis	11/11→06/16	M9T 670	Diesel	2299	4	16	89
NV400 Platform/Chassis	11/11→06/16	M9T 672	Diesel	2299	4	16	89
NV400 Platform/Chassis	11/11→06/16	M9T 676	Diesel	2299	4	16	89
NV400 Platform/Chassis	11/11→06/16	M9T 678	Diesel	2299	4	16	89
NV400 Platform/Chassis	11/11→06/16	M9T 680	Diesel	2299	4	16	89
NV400 Platform/Chassis	11/11→06/16	M9T 686	Diesel	2299	4	16	89
NV400 Platform/Chassis	11/11→06/16	M9T 690	Diesel	2299	4	16	89
NV400 Platform/Chassis	11/11→06/16	M9T 692	Diesel	2299	4	16	89
NV400 Platform/Chassis	11/11→06/16	M9T 694	Diesel	2299	4	16	89
NV400 Platform/Chassis	11/11→06/16	M9T 696	Diesel	2299	4	16	89
NV400 Platform/Chassis	11/11→06/16	M9T 698	Diesel	2299	4	16	89
NV400 Platform/Chassis	11/11→06/16	M9T 870	Diesel	2299	4	16	89
NV400 Platform/Chassis	11/11→06/16	M9T 896	Diesel	2299	4	16	89
NV400 Platform/Chassis	06/14→06/16	M9T 702	Diesel	2299	4	16	89
NV400 Platform/Chassis	06/14→	M9T	Diesel	2299	4	16	89
NV400 Platform/Chassis	08/14→06/16	M9T 880	Diesel	2299	4	16	89
NV 1500 Standard Cargo Van	09/11→	VQ40DE	Petrol	3954	6	24	125
NV 2500 Standard Cargo Van	09/11→	VQ40DE	Petrol	3954	6	24	125
NV 3500 Standard Cargo Van	09/11→	VQ40DE	Petrol	3954	6	24	125
NV 3500 Standard Passenger Van	09/11→	VQ40DE	Petrol	3954	6	24	125
Paladin	02/03→12/08	VG33E	Petrol	3275	6	12	121
Pao	03/89→11/91	MA10S	Petrol	988	4	8	9
Pathfinder I (WD21)	07/86→08/95	VG30I	Petrol	2960	6	12	114
Pathfinder I (WD21)	07/86→10/95	VG30E	Petrol	2960	6	12	114
Pathfinder I (WD21)	07/86→10/95	Z24i	Petrol	2389	4	8	94
Pathfinder I (WD21)	05/92→10/95	TD27	Diesel	2663	4	8	106
Pathfinder II (R50)	09/97→12/04	QD32ETI	Diesel	3153	4	8	119
Pathfinder II (R50)	09/97→12/04	TD27ETi	Diesel	2664	4	8	106
Pathfinder II (R50)	09/97→12/04	VG33E	Petrol	3275	6	12	121
Pathfinder II (R50)	05/99→12/04	KA24DE	Petrol	2389	4	16	91
Pathfinder II (R50)	09/99→02/02	KA24E	Petrol	2389	4	12	92
Pathfinder II (R50)	09/99→12/04	ZD30DDTi	Diesel	2953	4	16	118
Pathfinder II (R50)	09/00→12/04	VQ35DE	Petrol	3498	6	24	122
Pathfinder II (R50)	11/00→12/04	VQ35	Petrol	3498	6	24	122
Pathfinder III (R51)	01/05→	VQ40DE	Petrol	3954	6	24	125
Pathfinder III (R51)	01/05→	YD25DDTi	Diesel	2488	4	16	102
Pathfinder IV (R52)	09/12→	VQ35DE	Petrol	3498	6	24	122
Pathfinder IV (R52)	09/12→	YD25DDTi	Diesel	2488	4	16	102
Pathfinder IV (R52)	08/13→	VQ35	Petrol	3498	6	24	122
Pathfinder IV (R52)	09/13→	QR25DER	Petrol	2488	4	16	97
Pathfinder IV (R52)	09/16→	VQ35DD	Petrol	3498	6	24	122
Patrol GR I (Y60, GR)	02/88→12/95	TB42E	Petrol	4169	6	12	127
Patrol GR IV (Y60, GR)	09/88→02/98	RD28T	Diesel	2826	6	12	109
Patrol GR IV (Y60, GR)	11/88→06/97	TD42	Diesel	4169	6	12	128
Patrol GR IV (Y60, GR)	11/88→02/98	TB42E	Petrol	4169	6	12	127
Patrol GR IV Platform/Chassis (Y60)	01/94→12/97	RD28T	Diesel	2826	6	12	109
Patrol GR V Pickup (Y61)	06/06→	TD42T	Diesel	4169	6	12	129
Patrol GR V Pickup (Y61)	11/13→	VQ40DE	Petrol	3954	6	24	125
Patrol GR V Pickup (Y61)	08/14→	ZD30DDTi	Diesel	2953	4	16	118
Patrol GR V Pickup (Y61)	12/14→	TB48DE	Petrol	4759	6	24	131
Patrol GR V Platform/Chassis (Y61)	05/98→03/03	TD42	Diesel	4169	6	12	128
Patrol GR V Platform/Chassis (Y61)	05/99→09/07	TD42T	Diesel	4169	6	12	129
Patrol GR V Platform/Chassis (Y61)	09/07→	ZD30DDTi	Diesel	2953	4	16	118
Patrol GR V Wagon (Y61)	06/97→05/00	RD28Ti	Diesel	2826	6	12	110
Patrol GR V Wagon (Y61)	06/97→	TD42T	Diesel	4169	6	12	129
Patrol GR V Wagon (Y61)	03/98→04/01	RD28T	Diesel	2826	6	12	109
Patrol GR V Wagon (Y61)	05/98→06/01	SD33	Diesel	3246	6	12	120
Patrol GR V Wagon (Y61)	05/98→06/01	TD27T	Diesel	2664	4	8	106
Patrol GR V Wagon (Y61)	05/98→03/03	TD42	Diesel	4169	6	12	128
Patrol GR V Wagon (Y61)	03/00→08/02	TB42E	Petrol	4169	6	12	127
Patrol GR V Wagon (Y61)	03/00→08/02	TB42S	Petrol	4169	6	12	127
Patrol GR V Wagon (Y61)	03/00→	TB48DE	Petrol	4759	6	24	131
Patrol GR V Wagon (Y61)	05/00→	ZD30DDTi	Diesel	2953	4	16	118
Patrol III/1 Hardtop (K160)	11/79→08/88	SD33	Diesel	3246	6	12	120
Patrol III/1 Hardtop (K160)	07/80→08/88	L28	Petrol	2753	6	12	107



CC











9

Patrol III/1 Hardtop (K160)	07/83→08/88	SD33T	Diesel	3246	6	12	120
Patrol III/1 Platform/Chassis (MQ, MK, GQ)	06/80→12/87	SD33	Diesel	3246	6	12	120
Patrol III/1 Platform/Chassis (MQ, MK, GQ)	06/80→12/97	TB42	Petrol	4169	6	12	126
Patrol III/1 Platform/Chassis (MQ, MK, GQ)	01/84→12/87	SD33T	Diesel	3246	6	12	120
Patrol III/1 Platform/Chassis (MQ, MK, GQ)	01/88→12/97	TD42	Diesel	4169	6	12	128
Patrol III/1 Station Wagon (W160)	11/79→08/88	SD33	Diesel	3246	6	12	120
Patrol III/1 Station Wagon (W160)	07/80→08/88	L28	Petrol	2753	6	12	107
Patrol III/1 Station Wagon (W160)	07/83→08/88	SD33T	Diesel	3246	6	12	120
Patrol III/2 Hardtop (K260)	05/86→06/90	L28	Petrol	2753	6	12	107
Patrol III/2 Hardtop (K260)	05/86→06/90	RD28T	Diesel	2826	6	12	109
Patrol III/2 Hardtop (K260)	01/88→12/97	TB42E	Petrol	4169	6	12	127
Patrol III/2 Hardtop (K260)	01/88→12/97	TD42	Diesel	4169	6	12	128
Patrol III/2 Hardtop (K260)	08/88→06/90	SD33T	Diesel	3246	6	12	120
Patrol III/2 Hardtop (K260)	03/89→10/93	RB30S	Petrol	2962	6	12	112
Patrol III/2 Hardtop (K260)	03/89→03/96	RD28	Diesel	2826	6	12	109
Patrol III/2 Station Wagon (W260)	08/88→06/90	SD33T	Diesel	3246	6	12	120
Patrol III/2 Station Wagon (W260)	03/89→10/93	RB30S	Petrol	2962	6	12	112
Patrol III/2 Station Wagon (W260)	03/89→03/96	RD28	Diesel	2826	6	12	109
Patrol III/2 Station Wagon (W260)	06/89→11/95	RD28T	Diesel	2826	6	12	109
Pick Up (720)	01/80→03/86	L18	Petrol	1770	4	8	55
Pick Up (720)	12/80→05/84	J16	Petrol	1567	4	8	41
Pick Up (720)	01/82→09/84	SD22	Diesel	2164	4	8	85
Pick Up (720)	04/83→03/86	SD23	Diesel	2289	4	8	90
Pick Up (720)	04/83→03/86	SD25	Diesel	2488	4	8	99
Pick Up (720)	04/83→03/86	Z22	Petrol	2188	4	8	87
Pick Up (D21)	09/85→08/88	SD23	Diesel	2289	4	8	90
Pick Up (D21)	09/85→08/95	Z20	Petrol	1952	4	8	73
Pick Up (D21)	09/85→12/96	VG30E	Petrol	2960	6	12	114
Pick Up (D21)	09/85→12/96	Z24	Petrol	2388	4	8	94
Pick Up (D21)	09/85→12/97	Z24i	Petrol	2389	4	8	94
Pick Up (D21)	09/85→02/98	SD25	Diesel	2488	4	8	99
Pick Up (D21)	08/87→02/98	TD25	Diesel	2494	4	8	100
Pick Up (D21)	08/87→02/98	TD27	Diesel	2663	4	8	106
Pick Up (D21)	09/87→12/96	TD27T	Diesel	2664	4	8	106
Pick Up (D21)	02/92→02/98	KA24E	Petrol	2389	4	12	92
Pick Up (D22)	01/97→08/01	SR20DE	Petrol	1998	4	16	81
Pick Up (D22)	01/97→10/01	VG30E	Petrol	2960	6	12	114
Pick Up (D22)	01/97→10/02	TD27T	Diesel	2664	4	8	106
Pick Up (D22)	01/97→12/02	Z24S	Petrol	2389	4	8	94
Pick Up (D22)	01/97→04/05	QD32	Diesel	3153	4	8	119
Pick Up (D22)	01/97→04/05	Z24	Petrol	2388	4	8	94
Pick Up (D22)	03/97→04/05	KA24E	Petrol	2389	4	12	92
Pick Up (D22)	02/98→04/05	TD25	Diesel	2494	4	8	100
Pick Up (D22)	02/98→04/05	TD27	Diesel	2663	4	8	106
Pick Up (D22)	05/98→04/05	TD25Ti	Diesel	2494	4	8	100
Pick Up (D22)	11/01→04/05	ZD30	Diesel	2953	4	16	118
Pick Up (D22)	11/01→	KA24DE	Petrol	2389	4	16	91
Pick Up (D22)	03/02→04/05	YD25DDTi	Diesel	2488	4	16	102
Pick Up (D22)	01/03→04/05	VG33E	Petrol	3275	6	12	121
Pino (HC24)	03/07→12/12	K6A	Petrol	658	3	12	2
Pintara Estate (R31)	06/86→10/90	CA20E	Petrol	1974	4	8	66
Pintara Hatchback (U12)	11/90→10/92	CA20E	Petrol	1974	4	8	66
Pintara Hatchback (U12)	11/90→10/92	KA24E	Petrol	2389	4	12	92
Pintara Saloon (R31)	06/86→10/90	CA20E	Petrol	1974	4	8	66
Pintara Saloon (U12)	11/89→10/92	CA20E	Petrol	1974	4	8	66
Pintara Saloon (U12)	11/89→10/92	KA24E	Petrol	2389	4	12	92
Pixo (UA0)	06/09→	K10 B	Petrol	996	3	12	8
Platina	06/01→12/10	K4M	Petrol	1598	4	16	42
Prairie (M10, NM10)	07/83→10/87	CA18S	Petrol	1809	4	8	49
Prairie (M10, NM10)	01/84→12/87	E15S	Petrol	1488	4	8	28
Prairie (M10, NM10)	01/86→09/88	CA20E	Petrol	1974	4	8	66
Prairie (M10, NM10)	01/86→09/88	CA20S	Petrol	1974	4	8	66
Prairie Liberty (_M12)	11/98→05/01	SR20DE	Petrol	1998	4	16	81
Prairie Liberty (_M12)	11/98→05/01	SR20DET	Petrol	1998	4	16	81
Prairie Liberty (_M12)	05/01→12/04	QR20DE	Petrol	1998	4	16	78
Prairie Pro (M11)	10/88→12/92	CA20E	Petrol	1974	4	8	66
Prairie Pro (M11)	09/89→07/94	KA24E	Petrol	2389	4	12	92
Prairie Pro (M11)	10/89→03/92	CA20S	Petrol	1974	4	8	66
Prairie Pro (M11)	01/95→10/98	SR20DE	Petrol	1998	4	16	81
Presage (U30)	03/98→12/03	YD25DDTi	Diesel	2488	4	16	102
Presage (U30)	08/98→08/02	KA24DE	Petrol	2389	4	16	91
Presage (U30)	08/01→06/03	QR25DE	Petrol	2488	4	16	97
Presage (U30)	08/01→06/03	VQ30DE	Petrol	2988	6	24	117
Presage (U31)	09/03→12/09	QR25DE	Petrol	2488	4	16	97
Presage (U31)	09/03→12/09	VQ35DE	Petrol	3498	6	24	122
Presea	08/97→08/00	GA15DE	Petrol	1498	4	16	29
Presea	08/97→08/00	SR18DE	Petrol	1838	4	16	60
Presea	08/97→08/00	SR20DE	Petrol	1998	4	16	81



Model	Year Range	Engine Code	Fuel	CC	Power (kW)	Power (hp)	Price
President (JHG50)	03/90→10/02	VH45DE	Petrol	4494	8	32	130
President (PGF50)	10/03→08/10	VK45DE	Petrol	4494	8	32	130
Primastar Box (X83)	09/02→	F9Q 760	Diesel	1870	4	8	62
Primastar Box (X83)	09/02→	F9Q 762	Diesel	1870	4	8	62
Primastar Box (X83)	02/03→	F4R 720	Petrol	1998	4	16	68
Primastar Box (X83)	07/03→	G9U 730	Diesel	2464	4	16	95
Primastar Box (X83)	04/06→	F4R 820	Petrol	1998	4	16	68
Primastar Box (X83)	09/06→	G9U 632	Diesel	2464	4	16	95
Primastar Box (X83)	09/06→	M9R 630	Diesel	1995	4	16	76
Primastar Box (X83)	09/06→	M9R 780	Diesel	1995	4	16	76
Primastar Box (X83)	09/06→	M9R 782	Diesel	1995	4	16	76
Primastar Box (X83)	09/08→	G9U 630	Diesel	2464	4	16	95
Primastar Bus (X83)	03/01→	F4R 720	Petrol	1998	4	16	68
Primastar Bus (X83)	03/01→	F4R 722	Petrol	1998	4	16	68
Primastar Bus (X83)	03/01→	F9Q 760	Diesel	1870	4	8	62
Primastar Bus (X83)	03/01→	F9Q 762	Diesel	1870	4	8	62
Primastar Bus (X83)	07/03→	G9U 730	Diesel	2464	4	16	95
Primastar Bus (X83)	04/06→	F4R 820	Petrol	1998	4	16	68
Primastar Bus (X83)	09/06→	G9U 632	Diesel	2464	4	16	95
Primastar Bus (X83)	09/06→	M9R 780	Diesel	1995	4	16	76
Primastar Bus (X83)	09/06→	M9R 782	Diesel	1995	4	16	76
Primastar Bus (X83)	09/08→	G9U 630	Diesel	2464	4	16	95
Primastar Platform/Chassis (X83)	07/02→08/06	F4R 720	Petrol	1998	4	16	68
Primastar Platform/Chassis (X83)	07/02→08/06	F9Q 760	Diesel	1870	4	8	62
Primastar Platform/Chassis (X83)	04/06→	G9U 630	Diesel	2464	4	16	95
Primera (P10)	06/90→01/96	GA16DS	Petrol	1597	4	16	37
Primera (P10)	06/90→06/96	SR20DE	Petrol	1998	4	16	81
Primera (P10)	06/90→06/96	SR20DI	Petrol	1998	4	16	82
Primera (P10)	01/91→01/96	CD20	Diesel	1974	4	8	67
Primera (P10)	06/93→01/96	GA16DE	Petrol	1597	4	16	37
Primera (P11)	06/96→05/99	QG18DD	Petrol	1769	4	16	58
Primera (P11)	06/96→12/01	QG16DE	Petrol	1597	4	16	37
Primera (P11)	09/96→12/01	CD20T	Diesel	1974	4	8	67
Primera (P11)	09/96→12/01	GA16DE	Petrol	1597	4	16	37
Primera (P11)	09/96→12/01	SR20DE	Petrol	1998	4	16	81
Primera (P11)	08/99→12/01	QG18DE	Petrol	1769	4	16	59
Primera (P12)	01/02→	QG16DE	Petrol	1597	4	16	37
Primera (P12)	01/02→	QR25DE	Petrol	2488	4	16	97
Primera (P12)	03/02→	QG18DE	Petrol	1769	4	16	59
Primera (P12)	03/02→	QR20DE	Petrol	1998	4	16	78
Primera (P12)	03/02→	YD22DDT	Diesel	2184	4	16	86
Primera (P12)	08/02→	F9Q	Diesel	1870	4	8	61
Primera Estate (WP12)	01/02→	QG16DE	Petrol	1597	4	16	37
Primera Estate (WP12)	01/02→	QG25DD	Petrol	2488	4	16	96
Primera Estate (WP12)	03/02→	QG18DE	Petrol	1769	4	16	59
Primera Estate (WP12)	03/02→	QR20DE	Petrol	1998	4	16	78
Primera Estate (WP12)	03/02→	YD22DDT	Diesel	2184	4	16	86
Primera Estate (WP12)	08/02→	F9Q	Diesel	1870	4	8	61
Primera Hatchback (P10)	06/90→01/96	GA16DS	Petrol	1597	4	16	37
Primera Hatchback (P10)	06/90→06/96	SR20DE	Petrol	1998	4	16	81
Primera Hatchback (P10)	06/90→06/96	SR20DI	Petrol	1998	4	16	82
Primera Hatchback (P10)	01/91→01/96	CD20	Diesel	1974	4	8	67
Primera Hatchback (P10)	06/93→01/96	GA16DE	Petrol	1597	4	16	37
Primera Hatchback (P11)	09/96→07/02	CD20T	Diesel	1974	4	8	67
Primera Hatchback (P11)	09/96→07/02	GA16DE	Petrol	1597	4	16	37
Primera Hatchback (P11)	09/96→07/02	SR20DE	Petrol	1998	4	16	81
Primera Hatchback (P11)	08/99→07/02	QG18DE	Petrol	1769	4	16	59
Primera Hatchback (P11)	09/00→07/02	QG16DE	Petrol	1597	4	16	37
Primera Hatchback (P12)	01/02→	QR25DE	Petrol	2488	4	16	97
Primera Hatchback (P12)	07/02→	QG16DE	Petrol	1597	4	16	37
Primera Hatchback (P12)	07/02→	QG18DE	Petrol	1769	4	16	59
Primera Hatchback (P12)	07/02→	QR20DE	Petrol	1998	4	16	78
Primera Hatchback (P12)	07/02→	YD22DDT	Diesel	2184	4	16	86
Primera Hatchback (P12)	08/02→	F9Q	Diesel	1870	4	8	61
Primera Traveller (W10)	07/90→12/95	CD20	Diesel	1974	4	8	67
Primera Traveller (W10)	07/90→03/98	GA16DS	Petrol	1597	4	16	37
Primera Traveller (W10)	07/90→03/98	SR20DI	Petrol	1998	4	16	82
Primera Traveller (W10)	02/91→03/98	GA16DE	Petrol	1597	4	16	37
Primera Traveller (W10)	07/94→01/98	SR20DE	Petrol	1998	4	16	81
Primera Traveller (WP11)	06/96→05/99	QG18DD	Petrol	1769	4	16	58
Primera Traveller (WP11)	06/96→12/01	SR20DE	Petrol	1998	4	16	81
Primera Traveller (WP11)	04/98→12/01	CD20T	Diesel	1974	4	8	67
Primera Traveller (WP11)	04/98→12/01	QG16DE	Petrol	1597	4	16	37
Primera Traveller (WP11)	04/98→01/02	GA16DE	Petrol	1597	4	16	37
Primera Traveller (WP11)	08/99→12/01	QG18DE	Petrol	1769	4	16	59
Pulsar (N17)	08/12→	HR16DE	Petrol	1598	4	16	40
Pulsar (N17)	08/12→	MRA8DE	Petrol	1798	4	16	57
Pulsar Hatchback (C13)	10/14→	HR12DDT	Petrol	1197	4	16	17

							
Pulsar Hatchback (C13)	10/14→	K9K	Diesel	1461	4	8	32
Pulsar Hatchback (C13)	02/15→	MR16DDT	Petrol	1618	4	16	44
Pulsar Hatchback (N10)	09/78→06/82	A14	Petrol	1397	4	8	21
Pulsar Hatchback (N10)	11/78→12/82	A15	Petrol	1488	4	8	26
Pulsar Hatchback (N10)	09/81→06/82	A14S	Petrol	1397	4	8	21
Pulsar Hatchback (N12)	01/82→07/86	E15S	Petrol	1488	4	8	28
Pulsar Hatchback (N12)	01/83→12/83	E16	Petrol	1597	4	8	36
Pulsar Hatchback (N12)	01/83→12/87	E15	Petrol	1488	4	8	28
Pulsar Hatchback (N12)	09/83→03/86	E16i	Petrol	1597	4	8	36
Pulsar Hatchback (N12)	01/84→12/87	E15ET	Petrol	1488	4	8	28
Pulsar Hatchback (N12)	01/86→12/87	E13	Petrol	1269	4	8	20
Pulsar Hatchback (N14)	10/92→06/95	GA16DE	Petrol	1597	4	16	37
Pulsar Hatchback (N15)	07/95→05/00	QG18DE	Petrol	1769	4	16	59
Pulsar I Saloon (N15)	07/95→07/00	GA16DE	Petrol	1597	4	16	37
Pulsar I Saloon (N15)	07/95→07/00	SR20DE	Petrol	1998	4	16	81
Pulsar NX Coupe	09/82→12/84	E15T	Petrol	1488	4	8	28
Pulsar NX Coupe	09/82→12/87	E16	Petrol	1597	4	8	36
Pulsar NX Coupe	09/86→12/87	CA16DE	Petrol	1598	4	16	35
Pulsar NX Coupe	09/87→12/89	CA18DE	Petrol	1809	4	16	50
Pulsar NX Coupe	09/88→12/90	GA16i	Petrol	1597	4	12	38
Pulsar Saloon (N12)	06/83→05/86	E13	Petrol	1269	4	8	20
Pulsar Saloon (N12)	06/83→05/86	E15	Petrol	1488	4	8	28
Q40 Saloon	09/14→	VQ37VHR	Petrol	3696	6	24	123
Q45 (F50)	02/01→	VK45DE	Petrol	4494	8	32	130
Q45 I	01/89→12/96	VH45DE	Petrol	4494	8	32	130
Q45 III (F50)	09/01→12/06	VK45DE	Petrol	4494	8	32	130
Q50	04/13→	VQ35HR	Petrol	3498	6	24	122
Q50	04/13→	VQ37VHR	Petrol	3696	6	24	123
Q50	04/14→	VQ37HR	Petrol	3696	6	24	123
Q60 Convertible	10/13→	VQ37VHR	Petrol	3696	6	24	123
Q60 Coupe	10/13→	VQ37VHR	Petrol	3696	6	24	123
Q70 (Y51)	03/13→	VQ35HR	Petrol	3498	6	24	122
Q70 (Y51)	03/13→	VQ37VHR	Petrol	3696	6	24	123
Qashqai	11/08→	HR16DE	Petrol	1598	4	16	40
Qashqai II (J11, J11_)	11/13→	HR12DDT	Petrol	1197	4	16	17
Qashqai II (J11, J11_)	11/13→	K9K 636	Diesel	1461	4	8	32
Qashqai II (J11, J11_)	11/13→	R9M	Diesel	1598	4	16	46
Qashqai II (J11, J11_)	06/14→	MR20DD	Petrol	1997	4	16	77
Qashqai II (J11, J11_)	10/14→	MR16DDT	Petrol	1618	4	16	44
Qashqai / Qashqai +2 I (J10, JJ10)	02/07→12/13	HR16DE	Petrol	1598	4	16	40
Qashqai / Qashqai +2 I (J10, JJ10)	02/07→12/13	K9K 282	Diesel	1461	4	8	32
Qashqai / Qashqai +2 I (J10, JJ10)	02/07→12/13	K9K 292	Diesel	1461	4	8	32
Qashqai / Qashqai +2 I (J10, JJ10)	02/07→12/13	M1D	Diesel	1994	4	16	76
Qashqai / Qashqai +2 I (J10, JJ10)	02/07→12/13	M9R	Diesel	1995	4	16	76
Qashqai / Qashqai +2 I (J10, JJ10)	02/07→12/13	MR20DE	Petrol	1997	4	16	77
Qashqai / Qashqai +2 I (J10, JJ10)	01/10→12/13	K9K 430	Diesel	1461	4	8	32
Qashqai / Qashqai +2 I (J10, JJ10)	10/11→12/13	R9M	Diesel	1598	4	16	46
Quest (RE52)	02/12→	VQ35DE	Petrol	3498	6	24	122
Quest (V40)	05/92→09/98	VG30E	Petrol	2960	6	12	114
Quest (V42)	05/03→	VQ35DE	Petrol	3498	6	24	122
Quest Mini Passenger Van	09/98→12/02	VG33E	Petrol	3275	6	12	121
QX4	01/97→	VG33E	Petrol	3275	6	12	121
QX4	09/00→12/03	VQ35DE	Petrol	3498	6	24	122
QX50	08/13→	VQ37HR	Petrol	3696	6	24	123
QX50	08/13→	VQ37VHR	Petrol	3696	6	24	123
QX60	04/12→	VQ35DE	Petrol	3498	6	24	122
QX60	09/13→	QR25DER	Petrol	2488	4	16	97
QX60	08/14→	QR25	Petrol	2488	4	16	97
QX70	08/13→	VQ35HR	Petrol	3498	6	24	122
QX70	08/13→	VQ37VHR	Petrol	3696	6	24	123
Rasheen	08/94→06/00	GA15DE	Petrol	1498	4	16	29
Rnessa (N30)	11/97→07/01	KA24DE	Petrol	2389	4	16	91
Rnessa (N30)	11/97→07/01	SR20DE	Petrol	1998	4	16	81
Rnessa (N30)	11/97→07/01	SR20DET	Petrol	1998	4	16	81
Rogue	01/07→12/13	QR25DE	Petrol	2488	4	16	97
Roox	03/09→	K6A	Petrol	658	3	12	2
Roox	01/10→02/13	K6A-T	Petrol	658	3	12	2
Sani Closed Off-Road Vehicle	07/86→08/89	VG30I	Petrol	2960	6	12	114
Sani Closed Off-Road Vehicle	07/86→10/95	Z24i	Petrol	2389	4	8	94
Sani Closed Off-Road Vehicle	08/92→12/99	VG30E	Petrol	2960	6	12	114
Sani Closed Off-Road Vehicle	11/95→07/00	VG33E	Petrol	3275	6	12	121
Sani Closed Off-Road Vehicle	01/96→12/99	TD27	Diesel	2663	4	8	106
Sani Closed Off-Road Vehicle	09/99→07/04	KA24E	Petrol	2389	4	12	92
Sani Closed Off-Road Vehicle	08/00→07/04	VQ35	Petrol	3498	6	24	122
Sani Closed Off-Road Vehicle	01/05→	VQ40DE	Petrol	3954	6	24	125
Sani Closed Off-Road Vehicle	01/05→	YD25DDTi	Diesel	2488	4	16	102
S-Cargo Box	01/89→03/94	E15S	Petrol	1488	4	8	28
Sentra Hatchback	09/81→12/83	E15S	Petrol	1488	4	8	28











CC



9

Sentra Hatchback	09/84→12/86	CD17	Diesel	1681	4	8	47
Sentra III (B13)	01/90→12/94	GA16DS	Petrol	1597	4	16	37
Sentra III (B13)	02/92→12/94	SR20DE	Petrol	1998	4	16	81
Sentra IV (B14)	01/95→09/99	GA16DS	Petrol	1597	4	16	37
Sentra V (B15)	07/98→06/01	GA16DE	Petrol	1597	4	16	37
Sentra V (B15)	01/00→09/06	QG18DE	Petrol	1769	4	16	59
Sentra V (B15)	01/00→12/06	SR20DE	Petrol	1998	4	16	81
Sentra V (B15)	06/02→12/06	QR25DE	Petrol	2488	4	16	97
Sentra VI (B16)	09/06→12/12	QR25DE	Petrol	2488	4	16	97
Sentra VI (B16)	10/06→12/12	MR20DE	Petrol	1997	4	16	77
Sentra VII (B17)	08/12→	MRA8DE	Petrol	1798	4	16	57
Sentra VII (B17)	05/13→	HR16DE	Petrol	1598	4	16	40
Sentra VII (B17)	01/14→	MR20DE	Petrol	1997	4	16	77
Sentra Saloon	09/84→12/86	CD17	Diesel	1681	4	8	47
Serena (C23)	06/91→09/96	CD20T	Diesel	1974	4	8	67
Serena (C23)	06/91→09/01	CD20	Diesel	1974	4	8	67
Serena (C23)	11/92→09/01	LD20	Diesel	1952	4	8	63
Serena (C23)	11/92→09/01	SR20DE	Petrol	1998	4	16	81
Serena (C23)	02/93→09/01	GA16DE	Petrol	1597	4	16	37
Serena (C23)	01/95→09/01	LD23	Diesel	2283	4	8	88
Serena (C23)	09/96→06/99	CD20ET	Diesel	1974	4	8	67
Serena (C23M)	07/94→08/00	KA24E	Petrol	2389	4	12	92
Serena (C23M)	10/94→08/00	GA16DE	Petrol	1597	4	16	37
Serena (C24)	06/99→09/05	YD25DDTi	Diesel	2488	4	16	102
Serena (C24)	09/00→09/05	SR20DE	Petrol	1998	4	16	81
Serena (C25)	04/05→08/12	MR20DE	Petrol	1997	4	16	77
Serena (C26)	11/10→07/16	MR20DD	Petrol	1997	4	16	77
Serena (C27)	08/16→	MR20DD	Petrol	1997	4	16	77
Shuaike	01/14→	HR16DE	Petrol	1598	4	16	40
Silvia (S12)	06/83→07/85	Z22E	Petrol	2188	4	8	87
Silvia (S12)	08/83→12/88	CA18ET	Petrol	1809	4	8	51
Silvia (S12)	01/84→12/88	CA20E	Petrol	1974	4	8	66
Silvia (S12)	04/84→09/88	FJ20E	Petrol	1991	4	8	70
Silvia (S12)	09/86→12/88	VG30E	Petrol	2960	6	12	114
Silvia (S15)	09/99→08/02	SR20DE	Petrol	1998	4	16	81
Silvia (S15)	11/00→12/03	SR20DET	Petrol	1998	4	16	81
Silvia (S110)	01/79→06/81	Z20E	Petrol	1952	4	8	64
Silvia (S110)	01/79→05/83	L18E	Petrol	1770	4	8	55
Silvia (S110)	07/81→07/83	Z22E	Petrol	2188	4	8	87
Silvia Convertible	08/88→03/94	CA18DT	Petrol	1809	4	16	50
Silvia Coupe	08/88→03/94	CA18DT	Petrol	1809	4	16	50
Silvia Hatchback (S12)	06/83→12/88	CA20E	Petrol	1974	4	8	66
Skyline (C210)	09/78→07/81	L24	Petrol	2393	6	12	93
Skyline (R30)	03/81→06/86	L24E	Petrol	2393	6	12	93
Skyline (R30)	08/81→07/84	L18S	Petrol	1770	4	8	55
Skyline (R30)	08/81→07/84	LD20	Diesel	1952	4	8	63
Skyline (R30)	08/81→07/84	LD28	Diesel	2792	6	12	108
Skyline (R30)	08/81→07/84	Z20E	Petrol	1952	4	8	64
Skyline (R30)	01/82→06/86	L20B	Petrol	1952	4	8	73
Skyline (R30)	01/82→06/86	L28E	Petrol	2753	6	12	105
Skyline (R31)	07/86→03/89	CA18S	Petrol	1809	4	8	49
Skyline (R31)	07/86→03/89	RB20DE	Petrol	1998	6	24	79
Skyline (R31)	07/86→12/90	RB30E	Petrol	2962	6	12	112
Skyline (R31)	01/87→01/90	RB20DET	Petrol	1998	6	24	79
Skyline (R32)	03/89→06/93	CA18i	Petrol	1809	4	8	49
Skyline (R32)	03/89→06/93	RB20DE	Petrol	1998	6	24	79
Skyline (R32)	03/89→06/93	RB20DET	Petrol	1998	6	24	79
Skyline (R32)	03/89→06/93	RB20E	Petrol	1998	6	12	80
Skyline (R32)	03/89→06/93	RB25DE	Petrol	2498	6	24	98
Skyline (R33)	07/93→05/98	RB20E	Petrol	1998	6	12	80
Skyline (R33)	07/93→05/98	RB25DE	Petrol	2498	6	24	98
Skyline (R34)	05/98→08/02	RB25DET	Petrol	2498	6	24	98
Skyline (R34)	06/98→07/00	RB20DE	Petrol	1998	6	24	79
Skyline (R34)	06/98→07/00	RB25DEH	Petrol	2498	6	24	98
Skyline (V35)	02/01→12/07	VQ35DE	Petrol	3498	6	24	122
Skyline (V35)	01/06→12/07	VQ25DD	Petrol	2496	6	24	101
Skyline (V35)	01/06→12/07	VQ30DD	Petrol	2987	6	24	117
Skyline (V36)	12/06→12/11	VQ35HR	Petrol	3498	6	24	122
Skyline (V36)	12/08→12/14	VQ37VHR	Petrol	3696	6	24	123
Skyline (_ V37)	02/14→	VQ35HR	Petrol	3498	6	24	122
Skyline Coupe (R31)	08/85→05/90	RB20DE	Petrol	1998	6	24	79
Skyline Coupe (R31)	08/85→05/90	RB20DET	Petrol	1998	6	24	79
Skyline Coupe (R32)	03/89→06/93	RB20DE	Petrol	1998	6	24	79
Skyline Coupe (R32)	03/89→06/93	RB20DET	Petrol	1998	6	24	79
Skyline Coupe (R32)	04/89→06/93	RB26DETT	Petrol	2568	6	24	104
Skyline Coupe (R33)	07/93→05/98	RB20E	Petrol	1998	6	12	80
Skyline Coupe (R33)	07/93→05/98	RB25DE	Petrol	2498	6	24	98
Skyline Coupe (R33)	01/94→07/00	RB25DET	Petrol	2498	6	24	98

							
Skyline Coupe (R33)	07/94→09/99	RB26DETT	Petrol	2568	6	24	104
Skyline Coupe (R34)	05/98→01/06	RB25DET	Petrol	2498	6	24	98
Skyline Coupe (R34)	06/98→07/00	RB20DE	Petrol	1998	6	24	79
Skyline Coupe (R34)	06/98→07/00	RB25DEH	Petrol	2498	6	24	98
Skyline Coupe (R34)	01/99→02/08	RB26DETT	Petrol	2568	6	24	104
Skyline Coupe (V35)	08/03→12/06	VQ30DD	Petrol	2987	6	24	117
Skyline Coupe (V35)	08/03→08/07	VQ35DE	Petrol	3498	6	24	122
Skyline Coupe (V35)	01/06→08/07	VQ25DD	Petrol	2496	6	24	101
Skyline Crossover (J50)	07/09→	VQ37VHR	Petrol	3696	6	24	123
Skyline Estate (R30)	03/81→06/86	L24E	Petrol	2393	6	12	93
Skyline Estate (R30)	08/81→07/84	LD20	Diesel	1952	4	8	63
Skyline Estate (R30)	08/81→07/84	LD28	Diesel	2792	6	12	108
Skyline Estate (R30)	08/81→07/84	Z20E	Petrol	1952	4	8	64
Skyline Estate (R31)	07/86→12/90	RB30E	Petrol	2962	6	12	112
Stagea (M35)	10/01→06/03	VQ25DET	Petrol	2496	6	24	101
Stagea (M35)	10/01→06/03	VQ30DD	Petrol	2987	6	24	117
Stagea (M35)	10/01→12/07	VQ25DD	Petrol	2496	6	24	101
Stagea (M35)	04/06→12/07	VQ35DE	Petrol	3498	6	24	122
Stagea (WC34)	09/96→10/01	RB20E	Petrol	1998	6	12	80
Stagea (WC34)	09/96→10/01	RB25DE	Petrol	2498	6	24	98
Stagea (WC34)	09/96→10/01	RB25DET	Petrol	2498	6	24	98
Stagea (WC34)	09/96→10/01	RB26DETT	Petrol	2568	6	24	104
Stanza (T11)	08/81→12/85	CA16S	Petrol	1598	4	8	34
Stanza (T11)	09/82→12/83	CA20S	Petrol	1974	4	8	66
Stanza (T11)	03/83→12/85	CA18S	Petrol	1809	4	8	49
Stanza (T11)	09/83→12/85	CA20E	Petrol	1974	4	8	66
Stanza Hatchback	01/86→06/89	CA20DE	Petrol	1973	4	8	66
Stanza Hatchback (T11)	08/81→12/83	CA20S	Petrol	1974	4	8	66
Stanza Hatchback (T11)	08/81→12/85	CA16S	Petrol	1598	4	8	34
Stanza Hatchback (T11)	08/81→12/85	CA18	Petrol	1809	4	8	49
Stanza Hatchback (T11)	08/81→12/85	CA18S	Petrol	1809	4	8	49
Stanza Hatchback (T11)	04/83→12/85	CA20E	Petrol	1974	4	8	66
Stanza Hatchback (T12)	09/86→12/89	CA20E	Petrol	1974	4	8	66
Stanza Saloon	01/86→06/89	CA20DE	Petrol	1973	4	8	66
Stanza Saloon (T12)	09/85→12/89	CA20E	Petrol	1974	4	8	66
Stanza Saloon (U12)	09/89→12/92	KA24E	Petrol	2389	4	12	92
Sunny	01/11→	HRI5DE	Petrol	1498	4	16	30
Sunny	01/11→	K9K 772	Diesel	1461	4	8	32
Sunny (140Y, 150Y)	01/70→02/82	A14	Petrol	1397	4	8	21
Sunny (140Y, 150Y)	07/73→02/82	A12	Petrol	1171	4	8	10
Sunny (140Y, 150Y)	06/79→02/82	A15	Petrol	1488	4	8	26
Sunny Coupe	04/00→09/03	QG18DE	Petrol	1769	4	16	59
Sunny Coupe (B10)	05/69→05/70	A10	Petrol	988	4	8	4
Sunny Estate (B110)	06/70→04/74	A12	Petrol	1171	4	8	10
Sunny Estate (VB10)	03/67→06/70	A10	Petrol	988	4	8	4
Sunny Hatchback	04/00→08/03	QG15DE	Petrol	1498	4	16	29
Sunny I (B11)	03/82→05/86	E15	Petrol	1488	4	8	28
Sunny I (B11)	03/82→10/86	E15S	Petrol	1488	4	8	28
Sunny I (B11)	03/82→09/87	E13	Petrol	1269	4	8	20
Sunny I (B11)	03/82→12/87	CD17	Diesel	1681	4	8	47
Sunny I (B11)	05/84→02/86	E16	Petrol	1597	4	8	36
Sunny I (B11)	07/86→10/88	E16S	Petrol	1597	4	8	36
Sunny I (B11)	07/86→12/88	E16I	Petrol	1597	4	8	36
Sunny I (B11)	09/86→07/90	GA15DS	Petrol	1497	4	16	29
Sunny I (B11)	07/88→07/90	GA16DE	Petrol	1597	4	16	37
Sunny I (B11)	09/88→12/90	GA16i	Petrol	1597	4	12	38
Sunny I Coupe (B11)	03/82→05/86	E15	Petrol	1488	4	8	28
Sunny I Coupe (B11)	03/82→10/86	E15S	Petrol	1488	4	8	28
Sunny I Coupe (B11)	04/82→09/86	E13	Petrol	1269	4	8	20
Sunny I Coupe (B11)	05/84→07/86	E16S	Petrol	1597	4	8	36
Sunny I Coupe (B11)	09/84→12/85	E16	Petrol	1597	4	8	36
Sunny I Coupe (B11)	09/84→12/86	CD17	Diesel	1681	4	8	47
Sunny I Coupe (B11)	09/86→12/87	E16i	Petrol	1597	4	8	36
Sunny I Traveller (B11)	03/82→01/84	E15	Petrol	1488	4	8	28
Sunny I Traveller (B11)	03/82→10/86	CD17	Diesel	1681	4	8	47
Sunny I Traveller (B11)	03/82→10/86	E15S	Petrol	1488	4	8	28
Sunny I Traveller (B11)	03/82→12/88	E16i	Petrol	1597	4	8	36
Sunny I Traveller (B11)	08/82→08/90	E13	Petrol	1269	4	8	20
Sunny I Traveller (B11)	06/86→08/90	E16	Petrol	1597	4	8	36
Sunny I Traveller (B11)	09/88→08/90	GA16i	Petrol	1597	4	12	38
Sunny II (N13)	06/86→10/88	E15S	Petrol	1488	4	8	28
Sunny II (N13)	06/86→10/88	E16S	Petrol	1597	4	8	36
Sunny II (N13)	06/86→05/89	CD17	Diesel	1681	4	8	47
Sunny II (N13)	06/86→10/90	E16i	Petrol	1597	4	8	36
Sunny II (N13)	06/86→10/91	E16	Petrol	1597	4	8	36
Sunny II (N13)	07/86→06/91	GA16S	Petrol	1597	4	12	39
Sunny II (N13)	07/86→10/91	E13S	Petrol	1269	4	8	20
Sunny II (N13)	02/87→10/88	CA16D	Petrol	1598	4	16	35











CC



9

Sunny II (N13)	02/87→10/88	GA16DE	Petrol	1597	4	16	37
Sunny II (N13)	09/87→12/90	E16E	Petrol	1597	4	8	36
Sunny II (N13)	10/88→09/90	GA14DS	Petrol	1392	4	16	22
Sunny II (N13)	10/88→06/91	GA16i	Petrol	1597	4	12	38
Sunny II (N13)	10/88→08/91	GA14S	Petrol	1392	4	16	23
Sunny II Coupe (B12)	06/86→10/88	E15S	Petrol	1488	4	8	28
Sunny II Coupe (B12)	06/86→10/88	E16S	Petrol	1597	4	8	36
Sunny II Coupe (B12)	06/86→05/89	E16i	Petrol	1597	4	8	36
Sunny II Coupe (B12)	05/87→05/89	CA16D	Petrol	1598	4	16	35
Sunny II Coupe (B12)	09/88→06/91	GA16i	Petrol	1597	4	12	38
Sunny II Coupe (B12)	10/88→09/90	GA16S	Petrol	1597	4	12	39
Sunny II Coupe (B12)	01/89→06/91	CA18D	Petrol	1809	4	16	50
Sunny II Hatchback (N13)	06/86→10/88	E13S	Petrol	1269	4	8	20
Sunny II Hatchback (N13)	06/86→10/88	E15S	Petrol	1488	4	8	28
Sunny II Hatchback (N13)	06/86→10/88	E16S	Petrol	1597	4	8	36
Sunny II Hatchback (N13)	06/86→10/90	E16i	Petrol	1597	4	8	36
Sunny II Hatchback (N13)	06/86→10/90	GA16i	Petrol	1597	4	12	38
Sunny II Hatchback (N13)	06/86→01/91	CD17	Diesel	1681	4	8	47
Sunny II Hatchback (N13)	07/86→09/90	E10S	Petrol	988	4	8	7
Sunny II Hatchback (N13)	02/87→10/88	GA16DE	Petrol	1597	4	16	37
Sunny II Hatchback (N13)	06/87→05/89	CA16D	Petrol	1598	4	16	35
Sunny II Hatchback (N13)	07/87→09/91	16LF	Petrol	1598	4	8	34
Sunny II Hatchback (N13)	10/88→08/91	GA14S	Petrol	1392	4	16	23
Sunny II Hatchback (N13)	01/89→06/91	CA18D	Petrol	1809	4	16	50
Sunny II Traveller (B12)	01/86→06/91	CD17	Diesel	1681	4	8	47
Sunny II Traveller (B12)	06/86→10/88	E15S	Petrol	1488	4	8	28
Sunny II Traveller (B12)	06/86→10/88	E16S	Petrol	1597	4	8	36
Sunny II Traveller (B12)	06/86→05/89	E16i	Petrol	1597	4	8	36
Sunny II Traveller (B12)	10/88→06/91	GA16i	Petrol	1597	4	12	38
Sunny III (N14)	05/90→12/92	CA18DE	Petrol	1809	4	16	50
Sunny III (N14)	08/90→12/96	GA16DE	Petrol	1597	4	16	37
Sunny III (N14)	08/90→12/96	SR20DE	Petrol	1998	4	16	81
Sunny III (N14)	10/90→05/95	CD20	Diesel	1974	4	8	67
Sunny III (N14)	10/90→05/95	GA16DS	Petrol	1597	4	16	37
Sunny III (N14)	10/90→06/95	GA14DE	Petrol	1392	4	16	22
Sunny III (N14)	10/90→06/95	GA14DS	Petrol	1392	4	16	22
Sunny III (N14)	10/90→06/95	GA16DEL	Petrol	1597	4	16	37
Sunny III (N14)	01/92→12/92	E16S	Petrol	1597	4	8	36
Sunny III Box (Y10)	11/90→03/00	CD17	Diesel	1681	4	8	47
Sunny III Box (Y10)	10/92→03/00	GA16DE	Petrol	1597	4	16	37
Sunny III Coupe	11/95→12/97	SR20DE	Petrol	1998	4	16	81
Sunny III Hatchback (N14)	10/90→05/95	CD20	Diesel	1974	4	8	67
Sunny III Hatchback (N14)	10/90→05/95	GA14DE	Petrol	1392	4	16	22
Sunny III Hatchback (N14)	10/90→05/95	GA16DE	Petrol	1597	4	16	37
Sunny III Hatchback (N14)	10/90→05/95	GA16DS	Petrol	1597	4	16	37
Sunny III Hatchback (N14)	10/90→05/95	SR20DE	Petrol	1998	4	16	81
Sunny III Hatchback (N14)	10/90→05/95	SR20DET	Petrol	1998	4	16	81
Sunny III Hatchback (N14)	10/90→06/95	GA14DS	Petrol	1392	4	16	22
Sunny III Hatchback (N14)	10/90→06/95	GA16DEL	Petrol	1597	4	16	37
Sunny III Liftback (N14)	10/90→05/95	CD20	Diesel	1974	4	8	67
Sunny III Liftback (N14)	10/90→05/95	GA16DS	Petrol	1597	4	16	37
Sunny III Liftback (N14)	10/90→05/95	SR20DE	Petrol	1998	4	16	81
Sunny III Liftback (N14)	10/90→06/95	GA14DE	Petrol	1392	4	16	22
Sunny III Liftback (N14)	10/90→06/95	GA14DS	Petrol	1392	4	16	22
Sunny III Liftback (N14)	10/90→06/95	GA16DEL	Petrol	1597	4	16	37
Sunny III Liftback (N14)	10/90→10/95	GA16DE	Petrol	1597	4	16	37
Sunny III Traveller (Y10)	11/90→03/00	GA16DS	Petrol	1597	4	16	37
Sunny III Traveller (Y10)	06/91→03/00	CD20	Diesel	1974	4	8	67
Sunny III Traveller (Y10)	06/91→03/00	GA16DE	Petrol	1597	4	16	37
Sunny IV Hatchback	04/00→09/03	QG18DE	Petrol	1769	4	16	59
Sunny IV Saloon (B15)	09/97→12/99	SR20DE	Petrol	1998	4	16	81
Sunny IV Saloon (B15)	09/97→03/00	QG13DE	Petrol	1295	4	16	19
Sunny IV Saloon (B15)	09/97→03/00	QG15DE	Petrol	1498	4	16	29
Sunny IV Saloon (B15)	09/97→09/03	GA16DE	Petrol	1597	4	16	37
Sunny IV Saloon (B15)	09/97→09/03	QG16DE	Petrol	1597	4	16	37
Sunny Saloon	01/00→05/02	SR20DE	Petrol	1998	4	16	81
Sunny Saloon	04/00→09/03	QG18DE	Petrol	1769	4	16	59
Sunny Saloon (B10)	03/67→06/70	A10	Petrol	988	4	8	4
Sunny Saloon (B110)	06/70→04/74	A12	Petrol	1171	4	8	10
Sunny Traveller (140Y, 150Y)	06/79→12/79	A12A	Petrol	1237	4	8	11
Sunny Traveller (140Y, 150Y)	06/79→02/82	A14	Petrol	1397	4	8	21
Sunny Traveller (140Y, 150Y)	06/79→02/82	A15	Petrol	1488	4	8	26
Sylphy (B17)	07/12→03/16	HR16DE	Petrol	1598	4	16	40
Sylphy (B17)	08/12→	HR16DE	Petrol	1598	4	16	40
Sylphy (B17)	08/12→	MRA8DE	Petrol	1798	4	16	57
Teana (J31)	04/06→06/08	VQ35DE	Petrol	3498	6	24	122
Teana (J32)	06/08→11/10	VQ35DE	Petrol	3498	6	24	122
Teana (L33)	11/10→	VQ35DE	Petrol	3498	6	24	122

							
Teana I (J31)	02/03→09/08	QR25DE	Petrol	2488	4	16	97
Teana I (J31)	10/03→06/08	QR20DE	Petrol	1998	4	16	78
Teana I (J31)	10/03→06/08	VQ35DE	Petrol	3498	6	24	122
Teana II (J32)	06/08→12/12	QR25DE	Petrol	2488	4	16	97
Teana II (J32)	07/08→09/13	VQ25DE	Petrol	2496	6	24	101
Teana II (J32)	07/08→09/13	VQ35DE	Petrol	3498	6	24	122
Teana III (J33, L33)	09/13→	MR20DE	Petrol	1997	4	16	77
Teana III (J33, L33)	09/13→	QR25DE	Petrol	2488	4	16	97
Terrano (D10)	03/14→	K4M	Petrol	1598	4	16	42
Terrano (D10)	03/14→	K9K	Diesel	1461	4	8	32
Terrano I (WD21)	07/86→08/89	VG30I	Petrol	2960	6	12	114
Terrano I (WD21)	07/86→10/95	Z24i	Petrol	2389	4	8	94
Terrano I (WD21)	02/89→02/96	TD27T	Diesel	2664	4	8	106
Terrano I (WD21)	01/90→12/95	VG30E	Petrol	2960	6	12	114
Terrano II (R20)	10/92→10/97	QD32ETI	Diesel	3153	4	8	119
Terrano II (R20)	10/92→12/04	VG33E	Petrol	3275	6	12	121
Terrano II (R20)	02/93→01/02	TD27T	Diesel	2664	4	8	106
Terrano II (R20)	02/93→09/07	KA24E	Petrol	2389	4	12	92
Terrano II (R20)	10/94→06/03	VQ35DE	Petrol	3498	6	24	122
Terrano II (R20)	05/96→09/07	TD27TI	Diesel	2664	4	8	106
Terrano II (R20)	10/97→12/04	ZD30DDTi	Diesel	2953	4	16	118
Terrano II (R20)	05/02→09/07	ZD30	Diesel	2953	4	16	118
Terrano II Van (R20)	06/98→09/07	TD27TI	Diesel	2664	4	8	106
Terrano II Van (R20)	04/03→09/07	ZD30	Diesel	2953	4	16	118
Terrano II Van (R20)	04/03→09/07	ZD30Ti	Diesel	2953	4	16	118
Tiida Hatchback	05/04→02/07	HR18DE	Petrol	1769	4	16	53
Tiida Hatchback (C11)	05/04→08/12	HR15DE	Petrol	1498	4	16	30
Tiida Hatchback (C11)	08/05→06/13	HR16DE	Petrol	1598	4	16	40
Tiida Hatchback (C11)	02/06→12/11	MR18DE	Petrol	1798	4	16	56
Tiida Hatchback (C11)	09/07→12/11	K9K	Diesel	1461	4	8	32
Tiida Hatchback (C11)	09/07→12/11	K9K 278	Diesel	1461	4	8	32
Tiida Hatchback (C12)	05/11→	HR16DE	Petrol	1598	4	16	40
Tiida Hatchback (C12)	08/12→12/13	MR18DE	Petrol	1798	4	16	56
Tiida Hatchback (C12)	02/13→	MR16DDT	Petrol	1618	4	16	44
Tiida Qida Hatchback (C11)	07/05→	HR16DE	Petrol	1598	4	16	40
Tiida Qida Hatchback (C13Z)	05/16→	HR16DE	Petrol	1598	4	16	40
Tiida Saloon (SC11)	10/04→06/13	HR15DE	Petrol	1498	4	16	30
Tiida Saloon (SC11)	05/06→06/13	HR16DE	Petrol	1598	4	16	40
Tiida Saloon (SC11)	08/06→06/13	MR18DE	Petrol	1798	4	16	56
Tiida Saloon (SC11)	01/07→12/12	K9K	Diesel	1461	4	8	32
Tiida Saloon (SC11)	01/07→12/12	K9K 278	Diesel	1461	4	8	32
Tiida Saloon (SC12)	08/11→	MR18DE	Petrol	1798	4	16	56
Tiida Saloon (SC12)	09/12→	HR16DE	Petrol	1598	4	16	40
Tiida Yida Saloon (C11)	04/05→	HR16DE	Petrol	1598	4	16	40
Trade Box	11/86→10/98	LD20	Diesel	1952	4	8	63
Trade Box	04/93→10/98	BD30II	Diesel	2953	4	8	111
Trade Box	06/96→10/01	BD-30Ti	Diesel	2953	4	8	111
Trade Box Body / Estate	01/96→12/98	BD-30Ti	Diesel	2953	4	8	111
Trade Box Body / Estate	05/97→12/00	LD23	Diesel	2283	4	8	88
Trade Bus	06/96→10/01	BD-30Ti	Diesel	2953	4	8	111
Trade Platform/Chassis	11/86→10/98	LD20	Diesel	1952	4	8	63
Trade Platform/Chassis	04/93→12/98	BD30II	Diesel	2953	4	8	111
Trade Platform/Chassis	01/96→09/04	BD-30Ti	Diesel	2953	4	8	111
Trade Platform/Chassis	06/96→10/01	LD23	Diesel	2283	4	8	88
Trade Platform/Chassis	11/98→09/04	TD27T	Diesel	2664	4	8	106
Tsuru	10/91→03/00	E16S	Petrol	1597	4	8	36
Tsuru	10/91→12/07	E16E	Petrol	1597	4	8	36
Tsuru	10/91→12/07	GA13DS	Petrol	1295	4	16	19
Tsuru	10/91→12/07	GA14DS	Petrol	1392	4	16	22
Tsuru	10/91→12/07	GA16DS	Petrol	1597	4	16	37
Tsuru	10/91→12/07	SR20DE	Petrol	1998	4	16	81
Tsuru	11/94→	GA16DE	Petrol	1597	4	16	37
Tsuru	09/99→	GA16DNE	Petrol	1597	4	16	37
Tsuru Saloon	09/06→12/12	GA16DNE	Petrol	1597	4	16	37
Tsuru Saloon (B13)	09/12→	GA16DNE	Petrol	1597	4	16	37
Urvan Box	10/95→08/00	TD27ETi	Diesel	2664	4	8	106
Urvan Box (E23)	07/81→11/82	SD22	Diesel	2164	4	8	85
Urvan Box (E23)	11/82→05/87	SD23	Diesel	2289	4	8	90
Urvan Box (E23)	12/82→11/98	Z20	Petrol	1952	4	8	73
Urvan Box (E24)	06/86→09/94	Z20S	Petrol	1952	4	8	73
Urvan Box (E24)	09/86→05/97	Z24i	Petrol	2389	4	8	94
Urvan Box (E24)	03/87→04/97	TD27	Diesel	2663	4	8	106
Urvan Box (E24)	05/87→05/97	Z20	Petrol	1952	4	8	73
Urvan Box (E24)	01/88→05/97	TD23	Diesel	2289	4	8	90
Urvan Box (E24)	12/88→05/97	TD25	Diesel	2494	4	8	100
Urvan Box (E24)	02/92→09/94	LD20	Diesel	1952	4	8	63
Urvan Box (E24)	02/92→04/97	SD33	Diesel	3246	6	12	120
Urvan Box (E24)	02/92→04/97	SD33T	Diesel	3246	6	12	120



















CC











9

Urvan Box (E24)	02/92→04/97	VG30S	Petrol	2960	6	12	114
Urvan Box (E25)	10/00→01/12	ZD30DD	Diesel	2953	4	16	118
Urvan Bus (E23)	11/80→07/82	J16	Petrol	1567	4	8	41
Urvan Bus (E23)	11/80→07/83	SD22	Diesel	2164	4	8	85
Urvan Bus (E23)	12/82→11/88	Z20	Petrol	1952	4	8	73
Urvan Bus (E23)	04/85→11/88	SD23	Diesel	2289	4	8	90
Urvan Bus (E24)	06/86→09/94	Z20S	Petrol	1952	4	8	73
Urvan Bus (E24)	03/87→04/97	TD27	Diesel	2663	4	8	106
Urvan Bus (E24)	05/89→10/96	TD25	Diesel	2494	4	8	100
Urvan Bus (E24)	05/89→05/97	Z24i	Petrol	2389	4	8	94
Urvan Bus (E24)	02/92→04/97	SD33T	Diesel	3246	6	12	120
Urvan Bus (E24)	02/92→04/97	VG30S	Petrol	2960	6	12	114
Urvan Bus (E24)	10/95→08/00	TD27TI	Diesel	2664	4	8	106
Urvan Bus (E24)	10/95→08/00	VG30E	Petrol	2960	6	12	114
Urvan Bus (E24)	05/01→11/10	KA24DE	Petrol	2389	4	16	91
Urvan Bus (V2_)	10/00→11/10	ZD30DD	Diesel	2953	4	16	118
Vanette Box (C22)	10/86→12/95	A15S	Petrol	1488	4	8	27
Vanette Box (C22)	11/88→03/94	Z20S	Petrol	1952	4	8	73
Vanette Box (C22)	07/91→01/95	LD20II	Diesel	1952	4	8	74
Vanette Box (C120)	07/81→06/87	A15S	Petrol	1488	4	8	27
Vanette Box (C120)	07/82→12/84	A12	Petrol	1171	4	8	10
Vanette Box (C120)	07/82→06/87	A15	Petrol	1488	4	8	26
Vanette Box (C120)	09/82→06/87	Z20S	Petrol	1952	4	8	73
Vanette Box (C120)	11/82→06/87	LD20	Diesel	1952	4	8	63
Vanette Box (S21)	09/03→02/12	F8	Petrol	1789	4	8	52
Vanette Bus (C22)	10/86→12/95	A15S	Petrol	1488	4	8	27
Vanette Bus (C22)	10/86→12/95	LD20	Diesel	1952	4	8	63
Vanette Bus (C22)	10/86→12/95	Z24i	Petrol	2389	4	8	94
Vanette Bus (C22)	07/87→08/94	Z20S	Petrol	1952	4	8	73
Vanette Bus (KC120)	06/81→12/87	A15S	Petrol	1488	4	8	27
Vanette Bus (KC120)	07/82→10/84	A12	Petrol	1171	4	8	10
Vanette Bus (KC120)	09/82→12/87	Z20S	Petrol	1952	4	8	73
Vanette Bus (KC120)	01/83→12/87	A15	Petrol	1488	4	8	26
Vanette Bus (KC120)	01/86→06/87	LD20	Diesel	1952	4	8	63
Vanette Bus (S20)	04/94→05/99	FE	Petrol	1998	4	8	69
Vanette Bus (S21)	09/03→02/12	F8	Petrol	1789	4	8	52
Vanette Cargo Box (HC 23)	09/94→05/01	GA16DE	Petrol	1597	4	16	37
Vanette Cargo Box (HC 23)	09/94→05/02	LD23	Diesel	2283	4	8	88
Vanette Cargo Bus (HC 23)	09/94→05/01	GA16DE	Petrol	1597	4	16	37
Vanette Cargo Bus (HC 23)	09/94→05/01	LD23	Diesel	2283	4	8	88
Vanette Cargo Bus (HC 23)	01/96→05/01	LD20	Diesel	1952	4	8	63
Vanette Platform/Chassis (S21)	09/03→	F8	Petrol	1789	4	8	52
Versa I	08/06→	MR18DE	Petrol	1798	4	16	56
Versa I	01/07→	K9K 772	Diesel	1461	4	8	32
Versa I	09/08→	HR16DE	Petrol	1598	4	16	40
Versa II	08/11→	HR15DE	Petrol	1498	4	16	30
Versa II	08/11→	HR16DE	Petrol	1598	4	16	40
Versa II	08/11→	K9K	Diesel	1461	4	8	32
Versa II	01/12→	MR18DE	Petrol	1798	4	16	56
Versa II	08/12→	MRA8DE	Petrol	1798	4	16	57
Wingroad / AD Wagon (_Y10)	10/90→04/99	GA16DS	Petrol	1597	4	16	37
Wingroad / AD Wagon (_Y10)	04/94→08/98	CD20	Diesel	1974	4	8	67
Wingroad / AD Wagon (_Y11)	05/99→08/04	GA16DE	Petrol	1597	4	16	37
Wingroad / AD Wagon (_Y11)	10/03→11/05	QG15DE	Petrol	1498	4	16	29
Wingroad / AD Wagon (_Y11)	10/03→11/05	QG18DE	Petrol	1769	4	16	59
Wingroad / AD Wagon (_Y11)	10/03→11/05	QR20DE	Petrol	1998	4	16	78
Wingroad / AD Wagon (_Y12)	11/05→	CR12DE	Petrol	1240	4	16	13
Wingroad / AD Wagon (_Y12)	11/05→	HR15DE	Petrol	1498	4	16	30
Wingroad / AD Wagon (_Y12)	11/05→	MR18DE	Petrol	1798	4	16	56
Xterra (N50)	01/05→	VQ40DE	Petrol	3954	6	24	125
Xterra (WD22_)	01/99→12/04	VG33E	Petrol	3275	6	12	121
Xterra (WD22_)	05/99→12/04	KA24DE	Petrol	2389	4	16	91
Xterra (WD22_)	05/99→12/04	VG33ER	Petrol	3275	6	12	121
X-Trail (T30)	06/01→01/13	QR25DE	Petrol	2488	4	16	97
X-Trail (T30)	06/01→01/13	YD22DDTi	Diesel	2184	4	16	86
X-Trail (T30)	07/01→10/05	YD22ETi	Diesel	2184	4	16	86
X-Trail (T30)	07/01→01/13	QR20DE	Petrol	1998	4	16	78
X-Trail (T31)	03/07→02/14	MR20DE	Petrol	1997	4	16	77
X-Trail (T31)	06/07→11/13	M9R	Diesel	1995	4	16	76
X-Trail (T31)	06/07→11/13	M9R 760	Diesel	1995	4	16	76
X-Trail (T31)	06/07→	QR25DE	Petrol	2488	4	16	97
X-Trail (T32_)	12/13→	MR20DD	Petrol	1997	4	16	77
X-Trail (T32_)	12/13→	QR25DE	Petrol	2488	4	16	97
X-Trail (T32_)	12/13→	R9M	Diesel	1598	4	16	46
X-Trail (T32_)	06/15→	MR16DDT	Petrol	1618	4	16	44
X-Trail (T32_)	10/16→	M9R	Diesel	1995	4	16	76

	CC				9		CC				9
3B20	659	3	12	Petrol	1	FE	1998	4	8	Petrol	69
16LF	1598	4	8	Petrol	34	FJ20E	1991	4	8	Petrol	70
18LE	1796	4	8	Petrol	48	G9T 722	2188	4	16	Diesel	84
274930	1991	4	16	Petrol	65	G9T 750	2188	4	16	Diesel	84
A10	988	4	8	Petrol	4	G9U 135	2464	4	16	Diesel	95
A10S	988	4	8	Petrol	4	G9U 630	2464	4	16	Diesel	95
A12	1171	4	8	Petrol	10	G9U 632	2464	4	16	Diesel	95
A12A	1237	4	8	Petrol	11	G9U 650	2464	4	16	Diesel	95
A12S	1237	4	8	Petrol	10	G9U 720	2464	4	16	Diesel	95
A14	1397	4	8	Petrol	21	G9U 730	2464	4	16	Diesel	95
A14S	1397	4	8	Petrol	21	GA13DE	1295	4	16	Petrol	19
A15	1488	4	8	Petrol	26	GA13DS	1295	4	16	Petrol	19
A15E	1488	4	8	Petrol	27	GA14DE	1392	4	16	Petrol	22
A15S	1488	4	8	Petrol	27	GA14DS	1392	4	16	Petrol	22
B4-40Ti	3990	4	8	Diesel	124	GA14S	1392	4	16	Petrol	23
B6-60	5985	6	12	Diesel	132	GA15DE	1498	4	16	Petrol	29
B6-60Ti-H	5985	6	12	Diesel	132	GA15DS	1497	4	16	Petrol	29
B6-60Ti-L	5985	6	12	Diesel	132	GA16DE	1597	4	16	Petrol	37
B660N	5985	6	12	Diesel	132	GA16DEL	1597	4	16	Petrol	37
B660T	5985	6	12	Diesel	132	GA16DNE	1597	4	16	Petrol	37
B660TI	5985	6	12	Diesel	132	GA16DS	1597	4	16	Petrol	37
BD30	2953	4	8	Diesel	111	GA16i	1597	4	12	Petrol	38
BD30II	2953	4	8	Diesel	111	GA16S	1597	4	12	Petrol	39
BD-30Ti	2953	4	8	Diesel	111	H4B 408	898	3	12	Petrol	3
BD-40Ti	3990	4	8	Diesel	124	HR12DDR	1198	3	12	Petrol	16
CA16D	1598	4	16	Petrol	35	HR12DDT	1197	4	16	Petrol	17
CA16DE	1598	4	16	Petrol	35	HR12DE	1198	3	12	Petrol	16
CA16S	1598	4	8	Petrol	34	HR15DE	1498	4	16	Petrol	30
CA18	1809	4	8	Petrol	49	HR16DE	1598	4	16	Petrol	40
CA18D	1809	4	16	Petrol	50	HR16DE	1598	4	16	Petrol	40
CA18DE	1809	4	16	Petrol	50	HR16DE	1598	4	16	Petrol	40
CA18DET	1809	4	16	Petrol	50	HR18DE	1769	4	16	Petrol	53
CA18DT	1809	4	16	Petrol	50	J15	1483	4	8	Petrol	31
CA18ET	1809	4	8	Petrol	51	J16	1567	4	8	Petrol	41
CA18i	1809	4	8	Petrol	49	JN	1781	4	8	Petrol	54
CA18N	1809	4	8	Petrol	49	K4M	1598	4	16	Petrol	42
CA18S	1809	4	8	Petrol	49	K4M 742	1598	4	16	Petrol	42
CA18T	1809	4	8	Petrol	51	K4M 752	1598	4	16	Petrol	42
CA20DE	1973	4	8	Petrol	66	K6A	658	3	12	Petrol	2
CA20E	1974	4	8	Petrol	66	K6A-T	658	3	12	Petrol	2
CA20S	1974	4	8	Petrol	66	K7J 700	1390	4	8	Petrol	24
CD17	1681	4	8	Diesel	47	K9K	1461	4	8	Diesel	32
CD20	1974	4	8	Diesel	67	K9K 270	1461	4	8	Diesel	32
CD20ET	1974	4	8	Diesel	67	K9K 276	1461	4	8	Diesel	32
CD20T	1974	4	8	Diesel	67	K9K 278	1461	4	8	Diesel	32
CD23	2283	4	8	Diesel	88	K9K 282	1461	4	8	Diesel	32
CG10DE	998	4	16	Petrol	5	K9K 292	1461	4	8	Diesel	32
CG12DE	1240	4	16	Petrol	12	K9K 400	1461	4	8	Diesel	32
CG13DE	1275	4	16	Petrol	19	K9K 410	1461	4	8	Diesel	32
CGA3DE	1348	4	16	Petrol	19	K9K 430	1461	4	8	Diesel	32
CR10DE	997	4	16	Petrol	5	K9K 608	1461	4	8	Diesel	32
CR12DE	1240	4	16	Petrol	13	K9K 628	1461	4	8	Diesel	32
CR14DE	1386	4	16	Petrol	22	K9K 636	1461	4	8	Diesel	32
D4D	998	4	16	Petrol	6	K9K 646	1461	4	8	Diesel	32
D4F 712	1149	4	16	Petrol	14	K9K 700	1461	4	8	Diesel	32
D7F 764	1149	4	8	Petrol	15	K9K 702	1461	4	8	Diesel	32
E10	988	4	8	Petrol	7	K9K 704	1461	4	8	Diesel	32
E10S	988	4	8	Petrol	7	K9K 708	1461	4	8	Diesel	32
E13	1269	4	8	Petrol	20	K9K 710	1461	4	8	Diesel	32
E13S	1269	4	8	Petrol	20	K9K 714	1461	4	8	Diesel	32
E15	1488	4	8	Petrol	28	K9K 716	1461	4	8	Diesel	32
E15ET	1488	4	8	Petrol	28	K9K 722	1461	4	8	Diesel	32
E15S	1488	4	8	Petrol	28	K9K 728	1461	4	8	Diesel	32
E15T	1488	4	8	Petrol	28	K9K 732	1461	4	8	Diesel	32
E16	1597	4	8	Petrol	36	K9K 764	1461	4	8	Diesel	32
E16E	1597	4	8	Petrol	36	K9K 772	1461	4	8	Diesel	32
E16I	1597	4	8	Petrol	36	K9K 892	1461	4	8	Diesel	32
E16i	1597	4	8	Petrol	36	K9K 896	1461	4	8	Diesel	32
E16S	1597	4	8	Petrol	36	K10 B	996	3	12	Petrol	8
F4R 720	1998	4	16	Petrol	68	KA20DE	1998	4	16	Petrol	71
F4R 722	1998	4	16	Petrol	68	KA24DE	2389	4	16	Petrol	91
F4R 820	1998	4	16	Petrol	68	KA24DEN	2389	4	16	Petrol	91
F8	1789	4	8	Petrol	52	KA24E	2389	4	12	Petrol	92
F9Q	1870	4	8	Diesel	61	L14	1428	4	8	Petrol	25
F9Q 760	1870	4	8	Diesel	62	L16	1595	4	8	Petrol	43
F9Q 762	1870	4	8	Diesel	62	L16S	1595	4	8	Petrol	43
F9Q 772	1870	4	8	Diesel	62	L16T	1595	4	8	Petrol	43
F9Q 774	1870	4	8	Diesel	62	L18	1770	4	8	Petrol	55

	CC				9		CC				9
L18E	1770	4	8	Petrol	55	R9M 452	1598	4	16	Diesel	46
L18S	1770	4	8	Petrol	55	RB20DE	1998	6	24	Petrol	79
L18T	1770	4	8	Petrol	55	RB20DET	1998	6	24	Petrol	79
L18T	1770	4	8	Petrol	55	RB20E	1998	6	12	Petrol	80
L20	1998	6	12	Petrol	72	RB20ET	1998	6	12	Petrol	80
L20A	1998	6	12	Petrol	72	RB25DE	2498	6	24	Petrol	98
L20B	1952	4	8	Petrol	73	RB25DEH	2498	6	24	Petrol	98
L20E	1998	6	12	Petrol	72	RB25DET	2498	6	24	Petrol	98
L20ET	1998	6	12	Petrol	72	RB26DETT	2568	6	24	Petrol	104
L24	2393	6	12	Petrol	93	RB30E	2962	6	12	Petrol	112
L24E	2393	6	12	Petrol	93	RB30S	2962	6	12	Petrol	112
L24S	2393	6	12	Petrol	93	RD28	2826	6	12	Diesel	109
L26	2565	6	12	Petrol	103	RD28E	2826	6	12	Diesel	109
L28	2753	6	12	Petrol	107	RD28T	2826	6	12	Diesel	109
L28E	2753	6	12	Petrol	105	RD28Ti	2826	6	12	Diesel	110
L28ET	2753	6	12	Petrol	107	SD22	2164	4	8	Diesel	85
LD20	1952	4	8	Diesel	63	SD23	2289	4	8	Diesel	90
LD20E	1952	4	8	Diesel	74	SD25	2488	4	8	Diesel	99
LD20II	1952	4	8	Diesel	74	SD33	3246	6	12	Diesel	120
LD20III	1952	4	8	Diesel	74	SD33T	3246	6	12	Diesel	120
LD20IIL	1952	4	8	Diesel	74	SR18DE	1838	4	16	Petrol	60
LD20T	1952	4	8	Diesel	74	SR20DE	1998	4	16	Petrol	81
LD23	2283	4	8	Diesel	88	SR20De	1998	4	16	Petrol	81
LD28	2792	6	12	Diesel	108	SR20DE	1998	4	16	Petrol	81
LF-VDS	1999	4	16	Petrol	75	SR20DET	1998	4	16	Petrol	81
LF-VE	1998	4	16	Petrol	75	SR20DI	1998	4	16	Petrol	82
M1D	1994	4	16	Diesel	76	TB42	4169	6	12	Petrol	126
M9R	1995	4	16	Diesel	76	TB42E	4169	6	12	Petrol	127
M9R 630	1995	4	16	Diesel	76	TB42S	4169	6	12	Petrol	127
M9R 760	1995	4	16	Diesel	76	TB48DE	4759	6	24	Petrol	131
M9R 780	1995	4	16	Diesel	76	TD15	1527	4	8	Diesel	33
M9R 782	1995	4	16	Diesel	76	TD23	2289	4	8	Diesel	90
M9T	2299	4	16	Diesel	89	TD25	2494	4	8	Diesel	100
M9T 670	2299	4	16	Diesel	89	TD25TI	2494	4	8	Diesel	100
M9T 672	2299	4	16	Diesel	89	TD27	2663	4	8	Diesel	106
M9T 676	2299	4	16	Diesel	89	TD27ETi	2664	4	8	Diesel	106
M9T 678	2299	4	16	Diesel	89	TD27T	2664	4	8	Diesel	106
M9T 680	2299	4	16	Diesel	89	TD27TI	2664	4	8	Diesel	106
M9T 686	2299	4	16	Diesel	89	TD42	4169	6	12	Diesel	128
M9T 690	2299	4	16	Diesel	89	TD42T	4169	6	12	Diesel	129
M9T 692	2299	4	16	Diesel	89	VE30DE	2960	6	24	Petrol	113
M9T 694	2299	4	16	Diesel	89	VG20DET	1998	6	24	Petrol	79
M9T 696	2299	4	16	Diesel	89	VG20E	1998	6	12	Petrol	72
M9T 698	2299	4	16	Diesel	89	VG20ET	1998	6	12	Petrol	72
M9T 702	2299	4	16	Diesel	89	VG30	2959	6	12	Petrol	114
M9T 870	2299	4	16	Diesel	89	VG30DE	2960	6	24	Petrol	113
M9T 880	2299	4	16	Diesel	89	VG30DE	2960	6	24	Petrol	115
M9T 896	2299	4	16	Diesel	89	VG30DET	2960	6	24	Petrol	115
MA10	988	4	8	Petrol	9	VG30DETT	2960	6	24	Petrol	115
MA10ET	988	4	8	Petrol	9	VG30E	2960	6	12	Petrol	114
MA10S	988	4	8	Petrol	9	VG30E	2960	6	12	Petrol	116
MA12S	1235	4	8	Petrol	18	VG30ET	2960	6	12	Petrol	114
MR16DDT	1618	4	16	Petrol	44	VG30I	2960	6	12	Petrol	114
MR16DE	1598	4	16	Petrol	45	VG30S	2960	6	12	Petrol	114
MR18DE	1798	4	16	Petrol	56	VG30T	2959	6	12	Petrol	114
MR20DD	1997	4	16	Petrol	77	VG33E	3275	6	12	Petrol	121
MR20DE	1997	4	16	Petrol	77	VG33E	3275	6	12	Petrol	121
MRA8DE	1798	4	16	Petrol	57	VG33E	3275	6	12	Petrol	121
QD32	3153	4	8	Diesel	119	VG33ER	3275	6	12	Petrol	121
QD32ETI	3153	4	8	Diesel	119	VG35DE	3498	6	24	Petrol	122
QG13DE	1295	4	16	Petrol	19	VH45DE	4494	8	32	Petrol	130
QG15DE	1498	4	16	Petrol	29	VH45DE	4494	8	32	Petrol	130
QG16DE	1597	4	16	Petrol	37	VK45DD	4494	8	32	Petrol	130
QG18DD	1769	4	16	Petrol	58	VK45DE	4494	8	32	Petrol	130
QG18DE	1769	4	16	Petrol	59	VK45DE	4494	8	32	Petrol	130
QG25DD	2488	4	16	Petrol	96	VQ20DE	1995	6	24	Petrol	83
QR20DD	1998	4	16	Petrol	78	VQ25DD	2496	6	24	Petrol	101
QR20DE	1998	4	16	Petrol	78	VQ25DE	2496	6	24	Petrol	101
QR25	2488	4	16	Petrol	97	VQ25DET	2496	6	24	Petrol	101
QR25	2488	4	16	Petrol	97	VQ30DD	2987	6	24	Petrol	117
QR25DD	2488	4	16	Petrol	97	VQ30DE	2988	6	24	Petrol	117
QR25DE	2488	4	16	Petrol	97	VQ30DE	2988	6	24	Petrol	117
QR25DER	2488	4	16	Petrol	97	VQ35	3498	6	24	Petrol	122
QR25DER	2488	4	16	Petrol	97	VQ35DD	3498	6	24	Petrol	122
QR25DER	2488	4	16	Petrol	97	VQ35DE	3498	6	24	Petrol	122
R06A	658	3	12	Petrol	2	VQ35DE	3498	6	24	Petrol	122
R9M	1598	4	16	Diesel	46	VQ35DE	3498	6	24	Petrol	122
R9M 413	1598	4	16	Diesel	46	VQ35HR	3498	6	24	Petrol	122

	CC				9		CC				9
VQ35HR	3498	6	24	Petrol	122						
VQ37HR	3696	6	24	Petrol	123						
VQ37HR	3696	6	24	Petrol	123						
VQ37VHR	3696	6	24	Petrol	123						
VQ37VHR	3696	6	24	Petrol	123						
VQ40	3954	6	24	Petrol	125						
VQ40DE	3954	6	24	Petrol	125						
YD22D	2184	4	16	Diesel	86						
YD22DDT	2184	4	16	Diesel	86						
YD22DDTi	2184	4	16	Diesel	86						
YD22ETi	2184	4	16	Diesel	86						
YD25DDTi	2488	4	16	Diesel	102						
YD25ETi	2488	4	16	Diesel	102						
YD25K3LD-5HO	2488	4	16	Diesel	102						
YD25K3LD-5LO	2488	4	16	Diesel	102						
YD25K3LD-5MI	2488	4	16	Diesel	102						
YS23DDT	2299	4	16	Diesel	89						
YS23DDTi	2299	4	16	Diesel	89						
Z16	1595	4	8	Petrol	43						
Z18	1770	4	8	Petrol	55						
Z20	1952	4	8	Petrol	73						
Z20E	1952	4	8	Petrol	64						
Z20S	1952	4	8	Petrol	73						
Z22	2188	4	8	Petrol	87						
Z22E	2188	4	8	Petrol	87						
Z24	2388	4	8	Petrol	94						
Z24i	2389	4	8	Petrol	94						
Z24S	2389	4	8	Petrol	94						
ZD30	2953	4	16	Diesel	118						
ZD30DD	2953	4	16	Diesel	118						
ZD30DDT	2953	4	16	Diesel	118						
ZD30DDTi	2953	4	16	Diesel	118						
ZD30H HD-5	2953	4	16	Diesel	118						
ZD30Ti	2953	4	16	Diesel	118						

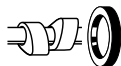

1 0.7L Petrol

3B20	3 Cyl.	12 Valves	659cc	TD29898
HR5096				

2 0.7L Petrol

K6A	3 Cyl.	12 Valves	658cc	TD29802
K6A-T	3 Cyl.	12 Valves	658cc	TD33931
R06A	3 Cyl.	12 Valves	658cc	TD31316
PA928 (x12)				NA5016 35.00 x 47.00 x 7.00mm, FPM/ACM

3 0.9L Petrol

H4B 408	3 Cyl.	12 Valves	898cc	TD34137
PB681 (x12)				NB734 35.00 x 50.00 x 8.00mm, FPM

4 1.0L Petrol

A10	4 Cyl.	8 Valves	988cc	TD11047
A10S	4 Cyl.	8 Valves	988cc	TD2382
KJ208 (x8)				NJ022 38.00 x 55.00 x 9.00mm, FPM/ACM NJ021 60.00 x 82.00 x 12.00mm, FPM/ACM

5 1.0L Petrol

CG10DE	4 Cyl.	16 Valves	998cc	TD4700
CR10DE	4 Cyl.	16 Valves	997cc	TD17646
PB681 (x16)				NJ933 35.00 x 50.00 x 8.00mm, FPM NJ765 40.00 x 52.00 x 7.00mm, NBR NJ284 84.00 x 104.00 x 11.00mm, MVQ

6 1.0L Petrol

D4D	4 Cyl.	16 Valves	998cc	TD32718
				NA5326 32.00 x 44.00 x 6.00mm, PTFE NA5348 70.00 x 86.00 x 7.00mm, PTFE

7 1.0L Petrol

E10	4 Cyl.	8 Valves	988cc	TD2424
E10S	4 Cyl.	8 Valves	988cc	TD2425
PA203 (x8)				NJ287 80.00 x 100.00 x 10.00mm, MVQ

8 1.0L Petrol

K10 B	3 Cyl.	12 Valves	996cc	TD24676
PA928 (x12)				
HR5075 (x2)				



9 1.0L		Petrol		
MA10	4 Cyl.	8 Valves	988cc	TD2492
MA10ET	4 Cyl.	8 Valves	988cc	TD25307
MA10S	4 Cyl.	8 Valves	988cc	TD2493
PA079 (x8) HR5112	NJ363 38.00 x 54.00 x 7.00mm, NBR		NJ363 38.00 x 54.00 x 7.00mm, NBR NJ364 75.00 x 94.00 x 10.00mm, MVQ	

10 1.2L		Petrol		
A12	4 Cyl.	8 Valves	1171cc	TD2383
A12S	4 Cyl.	8 Valves	1237cc	TD2384
KJ208 (x8)			NJ022 38.00 x 55.00 x 9.00mm, FPM/ACM NJ021 60.00 x 82.00 x 12.00mm, FPM/ACM	

11 1.2L		Petrol		
A12A	4 Cyl.	8 Valves	1237cc	TD32886
			NJ022 38.00 x 55.00 x 9.00mm, FPM/ACM NJ021 60.00 x 82.00 x 12.00mm, FPM/ACM	

12 1.2L		Petrol		
CG12DE	4 Cyl.	16 Valves	1240cc	TD23874
PB681 (x16)			NJ765 40.00 x 52.00 x 7.00mm, NBR NJ284 84.00 x 104.00 x 11.00mm, MVQ	

13 1.2L		Petrol		
CR12DE	4 Cyl.	16 Valves	1240cc	TD17647
PB681 (x16)			NJ222 40.00 x 52.00 x 7.00mm, FPM NJ765 40.00 x 52.00 x 7.00mm, NBR NJ284 84.00 x 104.00 x 11.00mm, MVQ	

14 1.2L		Petrol		
D4F 712	4 Cyl.	16 Valves	1149cc	TD18984
	NA5261 28.00 x 47.00 x 8.00mm, PTFE/ACM		NA5326 32.00 x 44.00 x 6.00mm, PTFE NA5348 70.00 x 86.00 x 7.00mm, PTFE	

15 1.2L		Petrol		
D7F 764	4 Cyl.	8 Valves	1149cc	TD22375
HR789	NA5053 30.00 x 42.00 x 7.00mm, FPM		NA5326 32.00 x 44.00 x 6.00mm, PTFE NA5348 70.00 x 86.00 x 7.00mm, PTFE	

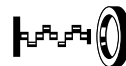

16 1.2L

Petrol

HR12DDR	3 Cyl.	12 Valves	1198cc	TD24766
HR12DE	3 Cyl.	12 Valves	1198cc	TD24765
	NJ449 40.00 x 52.00 x 6.00mm, NBR		NJ449 40.00 x 52.00 x 6.00mm, NBR	

17 1.2L

Petrol

HR12DDT	4 Cyl.	16 Valves	1197cc	TD30949
PB681 (x16)				
				NJ449 40.00 x 52.00 x 6.00mm, NBR

18 1.2L

Petrol

MA12S	4 Cyl.	8 Valves	1235cc	TD2494
PA079 (x8)				
HR5112				
		NJ363 38.00 x 54.00 x 7.00mm, NBR	NJ363 38.00 x 54.00 x 7.00mm, NBR	
			NJ364 75.00 x 94.00 x 10.00mm, MVQ	

19 1.3L

Petrol

CG13DE	4 Cyl.	16 Valves	1275cc	TD2423
CGA3DE	4 Cyl.	16 Valves	1348cc	TD16315
GA13DE	4 Cyl.	16 Valves	1295cc	TD2441
GA13DS	4 Cyl.	16 Valves	1295cc	TD28202
QG13DE	4 Cyl.	16 Valves	1295cc	TD17649
PB681 (x16)				
		NJ933 35.00 x 50.00 x 8.00mm, FPM	NJ765 40.00 x 52.00 x 7.00mm, NBR	
			NJ284 84.00 x 104.00 x 11.00mm, MVQ	

20 1.3L

Petrol

E13	4 Cyl.	8 Valves	1269cc	TD2426
E13S	4 Cyl.	8 Valves	1269cc	TD2427
PA203 (x8)				
		NJ288 40.00 x 55.00 x 9.00mm, NBR	NJ353 35.00 x 49.00 x 6.00mm, NBR	
			NJ287 80.00 x 100.00 x 10.00mm, MVQ	

21 1.4L

Petrol

A14	4 Cyl.	8 Valves	1397cc	TD4694
A14S	4 Cyl.	8 Valves	1397cc	TD2387
KJ454 (x8)				
			NJ022 38.00 x 55.00 x 9.00mm, FPM/ACM	
			NJ004 60.00 x 82.00 x 12.00mm, FPM/ACM	

22 1.4L

Petrol

CR14DE	4 Cyl.	16 Valves	1386cc	TD17648
GA14DE	4 Cyl.	16 Valves	1392cc	TD4703
GA14DS	4 Cyl.	16 Valves	1392cc	TD4704
PB681 (x16)				
			NJ765 40.00 x 52.00 x 7.00mm, NBR	
			NJ284 84.00 x 104.00 x 11.00mm, MVQ	



23 1.4L Petrol

GA14S	4 Cyl.	16 Valves	1392cc	TD2445
PA874 (x8)				
			NJ765 (F) 40.00 x 52.00 x 7.00mm, NBR NJ284 (R) 84.00 x 104.00 x 11.00mm, MVQ	

24 1.4L Petrol

K7J 700	4 Cyl.	8 Valves	1390cc	TD31236
HR816 (S)				
			NA5053 30.00 x 42.00 x 7.00mm, FPM NA5016 (F) 35.00 x 47.00 x 7.00mm, FPM/ACM NF835 (R) 80.00 x 100.00 x 8.00mm, FPM/ACM	

25 1.4L Petrol

L14	4 Cyl.	8 Valves	1428cc	TD2463
PA933 (x8)				
			NJ056 (F) 80.00 x 100.00 x 13.00mm, MVQ NJ045 (F) 48.00 x 70.00 x 9.00mm, NBR	

26 1.5L Petrol

A15	4 Cyl.	8 Valves	1488cc	TD4695
KJ454 (x8)				
			NJ022 (F) 38.00 x 55.00 x 9.00mm, FPM/ACM NJ004 (R) 60.00 x 82.00 x 12.00mm, FPM/ACM	

27 1.5L Petrol

A15E	4 Cyl.	8 Valves	1488cc	TD2390
A15S	4 Cyl.	8 Valves	1488cc	TD2391
KJ454 (x8)				
			NJ022 (F) 38.00 x 55.00 x 9.00mm, FPM/ACM NJ021 (F) 60.00 x 82.00 x 12.00mm, FPM/ACM	

28 1.5L Petrol

E15	4 Cyl.	8 Valves	1488cc	TD2428
E15ET	4 Cyl.	8 Valves	1488cc	TD5360
E15S	4 Cyl.	8 Valves	1488cc	TD2429
E15T	4 Cyl.	8 Valves	1488cc	TD2430
PA203 (x8)				
			NJ288 40.00 x 55.00 x 9.00mm, NBR NJ286 (F) 36.00 x 49.00 x 7.00mm, NBR NJ287 (R) 80.00 x 100.00 x 10.00mm, MVQ	

29 1.5L Petrol

GA15DE	4 Cyl.	16 Valves	1498cc	TD2446
GA15DS	4 Cyl.	16 Valves	1497cc	TD32730
QG15DE	4 Cyl.	16 Valves	1498cc	TD16313
PB681 (x16)				
			NJ765 (F) 40.00 x 52.00 x 7.00mm, NBR NJ284 (R) 84.00 x 104.00 x 11.00mm, MVQ	



30 1.5L

Petrol

HR15DE 4 Cyl. 16 Valves 1498cc TD19289

NJ449
 40.00 x 52.00 x 6.00mm, NBR

31 1.5L

Petrol

J15 4 Cyl. 8 Valves 1483cc TD2455

NJ050
 39.70 x 62.00 x 11.00mm, NBR
KV417 (x2)

32 1.5L

Diesel

K9K 4 Cyl. 8 Valves 1461cc TD31672

K9K 270 4 Cyl. 8 Valves 1461cc TD32710

K9K 276 4 Cyl. 8 Valves 1461cc TD23877

K9K 278 4 Cyl. 8 Valves 1461cc TD33676

K9K 282 4 Cyl. 8 Valves 1461cc TD33836

K9K 292 4 Cyl. 8 Valves 1461cc TD24675

K9K 400 4 Cyl. 8 Valves 1461cc TD31619

K9K 410 4 Cyl. 8 Valves 1461cc TD29686

K9K 430 4 Cyl. 8 Valves 1461cc TD29685

K9K 608 4 Cyl. 8 Valves 1461cc TD29422

K9K 628 4 Cyl. 8 Valves 1461cc TD31622

K9K 636 4 Cyl. 8 Valves 1461cc TD29420

K9K 646 4 Cyl. 8 Valves 1461cc TD31623

K9K 700 4 Cyl. 8 Valves 1461cc TD21368

K9K 702 4 Cyl. 8 Valves 1461cc TD23878

K9K 704 4 Cyl. 8 Valves 1461cc TD17660

K9K 708 4 Cyl. 8 Valves 1461cc TD26291

K9K 710 4 Cyl. 8 Valves 1461cc TD26066

K9K 714 4 Cyl. 8 Valves 1461cc TD26067

K9K 716 4 Cyl. 8 Valves 1461cc TD29537

K9K 722 4 Cyl. 8 Valves 1461cc TD20971

K9K 728 4 Cyl. 8 Valves 1461cc TD24669

K9K 732 4 Cyl. 8 Valves 1461cc TD29682

K9K 764 4 Cyl. 8 Valves 1461cc TD29684

K9K 772 4 Cyl. 8 Valves 1461cc TD28006

K9K 892 4 Cyl. 8 Valves 1461cc TD31620

K9K 896 4 Cyl. 8 Valves 1461cc TD31123

PA5041 (x8)
HR817

NA5215
28.00 x 42.00 x 5.00mm, FPM
→11/06
NA5328
28.00 x 42.00 x 6.00mm, PTFE/ACM
11/06→

NA5255
 35.00 x 47.00 x 7.00mm, PTFE/ACM
NA5118
 80.00 x 100.00 x 9.00mm, PTFE

33 1.5L

Diesel

TD15 4 Cyl. 8 Valves 1527cc TD16316

HR816

NF817
36.00 x 50.00 x 7.00mm, FPM

NF870
 42.00 x 66.00 x 6.00mm, FPM/ACM
NF850
 85.00 x 105.00 x 8.00mm, FPM

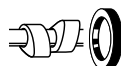

34 1.6L

Petrol

16LF	4 Cyl.	8 Valves	1598cc	TD25223
CA16S	4 Cyl.	8 Valves	1598cc	TD2402
PA079 (x8) HR5112	NJ285 34.00 x 48.00 x 8.00mm, NBR	NJ280 33.00 x 47.00 x 8.00mm, NBR NJ284 84.00 x 104.00 x 11.00mm, MVQ		

35 1.6L

Petrol

CA16D	4 Cyl.	16 Valves	1598cc	TD2401
CA16DE	4 Cyl.	16 Valves	1598cc	TD24807
PA874 (x16)	NJ765 (x2) 40.00 x 52.00 x 7.00mm, NBR	NJ765 40.00 x 52.00 x 7.00mm, NBR NJ284 84.00 x 104.00 x 11.00mm, MVQ		

36 1.6L

Petrol

E16	4 Cyl.	8 Valves	1597cc	TD2432
E16E	4 Cyl.	8 Valves	1597cc	TD28064
E16I	4 Cyl.	8 Valves	1597cc	TD2433
E16i	4 Cyl.	8 Valves	1597cc	TD4701
E16S	4 Cyl.	8 Valves	1597cc	TD2435
PA203 (x8)	NJ288 40.00 x 55.00 x 9.00mm, NBR	NJ353 35.00 x 49.00 x 6.00mm, NBR NJ287 80.00 x 100.00 x 10.00mm, MVQ		

37 1.6L

Petrol

GA16DE	4 Cyl.	16 Valves	1597cc	TD4705
GA16DEL	4 Cyl.	16 Valves	1597cc	TD19701
GA16DNE	4 Cyl.	16 Valves	1597cc	TD29353
GA16DS	4 Cyl.	16 Valves	1597cc	TD4706
QG16DE	4 Cyl.	16 Valves	1597cc	TD16317
PB681 (x16)		NJ765 40.00 x 52.00 x 7.00mm, NBR NJ284 84.00 x 104.00 x 11.00mm, MVQ		

38 1.6L

Petrol

GA16i	4 Cyl.	12 Valves	1597cc	TD4707
PA874 (x8)		NJ765 40.00 x 52.00 x 7.00mm, NBR NJ284 84.00 x 104.00 x 11.00mm, MVQ		

39 1.6L

Petrol

GA16S	4 Cyl.	12 Valves	1597cc	TD2452
PB681 (x12)		NJ765 40.00 x 52.00 x 7.00mm, NBR NJ284 84.00 x 104.00 x 11.00mm, MVQ		

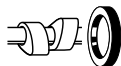

40 1.6L

Petrol

HR16DE	4 Cyl.	16 Valves	1598cc	TD26140
HR16DE	4 Cyl.	16 Valves	1598cc	TD30271
HR16DE	4 Cyl.	16 Valves	1598cc	TD18677

NA5223
40.00 x 52.00 x 7.00mm, FPM

41 1.6L

Petrol

J16	4 Cyl.	8 Valves	1567cc	TD2456
KJ453 (x8)				

42 1.6L

Petrol

K4M	4 Cyl.	16 Valves	1598cc	TD31398
K4M 742	4 Cyl.	16 Valves	1598cc	TD32731
K4M 752	4 Cyl.	16 Valves	1598cc	TD21398

PA5013 (x16)

NA5328 (x2)
28.00 x 42.00 x 6.00mm, PTFE/ACM

NA5016
35.00 x 47.00 x 7.00mm, FPM/ACM
NF835
80.00 x 100.00 x 8.00mm, FPM/ACM

43 1.6L

Petrol

L16	4 Cyl.	8 Valves	1595cc	TD2464
L16S	4 Cyl.	8 Valves	1595cc	TD2465
L16T	4 Cyl.	8 Valves	1595cc	TD11107
Z16	4 Cyl.	8 Valves	1595cc	TD2555

PA933 (x8)

NJ056
80.00 x 100.00 x 13.00mm, MVQ
NJ045
48.00 x 70.00 x 9.00mm, NBR

44 1.6L

Petrol

MR16DDT	4 Cyl.	16 Valves	1618cc	TD24818
---------	--------	-----------	--------	---------

PB681 (x16)

NK106
46.00 x 58.00 x 7.00mm, ACM
NJ765
40.00 x 52.00 x 7.00mm, NBR

45 1.6L

Petrol

MR16DE	4 Cyl.	16 Valves	1598cc	TD22692
--------	--------	-----------	--------	---------

NK106
46.00 x 58.00 x 7.00mm, ACM

46 1.6L

Diesel

R9M	4 Cyl.	16 Valves	1598cc	TD28080
R9M 413	4 Cyl.	16 Valves	1598cc	TD34314
R9M 452	4 Cyl.	16 Valves	1598cc	TD34315

PA5041 (x16)
HR791

NA5333
48.00 x 81.00 x 11.5mm, FPM/ACM

47 1.7L

Diesel

CD17	4 Cyl.	8 Valves	1681cc	TD2419
------	--------	----------	--------	--------

PA079 (x8)
HR5112

NJ285
34.00 x 48.00 x 8.00mm, NBR

NJ368
33.00 x 47.00 x 7.00mm, NBR



48 1.8L Petrol

18LE	4 Cyl.	8 Valves	1796cc	TD25281
	NC006 35.00 x 48.00 x 7.00mm, MVQ		NB700 31.00 x 50.00 x 8.00mm, MVQ	

49 1.8L Petrol

CA18	4 Cyl.	8 Valves	1809cc	TD11048
CA18i	4 Cyl.	8 Valves	1809cc	TD2411
CA18N	4 Cyl.	8 Valves	1809cc	TD2412
CA18S	4 Cyl.	8 Valves	1809cc	TD4696
PA079 (x8) HR5112	NJ285 34.00 x 48.00 x 8.00mm, NBR		NJ280 33.00 x 47.00 x 8.00mm, NBR NJ284 84.00 x 104.00 x 11.00mm, MVQ	

50 1.8L Petrol

CA18D	4 Cyl.	16 Valves	1809cc	TD2405
CA18DE	4 Cyl.	16 Valves	1809cc	TD2406
CA18DET	4 Cyl.	16 Valves	1809cc	TD2408
CA18DT	4 Cyl.	16 Valves	1809cc	TD23873
PA874 (x16)	NJ765 (x2) 40.00 x 52.00 x 7.00mm, NBR		NJ765 40.00 x 52.00 x 7.00mm, NBR NJ284 84.00 x 104.00 x 11.00mm, MVQ	

51 1.8L Petrol

CA18ET	4 Cyl.	8 Valves	1809cc	TD2410
CA18T	4 Cyl.	8 Valves	1809cc	TD2414
PA079 (x8) HR5112	NJ285 34.00 x 48.00 x 8.00mm, NBR		NJ368 33.00 x 47.00 x 7.00mm, NBR NJ284 84.00 x 104.00 x 11.00mm, MVQ	

52 1.8L Petrol

F8	4 Cyl.	8 Valves	1789cc	TD34012
KJ710 (x8)	NJ324 34.00 x 48.00 x 7.00mm, ACM		NJ324 34.00 x 48.00 x 7.00mm, ACM NJ325 90.00 x 110.00 x 9.00mm, MVQ	

53 1.8L Petrol

HR18DE	4 Cyl.	16 Valves	1769cc	TD20608
PB681 (x16)			NJ765 40.00 x 52.00 x 7.00mm, NBR	

54 1.8L Petrol

JN	4 Cyl.	8 Valves	1781cc	TD2457
HR569				

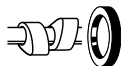

55 1.8L

Petrol

L18	4 Cyl.	8 Valves	1770cc	TD2466
L18E	4 Cyl.	8 Valves	1770cc	TD18870
L18S	4 Cyl.	8 Valves	1770cc	TD2467
L18T	4 Cyl.	8 Valves	1770cc	TD2468
L18T	4 Cyl.	8 Valves	1770cc	TD34409
Z18	4 Cyl.	8 Valves	1770cc	TD2556
PA933 (x8)				NJ056 80.00 x 100.00 x 13.00mm, MVQ NJ045 48.00 x 70.00 x 9.00mm, NBR

56 1.8L

Petrol

MR18DE	4 Cyl.	16 Valves	1798cc	TD19304
PB681 (x16)				NK106 46.00 x 58.00 x 7.00mm, ACM

57 1.8L

Petrol

MRA8DE	4 Cyl.	16 Valves	1798cc	TD28198
				NK106 46.00 x 58.00 x 7.00mm, ACM

58 1.8L

Petrol

QG18DD	4 Cyl.	16 Valves	1769cc	TD19702
PB681 (x16)				NJ284 84.00 x 104.00 x 11.00mm, MVQ

59 1.8L

Petrol

QG18DE	4 Cyl.	16 Valves	1769cc	TD11487
PB681 (x16)				NJ765 40.00 x 52.00 x 7.00mm, NBR NJ284 84.00 x 104.00 x 11.00mm, MVQ

60 1.8L

Petrol

SR18DE	4 Cyl.	16 Valves	1838cc	TD2517
PA874 (x16)				NK106 46.00 x 58.00 x 7.00mm, ACM NJ284 84.00 x 104.00 x 11.00mm, MVQ

61 1.9L

Diesel

F9Q	4 Cyl.	8 Valves	1870cc	TD31671
HR816				NF846 25.00 x 42.00 x 7.00mm, FPM/ACM NA5036 42.00 x 54.00 x 6.00mm, FPM NF850 85.00 x 105.00 x 8.00mm, FPM



62 1.9L		Diesel			
F9Q 760	4 Cyl.	8 Valves	1870cc		TD20980
F9Q 762	4 Cyl.	8 Valves	1870cc		TD20991
F9Q 772	4 Cyl.	8 Valves	1870cc		TD19378
F9Q 774	4 Cyl.	8 Valves	1870cc		TD26548
HR816		NF846	25.00 x 42.00 x 7.00mm, FPM/ACM	NA5036	42.00 x 54.00 x 6.00mm, FPM
				NA5037	85.00 x 105.00 x 11.00mm, ACM

63 1.9L		Diesel			
LD20	4 Cyl.	8 Valves	1952cc		TD2482
PA933 (x8)				NK106	46.00 x 58.00 x 7.00mm, ACM
				NJ045	48.00 x 70.00 x 9.00mm, NBR
				NJ287	80.00 x 100.00 x 10.00mm, MVQ

64 1.9L		Petrol			
Z20E	4 Cyl.	8 Valves	1952cc		TD2559
PA933 (x8)					

65 2.0L		Petrol			
274930	4 Cyl.	16 Valves	1991cc		TD30884
HR791					

66 2.0L		Petrol			
CA20DE	4 Cyl.	8 Valves	1973cc		TD20607
CA20E	4 Cyl.	8 Valves	1974cc		TD2416
CA20S	4 Cyl.	8 Valves	1974cc		TD4697
PA079 (x8)		NJ285	34.00 x 48.00 x 8.00mm, NBR	NJ280	33.00 x 47.00 x 8.00mm, NBR
HR5112				NJ284	84.00 x 104.00 x 11.00mm, MVQ

67 2.0L		Diesel			
CD20	4 Cyl.	8 Valves	1974cc		TD4698
CD20ET	4 Cyl.	8 Valves	1974cc		TD34033
CD20T	4 Cyl.	8 Valves	1974cc		TD5509
PA079 (x8)		NJ285	34.00 x 48.00 x 8.00mm, NBR	NJ765	40.00 x 52.00 x 7.00mm, NBR
HR5112				NJ284	84.00 x 104.00 x 11.00mm, MVQ

68 2.0L		Petrol			
F4R 720	4 Cyl.	16 Valves	1998cc		TD19376
F4R 722	4 Cyl.	16 Valves	1998cc		TD19377
F4R 820	4 Cyl.	16 Valves	1998cc		TD34444
PA5013 (x16)		NA5257 (x2)	28.00 x 47.00 x 5.50mm, FPM	NA5036	42.00 x 54.00 x 6.00mm, FPM
				NA5037	85.00 x 105.00 x 11.00mm, ACM

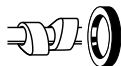

69 2.0L

Petrol

FE	4 Cyl.	8 Valves	1998cc	TD34032
				NJ324 34.00 x 48.00 x 7.00mm, ACM NJ325 90.00 x 110.00 x 9.00mm, MVQ

70 2.0L

Petrol

FJ20E	4 Cyl.	8 Valves	1991cc	TD4702
				NJ287 80.00 x 100.00 x 10.00mm, MVQ

71 2.0L

Petrol

KA20DE	4 Cyl.	16 Valves	1998cc	TD25834
				NK106 46.00 x 58.00 x 7.00mm, ACM NJ287 80.00 x 100.00 x 10.00mm, MVQ

72 2.0L

Petrol

L20	6 Cyl.	12 Valves	1998cc	TD2469
L20A	6 Cyl.	12 Valves	1998cc	TD2470
L20E	6 Cyl.	12 Valves	1998cc	TD2472
L20ET	6 Cyl.	12 Valves	1998cc	TD2473
VG20E	6 Cyl.	12 Valves	1998cc	TD2538
VG20ET	6 Cyl.	12 Valves	1998cc	TD2539
PA933 (x12)				NJ765 40.00 x 52.00 x 7.00mm, NBR NJ765 40.00 x 52.00 x 7.00mm, NBR NJ287 80.00 x 100.00 x 10.00mm, MVQ

73 2.0L

Petrol

L20B	4 Cyl.	8 Valves	1952cc	TD2471
Z20	4 Cyl.	8 Valves	1952cc	TD2557
Z20S	4 Cyl.	8 Valves	1952cc	TD2560
PA933 (x8)				

74 2.0L

Diesel

LD20E	4 Cyl.	8 Valves	1952cc	TD2484
LD20II	4 Cyl.	8 Valves	1952cc	TD2485
LD20IIE	4 Cyl.	8 Valves	1952cc	TD2487
LD20IIL	4 Cyl.	8 Valves	1952cc	TD2488
LD20T	4 Cyl.	8 Valves	1952cc	TD2489
PA933 (x8)				NK106 46.00 x 58.00 x 7.00mm, ACM NJ045 48.00 x 70.00 x 9.00mm, NBR NJ287 80.00 x 100.00 x 10.00mm, MVQ



75 2.0L Petrol

LF-VDS	4 Cyl.	16 Valves	1999cc	TD34047
LF-VE	4 Cyl.	16 Valves	1998cc	TD33966
HR5063				NA5157 37.00 x 50.00 x 8.00mm, PTFE LK5005 88.00 x 188.00 x 15.000mm, PTFE

76 2.0L Diesel

M1D	4 Cyl.	16 Valves	1994cc	TD21038
M9R	4 Cyl.	16 Valves	1995cc	TD22892
M9R 630	4 Cyl.	16 Valves	1995cc	TD26730
M9R 760	4 Cyl.	16 Valves	1995cc	TD20981
M9R 780	4 Cyl.	16 Valves	1995cc	TD20890
M9R 782	4 Cyl.	16 Valves	1995cc	TD24668
HR814				NA5333 48.00 x 81.00 x 11.5mm, FPM/ACM LK5022 94.00 x 161.00 x 10.00mm, PTFE/ACM

77 2.0L Petrol

MR20DD	4 Cyl.	16 Valves	1997cc	TD26207
MR20DE	4 Cyl.	16 Valves	1997cc	TD19288
PB681 (x16)				NK106 46.00 x 58.00 x 7.00mm, ACM

78 2.0L Petrol

QR20DD	4 Cyl.	16 Valves	1998cc	TD31608
QR20DE	4 Cyl.	16 Valves	1998cc	TD16319
PA874 (x16)				NK106 46.00 x 58.00 x 7.00mm, ACM NJ284 84.00 x 104.00 x 11.00mm, MVQ

79 2.0L Petrol

RB20DE	6 Cyl.	24 Valves	1998cc	TD2498
RB20DET	6 Cyl.	24 Valves	1998cc	TD2500
VG20DET	6 Cyl.	24 Valves	1998cc	TD2537
PA874 (x24)	NJ765 (x2) 40.00 x 52.00 x 7.00mm, NBR			NJ765 40.00 x 52.00 x 7.00mm, NBR NJ287 80.00 x 100.00 x 10.00mm, MVQ

80 2.0L Petrol

RB20E	6 Cyl.	12 Valves	1998cc	TD2502
RB20ET	6 Cyl.	12 Valves	1998cc	TD2504
PA933 (x12)	NJ765 (x2) 40.00 x 52.00 x 7.00mm, NBR			NJ765 40.00 x 52.00 x 7.00mm, NBR NJ287 80.00 x 100.00 x 10.00mm, MVQ

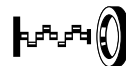
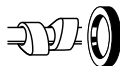

81 2.0L

Petrol

SR20DE	4 Cyl.	16 Valves	1998cc	TD2521
SR20DE	4 Cyl.	16 Valves	1998cc	TD1640
SR20De	4 Cyl.	16 Valves	1998cc	TD19324
SR20DET	4 Cyl.	16 Valves	1998cc	TD4713

PA079 (x8)
03/91→12/95
PA874 (x8)
03/91→12/95
HR767
03/91→12/95
HR768
03/91→12/95

NK106
46.00 x 58.00 x 7.00mm, ACM
NJ284
84.00 x 104.00 x 11.00mm, MVQ

82 2.0L

Petrol

SR20DI	4 Cyl.	16 Valves	1998cc	TD2525
PA874 (x16) HR768 (x2)				

NK106
46.00 x 58.00 x 7.00mm, ACM
NJ284
84.00 x 104.00 x 11.00mm, MVQ

83 2.0L

Petrol

VQ20DE	6 Cyl.	24 Valves	1995cc	TD4715
PA874 (x24)				

84 2.2L

Diesel

G9T 722	4 Cyl.	16 Valves	2188cc	TD19379
G9T 750	4 Cyl.	16 Valves	2188cc	TD23886
PA5041 (x16) HR791				

NA5053 (x2)
30.00 x 42.00 x 7.00mm, FPM

NA5446
60.00 x 75.00 x 7.00mm, PTFE/ACM
NA5447
70.00 x 85.00 x 7.00mm, PTFE/ACM
NF860
93.00 x 108.00 x 7.00mm, FPM/ACM

85 2.2L

Diesel

SD22	4 Cyl.	8 Valves	2164cc	TD2512

NJ369
58.00 x 80.00 x 12.00mm, ACM
NJ287
80.00 x 100.00 x 10.00mm, MVQ

86 2.2L

Diesel

YD22D	4 Cyl.	16 Valves	2184cc	TD31633
YD22DDT	4 Cyl.	16 Valves	2184cc	TD16314
YD22DDTi	4 Cyl.	16 Valves	2184cc	TD16229
YD22ETI	4 Cyl.	16 Valves	2184cc	TD16320
PA874 (x16)				

NJ284
84.00 x 104.00 x 11.00mm, MVQ

87 2.2L

Petrol

Z22	4 Cyl.	8 Valves	2188cc	TD2562
Z22E	4 Cyl.	8 Valves	2188cc	TD28062
PA933 (x8)				

NJ056
80.00 x 100.00 x 13.00mm, MVQ
NJ045
48.00 x 70.00 x 9.00mm, NBR



88 2.3L Diesel

CD23	4 Cyl.	8 Valves	2283cc	TD4699
LD23	4 Cyl.	8 Valves	2283cc	TD8360
PA933 (x8)				

89 2.3L Diesel

M9T	4 Cyl.	16 Valves	2299cc	TD31669
M9T 670	4 Cyl.	16 Valves	2299cc	TD26543
M9T 672	4 Cyl.	16 Valves	2299cc	TD26768
M9T 676	4 Cyl.	16 Valves	2299cc	TD26769
M9T 678	4 Cyl.	16 Valves	2299cc	TD26770
M9T 680	4 Cyl.	16 Valves	2299cc	TD26771
M9T 686	4 Cyl.	16 Valves	2299cc	TD26772
M9T 690	4 Cyl.	16 Valves	2299cc	TD26544
M9T 692	4 Cyl.	16 Valves	2299cc	TD26773
M9T 694	4 Cyl.	16 Valves	2299cc	TD26774
M9T 696	4 Cyl.	16 Valves	2299cc	TD26775
M9T 698	4 Cyl.	16 Valves	2299cc	TD26776
M9T 702	4 Cyl.	16 Valves	2299cc	TD32745
M9T 870	4 Cyl.	16 Valves	2299cc	TD31670
M9T 880	4 Cyl.	16 Valves	2299cc	TD30783
M9T 896	4 Cyl.	16 Valves	2299cc	TD31982
YS23DDT	4 Cyl.	16 Valves	2299cc	TD32294
YS23DDTT	4 Cyl.	16 Valves	2299cc	TD32753
HR814				
				NA5333 48.00 x 81.00 x 11.5mm, FPM/ACM LK5022 94.00 x 161.00 x 10.00mm, PTFE/ACM

90 2.3L Diesel

SD23	4 Cyl.	8 Valves	2289cc	TD2513
TD23	4 Cyl.	8 Valves	2289cc	TD2528
PA378 (x8)				

91 2.4L Petrol

KA24DE	4 Cyl.	16 Valves	2389cc	TD2459
KA24DEN	4 Cyl.	16 Valves	2389cc	TD26563
				NK106 46.00 x 58.00 x 7.00mm, ACM NJ287 80.00 x 100.00 x 10.00mm, MVQ

92 2.4L Petrol

KA24E	4 Cyl.	12 Valves	2389cc	TD2462
PA079 (x8)				
PA933 (x4)				
				NK106 46.00 x 58.00 x 7.00mm, ACM NJ287 80.00 x 100.00 x 10.00mm, MVQ

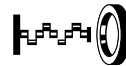
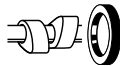

93 2.4L

Petrol

L24	6 Cyl.	12 Valves	2393cc	TD2474
L24E	6 Cyl.	12 Valves	2393cc	TD4708
L24S	6 Cyl.	12 Valves	2393cc	TD4709

PA933 (x12)

NJ056
80.00 x 100.00 x 13.00mm, MVQ

NJ045
48.00 x 70.00 x 9.00mm, NBR

94 2.4L

Petrol

Z24	4 Cyl.	8 Valves	2388cc	TD2563
Z24i	4 Cyl.	8 Valves	2389cc	TD4716
Z24S	4 Cyl.	8 Valves	2389cc	TD2566

PA933 (x8)

NJ056
80.00 x 100.00 x 13.00mm, MVQ

NJ045
48.00 x 70.00 x 9.00mm, NBR

95 2.5L

Diesel

G9U 135	4 Cyl.	16 Valves	2464cc	TD17658
G9U 630	4 Cyl.	16 Valves	2464cc	TD24664
G9U 632	4 Cyl.	16 Valves	2464cc	TD24665
G9U 650	4 Cyl.	16 Valves	2464cc	TD23875
G9U 720	4 Cyl.	16 Valves	2464cc	TD21010
G9U 730	4 Cyl.	16 Valves	2464cc	TD18702

PA5041 (x16)
HR791

NA5053 (x2)
30.00 x 42.00 x 7.00mm, FPM

NA5446
60.00 x 75.00 x 7.00mm, PTFE/ACM

NA5447
70.00 x 85.00 x 7.00mm, PTFE/ACM

NF860
93.00 x 108.00 x 7.00mm, FPM/ACM

96 2.5L

Petrol

QG25DD	4 Cyl.	16 Valves	2488cc	TD20015
--------	--------	-----------	--------	---------

PA874 (x16)

NJ284
84.00 x 104.00 x 11.00mm, MVQ

97 2.5L

Petrol

QR25	4 Cyl.	16 Valves	2488cc	TD32064
QR25	4 Cyl.	16 Valves	2488cc	TD29701
QR25DD	4 Cyl.	16 Valves	2488cc	TD31612
QR25DE	4 Cyl.	16 Valves	2488cc	TD17652
QR25DER	4 Cyl.	16 Valves	2488cc	TD32984
QR25DER	4 Cyl.	16 Valves	2488cc	TD31660
QR25DER	4 Cyl.	16 Valves	2488cc	TD31668

PA874 (x16)

NK106
46.00 x 58.00 x 7.00mm, ACM

NJ284
84.00 x 104.00 x 11.00mm, MVQ



98 2.5L		Petrol		
RB25DE	6 Cyl.	24 Valves	2498cc	TD2505
RB25DEH	6 Cyl.	24 Valves	2498cc	TD20609
RB25DET	6 Cyl.	24 Valves	2498cc	TD2506
PA874 (x24)	NJ765 (x2) 40.00 x 52.00 x 7.00mm, NBR		NJ765 40.00 x 52.00 x 7.00mm, NBR NJ287 80.00 x 100.00 x 10.00mm, MVQ	

99 2.5L		Diesel		
SD25	4 Cyl.	8 Valves	2488cc	TD2514
PA378 (x8)			NJ369 58.00 x 80.00 x 12.00mm, ACM NJ287 80.00 x 100.00 x 10.00mm, MVQ	

100 2.5L		Diesel		
TD25	4 Cyl.	8 Valves	2494cc	TD4714
TD25TI	4 Cyl.	8 Valves	2494cc	TD10589
PA378 (x8)			NJ831 58.00 x 80.00 x 10.00mm, NBR NJ829 86.00 x 100.00 x 10.00mm, MVQ	

101 2.5L		Petrol		
VQ25DD	6 Cyl.	24 Valves	2496cc	TD23752
VQ25DE	6 Cyl.	24 Valves	2496cc	TD5382
VQ25DET	6 Cyl.	24 Valves	2496cc	TD23753
PA874 (x24)				

102 2.5L		Diesel		
YD25DDTi	4 Cyl.	16 Valves	2488cc	TD17650
YD25ETi	4 Cyl.	16 Valves	2488cc	TD26328
YD25K3LD-5HO	4 Cyl.	16 Valves	2488cc	TD32985
YD25K3LD-5LO	4 Cyl.	16 Valves	2488cc	TD26698
YD25K3LD-5MI	4 Cyl.	16 Valves	2488cc	TD26699
PA874 (x16)			NJ284 84.00 x 104.00 x 11.00mm, MVQ	

103 2.6L		Petrol		
L26	6 Cyl.	12 Valves	2565cc	TD2477
PA933 (x12)				

104 2.6L		Petrol		
RB26DETT	6 Cyl.	24 Valves	2568cc	TD2507
PA079 (x24)	NJ765 (x2) 40.00 x 52.00 x 7.00mm, NBR		NJ765 40.00 x 52.00 x 7.00mm, NBR	

105 2.7L		Petrol		
L28E	6 Cyl.	12 Valves	2753cc	TD2479
PA933 (x12)			NJ045 48.00 x 70.00 x 9.00mm, NBR	



106 2.7L Diesel

TD27	4 Cyl.	8 Valves	2663cc	TD2532
TD27ETi	4 Cyl.	8 Valves	2664cc	TD9896
TD27T	4 Cyl.	8 Valves	2664cc	TD2533
TD27Ti	4 Cyl.	8 Valves	2664cc	TD9478

PA378 (x8)				NJ831 58.00 x 80.00 x 10.00mm, NBR NJ829 86.00 x 100.00 x 10.00mm, MVQ
------------	--	--	--	---

107 2.8L Petrol

L28	6 Cyl.	12 Valves	2753cc	TD2478
L28ET	6 Cyl.	12 Valves	2753cc	TD2480

PA933 (x12)				NJ045 48.00 x 70.00 x 9.00mm, NBR
-------------	--	--	--	---

108 2.8L Diesel

LD28	6 Cyl.	12 Valves	2792cc	TD2490
------	--------	-----------	--------	--------

PA933 (x12)				NJ045 48.00 x 70.00 x 9.00mm, NBR
-------------	--	--	--	---

109 2.8L Diesel

RD28	6 Cyl.	12 Valves	2826cc	TD4711
RD28E	6 Cyl.	12 Valves	2826cc	TD33997
RD28T	6 Cyl.	12 Valves	2826cc	TD2511

PA079 (x12)	NJ285 34.00 x 48.00 x 8.00mm, NBR	NJ765 40.00 x 52.00 x 7.00mm, NBR NJ287 80.00 x 100.00 x 10.00mm, MVQ
-------------	---	--

110 2.8L Diesel

RD28Ti	6 Cyl.	12 Valves	2826cc	TD13751
--------	--------	-----------	--------	---------

PA079 (x12)	NJ285 34.00 x 48.00 x 8.00mm, NBR	NJ222 40.00 x 52.00 x 7.00mm, FPM NJ765 40.00 x 52.00 x 7.00mm, NBR
-------------	---	--

111 3.0L Diesel

BD30	4 Cyl.	8 Valves	2953cc	TD2398
BD30II	4 Cyl.	8 Valves	2953cc	TD2399
BD-30Ti	4 Cyl.	8 Valves	2953cc	TD8327

PA378 (x8)				NJ831 58.00 x 80.00 x 10.00mm, NBR NJ829 86.00 x 100.00 x 10.00mm, MVQ
------------	--	--	--	---

112 3.0L Petrol

RB30E	6 Cyl.	12 Valves	2962cc	TD2508
RB30S	6 Cyl.	12 Valves	2962cc	TD2509

				NJ222 40.00 x 52.00 x 7.00mm, FPM NJ765 40.00 x 52.00 x 7.00mm, NBR
--	--	--	--	--



113 3.0L		Petrol		
VE30DE	6 Cyl.	24 Valves	2960cc	TD2536
VG30DE	6 Cyl.	24 Valves	2960cc	TD2541
PA874 (x24)	NJ765 (x2) 40.00 x 52.00 x 7.00mm, NBR		NJ222 40.00 x 52.00 x 7.00mm, FPM NJ765 40.00 x 52.00 x 7.00mm, NBR	

114 3.0L		Petrol		
VG30	6 Cyl.	12 Valves	2959cc	TD2540
VG30E	6 Cyl.	12 Valves	2960cc	TD2544
VG30ET	6 Cyl.	12 Valves	2960cc	TD2549
VG30I	6 Cyl.	12 Valves	2960cc	TD19290
VG30S	6 Cyl.	12 Valves	2960cc	TD2550
VG30T	6 Cyl.	12 Valves	2959cc	TD2551
PA079 (x6) PA933 (x6)	NJ285 34.00 x 48.00 x 8.00mm, NBR		NJ368 33.00 x 47.00 x 7.00mm, NBR →01/95 NJ765 40.00 x 52.00 x 7.00mm, NBR NJ284 84.00 x 104.00 x 11.00mm, MVQ	

115 3.0L		Petrol		
VG30DE	6 Cyl.	24 Valves	2960cc	TD1641
VG30DET	6 Cyl.	24 Valves	2960cc	TD2542
VG30DETT	6 Cyl.	24 Valves	2960cc	TD2543
PA874 (x24)	NJ765 (x2) 40.00 x 52.00 x 7.00mm, NBR		NJ765 40.00 x 52.00 x 7.00mm, NBR NJ284 84.00 x 104.00 x 11.00mm, MVQ	

116 3.0L		Petrol		
VG30E	6 Cyl.	12 Valves	2960cc	TD21127
PA933 (x6) PA079 (x6)	NJ285 34.00 x 48.00 x 8.00mm, NBR		NJ368 33.00 x 47.00 x 7.00mm, NBR →01/95 NJ765 40.00 x 52.00 x 7.00mm, NBR NJ284 84.00 x 104.00 x 11.00mm, MVQ	

117 3.0L		Petrol		
VQ30DD	6 Cyl.	24 Valves	2987cc	TD23756
VQ30DE	6 Cyl.	24 Valves	2988cc	TD20348
VQ30DE	6 Cyl.	24 Valves	2988cc	TD2553
PA874 (x24)				

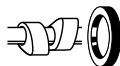

118 3.0L

Diesel

ZD30	4 Cyl.	16 Valves	2953cc	TD19371
ZD30DD	4 Cyl.	16 Valves	2953cc	TD19697
ZD30DDT	4 Cyl.	16 Valves	2953cc	TD20345
ZD30DDTi	4 Cyl.	16 Valves	2953cc	TD14288
ZD30H HD-5	4 Cyl.	16 Valves	2953cc	TD26700
ZD30Ti	4 Cyl.	16 Valves	2953cc	TD17659
PA079 (x16) HR5112 (x2)				

119 3.2L

Diesel

QD32	4 Cyl.	8 Valves	3153cc	TD16476
QD32ETi	4 Cyl.	8 Valves	3153cc	TD9897
PA378 (x8)				NJ831 (x2) 58.00 x 80.00 x 10.00mm, NBR NJ829 (x2) 86.00 x 100.00 x 10.00mm, MVQ

120 3.2L

Diesel

SD33	6 Cyl.	12 Valves	3246cc	TD2515
SD33T	6 Cyl.	12 Valves	3246cc	TD2516
				LV501 (x2)

121 3.3L

Petrol

VG33E	6 Cyl.	12 Valves	3275cc	TD9895
VG33E	6 Cyl.	12 Valves	3275cc	TD20122
VG33E	6 Cyl.	12 Valves	3275cc	TD21128
VG33ER	6 Cyl.	12 Valves	3275cc	TD19291
PA079 (x6) PA933 (x6)				NJ285 34.00 x 48.00 x 8.00mm, NBR NJ222 (x2) 40.00 x 52.00 x 7.00mm, FPM NJ765 (x2) 40.00 x 52.00 x 7.00mm, NBR

122 3.5L

Petrol

VG35DE	6 Cyl.	24 Valves	3498cc	TD28063
VQ35	6 Cyl.	24 Valves	3498cc	TD16132
VQ35DD	6 Cyl.	24 Valves	3498cc	TD33835
VQ35DE	6 Cyl.	24 Valves	3498cc	TD17651
VQ35DE	6 Cyl.	24 Valves	3498cc	TD18336
VQ35DE	6 Cyl.	24 Valves	3498cc	TD26144
VQ35HR	6 Cyl.	24 Valves	3498cc	TD20002
VQ35HR	6 Cyl.	24 Valves	3498cc	TD23872
PA874 (x24)				

123 3.7L

Petrol

VQ37HR	6 Cyl.	24 Valves	3696cc	TD29238
VQ37HR	6 Cyl.	24 Valves	3696cc	TD25254
VQ37VHR	6 Cyl.	24 Valves	3696cc	TD20068
VQ37VHR	6 Cyl.	24 Valves	3696cc	TD20741
PA874 (x24)				

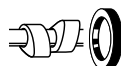

124 4.0L		Diesel			
B4-40Ti	4 Cyl.	8 Valves	3990cc		TD8328
BD-40Ti	4 Cyl.	8 Valves	3990cc		TD17172
				NB932 60.33 x 79.40 x 9.50mm, FPM NB933 133.35 x 158.75 x 12.63mm, FPM	

125 4.0L		Petrol			
VQ40	6 Cyl.	24 Valves	3954cc		TD19303
VQ40DE	6 Cyl.	24 Valves	3954cc		TD19294
PA874 (x24)					

126 4.2L		Petrol			
TB42	6 Cyl.	12 Valves	4169cc		TD24367
PA378 (x12)					
				NJ831 58.00 x 80.00 x 10.00mm, NBR NJ829 86.00 x 100.00 x 10.00mm, MVQ	

127 4.2L		Petrol			
TB42E	6 Cyl.	12 Valves	4169cc		TD2526
TB42S	6 Cyl.	12 Valves	4169cc		TD2527
PA378 (x12)					

128 4.2L		Diesel			
TD42	6 Cyl.	12 Valves	4169cc		TD2535
PA378 (x12)					

129 4.2L		Diesel			
TD42T	6 Cyl.	12 Valves	4169cc		TD10368
PA378 (x12)					
				NJ831 58.00 x 80.00 x 10.00mm, NBR NJ829 86.00 x 100.00 x 10.00mm, MVQ	

130 4.5L		Petrol			
VH45DE	8 Cyl.	32 Valves	4494cc		TD1642
VH45DE	8 Cyl.	32 Valves	4494cc		TD18722
VK45DD	8 Cyl.	32 Valves	4494cc		TD27274
VK45DE	8 Cyl.	32 Valves	4494cc		TD19293
VK45DE	8 Cyl.	32 Valves	4494cc		TD17661
				NJ284 84.00 x 104.00 x 11.00mm, MVQ	

131 4.8L		Petrol			
TB48DE	6 Cyl.	24 Valves	4759cc		TD18731
				NJ831 58.00 x 80.00 x 10.00mm, NBR	

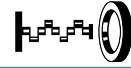

132 6.0L

Diesel

B6-60	6 Cyl.	12 Valves	5985cc	TD6738
B6-60Ti-H	6 Cyl.	12 Valves	5985cc	TD28282
B6-60Ti-L	6 Cyl.	12 Valves	5985cc	TD8329
B660N	6 Cyl.	12 Valves	5985cc	TD17173
B660T	6 Cyl.	12 Valves	5985cc	TD2397
B660TI	6 Cyl.	12 Valves	5985cc	TD22471

NB932

60.33 x 79.40 x 9.50mm, FPM

NB933

133.35 x 158.75 x 12.63mm, FPM



2 Eleven	04/07→07/11	2ZZ-GE	Petrol	1796	4	16	71
21	01/94→12/02	16 K4F	Petrol	1588	4	16	32
21	08/95→12/02	Z 20 LET	Petrol	1998	4	16	119
21	01/97→	K18K4	Petrol	1796	4	16	85
21	04/97→08/02	K 1.8	Petrol	1796	4	16	84
Adam (M13)	10/12→	A 12 XEL	Petrol	1229	4	16	10
Adam (M13)	10/12→	A 14 XEL	Petrol	1398	4	16	20
Adam (M13)	10/12→	A 14 XER	Petrol	1398	4	16	20
Adam (M13)	10/12→	B 12 XEL	Petrol	1229	4	16	10
Adam (M13)	10/12→	B 12 XER	Petrol	1229	4	16	10
Adam (M13)	10/12→	B 14 XEL	Petrol	1398	4	16	20
Adam (M13)	10/12→	B 14 XER	Petrol	1398	4	16	20
Adam (M13)	11/14→	B 14 NEH	Petrol	1364	4	16	20
Adam (M13)	11/14→	B 14 NET	Petrol	1364	4	16	20
Admiral A	10/65→03/69	28 S	Petrol	2784	6	12	159
Admiral A	10/67→03/69	28 HL	Petrol	2784	6	12	159
Admiral B	03/69→07/76	28 H	Petrol	2784	6	12	158
Admiral B	03/69→01/78	28 E	Petrol	2784	6	12	157
Admiral B	03/69→01/78	28 S	Petrol	2784	6	12	159
Agila (A) (H00)	09/00→12/07	Z 10 XE	Petrol	973	3	12	3
Agila (A) (H00)	09/00→12/07	Z 12 XE	Petrol	1199	4	16	10
Agila (A) (H00)	08/03→12/07	Z 10 XEP	Petrol	998	3	12	3
Agila (A) (H00)	08/03→12/07	Z 13 DT	Diesel	1248	4	16	15
Agila (A) (H00)	07/04→12/07	Z 12 XEP	Petrol	1229	4	16	10
Agila (B) (H08)	04/08→	D13A	Diesel	1248	4	16	12
Agila (B) (H08)	04/08→	K10B	Petrol	996	3	12	6
Agila (B) (H08)	04/08→	K12B	Petrol	1242	4	16	13
Agila (B) (H08)	04/08→	Z 13 DTJ	Diesel	1248	4	16	15
Agila Mk I (A) (H00)	02/00→11/06	Z 10 XEP	Petrol	998	3	12	3
Agila Mk I (A) (H00)	09/00→08/05	Z 10 XE	Petrol	973	3	12	3
Agila Mk I (A) (H00)	09/00→03/08	Z 12 XE	Petrol	1199	4	16	10
Agila Mk I (A) (H00)	07/04→11/06	Z 12 XEP	Petrol	1229	4	16	10
Agila Mk II (B) (H08)	01/08→11/14	D13A	Diesel	1248	4	16	12
Agila Mk II (B) (H08)	01/08→11/14	K10B	Petrol	996	3	12	6
Agila Mk II (B) (H08)	01/08→11/14	K12B	Petrol	1242	4	16	13
Agila Mk II (B) (H08)	01/08→11/14	Z 13 DTJ	Diesel	1248	4	16	15
Ampera (R12)	11/11→	A 14 XFL	Petrol	1398	4	16	20
Ampera (R12)	03/12→	A 14 XFL	Petrol	1398	4	16	20
Antara (J26, H26)	08/06→04/15	Z 20 DM	Diesel	1991	4	16	118
Antara (J26, H26)	08/06→04/15	Z 20 DMH	Diesel	1991	4	16	118
Antara (J26, H26)	08/06→04/15	Z 24 XED	Petrol	2405	4	16	141
Antara (J26, H26)	08/06→	Z 24 XE	Petrol	2405	4	16	141
Antara (J26, H26)	11/10→04/15	A 24 XE	Petrol	2384	4	16	139
Antara (J26, H26)	12/10→	A 22 DM	Diesel	2231	4	16	127
Antara (J26, H26)	12/10→	A 22 DMH	Diesel	2231	4	16	127
Antara (L07)	05/06→	Z 20 DMH	Diesel	1991	4	16	118
Antara (L07)	05/06→	Z 20 S	Diesel	1991	4	16	118
Antara (L07)	05/06→	Z 24 XED	Petrol	2405	4	16	141
Antara (L07)	01/07→	Z 24 XE	Petrol	2405	4	16	141
Antara (L07)	03/07→	Z 32 SEE	Petrol	3195	6	24	172
Antara (L07)	09/08→	Z 20 DM	Diesel	1991	4	16	118
Antara (L07)	12/10→	A 22 DM	Diesel	2231	4	16	127
Antara (L07)	12/10→	A 22 DMH	Diesel	2231	4	16	127
Antara (L07)	12/10→	A 24 XE	Petrol	2384	4	16	139
Arena Box (A97)	01/97→12/01	19 DJ	Diesel	1870	4	8	91
Arena Box (A97)	01/97→12/01	19 DL	Diesel	1870	4	8	91
Arena Box (A97)	01/97→12/01	25 DG	Diesel	2499	4	8	144
Arena Box (A97)	01/97→12/01	25 DM	Diesel	2499	4	8	145
Arena Box (TB, TF)	03/98→08/01	F8Q 600	Diesel	1870	4	8	91
Arena Box (TB, TF)	03/98→08/01	F8Q 606	Diesel	1870	4	8	96
Arena Box (TB, TF)	03/98→08/01	S8U 758	Diesel	2499	4	8	151
Arena Box (TB, TF)	03/98→08/01	S8U 780	Diesel	2499	4	8	151
Arena Box (TB, TF)	03/98→08/01	S8U 782	Diesel	2499	4	8	151
Arena Bus (A97)	01/97→12/01	19 DJ	Diesel	1870	4	8	91
Arena Bus (A97)	01/97→12/01	19 DL	Diesel	1870	4	8	91
Arena Bus (A97)	01/97→12/01	25 DG	Diesel	2499	4	8	144
Arena Bus (A97)	01/97→12/01	25 DM	Diesel	2499	4	8	145
Arena Combi (A97)	03/98→08/01	F8Q 600	Diesel	1870	4	8	91
Arena Combi (A97)	03/98→08/01	F8Q 606	Diesel	1870	4	8	96
Arena Combi (A97)	03/98→08/01	F8Q 606	Diesel	1870	4	8	96
Arena Combi (A97)	03/98→08/01	S8U 758	Diesel	2499	4	8	151
Arena Combi (A97)	03/98→08/01	S8U 780	Diesel	2499	4	8	151
Arena Combi (A97)	03/98→08/01	S8U 782	Diesel	2499	4	8	151
Arena Van (A97)	03/98→08/01	F8Q 600	Diesel	1870	4	8	96
Arena Van (A97)	03/98→08/01	F8Q 606	Diesel	1870	4	8	96
Arena Van (A97)	03/98→08/01	S8U 758	Diesel	2499	4	8	151
Arena Van (A97)	03/98→08/01	S8U 780	Diesel	2499	4	8	151
Arena Van (A97)	03/98→08/01	S8U 782	Diesel	2499	4	8	151



CC



9

Ascona A (81, 86, 87, 88)	10/70→08/75	16 N	Petrol	1584	4	8	34
Ascona A (81, 86, 87, 88)	10/70→08/75	16 S	Petrol	1584	4	8	37
Ascona A (81, 86, 87, 88)	03/71→08/75	19 S	Petrol	1897	4	8	94
Ascona A (81, 86, 87, 88)	04/72→08/75	12 S	Petrol	1196	4	8	8
Ascona A (81, 86, 87, 88)	09/74→08/75	19 N	Petrol	1897	4	8	93
Ascona A Voyage (84, 89)	10/70→08/75	16 N	Petrol	1584	4	8	34
Ascona A Voyage (84, 89)	10/70→08/75	16 S	Petrol	1584	4	8	37
Ascona A Voyage (84, 89)	10/70→08/75	19 S	Petrol	1897	4	8	94
Ascona B (81, 86, 87, 88)	09/75→02/79	12 S	Petrol	1196	4	8	8
Ascona B (81, 86, 87, 88)	09/75→08/81	16 N	Petrol	1584	4	8	34
Ascona B (81, 86, 87, 88)	09/75→08/81	16 S	Petrol	1584	4	8	37
Ascona B (81, 86, 87, 88)	09/75→08/81	19 S	Petrol	1897	4	8	94
Ascona B (81, 86, 87, 88)	08/76→02/79	12 N	Petrol	1196	4	8	8
Ascona B (81, 86, 87, 88)	08/76→08/81	19 N	Petrol	1897	4	8	93
Ascona B (81, 86, 87, 88)	08/77→08/81	20 N	Petrol	1979	4	8	105
Ascona B (81, 86, 87, 88)	08/77→08/81	20 S	Petrol	1979	4	8	105
Ascona B (81, 86, 87, 88)	08/78→08/81	20 D	Diesel	1998	4	8	103
Ascona B (81, 86, 87, 88)	03/79→08/81	13 N	Petrol	1297	4	8	14
Ascona B (81, 86, 87, 88)	08/79→08/81	13 S	Petrol	1297	4	8	14
Ascona B (81, 86, 87, 88)	08/79→08/81	20 E	Petrol	1979	4	8	104
Ascona C (J82)	09/81→08/86	13 N	Petrol	1297	4	8	14
Ascona C (J82)	09/81→08/86	16 SH	Petrol	1598	4	8	39
Ascona C (J82)	09/81→09/87	16 N	Petrol	1598	4	8	35
Ascona C (J82)	09/81→08/88	13 S	Petrol	1297	4	8	14
Ascona C (J82)	03/82→08/88	16 D	Diesel	1598	4	8	31
Ascona C (J82)	03/82→08/88	16 DA	Diesel	1598	4	8	31
Ascona C (J82)	09/82→08/86	18 E	Petrol	1796	4	8	73
Ascona C (J82)	01/85→08/86	C 18 NE	Petrol	1796	4	8	80
Ascona C (J82)	01/85→08/86	S 18 NV	Petrol	1796	4	8	77
Ascona C (J82)	09/86→08/88	16 SV	Petrol	1598	4	8	36
Ascona C (J82)	09/86→08/88	20 NE	Petrol	1998	4	8	106
Ascona C (J82)	09/86→08/88	C 16 LZ	Petrol	1598	4	8	36
Ascona C (J82)	09/86→08/88	C 16 NZ	Petrol	1598	4	8	36
Ascona C (J82)	09/86→08/88	C 20 NE	Petrol	1998	4	8	106
Ascona C (J82)	03/87→08/88	20 SEH	Petrol	1998	4	8	106
Ascona C (J82)	08/87→08/88	C 20 NEF	Petrol	1998	4	8	106
Ascona C (J82)	09/87→08/88	E 16 LZ	Petrol	1598	4	8	36
Ascona C (J82)	09/87→08/88	E 16 NZ	Petrol	1598	4	8	36
Ascona C (J82)	09/87→08/88	E 18 NV	Petrol	1796	4	8	77
Ascona C Hatchback (J82)	09/81→08/86	13 N	Petrol	1297	4	8	14
Ascona C Hatchback (J82)	09/81→08/86	16 SH	Petrol	1598	4	8	39
Ascona C Hatchback (J82)	09/81→08/88	13 S	Petrol	1297	4	8	14
Ascona C Hatchback (J82)	09/81→08/88	16 N	Petrol	1598	4	8	35
Ascona C Hatchback (J82)	03/82→08/88	16 D	Diesel	1598	4	8	31
Ascona C Hatchback (J82)	03/82→08/88	16 DA	Diesel	1598	4	8	31
Ascona C Hatchback (J82)	09/82→08/86	18 E	Petrol	1796	4	8	73
Ascona C Hatchback (J82)	01/85→08/86	C 18 NE	Petrol	1796	4	8	80
Ascona C Hatchback (J82)	01/85→08/86	S 18 NV	Petrol	1796	4	8	77
Ascona C Hatchback (J82)	09/86→08/88	16 SV	Petrol	1598	4	8	36
Ascona C Hatchback (J82)	09/86→08/88	20 NE	Petrol	1998	4	8	106
Ascona C Hatchback (J82)	09/86→08/88	C 16 LZ	Petrol	1598	4	8	36
Ascona C Hatchback (J82)	09/86→08/88	C 16 NZ	Petrol	1598	4	8	36
Ascona C Hatchback (J82)	09/86→08/88	C 20 NE	Petrol	1998	4	8	106
Ascona C Hatchback (J82)	03/87→08/88	20 SEH	Petrol	1998	4	8	106
Ascona C Hatchback (J82)	09/87→08/88	E 16 NZ	Petrol	1598	4	8	36
Ascona C Hatchback (J82)	09/87→08/88	E 18 NV	Petrol	1796	4	8	77
Astra	10/79→08/84	12 S	Petrol	1196	4	8	8
Astra (AH)	07/05→03/07	Z 18 XE	Petrol	1796	4	16	89
Astra (AH)	06/06→03/10	Z 19 DTH	Diesel	1910	4	16	100
Astra (AH)	12/06→03/08	Z 22 YH	Petrol	2198	4	16	132
Astra (AH)	04/07→03/10	Z 18 XER	Petrol	1796	4	16	79
Astra Classic (L48)	01/09→	A 17 DTJ	Diesel	1686	4	16	64
Astra Classic (L48)	01/09→	A 17 DTR	Diesel	1686	4	16	64
Astra Classic (L48)	01/09→	Z 13 DTH	Diesel	1248	4	16	15
Astra Classic (L48)	01/09→	Z 16 XER	Petrol	1598	4	16	41
Astra Classic (L48)	01/09→	Z 17 DTJ	Diesel	1686	4	16	64
Astra Classic (L48)	02/13→	Z 18 XER	Petrol	1796	4	16	79
Astra Classic Estate	01/09→	A 17 DTR	Diesel	1686	4	16	64
Astra Classic Estate	01/09→	Z 16 XER	Petrol	1598	4	16	41
Astra Classic Estate	01/09→	Z 17 DTJ	Diesel	1686	4	16	64
Astra Classic Saloon	01/09→	A 17 DTR	Diesel	1686	4	16	64
Astra Classic Saloon	01/09→	Z 16 XER	Petrol	1598	4	16	41
Astra Classic Saloon	01/09→	Z 17 DTJ	Diesel	1686	4	16	64
Astra Convertible (TS)	06/02→07/04	Z 20 LER	Petrol	1998	4	16	113
Astra Convertible (TS)	06/02→07/04	Z 20 LET	Petrol	1998	4	16	113
Astra Convertible (TS)	06/02→12/06	Z 22 SE	Petrol	2198	4	16	132
Astra Estate	09/79→08/84	13 S	Petrol	1297	4	8	14
Astra Estate	09/81→08/86	16 SH	Petrol	1598	4	8	39



Model	Year Range	Engine	Fuel	CC	Power (kW)	Power (hp)	0-100 (s)
Astra Estate	02/82→08/86	16 D	Diesel	1598	4	8	31
Astra Estate (AH)	07/05→03/07	Z 18 XE	Petrol	1796	4	16	89
Astra Estate (AH)	04/07→03/10	Z 18 XER	Petrol	1796	4	16	79
Astra F (T92)	09/91→09/93	14 NV	Petrol	1389	4	8	18
Astra F (T92)	09/91→09/98	C 14 NZ	Petrol	1389	4	8	18
Astra F (T92)	09/91→09/98	X 14 NZ	Petrol	1389	4	8	18
Astra F (T92)	03/92→09/92	17 D	Diesel	1700	4	8	59
Astra F (T92)	03/92→09/98	17 DT (TC4EE1)	Diesel	1686	4	8	60
Astra F (T92)	03/92→09/98	C 14 SE	Petrol	1389	4	8	18
Astra F (T92)	03/92→09/98	C 16 NZ	Petrol	1598	4	8	36
Astra F (T92)	03/92→09/98	C 18 NZ	Petrol	1796	4	8	81
Astra F (T92)	03/92→09/98	C 20 NE	Petrol	1998	4	8	106
Astra F (T92)	03/92→09/98	X 16 SZR	Petrol	1598	4	8	36
Astra F (T92)	03/92→09/98	X 17 DT (TC4EE1)	Diesel	1686	4	8	60
Astra F (T92)	05/92→12/94	C 16 SE	Petrol	1598	4	8	36
Astra F (T92)	07/92→09/98	17 DR	Diesel	1700	4	8	59
Astra F (T92)	09/92→09/98	14 SE	Petrol	1389	4	8	18
Astra F (T92)	05/93→07/96	X 16 SZ	Petrol	1598	4	8	36
Astra F (T92)	06/93→10/94	C 18 XE	Petrol	1799	4	16	82
Astra F (T92)	08/94→09/98	X 16 XEL	Petrol	1598	4	16	47
Astra F (T92)	11/94→09/98	C 18 XEL	Petrol	1799	4	16	82
Astra F (T92)	11/94→09/98	X 17 DTL	Diesel	1700	4	8	59
Astra F (T92)	11/94→09/98	X 18 XE	Petrol	1799	4	16	82
Astra F (T92)	02/95→09/98	X 20 XEV	Petrol	1998	4	16	113
Astra F (T92)	09/95→09/96	18 SE	Petrol	1796	4	8	78
Astra F (T92)	09/95→08/97	C 18 SEL	Petrol	1796	4	16	82
Astra F (T92)	09/95→09/98	16 LZ2	Petrol	1598	4	8	33
Astra F (T92)	09/95→09/98	16 NZR	Petrol	1598	4	8	36
Astra F (T92)	02/96→09/98	X 14 XE	Petrol	1389	4	16	22
Astra F Classic Estate (T92)	01/98→01/05	X 14 NZ	Petrol	1389	4	8	18
Astra F Classic Estate (T92)	01/98→01/05	X 16 SZR	Petrol	1598	4	8	36
Astra F Classic Estate (T92)	01/98→01/05	X 16 XEL	Petrol	1598	4	16	47
Astra F Classic Hatchback (T92)	01/98→08/02	X 14 NZ	Petrol	1389	4	8	18
Astra F Classic Hatchback (T92)	01/98→08/02	X 16 SZR	Petrol	1598	4	8	36
Astra F Classic Hatchback (T92)	01/98→08/02	X 16 XEL	Petrol	1598	4	16	47
Astra F Classic Saloon (T92)	01/98→08/02	X 14 NZ	Petrol	1389	4	8	18
Astra F Classic Saloon (T92)	01/98→08/02	X 16 SZR	Petrol	1598	4	8	36
Astra F Classic Saloon (T92)	01/98→08/02	X 16 XEL	Petrol	1598	4	16	47
Astra F Convertible (T92)	03/93→10/94	C 20 NE	Petrol	1998	4	8	106
Astra F Convertible (T92)	03/93→08/96	X 16 SZ	Petrol	1598	4	8	36
Astra F Convertible (T92)	05/93→03/01	C 14 SE	Petrol	1389	4	8	18
Astra F Convertible (T92)	11/94→03/01	C 18 XEL	Petrol	1799	4	16	82
Astra F Convertible (T92)	11/94→03/01	X 18 XE	Petrol	1799	4	16	82
Astra F Convertible (T92)	01/96→03/01	X 14 XE	Petrol	1389	4	16	22
Astra F Convertible (T92)	01/96→03/01	X 16 SZR	Petrol	1598	4	8	36
Astra F Estate (T92)	09/91→09/93	14 NV	Petrol	1389	4	8	18
Astra F Estate (T92)	09/91→07/94	C 20 NE	Petrol	1998	4	8	106
Astra F Estate (T92)	09/91→01/98	C 14 NZ	Petrol	1389	4	8	18
Astra F Estate (T92)	09/91→01/98	C 16 NZ	Petrol	1598	4	8	36
Astra F Estate (T92)	09/91→01/98	C 18 NZ	Petrol	1796	4	8	81
Astra F Estate (T92)	09/91→01/98	X 16 SZR	Petrol	1598	4	8	36
Astra F Estate (T92)	12/91→09/92	17 D	Diesel	1700	4	8	59
Astra F Estate (T92)	12/91→01/98	17 DT (TC4EE1)	Diesel	1686	4	8	60
Astra F Estate (T92)	12/91→01/98	X 17 DT (TC4EE1)	Diesel	1686	4	8	60
Astra F Estate (T92)	03/92→12/94	C 16 SE	Petrol	1598	4	8	36
Astra F Estate (T92)	03/92→01/98	C 14 SE	Petrol	1389	4	8	18
Astra F Estate (T92)	07/92→01/98	17 DR	Diesel	1700	4	8	59
Astra F Estate (T92)	09/92→01/98	14 SE	Petrol	1389	4	8	18
Astra F Estate (T92)	03/93→01/98	C 20 XE	Petrol	1998	4	16	112
Astra F Estate (T92)	05/93→07/96	X 16 SZ	Petrol	1598	4	8	36
Astra F Estate (T92)	06/93→01/98	C 18 XE	Petrol	1799	4	16	82
Astra F Estate (T92)	07/94→01/98	C 18 XEL	Petrol	1799	4	16	82
Astra F Estate (T92)	07/94→01/98	X 18 XE	Petrol	1799	4	16	82
Astra F Estate (T92)	08/94→01/98	X 16 XEL	Petrol	1598	4	16	47
Astra F Estate (T92)	11/94→01/98	X 17 DTL	Diesel	1700	4	8	59
Astra F Estate (T92)	02/95→01/98	X 20 XEV	Petrol	1998	4	16	113
Astra F Estate (T92)	09/95→01/98	16 LZ2	Petrol	1598	4	8	33
Astra F Estate (T92)	09/95→01/98	16 NZR	Petrol	1598	4	8	36
Astra F Estate (T92)	02/96→01/98	X 14 XE	Petrol	1389	4	16	22
Astra F Hatchback (T92)	09/91→09/93	14 NV	Petrol	1389	4	8	18
Astra F Hatchback (T92)	09/91→01/98	C 16 NZ	Petrol	1598	4	8	36
Astra F Hatchback (T92)	09/91→01/98	C 18 NZ	Petrol	1796	4	8	81
Astra F Hatchback (T92)	09/91→01/98	C 20 NE	Petrol	1998	4	8	106
Astra F Hatchback (T92)	09/91→01/98	C 20 XE	Petrol	1998	4	16	112
Astra F Hatchback (T92)	09/91→01/98	X 16 SZR	Petrol	1598	4	8	36
Astra F Hatchback (T92)	11/91→07/93	18 SE	Petrol	1796	4	8	78
Astra F Hatchback (T92)	12/91→09/92	17 D	Diesel	1700	4	8	59
Astra F Hatchback (T92)	12/91→01/98	17 DT (TC4EE1)	Diesel	1686	4	8	60



CC



9

Astra F Hatchback (T92)	12/91→01/98	X 17 DT (TC4EE1)	Diesel	1686	4	8	60
Astra F Hatchback (T92)	03/92→12/94	C 16 SE	Petrol	1598	4	8	36
Astra F Hatchback (T92)	03/92→01/98	C 14 NZ	Petrol	1389	4	8	18
Astra F Hatchback (T92)	03/92→01/98	C 14 SE	Petrol	1389	4	8	18
Astra F Hatchback (T92)	07/92→01/98	17 DR	Diesel	1700	4	8	59
Astra F Hatchback (T92)	09/92→01/98	14 SE	Petrol	1389	4	8	18
Astra F Hatchback (T92)	05/93→07/96	X 16 SZ	Petrol	1598	4	8	36
Astra F Hatchback (T92)	06/93→08/94	C 18 XE	Petrol	1799	4	16	82
Astra F Hatchback (T92)	08/94→01/98	X 16 XEL	Petrol	1598	4	16	47
Astra F Hatchback (T92)	09/94→01/98	C 18 XEL	Petrol	1799	4	16	82
Astra F Hatchback (T92)	09/94→01/98	X 18 XE	Petrol	1799	4	16	82
Astra F Hatchback (T92)	11/94→01/98	X 17 DTL	Diesel	1700	4	8	59
Astra F Hatchback (T92)	02/95→01/98	X 20 XEV	Petrol	1998	4	16	113
Astra F Hatchback (T92)	09/95→01/98	16 LZ2	Petrol	1598	4	8	33
Astra F Hatchback (T92)	09/95→01/98	16 NZR	Petrol	1598	4	8	36
Astra F Hatchback (T92)	01/96→01/98	X 14 XE	Petrol	1389	4	16	22
Astra F Van (T92)	10/91→04/93	C 16 NZ	Petrol	1598	4	8	36
Astra F Van (T92)	10/91→01/99	C 14 NZ	Petrol	1389	4	8	18
Astra F Van (T92)	12/91→09/92	17 D	Diesel	1700	4	8	59
Astra F Van (T92)	07/92→01/99	17 DR	Diesel	1700	4	8	59
Astra F Van (T92)	02/93→07/96	X 16 SZ	Petrol	1598	4	8	36
Astra F Van (T92)	08/94→03/98	X 16 XEL	Petrol	1598	4	16	47
Astra F Van (T92)	08/94→01/99	X 17 DTL	Diesel	1700	4	8	59
Astra F Van (T92)	03/95→02/98	X 17 DT (TC4EE1)	Diesel	1686	4	8	60
Astra G Box (F70)	01/99→09/00	X 16 SZR	Petrol	1598	4	8	36
Astra G Box (F70)	01/99→04/05	X 17 DTL	Diesel	1700	4	8	59
Astra G Box (F70)	01/99→04/05	X 20 DTL	Diesel	1995	4	16	117
Astra G Box (F70)	02/00→04/05	Y 17 DT	Diesel	1686	4	16	64
Astra G Box (F70)	09/00→04/05	Z 16 SE	Petrol	1598	4	8	55
Astra G Box (F70)	10/04→04/05	Z 16 XEP	Petrol	1598	4	16	57
Astra G Convertible (T98)	03/01→10/05	Z 16 XE	Petrol	1598	4	16	47
Astra G Convertible (T98)	03/01→10/05	Z 18 XE	Petrol	1796	4	16	88
Astra G Convertible (T98)	03/01→10/05	Z 22 SE	Petrol	2198	4	16	132
Astra G Convertible (T98)	03/02→10/05	Z 20 LET	Petrol	1998	4	16	113
Astra G Convertible (T98)	09/02→10/05	Y 22 DTR	Diesel	2172	4	16	133
Astra G Convertible (T98)	01/03→10/05	Z 16 XEP	Petrol	1598	4	16	57
Astra G Coupe (T98)	03/00→10/00	X 18 XE1	Petrol	1796	4	16	86
Astra G Coupe (T98)	03/00→05/05	Z 16 XE	Petrol	1598	4	16	47
Astra G Coupe (T98)	03/00→05/05	Z 16 XEP	Petrol	1598	4	16	57
Astra G Coupe (T98)	09/00→05/05	Z 18 XE	Petrol	1796	4	16	88
Astra G Coupe (T98)	09/00→05/05	Z 20 LET	Petrol	1998	4	16	113
Astra G Coupe (T98)	09/00→05/05	Z 22 SE	Petrol	2198	4	16	132
Astra G Coupe (T98)	09/02→05/05	Y 22 DTR	Diesel	2172	4	16	133
Astra G Estate (T98)	02/98→08/00	X 17 DTL	Diesel	1700	4	8	59
Astra G Estate (T98)	02/98→09/00	X 12 XE	Petrol	1199	4	16	10
Astra G Estate (T98)	02/98→09/00	X 16 SZR	Petrol	1598	4	8	36
Astra G Estate (T98)	02/98→09/00	X 18 XE1	Petrol	1796	4	16	86
Astra G Estate (T98)	02/98→07/04	X 16 XEL	Petrol	1598	4	16	47
Astra G Estate (T98)	02/98→07/04	X 20 DTL	Diesel	1995	4	16	117
Astra G Estate (T98)	02/98→07/04	X 20 XEV	Petrol	1998	4	16	113
Astra G Estate (T98)	02/98→07/04	Y 20 DTL	Diesel	1995	4	16	117
Astra G Estate (T98)	02/98→07/04	Z 16 XE	Petrol	1598	4	16	47
Astra G Estate (T98)	06/98→07/04	X 14 XE	Petrol	1389	4	16	22
Astra G Estate (T98)	06/98→07/04	Z 14 XE	Petrol	1389	4	16	22
Astra G Estate (T98)	08/99→07/04	X 20 DTH	Diesel	1995	4	16	117
Astra G Estate (T98)	08/99→07/04	Y 20 DTH	Diesel	1995	4	16	117
Astra G Estate (T98)	02/00→07/04	Y 17 DT	Diesel	1686	4	16	64
Astra G Estate (T98)	09/00→07/04	Z 12 XE	Petrol	1199	4	16	10
Astra G Estate (T98)	09/00→07/04	Z 16 SE	Petrol	1598	4	8	55
Astra G Estate (T98)	09/00→07/04	Z 18 XE	Petrol	1796	4	16	88
Astra G Estate (T98)	03/01→07/04	Z 22 SE	Petrol	2198	4	16	132
Astra G Estate (T98)	09/02→07/04	Y 22 DTR	Diesel	2172	4	16	133
Astra G Estate (T98)	09/02→07/04	Z 20 LET	Petrol	1998	4	16	113
Astra G Estate (T98)	12/02→07/09	Z 16 XEP	Petrol	1598	4	16	57
Astra G Estate (T98)	02/03→07/04	Z 18 XEL	Petrol	1796	4	16	86
Astra G Estate (T98)	03/03→07/04	Z 16 YNG	Petrol	1598	4	16	54
Astra G Estate (T98)	04/03→07/09	Z 17 DTL	Diesel	1686	4	16	64
Astra G Estate (T98)	10/04→12/09	Z 14 XEP	Petrol	1364	4	16	20
Astra G Hatchback (T98)	02/98→08/00	X 17 DTL	Diesel	1700	4	8	59
Astra G Hatchback (T98)	02/98→09/00	X 12 XE	Petrol	1199	4	16	10
Astra G Hatchback (T98)	02/98→09/00	X 16 SZR	Petrol	1598	4	8	36
Astra G Hatchback (T98)	02/98→09/00	X 18 XE1	Petrol	1796	4	16	86
Astra G Hatchback (T98)	02/98→01/05	C 16 SEL	Petrol	1598	4	16	47
Astra G Hatchback (T98)	02/98→01/05	C 20 SEL	Petrol	1998	4	16	113
Astra G Hatchback (T98)	02/98→01/05	X 14 XE	Petrol	1389	4	16	22
Astra G Hatchback (T98)	02/98→01/05	X 16 XEL	Petrol	1598	4	16	47
Astra G Hatchback (T98)	02/98→01/05	X 20 DTL	Diesel	1995	4	16	117
Astra G Hatchback (T98)	02/98→01/05	X 20 XEV	Petrol	1998	4	16	113



Model	Year Range	Engine	Fuel	CC	Power (kW)	Power (HP)	0-100 (s)
Astra G Hatchback (T98)	02/98→01/05	Y 20 DTL	Diesel	1995	4	16	117
Astra G Hatchback (T98)	02/98→01/05	Z 14 XE	Petrol	1389	4	16	22
Astra G Hatchback (T98)	02/98→01/05	Z 16 XE	Petrol	1598	4	16	47
Astra G Hatchback (T98)	08/99→01/05	X 20 DTH	Diesel	1995	4	16	117
Astra G Hatchback (T98)	08/99→01/05	Y 20 DTH	Diesel	1995	4	16	117
Astra G Hatchback (T98)	11/99→09/02	X 20 XER	Petrol	1998	4	16	113
Astra G Hatchback (T98)	02/00→01/05	Y 17 DT	Diesel	1686	4	16	64
Astra G Hatchback (T98)	06/00→01/05	Z 22 SE	Petrol	2198	4	16	132
Astra G Hatchback (T98)	09/00→01/05	Z 12 XE	Petrol	1199	4	16	10
Astra G Hatchback (T98)	09/00→01/05	Z 16 SE	Petrol	1598	4	8	55
Astra G Hatchback (T98)	09/00→01/05	Z 18 XE	Petrol	1796	4	16	88
Astra G Hatchback (T98)	09/02→01/05	Y 22 DTR	Diesel	2172	4	16	133
Astra G Hatchback (T98)	09/02→01/05	Z 20 LET	Petrol	1998	4	16	113
Astra G Hatchback (T98)	12/02→12/09	Z 16 XEP	Petrol	1598	4	16	57
Astra G Hatchback (T98)	02/03→01/04	Z 18 XEL	Petrol	1796	4	16	86
Astra G Hatchback (T98)	04/03→12/09	Z 17 DTL	Diesel	1686	4	16	64
Astra G Hatchback (T98)	09/07→12/09	Z 14 XEP	Petrol	1364	4	16	20
Astra G Saloon (T98)	09/98→08/00	X 17 DTL	Diesel	1700	4	8	59
Astra G Saloon (T98)	09/98→09/00	X 12 XE	Petrol	1199	4	16	10
Astra G Saloon (T98)	09/98→09/00	X 16 SZR	Petrol	1598	4	8	36
Astra G Saloon (T98)	09/98→09/00	X 18 XE1	Petrol	1796	4	16	86
Astra G Saloon (T98)	09/98→01/05	X 14 XE	Petrol	1389	4	16	22
Astra G Saloon (T98)	09/98→01/05	X 16 XEL	Petrol	1598	4	16	47
Astra G Saloon (T98)	09/98→01/05	X 20 DTL	Diesel	1995	4	16	117
Astra G Saloon (T98)	09/98→01/05	X 20 XEV	Petrol	1998	4	16	113
Astra G Saloon (T98)	09/98→01/05	Y 20 DTL	Diesel	1995	4	16	117
Astra G Saloon (T98)	09/98→01/05	Z 14 XE	Petrol	1389	4	16	22
Astra G Saloon (T98)	09/98→01/05	Z 16 XE	Petrol	1598	4	16	47
Astra G Saloon (T98)	08/99→01/05	X 20 DTH	Diesel	1995	4	16	117
Astra G Saloon (T98)	08/99→01/05	Y 20 DTH	Diesel	1995	4	16	117
Astra G Saloon (T98)	02/00→01/05	Y 17 DT	Diesel	1686	4	16	64
Astra G Saloon (T98)	06/00→01/05	Z 18 XE	Petrol	1796	4	16	88
Astra G Saloon (T98)	09/00→01/05	Z 12 XE	Petrol	1199	4	16	10
Astra G Saloon (T98)	09/00→01/05	Z 16 SE	Petrol	1598	4	8	55
Astra G Saloon (T98)	03/01→01/05	Z 22 SE	Petrol	2198	4	16	132
Astra G Saloon (T98)	09/02→01/05	Y 22 DTR	Diesel	2172	4	16	133
Astra G Saloon (T98)	12/02→12/09	Z 16 XEP	Petrol	1598	4	16	57
Astra G Saloon (T98)	02/03→01/05	Z 18 XEL	Petrol	1796	4	16	86
Astra G Saloon (T98)	04/03→12/09	Z 17 DTL	Diesel	1686	4	16	64
Astra G Saloon (T98)	09/07→12/09	Z 14 XEP	Petrol	1364	4	16	20
Astra H	04/04→10/04	Z 14 XEL	Petrol	1364	4	16	20
Astra H (A04)	01/04→10/10	Z 18 XE	Petrol	1796	4	16	88
Astra H (A04)	03/04→10/10	Z 14 XEP	Petrol	1364	4	16	20
Astra H (A04)	03/04→10/10	Z 16 XE1	Petrol	1598	4	16	56
Astra H (A04)	03/04→10/10	Z 16 XEP	Petrol	1598	4	16	57
Astra H (A04)	03/04→10/10	Z 17 DTH	Diesel	1686	4	16	64
Astra H (A04)	03/04→10/10	Z 17 DTL	Diesel	1686	4	16	64
Astra H (A04)	03/04→10/10	Z 20 LEL	Petrol	1998	4	16	113
Astra H (A04)	04/04→10/04	Z 14 XEL	Petrol	1364	4	16	20
Astra H (A04)	04/04→10/10	Z 19 DTJ	Diesel	1910	4	16	100
Astra H (A04)	06/04→10/10	Z 19 DT	Diesel	1910	4	8	99
Astra H (A04)	09/04→10/10	Z 19 DTH	Diesel	1910	4	16	100
Astra H (A04)	09/04→10/10	Z 20 LER	Petrol	1998	4	16	113
Astra H (A04)	03/05→10/10	Z 20 LEH	Petrol	1998	4	16	113
Astra H (A04)	08/05→10/10	Z 12 XEP	Petrol	1229	4	16	10
Astra H (A04)	08/05→10/10	Z 13 DTH	Diesel	1248	4	16	15
Astra H (A04)	09/05→10/10	Z 19 DTL	Diesel	1910	4	8	99
Astra H (A04)	11/05→10/10	Z 16 YNG	Petrol	1598	4	16	54
Astra H (A04)	01/06→10/10	A 18 XER	Petrol	1796	4	16	79
Astra H (A04)	01/06→10/10	Z 18 XER	Petrol	1796	4	16	79
Astra H (A04)	12/06→05/14	A 16 XER	Petrol	1598	4	16	41
Astra H (A04)	12/06→05/14	Z 16 XER	Petrol	1598	4	16	41
Astra H (A04)	02/07→10/10	Z 16 LET	Petrol	1598	4	16	41
Astra H (A04)	02/07→05/14	A 17 DTJ	Diesel	1686	4	16	64
Astra H (A04)	02/07→05/14	A 17 DTR	Diesel	1686	4	16	64
Astra H (A04)	02/07→05/14	Z 17 DTJ	Diesel	1686	4	16	64
Astra H (A04)	02/07→05/14	Z 17 DTR	Diesel	1686	4	16	64
Astra Hatchback	09/79→08/84	13 S	Petrol	1297	4	8	14
Astra Hatchback	02/82→08/84	12 S	Petrol	1196	4	8	8
Astra Hatchback	03/82→08/86	16 D	Diesel	1598	4	8	31
Astra Hatchback	03/83→08/86	18 E	Petrol	1796	4	8	73
Astra Hatchback (LB, LC)	08/84→03/86	E15	Petrol	1488	4	8	26
Astra Hatchback (LB, LC)	04/86→06/87	E16	Petrol	1597	4	8	48
Astra Hatchback (LD)	07/87→07/89	18LE	Petrol	1796	4	8	75
Astra Hatchback (PJ)	12/14→	A 20 NFT	Petrol	1998	4	16	111
Astra Hatchback (TR)	08/95→09/98	X 20 XEV	Petrol	1998	4	16	113
Astra Hatchback (TR)	09/96→09/98	C 18 XEL	Petrol	1799	4	16	82
Astra Hatchback (TS)	02/98→08/00	X 18 XE1	Petrol	1796	4	16	87



CC



9

Astra Hatchback (TS)	09/00→07/04	Z 22 SE	Petrol	2198	4	16	132
Astra Hatchback (TS)	09/00→10/04	Z 18 XE	Petrol	1796	4	16	89
Astra Hatchback (TS)	05/03→07/04	Z 20 LET	Petrol	1998	4	16	113
Astra H Box (L70)	02/04→11/04	Z 16 XEP	Petrol	1598	4	16	57
Astra H Box (L70)	03/04→10/10	Z 17 DTH	Diesel	1686	4	16	64
Astra H Box (L70)	08/04→10/10	Z 19 DTJ	Diesel	1910	4	16	100
Astra H Box (L70)	09/04→10/10	Z 19 DTH	Diesel	1910	4	16	100
Astra H Box (L70)	08/05→10/10	Z 13 DTH	Diesel	1248	4	16	15
Astra H Box (L70)	09/05→10/10	Z 19 DT	Diesel	1910	4	8	99
Astra H Box (L70)	02/07→10/10	A 17 DTJ	Diesel	1686	4	16	64
Astra H Box (L70)	02/07→10/10	A 17 DTR	Diesel	1686	4	16	64
Astra H Box (L70)	02/07→10/10	Z 17 DTJ	Diesel	1686	4	16	64
Astra H Box (L70)	02/07→10/10	Z 17 DTR	Diesel	1686	4	16	64
Astra H Estate (A04)	08/04→10/10	Z 14 XEL	Petrol	1364	4	16	20
Astra H Estate (A04)	08/04→10/10	Z 14 XEP	Petrol	1364	4	16	20
Astra H Estate (A04)	08/04→10/10	Z 16 XE1	Petrol	1598	4	16	56
Astra H Estate (A04)	08/04→10/10	Z 16 XEP	Petrol	1598	4	16	57
Astra H Estate (A04)	08/04→10/10	Z 17 DTH	Diesel	1686	4	16	64
Astra H Estate (A04)	08/04→10/10	Z 17 DTL	Diesel	1686	4	16	64
Astra H Estate (A04)	08/04→10/10	Z 18 XE	Petrol	1796	4	16	88
Astra H Estate (A04)	08/04→10/10	Z 19 DTJ	Diesel	1910	4	16	100
Astra H Estate (A04)	08/04→10/10	Z 20 LEL	Petrol	1998	4	16	113
Astra H Estate (A04)	09/04→10/10	Z 19 DTH	Diesel	1910	4	16	100
Astra H Estate (A04)	09/04→10/10	Z 20 LER	Petrol	1998	4	16	113
Astra H Estate (A04)	08/05→10/10	A 18 XER	Petrol	1796	4	16	79
Astra H Estate (A04)	08/05→10/10	Z 13 DTH	Diesel	1248	4	16	15
Astra H Estate (A04)	08/05→10/10	Z 18 XER	Petrol	1796	4	16	79
Astra H Estate (A04)	09/05→10/10	Z 19 DT	Diesel	1910	4	8	99
Astra H Estate (A04)	09/05→10/10	Z 19 DTL	Diesel	1910	4	8	99
Astra H Estate (A04)	11/05→10/10	Z 16 YNG	Petrol	1598	4	16	54
Astra H Estate (A04)	12/06→05/14	A 16 XER	Petrol	1598	4	16	41
Astra H Estate (A04)	12/06→05/14	Z 16 XER	Petrol	1598	4	16	41
Astra H Estate (A04)	02/07→10/10	Z 16 LET	Petrol	1598	4	16	41
Astra H Estate (A04)	02/07→05/14	A 17 DTJ	Diesel	1686	4	16	64
Astra H Estate (A04)	02/07→05/14	A 17 DTR	Diesel	1686	4	16	64
Astra H Estate (A04)	02/07→05/14	Z 17 DTJ	Diesel	1686	4	16	64
Astra H Estate (A04)	02/07→05/14	Z 17 DTR	Diesel	1686	4	16	64
Astra H GTC (L08)	03/05→10/10	Z 14 XEL	Petrol	1364	4	16	20
Astra H GTC (L08)	03/05→10/10	Z 14 XEP	Petrol	1364	4	16	20
Astra H GTC (L08)	03/05→10/10	Z 16 XE1	Petrol	1598	4	16	56
Astra H GTC (L08)	03/05→10/10	Z 16 XEP	Petrol	1598	4	16	57
Astra H GTC (L08)	03/05→10/10	Z 17 DTH	Diesel	1686	4	16	64
Astra H GTC (L08)	03/05→10/10	Z 17 DTL	Diesel	1686	4	16	64
Astra H GTC (L08)	03/05→10/10	Z 18 XE	Petrol	1796	4	16	88
Astra H GTC (L08)	03/05→10/10	Z 19 DTH	Diesel	1910	4	16	100
Astra H GTC (L08)	03/05→10/10	Z 19 DTJ	Diesel	1910	4	16	100
Astra H GTC (L08)	03/05→10/10	Z 20 LEL	Petrol	1998	4	16	113
Astra H GTC (L08)	03/05→10/10	Z 20 LER	Petrol	1998	4	16	113
Astra H GTC (L08)	04/05→10/10	Z 13 DTH	Diesel	1248	4	16	15
Astra H GTC (L08)	08/05→10/10	Z 12 XEP	Petrol	1229	4	16	10
Astra H GTC (L08)	08/05→10/10	Z 20 LEH	Petrol	1998	4	16	113
Astra H GTC (L08)	09/05→10/10	Z 19 DT	Diesel	1910	4	8	99
Astra H GTC (L08)	11/05→10/10	Z 16 YNG	Petrol	1598	4	16	54
Astra H GTC (L08)	01/06→10/10	Z 18 XER	Petrol	1796	4	16	79
Astra H GTC (L08)	01/06→10/10	Z 19 DTL	Diesel	1910	4	8	99
Astra H GTC (L08)	12/06→10/10	Z 16 XER	Petrol	1598	4	16	41
Astra H GTC (L08)	02/07→10/10	A 17 DTJ	Diesel	1686	4	16	64
Astra H GTC (L08)	02/07→10/10	A 17 DTR	Diesel	1686	4	16	64
Astra H GTC (L08)	02/07→10/10	Z 16 LET	Petrol	1598	4	16	41
Astra H Saloon (L69)	02/07→10/10	A 18 XER	Petrol	1796	4	16	79
Astra H Saloon (L69)	02/07→10/10	Z 13 DTH	Diesel	1248	4	16	15
Astra H Saloon (L69)	02/07→10/10	Z 17 DTH	Diesel	1686	4	16	64
Astra H Saloon (L69)	02/07→10/10	Z 18 XER	Petrol	1796	4	16	79
Astra H Saloon (L69)	02/07→05/14	A 17 DTR	Diesel	1686	4	16	64
Astra H Saloon (L69)	02/07→05/14	Z 16 XER	Petrol	1598	4	16	41
Astra H Saloon (L69)	02/07→05/14	Z 17 DTJ	Diesel	1686	4	16	64
Astra H Saloon (L69)	02/07→05/14	Z 17 DTR	Diesel	1686	4	16	64
Astra H TwinTop (A04)	09/05→10/10	A 18 XER	Petrol	1796	4	16	79
Astra H TwinTop (A04)	09/05→10/10	Z 16 XE1	Petrol	1598	4	16	56
Astra H TwinTop (A04)	09/05→10/10	Z 16 XEP	Petrol	1598	4	16	57
Astra H TwinTop (A04)	09/05→10/10	Z 18 XE	Petrol	1796	4	16	88
Astra H TwinTop (A04)	09/05→10/10	Z 18 XER	Petrol	1796	4	16	79
Astra H TwinTop (A04)	09/05→10/10	Z 19 DTH	Diesel	1910	4	16	100
Astra H TwinTop (A04)	09/05→10/10	Z 20 LEL	Petrol	1998	4	16	113
Astra H TwinTop (A04)	09/05→10/10	Z 20 LER	Petrol	1998	4	16	113
Astra H TwinTop (A04)	10/05→10/10	Z 14 XEP	Petrol	1364	4	16	20
Astra H TwinTop (A04)	12/06→10/10	Z 16 XER	Petrol	1598	4	16	41
Astra H TwinTop (A04)	02/07→10/10	Z 16 LET	Petrol	1598	4	16	41



Model	Year Range	Engine	Fuel	CC	Gears	Steering	Box
Astra Mk II Belmont (T85)	09/85→08/91	13 S	Petrol	1297	4	8	14
Astra Mk II Belmont (T85)	09/85→08/91	16 DA	Diesel	1598	4	8	31
Astra Mk II Belmont (T85)	09/85→08/91	16 SH	Petrol	1598	4	8	39
Astra Mk II Belmont (T85)	09/85→08/91	18 E	Petrol	1796	4	8	73
Astra Mk II Belmont (T85)	09/85→08/91	18 SE	Petrol	1796	4	8	78
Astra Mk II Belmont (T85)	09/85→08/91	C 13 N	Petrol	1297	4	8	14
Astra Mk II Belmont (T85)	10/85→08/86	C 18 NE	Petrol	1796	4	8	80
Astra Mk II Belmont (T85)	01/87→08/89	15 DT	Diesel	1488	4	8	24
Astra Mk II Belmont (T85)	01/88→08/90	15 DT (T4EC1)	Diesel	1488	4	8	24
Astra Mk II Belmont (T85)	01/89→12/91	16 SV	Petrol	1598	4	8	36
Astra Mk II Belmont (T85)	01/89→12/91	17 D	Diesel	1699	4	8	59
Astra Mk II Belmont (T85)	10/89→12/91	14 NV	Petrol	1389	4	8	18
Astra Mk II Belmont (T85)	01/90→12/91	C 14 NZ	Petrol	1389	4	8	18
Astra Mk II Convertible (T85)	01/87→12/91	16 SV	Petrol	1598	4	8	36
Astra Mk II Convertible (T85)	01/87→12/91	20 NE	Petrol	1998	4	8	106
Astra Mk II Convertible (T85)	01/91→08/93	C 20 NE	Petrol	1998	4	8	106
Astra Mk II Estate (T85)	09/84→08/86	16 SH	Petrol	1598	4	8	39
Astra Mk II Estate (T85)	09/84→12/88	12 S	Petrol	1196	4	8	8
Astra Mk II Estate (T85)	09/84→12/89	16 DA	Diesel	1598	4	8	31
Astra Mk II Estate (T85)	09/84→08/91	13 S	Petrol	1297	4	8	14
Astra Mk II Estate (T85)	09/84→08/91	16 SV	Petrol	1598	4	8	36
Astra Mk II Estate (T85)	01/88→08/91	15 DT (T4EC1)	Diesel	1488	4	8	24
Astra Mk II Estate (T85)	01/89→08/91	14 NV	Petrol	1389	4	8	18
Astra Mk II Estate (T85)	02/89→08/91	17 D	Diesel	1699	4	8	59
Astra Mk II Estate (T85)	01/90→08/91	18 E	Petrol	1796	4	8	73
Astra Mk II Hatchback (T85)	09/84→08/86	16 SH	Petrol	1598	4	8	39
Astra Mk II Hatchback (T85)	09/84→12/89	16 DA	Diesel	1598	4	8	31
Astra Mk II Hatchback (T85)	09/84→08/91	12 S	Petrol	1196	4	8	8
Astra Mk II Hatchback (T85)	09/84→08/91	13 N	Petrol	1297	4	8	14
Astra Mk II Hatchback (T85)	09/84→08/91	13 S	Petrol	1297	4	8	14
Astra Mk II Hatchback (T85)	09/84→08/91	16 SV	Petrol	1598	4	8	36
Astra Mk II Hatchback (T85)	09/84→08/91	18 E	Petrol	1796	4	8	73
Astra Mk II Hatchback (T85)	09/84→08/91	18 SE	Petrol	1796	4	8	78
Astra Mk II Hatchback (T85)	09/86→08/91	20 NE	Petrol	1998	4	8	106
Astra Mk II Hatchback (T85)	09/86→08/91	20 SEH	Petrol	1998	4	8	106
Astra Mk II Hatchback (T85)	03/88→08/91	C 20 XE	Petrol	1998	4	16	112
Astra Mk II Hatchback (T85)	05/88→08/91	20 XE	Petrol	1998	4	16	109
Astra Mk II Hatchback (T85)	01/89→08/91	17 DR	Diesel	1699	4	8	59
Astra Mk II Hatchback (T85)	01/90→08/91	14 NV	Petrol	1389	4	8	18
Astra Mk II Hatchback (T85)	01/90→08/91	C 14 NZ	Petrol	1389	4	8	18
Astra Mk III (F) (T92)	12/91→09/98	17 DT (TC4EE1)	Diesel	1686	4	8	60
Astra Mk III (F) (T92)	03/92→09/92	17 D	Diesel	1699	4	8	59
Astra Mk III (F) (T92)	03/92→09/98	C 16 NZ	Petrol	1598	4	8	36
Astra Mk III (F) (T92)	03/92→09/98	C 18 NZ	Petrol	1796	4	8	81
Astra Mk III (F) (T92)	03/92→09/98	C 20 NE	Petrol	1998	4	8	106
Astra Mk III (F) (T92)	03/92→09/98	X 16 SZR	Petrol	1598	4	8	36
Astra Mk III (F) (T92)	04/92→09/98	C 14 NZ	Petrol	1389	4	8	18
Astra Mk III (F) (T92)	04/92→09/98	C 14 SE	Petrol	1389	4	8	18
Astra Mk III (F) (T92)	05/92→12/94	C 16 SE	Petrol	1598	4	8	36
Astra Mk III (F) (T92)	07/92→09/98	17 DR	Diesel	1699	4	8	59
Astra Mk III (F) (T92)	06/93→10/94	C 18 XE	Petrol	1799	4	16	82
Astra Mk III (F) (T92)	01/94→12/96	C 18 XEL	Petrol	1799	4	16	82
Astra Mk III (F) (T92)	08/94→07/96	X 16 SZ	Petrol	1598	4	8	36
Astra Mk III (F) (T92)	08/94→09/98	X 16 XEL	Petrol	1598	4	16	47
Astra Mk III (F) (T92)	08/94→09/98	X 17 DTL	Diesel	1699	4	8	59
Astra Mk III (F) (T92)	02/95→09/98	X 20 XEV	Petrol	1998	4	16	113
Astra Mk III (F) (T92)	09/95→02/98	18 SE	Petrol	1796	4	8	78
Astra Mk III (F) (T92)	02/96→09/98	X 14 XE	Petrol	1389	4	16	22
Astra Mk III (F) Convertible (T92)	03/93→10/94	C 20 NE	Petrol	1998	4	8	106
Astra Mk III (F) Convertible (T92)	03/93→08/96	X 16 SZ	Petrol	1598	4	8	36
Astra Mk III (F) Convertible (T92)	05/93→03/01	C 14 SE	Petrol	1389	4	8	18
Astra Mk III (F) Convertible (T92)	01/94→02/98	X 20 XEV	Petrol	1998	4	16	113
Astra Mk III (F) Convertible (T92)	03/94→08/95	C 16 SE	Petrol	1598	4	8	36
Astra Mk III (F) Convertible (T92)	09/94→08/96	C 18 XE	Petrol	1799	4	16	82
Astra Mk III (F) Convertible (T92)	11/94→03/01	C 18 XEL	Petrol	1799	4	16	82
Astra Mk III (F) Convertible (T92)	11/94→03/01	X 18 XE	Petrol	1799	4	16	82
Astra Mk III (F) Convertible (T92)	01/96→03/01	X 14 XE	Petrol	1389	4	16	22
Astra Mk III (F) Convertible (T92)	01/96→03/01	X 16 SZR	Petrol	1598	4	8	36
Astra Mk III (F) Estate (T92)	03/91→12/94	17 DR	Diesel	1699	4	8	59
Astra Mk III (F) Estate (T92)	03/91→12/94	C 16 SE	Petrol	1598	4	8	36
Astra Mk III (F) Estate (T92)	03/91→02/98	C 14 SE	Petrol	1389	4	8	18
Astra Mk III (F) Estate (T92)	09/91→02/98	14 NV	Petrol	1389	4	8	18
Astra Mk III (F) Estate (T92)	09/91→02/98	C 14 NZ	Petrol	1389	4	8	18
Astra Mk III (F) Estate (T92)	09/91→02/98	C 16 NZ	Petrol	1598	4	8	36
Astra Mk III (F) Estate (T92)	09/91→02/98	C 18 NZ	Petrol	1796	4	8	81
Astra Mk III (F) Estate (T92)	09/91→02/98	C 20 NE	Petrol	1998	4	8	106
Astra Mk III (F) Estate (T92)	09/91→02/98	E 16 NZ	Petrol	1598	4	8	36
Astra Mk III (F) Estate (T92)	12/91→02/98	17 D	Diesel	1699	4	8	59



CC



9

Astra Mk III (F) Estate (T92)	12/91→02/98	17 DT (TC4EE1)	Diesel	1686	4	8	60
Astra Mk III (F) Estate (T92)	01/94→02/98	X 16 XEL	Petrol	1598	4	16	47
Astra Mk III (F) Estate (T92)	01/94→02/98	X 17 DTL	Diesel	1699	4	8	59
Astra Mk III (F) Estate (T92)	01/94→02/98	X 20 XEV	Petrol	1998	4	16	113
Astra Mk III (F) Estate (T92)	07/94→02/98	X 16 SZ	Petrol	1598	4	8	36
Astra Mk III (F) Estate (T92)	09/94→02/98	C 18 XE	Petrol	1799	4	16	82
Astra Mk III (F) Estate (T92)	09/94→02/98	C 18 XEL	Petrol	1799	4	16	82
Astra Mk III (F) Estate (T92)	09/94→02/98	X 18 XE	Petrol	1799	4	16	82
Astra Mk III (F) Estate (T92)	02/96→01/98	X 14 XE	Petrol	1389	4	16	22
Astra Mk III (F) Hatchback (T92)	09/91→12/94	17 DR	Diesel	1699	4	8	59
Astra Mk III (F) Hatchback (T92)	09/91→02/98	14 NV	Petrol	1389	4	8	18
Astra Mk III (F) Hatchback (T92)	09/91→02/98	C 14 NZ	Petrol	1389	4	8	18
Astra Mk III (F) Hatchback (T92)	09/91→02/98	C 16 NZ	Petrol	1598	4	8	36
Astra Mk III (F) Hatchback (T92)	09/91→02/98	C 18 NZ	Petrol	1796	4	8	81
Astra Mk III (F) Hatchback (T92)	09/91→02/98	C 20 NE	Petrol	1998	4	8	106
Astra Mk III (F) Hatchback (T92)	09/91→02/98	C 20 XE	Petrol	1998	4	16	112
Astra Mk III (F) Hatchback (T92)	09/91→02/98	E 16 NZ	Petrol	1598	4	8	36
Astra Mk III (F) Hatchback (T92)	12/91→02/98	17 D	Diesel	1699	4	8	59
Astra Mk III (F) Hatchback (T92)	12/91→02/98	17 DT (TC4EE1)	Diesel	1686	4	8	60
Astra Mk III (F) Hatchback (T92)	03/92→02/98	C 14 SE	Petrol	1389	4	8	18
Astra Mk III (F) Hatchback (T92)	03/92→02/98	C 16 SE	Petrol	1598	4	8	36
Astra Mk III (F) Hatchback (T92)	02/93→12/96	X 16 SZ	Petrol	1598	4	8	36
Astra Mk III (F) Hatchback (T92)	01/94→02/98	X 16 XEL	Petrol	1598	4	16	47
Astra Mk III (F) Hatchback (T92)	01/94→02/98	X 20 XEV	Petrol	1998	4	16	113
Astra Mk III (F) Hatchback (T92)	08/94→02/98	X 17 DTL	Diesel	1699	4	8	59
Astra Mk III (F) Hatchback (T92)	09/94→02/98	C 18 XE	Petrol	1799	4	16	82
Astra Mk III (F) Hatchback (T92)	09/94→02/98	C 18 XEL	Petrol	1799	4	16	82
Astra Mk III (F) Hatchback (T92)	02/96→02/98	X 14 XE	Petrol	1389	4	16	22
Astra Mk IV (G) Convertible (T98)	03/01→10/05	Z 16 XE	Petrol	1598	4	16	47
Astra Mk IV (G) Convertible (T98)	03/01→10/05	Z 18 XE	Petrol	1796	4	16	89
Astra Mk IV (G) Convertible (T98)	03/01→10/05	Z 22 SE	Petrol	2198	4	16	132
Astra Mk IV (G) Convertible (T98)	03/02→10/05	Z 20 LET	Petrol	1998	4	16	113
Astra Mk IV (G) Convertible (T98)	03/03→10/05	Z 16 XEP	Petrol	1598	4	16	57
Astra Mk IV (G) Coupe (T98)	03/00→08/05	X 18 XE1	Petrol	1796	4	16	86
Astra Mk IV (G) Coupe (T98)	03/00→08/05	Z 16 XEP	Petrol	1598	4	16	57
Astra Mk IV (G) Coupe (T98)	03/00→08/05	Z 18 XEL	Petrol	1796	4	16	86
Astra Mk IV (G) Coupe (T98)	03/00→08/05	Z 22 SE	Petrol	2198	4	16	132
Astra Mk IV (G) Coupe (T98)	09/00→08/05	Z 18 XE	Petrol	1796	4	16	89
Astra Mk IV (G) Coupe (T98)	09/00→08/05	Z 20 LET	Petrol	1998	4	16	113
Astra Mk IV (G) Estate (T98)	02/98→08/00	X 17 DTL	Diesel	1699	4	8	59
Astra Mk IV (G) Estate (T98)	02/98→08/00	X 18 XE1	Petrol	1796	4	16	86
Astra Mk IV (G) Estate (T98)	02/98→09/00	X 12 XE	Petrol	1199	4	16	10
Astra Mk IV (G) Estate (T98)	02/98→05/05	X 14 XE	Petrol	1389	4	16	22
Astra Mk IV (G) Estate (T98)	02/98→05/05	X 20 XEV	Petrol	1998	4	16	113
Astra Mk IV (G) Estate (T98)	02/98→05/05	Z 14 XE	Petrol	1389	4	16	22
Astra Mk IV (G) Estate (T98)	03/98→04/04	X 16 SZR	Petrol	1598	4	8	36
Astra Mk IV (G) Estate (T98)	03/98→04/04	X 20 DTH	Diesel	1995	4	16	117
Astra Mk IV (G) Estate (T98)	03/98→04/04	X 20 DTL	Diesel	1995	4	16	117
Astra Mk IV (G) Estate (T98)	03/98→04/04	Y 20 DTH	Diesel	1995	4	16	117
Astra Mk IV (G) Estate (T98)	03/98→04/04	Y 20 DTL	Diesel	1995	4	16	117
Astra Mk IV (G) Estate (T98)	03/98→08/04	X 16 XEL	Petrol	1598	4	16	47
Astra Mk IV (G) Estate (T98)	03/98→08/04	Z 16 XE	Petrol	1598	4	16	47
Astra Mk IV (G) Estate (T98)	03/98→05/05	Z 16 SE	Petrol	1598	4	8	55
Astra Mk IV (G) Estate (T98)	10/99→05/05	X 20 XER	Petrol	1998	4	16	113
Astra Mk IV (G) Estate (T98)	02/00→05/05	Y 17 DT	Diesel	1686	4	16	64
Astra Mk IV (G) Estate (T98)	09/00→05/05	Z 12 XE	Petrol	1199	4	16	10
Astra Mk IV (G) Estate (T98)	09/00→05/05	Z 18 XE	Petrol	1796	4	16	89
Astra Mk IV (G) Estate (T98)	03/01→05/05	Z 22 SE	Petrol	2198	4	16	132
Astra Mk IV (G) Estate (T98)	08/02→05/05	Z 20 LET	Petrol	1998	4	16	113
Astra Mk IV (G) Estate (T98)	12/02→05/05	Z 16 XEP	Petrol	1598	4	16	57
Astra Mk IV (G) Estate (T98)	04/03→05/05	Z 17 DTL	Diesel	1686	4	16	64
Astra Mk IV (G) Hatchback (T98)	02/98→08/00	X 17 DTL	Diesel	1699	4	8	59
Astra Mk IV (G) Hatchback (T98)	02/98→09/00	X 12 XE	Petrol	1199	4	16	10
Astra Mk IV (G) Hatchback (T98)	02/98→09/00	X 16 SZR	Petrol	1598	4	8	36
Astra Mk IV (G) Hatchback (T98)	02/98→09/00	X 18 XE1	Petrol	1796	4	16	86
Astra Mk IV (G) Hatchback (T98)	02/98→05/05	X 14 XE	Petrol	1389	4	16	22
Astra Mk IV (G) Hatchback (T98)	02/98→05/05	X 16 XEL	Petrol	1598	4	16	47
Astra Mk IV (G) Hatchback (T98)	02/98→05/05	X 20 DTL	Diesel	1995	4	16	117
Astra Mk IV (G) Hatchback (T98)	02/98→05/05	X 20 XEV	Petrol	1998	4	16	113
Astra Mk IV (G) Hatchback (T98)	02/98→05/05	Y 20 DTL	Diesel	1995	4	16	117
Astra Mk IV (G) Hatchback (T98)	02/98→05/05	Z 14 XE	Petrol	1389	4	16	22
Astra Mk IV (G) Hatchback (T98)	02/98→05/05	Z 16 XE	Petrol	1598	4	16	47
Astra Mk IV (G) Hatchback (T98)	08/99→05/05	X 20 DTH	Diesel	1995	4	16	117
Astra Mk IV (G) Hatchback (T98)	08/99→05/05	Y 20 DTH	Diesel	1995	4	16	117
Astra Mk IV (G) Hatchback (T98)	10/99→08/00	X 20 XER	Petrol	1998	4	16	113
Astra Mk IV (G) Hatchback (T98)	02/00→05/05	Y 17 DT	Diesel	1686	4	16	64
Astra Mk IV (G) Hatchback (T98)	07/00→05/05	Z 16 SE	Petrol	1598	4	8	55
Astra Mk IV (G) Hatchback (T98)	09/00→05/05	Z 12 XE	Petrol	1199	4	16	10



Model	Year Range	Engine	Fuel	CC	Power (kW)	Power (hp)	0-100 (s)
Astra Mk IV (G) Hatchback (T98)	09/00→05/05	Z 18 XE	Petrol	1796	4	16	89
Astra Mk IV (G) Hatchback (T98)	03/01→05/05	Z 22 SE	Petrol	2198	4	16	132
Astra Mk IV (G) Hatchback (T98)	11/01→05/05	Z 20 LET	Petrol	1998	4	16	113
Astra Mk IV (G) Hatchback (T98)	12/02→05/05	Z 16 XEP	Petrol	1598	4	16	57
Astra Mk IV (G) Hatchback (T98)	04/03→05/05	Z 17 DTL	Diesel	1686	4	16	64
Astra Mk IV (G) Saloon (T98)	02/98→07/04	X 18 XE1	Petrol	1796	4	16	86
Astra Mk IV (G) Saloon (T98)	02/98→07/04	X 20 DTH	Diesel	1995	4	16	117
Astra Mk IV (G) Saloon (T98)	02/98→07/04	X 20 DTL	Diesel	1995	4	16	117
Astra Mk IV (G) Saloon (T98)	02/98→07/04	Y 20 DTH	Diesel	1995	4	16	117
Astra Mk IV (G) Saloon (T98)	02/98→07/04	Y 20 DTL	Diesel	1995	4	16	117
Astra Mk IV (G) Saloon (T98)	02/98→07/04	Z 18 XE	Petrol	1796	4	16	89
Astra Mk IV (G) Saloon (T98)	09/98→08/00	X 17 DTL	Diesel	1699	4	8	59
Astra Mk IV (G) Saloon (T98)	09/98→09/00	X 12 XE	Petrol	1199	4	16	10
Astra Mk IV (G) Saloon (T98)	09/98→09/00	X 16 SZR	Petrol	1598	4	8	36
Astra Mk IV (G) Saloon (T98)	09/98→05/05	C 16 SEL	Petrol	1598	4	16	47
Astra Mk IV (G) Saloon (T98)	09/98→05/05	X 14 XE	Petrol	1389	4	16	22
Astra Mk IV (G) Saloon (T98)	09/98→05/05	X 16 XEL	Petrol	1598	4	16	47
Astra Mk IV (G) Saloon (T98)	09/98→05/05	X 20 XEV	Petrol	1998	4	16	113
Astra Mk IV (G) Saloon (T98)	09/98→05/05	Z 14 XE	Petrol	1389	4	16	22
Astra Mk IV (G) Saloon (T98)	09/98→05/05	Z 16 XE	Petrol	1598	4	16	47
Astra Mk IV (G) Saloon (T98)	09/98→05/05	Z 16 XEP	Petrol	1598	4	16	57
Astra Mk IV (G) Saloon (T98)	10/99→05/05	X 20 XER	Petrol	1998	4	16	113
Astra Mk IV (G) Saloon (T98)	02/00→05/05	Y 17 DT	Diesel	1686	4	16	64
Astra Mk IV (G) Saloon (T98)	07/00→05/05	Z 16 SE	Petrol	1598	4	8	55
Astra Mk IV (G) Saloon (T98)	09/00→05/05	Z 12 XE	Petrol	1199	4	16	10
Astra Mk IV (G) Saloon (T98)	03/01→05/05	Z 22 SE	Petrol	2198	4	16	132
Astra Mk IV (G) Saloon (T98)	09/02→05/05	Y 22 DTR	Diesel	2172	4	16	133
Astra Mk IV (G) Saloon (T98)	04/03→05/05	Z 17 DTL	Diesel	1686	4	16	64
Astra Mk V (H) Estate (A04)	08/04→03/09	A 16 XER	Petrol	1598	4	16	41
Astra Mk V (H) Estate (A04)	08/04→03/09	Z 13 DTH	Diesel	1248	4	16	15
Astra Mk V (H) Estate (A04)	08/04→03/09	Z 14 XEP	Petrol	1364	4	16	20
Astra Mk V (H) Estate (A04)	08/04→03/09	Z 16 LET	Petrol	1598	4	16	41
Astra Mk V (H) Estate (A04)	08/04→03/09	Z 16 XEP	Petrol	1598	4	16	57
Astra Mk V (H) Estate (A04)	08/04→03/09	Z 16 XER	Petrol	1598	4	16	41
Astra Mk V (H) Estate (A04)	08/04→03/09	Z 17 DTH	Diesel	1686	4	16	64
Astra Mk V (H) Estate (A04)	08/04→03/09	Z 19 DT	Diesel	1910	4	8	99
Astra Mk V (H) Estate (A04)	08/04→03/09	Z 19 DTH	Diesel	1910	4	16	100
Astra Mk V (H) Estate (A04)	08/04→03/09	Z 19 DTL	Diesel	1910	4	8	99
Astra Mk V (H) Estate (A04)	08/04→05/09	Z 17 DTL	Diesel	1686	4	16	64
Astra Mk V (H) Estate (A04)	08/04→10/10	Z 14 XEL	Petrol	1364	4	16	20
Astra Mk V (H) Estate (A04)	08/04→10/10	Z 20 LEL	Petrol	1998	4	16	113
Astra Mk V (H) Estate (A04)	08/04→10/10	Z 20 LER	Petrol	1998	4	16	113
Astra Mk V (H) Estate (A04)	08/04→10/12	A 17 DTJ	Diesel	1686	4	16	64
Astra Mk V (H) Estate (A04)	08/04→10/12	Z 17 DTJ	Diesel	1686	4	16	64
Astra Mk V (H) Estate (A04)	10/04→03/09	Z 18 XE	Petrol	1796	4	16	89
Astra Mk V (H) Estate (A04)	12/05→10/10	A 18 XER	Petrol	1796	4	16	79
Astra Mk V (H) Estate (A04)	12/05→10/10	Z 18 XER	Petrol	1796	4	16	79
Astra Mk V (H) Estate (A04)	02/07→10/10	A 17 DTR	Diesel	1686	4	16	64
Astra Mk V (H) Estate (A04)	02/07→10/10	Z 17 DTR	Diesel	1686	4	16	64
Astra Mk V (H) Hatchback (A04)	01/04→05/09	A 17 DTJ	Diesel	1686	4	16	64
Astra Mk V (H) Hatchback (A04)	01/04→05/09	A 18 XER	Petrol	1796	4	16	79
Astra Mk V (H) Hatchback (A04)	01/04→05/09	Z 13 DTH	Diesel	1248	4	16	15
Astra Mk V (H) Hatchback (A04)	01/04→05/09	Z 14 XEP	Petrol	1364	4	16	20
Astra Mk V (H) Hatchback (A04)	01/04→05/09	Z 16 XEP	Petrol	1598	4	16	57
Astra Mk V (H) Hatchback (A04)	01/04→05/09	Z 16 XER	Petrol	1598	4	16	41
Astra Mk V (H) Hatchback (A04)	01/04→05/09	Z 17 DTH	Diesel	1686	4	16	64
Astra Mk V (H) Hatchback (A04)	01/04→05/09	Z 17 DTJ	Diesel	1686	4	16	64
Astra Mk V (H) Hatchback (A04)	01/04→05/09	Z 17 DTL	Diesel	1686	4	16	64
Astra Mk V (H) Hatchback (A04)	01/04→05/09	Z 18 XE	Petrol	1796	4	16	89
Astra Mk V (H) Hatchback (A04)	01/04→05/09	Z 18 XER	Petrol	1796	4	16	79
Astra Mk V (H) Hatchback (A04)	01/04→05/09	Z 19 DT	Diesel	1910	4	8	99
Astra Mk V (H) Hatchback (A04)	01/04→05/09	Z 19 DTH	Diesel	1910	4	16	100
Astra Mk V (H) Hatchback (A04)	01/04→05/09	Z 19 DTJ	Diesel	1910	4	16	100
Astra Mk V (H) Hatchback (A04)	01/04→05/09	Z 20 LEH	Petrol	1998	4	16	113
Astra Mk V (H) Hatchback (A04)	01/04→05/09	Z 20 LEL	Petrol	1998	4	16	113
Astra Mk V (H) Hatchback (A04)	01/04→05/09	Z 20 LER	Petrol	1998	4	16	113
Astra Mk V (H) Hatchback (A04)	04/04→12/05	Z 14 XEL	Petrol	1364	4	16	20
Astra Mk V (H) Hatchback (A04)	09/06→09/09	Z 16 LET	Petrol	1598	4	16	41
Astra Mk V (H) Sport Hatch (A04)	02/05→11/10	Z 14 XEL	Petrol	1364	4	16	20
Astra Mk V (H) Sport Hatch (A04)	02/05→11/10	Z 16 XEP	Petrol	1598	4	16	57
Astra Mk V (H) Sport Hatch (A04)	02/05→11/10	Z 17 DTH	Diesel	1686	4	16	64
Astra Mk V (H) Sport Hatch (A04)	02/05→11/10	Z 18 XE	Petrol	1796	4	16	89
Astra Mk V (H) Sport Hatch (A04)	02/05→11/10	Z 19 DT	Diesel	1910	4	8	99
Astra Mk V (H) Sport Hatch (A04)	02/05→11/10	Z 19 DTH	Diesel	1910	4	16	100
Astra Mk V (H) Sport Hatch (A04)	02/05→11/10	Z 20 LEL	Petrol	1998	4	16	113
Astra Mk V (H) Sport Hatch (A04)	03/05→11/10	Z 14 XEP	Petrol	1364	4	16	20
Astra Mk V (H) Sport Hatch (A04)	04/05→11/10	Z 13 DTH	Diesel	1248	4	16	15
Astra Mk V (H) Sport Hatch (A04)	08/05→11/10	Z 19 DTL	Diesel	1910	4	8	99



CC



9

Astra Mk V (H) Sport Hatch (A04)	10/06→11/10	Z 16 LET	Petrol	1598	4	16	41
Astra Mk V (H) Sport Hatch (A04)	12/06→11/10	Z 16 XER	Petrol	1598	4	16	41
Astra Mk V (H) Sport Hatch (A04)	02/07→11/10	A 17 DTJ	Diesel	1686	4	16	64
Astra Mk V (H) Sport Hatch (A04)	03/07→11/10	A 18 XER	Petrol	1796	4	16	79
Astra Mk V (H) Sport Hatch (A04)	03/07→11/10	Z 18 XER	Petrol	1796	4	16	79
Astra Mk V (H) Sport Hatch (A04)	02/09→11/10	Z 20 LEH	Petrol	1998	4	16	113
Astra Mk V (H) TwinTop (A04)	09/05→11/10	Z 16 XEP	Petrol	1598	4	16	57
Astra Mk V (H) TwinTop (A04)	01/06→11/10	Z 19 DTH	Diesel	1910	4	16	100
Astra Mk V (H) TwinTop (A04)	01/06→11/10	Z 20 LER	Petrol	1998	4	16	113
Astra Mk V (H) TwinTop (A04)	02/06→11/10	Z 20 LEL	Petrol	1998	4	16	113
Astra Mk V (H) TwinTop (A04)	10/06→11/10	Z 16 LET	Petrol	1598	4	16	41
Astra Mk V (H) TwinTop (A04)	10/06→11/10	Z 16 XER	Petrol	1598	4	16	41
Astra Mk V (H) TwinTop (A04)	05/08→11/10	Z 18 XER	Petrol	1796	4	16	79
Astra Mk VI (J) (P10)	12/09→	A 13 DTE	Diesel	1248	4	16	15
Astra Mk VI (J) (P10)	12/09→	A 14 NET	Petrol	1364	4	16	20
Astra Mk VI (J) (P10)	12/09→	A 14 XEL	Petrol	1398	4	16	20
Astra Mk VI (J) (P10)	12/09→	A 14 XER	Petrol	1398	4	16	20
Astra Mk VI (J) (P10)	12/09→	A 16 LET	Petrol	1598	4	16	41
Astra Mk VI (J) (P10)	12/09→	A 16 XER	Petrol	1598	4	16	41
Astra Mk VI (J) (P10)	12/09→	A 17 DTC	Diesel	1686	4	16	64
Astra Mk VI (J) (P10)	12/09→	A 17 DTE	Diesel	1686	4	16	64
Astra Mk VI (J) (P10)	12/09→	A 17 DTJ	Diesel	1686	4	16	64
Astra Mk VI (J) (P10)	12/09→	A 17 DTR	Diesel	1686	4	16	64
Astra Mk VI (J) (P10)	12/09→	A 20 DTH	Diesel	1956	4	16	110
Astra Mk VI (J) (P10)	12/09→	B 14 NET	Petrol	1364	4	16	20
Astra Mk VI (J) (P10)	12/09→	B 14 XER	Petrol	1398	4	16	20
Astra Mk VI (J) (P10)	12/09→	B 16 XER	Petrol	1598	4	16	45
Astra Mk VI (J) (P10)	10/10→	A 17 DTL	Diesel	1686	4	16	64
Astra Mk VI (J) (P10)	06/11→	A 17 DTF	Diesel	1686	4	16	64
Astra Mk VI (J) (P10)	06/11→	A 17 DTS	Diesel	1686	4	16	64
Astra Mk VI (J) (P10)	08/11→	A 14 NEL	Petrol	1364	4	16	20
Astra Mk VI (J) (P10)	12/12→	A 20 DTR	Diesel	1956	4	16	110
Astra Mk VI (J) Estate (P10)	10/10→	A 13 DTE	Diesel	1248	4	16	15
Astra Mk VI (J) Estate (P10)	10/10→	A 14 NEL	Petrol	1364	4	16	20
Astra Mk VI (J) Estate (P10)	10/10→	A 14 NET	Petrol	1364	4	16	20
Astra Mk VI (J) Estate (P10)	10/10→	A 14 XEL	Petrol	1398	4	16	20
Astra Mk VI (J) Estate (P10)	10/10→	A 14 XER	Petrol	1398	4	16	20
Astra Mk VI (J) Estate (P10)	10/10→	A 16 LET	Petrol	1598	4	16	41
Astra Mk VI (J) Estate (P10)	10/10→	A 16 XER	Petrol	1598	4	16	41
Astra Mk VI (J) Estate (P10)	10/10→	A 17 DTC	Diesel	1686	4	16	64
Astra Mk VI (J) Estate (P10)	10/10→	A 17 DTE	Diesel	1686	4	16	64
Astra Mk VI (J) Estate (P10)	10/10→	A 17 DTJ	Diesel	1686	4	16	64
Astra Mk VI (J) Estate (P10)	10/10→	A 17 DTL	Diesel	1686	4	16	64
Astra Mk VI (J) Estate (P10)	10/10→	A 17 DTN	Diesel	1686	4	16	65
Astra Mk VI (J) Estate (P10)	10/10→	A 17 DTR	Diesel	1686	4	16	64
Astra Mk VI (J) Estate (P10)	10/10→	A 20 DTH	Diesel	1956	4	16	110
Astra Mk VI (J) Estate (P10)	10/10→	B 14 NET	Petrol	1364	4	16	20
Astra Mk VI (J) Estate (P10)	10/10→	B 14 XER	Petrol	1398	4	16	20
Astra Mk VI (J) Estate (P10)	10/10→	B 16 XER	Petrol	1598	4	16	45
Astra Mk VI (J) Estate (P10)	06/11→05/14	A 17 DTF	Diesel	1686	4	16	64
Astra Mk VI (J) Estate (P10)	06/11→05/14	A 17 DTS	Diesel	1686	4	16	64
Astra Mk VI (J) Estate (P10)	12/12→	A 20 DTR	Diesel	1956	4	16	110
Astra Mk VI (J) GTC (P10)	10/11→	A 14 NEL	Petrol	1364	4	16	20
Astra Mk VI (J) GTC (P10)	10/11→	A 14 NET	Petrol	1364	4	16	20
Astra Mk VI (J) GTC (P10)	10/11→	A 14 XER	Petrol	1398	4	16	20
Astra Mk VI (J) GTC (P10)	10/11→	A 16 LET	Petrol	1598	4	16	41
Astra Mk VI (J) GTC (P10)	10/11→	A 17 DTC	Diesel	1686	4	16	64
Astra Mk VI (J) GTC (P10)	10/11→	A 17 DTE	Diesel	1686	4	16	64
Astra Mk VI (J) GTC (P10)	10/11→	A 17 DTF	Diesel	1686	4	16	64
Astra Mk VI (J) GTC (P10)	10/11→	A 17 DTJ	Diesel	1686	4	16	64
Astra Mk VI (J) GTC (P10)	10/11→	A 17 DTS	Diesel	1686	4	16	64
Astra Mk VI (J) GTC (P10)	10/11→	A 20 DTH	Diesel	1956	4	16	110
Astra Mk VI (J) GTC (P10)	10/11→	B 14 NEL	Petrol	1364	4	16	20
Astra Mk VI (J) GTC (P10)	10/11→	B 14 NET	Petrol	1364	4	16	20
Astra Mk VI (J) GTC (P10)	04/12→	A 20 NFT	Petrol	1998	4	16	111
Astra Mk VI (J) GTC (P10)	04/12→	B 20 NFT	Petrol	1998	4	16	111
Astra Mk VI (J) GTC (P10)	12/12→	A 20 DTR	Diesel	1956	4	16	110
Astra Mk VI (J) GTC (P10)	09/13→	B 16 SHT	Petrol	1598	4	16	44
Astra Mk VI (J) Saloon (P10)	06/12→	A 13 DTE	Diesel	1248	4	16	15
Astra Mk VI (J) Saloon (P10)	06/12→	A 14 NET	Petrol	1364	4	16	20
Astra Mk VI (J) Saloon (P10)	06/12→	A 14 XER	Petrol	1398	4	16	20
Astra Mk VI (J) Saloon (P10)	06/12→	A 16 LET	Petrol	1598	4	16	41
Astra Mk VI (J) Saloon (P10)	06/12→	A 16 XER	Petrol	1598	4	16	41
Astra Mk VI (J) Saloon (P10)	06/12→	A 17 DTC	Diesel	1686	4	16	64
Astra Mk VI (J) Saloon (P10)	06/12→	A 17 DTE	Diesel	1686	4	16	64
Astra Mk VI (J) Saloon (P10)	06/12→	A 17 DTF	Diesel	1686	4	16	64
Astra Mk VI (J) Saloon (P10)	06/12→	A 17 DTJ	Diesel	1686	4	16	64
Astra Mk VI (J) Saloon (P10)	06/12→	A 17 DTS	Diesel	1686	4	16	64



CC



9

Model	Year	Engine	Fuel	CC	Wrench	Screwdriver	9
Astra Mk VI (J) Saloon (P10)	06/12→	B 14 NET	Petrol	1364	4	16	20
Astra Mk VI (J) Saloon (P10)	06/12→	B 16 XER	Petrol	1598	4	16	45
Astra Mk VI (J) Saloon (P10)	12/12→	A 20 DTR	Diesel	1956	4	16	110
Astra Mk VII (K) (B16)	11/15→	B 16 SHT	Petrol	1598	4	16	44
Astra Mk VII (K) Estate (B16)	11/15→	B 16 SHT	Petrol	1598	4	16	44
Astra J (P10)	12/09→	A 13 DTE	Diesel	1248	4	16	15
Astra J (P10)	12/09→	A 14 NET	Petrol	1364	4	16	20
Astra J (P10)	12/09→	A 14 XEL	Petrol	1398	4	16	20
Astra J (P10)	12/09→	A 14 XER	Petrol	1398	4	16	20
Astra J (P10)	12/09→	A 16 LET	Petrol	1598	4	16	41
Astra J (P10)	12/09→	A 16 XER	Petrol	1598	4	16	41
Astra J (P10)	12/09→	A 17 DTC	Diesel	1686	4	16	64
Astra J (P10)	12/09→	A 17 DTE	Diesel	1686	4	16	64
Astra J (P10)	12/09→	A 17 DTF	Diesel	1686	4	16	64
Astra J (P10)	12/09→	A 17 DTJ	Diesel	1686	4	16	64
Astra J (P10)	12/09→	A 17 DTR	Diesel	1686	4	16	64
Astra J (P10)	12/09→	A 17 DTS	Diesel	1686	4	16	64
Astra J (P10)	12/09→	A 20 DTH	Diesel	1956	4	16	110
Astra J (P10)	12/09→	B 16 XER	Petrol	1598	4	16	41
Astra J (P10)	10/10→	A 14 NEL	Petrol	1364	4	16	20
Astra J (P10)	10/10→	A 17 DTL	Diesel	1686	4	16	64
Astra J (P10)	10/10→	B 14 NEL	Petrol	1364	4	16	20
Astra J (P10)	12/12→	A 20 DTR	Diesel	1956	4	16	110
Astra J GTC	10/11→	A 14 NEL	Petrol	1364	4	16	20
Astra J GTC	10/11→	A 14 NET	Petrol	1364	4	16	20
Astra J GTC	10/11→	A 14 XER	Petrol	1398	4	16	20
Astra J GTC	10/11→	A 16 LET	Petrol	1598	4	16	41
Astra J GTC	10/11→	A 17 DTC	Diesel	1686	4	16	64
Astra J GTC	10/11→	A 17 DTE	Diesel	1686	4	16	64
Astra J GTC	10/11→	A 17 DTF	Diesel	1686	4	16	64
Astra J GTC	10/11→	A 17 DTJ	Diesel	1686	4	16	64
Astra J GTC	10/11→	A 17 DTS	Diesel	1686	4	16	64
Astra J GTC	10/11→	A 18 XER	Petrol	1796	4	16	79
Astra J GTC	10/11→	A 20 DTH	Diesel	1956	4	16	110
Astra J GTC	10/11→	B 14 NEL	Petrol	1364	4	16	20
Astra J GTC	10/11→	B 14 NET	Petrol	1364	4	16	20
Astra J GTC	04/12→	A 20 NFT	Petrol	1998	4	16	111
Astra J GTC	04/12→	B 20 NFT	Petrol	1998	4	16	111
Astra J GTC	10/12→	A 20 DTR	Diesel	1956	4	16	110
Astra J GTC	07/13→	B 16 SHT	Petrol	1598	4	16	44
Astra J Saloon	06/12→	A 13 DTE	Diesel	1248	4	16	15
Astra J Saloon	06/12→	A 14 NEL	Petrol	1364	4	16	20
Astra J Saloon	06/12→	A 14 NET	Petrol	1364	4	16	20
Astra J Saloon	06/12→	A 14 XER	Petrol	1398	4	16	20
Astra J Saloon	06/12→	A 16 LET	Petrol	1598	4	16	41
Astra J Saloon	06/12→	A 16 XER	Petrol	1598	4	16	41
Astra J Saloon	06/12→	A 17 DTC	Diesel	1686	4	16	64
Astra J Saloon	06/12→	A 17 DTE	Diesel	1686	4	16	64
Astra J Saloon	06/12→	A 17 DTF	Diesel	1686	4	16	64
Astra J Saloon	06/12→	A 17 DTJ	Diesel	1686	4	16	64
Astra J Saloon	06/12→	A 17 DTS	Diesel	1686	4	16	64
Astra J Saloon	06/12→	B 14 NEL	Petrol	1364	4	16	20
Astra J Saloon	06/12→	B 14 NET	Petrol	1364	4	16	20
Astra J Saloon	06/12→	B 16 XER	Petrol	1598	4	16	41
Astra J Sports Tourer (P10)	10/10→10/15	A 14 XEL	Petrol	1398	4	16	20
Astra J Sports Tourer (P10)	10/10→	A 13 DTE	Diesel	1248	4	16	15
Astra J Sports Tourer (P10)	10/10→	A 14 NEL	Petrol	1364	4	16	20
Astra J Sports Tourer (P10)	10/10→	A 14 NET	Petrol	1364	4	16	20
Astra J Sports Tourer (P10)	10/10→	A 14 XER	Petrol	1398	4	16	20
Astra J Sports Tourer (P10)	10/10→	A 16 LET	Petrol	1598	4	16	41
Astra J Sports Tourer (P10)	10/10→	A 16 XER	Petrol	1598	4	16	41
Astra J Sports Tourer (P10)	10/10→	A 17 DTC	Diesel	1686	4	16	64
Astra J Sports Tourer (P10)	10/10→	A 17 DTE	Diesel	1686	4	16	64
Astra J Sports Tourer (P10)	10/10→	A 17 DTF	Diesel	1686	4	16	64
Astra J Sports Tourer (P10)	10/10→	A 17 DTJ	Diesel	1686	4	16	64
Astra J Sports Tourer (P10)	10/10→	A 17 DTL	Diesel	1686	4	16	64
Astra J Sports Tourer (P10)	10/10→	A 17 DTN	Diesel	1686	4	16	64
Astra J Sports Tourer (P10)	10/10→	A 17 DTR	Diesel	1686	4	16	64
Astra J Sports Tourer (P10)	10/10→	A 17 DTS	Diesel	1686	4	16	64
Astra J Sports Tourer (P10)	10/10→	A 20 DTH	Diesel	1956	4	16	110
Astra J Sports Tourer (P10)	10/10→	B 14 NEL	Petrol	1364	4	16	20
Astra J Sports Tourer (P10)	10/10→	B 14 NET	Petrol	1364	4	16	20
Astra J Sports Tourer (P10)	10/10→	B 16 XER	Petrol	1598	4	16	41
Astra J Sports Tourer (P10)	12/12→	A 20 DTR	Diesel	1956	4	16	110
Astra K (B16)	11/15→	B 16 SHT	Petrol	1598	4	16	44
Astra K Sports Tourer (B16)	11/15→	B 16 SHT	Petrol	1598	4	16	44
Astramax (T85)	08/85→12/89	13 N	Petrol	1297	4	8	14
Astramax (T85)	08/85→12/89	13 NB	Petrol	1297	4	8	14











CC



9

Astramax (T85)	08/85→12/89	13 S	Petrol	1297	4	8	14
Astramax (T85)	09/85→12/91	16 SV	Petrol	1598	4	8	36
Astramax (T85)	09/85→06/94	17 DR	Diesel	1699	4	8	59
Astramax (T85)	05/86→06/90	16 DA	Diesel	1598	4	8	31
Astramax (T85)	01/89→07/94	17 D	Diesel	1699	4	8	59
Astramax (T85)	07/89→08/91	14 NV	Petrol	1389	4	8	18
Astramax (T85)	08/91→07/94	C 14 NZ	Petrol	1389	4	8	18
Astramax (T85)	08/91→10/94	C 16 NZ	Petrol	1598	4	8	36
Astra Saloon (LD)	07/87→07/89	18LE	Petrol	1796	4	8	75
Astra Saloon (TR)	09/96→09/98	C 18 XEL	Petrol	1799	4	16	82
Astra Saloon (TS)	02/98→08/00	X 18 XE1	Petrol	1796	4	16	87
Astra Saloon (TS)	09/00→10/04	Z 18 XE	Petrol	1796	4	16	89
Astra Sportsback (AH)	07/05→03/08	Z 18 XE	Petrol	1796	4	16	89
Astra Sportsback (AH)	06/06→03/10	Z 20 LER	Petrol	1998	4	16	113
Astra Sportsback (AH)	12/06→03/10	Z 22 YH	Petrol	2198	4	16	132
Astra Sportsback (AH)	04/07→03/10	Z 18 XER	Petrol	1796	4	16	79
Astra Twintop (AH)	03/08→03/10	Z 22 YH	Petrol	2198	4	16	132
Astravan Mk III (F) (T92)	01/91→08/94	17 DR	Diesel	1699	4	8	59
Astravan Mk III (F) (T92)	01/91→10/94	C 14 NZ	Petrol	1389	4	8	18
Astravan Mk III (F) (T92)	01/91→08/98	C 16 NZ	Petrol	1598	4	8	36
Astravan Mk III (F) (T92)	01/94→08/98	X 17 DTL	Diesel	1699	4	8	59
Astravan Mk III (F) (T92)	02/94→10/96	X 16 SZ	Petrol	1598	4	8	36
Astravan Mk IV (G) (T98)	08/98→09/00	X 16 SZR	Petrol	1598	4	8	36
Astravan Mk IV (G) (T98)	08/98→08/06	X 17 DTL	Diesel	1699	4	8	59
Astravan Mk IV (G) (T98)	08/98→08/06	X 20 DTL	Diesel	1995	4	16	117
Astravan Mk IV (G) (T98)	07/00→08/05	Z 16 XE	Petrol	1598	4	16	47
Astravan Mk IV (G) (T98)	09/00→05/05	X 14 XE	Petrol	1389	4	16	22
Astravan Mk IV (G) (T98)	09/00→05/05	Z 14 XE	Petrol	1389	4	16	22
Astravan Mk IV (G) (T98)	09/00→08/06	Z 16 SE	Petrol	1598	4	8	55
Astravan Mk IV (G) (T98)	04/01→08/06	Y 17 DT	Diesel	1686	4	16	64
Astravan Mk IV (G) (T98)	04/04→08/06	Y 20 DTH	Diesel	1995	4	16	117
Astravan Mk IV (G) (T98)	04/04→08/06	Z 17 DTL	Diesel	1686	4	16	64
Astravan Mk V (H) (A04)	03/05→07/06	Z 17 DTL	Diesel	1686	4	16	64
Astravan Mk V (H) (A04)	03/05→11/11	Z 17 DTH	Diesel	1686	4	16	64
Astravan Mk V (H) (A04)	03/05→11/11	Z 19 DT	Diesel	1910	4	8	99
Astravan Mk V (H) (A04)	03/05→11/11	Z 19 DTH	Diesel	1910	4	16	100
Astravan Mk V (H) (A04)	03/05→	Z 14 XEP	Petrol	1364	4	16	20
Astravan Mk V (H) (A04)	03/05→	Z 16 XE1	Petrol	1598	4	16	56
Astravan Mk V (H) (A04)	03/05→	Z 16 XEP	Petrol	1598	4	16	57
Astravan Mk V (H) (A04)	08/05→	Z 13 DTH	Diesel	1248	4	16	15
Astravan Mk V (H) (A04)	06/11→12/13	A 17 DTJ	Diesel	1686	4	16	64
Astravan Mk V (H) (A04)	06/11→12/13	Z 17 DTJ	Diesel	1686	4	16	64
Astravan Mk V (H) (A04)	11/11→	A 17 DTR	Diesel	1686	4	16	64
Astravan Mk V (H) (A04)	11/11→	Z 17 DTR	Diesel	1686	4	16	64
Barina Convertible (SB)	11/97→11/00	C 14 SE	Petrol	1389	4	8	18
Barina Hatchback (MB)	02/85→08/86	G13A	Petrol	1324	4	8	16
Barina Hatchback (ML)	08/86→12/89	G13A	Petrol	1324	4	8	16
Barina Hatchback (SB)	04/94→07/97	C 12 NZ	Petrol	1196	4	8	9
Barina Hatchback (SB)	04/94→07/97	C 14 NZ	Petrol	1389	4	8	18
Barina Hatchback (SB)	04/94→08/98	X 16 XE	Petrol	1598	4	16	47
Barina Hatchback (SB)	09/97→02/01	C 14 SE	Petrol	1389	4	8	18
Barina Hatchback (TK)	03/05→06/12	F16D3	Petrol	1598	4	16	49
Barina Hatchback (TM)	11/11→	F16D4	Petrol	1598	4	16	41
Barina Hatchback (TM)	07/13→	A 14 NET	Petrol	1364	4	16	20
Barina Hatchback (XC)	09/00→12/03	X 14 XE	Petrol	1389	4	16	22
Barina Hatchback (XC)	09/00→12/03	Z 14 XE	Petrol	1389	4	16	22
Barina Hatchback (XC)	09/00→02/05	Z 18 XE	Petrol	1796	4	16	89
Barina Hatchback (XC)	01/04→02/05	Z 14 XEP	Petrol	1364	4	16	20
Barina Saloon (TK)	11/05→06/12	F16D3	Petrol	1598	4	16	49
Barina Saloon (TM)	12/12→	F16D4	Petrol	1598	4	16	41
Barina Spark (MJ)	10/10→12/15	B12D1	Petrol	1206	4	16	11
Brava Pickup (TFO, TF1)	12/88→09/96	C223	Diesel	2238	4	8	130
Brava Pickup (TFO, TF1)	06/90→08/94	4 ZD1	Petrol	2255	4	8	134
Brava Pickup (TFO, TF1)	06/90→12/02	4JAI-T	Diesel	2499	4	8	143
Brava Pickup (TFO, TF1)	07/90→09/92	4FD1	Diesel	2189	4	8	121
Brava Pickup (TFO, TF1)	07/91→07/01	4 JG2 T	Diesel	3059	4	8	169
Brava Pickup (TFO, TF1)	08/91→12/02	4JAI	Diesel	2499	4	8	142
Brava Pickup (TFO, TF1)	08/94→09/96	23 P	Petrol	2254	4	8	134
Calibra (C89)	06/90→02/94	C 20 XE	Petrol	1998	4	16	112
Calibra (C89)	06/90→07/97	C 20 NE	Petrol	1998	4	8	106
Calibra (C89)	06/90→07/97	X 20 XEV	Petrol	1998	4	16	113
Calibra (C89)	03/92→07/97	C 20 LET	Petrol	1998	4	16	109
Calibra (C89)	04/93→07/97	C 25 XE	Petrol	2498	6	24	149
Calibra (C89)	04/93→07/97	X 25 XE	Petrol	2498	6	24	149
Calibra (YE)	10/91→07/95	C 20 NE	Petrol	1998	4	8	107
Calibra (YE)	10/91→07/95	C 20 XE	Petrol	1998	4	16	112
Calibra (YE)	03/92→11/97	C 20 LET	Petrol	1998	4	16	112
Calibra (YE)	07/95→11/97	C 25 XE	Petrol	2498	6	24	149

							
Calibra (YE)	07/95→11/97	X 20 XEV	Petrol	1998	4	16	113
Calibra (YE)	07/95→11/97	X 25 XE	Petrol	2498	6	24	149
Calibra A (C89)	06/90→02/94	C 20 XE	Petrol	1998	4	16	112
Calibra A (C89)	06/90→07/97	C 20 NE	Petrol	1998	4	8	106
Calibra A (C89)	03/92→07/97	C 20 LET	Petrol	1998	4	16	109
Calibra A (C89)	04/93→07/97	C 25 XE	Petrol	2498	6	24	149
Calibra A (C89)	04/93→07/97	X 25 XE	Petrol	2498	6	24	149
Calibra A (C89)	02/94→07/97	X 20 XEV	Petrol	1998	4	16	113
Campo (TFO, TF1)	08/87→09/96	C223	Diesel	2238	4	8	130
Campo (TFO, TF1)	09/90→08/92	4FD1	Diesel	2189	4	8	121
Campo (TFO, TF1)	08/91→09/96	4 ZD1	Petrol	2255	4	8	134
Campo (TFO, TF1)	08/91→12/01	4JA1	Diesel	2499	4	8	142
Campo (TFO, TF1)	12/92→06/01	4 JG2T	Diesel	3059	4	8	169
Campo (TFO, TF1)	07/94→06/01	4JA1-T	Diesel	2499	4	8	143
Campo (TFO, TF1)	08/94→09/96	23 P	Petrol	2254	4	8	134
Captiva (CG)	12/09→12/11	Z 24 XED	Petrol	2405	4	16	141
Captiva 5 (CG5)	03/11→	A 24 XE	Petrol	2384	4	16	139
Captiva 7 (CG7)	03/11→	A 24 XE	Petrol	2384	4	16	139
Captiva 7 (CG7)	03/11→	LE9	Petrol	2384	4	16	139
Carlton Mk II	10/78→08/82	20 N	Petrol	1979	4	8	105
Carlton Mk II	10/78→08/86	C 20 NEJ	Petrol	1998	4	8	106
Carlton Mk II	09/80→08/86	23 D	Diesel	2260	4	8	135
Carlton Mk II	09/81→08/86	18 N	Petrol	1796	4	8	76
Carlton Mk II	12/82→08/86	18 S	Petrol	1796	4	8	73
Carlton Mk II	01/83→12/84	20 E	Petrol	1979	4	8	104
Carlton Mk II	01/83→12/84	20 S	Petrol	1979	4	8	105
Carlton Mk II	09/83→08/86	23 TD	Diesel	2260	4	8	126
Carlton Mk II	11/84→08/86	22 E	Petrol	2197	4	8	123
Carlton Mk II Estate	09/77→08/86	20 E	Petrol	1979	4	8	104
Carlton Mk II Estate	09/77→08/86	20 S	Petrol	1979	4	8	105
Carlton Mk II Estate	09/80→08/86	23 D	Diesel	2260	4	8	135
Carlton Mk II Estate	09/81→08/86	18 N	Petrol	1796	4	8	76
Carlton Mk II Estate	01/82→08/86	C 20 NEJ	Petrol	1998	4	8	106
Carlton Mk II Estate	11/82→08/86	18 S	Petrol	1796	4	8	73
Carlton Mk II Estate	09/83→08/86	23 TD	Diesel	2260	4	8	126
Carlton Mk II Estate	11/84→08/86	22 E	Petrol	2197	4	8	123
Carlton Mk III (V87)	09/86→08/87	18 NV	Petrol	1796	4	8	77
Carlton Mk III (V87)	09/86→03/94	18 SEH	Petrol	1796	4	8	77
Carlton Mk III (V87)	09/86→03/94	18 SV	Petrol	1796	4	8	77
Carlton Mk III (V87)	09/86→03/94	20 SE	Petrol	1998	4	8	106
Carlton Mk III (V87)	09/86→03/94	23 YD	Diesel	2260	4	8	135
Carlton Mk III (V87)	09/86→03/94	C 20 NE	Petrol	1998	4	8	106
Carlton Mk III (V87)	10/86→08/88	23 YDT	Diesel	2260	4	8	136
Carlton Mk III (V87)	03/87→12/87	C 30 LE	Petrol	2969	6	12	164
Carlton Mk III (V87)	03/87→09/90	30 NE	Petrol	2969	6	12	164
Carlton Mk III (V87)	09/87→03/94	E 18 NVR	Petrol	1796	4	8	77
Carlton Mk III (V87)	03/88→03/94	C 30 NE	Petrol	2969	6	12	164
Carlton Mk III (V87)	08/88→03/94	23 DTR	Diesel	2260	4	8	136
Carlton Mk III (V87)	09/88→03/94	C 24 NE	Petrol	2410	4	8	140
Carlton Mk III (V87)	09/89→03/94	C 30 SE	Petrol	2969	6	24	165
Carlton Mk III (V87)	09/89→03/94	C 30 SEJ	Petrol	2969	6	24	165
Carlton Mk III (V87)	09/90→03/94	C 20 NEF	Petrol	1998	4	8	106
Carlton Mk III (V87)	09/90→03/94	C 20 NEJ	Petrol	1998	4	8	106
Carlton Mk III (V87)	09/90→03/94	C 26 NE	Petrol	2594	6	12	154
Carlton Mk III Estate (V87)	09/86→08/87	18 NV	Petrol	1796	4	8	77
Carlton Mk III Estate (V87)	09/86→08/88	23 YDT	Diesel	2260	4	8	136
Carlton Mk III Estate (V87)	09/86→03/94	18 SEH	Petrol	1796	4	8	77
Carlton Mk III Estate (V87)	09/86→03/94	18 SV	Petrol	1796	4	8	77
Carlton Mk III Estate (V87)	09/86→03/94	20 SE	Petrol	1998	4	8	106
Carlton Mk III Estate (V87)	09/86→03/94	23 YD	Diesel	2260	4	8	135
Carlton Mk III Estate (V87)	09/86→03/94	C 20 NE	Petrol	1998	4	8	106
Carlton Mk III Estate (V87)	03/87→03/94	C 30 NE	Petrol	2969	6	12	164
Carlton Mk III Estate (V87)	09/87→03/94	E 18 NVR	Petrol	1796	4	8	77
Carlton Mk III Estate (V87)	09/88→03/94	23 DTR	Diesel	2260	4	8	136
Carlton Mk III Estate (V87)	09/88→03/94	C 24 NE	Petrol	2410	4	8	140
Carlton Mk III Estate (V87)	09/89→03/94	C 30 SEJ	Petrol	2969	6	24	165
Carlton Mk III Estate (V87)	09/90→03/94	C 20 NEF	Petrol	1998	4	8	106
Carlton Mk III Estate (V87)	09/90→03/94	C 20 NEJ	Petrol	1998	4	8	106
Carlton Mk III Estate (V87)	09/90→03/94	C 26 NE	Petrol	2594	6	12	154
Cascada (W13)	03/13→	A 14 NEL	Petrol	1364	4	16	20
Cascada (W13)	03/13→	A 14 NET	Petrol	1364	4	16	20
Cascada (W13)	03/13→	A 20 DTH	Diesel	1956	4	16	110
Cascada (W13)	03/13→	A 20 DTR	Diesel	1956	4	16	110
Cascada (W13)	11/13→	B 16 SHT	Petrol	1598	4	16	44
Cascada Convertible (W13)	02/13→	A 14 NEL	Petrol	1364	4	16	20
Cascada Convertible (W13)	02/13→	A 14 NET	Petrol	1364	4	16	20
Cascada Convertible (W13)	02/13→	A 20 DTH	Diesel	1956	4	16	110
Cascada Convertible (W13)	02/13→	A 20 DTR	Diesel	1956	4	16	110



CC



9

Cascada Convertible (W13)	02/13→	B 14 NET	Petrol	1364	4	16	20
Cascada Convertible (W13)	11/13→	B 16 SHT	Petrol	1598	4	16	44
Cavalier	03/75→08/81	16 N (CIH)	Petrol	1584	4	8	34
Cavalier	08/75→08/81	16 S CIH	Petrol	1584	4	8	38
Cavalier	10/75→03/78	19 S	Petrol	1897	4	8	94
Cavalier	08/77→08/81	13 N	Petrol	1297	4	8	14
Cavalier	01/78→08/81	20 S	Petrol	1979	4	8	105
Cavalier CC	09/75→08/81	16 S CIH	Petrol	1584	4	8	38
Cavalier CC	08/77→08/81	20 S	Petrol	1979	4	8	105
Cavalier Coupe	10/75→03/78	19 S	Petrol	1897	4	8	94
Cavalier Coupe	03/78→08/81	20 S	Petrol	1979	4	8	105
Cavalier Mk II	09/87→08/88	20 SEH	Petrol	1998	4	8	106
Cavalier Mk II (J82)	09/81→08/88	13 N	Petrol	1297	4	8	14
Cavalier Mk II (J82)	09/81→08/88	13 S	Petrol	1297	4	8	14
Cavalier Mk II (J82)	09/81→08/88	16 N	Petrol	1598	4	8	35
Cavalier Mk II (J82)	09/81→08/88	16 SH	Petrol	1598	4	8	39
Cavalier Mk II (J82)	09/81→08/88	18 E	Petrol	1796	4	8	73
Cavalier Mk II (J82)	09/81→08/88	18 SE	Petrol	1796	4	8	78
Cavalier Mk II (J82)	03/82→08/88	16 D	Diesel	1598	4	8	31
Cavalier Mk II (J82)	01/85→08/86	C 18 NE	Petrol	1796	4	8	80
Cavalier Mk II (J82)	08/86→08/88	C 16 LZ	Petrol	1598	4	8	36
Cavalier Mk II (J82)	08/86→08/88	C 16 NZ	Petrol	1598	4	8	36
Cavalier Mk II (J82)	08/86→08/88	E 16 NZ	Petrol	1598	4	8	36
Cavalier Mk II (J82)	08/86→08/88	E 18 NV	Petrol	1796	4	8	77
Cavalier Mk II (J82)	09/86→08/88	20 NE	Petrol	1998	4	8	106
Cavalier Mk II (J82)	09/86→08/88	20 SE	Petrol	1998	4	8	106
Cavalier Mk II (J82)	09/86→08/88	C 20 NE	Petrol	1998	4	8	106
Cavalier Mk II (J82)	03/87→08/88	20 SEH	Petrol	1998	4	8	106
Cavalier Mk II Convertible (J82)	03/85→10/88	18 SE	Petrol	1796	4	8	78
Cavalier Mk II Estate (J82)	09/81→08/86	18 E	Petrol	1796	4	8	73
Cavalier Mk II Estate (J82)	09/81→08/86	18 SE	Petrol	1796	4	8	78
Cavalier Mk II Estate (J82)	09/81→08/88	13 S	Petrol	1297	4	8	14
Cavalier Mk II Estate (J82)	03/82→08/88	16 DA	Diesel	1598	4	8	31
Cavalier Mk II Estate (J82)	10/83→08/88	16 SH	Petrol	1598	4	8	39
Cavalier Mk II Hatchback	09/87→08/88	20 SEH	Petrol	1998	4	8	106
Cavalier Mk II Hatchback (J82)	09/81→08/88	13 NB	Petrol	1297	4	8	14
Cavalier Mk II Hatchback (J82)	09/81→08/88	13 S	Petrol	1297	4	8	14
Cavalier Mk II Hatchback (J82)	09/81→08/88	16 SH	Petrol	1598	4	8	39
Cavalier Mk II Hatchback (J82)	09/81→08/88	18 E	Petrol	1796	4	8	73
Cavalier Mk II Hatchback (J82)	09/81→08/88	18 SE	Petrol	1796	4	8	78
Cavalier Mk II Hatchback (J82)	03/82→08/88	16 D	Diesel	1598	4	8	31
Cavalier Mk II Hatchback (J82)	03/82→08/88	16 DA	Diesel	1598	4	8	31
Cavalier Mk II Hatchback (J82)	09/86→08/88	20 SE	Petrol	1998	4	8	106
Cavalier Mk II Hatchback (J82)	09/86→08/88	C 20 NE	Petrol	1998	4	8	106
Cavalier Mk II Hatchback (J82)	03/87→08/88	20 SEH	Petrol	1998	4	8	106
Cavalier Mk III (J87)	09/89→08/92	20 XE	Petrol	1998	4	16	109
Cavalier Mk III (J89)	08/88→06/94	C 25 XE	Petrol	2498	6	24	149
Cavalier Mk III (J89)	09/88→09/92	17 D	Diesel	1699	4	8	59
Cavalier Mk III (J89)	09/88→09/92	20 SEH	Petrol	1998	4	8	106
Cavalier Mk III (J89)	09/88→10/92	20 NE	Petrol	1998	4	8	106
Cavalier Mk III (J89)	09/88→05/93	16 SV	Petrol	1598	4	8	36
Cavalier Mk III (J89)	09/88→08/95	18 SV	Petrol	1796	4	8	77
Cavalier Mk III (J89)	09/88→11/95	14 NV	Petrol	1389	4	8	18
Cavalier Mk III (J89)	09/88→11/95	17 DT (TC4EE1)	Diesel	1686	4	8	60
Cavalier Mk III (J89)	09/88→11/95	C 18 NZ	Petrol	1796	4	8	81
Cavalier Mk III (J89)	09/88→11/95	C 20 XE	Petrol	1998	4	16	112
Cavalier Mk III (J89)	09/88→11/95	E 16 NZ	Petrol	1598	4	8	36
Cavalier Mk III (J89)	09/89→08/92	20 XE	Petrol	1998	4	16	109
Cavalier Mk III (J89)	09/89→08/92	E 18 NVR	Petrol	1796	4	8	77
Cavalier Mk III (J89)	09/90→11/95	C 20 NE	Petrol	1998	4	8	106
Cavalier Mk III (J89)	06/92→11/94	C 20 LET	Petrol	1998	4	16	109
Cavalier Mk III (J89)	07/92→11/95	17 DR	Diesel	1699	4	8	59
Cavalier Mk III (J89)	09/93→11/95	X 16 SZ	Petrol	1598	4	8	36
Cavalier Mk III (J89)	09/93→11/95	X 20 XEV	Petrol	1998	4	16	113
Cavalier Mk III Hatchback (J89)	09/88→10/90	18 SV	Petrol	1796	4	8	77
Cavalier Mk III Hatchback (J89)	09/88→09/92	17 D	Diesel	1699	4	8	59
Cavalier Mk III Hatchback (J89)	09/88→09/92	20 SEH	Petrol	1998	4	8	106
Cavalier Mk III Hatchback (J89)	09/88→10/92	20 NE	Petrol	1998	4	8	106
Cavalier Mk III Hatchback (J89)	09/88→05/93	16 SV	Petrol	1598	4	8	36
Cavalier Mk III Hatchback (J89)	09/88→06/94	C 25 XE	Petrol	2498	6	24	149
Cavalier Mk III Hatchback (J89)	09/88→11/95	14 NV	Petrol	1389	4	8	18
Cavalier Mk III Hatchback (J89)	09/88→11/95	17 DT (TC4EE1)	Diesel	1686	4	8	60
Cavalier Mk III Hatchback (J89)	09/88→11/95	C 18 NZ	Petrol	1796	4	8	81
Cavalier Mk III Hatchback (J89)	09/88→11/95	C 20 XE	Petrol	1998	4	16	112
Cavalier Mk III Hatchback (J89)	09/88→11/95	E 16 NZ	Petrol	1598	4	8	36
Cavalier Mk III Hatchback (J89)	09/90→11/95	C 20 NE	Petrol	1998	4	8	106
Cavalier Mk III Hatchback (J89)	07/92→11/95	17 DR	Diesel	1699	4	8	59
Cavalier Mk III Hatchback (J89)	09/93→11/95	X 16 SZ	Petrol	1598	4	8	36



Model	Year Range	Engine	Fuel	CC	Power (kW)	Power (hp)	Weight (kg)
Cavalier Mk III Hatchback (J89)	09/93→11/95	X 20 XEV	Petrol	1998	4	16	113
Cavalier Saloon	08/75→08/81	16 S CIH	Petrol	1584	4	8	38
Cavalier Saloon	01/79→01/81	20 S	Petrol	1979	4	8	105
Chevette	03/75→12/85	13 N	Petrol	1297	4	8	14
Chevette	03/75→12/85	13 S	Petrol	1297	4	8	14
Chevette Estate	09/76→12/85	13 N	Petrol	1297	4	8	14
Chevette Estate	09/76→12/85	13 S	Petrol	1297	4	8	14
Chevette Hatchback	03/75→12/85	13 N	Petrol	1297	4	8	14
Chevette Hatchback	03/75→12/85	13 S	Petrol	1297	4	8	14
Combo (71_)	07/94→10/01	17 D (4EE1)	Diesel	1686	4	8	60
Combo (71_)	07/94→10/01	C 12 NZ	Petrol	1196	4	8	9
Combo (71_)	07/94→10/01	C 14 NZ	Petrol	1389	4	8	18
Combo (71_)	07/94→10/01	C 14 SE	Petrol	1389	4	8	18
Combo (71_)	07/94→10/01	X 12 SZ	Petrol	1195	4	8	9
Combo (71_)	07/94→10/01	X 14 SZ	Petrol	1389	4	8	18
Combo (71_)	07/94→10/01	X 17 D (4EE1)	Diesel	1686	4	8	67
Combo (71_)	08/99→10/01	X 14 XE	Petrol	1389	4	16	22
Combo Box (SB)	03/96→07/97	C 14 NZ	Petrol	1389	4	8	18
Combo Box (SB)	07/97→09/02	C 14 SE	Petrol	1389	4	8	18
Combo Box (XC)	09/02→04/05	Z 16 SE	Petrol	1598	4	8	36
Combo Box (XC)	04/05→12/12	Z 14 XEP	Petrol	1364	4	16	20
Combo Box Body / Estate	10/01→	Y 17 DT	Diesel	1686	4	16	64
Combo Box Body / Estate	10/01→	Y 17 DTL	Diesel	1686	4	16	64
Combo Box Body / Estate	10/01→	Z 16 SE	Petrol	1598	4	8	55
Combo Box Body / Estate	12/04→	Z 17 DTH	Diesel	1686	4	16	64
Combo Box Body / Estate	04/05→	Z 16 YNG	Petrol	1598	4	16	54
Combo Box Body / Estate	08/05→	Z 13 DT	Diesel	1248	4	16	15
Combo Box Body / Estate	08/05→	Z 14 XEP	Petrol	1364	4	16	20
Combo Box Body / Estate	10/05→12/12	Z 13 DTJ	Diesel	1248	4	16	15
Combo Box Body / Estate (X12)	02/12→	A 13 FD	Diesel	1248	4	16	15
Combo Box Body / Estate (X12)	02/12→	A 14 FC	Petrol	1368	4	16	19
Combo Box Body / Estate (X12)	02/12→	A 14 FP	Petrol	1368	4	16	19
Combo Box Body / Estate (X12)	02/12→	A 16 FDH	Diesel	1598	4	16	40
Combo Box Body / Estate (X12)	02/12→	A 16 FDL	Diesel	1598	4	16	40
Combo Box Body / Estate (X12)	02/12→	A 20 FD	Diesel	1956	4	16	110
Combo Box Body / Estate (X12)	02/12→	B 13 DTC	Diesel	1248	4	16	15
Combo Mk I (B)	07/94→10/01	17 D (4EE1)	Diesel	1686	4	8	60
Combo Mk I (B)	07/94→10/01	C 12 NZ	Petrol	1196	4	8	9
Combo Mk I (B)	07/94→10/01	C 14 NZ	Petrol	1389	4	8	18
Combo Mk I (B)	07/94→10/01	C 14 SE	Petrol	1389	4	8	18
Combo Mk I (B)	07/94→10/01	X 12 SZ	Petrol	1195	4	8	9
Combo Mk I (B)	07/94→10/01	X 17 D (4EE1)	Diesel	1686	4	8	67
Combo Mk I (B)	08/99→10/01	X 14 XE	Petrol	1389	4	16	22
Combo Mk II (C) Box Body / Estate (F25)	09/01→11/11	Y 17 DTL	Diesel	1686	4	16	64
Combo Mk II (C) Box Body / Estate (F25)	09/01→11/11	Z 16 SE	Petrol	1598	4	8	55
Combo Mk II (C) Box Body / Estate (F25)	10/01→05/07	Z 14 XE	Petrol	1389	4	16	22
Combo Mk II (C) Box Body / Estate (F25)	10/01→11/11	Y 17 DT	Diesel	1686	4	16	64
Combo Mk II (C) Box Body / Estate (F25)	01/04→11/11	Z 14 XEP	Petrol	1364	4	16	20
Combo Mk II (C) Box Body / Estate (F25)	09/04→02/12	Z 13 DT	Diesel	1248	4	16	15
Combo Mk II (C) Box Body / Estate (F25)	12/04→11/11	Z 17 DTH	Diesel	1686	4	16	64
Combo Mk II (C) Box Body / Estate (F25)	04/05→02/12	Z 16 YNG	Petrol	1598	4	16	54
Combo Mk II (C) Box Body / Estate (F25)	10/05→11/11	Z 13 DTJ	Diesel	1248	4	16	15
Combo Mk III (D) Box Body / Estate (X12)	11/11→	A 13 FD	Diesel	1248	4	16	15
Combo Mk III (D) Box Body / Estate (X12)	11/11→	A 14 FC	Petrol	1368	4	16	19
Combo Mk III (D) Box Body / Estate (X12)	11/11→	A 14 FP	Petrol	1368	4	16	19
Combo Mk III (D) Box Body / Estate (X12)	11/11→	A 16 FDH	Diesel	1598	4	16	40
Combo Mk III (D) Box Body / Estate (X12)	11/11→	A 16 FDL	Diesel	1598	4	16	40
Combo Mk III (D) Box Body / Estate (X12)	11/11→	A 20 FD	Diesel	1956	4	16	110
Combo Mk III (D) Box Body / Estate (X12)	02/12→	B 13 DTC	Diesel	1248	4	16	15
Combo Platform/Chassis (X12)	08/12→	A 13 FD	Diesel	1248	4	16	15
Combo Platform/Chassis (X12)	08/12→	A 20 FD	Diesel	1956	4	16	110
Combo Tour	10/01→	Y 17 DT	Diesel	1686	4	16	64
Combo Tour	10/01→	Y 17 DTL	Diesel	1686	4	16	64
Combo Tour	10/01→	Z 16 SE	Petrol	1598	4	8	55
Combo Tour	10/04→	Y 13 DT	Diesel	1248	4	16	15
Combo Tour	10/04→	Z 13 DT	Diesel	1248	4	16	15
Combo Tour	10/04→	Z 14 XEP	Petrol	1364	4	16	20
Combo Tour	12/04→	Z 17 DTH	Diesel	1686	4	16	64
Combo Tour	04/05→	Z 16 YNG	Petrol	1598	4	16	54
Combo Tour	10/05→	Z 13 DTJ	Diesel	1248	4	16	15
Combo Tour (X12)	02/12→	A 13 FD	Diesel	1248	4	16	15
Combo Tour (X12)	02/12→	A 14 FC	Petrol	1368	4	16	19
Combo Tour (X12)	02/12→	A 14 FP	Petrol	1368	4	16	19
Combo Tour (X12)	02/12→	A 16 FDH	Diesel	1598	4	16	40
Combo Tour (X12)	02/12→	A 16 FDL	Diesel	1598	4	16	40
Combo Tour (X12)	02/12→	A 20 FD	Diesel	1956	4	16	110
Combo Tour Mk II (C) (F25)	09/01→06/04	Y 17 DTL	Diesel	1686	4	16	64
Combo Tour Mk II (C) (F25)	10/01→06/04	Z 16 SE	Petrol	1598	4	8	55



CC



9

Combo Tour Mk II (C) (F25)	10/01→02/12	Y 17 DT	Diesel	1686	4	16	64
Combo Tour Mk II (C) (F25)	09/04→09/06	Y 13 DT	Diesel	1248	4	16	15
Combo Tour Mk II (C) (F25)	09/04→09/06	Z 13 DT	Diesel	1248	4	16	15
Combo Tour Mk II (C) (F25)	10/04→09/10	Z 14 XEP	Petrol	1364	4	16	20
Combo Tour Mk II (C) (F25)	12/04→09/10	Z 17 DTH	Diesel	1686	4	16	64
Combo Tour Mk II (C) (F25)	04/05→02/12	Z 16 YNG	Petrol	1598	4	16	54
Combo Tour Mk II (C) (F25)	07/06→02/12	Z 13 DTJ	Diesel	1248	4	16	15
Commodore A	08/67→08/69	25 S	Petrol	2490	6	12	148
Commodore A	08/67→01/72	25 H	Petrol	2490	6	12	147
Commodore A	08/69→01/72	25 E	Petrol	2490	6	12	147
Commodore A	08/69→01/72	25 SV	Petrol	2490	6	12	148
Commodore A	05/70→01/72	28 HL	Petrol	2784	6	12	159
Commodore A Coupe	08/67→08/69	25 S	Petrol	2490	6	12	148
Commodore A Coupe	08/67→01/72	25 H	Petrol	2490	6	12	147
Commodore A Coupe	08/69→01/72	25 E	Petrol	2490	6	12	147
Commodore A Coupe	08/69→01/72	25 SV	Petrol	2490	6	12	148
Commodore A Coupe	05/70→01/72	28 HL	Petrol	2784	6	12	159
Commodore B	01/72→08/75	25 H	Petrol	2490	6	12	147
Commodore B	01/72→07/78	25 S	Petrol	2490	6	12	148
Commodore B	01/72→07/78	28 HC	Petrol	2784	6	12	159
Commodore B	07/72→02/75	28 E	Petrol	2784	6	12	157
Commodore B	07/72→02/75	28 EC	Petrol	2784	6	12	157
Commodore B Coupe	01/72→08/75	25 H	Petrol	2490	6	12	147
Commodore B Coupe	01/72→07/78	25 S	Petrol	2490	6	12	148
Commodore B Coupe	07/72→02/75	28 E	Petrol	2784	6	12	157
Commodore B Coupe	07/72→02/75	28 EC	Petrol	2784	6	12	157
Commodore B Coupe	12/72→07/78	28 HC	Petrol	2784	6	12	159
Commodore C (14_, 19_)	08/78→12/82	25 S	Petrol	2490	6	12	148
Commodore C (14_, 19_)	05/81→12/82	25 E	Petrol	2490	6	12	147
Commodore C Estate (61)	12/80→12/82	25 E	Petrol	2490	6	12	147
Commodore C Estate (61)	12/80→12/82	25 S	Petrol	2490	6	12	148
Corsa A Box (S83)	02/86→04/89	10 S	Petrol	993	4	8	2
Corsa A Box (S83)	02/86→04/89	12 NC	Petrol	1196	4	8	8
Corsa A Box (S83)	02/86→04/89	12 ST	Petrol	1196	4	8	9
Corsa A Box (S83)	02/86→04/89	13 NB	Petrol	1297	4	8	14
Corsa A Box (S83)	02/86→04/89	13 SB	Petrol	1297	4	8	14
Corsa A Box (S83)	02/86→04/89	E 12 GV	Petrol	1196	4	8	8
Corsa A Box (S83)	02/86→07/90	12 S	Petrol	1196	4	8	8
Corsa A Box (S83)	06/87→04/89	15 D (4EC1)	Diesel	1488	4	8	24
Corsa A Hatchback (S83)	09/82→10/89	13 SB	Petrol	1297	4	8	14
Corsa A Hatchback (S83)	09/82→02/90	12 ST	Petrol	1196	4	8	9
Corsa A Hatchback (S83)	09/82→08/90	12 NC	Petrol	1196	4	8	8
Corsa A Hatchback (S83)	09/82→08/90	12 S	Petrol	1196	4	8	8
Corsa A Hatchback (S83)	09/82→08/90	E 12 GV	Petrol	1196	4	8	8
Corsa A Hatchback (S83)	09/82→03/93	10 S	Petrol	993	4	8	2
Corsa A Hatchback (S83)	01/85→03/93	C 14 NZ	Petrol	1389	4	8	18
Corsa A Hatchback (S83)	09/85→10/89	13 NB	Petrol	1297	4	8	14
Corsa A Hatchback (S83)	09/86→09/90	C 13 N	Petrol	1297	4	8	14
Corsa A Hatchback (S83)	09/87→03/93	15 D (4EC1)	Diesel	1488	4	8	24
Corsa A Hatchback (S83)	03/88→03/93	15 DT (T4EC1)	Diesel	1488	4	8	24
Corsa A Hatchback (S83)	05/88→03/92	E 16 SE	Petrol	1598	4	8	36
Corsa A Hatchback (S83)	08/88→09/92	C 16 NZ	Petrol	1598	4	8	36
Corsa A Hatchback (S83)	09/89→03/93	C 12 NZ	Petrol	1196	4	8	9
Corsa A Hatchback (S83)	09/89→03/93	C 16 SEI	Petrol	1598	4	8	36
Corsa A Hatchback (S83)	01/90→03/93	12 NV	Petrol	1196	4	8	9
Corsa A Hatchback (S83)	01/90→03/93	14 NV	Petrol	1389	4	8	18
Corsa A Hatchback (S83)	09/91→03/93	C 14 SE	Petrol	1389	4	8	18
Corsa A Hatchback (S83)	02/92→03/93	C 16 SE	Petrol	1598	4	8	36
Corsa A TR (S83)	09/82→10/87	12 S	Petrol	1196	4	8	8
Corsa A TR (S83)	09/82→10/87	13 SB	Petrol	1297	4	8	14
Corsa A TR (S83)	09/82→09/92	10 S	Petrol	993	4	8	2
Corsa A TR (S83)	09/82→03/93	12 ST	Petrol	1196	4	8	9
Corsa A TR (S83)	01/85→10/87	12 NC	Petrol	1196	4	8	8
Corsa A TR (S83)	01/85→10/87	E 12 GV	Petrol	1196	4	8	8
Corsa A TR (S83)	09/85→10/87	13 NB	Petrol	1297	4	8	14
Corsa A TR (S83)	09/85→10/87	C 13 N	Petrol	1297	4	8	14
Corsa A TR (S83)	10/87→11/92	15 D (4EC1)	Diesel	1488	4	8	24
Corsa A TR (S83)	10/87→03/93	15 DT (T4EC1)	Diesel	1488	4	8	24
Corsa A TR (S83)	09/89→03/93	14 NV	Petrol	1389	4	8	18
Corsa A TR (S83)	09/89→03/93	C 12 NZ	Petrol	1196	4	8	9
Corsa A TR (S83)	10/89→03/93	C 14 NZ	Petrol	1389	4	8	18
Corsa B (73_, 78_, 79_)	04/93→08/94	C 14 SE	Petrol	1389	4	8	18
Corsa B (S93)	03/93→09/00	12 NZ	Petrol	1195	4	8	9
Corsa B (S93)	03/93→09/00	15 D (4EC1)	Diesel	1488	4	8	24
Corsa B (S93)	03/93→09/00	15 DT (T4EC1)	Diesel	1488	4	8	24
Corsa B (S93)	03/93→09/00	C 12 NZ	Petrol	1196	4	8	9
Corsa B (S93)	03/93→09/00	C 14 NZ	Petrol	1389	4	8	18
Corsa B (S93)	03/93→09/00	C 14 SE	Petrol	1389	4	8	18



Model	Year Range	Engine	Fuel	CC	Power (kW)	Power (hp)	0-100 (s)
Corsa B (S93)	03/93→09/00	C 16 XE	Petrol	1598	4	16	47
Corsa B (S93)	03/93→09/00	X 12 SZ	Petrol	1195	4	8	9
Corsa B (S93)	03/93→09/00	X 14 SZ	Petrol	1389	4	8	18
Corsa B (S93)	03/93→09/00	X 15 DT (T4EC1)	Diesel	1488	4	8	24
Corsa B (S93)	09/94→09/00	X 14 XE	Petrol	1389	4	16	22
Corsa B (S93)	09/94→09/00	X 16 XE	Petrol	1598	4	16	47
Corsa B (S93)	01/96→12/02	13 NB	Petrol	1297	4	8	14
Corsa B (S93)	02/96→09/00	17 D (4EE1)	Diesel	1686	4	8	60
Corsa B (S93)	02/96→09/00	X 17 D (4EE1)	Diesel	1686	4	8	67
Corsa B (S93)	11/96→09/00	X 10 XE	Petrol	973	3	12	3
Corsa B (S93)	08/97→09/00	C 14 SEL	Petrol	1389	4	16	21
Corsa B (S93)	08/97→09/00	C 16 SEL	Petrol	1598	4	16	47
Corsa B (S93)	03/98→09/00	X 12 XE	Petrol	1199	4	16	10
Corsa B Box (S93)	08/99→09/00	17 D (4EE1)	Diesel	1686	4	8	60
Corsa B Box (S93)	08/99→09/00	C 14 NZ	Petrol	1389	4	8	18
Corsa B Box (S93)	08/99→09/00	X 14 SZ	Petrol	1389	4	8	18
Corsa B Box (S93)	08/99→09/00	X 17 D (4EE1)	Diesel	1686	4	8	67
Corsa B Box (S93)	08/99→09/00	Y 16 YNG	Petrol	1598	4	16	54
Corsa B Estate (F35)	01/99→12/02	X 14 XE	Petrol	1389	4	16	22
Corsa B Estate (F35)	01/99→12/02	X 17 D (4EE1)	Diesel	1686	4	8	67
Corsa C (X01)	09/00→06/03	Z 10 XE	Petrol	973	3	12	3
Corsa C (X01)	09/00→12/09	Y 17 DT	Diesel	1686	4	16	64
Corsa C (X01)	09/00→12/09	Y 17 DTL	Diesel	1686	4	16	64
Corsa C (X01)	09/00→12/09	Z 12 XE	Petrol	1199	4	16	10
Corsa C (X01)	09/00→12/09	Z 14 XE	Petrol	1389	4	16	22
Corsa C (X01)	09/00→12/09	Z 16 SE	Petrol	1598	4	8	55
Corsa C (X01)	09/00→12/09	Z 18 XE	Petrol	1796	4	16	88
Corsa C (X01)	01/02→12/09	14 SE	Petrol	1389	4	8	18
Corsa C (X01)	01/02→12/09	Z 18 XEL	Petrol	1796	4	16	86
Corsa C (X01)	05/03→12/09	Y 16 YNG	Petrol	1598	4	16	54
Corsa C (X01)	05/03→12/09	Z 16 YNG	Petrol	1598	4	16	54
Corsa C (X01)	06/03→12/09	Z 10 XEP	Petrol	998	3	12	3
Corsa C (X01)	06/03→12/09	Z 13 DT	Diesel	1248	4	16	15
Corsa C (X01)	06/03→12/09	Z 14 XEP	Petrol	1364	4	16	20
Corsa C (X01)	06/03→12/09	Z 17 DTH	Diesel	1686	4	16	64
Corsa C (X01)	07/04→12/09	Z 12 XEP	Petrol	1229	4	16	10
Corsa C Box (X01)	09/00→	Y 17 DT	Diesel	1686	4	16	64
Corsa C Box (X01)	09/00→	Y 17 DTL	Diesel	1686	4	16	64
Corsa C Box (X01)	09/00→	Z 12 XE	Petrol	1199	4	16	10
Corsa C Box (X01)	08/03→	Z 14 XEP	Petrol	1364	4	16	20
Corsa C Box (X01)	08/03→	Z 17 DTH	Diesel	1686	4	16	64
Corsa C Box (X01)	07/05→	Z 12 XEP	Petrol	1229	4	16	10
Corsa C Box (X01)	08/05→	Z 13 DT	Diesel	1248	4	16	15
Corsa C Box (X01)	08/05→	Z 16 YNG	Petrol	1598	4	16	54
Corsa Classic Saloon	08/94→07/02	C 14 NZ	Petrol	1389	4	8	18
Corsa Classic Saloon	01/97→12/02	13 NB	Petrol	1297	4	8	14
Corsa Classic Saloon	01/00→12/03	C 16 SEL	Petrol	1598	4	16	47
Corsa Classic Saloon	07/00→05/01	Z 14 XE	Petrol	1389	4	16	22
Corsa Classic Saloon	07/00→12/03	Z 14 XEP	Petrol	1364	4	16	20
Corsa Classic Saloon	01/02→12/05	Z 18 XEL	Petrol	1796	4	16	86
Corsa D (S07)	07/06→	A 13 DTC	Diesel	1248	4	16	15
Corsa D (S07)	07/06→	Z 10 XEP	Petrol	998	3	12	3
Corsa D (S07)	07/06→	Z 12 XEP	Petrol	1229	4	16	10
Corsa D (S07)	07/06→	Z 13 DTH	Diesel	1248	4	16	15
Corsa D (S07)	07/06→	Z 13 DTJ	Diesel	1248	4	16	15
Corsa D (S07)	07/06→	Z 14 XEP	Petrol	1364	4	16	20
Corsa D (S07)	07/06→	Z 17 DTR	Diesel	1686	4	16	64
Corsa D (S07)	02/07→	A 16 LEL	Petrol	1598	4	16	41
Corsa D (S07)	02/07→	A 16 LER	Petrol	1598	4	16	41
Corsa D (S07)	02/07→	A 16 LET	Petrol	1598	4	16	41
Corsa D (S07)	02/07→	B 16 LER	Petrol	1598	4	16	41
Corsa D (S07)	02/07→	Z 16 LEL	Petrol	1598	4	16	41
Corsa D (S07)	02/07→	Z 16 LER	Petrol	1598	4	16	41
Corsa D (S07)	02/07→	Z 16 LET	Petrol	1598	4	16	41
Corsa D (S07)	09/09→	A 14 XEL	Petrol	1398	4	16	20
Corsa D (S07)	01/10→	A 10 XEP	Petrol	998	3	12	3
Corsa D (S07)	06/10→	A 12 XEL	Petrol	1229	4	16	10
Corsa D (S07)	06/10→	A 12 XER	Petrol	1229	4	16	10
Corsa D (S07)	06/10→	A 13 DTE	Diesel	1248	4	16	15
Corsa D (S07)	06/10→	A 13 DTR	Diesel	1248	4	16	15
Corsa D (S07)	06/10→	A 14 XER	Petrol	1398	4	16	20
Corsa D (S07)	06/10→	A 17 DTS	Diesel	1686	4	16	64
Corsa D (S07)	06/10→	Z 13 DTE	Diesel	1248	4	16	15
Corsa D (S07)	06/11→	A 16 LES	Petrol	1598	4	16	41
Corsa D (S07)	07/12→	A 14 NEL	Petrol	1364	4	16	20
Corsa D Van (S07)	07/06→	A 10 XEP	Petrol	998	3	12	3
Corsa D Van (S07)	07/06→	A 13 DTC	Diesel	1248	4	16	15
Corsa D Van (S07)	07/06→	Z 13 DTH	Diesel	1248	4	16	15



CC



9

Corsa D Van (S07)	07/06→	Z 13 DTJ	Diesel	1248	4	16	15
Corsa D Van (S07)	07/09→	Z 12 XEP	Petrol	1229	4	16	10
Corsa D Van (S07)	06/10→	A 12 XEL	Petrol	1229	4	16	10
Corsa D Van (S07)	06/10→	A 12 XER	Petrol	1229	4	16	10
Corsa D Van (S07)	06/10→	A 13 DTE	Diesel	1248	4	16	15
Corsa D Van (S07)	06/10→	A 13 DTR	Diesel	1248	4	16	15
Corsa D Van (S07)	06/10→	Z 13 DTE	Diesel	1248	4	16	15
Corsa E (X15)	09/14→	B 12 XEL	Petrol	1229	4	16	10
Corsa E (X15)	09/14→	B 12 XER	Petrol	1229	4	16	10
Corsa E (X15)	09/14→	B 13 DTC	Diesel	1248	4	16	15
Corsa E (X15)	09/14→	B 13 DTE	Diesel	1248	4	16	15
Corsa E (X15)	09/14→	B 13 DTR	Diesel	1248	4	16	15
Corsa E (X15)	09/14→	B 14 NEJ	Petrol	1364	4	16	20
Corsa E (X15)	09/14→	B 14 XEJ	Petrol	1398	4	16	20
Corsa E (X15)	09/14→	B 14 XEL	Petrol	1398	4	16	20
Corsa E (X15)	03/15→	B 14 MEH	Petrol	1364	4	16	20
Corsa E (X15)	03/15→	B 16 LER	Petrol	1598	4	16	41
Corsa E (X15)	03/15→	B 16 LES	Petrol	1598	4	16	41
Corsa E Van (X15)	09/14→	B 13 DTE	Diesel	1248	4	16	15
Corsa E Van (X15)	09/14→	B 13 DTR	Diesel	1248	4	16	15
Corsa E Van (X15)	09/14→	B 14 XEJ	Petrol	1398	4	16	20
Corsa E Van (X15)	09/14→	B 14 XEL	Petrol	1398	4	16	20
Corsa E Van (X15)	01/15→	B 12 XEL	Petrol	1229	4	16	10
Corsa E Van (X15)	01/15→	B 13 DTC	Diesel	1248	4	16	15
Corsa Mk I (B) (S93)	12/92→12/96	15 D	Diesel	1488	4	8	24
Corsa Mk I (B) (S93)	03/93→10/96	15 DT (T4EC1)	Diesel	1488	4	8	24
Corsa Mk I (B) (S93)	03/93→10/96	X 15 DT (T4EC1)	Diesel	1488	4	8	24
Corsa Mk I (B) (S93)	03/93→09/00	C 12 NZ	Petrol	1196	4	8	9
Corsa Mk I (B) (S93)	03/93→09/00	C 14 NZ	Petrol	1389	4	8	18
Corsa Mk I (B) (S93)	03/93→09/00	C 14 SE	Petrol	1389	4	8	18
Corsa Mk I (B) (S93)	03/93→09/00	C 16 XE	Petrol	1598	4	16	47
Corsa Mk I (B) (S93)	03/93→09/00	X 12 SZ	Petrol	1195	4	8	9
Corsa Mk I (B) (S93)	03/93→09/00	X 14 SZ	Petrol	1389	4	8	18
Corsa Mk I (B) (S93)	09/94→09/00	X 14 XE	Petrol	1389	4	16	22
Corsa Mk I (B) (S93)	09/94→09/00	X 16 XE	Petrol	1598	4	16	47
Corsa Mk I (B) (S93)	02/96→09/00	17 D (4EE1)	Diesel	1686	4	8	60
Corsa Mk I (B) (S93)	02/96→09/00	X 17 D (4EE1)	Diesel	1686	4	8	67
Corsa Mk I (B) (S93)	11/96→09/00	X 10 XE	Petrol	973	3	12	3
Corsa Mk I (B) (S93)	08/97→09/00	C 14 SEL	Petrol	1389	4	16	21
Corsa Mk I (B) (S93)	08/97→09/00	C 16 SEL	Petrol	1598	4	16	47
Corsa Mk I (B) (S93)	03/98→09/00	X 12 XE	Petrol	1199	4	16	10
Corsa Mk II (C) (X01)	08/00→10/04	Z 16 SE	Petrol	1598	4	8	55
Corsa Mk II (C) (X01)	08/00→09/06	Y 17 DT	Diesel	1686	4	16	64
Corsa Mk II (C) (X01)	08/00→09/06	Y 17 DTL	Diesel	1686	4	16	64
Corsa Mk II (C) (X01)	08/00→09/06	Z 13 DT	Diesel	1248	4	16	15
Corsa Mk II (C) (X01)	08/00→09/06	Z 17 DTH	Diesel	1686	4	16	64
Corsa Mk II (C) (X01)	08/00→09/06	Z 18 XE	Petrol	1796	4	16	89
Corsa Mk II (C) (X01)	09/00→10/03	Z 10 XE	Petrol	973	3	12	3
Corsa Mk II (C) (X01)	09/00→10/06	Z 12 XE	Petrol	1199	4	16	10
Corsa Mk II (C) (X01)	09/00→10/06	Z 14 XE	Petrol	1389	4	16	22
Corsa Mk II (C) (X01)	06/03→10/06	Z 14 XEP	Petrol	1364	4	16	20
Corsa Mk II (C) (X01)	11/03→10/06	Z 10 XEP	Petrol	998	3	12	3
Corsa Mk II (C) (X01)	07/04→10/06	Z 12 XEP	Petrol	1229	4	16	10
Corsa Mk II (C) (X01)	09/05→09/06	Z 13 DTJ	Diesel	1248	4	16	15
Corsa Mk III (D) (S07)	07/06→08/14	A 13 DTC	Diesel	1248	4	16	15
Corsa Mk III (D) (S07)	07/06→08/14	Z 13 DTH	Diesel	1248	4	16	15
Corsa Mk III (D) (S07)	07/06→08/14	Z 13 DTJ	Diesel	1248	4	16	15
Corsa Mk III (D) (S07)	07/06→08/14	Z 14 XEP	Petrol	1364	4	16	20
Corsa Mk III (D) (S07)	11/06→08/14	A 10 XEP	Petrol	998	3	12	3
Corsa Mk III (D) (S07)	11/06→08/14	A 12 XER	Petrol	1229	4	16	10
Corsa Mk III (D) (S07)	11/06→08/14	A 17 DTS	Diesel	1686	4	16	64
Corsa Mk III (D) (S07)	11/06→08/14	Z 10 XEP	Petrol	998	3	12	3
Corsa Mk III (D) (S07)	11/06→08/14	Z 12 XEP	Petrol	1229	4	16	10
Corsa Mk III (D) (S07)	11/06→08/14	Z 17 DTR	Diesel	1686	4	16	64
Corsa Mk III (D) (S07)	02/07→08/14	A 16 LER	Petrol	1598	4	16	41
Corsa Mk III (D) (S07)	02/07→08/14	B 16 LER	Petrol	1598	4	16	43
Corsa Mk III (D) (S07)	02/07→08/14	Z 16 LER	Petrol	1598	4	16	41
Corsa Mk III (D) (S07)	05/07→08/14	A 16 LEL	Petrol	1598	4	16	41
Corsa Mk III (D) (S07)	09/09→08/14	A 14 XEL	Petrol	1398	4	16	20
Corsa Mk III (D) (S07)	06/10→08/14	A 12 XEL	Petrol	1229	4	16	10
Corsa Mk III (D) (S07)	06/10→08/14	A 13 DTE	Diesel	1248	4	16	15
Corsa Mk III (D) (S07)	06/10→08/14	A 13 DTR	Diesel	1248	4	16	15
Corsa Mk III (D) (S07)	06/10→08/14	Z 13 DTE	Diesel	1248	4	16	15
Corsa Mk III (D) (S07)	07/10→08/14	A 14 XER	Petrol	1398	4	16	20
Corsa Mk III (D) (S07)	06/11→08/14	A 16 LES	Petrol	1598	4	16	41
Corsa Mk III (D) (S07)	07/12→08/14	A 14 NEL	Petrol	1364	4	16	20
Corsa Mk IV (E) (X15)	08/14→	B 12 XEL	Petrol	1229	4	16	10
Corsa Mk IV (E) (X15)	08/14→	B 12 XER	Petrol	1229	4	16	10



Corsa Mk IV (E) (X15)	08/14→	B 13 DTC	Diesel	1248	4	16	15
Corsa Mk IV (E) (X15)	08/14→	B 13 DTE	Diesel	1248	4	16	15
Corsa Mk IV (E) (X15)	08/14→	B 13 DTR	Diesel	1248	4	16	15
Corsa Mk IV (E) (X15)	08/14→	B 14 NEJ	Petrol	1364	4	16	20
Corsa Mk IV (E) (X15)	08/14→	B 14 NEL	Petrol	1364	4	16	20
Corsa Mk IV (E) (X15)	08/14→	B 14 XEJ	Petrol	1398	4	16	20
Corsa Mk IV (E) (X15)	08/14→	B 14 XEL	Petrol	1398	4	16	20
Corsa Mk IV (E) (X15)	08/14→	B 14 XER	Petrol	1398	4	16	20
Corsa Mk IV (E) (X15)	04/15→	B 16 LER	Petrol	1598	4	16	43
Corsa Mk IV (E) (X15)	04/15→	B 16 LES	Petrol	1598	4	16	43
Corsa Mk IV (E) (X15)	07/15→	B 14 NEH	Petrol	1364	4	16	20
Corsa Mk IV (E) (X15)	07/15→	B 14 NET	Petrol	1364	4	16	20
Corsa Utility Pickup	01/96→12/02	13 NB	Petrol	1297	4	8	14
Corsa Utility Pickup	07/00→12/10	Z 14 XE	Petrol	1389	4	16	22
Corsa Utility Pickup	08/01→12/10	Y 17 DT	Diesel	1686	4	16	64
Corsa Utility Pickup	11/01→06/04	Y 17 DTL	Diesel	1686	4	16	64
Corsa Utility Pickup	01/03→12/06	X 17 D (4EE1)	Diesel	1686	4	8	67
Corsa Utility Pickup	01/03→12/10	Z 18 XEL	Petrol	1796	4	16	86
Corsavan Mk I (B) (S93)	01/94→09/00	17 D (4EE1)	Diesel	1686	4	8	60
Corsavan Mk I (B) (S93)	01/94→09/00	C 14 NZ	Petrol	1389	4	8	18
Corsavan Mk I (B) (S93)	01/94→09/00	X 17 D (4EE1)	Diesel	1686	4	8	67
Corsavan Mk I (B) (S93)	08/94→12/95	15 D	Diesel	1488	4	8	24
Corsavan Mk II (C) (X01)	09/00→06/06	Y 17 DT	Diesel	1686	4	16	64
Corsavan Mk II (C) (X01)	09/00→06/06	Y 17 DTL	Diesel	1686	4	16	64
Corsavan Mk II (C) (X01)	09/00→06/06	Z 12 XE	Petrol	1199	4	16	10
Corsavan Mk II (C) (X01)	11/03→06/06	Z 14 XEP	Petrol	1364	4	16	20
Corsavan Mk II (C) (X01)	04/04→06/06	Z 13 DT	Diesel	1248	4	16	15
Corsavan Mk III (D) (S07)	07/06→	A 13 DTC	Diesel	1248	4	16	15
Corsavan Mk III (D) (S07)	07/06→	A 13 DTE	Diesel	1248	4	16	15
Corsavan Mk III (D) (S07)	07/06→	A 13 DTR	Diesel	1248	4	16	15
Corsavan Mk III (D) (S07)	07/06→	B 13 DTR	Diesel	1248	4	16	15
Corsavan Mk III (D) (S07)	07/06→	Z 13 DTE	Diesel	1248	4	16	15
Corsavan Mk III (D) (S07)	07/06→	Z 13 DTH	Diesel	1248	4	16	15
Corsavan Mk III (D) (S07)	07/06→	Z 13 DTJ	Diesel	1248	4	16	15
Corsavan Mk III (D) (S07)	07/09→	Z 12 XEP	Petrol	1229	4	16	10
Corsavan Mk III (D) (S07)	01/10→	A 12 XEL	Petrol	1229	4	16	10
Corsavan Mk IV (E) (X15)	10/14→	B 12 XEL	Petrol	1229	4	16	10
Corsavan Mk IV (E) (X15)	10/14→	B 13 DTC	Diesel	1248	4	16	15
Corsavan Mk IV (E) (X15)	10/14→	B 13 DTE	Diesel	1248	4	16	15
Corsavan Mk IV (E) (X15)	10/14→	B 13 DTR	Diesel	1248	4	16	15
Corsavan Mk IV (E) (X15)	10/14→	B 14 XEJ	Petrol	1398	4	16	20
Cruze Hatchback (JH)	11/11→12/16	A 14 NET	Petrol	1364	4	16	20
Cruze Saloon (JH)	04/11→12/16	A 14 NET	Petrol	1364	4	16	20
Diplomat B	03/69→08/78	28 E	Petrol	2784	6	12	157
Diplomat B	09/72→08/78	28 HC	Petrol	2784	6	12	159
Drover (QB)	03/85→12/87	G13A	Petrol	1324	4	8	16
Drover Pickup (QB)	03/85→12/87	G13A	Petrol	1324	4	8	16
Elan	09/89→11/95	4XE1	Petrol	1588	4	16	29
Elan	09/89→11/95	4XE1-T	Petrol	1588	4	16	30
Elise	11/98→01/01	18 K4G	Petrol	1796	4	16	74
Elise	05/02→	2ZZ-GE	Petrol	1796	4	16	71
Elise	10/03→	1ZZ-FE	Petrol	1796	4	16	69
Elise	06/07→	1ZR-FAE	Petrol	1598	4	16	27
Elise	06/07→	2ZR-FE	Petrol	1798	4	16	70
Europa S	07/06→	Z 20 LER	Petrol	1998	4	16	113
Evora	05/09→	2GR-FE	Petrol	3456	6	24	173
Exige	06/12→	2GR-FE	Petrol	3456	6	24	173
Exige (SCC_)	05/00→06/12	2ZZ-GE	Petrol	1796	4	16	71
Frontera (UES)	10/95→03/99	X 20 SE	Petrol	1998	4	8	107
Frontera (UES)	08/98→04/04	6VD1	Petrol	3165	6	24	170
Frontera (UES)	02/99→07/02	X 22 SE	Petrol	2198	4	16	129
Frontera A (U92)	03/92→10/98	23 DTR	Diesel	2260	4	8	136
Frontera A (U92)	03/92→10/98	C 24 NE	Petrol	2410	4	8	140
Frontera A (U92)	03/95→10/98	28 TDI (4JB1-T)	Diesel	2771	4	8	156
Frontera A (U92)	03/95→10/98	X 22 XE	Petrol	2198	4	16	129
Frontera A Sport (U92)	03/92→10/98	C 20 NE	Petrol	1998	4	8	106
Frontera A Sport (U92)	03/92→10/98	X 20 SE	Petrol	1998	4	8	106
Frontera A Sport (U92)	03/95→08/96	28 TDI (4JB1-T)	Diesel	2771	4	8	156
Frontera B (U99)	10/98→09/02	X 22 DTH	Diesel	2171	4	16	133
Frontera B (U99)	10/98→	6 VD1	Petrol	3165	6	24	170
Frontera B (U99)	10/98→	X 22 SE	Petrol	2198	4	16	129
Frontera B (U99)	10/98→	Y 22 DTH	Diesel	2172	4	16	133
Frontera B (U99)	10/98→	Y 22 SE	Petrol	2198	4	16	129
Frontera B (U99)	10/98→	Y 32 NE	Petrol	3165	6	24	170
Frontera Mk I (A) (U92)	09/91→06/98	23 DTR	Diesel	2260	4	8	136
Frontera Mk I (A) (U92)	03/92→10/98	C 24 NE	Petrol	2410	4	8	140
Frontera Mk I (A) (U92)	01/95→12/96	28 TDI (4JB1-T)	Diesel	2771	4	8	156
Frontera Mk I (A) (U92)	03/95→10/98	X 22 XE	Petrol	2198	4	16	129



CC



9

Frontera Mk I (A) (U92)	04/95→08/98	C 20 NE	Petrol	1998	4	8	106
Frontera Mk I (A) (U92)	04/95→08/98	X 20 SE	Petrol	1998	4	8	106
Frontera Mk I (A) Sport (U92)	03/92→10/98	C 20 NE	Petrol	1998	4	8	106
Frontera Mk I (A) Sport (U92)	03/92→10/98	X 20 SE	Petrol	1998	4	8	106
Frontera Mk I (A) Sport (U92)	01/95→12/96	28 TDI (4JB1-T)	Diesel	2771	4	8	156
Frontera Mk II (B) (U99)	10/98→09/04	X 22 DTH	Diesel	2171	4	16	133
Frontera Mk II (B) (U99)	10/98→09/04	Y 22 DTH	Diesel	2171	4	16	133
Frontera Mk II (B) (U99)	10/98→10/04	6 VDI	Petrol	3165	6	24	170
Frontera Mk II (B) (U99)	10/98→10/04	X 22 SE	Petrol	2198	4	16	129
Frontera Mk II (B) (U99)	10/98→10/04	Y 22 SE	Petrol	2198	4	16	129
Frontera Mk II (B) (U99)	10/98→10/04	Y 32 NE	Petrol	3165	6	24	170
Gemini Saloon (RB)	05/85→05/86	4XC1	Petrol	1471	4	8	23
GT	09/68→12/70	11 SR	Petrol	1078	4	8	7
GT	09/68→08/73	19 S	Petrol	1897	4	8	94
GT Convertible (M07)	06/07→	LNF	Petrol	1998	4	16	115
GT Convertible (M07)	06/07→	Z 20 NHH	Petrol	1998	4	16	115
Insignia A (G09)	07/08→	A 16 LET	Petrol	1598	4	16	41
Insignia A (G09)	07/08→	A 16 XER	Petrol	1598	4	16	41
Insignia A (G09)	07/08→	A 18 XER	Petrol	1796	4	16	79
Insignia A (G09)	07/08→	A 20 DT	Diesel	1956	4	16	110
Insignia A (G09)	07/08→	A 20 DTC	Diesel	1956	4	16	110
Insignia A (G09)	07/08→	A 20 DTH	Diesel	1956	4	16	110
Insignia A (G09)	07/08→	A 20 DTJ	Diesel	1956	4	16	110
Insignia A (G09)	07/08→	A 20 DTL	Diesel	1956	4	16	110
Insignia A (G09)	07/08→	A 20 DTR	Diesel	1956	4	16	110
Insignia A (G09)	07/08→	A 20 NHT	Petrol	1998	4	16	111
Insignia A (G09)	04/11→	A 14 NET	Petrol	1364	4	16	20
Insignia A (G09)	04/11→	B 14 NET	Petrol	1364	4	16	20
Insignia A (G09)	09/11→	A 20 NFT	Petrol	1998	4	16	111
Insignia A (G09)	03/12→	A 20 DTE	Diesel	1956	4	16	110
Insignia A Country Tourer (G09)	07/08→03/17	A 20 DT	Diesel	1956	4	16	110
Insignia A Country Tourer (G09)	07/08→03/17	A 20 DTJ	Diesel	1956	4	16	110
Insignia A Country Tourer (G09)	03/12→03/17	A 20 DTE	Diesel	1956	4	16	110
Insignia A Country Tourer (G09)	09/13→03/17	A 20 DTH	Diesel	1956	4	16	110
Insignia A Country Tourer (G09)	09/13→03/17	A 20 DTR	Diesel	1956	4	16	110
Insignia A Country Tourer (G09)	09/13→03/17	A 20 NHT	Petrol	1998	4	16	111
Insignia A Saloon (G09)	07/08→	A 16 XER	Petrol	1598	4	16	41
Insignia A Saloon (G09)	07/08→	A 18 XER	Petrol	1796	4	16	79
Insignia A Saloon (G09)	07/08→	A 20 DT	Diesel	1956	4	16	110
Insignia A Saloon (G09)	07/08→	A 20 DTC	Diesel	1956	4	16	110
Insignia A Saloon (G09)	07/08→	A 20 DTH	Diesel	1956	4	16	110
Insignia A Saloon (G09)	07/08→	A 20 DTJ	Diesel	1956	4	16	110
Insignia A Saloon (G09)	07/08→	A 20 DTL	Diesel	1956	4	16	110
Insignia A Saloon (G09)	07/08→	A 20 DTR	Diesel	1956	4	16	110
Insignia A Saloon (G09)	07/08→	A 20 NFT	Petrol	1998	4	16	111
Insignia A Saloon (G09)	07/08→	A 20 NHT	Petrol	1998	4	16	111
Insignia A Saloon (G09)	01/09→	A 16 LET	Petrol	1598	4	16	41
Insignia A Saloon (G09)	04/11→	A 14 NET	Petrol	1364	4	16	20
Insignia A Saloon (G09)	04/11→	B 14 NET	Petrol	1364	4	16	20
Insignia A Saloon (G09)	03/12→	A 20 DTE	Diesel	1956	4	16	110
Insignia A Sports Tourer (G09)	07/08→06/12	A 16 XER	Petrol	1598	4	16	41
Insignia A Sports Tourer (G09)	07/08→06/13	A 18 XER	Petrol	1796	4	16	79
Insignia A Sports Tourer (G09)	07/08→	A 20 DT	Diesel	1956	4	16	110
Insignia A Sports Tourer (G09)	07/08→	A 20 DTC	Diesel	1956	4	16	110
Insignia A Sports Tourer (G09)	07/08→	A 20 DTH	Diesel	1956	4	16	110
Insignia A Sports Tourer (G09)	07/08→	A 20 DTJ	Diesel	1956	4	16	110
Insignia A Sports Tourer (G09)	07/08→	A 20 DTL	Diesel	1956	4	16	110
Insignia A Sports Tourer (G09)	07/08→	A 20 DTR	Diesel	1956	4	16	110
Insignia A Sports Tourer (G09)	07/08→	A 20 NHT	Petrol	1998	4	16	111
Insignia A Sports Tourer (G09)	01/09→06/13	A 16 LET	Petrol	1598	4	16	41
Insignia A Sports Tourer (G09)	09/10→	A 20 NFT	Petrol	1998	4	16	111
Insignia A Sports Tourer (G09)	09/11→06/13	A 14 NET	Petrol	1364	4	16	20
Insignia A Sports Tourer (G09)	03/12→	A 20 DTE	Diesel	1956	4	16	110
Insignia B Grand Sport (Z18)	03/17→	B 20 NFT	Petrol	1998	4	16	111
Insignia B Sports Tourer (Z18)	03/17→	B 20 NFT	Petrol	1998	4	16	111
Insignia Mk I (A) (G09)	07/08→12/14	A 20 DT	Diesel	1956	4	16	110
Insignia Mk I (A) (G09)	07/08→12/14	A 20 DTJ	Diesel	1956	4	16	110
Insignia Mk I (A) (G09)	07/08→05/17	A 18 XER	Petrol	1796	4	16	79
Insignia Mk I (A) (G09)	07/08→05/17	A 20 DTC	Diesel	1956	4	16	110
Insignia Mk I (A) (G09)	07/08→05/17	A 20 DTH	Diesel	1956	4	16	110
Insignia Mk I (A) (G09)	07/08→05/17	A 20 DTL	Diesel	1956	4	16	110
Insignia Mk I (A) (G09)	07/08→05/17	A 20 NFT	Petrol	1998	4	16	111
Insignia Mk I (A) (G09)	07/08→05/17	A 20 NHT	Petrol	1998	4	16	111
Insignia Mk I (A) (G09)	07/08→05/17	B 18 XER	Petrol	1796	4	16	79
Insignia Mk I (A) (G09)	10/08→05/17	A 20 DTR	Diesel	1956	4	16	110
Insignia Mk I (A) (G09)	01/09→05/17	A 16 LET	Petrol	1598	4	16	41
Insignia Mk I (A) (G09)	04/11→05/17	A 14 NET	Petrol	1364	4	16	20
Insignia Mk I (A) (G09)	04/11→05/17	B 14 NET	Petrol	1364	4	16	20



Insignia Mk I (A) (G09)	09/11→05/17	B 20 NHT	Petrol	1998	4	16	111
Insignia Mk I (A) (G09)	03/12→05/17	A 20 DTE	Diesel	1956	4	16	110
Insignia Mk I (A) Country Tourer (G09)	07/08→12/14	A 20 DT	Diesel	1956	4	16	110
Insignia Mk I (A) Country Tourer (G09)	07/08→12/14	A 20 DTJ	Diesel	1956	4	16	110
Insignia Mk I (A) Country Tourer (G09)	09/11→05/17	A 20 NFT	Petrol	1998	4	16	111
Insignia Mk I (A) Country Tourer (G09)	09/11→05/17	A 20 NHT	Petrol	1998	4	16	111
Insignia Mk I (A) Country Tourer (G09)	09/11→05/17	B 20 NHT	Petrol	1998	4	16	111
Insignia Mk I (A) Country Tourer (G09)	03/12→03/16	A 20 DTE	Diesel	1956	4	16	110
Insignia Mk I (A) Country Tourer (G09)	03/12→05/17	A 20 DTR	Diesel	1956	4	16	110
Insignia Mk I (A) Country Tourer (G09)	07/13→05/17	A 20 DTH	Diesel	1956	4	16	110
Insignia Mk I (A) Estate (G09)	07/08→12/14	A 20 DT	Diesel	1956	4	16	110
Insignia Mk I (A) Estate (G09)	07/08→12/14	A 20 DTJ	Diesel	1956	4	16	110
Insignia Mk I (A) Estate (G09)	07/08→05/17	A 18 XER	Petrol	1796	4	16	79
Insignia Mk I (A) Estate (G09)	07/08→05/17	A 20 DTC	Diesel	1956	4	16	110
Insignia Mk I (A) Estate (G09)	07/08→05/17	A 20 DTH	Diesel	1956	4	16	110
Insignia Mk I (A) Estate (G09)	07/08→05/17	A 20 DTL	Diesel	1956	4	16	110
Insignia Mk I (A) Estate (G09)	07/08→05/17	A 20 NFT	Petrol	1998	4	16	111
Insignia Mk I (A) Estate (G09)	07/08→05/17	A 20 NHT	Petrol	1998	4	16	111
Insignia Mk I (A) Estate (G09)	07/08→05/17	B 18 XER	Petrol	1796	4	16	79
Insignia Mk I (A) Estate (G09)	11/08→05/17	A 20 DTR	Diesel	1956	4	16	110
Insignia Mk I (A) Estate (G09)	01/09→05/17	A 16 LET	Petrol	1598	4	16	41
Insignia Mk I (A) Estate (G09)	04/11→05/17	A 14 NET	Petrol	1364	4	16	20
Insignia Mk I (A) Estate (G09)	04/11→05/17	B 14 NET	Petrol	1364	4	16	20
Insignia Mk I (A) Estate (G09)	09/11→05/17	B 20 NHT	Petrol	1998	4	16	111
Insignia Mk I (A) Estate (G09)	03/12→05/17	A 20 DTE	Diesel	1956	4	16	110
Insignia Mk I (A) Saloon (G09)	07/08→12/14	A 20 DT	Diesel	1956	4	16	110
Insignia Mk I (A) Saloon (G09)	07/08→12/14	A 20 DTJ	Diesel	1956	4	16	110
Insignia Mk I (A) Saloon (G09)	07/08→05/17	A 18 XER	Petrol	1796	4	16	79
Insignia Mk I (A) Saloon (G09)	07/08→05/17	A 20 DTC	Diesel	1956	4	16	110
Insignia Mk I (A) Saloon (G09)	07/08→05/17	A 20 DTH	Diesel	1956	4	16	110
Insignia Mk I (A) Saloon (G09)	07/08→05/17	A 20 DTL	Diesel	1956	4	16	110
Insignia Mk I (A) Saloon (G09)	07/08→05/17	A 20 NFT	Petrol	1998	4	16	111
Insignia Mk I (A) Saloon (G09)	07/08→05/17	A 20 NHT	Petrol	1998	4	16	111
Insignia Mk I (A) Saloon (G09)	07/08→05/17	B 18 XER	Petrol	1796	4	16	79
Insignia Mk I (A) Saloon (G09)	11/08→05/17	A 20 DTR	Diesel	1956	4	16	110
Insignia Mk I (A) Saloon (G09)	01/09→05/17	A 16 LET	Petrol	1598	4	16	41
Insignia Mk I (A) Saloon (G09)	04/11→05/17	A 14 NET	Petrol	1364	4	16	20
Insignia Mk I (A) Saloon (G09)	09/11→05/17	B 20 NHT	Petrol	1998	4	16	111
Insignia Mk I (A) Saloon (G09)	03/12→05/17	A 20 DTE	Diesel	1956	4	16	110
Insignia Mk II (B) (Z18)	03/17→	B 20 NFT	Petrol	1998	4	16	111
Insignia Mk II (B) Estate (Z18)	03/17→	B 20 NFT	Petrol	1998	4	16	111
Jackaroo (UBS)	10/87→09/91	4J81-T	Diesel	2771	4	8	156
Jackaroo / Monterey (UBS)	04/92→02/98	4JG2-TC	Diesel	3059	4	8	169
Jackaroo / Monterey (UBS)	04/92→02/98	6VD1	Petrol	3165	6	24	170
Jackaroo / Monterey (UBS)	03/98→09/04	6VE1	Petrol	3494	6	24	174
Kadett A	09/62→08/65	10 N	Petrol	993	4	8	2
Kadett A	09/62→08/65	10 S	Petrol	993	4	8	2
Kadett A Coupe	10/63→08/65	10 S	Petrol	993	4	8	2
Kadett A Estate	03/63→08/65	10 N	Petrol	993	4	8	2
Kadett A Estate	03/63→08/65	10 S	Petrol	993	4	8	2
Kadett B	09/65→07/71	11 S	Petrol	1078	4	8	7
Kadett B	09/65→08/73	11 N	Petrol	1078	4	8	7
Kadett B	11/66→07/71	11 SR	Petrol	1078	4	8	7
Kadett B	08/67→08/71	17 S	Petrol	1698	4	8	63
Kadett B	08/71→08/73	12 S	Petrol	1196	4	8	8
Kadett B Coupe	09/65→07/71	11 S	Petrol	1078	4	8	7
Kadett B Coupe	09/65→08/73	11 N	Petrol	1078	4	8	7
Kadett B Coupe	11/66→07/71	11 SR	Petrol	1078	4	8	7
Kadett B Coupe	08/67→08/73	19 S	Petrol	1897	4	8	94
Kadett B Coupe	08/71→08/73	12 S	Petrol	1196	4	8	8
Kadett B Estate	09/65→07/71	11 S	Petrol	1078	4	8	7
Kadett B Estate	09/65→08/73	11 N	Petrol	1078	4	8	7
Kadett B Estate	08/71→08/73	12 S	Petrol	1196	4	8	8
Kadett C	08/73→07/79	12 N	Petrol	1196	4	8	8
Kadett C	08/73→07/79	12 S	Petrol	1196	4	8	8
Kadett C	01/74→07/79	10 N	Petrol	993	4	8	2
Kadett C	05/77→07/79	16 S	Petrol	1584	4	8	37
Kadett C Aero	09/76→08/79	12 S	Petrol	1196	4	8	8
Kadett C City	08/73→07/79	12 S	Petrol	1196	4	8	8
Kadett C City	05/75→07/79	10 N	Petrol	993	4	8	2
Kadett C City	05/75→07/79	12 N	Petrol	1196	4	8	8
Kadett C City	05/77→07/79	16 S	Petrol	1584	4	8	37
Kadett C Coupe	08/73→07/79	12 N	Petrol	1196	4	8	8
Kadett C Coupe	08/73→07/79	12 S	Petrol	1196	4	8	8
Kadett C Coupe	01/74→07/79	10 N	Petrol	993	4	8	2
Kadett C Coupe	09/75→07/77	19 E	Petrol	1897	4	8	92
Kadett C Coupe	05/77→07/79	16 S	Petrol	1584	4	8	37
Kadett C Coupe	08/77→07/79	20 E	Petrol	1979	4	8	104









CC



9

Kadett C Coupe	08/77→07/79	20 EH	Petrol	1979	4	8	105
Kadett C Estate	08/73→07/79	12 N	Petrol	1196	4	8	8
Kadett C Estate	08/73→07/79	12 S	Petrol	1196	4	8	8
Kadett C Estate	01/74→07/79	10 N	Petrol	993	4	8	2
Kadett C Estate	05/77→07/79	16 S	Petrol	1584	4	8	37
Kadett D (31_-34_, 41_-44_)	08/79→07/82	12 N	Petrol	1196	4	8	8
Kadett D (31_-34_, 41_-44_)	08/79→08/84	10 S	Petrol	993	4	8	2
Kadett D (31_-34_, 41_-44_)	08/79→08/84	12 S	Petrol	1196	4	8	8
Kadett D (31_-34_, 41_-44_)	08/79→08/84	13 N	Petrol	1297	4	8	14
Kadett D (31_-34_, 41_-44_)	08/79→08/84	13 S	Petrol	1297	4	8	14
Kadett D (31_-34_, 41_-44_)	09/79→08/82	10 N	Petrol	993	4	8	2
Kadett D (31_-34_, 41_-44_)	09/81→08/84	16 SH	Petrol	1598	4	8	39
Kadett D (31_-34_, 41_-44_)	03/82→08/84	16 D	Diesel	1598	4	8	31
Kadett D (31_-34_, 41_-44_)	08/82→08/84	12 ST	Petrol	1196	4	8	9
Kadett D (31_-34_, 41_-44_)	02/83→08/84	18 E	Petrol	1796	4	8	73
Kadett D (32_,37_,39_, 42)	08/79→08/84	12 S	Petrol	1196	4	8	8
Kadett D (32_,37_,39_, 42)	08/79→08/84	13 S	Petrol	1297	4	8	14
Kadett D (32_,37_,39_, 42)	08/79→08/84	C 13 N	Petrol	1297	4	8	14
Kadett D (32_,37_,39_, 42)	09/79→08/82	10 N	Petrol	993	4	8	2
Kadett D (32_,37_,39_, 42)	09/79→08/84	10 S	Petrol	993	4	8	2
Kadett D (32_,37_,39_, 42)	03/82→08/84	16 D	Diesel	1598	4	8	31
Kadett D Estate (35_, 36_, 45_, 46_)	08/79→07/82	12 N	Petrol	1196	4	8	8
Kadett D Estate (35_, 36_, 45_, 46_)	08/79→08/84	12 S	Petrol	1196	4	8	8
Kadett D Estate (35_, 36_, 45_, 46_)	08/79→08/84	13 N	Petrol	1297	4	8	14
Kadett D Estate (35_, 36_, 45_, 46_)	08/79→08/84	13 S	Petrol	1297	4	8	14
Kadett D Estate (35_, 36_, 45_, 46_)	09/81→08/84	16 SH	Petrol	1598	4	8	39
Kadett D Estate (35_, 36_, 45_, 46_)	03/82→08/84	16 D	Diesel	1598	4	8	31
Kadett E (T85)	09/84→07/86	12 SC	Petrol	1196	4	8	8
Kadett E (T85)	09/84→08/86	16 SH	Petrol	1598	4	8	39
Kadett E (T85)	09/84→08/87	13 S	Petrol	1297	4	8	14
Kadett E (T85)	09/84→01/89	16 D	Diesel	1598	4	8	31
Kadett E (T85)	09/84→01/89	16 DA	Diesel	1598	4	8	31
Kadett E (T85)	09/84→08/89	13 N	Petrol	1297	4	8	14
Kadett E (T85)	09/84→08/89	13 NB	Petrol	1297	4	8	14
Kadett E (T85)	09/84→08/90	18 E	Petrol	1796	4	8	73
Kadett E (T85)	09/84→08/90	18 SE	Petrol	1796	4	8	78
Kadett E (T85)	09/85→08/91	C 13 N	Petrol	1297	4	8	14
Kadett E (T85)	10/85→08/86	C 18 NE	Petrol	1796	4	8	80
Kadett E (T85)	01/86→12/93	20 NE	Petrol	1998	4	8	106
Kadett E (T85)	09/86→08/91	16 SV	Petrol	1598	4	8	36
Kadett E (T85)	09/86→08/91	C 16 LZ	Petrol	1598	4	8	36
Kadett E (T85)	09/86→08/91	C 16 NZ	Petrol	1598	4	8	36
Kadett E (T85)	09/86→08/91	E 16 NZ	Petrol	1598	4	8	36
Kadett E (T85)	03/87→08/91	20 SE	Petrol	1998	4	8	106
Kadett E (T85)	03/87→08/91	C 20 NE	Petrol	1998	4	8	106
Kadett E (T85)	09/87→08/91	E 16 SE	Petrol	1598	4	8	36
Kadett E (T85)	09/87→08/91	E 18 NV	Petrol	1796	4	8	77
Kadett E (T85)	07/88→08/91	15 DT (T4EC1)	Diesel	1488	4	8	24
Kadett E (T85)	02/89→08/91	17 D	Diesel	1700	4	8	59
Kadett E (T85)	01/90→08/91	14 NV	Petrol	1389	4	8	18
Kadett E (T85)	01/90→08/91	C 14 NZ	Petrol	1389	4	8	18
Kadett E (T85)	09/90→08/91	18 SV	Petrol	1796	4	8	77
Kadett E (T85)	09/90→08/91	C 18 NT	Petrol	1796	4	8	77
Kadett E (T85)	09/90→08/91	C 18 NZ	Petrol	1796	4	8	81
Kadett E Box (T85)	08/84→08/88	16 D	Diesel	1598	4	8	31
Kadett E Box (T85)	08/84→08/88	16 DA	Diesel	1598	4	8	31
Kadett E Box (T85)	08/84→09/92	C 18 NT	Petrol	1796	4	8	77
Kadett E Box (T85)	09/84→07/86	12 SC	Petrol	1196	4	8	8
Kadett E Box (T85)	09/84→07/89	13 N	Petrol	1297	4	8	14
Kadett E Box (T85)	09/84→07/89	13 NB	Petrol	1297	4	8	14
Kadett E Box (T85)	08/88→09/92	17 D	Diesel	1700	4	8	59
Kadett E Box (T85)	08/89→09/93	C 16 NZ	Petrol	1598	4	8	36
Kadett E Box (T85)	01/90→08/91	C 14 NZ	Petrol	1389	4	8	18
Kadett E Combo (T85)	01/86→12/89	13 N	Petrol	1297	4	8	14
Kadett E Combo (T85)	01/86→12/89	13 S	Petrol	1297	4	8	14
Kadett E Combo (T85)	01/86→12/89	16 DA	Diesel	1598	4	8	31
Kadett E Combo (T85)	09/86→12/91	16 SV	Petrol	1598	4	8	36
Kadett E Combo (T85)	09/86→06/93	16 SH	Petrol	1598	4	8	39
Kadett E Combo (T85)	01/89→07/94	17 D	Diesel	1700	4	8	59
Kadett E Combo (T85)	07/89→08/91	14 NV	Petrol	1389	4	8	18
Kadett E Combo (T85)	08/91→07/94	C 14 NZ	Petrol	1389	4	8	18
Kadett E Combo (T85)	08/91→07/94	C 16 NZ	Petrol	1598	4	8	36
Kadett E Combo (T85)	07/92→07/94	17 DR	Diesel	1700	4	8	59
Kadett E Convertible (T85)	10/86→02/93	20 NE	Petrol	1998	4	8	106
Kadett E Convertible (T85)	10/86→02/93	C 20 NE	Petrol	1998	4	8	106
Kadett E Convertible (T85)	10/86→02/93	E 16 NZ	Petrol	1598	4	8	36
Kadett E Convertible (T85)	03/87→02/93	13 S	Petrol	1297	4	8	14
Kadett E Convertible (T85)	10/87→02/93	C 16 LZ	Petrol	1598	4	8	36

				CC			9
Kadett E Convertible (T85)	10/87→02/93	C 16 NZ	Petrol	1598	4	8	36
Kadett E Convertible (T85)	07/89→02/93	16 SV	Petrol	1598	4	8	36
Kadett E Convertible (T85)	01/90→08/91	C 14 NZ	Petrol	1389	4	8	18
Kadett E Convertible (T85)	08/90→02/93	14 NV	Petrol	1389	4	8	18
Kadett E Convertible (T85)	09/90→05/92	20 SER	Petrol	1998	4	16	108
Kadett E Convertible (T85)	09/90→05/92	C 20 XE	Petrol	1998	4	16	112
Kadett E Estate (T85)	09/84→07/86	12 SC	Petrol	1196	4	8	8
Kadett E Estate (T85)	09/84→08/86	16 SH	Petrol	1598	4	8	39
Kadett E Estate (T85)	09/84→08/86	18 E	Petrol	1796	4	8	73
Kadett E Estate (T85)	09/84→12/87	13 S	Petrol	1297	4	8	14
Kadett E Estate (T85)	09/84→01/89	16 D	Diesel	1598	4	8	31
Kadett E Estate (T85)	09/84→01/89	16 DA	Diesel	1598	4	8	31
Kadett E Estate (T85)	09/84→08/91	13 N	Petrol	1297	4	8	14
Kadett E Estate (T85)	06/85→08/91	C 18 NT	Petrol	1796	4	8	77
Kadett E Estate (T85)	06/85→08/91	C 18 NZ	Petrol	1796	4	8	81
Kadett E Estate (T85)	09/85→08/91	C 13 N	Petrol	1297	4	8	14
Kadett E Estate (T85)	10/85→08/86	C 18 NE	Petrol	1796	4	8	80
Kadett E Estate (T85)	09/86→08/91	16 SV	Petrol	1598	4	8	36
Kadett E Estate (T85)	09/86→08/91	C 16 LZ	Petrol	1598	4	8	36
Kadett E Estate (T85)	09/86→08/91	C 16 NZ	Petrol	1598	4	8	36
Kadett E Estate (T85)	09/86→08/91	E 16 NZ	Petrol	1598	4	8	36
Kadett E Estate (T85)	09/87→08/91	20 NE	Petrol	1998	4	8	106
Kadett E Estate (T85)	09/87→08/91	C 20 NE	Petrol	1998	4	8	106
Kadett E Estate (T85)	09/87→08/91	E 18 NV	Petrol	1796	4	8	77
Kadett E Estate (T85)	07/88→08/91	15 DT (T4EC1)	Diesel	1488	4	8	24
Kadett E Estate (T85)	12/88→08/91	18 SE	Petrol	1796	4	8	78
Kadett E Estate (T85)	02/89→08/91	17 D	Diesel	1700	4	8	59
Kadett E Estate (T85)	01/90→08/91	14 NV	Petrol	1389	4	8	18
Kadett E Estate (T85)	01/90→08/91	C 14 NZ	Petrol	1389	4	8	18
Kadett E Hatchback (T85)	09/84→07/86	12 SC	Petrol	1196	4	8	8
Kadett E Hatchback (T85)	09/84→08/86	16 SH	Petrol	1598	4	8	39
Kadett E Hatchback (T85)	09/84→08/86	18 E	Petrol	1796	4	8	73
Kadett E Hatchback (T85)	09/84→12/87	13 S	Petrol	1297	4	8	14
Kadett E Hatchback (T85)	09/84→01/89	16 D	Diesel	1598	4	8	31
Kadett E Hatchback (T85)	09/84→01/89	16 DA	Diesel	1598	4	8	31
Kadett E Hatchback (T85)	09/84→08/91	13 N	Petrol	1297	4	8	14
Kadett E Hatchback (T85)	09/84→08/91	13 NB	Petrol	1297	4	8	14
Kadett E Hatchback (T85)	06/85→08/91	C 18 NT	Petrol	1796	4	8	77
Kadett E Hatchback (T85)	06/85→08/91	C 18 NZ	Petrol	1796	4	8	81
Kadett E Hatchback (T85)	06/85→08/91	S 18 NV	Petrol	1796	4	8	77
Kadett E Hatchback (T85)	09/85→08/91	C 13 N	Petrol	1297	4	8	14
Kadett E Hatchback (T85)	10/85→08/86	C 18 NE	Petrol	1796	4	8	80
Kadett E Hatchback (T85)	09/86→08/91	16 SV	Petrol	1598	4	8	36
Kadett E Hatchback (T85)	09/86→08/91	20 NE	Petrol	1998	4	8	106
Kadett E Hatchback (T85)	09/86→08/91	20 SEH	Petrol	1998	4	8	106
Kadett E Hatchback (T85)	09/86→08/91	C 16 LZ	Petrol	1598	4	8	36
Kadett E Hatchback (T85)	09/86→08/91	C 16 NZ	Petrol	1598	4	8	36
Kadett E Hatchback (T85)	09/86→08/91	C 20 NE	Petrol	1998	4	8	106
Kadett E Hatchback (T85)	09/86→08/91	E 16 NZ	Petrol	1598	4	8	36
Kadett E Hatchback (T85)	09/87→08/91	E 18 NV	Petrol	1796	4	8	77
Kadett E Hatchback (T85)	12/87→08/91	20 XE	Petrol	1998	4	16	109
Kadett E Hatchback (T85)	03/88→08/91	20 XEJ	Petrol	1998	4	16	109
Kadett E Hatchback (T85)	03/88→08/91	C 20 XE	Petrol	1998	4	16	112
Kadett E Hatchback (T85)	07/88→08/91	15 DT (T4EC1)	Diesel	1488	4	8	24
Kadett E Hatchback (T85)	02/89→08/91	17 D	Diesel	1700	4	8	59
Kadett E Hatchback (T85)	09/89→08/91	C 14 SE	Petrol	1389	4	8	18
Kadett E Hatchback (T85)	01/90→08/91	14 NV	Petrol	1389	4	8	18
Kadett E Hatchback (T85)	01/90→08/91	C 14 NZ	Petrol	1389	4	8	18
Kadett Hatchback	09/90→08/91	C 18 NZ	Petrol	1796	4	8	81
Kadett Hatchback	09/94→05/00	C 20 NE	Petrol	1998	4	8	106
Kadett Hatchback	03/95→05/00	X 16 SZR	Petrol	1598	4	8	36
Kapitän A	03/64→12/68	28 HL	Petrol	2784	6	12	159
Kapitän A	03/64→12/68	28 S	Petrol	2784	6	12	159
Malibu (V300)	05/13→	LE9	Petrol	2384	4	16	139
Manta A (58_ 59_)	09/70→08/75	16 N	Petrol	1584	4	8	34
Manta A (58_ 59_)	09/70→08/75	16 S	Petrol	1584	4	8	37
Manta A (58_ 59_)	09/70→08/75	19 S	Petrol	1897	4	8	94
Manta A (58_ 59_)	04/72→08/75	12 S	Petrol	1196	4	8	8
Manta A (58_ 59_)	02/74→08/75	19 E	Petrol	1897	4	8	92
Manta A (58_ 59_)	09/74→08/75	19 N	Petrol	1897	4	8	93
Manta B (58_ 59_)	09/75→08/77	19 E	Petrol	1897	4	8	92
Manta B (58_ 59_)	09/75→02/79	12 S	Petrol	1196	4	8	8
Manta B (58_ 59_)	09/75→12/80	16 N	Petrol	1584	4	8	34
Manta B (58_ 59_)	09/75→12/80	19 S	Petrol	1897	4	8	94
Manta B (58_ 59_)	09/75→12/81	16 S	Petrol	1584	4	8	37
Manta B (58_ 59_)	08/76→12/81	19 N	Petrol	1897	4	8	93
Manta B (58_ 59_)	08/76→07/83	12 N	Petrol	1196	4	8	8
Manta B (58_ 59_)	08/77→12/80	20 N	Petrol	1979	4	8	105









CC



9

Manta B (58, 59)	08/77→08/84	20 S	Petrol	1979	4	8	105
Manta B (58, 59)	08/77→08/88	20 E	Petrol	1979	4	8	104
Manta B (58, 59)	03/79→12/80	13 N	Petrol	1297	4	8	14
Manta B (58, 59)	08/81→08/86	13 S	Petrol	1297	4	8	14
Manta B (58, 59)	07/82→08/87	18 S	Petrol	1796	4	8	73
Manta B CC (53, 55)	09/75→12/80	16 N	Petrol	1584	4	8	34
Manta B CC (53, 55)	09/75→08/81	16 S	Petrol	1584	4	8	37
Manta B CC (53, 55)	08/76→12/81	19 N	Petrol	1897	4	8	93
Manta B CC (53, 55)	08/77→12/80	20 N	Petrol	1979	4	8	105
Manta B CC (53, 55)	08/77→08/84	20 S	Petrol	1979	4	8	105
Manta B CC (53, 55)	08/77→08/88	20 E	Petrol	1979	4	8	104
Manta B CC (53, 55)	03/79→12/80	13 N	Petrol	1297	4	8	14
Manta B CC (53, 55)	08/79→08/86	13 S	Petrol	1297	4	8	14
Manta B CC (53, 55)	08/81→07/88	20 ER	Petrol	1979	4	8	105
Manta B CC (53, 55)	07/82→08/87	18 S	Petrol	1796	4	8	73
Meriva	05/03→01/06	Z 16 XE	Petrol	1598	4	16	47
Meriva	05/03→05/10	Z 16 SE	Petrol	1598	4	8	55
Meriva	05/03→05/10	Z 18 XE	Petrol	1796	4	16	88
Meriva	09/03→05/10	Y 17 DT	Diesel	1686	4	16	64
Meriva	09/03→05/10	Z 13 DTJ	Diesel	1248	4	16	15
Meriva	09/03→05/10	Z 17 DT	Diesel	1686	4	16	64
Meriva	09/03→05/10	Z 17 DTH	Diesel	1686	4	16	64
Meriva	07/04→05/10	Z 14 XEP	Petrol	1364	4	16	20
Meriva	04/05→05/10	Y 13 DT	Diesel	1248	4	16	15
Meriva	04/05→05/10	Z 13 DT	Diesel	1248	4	16	15
Meriva	09/05→05/10	Z 16 LET	Petrol	1598	4	16	41
Meriva	01/06→05/10	Z 16 XEP	Petrol	1598	4	16	57
Meriva	09/06→05/10	A 17 DTR	Diesel	1686	4	16	64
Meriva	09/06→05/10	Z 17 DTR	Diesel	1686	4	16	64
Meriva B	06/10→	A 13 DTC	Diesel	1248	4	16	15
Meriva B	06/10→	A 13 DTE	Diesel	1248	4	16	15
Meriva B	06/10→	A 14 NEL	Petrol	1364	4	16	20
Meriva B	06/10→	A 14 NET	Petrol	1364	4	16	20
Meriva B	06/10→	A 14 XER	Petrol	1398	4	16	20
Meriva B	06/10→	A 17 DT	Diesel	1686	4	16	64
Meriva B	06/10→	A 17 DTC	Diesel	1686	4	16	64
Meriva B	06/10→	A 17 DTI	Diesel	1686	4	16	64
Meriva B	06/10→	A 17 DTS	Diesel	1686	4	16	64
Meriva B	06/10→	B 14 NEL	Petrol	1364	4	16	20
Meriva B	06/10→	B 14 NET	Petrol	1364	4	16	20
Meriva B	06/10→	B 14 XER	Petrol	1398	4	16	20
Meriva Mk I (A)	01/03→09/05	Z 16 XE	Petrol	1598	4	16	47
Meriva Mk I (A)	01/03→10/09	Z 13 DTJ	Diesel	1248	4	16	15
Meriva Mk I (A)	01/03→06/10	Z 14 XEP	Petrol	1364	4	16	20
Meriva Mk I (A)	01/03→06/10	Z 16 SE	Petrol	1598	4	8	55
Meriva Mk I (A)	05/03→06/10	Z 16 XEP	Petrol	1598	4	16	57
Meriva Mk I (A)	05/03→06/10	Z 18 XE	Petrol	1796	4	16	89
Meriva Mk I (A)	06/03→06/10	Y 17 DT	Diesel	1686	4	16	64
Meriva Mk I (A)	09/03→06/10	Z 17 DT	Diesel	1686	4	16	68
Meriva Mk I (A)	09/03→06/10	Z 17 DTH	Diesel	1686	4	16	64
Meriva Mk I (A)	04/05→06/10	Y 13 DT	Diesel	1248	4	16	15
Meriva Mk I (A)	04/05→06/10	Z 13 DT	Diesel	1248	4	16	15
Meriva Mk I (A)	05/06→06/10	Z 16 LET	Petrol	1598	4	16	41
Meriva Mk I (A)	08/06→05/10	Z 17 DTR	Diesel	1686	4	16	64
Meriva Mk II (B) (S10)	06/10→	A 13 DTC	Diesel	1248	4	16	15
Meriva Mk II (B) (S10)	06/10→	A 13 DTE	Diesel	1248	4	16	15
Meriva Mk II (B) (S10)	06/10→	A 14 NEL	Petrol	1364	4	16	20
Meriva Mk II (B) (S10)	06/10→	A 14 NET	Petrol	1364	4	16	20
Meriva Mk II (B) (S10)	06/10→	A 14 XER	Petrol	1398	4	16	20
Meriva Mk II (B) (S10)	06/10→	A 17 DT	Diesel	1686	4	16	64
Meriva Mk II (B) (S10)	06/10→	A 17 DTC	Diesel	1686	4	16	64
Meriva Mk II (B) (S10)	06/10→	A 17 DTI	Diesel	1686	4	16	65
Meriva Mk II (B) (S10)	06/10→	A 17 DTS	Diesel	1686	4	16	64
Meriva Mk II (B) (S10)	06/10→	B 14 NEL	Petrol	1364	4	16	20
Meriva Mk II (B) (S10)	06/10→	B 14 NET	Petrol	1364	4	16	20
Meriva Mk II (B) (S10)	06/10→	B 14 XER	Petrol	1398	4	16	20
Midi Box (MID)	09/84→07/88	4FC1	Diesel	1995	4	8	101
Midi Box (MID)	01/85→12/90	4ZB1	Petrol	1817	4	8	72
Midi Box (MID)	03/88→12/94	22DIE	Diesel	2189	4	8	122
Midi Bus (MID)	09/84→05/88	4FC1	Diesel	1995	4	8	101
Midi Bus (MID)	09/84→05/88	4ZB1	Petrol	1817	4	8	72
Midi II Bus (MID)	06/88→07/90	4FC1T	Diesel	1995	4	8	101
Midi II Bus (MID)	06/88→12/94	4FD1	Diesel	2189	4	8	121
Midi II Bus (MID)	06/88→08/97	4ZC1	Petrol	1994	4	8	102
Midi II Bus (MID)	07/90→08/94	22DIE	Diesel	2189	4	8	122
Midi II Bus (MID)	01/94→08/97	4FG1T	Diesel	2380	4	8	138
Mokka	01/13→	A 18 XER	Petrol	1796	4	16	79
Mokka / X (J13)	06/12→	A 14 NET	Petrol	1364	4	16	20

				CC			9
Mokka / X (J13)	06/12→	A 16 XER	Petrol	1598	4	16	41
Mokka / X (J13)	06/12→	A 17 DTS	Diesel	1686	4	16	64
Mokka / X (J13)	06/12→	B 14 NET	Petrol	1364	4	16	20
Mokka / X (J13)	06/12→	B 16 XER	Petrol	1598	4	16	41
Mokka / X (J13)	06/12→	B 16 XER	Petrol	1598	4	16	45
Monterey (M92)	09/91→07/98	4 JG2TC	Diesel	3059	4	8	169
Monterey (M92)	06/92→07/98	6 VD1	Petrol	3165	6	24	170
Monterey A (M92)	09/91→07/98	4 JG2TC	Diesel	3059	4	8	169
Monterey A (M92)	06/92→07/98	6 VD1	Petrol	3165	6	24	170
Monterey B (M98)	07/98→08/99	4 JX1	Diesel	2999	4	16	163
Monterey B (M98)	07/98→08/99	6 VE1	Petrol	3494	6	24	174
Monterey Mk II (M98)	07/98→08/99	4 JX1	Diesel	2999	4	16	163
Monterey Mk II (M98)	07/98→08/99	6 VE1	Petrol	3494	6	24	174
Monza A (22_)	02/78→04/81	28 H	Petrol	2784	6	12	158
Monza A (22_)	02/78→08/86	30 E	Petrol	2969	6	12	161
Monza A (22_)	04/78→07/82	30 H	Petrol	2969	6	12	162
Monza A (22_)	05/81→08/86	H 25 E	Petrol	2490	6	12	147
Monza A (22_)	03/83→10/84	H 20 E	Petrol	1979	4	8	105
Monza A (22_)	06/84→08/86	25 E	Petrol	2490	6	12	147
Monza A (22_)	11/84→08/86	22 E	Petrol	2197	4	8	123
Monza A (22_)	09/85→08/86	C 30 LE	Petrol	2969	6	12	161
Movano B Box (X62)	05/10→	M9T 670	Diesel	2298	4	16	137
Movano B Box (X62)	05/10→	M9T 672	Diesel	2298	4	16	137
Movano B Box (X62)	05/10→	M9T 676	Diesel	2298	4	16	137
Movano B Box (X62)	05/10→	M9T 678	Diesel	2298	4	16	137
Movano B Box (X62)	05/10→	M9T 680	Diesel	2298	4	16	137
Movano B Box (X62)	05/10→	M9T 686	Diesel	2298	4	16	137
Movano B Box (X62)	05/10→	M9T 690	Diesel	2298	4	16	137
Movano B Box (X62)	05/10→	M9T 692	Diesel	2298	4	16	137
Movano B Box (X62)	05/10→	M9T 694	Diesel	2298	4	16	137
Movano B Box (X62)	05/10→	M9T 696	Diesel	2298	4	16	137
Movano B Box (X62)	05/10→	M9T 698	Diesel	2298	4	16	137
Movano B Box (X62)	05/10→	M9T 876	Diesel	2299	4	16	137
Movano B Box (X62)	02/12→	M9T 870	Diesel	2299	4	16	137
Movano B Box (X62)	01/13→	M9T 880	Diesel	2298	4	16	137
Movano B Box (X62)	05/14→	M9T 700	Diesel	2299	4	16	137
Movano B Box (X62)	05/14→	M9T 702	Diesel	2299	4	16	137
Movano B Box (X62)	11/16→	M9T 704	Diesel	2298	4	16	137
Movano B Box (X62)	11/16→	M9T 706	Diesel	2298	4	16	137
Movano B Box (X62)	11/16→	M9T 710	Diesel	2298	4	16	137
Movano B Bus	12/10→	M9T 670	Diesel	2298	4	16	137
Movano B Bus	12/10→	M9T 672	Diesel	2298	4	16	137
Movano B Bus	12/10→	M9T 676	Diesel	2298	4	16	137
Movano B Bus	12/10→	M9T 678	Diesel	2298	4	16	137
Movano B Bus	12/10→	M9T 680	Diesel	2298	4	16	137
Movano B Bus	12/10→	M9T 876	Diesel	2299	4	16	137
Movano B Bus	01/13→	M9T 880	Diesel	2298	4	16	137
Movano B Bus	05/14→	M9T 702	Diesel	2299	4	16	137
Movano B Bus	05/14→	M9T 870	Diesel	2299	4	16	137
Movano Box (F9)	01/99→09/00	S8U 770	Diesel	2499	4	8	151
Movano Box (F9)	01/99→09/00	S8U 772	Diesel	2499	4	8	151
Movano Box (F9)	01/99→10/01	S9W 700	Diesel	2799	4	8	160
Movano Box (F9)	01/99→10/01	S9W 702	Diesel	2799	4	8	160
Movano Box (F9)	09/00→10/01	F9Q 770	Diesel	1870	4	8	97
Movano Box (F9)	09/00→	G9T 720	Diesel	2188	4	16	131
Movano Box (F9)	09/00→	G9T 722	Diesel	2188	4	16	131
Movano Box (F9)	09/00→	G9T 750	Diesel	2188	4	16	131
Movano Box (F9)	10/01→	F9Q 772	Diesel	1870	4	8	97
Movano Box (F9)	10/01→	F9Q 774	Diesel	1870	4	8	97
Movano Box (F9)	10/01→	G9U 720	Diesel	2464	4	16	150
Movano Box (F9)	10/01→	G9U 724	Diesel	2464	4	16	150
Movano Box (F9)	10/01→	G9U 754	Diesel	2464	4	16	150
Movano Box (F9)	10/03→	G9U 632	Diesel	2464	4	16	150
Movano Box (F9)	10/03→	G9U 650	Diesel	2464	4	16	150
Movano Box (F9)	10/03→	ZD3 200	Diesel	2953	4	16	168
Movano Box (F9)	10/03→	ZD3 202	Diesel	2953	4	16	168
Movano B Platform/Chassis (X62)	05/10→	M9T 670	Diesel	2298	4	16	137
Movano B Platform/Chassis (X62)	05/10→	M9T 672	Diesel	2298	4	16	137
Movano B Platform/Chassis (X62)	05/10→	M9T 676	Diesel	2298	4	16	137
Movano B Platform/Chassis (X62)	05/10→	M9T 678	Diesel	2298	4	16	137
Movano B Platform/Chassis (X62)	05/10→	M9T 680	Diesel	2298	4	16	137
Movano B Platform/Chassis (X62)	05/10→	M9T 690	Diesel	2298	4	16	137
Movano B Platform/Chassis (X62)	05/10→	M9T 692	Diesel	2298	4	16	137
Movano B Platform/Chassis (X62)	05/10→	M9T 694	Diesel	2298	4	16	137
Movano B Platform/Chassis (X62)	05/10→	M9T 696	Diesel	2298	4	16	137
Movano B Platform/Chassis (X62)	05/10→	M9T 698	Diesel	2298	4	16	137
Movano B Platform/Chassis (X62)	05/10→	M9T 876	Diesel	2299	4	16	137
Movano B Platform/Chassis (X62)	01/13→	M9T 880	Diesel	2298	4	16	137



CC



9

Movano B Platform/Chassis (X62)	05/14→	M9T 700	Diesel	2299	4	16	137
Movano B Platform/Chassis (X62)	05/14→	M9T 702	Diesel	2299	4	16	137
Movano B Platform/Chassis (X62)	05/14→	M9T 870	Diesel	2299	4	16	137
Movano B Platform/Chassis (X62)	11/16→	M9T 704	Diesel	2298	4	16	137
Movano B Platform/Chassis (X62)	11/16→	M9T 706	Diesel	2298	4	16	137
Movano B Platform/Chassis (X62)	11/16→	M9T 710	Diesel	2298	4	16	137
Movano Combi (X70)	07/98→09/00	S8U 770	Diesel	2499	4	8	151
Movano Combi (X70)	07/98→09/00	S8U 772	Diesel	2499	4	8	151
Movano Combi (X70)	07/98→10/01	S9W 700	Diesel	2799	4	8	160
Movano Combi (X70)	07/98→10/01	S9W 702	Diesel	2799	4	8	160
Movano Combi (X70)	09/00→10/01	F9Q 770	Diesel	1870	4	8	97
Movano Combi (X70)	09/00→	G9T 720	Diesel	2188	4	16	131
Movano Combi (X70)	09/00→	G9T 722	Diesel	2188	4	16	131
Movano Combi (X70)	09/00→	G9T 750	Diesel	2188	4	16	131
Movano Combi (X70)	10/01→	F9Q 772	Diesel	1870	4	8	97
Movano Combi (X70)	10/01→	F9Q 774	Diesel	1870	4	8	97
Movano Combi (X70)	10/01→	G9U 720	Diesel	2464	4	16	150
Movano Combi (X70)	10/01→	G9U 724	Diesel	2464	4	16	150
Movano Combi (X70)	10/01→	G9U 750	Diesel	2464	4	16	150
Movano Combi (X70)	10/01→	G9U 754	Diesel	2464	4	16	150
Movano Combi (X70)	10/03→	ZD3 200	Diesel	2953	4	16	168
Movano Combi (X70)	10/03→	ZD3 202	Diesel	2953	4	16	168
Movano Combi (X70)	08/06→	G9U 632	Diesel	2464	4	16	150
Movano Combi (X70)	08/06→	G9U 650	Diesel	2464	4	16	150
Movano Dumptruck (X70)	01/99→09/00	S8U 770	Diesel	2499	4	8	151
Movano Dumptruck (X70)	01/99→09/00	S8U 772	Diesel	2499	4	8	151
Movano Dumptruck (X70)	01/99→10/01	S9W 700	Diesel	2799	4	8	160
Movano Dumptruck (X70)	01/99→10/01	S9W 702	Diesel	2799	4	8	160
Movano Dumptruck (X70)	09/00→	G9T 720	Diesel	2188	4	16	131
Movano Dumptruck (X70)	09/00→	G9T 722	Diesel	2188	4	16	131
Movano Dumptruck (X70)	09/00→	G9T 750	Diesel	2188	4	16	131
Movano Dumptruck (X70)	10/01→	G9U 720	Diesel	2464	4	16	150
Movano Dumptruck (X70)	10/01→	G9U 724	Diesel	2464	4	16	150
Movano Dumptruck (X70)	10/01→	G9U 750	Diesel	2464	4	16	150
Movano Dumptruck (X70)	10/01→	G9U 754	Diesel	2464	4	16	150
Movano Dumptruck (X70)	10/03→	ZD3 200	Diesel	2953	4	16	168
Movano Dumptruck (X70)	10/03→	ZD3 202	Diesel	2953	4	16	168
Movano Dumptruck (X70)	08/06→	G9U 632	Diesel	2464	4	16	150
Movano Dumptruck (X70)	08/06→	G9U 650	Diesel	2464	4	16	150
Movano Mk I (A) Chassis/Cab (X70)	10/98→10/01	S9W 702	Diesel	2799	4	8	160
Movano Mk I (A) Chassis/Cab (X70)	10/98→08/02	S8U 770	Diesel	2499	4	8	151
Movano Mk I (A) Chassis/Cab (X70)	10/98→08/02	S8U 772	Diesel	2499	4	8	151
Movano Mk I (A) Chassis/Cab (X70)	09/00→05/10	G9T 720	Diesel	2188	4	16	131
Movano Mk I (A) Chassis/Cab (X70)	09/00→05/10	G9T 722	Diesel	2188	4	16	131
Movano Mk I (A) Chassis/Cab (X70)	09/00→05/10	G9T 750	Diesel	2188	4	16	131
Movano Mk I (A) Chassis/Cab (X70)	10/01→05/10	G9U 720	Diesel	2464	4	16	150
Movano Mk I (A) Chassis/Cab (X70)	10/01→05/10	G9U 724	Diesel	2464	4	16	150
Movano Mk I (A) Chassis/Cab (X70)	10/01→05/10	G9U 750	Diesel	2464	4	16	150
Movano Mk I (A) Chassis/Cab (X70)	10/01→05/10	G9U 754	Diesel	2464	4	16	150
Movano Mk I (A) Chassis/Cab (X70)	10/03→05/10	ZD3 200	Diesel	2953	4	16	168
Movano Mk I (A) Chassis/Cab (X70)	10/03→05/10	ZD3 202	Diesel	2953	4	16	168
Movano Mk I (A) Chassis/Cab (X70)	04/04→05/10	G9U 650	Diesel	2464	4	16	150
Movano Mk I (A) Chassis/Cab (X70)	08/06→05/10	G9U 632	Diesel	2464	4	16	150
Movano Mk I (A) Combi (X70)	10/98→09/00	S8U 770	Diesel	2499	4	8	151
Movano Mk I (A) Combi (X70)	10/98→10/01	S9W 702	Diesel	2799	4	8	160
Movano Mk I (A) Combi (X70)	09/00→10/01	F9Q 770	Diesel	1870	4	8	97
Movano Mk I (A) Combi (X70)	09/00→05/10	G9T 720	Diesel	2188	4	16	131
Movano Mk I (A) Combi (X70)	09/00→05/10	G9T 750	Diesel	2188	4	16	131
Movano Mk I (A) Combi (X70)	10/01→08/09	G9U 650	Diesel	2464	4	16	150
Movano Mk I (A) Combi (X70)	10/01→08/09	G9U 720	Diesel	2464	4	16	150
Movano Mk I (A) Combi (X70)	10/01→08/09	G9U 750	Diesel	2464	4	16	150
Movano Mk I (A) Combi (X70)	10/01→08/09	G9U 754	Diesel	2464	4	16	150
Movano Mk I (A) Combi (X70)	10/01→05/10	F9Q 774	Diesel	1870	4	8	97
Movano Mk I (A) Combi (X70)	02/03→05/10	G9U 632	Diesel	2464	4	16	150
Movano Mk I (A) Combi (X70)	10/03→05/10	ZD3 200	Diesel	2953	4	16	168
Movano Mk I (A) Van (X70)	10/98→09/00	S8U 770	Diesel	2499	4	8	151
Movano Mk I (A) Van (X70)	10/98→10/01	S9W 702	Diesel	2799	4	8	160
Movano Mk I (A) Van (X70)	09/00→10/01	F9Q 770	Diesel	1870	4	8	97
Movano Mk I (A) Van (X70)	09/00→05/10	G9T 720	Diesel	2188	4	16	131
Movano Mk I (A) Van (X70)	09/00→05/10	G9T 722	Diesel	2188	4	16	131
Movano Mk I (A) Van (X70)	09/00→05/10	G9T 750	Diesel	2188	4	16	131
Movano Mk I (A) Van (X70)	10/01→05/10	F9Q 774	Diesel	1870	4	8	97
Movano Mk I (A) Van (X70)	10/01→05/10	G9U 720	Diesel	2464	4	16	150
Movano Mk I (A) Van (X70)	10/01→05/10	G9U 724	Diesel	2464	4	16	150
Movano Mk I (A) Van (X70)	10/01→05/10	G9U 750	Diesel	2464	4	16	150
Movano Mk I (A) Van (X70)	10/01→05/10	G9U 754	Diesel	2464	4	16	150
Movano Mk I (A) Van (X70)	10/03→05/10	ZD3 202	Diesel	2953	4	16	168
Movano Mk I (A) Van (X70)	04/04→05/10	G9U 650	Diesel	2464	4	16	150



Movano Mk I (A) Van (X70)	08/06 → 05/10	G9U 632	Diesel	2464	4	16	150
Movano Mk II (B) Chassis/Cab (X62)	05/10 →	M9T 670	Diesel	2298	4	16	137
Movano Mk II (B) Chassis/Cab (X62)	05/10 →	M9T 672	Diesel	2298	4	16	137
Movano Mk II (B) Chassis/Cab (X62)	05/10 →	M9T 676	Diesel	2298	4	16	137
Movano Mk II (B) Chassis/Cab (X62)	05/10 →	M9T 678	Diesel	2298	4	16	137
Movano Mk II (B) Chassis/Cab (X62)	05/10 →	M9T 680	Diesel	2298	4	16	137
Movano Mk II (B) Chassis/Cab (X62)	05/10 →	M9T 696	Diesel	2298	4	16	137
Movano Mk II (B) Chassis/Cab (X62)	05/10 →	M9T 870	Diesel	2298	4	16	137
Movano Mk II (B) Chassis/Cab (X62)	05/10 →	M9T 876	Diesel	2299	4	16	137
Movano Mk II (B) Chassis/Cab (X62)	07/10 →	M9T 686	Diesel	2298	4	16	137
Movano Mk II (B) Chassis/Cab (X62)	07/10 →	M9T 690	Diesel	2298	4	16	137
Movano Mk II (B) Chassis/Cab (X62)	07/10 →	M9T 692	Diesel	2298	4	16	137
Movano Mk II (B) Chassis/Cab (X62)	07/10 →	M9T 694	Diesel	2298	4	16	137
Movano Mk II (B) Chassis/Cab (X62)	07/10 →	M9T 698	Diesel	2298	4	16	137
Movano Mk II (B) Chassis/Cab (X62)	07/10 →	M9T 898	Diesel	2298	4	16	137
Movano Mk II (B) Chassis/Cab (X62)	01/13 →	M9T 880	Diesel	2298	4	16	137
Movano Mk II (B) Chassis/Cab (X62)	05/14 →	M9T 700	Diesel	2298	4	16	137
Movano Mk II (B) Chassis/Cab (X62)	05/14 →	M9T 702	Diesel	2298	4	16	137
Movano Mk II (B) Chassis/Cab (X62)	10/16 →	M9T 704	Diesel	2298	4	16	137
Movano Mk II (B) Chassis/Cab (X62)	10/16 →	M9T 710	Diesel	2298	4	16	137
Movano Mk II (B) Chassis/Cab (X62)	11/16 →	M9T 706	Diesel	2298	4	16	137
Movano Mk II (B) Combi (X62)	05/10 →	M9T 670	Diesel	2298	4	16	137
Movano Mk II (B) Combi (X62)	05/10 →	M9T 672	Diesel	2298	4	16	137
Movano Mk II (B) Combi (X62)	05/10 →	M9T 676	Diesel	2298	4	16	137
Movano Mk II (B) Combi (X62)	05/10 →	M9T 678	Diesel	2298	4	16	137
Movano Mk II (B) Combi (X62)	05/10 →	M9T 680	Diesel	2298	4	16	137
Movano Mk II (B) Combi (X62)	05/10 →	M9T 876	Diesel	2299	4	16	137
Movano Mk II (B) Combi (X62)	01/13 →	M9T 880	Diesel	2298	4	16	137
Movano Mk II (B) Combi (X62)	05/14 →	M9T 702	Diesel	2298	4	16	137
Movano Mk II (B) Combi (X62)	05/14 →	M9T 870	Diesel	2298	4	16	137
Movano Mk II (B) Combi (X62)	07/15 →	M9T 706	Diesel	2298	4	16	137
Movano Mk II (B) Combi (X62)	10/16 →	M9T 704	Diesel	2298	4	16	137
Movano Mk II (B) Combi (X62)	10/16 →	M9T 710	Diesel	2298	4	16	137
Movano Mk II (B) VAN (X62)	05/10 →	M9T 670	Diesel	2298	4	16	137
Movano Mk II (B) VAN (X62)	05/10 →	M9T 672	Diesel	2298	4	16	137
Movano Mk II (B) VAN (X62)	05/10 →	M9T 676	Diesel	2298	4	16	137
Movano Mk II (B) VAN (X62)	05/10 →	M9T 678	Diesel	2298	4	16	137
Movano Mk II (B) VAN (X62)	05/10 →	M9T 680	Diesel	2298	4	16	137
Movano Mk II (B) VAN (X62)	05/10 →	M9T 686	Diesel	2298	4	16	137
Movano Mk II (B) VAN (X62)	05/10 →	M9T 690	Diesel	2298	4	16	137
Movano Mk II (B) VAN (X62)	05/10 →	M9T 692	Diesel	2298	4	16	137
Movano Mk II (B) VAN (X62)	05/10 →	M9T 694	Diesel	2298	4	16	137
Movano Mk II (B) VAN (X62)	05/10 →	M9T 696	Diesel	2298	4	16	137
Movano Mk II (B) VAN (X62)	05/10 →	M9T 698	Diesel	2298	4	16	137
Movano Mk II (B) VAN (X62)	05/10 →	M9T 870	Diesel	2298	4	16	137
Movano Mk II (B) VAN (X62)	05/10 →	M9T 876	Diesel	2299	4	16	137
Movano Mk II (B) VAN (X62)	01/13 →	M9T 880	Diesel	2298	4	16	137
Movano Mk II (B) VAN (X62)	05/14 →	M9T 700	Diesel	2298	4	16	137
Movano Mk II (B) VAN (X62)	05/14 →	M9T 702	Diesel	2298	4	16	137
Movano Mk II (B) VAN (X62)	10/16 →	M9T 704	Diesel	2298	4	16	137
Movano Mk II (B) VAN (X62)	10/16 →	M9T 710	Diesel	2298	4	16	137
Movano Mk II (B) VAN (X62)	11/16 →	M9T 706	Diesel	2298	4	16	137
Movano Platform/Chassis (X70)	07/98 → 09/00	S8U 770	Diesel	2499	4	8	151
Movano Platform/Chassis (X70)	07/98 → 09/00	S8U 772	Diesel	2499	4	8	151
Movano Platform/Chassis (X70)	07/98 → 10/01	S9W 700	Diesel	2799	4	8	160
Movano Platform/Chassis (X70)	07/98 → 10/01	S9W 702	Diesel	2799	4	8	160
Movano Platform/Chassis (X70)	09/00 →	G9T 720	Diesel	2188	4	16	131
Movano Platform/Chassis (X70)	09/00 →	G9T 722	Diesel	2188	4	16	131
Movano Platform/Chassis (X70)	09/00 →	G9T 750	Diesel	2188	4	16	131
Movano Platform/Chassis (X70)	10/01 →	G9U 720	Diesel	2464	4	16	150
Movano Platform/Chassis (X70)	10/01 →	G9U 724	Diesel	2464	4	16	150
Movano Platform/Chassis (X70)	10/01 →	G9U 750	Diesel	2464	4	16	150
Movano Platform/Chassis (X70)	10/01 →	G9U 754	Diesel	2464	4	16	150
Movano Platform/Chassis (X70)	10/03 →	ZD3 200	Diesel	2953	4	16	168
Movano Platform/Chassis (X70)	10/03 →	ZD3 202	Diesel	2953	4	16	168
Movano Platform/Chassis (X70)	08/06 →	G9U 632	Diesel	2464	4	16	150
Movano Platform/Chassis (X70)	08/06 →	G9U 650	Diesel	2464	4	16	150
Nova (S83)	09/82 → 10/87	10 S	Petrol	993	4	8	2
Nova (S83)	09/82 → 10/87	12 ST	Petrol	1196	4	8	9
Nova (S83)	09/82 → 10/87	13 SB	Petrol	1297	4	8	14
Nova (S83)	01/85 → 10/87	12 NC	Petrol	1196	4	8	8
Nova (S83)	01/85 → 10/87	E 12 GV	Petrol	1196	4	8	8
Nova (S83)	09/85 → 10/87	13 NB	Petrol	1297	4	8	14
Nova (S83)	09/87 → 02/93	15 D	Diesel	1488	4	8	24
Nova (S83)	01/90 → 02/93	14 NV	Petrol	1389	4	8	18
Nova (S83)	01/90 → 02/93	15 DT (T4EC1)	Diesel	1488	4	8	24
Nova (S83)	09/90 → 08/92	C 14 SE	Petrol	1389	4	8	18
Nova (S83)	10/90 → 08/92	C 14 NZ	Petrol	1389	4	8	18



CC



9

Nova Hatchback (LF)	09/91→10/94	4A-FE	Petrol	1587	4	16	28
Nova Hatchback (LG)	10/94→12/97	4A-FE	Petrol	1587	4	16	28
Nova Hatchback (S83)	05/83→10/89	13 SB	Petrol	1297	4	8	14
Nova Hatchback (S83)	05/83→02/90	12 ST	Petrol	1196	4	8	9
Nova Hatchback (S83)	05/83→03/93	10 S	Petrol	993	4	8	2
Nova Hatchback (S83)	01/85→10/89	12 NC	Petrol	1196	4	8	8
Nova Hatchback (S83)	01/85→10/89	E 12 GV	Petrol	1196	4	8	8
Nova Hatchback (S83)	09/85→10/89	13 NB	Petrol	1297	4	8	14
Nova Hatchback (S83)	09/87→03/93	15 D	Diesel	1488	4	8	24
Nova Hatchback (S83)	01/88→02/90	12 S	Petrol	1196	4	8	8
Nova Hatchback (S83)	05/88→03/92	E 16 SE	Petrol	1598	4	8	36
Nova Hatchback (S83)	09/89→03/93	C 12 NZ	Petrol	1196	4	8	9
Nova Hatchback (S83)	09/89→03/93	C 13 N	Petrol	1297	4	8	14
Nova Hatchback (S83)	09/89→03/93	C 16 SEI	Petrol	1598	4	8	36
Nova Hatchback (S83)	01/90→03/93	12 NV	Petrol	1196	4	8	9
Nova Hatchback (S83)	01/90→03/93	14 NV	Petrol	1389	4	8	18
Nova Hatchback (S83)	01/90→03/93	15 DT (T4EC1)	Diesel	1488	4	8	24
Nova Hatchback (S83)	01/90→03/93	C 14 NZ	Petrol	1389	4	8	18
Nova Hatchback (S83)	09/91→03/93	C 14 SE	Petrol	1389	4	8	18
Nova Hatchback (S83)	02/92→03/93	C 16 SE	Petrol	1598	4	8	36
Nova Saloon (LF)	09/91→10/94	4A-FE	Petrol	1587	4	16	28
Nova Saloon (LG)	10/94→12/97	4A-FE	Petrol	1587	4	16	28
Novavan (S83)	01/90→10/94	12 NV	Petrol	1196	4	8	9
Novavan (S83)	11/90→03/93	14 NV	Petrol	1389	4	8	18
Novavan (S83)	01/91→10/94	15 D	Diesel	1488	4	8	24
Novavan (S83)	10/91→12/91	10 S	Petrol	993	4	8	2
Olympia A	08/67→08/71	11 SR	Petrol	1078	4	8	7
Olympia A	08/67→08/71	17 S	Petrol	1698	4	8	63
Olympia A Coupe	08/67→08/71	11 SR	Petrol	1078	4	8	7
Olympia A Coupe	08/67→08/71	17 S	Petrol	1698	4	8	63
Olympia A Coupe	08/67→08/71	19 S	Petrol	1897	4	8	94
Omega (B) (V94)	01/94→06/03	Y 22 XE	Petrol	2198	4	16	129
Omega (B) (V94)	01/94→06/03	Z 22 XE	Petrol	2198	4	16	129
Omega (B) (V94)	03/94→09/99	X 20 SE	Petrol	1998	4	8	106
Omega (B) (V94)	03/94→09/00	X 25 XE	Petrol	2498	6	24	149
Omega (B) (V94)	03/94→07/01	X 20 XEV	Petrol	1998	4	16	113
Omega (B) (V94)	04/94→07/00	X 30 XE	Petrol	2962	6	24	166
Omega (B) (V94)	04/94→07/01	25 DT	Diesel	2497	6	12	146
Omega (B) (V94)	04/94→07/01	X 25 DT	Diesel	2497	6	12	146
Omega (B) (V94)	09/95→09/96	20 SE	Petrol	1998	4	8	106
Omega (B) (V94)	01/98→09/00	X 20 DTH	Diesel	1995	4	16	117
Omega (B) (V94)	08/00→07/03	Y 22 DTH	Diesel	2171	4	16	133
Omega (B) (V94)	08/00→07/03	Y 26 SE	Petrol	2597	6	24	155
Omega (B) (V94)	02/01→07/03	Y 32 SE	Petrol	3175	6	24	171
Omega (B) (V94)	09/01→07/03	Y 25 DT	Diesel	2497	6	24	153
Omega (B) Estate (V94)	02/94→06/03	Y 22 XE	Petrol	2198	4	16	129
Omega (B) Estate (V94)	02/94→06/03	Z 22 XE	Petrol	2198	4	16	129
Omega (B) Estate (V94)	03/94→09/99	X 20 SE	Petrol	1998	4	8	106
Omega (B) Estate (V94)	03/94→09/00	X 25 XE	Petrol	2498	6	24	149
Omega (B) Estate (V94)	03/94→07/01	X 20 XEV	Petrol	1998	4	16	113
Omega (B) Estate (V94)	04/94→07/01	25 DT	Diesel	2497	6	12	146
Omega (B) Estate (V94)	04/94→07/01	X 25 DT	Diesel	2497	6	12	146
Omega (B) Estate (V94)	07/94→07/00	X 30 XE	Petrol	2962	6	24	166
Omega (B) Estate (V94)	01/98→09/00	X 20 DTH	Diesel	1995	4	16	117
Omega (B) Estate (V94)	08/00→06/03	Y 22 DTH	Diesel	2171	4	16	133
Omega (B) Estate (V94)	08/00→06/03	Y 26 SE	Petrol	2597	6	24	155
Omega (B) Estate (V94)	02/01→06/03	Y 32 SE	Petrol	3175	6	24	171
Omega (B) Estate (V94)	09/01→06/03	Y 25 DT	Diesel	2497	6	24	153
Omega A (V87)	09/86→08/87	18 NV	Petrol	1796	4	8	77
Omega A (V87)	09/86→03/94	18 SEH	Petrol	1796	4	8	77
Omega A (V87)	09/86→03/94	18 SV	Petrol	1796	4	8	77
Omega A (V87)	09/86→03/94	20 SE	Petrol	1998	4	8	106
Omega A (V87)	09/86→04/94	C 20 NE	Petrol	1998	4	8	106
Omega A (V87)	10/86→08/88	23 YDT	Diesel	2260	4	8	126
Omega A (V87)	10/86→03/94	23 YD	Diesel	2260	4	8	135
Omega A (V87)	03/87→12/87	C 30 LE	Petrol	2969	6	12	161
Omega A (V87)	03/87→09/90	30 NE	Petrol	2969	6	12	164
Omega A (V87)	09/87→03/94	E 18 NVR	Petrol	1796	4	8	77
Omega A (V87)	03/88→03/94	C 30 NE	Petrol	2969	6	12	164
Omega A (V87)	08/88→03/94	23 DTR	Diesel	2260	4	8	136
Omega A (V87)	09/88→03/94	C 24 NE	Petrol	2410	4	8	140
Omega A (V87)	09/89→03/94	C 30 SE	Petrol	2969	6	24	165
Omega A (V87)	09/89→03/94	C 30 SEJ	Petrol	2969	6	24	165
Omega A (V87)	09/90→03/94	C 20 NEF	Petrol	1998	4	8	106
Omega A (V87)	09/90→03/94	C 20 NEJ	Petrol	1998	4	8	106
Omega A (V87)	09/90→03/94	C 26 NE	Petrol	2594	6	12	154
Omega A (V87)	03/91→07/92	C 30 XEI	Petrol	2969	6	24	165
Omega A Estate (66_, 67_)	09/87→04/94	C 20 NE	Petrol	1998	4	8	106



CC



9

Omega A Estate (V87)	09/86→08/87	18 NV	Petrol	1796	4	8	77
Omega A Estate (V87)	09/86→08/88	23 YDT	Diesel	2260	4	8	126
Omega A Estate (V87)	09/86→03/94	18 SEH	Petrol	1796	4	8	77
Omega A Estate (V87)	09/86→03/94	18 SV	Petrol	1796	4	8	77
Omega A Estate (V87)	09/86→03/94	20 SE	Petrol	1998	4	8	106
Omega A Estate (V87)	09/86→03/94	23 YD	Diesel	2260	4	8	135
Omega A Estate (V87)	09/86→03/94	C 20 NE	Petrol	1998	4	8	106
Omega A Estate (V87)	03/87→09/90	30 NE	Petrol	2969	6	12	164
Omega A Estate (V87)	03/87→03/94	C 30 LE	Petrol	2969	6	12	161
Omega A Estate (V87)	03/87→03/94	C 30 NE	Petrol	2969	6	12	164
Omega A Estate (V87)	09/87→03/94	E 18 NVR	Petrol	1796	4	8	77
Omega A Estate (V87)	09/88→03/94	23 DTR	Diesel	2260	4	8	136
Omega A Estate (V87)	09/88→03/94	C 24 NE	Petrol	2410	4	8	140
Omega A Estate (V87)	09/88→04/94	C 30 SE	Petrol	2969	6	24	165
Omega A Estate (V87)	09/89→03/94	C 30 SEJ	Petrol	2969	6	24	165
Omega A Estate (V87)	09/90→03/94	C 20 NEF	Petrol	1998	4	8	106
Omega A Estate (V87)	09/90→03/94	C 20 NEJ	Petrol	1998	4	8	106
Omega A Estate (V87)	09/90→03/94	C 26 NE	Petrol	2594	6	12	154
Omega B (V94)	03/94→09/99	X 20 SE	Petrol	1998	4	8	106
Omega B (V94)	03/94→09/99	X 20 XEV	Petrol	1998	4	16	113
Omega B (V94)	03/94→09/00	X 25 XE	Petrol	2498	6	24	149
Omega B (V94)	03/94→12/00	20 SE	Petrol	1998	4	8	106
Omega B (V94)	04/94→02/01	X 30 XE	Petrol	2962	6	24	166
Omega B (V94)	04/94→07/03	25 DT	Diesel	2497	6	12	146
Omega B (V94)	04/94→07/03	X 25 DT	Diesel	2497	6	12	146
Omega B (V94)	04/94→07/03	X 25 TD	Diesel	2498	6	12	146
Omega B (V94)	09/97→09/00	X 20 DTH	Diesel	1995	4	16	117
Omega B (V94)	09/99→07/03	Y 22 XE	Petrol	2198	4	16	129
Omega B (V94)	09/99→07/03	Z 22 XE	Petrol	2198	4	16	129
Omega B (V94)	09/00→07/03	Y 22 DTH	Diesel	2172	4	16	133
Omega B (V94)	09/00→07/03	Y 26 SE	Petrol	2597	6	24	155
Omega B (V94)	01/01→07/03	Y 22 DTR	Diesel	2172	4	16	133
Omega B (V94)	02/01→07/03	Y 32 SE	Petrol	3175	6	24	171
Omega B (V94)	09/01→07/03	Y 25 DT	Diesel	2497	6	24	153
Omega B Estate (V94)	03/94→09/99	X 20 SE	Petrol	1998	4	8	106
Omega B Estate (V94)	03/94→09/99	X 20 XEV	Petrol	1998	4	16	113
Omega B Estate (V94)	03/94→09/00	X 25 XE	Petrol	2498	6	24	149
Omega B Estate (V94)	04/94→02/01	X 30 XE	Petrol	2962	6	24	166
Omega B Estate (V94)	04/94→07/01	25 DT	Diesel	2497	6	12	146
Omega B Estate (V94)	04/94→07/01	X 25 DT	Diesel	2497	6	12	146
Omega B Estate (V94)	04/94→07/01	X 25 TD	Diesel	2498	6	12	146
Omega B Estate (V94)	09/97→09/00	X 20 DTH	Diesel	1995	4	16	117
Omega B Estate (V94)	09/99→07/03	Y 22 XE	Petrol	2198	4	16	129
Omega B Estate (V94)	09/99→07/03	Z 22 XE	Petrol	2198	4	16	129
Omega B Estate (V94)	09/00→07/03	Y 22 DTH	Diesel	2172	4	16	133
Omega B Estate (V94)	09/00→07/03	Y 26 SE	Petrol	2597	6	24	155
Omega B Estate (V94)	02/01→07/03	Y 32 SE	Petrol	3175	6	24	171
Omega B Estate (V94)	09/01→07/03	Y 25 DT	Diesel	2497	6	24	153
Rascal Bus (RAS)	07/86→08/93	F10A	Petrol	970	4	8	5
Rascal Pickup (RAS)	07/86→08/93	F10A	Petrol	970	4	8	5
Rekord	02/72→12/78	17 S	Petrol	1698	4	8	63
Rekord	02/72→12/78	19 SH	Petrol	1897	4	8	95
Rekord	02/72→12/78	25 H	Petrol	2490	6	12	147
Rekord	02/72→12/78	25 S	Petrol	2490	6	12	147
Rekord A	03/63→08/65	15 N	Petrol	1492	4	8	25
Rekord A	03/63→08/65	17 N	Petrol	1698	4	8	62
Rekord A	04/64→08/65	17 S	Petrol	1698	4	8	63
Rekord A Estate	03/63→08/65	17 N	Petrol	1698	4	8	62
Rekord B	08/65→08/66	15 NB	Petrol	1492	4	8	25
Rekord B	08/65→12/66	17 S	Petrol	1698	4	8	63
Rekord B	08/65→12/66	19 S	Petrol	1897	4	8	94
Rekord B	09/65→08/66	19 N	Petrol	1897	4	8	93
Rekord B Coupe	08/65→12/66	17 N	Petrol	1698	4	8	62
Rekord B Coupe	08/65→02/67	19 S	Petrol	1897	4	8	94
Rekord B Estate	08/65→08/66	15 NB	Petrol	1492	4	8	25
Rekord B Estate	08/65→12/66	17 N	Petrol	1698	4	8	62
Rekord C	08/66→09/69	22 N	Petrol	2239	6	12	124
Rekord C	08/66→12/71	15 NB	Petrol	1492	4	8	25
Rekord C	08/66→12/71	17 N	Petrol	1698	4	8	62
Rekord C	08/66→12/71	17 S	Petrol	1698	4	8	63
Rekord C	08/66→12/71	19 S	Petrol	1897	4	8	94
Rekord C	08/67→12/71	19 SH	Petrol	1897	4	8	95
Rekord C Coupe	08/66→09/69	22 N	Petrol	2239	6	12	124
Rekord C Coupe	08/66→12/71	17 S	Petrol	1698	4	8	63
Rekord C Coupe	08/66→12/71	19 S	Petrol	1897	4	8	94
Rekord C Coupe	08/67→12/71	19 SH	Petrol	1897	4	8	95
Rekord C Estate	08/66→12/71	15 NB	Petrol	1492	4	8	25
Rekord C Estate	08/66→12/71	17 N	Petrol	1698	4	8	62









CC



9

Rekord C Estate	08/66→12/71	17 S	Petrol	1698	4	8	63
Rekord C Estate	08/66→12/71	19 S	Petrol	1897	4	8	94
Rekord Coupe	02/72→12/78	19 SH	Petrol	1897	4	8	95
Rekord Coupe	02/72→12/78	25 H	Petrol	2490	6	12	147
Rekord Coupe	02/72→12/78	25 S	Petrol	2490	6	12	147
Rekord D	01/72→02/75	17 S	Petrol	1698	4	8	63
Rekord D	01/72→08/77	17 N	Petrol	1698	4	8	62
Rekord D	01/72→08/77	19 SH	Petrol	1897	4	8	95
Rekord D	09/72→08/77	21 D	Diesel	2068	4	8	120
Rekord D	08/74→08/77	20 D	Diesel	1998	4	8	103
Rekord D	03/75→08/77	19 N	Petrol	1897	4	8	93
Rekord D	09/75→08/77	20 S	Petrol	1979	4	8	105
Rekord D Coupe	01/72→02/75	17 S	Petrol	1698	4	8	63
Rekord D Coupe	01/72→08/77	19 SH	Petrol	1897	4	8	95
Rekord D Coupe	03/75→08/77	19 N	Petrol	1897	4	8	93
Rekord D Coupe	09/75→08/77	20 S	Petrol	1979	4	8	105
Rekord D Estate	01/72→02/75	17 S	Petrol	1698	4	8	63
Rekord D Estate	01/72→08/77	17 N	Petrol	1698	4	8	62
Rekord D Estate	01/72→08/77	19 SH	Petrol	1897	4	8	95
Rekord D Estate	09/72→08/77	21 D	Diesel	2068	4	8	120
Rekord D Estate	08/74→08/77	20 D	Diesel	1998	4	8	103
Rekord D Estate	03/75→08/77	19 N	Petrol	1897	4	8	93
Rekord D Estate	09/75→08/77	20 S	Petrol	1979	4	8	105
Rekord E	12/83→12/91	20 NE	Petrol	1998	4	8	106
Rekord E	12/83→12/91	20 SE	Petrol	1998	4	8	106
Rekord E	01/88→12/90	20 SEH	Petrol	1998	4	8	106
Rekord E (17_-19_, 11_, 14_, 16_)	08/77→08/86	20 S	Petrol	1979	4	8	105
Rekord E (17_-19_, 11_, 14_, 16_)	09/77→07/78	21 D	Diesel	2068	4	8	120
Rekord E (17_-19_, 11_, 14_, 16_)	09/77→10/82	17 N	Petrol	1698	4	8	62
Rekord E (17_-19_, 11_, 14_, 16_)	09/77→10/82	19 N	Petrol	1897	4	8	93
Rekord E (17_-19_, 11_, 14_, 16_)	09/77→10/82	20 D	Diesel	1998	4	8	103
Rekord E (17_-19_, 11_, 14_, 16_)	09/77→10/82	20 N	Petrol	1979	4	8	105
Rekord E (17_-19_, 11_, 14_, 16_)	09/77→10/84	20 E	Petrol	1979	4	8	104
Rekord E (17_-19_, 11_, 14_, 16_)	08/78→08/86	23 D	Diesel	2260	4	8	125
Rekord E (17_-19_, 11_, 14_, 16_)	11/82→08/86	18 N	Petrol	1796	4	8	73
Rekord E (17_-19_, 11_, 14_, 16_)	11/82→08/86	18 S	Petrol	1796	4	8	73
Rekord E (17_-19_, 11_, 14_, 16_)	06/84→08/86	23 TD	Diesel	2260	4	8	126
Rekord E (17_-19_, 11_, 14_, 16_)	11/84→08/86	22 E	Petrol	2197	4	8	123
Rekord E (17_-19_, 11_, 14_, 16_)	05/85→08/86	C 18 NV	Petrol	1796	4	8	80
Rekord E Estate (61_, 66_, 67_)	08/77→08/86	20 S	Petrol	1979	4	8	105
Rekord E Estate (61_, 66_, 67_)	09/77→07/78	21 D	Diesel	2068	4	8	120
Rekord E Estate (61_, 66_, 67_)	09/77→10/82	17 N	Petrol	1698	4	8	62
Rekord E Estate (61_, 66_, 67_)	09/77→10/82	19 N	Petrol	1897	4	8	93
Rekord E Estate (61_, 66_, 67_)	09/77→10/82	20 D	Diesel	1998	4	8	103
Rekord E Estate (61_, 66_, 67_)	09/77→10/82	20 N	Petrol	1979	4	8	105
Rekord E Estate (61_, 66_, 67_)	09/77→10/84	20 E	Petrol	1979	4	8	104
Rekord E Estate (61_, 66_, 67_)	08/78→08/86	23 D	Diesel	2260	4	8	125
Rekord E Estate (61_, 66_, 67_)	11/82→08/86	18 N	Petrol	1796	4	8	73
Rekord E Estate (61_, 66_, 67_)	11/82→08/86	18 S	Petrol	1796	4	8	73
Rekord E Estate (61_, 66_, 67_)	06/84→08/86	23 TD	Diesel	2260	4	8	126
Rekord E Estate (61_, 66_, 67_)	11/84→08/86	22 E	Petrol	2197	4	8	123
Rekord E Estate (61_, 66_, 67_)	05/85→08/86	C 18 NV	Petrol	1796	4	8	80
Rekord P1 Estate	07/57→07/60	17 L	Petrol	1698	4	8	61
Rodeo Pickup (RA)	02/03→12/05	6VE1	Petrol	3494	6	24	174
Rodeo Pickup (TF)	05/90→02/03	4JB1-T	Diesel	2771	4	8	156
Rodeo Pickup (TF)	02/98→02/03	6VD1	Petrol	3165	6	24	170
Rodeo Pickup (TF)	06/98→02/03	C 22 NE	Petrol	2198	4	8	128
Rodeo Platform/Chassis (RA)	02/03→12/05	6VE1	Petrol	3494	6	24	174
Rodeo Platform/Chassis (TF)	05/90→02/03	4JB1-T	Diesel	2771	4	8	156
Rodeo Platform/Chassis (TF)	02/98→02/03	6VD1	Petrol	3165	6	24	170
Rodeo Platform/Chassis (TF)	06/98→02/03	C 22 NE	Petrol	2198	4	8	128
Royale	02/78→04/81	28 H	Petrol	2784	6	12	158
Royale	02/78→12/86	30 E	Petrol	2969	6	12	164
Royale	04/78→07/82	30 H	Petrol	2969	6	12	161
Royale	05/78→12/80	25 S	Petrol	2490	6	12	147
Royale	01/83→08/84	H 25 E	Petrol	2490	6	12	147
Royale	03/83→10/84	H 20 E	Petrol	1979	4	8	105
Royale	09/84→08/87	25 E	Petrol	2490	6	12	147
Royale	11/84→08/87	22 E	Petrol	2197	4	8	123
Royale	11/84→08/87	23 TD	Diesel	2260	4	8	126
Royale	09/85→08/87	C 30 LE	Petrol	2969	6	12	164
Royale Coupe	02/78→08/86	30 E	Petrol	2969	6	12	164
Royale Coupe	10/79→10/82	28 H	Petrol	2784	6	12	158
Senator	02/78→08/87	28 H	Petrol	2784	6	12	158
Senator	04/78→07/82	30 H	Petrol	2969	6	12	161
Senator	05/78→12/80	25 S	Petrol	2490	6	12	147
Senator	03/83→10/84	H 20 E	Petrol	1979	4	8	105
Senator	09/84→12/86	30 E	Petrol	2969	6	12	164

							
Senator	09/84→08/87	25 E	Petrol	2490	6	12	147
Senator	11/84→08/87	22 E	Petrol	2197	4	8	123
Senator	11/84→08/87	23 TD	Diesel	2260	4	8	126
Senator	09/85→08/87	C 30 LE	Petrol	2969	6	12	164
Senator A (29_)	02/78→04/81	28 H	Petrol	2784	6	12	158
Senator A (29_)	02/78→12/86	30 E	Petrol	2969	6	12	161
Senator A (29_)	04/78→07/82	30 H	Petrol	2969	6	12	162
Senator A (29_)	05/78→12/80	25 S	Petrol	2490	6	12	148
Senator A (29_)	01/83→08/84	H 25 E	Petrol	2490	6	12	147
Senator A (29_)	03/83→10/84	H 20 E	Petrol	1979	4	8	105
Senator A (29_)	09/84→08/87	25 E	Petrol	2490	6	12	147
Senator A (29_)	11/84→08/87	22 E	Petrol	2197	4	8	123
Senator A (29_)	11/84→08/87	23 TD	Diesel	2260	4	8	126
Senator A (29_)	09/85→08/87	C 30 LE	Petrol	2969	6	12	161
Senator B (V88)	09/87→09/93	C 30 LE	Petrol	2969	6	12	161
Senator B (V88)	01/88→09/90	30 NE	Petrol	2969	6	12	164
Senator B (V88)	01/88→09/93	C 30 NE	Petrol	2969	6	12	164
Senator B (V88)	09/89→09/93	C 30 SE	Petrol	2969	6	24	165
Senator B (V88)	09/90→09/93	25 NE	Petrol	2490	6	12	147
Senator B (V88)	09/90→09/93	C 26 NE	Petrol	2594	6	12	154
Senator Mk II (B) (V88)	09/87→09/90	30 NE	Petrol	2969	6	12	164
Senator Mk II (B) (V88)	09/87→10/90	25 E	Petrol	2490	6	12	147
Senator Mk II (B) (V88)	09/87→09/93	C 30 LE	Petrol	2969	6	12	164
Senator Mk II (B) (V88)	01/88→09/93	C 30 NE	Petrol	2969	6	12	164
Senator Mk II (B) (V88)	09/89→09/93	C 30 SE	Petrol	2969	6	24	165
Senator Mk II (B) (V88)	09/90→09/93	C 26 NE	Petrol	2594	6	12	154
Seven (CF)	01/86→12/91	TV 17 HC	Petrol	1699	4	16	66
Seven (CF)	04/90→09/92	C 20 LET	Petrol	1998	4	16	112
Seven (CF)	04/91→	14 K4F	Petrol	1396	4	16	17
Seven (CF)	10/92→09/95	Z 20 LET	Petrol	1998	4	16	119
Seven (CF)	01/95→01/15	16 K4F	Petrol	1588	4	16	32
Seven (CF)	01/96→01/15	18 K4F	Petrol	1796	4	16	74
Seven (CF)	01/97→	K18K4	Petrol	1796	4	16	85
Seven (CF)	04/11→	SIDA	Petrol	1596	4	16	52
Seven (CF)	12/13→	K6A	Petrol	658	3	12	1
Signum (Z03)	03/03→10/08	Z 20 NET	Petrol	1998	4	16	111
Signum (Z03)	05/03→05/08	Y 20 DTH	Diesel	1995	4	16	117
Signum (Z03)	05/03→05/08	Y 22 DTR	Diesel	2172	4	16	133
Signum (Z03)	05/03→05/08	Y 30 DT	Diesel	2958	6	24	167
Signum (Z03)	05/03→05/08	Z 22 YH	Petrol	2198	4	16	132
Signum (Z03)	05/03→05/08	Z 32 SE	Petrol	3175	6	24	171
Signum (Z03)	05/03→	Y 20 DTH	Diesel	1995	4	16	117
Signum (Z03)	05/03→	Y 22 DTR	Diesel	2172	4	16	133
Signum (Z03)	05/03→	Y 30 DT	Diesel	2958	6	24	167
Signum (Z03)	05/03→	Z 18 XE	Petrol	1796	4	16	88
Signum (Z03)	05/03→	Z 20 NET	Petrol	1998	4	16	111
Signum (Z03)	05/03→	Z 22 YH	Petrol	2198	4	16	132
Signum (Z03)	05/03→	Z 32 SE	Petrol	3175	6	24	171
Signum (Z03)	06/03→07/05	Z 18 XE	Petrol	1796	4	16	89
Signum (Z03)	04/04→03/08	Z 19 DT	Diesel	1910	4	8	99
Signum (Z03)	04/04→03/08	Z 19 DTH	Diesel	1910	4	16	100
Signum (Z03)	04/04→	Z 19 DT	Diesel	1910	4	8	99
Signum (Z03)	04/04→	Z 19 DTH	Diesel	1910	4	16	100
Signum (Z03)	01/05→05/08	Z 19 DTL	Diesel	1910	4	8	99
Signum (Z03)	07/05→06/08	Z 30 DT	Diesel	2958	6	24	167
Signum (Z03)	08/05→05/08	Z 18 XER	Petrol	1796	4	16	79
Signum (Z03)	08/05→	Z 19 DTL	Diesel	1910	4	8	99
Signum (Z03)	09/05→	Z 18 XER	Petrol	1796	4	16	79
Signum (Z03)	09/05→	Z 30 DT	Diesel	2959	6	24	167
Sintra	11/96→04/99	X 22 XE	Petrol	2198	4	16	129
Sintra	11/96→04/99	X 30 XE	Petrol	2962	6	24	166
Sintra	07/97→04/99	X 22 DTH	Diesel	2171	4	16	133
Speedster (E01)	09/00→	Z 22 SE	Petrol	2198	4	16	132
Speedster (E01)	03/01→09/06	Z 22 SE	Petrol	2198	4	16	132
Speedster (E01)	04/03→	Z 20 LET	Petrol	1998	4	16	113
Super Seven (CF)	04/90→09/92	Z 20 LET	Petrol	1998	4	16	119
Super Seven (CF)	10/92→09/95	C 20 XE	Petrol	1998	4	16	112
Super Seven (CF)	06/01→09/04	C 20 LET	Petrol	1998	4	16	112
Tigra (S93)	07/94→08/98	X 16 XE	Petrol	1598	4	16	47
Tigra (S93)	07/94→12/00	X 14 XE	Petrol	1389	4	16	22
Tigra (S93)	08/97→08/98	C 16 SEL	Petrol	1598	4	16	47
Tigra (XC)	09/05→12/07	Z 18 XE	Petrol	1796	4	16	89
Tigra Mk I (S93)	07/94→12/00	X 14 XE	Petrol	1389	4	16	22
Tigra Mk I (S93)	07/94→12/00	X 16 XE	Petrol	1598	4	16	47
Tigra TwinTop (X04)	06/04→08/09	Z 13 DT	Diesel	1248	4	16	15
Tigra TwinTop (X04)	06/04→08/09	Z 14 XEP	Petrol	1364	4	16	20
Tigra TwinTop (X04)	06/04→08/09	Z 18 XE	Petrol	1796	4	16	89
Tigra TwinTop (X04)	06/04→	Z 13 DT	Diesel	1248	4	16	15



CC



9

Tigra TwinTop (X04)	06/04→	Z 14 XEP	Petrol	1364	4	16	20
Tigra TwinTop (X04)	06/04→	Z 18 XE	Petrol	1796	4	16	88
Trax (TJ)	08/14→	A 14 NET	Petrol	1364	4	16	20
Vectra (B) (J96)	08/95→10/01	X 16 SZR	Petrol	1598	4	8	36
Vectra (B) (J96)	08/95→10/01	X 16 XEL	Petrol	1598	4	16	47
Vectra (B) (J96)	08/95→10/01	X 20 DTH	Diesel	1995	4	16	117
Vectra (B) (J96)	08/95→10/01	X 20 DTL	Diesel	1995	4	16	117
Vectra (B) (J96)	08/95→10/01	Y 16 XE	Petrol	1598	4	16	53
Vectra (B) (J96)	08/95→10/01	Y 20 DTH	Diesel	1995	4	16	117
Vectra (B) (J96)	08/95→10/01	Y 22 DTR	Diesel	2172	4	16	133
Vectra (B) (J96)	08/95→10/01	Z 16 XE	Petrol	1598	4	16	47
Vectra (B) (J96)	08/95→10/01	Z 22 SE	Petrol	2198	4	16	132
Vectra (B) (J96)	09/95→08/00	X 25 XE	Petrol	2498	6	24	149
Vectra (B) (J96)	10/95→11/96	X 17 DT (TC4EE1)	Diesel	1686	4	8	60
Vectra (B) (J96)	10/95→09/00	X 18 XE	Petrol	1799	4	16	82
Vectra (B) (J96)	10/95→09/00	X 18 XE1	Petrol	1796	4	16	86
Vectra (B) (J96)	10/95→09/00	Z 18 XEL	Petrol	1796	4	16	86
Vectra (B) (J96)	10/95→01/01	X 20 XEV	Petrol	1998	4	16	113
Vectra (B) (J96)	09/00→03/02	Y 26 SE	Petrol	2597	6	24	155
Vectra (B) (J96)	09/00→03/02	Z 18 XE	Petrol	1796	4	16	89
Vectra (B) Estate (J96)	08/95→10/01	X 20 DTH	Diesel	1995	4	16	117
Vectra (B) Estate (J96)	08/95→10/01	X 20 DTL	Diesel	1995	4	16	117
Vectra (B) Estate (J96)	08/95→10/01	Y 20 DTH	Diesel	1995	4	16	117
Vectra (B) Estate (J96)	08/95→10/01	Y 22 DTR	Diesel	2172	4	16	133
Vectra (B) Estate (J96)	08/95→10/01	Z 22 SE	Petrol	2198	4	16	132
Vectra (B) Estate (J96)	10/95→01/01	X 20 XEV	Petrol	1998	4	16	113
Vectra (B) Estate (J96)	09/96→09/00	X 18 XE	Petrol	1799	4	16	82
Vectra (B) Estate (J96)	11/96→08/00	X 25 XE	Petrol	2498	6	24	149
Vectra (B) Estate (J96)	11/96→09/00	X 18 XE1	Petrol	1796	4	16	86
Vectra (B) Estate (J96)	09/00→03/02	Y 26 SE	Petrol	2597	6	24	155
Vectra (B) Estate (J96)	09/00→03/02	Z 18 XE	Petrol	1796	4	16	89
Vectra (B) Hatchback (J96)	08/95→10/01	X 16 SZR	Petrol	1598	4	8	36
Vectra (B) Hatchback (J96)	08/95→10/01	X 16 XEL	Petrol	1598	4	16	47
Vectra (B) Hatchback (J96)	08/95→10/01	X 20 DTL	Diesel	1995	4	16	117
Vectra (B) Hatchback (J96)	08/95→10/01	Y 16 XE	Petrol	1598	4	16	53
Vectra (B) Hatchback (J96)	08/95→10/01	Y 22 DTR	Diesel	2172	4	16	133
Vectra (B) Hatchback (J96)	08/95→10/01	Z 16 XE	Petrol	1598	4	16	47
Vectra (B) Hatchback (J96)	09/95→08/00	X 25 XE	Petrol	2498	6	24	149
Vectra (B) Hatchback (J96)	09/95→09/00	X 18 XE	Petrol	1799	4	16	82
Vectra (B) Hatchback (J96)	10/95→11/96	X 17 DT (TC4EE1)	Diesel	1686	4	8	60
Vectra (B) Hatchback (J96)	10/95→09/00	X 18 XE1	Petrol	1796	4	16	86
Vectra (B) Hatchback (J96)	10/95→01/01	X 20 XEV	Petrol	1998	4	16	113
Vectra (B) Hatchback (J96)	06/97→10/01	X 20 DTH	Diesel	1995	4	16	117
Vectra (B) Hatchback (J96)	06/97→10/01	Y 20 DTH	Diesel	1995	4	16	117
Vectra (B) Hatchback (J96)	09/00→07/03	Y 26 SE	Petrol	2597	6	24	155
Vectra (B) Hatchback (J96)	09/00→07/03	Z 18 XE	Petrol	1796	4	16	89
Vectra (B) Hatchback (J96)	09/00→07/03	Z 22 SE	Petrol	2198	4	16	132
Vectra (A) (86, 87_)	08/92→08/95	C 25 XE	Petrol	2498	6	24	149
Vectra (A) (J89)	09/88→07/89	E 18 NVR	Petrol	1796	4	8	77
Vectra (A) (J89)	09/88→09/89	C 20 NEF	Petrol	1998	4	8	106
Vectra (A) (J89)	09/88→10/90	20 NE	Petrol	1998	4	8	106
Vectra (A) (J89)	09/88→06/92	14 NV	Petrol	1389	4	8	18
Vectra (A) (J89)	09/88→09/92	20 SEH	Petrol	1998	4	8	106
Vectra (A) (J89)	09/88→05/93	16 SV	Petrol	1598	4	8	36
Vectra (A) (J89)	09/88→11/95	C 16 NZ	Petrol	1598	4	8	36
Vectra (A) (J89)	09/88→11/95	C 16 NZ2	Petrol	1598	4	8	36
Vectra (A) (J89)	09/88→11/95	C 20 NE	Petrol	1998	4	8	106
Vectra (A) (J89)	09/88→11/95	E 16 NZ	Petrol	1598	4	8	36
Vectra (A) (J89)	10/88→09/92	17 D	Diesel	1700	4	8	59
Vectra (A) (J89)	01/89→06/94	20 XEJ	Petrol	1998	4	16	109
Vectra (A) (J89)	09/89→10/90	18 SV	Petrol	1796	4	8	77
Vectra (A) (J89)	02/90→11/95	C 20 XE	Petrol	1998	4	16	112
Vectra (A) (J89)	03/90→11/95	17 DT (TC4EE1)	Diesel	1686	4	8	60
Vectra (A) (J89)	03/90→11/95	C 18 NZ	Petrol	1796	4	8	81
Vectra (A) (J89)	03/90→11/95	X 17 DT (TC4EE1)	Diesel	1686	4	8	60
Vectra (A) (J89)	07/92→11/95	17 DR	Diesel	1700	4	8	59
Vectra (A) (J89)	08/92→11/95	C 16 LZ2	Petrol	1598	4	8	46
Vectra (A) (J89)	02/93→11/95	C 25 XE	Petrol	2498	6	24	149
Vectra (A) (J89)	09/93→11/95	16 LZ2	Petrol	1598	4	8	33
Vectra (A) (J89)	09/93→11/95	X 16 SZ	Petrol	1598	4	8	36
Vectra (A) (J89)	06/94→11/95	C 20 LET	Petrol	1998	4	16	109
Vectra (A) (J89)	06/94→11/95	X 20 XEV	Petrol	1998	4	16	113
Vectra (A) Hatchback (J89)	04/88→09/89	C 20 NEF	Petrol	1998	4	8	106
Vectra (A) Hatchback (J89)	04/88→06/92	14 NV	Petrol	1389	4	8	18
Vectra (A) Hatchback (J89)	08/88→06/94	E 16 NZ	Petrol	1598	4	8	36
Vectra (A) Hatchback (J89)	09/88→07/89	E 18 NVR	Petrol	1796	4	8	77
Vectra (A) Hatchback (J89)	09/88→10/90	18 SV	Petrol	1796	4	8	77
Vectra (A) Hatchback (J89)	09/88→10/90	20 NE	Petrol	1998	4	8	106



Model	Year Range	Engine	Fuel	CC	Gears	Power (kW)	Power (hp)
Vectra (A) Hatchback (J89)	09/88→09/92	17 D	Diesel	1700	4	8	59
Vectra (A) Hatchback (J89)	09/88→05/93	16 SV	Petrol	1598	4	8	36
Vectra (A) Hatchback (J89)	09/88→11/95	20 SEH	Petrol	1998	4	8	106
Vectra (A) Hatchback (J89)	09/88→11/95	C 16 NZ	Petrol	1598	4	8	36
Vectra (A) Hatchback (J89)	09/88→11/95	C 16 NZ2	Petrol	1598	4	8	36
Vectra (A) Hatchback (J89)	09/88→11/95	C 20 NE	Petrol	1998	4	8	106
Vectra (A) Hatchback (J89)	02/89→10/90	20 XEJ	Petrol	1998	4	16	109
Vectra (A) Hatchback (J89)	08/89→11/95	C 20 XE	Petrol	1998	4	16	112
Vectra (A) Hatchback (J89)	03/90→11/95	17 DT (TC4EE1)	Diesel	1686	4	8	60
Vectra (A) Hatchback (J89)	03/90→11/95	C 18 NZ	Petrol	1796	4	8	81
Vectra (A) Hatchback (J89)	03/90→11/95	X 17 DT (TC4EE1)	Diesel	1686	4	8	60
Vectra (A) Hatchback (J89)	07/92→11/95	17 DR	Diesel	1700	4	8	59
Vectra (A) Hatchback (J89)	08/92→07/93	C 16 LZ2	Petrol	1598	4	8	46
Vectra (A) Hatchback (J89)	02/93→11/95	C 25 XE	Petrol	2498	6	24	149
Vectra (A) Hatchback (J89)	09/93→11/95	16 LZ2	Petrol	1598	4	8	33
Vectra (A) Hatchback (J89)	09/93→11/95	X 16 SZ	Petrol	1598	4	8	36
Vectra (A) Hatchback (J89)	06/94→11/95	X 20 XEV	Petrol	1998	4	16	113
Vectra (B) (36_)	09/95→08/96	16 SV	Petrol	1598	4	8	36
Vectra (B) (J96)	10/95→12/98	X 17 DT (TC4EE1)	Diesel	1686	4	8	60
Vectra (B) (J96)	10/95→09/00	C 20 SEL	Petrol	1998	4	16	113
Vectra (B) (J96)	10/95→09/00	X 18 XE	Petrol	1799	4	16	82
Vectra (B) (J96)	10/95→09/00	X 18 XE1	Petrol	1796	4	16	86
Vectra (B) (J96)	10/95→09/00	X 20 XEV	Petrol	1998	4	16	113
Vectra (B) (J96)	10/95→09/00	X 25 XE	Petrol	2498	6	24	149
Vectra (B) (J96)	10/95→09/00	Z 18 XEL	Petrol	1796	4	16	86
Vectra (B) (J96)	10/95→04/02	16 LZ2	Petrol	1598	4	8	33
Vectra (B) (J96)	10/95→04/02	20 NEJ	Petrol	1998	4	8	107
Vectra (B) (J96)	10/95→04/02	C 20 NE	Petrol	1998	4	8	106
Vectra (B) (J96)	10/95→04/02	X 16 SZR	Petrol	1598	4	8	36
Vectra (B) (J96)	10/95→04/02	X 16 XEL	Petrol	1598	4	16	47
Vectra (B) (J96)	10/95→04/02	Y 16 XE	Petrol	1598	4	16	53
Vectra (B) (J96)	10/95→04/02	Z 16 XE	Petrol	1598	4	16	47
Vectra (B) (J96)	11/96→04/02	X 20 DTL	Diesel	1995	4	16	117
Vectra (B) (J96)	06/97→04/02	X 20 DTH	Diesel	1995	4	16	117
Vectra (B) (J96)	06/97→04/02	Y 20 DTH	Diesel	1995	4	16	117
Vectra (B) (J96)	09/00→04/02	Y 22 DTR	Diesel	2172	4	16	133
Vectra (B) (J96)	09/00→04/02	Y 26 SE	Petrol	2597	6	24	155
Vectra (B) (J96)	09/00→04/02	Z 18 XE	Petrol	1796	4	16	88
Vectra (B) (J96)	09/00→04/02	Z 22 SE	Petrol	2198	4	16	132
Vectra (B) Estate (J96)	11/96→12/97	X 17 DT (TC4EE1)	Diesel	1686	4	8	60
Vectra (B) Estate (J96)	11/96→06/00	16 LZ2	Petrol	1598	4	8	33
Vectra (B) Estate (J96)	11/96→06/00	X 16 SZR	Petrol	1598	4	8	36
Vectra (B) Estate (J96)	11/96→06/00	X 20 DTL	Diesel	1995	4	16	117
Vectra (B) Estate (J96)	11/96→09/00	C 20 SEL	Petrol	1998	4	16	113
Vectra (B) Estate (J96)	11/96→09/00	X 18 XE	Petrol	1799	4	16	82
Vectra (B) Estate (J96)	11/96→09/00	X 18 XE1	Petrol	1796	4	16	86
Vectra (B) Estate (J96)	11/96→09/00	X 20 XEV	Petrol	1998	4	16	113
Vectra (B) Estate (J96)	11/96→09/00	X 25 XE	Petrol	2498	6	24	149
Vectra (B) Estate (J96)	11/96→09/00	Z 18 XEL	Petrol	1796	4	16	86
Vectra (B) Estate (J96)	11/96→02/02	20 NEJ	Petrol	1998	4	8	107
Vectra (B) Estate (J96)	11/96→07/02	X 16 XEL	Petrol	1598	4	16	47
Vectra (B) Estate (J96)	11/96→07/02	Y 16 XE	Petrol	1598	4	16	53
Vectra (B) Estate (J96)	11/96→07/02	Z 16 XE	Petrol	1598	4	16	47
Vectra (B) Estate (J96)	06/97→07/03	X 20 DTH	Diesel	1995	4	16	117
Vectra (B) Estate (J96)	06/97→07/03	Y 20 DTH	Diesel	1995	4	16	117
Vectra (B) Estate (J96)	09/00→07/03	Y 22 DTR	Diesel	2172	4	16	133
Vectra (B) Estate (J96)	09/00→07/03	Y 26 SE	Petrol	2597	6	24	155
Vectra (B) Estate (J96)	09/00→07/03	Z 18 XE	Petrol	1796	4	16	88
Vectra (B) Estate (J96)	09/00→07/03	Z 22 SE	Petrol	2198	4	16	132
Vectra (B) Hatchback (J96)	10/95→12/98	X 17 DT (TC4EE1)	Diesel	1686	4	8	60
Vectra (B) Hatchback (J96)	10/95→09/00	C 20 SEL	Petrol	1998	4	16	113
Vectra (B) Hatchback (J96)	10/95→09/00	X 18 XE	Petrol	1799	4	16	82
Vectra (B) Hatchback (J96)	10/95→09/00	X 18 XE1	Petrol	1796	4	16	86
Vectra (B) Hatchback (J96)	10/95→09/00	X 20 XEV	Petrol	1998	4	16	113
Vectra (B) Hatchback (J96)	10/95→09/00	X 25 XE	Petrol	2498	6	24	149
Vectra (B) Hatchback (J96)	10/95→09/00	Z 18 XEL	Petrol	1796	4	16	86
Vectra (B) Hatchback (J96)	10/95→02/02	20 NEJ	Petrol	1998	4	8	107
Vectra (B) Hatchback (J96)	10/95→07/02	X 16 XEL	Petrol	1598	4	16	47
Vectra (B) Hatchback (J96)	10/95→07/02	Y 16 XE	Petrol	1598	4	16	53
Vectra (B) Hatchback (J96)	10/95→07/02	Z 16 XE	Petrol	1598	4	16	47
Vectra (B) Hatchback (J96)	10/95→07/03	16 LZ2	Petrol	1598	4	8	33
Vectra (B) Hatchback (J96)	10/95→07/03	X 16 SZR	Petrol	1598	4	8	36
Vectra (B) Hatchback (J96)	11/96→06/00	X 20 DTL	Diesel	1995	4	16	117
Vectra (B) Hatchback (J96)	06/97→07/03	X 20 DTH	Diesel	1995	4	16	117
Vectra (B) Hatchback (J96)	06/97→07/03	Y 20 DTH	Diesel	1995	4	16	117
Vectra (B) Hatchback (J96)	09/00→07/03	Y 22 DTR	Diesel	2172	4	16	133
Vectra (B) Hatchback (J96)	09/00→07/03	Y 26 SE	Petrol	2597	6	24	155
Vectra (B) Hatchback (J96)	09/00→07/03	Z 18 XE	Petrol	1796	4	16	88



CC



9

Model	Period	Engine	Fuel	CC	Power	Speed	Consumption
Vectra (B) Hatchback (J96)	09/00→07/03	Z 22 SE	Petrol	2198	4	16	132
Vectra (C) (Z02)	04/02→	Y 20 DTH	Diesel	1995	4	16	117
Vectra (C) (Z02)	04/02→	Y 22 DTR	Diesel	2172	4	16	133
Vectra (C) (Z02)	04/02→	Z 18 XE	Petrol	1796	4	16	88
Vectra (C) (Z02)	04/02→	Z 18 XEL	Petrol	1796	4	16	86
Vectra (C) (Z02)	04/02→	Z 22 SE	Petrol	2198	4	16	132
Vectra (C) (Z02)	08/02→	Z 32 SE	Petrol	3175	6	24	171
Vectra (C) (Z02)	03/03→	Z 20 NET	Petrol	1998	4	16	111
Vectra (C) (Z02)	06/03→	Y 30 DT	Diesel	2958	6	24	167
Vectra (C) (Z02)	10/03→	Z 22 YH	Petrol	2198	4	16	132
Vectra (C) (Z02)	04/04→01/09	Z 19 DT	Diesel	1910	4	8	99
Vectra (C) (Z02)	04/04→	Z 19 DTH	Diesel	1910	4	16	100
Vectra (C) (Z02)	06/04→	Z 16 XE	Petrol	1598	4	16	47
Vectra (C) (Z02)	08/05→	Z 30 DT	Diesel	2959	6	24	167
Vectra (C) (Z02)	10/05→	Z 19 DTL	Diesel	1910	4	8	99
Vectra (C) (Z02)	01/06→	Z 16 XEP	Petrol	1598	4	16	57
Vectra (C) (Z02)	01/06→	Z 18 XER	Petrol	1796	4	16	79
Vectra (C) Estate (Z02)	10/03→	Y 20 DTH	Diesel	1995	4	16	117
Vectra (C) Estate (Z02)	10/03→	Y 22 DTR	Diesel	2172	4	16	133
Vectra (C) Estate (Z02)	10/03→	Y 30 DT	Diesel	2958	6	24	167
Vectra (C) Estate (Z02)	10/03→	Z 18 XE	Petrol	1796	4	16	88
Vectra (C) Estate (Z02)	10/03→	Z 20 NET	Petrol	1998	4	16	111
Vectra (C) Estate (Z02)	10/03→	Z 22 YH	Petrol	2198	4	16	132
Vectra (C) Estate (Z02)	10/03→	Z 32 SE	Petrol	3175	6	24	171
Vectra (C) Estate (Z02)	04/04→01/09	Z 19 DT	Diesel	1910	4	8	99
Vectra (C) Estate (Z02)	04/04→	Z 19 DTH	Diesel	1910	4	16	100
Vectra (C) Estate (Z02)	06/04→	Z 16 XE	Petrol	1598	4	16	47
Vectra (C) Estate (Z02)	08/05→	Z 30 DT	Diesel	2959	6	24	167
Vectra (C) Estate (Z02)	10/05→	Z 19 DTL	Diesel	1910	4	8	99
Vectra (C) Estate (Z02)	01/06→	Z 16 XEP	Petrol	1598	4	16	57
Vectra (C) Estate (Z02)	01/06→	Z 18 XER	Petrol	1796	4	16	79
Vectra (C) GTS (Z02)	08/02→12/06	Z 18 XEL	Petrol	1796	4	16	86
Vectra (C) GTS (Z02)	08/02→	Y 20 DTH	Diesel	1995	4	16	117
Vectra (C) GTS (Z02)	08/02→	Y 22 DTR	Diesel	2172	4	16	133
Vectra (C) GTS (Z02)	08/02→	Z 18 XE	Petrol	1796	4	16	88
Vectra (C) GTS (Z02)	08/02→	Z 22 SE	Petrol	2198	4	16	132
Vectra (C) GTS (Z02)	08/02→	Z 32 SE	Petrol	3175	6	24	171
Vectra (C) GTS (Z02)	03/03→	Z 20 NET	Petrol	1998	4	16	111
Vectra (C) GTS (Z02)	06/03→	Y 30 DT	Diesel	2958	6	24	167
Vectra (C) GTS (Z02)	10/03→	Z 22 YH	Petrol	2198	4	16	132
Vectra (C) GTS (Z02)	04/04→01/09	Z 19 DT	Diesel	1910	4	8	99
Vectra (C) GTS (Z02)	04/04→	Z 19 DTH	Diesel	1910	4	16	100
Vectra (C) GTS (Z02)	08/05→	Z 16 XE	Petrol	1598	4	16	47
Vectra (C) GTS (Z02)	08/05→	Z 30 DT	Diesel	2959	6	24	167
Vectra (C) GTS (Z02)	10/05→	Z 19 DTL	Diesel	1910	4	8	99
Vectra (C) GTS (Z02)	01/06→	Z 16 XEP	Petrol	1598	4	16	57
Vectra (C) GTS (Z02)	01/06→	Z 18 XER	Petrol	1796	4	16	79
Vectra Hatchback (JR)	06/97→12/98	X 20 XEV	Petrol	1998	4	16	113
Vectra Hatchback (JR)	06/97→12/98	X 25 XE	Petrol	2498	6	24	149
Vectra Hatchback (JS)	08/98→12/02	X 25 XE	Petrol	2498	6	24	149
Vectra Hatchback (JS)	11/00→12/02	Y 26 SE	Petrol	2597	6	24	155
Vectra Hatchback (ZC)	04/02→12/06	Z 22 SE	Petrol	2198	4	16	132
Vectra Hatchback (ZC)	08/02→12/06	Z 32 SE	Petrol	3175	6	24	171
Vectra Mk II (C) (Z02)	01/00→10/08	Z 20 NET	Petrol	1998	4	16	111
Vectra Mk II (C) (Z02)	01/02→10/08	Z 22 SE	Petrol	2198	4	16	132
Vectra Mk II (C) (Z02)	01/02→10/08	Z 22 YH	Petrol	2198	4	16	132
Vectra Mk II (C) (Z02)	04/02→07/08	Z 18 XE	Petrol	1796	4	16	89
Vectra Mk II (C) (Z02)	04/02→09/08	Z 19 DT	Diesel	1910	4	8	99
Vectra Mk II (C) (Z02)	04/02→10/08	Y 20 DTH	Diesel	1995	4	16	117
Vectra Mk II (C) (Z02)	04/02→10/08	Y 22 DTR	Diesel	2172	4	16	133
Vectra Mk II (C) (Z02)	06/03→08/05	Y 30 DT	Diesel	2958	6	24	167
Vectra Mk II (C) (Z02)	06/03→07/08	Z 32 SE	Petrol	3175	6	24	171
Vectra Mk II (C) (Z02)	04/04→08/08	Z 19 DTH	Diesel	1910	4	16	100
Vectra Mk II (C) (Z02)	08/05→07/08	Z 30 DT	Diesel	2958	6	24	167
Vectra Mk II (C) (Z02)	01/06→07/08	Z 18 XER	Petrol	1796	4	16	79
Vectra Mk II (C) (Z02)	10/03→08/05	Y 30 DT	Diesel	2958	6	24	167
Vectra Mk II (C) Estate (Z02)	10/03→08/05	Z 18 XE	Petrol	1796	4	16	89
Vectra Mk II (C) Estate (Z02)	10/03→08/05	Z 32 SE	Petrol	3175	6	24	171
Vectra Mk II (C) Estate (Z02)	10/03→07/08	Y 20 DTH	Diesel	1995	4	16	117
Vectra Mk II (C) Estate (Z02)	10/03→07/08	Y 22 DTR	Diesel	2172	4	16	133
Vectra Mk II (C) Estate (Z02)	10/03→07/08	Z 20 NET	Petrol	1998	4	16	111
Vectra Mk II (C) Estate (Z02)	10/03→07/08	Z 22 YH	Petrol	2198	4	16	132
Vectra Mk II (C) Estate (Z02)	04/04→07/08	Z 19 DT	Diesel	1910	4	8	99
Vectra Mk II (C) Estate (Z02)	04/04→05/09	Z 19 DTH	Diesel	1910	4	16	100
Vectra Mk II (C) Estate (Z02)	08/05→07/08	Z 30 DT	Diesel	2958	6	24	167
Vectra Mk II (C) Estate (Z02)	01/06→07/08	Z 18 XER	Petrol	1796	4	16	79
Vectra Mk II (C) Estate (Z02)	09/06→07/08	Z 16 XEP	Petrol	1598	4	16	57
Vectra Mk II (C) GTS (Z02)	08/02→07/08	Y 20 DTH	Diesel	1995	4	16	117



Model	Period	Engine	Fuel	CC	Power (kW)	Power (hp)	Price
Vectra Mk II (C) GTS (Z02)	08/02→07/08	Y 22 DTR	Diesel	2172	4	16	133
Vectra Mk II (C) GTS (Z02)	08/02→07/08	Z 18 XE	Petrol	1796	4	16	89
Vectra Mk II (C) GTS (Z02)	08/02→07/08	Z 19 DT	Diesel	1910	4	8	99
Vectra Mk II (C) GTS (Z02)	08/02→07/08	Z 22 SE	Petrol	2198	4	16	132
Vectra Mk II (C) GTS (Z02)	08/02→07/08	Z 32 SE	Petrol	3175	6	24	171
Vectra Mk II (C) GTS (Z02)	03/03→07/08	Z 20 NET	Petrol	1998	4	16	111
Vectra Mk II (C) GTS (Z02)	06/03→08/05	Y 30 DT	Diesel	2958	6	24	167
Vectra Mk II (C) GTS (Z02)	10/03→08/05	Z 22 YH	Petrol	2198	4	16	132
Vectra Mk II (C) GTS (Z02)	04/04→07/08	Z 19 DTH	Diesel	1910	4	16	100
Vectra Mk II (C) GTS (Z02)	08/05→07/08	Z 30 DT	Diesel	2958	6	24	167
Vectra Mk II (C) GTS (Z02)	01/06→07/08	Z 18 XER	Petrol	1796	4	16	79
Vectra Saloon (JR)	06/97→12/98	X 20 XEV	Petrol	1998	4	16	113
Vectra Saloon (JR)	06/97→12/98	X 25 XE	Petrol	2498	6	24	149
Vectra Saloon (JS)	07/00→07/02	Y 26 SE	Petrol	2597	6	24	155
Vectra Saloon (ZC)	04/02→12/06	Z 22 SE	Petrol	2198	4	16	132
Vectra Saloon (ZC)	08/02→12/06	Z 32 SE	Petrol	3175	6	24	171
Viceroy	01/80→10/82	25 S	Petrol	2490	6	12	147
Viva Estate (JF)	03/05→12/09	F18D3	Petrol	1796	4	16	83
Viva Hatchback (JF)	03/05→12/09	F18D3	Petrol	1796	4	16	83
Vivaro Box (F7)	08/01→	F4R 720	Petrol	1998	4	16	114
Vivaro Box (F7)	08/01→	F9Q 760	Diesel	1870	4	8	97
Vivaro Box (F7)	08/01→	F9Q 762	Diesel	1870	4	8	97
Vivaro Box (F7)	05/03→	G9U 730	Diesel	2464	4	16	150
Vivaro Box (F7)	08/06→	F4R 820	Petrol	1998	4	16	114
Vivaro Box (F7)	08/06→	G9MB6	Diesel	2463	4	16	150
Vivaro Box (F7)	08/06→	G9U 630	Diesel	2464	4	16	150
Vivaro Box (F7)	08/06→	M9R 630	Diesel	1995	4	16	116
Vivaro Box (F7)	08/06→	M9R 692	Diesel	1995	4	16	116
Vivaro Box (F7)	08/06→	M9R 780	Diesel	1995	4	16	116
Vivaro Box (F7)	08/06→	M9R 782	Diesel	1995	4	16	116
Vivaro Box (F7)	08/06→	M9R 784	Diesel	1995	4	16	116
Vivaro Box (F7)	08/06→	M9R 786	Diesel	1995	4	16	116
Vivaro Box (F7)	08/06→	M9R 788	Diesel	1995	4	16	116
Vivaro Box (X82)	05/14→	R9M 408	Diesel	1598	4	16	50
Vivaro Box (X82)	05/14→	R9M 450	Diesel	1598	4	16	50
Vivaro Box (X82)	06/14→	R9M 408	Diesel	1598	4	16	51
Vivaro Box (X82)	06/14→	R9M 450	Diesel	1598	4	16	51
Vivaro Box (X82)	03/16→	R9M 452	Diesel	1598	4	16	51
Vivaro Box (X82)	08/16→	R9M 413	Diesel	1598	4	16	50
Vivaro Box (X82)	08/16→	R9M 413	Diesel	1598	4	16	51
Vivaro Box (X83)	08/01→12/06	F4R 720	Petrol	1998	4	16	114
Vivaro Box (X83)	08/01→12/06	F9Q 760	Diesel	1870	4	8	97
Vivaro Box (X83)	08/01→12/06	F9Q 762	Diesel	1870	4	8	97
Vivaro Box (X83)	07/03→07/14	G9U 730	Diesel	2464	4	16	150
Vivaro Box (X83)	01/06→07/14	M9R 630	Diesel	1995	4	16	116
Vivaro Box (X83)	01/06→07/14	M9R 780	Diesel	1995	4	16	116
Vivaro Box (X83)	01/06→07/14	M9R 782	Diesel	1995	4	16	116
Vivaro Box (X83)	01/06→07/14	M9R 786	Diesel	1995	4	16	116
Vivaro Box (X83)	08/06→07/14	F4R 820	Petrol	1998	4	16	114
Vivaro Box (X83)	08/06→07/14	G9U 630	Diesel	2464	4	16	150
Vivaro Box (X83)	08/06→07/14	M9R 692	Diesel	1995	4	16	116
Vivaro Box (X83)	08/06→07/14	M9R 788	Diesel	1995	4	16	116
Vivaro Combi (X82)	05/14→	R9M 408	Diesel	1598	4	16	50
Vivaro Combi (X82)	05/14→	R9M 450	Diesel	1598	4	16	50
Vivaro Combi (X82)	06/14→	R9M 408	Diesel	1598	4	16	51
Vivaro Combi (X82)	06/14→	R9M 450	Diesel	1598	4	16	51
Vivaro Combi (X82)	04/15→	R9M 413	Diesel	1598	4	16	51
Vivaro Combi (X82)	04/15→	R9M 452	Diesel	1598	4	16	51
Vivaro Combi (X82)	08/16→	R9M 413	Diesel	1598	4	16	50
Vivaro Combi (X83)	08/01→12/06	F4R 720	Petrol	1998	4	16	114
Vivaro Combi (X83)	08/01→12/06	F9Q 760	Diesel	1870	4	8	97
Vivaro Combi (X83)	08/01→12/06	F9Q 762	Diesel	1870	4	8	97
Vivaro Combi (X83)	08/01→	F4R 720	Petrol	1998	4	16	114
Vivaro Combi (X83)	08/01→	F9Q 760	Diesel	1870	4	8	97
Vivaro Combi (X83)	08/01→	F9Q 762	Diesel	1870	4	8	97
Vivaro Combi (X83)	05/03→	G9U 730	Diesel	2464	4	16	150
Vivaro Combi (X83)	07/03→07/14	G9U 730	Diesel	2464	4	16	150
Vivaro Combi (X83)	01/06→07/14	G9U 630	Diesel	2464	4	16	150
Vivaro Combi (X83)	01/06→07/14	M9R 630	Diesel	1995	4	16	116
Vivaro Combi (X83)	01/06→07/14	M9R 780	Diesel	1995	4	16	116
Vivaro Combi (X83)	01/06→07/14	M9R 782	Diesel	1995	4	16	116
Vivaro Combi (X83)	01/06→07/14	M9R 786	Diesel	1995	4	16	116
Vivaro Combi (X83)	08/06→07/14	F4R 820	Petrol	1998	4	16	114
Vivaro Combi (X83)	08/06→07/14	M9R 784	Diesel	1995	4	16	116
Vivaro Combi (X83)	08/06→07/14	M9R 788	Diesel	1995	4	16	116
Vivaro Combi (X83)	08/06→	F4R 820	Petrol	1998	4	16	114
Vivaro Combi (X83)	08/06→	G9U 630	Diesel	2464	4	16	150
Vivaro Combi (X83)	08/06→	M9R 630	Diesel	1995	4	16	116



CC



















9









Vivaro Combi (X83)	08/06→	M9R 692	Diesel	1995	4	16	116
Vivaro Combi (X83)	08/06→	M9R 780	Diesel	1995	4	16	116
Vivaro Combi (X83)	08/06→	M9R 782	Diesel	1995	4	16	116
Vivaro Combi (X83)	08/06→	M9R 784	Diesel	1995	4	16	116
Vivaro Combi (X83)	08/06→	M9R 786	Diesel	1995	4	16	116
Vivaro Combi (X83)	08/06→	M9R 788	Diesel	1995	4	16	116
Vivaro Platform/Chassis (X82)	05/14→	R9M 408	Diesel	1598	4	16	50
Vivaro Platform/Chassis (X82)	05/14→	R9M 450	Diesel	1598	4	16	50
Vivaro Platform/Chassis (X82)	06/14→	R9M 408	Diesel	1598	4	16	51
Vivaro Platform/Chassis (X82)	06/14→	R9M 450	Diesel	1598	4	16	51
Vivaro Platform/Chassis (X82)	11/16→	R9M 452	Diesel	1598	4	16	51
Vivaro Platform/Chassis (X83)	08/01→	F9Q 762	Diesel	1870	4	8	97
Vivaro Platform/Chassis (X83)	04/03→07/06	G9U 730	Diesel	2464	4	16	150
Vivaro Platform/Chassis (X83)	04/03→07/14	F4R 720	Petrol	1998	4	16	114
Vivaro Platform/Chassis (X83)	04/03→07/14	F9Q 762	Diesel	1870	4	8	97
Vivaro Platform/Chassis (X83)	08/03→	F4R 720	Petrol	1998	4	16	114
Vivaro Platform/Chassis (X83)	08/03→	G9U 730	Diesel	2464	4	16	150
Vivaro Platform/Chassis (X83)	01/06→07/14	M9R 630	Diesel	1995	4	16	116
Vivaro Platform/Chassis (X83)	01/06→07/14	M9R 780	Diesel	1995	4	16	116
Vivaro Platform/Chassis (X83)	01/06→07/14	M9R 782	Diesel	1995	4	16	116
Vivaro Platform/Chassis (X83)	01/06→07/14	M9R 786	Diesel	1995	4	16	116
Vivaro Platform/Chassis (X83)	01/06→	M9R 630	Diesel	1995	4	16	116
Vivaro Platform/Chassis (X83)	01/06→	M9R 780	Diesel	1995	4	16	116
Vivaro Platform/Chassis (X83)	01/06→	M9R 782	Diesel	1995	4	16	116
Vivaro Platform/Chassis (X83)	01/06→	M9R 786	Diesel	1995	4	16	116
Vivaro Platform/Chassis (X83)	08/06→07/14	F4R 820	Petrol	1998	4	16	114
Vivaro Platform/Chassis (X83)	08/06→07/14	G9U 630	Diesel	2464	4	16	150
Vivaro Platform/Chassis (X83)	08/06→07/14	M9R 788	Diesel	1995	4	16	116
Vivaro Platform/Chassis (X83)	08/06→	F4R 820	Petrol	1998	4	16	114
Vivaro Platform/Chassis (X83)	08/06→	F9Q 760	Diesel	1870	4	8	97
Vivaro Platform/Chassis (X83)	08/06→	G9U 630	Diesel	2464	4	16	150
Viva Saloon (JF)	03/05→12/09	F18D3	Petrol	1796	4	16	83
VX220 (E01)	09/00→07/05	Z 22 SE	Petrol	2198	4	16	132
VX220 (E01)	03/01→07/05	Z 20 LET	Petrol	1998	4	16	113
Zafira (TT)	06/01→02/06	Z 22 SE	Petrol	2198	4	16	132
Zafira A (F75_)	04/99→09/00	X 18 XE1	Petrol	1796	4	16	86
Zafira A (F75_)	04/99→06/05	X 16 XEL	Petrol	1598	4	16	47
Zafira A (F75_)	04/99→06/05	Z 16 XE	Petrol	1598	4	16	47
Zafira A (F75_)	07/99→06/05	X 20 DTL	Diesel	1995	4	16	117
Zafira A (F75_)	09/00→06/05	Y 20 DTH	Diesel	1995	4	16	117
Zafira A (F75_)	09/00→06/05	Z 18 XE	Petrol	1796	4	16	88
Zafira A (F75_)	09/00→06/05	Z 22 SE	Petrol	2198	4	16	132
Zafira A (F75_)	09/01→06/05	Z 16 YNG	Petrol	1598	4	16	54
Zafira A (F75_)	09/01→06/05	Z 20 LET	Petrol	1998	4	16	113
Zafira A (F75_)	01/02→06/05	Y 22 DTR	Diesel	2172	4	16	133
Zafira A (F75_)	11/02→06/05	Z 20 LER	Petrol	1998	4	16	113
Zafira A (F75_)	10/03→06/05	Z 16 XEP	Petrol	1598	4	16	57
Zafira B (A05)	07/05→	A 18 XER	Petrol	1796	4	16	79
Zafira B (A05)	07/05→	Z 16 XE1	Petrol	1598	4	16	56
Zafira B (A05)	07/05→	Z 16 XEP	Petrol	1598	4	16	57
Zafira B (A05)	07/05→	Z 18 XER	Petrol	1796	4	16	79
Zafira B (A05)	07/05→	Z 19 DT	Diesel	1910	4	8	99
Zafira B (A05)	07/05→	Z 19 DTH	Diesel	1910	4	16	100
Zafira B (A05)	07/05→	Z 19 DTL	Diesel	1910	4	8	99
Zafira B (A05)	07/05→	Z 20 LER	Petrol	1998	4	16	113
Zafira B (A05)	07/05→	Z 22 YH	Petrol	2198	4	16	132
Zafira B (A05)	01/06→	Z 16 SE	Petrol	1598	4	8	55
Zafira B (A05)	01/06→	Z 16 YNG	Petrol	1598	4	16	54
Zafira B (A05)	01/06→	Z 20 LEH	Petrol	1998	4	16	113
Zafira B (A05)	01/08→	A 16 XER	Petrol	1598	4	16	41
Zafira B (A05)	01/08→	A 17 DTJ	Diesel	1686	4	16	64
Zafira B (A05)	01/08→	A 17 DTR	Diesel	1686	4	16	64
Zafira B (A05)	01/08→	Z 16 XER	Petrol	1598	4	16	41
Zafira B (A05)	01/08→	Z 17 DTJ	Diesel	1686	4	16	64
Zafira B (A05)	02/09→	A 16 XNT	Gas	1598	4	16	42
Zafira B (A05)	02/09→	Z 16 XNT	Gas	1598	4	16	42
Zafira B (A05)	06/13→	A 18 XEL	Petrol	1796	4	16	79
Zafira B Van (A05)	07/05→	A 18 XER	Petrol	1796	4	16	79
Zafira B Van (A05)	07/05→	Z 18 XER	Petrol	1796	4	16	79
Zafira B Van (A05)	01/08→	A 17 DTJ	Diesel	1686	4	16	64
Zafira B Van (A05)	01/08→	A 17 DTR	Diesel	1686	4	16	64
Zafira B Van (A05)	01/08→	Z 17 DTJ	Diesel	1686	4	16	64
Zafira B Van (A05)	02/09→	A 16 XNT	Gas	1598	4	16	42
Zafira B Van (A05)	02/09→	Z 16 XNT	Gas	1598	4	16	42
Zafira Mk I (A) (F75)	11/98→08/04	Z 22 SE	Petrol	2198	4	16	132
Zafira Mk I (A) (F75)	11/98→08/05	X 16 XEL	Petrol	1598	4	16	47
Zafira Mk I (A) (F75)	11/98→08/05	Z 16 XE	Petrol	1598	4	16	47
Zafira Mk I (A) (F75)	04/99→08/05	Y 20 DTH	Diesel	1995	4	16	117



















Model	Year Range	Engine Code	Fuel Type	CC	Seats	Wheels	Price
Zafira Mk I (A) (F75)	05/99→08/00	X 18 XE1	Petrol	1796	4	16	86
Zafira Mk I (A) (F75)	10/99→08/05	X 20 DTL	Diesel	1995	4	16	117
Zafira Mk I (A) (F75)	09/00→08/05	Z 18 XE	Petrol	1796	4	16	89
Zafira Mk I (A) (F75)	06/01→06/05	Y 22 DTR	Diesel	2172	4	16	133
Zafira Mk I (A) (F75)	09/01→06/05	Z 16 YNG	Petrol	1598	4	16	54
Zafira Mk I (A) (F75)	09/01→06/05	Z 20 LET	Petrol	1998	4	16	113
Zafira Mk II (B) (M75)	04/05→11/14	A 18 XER	Petrol	1796	4	16	79
Zafira Mk II (B) (M75)	04/05→11/14	Z 18 XER	Petrol	1796	4	16	79
Zafira Mk II (B) (M75)	07/05→11/14	Z 16 XE1	Petrol	1598	4	16	56
Zafira Mk II (B) (M75)	07/05→11/14	Z 16 XEP	Petrol	1598	4	16	57
Zafira Mk II (B) (M75)	07/05→11/14	Z 16 YNG	Petrol	1598	4	16	54
Zafira Mk II (B) (M75)	07/05→11/14	Z 19 DT	Diesel	1910	4	8	99
Zafira Mk II (B) (M75)	07/05→11/14	Z 19 DTH	Diesel	1910	4	16	100
Zafira Mk II (B) (M75)	07/05→11/14	Z 19 DTL	Diesel	1910	4	8	99
Zafira Mk II (B) (M75)	07/05→11/14	Z 20 LER	Petrol	1998	4	16	113
Zafira Mk II (B) (M75)	07/05→11/14	Z 22 YH	Petrol	2198	4	16	132
Zafira Mk II (B) (M75)	01/06→11/14	Z 20 LEH	Petrol	1998	4	16	113
Zafira Mk II (B) (M75)	12/07→11/14	A 16 XER	Petrol	1598	4	16	41
Zafira Mk II (B) (M75)	12/07→11/14	Z 16 XER	Petrol	1598	4	16	41
Zafira Mk II (B) (M75)	01/08→11/14	A 17 DTR	Diesel	1686	4	16	64
Zafira Mk II (B) (M75)	02/09→11/14	A 16 XNT	Gas	1598	4	16	42
Zafira Mk II (B) (M75)	02/09→11/14	Z 16 XNT	Gas	1598	4	16	58
Zafira Mk II (B) (M75)	04/09→11/14	A 17 DTJ	Diesel	1686	4	16	64
Zafira Mk II (B) (M75)	04/09→11/14	Z 17 DTJ	Diesel	1686	4	16	64
Zafira Mk II (B) (M75)	04/13→11/14	A 18 XEL	Petrol	1796	4	16	79
Zafira Mk III (P12)	10/11→	A 14 NEL	Petrol	1364	4	16	20
Zafira Mk III (P12)	10/11→	A 14 NET	Petrol	1364	4	16	20
Zafira Mk III (P12)	10/11→	A 16 XNT	Gas	1598	4	16	42
Zafira Mk III (P12)	10/11→	A 18 XEL	Petrol	1796	4	16	79
Zafira Mk III (P12)	10/11→	A 18 XER	Petrol	1796	4	16	79
Zafira Mk III (P12)	10/11→	A 20 DT	Diesel	1956	4	16	110
Zafira Mk III (P12)	10/11→	A 20 DTH	Diesel	1956	4	16	110
Zafira Mk III (P12)	10/11→	A 20 DTL	Diesel	1956	4	16	110
Zafira Mk III (P12)	10/11→	B 14 NET	Petrol	1364	4	16	20
Zafira Mk III (P12)	10/11→	Y 20 DTJ	Diesel	1956	4	16	110
Zafira Mk III (P12)	10/11→	Z 20 DTJ	Diesel	1956	4	16	110
Zafira Mk III (P12)	01/13→	A 20 DTR	Diesel	1956	4	16	110
Zafira Mk III (P12)	07/13→	B 16 SHT	Petrol	1598	4	16	44
Zafira Tourer C (P12)	10/11→	A 14 NEL	Petrol	1364	4	16	20
Zafira Tourer C (P12)	10/11→	A 14 NET	Petrol	1364	4	16	20
Zafira Tourer C (P12)	10/11→	A 16 XNT	Gas	1598	4	16	42
Zafira Tourer C (P12)	10/11→	A 18 XEL	Petrol	1796	4	16	79
Zafira Tourer C (P12)	10/11→	A 18 XER	Petrol	1796	4	16	79
Zafira Tourer C (P12)	10/11→	A 20 DT	Diesel	1956	4	16	110
Zafira Tourer C (P12)	10/11→	A 20 DTH	Diesel	1956	4	16	110
Zafira Tourer C (P12)	10/11→	A 20 DTL	Diesel	1956	4	16	110
Zafira Tourer C (P12)	10/11→	B 14 NEL	Petrol	1364	4	16	20
Zafira Tourer C (P12)	10/11→	B 14 NET	Petrol	1364	4	16	20
Zafira Tourer C (P12)	10/11→	B 16 XNT	Gas	1598	4	16	42
Zafira Tourer C (P12)	10/11→	Y 20 DTJ	Diesel	1956	4	16	110
Zafira Tourer C (P12)	10/11→	Z 20 DTJ	Diesel	1956	4	16	110
Zafira Tourer C (P12)	01/13→	A 20 DTR	Diesel	1956	4	16	110









	CC				9		CC				9
1ZR-FAE	1598	4	16	Petrol	27	16 K4F	1588	4	16	Petrol	32
1ZZ-FE	1796	4	16	Petrol	69	16 LZ2	1598	4	8	Petrol	33
2GR-FE	3456	6	24	Petrol	173	16 N	1584	4	8	Petrol	34
2ZR-FE	1798	4	16	Petrol	70	16 N	1598	4	8	Petrol	35
2ZZ-GE	1796	4	16	Petrol	71	16 N	1598	4	8	Petrol	35
4A-FE	1587	4	16	Petrol	28	16 N (CIH)	1584	4	8	Petrol	34
4FC1	1995	4	8	Diesel	101	16 NZR	1598	4	8	Petrol	36
4FC1T	1995	4	8	Diesel	101	16 S	1584	4	8	Petrol	37
4FD1	2189	4	8	Diesel	121	16 S CIH	1584	4	8	Petrol	38
4FD1	2189	4	8	Diesel	121	16 SH	1598	4	8	Petrol	39
4FG1T	2380	4	8	Diesel	138	16 SH	1598	4	8	Petrol	39
4JA1	2499	4	8	Diesel	142	16 SV	1598	4	8	Petrol	36
4JA1	2499	4	8	Diesel	142	16 SV	1598	4	8	Petrol	36
4JA1-T	2499	4	8	Diesel	143	17 D	1699	4	8	Diesel	59
4JA1-T	2499	4	8	Diesel	143	17 D	1700	4	8	Diesel	59
4JB1-T	2771	4	8	Diesel	156	17 D (4EE1)	1686	4	8	Diesel	60
4 JG2 T	3059	4	8	Diesel	169	17 D (4EE1)	1686	4	8	Diesel	60
4 JG2T	3059	4	8	Diesel	169	17 DR	1699	4	8	Diesel	59
4 JG2TC	3059	4	8	Diesel	169	17 DR	1700	4	8	Diesel	59
4 JG2TC	3059	4	8	Diesel	169	17 DT (TC4EE1)	1686	4	8	Diesel	60
4JG2-TC	3059	4	8	Diesel	169	17 DT (TC4EE1)	1686	4	8	Diesel	60
4 JX1	2999	4	16	Diesel	163	17 L	1698	4	8	Petrol	61
4 JX1	2999	4	16	Diesel	163	17 N	1698	4	8	Petrol	62
4XC1	1471	4	8	Petrol	23	17 S	1698	4	8	Petrol	63
4XE1	1588	4	16	Petrol	29	17 S	1698	4	8	Petrol	63
4XE1-T	1588	4	16	Petrol	30	18 E	1796	4	8	Petrol	73
4ZB1	1817	4	8	Petrol	72	18 E	1796	4	8	Petrol	73
4ZC1	1994	4	8	Petrol	102	18 K4F	1796	4	16	Petrol	74
4 ZD1	2255	4	8	Petrol	134	18 K4G	1796	4	16	Petrol	74
4 ZD1	2255	4	8	Petrol	134	18LE	1796	4	8	Petrol	75
6 VDI	3165	6	24	Petrol	170	18 N	1796	4	8	Petrol	73
6 VDI	3165	6	24	Petrol	170	18 N	1796	4	8	Petrol	76
6VD1	3165	6	24	Petrol	170	18 NV	1796	4	8	Petrol	77
6 VE1	3494	6	24	Petrol	174	18 NV	1796	4	8	Petrol	77
6 VE1	3494	6	24	Petrol	174	18 S	1796	4	8	Petrol	73
6VE1	3494	6	24	Petrol	174	18 S	1796	4	8	Petrol	73
10 N	993	4	8	Petrol	2	18 SE	1796	4	8	Petrol	78
10 S	993	4	8	Petrol	2	18 SE	1796	4	8	Petrol	78
10 S	993	4	8	Petrol	2	18 SEH	1796	4	8	Petrol	77
11 N	1078	4	8	Petrol	7	18 SEH	1796	4	8	Petrol	77
11 S	1078	4	8	Petrol	7	18 SV	1796	4	8	Petrol	77
11 SR	1078	4	8	Petrol	7	18 SV	1796	4	8	Petrol	77
12 N	1196	4	8	Petrol	8	19 DJ	1870	4	8	Diesel	91
12 N	1196	4	8	Petrol	8	19 DL	1870	4	8	Diesel	91
12 NC	1196	4	8	Petrol	8	19 E	1897	4	8	Petrol	92
12 NC	1196	4	8	Petrol	8	19 N	1897	4	8	Petrol	93
12 NV	1196	4	8	Petrol	9	19 S	1897	4	8	Petrol	94
12 NV	1196	4	8	Petrol	9	19 S	1897	4	8	Petrol	94
12 NZ	1195	4	8	Petrol	9	19 SH	1897	4	8	Petrol	95
12 S	1196	4	8	Petrol	8	19 SH	1897	4	8	Petrol	95
12 S	1196	4	8	Petrol	8	20 D	1998	4	8	Diesel	103
12 SC	1196	4	8	Petrol	8	20 E	1979	4	8	Petrol	104
12 SC	1196	4	8	Petrol	8	20 E	1979	4	8	Petrol	104
12 ST	1196	4	8	Petrol	9	20 EH	1979	4	8	Petrol	105
12 ST	1196	4	8	Petrol	9	20 ER	1979	4	8	Petrol	105
13 N	1297	4	8	Petrol	14	20 N	1979	4	8	Petrol	105
13 N	1297	4	8	Petrol	14	20 N	1979	4	8	Petrol	105
13 NB	1297	4	8	Petrol	14	20 NE	1998	4	8	Petrol	106
13 NB	1297	4	8	Petrol	14	20 NE	1998	4	8	Petrol	106
13 S	1297	4	8	Petrol	14	20 NEJ	1998	4	8	Petrol	107
13 S	1297	4	8	Petrol	14	20 NEJ	1998	4	8	Petrol	107
13 SB	1297	4	8	Petrol	14	20 S	1979	4	8	Petrol	105
13 SB	1297	4	8	Petrol	14	20 S	1979	4	8	Petrol	105
14 K4F	1396	4	16	Petrol	17	20 SE	1998	4	8	Petrol	106
14 NV	1389	4	8	Petrol	18	20 SE	1998	4	8	Petrol	106
14 NV	1389	4	8	Petrol	18	20 SEH	1998	4	8	Petrol	106
14 SE	1389	4	8	Petrol	18	20 SEH	1998	4	8	Petrol	106
15 D	1488	4	8	Diesel	24	20 SER	1998	4	16	Petrol	108
15 D (4EC1)	1488	4	8	Diesel	24	20 XE	1998	4	16	Petrol	109
15 DT	1488	4	8	Diesel	24	20 XE	1998	4	16	Petrol	109
15 DT (T4EC1)	1488	4	8	Diesel	24	20 XEJ	1998	4	16	Petrol	109
15 DT (T4EC1)	1488	4	8	Diesel	24	21 D	2068	4	8	Diesel	120
15 N	1492	4	8	Petrol	25	22DIE	2189	4	8	Diesel	122
15 NB	1492	4	8	Petrol	25	22 E	2197	4	8	Petrol	123
16 D	1598	4	8	Diesel	31	22 E	2197	4	8	Petrol	123
16 D	1598	4	8	Diesel	31	22 N	2239	6	12	Petrol	124
16 DA	1598	4	8	Diesel	31	23 D	2260	4	8	Diesel	125
16 DA	1598	4	8	Diesel	31	23 D	2260	4	8	Diesel	135

	CC				9		CC				9
23 DC	2260	4	8	Diesel	135	A 16 LES	1598	4	16	Petrol	41
23 DTR	2260	4	8	Diesel	136	A 16 LES	1598	4	16	Petrol	41
23 DTR	2260	4	8	Diesel	136	A 16 LET	1598	4	16	Petrol	41
23 P	2254	4	8	Petrol	134	A 16 LET	1598	4	16	Petrol	41
23 P	2254	4	8	Petrol	134	A 16 XER	1598	4	16	Petrol	41
23 TD	2260	4	8	Diesel	126	A 16 XER	1598	4	16	Petrol	41
23 TD	2260	4	8	Diesel	126	A 16 XNT	1598	4	16	Gas	42
23 YD	2260	4	8	Diesel	135	A 16 XNT	1598	4	16	Gas	42
23 YD	2260	4	8	Diesel	135	A 17 DT	1686	4	16	Diesel	64
23 YDT	2260	4	8	Diesel	126	A 17 DT	1686	4	16	Diesel	64
23 YDT	2260	4	8	Diesel	136	A 17 DTC	1686	4	16	Diesel	64
25 DG	2499	4	8	Diesel	144	A 17 DTC	1686	4	16	Diesel	64
25 DM	2499	4	8	Diesel	145	A 17 DTE	1686	4	16	Diesel	64
25 DT	2497	6	12	Diesel	146	A 17 DTE	1686	4	16	Diesel	64
25 DT	2497	6	12	Diesel	146	A 17 DTF	1686	4	16	Diesel	64
25 E	2490	6	12	Petrol	147	A 17 DTF	1686	4	16	Diesel	64
25 E	2490	6	12	Petrol	147	A 17 DTI	1686	4	16	Diesel	64
25 H	2490	6	12	Petrol	147	A 17 DTI	1686	4	16	Diesel	65
25 H	2490	6	12	Petrol	147	A 17 DTJ	1686	4	16	Diesel	64
25 NE	2490	6	12	Petrol	147	A 17 DTJ	1686	4	16	Diesel	64
25 S	2490	6	12	Petrol	147	A 17 DTL	1686	4	16	Diesel	64
25 S	2490	6	12	Petrol	147	A 17 DTL	1686	4	16	Diesel	64
25 S	2490	6	12	Petrol	148	A 17 DTN	1686	4	16	Diesel	64
25 SV	2490	6	12	Petrol	148	A 17 DTN	1686	4	16	Diesel	65
28 E	2784	6	12	Petrol	157	A 17 DTR	1686	4	16	Diesel	64
28 EC	2784	6	12	Petrol	157	A 17 DTR	1686	4	16	Diesel	64
28 H	2784	6	12	Petrol	158	A 17 DTS	1686	4	16	Diesel	64
28 H	2784	6	12	Petrol	158	A 17 DTS	1686	4	16	Diesel	64
28 HC	2784	6	12	Petrol	159	A 18 XEL	1796	4	16	Petrol	79
28 HL	2784	6	12	Petrol	159	A 18 XEL	1796	4	16	Petrol	79
28 S	2784	6	12	Petrol	159	A 18 XER	1796	4	16	Petrol	79
28 TDI (4JB1-T)	2771	4	8	Diesel	156	A 18 XER	1796	4	16	Petrol	79
28 TDI (4JB1-T)	2771	4	8	Diesel	156	A 20 DT	1956	4	16	Diesel	110
30 E	2969	6	12	Petrol	161	A 20 DT	1956	4	16	Diesel	110
30 E	2969	6	12	Petrol	164	A 20 DTC	1956	4	16	Diesel	110
30 H	2969	6	12	Petrol	161	A 20 DTC	1956	4	16	Diesel	110
30 H	2969	6	12	Petrol	162	A 20 DTE	1956	4	16	Diesel	110
30 NE	2969	6	12	Petrol	164	A 20 DTE	1956	4	16	Diesel	110
30 NE	2969	6	12	Petrol	164	A 20 DTH	1956	4	16	Diesel	110
198 A4.000	1368	4	16	Petrol	19	A 20 DTH	1956	4	16	Diesel	110
843 A1.000	1368	4	16	Petrol	19	A 20 DTJ	1956	4	16	Diesel	110
A 10 XEP	998	3	12	Petrol	3	A 20 DTJ	1956	4	16	Diesel	110
A 10 XEP	998	3	12	Petrol	3	A 20 DTL	1956	4	16	Diesel	110
A 12 XEL	1229	4	16	Petrol	10	A 20 DTL	1956	4	16	Diesel	110
A 12 XEL	1229	4	16	Petrol	10	A 20 DTR	1956	4	16	Diesel	110
A 12 XER	1229	4	16	Petrol	10	A 20 DTR	1956	4	16	Diesel	110
A 12 XER	1229	4	16	Petrol	10	A 20 DTR	1956	4	16	Diesel	110
A 13 DTC	1248	4	16	Diesel	15	A 20 FD	1956	4	16	Diesel	110
A 13 DTC	1248	4	16	Diesel	15	A 20 NFT	1998	4	16	Petrol	111
A 13 DTE	1248	4	16	Diesel	15	A 20 NFT	1998	4	16	Petrol	111
A 13 DTE	1248	4	16	Diesel	15	A 20 NFT	1998	4	16	Petrol	111
A 13 DTR	1248	4	16	Diesel	15	A 20 NHT	1998	4	16	Petrol	111
A 13 DTR	1248	4	16	Diesel	15	A 20 NHT	1998	4	16	Petrol	111
A 13 FD	1248	4	16	Diesel	15	A 22 DM	2231	4	16	Diesel	127
A 13 FD	1248	4	16	Diesel	15	A 22 DM	2231	4	16	Diesel	127
A 14 FC	1368	4	16	Petrol	19	A 22 DMH	2231	4	16	Diesel	127
A 14 FC	1368	4	16	Petrol	19	A 22 DMH	2231	4	16	Diesel	127
A 14 FP	1368	4	16	Petrol	19	A 24 XE	2384	4	16	Petrol	139
A 14 FP	1368	4	16	Petrol	19	A 24 XE	2384	4	16	Petrol	139
A 14 NEL	1364	4	16	Petrol	20	A 24 XE	2384	4	16	Petrol	139
A 14 NEL	1364	4	16	Petrol	20	B12D1	1206	4	16	Petrol	11
A 14 NET	1364	4	16	Petrol	20	B 12 XEL	1229	4	16	Petrol	10
A 14 NET	1364	4	16	Petrol	20	B 12 XEL	1229	4	16	Petrol	10
A 14 NET	1364	4	16	Petrol	20	B 12 XER	1229	4	16	Petrol	10
A 14 XEL	1398	4	16	Petrol	20	B 12 XER	1229	4	16	Petrol	10
A 14 XEL	1398	4	16	Petrol	20	B 13 DTC	1248	4	16	Diesel	15
A 14 XER	1398	4	16	Petrol	20	B 13 DTC	1248	4	16	Diesel	15
A 14 XER	1398	4	16	Petrol	20	B 13 DTE	1248	4	16	Diesel	15
A 14 XFL	1398	4	16	Petrol	20	B 13 DTE	1248	4	16	Diesel	15
A 14 XFL	1398	4	16	Petrol	20	B 13 DTR	1248	4	16	Diesel	15
A 16 FDH	1598	4	16	Diesel	40	B 13 DTR	1248	4	16	Diesel	15
A 16 FDH	1598	4	16	Diesel	40	B 14 NEH	1364	4	16	Petrol	20
A 16 FDL	1598	4	16	Diesel	40	B 14 NEH	1364	4	16	Petrol	20
A 16 FDL	1598	4	16	Diesel	40	B 14 NEJ	1364	4	16	Petrol	20
A 16 LEL	1598	4	16	Petrol	41	B 14 NEJ	1364	4	16	Petrol	20
A 16 LEL	1598	4	16	Petrol	41	B 14 NEL	1364	4	16	Petrol	20
A 16 LER	1598	4	16	Petrol	41	B 14 NEL	1364	4	16	Petrol	20
A 16 LER	1598	4	16	Petrol	41	B 14 NET	1364	4	16	Petrol	20

	CC				9		CC				9
B 14 NET	1364	4	16	Petrol	20	C 22 SEL	2198	4	16	Petrol	129
B 14 XEJ	1398	4	16	Petrol	20	C 24 NE	2410	4	8	Petrol	140
B 14 XEJ	1398	4	16	Petrol	20	C 24 NE	2410	4	8	Petrol	140
B 14 XEL	1398	4	16	Petrol	20	C 25 XE	2498	6	24	Petrol	149
B 14 XEL	1398	4	16	Petrol	20	C 25 XE	2498	6	24	Petrol	149
B 14 XER	1398	4	16	Petrol	20	C 25 XE	2498	6	24	Petrol	149
B 14 XER	1398	4	16	Petrol	20	C 26 NE	2594	6	12	Petrol	154
B 16 LER	1598	4	16	Petrol	41	C 26 NE	2594	6	12	Petrol	154
B 16 LER	1598	4	16	Petrol	43	C 30 LE	2969	6	12	Petrol	161
B 16 LES	1598	4	16	Petrol	41	C 30 LE	2969	6	12	Petrol	164
B 16 LES	1598	4	16	Petrol	43	C 30 NE	2969	6	12	Petrol	164
B 16 SHT	1598	4	16	Petrol	44	C 30 NE	2969	6	12	Petrol	164
B 16 SHT	1598	4	16	Petrol	44	C 30 SE	2969	6	24	Petrol	165
B 16 XER	1598	4	16	Petrol	41	C 30 SE	2969	6	24	Petrol	165
B 16 XER	1598	4	16	Petrol	45	C 30 SEJ	2969	6	24	Petrol	165
B 16 XNT	1598	4	16	Gas	42	C 30 SEJ	2969	6	24	Petrol	165
B 18 XER	1796	4	16	Petrol	79	C 30 XEI	2969	6	24	Petrol	165
B 20 NFT	1998	4	16	Petrol	111	C223	2238	4	8	Diesel	130
B 20 NFT	1998	4	16	Petrol	111	C223	2238	4	8	Diesel	130
B 20 NHT	1998	4	16	Petrol	111	CB	993	3	6	Petrol	4
C 12 NZ	1196	4	8	Petrol	9	D13A	1248	4	16	Diesel	12
C 12 NZ	1196	4	8	Petrol	9	D13A	1248	4	16	Diesel	12
C 12 NZ	1196	4	8	Petrol	9	E 12 GV	1196	4	8	Petrol	8
C 13 N	1297	4	8	Petrol	14	E 12 GV	1196	4	8	Petrol	8
C 13 N	1297	4	8	Petrol	14	E15	1488	4	8	Petrol	26
C 14 NZ	1389	4	8	Petrol	18	E16	1597	4	8	Petrol	48
C 14 NZ	1389	4	8	Petrol	18	E 16 LZ	1598	4	8	Petrol	36
C 14 NZ	1389	4	8	Petrol	18	E 16 NZ	1598	4	8	Petrol	36
C 14 SE	1389	4	8	Petrol	18	E 16 NZ	1598	4	8	Petrol	36
C 14 SE	1389	4	8	Petrol	18	E 16 SE	1598	4	8	Petrol	36
C 14 SE	1389	4	8	Petrol	18	E 16 SE	1598	4	8	Petrol	36
C 14 SEL	1389	4	16	Petrol	21	E 18 NV	1796	4	8	Petrol	77
C 14 SEL	1389	4	16	Petrol	21	E 18 NV	1796	4	8	Petrol	77
C 16 LZ	1598	4	8	Petrol	36	E 18 NVR	1796	4	8	Petrol	77
C 16 LZ	1598	4	8	Petrol	36	E 18 NVR	1796	4	8	Petrol	77
C 16 LZ2	1598	4	8	Petrol	46	F4R 720	1998	4	16	Petrol	114
C 16 NZ	1598	4	8	Petrol	36	F4R 720	1998	4	16	Petrol	114
C 16 NZ	1598	4	8	Petrol	36	F4R 820	1998	4	16	Petrol	114
C 16 NZ2	1598	4	8	Petrol	36	F4R 820	1998	4	16	Petrol	114
C 16 SE	1598	4	8	Petrol	36	F8Q 600	1870	4	8	Diesel	91
C 16 SE	1598	4	8	Petrol	36	F8Q 600	1870	4	8	Diesel	96
C 16 SEI	1598	4	8	Petrol	36	F8Q 606	1870	4	8	Diesel	96
C 16 SEI	1598	4	8	Petrol	36	F8Q 606	1870	4	8	Diesel	96
C 16 SEL	1598	4	16	Petrol	47	F9Q 760	1870	4	8	Diesel	97
C 16 SEL	1598	4	16	Petrol	47	F9Q 760	1870	4	8	Diesel	97
C 16 SEL	1598	4	16	Petrol	47	F9Q 762	1870	4	8	Diesel	97
C 16 XE	1598	4	16	Petrol	47	F9Q 762	1870	4	8	Diesel	97
C 16 XE	1598	4	16	Petrol	47	F9Q 770	1870	4	8	Diesel	97
C 18 NE	1796	4	8	Petrol	80	F9Q 770	1870	4	8	Diesel	97
C 18 NE	1796	4	8	Petrol	80	F9Q 772	1870	4	8	Diesel	97
C 18 NT	1796	4	8	Petrol	77	F9Q 772	1870	4	8	Diesel	97
C 18 NV	1796	4	8	Petrol	80	F9Q 774	1870	4	8	Diesel	97
C 18 NZ	1796	4	8	Petrol	81	F9Q 774	1870	4	8	Diesel	97
C 18 NZ	1796	4	8	Petrol	81	F10A	970	4	8	Petrol	5
C 18 SEL	1796	4	16	Petrol	82	F16D3	1598	4	16	Petrol	49
C 18 XE	1799	4	16	Petrol	82	F16D4	1598	4	16	Petrol	41
C 18 XE	1799	4	16	Petrol	82	F18D3	1796	4	16	Petrol	83
C 18 XEL	1799	4	16	Petrol	82	G9MB6	2463	4	16	Diesel	150
C 18 XEL	1799	4	16	Petrol	82	G9T 720	2188	4	16	Diesel	131
C 18 XEL	1799	4	16	Petrol	82	G9T 720	2188	4	16	Diesel	131
C 20 LET	1998	4	16	Petrol	109	G9T 722	2188	4	16	Diesel	131
C 20 LET	1998	4	16	Petrol	109	G9T 722	2188	4	16	Diesel	131
C 20 LET	1998	4	16	Petrol	112	G9T 750	2188	4	16	Diesel	131
C 20 LET	1998	4	16	Petrol	112	G9T 750	2188	4	16	Diesel	131
C 20 NE	1998	4	8	Petrol	106	G9U 630	2464	4	16	Diesel	150
C 20 NE	1998	4	8	Petrol	106	G9U 630	2464	4	16	Diesel	150
C 20 NE	1998	4	8	Petrol	107	G9U 632	2464	4	16	Diesel	150
C 20 NEF	1998	4	8	Petrol	106	G9U 632	2464	4	16	Diesel	150
C 20 NEF	1998	4	8	Petrol	106	G9U 650	2464	4	16	Diesel	150
C 20 NEJ	1998	4	8	Petrol	106	G9U 650	2464	4	16	Diesel	150
C 20 NEJ	1998	4	8	Petrol	106	G9U 720	2464	4	16	Diesel	150
C 20 SEL	1998	4	16	Petrol	113	G9U 720	2464	4	16	Diesel	150
C 20 XE	1998	4	16	Petrol	112	G9U 724	2464	4	16	Diesel	150
C 20 XE	1998	4	16	Petrol	112	G9U 724	2464	4	16	Diesel	150
C 20 XE	1998	4	16	Petrol	112	G9U 730	2464	4	16	Diesel	150
C 20 XE	1998	4	16	Petrol	112	G9U 730	2464	4	16	Diesel	150
C 22 NE	2198	4	8	Petrol	128	G9U 750	2464	4	16	Diesel	150
C 22 SEL	2198	4	16	Petrol	129	G9U 750	2464	4	16	Diesel	150

	CC				9		CC				9
G9U 754	2464	4	16	Diesel	150	R9M 452	1598	4	16	Diesel	51
G9U 754	2464	4	16	Diesel	150	S8U 758	2499	4	8	Diesel	151
G13A	1324	4	8	Petrol	16	S8U 758	2499	4	8	Diesel	151
H 20 E	1979	4	8	Petrol	105	S8U 770	2499	4	8	Diesel	151
H 20 E	1979	4	8	Petrol	105	S8U 770	2499	4	8	Diesel	151
H 25 E	2490	6	12	Petrol	147	S8U 772	2499	4	8	Diesel	151
H 25 E	2490	6	12	Petrol	147	S8U 772	2499	4	8	Diesel	151
K 1.8	1796	4	16	Petrol	84	S8U 780	2499	4	8	Diesel	151
K6A	658	3	12	Petrol	1	S8U 780	2499	4	8	Diesel	151
K10B	996	3	12	Petrol	6	S8U 782	2499	4	8	Diesel	151
K10B	996	3	12	Petrol	6	S8U 782	2499	4	8	Diesel	151
K12B	1242	4	16	Petrol	13	S9W 700	2799	4	8	Diesel	160
K12B	1242	4	16	Petrol	13	S9W 700	2799	4	8	Diesel	160
K18K4	1796	4	16	Petrol	85	S9W 702	2799	4	8	Diesel	160
L61	2198	4	16	Petrol	132	S9W 702	2799	4	8	Diesel	160
LE9	2384	4	16	Petrol	139	S 18 NV	1796	4	8	Petrol	77
LNF	1998	4	16	Petrol	115	S 18 NV	1796	4	8	Petrol	77
M9R 630	1995	4	16	Diesel	116	SIDA	1596	4	16	Petrol	52
M9R 630	1995	4	16	Diesel	116	TV 17 HC	1699	4	16	Petrol	66
M9R 692	1995	4	16	Diesel	116	X 10 XE	973	3	12	Petrol	3
M9R 692	1995	4	16	Diesel	116	X 10 XE	973	3	12	Petrol	3
M9R 780	1995	4	16	Diesel	116	X 12 SZ	1195	4	8	Petrol	9
M9R 780	1995	4	16	Diesel	116	X 12 SZ	1195	4	8	Petrol	9
M9R 782	1995	4	16	Diesel	116	X 12 XE	1199	4	16	Petrol	10
M9R 782	1995	4	16	Diesel	116	X 12 XE	1199	4	16	Petrol	10
M9R 784	1995	4	16	Diesel	116	X 14 NZ	1389	4	8	Petrol	18
M9R 784	1995	4	16	Diesel	116	X 14 SZ	1389	4	8	Petrol	18
M9R 786	1995	4	16	Diesel	116	X 14 SZ	1389	4	8	Petrol	18
M9R 786	1995	4	16	Diesel	116	X 14 XE	1389	4	16	Petrol	22
M9R 788	1995	4	16	Diesel	116	X 14 XE	1389	4	16	Petrol	22
M9R 788	1995	4	16	Diesel	116	X 14 XE	1389	4	16	Petrol	22
M9T 670	2298	4	16	Diesel	137	X 14 XE	1389	4	16	Petrol	22
M9T 670	2298	4	16	Diesel	137	X 15 DT (T4EC1)	1488	4	8	Diesel	24
M9T 672	2298	4	16	Diesel	137	X 15 DT (T4EC1)	1488	4	8	Diesel	24
M9T 672	2298	4	16	Diesel	137	X 16 SZ	1598	4	8	Petrol	36
M9T 676	2298	4	16	Diesel	137	X 16 SZ	1598	4	8	Petrol	36
M9T 676	2298	4	16	Diesel	137	X 16 SZR	1598	4	8	Petrol	36
M9T 676	2298	4	16	Diesel	137	X 16 SZR	1598	4	8	Petrol	36
M9T 678	2298	4	16	Diesel	137	X 16 XE	1598	4	16	Petrol	47
M9T 678	2298	4	16	Diesel	137	X 16 XE	1598	4	16	Petrol	47
M9T 680	2298	4	16	Diesel	137	X 16 XE	1598	4	16	Petrol	47
M9T 680	2298	4	16	Diesel	137	X 16 XE	1598	4	16	Petrol	47
M9T 686	2298	4	16	Diesel	137	X 16 XEL	1598	4	16	Petrol	47
M9T 686	2298	4	16	Diesel	137	X 16 XEL	1598	4	16	Petrol	47
M9T 690	2298	4	16	Diesel	137	X 16 XEL	1598	4	16	Petrol	47
M9T 690	2298	4	16	Diesel	137	X 16 XEL	1598	4	16	Petrol	47
M9T 692	2298	4	16	Diesel	137	X 17 D (4EE1)	1686	4	8	Diesel	67
M9T 692	2298	4	16	Diesel	137	X 17 D (4EE1)	1686	4	8	Diesel	67
M9T 694	2298	4	16	Diesel	137	X 17 DT (TC4EE1)	1686	4	8	Diesel	60
M9T 694	2298	4	16	Diesel	137	X 17 DT (TC4EE1)	1686	4	8	Diesel	60
M9T 696	2298	4	16	Diesel	137	X 17 DTL	1699	4	8	Diesel	59
M9T 696	2298	4	16	Diesel	137	X 17 DTL	1700	4	8	Diesel	59
M9T 698	2298	4	16	Diesel	137	X 18 XE	1799	4	16	Petrol	82
M9T 698	2298	4	16	Diesel	137	X 18 XE	1799	4	16	Petrol	82
M9T 700	2298	4	16	Diesel	137	X 18 XE1	1796	4	16	Petrol	86
M9T 700	2299	4	16	Diesel	137	X 18 XE1	1796	4	16	Petrol	86
M9T 702	2298	4	16	Diesel	137	X 18 XE1	1796	4	16	Petrol	87
M9T 702	2299	4	16	Diesel	137	X 20 DTH	1995	4	16	Diesel	117
M9T 704	2298	4	16	Diesel	137	X 20 DTH	1995	4	16	Diesel	117
M9T 704	2298	4	16	Diesel	137	X 20 DTL	1995	4	16	Diesel	117
M9T 706	2298	4	16	Diesel	137	X 20 DTL	1995	4	16	Diesel	117
M9T 706	2298	4	16	Diesel	137	X 20 SE	1998	4	8	Petrol	106
M9T 710	2298	4	16	Diesel	137	X 20 SE	1998	4	8	Petrol	106
M9T 710	2298	4	16	Diesel	137	X 20 SE	1998	4	8	Petrol	107
M9T 710	2298	4	16	Diesel	137	X 20 XER	1998	4	16	Petrol	113
M9T 710	2298	4	16	Diesel	137	X 20 XER	1998	4	16	Petrol	113
M9T 870	2299	4	16	Diesel	137	X 20 XEV	1998	4	16	Petrol	113
M9T 870	2299	4	16	Diesel	137	X 20 XEV	1998	4	16	Petrol	113
M9T 876	2299	4	16	Diesel	137	X 20 XEV	1998	4	16	Petrol	113
M9T 876	2299	4	16	Diesel	137	X 22 DTH	2171	4	16	Diesel	133
M9T 880	2298	4	16	Diesel	137	X 22 DTH	2171	4	16	Diesel	133
M9T 880	2298	4	16	Diesel	137	X 22 SE	2198	4	16	Petrol	129
M9T 896	2298	4	16	Diesel	137	X 22 SE	2198	4	16	Petrol	129
M9T 898	2298	4	16	Diesel	137	X 22 SE	2198	4	16	Petrol	129
M9T 898	2298	4	16	Diesel	137	X 22 SE	2198	4	16	Petrol	129
M9T 898	2298	4	16	Diesel	137	X 22 XE	2198	4	16	Petrol	129
R9M 408	1598	4	16	Diesel	50	X 22 XE	2198	4	16	Petrol	129
R9M 408	1598	4	16	Diesel	51	X 25 DT	2497	6	12	Diesel	146
R9M 413	1598	4	16	Diesel	50	X 25 DT	2497	6	12	Diesel	146
R9M 413	1598	4	16	Diesel	51	X 25 TD	2498	6	12	Diesel	146
R9M 450	1598	4	16	Diesel	50	X 25 TD	2498	6	12	Diesel	152
R9M 450	1598	4	16	Diesel	51	X 25 XE	2498	6	24	Petrol	149

	CC				9		CC				9
X 25 XE	2498	6	24	Petrol	149	Z 16 XE1	1598	4	16	Petrol	56
X 25 XE	2498	6	24	Petrol	149	Z 16 XE1	1598	4	16	Petrol	56
X 30 XE	2962	6	24	Petrol	166	Z 16 XEP	1598	4	16	Petrol	57
X 30 XE	2962	6	24	Petrol	166	Z 16 XEP	1598	4	16	Petrol	57
Y 13 DT	1248	4	16	Diesel	15	Z 16 XER	1598	4	16	Petrol	41
Y 13 DT	1248	4	16	Diesel	15	Z 16 XER	1598	4	16	Petrol	41
Y 16 XE	1598	4	16	Petrol	53	Z 16 XNT	1598	4	16	Gas	42
Y 16 XE	1598	4	16	Petrol	53	Z 16 XNT	1598	4	16	Gas	58
Y 16 YNG	1598	4	16	Petrol	54	Z 16 YNG	1598	4	16	Petrol	54
Y 16 YNG	1598	4	16	Petrol	54	Z 16 YNG	1598	4	16	Petrol	54
Y 17 DT	1686	4	16	Diesel	64	Z 17 DT	1686	4	16	Diesel	64
Y 17 DT	1686	4	16	Diesel	64	Z 17 DT	1686	4	16	Diesel	68
Y 17 DTL	1686	4	16	Diesel	64	Z 17 DTH	1686	4	16	Diesel	64
Y 17 DTL	1686	4	16	Diesel	64	Z 17 DTH	1686	4	16	Diesel	64
Y 20 DTH	1995	4	16	Diesel	117	Z 17 DTJ	1686	4	16	Diesel	64
Y 20 DTH	1995	4	16	Diesel	117	Z 17 DTJ	1686	4	16	Diesel	64
Y 20 DTJ	1956	4	16	Diesel	110	Z 17 DTL	1686	4	16	Diesel	64
Y 20 DTJ	1956	4	16	Diesel	110	Z 17 DTL	1686	4	16	Diesel	64
Y 20 DTL	1995	4	16	Diesel	117	Z 17 DTR	1686	4	16	Diesel	64
Y 20 DTL	1995	4	16	Diesel	117	Z 17 DTR	1686	4	16	Diesel	64
Y 22 DTH	2171	4	16	Diesel	133	Z 18 XE	1796	4	16	Petrol	88
Y 22 DTH	2172	4	16	Diesel	133	Z 18 XE	1796	4	16	Petrol	89
Y 22 DTR	2172	4	16	Diesel	133	Z 18 XE	1796	4	16	Petrol	89
Y 22 DTR	2172	4	16	Diesel	133	Z 18 XEL	1796	4	16	Petrol	86
Y 22 SE	2198	4	16	Petrol	129	Z 18 XEL	1796	4	16	Petrol	86
Y 22 SE	2198	4	16	Petrol	129	Z 18 XEP	1796	4	16	Petrol	79
Y 22 XE	2198	4	16	Petrol	129	Z 18 XEP	1796	4	16	Petrol	90
Y 25 DT	2497	6	24	Diesel	153	Z 18 XER	1796	4	16	Petrol	79
Y 25 DT	2497	6	24	Diesel	153	Z 18 XER	1796	4	16	Petrol	79
Y 26 SE	2597	6	24	Petrol	155	Z 19 D	1910	4	16	Diesel	98
Y 26 SE	2597	6	24	Petrol	155	Z 19 DT	1910	4	8	Diesel	99
Y 26 SE	2597	6	24	Petrol	155	Z 19 DT	1910	4	8	Diesel	99
Y 30 DT	2958	6	24	Diesel	167	Z 19 DTH	1910	4	16	Diesel	100
Y 30 DT	2958	6	24	Diesel	167	Z 19 DTH	1910	4	16	Diesel	100
Y 32 NE	3165	6	24	Petrol	170	Z 19 DTH	1910	4	16	Diesel	100
Y 32 NE	3165	6	24	Petrol	170	Z 19 DTJ	1910	4	16	Diesel	100
Y 32 SE	3175	6	24	Petrol	171	Z 19 DTJ	1910	4	16	Diesel	100
Y 32 SE	3175	6	24	Petrol	171	Z 19 DTL	1910	4	8	Diesel	99
Z 10 XE	973	3	12	Petrol	3	Z 19 DTL	1910	4	8	Diesel	99
Z 10 XE	973	3	12	Petrol	3	Z 20 DM	1991	4	16	Diesel	118
Z 10 XEP	998	3	12	Petrol	3	Z 20 DM	1991	4	16	Diesel	118
Z 10 XEP	998	3	12	Petrol	3	Z 20 DMH	1991	4	16	Diesel	118
Z 12 XE	1199	4	16	Petrol	10	Z 20 DMH	1991	4	16	Diesel	118
Z 12 XE	1199	4	16	Petrol	10	Z 20 DTJ	1956	4	16	Diesel	110
Z 12 XEP	1229	4	16	Petrol	10	Z 20 DTJ	1956	4	16	Diesel	110
Z 12 XEP	1229	4	16	Petrol	10	Z 20 LEH	1998	4	16	Petrol	113
Z 13 DT	1248	4	16	Diesel	15	Z 20 LEH	1998	4	16	Petrol	113
Z 13 DT	1248	4	16	Diesel	15	Z 20 LEL	1998	4	16	Petrol	113
Z 13 DTE	1248	4	16	Diesel	15	Z 20 LEL	1998	4	16	Petrol	113
Z 13 DTE	1248	4	16	Diesel	15	Z 20 LER	1998	4	16	Petrol	113
Z 13 DTH	1248	4	16	Diesel	15	Z 20 LER	1998	4	16	Petrol	113
Z 13 DTH	1248	4	16	Diesel	15	Z 20 LER	1998	4	16	Petrol	113
Z 13 DTI	1248	4	16	Diesel	15	Z 20 LER	1998	4	16	Petrol	113
Z 13 DTJ	1248	4	16	Diesel	15	Z 20 LET	1998	4	16	Petrol	113
Z 13 DTJ	1248	4	16	Diesel	15	Z 20 LET	1998	4	16	Petrol	113
Z 13 DTR	1248	4	16	Diesel	15	Z 20 LET	1998	4	16	Petrol	113
Z 13 DTR	1248	4	16	Diesel	15	Z 20 LET	1998	4	16	Petrol	113
Z 14 XE	1389	4	16	Petrol	22	Z 20 LET	1998	4	16	Petrol	119
Z 14 XE	1389	4	16	Petrol	22	Z 20 NET	1998	4	16	Petrol	111
Z 14 XE	1389	4	16	Petrol	22	Z 20 NET	1998	4	16	Petrol	111
Z 14 XEL	1364	4	16	Petrol	20	Z 20 NHH	1998	4	16	Petrol	115
Z 14 XEL	1364	4	16	Petrol	20	Z 20 S	1991	4	16	Diesel	118
Z 14 XEP	1364	4	16	Petrol	20	Z 22 SE	2198	4	16	Petrol	132
Z 14 XEP	1364	4	16	Petrol	20	Z 22 SE	2198	4	16	Petrol	132
Z 14 XEP	1364	4	16	Petrol	20	Z 22 SE	2198	4	16	Petrol	132
Z 14 XEP	1364	4	16	Petrol	20	Z 22 SE	2198	4	16	Petrol	129
Z 16 LEL	1598	4	16	Petrol	41	Z 22 XE	2198	4	16	Petrol	129
Z 16 LEL	1598	4	16	Petrol	41	Z 22 YH	2198	4	16	Petrol	132
Z 16 LER	1598	4	16	Petrol	41	Z 22 YH	2198	4	16	Petrol	132
Z 16 LER	1598	4	16	Petrol	41	Z 22 YH	2198	4	16	Petrol	132
Z 16 LET	1598	4	16	Petrol	41	Z 24 SE	2405	4	16	Petrol	141
Z 16 LET	1598	4	16	Petrol	41	Z 24 SED	2405	4	16	Petrol	141
Z 16 SE	1598	4	8	Petrol	36	Z 24 XE	2405	4	16	Petrol	141
Z 16 SE	1598	4	8	Petrol	55	Z 24 XE	2405	4	16	Petrol	141
Z 16 SE	1598	4	8	Petrol	55	Z 24 XED	2405	4	16	Petrol	141
Z 16 XE	1598	4	16	Petrol	47	Z 24 XED	2405	4	16	Petrol	141
Z 16 XE	1598	4	16	Petrol	47	Z 24 XED	2405	4	16	Petrol	141
Z 16 XE	1598	4	16	Petrol	47	Z 30 DT	2958	6	24	Diesel	167

	CC				9		CC				9
Z 30 DT	2959	6	24	Diesel	167						
Z 32 SE	3175	6	24	Petrol	171						
Z 32 SE	3175	6	24	Petrol	171						
Z 32 SE	3175	6	24	Petrol	171						
Z 32 SEE	3195	6	24	Petrol	172						
Z 32 SEE	3195	6	24	Petrol	172						
ZD3 200	2953	4	16	Diesel	168						
ZD3 200	2953	4	16	Diesel	168						
ZD3 202	2953	4	16	Diesel	168						
ZD3 202	2953	4	16	Diesel	168						

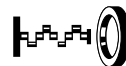
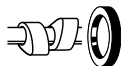

1 0.7L Petrol

K6A	3 Cyl.	12 Valves	658cc	TD31746
PA928 (x12)				

2 1.0L Petrol

10 N	4 Cyl.	8 Valves	993cc	TD2576
10 S	4 Cyl.	8 Valves	993cc	TD17551
10 S	4 Cyl.	8 Valves	993cc	TD2578
HR291 (x2)				
				NB691 (x2) 54.00 x 82.00 x 9.00mm, ACM

3 1.0L Petrol

A 10 XEP	3 Cyl.	12 Valves	998cc	TD24905
A 10 XEP	3 Cyl.	12 Valves	998cc	TD24906
X 10 XE	3 Cyl.	12 Valves	973cc	TD17619
X 10 XE	3 Cyl.	12 Valves	973cc	TD5512
Z 10 XE	3 Cyl.	12 Valves	973cc	TD14008
Z 10 XE	3 Cyl.	12 Valves	973cc	TD17630
Z 10 XEP	3 Cyl.	12 Valves	998cc	TD19349
Z 10 XEP	3 Cyl.	12 Valves	998cc	TD17475
PA5025 (x12)				
HR5096 (x2)				
				NA5108 (x2) 42.00 x 55.00 x 7.00mm, FPM/ACM NB698 (x2) 80.00 x 98.00 x 10.00mm, FPM

4 1.0L Petrol

CB	3 Cyl.	6 Valves	993cc	TD26956
PA387 (x6)				
				NJ268 32.00 x 48.00 x 7.00mm, NBR
				NJ324 (x2) 34.00 x 48.00 x 7.00mm, ACM NJ269 (x2) 58.00 x 74.00 x 10.00mm, ACM

5 1.0L Petrol

F10A	4 Cyl.	8 Valves	970cc	TD29536
PA305 (x8)				
				NJ336 32.00 x 47.00 x 8.00mm, NBR
				NJ337 (x2) 60.00 x 80.00 x 8.00mm, NBR

6 1.0L Petrol

K10B	3 Cyl.	12 Valves	996cc	TD23362
K10B	3 Cyl.	12 Valves	996cc	TD24738
HR5128 (x2)				

7 1.1L Petrol

11 N	4 Cyl.	8 Valves	1078cc	TD2580
11 S	4 Cyl.	8 Valves	1078cc	TD2581
11 SR	4 Cyl.	8 Valves	1078cc	TD2582
				NB691 (x2) 54.00 x 82.00 x 9.00mm, ACM

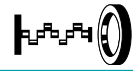
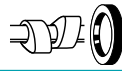

8 1.2L		Petrol			
12 N		4 Cyl.	8 Valves	1196cc	TD17554
12 N		4 Cyl.	8 Valves	1196cc	TD2583
12 NC		4 Cyl.	8 Valves	1196cc	TD17555
12 NC		4 Cyl.	8 Valves	1196cc	TD4717
12 S		4 Cyl.	8 Valves	1196cc	TD17556
12 S		4 Cyl.	8 Valves	1196cc	TD4720
12 SC		4 Cyl.	8 Valves	1196cc	TD17598
12 SC		4 Cyl.	8 Valves	1196cc	TD4721
E 12 GV		4 Cyl.	8 Valves	1196cc	TD22847
E 12 GV		4 Cyl.	8 Valves	1196cc	TD4809
HR291 (x2)					NB628 45.00 x 60.00 x 9.00mm, ACM NB691 54.00 x 82.00 x 9.00mm, ACM

9 1.2L		Petrol			
12 NV		4 Cyl.	8 Valves	1196cc	TD22840
12 NV		4 Cyl.	8 Valves	1196cc	TD4718
12 NZ		4 Cyl.	8 Valves	1195cc	TD4719
12 ST		4 Cyl.	8 Valves	1196cc	TD17599
12 ST		4 Cyl.	8 Valves	1196cc	TD4722
C 12 NZ		4 Cyl.	8 Valves	1196cc	TD17553
C 12 NZ		4 Cyl.	8 Valves	1196cc	TD23473
C 12 NZ		4 Cyl.	8 Valves	1196cc	TD4780
X 12 SZ		4 Cyl.	8 Valves	1195cc	TD17552
X 12 SZ		4 Cyl.	8 Valves	1195cc	TD2732
PA565 (x8) Eng no. 12ST-19230855 → HR342	NC006 35.00 x 48.00 x 7.00mm, MVQ			NB697 26.00 x 42.00 x 8.00mm, FPM NB698 80.00 x 98.00 x 10.00mm, FPM	

10 1.2L		Petrol			
A 12 XEL		4 Cyl.	16 Valves	1229cc	TD24371
A 12 XEL		4 Cyl.	16 Valves	1229cc	TD24747
A 12 XER		4 Cyl.	16 Valves	1229cc	TD24752
A 12 XER		4 Cyl.	16 Valves	1229cc	TD24372
B 12 XEL		4 Cyl.	16 Valves	1229cc	TD29770
B 12 XEL		4 Cyl.	16 Valves	1229cc	TD29662
B 12 XER		4 Cyl.	16 Valves	1229cc	TD30378
B 12 XER		4 Cyl.	16 Valves	1229cc	TD33723
X 12 XE		4 Cyl.	16 Valves	1199cc	TD17620
X 12 XE		4 Cyl.	16 Valves	1199cc	TD9508
Z 12 XE		4 Cyl.	16 Valves	1199cc	TD17935
Z 12 XE		4 Cyl.	16 Valves	1199cc	TD14009
Z 12 XEP		4 Cyl.	16 Valves	1229cc	TD18012
Z 12 XEP		4 Cyl.	16 Valves	1229cc	TD19350
PA5025 (x16) HR5048				NA5108 42.00 x 55.00 x 7.00mm, FPM/ACM NB698 80.00 x 98.00 x 10.00mm, FPM	

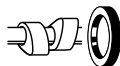

11 1.2L

Petrol

B12D1	4 Cyl.	16 Valves	1206cc	TD25009
HR5125				NA5351 36.00 x 50.00 x 6.00mm, FPM NA5478 60.00 x 80.00 x 8.00mm, FPM

12 1.2L

Diesel

D13A	4 Cyl.	16 Valves	1248cc	TD23364
D13A	4 Cyl.	16 Valves	1248cc	TD25752
HR5088				NA5223 40.00 x 52.00 x 7.00mm, FPM NA5230 78.00 x 100.00 x 9.00mm, PTFE

13 1.2L

Petrol

K12B	4 Cyl.	16 Valves	1242cc	TD24739
K12B	4 Cyl.	16 Valves	1242cc	TD23363
HR5128				

14 1.3L

Petrol

13 N	4 Cyl.	8 Valves	1297cc	TD17558
13 N	4 Cyl.	8 Valves	1297cc	TD4723
13 NB	4 Cyl.	8 Valves	1297cc	TD17560
13 NB	4 Cyl.	8 Valves	1297cc	TD4724
13 S	4 Cyl.	8 Valves	1297cc	TD17561
13 S	4 Cyl.	8 Valves	1297cc	TD4725
13 SB	4 Cyl.	8 Valves	1297cc	TD4726
13 SB	4 Cyl.	8 Valves	1297cc	TD17600
C 13 N	4 Cyl.	8 Valves	1297cc	TD4781
C 13 N	4 Cyl.	8 Valves	1297cc	TD18673
PA565 (x8) HR342	NC006 35.00 x 48.00 x 7.00mm, MVQ			NB697 26.00 x 42.00 x 8.00mm, FPM NB698 80.00 x 98.00 x 10.00mm, FPM

15 1.3L

Diesel

A 13 DTC	4 Cyl.	16 Valves	1248cc	TD24265
A 13 DTC	4 Cyl.	16 Valves	1248cc	TD24745
A 13 DTE	4 Cyl.	16 Valves	1248cc	TD23881
A 13 DTE	4 Cyl.	16 Valves	1248cc	TD24232
A 13 DTR	4 Cyl.	16 Valves	1248cc	TD28000
A 13 DTR	4 Cyl.	16 Valves	1248cc	TD24378
A 13 FD	4 Cyl.	16 Valves	1248cc	TD26182
A 13 FD	4 Cyl.	16 Valves	1248cc	TD26203
B 13 DTC	4 Cyl.	16 Valves	1248cc	TD29664
B 13 DTC	4 Cyl.	16 Valves	1248cc	TD29775
B 13 DTE	4 Cyl.	16 Valves	1248cc	TD29665
B 13 DTE	4 Cyl.	16 Valves	1248cc	TD29776
B 13 DTR	4 Cyl.	16 Valves	1248cc	TD31487
B 13 DTR	4 Cyl.	16 Valves	1248cc	TD30379
Y 13 DT	4 Cyl.	16 Valves	1248cc	TD23798
Y 13 DT	4 Cyl.	16 Valves	1248cc	TD20084

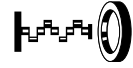
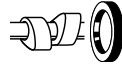

Z 13 DT	4 Cyl.	16 Valves	1248cc	TD17477
Z 13 DT	4 Cyl.	16 Valves	1248cc	TD18361
Z 13 DTE	4 Cyl.	16 Valves	1248cc	TD24376
Z 13 DTE	4 Cyl.	16 Valves	1248cc	TD24377
Z 13 DTH	4 Cyl.	16 Valves	1248cc	TD18654
Z 13 DTH	4 Cyl.	16 Valves	1248cc	TD18653
Z 13 DTI	4 Cyl.	16 Valves	1248cc	TD23707
Z 13 DTJ	4 Cyl.	16 Valves	1248cc	TD19348
Z 13 DTJ	4 Cyl.	16 Valves	1248cc	TD18989
Z 13 DTR	4 Cyl.	16 Valves	1248cc	TD23708
Z 13 DTR	4 Cyl.	16 Valves	1248cc	TD25258

HR5088

NA5223

40.00 x 52.00 x 7.00mm, FPM

NA5230

78.00 x 100.00 x 9.00mm, PTFE

16 1.3L

Petrol

G13A	4 Cyl.	8 Valves	1324cc	TD23483
------	--------	----------	--------	---------

NJ377

32.00 x 47.00 x 6.00mm, ACM

17 1.4L

Petrol

14 K4F	4 Cyl.	16 Valves	1396cc	TD29219
--------	--------	-----------	--------	---------

HR752

NC065 (x2)

30.00 x 40.00 x 7.00mm, FPM

NB998 (x2)

30.00 x 40.00 x 7.00mm, FPM

NB828

27.50 x 39.50 x 7.00mm, FPM

NB829

79.95 x 116.00; 126.00 x 11.50mm, FPM

18 1.4L

Petrol

14 NV	4 Cyl.	8 Valves	1389cc	TD17562
14 NV	4 Cyl.	8 Valves	1389cc	TD4728
14 SE	4 Cyl.	8 Valves	1389cc	TD4730
C 14 NZ	4 Cyl.	8 Valves	1389cc	TD23474
C 14 NZ	4 Cyl.	8 Valves	1389cc	TD4782
C 14 NZ	4 Cyl.	8 Valves	1389cc	TD17581
C 14 SE	4 Cyl.	8 Valves	1389cc	TD17582
C 14 SE	4 Cyl.	8 Valves	1389cc	TD19900
C 14 SE	4 Cyl.	8 Valves	1389cc	TD4783
X 14 NZ	4 Cyl.	8 Valves	1389cc	TD14828
X 14 SZ	4 Cyl.	8 Valves	1389cc	TD8405
X 14 SZ	4 Cyl.	8 Valves	1389cc	TD17621

PA565 (x8)

HR342

NC006

35.00 x 48.00 x 7.00mm, MVQ

NB697

26.00 x 42.00 x 8.00mm, FPM

NB698

80.00 x 98.00 x 10.00mm, FPM

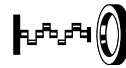
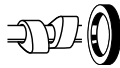

19 1.4L

Petrol

198 A4.000	4 Cyl.	16 Valves	1368cc	TD26414
843 A1.000	4 Cyl.	16 Valves	1368cc	TD26415
A 14 FC	4 Cyl.	16 Valves	1368cc	TD26199
A 14 FC	4 Cyl.	16 Valves	1368cc	TD26181
A 14 FP	4 Cyl.	16 Valves	1368cc	TD26180
A 14 FP	4 Cyl.	16 Valves	1368cc	TD26198
HR814	NA5058 (x2) 40.00 x 55.00 x 7.00mm, FPM		NA5057 27.00 x 37.00 x 7.00mm, FPM	LK5001 74.00 x 187.50 x 17.000mm, FPM

20 1.4L

Petrol

A 14 NEL	4 Cyl.	16 Valves	1364cc	TD24264
A 14 NEL	4 Cyl.	16 Valves	1364cc	TD24744
A 14 NET	4 Cyl.	16 Valves	1364cc	TD23882
A 14 NET	4 Cyl.	16 Valves	1364cc	TD24731
A 14 NET	4 Cyl.	16 Valves	1364cc	TD25010
A 14 XEL	4 Cyl.	16 Valves	1398cc	TD24373
A 14 XEL	4 Cyl.	16 Valves	1398cc	TD24743
A 14 XER	4 Cyl.	16 Valves	1398cc	TD23855
A 14 XER	4 Cyl.	16 Valves	1398cc	TD24542
A 14 XFL	4 Cyl.	16 Valves	1398cc	TD25753
A 14 XFL	4 Cyl.	16 Valves	1398cc	TD26215
B 14 NEH	4 Cyl.	16 Valves	1364cc	TD30856
B 14 NEH	4 Cyl.	16 Valves	1364cc	TD31383
B 14 NEJ	4 Cyl.	16 Valves	1364cc	TD29737
B 14 NEJ	4 Cyl.	16 Valves	1364cc	TD33727
B 14 NEL	4 Cyl.	16 Valves	1364cc	TD28264
B 14 NEL	4 Cyl.	16 Valves	1364cc	TD29773
B 14 NET	4 Cyl.	16 Valves	1364cc	TD30248
B 14 NET	4 Cyl.	16 Valves	1364cc	TD28263
B 14 XEJ	4 Cyl.	16 Valves	1398cc	TD29778
B 14 XEJ	4 Cyl.	16 Valves	1398cc	TD32763
B 14 XEL	4 Cyl.	16 Valves	1398cc	TD29663
B 14 XEL	4 Cyl.	16 Valves	1398cc	TD29771
B 14 XER	4 Cyl.	16 Valves	1398cc	TD28262
B 14 XER	4 Cyl.	16 Valves	1398cc	TD30249
Z 14 XEL	4 Cyl.	16 Valves	1364cc	TD18552
Z 14 XEL	4 Cyl.	16 Valves	1364cc	TD25529
Z 14 XEP	4 Cyl.	16 Valves	1364cc	TD17476
Z 14 XEP	4 Cyl.	16 Valves	1364cc	TD18228
Z 14 XEP	4 Cyl.	16 Valves	1364cc	TD19887
PA5025 (x16) HR5048			NA5108 42.00 x 55.00 x 7.00mm, FPM/ACM	NB698 80.00 x 98.00 x 10.00mm, FPM

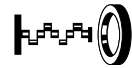
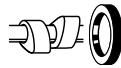

21 1.4L Petrol				
C 14 SEL	4 Cyl.	16 Valves	1389cc	TD16393
C 14 SEL	4 Cyl.	16 Valves	1389cc	TD21363
PA5041 (x16) HR791	NC006 (x2) 35.00 x 48.00 x 7.00mm, MVQ 08/97→09/00		NB697 26.00 x 42.00 x 8.00mm, FPM 08/97→09/00 NB698 80.00 x 98.00 x 10.00mm, FPM 08/97→09/00	

22 1.4L Petrol				
X 14 XE	4 Cyl.	16 Valves	1389cc	TD17589
X 14 XE	4 Cyl.	16 Valves	1389cc	TD2733
X 14 XE	4 Cyl.	16 Valves	1389cc	TD19897
Z 14 XE	4 Cyl.	16 Valves	1389cc	TD14920
Z 14 XE	4 Cyl.	16 Valves	1389cc	TD17631
Z 14 XE	4 Cyl.	16 Valves	1389cc	TD19888
PA5041 (x16) HR791	NC006 (x2) 35.00 x 48.00 x 7.00mm, MVQ		NB697 26.00 x 42.00 x 8.00mm, FPM NB698 80.00 x 98.00 x 10.00mm, FPM	

23 1.5L Petrol				
4XC1	4 Cyl.	8 Valves	1471cc	TD23485
PA658 (x8)	NJ449 40.00 x 52.00 x 6.00mm, NBR		NA5322 32.00 x 44.00 x 6.00mm, ACM NK103 87.00 x 100.00 x 8.50mm, FPM	

24 1.5L Diesel				
15 D	4 Cyl.	8 Valves	1488cc	TD21906
15 D (4EC1)	4 Cyl.	8 Valves	1488cc	TD4732
15 DT	4 Cyl.	8 Valves	1488cc	TD17578
15 DT (T4EC1)	4 Cyl.	8 Valves	1488cc	TD18227
15 DT (T4EC1)	4 Cyl.	8 Valves	1488cc	TD4733
X 15 DT (T4EC1)	4 Cyl.	8 Valves	1488cc	TD22871
X 15 DT (T4EC1)	4 Cyl.	8 Valves	1488cc	TD5301
PA658 (x8)	NJ449 40.00 x 52.00 x 6.00mm, NBR		NJ449 40.00 x 52.00 x 6.00mm, NBR NK103 87.00 x 100.00 x 8.50mm, FPM	

25 1.5L Petrol				
15 N	4 Cyl.	8 Valves	1492cc	TD32342
15 NB	4 Cyl.	8 Valves	1492cc	TD32343
			NB628 45.00 x 60.00 x 9.00mm, ACM	

26 1.5L Petrol				
E15	4 Cyl.	8 Valves	1488cc	TD23467
			NJ287 80.00 x 100.00 x 10.00mm, MVQ	

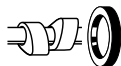

27 1.6L

Petrol

1ZR-FAE	4 Cyl.	16 Valves	1598cc	TD24847
PA5020 (x16)				NA5260 38.00 x 50.00 x 6.00mm, FPM NA5089 38.00 x 50.00 x 8.00mm, NBR

28 1.6L

Petrol

4A-FE	4 Cyl.	16 Valves	1587cc	TD19917
PA425 (x16)				NJ349 32.50 x 46.00 x 6.00mm, NBR NJ001 70.00 x 92.00 x 8.50mm, MVQ

29 1.6L

Petrol

4XE1	4 Cyl.	16 Valves	1588cc	TD10132
				NJ449 (x2) 40.00 x 52.00 x 6.00mm, NBR NA5322 32.00 x 44.00 x 6.00mm, ACM NJ446 87.00 x 100.00 x 8.00mm, MVQ

30 1.6L

Petrol

4XE1-T	4 Cyl.	16 Valves	1588cc	TD1877
				NA5347 (x2) 30.0 x 45.0 x 7.00mm, FPM NA576 36.50 x 52.30 x 8.00mm, MVQ

31 1.6L

Diesel

16 D	4 Cyl.	8 Valves	1598cc	TD17563
16 D	4 Cyl.	8 Valves	1598cc	TD4734
16 DA	4 Cyl.	8 Valves	1598cc	TD17601
16 DA	4 Cyl.	8 Valves	1598cc	TD4735
HR343				NC006 35.00 x 48.00 x 7.00mm, MVQ NB734 35.00 x 50.00 x 8.00mm, FPM NB701 86.00 x 104.00 x 11.00mm, FPM →Eng no. 16DA-14498630 NB806 90.00 x 104.00 x 11.00mm, FPM Eng no. 16DA-14498631 →

32 1.6L

Petrol

16 K4F	4 Cyl.	16 Valves	1588cc	TD31621
HR752				NC065 (x2) 30.00 x 40.00 x 7.00mm, FPM NB998 (x2) 30.00 x 40.00 x 7.00mm, FPM NB828 27.50 x 39.50 x 7.00mm, FPM NB829 79.95 x 116.00; 126.00 x 11.50mm, FPM

33 1.6L



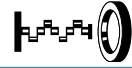

Petrol

16 LZ2	4 Cyl.	8 Valves	1598cc	TD4736
PA565 (x8) HR342				NC006 35.00 x 48.00 x 7.00mm, MVQ NB807 55.00 x 70.10 x 8.00mm, FPM NB700 31.00 x 50.00 x 8.00mm, MVQ NB806 90.00 x 104.00 x 11.00mm, FPM







34 1.6L

Petrol

16 N	4 Cyl.	8 Valves	1584cc	TD2609
16 N (CIH)	4 Cyl.	8 Valves	1584cc	TD22841
PA619  (x4) Eng no. 16N300001 → HR336  (x2)		NB628  45.00 x 60.00 x 9.00mm, ACM NB469  77.00 x 100.00 x 11.50mm, FPM		



35 1.6L

Petrol

16 N	4 Cyl.	8 Valves	1598cc	TD17602
16 N	4 Cyl.	8 Valves	1598cc	TD5281
PA619  (x4) Eng no. 16N300001 → HR343 		NC006 35.00 x 48.00 x 7.00mm, MVQ NB700  31.00 x 50.00 x 8.00mm, MVQ NB701  86.00 x 104.00 x 11.00mm, FPM		





36 1.6L

Petrol

16 NZR	4 Cyl.	8 Valves	1598cc	TD16169
16 SV	4 Cyl.	8 Valves	1598cc	TD17565
16 SV	4 Cyl.	8 Valves	1598cc	TD4740
C 16 LZ	4 Cyl.	8 Valves	1598cc	TD21362
C 16 LZ	4 Cyl.	8 Valves	1598cc	TD4784
C 16 NZ	4 Cyl.	8 Valves	1598cc	TD17583
C 16 NZ	4 Cyl.	8 Valves	1598cc	TD4785
C 16 NZ2	4 Cyl.	8 Valves	1598cc	TD5308
C 16 SE	4 Cyl.	8 Valves	1598cc	TD17608
C 16 SE	4 Cyl.	8 Valves	1598cc	TD4787
C 16 SEI	4 Cyl.	8 Valves	1598cc	TD22864
C 16 SEI	4 Cyl.	8 Valves	1598cc	TD4788
E 16 LZ	4 Cyl.	8 Valves	1598cc	TD25784
E 16 NZ	4 Cyl.	8 Valves	1598cc	TD17618
E 16 NZ	4 Cyl.	8 Valves	1598cc	TD4810
E 16 SE	4 Cyl.	8 Valves	1598cc	TD17586
E 16 SE	4 Cyl.	8 Valves	1598cc	TD4811
X 16 SZ	4 Cyl.	8 Valves	1598cc	TD17622
X 16 SZ	4 Cyl.	8 Valves	1598cc	TD2734
X 16 SZR	4 Cyl.	8 Valves	1598cc	TD4819
X 16 SZR	4 Cyl.	8 Valves	1598cc	TD17623
Z 16 SE	4 Cyl.	8 Valves	1598cc	TD19886
PA565 (x8) HR342 		NC006 35.00 x 48.00 x 7.00mm, MVQ NB697  26.00 x 42.00 x 8.00mm, FPM NB698  80.00 x 98.00 x 10.00mm, FPM		

37 1.6L

Petrol

16 S	4 Cyl.	8 Valves	1584cc	TD4737
PA619  (x4) HR336  (x2) Eng no. 16S230706 →		NB628  45.00 x 60.00 x 9.00mm, ACM NB469  77.00 x 100.00 x 11.50mm, FPM		



38 1.6L

Petrol

16 S CIH	4 Cyl.	8 Valves	1584cc	TD25054
				NB628 45.00 x 60.00 x 9.00mm, ACM NB469 77.00 x 100.00 x 11.50mm, FPM

39 1.6L

Petrol

16 SH	4 Cyl.	8 Valves	1598cc	TD4739
16 SH	4 Cyl.	8 Valves	1598cc	TD17564
HR343				NC006 35.00 x 48.00 x 7.00mm, MVQ NB700 31.00 x 50.00 x 8.00mm, MVQ NB701 86.00 x 104.00 x 11.00mm, FPM

40 1.6L

Diesel

A 16 FDH	4 Cyl.	16 Valves	1598cc	TD26183
A 16 FDH	4 Cyl.	16 Valves	1598cc	TD26201
A 16 FDL	4 Cyl.	16 Valves	1598cc	TD26184
A 16 FDL	4 Cyl.	16 Valves	1598cc	TD26200
HR5119				NA5347 (x2) 30.0 x 45.0 x 7.00mm, FPM NA5070 31.00 x 41.00 x 7.00mm, FPM NF888 93.00 x 139.70;172.00 x 12.00mm, FPM

41 1.6L

Petrol

A 16 LEL	4 Cyl.	16 Valves	1598cc	TD24374
A 16 LEL	4 Cyl.	16 Valves	1598cc	TD24756
A 16 LER	4 Cyl.	16 Valves	1598cc	TD24375
A 16 LER	4 Cyl.	16 Valves	1598cc	TD25059
A 16 LES	4 Cyl.	16 Valves	1598cc	TD26299
A 16 LES	4 Cyl.	16 Valves	1598cc	TD26300
A 16 LET	4 Cyl.	16 Valves	1598cc	TD22589
A 16 LET	4 Cyl.	16 Valves	1598cc	TD22590
A 16 XER	4 Cyl.	16 Valves	1598cc	TD22588
A 16 XER	4 Cyl.	16 Valves	1598cc	TD22587
B 16 LER	4 Cyl.	16 Valves	1598cc	TD29608
B 16 LES	4 Cyl.	16 Valves	1598cc	TD29609
B 16 XER	4 Cyl.	16 Valves	1598cc	TD31851
F16D4	4 Cyl.	16 Valves	1598cc	TD26345
Z 16 LEL	4 Cyl.	16 Valves	1598cc	TD20857
Z 16 LEL	4 Cyl.	16 Valves	1598cc	TD24910
Z 16 LER	4 Cyl.	16 Valves	1598cc	TD20059
Z 16 LER	4 Cyl.	16 Valves	1598cc	TD20164
Z 16 LET	4 Cyl.	16 Valves	1598cc	TD19347
Z 16 LET	4 Cyl.	16 Valves	1598cc	TD19313
Z 16 XER	4 Cyl.	16 Valves	1598cc	TD20060
Z 16 XER	4 Cyl.	16 Valves	1598cc	TD21873
HR5087				NC006 (x2) 35.00 x 48.00 x 7.00mm, MVQ NA5174 31.50 x 42.00 x 7.00mm, FPM NA5350 80.00 x 98.00 x 17.70mm, PTFE/ACM

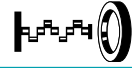

42 1.6L		Gas		
A 16 XNT	4 Cyl.	16 Valves	1598cc	TD24983
A 16 XNT	4 Cyl.	16 Valves	1598cc	TD25439
B 16 XNT	4 Cyl.	16 Valves	1598cc	TD29610
Z 16 XNT	4 Cyl.	16 Valves	1598cc	TD23361
HR5087	NC006 (x2) 35.00 x 48.00 x 7.00mm, MVQ		NA5174 31.50 x 42.00 x 7.00mm, FPM NA5350 80.00 x 98.00 x 17.70mm, PTFE/ACM	

43 1.6L		Petrol		
B 16 LER	4 Cyl.	16 Valves	1598cc	TD33728
B 16 LES	4 Cyl.	16 Valves	1598cc	TD30807
HR5087	NC006 35.00 x 48.00 x 7.00mm, MVQ		NA5174 31.50 x 42.00 x 7.00mm, FPM NA5350 80.00 x 98.00 x 17.70mm, PTFE/ACM	

44 1.6L		Petrol		
B 16 SHT	4 Cyl.	16 Valves	1598cc	TD31457
B 16 SHT	4 Cyl.	16 Valves	1598cc	TD31458
	NC006 35.00 x 48.00 x 7.00mm, MVQ		NA5174 31.50 x 42.00 x 7.00mm, FPM	

45 1.6L		Petrol		
B 16 XER	4 Cyl.	16 Valves	1598cc	TD32196
HR5087	NC006 35.00 x 48.00 x 7.00mm, MVQ		NA5174 31.50 x 42.00 x 7.00mm, FPM	

46 1.6L		Petrol		
C 16 LZ2	4 Cyl.	8 Valves	1598cc	TD21179
PA565 (x8) HR342	NC006 35.00 x 48.00 x 7.00mm, MVQ NB807 55.00 x 70.10 x 8.00mm, FPM		NB700 31.00 x 50.00 x 8.00mm, MVQ NB698 80.00 x 98.00 x 10.00mm, FPM	

47 1.6L		Petrol		
C 16 SEL	4 Cyl.	16 Valves	1598cc	TD16394
C 16 SEL	4 Cyl.	16 Valves	1598cc	TD25534
C 16 SEL	4 Cyl.	16 Valves	1598cc	TD23469
C 16 XE	4 Cyl.	16 Valves	1598cc	TD17609
C 16 XE	4 Cyl.	16 Valves	1598cc	TD4789
X 16 XE	4 Cyl.	16 Valves	1598cc	TD17624
X 16 XE	4 Cyl.	16 Valves	1598cc	TD19896
X 16 XE	4 Cyl.	16 Valves	1598cc	TD2735
X 16 XEL	4 Cyl.	16 Valves	1598cc	TD19895
X 16 XEL	4 Cyl.	16 Valves	1598cc	TD4820
X 16 XEL	4 Cyl.	16 Valves	1598cc	TD17590
Z 16 XE	4 Cyl.	16 Valves	1598cc	TD17937
Z 16 XE	4 Cyl.	16 Valves	1598cc	TD19885
Z 16 XE	4 Cyl.	16 Valves	1598cc	TD14923
PA5041 (x16) HR791	NC006 (x2) 35.00 x 48.00 x 7.00mm, MVQ		NB697 26.00 x 42.00 x 8.00mm, FPM NB698 80.00 x 98.00 x 10.00mm, FPM	



48 1.6L

Petrol

E16	4 Cyl.	8 Valves	1597cc	TD23468
PA203 (x8)	NJ288 40.00 x 55.00 x 9.00mm, NBR		NJ287 80.00 x 100.00 x 10.00mm, MVQ	

49 1.6L

Petrol

F16D3	4 Cyl.	16 Valves	1598cc	TD23607
NA5164 (x16) HR5092	NA5190 (x2) 42.00 x 56.00 x 7.00mm, FPM		NA5190 42.00 x 56.00 x 7.00mm, FPM NB698 80.00 x 98.00 x 10.00mm, FPM	

50 1.6L

Diesel

R9M 408	4 Cyl.	16 Valves	1598cc	TD30950
R9M 413	4 Cyl.	16 Valves	1598cc	TD33688
R9M 450	4 Cyl.	16 Valves	1598cc	TD30951
PA5041 (x16) HR791			NA5333 48.00 x 81.00 x 11.5mm, FPM/ACM	

51 1.6L

Diesel

R9M 408	4 Cyl.	16 Valves	1598cc	TD31564
R9M 413	4 Cyl.	16 Valves	1598cc	TD33677
R9M 450	4 Cyl.	16 Valves	1598cc	TD31565
R9M 452	4 Cyl.	16 Valves	1598cc	TD33678
PA5041 (x16) HR791	NC006 (x2) 35.00 x 48.00 x 7.00mm, MVQ		NA5333 48.00 x 81.00 x 11.5mm, FPM/ACM	

52 1.6L

Petrol

SIDA	4 Cyl.	16 Valves	1596cc	TD31751
HR808 HR809			NA5137 33.00 x 47.00 x 5.00mm, FPM LK5004 80.00 x 182.00 x 19.400mm, PTFE	

53 1.6L

Petrol

Y 16 XE	4 Cyl.	16 Valves	1598cc	TD13688
Y 16 XE	4 Cyl.	16 Valves	1598cc	TD22874
PA5041 (x16) HR791	NC006 (x4) 35.00 x 48.00 x 7.00mm, MVQ		NB697 26.00 x 42.00 x 8.00mm, FPM NB698 80.00 x 98.00 x 10.00mm, FPM	

54 1.6L

Petrol

Y 16 YNG	4 Cyl.	16 Valves	1598cc	TD25867
Y 16 YNG	4 Cyl.	16 Valves	1598cc	TD25866
Z 16 YNG	4 Cyl.	16 Valves	1598cc	TD17893
Z 16 YNG	4 Cyl.	16 Valves	1598cc	TD24742
PA5041 (x16) HR791	NC006 (x2) 35.00 x 48.00 x 7.00mm, MVQ		NB697 26.00 x 42.00 x 8.00mm, FPM NA5327 80.00 x 98.00 x 14.50mm, PTFE	

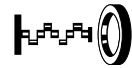
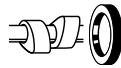

55 1.6L Petrol

Z 16 SE	4 Cyl.	8 Valves	1598cc	TD15089
Z 16 SE	4 Cyl.	8 Valves	1598cc	TD17632
PA565 (x8) HR342	NC006 (x2) 35.00 x 48.00 x 7.00mm, MVQ	NB697 26.00 x 42.00 x 8.00mm, FPM NB698 80.00 x 98.00 x 10.00mm, FPM		

56 1.6L Petrol

Z 16 XE1	4 Cyl.	16 Valves	1598cc	TD21875
Z 16 XE1	4 Cyl.	16 Valves	1598cc	TD23720
HR5087	NC006 (x2) 35.00 x 48.00 x 7.00mm, MVQ	NA5174 31.50 x 42.00 x 7.00mm, FPM NA5327 80.00 x 98.00 x 14.50mm, PTFE		

57 1.6L Petrol

Z 16 XEP	4 Cyl.	16 Valves	1598cc	TD17892
Z 16 XEP	4 Cyl.	16 Valves	1598cc	TD17939
HR5087	NC006 (x2) 35.00 x 48.00 x 7.00mm, MVQ	NA5174 31.50 x 42.00 x 7.00mm, FPM NB698 80.00 x 98.00 x 10.00mm, FPM →Eng no. 20DS3627 NA5327 80.00 x 98.00 x 14.50mm, PTFE Eng no. 20DS3628→		

58 1.6L Gas

Z 16 XNT	4 Cyl.	16 Valves	1598cc	TD25440
		NA5174 31.50 x 42.00 x 7.00mm, FPM NA5350 80.00 x 98.00 x 17.70mm, PTFE/ACM		

59 1.7L Diesel

17 D	4 Cyl.	8 Valves	1699cc	TD17566
17 D	4 Cyl.	8 Valves	1700cc	TD4742
17 DR	4 Cyl.	8 Valves	1699cc	TD17567
17 DR	4 Cyl.	8 Valves	1700cc	TD4744
X 17 DTL	4 Cyl.	8 Valves	1699cc	TD17591
X 17 DTL	4 Cyl.	8 Valves	1700cc	TD4821
HR343	NC006 35.00 x 48.00 x 7.00mm, MVQ	NB734 35.00 x 50.00 x 8.00mm, FPM NB806 90.00 x 104.00 x 11.00mm, FPM		

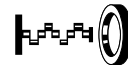
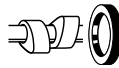

60 1.7L

Diesel

17 D (4EE1)	4 Cyl.	8 Valves	1686cc	TD22845
17 D (4EE1)	4 Cyl.	8 Valves	1686cc	TD5284
17 DT (TC4EE1)	4 Cyl.	8 Valves	1686cc	TD4747
17 DT (TC4EE1)	4 Cyl.	8 Valves	1686cc	TD22846
X 17 DT (TC4EE1)	4 Cyl.	8 Valves	1686cc	TD4822
X 17 DT (TC4EE1)	4 Cyl.	8 Valves	1686cc	TD22873
PA658 (x8)	NJ449 40.00 x 52.00 x 6.00mm, NBR		NJ449 40.00 x 52.00 x 6.00mm, NBR NK103 87.00 x 100.00 x 8.50mm, FPM	

61 1.7L

Petrol

17 L	4 Cyl.	8 Valves	1698cc	TD26222
PA619 (x4) HR336			NB628 45.00 x 60.00 x 9.00mm, ACM NB469 77.00 x 100.00 x 11.50mm, FPM	

62 1.7L

Petrol

17 N	4 Cyl.	8 Valves	1698cc	TD2623
PA619 (x4) Eng no. 17N400001 → HR336			NB628 45.00 x 60.00 x 9.00mm, ACM NB469 77.00 x 100.00 x 11.50mm, FPM	

63 1.7L

Petrol

17 S	4 Cyl.	8 Valves	1698cc	TD2625
17 S	4 Cyl.	8 Valves	1698cc	TD22415
PA619 (x4) Eng no. 17S795337 → HR336			NB628 45.00 x 60.00 x 9.00mm, ACM NB469 77.00 x 100.00 x 11.50mm, FPM	

64 1.7L

Diesel

A 17 DT	4 Cyl.	16 Valves	1686cc	TD24266
A 17 DT	4 Cyl.	16 Valves	1686cc	TD24746
A 17 DTC	4 Cyl.	16 Valves	1686cc	TD24379
A 17 DTC	4 Cyl.	16 Valves	1686cc	TD25259
A 17 DTE	4 Cyl.	16 Valves	1686cc	TD25742
A 17 DTE	4 Cyl.	16 Valves	1686cc	TD25743
A 17 DTF	4 Cyl.	16 Valves	1686cc	TD25740
A 17 DTF	4 Cyl.	16 Valves	1686cc	TD25744
A 17 DTI	4 Cyl.	16 Valves	1686cc	TD28265
A 17 DTJ	4 Cyl.	16 Valves	1686cc	TD20751
A 17 DTJ	4 Cyl.	16 Valves	1686cc	TD24659
A 17 DTL	4 Cyl.	16 Valves	1686cc	TD25741
A 17 DTL	4 Cyl.	16 Valves	1686cc	TD25745
A 17 DTN	4 Cyl.	16 Valves	1686cc	TD31004
A 17 DTR	4 Cyl.	16 Valves	1686cc	TD20061
A 17 DTR	4 Cyl.	16 Valves	1686cc	TD20165
A 17 DTS	4 Cyl.	16 Valves	1686cc	TD24267
A 17 DTS	4 Cyl.	16 Valves	1686cc	TD24732
Y 17 DT	4 Cyl.	16 Valves	1686cc	TD13689

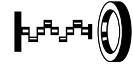
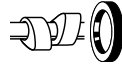

Y 17 DT	4 Cyl.	16 Valves	1686cc	TD18380
Y 17 DTL	4 Cyl.	16 Valves	1686cc	TD14921
Y 17 DTL	4 Cyl.	16 Valves	1686cc	TD18381
Z 17 DT	4 Cyl.	16 Valves	1686cc	TD25865
Z 17 DTH	4 Cyl.	16 Valves	1686cc	TD17478
Z 17 DTH	4 Cyl.	16 Valves	1686cc	TD17941
Z 17 DTJ	4 Cyl.	16 Valves	1686cc	TD24044
Z 17 DTJ	4 Cyl.	16 Valves	1686cc	TD24045
Z 17 DTL	4 Cyl.	16 Valves	1686cc	TD17945
Z 17 DTL	4 Cyl.	16 Valves	1686cc	TD17947
Z 17 DTR	4 Cyl.	16 Valves	1686cc	TD19314
Z 17 DTR	4 Cyl.	16 Valves	1686cc	TD21871
PA5041 (x16) HR791	NB884 (x2) 38.00 x 50.00 x 5.50mm, FPM		NJ449 40.00 x 52.00 x 6.00mm, NBR NK103 87.00 x 100.00 x 8.50mm, FPM	

65 1.7L

Diesel

A 17 DTI	4 Cyl.	16 Valves	1686cc	TD30247
A 17 DTN	4 Cyl.	16 Valves	1686cc	TD34197
PA5041 (x16) HR791	NB884 38.00 x 50.00 x 5.50mm, FPM		NJ449 40.00 x 52.00 x 6.00mm, NBR NK103 87.00 x 100.00 x 8.50mm, FPM	

66 1.7L

Petrol

TV 17 HC	4 Cyl.	16 Valves	1699cc	TD31752
			NB564 60.45 x 76.18 x 10.00mm, FPM	

67 1.7L

Diesel

X 17 D (4EE1)	4 Cyl.	8 Valves	1686cc	TD22872
X 17 D (4EE1)	4 Cyl.	8 Valves	1686cc	TD5298
PA658 (x8)	NJ449 40.00 x 52.00 x 6.00mm, NBR		NJ450 45.00 x 68.00 x 12.00mm, NBR NK103 87.00 x 100.00 x 8.50mm, FPM	

68 1.7L

Diesel

Z 17 DT	4 Cyl.	16 Valves	1686cc	TD34165
			NJ449 40.00 x 52.00 x 6.00mm, NBR NK103 87.00 x 100.00 x 8.50mm, FPM	

69 1.8L

Petrol

IZZ-FE	4 Cyl.	16 Valves	1796cc	TD20080
PA5020 (x8) PA5019 (x8)	NB799 38.00 x 50.00 x 7.00mm, FPM		NA5089 38.00 x 50.00 x 8.00mm, NBR NA5090 76.00 x 94.00 x 8.50mm, FPM	

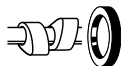

70 1.8L

Petrol

2ZR-FE	4 Cyl.	16 Valves	1798cc	TD26731
PA5020 (x16)				NA5260 38.00 x 50.00 x 6.00mm, FPM →08/10 NA5089 38.00 x 50.00 x 8.00mm, NBR 08/10→

71 1.8L

Petrol

2ZZ-GE	4 Cyl.	16 Valves	1796cc	TD17319
				NJ347 (x2) 38.00 x 50.00 x 8.00mm, NBR NA5089 38.00 x 50.00 x 8.00mm, NBR NJ215 85.00 x 105.00 x 10.00mm, FPM

72 1.8L

Petrol

4ZB1	4 Cyl.	8 Valves	1817cc	TD26951
PA933 (x8)				NA5347 30.0 x 45.0 x 7.00mm, FPM NJ323 40.00 x 56.00 x 7.00mm, NBR NJ322 95.00 x 118.00 x 10.00mm, NBR

73 1.8L

Petrol

18 E	4 Cyl.	8 Valves	1796cc	TD17568
18 E	4 Cyl.	8 Valves	1796cc	TD4749
18 N	4 Cyl.	8 Valves	1796cc	TD4750
18 S	4 Cyl.	8 Valves	1796cc	TD17603
18 S	4 Cyl.	8 Valves	1796cc	TD4752
PA619 (x8) HR343				NC006 35.00 x 48.00 x 7.00mm, MVQ NB700 31.00 x 50.00 x 8.00mm, MVQ NB701 86.00 x 104.00 x 11.00mm, FPM

74 1.8L

Petrol

18 K4F	4 Cyl.	16 Valves	1796cc	TD31747
18 K4G	4 Cyl.	16 Valves	1796cc	TD30263
HR752				NC065 (x2) 30.00 x 40.00 x 7.00mm, FPM NB998 (x2) 30.00 x 40.00 x 7.00mm, FPM NB828 27.50 x 39.50 x 7.00mm, FPM NB829 79.95 x 116.00; 126.00 x 11.50mm, FPM

75 1.8L

Petrol

18LE	4 Cyl.	8 Valves	1796cc	TD23609
				NC006 35.00 x 48.00 x 7.00mm, MVQ NB700 31.00 x 50.00 x 8.00mm, MVQ

76 1.8L

Petrol

18 N	4 Cyl.	8 Valves	1796cc	TD34177
HR343				NC006 35.00 x 48.00 x 7.00mm, MVQ NB700 31.00 x 50.00 x 8.00mm, MVQ NB701 86.00 x 104.00 x 11.00mm, FPM

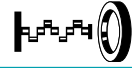

77 1.8L		Petrol			
18 NV	4 Cyl.	8 Valves	1796cc		TD17569
18 NV	4 Cyl.	8 Valves	1796cc		TD4751
18 SEH	4 Cyl.	8 Valves	1796cc		TD17570
18 SEH	4 Cyl.	8 Valves	1796cc		TD4754
18 SV	4 Cyl.	8 Valves	1796cc		TD4755
18 SV	4 Cyl.	8 Valves	1796cc		TD17571
C 18 NT	4 Cyl.	8 Valves	1796cc		TD4791
E 18 NV	4 Cyl.	8 Valves	1796cc		TD17587
E 18 NV	4 Cyl.	8 Valves	1796cc		TD4812
E 18 NVR	4 Cyl.	8 Valves	1796cc		TD17588
E 18 NVR	4 Cyl.	8 Valves	1796cc		TD4813
S 18 NV	4 Cyl.	8 Valves	1796cc		TD17891
S 18 NV	4 Cyl.	8 Valves	1796cc		TD21884
PA565 (x8) HR342	NC006		35.00 x 48.00 x 7.00mm, MVQ	NB700	31.00 x 50.00 x 8.00mm, MVQ
	NB807		55.00 x 70.10 x 8.00mm, FPM	NB806	90.00 x 104.00 x 11.00mm, FPM

78 1.8L		Petrol			
18 SE	4 Cyl.	8 Valves	1796cc		TD17604
18 SE	4 Cyl.	8 Valves	1796cc		TD4753
PA619 (x8) HR343 →Eng no. 14360690 HR342 Eng no. 14360691→	NC006		35.00 x 48.00 x 7.00mm, MVQ	NB700	31.00 x 50.00 x 8.00mm, MVQ
				NB701	86.00 x 104.00 x 11.00mm, FPM

79 1.8L		Petrol			
A 18 XEL	4 Cyl.	16 Valves	1796cc		TD25517
A 18 XEL	4 Cyl.	16 Valves	1796cc		TD25706
A 18 XER	4 Cyl.	16 Valves	1796cc		TD22591
A 18 XER	4 Cyl.	16 Valves	1796cc		TD22592
B 18 XER	4 Cyl.	16 Valves	1796cc		TD32833
Z 18 XEP	4 Cyl.	16 Valves	1796cc		TD18437
Z 18 XER	4 Cyl.	16 Valves	1796cc		TD23603
Z 18 XER	4 Cyl.	16 Valves	1796cc		TD18838
Z 18 XER	4 Cyl.	16 Valves	1796cc		TD18730
HR5087	NC006 (x2)		35.00 x 48.00 x 7.00mm, MVQ	NA5174	31.50 x 42.00 x 7.00mm, FPM
				NA5350	80.00 x 98.00 x 17.70mm, PTFE/ACM

80 1.8L		Petrol			
C 18 NE	4 Cyl.	8 Valves	1796cc		TD22865
C 18 NE	4 Cyl.	8 Valves	1796cc		TD4790
C 18 NV	4 Cyl.	8 Valves	1796cc		TD4792
PA565 (x8) HR342	NC006		35.00 x 48.00 x 7.00mm, MVQ	NB700	31.00 x 50.00 x 8.00mm, MVQ
				NB806	90.00 x 104.00 x 11.00mm, FPM

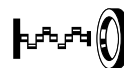

81 1.8L

Petrol

C 18 NZ	4 Cyl.	8 Valves	1796cc	TD4793
C 18 NZ	4 Cyl.	8 Valves	1796cc	TD17610
PA565 (x8) HR342	NB807 55.00 x 70.10 x 8.00mm, FPM →12/85		NB700 31.00 x 50.00 x 8.00mm, MVQ NB806 90.00 x 104.00 x 11.00mm, FPM	
	NC006 35.00 x 48.00 x 7.00mm, MVQ			

82 1.8L

Petrol

C 18 SEL	4 Cyl.	16 Valves	1796cc	TD25435
C 18 XE	4 Cyl.	16 Valves	1799cc	TD4795
C 18 XE	4 Cyl.	16 Valves	1799cc	TD17611
C 18 XEL	4 Cyl.	16 Valves	1799cc	TD17636
C 18 XEL	4 Cyl.	16 Valves	1799cc	TD23470
C 18 XEL	4 Cyl.	16 Valves	1799cc	TD4796
X 18 XE	4 Cyl.	16 Valves	1799cc	TD4823
X 18 XE	4 Cyl.	16 Valves	1799cc	TD17625
PA5041 (x16) HR791	NC006 (x2) 35.00 x 48.00 x 7.00mm, MVQ		NB700 31.00 x 50.00 x 8.00mm, MVQ NB806 90.00 x 104.00 x 11.00mm, FPM	

83 1.8L

Petrol

F18D3	4 Cyl.	16 Valves	1796cc	TD23513
PA5041 (x16) HR791	NC006 (x2) 35.00 x 48.00 x 7.00mm, MVQ		NB700 31.00 x 50.00 x 8.00mm, MVQ NB698 80.00 x 98.00 x 10.00mm, FPM	

84 1.8L

Petrol

K 1.8	4 Cyl.	16 Valves	1796cc	TD31745
	NC065 (x2) 30.00 x 40.00 x 7.00mm, FPM NB998 (x2) 30.00 x 40.00 x 7.00mm, FPM		NB828 27.50 x 39.50 x 7.00mm, FPM NB829 79.95 x 116.00; 126.00 x 11.50mm, FPM	

85 1.8L

Petrol

K18K4	4 Cyl.	16 Valves	1796cc	TD34250
	NC065 (x2) 30.00 x 40.00 x 7.00mm, FPM			

86 1.8L

Petrol

X 18 XE1	4 Cyl.	16 Valves	1796cc	TD17626
X 18 XE1	4 Cyl.	16 Valves	1796cc	TD9509
Z 18 XEL	4 Cyl.	16 Valves	1796cc	TD17987
Z 18 XEL	4 Cyl.	16 Valves	1796cc	TD17894
PA5025 (x16) HR5048	NC006 (x2) 35.00 x 48.00 x 7.00mm, MVQ		NC065 30.00 x 40.00 x 7.00mm, FPM →Ch no. 21-28999999; 2B999999; 2H999999 NA5174 31.50 x 42.00 x 7.00mm, FPM Ch no. 32000001; 4G000001 → NB698 80.00 x 98.00 x 10.00mm, FPM	

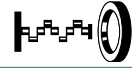

87 1.8L Petrol

X 18 XE1	4 Cyl.	16 Valves	1796cc	TD19894
PA5025 (x16) HR5048 	NC006 (x2) 35.00 x 48.00 x 7.00mm, MVQ		NA5174  31.50 x 42.00 x 7.00mm, FPM NB698  80.00 x 98.00 x 10.00mm, FPM	

88 1.8L Petrol

Z 18 XE	4 Cyl.	16 Valves	1796cc	TD14922
PA5025 (x16) HR5048 	NC006 (x2) 35.00 x 48.00 x 7.00mm, MVQ		NA5174  31.50 x 42.00 x 7.00mm, FPM Ch no. 32000001; 4G000001 → NB698  80.00 x 98.00 x 10.00mm, FPM	



89 1.8L Petrol

Z 18 XE	4 Cyl.	16 Valves	1796cc	TD17633
Z 18 XE	4 Cyl.	16 Valves	1796cc	TD19884
PA5025 (x16) HR5048 	NC006 (x2) 35.00 x 48.00 x 7.00mm, MVQ		NA5174  31.50 x 42.00 x 7.00mm, FPM Ch no. 32000001; 4G000001 → NB698  80.00 x 98.00 x 10.00mm, FPM → Eng no. 20DR5879 NA5327  80.00 x 98.00 x 14.50mm, PTFE Eng no. 20DR5880 →	





90 1.8L Petrol

Z 18 XEP	4 Cyl.	16 Valves	1796cc	TD18837
HR5087 			NA5174  31.50 x 42.00 x 7.00mm, FPM NA5350  80.00 x 98.00 x 17.70mm, PTFE/ACM	

91 1.9L Diesel

19 DJ	4 Cyl.	8 Valves	1870cc	TD25442
19 DL	4 Cyl.	8 Valves	1870cc	TD25443
F8Q 600	4 Cyl.	8 Valves	1870cc	TD21361
HR569 	NF846 25.00 x 42.00 x 7.00mm, FPM/ACM		NA5036  42.00 x 54.00 x 6.00mm, FPM NF850  85.00 x 105.00 x 8.00mm, FPM	

92 1.9L Petrol

19 E	4 Cyl.	8 Valves	1897cc	TD2635
PA619  (x4) HR336   Eng no. 19E18851 →			NB628  45.00 x 60.00 x 9.00mm, ACM NB469  77.00 x 100.00 x 11.50mm, FPM	

93 1.9L Petrol

19 N	4 Cyl.	8 Valves	1897cc	TD2636
PA619  (x4) Eng no. 19SH300000 → HR336  			NB628  45.00 x 60.00 x 9.00mm, ACM NB469  77.00 x 100.00 x 11.50mm, FPM	

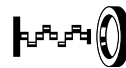
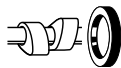

94 1.9L

Petrol

19 S	4 Cyl.	8 Valves	1897cc	TD19717
19 S	4 Cyl.	8 Valves	1897cc	TD4756
PA619 (x4) Eng no. 19S300001 → HR336				NB628 45.00 x 60.00 x 9.00mm, ACM NB469 77.00 x 100.00 x 11.50mm, FPM

95 1.9L

Petrol

19 SH	4 Cyl.	8 Valves	1897cc	TD22416
19 SH	4 Cyl.	8 Valves	1897cc	TD2640
PA619 (x4) Eng no. 19SH300000 → HR336 Eng no. 19SH62778 →				NB628 45.00 x 60.00 x 9.00mm, ACM NB469 77.00 x 100.00 x 11.50mm, FPM

96 1.9L

Diesel

F8Q 600	4 Cyl.	8 Valves	1870cc	TD21360
F8Q 606	4 Cyl.	8 Valves	1870cc	TD21358
F8Q 606	4 Cyl.	8 Valves	1870cc	TD21359
HR569		NF846 25.00 x 42.00 x 7.00mm, FPM/ACM		NA5036 42.00 x 54.00 x 6.00mm, FPM NA5037 85.00 x 105.00 x 11.00mm, ACM

97 1.9L

Diesel

F9Q 760	4 Cyl.	8 Valves	1870cc	TD18872
F9Q 760	4 Cyl.	8 Valves	1870cc	TD19375
F9Q 762	4 Cyl.	8 Valves	1870cc	TD18494
F9Q 762	4 Cyl.	8 Valves	1870cc	TD21148
F9Q 770	4 Cyl.	8 Valves	1870cc	TD19351
F9Q 770	4 Cyl.	8 Valves	1870cc	TD19374
F9Q 772	4 Cyl.	8 Valves	1870cc	TD23125
F9Q 772	4 Cyl.	8 Valves	1870cc	TD19363
F9Q 774	4 Cyl.	8 Valves	1870cc	TD18252
F9Q 774	4 Cyl.	8 Valves	1870cc	TD19352
HR816		NF846 25.00 x 42.00 x 7.00mm, FPM/ACM		NA5036 42.00 x 54.00 x 6.00mm, FPM NA5037 85.00 x 105.00 x 11.00mm, ACM

98 1.9L

Diesel





Z 19 D	4 Cyl.	16 Valves	1910cc	TD23596
HR569 (x2)		NA5347 30.0 x 45.0 x 7.00mm, FPM		NA5070 31.00 x 41.00 x 7.00mm, FPM

99 1.9L

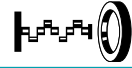

Diesel

Z 19 DT	4 Cyl.	8 Valves	1910cc	TD18046
Z 19 DT	4 Cyl.	8 Valves	1910cc	TD18659
Z 19 DTL	4 Cyl.	8 Valves	1910cc	TD18671
Z 19 DTL	4 Cyl.	8 Valves	1910cc	TD20149
HR569		NA5053 30.00 x 42.00 x 7.00mm, FPM		NA5070 31.00 x 41.00 x 7.00mm, FPM NF888 93.00 x 139.70; 172.00 x 12.00mm, FPM











100 1.9L		Diesel		
Z 19 DTH	4 Cyl.	16 Valves	1910cc	TD22454
Z 19 DTH	4 Cyl.	16 Valves	1910cc	TD18014
Z 19 DTH	4 Cyl.	16 Valves	1910cc	TD18016
Z 19 DTJ	4 Cyl.	16 Valves	1910cc	TD18017
Z 19 DTJ	4 Cyl.	16 Valves	1910cc	TD18011
HR5095 	NA5347 (x2) 30.0 x 45.0 x 7.00mm, FPM			NA5070  31.00 x 41.00 x 7.00mm, FPM
→Eng no. 17180894				NF888  93.00 x 139.70;172.00 x 12.00mm, FPM
HR5119 				
Eng no. 17180895→				

101 2.0L		Diesel		
4FC1	4 Cyl.	8 Valves	1995cc	TD26953
4FC1T	4 Cyl.	8 Valves	1995cc	TD20065
PA933 (x8)	NJ321 28.00 x 47.00 x 8.00mm, NBR			NA5051  40.00 x 56.00 x 7.00mm, FPM
				NJ158  95.00 x 118.00 x 10.00mm, ACM

102 2.0L		Petrol		
4ZC1	4 Cyl.	8 Valves	1994cc	TD27098
PA933 (x8)	NA5347 30.0 x 45.0 x 7.00mm, FPM			NJ323  40.00 x 56.00 x 7.00mm, NBR
				NJ322  95.00 x 118.00 x 10.00mm, NBR

103 2.0L		Diesel		
20 D	4 Cyl.	8 Valves	1998cc	TD4757
PA619 (x8)				NB628  45.00 x 60.00 x 9.00mm, ACM
Eng no. 20D20915→20D129251				NB690  81.00 x 100.10 x 11.50mm, FPM
HR336  (x2)				

104 2.0L		Petrol		
20 E	4 Cyl.	8 Valves	1979cc	TD18375
20 E	4 Cyl.	8 Valves	1979cc	TD2642
PA565 (x8)	NC006 35.00 x 48.00 x 7.00mm, MVQ			NB628  45.00 x 60.00 x 9.00mm, ACM
HR342 				NB469  77.00 x 100.00 x 11.50mm, FPM

105 2.0L		Petrol		
20 EH	4 Cyl.	8 Valves	1979cc	TD2645
20 ER	4 Cyl.	8 Valves	1979cc	TD26220
20 N	4 Cyl.	8 Valves	1979cc	TD34455
20 N	4 Cyl.	8 Valves	1979cc	TD4758
20 S	4 Cyl.	8 Valves	1979cc	TD17572
20 S	4 Cyl.	8 Valves	1979cc	TD4762
H 20 E	4 Cyl.	8 Valves	1979cc	TD5306
H 20 E	4 Cyl.	8 Valves	1979cc	TD22869
PA619  (x4)				NB628  45.00 x 60.00 x 9.00mm, ACM
HR336  				NB469  77.00 x 100.00 x 11.50mm, FPM

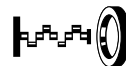

106 2.0L Petrol

20 NE	4 Cyl.	8 Valves	1998cc	TD17637
20 NE	4 Cyl.	8 Valves	1998cc	TD4759
20 SE	4 Cyl.	8 Valves	1998cc	TD17573
20 SE	4 Cyl.	8 Valves	1998cc	TD2651
20 SEH	4 Cyl.	8 Valves	1998cc	TD17574
20 SEH	4 Cyl.	8 Valves	1998cc	TD4763
C 20 NE	4 Cyl.	8 Valves	1998cc	TD4799
C 20 NE	4 Cyl.	8 Valves	1998cc	TD17584
C 20 NEF	4 Cyl.	8 Valves	1998cc	TD22866
C 20 NEF	4 Cyl.	8 Valves	1998cc	TD5270
C 20 NEJ	4 Cyl.	8 Valves	1998cc	TD22867
C 20 NEJ	4 Cyl.	8 Valves	1998cc	TD4800
X 20 SE	4 Cyl.	8 Valves	1998cc	TD17593
X 20 SE	4 Cyl.	8 Valves	1998cc	TD2736

PA565 (x8) HR342	NC006 35.00 x 48.00 x 7.00mm, MVQ NB807 55.00 x 70.10 x 8.00mm, FPM	NB700 31.00 x 50.00 x 8.00mm, MVQ NB806 90.00 x 104.00 x 11.00mm, FPM
---------------------	--	--

107 2.0L Petrol

20 NEJ	4 Cyl.	8 Valves	1998cc	TD4761
20 NEJ	4 Cyl.	8 Valves	1998cc	TD25533
C 20 NE	4 Cyl.	8 Valves	1998cc	TD23475
X 20 SE	4 Cyl.	8 Valves	1998cc	TD23606

PA565 (x8) HR342	NC006 35.00 x 48.00 x 7.00mm, MVQ	NB700 31.00 x 50.00 x 8.00mm, MVQ NB806 90.00 x 104.00 x 11.00mm, FPM
---------------------	--------------------------------------	--

108 2.0L Petrol

20 SER	4 Cyl.	16 Valves	1998cc	TD18871
--------	--------	-----------	--------	---------

PA565 (x8) HR342 (x2)	NC006 35.00 x 48.00 x 7.00mm, MVQ NB807 55.00 x 70.10 x 8.00mm, FPM	NB700 31.00 x 50.00 x 8.00mm, MVQ NB806 90.00 x 104.00 x 11.00mm, FPM
--------------------------	--	--

109 2.0L Petrol

20 XE	4 Cyl.	16 Valves	1998cc	TD17605
20 XE	4 Cyl.	16 Valves	1998cc	TD4765
20 XEJ	4 Cyl.	16 Valves	1998cc	TD4764
C 20 LET	4 Cyl.	16 Valves	1998cc	TD4798
C 20 LET	4 Cyl.	16 Valves	1998cc	TD17612

PA565 (x16) HR342 (x2)	NC006 (x2) 35.00 x 48.00 x 7.00mm, MVQ	NB884 38.00 x 50.00 x 5.50mm, FPM NB806 90.00 x 104.00 x 11.00mm, FPM
---------------------------	---	--

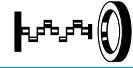

110 2.0L Diesel

A 20 DT	4 Cyl.	16 Valves	1956cc	TD25781
A 20 DT	4 Cyl.	16 Valves	1956cc	TD25782
A 20 DTC	4 Cyl.	16 Valves	1956cc	TD22598
A 20 DTC	4 Cyl.	16 Valves	1956cc	TD22597
A 20 DTE	4 Cyl.	16 Valves	1956cc	TD28276
A 20 DTE	4 Cyl.	16 Valves	1956cc	TD28123
A 20 DTH	4 Cyl.	16 Valves	1956cc	TD22601
A 20 DTH	4 Cyl.	16 Valves	1956cc	TD22603
A 20 DTJ	4 Cyl.	16 Valves	1956cc	TD22599
A 20 DTJ	4 Cyl.	16 Valves	1956cc	TD22600
A 20 DTL	4 Cyl.	16 Valves	1956cc	TD25780
A 20 DTL	4 Cyl.	16 Valves	1956cc	TD25724
A 20 DTR	4 Cyl.	16 Valves	1956cc	TD22604
A 20 DTR	4 Cyl.	16 Valves	1956cc	TD25210
A 20 FD	4 Cyl.	16 Valves	1956cc	TD26185
A 20 FD	4 Cyl.	16 Valves	1956cc	TD26202
Y 20 DTJ	4 Cyl.	16 Valves	1956cc	TD26542
Y 20 DTJ	4 Cyl.	16 Valves	1956cc	TD27238
Z 20 DTJ	4 Cyl.	16 Valves	1956cc	TD25783
Z 20 DTJ	4 Cyl.	16 Valves	1956cc	TD26541

HR5119

NA5347 (x2)
30.0 x 45.0 x 7.00mm, FPM

NA5070
31.00 x 41.00 x 7.00mm, FPM
NF888
93.00 x 139.70;172.00 x 12.00mm, FPM

111 2.0L Petrol

A 20 NFT	4 Cyl.	16 Valves	1998cc	TD24786
A 20 NFT	4 Cyl.	16 Valves	1998cc	TD24965
A 20 NFT	4 Cyl.	16 Valves	1998cc	TD32744
A 20 NHT	4 Cyl.	16 Valves	1998cc	TD22593
A 20 NHT	4 Cyl.	16 Valves	1998cc	TD22594
B 20 NFT	4 Cyl.	16 Valves	1998cc	TD32928
B 20 NFT	4 Cyl.	16 Valves	1998cc	TD32920
B 20 NHT	4 Cyl.	16 Valves	1998cc	TD34081
Z 20 NET	4 Cyl.	16 Valves	1998cc	TD20350
Z 20 NET	4 Cyl.	16 Valves	1998cc	TD18146

HR5127

NA5108
42.00 x 55.00 x 7.00mm, FPM/ACM
NB806
90.00 x 104.00 x 11.00mm, FPM

112 2.0L Petrol

C 20 LET	4 Cyl.	16 Valves	1998cc	TD23601
C 20 LET	4 Cyl.	16 Valves	1998cc	TD19840
C 20 XE	4 Cyl.	16 Valves	1998cc	TD4801
C 20 XE	4 Cyl.	16 Valves	1998cc	TD23476
C 20 XE	4 Cyl.	16 Valves	1998cc	TD17585
C 20 XE	4 Cyl.	16 Valves	1998cc	TD19841

PA565 (x16)
HR342 (x2)

NC006 (x2)
35.00 x 48.00 x 7.00mm, MVQ

NB700
31.00 x 50.00 x 8.00mm, MVQ
NB806
90.00 x 104.00 x 11.00mm, FPM



113 2.0L Petrol

C 20 SEL	4 Cyl.	16 Valves	1998cc	TD15968
X 20 XER	4 Cyl.	16 Valves	1998cc	TD13690
X 20 XER	4 Cyl.	16 Valves	1998cc	TD21880
X 20 XEV	4 Cyl.	16 Valves	1998cc	TD2737
X 20 XEV	4 Cyl.	16 Valves	1998cc	TD17594
X 20 XEV	4 Cyl.	16 Valves	1998cc	TD19893
Z 20 LEH	4 Cyl.	16 Valves	1998cc	TD19201
Z 20 LEH	4 Cyl.	16 Valves	1998cc	TD20353
Z 20 LEL	4 Cyl.	16 Valves	1998cc	TD18018
Z 20 LEL	4 Cyl.	16 Valves	1998cc	TD18019
Z 20 LER	4 Cyl.	16 Valves	1998cc	TD24840
Z 20 LER	4 Cyl.	16 Valves	1998cc	TD18028
Z 20 LER	4 Cyl.	16 Valves	1998cc	TD20352
Z 20 LER	4 Cyl.	16 Valves	1998cc	TD23471
Z 20 LET	4 Cyl.	16 Valves	1998cc	TD19882
Z 20 LET	4 Cyl.	16 Valves	1998cc	TD17944
Z 20 LET	4 Cyl.	16 Valves	1998cc	TD15090

PA5041 (x16)
HR791

NC006 (x2)
35.00 x 48.00 x 7.00mm, MVQ

NB700
31.00 x 50.00 x 8.00mm, MVQ
NB806
90.00 x 104.00 x 11.00mm, FPM

114 2.0L Petrol

F4R 720	4 Cyl.	16 Valves	1998cc	TD19216
F4R 720	4 Cyl.	16 Valves	1998cc	TD18194
F4R 820	4 Cyl.	16 Valves	1998cc	TD21037
F4R 820	4 Cyl.	16 Valves	1998cc	TD21905

PA5013 (x16)

NA5257 (x2)
28.00 x 47.00 x 5.50mm, FPM

NA5036
42.00 x 54.00 x 6.00mm, FPM
NA5037
85.00 x 105.00 x 11.00mm, ACM

115 2.0L Petrol

LNF	4 Cyl.	16 Valves	1998cc	TD21018
Z 20 NHH	4 Cyl.	16 Valves	1998cc	TD20064

HR5127

NA5108
42.00 x 55.00 x 7.00mm, FPM/ACM

116 2.0L Diesel

M9R 630	4 Cyl.	16 Valves	1995cc	TD25645
M9R 630	4 Cyl.	16 Valves	1995cc	TD25646
M9R 692	4 Cyl.	16 Valves	1995cc	TD28089
M9R 692	4 Cyl.	16 Valves	1995cc	TD32897
M9R 780	4 Cyl.	16 Valves	1995cc	TD20888
M9R 780	4 Cyl.	16 Valves	1995cc	TD20889
M9R 782	4 Cyl.	16 Valves	1995cc	TD24726
M9R 782	4 Cyl.	16 Valves	1995cc	TD21889
M9R 784	4 Cyl.	16 Valves	1995cc	TD21904
M9R 784	4 Cyl.	16 Valves	1995cc	TD25140
M9R 786	4 Cyl.	16 Valves	1995cc	TD25139

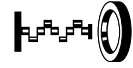
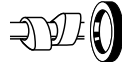

M9R 786	4 Cyl.	16 Valves	1995cc	TD25647
M9R 788	4 Cyl.	16 Valves	1995cc	TD25143
M9R 788	4 Cyl.	16 Valves	1995cc	TD25644
HR814				
				NA5333 48.00 x 81.00 x 11.5mm, FPM/ACM LK5022 94.00 x 161.00 x 10.00mm, PTFE/ACM

117 2.0L

Diesel

X 20 DTH	4 Cyl.	16 Valves	1995cc	TD17592
X 20 DTH	4 Cyl.	16 Valves	1995cc	TD9729
X 20 DTL	4 Cyl.	16 Valves	1995cc	TD17627
X 20 DTL	4 Cyl.	16 Valves	1995cc	TD4824
Y 20 DTH	4 Cyl.	16 Valves	1995cc	TD17924
Y 20 DTH	4 Cyl.	16 Valves	1995cc	TD13752
Y 20 DTL	4 Cyl.	16 Valves	1995cc	TD17926
Y 20 DTL	4 Cyl.	16 Valves	1995cc	TD15848
PA5041 (x16) HR791				NA5069 55.00 x 68.00 x 8.00mm, FPM NA5209 99.00 x 114.00 x 11.00mm, FPM

118 2.0L

Diesel

Z 20 DM	4 Cyl.	16 Valves	1991cc	TD24741
Z 20 DM	4 Cyl.	16 Valves	1991cc	TD21017
Z 20 DMH	4 Cyl.	16 Valves	1991cc	TD19203
Z 20 DMH	4 Cyl.	16 Valves	1991cc	TD19219
Z 20 S	4 Cyl.	16 Valves	1991cc	TD20856
				NF817 (x2) 36.00 x 50.00 x 7.00mm, FPM NA5139 32.00 x 45.00 x 6.00mm, FPM

119 2.0L

Petrol

Z 20 LET	4 Cyl.	16 Valves	1998cc	TD31748
PA5041 (x16) HR791				NB700 31.00 x 50.00 x 8.00mm, MVQ NB806 90.00 x 104.00 x 11.00mm, FPM

120 2.1L

Diesel

21 D	4 Cyl.	8 Valves	2068cc	TD2658
PA619 (x8) HR336 (x2)				NB628 45.00 x 60.00 x 9.00mm, ACM NB690 81.00 x 100.10 x 11.50mm, FPM

121 2.2L

Diesel

4FD1	4 Cyl.	8 Valves	2189cc	TD20066
4FD1	4 Cyl.	8 Valves	2189cc	TD25450
PA933 (x8)				NJ321 28.00 x 47.00 x 8.00mm, NBR NJ158 95.00 x 118.00 x 10.00mm, ACM



122 2.2L

Diesel

22DIE	4 Cyl.	8 Valves	2189cc	TD26949
PA933 (x8)				NJ323 40.00 x 56.00 x 7.00mm, NBR NJ322 95.00 x 118.00 x 10.00mm, NBR

123 2.2L

Petrol

22 E	4 Cyl.	8 Valves	2197cc	TD17606
22 E	4 Cyl.	8 Valves	2197cc	TD2659
PA619 (x8) HR336 (x2)				NB628 45.00 x 60.00 x 9.00mm, ACM NB469 77.00 x 100.00 x 11.50mm, FPM

124 2.2L

Petrol

22 N	6 Cyl.	12 Valves	2239cc	TD32349
				NB628 45.00 x 60.00 x 9.00mm, ACM NB469 77.00 x 100.00 x 11.50mm, FPM

125 2.2L

Diesel

23 D	4 Cyl.	8 Valves	2260cc	TD2663
PA619 (x8) HR336 (x2)				NB628 45.00 x 60.00 x 9.00mm, ACM NB690 81.00 x 100.10 x 11.50mm, FPM

126 2.2L

Diesel

23 TD	4 Cyl.	8 Valves	2260cc	TD2665
23 TD	4 Cyl.	8 Valves	2260cc	TD17577
23 YDT	4 Cyl.	8 Valves	2260cc	TD4769
				NB628 45.00 x 60.00 x 9.00mm, ACM NB690 81.00 x 100.10 x 11.50mm, FPM

127 2.2L

Diesel

A 22 DM	4 Cyl.	16 Valves	2231cc	TD24797
A 22 DM	4 Cyl.	16 Valves	2231cc	TD24787
A 22 DMH	4 Cyl.	16 Valves	2231cc	TD24788
A 22 DMH	4 Cyl.	16 Valves	2231cc	TD24798
HR5119				

128 2.2L

Petrol

C 22 NE	4 Cyl.	8 Valves	2198cc	TD23498
PA565 (x8) HR342	NC006		35.00 x 48.00 x 7.00mm, MVQ	NB700 31.00 x 50.00 x 8.00mm, MVQ NB806 90.00 x 104.00 x 11.00mm, FPM

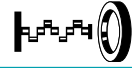

129 2.2L		Petrol			
C 22 SEL	4 Cyl.	16 Valves	2198cc		TD22202
C 22 SEL	4 Cyl.	16 Valves	2198cc		TD22204
X 22 SE	4 Cyl.	16 Valves	2198cc		TD15849
X 22 SE	4 Cyl.	16 Valves	2198cc		TD17918
X 22 SE	4 Cyl.	16 Valves	2198cc		TD23605
X 22 XE	4 Cyl.	16 Valves	2198cc		TD17628
X 22 XE	4 Cyl.	16 Valves	2198cc		TD4827
Y 22 SE	4 Cyl.	16 Valves	2198cc		TD15093
Y 22 SE	4 Cyl.	16 Valves	2198cc		TD17930
Y 22 XE	4 Cyl.	16 Valves	2198cc		TD13048
Y 22 XE	4 Cyl.	16 Valves	2198cc		TD17933
Z 22 XE	4 Cyl.	16 Valves	2198cc		TD15850
Z 22 XE	4 Cyl.	16 Valves	2198cc		TD22877
PA5041 (x16) HR791	NC006 (x2) 35.00 x 48.00 x 7.00mm, MVQ		NB700 31.00 x 50.00 x 8.00mm, MVQ NB806 90.00 x 104.00 x 11.00mm, FPM		

130 2.2L		Diesel			
C223	4 Cyl.	8 Valves	2238cc		TD22879
C223	4 Cyl.	8 Valves	2238cc		TD22878
PA418 (x8)	NJ267 42.00 x 55.00 x 9.00mm, NBR		NJ265 82.00 x 105.00 x 13.00mm, MVQ		

131 2.2L		Diesel			
G9T 720	4 Cyl.	16 Valves	2188cc		TD18875
G9T 720	4 Cyl.	16 Valves	2188cc		TD19353
G9T 722	4 Cyl.	16 Valves	2188cc		TD19356
G9T 722	4 Cyl.	16 Valves	2188cc		TD21397
G9T 750	4 Cyl.	16 Valves	2188cc		TD19355
G9T 750	4 Cyl.	16 Valves	2188cc		TD23885
PA5041 (x16) HR791	NA5053 (x2) 30.00 x 42.00 x 7.00mm, FPM		NA5446 60.00 x 75.00 x 7.00mm, PTFE/ACM NA5447 70.00 x 85.00 x 7.00mm, PTFE/ACM		

132 2.2L		Petrol			
L61	4 Cyl.	16 Valves	2198cc		TD18706
Z 22 SE	4 Cyl.	16 Valves	2198cc		TD14668
Z 22 SE	4 Cyl.	16 Valves	2198cc		TD17683
Z 22 SE	4 Cyl.	16 Valves	2198cc		TD19879
Z 22 YH	4 Cyl.	16 Valves	2198cc		TD18021
Z 22 YH	4 Cyl.	16 Valves	2198cc		TD19877
Z 22 YH	4 Cyl.	16 Valves	2198cc		TD18020
HR5127			NA5108 42.00 x 55.00 x 7.00mm, FPM/ACM NB806 90.00 x 104.00 x 11.00mm, FPM		



133 2.2L

Diesel

X 22 DTH	4 Cyl.	16 Valves	2171cc	TD17916
X 22 DTH	4 Cyl.	16 Valves	2171cc	TD9510
Y 22 DTH	4 Cyl.	16 Valves	2171cc	TD17928
Y 22 DTH	4 Cyl.	16 Valves	2172cc	TD15091
Y 22 DTR	4 Cyl.	16 Valves	2172cc	TD17629
Y 22 DTR	4 Cyl.	16 Valves	2172cc	TD14924

PA5041 (x16)
HR791

NA5069
55.00 x 68.00 x 8.00mm, FPM
NA5209
99.00 x 114.00 x 11.00mm, FPM

134 2.3L

Petrol

4 ZD1	4 Cyl.	8 Valves	2255cc	TD22858
4 ZD1	4 Cyl.	8 Valves	2255cc	TD5446
23 P	4 Cyl.	8 Valves	2254cc	TD18675
23 P	4 Cyl.	8 Valves	2254cc	TD18676

PA933 (x8)

NA5347
30.0 x 45.0 x 7.00mm, FPM

NJ323
40.00 x 56.00 x 7.00mm, NBR
NJ322
95.00 x 118.00 x 10.00mm, NBR

135 2.3L

Diesel

23 D	4 Cyl.	8 Valves	2260cc	TD17575
23 DC	4 Cyl.	8 Valves	2260cc	TD2662
23 YD	4 Cyl.	8 Valves	2260cc	TD17914
23 YD	4 Cyl.	8 Valves	2260cc	TD4768

PA619 (x8)
HR336

NB628
45.00 x 60.00 x 9.00mm, ACM
NB690
81.00 x 100.10 x 11.50mm, FPM

136 2.3L

Diesel

23 DTR	4 Cyl.	8 Valves	2260cc	TD17576
23 DTR	4 Cyl.	8 Valves	2260cc	TD4767
23 YDT	4 Cyl.	8 Valves	2260cc	TD17579

NB628
45.00 x 60.00 x 9.00mm, ACM
NB690
81.00 x 100.10 x 11.50mm, FPM

137 2.3L

Diesel

M9T 670	4 Cyl.	16 Valves	2298cc	TD24749
M9T 670	4 Cyl.	16 Valves	2298cc	TD25055
M9T 672	4 Cyl.	16 Valves	2298cc	TD25155
M9T 672	4 Cyl.	16 Valves	2298cc	TD25226
M9T 676	4 Cyl.	16 Valves	2298cc	TD24748
M9T 676	4 Cyl.	16 Valves	2298cc	TD25056
M9T 678	4 Cyl.	16 Valves	2298cc	TD25156
M9T 678	4 Cyl.	16 Valves	2298cc	TD25157
M9T 680	4 Cyl.	16 Valves	2298cc	TD25137
M9T 680	4 Cyl.	16 Valves	2298cc	TD25138
M9T 686	4 Cyl.	16 Valves	2298cc	TD25231
M9T 686	4 Cyl.	16 Valves	2298cc	TD25152

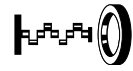
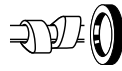

M9T 690	4 Cyl.	16 Valves	2298cc	TD25105
M9T 690	4 Cyl.	16 Valves	2298cc	TD25230
M9T 692	4 Cyl.	16 Valves	2298cc	TD25106
M9T 692	4 Cyl.	16 Valves	2298cc	TD25224
M9T 694	4 Cyl.	16 Valves	2298cc	TD24750
M9T 694	4 Cyl.	16 Valves	2298cc	TD25058
M9T 696	4 Cyl.	16 Valves	2298cc	TD25149
M9T 696	4 Cyl.	16 Valves	2298cc	TD25225
M9T 698	4 Cyl.	16 Valves	2298cc	TD24751
M9T 698	4 Cyl.	16 Valves	2298cc	TD25057
M9T 700	4 Cyl.	16 Valves	2298cc	TD29896
M9T 700	4 Cyl.	16 Valves	2299cc	TD29659
M9T 702	4 Cyl.	16 Valves	2298cc	TD29895
M9T 702	4 Cyl.	16 Valves	2299cc	TD29658
M9T 704	4 Cyl.	16 Valves	2298cc	TD34433
M9T 704	4 Cyl.	16 Valves	2298cc	TD34432
M9T 706	4 Cyl.	16 Valves	2298cc	TD32759
M9T 706	4 Cyl.	16 Valves	2298cc	TD34430
M9T 710	4 Cyl.	16 Valves	2298cc	TD34431
M9T 710	4 Cyl.	16 Valves	2298cc	TD34434
M9T 870	4 Cyl.	16 Valves	2298cc	TD29897
M9T 870	4 Cyl.	16 Valves	2299cc	TD29657
M9T 876	4 Cyl.	16 Valves	2299cc	TD31131
M9T 876	4 Cyl.	16 Valves	2299cc	TD31130
M9T 880	4 Cyl.	16 Valves	2298cc	TD28582
M9T 880	4 Cyl.	16 Valves	2298cc	TD31642
M9T 896	4 Cyl.	16 Valves	2298cc	TD28580
M9T 898	4 Cyl.	16 Valves	2298cc	TD28581
M9T 898	4 Cyl.	16 Valves	2298cc	TD34462

HR814

NA5333

48.00 x 81.00 x 11.5mm, FPM/ACM

LK5022

94.00 x 161.00 x 10.00mm, PTFE/ACM

138 2.4L

Diesel

4FG1T	4 Cyl.	8 Valves	2380cc	TD20067
PA933 (x8)	NJ321	28.00 x 47.00 x 8.00mm, NBR	NJ323	40.00 x 56.00 x 7.00mm, NBR
			NJ158	95.00 x 118.00 x 10.00mm, ACM

139 2.4L

Petrol

A 24 XE	4 Cyl.	16 Valves	2384cc	TD30958
A 24 XE	4 Cyl.	16 Valves	2384cc	TD24791
A 24 XE	4 Cyl.	16 Valves	2384cc	TD24792
LE9	4 Cyl.	16 Valves	2384cc	TD32719

HR5127

NA5108

42.00 x 55.00 x 7.00mm, FPM/ACM

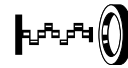
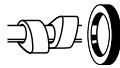

140 2.4L

Petrol

C 24 NE	4 Cyl.	8 Valves	2410cc	TD4803
C 24 NE	4 Cyl.	8 Valves	2410cc	TD17613
PA619 (x8) HR336 (x2)				NB628 (x2) 45.00 x 60.00 x 9.00mm, ACM NB469 (x2) 77.00 x 100.00 x 11.50mm, FPM

141 2.4L

Petrol

Z 24 SE	4 Cyl.	16 Valves	2405cc	TD21015
Z 24 SED	4 Cyl.	16 Valves	2405cc	TD20749
Z 24 XE	4 Cyl.	16 Valves	2405cc	TD21016
Z 24 XE	4 Cyl.	16 Valves	2405cc	TD34454
Z 24 XED	4 Cyl.	16 Valves	2405cc	TD19220
Z 24 XED	4 Cyl.	16 Valves	2405cc	TD19221
Z 24 XED	4 Cyl.	16 Valves	2405cc	TD22455
PA5041 (x16) HR791 (x2)	NC006 (x2) 35.00 x 48.00 x 7.00mm, MVQ	NB700 (x2) 31.00 x 50.00 x 8.00mm, MVQ NB806 (x2) 90.00 x 104.00 x 11.00mm, FPM		

142 2.5L

Diesel

4JA1	4 Cyl.	8 Valves	2499cc	TD15868
4JA1	4 Cyl.	8 Valves	2499cc	TD18377
PA418 (x8)	NA5051 40.00 x 56.00 x 7.00mm, FPM	NJ014 (x2) 50.00 x 68.00 x 9.00mm, NBR NJ322 (x2) 95.00 x 118.00 x 10.00mm, NBR →06/94		

143 2.5L

Diesel

4JA1-T	4 Cyl.	8 Valves	2499cc	TD5447
4JA1-T	4 Cyl.	8 Valves	2499cc	TD22853
PA418 (x8)	NA5051 40.00 x 56.00 x 7.00mm, FPM	NJ014 (x2) 50.00 x 68.00 x 9.00mm, NBR NJ322 (x2) 95.00 x 118.00 x 10.00mm, NBR		

144 2.5L

Diesel

25 DG	4 Cyl.	8 Valves	2499cc	TD25444
HR602 (x2)	NP068 55.00 x 70.00 x 8.00mm, FPM	NF885 (x2) 70.00 x 159.00 ; 179.00 x 16.00mm, FPM		

145 2.5L

Diesel

25 DM	4 Cyl.	8 Valves	2499cc	TD25445
HR602 (x2)	NP068 55.00 x 70.00 x 8.00mm, FPM	NF885 (x2) 70.00 x 159.00 ; 179.00 x 16.00mm, FPM NF853 (x2) 100.00 x 118.00 x 10.00mm, FPM NF883 (x2) 114.00 x 171.00 x 13.00mm, FPM		

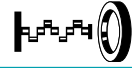

146 2.5L		Diesel			
25 DT		6 Cyl.	12 Valves	2497cc	TD22848
25 DT		6 Cyl.	12 Valves	2497cc	TD4817
X 25 DT		6 Cyl.	12 Valves	2497cc	TD17595
X 25 DT		6 Cyl.	12 Valves	2497cc	TD4828
X 25 TD		6 Cyl.	12 Valves	2498cc	TD17322
PA5041 (x12)					NF637 F 48.00 x 65.00 x 10.00mm, FPM
HR280 S					NB431 R 90.00 x 110.00 x 12.00mm, FPM

147 2.5L		Petrol			
25 E		6 Cyl.	12 Valves	2490cc	TD17681
25 E		6 Cyl.	12 Valves	2490cc	TD2668
25 H		6 Cyl.	12 Valves	2490cc	TD22417
25 H		6 Cyl.	12 Valves	2490cc	TD2669
25 NE		6 Cyl.	12 Valves	2490cc	TD11147
25 S		6 Cyl.	12 Valves	2490cc	TD22849
25 S		6 Cyl.	12 Valves	2490cc	TD22418
H 25 E		6 Cyl.	12 Valves	2490cc	TD22870
H 25 E		6 Cyl.	12 Valves	2490cc	TD5260
PA619 (x12)					NB628 F 45.00 x 60.00 x 9.00mm, ACM
HR336 S (x3)					NB469 R 77.00 x 100.00 x 11.50mm, FPM

148 2.5L		Petrol			
25 S		6 Cyl.	12 Valves	2490cc	TD2671
25 SV		6 Cyl.	12 Valves	2490cc	TD26221
PA619 (x12)					NB628 F 45.00 x 60.00 x 9.00mm, ACM
Eng no. 25S150001 →					NB469 R 77.00 x 100.00 x 11.50mm, FPM
HR336 S (x3)					

149 2.5L		Petrol			
C 25 XE		6 Cyl.	24 Valves	2498cc	TD17635
C 25 XE		6 Cyl.	24 Valves	2498cc	TD23477
C 25 XE		6 Cyl.	24 Valves	2498cc	TD4804
X 25 XE		6 Cyl.	24 Valves	2498cc	TD2738
X 25 XE		6 Cyl.	24 Valves	2498cc	TD23512
X 25 XE		6 Cyl.	24 Valves	2498cc	TD17634
PA5041 (x24)					NB884 F 38.00 x 50.00 x 5.50mm, FPM
HR5062 S		NC006 (x4)		35.00 x 48.00 x 7.00mm, MVQ	NB806 R 90.00 x 104.00 x 11.00mm, FPM

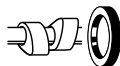

150 2.5L

Diesel

G9MB6	4 Cyl.	16 Valves	2463cc	TD20330
G9U 630	4 Cyl.	16 Valves	2464cc	TD20987
G9U 630	4 Cyl.	16 Valves	2464cc	TD21903
G9U 632	4 Cyl.	16 Valves	2464cc	TD21014
G9U 632	4 Cyl.	16 Valves	2464cc	TD24755
G9U 650	4 Cyl.	16 Valves	2464cc	TD24737
G9U 650	4 Cyl.	16 Valves	2464cc	TD21012
G9U 720	4 Cyl.	16 Valves	2464cc	TD18874
G9U 720	4 Cyl.	16 Valves	2464cc	TD19358
G9U 724	4 Cyl.	16 Valves	2464cc	TD19367
G9U 724	4 Cyl.	16 Valves	2464cc	TD19368
G9U 730	4 Cyl.	16 Valves	2464cc	TD18497
G9U 730	4 Cyl.	16 Valves	2464cc	TD18701
G9U 750	4 Cyl.	16 Valves	2464cc	TD19365
G9U 750	4 Cyl.	16 Valves	2464cc	TD23887
G9U 754	4 Cyl.	16 Valves	2464cc	TD19369
G9U 754	4 Cyl.	16 Valves	2464cc	TD19817

PA5041 (x16)
HR791

NA5053 (x2)
30.00 x 42.00 x 7.00mm, FPM

NA5446
60.00 x 75.00 x 7.00mm, PTFE/ACM

NA5447
70.00 x 85.00 x 7.00mm, PTFE/ACM

NF860
93.00 x 108.00 x 7.00mm, FPM/ACM

151 2.5L

Diesel

S8U 758	4 Cyl.	8 Valves	2499cc	TD22880
S8U 758	4 Cyl.	8 Valves	2499cc	TD22883
S8U 770	4 Cyl.	8 Valves	2499cc	TD22881
S8U 770	4 Cyl.	8 Valves	2499cc	TD19357
S8U 772	4 Cyl.	8 Valves	2499cc	TD19364
S8U 772	4 Cyl.	8 Valves	2499cc	TD23888
S8U 780	4 Cyl.	8 Valves	2499cc	TD22882
S8U 780	4 Cyl.	8 Valves	2499cc	TD22884
S8U 782	4 Cyl.	8 Valves	2499cc	TD24143
S8U 782	4 Cyl.	8 Valves	2499cc	TD22885

HR602

NP068
55.00 x 70.00 x 8.00mm, FPM

NF885
70.00 x 159.00 ; 179.00 x 16.00mm, FPM

NF883
114.00 x 171.00 x 13.00mm, FPM

152 2.5L

Diesel

X 25 TD	6 Cyl.	12 Valves	2498cc	TD17920
---------	--------	-----------	--------	---------

PA5041 (x12)
HR280

NF637
48.00 x 65.00 x 10.00mm, FPM

NA5104
90.00 x 110.00 x 12.00mm, PTFE

153 2.5L

Diesel

Y 25 DT	6 Cyl.	24 Valves	2497cc	TD22875
Y 25 DT	6 Cyl.	24 Valves	2497cc	TD16301

PA5016 (x24)
HR5121

NA5104
90.00 x 110.00 x 12.00mm, PTFE

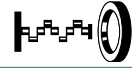

154 2.6L Petrol

C 26 NE	6 Cyl.	12 Valves	2594cc	TD17614
C 26 NE	6 Cyl.	12 Valves	2594cc	TD4805
PA619 (x12) HR336 (x3)				NB628 (x4) 45.00 x 60.00 x 9.00mm, ACM NB469 (x3) 77.00 x 100.00 x 11.50mm, FPM

155 2.6L Petrol

Y 26 SE	6 Cyl.	24 Valves	2597cc	TD19891
Y 26 SE	6 Cyl.	24 Valves	2597cc	TD14925
Y 26 SE	6 Cyl.	24 Valves	2597cc	TD18888
PA5041 (x24) HR5062 (x4)	NC006 (x4) 35.00 x 48.00 x 7.00mm, MVQ			NB884 (x4) 38.00 x 50.00 x 5.50mm, FPM NB806 (x3) 90.00 x 104.00 x 11.00mm, FPM

156 2.8L Diesel

4JB1-T	4 Cyl.	8 Valves	2771cc	TD23491
28 TDI (4JB1-T)	4 Cyl.	8 Valves	2771cc	TD22851
28 TDI (4JB1-T)	4 Cyl.	8 Valves	2771cc	TD4774
PA418 (x8)	NA5051 40.00 x 56.00 x 7.00mm, FPM			NJ014 (x4) 50.00 x 68.00 x 9.00mm, NBR NJ322 (x3) 95.00 x 118.00 x 10.00mm, NBR

157 2.8L Petrol

28 E	6 Cyl.	12 Valves	2784cc	TD2675
28 EC	6 Cyl.	12 Valves	2784cc	TD2676
PA619 (x6) HR336 (x3)				NB628 (x4) 45.00 x 60.00 x 9.00mm, ACM NB469 (x3) 77.00 x 100.00 x 11.50mm, FPM

158 2.8L Petrol

28 H	6 Cyl.	12 Valves	2784cc	TD2677
28 H	6 Cyl.	12 Valves	2784cc	TD17607
PA619 (x12) Eng no. 28H102081 → HR336 (x3) Eng no. 28H102081 →				NB628 (x4) 45.00 x 60.00 x 9.00mm, ACM NB469 (x3) 77.00 x 100.00 x 11.50mm, FPM

159 2.8L Petrol

28 HC	6 Cyl.	12 Valves	2784cc	TD2678
28 HL	6 Cyl.	12 Valves	2784cc	TD4773
28 S	6 Cyl.	12 Valves	2784cc	TD2679
PA619 (x6) Eng no. 28S150001 → HR336 (x3)				NB628 (x4) 45.00 x 60.00 x 9.00mm, ACM NB469 (x3) 77.00 x 100.00 x 11.50mm, FPM

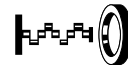
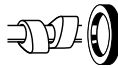

160 2.8L

Diesel

S9W 700	4 Cyl.	8 Valves	2799cc	TD21149
S9W 700	4 Cyl.	8 Valves	2799cc	TD21150
S9W 702	4 Cyl.	8 Valves	2799cc	TD19361
S9W 702	4 Cyl.	8 Valves	2799cc	TD19360

HR602

NP068
55.00 x 70.00 x 8.00mm, FPM

NF885
70.00 x 159.00 ; 179.00 x 16.00mm, FPM

NF883
114.00 x 171.00 x 13.00mm, FPM

161 2.9L

Petrol

30 E	6 Cyl.	12 Valves	2969cc	TD4775
30 H	6 Cyl.	12 Valves	2969cc	TD22852
C 30 LE	6 Cyl.	12 Valves	2969cc	TD4806

PA619 (x12)
HR336 (x3)

NB628
45.00 x 60.00 x 9.00mm, ACM

NB469
77.00 x 100.00 x 11.50mm, FPM

162 2.9L

Petrol

30 H	6 Cyl.	12 Valves	2969cc	TD5307
------	--------	-----------	--------	--------

PA619 (x12)
Eng no. 30H8632 →
HR336 (x3)

NB628
45.00 x 60.00 x 9.00mm, ACM

NB469
77.00 x 100.00 x 11.50mm, FPM

163 3.0L

Diesel

4 JX1	4 Cyl.	16 Valves	2999cc	TD10269
4 JX1	4 Cyl.	16 Valves	2999cc	TD22856

NJ321 (x2)
28.00 x 47.00 x 8.00mm, NBR

164 3.0L

Petrol

30 E	6 Cyl.	12 Valves	2969cc	TD17580
30 NE	6 Cyl.	12 Valves	2969cc	TD18376
30 NE	6 Cyl.	12 Valves	2969cc	TD4776
C 30 LE	6 Cyl.	12 Valves	2969cc	TD17615
C 30 NE	6 Cyl.	12 Valves	2969cc	TD17616
C 30 NE	6 Cyl.	12 Valves	2969cc	TD2709

PA619 (x12)
HR336 (x3)

NB628
45.00 x 60.00 x 9.00mm, ACM

NB469
77.00 x 100.00 x 11.50mm, FPM

165 3.0L

Petrol

C 30 SE	6 Cyl.	24 Valves	2969cc	TD17617
C 30 SE	6 Cyl.	24 Valves	2969cc	TD4807
C 30 SEJ	6 Cyl.	24 Valves	2969cc	TD18889
C 30 SEJ	6 Cyl.	24 Valves	2969cc	TD4808
C 30 XEI	6 Cyl.	24 Valves	2969cc	TD13749

PA565 (x24)
HR342 (x3)

NB690
81.00 x 100.10 x 11.50mm, FPM

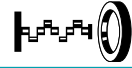

166 3.0L Petrol

X 30 XE	6 Cyl.	24 Valves	2962cc	TD17922
X 30 XE	6 Cyl.	24 Valves	2962cc	TD2739
PA5041 (x24) HR5062	NC006 (x4) 35.00 x 48.00 x 7.00mm, MVQ	NB884 38.00 x 50.00 x 5.50mm, FPM NB806 90.00 x 104.00 x 11.00mm, FPM		

167 3.0L Diesel

Y 30 DT	6 Cyl.	24 Valves	2958cc	TD20351
Y 30 DT	6 Cyl.	24 Valves	2958cc	TD18147
Z 30 DT	6 Cyl.	24 Valves	2958cc	TD19215
Z 30 DT	6 Cyl.	24 Valves	2959cc	TD18990
HR5094	NJ283 (x2) 36.00 x 50.00 x 8.00mm, NBR			

168 3.0L Diesel

ZD3 200	4 Cyl.	16 Valves	2953cc	TD19372
ZD3 200	4 Cyl.	16 Valves	2953cc	TD22408
ZD3 202	4 Cyl.	16 Valves	2953cc	TD19373
ZD3 202	4 Cyl.	16 Valves	2953cc	TD22409
PA079 (x16)				

169 3.1L Diesel

4 JG2 T	4 Cyl.	8 Valves	3059cc	TD26117
4 JG2T	4 Cyl.	8 Valves	3059cc	TD5448
4 JG2TC	4 Cyl.	8 Valves	3059cc	TD22854
4 JG2TC	4 Cyl.	8 Valves	3059cc	TD2715
4JG2-TC	4 Cyl.	8 Valves	3059cc	TD25114
PA418 (x8)	NA5051 40.00 x 56.00 x 7.00mm, FPM	NJ014 50.00 x 68.00 x 9.00mm, NBR NJ322 95.00 x 118.00 x 10.00mm, NBR		

170 3.2L Petrol

6 VD1	6 Cyl.	24 Valves	3165cc	TD10627
6 VD1	6 Cyl.	24 Valves	3165cc	TD22861
6VD1	6 Cyl.	24 Valves	3165cc	TD23501
Y 32 NE	6 Cyl.	24 Valves	3165cc	TD22876
Y 32 NE	6 Cyl.	24 Valves	3165cc	TD15094
HR5094	NA5347 (x2) 30.0 x 45.0 x 7.00mm, FPM	NA5108 42.00 x 55.00 x 7.00mm, FPM/ACM NJ158 95.00 x 118.00 x 10.00mm, ACM		

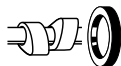

171 3.2L Petrol

Y 32 SE	6 Cyl.	24 Valves	3175cc	TD18887
Y 32 SE	6 Cyl.	24 Valves	3175cc	TD15851
Z 32 SE	6 Cyl.	24 Valves	3175cc	TD19878
Z 32 SE	6 Cyl.	24 Valves	3175cc	TD18013
Z 32 SE	6 Cyl.	24 Valves	3175cc	TD19217

PA5041 (x24)
HR5062

NC006 (x2)
35.00 x 48.00 x 7.00mm, MVQ

NB884
38.00 x 50.00 x 5.50mm, FPM
NB806
90.00 x 104.00 x 11.00mm, FPM

172 3.2L Petrol

Z 32 SEE	6 Cyl.	24 Valves	3195cc	TD19218
Z 32 SEE	6 Cyl.	24 Valves	3195cc	TD19222

PA5041 (x24)
HR5062

NB700
31.00 x 50.00 x 8.00mm, MVQ
NB806
90.00 x 104.00 x 11.00mm, FPM

173 3.5L Petrol









2GR-FE	6 Cyl.	24 Valves	3456cc	TD24837
PA5020 (x24)				

174 3.5L Petrol

6VE1	6 Cyl.	24 Valves	3494cc	TD23509
6 VE1	6 Cyl.	24 Valves	3494cc	TD22862
6 VE1	6 Cyl.	24 Valves	3494cc	TD10268

NA5347 (x2)
30.0 x 45.0 x 7.00mm, FPM

NA5108
42.00 x 55.00 x 7.00mm, FPM/ACM

	CC				9		CC				9
3.152	2490	3	6	Diesel	2						
4.203	3335	4	8	Diesel	3						
4.2032	3335	4	8	Diesel	3						
4.212	3475	4	8	Diesel	4						
4.236	3864	4	8	Diesel	5						
4.236 V	3864	4	8	Diesel	5						
4.248	4064	4	8	Diesel	8						
4.2482	4064	4	8	Diesel	8						
6.354	5794	6	12	Diesel	10						
6.354.2	5794	6	12	Diesel	10						
6.354.3	5794	6	12	Diesel	10						
6.354.4	5794	6	12	Diesel	10						
6.354 V	5794	6	12	Diesel	10						
6.357.2	5842	6	12	Diesel	10						
6.372	6100	6	12	Diesel	13						
6.372.4	6100	6	12	Diesel	13						
1004-4	3990	4	8	Diesel	7						
1004-40	3990	4	8	Diesel	7						
1004-40T	3990	4	8	Diesel	7						
1004-42	4230	4	8	Diesel	9						
1006-6	5984	6	12	Diesel	12						
1006-60	5984	6	12	Diesel	12						
1006-60T	5984	6	12	Diesel	12						
1006-60TW	5984	6	12	Diesel	12						
D 6.354	5800	6	12	Diesel	10						
D6.3544	5806	6	12	Diesel	10						
Phaser 110 T	3990	4	8	Diesel	7						
Phaser 110 TI	3990	4	8	Diesel	7						
Prima 65	1993	4	8	Diesel	1						
T4.236	3864	4	8	Diesel	6						
T 6.354	5794	6	12	Diesel	11						
T6.354.3 CC	5800	6	12	Diesel	11						
T6.3544	5794	6	12	Diesel	11						
V 8.510	8355	8	16	Diesel	14						
V8.540	8846	8	16	Diesel	15						



1 2.0L Diesel

Prima 65 4 Cyl. 8 Valves 1993cc TD7539

NB775
40.00 x 52.00 x 7.00mm, FPM
NB773
46.00 x 60.00 x 7.00mm, FPM

NB774
35.00 x 45.00 x 7.00mm, FPM
NB772
88.90 x 104.80 x 9.52mm, MVQ

2 2.5L Diesel

3.152 3 Cyl. 6 Valves 2490cc TD6788

HR636 (x2)

NA736
57.20 x 76.20 x 12.70mm, NBR+Leather
NB933
133.35 x 158.75 x 12.63mm, FPM
NB460
133.30 x 158.70 x 12.70mm, MVQ
KT633 (x2)

3 3.3L Diesel

4.203 4 Cyl. 8 Valves 3335cc TD7381

4.2032 4 Cyl. 8 Valves 3335cc TD29146

HR637

NA736
57.20 x 76.20 x 12.70mm, NBR+Leather
NB933
133.35 x 158.75 x 12.63mm, FPM
NB460
133.30 x 158.70 x 12.70mm, MVQ
KT633 (x2)

4 3.5L Diesel

4.212 4 Cyl. 8 Valves 3475cc TD29147

HR639

NB932
60.33 x 79.40 x 9.50mm, FPM
NB459
60.30 x 79.50 x 9.50mm, MVQ
NB933
133.35 x 158.75 x 12.63mm, FPM
NB460
133.30 x 158.70 x 12.70mm, MVQ
KT636 (x2)

5 3.9L Diesel

4.236 4 Cyl. 8 Valves 3864cc TD6398

4.236 V 4 Cyl. 8 Valves 3864cc TD6531

HR639

NB932
60.33 x 79.40 x 9.50mm, FPM
NB459
60.30 x 79.50 x 9.50mm, MVQ
NB933
133.35 x 158.75 x 12.63mm, FPM
NB460
133.30 x 158.70 x 12.70mm, MVQ
KT636 (x2)



6 3.9L Diesel

T4.236	4 Cyl.	8 Valves	3864cc	TD6746
HR639				
			NB932 60.33 x 79.40 x 9.50mm, FPM NB459 60.30 x 79.50 x 9.50mm, MVQ NB933 133.35 x 158.75 x 12.63mm, FPM NB460 133.30 x 158.70 x 12.70mm, MVQ	

7 4.0L Diesel

1004-4	4 Cyl.	8 Valves	3990cc	TD29134
1004-40	4 Cyl.	8 Valves	3990cc	TD20891
1004-40T	4 Cyl.	8 Valves	3990cc	TD29133
Phaser 110 T	4 Cyl.	8 Valves	3990cc	TD8659
Phaser 110 TI	4 Cyl.	8 Valves	3990cc	TD8662
			NB932 60.33 x 79.40 x 9.50mm, FPM NB459 60.30 x 79.50 x 9.50mm, MVQ NB933 133.35 x 158.75 x 12.63mm, FPM NB460 133.30 x 158.70 x 12.70mm, MVQ	

8 4.1L Diesel

4.248	4 Cyl.	8 Valves	4064cc	TD29149
4.2482	4 Cyl.	8 Valves	4064cc	TD29150
HR639				
			NB932 60.33 x 79.40 x 9.50mm, FPM NB459 60.30 x 79.50 x 9.50mm, MVQ NB933 133.35 x 158.75 x 12.63mm, FPM NB460 133.30 x 158.70 x 12.70mm, MVQ KT636 (x2)	

9 4.2L Diesel

1004-42	4 Cyl.	8 Valves	4230cc	TD23905
			NB932 60.33 x 79.40 x 9.50mm, FPM NB459 60.30 x 79.50 x 9.50mm, MVQ NB933 133.35 x 158.75 x 12.63mm, FPM NB460 133.30 x 158.70 x 12.70mm, MVQ	

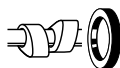

10 5.8L Diesel

6.354	6 Cyl.	12 Valves	5794cc	TD6713
6.354.2	6 Cyl.	12 Valves	5794cc	TD6548
6.354.3	6 Cyl.	12 Valves	5794cc	TD6400
6.354.4	6 Cyl.	12 Valves	5794cc	TD6546
6.354 V	6 Cyl.	12 Valves	5794cc	TD7158
6.357.2	6 Cyl.	12 Valves	5842cc	TD31282
D 6.354	6 Cyl.	12 Valves	5800cc	TD6701
D6.3544	6 Cyl.	12 Valves	5806cc	TD8702

HR638  (x2)

NB932 

60.33 x 79.40 x 9.50mm, FPM

NB459 

60.30 x 79.50 x 9.50mm, MVQ

NB933 

133.35 x 158.75 x 12.63mm, FPM

NB460 

133.30 x 158.70 x 12.70mm, MVQ

KT636  (x2)

11 5.8L Diesel

T 6.354	6 Cyl.	12 Valves	5794cc	TD6712
T6.354.3 CC	6 Cyl.	12 Valves	5800cc	TD6747
T6.3544	6 Cyl.	12 Valves	5794cc	TD8703

HR638  (x2)

NB932 

60.33 x 79.40 x 9.50mm, FPM

NB459 

60.30 x 79.50 x 9.50mm, MVQ

NB933 

133.35 x 158.75 x 12.63mm, FPM

NB460 

133.30 x 158.70 x 12.70mm, MVQ

12 6.0L Diesel

1006-6	6 Cyl.	12 Valves	5984cc	TD29135
1006-60	6 Cyl.	12 Valves	5984cc	TD29136
1006-60T	6 Cyl.	12 Valves	5984cc	TD29137
1006-60TW	6 Cyl.	12 Valves	5984cc	TD29138

NB932 

60.33 x 79.40 x 9.50mm, FPM

NB459 

60.30 x 79.50 x 9.50mm, MVQ

NB933 

133.35 x 158.75 x 12.63mm, FPM

NB460 

133.30 x 158.70 x 12.70mm, MVQ

13 6.1L Diesel

6.372	6 Cyl.	12 Valves	6100cc	TD20102
6.372.4	6 Cyl.	12 Valves	6100cc	TD20103

HR638  (x2)

NB932 

60.33 x 79.40 x 9.50mm, FPM

NB459 

60.30 x 79.50 x 9.50mm, MVQ

NB933 

133.35 x 158.75 x 12.63mm, FPM

NB460 

133.30 x 158.70 x 12.70mm, MVQ

KT636  (x2)

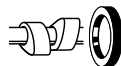

14 8.4L

Diesel

V 8.510	8 Cyl.	16 Valves	8355cc	TD6716
HR639  (x2)				NB932  60.33 x 79.40 x 9.50mm, FPM NB459  60.30 x 79.50 x 9.50mm, MVQ

15 8.8L

Diesel

V8.540	8 Cyl.	16 Valves	8846cc	TD6741
HR639  (x2)				NB932  60.33 x 79.40 x 9.50mm, FPM NB459  60.30 x 79.50 x 9.50mm, MVQ NB933  133.35 x 158.75 x 12.63mm, FPM NB460  133.30 x 158.70 x 12.70mm, MVQ



CC



9

104	10/72→10/79	108 (XV3)	Petrol	954	4	8	3
104	07/76→08/82	109 (XW3)	Petrol	1124	4	8	9
104	09/78→09/79	XW3S	Petrol	1124	4	8	15
104	08/79→06/83	129 (XZ5)	Petrol	1219	4	8	16
104	08/79→06/83	150 (XY6B)	Petrol	1360	4	8	34
104	10/79→10/83	108 (XV5)	Petrol	954	4	8	3
104	08/80→06/88	109F (XW7)	Petrol	1124	4	8	9
104	09/83→06/88	108C (XV8)	Petrol	954	4	8	3
104 Coupe	09/73→09/79	XW3S	Petrol	1124	4	8	15
104 Coupe	09/73→10/83	108 (XV3)	Petrol	954	4	8	3
104 Coupe	09/73→10/83	108 (XV5)	Petrol	954	4	8	3
104 Coupe	08/75→06/80	121 (XW3S)	Petrol	1124	4	8	9
104 Coupe	08/79→06/83	109 (XW3)	Petrol	1124	4	8	9
104 Coupe	08/79→06/84	150 (XY6B)	Petrol	1360	4	8	34
104 Coupe	08/79→06/88	109F (XW7)	Petrol	1124	4	8	9
106 I (1A, 1C)	08/91→03/96	K5A (TU3)	Petrol	1360	4	8	37
106 I (1A, 1C)	09/91→04/96	CDY (TU9M)	Petrol	954	4	8	5
106 I (1A, 1C)	09/91→04/96	CDZ (TU9M)	Petrol	954	4	8	5
106 I (1A, 1C)	09/91→04/96	HDZ (TU1M)	Petrol	1124	4	8	11
106 I (1A, 1C)	09/91→04/96	KDX (TU3MC)	Petrol	1361	4	8	36
106 I (1A, 1C)	09/91→04/96	KDY (TU3M)	Petrol	1361	4	8	39
106 I (1A, 1C)	09/91→04/96	KFZ (TU3J2/Z)	Petrol	1361	4	8	43
106 I (1A, 1C)	09/91→04/96	TU9	Petrol	954	4	8	5
106 I (1A, 1C)	09/92→04/96	K9Y (TUD3Y)	Diesel	1361	4	8	38
106 I (1A, 1C)	06/93→04/96	NFZ (TU5JP)	Petrol	1587	4	8	64
106 I (1A, 1C)	10/93→04/96	TU2J2	Petrol	1294	4	8	28
106 I (1A, 1C)	01/94→04/96	NFY (TU5J2)	Petrol	1587	4	8	64
106 I (1A, 1C)	06/94→04/96	VJY (TUD5)	Diesel	1527	4	8	49
106 I (1A, 1C)	06/94→04/96	VJZ (TUD5)	Diesel	1527	4	8	49
106 II (1)	05/96→10/99	CDY (TU9M)	Petrol	954	4	8	5
106 II (1)	05/96→10/99	NFZ (TU5JP)	Petrol	1587	4	8	64
106 II (1)	05/96→01/01	NFW (TU5J2)	Petrol	1587	4	8	66
106 II (1)	05/96→01/01	NFY (TU5J2)	Petrol	1587	4	8	64
106 II (1)	05/96→07/04	HDZ (TU1M)	Petrol	1124	4	8	11
106 II (1)	05/96→07/04	HFX (TU1JP)	Petrol	1124	4	8	11
106 II (1)	05/96→07/04	KFW (TU3JP)	Petrol	1360	4	8	42
106 II (1)	05/96→07/04	KFX (TU3JP)	Petrol	1361	4	8	36
106 II (1)	05/96→07/04	NFX (TU5J4)	Petrol	1587	4	16	62
106 II (1)	05/96→04/07	VJY (TUD5)	Diesel	1527	4	8	49
106 II (1)	01/97→03/01	CDZ (TU9M)	Petrol	954	4	8	5
106 II (1)	01/97→03/01	HDY (TU1M)	Petrol	1124	4	8	10
106 II (1)	04/98→04/07	VJX (TUD5)	Diesel	1527	4	8	49
106 II (1)	04/98→04/07	VJZ (TUD5)	Diesel	1527	4	8	49
106 Van (1_)	09/91→03/01	CDY (TU9M)	Petrol	954	4	8	5
106 Van (1_)	09/91→03/01	TU9	Petrol	954	4	8	5
106 Van (1_)	05/96→03/01	VJY (TUD5)	Diesel	1527	4	8	49
106 Van (1_)	10/00→03/01	VJX (TUD5)	Diesel	1527	4	8	49
107	06/05→	BHT (DV4TD)	Diesel	1398	4	8	33
107	06/05→	CFA (384F)	Petrol	998	3	12	4
107	06/05→	CFB (1KR)	Petrol	998	3	12	4
108	05/14→	TKR-FE	Petrol	998	3	12	4
108	05/14→	HMT (EB2D)	Petrol	1199	3	12	20
160	07/76→03/79	7R2	Petrol	1639	4	8	54
180	02/73→09/77	7T2	Petrol	1959	4	8	83
180	01/82→12/82	7S2	Petrol	1800	4	8	70
204	10/65→07/69	XK	Petrol	1130	4	8	14
204	07/69→07/77	XK4	Petrol	1130	4	8	14
204	09/73→12/77	XL4D	Diesel	1357	4	8	44
204	09/75→07/77	XK5	Petrol	1127	4	8	14
204 Break	05/68→05/73	XLD	Diesel	1225	4	8	21
204 Break	05/69→10/77	XK4	Petrol	1130	4	8	14
204 Break	01/73→10/77	XL4D	Diesel	1357	4	8	44
204 Convertible	01/67→05/69	XK	Petrol	1130	4	8	14
204 Convertible	05/69→10/70	XK4	Petrol	1130	4	8	14
204 Coupe	05/69→05/70	XK4	Petrol	1130	4	8	14
205 Box	02/83→07/87	109N (XW7)	Petrol	1124	4	8	9
205 Box	02/83→07/87	150G (XY7)	Petrol	1360	4	8	35
205 Box	02/83→07/90	A9A (XUD7)	Diesel	1769	4	8	72
205 Box	08/87→07/90	H1B (TU1)	Petrol	1124	4	8	10
205 Box	03/94→05/97	161A (XUD7)	Diesel	1769	4	8	68
205 I (741A/C)	02/83→07/87	B6D (XU51A)	Petrol	1580	4	8	58
205 I (741A/C)	02/83→10/87	108C (XV8)	Petrol	954	4	8	3
205 I (741A/C)	02/83→10/87	109F (XW7)	Petrol	1124	4	8	9
205 I (741A/C)	02/83→10/87	109N (XW7)	Petrol	1124	4	8	9
205 I (741A/C)	02/83→10/87	150 (XY6B)	Petrol	1360	4	8	34
205 I (741A/C)	02/83→10/87	150B (XY8)	Petrol	1360	4	8	35
205 I (741A/C)	02/83→10/87	150D (XY7)	Petrol	1360	4	8	34
205 I (741A/C)	02/83→10/87	150G (XY7)	Petrol	1360	4	8	35



CC



9

205 I (741A/C)	08/83→10/87	161A (XUD7)	Diesel	1769	4	8	68
205 I (741A/C)	02/84→10/87	G1A	Petrol	1294	4	8	27
205 I (741A/C)	02/84→10/87	Y2/K	Petrol	1442	4	8	50
205 I (741A/C)	12/84→10/87	180A (XU5J)	Petrol	1580	4	8	58
205 I (741A/C)	10/85→10/87	150H (XY8)	Petrol	1360	4	8	34
205 I (741A/C)	08/86→10/87	B1A (XU51C)	Petrol	1580	4	8	58
205 I (741A/C)	08/86→10/87	BAZ (XU5CP)	Petrol	1580	4	8	58
205 I (741A/C)	10/86→10/87	D6B (XU9JA)	Petrol	1905	4	8	77
205 I (741A/C)	03/87→10/87	B1E (XU51C)	Petrol	1580	4	8	58
205 I (741A/C)	03/87→10/87	DFZ (XU9J1)	Petrol	1905	4	8	77
205 I Convertible (741B, 20D)	04/86→12/88	150B (XY8)	Petrol	1360	4	8	35
205 I Convertible (741B, 20D)	04/86→12/88	150H (XY8)	Petrol	1360	4	8	34
205 I Convertible (741B, 20D)	04/86→10/90	180A (XU5J)	Petrol	1580	4	8	58
205 I Convertible (741B, 20D)	04/86→10/90	180Z (XU5J)	Petrol	1580	4	8	58
205 I Convertible (741B, 20D)	05/86→12/94	DFZ (XU9J1)	Petrol	1905	4	8	77
205 I Convertible (741B, 20D)	08/87→07/92	B6D (XU5JA)	Petrol	1580	4	8	58
205 I Convertible (741B, 20D)	08/87→06/94	K2B (TU3S)	Petrol	1360	4	8	36
205 I Convertible (741B, 20D)	08/87→12/94	H1B (TU1)	Petrol	1124	4	8	10
205 I Convertible (741B, 20D)	08/87→12/94	K1D (TU3A)	Petrol	1361	4	8	36
205 I Convertible (741B, 20D)	03/88→05/89	150D (XY7)	Petrol	1360	4	8	34
205 I Convertible (741B, 20D)	03/88→05/89	150G (XY7)	Petrol	1360	4	8	35
205 I Convertible (741B, 20D)	01/89→09/93	KAY (TU3CP)	Petrol	1361	4	8	36
205 I Convertible (741B, 20D)	10/89→12/94	HDZ (TU1M)	Petrol	1124	4	8	11
205 I Convertible (741B, 20D)	08/90→07/92	DKZ (XU9JAZ)	Petrol	1905	4	8	77
205 I Convertible (741B, 20D)	05/91→12/94	KDY (TU3M)	Petrol	1361	4	8	39
205 I Convertible (741B, 20D)	05/91→12/94	KDZ (TU3M)	Petrol	1361	4	8	36
205 I Convertible (741B, 20D)	08/92→12/94	BDY (XU5M3Z)	Petrol	1580	4	8	58
205 II (20A/C)	01/87→07/88	150 (XY6B)	Petrol	1360	4	8	34
205 II (20A/C)	01/87→12/90	F1	Petrol	1204	4	8	18
205 II (20A/C)	06/87→12/89	K2B (TU3S)	Petrol	1360	4	8	36
205 II (20A/C)	06/87→12/89	Y2/K	Petrol	1442	4	8	50
205 II (20A/C)	07/87→10/88	E1	Petrol	1118	4	8	8
205 II (20A/C)	07/87→09/98	161A (XUD7)	Diesel	1769	4	8	68
205 II (20A/C)	08/87→07/90	CDY (TU9M)	Petrol	954	4	8	5
205 II (20A/C)	08/87→09/93	KAY (TU3CP)	Petrol	1361	4	8	36
205 II (20A/C)	08/87→06/94	XUD9	Diesel	1905	4	8	78
205 II (20A/C)	10/87→05/89	150D (XY7)	Petrol	1360	4	8	34
205 II (20A/C)	10/87→05/89	150G (XY7)	Petrol	1360	4	8	35
205 II (20A/C)	10/87→05/89	D2A (XU92C)	Petrol	1905	4	8	77
205 II (20A/C)	10/87→12/89	180A (XU5J)	Petrol	1580	4	8	58
205 II (20A/C)	10/87→12/89	180Z (XU5J)	Petrol	1580	4	8	58
205 II (20A/C)	10/87→10/90	109N (XW7)	Petrol	1124	4	8	9
205 II (20A/C)	10/87→10/90	H1B (TU1)	Petrol	1124	4	8	10
205 II (20A/C)	10/87→10/90	K1D (TU3A)	Petrol	1361	4	8	36
205 II (20A/C)	10/87→10/90	TU24	Petrol	1294	4	8	29
205 II (20A/C)	10/87→05/97	DFZ (XU9J1)	Petrol	1905	4	8	77
205 II (20A/C)	10/87→05/97	DKZ (XU9JAZ)	Petrol	1905	4	8	77
205 II (20A/C)	10/87→09/98	B1A (XU51C)	Petrol	1580	4	8	58
205 II (20A/C)	10/87→09/98	B1E (XU51C)	Petrol	1580	4	8	58
205 II (20A/C)	10/87→09/98	BAZ (XU5CP)	Petrol	1580	4	8	58
205 II (20A/C)	10/87→09/98	D6B (XU9JA)	Petrol	1905	4	8	77
205 II (20A/C)	10/87→09/98	DJZ (XUD9Y)	Diesel	1905	4	8	78
205 II (20A/C)	10/87→09/98	TU9	Petrol	954	4	8	5
205 II (20A/C)	07/88→05/89	150B (XY8)	Petrol	1360	4	8	35
205 II (20A/C)	07/88→05/89	150H (XY8)	Petrol	1360	4	8	34
205 II (20A/C)	07/88→09/98	KDY (TU3M)	Petrol	1361	4	8	39
205 II (20A/C)	07/88→09/98	KDZ (TU3M)	Petrol	1361	4	8	36
205 II (20A/C)	07/88→09/98	KFX (TU3JP)	Petrol	1361	4	8	36
205 II (20A/C)	07/89→09/98	HDZ (TU1M)	Petrol	1124	4	8	11
205 II (20A/C)	01/90→09/98	A8B (XUD7TE)	Diesel	1769	4	8	68
205 II (20A/C)	05/90→09/98	BDY (XU5M2Z)	Petrol	1580	4	8	58
205 II (20A/C)	05/90→09/98	BDY (XU5M3Z)	Petrol	1580	4	8	58
205 II (20A/C)	08/90→07/92	171 (XU5S)	Petrol	1580	4	8	58
205 II (20A/C)	08/90→07/92	G1A	Petrol	1294	4	8	27
205 II (20A/C)	08/90→05/97	XUD7T	Diesel	1769	4	8	72
205 II (20A/C)	08/90→07/98	KDX (TU3MC)	Petrol	1361	4	8	36
205 II (20A/C)	08/90→07/98	TU32	Petrol	1361	4	8	36
205 II (20A/C)	08/92→05/97	CDZ (TU9M)	Petrol	954	4	8	5
206	01/06→02/09	TU5JP4	Petrol	1587	4	16	62
206+ (T3E)	01/09→	8HR (DV4C)	Diesel	1398	4	8	33
206+ (T3E)	01/09→	8HX (DV4TD)	Diesel	1398	4	8	33
206+ (T3E)	01/09→	8HZ (DV4TD)	Diesel	1398	4	8	33
206+ (T3E)	01/09→	HFX (TU1A)	Petrol	1124	4	8	12
206+ (T3E)	01/09→	HFX (TU1JP)	Petrol	1124	4	8	11
206+ (T3E)	01/09→	KFV (TU3A)	Petrol	1360	4	8	40
206+ (T3E)	01/09→	KFW (TU3A)	Petrol	1360	4	8	40
206+ (T3E)	01/09→	TU1AE5	Petrol	1124	4	8	13
206+ (T3E)	07/10→	NFU (TU5JP4)	Petrol	1587	4	16	65



CC



9

206+ (T3E)	09/10→	KFT (TU3A)	Petrol	1360	4	8	40
206 CC (2D)	09/00→	NFU (TU5JP4)	Petrol	1587	4	16	65
206 CC (2D)	09/00→	RFN (EW10J4)	Petrol	1997	4	16	88
206 CC (2D)	04/05→	9HZ (DV6TED4)	Diesel	1560	4	16	57
206 Hatchback (2A/C)	08/98→07/00	HFY (TU1JP)	Petrol	1124	4	8	12
206 Hatchback (2A/C)	09/98→11/01	WJY (DW8B)	Diesel	1868	4	8	78
206 Hatchback (2A/C)	09/98→11/01	WJZ (DW8)	Diesel	1868	4	8	78
206 Hatchback (2A/C)	09/98→10/03	NFZ (TU5JP)	Petrol	1587	4	8	64
206 Hatchback (2A/C)	09/98→	HFX (TU1JP)	Petrol	1124	4	8	11
206 Hatchback (2A/C)	09/98→	HFZ (TU1JP)	Petrol	1124	4	8	12
206 Hatchback (2A/C)	09/98→	KFW (TU3JP)	Petrol	1360	4	8	42
206 Hatchback (2A/C)	09/98→	KFX (TU3JP)	Petrol	1361	4	8	36
206 Hatchback (2A/C)	04/99→	RFR (DEW10J4)	Petrol	1997	4	16	88
206 Hatchback (2A/C)	06/99→	RFN (EW10J4)	Petrol	1997	4	16	88
206 Hatchback (2A/C)	12/99→	RHY (DW10TD)	Diesel	1997	4	8	98
206 Hatchback (2A/C)	12/00→	NFU (TU5JP4)	Petrol	1587	4	16	65
206 Hatchback (2A/C)	09/01→	8HX (DV4TD)	Diesel	1398	4	8	33
206 Hatchback (2A/C)	09/01→	8HZ (DV4TD)	Diesel	1398	4	8	33
206 Hatchback (2A/C)	07/03→	RFK (EW10J4S)	Petrol	1997	4	16	88
206 Hatchback (2A/C)	10/03→	KFU (ET3J4)	Petrol	1360	4	16	41
206 Hatchback (2A/C)	05/04→	9HY (DV6TED4)	Diesel	1560	4	16	57
206 Hatchback (2A/C)	05/04→	9HZ (DV6TED4)	Diesel	1560	4	16	57
206 Hatchback (2A/C)	01/06→11/09	KFV (TU3A)	Petrol	1360	4	8	40
206 Hatchback (2A/C)	05/06→09/07	KFV (TU3JP)	Petrol	1360	4	8	42
206 Hatchback (2A/C)	05/06→09/07	KFW (TU3A)	Petrol	1360	4	8	40
206 Saloon	03/07→	KFV (TU3A)	Petrol	1360	4	8	40
206 Saloon	03/07→	KFW (TU3JP)	Petrol	1360	4	8	42
206 Saloon	03/07→	NFU (TU5JP4)	Petrol	1587	4	16	65
206 Saloon	09/08→	8HZ (DV4TD)	Diesel	1398	4	8	33
206 SW (2E/K)	07/02→	8HX (DV4TD)	Diesel	1398	4	8	33
206 SW (2E/K)	07/02→	HFX (TU1JP)	Petrol	1124	4	8	11
206 SW (2E/K)	07/02→	KFV (TU3A)	Petrol	1360	4	8	40
206 SW (2E/K)	07/02→	KFW (TU3JP)	Petrol	1360	4	8	42
206 SW (2E/K)	07/02→	NFU (TU5JP4)	Petrol	1587	4	16	65
206 SW (2E/K)	07/02→	RFN (EW10J4)	Petrol	1997	4	16	88
206 SW (2E/K)	07/02→	RHY (DW10TD)	Diesel	1997	4	8	98
206 SW (2E/K)	10/03→	KFU (ET3J4)	Petrol	1360	4	16	41
206 SW (2E/K)	05/04→	9HZ (DV6TED4)	Diesel	1560	4	16	57
206 Van	04/99→05/07	WJY (DW8B)	Diesel	1868	4	8	78
206 Van	04/99→05/07	WJZ (DW8)	Diesel	1868	4	8	78
206 Van	09/01→03/09	8HX (DV4TD)	Diesel	1398	4	8	33
206 Van	09/01→03/09	8HZ (DV4TD)	Diesel	1398	4	8	33
207	03/09→12/14	TU5JP4	Petrol	1587	4	16	62
207 (WA_, WC_)	02/06→	5FX (EP6DT)	Petrol	1598	4	16	52
207 (WA_, WC_)	02/06→	8HR (DV4C)	Diesel	1398	4	8	33
207 (WA_, WC_)	02/06→	8HZ (DV4TD)	Diesel	1398	4	8	33
207 (WA_, WC_)	02/06→	9HV (DV6TED4)	Diesel	1560	4	16	57
207 (WA_, WC_)	02/06→	9HX (DV6ATED4)	Diesel	1560	4	16	57
207 (WA_, WC_)	02/06→	9HY (DV6TED4)	Diesel	1560	4	16	57
207 (WA_, WC_)	02/06→	9HZ (DV6TED4)	Diesel	1560	4	16	57
207 (WA_, WC_)	02/06→	KFU (ET3J4)	Petrol	1360	4	16	41
207 (WA_, WC_)	02/06→	KFV (TU3A)	Petrol	1360	4	8	40
207 (WA_, WC_)	02/06→	NFU (TU5JP4)	Petrol	1587	4	16	65
207 (WA_, WC_)	02/07→	5FS (EP6C)	Petrol	1598	4	16	52
207 (WA_, WC_)	02/07→	5FW (EP6)	Petrol	1598	4	16	52
207 (WA_, WC_)	02/07→	5FY (EP6DTS)	Petrol	1598	4	16	52
207 (WA_, WC_)	02/07→	EP6	Petrol	1598	4	16	52
207 (WA_, WC_)	06/07→	8FS (EP3)	Petrol	1397	4	16	32
207 (WA_, WC_)	06/07→	EP3	Petrol	1397	4	16	32
207 (WA_, WC_)	06/07→	EP3C	Petrol	1397	4	16	32
207 (WA_, WC_)	12/07→	KFT (TU3A)	Petrol	1360	4	8	40
207 (WA_, WC_)	08/08→	KFW (TU3A)	Petrol	1360	4	8	40
207 (WA_, WC_)	08/08→	KFW (TU3JP)	Petrol	1360	4	8	42
207 (WA_, WC_)	08/08→	N6A (TU5JP4)	Petrol	1587	4	16	62
207 (WA_, WC_)	10/08→10/11	RHY (DW10TD)	Diesel	1997	4	8	98
207 (WA_, WC_)	10/08→	WJZ (DW8)	Diesel	1868	4	8	78
207 (WA_, WC_)	08/09→	9HR (DV6C)	Diesel	1560	4	8	55
207 (WA_, WC_)	10/09→	5FR (EP6DT)	Petrol	1598	4	16	52
207 (WA_, WC_)	10/09→	8FR (EP3)	Petrol	1397	4	16	32
207 (WA_, WC_)	11/09→	9HP (DV6DTE)	Diesel	1560	4	8	55
207 CC (WD_)	02/07→	5FS (EP6C)	Petrol	1598	4	16	52
207 CC (WD_)	02/07→	5FW (EP6)	Petrol	1598	4	16	52
207 CC (WD_)	02/07→	5FX (EP6DT)	Petrol	1598	4	16	52
207 CC (WD_)	02/07→	9HZ (DV6TED4)	Diesel	1560	4	16	57
207 CC (WD_)	02/07→	EP6	Petrol	1598	4	16	52
207 CC (WD_)	08/09→	9HR (DV6C)	Diesel	1560	4	8	55
207 CC (WD_)	10/09→	5FR (EP6DT)	Petrol	1598	4	16	52
207 CC (WD_)	10/09→	5FV (EP6CDT)	Petrol	1598	4	16	52



CC



9

207 Saloon	12/07→	KFT (TU3A)	Petrol	1360	4	8	40
207 Saloon	12/07→	KFV (TU3A)	Petrol	1360	4	8	40
207 Saloon	12/07→	RHY (DW10TD)	Diesel	1997	4	8	98
207 Saloon	12/07→	WJY (DW8B)	Diesel	1868	4	8	78
207 Saloon	12/07→	WJZ (DW8)	Diesel	1868	4	8	78
207 Saloon	01/08→	N6A (TU5JP4)	Petrol	1587	4	16	62
207 Saloon	11/08→10/13	NFU (TU5JP4)	Petrol	1587	4	16	65
207 Saloon	11/08→12/14	TU5JP4	Petrol	1587	4	16	62
207 Saloon	11/08→	KFW (TU3A)	Petrol	1360	4	8	40
207 Saloon	01/11→	KFW (TU3JP)	Petrol	1360	4	8	42
207 SW (WK_)	02/07→	5FX (EP6DT)	Petrol	1598	4	16	52
207 SW (WK_)	02/07→	5FY (EP6DTS)	Petrol	1598	4	16	52
207 SW (WK_)	06/07→	5FS (EP6C)	Petrol	1598	4	16	52
207 SW (WK_)	06/07→	5FW (EP6)	Petrol	1598	4	16	52
207 SW (WK_)	06/07→	8FS (EP3)	Petrol	1397	4	16	32
207 SW (WK_)	06/07→	9HV (DV6TED4)	Diesel	1560	4	16	57
207 SW (WK_)	06/07→	9HX (DV6ATED4)	Diesel	1560	4	16	57
207 SW (WK_)	06/07→	9HZ (DV6TED4)	Diesel	1560	4	16	57
207 SW (WK_)	06/07→	EP3	Petrol	1397	4	16	32
207 SW (WK_)	06/07→	EP3C	Petrol	1397	4	16	32
207 SW (WK_)	06/07→	EP6	Petrol	1598	4	16	52
207 SW (WK_)	06/07→	KFT (TU3A)	Petrol	1360	4	8	40
207 SW (WK_)	06/07→	KFV (TU3A)	Petrol	1360	4	8	40
207 SW (WK_)	08/08→	KFW (TU3JP)	Petrol	1360	4	8	42
207 SW (WK_)	08/08→	N6A (TU5JP4)	Petrol	1587	4	16	62
207 SW (WK_)	10/08→10/11	RHY (DW10TD)	Diesel	1997	4	8	98
207 SW (WK_)	11/08→	NFU (TU5JP4)	Petrol	1587	4	16	65
207 SW (WK_)	08/09→	9HR (DV6C)	Diesel	1560	4	8	55
207 SW (WK_)	11/09→	8FR (EP3)	Petrol	1397	4	16	32
207 SW (WK_)	11/09→	9HP (DV6DTEd)	Diesel	1560	4	8	55
207 Van	04/07→	8HZ (DV4TD)	Diesel	1398	4	8	33
207 Van	04/07→	9HV (DV6TED4)	Diesel	1560	4	16	57
207 Van	04/07→	9HX (DV6ATED4)	Diesel	1560	4	16	57
207 Van	06/07→10/08	KFV (TU3A)	Petrol	1360	4	8	40
207 Van	11/09→	9HP (DV6DTEd)	Diesel	1560	4	8	55
208	03/12→	5FS (EP6C)	Petrol	1598	4	16	52
208	03/12→	5FV (EP6CDT)	Petrol	1598	4	16	52
208	03/12→	8FS (EP3)	Petrol	1397	4	16	32
208	03/12→	8HP (DV4C)	Diesel	1398	4	8	33
208	03/12→	8HR (DV4C)	Diesel	1398	4	8	33
208	03/12→	9HD (DV6CTED)	Diesel	1560	4	8	55
208	03/12→	9HP (DV6DTEd)	Diesel	1560	4	8	55
208	03/12→	EP3C	Petrol	1397	4	16	32
208	03/12→	HMZ (EB2F)	Petrol	1199	3	12	20
208	03/12→	ZMZ (EBO)	Petrol	999	3	12	7
208	08/12→	5FU (EP6CDTX)	Petrol	1598	4	16	52
208	01/13→	9HK (DV6ETEDM)	Diesel	1560	4	8	55
208	01/13→	BHW (DV6FE)	Diesel	1560	4	8	55
208	01/13→	HNZ (EB2DT)	Petrol	1199	3	12	20
208	01/13→	NFU (TU5JP4)	Petrol	1587	4	16	65
208	11/13→	BHZ (DV6FC)	Diesel	1560	4	8	55
208	04/14→	BHX (DV6FC)	Diesel	1560	4	8	55
208	01/15→	BHY (DV6FD)	Diesel	1560	4	8	55
208	02/16→	5FM (EP6CDTM)	Petrol	1598	4	16	51
208 Box	10/12→	8HR (DV4C)	Diesel	1398	4	8	33
208 Box	03/14→	9HP (DV6DTEd)	Diesel	1560	4	8	55
208 Box	04/15→	BHW (DV6FE)	Diesel	1560	4	8	55
301	11/12→	9HF (DV6DTEd)	Diesel	1560	4	8	55
301	11/12→	HMY (EB2M)	Petrol	1199	3	12	20
301	11/12→	NFP (EC5)	Petrol	1587	4	16	63
304 (_04M_)	10/69→09/75	XL3	Petrol	1290	4	8	25
304 (_04M_)	10/69→10/79	149 (XID)	Diesel	1548	4	8	48
304 (_04M_)	08/72→09/75	XL5S	Petrol	1290	4	8	25
304 (_04M_)	09/72→10/79	XL5	Petrol	1290	4	8	25
304 (_04M_)	10/76→10/79	XL4D	Diesel	1357	4	8	44
304 Break (_04D_)	09/70→08/77	XL5S	Petrol	1290	4	8	25
304 Break (_04D_)	09/70→10/80	XL5	Petrol	1290	4	8	25
304 Break (_04D_)	10/76→10/79	XL4D	Diesel	1357	4	8	44
304 Break (_04D_)	10/76→10/80	XK5	Petrol	1127	4	8	14
304 Convertible (_04B_)	03/70→09/73	XL3	Petrol	1290	4	8	25
304 Convertible (_04B_)	09/72→07/76	XL3S	Petrol	1290	4	8	25
304 Coupe (_04C_)	03/70→09/73	XL3	Petrol	1290	4	8	25
304 Coupe (_04C_)	03/72→04/75	XL3S	Petrol	1290	4	8	25
305 I (581A)	11/77→09/82	118 (XL5)	Petrol	1290	4	8	25
305 I (581A)	11/77→09/82	149 (XID)	Diesel	1548	4	8	48
305 I (581A)	11/77→09/82	XL5	Petrol	1290	4	8	25
305 I (581A)	11/79→09/82	142 (XR5)	Petrol	1472	4	8	47
305 I (581A)	05/80→09/82	117 (XR5S)	Petrol	1472	4	8	47



CC



9

305 I Break (581D)	08/80→09/82	118 (XL5)	Petrol	1290	4	8	25
305 I Break (581D)	08/80→09/82	142 (XR5)	Petrol	1472	4	8	47
305 I Break (581D)	08/80→09/82	149 (XID)	Diesel	1548	4	8	48
305 II (581M)	10/82→08/85	118 (XL5)	Petrol	1290	4	8	25
305 II (581M)	10/82→08/85	142 (XR5)	Petrol	1472	4	8	47
305 II (581M)	10/82→08/85	159 (XU9S)	Petrol	1905	4	8	77
305 II (581M)	10/82→06/88	171 (XU5S)	Petrol	1580	4	8	58
305 II (581M)	10/82→07/88	162 (XUD9)	Diesel	1905	4	8	78
305 II (581M)	10/82→07/88	D9A (XUD9)	Diesel	1905	4	8	78
305 II (581M)	10/82→12/88	B1A (XU51C)	Petrol	1580	4	8	58
305 II (581M)	11/82→12/88	161A (XUD7)	Diesel	1769	4	8	68
305 II (581M)	11/82→12/88	XK5	Petrol	1127	4	8	14
305 II (581M)	09/85→07/90	142 (XR5A)	Petrol	1472	4	8	47
305 II (581M)	11/86→12/88	BAZ (XU5CP)	Petrol	1580	4	8	58
305 II (581M)	11/86→12/88	DFZ (XU9J1)	Petrol	1905	4	8	77
305 II Break (581E)	10/82→08/86	118 (XL5)	Petrol	1290	4	8	25
305 II Break (581E)	10/82→08/86	142 (XR5)	Petrol	1472	4	8	47
305 II Break (581E)	10/82→12/88	162 (XUD9)	Diesel	1905	4	8	78
305 II Break (581E)	10/82→12/88	D9A (XUD9)	Diesel	1905	4	8	78
305 II Break (581E)	11/82→12/88	161A (XUD7)	Diesel	1769	4	8	68
305 II Break (581E)	11/82→12/88	B1A (XU51C)	Petrol	1580	4	8	58
305 II Break (581E)	09/83→12/87	171 (XU5S)	Petrol	1580	4	8	58
305 II Break (581E)	09/84→10/87	159 (XU9S)	Petrol	1905	4	8	77
305 II Break (581E)	09/85→10/86	142 (XR5A)	Petrol	1472	4	8	47
305 II Break (581E)	11/86→12/88	BAZ (XU5CP)	Petrol	1580	4	8	58
305 II Break (581E)	11/86→12/88	DFZ (XU9J1)	Petrol	1905	4	8	77
306 (7B, N3, N5)	02/94→10/95	D9B (XUD9A)	Diesel	1905	4	8	78
306 (7B, N3, N5)	02/94→10/95	XUD9	Diesel	1905	4	8	78
306 (7B, N3, N5)	02/94→04/97	XUD9TE	Diesel	1905	4	8	78
306 (7B, N3, N5)	02/94→05/01	DHY (XUD9TE)	Diesel	1905	4	8	78
306 (7B, N3, N5)	06/94→10/00	NFZ (TU5JP)	Petrol	1587	4	8	64
306 (7B, N3, N5)	06/94→05/01	D8A (XUD9TE)	Diesel	1905	4	8	78
306 (7B, N3, N5)	06/94→05/01	DJY (XUD9A)	Diesel	1905	4	8	78
306 (7B, N3, N5)	06/94→05/01	DJZ (XUD9Y)	Diesel	1905	4	8	78
306 (7B, N3, N5)	06/94→05/01	HDZ (TU1M)	Petrol	1124	4	8	11
306 (7B, N3, N5)	06/94→05/01	KDX (TU3MC)	Petrol	1361	4	8	36
306 (7B, N3, N5)	06/94→05/01	KFW (TU3JP)	Petrol	1360	4	8	42
306 (7B, N3, N5)	06/94→05/01	KFX (TU3JP)	Petrol	1361	4	8	36
306 (7B, N3, N5)	06/94→05/01	LFZ (XU7JP)	Petrol	1762	4	8	74
306 (7B, N3, N5)	06/94→05/01	RFT (XU10J4)	Petrol	1998	4	16	93
306 (7B, N3, N5)	06/94→05/01	RFY (XU10J4Z)	Petrol	1998	4	16	95
306 (7B, N3, N5)	07/94→05/01	RFX (XU10J2)	Petrol	1998	4	8	89
306 (7B, N3, N5)	03/97→05/01	RFV (XU10J4R)	Petrol	1998	4	16	94
306 (7B, N3, N5)	03/97→10/03	LFY (XU7JP4)	Petrol	1761	4	16	75
306 (7B, N3, N5)	05/97→06/00	A9A (XUD7)	Diesel	1769	4	8	72
306 (7B, N3, N5)	03/98→05/01	DHV (XUD9BSD)	Diesel	1905	4	8	78
306 (7B, N3, N5)	09/98→05/01	WJY (DW8B)	Diesel	1868	4	8	78
306 (7B, N3, N5)	09/98→08/03	WJZ (DW8)	Diesel	1868	4	8	78
306 (7B, N3, N5)	06/99→05/01	RHY (DW10TD)	Diesel	1997	4	8	98
306 (7B, N3, N5)	10/00→05/01	NFT (TU5JP)	Petrol	1587	4	8	64
306 Box Body / Estate (N_, 7_)	02/94→04/99	XUD9TE	Diesel	1905	4	8	78
306 Box Body / Estate (N_, 7_)	02/94→05/99	XUD9	Diesel	1905	4	8	78
306 Box Body / Estate (N_, 7_)	03/96→07/01	KFW (TU3JP)	Petrol	1360	4	8	42
306 Box Body / Estate (N_, 7_)	08/98→06/00	RHY (DW10TD)	Diesel	1997	4	8	98
306 Box Body / Estate (N_, 7_)	02/99→08/02	WJY (DW8B)	Diesel	1868	4	8	78
306 Box Body / Estate (N_, 7_)	02/99→08/02	WJZ (DW8)	Diesel	1868	4	8	78
306 Box Body / Hatchback	04/93→05/99	A9A (XUD7)	Diesel	1769	4	8	72
306 Box Body / Hatchback	07/93→12/94	HDY (TU1M)	Petrol	1124	4	8	10
306 Box Body / Hatchback	02/94→10/95	D9B (XUD9A)	Diesel	1905	4	8	78
306 Box Body / Hatchback	02/94→04/99	D8A (XUD9TE)	Diesel	1905	4	8	78
306 Box Body / Hatchback	02/94→05/99	DJY (XUD9A)	Diesel	1905	4	8	78
306 Box Body / Hatchback	03/96→07/01	KFX (TU3JP)	Petrol	1361	4	8	36
306 Box Body / Hatchback	02/99→08/01	WJY (DW8B)	Diesel	1868	4	8	78
306 Box Body / Hatchback	02/99→08/01	WJZ (DW8)	Diesel	1868	4	8	78
306 Break (7E, N3, N5)	07/95→04/02	DJY (XUD9A)	Diesel	1905	4	8	78
306 Break (7E, N3, N5)	02/97→04/02	D8A (XUD9TE)	Diesel	1905	4	8	78
306 Break (7E, N3, N5)	02/97→04/02	DHY (XUD9TE)	Diesel	1905	4	8	78
306 Break (7E, N3, N5)	03/97→10/00	NFZ (TU5JP)	Petrol	1587	4	8	64
306 Break (7E, N3, N5)	03/97→04/02	KFW (TU3JP)	Petrol	1360	4	8	42
306 Break (7E, N3, N5)	03/97→04/02	KFX (TU3JP)	Petrol	1361	4	8	36
306 Break (7E, N3, N5)	03/97→04/02	LFY (XU7JP4)	Petrol	1761	4	16	75
306 Break (7E, N3, N5)	03/97→04/02	LFZ (XU7JP)	Petrol	1762	4	8	74
306 Break (7E, N3, N5)	03/97→04/02	RFV (XU10J4R)	Petrol	1998	4	16	94
306 Break (7E, N3, N5)	03/98→04/02	DHV (XUD9BSD)	Diesel	1905	4	8	78
306 Break (7E, N3, N5)	09/98→04/02	WJY (DW8B)	Diesel	1868	4	8	78
306 Break (7E, N3, N5)	09/98→04/02	WJZ (DW8)	Diesel	1868	4	8	78
306 Break (7E, N3, N5)	06/99→04/02	RHY (DW10TD)	Diesel	1997	4	8	98
306 Break (7E, N3, N5)	10/00→04/02	NFT (TU5JP)	Petrol	1587	4	8	64



CC



9

306 Convertible (7D, N3, N5)	03/94→04/02	LFZ (XU7JP)	Petrol	1762	4	8	74
306 Convertible (7D, N3, N5)	03/94→04/02	RFX (XU10J2)	Petrol	1998	4	8	89
306 Convertible (7D, N3, N5)	04/96→10/00	NFZ (TU5JP)	Petrol	1587	4	8	64
306 Convertible (7D, N3, N5)	03/97→04/02	RFV (XU10J4R)	Petrol	1998	4	16	94
306 Convertible (7D, N3, N5)	07/00→04/02	LFY (XU7JP4)	Petrol	1761	4	16	75
306 Convertible (7D, N3, N5)	10/00→04/02	NFT (TU5JP)	Petrol	1587	4	8	64
306 Hatchback (7A, 7C, N3, N5)	04/93→04/97	XUD9TE	Diesel	1905	4	8	78
306 Hatchback (7A, 7C, N3, N5)	04/93→05/99	D9B (XUD9A)	Diesel	1905	4	8	78
306 Hatchback (7A, 7C, N3, N5)	04/93→05/99	XUD9	Diesel	1905	4	8	78
306 Hatchback (7A, 7C, N3, N5)	04/93→05/01	A9A (XUD7)	Diesel	1769	4	8	72
306 Hatchback (7A, 7C, N3, N5)	04/93→05/01	DHY (XUD9TE)	Diesel	1905	4	8	78
306 Hatchback (7A, 7C, N3, N5)	04/93→05/01	DJY (XUD9A)	Diesel	1905	4	8	78
306 Hatchback (7A, 7C, N3, N5)	05/93→05/01	D8A (XUD9TE)	Diesel	1905	4	8	78
306 Hatchback (7A, 7C, N3, N5)	05/93→05/01	DJZ (XUD9Y)	Diesel	1905	4	8	78
306 Hatchback (7A, 7C, N3, N5)	05/93→05/01	HDZ (TU1M)	Petrol	1124	4	8	11
306 Hatchback (7A, 7C, N3, N5)	05/93→05/01	KDX (TU3MC)	Petrol	1361	4	8	36
306 Hatchback (7A, 7C, N3, N5)	05/93→05/01	KFW (TU3JP)	Petrol	1360	4	8	42
306 Hatchback (7A, 7C, N3, N5)	05/93→05/01	KFX (TU3JP)	Petrol	1361	4	8	36
306 Hatchback (7A, 7C, N3, N5)	05/93→05/01	LFZ (XU7JP)	Petrol	1762	4	8	74
306 Hatchback (7A, 7C, N3, N5)	05/93→05/01	NFZ (XU5JP)	Petrol	1587	4	8	64
306 Hatchback (7A, 7C, N3, N5)	05/93→05/01	RFX (XU10J2)	Petrol	1998	4	8	89
306 Hatchback (7A, 7C, N3, N5)	05/93→05/01	RFY (XU10J4Z)	Petrol	1998	4	16	95
306 Hatchback (7A, 7C, N3, N5)	06/94→05/01	RFT (XU10J4)	Petrol	1998	4	16	93
306 Hatchback (7A, 7C, N3, N5)	03/96→05/01	RFS (XU10J4RS)	Petrol	1998	4	16	92
306 Hatchback (7A, 7C, N3, N5)	03/97→05/01	RFV (XU10J4R)	Petrol	1998	4	16	94
306 Hatchback (7A, 7C, N3, N5)	03/97→10/03	LFY (XU7JP4)	Petrol	1761	4	16	75
306 Hatchback (7A, 7C, N3, N5)	03/98→05/01	DHV (XUD9BSD)	Diesel	1905	4	8	78
306 Hatchback (7A, 7C, N3, N5)	09/98→05/01	WJY (DW8B)	Diesel	1868	4	8	78
306 Hatchback (7A, 7C, N3, N5)	09/98→08/03	WJZ (DW8)	Diesel	1868	4	8	78
306 Hatchback (7A, 7C, N3, N5)	06/99→05/01	RHY (DW10TD)	Diesel	1997	4	8	98
306 Hatchback (7A, 7C, N3, N5)	10/00→05/01	NFT (TU5JP)	Petrol	1587	4	8	64
307 (3A/C)	08/00→	KFW (TU3JP)	Petrol	1360	4	8	42
307 (3A/C)	08/00→	NFU (TU5JP4)	Petrol	1587	4	16	65
307 (3A/C)	08/00→	RFN (EW10J4)	Petrol	1997	4	16	88
307 (3A/C)	08/00→	RHS (DW10ATED)	Diesel	1997	4	8	98
307 (3A/C)	08/00→	RHY (DW10TD)	Diesel	1997	4	8	98
307 (3A/C)	10/01→	8HX (DV4TD)	Diesel	1398	4	8	33
307 (3A/C)	10/01→	8HZ (DV4TD)	Diesel	1398	4	8	33
307 (3A/C)	10/03→	RHR (DW10BTD4)	Diesel	1997	4	16	96
307 (3A/C)	11/03→	KFU (ET3J4)	Petrol	1360	4	16	41
307 (3A/C)	02/04→	9HY (DV6TED4)	Diesel	1560	4	16	57
307 (3A/C)	02/04→	9HZ (DV6TED4)	Diesel	1560	4	16	57
307 (3A/C)	03/05→	RFJ (EW10A)	Petrol	1997	4	16	91
307 (3A/C)	04/05→	9HV (DV6ATED4)	Diesel	1560	4	16	57
307 (3A/C)	04/05→	9HV (DV6TED4)	Diesel	1560	4	16	57
307 (3A/C)	04/05→	9HX (DV6ATED4)	Diesel	1560	4	16	57
307 (3A/C)	06/05→	RFK (EW10J4S)	Petrol	1997	4	16	88
307 (3A/C)	08/05→12/09	NFP (EC5)	Petrol	1587	4	16	63
307 (3A/C)	07/06→	N6A (TU5JP4)	Petrol	1587	4	16	62
307 Break (3E)	03/02→	8HZ (DV4TD)	Diesel	1398	4	8	33
307 Break (3E)	03/02→	NFU (TU5JP4)	Petrol	1587	4	16	65
307 Break (3E)	03/02→	RFN (EW10J4)	Petrol	1997	4	16	88
307 Break (3E)	03/02→	RHS (DW10ATED)	Diesel	1997	4	8	98
307 Break (3E)	03/02→	RHY (DW10TD)	Diesel	1997	4	8	98
307 Break (3E)	04/02→09/03	KFW (TU3JP)	Petrol	1360	4	8	42
307 Break (3E)	11/03→	KFU (ET3J4)	Petrol	1360	4	16	41
307 Break (3E)	02/04→	9HY (DV6TED4)	Diesel	1560	4	16	57
307 Break (3E)	02/04→	9HZ (DV6TED4)	Diesel	1560	4	16	57
307 Break (3E)	02/04→	RHR (DW10BTD4)	Diesel	1997	4	16	96
307 Break (3E)	03/05→	RFJ (EW10A)	Petrol	1997	4	16	91
307 Break (3E)	04/05→	9HV (DV6ATED4)	Diesel	1560	4	16	57
307 Break (3E)	06/05→	RFK (EW10J4S)	Petrol	1997	4	16	88
307 CC (3B)	10/03→	RFK (EW10J4S)	Petrol	1997	4	16	88
307 CC (3B)	10/03→	RFN (EW10J4)	Petrol	1997	4	16	88
307 CC (3B)	01/05→	RFJ (EW10A)	Petrol	1997	4	16	91
307 CC (3B)	02/05→	NFU (TU5JP4)	Petrol	1587	4	16	65
307 CC (3B)	06/05→	RHR (DW10BTD4)	Diesel	1997	4	16	96
307 Hatchback	02/08→12/12	EW10A	Petrol	1997	4	16	87
307 Hatchback	02/08→12/14	TU5JP4	Petrol	1587	4	16	62
307 Saloon	08/04→12/14	TU5JP4	Petrol	1587	4	16	62
307 Saloon	05/06→12/10	EW10A	Petrol	1997	4	16	87
307 Saloon	08/06→	NFU (TU5JP4)	Petrol	1587	4	16	65
307 Saloon	09/06→10/10	RHY (DW10TD)	Diesel	1997	4	8	98
307 Saloon	09/06→03/12	RHZ (DW10ATED)	Diesel	1997	4	8	98
307 Saloon	08/08→	RFN (EW10J4)	Petrol	1997	4	16	88
307 SW (3H)	03/02→06/05	8HZ (DV4TD)	Diesel	1398	4	8	33
307 SW (3H)	03/02→	NFU (TU5JP4)	Petrol	1587	4	16	65
307 SW (3H)	03/02→	RFN (EW10J4)	Petrol	1997	4	16	88



CC



9

307 SW (3H)	03/02→	RHS (DW10ATED)	Diesel	1997	4	8	98
307 SW (3H)	03/02→	RHY (DW10TD)	Diesel	1997	4	8	98
307 SW (3H)	04/02→09/03	KFW (TU3JP)	Petrol	1360	4	8	42
307 SW (3H)	11/03→	KFU (ET3J4)	Petrol	1360	4	16	41
307 SW (3H)	02/04→	9HY (DV6TED4)	Diesel	1560	4	16	57
307 SW (3H)	02/04→	9HZ (DV6TED4)	Diesel	1560	4	16	57
307 SW (3H)	02/04→	RHR (DW10BTED4)	Diesel	1997	4	16	96
307 SW (3H)	07/04→	RFJ (EW10A)	Petrol	1997	4	16	91
307 SW (3H)	12/06→	9HV (DV6ATED4)	Diesel	1560	4	16	57
307 SW (3H)	12/06→	9HX (DV6ATED4)	Diesel	1560	4	16	57
308 (4A, 4C)	09/07→	5FT (EP6DT)	Petrol	1598	4	16	52
308 (4A, 4C)	09/07→	5FW (EP6)	Petrol	1598	4	16	52
308 (4A, 4C)	09/07→	5FX (EP6DT)	Petrol	1598	4	16	52
308 (4A, 4C)	09/07→	8FS (EP3)	Petrol	1397	4	16	32
308 (4A, 4C)	09/07→	9HV (DV6TED4)	Diesel	1560	4	16	57
308 (4A, 4C)	09/07→	9HX (DV6ATED4)	Diesel	1560	4	16	57
308 (4A, 4C)	09/07→	9HZ (DV6TED4)	Diesel	1560	4	16	57
308 (4A, 4C)	09/07→	EP3	Petrol	1397	4	16	32
308 (4A, 4C)	09/07→	EP6	Petrol	1598	4	16	52
308 (4A, 4C)	09/07→	RHR (DW10BTED4)	Diesel	1997	4	16	96
308 (4A, 4C)	01/08→	RFJ (EW10A)	Petrol	1997	4	16	91
308 (4A, 4C)	03/08→	5FY (EP6DTS)	Petrol	1598	4	16	52
308 (4A, 4C)	04/08→	NFU (TU5JP4)	Petrol	1587	4	16	65
308 (4A, 4C)	10/09→	5FV (EP6CDT)	Petrol	1598	4	16	52
308 (4A, 4C)	11/09→	9HP (DV6DTE)	Diesel	1560	4	8	55
308 (4A, 4C)	12/09→	8FR (EP3)	Petrol	1397	4	16	32
308 (4A, 4C)	12/09→	9HR (DV6C)	Diesel	1560	4	8	55
308 (4A, 4C)	07/10→	EP6CDTX	Petrol	1598	4	16	52
308 (4A, 4C)	10/11→	RHE (DW10CTED4)	Diesel	1997	4	16	86
308 (4A, 4C)	02/12→	NFP (EC5)	Petrol	1587	4	16	63
308 (4A, 4C)	04/12→	RHH (DW10CTED4)	Diesel	1997	4	16	86
308 (4A, 4C)	03/13→	9HD (DV6C)	Diesel	1560	4	8	55
308 CC	04/09→	RHF (DW10BTED4)	Diesel	1997	4	16	96
308 CC	04/09→	RHR (DW10BTED4)	Diesel	1997	4	16	96
308 CC	06/09→	5FT (EP6DT)	Petrol	1598	4	16	52
308 CC	06/09→	5FV (EP6CDT)	Petrol	1598	4	16	52
308 CC	06/09→	5FX (EP6DT)	Petrol	1598	4	16	52
308 CC	06/09→	9HR (DV6C)	Diesel	1560	4	8	55
308 CC	06/09→	EP6	Petrol	1598	4	16	52
308 CC	06/09→	RHH (DW10CTED4)	Diesel	1997	4	16	86
308 CC	07/09→11/14	RFJ (EW10A)	Petrol	1997	4	16	91
308 CC	10/10→	EP6CDTX	Petrol	1598	4	16	52
308 CC	03/13→	9HD (DV6C)	Diesel	1560	4	8	55
308 II	09/13→	5FA (EP6CDT)	Petrol	1598	4	16	51
308 II	09/13→	5FV (EP6CDT)	Petrol	1598	4	16	52
308 II	09/13→	9HC (DV6C)	Diesel	1560	4	8	55
308 II	09/13→	9HP (DV6DTE)	Diesel	1560	4	8	55
308 II	09/13→	BHZ (DV6FC)	Diesel	1560	4	8	55
308 II	09/13→	HMZ (EB2F)	Petrol	1199	3	12	20
308 II	11/13→	AHX (DW10FD)	Diesel	1997	4	16	86
308 II	11/13→	HNY (EB2DTS)	Petrol	1199	3	12	20
308 II	11/13→	HNZ (EB2DT)	Petrol	1199	3	12	20
308 II	04/14→	BHY (DV6FD)	Diesel	1560	4	8	55
308 II	06/14→	5FM (EP6CDTM)	Petrol	1598	4	16	51
308 II	06/14→	AHW (DW10FC)	Diesel	1997	4	16	86
308 II	12/14→	NFP (EC5)	Petrol	1587	4	16	63
308 II	06/15→	5GN (EP6FDTR)	Petrol	1598	4	16	52
308 SW	09/07→	5FT (EP6DT)	Petrol	1598	4	16	52
308 SW	09/07→	5FW (EP6)	Petrol	1598	4	16	52
308 SW	09/07→	5FX (EP6DT)	Petrol	1598	4	16	52
308 SW	09/07→	8FS (EP3)	Petrol	1397	4	16	32
308 SW	09/07→	9HV (DV6ATED4)	Diesel	1560	4	16	57
308 SW	09/07→	9HX (DV6ATED4)	Diesel	1560	4	16	57
308 SW	09/07→	9HZ (DV6TED4)	Diesel	1560	4	16	57
308 SW	09/07→	EP6	Petrol	1598	4	16	52
308 SW	09/07→	RHR (DW10BTED4)	Diesel	1997	4	16	96
308 SW	01/08→	RFJ (EW10A)	Petrol	1997	4	16	91
308 SW	03/08→	5FY (EP6DTS)	Petrol	1598	4	16	52
308 SW	03/09→	NFU (TU5JP4)	Petrol	1587	4	16	65
308 SW	06/09→	RHH (DW10CTED4)	Diesel	1997	4	16	86
308 SW	10/09→	5FV (EP6CDT)	Petrol	1598	4	16	52
308 SW	11/09→	9HP (DV6DTE)	Diesel	1560	4	8	55
308 SW	12/09→	8FR (EP3)	Petrol	1397	4	16	32
308 SW	12/09→	9HR (DV6C)	Diesel	1560	4	8	55
308 SW	04/11→	RHE (DW10CTED4)	Diesel	1997	4	16	86
308 SW	03/13→	9HD (DV6C)	Diesel	1560	4	8	55
308 SW II	03/14→	5FV (EP6CDT)	Petrol	1598	4	16	52
308 SW II	03/14→	9HC (DV6C)	Diesel	1560	4	8	55



CC



9

308 SW II	03/14 →	BHZ (DV6FC)	Diesel	1560	4	8	55
308 SW II	03/14 →	HNY (EB2DTS)	Petrol	1199	3	12	20
308 SW II	03/14 →	HNZ (EB2DT)	Petrol	1199	3	12	20
308 SW II	04/14 →	BHY (DV6FD)	Diesel	1560	4	8	55
308 SW II	06/14 →	AHW (DW10FC)	Diesel	1997	4	16	86
309 I (10C, 10A)	10/85 →07/89	B1A (XU51C)	Petrol	1580	4	8	58
309 I (10C, 10A)	10/85 →07/89	B1D (XU51C)	Petrol	1580	4	8	58
309 I (10C, 10A)	10/85 →07/89	D2B (XU9S)	Petrol	1905	4	8	77
309 I (10C, 10A)	10/85 →07/89	E1	Petrol	1118	4	8	8
309 I (10C, 10A)	10/85 →07/89	G1A	Petrol	1294	4	8	27
309 I (10C, 10A)	10/85 →12/89	Y2/K	Petrol	1442	4	8	50
309 I (10C, 10A)	11/85 →09/88	180Z (XU5J)	Petrol	1580	4	8	58
309 I (10C, 10A)	11/85 →09/88	B6B (XU5J)	Petrol	1580	4	8	58
309 I (10C, 10A)	03/86 →07/89	DFZ (XU9J1)	Petrol	1905	4	8	77
309 I (10C, 10A)	06/86 →07/89	162 (XUD9)	Diesel	1905	4	8	78
309 I (10C, 10A)	06/86 →07/89	D9A (XUD9)	Diesel	1905	4	8	78
309 I (10C, 10A)	09/86 →12/89	BAZ (XU5CP)	Petrol	1580	4	8	58
309 I (10C, 10A)	10/86 →07/89	D6B (XU9JA)	Petrol	1905	4	8	77
309 I (10C, 10A)	08/87 →07/89	B1E (XU51C)	Petrol	1580	4	8	58
309 I (10C, 10A)	07/88 →07/89	DDZ (XU9M)	Petrol	1905	4	8	77
309 I (10C, 10A)	07/88 →07/89	DKZ (XU9JAZ)	Petrol	1905	4	8	77
309 I (10C, 10A)	03/89 →07/89	K1D (TU3A)	Petrol	1361	4	8	36
309 I (10C, 10A)	03/89 →07/89	K2B (TU3S)	Petrol	1360	4	8	36
309 I (10C, 10A)	03/89 →07/89	KDY (TU3M)	Petrol	1361	4	8	39
309 I (10C, 10A)	03/89 →07/89	KDZ (TU3M)	Petrol	1361	4	8	36
309 II (3C, 3A)	07/89 →12/93	161A (XUD7)	Diesel	1769	4	8	68
309 II (3C, 3A)	07/89 →12/93	162 (XUD9)	Diesel	1905	4	8	78
309 II (3C, 3A)	07/89 →12/93	B2A (XU52C/K)	Petrol	1580	4	8	58
309 II (3C, 3A)	07/89 →12/93	BDY (XU5M2Z)	Petrol	1580	4	8	58
309 II (3C, 3A)	07/89 →12/93	BDY (XU5M3Z)	Petrol	1580	4	8	58
309 II (3C, 3A)	07/89 →12/93	BDZ (XU5M)	Petrol	1580	4	8	58
309 II (3C, 3A)	07/89 →12/93	D9A (XUD9)	Diesel	1905	4	8	78
309 II (3C, 3A)	07/89 →12/93	DJZ (XUD9Y)	Diesel	1905	4	8	78
309 II (3C, 3A)	07/89 →12/93	DKZ (XU9JAZ)	Petrol	1905	4	8	77
309 II (3C, 3A)	07/89 →12/93	KDY (TU3M)	Petrol	1361	4	8	39
309 II (3C, 3A)	07/89 →12/93	KDZ (TU3M)	Petrol	1361	4	8	36
309 II (3C, 3A)	08/89 →07/90	D6C (XU9J4)	Petrol	1905	4	16	79
309 II (3C, 3A)	08/89 →12/93	A8B (XUD7TE)	Diesel	1769	4	8	68
309 II (3C, 3A)	08/89 →12/93	DFZ (XU9J1)	Petrol	1905	4	8	77
309 II (3C, 3A)	09/89 →10/93	D6B (XU9JA)	Petrol	1905	4	8	77
309 II (3C, 3A)	09/89 →10/93	H1B (TU1)	Petrol	1124	4	8	10
309 II (3C, 3A)	07/90 →12/93	K1D (TU3A)	Petrol	1361	4	8	36
309 II (3C, 3A)	08/90 →12/93	HDZ (TU1M)	Petrol	1124	4	8	11
309 II (3C, 3A)	10/90 →12/93	DDZ (XU9M)	Petrol	1905	4	8	77
309 II (3C, 3A)	10/90 →12/93	DFW (XU9J4Z)	Petrol	1905	4	16	79
309 II (3C, 3A)	10/91 →10/93	161 (XUD7)	Diesel	1769	4	8	68
405 I (15B)	01/87 →07/92	K5A (TU3)	Petrol	1360	4	8	37
405 I (15B)	01/87 →12/92	B2A (XU52C/K)	Petrol	1580	4	8	58
405 I (15B)	06/87 →07/92	D6C (XU9J4)	Petrol	1905	4	16	79
405 I (15B)	06/87 →12/92	DFZ (XU9J1)	Petrol	1905	4	8	77
405 I (15B)	06/87 →12/92	DKZ (XU9JAZ)	Petrol	1905	4	8	77
405 I (15B)	07/87 →06/88	BAZ (XU5CP)	Petrol	1580	4	8	58
405 I (15B)	07/87 →12/92	B1E (XU51C)	Petrol	1580	4	8	58
405 I (15B)	07/87 →12/92	BDY (XU5M2Z)	Petrol	1580	4	8	58
405 I (15B)	07/87 →12/92	BDZ (XU5M)	Petrol	1580	4	8	58
405 I (15B)	07/87 →12/92	D2C (XU92C)	Petrol	1905	4	8	77
405 I (15B)	07/87 →12/93	D6A (XU9J2)	Petrol	1905	4	8	77
405 I (15B)	10/87 →12/92	A8A (XUD7TE)	Diesel	1769	4	8	72
405 I (15B)	03/88 →12/92	AJZ (XUD7TEY)	Diesel	1769	4	8	72
405 I (15B)	03/88 →12/92	D9B (XUD9A)	Diesel	1905	4	8	78
405 I (15B)	04/88 →12/92	DFW (XU9J4Z)	Petrol	1905	4	16	79
405 I (15B)	07/88 →09/92	DJZ (XUD9Y)	Diesel	1905	4	8	78
405 I (15B)	07/88 →12/92	DDZ (XU9M)	Petrol	1905	4	8	77
405 I Break (15E)	06/87 →07/92	D6C (XU9J4)	Petrol	1905	4	16	79
405 I Break (15E)	04/88 →08/92	BDZ (XU5M)	Petrol	1580	4	8	58
405 I Break (15E)	05/88 →07/92	B2A (XU52C/K)	Petrol	1580	4	8	58
405 I Break (15E)	05/88 →07/92	K5A (TU3)	Petrol	1360	4	8	37
405 I Break (15E)	05/88 →08/92	DFZ (XU9J1)	Petrol	1905	4	8	77
405 I Break (15E)	10/88 →08/92	A8A (XUD7TE)	Diesel	1769	4	8	72
405 I Break (15E)	10/88 →08/92	AJZ (XUD7TEY)	Diesel	1769	4	8	72
405 I Break (15E)	10/88 →08/92	B1E (XU51C)	Petrol	1580	4	8	58
405 I Break (15E)	10/88 →08/92	BAZ (XU5CP)	Petrol	1580	4	8	58
405 I Break (15E)	10/88 →08/92	BDY (XU5M2Z)	Petrol	1580	4	8	58
405 I Break (15E)	10/88 →08/92	BDY (XU5M3Z)	Petrol	1580	4	8	58
405 I Break (15E)	10/88 →08/92	D2C (XU92C)	Petrol	1905	4	8	77
405 I Break (15E)	10/88 →08/92	D9B (XUD9A)	Diesel	1905	4	8	78
405 I Break (15E)	10/88 →08/92	DDZ (XU9M)	Petrol	1905	4	8	77
405 I Break (15E)	10/88 →08/92	DJY (XUD9A)	Diesel	1905	4	8	78











CC



9

405 I Break (15E)	10/88→08/92	DJZ (XUD9Y)	Diesel	1905	4	8	78
405 I Break (15E)	10/88→08/92	DKZ (XU9JAZ)	Petrol	1905	4	8	77
405 II (4B)	01/92→10/95	RFT (XU10J4)	Petrol	1998	4	16	93
405 II (4B)	01/92→11/97	DKZ (XU9JAZ)	Petrol	1905	4	8	77
405 II (4B)	08/92→10/95	BDY (XU5M2Z)	Petrol	1580	4	8	58
405 II (4B)	08/92→10/95	BDY (XU5M3Z)	Petrol	1580	4	8	58
405 II (4B)	08/92→10/95	BDZ (XU5M)	Petrol	1580	4	8	58
405 II (4B)	08/92→10/95	DHY (XUD9TE)	Diesel	1905	4	8	78
405 II (4B)	08/92→10/95	DJY (XUD9A)	Diesel	1905	4	8	78
405 II (4B)	08/92→10/95	DJZ (XUD9Y)	Diesel	1905	4	8	78
405 II (4B)	08/92→10/95	KDX (TU3MC)	Petrol	1361	4	8	36
405 II (4B)	08/92→10/95	RFX (XU10J2)	Petrol	1998	4	8	89
405 II (4B)	08/92→10/95	RFY (XU10J4Z)	Petrol	1998	4	16	95
405 II (4B)	08/92→10/95	RGZ (XU10J4TE/Z)	Petrol	1998	4	16	93
405 II (4B)	08/92→05/97	B2A (XU52C/K)	Petrol	1580	4	8	58
405 II (4B)	08/92→05/97	BFZ (XU5JP)	Petrol	1580	4	8	58
405 II (4B)	08/92→05/97	NFU (TU5JP4)	Petrol	1587	4	16	65
405 II (4B)	08/92→05/97	XUD9TE	Diesel	1905	4	8	78
405 II (4B)	08/92→11/99	LFZ (XU7JP)	Petrol	1762	4	8	74
405 II (4B)	08/97→11/99	D9B (XUD9A)	Diesel	1905	4	8	78
405 II Break (4E)	08/92→12/95	DHW (XUD9SD)	Diesel	1905	4	8	78
405 II Break (4E)	08/92→12/95	RGZ (XU10J4TE/Z)	Petrol	1998	4	16	93
405 II Break (4E)	08/92→10/96	BDY (XU5M2Z)	Petrol	1580	4	8	58
405 II Break (4E)	08/92→10/96	BDY (XU5M3Z)	Petrol	1580	4	8	58
405 II Break (4E)	08/92→10/96	BDZ (XU5M)	Petrol	1580	4	8	58
405 II Break (4E)	08/92→10/96	BFZ (XU5JP)	Petrol	1580	4	8	58
405 II Break (4E)	08/92→10/96	DHY (XUD9TE)	Diesel	1905	4	8	78
405 II Break (4E)	08/92→10/96	DJZ (XUD9Y)	Diesel	1905	4	8	78
405 II Break (4E)	08/92→10/96	KDX (TU3MC)	Petrol	1361	4	8	36
405 II Break (4E)	08/92→10/96	LFZ (XU7JP)	Petrol	1762	4	8	74
405 II Break (4E)	08/92→10/96	NFU (TU5JP4)	Petrol	1587	4	16	65
405 II Break (4E)	08/92→10/96	RFX (XU10J2)	Petrol	1998	4	8	89
405 II Break (4E)	08/92→10/98	D9B (XUD9A)	Diesel	1905	4	8	78
405 II Break (4E)	09/93→12/95	XUD9	Diesel	1905	4	8	78
405 II Break (4E)	06/94→10/96	DJY (XUD9A)	Diesel	1905	4	8	78
406 (8B)	10/95→10/97	D8B (XUD9TE)	Diesel	1905	4	8	78
406 (8B)	11/95→05/03	LFY (XU7JP4)	Petrol	1761	4	16	75
406 (8B)	11/95→05/04	BFZ (XU5JP)	Petrol	1580	4	8	58
406 (8B)	11/95→05/04	RFV (XU10J4R)	Petrol	1998	4	16	94
406 (8B)	01/96→05/04	DHX (XUD9TE)	Diesel	1905	4	8	78
406 (8B)	01/96→05/04	DHY (XUD9TE)	Diesel	1905	4	8	78
406 (8B)	01/96→05/04	P8C (XUD11BTE)	Diesel	2088	4	12	100
406 (8B)	04/96→05/04	RGX (XU10J2TE)	Petrol	1998	4	8	89
406 (8B)	10/96→03/99	LFZ (XU7JP)	Petrol	1762	4	8	74
406 (8B)	10/96→05/04	DHW (XUD9SD)	Diesel	1905	4	8	78
406 (8B)	10/96→05/04	XFZ (ES9J4)	Petrol	2946	6	24	132
406 (8B)	11/96→03/99	RGY (XU10J2TE)	Petrol	1998	4	8	89
406 (8B)	05/97→05/04	LFX (XU7JB)	Petrol	1761	4	8	74
406 (8B)	06/98→05/04	RHZ (DW10ATED)	Diesel	1997	4	8	98
406 (8B)	01/99→08/00	RFR (DEW10J4)	Petrol	1997	4	16	88
406 (8B)	02/99→05/04	RHY (DW10TD)	Diesel	1997	4	8	98
406 (8B)	03/00→05/04	4HX (DW12TED4/FAP)	Diesel	2179	4	16	108
406 (8B)	03/00→05/04	XFZ (ES9J4S)	Petrol	2946	6	24	132
406 (8B)	07/00→05/04	3FZ (EW12J4)	Petrol	2230	4	16	104
406 (8B)	08/00→06/04	RFN (EW10J4)	Petrol	1997	4	16	88
406 (8B)	10/00→05/04	6FZ (EW7J4)	Petrol	1749	4	16	69
406 (8B)	05/01→05/04	RLZ (EW10D)	Petrol	1997	4	16	88
406 (8B)	08/01→05/04	RHS (DW10ATED)	Diesel	1997	4	8	98
406 Break (8E/F)	10/96→03/99	LFZ (XU7JP)	Petrol	1762	4	8	74
406 Break (8E/F)	10/96→10/00	LFY (XU7JP4)	Petrol	1761	4	16	75
406 Break (8E/F)	10/96→10/04	DHW (XUD9SD)	Diesel	1905	4	8	78
406 Break (8E/F)	10/96→10/04	DHX (XUD9TE)	Diesel	1905	4	8	78
406 Break (8E/F)	10/96→10/04	P8C (XUD11BTE)	Diesel	2088	4	12	100
406 Break (8E/F)	10/96→10/04	RFV (XU10J4R)	Petrol	1998	4	16	94
406 Break (8E/F)	10/96→10/04	RGX (XU10J2TE)	Petrol	1998	4	8	89
406 Break (8E/F)	10/96→10/04	XFZ (ES9J4)	Petrol	2946	6	24	132
406 Break (8E/F)	11/96→03/99	RGY (XU10J2TE)	Petrol	1998	4	8	89
406 Break (8E/F)	05/97→10/04	LFX (XU7JB)	Petrol	1761	4	8	74
406 Break (8E/F)	01/99→10/00	RFR (DEW10J4)	Petrol	1997	4	16	88
406 Break (8E/F)	02/99→10/04	RHY (DW10TD)	Diesel	1997	4	8	98
406 Break (8E/F)	02/99→10/04	RHZ (DW10ATED)	Diesel	1997	4	8	98
406 Break (8E/F)	03/00→10/04	4HX (DW12TED4/FAP)	Diesel	2179	4	16	108
406 Break (8E/F)	03/00→10/04	XFZ (ES9J4S)	Petrol	2946	6	24	132
406 Break (8E/F)	07/00→10/04	3FZ (EW12J4)	Petrol	2230	4	16	104
406 Break (8E/F)	10/00→10/04	6FZ (EW7J4)	Petrol	1749	4	16	69
406 Break (8E/F)	10/00→10/04	RFN (EW10J4)	Petrol	1997	4	16	88
406 Break (8E/F)	05/01→10/04	RLZ (EW10D)	Petrol	1997	4	16	88
406 Break (8E/F)	08/01→10/04	RHS (DW10ATED)	Diesel	1997	4	8	98

							
406 Coupe (8C)	03/97→12/04	RFV (XU10J4R)	Petrol	1998	4	16	94
406 Coupe (8C)	03/97→12/04	XFZ (ES9J4)	Petrol	2946	6	24	132
406 Coupe (8C)	01/99→10/00	RFR (DEW10J4)	Petrol	1997	4	16	88
406 Coupe (8C)	03/00→12/04	4HX (DW12TED4/FAP)	Diesel	2179	4	16	108
406 Coupe (8C)	03/00→12/04	XFV (ES9J4S)	Petrol	2946	6	24	132
406 Coupe (8C)	10/00→12/04	RFN (EW10J4)	Petrol	1997	4	16	88
406 Coupe (8C)	03/02→12/04	3FZ (EW12J4)	Petrol	2230	4	16	104
407 (6D_)	05/04→	3FZ (EW12J4)	Petrol	2230	4	16	104
407 (6D_)	05/04→	6FZ (EW7J4)	Petrol	1749	4	16	69
407 (6D_)	05/04→	9HZ (DV6TED4)	Diesel	1560	4	16	57
407 (6D_)	05/04→	RFN (EW10J4)	Petrol	1997	4	16	88
407 (6D_)	05/04→	RHR (DW10BTE4)	Diesel	1997	4	16	96
407 (6D_)	05/04→	XFV (ES9A)	Petrol	2946	6	24	131
407 (6D_)	09/05→	3FY (EW12J4)	Petrol	2230	4	16	104
407 (6D_)	09/05→	6FY (EW7A)	Petrol	1749	4	16	69
407 (6D_)	09/05→	RFJ (EW10A)	Petrol	1997	4	16	91
407 (6D_)	10/05→	UHZ (DT17)	Diesel	2720	6	24	124
407 (6D_)	05/06→	4HT (DW12BTE4)	Diesel	2179	4	16	106
407 (6D_)	06/08→	4HP (DW12BTE4)	Diesel	2179	4	16	106
407 (6D_)	08/08→	RHF (DW10BTE4)	Diesel	1997	4	16	96
407 (6D_)	07/09→	RHH (DW10CTE4)	Diesel	1997	4	16	86
407 (6D_)	02/10→	RHE (DW10CTE4)	Diesel	1997	4	16	86
407 Coupe (6C_)	10/05→	3FY (EW12J4)	Petrol	2230	4	16	104
407 Coupe (6C_)	10/05→	RHR (DW10BTE4)	Diesel	1997	4	16	96
407 Coupe (6C_)	10/05→	UHZ (DT17)	Diesel	2720	6	24	124
407 Coupe (6C_)	10/05→	XFV (ES9A)	Petrol	2946	6	24	131
407 Coupe (6C_)	06/09→	DT20C	Diesel	2993	6	24	127
407 Coupe (6C_)	06/09→	RHH (DW10CTE4)	Diesel	1997	4	16	86
407 Coupe (6C_)	02/10→	RHE (DW10CTE4)	Diesel	1997	4	16	86
407 SW (6E_)	05/04→	3FZ (EW12J4)	Petrol	2230	4	16	104
407 SW (6E_)	05/04→	6FZ (EW7J4)	Petrol	1749	4	16	69
407 SW (6E_)	05/04→	9HZ (DV6TED4)	Diesel	1560	4	16	57
407 SW (6E_)	05/04→	RFN (EW10J4)	Petrol	1997	4	16	88
407 SW (6E_)	05/04→	RHR (DW10BTE4)	Diesel	1997	4	16	96
407 SW (6E_)	05/04→	XFV (ES9A)	Petrol	2946	6	24	131
407 SW (6E_)	11/04→	RHL (DW10BTE4)	Diesel	1997	4	16	96
407 SW (6E_)	09/05→	3FY (EW12J4)	Petrol	2230	4	16	104
407 SW (6E_)	09/05→	6FY (EW7A)	Petrol	1749	4	16	69
407 SW (6E_)	09/05→	RFJ (EW10A)	Petrol	1997	4	16	91
407 SW (6E_)	10/05→	UHZ (DT17)	Diesel	2720	6	24	124
407 SW (6E_)	05/06→	4HT (DW12BTE4)	Diesel	2179	4	16	106
407 SW (6E_)	06/08→	4HP (DW12BTE4)	Diesel	2179	4	16	106
407 SW (6E_)	07/09→	RHH (DW10CTE4)	Diesel	1997	4	16	86
407 SW (6E_)	02/10→	RHE (DW10CTE4)	Diesel	1997	4	16	86
408	11/10→	9HL (DV6C)	Diesel	1560	4	8	55
408	01/11→	5FE (EP6CDTMD)	Petrol	1598	4	16	52
408	01/11→	5GZ (EP6FDT)	Petrol	1598	4	16	52
408	03/11→	RFJ (EW10A)	Petrol	1997	4	16	91
408	04/11→	9HY (DV6TED4)	Diesel	1560	4	16	57
408	01/12→	5FS (EP6C)	Petrol	1598	4	16	52
408 Saloon	01/10→12/14	EW10A	Petrol	1997	4	16	87
408 Saloon	01/10→12/14	TU5JP4	Petrol	1587	4	16	62
504	11/86→05/95	XN1	Petrol	1971	4	8	84
504	11/86→10/99	XM7	Petrol	1796	4	8	71
504 (A_, M_)	07/68→02/71	KF5	Petrol	1796	4	8	73
504 (A_, M_)	07/68→02/71	KF6	Petrol	1796	4	8	73
504 (A_, M_)	07/68→02/71	XM	Petrol	1796	4	8	73
504 (A_, M_)	01/71→06/83	107 (XN2)	Petrol	1971	4	8	84
504 (A_, M_)	01/71→06/83	XM7	Petrol	1796	4	8	71
504 (A_, M_)	02/71→07/86	XD4x90	Diesel	2112	4	8	101
504 (A_, M_)	03/71→06/86	106 (XN1)	Petrol	1971	4	8	84
504 (A_, M_)	03/73→07/86	XD4x88	Diesel	1948	4	8	80
504 (A_, M_)	07/75→12/83	134 (XD2)	Diesel	2304	4	8	111
504 (A_, M_)	09/79→08/82	XD90	Diesel	2112	4	8	102
504 (A_, M_)	09/79→08/82	XN1	Petrol	1971	4	8	84
504 (A_, M_)	04/71→07/86	XD4x90	Diesel	2112	4	8	101
504 Break (D_, F_)	04/71→07/86	XM7	Petrol	1796	4	8	71
504 Break (D_, F_)	04/71→07/86	XN1	Petrol	1971	4	8	84
504 Break (D_, F_)	07/75→07/86	134 (XD2)	Diesel	2304	4	8	111
504 Convertible	10/74→08/84	107 (XN2)	Petrol	1971	4	8	84
504 Coupe	10/74→08/84	107 (XN2)	Petrol	1971	4	8	84
504 Coupe	10/77→08/84	140 (ZMJ)	Petrol	2664	6	12	123
504 Pickup	08/90→10/99	XD3P	Diesel	2497	4	8	115
504 Pickup (E_)	01/80→06/87	XC7P	Petrol	1618	4	8	67
504 Pickup (E_)	01/80→12/89	134 (XD2)	Diesel	2304	4	8	111
504 Pickup (E_)	01/80→12/89	XD4x88	Diesel	1948	4	8	80
504 Pickup (E_)	08/81→12/89	XM7	Petrol	1796	4	8	71
505 (551A)	05/79→09/84	XD2	Diesel	2304	4	8	111



CC



9

505 (551A)	08/79→10/86	829 (ZEJ)	Petrol	1995	4	8	85
505 (551A)	09/80→09/85	XN1	Petrol	1971	4	8	84
505 (551A)	09/80→06/86	147 (XD2S)	Diesel	2304	4	8	111
505 (551A)	11/80→12/85	106 (XN1)	Petrol	1971	4	8	84
505 (551A)	05/81→10/84	851 (ZDJ)	Petrol	2165	4	8	110
505 (551A)	06/81→10/85	105 (XM7)	Petrol	1796	4	8	71
505 (551A)	06/81→12/93	155 (XD3)	Diesel	2498	4	8	116
505 (551A)	08/83→12/93	851B (ZDJL)	Petrol	2165	4	8	110
505 (551A)	10/83→12/90	XD3T	Diesel	2497	4	8	114
505 (551A)	10/83→12/93	152A (XD3T)	Diesel	2498	4	8	114
505 (551A)	09/85→10/86	105C (XM7A)	Petrol	1796	4	8	71
505 (551A)	09/85→09/95	106E (XN1A)	Petrol	1971	4	8	84
505 (551A)	03/86→12/93	851X (ZDJL)	Petrol	2165	4	8	110
505 (551A)	06/86→12/93	154X (ZN3J)	Petrol	2849	6	12	125
505 (551A)	10/86→12/93	152B (XD3TE)	Diesel	2498	4	8	115
505 Break (551D)	04/82→09/85	XM7	Petrol	1796	4	8	71
505 Break (551D)	04/82→06/86	147 (XD2S)	Diesel	2304	4	8	111
505 Break (551D)	06/82→09/84	XD2	Diesel	2304	4	8	111
505 Break (551D)	08/83→12/85	106 (XN1)	Petrol	1971	4	8	84
505 Break (551D)	08/83→12/93	155 (XD3)	Diesel	2498	4	8	116
505 Break (551D)	09/85→12/86	851B (ZDJL)	Petrol	2165	4	8	110
505 Break (551D)	09/85→11/87	106E (XN1A)	Petrol	1971	4	8	84
505 Break (551D)	10/85→11/87	152A (XD3T)	Diesel	2498	4	8	114
505 Break (551D)	10/85→09/89	105C (XM7A)	Petrol	1796	4	8	71
505 Break (551D)	10/85→09/89	829 (ZEJ)	Petrol	1995	4	8	85
505 Break (551D)	10/85→08/91	XD3T	Diesel	2497	4	8	114
505 Break (551D)	01/86→12/93	851X (ZDJL)	Petrol	2165	4	8	110
505 Break (551D)	10/86→12/93	152B (XD3TE)	Diesel	2498	4	8	115
508	11/10→	4HL (DW12C)	Diesel	2179	4	16	106
508	11/10→	5FH (EP6C)	Petrol	1598	4	16	52
508	11/10→	5FN (EP6CDT)	Petrol	1598	4	16	52
508	11/10→	5FS (EP6C)	Petrol	1598	4	16	52
508	11/10→	5FV (EP6CDT)	Petrol	1598	4	16	52
508	11/10→	9HL (DV6C)	Diesel	1560	4	8	55
508	11/10→	9HR (DV6C)	Diesel	1560	4	8	55
508	11/10→	RHC (DW10CTED4)	Diesel	1997	4	16	86
508	11/10→	RHF (DW10BTED4)	Diesel	1997	4	16	96
508	11/10→	RHH (DW10CTED4)	Diesel	1997	4	16	86
508	11/10→	RHR (DW10BTED4)	Diesel	1997	4	16	96
508	01/12→	5GZ (EP6FDT)	Petrol	1598	4	16	52
508	02/12→	9HD (DV6CTED)	Diesel	1560	4	8	55
508	03/14→	BHZ (DV6FC)	Diesel	1560	4	8	55
508	04/14→	AHW (DW10FC)	Diesel	1997	4	16	86
508	04/14→	AHX (DW10FD)	Diesel	1997	4	16	86
508	09/14→	BHX (DV6FC)	Diesel	1560	4	8	55
508 SW	11/10→	4HL (DW12C)	Diesel	2179	4	16	106
508 SW	11/10→	5FH (EP6C)	Petrol	1598	4	16	52
508 SW	11/10→	5FS (EP6C)	Petrol	1598	4	16	52
508 SW	11/10→	5FV (EP6CDT)	Petrol	1598	4	16	52
508 SW	11/10→	5FX (EP6DT)	Petrol	1598	4	16	52
508 SW	11/10→	9HL (DV6C)	Diesel	1560	4	8	55
508 SW	11/10→	9HR (DV6C)	Diesel	1560	4	8	55
508 SW	11/10→	RHC (DW10CTED4)	Diesel	1997	4	16	86
508 SW	11/10→	RHF (DW10BTED4)	Diesel	1997	4	16	96
508 SW	11/10→	RHH (DW10CTED4)	Diesel	1997	4	16	86
508 SW	11/10→	RHR (DW10BTED4)	Diesel	1997	4	16	96
508 SW	02/12→	9HD (DV6CTED)	Diesel	1560	4	8	55
508 SW	03/14→	BHZ (DV6FC)	Diesel	1560	4	8	55
508 SW	04/14→	AHW (DW10FC)	Diesel	1997	4	16	86
508 SW	04/14→	AHX (DW10FD)	Diesel	1997	4	16	86
508 SW	09/14→	BHX (DV6FC)	Diesel	1560	4	8	55
604 (561A_)	08/77→05/83	112 (ZM)	Petrol	2664	6	12	123
604 (561A_)	08/77→05/83	140 (ZMJ)	Petrol	2664	6	12	123
604 (561A_)	09/79→05/83	147 (XD2S)	Diesel	2304	4	8	111
604 (561A_)	08/83→12/86	152A (XD3T)	Diesel	2498	4	8	114
604 (561A_)	09/83→07/87	154A (ZMJK)	Petrol	2849	6	12	125
605 (6B)	06/89→07/95	P9A (XUD11A)	Diesel	2138	4	12	100
605 (6B)	06/89→09/99	PHZ (XUD11ATE)	Diesel	2088	4	12	100
605 (6B)	06/89→09/99	RSA (XU102C)	Petrol	1998	4	8	89
605 (6B)	06/89→09/99	RFZ (XU10J2Z)	Petrol	1998	4	8	89
605 (6B)	08/89→06/94	SFZ (ZPJ/Z)	Petrol	2975	6	12	128
605 (6B)	08/89→06/94	SKZ (ZPJ4/Z)	Petrol	2963	6	24	129
605 (6B)	08/89→09/99	UFZ (ZPJ)	Petrol	2963	6	12	130
605 (6B)	08/89→09/99	UKZ (ZPJ4/Z)	Petrol	2963	6	24	129
605 (6B)	09/89→12/92	R6A (XU10J2)	Petrol	1998	4	8	89
605 (6B)	07/91→09/99	RGX (XU10J2TE)	Petrol	1998	4	8	89
605 (6B)	01/92→09/99	XFZ (ES9J4)	Petrol	2946	6	24	132
605 (6B)	07/92→09/99	RGY (XU10J2TE)	Petrol	1998	4	8	89



CC



9

605 (6B)	07/94→09/99	RFV (XU10J4R)	Petrol	1998	4	16	94
605 (6B)	07/94→09/99	THY (DK5ATE)	Diesel	2446	4	12	121
605 (6B)	08/94→09/99	P8C (XUD11BTE)	Diesel	2088	4	12	100
607 (9D, 9U)	02/00→08/05	3FZ (EW12J4)	Petrol	2230	4	16	104
607 (9D, 9U)	02/00→08/05	RFN (EW10J4)	Petrol	1997	4	16	88
607 (9D, 9U)	02/00→02/06	4HX (DW12TED4/FAP)	Diesel	2179	4	16	108
607 (9D, 9U)	02/00→07/11	XFX (ES9J4S)	Petrol	2946	6	24	132
607 (9D, 9U)	05/00→09/05	RHZ (DW10ATED)	Diesel	1997	4	8	98
607 (9D, 9U)	03/01→09/04	RHS (DW10ATED)	Diesel	1997	4	8	98
607 (9D, 9U)	03/04→07/11	XFV (ES9A)	Petrol	2946	6	24	131
607 (9D, 9U)	12/04→07/11	DT17TED4	Diesel	2721	6	24	124
607 (9D, 9U)	09/05→06/10	3FY (EW12J4)	Petrol	2230	4	16	104
607 (9D, 9U)	09/05→07/11	RHR (DW10BTE4)	Diesel	1997	4	16	96
607 (9D, 9U)	05/06→06/10	4HT (DW12BTE4)	Diesel	2179	4	16	106
806 (221)	06/94→08/02	RFU (XU10J2)	Petrol	1998	4	8	89
806 (221)	06/94→08/02	RGX (XU10J2TE)	Petrol	1998	4	8	89
806 (221)	07/95→08/02	DHX (XUD9TE)	Diesel	1905	4	8	78
806 (221)	07/95→08/02	LFW (XU7JP)	Petrol	1761	4	8	74
806 (221)	06/96→08/99	P8C (XUD11BTE)	Diesel	2088	4	12	100
806 (221)	05/97→08/02	DHY (XUD9TE)	Diesel	1905	4	8	78
806 (221)	05/98→09/00	RFV (XU10J4R)	Petrol	1998	4	16	94
806 (221)	08/99→08/02	RHW (DW10ATED4)	Diesel	1997	4	16	96
806 (221)	08/99→08/02	RHZ (DW10ATED)	Diesel	1997	4	8	98
806 (221)	09/00→08/02	RFN (EW10J4)	Petrol	1997	4	16	88
807 (E)	06/02→	3FZ (EW12J4)	Petrol	2230	4	16	104
807 (E)	06/02→	4HW (DW12BTE4)	Diesel	2179	4	16	107
807 (E)	06/02→	RFN (EW10J4)	Petrol	1997	4	16	88
807 (E)	06/02→	RHM (DW10ATED4)	Diesel	1997	4	16	96
807 (E)	06/02→	RHT (DW10ATED4)	Diesel	1997	4	16	96
807 (E)	06/02→	RHW (DW10ATED4)	Diesel	1997	4	16	96
807 (E)	06/02→	XFX (ES9J4S)	Petrol	2946	6	24	132
807 (E)	04/04→	4HZ (DW12TED4)	Diesel	2179	4	16	108
807 (E)	09/05→	RFJ (EW10A)	Petrol	1997	4	16	91
807 (E)	02/06→	RHK (DW10UTED4)	Diesel	1997	4	16	96
807 (E)	06/06→	4HR (DW12BTE4)	Diesel	2179	4	16	106
807 (E)	06/06→	4HT (DW12BTE4)	Diesel	2179	4	16	106
807 (E)	06/06→	RHR (DW10BTE4)	Diesel	1997	4	16	96
807 (E)	06/09→	RHH (DW10CTED4)	Diesel	1997	4	16	86
1007 (KM_)	04/05→	8HX (DV4TD)	Diesel	1398	4	8	33
1007 (KM_)	04/05→	8HZ (DV4TD)	Diesel	1398	4	8	33
1007 (KM_)	04/05→	KFV (TU3A)	Petrol	1360	4	8	40
1007 (KM_)	04/05→	KFV (TU3JP)	Petrol	1360	4	8	42
1007 (KM_)	04/05→	NFU (TU5JP4)	Petrol	1587	4	16	65
1007 (KM_)	10/05→	KFU (ET3J4)	Petrol	1360	4	16	41
1007 (KM_)	06/07→	9HZ (DV6TED4)	Diesel	1560	4	16	57
1307-1510	01/78→08/81	6G1D	Petrol	1294	4	8	24
1307-1510	10/78→01/80	6J2	Petrol	1577	4	8	53
1307-1510	11/78→04/81	6Y2D	Petrol	1424	4	8	30
1307-1510	11/78→08/81	6Y2	Petrol	1424	4	8	31
1307-1510	01/80→04/84	6G1	Petrol	1424	4	8	30
1307-1510	11/80→12/83	6J1	Petrol	1592	4	8	53
1307-1510	07/81→06/82	6J2A	Petrol	1592	4	8	53
2008	03/13→	5FS (EP6C)	Petrol	1598	4	16	52
2008	03/13→	9HD (DV6CTED)	Diesel	1560	4	8	55
2008	03/13→	9HP (DV6DTE4)	Diesel	1560	4	8	55
2008	03/13→	HMZ (EB2F)	Petrol	1199	3	12	20
2008	06/13→	8HR (DV4C)	Diesel	1398	4	8	33
2008	07/14→	BHX (DV6FC)	Diesel	1560	4	8	55
2008	07/14→	BHZ (DV6FC)	Diesel	1560	4	8	55
2008	01/15→	BHW (DV6FE)	Diesel	1560	4	8	55
2008	01/15→	BHY (DV6FD)	Diesel	1560	4	8	55
2008	01/15→	HNY (EB2DTS)	Petrol	1199	3	12	20
2008	01/15→	HNZ (EB2DT)	Petrol	1199	3	12	20
2008	02/16→	NFP (EC5)	Petrol	1587	4	16	63
3008	06/09→	5FS (EP6C)	Petrol	1598	4	16	52
3008	06/09→	5FV (EP6CDT)	Petrol	1598	4	16	52
3008	06/09→	5FW (EP6)	Petrol	1598	4	16	52
3008	06/09→	5FX (EP6DT)	Petrol	1598	4	16	52
3008	06/09→	9HZ (DV6TED4)	Diesel	1560	4	16	57
3008	06/09→	AHX (DW10FD)	Diesel	1997	4	16	86
3008	06/09→	EP6	Petrol	1598	4	16	52
3008	06/09→	RHE (DW10CTED4)	Diesel	1997	4	16	86
3008	06/09→	RHH (DW10CTED4)	Diesel	1997	4	16	86
3008	08/10→	9HR (DV6C)	Diesel	1560	4	8	55
3008	02/11→	RHC (DW10CTED4)	Diesel	1997	4	16	86
3008	02/13→	9HD (DV6C)	Diesel	1560	4	8	55
3008	02/13→	BHX (DV6FC)	Diesel	1560	4	8	55
3008	03/13→	9HD (DV6CTED)	Diesel	1560	4	8	55









CC



9

3008	05/14→	5GZ (EP6FDT)	Petrol	1598	4	16	52
3008	05/14→	BHZ (DV6FC)	Diesel	1560	4	8	55
3008	01/15→	HNY (EB2DTS)	Petrol	1199	3	12	20
3008 SUV	05/16→	5GZ (EP6FDT)	Petrol	1598	4	16	52
3008 SUV	05/16→	AHW (DW10FC)	Diesel	1997	4	16	86
3008 SUV	05/16→	AHX (DW10FD)	Diesel	1997	4	16	86
3008 SUV	05/16→	BHZ (DV6FC)	Diesel	1560	4	8	55
3008 SUV	05/16→	HNY (EB2DTS)	Petrol	1199	3	12	20
3008 SUV	11/16→	AHV (DW10FD)	Diesel	1997	4	16	86
3008 SUV	11/16→	BHX (DV6FC)	Diesel	1560	4	8	55
3008 SUV	11/16→	BHY (DV6FD)	Diesel	1560	4	8	55
4007 (GP_)	02/07→	4HK (DW12MTED4)	Diesel	2179	4	16	106
4007 (GP_)	02/07→	4HN (DW12MTED4)	Diesel	2179	4	16	106
4007 (GP_)	01/08→	SFY (4B12-MMC)	Petrol	2360	4	16	112
4007 (GP_)	01/08→	SFZ (4B12-MMC)	Petrol	2360	4	16	112
4007 (GP_)	11/10→	4B11	Petrol	1998	4	16	82
4008	05/12→	4B11	Petrol	1998	4	16	82
4008	05/12→	9HD (DV6C)	Diesel	1560	4	8	55
5008	06/09→	AHR (DW10FD)	Diesel	1997	4	16	86
5008	06/09→	AHX (DW10FD)	Diesel	1997	4	16	86
5008	06/09→	RHE (DW10CTED4)	Diesel	1997	4	16	86
5008	09/09→	SFS (EP6C)	Petrol	1598	4	16	52
5008	09/09→	5FV (EP6CDT)	Petrol	1598	4	16	52
5008	09/09→	5FW (EP6)	Petrol	1598	4	16	52
5008	09/09→	9HZ (DV6TED4)	Diesel	1560	4	16	57
5008	09/09→	EP6	Petrol	1598	4	16	52
5008	09/09→	RHH (DW10CTED4)	Diesel	1997	4	16	86
5008	08/10→	9HR (DV6C)	Diesel	1560	4	8	55
5008	02/12→	5FX (EP6DT)	Petrol	1598	4	16	52
5008	02/12→	5GZ (EP6FDT)	Petrol	1598	4	16	52
5008	02/12→	AHV (DW10FD)	Diesel	1997	4	16	86
5008	02/12→	RHD (DW10CTED4)	Diesel	1997	4	16	86
5008	03/13→	9HD (DV6CTED)	Diesel	1560	4	8	55
5008	05/14→	BHZ (DV6FC)	Diesel	1560	4	8	55
5008	01/15→	HNY (EB2DTS)	Petrol	1199	3	12	20
5008 II	12/16→	5GY (EP6FDTM)	Petrol	1598	4	16	51
5008 II	12/16→	5GZ (EP6FDT)	Petrol	1598	4	16	52
5008 II	12/16→	AHV (DW10FD)	Diesel	1997	4	16	86
5008 II	12/16→	AHW (DW10FC)	Diesel	1997	4	16	86
5008 II	12/16→	AHX (DW10FD)	Diesel	1997	4	16	86
5008 II	12/16→	BHX (DV6FC)	Diesel	1560	4	8	55
5008 II	12/16→	BHY (DV6FD)	Diesel	1560	4	8	55
5008 II	12/16→	BHZ (DV6FC)	Diesel	1560	4	8	55
5008 II	12/16→	HNY (EB2DTS)	Petrol	1199	3	12	20
Bipper (AA_)	02/08→	8HS (DV4TED)	Diesel	1398	4	8	33
Bipper (AA_)	02/08→	KFV (TU3A)	Petrol	1360	4	8	40
Bipper (AA_)	10/10→	199 A9.000	Diesel	1248	4	16	26
Bipper (AA_)	10/10→	FHZ (F13DTE5)	Diesel	1248	4	16	19
Bipper Tepee	04/08→	8HS (DV4TED)	Diesel	1398	4	8	33
Bipper Tepee	04/08→	KFV (TU3A)	Petrol	1360	4	8	40
Bipper Tepee	10/10→	199 A9.000	Diesel	1248	4	16	26
Bipper Tepee	10/10→	FHZ (F13DTE5)	Diesel	1248	4	16	19
Bipper Tepee	12/15→	FHY (F13DTE6)	Diesel	1248	4	16	19
Boxer Box	04/06→	4HU (P22DTE)	Diesel	2198	4	16	105
Boxer Box	04/06→	4HV (P22DTE)	Diesel	2198	4	16	105
Boxer Box	03/11→	4HG (P22DTE)	Diesel	2198	4	16	105
Boxer Box	03/11→	4HH (P22DTE)	Diesel	2198	4	16	105
Boxer Box	03/11→	4HJ (P22DTE)	Diesel	2198	4	16	105
Boxer Box	07/15→	AHN (DW10FUD)	Diesel	1997	4	16	86
Boxer Box	07/15→	AHP (DW10FUC)	Diesel	1997	4	16	86
Boxer Box (230L)	03/94→04/02	D8C (XUD9UTF)	Diesel	1905	4	8	78
Boxer Box (230L)	03/94→04/02	D9B (XUD9AU)	Diesel	1905	4	8	78
Boxer Box (230L)	03/94→04/02	T8A (DJ5T)	Diesel	2446	4	12	113
Boxer Box (230L)	03/94→04/02	T9A (DJ5)	Diesel	2446	4	12	113
Boxer Box (230L)	06/94→04/02	RFW (XU10J2)	Petrol	1998	4	8	89
Boxer Box (230L)	03/96→04/02	XUD9TE	Diesel	1905	4	8	78
Boxer Box (230L)	01/97→04/02	THX (DJ5TED)	Diesel	2446	4	8	120
Boxer Box (230L)	10/97→09/00	8140.43 (F28DT)	Diesel	2798	4	8	126
Boxer Box (230L)	01/99→02/02	8140.63 (F28D)	Diesel	2798	4	8	126
Boxer Box (230L)	07/99→04/02	DJY (XUD9A)	Diesel	1905	4	8	78
Boxer Box (230L)	10/00→04/02	8140.43S (F28DTCR)	Diesel	2798	4	8	126
Boxer Box (230L)	08/01→04/02	RHV (DW10UTD)	Diesel	1997	4	8	98
Boxer Box (244)	04/02→	4HY (DW12UTED)	Diesel	2179	4	8	109
Boxer Box (244)	04/02→	8140.43S (F28DTCR)	Diesel	2798	4	8	126
Boxer Box (244)	04/02→	RFL (XU10J2U)	Petrol	1998	4	8	89
Boxer Box (244)	04/02→	RHV (DW10TD)	Diesel	1997	4	8	98
Boxer Box (244)	04/02→	RHV (DW10UTD)	Diesel	1997	4	8	98
Boxer Box (244)	04/04→	8140.43N	Diesel	2798	4	8	126

				CC			9
Boxer Bus	04/06 →	4HU (P22DTE)	Diesel	2198	4	16	105
Boxer Bus	04/06 →	4HV (P22DTE)	Diesel	2198	4	16	105
Boxer Bus	03/11 →	4HG (P22DTE)	Diesel	2198	4	16	105
Boxer Bus	03/11 →	4HH (P22DTE)	Diesel	2198	4	16	105
Boxer Bus	03/11 →	4HJ (P22DTE)	Diesel	2198	4	16	105
Boxer Bus	07/15 →	AHN (DW10FUD)	Diesel	1997	4	16	86
Boxer Bus	07/15 →	AHP (DW10FUC)	Diesel	1997	4	16	86
Boxer Bus (230P)	03/94 →04/02	D8C (XUD9UTF)	Diesel	1905	4	8	78
Boxer Bus (230P)	03/94 →04/02	D9B (XUD9AU)	Diesel	1905	4	8	78
Boxer Bus (230P)	03/94 →04/02	RFW (XU10J2)	Petrol	1998	4	8	89
Boxer Bus (230P)	07/94 →04/02	T8A (DJ5T)	Diesel	2446	4	12	113
Boxer Bus (230P)	08/94 →04/02	DHY (XUD9TE)	Diesel	1905	4	8	78
Boxer Bus (230P)	08/94 →04/02	T9A (DJ5)	Diesel	2446	4	12	113
Boxer Bus (230P)	01/97 →04/02	THX (DJ5TED)	Diesel	2446	4	8	120
Boxer Bus (230P)	10/97 →09/00	8140.43 (F28DT)	Diesel	2798	4	8	126
Boxer Bus (230P)	01/99 →02/02	8140.63 (F28D)	Diesel	2798	4	8	126
Boxer Bus (230P)	10/00 →04/02	8140.43S (F28DTCR)	Diesel	2798	4	8	126
Boxer Bus (244, Z_)	04/02 →	4HY (DW12UTED)	Diesel	2179	4	8	109
Boxer Bus (244, Z_)	04/02 →	8140.43S (F28DTCR)	Diesel	2798	4	8	126
Boxer Bus (244, Z_)	04/02 →	RFL (XU10J2U)	Petrol	1998	4	8	89
Boxer Bus (244, Z_)	04/02 →	RHV (DW10TD)	Diesel	1997	4	8	98
Boxer Bus (244, Z_)	04/02 →	RHV (DW10UTD)	Diesel	1997	4	8	98
Boxer Bus (244, Z_)	04/04 →	8140.43N	Diesel	2798	4	8	126
Boxer Platform/Chassis	04/06 →	4HU (P22DTE)	Diesel	2198	4	16	105
Boxer Platform/Chassis	04/06 →	4HV (P22DTE)	Diesel	2198	4	16	105
Boxer Platform/Chassis	03/11 →	4HG (P22DTE)	Diesel	2198	4	16	105
Boxer Platform/Chassis	03/11 →	4HH (P22DTE)	Diesel	2198	4	16	105
Boxer Platform/Chassis	03/11 →	4HJ (P22DTE)	Diesel	2198	4	16	105
Boxer Platform/Chassis	07/15 →	AHN (DW10FUD)	Diesel	1997	4	16	86
Boxer Platform/Chassis	07/15 →	AHP (DW10FUC)	Diesel	1997	4	16	86
Boxer Platform/Chassis (244)	12/01 →03/05	8140.43 (F28DT)	Diesel	2798	4	8	126
Boxer Platform/Chassis (244)	04/02 →	4HY (DW12UTED)	Diesel	2179	4	8	109
Boxer Platform/Chassis (244)	04/02 →	8140.43S (F28DTCR)	Diesel	2798	4	8	126
Boxer Platform/Chassis (244)	04/02 →	RHV (DW10TD)	Diesel	1997	4	8	98
Boxer Platform/Chassis (244)	04/02 →	RHV (DW10UTD)	Diesel	1997	4	8	98
Boxer Platform/Chassis (244)	04/04 →	8140.43N	Diesel	2798	4	8	126
Boxer Platform/Chassis (ZCT_)	03/94 →04/02	DJY (XUD9A)	Diesel	1905	4	8	78
Boxer Platform/Chassis (ZCT_)	03/94 →04/02	T8A (DJ5T)	Diesel	2446	4	12	113
Boxer Platform/Chassis (ZCT_)	03/94 →04/02	T9A (DJ5)	Diesel	2446	4	12	113
Boxer Platform/Chassis (ZCT_)	06/94 →04/02	DHY (XUD9TE)	Diesel	1905	4	8	78
Boxer Platform/Chassis (ZCT_)	06/94 →04/02	RFW (XU10J2)	Petrol	1998	4	8	89
Boxer Platform/Chassis (ZCT_)	06/94 →04/02	XUD9TE	Diesel	1905	4	8	78
Boxer Platform/Chassis (ZCT_)	07/94 →04/02	D8C (XUD9UTF)	Diesel	1905	4	8	78
Boxer Platform/Chassis (ZCT_)	01/97 →04/02	THX (DJ5TED)	Diesel	2446	4	8	120
Boxer Platform/Chassis (ZCT_)	01/99 →02/02	8140.63 (F28D)	Diesel	2798	4	8	126
Boxer Platform/Chassis (ZCT_)	10/00 →04/02	8140.43S (F28DTCR)	Diesel	2798	4	8	126
Boxer Platform/Chassis (ZCT_)	12/01 →04/02	RFL (XU10J2U)	Petrol	1998	4	8	89
Expert (224)	10/95 →05/98	XUD9TE	Diesel	1905	4	8	78
Expert (224)	02/96 →05/98	D8B (XUD9TE)	Diesel	1905	4	8	78
Expert (224)	02/96 →12/98	D9B (XUD9AU)	Diesel	1905	4	8	78
Expert (224)	02/96 →09/00	222A2 (1580 SPI)	Petrol	1581	4	8	59
Expert (224)	02/96 →09/00	DHX (XUD9TE)	Diesel	1905	4	8	78
Expert (224)	10/96 →09/00	LFZ (XU7JP)	Petrol	1762	4	8	74
Expert (224)	07/00 →12/06	RFN (EW10J4)	Petrol	1997	4	16	88
Expert (224)	07/00 →12/06	RHW (DW10ATED4)	Diesel	1997	4	16	96
Expert (224)	07/00 →12/06	RHZ (DW10ATED)	Diesel	1997	4	8	98
Expert (224)	07/00 →12/06	RHZ (DW10BTED)	Diesel	1997	4	8	99
Expert (224)	07/00 →12/06	RHZ (DW10BTED+)	Diesel	1997	4	8	99
Expert (224)	07/00 →12/06	RHZ (DW10CTED)	Diesel	1997	4	8	98
Expert (224)	10/00 →10/06	RHX (DW10BTED)	Diesel	1997	4	8	98
Expert (224)	12/03 →12/06	WJY (DW8B)	Diesel	1868	4	8	78
Expert (224)	12/03 →12/06	WJZ (DW8)	Diesel	1868	4	8	78
Expert Box	04/16 →	AHH (DW10FC)	Diesel	1997	4	16	86
Expert Box	04/16 →	AHX (DW10FD)	Diesel	1997	4	16	86
Expert Box	04/16 →	BHV (DV6FDU)	Diesel	1560	4	8	55
Expert Box	04/16 →	BHX (DV6FC)	Diesel	1560	4	8	55
Expert Box (222)	02/96 →05/98	D8B (XUD9TE)	Diesel	1905	4	8	78
Expert Box (222)	02/96 →12/98	D9B (XUD9AU)	Diesel	1905	4	8	78
Expert Box (222)	02/96 →09/00	222A2 (1580 SPI)	Petrol	1581	4	8	59
Expert Box (222)	02/96 →09/00	DHX (XUD9TE)	Diesel	1905	4	8	78
Expert Box (222)	10/96 →09/00	LFZ (XU7JP)	Petrol	1762	4	8	74
Expert Box (222)	12/98 →12/06	WJY (DW8B)	Diesel	1868	4	8	78
Expert Box (222)	12/98 →12/06	WJZ (DW8)	Diesel	1868	4	8	78
Expert Box (222)	07/00 →12/06	RHW (DW10ATED4)	Diesel	1997	4	16	96
Expert Box (222)	07/00 →12/06	RHX (DW10BTED)	Diesel	1997	4	8	98
Expert Box (222)	07/00 →12/06	RHZ (DW10ATED)	Diesel	1997	4	8	98
Expert Box (222)	07/00 →12/06	RHZ (DW10BTED)	Diesel	1997	4	8	99
Expert Box (222)	07/00 →12/06	RHZ (DW10BTED+)	Diesel	1997	4	8	99









CC



9

Expert Box (222)	07/00→12/06	RHZ (DW10CTED)	Diesel	1997	4	8	98
Expert Box (222)	09/02→12/06	RFN (EW10J4)	Petrol	1997	4	16	88
Expert Box (VF3A_, VF3U_, VF3X_)	01/07→	9HH (DV6DUM)	Diesel	1560	4	8	55
Expert Box (VF3A_, VF3U_, VF3X_)	01/07→	9HM (DV6UC)	Diesel	1560	4	8	55
Expert Box (VF3A_, VF3U_, VF3X_)	01/07→	9HU (DV6UTED4)	Diesel	1560	4	16	57
Expert Box (VF3A_, VF3U_, VF3X_)	01/07→	RFH (EW10A)	Petrol	1997	4	16	90
Expert Box (VF3A_, VF3U_, VF3X_)	01/07→	RFJ (EW10A)	Petrol	1997	4	16	91
Expert Box (VF3A_, VF3U_, VF3X_)	01/07→	RHK (DW10UTED4)	Diesel	1997	4	16	96
Expert Box (VF3A_, VF3U_, VF3X_)	01/07→	RHR (DW10BTED4)	Diesel	1997	4	16	96
Expert Box (VF3A_, VF3U_, VF3X_)	09/09→	RHH (DW10CTED4)	Diesel	1997	4	16	86
Expert Box (VF3A_, VF3U_, VF3X_)	03/11→	AHZ (DW10CD)	Diesel	1997	4	16	86
Expert Platform/Chassis	01/07→	9HU (DV6UTED4)	Diesel	1560	4	16	57
Expert Platform/Chassis	01/07→	RHK (DW10UTED4)	Diesel	1997	4	16	96
Expert Platform/Chassis	01/07→	RHR (DW10BTED4)	Diesel	1997	4	16	96
Expert Platform/Chassis	09/09→	RHH (DW10CTED4)	Diesel	1997	4	16	86
Expert Platform/Chassis	03/11→	AHZ (DW10CD)	Diesel	1997	4	16	86
Expert Platform/Chassis	09/16→	AHX (DW10FD)	Diesel	1997	4	16	86
Expert Platform/Chassis	09/16→	BHV (DV6FDU)	Diesel	1560	4	8	55
Expert Platform/Chassis (223)	02/96→05/98	D8B (XUD9TE)	Diesel	1905	4	8	78
Expert Platform/Chassis (223)	02/96→12/98	D9B (XUD9AU)	Diesel	1905	4	8	78
Expert Platform/Chassis (223)	02/96→09/00	222A2 (1580 SPI)	Petrol	1581	4	8	59
Expert Platform/Chassis (223)	02/96→09/00	DHX (XUD9TE)	Diesel	1905	4	8	78
Expert Platform/Chassis (223)	06/98→09/01	WJY (DW8B)	Diesel	1868	4	8	78
Expert Platform/Chassis (223)	06/98→09/01	WJZ (DW8)	Diesel	1868	4	8	78
Expert Platform/Chassis (223)	10/00→10/06	RHW (DW10ATED4)	Diesel	1997	4	16	96
Expert Platform/Chassis (223)	10/00→10/06	RHX (DW10BTED)	Diesel	1997	4	8	98
Expert Tepee (VF3V_)	01/07→	9HH (DV6DUM)	Diesel	1560	4	8	55
Expert Tepee (VF3V_)	01/07→	9HM (DV6UC)	Diesel	1560	4	8	55
Expert Tepee (VF3V_)	01/07→	9HU (DV6UTED4)	Diesel	1560	4	16	57
Expert Tepee (VF3V_)	01/07→	RFH (EW10A)	Petrol	1997	4	16	90
Expert Tepee (VF3V_)	01/07→	RFJ (EW10A)	Petrol	1997	4	16	91
Expert Tepee (VF3V_)	01/07→	RHK (DW10UTED4)	Diesel	1997	4	16	96
Expert Tepee (VF3V_)	01/07→	RHR (DW10BTED4)	Diesel	1997	4	16	96
Expert Tepee (VF3V_)	09/09→	RHH (DW10CTED4)	Diesel	1997	4	16	86
Expert Tepee (VF3V_)	03/11→	AHY (DW10CE)	Diesel	1997	4	16	86
Expert Tepee (VF3V_)	03/11→	AHZ (DW10CD)	Diesel	1997	4	16	86
Express 1000 -1500 Bus	07/82→10/90	XNITA	Petrol	1971	4	8	84
Express 1000 -1500 Bus	07/82→10/94	CRD93	Diesel	2498	4	8	117
Express 1000 -1500 Bus	07/83→10/90	XM7T	Petrol	1796	4	8	73
Express 1000 -1500 Bus	06/87→10/94	CRD93LS	Diesel	2498	4	8	117
Express 1000 -1500 Bus	07/87→10/90	XUD9A	Diesel	1905	4	8	78
Express 1000 -1500 Platform/Chassis	07/82→10/94	CRD93	Diesel	2498	4	8	117
Express 1000 -1500 Platform/Chassis	07/82→10/94	XNITA	Petrol	1971	4	8	84
Express 1000 -1500 Platform/Chassis	06/87→10/94	CRD93LS	Diesel	2498	4	8	117
Express 1000 -1800 Box	07/81→10/90	XM7T	Petrol	1796	4	8	73
Express 1000 -1800 Box	07/82→10/90	XNITA	Petrol	1971	4	8	84
Express 1000 -1800 Box	07/82→10/94	CRD93	Diesel	2498	4	8	117
Express 1000 -1800 Box	06/87→10/94	CRD93LS	Diesel	2498	4	8	117
Express 1000 -1800 Box	07/87→10/90	XUD9A	Diesel	1905	4	8	78
Hoggar	05/10→	KFV (TU3A)	Petrol	1360	4	8	40
Hoggar	05/10→	NFU (TU5JP4)	Petrol	1587	4	16	65
Horizon	02/78→01/80	2G1	Petrol	1294	4	8	24
Horizon	09/78→06/86	2G1-BTC	Petrol	1294	4	8	24
Horizon	01/79→09/84	E1B	Petrol	1118	4	8	8
Horizon	07/79→06/86	2Y1	Petrol	1442	4	8	30
Horizon	07/79→06/86	Y2	Petrol	1424	4	8	46
Horizon	02/82→09/84	2Y1B	Petrol	1424	4	8	30
Horizon	07/82→06/86	6J2A	Petrol	1592	4	8	53
Horizon	07/82→06/86	XUD9	Diesel	1905	4	8	78
Horizon	08/83→07/85	J1B	Petrol	1592	4	8	53
J5 Box (280L)	09/81→08/90	CRD93	Diesel	2498	4	8	117
J5 Box (280L)	09/81→08/90	CRD93L	Diesel	2498	4	8	117
J5 Box (280L)	09/81→08/90	CRD93LS (U25/673)	Diesel	2498	4	8	117
J5 Box (280L)	09/81→08/90	XN1P	Petrol	1971	4	8	84
J5 Box (280L)	01/83→11/88	169B (XM7T)	Petrol	1796	4	8	71
J5 Box (280L)	09/87→08/90	D9B (XUD9A)	Diesel	1905	4	8	78
J5 Box (280L)	09/87→08/90	XN1T	Petrol	1971	4	8	84
J5 Box (280L)	09/87→08/90	XUD9	Diesel	1905	4	8	78
J5 Box (290L)	09/90→01/94	169B (XM7T)	Petrol	1796	4	8	71
J5 Box (290L)	09/90→01/94	170D (XN1TACP)	Petrol	1971	4	8	84
J5 Box (290L)	09/90→01/94	CRD93	Diesel	2498	4	8	117
J5 Box (290L)	09/90→01/94	CRD93L	Diesel	2498	4	8	117
J5 Box (290L)	09/90→01/94	XNITA	Petrol	1971	4	8	84
J5 Box (290L)	10/90→03/94	CRD93 (U25/661)	Diesel	2498	4	8	117
J5 Box (290L)	10/90→03/94	CRD93LS (U25/673)	Diesel	2498	4	8	117
J5 Box (290L)	10/90→03/94	D9B (XUD9A)	Diesel	1905	4	8	78
J5 Bus (280P)	09/81→08/90	XN1P	Petrol	1971	4	8	84
J5 Bus (280P)	09/81→09/90	170B (XN1T)	Petrol	1971	4	8	84

				CC			9
J5 Bus (280P)	09/81→09/90	CRD93 (U25/661)	Diesel	2498	4	8	117
J5 Bus (280P)	01/83→09/90	170 (XN1T)	Petrol	1971	4	8	84
J5 Bus (290P)	10/90→02/94	170D (XN1TACP)	Petrol	1971	4	8	84
J5 Bus (290P)	10/90→02/94	CRD93 (U25/661)	Diesel	2498	4	8	117
J5 Bus (290P)	10/90→02/94	CRD93LS (U25/673)	Diesel	2498	4	8	117
J5 Bus (290P)	10/90→02/94	D9B (XUD9A)	Diesel	1905	4	8	78
J5 Platform/Chassis (280L)	09/81→08/90	169B (XM7T)	Petrol	1796	4	8	71
J5 Platform/Chassis (280L)	09/81→08/90	CRD93	Diesel	2498	4	8	117
J5 Platform/Chassis (280L)	09/81→08/90	CRD93L	Diesel	2498	4	8	117
J5 Platform/Chassis (280L)	09/81→09/90	CRD93 (U25/661)	Diesel	2498	4	8	117
J5 Platform/Chassis (280L)	01/83→11/88	170 (XN1T)	Petrol	1971	4	8	84
J5 Platform/Chassis (280L)	01/86→11/88	170B (XN1T)	Petrol	1971	4	8	84
J5 Platform/Chassis (280L)	09/87→08/90	XUD9	Diesel	1905	4	8	78
J5 Platform/Chassis (290L)	09/90→01/94	169B (XM7T)	Petrol	1796	4	8	71
J5 Platform/Chassis (290L)	09/90→01/94	XN1TA	Petrol	1971	4	8	84
J5 Platform/Chassis (290L)	10/90→02/94	170D (XN1TACP)	Petrol	1971	4	8	84
J5 Platform/Chassis (290L)	10/90→02/94	CRD93 (U25/661)	Diesel	2498	4	8	117
J5 Platform/Chassis (290L)	10/90→02/94	CRD93LS (U25/673)	Diesel	2498	4	8	117
J5 Platform/Chassis (290L)	10/90→02/94	D9B (XUD9A)	Diesel	1905	4	8	78
J7 Box	08/68→07/77	XDP90	Diesel	2112	4	8	102
J7 Box	08/68→07/78	XDP88	Diesel	1948	4	8	81
J7 Box	08/68→03/80	XC7P	Petrol	1618	4	8	67
J7 Box	07/70→03/80	XM7P	Petrol	1796	4	8	71
J7 Box	07/77→03/80	XD2P94	Diesel	2304	4	8	111
J7 Bus	08/68→07/77	XDP90	Diesel	2112	4	8	102
J7 Bus	08/68→07/78	XDP88	Diesel	1948	4	8	81
J7 Bus	07/70→03/80	XC7P	Petrol	1618	4	8	67
J7 Bus	07/70→03/80	XM7P	Petrol	1796	4	8	71
J7 Bus	07/77→03/80	XD2P94	Diesel	2304	4	8	111
J7 Platform/Chassis	08/68→07/77	XDP90	Diesel	2112	4	8	102
J7 Platform/Chassis	08/68→07/78	XDP88	Diesel	1948	4	8	81
J7 Platform/Chassis	07/70→03/80	XC7P	Petrol	1618	4	8	67
J7 Platform/Chassis	07/70→03/80	XM7P	Petrol	1796	4	8	71
J7 Platform/Chassis	07/77→03/80	XD2P94	Diesel	2304	4	8	111
J9 Box	03/80→07/82	XD2PX94	Diesel	2304	4	8	111
J9 Box	03/80→06/87	XC7P	Petrol	1618	4	8	67
J9 Box	03/80→06/87	XDPX90	Diesel	2112	4	8	102
J9 Box	03/80→06/87	XN1P	Petrol	1971	4	8	84
J9 Box	07/82→06/87	XD3P	Diesel	2497	4	8	115
J9 Bus	03/80→07/82	XD2PX94	Diesel	2304	4	8	111
J9 Bus	03/80→06/87	XN1P	Petrol	1971	4	8	84
J9 Bus	08/82→06/87	XD3P	Diesel	2497	4	8	115
J9 Platform/Chassis	03/80→07/82	XD2PX94	Diesel	2304	4	8	111
J9 Platform/Chassis	03/80→06/87	XN1P	Petrol	1971	4	8	84
J9 Platform/Chassis	07/82→06/87	XD3P	Diesel	2497	4	8	115
Matra Bagheera (X)	01/74→03/78	3G4	Petrol	1294	4	8	24
Matra Bagheera (X)	11/79→09/80	Y2	Petrol	1424	4	8	46
Murena	08/81→01/85	X5J2A	Petrol	1577	4	8	53
Partner Box	04/08→	9HS (DV6TED4BU)	Diesel	1560	4	16	57
Partner Box	04/08→	9HT (DV6BTED4)	Diesel	1560	4	16	57
Partner Box	04/08→	9HW (DV6BTED4)	Diesel	1560	4	16	57
Partner Box	04/08→	9HX (DV6ATED4)	Diesel	1560	4	16	57
Partner Box	04/08→	9HX (DV6AUTED4)	Diesel	1560	4	16	55
Partner Box	04/08→	9HZ (DV6TED4)	Diesel	1560	4	16	57
Partner Box	04/08→	NFR (TU5JP4B)	Petrol	1587	4	16	62
Partner Box	04/08→	NFU (TU5JP4)	Petrol	1587	4	16	65
Partner Box	04/10→	5FS (EP6C)	Petrol	1598	4	16	52
Partner Box	04/10→	9HP (DV6DTED)	Diesel	1560	4	8	55
Partner Box	11/10→	5FK (EP6CB)	Petrol	1598	4	16	52
Partner Box	03/13→	9HF (DV6DTED)	Diesel	1560	4	8	55
Partner Box	03/13→	9HL (DV6C)	Diesel	1560	4	8	55
Partner Box	01/14→	9HK (DV6ETEDM)	Diesel	1560	4	8	55
Partner Box	01/14→	9HN (DV6ETED)	Diesel	1560	4	8	55
Partner Box	01/14→	BHW (DV6FE)	Diesel	1560	4	8	55
Partner Box	04/15→	BHY (DV6FD)	Diesel	1560	4	8	55
Partner Box	04/15→	BHZ (DV6FC)	Diesel	1560	4	8	55
Partner Box (5)	05/96→12/02	DJY (XUD9A)	Diesel	1905	4	8	78
Partner Box (5)	06/96→12/02	A9A (XUD7)	Diesel	1769	4	8	72
Partner Box (5)	06/96→09/05	HDZ (TU1M)	Petrol	1124	4	8	11
Partner Box (5)	06/96→12/15	KFX (TU3JP)	Petrol	1361	4	8	36
Partner Box (5)	06/96→12/15	TU32	Petrol	1361	4	8	36
Partner Box (5)	06/96→12/15	WJY (DW8B)	Diesel	1868	4	8	78
Partner Box (5)	06/96→12/15	WJZ (DW8)	Diesel	1868	4	8	78
Partner Box (5)	03/97→08/00	LFX (XU7JB)	Petrol	1761	4	8	74
Partner Box (5)	04/00→07/08	RHY (DW10TD)	Diesel	1997	4	8	98
Partner Box (5)	09/00→10/02	NFU (TU5JP4)	Petrol	1587	4	16	65
Partner Box (5)	11/02→10/06	KFV (TU3A)	Petrol	1360	4	8	40
Partner Box (5)	04/03→10/06	KFW (TU3JP)	Petrol	1360	4	8	42



















CC











9

Partner Box (5)	02/06→07/08	9HW (DV6BTED4)	Diesel	1560	4	16	57
Partner Box (5)	02/06→12/15	9HX (DV6ATED4)	Diesel	1560	4	16	57
Partner Combispac (5F)	05/96→12/98	XUD9	Diesel	1905	4	8	78
Partner Combispac (5F)	06/96→10/02	HDZ (TU1M)	Petrol	1124	4	8	11
Partner Combispac (5F)	06/96→10/02	HFX (TU1JP)	Petrol	1124	4	8	11
Partner Combispac (5F)	06/96→12/02	DJY (XUD9A)	Diesel	1905	4	8	78
Partner Combispac (5F)	06/96→12/15	KFW (TU3JP)	Petrol	1360	4	8	42
Partner Combispac (5F)	06/96→12/15	KFX (TU3JP)	Petrol	1361	4	8	36
Partner Combispac (5F)	06/96→12/15	TU32	Petrol	1361	4	8	36
Partner Combispac (5F)	05/97→12/03	LFX (XU7JB)	Petrol	1761	4	8	74
Partner Combispac (5F)	12/98→07/08	WJY (DW8B)	Diesel	1868	4	8	78
Partner Combispac (5F)	12/98→07/08	WJZ (DW8)	Diesel	1868	4	8	78
Partner Combispac (5F)	02/00→07/08	RHY (DW10TD)	Diesel	1997	4	8	98
Partner Combispac (5F)	09/00→12/15	NFU (TU5JP4)	Petrol	1587	4	16	65
Partner Combispac (5F)	10/05→07/08	KFV (TU3JP)	Petrol	1360	4	8	42
Partner Combispac (5F)	10/05→12/15	9HX (DV6ATED4)	Diesel	1560	4	16	57
Partner Combispac (5F)	02/06→12/13	9HW (DV6BTED4)	Diesel	1560	4	16	57
Partner Platform/Chassis	01/99→07/08	WJY (DW8B)	Diesel	1868	4	8	78
Partner Platform/Chassis	01/99→07/08	WJZ (DW8)	Diesel	1868	4	8	78
Partner Platform/Chassis	01/09→	9HS (DV6TED4BU)	Diesel	1560	4	16	57
Partner Platform/Chassis	01/09→	9HT (DV6BTED4)	Diesel	1560	4	16	57
Partner Platform/Chassis	01/09→	9HX (DV6ATED4)	Diesel	1560	4	16	57
Partner Platform/Chassis	03/13→	9HF (DV6DTED)	Diesel	1560	4	8	55
Partner Tepee	04/08→	9HN (DV6ETED4)	Diesel	1560	4	16	56
Partner Tepee	04/08→	9HT (DV6BTED4)	Diesel	1560	4	16	57
Partner Tepee	04/08→	9HV (DV6TED4)	Diesel	1560	4	16	57
Partner Tepee	04/08→	9HW (DV6BTED4)	Diesel	1560	4	16	57
Partner Tepee	04/08→	9HX (DV6ATED4)	Diesel	1560	4	16	57
Partner Tepee	04/08→	9HZ (DV6TED4)	Diesel	1560	4	16	57
Partner Tepee	04/08→	NFR (TU5JP4B)	Petrol	1587	4	16	62
Partner Tepee	04/08→	NFU (TU5JP4)	Petrol	1587	4	16	65
Partner Tepee	04/10→	SFS (EP6C)	Petrol	1598	4	16	52
Partner Tepee	04/10→	9HP (DV6DTED)	Diesel	1560	4	8	55
Partner Tepee	08/10→	SFK (EP6CB)	Petrol	1598	4	16	52
Partner Tepee	08/10→	9HL (DV6C)	Diesel	1560	4	8	55
Partner Tepee	03/13→	9HF (DV6DTED)	Diesel	1560	4	8	55
Partner Tepee	12/14→	BHY (DV6FD)	Diesel	1560	4	8	55
Partner Tepee	12/14→	BHZ (DV6FC)	Diesel	1560	4	8	55
Partner Tepee	01/15→	9HK (DV6ETEDM)	Diesel	1560	4	8	55
Partner Tepee	01/15→	BHW (DV6FE)	Diesel	1560	4	8	55
Partner Tepee	02/16→	HNZ (EB2DT)	Petrol	1199	3	12	20
Rancho	01/77→07/84	X3Y2	Petrol	1442	4	8	30
RCZ	03/10→	5FV (EP6CDT)	Petrol	1598	4	16	52
RCZ	03/10→	RHH (DW10CTED4)	Diesel	1997	4	16	86
RCZ	06/10→	EP6CDTX	Petrol	1598	4	16	52
RCZ	01/11→	5FM (EP6CDTM)	Petrol	1598	4	16	51
RCZ	03/11→	5FE (EP6CDTMD)	Petrol	1598	4	16	52
RCZ	06/13→	5FG (EP6CDTR)	Petrol	1598	4	16	52
Samba (51A)	01/81→12/85	5C1(XV5)	Petrol	947	4	8	2
Samba (51A)	01/81→12/85	5C1(XV8)	Petrol	947	4	8	2
Samba (51A)	01/81→06/86	XW7	Petrol	1124	4	8	9
Samba (51A)	01/81→06/86	XY7	Petrol	1361	4	8	35
Samba (51A)	01/81→10/86	XY8	Petrol	1361	4	8	45
Samba (51A)	01/83→10/86	129 D	Petrol	1210	4	8	17
Samba (51A)	06/83→10/86	150 D	Petrol	1351	4	8	35
Samba Convertible (51E)	01/81→06/86	XY8	Petrol	1361	4	8	45
Simca 1000	10/61→07/78	1D1	Petrol	944	4	8	1
Simca 1000	10/72→09/77	1G1	Petrol	1294	4	8	23
Simca 1000	10/76→07/78	3E1	Petrol	1118	4	8	8
Simca 1100 Break/Tourisme	10/68→05/72	3E1	Petrol	1118	4	8	8
Simca 1100 Break/Tourisme	10/76→09/79	3E1A	Petrol	1118	4	8	8
Simca 1100 Hatchback	10/72→09/77	3G4	Petrol	1294	4	8	24
Simca 1100 Hatchback	10/76→01/80	3E1	Petrol	1118	4	8	8
Simca 1100 Hatchback	10/76→01/80	3E1A	Petrol	1118	4	8	8
Simca 1609/1610	09/76→03/78	7R2	Petrol	1639	4	8	54
Simca 1609/1610	09/76→12/80	7S2	Petrol	1800	4	8	70
Simca 1609/1610	09/76→12/80	7T2	Petrol	1959	4	8	83
Solara	02/80→06/81	6J2	Petrol	1577	4	8	53
Solara	02/80→06/81	J1	Petrol	1577	4	8	61
Solara	02/80→06/81	J2	Petrol	1577	4	8	61
Solara	02/80→07/86	6G1D/VP	Petrol	1294	4	8	24
Solara	09/81→10/84	6J1	Petrol	1592	4	8	53
Solara	09/81→07/86	J1B	Petrol	1592	4	8	53
Tagora	08/81→10/83	9L6	Petrol	2645	6	12	122
Tagora	08/81→12/87	XD2S	Diesel	2288	4	8	111

	CC				9		CC				9
1D1	944	4	8	Petrol	1	9HD (DV6C)	1560	4	8	Diesel	55
1G1	1294	4	8	Petrol	23	9HD (DV6CTED)	1560	4	8	Diesel	55
1KR-FE	998	3	12	Petrol	4	9HF (DV6DTE)	1560	4	8	Diesel	55
2G1	1294	4	8	Petrol	24	9HH (DV6DUM)	1560	4	8	Diesel	55
2G1-BTC	1294	4	8	Petrol	24	9HJ (DV6DTE)	1560	4	8	Diesel	55
2Y1	1442	4	8	Petrol	30	9HK (DV6ETEDM)	1560	4	8	Diesel	55
2Y1B	1424	4	8	Petrol	30	9HL (DV6C)	1560	4	8	Diesel	55
3E1	1118	4	8	Petrol	8	9HM (DV6UC)	1560	4	8	Diesel	55
3E1A	1118	4	8	Petrol	8	9HN (DV6ETED)	1560	4	8	Diesel	55
3FY (EW12J4)	2230	4	16	Petrol	104	9HN (DV6ETED4)	1560	4	16	Diesel	56
3FZ (EW12J4)	2230	4	16	Petrol	104	9HP (DV6DTE)	1560	4	8	Diesel	55
3G4	1294	4	8	Petrol	24	9HR (DV6C)	1560	4	8	Diesel	55
4B11	1998	4	16	Petrol	82	9HS (DV6TED4BU)	1560	4	16	Diesel	57
4HG (P22DTE)	2198	4	16	Diesel	105	9HT (DV6BTED4)	1560	4	16	Diesel	57
4HH (P22DTE)	2198	4	16	Diesel	105	9HU (DV6UTED4)	1560	4	16	Diesel	57
4HJ (P22DTE)	2198	4	16	Diesel	105	9HV (DV6ATED4)	1560	4	16	Diesel	57
4HK (DW12MTED4)	2179	4	16	Diesel	106	9HV (DV6TED4)	1560	4	16	Diesel	57
4HL (DW12C)	2179	4	16	Diesel	106	9HW (DV6BTED4)	1560	4	16	Diesel	57
4HN (DW12MTED4)	2179	4	16	Diesel	106	9HX (DV6ATED4)	1560	4	16	Diesel	57
4HP (DW12BTED4)	2179	4	16	Diesel	106	9HX (DV6ATED4)	1560	4	16	Diesel	55
4HR (DW12BTED4)	2179	4	16	Diesel	106	9HY (DV6TED4)	1560	4	16	Diesel	57
4HS (DW12BTED4)	2179	4	16	Diesel	106	9HZ (DV6TED4)	1560	4	16	Diesel	57
4HT (DW12BTED4)	2179	4	16	Diesel	106	9L6	2645	6	12	Petrol	122
4HU (P22DTE)	2198	4	16	Diesel	105	105 (XM7)	1796	4	8	Petrol	71
4HV (P22DTE)	2198	4	16	Diesel	105	105C (XM7A)	1796	4	8	Petrol	71
4HW (DW12BTED4)	2179	4	16	Diesel	107	106 (XN1)	1971	4	8	Petrol	84
4HX (DW12TED4/FAP)	2179	4	16	Diesel	108	106E (XN1A)	1971	4	8	Petrol	84
4HY (DW12UTED)	2179	4	8	Diesel	109	107 (XN2)	1971	4	8	Petrol	84
4HZ (DW12TED4)	2179	4	16	Diesel	108	108 (XV3)	954	4	8	Petrol	3
5C1(XV5)	947	4	8	Petrol	2	108 (XV5)	954	4	8	Petrol	3
5C1(XV8)	947	4	8	Petrol	2	108C (XV8)	954	4	8	Petrol	3
5FA (EP6CDT)	1598	4	16	Petrol	51	109 (XW3)	1124	4	8	Petrol	9
5FD (EP6DTS)	1598	4	16	Petrol	52	109F (XW7)	1124	4	8	Petrol	9
5FE (EP6CDTM)	1598	4	16	Petrol	51	109N (XW7)	1124	4	8	Petrol	9
5FE (EP6CDTMD)	1598	4	16	Petrol	52	112 (ZM)	2664	6	12	Petrol	123
5FF (EP6DTS)	1598	4	16	Petrol	52	117 (XR5S)	1472	4	8	Petrol	47
5FG (EP6CDTR)	1598	4	16	Petrol	52	118 (XL5)	1290	4	8	Petrol	25
5FH (EP6C)	1598	4	16	Petrol	52	121 (XW3S)	1124	4	8	Petrol	9
5FK (EP6CB)	1598	4	16	Petrol	52	129 (XZ5)	1219	4	8	Petrol	16
5FM (EP6CDTM)	1598	4	16	Petrol	51	129 D	1210	4	8	Petrol	17
5FN (EP6CDT)	1598	4	16	Petrol	52	134 (XD2)	2304	4	8	Diesel	111
5FR (EP6DT)	1598	4	16	Petrol	52	140 (ZMJ)	2664	6	12	Petrol	123
5FS (EP6C)	1598	4	16	Petrol	52	142 (XR5)	1472	4	8	Petrol	47
5FT (EP6DT)	1598	4	16	Petrol	52	142 (XR5A)	1472	4	8	Petrol	47
5FU (EP6CDTX)	1598	4	16	Petrol	52	147 (XD2S)	2304	4	8	Diesel	111
5FV (EP6CDT)	1598	4	16	Petrol	52	149 (XID)	1548	4	8	Diesel	48
5FW (EP6)	1598	4	16	Petrol	52	150 (XY6B)	1360	4	8	Petrol	34
5FX (EP6DT)	1598	4	16	Petrol	52	150B (XY8)	1360	4	8	Petrol	35
5FY (EP6DTS)	1598	4	16	Petrol	52	150 D	1351	4	8	Petrol	35
5GL (EP6FDTMD)	1598	4	16	Petrol	51	150D (XY7)	1360	4	8	Petrol	34
5GM (EP6FDTX)	1598	4	16	Petrol	52	150G (XY7)	1360	4	8	Petrol	35
5GN (EP6FDTR)	1598	4	16	Petrol	52	150H (XY8)	1360	4	8	Petrol	34
5GP (EP6FDTR)	1598	4	16	Petrol	51	152A (XD3T)	2498	4	8	Diesel	114
5GX (EP6FDTMD)	1598	4	16	Petrol	51	152B (XD3TE)	2498	4	8	Diesel	115
5GY (EP6FDTM)	1598	4	16	Petrol	51	154A (ZMJK)	2849	6	12	Petrol	125
5GZ (EP6FDT)	1598	4	16	Petrol	52	154X (ZN3J)	2849	6	12	Petrol	125
6FY (EW7A)	1749	4	16	Petrol	69	155 (XD3)	2498	4	8	Diesel	116
6FZ (EW7J4)	1749	4	16	Petrol	69	159 (XU9S)	1905	4	8	Petrol	77
6G1	1424	4	8	Petrol	30	161 (XUD7)	1769	4	8	Diesel	68
6G1D	1294	4	8	Petrol	24	161A (XUD7)	1769	4	8	Diesel	68
6G1D/VP	1294	4	8	Petrol	24	162 (XUD9)	1905	4	8	Diesel	78
6J1	1592	4	8	Petrol	53	169B (XM7T)	1796	4	8	Petrol	71
6J2	1577	4	8	Petrol	53	170 (XNIT)	1971	4	8	Petrol	84
6J2A	1592	4	8	Petrol	53	170B (XNIT)	1971	4	8	Petrol	84
6Y2	1424	4	8	Petrol	31	170C (XNITA)	1971	4	8	Petrol	84
6Y2D	1424	4	8	Petrol	30	170D (XNITACP)	1971	4	8	Petrol	84
7R2	1639	4	8	Petrol	54	171 (XU5S)	1580	4	8	Petrol	58
7S2	1800	4	8	Petrol	70	180A (XU5J)	1580	4	8	Petrol	58
7T2	1959	4	8	Petrol	83	180Z (XU5J)	1580	4	8	Petrol	58
8FR (EP3)	1397	4	16	Petrol	32	199 A9.000	1248	4	16	Diesel	26
8FS (EP3)	1397	4	16	Petrol	32	222A2 (1580 SPI)	1581	4	8	Petrol	59
8HP (DV4C)	1398	4	8	Diesel	33	829 (ZEJ)	1995	4	8	Petrol	85
8HR (DV4C)	1398	4	8	Diesel	33	851 (ZDJ)	2165	4	8	Petrol	110
8HS (DV4TED)	1398	4	8	Diesel	33	851B (ZDJL)	2165	4	8	Petrol	110
8HT (DV4TD)	1398	4	8	Diesel	33	851X (ZDJL)	2165	4	8	Petrol	110
8HX (DV4TD)	1398	4	8	Diesel	33	1580 SPI	1581	4	8	Petrol	59
8HZ (DV4TD)	1398	4	8	Diesel	33	8140.23 (F28DTSE)	2798	4	8	Diesel	126
9HC (DV6C)	1560	4	8	Diesel	55	8140.43 (F28DT)	2798	4	8	Diesel	126

	CC				9		CC				9
8140.43N	2798	4	8	Diesel	126	F1	1204	4	8	Petrol	18
8140.43S (F28DTCR)	2798	4	8	Diesel	126	FHY (F13DTE6)	1248	4	16	Diesel	19
8140.63 (F28D)	2798	4	8	Diesel	126	FHZ (F13DTE5)	1248	4	16	Diesel	19
A8A (XUD7TE)	1769	4	8	Diesel	72	G1A	1294	4	8	Petrol	27
A8B (XUD7TE)	1769	4	8	Diesel	68	H1B (TU1)	1124	4	8	Petrol	10
A9A (XUD7)	1769	4	8	Diesel	72	HDY (TU1M)	1124	4	8	Petrol	10
AHH (DW10FC)	1997	4	16	Diesel	86	HDZ (TU1M)	1124	4	8	Petrol	11
AHN (DW10FUD)	1997	4	16	Diesel	86	HDZ (TU1M+)	1124	4	8	Petrol	12
AHP (DW10FUC)	1997	4	16	Diesel	86	HFX (TU1A)	1124	4	8	Petrol	12
AHR (DW10FD)	1997	4	16	Diesel	86	HFX (TU1JP)	1124	4	8	Petrol	11
AHV (DW10FD)	1997	4	16	Diesel	86	HFY (TU1JP)	1124	4	8	Petrol	12
AHW (DW10FC)	1997	4	16	Diesel	86	HFZ (TU1JP)	1124	4	8	Petrol	12
AHX (DW10FD)	1997	4	16	Diesel	86	HMT (EB2D)	1199	3	12	Petrol	20
AHY (DW10CE)	1997	4	16	Diesel	86	HMY (EB2M)	1199	3	12	Petrol	20
AHZ (DW10CD)	1997	4	16	Diesel	86	HMZ (EB2F)	1199	3	12	Petrol	20
AJZ (XUD7TEY)	1769	4	8	Diesel	72	HNY (EB2DTS)	1199	3	12	Petrol	20
B1A (XU51C)	1580	4	8	Petrol	58	HNZ (EB2DT)	1199	3	12	Petrol	20
B1D (XU51C)	1580	4	8	Petrol	58	J1	1577	4	8	Petrol	61
B1E (XU51C)	1580	4	8	Petrol	58	J1B	1592	4	8	Petrol	53
B2A (XU52C)	1580	4	8	Petrol	60	J2	1577	4	8	Petrol	61
B2A (XU52C/K)	1580	4	8	Petrol	58	K1D (TU3A)	1361	4	8	Petrol	36
B6B (XU5J)	1580	4	8	Petrol	58	K2B (TU3S)	1360	4	8	Petrol	36
B6D (XU5JA)	1580	4	8	Petrol	58	K5A (TU3)	1360	4	8	Petrol	37
BAZ (XU5CP)	1580	4	8	Petrol	58	K9Y (TUD3Y)	1361	4	8	Diesel	38
BDY (XU5M2Z)	1580	4	8	Petrol	58	KAY (TU3CP)	1361	4	8	Petrol	36
BDY (XU5M3Z)	1580	4	8	Petrol	58	KDX (TU3MC)	1361	4	8	Petrol	36
BDZ (XU5M)	1580	4	8	Petrol	58	KDY (TU3M)	1361	4	8	Petrol	39
BFZ (XU5JP)	1580	4	8	Petrol	58	KDZ (TU3M)	1361	4	8	Petrol	36
BHV (DV6FDU)	1560	4	8	Diesel	55	KF5	1796	4	8	Petrol	73
BHW (DV6FE)	1560	4	8	Diesel	55	KF6	1796	4	8	Petrol	73
BHX (DV6FC)	1560	4	8	Diesel	55	KFT (TU3A)	1360	4	8	Petrol	40
BHY (DV6FD)	1560	4	8	Diesel	55	KFU (ET3J4)	1360	4	16	Petrol	41
BHZ (DV6FC)	1560	4	8	Diesel	55	KFV (TU3A)	1360	4	8	Petrol	40
CDY (TU9M)	954	4	8	Petrol	5	KFV (TU3JP)	1360	4	8	Petrol	42
CDZ (TU9M)	954	4	8	Petrol	5	KFW (TU3A)	1360	4	8	Petrol	40
CFA (384F)	998	3	12	Petrol	4	KFW (TU3JP)	1360	4	8	Petrol	42
CFB (1KR)	998	3	12	Petrol	4	KFX (TU3JP)	1361	4	8	Petrol	36
CRD93	2498	4	8	Diesel	117	KFZ (TU3J2/Z)	1361	4	8	Petrol	43
CRD93	2498	4	8	Diesel	117	LFW (XU7JP)	1761	4	8	Petrol	74
CRD93 (U25/661)	2498	4	8	Diesel	117	LFY (XU7JB)	1761	4	8	Petrol	74
CRD93L	2498	4	8	Diesel	117	LFY (XU7JP4)	1761	4	16	Petrol	75
CRD93LS	2498	4	8	Diesel	117	LFZ (XU7JP)	1762	4	8	Petrol	74
CRD93LS (U25/673)	2498	4	8	Diesel	117	N6A (TU5JP4)	1587	4	16	Petrol	62
D2A (XU92C)	1905	4	8	Petrol	77	NFP (EC5)	1587	4	16	Petrol	63
D2B (XU95)	1905	4	8	Petrol	77	NFR (TU5JP4B)	1587	4	16	Petrol	62
D2C (XU92C)	1905	4	8	Petrol	77	NFT (TU5JP)	1587	4	8	Petrol	64
D6A (XU9J2)	1905	4	8	Petrol	77	NFU (TU5JP4)	1587	4	16	Petrol	65
D6B (XU9JA)	1905	4	8	Petrol	77	NFW (TU5J2)	1587	4	8	Petrol	66
D6C (XU9J4)	1905	4	16	Petrol	79	NFX (TU5J4)	1587	4	16	Petrol	62
D8A (XUD9TE)	1905	4	8	Diesel	78	NFY (TU5J2)	1587	4	8	Petrol	64
D8B (XUD9TE)	1905	4	8	Diesel	78	NFZ (TU5JP)	1587	4	8	Petrol	64
D8C (XUD9AU)	1905	4	8	Diesel	78	P8C (XUD11BTE)	2088	4	12	Diesel	100
D8C (XUD9UTF)	1905	4	8	Diesel	78	P9A (XUD11A)	2138	4	12	Diesel	100
D9A (XUD9)	1905	4	8	Diesel	78	PHZ (XUD11ATE)	2088	4	12	Diesel	100
D9B (XUD9A)	1905	4	8	Diesel	78	R5A (XU102C)	1998	4	8	Petrol	89
D9B (XUD9AU)	1905	4	8	Diesel	78	R6A (XU10J2)	1998	4	8	Petrol	89
DDZ (XU9M)	1905	4	8	Petrol	77	RFH (EW10A)	1997	4	16	Petrol	90
DFW (XU9JAZ)	1905	4	16	Petrol	79	RFJ (EW10A)	1997	4	16	Petrol	91
DFZ (XU9J1)	1905	4	8	Petrol	77	RFK (EW10J4S)	1997	4	16	Petrol	88
DHV (XUD9BSD)	1905	4	8	Diesel	78	RFL (XU10J2U)	1998	4	8	Petrol	89
DHW (XUD9SD)	1905	4	8	Diesel	78	RFN (EW10J4)	1997	4	16	Petrol	88
DHX (XUD9TE)	1905	4	8	Diesel	78	RFR (DEW10J4)	1997	4	16	Petrol	88
DHY (XUD9TE)	1905	4	8	Diesel	78	RFS (XU10J4RS)	1998	4	16	Petrol	92
DJY (XUD9A)	1905	4	8	Diesel	78	RFT (XU10J4)	1998	4	16	Petrol	93
DJZ (XUD9Y)	1905	4	8	Diesel	78	RFU (XU10J2)	1998	4	8	Petrol	89
DKZ (XU9JAZ)	1905	4	8	Petrol	77	RFV (XU10J4R)	1998	4	16	Petrol	94
DT17TED4	2721	6	24	Diesel	124	RFW (XU10J2)	1998	4	8	Petrol	89
DT20C	2993	6	24	Diesel	127	RFX (XU10J2)	1998	4	8	Petrol	89
E1	1118	4	8	Petrol	8	RFY (XU10J4Z)	1998	4	16	Petrol	95
E1B	1118	4	8	Petrol	8	RFZ (XU10J2Z)	1998	4	8	Petrol	89
EN 55	2498	4	8	Diesel	118	RGX (XU10J2CTE)	1998	4	8	Petrol	89
EP3	1397	4	16	Petrol	32	RGX (XU10J2TE)	1998	4	8	Petrol	89
EP3C	1397	4	16	Petrol	32	RGY (XU10J2TE)	1998	4	8	Petrol	89
EP6	1598	4	16	Petrol	52	RGZ (XU10J4TE/Z)	1998	4	16	Petrol	93
EP6CDTX	1598	4	16	Petrol	52	RHC (DW10CTED4)	1997	4	16	Diesel	86
ET 70	2496	4	8	Diesel	119	RHD (DW10CTED4)	1997	4	16	Diesel	86
EW10A	1997	4	16	Petrol	87	RHE (DW10CTED4)	1997	4	16	Diesel	86
EW10J4	1997	4	16	Petrol	88	RHF (DW10BTE4)	1997	4	16	Diesel	96

	CC				9		CC				9
RHH (DW10CTED4)	1997	4	16	Diesel	86	XM7T	1796	4	8	Petrol	73
RHK (DW10UTED4)	1997	4	16	Diesel	96	XN1	1971	4	8	Petrol	84
RHL (DW10BTED4)	1997	4	16	Diesel	96	XN1P	1971	4	8	Petrol	84
RHM (DW10ATED4)	1997	4	16	Diesel	96	XN1T	1971	4	8	Petrol	84
RHO (DW10DTED4)	1997	4	16	Diesel	97	XN1TA	1971	4	8	Petrol	84
RHR (DW10BTED4)	1997	4	16	Diesel	96	XN1TA	1971	4	8	Petrol	84
RHS (DW10ATED)	1997	4	8	Diesel	98	XUD7T	1769	4	8	Diesel	72
RHT (DW10ATED4)	1997	4	16	Diesel	96	XUD9	1905	4	8	Diesel	78
RHV (DW10TD)	1997	4	8	Diesel	98	XUD9	1905	4	8	Diesel	78
RHV (DW10UTD)	1997	4	8	Diesel	98	XUD9A	1905	4	8	Diesel	78
RHW (DW10ATED4)	1997	4	16	Diesel	96	XUD9TE	1905	4	8	Diesel	78
RHX (DW10BTED)	1997	4	8	Diesel	98	XV 5	954	4	8	Petrol	6
RHY (DW10TD)	1997	4	8	Diesel	98	XV 8	954	4	8	Petrol	6
RHZ (DW10ATED)	1997	4	8	Diesel	98	XW3S	1124	4	8	Petrol	15
RHZ (DW10BTED)	1997	4	8	Diesel	99	XW7	1124	4	8	Petrol	9
RHZ (DW10BTED+)	1997	4	8	Diesel	99	XY 6B	1360	4	8	Petrol	34
RHZ (DW10CTED)	1997	4	8	Diesel	98	XY7	1361	4	8	Petrol	35
RLZ (EW10D)	1997	4	16	Petrol	88	XY8	1361	4	8	Petrol	45
SFY (4B12-MMC)	2360	4	16	Petrol	112	XZ7R	1219	4	8	Petrol	22
SFZ (4B12-MMC)	2360	4	16	Petrol	112	Y2	1424	4	8	Petrol	46
SFZ (ZPJ/Z)	2975	6	12	Petrol	128	Y2/K	1442	4	8	Petrol	50
SKZ (ZPJ4/Z)	2963	6	24	Petrol	129	ZMZ (EBO)	999	3	12	Petrol	7
T8A (DJ5T)	2446	4	12	Diesel	113						
T9A (DJ5)	2446	4	12	Diesel	113						
THX (DJ5TED)	2446	4	8	Diesel	120						
THY (DK5ATE)	2446	4	12	Diesel	121						
TUIAE5	1124	4	8	Petrol	13						
TU2J2	1294	4	8	Petrol	28						
TU5JP4	1587	4	16	Petrol	62						
TU9	954	4	8	Petrol	5						
TU24	1294	4	8	Petrol	29						
TU32	1361	4	8	Petrol	36						
UFZ (ZPJ)	2963	6	12	Petrol	130						
UHZ (DT17)	2720	6	24	Diesel	124						
UHZ (DT17BTED4)	2720	6	24	Diesel	124						
UKZ (ZPJ4/Z)	2963	6	24	Petrol	129						
VJX (TUD5)	1527	4	8	Diesel	49						
VJY (TUD5)	1527	4	8	Diesel	49						
VJZ (TUD5)	1527	4	8	Diesel	49						
WJY (DW8B)	1868	4	8	Diesel	78						
WJZ (DW8)	1868	4	8	Diesel	78						
X3Y2	1442	4	8	Petrol	30						
X5J2A	1577	4	8	Petrol	53						
XC7	1618	4	8	Petrol	67						
XC7P	1618	4	8	Petrol	67						
XD2	2304	4	8	Diesel	111						
XD2	2304	4	8	Diesel	111						
XD2P94	2304	4	8	Diesel	111						
XD2PX94	2304	4	8	Diesel	111						
XD2S	2288	4	8	Diesel	111						
XD2S	2304	4	8	Diesel	111						
XD3P	2497	4	8	Diesel	115						
XD3T	2497	4	8	Diesel	114						
XD3TE	2498	4	8	Diesel	115						
XD4x88	1948	4	8	Diesel	80						
XD4x90	2112	4	8	Diesel	101						
XD90	2112	4	8	Diesel	102						
XDP 4.88	1948	4	8	Diesel	80						
XDP 4.90	2112	4	8	Diesel	103						
XDP85	1816	4	8	Diesel	76						
XDP88	1948	4	8	Diesel	81						
XDP90	2112	4	8	Diesel	102						
XDPX90	2112	4	8	Diesel	102						
XFV (ES9A)	2946	6	24	Petrol	131						
XFX (ES9J4S)	2946	6	24	Petrol	132						
XFZ (ES9J4)	2946	6	24	Petrol	132						
XK	1130	4	8	Petrol	14						
XK4	1130	4	8	Petrol	14						
XK5	1127	4	8	Petrol	14						
XL3	1290	4	8	Petrol	25						
XL3S	1290	4	8	Petrol	25						
XL4D	1357	4	8	Diesel	44						
XL5	1290	4	8	Petrol	25						
XL5S	1290	4	8	Petrol	25						
XLD	1225	4	8	Diesel	21						
XM	1796	4	8	Petrol	73						
XM7	1796	4	8	Petrol	71						
XM7P	1796	4	8	Petrol	71						

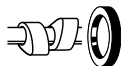

1 0.9L Petrol

1D1	4 Cyl.	8 Valves	944cc	TD5290
				NF695 40.00 x 58.00 x 8.00mm, ACM NF692 71.00 x 88.00 x 8.00mm, MVQ

2 0.9L Petrol

5C1(XV5)	4 Cyl.	8 Valves	947cc	TD4925
5C1(XV8)	4 Cyl.	8 Valves	947cc	TD4926
HR569				NJ242 35.00 x 50.00 x 8.00mm, NBR NF641 78.00 x 100.00 x 10.00mm, MVQ

3 0.9L Petrol

108 (XV3)	4 Cyl.	8 Valves	954cc	TD2892
108 (XV5)	4 Cyl.	8 Valves	954cc	TD2893
108C (XV8)	4 Cyl.	8 Valves	954cc	TD2894
HR300				NJ242 35.00 x 50.00 x 8.00mm, NBR NF641 78.00 x 100.00 x 10.00mm, MVQ

4 1.0L Petrol

1KR-FE	3 Cyl.	12 Valves	998cc	TD32322
CFA (384F)	3 Cyl.	12 Valves	998cc	TD32881
CFB (1KR)	3 Cyl.	12 Valves	998cc	TD34075
				NA5260 38.00 x 50.00 x 6.00mm, FPM NA5324 74.00 x 89.00 x 8.50mm, FPM

5 1.0L Petrol

CDY (TU9M)	4 Cyl.	8 Valves	954cc	TD4841
CDZ (TU9M)	4 Cyl.	8 Valves	954cc	TD9405
TU9	4 Cyl.	8 Valves	954cc	TD2783
HR816				NF817 36.00 x 50.00 x 7.00mm, FPM NF870 42.00 x 66.00 x 6.00mm, FPM/ACM NF850 85.00 x 105.00 x 8.00mm, FPM NF857 85.00 x 105.00 x 9.00mm, FPM/ACM

6 1.0L Petrol

XV 5	4 Cyl.	8 Valves	954cc	TD17982
XV 8	4 Cyl.	8 Valves	954cc	TD17983
HR569				NJ242 35.00 x 50.00 x 8.00mm, NBR NF641 78.00 x 100.00 x 10.00mm, MVQ



7 1.0L Petrol

ZMZ (EBO)	3 Cyl.	12 Valves	999cc	TD32359
				NA5363 61.00 x 75.00 x 8.00mm, PTFE/ACM LK5020 85.00 x 154.00 x 9.50mm, PTFE/ACM

8 1.1L Petrol

3E1	4 Cyl.	8 Valves	1118cc	TD3675
3E1A	4 Cyl.	8 Valves	1118cc	TD5300
E1	4 Cyl.	8 Valves	1118cc	TD4832
E1B	4 Cyl.	8 Valves	1118cc	TD3685
HR569				NF694 40.00 x 58.00 x 8.00mm, ACM NF692 71.00 x 88.00 x 8.00mm, MVQ

9 1.1L Petrol

109 (XW3)	4 Cyl.	8 Valves	1124cc	TD2895
109F (XW7)	4 Cyl.	8 Valves	1124cc	TD2899
109N (XW7)	4 Cyl.	8 Valves	1124cc	TD2900
121 (XW3S)	4 Cyl.	8 Valves	1124cc	TD2896
XW7	4 Cyl.	8 Valves	1124cc	TD4927
HR300				NJ242 35.00 x 50.00 x 8.00mm, NBR NF641 78.00 x 100.00 x 10.00mm, MVQ

10 1.1L Petrol

H1B (TU1)	4 Cyl.	8 Valves	1124cc	TD2758
HDY (TU1M)	4 Cyl.	8 Valves	1124cc	TD9404
HR816				NF817 36.00 x 50.00 x 7.00mm, FPM NF870 42.00 x 66.00 x 6.00mm, FPM/ACM NF850 85.00 x 105.00 x 8.00mm, FPM NF857 85.00 x 105.00 x 9.00mm, FPM/ACM

11 1.1L Petrol

HDZ (TU1M)	4 Cyl.	8 Valves	1124cc	TD4834
HFX (TU1JP)	4 Cyl.	8 Valves	1124cc	TD14728
HR816				NF817 36.00 x 50.00 x 7.00mm, FPM NA5363 61.00 x 75.00 x 8.00mm, PTFE/ACM NA5362 85.00 x 105.00 x 8.00mm, PTFE/ACM

12 1.1L Petrol

HDZ (TU1M+)	4 Cyl.	8 Valves	1124cc	TD26413
HFX (TU1A)	4 Cyl.	8 Valves	1124cc	TD25640
HFY (TU1JP)	4 Cyl.	8 Valves	1124cc	TD32323
HFZ (TU1JP)	4 Cyl.	8 Valves	1124cc	TD9848
HR816				NF817 36.00 x 50.00 x 7.00mm, FPM NF870 42.00 x 66.00 x 6.00mm, FPM/ACM NF850 85.00 x 105.00 x 8.00mm, FPM

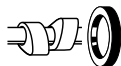

13 1.1L

Petrol

TU1AE5	4 Cyl.	8 Valves	1124cc	TD25641
HR816	NF817		NF870	
	36.00 x 50.00 x 7.00mm, FPM		42.00 x 66.00 x 6.00mm, FPM/ACM	
			NA5362	
			85.00 x 105.00 x 8.00mm, PTFE/ACM	

14 1.1L

Petrol

XK	4 Cyl.	8 Valves	1130cc	TD2814
XK4	4 Cyl.	8 Valves	1130cc	TD2820
XK5	4 Cyl.	8 Valves	1127cc	TD2815
HR300			NF640	
			60.50 x 78.00 x 9.00mm, MVQ	

15 1.1L

Petrol

XW3S	4 Cyl.	8 Valves	1124cc	TD12688
HR300	NJ933		NJ242	
	35.00 x 50.00 x 8.00mm, FPM		35.00 x 50.00 x 8.00mm, NBR	
			NF641	
			78.00 x 100.00 x 10.00mm, MVQ	

16 1.2L

Petrol

129 (XZ5)	4 Cyl.	8 Valves	1219cc	TD2906
HR300			NJ242	
			35.00 x 50.00 x 8.00mm, NBR	
			NF641	
			78.00 x 100.00 x 10.00mm, MVQ	

17 1.2L

Petrol

129 D	4 Cyl.	8 Valves	1210cc	TD5292
HR300	NJ933		NJ242	
	35.00 x 50.00 x 8.00mm, FPM		35.00 x 50.00 x 8.00mm, NBR	
			NF641	
			78.00 x 100.00 x 10.00mm, MVQ	

18 1.2L

Petrol

F1	4 Cyl.	8 Valves	1204cc	TD2750
HR300			NF694	
			40.00 x 58.00 x 8.00mm, ACM	
			NF692	
			71.00 x 88.00 x 8.00mm, MVQ	

19 1.2L

Diesel

FHY (F13DTE6)	4 Cyl.	16 Valves	1248cc	TD32883
FHZ (F13DTE5)	4 Cyl.	16 Valves	1248cc	TD33005
HR5088			NA5223	
			40.00 x 52.00 x 7.00mm, FPM	
			NA5230	
			78.00 x 100.00 x 9.00mm, PTFE	

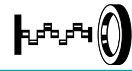
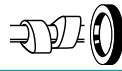

20 1.2L		Petrol			
HMT (EB2D)	3 Cyl.	12 Valves	1199cc		TD32324
HMY (EB2M)	3 Cyl.	12 Valves	1199cc		TD32325
HMZ (EB2F)	3 Cyl.	12 Valves	1199cc		TD32315
HNY (EB2DTS)	3 Cyl.	12 Valves	1199cc		TD28613
HNZ (EB2DT)	3 Cyl.	12 Valves	1199cc		TD29556
				NA5363 61.00 x 75.00 x 8.00mm, PTFE/ACM LK5020 85.00 x 154.00 x 9.50mm, PTFE/ACM	

21 1.2L		Diesel			
XLD	4 Cyl.	8 Valves	1225cc		TD2823
HR340					NF387 42.00 x 60.00 x 10.00mm, NBR NF640 60.50 x 78.00 x 9.00mm, MVQ

22 1.2L		Petrol			
XZ7R	4 Cyl.	8 Valves	1219cc		TD3696
HR569					NJ242 35.00 x 50.00 x 8.00mm, NBR NF641 78.00 x 100.00 x 10.00mm, MVQ

23 1.3L		Petrol			
1G1	4 Cyl.	8 Valves	1294cc		TD5289
				NF695 40.00 x 58.00 x 8.00mm, ACM NF692 71.00 x 88.00 x 8.00mm, MVQ	

24 1.3L		Petrol			
2G1	4 Cyl.	8 Valves	1294cc		TD3674
2G1-BTC	4 Cyl.	8 Valves	1294cc		TD3672
3G4	4 Cyl.	8 Valves	1294cc		TD5299
6G1D	4 Cyl.	8 Valves	1294cc		TD3677
6G1D/VP	4 Cyl.	8 Valves	1294cc		TD3686
HR569					NF694 40.00 x 58.00 x 8.00mm, ACM NF692 71.00 x 88.00 x 8.00mm, MVQ

25 1.3L		Petrol			
118 (XL5)	4 Cyl.	8 Valves	1290cc		TD2822
XL3	4 Cyl.	8 Valves	1290cc		TD2816
XL3S	4 Cyl.	8 Valves	1290cc		TD2818
XL5	4 Cyl.	8 Valves	1290cc		TD4844
XL5S	4 Cyl.	8 Valves	1290cc		TD2821
HR300					NF640 60.50 x 78.00 x 9.00mm, MVQ

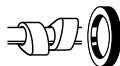

26 1.3L

Diesel

199 A9.000	4 Cyl.	16 Valves	1248cc	TD26979
HR5088				NA5223 40.00 x 52.00 x 7.00mm, FPM NA5230 78.00 x 100.00 x 9.00mm, PTFE

27 1.3L

Petrol

G1A	4 Cyl.	8 Valves	1294cc	TD4833
HR569				NF817 36.00 x 50.00 x 7.00mm, FPM NF694 40.00 x 58.00 x 8.00mm, ACM NF692 71.00 x 88.00 x 8.00mm, MVQ

28 1.3L

Petrol

TU2J2	4 Cyl.	8 Valves	1294cc	TD2763
HR816				NF817 36.00 x 50.00 x 7.00mm, FPM NF870 42.00 x 66.00 x 6.00mm, FPM/ACM NF850 85.00 x 105.00 x 8.00mm, FPM NF857 85.00 x 105.00 x 9.00mm, FPM/ACM

29 1.3L

Petrol

TU24	4 Cyl.	8 Valves	1294cc	TD12689
HR816				NF817 36.00 x 50.00 x 7.00mm, FPM NF870 42.00 x 66.00 x 6.00mm, FPM/ACM NF850 85.00 x 105.00 x 8.00mm, FPM

30 1.4L

Petrol

2Y1	4 Cyl.	8 Valves	1442cc	TD3697
2Y1B	4 Cyl.	8 Valves	1424cc	TD5295
6G1	4 Cyl.	8 Valves	1424cc	TD3676
6Y2D	4 Cyl.	8 Valves	1424cc	TD4921
X3Y2	4 Cyl.	8 Valves	1442cc	TD3693
HR569				NF694 40.00 x 58.00 x 8.00mm, ACM NF692 71.00 x 88.00 x 8.00mm, MVQ

31 1.4L

Petrol

6Y2	4 Cyl.	8 Valves	1424cc	TD4920
HR569				NA5058 40.00 x 55.00 x 7.00mm, FPM NF694 40.00 x 58.00 x 8.00mm, ACM NF692 71.00 x 88.00 x 8.00mm, MVQ

32 1.4L

Petrol

8FR (EP3)	4 Cyl.	16 Valves	1397cc	TD32314
8FS (EP3)	4 Cyl.	16 Valves	1397cc	TD24728
EP3	4 Cyl.	16 Valves	1397cc	TD24067
EP3C	4 Cyl.	16 Valves	1397cc	TD26999
HR5110				NA5363 61.00 x 75.00 x 8.00mm, PTFE/ACM NA5362 85.00 x 105.00 x 8.00mm, PTFE/ACM

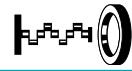
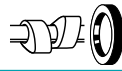

33 1.4L

Diesel

8HP (DV4C)	4 Cyl.	8 Valves	1398cc	TD28225
8HR (DV4C)	4 Cyl.	8 Valves	1398cc	TD28125
8HS (DV4TED)	4 Cyl.	8 Valves	1398cc	TD29164
8HT (DV4TD)	4 Cyl.	8 Valves	1398cc	TD24924
8HX (DV4TD)	4 Cyl.	8 Valves	1398cc	TD16368
8HZ (DV4TD)	4 Cyl.	8 Valves	1398cc	TD17509
PA5068 (x8) HR5120	NA5258 27.00 x 47.00 x 7.00mm, PTFE		NA5259 40.00 x 55.00 x 6.40mm, PTFE NA5325 85.00 x 105.00 x 8.80mm, PTFE	

34 1.4L

Petrol

150 (XY6B)	4 Cyl.	8 Valves	1360cc	TD2901
150D (XY7)	4 Cyl.	8 Valves	1360cc	TD2902
150H (XY8)	4 Cyl.	8 Valves	1360cc	TD2904
XY 6B HR569	4 Cyl.	8 Valves	1360cc	TD17984
				NJ242 35.00 x 50.00 x 8.00mm, NBR NF641 78.00 x 100.00 x 10.00mm, MVQ

35 1.4L

Petrol

150B (XY8)	4 Cyl.	8 Valves	1360cc	TD2905
150 D	4 Cyl.	8 Valves	1351cc	TD5291
150G (XY7)	4 Cyl.	8 Valves	1360cc	TD2903
XY7 HR300	4 Cyl.	8 Valves	1361cc	TD4928
				NJ242 35.00 x 50.00 x 8.00mm, NBR NF641 78.00 x 100.00 x 10.00mm, MVQ

36 1.4L

Petrol

K1D (TU3A)	4 Cyl.	8 Valves	1361cc	TD2766
K2B (TU3S)	4 Cyl.	8 Valves	1360cc	TD2779
KAY (TU3CP)	4 Cyl.	8 Valves	1361cc	TD2767
KDX (TU3MC)	4 Cyl.	8 Valves	1361cc	TD2777
KDZ (TU3M)	4 Cyl.	8 Valves	1361cc	TD2775
KFX (TU3JP)	4 Cyl.	8 Valves	1361cc	TD5396
TU32 HR816	4 Cyl.	8 Valves	1361cc	TD8507
		NF817 36.00 x 50.00 x 7.00mm, FPM		NF870 42.00 x 66.00 x 6.00mm, FPM/ACM NF850 85.00 x 105.00 x 8.00mm, FPM

37 1.4L

Petrol

KSA (TU3)	4 Cyl.	8 Valves	1360cc	TD26412
HR816	NF817 36.00 x 50.00 x 7.00mm, FPM		NA5331 42.00 x 66.00 x 7.00mm, PTFE NA5362 85.00 x 105.00 x 8.00mm, PTFE/ACM	



38 1.4L

Diesel

K9Y (TUD3Y)	4 Cyl.	8 Valves	1361cc	TD2786
HR816	NF817 36.00 x 50.00 x 7.00mm, FPM		NF870 42.00 x 66.00 x 6.00mm, FPM/ACM NF850 85.00 x 105.00 x 8.00mm, FPM	

39 1.4L

Petrol

KDY (TU3M)	4 Cyl.	8 Valves	1361cc	TD4836
HR816	NF817 36.00 x 50.00 x 7.00mm, FPM		NF870 42.00 x 66.00 x 6.00mm, FPM/ACM NF850 85.00 x 105.00 x 8.00mm, FPM NF857 85.00 x 105.00 x 9.00mm, FPM/ACM	

40 1.4L

Petrol

KFT (TU3A)	4 Cyl.	8 Valves	1360cc	TD24931
KFV (TU3A)	4 Cyl.	8 Valves	1360cc	TD21111
KFW (TU3A)	4 Cyl.	8 Valves	1360cc	TD24927
HR816	NA5364 36.00 x 50.00 x 8.00mm, ACM		NA5331 42.00 x 66.00 x 7.00mm, PTFE NA5362 85.00 x 105.00 x 8.00mm, PTFE/ACM	

41 1.4L

Petrol

KFU (ET3J4)	4 Cyl.	16 Valves	1360cc	TD17550
	NA5364 36.00 x 50.00 x 8.00mm, ACM NA5453 24.00 x 50.00 x 8.00mm, PTFE/ACM		NA5331 42.00 x 66.00 x 7.00mm, PTFE NF850 85.00 x 105.00 x 8.00mm, FPM	

42 1.4L

Petrol

KFV (TU3JP)	4 Cyl.	8 Valves	1360cc	TD18518
KFW (TU3JP)	4 Cyl.	8 Valves	1360cc	TD14729
HR816	NF817 36.00 x 50.00 x 7.00mm, FPM		NA5331 42.00 x 66.00 x 7.00mm, PTFE NF850 85.00 x 105.00 x 8.00mm, FPM	

43 1.4L

Petrol

KFZ (TU3J2/Z)	4 Cyl.	8 Valves	1361cc	TD2770
PA858 (x8) HR816	NF817 36.00 x 50.00 x 7.00mm, FPM		NF870 42.00 x 66.00 x 6.00mm, FPM/ACM NF850 85.00 x 105.00 x 8.00mm, FPM	

44 1.4L

Diesel

XL4D	4 Cyl.	8 Valves	1357cc	TD2819
HR340			NF387 42.00 x 60.00 x 10.00mm, NBR NF640 60.50 x 78.00 x 9.00mm, MVQ	



45 1.4L		Petrol			
XY8		4 Cyl.	8 Valves	1361cc	TD4929
HR569		NJ933 35.00 x 50.00 x 8.00mm, FPM		NJ242 35.00 x 50.00 x 8.00mm, NBR NF641 78.00 x 100.00 x 10.00mm, MVQ	
46 1.4L		Petrol			
Y2		4 Cyl.	8 Valves	1424cc	TD4930
HR569					
47 1.5L		Petrol			
117 (XR5S)		4 Cyl.	8 Valves	1472cc	TD2844
142 (XR5)		4 Cyl.	8 Valves	1472cc	TD2749
142 (XR5A)		4 Cyl.	8 Valves	1472cc	TD2842
HR300				NF640 60.50 x 78.00 x 9.00mm, MVQ	
48 1.5L		Diesel			
149 (XID)		4 Cyl.	8 Valves	1548cc	TD2812
				NF734 45.00 x 62.00 x 10.00mm, MVQ NF640 60.50 x 78.00 x 9.00mm, MVQ	
49 1.5L		Diesel			
VJX (TUD5)		4 Cyl.	8 Valves	1527cc	TD16193
VJY (TUD5)		4 Cyl.	8 Valves	1527cc	TD4842
VJZ (TUD5)		4 Cyl.	8 Valves	1527cc	TD33011
HR816		NF817 36.00 x 50.00 x 7.00mm, FPM		NF870 42.00 x 66.00 x 6.00mm, FPM/ACM NF850 85.00 x 105.00 x 8.00mm, FPM	
50 1.5L		Petrol			
Y2/K		4 Cyl.	8 Valves	1442cc	TD12429
HR569				NF694 40.00 x 58.00 x 8.00mm, ACM NF692 71.00 x 88.00 x 8.00mm, MVQ	
51 1.6L		Petrol			
5FA (EP6CDT)		4 Cyl.	16 Valves	1598cc	TD34216
5FE (EP6CDTM)		4 Cyl.	16 Valves	1598cc	TD34215
5FM (EP6CDTM)		4 Cyl.	16 Valves	1598cc	TD34208
5GL (EP6FDTMD)		4 Cyl.	16 Valves	1598cc	TD34219
5GP (EP6FDTR)		4 Cyl.	16 Valves	1598cc	TD34223
5GX (EP6FDTMD)		4 Cyl.	16 Valves	1598cc	TD34218
5GY (EP6FTDM)		4 Cyl.	16 Valves	1598cc	TD34217
				NA5363 61.00 x 75.00 x 8.00mm, PTFE/ACM NA5362 85.00 x 105.00 x 8.00mm, PTFE/ACM	



52 1.6L

Petrol

SFD (EP6DTS)	4 Cyl.	16 Valves	1598cc	TD34214
SFE (EP6CDTMD)	4 Cyl.	16 Valves	1598cc	TD33157
SFF (EP6DTS)	4 Cyl.	16 Valves	1598cc	TD34213
SFG (EP6CDTR)	4 Cyl.	16 Valves	1598cc	TD28725
5FH (EP6C)	4 Cyl.	16 Valves	1598cc	TD32319
5FK (EP6CB)	4 Cyl.	16 Valves	1598cc	TD32308
5FN (EP6CDT)	4 Cyl.	16 Valves	1598cc	TD32311
5FR (EP6DT)	4 Cyl.	16 Valves	1598cc	TD24702
5FS (EP6C)	4 Cyl.	16 Valves	1598cc	TD25101
5FT (EP6DT)	4 Cyl.	16 Valves	1598cc	TD24695
5FU (EP6CDTX)	4 Cyl.	16 Valves	1598cc	TD27999
5FV (EP6CDT)	4 Cyl.	16 Valves	1598cc	TD34209
5FW (EP6)	4 Cyl.	16 Valves	1598cc	TD31969
5FX (EP6DT)	4 Cyl.	16 Valves	1598cc	TD23766
5FY (EP6DTS)	4 Cyl.	16 Valves	1598cc	TD24723
5GM (EP6FDTX)	4 Cyl.	16 Valves	1598cc	TD34222
5GN (EP6FDTR)	4 Cyl.	16 Valves	1598cc	TD32419
5GZ (EP6FDT)	4 Cyl.	16 Valves	1598cc	TD31847
EP6	4 Cyl.	16 Valves	1598cc	TD20086
EP6CDTX	4 Cyl.	16 Valves	1598cc	TD24069

HR5110

NA5363

61.00 x 75.00 x 8.00mm, PTFE/ACM

NA5362

85.00 x 105.00 x 8.00mm, PTFE/ACM

53 1.6L

Petrol

6J1	4 Cyl.	8 Valves	1592cc	TD3678
6J2	4 Cyl.	8 Valves	1577cc	TD4919
6J2A	4 Cyl.	8 Valves	1592cc	TD3680
J1B	4 Cyl.	8 Valves	1592cc	TD3688
XSJ2A	4 Cyl.	8 Valves	1577cc	TD5294

HR569

NF694

40.00 x 58.00 x 8.00mm, ACM

NF692

71.00 x 88.00 x 8.00mm, MVQ

54 1.6L

Petrol

7R2	4 Cyl.	8 Valves	1639cc	TD5303
-----	--------	----------	--------	--------

NF694

40.00 x 58.00 x 8.00mm, ACM

55 1.6L

Diesel

9HC (DV6C)	4 Cyl.	8 Valves	1560cc	TD32307
9HD (DV6C)	4 Cyl.	8 Valves	1560cc	TD32320
9HD (DV6CTED)	4 Cyl.	8 Valves	1560cc	TD26896
9HF (DV6DTEd)	4 Cyl.	8 Valves	1560cc	TD26710
9HH (DV6DUM)	4 Cyl.	8 Valves	1560cc	TD29700
9HJ (DV6DTEdM)	4 Cyl.	8 Valves	1560cc	TD27967
9HK (DV6ETEdM)	4 Cyl.	8 Valves	1560cc	TD27968
9HL (DV6C)	4 Cyl.	8 Valves	1560cc	TD26986
9HM (DV6UC)	4 Cyl.	8 Valves	1560cc	TD29699



9HN (DV6ETED)	4 Cyl.	8 Valves	1560cc	TD32876
9HP (DV6DTED)	4 Cyl.	8 Valves	1560cc	TD27064
9HR (DV6C)	4 Cyl.	8 Valves	1560cc	TD26421
9HX (DV6AUTED4)	4 Cyl.	16 Valves	1560cc	TD34426
BHV (DV6FDU)	4 Cyl.	8 Valves	1560cc	TD33707
BHW (DV6FE)	4 Cyl.	8 Valves	1560cc	TD31071
BHX (DV6FC)	4 Cyl.	8 Valves	1560cc	TD29557
BHY (DV6FD)	4 Cyl.	8 Valves	1560cc	TD31070
BHZ (DV6FC)	4 Cyl.	8 Valves	1560cc	TD28620
PA5068 (x8) HR5120	NA5258 27.00 x 47.00 x 7.00mm, PTFE		NA5259 40.00 x 55.00 x 6.40mm, PTFE NA5325 85.00 x 105.00 x 8.80mm, PTFE	

56 1.6L

Diesel

9HN (DV6ETED4)	4 Cyl.	16 Valves	1560cc	TD31330
PA5068 (x16) HR5120	NA5258 27.00 x 47.00 x 7.00mm, PTFE		NA5259 40.00 x 55.00 x 6.40mm, PTFE NA5325 85.00 x 105.00 x 8.80mm, PTFE	

57 1.6L

Diesel

9HS (DV6TED4BU)	4 Cyl.	16 Valves	1560cc	TD29162
9HT (DV6BTED4)	4 Cyl.	16 Valves	1560cc	TD23537
9HU (DV6UTED4)	4 Cyl.	16 Valves	1560cc	TD24693
9HV (DV6ATED4)	4 Cyl.	16 Valves	1560cc	TD24730
9HV (DV6TED4)	4 Cyl.	16 Valves	1560cc	TD28634
9HW (DV6BTED4)	4 Cyl.	16 Valves	1560cc	TD24701
9HX (DV6ATED4)	4 Cyl.	16 Valves	1560cc	TD20147
9HY (DV6TED4)	4 Cyl.	16 Valves	1560cc	TD17506
9HZ (DV6TED4)	4 Cyl.	16 Valves	1560cc	TD18520
PA6072 (x16) HR5124	NA5258 27.00 x 47.00 x 7.00mm, PTFE		NA5259 40.00 x 55.00 x 6.40mm, PTFE NA5325 85.00 x 105.00 x 8.80mm, PTFE	

58 1.6L

Petrol

171 (XU5S)	4 Cyl.	8 Valves	1580cc	TD2865
180A (XU5J)	4 Cyl.	8 Valves	1580cc	TD2861
180Z (XU5J)	4 Cyl.	8 Valves	1580cc	TD2862
B1A (XU51C)	4 Cyl.	8 Valves	1580cc	TD2857
B1D (XU51C)	4 Cyl.	8 Valves	1580cc	TD2762
B1E (XU51C)	4 Cyl.	8 Valves	1580cc	TD2856
B2A (XU52C/K)	4 Cyl.	8 Valves	1580cc	TD12430
B6B (XU5J)	4 Cyl.	8 Valves	1580cc	TD2858
B6D (XU5JA)	4 Cyl.	8 Valves	1580cc	TD32312
BAZ (XU5CP)	4 Cyl.	8 Valves	1580cc	TD2859
BDY (XU5M2Z)	4 Cyl.	8 Valves	1580cc	TD4846

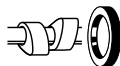

BDY (XU5M3Z)	4 Cyl.	8 Valves	1580cc	TD2864
BDZ (XU5M)	4 Cyl.	8 Valves	1580cc	TD2839
BFZ (XU5JP)	4 Cyl.	8 Valves	1580cc	TD2863
HR569	NF817 36.00 x 50.00 x 7.00mm, FPM	NA5191 42.00 x 62.00 x 7.00mm, PTFE NA5192 90.00 x 110.00 x 7.00mm, PTFE		

59 1.6L

Petrol

222A2 (1580 SPI)	4 Cyl.	8 Valves	1581cc	TD2753
1580 SPI	4 Cyl.	8 Valves	1581cc	TD8484
HR569	NA5187 30.00 x 52.00 x 7.00mm, ACM	NA5051 40.00 x 56.00 x 7.00mm, FPM NB808 64.00 x 80.00 x 8.00mm, FPM		

60 1.6L

Petrol

B2A (XU52C)	4 Cyl.	8 Valves	1580cc	TD29160
				NA5191 42.00 x 62.00 x 7.00mm, PTFE NA5192 90.00 x 110.00 x 7.00mm, PTFE

61 1.6L

Petrol

J1	4 Cyl.	8 Valves	1577cc	TD4922
J2	4 Cyl.	8 Valves	1577cc	TD4923
HR569				

62 1.6L

Petrol

N6A (TU5JP4)	4 Cyl.	16 Valves	1587cc	TD21503
NFR (TU5JP4B)	4 Cyl.	16 Valves	1587cc	TD24700
NFX (TU5J4)	4 Cyl.	16 Valves	1587cc	TD4839
TU5JP4	4 Cyl.	16 Valves	1587cc	TD24158
PA5041 (x16) HR791	NA5260 (x2) 38.00 x 50.00 x 6.00mm, FPM	NA5331 42.00 x 66.00 x 7.00mm, PTFE NF850 85.00 x 105.00 x 8.00mm, FPM		

63 1.6L

Petrol

NFP (EC5)	4 Cyl.	16 Valves	1587cc	TD28574
PA5041 (x16) HR791	NA5260 (x2) 38.00 x 50.00 x 6.00mm, FPM	NA5331 42.00 x 66.00 x 7.00mm, PTFE NA5362 85.00 x 105.00 x 8.00mm, PTFE/ACM		

64 1.6L

Petrol

NFT (TU5JP)	4 Cyl.	8 Valves	1587cc	TD32683
NFY (TU5J2)	4 Cyl.	8 Valves	1587cc	TD4838
NFZ (TU5JP)	4 Cyl.	8 Valves	1587cc	TD4840
HR816	NF817 36.00 x 50.00 x 7.00mm, FPM	NA5331 42.00 x 66.00 x 7.00mm, PTFE NF850 85.00 x 105.00 x 8.00mm, FPM		



65 1.6L		Petrol		
NFU (TU5JP4)	4 Cyl.	16 Valves	1587cc	TD15668
PA5041 (x16) HR791	NA5260 (x2) 38.00 x 50.00 x 6.00mm, FPM	NA5331 42.00 x 66.00 x 7.00mm, PTFE NF850 85.00 x 105.00 x 8.00mm, FPM NA5362 85.00 x 105.00 x 8.00mm, PTFE/ACM		

66 1.6L		Petrol		
NFW (TU5J2)	4 Cyl.	8 Valves	1587cc	TD4837
HR816	NF817 36.00 x 50.00 x 7.00mm, FPM	NF870 42.00 x 66.00 x 6.00mm, FPM/ACM NF850 85.00 x 105.00 x 8.00mm, FPM		

67 1.6L		Petrol		
XC7	4 Cyl.	8 Valves	1618cc	TD22472
XC7P	4 Cyl.	8 Valves	1618cc	TD8496
	NA5187 30.00 x 52.00 x 7.00mm, ACM	NA5051 40.00 x 56.00 x 7.00mm, FPM NB808 64.00 x 80.00 x 8.00mm, FPM		

68 1.7L		Diesel		
161 (XUD7)	4 Cyl.	8 Valves	1769cc	TD21268
161A (XUD7)	4 Cyl.	8 Valves	1769cc	TD2882
A8B (XUD7TE)	4 Cyl.	8 Valves	1769cc	TD10789
HR569	NF841 35.00 x 50.00 x 8.00mm, FPM	NA5191 42.00 x 62.00 x 7.00mm, PTFE NA5192 90.00 x 110.00 x 7.00mm, PTFE		

69 1.8L		Petrol		
6FY (EW7A)	4 Cyl.	16 Valves	1749cc	TD20026
6FZ (EW7J4)	4 Cyl.	16 Valves	1749cc	TD15190
HR5126	NA5455 39.00 x 50.00 x 7.00mm, PTFE/ACM NF817 36.00 x 50.00 x 7.00mm, FPM	NA5259 40.00 x 55.00 x 6.40mm, PTFE NF844 90.00 x 110.00 x 11.00mm, FPM/ACM		

70 1.8L		Petrol		
7S2	4 Cyl.	8 Valves	1800cc	TD5304
		NF694 40.00 x 58.00 x 8.00mm, ACM		

71 1.8L		Petrol		
10S (XM7)	4 Cyl.	8 Valves	1796cc	TD2826
105C (XM7A)	4 Cyl.	8 Valves	1796cc	TD2827
169B (XM7T)	4 Cyl.	8 Valves	1796cc	TD6793
XM7	4 Cyl.	8 Valves	1796cc	TD2825
XM7P	4 Cyl.	8 Valves	1796cc	TD8497
HR300		NA5191 42.00 x 62.00 x 7.00mm, PTFE NA5192 90.00 x 110.00 x 7.00mm, PTFE		

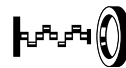
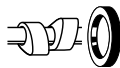

72 1.8L

Diesel

A8A (XUD7TE)	4 Cyl.	8 Valves	1769cc	TD2884
A9A (XUD7)	4 Cyl.	8 Valves	1769cc	TD12351
AJZ (XUD7TEY)	4 Cyl.	8 Valves	1769cc	TD2885
XUD7T	4 Cyl.	8 Valves	1769cc	TD18394

HR569

NF841
35.00 x 50.00 x 8.00mm, FPM

NA5191
42.00 x 62.00 x 7.00mm, PTFE
NA5192
90.00 x 110.00 x 7.00mm, PTFE

73 1.8L

Petrol

KF5	4 Cyl.	8 Valves	1796cc	TD2883
KF6	4 Cyl.	8 Valves	1796cc	TD2755
XM	4 Cyl.	8 Valves	1796cc	TD2824
XM7T	4 Cyl.	8 Valves	1796cc	TD9013

HR300

NA5191
42.00 x 62.00 x 7.00mm, PTFE

74 1.8L

Petrol

LFW (XU7JP)	4 Cyl.	8 Valves	1761cc	TD2867
LFX (XU7JB)	4 Cyl.	8 Valves	1761cc	TD12708
LFZ (XU7JP)	4 Cyl.	8 Valves	1762cc	TD2866

HR569

NF817
36.00 x 50.00 x 7.00mm, FPM

NA5191
42.00 x 62.00 x 7.00mm, PTFE
NA5192
90.00 x 110.00 x 7.00mm, PTFE

75 1.8L

Petrol

LFY (XU7JP4)	4 Cyl.	16 Valves	1761cc	TD4849
--------------	--------	-----------	--------	--------

HR5080

→12/96
→Eng no. 07359

HR5081

01/97→08/98

Eng no. 07360→07965

HR5126

05/98→

NF817 (x2)
36.00 x 50.00 x 7.00mm, FPM

NA5191
42.00 x 62.00 x 7.00mm, PTFE
NA5192
90.00 x 110.00 x 7.00mm, PTFE

76 1.8L

Diesel

XDP85	4 Cyl.	8 Valves	1816cc	TD8498
-------	--------	----------	--------	--------

HR340

NF780
45.00 x 60.00 x 7.00mm, ACM
NF387
42.00 x 60.00 x 10.00mm, NBR

77 1.9L

Petrol

159 (XU9S)	4 Cyl.	8 Valves	1905cc	TD2879
D2A (XU92C)	4 Cyl.	8 Valves	1905cc	TD2869
D2B (XU9S)	4 Cyl.	8 Valves	1905cc	TD2772
D2C (XU92C)	4 Cyl.	8 Valves	1905cc	TD2871
D6A (XU9J2)	4 Cyl.	8 Valves	1905cc	TD22159
D6B (XU9JA)	4 Cyl.	8 Valves	1905cc	TD2872



DDZ (XU9M)	4 Cyl.	8 Valves	1905cc	TD2878
DFZ (XU9J1)	4 Cyl.	8 Valves	1905cc	TD2870
DKZ (XU9JAZ)	4 Cyl.	8 Valves	1905cc	TD2877
HR569	NF817 36.00 x 50.00 x 7.00mm, FPM	NA5191 42.00 x 62.00 x 7.00mm, PTFE	NA5192 90.00 x 110.00 x 7.00mm, PTFE	

78 1.9L

Diesel

162 (XUD9)	4 Cyl.	8 Valves	1905cc	TD2886
D8A (XUD9TE)	4 Cyl.	8 Valves	1905cc	TD33015
D8B (XUD9TE)	4 Cyl.	8 Valves	1905cc	TD2751
D8C (XUD9AU)	4 Cyl.	8 Valves	1905cc	TD10827
D8C (XUD9UTF)	4 Cyl.	8 Valves	1905cc	TD2890
D9A (XUD9)	4 Cyl.	8 Valves	1905cc	TD2754
D9B (XUD9A)	4 Cyl.	8 Valves	1905cc	TD2834
D9B (XUD9AU)	4 Cyl.	8 Valves	1905cc	TD2880
DHV (XUD9BSD)	4 Cyl.	8 Valves	1905cc	TD9867
DHW (XUD9SD)	4 Cyl.	8 Valves	1905cc	TD9365
DHX (XUD9TE)	4 Cyl.	8 Valves	1905cc	TD2889
DHY (XUD9TE)	4 Cyl.	8 Valves	1905cc	TD2888
DJY (XUD9A)	4 Cyl.	8 Valves	1905cc	TD2887
DJZ (XUD9Y)	4 Cyl.	8 Valves	1905cc	TD2891
WJY (DW8B)	4 Cyl.	8 Valves	1868cc	TD13788
WJZ (DW8)	4 Cyl.	8 Valves	1868cc	TD9868
XUD9	4 Cyl.	8 Valves	1905cc	TD4924
XUD9	4 Cyl.	8 Valves	1905cc	TD8478
XUD9A	4 Cyl.	8 Valves	1905cc	TD9014
XUD9TE	4 Cyl.	8 Valves	1905cc	TD18953
HR569	NF841 35.00 x 50.00 x 8.00mm, FPM	NA5191 42.00 x 62.00 x 7.00mm, PTFE	NA5192 90.00 x 110.00 x 7.00mm, PTFE	

79 1.9L

Petrol

D6C (XU9J4)	4 Cyl.	16 Valves	1905cc	TD2873
DFW (XU9J4Z)	4 Cyl.	16 Valves	1905cc	TD2875
HR816 (x2)	NF817 (x2) 36.00 x 50.00 x 7.00mm, FPM	NA5191 42.00 x 62.00 x 7.00mm, PTFE	NA5192 90.00 x 110.00 x 7.00mm, PTFE	
	NF869 (x2) 32.00 x 45.00 x 8.00mm, FPM			

80 1.9L

Diesel

XD4x88	4 Cyl.	8 Valves	1948cc	TD2807
XDP 4.88	4 Cyl.	8 Valves	1948cc	TD22477
PA229 (x8)			NF387 42.00 x 60.00 x 10.00mm, NBR	
			KS696 (x2)	



81 1.9L

Diesel

XDP88	4 Cyl.	8 Valves	1948cc	TD8499
PA229 (x8)				NF780 45.00 x 60.00 x 7.00mm, ACM 09/85→ NF387 42.00 x 60.00 x 10.00mm, NBR KS696 (x2)

82 2.0L

Petrol

4B11	4 Cyl.	16 Valves	1998cc	TD26062
				NA5108 42.00 x 55.00 x 7.00mm, FPM/ACM NK143 85.00 x 103.00 x 8.00mm, FPM

83 2.0L

Petrol

7T2	4 Cyl.	8 Valves	1959cc	TD5305
				NF694 40.00 x 58.00 x 8.00mm, ACM

84 2.0L

Petrol

106 (XN1)	4 Cyl.	8 Valves	1971cc	TD2830
106E (XN1A)	4 Cyl.	8 Valves	1971cc	TD4845
107 (XN2)	4 Cyl.	8 Valves	1971cc	TD2831
170 (XN1T)	4 Cyl.	8 Valves	1971cc	TD2837
170B (XN1T)	4 Cyl.	8 Valves	1971cc	TD2836
170C (XN1TA)	4 Cyl.	8 Valves	1971cc	TD6804
170D (XN1TACP)	4 Cyl.	8 Valves	1971cc	TD5194
XN1	4 Cyl.	8 Valves	1971cc	TD2833
XN1P	4 Cyl.	8 Valves	1971cc	TD8502
XN1T	4 Cyl.	8 Valves	1971cc	TD22486
XN1TA	4 Cyl.	8 Valves	1971cc	TD8490
XN1TA	4 Cyl.	8 Valves	1971cc	TD9015
HR569				NA5191 42.00 x 62.00 x 7.00mm, PTFE

85 2.0L

Petrol

829 (ZEJ)	4 Cyl.	8 Valves	1995cc	TD2911
HR569				NA5016 35.00 x 47.00 x 7.00mm, FPM/ACM NF843 50.00 x 68.00 x 10.00mm, FPM/ACM NF844 90.00 x 110.00 x 11.00mm, FPM/ACM

86 2.0L

Diesel

AHH (DW10FC)	4 Cyl.	16 Valves	1997cc	TD33708
AHN (DW10FUD)	4 Cyl.	16 Valves	1997cc	TD33435
AHP (DW10FUC)	4 Cyl.	16 Valves	1997cc	TD33434
AHR (DW10FD)	4 Cyl.	16 Valves	1997cc	TD33420
AHV (DW10FD)	4 Cyl.	16 Valves	1997cc	TD31484
AHW (DW10FC)	4 Cyl.	16 Valves	1997cc	TD30806
AHX (DW10FD)	4 Cyl.	16 Valves	1997cc	TD28614
AHY (DW10CE)	4 Cyl.	16 Valves	1997cc	TD32318
AHZ (DW10CD)	4 Cyl.	16 Valves	1997cc	TD28621



RHC (DW10CTED4)	4 Cyl.	16 Valves	1997cc	TD28710
RHD (DW10CTED4)	4 Cyl.	16 Valves	1997cc	TD31482
RHE (DW10CTED4)	4 Cyl.	16 Valves	1997cc	TD25633
RHH (DW10CTED4)	4 Cyl.	16 Valves	1997cc	TD23536

HR5122

NA5035
27.00 x 47.00 x 7.00mm, FPM

NA5191
42.00 x 62.00 x 7.00mm, PTFE
NA5192
90.00 x 110.00 x 7.00mm, PTFE

87 2.0L

Petrol

EW10A	4 Cyl.	16 Valves	1997cc	TD24176
-------	--------	-----------	--------	---------

HR5126

NA5455
39.00 x 50.00 x 7.00mm, PTFE/ACM
NF817
36.00 x 50.00 x 7.00mm, FPM

NA5259
40.00 x 55.00 x 6.40mm, PTFE
NA5192
90.00 x 110.00 x 7.00mm, PTFE

88 2.0L

Petrol

EW10J4	4 Cyl.	16 Valves	1997cc	TD24177
RFK (EW10J4S)	4 Cyl.	16 Valves	1997cc	TD17846
RFN (EW10J4)	4 Cyl.	16 Valves	1997cc	TD15188
RFR (DEW10J4)	4 Cyl.	16 Valves	1997cc	TD12568
RLZ (EW10D)	4 Cyl.	16 Valves	1997cc	TD16234

HR5126

NF817 (x2)
36.00 x 50.00 x 7.00mm, FPM

NA5256
40.00 x 55.00 x 6.50mm, FPM
NF844
90.00 x 110.00 x 11.00mm, FPM/ACM

89 2.0L

Petrol

R5A (XU102C)	4 Cyl.	8 Valves	1998cc	TD8480
R6A (XU10J2)	4 Cyl.	8 Valves	1998cc	TD34200
RFL (XU10J2U)	4 Cyl.	8 Valves	1998cc	TD17511
RFU (XU10J2)	4 Cyl.	8 Valves	1998cc	TD2848
RFW (XU10J2)	4 Cyl.	8 Valves	1998cc	TD2847
RFX (XU10J2)	4 Cyl.	8 Valves	1998cc	TD2846
RFZ (XU10J2Z)	4 Cyl.	8 Valves	1998cc	TD2851
RGX (XU10J2CTE)	4 Cyl.	8 Valves	1998cc	TD29171
RGX (XU10J2TE)	4 Cyl.	8 Valves	1998cc	TD4847
RGY (XU10J2TE)	4 Cyl.	8 Valves	1998cc	TD2850

HR569

NF817
36.00 x 50.00 x 7.00mm, FPM

NA5191
42.00 x 62.00 x 7.00mm, PTFE
NA5192
90.00 x 110.00 x 7.00mm, PTFE

90 2.0L

Petrol

RFH (EW10A)	4 Cyl.	16 Valves	1997cc	TD23210
-------------	--------	-----------	--------	---------

HR5126

NA5455
39.00 x 50.00 x 7.00mm, PTFE/ACM
NF817
36.00 x 50.00 x 7.00mm, FPM

NA5259
40.00 x 55.00 x 6.40mm, PTFE
NF844
90.00 x 110.00 x 11.00mm, FPM/ACM

91 2.0L

Petrol

RFJ (EW10A)	4 Cyl.	16 Valves	1997cc	TD18690
-------------	--------	-----------	--------	---------

HR5126

NA5455
39.00 x 50.00 x 7.00mm, PTFE/ACM
NF817
36.00 x 50.00 x 7.00mm, FPM

NA5256
40.00 x 55.00 x 6.50mm, FPM
NF844
90.00 x 110.00 x 11.00mm, FPM/ACM

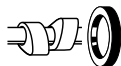

92 2.0L

Petrol

RFS (XU10J4RS)	4 Cyl.	16 Valves	1998cc	TD4848
PA5041 (x16) HR791	NF817 (x2) 36.00 x 50.00 x 7.00mm, FPM		NA5191 42.00 x 62.00 x 7.00mm, PTFE NA5192 90.00 x 110.00 x 7.00mm, PTFE	

93 2.0L

Petrol

RFT (XU10J4)	4 Cyl.	16 Valves	1998cc	TD2852
RGZ (XU10J4TE/Z)	4 Cyl.	16 Valves	1998cc	TD2854
HR816 (x2)	NF817 (x2) 36.00 x 50.00 x 7.00mm, FPM		NA5191 42.00 x 62.00 x 7.00mm, PTFE NA5192 90.00 x 110.00 x 7.00mm, PTFE	

94 2.0L

Petrol

RFV (XU10J4R)	4 Cyl.	16 Valves	1998cc	TD2853
HR5080 →12/96 →Eng no. 07359	NF817 (x2) 36.00 x 50.00 x 7.00mm, FPM		NA5191 42.00 x 62.00 x 7.00mm, PTFE NA5192 90.00 x 110.00 x 7.00mm, PTFE	
HR5081 01/97→08/98 Eng no. 07360→07965				
HR5126 09/98→				

95 2.0L

Petrol

RFY (XU10J4Z)	4 Cyl.	16 Valves	1998cc	TD2855
PA5041 (x16) HR816 (x2)	NF817 (x2) 36.00 x 50.00 x 7.00mm, FPM		NA5191 42.00 x 62.00 x 7.00mm, PTFE NA5192 90.00 x 110.00 x 7.00mm, PTFE	

96 2.0L

Diesel

RHF (DW10BTD4)	4 Cyl.	16 Valves	1997cc	TD26794
RHK (DW10UTD4)	4 Cyl.	16 Valves	1997cc	TD19814
RHL (DW10BTD4)	4 Cyl.	16 Valves	1997cc	TD34202
RHM (DW10ATED4)	4 Cyl.	16 Valves	1997cc	TD20790
RHR (DW10BTD4)	4 Cyl.	16 Valves	1997cc	TD17507
RHT (DW10ATED4)	4 Cyl.	16 Valves	1997cc	TD20789
RHW (DW10ATED4)	4 Cyl.	16 Valves	1997cc	TD17510
HR5046 (x2)	NA5035 27.00 x 47.00 x 7.00mm, FPM		NA5191 42.00 x 62.00 x 7.00mm, PTFE NA5192 90.00 x 110.00 x 7.00mm, PTFE	

97 2.0L

Diesel

RHO (DW10DTE4)	4 Cyl.	16 Valves	1997cc	TD23969
			NA5191 42.00 x 62.00 x 7.00mm, PTFE NA5192 90.00 x 110.00 x 7.00mm, PTFE	

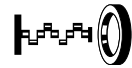
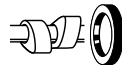

98 2.0L Diesel	
RHS (DW10ATED)	4 Cyl. 8 Valves 1997cc TD20417
RHV (DW10TD)	4 Cyl. 8 Valves 1997cc TD24911
RHV (DW10UTD)	4 Cyl. 8 Valves 1997cc TD17512
RHX (DW10BTED)	4 Cyl. 8 Valves 1997cc TD17515
RHY (DW10TD)	4 Cyl. 8 Valves 1997cc TD12569
RHZ (DW10ATED)	4 Cyl. 8 Valves 1997cc TD10727
RHZ (DW10CTED)	4 Cyl. 8 Valves 1997cc TD30833
HR5046	<p>NA5035 27.00 x 47.00 x 7.00mm, FPM</p> <p>NA5191 42.00 x 62.00 x 7.00mm, PTFE</p> <p>NA5192 90.00 x 110.00 x 7.00mm, PTFE</p>

99 2.0L Diesel	
RHZ (DW10BTED)	4 Cyl. 8 Valves 1997cc TD29311
RHZ (DW10BTED+)	4 Cyl. 8 Valves 1997cc TD33721
HR5046 (x2) 09/99→	<p>NA5035 27.00 x 47.00 x 7.00mm, FPM</p> <p>NA5191 42.00 x 62.00 x 7.00mm, PTFE</p> <p>NA5192 90.00 x 110.00 x 7.00mm, PTFE</p>

100 2.1L Diesel	
P8C (XUD11BTE)	4 Cyl. 12 Valves 2088cc TD4850
P9A (XUD11A)	4 Cyl. 12 Valves 2138cc TD11187
PHZ (XUD11ATE)	4 Cyl. 12 Valves 2088cc TD2881
HR805	<p>NF841 35.00 x 50.00 x 8.00mm, FPM</p> <p>NA5191 42.00 x 62.00 x 7.00mm, PTFE</p> <p>NA5192 90.00 x 110.00 x 7.00mm, PTFE</p>

101 2.1L Diesel	
XD4x90	4 Cyl. 8 Valves 2112cc TD2808
	<p>NF387 42.00 x 60.00 x 10.00mm, NBR →09/85</p> <p>NF780 45.00 x 60.00 x 7.00mm, ACM 09/85→</p> <p>KS696 (x2)</p>

102 2.1L Diesel	
XD90	4 Cyl. 8 Valves 2112cc TD24572
XDP90	4 Cyl. 8 Valves 2112cc TD8500
XDPX90	4 Cyl. 8 Valves 2112cc TD8503
PA229 (x8)	<p>NF387 42.00 x 60.00 x 10.00mm, NBR →09/85</p> <p>NF780 45.00 x 60.00 x 7.00mm, ACM 09/85→</p> <p>KS696 (x2)</p>

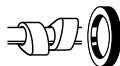

103 2.1L

Diesel

XDP 4.90	4 Cyl.	8 Valves	2112cc	TD21440
				NF780 45.00 x 60.00 x 7.00mm, ACM NF387 42.00 x 60.00 x 10.00mm, NBR KS696 (x2)

104 2.2L

Petrol

3FY (EW12J4)	4 Cyl.	16 Valves	2230cc	TD20025
3FZ (EW12J4)	4 Cyl.	16 Valves	2230cc	TD16129
HR5126				NF817 36.00 x 50.00 x 7.00mm, FPM NA5256 40.00 x 55.00 x 6.50mm, FPM NF844 90.00 x 110.00 x 11.00mm, FPM/ACM

105 2.2L

Diesel

4HG (P22DTE)	4 Cyl.	16 Valves	2198cc	TD32317
4HH (P22DTE)	4 Cyl.	16 Valves	2198cc	TD32520
4HJ (P22DTE)	4 Cyl.	16 Valves	2198cc	TD32316
4HU (P22DTE)	4 Cyl.	16 Valves	2198cc	TD24470
4HV (P22DTE)	4 Cyl.	16 Valves	2198cc	TD24469
HR5082				NA5031 50.00 x 86.50 x 13.70mm, PTFE NA5030 106.00 x 190.00 x 15.20mm, PTFE/FPM

106 2.2L

Diesel

4HK (DW12MTED4)	4 Cyl.	16 Valves	2179cc	TD24916
4HL (DW12C)	4 Cyl.	16 Valves	2179cc	TD24921
4HN (DW12MTED4)	4 Cyl.	16 Valves	2179cc	TD24727
4HP (DW12BTED4)	4 Cyl.	16 Valves	2179cc	TD24729
4HR (DW12BTED4)	4 Cyl.	16 Valves	2179cc	TD24914
4HS (DW12BTED4)	4 Cyl.	16 Valves	2179cc	TD24915
4HT (DW12BTED4)	4 Cyl.	16 Valves	2179cc	TD20028
HR5122				NA5035 27.00 x 47.00 x 7.00mm, FPM NA5191 42.00 x 62.00 x 7.00mm, PTFE NA5192 90.00 x 110.00 x 7.00mm, PTFE

107 2.2L

Diesel

4HW (DW12BTED4)	4 Cyl.	16 Valves	2179cc	TD24913
HR5122				NA5191 42.00 x 62.00 x 7.00mm, PTFE NA5192 90.00 x 110.00 x 7.00mm, PTFE

108 2.2L

Diesel

4HX (DW12TED4/FAP)	4 Cyl.	16 Valves	2179cc	TD16128
4HZ (DW12TED4)	4 Cyl.	16 Valves	2179cc	TD24912
HR5046 (x2)				NA5035 27.00 x 47.00 x 7.00mm, FPM NA5191 42.00 x 62.00 x 7.00mm, PTFE NA5192 90.00 x 110.00 x 7.00mm, PTFE



109 2.2L Diesel

4HY (DW12UTED)	4 Cyl.	8 Valves	2179cc	TD17513
HR5046	NA5035 27.00 x 47.00 x 7.00mm, FPM		NA5191 42.00 x 62.00 x 7.00mm, PTFE NA5192 90.00 x 110.00 x 7.00mm, PTFE	

110 2.2L Petrol

851 (ZDJ)	4 Cyl.	8 Valves	2165cc	TD2908
851B (ZDJL)	4 Cyl.	8 Valves	2165cc	TD2909
851X (ZDJL)	4 Cyl.	8 Valves	2165cc	TD2910
HR569	NA5016 35.00 x 47.00 x 7.00mm, FPM/ACM		NF843 50.00 x 68.00 x 10.00mm, FPM/ACM NF844 90.00 x 110.00 x 11.00mm, FPM/ACM	

111 2.3L Diesel

134 (XD2)	4 Cyl.	8 Valves	2304cc	TD2800
147 (XD2S)	4 Cyl.	8 Valves	2304cc	TD2802
XD2	4 Cyl.	8 Valves	2304cc	TD21365
XD2	4 Cyl.	8 Valves	2304cc	TD22473
XD2P94	4 Cyl.	8 Valves	2304cc	TD8501
XD2PX94	4 Cyl.	8 Valves	2304cc	TD8504
XD2S	4 Cyl.	8 Valves	2288cc	TD5288
XD2S	4 Cyl.	8 Valves	2304cc	TD22474
PA229 (x8)			NF780 45.00 x 60.00 x 7.00mm, ACM NF387 42.00 x 60.00 x 10.00mm, NBR KS696 (x2)	

112 2.4L Petrol

SFY (4B12-MMC)	4 Cyl.	16 Valves	2360cc	TD32328
SFZ (4B12-MMC)	4 Cyl.	16 Valves	2360cc	TD32327
			NA5108 42.00 x 55.00 x 7.00mm, FPM/ACM NK143 85.00 x 103.00 x 8.00mm, FPM	

113 2.4L Diesel

T8A (DJ5T)	4 Cyl.	12 Valves	2446cc	TD4831
T9A (DJ5)	4 Cyl.	12 Valves	2446cc	TD4830
HR662	NB959 35.00 x 50.00 x 7.00mm, FPM		NF866 64.00 x 88.00 x 6.00mm, FPM/ACM NF867 98.00 x 120.00 x 7.00mm, FPM/ACM	



114 2.5L

Diesel

152A (XD3T)	4 Cyl.	8 Valves	2498cc	TD2805
XD3T	4 Cyl.	8 Valves	2497cc	TD22475
PA229 (x8)	NF097 45.00 x 62.00 x 10.00mm, NBR		NF387 42.00 x 60.00 x 10.00mm, NBR →09/85 NF780 45.00 x 60.00 x 7.00mm, ACM 09/85→ KS696 (x2)	

115 2.5L

Diesel

152B (XD3TE)	4 Cyl.	8 Valves	2498cc	TD2806
XD3P	4 Cyl.	8 Valves	2497cc	TD8505
XD3TE	4 Cyl.	8 Valves	2498cc	TD22476
PA229 (x8)			NF387 42.00 x 60.00 x 10.00mm, NBR →09/85 NF780 45.00 x 60.00 x 7.00mm, ACM 09/85→ KS696 (x2)	

116 2.5L

Diesel

155 (XD3)	4 Cyl.	8 Valves	2498cc	TD2803
PA229 (x8)	NF097 (x2) 45.00 x 62.00 x 10.00mm, NBR		NF387 42.00 x 60.00 x 10.00mm, NBR →09/85 NF780 45.00 x 60.00 x 7.00mm, ACM 09/85→ KS696 (x2)	

117 2.5L

Diesel

CRD93	4 Cyl.	8 Valves	2498cc	TD21168
CRD93	4 Cyl.	8 Valves	2498cc	TD9017
CRD93 (U25/661)	4 Cyl.	8 Valves	2498cc	TD2747
CRD93L	4 Cyl.	8 Valves	2498cc	TD18876
CRD93LS	4 Cyl.	8 Valves	2498cc	TD9018
CRD93LS (U25/673)	4 Cyl.	8 Valves	2498cc	TD4829
HR340	NF741 29.00 x 46.00 x 10.00mm, ACM		NF776 75.00 x 90.00 x 11.50mm, FPM/ACM	

118 2.5L

Diesel

EN 55	4 Cyl.	8 Valves	2498cc	TD6685
PA229 (x8)	NB856 47.62 x 66.50 x 11.00mm, PTFE		NF780 45.00 x 60.00 x 7.00mm, ACM KS696 (x2)	

119 2.5L

Diesel

ET 70	4 Cyl.	8 Valves	2496cc	TD6686
PA229 (x8)	NB856 47.62 x 66.50 x 11.00mm, PTFE		NF780 45.00 x 60.00 x 7.00mm, ACM KS696 (x2)	



120 2.5L Diesel

THX (DJ5TED)	4 Cyl.	8 Valves	2446cc	TD11067
HR816	NB959 35.00 x 50.00 x 7.00mm, FPM		NF866 64.00 x 88.00 x 6.00mm, FPM/ACM NF867 98.00 x 120.00 x 7.00mm, FPM/ACM	

121 2.5L Diesel

THY (DK5ATE)	4 Cyl.	12 Valves	2446cc	TD2748
HR662	NB959 35.00 x 50.00 x 7.00mm, FPM		NF866 64.00 x 88.00 x 6.00mm, FPM/ACM NF867 98.00 x 120.00 x 7.00mm, FPM/ACM	

122 2.6L Petrol

9L6	6 Cyl.	12 Valves	2645cc	TD5287
HR300 (x2)	NF869 32.00 x 45.00 x 8.00mm, FPM		NF761 42.00 x 62.00 x 10.00mm, FPM/ACM NF634 80.00 x 100.00 x 13.00mm, MVQ	

123 2.7L Petrol

112 (ZM)	6 Cyl.	12 Valves	2664cc	TD2912
140 (ZMJ)	6 Cyl.	12 Valves	2664cc	TD2914
HR805	NF869 32.00 x 45.00 x 8.00mm, FPM		NF761 42.00 x 62.00 x 10.00mm, FPM/ACM NF634 80.00 x 100.00 x 13.00mm, MVQ	

124 2.7L Diesel

DT17TED4	6 Cyl.	24 Valves	2721cc	TD18175
UHZ (DT17)	6 Cyl.	24 Valves	2720cc	TD20027
UHZ (DT17BTED4)	6 Cyl.	24 Valves	2720cc	TD21317
HR5111	NA5318 (x2) 26.0 x 45.0 x 8.00mm, FPM		NA5323 35.00 x 50.00 x 7.00mm, PTFE LK5021 92.00 x 220.00 x 22.00mm, PTFE/ACM	

125 2.8L Petrol

154A (ZMJK)	6 Cyl.	12 Valves	2849cc	TD2913
154X (ZN3J)	6 Cyl.	12 Valves	2849cc	TD2917
HR805 →Eng no. 1889 HR569 (x2) Eng no. 1890→			NF761 42.00 x 62.00 x 10.00mm, FPM/ACM NF634 80.00 x 100.00 x 13.00mm, MVQ	

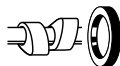

126 2.8L

Diesel

8140.23 (F28DTSE)	4 Cyl.	8 Valves	2798cc	TD24918
8140.43 (F28DT)	4 Cyl.	8 Valves	2798cc	TD21169
8140.43N	4 Cyl.	8 Valves	2798cc	TD24923
8140.43S (F28DTCR)	4 Cyl.	8 Valves	2798cc	TD17514
8140.63 (F28D)	4 Cyl.	8 Valves	2798cc	TD24917

HR602

NP068
55.00 x 70.00 x 8.00mm, FPM

NP067
50.00 x 70.00 x 10.00mm, FPM
NF885
70.00 x 159.00 ; 179.00 x 16.00mm, FPM
NF883
114.00 x 171.00 x 13.00mm, FPM

127 3.0L

Diesel

DT20C	6 Cyl.	24 Valves	2993cc	TD23527
-------	--------	-----------	--------	---------

HR5111

NA5318 (x2)
26.0 x 45.0 x 8.00mm, FPM

NA5323
35.00 x 50.00 x 7.00mm, PTFE
LK5021
92.00 x 220.00 x 22.00mm, PTFE/ACM

128 3.0L

Petrol

SFZ (ZPJ/Z)	6 Cyl.	12 Valves	2975cc	TD32309
-------------	--------	-----------	--------	---------

HR805

NA5191
42.00 x 62.00 x 7.00mm, PTFE
NF634
80.00 x 100.00 x 13.00mm, MVQ

129 3.0L

Petrol

SKZ (ZPJ4/Z)	6 Cyl.	24 Valves	2963cc	TD32310
UKZ (ZPJ4/Z)	6 Cyl.	24 Valves	2963cc	TD2921

HR800

NF869 (x2)
32.00 x 45.00 x 8.00mm, FPM

NA5191
42.00 x 62.00 x 7.00mm, PTFE
NF634
80.00 x 100.00 x 13.00mm, MVQ

130 3.0L

Petrol

UFZ (ZPJ)	6 Cyl.	12 Valves	2963cc	TD2920
-----------	--------	-----------	--------	--------

HR662

NF869 (x2)
32.00 x 45.00 x 8.00mm, FPM

NA5191
42.00 x 62.00 x 7.00mm, PTFE
NF634
80.00 x 100.00 x 13.00mm, MVQ

131 3.0L

Petrol

XFV (ES9A)	6 Cyl.	24 Valves	2946cc	TD18841
------------	--------	-----------	--------	---------

PA5041 (x24)
HR5062

NA5260 (x4)
38.00 x 50.00 x 6.00mm, FPM

NA5260
38.00 x 50.00 x 6.00mm, FPM
NF867
98.00 x 120.00 x 7.00mm, FPM/ACM

132 3.0L

Petrol

XFX (ES9J4S)	6 Cyl.	24 Valves	2946cc	TD13908
XFZ (ES9J4)	6 Cyl.	24 Valves	2946cc	TD9406

PA5041 (x24)
HR5062

NA5260 (x4)
38.00 x 50.00 x 6.00mm, FPM

NA5190
42.00 x 56.00 x 7.00mm, FPM
NF867
98.00 x 120.00 x 7.00mm, FPM/ACM



CC



9

Model	Year	Code	Fuel	CC	Gear	Steering	Power
718 Boxster (982)	04/16→	MDD.NC	Petrol	2497	4	16	10
718 Boxster (982)	04/16→	MDD.PA	Petrol	1988	4	16	6
718 Boxster (982)	04/16→	MDD.PB	Petrol	1988	4	16	6
718 Cayman (982)	04/16→	MDD.NC	Petrol	2497	4	16	10
718 Cayman (982)	04/16→	MDD.PA	Petrol	1988	4	16	6
718 Cayman (982)	04/16→	MDD.PB	Petrol	1988	4	16	6
911 (991)	12/11→	MA1.01	Petrol	3800	6	24	22
911 (991)	12/11→	MA1.03	Petrol	3800	6	24	22
911 (991)	12/11→	MA1.04	Petrol	3436	6	24	19
911 (991)	12/11→	MAB.03	Petrol	3800	6	24	22
911 (991)	12/11→	MAB.04	Petrol	3436	6	24	19
911 (991)	02/13→	MA1.70	Petrol	3800	6	24	22
911 (991)	08/13→	MA1.75	Petrol	3799	6	24	23
911 (991)	09/13→	MA1.71	Petrol	3800	6	24	22
911 (991)	04/15→	MA1.76	Petrol	3996	6	24	24
911 (991)	11/15→	MDC.HA	Petrol	2981	6	24	16
911 (991)	11/15→	MDC.KA	Petrol	2981	6	24	16
911 (991)	01/16→	MDA.BA	Petrol	3800	6	24	22
911 (991)	01/16→	MDB.CA	Petrol	3800	6	24	22
911 (996)	09/97→09/01	M 96.01	Petrol	3387	6	24	19
911 (996)	09/97→09/01	M 96.04	Petrol	3387	6	24	19
911 (996)	03/99→08/05	M 96.76	Petrol	3598	6	24	21
911 (996)	06/00→08/05	M 96.70	Petrol	3600	6	24	21
911 (996)	05/01→08/05	M 96.02	Petrol	3387	6	24	19
911 (996)	10/01→08/05	M 96.03	Petrol	3596	6	24	20
911 (996)	03/03→08/05	M 96.79	Petrol	3598	6	24	21
911 (997)	07/04→12/08	M 96.05	Petrol	3596	6	24	20
911 (997)	07/04→12/08	M 97.01	Petrol	3824	6	24	22
911 (997)	08/05→12/08	M 97.01S	Petrol	3824	6	24	22
911 (997)	03/06→12/09	M 97.76	Petrol	3600	6	24	21
911 (997)	03/06→12/12	M 97.70	Petrol	3600	6	24	21
911 (997)	09/06→12/09	M 96.70	Petrol	3600	6	24	21
911 (997)	09/07→12/12	M 97.70S	Petrol	3600	6	24	21
911 (997)	06/08→12/12	MA1.01	Petrol	3800	6	24	22
911 (997)	06/08→12/12	MA1.02	Petrol	3614	6	24	20
911 (997)	05/09→12/11	M 97.77	Petrol	3797	6	24	23
911 (997)	08/09→12/11	M 97.77R	Petrol	3797	6	24	23
911 (997)	09/09→12/12	MA1.70	Petrol	3800	6	24	22
911 (997)	07/11→12/12	M 97.74	Petrol	3996	6	24	24
911 Convertible (991)	03/12→	MA1.03	Petrol	3800	6	24	22
911 Convertible (991)	03/12→	MA1.04	Petrol	3436	6	24	19
911 Convertible (991)	03/12→	MAB.03	Petrol	3800	6	24	22
911 Convertible (991)	03/12→	MAB.04	Petrol	3436	6	24	19
911 Convertible (991)	12/13→	MA1.71	Petrol	3800	6	24	22
911 Convertible (991)	11/15→	MDC.HA	Petrol	2981	6	24	16
911 Convertible (991)	11/15→	MDC.KA	Petrol	2981	6	24	16
911 Convertible (991)	01/16→	MDA.BA	Petrol	3800	6	24	22
911 Convertible (991)	01/16→	MDB.CA	Petrol	3800	6	24	22
911 Convertible (996)	02/98→09/01	M 96.01	Petrol	3387	6	24	19
911 Convertible (996)	02/98→09/01	M 96.04	Petrol	3387	6	24	19
911 Convertible (996)	02/98→08/05	M 96.02	Petrol	3387	6	24	19
911 Convertible (996)	10/01→08/05	M 96.03	Petrol	3596	6	24	20
911 Convertible (996)	10/03→08/05	M 96.70	Petrol	3600	6	24	21
911 Convertible (997)	04/05→12/08	M 96.05	Petrol	3596	6	24	20
911 Convertible (997)	04/05→12/10	M 97.01	Petrol	3824	6	24	22
911 Convertible (997)	08/05→12/08	M 97.01S	Petrol	3824	6	24	22
911 Convertible (997)	09/07→12/09	M 96.70	Petrol	3600	6	24	21
911 Convertible (997)	09/07→12/09	M 97.70	Petrol	3600	6	24	21
911 Convertible (997)	06/08→12/12	MA1.01	Petrol	3800	6	24	22
911 Convertible (997)	06/08→12/12	MA1.02	Petrol	3614	6	24	20
911 Convertible (997)	09/09→12/12	MA1.70	Petrol	3800	6	24	22
911 Targa (991)	05/14→	MA1.03	Petrol	3800	6	24	22
911 Targa (991)	05/14→	MA1.04	Petrol	3436	6	24	19
911 Targa (991)	05/14→	MAB.03	Petrol	3800	6	24	22
911 Targa (991)	05/14→	MAB.04	Petrol	3436	6	24	19
911 Targa (991)	11/15→	MDC.HA	Petrol	2981	6	24	16
911 Targa (991)	11/15→	MDC.KA	Petrol	2981	6	24	16
911 Targa (996)	12/01→08/05	M 96.03	Petrol	3596	6	24	20
911 Targa (997)	07/06→12/08	M 96.05	Petrol	3596	6	24	20
911 Targa (997)	07/06→12/08	M 97.01	Petrol	3824	6	24	22
911 Targa (997)	10/08→12/12	MA1.01	Petrol	3800	6	24	22
911 Targa (997)	10/08→12/12	MA1.02	Petrol	3614	6	24	20
914	01/69→12/73	W	Petrol	1679	4	8	1
914	01/72→12/75	GB	Petrol	1971	4	8	3
914	01/73→12/74	GA	Petrol	1971	4	8	3
914	08/73→02/76	AN	Petrol	1795	4	8	2
914	01/74→12/75	EC	Petrol	1795	4	8	2
924	11/75→08/89	XJ	Petrol	1984	4	8	4



CC



9

924	11/75→08/89	XK	Petrol	1984	4	8	4
924	11/78→06/80	M 31.01	Petrol	1984	4	8	4
924	06/80→10/86	M 31.03	Petrol	1984	4	8	4
924	06/80→10/86	M 31.50	Petrol	1984	4	8	4
924	10/81→12/84	M 44.01	Petrol	2479	4	8	7
924	10/81→12/84	M 44.03	Petrol	2479	4	8	7
924	09/85→07/87	M 44.07	Petrol	2479	4	8	7
924	09/85→07/87	M 44.08	Petrol	2479	4	8	7
924	08/87→07/88	M 44.09	Petrol	2479	4	8	7
924	08/87→07/88	M 44.10	Petrol	2479	4	8	7
928	09/77→12/79	M 28.03	Petrol	4474	8	16	26
928	09/77→12/79	M 28.04	Petrol	4474	8	16	26
928	09/77→08/82	M 28.01	Petrol	4474	8	16	26
928	09/77→08/82	M 28.02	Petrol	4474	8	16	26
928	09/77→08/82	M 28.09	Petrol	4474	8	16	26
928	09/77→08/82	M 28.10	Petrol	4474	8	16	26
928	09/79→12/82	M 28.13	Petrol	4474	8	16	26
928	09/79→12/82	M 28.14	Petrol	4474	8	16	26
928	09/79→12/82	M 28.17	Petrol	4474	8	16	26
928	09/79→12/82	M 28.18	Petrol	4474	8	16	26
928	09/79→07/83	M 28.11	Petrol	4664	8	16	28
928	09/79→07/83	M 28.12	Petrol	4664	8	16	28
928	09/82→12/84	M 28.20	Petrol	4664	8	16	28
928	08/83→07/86	M 28.21	Petrol	4664	8	16	28
928	08/83→07/86	M 28.22	Petrol	4664	8	16	28
928	09/84→12/85	M 28.43	Petrol	4957	8	32	30
928	09/84→12/86	M 28.44	Petrol	4957	8	32	30
928	09/85→12/86	M 28.45	Petrol	4957	8	32	30
928	09/85→12/86	M 28.46	Petrol	4957	8	32	30
928	08/86→07/91	M 28.41	Petrol	4957	8	32	30
928	08/86→07/91	M 28.42	Petrol	4957	8	32	30
928	01/89→07/91	M 28.47	Petrol	4957	8	32	30
928	08/91→11/95	M 28.49	Petrol	5397	8	32	31
928	08/91→11/95	M 28.50	Petrol	5397	8	32	31
944	06/81→07/87	M 44.01	Petrol	2479	4	8	7
944	06/81→07/87	M 44.03	Petrol	2479	4	8	7
944	06/81→07/87	M 44.06	Petrol	2479	4	8	7
944	06/81→12/90	M 44.05	Petrol	2479	4	8	7
944	01/85→07/87	M 44.02	Petrol	2479	4	8	7
944	01/85→07/87	M 44.04	Petrol	2479	4	8	7
944	01/85→07/87	M 44.07	Petrol	2479	4	8	7
944	01/85→07/87	M 44.08	Petrol	2479	4	8	7
944	08/86→07/88	M 44.40	Petrol	2479	4	16	8
944	08/87→12/90	M 44.09	Petrol	2479	4	8	7
944	08/87→12/90	M 44.10	Petrol	2479	4	8	7
Boxster (981)	04/12→	MA1.22	Petrol	2706	6	24	11
Boxster (981)	04/12→	MA1.23	Petrol	3436	6	24	19
Boxster (986)	09/96→08/99	M 96.20	Petrol	2480	6	24	9
Boxster (986)	08/99→07/02	M 96.21	Petrol	3179	6	24	18
Boxster (986)	08/99→07/02	M 96.22	Petrol	2687	6	24	11
Boxster (986)	07/02→12/04	M 96.23	Petrol	2687	6	24	11
Boxster (986)	07/02→12/04	M 96.24	Petrol	3179	6	24	18
Boxster (987)	11/04→12/06	M 96.25	Petrol	2687	6	24	11
Boxster (987)	11/04→12/06	M 96.26	Petrol	3179	6	24	18
Boxster (987)	07/06→12/09	M 97.20	Petrol	2687	6	24	11
Boxster (987)	07/06→12/09	M 97.21	Petrol	3387	6	24	19
Boxster (987)	08/08→12/09	M 97.22	Petrol	3387	6	24	19
Boxster (987)	06/09→12/11	MA1.20	Petrol	2893	6	24	12
Boxster (987)	06/09→12/11	MA1.21	Petrol	3436	6	24	19
Boxster Spyder (981)	07/15→	MDB.XA	Petrol	3800	6	24	22
Boxster Spyder (987)	09/07→12/08	M 97.22	Petrol	3387	6	24	19
Boxster Spyder (987)	09/09→12/11	MA1.21	Petrol	3436	6	24	19
Carrera GT (980)	07/03→12/06	M 80.01	Petrol	5733	10	40	32
Cayenne (9PA)	09/02→09/07	M 48.00	Petrol	4511	8	32	27
Cayenne (9PA)	09/02→09/07	M 48.50	Petrol	4511	8	32	27
Cayenne (9PA)	08/03→09/07	M02.2Y	Petrol	3189	6	24	17
Cayenne (9PA)	01/04→09/07	M 48.50S	Petrol	4511	8	32	27
Cayenne (9PA)	03/06→09/07	M 48.50T	Petrol	4511	8	32	27
Cayenne (9PA)	02/07→09/10	M 48.01	Petrol	4806	8	32	29
Cayenne (9PA)	02/07→09/10	M 48.51	Petrol	4806	8	32	29
Cayenne (9PA)	02/07→09/10	M 55.01	Petrol	3598	6	24	20
Cayenne (9PA)	02/09→09/10	M 05.9D	Diesel	2967	6	24	13
Cayenne (92A)	06/10→	M 05.9E	Diesel	2967	6	24	13
Cayenne (92A)	06/10→	M 06.EC	Petrol	2995	6	24	14
Cayenne (92A)	06/10→	M 48.02	Petrol	4806	8	32	29
Cayenne (92A)	06/10→	M 48.52	Petrol	4806	8	32	29
Cayenne (92A)	06/10→	M 55.02	Petrol	3598	6	24	20
Cayenne (92A)	06/10→	MCE.YA	Petrol	3598	6	24	20















CC



9

Model	Year Range	Engine Code	Fuel Type	CC	Torque (kgm)	Power (hp)	0-100 (s)
Cayenne (92A)	06/10→	MCG.E	Petrol	2995	6	24	14
Cayenne (92A)	06/10→	MCG.EA	Petrol	2995	6	24	14
Cayenne (92A)	06/10→	MCG.FA	Petrol	2995	6	24	14
Cayenne (92A)	06/10→	MCN.RB	Diesel	2967	6	24	15
Cayenne (92A)	06/10→	MCR.CB	Diesel	2967	6	24	15
Cayenne (92A)	06/10→	MCV.VC	Diesel	2967	6	24	15
Cayenne (92A)	04/11→	MCJ.T	Petrol	2995	6	24	14
Cayenne (92A)	06/11→	MCR.C	Diesel	2967	6	24	15
Cayenne (92A)	06/11→	MCR.CA	Diesel	2967	6	24	15
Cayenne (92A)	10/12→	MCU.DB	Diesel	4134	8	32	25
Cayenne (92A)	08/14→	MCV.VB	Diesel	2967	6	24	15
Cayenne (92A)	10/14→	MCF.TB	Petrol	4806	8	32	29
Cayenne (92A)	10/14→	MCU.DC	Diesel	4134	8	32	25
Cayenne (92A)	10/14→	MCU.RA	Petrol	3604	6	24	20
Cayenne (92A)	10/14→	MCV.VA	Diesel	2967	6	24	13
Cayenne (92A)	01/15→	MCY.XA	Petrol	4806	8	32	29
Cayenne (92A)	02/15→	MCX.ZA	Petrol	3604	6	24	20
Cayman (981)	03/13→	MA1.22	Petrol	2706	6	24	11
Cayman (981)	03/13→	MA1.23	Petrol	3436	6	24	19
Cayman (981)	01/15→	MDB.XA	Petrol	3800	6	24	22
Cayman (987)	11/05→12/09	M 97.21	Petrol	3387	6	24	19
Cayman (987)	07/06→12/09	M 97.20	Petrol	2687	6	24	11
Cayman (987)	08/08→12/12	M 97.22	Petrol	3387	6	24	19
Cayman (987)	02/09→12/12	MA1.20	Petrol	2893	6	24	12
Cayman (987)	02/09→06/13	MA1.21	Petrol	3436	6	24	19
Cayman (987)	09/12→12/13	MA1.22	Petrol	2706	6	24	11
Macan (95B)	02/14→	MCD.UD	Diesel	2967	6	24	15
Macan (95B)	02/14→	MCT.BA	Diesel	2967	6	24	15
Macan (95B)	02/14→	MCT.BB	Diesel	2967	6	24	15
Macan (95B)	02/14→	MCT.BC	Diesel	2967	6	24	15
Macan (95B)	02/14→	MCT.LA	Petrol	3604	6	24	20
Macan (95B)	02/14→	MCT.MA	Petrol	2997	6	24	16
Macan (95B)	07/14→	MCN.CC	Petrol	1984	4	16	5
Macan (95B)	07/14→	MCY.NA	Petrol	1984	4	16	5
Macan (95B)	10/15→	MCY.NB	Petrol	1984	4	16	5
Macan (95B)	10/15→	MCY.PA	Petrol	1984	4	16	5
Macan (95B)	10/15→	MDC.NA	Petrol	2997	6	24	16
Panamera (970)	09/09→07/13	M 48.20	Petrol	4806	8	32	29
Panamera (970)	09/09→07/13	M 48.40	Petrol	4806	8	32	29
Panamera (970)	09/09→07/13	M 48.70	Petrol	4806	8	32	29
Panamera (970)	05/10→07/13	M 46.20	Petrol	3605	6	24	20
Panamera (970)	05/10→07/13	M 46.40	Petrol	3605	6	24	20
Panamera (970)	03/11→10/16	MCG.EA	Petrol	2995	6	24	14
Panamera (970)	03/11→10/16	MCG.FA	Petrol	2995	6	24	14
Panamera (970)	08/11→07/13	MCR.CB	Diesel	2967	6	24	15
Panamera (970)	08/11→07/13	MCR.CC	Diesel	2967	6	24	15
Panamera (970)	07/13→10/16	MCW.AA	Petrol	3605	6	24	20
Panamera (970)	07/13→10/16	MCW.BA	Petrol	4806	8	32	29
Panamera (970)	07/13→10/16	MCW.CA	Petrol	4806	8	32	29
Panamera (970)	07/13→10/16	MCW.DA	Petrol	2997	6	24	16
Panamera (970)	07/13→10/16	MCW.JA	Diesel	2967	6	24	15
Panamera (970)	07/13→10/16	MCX.NA	Petrol	3605	6	24	20
Panamera (970)	07/13→10/16	MCX.PA	Petrol	4806	8	32	29
Panamera (970)	07/13→10/16	MCX.RA	Petrol	4806	8	32	29
Panamera (970)	10/13→10/16	MCW.F	Petrol	2997	6	24	16
Panamera (970)	10/13→10/16	MCW.FA	Petrol	2997	6	24	16

	CC				9		CC				9
AN	1795	4	8	Petrol	2	M 96.26	3179	6	24	Petrol	18
EC	1795	4	8	Petrol	2	M 96.70	3600	6	24	Petrol	21
GA	1971	4	8	Petrol	3	M 96.76	3598	6	24	Petrol	21
GB	1971	4	8	Petrol	3	M 96.79	3598	6	24	Petrol	21
M02.2Y	3189	6	24	Petrol	17	M 97.01	3824	6	24	Petrol	22
M 05.9D	2967	6	24	Diesel	13	M 97.01S	3824	6	24	Petrol	22
M 05.9E	2967	6	24	Diesel	13	M 97.20	2687	6	24	Petrol	11
M 06.EC	2995	6	24	Petrol	14	M 97.21	3387	6	24	Petrol	19
M 28.01	4474	8	16	Petrol	26	M 97.22	3387	6	24	Petrol	19
M 28.02	4474	8	16	Petrol	26	M 97.70	3600	6	24	Petrol	21
M 28.03	4474	8	16	Petrol	26	M 97.70S	3600	6	24	Petrol	21
M 28.04	4474	8	16	Petrol	26	M 97.74	3996	6	24	Petrol	24
M 28.09	4474	8	16	Petrol	26	M 97.76	3600	6	24	Petrol	21
M 28.10	4474	8	16	Petrol	26	M 97.77	3797	6	24	Petrol	23
M 28.11	4664	8	16	Petrol	28	M 97.77R	3797	6	24	Petrol	23
M 28.12	4664	8	16	Petrol	28	MA1.01	3800	6	24	Petrol	22
M 28.13	4474	8	16	Petrol	26	MA1.02	3614	6	24	Petrol	20
M 28.14	4474	8	16	Petrol	26	MA1.03	3800	6	24	Petrol	22
M 28.15	4474	8	16	Petrol	26	MA1.04	3436	6	24	Petrol	19
M 28.16	4474	8	16	Petrol	26	MA1.20	2893	6	24	Petrol	12
M 28.17	4474	8	16	Petrol	26	MA1.21	3436	6	24	Petrol	19
M 28.18	4474	8	16	Petrol	26	MA1.22	2706	6	24	Petrol	11
M 28.19	4664	8	16	Petrol	28	MA1.23	3436	6	24	Petrol	19
M 28.20	4664	8	16	Petrol	28	MA1.70	3800	6	24	Petrol	22
M 28.21	4664	8	16	Petrol	28	MA1.71	3800	6	24	Petrol	22
M 28.22	4664	8	16	Petrol	28	MA1.75	3799	6	24	Petrol	23
M 28.41	4957	8	32	Petrol	30	MA1.76	3996	6	24	Petrol	24
M 28.42	4957	8	32	Petrol	30	MAB.03	3800	6	24	Petrol	22
M 28.43	4957	8	32	Petrol	30	MAB.04	3436	6	24	Petrol	19
M 28.44	4957	8	32	Petrol	30	MCD.UD	2967	6	24	Diesel	15
M 28.45	4957	8	32	Petrol	30	MCE.YA	3598	6	24	Petrol	20
M 28.46	4957	8	32	Petrol	30	MCF.TB	4806	8	32	Petrol	29
M 28.47	4957	8	32	Petrol	30	MCG.E	2995	6	24	Petrol	14
M 28.49	5397	8	32	Petrol	31	MCG.EA	2995	6	24	Petrol	14
M 28.50	5397	8	32	Petrol	31	MCG.FA	2995	6	24	Petrol	14
M 31.01	1984	4	8	Petrol	4	MCJ.T	2995	6	24	Petrol	14
M 31.02	1984	4	8	Petrol	4	MCN.CC	1984	4	16	Petrol	5
M 31.03	1984	4	8	Petrol	4	MCN.RB	2967	6	24	Diesel	15
M 31.50	1984	4	8	Petrol	4	MCR.C	2967	6	24	Diesel	15
M 44.01	2479	4	8	Petrol	7	MCR.CA	2967	6	24	Diesel	15
M 44.02	2479	4	8	Petrol	7	MCR.CB	2967	6	24	Diesel	15
M 44.03	2479	4	8	Petrol	7	MCR.CC	2967	6	24	Diesel	15
M 44.04	2479	4	8	Petrol	7	MCT.BA	2967	6	24	Diesel	15
M 44.05	2479	4	8	Petrol	7	MCT.BB	2967	6	24	Diesel	15
M 44.06	2479	4	8	Petrol	7	MCT.BC	2967	6	24	Diesel	15
M 44.07	2479	4	8	Petrol	7	MCT.LA	3604	6	24	Petrol	20
M 44.08	2479	4	8	Petrol	7	MCT.MA	2997	6	24	Petrol	16
M 44.09	2479	4	8	Petrol	7	MCU.DB	4134	8	32	Diesel	25
M 44.10	2479	4	8	Petrol	7	MCU.DC	4134	8	32	Diesel	25
M 44.40	2479	4	16	Petrol	8	MCU.RA	3604	6	24	Petrol	20
M 46.20	3605	6	24	Petrol	20	MCV.VA	2967	6	24	Diesel	13
M 46.40	3605	6	24	Petrol	20	MCV.VB	2967	6	24	Diesel	15
M 48.00	4511	8	32	Petrol	27	MCV.VC	2967	6	24	Diesel	15
M 48.01	4806	8	32	Petrol	29	MCW.AA	3605	6	24	Petrol	20
M 48.02	4806	8	32	Petrol	29	MCW.BA	4806	8	32	Petrol	29
M 48.10	3189	6	24	Petrol	17	MCW.CA	4806	8	32	Petrol	29
M 48.20	4806	8	32	Petrol	29	MCW.DA	2997	6	24	Petrol	16
M 48.40	4806	8	32	Petrol	29	MCW.F	2997	6	24	Petrol	16
M 48.50	4511	8	32	Petrol	27	MCW.FA	2997	6	24	Petrol	16
M 48.50S	4511	8	32	Petrol	27	MCW.JA	2967	6	24	Diesel	15
M 48.50T	4511	8	32	Petrol	27	MCX.NA	3605	6	24	Petrol	20
M 48.51	4806	8	32	Petrol	29	MCX.PA	4806	8	32	Petrol	29
M 48.52	4806	8	32	Petrol	29	MCX.RA	4806	8	32	Petrol	29
M 48.70	4806	8	32	Petrol	29	MCX.ZA	3604	6	24	Petrol	20
M 55.01	3598	6	24	Petrol	20	MCY.NA	1984	4	16	Petrol	5
M 55.02	3598	6	24	Petrol	20	MCY.NB	1984	4	16	Petrol	5
M 80.01	5733	10	40	Petrol	32	MCY.PA	1984	4	16	Petrol	5
M 96.01	3387	6	24	Petrol	19	MCY.XA	4806	8	32	Petrol	29
M 96.02	3387	6	24	Petrol	19	MDA.BA	3800	6	24	Petrol	22
M 96.03	3596	6	24	Petrol	20	MDB.CA	3800	6	24	Petrol	22
M 96.04	3387	6	24	Petrol	19	MDB.XA	3800	6	24	Petrol	22
M 96.05	3596	6	24	Petrol	20	MDC.HA	2981	6	24	Petrol	16
M 96.20	2480	6	24	Petrol	9	MDC.KA	2981	6	24	Petrol	16
M 96.21	3179	6	24	Petrol	18	MDC.NA	2997	6	24	Petrol	16
M 96.22	2687	6	24	Petrol	11	MDD.NC	2497	4	16	Petrol	10
M 96.23	2687	6	24	Petrol	11	MDD.PA	1988	4	16	Petrol	6
M 96.24	3179	6	24	Petrol	18	MDD.PB	1988	4	16	Petrol	6
M 96.25	2687	6	24	Petrol	11	W	1679	4	8	Petrol	1

		CC				9		CC				9
XJ		1984	4	8	Petrol	4						
XK		1984	4	8	Petrol	4						

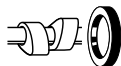

1 1.7L Petrol

W	4 Cyl.	8 Valves	1679cc	TD18881
				NB953
				75.00 x 95.00 x 12.00mm, FPM

2 1.8L Petrol

AN	4 Cyl.	8 Valves	1795cc	TD22922
EC	4 Cyl.	8 Valves	1795cc	TD33685
				NB953
				75.00 x 95.00 x 12.00mm, FPM

3 2.0L Petrol

GA	4 Cyl.	8 Valves	1971cc	TD33684
GB	4 Cyl.	8 Valves	1971cc	TD18879
				NB953
				75.00 x 95.00 x 12.00mm, FPM

4 2.0L Petrol

M 31.01	4 Cyl.	8 Valves	1984cc	TD2972
M 31.02	4 Cyl.	8 Valves	1984cc	TD29132
M 31.03	4 Cyl.	8 Valves	1984cc	TD2973
M 31.50	4 Cyl.	8 Valves	1984cc	TD2974
XJ	4 Cyl.	8 Valves	1984cc	TD2994
XK	4 Cyl.	8 Valves	1984cc	TD2995
PB394 (x8)	NA5001			
				32.00 x 47.00 x 10.00mm, FPM

5 2.0L Petrol

MCN.CC	4 Cyl.	16 Valves	1984cc	TD29606
MCY.NA	4 Cyl.	16 Valves	1984cc	TD29607
MCY.NB	4 Cyl.	16 Valves	1984cc	TD32697
MCY.PA	4 Cyl.	16 Valves	1984cc	TD32698
PA5041 (x16) HR791				

6 2.0L Petrol

MDD.PA	4 Cyl.	16 Valves	1988cc	TD32803
MDD.PB	4 Cyl.	16 Valves	1988cc	TD32801
PA5041 (x16) HR791				NA5305
				85.00 x 105.00 x 11.00mm, PTFE

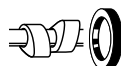

7 2.5L Petrol

M 44.01	4 Cyl.	8 Valves	2479cc	TD2975
M 44.02	4 Cyl.	8 Valves	2479cc	TD2976
M 44.03	4 Cyl.	8 Valves	2479cc	TD2977
M 44.04	4 Cyl.	8 Valves	2479cc	TD2978
M 44.05	4 Cyl.	8 Valves	2479cc	TD2979
M 44.06	4 Cyl.	8 Valves	2479cc	TD2980
M 44.07	4 Cyl.	8 Valves	2479cc	TD2981
M 44.08	4 Cyl.	8 Valves	2479cc	TD2982
M 44.09	4 Cyl.	8 Valves	2479cc	TD2983
M 44.10	4 Cyl.	8 Valves	2479cc	TD2984

NA5136
30.00 x 47.00 x 7.00mm, FPM

8 2.5L Petrol

M 44.40	4 Cyl.	16 Valves	2479cc	TD2987
---------	--------	-----------	--------	--------

HR816  (x2)

9 2.5L Petrol

M 96.20	6 Cyl.	24 Valves	2480cc	TD5460
---------	--------	-----------	--------	--------

PA5041 (x24)
HR5062 

NA5305 
85.00 x 105.00 x 11.00mm, PTFE

10 2.5L Petrol

MDD.NC	4 Cyl.	16 Valves	2497cc	TD32802
--------	--------	-----------	--------	---------

PA5041 (x16)
HR791 

NA5305 
85.00 x 105.00 x 11.00mm, PTFE

11 2.7L Petrol

M 96.22	6 Cyl.	24 Valves	2687cc	TD16157
M 96.23	6 Cyl.	24 Valves	2687cc	TD18196
M 96.25	6 Cyl.	24 Valves	2687cc	TD18568
M 97.20	6 Cyl.	24 Valves	2687cc	TD20979
MA1.22	6 Cyl.	24 Valves	2706cc	TD27062

PA5041 (x24)
HR5062 

NA5305 
85.00 x 105.00 x 11.00mm, PTFE

12 2.9L Petrol

MA1.20	6 Cyl.	24 Valves	2893cc	TD23315
--------	--------	-----------	--------	---------

PA5041 (x24)
HR5062 

NA5305 
85.00 x 105.00 x 11.00mm, PTFE

13 3.0L Diesel

M 05.9D	6 Cyl.	24 Valves	2967cc	TD27056
M 05.9E	6 Cyl.	24 Valves	2967cc	TD25678
M CV.VA	6 Cyl.	24 Valves	2967cc	TD32702

PA5041 (x24)
HR5062 

NA5001 (x2)
32.00 x 47.00 x 10.00mm, FPM

NA5329 
55.00 x 70.00 x 8.00mm, PTFE
NA5325 
85.00 x 105.00 x 8.80mm, PTFE



14 3.0L

Petrol

M 06.EC	6 Cyl.	24 Valves	2995cc	TD25673
MCG.E	6 Cyl.	24 Valves	2995cc	TD29603
MCG.EA	6 Cyl.	24 Valves	2995cc	TD25675
MCG.FA	6 Cyl.	24 Valves	2995cc	TD25674
MCJ.T	6 Cyl.	24 Valves	2995cc	TD25676

PA5041 (x24)
HR5062

NA5325
85.00 x 105.00 x 8.80mm, PTFE

15 3.0L

Diesel

MCD.UD	6 Cyl.	24 Valves	2967cc	TD32700
MCN.RB	6 Cyl.	24 Valves	2967cc	TD27957
MCR.C	6 Cyl.	24 Valves	2967cc	TD30993
MCR.CA	6 Cyl.	24 Valves	2967cc	TD25677
MCR.CB	6 Cyl.	24 Valves	2967cc	TD25679
MCR.CC	6 Cyl.	24 Valves	2967cc	TD26318
MCT.BA	6 Cyl.	24 Valves	2967cc	TD29254
MCT.BB	6 Cyl.	24 Valves	2967cc	TD29256
MCT.BC	6 Cyl.	24 Valves	2967cc	TD29255
MCV.VB	6 Cyl.	24 Valves	2967cc	TD30244
MCV.VC	6 Cyl.	24 Valves	2967cc	TD30992
MCW.JA	6 Cyl.	24 Valves	2967cc	TD32543

PA5041 (x24)
HR5062

NA5001 (x2)
32.00 x 47.00 x 10.00mm, FPM

NA5329
55.00 x 70.00 x 8.00mm, PTFE

16 3.0L

Petrol

MCT.MA	6 Cyl.	24 Valves	2997cc	TD29252
MCW.DA	6 Cyl.	24 Valves	2997cc	TD28008
MCW.F	6 Cyl.	24 Valves	2997cc	TD32540
MCW.FA	6 Cyl.	24 Valves	2997cc	TD32539
MDC.HA	6 Cyl.	24 Valves	2981cc	TD32692
MDC.KA	6 Cyl.	24 Valves	2981cc	TD32691
MDC.NA	6 Cyl.	24 Valves	2997cc	TD32699

PA5041 (x24)
HR5062

NA5305
85.00 x 105.00 x 11.00mm, PTFE

17 3.2L

Petrol

M02.2Y	6 Cyl.	24 Valves	3189cc	TD23319
M 48.10	6 Cyl.	24 Valves	3189cc	TD18467

PA5041 (x24)
HR5062

NA5106
35.00 x 48.00 x 10.00mm, PTFE
NA5305
85.00 x 105.00 x 11.00mm, PTFE

18 3.2L

Petrol

M 96.21	6 Cyl.	24 Valves	3179cc	TD16156
M 96.24	6 Cyl.	24 Valves	3179cc	TD18198
M 96.26	6 Cyl.	24 Valves	3179cc	TD23313

PA5041 (x24)
HR5062

NA5305
85.00 x 105.00 x 11.00mm, PTFE



19 3.4L Petrol

M 96.01	6 Cyl.	24 Valves	3387cc	TD9460
M 96.02	6 Cyl.	24 Valves	3387cc	TD17343
M 96.04	6 Cyl.	24 Valves	3387cc	TD17342
M 97.21	6 Cyl.	24 Valves	3387cc	TD23314
M 97.22	6 Cyl.	24 Valves	3387cc	TD23322
MA1.04	6 Cyl.	24 Valves	3436cc	TD26320
MA1.21	6 Cyl.	24 Valves	3436cc	TD23316
MA1.23	6 Cyl.	24 Valves	3436cc	TD27061
MAB.04	6 Cyl.	24 Valves	3436cc	TD32693

PA5041 (x24)
HR5062

NA5305
85.00 x 105.00 x 11.00mm, PTFE

20 3.6L Petrol

M 46.20	6 Cyl.	24 Valves	3605cc	TD25179
M 46.40	6 Cyl.	24 Valves	3605cc	TD25180
M 55.01	6 Cyl.	24 Valves	3598cc	TD23323
M 55.02	6 Cyl.	24 Valves	3598cc	TD25177
M 96.03	6 Cyl.	24 Valves	3596cc	TD17344
M 96.05	6 Cyl.	24 Valves	3596cc	TD18566
MA1.02	6 Cyl.	24 Valves	3614cc	TD21271
MCE.YA	6 Cyl.	24 Valves	3598cc	TD30991
MCT.LA	6 Cyl.	24 Valves	3604cc	TD29253
MCU.RA	6 Cyl.	24 Valves	3604cc	TD30633
MCW.AA	6 Cyl.	24 Valves	3605cc	TD32541
MCX.NA	6 Cyl.	24 Valves	3605cc	TD32542
MCX.ZA	6 Cyl.	24 Valves	3604cc	TD30631

PA5041 (x24)
HR5062

NA5305
85.00 x 105.00 x 11.00mm, PTFE

21 3.6L Petrol

M 96.70	6 Cyl.	24 Valves	3600cc	TD16158
M 96.76	6 Cyl.	24 Valves	3598cc	TD13628
M 96.79	6 Cyl.	24 Valves	3598cc	TD20764
M 97.70	6 Cyl.	24 Valves	3600cc	TD21272
M 97.70S	6 Cyl.	24 Valves	3600cc	TD21273
M 97.76	6 Cyl.	24 Valves	3600cc	TD21248

PA5041 (x24)
HR5062

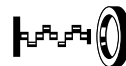
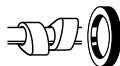

22 3.8L

Petrol

M 97.01	6 Cyl.	24 Valves	3824cc	TD18567
M 97.01S	6 Cyl.	24 Valves	3824cc	TD21250
MA1.01	6 Cyl.	24 Valves	3800cc	TD21249
MA1.03	6 Cyl.	24 Valves	3800cc	TD26321
MA1.70	6 Cyl.	24 Valves	3800cc	TD25671
MA1.71	6 Cyl.	24 Valves	3800cc	TD28544
MAB.03	6 Cyl.	24 Valves	3800cc	TD32694
MDA.BA	6 Cyl.	24 Valves	3800cc	TD32695
MDB.CA	6 Cyl.	24 Valves	3800cc	TD32696
MDB.XA	6 Cyl.	24 Valves	3800cc	TD30994

PA5041 (x24)
HR5062

NA5305
85.00 x 105.00 x 11.00mm, PTFE

23 3.8L

Petrol

M 97.77	6 Cyl.	24 Valves	3797cc	TD24404
M 97.77R	6 Cyl.	24 Valves	3797cc	TD25670
MA1.75	6 Cyl.	24 Valves	3799cc	TD28199

PA5041 (x24)
HR5062

24 4.0L

Petrol

M 97.74	6 Cyl.	24 Valves	3996cc	TD25672
MA1.76	6 Cyl.	24 Valves	3996cc	TD32620

PA5041 (x24)
HR5062

25 4.2L

Diesel

MCU.DB	8 Cyl.	32 Valves	4134cc	TD27055
MCU.DC	8 Cyl.	32 Valves	4134cc	TD29604

PA5041 (x32)
HR791

NA5307 (x2)
32.00 x 47.00 x 10.00mm, PTFE



26 4.5L

Petrol



M 28.01	8 Cyl.	16 Valves	4474cc	TD27764
M 28.02	8 Cyl.	16 Valves	4474cc	TD27765
M 28.03	8 Cyl.	16 Valves	4474cc	TD2952
M 28.04	8 Cyl.	16 Valves	4474cc	TD2953
M 28.09	8 Cyl.	16 Valves	4474cc	TD27766
M 28.10	8 Cyl.	16 Valves	4474cc	TD18880
M 28.13	8 Cyl.	16 Valves	4474cc	TD2956
M 28.14	8 Cyl.	16 Valves	4474cc	TD2957
M 28.15	8 Cyl.	16 Valves	4474cc	TD27767
M 28.16	8 Cyl.	16 Valves	4474cc	TD27768
M 28.17	8 Cyl.	16 Valves	4474cc	TD27769
M 28.18	8 Cyl.	16 Valves	4474cc	TD27770

NA5136 (x2)
30.00 x 47.00 x 7.00mm, FPM



27 4.5L		Petrol		
M 48.00	8 Cyl.	32 Valves	4511cc	TD18464
M 48.50	8 Cyl.	32 Valves	4511cc	TD18465
M 48.50S	8 Cyl.	32 Valves	4511cc	TD18466
M 48.50T	8 Cyl.	32 Valves	4511cc	TD33115
PA5041 (x32) HR791  (x2)				NA5305  85.00 x 105.00 x 11.00mm, PTFE

28 4.7L		Petrol		
M 28.11	8 Cyl.	16 Valves	4664cc	TD2954
M 28.12	8 Cyl.	16 Valves	4664cc	TD2955
M 28.19	8 Cyl.	16 Valves	4664cc	TD2958
M 28.20	8 Cyl.	16 Valves	4664cc	TD2959
M 28.21	8 Cyl.	16 Valves	4664cc	TD2960
M 28.22	8 Cyl.	16 Valves	4664cc	TD2961
NA5136 (x2) 30.00 x 47.00 x 7.00mm, FPM				

29 4.8L		Petrol		
M 48.01	8 Cyl.	32 Valves	4806cc	TD23320
M 48.02	8 Cyl.	32 Valves	4806cc	TD25178
M 48.20	8 Cyl.	32 Valves	4806cc	TD25181
M 48.40	8 Cyl.	32 Valves	4806cc	TD25182
M 48.51	8 Cyl.	32 Valves	4806cc	TD23321
M 48.52	8 Cyl.	32 Valves	4806cc	TD25558
M 48.70	8 Cyl.	32 Valves	4806cc	TD25561
MCF.TB	8 Cyl.	32 Valves	4806cc	TD29605
MCW.BA	8 Cyl.	32 Valves	4806cc	TD28010
MCW.CA	8 Cyl.	32 Valves	4806cc	TD32538
MCX.PA	8 Cyl.	32 Valves	4806cc	TD28011
MCX.RA	8 Cyl.	32 Valves	4806cc	TD28012
MCY.XA	8 Cyl.	32 Valves	4806cc	TD32701
PA5041 (x32) HR791  (x2)				NA5305  85.00 x 105.00 x 11.00mm, PTFE

30 5.0L		Petrol		
M 28.41	8 Cyl.	32 Valves	4957cc	TD2963
M 28.42	8 Cyl.	32 Valves	4957cc	TD2964
M 28.43	8 Cyl.	32 Valves	4957cc	TD2965
M 28.44	8 Cyl.	32 Valves	4957cc	TD2966
M 28.45	8 Cyl.	32 Valves	4957cc	TD2967
M 28.46	8 Cyl.	32 Valves	4957cc	TD2968
M 28.47	8 Cyl.	32 Valves	4957cc	TD2969
HR816  (x4)	NA5136 (x2) 30.00 x 47.00 x 7.00mm, FPM			

31 5.4L		Petrol		
M 28.49	8 Cyl.	32 Valves	5397cc	TD2970
M 28.50	8 Cyl.	32 Valves	5397cc	TD2971
NA5136 30.00 x 47.00 x 7.00mm, FPM				

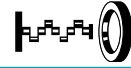

32 5.7L

Petrol

M 80.01

10 Cyl.

40 Valves

5733cc

TD20278

PA5041 (x40)

HR822  (x2)



CC



9

Model	Year Range	Engine	Fuel	CC	Wrench	Screwdriver	Pencil
Aeroback Hatchback (C2_A, C9_L)	10/88→06/91	4 G 13 P	Petrol	1299	4	12	1
Aeroback Hatchback (C2_A, C9_L)	10/88→11/96	4 G 15 M	Petrol	1468	4	12	2
Aeroback Hatchback (C2_A, C9_L)	10/88→12/02	4 G 13	Petrol	1299	4	12	1
Aeroback Hatchback (C2_A, C9_L)	01/91→09/93	4 G 15	Petrol	1468	4	12	2
Jumbuck Pickup	05/02→	4 G 15	Petrol	1468	4	12	2
Persona 300 (C9_M)	03/96→01/00	G 13 B	Petrol	1299	4	12	1
Persona 300 (C9_M)	03/96→07/00	4 G 15 M	Petrol	1468	4	12	2
Persona 300 (C9_M)	03/96→07/04	4 G 92	Petrol	1597	4	16	4
Persona 300 (C9_M)	03/96→07/04	4 G 93 (DOHC)	Petrol	1834	4	16	5
Persona 300 (C9_M)	09/96→07/00	G 15 B	Petrol	1468	4	12	3
Persona 300 (C9_M)	08/00→07/04	4 G 13 M	Petrol	1299	4	12	1
Persona 400 (C9_S)	01/94→07/00	4 G 15	Petrol	1468	4	12	2
Persona 400 (C9_S)	01/94→02/02	4 G 92	Petrol	1597	4	16	4
Persona 400 (C9_S)	01/94→06/03	4 G 13 P	Petrol	1299	4	12	1
Persona 400 (C9_S)	05/95→06/03	4 G 15 M	Petrol	1468	4	12	2
Persona 400 (C9_S)	05/96→04/99	4 D 68	Diesel	1998	4	8	6
Persona 400 (C9_S)	05/96→12/01	4 G 93 (DOHC)	Petrol	1834	4	16	5
Persona 400 (C9_S)	09/96→07/00	4 D 68 T	Diesel	1998	4	8	6
Persona 400 (C9_S)	10/05→02/08	4 G 13 M	Petrol	1299	4	12	1
Persona 400 Hatchback (C9_C, C9_S)	01/94→01/00	4 G 13	Petrol	1299	4	12	1
Persona 400 Hatchback (C9_C, C9_S)	01/94→07/00	4 G 15	Petrol	1468	4	12	2
Persona 400 Hatchback (C9_C, C9_S)	01/94→07/00	4 G 92	Petrol	1597	4	16	4
Persona 400 Hatchback (C9_C, C9_S)	05/96→04/99	4 D 68	Diesel	1998	4	8	6
Persona 400 Hatchback (C9_C, C9_S)	05/96→12/01	4 G 93 (DOHC)	Petrol	1834	4	16	5
Persona 400 Hatchback (C9_C, C9_S)	09/96→07/00	4 D 68 T	Diesel	1998	4	8	6
Persona 400 Hatchback (C9_C, C9_S)	10/05→02/08	4 G 13 M	Petrol	1299	4	12	1
Persona 400 Hatchback (C9_C, C9_S)	10/05→02/08	4 G 15 M	Petrol	1468	4	12	2
Persona Saloon	03/08→07/16	4 G 92	Petrol	1597	4	16	4
Putra Coupe	09/97→11/00	4 G 93 (DOHC)	Petrol	1834	4	16	5
Saga Hatchback	08/92→06/96	4 G 15 P	Petrol	1468	4	12	2
Saga Saloon	08/92→06/96	4 G 13 P	Petrol	1299	4	12	1
Saga Saloon	08/92→06/96	4 G 15 P	Petrol	1468	4	12	2
Saloon Saloon (C2_S)	01/91→09/93	4 G 13	Petrol	1299	4	12	1
Saloon Saloon (C2_S)	10/92→06/96	4 G 13 M	Petrol	1299	4	12	1
Satria (C9_M)	04/96→05/06	4 G 15	Petrol	1468	4	12	2
Satria (C9_M)	07/96→05/06	4 G 13	Petrol	1299	4	12	1
Satria (C9_M)	07/97→05/06	4 G 92	Petrol	1597	4	16	4
Satria (C9_M)	08/00→05/06	4 G 13 M	Petrol	1299	4	12	1
Satria (C9_M)	08/00→05/06	4 G 93 (DOHC)	Petrol	1834	4	16	5
Wira	01/00→	4 D 68	Diesel	1998	4	8	6
Wira	01/00→	4 G 93 (DOHC)	Petrol	1834	4	16	5
Wira	08/00→02/02	4 G 92	Petrol	1597	4	16	4
Wira	08/00→	4 G 13	Petrol	1299	4	12	1
Wira	08/00→	4 G 15	Petrol	1468	4	12	2
Wira	10/05→	4 G 13 M	Petrol	1299	4	12	1
Wira	10/05→	4 G 15 M	Petrol	1468	4	12	2
Wira Hatchback	01/00→	4 D 68	Diesel	1998	4	8	6
Wira Hatchback	08/00→12/01	4 G 93 (DOHC)	Petrol	1834	4	16	5
Wira Hatchback	08/00→	4 G 13	Petrol	1299	4	12	1
Wira Hatchback	08/00→	4 G 15 M	Petrol	1468	4	12	2
Wira Hatchback	10/05→	4 G 13 M	Petrol	1299	4	12	1



CC



9



CC



9

4 D 68	1998	4	8	Diesel	6
4 D 68 T	1998	4	8	Diesel	6
4 G 13	1299	4	12	Petrol	1
4 G 13 M	1299	4	12	Petrol	1
4 G 13 P	1299	4	12	Petrol	1
4 G 15	1468	4	12	Petrol	2
4 G 15 M	1468	4	12	Petrol	2
4 G 15 P	1468	4	12	Petrol	2
4 G 63	1997	4	16	Petrol	7
4 G 92	1597	4	16	Petrol	4
4 G 93 (DOHC)	1834	4	16	Petrol	5
6A12	1998	6	24	Petrol	8
G 13 B	1299	4	12	Petrol	1
G 15 B	1468	4	12	Petrol	3



1 1.3L Petrol

4 G 13	4 Cyl.	12 Valves	1299cc	TD3002
4 G 13 M	4 Cyl.	12 Valves	1299cc	TD22413
4 G 13 P	4 Cyl.	12 Valves	1299cc	TD18655
G 13 B	4 Cyl.	12 Valves	1299cc	TD3000

KJ570 (x12)

NJ933
35.00 x 50.00 x 8.00mm, FPM

NJ242
35.00 x 50.00 x 8.00mm, NBR
NJ006
72.00 x 96.00 x 9.00mm, MVQ

2 1.5L Petrol

4 G 15	4 Cyl.	12 Valves	1468cc	TD3003
4 G 15 M	4 Cyl.	12 Valves	1468cc	TD22414
4 G 15 P	4 Cyl.	12 Valves	1468cc	TD18051

KJ570 (x12)

NJ933
35.00 x 50.00 x 8.00mm, FPM

NJ252
30.00 x 46.00 x 7.00mm, NBR
NJ006
72.00 x 96.00 x 9.00mm, MVQ

3 1.5L Petrol

G 15 B	4 Cyl.	12 Valves	1468cc	TD3001
--------	--------	-----------	--------	--------

NJ933
35.00 x 50.00 x 8.00mm, FPM

NJ252
30.00 x 46.00 x 7.00mm, NBR
NJ006
72.00 x 96.00 x 9.00mm, MVQ

4 1.6L Petrol

4 G 92	4 Cyl.	16 Valves	1597cc	TD2999
--------	--------	-----------	--------	--------

NJ933
35.00 x 50.00 x 8.00mm, FPM

NK143
85.00 x 103.00 x 8.00mm, FPM

5 1.8L Petrol

4 G 93 (DOHC)	4 Cyl.	16 Valves	1834cc	TD18657
---------------	--------	-----------	--------	---------

NJ933
35.00 x 50.00 x 8.00mm, FPM

NJ874
37.00 x 50.00 x 6.00mm, ACM
NK143
85.00 x 103.00 x 8.00mm, FPM

6 2.0L Diesel

4 D 68	4 Cyl.	8 Valves	1998cc	TD22411
4 D 68 T	4 Cyl.	8 Valves	1998cc	TD22412

KJ211 (x8)

NJ933
35.00 x 50.00 x 8.00mm, FPM

NJ005
44.00 x 60.00 x 7.00mm, NBR
NK143
85.00 x 103.00 x 8.00mm, FPM

7 2.0L Petrol

4 G 63	4 Cyl.	16 Valves	1997cc	TD24447
--------	--------	-----------	--------	---------

NJ933
35.00 x 50.00 x 8.00mm, FPM

NJ005
44.00 x 60.00 x 7.00mm, NBR
NK143
85.00 x 103.00 x 8.00mm, FPM

PROTON

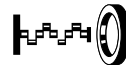
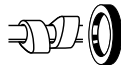

8 2.0L

Petrol

6A12

6 Cyl.

24 Valves

1998cc

TD24448

NJ933

35.00 x 50.00 x 8.00mm, FPM

NJ242

35.00 x 50.00 x 8.00mm, NBR

NJ005 

44.00 x 60.00 x 7.00mm, NBR

NK143 

85.00 x 103.00 x 8.00mm, FPM











CC



9

G-Modell (W 460)	03/79→08/87	OM 616.936	Diesel	2399	4	8	4
G-Modell (W 460)	12/79→12/91	OM 617.931	Diesel	2998	5	10	11
G-Modell (W 460)	02/80→07/87	M 115.973	Petrol	2307	4	8	3
G-Modell (W 460)	04/82→08/92	M 102.981	Petrol	2299	4	8	1
G-Modell (W 460)	04/82→08/92	M 102.987	Petrol	2299	4	8	2
G-Modell (W 460)	08/84→08/89	M 110.994	Petrol	2746	6	12	6
G-Modell (W 460)	10/87→12/92	OM 602.930	Diesel	2497	5	10	5
G-Modell (W 461)	04/92→08/97	OM 602.942	Diesel	2874	5	10	7
G-Modell (W 461)	06/93→07/00	M 102.996	Petrol	2298	4	8	2
G-Modell (W 461)	07/97→12/99	OM 602.983	Diesel	2874	5	10	8
G-Modell (W 463)	09/89→08/93	OM 603.931	Diesel	2996	6	12	10
G-Modell (W 463)	06/90→06/93	M 102.989	Petrol	2298	4	8	2
G-Modell (W 463)	06/90→08/93	M 103.987	Petrol	2960	6	12	9
G-Modell (W 463)	09/91→08/96	OM 603.972	Diesel	3449	6	12	13
G-Modell (W 463)	09/94→12/97	M 104.996	Petrol	3199	6	24	12
G-Modell (W 463)	01/95→04/98	M 104.952 (AMG 3,6)	Petrol	3606	6	24	14
G-Modell (W 463)	08/96→12/99	OM 606.964	Diesel	2996	6	24	10
G-Modell (W 463)	04/98→12/99	M 113.962	Petrol	4966	8	24	15
G-Modell (W 463)	04/99→12/99	M 113.982	Petrol	5439	8	24	16

	CC				9		CC				9
M 102.981	2299	4	8	Petrol	1						
M 102.987	2299	4	8	Petrol	2						
M 102.989	2298	4	8	Petrol	2						
M 102.996	2298	4	8	Petrol	2						
M 103.987	2960	6	12	Petrol	9						
M 104.952 (AMG 3,6)	3606	6	24	Petrol	14						
M 104.996	3199	6	24	Petrol	12						
M 110.994	2746	6	12	Petrol	6						
M 113.962	4966	8	24	Petrol	15						
M 113.982	5439	8	24	Petrol	16						
M 115.973	2307	4	8	Petrol	3						
OM 602.930	2497	5	10	Diesel	5						
OM 602.942	2874	5	10	Diesel	7						
OM 602.983	2874	5	10	Diesel	8						
OM 603.931	2996	6	12	Diesel	10						
OM 603.972	3449	6	12	Diesel	13						
OM 606.964	2996	6	24	Diesel	10						
OM 616.936	2399	4	8	Diesel	4						
OM 617.931	2998	5	10	Diesel	11						



1 2.3L Petrol

M 102.981	4 Cyl.	8 Valves	2299cc	TD22912
HR756				
			NB971 45.00 x 67.00 x 10.00mm, FPM NB974 93.00 x 114.00 x 13.00mm, FPM	

2 2.3L Petrol

M 102.987	4 Cyl.	8 Valves	2299cc	TD22911
M 102.989	4 Cyl.	8 Valves	2298cc	TD22919
M 102.996	4 Cyl.	8 Valves	2298cc	TD22921
HR756			NB973 45.00 x 67.00 x 8.00mm, FPM NB974 93.00 x 114.00 x 13.00mm, FPM	

3 2.3L Petrol

M 115.973	4 Cyl.	8 Valves	2307cc	TD26021
PB394 (x4)			NB975 45.00 x 74.50 x 12.00mm, FPM PA815 78.00 x 94.00 x 8.00mm	

4 2.4L Diesel

OM 616.936	4 Cyl.	8 Valves	2399cc	TD22910
			NB975 45.00 x 74.50 x 12.00mm, FPM PA815 78.00 x 94.00 x 8.00mm	

5 2.5L Diesel

OM 602.930	5 Cyl.	10 Valves	2497cc	TD22909
PB394 (x5) HR758			NB973 45.00 x 67.00 x 8.00mm, FPM NB974 93.00 x 114.00 x 13.00mm, FPM	

6 2.7L Petrol

M 110.994	6 Cyl.	12 Valves	2746cc	TD22908
PB394 (x6)			NA5264 45.00 x 67.00 x 13.00mm, FPM PA815 78.00 x 94.00 x 8.00mm	

7 2.9L Diesel

OM 602.942	5 Cyl.	10 Valves	2874cc	TD22920
PB394 (x5) HR758			NA5131 45.00 x 67.00 x 8.00mm, PTFE NB974 93.00 x 114.00 x 13.00mm, FPM	

8 2.9L Diesel

OM 602.983	5 Cyl.	10 Valves	2874cc	TD21112
PB394 (x5) HR758			NA5131 45.00 x 67.00 x 8.00mm, PTFE NA5074 93.00 x 133.50 x 15.50mm, PTFE	

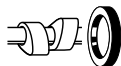

9 3.0L Petrol

M 103.987	6 Cyl.	12 Valves	2960cc	TD22918
HR759	NC065		NB973	
	30.00 x 40.00 x 7.00mm, FPM		45.00 x 67.00 x 8.00mm, FPM	
			NB974	
			93.00 x 114.00 x 13.00mm, FPM	

10 3.0L Diesel

OM 603.931	6 Cyl.	12 Valves	2996cc	TD22917
OM 606.964	6 Cyl.	24 Valves	2996cc	TD22916
PB394 (x6)			NB973	
HR760			45.00 x 67.00 x 8.00mm, FPM	
			NB974	
			93.00 x 114.00 x 13.00mm, FPM	

11 3.0L Diesel

OM 617.931	5 Cyl.	10 Valves	2998cc	TD22907
			NB975	
			45.00 x 74.50 x 12.00mm, FPM	
			PA815	
			78.00 x 94.00 x 8.00mm	

12 3.2L Petrol

M 104.996	6 Cyl.	24 Valves	3199cc	TD22915
HR5055			NB973	
Eng no. 0-001567 →			45.00 x 67.00 x 8.00mm, FPM	
HR5055			NB974	
Eng no. 2-042687 →			93.00 x 114.00 x 13.00mm, FPM	

13 3.4L Diesel

OM 603.972	6 Cyl.	12 Valves	3449cc	TD22914
PB394 (x6)			NB973	
HR760			45.00 x 67.00 x 8.00mm, FPM	
			NB974	
			93.00 x 114.00 x 13.00mm, FPM	

14 3.6L Petrol

M 104.952 (AMG 3,6)	6 Cyl.	24 Valves	3606cc	TD31758
HR5055			NB973	
			45.00 x 67.00 x 8.00mm, FPM	
			NB974	
			93.00 x 114.00 x 13.00mm, FPM	

15 5.0L Petrol

M 113.962	8 Cyl.	24 Valves	4966cc	TD22913
HR5055			NA5131	
			45.00 x 67.00 x 8.00mm, PTFE	
			NA5168	
			93.00 x 114.00 x 11.50mm, PTFE	

16 5.5L Petrol

M 113.982	8 Cyl.	24 Valves	5439cc	TD26095
HR5055			NA5131	
			45.00 x 67.00 x 8.00mm, PTFE	
			NA5168	
			93.00 x 114.00 x 11.50mm, PTFE	

				CC			9
4 (112_)	02/78→06/90	688 712	Petrol	1108	4	8	9
4 (112_)	06/78→06/90	C1E 714	Petrol	1108	4	8	10
4 (112_)	06/78→06/90	C1E 719	Petrol	1108	4	8	10
4 (112_)	12/85→06/93	689 710	Petrol	956	4	8	3
4 (112_)	06/87→06/93	C1C 708	Petrol	956	4	8	4
4 Box (R21_, R23_)	10/76→07/89	688 711	Petrol	1108	4	8	9
4 Box (R21_, R23_)	10/76→07/89	688 712	Petrol	1108	4	8	9
4 Box (R21_, R23_)	10/76→07/89	C1E 714	Petrol	1108	4	8	10
4 Box (R21_, R23_)	10/76→07/89	C1E 718	Petrol	1108	4	8	10
4 Box (R21_, R23_)	10/76→07/89	C1E 719	Petrol	1108	4	8	10
4 Box (R21_, R23_)	06/87→12/93	C1C 708	Petrol	956	4	8	4
5 (122_)	01/72→12/85	689 710	Petrol	956	4	8	3
5 (122_)	09/75→09/84	810 725	Petrol	1289	4	8	19
5 (122_)	09/76→09/79	810 726	Petrol	1289	4	8	19
5 (122_)	09/77→09/81	840 725	Petrol	1397	4	8	21
5 (122_)	06/79→09/84	810 719	Petrol	1289	4	8	19
5 (122_)	06/79→09/84	810 729	Petrol	1289	4	8	19
5 (122_)	06/80→03/85	840 730	Petrol	1397	4	8	21
5 (122_)	09/80→12/85	688 713	Petrol	1108	4	8	9
5 (122_)	09/80→12/85	C1E 726	Petrol	1108	4	8	10
5 (122_)	10/81→01/85	840 726	Petrol	1397	4	8	21
5 (122_)	01/82→12/85	847 725	Petrol	1397	4	8	22
5 (122_)	01/82→12/85	C2J 713	Petrol	1397	4	8	23
5 (122_)	06/82→09/84	847 712	Petrol	1397	4	8	22
5 Box (238_)	01/72→12/85	689 710	Petrol	956	4	8	3
5 Box (238_)	03/76→08/82	810 726	Petrol	1289	4	8	19
5 Box (238_)	09/80→12/85	688 713	Petrol	1108	4	8	9
5 Box (238_)	09/80→12/85	C1E 726	Petrol	1108	4	8	10
5 Box (238_)	09/80→12/85	C1E 750	Petrol	1108	4	8	10
5 Box (238_)	09/80→12/85	C1E 752	Petrol	1108	4	8	10
5 Box (238_)	09/80→12/85	C1E 754	Petrol	1108	4	8	10
6 (118_)	08/70→04/87	688.10	Petrol	1108	4	8	9
7 (124_)	03/75→12/82	688 710	Petrol	1037	4	8	2
8 (113_)	11/62→10/72	688.01	Petrol	1108	4	8	9
9 (L42_)	09/81→12/85	C2J 717	Petrol	1397	4	8	23
9 (L42_)	09/81→12/85	C2J 718	Petrol	1397	4	8	23
9 (L42_)	09/81→12/85	C2J 755	Petrol	1397	4	8	23
9 (L42_)	09/81→12/85	C2J 757	Petrol	1397	4	8	23
9 (L42_)	09/81→05/87	C1E 715	Petrol	1108	4	8	10
9 (L42_)	09/81→05/87	C1E 720	Petrol	1108	4	8	10
9 (L42_)	12/81→12/88	C1J 715	Petrol	1397	4	8	23
9 (L42_)	12/81→12/88	C1J 792	Petrol	1397	4	8	23
9 (L42_)	12/81→12/88	C1J 796	Petrol	1397	4	8	23
9 (L42_)	12/81→12/88	C2J 730	Petrol	1397	4	8	23
9 (L42_)	10/82→12/88	F8M 700	Diesel	1596	4	8	34
9 (L42_)	10/82→12/88	F8M 720	Diesel	1596	4	8	34
9 (L42_)	10/82→12/88	F8M 730	Diesel	1596	4	8	34
9 (L42_)	04/84→12/86	C1J 760	Petrol	1397	4	8	23
9 (L42_)	04/84→12/89	C1J 764	Petrol	1397	4	8	23
9 (L42_)	09/84→12/89	F2N 700	Petrol	1721	4	8	45
9 (L42_)	09/84→12/89	F2N 704	Petrol	1721	4	8	45
9 (L42_)	09/85→12/88	C1G 700	Petrol	1237	4	8	13
9 (L42_)	09/85→12/88	C1G 710	Petrol	1237	4	8	13
9 (L42_)	09/85→12/88	C2J 720	Petrol	1397	4	8	23
9 (L42_)	09/85→12/88	C2J 766	Petrol	1397	4	8	23
9 (L42_)	09/85→12/88	C2J 767	Petrol	1397	4	8	23
9 (L42_)	09/85→12/88	C2J 768	Petrol	1397	4	8	23
9 (L42_)	10/86→12/88	F2N 708	Petrol	1721	4	8	45
9 (L42_)	10/86→12/88	F2N 710	Petrol	1721	4	8	45
9 (L42_)	10/86→12/88	F2N 730	Petrol	1721	4	8	45
9 (L42_)	10/86→12/88	F2N 798	Petrol	1721	4	8	45
9 (L42_)	10/86→12/88	F3N 718	Petrol	1721	4	8	45
9 (L42_)	06/87→12/88	F3N 708	Petrol	1721	4	8	45
10 (119_)	05/66→10/72	688.01	Petrol	1108	4	8	9
10 (119_)	07/69→10/72	810.03	Petrol	1289	4	8	19
11 (B/C37_)	03/83→12/85	C2J 718	Petrol	1397	4	8	23
11 (B/C37_)	03/83→12/85	C2J 757	Petrol	1397	4	8	23
11 (B/C37_)	03/83→06/86	C1E 715	Petrol	1108	4	8	10
11 (B/C37_)	03/83→06/86	C1E 720	Petrol	1108	4	8	10
11 (B/C37_)	03/83→12/88	C1J 715	Petrol	1397	4	8	23
11 (B/C37_)	03/83→12/88	C2J 720	Petrol	1397	4	8	23
11 (B/C37_)	03/83→12/88	C2J 730	Petrol	1397	4	8	23
11 (B/C37_)	03/83→12/88	C2J 766	Petrol	1397	4	8	23
11 (B/C37_)	03/83→12/88	C2J 767	Petrol	1397	4	8	23
11 (B/C37_)	03/83→12/88	C2J 768	Petrol	1397	4	8	23
11 (B/C37_)	05/83→12/85	C2J 717	Petrol	1397	4	8	23
11 (B/C37_)	05/83→12/85	C2J 755	Petrol	1397	4	8	23
11 (B/C37_)	08/83→12/88	F8M 700	Diesel	1596	4	8	34



CC



9

11 (B/C37_)	08/83→12/88	F8M 720	Diesel	1596	4	8	34
11 (B/C37_)	08/83→12/88	F8M 730	Diesel	1596	4	8	34
11 (B/C37_)	10/83→12/87	F2N 700	Petrol	1721	4	8	45
11 (B/C37_)	10/83→12/87	F2N 704	Petrol	1721	4	8	45
11 (B/C37_)	02/84→12/86	C1J 764	Petrol	1397	4	8	23
11 (B/C37_)	04/84→12/86	C1J 760	Petrol	1397	4	8	23
11 (B/C37_)	10/84→12/88	C1G 700	Petrol	1237	4	8	13
11 (B/C37_)	10/84→12/88	C1G 710	Petrol	1237	4	8	13
11 (B/C37_)	10/84→12/88	F3N 718	Petrol	1721	4	8	45
11 (B/C37_)	10/86→12/88	C1J 770	Petrol	1397	4	8	23
11 (B/C37_)	10/86→12/88	C1J 782	Petrol	1397	4	8	23
11 (B/C37_)	10/86→12/88	F2N 708	Petrol	1721	4	8	45
11 (B/C37_)	10/86→12/88	F2N 710	Petrol	1721	4	8	45
11 (B/C37_)	10/86→12/88	F2N 730	Petrol	1721	4	8	45
11 (B/C37_)	10/86→12/88	F2N 798	Petrol	1721	4	8	45
11 (B/C37_)	06/87→12/88	F2N 732	Petrol	1721	4	8	45
11 (B/C37_)	06/87→12/88	F2N 742	Petrol	1721	4	8	45
11 (B/C37_)	06/87→12/88	F3N 708	Petrol	1721	4	8	45
11 Box (S37_)	03/83→06/86	C1E 715	Petrol	1108	4	8	10
11 Box (S37_)	03/83→06/86	C1E 720	Petrol	1108	4	8	10
11 Box (S37_)	03/83→09/86	C1J 715	Petrol	1397	4	8	23
11 Box (S37_)	03/83→09/86	C2J 730	Petrol	1397	4	8	23
11 Box (S37_)	03/83→12/86	C2J 768	Petrol	1397	4	8	23
11 Box (S37_)	08/83→12/88	F8M 700	Diesel	1596	4	8	34
11 Box (S37_)	08/83→12/88	F8M 720	Diesel	1596	4	8	34
11 Box (S37_)	08/83→12/88	F8M 730	Diesel	1596	4	8	34
11 Box (S37_)	10/84→12/88	C1G 700	Petrol	1237	4	8	13
11 Box (S37_)	10/84→12/88	C1G 710	Petrol	1237	4	8	13
12	10/69→08/80	810-02/97	Petrol	1289	4	8	19
12	08/70→12/74	807.20	Petrol	1565	4	8	32
12	08/70→12/74	821.20	Petrol	1565	4	8	33
12	08/70→08/76	821.10	Petrol	1565	4	8	33
12	08/70→08/76	821.11	Petrol	1565	4	8	33
12	09/70→12/72	821	Petrol	1565	4	8	33
12	08/72→08/80	810.05	Petrol	1289	4	8	19
12	08/72→08/80	810.06	Petrol	1289	4	8	19
12	07/75→04/80	810.02	Petrol	1289	4	8	19
12	08/76→12/89	C1J 791	Petrol	1397	4	8	23
12 Box	07/75→04/80	810.02	Petrol	1289	4	8	19
12 Estate	04/83→12/89	C1J 791	Petrol	1397	4	8	23
12 Toros Estate	04/89→10/00	C1J 791	Petrol	1397	4	8	23
12 Toros Saloon	04/89→10/00	C1J 791	Petrol	1397	4	8	23
12 Variable (117_)	08/70→07/75	821.20	Petrol	1565	4	8	33
12 Variable (117_)	08/70→08/76	821.10	Petrol	1565	4	8	33
12 Variable (117_)	08/70→08/76	821.11	Petrol	1565	4	8	33
12 Variable (117_)	10/70→08/80	810-02/97	Petrol	1289	4	8	19
12 Variable (117_)	08/73→08/80	810.05	Petrol	1289	4	8	19
12 Variable (117_)	08/73→08/80	810.06	Petrol	1289	4	8	19
12 Variable (117_)	07/75→04/80	810.02	Petrol	1289	4	8	19
12 Variable (117_)	08/76→08/80	C1J 791	Petrol	1397	4	8	23
14 (121_)	05/76→12/83	129	Petrol	1218	4	8	12
14 (121_)	09/79→06/83	150	Petrol	1360	4	8	20
14 (121_)	12/81→12/83	X5J	Petrol	1360	4	8	20
15 (130_)	09/71→12/72	821	Petrol	1565	4	8	33
15 (130_)	03/72→10/80	807.10	Petrol	1565	4	8	31
15 (130_)	03/72→10/80	810.05	Petrol	1289	4	8	19
16 (115_)	09/65→10/75	697.01	Petrol	1469	4	8	28
16 (115_)	09/67→08/80	821	Petrol	1565	4	8	33
16 (115_)	09/68→08/80	807	Petrol	1565	4	8	31
16 (115_)	09/68→08/80	807.04	Petrol	1565	4	8	31
16 (115_)	09/68→08/80	807.05	Petrol	1565	4	8	31
16 (115_)	01/71→08/80	821.03	Petrol	1565	4	8	33
16 (115_)	01/71→08/80	821.04	Petrol	1565	4	8	33
16 (115_)	06/74→08/80	843	Petrol	1647	4	8	31
16 (115_)	06/74→08/80	843.01	Petrol	1647	4	8	31
17	03/72→12/74	807	Petrol	1565	4	8	31
17	03/72→10/80	807.10	Petrol	1565	4	8	31
17	03/74→10/80	844.12	Petrol	1605	4	8	31
17	06/74→08/79	843.05	Petrol	1647	4	8	31
18 (134_)	04/78→09/82	841 725	Petrol	1647	4	8	31
18 (134_)	04/78→09/82	841 726	Petrol	1647	4	8	31
18 (134_)	04/78→07/86	847 720	Petrol	1397	4	8	22
18 (134_)	04/78→07/86	847 722	Petrol	1397	4	8	22
18 (134_)	10/80→09/82	807 727	Petrol	1565	4	8	31
18 (134_)	11/81→07/86	852 710	Diesel	2068	4	8	81
18 (134_)	11/81→07/86	J85 711	Diesel	2068	4	8	81
18 (134_)	11/81→07/86	J85 712	Diesel	2068	4	8	81
18 (134_)	04/82→07/86	841 717	Petrol	1647	4	8	31



CC



9

18 (134 _)	04/82→11/93	A2M 723	Petrol	1647	4	8	31
18 (134 _)	05/82→07/86	A6M 725	Petrol	1647	4	8	31
18 (134 _)	05/82→07/86	A6M 726	Petrol	1647	4	8	31
18 (134 _)	05/82→07/86	J6R 716	Petrol	1995	4	8	64
18 (134 _)	09/82→07/86	A7L 752	Petrol	1647	4	8	31
18 (134 _)	10/82→07/86	A5L 717	Petrol	1565	4	8	31
18 (134 _)	10/82→07/86	A5L 718	Petrol	1565	4	8	31
18 (134 _)	06/84→07/86	J7T 718	Petrol	2165	4	8	87
18 (134 _)	02/92→11/94	J6T 792	Petrol	2165	4	8	87
18 Box	05/79→07/86	847 720	Petrol	1397	4	8	22
18 Box	05/79→07/86	847 722	Petrol	1397	4	8	22
18 Box	11/81→07/86	852 710	Diesel	2068	4	8	81
18 Box	11/81→07/86	J8S 711	Diesel	2068	4	8	81
18 Variable (135 _)	02/79→09/82	841 725	Petrol	1647	4	8	31
18 Variable (135 _)	05/79→09/82	841 726	Petrol	1647	4	8	31
18 Variable (135 _)	05/79→07/86	847 720	Petrol	1397	4	8	22
18 Variable (135 _)	05/79→07/86	847 722	Petrol	1397	4	8	22
18 Variable (135 _)	05/79→07/86	J8S 711	Diesel	2068	4	8	81
18 Variable (135 _)	11/80→07/86	852 710	Diesel	2068	4	8	81
18 Variable (135 _)	10/81→12/86	J6R 716	Petrol	1995	4	8	64
18 Variable (135 _)	01/82→07/86	841 717	Petrol	1647	4	8	31
18 Variable (135 _)	01/82→11/93	A2M 723	Petrol	1647	4	8	31
18 Variable (135 _)	05/82→07/86	A6M 725	Petrol	1647	4	8	31
18 Variable (135 _)	05/82→07/86	A6M 726	Petrol	1647	4	8	31
18 Variable (135 _)	09/82→07/86	807 727	Petrol	1565	4	8	31
18 Variable (135 _)	10/82→07/86	A5L 717	Petrol	1565	4	8	31
18 Variable (135 _)	10/82→07/86	A5L 718	Petrol	1565	4	8	31
18 Variable (135 _)	05/83→12/86	J6R 714	Petrol	1995	4	8	64
18 Variable (135 _)	10/83→09/86	A7L 752	Petrol	1647	4	8	31
19 I (B/C53 _)	01/88→12/92	C1G 730	Petrol	1237	4	8	13
19 I (B/C53 _)	01/88→12/92	E6J 700	Petrol	1390	4	8	25
19 I (B/C53 _)	01/88→12/92	E6J 701	Petrol	1390	4	8	25
19 I (B/C53 _)	07/88→04/92	F2N 721	Petrol	1721	4	8	45
19 I (B/C53 _)	07/88→04/92	F2N 722	Petrol	1721	4	8	45
19 I (B/C53 _)	09/88→04/92	F2N 720	Petrol	1721	4	8	45
19 I (B/C53 _)	09/88→04/92	F3N 740	Petrol	1721	4	8	45
19 I (B/C53 _)	09/88→04/92	F3N 741	Petrol	1721	4	8	45
19 I (B/C53 _)	09/88→04/92	F3N 742	Petrol	1721	4	8	45
19 I (B/C53 _)	09/88→04/92	F3N 743	Petrol	1721	4	8	45
19 I (B/C53 _)	09/88→04/92	F8Q 706	Diesel	1870	4	8	55
19 I (B/C53 _)	09/88→04/92	F8Q 742	Diesel	1870	4	8	55
19 I (B/C53 _)	01/89→12/89	C2J 772	Petrol	1397	4	8	23
19 I (B/C53 _)	01/89→04/92	C3J 710	Petrol	1397	4	8	23
19 I (B/C53 _)	06/89→04/92	F3N 746	Petrol	1721	4	8	45
19 I (B/C53 _)	06/89→04/92	F7P 700	Petrol	1764	4	16	53
19 I (B/C53 _)	06/89→04/92	F7P 704	Petrol	1764	4	16	53
19 I (B/C53 _)	09/90→04/92	E7J 700	Petrol	1390	4	8	25
19 I (B/C53 _)	09/90→04/92	F8Q 610	Diesel	1870	4	8	55
19 I (B/C53 _)	09/90→04/92	F8Q 740	Diesel	1870	4	8	55
19 I (B/C53 _)	05/92→09/94	F3P 765	Petrol	1794	4	8	50
19 I Box (S53 _)	01/88→12/92	C1G 730	Petrol	1237	4	8	13
19 I Box (S53 _)	01/88→12/92	E6J 700	Petrol	1390	4	8	25
19 I Box (S53 _)	01/88→12/92	F8Q 706	Diesel	1870	4	8	55
19 I Box (S53 _)	01/88→12/92	F8Q 742	Diesel	1870	4	8	55
19 I Cabriolet (D53 _)	07/91→04/92	F2N 724	Petrol	1721	4	8	45
19 I Cabriolet (D53 _)	07/91→04/92	F3N 742	Petrol	1721	4	8	45
19 I Cabriolet (D53 _)	07/91→04/92	F3N 743	Petrol	1721	4	8	45
19 I Cabriolet (D53 _)	07/91→04/92	F7P 700	Petrol	1764	4	16	53
19 I Cabriolet (D53 _)	07/91→04/92	F7P 704	Petrol	1764	4	16	53
19 I Chamade (L53 _)	01/88→12/92	C1G 730	Petrol	1237	4	8	13
19 I Chamade (L53 _)	07/88→08/90	E6J 700	Petrol	1390	4	8	25
19 I Chamade (L53 _)	07/88→08/90	E6J 701	Petrol	1390	4	8	25
19 I Chamade (L53 _)	07/88→04/92	C1E 700	Petrol	1108	4	8	10
19 I Chamade (L53 _)	07/88→04/92	C2J 772	Petrol	1397	4	8	23
19 I Chamade (L53 _)	07/88→04/92	C3J 710	Petrol	1397	4	8	23
19 I Chamade (L53 _)	07/88→04/92	F3N 742	Petrol	1721	4	8	45
19 I Chamade (L53 _)	07/88→04/92	F3N 743	Petrol	1721	4	8	45
19 I Chamade (L53 _)	08/88→12/92	F3N 746	Petrol	1721	4	8	45
19 I Chamade (L53 _)	09/88→12/92	F2N 720	Petrol	1721	4	8	45
19 I Chamade (L53 _)	09/88→12/92	F2N 721	Petrol	1721	4	8	45
19 I Chamade (L53 _)	06/89→08/90	F7P 700	Petrol	1764	4	16	53
19 I Chamade (L53 _)	10/89→04/92	F3N 740	Petrol	1721	4	8	45
19 I Chamade (L53 _)	10/89→04/92	F3N 741	Petrol	1721	4	8	45
19 I Chamade (L53 _)	10/89→04/92	F7P 704	Petrol	1764	4	16	53
19 I Chamade (L53 _)	10/89→04/92	F8Q 706	Diesel	1870	4	8	55
19 I Chamade (L53 _)	10/89→04/92	F8Q 742	Diesel	1870	4	8	55
19 I Chamade (L53 _)	09/90→04/92	E7J 700	Petrol	1390	4	8	25
19 I Chamade (L53 _)	09/90→04/92	F8Q 740	Diesel	1870	4	8	55











CC



9

19 II (B/C53_)	01/92→12/95	E7J 706	Petrol	1390	4	8	25
19 II (B/C53_)	01/92→12/95	E7J 742	Petrol	1390	4	8	25
19 II (B/C53_)	01/92→12/98	E6J 700	Petrol	1390	4	8	25
19 II (B/C53_)	04/92→05/94	F3P 700	Petrol	1794	4	8	50
19 II (B/C53_)	04/92→12/95	C1G 730	Petrol	1237	4	8	13
19 II (B/C53_)	04/92→12/95	C3J 710	Petrol	1397	4	8	23
19 II (B/C53_)	04/92→12/95	F3N 740	Petrol	1721	4	8	45
19 II (B/C53_)	04/92→12/95	F3N 741	Petrol	1721	4	8	45
19 II (B/C53_)	04/92→12/95	F3N 743	Petrol	1721	4	8	45
19 II (B/C53_)	04/92→12/95	F3P 706	Petrol	1794	4	8	50
19 II (B/C53_)	04/92→12/95	F3P 707	Petrol	1794	4	8	50
19 II (B/C53_)	04/92→12/95	F3P 708	Petrol	1794	4	8	50
19 II (B/C53_)	04/92→12/95	F3P 760	Petrol	1794	4	8	50
19 II (B/C53_)	04/92→12/95	F7P 704	Petrol	1764	4	16	53
19 II (B/C53_)	04/92→12/95	F8Q 742	Diesel	1870	4	8	55
19 II (B/C53_)	04/92→12/95	F8Q 744	Diesel	1870	4	8	55
19 II (B/C53_)	05/92→09/94	E7F 730	Petrol	1171	4	8	17
19 II (B/C53_)	05/92→09/94	F3N 746	Petrol	1721	4	8	45
19 II (B/C53_)	05/93→06/01	F3P 740	Petrol	1794	4	8	50
19 II (B/C53_)	05/93→06/01	F3P 742	Petrol	1794	4	8	50
19 II (B/C53_)	05/94→12/95	F3P 682	Petrol	1783	4	8	49
19 II (B/C53_)	05/94→12/95	F3P 765	Petrol	1794	4	8	50
19 II (B/C53_)	10/94→12/97	F7P 700	Petrol	1764	4	16	53
19 II (B/C53_)	10/96→06/01	C1J 748	Petrol	1397	4	8	23
19 II (B/C53_)	10/96→06/01	E6J 706	Petrol	1390	4	8	25
19 II (B/C53_)	10/96→06/01	F3N 747	Petrol	1721	4	8	46
19 II (B/C53_)	10/96→06/01	F7P 702	Petrol	1764	4	16	53
19 II (B/C53_)	10/96→06/01	F8Q 748	Diesel	1870	4	8	55
19 II (B/C53_)	10/96→06/01	F8Q 754	Diesel	1870	4	8	55
19 II (B/C53_)	10/97→06/99	K4M 734	Petrol	1598	4	16	36
19 II (B/C53_)	07/98→06/01	K4M 744	Petrol	1598	4	16	36
19 II (B/C53_)	10/98→06/01	K4J 718	Petrol	1390	4	16	27
19 II Box (S53_)	03/92→12/95	C1G 730	Petrol	1237	4	8	13
19 II Box (S53_)	03/92→12/95	E6J 700	Petrol	1390	4	8	25
19 II Box (S53_)	03/92→12/95	F8Q 706	Diesel	1870	4	8	55
19 II Box (S53_)	03/92→12/95	F8Q 740	Diesel	1870	4	8	55
19 II Box (S53_)	03/92→12/95	F8Q 742	Diesel	1870	4	8	55
19 II Cabriolet (D53_, 853_)	04/92→09/93	F3N 742	Petrol	1721	4	8	45
19 II Cabriolet (D53_, 853_)	04/92→09/93	F3N 743	Petrol	1721	4	8	45
19 II Cabriolet (D53_, 853_)	04/92→06/96	F3P 704	Petrol	1794	4	8	50
19 II Cabriolet (D53_, 853_)	04/92→06/96	F3P 705	Petrol	1794	4	8	50
19 II Cabriolet (D53_, 853_)	04/92→06/96	F3P 706	Petrol	1794	4	8	50
19 II Cabriolet (D53_, 853_)	04/92→06/96	F3P 707	Petrol	1794	4	8	50
19 II Cabriolet (D53_, 853_)	04/92→06/96	F3P 708	Petrol	1794	4	8	50
19 II Cabriolet (D53_, 853_)	04/92→06/96	F3P 760	Petrol	1794	4	8	50
19 II Cabriolet (D53_, 853_)	04/92→06/96	F7P 704	Petrol	1764	4	16	53
19 II Cabriolet (D53_, 853_)	07/94→06/96	F3P 682	Petrol	1783	4	8	49
19 II Cabriolet (D53_, 853_)	07/94→06/96	F3P 764	Petrol	1783	4	8	50
19 II Cabriolet (D53_, 853_)	07/94→06/96	F3P 765	Petrol	1794	4	8	50
19 II Cabriolet (D53_, 853_)	10/96→06/01	F3N 747	Petrol	1721	4	8	46
19 II Chamade (L53_)	04/92→11/95	F3P 700	Petrol	1794	4	8	50
19 II Chamade (L53_)	04/92→12/95	C3J 710	Petrol	1397	4	8	23
19 II Chamade (L53_)	04/92→12/95	F3N 740	Petrol	1721	4	8	45
19 II Chamade (L53_)	04/92→12/95	F3N 741	Petrol	1721	4	8	45
19 II Chamade (L53_)	04/92→12/95	F3N 742	Petrol	1721	4	8	45
19 II Chamade (L53_)	04/92→12/95	F3N 743	Petrol	1721	4	8	45
19 II Chamade (L53_)	04/92→12/95	F3P 704	Petrol	1794	4	8	50
19 II Chamade (L53_)	04/92→12/95	F3P 705	Petrol	1794	4	8	50
19 II Chamade (L53_)	04/92→12/95	F3P 706	Petrol	1794	4	8	50
19 II Chamade (L53_)	04/92→12/95	F3P 707	Petrol	1794	4	8	50
19 II Chamade (L53_)	04/92→12/95	F3P 708	Petrol	1794	4	8	50
19 II Chamade (L53_)	04/92→12/95	F3P 760	Petrol	1794	4	8	50
19 II Chamade (L53_)	04/92→12/95	F7P 704	Petrol	1764	4	16	53
19 II Chamade (L53_)	04/92→12/95	F8Q 742	Diesel	1870	4	8	55
19 II Chamade (L53_)	04/92→12/95	F8Q 744	Diesel	1870	4	8	55
19 II Chamade (L53_)	05/92→09/94	C1J 742	Petrol	1397	4	8	23
19 II Chamade (L53_)	05/92→09/94	C2J 772	Petrol	1397	4	8	23
19 II Chamade (L53_)	05/92→09/94	E7F 730	Petrol	1171	4	8	17
19 II Chamade (L53_)	05/92→09/94	F3P 765	Petrol	1794	4	8	50
19 II Chamade (L53_)	05/92→11/95	F8Q 740	Diesel	1870	4	8	55
19 II Chamade (L53_)	01/93→08/95	F2N 720	Petrol	1721	4	8	45
19 II Chamade (L53_)	01/93→08/95	F2N 721	Petrol	1721	4	8	45
19 II Chamade (L53_)	11/93→12/95	E7J 742	Petrol	1390	4	8	25
19 II Chamade (L53_)	05/94→12/95	F3P 682	Petrol	1783	4	8	49
19 II Chamade (L53_)	10/94→11/95	E6J 700	Petrol	1390	4	8	25
19 II Chamade (L53_)	10/94→11/95	E7J 706	Petrol	1390	4	8	25
19 II Chamade (L53_)	10/96→09/98	F3P 716	Petrol	1794	4	8	50
19 II Chamade (L53_)	10/96→09/98	F3P 717	Petrol	1794	4	8	50

							
19 II Chamade (L53_)	10/96→06/01	C1J 748	Petrol	1397	4	8	23
19 II Chamade (L53_)	10/96→06/01	F8Q 754	Diesel	1870	4	8	55
19 II Chamade (L53_)	10/96→06/01	K7M 703	Petrol	1598	4	8	39
19 II Chamade (L53_)	10/98→06/01	K4J 715	Petrol	1390	4	16	27
20 (127_)	10/75→05/77	843	Petrol	1647	4	8	31
20 (127_)	05/77→12/83	843 720	Petrol	1647	4	8	31
20 (127_)	05/77→12/83	843 721	Petrol	1647	4	8	31
20 (127_)	10/77→10/80	829.01	Petrol	1995	4	8	64
20 (127_)	10/77→10/80	829 700	Petrol	1995	4	8	64
20 (127_)	10/77→10/80	829 701	Petrol	1995	4	8	64
20 (127_)	10/80→12/83	852	Diesel	2068	4	8	81
20 (127_)	10/80→12/83	829 702	Petrol	1995	4	8	64
20 (127_)	10/80→12/83	829 703	Petrol	1995	4	8	64
20 (127_)	10/80→12/83	851 700	Petrol	2165	4	8	84
20 (127_)	01/82→12/83	J8S 702	Diesel	2068	4	8	81
21 (B48_)	07/89→06/92	J7R 750	Petrol	1995	4	8	64
21 (B48_)	07/89→06/92	J7R 751	Petrol	1995	4	8	64
21 (B48_)	07/89→05/93	F2N 711	Petrol	1721	4	8	45
21 (B48_)	07/89→05/93	F2N 712	Petrol	1721	4	8	45
21 (B48_)	07/89→05/93	F2N 754	Petrol	1721	4	8	45
21 (B48_)	07/89→05/93	F3N 726	Petrol	1721	4	8	45
21 (B48_)	07/89→05/93	J7R 740	Petrol	1995	4	12	73
21 (B48_)	07/89→05/93	J7R 754	Petrol	1995	4	12	73
21 (B48_)	07/89→05/93	J8S 704	Diesel	2068	4	8	81
21 (B48_)	07/89→06/94	J7T 755	Petrol	2165	4	8	87
21 (B48_)	07/89→06/94	J8S 784	Diesel	2068	4	8	81
21 (B48_)	09/89→12/92	J8S 600	Diesel	2068	4	8	81
21 (B48_)	09/89→12/92	J8S 740	Diesel	2068	4	8	81
21 (B48_)	09/89→05/93	C2J 770	Petrol	1397	4	8	23
21 (B48_)	09/89→12/93	J7R 746	Petrol	1995	4	8	64
21 (B48_)	09/89→12/93	J7R 747	Petrol	1995	4	8	64
21 (B48_)	09/89→01/94	F8Q 710	Diesel	1870	4	8	55
21 (B48_)	09/89→06/94	F3N 722	Petrol	1721	4	8	45
21 (B48_)	09/89→06/94	F3N 723	Petrol	1721	4	8	45
21 (B48_)	09/89→06/94	J7T 754	Petrol	2165	4	8	87
21 (B48_)	09/89→06/94	J8S 714	Diesel	2068	4	8	81
21 (B48_)	09/89→06/94	J8S 786	Diesel	2068	4	8	81
21 (B48_)	09/89→06/94	J8S 788	Diesel	2068	4	8	81
21 (B48_)	01/90→06/94	J6T 790	Petrol	2165	4	8	87
21 Box (S48_)	06/86→08/94	F8Q 710	Diesel	1870	4	8	55
21 Box (S48_)	06/86→08/94	J8S 704	Diesel	2068	4	8	81
21 Box (S48_)	06/86→04/95	F2N 710	Petrol	1721	4	8	45
21 Estate (K48_)	03/86→12/93	J7R 746	Petrol	1995	4	8	64
21 Estate (K48_)	03/86→12/93	J7R 747	Petrol	1995	4	8	64
21 Estate (K48_)	03/86→08/94	F8Q 710	Diesel	1870	4	8	55
21 Estate (K48_)	06/86→12/89	F2N 750	Petrol	1721	4	8	45
21 Estate (K48_)	06/86→06/92	J7R 750	Petrol	1995	4	8	64
21 Estate (K48_)	06/86→06/92	J7R 751	Petrol	1995	4	8	64
21 Estate (K48_)	06/86→03/93	F2N 712	Petrol	1721	4	8	45
21 Estate (K48_)	06/86→12/93	F3N 722	Petrol	1721	4	8	45
21 Estate (K48_)	06/86→12/93	F3N 723	Petrol	1721	4	8	45
21 Estate (K48_)	06/86→12/93	J7T 754	Petrol	2165	4	8	87
21 Estate (K48_)	06/86→12/93	J7T 755	Petrol	2165	4	8	87
21 Estate (K48_)	10/86→12/88	F2N 710	Petrol	1721	4	8	45
21 Estate (K48_)	10/86→05/92	J8S 704	Diesel	2068	4	8	81
21 Estate (K48_)	10/86→11/93	J8S 714	Diesel	2068	4	8	81
21 Estate (K48_)	10/86→11/93	J8S 786	Diesel	2068	4	8	81
21 Estate (K48_)	10/86→11/93	J8S 788	Diesel	2068	4	8	81
21 Estate (K48_)	06/87→04/89	F2N 752	Petrol	1721	4	8	45
21 Estate (K48_)	05/88→06/93	F3N 726	Petrol	1721	4	8	45
21 Estate (K48_)	08/89→12/92	J8S 600	Diesel	2068	4	8	81
21 Estate (K48_)	08/89→12/92	J8S 740	Diesel	2068	4	8	81
21 Estate (K48_)	01/90→07/97	J6T 790	Petrol	2165	4	8	87
21 Estate (K48_)	06/90→02/94	J7R 740	Petrol	1995	4	12	73
21 Estate (K48_)	06/91→05/93	J6R 758	Petrol	1995	4	8	64
21 Estate (K48_)	06/91→05/93	J6R 759	Petrol	1995	4	8	64
21 Estate (K48_)	06/91→05/93	J6R 792	Petrol	1995	4	8	64
21 Estate (K48_)	02/92→09/95	J8S 784	Diesel	2068	4	8	81
21 Saloon (L48_)	03/86→12/87	F2N 712	Petrol	1721	4	8	45
21 Saloon (L48_)	03/86→06/89	J7R 750	Petrol	1995	4	8	64
21 Saloon (L48_)	03/86→06/89	J7R 751	Petrol	1995	4	8	64
21 Saloon (L48_)	03/86→12/89	J8S 704	Diesel	2068	4	8	81
21 Saloon (L48_)	03/86→03/93	F2N 710	Petrol	1721	4	8	45
21 Saloon (L48_)	03/86→10/93	J6R 758	Petrol	1995	4	8	64
21 Saloon (L48_)	03/86→10/93	J6R 759	Petrol	1995	4	8	64
21 Saloon (L48_)	03/86→10/93	J6R 792	Petrol	1995	4	8	64
21 Saloon (L48_)	03/86→10/93	J6R 793	Petrol	1995	4	8	64
21 Saloon (L48_)	03/86→12/93	J7R 746	Petrol	1995	4	8	64



21 Saloon (L48_)	03/86→12/93	J7R 747	Petrol	1995	4	8	64
21 Saloon (L48_)	03/86→02/94	F3N 722	Petrol	1721	4	8	45
21 Saloon (L48_)	03/86→02/94	F3N 723	Petrol	1721	4	8	45
21 Saloon (L48_)	03/86→06/94	J8S 714	Diesel	2068	4	8	81
21 Saloon (L48_)	03/86→06/94	J8S 786	Diesel	2068	4	8	81
21 Saloon (L48_)	03/86→06/94	J8S 788	Diesel	2068	4	8	81
21 Saloon (L48_)	04/86→02/94	J7T 755	Petrol	2165	4	8	87
21 Saloon (L48_)	07/86→02/94	F2N 750	Petrol	1721	4	8	45
21 Saloon (L48_)	07/86→02/94	F3N 726	Petrol	1721	4	8	45
21 Saloon (L48_)	07/86→02/94	J7T 754	Petrol	2165	4	8	87
21 Saloon (L48_)	04/87→10/93	J7R 752	Petrol	1995	4	8	64
21 Saloon (L48_)	06/87→04/89	F2N 752	Petrol	1721	4	8	45
21 Saloon (L48_)	06/88→10/93	C2J 770	Petrol	1397	4	8	23
21 Saloon (L48_)	05/89→06/94	J8S 600	Diesel	2068	4	8	81
21 Saloon (L48_)	05/89→06/94	J8S 740	Diesel	2068	4	8	81
21 Saloon (L48_)	08/89→10/93	F8Q 710	Diesel	1870	4	8	55
21 Saloon (L48_)	08/89→08/94	J7R 754	Petrol	1995	4	12	73
21 Saloon (L48_)	12/89→06/94	J7R 740	Petrol	1995	4	12	73
21 Saloon (L48_)	02/90→10/92	J7R 756	Petrol	1995	4	8	64
21 Saloon (L48_)	03/92→07/97	J7T 730	Petrol	2165	4	8	87
21 Saloon (L48_)	03/92→07/97	J7T 731	Petrol	2165	4	8	87
21 Saloon (L48_)	10/92→06/94	J8S 784	Diesel	2068	4	8	81
25 (B29_)	04/84→05/89	J8S 706	Diesel	2068	4	8	81
25 (B29_)	04/84→08/89	Z7V 708	Petrol	2664	6	12	115
25 (B29_)	04/84→08/89	Z7V 709	Petrol	2664	6	12	115
25 (B29_)	04/84→08/89	Z7V 711	Petrol	2664	6	12	115
25 (B29_)	04/84→12/89	J7T 706	Petrol	2165	4	8	87
25 (B29_)	04/84→12/89	J7T 707	Petrol	2165	4	8	87
25 (B29_)	04/84→12/89	J7T 714	Petrol	2165	4	8	87
25 (B29_)	04/84→12/89	J7T 715	Petrol	2165	4	8	87
25 (B29_)	04/84→12/89	J7T 730	Petrol	2165	4	8	87
25 (B29_)	04/84→12/89	J7T 731	Petrol	2165	4	8	87
25 (B29_)	04/84→12/92	J6R 706	Petrol	1995	4	8	64
25 (B29_)	04/84→12/92	J6R 707	Petrol	1995	4	8	64
25 (B29_)	04/84→12/92	J6R 760	Petrol	1995	4	8	64
25 (B29_)	04/84→12/92	J6R 762	Petrol	1995	4	8	64
25 (B29_)	04/84→12/92	J6R 763	Petrol	1995	4	8	64
25 (B29_)	04/84→12/92	J8S 708	Diesel	2068	4	8	81
25 (B29_)	04/84→12/92	J8S 738	Diesel	2068	4	8	81
25 (B29_)	10/84→05/90	Z7U 702	Petrol	2458	6	12	94
25 (B29_)	11/85→12/92	J7T 708	Petrol	2165	4	8	87
25 (B29_)	11/85→12/92	J7T 732	Petrol	2165	4	8	87
25 (B29_)	06/86→02/88	Z7W 702	Petrol	2849	6	12	119
25 (B29_)	09/86→12/92	J7T 733	Petrol	2165	4	8	87
25 (B29_)	03/87→12/93	J7R 722	Petrol	1995	4	8	64
25 (B29_)	03/87→12/93	J7R 723	Petrol	1995	4	8	64
25 (B29_)	06/87→02/90	Z7W 700	Petrol	2849	6	12	119
25 (B29_)	06/87→12/92	Z7W 706	Petrol	2849	6	12	119
25 (B29_)	06/87→12/92	Z7W 707	Petrol	2849	6	12	119
25 (B29_)	06/87→12/92	Z7W 709	Petrol	2849	6	12	119
25 (B29_)	06/88→12/93	J7R 720	Petrol	1995	4	12	73
25 (B29_)	06/88→12/93	J7R 721	Petrol	1995	4	12	73
25 (B29_)	06/89→12/92	J7R 726	Petrol	1995	4	12	73
25 (B29_)	06/89→12/92	J8S 736	Diesel	2068	4	8	81
25 (B29_)	01/90→12/92	Z7U 700	Petrol	2458	6	12	111
30 (127_)	02/75→08/78	112	Petrol	2664	6	12	113
30 (127_)	07/78→01/84	144	Petrol	2664	6	12	113
30 (127_)	10/78→12/83	140	Petrol	2664	6	12	113
30 (127_)	02/82→03/86	J8S 702	Diesel	2068	4	8	81
Alliance Saloon	09/83→12/86	F2N 730	Petrol	1721	4	8	45
Avantime (DE0_)	09/01→05/03	L7X 720	Petrol	2946	6	24	122
Avantime (DE0_)	09/01→05/03	L7X 721	Petrol	2946	6	24	122
Avantime (DE0_)	11/01→05/03	F4R 760	Petrol	1998	4	16	69
Avantime (DE0_)	11/01→05/03	F4R 761	Petrol	1998	4	16	69
Avantime (DE0_)	05/02→05/03	G9T 712	Diesel	2188	4	16	86
B Box Body / Estate	01/83→12/90	8140.61.235	Diesel	2445	4	8	92
B Box Body / Estate	04/86→09/90	8140.21.235 IDS	Diesel	2445	4	8	90
B Box Body / Estate	08/90→01/92	8140.27.2530 IDS	Diesel	2499	4	8	98
B Platform/Chassis	01/83→12/90	8140.61.235	Diesel	2445	4	8	92
B Platform/Chassis	04/84→06/99	8140.43.2585	Diesel	2800	4	8	116
B Platform/Chassis	04/86→01/92	8140.21.235 IDS	Diesel	2445	4	8	90
B Platform/Chassis	08/90→01/92	8140.27.2530 IDS	Diesel	2499	4	8	98
Captur (J5_)	06/13→	H4B 400	Petrol	898	3	12	1
Captur (J5_)	06/13→	H5F 403	Petrol	1197	4	16	18
Captur (J5_)	06/13→	K9K 608	Diesel	1461	4	8	29
Captur (J5_)	06/13→	K9K 609	Diesel	1461	4	8	29
Captur (J5_)	01/15→	K9K 646	Diesel	1461	4	8	29
Captur (J5_)	01/16→	H5F 408	Petrol	1197	4	16	18



CC











9

Captur (J5_)	01/16→	H5F 412	Petrol	1197	4	16	18
Clio Grandtour (KR0/1_)	02/08→	D4F 740	Petrol	1149	4	16	15
Clio Grandtour (KR0/1_)	02/08→	D4F 764	Petrol	1149	4	16	15
Clio Grandtour (KR0/1_)	02/08→	D4F 784	Petrol	1149	4	16	15
Clio Grandtour (KR0/1_)	02/08→	K4M 800	Petrol	1598	4	16	37
Clio Grandtour (KR0/1_)	02/08→	K4M 801	Petrol	1598	4	16	37
Clio Grandtour (KR0/1_)	02/08→	K9K 714	Diesel	1461	4	8	29
Clio Grandtour (KR0/1_)	02/08→	K9K 764	Diesel	1461	4	8	29
Clio Grandtour (KR0/1_)	02/08→	K9K 766	Diesel	1461	4	8	29
Clio Grandtour (KR0/1_)	02/08→	K9K 768	Diesel	1461	4	8	29
Clio Grandtour (KR0/1_)	02/08→	K9K 772	Diesel	1461	4	8	29
Clio Grandtour (KR0/1_)	02/08→	K9K 774	Diesel	1461	4	8	29
Clio Grandtour (KR0/1_)	11/08→	K4M 862	Petrol	1598	4	16	37
Clio Grandtour (KR0/1_)	02/10→	K4J 780	Petrol	1390	4	16	27
Clio Grandtour (KR0/1_)	02/10→	K9K 752	Diesel	1461	4	8	29
Clio Grandtour (KR0/1_)	08/10→	K9K 770	Diesel	1461	4	8	29
Clio Grandtour (KR0/1_)	09/10→	D4F 786	Petrol	1149	4	16	15
Clio I (B/C57_, 5/357_)	05/90→03/96	E5F 710	Petrol	1171	4	8	17
Clio I (B/C57_, 5/357_)	05/90→02/98	E6J 712	Petrol	1390	4	8	25
Clio I (B/C57_, 5/357_)	05/90→02/98	E6J 713	Petrol	1390	4	8	25
Clio I (B/C57_, 5/357_)	05/90→02/98	E6J 760	Petrol	1390	4	8	25
Clio I (B/C57_, 5/357_)	05/90→09/98	E7F 700	Petrol	1171	4	8	17
Clio I (B/C57_, 5/357_)	05/90→09/98	E7F 708	Petrol	1171	4	8	17
Clio I (B/C57_, 5/357_)	05/90→09/98	E7F 750	Petrol	1171	4	8	17
Clio I (B/C57_, 5/357_)	08/90→09/98	F3P 755	Petrol	1783	4	8	49
Clio I (B/C57_, 5/357_)	01/91→12/93	F2N 770	Petrol	1721	4	8	45
Clio I (B/C57_, 5/357_)	01/91→03/96	F7P 722	Petrol	1764	4	16	53
Clio I (B/C57_, 5/357_)	01/91→06/96	E7F 706	Petrol	1171	4	8	17
Clio I (B/C57_, 5/357_)	01/91→09/98	C1E 700	Petrol	1108	4	8	10
Clio I (B/C57_, 5/357_)	01/91→09/98	E7J 601	Petrol	1390	4	8	25
Clio I (B/C57_, 5/357_)	01/91→09/98	E7J 710	Petrol	1390	4	8	25
Clio I (B/C57_, 5/357_)	01/91→09/98	E7J 711	Petrol	1390	4	8	25
Clio I (B/C57_, 5/357_)	01/91→09/98	E7J 718	Petrol	1390	4	8	25
Clio I (B/C57_, 5/357_)	01/91→09/98	E7J 719	Petrol	1390	4	8	25
Clio I (B/C57_, 5/357_)	01/91→09/98	E7J 754	Petrol	1390	4	8	25
Clio I (B/C57_, 5/357_)	01/91→09/98	E7J 756	Petrol	1390	4	8	25
Clio I (B/C57_, 5/357_)	01/91→09/98	E7J 757	Petrol	1390	4	8	25
Clio I (B/C57_, 5/357_)	01/91→09/98	F3P 710	Petrol	1794	4	8	50
Clio I (B/C57_, 5/357_)	01/91→09/98	F3P 714	Petrol	1794	4	8	50
Clio I (B/C57_, 5/357_)	01/91→09/98	F8Q 730	Diesel	1870	4	8	55
Clio I (B/C57_, 5/357_)	01/91→09/98	F8Q 732	Diesel	1870	4	8	55
Clio I (B/C57_, 5/357_)	01/93→08/95	F3P 712	Petrol	1794	4	8	50
Clio I (B/C57_, 5/357_)	01/94→09/98	F7R 700	Petrol	1998	4	16	71
Clio I (B/C57_, 5/357_)	08/94→09/98	F3P 754	Petrol	1794	4	8	50
Clio I (B/C57_, 5/357_)	08/95→09/98	F3P 758	Petrol	1783	4	8	50
Clio I (B/C57_, 5/357_)	01/96→12/96	C3G 720	Petrol	1239	4	8	14
Clio I (B/C57_, 5/357_)	01/96→09/98	D7F 730	Petrol	1149	4	8	16
Clio I (B/C57_, 5/357_)	05/96→02/98	F8Q 632	Diesel	1870	4	8	56
Clio I (B/C57_, 5/357_)	05/96→02/98	F8Q 676	Diesel	1870	4	8	59
Clio I (B/C57_, 5/357_)	05/96→02/98	F8Q 696	Diesel	1870	4	8	59
Clio I (B/C57_, 5/357_)	05/96→02/98	F8Q 714	Diesel	1870	4	8	55
Clio I (B/C57_, 5/357_)	01/97→09/98	F8Q 678	Diesel	1870	4	8	59
Clio I Box (S57_)	01/91→09/98	C1E 700	Petrol	1108	4	8	10
Clio I Box (S57_)	01/91→09/98	E7F 706	Petrol	1171	4	8	17
Clio I Box (S57_)	01/91→09/98	E7F 750	Petrol	1171	4	8	17
Clio I Box (S57_)	01/91→09/98	F8Q 730	Diesel	1870	4	8	55
Clio I Box (S57_)	01/91→09/98	F8Q 732	Diesel	1870	4	8	55
Clio I Box (S57_)	06/94→02/98	C3G 720	Petrol	1239	4	8	14
Clio I Box (S57_)	04/96→02/98	F8Q 678	Diesel	1870	4	8	59
Clio II (BB0/1/2_, CB0/1/2_)	09/98→05/05	E7J 634	Petrol	1390	4	8	25
Clio II (BB0/1/2_, CB0/1/2_)	09/98→05/05	E7J 780	Petrol	1390	4	8	25
Clio II (BB0/1/2_, CB0/1/2_)	09/98→05/05	F8Q 630	Diesel	1870	4	8	56
Clio II (BB0/1/2_, CB0/1/2_)	09/98→05/05	K7J 700	Petrol	1390	4	8	25
Clio II (BB0/1/2_, CB0/1/2_)	09/98→05/05	K7M 744	Petrol	1598	4	8	39
Clio II (BB0/1/2_, CB0/1/2_)	09/98→05/05	K7M 745	Petrol	1598	4	8	39
Clio II (BB0/1/2_, CB0/1/2_)	09/98→05/05	K7M 746	Petrol	1598	4	8	39
Clio II (BB0/1/2_, CB0/1/2_)	09/98→	D7F 710	Petrol	1149	4	8	16
Clio II (BB0/1/2_, CB0/1/2_)	09/98→	D7F 720	Petrol	1149	4	8	16
Clio II (BB0/1/2_, CB0/1/2_)	09/98→	D7F 722	Petrol	1149	4	8	16
Clio II (BB0/1/2_, CB0/1/2_)	09/98→	D7F 726	Petrol	1149	4	8	16
Clio II (BB0/1/2_, CB0/1/2_)	09/98→	D7F 746	Petrol	1149	4	8	16
Clio II (BB0/1/2_, CB0/1/2_)	09/98→	D7F 764	Petrol	1149	4	8	16
Clio II (BB0/1/2_, CB0/1/2_)	09/98→	D7F 766	Petrol	1149	4	8	16
Clio II (BB0/1/2_, CB0/1/2_)	09/98→	K4M 708	Petrol	1598	4	16	36
Clio II (BB0/1/2_, CB0/1/2_)	09/98→	K4M 740	Petrol	1598	4	16	36
Clio II (BB0/1/2_, CB0/1/2_)	09/98→	K4M 742	Petrol	1598	4	16	36
Clio II (BB0/1/2_, CB0/1/2_)	09/98→	K4M 743	Petrol	1598	4	16	36
Clio II (BB0/1/2_, CB0/1/2_)	09/98→	K4M 744	Petrol	1598	4	16	36









Clio II (BB0/1/2, CB0/1/2)	09/98→	K4M 745	Petrol	1598	4	16	36
Clio II (BB0/1/2, CB0/1/2)	09/98→	K4M 748	Petrol	1598	4	16	36
Clio II (BB0/1/2, CB0/1/2)	10/99→	K4J 712	Petrol	1390	4	16	27
Clio II (BB0/1/2, CB0/1/2)	10/99→	K4J 713	Petrol	1390	4	16	27
Clio II (BB0/1/2, CB0/1/2)	12/99→05/05	F9Q 780	Diesel	1870	4	8	62
Clio II (BB0/1/2, CB0/1/2)	02/00→05/01	D7D 760	Petrol	999	4	8	7
Clio II (BB0/1/2, CB0/1/2)	02/00→05/01	F8Q 632	Diesel	1870	4	8	56
Clio II (BB0/1/2, CB0/1/2)	02/00→	F4R 730	Petrol	1998	4	16	69
Clio II (BB0/1/2, CB0/1/2)	02/00→	F4R 736	Petrol	1998	4	16	69
Clio II (BB0/1/2, CB0/1/2)	08/00→	K4J 710	Petrol	1390	4	16	27
Clio II (BB0/1/2, CB0/1/2)	08/00→	K4J 711	Petrol	1390	4	16	27
Clio II (BB0/1/2, CB0/1/2)	11/00→12/02	L7X 760	Petrol	2946	6	24	122
Clio II (BB0/1/2, CB0/1/2)	06/01→	D4F 706	Petrol	1149	4	16	15
Clio II (BB0/1/2, CB0/1/2)	06/01→	D4F 712	Petrol	1149	4	16	15
Clio II (BB0/1/2, CB0/1/2)	06/01→	D4F 714	Petrol	1149	4	16	15
Clio II (BB0/1/2, CB0/1/2)	06/01→	D4F 722	Petrol	1149	4	16	15
Clio II (BB0/1/2, CB0/1/2)	06/01→	D4F 728	Petrol	1149	4	16	15
Clio II (BB0/1/2, CB0/1/2)	06/01→	K9K 700	Diesel	1461	4	8	29
Clio II (BB0/1/2, CB0/1/2)	06/01→	K9K 702	Diesel	1461	4	8	29
Clio II (BB0/1/2, CB0/1/2)	06/01→	K9K 704	Diesel	1461	4	8	29
Clio II (BB0/1/2, CB0/1/2)	09/01→12/05	F4R	Petrol	1998	4	16	69
Clio II (BB0/1/2, CB0/1/2)	12/02→	L7X 762	Petrol	2946	6	24	122
Clio II (BB0/1/2, CB0/1/2)	01/04→	F4R 738	Petrol	1998	4	16	69
Clio II (BB0/1/2, CB0/1/2)	01/04→	K9K 712	Diesel	1461	4	8	29
Clio II (BB0/1/2, CB0/1/2)	08/04→	K9K 714	Diesel	1461	4	8	29
Clio II (BB0/1/2, CB0/1/2)	06/05→	K9K 740	Diesel	1461	4	8	29
Clio II (BB0/1/2, CB0/1/2)	11/05→	D4D 754	Petrol	999	4	16	6
Clio II (BB0/1/2, CB0/1/2)	02/07→	K9K 718	Diesel	1461	4	8	29
Clio II Box (SB0/1/2)	09/98→	D7F 720	Petrol	1149	4	8	16
Clio II Box (SB0/1/2)	09/98→	D7F 726	Petrol	1149	4	8	16
Clio II Box (SB0/1/2)	09/98→	D7F 746	Petrol	1149	4	8	16
Clio II Box (SB0/1/2)	09/98→	F8Q 630	Diesel	1870	4	8	56
Clio II Box (SB0/1/2)	03/99→01/00	F8Q 662	Diesel	1870	4	8	56
Clio II Box (SB0/1/2)	03/99→10/03	D7F 722	Petrol	1149	4	8	16
Clio II Box (SB0/1/2)	02/00→05/01	F8Q 632	Diesel	1870	4	8	56
Clio II Box (SB0/1/2)	02/00→05/01	F9Q 780	Diesel	1870	4	8	62
Clio II Box (SB0/1/2)	06/01→	K9K 700	Diesel	1461	4	8	29
Clio II Box (SB0/1/2)	06/01→	K9K 702	Diesel	1461	4	8	29
Clio II Box (SB0/1/2)	06/01→	K9K 704	Diesel	1461	4	8	29
Clio II Box (SB0/1/2)	11/03→	K4M 746	Petrol	1598	4	16	36
Clio II Box (SB0/1/2)	11/03→	K9K 710	Diesel	1461	4	8	29
Clio II Box (SB0/1/2)	11/03→	K9K 716	Diesel	1461	4	8	29
Clio II Box (SB0/1/2)	04/04→	K9K 714	Diesel	1461	4	8	29
Clio III (BR0/1, CR0/1)	05/05→06/09	D7F 766	Petrol	1149	4	8	16
Clio III (BR0/1, CR0/1)	05/05→	K9K 752	Diesel	1461	4	8	29
Clio III (BR0/1, CR0/1)	06/05→	D4F 706	Petrol	1149	4	16	15
Clio III (BR0/1, CR0/1)	06/05→	D4F 740	Petrol	1149	4	16	15
Clio III (BR0/1, CR0/1)	06/05→	D4F 764	Petrol	1149	4	16	15
Clio III (BR0/1, CR0/1)	06/05→	K4J 780	Petrol	1390	4	16	27
Clio III (BR0/1, CR0/1)	06/05→	K4M 800	Petrol	1598	4	16	37
Clio III (BR0/1, CR0/1)	06/05→	K4M 801	Petrol	1598	4	16	37
Clio III (BR0/1, CR0/1)	06/05→	K4M 804	Petrol	1598	4	16	37
Clio III (BR0/1, CR0/1)	06/05→	K9K 714	Diesel	1461	4	8	29
Clio III (BR0/1, CR0/1)	06/05→	K9K 764	Diesel	1461	4	8	29
Clio III (BR0/1, CR0/1)	06/05→	K9K 766	Diesel	1461	4	8	29
Clio III (BR0/1, CR0/1)	06/05→	K9K 768	Diesel	1461	4	8	29
Clio III (BR0/1, CR0/1)	06/05→	K9K 772	Diesel	1461	4	8	29
Clio III (BR0/1, CR0/1)	06/05→	K9K 774	Diesel	1461	4	8	29
Clio III (BR0/1, CR0/1)	02/06→	F4R 830	Petrol	1998	4	16	69
Clio III (BR0/1, CR0/1)	09/06→	M4R 700	Petrol	1997	4	16	75
Clio III (BR0/1, CR0/1)	09/06→	M4R 701	Petrol	1997	4	16	75
Clio III (BR0/1, CR0/1)	05/07→	D4F 784	Petrol	1149	4	16	15
Clio III (BR0/1, CR0/1)	11/07→	K9K 750	Diesel	1461	4	8	29
Clio III (BR0/1, CR0/1)	07/08→	D4F 712	Petrol	1149	4	16	15
Clio III (BR0/1, CR0/1)	07/08→	D4F 742	Petrol	1149	4	16	15
Clio III (BR0/1, CR0/1)	06/09→	K4M 862	Petrol	1598	4	16	37
Clio III (BR0/1, CR0/1)	08/10→	K9K 770	Diesel	1461	4	8	29
Clio III (BR0/1, CR0/1)	09/10→	D4F 786	Petrol	1149	4	16	15
Clio III Box (SB, SR)	06/05→07/10	K9K 766	Diesel	1461	4	8	29
Clio III Box (SB, SR)	10/05→10/07	K9K 764	Diesel	1461	4	8	29
Clio III Box (SB, SR)	10/05→07/10	K9K 768	Diesel	1461	4	8	29
Clio III Box (SB, SR)	11/05→12/14	D4F 740	Petrol	1149	4	16	15
Clio III Box (SB, SR)	11/07→12/11	D4F 784	Petrol	1149	4	16	15
Clio III Box (SB, SR)	08/10→12/14	K9K 770	Diesel	1461	4	8	29
Clio IV (BH)	11/12→	D4D 754	Petrol	999	4	16	6
Clio IV (BH)	11/12→	D4F 728	Petrol	1149	4	16	15
Clio IV (BH)	11/12→	D4F 740	Petrol	1149	4	16	15
Clio IV (BH)	11/12→	H4B 400	Petrol	898	3	12	1

							
Clio IV (BH_)	11/12→	K9K 608	Diesel	1461	4	8	29
Clio IV (BH_)	11/12→	K9K 612	Diesel	1461	4	8	29
Clio IV (BH_)	11/12→	K9K 628	Diesel	1461	4	8	29
Clio IV (BH_)	03/13→	H5F 403	Petrol	1197	4	16	18
Clio IV (BH_)	03/13→	M5M 400	Petrol	1618	4	16	40
Clio IV (BH_)	03/13→	M5M 450	Petrol	1618	4	16	40
Clio IV (BH_)	01/16→	H5F 412	Petrol	1197	4	16	18
Clio IV (BH_)	06/16→	K9K 646	Diesel	1461	4	8	29
Clio IV Box	01/14→	H4B 400	Petrol	898	3	12	1
Clio IV Box	01/14→	H4B 408	Petrol	898	3	12	1
Clio IV Box	01/14→	K9K 608	Diesel	1461	4	8	29
Clio IV Box	01/14→	K9K 612	Diesel	1461	4	8	29
Clio IV Grandtour (KH_)	01/13→	D4F 740	Petrol	1149	4	16	15
Clio IV Grandtour (KH_)	01/13→	H4B 400	Petrol	898	3	12	1
Clio IV Grandtour (KH_)	01/13→	K9K 608	Diesel	1461	4	8	29
Clio IV Grandtour (KH_)	01/13→	K9K 612	Diesel	1461	4	8	29
Clio IV Grandtour (KH_)	03/13→	H5F 403	Petrol	1197	4	16	18
Clio IV Grandtour (KH_)	01/16→	H5F 412	Petrol	1197	4	16	18
Clio IV Grandtour (KH_)	06/16→	K9K 646	Diesel	1461	4	8	29
Dokker	12/13→	K7M 812	Petrol	1598	4	8	39
Dokker	12/13→	K9K 612	Diesel	1461	4	8	29
Duster	06/09→	K9K 884	Diesel	1461	4	8	29
Duster	02/12→	F4R 403	Petrol	1998	4	16	69
Duster	02/12→	F4R 405	Petrol	1998	4	16	69
Duster	02/12→	K4M 616	Petrol	1598	4	16	36
Duster (HS_)	01/11→	F4R 400	Petrol	1998	4	16	69
Duster (HS_)	01/11→	F4R 402	Petrol	1998	4	16	69
Duster (HS_)	01/11→	F4R 403	Petrol	1998	4	16	69
Duster (HS_)	01/11→	F4R 404	Petrol	1998	4	16	69
Duster (HS_)	01/11→	F4R 405	Petrol	1998	4	16	69
Duster (HS_)	01/11→	F4R 408	Petrol	1998	4	16	69
Duster (HS_)	01/11→	K4M 690	Petrol	1598	4	16	38
Duster (HS_)	06/11→	K4M 616	Petrol	1598	4	16	36
Duster (HS_)	06/11→	K9K 884	Diesel	1461	4	8	29
Duster (HS_)	02/12→	F4R	Petrol	1998	4	16	69
Duster (HS_)	02/12→	K4M 718	Petrol	1598	4	16	36
Duster (HS_)	02/12→	K9K 796	Diesel	1461	4	8	29
Duster (HS_)	09/13→	K9K 856	Diesel	1461	4	8	29
Duster (HS_)	09/13→	K9K 858	Diesel	1461	4	8	29
Duster (HS_)	09/13→	K9K 898	Diesel	1461	4	8	29
Duster (HS_)	09/14→	K9K 896	Diesel	1461	4	8	29
Espace I (J11_)	07/84→12/90	J6R 234	Petrol	1995	4	8	64
Espace I (J11_)	07/84→12/90	J6R 236	Petrol	1995	4	8	64
Espace I (J11_)	10/84→12/90	J8S 240	Diesel	2068	4	8	81
Espace I (J11_)	10/84→12/90	J8S 774	Diesel	2068	4	8	81
Espace I (J11_)	10/84→12/90	J8S 776	Diesel	2068	4	8	81
Espace I (J11_)	07/86→12/90	J7T 770	Petrol	2165	4	8	87
Espace I (J11_)	01/88→12/90	J6R 734	Petrol	1995	4	8	64
Espace I (J11_)	03/88→12/92	J7R 760	Petrol	1995	4	8	64
Espace II (J/S63_)	01/91→10/96	J7R 768	Petrol	1995	4	8	64
Espace II (J/S63_)	01/91→10/96	J7T 776	Petrol	2165	4	8	87
Espace II (J/S63_)	01/91→10/96	J8S 610	Diesel	2068	4	8	83
Espace II (J/S63_)	01/91→10/96	J8S 772	Diesel	2068	4	8	81
Espace II (J/S63_)	01/91→10/96	J8S 776	Diesel	2068	4	8	81
Espace II (J/S63_)	01/91→10/96	J8S 778	Diesel	2068	4	8	81
Espace II (J/S63_)	01/91→10/96	Z7W 712	Petrol	2849	6	12	119
Espace II (J/S63_)	01/91→10/96	Z7W 713	Petrol	2849	6	12	119
Espace II (J/S63_)	01/91→10/96	Z7W 717	Petrol	2849	6	12	119
Espace II (J/S63_)	01/91→12/96	J7T 772	Petrol	2165	4	8	87
Espace II (J/S63_)	01/91→12/96	J7T 773	Petrol	2165	4	8	87
Espace II (J/S63_)	11/94→10/96	J8S 612	Diesel	2068	4	8	81
Espace III (JEO_)	11/96→10/98	Z7X 775	Petrol	2963	6	12	124
Espace III (JEO_)	11/96→10/00	F3R 728	Petrol	1998	4	8	65
Espace III (JEO_)	11/96→10/00	F3R 729	Petrol	1998	4	8	65
Espace III (JEO_)	11/96→10/00	F3R 742	Petrol	1998	4	8	65
Espace III (JEO_)	11/96→10/00	F3R 768	Petrol	1998	4	8	65
Espace III (JEO_)	11/96→10/00	F3R 769	Petrol	1998	4	8	65
Espace III (JEO_)	11/96→10/00	G8T 714	Diesel	2188	4	12	85
Espace III (JEO_)	11/96→10/00	G8T 716	Diesel	2188	4	12	85
Espace III (JEO_)	11/96→10/00	G8T 760	Diesel	2188	4	12	85
Espace III (JEO_)	10/98→10/02	F4R 700	Petrol	1998	4	16	69
Espace III (JEO_)	10/98→10/02	F4R 701	Petrol	1998	4	16	69
Espace III (JEO_)	10/98→10/02	L7X 727	Petrol	2946	6	24	122
Espace III (JEO_)	02/99→10/02	F9Q 722	Diesel	1870	4	8	62
Espace III (JEO_)	07/00→10/02	G9T 710	Diesel	2188	4	16	86
Espace III (JEO_)	10/00→10/02	G9T 642	Diesel	2188	4	16	86
Espace IV (JKO/1_)	11/02→02/05	F4R 790	Petrol	1998	4	16	69
Espace IV (JKO/1_)	11/02→	F4R 792	Petrol	1998	4	16	69



Espace IV (JK0/1_)	11/02→	F4R 794	Petrol	1998	4	16	69
Espace IV (JK0/1_)	11/02→	F4R 795	Petrol	1998	4	16	69
Espace IV (JK0/1_)	11/02→	F4R 796	Petrol	1998	4	16	69
Espace IV (JK0/1_)	11/02→	F4R 797	Petrol	1998	4	16	69
Espace IV (JK0/1_)	11/02→	F9Q 680	Diesel	1870	4	8	62
Espace IV (JK0/1_)	11/02→	F9Q 820	Diesel	1870	4	8	62
Espace IV (JK0/1_)	11/02→	F9Q 826	Diesel	1870	4	8	62
Espace IV (JK0/1_)	11/02→	G9T 742	Diesel	2188	4	16	86
Espace IV (JK0/1_)	11/02→	G9T 743	Diesel	2188	4	16	86
Espace IV (JK0/1_)	11/02→	P9X 701	Diesel	2958	6	24	123
Espace IV (JK0/1_)	11/02→	V4Y 711	Petrol	3498	6	24	126
Espace IV (JK0/1_)	11/02→	V4Y 715	Petrol	3498	6	24	126
Espace IV (JK0/1_)	04/05→	F4R 896	Petrol	1998	4	16	69
Espace IV (JK0/1_)	04/05→	F4R 897	Petrol	1998	4	16	69
Espace IV (JK0/1_)	09/05→	P9X 715	Diesel	2958	6	24	123
Espace IV (JK0/1_)	01/06→	M9R 740	Diesel	1995	4	16	77
Espace IV (JK0/1_)	01/06→	M9R 750	Diesel	1995	4	16	77
Espace IV (JK0/1_)	01/06→	M9R 760	Diesel	1995	4	16	77
Espace IV (JK0/1_)	01/06→	M9R 761	Diesel	1995	4	16	77
Espace IV (JK0/1_)	01/06→	M9R 762	Diesel	1995	4	16	77
Espace IV (JK0/1_)	01/06→	M9R 763	Diesel	1995	4	16	77
Espace IV (JK0/1_)	01/06→	M9R 814	Diesel	1995	4	16	77
Espace IV (JK0/1_)	01/06→	M9R 815	Diesel	1995	4	16	77
Espace IV (JK0/1_)	01/06→	M9R 859	Diesel	1995	4	16	77
Espace IV (JK0/1_)	02/06→	G9T 645	Diesel	2188	4	16	86
Espace V (JR_)	02/15→	M5M 450	Petrol	1618	4	16	40
Espace V (JR_)	06/15→	R9M 409	Diesel	1598	4	16	42
Espace V (JR_)	06/15→	R9M 452	Diesel	1598	4	16	43
Estafette (213_)	02/62→12/81	688.01	Petrol	1108	4	8	9
Estafette (213_)	08/69→12/81	810.01	Petrol	1289	4	8	19
Express Pickup	07/95→10/97	F8Q 640	Diesel	1870	4	8	55
Express Pickup	07/95→10/99	C3G 710	Petrol	1239	4	8	14
Express Pickup	07/95→10/99	F8Q 724	Diesel	1870	4	8	55
Express Pickup	07/95→10/99	F8Q 776	Diesel	1870	4	8	55
Fluence (L30_)	02/10→	K4M 838	Petrol	1598	4	16	37
Fluence (L30_)	02/10→	K4M 839	Petrol	1598	4	16	37
Fluence (L30_)	02/10→	K9K 830	Diesel	1461	4	8	29
Fluence (L30_)	02/10→	K9K 832	Diesel	1461	4	8	29
Fluence (L30_)	02/10→	K9K 834	Diesel	1461	4	8	29
Fluence (L30_)	02/10→	K9K 836	Diesel	1461	4	8	29
Fluence (L30_)	02/10→	K9K 837	Diesel	1461	4	8	29
Fluence (L30_)	02/10→	M4R 714	Petrol	1997	4	16	75
Fluence (L30_)	02/10→	M4R 751	Petrol	1998	4	16	75
Fluence (L30_)	02/11→	F4R 872	Petrol	1998	4	16	69
Fluence (L30_)	07/14→	K9K 826	Diesel	1461	4	8	29
Fluence (L30_)	07/14→	R9M 402	Diesel	1598	4	16	42
Fuego (136_)	02/80→10/85	847 720	Petrol	1397	4	8	22
Fuego (136_)	10/80→10/85	829 710	Petrol	1995	4	8	64
Fuego (136_)	10/80→10/85	843 723	Petrol	1647	4	8	31
Fuego (136_)	10/80→10/85	843 724	Petrol	1647	4	8	31
Fuego (136_)	10/80→10/85	A6M 725	Petrol	1647	4	8	31
Fuego (136_)	10/80→10/85	A6M 726	Petrol	1647	4	8	31
Fuego (136_)	10/80→10/85	J6R 710	Petrol	1995	4	8	64
Fuego (136_)	10/80→10/85	J6R 712	Petrol	1995	4	8	64
Fuego (136_)	10/80→10/85	J6R 713	Petrol	1995	4	8	64
Fuego (136_)	10/80→10/85	J6R 715	Petrol	1995	4	8	64
Fuego (136_)	10/80→10/85	J6R 726	Petrol	1995	4	8	64
Fuego (136_)	02/81→11/86	J6R 714	Petrol	1995	4	8	64
Fuego (136_)	08/82→10/85	J8S 712	Diesel	2068	4	8	81
Fuego (136_)	04/83→10/85	A2M 723	Petrol	1647	4	8	31
Fuego (136_)	08/83→10/85	A5L 750	Petrol	1565	4	8	31
Fuego (136_)	11/84→06/88	J7T 718	Petrol	2165	4	8	87
Grand Scénic II (JMO/1_)	04/04→	F4R 770	Petrol	1998	4	16	69
Grand Scénic II (JMO/1_)	04/04→	F4R 771	Petrol	1998	4	16	69
Grand Scénic II (JMO/1_)	04/04→	F4R 776	Petrol	1998	4	16	69
Grand Scénic II (JMO/1_)	04/04→	F9Q 812	Diesel	1870	4	8	62
Grand Scénic II (JMO/1_)	04/04→	K4M 761	Petrol	1598	4	16	37
Grand Scénic II (JMO/1_)	04/04→	K4M 782	Petrol	1598	4	16	37
Grand Scénic II (JMO/1_)	04/04→	K9K 722	Diesel	1461	4	8	29
Grand Scénic II (JMO/1_)	04/04→	K9K 728	Diesel	1461	4	8	29
Grand Scénic II (JMO/1_)	05/05→01/09	F9Q 803	Diesel	1870	4	8	62
Grand Scénic II (JMO/1_)	05/05→01/09	F9Q 804	Diesel	1870	4	8	62
Grand Scénic II (JMO/1_)	05/05→	F9Q 816	Diesel	1870	4	8	62
Grand Scénic II (JMO/1_)	05/05→	F9Q 818	Diesel	1870	4	8	62
Grand Scénic II (JMO/1_)	05/05→	F9Q E 804	Diesel	1870	4	8	62
Grand Scénic II (JMO/1_)	05/05→	F9Q EE 804	Diesel	1870	4	8	62
Grand Scénic II (JMO/1_)	05/05→	F9Q J 803	Diesel	1870	4	8	62
Grand Scénic II (JMO/1_)	05/05→	K9K 732	Diesel	1461	4	8	29

				CC			9
Grand Scénic II (JM0/1_)	09/05→	M9R 700	Diesel	1995	4	16	77
Grand Scénic II (JM0/1_)	09/05→	M9R 721	Diesel	1995	4	16	77
Grand Scénic II (JM0/1_)	09/05→	M9R 722	Diesel	1995	4	16	77
Grand Scénic II (JM0/1_)	06/06→11/08	K4M 766	Petrol	1598	4	16	37
Grand Scénic II (JM0/1_)	06/06→11/08	K4M 812	Petrol	1598	4	16	37
Grand Scénic II (JM0/1_)	06/06→11/08	K9K 734	Diesel	1461	4	8	29
Grand Scénic II (JM0/1_)	06/06→	K4M 788	Petrol	1598	4	16	36
Grand Scénic III (JZ0/1_)	02/09→	F9Q 870	Diesel	1870	4	8	62
Grand Scénic III (JZ0/1_)	02/09→	F9Q 872	Diesel	1870	4	8	62
Grand Scénic III (JZ0/1_)	02/09→	H4J 700	Petrol	1397	4	16	26
Grand Scénic III (JZ0/1_)	02/09→	K4M 858	Petrol	1598	4	16	37
Grand Scénic III (JZ0/1_)	02/09→	K4M 866	Petrol	1598	4	16	37
Grand Scénic III (JZ0/1_)	02/09→	K9K 832	Diesel	1461	4	8	29
Grand Scénic III (JZ0/1_)	02/09→	M4R 711	Petrol	1997	4	16	75
Grand Scénic III (JZ0/1_)	02/09→	M9R 615	Diesel	1995	4	16	77
Grand Scénic III (JZ0/1_)	04/09→	K9K 636	Diesel	1461	4	8	29
Grand Scénic III (JZ0/1_)	04/09→	K9K 830	Diesel	1461	4	8	29
Grand Scénic III (JZ0/1_)	04/09→	K9K 836	Diesel	1461	4	8	29
Grand Scénic III (JZ0/1_)	04/09→	K9K 837	Diesel	1461	4	8	29
Grand Scénic III (JZ0/1_)	04/09→	M9R 610	Diesel	1995	4	16	77
Grand Scénic III (JZ0/1_)	11/10→	K9K 846	Diesel	1461	4	8	29
Grand Scénic III (JZ0/1_)	04/11→	R9M 402	Diesel	1598	4	16	42
Grand Scénic III (JZ0/1_)	04/11→	R9M 404	Diesel	1598	4	16	42
Grand Scénic III (JZ0/1_)	04/12→	H5F 400	Petrol	1197	4	16	18
Grand Scénic III (JZ0/1_)	01/13→	H5F 404	Petrol	1198	4	16	18
Grand Scénic IV (R9_)	09/16→	H5F 408	Petrol	1197	4	16	18
Grand Scénic IV (R9_)	09/16→	K9K 646	Diesel	1461	4	8	29
Grand Scénic IV (R9_)	09/16→	K9K 647	Diesel	1461	4	8	29
Grand Scénic IV (R9_)	09/16→	R9M 409	Diesel	1598	4	16	42
Grand Scénic IV (R9_)	09/16→	R9M 452	Diesel	1598	4	16	43
Kadjar (HA_, HL_)	06/15→	H5F 408	Petrol	1197	4	16	18
Kadjar (HA_, HL_)	06/15→	K9K 646	Diesel	1461	4	8	29
Kadjar (HA_, HL_)	06/15→	K9K 647	Diesel	1461	4	8	29
Kadjar (HA_, HL_)	06/15→	R9M 414	Diesel	1598	4	16	42
Kangoo (KC0/1_)	08/97→	D7F 710	Petrol	1149	4	8	16
Kangoo (KC0/1_)	08/97→	D7F 720	Petrol	1149	4	8	16
Kangoo (KC0/1_)	08/97→	D7F 722	Petrol	1149	4	8	16
Kangoo (KC0/1_)	08/97→	D7F 726	Petrol	1149	4	8	16
Kangoo (KC0/1_)	08/97→	D7F 744	Petrol	1149	4	8	16
Kangoo (KC0/1_)	08/97→	D7F 746	Petrol	1149	4	8	16
Kangoo (KC0/1_)	08/97→	E7J 634	Petrol	1390	4	8	25
Kangoo (KC0/1_)	08/97→	E7J 635	Petrol	1390	4	8	25
Kangoo (KC0/1_)	08/97→	E7J 780	Petrol	1390	4	8	25
Kangoo (KC0/1_)	08/97→	F8Q 630	Diesel	1870	4	8	56
Kangoo (KC0/1_)	08/97→	F8Q 632	Diesel	1870	4	8	56
Kangoo (KC0/1_)	08/97→	F8Q 662	Diesel	1870	4	8	56
Kangoo (KC0/1_)	08/97→	K7J 700	Petrol	1390	4	8	25
Kangoo (KC0/1_)	08/97→	K7J 701	Petrol	1390	4	8	25
Kangoo (KC0/1_)	09/99→06/01	K7M 746	Petrol	1598	4	8	39
Kangoo (KC0/1_)	02/00→	F9Q 780	Diesel	1870	4	8	62
Kangoo (KC0/1_)	06/01→	D4F 712	Petrol	1149	4	16	15
Kangoo (KC0/1_)	06/01→	D4F 714	Petrol	1149	4	16	15
Kangoo (KC0/1_)	06/01→	D4F 716	Petrol	1149	4	16	15
Kangoo (KC0/1_)	06/01→	D4F 730	Petrol	1149	4	16	15
Kangoo (KC0/1_)	06/01→	K4M 706	Petrol	1598	4	16	36
Kangoo (KC0/1_)	06/01→	K4M 750	Petrol	1598	4	16	36
Kangoo (KC0/1_)	06/01→	K4M 752	Petrol	1598	4	16	36
Kangoo (KC0/1_)	06/01→	K4M 753	Petrol	1598	4	16	36
Kangoo (KC0/1_)	10/01→	F9Q 782	Diesel	1870	4	8	62
Kangoo (KC0/1_)	10/01→	F9Q 790	Diesel	1870	4	8	62
Kangoo (KC0/1_)	12/01→	K9K 700	Diesel	1461	4	8	29
Kangoo (KC0/1_)	12/01→	K9K 704	Diesel	1461	4	8	29
Kangoo (KC0/1_)	01/02→01/07	D4D 700	Petrol	999	4	16	6
Kangoo (KC0/1_)	01/02→01/07	D4D 720	Petrol	999	4	16	6
Kangoo (KC0/1_)	07/02→	K9K 702	Diesel	1461	4	8	29
Kangoo (KC0/1_)	07/02→	K9K 710	Diesel	1461	4	8	29
Kangoo (KC0/1_)	06/05→	K4M 850	Petrol	1598	4	16	36
Kangoo (KC0/1_)	06/05→	K9K 714	Diesel	1461	4	8	29
Kangoo (KC0/1_)	06/05→	K9K 718	Diesel	1461	4	8	29
Kangoo (KC0/1_)	01/07→	K4M 730	Petrol	1598	4	16	36
Kangoo Be Bop (KWO/1_)	02/09→	K4M 830	Petrol	1598	4	16	37
Kangoo Be Bop (KWO/1_)	02/09→	K9K 806	Diesel	1461	4	8	29
Kangoo Be Bop (KWO/1_)	06/09→	K9K 804	Diesel	1461	4	8	29
Kangoo Be Bop (KWO/1_)	06/09→	K9K 808	Diesel	1461	4	8	29
Kangoo Be Bop (KWO/1_)	09/10→	K9K 802	Diesel	1461	4	8	29
Kangoo Be Bop (KWO/1_)	11/13→	K4M 730	Petrol	1598	4	16	36
Kangoo Be Bop (KWO/1_)	11/13→	K9K 714	Diesel	1461	4	8	29
Kangoo Express (FC0/1_)	08/97→	D7F 710	Petrol	1149	4	8	16



CC



9

Kangoo Express (FCO/1_)	08/97→	D7F 720	Petrol	1149	4	8	16
Kangoo Express (FCO/1_)	08/97→	D7F 722	Petrol	1149	4	8	16
Kangoo Express (FCO/1_)	08/97→	D7F 726	Petrol	1149	4	8	16
Kangoo Express (FCO/1_)	08/97→	D7F 744	Petrol	1149	4	8	16
Kangoo Express (FCO/1_)	08/97→	D7F 746	Petrol	1149	4	8	16
Kangoo Express (FCO/1_)	08/97→	E7J 634	Petrol	1390	4	8	25
Kangoo Express (FCO/1_)	08/97→	E7J 635	Petrol	1390	4	8	25
Kangoo Express (FCO/1_)	08/97→	E7J 780	Petrol	1390	4	8	25
Kangoo Express (FCO/1_)	08/97→	F8Q 630	Diesel	1870	4	8	56
Kangoo Express (FCO/1_)	08/97→	F8Q 632	Diesel	1870	4	8	56
Kangoo Express (FCO/1_)	08/97→	F8Q 662	Diesel	1870	4	8	56
Kangoo Express (FCO/1_)	08/97→	K7J 701	Petrol	1390	4	8	25
Kangoo Express (FCO/1_)	07/98→07/01	D7F 764	Petrol	1149	4	8	16
Kangoo Express (FCO/1_)	07/98→07/01	D7F 766	Petrol	1149	4	8	16
Kangoo Express (FCO/1_)	09/99→06/01	K7M 746	Petrol	1598	4	8	39
Kangoo Express (FCO/1_)	02/00→	F9Q 780	Diesel	1870	4	8	62
Kangoo Express (FCO/1_)	10/01→	D4F 712	Petrol	1149	4	16	15
Kangoo Express (FCO/1_)	10/01→	D4F 714	Petrol	1149	4	16	15
Kangoo Express (FCO/1_)	10/01→	D4F 730	Petrol	1149	4	16	15
Kangoo Express (FCO/1_)	10/01→	F9Q 782	Diesel	1870	4	8	62
Kangoo Express (FCO/1_)	10/01→	F9Q 790	Diesel	1870	4	8	62
Kangoo Express (FCO/1_)	10/01→	K4M 706	Petrol	1598	4	16	36
Kangoo Express (FCO/1_)	10/01→	K4M 750	Petrol	1598	4	16	36
Kangoo Express (FCO/1_)	10/01→	K4M 752	Petrol	1598	4	16	36
Kangoo Express (FCO/1_)	10/01→	K4M 753	Petrol	1598	4	16	36
Kangoo Express (FCO/1_)	12/01→	K9K 700	Diesel	1461	4	8	29
Kangoo Express (FCO/1_)	12/01→	K9K 702	Diesel	1461	4	8	29
Kangoo Express (FCO/1_)	12/01→	K9K 704	Diesel	1461	4	8	29
Kangoo Express (FCO/1_)	01/02→01/07	D4D 700	Petrol	999	4	16	6
Kangoo Express (FCO/1_)	01/02→01/07	D4D 720	Petrol	999	4	16	6
Kangoo Express (FCO/1_)	01/02→	D7D 700	Petrol	999	4	8	7
Kangoo Express (FCO/1_)	04/03→	K9K 710	Diesel	1461	4	8	29
Kangoo Express (FCO/1_)	06/05→	K4M 850	Petrol	1598	4	16	36
Kangoo Express (FCO/1_)	06/05→	K9K 714	Diesel	1461	4	8	29
Kangoo Express (FCO/1_)	06/05→	K9K 718	Diesel	1461	4	8	29
Kangoo Express (FCO/1_)	10/05→	K9K 716	Diesel	1461	4	8	29
Kangoo Express (FWO/1_)	02/08→12/09	K4M 706	Petrol	1598	4	16	36
Kangoo Express (FWO/1_)	02/08→12/09	K4M 730	Petrol	1598	4	16	36
Kangoo Express (FWO/1_)	02/08→	K4M 830	Petrol	1598	4	16	37
Kangoo Express (FWO/1_)	02/08→	K4M 834	Petrol	1598	4	16	37
Kangoo Express (FWO/1_)	02/08→	K7M 750	Petrol	1598	4	8	39
Kangoo Express (FWO/1_)	02/08→	K9K 800	Diesel	1461	4	8	29
Kangoo Express (FWO/1_)	02/08→	K9K 802	Diesel	1461	4	8	29
Kangoo Express (FWO/1_)	02/08→	K9K 806	Diesel	1461	4	8	29
Kangoo Express (FWO/1_)	05/08→01/14	K9K 700	Diesel	1461	4	8	29
Kangoo Express (FWO/1_)	06/09→	K9K 608	Diesel	1461	4	8	29
Kangoo Express (FWO/1_)	06/09→	K9K 808	Diesel	1461	4	8	29
Kangoo Express (FWO/1_)	09/10→	K9K 804	Diesel	1461	4	8	29
Kangoo Express (FWO/1_)	07/13→	H5F 400	Petrol	1197	4	16	18
Kangoo Express (FWO/1_)	09/13→	K9K 636	Diesel	1461	4	8	29
Kangoo / Grand Kangoo (KWO/1_)	02/08→	K4M 830	Petrol	1598	4	16	37
Kangoo / Grand Kangoo (KWO/1_)	02/08→	K4M 831	Petrol	1598	4	16	37
Kangoo / Grand Kangoo (KWO/1_)	02/08→	K4M 834	Petrol	1598	4	16	37
Kangoo / Grand Kangoo (KWO/1_)	02/08→	K4M 850	Petrol	1598	4	16	36
Kangoo / Grand Kangoo (KWO/1_)	02/08→	K7M 750	Petrol	1598	4	8	39
Kangoo / Grand Kangoo (KWO/1_)	02/08→	K9K 714	Diesel	1461	4	8	29
Kangoo / Grand Kangoo (KWO/1_)	02/08→	K9K 800	Diesel	1461	4	8	29
Kangoo / Grand Kangoo (KWO/1_)	02/08→	K9K 802	Diesel	1461	4	8	29
Kangoo / Grand Kangoo (KWO/1_)	02/08→	K9K 804	Diesel	1461	4	8	29
Kangoo / Grand Kangoo (KWO/1_)	02/08→	K9K 806	Diesel	1461	4	8	29
Kangoo / Grand Kangoo (KWO/1_)	02/08→	K9K 840	Diesel	1461	4	8	29
Kangoo / Grand Kangoo (KWO/1_)	01/09→	K9K 700	Diesel	1461	4	8	29
Kangoo / Grand Kangoo (KWO/1_)	01/10→	K4M 730	Petrol	1598	4	16	36
Kangoo / Grand Kangoo (KWO/1_)	11/12→	K9K 608	Diesel	1461	4	8	29
Kangoo / Grand Kangoo (KWO/1_)	11/12→	K9K 808	Diesel	1461	4	8	29
Kangoo / Grand Kangoo (KWO/1_)	03/13→	K9K 636	Diesel	1461	4	8	29
Kangoo / Grand Kangoo (KWO/1_)	07/13→	H5F 400	Petrol	1197	4	16	18
Koleos I (HY_)	09/08→	2TR 700	Petrol	2488	4	16	95
Koleos I (HY_)	09/08→	2TR 702	Petrol	2488	4	16	95
Koleos I (HY_)	09/08→	2TR 703	Petrol	2488	4	16	95
Koleos I (HY_)	09/08→	M9R 830	Diesel	1995	4	16	77
Koleos I (HY_)	09/08→	M9R 832	Diesel	1995	4	16	77
Koleos I (HY_)	09/08→	M9R 855	Diesel	1995	4	16	77
Koleos I (HY_)	09/08→	M9R 856	Diesel	1995	4	16	77
Koleos I (HY_)	09/08→	M9R 862	Diesel	1995	4	16	77
Koleos I (HY_)	09/08→	M9R 865	Diesel	1995	4	16	77
Koleos I (HY_)	09/08→	M9R 866	Diesel	1995	4	16	77
Koleos II	08/16→	R9M 409	Diesel	1598	4	16	42



CC



9

Koleos II	08/16 →	R9M 414	Diesel	1598	4	16	42
Laguna Coupe (DT0/1)	09/08 →	F4R 800	Petrol	1998	4	16	69
Laguna Coupe (DT0/1)	09/08 →	F4R 811	Petrol	1998	4	16	69
Laguna Coupe (DT0/1)	09/08 →	F4Rt 811	Petrol	1998	4	16	69
Laguna Coupe (DT0/1)	09/08 →	M9R 800	Diesel	1995	4	16	77
Laguna Coupe (DT0/1)	09/08 →	M9R 802	Diesel	1995	4	16	77
Laguna Coupe (DT0/1)	09/08 →	M9R 805	Diesel	1995	4	16	77
Laguna Coupe (DT0/1)	09/08 →	M9R 809	Diesel	1995	4	16	77
Laguna Coupe (DT0/1)	09/08 →	M9R 814	Diesel	1995	4	16	77
Laguna Coupe (DT0/1)	09/08 →	M9R 815	Diesel	1995	4	16	77
Laguna Coupe (DT0/1)	09/08 →	M9R 816	Diesel	1995	4	16	77
Laguna Coupe (DT0/1)	09/08 →	M9R 820	Diesel	1995	4	16	77
Laguna Coupe (DT0/1)	09/08 →	V4Y 713	Petrol	3498	6	24	126
Laguna Coupe (DT0/1)	03/12 →	K9K 846	Diesel	1461	4	8	29
Laguna I (B56, 556)	11/93 →03/01	F3P 720	Petrol	1794	4	8	47
Laguna I (B56, 556)	11/93 →03/01	F3P 724	Petrol	1794	4	8	47
Laguna I (B56, 556)	11/93 →03/01	F3R 722	Petrol	1998	4	8	65
Laguna I (B56, 556)	11/93 →03/01	F3R 723	Petrol	1998	4	8	65
Laguna I (B56, 556)	11/93 →03/01	G8T 706	Diesel	2188	4	12	85
Laguna I (B56, 556)	11/93 →03/01	G8T 752	Diesel	2188	4	12	85
Laguna I (B56, 556)	11/93 →03/01	G8T 790	Diesel	2188	4	12	85
Laguna I (B56, 556)	11/93 →03/01	G8T 794	Diesel	2188	4	12	85
Laguna I (B56, 556)	11/93 →03/01	Z7X 760	Petrol	2963	6	12	124
Laguna I (B56, 556)	11/93 →03/01	Z7X 765	Petrol	2963	6	12	124
Laguna I (B56, 556)	06/95 →06/98	F3P 676	Petrol	1794	4	8	47
Laguna I (B56, 556)	06/95 →02/01	F3P 674	Petrol	1783	4	8	48
Laguna I (B56, 556)	06/95 →02/01	F3R 768	Petrol	1998	4	8	65
Laguna I (B56, 556)	06/95 →03/01	F3P 678	Petrol	1783	4	8	47
Laguna I (B56, 556)	06/95 →03/01	N7Q 700	Petrol	1948	4	16	79
Laguna I (B56, 556)	06/95 →03/01	N7Q 704	Petrol	1948	4	16	79
Laguna I (B56, 556)	08/95 →03/01	F3P 670	Petrol	1783	4	8	47
Laguna I (B56, 556)	03/96 →03/01	G8T 760	Diesel	2188	4	12	85
Laguna I (B56, 556)	03/97 →08/02	L7X 700	Petrol	2946	6	24	122
Laguna I (B56, 556)	03/97 →08/02	L7X 701	Petrol	2946	6	24	122
Laguna I (B56, 556)	10/97 →03/01	F9Q 710	Diesel	1870	4	8	62
Laguna I (B56, 556)	10/97 →03/01	F9Q 717	Diesel	1870	4	8	62
Laguna I (B56, 556)	10/97 →08/02	F9Q 716	Diesel	1870	4	8	62
Laguna I (B56, 556)	11/97 →03/01	K4M 720	Petrol	1598	4	16	36
Laguna I (B56, 556)	11/97 →03/01	K4M 724	Petrol	1598	4	16	36
Laguna I (B56, 556)	04/98 →03/01	F4P 760	Petrol	1783	4	16	51
Laguna I (B56, 556)	04/98 →03/01	F4P 770	Petrol	1783	4	16	52
Laguna I (B56, 556)	03/99 →03/01	F3R 611	Petrol	1998	4	8	66
Laguna I (B56, 556)	09/99 →03/01	F4R 780	Petrol	1998	4	16	69
Laguna I (B56, 556)	09/99 →03/01	F9Q 718	Diesel	1870	4	8	62
Laguna I Grandtour (K56)	09/95 →03/01	F3P 670	Petrol	1783	4	8	47
Laguna I Grandtour (K56)	09/95 →03/01	F3P 678	Petrol	1783	4	8	47
Laguna I Grandtour (K56)	09/95 →03/01	F3P 720	Petrol	1794	4	8	47
Laguna I Grandtour (K56)	09/95 →03/01	F3P 724	Petrol	1794	4	8	47
Laguna I Grandtour (K56)	09/95 →03/01	F3R 722	Petrol	1998	4	8	65
Laguna I Grandtour (K56)	09/95 →03/01	F3R 723	Petrol	1998	4	8	65
Laguna I Grandtour (K56)	09/95 →03/01	G8T 706	Diesel	2188	4	12	85
Laguna I Grandtour (K56)	09/95 →03/01	G8T 752	Diesel	2188	4	12	85
Laguna I Grandtour (K56)	09/95 →03/01	G8T 790	Diesel	2188	4	12	85
Laguna I Grandtour (K56)	09/95 →03/01	G8T 794	Diesel	2188	4	12	85
Laguna I Grandtour (K56)	09/95 →03/01	N7Q 700	Petrol	1948	4	16	79
Laguna I Grandtour (K56)	09/95 →03/01	N7Q 704	Petrol	1948	4	16	79
Laguna I Grandtour (K56)	02/96 →03/01	Z7X 765	Petrol	2963	6	12	124
Laguna I Grandtour (K56)	03/96 →03/01	G8T 760	Diesel	2188	4	12	85
Laguna I Grandtour (K56)	03/97 →03/01	L7X 701	Petrol	2946	6	24	122
Laguna I Grandtour (K56)	03/97 →08/02	L7X 700	Petrol	2946	6	24	122
Laguna I Grandtour (K56)	10/97 →03/01	F9Q 710	Diesel	1870	4	8	62
Laguna I Grandtour (K56)	10/97 →03/01	F9Q 716	Diesel	1870	4	8	62
Laguna I Grandtour (K56)	10/97 →03/01	F9Q 717	Diesel	1870	4	8	62
Laguna I Grandtour (K56)	11/97 →03/01	K4M 720	Petrol	1598	4	16	36
Laguna I Grandtour (K56)	11/97 →03/01	K4M 724	Petrol	1598	4	16	36
Laguna I Grandtour (K56)	04/98 →03/01	F4P 760	Petrol	1783	4	16	51
Laguna I Grandtour (K56)	10/98 →01/01	F3R 728	Petrol	1998	4	8	65
Laguna I Grandtour (K56)	10/98 →01/01	F3R 768	Petrol	1998	4	8	65
Laguna I Grandtour (K56)	09/99 →03/01	F4R 780	Petrol	1998	4	16	69
Laguna I Grandtour (K56)	09/99 →03/01	F9Q 718	Diesel	1870	4	8	62
Laguna II (BG0/1)	03/01 →05/05	K4M 718	Petrol	1598	4	16	36
Laguna II (BG0/1)	03/01 →	F4P 770	Petrol	1783	4	16	52
Laguna II (BG0/1)	03/01 →	F4P 771	Petrol	1783	4	16	52
Laguna II (BG0/1)	03/01 →	F4P 772	Petrol	1783	4	16	52
Laguna II (BG0/1)	03/01 →	F4P 773	Petrol	1783	4	16	52
Laguna II (BG0/1)	03/01 →	F4P 774	Petrol	1783	4	16	52
Laguna II (BG0/1)	03/01 →	F4P 775	Petrol	1783	4	16	52
Laguna II (BG0/1)	03/01 →	F9Q 650	Diesel	1870	4	8	62











CC







9

Laguna II (BG0/1_)	03/01→	F9Q 670	Diesel	1870	4	8	62
Laguna II (BG0/1_)	03/01→	F9Q 674	Diesel	1870	4	8	62
Laguna II (BG0/1_)	03/01→	F9Q 718	Diesel	1870	4	8	62
Laguna II (BG0/1_)	03/01→	F9Q 750	Diesel	1870	4	8	62
Laguna II (BG0/1_)	03/01→	F9Q 754	Diesel	1870	4	8	62
Laguna II (BG0/1_)	03/01→	K4M 710	Petrol	1598	4	16	36
Laguna II (BG0/1_)	03/01→	K4M 714	Petrol	1598	4	16	36
Laguna II (BG0/1_)	03/01→	L7X 731	Petrol	2946	6	24	122
Laguna II (BG0/1_)	04/01→	F5R 700	Petrol	1998	4	16	70
Laguna II (BG0/1_)	04/01→	F5R 701	Petrol	1998	4	16	70
Laguna II (BG0/1_)	06/01→	F9Q 752	Diesel	1870	4	8	62
Laguna II (BG0/1_)	10/01→	G9T 700	Diesel	2188	4	16	86
Laguna II (BG0/1_)	10/01→	G9T 702	Diesel	2188	4	16	86
Laguna II (BG0/1_)	08/02→	F4R 712	Petrol	1998	4	16	69
Laguna II (BG0/1_)	08/02→	F4R 713	Petrol	1998	4	16	69
Laguna II (BG0/1_)	08/02→	F4R 714	Petrol	1998	4	16	69
Laguna II (BG0/1_)	08/02→	F4R 715	Petrol	1998	4	16	69
Laguna II (BG0/1_)	09/02→12/06	L7X 733	Petrol	2946	6	24	122
Laguna II (BG0/1_)	01/03→	F4R 764	Petrol	1998	4	16	69
Laguna II (BG0/1_)	01/03→	F4R 765	Petrol	1998	4	16	69
Laguna II (BG0/1_)	01/03→	F4R 786	Petrol	1998	4	16	69
Laguna II (BG0/1_)	01/03→	F4R 787	Petrol	1998	4	16	69
Laguna II (BG0/1_)	03/04→	F9Q 664	Diesel	1870	4	8	62
Laguna II (BG0/1_)	04/04→	G9T 600	Diesel	2188	4	16	86
Laguna II (BG0/1_)	01/05→	F4R 784	Petrol	1998	4	16	69
Laguna II (BG0/1_)	01/05→	F4R 886	Petrol	1998	4	16	69
Laguna II (BG0/1_)	01/05→	F4R 887	Petrol	1998	4	16	69
Laguna II (BG0/1_)	01/05→	F9Q 758	Diesel	1870	4	8	62
Laguna II (BG0/1_)	02/05→	K4M 716	Petrol	1598	4	16	37
Laguna II (BG0/1_)	05/05→	F9Q 759	Diesel	1870	4	8	62
Laguna II (BG0/1_)	05/05→	G9T 605	Diesel	2188	4	16	86
Laguna II (BG0/1_)	05/05→	G9T 706	Diesel	2188	4	16	86
Laguna II (BG0/1_)	05/05→	G9T 707	Diesel	2188	4	16	86
Laguna II (BG0/1_)	08/05→	M9R 740	Diesel	1995	4	16	77
Laguna II (BG0/1_)	01/06→	M9R 760	Diesel	1995	4	16	77
Laguna II Grandtour (KGO/1_)	03/01→	F4P 770	Petrol	1783	4	16	52
Laguna II Grandtour (KGO/1_)	03/01→	F4P 771	Petrol	1783	4	16	52
Laguna II Grandtour (KGO/1_)	03/01→	F4P 773	Petrol	1783	4	16	52
Laguna II Grandtour (KGO/1_)	03/01→	F4P 774	Petrol	1783	4	16	52
Laguna II Grandtour (KGO/1_)	03/01→	F4P 775	Petrol	1783	4	16	52
Laguna II Grandtour (KGO/1_)	03/01→	F9Q 670	Diesel	1870	4	8	62
Laguna II Grandtour (KGO/1_)	03/01→	F9Q 674	Diesel	1870	4	8	62
Laguna II Grandtour (KGO/1_)	03/01→	F9Q 718	Diesel	1870	4	8	62
Laguna II Grandtour (KGO/1_)	03/01→	F9Q 750	Diesel	1870	4	8	62
Laguna II Grandtour (KGO/1_)	03/01→	F9Q 754	Diesel	1870	4	8	62
Laguna II Grandtour (KGO/1_)	03/01→	K4M 710	Petrol	1598	4	16	36
Laguna II Grandtour (KGO/1_)	03/01→	K4M 714	Petrol	1598	4	16	36
Laguna II Grandtour (KGO/1_)	03/01→	L7X 731	Petrol	2946	6	24	122
Laguna II Grandtour (KGO/1_)	04/01→	F5R 700	Petrol	1998	4	16	70
Laguna II Grandtour (KGO/1_)	04/01→	F5R 701	Petrol	1998	4	16	70
Laguna II Grandtour (KGO/1_)	06/01→10/03	K4M 718	Petrol	1598	4	16	36
Laguna II Grandtour (KGO/1_)	06/01→	F9Q 752	Diesel	1870	4	8	62
Laguna II Grandtour (KGO/1_)	10/01→	G9T 702	Diesel	2188	4	16	86
Laguna II Grandtour (KGO/1_)	08/02→	F4R 712	Petrol	1998	4	16	69
Laguna II Grandtour (KGO/1_)	08/02→	F4R 713	Petrol	1998	4	16	69
Laguna II Grandtour (KGO/1_)	08/02→	F4R 714	Petrol	1998	4	16	69
Laguna II Grandtour (KGO/1_)	08/02→	F4R 715	Petrol	1998	4	16	69
Laguna II Grandtour (KGO/1_)	09/02→12/05	L7X 733	Petrol	2946	6	24	122
Laguna II Grandtour (KGO/1_)	01/03→	F4R 764	Petrol	1998	4	16	69
Laguna II Grandtour (KGO/1_)	01/03→	F4R 765	Petrol	1998	4	16	69
Laguna II Grandtour (KGO/1_)	01/03→	F4R 786	Petrol	1998	4	16	69
Laguna II Grandtour (KGO/1_)	01/03→	F4R 787	Petrol	1998	4	16	69
Laguna II Grandtour (KGO/1_)	08/03→	F9Q 664	Diesel	1870	4	8	62
Laguna II Grandtour (KGO/1_)	04/04→	G9T 600	Diesel	2188	4	16	86
Laguna II Grandtour (KGO/1_)	01/05→	F4R 784	Petrol	1998	4	16	69
Laguna II Grandtour (KGO/1_)	01/05→	F4R 886	Petrol	1998	4	16	69
Laguna II Grandtour (KGO/1_)	01/05→	F4R 887	Petrol	1998	4	16	69
Laguna II Grandtour (KGO/1_)	01/05→	F9Q 758	Diesel	1870	4	8	62
Laguna II Grandtour (KGO/1_)	02/05→	K4M 716	Petrol	1598	4	16	37
Laguna II Grandtour (KGO/1_)	05/05→	F9Q 759	Diesel	1870	4	8	62
Laguna II Grandtour (KGO/1_)	05/05→	G9T 706	Diesel	2188	4	16	86
Laguna II Grandtour (KGO/1_)	05/05→	G9T 707	Diesel	2188	4	16	86
Laguna II Grandtour (KGO/1_)	08/05→	M9R 740	Diesel	1995	4	16	77
Laguna II Grandtour (KGO/1_)	01/06→	M9R 760	Diesel	1995	4	16	77
Laguna III (BT0/1)	10/07→	F4R 811	Petrol	1998	4	16	69
Laguna III (BT0/1)	10/07→	K4M 824	Petrol	1598	4	16	37
Laguna III (BT0/1)	10/07→	K9K 780	Diesel	1461	4	8	29
Laguna III (BT0/1)	10/07→	K9K 782	Diesel	1461	4	8	29

							
Laguna III (BT0/1)	10/07→	M4R 704	Petrol	1997	4	16	75
Laguna III (BT0/1)	10/07→	M4R 726	Petrol	1997	4	16	75
Laguna III (BT0/1)	10/07→	M9R 742	Diesel	1995	4	16	77
Laguna III (BT0/1)	10/07→	M9R 744	Diesel	1995	4	16	77
Laguna III (BT0/1)	10/07→	M9R 802	Diesel	1995	4	16	77
Laguna III (BT0/1)	10/07→	M9R 805	Diesel	1995	4	16	77
Laguna III (BT0/1)	10/07→	M9R 814	Diesel	1995	4	16	77
Laguna III (BT0/1)	01/08→	M9R 800	Diesel	1995	4	16	77
Laguna III (BT0/1)	01/08→	M9R 809	Diesel	1995	4	16	77
Laguna III (BT0/1)	01/08→	M9R 815	Diesel	1995	4	16	77
Laguna III (BT0/1)	03/08→	F4R 800	Petrol	1998	4	16	69
Laguna III (BT0/1)	03/08→	M9R 816	Diesel	1995	4	16	77
Laguna III (BT0/1)	04/08→	V4Y 713	Petrol	3498	6	24	126
Laguna III Grandtour (KT0/1)	10/07→	F4R 811	Petrol	1998	4	16	69
Laguna III Grandtour (KT0/1)	10/07→	K4M 824	Petrol	1598	4	16	37
Laguna III Grandtour (KT0/1)	10/07→	K9K 780	Diesel	1461	4	8	29
Laguna III Grandtour (KT0/1)	10/07→	K9K 782	Diesel	1461	4	8	29
Laguna III Grandtour (KT0/1)	10/07→	M4R 704	Petrol	1997	4	16	75
Laguna III Grandtour (KT0/1)	10/07→	M4R 726	Petrol	1997	4	16	75
Laguna III Grandtour (KT0/1)	10/07→	M9R 742	Diesel	1995	4	16	77
Laguna III Grandtour (KT0/1)	10/07→	M9R 744	Diesel	1995	4	16	77
Laguna III Grandtour (KT0/1)	10/07→	M9R 802	Diesel	1995	4	16	77
Laguna III Grandtour (KT0/1)	10/07→	M9R 805	Diesel	1995	4	16	77
Laguna III Grandtour (KT0/1)	10/07→	M9R 814	Diesel	1995	4	16	77
Laguna III Grandtour (KT0/1)	01/08→	M9R 800	Diesel	1995	4	16	77
Laguna III Grandtour (KT0/1)	01/08→	M9R 809	Diesel	1995	4	16	77
Laguna III Grandtour (KT0/1)	01/08→	M9R 815	Diesel	1995	4	16	77
Laguna III Grandtour (KT0/1)	03/08→	F4R 800	Petrol	1998	4	16	69
Laguna III Grandtour (KT0/1)	03/08→	M9R 816	Diesel	1995	4	16	77
Laguna III Grandtour (KT0/1)	03/08→	M9R 820	Diesel	1995	4	16	77
Laguna III Grandtour (KT0/1)	04/08→	V4Y 713	Petrol	3498	6	24	126
Latitude (L70_)	07/10→	K9K 782	Diesel	1461	4	8	29
Latitude (L70_)	02/11→	M4R 746	Petrol	1997	4	16	75
Latitude (L70_)	02/11→	M9R 824	Diesel	1995	4	16	77
Latitude (L70_)	02/11→	M9R 846	Diesel	1995	4	16	77
Latitude (L70_)	05/11→	M9R 804	Diesel	1995	4	16	77
Latitude (L70_)	05/11→	M9R 817	Diesel	1995	4	16	77
Latitude (L70_)	05/11→	M9R 844	Diesel	1995	4	16	77
Latitude (L70_)	12/13→	M9R 756	Diesel	1995	4	16	78
Lodgy (JS_)	01/15→	K9K 830	Diesel	1461	4	8	29
Lodgy (JS_)	01/15→	K9K 846	Diesel	1461	4	8	29
Logan EXPRESS	04/07→	K7M 710	Petrol	1598	4	8	39
Logan EXPRESS	04/07→	K9K 792	Diesel	1461	4	8	29
Logan I (LS_)	09/04→	K7J 710	Petrol	1390	4	8	25
Logan I (LS_)	09/04→	K7M 710	Petrol	1598	4	8	39
Logan I (LS_)	02/07→09/10	K4M 706	Petrol	1598	4	16	36
Logan I (LS_)	04/07→	K4M 690	Petrol	1598	4	16	38
Logan I (LS_)	04/07→	K4M 697	Petrol	1598	4	16	36
Logan I (LS_)	04/07→	K9K 792	Diesel	1461	4	8	29
Logan I (LS_)	07/07→09/13	K4M 698	Petrol	1598	4	16	36
Logan I (LS_)	11/07→08/12	K7M 714	Petrol	1598	4	8	39
Logan I (LS_)	02/08→	K9K 796	Diesel	1461	4	8	29
Logan I (LS_)	05/08→	K7M 718	Petrol	1598	4	8	39
Logan I (LS_)	06/11→	K9K 700	Diesel	1461	4	8	29
Logan I (LS_)	06/11→	K9K 790	Diesel	1461	4	8	29
Logan I (LS_)	06/11→	K9K 794	Diesel	1461	4	8	29
Logan I Estate (KS_)	04/07→	K4M 697	Petrol	1598	4	16	36
Logan I Estate (KS_)	04/07→	K7M 710	Petrol	1598	4	8	39
Logan I Estate (KS_)	04/07→	K9K 792	Diesel	1461	4	8	29
Logan I Estate (KS_)	10/07→	K7J 710	Petrol	1390	4	8	25
Logan I Estate (KS_)	02/08→	K9K 796	Diesel	1461	4	8	29
Logan I Estate (KS_)	06/11→	K9K 790	Diesel	1461	4	8	29
Logan I Estate (KS_)	06/11→	K9K 794	Diesel	1461	4	8	29
Logan II (B8_)	09/12→12/15	K7M 764	Petrol	1598	4	8	39
Logan II (B8_)	10/13→	D4D 754	Petrol	999	4	16	6
Logan II (B8_)	11/13→	D4F 732	Petrol	1149	4	16	15
Logan II (B8_)	11/13→	D4F 734	Petrol	1149	4	16	15
Logan II (B8_)	11/13→	K4M 842	Petrol	1598	4	16	36
Logan II (B8_)	11/13→	K7M 812	Petrol	1598	4	8	39
Logan II (B8_)	12/13→	K9K 838	Diesel	1461	4	8	29
Logan II Estate (K8_)	12/13→	D4F 732	Petrol	1149	4	16	15
Logan II Estate (K8_)	12/13→	D4F 734	Petrol	1149	4	16	15
Logan II Estate (K8_)	12/13→	K7M 812	Petrol	1598	4	8	39
Logan II Estate (K8_)	12/13→	K9K 838	Diesel	1461	4	8	29
Mascott Box Body / Estate	01/99→12/01	8140.63.2585	Diesel	2800	4	8	116
Mascott Box Body / Estate	01/99→06/04	8140.43.B.3586	Diesel	2800	4	8	116
Mascott Box Body / Estate	01/99→06/04	8140.43.B.3588	Diesel	2800	4	8	116
Mascott Box Body / Estate	01/99→06/04	8140.43.C.2586	Diesel	2800	4	8	116









Model	Year Range	Engine Code	Fuel	CC	Cylinders	Power (kW)	Power (hp)
Mascott Box Body / Estate	01/99→06/04	8140.43.S.2585	Diesel	2800	4	8	116
Mascott Box Body / Estate	01/99→06/04	8140.43.S.3585	Diesel	2800	4	8	116
Mascott Box Body / Estate	01/01→06/04	8140-43 k	Diesel	2800	4	8	116
Mascott Box Body / Estate	10/01→06/04	8140.43.N.3585	Diesel	2798	4	8	116
Mascott Box Body / Estate	05/04→10/10	DXi 3	Diesel	2953	4	16	121
Mascott Box Body / Estate	05/04→10/10	ZD3 A 600	Diesel	2953	4	16	121
Mascott Box Body / Estate	05/04→10/10	ZD3 A 604	Diesel	2953	4	16	121
Mascott Dumptruck	01/00→06/04	8140.43.B.3586	Diesel	2800	4	8	116
Mascott Dumptruck	01/00→06/04	8140.43.B.3588	Diesel	2800	4	8	116
Mascott Dumptruck	01/00→06/04	8140.43.C.2586	Diesel	2800	4	8	116
Mascott Platform/Chassis	01/99→12/01	8140.63.2585	Diesel	2800	4	8	116
Mascott Platform/Chassis	01/99→06/04	8140.43.B.3586	Diesel	2800	4	8	116
Mascott Platform/Chassis	01/99→06/04	8140.43.B.3588	Diesel	2800	4	8	116
Mascott Platform/Chassis	01/99→06/04	8140.43.C.2586	Diesel	2800	4	8	116
Mascott Platform/Chassis	01/99→06/04	8140.43.S.2585	Diesel	2800	4	8	116
Mascott Platform/Chassis	01/99→06/04	8140.43.S.3585	Diesel	2800	4	8	116
Mascott Platform/Chassis	01/01→06/04	8140-43 k	Diesel	2800	4	8	116
Mascott Platform/Chassis	10/01→06/04	8140.43.N.3585	Diesel	2798	4	8	116
Mascott Platform/Chassis	05/04→12/10	ZD3 A 600	Diesel	2953	4	16	121
Mascott Platform/Chassis	05/04→12/10	ZD3 A 604	Diesel	2953	4	16	121
Mascott Platform/Chassis	05/04→12/13	DXi 3	Diesel	2953	4	16	121
Master I Box (T__)	07/80→08/89	S8U 731	Diesel	2445	4	8	93
Master I Box (T__)	08/80→10/86	829 731	Petrol	1995	4	8	64
Master I Box (T__)	08/80→08/89	8140.61.2300	Diesel	2445	4	8	91
Master I Box (T__)	08/80→07/98	J7T 782	Petrol	2165	4	8	87
Master I Box (T__)	08/80→07/98	J7T 788	Petrol	2165	4	8	87
Master I Box (T__)	08/80→07/98	J8S 330	Diesel	2068	4	8	81
Master I Box (T__)	07/83→12/92	S8U 730	Diesel	2445	4	8	93
Master I Box (T__)	06/85→10/89	829 730	Petrol	1995	4	8	64
Master I Box (T__)	06/85→10/89	J5R 728	Petrol	1995	4	8	64
Master I Box (T__)	10/86→07/98	J5R 718	Petrol	1995	4	8	64
Master I Box (T__)	08/89→07/98	8140.27.2500	Diesel	2499	4	8	97
Master I Box (T__)	08/89→07/98	8140.27.2510	Diesel	2499	4	8	97
Master I Box (T__)	08/89→07/98	8140.27.2580	Diesel	2499	4	8	97
Master I Box (T__)	08/89→07/98	8140.67.2510	Diesel	2499	4	8	102
Master I Box (T__)	08/89→07/98	S8U 742	Diesel	2499	4	8	97
Master I Box (T__)	08/89→07/98	S9U 702	Diesel	2499	4	8	97
Master I Box (T__)	08/89→07/98	S9U 714	Diesel	2499	4	8	97
Master I Box (T__)	08/89→07/98	S9U 740	Diesel	2499	4	8	99
Master I Bus (T__)	08/80→09/86	829 731	Petrol	1995	4	8	64
Master I Bus (T__)	08/80→08/89	8140.61.2300	Diesel	2445	4	8	91
Master I Bus (T__)	08/80→10/89	S8U 731	Diesel	2445	4	8	93
Master I Bus (T__)	08/80→07/98	J7T 782	Petrol	2165	4	8	87
Master I Bus (T__)	08/80→07/98	J7T 788	Petrol	2165	4	8	87
Master I Bus (T__)	08/80→07/98	J8S 330	Diesel	2068	4	8	81
Master I Bus (T__)	06/85→10/89	J5R 728	Petrol	1995	4	8	64
Master I Bus (T__)	10/86→07/98	J5R 718	Petrol	1995	4	8	64
Master I Bus (T__)	08/89→07/98	8140.27.2500	Diesel	2499	4	8	97
Master I Bus (T__)	08/89→07/98	8140.27.2510	Diesel	2499	4	8	97
Master I Bus (T__)	08/89→07/98	8140.27.2580	Diesel	2499	4	8	97
Master I Bus (T__)	08/89→07/98	8140.67.2510	Diesel	2499	4	8	102
Master I Bus (T__)	08/89→07/98	S8U 742	Diesel	2499	4	8	97
Master I Bus (T__)	08/89→07/98	S9U 702	Diesel	2499	4	8	97
Master I Bus (T__)	08/89→07/98	S9U 714	Diesel	2499	4	8	97
Master I Platform/Chassis (P__)	07/80→06/85	829 731	Petrol	1995	4	8	64
Master I Platform/Chassis (P__)	07/80→10/89	S8U 742	Diesel	2499	4	8	97
Master I Platform/Chassis (P__)	09/80→07/98	8140.61.2300	Diesel	2445	4	8	91
Master I Platform/Chassis (P__)	09/80→07/98	S8U 731	Diesel	2445	4	8	93
Master I Platform/Chassis (P__)	10/82→09/86	829 730	Petrol	1995	4	8	64
Master I Platform/Chassis (P__)	10/86→07/98	J5R 728	Petrol	1995	4	8	64
Master I Platform/Chassis (P__)	11/89→07/93	J5R 718	Petrol	1995	4	8	64
Master I Platform/Chassis (P__)	11/89→07/93	J8S 330	Diesel	2068	4	8	81
Master I Platform/Chassis (P__)	11/89→10/93	S9U 702	Diesel	2499	4	8	97
Master I Platform/Chassis (P__)	11/89→12/95	J5R 716	Petrol	1995	4	8	64
Master I Platform/Chassis (P__)	08/93→02/98	J7T 788	Petrol	2165	4	8	87
Master I Platform/Chassis (P__)	08/93→02/98	S8U 730	Diesel	2445	4	8	93
Master I Platform/Chassis (P__)	08/93→02/98	S9U 740	Diesel	2499	4	8	99
Master II Box (FD)	07/98→01/01	S8U 770	Diesel	2499	4	8	108
Master II Box (FD)	07/98→09/04	S9W 702	Diesel	2799	4	8	116
Master II Box (FD)	09/00→	F9Q 770	Diesel	1870	4	8	62
Master II Box (FD)	09/00→	G9T 720	Diesel	2188	4	16	86
Master II Box (FD)	09/00→	G9T 722	Diesel	2188	4	16	86
Master II Box (FD)	09/00→	G9T 750	Diesel	2188	4	16	86
Master II Box (FD)	10/01→	G9U 720	Diesel	2464	4	16	105
Master II Box (FD)	10/01→	G9U 724	Diesel	2464	4	16	105
Master II Box (FD)	10/01→	G9U 750	Diesel	2464	4	16	105
Master II Box (FD)	10/01→	G9U 754	Diesel	2464	4	16	105
Master II Box (FD)	11/01→	F9Q 772	Diesel	1870	4	8	62

				CC			9
Master II Box (FD)	11/01→	F9Q 774	Diesel	1870	4	8	62
Master II Box (FD)	01/02→09/04	S8W 700	Diesel	2799	4	8	116
Master II Box (FD)	01/02→09/04	S9W 700	Diesel	2799	4	8	116
Master II Box (FD)	10/03→	ZD3 202	Diesel	2953	4	16	121
Master II Box (FD)	06/05→	ZD3 A 604	Diesel	2953	4	16	121
Master II Box (FD)	06/05→	ZD3 600	Diesel	2953	4	16	121
Master II Box (FD)	08/06→	G9U 632	Diesel	2464	4	16	105
Master II Box (FD)	08/06→	G9U 650	Diesel	2464	4	16	105
Master II Bus (JD)	07/98→01/01	S8U 770	Diesel	2499	4	8	108
Master II Bus (JD)	07/98→10/01	S9W 702	Diesel	2799	4	8	116
Master II Bus (JD)	09/00→	F9Q 770	Diesel	1870	4	8	62
Master II Bus (JD)	09/00→	G9T 720	Diesel	2188	4	16	86
Master II Bus (JD)	09/00→	G9T 722	Diesel	2188	4	16	86
Master II Bus (JD)	09/00→	G9T 750	Diesel	2188	4	16	86
Master II Bus (JD)	10/01→	G9U 720	Diesel	2464	4	16	105
Master II Bus (JD)	10/01→	G9U 750	Diesel	2464	4	16	105
Master II Bus (JD)	10/01→	G9U 754	Diesel	2464	4	16	105
Master II Bus (JD)	11/01→	F9Q 772	Diesel	1870	4	8	62
Master II Bus (JD)	11/01→	F9Q 774	Diesel	1870	4	8	62
Master II Bus (JD)	10/03→	ZD3 200	Diesel	2953	4	16	121
Master II Bus (JD)	10/03→	ZD3 202	Diesel	2953	4	16	121
Master II Bus (JD)	08/06→	G9U 632	Diesel	2464	4	16	105
Master II Bus (JD)	08/06→	G9U 650	Diesel	2464	4	16	105
Master II Platform/Chassis (ED/HD/UD)	07/98→01/01	S8U 770	Diesel	2499	4	8	108
Master II Platform/Chassis (ED/HD/UD)	07/98→10/01	S9W 702	Diesel	2799	4	8	116
Master II Platform/Chassis (ED/HD/UD)	09/00→	G9T 720	Diesel	2188	4	16	86
Master II Platform/Chassis (ED/HD/UD)	09/00→	G9T 722	Diesel	2188	4	16	86
Master II Platform/Chassis (ED/HD/UD)	09/00→	G9T 750	Diesel	2188	4	16	86
Master II Platform/Chassis (ED/HD/UD)	10/01→	G9U 720	Diesel	2464	4	16	105
Master II Platform/Chassis (ED/HD/UD)	10/01→	G9U 724	Diesel	2464	4	16	105
Master II Platform/Chassis (ED/HD/UD)	10/01→	G9U 750	Diesel	2464	4	16	105
Master II Platform/Chassis (ED/HD/UD)	10/01→	G9U 754	Diesel	2464	4	16	105
Master II Platform/Chassis (ED/HD/UD)	10/03→	ZD3 200	Diesel	2953	4	16	121
Master II Platform/Chassis (ED/HD/UD)	10/03→	ZD3 202	Diesel	2953	4	16	121
Master II Platform/Chassis (ED/HD/UD)	06/05→	ZD3 A 604	Diesel	2953	4	16	121
Master II Platform/Chassis (ED/HD/UD)	06/05→	ZD3 600	Diesel	2953	4	16	121
Master II Platform/Chassis (ED/HD/UD)	08/06→	G9U 632	Diesel	2464	4	16	105
Master II Platform/Chassis (ED/HD/UD)	08/06→	G9U 650	Diesel	2464	4	16	105
Master III Box (FV)	02/10→	M9T 670	Diesel	2298	4	16	89
Master III Box (FV)	02/10→	M9T 672	Diesel	2298	4	16	89
Master III Box (FV)	02/10→	M9T 676	Diesel	2298	4	16	89
Master III Box (FV)	02/10→	M9T 678	Diesel	2298	4	16	89
Master III Box (FV)	02/10→	M9T 680	Diesel	2298	4	16	89
Master III Box (FV)	02/10→	M9T 686	Diesel	2298	4	16	89
Master III Box (FV)	02/10→	M9T 690	Diesel	2298	4	16	89
Master III Box (FV)	02/10→	M9T 692	Diesel	2298	4	16	89
Master III Box (FV)	02/10→	M9T 694	Diesel	2298	4	16	89
Master III Box (FV)	02/10→	M9T 696	Diesel	2298	4	16	89
Master III Box (FV)	02/10→	M9T 698	Diesel	2298	4	16	89
Master III Box (FV)	02/10→	M9T 870	Diesel	2299	4	16	89
Master III Box (FV)	02/10→	M9T 890	Diesel	2298	4	16	89
Master III Box (FV)	02/10→	M9T 896	Diesel	2298	4	16	89
Master III Box (FV)	03/13→	M9T 880	Diesel	2298	4	16	89
Master III Box (FV)	03/13→	M9T 898	Diesel	2298	4	16	89
Master III Box (FV)	07/14→	M9T 700	Diesel	2298	4	16	89
Master III Box (FV)	07/14→	M9T 702	Diesel	2298	4	16	89
Master III Box (FV)	07/15→	M9T 706	Diesel	2299	4	16	89
Master III Bus (JV)	02/11→	M9T 670	Diesel	2298	4	16	89
Master III Bus (JV)	02/11→	M9T 672	Diesel	2298	4	16	89
Master III Bus (JV)	02/11→	M9T 676	Diesel	2298	4	16	89
Master III Bus (JV)	02/11→	M9T 680	Diesel	2298	4	16	89
Master III Bus (JV)	02/11→	M9T 870	Diesel	2299	4	16	89
Master III Bus (JV)	10/12→	M9T 880	Diesel	2298	4	16	89
Master III Bus (JV)	07/14→	M9T 700	Diesel	2298	4	16	89
Master III Bus (JV)	07/14→	M9T 702	Diesel	2298	4	16	89
Master III Bus (JV)	09/14→	M9T 890	Diesel	2298	4	16	89
Master III Bus (JV)	07/15→	M9T 706	Diesel	2299	4	16	89
Master III Platform/Chassis (EV, HV, UV)	02/10→	M9T 670	Diesel	2298	4	16	89
Master III Platform/Chassis (EV, HV, UV)	02/10→	M9T 672	Diesel	2298	4	16	89
Master III Platform/Chassis (EV, HV, UV)	02/10→	M9T 676	Diesel	2298	4	16	89
Master III Platform/Chassis (EV, HV, UV)	02/10→	M9T 678	Diesel	2298	4	16	89
Master III Platform/Chassis (EV, HV, UV)	02/10→	M9T 680	Diesel	2298	4	16	89
Master III Platform/Chassis (EV, HV, UV)	02/10→	M9T 686	Diesel	2298	4	16	89
Master III Platform/Chassis (EV, HV, UV)	02/10→	M9T 690	Diesel	2298	4	16	89
Master III Platform/Chassis (EV, HV, UV)	02/10→	M9T 692	Diesel	2298	4	16	89
Master III Platform/Chassis (EV, HV, UV)	02/10→	M9T 694	Diesel	2298	4	16	89
Master III Platform/Chassis (EV, HV, UV)	02/10→	M9T 696	Diesel	2298	4	16	89
Master III Platform/Chassis (EV, HV, UV)	02/10→	M9T 698	Diesel	2298	4	16	89









Master III Platform/Chassis (EV, HV, UV)	02/10→	M9T 870	Diesel	2299	4	16	89
Master III Platform/Chassis (EV, HV, UV)	02/10→	M9T 890	Diesel	2298	4	16	89
Master III Platform/Chassis (EV, HV, UV)	02/10→	M9T 896	Diesel	2298	4	16	89
Master III Platform/Chassis (EV, HV, UV)	03/13→	M9T 880	Diesel	2298	4	16	89
Master III Platform/Chassis (EV, HV, UV)	03/13→	M9T 898	Diesel	2298	4	16	89
Master III Platform/Chassis (EV, HV, UV)	07/14→	M9T 700	Diesel	2298	4	16	89
Master III Platform/Chassis (EV, HV, UV)	07/14→	M9T 702	Diesel	2298	4	16	89
Megane CC (EZO/1_)	06/10→	F4R 870	Petrol	1998	4	16	69
Megane CC (EZO/1_)	06/10→	F4R 872	Petrol	1998	4	16	69
Megane CC (EZO/1_)	06/10→	F9Q 870	Diesel	1870	4	8	62
Megane CC (EZO/1_)	06/10→	H4J 700	Petrol	1397	4	16	26
Megane CC (EZO/1_)	06/10→	K4M 858	Petrol	1598	4	16	37
Megane CC (EZO/1_)	06/10→	K4M 866	Petrol	1598	4	16	37
Megane CC (EZO/1_)	06/10→	K9K 837	Diesel	1461	4	8	29
Megane CC (EZO/1_)	06/10→	M4R 711	Petrol	1997	4	16	75
Megane CC (EZO/1_)	06/10→	M4R 713	Petrol	1997	4	16	75
Megane CC (EZO/1_)	06/10→	M9R 610	Diesel	1995	4	16	77
Megane CC (EZO/1_)	04/11→	R9M 402	Diesel	1598	4	16	42
Megane CC (EZO/1_)	10/11→	F4R 874	Petrol	1998	4	16	69
Megane CC (EZO/1_)	01/13→	H5F 404	Petrol	1198	4	16	18
Megane I (BAO/1_)	08/95→03/99	K7M 702	Petrol	1598	4	8	39
Megane I (BAO/1_)	01/96→03/99	E7J 624	Petrol	1390	4	8	25
Megane I (BAO/1_)	01/96→03/99	K7M 703	Petrol	1598	4	8	39
Megane I (BAO/1_)	01/96→03/99	K7M 720	Petrol	1598	4	8	39
Megane I (BAO/1_)	01/96→03/99	K7M 790	Petrol	1598	4	8	39
Megane I (BAO/1_)	01/96→08/03	E7J 626	Petrol	1390	4	8	25
Megane I (BAO/1_)	01/96→08/03	E7J 764	Petrol	1390	4	8	25
Megane I (BAO/1_)	01/96→08/03	F3R 750	Petrol	1998	4	8	65
Megane I (BAO/1_)	01/96→08/03	F3R 751	Petrol	1998	4	8	65
Megane I (BAO/1_)	01/96→08/03	F8Q 620	Diesel	1870	4	8	55
Megane I (BAO/1_)	01/96→08/03	F8Q 622	Diesel	1870	4	8	56
Megane I (BAO/1_)	01/96→08/03	F8Q 624	Diesel	1870	4	8	57
Megane I (BAO/1_)	01/96→08/03	F8Q 784	Diesel	1870	4	8	57
Megane I (BAO/1_)	01/96→08/03	F8Q 786	Diesel	1870	4	8	56
Megane I (BAO/1_)	07/96→08/03	F7R 710	Petrol	1998	4	16	71
Megane I (BAO/1_)	07/96→08/03	F7R 714	Petrol	1998	4	16	72
Megane I (BAO/1_)	03/97→02/01	F9Q 730	Diesel	1870	4	8	62
Megane I (BAO/1_)	03/97→02/01	F9Q 731	Diesel	1870	4	8	62
Megane I (BAO/1_)	03/97→02/01	F9Q 734	Diesel	1870	4	8	62
Megane I (BAO/1_)	03/97→02/01	F9Q 736	Diesel	1870	4	8	62
Megane I (BAO/1_)	05/98→05/01	F3R 791	Petrol	1998	4	8	65
Megane I (BAO/1_)	05/98→05/01	F3R 796	Petrol	1998	4	8	65
Megane I (BAO/1_)	05/98→05/01	F3R 797	Petrol	1998	4	8	65
Megane I (BAO/1_)	05/98→05/01	F3R 798	Petrol	1998	4	8	65
Megane I (BAO/1_)	03/99→08/03	F9Q 732	Diesel	1870	4	8	62
Megane I (BAO/1_)	03/99→08/03	F9Q 738	Diesel	1870	4	8	62
Megane I (BAO/1_)	03/99→08/03	K4J 714	Petrol	1390	4	16	27
Megane I (BAO/1_)	03/99→08/03	K4J 750	Petrol	1390	4	16	27
Megane I (BAO/1_)	03/99→08/03	K4M 700	Petrol	1598	4	16	36
Megane I (BAO/1_)	03/99→08/03	K4M 701	Petrol	1598	4	16	36
Megane I (BAO/1_)	03/99→08/03	K4M 704	Petrol	1598	4	16	36
Megane I (BAO/1_)	03/99→08/03	K4M 708	Petrol	1598	4	16	36
Megane I (BAO/1_)	02/00→09/00	K7M 704	Petrol	1598	4	8	39
Megane I (BAO/1_)	01/01→08/03	F4P 720	Petrol	1783	4	16	51
Megane I (BAO/1_)	01/01→08/03	F4P 722	Petrol	1783	4	16	51
Megane I (BAO/1_)	02/01→08/03	F9Q 733	Diesel	1870	4	8	62
Megane I (BAO/1_)	02/01→08/03	F9Q 744	Diesel	1870	4	8	62
Megane I Cabriolet (EA0/1_)	10/96→03/99	K7M 702	Petrol	1598	4	8	39
Megane I Cabriolet (EA0/1_)	10/96→03/99	K7M 703	Petrol	1598	4	8	39
Megane I Cabriolet (EA0/1_)	10/96→11/99	F7R 710	Petrol	1998	4	16	71
Megane I Cabriolet (EA0/1_)	10/96→11/00	F7R 714	Petrol	1998	4	16	72
Megane I Cabriolet (EA0/1_)	04/97→08/03	F3R 750	Petrol	1998	4	8	65
Megane I Cabriolet (EA0/1_)	04/97→08/03	F3R 798	Petrol	1998	4	8	65
Megane I Cabriolet (EA0/1_)	03/99→08/03	F3R 791	Petrol	1998	4	8	65
Megane I Cabriolet (EA0/1_)	03/99→08/03	F3R 796	Petrol	1998	4	8	65
Megane I Cabriolet (EA0/1_)	03/99→08/03	K4J 714	Petrol	1390	4	16	27
Megane I Cabriolet (EA0/1_)	03/99→08/03	K4J 750	Petrol	1390	4	16	27
Megane I Cabriolet (EA0/1_)	03/99→08/03	K4M 700	Petrol	1598	4	16	36
Megane I Cabriolet (EA0/1_)	03/99→08/03	K4M 701	Petrol	1598	4	16	36
Megane I Cabriolet (EA0/1_)	03/99→08/03	K4M 708	Petrol	1598	4	16	36
Megane I Cabriolet (EA0/1_)	11/99→08/03	F5R 740	Petrol	1998	4	16	70
Megane I Cabriolet (EA0/1_)	01/02→08/03	F4R 746	Petrol	1998	4	16	69
Megane I Cabriolet (EA0/1_)	01/02→08/03	F4R 770	Petrol	1998	4	16	69
Megane I Classic (LA0/1_)	09/96→03/99	K7M 702	Petrol	1598	4	8	39
Megane I Classic (LA0/1_)	09/96→03/99	K7M 703	Petrol	1598	4	8	39
Megane I Classic (LA0/1_)	09/96→03/99	K7M 720	Petrol	1598	4	8	39
Megane I Classic (LA0/1_)	09/96→03/99	K7M 790	Petrol	1598	4	8	39
Megane I Classic (LA0/1_)	09/96→08/03	E7J 626	Petrol	1390	4	8	25

				CC			9
Megane I Classic (LAO/1_)	09/96→08/03	E7J 764	Petrol	1390	4	8	25
Megane I Classic (LAO/1_)	09/96→08/03	F3R 750	Petrol	1998	4	8	65
Megane I Classic (LAO/1_)	09/96→08/03	F3R 751	Petrol	1998	4	8	65
Megane I Classic (LAO/1_)	09/96→08/03	F3R 752	Petrol	1998	4	8	67
Megane I Classic (LAO/1_)	09/96→08/03	F3R 791	Petrol	1998	4	8	65
Megane I Classic (LAO/1_)	09/96→08/03	F3R 796	Petrol	1998	4	8	65
Megane I Classic (LAO/1_)	09/96→08/03	F3R 797	Petrol	1998	4	8	65
Megane I Classic (LAO/1_)	09/96→08/03	F3R 798	Petrol	1998	4	8	65
Megane I Classic (LAO/1_)	09/96→08/03	F8Q 620	Diesel	1870	4	8	55
Megane I Classic (LAO/1_)	09/96→08/03	F8Q 624	Diesel	1870	4	8	57
Megane I Classic (LAO/1_)	09/96→08/03	F8Q 784	Diesel	1870	4	8	57
Megane I Classic (LAO/1_)	09/96→08/03	F8Q 786	Diesel	1870	4	8	56
Megane I Classic (LAO/1_)	03/97→02/01	F9Q 730	Diesel	1870	4	8	62
Megane I Classic (LAO/1_)	03/97→02/01	F9Q 731	Diesel	1870	4	8	62
Megane I Classic (LAO/1_)	03/97→02/01	F9Q 734	Diesel	1870	4	8	62
Megane I Classic (LAO/1_)	03/97→02/01	F9Q 736	Diesel	1870	4	8	62
Megane I Classic (LAO/1_)	01/99→08/08	K4M 706	Petrol	1598	4	16	36
Megane I Classic (LAO/1_)	03/99→08/03	F9Q 733	Diesel	1870	4	8	62
Megane I Classic (LAO/1_)	03/99→08/03	K4J 714	Petrol	1390	4	16	27
Megane I Classic (LAO/1_)	03/99→08/03	K4J 750	Petrol	1390	4	16	27
Megane I Classic (LAO/1_)	03/99→08/03	K4M 700	Petrol	1598	4	16	36
Megane I Classic (LAO/1_)	03/99→08/03	K4M 701	Petrol	1598	4	16	36
Megane I Classic (LAO/1_)	03/99→08/03	K4M 708	Petrol	1598	4	16	36
Megane I Classic (LAO/1_)	02/00→09/00	K7M 704	Petrol	1598	4	8	39
Megane I Classic (LAO/1_)	01/01→08/03	F4P 720	Petrol	1783	4	16	51
Megane I Classic (LAO/1_)	01/01→08/03	F4P 722	Petrol	1783	4	16	51
Megane I Classic (LAO/1_)	02/01→08/03	F9Q 732	Diesel	1870	4	8	62
Megane I Classic (LAO/1_)	02/01→08/03	F9Q 738	Diesel	1870	4	8	62
Megane I Classic (LAO/1_)	02/01→08/03	F9Q 744	Diesel	1870	4	8	62
Megane I Classic (LAO/1_)	03/01→08/03	F4R 747	Petrol	1998	4	16	69
Megane I Classic (LAO/1_)	03/01→08/03	F5R 740	Petrol	1998	4	16	70
Megane I Coach (DAO/1_)	03/96→03/99	K7M 702	Petrol	1598	4	8	39
Megane I Coach (DAO/1_)	03/96→03/99	K7M 703	Petrol	1598	4	8	39
Megane I Coach (DAO/1_)	03/96→11/99	F7R 710	Petrol	1998	4	16	71
Megane I Coach (DAO/1_)	03/96→11/00	F7R 714	Petrol	1998	4	16	72
Megane I Coach (DAO/1_)	03/96→08/03	F3R 750	Petrol	1998	4	8	65
Megane I Coach (DAO/1_)	03/96→08/03	F3R 751	Petrol	1998	4	8	65
Megane I Coach (DAO/1_)	03/96→08/03	F3R 798	Petrol	1998	4	8	65
Megane I Coach (DAO/1_)	03/97→02/01	F9Q 731	Diesel	1870	4	8	62
Megane I Coach (DAO/1_)	03/97→02/01	F9Q 734	Diesel	1870	4	8	62
Megane I Coach (DAO/1_)	03/97→02/01	F9Q 736	Diesel	1870	4	8	62
Megane I Coach (DAO/1_)	03/99→08/03	F3R 791	Petrol	1998	4	8	65
Megane I Coach (DAO/1_)	03/99→08/03	F3R 796	Petrol	1998	4	8	65
Megane I Coach (DAO/1_)	03/99→08/03	F9Q 732	Diesel	1870	4	8	62
Megane I Coach (DAO/1_)	03/99→08/03	F9Q 733	Diesel	1870	4	8	62
Megane I Coach (DAO/1_)	03/99→08/03	K4J 714	Petrol	1390	4	16	27
Megane I Coach (DAO/1_)	03/99→08/03	K4J 750	Petrol	1390	4	16	27
Megane I Coach (DAO/1_)	03/99→08/03	K4M 700	Petrol	1598	4	16	36
Megane I Coach (DAO/1_)	03/99→08/03	K4M 701	Petrol	1598	4	16	36
Megane I Coach (DAO/1_)	03/99→08/03	K4M 708	Petrol	1598	4	16	36
Megane I Coach (DAO/1_)	11/99→08/03	F5R 740	Petrol	1998	4	16	70
Megane I Coach (DAO/1_)	01/02→08/03	F4R 746	Petrol	1998	4	16	69
Megane I Grandtour (KAO/1_)	03/99→02/01	F9Q 731	Diesel	1870	4	8	62
Megane I Grandtour (KAO/1_)	03/99→02/01	F9Q 736	Diesel	1870	4	8	62
Megane I Grandtour (KAO/1_)	03/99→08/03	E7J 626	Petrol	1390	4	8	25
Megane I Grandtour (KAO/1_)	03/99→08/03	F9Q 732	Diesel	1870	4	8	62
Megane I Grandtour (KAO/1_)	03/99→08/03	K4J 714	Petrol	1390	4	16	27
Megane I Grandtour (KAO/1_)	03/99→08/03	K4J 750	Petrol	1390	4	16	27
Megane I Grandtour (KAO/1_)	03/99→08/03	K4M 700	Petrol	1598	4	16	36
Megane I Grandtour (KAO/1_)	03/99→08/03	K4M 701	Petrol	1598	4	16	36
Megane I Grandtour (KAO/1_)	03/99→08/03	K4M 704	Petrol	1598	4	16	36
Megane I Grandtour (KAO/1_)	03/99→08/03	K4M 708	Petrol	1598	4	16	36
Megane I Grandtour (KAO/1_)	03/99→08/03	K7M 702	Petrol	1598	4	8	39
Megane I Grandtour (KAO/1_)	03/99→08/03	K7M 703	Petrol	1598	4	8	39
Megane I Grandtour (KAO/1_)	04/99→08/03	F8Q 622	Diesel	1870	4	8	56
Megane I Grandtour (KAO/1_)	04/99→08/03	F8Q 790	Diesel	1870	4	8	61
Megane I Grandtour (KAO/1_)	01/01→08/03	F4P 720	Petrol	1783	4	16	51
Megane I Grandtour (KAO/1_)	01/01→08/03	F4P 722	Petrol	1783	4	16	51
Megane I Grandtour (KAO/1_)	02/01→08/03	F9Q 733	Diesel	1870	4	8	62
Megane I Grandtour (KAO/1_)	02/01→08/03	F9Q 738	Diesel	1870	4	8	62
Megane I Grandtour (KAO/1_)	02/01→08/03	F9Q 744	Diesel	1870	4	8	62
Megane II (BMO/1_, CMO/1_)	11/02→08/06	F9Q 808	Diesel	1870	4	8	62
Megane II (BMO/1_, CMO/1_)	11/02→02/08	F9Q 800	Diesel	1870	4	8	62
Megane II (BMO/1_, CMO/1_)	11/02→02/08	K4J 730	Petrol	1390	4	16	27
Megane II (BMO/1_, CMO/1_)	11/02→02/08	K4J 740	Petrol	1390	4	16	27
Megane II (BMO/1_, CMO/1_)	11/02→02/08	K9K 722	Diesel	1461	4	8	29
Megane II (BMO/1_, CMO/1_)	11/02→06/08	K4M 760	Petrol	1598	4	16	37
Megane II (BMO/1_, CMO/1_)	11/02→12/09	F9Q 804	Diesel	1870	4	8	62



Megane II (BMO/1_ CMO/1_)	11/02→12/09	F9Q 816	Diesel	1870	4	8	62
Megane II (BMO/1_ CMO/1_)	11/02→12/09	F9Q 818	Diesel	1870	4	8	62
Megane II (BMO/1_ CMO/1_)	11/02→12/10	F4R 770	Petrol	1998	4	16	69
Megane II (BMO/1_ CMO/1_)	09/03→12/09	F4R	Petrol	1998	4	16	69
Megane II (BMO/1_ CMO/1_)	10/03→03/06	K9K 728	Diesel	1461	4	8	29
Megane II (BMO/1_ CMO/1_)	10/03→03/06	K9K 729	Diesel	1461	4	8	29
Megane II (BMO/1_ CMO/1_)	10/03→02/08	K4J 732	Petrol	1390	4	16	27
Megane II (BMO/1_ CMO/1_)	05/04→02/08	F4R 776	Petrol	1998	4	16	69
Megane II (BMO/1_ CMO/1_)	05/04→10/09	F4R 774	Petrol	1998	4	16	69
Megane II (BMO/1_ CMO/1_)	05/04→10/09	F4Ri 774	Petrol	1998	4	16	69
Megane II (BMO/1_ CMO/1_)	05/05→02/08	K9K 724	Diesel	1461	4	8	29
Megane II (BMO/1_ CMO/1_)	05/05→06/08	K9K 732	Diesel	1461	4	8	29
Megane II (BMO/1_ CMO/1_)	05/05→06/08	K9K 734	Diesel	1461	4	8	29
Megane II (BMO/1_ CMO/1_)	05/05→12/09	F9Q 803	Diesel	1870	4	8	62
Megane II (BMO/1_ CMO/1_)	06/05→02/08	K4M 788	Petrol	1598	4	16	36
Megane II (BMO/1_ CMO/1_)	09/05→02/08	M9R 700	Diesel	1995	4	16	77
Megane II (BMO/1_ CMO/1_)	09/05→02/08	M9R 722	Diesel	1995	4	16	77
Megane II (BMO/1_ CMO/1_)	01/06→06/08	K4M 812	Petrol	1598	4	16	37
Megane II (BMO/1_ CMO/1_)	01/06→06/08	K4M 813	Petrol	1598	4	16	37
Megane II (BMO/1_ CMO/1_)	01/07→02/08	M9R 724	Diesel	1995	4	16	77
Megane II Box Body / Estate (KM_)	05/05→07/09	K9K 724	Diesel	1461	4	8	29
Megane II Coupé-Cabriolet (EMO/1_)	09/03→03/09	F9Q 800	Diesel	1870	4	8	62
Megane II Coupé-Cabriolet (EMO/1_)	09/03→03/09	F9Q 804	Diesel	1870	4	8	62
Megane II Coupé-Cabriolet (EMO/1_)	09/03→03/09	F9Q 816	Diesel	1870	4	8	62
Megane II Coupé-Cabriolet (EMO/1_)	09/03→03/09	F9Q 818	Diesel	1870	4	8	62
Megane II Coupé-Cabriolet (EMO/1_)	09/03→03/09	K4M 760	Petrol	1598	4	16	37
Megane II Coupé-Cabriolet (EMO/1_)	09/03→03/09	K4M 761	Petrol	1598	4	16	37
Megane II Coupé-Cabriolet (EMO/1_)	09/03→12/09	F4R 770	Petrol	1998	4	16	69
Megane II Coupé-Cabriolet (EMO/1_)	09/03→12/09	F4R 771	Petrol	1998	4	16	69
Megane II Coupé-Cabriolet (EMO/1_)	05/04→03/09	F4R 776	Petrol	1998	4	16	69
Megane II Coupé-Cabriolet (EMO/1_)	05/05→02/07	F9Q 803	Diesel	1870	4	8	62
Megane II Coupé-Cabriolet (EMO/1_)	06/05→03/09	K4M 788	Petrol	1598	4	16	36
Megane II Coupé-Cabriolet (EMO/1_)	09/05→12/06	F4R	Petrol	1998	4	16	69
Megane II Coupé-Cabriolet (EMO/1_)	09/05→03/09	M9R 700	Diesel	1995	4	16	77
Megane II Coupé-Cabriolet (EMO/1_)	09/05→03/09	M9R 722	Diesel	1995	4	16	77
Megane II Coupé-Cabriolet (EMO/1_)	01/06→06/08	K4M 812	Petrol	1598	4	16	37
Megane II Coupé-Cabriolet (EMO/1_)	01/06→06/08	K4M 813	Petrol	1598	4	16	37
Megane II Coupé-Cabriolet (EMO/1_)	03/06→06/08	K9K 732	Diesel	1461	4	8	29
Megane II Coupé-Cabriolet (EMO/1_)	01/07→06/09	K9K 734	Diesel	1461	4	8	29
Megane II Estate (KMO/1_)	08/03→05/06	K9K 722	Diesel	1461	4	8	29
Megane II Estate (KMO/1_)	08/03→07/09	F9Q 800	Diesel	1870	4	8	62
Megane II Estate (KMO/1_)	08/03→07/09	K4J 730	Petrol	1390	4	16	27
Megane II Estate (KMO/1_)	08/03→07/09	K4J 740	Petrol	1390	4	16	27
Megane II Estate (KMO/1_)	08/03→08/09	K4M 760	Petrol	1598	4	16	37
Megane II Estate (KMO/1_)	08/03→08/09	K4M 761	Petrol	1598	4	16	37
Megane II Estate (KMO/1_)	08/03→01/11	F4R 770	Petrol	1998	4	16	69
Megane II Estate (KMO/1_)	08/03→01/11	F4R 771	Petrol	1998	4	16	69
Megane II Estate (KMO/1_)	02/04→03/06	K9K 729	Diesel	1461	4	8	29
Megane II Estate (KMO/1_)	02/04→07/09	K9K 728	Diesel	1461	4	8	29
Megane II Estate (KMO/1_)	03/04→02/07	F9Q 808	Diesel	1870	4	8	62
Megane II Estate (KMO/1_)	05/05→06/08	K9K 732	Diesel	1461	4	8	29
Megane II Estate (KMO/1_)	05/05→06/08	K9K 734	Diesel	1461	4	8	29
Megane II Estate (KMO/1_)	05/05→07/09	F9Q 803	Diesel	1870	4	8	62
Megane II Estate (KMO/1_)	05/05→07/09	F9Q 804	Diesel	1870	4	8	62
Megane II Estate (KMO/1_)	05/05→07/09	F9Q 818	Diesel	1870	4	8	62
Megane II Estate (KMO/1_)	05/05→07/09	K4M 768	Petrol	1598	4	16	36
Megane II Estate (KMO/1_)	05/05→07/09	K9K 724	Diesel	1461	4	8	29
Megane II Estate (KMO/1_)	05/05→10/11	K4M 762	Petrol	1598	4	16	36
Megane II Estate (KMO/1_)	09/05→07/09	M9R 700	Diesel	1995	4	16	77
Megane II Estate (KMO/1_)	09/05→07/09	M9R 722	Diesel	1995	4	16	77
Megane II Estate (KMO/1_)	01/06→08/09	K4M 812	Petrol	1598	4	16	37
Megane II Estate (KMO/1_)	01/06→08/09	K4M 813	Petrol	1598	4	16	37
Megane II Estate (KMO/1_)	02/08→07/09	K4M 856	Petrol	1598	4	16	37
Megane II Saloon (LMO/1_)	09/03→12/07	F4R	Petrol	1998	4	16	69
Megane II Saloon (LMO/1_)	09/03→	F4R 770	Petrol	1998	4	16	69
Megane II Saloon (LMO/1_)	09/03→	F4R 771	Petrol	1998	4	16	69
Megane II Saloon (LMO/1_)	09/03→	F9Q 800	Diesel	1870	4	8	62
Megane II Saloon (LMO/1_)	09/03→	F9Q 808	Diesel	1870	4	8	62
Megane II Saloon (LMO/1_)	09/03→	K4J 730	Petrol	1390	4	16	27
Megane II Saloon (LMO/1_)	09/03→	K4J 732	Petrol	1390	4	16	27
Megane II Saloon (LMO/1_)	09/03→	K4J 740	Petrol	1390	4	16	27
Megane II Saloon (LMO/1_)	09/03→	K4M 760	Petrol	1598	4	16	37
Megane II Saloon (LMO/1_)	09/03→	K4M 761	Petrol	1598	4	16	37
Megane II Saloon (LMO/1_)	09/03→	K4M 768	Petrol	1598	4	16	36
Megane II Saloon (LMO/1_)	09/03→	K9K 722	Diesel	1461	4	8	29
Megane II Saloon (LMO/1_)	02/04→	K9K 728	Diesel	1461	4	8	29
Megane II Saloon (LMO/1_)	02/04→	K9K 729	Diesel	1461	4	8	29
Megane II Saloon (LMO/1_)	05/05→	F9Q 803	Diesel	1870	4	8	62

				CC			9
Megane II Saloon (LMO/1_)	05/05→	F9Q 804	Diesel	1870	4	8	62
Megane II Saloon (LMO/1_)	05/05→	F9Q 816	Diesel	1870	4	8	62
Megane II Saloon (LMO/1_)	05/05→	F9Q 818	Diesel	1870	4	8	62
Megane II Saloon (LMO/1_)	05/05→	K4M 762	Petrol	1598	4	16	36
Megane II Saloon (LMO/1_)	05/05→	K9K 724	Diesel	1461	4	8	29
Megane II Saloon (LMO/1_)	05/05→	K9K 732	Diesel	1461	4	8	29
Megane II Saloon (LMO/1_)	09/05→	M9R 700	Diesel	1995	4	16	77
Megane II Saloon (LMO/1_)	09/05→	M9R 722	Diesel	1995	4	16	77
Megane II Saloon (LMO/1_)	01/06→12/07	K4M 788	Petrol	1598	4	16	36
Megane II Saloon (LMO/1_)	01/06→	K4M 812	Petrol	1598	4	16	37
Megane II Saloon (LMO/1_)	01/06→	K4M 813	Petrol	1598	4	16	37
Megane II Saloon (LMO/1_)	03/06→	K4M 766	Petrol	1598	4	16	37
Megane II Saloon (LMO/1_)	01/07→	K9K 734	Diesel	1461	4	8	29
Megane III Coupe (DZO/1_)	11/08→	F4R 870	Petrol	1998	4	16	69
Megane III Coupe (DZO/1_)	11/08→	F4R 874	Petrol	1998	4	16	69
Megane III Coupe (DZO/1_)	11/08→	F9Q 870	Diesel	1870	4	8	62
Megane III Coupe (DZO/1_)	11/08→	F9Q 872	Diesel	1870	4	8	62
Megane III Coupe (DZO/1_)	11/08→	K4M 848	Petrol	1598	4	16	37
Megane III Coupe (DZO/1_)	11/08→	K4M 858	Petrol	1598	4	16	37
Megane III Coupe (DZO/1_)	11/08→	K4M 866	Petrol	1598	4	16	37
Megane III Coupe (DZO/1_)	11/08→	K9K 830	Diesel	1461	4	8	29
Megane III Coupe (DZO/1_)	11/08→	K9K 834	Diesel	1461	4	8	29
Megane III Coupe (DZO/1_)	02/09→	K9K 636	Diesel	1461	4	8	29
Megane III Coupe (DZO/1_)	02/09→	K9K 832	Diesel	1461	4	8	29
Megane III Coupe (DZO/1_)	02/09→	K9K 836	Diesel	1461	4	8	29
Megane III Coupe (DZO/1_)	02/09→	K9K 837	Diesel	1461	4	8	29
Megane III Coupe (DZO/1_)	02/09→	K9K 846	Diesel	1461	4	8	29
Megane III Coupe (DZO/1_)	04/09→	H4J 700	Petrol	1397	4	16	26
Megane III Coupe (DZO/1_)	04/09→	M9R 610	Diesel	1995	4	16	77
Megane III Coupe (DZO/1_)	04/09→	M9R 615	Diesel	1995	4	16	77
Megane III Coupe (DZO/1_)	05/09→	M4R 711	Petrol	1997	4	16	75
Megane III Coupe (DZO/1_)	04/11→	R9M 402	Diesel	1598	4	16	42
Megane III Coupe (DZO/1_)	03/12→	H5F 400	Petrol	1197	4	16	18
Megane III Coupe (DZO/1_)	06/12→	F4R 872	Petrol	1998	4	16	69
Megane III Coupe (DZO/1_)	01/13→	H5F 404	Petrol	1198	4	16	18
Megane III Grandtour (KZO/1)	11/08→	F4R 870	Petrol	1998	4	16	69
Megane III Grandtour (KZO/1)	11/08→	F4R 872	Petrol	1998	4	16	69
Megane III Grandtour (KZO/1)	11/08→	K4M 866	Petrol	1598	4	16	37
Megane III Grandtour (KZO/1)	02/09→	K9K 636	Diesel	1461	4	8	29
Megane III Grandtour (KZO/1)	02/09→	K9K 832	Diesel	1461	4	8	29
Megane III Grandtour (KZO/1)	02/09→	K9K 836	Diesel	1461	4	8	29
Megane III Grandtour (KZO/1)	02/09→	K9K 837	Diesel	1461	4	8	29
Megane III Grandtour (KZO/1)	02/09→	K9K 846	Diesel	1461	4	8	29
Megane III Grandtour (KZO/1)	03/09→	K9K 830	Diesel	1461	4	8	29
Megane III Grandtour (KZO/1)	04/09→	M9R 610	Diesel	1995	4	16	77
Megane III Grandtour (KZO/1)	05/09→	F9Q 870	Diesel	1870	4	8	62
Megane III Grandtour (KZO/1)	05/09→	F9Q 872	Diesel	1870	4	8	62
Megane III Grandtour (KZO/1)	05/09→	H4J 700	Petrol	1397	4	16	26
Megane III Grandtour (KZO/1)	05/09→	K4M 848	Petrol	1598	4	16	37
Megane III Grandtour (KZO/1)	05/09→	K4M 858	Petrol	1598	4	16	37
Megane III Grandtour (KZO/1)	05/09→	K9K 834	Diesel	1461	4	8	29
Megane III Grandtour (KZO/1)	05/09→	M4R 711	Petrol	1997	4	16	75
Megane III Grandtour (KZO/1)	05/09→	M4R 713	Petrol	1997	4	16	75
Megane III Grandtour (KZO/1)	05/09→	M4R F 713	Petrol	1997	4	16	75
Megane III Grandtour (KZO/1)	10/10→	M9R 615	Diesel	1995	4	16	77
Megane III Grandtour (KZO/1)	04/11→	R9M 402	Diesel	1598	4	16	42
Megane III Grandtour (KZO/1)	04/11→	R9M 404	Diesel	1598	4	16	42
Megane III Grandtour (KZO/1)	03/12→	H5F 400	Petrol	1197	4	16	18
Megane III Grandtour (KZO/1)	09/12→	F4R 874	Petrol	1998	4	16	69
Megane III Grandtour (KZO/1)	01/13→	H5F 404	Petrol	1198	4	16	18
Megane III Hatchback (BZO_)	11/08→	F4R 870	Petrol	1998	4	16	69
Megane III Hatchback (BZO_)	11/08→	F9Q 870	Diesel	1870	4	8	62
Megane III Hatchback (BZO_)	11/08→	F9Q 872	Diesel	1870	4	8	62
Megane III Hatchback (BZO_)	11/08→	K4M 848	Petrol	1598	4	16	37
Megane III Hatchback (BZO_)	11/08→	K4M 858	Petrol	1598	4	16	37
Megane III Hatchback (BZO_)	11/08→	K4M 866	Petrol	1598	4	16	37
Megane III Hatchback (BZO_)	11/08→	K9K 834	Diesel	1461	4	8	29
Megane III Hatchback (BZO_)	02/09→	K9K 636	Diesel	1461	4	8	29
Megane III Hatchback (BZO_)	02/09→	K9K 656	Diesel	1461	4	8	29
Megane III Hatchback (BZO_)	02/09→	K9K 657	Diesel	1461	4	8	29
Megane III Hatchback (BZO_)	02/09→	K9K 832	Diesel	1461	4	8	29
Megane III Hatchback (BZO_)	02/09→	K9K 836	Diesel	1461	4	8	29
Megane III Hatchback (BZO_)	02/09→	K9K 837	Diesel	1461	4	8	29
Megane III Hatchback (BZO_)	02/09→	K9K 846	Diesel	1461	4	8	29
Megane III Hatchback (BZO_)	02/09→	M4R 711	Petrol	1997	4	16	75
Megane III Hatchback (BZO_)	02/09→	M4R 713	Petrol	1997	4	16	75
Megane III Hatchback (BZO_)	04/09→	H4J 700	Petrol	1397	4	16	26
Megane III Hatchback (BZO_)	04/09→	M9R 610	Diesel	1995	4	16	77



Megane III Hatchback (BZO _)	12/09→	K9K 830	Diesel	1461	4	8	29
Megane III Hatchback (BZO _)	10/10→	M9R 615	Diesel	1995	4	16	77
Megane III Hatchback (BZO _)	01/11→	M4R 710	Petrol	1997	4	16	76
Megane III Hatchback (BZO _)	01/11→	M4R 714	Petrol	1997	4	16	75
Megane III Hatchback (BZO _)	04/11→	R9M 402	Diesel	1598	4	16	42
Megane III Hatchback (BZO _)	04/11→	R9M 404	Diesel	1598	4	16	42
Megane III Hatchback (BZO _)	03/12→	H5F 400	Petrol	1197	4	16	18
Megane III Hatchback (BZO _)	06/12→	F4R 872	Petrol	1998	4	16	69
Megane III Hatchback (BZO _)	01/13→	H5F 404	Petrol	1198	4	16	18
Megane III Hatchback (BZO _)	11/13→	F4R 874	Petrol	1998	4	16	69
Megane III Hatchback (BZO _)	10/15→	K4M 838	Petrol	1598	4	16	37
Megane IV (B9A/M _)	11/15→	H5F 408	Petrol	1197	4	16	18
Megane IV (B9A/M _)	11/15→	K9K 646	Diesel	1461	4	8	29
Megane IV (B9A/M _)	11/15→	K9K 656	Diesel	1461	4	8	29
Megane IV (B9A/M _)	11/15→	K9K 657	Diesel	1461	4	8	29
Megane IV (B9A/M _)	11/15→	M5M 450	Petrol	1618	4	16	40
Megane IV (B9A/M _)	11/15→	R9M 409	Diesel	1598	4	16	42
Megane IV (B9A/M _)	11/15→	R9M 452	Diesel	1598	4	16	43
Megane IV (B9A/M _)	04/16→	F4R 874	Petrol	1998	4	16	69
Megane IV Grandtour (K9A/M _)	04/16→	H5F 408	Petrol	1197	4	16	18
Megane IV Grandtour (K9A/M _)	04/16→	K9K 656	Diesel	1461	4	8	29
Megane IV Grandtour (K9A/M _)	04/16→	K9K 657	Diesel	1461	4	8	29
Megane IV Grandtour (K9A/M _)	04/16→	M5M 450	Petrol	1618	4	16	40
Megane IV Grandtour (K9A/M _)	04/16→	R9M 409	Diesel	1598	4	16	42
Megane IV Grandtour (K9A/M _)	04/16→	R9M 409	Diesel	1598	4	16	42
Megane Scenic (JA0/1 _)	10/96→10/99	K7M 702	Petrol	1598	4	8	39
Megane Scenic (JA0/1 _)	10/96→10/99	K7M 703	Petrol	1598	4	8	39
Megane Scenic (JA0/1 _)	01/97→09/99	E7J 764	Petrol	1390	4	8	25
Megane Scenic (JA0/1 _)	01/97→09/99	F3R 751	Petrol	1998	4	8	65
Megane Scenic (JA0/1 _)	01/97→09/99	F8Q 784	Diesel	1870	4	8	57
Megane Scenic (JA0/1 _)	01/97→09/99	F8Q 786	Diesel	1870	4	8	56
Megane Scenic (JA0/1 _)	01/97→09/99	K7M 720	Petrol	1598	4	8	39
Megane Scenic (JA0/1 _)	01/97→10/99	F3R 750	Petrol	1998	4	8	65
Megane Scenic (JA0/1 _)	03/97→09/99	F8Q 790	Diesel	1870	4	8	61
Megane Scenic (JA0/1 _)	04/97→09/99	F9Q 730	Diesel	1870	4	8	62
Megane Scenic (JA0/1 _)	04/97→09/99	F9Q 734	Diesel	1870	4	8	62
Megane Scenic (JA0/1 _)	04/98→10/99	K4M 700	Petrol	1598	4	16	36
Megane Scenic (JA0/1 _)	04/98→10/99	K4M 701	Petrol	1598	4	16	36
Megane Scenic (JA0/1 _)	04/98→10/99	K4M 704	Petrol	1598	4	16	36
Megane Scenic (JA0/1 _)	04/98→10/99	K4M 708	Petrol	1598	4	16	36
Megane Scenic (JA0/1 _)	01/99→09/99	F3R 791	Petrol	1998	4	8	65
Megane Scenic (JA0/1 _)	01/99→09/99	F3R 796	Petrol	1998	4	8	65
Megane Scenic (JA0/1 _)	01/99→12/01	F3R 798	Petrol	1998	4	8	65
Messenger Box Body / Estate	09/90→06/99	8140.07.2530 ID	Diesel	2500	4	8	98
Messenger Box Body / Estate	09/90→06/99	8140.07.2585	Diesel	2500	4	8	98
Messenger Box Body / Estate	09/90→06/99	8140.67.2585	Diesel	2500	4	8	101
Messenger Box Body / Estate	01/94→09/96	8140.47.2585	Diesel	2500	4	8	100
Messenger Box Body / Estate	09/96→06/99	8140.23.2565	Diesel	2800	4	8	116
Messenger Box Body / Estate	09/96→06/99	8140.43.2585	Diesel	2800	4	8	116
Messenger Dumptruck	09/96→06/99	8140.43.2585	Diesel	2800	4	8	116
Messenger Platform/Chassis	09/90→06/99	8140.07.2530 ID	Diesel	2500	4	8	98
Messenger Platform/Chassis	09/90→06/99	8140.07.2585	Diesel	2500	4	8	98
Messenger Platform/Chassis	09/90→06/99	8140.67.2585	Diesel	2500	4	8	101
Messenger Platform/Chassis	10/91→07/96	8140.47.2530 IDR	Diesel	2499	4	8	98
Messenger Platform/Chassis	10/91→07/96	8140.47.2590	Diesel	2499	4	8	98
Messenger Platform/Chassis	01/94→09/96	8140.47.2585	Diesel	2500	4	8	100
Messenger Platform/Chassis	09/96→06/99	8140.23.2565	Diesel	2800	4	8	116
Messenger Platform/Chassis	09/96→06/99	8140.23.2585	Diesel	2800	4	16	117
Messenger Platform/Chassis	09/96→06/99	8140.43.2585	Diesel	2800	4	8	116
Messenger Truck Tractor	01/94→09/96	8140.47.2585	Diesel	2500	4	8	100
Messenger Truck Tractor	09/96→06/99	8140.43.2585	Diesel	2800	4	8	116
Modus / Grand Modus (F/JPO _)	09/04→	K9K 750	Diesel	1461	4	8	29
Modus / Grand Modus (F/JPO _)	12/04→	D4F 740	Petrol	1149	4	16	15
Modus / Grand Modus (F/JPO _)	12/04→	D4F 764	Petrol	1149	4	16	15
Modus / Grand Modus (F/JPO _)	12/04→	K4J 770	Petrol	1390	4	16	27
Modus / Grand Modus (F/JPO _)	12/04→	K4J 780	Petrol	1390	4	16	27
Modus / Grand Modus (F/JPO _)	12/04→	K4M 790	Petrol	1598	4	16	37
Modus / Grand Modus (F/JPO _)	12/04→	K4M 791	Petrol	1598	4	16	37
Modus / Grand Modus (F/JPO _)	12/04→	K4M 794	Petrol	1598	4	16	37
Modus / Grand Modus (F/JPO _)	12/04→	K4M 800	Petrol	1598	4	16	37
Modus / Grand Modus (F/JPO _)	12/04→	K4M 801	Petrol	1598	4	16	37
Modus / Grand Modus (F/JPO _)	12/04→	K9K 760	Diesel	1461	4	8	29
Modus / Grand Modus (F/JPO _)	12/04→	K9K 766	Diesel	1461	4	8	29
Modus / Grand Modus (F/JPO _)	12/04→	K9K 768	Diesel	1461	4	8	29
Modus / Grand Modus (F/JPO _)	12/04→	K9K 764	Diesel	1461	4	8	29
Modus / Grand Modus (F/JPO _)	05/05→	K9K 764	Diesel	1461	4	8	29
Modus / Grand Modus (F/JPO _)	05/07→	D4F 784	Petrol	1149	4	16	15
Modus / Grand Modus (F/JPO _)	05/07→	K9K 772	Diesel	1461	4	8	29
Modus / Grand Modus (F/JPO _)	10/10→	K9K 770	Diesel	1461	4	8	29
Modus / Grand Modus (F/JPO _)	04/11→	D4F 786	Petrol	1149	4	16	15



CC











9

Oroch	09/15→	K4M 690	Petrol	1598	4	16	38
Pulse (BDM_)	01/12→	K9K 740	Diesel	1461	4	8	29
QM3	12/13→	K9K 609	Diesel	1461	4	8	29
QM5	12/06→	2TR 702	Petrol	2488	4	16	95
QM5	12/06→	M9R 760	Diesel	1995	4	16	77
QM5	12/06→	M9R 833	Diesel	1995	4	16	77
QM6	09/16→	M9R 760	Diesel	1995	4	16	77
Rapid	09/94→03/98	F8Q 646	Diesel	1870	4	8	55
Rapid	09/94→03/98	F8Q 684	Diesel	1870	4	8	56
Rapid	09/94→03/98	F8Q 724	Diesel	1870	4	8	55
Rapid	09/94→03/98	F8Q 776	Diesel	1870	4	8	55
Rapid Box (F40_ G40_)	07/85→08/91	C1J 768	Petrol	1397	4	8	23
Rapid Box (F40_ G40_)	07/85→08/91	C1J 780	Petrol	1397	4	8	23
Rapid Box (F40_ G40_)	07/85→04/95	C1E 750	Petrol	1108	4	8	10
Rapid Box (F40_ G40_)	07/85→04/95	C1E 752	Petrol	1108	4	8	10
Rapid Box (F40_ G40_)	07/85→04/95	C1E 754	Petrol	1108	4	8	10
Rapid Box (F40_ G40_)	07/85→04/95	C1E 760	Petrol	1108	4	8	10
Rapid Box (F40_ G40_)	07/85→04/95	C1E 762	Petrol	1108	4	8	10
Rapid Box (F40_ G40_)	07/85→04/95	C1E 792	Petrol	1108	4	8	10
Rapid Box (F40_ G40_)	09/85→05/92	C1C 706	Petrol	956	4	8	4
Rapid Box (F40_ G40_)	03/86→08/91	C2J 784	Petrol	1397	4	8	23
Rapid Box (F40_ G40_)	03/86→08/98	F8M 720	Diesel	1596	4	8	34
Rapid Box (F40_ G40_)	03/86→08/98	F8M 730	Diesel	1596	4	8	34
Rapid Box (F40_ G40_)	03/86→08/98	F8M 736	Diesel	1596	4	8	34
Rapid Box (F40_ G40_)	03/86→08/98	F8M 760	Diesel	1596	4	8	34
Rapid Box (F40_ G40_)	06/87→09/91	C1E 756	Petrol	1108	4	8	10
Rapid Box (F40_ G40_)	08/88→03/98	C3J 700	Petrol	1397	4	8	23
Rapid Box (F40_ G40_)	08/88→03/98	C3J 702	Petrol	1397	4	8	23
Rapid Box (F40_ G40_)	08/88→03/98	C3J 760	Petrol	1397	4	8	23
Rapid Box (F40_ G40_)	08/88→03/98	C3J 762	Petrol	1397	4	8	23
Rapid Box (F40_ G40_)	09/91→08/93	C1G 726	Petrol	1237	4	8	13
Rapid Box (F40_ G40_)	09/91→08/93	E6J 734	Petrol	1390	4	8	25
Rapid Box (F40_ G40_)	09/91→03/98	C3G 710	Petrol	1239	4	8	14
Rapid Box (F40_ G40_)	09/91→03/98	C3G 712	Petrol	1239	4	8	14
Rapid Box (F40_ G40_)	09/91→03/98	E7J 720	Petrol	1390	4	8	25
Rapid Box (F40_ G40_)	09/91→03/98	E7J 724	Petrol	1390	4	8	25
Rapid Box (F40_ G40_)	09/91→03/98	E7J 726	Petrol	1390	4	8	25
Rapid Box (F40_ G40_)	09/91→03/98	E7J 773	Petrol	1390	4	8	25
Rapid Box (F40_ G40_)	09/91→03/98	F8Q 646	Diesel	1870	4	8	55
Rapid Box (F40_ G40_)	09/91→03/98	F8Q 722	Diesel	1870	4	8	55
Rapid Box (F40_ G40_)	09/91→03/98	F8Q 724	Diesel	1870	4	8	55
Rapid Box (F40_ G40_)	09/91→03/98	F8Q 774	Diesel	1870	4	8	55
Rapid Box (F40_ G40_)	09/91→03/98	F8Q 776	Diesel	1870	4	8	55
Rapid Box (F40_ G40_)	01/94→03/98	E7J 728	Petrol	1390	4	8	25
Rapid Box (F40_ G40_)	09/94→03/98	F8Q 640	Diesel	1870	4	8	55
Rapid Box (F40_ G40_)	09/94→03/98	F8Q 682	Diesel	1870	4	8	59
Rapid Box (F40_ G40_)	05/95→11/98	E7F 708	Petrol	1171	4	8	17
Rapid Box (F40_ G40_)	08/96→11/01	K4M 706	Petrol	1598	4	16	36
Rodeo 5 (4D_ 5E_)	11/81→12/87	688 712	Petrol	1108	4	8	9
Rodeo 6 (ACL_)	08/73→11/81	688.10	Petrol	1108	4	8	9
Safrane I (B54_)	04/92→07/96	J7R 734	Petrol	1995	4	12	73
Safrane I (B54_)	04/92→07/96	J7R 735	Petrol	1995	4	12	73
Safrane I (B54_)	04/92→07/96	J7T 760	Petrol	2165	4	12	88
Safrane I (B54_)	04/92→07/96	J7T 761	Petrol	2165	4	12	88
Safrane I (B54_)	04/92→07/96	J7T 762	Petrol	2165	4	8	87
Safrane I (B54_)	11/92→07/96	J7R 732	Petrol	1995	4	8	74
Safrane I (B54_)	11/92→07/96	J7R 733	Petrol	1995	4	8	74
Safrane I (B54_)	12/92→07/96	S8U 762	Diesel	2500	4	8	98
Safrane I (B54_)	12/92→07/96	S8U 763	Diesel	2500	4	8	98
Safrane I (B54_)	12/92→07/96	Z7X 722	Petrol	2963	6	12	124
Safrane I (B54_)	12/92→07/96	Z7X 723	Petrol	2963	6	12	124
Safrane I (B54_)	12/92→07/96	Z7X 753	Petrol	2963	6	12	124
Safrane I (B54_)	12/92→10/96	Z7X 721	Petrol	2963	6	12	124
Safrane I (B54_)	02/93→07/96	Z7X 726	Petrol	2963	6	12	124
Safrane I (B54_)	11/93→07/96	J8S 760	Diesel	2068	4	8	81
Safrane II (B54_)	07/96→12/00	G8T 740	Diesel	2188	4	12	85
Safrane II (B54_)	07/96→12/00	N7Q 710	Petrol	1948	4	16	79
Safrane II (B54_)	07/96→12/00	N7Q 711	Petrol	1948	4	16	79
Safrane II (B54_)	07/96→12/00	N7U 700	Petrol	2435	5	20	106
Safrane II (B54_)	07/96→12/00	N7U 701	Petrol	2435	5	20	106
Safrane II (B54_)	07/96→12/00	Z7X 755	Petrol	2963	6	12	124
Safrane II (B54_)	03/99→12/00	L7X 713	Petrol	2946	6	24	120
Sandero/stepway	12/07→	K4M 690	Petrol	1598	4	16	38
Sandero/stepway	12/07→	K7M 710	Petrol	1598	4	8	39
Sandero/stepway I (BS_)	11/07→08/12	K7M 714	Petrol	1598	4	8	39
Sandero/stepway I (BS_)	11/07→	D4D 754	Petrol	999	4	16	6
Sandero/stepway I (BS_)	02/08→11/11	K9K 700	Diesel	1461	4	8	29
Sandero/stepway I (BS_)	02/08→11/11	K9K 740	Diesel	1461	4	8	29



Model	Year	Engine	Fuel	CC	Wrench	Screwdriver	Box
Sandero/stepway I (BS_)	02/08→	K4M 706	Petrol	1598	4	16	36
Sandero/stepway I (BS_)	08/08→	K4M 766	Petrol	1598	4	16	37
Sandero/stepway I (BS_)	02/09→	K7J 710	Petrol	1390	4	8	25
Sandero/stepway I (BS_)	02/09→	K7M 710	Petrol	1598	4	8	39
Sandero/stepway I (BS_)	11/10→	K7M 718	Petrol	1598	4	8	39
Sandero/stepway I (BS_)	12/12→	K4M 690	Petrol	1598	4	16	38
Sandero/stepway I (BS_)	03/14→	K7M 764	Petrol	1598	4	8	39
Sandero/stepway II (B8_)	11/13→	K7M 812	Petrol	1598	4	8	39
Sandero/stepway II (B8_)	12/13→	D4F 732	Petrol	1149	4	16	15
Sandero/stepway II (B8_)	12/13→	D4F 734	Petrol	1149	4	16	15
Sandero/stepway II (B8_)	12/13→	K9K 830	Diesel	1461	4	8	29
Sandero/stepway II (B8_)	09/14→	K7M 764	Petrol	1598	4	8	39
Sandero/stepway II (B8_)	05/15→	K4M 842	Petrol	1598	4	16	36
Sandero/stepway II (B8_)	05/15→	K7M 710	Petrol	1598	4	8	39
Sandero/stepway II (B8_)	09/15→	H4B 400	Petrol	898	3	12	1
Scala (LJM_)	01/12→	K9K 766	Diesel	1461	4	8	29
Scénic I (JAO/1_)	09/99→03/01	F8Q 790	Diesel	1870	4	8	61
Scénic I (JAO/1_)	09/99→04/01	K4M 704	Petrol	1598	4	16	36
Scénic I (JAO/1_)	09/99→04/01	K4M 712	Petrol	1598	4	16	36
Scénic I (JAO/1_)	09/99→08/03	F4R 740	Petrol	1998	4	16	69
Scénic I (JAO/1_)	09/99→08/03	F4R 741	Petrol	1998	4	16	69
Scénic I (JAO/1_)	09/99→08/03	F4R 744	Petrol	1998	4	16	69
Scénic I (JAO/1_)	09/99→08/03	F4R 747	Petrol	1998	4	16	69
Scénic I (JAO/1_)	09/99→08/03	F9Q 731	Diesel	1870	4	8	62
Scénic I (JAO/1_)	09/99→08/03	F9Q 732	Diesel	1870	4	8	62
Scénic I (JAO/1_)	09/99→08/03	F9Q 733	Diesel	1870	4	8	62
Scénic I (JAO/1_)	09/99→08/03	F9Q 734	Diesel	1870	4	8	62
Scénic I (JAO/1_)	09/99→08/03	F9Q 736	Diesel	1870	4	8	62
Scénic I (JAO/1_)	09/99→08/03	K4J 714	Petrol	1390	4	16	27
Scénic I (JAO/1_)	09/99→08/03	K4J 750	Petrol	1390	4	16	27
Scénic I (JAO/1_)	09/99→09/03	K4M 700	Petrol	1598	4	16	36
Scénic I (JAO/1_)	09/99→09/03	K4M 706	Petrol	1598	4	16	36
Scénic I (JAO/1_)	06/00→08/03	F4R 746	Petrol	1998	4	16	69
Scénic I (JAO/1_)	07/00→08/03	F4P 722	Petrol	1783	4	16	51
Scénic I (JAO/1_)	11/00→08/03	F9Q 740	Diesel	1870	4	8	62
Scénic I (JAO/1_)	01/01→08/03	F4P 720	Petrol	1783	4	16	51
Scénic I (JAO/1_)	02/01→08/03	F9Q 744	Diesel	1870	4	8	62
Scénic I (JAO/1_)	03/01→08/03	K4M 709	Petrol	1598	4	16	36
Scénic I (JAO/1_)	03/01→09/03	K4M 708	Petrol	1598	4	16	36
Scénic I (JAO/1_)	06/01→09/03	K4M 701	Petrol	1598	4	16	36
Scénic I (JAO/1_)	12/02→08/03	F9Q 748	Diesel	1870	4	8	62
Scénic I (JAO/1_)	12/02→08/03	F9Q 796	Diesel	1870	4	8	62
Scénic II (JMO/1_)	06/03→07/10	F4R 746	Petrol	1998	4	16	69
Scénic II (JMO/1_)	06/03→	F4R 770	Petrol	1998	4	16	69
Scénic II (JMO/1_)	06/03→	F4R 771	Petrol	1998	4	16	69
Scénic II (JMO/1_)	06/03→	F9Q 804	Diesel	1870	4	8	62
Scénic II (JMO/1_)	06/03→	F9Q 812	Diesel	1870	4	8	62
Scénic II (JMO/1_)	06/03→	K4J 730	Petrol	1390	4	16	27
Scénic II (JMO/1_)	06/03→	K4J 740	Petrol	1390	4	16	27
Scénic II (JMO/1_)	06/03→	K4J 770	Petrol	1390	4	16	27
Scénic II (JMO/1_)	06/03→	K4M 761	Petrol	1598	4	16	37
Scénic II (JMO/1_)	06/03→	K4M 782	Petrol	1598	4	16	37
Scénic II (JMO/1_)	06/03→	K9K 722	Diesel	1461	4	8	29
Scénic II (JMO/1_)	08/03→05/06	K4M 764	Petrol	1598	4	16	36
Scénic II (JMO/1_)	11/03→	K9K 728	Diesel	1461	4	8	29
Scénic II (JMO/1_)	11/03→	K9K 729	Diesel	1461	4	8	29
Scénic II (JMO/1_)	04/04→10/08	F9Q 803	Diesel	1870	4	8	62
Scénic II (JMO/1_)	05/04→	F4R 776	Petrol	1998	4	16	69
Scénic II (JMO/1_)	03/05→	K4M 766	Petrol	1598	4	16	37
Scénic II (JMO/1_)	05/05→	F9Q 816	Diesel	1870	4	8	62
Scénic II (JMO/1_)	05/05→	F9Q 818	Diesel	1870	4	8	62
Scénic II (JMO/1_)	05/05→	F9Q J 803	Diesel	1870	4	8	62
Scénic II (JMO/1_)	05/05→	K9K 724	Diesel	1461	4	8	29
Scénic II (JMO/1_)	05/05→	K9K 732	Diesel	1461	4	8	29
Scénic II (JMO/1_)	09/05→	M9R 700	Diesel	1995	4	16	77
Scénic II (JMO/1_)	09/05→	M9R 721	Diesel	1995	4	16	77
Scénic II (JMO/1_)	09/05→	M9R 722	Diesel	1995	4	16	77
Scénic II (JMO/1_)	10/05→	K4M 706	Petrol	1598	4	16	36
Scénic II (JMO/1_)	10/05→	K4M 812	Petrol	1598	4	16	37
Scénic II (JMO/1_)	10/05→	K4M 813	Petrol	1598	4	16	37
Scénic II (JMO/1_)	06/06→	K4M 788	Petrol	1598	4	16	36
Scénic II (JMO/1_)	01/07→	K9K 734	Diesel	1461	4	8	29
Scénic III (JZO/1_)	02/09→	F9Q 870	Diesel	1870	4	8	62
Scénic III (JZO/1_)	02/09→	F9Q 872	Diesel	1870	4	8	62
Scénic III (JZO/1_)	02/09→	H4J 700	Petrol	1397	4	16	26
Scénic III (JZO/1_)	02/09→	K4M 858	Petrol	1598	4	16	37
Scénic III (JZO/1_)	02/09→	K4M 866	Petrol	1598	4	16	37
Scénic III (JZO/1_)	02/09→	K4M R 858	Petrol	1598	4	16	37

							
Scénic III (JZO/1_)	02/09→	K9K 832	Diesel	1461	4	8	29
Scénic III (JZO/1_)	02/09→	M4R 710	Petrol	1997	4	16	76
Scénic III (JZO/1_)	02/09→	M4R 711	Petrol	1997	4	16	75
Scénic III (JZO/1_)	02/09→	M4R 713	Petrol	1997	4	16	75
Scénic III (JZO/1_)	02/09→	M9R 615	Diesel	1995	4	16	77
Scénic III (JZO/1_)	04/09→	K9K 636	Diesel	1461	4	8	29
Scénic III (JZO/1_)	04/09→	K9K 656	Diesel	1461	4	8	29
Scénic III (JZO/1_)	04/09→	K9K 657	Diesel	1461	4	8	29
Scénic III (JZO/1_)	04/09→	K9K 830	Diesel	1461	4	8	29
Scénic III (JZO/1_)	04/09→	K9K 836	Diesel	1461	4	8	29
Scénic III (JZO/1_)	04/09→	K9K 837	Diesel	1461	4	8	29
Scénic III (JZO/1_)	04/09→	M9R 610	Diesel	1995	4	16	77
Scénic III (JZO/1_)	11/10→	K9K 846	Diesel	1461	4	8	29
Scénic III (JZO/1_)	04/11→	R9M 402	Diesel	1598	4	16	42
Scénic III (JZO/1_)	04/11→	R9M 404	Diesel	1598	4	16	42
Scénic III (JZO/1_)	04/12→	H5F 400	Petrol	1197	4	16	18
Scénic III (JZO/1_)	01/13→	H5F 404	Petrol	1198	4	16	18
Scénic IV (J9_)	09/16→	H5F 408	Petrol	1197	4	16	18
Scénic IV (J9_)	09/16→	K9K 646	Diesel	1461	4	8	29
Scénic IV (J9_)	09/16→	K9K 647	Diesel	1461	4	8	29
Scénic IV (J9_)	09/16→	K9K 846	Diesel	1461	4	8	29
Scénic IV (J9_)	09/16→	R9M 409	Diesel	1598	4	16	42
Scénic IV (J9_)	09/16→	R9M 452	Diesel	1598	4	16	43
SM3 (L38)	04/09→	HR16DE	Petrol	1598	4	16	35
SM3 (L38)	06/09→	K4M 858	Petrol	1598	4	16	37
SM3 (N16)	09/02→08/04	QG15DE	Petrol	1498	4	16	30
SM5 (A32)	02/98→10/01	SR20DE	Petrol	1998	4	16	80
SM5 (A34R)	09/04→12/09	MR20DE	Petrol	1998	4	16	75
SM5 (L43)	01/10→	MR16DDT	Petrol	1618	4	16	41
SM5 (L43)	01/10→	MR20DE	Petrol	1998	4	16	75
SM5 (L43)	01/11→	VQ25DE	Petrol	2496	6	24	110
SM6	01/16→	MR16DDT	Petrol	1618	4	16	41
SM6	01/16→	MR20DE	Petrol	1998	4	16	75
SM7 (L47)	08/11→	VQ35	Petrol	3498	6	24	126
SM7 (L47)	09/14→	MR20DE	Petrol	1998	4	16	75
Sport Spider (EFO_)	03/95→10/99	F7R 710	Petrol	1998	4	16	71
Super 5 (B/C40_)	10/84→06/88	C1J 768	Petrol	1397	4	8	23
Super 5 (B/C40_)	10/84→06/88	C1J 780	Petrol	1397	4	8	23
Super 5 (B/C40_)	10/84→10/88	C1E 754	Petrol	1108	4	8	10
Super 5 (B/C40_)	10/84→07/89	C2J 700	Petrol	1397	4	8	23
Super 5 (B/C40_)	10/84→07/89	C2J 780	Petrol	1397	4	8	23
Super 5 (B/C40_)	10/84→07/89	C2J 781	Petrol	1397	4	8	23
Super 5 (B/C40_)	10/84→07/89	C2J 788	Petrol	1397	4	8	23
Super 5 (B/C40_)	10/84→07/89	C2J 789	Petrol	1397	4	8	23
Super 5 (B/C40_)	10/84→07/89	C2J 798	Petrol	1397	4	8	23
Super 5 (B/C40_)	10/84→06/92	C1C 700	Petrol	956	4	8	4
Super 5 (B/C40_)	10/84→03/95	C1E 750	Petrol	1108	4	8	10
Super 5 (B/C40_)	10/84→03/95	C1E 752	Petrol	1108	4	8	10
Super 5 (B/C40_)	01/85→05/91	840 730	Petrol	1397	4	8	21
Super 5 (B/C40_)	04/85→08/90	C1J 782	Petrol	1397	4	8	23
Super 5 (B/C40_)	04/85→08/90	C1J 784	Petrol	1397	4	8	23
Super 5 (B/C40_)	04/85→08/90	C1J 788	Petrol	1397	4	8	23
Super 5 (B/C40_)	04/85→12/96	F8M 730	Diesel	1596	4	8	34
Super 5 (B/C40_)	08/85→12/96	F8M 720	Diesel	1596	4	8	34
Super 5 (B/C40_)	10/85→12/96	C3J 700	Petrol	1397	4	8	23
Super 5 (B/C40_)	10/85→12/96	C3J 702	Petrol	1397	4	8	23
Super 5 (B/C40_)	10/85→12/96	C3J 760	Petrol	1397	4	8	23
Super 5 (B/C40_)	01/86→03/95	C1E 756	Petrol	1108	4	8	10
Super 5 (B/C40_)	01/86→03/95	C1E 760	Petrol	1108	4	8	10
Super 5 (B/C40_)	10/86→08/91	F3N 702	Petrol	1721	4	8	45
Super 5 (B/C40_)	10/86→08/91	F3N 722	Petrol	1721	4	8	45
Super 5 (B/C40_)	10/86→03/95	F3N 716	Petrol	1721	4	8	45
Super 5 (B/C40_)	10/86→03/95	F3N 717	Petrol	1721	4	8	45
Super 5 (B/C40_)	01/87→08/90	C1G 702	Petrol	1237	4	8	13
Super 5 (B/C40_)	01/87→08/90	C1G 720	Petrol	1237	4	8	13
Super 5 (B/C40_)	01/87→08/90	C1G 722	Petrol	1237	4	8	13
Super 5 (B/C40_)	06/87→07/89	C2J 782	Petrol	1397	4	8	23
Super 5 (B/C40_)	06/87→08/90	C2J 784	Petrol	1397	4	8	23
Super 5 (B/C40_)	06/87→03/95	F2N 740	Petrol	1721	4	8	45
Super 5 (B/C40_)	06/87→03/95	F2N 742	Petrol	1721	4	8	45
Super 5 Box (S40_)	10/84→10/88	C1C 700	Petrol	956	4	8	4
Super 5 Box (S40_)	10/84→12/96	C1E 750	Petrol	1108	4	8	10
Super 5 Box (S40_)	10/84→12/96	C1E 752	Petrol	1108	4	8	10
Super 5 Box (S40_)	10/84→12/96	C1E 754	Petrol	1108	4	8	10
Super 5 Box (S40_)	10/84→12/96	F8M 720	Diesel	1596	4	8	34
Super 5 Box (S40_)	04/85→10/87	C1J 788	Petrol	1397	4	8	23
Super 5 Box (S40_)	09/85→07/86	C3J 700	Petrol	1397	4	8	23
Super 5 Box (S40_)	01/87→12/96	C1G 702	Petrol	1237	4	8	13











CC











9









SV110	07/94→12/00	TD27TI	Diesel	2664	4	8	114
Talisman (L2M_)	06/15→	R9M 452	Diesel	1598	4	16	43
Talisman (L2M_)	06/15→	R9M 453	Diesel	1598	4	16	42
Talisman (L2M_)	11/15→	K9K 646	Diesel	1461	4	8	29
Talisman (L2M_)	11/15→	K9K 647	Diesel	1461	4	8	29
Talisman (L2M_)	11/15→	M5M 450	Petrol	1618	4	16	40
Talisman (L2M_)	11/15→	R9M 409	Diesel	1598	4	16	42
Talisman Grandtour (KP_)	03/16→	K9K 646	Diesel	1461	4	8	29
Talisman Grandtour (KP_)	03/16→	K9K 647	Diesel	1461	4	8	29
Talisman Grandtour (KP_)	03/16→	M5M 450	Petrol	1618	4	16	40
Talisman Grandtour (KP_)	03/16→	R9M 409	Diesel	1598	4	16	42
Talisman Grandtour (KP_)	03/16→	R9M 452	Diesel	1598	4	16	43
Talisman Grandtour (KP_)	03/16→	R9M 453	Diesel	1598	4	16	42
Thalia (LBO/1/2_)	02/98→10/03	D7F 744	Petrol	1149	4	8	16
Thalia (LBO/1/2_)	02/98→10/03	D7F 746	Petrol	1149	4	8	16
Thalia (LBO/1/2_)	03/98→	K7M 746	Petrol	1598	4	8	39
Thalia I (LBO/1/2_)	02/98→05/01	F8Q 630	Diesel	1870	4	8	56
Thalia I (LBO/1/2_)	06/00→01/05	D4D 754	Petrol	999	4	16	6
Thalia I (LBO/1/2_)	08/00→	K4J 712	Petrol	1390	4	16	27
Thalia I (LBO/1/2_)	08/00→	K7J 700	Petrol	1390	4	8	25
Thalia I (LBO/1/2_)	06/01→	K9K 702	Diesel	1461	4	8	29
Thalia I (LBO/1/2_)	04/02→	D4F 706	Petrol	1149	4	16	15
Thalia I (LBO/1/2_)	04/02→	D4F 712	Petrol	1149	4	16	15
Thalia I (LBO/1/2_)	04/02→	K4M 740	Petrol	1598	4	16	36
Thalia I (LBO/1/2_)	04/02→	K9K 700	Diesel	1461	4	8	29
Thalia I (LBO/1/2_)	02/03→	K9K 714	Diesel	1461	4	8	29
Thalia I (LBO/1/2_)	01/04→12/08	K4M 736	Petrol	1598	4	16	36
Thalia I (LBO/1/2_)	04/04→11/09	K9K 706	Diesel	1461	4	8	29
Thalia I (LBO/1/2_)	06/05→	K9K 740	Diesel	1461	4	8	29
Thalia II (LU1/2_)	09/08→06/14	K7J 700	Petrol	1390	4	8	25
Thalia II (LU1/2_)	09/08→	D4F 728	Petrol	1149	4	16	15
Thalia II (LU1/2_)	09/08→	K4M 743	Petrol	1598	4	16	36
Thalia II (LU1/2_)	09/08→	K9K 718	Diesel	1461	4	8	29
Thalia II (LU1/2_)	09/08→	K9K 740	Diesel	1461	4	8	29
Thalia II (LU1/2_)	01/09→	K4M 744	Petrol	1598	4	16	36
Thalia II (LU1/2_)	01/09→	K4M 745	Petrol	1598	4	16	36
Thalia II (LU1/2_)	01/09→	K9K 700	Diesel	1461	4	8	29
Thalia II (LU1/2_)	01/09→	K9K 834	Diesel	1461	4	8	29
Thalia II (LU1/2_)	11/12→06/14	H4B 400	Petrol	898	3	12	1
Thalia II (LU1/2_)	11/12→06/14	K9K 612	Diesel	1461	4	8	29
Thalia III (L8_)	12/13→	D4F 732	Petrol	1149	4	16	15
Thalia III (L8_)	12/13→	K4M 842	Petrol	1598	4	16	36
Thalia III (L8_)	12/13→	K9K 612	Diesel	1461	4	8	29
Thalia III (L8_)	03/14→	K7M 812	Petrol	1598	4	8	39
Trafic Box (T1, T3, T4)	03/80→04/89	847 700	Petrol	1397	4	8	22
Trafic Box (T1, T3, T4)	03/80→04/89	847 701	Petrol	1397	4	8	22
Trafic Box (T1, T3, T4)	03/80→04/89	C1J 700	Petrol	1397	4	8	23
Trafic Box (T1, T3, T4)	07/80→04/85	829 720	Petrol	1995	4	8	64
Trafic Box (T1, T3, T4)	09/80→04/89	852 750	Diesel	2068	4	8	81
Trafic Box (T1, T3, T4)	01/83→06/86	A1M 707	Petrol	1647	4	8	31
Trafic Box (T1, T3, T4)	01/83→06/86	A1M 708	Petrol	1647	4	8	31
Trafic Box (T1, T3, T4)	05/85→04/89	J5R 716	Petrol	1995	4	8	64
Trafic Box (T1, T3, T4)	06/86→04/89	FIN 724	Petrol	1721	4	8	44
Trafic Box (T1, T3, T4)	06/86→04/89	J5R 722	Petrol	1995	4	8	64
Trafic Box (T1, T3, T4)	06/86→04/89	J5R 726	Petrol	1995	4	8	64
Trafic Box (TXX)	03/89→08/94	FIN 724	Petrol	1721	4	8	44
Trafic Box (TXX)	03/89→03/01	S8U 750	Diesel	2499	4	8	107
Trafic Box (TXX)	05/89→08/90	J5R 716	Petrol	1995	4	8	64
Trafic Box (TXX)	05/89→06/91	C1J 700	Petrol	1397	4	8	23
Trafic Box (TXX)	05/89→06/94	852 750	Diesel	2068	4	8	81
Trafic Box (TXX)	05/89→06/94	J7T 780	Petrol	2165	4	8	87
Trafic Box (TXX)	05/89→03/01	8140.67.2500	Diesel	2499	4	8	101
Trafic Box (TXX)	05/89→03/01	8140.67.2550	Diesel	2499	4	8	103
Trafic Box (TXX)	05/89→03/01	8140.67.2580	Diesel	2499	4	8	103
Trafic Box (TXX)	05/89→03/01	S8U 752	Diesel	2499	4	8	99
Trafic Box (TXX)	05/89→03/01	S8U 758	Diesel	2499	4	8	99
Trafic Box (TXX)	07/89→08/92	C1J 768	Petrol	1397	4	8	23
Trafic Box (TXX)	08/92→08/94	FIN 720	Petrol	1721	4	8	44
Trafic Box (TXX)	06/94→10/97	J7T 600	Petrol	2165	4	8	87
Trafic Box (TXX)	06/94→10/97	J8S 620	Diesel	2068	4	8	81
Trafic Box (TXX)	06/94→10/97	J8S 758	Petrol	2068	4	8	81
Trafic Box (TXX)	06/97→03/01	F8Q 606	Diesel	1870	4	8	54
Trafic Bus (T5, T6, T7)	03/80→08/86	A1M 707	Petrol	1647	4	8	31
Trafic Bus (T5, T6, T7)	03/80→04/89	847 700	Petrol	1397	4	8	22
Trafic Bus (T5, T6, T7)	03/80→04/89	847 701	Petrol	1397	4	8	22
Trafic Bus (T5, T6, T7)	03/80→04/89	852 750	Diesel	2068	4	8	81
Trafic Bus (T5, T6, T7)	03/80→04/89	C1J 700	Petrol	1397	4	8	23
Trafic Bus (T5, T6, T7)	07/80→04/85	829 720	Petrol	1995	4	8	64









							
Trafic Bus (T5, T6, T7)	01/84→06/86	841 705	Petrol	1647	4	8	31
Trafic Bus (T5, T6, T7)	01/84→06/86	A1M 708	Petrol	1647	4	8	31
Trafic Bus (T5, T6, T7)	06/86→04/89	F1N 724	Petrol	1721	4	8	44
Trafic Bus (T5, T6, T7)	06/86→04/89	J5R 716	Petrol	1995	4	8	64
Trafic Bus (T5, T6, T7)	06/86→04/89	J5R 722	Petrol	1995	4	8	64
Trafic Bus (T5, T6, T7)	06/86→04/89	J5R 726	Petrol	1995	4	8	64
Trafic Bus (TXW)	03/89→03/01	S8U 750	Diesel	2499	4	8	107
Trafic Bus (TXW)	05/89→08/90	J5R 726	Petrol	1995	4	8	64
Trafic Bus (TXW)	05/89→06/94	852 720	Diesel	2068	4	8	81
Trafic Bus (TXW)	05/89→06/94	852 750	Diesel	2068	4	8	81
Trafic Bus (TXW)	05/89→06/94	J7T 780	Petrol	2165	4	8	87
Trafic Bus (TXW)	05/89→03/01	8140.67.2500	Diesel	2499	4	8	101
Trafic Bus (TXW)	05/89→03/01	8140.67.2550	Diesel	2499	4	8	103
Trafic Bus (TXW)	05/89→03/01	8140.67.2580	Diesel	2499	4	8	103
Trafic Bus (TXW)	05/89→03/01	S8U 752	Diesel	2499	4	8	99
Trafic Bus (TXW)	05/89→03/01	S8U 758	Diesel	2499	4	8	99
Trafic Bus (TXW)	08/92→08/94	F1N 724	Petrol	1721	4	8	44
Trafic Bus (TXW)	06/94→10/97	J7T 600	Petrol	2165	4	8	87
Trafic Bus (TXW)	06/94→10/97	J8S 620	Diesel	2068	4	8	81
Trafic Bus (TXW)	06/94→10/97	J8S 758	Diesel	2068	4	8	81
Trafic Bus (TXW)	06/97→03/01	F8Q 606	Diesel	1870	4	8	54
Trafic II Box (FL)	03/01→	F4R 720	Petrol	1998	4	16	69
Trafic II Box (FL)	03/01→	F4R 722	Petrol	1998	4	16	69
Trafic II Box (FL)	03/01→	F9Q 760	Diesel	1870	4	8	62
Trafic II Box (FL)	03/01→	F9Q 762	Diesel	1870	4	8	62
Trafic II Box (FL)	03/03→	G9U 730	Diesel	2464	4	16	105
Trafic II Box (FL)	08/06→	F4R 820	Petrol	1998	4	16	69
Trafic II Box (FL)	08/06→	G9U 630	Diesel	2464	4	16	105
Trafic II Box (FL)	08/06→	M9R 630	Diesel	1995	4	16	77
Trafic II Box (FL)	08/06→	M9R 692	Diesel	1995	4	16	77
Trafic II Box (FL)	08/06→	M9R 780	Diesel	1995	4	16	77
Trafic II Box (FL)	08/06→	M9R 782	Diesel	1995	4	16	77
Trafic II Box (FL)	08/06→	M9R 786	Diesel	1995	4	16	77
Trafic II Bus (JL)	03/01→	F4R 720	Petrol	1998	4	16	69
Trafic II Bus (JL)	03/01→	F4R 722	Petrol	1998	4	16	69
Trafic II Bus (JL)	03/01→	F9Q 760	Diesel	1870	4	8	62
Trafic II Bus (JL)	03/01→	F9Q 762	Diesel	1870	4	8	62
Trafic II Bus (JL)	03/03→	G9U 730	Diesel	2464	4	16	105
Trafic II Bus (JL)	08/06→	F4R 820	Petrol	1998	4	16	69
Trafic II Bus (JL)	08/06→	G9U 630	Diesel	2464	4	16	105
Trafic II Bus (JL)	08/06→	M9R 630	Diesel	1995	4	16	77
Trafic II Bus (JL)	08/06→	M9R 692	Diesel	1995	4	16	77
Trafic II Bus (JL)	08/06→	M9R 780	Diesel	1995	4	16	77
Trafic II Bus (JL)	08/06→	M9R 782	Diesel	1995	4	16	77
Trafic II Bus (JL)	08/06→	M9R 786	Diesel	1995	4	16	77
Trafic II Platform/Chassis (EL)	03/01→	F4R 720	Petrol	1998	4	16	69
Trafic II Platform/Chassis (EL)	03/01→	F9Q 760	Diesel	1870	4	8	62
Trafic II Platform/Chassis (EL)	03/01→	F9Q 762	Diesel	1870	4	8	62
Trafic II Platform/Chassis (EL)	03/01→	G9U 730	Diesel	2464	4	16	105
Trafic II Platform/Chassis (EL)	08/06→	F4R 820	Petrol	1998	4	16	69
Trafic II Platform/Chassis (EL)	08/06→	G9U 630	Diesel	2464	4	16	105
Trafic II Platform/Chassis (EL)	08/06→	M9R 780	Diesel	1995	4	16	77
Trafic II Platform/Chassis (EL)	08/06→	M9R 782	Diesel	1995	4	16	77
Trafic II Platform/Chassis (EL)	08/06→	M9R 786	Diesel	1995	4	16	77
Trafic III Box (FG_)	05/14→	R9M 408	Diesel	1598	4	16	43
Trafic III Box (FG_)	05/14→	R9M 450	Diesel	1598	4	16	43
Trafic III Bus (JG_)	05/14→	R9M 408	Diesel	1598	4	16	43
Trafic III Bus (JG_)	05/14→	R9M 450	Diesel	1598	4	16	43
Trafic III Bus (JG_)	07/15→	R9M 413	Diesel	1598	4	16	43
Trafic III Bus (JG_)	07/15→	R9M 452	Diesel	1598	4	16	43
Trafic III Platform/Chassis (EG_)	06/14→	R9M 450	Diesel	1598	4	16	43
Trafic Platform/Chassis (P6)	03/80→06/86	841 705	Petrol	1647	4	8	31
Trafic Platform/Chassis (P6)	03/80→06/86	A1M 705	Petrol	1647	4	8	31
Trafic Platform/Chassis (P6)	03/80→12/86	829 720	Petrol	1995	4	8	64
Trafic Platform/Chassis (P6)	03/80→12/86	829 721	Petrol	1995	4	8	64
Trafic Platform/Chassis (P6)	03/80→04/89	8140.61.240	Diesel	2445	4	8	93
Trafic Platform/Chassis (P6)	03/80→04/89	847 700	Petrol	1397	4	8	22
Trafic Platform/Chassis (P6)	03/80→04/89	852 720	Diesel	2068	4	8	81
Trafic Platform/Chassis (P6)	03/80→04/89	C1J 700	Petrol	1397	4	8	23
Trafic Platform/Chassis (P6)	03/80→04/89	J5R 726	Petrol	1995	4	8	64
Trafic Platform/Chassis (P6)	03/80→04/89	S8U 720	Diesel	2445	4	8	99
Trafic Platform/Chassis (P6)	03/80→04/89	S8U 722	Diesel	2445	4	8	99
Trafic Platform/Chassis (P6)	07/80→02/89	852 750	Diesel	2068	4	8	81
Trafic Platform/Chassis (P6)	05/85→02/89	J5R 716	Petrol	1995	4	8	64
Trafic Platform/Chassis (P6)	05/85→02/89	J8S 750	Diesel	2068	4	8	81
Trafic Platform/Chassis (P6)	06/86→04/89	F1N 722	Petrol	1721	4	8	44
Trafic Platform/Chassis (PXX)	03/89→08/94	S8U 750	Diesel	2499	4	8	107
Trafic Platform/Chassis (PXX)	03/89→10/97	J5R 726	Petrol	1995	4	8	64



















Trafic Platform/Chassis (PXX)	05/89→06/94	852 720	Diesel	2068	4	8	81
Trafic Platform/Chassis (PXX)	05/89→06/94	J7T 780	Petrol	2165	4	8	87
Trafic Platform/Chassis (PXX)	05/89→08/94	FIN 722	Petrol	1721	4	8	44
Trafic Platform/Chassis (PXX)	05/89→03/01	8140.61.240	Diesel	2445	4	8	93
Trafic Platform/Chassis (PXX)	05/89→03/01	S8U 720	Diesel	2445	4	8	99
Trafic Platform/Chassis (PXX)	05/89→03/01	S8U 722	Diesel	2445	4	8	99
Trafic Platform/Chassis (PXX)	06/94→10/97	J8S 758	Diesel	2068	4	8	81
Trafic Platform/Chassis (PXX)	06/94→04/98	J8S 620	Diesel	2068	4	8	81
Trafic Platform/Chassis (PXX)	09/94→04/98	J7T 600	Petrol	2165	4	8	87
Trafic Platform/Chassis (PXX)	09/94→03/01	S8U 758	Diesel	2499	4	8	99
Trafic Platform/Chassis (PXX)	05/98→03/01	S8U 780	Diesel	2499	4	8	108
Twingo (C06_)	09/98→08/00	D7F 702	Petrol	1149	4	8	16
Twingo (C06_)	09/98→08/00	D7F 703	Petrol	1149	4	8	16
Twingo (C06_)	09/98→08/00	D7F 704	Petrol	1149	4	8	16
Twingo I (C06_)	03/93→10/96	C3G 700	Petrol	1239	4	8	14
Twingo I (C06_)	03/93→10/96	C3G 702	Petrol	1239	4	8	14
Twingo I (C06_)	05/96→06/07	D7F 700	Petrol	1149	4	8	11
Twingo I (C06_)	05/96→06/07	D7F 701	Petrol	1149	4	8	16
Twingo I (C06_)	05/96→06/07	D7F 702	Petrol	1149	4	8	16
Twingo I (C06_)	05/96→06/07	D7F 703	Petrol	1149	4	8	16
Twingo I (C06_)	05/96→06/07	D7F 704	Petrol	1149	4	8	16
Twingo I (C06_)	01/00→05/07	D7D 740	Petrol	999	4	8	7
Twingo I (C06_)	01/01→06/07	D4F 702	Petrol	1149	4	16	15
Twingo I (C06_)	03/01→05/07	D4D 712	Petrol	999	4	16	6
Twingo I (C06_)	10/03→06/07	D7F 708	Petrol	1149	4	8	16
Twingo I (C06_)	08/04→06/07	D4F 708	Petrol	1149	4	16	15
Twingo I Box (S06_)	03/93→05/96	C3G 700	Petrol	1239	4	8	14
Twingo I Box (S06_)	03/93→05/96	C3G 702	Petrol	1239	4	8	14
Twingo I Box (S06_)	05/96→08/04	D7F 700	Petrol	1149	4	8	11
Twingo I Box (S06_)	05/96→08/04	D7F 701	Petrol	1149	4	8	16
Twingo I Box (S06_)	05/96→08/04	D7F 702	Petrol	1149	4	8	16
Twingo I Box (S06_)	05/96→08/04	D7F 703	Petrol	1149	4	8	16
Twingo I Box (S06_)	05/96→08/04	D7F 704	Petrol	1149	4	8	16
Twingo I Box (S06_)	05/96→08/04	D7F 706	Petrol	1149	4	8	16
Twingo II (CNO_)	03/07→	D4F 764	Petrol	1149	4	16	15
Twingo II (CNO_)	03/07→	D4F 770	Petrol	1149	4	16	15
Twingo II (CNO_)	03/07→	D4F 772	Petrol	1149	4	16	15
Twingo II (CNO_)	03/07→	D4F 780	Petrol	1149	4	16	15
Twingo II (CNO_)	03/07→	D4F 782	Petrol	1149	4	16	15
Twingo II (CNO_)	03/07→	D7F 800	Petrol	1149	4	8	16
Twingo II (CNO_)	03/07→	K9K 740	Diesel	1461	4	8	29
Twingo II (CNO_)	04/08→	K9K 718	Diesel	1461	4	8	29
Twingo II (CNO_)	05/08→	K4M 854	Petrol	1598	4	16	37
Twingo II (CNO_)	10/10→	K9K 820	Diesel	1461	4	8	29
Twingo III (BCM_)	09/14→	H4B 401	Petrol	898	3	12	1
Twingo III (BCM_)	09/14→	H4D 400	Petrol	999	3	12	8
Vel Satis (BJO_)	06/02→	F4R 762	Petrol	1998	4	16	69
Vel Satis (BJO_)	06/02→	F4R 763	Petrol	1998	4	16	69
Vel Satis (BJO_)	06/02→	G9T 702	Diesel	2188	4	16	86
Vel Satis (BJO_)	06/02→	G9T 703	Diesel	2188	4	16	86
Vel Satis (BJO_)	06/02→	P9X 701	Diesel	2958	6	24	123
Vel Satis (BJO_)	06/02→	V4Y 701	Petrol	3498	6	24	126
Vel Satis (BJO_)	06/02→	V4Y 711	Petrol	3498	6	24	126
Vel Satis (BJO_)	06/02→	V4Y 715	Petrol	3498	6	24	126
Vel Satis (BJO_)	04/04→	F4R 766	Petrol	1998	4	16	69
Vel Satis (BJO_)	04/04→	F4R 767	Petrol	1998	4	16	69
Vel Satis (BJO_)	04/04→	G9T 600	Diesel	2188	4	16	86
Vel Satis (BJO_)	09/04→	G9T 606	Diesel	2188	4	16	86
Vel Satis (BJO_)	09/04→	G9T 607	Diesel	2188	4	16	86
Vel Satis (BJO_)	09/04→	G9T 700	Diesel	2188	4	16	86
Vel Satis (BJO_)	04/05→	F4R 867	Petrol	1998	4	16	69
Vel Satis (BJO_)	08/05→	M9R 760	Diesel	1995	4	16	77
Vel Satis (BJO_)	01/06→	M9R 762	Diesel	1995	4	16	77
Vel Satis (BJO_)	01/06→	M9R 763	Diesel	1995	4	16	77
Vel Satis (BJO_)	06/06→	P9X 715	Diesel	2958	6	24	123
Wind (E4M_)	07/10→	D4F 782	Petrol	1149	4	16	15
Wind (E4M_)	07/10→	K4M 854	Petrol	1598	4	16	37
Wind (E4M_)	02/11→	D4F 780	Petrol	1149	4	16	15









	CC				9		CC				9
2TR 700	2488	4	16	Petrol	95	843.05	1647	4	8	Petrol	31
2TR 702	2488	4	16	Petrol	95	843.20	1647	4	8	Petrol	31
2TR 702	2488	4	16	Petrol	95	843.21	1647	4	8	Petrol	31
2TR 703	2488	4	16	Petrol	95	843.719	1647	4	8	Petrol	31
2TR A 703	2488	4	16	Petrol	96	844.12	1605	4	8	Petrol	31
2TR B 700	2488	4	16	Petrol	96	847.99	1397	4	8	Petrol	22
112	2664	6	12	Petrol	113	852	2068	4	8	Diesel	81
129	1218	4	8	Petrol	12	852 J8S	2068	4	8	Diesel	81
140	2664	6	12	Petrol	113	8140.07.2530 ID	2500	4	8	Diesel	98
144	2664	6	12	Petrol	113	8140.07.2530 ID	2500	4	8	Diesel	98
144.01	2664	6	12	Petrol	113	8140.07.2585	2500	4	8	Diesel	98
150	1360	4	8	Petrol	20	8140.07.2585	2500	4	8	Diesel	98
597.02	5278	6	12	Diesel	133	8140.07.2700	2499	4	8	Diesel	98
688.01	1108	4	8	Petrol	9	8140.07.3700	2499	4	8	Diesel	98
688.03	1108	4	8	Petrol	9	8140.21.235 IDS	2445	4	8	Diesel	90
688.06	1108	4	8	Petrol	9	8140.21.235 IDS	2445	4	8	Diesel	90
688.09	1108	4	8	Petrol	9	8140.23.2565	2800	4	8	Diesel	116
688.10	1108	4	8	Petrol	9	8140.23.2565	2800	4	8	Diesel	116
688.11	1108	4	8	Petrol	9	8140.23.2585	2800	4	16	Diesel	117
688.12	1108	4	8	Petrol	9	8140.23.2585	2800	4	16	Diesel	117
689.01	956	4	8	Petrol	3	8140.27.2500	2499	4	8	Diesel	97
689.10	956	4	8	Petrol	3	8140.27.2510	2499	4	8	Diesel	97
697.01	1469	4	8	Petrol	28	8140.27.2512	2499	4	8	Diesel	97
712	3320	4	8	Diesel	125	8140.27.2530 IDS	2499	4	8	Diesel	98
712.01	3320	4	8	Diesel	125	8140.27.2530 IDS	2499	4	8	Diesel	98
712.03	3320	4	8	Diesel	125	8140.27.2560	2499	4	8	Diesel	97
712.04	3320	4	8	Diesel	125	8140.27.2565 IDS	2500	4	8	Diesel	97
712-01-03	3320	4	8	Diesel	125	8140.27.2580	2499	4	8	Diesel	97
712-01-04	3320	4	8	Diesel	125	8140.27.2582	2499	4	8	Diesel	97
712-18	3600	4	8	Diesel	127	8140.27.2585	2500	4	8	Diesel	98
720	3590	4	8	Diesel	128	8140.27.2700	2500	4	8	Diesel	98
720.01	3596	4	8	Diesel	128	8140.43.2585	2800	4	8	Diesel	116
720.02	3596	4	8	Diesel	128	8140.43.2585	2800	4	8	Diesel	116
720.03	3596	4	8	Diesel	128	8140.43.3700	2798	4	8	Diesel	116
720.05	3596	4	8	Diesel	128	8140.43.B.3586	2800	4	8	Diesel	116
720.08	3596	4	8	Diesel	128	8140.43.B.3586	2800	4	8	Diesel	116
720.12	3590	4	8	Diesel	129	8140.43.B.3588	2800	4	8	Diesel	116
797	5453	6	12	Diesel	134	8140.43.B.3588	2800	4	8	Diesel	116
797-10	5490	6	12	Diesel	134	8140.43.C.2586	2800	4	8	Diesel	116
797-20	5490	6	12	Diesel	134	8140.43.C.2586	2800	4	8	Diesel	116
797-21	5453	6	12	Diesel	134	8140.43.S.2585	2800	4	8	Diesel	116
797-26	5490	6	12	Diesel	134	8140.43.S.2585	2800	4	8	Diesel	116
797 NFA	5491	6	12	Diesel	134	8140.43.S.3585	2800	4	8	Diesel	116
798	5490	6	12	Diesel	135	8140.43.S.3585	2800	4	8	Diesel	116
798-10	5490	6	12	Diesel	135	8140.43N.3585	2798	4	8	Diesel	116
798-13	5490	6	12	Diesel	135	8140.43N.3585	2798	4	8	Diesel	116
798-20	5490	6	12	Diesel	135	8140.47.2530 IDR	2499	4	8	Diesel	98
807	1565	4	8	Petrol	31	8140.47.2530 IDR	2499	4	8	Diesel	98
807.04	1565	4	8	Petrol	31	8140.47.2535	2499	4	8	Diesel	99
807.05	1565	4	8	Petrol	31	8140.47.2580	2500	4	8	Diesel	100
807.10	1565	4	8	Petrol	31	8140.47.2585	2500	4	8	Diesel	98
807.20	1565	4	8	Petrol	32	8140.47.2585	2500	4	8	Diesel	100
810.01	1289	4	8	Petrol	19	8140.47.2590	2499	4	8	Diesel	98
810.02	1289	4	8	Petrol	19	8140.47.2590	2499	4	8	Diesel	98
810.03	1289	4	8	Petrol	19	8140.47.2700	2499	4	8	Diesel	98
810.05	1289	4	8	Petrol	19	8140.47.2721	2499	4	8	Diesel	98
810.06	1289	4	8	Petrol	19	8140.47.2785	2499	4	8	Diesel	98
810.10	1289	4	8	Petrol	19	8140.61.2300	2445	4	8	Diesel	91
810.19	1289	4	8	Petrol	19	8140.61.235	2445	4	8	Diesel	91
810.25	1289	4	8	Petrol	19	8140.61.235	2445	4	8	Diesel	92
810.26	1289	4	8	Petrol	19	8140.61.240	2445	4	8	Diesel	93
810.29	1289	4	8	Petrol	19	8140.63.2585	2800	4	8	Diesel	116
810.96	1289	4	8	Petrol	19	8140.63.2585	2800	4	8	Diesel	116
810.97	1289	4	8	Petrol	19	8140.67.2500	2499	4	8	Diesel	101
810.99	1289	4	8	Petrol	19	8140.67.2510	2499	4	8	Diesel	102
810-02/97	1289	4	8	Petrol	19	8140.67.2550	2499	4	8	Diesel	103
821	1565	4	8	Petrol	33	8140.67.2580	2499	4	8	Diesel	103
821.01	1565	4	8	Petrol	33	8140.67.2585	2500	4	8	Diesel	101
821.02	1565	4	8	Petrol	33	8140.67.2585	2500	4	8	Diesel	103
821.03	1565	4	8	Petrol	33	8140-07	2500	4	8	Diesel	97
821.04	1565	4	8	Petrol	33	8140-27	2500	4	8	Diesel	97
821.10	1565	4	8	Petrol	33	8140-27 IDS	2500	4	8	Diesel	97
821.11	1565	4	8	Petrol	33	8140-43 k	2800	4	8	Diesel	116
821.20	1565	4	8	Petrol	33	8140-43 k	2800	4	8	Diesel	116
829.00	1995	4	8	Petrol	64	8140-47	2499	4	8	Diesel	97
829.01	1995	4	8	Petrol	64	688 02	1108	4	8	Petrol	9
843	1647	4	8	Petrol	31	688 13	1108	4	8	Petrol	9
843.01	1647	4	8	Petrol	31	689 71	956	4	8	Petrol	3









	CC				9		CC				9
688 710	1037	4	8	Petrol	2	C1G 722	1237	4	8	Petrol	13
688 711	1108	4	8	Petrol	9	C1G 726	1237	4	8	Petrol	13
688 712	1108	4	8	Petrol	9	C1G 730	1237	4	8	Petrol	13
688 713	1108	4	8	Petrol	9	C1J 700	1397	4	8	Petrol	23
689 710	956	4	8	Petrol	3	C1J 715	1397	4	8	Petrol	23
807 727	1565	4	8	Petrol	31	C1J 742	1397	4	8	Petrol	23
810 719	1289	4	8	Petrol	19	C1J 748	1397	4	8	Petrol	23
810 725	1289	4	8	Petrol	19	C1J 760	1397	4	8	Petrol	23
810 726	1289	4	8	Petrol	19	C1J 764	1397	4	8	Petrol	23
810 729	1289	4	8	Petrol	19	C1J 768	1397	4	8	Petrol	23
829 700	1995	4	8	Petrol	64	C1J 770	1397	4	8	Petrol	23
829 701	1995	4	8	Petrol	64	C1J 780	1397	4	8	Petrol	23
829 702	1995	4	8	Petrol	64	C1J 782	1397	4	8	Petrol	23
829 703	1995	4	8	Petrol	64	C1J 784	1397	4	8	Petrol	23
829 710	1995	4	8	Petrol	64	C1J 788	1397	4	8	Petrol	23
829 720	1995	4	8	Petrol	64	C1J 791	1397	4	8	Petrol	23
829 721	1995	4	8	Petrol	64	C1J 792	1397	4	8	Petrol	23
829 730	1995	4	8	Petrol	64	C1J 793	1397	4	8	Petrol	23
829 731	1995	4	8	Petrol	64	C1J 796	1397	4	8	Petrol	23
840 725	1397	4	8	Petrol	21	C2J 700	1397	4	8	Petrol	23
840 726	1397	4	8	Petrol	21	C2J 713	1397	4	8	Petrol	23
840 730	1397	4	8	Petrol	21	C2J 717	1397	4	8	Petrol	23
841 705	1647	4	8	Petrol	31	C2J 718	1397	4	8	Petrol	23
841 717	1647	4	8	Petrol	31	C2J 720	1397	4	8	Petrol	23
841 725	1647	4	8	Petrol	31	C2J 730	1397	4	8	Petrol	23
841 726	1647	4	8	Petrol	31	C2J 755	1397	4	8	Petrol	23
843 718	1647	4	8	Petrol	31	C2J 756	1397	4	8	Petrol	23
843 720	1647	4	8	Petrol	31	C2J 757	1397	4	8	Petrol	23
843 721	1647	4	8	Petrol	31	C2J 760	1397	4	8	Petrol	23
843 723	1647	4	8	Petrol	31	C2J 766	1397	4	8	Petrol	23
843 724	1647	4	8	Petrol	31	C2J 767	1397	4	8	Petrol	23
847 700	1397	4	8	Petrol	22	C2J 768	1397	4	8	Petrol	23
847 701	1397	4	8	Petrol	22	C2J 770	1397	4	8	Petrol	23
847 712	1397	4	8	Petrol	22	C2J 772	1397	4	8	Petrol	23
847 720	1397	4	8	Petrol	22	C2J 776	1397	4	8	Petrol	23
847 722	1397	4	8	Petrol	22	C2J 780	1397	4	8	Petrol	23
847 725	1397	4	8	Petrol	22	C2J 781	1397	4	8	Petrol	23
851 700	2165	4	8	Petrol	84	C2J 782	1397	4	8	Petrol	23
852 700	2068	4	8	Diesel	81	C2J 784	1397	4	8	Petrol	23
852 710	2068	4	8	Diesel	81	C2J 788	1397	4	8	Petrol	23
852 720	2068	4	8	Diesel	81	C2J 789	1397	4	8	Petrol	23
852 750	2068	4	8	Diesel	81	C2J 792	1397	4	8	Petrol	23
A1M 705	1647	4	8	Petrol	31	C2J 794	1397	4	8	Petrol	23
A1M 707	1647	4	8	Petrol	31	C2J 796	1397	4	8	Petrol	23
A1M 708	1647	4	8	Petrol	31	C2J 797	1397	4	8	Petrol	23
A2M 723	1647	4	8	Petrol	31	C2J 798	1397	4	8	Petrol	23
A2M 725	1647	4	8	Petrol	31	C2L 717	1397	4	8	Petrol	24
A2M 726	1647	4	8	Petrol	31	C3G 700	1239	4	8	Petrol	14
A5L 717	1565	4	8	Petrol	31	C3G 702	1239	4	8	Petrol	14
A5L 718	1565	4	8	Petrol	31	C3G 710	1239	4	8	Petrol	14
A5L 750	1565	4	8	Petrol	31	C3G 712	1239	4	8	Petrol	14
A6M 725	1647	4	8	Petrol	31	C3G 720	1239	4	8	Petrol	14
A6M 726	1647	4	8	Petrol	31	C3G 750	1239	4	8	Petrol	14
A7L 752	1647	4	8	Petrol	31	C3J 700	1397	4	8	Petrol	23
C1C 700	956	4	8	Petrol	4	C3J 702	1397	4	8	Petrol	23
C1C 706	956	4	8	Petrol	4	C3J 710	1397	4	8	Petrol	23
C1C 708	956	4	8	Petrol	4	C3J-750	1397	4	8	Petrol	23
C1C 754	956	4	8	Petrol	4	C3J-751	1397	4	8	Petrol	23
C1E 688	1108	4	8	Petrol	10	C3J-752	1397	4	8	Petrol	23
C1E 700	1108	4	8	Petrol	10	C3J-753	1397	4	8	Petrol	23
C1E 714	1108	4	8	Petrol	10	C3J 756	1397	4	8	Petrol	23
C1E 715	1108	4	8	Petrol	10	C3J 760	1397	4	8	Petrol	23
C1E 718	1108	4	8	Petrol	10	C3J 762	1397	4	8	Petrol	23
C1E 719	1108	4	8	Petrol	10	CG10DE	998	4	16	Petrol	5
C1E 720	1108	4	8	Petrol	10	D4D 700	999	4	16	Petrol	6
C1E 726	1108	4	8	Petrol	10	D4D 712	999	4	16	Petrol	6
C1E 750	1108	4	8	Petrol	10	D4D 720	999	4	16	Petrol	6
C1E 752	1108	4	8	Petrol	10	D4D 754	999	4	16	Petrol	6
C1E 754	1108	4	8	Petrol	10	D4F 702	1149	4	16	Petrol	15
C1E 756	1108	4	8	Petrol	10	D4F 704	1149	4	16	Petrol	15
C1E 760	1108	4	8	Petrol	10	D4F 706	1149	4	16	Petrol	15
C1E 762	1108	4	8	Petrol	10	D4F 708	1149	4	16	Petrol	15
C1E 764	1108	4	8	Petrol	10	D4F 712	1149	4	16	Petrol	15
C1E 792	1108	4	8	Petrol	10	D4F 714	1149	4	16	Petrol	15
C1G 700	1237	4	8	Petrol	13	D4F 716	1149	4	16	Petrol	15
C1G 702	1237	4	8	Petrol	13	D4F 722	1149	4	16	Petrol	15
C1G 710	1237	4	8	Petrol	13	D4F 728	1149	4	16	Petrol	15
C1G 720	1237	4	8	Petrol	13	D4F 730	1149	4	16	Petrol	15









	CC				9		CC				9
D4F 732	1149	4	16	Petrol	15	E7J 706	1390	4	8	Petrol	25
D4F 734	1149	4	16	Petrol	15	E7J 707	1390	4	8	Petrol	25
D4F 740	1149	4	16	Petrol	15	E7J 710	1390	4	8	Petrol	25
D4F 742	1149	4	16	Petrol	15	E7J 711	1390	4	8	Petrol	25
D4F 764	1149	4	16	Petrol	15	E7J 718	1390	4	8	Petrol	25
D4F 770	1149	4	16	Petrol	15	E7J 719	1390	4	8	Petrol	25
D4F 772	1149	4	16	Petrol	15	E7J 720	1390	4	8	Petrol	25
D4F 780	1149	4	16	Petrol	15	E7J 724	1390	4	8	Petrol	25
D4F 782	1149	4	16	Petrol	15	E7J 726	1390	4	8	Petrol	25
D4F 784	1149	4	16	Petrol	15	E7J 728	1390	4	8	Petrol	25
D4F 786	1149	4	16	Petrol	15	E7J 742	1390	4	8	Petrol	25
D4F 790	1149	4	16	Petrol	15	E7J 745	1390	4	8	Petrol	25
D7D 700	999	4	8	Petrol	7	E7J 754	1390	4	8	Petrol	25
D7D 740	999	4	8	Petrol	7	E7J 756	1390	4	8	Petrol	25
D7D 760	999	4	8	Petrol	7	E7J 757	1390	4	8	Petrol	25
D7F 700	1149	4	8	Petrol	11	E7J 764	1390	4	8	Petrol	25
D7F 701	1149	4	8	Petrol	16	E7J 770	1390	4	8	Petrol	25
D7F 702	1149	4	8	Petrol	16	E7J 771	1390	4	8	Petrol	25
D7F 703	1149	4	8	Petrol	16	E7J 773	1390	4	8	Petrol	25
D7F 704	1149	4	8	Petrol	16	E7J 780	1390	4	8	Petrol	25
D7F 706	1149	4	8	Petrol	16	EE9-502	16510	8	32	Diesel	155
D7F 708	1149	4	8	Petrol	16	F1N 720	1721	4	8	Petrol	44
D7F 710	1149	4	8	Petrol	16	F1N 722	1721	4	8	Petrol	44
D7F 720	1149	4	8	Petrol	16	F1N 724	1721	4	8	Petrol	44
D7F 722	1149	4	8	Petrol	16	F2N 700	1721	4	8	Petrol	45
D7F 726	1149	4	8	Petrol	16	F2N 704	1721	4	8	Petrol	45
D7F 730	1149	4	8	Petrol	16	F2N 708	1721	4	8	Petrol	45
D7F 744	1149	4	8	Petrol	16	F2N 710	1721	4	8	Petrol	45
D7F 746	1149	4	8	Petrol	16	F2N 711	1721	4	8	Petrol	45
D7F 764	1149	4	8	Petrol	16	F2N 712	1721	4	8	Petrol	45
D7F 766	1149	4	8	Petrol	16	F2N 716	1721	4	8	Petrol	45
D7F 800	1149	4	8	Petrol	16	F2N 720	1721	4	8	Petrol	45
dCi 4B	4120	4	12	Diesel	130	F2N 721	1721	4	8	Petrol	45
dCi 4C	4120	4	12	Diesel	130	F2N 722	1721	4	8	Petrol	45
dci 6A	6177	6	24	Diesel	137	F2N 724	1721	4	8	Petrol	45
dci 6W	6177	6	24	Diesel	137	F2N 726	1721	4	8	Petrol	45
dCi 11-270	11100	6	24	Diesel	146	F2N 727	1721	4	8	Petrol	45
dCi 11 B/43	11100	6	12	Diesel	147	F2N 728	1721	4	8	Petrol	45
dCi 11C	11100	6	24	Diesel	146	F2N 730	1721	4	8	Petrol	45
dCi 11E	11100	6	24	Diesel	146	F2N 732	1721	4	8	Petrol	45
dCi 11G	11100	6	24	Diesel	146	F2N 740	1721	4	8	Petrol	45
DTI 3	2953	4	16	Diesel	121	F2N 742	1721	4	8	Petrol	45
DXi 3	2953	4	16	Diesel	121	F2N 750	1721	4	8	Petrol	45
DXi 3	2953	4	16	Diesel	121	F2N 752	1721	4	8	Petrol	45
DXi 5	4764	4	16	Diesel	132	F2N 753	1721	4	8	Petrol	45
DXi 7	7200	6	24	Diesel	139	F2N 754	1721	4	8	Petrol	45
DXi 11	10800	6	24	Diesel	145	F2N 758	1721	4	8	Petrol	45
DXi 12	12130	6	24	Diesel	152	F2N 770	1721	4	8	Petrol	45
DXi 13	12800	6	24	Diesel	153	F2N 783	1721	4	8	Petrol	45
DXi 2,5	2490	4	16	Diesel	104	F2N 786	1721	4	8	Petrol	45
DXi 13 440	12800	6	24	Diesel	153	F2N 796	1721	4	8	Petrol	45
DXi 13 460	12800	6	24	Diesel	153	F2N 797	1721	4	8	Petrol	45
DXi 13 480	12800	6	24	Diesel	153	F2N 798	1721	4	8	Petrol	45
DXi 13 500	12800	6	24	Diesel	153	F3N 702	1721	4	8	Petrol	45
DXi 13 520	12800	6	24	Diesel	153	F3N-704	1721	4	8	Petrol	45
E5F 710	1171	4	8	Petrol	17	F3N-705	1721	4	8	Petrol	45
E5F 716	1171	4	8	Petrol	17	F3N 708	1721	4	8	Petrol	45
E6J 700	1390	4	8	Petrol	25	F3N 716	1721	4	8	Petrol	45
E6J 701	1390	4	8	Petrol	25	F3N 717	1721	4	8	Petrol	45
E6J 706	1390	4	8	Petrol	25	F3N 718	1721	4	8	Petrol	45
E6J 712	1390	4	8	Petrol	25	F3N 722	1721	4	8	Petrol	45
E6J 713	1390	4	8	Petrol	25	F3N 723	1721	4	8	Petrol	45
E6J 718	1390	4	8	Petrol	25	F3N 726	1721	4	8	Petrol	45
E6J 734	1390	4	8	Petrol	25	F3N 740	1721	4	8	Petrol	45
E6J 738	1390	4	8	Petrol	25	F3N 741	1721	4	8	Petrol	45
E6J 760	1390	4	8	Petrol	25	F3N 742	1721	4	8	Petrol	45
E7F 700	1171	4	8	Petrol	17	F3N 743	1721	4	8	Petrol	45
E7F 704	1171	4	8	Petrol	17	F3N 746	1721	4	8	Petrol	45
E7F 706	1171	4	8	Petrol	17	F3N 747	1721	4	8	Petrol	46
E7F 708	1171	4	8	Petrol	17	F3P 670	1783	4	8	Petrol	47
E7F 730	1171	4	8	Petrol	17	F3P 674	1783	4	8	Petrol	48
E7F 750	1171	4	8	Petrol	17	F3P 676	1794	4	8	Petrol	47
E7J 601	1390	4	8	Petrol	25	F3P 678	1783	4	8	Petrol	47
E7J 624	1390	4	8	Petrol	25	F3P 682	1783	4	8	Petrol	49
E7J 626	1390	4	8	Petrol	25	F3P 700	1794	4	8	Petrol	50
E7J 634	1390	4	8	Petrol	25	F3P 704	1794	4	8	Petrol	50
E7J 635	1390	4	8	Petrol	25	F3P 705	1794	4	8	Petrol	50
E7J 700	1390	4	8	Petrol	25	F3P 706	1794	4	8	Petrol	50









	CC				9		CC				9
F3P 707	1794	4	8	Petrol	50	F4R 774	1998	4	16	Petrol	69
F3P 708	1794	4	8	Petrol	50	F4R 776	1998	4	16	Petrol	69
F3P 710	1794	4	8	Petrol	50	F4R 780	1998	4	16	Petrol	69
F3P 712	1794	4	8	Petrol	50	F4R 784	1998	4	16	Petrol	69
F3P 714	1794	4	8	Petrol	50	F4R 786	1998	4	16	Petrol	69
F3P 716	1794	4	8	Petrol	50	F4R 787	1998	4	16	Petrol	69
F3P 717	1794	4	8	Petrol	50	F4R 790	1998	4	16	Petrol	69
F3P 718	1794	4	8	Petrol	50	F4R 791	1998	4	16	Petrol	69
F3P 720	1794	4	8	Petrol	47	F4R 792	1998	4	16	Petrol	69
F3P 724	1794	4	8	Petrol	47	F4R 794	1998	4	16	Petrol	69
F3P 740	1794	4	8	Petrol	50	F4R 795	1998	4	16	Petrol	69
F3P 742	1794	4	8	Petrol	50	F4R 796	1998	4	16	Petrol	69
F3P 754	1794	4	8	Petrol	50	F4R 797	1998	4	16	Petrol	69
F3P 755	1783	4	8	Petrol	49	F4R 800	1998	4	16	Petrol	69
F3P 758	1783	4	8	Petrol	50	F4R 811	1998	4	16	Petrol	69
F3P 760	1794	4	8	Petrol	50	F4R 820	1998	4	16	Petrol	69
F3P 764	1783	4	8	Petrol	50	F4R 830	1998	4	16	Petrol	69
F3P 765	1794	4	8	Petrol	50	F4R 832	1998	4	16	Petrol	69
F3R 200	1998	4	8	Petrol	65	F4R 867	1998	4	16	Petrol	69
F3R 611	1998	4	8	Petrol	66	F4R 870	1998	4	16	Petrol	69
F3R 722	1998	4	8	Petrol	65	F4R 872	1998	4	16	Petrol	69
F3R 723	1998	4	8	Petrol	65	F4R 874	1998	4	16	Petrol	69
F3R 728	1998	4	8	Petrol	65	F4R 886	1998	4	16	Petrol	69
F3R 729	1998	4	8	Petrol	65	F4R 887	1998	4	16	Petrol	69
F3R 742	1998	4	8	Petrol	65	F4R 896	1998	4	16	Petrol	69
F3R 750	1998	4	8	Petrol	65	F4R 897	1998	4	16	Petrol	69
F3R 751	1998	4	8	Petrol	65	F4R L 870	1998	4	16	Petrol	69
F3R 752	1998	4	8	Petrol	67	F4Rt 774	1998	4	16	Petrol	69
F3R 768	1998	4	8	Petrol	65	F4Rt 800	1998	4	16	Petrol	69
F3R 769	1998	4	8	Petrol	65	F4Rt 811	1998	4	16	Petrol	69
F3R 791	1998	4	8	Petrol	65	F4R Z 770	1998	4	16	Petrol	69
F3R 796	1998	4	8	Petrol	65	F5R 700	1998	4	16	Petrol	70
F3R 797	1998	4	8	Petrol	65	F5R 701	1998	4	16	Petrol	70
F3R 798	1998	4	8	Petrol	65	F5R 740	1998	4	16	Petrol	70
F3R J7	1998	4	8	Petrol	68	F7P 700	1764	4	16	Petrol	53
F4P 720	1783	4	16	Petrol	51	F7P 702	1764	4	16	Petrol	53
F4P 722	1783	4	16	Petrol	51	F7P 704	1764	4	16	Petrol	53
F4P 760	1783	4	16	Petrol	51	F7P 720	1764	4	16	Petrol	53
F4P 770	1783	4	16	Petrol	52	F7P 722	1764	4	16	Petrol	53
F4P 771	1783	4	16	Petrol	52	F7R 700	1998	4	16	Petrol	71
F4P 772	1783	4	16	Petrol	52	F7R 710	1998	4	16	Petrol	71
F4P 773	1783	4	16	Petrol	52	F7R 712	1998	4	16	Petrol	72
F4P 774	1783	4	16	Petrol	52	F7R 714	1998	4	16	Petrol	72
F4P 775	1783	4	16	Petrol	52	F7R 720	1998	4	16	Petrol	71
F4R	1998	4	16	Petrol	69	F8M 700	1596	4	8	Diesel	34
F4R 400	1998	4	16	Petrol	69	F8M 720	1596	4	8	Diesel	34
F4R 402	1998	4	16	Petrol	69	F8M 730	1596	4	8	Diesel	34
F4R 403	1998	4	16	Petrol	69	F8M 736	1596	4	8	Diesel	34
F4R 404	1998	4	16	Petrol	69	F8M 760	1596	4	8	Diesel	34
F4R 405	1998	4	16	Petrol	69	F8Q 600	1870	4	8	Diesel	54
F4R 408	1998	4	16	Petrol	69	F8Q 606	1870	4	8	Diesel	54
F4R 700	1998	4	16	Petrol	69	F8Q 610	1870	4	8	Diesel	55
F4R 701	1998	4	16	Petrol	69	F8Q 620	1870	4	8	Diesel	55
F4R 712	1998	4	16	Petrol	69	F8Q 622	1870	4	8	Diesel	56
F4R 713	1998	4	16	Petrol	69	F8Q 624	1870	4	8	Diesel	57
F4R 714	1998	4	16	Petrol	69	F8Q 630	1870	4	8	Diesel	56
F4R 715	1998	4	16	Petrol	69	F8Q 632	1870	4	8	Diesel	56
F4R 720	1998	4	16	Petrol	69	F8Q 636	1870	4	8	Diesel	56
F4R 722	1998	4	16	Petrol	69	F8Q 640	1870	4	8	Diesel	55
F4R 730	1998	4	16	Petrol	69	F8Q 644	1870	4	8	Diesel	58
F4R 732	1998	4	16	Petrol	69	F8Q 646	1870	4	8	Diesel	55
F4R 736	1998	4	16	Petrol	69	F8Q 648	1870	4	8	Diesel	56
F4R 738	1998	4	16	Petrol	69	F8Q 662	1870	4	8	Diesel	56
F4R 740	1998	4	16	Petrol	69	F8Q 676	1870	4	8	Diesel	59
F4R 741	1998	4	16	Petrol	69	F8Q 678	1870	4	8	Diesel	59
F4R 744	1998	4	16	Petrol	69	F8Q 680	1870	4	8	Diesel	56
F4R 746	1998	4	16	Petrol	69	F8Q 682	1870	4	8	Diesel	59
F4R 747	1998	4	16	Petrol	69	F8Q 684	1870	4	8	Diesel	56
F4R 760	1998	4	16	Petrol	69	F8Q 696	1870	4	8	Diesel	59
F4R 761	1998	4	16	Petrol	69	F8Q 706	1870	4	8	Diesel	55
F4R 762	1998	4	16	Petrol	69	F8Q 710	1870	4	8	Diesel	55
F4R 763	1998	4	16	Petrol	69	F8Q 714	1870	4	8	Diesel	55
F4R 764	1998	4	16	Petrol	69	F8Q 722	1870	4	8	Diesel	55
F4R 765	1998	4	16	Petrol	69	F8Q 724	1870	4	8	Diesel	55
F4R 766	1998	4	16	Petrol	69	F8Q 730	1870	4	8	Diesel	55
F4R 767	1998	4	16	Petrol	69	F8Q 732	1870	4	8	Diesel	55
F4R 770	1998	4	16	Petrol	69	F8Q 740	1870	4	8	Diesel	55
F4R 771	1998	4	16	Petrol	69	F8Q 742	1870	4	8	Diesel	55

	CC				9		CC				9
F8Q 744	1870	4	8	Diesel	55	G9T 607	2188	4	16	Diesel	86
F8Q 748	1870	4	8	Diesel	55	G9T 642	2188	4	16	Diesel	86
F8Q 754	1870	4	8	Diesel	55	G9T 645	2188	4	16	Diesel	86
F8Q 764	1870	4	8	Diesel	55	G9T 700	2188	4	16	Diesel	86
F8Q 768	1870	4	8	Diesel	55	G9T 702	2188	4	16	Diesel	86
F8Q 774	1870	4	8	Diesel	55	G9T 703	2188	4	16	Diesel	86
F8Q 776	1870	4	8	Diesel	55	G9T 704	2188	4	16	Diesel	86
F8Q 784	1870	4	8	Diesel	57	G9T 706	2188	4	16	Diesel	86
F8Q 785	1870	4	8	Diesel	60	G9T 707	2188	4	16	Diesel	86
F8Q 786	1870	4	8	Diesel	56	G9T 710	2188	4	16	Diesel	86
F8Q 788	1870	4	8	Diesel	55	G9T 712	2188	4	16	Diesel	86
F8Q 790	1870	4	8	Diesel	61	G9T 720	2188	4	16	Diesel	86
F9Q 650	1870	4	8	Diesel	62	G9T 722	2188	4	16	Diesel	86
F9Q 664	1870	4	8	Diesel	62	G9T 742	2188	4	16	Diesel	86
F9Q 670	1870	4	8	Diesel	62	G9T 743	2188	4	16	Diesel	86
F9Q 674	1870	4	8	Diesel	62	G9T 750	2188	4	16	Diesel	86
F9Q 680	1870	4	8	Diesel	62	G9U 630	2464	4	16	Diesel	105
F9Q 710	1870	4	8	Diesel	62	G9U 632	2464	4	16	Diesel	105
F9Q 716	1870	4	8	Diesel	62	G9U 650	2464	4	16	Diesel	105
F9Q 717	1870	4	8	Diesel	62	G9U 720	2464	4	16	Diesel	105
F9Q 718	1870	4	8	Diesel	62	G9U 724	2464	4	16	Diesel	105
F9Q 722	1870	4	8	Diesel	62	G9U 730	2464	4	16	Diesel	105
F9Q 730	1870	4	8	Diesel	62	G9U 750	2464	4	16	Diesel	105
F9Q 731	1870	4	8	Diesel	62	G9U 754	2464	4	16	Diesel	105
F9Q 732	1870	4	8	Diesel	62	H4B 400	898	3	12	Petrol	1
F9Q 733	1870	4	8	Diesel	62	H4B 401	898	3	12	Petrol	1
F9Q 734	1870	4	8	Diesel	62	H4B 408	898	3	12	Petrol	1
F9Q 736	1870	4	8	Diesel	62	H4D 400	999	3	12	Petrol	8
F9Q 738	1870	4	8	Diesel	62	H4J 700	1397	4	16	Petrol	26
F9Q 740	1870	4	8	Diesel	62	H4J A 700	1397	4	16	Petrol	26
F9Q 744	1870	4	8	Diesel	62	H4J A 702	1397	4	16	Petrol	26
F9Q 746	1870	4	8	Diesel	62	H5F 400	1197	4	16	Petrol	18
F9Q 748	1870	4	8	Diesel	62	H5F 402	1198	4	16	Petrol	18
F9Q 750	1870	4	8	Diesel	62	H5F 403	1197	4	16	Petrol	18
F9Q 751	1870	4	8	Diesel	62	H5F 404	1198	4	16	Petrol	18
F9Q 752	1870	4	8	Diesel	62	H5F 408	1197	4	16	Petrol	18
F9Q 754	1870	4	8	Diesel	62	H5F 412	1197	4	16	Petrol	18
F9Q 756	1870	4	8	Diesel	62	HR16DE	1598	4	16	Petrol	35
F9Q 758	1870	4	8	Diesel	62	J5R 716	1995	4	8	Petrol	64
F9Q 759	1870	4	8	Diesel	62	J5R 718	1995	4	8	Petrol	64
F9Q 760	1870	4	8	Diesel	62	J5R 722	1995	4	8	Petrol	64
F9Q 762	1870	4	8	Diesel	62	J5R 726	1995	4	8	Petrol	64
F9Q 770	1870	4	8	Diesel	62	J5R 728	1995	4	8	Petrol	64
F9Q 772	1870	4	8	Diesel	62	J5R 800	1995	4	8	Petrol	64
F9Q 774	1870	4	8	Diesel	62	J6R 234	1995	4	8	Petrol	64
F9Q 780	1870	4	8	Diesel	62	J6R 236	1995	4	8	Petrol	64
F9Q 782	1870	4	8	Diesel	62	J6R 706	1995	4	8	Petrol	64
F9Q 790	1870	4	8	Diesel	62	J6R 707	1995	4	8	Petrol	64
F9Q 796	1870	4	8	Diesel	62	J6R 710	1995	4	8	Petrol	64
F9Q 800	1870	4	8	Diesel	62	J6R 711	1995	4	8	Petrol	64
F9Q 803	1870	4	8	Diesel	62	J6R 712	1995	4	8	Petrol	64
F9Q 804	1870	4	8	Diesel	62	J6R 713	1995	4	8	Petrol	64
F9Q 808	1870	4	8	Diesel	62	J6R 714	1995	4	8	Petrol	64
F9Q 812	1870	4	8	Diesel	62	J6R 715	1995	4	8	Petrol	64
F9Q 816	1870	4	8	Diesel	62	J6R 716	1995	4	8	Petrol	64
F9Q 818	1870	4	8	Diesel	62	J6R 726	1995	4	8	Petrol	64
F9Q 820	1870	4	8	Diesel	62	J6R 734	1995	4	8	Petrol	64
F9Q 826	1870	4	8	Diesel	62	J6R 758	1995	4	8	Petrol	64
F9Q 870	1870	4	8	Diesel	62	J6R 759	1995	4	8	Petrol	64
F9Q 872	1870	4	8	Diesel	62	J6R 760	1995	4	8	Petrol	64
F9Q E 804	1870	4	8	Diesel	62	J6R 762	1995	4	8	Petrol	64
F9Q EE 804	1870	4	8	Diesel	62	J6R 763	1995	4	8	Petrol	64
F9Q J 803	1870	4	8	Diesel	62	J6R 792	1995	4	8	Petrol	64
F9Q J 804	1870	4	8	Diesel	62	J6R 793	1995	4	8	Petrol	64
F9Q N 870	1870	4	16	Diesel	63	J6T 790	2165	4	8	Petrol	87
F9Q P 872	1870	4	8	Diesel	62	J6T 791	2165	4	8	Petrol	87
G8T 706	2188	4	12	Diesel	85	J6T 792	2165	4	8	Petrol	87
G8T 714	2188	4	12	Diesel	85	J7R 720	1995	4	12	Petrol	73
G8T 716	2188	4	12	Diesel	85	J7R 721	1995	4	12	Petrol	73
G8T 740	2188	4	12	Diesel	85	J7R 722	1995	4	8	Petrol	64
G8T 752	2188	4	12	Diesel	85	J7R 723	1995	4	8	Petrol	64
G8T 760	2188	4	12	Diesel	85	J7R 726	1995	4	12	Petrol	73
G8T 790	2188	4	12	Diesel	85	J7R 732	1995	4	8	Petrol	74
G8T 792	2188	4	12	Diesel	85	J7R 733	1995	4	8	Petrol	74
G8T 794	2188	4	12	Diesel	85	J7R 734	1995	4	12	Petrol	73
G9T 600	2188	4	16	Diesel	86	J7R 735	1995	4	12	Petrol	73
G9T 605	2188	4	16	Diesel	86	J7R 738	1995	4	8	Petrol	74
G9T 606	2188	4	16	Diesel	86	J7R 739	1995	4	8	Petrol	74

	CC				9		CC				9
J7R 740	1995	4	12	Petrol	73	K4J 700	1390	4	16	Petrol	27
J7R 746	1995	4	8	Petrol	64	K4J 710	1390	4	16	Petrol	27
J7R 747	1995	4	8	Petrol	64	K4J 711	1390	4	16	Petrol	27
J7R 750	1995	4	8	Petrol	64	K4J 712	1390	4	16	Petrol	27
J7R 751	1995	4	8	Petrol	64	K4J 713	1390	4	16	Petrol	27
J7R 752	1995	4	8	Petrol	64	K4J 714	1390	4	16	Petrol	27
J7R 754	1995	4	12	Petrol	73	K4J 715	1390	4	16	Petrol	27
J7R 756	1995	4	8	Petrol	64	K4J 718	1390	4	16	Petrol	27
J7R 760	1995	4	8	Petrol	64	K4J 730	1390	4	16	Petrol	27
J7R 768	1995	4	8	Petrol	64	K4J 732	1390	4	16	Petrol	27
J7T 284	2165	4	8	Petrol	87	K4J 740	1390	4	16	Petrol	27
J7T 600	2165	4	8	Petrol	87	K4J 750	1390	4	16	Petrol	27
J7T 706	2165	4	8	Petrol	87	K4J 770	1390	4	16	Petrol	27
J7T 707	2165	4	8	Petrol	87	K4J 780	1390	4	16	Petrol	27
J7T 708	2165	4	8	Petrol	87	K4J D 729	1390	4	16	Petrol	27
J7T 714	2165	4	8	Petrol	87	K4J D 740	1390	4	16	Petrol	27
J7T 715	2165	4	8	Petrol	87	K4M 616	1598	4	16	Petrol	36
J7T 718	2165	4	8	Petrol	87	K4M 690	1598	4	16	Petrol	38
J7T 719	2165	4	8	Petrol	87	K4M 697	1598	4	16	Petrol	36
J7T 726	2165	4	8	Petrol	87	K4M 698	1598	4	16	Petrol	36
J7T 727	2165	4	8	Petrol	87	K4M 700	1598	4	16	Petrol	36
J7T 730	2165	4	8	Petrol	87	K4M 701	1598	4	16	Petrol	36
J7T 731	2165	4	8	Petrol	87	K4M 704	1598	4	16	Petrol	36
J7T 732	2165	4	8	Petrol	87	K4M 706	1598	4	16	Petrol	36
J7T 733	2165	4	8	Petrol	87	K4M 707	1598	4	16	Petrol	36
J7T 734	2165	4	8	Petrol	87	K4M 708	1598	4	16	Petrol	36
J7T 736	2165	4	8	Petrol	87	K4M 709	1598	4	16	Petrol	36
J7T 754	2165	4	8	Petrol	87	K4M 710	1598	4	16	Petrol	36
J7T 755	2165	4	8	Petrol	87	K4M 711	1598	4	16	Petrol	36
J7T 756	2165	4	8	Petrol	87	K4M 712	1598	4	16	Petrol	36
J7T 760	2165	4	12	Petrol	88	K4M 714	1598	4	16	Petrol	36
J7T 761	2165	4	12	Petrol	88	K4M 716	1598	4	16	Petrol	37
J7T 762	2165	4	8	Petrol	87	K4M 718	1598	4	16	Petrol	36
J7T 763	2165	4	8	Petrol	87	K4M 720	1598	4	16	Petrol	36
J7T 770	2165	4	8	Petrol	87	K4M 724	1598	4	16	Petrol	36
J7T 772	2165	4	8	Petrol	87	K4M 730	1598	4	16	Petrol	36
J7T 773	2165	4	8	Petrol	87	K4M 732	1598	4	16	Petrol	36
J7T 776	2165	4	8	Petrol	87	K4M 734	1598	4	16	Petrol	36
J7T 780	2165	4	8	Petrol	87	K4M 736	1598	4	16	Petrol	36
J7T 782	2165	4	8	Petrol	87	K4M 740	1598	4	16	Petrol	36
J7T 788	2165	4	8	Petrol	87	K4M 742	1598	4	16	Petrol	36
J8S 120	2068	4	8	Diesel	81	K4M 743	1598	4	16	Petrol	36
J8S 174	2068	4	8	Diesel	82	K4M 744	1598	4	16	Petrol	36
J8S 232 (852.232)	2068	4	8	Diesel	81	K4M 745	1598	4	16	Petrol	36
J8S 234	2068	4	8	Diesel	81	K4M 746	1598	4	16	Petrol	36
J8S 240	2068	4	8	Diesel	81	K4M 748	1598	4	16	Petrol	36
J8S 330	2068	4	8	Diesel	81	K4M 750	1598	4	16	Petrol	36
J8S 600	2068	4	8	Diesel	81	K4M 752	1598	4	16	Petrol	36
J8S 604	2068	4	8	Diesel	81	K4M 753	1598	4	16	Petrol	36
J8S 610	2068	4	8	Diesel	83	K4M 754	1598	4	16	Petrol	36
J8S 612	2068	4	8	Diesel	81	K4M 760	1598	4	16	Petrol	37
J8S 620	2068	4	8	Diesel	81	K4M 761	1598	4	16	Petrol	37
J8S 622	2068	4	8	Diesel	82	K4M 762	1598	4	16	Petrol	36
J8S 702	2068	4	8	Diesel	81	K4M 764	1598	4	16	Petrol	36
J8S 704	2068	4	8	Diesel	81	K4M 766	1598	4	16	Petrol	37
J8S 706	2068	4	8	Diesel	81	K4M 768	1598	4	16	Petrol	36
J8S 708	2068	4	8	Diesel	81	K4M 776	1598	4	16	Petrol	37
J8S 711	2068	4	8	Diesel	81	K4M 782	1598	4	16	Petrol	37
J8S 712	2068	4	8	Diesel	81	K4M 788	1598	4	16	Petrol	36
J8S 714	2068	4	8	Diesel	81	K4M 790	1598	4	16	Petrol	37
J8S 736	2068	4	8	Diesel	81	K4M 791	1598	4	16	Petrol	37
J8S 738	2068	4	8	Diesel	81	K4M 792	1598	4	16	Petrol	37
J8S 740	2068	4	8	Diesel	81	K4M 794	1598	4	16	Petrol	37
J8S 742	2068	4	8	Diesel	81	K4M 800	1598	4	16	Petrol	37
J8S 746	2068	4	8	Diesel	81	K4M 801	1598	4	16	Petrol	37
J8S 750	2068	4	8	Diesel	81	K4M 804	1598	4	16	Petrol	37
J8S 758	2068	4	8	Diesel	81	K4M 812	1598	4	16	Petrol	37
J8S 760	2068	4	8	Diesel	81	K4M 813	1598	4	16	Petrol	37
J8S 772	2068	4	8	Diesel	81	K4M 824	1598	4	16	Petrol	37
J8S 774	2068	4	8	Diesel	81	K4M 830	1598	4	16	Petrol	37
J8S 776	2068	4	8	Diesel	81	K4M 831	1598	4	16	Petrol	37
J8S 778	2068	4	8	Diesel	81	K4M 834	1598	4	16	Petrol	37
J8S 784	2068	4	8	Diesel	81	K4M 838	1598	4	16	Petrol	37
J8S 786	2068	4	8	Diesel	81	K4M 839	1598	4	16	Petrol	37
J8S 788	2068	4	8	Diesel	81	K4M 842	1598	4	16	Petrol	36
J8S 800	2068	4	8	Diesel	81	K4M 848	1598	4	16	Petrol	37
J8S 814	2068	4	8	Diesel	81	K4M 850	1598	4	16	Petrol	36
J8S 890	2068	4	8	Diesel	81	K4M 854	1598	4	16	Petrol	37

	CC				9		CC				9
K4M 856	1598	4	16	Petrol	37	K9K 790	1461	4	8	Diesel	29
K4M 858	1598	4	16	Petrol	37	K9K 792	1461	4	8	Diesel	29
K4M 858	1598	4	16	Petrol	37	K9K 794	1461	4	8	Diesel	29
K4M 862	1598	4	16	Petrol	37	K9K 796	1461	4	8	Diesel	29
K4M 866	1598	4	16	Petrol	37	K9K 800	1461	4	8	Diesel	29
K4M 8 788	1598	4	16	Petrol	36	K9K 802	1461	4	8	Diesel	29
K4M 9 766	1598	4	16	Petrol	37	K9K 804	1461	4	8	Diesel	29
K4M C 812	1598	4	16	Petrol	37	K9K 806	1461	4	8	Diesel	29
K4M C 813	1598	4	16	Petrol	37	K9K 808	1461	4	8	Diesel	29
K4M D 812	1598	4	16	Petrol	37	K9K 812	1461	4	8	Diesel	29
K4M D 813	1598	4	16	Petrol	37	K9K 814	1461	4	8	Diesel	29
K4M P 848	1598	4	16	Petrol	36	K9K 820	1461	4	8	Diesel	29
K4M R 858	1598	4	16	Petrol	37	K9K 826	1461	4	8	Diesel	29
K4M T 782	1598	4	16	Petrol	37	K9K 830	1461	4	8	Diesel	29
K4M T 866	1598	4	16	Petrol	37	K9K 832	1461	4	8	Diesel	29
K4M W 761	1598	4	16	Petrol	37	K9K 834	1461	4	8	Diesel	29
K7J 700	1390	4	8	Petrol	25	K9K 836	1461	4	8	Diesel	29
K7J 701	1390	4	8	Petrol	25	K9K 837	1461	4	8	Diesel	29
K7J 710	1390	4	8	Petrol	25	K9K 838	1461	4	8	Diesel	29
K7J 714	1390	4	8	Petrol	25	K9K 840	1461	4	8	Diesel	29
K7M 690	1598	4	8	Petrol	39	K9K 846	1461	4	8	Diesel	29
K7M 702	1598	4	8	Petrol	39	K9K 856	1461	4	8	Diesel	29
K7M 703	1598	4	8	Petrol	39	K9K 858	1461	4	8	Diesel	29
K7M 704	1598	4	8	Petrol	39	K9K 884	1461	4	8	Diesel	29
K7M 710	1598	4	8	Petrol	39	K9K 896	1461	4	8	Diesel	29
K7M 714	1598	4	8	Petrol	39	K9K 898	1461	4	8	Diesel	29
K7M 718	1598	4	8	Petrol	39	K9K F 830	1461	4	8	Diesel	29
K7M 720	1598	4	8	Petrol	39	K9K G 724	1461	4	8	Diesel	29
K7M 732	1598	4	8	Petrol	39	K9K G 832	1461	4	8	Diesel	29
K7M 734	1598	4	8	Petrol	39	K9K H 834	1461	4	8	Diesel	29
K7M 744	1598	4	8	Petrol	39	K9K J 836	1461	4	8	Diesel	29
K7M 745	1598	4	8	Petrol	39	K9K N 837	1461	4	8	Diesel	29
K7M 746	1598	4	8	Petrol	39	K9K P 732	1461	4	8	Diesel	29
K7M 750	1598	4	8	Petrol	39	L7X 700	2946	6	24	Petrol	122
K7M 764	1598	4	8	Petrol	39	L7X 701	2946	6	24	Petrol	122
K7M 790	1598	4	8	Petrol	39	L7X 713	2946	6	24	Petrol	120
K7M 812	1598	4	8	Petrol	39	L7X 720	2946	6	24	Petrol	122
K9K 276	1461	4	8	Diesel	29	L7X 721	2946	6	24	Petrol	122
K9K 608	1461	4	8	Diesel	29	L7X 722	2946	6	24	Petrol	122
K9K 609	1461	4	8	Diesel	29	L7X 727	2946	6	24	Petrol	122
K9K 609	1461	4	8	Diesel	29	L7X 731	2946	6	24	Petrol	122
K9K 612	1461	4	8	Diesel	29	L7X 732	2946	6	24	Petrol	122
K9K 628	1461	4	8	Diesel	29	L7X 733	2946	6	24	Petrol	122
K9K 636	1461	4	8	Diesel	29	L7X 760	2946	6	24	Petrol	122
K9K 646	1461	4	8	Diesel	29	L7X 762	2946	6	24	Petrol	122
K9K 647	1461	4	8	Diesel	29	M4R 700	1997	4	16	Petrol	75
K9K 656	1461	4	8	Diesel	29	M4R 701	1997	4	16	Petrol	75
K9K 657	1461	4	8	Diesel	29	M4R 704	1997	4	16	Petrol	75
K9K 700	1461	4	8	Diesel	29	M4R 710	1997	4	16	Petrol	76
K9K 702	1461	4	8	Diesel	29	M4R 711	1997	4	16	Petrol	75
K9K 704	1461	4	8	Diesel	29	M4R 713	1997	4	16	Petrol	75
K9K 706	1461	4	8	Diesel	29	M4R 714	1997	4	16	Petrol	75
K9K 708	1461	4	8	Diesel	29	M4R 726	1997	4	16	Petrol	75
K9K 710	1461	4	8	Diesel	29	M4R 746	1997	4	16	Petrol	75
K9K 712	1461	4	8	Diesel	29	M4R 751	1998	4	16	Petrol	75
K9K 714	1461	4	8	Diesel	29	M4R F 711	1997	4	16	Petrol	75
K9K 716	1461	4	8	Diesel	29	M4R F 712	1997	4	16	Petrol	75
K9K 718	1461	4	8	Diesel	29	M4R F 713	1997	4	16	Petrol	75
K9K 722	1461	4	8	Diesel	29	M5M 400	1618	4	16	Petrol	40
K9K 724	1461	4	8	Diesel	29	M5M 450	1618	4	16	Petrol	40
K9K 728	1461	4	8	Diesel	29	M9R 610	1995	4	16	Diesel	77
K9K 729	1461	4	8	Diesel	29	M9R 615	1995	4	16	Diesel	77
K9K 732	1461	4	8	Diesel	29	M9R 630	1995	4	16	Diesel	77
K9K 734	1461	4	8	Diesel	29	M9R 692	1995	4	16	Diesel	77
K9K 740	1461	4	8	Diesel	29	M9R 700	1995	4	16	Diesel	77
K9K 742	1461	4	8	Diesel	29	M9R 721	1995	4	16	Diesel	77
K9K 750	1461	4	8	Diesel	29	M9R 722	1995	4	16	Diesel	77
K9K 752	1461	4	8	Diesel	29	M9R 724	1995	4	16	Diesel	77
K9K 760	1461	4	8	Diesel	29	M9R 740	1995	4	16	Diesel	77
K9K 762	1461	4	8	Diesel	29	M9R 742	1995	4	16	Diesel	77
K9K 764	1461	4	8	Diesel	29	M9R 744	1995	4	16	Diesel	77
K9K 766	1461	4	8	Diesel	29	M9R 746	1995	4	16	Diesel	77
K9K 768	1461	4	8	Diesel	29	M9R 748	1995	4	16	Diesel	77
K9K 770	1461	4	8	Diesel	29	M9R 750	1995	4	16	Diesel	77
K9K 772	1461	4	8	Diesel	29	M9R 756	1995	4	16	Diesel	78
K9K 774	1461	4	8	Diesel	29	M9R 760	1995	4	16	Diesel	77
K9K 780	1461	4	8	Diesel	29	M9R 760	1995	4	16	Diesel	77
K9K 782	1461	4	8	Diesel	29	M9R 761	1995	4	16	Diesel	77

	CC				9		CC				9
M9R 762	1995	4	16	Diesel	77	MDS 06.35.40 A	12024	6	12	Diesel	150
M9R 763	1995	4	16	Diesel	77	MDS 06.35.40 A	12024	6	12	Diesel	150
M9R 780	1995	4	16	Diesel	77	MDS 06.35.40 H	12024	6	12	Diesel	150
M9R 782	1995	4	16	Diesel	77	MDS 06.35.40 I	12024	6	12	Diesel	150
M9R 784	1995	4	16	Diesel	77	MID 06.20.30	8822	6	12	Diesel	140
M9R 786	1995	4	16	Diesel	77	MID 06.20.30	8822	6	12	Diesel	140
M9R 788	1995	4	16	Diesel	77	MID 06.20.30 C	8822	6	12	Diesel	140
M9R 800	1995	4	16	Diesel	77	MID 06.20.30 D	8822	6	12	Diesel	140
M9R 802	1995	4	16	Diesel	77	MID 06.20.30 G	8822	6	12	Diesel	140
M9R 804	1995	4	16	Diesel	77	MID 06.20.30 H	8820	6	12	Diesel	140
M9R 805	1995	4	16	Diesel	77	MID 06.20.45	9839	6	12	Diesel	142
M9R 809	1995	4	16	Diesel	77	MIDR 04.02.26 A/4	4118	4	8	Diesel	131
M9R 814	1995	4	16	Diesel	77	MIDR 04.02.26 A/41	4118	4	8	Diesel	131
M9R 815	1995	4	16	Diesel	77	MIDR 04.02.26 B/4	4118	4	8	Diesel	131
M9R 816	1995	4	16	Diesel	77	MIDR 04.02.26 B/41	4118	4	8	Diesel	131
M9R 817	1995	4	16	Diesel	77	MIDR 06.02.12	5491	6	12	Diesel	136
M9R 820	1995	4	16	Diesel	77	MIDR 06.02.12 A	5491	6	12	Diesel	136
M9R 824	1995	4	16	Diesel	77	MIDR 06.02.12 B	5491	6	12	Diesel	136
M9R 828	1995	4	16	Diesel	78	MIDR 06.02.12 C	5491	6	12	Diesel	136
M9R 830	1995	4	16	Diesel	77	MIDR 06.02.12 D	5491	6	12	Diesel	136
M9R 832	1995	4	16	Diesel	77	MIDR 06.02.12 D3	5491	6	12	Diesel	136
M9R 833	1995	4	16	Diesel	77	MIDR 06.02.12 F	5491	6	12	Diesel	136
M9R 833	1995	4	16	Diesel	77	MIDR 06.02.12 L	5491	6	12	Diesel	136
M9R 844	1995	4	16	Diesel	77	MIDR 06.02.26	6177	6	12	Diesel	138
M9R 845	1995	4	16	Diesel	77	MIDR 06.02.26 D	6177	6	12	Diesel	138
M9R 846	1995	4	16	Diesel	77	MIDR 06.02.26 DU	6177	6	12	Diesel	138
M9R 849	1995	4	16	Diesel	77	MIDR 06.02.26 H	6177	6	12	Diesel	138
M9R 854	1995	4	16	Diesel	78	MIDR 06.02.26 I	6177	6	12	Diesel	138
M9R 855	1995	4	16	Diesel	77	MIDR 06.02.26 K	6177	6	12	Diesel	138
M9R 856	1995	4	16	Diesel	77	MIDR 06.02.26 L	6177	6	12	Diesel	138
M9R 857	1995	4	16	Diesel	77	MIDR 06.02.26 L2	6177	6	12	Diesel	138
M9R 858	1995	4	16	Diesel	77	MIDR 06.02.26 M	6177	6	12	Diesel	138
M9R 859	1995	4	16	Diesel	77	MIDR 06.02.26 M2	6177	6	12	Diesel	138
M9R 862	1995	4	16	Diesel	77	MIDR 06.02.26 Q	6177	6	12	Diesel	138
M9R 864	1995	4	16	Diesel	77	MIDR 06.02.26 S	6177	6	12	Diesel	138
M9R 865	1995	4	16	Diesel	77	MIDR 06.02.26 U	6177	6	12	Diesel	138
M9R 866	1995	4	16	Diesel	77	MIDR 06.02.26 U/4	6177	6	12	Diesel	138
M9R A 700	1995	4	16	Diesel	77	MIDR 06.02.26 V	6177	6	12	Diesel	138
M9Ra 742	1995	4	16	Diesel	77	MIDR 06.02.26 V/4	6177	6	12	Diesel	138
M9R B 610	1995	4	16	Diesel	77	MIDR 06.02.26 V/41	6180	6	12	Diesel	138
M9R B 721	1995	4	16	Diesel	77	MIDR 06.02.26 W	6177	6	12	Diesel	138
M9R C 613	1995	4	16	Diesel	77	MIDR 06.02.26 W/4	6177	6	12	Diesel	138
M9R C 615	1995	4	16	Diesel	77	MIDR 06.02.26 W/41	6177	6	12	Diesel	138
M9R C 830	1995	4	16	Diesel	77	MIDR 06.02.26 X	6177	6	12	Diesel	138
M9R D 833	1995	4	16	Diesel	77	MIDR 06.02.26 Y	6177	6	12	Diesel	138
M9R G 832	1995	4	16	Diesel	77	MIDR 06.02.26 Y/41	6177	6	12	Diesel	138
M9Rk 800	1995	4	16	Diesel	77	MIDR 06.20.30	8822	6	12	Diesel	140
M9Rk 802	1995	4	16	Diesel	77	MIDR 06.20.30 A	8822	6	12	Diesel	140
M9Rk 805	1995	4	16	Diesel	77	MIDR 06.20.30 B	8822	6	12	Diesel	140
M9Rk 806	1995	4	16	Diesel	77	MIDR 06.20.30 C	8822	6	12	Diesel	140
M9Rk 816	1995	4	16	Diesel	77	MIDR 06.20.45	9839	6	12	Diesel	143
M9T 670	2298	4	16	Diesel	89	MIDR 06.20.45 A	9839	6	12	Diesel	142
M9T 672	2298	4	16	Diesel	89	MIDR 06.20.45 A2	9839	6	12	Diesel	144
M9T 676	2298	4	16	Diesel	89	MIDR 06.20.45 B3	9839	6	12	Diesel	142
M9T 678	2298	4	16	Diesel	89	MIDR 06.20.45 BC	9839	6	12	Diesel	142
M9T 680	2298	4	16	Diesel	89	MIDR 06.20.45 C	9839	6	12	Diesel	142
M9T 686	2298	4	16	Diesel	89	MIDR 06.20.45 C/4	9839	6	12	Diesel	142
M9T 690	2298	4	16	Diesel	89	MIDR 06.20.45 D	9839	6	12	Diesel	144
M9T 692	2298	4	16	Diesel	89	MIDR 06.20.45 D/41	9839	6	12	Diesel	142
M9T 694	2298	4	16	Diesel	89	MIDR 06.20.45 D3	9839	6	12	Diesel	144
M9T 696	2298	4	16	Diesel	89	MIDR 06.20.45 DD	9839	6	12	Diesel	142
M9T 698	2298	4	16	Diesel	89	MIDR 06.20.45 E	9839	6	12	Diesel	142
M9T 700	2298	4	16	Diesel	89	MIDR 06.20.45 E/41	9839	6	12	Diesel	142
M9T 702	2298	4	16	Diesel	89	MIDR 06.20.45 E2	9839	6	12	Diesel	142
M9T 706	2299	4	16	Diesel	89	MIDR 06.20.45 E3	9839	6	12	Diesel	142
M9T 870	2299	4	16	Diesel	89	MIDR 06.20.45 F3	9839	6	12	Diesel	142
M9T 880	2298	4	16	Diesel	89	MIDR 06.20.45 H	9839	6	12	Diesel	144
M9T 890	2298	4	16	Diesel	89	MIDR 06.20.45 I3	9839	6	12	Diesel	142
M9T 896	2298	4	16	Diesel	89	MIDR 06.20.45 I41	9839	6	12	Diesel	142
M9T 898	2298	4	16	Diesel	89	MIDR 06.20.45 J	9839	6	12	Diesel	142
MACK E.TECH A/46	12000	6	24	Diesel	149	MIDR 06.20.45 J3	9839	6	12	Diesel	142
MACK E.TECH B/46	12000	6	24	Diesel	149	MIDR 06.20.45 K	9839	6	12	Diesel	142
MACK E.TECH C/46	12000	6	24	Diesel	149	MIDR 06.20.45 L	9839	6	12	Diesel	142
Mack-EE9-530	16510	8	32	Diesel	155	MIDR 06.20.45 M	9839	6	12	Diesel	142
Mack-EE9-560	16400	8	32	Diesel	154	MIDR 06.20.45 M3	9839	6	12	Diesel	144
MDR 06.35.40	12024	6	12	Diesel	150	MIDR 06.20.45 M41	9839	6	12	Diesel	142
MDS 06.35.40	12024	6	12	Diesel	150	MIDR 06.20.45 R41	9839	6	12	Diesel	142
MDS 06.35.40	12024	6	12	Diesel	150	MIDR 06.23.56	11122	6	12	Diesel	148

	CC				9		CC				9
MIDR 06.23.56 A/3	11122	6	12	Diesel	148	R9M 414	1598	4	16	Diesel	42
MIDR 06.23.56 A/41	11122	6	12	Diesel	148	R9M 450	1598	4	16	Diesel	43
MIDR 06.23.56 B/41	11122	6	12	Diesel	148	R9M 452	1598	4	16	Diesel	43
MIDR 06.23.56 B/43	11122	6	12	Diesel	148	R9M 453	1598	4	16	Diesel	42
MIDR 06.24.65	11955	6	24	Diesel	151	S8U 720	2445	4	8	Diesel	99
MIDR 06.24.65 A/42	11955	6	24	Diesel	149	S8U 722	2445	4	8	Diesel	99
MIDR 06.24.65 A/46	11955	6	24	Diesel	151	S8U 730	2445	4	8	Diesel	93
MIDR 06.24.65 AB	11955	6	24	Diesel	151	S8U 731	2445	4	8	Diesel	93
MIDR 06.24.65 B/42	11955	6	24	Diesel	149	S8U 742	2499	4	8	Diesel	97
MIDR 06.24.65 B/46	11955	6	24	Diesel	151	S8U 748	2445	4	8	Diesel	97
MIDR 06.24.65 C/42	11955	6	24	Diesel	149	S8U 750	2499	4	8	Diesel	107
MIDR 06.24.65 C/46	11955	6	24	Diesel	151	S8U 752	2499	4	8	Diesel	99
MIDR 06.35.40	12024	6	12	Diesel	150	S8U 758	2499	4	8	Diesel	99
MIDR 06.35.40 C	12024	6	12	Diesel	150	S8U 762	2500	4	8	Diesel	98
MIDR 06.35.40 G	12024	6	12	Diesel	150	S8U 763	2500	4	8	Diesel	98
MIDR 06.35.40 H	12024	6	12	Diesel	150	S8U 770	2499	4	8	Diesel	108
MIDR 06.35.40 J/3	12024	6	12	Diesel	150	S8U 772	2499	4	8	Diesel	109
MIDR 06.35.40 J1	12024	6	12	Diesel	150	S8U 780	2499	4	8	Diesel	108
MIDR 06.35.40 L1	12024	6	12	Diesel	150	S8U 782	2499	4	8	Diesel	108
MIDR 06.35.40 M3	12024	6	12	Diesel	150	S8W 700	2799	4	8	Diesel	116
MIDR 06.35.40 N/3	12024	6	12	Diesel	150	S9U 700	2499	4	8	Diesel	97
MIDR 06.35.40 P/41	12024	6	12	Diesel	150	S9U 702	2499	4	8	Diesel	97
MIDS 06.02.12	5491	6	12	Diesel	136	S9U 704	2499	4	8	Diesel	97
MIDS 06.02.12 B	5491	6	12	Diesel	136	S9U 714	2499	4	8	Diesel	97
MIDS 06.02.12 C	5491	6	12	Diesel	136	S9U 740	2499	4	8	Diesel	99
MIDS 06.02.12 D	5491	6	12	Diesel	136	S9W 700	2799	4	8	Diesel	116
MIDS 06.02.12 D/3	5491	6	12	Diesel	136	S9W 702	2799	4	8	Diesel	116
MIDS 06.02.26 P	5491	6	12	Diesel	136	SR20DE	1998	4	16	Petrol	80
MIDS 06.20.30	8822	6	12	Diesel	140	TD27TI	2664	4	8	Diesel	114
MIDS 06.20.30	8822	6	12	Diesel	140	V4Y 701	3498	6	24	Petrol	126
MIDS 06.20.30 B	8822	6	12	Diesel	140	V4Y 711	3498	6	24	Petrol	126
MIDS 06.20.30 D	8822	6	12	Diesel	140	V4Y 713	3498	6	24	Petrol	126
MIDS 06.20.30 D	8822	6	12	Diesel	140	V4Y 715	3498	6	24	Petrol	126
MIDS 06.20.30 E	8822	6	12	Diesel	140	VQ25DE	2496	6	24	Petrol	110
MIDS 06.20.30 K	8822	6	12	Diesel	141	VQ35	3498	6	24	Petrol	126
MIDS 06.20.30 N	8822	6	12	Diesel	140	VQ35DE	3498	6	24	Petrol	126
MIDS 06.20.30 NI	8822	6	12	Diesel	140	X5J	1360	4	8	Petrol	20
MIDS 06.20.30 P	8822	6	12	Diesel	140	Z6W 700	2850	6	12	Petrol	118
MIDS 06.20.45	9839	6	12	Diesel	142	Z6W 702	2850	6	12	Petrol	118
MIDS 06.20.45 B	9839	6	12	Diesel	142	Z7U 700	2458	6	12	Petrol	111
MIDS 06.20.45 D	9839	6	12	Diesel	142	Z7U 702	2458	6	12	Petrol	94
MIDS 06.20.45 F	9839	6	12	Diesel	142	Z7U 730	2458	6	12	Petrol	111
MIDS 06.20.45 J	9839	6	12	Diesel	142	Z7U 734	2458	6	12	Petrol	111
MIDS 06.20.45 J3	9839	6	12	Diesel	142	Z7V 708	2664	6	12	Petrol	115
MIDS 06.35.40	12024	6	12	Diesel	150	Z7V 709	2664	6	12	Petrol	115
MIDS 06.35.40 B	12024	6	12	Diesel	150	Z7V 711	2664	6	12	Petrol	115
MIDS 06.35.40 D	12024	6	12	Diesel	150	Z7W 700	2849	6	12	Petrol	119
MIDS 06.35.40 E	12024	6	12	Diesel	150	Z7W 701	2849	6	12	Petrol	112
MIHR 06.20.45 A41	9839	6	12	Diesel	142	Z7W 702	2849	6	12	Petrol	119
MIP 06.20.30	8820	6	12	Diesel	140	Z7W 706	2849	6	12	Petrol	119
MIPR 06.20.45	9840	6	12	Diesel	142	Z7W 707	2849	6	12	Petrol	119
MIPR 06.20.45 A	9840	6	12	Diesel	142	Z7W 709	2849	6	12	Petrol	119
MIPR 06.20.45 A3	9840	6	12	Diesel	142	Z7W 712	2849	6	12	Petrol	119
MIPR 06.20.45 B3	9840	6	12	Diesel	142	Z7W 713	2849	6	12	Petrol	119
MIPR 06.20.45 C3	9840	6	12	Diesel	142	Z7W 717	2849	6	12	Petrol	119
MIPS 06.20.30	8820	6	12	Diesel	140	Z7X 27	2963	6	12	Petrol	124
MIPS 06.20.45	9840	6	12	Diesel	142	Z7X 721	2963	6	12	Petrol	124
MIPS 06.20.45 A	9840	6	12	Diesel	142	Z7X 722	2963	6	12	Petrol	124
MIPS 06.20.45 B	9840	6	12	Diesel	142	Z7X 723	2963	6	12	Petrol	124
MIPS 06.20.45 C	9840	6	12	Diesel	142	Z7X 726	2963	6	12	Petrol	124
MIS 06.20.30	8820	6	12	Diesel	140	Z7X 744	2975	6	12	Petrol	124
MR16DDT	1618	4	16	Petrol	41	Z7X 753	2963	6	12	Petrol	124
MR20DE	1998	4	16	Petrol	75	Z7X 755	2963	6	12	Petrol	124
MS 06.35 T	12024	6	12	Diesel	150	Z7X 760	2963	6	12	Petrol	124
N7Q 700	1948	4	16	Petrol	79	Z7X 765	2963	6	12	Petrol	124
N7Q 704	1948	4	16	Petrol	79	Z7X 767	2963	6	12	Petrol	124
N7Q 710	1948	4	16	Petrol	79	Z7X 775	2963	6	12	Petrol	124
N7Q 711	1948	4	16	Petrol	79	ZD3 A 600	2953	4	16	Diesel	121
N7U 700	2435	5	20	Petrol	106	ZD3 A 600	2953	4	16	Diesel	121
N7U 701	2435	5	20	Petrol	106	ZD3 A 604	2953	4	16	Diesel	121
P9X 701	2958	6	24	Diesel	123	ZD3 A 604	2953	4	16	Diesel	121
P9X 715	2958	6	24	Diesel	123	ZD3 A 608	2953	4	16	Diesel	121
QG15DE	1498	4	16	Petrol	30	ZD3 200	2953	4	16	Diesel	121
R9M 402	1598	4	16	Diesel	42	ZD3 202	2953	4	16	Diesel	121
R9M 404	1598	4	16	Diesel	42	ZD3 600	2953	4	16	Diesel	121
R9M 408	1598	4	16	Diesel	43	ZD3 604	2953	4	16	Diesel	121
R9M 409	1598	4	16	Diesel	42	ZD3 606	2953	4	16	Diesel	121
R9M 413	1598	4	16	Diesel	43						

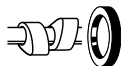

1 0.9L Petrol

H4B 400	3 Cyl.	12 Valves	898cc	TD32304
H4B 401	3 Cyl.	12 Valves	898cc	TD32306
H4B 408	3 Cyl.	12 Valves	898cc	TD34138

PB681 (x12)

NJ449
40.00 x 52.00 x 6.00mm, NBR
NK103
87.00 x 100.00 x 8.50mm, FPM

2 1.0L Petrol

688 710	4 Cyl.	8 Valves	1037cc	TD32131
---------	--------	----------	--------	---------

HR816

NF535
30.00 x 42.00 x 8.00mm, NBR

NF834
35.00 x 50.00 x 8.00mm, FPM
NF722
35.00 x 50.00 x 10.00mm, MVQ
NF634
80.00 x 100.00 x 13.00mm, MVQ

3 1.0L Petrol

689.01	4 Cyl.	8 Valves	956cc	TD21063
689.10	4 Cyl.	8 Valves	956cc	TD29127
689 71	4 Cyl.	8 Valves	956cc	TD3016
689 710	4 Cyl.	8 Valves	956cc	TD3017

NF535
30.00 x 42.00 x 8.00mm, NBR

NF834
35.00 x 50.00 x 8.00mm, FPM
NF722
35.00 x 50.00 x 10.00mm, MVQ
NF634
80.00 x 100.00 x 13.00mm, MVQ

4 1.0L Petrol

C1C 700	4 Cyl.	8 Valves	956cc	TD3097
C1C 706	4 Cyl.	8 Valves	956cc	TD3098
C1C 708	4 Cyl.	8 Valves	956cc	TD3099
C1C 754	4 Cyl.	8 Valves	956cc	TD22353

HR816

NF722
35.00 x 50.00 x 10.00mm, MVQ
NF835
80.00 x 100.00 x 8.00mm, FPM/ACM

5 1.0L Petrol

CG10DE	4 Cyl.	16 Valves	998cc	TD22183
--------	--------	-----------	-------	---------

PB681 (x16)

NJ933
35.00 x 50.00 x 8.00mm, FPM

NJ765
40.00 x 52.00 x 7.00mm, NBR
NJ284
84.00 x 104.00 x 11.00mm, MVQ



6 1.0L Petrol

D4D 700	4 Cyl.	16 Valves	999cc	TD17268
D4D 712	4 Cyl.	16 Valves	999cc	TD34053
D4D 720	4 Cyl.	16 Valves	999cc	TD17269
D4D 754	4 Cyl.	16 Valves	999cc	TD32361

NA5261
28.00 x 47.00 x 8.00mm, PTFE/ACM

NA5322
32.00 x 44.00 x 6.00mm, ACM

NA5326
32.00 x 44.00 x 6.00mm, PTFE

NA5348
70.00 x 86.00 x 7.00mm, PTFE

7 1.0L Petrol

D7D 700	4 Cyl.	8 Valves	999cc	TD28713
D7D 740	4 Cyl.	8 Valves	999cc	TD29727
D7D 760	4 Cyl.	8 Valves	999cc	TD20901

HR789

NA5053
30.00 x 42.00 x 7.00mm, FPM

NA5322
32.00 x 44.00 x 6.00mm, ACM

NA5326
32.00 x 44.00 x 6.00mm, PTFE

NA5348
70.00 x 86.00 x 7.00mm, PTFE

8 1.0L Petrol

H4D 400	3 Cyl.	12 Valves	999cc	TD32362
---------	--------	-----------	-------	---------

PB681 (x12)

NK103
87.00 x 100.00 x 8.50mm, FPM

9 1.1L Petrol

688.01	4 Cyl.	8 Valves	1108cc	TD22490
688.02	4 Cyl.	8 Valves	1108cc	TD3012
688.03	4 Cyl.	8 Valves	1108cc	TD22492
688.06	4 Cyl.	8 Valves	1108cc	TD29124
688.09	4 Cyl.	8 Valves	1108cc	TD29125
688.10	4 Cyl.	8 Valves	1108cc	TD21382
688.11	4 Cyl.	8 Valves	1108cc	TD28180
688.12	4 Cyl.	8 Valves	1108cc	TD29126
688.13	4 Cyl.	8 Valves	1108cc	TD23801
688.711	4 Cyl.	8 Valves	1108cc	TD3014
688.712	4 Cyl.	8 Valves	1108cc	TD3015
688.713	4 Cyl.	8 Valves	1108cc	TD3013

HR816

NF535
30.00 x 42.00 x 8.00mm, NBR

NF834
35.00 x 50.00 x 8.00mm, FPM

NF634
80.00 x 100.00 x 13.00mm, MVQ
01/78 →

NF835
80.00 x 100.00 x 8.00mm, FPM/ACM

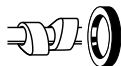

10 1.1L

Petrol

C1E 688	4 Cyl.	8 Valves	1108cc	TD24999
C1E 700	4 Cyl.	8 Valves	1108cc	TD3100
C1E 714	4 Cyl.	8 Valves	1108cc	TD3101
C1E 715	4 Cyl.	8 Valves	1108cc	TD3102
C1E 718	4 Cyl.	8 Valves	1108cc	TD3103
C1E 719	4 Cyl.	8 Valves	1108cc	TD3104
C1E 720	4 Cyl.	8 Valves	1108cc	TD3105
C1E 726	4 Cyl.	8 Valves	1108cc	TD3011
C1E 750	4 Cyl.	8 Valves	1108cc	TD3106
C1E 752	4 Cyl.	8 Valves	1108cc	TD3107
C1E 754	4 Cyl.	8 Valves	1108cc	TD3108
C1E 756	4 Cyl.	8 Valves	1108cc	TD3109
C1E 760	4 Cyl.	8 Valves	1108cc	TD3110
C1E 762	4 Cyl.	8 Valves	1108cc	TD3111
C1E 764	4 Cyl.	8 Valves	1108cc	TD3112
C1E 792	4 Cyl.	8 Valves	1108cc	TD3113

HR643

NF535
30.00 x 42.00 x 8.00mm, NBR

NF722
35.00 x 50.00 x 10.00mm, MVQ
NF634
80.00 x 100.00 x 13.00mm, MVQ

11 1.1L

Petrol

D7F 700	4 Cyl.	8 Valves	1149cc	TD5520
---------	--------	----------	--------	--------

HR789

NA5053
30.00 x 42.00 x 7.00mm, FPM

NA5322
32.00 x 44.00 x 6.00mm, ACM
NA5326
32.00 x 44.00 x 6.00mm, PTFE
NA5348
70.00 x 86.00 x 7.00mm, PTFE

12 1.2L

Petrol

129	4 Cyl.	8 Valves	1218cc	TD3007
-----	--------	----------	--------	--------

HR300

NJ242
35.00 x 50.00 x 8.00mm, NBR
NF641
78.00 x 100.00 x 10.00mm, MVQ

13 1.2L

Petrol

C1G 700	4 Cyl.	8 Valves	1237cc	TD3114
C1G 702	4 Cyl.	8 Valves	1237cc	TD3115
C1G 710	4 Cyl.	8 Valves	1237cc	TD3116
C1G 720	4 Cyl.	8 Valves	1237cc	TD3117
C1G 722	4 Cyl.	8 Valves	1237cc	TD3118
C1G 726	4 Cyl.	8 Valves	1237cc	TD3119
C1G 730	4 Cyl.	8 Valves	1237cc	TD3120

HR643

NF722
35.00 x 50.00 x 10.00mm, MVQ
NF634
80.00 x 100.00 x 13.00mm, MVQ



14 1.2L		Petrol			
C3G 700	4 Cyl.	8 Valves	1239cc		TD3172
C3G 702	4 Cyl.	8 Valves	1239cc		TD5515
C3G 710	4 Cyl.	8 Valves	1239cc		TD3173
C3G 712	4 Cyl.	8 Valves	1239cc		TD16545
C3G 720	4 Cyl.	8 Valves	1239cc		TD14314
C3G 750	4 Cyl.	8 Valves	1239cc		TD22356
HR816				NF834 35.00 x 50.00 x 8.00mm, FPM NF835 80.00 x 100.00 x 8.00mm, FPM/ACM	

15 1.2L		Petrol			
D4F 702	4 Cyl.	16 Valves	1149cc		TD16272
D4F 704	4 Cyl.	16 Valves	1149cc		TD16273
D4F 706	4 Cyl.	16 Valves	1149cc		TD21205
D4F 708	4 Cyl.	16 Valves	1149cc		TD19014
D4F 712	4 Cyl.	16 Valves	1149cc		TD16186
D4F 714	4 Cyl.	16 Valves	1149cc		TD16187
D4F 716	4 Cyl.	16 Valves	1149cc		TD17270
D4F 722	4 Cyl.	16 Valves	1149cc		TD19671
D4F 728	4 Cyl.	16 Valves	1149cc		TD21206
D4F 730	4 Cyl.	16 Valves	1149cc		TD21207
D4F 732	4 Cyl.	16 Valves	1149cc		TD23528
D4F 734	4 Cyl.	16 Valves	1149cc		TD32135
D4F 740	4 Cyl.	16 Valves	1149cc		TD18421
D4F 742	4 Cyl.	16 Valves	1149cc		TD24895
D4F 764	4 Cyl.	16 Valves	1149cc		TD18530
D4F 770	4 Cyl.	16 Valves	1149cc		TD30659
D4F 772	4 Cyl.	16 Valves	1149cc		TD20444
D4F 780	4 Cyl.	16 Valves	1149cc		TD20442
D4F 782	4 Cyl.	16 Valves	1149cc		TD23978
D4F 784	4 Cyl.	16 Valves	1149cc		TD20813
D4F 786	4 Cyl.	16 Valves	1149cc		TD27696
D4F 790	4 Cyl.	16 Valves	1149cc		TD29123
				NA5261 28.00 x 47.00 x 8.00mm, PTFE/ACM	NA5326 32.00 x 44.00 x 6.00mm, PTFE NA5348 70.00 x 86.00 x 7.00mm, PTFE

16 1.2L		Petrol			
D7F 701	4 Cyl.	8 Valves	1149cc		TD5521
D7F 702	4 Cyl.	8 Valves	1149cc		TD16274
D7F 703	4 Cyl.	8 Valves	1149cc		TD16275
D7F 704	4 Cyl.	8 Valves	1149cc		TD16276
D7F 706	4 Cyl.	8 Valves	1149cc		TD18178
D7F 708	4 Cyl.	8 Valves	1149cc		TD26522
D7F 710	4 Cyl.	8 Valves	1149cc		TD9624
D7F 720	4 Cyl.	8 Valves	1149cc		TD14328
D7F 722	4 Cyl.	8 Valves	1149cc		TD16326
D7F 726	4 Cyl.	8 Valves	1149cc		TD14329
D7F 730	4 Cyl.	8 Valves	1149cc		TD5522

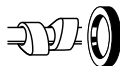

D7F 744	4 Cyl.	8 Valves	1149cc	TD17266
D7F 746	4 Cyl.	8 Valves	1149cc	TD17267
D7F 764	4 Cyl.	8 Valves	1149cc	TD20903
D7F 766	4 Cyl.	8 Valves	1149cc	TD19670
D7F 800	4 Cyl.	8 Valves	1149cc	TD20443

HR789

NA5053
30.00 x 42.00 x 7.00mm, FPM

NA5322
32.00 x 44.00 x 6.00mm, ACM

NA5326
32.00 x 44.00 x 6.00mm, PTFE

NA5348
70.00 x 86.00 x 7.00mm, PTFE

17 1.2L

Petrol

E5F 710	4 Cyl.	8 Valves	1171cc	TD3181
E5F 716	4 Cyl.	8 Valves	1171cc	TD3182
E7F 700	4 Cyl.	8 Valves	1171cc	TD3192
E7F 704	4 Cyl.	8 Valves	1171cc	TD3193
E7F 706	4 Cyl.	8 Valves	1171cc	TD3194
E7F 708	4 Cyl.	8 Valves	1171cc	TD3195
E7F 730	4 Cyl.	8 Valves	1171cc	TD3196
E7F 750	4 Cyl.	8 Valves	1171cc	TD3197

HR816

NA5053
30.00 x 42.00 x 7.00mm, FPM

NA5016
35.00 x 47.00 x 7.00mm, FPM/ACM

NF835
80.00 x 100.00 x 8.00mm, FPM/ACM

18 1.2L

Petrol

HSF 400	4 Cyl.	16 Valves	1197cc	TD26688
HSF 402	4 Cyl.	16 Valves	1198cc	TD27173
HSF 403	4 Cyl.	16 Valves	1197cc	TD32138
HSF 404	4 Cyl.	16 Valves	1198cc	TD27989
HSF 408	4 Cyl.	16 Valves	1197cc	TD32415
HSF 412	4 Cyl.	16 Valves	1197cc	TD33419

PB681 (x16)

19 1.3L

Petrol

810.01	4 Cyl.	8 Valves	1289cc	TD8555
810.02	4 Cyl.	8 Valves	1289cc	TD3033
810-02/97	4 Cyl.	8 Valves	1289cc	TD3032
810.03	4 Cyl.	8 Valves	1289cc	TD23613
810.05	4 Cyl.	8 Valves	1289cc	TD21386
810.06	4 Cyl.	8 Valves	1289cc	TD3034
810.10	4 Cyl.	8 Valves	1289cc	TD21387
810.19	4 Cyl.	8 Valves	1289cc	TD29129
810.25	4 Cyl.	8 Valves	1289cc	TD22391
810.26	4 Cyl.	8 Valves	1289cc	TD22392
810.29	4 Cyl.	8 Valves	1289cc	TD29130
810.96	4 Cyl.	8 Valves	1289cc	TD3039
810.97	4 Cyl.	8 Valves	1289cc	TD3040
810.99	4 Cyl.	8 Valves	1289cc	TD29131
810 719	4 Cyl.	8 Valves	1289cc	TD3035



810 725	4 Cyl.	8 Valves	1289cc	TD3036
810 726	4 Cyl.	8 Valves	1289cc	TD3037
810 729	4 Cyl.	8 Valves	1289cc	TD3038
		NF535 30.00 x 42.00 x 8.00mm, NBR	NF722 35.00 x 50.00 x 10.00mm, MVQ	
			NF634 80.00 x 100.00 x 13.00mm, MVQ	

20 1.4L

Petrol

150	4 Cyl.	8 Valves	1360cc	TD3008
X5J	4 Cyl.	8 Valves	1360cc	TD3434
HR300			NJ242 35.00 x 50.00 x 8.00mm, NBR	
			NF641 78.00 x 100.00 x 10.00mm, MVQ	

21 1.4L

Petrol

840 725	4 Cyl.	8 Valves	1397cc	TD3052
840 726	4 Cyl.	8 Valves	1397cc	TD3053
840 730	4 Cyl.	8 Valves	1397cc	TD3054
		NF535 30.00 x 42.00 x 8.00mm, NBR	NF634 80.00 x 100.00 x 13.00mm, MVQ	

22 1.4L

Petrol

847.99	4 Cyl.	8 Valves	1397cc	TD3071
847 700	4 Cyl.	8 Valves	1397cc	TD3067
847 701	4 Cyl.	8 Valves	1397cc	TD3072
847 712	4 Cyl.	8 Valves	1397cc	TD3068
847 720	4 Cyl.	8 Valves	1397cc	TD5054
847 722	4 Cyl.	8 Valves	1397cc	TD4853
847 725	4 Cyl.	8 Valves	1397cc	TD3070
HR643			NF722 35.00 x 50.00 x 10.00mm, MVQ	
			NF634 80.00 x 100.00 x 13.00mm, MVQ	

23 1.4L

Petrol

C1J 700	4 Cyl.	8 Valves	1397cc	TD3122
C1J 715	4 Cyl.	8 Valves	1397cc	TD3123
C1J 742	4 Cyl.	8 Valves	1397cc	TD3125
C1J 748	4 Cyl.	8 Valves	1397cc	TD27328
C1J 760	4 Cyl.	8 Valves	1397cc	TD3126
C1J 764	4 Cyl.	8 Valves	1397cc	TD3127
C1J 768	4 Cyl.	8 Valves	1397cc	TD3128
C1J 770	4 Cyl.	8 Valves	1397cc	TD3129
C1J 780	4 Cyl.	8 Valves	1397cc	TD3130
C1J 782	4 Cyl.	8 Valves	1397cc	TD3131
C1J 784	4 Cyl.	8 Valves	1397cc	TD3133
C1J 788	4 Cyl.	8 Valves	1397cc	TD3134
C1J 791	4 Cyl.	8 Valves	1397cc	TD23611
C1J 792	4 Cyl.	8 Valves	1397cc	TD3135
C1J 793	4 Cyl.	8 Valves	1397cc	TD29259
C1J 796	4 Cyl.	8 Valves	1397cc	TD3136
C2J 700	4 Cyl.	8 Valves	1397cc	TD3137

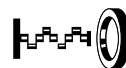

C2J 713	4 Cyl.	8 Valves	1397cc	TD3138
C2J 717	4 Cyl.	8 Valves	1397cc	TD3141
C2J 718	4 Cyl.	8 Valves	1397cc	TD3143
C2J 720	4 Cyl.	8 Valves	1397cc	TD3144
C2J 730	4 Cyl.	8 Valves	1397cc	TD3145
C2J 755	4 Cyl.	8 Valves	1397cc	TD5445
C2J 756	4 Cyl.	8 Valves	1397cc	TD3146
C2J 757	4 Cyl.	8 Valves	1397cc	TD3147
C2J 760	4 Cyl.	8 Valves	1397cc	TD3148
C2J 766	4 Cyl.	8 Valves	1397cc	TD3149
C2J 767	4 Cyl.	8 Valves	1397cc	TD3151
C2J 768	4 Cyl.	8 Valves	1397cc	TD3152
C2J 770	4 Cyl.	8 Valves	1397cc	TD3153
C2J 772	4 Cyl.	8 Valves	1397cc	TD3154
C2J 776	4 Cyl.	8 Valves	1397cc	TD3155
C2J 780	4 Cyl.	8 Valves	1397cc	TD3156
C2J 781	4 Cyl.	8 Valves	1397cc	TD3157
C2J 782	4 Cyl.	8 Valves	1397cc	TD3158
C2J 784	4 Cyl.	8 Valves	1397cc	TD3161
C2J 788	4 Cyl.	8 Valves	1397cc	TD3162
C2J 789	4 Cyl.	8 Valves	1397cc	TD3163
C2J 792	4 Cyl.	8 Valves	1397cc	TD3164
C2J 794	4 Cyl.	8 Valves	1397cc	TD3165
C2J 796	4 Cyl.	8 Valves	1397cc	TD3166
C2J 797	4 Cyl.	8 Valves	1397cc	TD3167
C2J 798	4 Cyl.	8 Valves	1397cc	TD3168
C3J 700	4 Cyl.	8 Valves	1397cc	TD4856
C3J 702	4 Cyl.	8 Valves	1397cc	TD3175
C3J 710	4 Cyl.	8 Valves	1397cc	TD3176
C3J-750	4 Cyl.	8 Valves	1397cc	TD189
C3J-751	4 Cyl.	8 Valves	1397cc	TD190
C3J-752	4 Cyl.	8 Valves	1397cc	TD191
C3J-753	4 Cyl.	8 Valves	1397cc	TD192
C3J 756	4 Cyl.	8 Valves	1397cc	TD3177
C3J 760	4 Cyl.	8 Valves	1397cc	TD3179
C3J 762	4 Cyl.	8 Valves	1397cc	TD3180

HR816

NF834
35.00 x 50.00 x 8.00mm, FPM

NF722
35.00 x 50.00 x 10.00mm, MVQ
NF634
80.00 x 100.00 x 13.00mm, MVQ

24 1.4L

Petrol

C2L 717	4 Cyl.	8 Valves	1397cc	TD3171
---------	--------	----------	--------	--------

NF834
35.00 x 50.00 x 8.00mm, FPM

NF722
35.00 x 50.00 x 10.00mm, MVQ
NF634
80.00 x 100.00 x 13.00mm, MVQ



25 1.4L Petrol

E6J 700	4 Cyl.	8 Valves	1390cc	TD3183
E6J 701	4 Cyl.	8 Valves	1390cc	TD3184
E6J 706	4 Cyl.	8 Valves	1390cc	TD3185
E6J 712	4 Cyl.	8 Valves	1390cc	TD3186
E6J 713	4 Cyl.	8 Valves	1390cc	TD3187
E6J 718	4 Cyl.	8 Valves	1390cc	TD3188
E6J 734	4 Cyl.	8 Valves	1390cc	TD3189
E6J 738	4 Cyl.	8 Valves	1390cc	TD3190
E6J 760	4 Cyl.	8 Valves	1390cc	TD3191
E7J 601	4 Cyl.	8 Valves	1390cc	TD3198
E7J 624	4 Cyl.	8 Valves	1390cc	TD5526
E7J 626	4 Cyl.	8 Valves	1390cc	TD16362
E7J 634	4 Cyl.	8 Valves	1390cc	TD17271
E7J 635	4 Cyl.	8 Valves	1390cc	TD17272
E7J 700	4 Cyl.	8 Valves	1390cc	TD3199
E7J 706	4 Cyl.	8 Valves	1390cc	TD3200
E7J 707	4 Cyl.	8 Valves	1390cc	TD3201
E7J 710	4 Cyl.	8 Valves	1390cc	TD3203
E7J 711	4 Cyl.	8 Valves	1390cc	TD3204
E7J 718	4 Cyl.	8 Valves	1390cc	TD3205
E7J 719	4 Cyl.	8 Valves	1390cc	TD3206
E7J 720	4 Cyl.	8 Valves	1390cc	TD3207
E7J 724	4 Cyl.	8 Valves	1390cc	TD3208
E7J 726	4 Cyl.	8 Valves	1390cc	TD5508
E7J 728	4 Cyl.	8 Valves	1390cc	TD3209
E7J 742	4 Cyl.	8 Valves	1390cc	TD3212
E7J 745	4 Cyl.	8 Valves	1390cc	TD3210
E7J 754	4 Cyl.	8 Valves	1390cc	TD3211
E7J 756	4 Cyl.	8 Valves	1390cc	TD17279
E7J 757	4 Cyl.	8 Valves	1390cc	TD17282
E7J 764	4 Cyl.	8 Valves	1390cc	TD4858
E7J 770	4 Cyl.	8 Valves	1390cc	TD20896
E7J 771	4 Cyl.	8 Valves	1390cc	TD20897
E7J 773	4 Cyl.	8 Valves	1390cc	TD3213
E7J 780	4 Cyl.	8 Valves	1390cc	TD9623
K7J 700	4 Cyl.	8 Valves	1390cc	TD17470
K7J 701	4 Cyl.	8 Valves	1390cc	TD17851
K7J 710	4 Cyl.	8 Valves	1390cc	TD18138
K7J 714	4 Cyl.	8 Valves	1390cc	TD23530

HR816

NA5053
30.00 x 42.00 x 7.00mm, FPM

NA5016
35.00 x 47.00 x 7.00mm, FPM/ACM
NF835
80.00 x 100.00 x 8.00mm, FPM/ACM

26 1.4L Petrol

H4J 700	4 Cyl.	16 Valves	1397cc	TD23518
H4J A 700	4 Cyl.	16 Valves	1397cc	TD23519
H4J A 702	4 Cyl.	16 Valves	1397cc	TD23563

PB681 (x16)

NK103
87.00 x 100.00 x 8.50mm, FPM

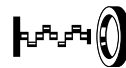
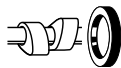

27 1.4L Petrol

K4J 700	4 Cyl.	16 Valves	1390cc	TD16342
K4J 710	4 Cyl.	16 Valves	1390cc	TD19673
K4J 711	4 Cyl.	16 Valves	1390cc	TD19672
K4J 712	4 Cyl.	16 Valves	1390cc	TD14330
K4J 713	4 Cyl.	16 Valves	1390cc	TD14331
K4J 714	4 Cyl.	16 Valves	1390cc	TD16349
K4J 715	4 Cyl.	16 Valves	1390cc	TD20907
K4J 718	4 Cyl.	16 Valves	1390cc	TD27308
K4J 730	4 Cyl.	16 Valves	1390cc	TD16531
K4J 732	4 Cyl.	16 Valves	1390cc	TD20910
K4J 740	4 Cyl.	16 Valves	1390cc	TD21208
K4J 750	4 Cyl.	16 Valves	1390cc	TD13310
K4J 770	4 Cyl.	16 Valves	1390cc	TD18422
K4J 780	4 Cyl.	16 Valves	1390cc	TD18533
K4J D 729	4 Cyl.	16 Valves	1390cc	TD20822
K4J D 740	4 Cyl.	16 Valves	1390cc	TD19686

PA5013 (x16)

NA5215 (x2)
28.00 x 42.00 x 5.00mm, FPM

NA5016
35.00 x 47.00 x 7.00mm, FPM/ACM
NF835
80.00 x 100.00 x 8.00mm, FPM/ACM

28 1.5L Petrol

697.01	4 Cyl.	8 Valves	1469cc	TD29128
--------	--------	----------	--------	---------

NF634
80.00 x 100.00 x 13.00mm, MVQ

29 1.5L Diesel

K9K 276	4 Cyl.	8 Valves	1461cc	TD23876
K9K 608	4 Cyl.	8 Valves	1461cc	TD27682
K9K 609	4 Cyl.	8 Valves	1461cc	TD30432
K9K 609	4 Cyl.	8 Valves	1461cc	TD32139
K9K 612	4 Cyl.	8 Valves	1461cc	TD27683
K9K 628	4 Cyl.	8 Valves	1461cc	TD34237
K9K 636	4 Cyl.	8 Valves	1461cc	TD28220
K9K 646	4 Cyl.	8 Valves	1461cc	TD32413
K9K 647	4 Cyl.	8 Valves	1461cc	TD32414
K9K 656	4 Cyl.	8 Valves	1461cc	TD32894
K9K 657	4 Cyl.	8 Valves	1461cc	TD32895
K9K 700	4 Cyl.	8 Valves	1461cc	TD16219
K9K 702	4 Cyl.	8 Valves	1461cc	TD16344
K9K 704	4 Cyl.	8 Valves	1461cc	TD16343
K9K 706	4 Cyl.	8 Valves	1461cc	TD20974
K9K 708	4 Cyl.	8 Valves	1461cc	TD26047
K9K 710	4 Cyl.	8 Valves	1461cc	TD17488
K9K 712	4 Cyl.	8 Valves	1461cc	TD18419
K9K 714	4 Cyl.	8 Valves	1461cc	TD21173
K9K 716	4 Cyl.	8 Valves	1461cc	TD22179
K9K 718	4 Cyl.	8 Valves	1461cc	TD21171
K9K 722	4 Cyl.	8 Valves	1461cc	TD16534
K9K 724	4 Cyl.	8 Valves	1461cc	TD20988



K9K 728	4 Cyl.	8 Valves	1461cc	TD20706
K9K 729	4 Cyl.	8 Valves	1461cc	TD20707
K9K 732	4 Cyl.	8 Valves	1461cc	TD20829
K9K 734	4 Cyl.	8 Valves	1461cc	TD22192
K9K 740	4 Cyl.	8 Valves	1461cc	TD20446
K9K 742	4 Cyl.	8 Valves	1461cc	TD33477
K9K 750	4 Cyl.	8 Valves	1461cc	TD21133
K9K 752	4 Cyl.	8 Valves	1461cc	TD21134
K9K 760	4 Cyl.	8 Valves	1461cc	TD21135
K9K 762	4 Cyl.	8 Valves	1461cc	TD20922
K9K 764	4 Cyl.	8 Valves	1461cc	TD18538
K9K 766	4 Cyl.	8 Valves	1461cc	TD18537
K9K 768	4 Cyl.	8 Valves	1461cc	TD18536
K9K 770	4 Cyl.	8 Valves	1461cc	TD25691
K9K 772	4 Cyl.	8 Valves	1461cc	TD23549
K9K 774	4 Cyl.	8 Valves	1461cc	TD31279
K9K 780	4 Cyl.	8 Valves	1461cc	TD20817
K9K 782	4 Cyl.	8 Valves	1461cc	TD27990
K9K 790	4 Cyl.	8 Valves	1461cc	TD21438
K9K 792	4 Cyl.	8 Valves	1461cc	TD21439
K9K 794	4 Cyl.	8 Valves	1461cc	TD23795
K9K 796	4 Cyl.	8 Valves	1461cc	TD26080
K9K 800	4 Cyl.	8 Valves	1461cc	TD22193
K9K 802	4 Cyl.	8 Valves	1461cc	TD20830
K9K 804	4 Cyl.	8 Valves	1461cc	TD20831
K9K 806	4 Cyl.	8 Valves	1461cc	TD20832
K9K 808	4 Cyl.	8 Valves	1461cc	TD26258
K9K 812	4 Cyl.	8 Valves	1461cc	TD24967
K9K 814	4 Cyl.	8 Valves	1461cc	TD33478
K9K 820	4 Cyl.	8 Valves	1461cc	TD25692
K9K 826	4 Cyl.	8 Valves	1461cc	TD29780
K9K 830	4 Cyl.	8 Valves	1461cc	TD25693
K9K 832	4 Cyl.	8 Valves	1461cc	TD23521
K9K 834	4 Cyl.	8 Valves	1461cc	TD23742
K9K 836	4 Cyl.	8 Valves	1461cc	TD23743
K9K 837	4 Cyl.	8 Valves	1461cc	TD26246
K9K 838	4 Cyl.	8 Valves	1461cc	TD32417
K9K 840	4 Cyl.	8 Valves	1461cc	TD22194
K9K 846	4 Cyl.	8 Valves	1461cc	TD24579
K9K 856	4 Cyl.	8 Valves	1461cc	TD34471
K9K 858	4 Cyl.	8 Valves	1461cc	TD34472
K9K 884	4 Cyl.	8 Valves	1461cc	TD27697
K9K 896	4 Cyl.	8 Valves	1461cc	TD33638
K9K 898	4 Cyl.	8 Valves	1461cc	TD34473
K9K F 830	4 Cyl.	8 Valves	1461cc	TD23566
K9K G 724	4 Cyl.	8 Valves	1461cc	TD19692
K9K G 832	4 Cyl.	8 Valves	1461cc	TD23522
K9K H 834	4 Cyl.	8 Valves	1461cc	TD23569

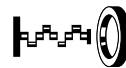
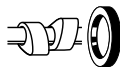

K9K J 836	4 Cyl.	8 Valves	1461cc	TD23567
K9K N 837	4 Cyl.	8 Valves	1461cc	TD24968
K9K P 732	4 Cyl.	8 Valves	1461cc	TD19693
PA5041 (x8) HR817	NA5215 28.00 x 42.00 x 5.00mm, FPM →Eng no. 061106		NA5255 35.00 x 47.00 x 7.00mm, PTFE/ACM	
	NA5328 28.00 x 42.00 x 6.00mm, PTFE/ACM Eng no. 061106→		NA5118 80.00 x 100.00 x 9.00mm, PTFE	

30 1.5L

Petrol

QG15DE	4 Cyl.	16 Valves	1498cc	TD33772
PB681 (x16)			NJ765 40.00 x 52.00 x 7.00mm, NBR	
			NJ284 84.00 x 104.00 x 11.00mm, MVQ	

31 1.6L

Petrol

807	4 Cyl.	8 Valves	1565cc	TD3029
807.04	4 Cyl.	8 Valves	1565cc	TD21384
807.05	4 Cyl.	8 Valves	1565cc	TD21385
807.10	4 Cyl.	8 Valves	1565cc	TD22182
807 727	4 Cyl.	8 Valves	1565cc	TD3030
841 705	4 Cyl.	8 Valves	1647cc	TD3057
841 717	4 Cyl.	8 Valves	1647cc	TD4854
841 725	4 Cyl.	8 Valves	1647cc	TD3056
841 726	4 Cyl.	8 Valves	1647cc	TD3055
843	4 Cyl.	8 Valves	1647cc	TD3058
843.01	4 Cyl.	8 Valves	1647cc	TD21391
843.05	4 Cyl.	8 Valves	1647cc	TD21381
843.20	4 Cyl.	8 Valves	1647cc	TD22346
843.21	4 Cyl.	8 Valves	1647cc	TD5381
843 718	4 Cyl.	8 Valves	1647cc	TD3060
843.719	4 Cyl.	8 Valves	1647cc	TD3063
843 720	4 Cyl.	8 Valves	1647cc	TD3059
843 721	4 Cyl.	8 Valves	1647cc	TD5429
843 723	4 Cyl.	8 Valves	1647cc	TD3061
843 724	4 Cyl.	8 Valves	1647cc	TD3062
844.12	4 Cyl.	8 Valves	1605cc	TD23615
A1M 705	4 Cyl.	8 Valves	1647cc	TD12868
A1M 707	4 Cyl.	8 Valves	1647cc	TD3082
A1M 708	4 Cyl.	8 Valves	1647cc	TD3083
A2M 723	4 Cyl.	8 Valves	1647cc	TD5055
A2M 725	4 Cyl.	8 Valves	1647cc	TD3086
A2M 726	4 Cyl.	8 Valves	1647cc	TD3087
A5L 717	4 Cyl.	8 Valves	1565cc	TD3088
A5L 718	4 Cyl.	8 Valves	1565cc	TD5430
A5L 750	4 Cyl.	8 Valves	1565cc	TD3089
A6M 725	4 Cyl.	8 Valves	1647cc	TD3090
A6M 726	4 Cyl.	8 Valves	1647cc	TD3091
A7L 752	4 Cyl.	8 Valves	1647cc	TD3093

NF634
80.00 x 100.00 x 13.00mm, MVQ



32 1.6L

Petrol

807.20	4 Cyl.	8 Valves	1565cc	TD19214
				NF198 40.00 x 55.00 x 8.00mm, NBR NF634 80.00 x 100.00 x 13.00mm, MVQ

33 1.6L

Petrol

821	4 Cyl.	8 Valves	1565cc	TD3042
821.01	4 Cyl.	8 Valves	1565cc	TD29263
821.02	4 Cyl.	8 Valves	1565cc	TD29262
821.03	4 Cyl.	8 Valves	1565cc	TD21388
821.04	4 Cyl.	8 Valves	1565cc	TD21389
821.10	4 Cyl.	8 Valves	1565cc	TD14890
821.11	4 Cyl.	8 Valves	1565cc	TD22247
821.20	4 Cyl.	8 Valves	1565cc	TD12308
				NF685 45.00 x 60.00 x 10.00mm, ACM NF634 80.00 x 100.00 x 13.00mm, MVQ

34 1.6L

Diesel

F8M 700	4 Cyl.	8 Valves	1596cc	TD3282
F8M 720	4 Cyl.	8 Valves	1596cc	TD3283
F8M 730	4 Cyl.	8 Valves	1596cc	TD3284
F8M 736	4 Cyl.	8 Valves	1596cc	TD3285
F8M 760	4 Cyl.	8 Valves	1596cc	TD3286
HR569	NF846 25.00 x 42.00 x 7.00mm, FPM/ACM			NF843 50.00 x 68.00 x 10.00mm, FPM/ACM NF648 50.00 x 68.00 x 10.00mm, MVQ NF850 85.00 x 105.00 x 8.00mm, FPM

35 1.6L

Petrol

HR16DE	4 Cyl.	16 Valves	1598cc	TD31823
				NA5223 40.00 x 52.00 x 7.00mm, FPM

36 1.6L

Petrol

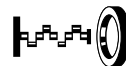
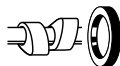

K4M 8 788	4 Cyl.	16 Valves	1598cc	TD19690
K4M 616	4 Cyl.	16 Valves	1598cc	TD27695
K4M 697	4 Cyl.	16 Valves	1598cc	TD23897
K4M 698	4 Cyl.	16 Valves	1598cc	TD23898
K4M 700	4 Cyl.	16 Valves	1598cc	TD13308
K4M 701	4 Cyl.	16 Valves	1598cc	TD13309
K4M 704	4 Cyl.	16 Valves	1598cc	TD16346
K4M 706	4 Cyl.	16 Valves	1598cc	TD21193
K4M 707	4 Cyl.	16 Valves	1598cc	TD26523
K4M 708	4 Cyl.	16 Valves	1598cc	TD16345
K4M 709	4 Cyl.	16 Valves	1598cc	TD21194
K4M 710	4 Cyl.	16 Valves	1598cc	TD16214
K4M 711	4 Cyl.	16 Valves	1598cc	TD16215
K4M 712	4 Cyl.	16 Valves	1598cc	TD21163



K4M 714	4 Cyl.	16 Valves	1598cc	TD21164
K4M 718	4 Cyl.	16 Valves	1598cc	TD21162
K4M 720	4 Cyl.	16 Valves	1598cc	TD16269
K4M 724	4 Cyl.	16 Valves	1598cc	TD16270
K4M 730	4 Cyl.	16 Valves	1598cc	TD21195
K4M 732	4 Cyl.	16 Valves	1598cc	TD20911
K4M 734	4 Cyl.	16 Valves	1598cc	TD20912
K4M 736	4 Cyl.	16 Valves	1598cc	TD21201
K4M 740	4 Cyl.	16 Valves	1598cc	TD18445
K4M 742	4 Cyl.	16 Valves	1598cc	TD20913
K4M 743	4 Cyl.	16 Valves	1598cc	TD20914
K4M 744	4 Cyl.	16 Valves	1598cc	TD19674
K4M 745	4 Cyl.	16 Valves	1598cc	TD19675
K4M 746	4 Cyl.	16 Valves	1598cc	TD20915
K4M 748	4 Cyl.	16 Valves	1598cc	TD11567
K4M 750	4 Cyl.	16 Valves	1598cc	TD17489
K4M 752	4 Cyl.	16 Valves	1598cc	TD16370
K4M 753	4 Cyl.	16 Valves	1598cc	TD17494
K4M 754	4 Cyl.	16 Valves	1598cc	TD21176
K4M 762	4 Cyl.	16 Valves	1598cc	TD21202
K4M 764	4 Cyl.	16 Valves	1598cc	TD20916
K4M 768	4 Cyl.	16 Valves	1598cc	TD21203
K4M 788	4 Cyl.	16 Valves	1598cc	TD21204
K4M 842	4 Cyl.	16 Valves	1598cc	TD32416
K4M 850	4 Cyl.	16 Valves	1598cc	TD26565
K4M P 848	4 Cyl.	16 Valves	1598cc	TD24253

PA5013 (x16)

NA5215 (x2)
28.00 x 42.00 x 5.00mm, FPM

NA5016 
35.00 x 47.00 x 7.00mm, FPM/ACM
NF835 
80.00 x 100.00 x 8.00mm, FPM/ACM

37 1.6L

Petrol

K4M 9 766	4 Cyl.	16 Valves	1598cc	TD19687
K4M 716	4 Cyl.	16 Valves	1598cc	TD21200
K4M 760	4 Cyl.	16 Valves	1598cc	TD16532
K4M 761	4 Cyl.	16 Valves	1598cc	TD18302
K4M 766	4 Cyl.	16 Valves	1598cc	TD26524
K4M 776	4 Cyl.	16 Valves	1598cc	TD26525
K4M 782	4 Cyl.	16 Valves	1598cc	TD18303
K4M 790	4 Cyl.	16 Valves	1598cc	TD18898
K4M 791	4 Cyl.	16 Valves	1598cc	TD18899
K4M 792	4 Cyl.	16 Valves	1598cc	TD20894
K4M 794	4 Cyl.	16 Valves	1598cc	TD20895
K4M 800	4 Cyl.	16 Valves	1598cc	TD18534
K4M 801	4 Cyl.	16 Valves	1598cc	TD18535
K4M 804	4 Cyl.	16 Valves	1598cc	TD18532
K4M 812	4 Cyl.	16 Valves	1598cc	TD21294
K4M 813	4 Cyl.	16 Valves	1598cc	TD26333
K4M 824	4 Cyl.	16 Valves	1598cc	TD20814
K4M 830	4 Cyl.	16 Valves	1598cc	TD23581
K4M 831	4 Cyl.	16 Valves	1598cc	TD26526



K4M 834	4 Cyl.	16 Valves	1598cc	TD26128
K4M 838	4 Cyl.	16 Valves	1598cc	TD26123
K4M 839	4 Cyl.	16 Valves	1598cc	TD26124
K4M 848	4 Cyl.	16 Valves	1598cc	TD26527
K4M 854	4 Cyl.	16 Valves	1598cc	TD21229
K4M 856	4 Cyl.	16 Valves	1598cc	TD26528
K4M 858	4 Cyl.	16 Valves	1598cc	TD23580
K4M 858	4 Cyl.	16 Valves	1598cc	TD33631
K4M 862	4 Cyl.	16 Valves	1598cc	TD23548
K4M 866	4 Cyl.	16 Valves	1598cc	TD23553
K4M C 812	4 Cyl.	16 Valves	1598cc	TD21104
K4M C 813	4 Cyl.	16 Valves	1598cc	TD19689
K4M D 812	4 Cyl.	16 Valves	1598cc	TD21107
K4M D 813	4 Cyl.	16 Valves	1598cc	TD21105
K4M R 858	4 Cyl.	16 Valves	1598cc	TD24969
K4M T 782	4 Cyl.	16 Valves	1598cc	TD20824
K4M T 866	4 Cyl.	16 Valves	1598cc	TD23552
K4M W 761	4 Cyl.	16 Valves	1598cc	TD20827

PA5013 (x16)

NA5328

28.00 x 42.00 x 6.00mm, PTFE/ACM

NA5457

33.00 x 42.00 x 6.00mm, PTFE/ACM

NA5016

35.00 x 47.00 x 7.00mm, FPM/ACM

NF835

80.00 x 100.00 x 8.00mm, FPM/ACM

38 1.6L

Petrol

K4M 690	4 Cyl.	16 Valves	1598cc	TD22187
---------	--------	-----------	--------	---------

PA5013 (x16)

NA5215 (x2)

28.00 x 42.00 x 5.00mm, FPM

NA5016

35.00 x 47.00 x 7.00mm, FPM/ACM

NF835

80.00 x 100.00 x 8.00mm, FPM/ACM

39 1.6L

Petrol

K7M 690	4 Cyl.	8 Valves	1598cc	TD22190
K7M 702	4 Cyl.	8 Valves	1598cc	TD4876
K7M 703	4 Cyl.	8 Valves	1598cc	TD4877
K7M 704	4 Cyl.	8 Valves	1598cc	TD20917
K7M 710	4 Cyl.	8 Valves	1598cc	TD18139
K7M 714	4 Cyl.	8 Valves	1598cc	TD32299
K7M 718	4 Cyl.	8 Valves	1598cc	TD23534
K7M 720	4 Cyl.	8 Valves	1598cc	TD4878
K7M 732	4 Cyl.	8 Valves	1598cc	TD23532
K7M 734	4 Cyl.	8 Valves	1598cc	TD27699
K7M 744	4 Cyl.	8 Valves	1598cc	TD14332
K7M 745	4 Cyl.	8 Valves	1598cc	TD14333
K7M 746	4 Cyl.	8 Valves	1598cc	TD20918
K7M 750	4 Cyl.	8 Valves	1598cc	TD22191
K7M 764	4 Cyl.	8 Valves	1598cc	TD32300
K7M 790	4 Cyl.	8 Valves	1598cc	TD4879
K7M 812	4 Cyl.	8 Valves	1598cc	TD32301

HR816

NA5053

30.00 x 42.00 x 7.00mm, FPM

NA5016

35.00 x 47.00 x 7.00mm, FPM/ACM

NF835

80.00 x 100.00 x 8.00mm, FPM/ACM

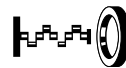
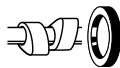

40 1.6L

Petrol

MSM 400	4 Cyl.	16 Valves	1618cc	TD32079
MSM 450	4 Cyl.	16 Valves	1618cc	TD31367
PB681 (x16)				NK106 46.00 x 58.00 x 7.00mm, ACM

41 1.6L

Petrol

MR16DDT	4 Cyl.	16 Valves	1618cc	TD31825
PB681 (x16)				NK106 46.00 x 58.00 x 7.00mm, ACM NJ765 40.00 x 52.00 x 7.00mm, NBR

42 1.6L

Diesel

R9M 402	4 Cyl.	16 Valves	1598cc	TD26297
R9M 404	4 Cyl.	16 Valves	1598cc	TD26298
R9M 409	4 Cyl.	16 Valves	1598cc	TD31368
R9M 414	4 Cyl.	16 Valves	1598cc	TD32298
R9M 453	4 Cyl.	16 Valves	1598cc	TD33141
PA5041 (x16)				NA5333 48.00 x 81.00 x 11.5mm, FPM/ACM

43 1.6L

Diesel

R9M 408	4 Cyl.	16 Valves	1598cc	TD32296
R9M 413	4 Cyl.	16 Valves	1598cc	TD32995
R9M 450	4 Cyl.	16 Valves	1598cc	TD32297
R9M 452	4 Cyl.	16 Valves	1598cc	TD31369
PA5041 (x16) HR791				NA5333 48.00 x 81.00 x 11.5mm, FPM/ACM

44 1.7L

Petrol

F1N 720	4 Cyl.	8 Valves	1721cc	TD3216
F1N 722	4 Cyl.	8 Valves	1721cc	TD3217
F1N 724	4 Cyl.	8 Valves	1721cc	TD3218
HR569				NF847 22.00 x 45.00 x 7.00mm, FPM/ACM NF846 25.00 x 42.00 x 7.00mm, FPM/ACM NF843 50.00 x 68.00 x 10.00mm, FPM/ACM NF648 50.00 x 68.00 x 10.00mm, MVQ NF850 85.00 x 105.00 x 8.00mm, FPM

45 1.7L

Petrol

F2N 700	4 Cyl.	8 Valves	1721cc	TD3219
F2N 704	4 Cyl.	8 Valves	1721cc	TD3220
F2N 708	4 Cyl.	8 Valves	1721cc	TD3221
F2N 710	4 Cyl.	8 Valves	1721cc	TD3222
F2N 711	4 Cyl.	8 Valves	1721cc	TD3223
F2N 712	4 Cyl.	8 Valves	1721cc	TD3224
F2N 716	4 Cyl.	8 Valves	1721cc	TD3226
F2N 720	4 Cyl.	8 Valves	1721cc	TD4862
F2N 721	4 Cyl.	8 Valves	1721cc	TD3228
F2N 722	4 Cyl.	8 Valves	1721cc	TD3229
F2N 724	4 Cyl.	8 Valves	1721cc	TD3230
F2N 726	4 Cyl.	8 Valves	1721cc	TD3231



F2N 727	4 Cyl.	8 Valves	1721cc	TD3232
F2N 728	4 Cyl.	8 Valves	1721cc	TD3233
F2N 730	4 Cyl.	8 Valves	1721cc	TD3234
F2N 732	4 Cyl.	8 Valves	1721cc	TD3235
F2N 740	4 Cyl.	8 Valves	1721cc	TD3236
F2N 742	4 Cyl.	8 Valves	1721cc	TD4861
F2N 750	4 Cyl.	8 Valves	1721cc	TD3238
F2N 752	4 Cyl.	8 Valves	1721cc	TD3239
F2N 753	4 Cyl.	8 Valves	1721cc	TD22362
F2N 754	4 Cyl.	8 Valves	1721cc	TD3240
F2N 758	4 Cyl.	8 Valves	1721cc	TD3241
F2N 770	4 Cyl.	8 Valves	1721cc	TD3242
F2N 783	4 Cyl.	8 Valves	1721cc	TD3243
F2N 786	4 Cyl.	8 Valves	1721cc	TD3244
F2N 796	4 Cyl.	8 Valves	1721cc	TD3245
F2N 797	4 Cyl.	8 Valves	1721cc	TD3246
F2N 798	4 Cyl.	8 Valves	1721cc	TD3247
F3N 702	4 Cyl.	8 Valves	1721cc	TD3249
F3N-704	4 Cyl.	8 Valves	1721cc	TD193
F3N-705	4 Cyl.	8 Valves	1721cc	TD194
F3N 708	4 Cyl.	8 Valves	1721cc	TD3250
F3N 716	4 Cyl.	8 Valves	1721cc	TD3251
F3N 717	4 Cyl.	8 Valves	1721cc	TD3252
F3N 718	4 Cyl.	8 Valves	1721cc	TD4863
F3N 722	4 Cyl.	8 Valves	1721cc	TD3254
F3N 723	4 Cyl.	8 Valves	1721cc	TD3255
F3N 726	4 Cyl.	8 Valves	1721cc	TD3256
F3N 740	4 Cyl.	8 Valves	1721cc	TD3257
F3N 741	4 Cyl.	8 Valves	1721cc	TD3258
F3N 742	4 Cyl.	8 Valves	1721cc	TD3259
F3N 743	4 Cyl.	8 Valves	1721cc	TD3260
F3N 746	4 Cyl.	8 Valves	1721cc	TD3261

HR569

NF846
25.00 x 42.00 x 7.00mm, FPM/ACM
NF847
22.00 x 45.00 x 7.00mm, FPM/ACM

NF843
50.00 x 68.00 x 10.00mm, FPM/ACM
NF648
50.00 x 68.00 x 10.00mm, MVQ
NF850
85.00 x 105.00 x 8.00mm, FPM

46 1.7L

Petrol

F3N 747	4 Cyl.	8 Valves	1721cc	TD27329
HR569	NF846 25.00 x 42.00 x 7.00mm, FPM/ACM NF847 22.00 x 45.00 x 7.00mm, FPM/ACM	NF843 50.00 x 68.00 x 10.00mm, FPM/ACM NF850 85.00 x 105.00 x 8.00mm, FPM		

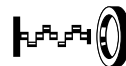
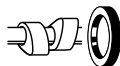

47 1.8L

Petrol

F3P 670	4 Cyl.	8 Valves	1783cc	TD5541
F3P 676	4 Cyl.	8 Valves	1794cc	TD20049
F3P 678	4 Cyl.	8 Valves	1783cc	TD5542
F3P 720	4 Cyl.	8 Valves	1794cc	TD3270
F3P 724	4 Cyl.	8 Valves	1794cc	TD3271

HR569

NF846
25.00 x 42.00 x 7.00mm, FPM/ACM
NF847
22.00 x 45.00 x 7.00mm, FPM/ACM

NF843
50.00 x 68.00 x 10.00mm, FPM/ACM
→04/97

NA5036
42.00 x 54.00 x 6.00mm, FPM
04/97→

NA5037
85.00 x 105.00 x 11.00mm, ACM

NF850
85.00 x 105.00 x 8.00mm, FPM

48 1.8L

Petrol

F3P 674	4 Cyl.	8 Valves	1783cc	TD18885
---------	--------	----------	--------	---------

HR569

NF847
22.00 x 45.00 x 7.00mm, FPM/ACM
NF846
25.00 x 42.00 x 7.00mm, FPM/ACM

NF843
50.00 x 68.00 x 10.00mm, FPM/ACM
→04/97

NA5036
42.00 x 54.00 x 6.00mm, FPM
04/97→

NA5037
85.00 x 105.00 x 11.00mm, ACM

NF850
85.00 x 105.00 x 8.00mm, FPM

49 1.8L

Petrol

F3P 682	4 Cyl.	8 Valves	1783cc	TD5483
F3P 755	4 Cyl.	8 Valves	1783cc	TD3272

HR569

NF847
22.00 x 45.00 x 7.00mm, FPM/ACM
NF846
25.00 x 42.00 x 7.00mm, FPM/ACM

NF843
50.00 x 68.00 x 10.00mm, FPM/ACM

NF850
85.00 x 105.00 x 8.00mm, FPM

50 1.8L

Petrol

F3P 700	4 Cyl.	8 Valves	1794cc	TD3262
F3P 704	4 Cyl.	8 Valves	1794cc	TD5488
F3P 705	4 Cyl.	8 Valves	1794cc	TD3263
F3P 706	4 Cyl.	8 Valves	1794cc	TD3264
F3P 707	4 Cyl.	8 Valves	1794cc	TD3265
F3P 708	4 Cyl.	8 Valves	1794cc	TD3266
F3P 710	4 Cyl.	8 Valves	1794cc	TD3267
F3P 712	4 Cyl.	8 Valves	1794cc	TD3268
F3P 714	4 Cyl.	8 Valves	1794cc	TD3269
F3P 716	4 Cyl.	8 Valves	1794cc	TD32283
F3P 717	4 Cyl.	8 Valves	1794cc	TD32284
F3P 718	4 Cyl.	8 Valves	1794cc	TD32287
F3P 740	4 Cyl.	8 Valves	1794cc	TD32285
F3P 742	4 Cyl.	8 Valves	1794cc	TD32286
F3P 754	4 Cyl.	8 Valves	1794cc	TD5523
F3P 758	4 Cyl.	8 Valves	1783cc	TD3273



F3P 760	4 Cyl.	8 Valves	1794cc	TD3274
F3P 764	4 Cyl.	8 Valves	1783cc	TD9554
F3P 765	4 Cyl.	8 Valves	1794cc	TD5494
HR569	NF846	NF847	NF843	NF850
	25.00 x 42.00 x 7.00mm, FPM/ACM	22.00 x 45.00 x 7.00mm, FPM/ACM	50.00 x 68.00 x 10.00mm, FPM/ACM	85.00 x 105.00 x 8.00mm, FPM

51 1.8L

Petrol

F4P 720	4 Cyl.	16 Valves	1783cc	TD16220
F4P 722	4 Cyl.	16 Valves	1783cc	TD16221
F4P 760	4 Cyl.	16 Valves	1783cc	TD16189
PA5013 (x16)	NA5257 (x2)	NA5036	NA5037	
	28.00 x 47.00 x 5.50mm, FPM	42.00 x 54.00 x 6.00mm, FPM	85.00 x 105.00 x 11.00mm, ACM	

52 1.8L

Petrol

F4P 770	4 Cyl.	16 Valves	1783cc	TD16216
F4P 771	4 Cyl.	16 Valves	1783cc	TD18272
F4P 772	4 Cyl.	16 Valves	1783cc	TD21211
F4P 773	4 Cyl.	16 Valves	1783cc	TD16217
F4P 774	4 Cyl.	16 Valves	1783cc	TD18273
F4P 775	4 Cyl.	16 Valves	1783cc	TD18274
PA5013 (x16)	NA5257	NA5036	NA5037	
	28.00 x 47.00 x 5.50mm, FPM	42.00 x 54.00 x 6.00mm, FPM	85.00 x 105.00 x 11.00mm, ACM	
	NA5448			
	34.00 x 47.00 x 5.50mm, FPM			

53 1.8L

Petrol

F7P 700	4 Cyl.	16 Valves	1764cc	TD3277
F7P 702	4 Cyl.	16 Valves	1764cc	TD27307
F7P 704	4 Cyl.	16 Valves	1764cc	TD3278
F7P 720	4 Cyl.	16 Valves	1764cc	TD3279
F7P 722	4 Cyl.	16 Valves	1764cc	TD3280
HR816 (x2)	NF846 (x2)	NF843	NF850	
	25.00 x 42.00 x 7.00mm, FPM/ACM	50.00 x 68.00 x 10.00mm, FPM/ACM	85.00 x 105.00 x 8.00mm, FPM	

54 1.9L

Diesel

F8Q 600	4 Cyl.	8 Valves	1870cc	TD16330
F8Q 606	4 Cyl.	8 Valves	1870cc	TD9690
HR569	NF846	NA5036	NA5037	
	25.00 x 42.00 x 7.00mm, FPM/ACM	42.00 x 54.00 x 6.00mm, FPM	85.00 x 105.00 x 11.00mm, ACM	

55 1.9L

Diesel

F8Q 610	4 Cyl.	8 Valves	1870cc	TD19666
F8Q 620	4 Cyl.	8 Valves	1870cc	TD4867
F8Q 640	4 Cyl.	8 Valves	1870cc	TD5510
F8Q 646	4 Cyl.	8 Valves	1870cc	TD21252
F8Q 706	4 Cyl.	8 Valves	1870cc	TD3287
F8Q 710	4 Cyl.	8 Valves	1870cc	TD3288

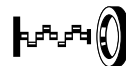
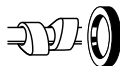

F8Q 714	4 Cyl.	8 Valves	1870cc	TD3289
F8Q 722	4 Cyl.	8 Valves	1870cc	TD3290
F8Q 724	4 Cyl.	8 Valves	1870cc	TD3291
F8Q 730	4 Cyl.	8 Valves	1870cc	TD4868
F8Q 732	4 Cyl.	8 Valves	1870cc	TD4869
F8Q 740	4 Cyl.	8 Valves	1870cc	TD3294
F8Q 742	4 Cyl.	8 Valves	1870cc	TD3295
F8Q 744	4 Cyl.	8 Valves	1870cc	TD3296
F8Q 748	4 Cyl.	8 Valves	1870cc	TD27320
F8Q 754	4 Cyl.	8 Valves	1870cc	TD27327
F8Q 764	4 Cyl.	8 Valves	1870cc	TD3297
F8Q 768	4 Cyl.	8 Valves	1870cc	TD19234
F8Q 774	4 Cyl.	8 Valves	1870cc	TD3298
F8Q 776	4 Cyl.	8 Valves	1870cc	TD3299
F8Q 788	4 Cyl.	8 Valves	1870cc	TD21256

HR569

NF846
25.00 x 42.00 x 7.00mm, FPM/ACM

NF843
50.00 x 68.00 x 10.00mm, FPM/ACM
NF850
85.00 x 105.00 x 8.00mm, FPM

56 1.9L

Diesel

F8Q 622	4 Cyl.	8 Valves	1870cc	TD18295
F8Q 630	4 Cyl.	8 Valves	1870cc	TD9626
F8Q 632	4 Cyl.	8 Valves	1870cc	TD17431
F8Q 636	4 Cyl.	8 Valves	1870cc	TD21227
F8Q 648	4 Cyl.	8 Valves	1870cc	TD21251
F8Q 662	4 Cyl.	8 Valves	1870cc	TD9625
F8Q 680	4 Cyl.	8 Valves	1870cc	TD21253
F8Q 684	4 Cyl.	8 Valves	1870cc	TD21254
F8Q 786	4 Cyl.	8 Valves	1870cc	TD16352

HR569

NF846
25.00 x 42.00 x 7.00mm, FPM/ACM

NA5036
42.00 x 54.00 x 6.00mm, FPM
NA5037
85.00 x 105.00 x 11.00mm, ACM
NF850
85.00 x 105.00 x 8.00mm, FPM

57 1.9L

Diesel

F8Q 624	4 Cyl.	8 Valves	1870cc	TD16348
F8Q 784	4 Cyl.	8 Valves	1870cc	TD4870

HR569

NF846
25.00 x 42.00 x 7.00mm, FPM/ACM

NF843
50.00 x 68.00 x 10.00mm, FPM/ACM
→04/97
NA5036
42.00 x 54.00 x 6.00mm, FPM
04/97→
NF850
85.00 x 105.00 x 8.00mm, FPM

58 1.9L

Diesel

F8Q 644	4 Cyl.	8 Valves	1870cc	TD21146
----------------	--------	----------	--------	----------------

HR569

NF846
25.00 x 42.00 x 7.00mm, FPM/ACM

NF850
85.00 x 105.00 x 8.00mm, FPM



59 1.9L Diesel

F8Q 676	4 Cyl.	8 Valves	1870cc	TD23895
F8Q 678	4 Cyl.	8 Valves	1870cc	TD20390
F8Q 682	4 Cyl.	8 Valves	1870cc	TD16544
F8Q 696	4 Cyl.	8 Valves	1870cc	TD21255

HR569

NF846

25.00 x 42.00 x 7.00mm, FPM/ACM

NF843

50.00 x 68.00 x 10.00mm, FPM/ACM

→04/97

NA5036

42.00 x 54.00 x 6.00mm, FPM

04/97→

NA5037

85.00 x 105.00 x 11.00mm, ACM

NF850

85.00 x 105.00 x 8.00mm, FPM

60 1.9L Diesel

F8Q 785	4 Cyl.	8 Valves	1870cc	TD22363
----------------	--------	----------	--------	----------------

HR569

NF846

25.00 x 42.00 x 7.00mm, FPM/ACM

61 1.9L Diesel

F8Q 790	4 Cyl.	8 Valves	1870cc	TD18290
----------------	--------	----------	--------	----------------

HR569

NF846

25.00 x 42.00 x 7.00mm, FPM/ACM

NA5036

42.00 x 54.00 x 6.00mm, FPM

NF843

50.00 x 68.00 x 10.00mm, FPM/ACM

NA5037

85.00 x 105.00 x 11.00mm, ACM

NF850

85.00 x 105.00 x 8.00mm, FPM

62 1.9L Diesel

F9Q 650	4 Cyl.	8 Valves	1870cc	TD21223
F9Q 664	4 Cyl.	8 Valves	1870cc	TD19677
F9Q 670	4 Cyl.	8 Valves	1870cc	TD21224
F9Q 674	4 Cyl.	8 Valves	1870cc	TD21225
F9Q 680	4 Cyl.	8 Valves	1870cc	TD18286
F9Q 710	4 Cyl.	8 Valves	1870cc	TD16190
F9Q 716	4 Cyl.	8 Valves	1870cc	TD16191
F9Q 717	4 Cyl.	8 Valves	1870cc	TD21136
F9Q 718	4 Cyl.	8 Valves	1870cc	TD16192
F9Q 722	4 Cyl.	8 Valves	1870cc	TD16305
F9Q 730	4 Cyl.	8 Valves	1870cc	TD11427
F9Q 731	4 Cyl.	8 Valves	1870cc	TD16353
F9Q 732	4 Cyl.	8 Valves	1870cc	TD16347
F9Q 733	4 Cyl.	8 Valves	1870cc	TD16363
F9Q 734	4 Cyl.	8 Valves	1870cc	TD11428
F9Q 736	4 Cyl.	8 Valves	1870cc	TD16354
F9Q 738	4 Cyl.	8 Valves	1870cc	TD21137
F9Q 740	4 Cyl.	8 Valves	1870cc	TD16341
F9Q 744	4 Cyl.	8 Valves	1870cc	TD16361
F9Q 746	4 Cyl.	8 Valves	1870cc	TD24971
F9Q 748	4 Cyl.	8 Valves	1870cc	TD21138
F9Q 750	4 Cyl.	8 Valves	1870cc	TD17028

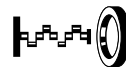
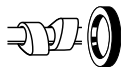

F9Q 751	4 Cyl.	8 Valves	1870cc	TD21226
F9Q 752	4 Cyl.	8 Valves	1870cc	TD21139
F9Q 754	4 Cyl.	8 Valves	1870cc	TD20841
F9Q 756	4 Cyl.	8 Valves	1870cc	TD17064
F9Q 758	4 Cyl.	8 Valves	1870cc	TD19678
F9Q 759	4 Cyl.	8 Valves	1870cc	TD19679
F9Q 760	4 Cyl.	8 Valves	1870cc	TD16529
F9Q 762	4 Cyl.	8 Valves	1870cc	TD18691
F9Q 770	4 Cyl.	8 Valves	1870cc	TD15688
F9Q 772	4 Cyl.	8 Valves	1870cc	TD16304
F9Q 774	4 Cyl.	8 Valves	1870cc	TD19370
F9Q 780	4 Cyl.	8 Valves	1870cc	TD16339
F9Q 782	4 Cyl.	8 Valves	1870cc	TD17498
F9Q 790	4 Cyl.	8 Valves	1870cc	TD16358
F9Q 796	4 Cyl.	8 Valves	1870cc	TD24972
F9Q 800	4 Cyl.	8 Valves	1870cc	TD16535
F9Q 803	4 Cyl.	8 Valves	1870cc	TD20973
F9Q 804	4 Cyl.	8 Valves	1870cc	TD20391
F9Q 808	4 Cyl.	8 Valves	1870cc	TD21147
F9Q 812	4 Cyl.	8 Valves	1870cc	TD20392
F9Q 816	4 Cyl.	8 Valves	1870cc	TD22184
F9Q 818	4 Cyl.	8 Valves	1870cc	TD22185
F9Q 820	4 Cyl.	8 Valves	1870cc	TD18287
F9Q 826	4 Cyl.	8 Valves	1870cc	TD18288
F9Q 870	4 Cyl.	8 Valves	1870cc	TD23617
F9Q 872	4 Cyl.	8 Valves	1870cc	TD23555
F9Q E 804	4 Cyl.	8 Valves	1870cc	TD19683
F9Q EE 804	4 Cyl.	8 Valves	1870cc	TD19696
F9Q J 803	4 Cyl.	8 Valves	1870cc	TD19694
F9Q J 804	4 Cyl.	8 Valves	1870cc	TD21106
F9Q P 872	4 Cyl.	8 Valves	1870cc	TD23554

HR816

NF846

25.00 x 42.00 x 7.00mm, FPM/ACM

NA5036

42.00 x 54.00 x 6.00mm, FPM

NA5037

85.00 x 105.00 x 11.00mm, ACM

63 1.9L

Diesel

F9Q N 870	4 Cyl.	16 Valves	1870cc	TD23568
-----------	--------	-----------	--------	---------

HR816 (x2)

NF846

25.00 x 42.00 x 7.00mm, FPM/ACM

NA5036

42.00 x 54.00 x 6.00mm, FPM

NA5037

85.00 x 105.00 x 11.00mm, ACM

64 2.0L

Petrol

829.00	4 Cyl.	8 Valves	1995cc	TD29261
829.01	4 Cyl.	8 Valves	1995cc	TD21390
829 700	4 Cyl.	8 Valves	1995cc	TD3043
829 701	4 Cyl.	8 Valves	1995cc	TD5428
829 702	4 Cyl.	8 Valves	1995cc	TD3307
829 703	4 Cyl.	8 Valves	1995cc	TD5427
829 710	4 Cyl.	8 Valves	1995cc	TD3044
829 720	4 Cyl.	8 Valves	1995cc	TD5561



829 721	4 Cyl.	8 Valves	1995cc	TD5562
829 730	4 Cyl.	8 Valves	1995cc	TD3045
829 731	4 Cyl.	8 Valves	1995cc	TD3046
J5R 716	4 Cyl.	8 Valves	1995cc	TD3302
J5R 718	4 Cyl.	8 Valves	1995cc	TD3303
J5R 722	4 Cyl.	8 Valves	1995cc	TD3304
J5R 726	4 Cyl.	8 Valves	1995cc	TD3305
J5R 728	4 Cyl.	8 Valves	1995cc	TD3306
J5R 800	4 Cyl.	8 Valves	1995cc	TD21103
J6R 234	4 Cyl.	8 Valves	1995cc	TD3308
J6R 236	4 Cyl.	8 Valves	1995cc	TD3309
J6R 706	4 Cyl.	8 Valves	1995cc	TD3310
J6R 707	4 Cyl.	8 Valves	1995cc	TD3311
J6R 710	4 Cyl.	8 Valves	1995cc	TD3312
J6R 711	4 Cyl.	8 Valves	1995cc	TD5063
J6R 712	4 Cyl.	8 Valves	1995cc	TD3314
J6R 713	4 Cyl.	8 Valves	1995cc	TD3315
J6R 714	4 Cyl.	8 Valves	1995cc	TD5062
J6R 715	4 Cyl.	8 Valves	1995cc	TD3319
J6R 716	4 Cyl.	8 Valves	1995cc	TD5064
J6R 726	4 Cyl.	8 Valves	1995cc	TD3322
J6R 734	4 Cyl.	8 Valves	1995cc	TD3323
J6R 758	4 Cyl.	8 Valves	1995cc	TD3324
J6R 759	4 Cyl.	8 Valves	1995cc	TD3325
J6R 760	4 Cyl.	8 Valves	1995cc	TD3326
J6R 762	4 Cyl.	8 Valves	1995cc	TD3327
J6R 763	4 Cyl.	8 Valves	1995cc	TD3328
J6R 792	4 Cyl.	8 Valves	1995cc	TD3329
J6R 793	4 Cyl.	8 Valves	1995cc	TD3330
J7R 722	4 Cyl.	8 Valves	1995cc	TD3335
J7R 723	4 Cyl.	8 Valves	1995cc	TD3336
J7R 746	4 Cyl.	8 Valves	1995cc	TD3345
J7R 747	4 Cyl.	8 Valves	1995cc	TD3346
J7R 750	4 Cyl.	8 Valves	1995cc	TD3347
J7R 751	4 Cyl.	8 Valves	1995cc	TD3348
J7R 752	4 Cyl.	8 Valves	1995cc	TD3349
J7R 756	4 Cyl.	8 Valves	1995cc	TD3351
J7R 760	4 Cyl.	8 Valves	1995cc	TD3352
J7R 768	4 Cyl.	8 Valves	1995cc	TD3353

HR569

NA5016

35.00 x 47.00 x 7.00mm, FPM/ACM

NF843

50.00 x 68.00 x 10.00mm, FPM/ACM

NF844

90.00 x 110.00 x 11.00mm, FPM/ACM



65 2.0L

Petrol

F3R 200	4 Cyl.	8 Valves	1998cc	TD21210
F3R 722	4 Cyl.	8 Valves	1998cc	TD3275
F3R 723	4 Cyl.	8 Valves	1998cc	TD3276
F3R 728	4 Cyl.	8 Valves	1998cc	TD16177
F3R 729	4 Cyl.	8 Valves	1998cc	TD16178
F3R 742	4 Cyl.	8 Valves	1998cc	TD16372
F3R 750	4 Cyl.	8 Valves	1998cc	TD4865
F3R 751	4 Cyl.	8 Valves	1998cc	TD16357
F3R 768	4 Cyl.	8 Valves	1998cc	TD16373
F3R 769	4 Cyl.	8 Valves	1998cc	TD16374
F3R 791	4 Cyl.	8 Valves	1998cc	TD16350
F3R 796	4 Cyl.	8 Valves	1998cc	TD16351
F3R 797	4 Cyl.	8 Valves	1998cc	TD20050
F3R 798	4 Cyl.	8 Valves	1998cc	TD20051

HR569

NF846
25.00 x 42.00 x 7.00mm, FPM/ACM

NF847
22.00 x 45.00 x 7.00mm, FPM/ACM

NF843
50.00 x 68.00 x 10.00mm, FPM/ACM
→04/97

NA5036
42.00 x 54.00 x 6.00mm, FPM
04/97→

NA5037
85.00 x 105.00 x 11.00mm, ACM

NF850
85.00 x 105.00 x 8.00mm, FPM

66 2.0L

Petrol

F3R 611	4 Cyl.	8 Valves	1998cc	TD20904
---------	--------	----------	--------	---------

HR569

NF846
25.00 x 42.00 x 7.00mm, FPM/ACM

NF847
22.00 x 45.00 x 7.00mm, FPM/ACM

NA5036
42.00 x 54.00 x 6.00mm, FPM

NA5037
85.00 x 105.00 x 11.00mm, ACM

NF850
85.00 x 105.00 x 8.00mm, FPM

67 2.0L

Petrol

F3R 752	4 Cyl.	8 Valves	1998cc	TD20052
---------	--------	----------	--------	---------

HR569

NF846
25.00 x 42.00 x 7.00mm, FPM/ACM

NF847
22.00 x 45.00 x 7.00mm, FPM/ACM

NF843
50.00 x 68.00 x 10.00mm, FPM/ACM

NF850
85.00 x 105.00 x 8.00mm, FPM

68 2.0L

Petrol

F3R J7	4 Cyl.	8 Valves	1998cc	TD5504
--------	--------	----------	--------	--------

HR569

NF847
22.00 x 45.00 x 7.00mm, FPM/ACM

NF846
25.00 x 42.00 x 7.00mm, FPM/ACM

NA5036
42.00 x 54.00 x 6.00mm, FPM

NF843
50.00 x 68.00 x 10.00mm, FPM/ACM

NA5037
85.00 x 105.00 x 11.00mm, ACM

NF850
85.00 x 105.00 x 8.00mm, FPM



69	2.0L	Petrol			
F4R		4 Cyl.	16 Valves	1998cc	TD29449
F4R 400		4 Cyl.	16 Valves	1998cc	TD32281
F4R 402		4 Cyl.	16 Valves	1998cc	TD29258
F4R 403		4 Cyl.	16 Valves	1998cc	TD32136
F4R 404		4 Cyl.	16 Valves	1998cc	TD32282
F4R 405		4 Cyl.	16 Valves	1998cc	TD32137
F4R 408		4 Cyl.	16 Valves	1998cc	TD32288
F4R 700		4 Cyl.	16 Valves	1998cc	TD16306
F4R 701		4 Cyl.	16 Valves	1998cc	TD16307
F4R 712		4 Cyl.	16 Valves	1998cc	TD18276
F4R 713		4 Cyl.	16 Valves	1998cc	TD18278
F4R 714		4 Cyl.	16 Valves	1998cc	TD18279
F4R 715		4 Cyl.	16 Valves	1998cc	TD18280
F4R 720		4 Cyl.	16 Valves	1998cc	TD16359
F4R 722		4 Cyl.	16 Valves	1998cc	TD16360
F4R 730		4 Cyl.	16 Valves	1998cc	TD14334
F4R 732		4 Cyl.	16 Valves	1998cc	TD21212
F4R 736		4 Cyl.	16 Valves	1998cc	TD21213
F4R 738		4 Cyl.	16 Valves	1998cc	TD19676
F4R 740		4 Cyl.	16 Valves	1998cc	TD16355
F4R 741		4 Cyl.	16 Valves	1998cc	TD16356
F4R 744		4 Cyl.	16 Valves	1998cc	TD16340
F4R 746		4 Cyl.	16 Valves	1998cc	TD21214
F4R 747		4 Cyl.	16 Valves	1998cc	TD21215
F4R 760		4 Cyl.	16 Valves	1998cc	TD16478
F4R 761		4 Cyl.	16 Valves	1998cc	TD16480
F4R 762		4 Cyl.	16 Valves	1998cc	TD16286
F4R 763		4 Cyl.	16 Valves	1998cc	TD16376
F4R 764		4 Cyl.	16 Valves	1998cc	TD18281
F4R 765		4 Cyl.	16 Valves	1998cc	TD18282
F4R 766		4 Cyl.	16 Valves	1998cc	TD19668
F4R 767		4 Cyl.	16 Valves	1998cc	TD19669
F4R 770		4 Cyl.	16 Valves	1998cc	TD16533
F4R 771		4 Cyl.	16 Valves	1998cc	TD18301
F4R 774		4 Cyl.	16 Valves	1998cc	TD20906
F4R 776		4 Cyl.	16 Valves	1998cc	TD19695
F4R 780		4 Cyl.	16 Valves	1998cc	TD16475
F4R 784		4 Cyl.	16 Valves	1998cc	TD21216
F4R 786		4 Cyl.	16 Valves	1998cc	TD18283
F4R 787		4 Cyl.	16 Valves	1998cc	TD18284
F4R 790		4 Cyl.	16 Valves	1998cc	TD17057
F4R 791		4 Cyl.	16 Valves	1998cc	TD17058
F4R 792		4 Cyl.	16 Valves	1998cc	TD21197
F4R 794		4 Cyl.	16 Valves	1998cc	TD17059
F4R 795		4 Cyl.	16 Valves	1998cc	TD17060
F4R 796		4 Cyl.	16 Valves	1998cc	TD23108
F4R 797		4 Cyl.	16 Valves	1998cc	TD17061
F4R 800		4 Cyl.	16 Valves	1998cc	TD22188
F4R 811		4 Cyl.	16 Valves	1998cc	TD22189

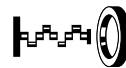
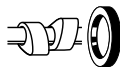

F4R 820	4 Cyl.	16 Valves	1998cc	TD19712
F4R 830	4 Cyl.	16 Valves	1998cc	TD20836
F4R 832	4 Cyl.	16 Valves	1998cc	TD23547
F4R 867	4 Cyl.	16 Valves	1998cc	TD21217
F4R 870	4 Cyl.	16 Valves	1998cc	TD23616
F4R 872	4 Cyl.	16 Valves	1998cc	TD26242
F4R 874	4 Cyl.	16 Valves	1998cc	TD24254
F4R 886	4 Cyl.	16 Valves	1998cc	TD21218
F4R 887	4 Cyl.	16 Valves	1998cc	TD21219
F4R 896	4 Cyl.	16 Valves	1998cc	TD23891
F4R 897	4 Cyl.	16 Valves	1998cc	TD21220
F4R L 870	4 Cyl.	16 Valves	1998cc	TD24970
F4Rt 774	4 Cyl.	16 Valves	1998cc	TD21108
F4Rt 800	4 Cyl.	16 Valves	1998cc	TD23054
F4Rt 811	4 Cyl.	16 Valves	1998cc	TD20816
F4R Z 770	4 Cyl.	16 Valves	1998cc	TD19691

PA5013 (x16)

NA5257 (x2)
28.00 x 47.00 x 5.50mm, FPM
NA5448 (x2)
34.00 x 47.00 x 5.50mm, FPM

NA5036
42.00 x 54.00 x 6.00mm, FPM
NA5037
85.00 x 105.00 x 11.00mm, ACM

70 2.0L

Petrol

F5R 700	4 Cyl.	16 Valves	1998cc	TD16369
F5R 701	4 Cyl.	16 Valves	1998cc	TD21228
F5R 740	4 Cyl.	16 Valves	1998cc	TD13311

NA5257 (x2)
28.00 x 47.00 x 5.50mm, FPM

NA5036
42.00 x 54.00 x 6.00mm, FPM
NA5037
85.00 x 105.00 x 11.00mm, ACM

71 2.0L

Petrol

F7R 700	4 Cyl.	16 Valves	1998cc	TD3281
F7R 710	4 Cyl.	16 Valves	1998cc	TD4866
F7R 720	4 Cyl.	16 Valves	1998cc	TD23894

HR816 (x2)

NF846 (x2)
25.00 x 42.00 x 7.00mm, FPM/ACM

NF843
50.00 x 68.00 x 10.00mm, FPM/ACM
→04/97
NA5036
42.00 x 54.00 x 6.00mm, FPM
04/97→
NA5037
85.00 x 105.00 x 11.00mm, ACM
NF850
85.00 x 105.00 x 8.00mm, FPM

72 2.0L

Petrol

F7R 712	4 Cyl.	16 Valves	1998cc	TD23893
F7R 714	4 Cyl.	16 Valves	1998cc	TD16278

HR816 (x2)

NF846 (x2)
25.00 x 42.00 x 7.00mm, FPM/ACM

NA5036
42.00 x 54.00 x 6.00mm, FPM
NF844
90.00 x 110.00 x 11.00mm, FPM/ACM



73 2.0L		Petrol			
J7R 720	4 Cyl.	12 Valves	1995cc		TD3333
J7R 721	4 Cyl.	12 Valves	1995cc		TD3334
J7R 726	4 Cyl.	12 Valves	1995cc		TD3337
J7R 734	4 Cyl.	12 Valves	1995cc		TD3340
J7R 735	4 Cyl.	12 Valves	1995cc		TD3341
J7R 740	4 Cyl.	12 Valves	1995cc		TD3344
J7R 754	4 Cyl.	12 Valves	1995cc		TD3350
HR662		NF687 35.00 x 47.00 x 7.00mm, FPM		NF843 50.00 x 68.00 x 10.00mm, FPM/ACM	
		NA5016 35.00 x 47.00 x 7.00mm, FPM/ACM		NF844 90.00 x 110.00 x 11.00mm, FPM/ACM	

74 2.0L		Petrol			
J7R 732	4 Cyl.	8 Valves	1995cc		TD3338
J7R 733	4 Cyl.	8 Valves	1995cc		TD3339
J7R 738	4 Cyl.	8 Valves	1995cc		TD3342
J7R 739	4 Cyl.	8 Valves	1995cc		TD3343
HR569		NF687 35.00 x 47.00 x 7.00mm, FPM		NF843 50.00 x 68.00 x 10.00mm, FPM/ACM	
		NA5016 35.00 x 47.00 x 7.00mm, FPM/ACM		NF844 90.00 x 110.00 x 11.00mm, FPM/ACM	

75 2.0L		Petrol			
M4R 700	4 Cyl.	16 Valves	1997cc		TD21165
M4R 701	4 Cyl.	16 Valves	1997cc		TD21166
M4R 704	4 Cyl.	16 Valves	1997cc		TD20815
M4R 711	4 Cyl.	16 Valves	1997cc		TD23561
M4R 713	4 Cyl.	16 Valves	1997cc		TD26243
M4R 714	4 Cyl.	16 Valves	1997cc		TD26125
M4R 726	4 Cyl.	16 Valves	1997cc		TD26530
M4R 746	4 Cyl.	16 Valves	1997cc		TD26133
M4R 751	4 Cyl.	16 Valves	1998cc		TD26126
M4R F 711	4 Cyl.	16 Valves	1997cc		TD23560
M4R F 712	4 Cyl.	16 Valves	1997cc		TD23564
M4R F 713	4 Cyl.	16 Valves	1997cc		TD23565
MR20DE	4 Cyl.	16 Valves	1998cc		TD31827
PB681 (x16)				NK106 46.00 x 58.00 x 7.00mm, ACM	

76 2.0L		Petrol			
M4R 710	4 Cyl.	16 Valves	1997cc		TD26529
				NK106 46.00 x 58.00 x 7.00mm, ACM	

77 2.0L		Diesel			
M9R 610	4 Cyl.	16 Valves	1995cc		TD23557
M9R 615	4 Cyl.	16 Valves	1995cc		TD23559
M9R 630	4 Cyl.	16 Valves	1995cc		TD26729
M9R 692	4 Cyl.	16 Valves	1995cc		TD26569
M9R 700	4 Cyl.	16 Valves	1995cc		TD20708
M9R 721	4 Cyl.	16 Valves	1995cc		TD23502
M9R 722	4 Cyl.	16 Valves	1995cc		TD23503

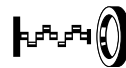
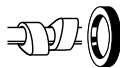

M9R 724	4 Cyl.	16 Valves	1995cc	TD22195
M9R 740	4 Cyl.	16 Valves	1995cc	TD19680
M9R 742	4 Cyl.	16 Valves	1995cc	TD23504
M9R 744	4 Cyl.	16 Valves	1995cc	TD23505
M9R 746	4 Cyl.	16 Valves	1995cc	TD23506
M9R 748	4 Cyl.	16 Valves	1995cc	TD23507
M9R 750	4 Cyl.	16 Valves	1995cc	TD23508
M9R 760	4 Cyl.	16 Valves	1995cc	TD19681
M9R 760	4 Cyl.	16 Valves	1995cc	TD30433
M9R 761	4 Cyl.	16 Valves	1995cc	TD23899
M9R 762	4 Cyl.	16 Valves	1995cc	TD23900
M9R 763	4 Cyl.	16 Valves	1995cc	TD23901
M9R 780	4 Cyl.	16 Valves	1995cc	TD19714
M9R 782	4 Cyl.	16 Valves	1995cc	TD23109
M9R 784	4 Cyl.	16 Valves	1995cc	TD25141
M9R 786	4 Cyl.	16 Valves	1995cc	TD24966
M9R 788	4 Cyl.	16 Valves	1995cc	TD25142
M9R 800	4 Cyl.	16 Valves	1995cc	TD22196
M9R 802	4 Cyl.	16 Valves	1995cc	TD22197
M9R 804	4 Cyl.	16 Valves	1995cc	TD26134
M9R 805	4 Cyl.	16 Valves	1995cc	TD26244
M9R 809	4 Cyl.	16 Valves	1995cc	TD22198
M9R 814	4 Cyl.	16 Valves	1995cc	TD26247
M9R 815	4 Cyl.	16 Valves	1995cc	TD26531
M9R 816	4 Cyl.	16 Valves	1995cc	TD22199
M9R 817	4 Cyl.	16 Valves	1995cc	TD26135
M9R 820	4 Cyl.	16 Valves	1995cc	TD26532
M9R 824	4 Cyl.	16 Valves	1995cc	TD26073
M9R 830	4 Cyl.	16 Valves	1995cc	TD22206
M9R 832	4 Cyl.	16 Valves	1995cc	TD22207
M9R 833	4 Cyl.	16 Valves	1995cc	TD33630
M9R 833	4 Cyl.	16 Valves	1995cc	TD26252
M9R 844	4 Cyl.	16 Valves	1995cc	TD26533
M9R 845	4 Cyl.	16 Valves	1995cc	TD26254
M9R 846	4 Cyl.	16 Valves	1995cc	TD26534
M9R 849	4 Cyl.	16 Valves	1995cc	TD26253
M9R 855	4 Cyl.	16 Valves	1995cc	TD26248
M9R 856	4 Cyl.	16 Valves	1995cc	TD26249
M9R 857	4 Cyl.	16 Valves	1995cc	TD31479
M9R 858	4 Cyl.	16 Valves	1995cc	TD31480
M9R 859	4 Cyl.	16 Valves	1995cc	TD31481
M9R 862	4 Cyl.	16 Valves	1995cc	TD26255
M9R 864	4 Cyl.	16 Valves	1995cc	TD26256
M9R 865	4 Cyl.	16 Valves	1995cc	TD26250
M9R 866	4 Cyl.	16 Valves	1995cc	TD26251
M9R A 700	4 Cyl.	16 Valves	1995cc	TD19684
M9R_a 742	4 Cyl.	16 Valves	1995cc	TD20818
M9R B 610	4 Cyl.	16 Valves	1995cc	TD23556
M9R B 721	4 Cyl.	16 Valves	1995cc	TD19685
M9R C 613	4 Cyl.	16 Valves	1995cc	TD23570



M9R C 615	4 Cyl.	16 Valves	1995cc	TD23558
M9R C 830	4 Cyl.	16 Valves	1995cc	TD20968
M9R D 833	4 Cyl.	16 Valves	1995cc	TD20967
M9R G 832	4 Cyl.	16 Valves	1995cc	TD20966
M9Rk 800	4 Cyl.	16 Valves	1995cc	TD20821
M9Rk 802	4 Cyl.	16 Valves	1995cc	TD20819
M9Rk 805	4 Cyl.	16 Valves	1995cc	TD20820
M9Rk 806	4 Cyl.	16 Valves	1995cc	TD23055
M9Rk 816	4 Cyl.	16 Valves	1995cc	TD23056
HR814				
				NA5333 48.00 x 81.00 x 11.5mm, FPM/ACM LK5022 94.00 x 161.00 x 10.00mm, PTFE/ACM

78 2.0L

Diesel

M9R 756	4 Cyl.	16 Valves	1995cc	TD34140
M9R 828	4 Cyl.	16 Valves	1995cc	TD31477
M9R 854	4 Cyl.	16 Valves	1995cc	TD31478
				LK5022 94.00 x 161.00 x 10.00mm, PTFE/ACM

79 2.0L

Petrol

N7Q 700	4 Cyl.	16 Valves	1948cc	TD5529
N7Q 704	4 Cyl.	16 Valves	1948cc	TD5530
N7Q 710	4 Cyl.	16 Valves	1948cc	TD5547
N7Q 711	4 Cyl.	16 Valves	1948cc	TD5548
HR816 (x2)				
				NA5138 (x2) 44.50 x 57.20 x 6.75mm, ACM NA5136 (x2) 30.00 x 47.00 x 7.00mm, FPM NA5018 35.00 x 47.00 x 5.60mm, FPM NA5017 98.00 x 110.00 x 8.50mm, FPM

80 2.0L

Petrol

SR20DE	4 Cyl.	16 Valves	1998cc	TD33773
PA079 (x8)				
PA874 (x8)				
HR767				
HR768				
				NK106 46.00 x 58.00 x 7.00mm, ACM NJ284 84.00 x 104.00 x 11.00mm, MVQ

81 2.1L

Diesel

852	4 Cyl.	8 Valves	2068cc	TD3077
852 700	4 Cyl.	8 Valves	2068cc	TD29260
852 710	4 Cyl.	8 Valves	2068cc	TD3078
852 720	4 Cyl.	8 Valves	2068cc	TD3079
852 750	4 Cyl.	8 Valves	2068cc	TD3080
852 J85	4 Cyl.	8 Valves	2068cc	TD3081
J8S 120	4 Cyl.	8 Valves	2068cc	TD3383
J8S 232 (852.232)	4 Cyl.	8 Valves	2068cc	TD3384
J8S 234	4 Cyl.	8 Valves	2068cc	TD3385
J8S 240	4 Cyl.	8 Valves	2068cc	TD3386
J8S 330	4 Cyl.	8 Valves	2068cc	TD3387
J8S 600	4 Cyl.	8 Valves	2068cc	TD3388
J8S 604	4 Cyl.	8 Valves	2068cc	TD3389
J8S 612	4 Cyl.	8 Valves	2068cc	TD5525
J8S 620	4 Cyl.	8 Valves	2068cc	TD5564

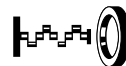
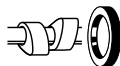

J8S 702	4 Cyl.	8 Valves	2068cc	TD3382
J8S 704	4 Cyl.	8 Valves	2068cc	TD3391
J8S 706	4 Cyl.	8 Valves	2068cc	TD3392
J8S 708	4 Cyl.	8 Valves	2068cc	TD3393
J8S 711	4 Cyl.	8 Valves	2068cc	TD5431
J8S 712	4 Cyl.	8 Valves	2068cc	TD3394
J8S 714	4 Cyl.	8 Valves	2068cc	TD3395
J8S 736	4 Cyl.	8 Valves	2068cc	TD3396
J8S 738	4 Cyl.	8 Valves	2068cc	TD3397
J8S 740	4 Cyl.	8 Valves	2068cc	TD3398
J8S 742	4 Cyl.	8 Valves	2068cc	TD3399
J8S 746	4 Cyl.	8 Valves	2068cc	TD3400
J8S 750	4 Cyl.	8 Valves	2068cc	TD22186
J8S 758	4 Cyl.	8 Valves	2068cc	TD5565
J8S 760	4 Cyl.	8 Valves	2068cc	TD3401
J8S 772	4 Cyl.	8 Valves	2068cc	TD3402
J8S 774	4 Cyl.	8 Valves	2068cc	TD3403
J8S 776	4 Cyl.	8 Valves	2068cc	TD3404
J8S 778	4 Cyl.	8 Valves	2068cc	TD3405
J8S 784	4 Cyl.	8 Valves	2068cc	TD3406
J8S 786	4 Cyl.	8 Valves	2068cc	TD3407
J8S 788	4 Cyl.	8 Valves	2068cc	TD3408
J8S 800	4 Cyl.	8 Valves	2068cc	TD26568
J8S 814	4 Cyl.	8 Valves	2068cc	TD21257
J8S 890	4 Cyl.	8 Valves	2068cc	TD21258

HR569

NA5016
35.00 x 47.00 x 7.00mm, FPM/ACM

NF843
50.00 x 68.00 x 10.00mm, FPM/ACM
NF844
90.00 x 110.00 x 11.00mm, FPM/ACM

82 2.1L

Diesel

J8S 174	4 Cyl.	8 Valves	2068cc	TD29122
J8S 622	4 Cyl.	8 Valves	2068cc	TD23794

HR569

NF687
35.00 x 47.00 x 7.00mm, FPM

NF843
50.00 x 68.00 x 10.00mm, FPM/ACM
NF844
90.00 x 110.00 x 11.00mm, FPM/ACM

83 2.1L

Diesel

J8S 610	4 Cyl.	8 Valves	2068cc	TD3390
---------	--------	----------	--------	--------

HR569

NA5187
30.00 x 52.00 x 7.00mm, ACM
NA5016
35.00 x 47.00 x 7.00mm, FPM/ACM

NF843
50.00 x 68.00 x 10.00mm, FPM/ACM
NF844
90.00 x 110.00 x 11.00mm, FPM/ACM

84 2.2L

Petrol

851 700	4 Cyl.	8 Valves	2165cc	TD3076
---------	--------	----------	--------	--------

HR569

NF687
35.00 x 47.00 x 7.00mm, FPM
NA5016
35.00 x 47.00 x 7.00mm, FPM/ACM

NF843
50.00 x 68.00 x 10.00mm, FPM/ACM
NF844
90.00 x 110.00 x 11.00mm, FPM/ACM



85 2.2L

Diesel

G8T 706	4 Cyl.	12 Valves	2188cc	TD3301
G8T 714	4 Cyl.	12 Valves	2188cc	TD16308
G8T 716	4 Cyl.	12 Valves	2188cc	TD16309
G8T 740	4 Cyl.	12 Valves	2188cc	TD3300
G8T 752	4 Cyl.	12 Valves	2188cc	TD4872
G8T 760	4 Cyl.	12 Valves	2188cc	TD4871
G8T 790	4 Cyl.	12 Valves	2188cc	TD4873
G8T 792	4 Cyl.	12 Valves	2188cc	TD18886
G8T 794	4 Cyl.	12 Valves	2188cc	TD4874

HR662

NF858

33.00 x 43.00 x 6.00mm, FPM

NF861

46.00 x 59.00 x 7.00mm, FPM

NF860

93.00 x 108.00 x 7.00mm, FPM/ACM

86 2.2L

Diesel

G9T 600	4 Cyl.	16 Valves	2188cc	TD19667
G9T 605	4 Cyl.	16 Valves	2188cc	TD19682
G9T 606	4 Cyl.	16 Valves	2188cc	TD21209
G9T 607	4 Cyl.	16 Valves	2188cc	TD23896
G9T 642	4 Cyl.	16 Valves	2188cc	TD23177
G9T 645	4 Cyl.	16 Valves	2188cc	TD21198
G9T 700	4 Cyl.	16 Valves	2188cc	TD20978
G9T 702	4 Cyl.	16 Valves	2188cc	TD16288
G9T 703	4 Cyl.	16 Valves	2188cc	TD16377
G9T 704	4 Cyl.	16 Valves	2188cc	TD20975
G9T 706	4 Cyl.	16 Valves	2188cc	TD20976
G9T 707	4 Cyl.	16 Valves	2188cc	TD20977
G9T 710	4 Cyl.	16 Valves	2188cc	TD16310
G9T 712	4 Cyl.	16 Valves	2188cc	TD18298
G9T 720	4 Cyl.	16 Valves	2188cc	TD14928
G9T 722	4 Cyl.	16 Valves	2188cc	TD16302
G9T 742	4 Cyl.	16 Valves	2188cc	TD17062
G9T 743	4 Cyl.	16 Valves	2188cc	TD17063
G9T 750	4 Cyl.	16 Valves	2188cc	TD19088

PA5041 (x16)

HR791

NA5053 (x2)

30.00 x 42.00 x 7.00mm, FPM

NA5446

60.00 x 75.00 x 7.00mm, PTFE/ACM

NA5447

70.00 x 85.00 x 7.00mm, PTFE/ACM

NF860

93.00 x 108.00 x 7.00mm, FPM/ACM

87 2.2L

Petrol

J6T 790	4 Cyl.	8 Valves	2165cc	TD3331
J6T 791	4 Cyl.	8 Valves	2165cc	TD3332
J6T 792	4 Cyl.	8 Valves	2165cc	TD33647
J7T 284	4 Cyl.	8 Valves	2165cc	TD3354
J7T 600	4 Cyl.	8 Valves	2165cc	TD5563
J7T 706	4 Cyl.	8 Valves	2165cc	TD3355
J7T 707	4 Cyl.	8 Valves	2165cc	TD3356
J7T 708	4 Cyl.	8 Valves	2165cc	TD3357
J7T 714	4 Cyl.	8 Valves	2165cc	TD3358

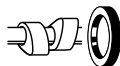

J7T 715	4 Cyl.	8 Valves	2165cc	TD3359
J7T 718	4 Cyl.	8 Valves	2165cc	TD3360
J7T 719	4 Cyl.	8 Valves	2165cc	TD3362
J7T 726	4 Cyl.	8 Valves	2165cc	TD195
J7T 727	4 Cyl.	8 Valves	2165cc	TD196
J7T 730	4 Cyl.	8 Valves	2165cc	TD3364
J7T 731	4 Cyl.	8 Valves	2165cc	TD3365
J7T 732	4 Cyl.	8 Valves	2165cc	TD3366
J7T 733	4 Cyl.	8 Valves	2165cc	TD3367
J7T 734	4 Cyl.	8 Valves	2165cc	TD3368
J7T 736	4 Cyl.	8 Valves	2165cc	TD3369
J7T 754	4 Cyl.	8 Valves	2165cc	TD3370
J7T 755	4 Cyl.	8 Valves	2165cc	TD3371
J7T 756	4 Cyl.	8 Valves	2165cc	TD3372
J7T 762	4 Cyl.	8 Valves	2165cc	TD3375
J7T 763	4 Cyl.	8 Valves	2165cc	TD3376
J7T 770	4 Cyl.	8 Valves	2165cc	TD3377
J7T 772	4 Cyl.	8 Valves	2165cc	TD3378
J7T 773	4 Cyl.	8 Valves	2165cc	TD5524
J7T 776	4 Cyl.	8 Valves	2165cc	TD3379
J7T 780	4 Cyl.	8 Valves	2165cc	TD3380
J7T 782	4 Cyl.	8 Valves	2165cc	TD3381
J7T 788	4 Cyl.	8 Valves	2165cc	TD12736

HR569

NA5016
35.00 x 47.00 x 7.00mm, FPM/ACM

NF843
50.00 x 68.00 x 10.00mm, FPM/ACM
NF844
90.00 x 110.00 x 11.00mm, FPM/ACM

88 2.2L

Petrol

J7T 760	4 Cyl.	12 Valves	2165cc	TD3373
J7T 761	4 Cyl.	12 Valves	2165cc	TD3374

HR569 (x2)

NA5016
35.00 x 47.00 x 7.00mm, FPM/ACM

NF843
50.00 x 68.00 x 10.00mm, FPM/ACM
NF844
90.00 x 110.00 x 11.00mm, FPM/ACM

89 2.3L

Diesel

M9T 670	4 Cyl.	16 Valves	2298cc	TD24269
M9T 672	4 Cyl.	16 Valves	2298cc	TD25154
M9T 676	4 Cyl.	16 Valves	2298cc	TD24268
M9T 678	4 Cyl.	16 Valves	2298cc	TD25158
M9T 680	4 Cyl.	16 Valves	2298cc	TD24295
M9T 686	4 Cyl.	16 Valves	2298cc	TD25151
M9T 690	4 Cyl.	16 Valves	2298cc	TD24270
M9T 692	4 Cyl.	16 Valves	2298cc	TD24271
M9T 694	4 Cyl.	16 Valves	2298cc	TD24272
M9T 696	4 Cyl.	16 Valves	2298cc	TD25150
M9T 698	4 Cyl.	16 Valves	2298cc	TD24273
M9T 700	4 Cyl.	16 Valves	2298cc	TD32302
M9T 702	4 Cyl.	16 Valves	2298cc	TD32303
M9T 706	4 Cyl.	16 Valves	2299cc	TD33705
M9T 870	4 Cyl.	16 Valves	2299cc	TD29755



M9T 880	4 Cyl.	16 Valves	2298cc	TD29756
M9T 890	4 Cyl.	16 Valves	2298cc	TD29758
M9T 896	4 Cyl.	16 Valves	2298cc	TD29759
M9T 898	4 Cyl.	16 Valves	2298cc	TD29757

HR814

NA5333

48.00 x 81.00 x 11.5mm, FPM/ACM

LK5022

94.00 x 161.00 x 10.00mm, PTFE/ACM

90 2.4L

Diesel

8140.21.235 IDS	4 Cyl.	8 Valves	2445cc	TD32566
8140.21.235 IDS	4 Cyl.	8 Valves	2445cc	TD3418

HR602

NP068

55.00 x 70.00 x 8.00mm, FPM

NB946

70.00 x 90.00 x 10.00mm, FPM

NF833

90.00 x 115.00 x 13.00mm, FPM

91 2.4L

Diesel

8140.61.235	4 Cyl.	8 Valves	2445cc	TD3430
8140.61.2300	4 Cyl.	8 Valves	2445cc	TD3429

HR602

NP068

55.00 x 70.00 x 8.00mm, FPM

NB946

70.00 x 90.00 x 10.00mm, FPM

NF853

100.00 x 118.00 x 10.00mm, FPM

92 2.4L

Diesel

8140.61.235	4 Cyl.	8 Valves	2445cc	TD32572
-------------	--------	----------	--------	---------

HR602

NB946

70.00 x 90.00 x 10.00mm, FPM

NF833

90.00 x 115.00 x 13.00mm, FPM

→09/90

NF853

100.00 x 118.00 x 10.00mm, FPM

09/90→

93 2.4L

Diesel

8140.61.240	4 Cyl.	8 Valves	2445cc	TD12871
S8U 730	4 Cyl.	8 Valves	2445cc	TD12873
S8U 731	4 Cyl.	8 Valves	2445cc	TD12730

HR602

NP068

55.00 x 70.00 x 8.00mm, FPM

NB946

70.00 x 90.00 x 10.00mm, FPM

NF833

90.00 x 115.00 x 13.00mm, FPM

→09/90

NF853

100.00 x 118.00 x 10.00mm, FPM

09/90→

94 2.4L

Petrol

Z7U 702	6 Cyl.	12 Valves	2458cc	TD3438
---------	--------	-----------	--------	--------

HR569 (x2)

NF761

42.00 x 62.00 x 10.00mm, FPM/ACM

NF634

80.00 x 100.00 x 13.00mm, MVQ

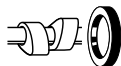

95 2.5L

Petrol

2TR 700	4 Cyl.	16 Valves	2488cc	TD26240
2TR 702	4 Cyl.	16 Valves	2488cc	TD23980
2TR 702	4 Cyl.	16 Valves	2488cc	TD33628
2TR 703	4 Cyl.	16 Valves	2488cc	TD26241

PA874 (x16)

NK106

46.00 x 58.00 x 7.00mm, ACM

NJ284

84.00 x 104.00 x 11.00mm, MVQ

96 2.5L

Petrol

2TR A 703	4 Cyl.	16 Valves	2488cc	TD20965
2TR B 700	4 Cyl.	16 Valves	2488cc	TD20964

NK106

46.00 x 58.00 x 7.00mm, ACM

NJ284

84.00 x 104.00 x 11.00mm, MVQ

97 2.5L

Diesel

8140-07	4 Cyl.	8 Valves	2500cc	TD8524
8140-27	4 Cyl.	8 Valves	2500cc	TD8529
8140.27.2500	4 Cyl.	8 Valves	2499cc	TD3419
8140.27.2510	4 Cyl.	8 Valves	2499cc	TD3420
8140.27.2512	4 Cyl.	8 Valves	2499cc	TD3421
8140.27.2560	4 Cyl.	8 Valves	2499cc	TD8623
8140.27.2565 IDS	4 Cyl.	8 Valves	2500cc	TD12197
8140.27.2580	4 Cyl.	8 Valves	2499cc	TD3423
8140.27.2582	4 Cyl.	8 Valves	2499cc	TD3424
8140-27 IDS	4 Cyl.	8 Valves	2500cc	TD8530
8140-47	4 Cyl.	8 Valves	2499cc	TD8533
S8U 742	4 Cyl.	8 Valves	2499cc	TD5442
S8U 748	4 Cyl.	8 Valves	2445cc	TD12735
S9U 700	4 Cyl.	8 Valves	2499cc	TD12734
S9U 702	4 Cyl.	8 Valves	2499cc	TD12731
S9U 704	4 Cyl.	8 Valves	2499cc	TD12733
S9U 714	4 Cyl.	8 Valves	2499cc	TD12732

HR602

NP068

55.00 x 70.00 x 8.00mm, FPM

NB946

70.00 x 90.00 x 10.00mm, FPM

NF833

90.00 x 115.00 x 13.00mm, FPM

→08/90

NF853

100.00 x 118.00 x 10.00mm, FPM

09/90→

98 2.5L

Diesel

8140.07.2530 ID	4 Cyl.	8 Valves	2500cc	TD32565
8140.07.2530 ID	4 Cyl.	8 Valves	2500cc	TD3417
8140.07.2585	4 Cyl.	8 Valves	2500cc	TD12192
8140.07.2585	4 Cyl.	8 Valves	2500cc	TD32573
8140.07.2700	4 Cyl.	8 Valves	2499cc	TD22385
8140.07.3700	4 Cyl.	8 Valves	2499cc	TD22386
8140.27.2530 IDS	4 Cyl.	8 Valves	2499cc	TD32571
8140.27.2530 IDS	4 Cyl.	8 Valves	2499cc	TD3422

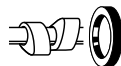

8140.27.2585	4 Cyl.	8 Valves	2500cc	TD12195
8140.27.2700	4 Cyl.	8 Valves	2500cc	TD21392
8140.47.2530 IDR	4 Cyl.	8 Valves	2499cc	TD3425
8140.47.2530 IDR	4 Cyl.	8 Valves	2499cc	TD32569
8140.47.2585	4 Cyl.	8 Valves	2500cc	TD3428
8140.47.2590	4 Cyl.	8 Valves	2499cc	TD12199
8140.47.2590	4 Cyl.	8 Valves	2499cc	TD32577
8140.47.2700	4 Cyl.	8 Valves	2499cc	TD22395
8140.47.2721	4 Cyl.	8 Valves	2499cc	TD22396
8140.47.2785	4 Cyl.	8 Valves	2499cc	TD22397
S8U 762	4 Cyl.	8 Valves	2500cc	TD3415
S8U 763	4 Cyl.	8 Valves	2500cc	TD3416

HR602

NP068
55.00 x 70.00 x 8.00mm, FPM

NB946
70.00 x 90.00 x 10.00mm, FPM
NF853
100.00 x 118.00 x 10.00mm, FPM

99 2.5L

Diesel

8140.47.2535	4 Cyl.	8 Valves	2499cc	TD3426
S8U 720	4 Cyl.	8 Valves	2445cc	TD3413
S8U 722	4 Cyl.	8 Valves	2445cc	TD3414
S8U 752	4 Cyl.	8 Valves	2499cc	TD5567
S8U 758	4 Cyl.	8 Valves	2499cc	TD9689
S9U 740	4 Cyl.	8 Valves	2499cc	TD12728

HR602

NP068
55.00 x 70.00 x 8.00mm, FPM

NB946
70.00 x 90.00 x 10.00mm, FPM
NF833
90.00 x 115.00 x 13.00mm, FPM
→09/90
NF853
100.00 x 118.00 x 10.00mm, FPM
09/90→

100 2.5L

Diesel

8140.47.2580	4 Cyl.	8 Valves	2500cc	TD3427
8140.47.2585	4 Cyl.	8 Valves	2500cc	TD32570

HR602

NP068
55.00 x 70.00 x 8.00mm, FPM

NB946
70.00 x 90.00 x 10.00mm, FPM
→09/97
NF885
70.00 x 159.00 ; 179.00 x 16.00mm, FPM
09/97→
NF853
100.00 x 118.00 x 10.00mm, FPM
→09/97
NF883
114.00 x 171.00 x 13.00mm, FPM
09/97→



101 2.5L

Diesel

8140.67.2500 4 Cyl. 8 Valves 2499cc TD3431

8140.67.2585 4 Cyl. 8 Valves 2500cc TD32574

HR602

NP068
55.00 x 70.00 x 8.00mm, FPM

NB946
70.00 x 90.00 x 10.00mm, FPM
→09/97
NF885
70.00 x 159.00 ; 179.00 x 16.00mm, FPM
09/97→
NF833
90.00 x 115.00 x 13.00mm, FPM
→09/90
NF853
100.00 x 118.00 x 10.00mm, FPM
09/90→

102 2.5L

Diesel

8140.67.2510 4 Cyl. 8 Valves 2499cc TD3432

HR602

NP068
55.00 x 70.00 x 8.00mm, FPM

NF885
70.00 x 159.00 ; 179.00 x 16.00mm, FPM
09/97→
NF853
100.00 x 118.00 x 10.00mm, FPM
09/90→

103 2.5L

Diesel

8140.67.2550 4 Cyl. 8 Valves 2499cc TD12872

8140.67.2580 4 Cyl. 8 Valves 2499cc TD3433

8140.67.2585 4 Cyl. 8 Valves 2500cc TD12193

HR602

NP068
55.00 x 70.00 x 8.00mm, FPM

NF885
70.00 x 159.00 ; 179.00 x 16.00mm, FPM
→09/97
NB946
70.00 x 90.00 x 10.00mm, FPM
09/97→
NF833
90.00 x 115.00 x 13.00mm, FPM
→09/90
NF853
100.00 x 118.00 x 10.00mm, FPM
09/90→

104 2.5L

Diesel

DXi 2,5 4 Cyl. 16 Valves 2490cc TD19718

NJ284
84.00 x 104.00 x 11.00mm, MVQ

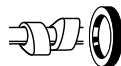

105 2.5L		Diesel			
G9U 630		4 Cyl.	16 Valves	2464cc	TD19713
G9U 632		4 Cyl.	16 Valves	2464cc	TD21013
G9U 650		4 Cyl.	16 Valves	2464cc	TD21011
G9U 720		4 Cyl.	16 Valves	2464cc	TD16303
G9U 724		4 Cyl.	16 Valves	2464cc	TD19366
G9U 730		4 Cyl.	16 Valves	2464cc	TD18275
G9U 750		4 Cyl.	16 Valves	2464cc	TD19359
G9U 754		4 Cyl.	16 Valves	2464cc	TD19085
PA5041 (x16) HR791		NA5053 30.00 x 42.00 x 7.00mm, FPM		NA5446 60.00 x 75.00 x 7.00mm, PTFE/ACM NA5447 70.00 x 85.00 x 7.00mm, PTFE/ACM NF860 93.00 x 108.00 x 7.00mm, FPM/ACM	

106 2.5L		Petrol			
N7U 700		5 Cyl.	20 Valves	2435cc	TD5551
N7U 701		5 Cyl.	20 Valves	2435cc	TD5552
HR816 (x3)		NA5138 (x2) 44.50 x 57.20 x 6.75mm, ACM NA5136 (x2) 30.00 x 47.00 x 7.00mm, FPM		NA5018 35.00 x 47.00 x 5.60mm, FPM NA5017 98.00 x 110.00 x 8.50mm, FPM	

107 2.5L		Diesel			
S8U 750		4 Cyl.	8 Valves	2499cc	TD5566
HR602		NP068 55.00 x 70.00 x 8.00mm, FPM		NF833 90.00 x 115.00 x 13.00mm, FPM →09/90 NF853 100.00 x 118.00 x 10.00mm, FPM 09/90→	

108 2.5L		Diesel			
S8U 770		4 Cyl.	8 Valves	2499cc	TD13409
S8U 780		4 Cyl.	8 Valves	2499cc	TD16328
S8U 782		4 Cyl.	8 Valves	2499cc	TD16329
HR602		NP068 55.00 x 70.00 x 8.00mm, FPM		NF885 70.00 x 159.00 ; 179.00 x 16.00mm, FPM NF883 114.00 x 171.00 x 13.00mm, FPM	

109 2.5L		Diesel			
S8U 772		4 Cyl.	8 Valves	2499cc	TD23889
HR602		NP068 55.00 x 70.00 x 8.00mm, FPM		NF885 70.00 x 159.00 ; 179.00 x 16.00mm, FPM NF883 114.00 x 171.00 x 13.00mm, FPM →08/90	

110 2.5L		Petrol			
VQ25DE		6 Cyl.	24 Valves	2496cc	TD33774
PA874 (x24)					

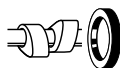

111 2.5L Petrol

Z7U 700	6 Cyl.	12 Valves	2458cc	TD3437
Z7U 730	6 Cyl.	12 Valves	2458cc	TD3439
Z7U 734	6 Cyl.	12 Valves	2458cc	TD3440

HR569 (x2)

NF761
42.00 x 62.00 x 10.00mm, FPM/ACM

NF634
80.00 x 100.00 x 13.00mm, MVQ

112 2.5L Petrol

Z7W 701	6 Cyl.	12 Valves	2849cc	TD3445
---------	--------	-----------	--------	--------

HR569 (x2)

NF869
32.00 x 45.00 x 8.00mm, FPM

NF634
80.00 x 100.00 x 13.00mm, MVQ

113 2.6L Petrol

112	6 Cyl.	12 Valves	2664cc	TD3410
140	6 Cyl.	12 Valves	2664cc	TD3411
144	6 Cyl.	12 Valves	2664cc	TD3412
144.01	6 Cyl.	12 Valves	2664cc	TD22488

HR300 (x2)

NF687
35.00 x 47.00 x 7.00mm, FPM

NF761
42.00 x 62.00 x 10.00mm, FPM/ACM

NF634
80.00 x 100.00 x 13.00mm, MVQ

114 2.7L Diesel

TD27TI	4 Cyl.	8 Valves	2664cc	TD33632
--------	--------	----------	--------	---------

PA378 (x8)

NJ831
58.00 x 80.00 x 10.00mm, NBR

NJ829
86.00 x 100.00 x 10.00mm, MVQ

115 2.7L Petrol

Z7V 708	6 Cyl.	12 Valves	2664cc	TD3441
Z7V 709	6 Cyl.	12 Valves	2664cc	TD3442
Z7V 711	6 Cyl.	12 Valves	2664cc	TD3443

HR805

NF634
80.00 x 100.00 x 13.00mm, MVQ

116 2.8L Diesel

8140.23.2565	4 Cyl.	8 Valves	2800cc	TD17285
8140.23.2565	4 Cyl.	8 Valves	2800cc	TD32588
8140.43.2585	4 Cyl.	8 Valves	2800cc	TD12198
8140.43.2585	4 Cyl.	8 Valves	2800cc	TD32578
8140.43.3700	4 Cyl.	8 Valves	2798cc	TD22394
8140.43.B.3586	4 Cyl.	8 Valves	2800cc	TD32584
8140.43.B.3586	4 Cyl.	8 Valves	2800cc	TD17194
8140.43.B.3588	4 Cyl.	8 Valves	2800cc	TD17195
8140.43.B.3588	4 Cyl.	8 Valves	2800cc	TD32585
8140.43.C.2586	4 Cyl.	8 Valves	2800cc	TD14090
8140.43.C.2586	4 Cyl.	8 Valves	2800cc	TD32580
8140-43 k	4 Cyl.	8 Valves	2800cc	TD16211
8140-43 k	4 Cyl.	8 Valves	2800cc	TD32582
8140.43N.3585	4 Cyl.	8 Valves	2798cc	TD32587
8140.43N.3585	4 Cyl.	8 Valves	2798cc	TD17197



8140.43.S.2585	4 Cyl.	8 Valves	2800cc	TD14091
8140.43.S.2585	4 Cyl.	8 Valves	2800cc	TD32581
8140.43.S.3585	4 Cyl.	8 Valves	2800cc	TD17196
8140.43.S.3585	4 Cyl.	8 Valves	2800cc	TD32586
8140.63.2585	4 Cyl.	8 Valves	2800cc	TD14089
8140.63.2585	4 Cyl.	8 Valves	2800cc	TD32579
S8W 700	4 Cyl.	8 Valves	2799cc	TD33219
S9W 700	4 Cyl.	8 Valves	2799cc	TD19362
S9W 702	4 Cyl.	8 Valves	2799cc	TD13408
HR602	NP068 55.00 x 70.00 x 8.00mm, FPM		NF885 70.00 x 159.00 ;179.00 x 16.00mm, FPM NF883 114.00 x 171.00 x 13.00mm, FPM	

117 2.8L
Diesel

8140.23.2585	4 Cyl.	16 Valves	2800cc	TD12194
8140.23.2585	4 Cyl.	16 Valves	2800cc	TD32575
HR602 (x2)	NP068 55.00 x 70.00 x 8.00mm, FPM		NF885 70.00 x 159.00 ;179.00 x 16.00mm, FPM NF883 114.00 x 171.00 x 13.00mm, FPM	

118 2.8L
Petrol

Z6W 700	6 Cyl.	12 Valves	2850cc	TD3435
Z6W 702	6 Cyl.	12 Valves	2850cc	TD3436
HR805			NA5191 42.00 x 62.00 x 7.00mm, PTFE NF835 80.00 x 100.00 x 8.00mm, FPM/ACM	

119 2.8L
Petrol

Z7W 700	6 Cyl.	12 Valves	2849cc	TD3444
Z7W 702	6 Cyl.	12 Valves	2849cc	TD3446
Z7W 706	6 Cyl.	12 Valves	2849cc	TD3447
Z7W 707	6 Cyl.	12 Valves	2849cc	TD3448
Z7W 709	6 Cyl.	12 Valves	2849cc	TD3449
Z7W 712	6 Cyl.	12 Valves	2849cc	TD3450
Z7W 713	6 Cyl.	12 Valves	2849cc	TD3451
Z7W 717	6 Cyl.	12 Valves	2849cc	TD17866
HR805			NF634 80.00 x 100.00 x 13.00mm, MVQ	

120 2.9L
Petrol

L7X 713	6 Cyl.	24 Valves	2946cc	TD17251
PA5041 (x24) HR5062	NA5260 (x4) 38.00 x 50.00 x 6.00mm, FPM		NA5190 42.00 x 56.00 x 7.00mm, FPM NF867 98.00 x 120.00 x 7.00mm, FPM/ACM	

121 3.0L
Diesel

DTI 3	4 Cyl.	16 Valves	2953cc	TD33639
DXi 3	4 Cyl.	16 Valves	2953cc	TD32591
DXi 3	4 Cyl.	16 Valves	2953cc	TD19082
ZD3 200	4 Cyl.	16 Valves	2953cc	TD19086
ZD3 202	4 Cyl.	16 Valves	2953cc	TD19087

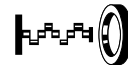
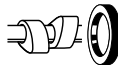

ZD3 600	4 Cyl.	16 Valves	2953cc	TD20728
ZD3 604	4 Cyl.	16 Valves	2953cc	TD26537
ZD3 606	4 Cyl.	16 Valves	2953cc	TD26539
ZD3 A 600	4 Cyl.	16 Valves	2953cc	TD17867
ZD3 A 600	4 Cyl.	16 Valves	2953cc	TD32589
ZD3 A 604	4 Cyl.	16 Valves	2953cc	TD32590
ZD3 A 604	4 Cyl.	16 Valves	2953cc	TD17868
ZD3 A 608	4 Cyl.	16 Valves	2953cc	TD26566
PA079 (x16)				

122 3.0L

Petrol

L7X 700	6 Cyl.	24 Valves	2946cc	TD16207
L7X 701	6 Cyl.	24 Valves	2946cc	TD16208
L7X 720	6 Cyl.	24 Valves	2946cc	TD18299
L7X 721	6 Cyl.	24 Valves	2946cc	TD18300
L7X 722	6 Cyl.	24 Valves	2946cc	TD21192
L7X 727	6 Cyl.	24 Valves	2946cc	TD16311
L7X 731	6 Cyl.	24 Valves	2946cc	TD16218
L7X 732	6 Cyl.	24 Valves	2946cc	TD20114
L7X 733	6 Cyl.	24 Valves	2946cc	TD20115
L7X 760	6 Cyl.	24 Valves	2946cc	TD16213
L7X 762	6 Cyl.	24 Valves	2946cc	TD18285

PA5041 (x24)
HR5062

NA5260 (x4)
38.00 x 50.00 x 6.00mm, FPM

NA5190
42.00 x 56.00 x 7.00mm, FPM
NF867
98.00 x 120.00 x 7.00mm, FPM/ACM

123 3.0L

Diesel

P9X 701	6 Cyl.	24 Valves	2958cc	TD16289
P9X 715	6 Cyl.	24 Valves	2958cc	TD21199

HR5094

NJ283
36.00 x 50.00 x 8.00mm, NBR

124 3.0L

Petrol

Z7X 27	6 Cyl.	12 Valves	2963cc	TD5505
Z7X 721	6 Cyl.	12 Valves	2963cc	TD3452
Z7X 722	6 Cyl.	12 Valves	2963cc	TD3453
Z7X 723	6 Cyl.	12 Valves	2963cc	TD3454
Z7X 726	6 Cyl.	12 Valves	2963cc	TD3455
Z7X 744	6 Cyl.	12 Valves	2975cc	TD3456
Z7X 753	6 Cyl.	12 Valves	2963cc	TD3457
Z7X 755	6 Cyl.	12 Valves	2963cc	TD23902
Z7X 760	6 Cyl.	12 Valves	2963cc	TD3458
Z7X 765	6 Cyl.	12 Valves	2963cc	TD3459
Z7X 767	6 Cyl.	12 Valves	2963cc	TD23903
Z7X 775	6 Cyl.	12 Valves	2963cc	TD12228

HR805

NF869
32.00 x 45.00 x 8.00mm, FPM

NA5191
42.00 x 62.00 x 7.00mm, PTFE
NF835
80.00 x 100.00 x 8.00mm, FPM/ACM
NF634
80.00 x 100.00 x 13.00mm, MVQ



125 3.3L		Diesel			
712	4 Cyl.	8 Valves	3320cc		TD8669
712.01	4 Cyl.	8 Valves	3320cc		TD29080
712-01-03	4 Cyl.	8 Valves	3320cc		TD3019
712-01-04	4 Cyl.	8 Valves	3320cc		TD3020
712.03	4 Cyl.	8 Valves	3320cc		TD29081
712.04	4 Cyl.	8 Valves	3320cc		TD29082
		NA5039 95.00 x 120.00 x 13.00mm, FPM		NF604 50.00 x 70.00 x 10.00mm, MVQ Eng no. 7105→ NF603 95.00 x 120.00 x 13.00mm, MVQ →Eng no. 7104 NF715 110.00 x 130.00 x 13.00mm, MVQ Eng no. 7105→	

126 3.5L		Petrol			
V4Y 701	6 Cyl.	24 Valves	3498cc		TD16287
V4Y 711	6 Cyl.	24 Valves	3498cc		TD16708
V4Y 713	6 Cyl.	24 Valves	3498cc		TD23714
V4Y 715	6 Cyl.	24 Valves	3498cc		TD21196
VQ35	6 Cyl.	24 Valves	3498cc		TD30337
VQ35DE	6 Cyl.	24 Valves	3498cc		TD30338
PA874 (x24)					

127 3.6L		Diesel			
712-18	4 Cyl.	8 Valves	3600cc		TD3021
		NA5039 95.00 x 120.00 x 13.00mm, FPM		NF604 50.00 x 70.00 x 10.00mm, MVQ Eng no. 7105→ NF603 95.00 x 120.00 x 13.00mm, MVQ →Eng no. 7104 NF715 110.00 x 130.00 x 13.00mm, MVQ Eng no. 7105→	

128 3.6L		Diesel			
720	4 Cyl.	8 Valves	3590cc		TD3022
720.01	4 Cyl.	8 Valves	3596cc		TD29087
720.02	4 Cyl.	8 Valves	3596cc		TD29088
720.03	4 Cyl.	8 Valves	3596cc		TD29089
720.05	4 Cyl.	8 Valves	3596cc		TD29090
720.08	4 Cyl.	8 Valves	3596cc		TD29091
				NF604 50.00 x 70.00 x 10.00mm, MVQ NA5181 110.00 x 130.00 x 13.00mm, PTFE	

129 3.6L		Diesel			
720.12	4 Cyl.	8 Valves	3590cc		TD8609
				NF636 55.00 x 70.00 x 10.00mm, MVQ NA5181 110.00 x 130.00 x 13.00mm, PTFE	

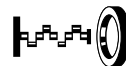
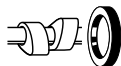



130 4.1L

Diesel

dCi 4B	4 Cyl.	12 Valves	4120cc	TD17333
dCi 4C	4 Cyl.	12 Valves	4120cc	TD17335
PA6062 (x12) HR5129  (x3)				NA5474  80.00 x 100.00 x 13.00mm, PTFE/ACM NA5181  110.00 x 130.00 x 13.00mm, PTFE

131 4.1L

Diesel

MIDR 04.02.26 A/4	4 Cyl.	8 Valves	4118cc	TD14509
MIDR 04.02.26 A/41	4 Cyl.	8 Valves	4118cc	TD12269
MIDR 04.02.26 B/4	4 Cyl.	8 Valves	4118cc	TD14510
MIDR 04.02.26 B/41	4 Cyl.	8 Valves	4118cc	TD12268
PA6062 (x8) HR5129  (x2)				NA5474  80.00 x 100.00 x 13.00mm, PTFE/ACM NA5181  110.00 x 130.00 x 13.00mm, PTFE

132 4.8L

Diesel

DXi 5	4 Cyl.	16 Valves	4764cc	TD19015
HR602  (x2)				NA5459  81.00 x 104.00 x 11.00mm, FPM NA5475  130.00 x 150.00 x 12.00mm, FPM NF831  130.00 x 150.00 x 13.00mm, PTFE



133 5.3L

Diesel

597.02	6 Cyl.	12 Valves	5278cc	TD29121
				NA5181  110.00 x 130.00 x 13.00mm, PTFE

134 5.5L

Diesel

797	6 Cyl.	12 Valves	5453cc	TD8610
797-10	6 Cyl.	12 Valves	5490cc	TD8611
797-20	6 Cyl.	12 Valves	5490cc	TD8607
797-21	6 Cyl.	12 Valves	5453cc	TD8658
797-26	6 Cyl.	12 Valves	5490cc	TD8593
797 NFA	6 Cyl.	12 Valves	5491cc	TD8660
				NF715  110.00 x 130.00 x 13.00mm, MVQ NA5181  110.00 x 130.00 x 13.00mm, PTFE

135 5.5L

Diesel

798	6 Cyl.	12 Valves	5490cc	TD8613
798-10	6 Cyl.	12 Valves	5490cc	TD6210
798-13	6 Cyl.	12 Valves	5490cc	TD5861
798-20	6 Cyl.	12 Valves	5490cc	TD8606
				NA5181  110.00 x 130.00 x 13.00mm, PTFE



136 5.5L Diesel

MIDR 06.02.12	6 Cyl.	12 Valves	5491cc	TD8547
MIDR 06.02.12 A	6 Cyl.	12 Valves	5491cc	TD5644
MIDR 06.02.12 B	6 Cyl.	12 Valves	5491cc	TD8644
MIDR 06.02.12 C	6 Cyl.	12 Valves	5491cc	TD5985
MIDR 06.02.12 D	6 Cyl.	12 Valves	5491cc	TD8583
MIDR 06.02.12 D3	6 Cyl.	12 Valves	5491cc	TD8663
MIDR 06.02.12 F	6 Cyl.	12 Valves	5491cc	TD6267
MIDR 06.02.12 L	6 Cyl.	12 Valves	5491cc	TD6318
MIDS 06.02.12	6 Cyl.	12 Valves	5491cc	TD8545
MIDS 06.02.12 B	6 Cyl.	12 Valves	5491cc	TD8608
MIDS 06.02.12 C	6 Cyl.	12 Valves	5491cc	TD8615
MIDS 06.02.12 D	6 Cyl.	12 Valves	5491cc	TD29111
MIDS 06.02.12 D/3	6 Cyl.	12 Valves	5491cc	TD14068
MIDS 06.02.26 P	6 Cyl.	12 Valves	5491cc	TD8617

PA6062 (x12)
HR5129  (x3)

NA5474 
80.00 x 100.00 x 13.00mm, PTFE/ACM
NA5181 
110.00 x 130.00 x 13.00mm, PTFE

137 6.2L Diesel

dci 6A	6 Cyl.	24 Valves	6177cc	TD17339
dci 6W	6 Cyl.	24 Valves	6177cc	TD17338

PA6062 (x24)
HR5129  (x6)

NA5474 
80.00 x 100.00 x 13.00mm, PTFE/ACM
NA5181 
110.00 x 130.00 x 13.00mm, PTFE

138 6.2L Diesel

MIDR 06.02.26	6 Cyl.	12 Valves	6177cc	TD14049
MIDR 06.02.26 D	6 Cyl.	12 Valves	6177cc	TD5862
MIDR 06.02.26 DU	6 Cyl.	12 Valves	6177cc	TD29098
MIDR 06.02.26 H	6 Cyl.	12 Valves	6177cc	TD5645
MIDR 06.02.26 I	6 Cyl.	12 Valves	6177cc	TD5986
MIDR 06.02.26 V	6 Cyl.	12 Valves	6177cc	TD8618
MIDR 06.02.26 X	6 Cyl.	12 Valves	6177cc	TD8536
MIDR 06.02.26 K	6 Cyl.	12 Valves	6177cc	TD7554
MIDR 06.02.26 L	6 Cyl.	12 Valves	6177cc	TD7552
MIDR 06.02.26 L2	6 Cyl.	12 Valves	6177cc	TD7553
MIDR 06.02.26 M	6 Cyl.	12 Valves	6177cc	TD7556
MIDR 06.02.26 M2	6 Cyl.	12 Valves	6177cc	TD7555
MIDR 06.02.26 Q	6 Cyl.	12 Valves	6177cc	TD8584
MIDR 06.02.26 S	6 Cyl.	12 Valves	6177cc	TD6211
MIDR 06.02.26 U	6 Cyl.	12 Valves	6177cc	TD8616
MIDR 06.02.26 U/4	6 Cyl.	12 Valves	6177cc	TD12208
MIDR 06.02.26 V/4	6 Cyl.	12 Valves	6177cc	TD14508
MIDR 06.02.26 V/41	6 Cyl.	12 Valves	6180cc	TD12248
MIDR 06.02.26 W	6 Cyl.	12 Valves	6177cc	TD8587
MIDR 06.02.26 W/4	6 Cyl.	12 Valves	6177cc	TD14511

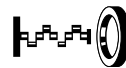
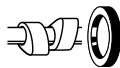

MIDR 06.02.26 W/41	6 Cyl.	12 Valves	6177cc	TD8638
MIDR 06.02.26 Y	6 Cyl.	12 Valves	6177cc	TD29099
MIDR 06.02.26 Y/41	6 Cyl.	12 Valves	6177cc	TD8639
PA6062 (x12) HR5129 (x3)				NA5474 F 80.00 x 100.00 x 13.00mm, PTFE/ACM NA5181 R 110.00 x 130.00 x 13.00mm, PTFE

139 7.2L

Diesel

DXi 7	6 Cyl.	24 Valves	7200cc	TD19016
HR602 (x3)				NA5459 F 81.00 x 104.00 x 11.00mm, FPM NA5475 R 130.00 x 150.00 x 12.00mm, FPM NF831 R 130.00 x 130.00 x 13.00mm, PTFE

140 8.8L

Diesel

MID 06.20.30	6 Cyl.	12 Valves	8822cc	TD26707
MID 06.20.30	6 Cyl.	12 Valves	8822cc	TD6502
MID 06.20.30 C	6 Cyl.	12 Valves	8822cc	TD12249
MID 06.20.30 D	6 Cyl.	12 Valves	8822cc	TD12250
MID 06.20.30 G	6 Cyl.	12 Valves	8822cc	TD8598
MID 06.20.30 H	6 Cyl.	12 Valves	8820cc	TD12255
MIDR 06.20.30	6 Cyl.	12 Valves	8822cc	TD29105
MIDR 06.20.30 A	6 Cyl.	12 Valves	8822cc	TD8603
MIDR 06.20.30 B	6 Cyl.	12 Valves	8822cc	TD5646
MIDR 06.20.30 C	6 Cyl.	12 Valves	8822cc	TD5987
MIDS 06.20.30	6 Cyl.	12 Valves	8822cc	TD8595
MIDS 06.20.30	6 Cyl.	12 Valves	8822cc	TD6503
MIDS 06.20.30 B	6 Cyl.	12 Valves	8822cc	TD8599
MIDS 06.20.30 D	6 Cyl.	12 Valves	8822cc	TD6509
MIDS 06.20.30 D	6 Cyl.	12 Valves	8822cc	TD8604
MIDS 06.20.30 E	6 Cyl.	12 Valves	8822cc	TD12256
MIDS 06.20.30 N	6 Cyl.	12 Valves	8822cc	TD8535
MIDS 06.20.30 N1	6 Cyl.	12 Valves	8822cc	TD8586
MIDS 06.20.30 P	6 Cyl.	12 Valves	8822cc	TD8590
MIP 06.20.30	6 Cyl.	12 Valves	8820cc	TD8627
MIPS 06.20.30	6 Cyl.	12 Valves	8820cc	TD8626
MIS 06.20.30	6 Cyl.	12 Valves	8820cc	TD29115

NA5474 F
 80.00 x 100.00 x 13.00mm, PTFE/ACM
 →10/85
NA5463 R
 150.00 x 172.00 x 13.00mm, PTFE/ACM

141 8.8L

Diesel

MIDS 06.20.30 K	6 Cyl.	12 Valves	8822cc	TD7557
				NA5474 F 80.00 x 100.00 x 13.00mm, PTFE/ACM NA5463 R 150.00 x 172.00 x 13.00mm, PTFE/ACM



142 9.8L		Diesel			
MIDR 06.20.45	6 Cyl.	12 Valves	9839cc		TD8534
MIDR 06.20.45 A	6 Cyl.	12 Valves	9839cc		TD8591
MIDR 06.20.45 B3	6 Cyl.	12 Valves	9839cc		TD8592
MIDR 06.20.45 BC	6 Cyl.	12 Valves	9839cc		TD29106
MIDR 06.20.45 C	6 Cyl.	12 Valves	9839cc		TD8580
MIDR 06.20.45 C/4	6 Cyl.	12 Valves	9839cc		TD17421
MIDR 06.20.45 D/41	6 Cyl.	12 Valves	9839cc		TD8641
MIDR 06.20.45 DD	6 Cyl.	12 Valves	9839cc		TD29107
MIDR 06.20.45 E	6 Cyl.	12 Valves	9839cc		TD5860
MIDR 06.20.45 E2	6 Cyl.	12 Valves	9839cc		TD8540
MIDR 06.20.45 E3	6 Cyl.	12 Valves	9839cc		TD8541
MIDR 06.20.45 E/41	6 Cyl.	12 Valves	9839cc		TD8642
MIDR 06.20.45 F3	6 Cyl.	12 Valves	9839cc		TD8646
MIDR 06.20.45 I3	6 Cyl.	12 Valves	9839cc		TD12190
MIDR 06.20.45 I41	6 Cyl.	12 Valves	9839cc		TD12191
MIDR 06.20.45 J	6 Cyl.	12 Valves	9839cc		TD29108
MIDR 06.20.45 J3	6 Cyl.	12 Valves	9839cc		TD12204
MIDR 06.20.45 K	6 Cyl.	12 Valves	9839cc		TD7550
MIDR 06.20.45 L	6 Cyl.	12 Valves	9839cc		TD7551
MIDR 06.20.45 M	6 Cyl.	12 Valves	9839cc		TD8581
MIDR 06.20.45 M41	6 Cyl.	12 Valves	9839cc		TD21231
MIDR 06.20.45 R41	6 Cyl.	12 Valves	9839cc		TD21230
MIDS 06.20.45	6 Cyl.	12 Valves	9839cc		TD8633
MIDS 06.20.45 B	6 Cyl.	12 Valves	9839cc		TD8537
MIDS 06.20.45 D	6 Cyl.	12 Valves	9839cc		TD8647
MIDS 06.20.45 F	6 Cyl.	12 Valves	9839cc		TD8648
MIDS 06.20.45 J	6 Cyl.	12 Valves	9839cc		TD8588
MIDS 06.20.45 J3	6 Cyl.	12 Valves	9839cc		TD8589
MIHR 06.20.45 A41	6 Cyl.	12 Valves	9839cc		TD21269
MIPR 06.20.45	6 Cyl.	12 Valves	9840cc		TD29114
MIPR 06.20.45 A	6 Cyl.	12 Valves	9840cc		TD8634
MIPR 06.20.45 A3	6 Cyl.	12 Valves	9840cc		TD8635
MIPR 06.20.45 B3	6 Cyl.	12 Valves	9840cc		TD8628
MIPR 06.20.45 C3	6 Cyl.	12 Valves	9840cc		TD8629
MIPS 06.20.45	6 Cyl.	12 Valves	9840cc		TD8630
MIPS 06.20.45 A	6 Cyl.	12 Valves	9840cc		TD8631
MIPS 06.20.45 B	6 Cyl.	12 Valves	9840cc		TD8636
MIPS 06.20.45 C	6 Cyl.	12 Valves	9840cc		TD8632

NA5474 
80.00 x 100.00 x 13.00mm, PTFE/ACM
→10/85

NA5463 
150.00 x 172.00 x 13.00mm, PTFE/ACM

143 9.8L		Diesel			
MIDR 06.20.45	6 Cyl.	12 Valves	9839cc		TD8414

NA5463 
150.00 x 172.00 x 13.00mm, PTFE/ACM



144 9.8L

Diesel

MIDR 06.20.45 A2	6 Cyl.	12 Valves	9839cc	TD8579
MIDR 06.20.45 D	6 Cyl.	12 Valves	9839cc	TD8538
MIDR 06.20.45 D3	6 Cyl.	12 Valves	9839cc	TD8539
MIDR 06.20.45 H	6 Cyl.	12 Valves	9839cc	TD6209
MIDR 06.20.45 M3	6 Cyl.	12 Valves	9839cc	TD8582

NA5474 F
80.00 x 100.00 x 13.00mm, PTFE/ACM
NA5463 R
150.00 x 172.00 x 13.00mm, PTFE/ACM

145 10.8L

Diesel

DXi 11	6 Cyl.	24 Valves	10800cc	TD19017
--------	--------	-----------	---------	---------

NA5461 F
136.00 x 159.00 x 13.00mm, PTFE/ACM

146 11.0L

Diesel

dCi 11-270	6 Cyl.	24 Valves	11100cc	TD16876
dCi 11C	6 Cyl.	24 Valves	11100cc	TD16880
dCi 11E	6 Cyl.	24 Valves	11100cc	TD16879
dCi 11G	6 Cyl.	24 Valves	11100cc	TD16878

NA5451 F
90.00 x 120.00 x 11.00mm, PTFE
NA5452 R
160.00 x 190.00 x 13.00mm, PTFE

147 11.1L

Diesel

dCi 11 B/43	6 Cyl.	12 Valves	11100cc	TD14848
-------------	--------	-----------	---------	---------

NA5451 F
90.00 x 120.00 x 11.00mm, PTFE
NA5452 R
160.00 x 190.00 x 13.00mm, PTFE

148 11.1L

Diesel

MIDR 06.23.56	6 Cyl.	12 Valves	11122cc	TD29109
MIDR 06.23.56 A/3	6 Cyl.	12 Valves	11122cc	TD17528
MIDR 06.23.56 A/41	6 Cyl.	12 Valves	11122cc	TD8643
MIDR 06.23.56 B/41	6 Cyl.	12 Valves	11122cc	TD12207
MIDR 06.23.56 B/43	6 Cyl.	12 Valves	11122cc	TD29110

NA5463 R
150.00 x 172.00 x 13.00mm, PTFE/ACM

149 12.0L

Diesel

MACK E.TECH A/46	6 Cyl.	24 Valves	12000cc	TD14770
MACK E.TECH B/46	6 Cyl.	24 Valves	12000cc	TD14771
MACK E.TECH C/46	6 Cyl.	24 Valves	12000cc	TD14772
MIDR 06.24.65 A/42	6 Cyl.	24 Valves	11955cc	TD12148
MIDR 06.24.65 B/42	6 Cyl.	24 Valves	11955cc	TD12188
MIDR 06.24.65 C/42	6 Cyl.	24 Valves	11955cc	TD12189

PA6064 (x24)
→10/01
HR5118 S
→10/01

NA5356 F
82.50 x 101.60 x 12.00mm, PTFE
NA5355 R
153.00 x 171.45 x 11.00mm, PTFE



150 12.0L	Diesel			
MDR 06.35.40	6 Cyl.	12 Valves	12024cc	TD6499
MDS 06.35.40	6 Cyl.	12 Valves	12024cc	TD6500
MDS 06.35.40	6 Cyl.	12 Valves	12024cc	TD8668
MDS 06.35.40 A	6 Cyl.	12 Valves	12024cc	TD6501
MDS 06.35.40 A	6 Cyl.	12 Valves	12024cc	TD26708
MDS 06.35.40 H	6 Cyl.	12 Valves	12024cc	TD8596
MDS 06.35.40 I	6 Cyl.	12 Valves	12024cc	TD8601
MIDR 06.35.40	6 Cyl.	12 Valves	12024cc	TD19965
MIDR 06.35.40 C	6 Cyl.	12 Valves	12024cc	TD8645
MIDR 06.35.40 G	6 Cyl.	12 Valves	12024cc	TD12202
MIDR 06.35.40 H	6 Cyl.	12 Valves	12024cc	TD8516
MIDR 06.35.40 J1	6 Cyl.	12 Valves	12024cc	TD8653
MIDR 06.35.40 J/3	6 Cyl.	12 Valves	12024cc	TD8519
MIDR 06.35.40 L1	6 Cyl.	12 Valves	12024cc	TD8517
MIDR 06.35.40 M3	6 Cyl.	12 Valves	12024cc	TD8543
MIDR 06.35.40 N/3	6 Cyl.	12 Valves	12024cc	TD8518
MIDR 06.35.40 P/41	6 Cyl.	12 Valves	12024cc	TD12187
MIDS 06.35.40	6 Cyl.	12 Valves	12024cc	TD29112
MIDS 06.35.40 B	6 Cyl.	12 Valves	12024cc	TD29113
MIDS 06.35.40 D	6 Cyl.	12 Valves	12024cc	TD8542
MIDS 06.35.40 E	6 Cyl.	12 Valves	12024cc	TD8597
MS 06.35 T	6 Cyl.	12 Valves	12024cc	TD29119

NA5474 80.00 x 100.00 x 13.00mm, PTFE/ACM
NA5475 130.00 x 150.00 x 12.00mm, FPM
NF831 130.00 x 150.00 x 13.00mm, PTFE

151 12.0L	Diesel			
MIDR 06.24.65	6 Cyl.	24 Valves	11955cc	TD29100
MIDR 06.24.65 A/46	6 Cyl.	24 Valves	11955cc	TD29101
MIDR 06.24.65 AB	6 Cyl.	24 Valves	11955cc	TD29102
MIDR 06.24.65 B/46	6 Cyl.	24 Valves	11955cc	TD29103
MIDR 06.24.65 C/46	6 Cyl.	24 Valves	11955cc	TD29104

NA5356 82.50 x 101.60 x 12.00mm, PTFE
NA5355 153.00 x 171.45 x 11.00mm, PTFE

152 12.1L	Diesel			
DXi 12	6 Cyl.	24 Valves	12130cc	TD19083
HR660				

NA5360 45.00 x 62.00 x 8.00mm, ACM
NA5359 180.00 x 205.00 x 15.00mm, FPM



153 12.8L

Diesel

DXi 13	6 Cyl.	24 Valves	12800cc	TD19084
DXi 13 440	6 Cyl.	24 Valves	12800cc	TD29092
DXi 13 460	6 Cyl.	24 Valves	12800cc	TD29093
DXi 13 480	6 Cyl.	24 Valves	12800cc	TD29094
DXi 13 500	6 Cyl.	24 Valves	12800cc	TD29095
DXi 13 520	6 Cyl.	24 Valves	12800cc	TD29096

NA5461

136.00 x 159.00 x 13.00mm, PTFE/ACM

NA5359

180.00 x 205.00 x 15.00mm, FPM

154 16.4L

Diesel

Mack-EE9-560	8 Cyl.	32 Valves	16400cc	TD12147
--------------	--------	-----------	---------	---------

NA5355

153.00 x 171.45 x 11.00mm, PTFE

155 16.5L

Diesel

EE9-502	8 Cyl.	32 Valves	16510cc	TD26706
Mack-EE9-530	8 Cyl.	32 Valves	16510cc	TD8521

NA5355

153.00 x 171.45 x 11.00mm, PTFE



CC



9

25 (RF)	09/99→05/05	11 K4F	Petrol	1119	4	16	3
25 (RF)	10/99→05/05	14 K4F	Petrol	1396	4	16	9
25 (RF)	10/99→05/05	14 K4M	Petrol	1396	4	16	9
25 (RF)	10/99→05/05	16 K4F	Petrol	1588	4	16	13
25 (RF)	10/99→05/05	18 K4F	Petrol	1796	4	16	19
25 (RF)	10/99→05/05	20 T2N	Diesel	1994	4	8	29
25 (RF)	02/00→05/05	18 K4K	Petrol	1796	4	16	19
45 (RT)	02/00→05/05	14 K4F	Petrol	1396	4	16	9
45 (RT)	02/00→05/05	16 K4F	Petrol	1588	4	16	13
45 (RT)	02/00→05/05	18 K4F	Petrol	1796	4	16	19
45 (RT)	02/00→05/05	20 K4F	Petrol	1997	6	24	27
45 (RT)	02/00→05/05	20 T2N	Diesel	1994	4	8	29
45 Saloon (RT)	02/00→05/05	14 K4F	Petrol	1396	4	16	9
45 Saloon (RT)	02/00→05/05	16 K4F	Petrol	1588	4	16	13
45 Saloon (RT)	02/00→05/05	18 K4F	Petrol	1796	4	16	19
45 Saloon (RT)	02/00→05/05	20 K4F	Petrol	1997	6	24	27
45 Saloon (RT)	02/00→05/05	20 T2N	Diesel	1994	4	8	29
75 (RJ)	02/99→10/01	KV 6	Petrol	2497	6	24	46
75 (RJ)	02/99→05/05	20 K4F	Petrol	1997	6	24	27
75 (RJ)	02/99→05/05	K 1.8	Petrol	1796	4	16	19
75 (RJ)	02/99→05/05	M 47 R	Diesel	1950	4	16	35
75 (RJ)	10/01→05/05	25 K4F	Petrol	2497	6	24	44
75 (RJ)	02/03→05/05	204D2	Diesel	1951	4	16	31
75 (RJ)	05/03→05/05	18 K4G	Petrol	1795	4	16	19
75 Tourer (RJ)	08/01→05/05	20 K4F	Petrol	1997	6	24	27
75 Tourer (RJ)	08/01→05/05	K 1.8	Petrol	1796	4	16	19
75 Tourer (RJ)	08/01→05/05	KV 6	Petrol	2497	6	24	46
75 Tourer (RJ)	08/01→05/05	M 47 R	Diesel	1950	4	16	35
75 Tourer (RJ)	02/03→05/05	204D2	Diesel	1951	4	16	31
75 Tourer (RJ)	05/03→05/05	18 K4G	Petrol	1795	4	16	19
100 Convertible (XP)	04/94→10/97	11 K2D	Petrol	1119	4	8	2
100 Convertible (XP)	04/94→10/97	14 K2A	Petrol	1396	4	8	8
100 Convertible (XP)	04/94→10/97	14 K2D	Petrol	1396	4	8	8
100 Convertible (XP)	03/97→10/98	14 K4F	Petrol	1396	4	16	9
100 / Metro (XP)	03/90→12/98	11 K2A	Petrol	1119	4	8	2
100 / Metro (XP)	03/90→12/98	11 K2D	Petrol	1119	4	8	2
100 / Metro (XP)	03/90→12/98	14 K2A	Petrol	1396	4	8	8
100 / Metro (XP)	03/90→12/98	14 K2D	Petrol	1396	4	8	8
100 / Metro (XP)	03/90→12/98	14 K4C	Petrol	1396	4	16	9
100 / Metro (XP)	03/90→12/98	14 K4D	Petrol	1396	4	16	9
100 / Metro (XP)	04/90→05/92	12 HL	Petrol	1275	4	8	6
100 / Metro (XP)	08/91→12/98	14 K4F	Petrol	1396	4	16	9
100 / Metro (XP)	10/92→12/94	TUD 3	Diesel	1361	4	8	10
100 / Metro (XP)	12/94→12/98	TUD 5	Diesel	1527	4	8	11
200 Convertible (XW)	04/90→02/96	D 16 Z2	Petrol	1590	4	16	17
200 Convertible (XW)	04/90→11/99	14 K4C	Petrol	1396	4	16	9
200 Convertible (XW)	01/92→11/99	14 K4D	Petrol	1396	4	16	9
200 Convertible (XW)	01/92→11/99	D 16 A8	Petrol	1590	4	16	16
200 Convertible (XW)	01/93→11/99	14 K4F	Petrol	1396	4	16	9
200 Convertible (XW)	01/96→11/99	16 K4F	Petrol	1588	4	16	13
200 Coupe (XW)	10/92→06/99	20 T4G	Petrol	1994	4	16	30
200 Coupe (XW)	10/92→06/99	D 16 A8	Petrol	1590	4	16	16
200 Coupe (XW)	05/94→06/99	20 T4H	Petrol	1994	4	16	30
200 Coupe (XW)	01/96→12/97	16 K4F	Petrol	1588	4	16	13
200 Hatchback (RF)	11/95→03/00	14 K2F	Petrol	1396	4	8	8
200 Hatchback (RF)	11/95→03/00	14 K4F	Petrol	1396	4	16	9
200 Hatchback (RF)	11/95→03/00	16 K4F	Petrol	1588	4	16	13
200 Hatchback (RF)	11/95→03/00	18 K4K	Petrol	1796	4	16	19
200 Hatchback (RF)	11/95→03/00	20 T2N	Diesel	1994	4	8	29
200 Hatchback (RF)	11/95→03/00	20 T2R	Diesel	1994	4	8	29
200 Hatchback (RF)	01/96→12/97	14 K4D	Petrol	1396	4	16	9
200 Hatchback (RF)	01/98→03/00	11 K2D	Petrol	1119	4	8	2
200 Hatchback (RF)	03/98→11/00	XUD 7TE	Diesel	1769	4	8	21
200 Hatchback (RF)	08/99→03/00	18 K4F	Petrol	1796	4	16	19
200 Hatchback (XW)	10/89→10/95	14 K4C	Petrol	1396	4	16	9
200 Hatchback (XW)	10/89→10/95	14 K4D	Petrol	1396	4	16	9
200 Hatchback (XW)	10/89→10/95	D 16 A7	Petrol	1590	4	16	15
200 Hatchback (XW)	10/89→10/95	D 16 Z2	Petrol	1590	4	16	17
200 Hatchback (XW)	09/90→10/95	D 16 A8	Petrol	1590	4	16	16
200 Hatchback (XW)	09/90→10/95	D 16 A9	Petrol	1590	4	16	16
200 Hatchback (XW)	09/91→10/95	20 M4F	Petrol	1994	4	16	28
200 Hatchback (XW)	09/91→10/95	XUD 7TE	Diesel	1769	4	8	21
200 Hatchback (XW)	09/91→10/95	XUD 9	Diesel	1905	4	8	22
200 Hatchback (XW)	12/92→10/95	14 K4F	Petrol	1396	4	16	9
200 Hatchback (XW)	01/93→10/95	20 T4G	Petrol	1994	4	16	30
200 Hatchback (XW)	01/93→10/95	20 T4H	Petrol	1994	4	16	30
200 Hatchback (XW)	09/93→10/95	14 K2A	Petrol	1396	4	8	8
200 Hatchback (XW)	09/93→10/95	14 K2D	Petrol	1396	4	8	8















CC



9

200 Saloon (XH)	03/85→09/89	16 H	Petrol	1598	4	8	12
200 Saloon (XH)	09/85→09/89	EV 2	Petrol	1342	4	12	7
400 (RT)	05/95→03/00	14 K4F	Petrol	1396	4	16	9
400 (RT)	05/95→03/00	16 K4F	Petrol	1588	4	16	13
400 (RT)	05/95→03/00	20 T2N	Diesel	1994	4	8	29
400 (RT)	05/95→03/00	D16B2	Petrol	1590	4	16	15
400 (RT)	05/95→03/00	D 16 Y2	Petrol	1590	4	16	15
400 (RT)	11/95→03/00	20 T2R	Diesel	1994	4	8	29
400 (RT)	12/95→03/00	20 T4H	Petrol	1994	4	16	30
400 (RT)	03/96→12/99	14 K2F	Petrol	1396	4	8	8
400 (XW)	04/90→04/95	14 K4C	Petrol	1396	4	16	9
400 (XW)	04/90→04/95	14 K4D	Petrol	1396	4	16	9
400 (XW)	04/90→04/95	D 16 A7	Petrol	1590	4	16	15
400 (XW)	04/90→04/95	D 16 A8	Petrol	1590	4	16	16
400 (XW)	04/90→04/95	D 16 A9	Petrol	1590	4	16	16
400 (XW)	04/90→04/95	D 16 Z2	Petrol	1590	4	16	17
400 (XW)	09/91→04/95	XUD 7TE	Diesel	1769	4	8	21
400 (XW)	09/91→04/95	XUD9	Diesel	1905	4	8	22
400 (XW)	02/92→04/95	20 M4F	Petrol	1994	4	16	28
400 (XW)	10/92→04/95	14 K4F	Petrol	1396	4	16	9
400 (XW)	01/93→04/95	20 T4G	Petrol	1994	4	16	30
400 (XW)	01/93→04/95	20 T4H	Petrol	1994	4	16	30
400 Hatchback (RT)	05/95→03/00	14 K4F	Petrol	1396	4	16	9
400 Hatchback (RT)	05/95→03/00	16 K4F	Petrol	1588	4	16	13
400 Hatchback (RT)	05/95→03/00	20 T2N	Diesel	1994	4	8	29
400 Hatchback (RT)	06/95→03/00	D16B2	Petrol	1590	4	16	15
400 Hatchback (RT)	06/95→03/00	D 16 Y2	Petrol	1590	4	16	15
400 Hatchback (RT)	11/95→03/00	20 T2R	Diesel	1994	4	8	29
400 Hatchback (RT)	12/95→03/00	20 T4H	Petrol	1994	4	16	30
400 Hatchback (RT)	03/96→12/97	14 K2F	Petrol	1396	4	8	8
400 Tourer (XW)	09/93→11/98	XUD 7TE	Diesel	1769	4	8	21
400 Tourer (XW)	05/94→11/98	20 T4H	Petrol	1994	4	16	30
400 Tourer (XW)	05/94→11/98	D 16 A8	Petrol	1590	4	16	16
400 Tourer (XW)	05/94→11/98	D 16 Z2	Petrol	1590	4	16	17
400 Tourer (XW)	06/96→11/98	18 K4K	Petrol	1796	4	16	19
416i	05/86→12/89	D 16 A3	Petrol	1590	4	16	14
600 (RH)	08/93→06/96	F 20 Z2	Petrol	1997	4	16	34
600 (RH)	08/93→02/99	F 20 Z1	Petrol	1997	4	16	34
600 (RH)	08/93→02/99	H 23 A3	Petrol	2259	4	16	37
600 (RH)	07/94→02/99	20 T4G	Petrol	1994	4	16	30
600 (RH)	12/94→02/99	20 T2N	Diesel	1994	4	8	29
600 (RH)	03/96→02/99	F 18 A3	Petrol	1850	4	16	20
800 (XS)	10/86→10/88	20 HD	Petrol	1994	4	16	24
800 (XS)	10/86→12/91	20 HS	Petrol	1994	4	16	25
800 (XS)	10/86→12/91	C 25 A1	Petrol	2494	6	24	45
800 (XS)	10/86→12/91	C 25 A2	Petrol	2494	6	24	45
800 (XS)	02/88→12/91	C 27 A2	Petrol	2675	6	24	47
800 (XS)	02/88→02/99	C 27 A1	Petrol	2675	6	24	47
800 (XS)	10/88→10/91	20 HT	Petrol	1994	4	16	26
800 (XS)	10/88→12/91	20 HD M 16	Petrol	1994	4	16	24
800 (XS)	01/92→02/99	20 T4H	Petrol	1994	4	16	30
800 (XS)	01/92→02/99	T 16	Petrol	1994	4	16	36
800 (XS)	04/94→03/96	20 T4G	Petrol	1994	4	16	30
800 (XS)	04/96→02/99	25 K4F	Petrol	2497	6	24	44
800 Coupe	08/92→02/99	C 27 A1	Petrol	2675	6	24	47
800 Coupe	02/96→02/99	20 T4G	Petrol	1994	4	16	30
800 Coupe	04/96→02/99	25 K4F	Petrol	2497	6	24	44
800 Hatchback (XS)	10/86→12/91	20 HS	Petrol	1994	4	16	25
800 Hatchback (XS)	08/87→02/99	20 T4H	Petrol	1994	4	16	30
800 Hatchback (XS)	10/88→10/91	20 HT	Petrol	1994	4	16	26
800 Hatchback (XS)	10/88→10/91	C 25 A2	Petrol	2494	6	24	45
800 Hatchback (XS)	10/88→12/91	20 HD	Petrol	1994	4	16	24
800 Hatchback (XS)	10/88→12/91	20 HD M 16	Petrol	1994	4	16	24
800 Hatchback (XS)	10/88→12/91	C 27 A2	Petrol	2675	6	24	47
800 Hatchback (XS)	10/88→02/99	C 27 A1	Petrol	2675	6	24	47
800 Hatchback (XS)	01/92→02/99	T 16	Petrol	1994	4	16	36
800 Hatchback (XS)	04/94→03/96	20 T4G	Petrol	1994	4	16	30
800 Hatchback (XS)	02/96→10/98	25 K4F	Petrol	2497	6	24	44
2000-3500 Hatchback (SD1)	06/76→10/86	38 A	Petrol	3528	8	16	48
2000-3500 Hatchback (SD1)	06/76→10/86	39 A	Petrol	3528	8	16	48
2000-3500 Hatchback (SD1)	10/82→10/86	30 A	Petrol	3528	8	16	48
2000-3500 Hatchback (SD1)	10/82→10/86	31 A	Petrol	3528	8	16	48
Coupe	03/96→11/99	16 K4F	Petrol	1588	4	16	13
Coupe	03/96→11/99	18 K4K	Petrol	1796	4	16	19
Maestro	09/90→01/95	12 HE	Petrol	1275	4	8	6
Maestro	09/90→01/95	16 H	Petrol	1598	4	8	12
Maestro	09/90→01/95	BB	Diesel	1996	4	8	32
Mini	01/91→02/94	12 A2A	Petrol	1273	4	8	4

				CC			9
Mini	01/92→04/95	12 A2D	Petrol	1273	4	8	4
Mini	01/92→11/00	12 A2E	Petrol	1273	4	8	4
Mini	01/92→11/00	12 A2L	Petrol	1275	4	8	4
Mini	04/92→11/00	12 A2B	Petrol	1273	4	8	4
Mini Convertible (XN)	09/92→04/95	12 A2E	Petrol	1273	4	8	4
Mini Convertible (XN)	02/98→05/01	12 A2L	Petrol	1275	4	8	4
Mini-moke	09/86→09/93	99 H	Petrol	998	4	8	1
Montego	10/88→10/94	20 H	Petrol	1994	4	8	23
Montego	10/88→10/95	BB	Diesel	1996	4	8	32
Montego Estate (XE)	10/84→10/88	12 HL	Petrol	1275	4	8	6
Montego Estate (XE)	10/88→12/93	20 H	Petrol	1994	4	8	23
Montego Estate (XE)	01/93→12/93	BB	Diesel	1996	4	8	32
Quintet	05/83→10/85	EL	Petrol	1602	4	8	18
Streetwise	08/03→05/05	14 K4F	Petrol	1396	4	16	9
Streetwise	08/03→05/05	14 K4M	Petrol	1396	4	16	9
Streetwise	08/03→05/05	18 K4F	Petrol	1796	4	16	19
Streetwise	08/03→05/05	20 T2N	Diesel	1994	4	8	29
Streetwise	01/04→05/05	16 K4F	Petrol	1588	4	16	13

	CC				9		CC				9
11 D	3528	8	16	Petrol	48	H 23 A3	2259	4	16	Petrol	37
11 K2A	1119	4	8	Petrol	2	K 1.8	1796	4	16	Petrol	19
11 K2D	1119	4	8	Petrol	2	KV 6	2497	6	24	Petrol	46
11 K4F	1119	4	16	Petrol	3	M 47 R	1950	4	16	Diesel	35
12 A2A	1273	4	8	Petrol	4	T 16	1994	4	16	Petrol	36
12 A2B	1273	4	8	Petrol	4	TUD 3	1361	4	8	Diesel	10
12 A2D	1273	4	8	Petrol	4	TUD 5	1527	4	8	Diesel	11
12 A2E	1273	4	8	Petrol	4	XUD 7TE	1769	4	8	Diesel	21
12 A2L	1275	4	8	Petrol	4	XUD9	1905	4	8	Diesel	22
12 H	1275	4	8	Petrol	5						
12 HE	1275	4	8	Petrol	6						
12 HL	1275	4	8	Petrol	6						
12 L	2496	4	8	Diesel	38						
14 K2A	1396	4	8	Petrol	8						
14 K2D	1396	4	8	Petrol	8						
14 K2F	1396	4	8	Petrol	8						
14 K4C	1396	4	16	Petrol	9						
14 K4D	1396	4	16	Petrol	9						
14 K4F	1396	4	16	Petrol	9						
14 K4M	1396	4	16	Petrol	9						
14 L	2496	4	8	Diesel	39						
16 H	1598	4	8	Petrol	12						
16 K4F	1588	4	16	Petrol	13						
18 K4F	1796	4	16	Petrol	19						
18 K4G	1795	4	16	Petrol	19						
18 K4K	1796	4	16	Petrol	19						
19 L	2496	4	8	Diesel	40						
20 H	1994	4	8	Petrol	23						
20 HD	1994	4	16	Petrol	24						
20 HD M 16	1994	4	16	Petrol	24						
20 HS	1994	4	16	Petrol	25						
20 HT	1994	4	16	Petrol	26						
20 K4F	1997	6	24	Petrol	27						
20 M4F	1994	4	16	Petrol	28						
20 T2N	1994	4	8	Diesel	29						
20 T2R	1994	4	8	Diesel	29						
20 T4G	1994	4	16	Petrol	30						
20 T4H	1994	4	16	Petrol	30						
21 L	2495	4	8	Diesel	41						
22 D	3531	8	16	Petrol	48						
23 L	2495	4	8	Diesel	42						
24 D	3528	8	16	Petrol	48						
25 D	3528	8	16	Petrol	48						
25 K4F	2497	6	24	Petrol	44						
30 A	3528	8	16	Petrol	48						
31 A	3528	8	16	Petrol	48						
31 D	3528	8	16	Petrol	48						
35 D	3950	8	16	Petrol	49						
36 D	3950	8	16	Petrol	49						
37 D	3950	8	16	Petrol	49						
38 A	3528	8	16	Petrol	48						
38 D	3950	8	16	Petrol	49						
39 A	3528	8	16	Petrol	48						
40 D	4275	8	16	Petrol	51						
42 D	3947	8	16	Petrol	50						
46 D	4553	8	16	Petrol	52						
99 H	998	4	8	Petrol	1						
204D2	1951	4	16	Diesel	31						
25 6T (BMW)	2497	6	12	Diesel	43						
BB	1996	4	8	Diesel	32						
C 25 A1	2494	6	12	Petrol	45						
C 25 A2	2494	6	24	Petrol	45						
C 27 A1	2675	6	24	Petrol	47						
C 27 A2	2675	6	24	Petrol	47						
C 27A V6	2675	6	24	Petrol	47						
D 16 A3	1590	4	16	Petrol	14						
D 16 A7	1590	4	16	Petrol	15						
D 16 A8	1590	4	16	Petrol	16						
D 16 A9	1590	4	16	Petrol	16						
DI6B2	1590	4	16	Petrol	15						
D 16 Y2	1590	4	16	Petrol	15						
D 16 Z2	1590	4	16	Petrol	17						
EL	1602	4	8	Petrol	18						
EV 2	1342	4	12	Petrol	7						
F 18 A3	1850	4	16	Petrol	20						
F 20 A4	1997	4	16	Petrol	33						
F 20 Z1	1997	4	16	Petrol	34						
F 20 Z2	1997	4	16	Petrol	34						



1 1.0L		Petrol		
99 H	4 Cyl.	8 Valves	998cc	TD27689
HR339				
2 1.1L		Petrol		
11 K2A	4 Cyl.	8 Valves	1119cc	TD9488
11 K2D	4 Cyl.	8 Valves	1119cc	TD4884
HR656				
		NC065 30.00 x 40.00 x 7.00mm, FPM NB998 30.00 x 40.00 x 7.00mm, FPM	NB828 27.50 x 39.50 x 7.00mm, FPM NB829 79.95 x 116.00; 126.00 x 11.50mm, FPM	
3 1.1L		Petrol		
11 K4F	4 Cyl.	16 Valves	1119cc	TD18365
NC065 (x2) 30.00 x 40.00 x 7.00mm, FPM NB998 (x2) 30.00 x 40.00 x 7.00mm, FPM				
4 1.3L		Petrol		
12 A2A	4 Cyl.	8 Valves	1273cc	TD9490
12 A2B	4 Cyl.	8 Valves	1273cc	TD4880
12 A2D	4 Cyl.	8 Valves	1273cc	TD3473
12 A2E	4 Cyl.	8 Valves	1273cc	TD3487
12 A2L	4 Cyl.	8 Valves	1275cc	TD9489
HR339				
		NA473 39.70 x 59.00 x 9.50mm, NBR		
5 1.3L		Petrol		
12 H	4 Cyl.	8 Valves	1275cc	TD22364
HR339				
		NA473 39.70 x 59.00 x 9.50mm, NBR NA584 55.00 x 70.00 x 10.00mm, MVQ		
6 1.3L		Petrol		
12 HE	4 Cyl.	8 Valves	1275cc	TD26936
12 HL	4 Cyl.	8 Valves	1275cc	TD22905
HR339				
		NA473 39.70 x 59.00 x 9.50mm, NBR NB291 82.60 x 98.70 x 12.70mm, MVQ		
7 1.3L		Petrol		
EV 2	4 Cyl.	12 Valves	1342cc	TD4883
PA528 (x8) PA531 (x4)				
		NJ313 29.00 x 45.00 x 8.00mm, ACM	NJ381 31.00 x 46.00 x 8.00mm, NBR NJ312 80.00 x 100.00 x 10.00mm, MVQ	

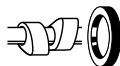

8 1.4L Petrol

14 K2A	4 Cyl.	8 Valves	1396cc	TD3477
14 K2D	4 Cyl.	8 Valves	1396cc	TD3478
14 K2F	4 Cyl.	8 Valves	1396cc	TD9499

HR656

NC065 (x2)
30.00 x 40.00 x 7.00mm, FPM
NB998 (x2)
30.00 x 40.00 x 7.00mm, FPM

NB828
27.50 x 39.50 x 7.00mm, FPM
NB829
79.95 x 116.00; 126.00 x 11.50mm, FPM

9 1.4L Petrol

14 K4C	4 Cyl.	16 Valves	1396cc	TD3480
14 K4D	4 Cyl.	16 Valves	1396cc	TD3488
14 K4F	4 Cyl.	16 Valves	1396cc	TD3481
14 K4M	4 Cyl.	16 Valves	1396cc	TD18231

HR752

NC065 (x2)
30.00 x 40.00 x 7.00mm, FPM
NB998 (x2)
30.00 x 40.00 x 7.00mm, FPM

NB828
27.50 x 39.50 x 7.00mm, FPM
NB829
79.95 x 116.00; 126.00 x 11.50mm, FPM

10 1.4L Diesel

TUD 3	4 Cyl.	8 Valves	1361cc	TD12127
-------	--------	----------	--------	---------

HR816

NF817
36.00 x 50.00 x 7.00mm, FPM

NF870
42.00 x 66.00 x 6.00mm, FPM/ACM
NF850
85.00 x 105.00 x 8.00mm, FPM
NF857
85.00 x 105.00 x 9.00mm, FPM/ACM
NA5362
85.00 x 105.00 x 8.00mm, PTFE/ACM

11 1.5L Diesel

TUD 5	4 Cyl.	8 Valves	1527cc	TD3490
-------	--------	----------	--------	--------

HR816

NF817
36.00 x 50.00 x 7.00mm, FPM

NF870
42.00 x 66.00 x 6.00mm, FPM/ACM
NF850
85.00 x 105.00 x 8.00mm, FPM
NF857
85.00 x 105.00 x 9.00mm, FPM/ACM
NA5362
85.00 x 105.00 x 8.00mm, PTFE/ACM

12 1.6L Petrol

16 H	4 Cyl.	8 Valves	1598cc	TD9503
------	--------	----------	--------	--------

HR752

NB775 (x2)
40.00 x 52.00 x 7.00mm, FPM

NB586
30.00 x 40.00 x 7.00mm, MVQ
NB772
88.90 x 104.80 x 9.52mm, MVQ

13 1.6L Petrol

16 K4F	4 Cyl.	16 Valves	1588cc	TD9358
--------	--------	-----------	--------	--------

HR752

NC065 (x2)
30.00 x 40.00 x 7.00mm, FPM
NB998 (x2)
30.00 x 40.00 x 7.00mm, FPM

NB828
27.50 x 39.50 x 7.00mm, FPM
NB829
79.95 x 116.00; 126.00 x 11.50mm, FPM



14 1.6L Petrol

D 16 A3 4 Cyl. 16 Valves 1590cc TD25478

NJ254 (x2)
27.00 x 43.00 x 9.00mm, NBR

15 1.6L Petrol

D 16 A7 4 Cyl. 16 Valves 1590cc TD18331

D16B2 4 Cyl. 16 Valves 1590cc TD27728

D 16 Y2 4 Cyl. 16 Valves 1590cc TD9498

PB355 (x8)
PB356 (x8)

NJ313
29.00 x 45.00 x 8.00mm, ACM

NJ381 (x2)
31.00 x 46.00 x 8.00mm, NBR
NJ312 (x2)
80.00 x 100.00 x 10.00mm, MVQ

16 1.6L Petrol

D 16 A8 4 Cyl. 16 Valves 1590cc TD4881

D 16 A9 4 Cyl. 16 Valves 1590cc TD18330

PB156 (x8)
PB354 (x8)

NJ254 (x2)
27.00 x 43.00 x 9.00mm, NBR

NJ381 (x2)
31.00 x 46.00 x 8.00mm, NBR
NJ312 (x2)
80.00 x 100.00 x 10.00mm, MVQ

17 1.6L Petrol

D 16 Z2 4 Cyl. 16 Valves 1590cc TD3467

PB355 (x8)
PB356 (x8)

NJ313
29.00 x 45.00 x 8.00mm, ACM

18 1.6L Petrol

EL 4 Cyl. 8 Valves 1602cc TD25222

NJ254
27.00 x 43.00 x 9.00mm, NBR

NJ072 (x2)
35.00 x 50.00 x 8.00mm, NBR

19 1.8L Petrol

18 K4F 4 Cyl. 16 Valves 1796cc TD9483

18 K4G 4 Cyl. 16 Valves 1795cc TD26623

18 K4K 4 Cyl. 16 Valves 1796cc TD3500

K 1.8 4 Cyl. 16 Valves 1796cc TD11607

HR752 (x2)

NC065 (x2)
30.00 x 40.00 x 7.00mm, FPM
NB998 (x2)
30.00 x 40.00 x 7.00mm, FPM

NB828 (x2)
27.50 x 39.50 x 7.00mm, FPM
NB829 (x2)
79.95 x 116.00; 126.00 x 11.50mm, FPM

20 1.8L Petrol

F 18 A3 4 Cyl. 16 Valves 1850cc TD9491

PB355 (x8)
PB356 (x8)

NJ134
28.00 x 42.00 x 8.00mm, MVQ

NA5242 (x2)
40.00 x 52.00 x 7.00mm, ACM

21 1.8L Diesel

XUD 7TE 4 Cyl. 8 Valves 1769cc TD3504

HR569 (x2)

NF841
35.00 x 50.00 x 8.00mm, FPM

NA5191 (x2)
42.00 x 62.00 x 7.00mm, PTFE
NA5192 (x2)
90.00 x 110.00 x 7.00mm, PTFE

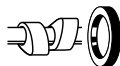

22 1.9L

Diesel

XUD9	4 Cyl.	8 Valves	1905cc	TD32224
HR569	NF841 35.00 x 50.00 x 8.00mm, FPM		NA5191 42.00 x 62.00 x 7.00mm, PTFE NA5192 90.00 x 110.00 x 7.00mm, PTFE	

23 2.0L

Petrol

20 H	4 Cyl.	8 Valves	1994cc	TD3482
HR339 →12/89 HR802 01/90→	NB775 40.00 x 52.00 x 7.00mm, FPM		NB774 35.00 x 45.00 x 7.00mm, FPM NB772 88.90 x 104.80 x 9.52mm, MVQ	

24 2.0L

Petrol

20 HD	4 Cyl.	16 Valves	1994cc	TD3484
20 HD M 16	4 Cyl.	16 Valves	1994cc	TD3485
HR339 (x2) →12/89 HR802 01/90→	NB775 40.00 x 52.00 x 7.00mm, FPM		NB774 35.00 x 45.00 x 7.00mm, FPM NB772 88.90 x 104.80 x 9.52mm, MVQ	

25 2.0L

Petrol

20 HS	4 Cyl.	16 Valves	1994cc	TD18411
HR802 Eng no. 20H/E83/104398;20H/E84/100121; 20H/E85/101991;20H/E86/100282→ HR339 (x2) Eng no. 20H/E83/104397;20H/E85/101990→ 20H/E84/100120;20H/E86/100281			NB774 35.00 x 45.00 x 7.00mm, FPM NB772 88.90 x 104.80 x 9.52mm, MVQ	

26 2.0L

Petrol

20 HT	4 Cyl.	16 Valves	1994cc	TD34196
	NB775 40.00 x 52.00 x 7.00mm, FPM		NB586 30.00 x 40.00 x 7.00mm, MVQ →12/85 NB774 35.00 x 45.00 x 7.00mm, FPM NB772 88.90 x 104.80 x 9.52mm, MVQ 12/85→	

27 2.0L

Petrol

20 K4F	6 Cyl.	24 Valves	1997cc	TD18238
HR5031 (x2)	NC065 (x2) 30.00 x 40.00 x 7.00mm, FPM NB998 (x4) 30.00 x 40.00 x 7.00mm, FPM		NA5083 32.50 x 45.00 x 7.70mm, FPM LK5000 89.00 x 116.00 x 10.20mm, FPM	

28 2.0L

Petrol

20 M4F	4 Cyl.	16 Valves	1994cc	TD9502
HR802			NB774 35.00 x 45.00 x 7.00mm, FPM NB843 128.00 x 145.00 x 28.00mm, FPM	



29 2.0L Diesel					
20 T2N	4 Cyl.	8 Valves	1994cc		TD9496
20 T2R	4 Cyl.	8 Valves	1994cc		TD9497
PB354 (x8) HR5051	NB775 (x2) 40.00 x 52.00 x 7.00mm, FPM		NB774 35.00 x 45.00 x 7.00mm, FPM NB843 128.00 x 145.00 x 28.00mm, FPM		
30 2.0L Petrol					
20 T4G	4 Cyl.	16 Valves	1994cc		TD4885
20 T4H	4 Cyl.	16 Valves	1994cc		TD3479
HR802 →12/94 HR656 (x2) 01/95→			NB774 35.00 x 45.00 x 7.00mm, FPM NB843 128.00 x 145.00 x 28.00mm, FPM		
31 2.0L Diesel					
204D2	4 Cyl.	16 Valves	1951cc		TD18240
PA5016 (x16) HR5045			NA5104 90.00 x 110.00 x 12.00mm, PTFE		
32 2.0L Diesel					
BB	4 Cyl.	8 Valves	1996cc		TD3486
				NB774 35.00 x 45.00 x 7.00mm, FPM NB772 88.90 x 104.80 x 9.52mm, MVQ	
33 2.0L Petrol					
F 20 A4	4 Cyl.	16 Valves	1997cc		TD21379
PB355 (x8) PB356 (x8)	NJ134 28.00 x 42.00 x 8.00mm, MVQ		NA5242 40.00 x 52.00 x 7.00mm, ACM		
34 2.0L Petrol					
F 20 Z1	4 Cyl.	16 Valves	1997cc		TD3470
F 20 Z2	4 Cyl.	16 Valves	1997cc		TD4882
PB355 (x8) PB356 (x8)	NJ134 28.00 x 42.00 x 8.00mm, MVQ		NA5242 40.00 x 52.00 x 7.00mm, ACM		
35 2.0L Diesel					
M 47 R	4 Cyl.	16 Valves	1950cc		TD11609
PA5016 (x16) HR5045			NA5103 55.00 x 68.00 x 8.00mm, PTFE NB431 90.00 x 110.00 x 12.00mm, FPM NA5104 90.00 x 110.00 x 12.00mm, PTFE		
36 2.0L Petrol					
T 16	4 Cyl.	16 Valves	1994cc		TD4886
				NB774 35.00 x 45.00 x 7.00mm, FPM NB843 128.00 x 145.00 x 28.00mm, FPM	

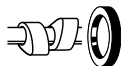



37 2.3L

Petrol

H 23 A3	4 Cyl.	16 Valves	2259cc	TD3471
PB156  (x8) PB354  (x8)	NJ134 (x2) 28.00 x 42.00 x 8.00mm, MVQ	NA5242  40.00 x 52.00 x 7.00mm, ACM		

38 2.5L

Diesel

12 L	4 Cyl.	8 Valves	2496cc	TD3461
HR801 	NB775 40.00 x 52.00 x 7.00mm, FPM	NC009  57.20 x 74.00 x 9.70mm, NBR LK5009  99.00 x 118.00 x 16.50mm, PTFE		

39 2.5L

Diesel

14 L	4 Cyl.	8 Valves	2496cc	TD3491
HR801 	NC008 47.00 x 62.00 x 10.00mm, FPM	NC009  57.20 x 74.00 x 9.70mm, NBR LK5009  99.00 x 118.00 x 16.50mm, PTFE		

40 2.5L

Diesel

19 L	4 Cyl.	8 Valves	2496cc	TD9482
HR343 	NB775 40.00 x 52.00 x 7.00mm, FPM →02/94 NC008 47.00 x 62.00 x 10.00mm, FPM 03/94→	NC009  57.20 x 74.00 x 9.70mm, NBR LK5009  99.00 x 118.00 x 16.50mm, PTFE		

41 2.5L

Diesel

21 L	4 Cyl.	8 Valves	2495cc	TD15168
HR343 	NB775 40.00 x 52.00 x 7.00mm, FPM →02/94	LK5009  99.00 x 118.00 x 16.50mm, PTFE		

42 2.5L

Diesel

23 L	4 Cyl.	8 Valves	2495cc	TD9481
HR343 		LK5009  99.00 x 118.00 x 16.50mm, PTFE		





43 2.5L

Diesel



25 6T (BMW)	6 Cyl.	12 Valves	2497cc	TD9485
PA5041 (x12) HR280 		NF637  48.00 x 65.00 x 10.00mm, FPM NB431  90.00 x 110.00 x 12.00mm, FPM		

44 2.5L



Petrol

25 K4F	6 Cyl.	24 Valves	2497cc	TD9492
HR5031  (x2)	NC065  (x2) 30.00 x 40.00 x 7.00mm, FPM NB998  (x4) 30.00 x 40.00 x 7.00mm, FPM	NA5083  32.50 x 45.00 x 7.70mm, FPM LK5000  89.00 x 116.00 x 10.20mm, FPM		

**45 2.5L****Petrol**

C 25 A1	6 Cyl.	12 Valves	2494cc	TD3463
C 25 A2	6 Cyl.	24 Valves	2494cc	TD3462
PA528  (x12)	NJ933 (x2) 35.00 x 50.00 x 8.00mm, FPM	NJ675  80.00 x 98.00 x 10.00mm, NBR		



46 2.5L**Petrol**

KV 6	6 Cyl.	24 Valves	2497cc	TD11608
HR5031  (x2)	NB998 (x4) 30.00 x 40.00 x 7.00mm, FPM	NA5083  32.50 x 45.00 x 7.70mm, FPM		
	NC065  (x2) 30.00 x 40.00 x 7.00mm, FPM	LK5000  89.00 x 116.00 x 10.20mm, FPM		

47 2.7L**Petrol**

C 27 A1	6 Cyl.	24 Valves	2675cc	TD3465
C 27 A2	6 Cyl.	24 Valves	2675cc	TD3464
C 27A V6	6 Cyl.	24 Valves	2675cc	TD3466
PA528  (x12)	NJ933 (x2) 35.00 x 50.00 x 8.00mm, FPM	NJ675  80.00 x 98.00 x 10.00mm, NBR		

48 3.5L**Petrol**

11 D	8 Cyl.	16 Valves	3528cc	TD3494
22 D	8 Cyl.	16 Valves	3531cc	TD3498
24 D	8 Cyl.	16 Valves	3528cc	TD3496
25 D	8 Cyl.	16 Valves	3528cc	TD3495
30 A	8 Cyl.	16 Valves	3528cc	TD3476
31 A	8 Cyl.	16 Valves	3528cc	TD3475
31 D	8 Cyl.	16 Valves	3528cc	TD9484
38 A	8 Cyl.	16 Valves	3528cc	TD9501
39 A	8 Cyl.	16 Valves	3528cc	TD9500
HR5052  (x2)		NB849  48.70 x 63.50 x 8.00mm, FPM		
		NB291  82.60 x 98.70 x 12.70mm, MVQ		

49 3.9L**Petrol**

35 D	8 Cyl.	16 Valves	3950cc	TD3499
36 D	8 Cyl.	16 Valves	3950cc	TD3468
37 D	8 Cyl.	16 Valves	3950cc	TD3497
38 D	8 Cyl.	16 Valves	3950cc	TD3493
HR5054  (x2)		NB849  48.70 x 63.50 x 8.00mm, FPM		
		NB291  82.60 x 98.70 x 12.70mm, MVQ		

50 3.9L**Petrol**

42 D	8 Cyl.	16 Valves	3947cc	TD9486
HR5053 		NB849  48.70 x 63.50 x 8.00mm, FPM		
		NB291  82.60 x 98.70 x 12.70mm, MVQ		

ROVER

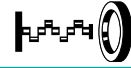

51 4.3L

Petrol

40 D

8 Cyl.

16 Valves

4275cc

TD3492

HR5053

NB849

48.70 x 63.50 x 8.00mm, FPM

NB291

82.60 x 98.70 x 12.70mm, MVQ

52 4.6L

Petrol

46 D

8 Cyl.

16 Valves

4553cc

TD9487

HR5053

NB849

48.70 x 63.50 x 8.00mm, FPM

NB291

82.60 x 98.70 x 12.70mm, MVQ



CC



9

9-2X Estate	09/04→12/05	EJ205	Petrol	1994	4	16	14
9-2X Estate	09/04→12/06	EJ255	Petrol	2457	4	16	20
9-2X Estate	09/05→12/06	EJ255	Petrol	2457	4	16	20
9-3 (YS3D)	02/98→11/00	X 22 DTH	Diesel	2171	4	16	16
9-3 (YS3D)	02/98→09/02	B204I	Petrol	1985	4	16	12
9-3 (YS3D)	02/98→09/02	B204L	Petrol	1985	4	16	12
9-3 (YS3D)	02/98→09/02	B204R	Petrol	1985	4	16	12
9-3 (YS3D)	02/98→09/02	B205E	Petrol	1985	4	16	13
9-3 (YS3D)	02/98→09/02	B205L	Petrol	1985	4	16	13
9-3 (YS3D)	02/98→09/02	B234I	Petrol	2290	4	16	17
9-3 (YS3D)	02/98→09/02	D223L	Diesel	2171	4	16	16
9-3 (YS3D)	10/98→09/02	B204E	Petrol	1985	4	16	12
9-3 (YS3D)	10/98→09/02	B235R	Petrol	2290	4	16	18
9-3 (YS3D)	10/99→09/02	B205R	Petrol	1985	4	16	13
9-3 (YS3F)	09/02→02/15	B207E	Petrol	1998	4	16	10
9-3 (YS3F)	09/02→02/15	B207L	Petrol	1998	4	16	10
9-3 (YS3F)	09/02→02/15	B207R	Petrol	1998	4	16	10
9-3 (YS3F)	09/02→02/15	D223L	Diesel	2171	4	16	16
9-3 (YS3F)	01/04→02/15	Z 18 XE	Petrol	1796	4	16	5
9-3 (YS3F)	09/04→02/15	Z 19 DT	Diesel	1910	4	8	7
9-3 (YS3F)	09/04→02/15	Z 19 DTH	Diesel	1910	4	16	8
9-3 (YS3F)	01/07→02/15	B207G	Petrol	1998	4	16	10
9-3 (YS3F)	01/07→02/15	B207H	Petrol	1998	4	16	10
9-3 (YS3F)	12/07→02/15	A 19 DTR	Diesel	1910	4	16	6
9-3 (YS3F)	12/07→02/15	Z 19 DTR	Diesel	1910	4	16	6
9-3 (YS3F)	01/08→02/15	A 20 NFT	Petrol	1998	4	16	10
9-3 (YS3F)	05/09→02/15	B207M	Petrol	1998	4	16	10
9-3 Cabriolet (YS3D)	02/98→08/03	B204I	Petrol	1985	4	16	12
9-3 Cabriolet (YS3D)	02/98→08/03	B204L	Petrol	1985	4	16	12
9-3 Cabriolet (YS3D)	02/98→08/03	B204R	Petrol	1985	4	16	12
9-3 Cabriolet (YS3D)	02/98→08/03	B205E	Petrol	1985	4	16	13
9-3 Cabriolet (YS3D)	02/98→08/03	B205L	Petrol	1985	4	16	13
9-3 Cabriolet (YS3D)	02/98→08/03	B234I	Petrol	2290	4	16	17
9-3 Cabriolet (YS3D)	10/98→08/03	B204E	Petrol	1985	4	16	12
9-3 Cabriolet (YS3D)	09/99→08/03	B235R	Petrol	2290	4	16	18
9-3 Cabriolet (YS3D)	10/99→08/03	B205R	Petrol	1985	4	16	13
9-3 Convertible (YS3F)	08/03→02/15	B207E	Petrol	1998	4	16	10
9-3 Convertible (YS3F)	08/03→02/15	B207L	Petrol	1998	4	16	10
9-3 Convertible (YS3F)	08/03→02/15	B207R	Petrol	1998	4	16	10
9-3 Convertible (YS3F)	01/04→02/15	Z 18 XE	Petrol	1796	4	16	5
9-3 Convertible (YS3F)	09/04→02/15	Z 19 DT	Diesel	1910	4	8	7
9-3 Convertible (YS3F)	01/06→02/15	Z 19 DTH	Diesel	1910	4	16	8
9-3 Convertible (YS3F)	06/07→02/15	B207M	Petrol	1998	4	16	10
9-3 Convertible (YS3F)	12/07→02/15	A 19 DTR	Diesel	1910	4	16	6
9-3 Convertible (YS3F)	12/07→02/15	Z 19 DTR	Diesel	1910	4	16	6
9-3 Convertible (YS3F)	01/11→02/15	A 20 NFT	Petrol	1998	4	16	10
9-3 Convertible (YS3F)	01/11→02/15	B207G	Petrol	1998	4	16	10
9-3 Convertible (YS3F)	01/11→02/15	B207H	Petrol	1998	4	16	10
9-3 Estate (YS3F)	03/05→02/15	B207E	Petrol	1998	4	16	10
9-3 Estate (YS3F)	03/05→02/15	B207L	Petrol	1998	4	16	10
9-3 Estate (YS3F)	03/05→02/15	B207R	Petrol	1998	4	16	10
9-3 Estate (YS3F)	03/05→02/15	Z 18 XE	Petrol	1796	4	16	5
9-3 Estate (YS3F)	03/05→02/15	Z 19 DT	Diesel	1910	4	8	7
9-3 Estate (YS3F)	03/05→02/15	Z 19 DTH	Diesel	1910	4	16	8
9-3 Estate (YS3F)	01/07→02/15	B207G	Petrol	1998	4	16	10
9-3 Estate (YS3F)	12/07→02/15	A 19 DTR	Diesel	1910	4	16	6
9-3 Estate (YS3F)	12/07→02/15	Z 19 DTR	Diesel	1910	4	16	6
9-3 Estate (YS3F)	02/09→02/15	B207M	Petrol	1998	4	16	10
9-3 Estate (YS3F)	01/11→02/15	A 20 NFT	Petrol	1998	4	16	10
9-3 Estate (YS3F)	01/11→02/15	B207H	Petrol	1998	4	16	10
9-3X	02/09→12/12	A 19 DTR	Diesel	1910	4	16	6
9-3X	02/09→12/12	B207R	Petrol	1998	4	16	10
9-3X	02/09→12/12	Z 19 DTR	Diesel	1910	4	16	6
9-3X	01/11→12/12	A 20 NFT	Petrol	1998	4	16	10
9-5 (YS3E)	09/97→12/09	B205E	Petrol	1985	4	16	13
9-5 (YS3E)	09/97→12/09	B235E	Petrol	2290	4	16	18
9-5 (YS3E)	01/98→12/09	B308E	Petrol	2962	6	24	21
9-5 (YS3E)	09/99→12/09	B235R	Petrol	2290	4	16	18
9-5 (YS3E)	07/00→12/09	B205L	Petrol	1985	4	16	13
9-5 (YS3E)	07/01→12/09	D308L	Diesel	2958	6	24	22
9-5 (YS3E)	03/02→12/09	D223L	Diesel	2171	4	16	16
9-5 (YS3E)	07/03→12/09	B235L	Petrol	2290	4	16	18
9-5 (YS3E)	01/06→12/09	Z 19 DTH	Diesel	1910	4	16	8
9-5 (YS3G)	05/10→01/12	A 16 LET	Petrol	1598	4	16	4
9-5 (YS3G)	05/10→01/12	A 20 DTH	Diesel	1956	4	16	9
9-5 (YS3G)	05/10→01/12	A 20 DTR	Diesel	1956	4	16	9
9-5 (YS3G)	05/10→01/12	A 20 NFT	Petrol	1998	4	16	10
9-5 (YS3G)	05/10→01/12	A 20 NHT	Petrol	1998	4	16	10



9-5 Estate (YS3E)	10/98→12/09	B205E	Petrol	1985	4	16	13
9-5 Estate (YS3E)	10/98→12/09	B235E	Petrol	2290	4	16	18
9-5 Estate (YS3E)	10/98→12/09	B308E	Petrol	2962	6	24	21
9-5 Estate (YS3E)	09/99→12/09	B235R	Petrol	2290	4	16	18
9-5 Estate (YS3E)	07/00→07/01	B205L	Petrol	1985	4	16	13
9-5 Estate (YS3E)	07/01→12/09	D308L	Diesel	2958	6	24	22
9-5 Estate (YS3E)	03/02→12/09	D223L	Diesel	2171	4	16	16
9-5 Estate (YS3E)	07/03→12/09	B235L	Petrol	2290	4	16	18
9-5 Estate (YS3E)	01/06→12/09	Z 19 DTH	Diesel	1910	4	16	8
9-5 Estate (YS3E)	01/07→12/09	Z 19 DTR	Diesel	1910	4	16	6
90	08/84→08/87	B 20 I	Petrol	1985	4	8	11
95 Station Wagon	10/65→12/78	Ford V4	Petrol	1498	4	8	3
96	10/65→08/80	Ford V4	Petrol	1498	4	8	3
99	09/71→12/74	B 20	Petrol	1985	4	8	11
99	04/72→08/74	B20I	Petrol	1985	4	8	11
99	10/72→08/74	B 20 P	Petrol	1985	4	8	11
99	09/74→12/84	B 20 C	Petrol	1985	4	8	11
99	09/74→12/84	B 20 I	Petrol	1985	4	8	11
99 Combi Coupe	03/76→05/78	B20T	Petrol	1985	4	8	11
99 Combi Coupe	10/77→06/80	BSI 20	Petrol	1985	4	8	11
99 Combi Coupe	02/79→01/84	B 20	Petrol	1985	4	8	11
99 Combi Coupe	01/81→12/84	BI 20	Petrol	1985	4	8	11
600	01/80→12/86	831 A1.000	Petrol	1498	4	8	2
600	01/80→12/86	831 A2.000	Petrol	1301	4	8	1
900 I (AC4, AM4)	01/79→08/90	BI 20	Petrol	1985	4	8	11
900 I (AC4, AM4)	10/80→07/85	B20IS	Petrol	1985	4	8	11
900 I (AC4, AM4)	10/80→07/85	BSI 20	Petrol	1985	4	8	11
900 I (AC4, AM4)	11/80→08/84	B20T	Petrol	1985	4	8	11
900 I (AC4, AM4)	11/80→08/84	BT 20	Petrol	1985	4	8	11
900 I (AC4, AM4)	11/80→08/90	B20IXI	Petrol	1985	4	8	11
900 I (AC4, AM4)	07/82→12/88	B 20	Petrol	1985	4	8	11
900 I (AC4, AM4)	07/82→12/88	B20IXC	Petrol	1985	4	8	11
900 I (AC4, AM4)	09/83→08/90	B20I	Petrol	1985	4	8	11
900 I (AC4, AM4)	01/84→12/93	B202XL	Petrol	1985	4	16	12
900 I (AC4, AM4)	01/86→12/88	B202XI	Petrol	1985	4	16	12
900 I (AC4, AM4)	01/86→12/91	B20IXL	Petrol	1985	4	8	11
900 I (AC4, AM4)	10/87→12/93	B202I	Petrol	1985	4	16	12
900 I (AC4, AM4)	01/88→12/90	B20IL	Petrol	1985	4	8	11
900 I (AC4, AM4)	10/89→12/93	B212I	Petrol	2119	4	16	15
900 I (AC4, AM4)	07/91→12/93	B202S	Petrol	1985	4	16	12
900 I Combi Coupe	06/78→10/91	B20I	Petrol	1985	4	8	11
900 I Combi Coupe	09/78→08/84	B20T	Petrol	1985	4	8	11
900 I Combi Coupe	09/78→08/84	BT 20	Petrol	1985	4	8	11
900 I Combi Coupe	09/78→07/85	B20IS	Petrol	1985	4	8	11
900 I Combi Coupe	09/78→07/85	BSI 20	Petrol	1985	4	8	11
900 I Combi Coupe	09/78→12/88	BI 20	Petrol	1985	4	8	11
900 I Combi Coupe	09/79→12/88	B 20	Petrol	1985	4	8	11
900 I Combi Coupe	09/79→12/88	B20IXC	Petrol	1985	4	8	11
900 I Combi Coupe	11/80→12/88	B20IXI	Petrol	1985	4	8	11
900 I Combi Coupe	02/84→06/94	B202XL	Petrol	1985	4	16	12
900 I Combi Coupe	01/86→12/88	B202XI	Petrol	1985	4	16	12
900 I Combi Coupe	01/86→12/91	B20IXL	Petrol	1985	4	8	11
900 I Combi Coupe	10/86→09/89	B20IL	Petrol	1985	4	8	11
900 I Combi Coupe	01/89→08/92	B202I	Petrol	1985	4	16	12
900 I Combi Coupe	10/89→12/93	B212I	Petrol	2119	4	16	15
900 I Combi Coupe	05/91→10/93	B202S	Petrol	1985	4	16	12
900 I Combi Coupe	01/93→06/94	B202L	Petrol	1985	4	16	12
900 I Convertible	10/85→09/89	B20I	Petrol	1985	4	8	11
900 I Convertible	11/86→06/94	B202XL	Petrol	1985	4	16	12
900 I Convertible	10/89→06/94	B212I	Petrol	2119	4	16	15
900 I Convertible	01/90→06/94	B202I	Petrol	1985	4	16	12
900 I Convertible	05/91→06/94	B202S	Petrol	1985	4	16	12
900 II	07/93→07/94	B206I	Petrol	1985	4	16	12
900 II	07/93→02/98	B204L	Petrol	1985	4	16	12
900 II	07/93→02/98	B234I	Petrol	2290	4	16	17
900 II	07/93→02/98	B258I	Petrol	2498	6	24	19
900 II	09/93→12/94	B212I	Petrol	2119	4	16	15
900 II	08/94→02/98	B204I	Petrol	1985	4	16	12
900 II Convertible	12/93→02/98	B204I	Petrol	1985	4	16	12
900 II Convertible	12/93→02/98	B204L	Petrol	1985	4	16	12
900 II Convertible	12/93→02/98	B234I	Petrol	2290	4	16	17
900 II Convertible	12/93→02/98	B258I	Petrol	2498	6	24	19
900 II Coupe	12/93→07/94	B206I	Petrol	1985	4	16	12
900 II Coupe	12/93→02/98	B204L	Petrol	1985	4	16	12
900 II Coupe	12/93→02/98	B234I	Petrol	2290	4	16	17
900 II Coupe	12/93→02/98	B258I	Petrol	2498	6	24	19
900 II Coupe	08/94→02/98	B204I	Petrol	1985	4	16	12
9000	04/85→08/93	B202XL	Petrol	1985	4	16	12



CC



9

Model	Period	Engine Code	Fuel	CC	Seats	Wheels	Doors
9000	10/88→12/98	B202I	Petrol	1985	4	16	12
9000	06/89→12/98	B202L	Petrol	1985	4	16	12
9000	08/89→12/98	B234I	Petrol	2290	4	16	17
9000	09/89→08/90	B204L	Petrol	1985	4	16	12
9000	03/90→09/93	B202	Petrol	1985	4	16	12
9000	07/90→12/98	B234L	Petrol	2290	4	16	17
9000	09/90→10/98	B234R	Petrol	2290	4	16	17
9000	09/92→12/98	B202S	Petrol	1985	4	16	12
9000	09/92→12/98	B204E	Petrol	1985	4	16	12
9000	09/93→12/98	B204I	Petrol	1985	4	16	12
9000	09/93→12/98	B204S	Petrol	1985	4	16	12
9000	09/93→12/98	B234E	Petrol	2290	4	16	17
9000	07/94→12/98	B308I	Petrol	2962	6	24	21
9000 Hatchback	09/84→08/93	B202XL	Petrol	1985	4	16	12
9000 Hatchback	09/84→12/98	B202L	Petrol	1985	4	16	12
9000 Hatchback	12/85→12/88	B202XI	Petrol	1985	4	16	12
9000 Hatchback	10/88→12/98	B202I	Petrol	1985	4	16	12
9000 Hatchback	06/89→12/92	B202	Petrol	1985	4	16	12
9000 Hatchback	09/89→12/98	B234I	Petrol	2290	4	16	17
9000 Hatchback	09/90→12/98	B234L	Petrol	2290	4	16	17
9000 Hatchback	02/93→12/98	B234R	Petrol	2290	4	16	17
9000 Hatchback	09/93→12/98	B202S	Petrol	1985	4	16	12
9000 Hatchback	09/93→12/98	B204E	Petrol	1985	4	16	12
9000 Hatchback	09/93→12/98	B204I	Petrol	1985	4	16	12
9000 Hatchback	09/93→12/98	B204S	Petrol	1985	4	16	12
9000 Hatchback	09/93→12/98	B234E	Petrol	2290	4	16	17
9000 Hatchback	07/94→12/98	B308I	Petrol	2962	6	24	21



CC



9



CC



9

831 A1.000	1498	4	8	Petrol	2
831 A2.000	1301	4	8	Petrol	1
A 16 LET	1598	4	16	Petrol	4
A 19 DTR	1910	4	16	Diesel	6
A 20 DTH	1956	4	16	Diesel	9
A 20 DTR	1956	4	16	Diesel	9
A 20 NFT	1998	4	16	Petrol	10
A 20 NHT	1998	4	16	Petrol	10
B 20	1985	4	8	Petrol	11
B 20 C	1985	4	8	Petrol	11
B 20 I	1985	4	8	Petrol	11
B 20 P	1985	4	8	Petrol	11
B20T	1985	4	8	Petrol	11
B201	1985	4	8	Petrol	11
B201I	1985	4	8	Petrol	11
B201L	1985	4	8	Petrol	11
B201S	1985	4	8	Petrol	11
B201XC	1985	4	8	Petrol	11
B201XI	1985	4	8	Petrol	11
B201XL	1985	4	8	Petrol	11
B202	1985	4	16	Petrol	12
B202I	1985	4	16	Petrol	12
B202L	1985	4	16	Petrol	12
B202S	1985	4	16	Petrol	12
B202XI	1985	4	16	Petrol	12
B202XL	1985	4	16	Petrol	12
B204E	1985	4	16	Petrol	12
B204I	1985	4	16	Petrol	12
B204L	1985	4	16	Petrol	12
B204R	1985	4	16	Petrol	12
B204S	1985	4	16	Petrol	12
B205E	1985	4	16	Petrol	13
B205F	1985	4	16	Petrol	13
B205L	1985	4	16	Petrol	13
B205R	1985	4	16	Petrol	13
B206I	1985	4	16	Petrol	12
B207E	1998	4	16	Petrol	10
B207G	1998	4	16	Petrol	10
B207H	1998	4	16	Petrol	10
B207L	1998	4	16	Petrol	10
B207M	1998	4	16	Petrol	10
B207R	1998	4	16	Petrol	10
B212I	2119	4	16	Petrol	15
B234E	2290	4	16	Petrol	17
B234I	2290	4	16	Petrol	17
B234L	2290	4	16	Petrol	17
B234R	2290	4	16	Petrol	17
B235E	2290	4	16	Petrol	18
B235L	2290	4	16	Petrol	18
B235R	2290	4	16	Petrol	18
B258I	2498	6	24	Petrol	19
B308E	2962	6	24	Petrol	21
B308I	2962	6	24	Petrol	21
BI 20	1985	4	8	Petrol	11
BSI 20	1985	4	8	Petrol	11
BT 20	1985	4	8	Petrol	11
D223L	2171	4	16	Diesel	16
D308L	2958	6	24	Diesel	22
EJ205	1994	4	16	Petrol	14
EJ253	2457	4	16	Petrol	20
EJ255	2457	4	16	Petrol	20
Ford V4	1498	4	8	Petrol	3
X 22 DTH	2171	4	16	Diesel	16
Y 22 DTH	2171	4	16	Diesel	16
Z 18 XE	1796	4	16	Petrol	5
Z 19 DT	1910	4	8	Diesel	7
Z 19 DTH	1910	4	16	Diesel	8
Z 19 DTJ	1910	4	16	Diesel	8
Z 19 DTR	1910	4	16	Diesel	6



1 1.3L		Petrol		
831 A2.000	4 Cyl.	8 Valves	1301cc	TD31803
HR569	NA5187 30.00 x 52.00 x 7.00mm, ACM	NA5051 40.00 x 56.00 x 7.00mm, FPM	NA5049 64.00 x 80.00 x 8.00mm, ACM	
2 1.5L		Petrol		
831 A1.000	4 Cyl.	8 Valves	1498cc	TD31804
HR569	NA5187 30.00 x 52.00 x 7.00mm, ACM	NA5051 40.00 x 56.00 x 7.00mm, FPM	NA5049 64.00 x 80.00 x 8.00mm, ACM	
3 1.5L		Petrol		
Ford V4	4 Cyl.	8 Valves	1498cc	TD3535
		NB564 60.45 x 76.18 x 10.00mm, FPM		
4 1.6L		Petrol		
A 16 LET	4 Cyl.	16 Valves	1598cc	TD24444
HR5087	NC006 (x2) 35.00 x 48.00 x 7.00mm, MVQ	NA5174 31.50 x 42.00 x 7.00mm, FPM	NA5350 80.00 x 98.00 x 17.70mm, PTFE/ACM	
5 1.8L		Petrol		
Z 18 XE	4 Cyl.	16 Valves	1796cc	TD18079
PA5025 (x16) HR5048	NC006 (x2) 35.00 x 48.00 x 7.00mm, MVQ	NA5174 31.50 x 42.00 x 7.00mm, FPM	NB698 80.00 x 98.00 x 10.00mm, FPM	
6 1.9L		Diesel		
A 19 DTR	4 Cyl.	16 Valves	1910cc	TD25002
Z 19 DTR	4 Cyl.	16 Valves	1910cc	TD23523
HR5119	NA5347 30.0 x 45.0 x 7.00mm, FPM	NA5070 31.00 x 41.00 x 7.00mm, FPM	NF888 93.00 x 139.70;172.00 x 12.00mm, FPM	
7 1.9L		Diesel		
Z 19 DT	4 Cyl.	8 Valves	1910cc	TD18086
HR569	NA5053 30.00 x 42.00 x 7.00mm, FPM	NA5070 31.00 x 41.00 x 7.00mm, FPM	NF888 93.00 x 139.70;172.00 x 12.00mm, FPM	
8 1.9L		Diesel		
Z 19 DTH	4 Cyl.	16 Valves	1910cc	TD18084
Z 19 DTJ	4 Cyl.	16 Valves	1910cc	TD24819
HR5095 →Eng no. 17180894 HR5119 Eng no. 17180895→	NA5347 30.0 x 45.0 x 7.00mm, FPM	NA5070 31.00 x 41.00 x 7.00mm, FPM	NF888 93.00 x 139.70;172.00 x 12.00mm, FPM	



9 2.0L Diesel

A 20 DTH	4 Cyl.	16 Valves	1956cc	TD24003
A 20 DTR	4 Cyl.	16 Valves	1956cc	TD24442
HR5119	NA5347 (x2) 30.0 x 45.0 x 7.00mm, FPM		NA5070 31.00 x 41.00 x 7.00mm, FPM NF888 93.00 x 139.70; 172.00 x 12.00mm, FPM	



10 2.0L Petrol



A 20 NFT	4 Cyl.	16 Valves	1998cc	TD24445
A 20 NHT	4 Cyl.	16 Valves	1998cc	TD24002
B207E	4 Cyl.	16 Valves	1998cc	TD18081
B207G	4 Cyl.	16 Valves	1998cc	TD26642
B207H	4 Cyl.	16 Valves	1998cc	TD26641
B207L	4 Cyl.	16 Valves	1998cc	TD18082
B207M	4 Cyl.	16 Valves	1998cc	TD28310
B207R	4 Cyl.	16 Valves	1998cc	TD18083
HR5127			NA5108 42.00 x 55.00 x 7.00mm, FPM/ACM NB806 90.00 x 104.00 x 11.00mm, FPM	



11 2.0L Petrol



B 20	4 Cyl.	8 Valves	1985cc	TD3505
B 20 C	4 Cyl.	8 Valves	1985cc	TD3506
B 20 I	4 Cyl.	8 Valves	1985cc	TD3507
B 20 P	4 Cyl.	8 Valves	1985cc	TD5380
B20T	4 Cyl.	8 Valves	1985cc	TD3513
B201	4 Cyl.	8 Valves	1985cc	TD3510
B201I	4 Cyl.	8 Valves	1985cc	TD25597
B201L	4 Cyl.	8 Valves	1985cc	TD26115
B201S	4 Cyl.	8 Valves	1985cc	TD3512
B201XC	4 Cyl.	8 Valves	1985cc	TD3508
B201XI	4 Cyl.	8 Valves	1985cc	TD3509
B201XL	4 Cyl.	8 Valves	1985cc	TD5367
BI 20	4 Cyl.	8 Valves	1985cc	TD3528
BSI 20	4 Cyl.	8 Valves	1985cc	TD3530
BT 20	4 Cyl.	8 Valves	1985cc	TD3531
			NB714 48.00 x 66.70 x 10.00mm, FPM NB847 88.00 x 108.00 x 11.00mm, FPM	





12 2.0L		Petrol			
B202	4 Cyl.	16 Valves	1985cc		TD5374
B202I	4 Cyl.	16 Valves	1985cc		TD3515
B202L	4 Cyl.	16 Valves	1985cc		TD3519
B202S	4 Cyl.	16 Valves	1985cc		TD5365
B202XI	4 Cyl.	16 Valves	1985cc		TD3514
B202XL	4 Cyl.	16 Valves	1985cc		TD3517
B204E	4 Cyl.	16 Valves	1985cc		TD5372
B204I	4 Cyl.	16 Valves	1985cc		TD3518
B204L	4 Cyl.	16 Valves	1985cc		TD5369
B204R	4 Cyl.	16 Valves	1985cc		TD13388
B204S	4 Cyl.	16 Valves	1985cc		TD25001
B206I	4 Cyl.	16 Valves	1985cc		TD3520
HR816  (x2)				NB714  48.00 x 66.70 x 10.00mm, FPM NB847  88.00 x 108.00 x 11.00mm, FPM	

13 2.0L		Petrol			
B205E	4 Cyl.	16 Valves	1985cc		TD9447
B205F	4 Cyl.	16 Valves	1985cc		TD25008
B205L	4 Cyl.	16 Valves	1985cc		TD20490
B205R	4 Cyl.	16 Valves	1985cc		TD18088
HR5072 				NB714  48.00 x 66.70 x 10.00mm, FPM NB847  88.00 x 108.00 x 11.00mm, FPM	

14 2.0L		Petrol			
EJ205	4 Cyl.	16 Valves	1994cc		TD29446
PA425 (x16)				NK117 32.00 x 45.00 x 8.00mm, ACM NA5226  33.0 x 49.0 x 8.0mm, FPM NK139  86.00 x 103.00 x 10.00mm, FPM	

15 2.1L		Petrol			
B212I	4 Cyl.	16 Valves	2119cc		TD3521
HR816  (x2)				NB714  48.00 x 66.70 x 10.00mm, FPM NB847  88.00 x 108.00 x 11.00mm, FPM	

16 2.2L		Diesel			
D223L	4 Cyl.	16 Valves	2171cc		TD18087
X 22 DTH	4 Cyl.	16 Valves	2171cc		TD9750
Y 22 DTH	4 Cyl.	16 Valves	2171cc		TD19130
PA5041 (x16) HR791 				NA5069  55.00 x 68.00 x 8.00mm, FPM NA5209  99.00 x 114.00 x 11.00mm, FPM	



17 2.3L

Petrol

B234E	4 Cyl.	16 Valves	2290cc	TD3522
B234I	4 Cyl.	16 Valves	2290cc	TD3523
B234L	4 Cyl.	16 Valves	2290cc	TD3525
B234R	4 Cyl.	16 Valves	2290cc	TD3524

HR816 (x2)

NB714

48.00 x 66.70 x 10.00mm, FPM

NB847

88.00 x 108.00 x 11.00mm, FPM

18 2.3L

Petrol

B235E	4 Cyl.	16 Valves	2290cc	TD9448
B235L	4 Cyl.	16 Valves	2290cc	TD18090
B235R	4 Cyl.	16 Valves	2290cc	TD18089

HR5072

NB714

48.00 x 66.70 x 10.00mm, FPM

NB847

88.00 x 108.00 x 11.00mm, FPM

19 2.5L

Petrol

B258I	6 Cyl.	24 Valves	2498cc	TD3526
-------	--------	-----------	--------	--------

PA5041 (x24)

HR5062

NC006 (x4)

35.00 x 48.00 x 7.00mm, MVQ

NB884

38.00 x 50.00 x 5.50mm, FPM

NB806

90.00 x 104.00 x 11.00mm, FPM

20 2.5L

Petrol

EJ253	4 Cyl.	16 Valves	2457cc	TD29447
EJ255	4 Cyl.	16 Valves	2457cc	TD29445

PA425 (x16)

NK117

32.00 x 45.00 x 8.00mm, ACM

NA5226

33.0 x 49.0 x 8.0mm, FPM

NK139

86.00 x 103.00 x 10.00mm, FPM

21 3.0L

Petrol

B308E	6 Cyl.	24 Valves	2962cc	TD9449
B308I	6 Cyl.	24 Valves	2962cc	TD5373

PA5041 (x24)

HR5062

NC006 (x4)

35.00 x 48.00 x 7.00mm, MVQ

NB884

38.00 x 50.00 x 5.50mm, FPM

NB806

90.00 x 104.00 x 11.00mm, FPM

22 3.0L

Diesel

D308L	6 Cyl.	24 Valves	2958cc	TD18091
-------	--------	-----------	--------	---------









HR5094









NJ283 (x2)

36.00 x 50.00 x 8.00mm, NBR

NJ158

95.00 x 118.00 x 10.00mm, ACM

	CC				9		CC				9
D 8	7800	6	12	Diesel	1	DC 13.102	12742	6	24	Diesel	12
D 8.01 B09	7800	6	12	Diesel	1	DC 13.103	12742	6	24	Diesel	12
D 8.02 B09	7790	6	12	Diesel	1	DC 13.104	12742	6	24	Diesel	12
D 8 R 01	7800	6	12	Diesel	1	DC 13.106	12742	6	24	Diesel	12
D 11	11022	6	12	Diesel	9	DC 13.107	12742	6	24	Diesel	12
D 11 R 23	11022	6	12	Diesel	9	DC 13.108	12742	6	24	Diesel	12
D 14	14181	8	16	Diesel	13	DC 13.109	12742	6	24	Diesel	12
DC 9.01	9000	6	12	Diesel	5	DC 13.11	12742	6	24	Diesel	12
DC 9.02	9000	6	12	Diesel	5	DC 13.110	12742	6	24	Diesel	12
DC 9.03	9000	6	12	Diesel	5	DC 13.111	12742	6	24	Diesel	12
DC 9.04	9000	6	12	Diesel	5	DC 13.112	12742	6	24	Diesel	12
DC 9.05	9000	6	12	Diesel	5	DC 13.113	12742	6	24	Diesel	12
DC 9.06	9000	6	12	Diesel	5	DC 13.114	12742	6	24	Diesel	12
DC 09.101	9300	5	20	Diesel	6	DC 13.115	12742	6	24	Diesel	12
DC 9.101	9300	5	20	Diesel	6	DC 13.116	12742	6	24	Diesel	12
DC 9.102	9300	5	20	Diesel	6	DC 13.119	12742	6	24	Diesel	12
DC 09.108	9300	5	20	Diesel	6	DC 13.120	12742	6	24	Diesel	12
DC 09.109	9300	5	20	Diesel	6	DC 13.121	12742	6	24	Diesel	12
DC 9.109	9300	5	20	Diesel	6	DC 13.124	12742	6	24	Diesel	12
DC 9.11	8867	5	20	Diesel	3	DC 13.125	12742	6	24	Diesel	12
DC 09.110	9300	5	20	Diesel	6	DC 13.141	12742	6	24	Diesel	12
DC 09.111	9300	5	20	Diesel	6	DC 13.147	12742	6	24	Diesel	12
DC 09.112	9300	5	20	Diesel	6	DC 13.148	12742	6	24	Diesel	12
DC 09.113	9300	5	20	Diesel	6	DC 13.155	12742	6	24	Diesel	12
DC 09.114	9300	5	20	Diesel	6	DC 16.01	15600	8	32	Diesel	15
DC 09.115	9300	5	20	Diesel	6	DC 16.02	15600	8	32	Diesel	15
DC 9.12	8867	5	20	Diesel	3	DC 16.03	15600	8	32	Diesel	15
DC 9.13	8867	5	20	Diesel	3	DC 16.04	15600	8	32	Diesel	15
DC 9.16	8867	5	20	Diesel	3	DC 16.05	15600	8	32	Diesel	15
DC 9.17	8867	5	20	Diesel	3	DC 16.06	15600	8	32	Diesel	15
DC 9.18	8867	5	20	Diesel	3	DC 16.08	15600	8	32	Diesel	15
DC 9.19	8867	5	20	Diesel	3	DC 16.09	15600	8	32	Diesel	15
DC 9.20	8867	5	20	Diesel	3	DC 16.101	16352	8	32	Diesel	16
DC 9.21	8867	5	20	Diesel	3	DC 16.102	16352	8	32	Diesel	16
DC 9.22	9300	5	20	Diesel	6	DC 16.103	16352	8	32	Diesel	16
DC 9.24	9300	5	20	Diesel	6	DC 16.17	15600	8	32	Diesel	15
DC 9.28	9300	5	20	Diesel	6	DC 16.18	15600	8	32	Diesel	15
DC 9.29	9300	5	20	Diesel	6	DC 16.19	15600	8	32	Diesel	15
DC 9.30	9300	5	20	Diesel	6	DC 16.21	16352	8	32	Diesel	16
DC 9.31	8870	5	20	Diesel	3	DC 16.22	15600	8	32	Diesel	15
DC 9.32	9300	5	20	Diesel	6	DN 8.01	7800	6	12	Diesel	1
DC 9.35	9300	5	20	Diesel	6	DN 9.01	8475	6	12	Diesel	2
DC 9.36	9300	5	20	Diesel	6	DN 11.01	11020	6	12	Diesel	9
DC 9.37	9300	5	20	Diesel	6	DN 11.01 B10	11022	6	12	Diesel	9
DC 9.38	9300	5	20	Diesel	6	DN 11.01 C 09	11020	6	12	Diesel	9
DC 9.39	9300	5	20	Diesel	6	DN 11.04 B10	11022	6	12	Diesel	9
DC 09.E02	9300	5	20	Diesel	6	DN 11.04 C 01	11022	6	12	Diesel	9
DC 9E.02	8867	5	20	Petrol	4	DN 11.06	11020	6	12	Diesel	9
DC 11.01	10600	6	24	Diesel	8	DN 11.06 B	11020	6	12	Diesel	9
DC 11.02	10600	6	24	Diesel	8	DN 11.06 C	11020	6	12	Diesel	9
DC 11.03	10600	6	24	Diesel	8	DN 11.07	11022	6	12	Diesel	9
DC 11.04	10600	6	24	Diesel	8	DN 11.08	11022	6	12	Diesel	9
DC 11.07	10600	6	24	Diesel	8	DN 11.08 B01	11020	6	12	Diesel	9
DC 11.08	10600	6	24	Diesel	8	DS 8	7800	6	12	Diesel	1
DC 11.09	10600	6	24	Diesel	8	DS 8.01	7800	6	12	Diesel	1
DC 12.01	11700	6	24	Diesel	11	DS 8.01 B10	7800	6	12	Diesel	1
DC 12.02	11700	6	24	Diesel	11	DS 8.01 B11	7800	6	12	Diesel	1
DC 12.03	11700	6	24	Diesel	11	DS 8.01 B12	7800	6	12	Diesel	1
DC 12.06	11700	6	24	Diesel	11	DS 8.05	7800	6	12	Diesel	1
DC 12.07	11700	6	24	Diesel	11	DS 8.05 B	7800	6	12	Diesel	1
DC 12.09	11700	6	24	Diesel	11	DS 8.06	7800	6	12	Diesel	1
DC 12.10	11700	6	24	Diesel	11	DS 9.01	8475	6	12	Diesel	2
DC 12.12	11700	6	24	Diesel	11	DS 9.02	8475	6	12	Diesel	2
DC 12.13	11700	6	24	Diesel	11	DS 9.03 B 01	8480	6	12	Diesel	2
DC 12.14	11716	6	24	Diesel	11	DS 9.03 B 02	8480	6	12	Diesel	2
DC 12.15	11716	6	24	Diesel	11	DS 9.05	8475	6	12	Diesel	2
DC 12.17	11716	6	24	Diesel	11	DS 9.05 B 01	8475	6	12	Diesel	2
DC 12.18	11716	6	24	Diesel	11	DS 9.05 B 02	8475	6	12	Diesel	2
DC 12.22	11716	6	24	Diesel	11	DS 9.06	8475	6	12	Diesel	2
DC 12.23	11716	6	24	Diesel	11	DS 9.08	8475	6	12	Diesel	2
DC 12.24	11716	6	24	Diesel	11	DS 11	11022	6	12	Diesel	9
DC 12.26	11716	6	24	Diesel	11	DS 11.01	11022	6	12	Diesel	9
DC 13.05	12742	6	24	Diesel	12	DS 11.01 B 06	11000	6	12	Diesel	9
DC 13.06	12742	6	24	Diesel	12	DS 11.02	11022	6	12	Diesel	9
DC 13.07	12742	6	24	Diesel	12	DS 11.10	11020	6	12	Diesel	9
DC 13.08	12742	6	24	Diesel	12	DS 11.14	11022	6	12	Diesel	9
DC 13.10	12742	6	24	Diesel	12	DS 11.15	11022	6	12	Diesel	9
DC 13.101	12742	6	24	Diesel	12	DS 11.15 B	11022	6	12	Diesel	9

	CC				9		CC				9
DS 11.18	11022	6	12	Diesel	9	DSC 11.81	11020	6	12	Diesel	9
DS 11.22	11022	6	12	Diesel	9	DSC 12.01	11700	6	24	Diesel	11
DS 11.23	11022	6	12	Diesel	9	DSC 12.02	11700	6	24	Diesel	11
DS 11.25	11022	6	12	Diesel	9	DSC 12.03	11700	6	24	Diesel	11
DS 11.34	11020	6	12	Diesel	9	DSC 12.05	11700	6	24	Diesel	11
DS 11.34 B	11020	6	12	Diesel	9	DSC 12.06	11700	6	24	Diesel	11
DS 11.34 BO 6	11020	6	12	Diesel	9	DSC 14.01	14190	8	16	Diesel	14
DS 11.34 C	11020	6	12	Diesel	9	DSC 14.02	14190	8	16	Diesel	14
DS 11.71	11020	6	12	Diesel	9	DSC 14.03	14190	8	16	Diesel	14
DS 11.71 C	11020	6	12	Diesel	9	DSC 14.03 L07	14188	8	16	Diesel	14
DS 11.72	11022	6	12	Diesel	9	DSC 14.04	14190	8	16	Diesel	14
DS 11.73	11020	6	12	Diesel	9	DSC 14.05	14190	8	16	Diesel	14
DS 11.73 B	11020	6	12	Diesel	9	DSC 14.06	14190	8	16	Diesel	14
DS 11.74	11020	6	12	Diesel	9	DSC 14.07 L 01	14200	8	16	Diesel	14
DS 11.74 C	11020	6	12	Diesel	9	DSC 14.08	14190	8	16	Diesel	14
DS 11.75	11020	6	12	Diesel	9	DSC 14.09	14190	8	16	Diesel	14
DS 11.76	11020	6	12	Diesel	9	DSC 14.10	14190	8	16	Diesel	14
DS 11.77	11020	6	12	Diesel	9	DSC 14.13	14200	8	16	Diesel	14
DS 11.78	11020	6	12	Diesel	9	DSC 14.15	14200	8	16	Diesel	14
DS 14	14181	8	16	Diesel	14	DSC 14.16	14190	8	16	Diesel	14
DS 14.01	14190	8	16	Diesel	14	DSI 8.01	7800	6	12	Diesel	1
DS 14.01 L 01	14200	8	16	Diesel	14	DSI 8.01 B	7800	6	12	Diesel	1
DS 14.02	14190	8	16	Diesel	14	DT 12.02	11716	6	24	Diesel	11
DS 14.06	14190	8	16	Diesel	14	DT 12.03	11716	6	24	Diesel	11
DS 14.06 L 01	14200	8	16	Diesel	14	DT 12.06	11716	6	24	Diesel	11
DS 14.07	14190	8	16	Diesel	14	DT 12.08	11716	6	24	Diesel	11
DS 14 LB 05	14200	8	16	Diesel	14	DT 12.10	11716	6	24	Diesel	11
DS 14 LB 08	14200	8	16	Diesel	14	DT 12.11	11716	6	24	Diesel	11
DSC 9.01	8475	6	12	Diesel	2	DT 12.12	11716	6	24	Diesel	11
DSC 9.02	8475	6	12	Diesel	2	DT 12.14	11716	6	24	Diesel	11
DSC 9.07	8475	6	12	Diesel	2	DT 12.17	11716	6	24	Diesel	11
DSC 9.08	8475	6	12	Diesel	2	DT 12.18	11716	6	24	Diesel	11
DSC 9.09	8475	6	12	Diesel	2	DT 13.07	12742	6	24	Diesel	12
DSC 9.10	8475	6	12	Diesel	2	DT 13.10	12742	6	24	Diesel	12
DSC 9.11	9000	6	12	Diesel	5	DT 13.125	12742	6	24	Diesel	12
DSC 9.12	9000	6	12	Diesel	5	DT 16.08	15600	8	32	Diesel	15
DSC 9.13	9000	6	12	Diesel	5	DTC 11.01	11020	6	12	Diesel	9
DSC 9.15	9000	6	12	Diesel	5	DTC 11.02	11020	6	12	Diesel	9
DSC 11.01	11020	6	12	Diesel	9	OC 09.101	9300	5	20	Gas	7
DSC 11.01 B	11022	6	12	Diesel	9	OC 09.102	9300	5	20	Gas	7
DSC 11.02	11022	6	12	Diesel	9	OC 9.G04	9300	5	20	Gas	7
DSC 11.03	11020	6	12	Diesel	9	OC 9.G05	9300	5	20	Gas	7
DSC 11.04	11020	6	12	Diesel	9	OCS 11.03	11020	6	12	Gas	10
DSC 11.04 C	11020	6	12	Diesel	9						
DSC 11.06	11020	6	12	Diesel	9						
DSC 11.07	11020	6	12	Diesel	9						
DSC 11.08	11020	6	12	Diesel	9						
DSC 11.08 B	11020	6	12	Diesel	9						
DSC 11.08 C	11020	6	12	Diesel	9						
DSC 11.10	11020	6	12	Diesel	9						
DSC 11.12	11020	6	12	Diesel	9						
DSC 11.13	11020	6	12	Diesel	9						
DSC 11.13 B	11020	6	12	Diesel	9						
DSC 11.16	11020	6	12	Diesel	9						
DSC 11.16 B	11020	6	12	Diesel	9						
DSC 11.17	11020	6	12	Diesel	9						
DSC 11.17 B	11020	6	12	Diesel	9						
DSC 11.18	11020	6	12	Diesel	9						
DSC 11.18 B	11020	6	12	Diesel	9						
DSC 11.18 BO 1	11020	6	12	Diesel	9						
DSC 11.18 L01	11020	6	12	Diesel	9						
DSC 11.21	11020	6	12	Diesel	9						
DSC 11.22	11020	6	12	Diesel	9						
DSC 11.23	11020	6	12	Diesel	9						
DSC 11.24	11020	6	12	Diesel	9						
DSC 11.27	11020	6	12	Diesel	9						
DSC 11.27 C	11020	6	12	Diesel	9						
DSC 11.30	11020	6	12	Diesel	9						
DSC 11.32	11020	6	12	Diesel	9						
DSC 11.33	11020	6	12	Diesel	9						
DSC 11.35	11020	6	12	Diesel	9						
DSC 11.36	11020	6	12	Diesel	9						
DSC 11.39	11020	6	12	Diesel	9						
DSC 11.70	11020	6	12	Diesel	9						
DSC 11.71	11020	6	12	Diesel	9						
DSC 11.74	11020	6	12	Diesel	9						
DSC 11.75	11020	6	12	Diesel	9						
DSC 11.79	11000	6	12	Diesel	9						



1 7.8L Diesel

D 8	6 Cyl.	12 Valves	7800cc	TD8795
D 8.01 B09	6 Cyl.	12 Valves	7800cc	TD5871
D 8.02 B09	6 Cyl.	12 Valves	7790cc	TD6219
D 8 R 01	6 Cyl.	12 Valves	7800cc	TD8834
DN 8.01	6 Cyl.	12 Valves	7800cc	TD8838
DS 8	6 Cyl.	12 Valves	7800cc	TD8796
DS 8.01	6 Cyl.	12 Valves	7800cc	TD8842
DS 8.01 B10	6 Cyl.	12 Valves	7800cc	TD8797
DS 8.01 B11	6 Cyl.	12 Valves	7800cc	TD5873
DS 8.01 B12	6 Cyl.	12 Valves	7800cc	TD6221
DS 8.05	6 Cyl.	12 Valves	7800cc	TD8839
DS 8.05 B	6 Cyl.	12 Valves	7800cc	TD8807
DS 8.06	6 Cyl.	12 Valves	7800cc	TD8840
DSI 8.01	6 Cyl.	12 Valves	7800cc	TD8841
DSI 8.01 B	6 Cyl.	12 Valves	7800cc	TD8809

NB618 F
80.00 x 100.40 x 13.00mm, PTFE

NA5474 F
80.00 x 100.00 x 13.00mm, PTFE/ACM

NB619 R
130.00 x 160.00 x 15.00mm, FPM

NA5470 R
130.00 x 160.00 x 13.00mm, PTFE/ACM

2 8.5L Diesel

DN 9.01	6 Cyl.	12 Valves	8475cc	TD8843
DS 9.01	6 Cyl.	12 Valves	8475cc	TD8844
DS 9.02	6 Cyl.	12 Valves	8475cc	TD8845
DS 9.03 B 01	6 Cyl.	12 Valves	8480cc	TD5875
DS 9.03 B 02	6 Cyl.	12 Valves	8480cc	TD6223
DS 9.05	6 Cyl.	12 Valves	8475cc	TD8846
DS 9.05 B 01	6 Cyl.	12 Valves	8475cc	TD5876
DS 9.05 B 02	6 Cyl.	12 Valves	8475cc	TD6224
DS 9.06	6 Cyl.	12 Valves	8475cc	TD8847
DS 9.08	6 Cyl.	12 Valves	8475cc	TD8850
DSC 9.01	6 Cyl.	12 Valves	8475cc	TD8848
DSC 9.02	6 Cyl.	12 Valves	8475cc	TD8849
DSC 9.07	6 Cyl.	12 Valves	8475cc	TD8851
DSC 9.08	6 Cyl.	12 Valves	8475cc	TD8810
DSC 9.09	6 Cyl.	12 Valves	8475cc	TD13068
DSC 9.10	6 Cyl.	12 Valves	8475cc	TD8852

NB618 F
80.00 x 100.40 x 13.00mm, PTFE

NA5474 F
80.00 x 100.00 x 13.00mm, PTFE/ACM

NB619 R
130.00 x 160.00 x 15.00mm, FPM

NA5470 R
130.00 x 160.00 x 13.00mm, PTFE/ACM



3 8.9L Diesel

DC 9.11	5 Cyl.	20 Valves	8867cc	TD18048
DC 9.12	5 Cyl.	20 Valves	8867cc	TD18047
DC 9.13	5 Cyl.	20 Valves	8867cc	TD18045
DC 9.16	5 Cyl.	20 Valves	8867cc	TD18641
DC 9.17	5 Cyl.	20 Valves	8867cc	TD18642
DC 9.18	5 Cyl.	20 Valves	8867cc	TD18643
DC 9.19	5 Cyl.	20 Valves	8867cc	TD30310
DC 9.20	5 Cyl.	20 Valves	8867cc	TD21006
DC 9.21	5 Cyl.	20 Valves	8867cc	TD30318
DC 9.31	5 Cyl.	20 Valves	8870cc	TD29222

PA6063 (x20)

NA5300 **F**

120.00 x 140.00 x 12.00mm, PTFE

NA5471 **R**

145.00 x 175.00 x 13.00mm, PTFE/FPM

4 8.9L Petrol

DC 9E.02	5 Cyl.	20 Valves	8867cc	TD23701
----------	--------	-----------	--------	---------

PA6063 (x20)

NA5300 **F**

120.00 x 140.00 x 12.00mm, PTFE

NA5471 **R**

145.00 x 175.00 x 13.00mm, PTFE/FPM

5 9.0L Diesel

DC 9.01	6 Cyl.	12 Valves	9000cc	TD15408
DC 9.02	6 Cyl.	12 Valves	9000cc	TD15411
DC 9.03	6 Cyl.	12 Valves	9000cc	TD15413
DC 9.04	6 Cyl.	12 Valves	9000cc	TD15410
DC 9.05	6 Cyl.	12 Valves	9000cc	TD15412
DC 9.06	6 Cyl.	12 Valves	9000cc	TD15414
DSC 9.11	6 Cyl.	12 Valves	9000cc	TD8854
DSC 9.12	6 Cyl.	12 Valves	9000cc	TD8855
DSC 9.13	6 Cyl.	12 Valves	9000cc	TD8853
DSC 9.15	6 Cyl.	12 Valves	9000cc	TD12608

NA5474 **F**

80.00 x 100.00 x 13.00mm, PTFE/ACM

NA5470 **R**

130.00 x 160.00 x 13.00mm, PTFE/ACM



6 9.3L		Diesel			
DC 9.22	5 Cyl.	20 Valves	9300cc	TD20871	
DC 9.24	5 Cyl.	20 Valves	9300cc	TD23693	
DC 9.28	5 Cyl.	20 Valves	9300cc	TD34474	
DC 9.29	5 Cyl.	20 Valves	9300cc	TD20870	
DC 9.30	5 Cyl.	20 Valves	9300cc	TD20847	
DC 9.32	5 Cyl.	20 Valves	9300cc	TD20872	
DC 9.35	5 Cyl.	20 Valves	9300cc	TD20848	
DC 9.36	5 Cyl.	20 Valves	9300cc	TD20869	
DC 9.37	5 Cyl.	20 Valves	9300cc	TD23697	
DC 9.38	5 Cyl.	20 Valves	9300cc	TD23696	
DC 9.39	5 Cyl.	20 Valves	9300cc	TD23695	
DC 9.101	5 Cyl.	20 Valves	9300cc	TD28140	
DC 09.101	5 Cyl.	20 Valves	9300cc	TD29852	
DC 9.102	5 Cyl.	20 Valves	9300cc	TD28139	
DC 09.108	5 Cyl.	20 Valves	9300cc	TD29000	
DC 09.109	5 Cyl.	20 Valves	9300cc	TD28130	
DC 9.109	5 Cyl.	20 Valves	9300cc	TD30340	
DC 09.110	5 Cyl.	20 Valves	9300cc	TD28131	
DC 09.111	5 Cyl.	20 Valves	9300cc	TD28998	
DC 09.112	5 Cyl.	20 Valves	9300cc	TD29001	
DC 09.113	5 Cyl.	20 Valves	9300cc	TD28999	
DC 09.114	5 Cyl.	20 Valves	9300cc	TD28145	
DC 09.115	5 Cyl.	20 Valves	9300cc	TD28146	
DC 09.E02	5 Cyl.	20 Valves	9300cc	TD29017	
PA6063 (x20)				NA5473 135.00 x 153.00 x 13.00mm, PTFE NA5472 155.00 x 185.00 x 13.00mm, PTFE/FPM	

7 9.3L		Gas			
OC 09.101	5 Cyl.	20 Valves	9300cc	TD29002	
OC 09.102	5 Cyl.	20 Valves	9300cc	TD29004	
OC 9.G04	5 Cyl.	20 Valves	9300cc	TD28128	
OC 9.G05	5 Cyl.	20 Valves	9300cc	TD28129	
PA6063 (x20)				NA5473 135.00 x 153.00 x 13.00mm, PTFE NA5472 155.00 x 185.00 x 13.00mm, PTFE/FPM	

8 10.6L		Diesel			
DC 11.01	6 Cyl.	24 Valves	10600cc	TD12769	
DC 11.02	6 Cyl.	24 Valves	10600cc	TD12772	
DC 11.03	6 Cyl.	24 Valves	10600cc	TD15415	
DC 11.04	6 Cyl.	24 Valves	10600cc	TD15416	
DC 11.07	6 Cyl.	24 Valves	10600cc	TD21005	
DC 11.08	6 Cyl.	24 Valves	10600cc	TD17451	
DC 11.09	6 Cyl.	24 Valves	10600cc	TD17452	
PA6063 (x24) HR5117				NA5300 120.00 x 140.00 x 12.00mm, PTFE NA5471 145.00 x 175.00 x 13.00mm, PTFE/FPM	

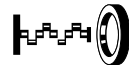
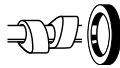

9	11.0L	Diesel			
D 11		6 Cyl.	12 Valves	11022cc	TD8794
D 11 R 23		6 Cyl.	12 Valves	11022cc	TD8805
DN 11.01		6 Cyl.	12 Valves	11020cc	TD8806
DN 11.01 B10		6 Cyl.	12 Valves	11022cc	TD5872
DN 11.01 C 09		6 Cyl.	12 Valves	11020cc	TD8836
DN 11.04 B10		6 Cyl.	12 Valves	11022cc	TD6220
DN 11.04 C 01		6 Cyl.	12 Valves	11022cc	TD8837
DN 11.06		6 Cyl.	12 Valves	11020cc	TD8875
DN 11.06 B		6 Cyl.	12 Valves	11020cc	TD8800
DN 11.06 C		6 Cyl.	12 Valves	11020cc	TD8817
DN 11.07		6 Cyl.	12 Valves	11022cc	TD8808
DN 11.08		6 Cyl.	12 Valves	11022cc	TD8886
DN 11.08 B01		6 Cyl.	12 Valves	11020cc	TD8889
DS 11		6 Cyl.	12 Valves	11022cc	TD8798
DS 11.01		6 Cyl.	12 Valves	11022cc	TD5874
DS 11.01 B 06		6 Cyl.	12 Valves	11000cc	TD8799
DS 11.02		6 Cyl.	12 Valves	11022cc	TD8864
DS 11.10		6 Cyl.	12 Valves	11020cc	TD8865
DS 11.14		6 Cyl.	12 Valves	11022cc	TD6222
DS 11.15		6 Cyl.	12 Valves	11022cc	TD8803
DS 11.15 B		6 Cyl.	12 Valves	11022cc	TD8801
DS 11.18		6 Cyl.	12 Valves	11022cc	TD8857
DS 11.22		6 Cyl.	12 Valves	11022cc	TD7436
DS 11.23		6 Cyl.	12 Valves	11022cc	TD7180
DS 11.25		6 Cyl.	12 Valves	11022cc	TD8856
DS 11.34		6 Cyl.	12 Valves	11020cc	TD8869
DS 11.34 B		6 Cyl.	12 Valves	11020cc	TD8818
DS 11.34 BO 6		6 Cyl.	12 Valves	11020cc	TD8830
DS 11.34 C		6 Cyl.	12 Valves	11020cc	TD8866
DS 11.71		6 Cyl.	12 Valves	11020cc	TD8873
DS 11.71 C		6 Cyl.	12 Valves	11020cc	TD5878
DS 11.72		6 Cyl.	12 Valves	11022cc	TD8858
DS 11.73		6 Cyl.	12 Valves	11020cc	TD8859
DS 11.73 B		6 Cyl.	12 Valves	11020cc	TD8819
DS 11.74		6 Cyl.	12 Valves	11020cc	TD8820
DS 11.74 C		6 Cyl.	12 Valves	11020cc	TD6226
DS 11.75		6 Cyl.	12 Valves	11020cc	TD8821
DS 11.76		6 Cyl.	12 Valves	11020cc	TD8890
DS 11.77		6 Cyl.	12 Valves	11020cc	TD8876
DS 11.78		6 Cyl.	12 Valves	11020cc	TD8822
DSC 11.01		6 Cyl.	12 Valves	11020cc	TD8811
DSC 11.01 B		6 Cyl.	12 Valves	11022cc	TD8802
DSC 11.02		6 Cyl.	12 Valves	11022cc	TD8860
DSC 11.03		6 Cyl.	12 Valves	11020cc	TD8862
DSC 11.04		6 Cyl.	12 Valves	11020cc	TD8868
DSC 11.04 C		6 Cyl.	12 Valves	11020cc	TD5879
DSC 11.06		6 Cyl.	12 Valves	11020cc	TD8863
DSC 11.07		6 Cyl.	12 Valves	11020cc	TD30335
DSC 11.08		6 Cyl.	12 Valves	11020cc	TD8823



DSC 11.08 B	6 Cyl.	12 Valves	11020cc	TD8828
DSC 11.08 C	6 Cyl.	12 Valves	11020cc	TD8867
DSC 11.10	6 Cyl.	12 Valves	11020cc	TD8877
DSC 11.12	6 Cyl.	12 Valves	11020cc	TD8861
DSC 11.13	6 Cyl.	12 Valves	11020cc	TD8878
DSC 11.13 B	6 Cyl.	12 Valves	11020cc	TD8824
DSC 11.16	6 Cyl.	12 Valves	11020cc	TD8879
DSC 11.16 B	6 Cyl.	12 Valves	11020cc	TD8825
DSC 11.17	6 Cyl.	12 Valves	11020cc	TD8880
DSC 11.17 B	6 Cyl.	12 Valves	11020cc	TD8829
DSC 11.18	6 Cyl.	12 Valves	11020cc	TD8826
DSC 11.18 B	6 Cyl.	12 Valves	11020cc	TD8827
DSC 11.18 BO 1	6 Cyl.	12 Valves	11020cc	TD8831
DSC 11.18 L01	6 Cyl.	12 Valves	11020cc	TD8891
DSC 11.21	6 Cyl.	12 Valves	11020cc	TD8812
DSC 11.22	6 Cyl.	12 Valves	11020cc	TD8813
DSC 11.23	6 Cyl.	12 Valves	11020cc	TD8814
DSC 11.24	6 Cyl.	12 Valves	11020cc	TD8870
DSC 11.27	6 Cyl.	12 Valves	11020cc	TD8871
DSC 11.27 C	6 Cyl.	12 Valves	11020cc	TD6227
DSC 11.30	6 Cyl.	12 Valves	11020cc	TD8881
DSC 11.32	6 Cyl.	12 Valves	11020cc	TD8887
DSC 11.33	6 Cyl.	12 Valves	11020cc	TD8888
DSC 11.35	6 Cyl.	12 Valves	11020cc	TD8815
DSC 11.36	6 Cyl.	12 Valves	11020cc	TD8816
DSC 11.39	6 Cyl.	12 Valves	11020cc	TD8882
DSC 11.70	6 Cyl.	12 Valves	11020cc	TD8884
DSC 11.71	6 Cyl.	12 Valves	11020cc	TD8872
DSC 11.74	6 Cyl.	12 Valves	11020cc	TD22369
DSC 11.75	6 Cyl.	12 Valves	11020cc	TD22370
DSC 11.79	6 Cyl.	12 Valves	11000cc	TD12768
DSC 11.81	6 Cyl.	12 Valves	11020cc	TD17286
DTC 11.01	6 Cyl.	12 Valves	11020cc	TD8883
DTC 11.02	6 Cyl.	12 Valves	11020cc	TD8885

NB618 F
80.00 x 100.40 x 13.00mm, PTFE
NA5474 F
80.00 x 100.00 x 13.00mm, PTFE/ACM
NB619 R
130.00 x 160.00 x 15.00mm, FPM
NA5470 R
130.00 x 160.00 x 13.00mm, PTFE/ACM

10 11.0L

Gas

OSC 11.03	6 Cyl.	12 Valves	11020cc	TD20924
-----------	--------	-----------	---------	---------

NB618 F
80.00 x 100.40 x 13.00mm, PTFE
NA5474 F
80.00 x 100.00 x 13.00mm, PTFE/ACM
NB619 R
130.00 x 160.00 x 15.00mm, FPM
NA5470 R
130.00 x 160.00 x 13.00mm, PTFE/ACM

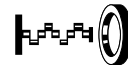
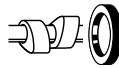

11 11.7L

Diesel

DC 12.01	6 Cyl.	24 Valves	11700cc	TD15418
DC 12.02	6 Cyl.	24 Valves	11700cc	TD21080
DC 12.03	6 Cyl.	24 Valves	11700cc	TD16852
DC 12.06	6 Cyl.	24 Valves	11700cc	TD20875
DC 12.07	6 Cyl.	24 Valves	11700cc	TD30400
DC 12.09	6 Cyl.	24 Valves	11700cc	TD22367
DC 12.10	6 Cyl.	24 Valves	11700cc	TD18644
DC 12.12	6 Cyl.	24 Valves	11700cc	TD34452
DC 12.13	6 Cyl.	24 Valves	11700cc	TD18645
DC 12.14	6 Cyl.	24 Valves	11716cc	TD17453
DC 12.15	6 Cyl.	24 Valves	11716cc	TD18647
DC 12.17	6 Cyl.	24 Valves	11716cc	TD20873
DC 12.18	6 Cyl.	24 Valves	11716cc	TD20874
DC 12.22	6 Cyl.	24 Valves	11716cc	TD23694
DC 12.23	6 Cyl.	24 Valves	11716cc	TD23698
DC 12.24	6 Cyl.	24 Valves	11716cc	TD23699
DC 12.26	6 Cyl.	24 Valves	11716cc	TD23700
DSC 12.01	6 Cyl.	24 Valves	11700cc	TD8892
DSC 12.02	6 Cyl.	24 Valves	11700cc	TD8893
DSC 12.03	6 Cyl.	24 Valves	11700cc	TD22371
DSC 12.05	6 Cyl.	24 Valves	11700cc	TD12870
DSC 12.06	6 Cyl.	24 Valves	11700cc	TD22372
DT 12.02	6 Cyl.	24 Valves	11716cc	TD16495
DT 12.03	6 Cyl.	24 Valves	11716cc	TD18648
DT 12.06	6 Cyl.	24 Valves	11716cc	TD17455
DT 12.08	6 Cyl.	24 Valves	11716cc	TD16716
DT 12.10	6 Cyl.	24 Valves	11716cc	TD29079
DT 12.11	6 Cyl.	24 Valves	11716cc	TD17454
DT 12.12	6 Cyl.	24 Valves	11716cc	TD18646
DT 12.14	6 Cyl.	24 Valves	11716cc	TD20876
DT 12.17	6 Cyl.	24 Valves	11716cc	TD20878
DT 12.18	6 Cyl.	24 Valves	11716cc	TD20877

PA6063 (x24)
HR5117

NA5300

120.00 x 140.00 x 12.00mm, PTFE

NA5471

145.00 x 175.00 x 13.00mm, PTFE/FPM



12 12.7L Diesel

DC 13.05	6 Cyl.	24 Valves	12742cc	TD20882
DC 13.06	6 Cyl.	24 Valves	12742cc	TD20887
DC 13.07	6 Cyl.	24 Valves	12742cc	TD20886
DC 13.08	6 Cyl.	24 Valves	12742cc	TD20885
DC 13.10	6 Cyl.	24 Valves	12742cc	TD20884
DC 13.11	6 Cyl.	24 Valves	12742cc	TD20883
DC 13.101	6 Cyl.	24 Valves	12742cc	TD28144
DC 13.102	6 Cyl.	24 Valves	12742cc	TD28143
DC 13.103	6 Cyl.	24 Valves	12742cc	TD28142
DC 13.104	6 Cyl.	24 Valves	12742cc	TD28141
DC 13.106	6 Cyl.	24 Valves	12742cc	TD29021
DC 13.107	6 Cyl.	24 Valves	12742cc	TD28496
DC 13.108	6 Cyl.	24 Valves	12742cc	TD28475
DC 13.109	6 Cyl.	24 Valves	12742cc	TD28126
DC 13.110	6 Cyl.	24 Valves	12742cc	TD28127
DC 13.111	6 Cyl.	24 Valves	12742cc	TD29019
DC 13.112	6 Cyl.	24 Valves	12742cc	TD28135
DC 13.113	6 Cyl.	24 Valves	12742cc	TD28133
DC 13.114	6 Cyl.	24 Valves	12742cc	TD28132
DC 13.115	6 Cyl.	24 Valves	12742cc	TD29007
DC 13.116	6 Cyl.	24 Valves	12742cc	TD29006
DC 13.119	6 Cyl.	24 Valves	12742cc	TD30800
DC 13.120	6 Cyl.	24 Valves	12742cc	TD28134
DC 13.121	6 Cyl.	24 Valves	12742cc	TD28136
DC 13.124	6 Cyl.	24 Valves	12742cc	TD29008
DC 13.125	6 Cyl.	24 Valves	12742cc	TD29009
DC 13.141	6 Cyl.	24 Valves	12742cc	TD34121
DC 13.147	6 Cyl.	24 Valves	12742cc	TD30799
DC 13.148	6 Cyl.	24 Valves	12742cc	TD34122
DC 13.155	6 Cyl.	24 Valves	12742cc	TD34123
DT 13.07	6 Cyl.	24 Valves	12742cc	TD34449
DT 13.10	6 Cyl.	24 Valves	12742cc	TD34450
DT 13.125	6 Cyl.	24 Valves	12742cc	TD34451

PA6063 (x24)
HR5117

NA5473
135.00 x 153.00 x 13.00mm, PTFE
NA5472
155.00 x 185.00 x 13.00mm, PTFE/FPM

13 14.2L Diesel

D 14	8 Cyl.	16 Valves	14181cc	TD8804
------	--------	-----------	---------	--------

NB618
80.00 x 100.40 x 13.00mm, PTFE
NA5474
80.00 x 100.00 x 13.00mm, PTFE/ACM
NB619
130.00 x 160.00 x 15.00mm, FPM
NA5470
130.00 x 160.00 x 13.00mm, PTFE/ACM

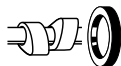

14 14.2L

Diesel

DS 14	8 Cyl.	16 Valves	14181 cc	TD8835
DS 14.01	8 Cyl.	16 Valves	14190cc	TD8902
DS 14.01 L 01	8 Cyl.	16 Valves	14200cc	TD8903
DS 14.02	8 Cyl.	16 Valves	14190cc	TD22368
DS 14.06	8 Cyl.	16 Valves	14190cc	TD8896
DS 14.06 L 01	8 Cyl.	16 Valves	14200cc	TD8904
DS 14.07	8 Cyl.	16 Valves	14190cc	TD8897
DS 14 LB 05	8 Cyl.	16 Valves	14200cc	TD8894
DS 14 LB 08	8 Cyl.	16 Valves	14200cc	TD8895
DSC 14.01	8 Cyl.	16 Valves	14190cc	TD8898
DSC 14.02	8 Cyl.	16 Valves	14190cc	TD8899
DSC 14.03	8 Cyl.	16 Valves	14190cc	TD8906
DSC 14.03 L07	8 Cyl.	16 Valves	14188cc	TD8913
DSC 14.04	8 Cyl.	16 Valves	14190cc	TD8907
DSC 14.05	8 Cyl.	16 Valves	14190cc	TD8900
DSC 14.06	8 Cyl.	16 Valves	14190cc	TD8901
DSC 14.07 L 01	8 Cyl.	16 Valves	14200cc	TD8905
DSC 14.08	8 Cyl.	16 Valves	14190cc	TD8908
DSC 14.09	8 Cyl.	16 Valves	14190cc	TD8909
DSC 14.10	8 Cyl.	16 Valves	14190cc	TD8910
DSC 14.13	8 Cyl.	16 Valves	14200cc	TD8911
DSC 14.15	8 Cyl.	16 Valves	14200cc	TD8914
DSC 14.16	8 Cyl.	16 Valves	14190cc	TD8912

PA6063 (x16)

NB618

80.00 x 100.40 x 13.00mm, PTFE

NA5474

80.00 x 100.00 x 13.00mm, PTFE/ACM

NB619

130.00 x 160.00 x 15.00mm, FPM

NA5470

130.00 x 160.00 x 13.00mm, PTFE/ACM

15 15.6L

Diesel

DC 16.01	8 Cyl.	32 Valves	15600cc	TD15429
DC 16.02	8 Cyl.	32 Valves	15600cc	TD15428
DC 16.03	8 Cyl.	32 Valves	15600cc	TD17458
DC 16.04	8 Cyl.	32 Valves	15600cc	TD17457
DC 16.05	8 Cyl.	32 Valves	15600cc	TD18649
DC 16.06	8 Cyl.	32 Valves	15600cc	TD18650
DC 16.08	8 Cyl.	32 Valves	15600cc	TD18652
DC 16.09	8 Cyl.	32 Valves	15600cc	TD18651
DC 16.17	8 Cyl.	32 Valves	15600cc	TD20881
DC 16.18	8 Cyl.	32 Valves	15600cc	TD20880
DC 16.19	8 Cyl.	32 Valves	15600cc	TD20879
DC 16.22	8 Cyl.	32 Valves	15600cc	TD28138
DT 16.08	8 Cyl.	32 Valves	15600cc	TD21019

PA6063 (x32)

NA5300

120.00 x 140.00 x 12.00mm, PTFE

NA5471

145.00 x 175.00 x 13.00mm, PTFE/FPM

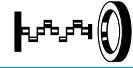

16 16.4L Diesel

DC 16.21	8 Cyl.	32 Valves	16352cc	TD23988
DC 16.101	8 Cyl.	32 Valves	16352cc	TD29011
DC 16.102	8 Cyl.	32 Valves	16352cc	TD29012
DC 16.103	8 Cyl.	32 Valves	16352cc	TD29015

PA6063 (x32)

NA5300

120.00 x 140.00 x 12.00mm, PTFE

NA5471

145.00 x 175.00 x 13.00mm, PTFE/FPM











CC



9

124	01/68→12/76	124 A.000	Petrol	1197	4	8	19
124	01/70→12/76	124 A9.000	Petrol	1592	4	8	53
124	01/70→12/76	FA14	Petrol	1438	4	8	31
124 Estate	01/70→12/76	124 A.000	Petrol	1197	4	8	19
127 (127A)	04/72→12/82	A112 A5.000	Petrol	903	4	8	4
128	01/76→12/80	124 A.000	Petrol	1197	4	8	19
128	01/76→12/80	124 B2.000	Petrol	1438	4	8	33
131	06/78→12/85	131 C4.000	Petrol	1995	4	8	102
131	06/78→12/86	8144.61	Diesel	2445	4	8	121
131	03/82→01/85	132 BB 0A 0	Petrol	1592	4	8	55
132	05/73→12/80	132B0000	Petrol	1592	4	8	55
132	05/79→12/82	OM 615.912	Diesel	2197	4	8	118
850	01/66→12/74	120G100	Petrol	843	4	8	7
850	01/66→12/74	126G100	Petrol	843	4	8	8
850	07/70→10/75	100 GL.040	Petrol	903	4	8	4
850	02/72→07/75	100 GL 6000	Petrol	843	4	8	1
Alhambra (7V8, 7V9)	04/96→03/10	1Z	Diesel	1896	4	8	87
Alhambra (7V8, 7V9)	04/96→03/10	ADY	Petrol	1984	4	8	104
Alhambra (7V8, 7V9)	04/96→03/10	AHU	Diesel	1896	4	8	94
Alhambra (7V8, 7V9)	04/96→03/10	ANU	Diesel	1896	4	8	95
Alhambra (7V8, 7V9)	04/96→03/10	ATM	Petrol	1984	4	8	106
Alhambra (7V8, 7V9)	08/96→06/00	AFN	Diesel	1896	4	8	91
Alhambra (7V8, 7V9)	08/96→06/00	AVG	Diesel	1896	4	8	97
Alhambra (7V8, 7V9)	10/97→03/10	AJH	Petrol	1781	4	20	81
Alhambra (7V8, 7V9)	10/97→03/10	AWC	Petrol	1781	4	20	81
Alhambra (7V8, 7V9)	06/00→03/10	AUE	Petrol	2792	6	24	122
Alhambra (7V8, 7V9)	06/00→03/10	AUY	Diesel	1896	4	8	95
Alhambra (7V8, 7V9)	06/00→03/10	AYL	Petrol	2792	6	24	122
Alhambra (7V8, 7V9)	06/00→03/10	BVK	Diesel	1896	4	8	95
Alhambra (7V8, 7V9)	11/02→11/08	ASZ	Diesel	1896	4	8	95
Alhambra (7V8, 7V9)	05/05→05/07	BTB	Diesel	1896	4	8	95
Alhambra (7V8, 7V9)	11/05→03/10	BRT	Diesel	1968	4	8	110
Alhambra (710, 711)	06/10→05/11	CFFA	Diesel	1968	4	16	112
Alhambra (710, 711)	06/10→	CAVA	Petrol	1390	4	16	45
Alhambra (710, 711)	06/10→	CFFB	Diesel	1968	4	16	112
Alhambra (710, 711)	06/10→	CFGB	Diesel	1968	4	16	112
Alhambra (710, 711)	06/10→	CNWB	Petrol	1390	4	16	45
Alhambra (710, 711)	06/10→	CTHA	Petrol	1390	4	16	45
Alhambra (710, 711)	11/10→	CCZA	Petrol	1984	4	16	113
Alhambra (710, 711)	05/11→	CFFE	Diesel	1968	4	16	112
Alhambra (710, 711)	05/11→	CUVA	Diesel	1968	4	16	116
Alhambra (710, 711)	11/12→	CDAA	Petrol	1798	4	16	83
Alhambra (710, 711)	11/12→	CFGC	Diesel	1968	4	16	112
Alhambra (710, 711)	05/15→	CUVC	Diesel	1968	4	16	116
Alhambra (710, 711)	05/15→	CUWA	Diesel	1968	4	16	116
Alhambra (710, 711)	05/15→	CZDA	Petrol	1395	4	16	46
Alhambra (710, 711)	05/15→	DEDA	Petrol	1984	4	16	115
Alhambra (710, 711)	05/15→	DFLA	Diesel	1968	4	16	117
Alhambra (710, 711)	05/15→	DFMA	Diesel	1968	4	16	117
Altea (5P1)	03/04→05/09	AZV	Diesel	1968	4	16	107
Altea (5P1)	03/04→	BGU	Petrol	1595	4	8	62
Altea (5P1)	03/04→	BKD	Diesel	1968	4	16	108
Altea (5P1)	03/04→	BSE	Petrol	1595	4	8	62
Altea (5P1)	03/04→	BSF	Petrol	1595	4	8	62
Altea (5P1)	03/04→	CCSA	Petrol	1595	4	8	62
Altea (5P1)	03/04→	CFHC	Diesel	1968	4	16	112
Altea (5P1)	03/04→	CMXA	Petrol	1595	4	8	62
Altea (5P1)	04/04→	BJB	Diesel	1896	4	8	99
Altea (5P1)	04/04→	BKC	Diesel	1896	4	8	99
Altea (5P1)	04/04→	BLS	Diesel	1896	4	8	99
Altea (5P1)	04/04→	BXE	Diesel	1896	4	8	99
Altea (5P1)	05/04→03/09	BLR	Petrol	1984	4	16	109
Altea (5P1)	05/04→03/09	BLY	Petrol	1984	4	16	109
Altea (5P1)	05/04→03/09	BVY	Petrol	1984	4	16	109
Altea (5P1)	05/04→03/09	BVZ	Petrol	1984	4	16	109
Altea (5P1)	11/05→	BMM	Diesel	1968	4	8	110
Altea (5P1)	03/06→	BMN	Diesel	1968	4	16	107
Altea (5P1)	03/06→	CEGA	Diesel	1968	4	16	112
Altea (5P1)	04/06→05/09	BWA	Petrol	1984	4	16	111
Altea (5P1)	05/06→	BXW	Petrol	1390	4	16	44
Altea (5P1)	05/06→	CGGB	Petrol	1390	4	16	37
Altea (5P1)	01/07→	BYT	Petrol	1798	4	16	83
Altea (5P1)	01/07→	BZB	Petrol	1798	4	16	83
Altea (5P1)	01/07→	CDAA	Petrol	1798	4	16	83
Altea (5P1)	11/07→	CAXC	Petrol	1390	4	16	45
Altea (5P1)	08/09→	BXF	Diesel	1896	4	8	99
Altea (5P1)	09/09→	CHGA	Petrol	1595	4	8	62
Altea (5P1)	10/09→	CAYC	Diesel	1598	4	16	68

							
Altea (5P1)	04/10→	CBZB	Petrol	1197	4	8	24
Altea (5P1)	11/10→	CAYB	Diesel	1598	4	16	68
Altea XL (5P5, 5P8)	10/06→03/09	BVY	Petrol	1984	4	16	109
Altea XL (5P5, 5P8)	10/06→03/09	BVZ	Petrol	1984	4	16	109
Altea XL (5P5, 5P8)	10/06→05/09	BWA	Petrol	1984	4	16	111
Altea XL (5P5, 5P8)	10/06→	BKC	Diesel	1896	4	8	99
Altea XL (5P5, 5P8)	10/06→	BKD	Diesel	1968	4	16	108
Altea XL (5P5, 5P8)	10/06→	BLS	Diesel	1896	4	8	99
Altea XL (5P5, 5P8)	10/06→	BMM	Diesel	1968	4	8	110
Altea XL (5P5, 5P8)	10/06→	BSE	Petrol	1595	4	8	62
Altea XL (5P5, 5P8)	10/06→	BSF	Petrol	1595	4	8	62
Altea XL (5P5, 5P8)	10/06→	BXE	Diesel	1896	4	8	99
Altea XL (5P5, 5P8)	10/06→	BXW	Petrol	1390	4	16	44
Altea XL (5P5, 5P8)	10/06→	CCSA	Petrol	1595	4	8	62
Altea XL (5P5, 5P8)	10/06→	CFHC	Diesel	1968	4	16	112
Altea XL (5P5, 5P8)	10/06→	CGGB	Petrol	1390	4	16	37
Altea XL (5P5, 5P8)	10/06→	CMXA	Petrol	1595	4	8	62
Altea XL (5P5, 5P8)	11/06→03/09	AZV	Diesel	1968	4	16	107
Altea XL (5P5, 5P8)	01/07→	BYT	Petrol	1798	4	16	83
Altea XL (5P5, 5P8)	01/07→	BZB	Petrol	1798	4	16	83
Altea XL (5P5, 5P8)	01/07→	CDAA	Petrol	1798	4	16	83
Altea XL (5P5, 5P8)	06/07→	BMN	Diesel	1968	4	16	107
Altea XL (5P5, 5P8)	06/07→	CEGA	Diesel	1968	4	16	112
Altea XL (5P5, 5P8)	06/07→	CFJA	Diesel	1968	4	16	112
Altea XL (5P5, 5P8)	11/07→	CAXC	Petrol	1390	4	16	45
Altea XL (5P5, 5P8)	05/09→	CCZB	Petrol	1984	4	16	113
Altea XL (5P5, 5P8)	08/09→	BXF	Diesel	1896	4	8	99
Altea XL (5P5, 5P8)	09/09→	CHGA	Petrol	1595	4	8	62
Altea XL (5P5, 5P8)	10/09→	CAYC	Diesel	1598	4	16	68
Altea XL (5P5, 5P8)	04/10→	CBZB	Petrol	1197	4	8	24
Altea XL (5P5, 5P8)	11/10→	CAYB	Diesel	1598	4	16	68
Arona (KJ7)	07/17→	CHZJ	Petrol	999	3	12	17
Arosa (6H)	05/97→06/04	AER	Petrol	999	4	8	11
Arosa (6H)	05/97→06/04	AEX	Petrol	1391	4	8	35
Arosa (6H)	05/97→06/04	AKK	Petrol	1390	4	8	38
Arosa (6H)	05/97→06/04	AKV	Petrol	1391	4	8	39
Arosa (6H)	05/97→06/04	ALD	Petrol	999	4	8	13
Arosa (6H)	05/97→06/04	ALL	Petrol	999	4	8	14
Arosa (6H)	05/97→06/04	ANV	Petrol	999	4	8	13
Arosa (6H)	05/97→06/04	ANW	Petrol	1390	4	8	38
Arosa (6H)	05/97→06/04	APQ	Petrol	1391	4	8	41
Arosa (6H)	05/97→06/04	AUC	Petrol	999	4	8	13
Arosa (6H)	05/97→06/04	AUD	Petrol	1390	4	8	38
Arosa (6H)	08/97→06/04	AKU	Diesel	1716	4	8	75
Arosa (6H)	10/98→01/01	AHT	Petrol	997	4	8	12
Arosa (6H)	01/00→06/04	AFK	Petrol	1390	4	16	37
Arosa (6H)	01/00→06/04	AMF	Diesel	1422	3	6	40
Arosa (6H)	01/00→06/04	AQQ	Petrol	1390	4	16	42
Arosa (6H)	01/00→06/04	AUB	Petrol	1390	4	16	37
Ateca (KH7)	04/16→	DDYA	Diesel	1598	4	16	69
Ateca (KH7)	04/16→	DFFA	Diesel	1968	4	16	117
Ateca (KH7)	05/16→	CHZJ	Petrol	999	3	12	17
Ateca (KH7)	06/16→	CZEA	Petrol	1395	4	16	49
Ateca (KH7)	06/16→	DFHA	Diesel	1968	4	16	117
Ateca (KH7)	10/16→	CRVA	Diesel	1968	4	16	116
Ateca (KH7)	10/16→	CRVC	Diesel	1968	4	16	116
Cordoba (6K1, 6K2)	02/93→08/94	2G	Petrol	1272	4	8	28
Cordoba (6K1, 6K2)	02/93→08/94	AAV	Petrol	1272	4	8	28
Cordoba (6K1, 6K2)	02/93→08/96	1Y	Diesel	1896	4	8	86
Cordoba (6K1, 6K2)	02/93→08/96	AAZ	Diesel	1896	4	8	88
Cordoba (6K1, 6K2)	02/93→06/99	2E	Petrol	1984	4	8	101
Cordoba (6K1, 6K2)	02/93→06/99	ABS	Petrol	1781	4	8	76
Cordoba (6K1, 6K2)	02/93→06/99	ABU	Petrol	1598	4	8	57
Cordoba (6K1, 6K2)	02/93→06/99	ACC	Petrol	1781	4	8	77
Cordoba (6K1, 6K2)	02/93→06/99	ADZ	Petrol	1781	4	8	79
Cordoba (6K1, 6K2)	02/93→06/99	AEE	Petrol	1598	4	8	58
Cordoba (6K1, 6K2)	02/93→06/99	AGG	Petrol	1984	4	8	105
Cordoba (6K1, 6K2)	02/93→06/99	ALM	Petrol	1598	4	8	61
Cordoba (6K1, 6K2)	10/93→08/96	ADL	Petrol	1781	4	16	78
Cordoba (6K1, 6K2)	05/94→06/99	1F	Petrol	1595	4	8	52
Cordoba (6K1, 6K2)	06/94→06/99	ABD	Petrol	1390	4	8	34
Cordoba (6K1, 6K2)	06/94→06/99	AEX	Petrol	1391	4	8	35
Cordoba (6K1, 6K2)	06/94→06/99	AKV	Petrol	1391	4	8	39
Cordoba (6K1, 6K2)	06/94→06/99	APQ	Petrol	1391	4	8	41
Cordoba (6K1, 6K2)	07/96→10/99	AFT	Petrol	1595	4	8	60
Cordoba (6K1, 6K2)	07/96→10/99	AKL	Petrol	1595	4	8	59
Cordoba (6K1, 6K2)	08/96→06/99	1Z	Diesel	1896	4	8	87
Cordoba (6K1, 6K2)	08/96→06/99	ABF	Petrol	1984	4	16	103











CC



9

Cordoba (6K1, 6K2)	08/96→06/99	AEY	Diesel	1896	4	8	90
Cordoba (6K1, 6K2)	08/96→06/99	AHU	Diesel	1896	4	8	94
Cordoba (6K1, 6K2)	09/96→06/99	AER	Petrol	999	4	8	11
Cordoba (6K1, 6K2)	09/96→06/99	AFH	Petrol	1390	4	16	36
Cordoba (6K1, 6K2)	03/97→06/99	AFN	Diesel	1896	4	8	91
Cordoba (6K1, 6K2)	12/97→04/99	ANX	Petrol	1390	4	8	41
Cordoba (6K2)	06/99→09/02	ACC	Petrol	1781	4	8	77
Cordoba (6K2)	06/99→10/02	AEH	Petrol	1595	4	8	59
Cordoba (6K2)	06/99→10/02	AGP	Diesel	1896	4	8	92
Cordoba (6K2)	06/99→10/02	AGR	Diesel	1896	4	8	92
Cordoba (6K2)	06/99→10/02	AHU	Diesel	1896	4	8	94
Cordoba (6K2)	06/99→10/02	AKK	Petrol	1390	4	8	38
Cordoba (6K2)	06/99→10/02	AKL	Petrol	1595	4	8	59
Cordoba (6K2)	06/99→10/02	ALD	Petrol	999	4	8	13
Cordoba (6K2)	06/99→10/02	ALH	Diesel	1896	4	8	93
Cordoba (6K2)	06/99→10/02	ALM	Petrol	1598	4	8	61
Cordoba (6K2)	06/99→10/02	ANV	Petrol	999	4	8	13
Cordoba (6K2)	06/99→10/02	ANW	Petrol	1390	4	8	38
Cordoba (6K2)	06/99→10/02	APF	Petrol	1595	4	8	63
Cordoba (6K2)	06/99→10/02	AQM	Diesel	1896	4	8	92
Cordoba (6K2)	06/99→10/02	ASK	Diesel	1896	4	8	97
Cordoba (6K2)	06/99→10/02	ASV	Diesel	1896	4	8	92
Cordoba (6K2)	06/99→10/02	AUC	Petrol	999	4	8	13
Cordoba (6K2)	06/99→10/02	AUD	Petrol	1390	4	8	38
Cordoba (6K2)	06/99→10/02	AUR	Petrol	1595	4	8	63
Cordoba (6K2)	02/00→10/02	AQQ	Petrol	1390	4	16	42
Cordoba (6K2)	02/00→10/02	AUB	Petrol	1390	4	16	37
Cordoba (6K2)	05/00→10/02	APE	Petrol	1390	4	16	37
Cordoba (6K2)	05/00→10/02	AUA	Petrol	1390	4	16	37
Cordoba (6K2)	07/00→10/02	AQX	Petrol	1781	4	20	82
Cordoba (6K2)	07/00→10/02	AYP	Petrol	1781	4	20	82
Cordoba (6L2)	09/02→12/07	BBY	Petrol	1390	4	16	37
Cordoba (6L2)	09/02→12/07	BKY	Petrol	1390	4	16	37
Cordoba (6L2)	09/02→11/09	ASY	Diesel	1896	4	8	95
Cordoba (6L2)	09/02→11/09	ATD	Diesel	1896	4	8	95
Cordoba (6L2)	09/02→11/09	AXR	Diesel	1896	4	8	95
Cordoba (6L2)	09/02→11/09	AZL	Petrol	1984	4	8	106
Cordoba (6L2)	09/02→11/09	BBX	Petrol	1984	4	8	106
Cordoba (6L2)	09/02→11/09	BMT	Diesel	1896	4	8	99
Cordoba (6L2)	10/02→12/05	AMF	Diesel	1422	3	6	40
Cordoba (6L2)	10/02→06/06	AZQ	Petrol	1198	3	12	21
Cordoba (6L2)	10/02→06/06	BME	Petrol	1198	3	12	23
Cordoba (6L2)	10/02→11/09	ASZ	Diesel	1896	4	8	95
Cordoba (6L2)	10/02→11/09	AUB	Petrol	1390	4	16	37
Cordoba (6L2)	10/02→11/09	BBZ	Petrol	1390	4	16	37
Cordoba (6L2)	10/02→11/09	BLT	Diesel	1896	4	8	95
Cordoba (6L2)	04/03→11/09	BAH	Petrol	1598	4	8	66
Cordoba (6L2)	05/05→11/09	BNM	Diesel	1422	3	6	40
Cordoba (6L2)	06/05→11/09	BMS	Diesel	1422	3	6	43
Cordoba (6L2)	06/05→11/09	BNV	Diesel	1422	3	6	40
Cordoba (6L2)	05/06→11/09	BXV	Petrol	1198	3	12	23
Cordoba (6L2)	05/06→11/09	BXW	Petrol	1390	4	16	44
Cordoba (6L2)	11/06→11/09	BTS	Petrol	1598	4	16	67
Cordoba Vario (6K5)	08/96→06/99	IZ	Diesel	1896	4	8	87
Cordoba Vario (6K5)	08/96→06/99	ACC	Petrol	1781	4	8	77
Cordoba Vario (6K5)	08/96→06/99	AHU	Diesel	1896	4	8	94
Cordoba Vario (6K5)	09/96→06/99	AEE	Petrol	1598	4	8	58
Cordoba Vario (6K5)	09/96→06/99	AEX	Petrol	1391	4	8	35
Cordoba Vario (6K5)	09/96→06/99	AEY	Diesel	1896	4	8	90
Cordoba Vario (6K5)	09/96→06/99	AFT	Petrol	1595	4	8	60
Cordoba Vario (6K5)	09/96→06/99	AKV	Petrol	1391	4	8	39
Cordoba Vario (6K5)	09/96→06/99	APQ	Petrol	1391	4	8	41
Cordoba Vario (6K5)	09/96→12/02	ALM	Petrol	1598	4	8	61
Cordoba Vario (6K5)	05/97→06/99	IF	Petrol	1595	4	8	52
Cordoba Vario (6K5)	07/97→06/99	AFN	Diesel	1896	4	8	91
Cordoba Vario (6K5)	06/99→12/02	ABU	Petrol	1598	4	8	57
Cordoba Vario (6K5)	06/99→12/02	AEH	Petrol	1595	4	8	59
Cordoba Vario (6K5)	06/99→12/02	AGP	Diesel	1896	4	8	92
Cordoba Vario (6K5)	06/99→12/02	AGR	Diesel	1896	4	8	92
Cordoba Vario (6K5)	06/99→12/02	AKK	Petrol	1390	4	8	38
Cordoba Vario (6K5)	06/99→12/02	AKL	Petrol	1595	4	8	59
Cordoba Vario (6K5)	06/99→12/02	ALH	Diesel	1896	4	8	93
Cordoba Vario (6K5)	06/99→12/02	ANW	Petrol	1390	4	8	38
Cordoba Vario (6K5)	06/99→12/02	APE	Petrol	1390	4	16	37
Cordoba Vario (6K5)	06/99→12/02	APF	Petrol	1595	4	8	63
Cordoba Vario (6K5)	06/99→12/02	AQM	Diesel	1896	4	8	92
Cordoba Vario (6K5)	06/99→12/02	ASK	Diesel	1896	4	8	97
Cordoba Vario (6K5)	06/99→12/02	ASV	Diesel	1896	4	8	92

							
Cordoba Vario (6K5)	06/99→12/02	AUA	Petrol	1390	4	16	37
Cordoba Vario (6K5)	06/99→12/02	AUD	Petrol	1390	4	8	38
Cordoba Vario (6K5)	06/99→12/02	AUR	Petrol	1595	4	8	63
Exeo (3R2)	12/08→05/10	CFMA	Petrol	1781	4	20	81
Exeo (3R2)	12/08→	CAGA	Diesel	1968	4	16	112
Exeo (3R2)	12/08→	CAGC	Diesel	1968	4	16	112
Exeo (3R2)	12/08→	CJCA	Diesel	1968	4	16	112
Exeo (3R2)	12/08→	CJCC	Diesel	1968	4	16	112
Exeo (3R2)	02/09→	CAHA	Diesel	1968	4	16	112
Exeo (3R2)	02/09→	CGLB	Diesel	1968	4	16	112
Exeo (3R2)	03/09→09/10	ALZ	Petrol	1595	4	8	62
Exeo (3R2)	03/09→	BWE	Petrol	1984	4	16	111
Exeo (3R2)	05/10→	CDHB	Petrol	1798	4	16	83
Exeo (3R2)	05/10→	CDND	Petrol	1984	4	16	113
Exeo (3R2)	09/10→	CDHA	Petrol	1798	4	16	83
Exeo ST (3R5)	05/09→	CAGA	Diesel	1968	4	16	112
Exeo ST (3R5)	05/09→	CAHA	Diesel	1968	4	16	112
Exeo ST (3R5)	05/09→	CGLB	Diesel	1968	4	16	112
Exeo ST (3R5)	05/09→	CJCA	Diesel	1968	4	16	112
Exeo ST (3R5)	06/09→05/10	CFMA	Petrol	1781	4	20	81
Exeo ST (3R5)	06/09→09/10	ALZ	Petrol	1595	4	8	62
Exeo ST (3R5)	06/09→	BWE	Petrol	1984	4	16	111
Exeo ST (3R5)	07/09→	CAGC	Diesel	1968	4	16	112
Exeo ST (3R5)	07/09→	CJCC	Diesel	1968	4	16	112
Exeo ST (3R5)	05/10→	CDHB	Petrol	1798	4	16	83
Exeo ST (3R5)	05/10→	CDND	Petrol	1984	4	16	113
Exeo ST (3R5)	09/10→	CDHA	Petrol	1798	4	16	83
Fura (025A)	01/82→06/86	100 GL 3000	Petrol	903	4	8	5
Fura (025A)	01/82→06/86	HB 90	Petrol	903	4	8	9
Fura (025A)	03/84→12/86	09 NCA	Petrol	903	4	8	2
Fura (025A)	03/84→12/86	100 GL 7000	Petrol	903	4	8	6
Ibiza I (021A)	06/84→05/93	022 A.5000	Diesel	1714	4	8	72
Ibiza I (021A)	11/84→05/93	021 A 2000	Petrol	1461	4	8	50
Ibiza I (021A)	11/84→12/93	021 A 1000	Petrol	1193	4	8	20
Ibiza I (021A)	08/86→05/93	146 A 000	Petrol	903	4	8	6
Ibiza I (021A)	10/86→05/93	021 B.2000	Petrol	1461	4	8	32
Ibiza I (021A)	10/86→05/93	021 C.2000	Petrol	1461	4	8	32
Ibiza I (021A)	10/86→05/93	021 D.2000	Petrol	1461	4	8	32
Ibiza I (021A)	01/89→05/93	021 C.1000	Petrol	1193	4	8	20
Ibiza I (021A)	08/90→05/93	09 NCA	Petrol	903	4	8	2
Ibiza I (021A)	01/91→05/93	021 A.3000	Petrol	1675	4	8	71
Ibiza I (021A)	01/91→05/93	021 B.3000	Petrol	1675	4	8	71
Ibiza II (6K1)	03/93→08/96	AAZ	Diesel	1896	4	8	88
Ibiza II (6K1)	03/93→09/96	AAU	Petrol	1043	4	8	10
Ibiza II (6K1)	03/93→08/99	2E	Petrol	1984	4	8	101
Ibiza II (6K1)	03/93→08/99	2G	Petrol	1272	4	8	28
Ibiza II (6K1)	03/93→08/99	AAV	Petrol	1272	4	8	28
Ibiza II (6K1)	03/93→08/99	ABS	Petrol	1781	4	8	76
Ibiza II (6K1)	03/93→08/99	ACC	Petrol	1781	4	8	77
Ibiza II (6K1)	03/93→08/99	ADZ	Petrol	1781	4	8	79
Ibiza II (6K1)	03/93→08/99	AGG	Petrol	1984	4	8	105
Ibiza II (6K1)	03/93→02/02	ABU	Petrol	1598	4	8	57
Ibiza II (6K1)	03/93→02/02	AEE	Petrol	1598	4	8	58
Ibiza II (6K1)	03/93→02/02	ALM	Petrol	1598	4	8	61
Ibiza II (6K1)	04/93→08/96	1Y	Diesel	1896	4	8	86
Ibiza II (6K1)	09/93→02/02	ABD	Petrol	1390	4	8	34
Ibiza II (6K1)	09/93→02/02	AEX	Petrol	1391	4	8	35
Ibiza II (6K1)	09/93→02/02	AKK	Petrol	1390	4	8	38
Ibiza II (6K1)	09/93→02/02	AKV	Petrol	1391	4	8	39
Ibiza II (6K1)	09/93→02/02	ANW	Petrol	1390	4	8	38
Ibiza II (6K1)	09/93→02/02	APQ	Petrol	1391	4	8	41
Ibiza II (6K1)	09/93→02/02	AUD	Petrol	1390	4	8	38
Ibiza II (6K1)	11/93→08/96	ADL	Petrol	1781	4	16	78
Ibiza II (6K1)	09/94→06/99	1F	Petrol	1595	4	8	52
Ibiza II (6K1)	04/96→02/02	AEH	Petrol	1595	4	8	59
Ibiza II (6K1)	04/96→02/02	AFT	Petrol	1595	4	8	60
Ibiza II (6K1)	04/96→02/02	AKL	Petrol	1595	4	8	59
Ibiza II (6K1)	04/96→02/02	APF	Petrol	1595	4	8	63
Ibiza II (6K1)	04/96→02/02	AUR	Petrol	1595	4	8	63
Ibiza II (6K1)	08/96→08/99	ABF	Petrol	1984	4	16	103
Ibiza II (6K1)	08/96→08/99	AEY	Diesel	1896	4	8	90
Ibiza II (6K1)	08/96→02/02	1Z	Diesel	1896	4	8	87
Ibiza II (6K1)	08/96→02/02	AGR	Diesel	1896	4	8	92
Ibiza II (6K1)	08/96→02/02	AHU	Diesel	1896	4	8	94
Ibiza II (6K1)	08/96→02/02	ALH	Diesel	1896	4	8	93
Ibiza II (6K1)	09/96→02/02	AER	Petrol	999	4	8	11
Ibiza II (6K1)	09/96→02/02	ALD	Petrol	999	4	8	13
Ibiza II (6K1)	09/96→02/02	ANV	Petrol	999	4	8	13











CC



9

Ibiza II (6K1)	09/96→02/02	AUC	Petrol	999	4	8	13
Ibiza II (6K1)	02/97→02/02	AFN	Diesel	1896	4	8	91
Ibiza II (6K1)	02/97→02/02	ASK	Diesel	1896	4	8	97
Ibiza II (6K1)	02/97→02/02	ASV	Diesel	1896	4	8	92
Ibiza II (6K1)	06/97→02/02	AFH	Petrol	1390	4	16	36
Ibiza II (6K1)	06/97→02/02	AQQ	Petrol	1390	4	16	42
Ibiza II (6K1)	06/97→02/02	AUB	Petrol	1390	4	16	37
Ibiza II (6K1)	12/97→04/99	ANX	Petrol	1390	4	8	41
Ibiza II (6K1)	08/99→02/02	AGP	Diesel	1896	4	8	92
Ibiza II (6K1)	08/99→02/02	AQM	Diesel	1896	4	8	92
Ibiza II (6K1)	10/99→02/02	AST	Petrol	999	4	16	15
Ibiza II (6K1)	10/99→02/02	AVZ	Petrol	999	4	16	15
Ibiza II (6K1)	05/00→02/02	APE	Petrol	1390	4	16	37
Ibiza II (6K1)	05/00→02/02	AUA	Petrol	1390	4	16	37
Ibiza II (6K1)	07/00→02/02	AQX	Petrol	1781	4	20	82
Ibiza II (6K1)	07/00→02/02	AYP	Petrol	1781	4	20	82
Ibiza III (6L1)	02/02→12/05	ASY	Diesel	1896	4	8	95
Ibiza III (6L1)	02/02→06/06	AZQ	Petrol	1198	3	12	21
Ibiza III (6L1)	02/02→06/06	BME	Petrol	1198	3	12	23
Ibiza III (6L1)	02/02→12/07	BBY	Petrol	1390	4	16	37
Ibiza III (6L1)	02/02→12/07	BKY	Petrol	1390	4	16	37
Ibiza III (6L1)	02/02→11/09	ASZ	Diesel	1896	4	8	95
Ibiza III (6L1)	02/02→11/09	ATD	Diesel	1896	4	8	95
Ibiza III (6L1)	02/02→11/09	AUB	Petrol	1390	4	16	37
Ibiza III (6L1)	02/02→11/09	AXR	Diesel	1896	4	8	95
Ibiza III (6L1)	02/02→11/09	BBZ	Petrol	1390	4	16	37
Ibiza III (6L1)	02/02→11/09	BLT	Diesel	1896	4	8	95
Ibiza III (6L1)	02/02→11/09	BMT	Diesel	1896	4	8	99
Ibiza III (6L1)	04/02→11/09	AZL	Petrol	1984	4	8	106
Ibiza III (6L1)	04/02→11/09	BBX	Petrol	1984	4	8	106
Ibiza III (6L1)	05/02→12/05	AMF	Diesel	1422	3	6	40
Ibiza III (6L1)	02/03→11/09	BAH	Petrol	1598	4	8	66
Ibiza III (6L1)	12/03→05/08	BJX	Petrol	1781	4	20	81
Ibiza III (6L1)	12/03→05/08	BKV	Petrol	1781	4	20	82
Ibiza III (6L1)	01/04→02/08	BBU	Petrol	1781	4	20	81
Ibiza III (6L1)	01/04→02/08	BLZ	Petrol	1781	4	20	81
Ibiza III (6L1)	03/04→02/08	BPX	Diesel	1896	4	8	95
Ibiza III (6L1)	03/04→02/08	BUK	Diesel	1896	4	8	95
Ibiza III (6L1)	05/05→11/09	BNM	Diesel	1422	3	6	40
Ibiza III (6L1)	06/05→11/09	BMS	Diesel	1422	3	6	43
Ibiza III (6L1)	06/05→11/09	BNV	Diesel	1422	3	6	40
Ibiza III (6L1)	05/06→11/09	BXV	Petrol	1198	3	12	23
Ibiza III (6L1)	05/06→11/09	BXW	Petrol	1390	4	16	44
Ibiza III (6L1)	11/06→11/09	BTS	Petrol	1598	4	16	67
Ibiza III (6L1)	06/07→05/08	BBM	Petrol	1198	3	6	22
Ibiza IV (6J5, 6P1)	03/08→06/10	BLS	Diesel	1896	4	8	99
Ibiza IV (6J5, 6P1)	03/08→	BXW	Petrol	1390	4	16	44
Ibiza IV (6J5, 6P1)	03/08→	BZG	Petrol	1198	3	12	23
Ibiza IV (6J5, 6P1)	03/08→	CGGB	Petrol	1390	4	16	37
Ibiza IV (6J5, 6P1)	03/08→	CGPA	Petrol	1198	3	12	23
Ibiza IV (6J5, 6P1)	03/08→	CJLB	Petrol	1198	3	12	23
Ibiza IV (6J5, 6P1)	05/08→	BTS	Petrol	1598	4	16	67
Ibiza IV (6J5, 6P1)	07/08→06/10	BMS	Diesel	1422	3	6	43
Ibiza IV (6J5, 6P1)	07/08→06/10	BXJ	Diesel	1896	4	8	99
Ibiza IV (6J5, 6P1)	09/08→	BAH	Petrol	1598	4	8	66
Ibiza IV (6J5, 6P1)	10/08→	CEKA	Petrol	1984	4	8	114
Ibiza IV (6J5, 6P1)	05/09→	CAYB	Diesel	1598	4	16	68
Ibiza IV (6J5, 6P1)	05/09→	CAYC	Diesel	1598	4	16	68
Ibiza IV (6J5, 6P1)	05/09→	CLNA	Diesel	1598	4	16	68
Ibiza IV (6J5, 6P1)	06/09→	CAVF	Petrol	1390	4	16	45
Ibiza IV (6J5, 6P1)	06/09→	CNUB	Petrol	1390	4	16	45
Ibiza IV (6J5, 6P1)	06/09→	CTHF	Petrol	1390	4	16	45
Ibiza IV (6J5, 6P1)	06/09→	CTJB	Petrol	1390	4	16	45
Ibiza IV (6J5, 6P1)	07/09→	CGPB	Petrol	1198	3	12	23
Ibiza IV (6J5, 6P1)	01/10→	CFHD	Diesel	1968	4	16	112
Ibiza IV (6J5, 6P1)	05/10→	CFWA	Diesel	1199	3	12	25
Ibiza IV (6J5, 6P1)	09/10→	CBZB	Petrol	1197	4	8	24
Ibiza IV (6J5, 6P1)	05/11→	CNKA	Petrol	1598	4	16	67
Ibiza IV (6J5, 6P1)	08/12→	CBZA	Petrol	1197	4	8	24
Ibiza IV (6J5, 6P1)	10/13→	CPTA	Petrol	1395	4	16	47
Ibiza IV (6J5, 6P1)	05/15→	CHYB	Petrol	999	3	12	16
Ibiza IV (6J5, 6P1)	05/15→	CHZB	Petrol	999	3	12	16
Ibiza IV (6J5, 6P1)	05/15→	CHZC	Petrol	999	3	12	16
Ibiza IV (6J5, 6P1)	05/15→	CJZC	Petrol	1197	4	16	27
Ibiza IV (6J5, 6P1)	05/15→	CUSA	Diesel	1422	3	12	48
Ibiza IV (6J5, 6P1)	05/15→	CUSB	Diesel	1422	3	12	48
Ibiza IV (6J5, 6P1)	05/15→	CUTA	Diesel	1422	3	12	48
Ibiza IV (6J5, 6P1)	07/15→	CWVA	Petrol	1598	4	16	70

							
Ibiza IV (6J5, 6P1)	09/15→	CJZD	Petrol	1197	4	16	27
Ibiza IV (6J5, 6P1)	11/15→	CZEA	Petrol	1395	4	16	49
Ibiza IV Sportcoupe (6J1, 6P5)	07/08→06/10	BLS	Diesel	1896	4	8	99
Ibiza IV Sportcoupe (6J1, 6P5)	07/08→06/10	BMS	Diesel	1422	3	6	43
Ibiza IV Sportcoupe (6J1, 6P5)	07/08→06/10	BXJ	Diesel	1896	4	8	99
Ibiza IV Sportcoupe (6J1, 6P5)	07/08→	BTS	Petrol	1598	4	16	67
Ibiza IV Sportcoupe (6J1, 6P5)	07/08→	BXW	Petrol	1390	4	16	44
Ibiza IV Sportcoupe (6J1, 6P5)	07/08→	BZG	Petrol	1198	3	12	23
Ibiza IV Sportcoupe (6J1, 6P5)	07/08→	CGGB	Petrol	1390	4	16	37
Ibiza IV Sportcoupe (6J1, 6P5)	07/08→	CGPA	Petrol	1198	3	12	23
Ibiza IV Sportcoupe (6J1, 6P5)	07/08→	CJLB	Petrol	1198	3	12	23
Ibiza IV Sportcoupe (6J1, 6P5)	10/08→	CEKA	Petrol	1984	4	8	114
Ibiza IV Sportcoupe (6J1, 6P5)	05/09→	CAYB	Diesel	1598	4	16	68
Ibiza IV Sportcoupe (6J1, 6P5)	05/09→	CAYC	Diesel	1598	4	16	68
Ibiza IV Sportcoupe (6J1, 6P5)	05/09→	CLNA	Diesel	1598	4	16	68
Ibiza IV Sportcoupe (6J1, 6P5)	06/09→	CAVE	Petrol	1390	4	16	45
Ibiza IV Sportcoupe (6J1, 6P5)	06/09→	CAVF	Petrol	1390	4	16	45
Ibiza IV Sportcoupe (6J1, 6P5)	06/09→	CNUB	Petrol	1390	4	16	45
Ibiza IV Sportcoupe (6J1, 6P5)	06/09→	CTHE	Petrol	1390	4	16	45
Ibiza IV Sportcoupe (6J1, 6P5)	06/09→	CTHF	Petrol	1390	4	16	45
Ibiza IV Sportcoupe (6J1, 6P5)	06/09→	CTJB	Petrol	1390	4	16	45
Ibiza IV Sportcoupe (6J1, 6P5)	06/09→	CTJC	Petrol	1390	4	16	45
Ibiza IV Sportcoupe (6J1, 6P5)	07/09→	CGPB	Petrol	1198	3	12	23
Ibiza IV Sportcoupe (6J1, 6P5)	01/10→	CFHD	Diesel	1968	4	16	112
Ibiza IV Sportcoupe (6J1, 6P5)	05/10→	CFWA	Diesel	1199	3	12	25
Ibiza IV Sportcoupe (6J1, 6P5)	09/10→	CBZB	Petrol	1197	4	8	24
Ibiza IV Sportcoupe (6J1, 6P5)	05/11→	CNKA	Petrol	1598	4	16	67
Ibiza IV Sportcoupe (6J1, 6P5)	08/12→	CBZA	Petrol	1197	4	8	24
Ibiza IV Sportcoupe (6J1, 6P5)	10/13→	CPTA	Petrol	1395	4	16	47
Ibiza IV Sportcoupe (6J1, 6P5)	05/15→	CHYB	Petrol	999	3	12	16
Ibiza IV Sportcoupe (6J1, 6P5)	05/15→	CHZB	Petrol	999	3	12	16
Ibiza IV Sportcoupe (6J1, 6P5)	05/15→	CHZC	Petrol	999	3	12	16
Ibiza IV Sportcoupe (6J1, 6P5)	05/15→	CJZC	Petrol	1197	4	16	27
Ibiza IV Sportcoupe (6J1, 6P5)	05/15→	CUSA	Diesel	1422	3	12	48
Ibiza IV Sportcoupe (6J1, 6P5)	05/15→	CUSB	Diesel	1422	3	12	48
Ibiza IV Sportcoupe (6J1, 6P5)	05/15→	CUTA	Diesel	1422	3	12	48
Ibiza IV Sportcoupe (6J1, 6P5)	07/15→	CWVA	Petrol	1598	4	16	70
Ibiza IV Sportcoupe (6J1, 6P5)	09/15→	CJZD	Petrol	1197	4	16	27
Ibiza IV Sportcoupe (6J1, 6P5)	11/15→	CZEA	Petrol	1395	4	16	49
Ibiza IV Sportcoupe (6J1, 6P5)	11/15→	DAJA	Petrol	1798	4	16	83
Ibiza IV ST (6J8, 6P8)	03/10→	CAYB	Diesel	1598	4	16	68
Ibiza IV ST (6J8, 6P8)	03/10→	CAYC	Diesel	1598	4	16	68
Ibiza IV ST (6J8, 6P8)	03/10→	CGGB	Petrol	1390	4	16	37
Ibiza IV ST (6J8, 6P8)	03/10→	CLNA	Diesel	1598	4	16	68
Ibiza IV ST (6J8, 6P8)	04/10→	CFWA	Diesel	1199	3	12	25
Ibiza IV ST (6J8, 6P8)	05/10→	BZG	Petrol	1198	3	12	23
Ibiza IV ST (6J8, 6P8)	05/10→	CGPA	Petrol	1198	3	12	23
Ibiza IV ST (6J8, 6P8)	05/10→	CGPB	Petrol	1198	3	12	23
Ibiza IV ST (6J8, 6P8)	05/10→	CJLB	Petrol	1198	3	12	23
Ibiza IV ST (6J8, 6P8)	09/10→	CBZB	Petrol	1197	4	8	24
Ibiza IV ST (6J8, 6P8)	02/12→	BTS	Petrol	1598	4	16	67
Ibiza IV ST (6J8, 6P8)	02/12→	CAVF	Petrol	1390	4	16	45
Ibiza IV ST (6J8, 6P8)	02/12→	CNUB	Petrol	1390	4	16	45
Ibiza IV ST (6J8, 6P8)	02/12→	CTHF	Petrol	1390	4	16	45
Ibiza IV ST (6J8, 6P8)	02/12→	CTJB	Petrol	1390	4	16	45
Ibiza IV ST (6J8, 6P8)	09/12→	CBZA	Petrol	1197	4	8	24
Ibiza IV ST (6J8, 6P8)	10/13→	CPTA	Petrol	1395	4	16	47
Ibiza IV ST (6J8, 6P8)	05/15→	CHYB	Petrol	999	3	12	16
Ibiza IV ST (6J8, 6P8)	05/15→	CHZB	Petrol	999	3	12	16
Ibiza IV ST (6J8, 6P8)	05/15→	CHZC	Petrol	999	3	12	16
Ibiza IV ST (6J8, 6P8)	05/15→	CJZC	Petrol	1197	4	16	27
Ibiza IV ST (6J8, 6P8)	05/15→	CUSA	Diesel	1422	3	12	48
Ibiza IV ST (6J8, 6P8)	05/15→	CUSB	Diesel	1422	3	12	48
Ibiza IV ST (6J8, 6P8)	05/15→	CUTA	Diesel	1422	3	12	48
Ibiza IV ST (6J8, 6P8)	09/15→	CJZD	Petrol	1197	4	16	27
Ibiza IV ST (6J8, 6P8)	11/15→	CZEA	Petrol	1395	4	16	49
Ibiza V (KJ1)	01/17→	CHYB	Petrol	999	3	12	16
Ibiza V (KJ1)	01/17→	CHZJ	Petrol	999	3	12	17
Ibiza V (KJ1)	05/17→	CWVA	Petrol	1598	4	16	70
Inca (6K9)	11/95→05/98	1F	Petrol	1595	4	8	52
Inca (6K9)	11/95→06/03	1Y	Diesel	1896	4	8	86
Inca (6K9)	11/95→06/03	AEX	Petrol	1391	4	8	35
Inca (6K9)	11/95→06/03	AEY	Diesel	1896	4	8	90
Inca (6K9)	11/95→06/03	AKV	Petrol	1391	4	8	39
Inca (6K9)	11/95→06/03	APQ	Petrol	1391	4	8	41
Inca (6K9)	11/95→06/03	AUD	Petrol	1390	4	8	38
Inca (6K9)	11/95→06/03	AYQ	Diesel	1896	4	8	98
Inca (6K9)	09/96→06/03	AHB	Diesel	1716	4	8	74







CC



9

Inca (6K9)	09/96→06/03	ALH	Diesel	1896	4	8	93
Inca (6K9)	06/97→09/00	AEE	Petrol	1598	4	8	58
Inca (6K9)	06/97→09/00	ALM	Petrol	1598	4	8	61
Inca (6K9)	04/00→06/03	AUA	Petrol	1390	4	16	37
Leon (1M1)	11/99→06/06	AEH	Petrol	1595	4	8	59
Leon (1M1)	11/99→06/06	AGN	Petrol	1781	4	20	80
Leon (1M1)	11/99→06/06	AGR	Diesel	1896	4	8	92
Leon (1M1)	11/99→06/06	AHF	Diesel	1896	4	8	93
Leon (1M1)	11/99→06/06	AHW	Petrol	1390	4	16	37
Leon (1M1)	11/99→06/06	AJQ	Petrol	1781	4	20	82
Leon (1M1)	11/99→06/06	AKL	Petrol	1595	4	8	59
Leon (1M1)	11/99→06/06	ALH	Diesel	1896	4	8	93
Leon (1M1)	11/99→06/06	APE	Petrol	1390	4	16	37
Leon (1M1)	11/99→06/06	APF	Petrol	1595	4	8	63
Leon (1M1)	11/99→06/06	APG	Petrol	1781	4	20	82
Leon (1M1)	11/99→06/06	APP	Petrol	1781	4	20	82
Leon (1M1)	11/99→06/06	AQM	Diesel	1896	4	8	92
Leon (1M1)	11/99→06/06	ARY	Petrol	1781	4	20	82
Leon (1M1)	11/99→06/06	ASV	Diesel	1896	4	8	92
Leon (1M1)	11/99→06/06	AUA	Petrol	1390	4	16	37
Leon (1M1)	11/99→06/06	AUQ	Petrol	1781	4	20	80
Leon (1M1)	11/99→06/06	AXP	Petrol	1390	4	16	37
Leon (1M1)	11/99→06/06	BCA	Petrol	1390	4	16	37
Leon (1M1)	09/00→06/06	ARL	Diesel	1896	4	8	96
Leon (1M1)	09/00→06/06	ATN	Petrol	1598	4	16	64
Leon (1M1)	09/00→06/06	AUS	Petrol	1598	4	16	64
Leon (1M1)	09/00→06/06	AZD	Petrol	1598	4	16	65
Leon (1M1)	09/00→06/06	BCB	Petrol	1598	4	16	64
Leon (1M1)	02/01→06/06	AUE	Petrol	2792	6	24	122
Leon (1M1)	02/02→06/06	AMK	Petrol	1781	4	20	82
Leon (1M1)	05/02→06/04	BDE	Petrol	2792	6	24	122
Leon (1M1)	05/03→06/06	ASZ	Diesel	1896	4	8	95
Leon (1M1)	07/03→06/06	BAM	Petrol	1781	4	20	80
Leon (1M1)	10/05→06/06	AXR	Diesel	1896	4	8	95
Leon (1M1)	10/05→06/06	BFQ	Petrol	1595	4	8	62
Leon (1M1)	10/05→06/06	BGU	Petrol	1595	4	8	62
Leon (1P1)	05/05→03/09	BWA	Petrol	1984	4	16	111
Leon (1P1)	07/05→05/10	AZV	Diesel	1968	4	16	107
Leon (1P1)	07/05→05/10	BLR	Petrol	1984	4	16	109
Leon (1P1)	07/05→05/10	BLY	Petrol	1984	4	16	109
Leon (1P1)	07/05→05/10	BVY	Petrol	1984	4	16	109
Leon (1P1)	07/05→05/10	BVZ	Petrol	1984	4	16	109
Leon (1P1)	07/05→12/10	BKC	Diesel	1896	4	8	99
Leon (1P1)	07/05→12/10	BLS	Diesel	1896	4	8	99
Leon (1P1)	07/05→12/10	BXE	Diesel	1896	4	8	99
Leon (1P1)	07/05→12/12	BKD	Diesel	1968	4	16	108
Leon (1P1)	07/05→12/12	BSE	Petrol	1595	4	8	62
Leon (1P1)	07/05→12/12	BSF	Petrol	1595	4	8	62
Leon (1P1)	07/05→12/12	CCSA	Petrol	1595	4	8	62
Leon (1P1)	07/05→12/12	CFHC	Diesel	1968	4	16	112
Leon (1P1)	07/05→12/12	CLCB	Diesel	1968	4	16	112
Leon (1P1)	07/05→12/12	CMXA	Petrol	1595	4	8	62
Leon (1P1)	09/05→05/06	BWA1	Petrol	1984	4	16	111
Leon (1P1)	10/05→10/10	BMM	Diesel	1968	4	8	110
Leon (1P1)	05/06→12/12	BMN	Diesel	1968	4	16	107
Leon (1P1)	05/06→12/12	CEGA	Diesel	1968	4	16	112
Leon (1P1)	05/06→12/12	CFJA	Diesel	1968	4	16	112
Leon (1P1)	06/06→12/12	BXW	Petrol	1390	4	16	44
Leon (1P1)	06/06→12/12	CGGB	Petrol	1390	4	16	37
Leon (1P1)	11/06→05/11	BWJ	Petrol	1984	4	16	111
Leon (1P1)	11/06→05/11	CDLD	Petrol	1984	4	16	111
Leon (1P1)	06/07→12/10	BXF	Diesel	1896	4	8	99
Leon (1P1)	06/07→12/12	BZB	Petrol	1798	4	16	83
Leon (1P1)	06/07→12/12	CDAA	Petrol	1798	4	16	83
Leon (1P1)	11/07→12/12	CAXC	Petrol	1390	4	16	45
Leon (1P1)	06/09→12/12	CCZB	Petrol	1984	4	16	113
Leon (1P1)	09/09→12/12	CDLA	Petrol	1984	4	16	111
Leon (1P1)	12/09→12/12	CHGA	Petrol	1595	4	8	62
Leon (1P1)	02/10→12/12	CAYC	Diesel	1598	4	16	68
Leon (1P1)	02/10→12/12	CBZB	Petrol	1197	4	8	24
Leon (1P1)	11/10→12/12	CAYB	Diesel	1598	4	16	68
Leon (5F1)	09/12→	CHPA	Petrol	1395	4	16	46
Leon (5F1)	09/12→	CPTA	Petrol	1395	4	16	47
Leon (5F1)	09/12→	CUNA	Diesel	1968	4	16	116
Leon (5F1)	09/12→	CUPA	Diesel	1968	4	16	116
Leon (5F1)	10/12→	CKFC	Diesel	1968	4	16	116
Leon (5F1)	10/12→	CRMB	Diesel	1968	4	16	116
Leon (5F1)	11/12→	CLHA	Diesel	1598	4	16	69

				CC			9
Leon (5F1)	11/12→	CLHB	Diesel	1598	4	16	69
Leon (5F1)	11/12→	CMBA	Petrol	1395	4	16	46
Leon (5F1)	11/12→	CXSA	Petrol	1395	4	16	46
Leon (5F1)	12/12→	CJZB	Petrol	1197	4	16	27
Leon (5F1)	12/12→	CYVA	Petrol	1197	4	16	27
Leon (5F1)	01/13→	CJZA	Petrol	1197	4	16	27
Leon (5F1)	02/13→	CJSA	Petrol	1798	4	16	84
Leon (5F1)	02/13→	CPWA	Petrol	1395	4	16	46
Leon (5F1)	05/13→	CRVA	Diesel	1968	4	16	116
Leon (5F1)	05/13→	CRVC	Diesel	1968	4	16	116
Leon (5F1)	09/13→	CRKB	Diesel	1598	4	16	69
Leon (5F1)	09/13→	CXXB	Diesel	1598	4	16	69
Leon (5F1)	09/13→	DBKA	Diesel	1598	4	16	69
Leon (5F1)	10/13→	CJXA	Petrol	1984	4	16	115
Leon (5F1)	10/13→	CJXE	Petrol	1984	4	16	115
Leon (5F1)	04/14→	CYVB	Petrol	1197	4	16	27
Leon (5F1)	05/14→	CZCA	Petrol	1395	4	16	46
Leon (5F1)	05/14→	CZEA	Petrol	1395	4	16	49
Leon (5F1)	05/15→	CHZD	Petrol	999	3	12	16
Leon (5F1)	10/15→	CJXH	Petrol	1984	4	16	115
Leon (5F1)	11/16→	DDYA	Diesel	1598	4	16	69
Leon (5F1)	01/17→	CJXC	Petrol	1984	4	16	115
Leon SC (5F5)	01/13→	CJZB	Petrol	1197	4	16	27
Leon SC (5F5)	01/13→	CYVA	Petrol	1197	4	16	27
Leon SC (5F5)	02/13→	CHPA	Petrol	1395	4	16	46
Leon SC (5F5)	02/13→	CJSA	Petrol	1798	4	16	84
Leon SC (5F5)	02/13→	CJZA	Petrol	1197	4	16	27
Leon SC (5F5)	02/13→	CKFC	Diesel	1968	4	16	116
Leon SC (5F5)	02/13→	CLHA	Diesel	1598	4	16	69
Leon SC (5F5)	02/13→	CLHB	Diesel	1598	4	16	69
Leon SC (5F5)	02/13→	CMBA	Petrol	1395	4	16	46
Leon SC (5F5)	02/13→	CPTA	Petrol	1395	4	16	47
Leon SC (5F5)	02/13→	CRMB	Diesel	1968	4	16	116
Leon SC (5F5)	02/13→	CRVA	Diesel	1968	4	16	116
Leon SC (5F5)	02/13→	CXSA	Petrol	1395	4	16	46
Leon SC (5F5)	03/13→	CUNA	Diesel	1968	4	16	116
Leon SC (5F5)	03/13→	CUPA	Diesel	1968	4	16	116
Leon SC (5F5)	05/13→	CRVC	Diesel	1968	4	16	116
Leon SC (5F5)	09/13→	CRKB	Diesel	1598	4	16	69
Leon SC (5F5)	09/13→	CXXB	Diesel	1598	4	16	69
Leon SC (5F5)	09/13→	DBKA	Diesel	1598	4	16	69
Leon SC (5F5)	10/13→	CJXA	Petrol	1984	4	16	115
Leon SC (5F5)	10/13→	CJXE	Petrol	1984	4	16	115
Leon SC (5F5)	05/14→	CYVB	Petrol	1197	4	16	27
Leon SC (5F5)	05/14→	CZCA	Petrol	1395	4	16	46
Leon SC (5F5)	05/14→	CZEA	Petrol	1395	4	16	49
Leon SC (5F5)	05/15→	CHZD	Petrol	999	3	12	16
Leon SC (5F5)	10/15→	CJXH	Petrol	1984	4	16	115
Leon SC (5F5)	11/16→	DDYA	Diesel	1598	4	16	69
Leon SC (5F5)	01/17→	CJXC	Petrol	1984	4	16	115
Leon ST (5F8)	08/13→	CJZA	Petrol	1197	4	16	27
Leon ST (5F8)	08/13→	CUNA	Diesel	1968	4	16	116
Leon ST (5F8)	08/13→	CUPA	Diesel	1968	4	16	116
Leon ST (5F8)	09/13→	CRKB	Diesel	1598	4	16	69
Leon ST (5F8)	09/13→	CXXB	Diesel	1598	4	16	69
Leon ST (5F8)	09/13→	DBKA	Diesel	1598	4	16	69
Leon ST (5F8)	10/13→	CHPA	Petrol	1395	4	16	46
Leon ST (5F8)	10/13→	CJSA	Petrol	1798	4	16	84
Leon ST (5F8)	10/13→	CJXA	Petrol	1984	4	16	115
Leon ST (5F8)	10/13→	CJXE	Petrol	1984	4	16	115
Leon ST (5F8)	10/13→	CKFC	Diesel	1968	4	16	116
Leon ST (5F8)	10/13→	CLHA	Diesel	1598	4	16	69
Leon ST (5F8)	10/13→	CMBA	Petrol	1395	4	16	46
Leon ST (5F8)	10/13→	CPTA	Petrol	1395	4	16	47
Leon ST (5F8)	10/13→	CPWA	Petrol	1395	4	16	46
Leon ST (5F8)	10/13→	CRCB	Diesel	1968	4	16	116
Leon ST (5F8)	10/13→	CRLB	Diesel	1968	4	16	116
Leon ST (5F8)	10/13→	CRMB	Diesel	1968	4	16	116
Leon ST (5F8)	10/13→	CRVC	Diesel	1968	4	16	116
Leon ST (5F8)	10/13→	CXSA	Petrol	1395	4	16	46
Leon ST (5F8)	11/13→	CJZB	Petrol	1197	4	16	27
Leon ST (5F8)	11/13→	CLHB	Diesel	1598	4	16	69
Leon ST (5F8)	11/13→	CRVA	Diesel	1968	4	16	116
Leon ST (5F8)	11/13→	CYVA	Petrol	1197	4	16	27
Leon ST (5F8)	05/14→	CYVB	Petrol	1197	4	16	27
Leon ST (5F8)	05/14→	CZCA	Petrol	1395	4	16	46
Leon ST (5F8)	05/14→	CZEA	Petrol	1395	4	16	49
Leon ST (5F8)	11/14→	CJSB	Petrol	1798	4	16	84



CC



9

Leon ST (5F8)	05/15→	CHZD	Petrol	999	3	12	16
Leon ST (5F8)	10/15→	CJXH	Petrol	1984	4	16	115
Leon ST (5F8)	11/16→	CJXC	Petrol	1984	4	16	115
Leon ST (5F8)	11/16→	DDYA	Diesel	1598	4	16	69
Malaga (023A)	11/84→12/93	021 A 1000	Petrol	1193	4	8	20
Malaga (023A)	05/85→12/93	021 A 2000	Petrol	1461	4	8	50
Malaga (023A)	05/85→12/93	022 A.5000	Diesel	1714	4	8	72
Malaga (023A)	10/86→12/93	021 C.2000	Petrol	1461	4	8	32
Malaga (023A)	10/86→12/93	021 D.2000	Petrol	1461	4	8	32
Malaga (023A)	01/87→12/93	021 B.2000	Petrol	1461	4	8	32
Malaga (023A)	12/89→12/93	021 C.1000	Petrol	1193	4	8	20
Marbella (28)	08/86→12/93	08 NCA	Petrol	843	4	8	1
Marbella (28)	01/87→12/93	09 NCA	Petrol	903	4	8	2
Marbella (28)	01/87→11/96	100 GL 7000	Petrol	903	4	8	6
Marbella (28)	01/90→11/96	09 NCB	Petrol	903	4	8	3
Marbella (28)	11/96→10/98	08 NCB	Petrol	899	4	8	2
Marbella Box (028A)	01/87→12/93	08 NCA	Petrol	843	4	8	1
Marbella Box (028A)	01/87→12/93	09 NCA	Petrol	903	4	8	2
Marbella Box (028A)	01/87→12/93	09 NCB	Petrol	903	4	8	3
Mii (KF1)	10/11→	CHYA	Petrol	999	3	12	16
Mii (KF1)	10/11→	CHYB	Petrol	999	3	12	16
Mii (KF1)	11/12→	CPGA	Gas	999	3	12	18
Panda (141A)	10/80→12/86	100 GL 3000	Petrol	903	4	8	5
Ritmo (138)	07/78→09/83	12AC	Petrol	1197	4	8	19
Ritmo (138)	07/78→09/83	15G	Petrol	1438	4	8	31
Ritmo (138)	10/79→09/83	022 A.5000	Diesel	1714	4	8	72
Ronda (022A)	06/82→12/86	022 A.5000	Diesel	1714	4	8	72
Ronda (022A)	09/84→12/86	021 A 2000	Petrol	1461	4	8	50
Ronda (022A)	10/84→12/86	021 A 1000	Petrol	1193	4	8	20
Terra (24)	02/87→12/96	09 NCA	Petrol	903	4	8	2
Terra (24)	03/90→12/94	MN	Diesel	1272	4	8	29
Terra (24)	10/90→12/95	1 W	Diesel	1398	4	8	30
Terra (24)	02/92→12/94	09 NCB	Petrol	903	4	8	3
Terra Box (024A)	01/87→12/95	09 NCA	Petrol	903	4	8	2
Terra Box (024A)	01/90→12/95	09 NCB	Petrol	903	4	8	3
Terra Box (024A)	03/90→02/92	MN	Diesel	1272	4	8	29
Terra Box (024A)	10/90→02/92	1 W	Diesel	1398	4	8	30
Toledo I (1L)	05/91→12/96	RP	Petrol	1781	4	8	85
Toledo I (1L)	05/91→03/99	1F	Petrol	1595	4	8	52
Toledo I (1L)	05/91→03/99	1Y	Diesel	1896	4	8	86
Toledo I (1L)	05/91→03/99	2E	Petrol	1984	4	8	101
Toledo I (1L)	05/91→03/99	AAZ	Diesel	1896	4	8	88
Toledo I (1L)	05/91→03/99	ABN	Petrol	1595	4	8	56
Toledo I (1L)	05/91→03/99	AGG	Petrol	1984	4	8	105
Toledo I (1L)	05/91→03/99	EZ	Petrol	1595	4	8	56
Toledo I (1L)	05/91→03/99	KR	Petrol	1781	4	16	78
Toledo I (1L)	05/91→03/99	PL	Petrol	1781	4	16	78
Toledo I (1L)	11/93→12/96	ABS	Petrol	1781	4	8	76
Toledo I (1L)	11/93→12/96	ACC	Petrol	1781	4	8	77
Toledo I (1L)	11/93→12/96	ADZ	Petrol	1781	4	8	79
Toledo I (1L)	11/93→03/99	ABF	Petrol	1984	4	16	103
Toledo I (1L)	08/95→03/99	1Z	Diesel	1896	4	8	87
Toledo I (1L)	08/95→03/99	AHU	Diesel	1896	4	8	94
Toledo I (1L)	11/96→03/99	AFN	Diesel	1896	4	8	91
Toledo I (1L)	11/96→03/99	AFT	Petrol	1595	4	8	60
Toledo II (1M2)	10/98→11/00	AGZ	Petrol	2324	5	10	119
Toledo II (1M2)	10/98→07/04	AEH	Petrol	1595	4	8	59
Toledo II (1M2)	10/98→07/04	AGN	Petrol	1781	4	20	80
Toledo II (1M2)	10/98→07/04	AHF	Diesel	1896	4	8	93
Toledo II (1M2)	10/98→07/04	AKL	Petrol	1595	4	8	59
Toledo II (1M2)	10/98→07/04	APF	Petrol	1595	4	8	63
Toledo II (1M2)	10/98→07/04	APG	Petrol	1781	4	20	82
Toledo II (1M2)	10/98→07/04	ASV	Diesel	1896	4	8	92
Toledo II (1M2)	03/99→07/04	AGR	Diesel	1896	4	8	92
Toledo II (1M2)	03/99→07/04	ALH	Diesel	1896	4	8	93
Toledo II (1M2)	01/00→05/02	AHW	Petrol	1390	4	16	37
Toledo II (1M2)	01/00→05/02	APE	Petrol	1390	4	16	37
Toledo II (1M2)	01/00→05/02	AUA	Petrol	1390	4	16	37
Toledo II (1M2)	01/00→05/02	AXP	Petrol	1390	4	16	37
Toledo II (1M2)	01/00→05/02	BCA	Petrol	1390	4	16	37
Toledo II (1M2)	06/00→05/06	AUS	Petrol	1598	4	16	64
Toledo II (1M2)	06/00→05/06	AZD	Petrol	1598	4	16	65
Toledo II (1M2)	06/00→05/06	BCB	Petrol	1598	4	16	64
Toledo II (1M2)	09/00→11/03	AQN	Petrol	2324	5	20	120
Toledo II (1M2)	09/00→07/04	APP	Petrol	1781	4	20	82
Toledo II (1M2)	09/00→07/04	AUQ	Petrol	1781	4	20	80
Toledo II (1M2)	10/00→07/01	AUE	Petrol	2792	6	24	122
Toledo II (1M2)	10/00→07/04	ARL	Diesel	1896	4	8	96



















CC



9

Model	Period	Code	Fuel	CC	Gear	Steering	Power
Toledo II (1M2)	05/03→05/06	ASZ	Diesel	1896	4	8	95
Toledo II (1M2)	08/05→05/06	AXR	Diesel	1896	4	8	95
Toledo II (1M2)	08/05→05/06	BFQ	Petrol	1595	4	8	62
Toledo III (5P2)	04/04→05/09	BKD	Diesel	1968	4	16	108
Toledo III (5P2)	09/04→05/09	AZV	Diesel	1968	4	16	107
Toledo III (5P2)	10/04→05/09	BGU	Petrol	1595	4	8	62
Toledo III (5P2)	10/04→05/09	BJB	Diesel	1896	4	8	99
Toledo III (5P2)	10/04→05/09	BKC	Diesel	1896	4	8	99
Toledo III (5P2)	10/04→05/09	BLR	Petrol	1984	4	16	109
Toledo III (5P2)	10/04→05/09	BLS	Diesel	1896	4	8	99
Toledo III (5P2)	10/04→05/09	BLY	Petrol	1984	4	16	109
Toledo III (5P2)	10/04→05/09	BSE	Petrol	1595	4	8	62
Toledo III (5P2)	10/04→05/09	BSF	Petrol	1595	4	8	62
Toledo III (5P2)	10/04→05/09	BVY	Petrol	1984	4	16	109
Toledo III (5P2)	10/04→05/09	BVZ	Petrol	1984	4	16	109
Toledo III (5P2)	10/04→05/09	BXE	Diesel	1896	4	8	99
Toledo III (5P2)	10/04→05/09	CCSA	Petrol	1595	4	8	62
Toledo III (5P2)	11/05→05/09	BMM	Diesel	1968	4	8	110
Toledo III (5P2)	11/05→05/09	BWA	Petrol	1984	4	16	111
Toledo III (5P2)	01/06→05/09	BMN	Diesel	1968	4	16	107
Toledo III (5P2)	01/06→05/09	CEGA	Diesel	1968	4	16	112
Toledo III (5P2)	05/06→05/09	BXW	Petrol	1390	4	16	44
Toledo III (5P2)	01/07→05/09	BYT	Petrol	1798	4	16	83
Toledo III (5P2)	01/07→05/09	BZB	Petrol	1798	4	16	83
Toledo III (5P2)	01/07→05/09	CDAA	Petrol	1798	4	16	83
Toledo III (5P2)	11/07→05/09	CAXC	Petrol	1390	4	16	45
Toledo IV (KG3)	07/12→	CAXA	Petrol	1390	4	16	45
Toledo IV (KG3)	07/12→	CAYC	Diesel	1598	4	16	68
Toledo IV (KG3)	07/12→	CBZA	Petrol	1197	4	8	24
Toledo IV (KG3)	07/12→	CBZB	Petrol	1197	4	8	24
Toledo IV (KG3)	07/12→	CGPC	Petrol	1198	3	12	23
Toledo IV (KG3)	07/12→	CLNA	Diesel	1598	4	16	68
Toledo IV (KG3)	06/13→	CAYB	Diesel	1598	4	16	68
Toledo IV (KG3)	07/13→	CFNA	Petrol	1598	4	16	67
Toledo IV (KG3)	05/15→	CJZC	Petrol	1197	4	16	27
Toledo IV (KG3)	05/15→	CJZD	Petrol	1197	4	16	27
Toledo IV (KG3)	05/15→	CUSB	Diesel	1422	3	12	48
Toledo IV (KG3)	05/15→	CWVA	Petrol	1598	4	16	70
Toledo IV (KG3)	05/15→	CXMA	Diesel	1598	4	16	69
Toledo IV (KG3)	05/15→	CZCA	Petrol	1395	4	16	46
Toledo IV (KG3)	05/17→	CHZB	Petrol	999	3	12	16
Toledo IV (KG3)	05/17→	CHZC	Petrol	999	3	12	16

	CC				9		CC				9
1F	1595	4	8	Petrol	52	ALH	1896	4	8	Diesel	93
1 W	1398	4	8	Diesel	30	ALL	999	4	8	Petrol	14
1Y	1896	4	8	Diesel	86	ALM	1598	4	8	Petrol	61
1Z	1896	4	8	Diesel	87	ALZ	1595	4	8	Petrol	62
2E	1984	4	8	Petrol	101	AMF	1422	3	6	Diesel	40
2G	1272	4	8	Petrol	28	AMK	1781	4	20	Petrol	82
08 NCA	843	4	8	Petrol	1	ANM	1390	4	16	Petrol	37
08 NCB	899	4	8	Petrol	2	ANU	1896	4	8	Diesel	95
09 NCA	903	4	8	Petrol	2	ANV	999	4	8	Petrol	13
09 NCB	903	4	8	Petrol	3	ANW	1390	4	8	Petrol	38
12AC	1197	4	8	Petrol	19	ANX	1390	4	8	Petrol	41
15G	1438	4	8	Petrol	31	APE	1390	4	16	Petrol	37
021 A.3000	1675	4	8	Petrol	71	APF	1595	4	8	Petrol	63
021 A 1000	1193	4	8	Petrol	20	APG	1781	4	20	Petrol	82
021 A 2000	1461	4	8	Petrol	50	APP	1781	4	20	Petrol	82
021 B.2000	1461	4	8	Petrol	32	APQ	1391	4	8	Petrol	41
021 B.3000	1675	4	8	Petrol	71	AQM	1896	4	8	Diesel	92
021 C.1000	1193	4	8	Petrol	20	AQN	2324	5	20	Petrol	120
021 C.2000	1461	4	8	Petrol	32	AQQ	1390	4	16	Petrol	42
021 D.2000	1461	4	8	Petrol	32	AQX	1781	4	20	Petrol	82
022 A.5000	1714	4	8	Diesel	72	ARL	1896	4	8	Diesel	96
100 GL.040	903	4	8	Petrol	4	ARY	1781	4	20	Petrol	82
100 GL 3000	903	4	8	Petrol	5	ASK	1896	4	8	Diesel	97
100 GL 6000	843	4	8	Petrol	1	AST	999	4	16	Petrol	15
100 GL 7000	903	4	8	Petrol	6	ASV	1896	4	8	Diesel	92
120G100	843	4	8	Petrol	7	ASY	1896	4	8	Diesel	95
124 A.000	1197	4	8	Petrol	19	ASZ	1896	4	8	Diesel	95
124 A9.000	1592	4	8	Petrol	53	ATD	1896	4	8	Diesel	95
124 B2.000	1438	4	8	Petrol	33	ATM	1984	4	8	Petrol	106
124 B3.000	1585	4	8	Petrol	54	ATN	1598	4	16	Petrol	64
126G100	843	4	8	Petrol	8	AUA	1390	4	16	Petrol	37
131 C4.000	1995	4	8	Petrol	102	AUB	1390	4	16	Petrol	37
132B0000	1592	4	8	Petrol	55	AUC	999	4	8	Petrol	13
132 B1.000	1756	4	8	Petrol	73	AUD	1390	4	8	Petrol	38
132 BB OA O	1592	4	8	Petrol	55	AUE	2792	6	24	Petrol	122
138 A5.000	1714	4	8	Diesel	72	AUQ	1781	4	20	Petrol	80
146 A 000	903	4	8	Petrol	6	AUR	1595	4	8	Petrol	63
8144.61	2445	4	8	Diesel	121	AUS	1598	4	16	Petrol	64
A112 A5.000	903	4	8	Petrol	4	AUY	1896	4	8	Diesel	95
AAU	1043	4	8	Petrol	10	AVG	1896	4	8	Diesel	97
AAV	1272	4	8	Petrol	28	AVZ	999	4	16	Petrol	15
AAZ	1896	4	8	Diesel	88	AWC	1781	4	20	Petrol	81
ABD	1390	4	8	Petrol	34	AXP	1390	4	16	Petrol	37
ABF	1984	4	16	Petrol	103	AXR	1896	4	8	Diesel	95
ABN	1595	4	8	Petrol	56	AYL	2792	6	24	Petrol	122
ABS	1781	4	8	Petrol	76	AYP	1781	4	20	Petrol	82
ABU	1598	4	8	Petrol	57	AYQ	1896	4	8	Diesel	98
ACC	1781	4	8	Petrol	77	AZD	1598	4	16	Petrol	65
ADL	1781	4	16	Petrol	78	AZL	1984	4	8	Petrol	106
ADY	1984	4	8	Petrol	104	AZQ	1198	3	12	Petrol	21
ADZ	1781	4	8	Petrol	79	AZV	1968	4	16	Diesel	107
AEE	1598	4	8	Petrol	58	BAH	1598	4	8	Petrol	66
AEF	1896	4	8	Diesel	89	BAM	1781	4	20	Petrol	80
AEH	1595	4	8	Petrol	59	BBM	1198	3	6	Petrol	22
AER	999	4	8	Petrol	11	BBU	1781	4	20	Petrol	81
AEX	1391	4	8	Petrol	35	BBX	1984	4	8	Petrol	106
AEY	1896	4	8	Diesel	90	BBY	1390	4	16	Petrol	37
AFH	1390	4	16	Petrol	36	BBZ	1390	4	16	Petrol	37
AFK	1390	4	16	Petrol	37	BCA	1390	4	16	Petrol	37
AFN	1896	4	8	Diesel	91	BCB	1598	4	16	Petrol	64
AFT	1595	4	8	Petrol	60	BDE	2792	6	24	Petrol	122
AGG	1984	4	8	Petrol	105	BFQ	1595	4	8	Petrol	62
AGN	1781	4	20	Petrol	80	BGU	1595	4	8	Petrol	62
AGP	1896	4	8	Diesel	92	BJB	1896	4	8	Diesel	99
AGR	1896	4	8	Diesel	92	BJX	1781	4	20	Petrol	81
AGZ	2324	5	10	Petrol	119	BKC	1896	4	8	Diesel	99
AHB	1716	4	8	Diesel	74	BKD	1968	4	16	Diesel	108
AHF	1896	4	8	Diesel	93	BKV	1781	4	20	Petrol	82
AHT	997	4	8	Petrol	12	BKY	1390	4	16	Petrol	37
AHU	1896	4	8	Diesel	94	BLR	1984	4	16	Petrol	109
AHW	1390	4	16	Petrol	37	BLS	1896	4	8	Diesel	99
AJH	1781	4	20	Petrol	81	BLT	1896	4	8	Diesel	95
AJQ	1781	4	20	Petrol	82	BLY	1984	4	16	Petrol	109
AKK	1390	4	8	Petrol	38	BLZ	1781	4	20	Petrol	81
AKL	1595	4	8	Petrol	59	BME	1198	3	12	Petrol	23
AKU	1716	4	8	Diesel	75	BMM	1968	4	8	Diesel	110
AKV	1391	4	8	Petrol	39	BMN	1968	4	16	Diesel	107
ALD	999	4	8	Petrol	13	BMS	1422	3	6	Diesel	43

	CC				9		CC				9
BMT	1896	4	8	Diesel	99	CJSA	1798	4	16	Petrol	84
BNM	1422	3	6	Diesel	40	CJSB	1798	4	16	Petrol	84
BNV	1422	3	6	Diesel	40	CJXA	1984	4	16	Petrol	115
BPX	1896	4	8	Diesel	95	CJXC	1984	4	16	Petrol	115
BRT	1968	4	8	Diesel	110	CJXE	1984	4	16	Petrol	115
BSE	1595	4	8	Petrol	62	CJXH	1984	4	16	Petrol	115
BSF	1595	4	8	Petrol	62	CJZA	1197	4	16	Petrol	27
BTB	1896	4	8	Diesel	95	CJZB	1197	4	16	Petrol	27
BTS	1598	4	16	Petrol	67	CJZC	1197	4	16	Petrol	27
BUK	1896	4	8	Diesel	95	CJZD	1197	4	16	Petrol	27
BVK	1896	4	8	Diesel	95	CKFC	1968	4	16	Diesel	116
BVY	1984	4	16	Petrol	109	CLCB	1968	4	16	Diesel	112
BVZ	1984	4	16	Petrol	109	CLHA	1598	4	16	Diesel	69
BWA	1984	4	16	Petrol	111	CLHB	1598	4	16	Diesel	69
BWA1	1984	4	16	Petrol	111	CLNA	1598	4	16	Diesel	68
BWE	1984	4	16	Petrol	111	CMBA	1395	4	16	Petrol	46
BWJ	1984	4	16	Petrol	111	CMXA	1595	4	8	Petrol	62
BXE	1896	4	8	Diesel	99	CNKA	1598	4	16	Petrol	67
BXF	1896	4	8	Diesel	99	CNUB	1390	4	16	Petrol	45
BXJ	1896	4	8	Diesel	99	CNWB	1390	4	16	Petrol	45
BXV	1198	3	12	Petrol	23	CPGA	999	3	12	Gas	18
BXW	1390	4	16	Petrol	44	CPTA	1395	4	16	Petrol	47
BYT	1798	4	16	Petrol	83	CPWA	1395	4	16	Petrol	46
BZB	1798	4	16	Petrol	83	CRBC	1968	4	16	Diesel	116
BZG	1198	3	12	Petrol	23	CRKB	1598	4	16	Diesel	69
CAGA	1968	4	16	Diesel	112	CRLB	1968	4	16	Diesel	116
CAGC	1968	4	16	Diesel	112	CRMB	1968	4	16	Diesel	116
CAHA	1968	4	16	Diesel	112	CRVA	1968	4	16	Diesel	116
CAVA	1390	4	16	Petrol	45	CRVC	1968	4	16	Diesel	116
CAVE	1390	4	16	Petrol	45	CTHA	1390	4	16	Petrol	45
CAVF	1390	4	16	Petrol	45	CTHE	1390	4	16	Petrol	45
CAXA	1390	4	16	Petrol	45	CTHF	1390	4	16	Petrol	45
CAXC	1390	4	16	Petrol	45	CTJB	1390	4	16	Petrol	45
CAYA	1598	4	16	Diesel	68	CTJC	1390	4	16	Petrol	45
CAYB	1598	4	16	Diesel	68	CUNA	1968	4	16	Diesel	116
CAYC	1598	4	16	Diesel	68	CUPA	1968	4	16	Diesel	116
CBDB	1968	4	16	Diesel	112	CUSA	1422	3	12	Diesel	48
CBZA	1197	4	8	Petrol	24	CUSB	1422	3	12	Diesel	48
CBZB	1197	4	8	Petrol	24	CUTA	1422	3	12	Diesel	48
CCSA	1595	4	8	Petrol	62	CUVA	1968	4	16	Diesel	116
CCZA	1984	4	16	Petrol	113	CUVC	1968	4	16	Diesel	116
CCZB	1984	4	16	Petrol	113	CUWA	1968	4	16	Diesel	116
CDA	1798	4	16	Petrol	83	CWVA	1598	4	16	Petrol	70
CDHA	1798	4	16	Petrol	83	CXMA	1598	4	16	Diesel	69
CDHB	1798	4	16	Petrol	83	CXSA	1395	4	16	Petrol	46
CDLA	1984	4	16	Petrol	111	CXXB	1598	4	16	Diesel	69
CDLD	1984	4	16	Petrol	111	CYVA	1197	4	16	Petrol	27
CDND	1984	4	16	Petrol	113	CYVB	1197	4	16	Petrol	27
CEGA	1968	4	16	Diesel	112	CZCA	1395	4	16	Petrol	46
CEKA	1984	4	8	Petrol	114	CZDA	1395	4	16	Petrol	46
CFFA	1968	4	16	Diesel	112	CZEA	1395	4	16	Petrol	49
CFFB	1968	4	16	Diesel	112	DAJA	1798	4	16	Petrol	83
CFFE	1968	4	16	Diesel	112	DBKA	1598	4	16	Diesel	69
CFGB	1968	4	16	Diesel	112	DDYA	1598	4	16	Diesel	69
CFGC	1968	4	16	Diesel	112	DEDA	1984	4	16	Petrol	115
CFHC	1968	4	16	Diesel	112	DFFA	1968	4	16	Diesel	117
CFHD	1968	4	16	Diesel	112	DFHA	1968	4	16	Diesel	117
CFJA	1968	4	16	Diesel	112	DFLA	1968	4	16	Diesel	117
CFMA	1781	4	20	Petrol	81	DFMA	1968	4	16	Diesel	117
CFNA	1598	4	16	Petrol	67	DH	1915	4	8	Petrol	100
CFWA	1199	3	12	Diesel	25	EZ	1595	4	8	Petrol	56
CGGB	1390	4	16	Petrol	37	FA14	1438	4	8	Petrol	31
CGLB	1968	4	16	Diesel	112	FD	1470	4	8	Petrol	51
CGPA	1198	3	12	Petrol	23	HB 90	903	4	8	Petrol	9
CGPB	1198	3	12	Petrol	23	HM	1595	4	8	Petrol	56
CGPC	1198	3	12	Petrol	23	KR	1781	4	16	Petrol	78
CHFA	1198	3	6	Petrol	26	MN	1272	4	8	Diesel	29
CHGA	1595	4	8	Petrol	62	OM 615.912	2197	4	8	Diesel	118
CHPA	1395	4	16	Petrol	46	PL	1781	4	16	Petrol	78
CHYA	999	3	12	Petrol	16	RP	1781	4	8	Petrol	85
CHYB	999	3	12	Petrol	16						
CHZB	999	3	12	Petrol	16						
CHZC	999	3	12	Petrol	16						
CHZD	999	3	12	Petrol	16						
CHZJ	999	3	12	Petrol	17						
CJCA	1968	4	16	Diesel	112						
CJCC	1968	4	16	Diesel	112						
CJLB	1198	3	12	Petrol	23						

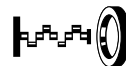
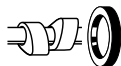
**1 0.8L****Petrol**

08 NCA	4 Cyl.	8 Valves	843cc	TD3556
100 GL 6000	4 Cyl.	8 Valves	843cc	TD3559
HR816				

NA5190
42.00 x 56.00 x 7.00mm, FPM

2 0.9L**Petrol**

08 NCB	4 Cyl.	8 Valves	899cc	TD5539
09 NCA	4 Cyl.	8 Valves	903cc	TD3557
HR816				

3 0.9L**Petrol**

09 NCB	4 Cyl.	8 Valves	903cc	TD5540
HR816				

NA5049
64.00 x 80.00 x 8.00mm, ACM
NB808
64.00 x 80.00 x 8.00mm, FPM

4 0.9L**Petrol**

100 GL.040	4 Cyl.	8 Valves	903cc	TD34389
A112 A5.000	4 Cyl.	8 Valves	903cc	TD20969
HR816				

NC048
38.00 x 52.00 x 6.00mm, FPM

NA5049
64.00 x 80.00 x 8.00mm, ACM
NB808
64.00 x 80.00 x 8.00mm, FPM

5 0.9L**Petrol**

100 GL 3000	4 Cyl.	8 Valves	903cc	TD3558
HR816				

NB307
40.00 x 56.00 x 7.00mm, ACM

6 0.9L**Petrol**

100 GL 7000	4 Cyl.	8 Valves	903cc	TD3560
146 A 000	4 Cyl.	8 Valves	903cc	TD9377
HR816				

NA5190
42.00 x 56.00 x 7.00mm, FPM

7 0.9L**Petrol**

120G100	4 Cyl.	8 Valves	843cc	TD34387

NA5190
42.00 x 56.00 x 7.00mm, FPM
NB808
64.00 x 80.00 x 8.00mm, FPM

8 0.9L**Petrol**

126G100	4 Cyl.	8 Valves	843cc	TD34388
HR816				

NA5190
42.00 x 56.00 x 7.00mm, FPM
NB808
64.00 x 80.00 x 8.00mm, FPM

9 0.9L**Petrol**

HB 90	4 Cyl.	8 Valves	903cc	TD3589

NC048
38.00 x 52.00 x 6.00mm, FPM

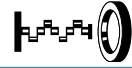

10 1.0L Petrol

AAU	4 Cyl.	8 Valves	1043cc	TD4892
HR569	NA5001 32.00 x 47.00 x 10.00mm, FPM			NA5001 32.00 x 47.00 x 10.00mm, FPM
→Ch no. 80-NW-500 000				NA5133 85.00 x 105.00 x 11.00mm, FPM
HR816				
Ch no. 80-PW-000 001 →				

11 1.0L Petrol

AER	4 Cyl.	8 Valves	999cc	TD5533
HR816	NA5001 32.00 x 47.00 x 10.00mm, FPM			NA5001 32.00 x 47.00 x 10.00mm, FPM
				LK5006 85.00 x 131.00 x 16.00mm, PTFE
				NA5133 85.00 x 105.00 x 11.00mm, FPM
				→Eng no. 220 083

12 1.0L Petrol

AHT	4 Cyl.	8 Valves	997cc	TD13889
HR816				NA5306 42.00 x 58.00 x 8.00mm, ACM
				01/99 →
				NA5133 85.00 x 105.00 x 11.00mm, FPM
				LK5006 85.00 x 131.00 x 16.00mm, PTFE

13 1.0L Petrol

ALD	4 Cyl.	8 Valves	999cc	TD13890
ANV	4 Cyl.	8 Valves	999cc	TD13888
AUC	4 Cyl.	8 Valves	999cc	TD16138
PA5041 (x8)	NA5185 32.00 x 42.00 x 6.00mm, FPM			NA5185 32.00 x 42.00 x 6.00mm, FPM
HR817				LK5006 85.00 x 131.00 x 16.00mm, PTFE

14 1.0L Petrol

ALL	4 Cyl.	8 Valves	999cc	TD13891
HR816	NA5001 32.00 x 47.00 x 10.00mm, FPM			NA5001 32.00 x 47.00 x 10.00mm, FPM
				LK5006 85.00 x 131.00 x 16.00mm, PTFE

15 1.0L Petrol

AST	4 Cyl.	16 Valves	999cc	TD16543
AVZ	4 Cyl.	16 Valves	999cc	TD16542
PA5041 (x16)	NA5185 32.00 x 42.00 x 6.00mm, FPM			NA5185 32.00 x 42.00 x 6.00mm, FPM
HR791				LK5006 85.00 x 131.00 x 16.00mm, PTFE

**16 1.0L****Petrol**

CHYA	3 Cyl.	12 Valves	999cc	TD26310
CHYB	3 Cyl.	12 Valves	999cc	TD26311
CHZB	3 Cyl.	12 Valves	999cc	TD31158
CHZC	3 Cyl.	12 Valves	999cc	TD31157
CHZD	3 Cyl.	12 Valves	999cc	TD31351

NA5456 (x2)
36.00 x 46.00 x 7.00mm, PTFE/ACM
NA5458
24.00 x 39.00 x 8.00mm, PTFE/ACM

17 1.0L**Petrol**

CHZJ	3 Cyl.	12 Valves	999cc	TD33629
------	--------	-----------	-------	---------

NA5458
24.00 x 39.00 x 8.00mm, PTFE/ACM
NA5456 (x2)
36.00 x 46.00 x 7.00mm, PTFE/ACM

18 1.0L**Gas**

CPGA	3 Cyl.	12 Valves	999cc	TD27264
------	--------	-----------	-------	---------

NA5456 (x2)
36.00 x 46.00 x 7.00mm, PTFE/ACM
NA5458
24.00 x 39.00 x 8.00mm, PTFE/ACM

19 1.2L**Petrol**

12AC	4 Cyl.	8 Valves	1197cc	TD34391
124 A.000	4 Cyl.	8 Valves	1197cc	TD3562

HR569

NB307
40.00 x 56.00 x 7.00mm, ACM
NA5050
70.00 x 90.00 x 10.00mm, ACM

20 1.2L**Petrol**

021 A 1000	4 Cyl.	8 Valves	1193cc	TD3553
021 C.1000	4 Cyl.	8 Valves	1193cc	TD9382

HR816

NB866
28.00 x 42.00 x 7.00mm, FPM

NA784
70.00 x 90.00 x 10.00mm, ACM

21 1.2L**Petrol**

AZQ	3 Cyl.	12 Valves	1198cc	TD16459
-----	--------	-----------	--------	---------

PA5041 (x12)
HR280

NA5106
35.00 x 48.00 x 10.00mm, PTFE
NA5305
85.00 x 105.00 x 11.00mm, PTFE
01/01→

22 1.2L**Petrol**

BBM	3 Cyl.	6 Valves	1198cc	TD21594
-----	--------	----------	--------	---------

PA5041 (x6)
HL5002

NA5106
35.00 x 48.00 x 10.00mm, PTFE
NA5305
85.00 x 105.00 x 11.00mm, PTFE
01/01→

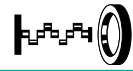
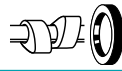
**23 1.2L****Petrol**

BME	3 Cyl.	12 Valves	1198cc	TD20510
BXV	3 Cyl.	12 Valves	1198cc	TD19426
BZG	3 Cyl.	12 Valves	1198cc	TD20839
CGPA	3 Cyl.	12 Valves	1198cc	TD23138
CGPB	3 Cyl.	12 Valves	1198cc	TD23097
CGPC	3 Cyl.	12 Valves	1198cc	TD27225
CILB	3 Cyl.	12 Valves	1198cc	TD29244
PA5041 (x12) HR280				NA5106 35.00 x 48.00 x 10.00mm, PTFE NA5305 85.00 x 105.00 x 11.00mm, PTFE

24 1.2L**Petrol**

CBZA	4 Cyl.	8 Valves	1197cc	TD23927
CBZB	4 Cyl.	8 Valves	1197cc	TD23908
PA5041 (x8) HR817	NA5124 32.00 x 47.00 x 10.00mm, PTFE/ACM	NA5124 32.00 x 47.00 x 10.00mm, PTFE/ACM		

25 1.2L**Diesel**

CFWA	3 Cyl.	12 Valves	1199cc	TD23935
PA5041 (x12) HR280	NA5361 (x2) 32.00 x 47.00 x 10.00mm, PTFE	NA5106 35.00 x 48.00 x 10.00mm, PTFE		

26 1.2L**Petrol**

CHFA	3 Cyl.	6 Valves	1198cc	TD23098
PA5041 (x6) HL5002				NA5106 35.00 x 48.00 x 10.00mm, PTFE NA5305 85.00 x 105.00 x 11.00mm, PTFE

27 1.2L**Petrol**

CJZA	4 Cyl.	16 Valves	1197cc	TD27252
CJZB	4 Cyl.	16 Valves	1197cc	TD27251
CJZC	4 Cyl.	16 Valves	1197cc	TD31156
CJZD	4 Cyl.	16 Valves	1197cc	TD31352
CYVA	4 Cyl.	16 Valves	1197cc	TD30802
CYVB	4 Cyl.	16 Valves	1197cc	TD29200
				NA5456 (x2) 36.00 x 46.00 x 7.00mm, PTFE/ACM NA5458 24.00 x 39.00 x 8.00mm, PTFE/ACM

28 1.3L**Petrol**

2G	4 Cyl.	8 Valves	1272cc	TD3571
AAV	4 Cyl.	8 Valves	1272cc	TD4893
HR569 →Ch no. 80-NW-500 000 HR816 Ch no. 80-PW-000 001→	NA5001 32.00 x 47.00 x 10.00mm, FPM	NA5001 32.00 x 47.00 x 10.00mm, FPM NA5133 85.00 x 105.00 x 11.00mm, FPM		

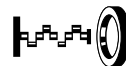
**29 1.3L****Diesel**

MN	4 Cyl.	8 Valves	1272cc	TD9401
HR569	NA5001 32.00 x 47.00 x 10.00mm, FPM		NA5001 32.00 x 47.00 x 10.00mm, FPM NA5133 85.00 x 105.00 x 11.00mm, FPM	

30 1.4L**Diesel**

1 W	4 Cyl.	8 Valves	1398cc	TD9402
HR569 HR816 Ch no. 80-PW-000 001 →	NA5001 32.00 x 47.00 x 10.00mm, FPM		NA5001 32.00 x 47.00 x 10.00mm, FPM NA5133 85.00 x 105.00 x 11.00mm, FPM	

31 1.4L**Petrol**

15G	4 Cyl.	8 Valves	1438cc	TD34393
FA14	4 Cyl.	8 Valves	1438cc	TD34376
			NB818 40.00 x 56.00 x 7.00mm, ACM NB307 40.00 x 56.00 x 7.0mm, ACM NA5050 70.00 x 90.00 x 10.00mm, ACM	

32 1.4L**Petrol**

021 B.2000	4 Cyl.	8 Valves	1461cc	TD9380
021 C.2000	4 Cyl.	8 Valves	1461cc	TD9381
021 D.2000	4 Cyl.	8 Valves	1461cc	TD9389
HR816	NB866 28.00 x 42.00 x 7.00mm, FPM			

33 1.4L**Petrol**

124 B2.000	4 Cyl.	8 Valves	1438cc	TD3563
HR569				

34 1.4L**Petrol**

ABD	4 Cyl.	8 Valves	1390cc	TD3574
HR816	NA5001 32.00 x 47.00 x 10.00mm, FPM		NA5001 32.00 x 47.00 x 10.00mm, FPM NA5133 85.00 x 105.00 x 11.00mm, FPM	

35 1.4L**Petrol**

AEX	4 Cyl.	8 Valves	1391cc	TD5532
HR816	NA5001 32.00 x 47.00 x 10.00mm, FPM		NA5001 32.00 x 47.00 x 10.00mm, FPM →Eng no. AEX 908 122 NA5185 32.00 x 42.00 x 6.00mm, FPM Eng no. AEX 908 123 → NA5133 85.00 x 105.00 x 11.00mm, FPM →Eng no. AEX 040 000 LK5006 85.00 x 131.00 x 16.000mm, PTFE Eng no. AEX 040 001 →	

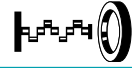
**36 1.4L****Petrol**

AFH	4 Cyl.	16 Valves	1390cc	TD5534
PA5041 (x16) HR791	NA5001 (x2) 32.00 x 47.00 x 10.00mm, FPM		NA5001 32.00 x 47.00 x 10.00mm, FPM NA5133 85.00 x 105.00 x 11.00mm, FPM →Eng no. AEY 050 000 LK5006 85.00 x 131.00 x 16.000mm, PTFE Eng no. AEY 050 001 →	

37 1.4L**Petrol**

AFK	4 Cyl.	16 Valves	1390cc	TD13893
AHW	4 Cyl.	16 Valves	1390cc	TD15529
ANM	4 Cyl.	16 Valves	1390cc	TD13894
APE	4 Cyl.	16 Valves	1390cc	TD13268
AUA	4 Cyl.	16 Valves	1390cc	TD16197
AUB	4 Cyl.	16 Valves	1390cc	TD16140
AXP	4 Cyl.	16 Valves	1390cc	TD16134
BBY	4 Cyl.	16 Valves	1390cc	TD16460
BBZ	4 Cyl.	16 Valves	1390cc	TD16541
BCA	4 Cyl.	16 Valves	1390cc	TD16434
BKY	4 Cyl.	16 Valves	1390cc	TD18750
CGGB	4 Cyl.	16 Valves	1390cc	TD23136
PA5041 (x16) HR791	NA5180 (x2) 27.00 x 42.00 x 8.00mm, FPM		NA5185 32.00 x 42.00 x 6.00mm, FPM	

38 1.4L**Petrol**

AKK	4 Cyl.	8 Valves	1390cc	TD13892
ANW	4 Cyl.	8 Valves	1390cc	TD13274
AUD	4 Cyl.	8 Valves	1390cc	TD16139
PA5041 (x8) HR817	NA5185 32.00 x 42.00 x 6.00mm, FPM		NA5185 32.00 x 42.00 x 6.00mm, FPM LK5006 85.00 x 131.00 x 16.000mm, PTFE	

39 1.4L**Petrol**

AKV	4 Cyl.	8 Valves	1391cc	TD12513
PA5041 (x8) HR816	NA5001 32.00 x 47.00 x 10.00mm, FPM		NA5001 32.00 x 47.00 x 10.00mm, FPM →Eng no. AKV 095 009 NA5185 32.00 x 42.00 x 6.00mm, FPM Eng no. AKV 095 010 → NA5133 85.00 x 105.00 x 11.00mm, FPM →Eng no. AKV 140 000 LK5006 85.00 x 131.00 x 16.000mm, PTFE Eng no. AKV 140 001 →	

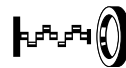
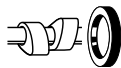
**40 1.4L****Diesel**

AMF	3 Cyl.	6 Valves	1422cc	TD13895
BNM	3 Cyl.	6 Valves	1422cc	TD18726
BNV	3 Cyl.	6 Valves	1422cc	TD18738

HR5068

NA5124
 32.00 x 47.00 x 10.00mm, PTFE/ACM

NA5106
 35.00 x 48.00 x 10.00mm, PTFE
LK5003
 85.00 x 131.00 x 15.700mm, PTFE
41 1.4L**Petrol**

ANX	4 Cyl.	8 Valves	1390cc	TD12514
APQ	4 Cyl.	8 Valves	1391cc	TD12515

HR816

NA5001
 32.00 x 47.00 x 10.00mm, FPM

NA5001
 32.00 x 47.00 x 10.00mm, FPM
LK5006
 85.00 x 131.00 x 16.000mm, PTFE
42 1.4L**Petrol**

AQQ	4 Cyl.	16 Valves	1390cc	TD15528
-----	--------	-----------	--------	---------

 PA5041 (x16)
 HR791

NA5180 (x2)
 27.00 x 42.00 x 8.00mm, FPM

NA5185
 32.00 x 42.00 x 6.00mm, FPM
NB806
 90.00 x 104.00 x 11.00mm, FPM
43 1.4L**Diesel**

BMS	3 Cyl.	6 Valves	1422cc	TD18727
-----	--------	----------	--------	---------

HR5068

NA5124
 32.00 x 47.00 x 10.00mm, PTFE/ACM

NA5106
 35.00 x 48.00 x 10.00mm, PTFE
44 1.4L**Petrol**

BXW	4 Cyl.	16 Valves	1390cc	TD19427
-----	--------	-----------	--------	---------

 PA5041 (x16)
 HR791

NA5180 (x2)
 27.00 x 42.00 x 8.00mm, FPM



NA5185
 32.00 x 42.00 x 6.00mm, FPM
LK5013
 85.00 x 111.00 x 15.50mm, PTFE
 →Ch no. 5P-7-032 500
45 1.4L**Petrol**

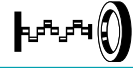

CAVA	4 Cyl.	16 Valves	1390cc	TD24449
CAVE	4 Cyl.	16 Valves	1390cc	TD23095
CAVF	4 Cyl.	16 Valves	1390cc	TD23096
CAXA	4 Cyl.	16 Valves	1390cc	TD27223
CAXC	4 Cyl.	16 Valves	1390cc	TD20488
CNUB	4 Cyl.	16 Valves	1390cc	TD26338
CNWB	4 Cyl.	16 Valves	1390cc	TD25702
CTHA	4 Cyl.	16 Valves	1390cc	TD27527
CTHE	4 Cyl.	16 Valves	1390cc	TD26916
CTHF	4 Cyl.	16 Valves	1390cc	TD26920
CTJB	4 Cyl.	16 Valves	1390cc	TD26919
CTJC	4 Cyl.	16 Valves	1390cc	TD26918

 PA5041 (x16)
 HR791

NA5106
 35.00 x 48.00 x 10.00mm, PTFE





46 1.4L		Petrol		
CHPA	4 Cyl.	16 Valves	1395cc	TD27254
CMBA	4 Cyl.	16 Valves	1395cc	TD27253
CPWA	4 Cyl.	16 Valves	1395cc	TD28854
CXSA	4 Cyl.	16 Valves	1395cc	TD28124
CZCA	4 Cyl.	16 Valves	1395cc	TD29306
CZDA	4 Cyl.	16 Valves	1395cc	TD32104
		NA5456  (x2) 36.00 x 46.00 x 7.00mm, PTFE/ACM NA5458  24.00 x 39.00 x 8.00mm, PTFE/ACM		





47 1.4L		Petrol		
CPTA	4 Cyl.	16 Valves	1395cc	TD27255
		NA5456  (x2) 36.00 x 46.00 x 7.00mm, PTFE/ACM NA5454  28.00 x 39.00 x 7.00mm, PTFE/ACM		

48 1.4L		Diesel		
CUSA	3 Cyl.	12 Valves	1422cc	TD31160
CUSB	3 Cyl.	12 Valves	1422cc	TD31161
CUTA	3 Cyl.	12 Valves	1422cc	TD31162
PA5041 (x12) HR280 			NA5361 (x2) 32.00 x 47.00 x 10.00mm, PTFE	

49 1.4L		Petrol		
CZEA	4 Cyl.	16 Valves	1395cc	TD29307
		NA5454 28.00 x 39.00 x 7.00mm, PTFE/ACM NA5456  (x2) 36.00 x 46.00 x 7.00mm, PTFE/ACM		

50 1.5L		Petrol		
021 A 2000 HR816 	4 Cyl.	8 Valves	1461cc	TD3554
		NB866 28.00 x 42.00 x 7.00mm, FPM		

51 1.5L		Petrol		
FD HR569 	4 Cyl.	8 Valves	1470cc	TD3584
		NA5001 32.00 x 47.00 x 10.00mm, FPM		

52 1.6L		Petrol		
1F HR569 	4 Cyl.	8 Valves	1595cc	TD4890
		NA5001 32.00 x 47.00 x 10.00mm, FPM NA5001  32.00 x 47.00 x 10.00mm, FPM NA5133  85.00 x 105.00 x 11.00mm, FPM LK5006  85.00 x 131.00 x 16.00mm, PTFE		

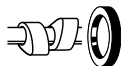
**53 1.6L****Petrol**

124 A9.000	4 Cyl.	8 Valves	1592cc	TD34377
HR569				
				NB307 40.00 x 56.00 x 7.0mm, ACM NA784 70.00 x 90.00 x 10.00mm, ACM

54 1.6L**Petrol**

124 B3.000	4 Cyl.	8 Valves	1585cc	TD3564
HR569				
				NA5187 30.00 x 52.00 x 7.00mm, ACM

55 1.6L**Petrol**

132B0000	4 Cyl.	8 Valves	1592cc	TD34384
132 BB OA O	4 Cyl.	8 Valves	1592cc	TD22904
HR569				
				NA5187 (x2) 30.00 x 52.00 x 7.00mm, ACM NB307 40.00 x 56.00 x 7.0mm, ACM NA784 70.00 x 90.00 x 10.00mm, ACM

56 1.6L**Petrol**

ABN	4 Cyl.	8 Valves	1595cc	TD17897
EZ	4 Cyl.	8 Valves	1595cc	TD4899
HM	4 Cyl.	8 Valves	1595cc	TD3590
HR569				
				NA5001 32.00 x 47.00 x 10.00mm, FPM NA5001 32.00 x 47.00 x 10.00mm, FPM NA5133 85.00 x 105.00 x 11.00mm, FPM

57 1.6L**Petrol**

ABU	4 Cyl.	8 Valves	1598cc	TD4897
HR816				
				NA5001 32.00 x 47.00 x 10.00mm, FPM NA5001 32.00 x 47.00 x 10.00mm, FPM NA5133 85.00 x 105.00 x 11.00mm, FPM LK5006 85.00 x 131.00 x 16.000mm, PTFE

58 1.6L**Petrol**

AEE	4 Cyl.	8 Valves	1598cc	TD10867
HR816				
				NA5001 32.00 x 47.00 x 10.00mm, FPM NA5001 32.00 x 47.00 x 10.00mm, FPM NA5185 32.00 x 42.00 x 6.00mm, FPM Eng no. 562 758 → NA5133 85.00 x 105.00 x 11.00mm, FPM LK5006 85.00 x 131.00 x 16.000mm, PTFE

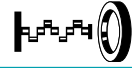

59 1.6L		Petrol		
AEH	4 Cyl.	8 Valves	1595cc	TD12488
AKL	4 Cyl.	8 Valves	1595cc	TD12509
HR816	NA5124 32.00 x 47.00 x 10.00mm, PTFE/ACM		NB716 35.00 x 48.00 x 10.00mm, FPM NA5106 35.00 x 48.00 x 10.00mm, PTFE LK5008 85.00 x 131.00 x 15.700mm, PTFE	

60 1.6L		Petrol		
AFT	4 Cyl.	8 Valves	1595cc	TD5536
HR816	NA5001 32.00 x 47.00 x 10.00mm, FPM		NA5001 32.00 x 47.00 x 10.00mm, FPM NA5133 85.00 x 105.00 x 11.00mm, FPM LK5008 85.00 x 131.00 x 15.700mm, PTFE	

61 1.6L		Petrol		
ALM	4 Cyl.	8 Valves	1598cc	TD12949
HR816	NA5001 32.00 x 47.00 x 10.00mm, FPM NA5185 32.00 x 42.00 x 6.00mm, FPM Eng no. 000 707 →		NA5001 32.00 x 47.00 x 10.00mm, FPM → Eng no. ALM 000 706 NA5185 32.00 x 42.00 x 6.00mm, FPM Eng no. 000 707 → LK5006 85.00 x 131.00 x 16.000mm, PTFE	

62 1.6L		Petrol		
ALZ	4 Cyl.	8 Valves	1595cc	TD22242
BFQ	4 Cyl.	8 Valves	1595cc	TD20621
BGU	4 Cyl.	8 Valves	1595cc	TD17352
BSE	4 Cyl.	8 Valves	1595cc	TD18245
BSF	4 Cyl.	8 Valves	1595cc	TD18246
CCSA	4 Cyl.	8 Valves	1595cc	TD20710
CHGA	4 Cyl.	8 Valves	1595cc	TD22676
CMXA	4 Cyl.	8 Valves	1595cc	TD24325
PA5041 (x8) HR817	NA5124 32.00 x 47.00 x 10.00mm, PTFE/ACM		NA5106 35.00 x 48.00 x 10.00mm, PTFE LK5008 85.00 x 131.00 x 15.700mm, PTFE	

63 1.6L		Petrol		
APF	4 Cyl.	8 Valves	1595cc	TD13269
AUR	4 Cyl.	8 Valves	1595cc	TD16200
HR816	NA5124 32.00 x 47.00 x 10.00mm, PTFE/ACM		NA5106 35.00 x 48.00 x 10.00mm, PTFE LK5008 85.00 x 131.00 x 15.700mm, PTFE	

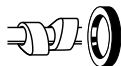
**64 1.6L****Petrol**

ATN	4 Cyl.	16 Valves	1598cc	TD15531
AUS	4 Cyl.	16 Valves	1598cc	TD15788
BCB	4 Cyl.	16 Valves	1598cc	TD16435

PA5041 (x16)
HR791

NA5180 (x2)
27.00 x 42.00 x 8.00mm, FPM

NA5185
32.00 x 42.00 x 6.00mm, FPM
LK5006
85.00 x 131.00 x 16.000mm, PTFE

65 1.6L**Petrol**

AZD	4 Cyl.	16 Valves	1598cc	TD16131
PA5041 (x16) HR791	NA5180 (x2) 27.00 x 42.00 x 8.00mm, FPM	NA5185 32.00 x 42.00 x 6.00mm, FPM		

66 1.6L**Petrol**

BAH	4 Cyl.	8 Valves	1598cc	TD17340
PA5041 (x8) HR817	NA5185 32.00 x 42.00 x 6.00mm, FPM	NA5185 32.00 x 42.00 x 6.00mm, FPM		

67 1.6L**Petrol**

BTS	4 Cyl.	16 Valves	1598cc	TD19428
CFNA	4 Cyl.	16 Valves	1598cc	TD27224
CNKA	4 Cyl.	16 Valves	1598cc	TD25408
PA5041 (x16) HR791		NA5106 35.00 x 48.00 x 10.00mm, PTFE		

68 1.6L**Diesel**

CAYA	4 Cyl.	16 Valves	1598cc	TD25762
CAYB	4 Cyl.	16 Valves	1598cc	TD22670
CAYC	4 Cyl.	16 Valves	1598cc	TD22671
CLNA	4 Cyl.	16 Valves	1598cc	TD23934
PA5041 (x16) HR791	NA5124 (x2) 32.00 x 47.00 x 10.00mm, PTFE/ACM →09/09 NA5361 (x2) 32.00 x 47.00 x 10.00mm, PTFE 10/09→	NA5106 35.00 x 48.00 x 10.00mm, PTFE LK5019 85.00 x 131.00 x 17.25mm, PTFE/ACM		

69 1.6L**Diesel**

CLHA	4 Cyl.	16 Valves	1598cc	TD27258
CLHB	4 Cyl.	16 Valves	1598cc	TD27263
CRKB	4 Cyl.	16 Valves	1598cc	TD27958
CXMA	4 Cyl.	16 Valves	1598cc	TD31353
CXXB	4 Cyl.	16 Valves	1598cc	TD31521
DBKA	4 Cyl.	16 Valves	1598cc	TD31523
DDYA	4 Cyl.	16 Valves	1598cc	TD33068
PA5041 (x16) HR791	NA5361 (x2) 32.00 x 47.00 x 10.00mm, PTFE	LK5017 85.00 x 130.90 x 15.75mm, PTFE		

70 1.6L**Petrol**

CWVA	4 Cyl.	16 Valves	1598cc	TD32086
	NA5456 (x2) 36.00 x 46.00 x 7.00mm, PTFE/ACM NA5458 24.00 x 39.00 x 8.00mm, PTFE/ACM			



71 1.7L Petrol

021 A.3000	4 Cyl.	8 Valves	1675cc	TD9383
021 B.3000	4 Cyl.	8 Valves	1675cc	TD9390
HR816	NB866			
	28.00 x 42.00 x 7.00mm, FPM			

72 1.7L Diesel

022 A.5000	4 Cyl.	8 Valves	1714cc	TD9391
138 A5.000	4 Cyl.	8 Valves	1714cc	TD3585
HR569	NA5187		NB307	
	30.00 x 52.00 x 7.00mm, ACM		40.00 x 56.00 x 7.0mm, ACM	

73 1.7L Petrol

132 B1.000	4 Cyl.	8 Valves	1756cc	TD21376
HR569	NA5187		NB307	
	30.00 x 52.00 x 7.00mm, ACM		40.00 x 56.00 x 7.0mm, ACM	

74 1.7L Diesel

AHB	4 Cyl.	8 Valves	1716cc	TD9403
HR816	NA5001		NA5001	
	32.00 x 47.00 x 10.00mm, FPM		32.00 x 47.00 x 10.00mm, FPM	
			LK5006	
			85.00 x 131.00 x 16.000mm, PTFE	

75 1.7L Diesel

AKU	4 Cyl.	8 Valves	1716cc	TD13896
HR816	NA5001		NA5001	
	32.00 x 47.00 x 10.00mm, FPM		32.00 x 47.00 x 10.00mm, FPM	
			NA5133	
			85.00 x 105.00 x 11.00mm, FPM	
			→ Eng no. 013 000	
			LK5006	
			85.00 x 131.00 x 16.000mm, PTFE	
			Eng no. 013 001 →	

76 1.8L Petrol

ABS	4 Cyl.	8 Valves	1781cc	TD3576
HR569	NA5001		NA5001	
→ Eng no. 935 645	32.00 x 47.00 x 10.00mm, FPM		32.00 x 47.00 x 10.00mm, FPM	
HR816			NA5133	
Eng no. 935 646 →			85.00 x 105.00 x 11.00mm, FPM	
			LK5006	
			85.00 x 131.00 x 16.000mm, PTFE	



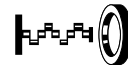
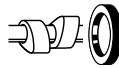

77 1.8L Petrol

ACC	4 Cyl.	8 Valves	1781cc	TD18752
HR816	NA5001		NA5001	
	32.00 x 47.00 x 10.00mm, FPM		32.00 x 47.00 x 10.00mm, FPM	
			NA5133	
			85.00 x 105.00 x 11.00mm, FPM	

**78 1.8L****Petrol**

ADL	4 Cyl.	16 Valves	1781cc	TD3578
KR	4 Cyl.	16 Valves	1781cc	TD3591
PL	4 Cyl.	16 Valves	1781cc	TD3595
HR816  (x2)	NA5001 (x2) 32.00 x 47.00 x 10.00mm, FPM		NA5001  32.00 x 47.00 x 10.00mm, FPM	NA5133  85.00 x 105.00 x 11.00mm, FPM



79 1.8L**Petrol**

ADZ	4 Cyl.	8 Valves	1781cc	TD9384
HR569  →Eng no. 011 565	NA5001 32.00 x 47.00 x 10.00mm, FPM		NA5001  32.00 x 47.00 x 10.00mm, FPM	NA5133  85.00 x 105.00 x 11.00mm, FPM
HR816  Eng no. 011 566→				



80 1.8L**Petrol**

AGN	4 Cyl.	20 Valves	1781cc	TD12510
AUQ	4 Cyl.	20 Valves	1781cc	TD16135
BAM	4 Cyl.	20 Valves	1781cc	TD17347
PA5041 (x20) HR822 	NA5124 (x2) 32.00 x 47.00 x 10.00mm, PTFE/ACM		NB716  35.00 x 48.00 x 10.00mm, FPM	NA5106  35.00 x 48.00 x 10.00mm, PTFE
			LK5003  85.00 x 131.00 x 15.700mm, PTFE	

81 1.8L**Petrol**

AJH	4 Cyl.	20 Valves	1781cc	TD17899
AWC	4 Cyl.	20 Valves	1781cc	TD14909
BBU	4 Cyl.	20 Valves	1781cc	TD17365
BJX	4 Cyl.	20 Valves	1781cc	TD17320
BLZ	4 Cyl.	20 Valves	1781cc	TD18751
CFMA	4 Cyl.	20 Valves	1781cc	TD22245
PA5041 (x20) HR822 	NA5124 (x2) 32.00 x 47.00 x 10.00mm, PTFE/ACM		NA5106  35.00 x 48.00 x 10.00mm, PTFE	LK5003  85.00 x 131.00 x 15.700mm, PTFE

82 1.8L**Petrol**

AJQ	4 Cyl.	20 Valves	1781cc	TD16199
AMK	4 Cyl.	20 Valves	1781cc	TD16436
APG	4 Cyl.	20 Valves	1781cc	TD15530
APP	4 Cyl.	20 Valves	1781cc	TD13270
AQX	4 Cyl.	20 Valves	1781cc	TD13275
ARY	4 Cyl.	20 Valves	1781cc	TD16136
AYP	4 Cyl.	20 Valves	1781cc	TD16201
BKV	4 Cyl.	20 Valves	1781cc	TD17321
PA5041 (x20) HR822 	NA5124 (x2) 32.00 x 47.00 x 10.00mm, PTFE/ACM		NB716  35.00 x 48.00 x 10.00mm, FPM	LK5003  85.00 x 131.00 x 15.700mm, PTFE

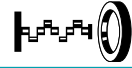
**83 1.8L****Petrol**

BYT	4 Cyl.	16 Valves	1798cc	TD19901
BZB	4 Cyl.	16 Valves	1798cc	TD19902
CDA	4 Cyl.	16 Valves	1798cc	TD21590
CDHA	4 Cyl.	16 Valves	1798cc	TD24317
CDHB	4 Cyl.	16 Valves	1798cc	TD24319
DAJA	4 Cyl.	16 Valves	1798cc	TD32087
PA5041 (x16) HR791				LK5016 85.00 x 164.00 x 11.00mm, PTFE

84 1.8L**Petrol**

CISA	4 Cyl.	16 Valves	1798cc	TD27256
CJSB	4 Cyl.	16 Valves	1798cc	TD30803
PA5041 (x16) HR791				

85 1.8L**Petrol**

RP	4 Cyl.	8 Valves	1781cc	TD3596
HR569	NA5001 (x2) 32.00 x 47.00 x 10.00mm, FPM	NA5001 32.00 x 47.00 x 10.00mm, FPM	NA5133 85.00 x 105.00 x 11.00mm, FPM	

86 1.9L**Diesel**

IY	4 Cyl.	8 Valves	1896cc	TD4891
HR569 →Eng no. 580 000	HR816 Eng no. 580 001→	NA5001 32.00 x 47.00 x 10.00mm, FPM	NA5001 32.00 x 47.00 x 10.00mm, FPM	NA5133 85.00 x 105.00 x 11.00mm, FPM
			LK5006 85.00 x 131.00 x 16.00mm, PTFE	

87 1.9L**Diesel**

IZ	4 Cyl.	8 Valves	1896cc	TD5527
HR569 →Eng no. 1Z-720 000	HR816 Eng no. 1Z-720 001→	NA5001 32.00 x 47.00 x 10.00mm, FPM	NA5001 32.00 x 47.00 x 10.00mm, FPM	NA5133 85.00 x 105.00 x 11.00mm, FPM
			LK5006 85.00 x 131.00 x 16.00mm, PTFE	

88 1.9L**Diesel**

AAZ	4 Cyl.	8 Valves	1896cc	TD4894
HR569 →Eng no. AAZ678000	HR816 Eng no. AAZ678000→	NA5001 32.00 x 47.00 x 10.00mm, FPM	NA5001 32.00 x 47.00 x 10.00mm, FPM	NA5133 85.00 x 105.00 x 11.00mm, FPM

89 1.9L**Diesel**

AEF	4 Cyl.	8 Valves	1896cc	TD9373
HR569 →Eng no. 007 000	HR816 Eng no. 007 001→	NA5001 32.00 x 47.00 x 10.00mm, FPM	NA5001 32.00 x 47.00 x 10.00mm, FPM	LK5006 85.00 x 131.00 x 16.00mm, PTFE
			NA5133 85.00 x 105.00 x 11.00mm, FPM	→Eng no. AEF 265 000



90 1.9L

Diesel

AEY	4 Cyl.	8 Valves	1896cc	TD5535
HR569	NA5001 32.00 x 47.00 x 10.00mm, FPM			NA5001 32.00 x 47.00 x 10.00mm, FPM
→Eng no. AEY002000				LK5006 85.00 x 131.00 x 16.000mm, PTFE
HR816				NA5133 85.00 x 105.00 x 11.00mm, FPM
Eng no. AEY002001→				→Eng no. AEY 050 000

91 1.9L

Diesel

AFN	4 Cyl.	8 Valves	1896cc	TD5531
HR569	NA5001 32.00 x 47.00 x 10.00mm, FPM			NA5001 32.00 x 47.00 x 10.00mm, FPM
→Eng no. 002 000				NA5133 85.00 x 105.00 x 11.00mm, FPM
HR816				→Eng no. AFN 576 000
Eng no. 002 001→				LK5006 85.00 x 131.00 x 16.000mm, PTFE
				Eng no. AFN 576 001→

92 1.9L

Diesel

AGP	4 Cyl.	8 Valves	1896cc	TD14808
AGR	4 Cyl.	8 Valves	1896cc	TD13278
AQM	4 Cyl.	8 Valves	1896cc	TD13271
ASV	4 Cyl.	8 Valves	1896cc	TD13273
HR816	NA5001 32.00 x 47.00 x 10.00mm, FPM			NB716 35.00 x 48.00 x 10.00mm, FPM
				NA5106 35.00 x 48.00 x 10.00mm, PTFE
				LK5003 85.00 x 131.00 x 15.700mm, PTFE

93 1.9L

Diesel

AHF	4 Cyl.	8 Valves	1896cc	TD12512
ALH	4 Cyl.	8 Valves	1896cc	TD13272
HR816	NA5001 32.00 x 47.00 x 10.00mm, FPM			NB716 35.00 x 48.00 x 10.00mm, FPM
				LK5003 85.00 x 131.00 x 15.700mm, PTFE

94 1.9L

Diesel

AHU	4 Cyl.	8 Valves	1896cc	TD5528
HR569	NA5001 32.00 x 47.00 x 10.00mm, FPM			NA5001 32.00 x 47.00 x 10.00mm, FPM
→Eng no. 720 000				NA5133 85.00 x 105.00 x 11.00mm, FPM
HR816				→Eng no. AHU 390 000
Eng no. 720 001→				LK5006 85.00 x 131.00 x 16.000mm, PTFE
				Eng no. AHU 390 001→



95 1.9L		Diesel			
ANU	4 Cyl.	8 Valves	1896cc		TD14911
ASY	4 Cyl.	8 Valves	1896cc		TD16461
ASZ	4 Cyl.	8 Valves	1896cc		TD16463
ATD	4 Cyl.	8 Valves	1896cc		TD16462
AUY	4 Cyl.	8 Valves	1896cc		TD14912
AXR	4 Cyl.	8 Valves	1896cc		TD18739
BLT	4 Cyl.	8 Valves	1896cc		TD20516
BPX	4 Cyl.	8 Valves	1896cc		TD17640
BTB	4 Cyl.	8 Valves	1896cc		TD20625
BUK	4 Cyl.	8 Valves	1896cc		TD22667
BVK	4 Cyl.	8 Valves	1896cc		TD20515
HR816	NA5124		NA5106		
	32.00 x 47.00 x 10.00mm, PTFE/ACM		35.00 x 48.00 x 10.00mm, PTFE		
			LK5003		
			85.00 x 131.00 x 15.700mm, PTFE		

96 1.9L		Diesel			
ARL	4 Cyl.	8 Valves	1896cc		TD15768
HR816	NA5124		NB716		
	32.00 x 47.00 x 10.00mm, PTFE/ACM		35.00 x 48.00 x 10.00mm, FPM		
			NA5106		
			35.00 x 48.00 x 10.00mm, PTFE		
			LK5003		
			85.00 x 131.00 x 15.700mm, PTFE		

97 1.9L		Diesel			
ASK	4 Cyl.	8 Valves	1896cc		TD13277
AVG	4 Cyl.	8 Valves	1896cc		TD23884
HR816	NA5001		NA5001		
	32.00 x 47.00 x 10.00mm, FPM		32.00 x 47.00 x 10.00mm, FPM		
			LK5006		
			85.00 x 131.00 x 16.000mm, PTFE		

98 1.9L		Diesel			
AYQ	4 Cyl.	8 Valves	1896cc		TD16198
HR816	NA5001		NA5001		
	32.00 x 47.00 x 10.00mm, FPM		32.00 x 47.00 x 10.00mm, FPM		
			LK5003		
			85.00 x 131.00 x 15.700mm, PTFE		

99 1.9L		Diesel			
BJB	4 Cyl.	8 Valves	1896cc		TD17356
BKC	4 Cyl.	8 Valves	1896cc		TD17355
BLS	4 Cyl.	8 Valves	1896cc		TD18268
BMT	4 Cyl.	8 Valves	1896cc		TD20495
BXE	4 Cyl.	8 Valves	1896cc		TD19819
BXF	4 Cyl.	8 Valves	1896cc		TD20866
BXJ	4 Cyl.	8 Valves	1896cc		TD20840
HR816	NA5124		NA5106		
	32.00 x 47.00 x 10.00mm, PTFE/ACM		35.00 x 48.00 x 10.00mm, PTFE		
			LK5012		
			85.00 x 132.00 x 15.70mm, PTFE		



100 1.9L Petrol

DH 4 Cyl. 8 Valves 1915cc TD3580

NB953
75.00 x 95.00 x 12.00mm, FPM

101 2.0L Petrol

2E 4 Cyl. 8 Valves 1984cc TD3570

HR569
→Eng no. 2E 565 664
HR816
Eng no. 2E 565 665→

NA5001
32.00 x 47.00 x 10.00mm, FPM

NA5001
32.00 x 47.00 x 10.00mm, FPM
NA5133
85.00 x 105.00 x 11.00mm, FPM

102 2.0L Petrol

131 C4.000 4 Cyl. 8 Valves 1995cc TD21375

HR569

NA5187 (x2)
30.00 x 52.00 x 7.00mm, ACM

NB307
40.00 x 56.00 x 7.0mm, ACM
NA5050
70.00 x 90.00 x 10.00mm, ACM

103 2.0L Petrol

ABF 4 Cyl. 16 Valves 1984cc TD4895

HR816 (x2)

NA5001 (x2)
32.00 x 47.00 x 10.00mm, FPM

NA5001
32.00 x 47.00 x 10.00mm, FPM
NA5133
85.00 x 105.00 x 11.00mm, FPM

104 2.0L Petrol

ADY 4 Cyl. 8 Valves 1984cc TD9386

HR569
→Eng no. 000 778
HR816
Eng no. 000 779→

NA5001
32.00 x 47.00 x 10.00mm, FPM
NA5124
32.00 x 47.00 x 10.00mm, PTFE/ACM

NA5001
32.00 x 47.00 x 10.00mm, FPM
NA5133
85.00 x 105.00 x 11.00mm, FPM
LK5006
85.00 x 131.00 x 16.000mm, PTFE

105 2.0L Petrol

AGG 4 Cyl. 8 Valves 1984cc TD5537

HR816

NA5001
32.00 x 47.00 x 10.00mm, FPM

NA5001
32.00 x 47.00 x 10.00mm, FPM
NA5133
85.00 x 105.00 x 11.00mm, FPM
LK5006
85.00 x 131.00 x 16.000mm, PTFE

106 2.0L Petrol

ATM 4 Cyl. 8 Valves 1984cc TD14908

AZL 4 Cyl. 8 Valves 1984cc TD17901

BBX 4 Cyl. 8 Valves 1984cc TD18446

HR816
NA5124
32.00 x 47.00 x 10.00mm, PTFE/ACM

NA5106
35.00 x 48.00 x 10.00mm, PTFE
LK5003
85.00 x 131.00 x 15.700mm, PTFE

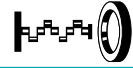
**107 2.0L****Diesel**

AZV	4 Cyl.	16 Valves	1968cc	TD18247
BMN	4 Cyl.	16 Valves	1968cc	TD18977
PA5041 (x16) HR791	NA5124 (x2) 32.00 x 47.00 x 10.00mm, PTFE/ACM		NA5106 35.00 x 48.00 x 10.00mm, PTFE LK5012 85.00 x 132.00 x 15.70mm, PTFE	

108 2.0L**Diesel**

BKD	4 Cyl.	16 Valves	1968cc	TD17357
PA5041 (x16) HR791	NA5124 (x2) 32.00 x 47.00 x 10.00mm, PTFE/ACM		NA5106 35.00 x 48.00 x 10.00mm, PTFE NA5124 32.00 x 47.00 x 10.00mm, PTFE/ACM LK5012 85.00 x 132.00 x 15.70mm, PTFE	

109 2.0L**Petrol**

BLR	4 Cyl.	16 Valves	1984cc	TD17353
BLY	4 Cyl.	16 Valves	1984cc	TD17354
BVY	4 Cyl.	16 Valves	1984cc	TD18266
BVZ	4 Cyl.	16 Valves	1984cc	TD18267
PA5041 (x16) HR791	NA5124 (x2) 32.00 x 47.00 x 10.00mm, PTFE/ACM		NA5106 35.00 x 48.00 x 10.00mm, PTFE LK5008 85.00 x 131.00 x 15.700mm, PTFE	

110 2.0L**Diesel**

BMM	4 Cyl.	8 Valves	1968cc	TD18269
BRT	4 Cyl.	8 Valves	1968cc	TD19388
HR816	NA5124 32.00 x 47.00 x 10.00mm, PTFE/ACM		NA5106 35.00 x 48.00 x 10.00mm, PTFE LK5012 85.00 x 132.00 x 15.70mm, PTFE	

111 2.0L**Petrol**

BWA	4 Cyl.	16 Valves	1984cc	TD19424
BWA1	4 Cyl.	16 Valves	1984cc	TD22668
BWE	4 Cyl.	16 Valves	1984cc	TD22246
BWJ	4 Cyl.	16 Valves	1984cc	TD19425
CDLA	4 Cyl.	16 Valves	1984cc	TD22673
CDLD	4 Cyl.	16 Valves	1984cc	TD23090
PA5041 (x16) HR791	NA5124 (x2) 32.00 x 47.00 x 10.00mm, PTFE/ACM		NA5106 35.00 x 48.00 x 10.00mm, PTFE LK5003 85.00 x 131.00 x 15.700mm, PTFE	

112 2.0L**Diesel**

CAGA	4 Cyl.	16 Valves	1968cc	TD22243
CAGC	4 Cyl.	16 Valves	1968cc	TD22669
CAHA	4 Cyl.	16 Valves	1968cc	TD22244
CBDB	4 Cyl.	16 Valves	1968cc	TD24327
CEGA	4 Cyl.	16 Valves	1968cc	TD22674
CFFA	4 Cyl.	16 Valves	1968cc	TD25404
CFFB	4 Cyl.	16 Valves	1968cc	TD24450

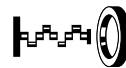
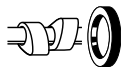

CFFE	4 Cyl.	16 Valves	1968cc	TD25403
CFGB	4 Cyl.	16 Valves	1968cc	TD24451
CFGC	4 Cyl.	16 Valves	1968cc	TD27529
CFHC	4 Cyl.	16 Valves	1968cc	TD24326
CFHD	4 Cyl.	16 Valves	1968cc	TD23582
CFJA	4 Cyl.	16 Valves	1968cc	TD24333
CGLB	4 Cyl.	16 Valves	1968cc	TD26498
CJCA	4 Cyl.	16 Valves	1968cc	TD26497
CJCC	4 Cyl.	16 Valves	1968cc	TD27013
CLCB	4 Cyl.	16 Valves	1968cc	TD25102

PA5041 (x16)
HR791

NA5361 (x2)
32.00 x 47.00 x 10.00mm, PTFE

NA5106
35.00 x 48.00 x 10.00mm, PTFE
LK5019
85.00 x 131.00 x 17.25mm, PTFE/ACM

113 2.0L

Petrol

CCZA	4 Cyl.	16 Valves	1984cc	TD24656
CCZB	4 Cyl.	16 Valves	1984cc	TD22672
CDND	4 Cyl.	16 Valves	1984cc	TD24320

PA5041 (x16)
HR791

LK5016
85.00 x 164.00 x 11.00mm, PTFE

114 2.0L

Petrol

CEKA	4 Cyl.	8 Valves	1984cc	TD22467
------	--------	----------	--------	---------

HR816

NA5106
35.00 x 48.00 x 10.00mm, PTFE/ACM

NA5106
35.00 x 48.00 x 10.00mm, PTFE
LK5003
85.00 x 131.00 x 15.700mm, PTFE

115 2.0L

Petrol

CJXA	4 Cyl.	16 Valves	1984cc	TD28851
CJXC	4 Cyl.	16 Valves	1984cc	TD34288
CJXE	4 Cyl.	16 Valves	1984cc	TD28852
CJXH	4 Cyl.	16 Valves	1984cc	TD32544
DEDA	4 Cyl.	16 Valves	1984cc	TD31430

PA5041 (x16)
HR791

116 2.0L

Diesel

CKFC	4 Cyl.	16 Valves	1968cc	TD27260
CRBC	4 Cyl.	16 Valves	1968cc	TD29194
CRLB	4 Cyl.	16 Valves	1968cc	TD29192
CRMB	4 Cyl.	16 Valves	1968cc	TD27261
CRVA	4 Cyl.	16 Valves	1968cc	TD27960
CRVC	4 Cyl.	16 Valves	1968cc	TD27959
CUNA	4 Cyl.	16 Valves	1968cc	TD28019
CUPA	4 Cyl.	16 Valves	1968cc	TD27262
CUVA	4 Cyl.	16 Valves	1968cc	TD33096
CUVC	4 Cyl.	16 Valves	1968cc	TD31428
CUWA	4 Cyl.	16 Valves	1968cc	TD31429

PA5041 (x16)
HR791

NA5361 (x2)
32.00 x 47.00 x 10.00mm, PTFE

LK5017
85.00 x 130.90 x 15.75mm, PTFE

**117 2.0L****Diesel**

DFFA	4 Cyl.	16 Valves	1968cc	TD33070
DFHA	4 Cyl.	16 Valves	1968cc	TD33633
DFLA	4 Cyl.	16 Valves	1968cc	TD33097
DFMA	4 Cyl.	16 Valves	1968cc	TD33093
PA5041 (x16) HR791	NA5361 32.00 x 47.00 x 10.00mm, PTFE	LK5017	85.00 x 130.90 x 15.75mm, PTFE	

118 2.2L**Diesel**

OM 615.912	4 Cyl.	8 Valves	2197cc	TD21374
			NB975	45.00 x 74.50 x 12.00mm, FPM
			PA815	78.00 x 94.00 x 8.00mm

119 2.3L**Petrol**

AGZ	5 Cyl.	10 Valves	2324cc	TD12511
HR816 (x2)			NA5106	35.00 x 48.00 x 10.00mm, PTFE
			NA5305	85.00 x 105.00 x 11.00mm, PTFE

120 2.3L**Petrol**

AQN	5 Cyl.	20 Valves	2324cc	TD16163
PA5041 (x20) HR822	NA5001 32.00 x 47.00 x 10.00mm, FPM	NA5106	35.00 x 48.00 x 10.00mm, PTFE	
		NA5305	85.00 x 105.00 x 11.00mm, PTFE	01/01 →

121 2.4L**Diesel**

8144.61	4 Cyl.	8 Valves	2445cc	TD3597
HR602	NP068 55.00 x 70.00 x 8.00mm, FPM	NF833	90.00 x 115.00 x 13.00mm, FPM	

122 2.8L**Petrol**

AUE	6 Cyl.	24 Valves	2792cc	TD16137
AYL	6 Cyl.	24 Valves	2792cc	TD14910
BDE	6 Cyl.	24 Valves	2792cc	TD18753
PA5041 (x24) HR5062			NA5106	35.00 x 48.00 x 10.00mm, PTFE
			NA5305	85.00 x 105.00 x 11.00mm, PTFE
				01/01 →











CC



9

105,120 (742)	08/76→12/90	742.12 X	Petrol	1174	4	8	5
105,120 (742)	08/76→12/90	742,10	Petrol	1046	4	8	1
105,120 (744)	02/83→12/90	742.12 X	Petrol	1174	4	8	5
105,120 (744)	10/83→12/90	742,10	Petrol	1046	4	8	1
105,120 (744)	10/83→12/90	742,12	Petrol	1164	4	8	5
130	02/85→10/91	781.136	Petrol	1289	4	8	16
130	02/85→10/91	742,13	Petrol	1280	4	8	15
130	01/87→10/91	135/8	Petrol	1280	4	8	13
Citigo	10/11→	CHYA	Petrol	999	3	12	3
Citigo	10/11→	CHYB	Petrol	999	3	12	3
Citigo	11/12→	CPGA	Gas	999	3	12	4
Fabia I (6Y2)	08/99→05/03	AME	Petrol	1397	4	8	17
Fabia I (6Y2)	08/99→05/03	AQW	Petrol	1397	4	8	17
Fabia I (6Y2)	08/99→05/03	ATZ	Petrol	1397	4	8	17
Fabia I (6Y2)	12/99→08/02	AQV	Petrol	996	4	8	2
Fabia I (6Y2)	12/99→08/02	ARV	Petrol	996	4	8	2
Fabia I (6Y2)	12/99→03/08	ASY	Diesel	1896	4	8	51
Fabia I (6Y2)	12/99→03/08	AUA	Petrol	1390	4	16	19
Fabia I (6Y2)	12/99→03/08	AUB	Petrol	1390	4	16	19
Fabia I (6Y2)	12/99→03/08	AZL	Petrol	1984	4	8	53
Fabia I (6Y2)	12/99→03/08	BBY	Petrol	1390	4	16	19
Fabia I (6Y2)	12/99→03/08	BBZ	Petrol	1390	4	16	19
Fabia I (6Y2)	12/99→03/08	BKY	Petrol	1390	4	16	19
Fabia I (6Y2)	01/00→03/08	ATD	Diesel	1896	4	8	51
Fabia I (6Y2)	01/00→03/08	AXR	Diesel	1896	4	8	51
Fabia I (6Y2)	08/00→08/02	AZE	Petrol	1397	4	8	17
Fabia I (6Y2)	08/00→08/02	AZF	Petrol	1397	4	8	17
Fabia I (6Y2)	08/02→03/08	AWY	Petrol	1198	3	6	6
Fabia I (6Y2)	08/02→03/08	BMD	Petrol	1198	3	6	8
Fabia I (6Y2)	01/03→03/08	AZQ	Petrol	1198	3	12	7
Fabia I (6Y2)	01/03→03/08	BME	Petrol	1198	3	12	9
Fabia I (6Y2)	04/03→03/08	AMF	Diesel	1422	3	6	18
Fabia I (6Y2)	06/03→03/08	ASZ	Diesel	1896	4	8	51
Fabia I (6Y2)	06/03→03/08	BLT	Diesel	1896	4	8	51
Fabia I (6Y2)	10/05→03/08	BNM	Diesel	1422	3	6	18
Fabia I (6Y2)	10/05→03/08	BNV	Diesel	1422	3	6	18
Fabia I (6Y2)	02/06→10/06	BUD	Petrol	1390	4	16	21
Fabia I Combi (6Y5)	04/00→03/03	AZE	Petrol	1397	4	8	17
Fabia I Combi (6Y5)	04/00→03/03	AZF	Petrol	1397	4	8	17
Fabia I Combi (6Y5)	04/00→05/03	AME	Petrol	1397	4	8	17
Fabia I Combi (6Y5)	04/00→05/03	AQW	Petrol	1397	4	8	17
Fabia I Combi (6Y5)	04/00→05/03	ATZ	Petrol	1397	4	8	17
Fabia I Combi (6Y5)	04/00→12/07	ASY	Diesel	1896	4	8	51
Fabia I Combi (6Y5)	04/00→12/07	ATD	Diesel	1896	4	8	51
Fabia I Combi (6Y5)	04/00→12/07	AUB	Petrol	1390	4	16	19
Fabia I Combi (6Y5)	04/00→12/07	AXR	Diesel	1896	4	8	51
Fabia I Combi (6Y5)	04/00→12/07	AZL	Petrol	1984	4	8	53
Fabia I Combi (6Y5)	04/00→12/07	BBZ	Petrol	1390	4	16	19
Fabia I Combi (6Y5)	05/00→12/07	AUA	Petrol	1390	4	16	19
Fabia I Combi (6Y5)	05/00→12/07	BBY	Petrol	1390	4	16	19
Fabia I Combi (6Y5)	05/00→12/07	BKY	Petrol	1390	4	16	19
Fabia I Combi (6Y5)	11/00→08/02	ARV	Petrol	996	4	8	2
Fabia I Combi (6Y5)	07/01→12/07	AWY	Petrol	1198	3	6	6
Fabia I Combi (6Y5)	07/01→12/07	BMD	Petrol	1198	3	6	8
Fabia I Combi (6Y5)	01/03→12/07	AZQ	Petrol	1198	3	12	7
Fabia I Combi (6Y5)	01/03→12/07	BME	Petrol	1198	3	12	9
Fabia I Combi (6Y5)	04/03→12/07	AMF	Diesel	1422	3	6	18
Fabia I Combi (6Y5)	10/05→12/07	BNM	Diesel	1422	3	6	18
Fabia I Combi (6Y5)	10/05→12/07	BNV	Diesel	1422	3	6	18
Fabia I Combi (6Y5)	04/06→12/07	BUD	Petrol	1390	4	16	21
Fabia I Praktik (6Y5)	07/01→05/03	AME	Petrol	1397	4	8	17
Fabia I Praktik (6Y5)	07/01→05/03	AQW	Petrol	1397	4	8	17
Fabia I Praktik (6Y5)	07/01→05/03	ATZ	Petrol	1397	4	8	17
Fabia I Praktik (6Y5)	07/01→12/07	ASY	Diesel	1896	4	8	51
Fabia I Praktik (6Y5)	07/01→12/07	AWY	Petrol	1198	3	6	6
Fabia I Praktik (6Y5)	07/01→12/07	BMD	Petrol	1198	3	6	8
Fabia I Praktik (6Y5)	01/03→12/07	AZQ	Petrol	1198	3	12	7
Fabia I Praktik (6Y5)	01/03→12/07	BME	Petrol	1198	3	12	9
Fabia I Praktik (6Y5)	10/05→12/07	BNM	Diesel	1422	3	6	18
Fabia I Saloon (6Y3)	10/99→12/07	AUA	Petrol	1390	4	16	19
Fabia I Saloon (6Y3)	10/99→12/07	BBY	Petrol	1390	4	16	19
Fabia I Saloon (6Y3)	10/99→12/07	BKY	Petrol	1390	4	16	19
Fabia I Saloon (6Y3)	11/99→12/07	ASY	Diesel	1896	4	8	51
Fabia I Saloon (6Y3)	12/99→12/07	AUB	Petrol	1390	4	16	19
Fabia I Saloon (6Y3)	12/99→12/07	AZL	Petrol	1984	4	8	53
Fabia I Saloon (6Y3)	12/99→12/07	BBZ	Petrol	1390	4	16	19
Fabia I Saloon (6Y3)	01/00→12/07	ATD	Diesel	1896	4	8	51
Fabia I Saloon (6Y3)	01/00→12/07	AXR	Diesel	1896	4	8	51

							
Fabia I Saloon (6Y3)	04/00→08/02	AZE	Petrol	1397	4	8	17
Fabia I Saloon (6Y3)	04/00→08/02	AZF	Petrol	1397	4	8	17
Fabia I Saloon (6Y3)	11/00→08/02	AQV	Petrol	996	4	8	2
Fabia I Saloon (6Y3)	11/00→08/02	ARV	Petrol	996	4	8	2
Fabia I Saloon (6Y3)	07/01→05/03	AME	Petrol	1397	4	8	17
Fabia I Saloon (6Y3)	07/01→05/03	AQW	Petrol	1397	4	8	17
Fabia I Saloon (6Y3)	07/01→05/03	ATZ	Petrol	1397	4	8	17
Fabia I Saloon (6Y3)	07/01→12/07	AWY	Petrol	1198	3	6	6
Fabia I Saloon (6Y3)	07/01→12/07	BMD	Petrol	1198	3	6	8
Fabia I Saloon (6Y3)	01/03→12/07	AZQ	Petrol	1198	3	12	7
Fabia I Saloon (6Y3)	01/03→12/07	BME	Petrol	1198	3	12	9
Fabia I Saloon (6Y3)	04/03→12/07	AMF	Diesel	1422	3	6	18
Fabia I Saloon (6Y3)	10/05→12/07	BNM	Diesel	1422	3	6	18
Fabia I Saloon (6Y3)	10/05→12/07	BNV	Diesel	1422	3	6	18
Fabia I Saloon (6Y3)	04/06→12/07	BUD	Petrol	1390	4	16	21
Fabia II (542)	12/06→12/14	BBM	Petrol	1198	3	6	6
Fabia II (542)	12/06→12/14	CHFA	Petrol	1198	3	6	8
Fabia II (542)	01/07→03/10	BMS	Diesel	1422	3	6	20
Fabia II (542)	01/07→03/10	BNV	Diesel	1422	3	6	18
Fabia II (542)	01/07→12/14	BXW	Petrol	1390	4	16	22
Fabia II (542)	01/07→12/14	BZG	Petrol	1198	3	12	9
Fabia II (542)	01/07→12/14	CEVA	Petrol	1198	3	12	9
Fabia II (542)	01/07→12/14	CGGB	Petrol	1390	4	16	19
Fabia II (542)	01/07→12/14	CGPA	Petrol	1198	3	12	9
Fabia II (542)	01/07→12/14	CHTA	Petrol	1198	3	12	9
Fabia II (542)	02/07→03/10	BNM	Diesel	1422	3	6	18
Fabia II (542)	04/07→03/10	BLS	Diesel	1896	4	8	52
Fabia II (542)	04/07→03/10	BSW	Diesel	1896	4	8	51
Fabia II (542)	04/07→12/14	BTS	Petrol	1598	4	16	34
Fabia II (542)	04/07→12/14	CFNA	Petrol	1598	4	16	34
Fabia II (542)	04/07→12/14	CLSA	Petrol	1598	4	16	34
Fabia II (542)	03/10→12/14	CAYB	Diesel	1598	4	16	35
Fabia II (542)	03/10→12/14	CAYC	Diesel	1598	4	16	35
Fabia II (542)	03/10→12/14	CBZA	Petrol	1197	4	8	10
Fabia II (542)	03/10→12/14	CBZB	Petrol	1197	4	8	10
Fabia II (542)	04/10→12/14	CAYA	Diesel	1598	4	16	35
Fabia II (542)	05/10→12/14	CAVE	Petrol	1390	4	16	23
Fabia II (542)	05/10→12/14	CFWA	Diesel	1199	3	12	11
Fabia II (542)	05/10→12/14	CTHE	Petrol	1390	4	16	23
Fabia II (542)	11/11→12/14	CGPB	Petrol	1198	3	12	9
Fabia II (542)	11/11→12/14	CJLA	Petrol	1198	3	12	9
Fabia II Combi (545)	10/07→03/10	BLS	Diesel	1896	4	8	52
Fabia II Combi (545)	10/07→03/10	BMS	Diesel	1422	3	6	20
Fabia II Combi (545)	10/07→03/10	BNM	Diesel	1422	3	6	18
Fabia II Combi (545)	10/07→03/10	BNV	Diesel	1422	3	6	18
Fabia II Combi (545)	10/07→03/10	BSW	Diesel	1896	4	8	51
Fabia II Combi (545)	10/07→11/14	BBM	Petrol	1198	3	6	6
Fabia II Combi (545)	10/07→11/14	CHFA	Petrol	1198	3	6	8
Fabia II Combi (545)	10/07→12/14	BTS	Petrol	1598	4	16	34
Fabia II Combi (545)	10/07→12/14	BXW	Petrol	1390	4	16	22
Fabia II Combi (545)	10/07→12/14	BZG	Petrol	1198	3	12	9
Fabia II Combi (545)	10/07→12/14	CEVA	Petrol	1198	3	12	9
Fabia II Combi (545)	10/07→12/14	CFNA	Petrol	1598	4	16	34
Fabia II Combi (545)	10/07→12/14	CGGB	Petrol	1390	4	16	19
Fabia II Combi (545)	10/07→12/14	CGPA	Petrol	1198	3	12	9
Fabia II Combi (545)	10/07→12/14	CHTA	Petrol	1198	3	12	9
Fabia II Combi (545)	03/10→12/14	CAYB	Diesel	1598	4	16	35
Fabia II Combi (545)	03/10→12/14	CAYC	Diesel	1598	4	16	35
Fabia II Combi (545)	03/10→12/14	CBZA	Petrol	1197	4	8	10
Fabia II Combi (545)	03/10→12/14	CBZB	Petrol	1197	4	8	10
Fabia II Combi (545)	04/10→12/14	CAYA	Diesel	1598	4	16	35
Fabia II Combi (545)	05/10→12/14	CAVE	Petrol	1390	4	16	23
Fabia II Combi (545)	05/10→12/14	CFWA	Diesel	1199	3	12	11
Fabia II Combi (545)	05/10→12/14	CTHE	Petrol	1390	4	16	23
Fabia II Combi (545)	11/11→12/14	CGPB	Petrol	1198	3	12	9
Fabia III (NJ3)	08/14→	CHYA	Petrol	999	3	12	3
Fabia III (NJ3)	08/14→	CHYB	Petrol	999	3	12	3
Fabia III (NJ3)	08/14→	CJZC	Petrol	1197	4	16	12
Fabia III (NJ3)	08/14→	CJZD	Petrol	1197	4	16	12
Fabia III (NJ3)	08/14→	CUSB	Diesel	1422	3	12	27
Fabia III (NJ3)	08/14→	CUTA	Diesel	1422	3	12	27
Fabia III (NJ3)	01/15→	CWVA	Petrol	1598	4	16	38
Fabia III (NJ3)	05/15→	CUSA	Diesel	1422	3	12	27
Fabia III Estate (NJ5)	10/14→	CHYA	Petrol	999	3	12	3
Fabia III Estate (NJ5)	10/14→	CHYB	Petrol	999	3	12	3
Fabia III Estate (NJ5)	10/14→	CJZC	Petrol	1197	4	16	12
Fabia III Estate (NJ5)	10/14→	CJZD	Petrol	1197	4	16	12
Fabia III Estate (NJ5)	10/14→	CUSB	Diesel	1422	3	12	27



CC



9

Fabia III Estate (NJ5)	10/14→	CUTA	Diesel	1422	3	12	27
Fabia III Estate (NJ5)	01/15→	CWVA	Petrol	1598	4	16	38
Fabia III Estate (NJ5)	05/15→	CUSA	Diesel	1422	3	12	27
Favorit (781)	05/89→09/94	781.135	Petrol	1289	4	8	16
Favorit (781)	01/90→09/94	781.135E	Petrol	1289	4	8	14
Favorit (781)	10/90→09/94	136 L	Petrol	1289	4	8	14
Favorit (781)	01/94→09/94	136B	Petrol	1289	4	8	14
Favorit Forman (785)	08/91→06/95	OHC	Petrol	1289	4	8	16
Favorit Forman (785)	09/91→06/95	781.135E	Petrol	1289	4	8	14
Favorit Forman (785)	12/91→06/95	781.135	Petrol	1289	4	8	16
Favorit Forman (785)	01/94→06/95	136B	Petrol	1289	4	8	14
Favorit Pickup (787)	06/92→09/93	781.136	Petrol	1289	4	8	16
Favorit Pickup (787)	12/92→06/97	135B	Petrol	1289	4	8	14
Favorit Pickup (787)	12/92→06/97	136B	Petrol	1289	4	8	14
Favorit Pickup (787)	12/92→06/97	781.135	Petrol	1289	4	8	16
Felicia I (6U1)	10/94→03/98	135B	Petrol	1289	4	8	14
Felicia I (6U1)	10/94→03/98	135 L	Petrol	1289	4	8	14
Felicia I (6U1)	10/94→03/98	136B	Petrol	1289	4	8	14
Felicia I (6U1)	10/94→03/98	AMG	Petrol	1289	4	8	14
Felicia I (6U1)	10/94→03/98	AMH	Petrol	1289	4	8	14
Felicia I (6U1)	10/94→03/98	AMJ	Petrol	1289	4	8	14
Felicia I (6U1)	08/95→03/98	AEE	Petrol	1598	4	8	30
Felicia I (6U1)	08/95→03/98	EAT11	Petrol	1598	4	8	39
Felicia I (6U1)	10/95→03/98	AEF	Diesel	1896	4	8	47
Felicia I Estate (6U5)	08/95→03/98	135B	Petrol	1289	4	8	14
Felicia I Estate (6U5)	08/95→03/98	135 L	Petrol	1289	4	8	14
Felicia I Estate (6U5)	08/95→03/98	136B	Petrol	1289	4	8	14
Felicia I Estate (6U5)	08/95→03/98	AEE	Petrol	1598	4	8	30
Felicia I Estate (6U5)	08/95→03/98	AMG	Petrol	1289	4	8	14
Felicia I Estate (6U5)	08/95→03/98	AMH	Petrol	1289	4	8	14
Felicia I Estate (6U5)	08/95→03/98	AMJ	Petrol	1289	4	8	14
Felicia I Estate (6U5)	10/95→03/98	AEF	Diesel	1896	4	8	47
Felicia I Pickup (6UF, 6U7)	10/95→04/02	AMJ	Petrol	1289	4	8	14
Felicia I Pickup (6UF, 6U7)	06/97→04/02	135B	Petrol	1289	4	8	14
Felicia I Pickup (6UF, 6U7)	06/97→04/02	135M	Petrol	1289	4	8	14
Felicia I Pickup (6UF, 6U7)	06/97→04/02	136B	Petrol	1289	4	8	14
Felicia I Pickup (6UF, 6U7)	06/97→04/02	136M	Petrol	1289	4	8	14
Felicia I Pickup (6UF, 6U7)	06/97→04/02	AEE	Petrol	1598	4	8	30
Felicia I Pickup (6UF, 6U7)	06/97→04/02	AEF	Diesel	1896	4	8	47
Felicia I Pickup (6UF, 6U7)	06/97→04/02	AMG	Petrol	1289	4	8	14
Felicia I Pickup (6UF, 6U7)	06/97→04/02	AMH	Petrol	1289	4	8	14
Felicia II (6U1)	01/98→06/01	AEE	Petrol	1598	4	8	30
Felicia II (6U1)	01/98→06/01	AEF	Diesel	1896	4	8	47
Felicia II (6U1)	01/98→06/01	AMG	Petrol	1289	4	8	14
Felicia II (6U1)	01/98→06/01	AMH	Petrol	1289	4	8	14
Felicia II (6U1)	01/98→06/01	AMJ	Petrol	1289	4	8	14
Felicia II Estate (6U5)	01/98→06/01	AEE	Petrol	1598	4	8	30
Felicia II Estate (6U5)	01/98→06/01	AEF	Diesel	1896	4	8	47
Felicia II Estate (6U5)	01/98→06/01	AMH	Petrol	1289	4	8	14
Karoq (NU7)	07/17→	DDYA	Diesel	1598	4	16	36
Karoq (NU7)	07/17→	DFHA	Diesel	1968	4	16	62
Kodiaq (NS7)	10/16→	CZCA	Petrol	1395	4	16	26
Kodiaq (NS7)	10/16→	CZDA	Petrol	1395	4	16	26
Kodiaq (NS7)	10/16→	CZEA	Petrol	1395	4	16	28
Kodiaq (NS7)	10/16→	CZPA	Petrol	1984	4	16	61
Kodiaq (NS7)	10/16→	DBGA	Diesel	1968	4	16	62
Kodiaq (NS7)	10/16→	DBGC	Diesel	1968	4	16	62
Kodiaq (NS7)	10/16→	DFGA	Diesel	1968	4	16	62
Kodiaq (NS7)	10/16→	DFHA	Diesel	1968	4	16	62
Octavia (1Z3)	06/07→03/14	BYJ	Petrol	1798	4	16	46
Octavia (1Z3)	04/10→12/14	CGZ	Petrol	1984	4	8	53
Octavia (5E3)	05/14→	CSS	Petrol	1395	4	16	26
Octavia Estate	08/17→	CSSA	Petrol	1395	4	16	26
Octavia I (1U2)	09/96→07/00	AGN	Petrol	1781	4	20	41
Octavia I (1U2)	09/96→09/04	AEE	Petrol	1598	4	8	30
Octavia I (1U2)	09/96→03/10	AGR	Diesel	1896	4	8	49
Octavia I (1U2)	09/96→03/10	ALH	Diesel	1896	4	8	49
Octavia I (1U2)	02/97→12/07	AEH	Petrol	1595	4	8	31
Octavia I (1U2)	02/97→12/07	AKL	Petrol	1595	4	8	31
Octavia I (1U2)	06/97→12/03	AGP	Diesel	1896	4	8	49
Octavia I (1U2)	06/97→12/03	AQM	Diesel	1896	4	8	49
Octavia I (1U2)	08/97→01/06	AHF	Diesel	1896	4	8	50
Octavia I (1U2)	08/97→01/06	ASV	Diesel	1896	4	8	49
Octavia I (1U2)	08/97→12/10	AGU	Petrol	1781	4	20	42
Octavia I (1U2)	08/97→12/10	ARX	Petrol	1781	4	20	43
Octavia I (1U2)	08/97→12/10	ARZ	Petrol	1781	4	20	43
Octavia I (1U2)	08/97→12/10	AUM	Petrol	1781	4	20	43
Octavia I (1U2)	04/99→03/01	AMD	Petrol	1397	4	8	17



CC



9

Octavia I (1U2)	04/99→05/07	AEG	Petrol	1984	4	8	53
Octavia I (1U2)	04/99→05/07	APK	Petrol	1984	4	8	53
Octavia I (1U2)	04/99→05/07	AQY	Petrol	1984	4	8	53
Octavia I (1U2)	04/99→05/07	AZH	Petrol	1984	4	8	53
Octavia I (1U2)	04/99→05/07	AZJ	Petrol	1984	4	8	53
Octavia I (1U2)	09/00→12/10	AXP	Petrol	1390	4	16	19
Octavia I (1U2)	09/00→12/10	BCA	Petrol	1390	4	16	19
Octavia I (1U2)	11/00→12/10	AVU	Petrol	1595	4	8	32
Octavia I (1U2)	11/00→12/10	BFQ	Petrol	1595	4	8	32
Octavia I (1U2)	05/01→01/06	AUQ	Petrol	1781	4	20	44
Octavia I (1U2)	09/02→09/04	ASZ	Diesel	1896	4	8	51
Octavia I (1U2)	10/05→12/10	AXR	Diesel	1896	4	8	51
Octavia I Combi (1U5)	07/98→07/00	AGN	Petrol	1781	4	20	41
Octavia I Combi (1U5)	07/98→12/03	AGP	Diesel	1896	4	8	49
Octavia I Combi (1U5)	07/98→12/03	AQM	Diesel	1896	4	8	49
Octavia I Combi (1U5)	07/98→09/04	AEE	Petrol	1598	4	8	30
Octavia I Combi (1U5)	07/98→01/06	AHF	Diesel	1896	4	8	50
Octavia I Combi (1U5)	07/98→01/06	ASV	Diesel	1896	4	8	49
Octavia I Combi (1U5)	07/98→12/07	AEH	Petrol	1595	4	8	31
Octavia I Combi (1U5)	07/98→12/07	AKL	Petrol	1595	4	8	31
Octavia I Combi (1U5)	07/98→03/10	AGR	Diesel	1896	4	8	49
Octavia I Combi (1U5)	07/98→03/10	ALH	Diesel	1896	4	8	49
Octavia I Combi (1U5)	07/98→12/10	AGU	Petrol	1781	4	20	42
Octavia I Combi (1U5)	07/98→12/10	ARX	Petrol	1781	4	20	43
Octavia I Combi (1U5)	07/98→12/10	ARZ	Petrol	1781	4	20	43
Octavia I Combi (1U5)	07/98→12/10	AUM	Petrol	1781	4	20	43
Octavia I Combi (1U5)	04/99→05/07	AEG	Petrol	1984	4	8	53
Octavia I Combi (1U5)	04/99→05/07	APK	Petrol	1984	4	8	53
Octavia I Combi (1U5)	04/99→05/07	AQY	Petrol	1984	4	8	53
Octavia I Combi (1U5)	04/99→05/07	AZH	Petrol	1984	4	8	53
Octavia I Combi (1U5)	04/99→05/07	AZJ	Petrol	1984	4	8	53
Octavia I Combi (1U5)	08/00→12/10	AXP	Petrol	1390	4	16	19
Octavia I Combi (1U5)	08/00→12/10	AXR	Diesel	1896	4	8	51
Octavia I Combi (1U5)	08/00→12/10	BCA	Petrol	1390	4	16	19
Octavia I Combi (1U5)	09/00→01/06	ATD	Diesel	1896	4	8	51
Octavia I Combi (1U5)	09/00→12/10	AVU	Petrol	1595	4	8	32
Octavia I Combi (1U5)	09/00→12/10	BFQ	Petrol	1595	4	8	32
Octavia I Combi (1U5)	08/02→01/06	AUQ	Petrol	1781	4	20	44
Octavia I Combi (1U5)	09/02→09/04	ASZ	Diesel	1896	4	8	51
Octavia II Combi (1Z5)	02/04→10/08	BLF	Petrol	1598	4	16	33
Octavia II Combi (1Z5)	02/04→05/10	AZV	Diesel	1968	4	16	54
Octavia II Combi (1Z5)	02/04→05/13	BKD	Diesel	1968	4	16	54
Octavia II Combi (1Z5)	02/04→05/13	CFHC	Diesel	1968	4	16	59
Octavia II Combi (1Z5)	02/04→05/13	CLCB	Diesel	1968	4	16	59
Octavia II Combi (1Z5)	05/04→05/06	BCA	Petrol	1390	4	16	19
Octavia II Combi (1Z5)	09/04→12/10	BJB	Diesel	1896	4	8	52
Octavia II Combi (1Z5)	09/04→12/10	BKC	Diesel	1896	4	8	52
Octavia II Combi (1Z5)	09/04→12/10	BLS	Diesel	1896	4	8	52
Octavia II Combi (1Z5)	09/04→12/10	BXE	Diesel	1896	4	8	52
Octavia II Combi (1Z5)	09/04→06/13	BGU	Petrol	1595	4	8	32
Octavia II Combi (1Z5)	09/04→06/13	BSE	Petrol	1595	4	8	32
Octavia II Combi (1Z5)	09/04→06/13	BSF	Petrol	1595	4	8	32
Octavia II Combi (1Z5)	09/04→06/13	CCSA	Petrol	1595	4	8	32
Octavia II Combi (1Z5)	09/04→06/13	CMXA	Petrol	1595	4	8	32
Octavia II Combi (1Z5)	11/04→10/08	BLR	Petrol	1984	4	16	55
Octavia II Combi (1Z5)	11/04→10/08	BLX	Petrol	1984	4	16	55
Octavia II Combi (1Z5)	11/04→10/08	BLY	Petrol	1984	4	16	55
Octavia II Combi (1Z5)	11/04→10/08	BVX	Petrol	1984	4	16	55
Octavia II Combi (1Z5)	11/04→10/08	BVY	Petrol	1984	4	16	55
Octavia II Combi (1Z5)	11/04→10/08	BVZ	Petrol	1984	4	16	55
Octavia II Combi (1Z5)	10/05→02/13	BWA	Petrol	1984	4	16	58
Octavia II Combi (1Z5)	10/05→02/13	CCZA	Petrol	1984	4	16	60
Octavia II Combi (1Z5)	11/05→05/10	BMM	Diesel	1968	4	8	56
Octavia II Combi (1Z5)	04/06→02/13	BMN	Diesel	1968	4	16	54
Octavia II Combi (1Z5)	04/06→02/13	CEGA	Diesel	1968	4	16	59
Octavia II Combi (1Z5)	05/06→06/13	BUD	Petrol	1390	4	16	21
Octavia II Combi (1Z5)	05/06→06/13	CGGA	Petrol	1390	4	16	19
Octavia II Combi (1Z5)	06/07→04/13	BZB	Petrol	1798	4	16	46
Octavia II Combi (1Z5)	06/07→04/13	CDAA	Petrol	1798	4	16	46
Octavia II Combi (1Z5)	11/08→06/13	CAXA	Petrol	1390	4	16	23
Octavia II Combi (1Z5)	03/09→06/13	CDAB	Petrol	1798	4	16	46
Octavia II Combi (1Z5)	06/09→04/13	CAYC	Diesel	1598	4	16	35
Octavia II Combi (1Z5)	08/09→11/12	CHGA	Petrol	1595	4	8	32
Octavia II Combi (1Z5)	02/10→04/13	CBZB	Petrol	1197	4	8	10
Octavia II Combi (1Z5)	03/10→06/13	CFHF	Diesel	1968	4	16	59
Octavia II Combi (1Z5)	03/10→06/13	CLCA	Diesel	1968	4	16	59
Octavia III (5E3)	11/12→	CHPA	Petrol	1395	4	16	26
Octavia III (5E3)	11/12→	CJSA	Petrol	1798	4	16	46



CC



9

Octavia III (5E3)	11/12→	CJZA	Petrol	1197	4	16	12
Octavia III (5E3)	11/12→	CJZB	Petrol	1197	4	16	12
Octavia III (5E3)	11/12→	CKFB	Diesel	1968	4	16	62
Octavia III (5E3)	11/12→	CKFC	Diesel	1968	4	16	62
Octavia III (5E3)	11/12→	CLHA	Diesel	1598	4	16	36
Octavia III (5E3)	11/12→	CLHB	Diesel	1598	4	16	36
Octavia III (5E3)	11/12→	CRMB	Diesel	1968	4	16	62
Octavia III (5E3)	11/12→	CRVC	Diesel	1968	4	16	62
Octavia III (5E3)	11/12→	DDYB	Diesel	1598	4	16	36
Octavia III (5E3)	05/13→	CHHB	Petrol	1984	4	16	61
Octavia III (5E3)	05/13→	CRKB	Diesel	1598	4	16	36
Octavia III (5E3)	05/13→	CUNA	Diesel	1968	4	16	62
Octavia III (5E3)	05/13→	CUPA	Diesel	1968	4	16	62
Octavia III (5E3)	05/13→	CXXB	Diesel	1598	4	16	36
Octavia III (5E3)	05/13→	DBKA	Diesel	1598	4	16	36
Octavia III (5E3)	11/13→	CPWA	Petrol	1395	4	16	26
Octavia III (5E3)	01/14→	CWVA	Petrol	1598	4	16	38
Octavia III (5E3)	08/14→	CHPB	Petrol	1395	4	16	26
Octavia III (5E3)	08/14→	CZDA	Petrol	1395	4	16	26
Octavia III (5E3)	09/14→	CJSB	Petrol	1798	4	16	46
Octavia III (5E3)	05/15→	CHHA	Petrol	1984	4	16	61
Octavia III (5E3)	05/15→	CYVB	Petrol	1197	4	16	12
Octavia III (5E3)	05/16→	CHZD	Petrol	999	3	12	3
Octavia III (5E3)	02/17→	DDYA	Diesel	1598	4	16	36
Octavia III (5E3)	02/17→	DLBA	Petrol	1984	4	16	61
Octavia III Combi (5E5)	11/12→	CHHB	Petrol	1984	4	16	61
Octavia III Combi (5E5)	11/12→	CHPA	Petrol	1395	4	16	26
Octavia III Combi (5E5)	11/12→	CJSA	Petrol	1798	4	16	46
Octavia III Combi (5E5)	11/12→	CJSB	Petrol	1798	4	16	46
Octavia III Combi (5E5)	11/12→	CJZA	Petrol	1197	4	16	12
Octavia III Combi (5E5)	11/12→	CJZB	Petrol	1197	4	16	12
Octavia III Combi (5E5)	11/12→	CKFB	Diesel	1968	4	16	62
Octavia III Combi (5E5)	11/12→	CKFC	Diesel	1968	4	16	62
Octavia III Combi (5E5)	11/12→	CLHA	Diesel	1598	4	16	36
Octavia III Combi (5E5)	11/12→	CLHB	Diesel	1598	4	16	36
Octavia III Combi (5E5)	11/12→	CRMB	Diesel	1968	4	16	62
Octavia III Combi (5E5)	11/12→	CRVC	Diesel	1968	4	16	62
Octavia III Combi (5E5)	11/12→	DDYB	Diesel	1598	4	16	36
Octavia III Combi (5E5)	05/13→	CRKB	Diesel	1598	4	16	36
Octavia III Combi (5E5)	05/13→	CUNA	Diesel	1968	4	16	62
Octavia III Combi (5E5)	05/13→	CUPA	Diesel	1968	4	16	62
Octavia III Combi (5E5)	05/13→	CXXB	Diesel	1598	4	16	36
Octavia III Combi (5E5)	05/13→	DBKA	Diesel	1598	4	16	36
Octavia III Combi (5E5)	11/13→	CPWA	Petrol	1395	4	16	26
Octavia III Combi (5E5)	01/14→	CWVA	Petrol	1598	4	16	38
Octavia III Combi (5E5)	08/14→	CHPB	Petrol	1395	4	16	26
Octavia III Combi (5E5)	08/14→	CZDA	Petrol	1395	4	16	26
Octavia III Combi (5E5)	05/15→	CHHA	Petrol	1984	4	16	61
Octavia III Combi (5E5)	05/15→	CYVB	Petrol	1197	4	16	12
Octavia III Combi (5E5)	05/16→	CHZD	Petrol	999	3	12	3
Octavia III Combi (5E5)	02/17→	DDYA	Diesel	1598	4	16	36
Octavia III Combi (5E5)	02/17→	DLBA	Petrol	1984	4	16	61
Octavia II (1Z3)	02/04→10/08	BLF	Petrol	1598	4	16	33
Octavia II (1Z3)	02/04→05/10	AZV	Diesel	1968	4	16	54
Octavia II (1Z3)	02/04→04/13	BKD	Diesel	1968	4	16	54
Octavia II (1Z3)	02/04→04/13	CFHC	Diesel	1968	4	16	59
Octavia II (1Z3)	02/04→04/13	CLCB	Diesel	1968	4	16	59
Octavia II (1Z3)	05/04→05/06	BCA	Petrol	1390	4	16	19
Octavia II (1Z3)	06/04→12/10	BJB	Diesel	1896	4	8	52
Octavia II (1Z3)	06/04→12/10	BKC	Diesel	1896	4	8	52
Octavia II (1Z3)	06/04→12/10	BLS	Diesel	1896	4	8	52
Octavia II (1Z3)	06/04→12/10	BXE	Diesel	1896	4	8	52
Octavia II (1Z3)	06/04→04/13	BUD	Petrol	1390	4	16	21
Octavia II (1Z3)	06/04→04/13	CGGA	Petrol	1390	4	16	19
Octavia II (1Z3)	06/04→06/13	BGU	Petrol	1595	4	8	32
Octavia II (1Z3)	06/04→06/13	BSE	Petrol	1595	4	8	32
Octavia II (1Z3)	06/04→06/13	BSF	Petrol	1595	4	8	32
Octavia II (1Z3)	06/04→06/13	CCSA	Petrol	1595	4	8	32
Octavia II (1Z3)	06/04→06/13	CMXA	Petrol	1595	4	8	32
Octavia II (1Z3)	11/04→10/08	BLR	Petrol	1984	4	16	55
Octavia II (1Z3)	11/04→10/08	BLY	Petrol	1984	4	16	55
Octavia II (1Z3)	11/04→10/08	BVY	Petrol	1984	4	16	55
Octavia II (1Z3)	11/04→10/08	BVZ	Petrol	1984	4	16	55
Octavia II (1Z3)	10/05→02/13	BWA	Petrol	1984	4	16	58
Octavia II (1Z3)	10/05→02/13	CCZA	Petrol	1984	4	16	60
Octavia II (1Z3)	11/05→05/10	BMM	Diesel	1968	4	8	56
Octavia II (1Z3)	04/06→02/13	BMN	Diesel	1968	4	16	54
Octavia II (1Z3)	04/06→02/13	CEGA	Diesel	1968	4	16	59



CC



9

Octavia II (1Z3)	06/07→04/13	BZB	Petrol	1798	4	16	46
Octavia II (1Z3)	06/07→04/13	CDAA	Petrol	1798	4	16	46
Octavia II (1Z3)	11/08→06/13	CAXA	Petrol	1390	4	16	23
Octavia II (1Z3)	03/09→06/13	CDAB	Petrol	1798	4	16	46
Octavia II (1Z3)	06/09→04/13	CAYC	Diesel	1598	4	16	35
Octavia II (1Z3)	08/09→11/12	CHGA	Petrol	1595	4	8	32
Octavia II (1Z3)	02/10→06/13	CBZB	Petrol	1197	4	8	10
Octavia II (1Z3)	03/10→06/13	CFHF	Diesel	1968	4	16	59
Octavia II (1Z3)	03/10→06/13	CLCA	Diesel	1968	4	16	59
Rapid (120G, 130G, 135G)	09/84→12/90	135/8	Petrol	1280	4	8	13
Rapid (120G, 130G, 135G)	03/85→08/88	742,13	Petrol	1280	4	8	15
Rapid (NA2)	10/11→	CLNA	Diesel	1598	4	16	35
Rapid (NA2)	10/11→	CLSA	Petrol	1598	4	16	34
Rapid (NA2)	04/13→	CKA	Petrol	1395	4	16	26
Rapid (NA2)	04/13→	CPD	Petrol	1598	4	16	37
Rapid (NA2)	01/14→	CWXB	Diesel	1498	4	16	29
Rapid (NH3)	07/12→	CAXA	Petrol	1390	4	16	23
Rapid (NH3)	07/12→	CAYC	Diesel	1598	4	16	35
Rapid (NH3)	07/12→	CBZA	Petrol	1197	4	8	10
Rapid (NH3)	07/12→	CBZB	Petrol	1197	4	8	10
Rapid (NH3)	07/12→	CFNA	Petrol	1598	4	16	34
Rapid (NH3)	07/12→	CGPC	Petrol	1198	3	12	9
Rapid (NH3)	07/12→	CLNA	Diesel	1598	4	16	35
Rapid (NH3)	08/13→	CAYB	Diesel	1598	4	16	35
Rapid (NH3)	05/15→	CJZC	Petrol	1197	4	16	12
Rapid (NH3)	05/15→	CJZD	Petrol	1197	4	16	12
Rapid (NH3)	05/15→	CUSB	Diesel	1422	3	12	27
Rapid (NH3)	05/15→	CWVA	Petrol	1598	4	16	38
Rapid (NH3)	05/15→	CXMA	Diesel	1598	4	16	36
Rapid (NH3)	05/15→	CZCA	Petrol	1395	4	16	26
Rapid Spaceback (NH1)	07/12→	CAXA	Petrol	1390	4	16	23
Rapid Spaceback (NH1)	07/12→	CAYC	Diesel	1598	4	16	35
Rapid Spaceback (NH1)	07/12→	CBZA	Petrol	1197	4	8	10
Rapid Spaceback (NH1)	07/12→	CBZB	Petrol	1197	4	8	10
Rapid Spaceback (NH1)	07/12→	CFNA	Petrol	1598	4	16	34
Rapid Spaceback (NH1)	07/12→	CGPC	Petrol	1198	3	12	9
Rapid Spaceback (NH1)	07/12→	CLNA	Diesel	1598	4	16	35
Rapid Spaceback (NH1)	08/13→	CAYB	Diesel	1598	4	16	35
Rapid Spaceback (NH1)	05/15→	CJZC	Petrol	1197	4	16	12
Rapid Spaceback (NH1)	05/15→	CJZD	Petrol	1197	4	16	12
Rapid Spaceback (NH1)	05/15→	CUSB	Diesel	1422	3	12	27
Rapid Spaceback (NH1)	05/15→	CXMA	Diesel	1598	4	16	36
Rapid Spaceback (NH1)	05/15→	CZCA	Petrol	1395	4	16	26
Rapid Spaceback (NH3)	04/14→	CPD	Petrol	1598	4	16	37
Rapid Spaceback (NH3)	09/15→	CKA	Petrol	1395	4	16	26
Roomster (5J)	03/06→05/06	AXR	Diesel	1896	4	8	51
Roomster (5J)	05/06→01/07	BME	Petrol	1198	3	12	9
Roomster (5J)	07/06→03/10	BNM	Diesel	1422	3	6	18
Roomster (5J)	09/06→03/10	BLS	Diesel	1896	4	8	52
Roomster (5J)	09/06→03/10	BMS	Diesel	1422	3	6	20
Roomster (5J)	09/06→03/10	BNV	Diesel	1422	3	6	18
Roomster (5J)	09/06→03/10	BSW	Diesel	1896	4	8	51
Roomster (5J)	09/06→05/15	BTS	Petrol	1598	4	16	34
Roomster (5J)	09/06→05/15	BXW	Petrol	1390	4	16	22
Roomster (5J)	09/06→05/15	CFNA	Petrol	1598	4	16	34
Roomster (5J)	09/06→05/15	CGGB	Petrol	1390	4	16	19
Roomster (5J)	01/07→05/15	BZG	Petrol	1198	3	12	9
Roomster (5J)	01/07→05/15	CGPA	Petrol	1198	3	12	9
Roomster (5J)	03/10→05/15	CAYB	Diesel	1598	4	16	35
Roomster (5J)	03/10→05/15	CAYC	Diesel	1598	4	16	35
Roomster (5J)	03/10→05/15	CBZA	Petrol	1197	4	8	10
Roomster (5J)	03/10→05/15	CBZB	Petrol	1197	4	8	10
Roomster (5J)	03/10→05/15	CFWA	Diesel	1199	3	12	11
Roomster Praktik (5J)	03/07→03/10	BMS	Diesel	1422	3	6	20
Roomster Praktik (5J)	03/07→03/10	BNM	Diesel	1422	3	6	18
Roomster Praktik (5J)	03/07→03/10	BNV	Diesel	1422	3	6	18
Roomster Praktik (5J)	03/07→05/15	BXW	Petrol	1390	4	16	22
Roomster Praktik (5J)	03/07→05/15	BZG	Petrol	1198	3	12	9
Roomster Praktik (5J)	03/07→05/15	CGGB	Petrol	1390	4	16	19
Roomster Praktik (5J)	03/07→05/15	CGPA	Petrol	1198	3	12	9
Roomster Praktik (5J)	03/10→05/15	CAYB	Diesel	1598	4	16	35
Roomster Praktik (5J)	03/10→05/15	CBZA	Petrol	1197	4	8	10
Roomster Praktik (5J)	03/10→05/15	CFWA	Diesel	1199	3	12	11
Superb (3U4)	06/02→03/08	BBG	Petrol	2771	6	30	64
Superb I (3U4)	12/01→08/03	AYM	Diesel	2496	6	24	63
Superb I (3U4)	12/01→03/08	AMX	Petrol	2771	6	30	64
Superb I (3U4)	12/01→03/08	AVF	Diesel	1896	4	8	51
Superb I (3U4)	12/01→03/08	AWT	Petrol	1781	4	20	45



CC



9

Superb I (3U4)	12/01→03/08	AWX	Diesel	1896	4	8	51
Superb I (3U4)	12/01→03/08	AZM	Petrol	1984	4	8	53
Superb I (3U4)	08/02→10/05	AVB	Diesel	1896	4	8	51
Superb I (3U4)	06/03→03/08	BDG	Diesel	2496	6	24	63
Superb I (3U4)	10/05→05/07	BSV	Diesel	1896	4	8	51
Superb I (3U4)	10/05→03/08	BSS	Diesel	1968	4	8	57
Superb I (3U4)	01/07→03/08	BPZ	Diesel	1896	4	8	51
Superb II (3T4)	03/08→05/10	BMP	Diesel	1968	4	8	56
Superb II (3T4)	03/08→11/10	BLS	Diesel	1896	4	8	52
Superb II (3T4)	03/08→11/10	BXE	Diesel	1896	4	8	52
Superb II (3T4)	03/08→05/15	BZB	Petrol	1798	4	16	46
Superb II (3T4)	03/08→05/15	CDA	Petrol	1798	4	16	46
Superb II (3T4)	07/08→05/15	CAXC	Petrol	1390	4	16	23
Superb II (3T4)	07/08→05/15	CBBB	Diesel	1968	4	16	59
Superb II (3T4)	07/08→05/15	CFGB	Diesel	1968	4	16	59
Superb II (3T4)	11/08→05/15	CDVA	Petrol	3597	6	24	65
Superb II (3T4)	01/09→05/15	BKD	Diesel	1968	4	16	54
Superb II (3T4)	01/09→05/15	CFFB	Diesel	1968	4	16	59
Superb II (3T4)	01/09→05/15	CLJA	Diesel	1968	4	16	59
Superb II (3T4)	03/09→05/15	CDAB	Petrol	1798	4	16	46
Superb II (3T4)	05/10→05/15	CCZA	Petrol	1984	4	16	60
Superb II (3T4)	09/10→05/15	CAYC	Diesel	1598	4	16	35
Superb II Estate (3T5)	10/09→03/10	BMP	Diesel	1968	4	8	56
Superb II Estate (3T5)	10/09→11/10	BLS	Diesel	1896	4	8	52
Superb II Estate (3T5)	10/09→11/10	BXE	Diesel	1896	4	8	52
Superb II Estate (3T5)	10/09→05/15	BKD	Diesel	1968	4	16	54
Superb II Estate (3T5)	10/09→05/15	CAXC	Petrol	1390	4	16	23
Superb II Estate (3T5)	10/09→05/15	CBBB	Diesel	1968	4	16	59
Superb II Estate (3T5)	10/09→05/15	CDA	Petrol	1798	4	16	46
Superb II Estate (3T5)	10/09→05/15	CDAB	Petrol	1798	4	16	46
Superb II Estate (3T5)	10/09→05/15	CDVA	Petrol	3597	6	24	65
Superb II Estate (3T5)	10/09→05/15	CFFB	Diesel	1968	4	16	59
Superb II Estate (3T5)	10/09→05/15	CFGB	Diesel	1968	4	16	59
Superb II Estate (3T5)	10/09→05/15	CLJA	Diesel	1968	4	16	59
Superb II Estate (3T5)	05/10→05/15	CCZA	Petrol	1984	4	16	60
Superb II Estate (3T5)	09/10→05/15	CAYC	Diesel	1598	4	16	35
Superb III	10/15→	CSS	Petrol	1395	4	16	26
Superb III (3V3)	03/15→	CHHB	Petrol	1984	4	16	61
Superb III (3V3)	03/15→	CJSA	Petrol	1798	4	16	46
Superb III (3V3)	03/15→	CJSC	Petrol	1798	4	16	46
Superb III (3V3)	03/15→	CJXA	Petrol	1984	4	16	61
Superb III (3V3)	03/15→	CRLB	Diesel	1968	4	16	62
Superb III (3V3)	03/15→	CZCA	Petrol	1395	4	16	26
Superb III (3V3)	03/15→	CZDA	Petrol	1395	4	16	26
Superb III (3V3)	03/15→	CZEA	Petrol	1395	4	16	28
Superb III (3V3)	03/15→	DCXA	Diesel	1598	4	16	36
Superb III (3V3)	03/15→	DCZA	Diesel	1598	4	16	36
Superb III (3V3)	03/15→	DDAA	Diesel	1968	4	16	62
Superb III (3V3)	03/15→	DFCA	Diesel	1968	4	16	62
Superb III (3V3)	03/15→	DFEA	Diesel	1968	4	16	62
Superb III (3V3)	03/15→	DFGA	Diesel	1968	4	16	62
Superb III Estate (3V5)	03/15→	CHHB	Petrol	1984	4	16	61
Superb III Estate (3V5)	03/15→	CJSA	Petrol	1798	4	16	46
Superb III Estate (3V5)	03/15→	CJSC	Petrol	1798	4	16	46
Superb III Estate (3V5)	03/15→	CJXA	Petrol	1984	4	16	61
Superb III Estate (3V5)	03/15→	CRLB	Diesel	1968	4	16	62
Superb III Estate (3V5)	03/15→	CZCA	Petrol	1395	4	16	26
Superb III Estate (3V5)	03/15→	CZDA	Petrol	1395	4	16	26
Superb III Estate (3V5)	03/15→	CZEA	Petrol	1395	4	16	28
Superb III Estate (3V5)	03/15→	DCXA	Diesel	1598	4	16	36
Superb III Estate (3V5)	03/15→	DCZA	Diesel	1598	4	16	36
Superb III Estate (3V5)	03/15→	DDAA	Diesel	1968	4	16	62
Superb III Estate (3V5)	03/15→	DFCA	Diesel	1968	4	16	62
Superb III Estate (3V5)	03/15→	DFEA	Diesel	1968	4	16	62
Yeti (5L)	05/09→	CBDB	Diesel	1968	4	16	59
Yeti (5L)	05/09→	CDA	Petrol	1798	4	16	46
Yeti (5L)	05/09→	CFHC	Diesel	1968	4	16	59
Yeti (5L)	05/09→	CLCB	Diesel	1968	4	16	59
Yeti (5L)	09/09→	CBZB	Petrol	1197	4	8	10
Yeti (5L)	11/09→	CDAB	Petrol	1798	4	16	46
Yeti (5L)	11/09→	CEGA	Diesel	1968	4	16	59
Yeti (5L)	11/09→	CFHA	Diesel	1968	4	16	59
Yeti (5L)	11/09→	CFHF	Diesel	1968	4	16	59
Yeti (5L)	11/09→	CFJA	Diesel	1968	4	16	59
Yeti (5L)	11/09→	CLCA	Diesel	1968	4	16	59
Yeti (5L)	11/09→	CUUA	Diesel	1968	4	16	62
Yeti (5L)	11/09→	DFSA	Diesel	1968	4	16	62
Yeti (5L)	06/10→	CAXA	Petrol	1390	4	16	23



















CC



9

Model	Year Range	Code	Fuel Type	CC	Cylinders	Power (kW)	Power (hp)
Yeti (5L)	11/10→	CAYC	Diesel	1598	4	16	35
Yeti (5L)	11/13→	CSS	Petrol	1395	4	16	26
Yeti (5L)	04/14→	CWVA	Petrol	1598	4	16	38
Yeti (5L)	05/15→	CUUB	Diesel	1968	4	16	62
Yeti (5L)	05/15→	CYVB	Petrol	1197	4	16	12
Yeti (5L)	05/15→	CZCA	Petrol	1395	4	16	26
Yeti (5L)	05/15→	CZDA	Petrol	1395	4	16	26

	CC				9		CC				9
135/8	1280	4	8	Petrol	13	BKD	1968	4	16	Diesel	54
135B	1289	4	8	Petrol	14	BKY	1390	4	16	Petrol	19
135 L	1289	4	8	Petrol	14	BLF	1598	4	16	Petrol	33
135M	1289	4	8	Petrol	14	BLR	1984	4	16	Petrol	55
136B	1289	4	8	Petrol	14	BLS	1896	4	8	Diesel	52
136 L	1289	4	8	Petrol	14	BLT	1896	4	8	Diesel	51
136M	1289	4	8	Petrol	14	BLX	1984	4	16	Petrol	55
742.12 X	1174	4	8	Petrol	5	BLY	1984	4	16	Petrol	55
781.135	1289	4	8	Petrol	16	BMD	1198	3	6	Petrol	8
781.135E	1289	4	8	Petrol	14	BME	1198	3	12	Petrol	9
781.136	1289	4	8	Petrol	16	BMM	1968	4	8	Diesel	56
742,10	1046	4	8	Petrol	1	BMN	1968	4	16	Diesel	54
742,12	1164	4	8	Petrol	5	BMP	1968	4	8	Diesel	56
742,13	1280	4	8	Petrol	15	BMS	1422	3	6	Diesel	20
ADR	1781	4	20	Petrol	40	BNM	1422	3	6	Diesel	18
AEE	1598	4	8	Petrol	30	BNV	1422	3	6	Diesel	18
AEF	1896	4	8	Diesel	47	BPZ	1896	4	8	Diesel	51
AEG	1984	4	8	Petrol	53	BSE	1595	4	8	Petrol	32
AEH	1595	4	8	Petrol	31	BSF	1595	4	8	Petrol	32
AEY	1896	4	8	Diesel	48	BSS	1968	4	8	Diesel	57
AGN	1781	4	20	Petrol	41	BSV	1896	4	8	Diesel	51
AGP	1896	4	8	Diesel	49	BSW	1896	4	8	Diesel	51
AGR	1896	4	8	Diesel	49	BTS	1598	4	16	Petrol	34
AGU	1781	4	20	Petrol	42	BUD	1390	4	16	Petrol	21
AHF	1896	4	8	Diesel	50	BVX	1984	4	16	Petrol	55
AKL	1595	4	8	Petrol	31	BVY	1984	4	16	Petrol	55
ALH	1896	4	8	Diesel	49	BVZ	1984	4	16	Petrol	55
AMD	1397	4	8	Petrol	17	BWA	1984	4	16	Petrol	58
AME	1397	4	8	Petrol	17	BWW	1998	4	8	Diesel	57
AMF	1422	3	6	Diesel	18	BXE	1896	4	8	Diesel	52
AMG	1289	4	8	Petrol	14	BXW	1390	4	16	Petrol	22
AMH	1289	4	8	Petrol	14	BYJ	1798	4	16	Petrol	46
AMJ	1289	4	8	Petrol	14	BYJ	1798	4	16	Petrol	46
AMX	2771	6	30	Petrol	64	BZB	1798	4	16	Petrol	46
APK	1984	4	8	Petrol	53	BZG	1198	3	12	Petrol	9
AQM	1896	4	8	Diesel	49	CAVE	1390	4	16	Petrol	23
AQV	996	4	8	Petrol	2	CAXA	1390	4	16	Petrol	23
AQW	1397	4	8	Petrol	17	CAXC	1390	4	16	Petrol	23
AQY	1984	4	8	Petrol	53	CAYA	1598	4	16	Diesel	35
ARV	996	4	8	Petrol	2	CAYB	1598	4	16	Diesel	35
ARX	1781	4	20	Petrol	43	CAYC	1598	4	16	Diesel	35
ARZ	1781	4	20	Petrol	43	CBBB	1968	4	16	Diesel	59
ASV	1896	4	8	Diesel	49	CBDB	1968	4	16	Diesel	59
ASY	1896	4	8	Diesel	51	CBZA	1197	4	8	Petrol	10
ASZ	1896	4	8	Diesel	51	CBZB	1197	4	8	Petrol	10
ATD	1896	4	8	Diesel	51	CCSA	1595	4	8	Petrol	32
ATZ	1397	4	8	Petrol	17	CCZA	1984	4	16	Petrol	60
AUA	1390	4	16	Petrol	19	CDAA	1798	4	16	Petrol	46
AUB	1390	4	16	Petrol	19	CDAB	1798	4	16	Petrol	46
AUM	1781	4	20	Petrol	43	CDDA	1390	4	16	Petrol	24
AUQ	1781	4	20	Petrol	44	CDEA	1598	4	16	Petrol	34
AVB	1896	4	8	Diesel	51	CDFA	1595	4	16	Petrol	34
AVF	1896	4	8	Diesel	51	CDVA	3597	6	24	Petrol	65
AVU	1595	4	8	Petrol	32	CEAA	1798	4	16	Petrol	46
AWT	1781	4	20	Petrol	45	CEGA	1968	4	16	Diesel	59
AWX	1896	4	8	Diesel	51	CEVA	1198	3	12	Petrol	9
AWY	1198	3	6	Petrol	6	CFBA	1390	4	16	Petrol	25
AXP	1390	4	16	Petrol	19	CFFB	1968	4	16	Diesel	59
AXR	1896	4	8	Diesel	51	CFGB	1968	4	16	Diesel	59
AYM	2496	6	24	Diesel	63	CFHA	1968	4	16	Diesel	59
AZE	1397	4	8	Petrol	17	CFHC	1968	4	16	Diesel	59
AZF	1397	4	8	Petrol	17	CFHF	1968	4	16	Diesel	59
AZH	1984	4	8	Petrol	53	CFJA	1968	4	16	Diesel	59
AZJ	1984	4	8	Petrol	53	CFNA	1598	4	16	Petrol	34
AZL	1984	4	8	Petrol	53	CFWA	1199	3	12	Diesel	11
AZM	1984	4	8	Petrol	53	CGGA	1390	4	16	Petrol	19
AZQ	1198	3	12	Petrol	7	CGGB	1390	4	16	Petrol	19
AZV	1968	4	16	Diesel	54	CGMA	1984	4	16	Petrol	60
BBG	2771	6	30	Petrol	64	CGPA	1198	3	12	Petrol	9
BBM	1198	3	6	Petrol	6	CGPB	1198	3	12	Petrol	9
BBY	1390	4	16	Petrol	19	CGPC	1198	3	12	Petrol	9
BBZ	1390	4	16	Petrol	19	CGZ	1984	4	8	Petrol	53
BCA	1390	4	16	Petrol	19	CHFA	1198	3	6	Petrol	8
BDG	2496	6	24	Diesel	63	CHGA	1595	4	8	Petrol	32
BFQ	1595	4	8	Petrol	32	CHHA	1984	4	16	Petrol	61
BGU	1595	4	8	Petrol	32	CHHB	1984	4	16	Petrol	61
BJB	1896	4	8	Diesel	52	CHPA	1395	4	16	Petrol	26
BKC	1896	4	8	Diesel	52	CHPB	1395	4	16	Petrol	26

	CC				9		CC				9
CHTA	1198	3	12	Petrol	9						
CHYA	999	3	12	Petrol	3						
CHYB	999	3	12	Petrol	3						
CHZD	999	3	12	Petrol	3						
CJLA	1198	3	12	Petrol	9						
CJSA	1798	4	16	Petrol	46						
CJSB	1798	4	16	Petrol	46						
CJSC	1798	4	16	Petrol	46						
CJXA	1984	4	16	Petrol	61						
CJZA	1197	4	16	Petrol	12						
CJZB	1197	4	16	Petrol	12						
CJZC	1197	4	16	Petrol	12						
CJZD	1197	4	16	Petrol	12						
CKA	1395	4	16	Petrol	26						
CKAA	1395	4	16	Petrol	26						
CKFB	1968	4	16	Diesel	62						
CKFC	1968	4	16	Diesel	62						
CLCA	1968	4	16	Diesel	59						
CLCB	1968	4	16	Diesel	59						
CLHA	1598	4	16	Diesel	36						
CLHB	1598	4	16	Diesel	36						
CLJA	1968	4	16	Diesel	59						
CLNA	1598	4	16	Diesel	35						
CLPA	1390	4	16	Petrol	23						
CLRA	1598	4	16	Petrol	34						
CLSA	1598	4	16	Petrol	34						
CMXA	1595	4	8	Petrol	32						
CPD	1598	4	16	Petrol	37						
CPDA	1598	4	16	Petrol	37						
CPGA	999	3	12	Gas	4						
CPJA	1598	4	16	Petrol	34						
CPWA	1395	4	16	Petrol	26						
CRKB	1598	4	16	Diesel	36						
CRLB	1968	4	16	Diesel	62						
CRMB	1968	4	16	Diesel	62						
CRVC	1968	4	16	Diesel	62						
CSS	1395	4	16	Petrol	26						
CSSA	1395	4	16	Petrol	26						
CTHE	1390	4	16	Petrol	23						
CUNA	1968	4	16	Diesel	62						
CUPA	1968	4	16	Diesel	62						
CUSA	1422	3	12	Diesel	27						
CUSB	1422	3	12	Diesel	27						
CUTA	1422	3	12	Diesel	27						
CUUA	1968	4	16	Diesel	62						
CUUB	1968	4	16	Diesel	62						
CWVA	1598	4	16	Petrol	38						
CWXB	1498	4	16	Diesel	29						
CXMA	1598	4	16	Diesel	36						
CXXB	1598	4	16	Diesel	36						
CYVB	1197	4	16	Petrol	12						
CZCA	1395	4	16	Petrol	26						
CZDA	1395	4	16	Petrol	26						
CZEA	1395	4	16	Petrol	28						
CZPA	1984	4	16	Petrol	61						
DBGA	1968	4	16	Diesel	62						
DBGC	1968	4	16	Diesel	62						
DBKA	1598	4	16	Diesel	36						
DCXA	1598	4	16	Diesel	36						
DCZA	1598	4	16	Diesel	36						
DDAA	1968	4	16	Diesel	62						
DDYA	1598	4	16	Diesel	36						
DDYB	1598	4	16	Diesel	36						
DFCA	1968	4	16	Diesel	62						
DFEA	1968	4	16	Diesel	62						
DFGA	1968	4	16	Diesel	62						
DFHA	1968	4	16	Diesel	62						
DFSA	1968	4	16	Diesel	62						
DLBA	1984	4	16	Petrol	61						
EAT11	1598	4	8	Petrol	39						
OHC	1289	4	8	Petrol	16						



1 1.0L Petrol

742,10 4 Cyl. 8 Valves 1046cc TD3608

NF634
80.00 x 100.00 x 13.00mm, MVQ

2 1.0L Petrol

AQV 4 Cyl. 8 Valves 996cc TD16238

ARV 4 Cyl. 8 Valves 996cc TD15368

HR816

NA5306
42.00 x 58.00 x 8.00mm, ACM
01/99→
NA5133
85.00 x 105.00 x 11.00mm, FPM

3 1.0L Petrol

CHYA 3 Cyl. 12 Valves 999cc TD26323

CHYB 3 Cyl. 12 Valves 999cc TD26325

CHZD 3 Cyl. 12 Valves 999cc TD33102

NA5456 (x2)
36.00 x 46.00 x 7.00mm, PTFE/ACM
NA5458
24.00 x 39.00 x 8.00mm, PTFE/ACM

4 1.0L Gas

CPGA 3 Cyl. 12 Valves 999cc TD27817

NA5456 (x2)
36.00 x 46.00 x 7.00mm, PTFE/ACM
NA5458
24.00 x 39.00 x 8.00mm, PTFE/ACM

5 1.2L Petrol

742,12 4 Cyl. 8 Valves 1164cc TD5345

742.12 X 4 Cyl. 8 Valves 1174cc TD5346

NF634
80.00 x 100.00 x 13.00mm, MVQ

6 1.2L Petrol

AWY 3 Cyl. 6 Valves 1198cc TD16524

BBM 3 Cyl. 6 Valves 1198cc TD20009

PA5041 (x6)
HL5002

NA5106
35.00 x 48.00 x 10.00mm, PTFE
NA5305
85.00 x 105.00 x 11.00mm, PTFE
01/01→

7 1.2L Petrol

AZQ 3 Cyl. 12 Valves 1198cc TD17070

PA5041 (x12)
HR280

NA5106
35.00 x 48.00 x 10.00mm, PTFE
NA5305
85.00 x 105.00 x 11.00mm, PTFE
01/01→

8 1.2L Petrol

BMD	3 Cyl.	6 Valves	1198cc	TD18835
CHFA	3 Cyl.	6 Valves	1198cc	TD23439
PA5041 (x6) HL5002				NA5106 35.00 x 48.00 x 10.00mm, PTFE NA5305 85.00 x 105.00 x 11.00mm, PTFE

9 1.2L Petrol

BME	3 Cyl.	12 Valves	1198cc	TD18836
BZG	3 Cyl.	12 Valves	1198cc	TD20010
CEVA	3 Cyl.	12 Valves	1198cc	TD20919
CGPA	3 Cyl.	12 Valves	1198cc	TD23524
CGPB	3 Cyl.	12 Valves	1198cc	TD24978
CGPC	3 Cyl.	12 Valves	1198cc	TD26993
CHTA	3 Cyl.	12 Valves	1198cc	TD24979
CJLA	3 Cyl.	12 Valves	1198cc	TD30804
PA5041 (x12) HR280				NA5106 35.00 x 48.00 x 10.00mm, PTFE NA5305 85.00 x 105.00 x 11.00mm, PTFE

10 1.2L Petrol

CBZA	4 Cyl.	8 Valves	1197cc	TD23928
CBZB	4 Cyl.	8 Valves	1197cc	TD23583
PA5041 (x8) HR817				NA5124 32.00 x 47.00 x 10.00mm, PTFE/ACM NA5124 32.00 x 47.00 x 10.00mm, PTFE/ACM

11 1.2L Diesel

CFWA	3 Cyl.	12 Valves	1199cc	TD24261
PA5041 (x12) HR280				NA5361 (x2) 32.00 x 47.00 x 10.00mm, PTFE NA5106 35.00 x 48.00 x 10.00mm, PTFE

12 1.2L Petrol

CJZA	4 Cyl.	16 Valves	1197cc	TD27806
CJZB	4 Cyl.	16 Valves	1197cc	TD27805
CJZC	4 Cyl.	16 Valves	1197cc	TD29846
CJZD	4 Cyl.	16 Valves	1197cc	TD29847
CYVB	4 Cyl.	16 Valves	1197cc	TD31355
				NA5456 (x2) 36.00 x 46.00 x 7.00mm, PTFE/ACM NA5458 24.00 x 39.00 x 8.00mm, PTFE/ACM

13 1.3L Petrol

135/8	4 Cyl.	8 Valves	1280cc	TD5348
				NA5133 85.00 x 105.00 x 11.00mm, FPM



14 1.3L

Petrol

135B	4 Cyl.	8 Valves	1289cc	TD13391
135 L	4 Cyl.	8 Valves	1289cc	TD13848
135M	4 Cyl.	8 Valves	1289cc	TD13392
136B	4 Cyl.	8 Valves	1289cc	TD13390
136 L	4 Cyl.	8 Valves	1289cc	TD5349
136M	4 Cyl.	8 Valves	1289cc	TD13393
781.135E	4 Cyl.	8 Valves	1289cc	TD13389
AMG	4 Cyl.	8 Valves	1289cc	TD13828
AMH	4 Cyl.	8 Valves	1289cc	TD13829
AMJ	4 Cyl.	8 Valves	1289cc	TD13849

HR816

NA5306
42.00 x 58.00 x 8.00mm, ACM
01/99→
NA5133
85.00 x 105.00 x 11.00mm, FPM

15 1.3L

Petrol

742,13	4 Cyl.	8 Valves	1280cc	TD4900
--------	--------	----------	--------	--------

NF634
80.00 x 100.00 x 13.00mm, MVQ

16 1.3L

Petrol

781.135	4 Cyl.	8 Valves	1289cc	TD5347
781.136	4 Cyl.	8 Valves	1289cc	TD28629
OHC	4 Cyl.	8 Valves	1289cc	TD4902

HR816

NA5306
42.00 x 58.00 x 8.00mm, ACM
NA5133
85.00 x 105.00 x 11.00mm, FPM

17 1.4L

Petrol

AMD	4 Cyl.	8 Valves	1397cc	TD13868
AME	4 Cyl.	8 Valves	1397cc	TD15373
AQW	4 Cyl.	8 Valves	1397cc	TD16240
ATZ	4 Cyl.	8 Valves	1397cc	TD15372
AZE	4 Cyl.	8 Valves	1397cc	TD16049
AZF	4 Cyl.	8 Valves	1397cc	TD16239

HR816

NA5306
42.00 x 58.00 x 8.00mm, ACM
01/99→
NA5133
85.00 x 105.00 x 11.00mm, FPM

18 1.4L

Diesel

AMF	3 Cyl.	6 Valves	1422cc	TD17348
BNM	3 Cyl.	6 Valves	1422cc	TD18740
BNV	3 Cyl.	6 Valves	1422cc	TD18741

HR5068

NA5124
32.00 x 47.00 x 10.00mm, PTFE/ACM

NA5106
35.00 x 48.00 x 10.00mm, PTFE
LK5003
85.00 x 131.00 x 15.700mm, PTFE



19 1.4L Petrol

AUA	4 Cyl.	16 Valves	1390cc	TD15374
AUB	4 Cyl.	16 Valves	1390cc	TD15375
AXP	4 Cyl.	16 Valves	1390cc	TD16050
BBY	4 Cyl.	16 Valves	1390cc	TD17471
BBZ	4 Cyl.	16 Valves	1390cc	TD17472
BCA	4 Cyl.	16 Valves	1390cc	TD17495
BKY	4 Cyl.	16 Valves	1390cc	TD18696
CGGA	4 Cyl.	16 Valves	1390cc	TD24838
CGGB	4 Cyl.	16 Valves	1390cc	TD24980

PA5041 (x16)
HR791

NA5180 (x2)
27.00 x 42.00 x 8.00mm, FPM

NA5185
32.00 x 42.00 x 6.00mm, FPM

20 1.4L Diesel

BMS	3 Cyl.	6 Valves	1422cc	TD19092
-----	--------	----------	--------	---------

HR5068

NA5124
32.00 x 47.00 x 10.00mm, PTFE/ACM

NA5106
35.00 x 48.00 x 10.00mm, PTFE

21 1.4L Petrol

BUD	4 Cyl.	16 Valves	1390cc	TD20190
-----	--------	-----------	--------	---------

PA5041 (x16)
HR791

NA5180 (x2)
27.00 x 42.00 x 8.00mm, FPM

NA5185
32.00 x 42.00 x 6.00mm, FPM
LK5013
85.00 x 111.00 x 15.50mm, PTFE
→10/06

22 1.4L Petrol

BXW	4 Cyl.	16 Valves	1390cc	TD19089
-----	--------	-----------	--------	---------

PA5041 (x16)
HR791

NA5180 (x2)
27.00 x 42.00 x 8.00mm, FPM

NA5185
32.00 x 42.00 x 6.00mm, FPM
LK5013
85.00 x 111.00 x 15.50mm, PTFE

23 1.4L Petrol

CAVE	4 Cyl.	16 Valves	1390cc	TD24217
CAXA	4 Cyl.	16 Valves	1390cc	TD21592
CAXC	4 Cyl.	16 Valves	1390cc	TD22677
CLPA	4 Cyl.	16 Valves	1390cc	TD26496
CTHE	4 Cyl.	16 Valves	1390cc	TD27361

PA5041 (x16)
HR791

NA5106
35.00 x 48.00 x 10.00mm, PTFE

24 1.4L Petrol

CDDA	4 Cyl.	16 Valves	1390cc	TD26495
------	--------	-----------	--------	---------

PA5041 (x16)
HR791

NA5106
35.00 x 48.00 x 10.00mm, PTFE/ACM
NA5180
27.00 x 42.00 x 8.00mm, FPM

NA5106
35.00 x 48.00 x 10.00mm, PTFE

25 1.4L Petrol

CFBA	4 Cyl.	16 Valves	1390cc	TD31378
------	--------	-----------	--------	---------

PA5041 (x16)
HR791

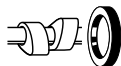

26 1.4L

Petrol

CHPA	4 Cyl.	16 Valves	1395cc	TD27808
CHPB	4 Cyl.	16 Valves	1395cc	TD31358
CKA	4 Cyl.	16 Valves	1395cc	TD33282
CKAA	4 Cyl.	16 Valves	1395cc	TD30897
CPWA	4 Cyl.	16 Valves	1395cc	TD29519
CSS	4 Cyl.	16 Valves	1395cc	TD33246
CSSA	4 Cyl.	16 Valves	1395cc	TD30899
CZCA	4 Cyl.	16 Valves	1395cc	TD31360
CZDA	4 Cyl.	16 Valves	1395cc	TD31357

NA5456 (x2)
36.00 x 46.00 x 7.00mm, PTFE/ACM
NA5458
24.00 x 39.00 x 8.00mm, PTFE/ACM

27 1.4L

Diesel

CUSA	3 Cyl.	12 Valves	1422cc	TD32272
CUSB	3 Cyl.	12 Valves	1422cc	TD29848
CUTA	3 Cyl.	12 Valves	1422cc	TD29849

PA5041 (x12)
HR280

NA5361 (x2)
32.00 x 47.00 x 10.00mm, PTFE

28 1.4L

Petrol

CZEA	4 Cyl.	16 Valves	1395cc	TD31648
------	--------	-----------	--------	---------

NA5456 (x2)
36.00 x 46.00 x 7.00mm, PTFE/ACM

29 1.5L

Diesel

CWXB	4 Cyl.	16 Valves	1498cc	TD32408
------	--------	-----------	--------	---------

PA5041 (x16)
HR791

NA5124
32.00 x 47.00 x 10.00mm, PTFE/ACM
→09/09

NA5361
32.00 x 47.00 x 10.00mm, PTFE
10/09→

NA5106
35.00 x 48.00 x 10.00mm, PTFE
LK5019
85.00 x 131.00 x 17.25mm, PTFE/ACM

30 1.6L

Petrol

AEE	4 Cyl.	8 Valves	1598cc	TD13394
-----	--------	----------	--------	---------

HR816

NA5001
32.00 x 47.00 x 10.00mm, FPM

NA5001
32.00 x 47.00 x 10.00mm, FPM
NA5185
32.00 x 42.00 x 6.00mm, FPM
Eng no. 562 758→
NA5133
85.00 x 105.00 x 11.00mm, FPM
LK5006
85.00 x 131.00 x 16.00mm, PTFE

31 1.6L

Petrol

AEH	4 Cyl.	8 Valves	1595cc	TD12950
-----	--------	----------	--------	---------

AKL	4 Cyl.	8 Valves	1595cc	TD12951
-----	--------	----------	--------	---------

HR816

NA5124
32.00 x 47.00 x 10.00mm, PTFE/ACM

NA5106
35.00 x 48.00 x 10.00mm, PTFE
LK5008
85.00 x 131.00 x 15.70mm, PTFE



32 1.6L Petrol

AVU	4 Cyl.	8 Valves	1595cc	TD16068
BFQ	4 Cyl.	8 Valves	1595cc	TD17912
BGU	4 Cyl.	8 Valves	1595cc	TD17496
BSE	4 Cyl.	8 Valves	1595cc	TD20898
BSF	4 Cyl.	8 Valves	1595cc	TD20899
CCSA	4 Cyl.	8 Valves	1595cc	TD20900
CHGA	4 Cyl.	8 Valves	1595cc	TD22691
CMXA	4 Cyl.	8 Valves	1595cc	TD24599

PA5041 (x8)
HR817

NA5124
32.00 x 47.00 x 10.00mm, PTFE/ACM

NA5106
35.00 x 48.00 x 10.00mm, PTFE
LK5008
85.00 x 131.00 x 15.700mm, PTFE

33 1.6L Petrol

BLF	4 Cyl.	16 Valves	1598cc	TD17501
-----	--------	-----------	--------	---------

PA5041 (x16)
HR791

NA5106
35.00 x 48.00 x 10.00mm, PTFE
LK5013
85.00 x 111.00 x 15.50mm, PTFE

34 1.6L Petrol

BTS	4 Cyl.	16 Valves	1598cc	TD19090
CDEA	4 Cyl.	16 Valves	1598cc	TD31214
CDFA	4 Cyl.	16 Valves	1595cc	TD31217
CFNA	4 Cyl.	16 Valves	1598cc	TD24981
CLRA	4 Cyl.	16 Valves	1598cc	TD31374
CLSA	4 Cyl.	16 Valves	1598cc	TD25763
CPJA	4 Cyl.	16 Valves	1598cc	TD31375

PA5041 (x16)
HR791

NA5106
35.00 x 48.00 x 10.00mm, PTFE

35 1.6L Diesel

CAYA	4 Cyl.	16 Valves	1598cc	TD24216
CAYB	4 Cyl.	16 Valves	1598cc	TD23929
CAYC	4 Cyl.	16 Valves	1598cc	TD22678
CLNA	4 Cyl.	16 Valves	1598cc	TD25764

PA5041 (x16)
HR791

NA5124
32.00 x 47.00 x 10.00mm, PTFE/ACM
→09/09
NA5361
32.00 x 47.00 x 10.00mm, PTFE
10/09→

NA5106
35.00 x 48.00 x 10.00mm, PTFE
LK5019
85.00 x 131.00 x 17.25mm, PTFE/ACM

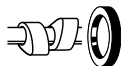

36 1.6L

Diesel

CLHA	4 Cyl.	16 Valves	1598cc	TD27810
CLHB	4 Cyl.	16 Valves	1598cc	TD27972
CRKB	4 Cyl.	16 Valves	1598cc	TD28543
CXMA	4 Cyl.	16 Valves	1598cc	TD31361
CXXB	4 Cyl.	16 Valves	1598cc	TD31372
DBKA	4 Cyl.	16 Valves	1598cc	TD31373
DCXA	4 Cyl.	16 Valves	1598cc	TD31652
DCZA	4 Cyl.	16 Valves	1598cc	TD31651
DDYA	4 Cyl.	16 Valves	1598cc	TD34415
DDYB	4 Cyl.	16 Valves	1598cc	TD34416

PA5041 (x16)
HR791

NA5361 (x2)
32.00 x 47.00 x 10.00mm, PTFE

LK5017
85.00 x 130.90 x 15.75mm, PTFE

37 1.6L

Petrol

CPD	4 Cyl.	16 Valves	1598cc	TD33298
CPDA	4 Cyl.	16 Valves	1598cc	TD30500

NA5458 (x2)
24.00 x 39.00 x 8.00mm, PTFE/ACM

38 1.6L

Petrol

CWVA	4 Cyl.	16 Valves	1598cc	TD29693
------	--------	-----------	--------	---------

NA5456 (x2)
36.00 x 46.00 x 7.00mm, PTFE/ACM

NA5458
24.00 x 39.00 x 8.00mm, PTFE/ACM

39 1.6L

Petrol

EA111	4 Cyl.	8 Valves	1598cc	TD4901
-------	--------	----------	--------	--------

HR816

NA5001
32.00 x 47.00 x 10.00mm, FPM

NA5133
85.00 x 105.00 x 11.00mm, FPM

40 1.8L

Petrol

ADR	4 Cyl.	20 Valves	1781cc	TD20805
-----	--------	-----------	--------	---------

PA5041 (x20)
HR822

NA5001 (x2)
32.00 x 47.00 x 10.00mm, FPM

NA5001
32.00 x 47.00 x 10.00mm, FPM
NA5133
85.00 x 105.00 x 11.00mm, FPM
LK5006
85.00 x 131.00 x 16.000mm, PTFE

41 1.8L

Petrol

AGN	4 Cyl.	20 Valves	1781cc	TD17903
-----	--------	-----------	--------	---------

PA5041 (x20)
HR822

NA5001 (x2)
32.00 x 47.00 x 10.00mm, FPM

NB716
35.00 x 48.00 x 10.00mm, FPM
NA5106
35.00 x 48.00 x 10.00mm, PTFE
LK5003
85.00 x 131.00 x 15.700mm, PTFE



42 1.8L

Petrol

AGU	4 Cyl.	20 Valves	1781cc	TD13396
PA5041 (x20) HR822	NA5001 (x2) 32.00 x 47.00 x 10.00mm, FPM		NB716 35.00 x 48.00 x 10.00mm, FPM	
	NA5124 (x2) 32.00 x 47.00 x 10.00mm, PTFE/ACM		NA5106 35.00 x 48.00 x 10.00mm, PTFE	
			LK5003 85.00 x 131.00 x 15.700mm, PTFE	

43 1.8L

Petrol

ARX	4 Cyl.	20 Valves	1781cc	TD16069
ARZ	4 Cyl.	20 Valves	1781cc	TD16030
AUM	4 Cyl.	20 Valves	1781cc	TD16070
PA5041 (x20) HR822	NA5124 (x2) 32.00 x 47.00 x 10.00mm, PTFE/ACM		NA5106 35.00 x 48.00 x 10.00mm, PTFE	
			LK5003 85.00 x 131.00 x 15.700mm, PTFE	

44 1.8L

Petrol

AUQ	4 Cyl.	20 Valves	1781cc	TD16279
PA5041 (x20) HR822	NA5124 (x2) 32.00 x 47.00 x 10.00mm, PTFE/ACM		NB716 35.00 x 48.00 x 10.00mm, FPM	
			NA5106 35.00 x 48.00 x 10.00mm, PTFE	
			LK5003 85.00 x 131.00 x 15.700mm, PTFE	

45 1.8L

Petrol

AWT	4 Cyl.	20 Valves	1781cc	TD16365
PA5041 (x20) HR822	NA5001 (x2) 32.00 x 47.00 x 10.00mm, FPM		NA5106 35.00 x 48.00 x 10.00mm, PTFE	
	NA5124 (x2) 32.00 x 47.00 x 10.00mm, PTFE/ACM		LK5003 85.00 x 131.00 x 15.700mm, PTFE	

46 1.8L

Petrol

BYJ	4 Cyl.	16 Valves	1798cc	TD26494
BYJ	4 Cyl.	16 Valves	1798cc	TD30978
BZB	4 Cyl.	16 Valves	1798cc	TD20902
CDAA	4 Cyl.	16 Valves	1798cc	TD20943
CDAB	4 Cyl.	16 Valves	1798cc	TD24597
CEAA	4 Cyl.	16 Valves	1798cc	TD31221
CJSA	4 Cyl.	16 Valves	1798cc	TD27809
CJSB	4 Cyl.	16 Valves	1798cc	TD27804
CJSC	4 Cyl.	16 Valves	1798cc	TD31649
PA5041 (x16) HR791			LK5016 85.00 x 164.00 x 11.00mm, PTFE	

47 1.9L

Diesel

AEF	4 Cyl.	8 Valves	1896cc	TD13395
HR569 →Eng no. 007 000	NA5001 32.00 x 47.00 x 10.00mm, FPM		NA5001 32.00 x 47.00 x 10.00mm, FPM	
HR816 Eng no. 007 001→			NA5133 85.00 x 105.00 x 11.00mm, FPM →Eng no. AEF 265 000	
			LK5006 85.00 x 131.00 x 16.000mm, PTFE Eng no. AEF 265 001→	

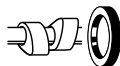

48 1.9L

Diesel

AEY	4 Cyl.	8 Valves	1896cc	TD18729
HR569	NA5001 32.00 x 47.00 x 10.00mm, FPM			NA5001 32.00 x 47.00 x 10.00mm, FPM
→Eng no. AEY 002 000				NA5133 85.00 x 105.00 x 11.00mm, FPM
HR816				→Eng no. AEY 050 000
Eng no. AEY 002 001→				LK5006 85.00 x 131.00 x 16.000mm, PTFE
				Eng no. AEY 050 001→

49 1.9L

Diesel

AGP	4 Cyl.	8 Valves	1896cc	TD16424
AGR	4 Cyl.	8 Valves	1896cc	TD17905
ALH	4 Cyl.	8 Valves	1896cc	TD16090
AQM	4 Cyl.	8 Valves	1896cc	TD16089
ASV	4 Cyl.	8 Valves	1896cc	TD16091
HR816	NA5001 32.00 x 47.00 x 10.00mm, FPM			NB716 35.00 x 48.00 x 10.00mm, FPM
				NA5106 35.00 x 48.00 x 10.00mm, PTFE
				LK5003 85.00 x 131.00 x 15.700mm, PTFE

50 1.9L

Diesel

AHF	4 Cyl.	8 Valves	1896cc	TD17910
HR816	NA5001 32.00 x 47.00 x 10.00mm, FPM			NB716 35.00 x 48.00 x 10.00mm, FPM
				LK5003 85.00 x 131.00 x 15.700mm, PTFE

51 1.9L

Diesel

ASY	4 Cyl.	8 Valves	1896cc	TD15376
ASZ	4 Cyl.	8 Valves	1896cc	TD17036
ATD	4 Cyl.	8 Valves	1896cc	TD15377
AVB	4 Cyl.	8 Valves	1896cc	TD17037
AVF	4 Cyl.	8 Valves	1896cc	TD18239
AWX	4 Cyl.	8 Valves	1896cc	TD16403
AXR	4 Cyl.	8 Valves	1896cc	TD20195
BLT	4 Cyl.	8 Valves	1896cc	TD20517
BPZ	4 Cyl.	8 Valves	1896cc	TD20205
BSV	4 Cyl.	8 Valves	1896cc	TD20206
BSW	4 Cyl.	8 Valves	1896cc	TD20004
HR816	NA5124 32.00 x 47.00 x 10.00mm, PTFE/ACM			NA5106 35.00 x 48.00 x 10.00mm, PTFE
				LK5003 85.00 x 131.00 x 15.700mm, PTFE



52 1.9L

Diesel

BJB	4 Cyl.	8 Valves	1896cc	TD17499
BKC	4 Cyl.	8 Valves	1896cc	TD17497
BLS	4 Cyl.	8 Valves	1896cc	TD19091
BXE	4 Cyl.	8 Valves	1896cc	TD20513

HR816

NA5124
32.00 x 47.00 x 10.00mm, PTFE/ACM

NA5106
35.00 x 48.00 x 10.00mm, PTFE
LK5012
85.00 x 132.00 x 15.70mm, PTFE

53 2.0L

Petrol

AEG	4 Cyl.	8 Valves	1984cc	TD16280
APK	4 Cyl.	8 Valves	1984cc	TD16031
AQY	4 Cyl.	8 Valves	1984cc	TD13869
AZH	4 Cyl.	8 Valves	1984cc	TD16092
AZJ	4 Cyl.	8 Valves	1984cc	TD17466
AZL	4 Cyl.	8 Valves	1984cc	TD16241
AZM	4 Cyl.	8 Valves	1984cc	TD16366
CGZ	4 Cyl.	8 Valves	1984cc	TD26150

HR816

NA5124
32.00 x 47.00 x 10.00mm, PTFE/ACM

NA5106
35.00 x 48.00 x 10.00mm, PTFE
LK5003
85.00 x 131.00 x 15.70mm, PTFE

54 2.0L

Diesel

AZV	4 Cyl.	16 Valves	1968cc	TD20909
BKD	4 Cyl.	16 Valves	1968cc	TD17500
BMN	4 Cyl.	16 Valves	1968cc	TD20735

PA5041 (x16)
HR791

NA5124 (x2)
32.00 x 47.00 x 10.00mm, PTFE/ACM

NA5106
35.00 x 48.00 x 10.00mm, PTFE
LK5012
85.00 x 132.00 x 15.70mm, PTFE

55 2.0L

Petrol

BLR	4 Cyl.	16 Valves	1984cc	TD18102
BLX	4 Cyl.	16 Valves	1984cc	TD20393
BLY	4 Cyl.	16 Valves	1984cc	TD18101
BVX	4 Cyl.	16 Valves	1984cc	TD20394
BVY	4 Cyl.	16 Valves	1984cc	TD20518
BVZ	4 Cyl.	16 Valves	1984cc	TD20519

PA5041 (x16)
HR791

NA5124 (x2)
32.00 x 47.00 x 10.00mm, PTFE/ACM

NA5106
35.00 x 48.00 x 10.00mm, PTFE
LK5008
85.00 x 131.00 x 15.70mm, PTFE

56 2.0L

Diesel

BMM	4 Cyl.	8 Valves	1968cc	TD19315
BMP	4 Cyl.	8 Valves	1968cc	TD20945

HR816

NA5124
32.00 x 47.00 x 10.00mm, PTFE/ACM

NA5106
35.00 x 48.00 x 10.00mm, PTFE
LK5012
85.00 x 132.00 x 15.70mm, PTFE

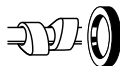

57 2.0L

Diesel

BSS	4 Cyl.	8 Valves	1968cc	TD19317
BWW	4 Cyl.	8 Valves	1998cc	TD20500
HR816	NA5124 32.00 x 47.00 x 10.00mm, PTFE/ACM		NA5106 35.00 x 48.00 x 10.00mm, PTFE LK5003 85.00 x 131.00 x 15.700mm, PTFE	

58 2.0L

Petrol

BWA	4 Cyl.	16 Valves	1984cc	TD20395
PA5041 (x16) HR791	NA5124 (x2) 32.00 x 47.00 x 10.00mm, PTFE/ACM		NA5106 35.00 x 48.00 x 10.00mm, PTFE LK5003 85.00 x 131.00 x 15.700mm, PTFE	

59 2.0L

Diesel

CBBB	4 Cyl.	16 Valves	1968cc	TD20944
CBDB	4 Cyl.	16 Valves	1968cc	TD23586
CEGA	4 Cyl.	16 Valves	1968cc	TD20905
CFFB	4 Cyl.	16 Valves	1968cc	TD23589
CFGB	4 Cyl.	16 Valves	1968cc	TD23591
CFHA	4 Cyl.	16 Valves	1968cc	TD23584
CFHC	4 Cyl.	16 Valves	1968cc	TD23587
CFHF	4 Cyl.	16 Valves	1968cc	TD23585
CFJA	4 Cyl.	16 Valves	1968cc	TD23588
CLCA	4 Cyl.	16 Valves	1968cc	TD24839
CLCB	4 Cyl.	16 Valves	1968cc	TD24598
CLJA	4 Cyl.	16 Valves	1968cc	TD23590
PA5041 (x16) HR791	NA5361 (x2) 32.00 x 47.00 x 10.00mm, PTFE		NA5106 35.00 x 48.00 x 10.00mm, PTFE LK5019 85.00 x 131.00 x 17.25mm, PTFE/ACM	

60 2.0L

Petrol

CCZA	4 Cyl.	16 Valves	1984cc	TD22171
CGMA	4 Cyl.	16 Valves	1984cc	TD31242
PA5041 (x16) HR791			LK5016 85.00 x 164.00 x 11.00mm, PTFE	

61 2.0L

Petrol

CHHA	4 Cyl.	16 Valves	1984cc	TD31359
CHHB	4 Cyl.	16 Valves	1984cc	TD28041
CJXA	4 Cyl.	16 Valves	1984cc	TD31650
CZPA	4 Cyl.	16 Valves	1984cc	TD33912
DLBA	4 Cyl.	16 Valves	1984cc	TD34417
PA5041 (x16) HR791				



62 2.0L Diesel

CKFB	4 Cyl.	16 Valves	1968cc	TD27971
CKFC	4 Cyl.	16 Valves	1968cc	TD27811
CRLB	4 Cyl.	16 Valves	1968cc	TD31653
CRMB	4 Cyl.	16 Valves	1968cc	TD30582
CRVC	4 Cyl.	16 Valves	1968cc	TD27970
CUNA	4 Cyl.	16 Valves	1968cc	TD29186
CUPA	4 Cyl.	16 Valves	1968cc	TD28040
CUUA	4 Cyl.	16 Valves	1968cc	TD34096
CUUB	4 Cyl.	16 Valves	1968cc	TD31364
DBGA	4 Cyl.	16 Valves	1968cc	TD34418
DBGC	4 Cyl.	16 Valves	1968cc	TD34419
DDAA	4 Cyl.	16 Valves	1968cc	TD31655
DFCA	4 Cyl.	16 Valves	1968cc	TD31656
DFEA	4 Cyl.	16 Valves	1968cc	TD31654
DFGA	4 Cyl.	16 Valves	1968cc	TD33915
DFHA	4 Cyl.	16 Valves	1968cc	TD33916
DFSA	4 Cyl.	16 Valves	1968cc	TD34066

PA5041 (x16)
HR791

NA5361 (x2)
32.00 x 47.00 x 10.00mm, PTFE

LK5017
85.00 x 130.90 x 15.75mm, PTFE

63 2.5L Diesel

AYM	6 Cyl.	24 Valves	2496cc	TD16404
BDG	6 Cyl.	24 Valves	2496cc	TD17350

PA5041 (x24)
HR5062

NA5001 (x2)
32.00 x 47.00 x 10.00mm, FPM

NB716
35.00 x 48.00 x 10.00mm, FPM
NA5349
85.00 x 105.00 x 12.00mm, PTFE/ACM

64 2.8L Petrol

AMX	6 Cyl.	30 Valves	2771cc	TD16367
BBG	6 Cyl.	30 Valves	2771cc	TD18754

PA5041 (x30)

NA5001 (x2)
32.00 x 47.00 x 10.00mm, FPM

NA5106
35.00 x 48.00 x 10.00mm, PTFE
NA5349
85.00 x 105.00 x 12.00mm, PTFE/ACM

65 3.6L Petrol

CDVA	6 Cyl.	24 Valves	3597cc	TD22679
------	--------	-----------	--------	---------

PA5041 (x24)
HR5062

NA5305
85.00 x 105.00 x 11.00mm, PTFE











CC



9

Cabrio (450)	03/00→01/04	M 160.910	Petrol	599	3	6	1
Cabrio (450)	03/00→01/04	M 160 E6AL B03	Petrol	599	3	6	1
Cabrio (450)	01/01→01/04	M 160.920	Petrol	698	3	6	2
Cabrio (450)	01/01→01/04	M 160 E6AL B05	Petrol	599	3	6	1
Cabrio (450)	03/01→01/04	OM 660.940	Diesel	799	3	6	4
Cabrio (450)	03/01→01/04	OM 660 DE 8LA	Diesel	799	3	6	4
City-Coupe (450)	07/98→01/04	M 160.910	Petrol	599	3	6	1
City-Coupe (450)	07/98→01/04	M 160.920	Petrol	698	3	6	2
City-Coupe (450)	07/98→01/04	M 160 E6AL B03	Petrol	599	3	6	1
City-Coupe (450)	07/98→01/04	M 160 E6AL B04	Petrol	599	3	6	1
City-Coupe (450)	11/99→01/04	OM 660.940	Diesel	799	3	6	4
City-Coupe (450)	11/99→01/04	OM 660 DE 8LA	Diesel	799	3	6	4
City-Coupe (450)	01/01→01/04	M 160 E6AL B05	Petrol	599	3	6	1
Crossblade (450)	06/02→12/03	M 160.910	Petrol	599	3	6	1
Forfour (454)	01/04→06/06	M 134.910	Petrol	1124	3	12	8
Forfour (454)	01/04→06/06	M 135.930	Petrol	1332	4	16	9
Forfour (454)	01/04→06/06	M 135.950	Petrol	1499	4	16	11
Forfour (454)	09/04→06/06	OM 639.939	Diesel	1493	3	12	12
Forfour (454)	02/05→06/06	M 134.911	Petrol	1124	3	12	8
Forfour (454)	05/05→06/06	M 122.950	Petrol	1468	4	16	10
Forfour Hatchback (453)	07/14→	M 281.920	Petrol	999	3	12	7
Forfour Hatchback (453)	11/14→	M 281.910	Petrol	898	3	12	5
Fortwo Cabrio (450)	01/04→12/06	M 160.910	Petrol	599	3	6	1
Fortwo Cabrio (450)	01/04→01/07	M 160.920	Petrol	698	3	6	2
Fortwo Cabrio (450)	01/04→01/07	OM 660.940	Diesel	799	3	6	4
Fortwo Cabrio (450)	01/04→01/07	OM 660 DE 8LA	Diesel	799	3	6	4
Fortwo Cabrio (451)	01/07→	M 132.910	Petrol	999	3	12	6
Fortwo Cabrio (451)	01/07→	M 132.930	Petrol	999	3	12	6
Fortwo Cabrio (451)	01/07→	OM 660.950	Diesel	799	3	6	4
Fortwo Cabrio (451)	08/09→	OM 660.951	Diesel	799	3	6	4
Fortwo Convertible (453)	09/15→	M 281.910	Petrol	898	3	12	5
Fortwo Convertible (453)	09/15→	M 281.920	Petrol	999	3	12	7
Fortwo Coupe (450)	01/04→01/07	M 160.920	Petrol	698	3	6	2
Fortwo Coupe (450)	01/04→01/07	OM 660.940	Diesel	799	3	6	4
Fortwo Coupe (450)	01/04→02/07	M 160.910	Petrol	599	3	6	1
Fortwo Coupe (451)	01/07→	M 132.910	Petrol	999	3	12	6
Fortwo Coupe (451)	01/07→	M 132.930	Petrol	999	3	12	6
Fortwo Coupe (451)	01/07→	OM 660.950	Diesel	799	3	6	4
Fortwo Coupe (451)	08/09→	OM 660.951	Diesel	799	3	6	4
Fortwo Coupe (453)	07/14→	M 281.920	Petrol	999	3	12	7
Fortwo Coupe (453)	09/14→	M 281.910	Petrol	898	3	12	5
Roadster (452)	04/03→11/05	M 160.921	Petrol	698	3	6	3
Roadster (452)	04/03→11/05	M 160.922	Petrol	698	3	6	3
Roadster (452)	12/03→11/05	M 160.923	Petrol	698	3	6	3
Roadster Coupe (452)	04/03→11/05	M 160.921	Petrol	698	3	6	3
Roadster Coupe (452)	06/03→11/05	M 160.922	Petrol	698	3	6	3
Roadster Coupe (452)	12/03→11/05	M 160.923	Petrol	698	3	6	3

	CC				9		CC				9
M 122.950	1468	4	16	Petrol	10						
M 132.910	999	3	12	Petrol	6						
M 132.930	999	3	12	Petrol	6						
M 134.910	1124	3	12	Petrol	8						
M 134.911	1124	3	12	Petrol	8						
M 135.930	1332	4	16	Petrol	9						
M 135.950	1499	4	16	Petrol	11						
M 160.910	599	3	6	Petrol	1						
M 160.920	698	3	6	Petrol	2						
M 160.921	698	3	6	Petrol	3						
M 160.922	698	3	6	Petrol	3						
M 160.923	698	3	6	Petrol	3						
M 160 E6AL B03	599	3	6	Petrol	1						
M 160 E6AL B04	599	3	6	Petrol	1						
M 160 E6AL B05	599	3	6	Petrol	1						
M 281.910	898	3	12	Petrol	5						
M 281.920	999	3	12	Petrol	7						
OM 639.939	1493	3	12	Diesel	12						
OM 660.940	799	3	6	Diesel	4						
OM 660.950	799	3	6	Diesel	4						
OM 660.951	799	3	6	Diesel	4						
OM 660 DE 8LA	799	3	6	Diesel	4						



1 0.6L Petrol

M 160.910	3 Cyl.	6 Valves	599cc	TD26102
M 160 E6AL B03	3 Cyl.	6 Valves	599cc	TD22902
M 160 E6AL B04	3 Cyl.	6 Valves	599cc	TD22903
M 160 E6AL B05	3 Cyl.	6 Valves	599cc	TD22901

PA5041 (x6)
HL5002

NA5109 40.00 x 62.00 x 8.00mm, PTFE
NA5118 80.00 x 100.00 x 9.00mm, PTFE

2 0.7L Petrol

M 160.920	3 Cyl.	6 Valves	698cc	TD26103
-----------	--------	----------	-------	---------

PA5041 (x6)
HL5002

NA5109 40.00 x 62.00 x 8.00mm, PTFE
NA5118 80.00 x 100.00 x 9.00mm, PTFE

3 0.7L Petrol

M 160.921	3 Cyl.	6 Valves	698cc	TD22100
M 160.922	3 Cyl.	6 Valves	698cc	TD26301
M 160.923	3 Cyl.	6 Valves	698cc	TD26104

PA5041 (x6)
HL5002

NA5332 40.00 x 62.00 x 8.00mm, FPM
NA5118 80.00 x 100.00 x 9.00mm, PTFE

4 0.8L Diesel

OM 660.940	3 Cyl.	6 Valves	799cc	TD26302
OM 660.950	3 Cyl.	6 Valves	799cc	TD20946
OM 660.951	3 Cyl.	6 Valves	799cc	TD24475
OM 660 DE 8LA	3 Cyl.	6 Valves	799cc	TD22900

PA5041 (x6)
HL5002

NA5332 40.00 x 62.00 x 8.00mm, FPM
NA5118 80.00 x 100.00 x 9.00mm, PTFE

5 0.9L Petrol

M 281.910	3 Cyl.	12 Valves	898cc	TD30408
-----------	--------	-----------	-------	---------

PB681 (x12)

NJ449 40.00 x 52.00 x 6.00mm, NBR

6 1.0L Petrol

M 132.910	3 Cyl.	12 Valves	999cc	TD20948
M 132.930	3 Cyl.	12 Valves	999cc	TD20947

PA5025 (x12)
HR5096

7 1.0L Petrol

M 281.920	3 Cyl.	12 Valves	999cc	TD29716
-----------	--------	-----------	-------	---------

PB681 (x12)

NJ449 40.00 x 52.00 x 6.00mm, NBR



8 1.1L Petrol

M 134.910	3 Cyl.	12 Valves	1124cc	TD25557
M 134.911	3 Cyl.	12 Valves	1124cc	TD25556
PA5025 (x12) HR5096				

9 1.3L Petrol

M 135.930	4 Cyl.	16 Valves	1332cc	TD25844
PA5025 (x16) HR5048				

10 1.5L Petrol

M 122.950	4 Cyl.	16 Valves	1468cc	TD27974
			NF841 (x2) 35.00 x 50.00 x 8.00mm, FPM	

11 1.5L Petrol

M 135.950	4 Cyl.	16 Valves	1499cc	TD22717
PA5025 (x16) HR5048				

12 1.5L Diesel

OM 639.939	3 Cyl.	12 Valves	1493cc	TD23800
PA5041 (x12) HL5002 (x2)			NA5332 40.00 x 62.00 x 8.00mm, FPM	











CC



9

Actyon I	11/06→	G23D	Petrol	2295	4	16	4
Chairman (HT_)	07/97→	M 104.992	Petrol	3199	6	24	18
Chairman (HT_)	07/97→	M 111.970	Petrol	2295	4	16	5
Chairman (HT_)	07/97→	M 111.974	Petrol	2295	4	16	6
Chairman (HT_)	08/99→	M 104.945	Petrol	2799	6	24	11
Istana Box	10/92→05/95	OM 602.940	Diesel	2874	5	10	13
Istana Box	06/95→11/03	OM 602.980	Diesel	2874	5	10	14
Istana Bus	10/92→05/95	OM 602.940	Diesel	2874	5	10	13
Istana Bus	06/95→11/03	OM 602.980	Diesel	2874	5	10	14
Korando (K4)	12/88→12/96	DC23	Diesel	2238	4	8	2
Korando (K4)	06/93→05/97	XD3P	Diesel	2497	4	8	10
Korando (KJ)	12/96→06/98	OM 601.940	Diesel	2299	4	8	8
Korando (KJ)	12/96→10/00	MB-OM 662	Diesel	2874	5	10	12
Korando (KJ)	12/96→11/02	M 104.995	Petrol	3199	6	24	18
Korando (KJ)	05/97→02/00	M 111.970	Petrol	2295	4	16	5
Korando (KJ)	05/97→10/02	E20	Petrol	1998	4	8	1
Korando (KJ)	06/97→11/06	M 104.992	Petrol	3199	6	24	18
Korando (KJ)	01/02→06/06	M 161.970	Petrol	2295	4	16	7
Korando Cabrio (KJ)	06/97→11/06	M 104.992	Petrol	3199	6	24	18
Korando Cabrio (KJ)	11/97→10/00	MB-OM 662	Diesel	2874	5	10	12
Korando Cabrio (KJ)	01/99→11/02	M 104.995	Petrol	3199	6	24	18
Korando Cabrio (KJ)	01/02→06/06	M 161.970	Petrol	2295	4	16	7
Kyron	11/06→	G23D	Petrol	2295	4	16	4
Kyron	03/08→	G32D	Petrol	3199	6	24	17
Kyron	01/10→	M 161.970	Petrol	2295	4	16	7
Musso (FJ)	03/93→04/97	OM 661.940	Diesel	2299	4	8	9
Musso (FJ)	10/95→04/99	MB-OM 661	Diesel	2299	4	8	8
Musso (FJ)	10/95→04/99	OM 601.940	Diesel	2299	4	8	8
Musso (FJ)	03/96→11/98	MB-OM 662	Diesel	2874	5	10	12
Musso (FJ)	06/96→09/04	M 104.992	Petrol	3199	6	24	18
Musso (FJ)	10/96→11/02	M 111.970	Petrol	2295	4	16	5
Musso (FJ)	10/96→05/05	E20	Petrol	1998	4	8	1
Rexton (GAB_)	04/02→	G32D	Petrol	3199	6	24	17
Rexton (GAB_)	05/02→	G23D	Petrol	2295	4	16	4
Rodius	05/05→	G32D	Petrol	3199	6	24	17

	CC				9		CC				9
DC23	2238	4	8	Diesel	2						
E20	1998	4	8	Petrol	1						
G23D	2295	4	16	Petrol	4						
G32D	3199	6	24	Petrol	17						
M 104.942	2799	6	24	Petrol	11						
M 104.945	2799	6	24	Petrol	11						
M 104.992	3199	6	24	Petrol	18						
M 104.995	3199	6	24	Petrol	18						
M 111.970	2295	4	16	Petrol	5						
M 111.974	2295	4	16	Petrol	6						
M 161.951	2295	4	16	Petrol	7						
M 161.970	2295	4	16	Petrol	7						
M 161.974	2295	4	16	Petrol	7						
MB OM 601	2299	4	8	Diesel	3						
MB-OM 661	2299	4	8	Diesel	8						
MB-OM 662	2874	5	10	Diesel	12						
MB-OM 601 29TD	2874	5	10	Diesel	12						
OM 601.940	2299	4	8	Diesel	8						
OM 602.940	2874	5	10	Diesel	13						
OM 602.980	2874	5	10	Diesel	14						
OM 661.940	2299	4	8	Diesel	9						
OM 662.940	2874	5	10	Diesel	15						
OM 662.983	2874	5	10	Diesel	16						
XD3P	2497	4	8	Diesel	10						

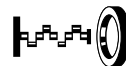
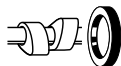

1 2.0L Petrol

E20	4 Cyl.	8 Valves	1998cc	TD5543
HR5085 (x2)				

2 2.2L Diesel

DC23	4 Cyl.	8 Valves	2238cc	TD3611
				NJ014 50.00 x 68.00 x 9.00mm, NBR NJ265 82.00 x 105.00 x 13.00mm, MVQ

3 2.2L Diesel

MB OM 601	4 Cyl.	8 Valves	2299cc	TD13312
PB394 (x4) HR757 				NA5131 45.00 x 67.00 x 8.00mm, PTFE NA5074 93.00 x 133.50 x 15.50mm, PTFE

4 2.3L Petrol

G23D	4 Cyl.	16 Valves	2295cc	TD26210
HR5085 (x4)				NB974 93.00 x 114.00 x 13.00mm, FPM NA5074 93.00 x 133.50 x 15.50mm, PTFE

5 2.3L Petrol

M 111.970	4 Cyl.	16 Valves	2295cc	TD5544
HR5085 (x4)				NB973 45.00 x 67.00 x 8.00mm, FPM NB974 93.00 x 114.00 x 13.00mm, FPM

6 2.3L Petrol

M 111.974	4 Cyl.	16 Valves	2295cc	TD19459
HR5085 (x4)				NB973 45.00 x 67.00 x 8.00mm, FPM NB974 93.00 x 114.00 x 13.00mm, FPM NA5074 93.00 x 133.50 x 15.50mm, PTFE

7 2.3L Petrol

M 161.951	4 Cyl.	16 Valves	2295cc	TD25638
M 161.970	4 Cyl.	16 Valves	2295cc	TD22101
M 161.974	4 Cyl.	16 Valves	2295cc	TD22102
HR5055				NB973 45.00 x 67.00 x 8.00mm, FPM NB974 93.00 x 114.00 x 13.00mm, FPM

8 2.3L Diesel

MB-OM 661	4 Cyl.	8 Valves	2299cc	TD9356
OM 601.940	4 Cyl.	8 Valves	2299cc	TD3612
PB394 (x4) HR757 				NA5131 45.00 x 67.00 x 8.00mm, PTFE NB974 93.00 x 114.00 x 13.00mm, FPM

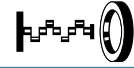

9 2.3L Diesel					
OM 661.940	4 Cyl.	8 Valves	2299cc		TD21373
PB394 (x4)				NA5131 45.00 x 67.00 x 8.00mm, PTFE NB974 93.00 x 114.00 x 13.00mm, FPM →Eng no. 710392 NA5074 93.00 x 133.50 x 15.50mm, PTFE Eng no. 710393→	

10 2.5L Diesel					
XD3P	4 Cyl.	8 Valves	2497cc		TD19458
PA229 (x8)				NF387 42.00 x 60.00 x 10.00mm, NBR →09/85 NF780 45.00 x 60.00 x 7.00mm, ACM 09/85→ KS696 (x2)	

11 2.8L Petrol					
M 104.942	6 Cyl.	24 Valves	2799cc		TD20447
M 104.945	6 Cyl.	24 Valves	2799cc		TD19845
HR5055				NB973 45.00 x 67.00 x 8.00mm, FPM NB974 93.00 x 114.00 x 13.00mm, FPM	

12 2.9L Diesel					
MB-OM 601 29TD	5 Cyl.	10 Valves	2874cc		TD11887
MB-OM 662	5 Cyl.	10 Valves	2874cc		TD9355
PB394 (x5) HR758				NA5131 45.00 x 67.00 x 8.00mm, PTFE NA5074 93.00 x 133.50 x 15.50mm, PTFE	

13 2.9L Diesel					
OM 602.940	5 Cyl.	10 Valves	2874cc		TD3613
PB394 (x10) HR758				NB973 45.00 x 67.00 x 8.00mm, FPM NA5131 45.00 x 67.00 x 8.00mm, PTFE NB974 93.00 x 114.00 x 13.00mm, FPM	

14 2.9L Diesel					
OM 602.980	5 Cyl.	10 Valves	2874cc		TD19846
PB394 (x10) HR758				NA5131 45.00 x 67.00 x 8.00mm, PTFE NA5074 93.00 x 133.50 x 15.50mm, PTFE	

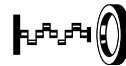
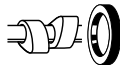

15 2.9L

Diesel

OM 662.940 5 Cyl. 10 Valves 2874cc TD21372

PB394 (x5)

NA5131

45.00 x 67.00 x 8.00mm, PTFE

NA5074

93.00 x 133.50 x 15.50mm, PTFE

16 2.9L

Diesel

OM 662.983 5 Cyl. 10 Valves 2874cc TD21371

HR758

NA5131

45.00 x 67.00 x 8.00mm, PTFE

NA5074

93.00 x 133.50 x 15.50mm, PTFE

17 3.2L

Petrol

G32D 6 Cyl. 24 Valves 3199cc TD26204

NB971

45.00 x 67.00 x 10.00mm, FPM

NB974

93.00 x 114.00 x 13.00mm, FPM

18 3.2L

Petrol

M 104.992 6 Cyl. 24 Valves 3199cc TD9357

M 104.995









HR5055

NB973

45.00 x 67.00 x 8.00mm, FPM

NB974

93.00 x 114.00 x 13.00mm, FPM

							
Baja Pickup	09/02→12/06	EJ253	Petrol	2457	4	16	26
Baja Pickup	09/03→12/06	EJ255	Petrol	2457	4	16	26
Chiffon	12/16→	KF	Petrol	658	3	12	1
Chiffon Custom	12/16→	KF	Petrol	658	3	12	1
Dex	03/07→11/10	K3-VE	Petrol	1298	4	16	9
Dias Wagon	09/09→	KF-DET	Petrol	658	3	12	1
Exiga (YA_)	05/08→	EJ20 (Turbo)	Petrol	1994	4	16	22
Exiga (YA_)	05/08→	EJ204	Petrol	1994	4	16	21
Exiga (YA_)	12/09→	EJ253	Petrol	2457	4	16	26
Forester (SF_)	03/97→02/02	EJ20 (Turbo)	Petrol	1994	4	16	22
Forester (SF_)	07/97→05/02	EJ25D	Petrol	2457	4	16	26
Forester (SF_)	08/97→09/02	EJ202	Petrol	1994	4	16	22
Forester (SF_)	06/98→09/02	EJ205	Petrol	1994	4	16	22
Forester (SF_)	09/98→05/02	EJ250	Petrol	2457	4	16	26
Forester (SG_)	06/02→05/05	EJ201	Petrol	1994	4	16	22
Forester (SG_)	06/02→05/05	EJ251	Petrol	2457	4	16	27
Forester (SG_)	09/02→05/05	EJ205	Petrol	1994	4	16	22
Forester (SG_)	11/02→08/05	EJ25	Petrol	2457	4	16	26
Forester (SG_)	01/04→12/09	EJ255	Petrol	2457	4	16	26
Forester (SG_)	01/05→10/12	EJ253	Petrol	2457	4	16	26
Forester (SG_)	06/05→05/08	EJ25D	Petrol	2457	4	16	26
Forester (SG_)	06/05→05/08	EJ204	Petrol	1994	4	16	21
Forester (SH_)	01/08→09/13	EJ204	Petrol	1994	4	16	21
Forester (SH_)	01/08→	EJ253	Petrol	2457	4	16	26
Forester (SH_)	06/08→09/13	EJ255	Petrol	2457	4	16	26
Forester (SH_)	01/09→09/13	EJ25	Petrol	2457	4	16	26
Impreza Coupe (GFC)	01/93→12/97	EJ18	Petrol	1820	4	16	19
Impreza Coupe (GFC)	09/94→12/95	EJ22	Petrol	2212	4	16	23
Impreza Coupe (GFC)	09/94→09/00	EJ22E	Petrol	2212	4	16	23
Impreza Coupe (GFC)	11/95→12/00	EJ20E	Petrol	1994	4	16	22
Impreza Coupe (GFC)	12/95→12/00	EJ201	Petrol	1994	4	16	22
Impreza Coupe (GFC)	12/96→12/00	EJ16E	Petrol	1597	4	16	17
Impreza Coupe (GFC)	12/96→12/00	EJ20G	Petrol	1994	4	16	22
Impreza Coupe (GFC)	12/96→12/00	EJ161	Petrol	1597	4	16	17
Impreza Coupe (GFC)	09/98→12/99	EJ253	Petrol	2457	4	16	26
Impreza Coupe (GFC)	09/98→09/00	EJ205P	Petrol	1994	4	16	22
Impreza Coupe (GFC)	09/98→12/00	EJ222	Petrol	2212	4	16	23
Impreza Estate	07/07→12/11	EJ255	Petrol	2457	4	16	26
Impreza Estate	09/07→12/11	EJ253	Petrol	2457	4	16	26
Impreza Estate	09/07→12/11	EJ257	Petrol	2457	4	16	26
Impreza Estate (GD, GG)	06/01→08/05	EJ22E	Petrol	2212	4	16	23
Impreza Estate (GD, GG)	06/01→	EL15	Petrol	1498	4	16	14
Impreza Estate (GF)	08/92→12/00	EJ16	Petrol	1597	4	16	17
Impreza Estate (GF)	08/92→12/00	EJ18	Petrol	1820	4	16	19
Impreza Estate (GF)	01/93→08/98	EJ16E	Petrol	1597	4	16	17
Impreza Estate (GF)	01/93→12/00	EJ161	Petrol	1597	4	16	17
Impreza Estate (GF)	03/94→12/00	EJ20 (Turbo)	Petrol	1994	4	16	22
Impreza Estate (GF)	09/94→09/00	EJ22E	Petrol	2212	4	16	23
Impreza Estate (GF)	11/95→06/96	EJ18E	Petrol	1820	4	16	19
Impreza Estate (GF)	11/95→08/98	EJ22	Petrol	2212	4	16	23
Impreza Estate (GF)	12/95→12/00	EJ20E	Petrol	1994	4	16	22
Impreza Estate (GF)	12/95→12/00	EJ201	Petrol	1994	4	16	22
Impreza Estate (GF)	06/98→12/00	EJ205	Petrol	1994	4	16	22
Impreza Estate (GF)	09/98→12/00	EJ222	Petrol	2212	4	16	23
Impreza Estate (GG)	10/00→12/01	EJ222	Petrol	2212	4	16	23
Impreza Estate (GG)	12/00→	EJ161	Petrol	1597	4	16	17
Impreza Estate (GG)	12/00→	EJ201	Petrol	1994	4	16	22
Impreza Estate (GG)	12/00→	EJ205	Petrol	1994	4	16	22
Impreza Estate (GG)	09/01→12/07	EJ253	Petrol	2457	4	16	26
Impreza Estate (GG)	09/05→06/07	EJ204	Petrol	1994	4	16	21
Impreza Estate (GG)	09/05→	EJ255	Petrol	2457	4	16	26
Impreza Estate (GG)	10/05→	EJ207	Petrol	1994	4	16	22
Impreza Estate (GG)	10/05→	EJ257	Petrol	2457	4	16	26
Impreza Estate (GG)	05/06→	EL15	Petrol	1498	4	16	14
Impreza Hatchback	12/02→09/05	EJ25	Petrol	2457	4	16	26
Impreza Hatchback	12/02→09/05	EJ205	Petrol	1994	4	16	22
Impreza Hatchback	12/02→09/05	EJ207	Petrol	1994	4	16	22
Impreza Hatchback	12/02→12/07	EJ201	Petrol	1994	4	16	22
Impreza Hatchback	09/05→12/07	EJ255	Petrol	2457	4	16	26
Impreza Hatchback	09/05→12/07	EJ257	Petrol	2457	4	16	26
Impreza Hatchback	10/05→12/07	EJ204	Petrol	1994	4	16	21
Impreza Hatchback (GR, GH, G3)	01/08→	EJ204	Petrol	1994	4	16	21
Impreza Hatchback (GR, GH, G3)	01/08→	EJ255	Petrol	2457	4	16	26
Impreza Hatchback (GR, GH, G3)	01/08→	EJ257	Petrol	2457	4	16	26
Impreza Hatchback (GR, GH, G3)	02/08→	EL15	Petrol	1498	4	16	14
Impreza Hatchback (GR, GH, G3)	08/08→10/10	EJ25	Petrol	2457	4	16	26
Impreza Hatchback (GR, GH, G3)	09/08→	EL154	Petrol	1498	4	16	14
Impreza Saloon (GC)	08/92→12/00	EJ16	Petrol	1597	4	16	17



CC



9

Impreza Saloon (GC)	08/92→12/00	EJ18	Petrol	1820	4	16	19
Impreza Saloon (GC)	08/92→12/00	EJ18E	Petrol	1820	4	16	19
Impreza Saloon (GC)	10/93→10/94	EJ20G	Petrol	1994	4	16	22
Impreza Saloon (GC)	03/94→12/00	EJ20 (Turbo)	Petrol	1994	4	16	22
Impreza Saloon (GC)	09/94→12/00	EJ22	Petrol	2212	4	16	23
Impreza Saloon (GC)	10/95→12/00	EJ20E	Petrol	1994	4	16	22
Impreza Saloon (GC)	10/95→12/00	EJ201	Petrol	1994	4	16	22
Impreza Saloon (GC)	06/98→12/00	EJ161	Petrol	1597	4	16	17
Impreza Saloon (GC)	06/98→12/00	EJ205	Petrol	1994	4	16	22
Impreza Saloon (GC)	09/98→09/00	EJ22E	Petrol	2212	4	16	23
Impreza Saloon (GC)	09/98→09/00	EJ205P	Petrol	1994	4	16	22
Impreza Saloon (GD)	10/00→12/01	EJ222	Petrol	2212	4	16	23
Impreza Saloon (GD)	10/00→12/07	EJ253	Petrol	2457	4	16	26
Impreza Saloon (GD)	12/00→	EJ161	Petrol	1597	4	16	17
Impreza Saloon (GD)	12/00→	EJ201	Petrol	1994	4	16	22
Impreza Saloon (GD)	12/00→	EJ205	Petrol	1994	4	16	22
Impreza Saloon (GD)	03/01→09/05	EJ251	Petrol	2457	4	16	27
Impreza Saloon (GD)	06/01→09/06	EJ16	Petrol	1597	4	16	17
Impreza Saloon (GD)	11/01→	EJ207	Petrol	1994	4	16	22
Impreza Saloon (GD)	09/05→	EJ204	Petrol	1994	4	16	21
Impreza Saloon (GD)	09/05→	EJ255	Petrol	2457	4	16	26
Impreza Saloon (GD)	09/05→	EJ257	Petrol	2457	4	16	26
Impreza Saloon (GD)	10/05→	EJ20 (Turbo)	Petrol	1994	4	16	22
Impreza Saloon (GD)	05/06→	EL15	Petrol	1498	4	16	14
Impreza Saloon (GD, GG)	06/01→08/05	EJ22E	Petrol	2212	4	16	23
Impreza Saloon (GD, GG)	06/01→09/05	EL154	Petrol	1498	4	16	14
Impreza Saloon (GD, GG)	06/01→	EL15	Petrol	1498	4	16	14
Impreza Saloon (GD, GG)	12/01→11/02	EJ205	Petrol	1994	4	16	22
Impreza Saloon (GD, GG)	12/02→09/05	EJ251	Petrol	2457	4	16	27
Impreza Saloon (GD, GG)	10/05→	EJ207	Petrol	1994	4	16	22
Impreza Saloon (GR)	07/07→	EJ255	Petrol	2457	4	16	26
Impreza Saloon (GR)	07/07→	EJ257	Petrol	2457	4	16	26
Impreza Saloon (GR)	01/08→12/11	EJ253	Petrol	2457	4	16	26
Impreza Saloon (GR)	02/08→	EL15	Petrol	1498	4	16	14
Impreza Saloon (GR)	08/08→10/10	EJ25	Petrol	2457	4	16	26
Impreza Saloon (GR)	08/08→03/11	EJ20	Petrol	1994	4	16	21
Impreza Saloon (GR)	01/11→	EJ204	Petrol	1994	4	16	21
Justy I (KAD)	11/84→10/95	EF10	Petrol	998	3	6	3
Justy I (KAD)	10/86→10/95	EF12	Petrol	1189	3	6	4
Justy II (JMA, MS)	04/01→11/03	G13BB	Petrol	1298	4	16	8
Justy III (G3X)	09/03→	M13A	Petrol	1328	4	16	10
Justy III (G3X)	09/03→	M15A	Petrol	1490	4	16	15
Justy IV	01/07→	TKR-FE	Petrol	998	3	12	2
Justy IV	03/08→	K3-VE	Petrol	1298	4	16	9
Justy MPV	11/16→	TKR-FE	Petrol	998	3	12	2
Legacy I (BC)	01/89→12/93	EJ18 SPI	Petrol	1820	4	8	20
Legacy I (BC)	01/89→07/94	EJ22 EMPI	Petrol	2212	4	16	23
Legacy I (BC)	05/89→12/93	EJ16	Petrol	1597	4	16	17
Legacy I (BC)	09/89→08/94	EJ22E	Petrol	2212	4	16	23
Legacy I (BC)	10/89→06/94	EJ22	Petrol	2212	4	16	23
Legacy I (BC)	08/91→12/93	EJ20E	Petrol	1994	4	16	22
Legacy I (BC)	08/91→07/94	EJ20 EMPI	Petrol	1994	4	16	21
Legacy I (BC)	05/92→07/94	EJ20-GN	Petrol	1994	4	16	22
Legacy I Estate (BC, BJF)	01/89→07/94	EJ18 SPI	Petrol	1820	4	8	20
Legacy I Estate (BC, BJF)	01/89→07/94	EJ22 EMPI	Petrol	2212	4	16	23
Legacy I Estate (BC, BJF)	01/89→08/94	EJ22	Petrol	2212	4	16	23
Legacy I Estate (BC, BJF)	01/89→08/94	EJ22E	Petrol	2212	4	16	23
Legacy I Estate (BC, BJF)	05/89→12/93	EJ16	Petrol	1597	4	16	17
Legacy I Estate (BC, BJF)	09/91→07/94	EJ20 EMPI	Petrol	1994	4	16	21
Legacy I Estate (BC, BJF)	05/92→07/94	EJ20-GN	Petrol	1994	4	16	22
Legacy II (BD)	06/94→11/98	EJ22	Petrol	2212	4	16	23
Legacy II (BD)	07/94→03/99	EJ22E	Petrol	2212	4	16	23
Legacy II (BD)	09/94→03/99	EJ20E	Petrol	1994	4	16	22
Legacy II (BD)	09/94→03/99	EJ22 EMPI	Petrol	2212	4	16	23
Legacy II (BD)	09/94→03/99	EJ201	Petrol	1994	4	16	22
Legacy II (BD)	09/95→03/99	EJ25D	Petrol	2457	4	16	26
Legacy II (BD)	09/96→11/98	EJ25	Petrol	2457	4	16	26
Legacy II (BD, BG)	05/96→09/98	EJ18E	Petrol	1820	4	16	19
Legacy II Estate (BG)	02/94→12/98	EJ22 EMPI	Petrol	2212	4	16	23
Legacy II Estate (BG)	02/94→12/99	EJ22E	Petrol	2212	4	16	23
Legacy II Estate (BG)	06/94→11/98	EJ22	Petrol	2212	4	16	23
Legacy II Estate (BG)	09/94→11/98	EJ20E	Petrol	1994	4	16	22
Legacy II Estate (BG)	09/94→11/98	EJ20 EMPI	Petrol	1994	4	16	21
Legacy II Estate (BG)	09/94→10/99	EJ201	Petrol	1994	4	16	22
Legacy II Estate (BG)	09/95→12/96	EJ25	Petrol	2457	4	16	26
Legacy II Estate (BG)	09/95→12/99	EJ25D	Petrol	2457	4	16	26
Legacy III (BE)	10/98→08/03	EJ25	Petrol	2457	4	16	26
Legacy III (BE)	04/99→08/03	EJ201	Petrol	1994	4	16	22

				CC			9
Legacy III (BE)	08/00→08/03	EJ206	Petrol	1994	4	16	22
Legacy III (BE)	09/00→08/03	EJ253	Petrol	2457	4	16	26
Legacy III (BE, BH)	06/02→08/03	EJ208	Petrol	1994	4	16	22
Legacy III Estate (BH)	12/98→08/03	EJ25	Petrol	2457	4	16	26
Legacy III Estate (BH)	12/98→08/03	EJ201	Petrol	1994	4	16	22
Legacy III Estate (BH)	09/99→08/03	EJ253	Petrol	2457	4	16	26
Legacy III Estate (BH)	08/00→08/03	EJ206	Petrol	1994	4	16	22
Legacy III Estate (BH)	06/02→08/03	EJ208	Petrol	1994	4	16	22
Legacy IV	06/05→04/09	EJ20Y	Petrol	1994	4	16	22
Legacy IV (BL)	09/03→10/05	EJ202	Petrol	1994	4	16	22
Legacy IV (BL)	09/03→11/06	EJ20 (Turbo)	Petrol	1994	4	16	22
Legacy IV (BL)	09/03→12/09	EJ25	Petrol	2457	4	16	26
Legacy IV (BL)	09/04→12/09	EJ255	Petrol	2457	4	16	26
Legacy IV (BL)	06/05→12/09	EJ204	Petrol	1994	4	16	21
Legacy IV (BL)	08/05→03/12	EJ20Y	Petrol	1994	4	16	22
Legacy IV (BL)	09/06→12/09	EJ25DET	Petrol	2457	4	16	26
Legacy IV (BL)	09/08→12/09	J3522	Petrol	3471	6	24	29
Legacy IV Estate (B13_)	06/05→04/09	EJ20Y	Petrol	1994	4	16	22
Legacy IV Estate (BP)	09/03→10/05	EJ202	Petrol	1994	4	16	22
Legacy IV Estate (BP)	09/03→11/06	EJ20 (Turbo)	Petrol	1994	4	16	22
Legacy IV Estate (BP)	09/03→12/09	EJ25	Petrol	2457	4	16	26
Legacy IV Estate (BP)	09/03→12/09	EJ204	Petrol	1994	4	16	21
Legacy IV Estate (BP)	09/04→12/08	EJ255	Petrol	2457	4	16	26
Legacy IV Estate (BP)	09/06→12/09	EJ25DET	Petrol	2457	4	16	26
Legacy IV Estate (BP)	09/07→12/08	EJ253	Petrol	2457	4	16	26
Legacy V (BM)	05/09→12/15	EJ255	Petrol	2457	4	16	26
Legacy V (BM)	06/09→12/15	EJ204	Petrol	1994	4	16	21
Legacy V (BM)	09/09→12/14	EJ253	Petrol	2457	4	16	26
Legacy V Estate (BR)	06/08→12/14	EJ206	Petrol	1994	4	16	22
Legacy V Estate (BR)	06/08→12/14	EJ208	Petrol	1994	4	16	22
Legacy V Estate (BR)	05/09→12/14	EJ25	Petrol	2457	4	16	26
Legacy V Estate (BR)	05/09→12/14	EJ255	Petrol	2457	4	16	26
Legacy V Estate (BR)	09/09→12/14	EJ204	Petrol	1994	4	16	21
Legacy V Estate (BR)	09/09→12/14	EJ253	Petrol	2457	4	16	26
Legacy Outback (BG)	01/96→12/99	EJ25D	Petrol	2457	4	16	26
Leone Coupe	09/78→12/79	EA71	Petrol	1595	4	8	16
Leone Estate	09/75→12/79	EA71	Petrol	1595	4	8	16
Leone Hardtop	09/75→12/84	EA71	Petrol	1595	4	8	16
Leone Hardtop	09/79→12/84	EA81	Petrol	1781	4	8	18
Leone Hatchback	09/86→12/87	EA71	Petrol	1595	4	8	16
Leone I (AB)	03/79→10/84	EA65	Petrol	1299	4	8	6
Leone I (AB)	03/79→10/84	EA71	Petrol	1595	4	8	16
Leone I (AB)	01/80→10/84	EA81	Petrol	1781	4	8	18
Leone I Estate	09/78→12/84	EA71	Petrol	1595	4	8	16
Leone I Estate	03/79→10/84	EA65	Petrol	1299	4	8	6
Leone I Estate	05/79→12/84	EA81	Petrol	1781	4	8	18
Leone I Hatchback	03/79→10/84	EA65	Petrol	1299	4	8	6
Leone I Hatchback	03/79→10/84	EA71	Petrol	1595	4	8	16
Leone I Hatchback	09/79→10/84	EA81	Petrol	1781	4	8	18
Leone II	11/84→12/89	EA81	Petrol	1781	4	8	18
Leone II	11/84→09/91	EA65	Petrol	1299	4	8	6
Leone II	11/84→12/94	EA71	Petrol	1595	4	8	16
Leone II Estate	09/84→12/89	EA81	Petrol	1781	4	8	18
Leone II Estate	03/85→12/94	EA71	Petrol	1595	4	8	16
Leone / Loyale Coupe	03/85→12/92	EA71	Petrol	1595	4	8	16
Leone Saloon	09/75→12/79	EA71	Petrol	1595	4	8	16
Libero Box	01/84→05/86	EF10	Petrol	998	3	6	3
Libero Box	08/86→07/94	EF12	Petrol	1189	3	6	4
Libero Box	08/87→07/94	EF12E	Petrol	1189	3	6	4
Libero Bus (E10, E12)	01/83→07/88	EF10	Petrol	998	3	6	3
Libero Bus (E10, E12)	08/86→02/00	EF12	Petrol	1189	3	6	4
Libero Bus (E10, E12)	08/91→04/94	EF12E	Petrol	1189	3	6	4
Lucra (L4_)	04/10→07/11	KF-VE	Petrol	658	3	12	1
Lucra (L4_)	04/10→	KF	Petrol	658	3	12	1
Lucra (L4_)	04/10→	KF-DET	Petrol	658	3	12	1
MV (AS_)	06/78→04/81	EA71	Petrol	1595	4	8	16
MV (AS_)	09/79→12/87	EA81	Petrol	1781	4	8	18
Outback (BE, BH)	10/98→07/00	EJ201	Petrol	1994	4	16	22
Outback (BE, BH)	09/99→08/03	EJ253	Petrol	2457	4	16	26
Outback (BE, BH)	10/00→08/03	EJ25	Petrol	2457	4	16	26
Outback (BL, BP)	09/03→10/05	EJ202	Petrol	1994	4	16	22
Outback (BL, BP)	09/03→09/09	EJ253	Petrol	2457	4	16	26
Outback (BL, BP)	09/03→06/10	EJ251	Petrol	2457	4	16	27
Outback (BL, BP)	11/03→09/09	EJ25D	Petrol	2457	4	16	26
Outback (BL, BP)	01/05→12/09	EJ255	Petrol	2457	4	16	26
Outback (BL, BP)	09/08→06/09	EJ25DET	Petrol	2457	4	16	26
Outback (BR)	09/09→	EJ253	Petrol	2457	4	16	26
Outback (BR)	09/12→	EJ25	Petrol	2457	4	16	26











CC



9

Model	Year Range	Engine	Fuel	CC	Cylinders	Length (mm)	Weight (kg)
Pleo (L275, L285)	04/10→	KF-DET	Petrol	658	3	12	1
Pleo (L275, L285)	04/10→	KF-VE	Petrol	658	3	12	1
Pleo Plus	01/12→	KF	Petrol	658	3	12	1
Sambar Truck Platform/Chassis	04/12→	KF	Petrol	658	3	12	1
Sambar Van Bus	04/12→	KF	Petrol	658	3	12	1
Sambar Van Pickup	04/12→	KF	Petrol	658	3	12	1
Standard Hatchback	09/79→12/87	EA71	Petrol	1595	4	8	16
Standard Hatchback	09/80→12/87	EA81	Petrol	1781	4	8	18
Standard Saloon	09/76→12/79	EA71	Petrol	1595	4	8	16
Stella	12/14→	KF	Petrol	658	3	12	1
SVX (CX)	09/92→12/97	EG33 DOHC	Petrol	3319	6	24	28
Traviq	08/00→08/05	Z 22 SE	Petrol	2198	4	16	24
Trezia	11/10→	1NR-FE	Petrol	1329	4	16	5
Trezia	03/11→	1ND-TV	Diesel	1364	4	8	12
Trezia	03/11→	1NR-FKE	Petrol	1329	4	16	5
Trezia	03/11→	1NZ-FE	Petrol	1496	4	16	13
WRX Estate	09/11→	EJ257	Petrol	2457	4	16	26
WRX Estate	09/12→	EJ255	Petrol	2457	4	16	26
WRX Hatchback (GP)	10/11→12/12	EJ257	Petrol	2457	4	16	26
WRX Saloon (GJ)	07/11→	EJ257	Petrol	2457	4	16	26
WRX Saloon (GJ)	09/11→	EJ255	Petrol	2457	4	16	26
WRX Saloon (GJ)	04/16→	EJ207	Petrol	1994	4	16	22

	CC				9		CC				9
1KR-FE	998	3	12	Petrol	2						
1ND-TV	1364	4	8	Diesel	12						
1NR-FE	1329	4	16	Petrol	5						
1NR-FKE	1329	4	16	Petrol	5						
1NZ-FE	1496	4	16	Petrol	13						
EA65	1299	4	8	Petrol	6						
EA71	1595	4	8	Petrol	16						
EA81	1781	4	8	Petrol	18						
EF10	998	3	6	Petrol	3						
EF12	1189	3	6	Petrol	4						
EF12E	1189	3	6	Petrol	4						
EG33 DOHC	3319	6	24	Petrol	28						
EJ16	1597	4	16	Petrol	17						
EJ16E	1597	4	16	Petrol	17						
EJ16J	1597	4	16	Petrol	17						
EJ18	1820	4	16	Petrol	19						
EJ18E	1820	4	16	Petrol	19						
EJ18 SPI	1820	4	8	Petrol	20						
EJ20	1994	4	16	Petrol	21						
EJ20 (Turbo)	1994	4	16	Petrol	22						
EJ20D	1994	4	16	Petrol	22						
EJ20E	1994	4	16	Petrol	22						
EJ20 EMPI	1994	4	16	Petrol	21						
EJ20G	1994	4	16	Petrol	22						
EJ20-GN	1994	4	16	Petrol	22						
EJ20H	1994	4	16	Petrol	22						
EJ20J	1994	4	16	Petrol	22						
EJ20R	1994	4	16	Petrol	22						
EJ20U	1994	4	16	Petrol	22						
EJ20Y	1994	4	16	Petrol	22						
EJ22	2212	4	16	Petrol	23						
EJ22E	2212	4	16	Petrol	23						
EJ22 EMPI	2212	4	16	Petrol	23						
EJ25	2457	4	16	Petrol	26						
EJ25D	2457	4	16	Petrol	26						
EJ25DET	2457	4	16	Petrol	26						
EJ161	1597	4	16	Petrol	17						
EJ201	1994	4	16	Petrol	22						
EJ202	1994	4	16	Petrol	22						
EJ204	1994	4	16	Petrol	21						
EJ205	1994	4	16	Petrol	22						
EJ205P	1994	4	16	Petrol	22						
EJ206	1994	4	16	Petrol	22						
EJ207	1994	4	16	Petrol	22						
EJ208	1994	4	16	Petrol	22						
EJ222	2212	4	16	Petrol	23						
EJ250	2457	4	16	Petrol	26						
EJ251	2457	4	16	Petrol	27						
EJ253	2457	4	16	Petrol	26						
EJ255	2457	4	16	Petrol	26						
EJ257	2457	4	16	Petrol	26						
EL15	1498	4	16	Petrol	14						
EL154	1498	4	16	Petrol	14						
G13B	1298	4	8	Petrol	7						
G13BB	1298	4	16	Petrol	8						
J35Z2	3471	6	24	Petrol	29						
K3-VE	1298	4	16	Petrol	9						
KF	658	3	12	Petrol	1						
KF-DET	658	3	12	Petrol	1						
KF-VE	658	3	12	Petrol	1						
M13A	1328	4	16	Petrol	10						
M15A	1490	4	16	Petrol	15						
Z 13 DT	1248	4	16	Diesel	11						
Z 22 SE	2198	4	16	Petrol	24						
Z 22 XE	2198	4	16	Petrol	25						

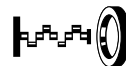
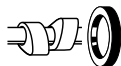

1 0.7L Petrol

KF	3 Cyl.	12 Valves	658cc	TD30998
KF-DET	3 Cyl.	12 Valves	658cc	TD30997
KF-VE	3 Cyl.	12 Valves	658cc	TD34071

NA5246
42.50 x 54.50 x 6.00mm, MVQ

2 1.0L Petrol

1KR-FE	3 Cyl.	12 Valves	998cc	TD26119
--------	--------	-----------	-------	---------

NA5260
38.00 x 50.00 x 6.00mm, FPM
NA5324
74.00 x 89.00 x 8.50mm, FPM

3 1.0L Petrol

EF10	3 Cyl.	6 Valves	998cc	TD3629
------	--------	----------	-------	--------

NJ846
38.50 x 53.00 x 8.00mm, NBR

NJ252
30.00 x 46.00 x 7.00mm, NBR

4 1.2L Petrol

EF12	3 Cyl.	6 Valves	1189cc	TD4905
EF12E	3 Cyl.	6 Valves	1189cc	TD9007

NJ846
38.50 x 53.00 x 8.00mm, NBR

NJ252
30.00 x 46.00 x 7.00mm, NBR

5 1.3L Petrol

1NR-FE	4 Cyl.	16 Valves	1329cc	TD25015
1NR-FKE	4 Cyl.	16 Valves	1329cc	TD30983

PA5020 (x16)
PA5019 (x8)

NA5088
75.00 x 107.00 x 8.00mm, FPM

6 1.3L Petrol

EA65	4 Cyl.	8 Valves	1299cc	TD11130
------	--------	----------	--------	---------

NJ022
38.00 x 55.00 x 9.00mm, FPM/ACM

7 1.3L Petrol

G13B	4 Cyl.	8 Valves	1298cc	TD19194
------	--------	----------	--------	---------

PA928 (x8)

NJ336
32.00 x 47.00 x 8.00mm, NBR

NJ377
32.00 x 47.00 x 6.00mm, ACM
NJ378
68.00 x 86.00 x 8.00mm, ACM

8 1.3L Petrol

G13BB	4 Cyl.	16 Valves	1298cc	TD18569
-------	--------	-----------	--------	---------

PA928 (x16)

NJ336
32.00 x 47.00 x 8.00mm, NBR

NJ377
32.00 x 47.00 x 6.00mm, ACM
NJ378
68.00 x 86.00 x 8.00mm, ACM

9 1.3L Petrol

K3-VE	4 Cyl.	16 Valves	1298cc	TD26813
-------	--------	-----------	--------	---------

NJ353
35.00 x 49.00 x 6.00mm, NBR
NA5324
74.00 x 89.00 x 8.50mm, FPM



10 1.3L Petrol

M13A	4 Cyl.	16 Valves	1328cc	TD24894
PA928 (x16)				
			NJ377 32.00 x 47.00 x 6.00mm, ACM NJ337 60.00 x 80.00 x 8.00mm, NBR	

11 1.3L Diesel

Z 13 DT	4 Cyl.	16 Valves	1248cc	TD21369
HR5088				
			NA5223 40.00 x 52.00 x 7.00mm, FPM NA5230 78.00 x 100.00 x 9.00mm, PTFE	

12 1.4L Diesel

1ND-TV	4 Cyl.	8 Valves	1364cc	TD25016
			NA5260 38.00 x 50.00 x 6.00mm, FPM NA5088 75.00 x 107.00 x 8.00mm, FPM	

13 1.5L Petrol

1NZ-FE	4 Cyl.	16 Valves	1496cc	TD30984
			NA5088 75.00 x 107.00 x 8.00mm, FPM	

14 1.5L Petrol

EL15	4 Cyl.	16 Valves	1498cc	TD27244
EL154	4 Cyl.	16 Valves	1498cc	TD31615
			NA5226 33.0 x 49.0 x 8.0mm, FPM	

15 1.5L Petrol

M15A	4 Cyl.	16 Valves	1490cc	TD20972
PA928 (x16)				
			NJ377 32.00 x 47.00 x 6.00mm, ACM NJ337 60.00 x 80.00 x 8.00mm, NBR	

16 1.6L Petrol

EA71	4 Cyl.	8 Valves	1595cc	TD11131
			NJ022 38.00 x 55.00 x 9.00mm, FPM/ACM	

17 1.6L Petrol

EJ16	4 Cyl.	16 Valves	1597cc	TD3634
EJ16E	4 Cyl.	16 Valves	1597cc	TD25044
EJ16J	4 Cyl.	16 Valves	1597cc	TD25043
EJ161	4 Cyl.	16 Valves	1597cc	TD25042
PA425 (x16)				
			NK117 32.00 x 45.00 x 8.00mm, ACM NA5226 33.0 x 49.0 x 8.0mm, FPM NK139 86.00 x 103.00 x 10.00mm, FPM	



18 1.8L

Petrol

EA81	4 Cyl.	8 Valves	1781cc	TD3622
------	--------	----------	--------	--------

NJ341
38.00 x 59.00 x 9.00mm, NBR

19 1.8L

Petrol

EJ18	4 Cyl.	16 Valves	1820cc	TD3636
------	--------	-----------	--------	--------

EJ18E	4 Cyl.	16 Valves	1820cc	TD20016
-------	--------	-----------	--------	---------

PA425 (x16)

NK117
32.00 x 45.00 x 8.00mm, ACM

NA5226
33.0 x 49.0 x 8.0mm, FPM
NK139
86.00 x 103.00 x 10.00mm, FPM

20 1.8L

Petrol

EJ18 SPI	4 Cyl.	8 Valves	1820cc	TD3637
----------	--------	----------	--------	--------

PA425 (x8)

NK117
32.00 x 45.00 x 8.00mm, ACM

NA5226
33.0 x 49.0 x 8.0mm, FPM
NK139
86.00 x 103.00 x 10.00mm, FPM

21 2.0L

Petrol

EJ20	4 Cyl.	16 Valves	1994cc	TD3640
------	--------	-----------	--------	--------

EJ20 EMPI	4 Cyl.	16 Valves	1994cc	TD3639
-----------	--------	-----------	--------	--------

EJ204	4 Cyl.	16 Valves	1994cc	TD25245
-------	--------	-----------	--------	---------

PA425 (x16)

NK117 (x2)
32.00 x 45.00 x 8.00mm, ACM

NA5226
33.0 x 49.0 x 8.0mm, FPM
NK139
86.00 x 103.00 x 10.00mm, FPM

22 2.0L

Petrol

EJ20 (Turbo)	4 Cyl.	16 Valves	1994cc	TD9431
--------------	--------	-----------	--------	--------

EJ20D	4 Cyl.	16 Valves	1994cc	TD25906
-------	--------	-----------	--------	---------

EJ20E	4 Cyl.	16 Valves	1994cc	TD20017
-------	--------	-----------	--------	---------

EJ20G	4 Cyl.	16 Valves	1994cc	TD18954
-------	--------	-----------	--------	---------

EJ20-GN	4 Cyl.	16 Valves	1994cc	TD3638
---------	--------	-----------	--------	--------

EJ20H	4 Cyl.	16 Valves	1994cc	TD25903
-------	--------	-----------	--------	---------

EJ20J	4 Cyl.	16 Valves	1994cc	TD18955
-------	--------	-----------	--------	---------

EJ20R	4 Cyl.	16 Valves	1994cc	TD25904
-------	--------	-----------	--------	---------

EJ20U	4 Cyl.	16 Valves	1994cc	TD31617
-------	--------	-----------	--------	---------

EJ20Y	4 Cyl.	16 Valves	1994cc	TD31618
-------	--------	-----------	--------	---------

EJ201	4 Cyl.	16 Valves	1994cc	TD25048
-------	--------	-----------	--------	---------

EJ202	4 Cyl.	16 Valves	1994cc	TD25049
-------	--------	-----------	--------	---------

EJ205	4 Cyl.	16 Valves	1994cc	TD19461
-------	--------	-----------	--------	---------

EJ205P	4 Cyl.	16 Valves	1994cc	TD20018
--------	--------	-----------	--------	---------

EJ206	4 Cyl.	16 Valves	1994cc	TD25905
-------	--------	-----------	--------	---------

EJ207	4 Cyl.	16 Valves	1994cc	TD25050
-------	--------	-----------	--------	---------

EJ208	4 Cyl.	16 Valves	1994cc	TD25051
-------	--------	-----------	--------	---------

PA425 (x16)

NK117
32.00 x 45.00 x 8.00mm, ACM

NA5226
33.0 x 49.0 x 8.0mm, FPM
NK139
86.00 x 103.00 x 10.00mm, FPM



23 2.2L Petrol

EJ22	4 Cyl.	16 Valves	2212cc	TD3641
EJ22E	4 Cyl.	16 Valves	2212cc	TD27247
EJ22 EMPI	4 Cyl.	16 Valves	2212cc	TD4908
EJ222	4 Cyl.	16 Valves	2212cc	TD29355

PA425 (x16)	NK117 32.00 x 45.00 x 8.00mm, ACM	NA5226 F 33.0 x 49.0 x 8.0mm, FPM NK139 R 86.00 x 103.00 x 10.00mm, FPM
-------------	--------------------------------------	--

24 2.2L Petrol

Z 22 SE	4 Cyl.	16 Valves	2198cc	TD34094
---------	--------	-----------	--------	---------

HR5127 S	NA5108 F 42.00 x 55.00 x 7.00mm, FPM/ACM NB806 R 90.00 x 104.00 x 11.00mm, FPM
----------	---

25 2.2L Petrol

Z 22 XE	4 Cyl.	16 Valves	2198cc	TD21370
---------	--------	-----------	--------	---------

PA5041 (x16) HR791 S	NC006 (x2) 35.00 x 48.00 x 7.00mm, MVQ	NB700 F 31.00 x 50.00 x 8.00mm, MVQ NB806 R 90.00 x 104.00 x 11.00mm, FPM
-------------------------	---	--

26 2.5L Petrol

EJ25	4 Cyl.	16 Valves	2457cc	TD18438
EJ25D	4 Cyl.	16 Valves	2457cc	TD9751
EJ25DET	4 Cyl.	16 Valves	2457cc	TD25276
EJ250	4 Cyl.	16 Valves	2457cc	TD31614
EJ253	4 Cyl.	16 Valves	2457cc	TD26127
EJ255	4 Cyl.	16 Valves	2457cc	TD26105
EJ257	4 Cyl.	16 Valves	2457cc	TD26106

PA425 (x16)	NK117 (x2) 32.00 x 45.00 x 8.00mm, ACM	NA5226 F 33.0 x 49.0 x 8.0mm, FPM NK139 R 86.00 x 103.00 x 10.00mm, FPM
-------------	---	--

27 2.5L Petrol

EJ251	4 Cyl.	16 Valves	2457cc	TD25052
-------	--------	-----------	--------	---------

PA425 (x16)	NK117 32.00 x 45.00 x 8.00mm, ACM	NA5226 F 33.0 x 49.0 x 8.0mm, FPM NK139 R 86.00 x 103.00 x 10.00mm, FPM
-------------	--------------------------------------	--

28 3.3L Petrol

EG33 DOHC	6 Cyl.	24 Valves	3319cc	TD3632
-----------	--------	-----------	--------	--------

PA425 (x24)	NK117 (x2) 32.00 x 45.00 x 8.00mm, ACM	NA5226 F 33.0 x 49.0 x 8.0mm, FPM NK139 R 86.00 x 103.00 x 10.00mm, FPM
-------------	---	--

29 3.5L Petrol

J35Z2	6 Cyl.	24 Valves	3471cc	TD33555
-------	--------	-----------	--------	---------

PB355 I (x12) PB356 E (x12)	NB698 R 80.00 x 98.00 x 10.00mm, FPM
--------------------------------	---









CC



9

Alto	09/85→05/88	F5A	Petrol	543	3	6	1
Alto	01/86→12/88	F8B	Petrol	796	3	6	5
Alto (OS)	06/82→08/84	F8B	Petrol	796	3	6	5
Alto (EC)	12/88→11/93	F8B	Petrol	796	3	6	5
Alto (EF)	11/93→06/96	F8B	Petrol	796	3	6	5
Alto (EF)	09/94→09/98	G10BB	Petrol	993	4	16	11
Alto (FF)	09/04→12/08	F10D	Petrol	1061	4	16	15
Alto (FF)	09/04→12/08	F10DN	Petrol	1061	4	16	15
Alto (FF)	10/04→01/09	K6A	Petrol	658	3	12	2
Alto (GF)	01/09→	K10B	Petrol	998	3	12	13
Alto (GF)	12/09→	K6A	Petrol	658	3	12	2
Alto (GF)	01/10→	F8D	Petrol	796	3	12	6
Alto (HA12, HA23)	01/00→06/02	G10BB	Petrol	993	4	16	11
Alto (HA36)	12/14→	R06A	Petrol	658	3	12	2
Alto Hatchback	07/09→	K10B	Petrol	996	3	12	13
Alto I (SS80)	10/83→12/85	F8A	Petrol	797	4	8	4
Alto III (EF)	10/98→09/00	G13BB	Petrol	1298	4	16	21
Alto III (EF)	10/98→09/00	G16B	Petrol	1590	4	16	34
Alto III (EF)	11/11→	R06A	Petrol	658	3	12	2
APV (GD)	10/03→	G15A	Petrol	1493	4	16	27
APV (GD)	06/05→	G16A (16V)	Petrol	1590	4	16	34
APV Platform/Chassis	01/10→	G16A (16V)	Petrol	1590	4	16	34
Baleno (EG)	03/95→08/98	G15A	Petrol	1493	4	16	27
Baleno (EG)	07/95→05/02	G13BB	Petrol	1298	4	16	21
Baleno (EG)	07/95→05/02	G16B	Petrol	1590	4	16	34
Baleno (EG)	03/96→05/02	J18A	Petrol	1839	4	16	37
Baleno (EG)	09/96→05/02	G13BA	Petrol	1298	4	8	20
Baleno (EG)	04/98→05/02	DHV (XUD9BSD)	Diesel	1905	4	8	39
Baleno (EG)	04/98→05/02	DHW (XUD9SD)	Diesel	1905	4	8	39
Baleno (FW, EW)	02/16→	K10C	Petrol	998	3	12	13
Baleno Estate (EG)	08/96→05/02	G16B	Petrol	1590	4	16	34
Baleno Estate (EG)	08/96→05/02	J18A	Petrol	1839	4	16	37
Baleno Estate (EG)	03/97→05/02	G13BB	Petrol	1298	4	16	21
Baleno Estate (EG)	04/98→05/02	DHV (XUD9BSD)	Diesel	1905	4	8	39
Baleno Estate (EG)	04/98→05/02	DHW (XUD9SD)	Diesel	1905	4	8	39
Baleno Hatchback (EG)	07/95→05/02	G13BB	Petrol	1298	4	16	21
Baleno Hatchback (EG)	07/95→05/02	G16B	Petrol	1590	4	16	34
Baleno Hatchback (EG)	03/96→05/02	J18A	Petrol	1839	4	16	37
Baleno Hatchback (EG)	04/96→05/02	G13BA	Petrol	1298	4	8	20
Baleno Hatchback (EG)	04/98→05/02	DHW (XUD9SD)	Diesel	1905	4	8	39
Carry Box	10/95→03/99	F10A	Petrol	970	4	8	7
Carry Box (OS)	11/80→10/85	F8A	Petrol	797	4	8	4
Carry Box (ED)	07/85→12/90	F10A	Petrol	970	4	8	7
Carry Box (FD)	02/99→09/04	K6A-T	Petrol	658	3	12	3
Carry Box (FD)	02/99→	G13BB	Petrol	1298	4	16	21
Carry Bus	03/99→12/06	G13BB	Petrol	1298	4	16	21
Carry Bus	09/01→07/05	R06A	Petrol	658	3	12	2
Carry Bus (OS)	03/81→03/85	F8A	Petrol	797	4	8	4
Carry Pickup	07/85→12/90	F10A	Petrol	970	4	8	7
Carry Platform/Chassis	08/92→01/99	F10A	Petrol	970	4	8	7
Carry Platform/Chassis (OS)	11/80→03/85	F8A	Petrol	797	4	8	4
Carry Platform/Chassis (FD, DA5_T, DA6_T)	02/99→09/04	F10A	Petrol	970	4	8	7
Carry Platform/Chassis (FD, DA5_T, DA6_T)	10/00→07/05	G13BB	Petrol	1298	4	16	21
Carry Platform/Chassis (FD, DA5_T, DA6_T)	10/04→	G16A (16V)	Petrol	1590	4	16	34
Carry Platform/Chassis (FD, DA5_T, DA6_T)	09/10→	R06A	Petrol	658	3	12	2
Celerio (LF)	03/14→	K10B	Petrol	998	3	12	13
Cervo	06/82→01/88	F5A	Petrol	543	3	6	1
Cervo (HG21)	11/06→03/10	K6A	Petrol	658	3	12	2
Ciaz	05/15→	K14B	Petrol	1372	4	16	26
Cultus	01/11→	G10B	Petrol	993	4	16	11
Equator Pickup	09/08→12/11	VQ40DE	Petrol	3954	6	24	55
Equator Pickup	09/08→12/12	QR25DE	Petrol	2488	4	16	53
Ertiga	04/12→	K14B	Petrol	1372	4	16	26
Every	05/12→	K6A	Petrol	658	3	12	2
Every	02/15→	R06A	Petrol	658	3	12	2
Every (DA64_)	08/05→	K6A-T	Petrol	658	3	12	3
Farmworker Pickup	01/11→	G13BB	Petrol	1298	4	16	21
Farmworker Platform/Chassis	01/11→	G13BB	Petrol	1298	4	16	21
Forenza Estate	09/04→12/08	L34	Petrol	1998	4	16	45
Forenza Saloon	09/03→12/08	L34	Petrol	1998	4	16	45
Forsa Hatchback	09/84→12/88	G10	Petrol	993	3	6	9
Fun	02/04→12/12	C 14 SE	Petrol	1389	4	8	25
Gazelle	01/07→12/10	K10B	Petrol	996	3	12	13
Grand Vitara I (FT, GT)	03/98→07/03	M13A	Petrol	1328	4	16	22
Grand Vitara I (FT, HT)	03/98→07/03	RF	Diesel	1998	4	8	48
Grand Vitara I (FT, HT)	03/98→08/05	J20A	Petrol	1995	4	16	44
Grand Vitara I (FT, HT)	03/98→09/05	G16B	Petrol	1590	4	16	34
Grand Vitara I (FT, HT)	04/98→09/05	H 25 A	Petrol	2493	6	24	52

				CC			9
Grand Vitara I (FT, HT)	04/00→09/05	RFM	Diesel	1998	4	8	48
Grand Vitara I (FT, HT)	06/01→08/06	H 27 A	Petrol	2736	6	24	54
Grand Vitara I (FT, HT)	07/01→09/05	RHW	Diesel	1997	4	16	51
Grand Vitara I (FT, HT)	07/01→09/05	RHZ	Diesel	1997	4	8	50
Grand Vitara I Convertible (GT)	03/98→07/03	G16B	Petrol	1590	4	16	34
Grand Vitara I Convertible (GT)	03/98→07/03	J20A	Petrol	1995	4	16	44
Grand Vitara II (JT)	05/05→07/06	G13BB	Petrol	1298	4	16	21
Grand Vitara II (JT)	09/05→02/15	M16A	Petrol	1586	4	16	36
Grand Vitara II (JT)	08/06→02/15	M13A	Petrol	1328	4	16	22
Grand Vitara II (JT, TE, TD)	04/05→12/08	H 27 A	Petrol	2736	6	24	54
Grand Vitara II (JT, TE, TD)	04/05→	M16A	Petrol	1586	4	16	36
Grand Vitara II (JT, TE, TD)	10/05→02/15	F9QB	Diesel	1870	4	8	40
Grand Vitara II (JT, TE, TD)	10/05→	J20A	Petrol	1995	4	16	44
Grand Vitara II (JT, TE, TD)	01/06→02/15	RHW	Diesel	1997	4	16	51
Hatch (SS)	02/80→12/85	F5A	Petrol	543	3	6	1
Hatch (SS)	11/80→12/85	F8B	Petrol	796	3	6	5
Hustler (MR31_, MR41_)	01/14→	R06A	Petrol	658	3	12	2
Ignis I (FH)	10/00→09/03	M13A	Petrol	1328	4	16	22
Ignis I (FH)	08/03→12/05	M15A	Petrol	1490	4	16	30
Ignis II (MH)	09/03→	M13A	Petrol	1328	4	16	22
Ignis II (MH)	09/03→	M15A	Petrol	1490	4	16	30
Ignis II (MH)	09/03→	Z13DT	Diesel	1248	4	16	23
Jimny (FJ)	09/98→10/03	F10AC	Petrol	970	4	8	8
Jimny (FJ)	09/98→	G13BB	Petrol	1298	4	16	21
Jimny (FJ)	09/00→	M13A	Petrol	1328	4	16	22
Jimny (FJ)	12/03→	K9K 700	Diesel	1461	4	8	29
Jimny (FJ)	05/04→	M16A	Petrol	1586	4	16	36
Jimny (FJ)	08/05→	K9K 266	Diesel	1461	4	8	28
Jimny (SJ, JA, JB)	11/88→03/98	G13BA	Petrol	1298	4	8	20
Karimun Wagon R	09/13→	K10B	Petrol	998	3	12	13
Kei Hatchback	06/98→12/05	K6A	Petrol	658	3	12	2
Kei Hatchback	06/98→12/05	K6A-T	Petrol	658	3	12	3
Kei Hatchback	09/98→	G13BA	Petrol	1298	4	8	20
Landy (SC25)	01/07→12/09	MR20DE	Petrol	1997	4	16	47
Landy (SC26)	01/10→	MR20	Petrol	1997	4	16	46
Landy (SC27)	12/16→	MR20	Petrol	1997	4	16	46
Lapin I (HE21)	01/02→12/09	K6A	Petrol	658	3	12	2
Lapin I (HE21)	01/02→12/09	K6A-T	Petrol	658	3	12	3
Lapin II (HE22)	09/09→05/15	K6A-T	Petrol	658	3	12	3
Liana (ER, RH_)	10/01→03/04	J20A	Petrol	1995	4	16	44
Liana (ER, RH_)	03/02→	M13A	Petrol	1328	4	16	22
Liana (ER, RH_)	03/02→	M16A	Petrol	1586	4	16	36
Liana (ER, RH_)	04/04→11/07	M15A	Petrol	1490	4	16	30
Liana (ER, RH_)	04/04→	8HY	Diesel	1398	4	16	24
Liana Estate (ER)	07/01→12/07	M13A	Petrol	1328	4	16	22
Liana Estate (ER)	07/01→12/07	M16A	Petrol	1586	4	16	36
Liana Estate (ER)	09/01→12/03	J20A	Petrol	1995	4	16	44
Liana Estate (ER)	04/04→12/07	8HY	Diesel	1398	4	16	24
Liana Hatchback	06/01→04/04	M16A	Petrol	1586	4	16	36
Liana Hatchback	01/02→12/06	M13A	Petrol	1328	4	16	22
LJ 80 (OL)	01/80→01/84	F8A	Petrol	797	4	8	4
LJ 80 Closed Off-Road Vehicle	11/77→12/81	F8A	Petrol	797	4	8	4
LJ 81 Closed Off-Road Vehicle	09/80→12/81	G10	Petrol	993	3	6	9
LJ 81 Pickup	11/77→12/81	F8A	Petrol	797	4	8	4
Maruti	02/88→12/94	F8B	Petrol	796	3	6	5
Mighty BOY	07/85→10/88	F5A	Petrol	543	3	6	1
MR Wagon	11/10→	K6A	Petrol	658	3	12	2
MR Wagon	11/10→	R06A	Petrol	658	3	12	2
MR Wagon (MF21)	04/01→03/06	K6A-T	Petrol	658	3	12	3
MR Wagon (MF22)	04/06→12/10	K6A	Petrol	658	3	12	2
MR Wagon (MF33)	01/11→	R06A	Petrol	658	3	12	2
Palette	08/12→	K6A-T	Petrol	658	3	12	3
Palette (MK21_)	01/08→	K6A	Petrol	658	3	12	2
Samurai (SJ)	11/88→12/04	F10A	Petrol	970	4	8	7
Samurai (SJ)	11/88→12/04	G13A	Petrol	1324	4	8	20
Samurai (SJ)	11/88→12/04	G13BA	Petrol	1298	4	8	20
Samurai (SJ)	11/88→12/04	G13BB	Petrol	1298	4	16	21
Samurai (SJ)	11/98→12/04	XUD9	Diesel	1905	4	8	39
SC100	03/77→12/82	F10A	Petrol	970	4	8	7
Sierra II Pickup (SJ)	12/88→02/00	F10A	Petrol	970	4	8	7
Sierra Open Off-Road Vehicle (SJ)	09/84→03/90	G13A	Petrol	1324	4	8	20
Sierra Open Off-Road Vehicle (SJ)	01/89→07/99	G13BA	Petrol	1298	4	8	20
Sierra Pickup (SJ)	09/81→12/88	F10A	Petrol	970	4	8	7
Sierra Pickup (SJ)	09/84→03/90	G13A	Petrol	1324	4	8	20
SJ 410	09/81→12/88	F10A	Petrol	970	4	8	7
SJ 410 Cabrio (OS)	09/81→12/88	F10A	Petrol	970	4	8	7
SJ 413 (OS)	09/84→12/85	G13B	Petrol	1298	4	16	21
SJ 413 (OS)	09/84→08/90	G13A	Petrol	1324	4	8	20



















CC



9

SJ 413 (OS)	11/88→08/90	G13BA	Petrol	1298	4	8	20
SJ 413 (OS)	11/88→08/90	G13BB	Petrol	1298	4	16	21
Solio	06/11→	K12B	Petrol	1242	4	16	18
Solio (MA34_)	04/04→05/08	M13A	Petrol	1328	4	16	22
Spacia (MK)	03/13→	R06A	Petrol	658	3	12	2
Splash (EX)	01/08→	D13A	Diesel	1248	4	16	16
Splash (EX)	01/08→	K10B	Petrol	998	3	12	13
Splash (EX)	01/08→	K12B	Petrol	1242	4	16	18
Splash (EX)	01/08→	Z 13 DTJ	Diesel	1248	4	16	23
Super Carry Box (ED)	09/87→07/92	F10A	Petrol	970	4	8	7
Super Carry Bus (ED)	10/85→03/99	F10A	Petrol	970	4	8	7
Swift+ Hatchback	09/03→12/09	LXV	Petrol	1598	4	16	35
Swift Convertible (SF413)	09/91→10/96	G13BA	Petrol	1298	4	8	20
Swift Convertible (SF413)	01/92→10/96	G13B	Petrol	1298	4	16	21
Swift I (AA)	10/83→03/89	G10	Petrol	993	3	6	9
Swift I (AA)	10/83→03/89	G10A	Petrol	993	3	6	10
Swift I (AA)	10/84→03/89	G13A	Petrol	1324	4	8	20
Swift I (AA)	02/85→12/89	G10T	Petrol	993	3	6	11
Swift I (AA)	08/85→03/89	G13B	Petrol	1298	4	16	21
Swift II Hatchback (EA, MA)	03/89→10/96	G16B	Petrol	1590	4	16	34
Swift II Hatchback (EA, MA)	03/89→12/97	G13BA	Petrol	1298	4	8	20
Swift II Hatchback (EA, MA)	03/89→05/01	G13A	Petrol	1324	4	8	20
Swift II Hatchback (EA, MA)	03/89→12/01	G13B	Petrol	1298	4	16	21
Swift II Hatchback (EA, MA)	03/89→12/05	G10A	Petrol	993	3	6	10
Swift II Hatchback (EA, MA)	06/01→12/03	G13BB	Petrol	1298	4	16	21
Swift II Saloon (AH, AJ)	03/89→12/95	G13B	Petrol	1298	4	16	21
Swift II Saloon (AH, AJ)	09/89→07/97	G13BA	Petrol	1298	4	8	20
Swift II Saloon (AH, AJ)	11/89→05/01	G16B	Petrol	1590	4	16	34
Swift II Saloon (AH, AJ)	09/91→05/01	G10A	Petrol	993	3	6	10
Swift III (MZ, EZ)	02/05→	M13A	Petrol	1328	4	16	22
Swift III (MZ, EZ)	02/05→	M15A	Petrol	1490	4	16	30
Swift III (MZ, EZ)	08/05→	D13A	Diesel	1248	4	16	16
Swift III (MZ, EZ)	08/05→	Z13DT	Diesel	1248	4	16	23
Swift III (MZ, EZ)	08/05→	Z 13 DTJ	Diesel	1248	4	16	23
Swift III (MZ, EZ)	05/06→	M16A	Petrol	1586	4	16	36
Swift III (MZ, EZ)	04/08→12/10	K12B	Petrol	1242	4	16	18
Swift IV (FZ, NZ)	10/10→	D13A	Diesel	1248	4	16	16
Swift IV (FZ, NZ)	10/10→	K12B	Petrol	1242	4	16	18
Swift IV (FZ, NZ)	02/11→	K14B	Petrol	1372	4	16	26
Swift IV (FZ, NZ)	01/12→	M16A	Petrol	1586	4	16	36
Swift V (AZ)	04/17→	K10C	Petrol	998	3	12	13
SX4 (EY, GY)	06/06→	D19AA	Diesel	1910	4	8	38
SX4 (EY, GY)	06/06→	J20A	Petrol	1995	4	16	44
SX4 (EY, GY)	06/06→	M15A	Petrol	1490	4	16	30
SX4 (EY, GY)	06/06→	M16A	Petrol	1586	4	16	36
SX4 (EY, GY)	04/07→	9HX	Diesel	1560	4	16	31
SX4 (EY, GY)	07/09→	D20AA	Diesel	1956	4	16	42
SX4 (GY)	06/06→	M16A	Petrol	1586	4	16	36
SX4 Saloon (GY)	10/07→01/10	J20A	Petrol	1995	4	16	44
SX4 Saloon (GY)	10/07→	M16A	Petrol	1586	4	16	36
SX4 S-Cross (JY)	08/13→	D16AA	Diesel	1598	4	16	32
SX4 S-Cross (JY)	08/13→	M16A	Petrol	1586	4	16	36
Vitara (ET)	12/03→12/05	RHP (DW10TD)	Diesel	1997	4	8	50
Vitara (ET, TA)	07/88→08/99	G16A (8V)	Petrol	1590	4	8	33
Vitara (ET, TA)	09/88→12/89	G13A	Petrol	1324	4	8	20
Vitara (ET, TA)	01/90→12/98	G16B	Petrol	1590	4	16	34
Vitara (ET, TA)	12/94→03/98	H 20 A	Petrol	1998	6	24	43
Vitara (ET, TA)	12/94→03/98	RF	Diesel	1998	4	8	48
Vitara (ET, TA)	01/95→03/98	XUD9A	Diesel	1905	4	8	39
Vitara (ET, TA)	09/95→12/98	J18A	Petrol	1839	4	16	37
Vitara (ET, TA)	12/95→03/98	H 25 A	Petrol	2493	6	24	52
Vitara (ET, TA)	08/96→03/98	XUD9SD	Diesel	1905	4	8	39
Vitara (ET, TA)	12/96→03/98	J20A	Petrol	1995	4	16	44
Vitara (LY)	02/15→	D16AA	Diesel	1598	4	16	32
Vitara (LY)	02/15→	M16A	Petrol	1586	4	16	36
Vitara (LY)	10/16→	J20A	Petrol	1995	4	16	44
Vitara Cabrio (ET)	12/03→12/05	RHP (DW10TD)	Diesel	1997	4	8	50
Vitara Cabrio (ET, TA)	07/88→01/95	G16A (8V)	Petrol	1590	4	8	33
Vitara Cabrio (ET, TA)	07/90→10/02	G16B	Petrol	1590	4	16	34
Vitara Cabrio (ET, TA)	01/95→03/98	XUD9A	Diesel	1905	4	8	39
Vitara Cabrio (ET, TA)	08/96→03/99	XUD9SD	Diesel	1905	4	8	39
Vitara Cabrio (ET, TA)	12/96→03/99	J20A	Petrol	1995	4	16	44
Wagon R	07/03→08/05	G10A	Petrol	993	3	6	10
Wagon R	06/04→08/05	Z 10 XEP	Petrol	998	3	12	14
Wagon R	06/04→08/05	Z 12 XEP	Petrol	1229	4	16	19
Wagon R (MC_)	07/97→07/98	K6A-T	Petrol	658	3	12	3
Wagon R (MC_)	07/97→07/00	K6A	Petrol	658	3	12	2
Wagon R (MH23)	09/08→08/12	K6A	Petrol	658	3	12	2

							
Wagon R (MH23)	09/08→08/12	K6A-T	Petrol	658	3	12	3
Wagon R (MH34)	07/13→	R06A	Petrol	658	3	12	2
Wagon R+ (EM)	10/97→10/00	K10A	Petrol	996	4	16	12
Wagon R+ (EM)	02/98→05/00	K12A	Petrol	1171	4	16	17
Wagon R+ (EM)	04/99→10/00	G13BB	Petrol	1298	4	16	21
Wagon R+ (MM)	05/00→	G13BB	Petrol	1298	4	16	21
Wagon R+ (MM)	08/00→07/03	K10A	Petrol	996	4	16	12
Wagon R+ (MM)	08/00→07/05	K6A-T	Petrol	658	3	12	3
Wagon R+ (MM)	08/00→	K6A	Petrol	658	3	12	2
Wagon R+ (MM)	08/01→	M13A	Petrol	1328	4	16	22
Wagon R+ (MM)	09/03→	Z13DT	Diesel	1248	4	16	23
Wagon R+ (MM)	09/12→	R06A	Petrol	658	3	12	2
X-90 (EL)	09/95→12/97	G16B	Petrol	1590	4	16	34

	CC				9		CC				9
8HY	1398	4	16	Diesel	24						
9HX	1560	4	16	Diesel	31						
C 14 SE	1389	4	8	Petrol	25						
D13A	1248	4	16	Diesel	16						
D16AA	1598	4	16	Diesel	32						
D19AA	1910	4	8	Diesel	38						
D20A	1956	4	16	Diesel	41						
D20AA	1956	4	16	Diesel	42						
DHV (XUD9BSD)	1905	4	8	Diesel	39						
DHW (XUD9SD)	1905	4	8	Diesel	39						
F5A	543	3	6	Petrol	1						
F8A	797	4	8	Petrol	4						
F8B	796	3	6	Petrol	5						
F8D	796	3	12	Petrol	6						
F9QB	1870	4	8	Diesel	40						
F10A	970	4	8	Petrol	7						
F10AC	970	4	8	Petrol	8						
F10D	1061	4	16	Petrol	15						
F10DN	1061	4	16	Petrol	15						
G10	993	3	6	Petrol	9						
G10A	993	3	6	Petrol	10						
G10B	993	4	16	Petrol	11						
G10BB	993	4	16	Petrol	11						
G10T	993	3	6	Petrol	11						
G13A	1324	4	8	Petrol	20						
G13B	1298	4	16	Petrol	21						
G13BA	1298	4	8	Petrol	20						
G13BB	1298	4	16	Petrol	21						
G15A	1493	4	16	Petrol	27						
G16A (16V)	1590	4	16	Petrol	34						
G16A (8V)	1590	4	8	Petrol	33						
G16B	1590	4	16	Petrol	34						
H 20 A	1998	6	24	Petrol	43						
H 25 A	2493	6	24	Petrol	52						
H 27 A	2736	6	24	Petrol	54						
J18A	1839	4	16	Petrol	37						
J20A	1995	4	16	Petrol	44						
K6A	658	3	12	Petrol	2						
K6A-T	658	3	12	Petrol	3						
K9K 266	1461	4	8	Diesel	28						
K9K 700	1461	4	8	Diesel	29						
K10A	996	4	16	Petrol	12						
K10B	996	3	12	Petrol	13						
K10B	998	3	12	Petrol	13						
K10C	998	3	12	Petrol	13						
K10CS	998	3	12	Petrol	13						
K12A	1171	4	16	Petrol	17						
K12B	1242	4	16	Petrol	18						
K14B	1372	4	16	Petrol	26						
L34	1998	4	16	Petrol	45						
LXV	1598	4	16	Petrol	35						
M13A	1328	4	16	Petrol	22						
M15A	1490	4	16	Petrol	30						
M16A	1586	4	16	Petrol	36						
MR20	1997	4	16	Petrol	46						
MR20DE	1997	4	16	Petrol	47						
QR25	2488	4	16	Petrol	53						
QR25DE	2488	4	16	Petrol	53						
R06A	658	3	12	Petrol	2						
RF	1998	4	8	Diesel	48						
RFM	1998	4	8	Diesel	48						
RFS	1998	4	8	Diesel	49						
RHP (DW10TD)	1997	4	8	Diesel	50						
RHW	1997	4	16	Diesel	51						
RHZ	1997	4	8	Diesel	50						
VQ40	3954	6	24	Petrol	55						
VQ40DE	3954	6	24	Petrol	55						
XUD9	1905	4	8	Diesel	39						
XUD9A	1905	4	8	Diesel	39						
XUD9SD	1905	4	8	Diesel	39						
Z 10 EXP	998	3	12	Petrol	14						
Z 10 XEP	998	3	12	Petrol	14						
Z 12 XEP	1229	4	16	Petrol	19						
Z13DT	1248	4	16	Diesel	23						
Z 13 DTJ	1248	4	16	Diesel	23						



1 0.5L		Petrol			
F5A		3 Cyl.	6 Valves	543cc	TD3652
PA305 (x6)		NJ336 32.00 x 47.00 x 8.00mm, NBR		NJ377 32.00 x 47.00 x 6.00mm, ACM NJ337 60.00 x 80.00 x 8.00mm, NBR	
2 0.7L		Petrol			
K6A		3 Cyl.	12 Valves	658cc	TD27207
R06A		3 Cyl.	12 Valves	658cc	TD27204
PA928 (x12)				NA5016 35.00 x 47.00 x 7.00mm, FPM/ACM	
3 0.7L		Petrol			
K6A-T		3 Cyl.	12 Valves	658cc	TD27209
				NA5016 35.00 x 47.00 x 7.00mm, FPM/ACM	
4 0.8L		Petrol			
F8A		4 Cyl.	8 Valves	797cc	TD4910
PA305 (x8)		NJ336 32.00 x 47.00 x 8.00mm, NBR		NJ377 32.00 x 47.00 x 6.00mm, ACM NJ337 60.00 x 80.00 x 8.00mm, NBR	
5 0.8L		Petrol			
F8B		3 Cyl.	6 Valves	796cc	TD3655
PA305 (x6)		NJ336 32.00 x 47.00 x 8.00mm, NBR		NJ377 32.00 x 47.00 x 6.00mm, ACM NJ337 60.00 x 80.00 x 8.00mm, NBR	
6 0.8L		Petrol			
F8D		3 Cyl.	12 Valves	796cc	TD33758
				NJ377 32.00 x 47.00 x 6.00mm, ACM NJ337 60.00 x 80.00 x 8.00mm, NBR	
7 1.0L		Petrol			
F10A		4 Cyl.	8 Valves	970cc	TD3650
PA305 (x8)		NJ336 32.00 x 47.00 x 8.00mm, NBR		NJ377 32.00 x 47.00 x 6.00mm, ACM NJ337 60.00 x 80.00 x 8.00mm, NBR	
8 1.0L		Petrol			
F10AC		4 Cyl.	8 Valves	970cc	TD26442
				NJ336 32.00 x 47.00 x 8.00mm, NBR NJ337 60.00 x 80.00 x 8.00mm, NBR	

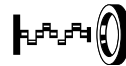
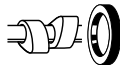

9 1.0L Petrol

G10	3 Cyl.	6 Valves	993cc	TD18370
PA305 (x6) →08/88	NJ336 32.00 x 47.00 x 8.00mm, NBR →08/88	NJ377 32.00 x 47.00 x 6.00mm, ACM		
PA928 (x6) 09/88→	NJ337 60.00 x 80.00 x 8.00mm, NBR 09/88→	NJ378 68.00 x 86.00 x 8.00mm, ACM		

10 1.0L Petrol

G10A	3 Cyl.	6 Valves	993cc	TD3658
PA928 (x6) HR5075	NJ336 32.00 x 47.00 x 8.00mm, NBR	NJ377 32.00 x 47.00 x 6.00mm, ACM		
		NJ378 68.00 x 86.00 x 8.00mm, ACM		

11 1.0L Petrol

G10B	4 Cyl.	16 Valves	993cc	TD5352
G10BB	4 Cyl.	16 Valves	993cc	TD24401
G10T	3 Cyl.	6 Valves	993cc	TD26633
	NJ336 32.00 x 47.00 x 8.00mm, NBR	NJ377 32.00 x 47.00 x 6.00mm, ACM		
		NJ378 68.00 x 86.00 x 8.00mm, ACM		

12 1.0L Petrol

K10A	4 Cyl.	16 Valves	996cc	TD22437
PA928 (x16)	NJ336 32.00 x 47.00 x 8.00mm, NBR	NJ377 32.00 x 47.00 x 6.00mm, ACM		
		NJ337 60.00 x 80.00 x 8.00mm, NBR		

13 1.0L Petrol

K10B	3 Cyl.	12 Valves	996cc	TD30418
K10B	3 Cyl.	12 Valves	998cc	TD21662
K10C	3 Cyl.	12 Valves	998cc	TD32637
K10CS	3 Cyl.	12 Valves	998cc	TD34546
HR5128				

14 1.0L Petrol

Z 10 EXP	3 Cyl.	12 Valves	998cc	TD22440
Z 10 XEP	3 Cyl.	12 Valves	998cc	TD27099
PA5025 (x12) HR5096		NA5108 42.00 x 55.00 x 7.00mm, FPM/ACM		
		NB698 80.00 x 98.00 x 10.00mm, FPM		

15 1.1L Petrol

F10D	4 Cyl.	16 Valves	1061cc	TD24250
F10DN	4 Cyl.	16 Valves	1061cc	TD22103
PA928 (x16)	NF687 35.00 x 47.00 x 7.00mm, FPM	NJ377 32.00 x 47.00 x 6.00mm, ACM		
		NJ337 60.00 x 80.00 x 8.00mm, NBR		



16 1.2L		Diesel			
D13A		4 Cyl.	16 Valves	1248cc	TD21664
HR5088					NA5223 40.00 x 52.00 x 7.00mm, FPM NA5230 78.00 x 100.00 x 9.00mm, PTFE
17 1.2L		Petrol			
K12A		4 Cyl.	16 Valves	1171cc	TD22438
PA928 (x16)					
18 1.2L		Petrol			
K12B		4 Cyl.	16 Valves	1242cc	TD21663
HR5128					
19 1.2L		Petrol			
Z 12 XEP		4 Cyl.	16 Valves	1229cc	TD19903
PA5025 (x16) HR5048					NA5108 42.00 x 55.00 x 7.00mm, FPM/ACM NB698 80.00 x 98.00 x 10.00mm, FPM
20 1.3L		Petrol			
G13A		4 Cyl.	8 Valves	1324cc	TD3659
G13BA		4 Cyl.	8 Valves	1298cc	TD3666
PA305 (x8)					NJ336 32.00 x 47.00 x 8.00mm, NBR NJ377 32.00 x 47.00 x 6.00mm, ACM NJ378 68.00 x 86.00 x 8.00mm, ACM
21 1.3L		Petrol			
G13B		4 Cyl.	16 Valves	1298cc	TD4915
G13BB		4 Cyl.	16 Valves	1298cc	TD11288
PA928 (x16)					NJ336 32.00 x 47.00 x 8.00mm, NBR NJ377 32.00 x 47.00 x 6.00mm, ACM NJ378 68.00 x 86.00 x 8.00mm, ACM
22 1.3L		Petrol			
M13A		4 Cyl.	16 Valves	1328cc	TD17430
PA425 (x16) →Eng no. 1047046 PA928 (x16) Eng no. 1047047→					NJ377 32.00 x 47.00 x 6.00mm, ACM NJ337 60.00 x 80.00 x 8.00mm, NBR
23 1.3L		Diesel			
Z13DT		4 Cyl.	16 Valves	1248cc	TD18265
Z 13 DTJ		4 Cyl.	16 Valves	1248cc	TD21665
HR5088					NA5223 40.00 x 52.00 x 7.00mm, FPM NA5230 78.00 x 100.00 x 9.00mm, PTFE

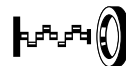
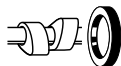

24 1.4L

Diesel

8HY	4 Cyl.	16 Valves	1398cc	TD18220
PA6072 (x16) HR5120	NA5258 27.00 x 47.00 x 7.00mm, PTFE	NA5259 40.00 x 55.00 x 6.40mm, PTFE NA5325 85.00 x 105.00 x 8.80mm, PTFE		

25 1.4L

Petrol

C 14 SE	4 Cyl.	8 Valves	1389cc	TD26169
PA565 (x8) HR342	NC006 35.00 x 48.00 x 7.00mm, MVQ	NB697 26.00 x 42.00 x 8.00mm, FPM NB698 80.00 x 98.00 x 10.00mm, FPM		

26 1.4L

Petrol

K14B	4 Cyl.	16 Valves	1372cc	TD26343
HR5128				

27 1.5L

Petrol

G15A	4 Cyl.	16 Valves	1493cc	TD20613
PA928 (x16)	NJ336 32.00 x 47.00 x 8.00mm, NBR	NJ377 32.00 x 47.00 x 6.00mm, ACM NJ378 68.00 x 86.00 x 8.00mm, ACM		

28 1.5L

Diesel

K9K 266	4 Cyl.	8 Valves	1461cc	TD24900
PA5041 (x16) HR817 (x2)	NA5215 28.00 x 42.00 x 5.00mm, FPM	NA5255 35.00 x 47.00 x 7.00mm, PTFE/ACM NA5118 80.00 x 100.00 x 9.00mm, PTFE		

29 1.5L

Diesel

K9K 700	4 Cyl.	8 Valves	1461cc	TD21367
PA5041 (x8) HR817	NA5215 28.00 x 42.00 x 5.00mm, FPM	NA5255 35.00 x 47.00 x 7.00mm, PTFE/ACM NA5118 80.00 x 100.00 x 9.00mm, PTFE		

30 1.5L

Petrol

M15A	4 Cyl.	16 Valves	1490cc	TD18264
PA928 (x16)		NJ377 32.00 x 47.00 x 6.00mm, ACM NJ337 60.00 x 80.00 x 8.00mm, NBR		

31 1.6L

Diesel

9HX	4 Cyl.	16 Valves	1560cc	TD21659
PA6072 (x16) HR5124	NA5258 27.00 x 47.00 x 7.00mm, PTFE	NA5259 40.00 x 55.00 x 6.40mm, PTFE NA5325 85.00 x 105.00 x 8.80mm, PTFE		



32 1.6L Diesel

D16AA	4 Cyl.	16 Valves	1598cc	TD30382
	NA5347 30.0 x 45.0 x 7.00mm, FPM		NA5070 31.00 x 41.00 x 7.00mm, FPM NF888 93.00 x 139.70; 172.00 x 12.00mm, FPM	

33 1.6L Petrol

G16A (8V) PA305 (x8)	4 Cyl.	8 Valves	1590cc	TD3667
	NJ336 32.00 x 47.00 x 8.00mm, NBR		NJ377 32.00 x 47.00 x 6.00mm, ACM NJ378 68.00 x 86.00 x 8.00mm, ACM	

34 1.6L Petrol

G16A (16V)	4 Cyl.	16 Valves	1590cc	TD25888
G16B PA928 (x16)	4 Cyl.	16 Valves	1590cc	TD4917
	NJ336 32.00 x 47.00 x 8.00mm, NBR		NJ377 32.00 x 47.00 x 6.00mm, ACM NJ378 68.00 x 86.00 x 8.00mm, ACM	

35 1.6L Petrol

LXV HR5087	4 Cyl.	16 Valves	1598cc	TD29476
			NA5174 31.50 x 42.00 x 7.00mm, FPM NA5350 80.00 x 98.00 x 17.70mm, PTFE/ACM	

36 1.6L Petrol

M16A PA928 (x16)	4 Cyl.	16 Valves	1586cc	TD18221
			NJ377 32.00 x 47.00 x 6.00mm, ACM NJ337 60.00 x 80.00 x 8.00mm, NBR	

37 1.8L Petrol

J18A	4 Cyl.	16 Valves	1839cc	TD5353
	NJ377 32.00 x 47.00 x 6.00mm, ACM			

38 1.9L Diesel

D19AA HR569	4 Cyl.	8 Valves	1910cc	TD20931
	NA5053 30.00 x 42.00 x 7.00mm, FPM		NA5070 31.00 x 41.00 x 7.00mm, FPM NF888 93.00 x 139.70; 172.00 x 12.00mm, FPM	



39 1.9L

Diesel

DHV (XUD9BSD)	4 Cyl.	8 Valves	1905cc	TD30748
DHW (XUD9SD)	4 Cyl.	8 Valves	1905cc	TD30747
XUD9	4 Cyl.	8 Valves	1905cc	TD16375
XUD9A	4 Cyl.	8 Valves	1905cc	TD5443
XUD9SD	4 Cyl.	8 Valves	1905cc	TD22439

HR569

NF841
35.00 x 50.00 x 8.00mm, FPM

NA5191
42.00 x 62.00 x 7.00mm, PTFE
NA5192
90.00 x 110.00 x 7.00mm, PTFE

40 1.9L

Diesel

F9QB	4 Cyl.	8 Valves	1870cc	TD25639
------	--------	----------	--------	---------

HR816

NF846
25.00 x 42.00 x 7.00mm, FPM/ACM

NA5036
42.00 x 54.00 x 6.00mm, FPM
NA5037
85.00 x 105.00 x 11.00mm, ACM

41 2.0L

Diesel

D20A	4 Cyl.	16 Valves	1956cc	TD24453
------	--------	-----------	--------	---------

NA5347
30.0 x 45.0 x 7.00mm, FPM

NA5070
31.00 x 41.00 x 7.00mm, FPM
NF888
93.00 x 139.70;172.00 x 12.00mm, FPM

42 2.0L

Diesel

D20AA	4 Cyl.	16 Valves	1956cc	TD23550
-------	--------	-----------	--------	---------

HR5119

NA5347
30.0 x 45.0 x 7.00mm, FPM

NA5070
31.00 x 41.00 x 7.00mm, FPM
NF888
93.00 x 139.70;172.00 x 12.00mm, FPM

43 2.0L

Petrol

H 20 A	6 Cyl.	24 Valves	1998cc	TD5355
--------	--------	-----------	--------	--------

PA425 (x24)

NJ336 (x2)
32.00 x 47.00 x 8.00mm, NBR

44 2.0L

Petrol

J20A	4 Cyl.	16 Valves	1995cc	TD18366
------	--------	-----------	--------	---------

PB314 (x16)

NJ377
32.00 x 47.00 x 6.00mm, ACM

45 2.0L

Petrol

L34	4 Cyl.	16 Valves	1998cc	TD32872
-----	--------	-----------	--------	---------

PA5041 (x16)
HR791

NC006 (x2)
35.00 x 48.00 x 7.00mm, MVQ

NB700
31.00 x 50.00 x 8.00mm, MVQ
NB806
90.00 x 104.00 x 11.00mm, FPM

46 2.0L

Petrol

MR20	4 Cyl.	16 Valves	1997cc	TD26214
------	--------	-----------	--------	---------

NK106
46.00 x 58.00 x 7.00mm, ACM





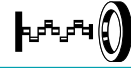



47 2.0L		Petrol			
MR20DE		4 Cyl.	16 Valves	1997cc	TD26212
PB681 (x16)					NK106 46.00 x 58.00 x 7.00mm, ACM
48 2.0L		Diesel			
RF		4 Cyl.	8 Valves	1998cc	TD5444
RFM		4 Cyl.	8 Valves	1998cc	TD19236
KJ710 (x8)					NJ448 30.00 x 44.00 x 7.00mm, NBR NJ324 34.00 x 48.00 x 7.00mm, ACM NJ325 90.00 x 110.00 x 9.00mm, MVQ
49 2.0L		Diesel			
RFS		4 Cyl.	8 Valves	1998cc	TD19237
					NB984 66.67 x 89.30 x 10.00mm, FPM NB788 79.40 x 95.30 x 11.10mm, PTFE NC086 79.80 x 184.00 x 18.80mm, PTFE
50 2.0L		Diesel			
RHP (DW10TD)		4 Cyl.	8 Valves	1997cc	TD26490
RHZ		4 Cyl.	8 Valves	1997cc	TD19715
HR5046					NA5035 27.00 x 47.00 x 7.00mm, FPM NA5191 42.00 x 62.00 x 7.00mm, PTFE NA5192 90.00 x 110.00 x 7.00mm, PTFE
51 2.0L		Diesel			
RHW		4 Cyl.	16 Valves	1997cc	TD18270
HR5046 (x2)					NA5035 27.00 x 47.00 x 7.00mm, FPM NA5191 42.00 x 62.00 x 7.00mm, PTFE NA5192 90.00 x 110.00 x 7.00mm, PTFE
52 2.5L		Petrol			
H 25 A		6 Cyl.	24 Valves	2493cc	TD11447
PA425 (x24)					NJ336 (x2) 32.00 x 47.00 x 8.00mm, NBR
53 2.5L		Petrol			
QR25		4 Cyl.	16 Valves	2488cc	TD24867
QR25DE		4 Cyl.	16 Valves	2488cc	TD29477
PA874 (x16)					NK106 46.00 x 58.00 x 7.00mm, ACM NJ284 84.00 x 104.00 x 11.00mm, MVQ
54 2.7L		Petrol			
H 27 A		6 Cyl.	24 Valves	2736cc	TD22436
PA425 (x24)					NJ336 (x2) 32.00 x 47.00 x 8.00mm, NBR



55 4.0L

Petrol

VQ40	6 Cyl.	24 Valves	3954cc	TD24866
VQ40DE	6 Cyl.	24 Valves	3954cc	TD29478
PA874 (x24)				

							
4 Runner (N1)	08/87→03/96	3VZ-E	Petrol	2959	6	12	133
4 Runner (N1)	01/89→03/96	3L	Diesel	2779	4	8	126
4 Runner (N1)	04/89→12/91	3Y-C	Petrol	1998	4	8	91
4 Runner (N1)	08/89→11/95	2L-T	Diesel	2446	4	8	111
4 Runner (N1)	09/89→12/95	22RE	Petrol	2367	4	8	114
4 Runner (N1)	09/89→12/95	22REC	Petrol	2367	4	8	116
4 Runner (N1)	10/89→10/90	4Y-EC	Petrol	2237	4	8	102
4 Runner (N1)	10/89→03/96	22R	Petrol	2367	4	8	116
4 Runner (N1)	08/93→03/96	1KZ-TE	Diesel	2982	4	8	129
4 Runner (N1)	10/93→03/96	1KZ-T	Diesel	2982	4	8	129
4 Runner (N5, N6, N7)	07/84→12/85	3Y-C	Petrol	1998	4	8	91
4 Runner (N5, N6, N7)	07/84→07/86	22R	Petrol	2367	4	8	116
4 Runner (N5, N6, N7)	07/84→05/88	2L	Diesel	2446	4	8	111
4 Runner (N5, N6, N7)	09/84→12/88	22RTEC	Petrol	2367	4	8	114
4 Runner (N5, N6, N7)	09/84→10/89	22REC	Petrol	2367	4	8	116
4 Runner (N5, N6, N7)	10/85→10/89	4Y-EC	Petrol	2237	4	8	102
4 Runner (N5, N6, N7)	11/85→12/88	4Y	Petrol	2237	4	8	102
4 Runner (N5, N6, N7)	09/87→10/89	3VZ-E	Petrol	2959	6	12	133
4 Runner (N5, N6, N7)	05/88→10/89	3L	Diesel	2779	4	8	126
4 Runner (N18)	11/95→08/02	3RZ-FE	Petrol	2694	4	16	125
4 Runner (N18)	11/95→11/02	1KZ-T	Diesel	2982	4	8	129
4 Runner (N18)	11/95→11/02	5VZ-FE	Petrol	3378	6	24	145
4 Runner (N18)	12/97→12/01	2L-T	Diesel	2446	4	8	111
4 Runner (N18)	09/00→07/02	1KZ-TE	Diesel	2982	4	8	129
4 Runner (N21)	08/02→07/09	1GR-FE	Petrol	3956	6	24	152
4 Runner (N28)	08/09→	1GR-FE	Petrol	3956	6	24	152
4 Runner (RN10, VZN13, VZN10, RN13)	01/90→08/92	3VZ-E	Petrol	2959	6	12	133
1000 (KP3)	04/69→08/88	2K	Petrol	993	4	8	6
1000 Box (KP36V)	04/69→08/88	2K	Petrol	993	4	8	6
Allion I (ZZT24, NZT24, AZT24)	06/01→04/05	1NZ-FE	Petrol	1497	4	16	27
Allion I (ZZT24, NZT24, AZT24)	06/01→06/07	1AZ-FSE	Petrol	1998	4	16	73
Allion I (ZZT24, NZT24, AZT24)	06/01→06/07	1ZZ-FE	Petrol	1794	4	16	57
Allion I (ZZT24, NZT24, AZT24)	06/01→06/07	2ZR-FE	Petrol	1798	4	16	61
Allion II (NZT26, ZRT26)	07/07→	1NZ-FE	Petrol	1497	4	16	27
Allion II (NZT26, ZRT26)	07/07→	2ZR-FAE	Petrol	1798	4	16	60
Allion II (NZT26, ZRT26)	07/07→	3ZR-FAE	Petrol	1987	4	16	94
Allion II (T26)	12/12→	2ZR-FAE	Petrol	1798	4	16	60
Allion II (T26)	12/12→	3ZR-FAE	Petrol	1987	4	16	94
Alphard (H1)	04/03→04/08	1MZ-FE	Petrol	2995	6	24	130
Alphard (H1)	09/03→04/08	2AZ-FE	Petrol	2362	4	16	108
Alphard (H1)	09/03→04/08	2AZ-FXE	Petrol	2362	4	16	108
Alphard I (ATH1, MNH1, ANH1)	09/03→04/08	2AZ-FXE	Petrol	2362	4	16	108
Alphard II (GGH2, ANH2, ATH2)	12/11→12/14	2AZ-FXE	Petrol	2362	4	16	108
Alphard / VELLFIRE (H2)	04/08→12/14	2AZ-FE	Petrol	2362	4	16	108
Alphard / VELLFIRE (H2)	04/08→12/14	2GR-FE	Petrol	3456	6	24	149
Alphard / VELLFIRE (H3)	02/15→	2AR-FE	Petrol	2494	4	16	118
Alphard / VELLFIRE (H3)	02/15→	2AR-FXE	Petrol	2494	4	16	118
Alphard / VELLFIRE (H3)	02/15→	2GR-FE	Petrol	3456	6	24	149
Altezza (E1)	01/99→07/05	1G-FE	Petrol	1988	6	24	76
Altezza (E1)	01/99→07/05	1G-GE	Petrol	1988	6	24	77
Altezza (E1)	02/99→07/05	3S-GE	Petrol	1998	4	16	88
Altezza (E1)	07/01→07/05	2JZ-GE	Petrol	2997	6	24	131
Altezza GITA (XE1)	01/99→06/01	1G-FE	Petrol	1988	6	24	76
Altezza GITA (XE1)	01/99→06/01	1G-GE	Petrol	1988	6	24	77
Altezza GITA (XE1)	02/99→06/05	3S-GE	Petrol	1998	4	16	88
Altezza GITA (XE1)	07/01→06/05	2JZ-GE	Petrol	2997	6	24	131
Aqua (NHP1)	12/11→	1NZ-FXE	Petrol	1497	4	16	27
Aristo (JZS16)	08/97→09/04	2JZ-GE	Petrol	2997	6	24	131
Aristo (JZS16)	04/99→09/04	3UZ-FE	Petrol	4293	8	32	161
Aristo (S14)	10/90→09/96	2JZ-GTE	Petrol	2997	6	24	131
Aristo (S14)	10/92→07/97	1UZ-FE	Petrol	3969	8	32	154
Aristo (S16)	08/97→09/04	2JZ-GTE	Petrol	2997	6	24	131
Aristo (UZS14, JZS14)	10/90→07/97	2JZ-GE	Petrol	2997	6	24	131
Ascent Hatchback	06/01→10/03	7A-FE	Petrol	1762	4	16	67
Ascent Saloon	06/01→10/03	7A-FE	Petrol	1762	4	16	67
Aurion (ACV5, GSV5)	09/11→	2GR-FE	Petrol	3456	6	24	149
Aurion (GSV4, ACV4)	11/00→09/11	2AZ-FXE	Petrol	2362	4	16	108
Aurion (GSV4, ACV4)	03/06→07/09	1AZ-FSE	Petrol	1998	4	16	73
Aurion (GSV4, ACV4)	03/06→07/09	2AZ-FE	Petrol	2362	4	16	108
Aurion (GSV4, ACV4)	03/06→09/11	2GR-FE	Petrol	3456	6	24	149
Aurion (V4)	10/06→09/11	2GR-FE	Petrol	3456	6	24	149
Auris (E15)	10/06→04/12	2GR-FE	Petrol	3456	6	24	149
Auris (E15)	10/06→09/12	2ZR-FAE	Petrol	1798	4	16	60
Auris (E15)	10/06→09/12	2ZR-FE	Petrol	1798	4	16	61
Auris (E15)	11/06→04/12	2AZ-FE	Petrol	2362	4	16	108
Auris (E15)	03/07→09/12	1AD-FTV	Diesel	1998	4	16	71
Auris (E15)	03/07→09/12	1ND-TV	Diesel	1364	4	8	22
Auris (E15)	03/07→09/12	1ZR-FE	Petrol	1598	4	16	42











CC



9

Auris (_E15_)	03/07→09/12	2AD-FHV	Diesel	2231	4	16	100
Auris (_E15_)	03/07→09/12	4ZZ-FE	Petrol	1398	4	16	25
Auris (_E15_)	05/09→09/12	1NR-FE	Petrol	1329	4	16	11
Auris (_E15_)	05/09→09/12	1ZR-FAE	Petrol	1598	4	16	42
Auris (_E15_)	09/09→09/12	1NZ-FE	Petrol	1497	4	16	27
Auris (_E15_)	09/10→09/12	2ZR-FXE	Petrol	1798	4	16	61
Auris (_E18_)	10/12→	1AD-FTV	Diesel	1998	4	16	71
Auris (_E18_)	10/12→	1ND-TV	Diesel	1364	4	8	22
Auris (_E18_)	10/12→	1NR-FE	Petrol	1329	4	16	11
Auris (_E18_)	10/12→	1ZR-FAE	Petrol	1598	4	16	42
Auris (_E18_)	10/12→	2ZR-FAE	Petrol	1798	4	16	60
Auris (_E18_)	10/12→	2ZR-FE	Petrol	1798	4	16	61
Auris (_E18_)	10/12→	2ZR-FXE	Petrol	1798	4	16	61
Auris (_E18_)	04/15→	1WW	Diesel	1598	4	16	39
Auris (NZE18_ , ZRE18_)	10/12→	1NZ-FE	Petrol	1497	4	16	27
Auris (NZE18_ , ZRE18_)	10/12→	2ZR-FAE	Petrol	1798	4	16	60
Auris Touring Sports (_E18_)	07/13→	1AD-FTV	Diesel	1998	4	16	71
Auris Touring Sports (_E18_)	07/13→	1ND-TV	Diesel	1364	4	8	22
Auris Touring Sports (_E18_)	07/13→	1NR-FE	Petrol	1329	4	16	11
Auris Touring Sports (_E18_)	07/13→	1ZR-FAE	Petrol	1598	4	16	42
Auris Touring Sports (_E18_)	07/13→	2ZR-FXE	Petrol	1798	4	16	61
Auris Touring Sports (_E18_)	04/15→	1WW	Diesel	1598	4	16	39
Auris Van Box (_E18_)	03/13→	1ND-TV	Diesel	1364	4	8	22
Avalon Saloon (GSX3_)	01/05→09/12	2GR-FE	Petrol	3456	6	24	149
Avalon Saloon (MCX1_)	03/95→05/05	1MZ-FE	Petrol	2995	6	24	130
Avalon Saloon (MCX2_)	08/01→04/05	2AZ-FE	Petrol	2362	4	16	108
Avalon Saloon (_X1_)	09/94→03/06	1MZ-FE	Petrol	2995	6	24	130
Avalon Saloon (_X2_)	09/99→06/05	1MZ-FE	Petrol	2995	6	24	130
Avalon Saloon (_X3_)	01/05→09/12	2GR-FE	Petrol	3456	6	24	149
Avalon Saloon (_X4_)	09/12→	2AR-FXE	Petrol	2494	4	16	118
Avalon Saloon (_X4_)	09/12→	2GR-FE	Petrol	3456	6	24	149
Avanza (F60_)	12/03→12/11	K3-VE	Petrol	1298	4	16	16
Avanza (F60_)	08/06→12/11	3SZ-VE	Petrol	1495	4	16	34
Avanza II (F65_)	11/11→	3SZ-VE	Petrol	1495	4	16	34
Avanza II (F65_)	11/11→	K3-VE	Petrol	1298	4	16	16
Avensis (_T22_)	09/97→10/00	3S-FE	Petrol	1998	4	16	86
Avensis (_T22_)	09/97→10/00	4A-FE	Petrol	1587	4	16	50
Avensis (_T22_)	09/97→10/00	7A-FE	Petrol	1762	4	16	67
Avensis (_T22_)	09/97→02/03	2C-TE	Diesel	1975	4	8	79
Avensis (_T22_)	10/97→05/98	2C-T	Diesel	1975	4	8	80
Avensis (_T22_)	10/99→02/03	1CD-FTV	Diesel	1995	4	16	74
Avensis (_T22_)	10/00→02/03	1AZ-FSE	Petrol	1998	4	16	73
Avensis (_T22_)	10/00→02/03	1ZZ-FE	Petrol	1794	4	16	57
Avensis (_T22_)	10/00→02/03	3ZZ-FE	Petrol	1598	4	16	47
Avensis (_T25_)	04/03→11/08	1AZ-FE	Petrol	1998	4	16	72
Avensis (_T25_)	04/03→11/08	1AZ-FSE	Petrol	1998	4	16	73
Avensis (_T25_)	04/03→11/08	1CD-FTV	Diesel	1995	4	16	74
Avensis (_T25_)	04/03→11/08	1ZZ-FE	Petrol	1794	4	16	57
Avensis (_T25_)	04/03→11/08	3ZZ-FE	Petrol	1598	4	16	47
Avensis (_T25_)	09/03→11/08	2AZ-FSE	Petrol	2362	4	16	109
Avensis (T25_)	04/05→11/08	3C-TE	Diesel	2184	4	8	101
Avensis (_T25_)	07/05→11/08	2AD-FHV	Diesel	2231	4	16	100
Avensis (_T25_)	10/05→11/08	2AD-FTV	Diesel	2231	4	16	100
Avensis (_T25_)	03/06→11/08	1AD-FTV	Diesel	1998	4	16	71
Avensis Estate (_T25_)	04/03→11/08	1AZ-FE	Petrol	1998	4	16	72
Avensis Estate (_T25_)	04/03→11/08	1AZ-FSE	Petrol	1998	4	16	73
Avensis Estate (_T25_)	04/03→11/08	1CD-FTV	Diesel	1995	4	16	74
Avensis Estate (_T25_)	04/03→11/08	1ZZ-FE	Petrol	1794	4	16	57
Avensis Estate (_T25_)	04/03→11/08	3ZZ-FE	Petrol	1598	4	16	47
Avensis Estate (_T25_)	09/03→11/08	2AZ-FSE	Petrol	2362	4	16	109
Avensis Estate (T25_)	04/05→11/08	3C-TE	Diesel	2184	4	8	101
Avensis Estate (_T25_)	07/05→11/08	2AD-FHV	Diesel	2231	4	16	100
Avensis Estate (_T25_)	10/05→11/08	2AD-FTV	Diesel	2231	4	16	100
Avensis Estate (_T25_)	03/06→11/08	1AD-FTV	Diesel	1998	4	16	71
Avensis Estate (_T27_)	02/09→	1AD-FTV	Diesel	1998	4	16	71
Avensis Estate (_T27_)	02/09→	1ZR-FAE	Petrol	1598	4	16	42
Avensis Estate (_T27_)	02/09→	2AD-FHV	Diesel	2231	4	16	100
Avensis Estate (_T27_)	02/09→	2AD-FTV	Diesel	2231	4	16	100
Avensis Estate (_T27_)	02/09→	2ZR-FAE	Petrol	1798	4	16	60
Avensis Estate (_T27_)	02/09→	3ZR-FAE	Petrol	1987	4	16	94
Avensis Estate (_T27_)	02/09→	3ZR-FE	Petrol	1987	4	16	94
Avensis Estate (_T27_)	04/15→	1WW	Diesel	1598	4	16	39
Avensis Estate (_T27_)	04/15→	2WW	Diesel	1995	4	16	84
Avensis Liftback (_T22_)	09/97→10/00	3S-FE	Petrol	1998	4	16	86
Avensis Liftback (_T22_)	09/97→10/00	4A-FE	Petrol	1587	4	16	50
Avensis Liftback (_T22_)	09/97→10/00	7A-FE	Petrol	1762	4	16	67
Avensis Liftback (_T22_)	09/97→02/03	2C-TE	Diesel	1975	4	8	79
Avensis Liftback (_T22_)	10/97→05/98	2C-T	Diesel	1975	4	8	80

							
Avensis Liftback (_T22_)	10/99→02/03	1CD-FTV	Diesel	1995	4	16	74
Avensis Liftback (_T22_)	10/00→02/03	1AZ-FSE	Petrol	1998	4	16	73
Avensis Liftback (_T22_)	10/00→02/03	1ZZ-FE	Petrol	1794	4	16	57
Avensis Liftback (_T22_)	10/00→02/03	3ZZ-FE	Petrol	1598	4	16	47
Avensis Saloon (_T25_)	04/03→11/08	1AZ-FE	Petrol	1998	4	16	72
Avensis Saloon (_T25_)	04/03→11/08	1AZ-FSE	Petrol	1998	4	16	73
Avensis Saloon (_T25_)	04/03→11/08	1CD-FTV	Diesel	1995	4	16	74
Avensis Saloon (_T25_)	04/03→11/08	1ZZ-FE	Petrol	1794	4	16	57
Avensis Saloon (_T25_)	04/03→11/08	3ZZ-FE	Petrol	1598	4	16	47
Avensis Saloon (_T25_)	09/03→11/08	2AZ-FSE	Petrol	2362	4	16	109
Avensis Saloon (T25)	04/05→11/08	3C-TE	Diesel	2184	4	8	101
Avensis Saloon (_T25_)	07/05→11/08	2AD-FHV	Diesel	2231	4	16	100
Avensis Saloon (_T25_)	10/05→11/08	2AD-FTV	Diesel	2231	4	16	100
Avensis Saloon (_T25_)	03/06→11/08	1AD-FTV	Diesel	1998	4	16	71
Avensis Saloon (_T27_)	11/08→04/11	1AZ-FE	Petrol	1998	4	16	72
Avensis Saloon (_T27_)	11/08→	1AD-FTV	Diesel	1998	4	16	71
Avensis Saloon (_T27_)	11/08→	1ZR-FAE	Petrol	1598	4	16	42
Avensis Saloon (_T27_)	11/08→	2AD-FHV	Diesel	2231	4	16	100
Avensis Saloon (_T27_)	11/08→	2AD-FTV	Diesel	2231	4	16	100
Avensis Saloon (_T27_)	11/08→	2ZR-FAE	Petrol	1798	4	16	60
Avensis Saloon (_T27_)	11/08→	3ZR-FAE	Petrol	1987	4	16	94
Avensis Saloon (_T27_)	11/08→	3ZR-FE	Petrol	1987	4	16	94
Avensis Saloon (_T27_)	04/15→	1WW	Diesel	1598	4	16	39
Avensis Saloon (_T27_)	04/15→	2WW	Diesel	1995	4	16	84
Avensis Station Wagon (_T22_)	09/97→10/00	3S-FE	Petrol	1998	4	16	86
Avensis Station Wagon (_T22_)	09/97→10/00	4A-FE	Petrol	1587	4	16	50
Avensis Station Wagon (_T22_)	09/97→10/00	7A-FE	Petrol	1762	4	16	67
Avensis Station Wagon (_T22_)	09/97→02/03	2C-TE	Diesel	1975	4	8	79
Avensis Station Wagon (_T22_)	10/97→05/98	2C-T	Diesel	1975	4	8	80
Avensis Station Wagon (_T22_)	10/99→02/03	1CD-FTV	Diesel	1995	4	16	74
Avensis Station Wagon (_T22_)	10/00→02/03	1AZ-FSE	Petrol	1998	4	16	73
Avensis Station Wagon (_T22_)	10/00→02/03	1ZZ-FE	Petrol	1794	4	16	57
Avensis Station Wagon (_T22_)	10/00→02/03	3ZZ-FE	Petrol	1598	4	16	47
Avensis Verso (_M2_)	08/01→08/05	1CD-FTV	Diesel	1995	4	16	74
Avensis Verso (_M2_)	08/01→11/09	1AZ-FE	Petrol	1998	4	16	72
Avensis Verso (_M2_)	10/03→11/09	2AZ-FE	Petrol	2362	4	16	108
Aygo (_B1_)	07/05→08/10	2WZ-TV	Diesel	1398	4	8	23
Aygo (_B1_)	07/05→	1KR-FE	Petrol	998	3	12	4
Aygo (_B4_)	05/14→	1KR-FE	Petrol	998	3	12	4
bB I (NCP3_)	01/00→11/05	2NZ-FE	Petrol	1299	4	16	12
bB I (NCP3_)	03/00→12/05	1NZ-FE	Petrol	1497	4	16	27
bB II (QNC2_)	12/05→	3SZ-VE	Petrol	1495	4	16	34
bB II (QNC2_)	12/05→	K3-VE	Petrol	1298	4	16	16
Blizzard (LD2_)	05/86→10/95	3Y	Petrol	1998	4	8	91
Blizzard (LD2_)	10/86→10/95	2L-TII	Diesel	2446	4	8	113
Blizzard (LD10)	03/82→12/83	L	Diesel	2188	4	8	105
Brevis (JCG1_)	10/99→09/02	1JZ-FSE	Petrol	2491	6	24	117
Caldina (ST19_ , ET19_ , CT19_ , AT19_)	02/92→09/97	4A-FE	Petrol	1587	4	16	50
Caldina (ST19_ , ET19_ , CT19_ , AT19_)	02/92→09/97	7A-FE	Petrol	1762	4	16	67
Caldina (ST19_ , ET19_ , CT19_ , AT19_)	02/92→10/97	3S-FE	Petrol	1998	4	16	86
Caldina (ST19_ , ET19_ , CT19_ , AT19_)	06/94→09/97	2C	Diesel	1975	4	8	79
Caldina (ST19_ , ET19_ , CT19_ , AT19_)	07/94→09/97	3S-GE	Petrol	1998	4	16	88
Caldina (ST21_ , CT21_ , AT21_)	10/97→09/01	3C-TE	Diesel	2184	4	8	101
Caldina (ST21_ , CT21_ , AT21_)	10/97→09/01	3S-GTE	Petrol	1998	4	16	88
Caldina (_T19_)	11/92→01/96	4S-FE	Petrol	1838	4	16	65
Caldina (_T19_)	11/92→08/97	3S-FE	Petrol	1998	4	16	86
Caldina (_T19_)	11/92→04/98	2C	Diesel	1975	4	8	79
Caldina (_T19_)	11/92→05/02	5E-FE	Petrol	1497	4	16	36
Caldina (_T19_)	01/96→08/97	2C-T	Diesel	1975	4	8	80
Caldina (_T19_)	05/98→05/02	3CE	Diesel	2184	4	8	101
Caldina (_T21_)	08/97→09/02	3C-TE	Diesel	2184	4	8	101
Caldina (_T21_)	08/97→09/02	3S-FE	Petrol	1998	4	16	86
Caldina (_T21_)	08/97→09/02	3S-GTE	Petrol	1998	4	16	88
Caldina (_T21_)	10/97→08/02	7A-FE	Petrol	1762	4	16	67
Caldina (_T24_)	09/02→06/07	1AZ-FSE	Petrol	1998	4	16	73
Caldina (_T24_)	09/02→06/07	1ZZ-FE	Petrol	1794	4	16	57
Caldina (_T24_)	09/02→06/07	3S-GTE	Petrol	1998	4	16	88
Caldina (ZZT24_ , ST24_ , AZT24_)	09/02→06/07	1AZ-FSE	Petrol	1998	4	16	73
Cami Closed Off-Road Vehicle (J1_)	06/99→12/05	K3-VE	Petrol	1298	4	16	16
Cami Closed Off-Road Vehicle (J1_)	06/99→12/05	K3-VET	Petrol	1298	4	16	16
Cami Closed Off-Road Vehicle (J1_)	06/99→12/05	K3-VT	Petrol	1298	4	16	16
Cami Closed Off-Road Vehicle (J12_E , J10_E)	05/99→09/00	HC-EJ	Petrol	1296	4	16	21
Camry	01/12→	4AR-FXE	Petrol	2494	4	16	122
Camry	03/12→	1AZ-FE	Petrol	1998	4	16	72
Camry (ACV4_)	06/06→12/11	2AZ-FE	Petrol	2362	4	16	107
Camry (ACV4_)	06/06→12/15	1AZ-FE	Petrol	1998	4	16	72
Camry (ACV4_)	04/10→12/11	3AZ-FXE	Petrol	2362	4	16	109
Camry (_CV1_ , _XV1_ , _V1_)	08/91→09/97	4S-FE	Petrol	1838	4	16	65



Camry (_CV2_, _XV2_)	08/96→09/99	2C-T	Diesel	1975	4	8	80
Camry (_CV2_, _XV2_)	08/96→07/01	2MZ-FE	Petrol	2496	6	24	120
Camry (_CV2_, _XV2_)	08/96→07/01	3VZ-FE	Petrol	2959	6	24	134
Camry (_CV2_, _XV2_)	08/96→07/01	4S-FE	Petrol	1838	4	16	65
Camry (MCV3_, ACV3_, _XV3_)	01/06→11/06	2AZ-FXE	Petrol	2362	4	16	108
Camry (_V1_)	06/91→07/97	3VZ-FE	Petrol	2959	6	24	134
Camry (_V1_)	06/91→09/97	3S-FE	Petrol	1998	4	16	86
Camry (_V1_)	06/91→09/97	5S-FE	Petrol	2164	4	16	103
Camry (_V1_)	08/93→09/97	3S-FSE	Petrol	1998	4	16	87
Camry (_V1_)	09/93→12/96	1MZ-FE	Petrol	2995	6	24	130
Camry (_V1_)	06/94→09/97	3C-T	Diesel	2184	4	8	101
Camry (_V2_)	10/86→08/88	1S-L	Petrol	1832	4	8	55
Camry (_V2_)	10/86→07/90	3S-GE	Petrol	1998	4	16	88
Camry (_V2_)	10/86→12/91	3S-FE	Petrol	1998	4	16	86
Camry (_V2_)	11/86→05/91	2C-T	Diesel	1975	4	8	80
Camry (_V2_)	09/87→12/91	2VZ-FE	Petrol	2508	6	24	121
Camry (_V2_)	09/89→06/91	3S-FC	Petrol	1998	4	16	85
Camry (_V2_)	08/96→11/01	1MZ-FE	Petrol	2995	6	24	130
Camry (_V2_)	08/96→11/01	5S-FE	Petrol	2164	4	16	103
Camry Coupe	09/93→12/96	1MZ-FE	Petrol	2995	6	24	130
Camry Coupe	09/94→12/96	5S-FE	Petrol	2164	4	16	103
Camry Estate (_CV2_, _XV2_)	08/96→07/01	1MZ-FE	Petrol	2995	6	24	130
Camry Estate (_CV2_, _XV2_)	08/96→07/01	2MZ-FE	Petrol	2496	6	24	120
Camry Estate (_V2_)	06/97→09/02	5S-FE	Petrol	2164	4	16	103
Camry Liftback (_V1_)	01/83→12/87	2S-EL	Petrol	1995	4	8	82
Camry Liftback (_V1_)	01/83→01/88	2S-ELC	Petrol	1995	4	8	83
Camry Liftback (_V1_)	02/83→10/86	1S-L	Petrol	1832	4	8	55
Camry Liftback (_V1_)	10/84→01/88	1C-TL	Diesel	1840	4	8	52
Camry Saloon (_V1_)	02/83→10/86	1S-L	Petrol	1832	4	8	55
Camry Saloon (_V1_)	02/83→01/88	2S-ELC	Petrol	1995	4	8	83
Camry Saloon (_V1_)	03/83→10/86	2S-EL	Petrol	1995	4	8	82
Camry Saloon (_V1_)	03/83→07/88	3S-FE	Petrol	1998	4	16	86
Camry Saloon (_V1_)	11/83→01/88	1C-TL	Diesel	1840	4	8	52
Camry Saloon (_V1_)	09/85→10/86	2C-TL	Diesel	1974	4	8	79
Camry Saloon (_V1_)	04/86→01/88	2S-E	Petrol	1995	4	8	82
Camry Saloon (_V3_)	08/01→11/06	1AZ-FE	Petrol	1998	4	16	72
Camry Saloon (_V3_)	08/01→11/06	1MZ-FE	Petrol	2995	6	24	130
Camry Saloon (_V3_)	09/01→11/06	2AZ-FE	Petrol	2362	4	16	108
Camry Saloon (_V3_)	07/03→01/06	3MZ-FE	Petrol	3311	6	24	143
Camry Saloon (_V4_)	01/06→09/11	2AZ-FE	Petrol	2362	4	16	108
Camry Saloon (_V4_)	01/06→09/11	2AZ-FXE	Petrol	2362	4	16	108
Camry Saloon (_V4_)	09/06→09/11	2GR-FE	Petrol	3456	6	24	149
Camry Saloon (_V4_)	01/09→09/11	2AR-FE	Petrol	2494	4	16	118
Camry Saloon (_V5_)	09/11→	2AR-FE	Petrol	2494	4	16	118
Camry Saloon (_V5_)	09/11→	2GR-FE	Petrol	3456	6	24	149
Camry Saloon (_XV4_)	01/06→09/11	1AZ-FE	Petrol	1998	4	16	72
Camry Saloon (_XV4_)	01/06→09/11	2AZ-FXE	Petrol	2362	4	16	108
Camry Saloon (_XV4_)	01/08→09/11	2GR-FE	Petrol	3456	6	24	149
Camry Saloon (_XV4_)	01/10→09/11	2AR-FE	Petrol	2494	4	16	118
Camry Saloon (XV5_)	09/11→	1AZ-FE	Petrol	1998	4	16	72
Camry Saloon (XV5_)	09/11→	2AR-FXE	Petrol	2494	4	16	118
Camry Saloon (XV5_)	09/11→	2GR-FE	Petrol	3456	6	24	149
Camry Saloon (XV5_)	01/12→	2AR-FE	Petrol	2494	4	16	118
Camry Solara Convertible (MCV2_, SXV2_)	02/00→11/02	1MZ-FE	Petrol	2995	6	24	130
Camry Solara Convertible (MCV2_, SXV2_)	02/00→11/02	5S-FE	Petrol	2164	4	16	103
Camry Solara Convertible (MCV3_, ACV3_)	02/04→11/08	3MZ-FE	Petrol	3311	6	24	143
Camry Solara Coupe (MCV2_, SXV2_)	06/98→06/01	1MZ-FE	Petrol	2995	6	24	130
Camry Solara Coupe (MCV2_, SXV2_)	06/98→06/01	5S-FE	Petrol	2164	4	16	103
Camry Solara Coupe (MCV3_, ACV3_)	07/03→07/08	3MZ-FE	Petrol	3311	6	24	143
Camry Station Wagon (_V1_)	06/91→07/96	3VZ-FE	Petrol	2959	6	24	134
Camry Station Wagon (_V1_)	06/91→12/96	5S-FE	Petrol	2164	4	16	103
Camry Station Wagon (_V1_)	09/93→12/96	1MZ-FE	Petrol	2995	6	24	130
Camry Station Wagon (_V2_)	11/86→08/88	1S	Petrol	1832	4	8	53
Camry Station Wagon (_V2_)	11/86→03/89	1S-I	Petrol	1832	4	8	53
Camry Station Wagon (_V2_)	11/86→05/91	2C-T	Diesel	1975	4	8	80
Camry Station Wagon (_V2_)	11/86→06/91	3S-FE	Petrol	1998	4	16	86
Camry Station Wagon (_V2_)	09/87→06/91	2VZ-FE	Petrol	2508	6	24	121
Camry Station Wagon (_V2_)	09/89→04/91	3S-FC	Petrol	1998	4	16	85
Camry Station Wagon (_XV1_, _CV1_, _V10)	02/93→04/95	5S-FE	Petrol	2164	4	16	103
Caribe Estate	05/84→01/88	3A	Petrol	1452	4	8	30
Caribe Estate	09/94→08/96	4E-FE	Petrol	1332	4	16	17
Caribe Estate	09/94→08/03	4A-FE	Petrol	1587	4	16	50
Caribe Estate	09/94→08/03	4S-FE	Petrol	1838	4	16	65
Caribe Estate	09/94→08/03	7A-FE	Petrol	1762	4	16	67
Caribe Saloon	10/86→08/94	2A	Petrol	1296	4	8	13
Carina (TA1_)	12/70→03/78	2T	Petrol	1588	4	8	44
Carina (TA4L, TA6_L)	08/77→09/83	2T	Petrol	1588	4	8	44
Carina (TA4L, TA6_L)	01/78→09/83	3T	Petrol	1770	4	8	64



CC



9

Carina (TA4L, TA6_L)	01/78→09/83	3T-C	Petrol	1770	4	8	64
Carina (TA4L, TA6_L)	04/82→09/83	1C	Diesel	1840	4	8	52
Carina E (_T19_)	04/92→01/96	2C	Diesel	1975	4	8	79
Carina E (_T19_)	04/92→09/97	3S-FE	Petrol	1998	4	16	86
Carina E (_T19_)	04/92→09/97	3S-GE	Petrol	1998	4	16	88
Carina E (_T19_)	04/92→09/97	4A-FE	Petrol	1587	4	16	50
Carina E (_T19_)	10/94→09/97	7A-FE	Petrol	1762	4	16	67
Carina E (_T19_)	01/96→09/97	2C-T	Diesel	1975	4	8	80
Carina ED (_T2_)	01/93→12/98	3S-FE	Petrol	1998	4	16	86
Carina ED (_T2_)	01/93→12/98	3S-GE	Petrol	1998	4	16	88
Carina ED (_T2_)	01/93→12/98	4S-FE	Petrol	1838	4	16	65
Carina ED (_T16_)	08/85→07/89	3S-FE	Petrol	1998	4	16	86
Carina ED (_T16_)	08/85→07/89	3S-GELU	Petrol	1998	4	16	88
Carina ED (_T16_)	08/85→07/89	4S-FI	Petrol	1838	4	16	66
Carina ED (_T18_)	09/89→08/90	4S-FI	Petrol	1838	4	16	66
Carina ED (_T18_)	09/89→08/91	3S-FE	Petrol	1998	4	16	86
Carina ED (_T18_)	09/89→09/93	3S-GE	Petrol	1998	4	16	88
Carina ED (_T18_)	09/89→09/93	4S-FE	Petrol	1838	4	16	65
Carina ED (_T18_)	08/91→09/93	3S-FSE	Petrol	1998	4	16	87
Carina E Saloon (_T19_)	04/92→09/97	3S-GE	Petrol	1998	4	16	88
Carina E Saloon (_T19_)	04/92→09/97	5A-FE	Petrol	1498	4	16	35
Carina E Saloon (_T19_)	04/92→09/97	7A-FE	Petrol	1762	4	16	67
Carina E Saloon (_T19_)	08/92→08/94	4S-FE	Petrol	1838	4	16	65
Carina E Saloon (_T19_)	08/92→01/96	2C	Diesel	1975	4	8	79
Carina E Saloon (_T19_)	12/92→09/97	3S-FE	Petrol	1998	4	16	86
Carina E Saloon (_T19_)	01/93→09/97	4A-FE	Petrol	1587	4	16	50
Carina E Saloon (_T19_)	01/96→09/97	2C-T	Diesel	1975	4	8	80
Carina E Sportswagon (_T19_)	04/92→09/97	4A-FE	Petrol	1587	4	16	50
Carina E Sportswagon (_T19_)	01/93→01/96	2C	Diesel	1975	4	8	79
Carina E Sportswagon (_T19_)	01/93→09/97	3S-FE	Petrol	1998	4	16	86
Carina E Sportswagon (_T19_)	10/94→09/97	7A-FE	Petrol	1762	4	16	67
Carina E Sportswagon (_T19_)	01/96→09/97	2C-T	Diesel	1975	4	8	80
Carina II (_T15_)	10/83→11/87	1S-L	Petrol	1832	4	8	55
Carina II (_T15_)	10/83→11/87	4A-L	Petrol	1588	4	8	48
Carina II (_T15_)	10/83→11/87	4A-LC	Petrol	1587	4	8	48
Carina II (_T15_)	02/84→05/88	2C-L	Diesel	1975	4	8	79
Carina II (_T17_)	12/87→11/89	4A-F	Petrol	1587	4	16	49
Carina II (_T17_)	12/87→03/92	3S-FE	Petrol	1998	4	16	86
Carina II (_T17_)	12/87→03/92	4A-FE	Petrol	1587	4	16	50
Carina II (_T17_)	03/88→06/92	2C-L	Diesel	1975	4	8	79
Carina II Saloon (_T15_)	08/83→11/87	3A-LU	Petrol	1452	4	8	30
Carina II Saloon (_T15_)	10/83→11/87	1S-EL	Petrol	1832	4	8	54
Carina II Saloon (_T15_)	10/83→11/87	4A-L	Petrol	1588	4	8	48
Carina II Saloon (_T15_)	10/83→11/87	4A-LC	Petrol	1587	4	8	48
Carina II Saloon (_T15_)	02/84→05/88	2C-L	Diesel	1975	4	8	79
Carina II Saloon (_T17_)	12/87→08/90	4A-F	Petrol	1587	4	16	49
Carina II Saloon (_T17_)	12/87→03/92	3S-FE	Petrol	1998	4	16	86
Carina II Saloon (_T17_)	12/87→03/92	4S-FI	Petrol	1838	4	16	66
Carina II Saloon (_T17_)	12/87→03/92	5A-F	Petrol	1497	4	16	35
Carina II Saloon (_T17_)	12/87→03/92	5A-FE	Petrol	1498	4	16	35
Carina II Saloon (_T17_)	12/87→06/92	4A-FE	Petrol	1587	4	16	50
Carina II Saloon (_T17_)	03/88→06/92	2C	Diesel	1975	4	8	79
Carina II Saloon (_T17_)	05/88→06/92	4A-GE	Petrol	1587	4	16	49
Carina II Saloon (_T17_)	05/90→06/92	4A-FHE	Petrol	1587	4	16	50
Carina II Station Wagon (_T17_)	12/87→12/89	4A-F	Petrol	1587	4	16	49
Carina II Station Wagon (_T17_)	12/87→01/92	2C-L	Diesel	1975	4	8	79
Carina II Station Wagon (_T17_)	12/87→03/92	4A-FE	Petrol	1587	4	16	50
Carina II Station Wagon (_T17_)	12/87→03/92	4S-FI	Petrol	1838	4	16	66
Carina II Station Wagon (_T17_)	12/87→03/92	5A-FE	Petrol	1498	4	16	35
Carina II Station Wagon (_T17_)	12/87→04/92	3S-FE	Petrol	1998	4	16	86
Carina Saloon	09/71→12/73	2T	Petrol	1588	4	8	44
Carina Saloon (_T21_)	08/96→08/01	2C-T	Diesel	1975	4	8	80
Carina Saloon (_T21_)	08/96→08/01	4A-GE	Petrol	1587	4	16	49
Carina Saloon (_T21_)	08/96→08/01	7A-FE	Petrol	1762	4	16	67
Carina Station Wagon (_A6_)	04/78→09/83	2T	Petrol	1588	4	8	44
Carina Station Wagon (_A6_)	02/80→09/83	3T	Petrol	1770	4	8	64
Carina Station Wagon (_A6_)	02/80→09/83	3T-C	Petrol	1770	4	8	64
Carina Station Wagon (_A6_)	04/82→09/83	1C	Diesel	1840	4	8	52
Carri Van (E9_)	01/00→07/06	HC-EJ	Petrol	1296	4	16	21
Carri Van (E9_)	01/02→07/06	4ZZ-FE	Petrol	1398	4	16	25
Celica (_A4_, _A6_)	08/77→07/81	18R-G	Petrol	1968	4	8	98
Celica (_A4_, _A6_)	09/77→12/80	20R	Petrol	2189	4	8	104
Celica (_A4_, _A6_)	02/79→07/81	2T	Petrol	1588	4	8	44
Celica (_A4_, _A6_)	02/79→07/81	18R	Petrol	1968	4	8	98
Celica (_A4_, _A6_)	07/81→12/84	22R	Petrol	2367	4	8	116
Celica (_A4_, _A6_)	09/81→08/85	5M-GE	Petrol	2759	6	12	127
Celica (_A4_, _A6_)	02/82→08/85	21R-C	Petrol	1972	4	8	78
Celica (_A4_, _A6_)	08/83→07/85	4A-GE	Petrol	1587	4	16	49



CC



9

Celica (A4, A6)	09/84→08/85	22REC	Petrol	2367	4	8	116
Celica (AT16, ST16)	08/87→08/89	15-EL	Petrol	1832	4	8	54
Celica (ST20, AT20)	11/93→08/99	5S-FE	Petrol	2164	4	16	103
Celica (T16)	04/86→08/89	4A-GEL	Petrol	1587	4	16	50
Celica (T16)	04/86→08/89	4A-L	Petrol	1588	4	8	48
Celica (T16)	01/87→08/89	3S-GEL	Petrol	1998	4	16	89
Celica (T20)	09/93→12/97	3S-FE	Petrol	1998	4	16	86
Celica (T20)	11/93→11/99	3S-GE	Petrol	1998	4	16	88
Celica (T20)	11/93→11/99	5S-FE	Petrol	2164	4	16	103
Celica (T20)	11/93→11/99	7A-FE	Petrol	1762	4	16	67
Celica (T20)	02/94→11/99	3S-GTE	Petrol	1998	4	16	88
Celica (T23)	08/99→09/05	1ZZ-FE	Petrol	1794	4	16	57
Celica (T23)	08/99→09/05	2ZZ-GE	Petrol	1796	4	16	63
Celica Convertible (T16)	08/85→12/85	22REC	Petrol	2367	4	8	116
Celica Convertible (T16)	08/85→08/89	3S-GELC	Petrol	1998	4	16	90
Celica Convertible (T16)	09/86→08/89	3S-FE	Petrol	1998	4	16	86
Celica Convertible (T16)	10/86→08/89	3S-GEL	Petrol	1998	4	16	89
Celica Convertible (T18)	10/89→11/93	3S-GE	Petrol	1998	4	16	88
Celica Convertible (T18)	09/91→11/93	5S-FE	Petrol	2164	4	16	103
Celica Convertible (T20)	11/93→08/99	3S-GE	Petrol	1998	4	16	88
Celica Convertible (T20)	09/94→08/99	5S-FE	Petrol	2164	4	16	103
Celica Coupe (A2)	01/73→11/77	18R	Petrol	1968	4	8	98
Celica Coupe (A2)	05/73→03/78	2TJ	Petrol	1588	4	8	45
Celica Coupe (A2)	09/74→12/77	20R	Petrol	2189	4	8	104
Celica Coupe (A2)	12/74→03/78	2T-G	Petrol	1588	4	8	45
Celica Coupe (A2)	02/76→03/78	2T	Petrol	1588	4	8	44
Celica Coupe (A4, A6)	08/77→06/81	18R-G	Petrol	1968	4	8	98
Celica Coupe (A4, A6)	08/77→07/81	4A-L	Petrol	1588	4	8	48
Celica Coupe (A4, A6)	09/77→12/80	20R	Petrol	2189	4	8	104
Celica Coupe (A4, A6)	04/78→07/81	2T-G	Petrol	1588	4	8	45
Celica Coupe (A4, A6)	02/79→07/81	2T	Petrol	1588	4	8	44
Celica Coupe (A4, A6)	01/81→07/81	22R	Petrol	2367	4	8	116
Celica Coupe (A6)	08/81→12/83	22R	Petrol	2367	4	8	116
Celica Coupe (A6)	08/81→12/85	21R-U	Petrol	1972	4	8	99
Celica Coupe (A6)	01/82→12/85	18R-G	Petrol	1968	4	8	98
Celica Coupe (A6)	10/83→09/84	2S-C	Petrol	1995	4	8	81
Celica Coupe (A6)	12/83→12/85	4A-GE	Petrol	1587	4	16	49
Celica Coupe (A6)	10/84→12/85	22REC	Petrol	2367	4	8	116
Celica Coupe (AT18, ST18)	10/89→10/93	5S-FE	Petrol	2164	4	16	103
Celica Coupe (ST16, AT16)	08/87→08/89	15-EL	Petrol	1832	4	8	54
Celica Coupe (T16)	09/85→12/86	2S-ELC	Petrol	1995	4	8	83
Celica Coupe (T16)	09/85→08/89	3S-GELC	Petrol	1998	4	16	90
Celica Coupe (T16)	09/86→08/89	3S-FE	Petrol	1998	4	16	86
Celica Coupe (T16)	08/87→08/89	3S-GEL	Petrol	1998	4	16	89
Celica Coupe (T16)	03/88→08/89	3S-GTE	Petrol	1998	4	16	88
Celica Coupe (T18)	09/89→11/93	3S-GTE	Petrol	1998	4	16	88
Celica Coupe (T18)	09/89→11/93	5S-FE	Petrol	2164	4	16	103
Celica Coupe (T18)	10/89→11/93	3S-GE	Petrol	1998	4	16	88
Celica Coupe (T18)	10/89→11/93	4A-FE	Petrol	1587	4	16	50
Celica Hatchback	09/75→12/77	20R	Petrol	2189	4	8	104
Celica Hatchback (T16)	08/85→08/89	3S-GEL	Petrol	1998	4	16	89
Celica Hatchback (T16)	08/85→08/89	3S-GELC	Petrol	1998	4	16	90
Celica Hatchback (T16)	09/85→12/86	2S-ELC	Petrol	1995	4	8	83
Celica Hatchback (T16)	09/85→12/89	4A-GEL	Petrol	1587	4	16	50
Celica Hatchback (T16)	04/86→08/89	4A-L	Petrol	1588	4	8	48
Celica Hatchback (T16)	01/87→12/87	3S-GTE	Petrol	1998	4	16	88
Celica Hatchback (T16)	01/87→08/89	3S-FE	Petrol	1998	4	16	86
Celica Hatchback (T16)	08/87→08/89	4A-GELC	Petrol	1587	4	16	50
Celica Supra (A6)	08/81→12/85	5M-GE	Petrol	2759	6	12	127
Celsior (UCF1)	12/88→04/93	1UZ-FE	Petrol	3969	8	32	154
Celsior (UCF2)	05/93→08/00	1UZ-FE	Petrol	3969	8	32	154
Celsior (UCF3)	09/00→08/06	3UZ-FE	Petrol	4293	8	32	161
Chaser (X8, X7)	08/84→09/91	21R	Petrol	1972	4	8	99
Chaser (X8, X7)	08/86→10/92	1G-FE	Petrol	1988	6	24	76
Chaser (X8, X7)	08/88→08/90	4S-FI	Petrol	1838	4	16	66
Chaser (X8, X7)	08/88→09/92	3V-P	Gas	1998	4	8	92
Chaser (X8, X7)	08/88→10/92	2L-T	Diesel	2446	4	8	111
Chaser (X8, X7)	08/89→09/92	7M-GE	Petrol	2954	6	24	137
Chaser (X8, X7)	08/90→09/92	4S-FE	Petrol	1838	4	16	65
Chaser (X8, X7)	08/90→10/92	1JZ-GE	Petrol	2491	6	24	117
Chaser (X8, X7)	08/90→10/92	1JZ-GTE	Petrol	2491	6	24	117
Chaser (X9)	10/92→06/96	2JZ-GE	Petrol	2997	6	24	131
Chaser (X9)	10/92→08/96	1G-FE	Petrol	1988	6	24	76
Chaser (X9)	10/92→08/96	1G-GE	Petrol	1988	6	24	77
Chaser (X9)	10/92→08/96	1JZ-GE	Petrol	2491	6	24	117
Chaser (X9)	10/92→08/96	1JZ-GTE	Petrol	2491	6	24	117
Chaser (X9)	10/92→08/96	2L	Diesel	2446	4	8	111
Chaser (X9)	10/92→08/96	2L-III	Diesel	2446	4	8	113



CC



9

Chaser (X9)	10/92→09/96	2L-TE	Diesel	2446	4	8	112
Chaser (X9)	10/92→09/96	4S-FE	Petrol	1838	4	16	65
Chaser (X9)	10/93→08/96	7A-FE	Petrol	1762	4	16	67
Chaser (X10)	09/96→07/99	2L-TE	Diesel	2446	4	8	112
Chaser (X10)	09/96→05/01	1G-FE	Petrol	1988	6	24	76
Chaser (X10)	10/96→05/01	1JZ-GE	Petrol	2491	6	24	117
Chaser (X10)	10/96→05/01	1JZ-GTE	Petrol	2491	6	24	117
C-HR (X1)	10/16→	2ZR-FXE	Petrol	1798	4	16	61
C-HR (X1)	11/16→	3ZR-FAE	Petrol	1987	4	16	94
Coaster Bus (B2, B3)	05/82→01/93	3B	Diesel	3432	4	8	144
Coaster Bus (B2, B3)	10/85→01/90	2H	Diesel	3980	6	12	155
Coaster Bus (B2, B3)	10/86→01/90	12HT	Diesel	3980	6	12	157
Coaster Bus (B2, B3)	10/87→01/93	1H-Z	Diesel	4164	6	12	159
Coaster Bus (B2, B3)	01/90→01/93	1HD-T	Diesel	4164	6	12	159
Coaster Bus (B4, B5)	01/93→06/99	3B	Diesel	3432	4	8	144
Coaster Bus (B4, B5)	01/93→	1HD-T	Diesel	4164	6	12	159
Coaster Bus (B4, B5)	01/93→	1H-Z	Diesel	4164	6	12	159
Coaster Bus (B4, B5)	07/99→07/04	1HD-FTE	Diesel	4164	6	24	158
Coaster Bus (BB1, RB1)	08/77→04/82	2B	Diesel	3197	4	8	142
Coaster Bus (BB1, RB1)	08/77→04/82	5R	Petrol	1997	4	8	97
Coaster Bus (BB1, RB1)	08/77→04/82	22R	Petrol	2367	4	8	116
Coaster Bus (FB3, HB3, BB2, RB2)	05/82→09/89	22R	Petrol	2367	4	8	116
Coaster Bus (TRB5, XZB5, RZB4, HZB5, BZB5, BB4)	02/93→10/03	3RZ-FE	Petrol	2694	4	16	125
Coaster Bus (TRB5, XZB5, RZB4, HZB5, BZB5, BB4)	08/04→	1H-Z	Diesel	4164	6	12	159
Conquest (E90)	01/95→12/95	4A-FE	Petrol	1587	4	16	50
Conquest (E90)	01/95→12/99	2E	Petrol	1296	4	12	15
Conquest (E90)	01/96→12/99	3ZZ-FE	Petrol	1598	4	16	47
Corolla (E7)	09/79→11/81	3T-C	Petrol	1770	4	8	64
Corolla (E7)	09/79→06/83	4K	Petrol	1290	4	8	19
Corolla (E7)	05/80→09/83	2T-G	Petrol	1588	4	8	45
Corolla (E7)	09/82→09/85	4A-C	Petrol	1587	4	8	48
Corolla (E7)	10/82→09/83	2T	Petrol	1588	4	8	44
Corolla (E7)	01/83→09/83	1C	Diesel	1840	4	8	52
Corolla (E8)	06/83→10/84	2A-L	Petrol	1296	4	8	13
Corolla (E8)	06/83→08/87	4A-L	Petrol	1588	4	8	48
Corolla (E8)	06/83→05/88	1C	Diesel	1840	4	8	52
Corolla (E8)	06/83→06/89	1C-L	Diesel	1839	4	8	52
Corolla (E8)	08/83→04/87	2E	Petrol	1296	4	12	15
Corolla (E8)	09/83→06/89	4A-LC	Petrol	1587	4	8	48
Corolla (E8)	10/84→08/87	2E-L	Petrol	1296	4	12	15
Corolla (E8)	10/84→08/87	2E-LC	Petrol	1296	4	12	15
Corolla (E8)	09/85→05/89	2A	Petrol	1296	4	8	13
Corolla (E9)	05/87→12/92	2E	Petrol	1296	4	12	15
Corolla (E9)	05/87→04/94	4A-GE	Petrol	1587	4	16	49
Corolla (E9)	07/87→06/93	1C	Diesel	1840	4	8	52
Corolla (E9)	08/87→04/92	5A-FE	Petrol	1498	4	16	35
Corolla (E9)	08/87→12/92	2E-E	Petrol	1296	4	12	15
Corolla (E9)	08/87→12/92	4A-F	Petrol	1587	4	16	49
Corolla (E9)	10/87→06/93	4A-FE	Petrol	1587	4	16	50
Corolla (E9)	11/87→10/89	3E	Petrol	1456	4	12	32
Corolla (E9)	09/92→12/93	7A-FE	Petrol	1762	4	16	67
Corolla (E10)	06/91→08/94	5A-FE	Petrol	1498	4	16	35
Corolla (E10)	05/92→07/95	7A-FE	Petrol	1762	4	16	67
Corolla (E10)	05/92→02/98	4A-FE	Petrol	1587	4	16	50
Corolla (E10)	07/92→04/97	2C	Diesel	1975	4	8	79
Corolla (E10)	07/92→04/97	2E	Petrol	1296	4	12	15
Corolla (E10)	07/92→07/99	4E-FE	Petrol	1332	4	16	17
Corolla (E10)	09/94→12/97	4A-F	Petrol	1587	4	16	49
Corolla (E10)	09/97→11/99	1ZZ-FE	Petrol	1794	4	16	57
Corolla (E11)	04/97→02/00	2C-E	Diesel	1975	4	8	79
Corolla (E11)	04/97→02/00	4A-FE	Petrol	1587	4	16	50
Corolla (E11)	04/97→02/00	4E-FE	Petrol	1332	4	16	17
Corolla (E11)	05/97→10/01	2E	Petrol	1296	4	12	15
Corolla (E11)	09/97→06/02	1ZZ-FE	Petrol	1794	4	16	57
Corolla (E11)	10/97→12/01	7A-FE	Petrol	1762	4	16	67
Corolla (E11)	04/98→10/01	3C-TE	Diesel	2184	4	8	101
Corolla (E11)	09/99→10/01	1NZ-FE	Petrol	1497	4	16	27
Corolla (E11)	02/00→11/01	1WZ	Diesel	1867	4	8	70
Corolla (E11)	02/00→11/01	3ZZ-FE	Petrol	1598	4	16	47
Corolla (E11)	02/00→11/01	4ZZ-FE	Petrol	1398	4	16	25
Corolla (E11)	08/00→11/01	1CD-FTV	Diesel	1995	4	16	74
Corolla (E12)	01/01→02/07	2ZZ-GE	Petrol	1796	4	16	63
Corolla (E12)	01/02→12/06	3ZZ-FE	Petrol	1598	4	16	47
Corolla (E12)	01/02→12/06	4ZZ-FE	Petrol	1398	4	16	25
Corolla (E12)	01/02→02/07	1CD-FTV	Diesel	1995	4	16	74
Corolla (E12)	06/04→12/07	1ZZ-FE	Petrol	1794	4	16	57
Corolla (E12)	07/04→02/07	1ND-TV	Diesel	1364	4	8	22
Corolla (E12)	10/06→02/07	1ZR-FE	Petrol	1598	4	16	42



CC



9

Corolla (E120)	02/04→01/07	1ZZ-FE	Petrol	1794	4	16	58
Corolla (E140)	10/10→12/14	1ZR-FE	Petrol	1598	4	16	43
Corolla (E170)	06/14→	1ZR-FE	Petrol	1598	4	16	43
Corolla (KE_)	01/71→07/79	2T	Petrol	1588	4	8	44
Corolla (KE_)	10/72→12/80	3K-B	Petrol	1166	4	8	8
Corolla (KE_)	10/72→12/80	3K-C	Petrol	1166	4	8	8
Corolla (KE_)	10/72→12/80	3K-H	Petrol	1166	4	8	8
Corolla (KE_)	11/78→11/81	4K-C	Petrol	1290	4	8	19
Corolla (ZZE12_, NDE12_, ZDE12_)	12/01→02/07	1ZZ-FE	Petrol	1794	4	16	57
Corolla Combi (TE72_)	07/75→01/80	3K	Petrol	1166	4	8	8
Corolla Combi (TE72_)	07/75→01/80	3K-B	Petrol	1166	4	8	8
Corolla Combi (TE72_)	07/75→01/80	3K-H	Petrol	1166	4	8	8
Corolla Combi (TE72_)	11/78→01/80	4K-C	Petrol	1290	4	8	19
Corolla Combi (TE72_)	09/79→07/82	3T-C	Petrol	1770	4	8	64
Corolla Compact (E9_)	05/87→04/92	2E	Petrol	1296	4	12	15
Corolla Compact (E9_)	08/87→04/92	1C	Diesel	1840	4	8	52
Corolla Compact (E9_)	08/87→04/92	4A-F	Petrol	1587	4	16	49
Corolla Compact (E9_)	08/87→04/92	4A-GE	Petrol	1587	4	16	49
Corolla Compact (E9_)	08/89→10/95	4A-FE	Petrol	1587	4	16	50
Corolla Compact (E9_)	11/89→04/92	5A-FE	Petrol	1498	4	16	35
Corolla Compact (E9_)	11/89→04/92	5E-FE	Petrol	1497	4	16	36
Corolla Compact (E9_)	10/92→09/94	7A-FE	Petrol	1762	4	16	67
Corolla Compact (E10_)	07/92→05/95	2E	Petrol	1296	4	12	15
Corolla Compact (E10_)	07/92→04/97	2C	Diesel	1975	4	8	79
Corolla Compact (E10_)	07/92→04/97	4E-FE	Petrol	1332	4	16	17
Corolla Compact (E10_)	07/92→11/99	4A-FE	Petrol	1587	4	16	50
Corolla Compact (E10_)	11/92→05/95	7A-FE	Petrol	1762	4	16	67
Corolla Compact (E11_)	04/97→02/00	2C-E	Diesel	1975	4	8	79
Corolla Compact (E11_)	04/97→02/00	4A-FE	Petrol	1587	4	16	50
Corolla Compact (E11_)	04/97→02/00	4E-FE	Petrol	1332	4	16	17
Corolla Compact (E11_)	04/98→10/01	3C-TE	Diesel	2184	4	8	101
Corolla Compact (E11_)	09/99→10/01	1NZ-FE	Petrol	1497	4	16	27
Corolla Compact (E11_)	02/00→01/02	1WZ	Diesel	1867	4	8	70
Corolla Compact (E11_)	02/00→01/02	3ZZ-FE	Petrol	1598	4	16	47
Corolla Compact (E11_)	02/00→01/02	4ZZ-FE	Petrol	1398	4	16	25
Corolla Compact (E11_)	08/00→01/02	1CD-FTV	Diesel	1995	4	16	74
Corolla Coupe (AE86)	05/83→06/87	4A-C	Petrol	1587	4	8	48
Corolla Coupe (AE86)	06/83→07/87	3A-U	Petrol	1452	4	8	30
Corolla Coupe (AE86)	06/83→07/87	4A-GE	Petrol	1587	4	16	49
Corolla Coupe (AE86)	09/84→07/87	4A-GEC	Petrol	1587	4	16	50
Corolla Coupe (E9_)	05/87→04/92	4A-GE	Petrol	1587	4	16	49
Corolla Coupe (E9_)	09/87→12/89	4A-F	Petrol	1587	4	16	49
Corolla Coupe (E9_)	05/89→12/92	4A-FE	Petrol	1587	4	16	50
Corolla Coupe (E9_)	05/89→10/95	5A-FE	Petrol	1498	4	16	35
Corolla Coupe (KE)	07/75→01/80	3K-B	Petrol	1166	4	8	8
Corolla Coupe (KE)	07/75→01/80	3K-C	Petrol	1166	4	8	8
Corolla Coupe (KE)	07/75→01/80	3K-H	Petrol	1166	4	8	8
Corolla Coupe (KE)	03/76→07/79	2T	Petrol	1588	4	8	44
Corolla Coupe (KE)	11/78→11/81	4K-C	Petrol	1290	4	8	19
Corolla Coupe (KE)	09/79→12/82	3T-C	Petrol	1770	4	8	64
Corolla Estate (E12_)	03/01→09/06	1NZ-FE	Petrol	1497	4	16	27
Corolla Estate (E12_)	03/01→09/06	2ZZ-GE	Petrol	1796	4	16	63
Corolla Estate (E12_)	01/02→02/07	1CD-FTV	Diesel	1995	4	16	74
Corolla Estate (E12_)	01/02→02/07	4ZZ-FE	Petrol	1398	4	16	25
Corolla Estate (E12_)	01/02→08/07	3ZZ-FE	Petrol	1598	4	16	47
Corolla Estate (E12_)	06/04→12/07	1ZZ-FE	Petrol	1794	4	16	57
Corolla Estate (E12_)	07/04→02/07	1ND-TV	Diesel	1364	4	8	22
Corolla Estate (E12J_, E12T_)	12/01→02/07	1ZZ-FE	Petrol	1794	4	16	57
Corolla Estate (E14_)	09/06→	1NZ-FE	Petrol	1497	4	16	27
Corolla Estate (E14_)	09/06→	2ZR-FAE	Petrol	1798	4	16	60
Corolla Estate (E14_)	09/06→	2ZR-FE	Petrol	1798	4	16	61
Corolla Estate (E16_)	10/14→	1NZ-FXE	Petrol	1497	4	16	27
Corolla Estate (NZE16_)	05/12→	1NZ-FE	Petrol	1497	4	16	27
Corolla Estate (NZE16_)	05/12→	2ZR-FAE	Petrol	1798	4	16	60
Corolla EX (E120)	05/07→12/17	1ZR-FE	Petrol	1598	4	16	43
Corolla FX Compact (E8B)	08/84→08/87	4A-C	Petrol	1587	4	8	48
Corolla FX Compact (E8B)	10/84→04/87	2E	Petrol	1296	4	12	15
Corolla FX Compact (E8B)	01/85→05/88	1C	Diesel	1840	4	8	52
Corolla FX Compact (E8B)	05/85→04/87	4A-GELC	Petrol	1587	4	16	50
Corolla FX Compact (E8B)	08/85→08/87	1C-L	Diesel	1839	4	8	52
Corolla FX Compact (E8B)	08/85→08/87	2E-L	Petrol	1296	4	12	15
Corolla FX Compact (E8B)	08/85→08/87	4A-GEL	Petrol	1587	4	16	50
Corolla FX Compact (E8B)	01/87→09/87	4A-LC	Petrol	1587	4	8	48
Corolla Hardtop	09/80→12/82	3T-C	Petrol	1770	4	8	64
Corolla Hardtop	09/82→12/83	4A-C	Petrol	1587	4	8	48
Corolla Hatchback (E7_)	09/79→05/83	2T	Petrol	1588	4	8	44
Corolla Hatchback (E7_)	09/79→05/83	4K	Petrol	1290	4	8	19
Corolla Hatchback (E7_)	09/79→07/83	4A	Petrol	1587	4	8	48



CC



9

Corolla Hatchback (_E7_)	09/79 → 09/83	3T-C	Petrol	1770	4	8	64
Corolla Hatchback (_E7_)	05/80 → 09/83	2T-G	Petrol	1588	4	8	45
Corolla Hatchback (_E7_)	08/82 → 09/83	3T	Petrol	1770	4	8	64
Corolla Hatchback (_E7_)	01/83 → 09/83	1C	Diesel	1840	4	8	52
Corolla Hatchback (KE, TE)	09/76 → 01/80	2T	Petrol	1588	4	8	44
Corolla Hatchback (KE, TE)	09/76 → 01/80	3K-B	Petrol	1166	4	8	8
Corolla Hatchback (KE, TE)	09/76 → 01/80	3K-C	Petrol	1166	4	8	8
Corolla Hatchback (KE, TE)	09/76 → 01/80	3K-H	Petrol	1166	4	8	8
Corolla Levin Coupe (E9_)	05/89 → 05/91	4A-GE	Petrol	1587	4	16	49
Corolla Levin Coupe (E9_)	05/89 → 05/91	5A-FE	Petrol	1498	4	16	35
Corolla Levin Coupe (_E10_)	06/91 → 08/97	4A-FE	Petrol	1587	4	16	50
Corolla Levin Coupe (_E10_)	06/91 → 08/97	4A-GZE	Petrol	1587	4	16	50
Corolla Levin Coupe (_E10_)	06/91 → 08/97	5A-FE	Petrol	1498	4	16	35
Corolla Levin Coupe (_E11_)	05/95 → 04/98	4A-GE	Petrol	1587	4	16	49
Corolla Levin Coupe (_E11_)	05/95 → 04/98	5A-FE	Petrol	1498	4	16	35
Corolla Liftback (_E8_)	06/83 → 09/84	2A-L	Petrol	1296	4	8	13
Corolla Liftback (_E8_)	06/83 → 08/87	1C-L	Diesel	1839	4	8	52
Corolla Liftback (_E8_)	06/83 → 12/87	4A-C	Petrol	1587	4	8	48
Corolla Liftback (_E8_)	06/83 → 05/88	1C	Diesel	1840	4	8	52
Corolla Liftback (_E8_)	06/83 → 05/88	4A-L	Petrol	1588	4	8	48
Corolla Liftback (_E8_)	08/83 → 04/87	2E	Petrol	1296	4	12	15
Corolla Liftback (_E8_)	09/84 → 05/89	4A-LC	Petrol	1587	4	8	48
Corolla Liftback (_E8_)	01/85 → 08/87	2E-L	Petrol	1296	4	12	15
Corolla Liftback (_E8_)	01/85 → 08/87	2E-LC	Petrol	1296	4	12	15
Corolla Liftback (_E8_)	05/85 → 04/87	4A-GEC	Petrol	1587	4	16	50
Corolla Liftback (_E8_)	05/85 → 04/87	4A-GELC	Petrol	1587	4	16	50
Corolla Liftback (_E8_)	09/85 → 05/89	2A	Petrol	1296	4	8	13
Corolla Liftback (_E9_)	07/87 → 04/92	2E	Petrol	1296	4	12	15
Corolla Liftback (_E9_)	07/87 → 09/94	4A-GE	Petrol	1587	4	16	49
Corolla Liftback (_E9_)	08/87 → 04/92	1C	Diesel	1840	4	8	52
Corolla Liftback (_E9_)	08/87 → 04/92	2E-E	Petrol	1296	4	12	15
Corolla Liftback (_E9_)	08/87 → 04/92	4A-F	Petrol	1587	4	16	49
Corolla Liftback (_E9_)	11/87 → 10/89	3E-E	Petrol	1456	4	12	32
Corolla Liftback (_E9_)	11/87 → 10/89	3E-TE	Petrol	1456	4	12	33
Corolla Liftback (_E9_)	08/89 → 10/95	4A-FE	Petrol	1587	4	16	50
Corolla Liftback (_E9_)	11/89 → 04/92	5A-FE	Petrol	1498	4	16	35
Corolla Liftback (_E9_)	11/89 → 04/92	5E-FE	Petrol	1497	4	16	36
Corolla Liftback (_E9_)	10/92 → 08/94	7A-FE	Petrol	1762	4	16	67
Corolla Liftback (_E10_)	07/92 → 05/95	2E	Petrol	1296	4	12	15
Corolla Liftback (_E10_)	07/92 → 04/97	2C	Diesel	1975	4	8	79
Corolla Liftback (_E10_)	07/92 → 04/97	4A-FE	Petrol	1587	4	16	50
Corolla Liftback (_E10_)	07/92 → 04/97	4E-FE	Petrol	1332	4	16	17
Corolla Liftback (_E10_)	11/92 → 05/95	7A-FE	Petrol	1762	4	16	67
Corolla Liftback (_E11_)	04/97 → 02/00	2C-E	Diesel	1975	4	8	79
Corolla Liftback (_E11_)	04/97 → 02/00	4A-FE	Petrol	1587	4	16	50
Corolla Liftback (_E11_)	04/97 → 02/00	4E-FE	Petrol	1332	4	16	17
Corolla Liftback (_E11_)	09/98 → 11/01	7A-FE	Petrol	1762	4	16	67
Corolla Liftback (_E11_)	02/00 → 01/02	1WZ	Diesel	1867	4	8	70
Corolla Liftback (_E11_)	02/00 → 01/02	3ZZ-FE	Petrol	1598	4	16	47
Corolla Liftback (_E11_)	02/00 → 01/02	4ZZ-FE	Petrol	1398	4	16	25
Corolla Liftback (_E11_)	09/00 → 01/02	1CD-FTV	Diesel	1995	4	16	74
Corolla Rumion (_AZE15_ , _NZE15_ , _ZRE15_)	09/07 →	1NZ-FE	Petrol	1497	4	16	27
Corolla Rumion (_AZE15_ , _NZE15_ , _ZRE15_)	09/07 →	2ZR-FAE	Petrol	1798	4	16	60
Corolla Rumion (_E15_)	05/10 →	2AZ-FE	Petrol	2362	4	16	108
Corolla Rumion (_E15_)	01/13 →	2ZR-FAE	Petrol	1798	4	16	60
Corolla Saloon (_E12_)	08/00 → 03/04	2NZ-FE	Petrol	1299	4	16	12
Corolla Saloon (_E12_)	03/01 → 07/07	1ZZ-FE	Petrol	1794	4	16	57
Corolla Saloon (_E12_)	05/01 → 07/07	1NZ-FE	Petrol	1497	4	16	27
Corolla Saloon (_E12_)	10/01 → 07/07	3ZZ-FE	Petrol	1598	4	16	47
Corolla Saloon (_E12_)	08/02 → 07/07	1CD-FTV	Diesel	1995	4	16	74
Corolla Saloon (_E12_)	08/02 → 07/07	4ZZ-FE	Petrol	1398	4	16	25
Corolla Saloon (_E12_)	07/04 → 07/07	1ND-TV	Diesel	1364	4	8	22
Corolla Saloon (_E12_)	09/04 → 12/06	2ZZ-GE	Petrol	1796	4	16	63
Corolla Saloon (_E12J_ , _E12T_)	11/01 → 07/07	1NZ-FE	Petrol	1497	4	16	27
Corolla Saloon (_E12J_ , _E12T_)	06/07 → 07/07	1ZZ-FE	Petrol	1794	4	16	57
Corolla Saloon (_E15_)	10/06 →	1ND-TV	Diesel	1364	4	8	22
Corolla Saloon (_E15_)	11/06 →	1ZZ-FE	Petrol	1794	4	16	57
Corolla Saloon (E15_)	11/06 →	2AD-FHV	Diesel	2231	4	16	100
Corolla Saloon (_E15_)	01/07 →	1AD-FTV	Diesel	1998	4	16	71
Corolla Saloon (_E15_)	01/07 →	1NR-FE	Petrol	1329	4	16	11
Corolla Saloon (_E15_)	01/07 →	1ZR-FE	Petrol	1598	4	16	42
Corolla Saloon (_E15_)	01/07 →	4ZZ-FE	Petrol	1398	4	16	25
Corolla Saloon (_E15_)	05/07 →	2ZR-FE	Petrol	1798	4	16	61
Corolla Saloon (E15_)	08/07 →	1NZ-FE	Petrol	1497	4	16	27
Corolla Saloon (E15_)	08/07 →	2ZR-FAE	Petrol	1798	4	16	60
Corolla Saloon (E15_)	08/07 →	3ZZ-FE	Petrol	1598	4	16	47
Corolla Saloon (_E15_)	12/07 →	3ZZ-FE	Petrol	1598	4	16	47
Corolla Saloon (_E15_)	01/08 →	2AZ-FE	Petrol	2362	4	16	108



CC



9

Corolla Saloon (_E15_)	01/08→	2ZR-FBE	Petrol	1798	4	16	60
Corolla Saloon (E15_)	03/08→	2NZ-FE	Petrol	1299	4	16	12
Corolla Saloon (_E15_)	08/08→	2ZR-FAE	Petrol	1798	4	16	60
Corolla Saloon (_E15_)	01/09→	1ZR-FAE	Petrol	1598	4	16	42
Corolla Saloon (_E15_)	04/10→	3ZR-FBE	Petrol	1987	4	16	95
Corolla Saloon (_E15_)	04/10→	3ZR-FE	Petrol	1987	4	16	94
Corolla Saloon (E15_)	08/10→	2ZR-FBE	Petrol	1798	4	16	60
Corolla Saloon (E15_)	08/10→	2ZR-FE	Petrol	1798	4	16	61
Corolla Saloon (_E15_)	08/10→	3ZR-FAE	Petrol	1987	4	16	94
Corolla Saloon (_E16_)	10/14→	1NZ-FXE	Petrol	1497	4	16	27
Corolla Saloon (_E18_ , ZRE17_)	06/13→	1ND-TV	Diesel	1364	4	8	22
Corolla Saloon (_E18_ , ZRE17_)	06/13→	1NR-FE	Petrol	1329	4	16	11
Corolla Saloon (_E18_ , ZRE17_)	06/13→	1ZR-FAE	Petrol	1598	4	16	42
Corolla Saloon (_E18_ , ZRE17_)	06/13→	1ZR-FE	Petrol	1598	4	16	42
Corolla Saloon (_E18_ , ZRE17_)	06/13→	2ZR-FBE	Petrol	1798	4	16	60
Corolla Saloon (_E18_ , ZRE17_)	06/13→	2ZR-FE	Petrol	1798	4	16	61
Corolla Saloon (_E18_ , ZRE17_)	09/13→	2ZR-FAE	Petrol	1798	4	16	60
Corolla Saloon (_E18_ , ZRE17_)	10/13→	3ZR-FE	Petrol	1987	4	16	94
Corolla Saloon (_E18_ , ZRE17_)	01/16→	3ZR-FBE	Petrol	1987	4	16	95
Corolla Saloon (_NZE16_)	05/12→	1NR-FE	Petrol	1329	4	16	11
Corolla Saloon (_NZE16_)	05/12→	1NZ-FE	Petrol	1497	4	16	27
Corolla Station Wagon (_E7_)	12/79→01/82	4K-C	Petrol	1290	4	8	19
Corolla Station Wagon (_E7_)	10/81→04/85	4A-C	Petrol	1587	4	8	48
Corolla Station Wagon (_E7_)	02/82→08/87	4K	Petrol	1290	4	8	19
Corolla Station Wagon (_E7_)	05/83→08/87	1C	Diesel	1840	4	8	52
Corolla Station Wagon (_E9_)	05/87→06/92	2E	Petrol	1296	4	12	15
Corolla Station Wagon (_E9_)	12/87→06/92	1C	Diesel	1840	4	8	52
Corolla Station Wagon (_E9_)	12/87→12/92	4A-F	Petrol	1587	4	16	49
Corolla Station Wagon (_E9_)	08/88→07/95	4A-FE	Petrol	1587	4	16	50
Corolla Verso (_E12_)	07/01→02/04	1NZ-FE	Petrol	1497	4	16	27
Corolla Verso (_E12_)	09/01→07/04	1CD-FTV	Diesel	1995	4	16	74
Corolla Verso (_E12_)	01/02→05/04	1ZZ-FE	Petrol	1794	4	16	57
Corolla Verso (_E12_)	01/02→05/04	3ZZ-FE	Petrol	1598	4	16	47
Corolla Verso (ZDE12_ , CDE12_)	09/01→05/04	4S-FE	Petrol	1838	4	16	65
Corolla Verso (ZDE12_ , CDE12_)	10/01→02/04	1ZZ-FE	Petrol	1794	4	16	57
Corolla Verso (ZER_ , ZZE12_ , R1_)	03/04→03/09	1NZ-FE	Petrol	1497	4	16	27
Corolla Verso (ZER_ , ZZE12_ , R1_)	03/04→03/09	1ZZ-FE	Petrol	1794	4	16	57
Corolla Verso (ZER_ , ZZE12_ , R1_)	03/04→03/09	8A-FE	Petrol	1342	4	16	20
Corolla Verso (ZER_ , ZZE12_ , R1_)	04/04→03/09	1CD-FTV	Diesel	1995	4	16	74
Corolla Verso (ZER_ , ZZE12_ , R1_)	04/04→03/09	3ZZ-FE	Petrol	1598	4	16	47
Corolla Verso (ZER_ , ZZE12_ , R1_)	10/05→03/09	2AD-FHV	Diesel	2231	4	16	100
Corolla Verso (ZER_ , ZZE12_ , R1_)	10/05→03/09	2AD-FTV	Diesel	2231	4	16	100
Corolla Verso (ZER_ , ZZE_ , R1_)	03/04→03/09	1ND-TV	Diesel	1364	4	8	22
Corolla Verso (ZER_ , ZZE_ , R1_)	03/04→03/09	4S-FE	Petrol	1838	4	16	65
Corolla Wagon (_E10_)	05/92→12/93	4A-F	Petrol	1587	4	16	49
Corolla Wagon (_E10_)	05/92→04/97	4A-FE	Petrol	1587	4	16	50
Corolla Wagon (_E10_)	07/92→05/95	2E	Petrol	1296	4	12	15
Corolla Wagon (_E10_)	07/92→04/97	2C	Diesel	1975	4	8	79
Corolla Wagon (_E10_)	07/92→04/97	4E-FE	Petrol	1332	4	16	17
Corolla Wagon (_E10_)	09/92→04/97	7A-FE	Petrol	1762	4	16	67
Corolla Wagon (_E10_)	08/95→04/97	4S-FE	Petrol	1838	4	16	65
Corolla Wagon (_E11_)	04/97→02/00	2C-E	Diesel	1975	4	8	79
Corolla Wagon (_E11_)	04/97→02/00	4A-FE	Petrol	1587	4	16	50
Corolla Wagon (_E11_)	04/97→02/00	4E-FE	Petrol	1332	4	16	17
Corolla Wagon (_E11_)	04/97→10/01	1CD-FTV	Diesel	1995	4	16	74
Corolla Wagon (_E11_)	04/97→10/01	7A-FE	Petrol	1762	4	16	67
Corolla Wagon (_E11_)	05/97→08/01	4S-FE	Petrol	1838	4	16	65
Corolla Wagon (_E11_)	02/00→10/01	1WZ	Diesel	1867	4	8	70
Corolla Wagon (_E11_)	02/00→10/01	3ZZ-FE	Petrol	1598	4	16	47
Corolla Wagon (_E11_)	02/00→10/01	4ZZ-FE	Petrol	1398	4	16	25
Corolla Wagon (_E11_)	09/00→10/01	1CD-FTV	Diesel	1995	4	16	74
Corona (RT1_)	09/74→05/79	20R	Petrol	2189	4	8	104
Corona (RT1_)	12/75→05/79	18R	Petrol	1968	4	8	98
Corona (ST)	08/83→04/87	2S-C	Petrol	1995	4	8	81
Corona (ST)	10/83→04/87	4A-L	Petrol	1588	4	8	48
Corona (ST)	11/83→11/86	1S-L	Petrol	1832	4	8	55
Corona (_T1_)	10/79→01/81	3T	Petrol	1770	4	8	64
Corona (_T1_)	09/80→12/82	22R	Petrol	2367	4	8	116
Corona (_T1_)	02/82→12/83	21R-C	Petrol	1972	4	8	78
Corona Coupe (_T16_)	08/85→08/87	3S-GELU	Petrol	1998	4	16	88
Corona Coupe (_T16_)	08/85→08/87	4A-GELU	Petrol	1587	4	16	50
Corona Coupe (_T16_)	08/85→05/88	1S-ILU	Petrol	1832	4	8	53
Corona Estate	08/83→04/87	2S-C	Petrol	1995	4	8	81
Corona Estate	11/84→04/87	22RE	Petrol	2367	4	8	114
Corona Estate	02/92→09/97	3S-FE	Petrol	1998	4	16	86
Corona Estate	02/92→09/97	4A-FE	Petrol	1587	4	16	50
Corona Estate	02/92→09/97	7A-FE	Petrol	1762	4	16	67
Corona Estate	07/94→09/97	2C-T	Diesel	1975	4	8	80



CC



9

Corona Estate (RT118)	09/74→12/77	20R	Petrol	2189	4	8	104
Corona Estate (RT118)	09/75→05/79	18R	Petrol	1968	4	8	98
Corona Estate (_T14_)	10/83→04/87	4A-L	Petrol	1588	4	8	48
Corona Estate (_T14_)	11/83→04/87	1S-L	Petrol	1832	4	8	55
Corona Estate (_T17_)	12/87→10/92	2C	Diesel	1975	4	8	79
Corona Estate (_T17_)	12/87→12/92	3S-FE	Petrol	1998	4	16	86
Corona Estate (_T17_)	12/87→12/92	4A-F	Petrol	1587	4	16	49
Corona Estate (XT)	09/80→12/82	22R	Petrol	2367	4	8	116
Corona EXIV Saloon (_T18_)	08/86→08/93	4S-FE	Petrol	1838	4	16	65
Corona EXIV Saloon (_T18_)	09/89→08/90	4S-FI	Petrol	1838	4	16	66
Corona EXIV Saloon (_T18_)	09/89→09/93	3S-FE	Petrol	1998	4	16	86
Corona EXIV Saloon (_T18_)	09/89→09/93	3S-GE	Petrol	1998	4	16	88
Corona Hardtop	09/74→12/77	20R	Petrol	2189	4	8	104
Corona Hatchback	12/87→10/89	4A-F	Petrol	1587	4	16	49
Corona Hatchback	12/87→01/92	2C	Diesel	1975	4	8	79
Corona Hatchback	12/87→09/97	3S-FE	Petrol	1998	4	16	86
Corona Hatchback	06/89→09/97	4A-FE	Petrol	1587	4	16	50
Corona Hatchback	02/92→01/96	4S-FE	Petrol	1838	4	16	65
Corona Hatchback	02/92→09/97	7A-FE	Petrol	1762	4	16	67
Corona Hatchback	07/94→09/97	2C-T	Diesel	1975	4	8	80
Corona Hatchback (_T13_)	09/78→12/80	20R	Petrol	2189	4	8	104
Corona Hatchback (_T13_)	09/78→12/81	16R	Petrol	1808	4	8	69
Corona Hatchback (_T13_)	06/79→07/81	3T	Petrol	1770	4	8	64
Corona Hatchback (_T13_)	09/80→12/81	22R	Petrol	2367	4	8	116
Corona Hatchback (_T17_)	12/87→11/89	4S-FI	Petrol	1838	4	16	66
Corona Hatchback (_T17_)	11/89→01/92	4S-FE	Petrol	1838	4	16	65
Corona Saloon	12/87→10/89	4A-F	Petrol	1587	4	16	49
Corona Saloon	12/87→01/92	3S-FE	Petrol	1998	4	16	86
Corona Saloon	06/89→09/97	4A-FE	Petrol	1587	4	16	50
Corona Saloon	02/92→09/97	7A-FE	Petrol	1762	4	16	67
Corona Saloon	07/94→09/97	2C-T	Diesel	1975	4	8	80
Corona Saloon	10/97→09/03	1G-GE	Petrol	1988	6	24	77
Corona Saloon (_T14_)	11/84→04/87	22RE	Petrol	2367	4	8	114
Corona Saloon (_T14_)	08/85→08/88	2S	Petrol	1995	4	8	81
Corona Saloon (_T17_)	11/87→08/89	5A-F	Petrol	1497	4	16	35
Corona Saloon (_T17_)	11/87→08/89	5A-FE	Petrol	1498	4	16	35
Corona Saloon (_T17_)	11/87→09/93	3S-GE	Petrol	1998	4	16	88
Corona Saloon (_T17_)	12/87→11/89	4S-FI	Petrol	1838	4	16	66
Corona Saloon (_T17_)	12/87→01/92	2C	Diesel	1975	4	8	79
Corona Saloon (_T17_)	09/89→09/93	3S-GEU	Petrol	1998	4	16	88
Corona Saloon (_T17_)	11/89→02/92	4S-FE	Petrol	1838	4	16	65
Corona Saloon (_T19_)	02/92→01/96	4S-FE	Petrol	1838	4	16	65
Corona Saloon (_T19_)	02/92→09/97	3S-FE	Petrol	1998	4	16	86
Corona Saloon (_T19_)	08/92→01/96	2C	Diesel	1975	4	8	79
Corona Saloon (_T19_)	10/93→09/95	3S-GE	Petrol	1998	4	16	88
Corona Saloon (_T21_)	01/96→02/00	2C-T	Diesel	1975	4	8	80
Corona Saloon (_T21_)	01/96→11/01	4A-FE	Petrol	1587	4	16	50
Corona Saloon (_T21_)	01/96→11/01	7A-FE	Petrol	1762	4	16	67
Corona Saloon (_T21_)	01/96→09/02	3S-FE	Petrol	1998	4	16	86
Corona Saloon (_T21_)	09/96→05/01	3S-FSE	Petrol	1998	4	16	87
Corona Saloon (_T21_)	01/98→05/01	3C-TE	Diesel	2184	4	8	101
Corona Saloon (_T21_)	01/00→09/03	1CD-FTV	Diesel	1995	4	16	74
Corsa Coupe	06/86→09/90	3E	Petrol	1456	4	12	32
Corsa Coupe	08/89→09/90	3E-E	Petrol	1456	4	12	32
Corsa Hatchback	06/86→09/90	3E	Petrol	1456	4	12	32
Corsa Hatchback	08/89→09/90	3E-E	Petrol	1456	4	12	32
Corsa Hatchback	11/94→07/99	1N-T	Diesel	1454	4	8	26
Corsa Hatchback	11/94→09/99	1N	Diesel	1453	4	8	26
Corsa Hatchback	11/94→09/99	4E-FE	Petrol	1332	4	16	17
Corsa Hatchback	11/94→09/99	5E-FE	Petrol	1497	4	16	36
Corsa Hatchback (_L4_)	09/90→09/94	1N-T	Diesel	1454	4	8	26
Corsa Hatchback (_L4_)	09/90→09/94	4E-FE	Petrol	1332	4	16	17
Corsa Hatchback (_L4_)	09/90→09/94	5E-FE	Petrol	1497	4	16	36
Corsa Saloon	10/90→07/99	1N-T	Diesel	1454	4	8	26
Corsa Saloon	10/90→09/99	5E-FE	Petrol	1497	4	16	36
Corsa Saloon	11/94→09/99	1N	Diesel	1453	4	8	26
Corsa Saloon	11/94→09/99	4E-FE	Petrol	1332	4	16	17
Corsa Saloon (_L4_)	09/90→09/94	5E-FE	Petrol	1497	4	16	36
Corsa Saloon (_L4_)	10/90→09/94	1N-T	Diesel	1454	4	8	26
Corsa Saloon (_L4_)	10/90→10/94	4E-FE	Petrol	1332	4	16	17
Cressida Estate	10/88→09/92	1G-FE	Petrol	1988	6	24	76
Cressida Estate	10/88→09/92	7M-GE	Petrol	2954	6	24	137
Cressida Estate	10/91→09/92	1JZ-GE	Petrol	2491	6	24	117
Cressida Estate (_X7_)	12/83→09/88	5M-GE	Petrol	2759	6	12	127
Cressida Estate (_X7_)	05/85→09/88	21R	Petrol	1972	4	8	99
Cressida Saloon	10/88→09/91	1G-FE	Petrol	1988	6	24	76
Cressida Saloon	10/88→09/92	2L-TII	Diesel	2446	4	8	113
Cressida Saloon	10/88→01/93	7M-GE	Petrol	2954	6	24	137



CC



9

Cressida Saloon (GX7_, MX73)	05/85→09/88	5M-GE	Petrol	2759	6	12	127
Cressida Saloon (_X3_)	07/77→07/81	18R	Petrol	1968	4	8	98
Cressida Saloon (_X6_)	09/80→07/84	L	Diesel	2188	4	8	105
Cressida Saloon (_X6_)	09/80→12/86	3T	Petrol	1770	4	8	64
Cressida Saloon (_X6_)	05/81→03/85	21R	Petrol	1972	4	8	99
Cressida Saloon (_X6_)	05/81→03/85	21R-C	Petrol	1972	4	8	78
Cressida Saloon (_X6_)	08/82→06/84	1G-E	Petrol	1988	6	12	75
Cressida Saloon (_X6_)	08/82→09/92	1G-FE	Petrol	1988	6	24	76
Cressida Saloon (_X6_)	09/82→12/88	5M-GE	Petrol	2759	6	12	127
Cressida Saloon (_X6_)	05/85→09/88	2Y	Petrol	1812	4	8	59
Cressida Saloon (_X6_)	01/87→09/92	22R	Petrol	2367	4	8	116
Cressida Saloon (_X6_)	09/88→09/92	7M-GE	Petrol	2954	6	24	137
Cressida Saloon (_X6_)	01/89→09/92	3Y	Petrol	1998	4	8	91
Cressida Saloon (_X7_)	01/85→10/88	2L-T	Diesel	2446	4	8	111
Cressida Saloon (_X8_)	08/88→07/96	22R	Petrol	2367	4	8	116
Cressida Saloon (_X8_)	10/88→08/92	1G-FE	Petrol	1988	6	24	76
Cressida Saloon (_X8_)	10/88→01/93	7M-GE	Petrol	2954	6	24	137
Cressida Station Wagon (_X3_)	12/77→03/81	18R	Petrol	1968	4	8	98
Cressida Station Wagon (_X6_)	02/81→03/85	21R	Petrol	1972	4	8	99
Cressida Station Wagon (_X6_)	06/81→03/85	L	Diesel	2188	4	8	105
Cressida Station Wagon (_X6_)	09/82→12/83	5M-GE	Petrol	2759	6	12	127
Cresta (_X5_, _X6_)	08/82→06/84	1S-U	Petrol	1832	4	8	56
Cresta (_X7_)	08/84→07/88	1S-U	Petrol	1832	4	8	56
Cresta Estate	10/96→09/01	1JZ-GE	Petrol	2491	6	24	117
Cresta Estate	10/96→09/01	2JZ-GE	Petrol	2997	6	24	131
Cresta Estate	10/96→09/01	3C-TE	Diesel	2184	4	8	101
Cresta Saloon	08/84→05/87	21R	Petrol	1972	4	8	99
Cresta Saloon	08/84→09/01	1G-FE	Petrol	1988	6	24	76
Cresta Saloon	08/84→09/01	1G-GE	Petrol	1988	6	24	77
Cresta Saloon	11/84→08/88	5M-GE	Petrol	2759	6	12	127
Cresta Saloon	06/87→08/88	22R	Petrol	2367	4	8	116
Cresta Saloon	09/88→10/96	2L	Diesel	2446	4	8	111
Cresta Saloon	09/88→10/96	7M-GE	Petrol	2954	6	24	137
Cresta Saloon	09/94→10/96	4S-FE	Petrol	1838	4	16	65
Cresta Saloon	10/96→06/01	2L-TE	Diesel	2446	4	8	112
Cresta Saloon	10/96→09/01	1JZ-GE	Petrol	2491	6	24	117
Cresta Saloon	10/96→09/01	2JZ-GE	Petrol	2997	6	24	131
Cresta Saloon	10/96→09/01	3C-TE	Diesel	2184	4	8	101
Cresta Saloon (_X8_)	08/88→09/92	3Y-P	Gas	1998	4	8	92
Cresta Saloon (_X8_)	09/88→10/92	4S-FE	Petrol	1838	4	16	65
Cresta Saloon (_X8_)	09/88→09/96	1G-FE	Petrol	1988	6	24	76
Cresta Saloon (_X8_)	09/88→09/96	1JZ-GTE	Petrol	2491	6	24	117
Cresta Saloon (_X8_)	09/88→09/96	2L-T	Diesel	2446	4	8	111
Cresta Saloon (_X8_)	09/88→09/96	2L-TE	Diesel	2446	4	8	112
Cresta Saloon (_X8_)	10/92→09/96	1JZ-GE	Petrol	2491	6	24	117
Cresta Saloon (_X8_)	10/92→09/96	2JZ-GE	Petrol	2997	6	24	131
Crown Comfort (_S1_)	12/95→07/08	3Y-PE	Gas	1998	4	8	92
Crown Estate	08/83→08/85	5M-GE	Petrol	2759	6	12	127
Crown Estate	09/99→08/03	1JZ-GE	Petrol	2491	6	24	117
Crown Saloon (CRS_, JZS_, GRS18_, UZS_)	09/03→02/08	3GR-FSE	Petrol	2994	6	24	132
Crown Saloon (CRS_, JZS_, GRS18_, UZS_)	09/03→02/08	3UZ-FE	Petrol	4293	8	32	161
Crown Saloon (CRS_, JZS_, GRS18_, UZS_)	09/04→02/08	3GR-FE	Petrol	2995	6	24	132
Crown Saloon (GRS20_)	02/08→11/12	2GR-FSE	Petrol	3456	6	24	149
Crown Saloon (GRS20_)	02/08→11/12	3GR-FSE	Petrol	2994	6	24	132
Crown Saloon (GRS20_)	04/09→11/12	1UR-FSE	Petrol	4608	8	32	163
Crown Saloon (GRS20_)	04/09→11/12	3UZ-FE	Petrol	4293	8	32	161
Crown Saloon (GRS21_, AWS21_)	12/12→	2AR-FSE	Petrol	2493	4	16	118
Crown Saloon (GRS21_, AWS21_)	12/12→	2GR-FSE	Petrol	3456	6	24	149
Crown Saloon (GRS21_, AWS21_)	12/12→	2GR-FXE	Petrol	3456	6	24	149
Crown Saloon (JZS13_, YS13_, LS13_, GS13_)	08/91→08/99	1UZ-FE	Petrol	3969	8	32	154
Crown Saloon (JZS13_, YS13_, LS13_, GS13_)	08/91→08/99	2JZ-GE	Petrol	2997	6	24	131
Crown Saloon (JZS13_, YS13_, LS13_, GS13_)	08/91→04/01	1JZ-GE	Petrol	2491	6	24	117
Crown Saloon (JZS13_, YS13_, LS13_, GS13_)	08/94→09/99	2L-TE	Diesel	2446	4	8	112
Crown Saloon (JZS13_, YS13_, LS13_, GS13_)	01/95→02/01	1G-FE	Petrol	1988	6	24	76
Crown Saloon (JZS17_)	09/99→07/02	2L-TE	Diesel	2446	4	8	112
Crown Saloon (LS13_, GS13_, MS13_, YS13_)	10/88→07/91	7M-GE	Petrol	2954	6	24	137
Crown Saloon (_S1_)	04/80→07/83	L	Diesel	2188	4	8	105
Crown Saloon (_S1_)	02/84→03/85	5M-GE	Petrol	2759	6	12	127
Crown Saloon (_S13_)	10/87→07/91	1G-E	Petrol	1988	6	12	75
Crown Saloon (_S17_)	09/99→08/03	1JZ-GTE	Petrol	2491	6	24	117
Crown Saloon (_S17_)	09/99→05/04	1UZ-FE	Petrol	3969	8	32	154
CT (ZWA10_)	12/10→	2ZR-FXE	Petrol	1798	4	16	62
CT (ZWA10_)	12/10→	5ZR-FXE	Petrol	1798	4	16	60
Curren Coupe	09/89→10/93	3S-GE	Petrol	1998	4	16	88
Curren Coupe	09/89→10/93	3S-GTE	Petrol	1998	4	16	88
Curren Coupe	09/89→10/93	4A-FE	Petrol	1587	4	16	50
Curren Coupe	09/89→09/94	5S-FE	Petrol	2164	4	16	103
Curren Coupe (ST20_)	11/93→10/98	3S-GE	Petrol	1998	4	16	88

				CC			9
Curren Coupe (ST20_)	11/93→10/98	7A-FE	Petrol	1762	4	16	67
Curren Coupe (ST20_)	02/94→07/98	3S-FE	Petrol	1998	4	16	86
Curren Coupe (ST20_)	10/95→10/98	4S-FE	Petrol	1838	4	16	65
Curren Coupe (ST20_)	10/95→10/98	5S-FE	Petrol	2164	4	16	103
Deliboy Bus (KXC1_, CXCI_)	10/89→10/95	2C	Diesel	1975	4	8	79
Deliboy Bus (KXC1_, CXCI_)	10/94→10/95	3C-TE	Diesel	2184	4	8	101
Duet (M11_, M10_)	09/98→04/04	EJ-DE	Petrol	989	3	12	7
Duet (M11_, M10_)	09/98→04/04	EJ-VE	Petrol	989	3	12	7
Duet (M11_, M10_)	09/98→04/04	K3-VE2	Petrol	1298	4	16	16
Dyna 100 Platform/Chassis (LY1_, YY1_)	05/95→07/01	2L	Diesel	2446	4	8	111
Dyna 100 Platform/Chassis (LY1_, YY1_)	05/95→07/01	2Y	Petrol	1812	4	8	59
Dyna 100 Platform/Chassis (YH_)	08/85→04/95	2Y	Petrol	1812	4	8	59
Dyna 150 Platform/Chassis (LY_)	08/88→08/98	3L	Diesel	2779	4	8	126
Dyna 150 Platform/Chassis (LY_)	09/88→06/95	3B	Diesel	3432	4	8	144
Dyna 150 Platform/Chassis (LY_)	09/88→07/01	2L	Diesel	2446	4	8	111
Dyna 150 Platform/Chassis (LY_)	09/98→07/01	5L	Diesel	2986	4	8	135
Dyna 150 Platform/Chassis (_Y_)	08/85→08/86	2Y	Petrol	1812	4	8	59
Dyna 150 Platform/Chassis (_Y_)	08/85→08/87	2L	Diesel	2446	4	8	111
Dyna 150 Platform/Chassis (_Y_)	08/85→08/88	3Y	Petrol	1998	4	8	91
Dyna 150 Platform/Chassis (_Y_)	08/85→08/88	B	Diesel	2977	4	8	140
Dyna 200 Platform/Chassis	01/85→05/95	11B	Diesel	2986	4	8	139
Dyna 200 Platform/Chassis	10/89→05/99	3B	Diesel	3432	4	8	144
Dyna 200 Platform/Chassis	10/93→07/01	4Y	Petrol	2237	4	8	102
Dyna 200 Platform/Chassis	06/95→07/01	3RZ-FE	Petrol	2694	4	16	125
Dyna 300 Box	06/98→07/01	2RZ-FE	Petrol	2438	4	16	115
Dyna 300 Platform/Chassis	06/95→05/99	3B	Diesel	3432	4	8	144
Dyna 300 Platform/Chassis	06/95→06/99	3RZ-FE	Petrol	2694	4	16	125
Dyna 300 Platform/Chassis	06/98→07/01	2RZ-FE	Petrol	2438	4	16	115
Dyna Box (BU20)	08/77→08/84	3B	Diesel	3432	4	8	144
Dyna Bus (KDY2_)	08/01→	1KD-FTV	Diesel	2982	4	16	128
Dyna Bus (LY1_, H8_)	08/87→07/01	2L	Diesel	2446	4	8	111
Dyna Bus (_U3_, U2_)	08/77→02/79	2J	Diesel	2449	4	8	110
Dyna Bus (_U3_, U2_)	08/77→08/87	13B	Diesel	3431	4	8	146
Dyna Pickup	08/77→04/79	2L	Diesel	2446	4	8	111
Dyna Platform/Chassis (KD_, LY_, Y2_, U3_, U4_)	08/01→	2KD-FTV	Diesel	2494	4	16	119
Dyna Platform/Chassis (KD_, LY_, Y2_, U3_, U4_)	08/01→	5L	Diesel	2986	4	8	135
Dyna Platform/Chassis (KD_, LY_, Y2_, U3_, U4_)	09/06→	1KD-FTV	Diesel	2982	4	16	128
Dyna Platform/Chassis (KD_, U7_, C6_, U6_, LY_, TRY2_, KD)	09/06→	1KD-FTV	Diesel	2982	4	16	128
Dyna Platform/Chassis (LH8_)	08/87→04/95	2L	Diesel	2446	4	8	111
Dyna Platform/Chassis (_U_, Y_)	08/77→04/79	2L	Diesel	2446	4	8	111
Dyna Platform/Chassis (_U_, Y_)	08/77→08/84	5R	Petrol	1997	4	8	97
Dyna Platform/Chassis (_U_, Y_)	08/77→10/84	B	Diesel	2977	4	8	140
Dyna Platform/Chassis (_U_, Y_)	08/77→11/84	2H	Diesel	3980	6	12	155
Dyna Platform/Chassis (_U_, Y_)	08/77→11/84	H	Diesel	3576	6	12	150
Dyna Platform/Chassis (_U_, Y_)	09/84→07/87	22R	Petrol	2367	4	8	116
Dyna Platform/Chassis (_U_, Y_)	09/84→08/87	2J	Diesel	2449	4	8	110
Dyna Platform/Chassis (_U_, Y_)	09/84→08/87	3Y	Petrol	1998	4	8	91
Dyna Platform/Chassis (_U_, Y_)	09/84→08/87	13B	Diesel	3431	4	8	146
Echo Hatchback (NCP13_, NCP12_)	08/99→03/03	2NZ-FE	Petrol	1299	4	16	12
Echo Hatchback (NCP13_, NCP12_)	04/03→08/05	1NZ-FE	Petrol	1497	4	16	27
Echo Hatchback (NCP13_, NCP12_)	04/03→08/05	2SZ-FE	Petrol	1298	4	16	16
Echo Hatchback (_P1_)	03/99→08/05	1SZ-FE	Petrol	998	4	16	5
Echo Hatchback (_P1_)	01/00→03/03	1ND-TV	Diesel	1364	4	8	22
Echo Saloon	04/99→08/05	1NZ-FE	Petrol	1497	4	16	27
Echo Saloon (_P1_)	08/00→01/06	1NZ-FE	Petrol	1497	4	16	27
Echo Saloon (_P1_)	04/03→08/05	2NZ-FE	Petrol	1299	4	16	12
ES (AVV6_, GSV6_, ASV6_)	06/12→	2AR-FE	Petrol	2494	4	16	118
ES (AVV6_, GSV6_, ASV6_)	06/12→	2AR-FXE	Petrol	2493	4	16	118
ES (AVV6_, GSV6_, ASV6_)	06/12→	2GR-FE	Petrol	3456	6	24	149
ES (GSV4_, ACV4_)	05/06→06/12	2GR-FE	Petrol	3456	6	24	149
ES (MCV_, VZV_)	10/96→06/08	1MZ-FE	Petrol	2995	6	24	130
ES (MCV_, VZV_)	06/03→12/06	3MZ-FE	Petrol	3311	6	24	143
ES (_V4_)	08/09→06/12	2AZ-FE	Petrol	2362	4	16	108
ES (_V4_)	09/10→06/12	2GR-FE	Petrol	3456	6	24	149
ES (_V6_)	06/12→	2AR-FE	Petrol	2494	4	16	118
ES (_V6_)	06/12→	2GR-FE	Petrol	3456	6	24	149
ES (_V6_)	09/12→	2AR-FXE	Petrol	2493	4	16	118
ES (VCV10_, VZV21_)	09/89→12/91	2VZ-FE	Petrol	2508	6	24	121
ES (VCV10_, VZV21_)	09/91→12/97	3VZ-FE	Petrol	2959	6	24	134
ES (VCV10_, VZV21_)	09/93→12/97	1MZ-FE	Petrol	2995	6	24	130
Esquire (_R8_)	10/14→	2ZR-FXE	Petrol	1978	4	16	61
Esquire (_R8_)	10/14→	3ZR-FAE	Petrol	1987	4	16	94
Estima Emina / Lucida (_R1_, R2_)	05/90→12/99	2TZ-FE	Petrol	2438	4	16	115
Estima Emina / Lucida (_R1_, R2_)	01/92→12/99	3C-TE	Diesel	2184	4	8	101
Estima Emina / Lucida (_R1_, R2_)	09/93→12/99	2TZ-FZE	Petrol	2438	4	16	115
Etiös (_K1_)	12/10→	3NR-FE	Petrol	1197	4	16	10
Etiös (_K1_)	09/11→	1ND-TV	Diesel	1364	4	8	22
Etiös (_K1_)	08/12→	1NR-FE	Petrol	1329	4	16	11



CC



9

Etiós Saloon (_K1_)	09/11→	1ND-TV	Diesel	1364	4	8	22
Etiós Saloon (_K1_)	08/12→	1NR-FE	Petrol	1329	4	16	11
Exsior	06/92→09/97	1G-GE	Petrol	1988	6	24	77
Exsior	06/92→09/97	1JZ-GE	Petrol	2491	6	24	117
FJ Cruiser (GSJ1_)	01/06→	1GR-FE	Petrol	3956	6	24	152
Fortuner (_N5_ , _N6_)	06/04→	1KD-FTV	Diesel	2982	4	16	128
Fortuner (_N5_ , _N6_)	07/05→	1GR-FE	Petrol	3956	6	24	152
Fortuner (_N5_ , _N6_)	01/09→05/15	2KD-FTV	Diesel	2494	4	16	119
Fortuner (_N15_ , _N16_)	05/15→	1GR-FE	Petrol	3956	6	24	152
Fortuner (_N15_ , _N16_)	05/15→	1KD-FTV	Diesel	2982	4	16	128
Fortuner Closed Off-Road Vehicle (TGNS_ , LAN5_ , KUN5_ , GGN5_)	01/09→05/15	2KD-FTV	Diesel	2494	4	16	119
Gaia (CXM1_ , SXM1_ , ACM1_)	05/98→10/03	1AZ-FSE	Petrol	1998	4	16	73
Gaia (CXM1_ , SXM1_ , ACM1_)	10/98→10/03	3C-TE	Diesel	2184	4	8	101
Gaia (_M1_)	05/98→03/01	3S-FE	Petrol	1998	4	16	86
Granvia (_H2_ , _H1_)	08/95→12/04	1KZ-TE	Diesel	2982	4	8	129
Granvia (_H2_ , _H1_)	08/95→12/04	3RZ-FE	Petrol	2694	4	16	125
Granvia (_H2_ , _H1_)	08/95→12/04	5VZ-FE	Petrol	3378	6	24	145
GS (GRL1_ , GWL1_)	01/12→	2GR-FSE	Petrol	3456	6	24	149
GS (GRS19_ , UZS19_ , GWS19_)	04/05→11/11	3UZ-FE	Petrol	4293	8	32	161
GS (GRS19_ , UZS19_ , GWS19_)	04/08→11/11	2GR-FSE	Petrol	3456	6	24	149
GS (GRS19_ , UZS19_ , URS19_)	01/05→11/11	1UR-FSE	Petrol	4608	8	32	163
GS (GRS19_ , UZS19_ , URS19_)	04/05→11/11	3GR-FE	Petrol	2995	6	24	132
GS (GRS19_ , UZS19_ , URS19_)	04/05→11/11	3GR-FSE	Petrol	2995	6	24	132
GS (GRS19_ , UZS19_ , URS19_)	04/05→11/11	3UZ-FE	Petrol	4293	8	32	161
GS (GRS19_ , UZS19_ , URS19_)	02/06→11/11	2GR-FSE	Petrol	3456	6	24	149
GS (GRS19_ , UZS19_ , URS19_)	09/08→11/11	1UR-FE	Petrol	4608	8	32	163
GS (JZS147_)	01/93→08/97	2JZ-GE	Petrol	2997	6	24	131
GS (JZS160_ , UZS161_ , UZS160_)	08/97→12/04	2JZ-GE	Petrol	2997	6	24	131
GS (JZS160_ , UZS161_ , UZS160_)	12/97→12/00	1UZ-FE	Petrol	3969	8	32	153
GS (JZS160_ , UZS161_ , UZS160_)	09/00→12/04	3UZ-FE	Petrol	4293	8	32	161
GS (_L1_)	09/11→	2GR-FSE	Petrol	3456	6	24	149
GS (_L1_)	01/12→	2GR-FXE	Petrol	3456	6	24	149
GS (_L1_)	10/13→	2AR-FSE	Petrol	2494	4	16	118
GX (_J12_)	09/05→12/06	3UZ-FE	Petrol	4293	8	32	161
GX (URJ15_)	11/09→	1UR-FE	Petrol	4608	8	32	163
GX (URJ15_)	09/13→	1GR-FE	Petrol	3956	6	24	152
Harrier (_U1_)	05/97→02/03	5S-FE	Petrol	2164	4	16	103
Harrier (_U1_)	12/97→01/03	1MZ-FE	Petrol	2995	6	24	130
Harrier (_U1_)	06/00→01/03	2AZ-FE	Petrol	2362	4	16	108
Harrier (_U3_)	02/03→12/08	1MZ-FE	Petrol	2995	6	24	130
Harrier (_U3_)	02/03→06/12	2AZ-FE	Petrol	2362	4	16	108
Harrier (_U3_)	10/03→05/12	3MZ-FE	Petrol	3311	6	24	143
Harrier (_U3_)	04/05→12/08	2GR-FE	Petrol	3456	6	24	149
Harrier (_U6_)	10/13→	3ZR-FAE	Petrol	1987	4	16	94
Harrier (_U6_)	01/14→	2AR-FXE	Petrol	2494	4	16	118
Hiace / Commuter V (TRH2_ , KDH2_)	08/04→	1KD-FTV	Diesel	2982	4	16	128
Hiace / Commuter V (TRH2_ , KDH2_)	01/05→	2KD-FTV	Diesel	2494	4	16	119
Hiace / Commuter V (TRH2_ , KDH2_)	01/05→	5L	Diesel	2986	4	8	135
Hiace I Box (RH1_ , LH3_ , RH3_ , RH2_ , LH2_ , LH1_)	02/77→03/83	12R	Petrol	1587	4	8	51
Hiace I Box (RH1_ , LH3_ , RH3_ , RH2_ , LH2_ , LH1_)	07/77→03/83	18R	Petrol	1968	4	8	98
Hiace I Box (RH1_ , LH3_ , RH3_ , RH2_ , LH2_ , LH1_)	01/79→03/83	L	Diesel	2188	4	8	105
Hiace I Wagon (LH1_ , RH1_ , LH3_ , RH3_ , LH2_ , RH2_)	02/77→11/82	12R	Petrol	1587	4	8	51
Hiace I Wagon (LH1_ , RH1_ , LH3_ , RH3_ , LH2_ , RH2_)	09/79→10/82	L	Diesel	2188	4	8	105
Hiace II Box (LH5_ , YH7_ , LH7_ , LH6_ , YH6_ , YH5_)	03/83→11/89	2Y	Petrol	1812	4	8	59
Hiace II Box (LH5_ , YH7_ , LH7_ , LH6_ , YH6_ , YH5_)	03/83→11/89	L	Diesel	2188	4	8	105
Hiace II Box (LH5_ , YH7_ , LH7_ , LH6_ , YH6_ , YH5_)	01/84→11/89	3Y	Petrol	1998	4	8	91
Hiace II Box (LH5_ , YH7_ , LH7_ , LH6_ , YH6_ , YH5_)	04/84→11/89	2L	Diesel	2446	4	8	111
Hiace II Box (LH5_ , YH7_ , LH7_ , LH6_ , YH6_ , YH5_)	08/87→08/89	4Y-EC	Petrol	2237	4	8	102
Hiace II Box (LH5_ , YH7_ , LH7_ , LH6_ , YH6_ , YH5_)	09/87→08/89	4Y	Petrol	2237	4	8	102
Hiace II Wagon (LH7_ , LH5_ , LH6_ , YH7_ , YH6_ , YH5_)	12/82→07/88	4Y-EC	Petrol	2237	4	8	102
Hiace II Wagon (LH7_ , LH5_ , LH6_ , YH7_ , YH6_ , YH5_)	03/83→11/89	2Y	Petrol	1812	4	8	59
Hiace II Wagon (LH7_ , LH5_ , LH6_ , YH7_ , YH6_ , YH5_)	03/83→11/89	L	Diesel	2188	4	8	105
Hiace II Wagon (LH7_ , LH5_ , LH6_ , YH7_ , YH6_ , YH5_)	08/84→08/89	2L	Diesel	2446	4	8	111
Hiace II Wagon (LH7_ , LH5_ , LH6_ , YH7_ , YH6_ , YH5_)	01/85→08/89	3Y	Petrol	1998	4	8	91
Hiace II Wagon (LH7_ , LH5_ , LH6_ , YH7_ , YH6_ , YH5_)	08/86→08/89	4Y	Petrol	2237	4	8	102
Hiace III Box (YH7_ , LH6_ , LH7_ , LH5_ , YH5_ , YH6_)	08/89→08/95	2RZ-E	Petrol	2438	4	8	114
Hiace III Box (YH7_ , LH6_ , LH7_ , LH5_ , YH5_ , YH6_)	08/89→10/96	2RZ	Petrol	2438	4	8	114
Hiace III Box (YH7_ , LH6_ , LH7_ , LH5_ , YH5_ , YH6_)	08/89→07/99	2L	Diesel	2446	4	8	111
Hiace III Box (YH7_ , LH6_ , LH7_ , LH5_ , YH5_ , YH6_)	08/89→08/00	3L	Diesel	2779	4	8	126
Hiace III Box (YH7_ , LH6_ , LH7_ , LH5_ , YH5_ , YH6_)	02/90→08/95	1RZ	Petrol	1998	4	8	78
Hiace III Box (YH7_ , LH6_ , LH7_ , LH5_ , YH5_ , YH6_)	06/92→12/04	4Y	Petrol	2237	4	8	102
Hiace III Box (YH7_ , LH6_ , LH7_ , LH5_ , YH5_ , YH6_)	08/96→06/99	1KZ-T	Diesel	2982	4	8	129
Hiace III Box (YH7_ , LH6_ , LH7_ , LH5_ , YH5_ , YH6_)	11/96→10/00	1RZ-E	Petrol	1998	4	8	78
Hiace III Box (YH7_ , LH6_ , LH7_ , LH5_ , YH5_ , YH6_)	08/98→08/04	5L	Diesel	2986	4	8	135
Hiace III Wagon (_H1_)	08/87→12/04	2L	Diesel	2446	4	8	111
Hiace III Wagon (_H1_)	08/89→10/96	2RZ	Petrol	2438	4	8	114
Hiace III Wagon (_H1_)	08/89→04/98	1RZ	Petrol	1998	4	8	78
Hiace III Wagon (_H1_)	08/89→08/00	3L	Diesel	2779	4	8	126

				CC			9
Hiace III Wagon (_H1_)	08/89→08/04	2RZ-E	Petrol	2438	4	8	114
Hiace III Wagon (_H1_)	01/92→08/95	4Y	Petrol	2237	4	8	102
Hiace III Wagon (_H1_)	08/93→08/04	1KZ-TE	Diesel	2982	4	8	129
Hiace III Wagon (_H1_)	08/95→08/01	5VZ-FE	Petrol	3378	6	24	145
Hiace III Wagon (_H1_)	11/96→10/00	1RZ-E	Petrol	1998	4	8	78
Hiace III Wagon (_H1_)	08/98→08/04	5L	Diesel	2986	4	8	135
Hiace III Wagon (_H1_)	08/01→08/04	2KD-FTV	Diesel	2494	4	16	119
Hiace III Wagon (LH1_ , RZH1_)	09/89→08/95	2L	Diesel	2446	4	8	111
Hiace IV Box (LXH1_ , RZH1_ , LH1_)	08/95→02/05	2RZ-E	Petrol	2438	4	8	114
Hiace IV Box (LXH1_ , RZH1_ , LH1_)	08/95→08/06	2L	Diesel	2446	4	8	111
Hiace IV Box (LXH1_ , RZH1_ , LH1_)	08/95→08/06	2L-T	Diesel	2446	4	8	111
Hiace IV Box (LXH1_ , RZH1_ , LH1_)	04/98→	3RZ-FE	Petrol	2694	4	16	125
Hiace IV Box (LXH1_ , RZH1_ , LH1_)	08/01→	2KD-FTV	Diesel	2494	4	16	119
Hiace IV Box (TRH2_ , KDH2_)	01/05→	1KD-FTV	Diesel	2982	4	16	128
Hiace IV Bus (_H1_ , _H2_)	08/95→04/98	2RZ-E	Petrol	2438	4	8	114
Hiace IV Bus (_H1_ , _H2_)	08/95→08/06	2L	Diesel	2446	4	8	111
Hiace IV Bus (_H1_ , _H2_)	08/95→08/06	2L-T	Diesel	2446	4	8	111
Hiace IV Bus (_H1_ , _H2_)	04/98→	3RZ-FE	Petrol	2694	4	16	125
Hiace IV Bus (_H1_ , _H2_)	08/01→	2KD-FTV	Diesel	2494	4	16	119
Hiace IV Wagon (TRH2_ , KDH2_)	01/05→	1KD-FTV	Diesel	2982	4	16	128
Hiace V Box (TRH2_ , KDH2_)	01/05→	1KD-FTV	Diesel	2982	4	16	128
Hiace V Box (TRH2_ , KDH2_)	01/05→	5L	Diesel	2986	4	8	135
Hiace V Box (TRH2_ , KDH2_)	09/06→	2KD-FTV	Diesel	2494	4	16	119
Hiace Pickup	02/77→11/82	12R	Petrol	1587	4	8	51
Hiace Pickup	01/79→07/85	L	Diesel	2188	4	8	105
Highlander (ASU4_ , GSU4_)	05/09→12/12	1AR-FE	Petrol	2672	4	16	124
Highlander (ASU4_ , GSU4_)	05/09→12/15	2GR-FE	Petrol	3456	6	24	149
Highlander (ASU5_ , GSU5_)	03/15→	2GR-FE	Petrol	3456	6	24	149
Hilux Closed Off-Road Vehicle (LN_ , KZNI_ , VZNI_)	08/88→08/97	2L-T	Diesel	2446	4	8	111
Hilux Closed Off-Road Vehicle (LN_ , KZNI_ , VZNI_)	08/89→11/95	2L-TE	Diesel	2446	4	8	112
Hilux Closed Off-Road Vehicle (LN_ , KZNI_ , VZNI_)	08/89→11/95	3VZ-E	Petrol	2959	6	12	133
Hilux Closed Off-Road Vehicle (LN_ , KZNI_ , VZNI_)	08/93→07/97	1KZ-T	Diesel	2982	4	8	129
Hilux Closed Off-Road Vehicle (LN_ , KZNI_ , VZNI_)	08/93→07/97	1KZ-TE	Diesel	2982	4	8	129
Hilux Closed Off-Road Vehicle (_N1_)	08/95→08/98	3L	Diesel	2779	4	8	126
Hilux Closed Off-Road Vehicle (_N1_)	11/95→07/04	5VZ-FE	Petrol	3378	6	24	145
Hilux Closed Off-Road Vehicle (_N1_)	01/02→02/05	5L	Diesel	2986	4	8	135
Hilux Closed Off-Road Vehicle (_N1_)	01/02→02/05	5L-E	Diesel	2986	4	8	135
Hilux Closed Off-Road Vehicle (RZNI_ , LN1_)	11/95→07/00	5VZ-FE	Petrol	3378	6	24	145
Hilux Closed Off-Road Vehicle (RZNI_ , LN1_)	08/97→07/01	2L-T	Diesel	2446	4	8	111
Hilux Closed Off-Road Vehicle (RZNI_ , LN1_)	08/01→07/04	3RZ-FE	Petrol	2694	4	16	125
Hilux Closed Off-Road Vehicle (ZNI3_ , LN9_ , RN1_ , YN8_ , LN8_)	08/89→11/95	3VZ-E	Petrol	2959	6	12	133
Hilux Closed Off-Road Vehicle (ZNI3_ , LN9_ , RN1_ , YN8_ , LN8_)	08/93→07/97	1KZ-T	Diesel	2982	4	8	129
Hilux I Pickup (_N1_)	05/68→05/72	2R	Petrol	1490	4	8	29
Hilux I Pickup (_N1_)	02/71→05/72	12R	Petrol	1587	4	8	51
Hilux II Pickup (_N2_)	05/72→12/74	18R	Petrol	1968	4	8	98
Hilux II Pickup (_N2_)	05/72→07/78	12R	Petrol	1587	4	8	51
Hilux II Pickup (_N2_)	04/74→06/78	20R	Petrol	2189	4	8	104
Hilux II Pickup (RN6_ , RN5_ , LN6_ , YN6_ , YN5_ , LN5_)	10/88→12/97	3L	Diesel	2779	4	8	126
Hilux II Pickup (RN6_ , RN5_ , LN6_ , YN6_ , YN5_ , LN5_)	10/88→12/97	22R	Petrol	2367	4	8	116
Hilux II Pickup (RN6_ , RN5_ , LN6_ , YN6_ , YN5_ , LN5_)	08/94→07/00	3RZ-FE	Petrol	2694	4	16	125
Hilux II Pickup (RN6_ , RN5_ , LN6_ , YN6_ , YN5_ , LN5_)	11/97→10/02	1RZ-E	Petrol	1998	4	8	78
Hilux II Pickup (RN6_ , RN5_ , LN6_ , YN6_ , YN5_ , LN5_)	11/97→04/05	5L	Diesel	2986	4	8	135
Hilux II Pickup (RN6_ , RN5_ , LN6_ , YN6_ , YN5_ , LN5_)	08/01→07/05	5VZ-FE	Petrol	3378	6	24	145
Hilux II Platform/Chassis (LN6_ , LN5_ , YN6_ , YN5_ , VZNI_ , RZ)	08/88→08/97	3L	Diesel	2779	4	8	126
Hilux II Platform/Chassis (LN6_ , LN5_ , YN6_ , YN5_ , VZNI_ , RZ)	10/88→12/97	22R	Petrol	2367	4	8	116
Hilux II Platform/Chassis (LN6_ , LN5_ , YN6_ , YN5_ , VZNI_ , RZ)	08/97→07/05	1RZ-E	Petrol	1998	4	8	78
Hilux II Platform/Chassis (LN6_ , LN5_ , YN6_ , YN5_ , VZNI_ , RZ)	08/97→08/05	1KZ-T	Diesel	2982	4	8	129
Hilux II Platform/Chassis (LN6_ , LN5_ , YN6_ , YN5_ , VZNI_ , RZ)	08/97→08/05	5L-E	Diesel	2986	4	8	135
Hilux III Pickup (_N3_ , _N4_)	08/78→07/83	12R	Petrol	1587	4	8	51
Hilux III Pickup (_N3_ , _N4_)	01/79→06/83	22R	Petrol	2367	4	8	116
Hilux III Pickup (_N3_ , _N4_)	01/79→03/84	18R	Petrol	1968	4	8	98
Hilux III Pickup (_N3_ , _N4_)	05/79→03/84	L	Diesel	2188	4	8	105
Hilux III Pickup (TGN1_ , GGN2_ , GGN1_ , KUN2_ , KUN1_)	10/06→	1KD-FTV	Diesel	2982	4	16	128
Hilux III Platform/Chassis (KUN1_ , TGN3_ , TGN2_ , TGN1_ , KUN2)	02/05→	1GR-FE	Petrol	3956	6	24	152
Hilux III Platform/Chassis (KUN1_ , TGN3_ , TGN2_ , TGN1_ , KUN2)	02/05→	1KD-FTV	Diesel	2982	4	16	128
Hilux IV Pickup (_N5_ , _N6_)	08/83→08/84	L	Diesel	2188	4	8	105
Hilux IV Pickup (_N5_ , _N6_)	08/83→12/88	2Y	Petrol	1812	4	8	59
Hilux IV Pickup (_N5_ , _N6_)	08/83→12/88	2Y-C	Petrol	1812	4	8	59
Hilux IV Pickup (_N5_ , _N6_)	08/83→03/89	4Y	Petrol	2237	4	8	102
Hilux IV Pickup (_N5_ , _N6_)	08/83→03/89	22R	Petrol	2367	4	8	116
Hilux IV Pickup (_N5_ , _N6_)	09/83→12/84	22REC	Petrol	2367	4	8	116
Hilux IV Pickup (_N5_ , _N6_)	11/83→09/87	1Y	Petrol	1626	4	8	40
Hilux IV Pickup (_N5_ , _N6_)	01/84→12/88	2L	Diesel	2446	4	8	111
Hilux IV Pickup (_N5_ , _N6_)	01/84→12/88	3Y	Petrol	1998	4	8	91
Hilux IV Pickup (_N5_ , _N6_)	09/84→12/88	22RTEC	Petrol	2367	4	8	114
Hilux IV Pickup (_N5_ , _N6_)	01/85→12/88	3Y-C	Petrol	1998	4	8	91
Hilux V Pickup (_N_ , KZNI_ , VZNI_)	09/88→08/97	2L-T	Diesel	2446	4	8	111
Hilux V Pickup (_N_ , KZNI_ , VZNI_)	09/88→08/97	3VZ-E	Petrol	2959	6	12	133











CC



9

Hilux V Pickup (_N_ , KZN1_ , VZN1_)	09/88→06/98	2L	Diesel	2446	4	8	111
Hilux V Pickup (_N_ , KZN1_ , VZN1_)	09/88→06/98	2Y	Petrol	1812	4	8	59
Hilux V Pickup (_N_ , KZN1_ , VZN1_)	01/89→07/97	22RE	Petrol	2367	4	8	114
Hilux V Pickup (_N_ , KZN1_ , VZN1_)	03/89→07/94	4Y	Petrol	2237	4	8	102
Hilux V Pickup (_N_ , KZN1_ , VZN1_)	08/93→11/95	1KZ-T	Diesel	2982	4	8	129
Hilux V Pickup (_N_ , KZN1_ , VZN1_)	08/93→11/95	1KZ-TE	Diesel	2982	4	8	129
Hilux V Pickup (_N_ , KZN1_ , VZN1_)	11/93→09/96	18R	Petrol	1968	4	8	98
Hilux V Pickup (_N_ , KZN1_ , VZN1_)	01/95→08/98	3L	Diesel	2779	4	8	126
Hilux VI Pickup (_N1_)	08/97→06/05	1KZ-TE	Diesel	2982	4	8	129
Hilux VI Pickup (_N1_)	08/97→07/05	1RZ-E	Petrol	1998	4	8	78
Hilux VI Pickup (_N1_)	08/97→07/05	3L	Diesel	2779	4	8	126
Hilux VI Pickup (_N1_)	08/97→07/05	5VZ-FE	Petrol	3378	6	24	145
Hilux VI Pickup (_N1_)	08/97→10/05	2RZ-FE	Petrol	2438	4	16	115
Hilux VI Pickup (_N1_)	08/97→02/06	2L	Diesel	2446	4	8	111
Hilux VI Pickup (_N1_)	11/97→04/05	3RZ-FE	Petrol	2694	4	16	125
Hilux VI Pickup (_N1_)	08/98→01/02	2L-T	Diesel	2446	4	8	111
Hilux VI Pickup (_N1_)	01/00→04/05	1KZ-T	Diesel	2982	4	8	129
Hilux VI Pickup (_N1_)	12/00→04/05	5L-E	Diesel	2986	4	8	135
Hilux VI Pickup (_N1_)	01/01→07/05	1RZ	Petrol	1998	4	8	78
Hilux VI Pickup (_N1_)	08/01→07/05	3VZ-E	Petrol	2959	6	12	133
Hilux VI Pickup (_N1_)	10/01→07/05	5L	Diesel	2986	4	8	135
Hilux VI Pickup (_N1_)	11/01→07/05	2KD-FTV	Diesel	2494	4	16	119
Hilux VII Pickup (_N1_ , _N2_ , _N3_)	11/04→	1KD-FTV	Diesel	2982	4	16	128
Hilux VII Pickup (_N1_ , _N2_ , _N3_)	11/04→	2KD-FTV	Diesel	2494	4	16	119
Hilux VII Pickup (_N1_ , _N2_ , _N3_)	07/05→	5L-E	Diesel	2986	4	8	135
Hilux VII Pickup (_N1_ , _N2_ , _N3_)	08/05→	1GR-FE	Petrol	3956	6	24	152
Hilux VIII Pickup (_N1_)	05/15→	2KD-FTV	Diesel	2494	4	16	119
Hilux VIII Pickup (_N1_)	05/15→	5L-E	Diesel	2986	4	8	135
Hilux VIII Pickup (_N1_)	07/15→	1GR-FE	Petrol	3956	6	24	152
Hilux VIII Pickup (_N1_)	08/15→	1KD-FTV	Diesel	2982	4	16	128
Hilux Platform/Chassis (LN_ , _N1_)	08/83→07/88	2Y	Petrol	1812	4	8	59
Hilux Platform/Chassis (LN_ , _N1_)	09/83→12/93	22REC	Petrol	2367	4	8	116
Hilux Platform/Chassis (LN_ , _N1_)	01/84→08/88	2L	Diesel	2446	4	8	111
Hilux Platform/Chassis (LN_ , _N1_)	09/84→12/88	22RTEC	Petrol	2367	4	8	114
Hilux Platform/Chassis (LN_ , _N1_)	09/84→12/93	22RE	Petrol	2367	4	8	114
Hilux Platform/Chassis (LN_ , _N1_)	09/87→12/93	3VZ-E	Petrol	2959	6	12	133
Hilux Platform/Chassis (LN_ , _N1_)	08/97→08/05	3RZ-FE	Petrol	2694	4	16	125
HS (ANF10)	07/09→	2AZ-FXE	Petrol	2362	4	16	107
Mark II Estate	11/83→03/88	2S-EL	Petrol	1995	4	8	82
Mark II Estate	04/88→09/96	2L	Diesel	2446	4	8	111
Mark II Estate	04/88→06/07	1G-FE	Petrol	1988	6	24	76
Mark II Estate	10/92→09/96	2L-TII	Diesel	2446	4	8	113
Mark II Estate	08/96→07/01	2JZ-GE	Petrol	2997	6	24	131
Mark II Estate	08/96→07/01	2MZ-FE	Petrol	2496	6	24	120
Mark II Estate	08/96→07/01	5S-FE	Petrol	2164	4	16	103
Mark II Estate	01/02→12/04	1JZ-FSE	Petrol	2491	6	24	117
Mark II Estate	01/02→06/07	1JZ-GE	Petrol	2491	6	24	117
Mark II Estate	01/02→06/07	1JZ-GTE	Petrol	2491	6	24	117
Mark II Saloon	08/80→10/83	L	Diesel	2188	4	8	105
Mark II Saloon	08/81→03/88	2L-TII	Diesel	2446	4	8	113
Mark II Saloon	08/82→10/83	1S-U	Petrol	1832	4	8	56
Mark II Saloon	11/83→03/88	1S-L	Petrol	1832	4	8	55
Mark II Saloon	11/83→03/88	2S-EL	Petrol	1995	4	8	82
Mark II Saloon	11/84→09/96	2L-TE	Diesel	2446	4	8	112
Mark II Saloon	04/88→09/92	1G-GE	Petrol	1988	6	24	77
Mark II Saloon	04/88→09/92	4S-FI	Petrol	1838	4	16	66
Mark II Saloon	04/88→09/01	1G-FE	Petrol	1988	6	24	76
Mark II Saloon	10/92→09/96	1JZ-GE	Petrol	2491	6	24	117
Mark II Saloon	10/92→09/96	4S-FE	Petrol	1838	4	16	65
Mark II Saloon	10/92→09/01	1JZ-GTE	Petrol	2491	6	24	117
Mark II Saloon	10/92→09/01	2JZ-GE	Petrol	2997	6	24	131
Mark II Saloon (_X10_)	09/96→09/00	1JZ-GE	Petrol	2491	6	24	117
Mark II Saloon (_X10_)	08/98→10/00	1G-FE	Petrol	1988	6	24	76
Mark II Saloon (_X11_)	10/02→11/04	1JZ-GE	Petrol	2491	6	24	117
Innova I (_N4_)	07/03→	5L-E	Diesel	2986	4	8	135
Innova I (_N4_)	08/04→	2L	Diesel	2446	4	8	111
IQ (_J1_)	01/09→	1KR-FE	Petrol	998	3	12	4
IQ (_J1_)	01/09→	1ND-TV	Diesel	1364	4	8	22
IQ (_J1_)	01/09→	1NR-FE	Petrol	1329	4	16	11
IQ (KGJ1_ , NGJ1_)	01/09→	1NR-FE	Petrol	1329	4	16	11
IS C (GSE2_)	04/09→	2GR-FSE	Petrol	3456	6	24	149
IS C (GSE2_)	11/10→	3GR-FE	Petrol	2995	6	24	132
IS I (JCE1_ , GXE1_)	04/99→07/05	1G-FE	Petrol	1988	6	24	76
IS I (JCE1_ , GXE1_)	09/00→07/05	2JZ-GE	Petrol	2997	6	24	131
IS II (GSE2_ , ALE2_ , USE2_)	10/05→03/13	2AD-FHV	Diesel	2231	4	16	100
IS II (GSE2_ , ALE2_ , USE2_)	10/05→03/13	2GR-FSE	Petrol	3456	6	24	149
IS II (GSE2_ , ALE2_ , USE2_)	08/08→03/13	3GR-FE	Petrol	2995	6	24	132
IS II (GSE2_ , ALE2_ , USE2_)	07/10→03/13	2AD-FTV	Diesel	2231	4	16	100

							
IS III (_E3_)	04/13→	2AR-FSE	Petrol	2494	4	16	118
IS III (_E3_)	04/13→	2GR-FSE	Petrol	3456	6	24	149
Isis (_M1_)	06/12→	3ZR-FAE	Petrol	1987	4	16	94
Isis (ZNM1_ , ANM1_ , ZGM1_)	07/04→	1AZ-FSE	Petrol	1998	4	16	73
Isis (ZNM1_ , ANM1_ , ZGM1_)	07/04→	1ZZ-FE	Petrol	1794	4	16	57
Isis (ZNM1_ , ANM1_ , ZGM1_)	04/07→	2ZR-FAE	Petrol	1798	4	16	60
Isis (ZNM1_ , ANM1_ , ZGM1_)	04/07→	3ZR-FAE	Petrol	1987	4	16	94
IS SportCross	10/01→10/05	2JZ-GE	Petrol	2997	6	24	131
IS SportCross	10/02→10/05	1G-FE	Petrol	1988	6	24	76
IST (NCP6_)	05/02→07/07	1NZ-FE	Petrol	1497	4	16	27
IST (NCP6_)	05/02→07/07	2NZ-FE	Petrol	1299	4	16	12
Kijang Bus (_F5_)	08/91→08/04	7K	Petrol	1781	4	8	68
Kijang Bus (_F5_)	01/95→12/00	2L	Diesel	2446	4	8	111
Kijang Bus (_F5_)	01/95→12/00	4Y-EC	Petrol	2237	4	8	102
Kijang Bus (_F5_)	01/95→12/01	2Y	Petrol	1812	4	8	59
Kijang Bus (_F5_)	04/99→06/03	2RZ-E	Petrol	2438	4	8	114
Kijang Bus (_F5_)	08/99→08/04	1RZ	Petrol	1998	4	8	78
Kijang Innova (TGN4_ , KUN4_)	08/04→	2KD-FTV	Diesel	2494	4	16	119
Kluger (_MCU2_ , _ACU2_)	06/00→05/07	1MZ-FE	Petrol	2995	6	24	130
Kluger (_MCU2_ , _ACU2_)	06/00→05/07	2AZ-FE	Petrol	2362	4	16	108
Kluger (_MCU2_ , _ACU2_)	10/03→05/07	3MZ-FE	Petrol	3311	6	24	143
Kluger (_MHU4_ , _GSU4_ , _ASU4_)	05/07→	1AR-FE	Petrol	2672	4	16	123
Kluger (_MHU4_ , _GSU4_ , _ASU4_)	05/07→	2GR-FE	Petrol	3456	6	24	149
Kluger (_U3_)	09/00→05/07	2AZ-FE	Petrol	2362	4	16	108
Kluger (_U3_)	08/03→05/07	3MZ-FE	Petrol	3311	6	24	143
Kluger (_U4_)	05/07→	2GR-FE	Petrol	3456	6	24	149
Kluger (_U4_)	09/07→12/10	3MZ-FE	Petrol	3311	6	24	143
Kluger (_U4_)	09/08→12/13	1AR-FE	Petrol	2672	4	16	123
Kluger (_U5_)	03/13→	1AR-FE	Petrol	2672	4	16	123
Kluger (_U5_)	09/13→	2GR-FE	Petrol	3456	6	24	149
Kluger (_U5_)	09/13→	2GR-FXE	Petrol	3456	6	24	149
Land Cruiser (_J4_ , _J5_)	01/69→01/75	F	Petrol	3878	6	12	151
Land Cruiser (_J4_ , _J5_)	03/69→10/84	B	Diesel	2977	4	8	140
Land Cruiser (_J4_ , _J5_)	09/74→04/86	2F	Petrol	4230	6	12	160
Land Cruiser (_J4_ , _J5_)	04/79→07/80	H	Diesel	3576	6	12	150
Land Cruiser (_J4_ , _J5_)	08/80→10/84	2H	Diesel	3980	6	12	155
Land Cruiser (_J4_ , _J5_)	08/80→10/84	3B	Diesel	3432	4	8	144
Land Cruiser (_J6_)	10/81→01/88	2F	Petrol	4230	6	12	160
Land Cruiser (_J6_)	10/81→01/88	2H	Diesel	3980	6	12	155
Land Cruiser (_J6_)	10/81→12/89	3B	Diesel	3432	4	8	144
Land Cruiser (_J6_)	11/84→08/87	3F	Petrol	3956	6	12	156
Land Cruiser (_J6_)	10/85→12/89	12HT	Diesel	3980	6	12	157
Land Cruiser (_J7_)	11/84→10/85	2L	Diesel	2446	4	8	111
Land Cruiser (_J7_)	11/84→05/93	22R	Petrol	2367	4	8	116
Land Cruiser (_J7_)	11/84→12/96	3B	Diesel	3432	4	8	144
Land Cruiser (_J7_)	01/85→10/92	3F	Petrol	3956	6	12	156
Land Cruiser (_J7_)	10/85→08/86	13BT	Diesel	3431	4	8	147
Land Cruiser (_J7_)	10/85→05/93	2L-T	Diesel	2446	4	8	111
Land Cruiser (_J7_)	12/88→12/96	22RE	Petrol	2367	4	8	114
Land Cruiser (_J7_)	01/90→12/94	1PZ	Diesel	3470	5	10	148
Land Cruiser (_J7_)	01/90→08/01	1H-Z	Diesel	4164	6	12	159
Land Cruiser (_J7_)	05/93→05/96	1KZ-T	Diesel	2982	4	8	129
Land Cruiser (_J7_)	01/97→08/01	12HT	Diesel	3980	6	12	157
Land Cruiser (_J7_)	09/01→06/06	1HD-FTE	Diesel	4164	6	24	158
Land Cruiser (_J7_)	11/01→02/07	1HD-FE	Diesel	4164	6	24	158
Land Cruiser (_J7_)	03/07→	1GR-FE	Petrol	3956	6	24	152
Land Cruiser (_J15_)	07/09→	5L-E	Diesel	2986	4	8	135
Land Cruiser (_J15_)	08/09→	1GR-FE	Petrol	3956	6	24	152
Land Cruiser (_J15_)	08/09→	1KD-FTV	Diesel	2982	4	16	128
Land Cruiser (LJ12_ , KDJ12_ , KZJ12_ , GRJ12_ , TRJ12_)	09/02→08/04	3RZ-FE	Petrol	2694	4	16	125
Land Cruiser (PZJ7_ , KZJ7_ , HZJ7_ , BJ7_ , LJ7_ , RJ7_)	08/87→12/89	2H	Diesel	3980	6	12	155
Land Cruiser (PZJ7_ , KZJ7_ , HZJ7_ , BJ7_ , LJ7_ , RJ7_)	01/90→08/01	3L	Diesel	2779	4	8	126
Land Cruiser (PZJ7_ , KZJ7_ , HZJ7_ , BJ7_ , LJ7_ , RJ7_)	03/07→	1VD-FTV	Diesel	4461	8	32	162
Land Cruiser (VDJ20_ , UZJ20_)	01/10→	1GR-FE	Petrol	3956	6	24	152
Land Cruiser (VDJ20_ , UZJ20_)	09/10→	1UR-FE	Petrol	4608	8	32	163
Land Cruiser 80 (_J8_)	01/90→09/91	1KZ-T	Diesel	2982	4	8	129
Land Cruiser 80 (_J8_)	01/90→08/92	1PZ	Diesel	3470	5	10	148
Land Cruiser 80 (_J8_)	01/90→05/93	22R	Petrol	2367	4	8	116
Land Cruiser 80 (_J8_)	01/90→12/97	1HD-T	Diesel	4164	6	12	159
Land Cruiser 80 (_J8_)	01/90→12/97	1H-Z	Diesel	4164	6	12	159
Land Cruiser 80 (_J8_)	03/95→12/97	1HD-FE	Diesel	4164	6	24	158
Land Cruiser 90 (_J9_)	04/95→07/02	3RZ-FE	Petrol	2694	4	16	125
Land Cruiser 90 (_J9_)	04/95→12/02	1KZ-TE	Diesel	2982	4	8	129
Land Cruiser 90 (_J9_)	03/96→12/02	5VZ-FE	Petrol	3378	6	24	145
Land Cruiser 90 (_J9_)	08/99→08/01	1H-Z	Diesel	4164	6	12	159
Land Cruiser 90 (_J9_)	02/00→	1KD-FTV	Diesel	2982	4	16	128
Land Cruiser 100 (_J1_)	01/98→08/07	1HD-FTE	Diesel	4164	6	24	158
Land Cruiser 100 (_J1_)	03/98→08/07	1H-Z	Diesel	4164	6	12	159











CC



9

Land Cruiser 200 (_J2_)	08/07→	1VD-FTV	Diesel	4461	8	32	162
Land Cruiser 200 (_J2_)	01/12→	1GR-FE	Petrol	3956	6	24	152
Land Cruiser 200 (_J2_)	01/12→	1UR-FE	Petrol	4608	8	32	163
Land Cruiser 200 (_J2_)	05/15→	1H-Z	Diesel	4164	6	12	159
Land Cruiser 300 (_J12_)	09/02→08/04	5VZ-FE	Petrol	3378	6	24	145
Land Cruiser 300 (_J12_)	09/02→07/09	1GR-FE	Petrol	3956	6	24	152
Land Cruiser 300 (_J12_)	09/02→07/09	1KD-FTV	Diesel	2982	4	16	128
Land Cruiser 300 (_J12_)	09/02→07/09	1KZ-TE	Diesel	2982	4	8	129
Land Cruiser 300 (_J12_)	09/02→07/09	5L-E	Diesel	2986	4	8	135
Land Cruiser 300 (_J12_)	02/05→07/09	1VD-FTV	Diesel	4461	8	32	162
Land Cruiser Hardtop (_J7_)	07/90→07/92	1H-Z	Diesel	4164	6	12	159
Land Cruiser Hardtop (_J7_)	07/90→05/96	2L-T	Diesel	2446	4	8	111
Land Cruiser Hardtop (_J7_)	05/93→05/96	1KZ-T	Diesel	2982	4	8	129
Land Cruiser Pickup (_J4_)	03/69→01/75	F	Petrol	3878	6	12	151
Land Cruiser Pickup (_J4_)	01/75→07/80	H	Diesel	3576	6	12	150
Land Cruiser Pickup (_J4_)	01/75→04/86	2F	Petrol	4230	6	12	160
Land Cruiser Pickup (_J4_)	08/80→10/84	2H	Diesel	3980	6	12	155
Land Cruiser Pickup (_J4_)	08/80→10/84	3B	Diesel	3432	4	8	144
Land Cruiser Pickup (_J7_)	01/85→03/90	2H	Diesel	3980	6	12	155
Land Cruiser Pickup (_J7_)	01/90→	1H-Z	Diesel	4164	6	12	159
Land Cruiser Pickup (_J7_)	11/01→02/07	1HD-FT	Diesel	4164	6	24	158
Land Cruiser Pickup (_J7_)	03/07→	1GR-FE	Petrol	3956	6	24	152
Land Cruiser Pickup (_J7_)	03/07→	1VD-FTV	Diesel	4461	8	32	162
Land Cruiser Softtop	01/60→12/68	F	Petrol	3878	6	12	151
Levin (ZRE18_, ZWE18_)	07/14→	1ZR	Petrol	1598	4	16	41
Levin (ZRE18_, ZWE18_)	07/14→	4ZR	Petrol	1598	4	16	41
Levin (ZRE18_, ZWE18_)	07/14→	7ZR	Petrol	1798	4	16	60
Lexcen (VN, VP)	08/87→07/93	C 30 NE	Petrol	2969	6	12	141
Liteace Box (CM3_V, KM3_V)	10/85→07/88	1C	Diesel	1840	4	8	52
Liteace Box (CM3_V, KM3_V)	10/85→07/88	3Y	Petrol	1998	4	8	91
Liteace Box (CM3_V, KM3_V)	08/88→07/89	3Y-C	Petrol	1998	4	8	91
Liteace Box (KM2_)	10/79→10/86	4K	Petrol	1290	4	8	19
Liteace Box (KM2_)	10/79→10/86	4K-C	Petrol	1290	4	8	19
Liteace Box (KM2_)	10/82→09/85	1C	Diesel	1840	4	8	52
Liteace Box (_M3_)	01/84→12/92	2Y	Petrol	1812	4	8	59
Liteace Box (_M3_)	09/85→03/98	5K	Petrol	1486	4	8	38
Liteace Box (_M3_)	10/85→08/88	1C	Diesel	1840	4	8	52
Liteace Box (_M3_)	03/86→09/88	3Y	Petrol	1998	4	8	91
Liteace Box (_M3_)	09/87→12/88	4Y-EC	Petrol	2237	4	8	102
Liteace Box (_M3_)	08/88→01/92	2C	Diesel	1975	4	8	79
Liteace Box (_R2_V)	01/92→05/94	2C	Diesel	1975	4	8	79
Liteace Box (_R2_V)	01/92→01/95	4Y-EC	Petrol	2237	4	8	102
Liteace Box (_R2_V)	01/92→01/95	5K	Petrol	1486	4	8	38
Liteace Box (S4_)	01/08→	3SZ-VE	Petrol	1495	4	16	34
Liteace Bus	10/97→08/01	1ZZ-FE	Petrol	1794	4	16	57
Liteace Bus	10/97→08/01	3S-FSE	Petrol	1998	4	16	87
Liteace Bus	01/98→08/02	3S-FE	Petrol	1998	4	16	86
Liteace Bus (CM30_G, KM30_G)	10/85→07/88	1C	Diesel	1840	4	8	52
Liteace Bus (CM30_G, KM30_G)	10/85→07/88	3Y	Petrol	1998	4	8	91
Liteace Bus (CM30_G, KM30_G)	08/88→07/89	3Y-C	Petrol	1998	4	8	91
Liteace Bus (_M3_)	10/85→07/88	2Y	Petrol	1812	4	8	59
Liteace Bus (_M3_)	10/85→07/88	2Y-C	Petrol	1812	4	8	59
Liteace Bus (_M3_)	10/85→01/92	2C	Diesel	1975	4	8	79
Liteace Bus (_M3_)	10/85→01/92	5K	Petrol	1486	4	8	38
Liteace Bus (_R2_LG)	01/92→05/94	2C	Diesel	1975	4	8	79
Liteace Bus (_R2_LG)	01/92→01/95	4Y-EC	Petrol	2237	4	8	102
Liteace Bus (_R2_LG)	01/92→01/95	5K	Petrol	1486	4	8	38
Liteace Bus (_R2_LG)	02/95→08/97	3C-TE	Diesel	2184	4	8	101
Liteace Bus (S4_)	01/10→	3SZ-VE	Petrol	1495	4	16	34
Liteace Platform/Chassis (S4_U)	01/08→	3SZ-VE	Petrol	1495	4	16	34
Liteace Wagon (YM2_, CM2_, KM2_)	10/79→09/85	4K	Petrol	1290	4	8	19
Liteace Wagon (YM2_, CM2_, KM2_)	10/82→09/85	1C	Diesel	1840	4	8	52
LS (_F1_)	09/89→12/95	1UZ-FE	Petrol	3969	8	32	153
LS (_F2_)	10/94→10/00	1UZ-FE	Petrol	3969	8	32	153
LS (_F3_)	10/00→08/06	3UZ-FE	Petrol	4293	8	32	161
LS (_F4_)	04/06→	1UR-FSE	Petrol	4608	8	32	163
LS (_F4_)	05/08→	1UR-FE	Petrol	4608	8	32	163
LS (UCF20)	10/97→07/00	1UZ-FE	Petrol	3969	8	32	153
LS (UVF4_, USF4_)	10/09→	1UR-FSE	Petrol	4608	8	32	163
LX (_J2_)	09/15→	1VD-FTV	Diesel	4461	8	32	162
LX (URJ201)	01/12→	1UR-FE	Petrol	4608	8	32	163
Majesta	09/99→08/03	1UZ-FE	Petrol	3969	8	32	154
Master Ace Surf Bus	02/85→08/90	2Y	Petrol	1812	4	8	59
Master Ace Surf Bus	02/85→08/90	3Y	Petrol	1998	4	8	91
Master Ace Surf Bus	02/85→10/93	2C	Diesel	1975	4	8	79
Master Ace Surf Bus	02/85→12/96	2C-T	Diesel	1975	4	8	80
Master Ace Surf Bus	02/85→08/99	3Y-EU	Petrol	1998	4	8	91
Master Ace Surf Bus	09/90→08/97	2Y-U	Petrol	1812	4	8	59

							
Matrix (_E13_)	01/02→12/06	2ZZ-GE	Petrol	1796	4	16	63
Matrix (_E13_)	01/02→12/07	1ZZ-FE	Petrol	1794	4	16	57
Matrix (_E14_)	01/08→05/14	2AZ-FE	Petrol	2362	4	16	108
Matrix (_E14_)	01/08→05/14	2ZR-FE	Petrol	1798	4	16	61
Modell F (CR2_ , YR2_)	11/82→07/86	2Y	Petrol	1812	4	8	59
Modell F (CR2_ , YR2_)	11/82→07/86	2Y-C	Petrol	1812	4	8	59
Modell F (CR2_ , YR2_)	08/84→08/88	3Y-C	Petrol	1998	4	8	91
Modell F (CR2_ , YR2_)	08/84→01/90	3Y	Petrol	1998	4	8	91
Modell F (CR2_ , YR2_)	04/85→08/88	2C	Diesel	1975	4	8	79
Modell F (CR2_ , YR2_)	08/85→01/90	4Y-EC	Petrol	2237	4	8	102
MR 2 I (AW1_)	06/84→11/89	4A-GELU	Petrol	1587	4	16	50
MR 2 I (AW1_)	09/84→06/90	4A-GELC	Petrol	1587	4	16	50
MR 2 I (AW1_)	11/84→06/90	4A-GEL	Petrol	1587	4	16	50
MR 2 I (AW1_)	08/86→12/89	4A-GZE	Petrol	1587	4	16	50
MR 2 II (SW2_)	12/89→08/92	3S-FE	Petrol	1998	4	16	86
MR 2 II (SW2_)	12/89→07/99	3S-GE	Petrol	1998	4	16	88
MR 2 II (SW2_)	12/89→07/99	3S-GTE	Petrol	1998	4	16	88
MR 2 II (SW2_)	09/90→12/95	5S-FE	Petrol	2164	4	16	103
MR 2 III (ZZW3_)	10/99→06/07	1ZZ-FE	Petrol	1794	4	16	57
Nadia	04/98→08/03	3S-FE	Petrol	1998	4	16	86
Nadia	04/98→08/03	3S-FSE	Petrol	1998	4	16	87
Nadia (SXN1_)	04/98→08/03	3S-FE	Petrol	1998	4	16	86
Noah/Voxy (_AZR6_)	12/01→06/07	1AZ-FSE	Petrol	1998	4	16	73
Noah/Voxy (_R7_)	06/07→09/13	3ZR-FE	Petrol	1987	4	16	94
Noah/Voxy (_R8_)	10/13→	2ZR-FXE	Petrol	1798	4	16	61
Noah/Voxy (_R8_)	10/13→	3ZR-FAE	Petrol	1987	4	16	94
Noah/Voxy (_ZRR7_)	06/07→	3ZR-FAE	Petrol	1987	4	16	94
NX (_Z1_)	07/14→	2AR-FXE	Petrol	2493	4	16	118
NX (_Z1_)	11/14→	3ZR-FAE	Petrol	1987	4	16	93
Opa (ZCT1_ , ACT1_)	04/00→08/03	1ZZ-FE	Petrol	1794	4	16	57
Opa (ZCT1_ , ACT1_)	08/00→04/05	1AZ-FSE	Petrol	1998	4	16	73
Origin (JCG1_)	08/00→03/01	2JZ-GE	Petrol	2997	6	24	131
Paseo Convertible (EL54_)	10/96→01/98	5E-FE	Petrol	1497	4	16	36
Paseo Coupe (EL44_)	06/88→08/95	5E-FE	Petrol	1497	4	16	36
Paseo Coupe (EL54_)	08/95→06/99	4E-FE	Petrol	1332	4	16	17
Paseo Coupe (EL54_)	08/95→06/99	5E-FE	Petrol	1497	4	16	36
Passo (M7_A)	04/16→	1KR-FE	Petrol	998	3	12	4
Passo (_NC1_ , _XC1_)	06/05→01/10	1KR-FE	Petrol	998	3	12	4
Passo (_NC1_ , _XC1_)	06/05→01/10	K3-VE	Petrol	1298	4	16	16
Passo (_NC1_ , _XC1_)	01/08→01/10	1NR-FE	Petrol	1329	4	16	11
Passo (_NGC3_ , _KGC3_)	02/10→	1KR-FE	Petrol	998	3	12	4
Passo (_NGC3_ , _KGC3_)	02/10→	1NR-FE	Petrol	1329	4	16	11
Passo Sette (M5_E)	12/08→	3SZ-VE	Petrol	1495	4	16	34
Pickup Cab & Chassis	09/78→12/83	20R	Petrol	2189	4	8	104
Pickup Cab & Chassis	09/80→12/83	L	Diesel	2188	4	8	105
Picnic (_XM1_)	05/96→12/01	3S-FE	Petrol	1998	4	16	86
Picnic (_XM1_)	08/97→12/01	3C-TE	Diesel	2184	4	8	101
Pixis Bus (S3_ M)	11/12→	KF-VE	Petrol	658	3	12	1
Pixis Epoch (LA3_)	05/12→	KF-VE	Petrol	658	3	12	1
Pixis Joy (LA2_)	08/16→	KF-VE	Petrol	658	3	12	1
Pixis Mega (LA7_)	07/15→	KF-VE	Petrol	658	3	12	1
Pixis Platform/Chassis (S2_)	12/11→06/14	KF-VE	Petrol	658	3	12	1
Pixis Space (L58_A , L57_A)	10/11→	KF-DET	Petrol	659	3	12	1
Pixis Space (L58_A , L57_A)	10/11→	KF-VE	Petrol	658	3	12	1
Platz (NCP1_)	09/02→08/05	1NZ-FE	Petrol	1497	4	16	27
Platz (NCP1_)	09/02→08/05	2NZ-FE	Petrol	1299	4	16	12
Platz (NCP1_ , SCP1_)	04/99→08/05	1NZ-FE	Petrol	1497	4	16	27
Platz (NCP1_ , SCP1_)	04/99→08/05	1SZ-FE	Petrol	998	4	16	5
Platz (NCP1_ , SCP1_)	08/99→08/05	2NZ-FE	Petrol	1299	4	16	12
Porte (_NNP1_)	07/04→07/12	1NZ-FE	Petrol	1497	4	16	27
Porte (_NNP1_)	07/04→07/12	2NZ-FE	Petrol	1299	4	16	12
Porte II (NCP14_)	08/12→	1NZ-FE	Petrol	1497	4	16	27
Porte II (_P14_)	08/12→	1NR-FE	Petrol	1329	4	16	11
Premio (NZT26_ , ZRT26_)	07/07→	1NZ-FE	Petrol	1497	4	16	27
Premio (NZT26_ , ZRT26_)	07/07→	2ZR-FAE	Petrol	1798	4	16	60
Premio (NZT26_ , ZRT26_)	07/07→	3ZR-FAE	Petrol	1987	4	16	94
Premio (_T24_)	12/01→05/07	1NZ-FE	Petrol	1497	4	16	27
Premio (_T24_)	12/01→06/07	1AZ-FSE	Petrol	1998	4	16	73
Premio (_T24_)	12/01→06/07	1ZZ-FE	Petrol	1794	4	16	57
Premio (_T26_)	07/07→	2ZR-FE	Petrol	1798	4	16	61
Premio (_T26_)	12/12→	1NZ-FE	Petrol	1497	4	16	27
Premio (_T26_)	12/12→	2ZR-FAE	Petrol	1798	4	16	60
Premio (_T26_)	12/12→	3ZR-FAE	Petrol	1987	4	16	94
Premio (ZZT24_ , NZT24_ , AZT24_)	12/01→05/07	1AZ-FSE	Petrol	1998	4	16	73
Premio (ZZT24_ , NZT24_ , AZT24_)	12/01→05/07	7A-FE	Petrol	1762	4	16	67
Previa (MCR3_ , ACR3_ , CLR3_)	02/00→01/06	2GR-FE	Petrol	3456	6	24	149
Previa (MCR3_ , ACR3_ , CLR3_)	10/00→08/03	3S-FE	Petrol	1998	4	16	86
Previa (MCR3_ , ACR3_ , CLR3_)	07/02→12/05	2AZ-FXE	Petrol	2362	4	16	108







CC



9

Previa (_R1_, _R2_)	05/90→08/00	2TZ-FE	Petrol	2438	4	16	115
Previa (_R1_, _R2_)	05/90→08/00	3C-TE	Diesel	2184	4	8	101
Previa (_R1_, _R2_)	09/93→12/97	2TZ-FZE	Petrol	2438	4	16	115
Previa (_R3_)	02/00→12/05	1MZ-FE	Petrol	2995	6	24	130
Previa (_R3_)	02/00→01/06	2AZ-FE	Petrol	2362	4	16	108
Previa (_R3_)	03/01→01/06	1CD-FTV	Diesel	1995	4	16	74
Previa (TCR2_, TCR1_)	05/90→12/99	2TZ-FZE	Petrol	2438	4	16	115
Previa III (ACR5_, GSR5_)	10/05→	2AZ-FE	Petrol	2362	4	16	108
Previa III (ACR5_, GSR5_)	01/06→	2GR-FE	Petrol	3456	6	24	149
Previa III (ACR5_, GSR5_)	05/12→	2AZ-FXE	Petrol	2362	4	16	108
Previa III (_R2_, _R5_)	01/06→	2AZ-FE	Petrol	2362	4	16	108
Previa III (_R2_, _R5_)	05/12→	2AZ-FXE	Petrol	2362	4	16	108
Prius (_W3_)	04/09→	2ZR-FXE	Petrol	1798	4	16	61
Prius (_W5_)	09/15→	2ZR-FXE	Petrol	1798	4	16	61
Prius C (NHP10_)	09/11→	1NZ-FXE	Petrol	1497	4	16	27
Prius Hatchback (_W2_)	08/03→03/09	1NZ-FXE	Petrol	1497	4	16	27
Prius PHV (_W52_)	09/16→	2ZR-FXE	Petrol	1798	4	16	61
Prius Plus (_W4_)	05/11→	2ZR-FXE	Petrol	1798	4	16	61
Prius Saloon (_W1_)	12/97→01/04	1NZ-FXE	Petrol	1497	4	16	27
Proace Box (MDZ_)	02/16→	3WZ-HV	Diesel	1560	4	8	46
Proace Box (MDZ_)	02/16→	3WZ-TV	Diesel	1560	4	8	46
Proace Box (MDZ_)	02/16→	4WZ-FHV	Diesel	1997	4	16	96
Proace Box (MDZ_)	02/16→	4WZ-FTV	Diesel	1997	4	16	96
Proace Box Body / Estate (MDX_)	06/13→03/16	3WZ-TV	Diesel	1560	4	8	46
Proace Box Body / Estate (MDX_)	06/13→03/16	4WZ-FHV	Diesel	1997	4	16	96
Proace Box Body / Estate (MDX_)	06/13→03/16	4WZ-FTV	Diesel	1997	4	16	96
Proace Box Body / Estate (MDX_)	06/13→03/16	4WZ-FTW	Diesel	1997	4	16	96
Proace Bus (MPY_)	02/16→	3WZ-HV	Diesel	1560	4	8	46
Proace Bus (MPY_)	02/16→	3WZ-TV	Diesel	1560	4	8	46
Proace Bus (MPY_)	02/16→	4WZ-FHV	Diesel	1997	4	16	96
Proace Bus (MPY_)	02/16→	4WZ-FTV	Diesel	1997	4	16	96
Proace Platform/Chassis (MDZ_)	02/16→	4WZ-FTV	Diesel	1997	4	16	96
Probox/Succeed (_NLP5_, _NCP5_)	07/02→08/14	1ND-TV	Diesel	1364	4	8	22
Probox/Succeed (_NLP5_, _NCP5_)	07/02→08/14	1NZ-FE	Petrol	1497	4	16	27
Probox/Succeed (_NLP5_, _NCP5_)	07/02→08/14	1NZ-FNE	Gas	1497	4	16	28
Probox/Succeed (_NLP5_, _NCP5_)	07/02→08/14	1NZ-FXE	Petrol	1497	4	16	27
Probox/Succeed (_NLP5_, _NCP5_)	07/02→08/14	2NZ-FE	Petrol	1299	4	16	12
Probox / Succeed (_P5_)	09/14→	1NZ-FE	Petrol	1497	4	16	27
Progres (JCG1_)	10/97→06/07	1JZ-FSE	Petrol	2491	6	24	117
Qualis (_F5_)	01/99→06/03	2Y	Petrol	1812	4	8	59
Qualis (_F5_)	01/99→10/04	1RZ-E	Petrol	1998	4	8	78
Qualis (_F5_)	01/99→10/04	2L	Diesel	2446	4	8	111
Qualis (_F5_)	04/99→06/03	2RZ-E	Petrol	2438	4	8	114
Qualis (_F5_)	07/03→10/04	5L	Diesel	2986	4	8	135
Quick Delivery (_H2_)	05/82→06/85	L	Diesel	2188	4	8	105
Quick Delivery (_Y15_, _H8_, _U6_)	08/85→04/95	2L	Diesel	2446	4	8	111
Quick Delivery (_Y15_, _H8_, _U6_)	08/85→07/95	B	Diesel	2977	4	8	140
Quick Delivery (_Y15_, _H8_, _U6_)	05/95→04/99	3L	Diesel	2779	4	8	126
Quick Delivery (_Y15_, _H8_, _U6_)	09/98→07/01	5L	Diesel	2986	4	8	135
Ractis (SCP10_, NCP10_)	09/05→08/10	1NZ-FE	Petrol	1497	4	16	27
Ractis (SCP10_, NCP10_)	09/05→08/10	2SZ-FE	Petrol	1298	4	16	16
Raum Box	05/93→10/97	5E-FE	Petrol	1497	4	16	36
Raum MPV (EXZ1_)	05/97→04/03	5E-FE	Petrol	1497	4	16	36
Raum MPV (NCZ2_)	05/03→	1NZ-FE	Petrol	1497	4	16	27
Rav4 Closed Off-Road Vehicle	04/09→08/13	1AZ-FE	Petrol	1998	4	16	72
Rav4 Closed Off-Road Vehicle	04/09→08/13	2AZ-FE	Petrol	2362	4	16	106
Rav 4 I (_A1_)	06/94→09/00	3S-FE	Petrol	1998	4	16	86
Rav 4 I (SXA1_)	01/94→09/99	3S-FE	Petrol	1998	4	16	86
Rav 4 I (SXA1_)	01/94→09/99	3S-GE	Petrol	1998	4	16	88
Rav 4 I Cabrio (_A1_)	12/97→06/00	3S-FE	Petrol	1998	4	16	86
Rav 4 II (_A2_)	06/00→11/05	1AZ-FE	Petrol	1998	4	16	72
Rav 4 II (_A2_)	08/00→11/05	1ZZ-FE	Petrol	1794	4	16	57
Rav 4 II (_A2_)	05/01→11/05	1CD-FTV	Diesel	1995	4	16	74
Rav 4 II (_A2_)	07/03→11/05	2AZ-FE	Petrol	2362	4	16	108
Rav 4 II (CLA2_, XA2_, ZCA2_, ACA2_)	08/03→11/05	2AZ-FE	Petrol	2362	4	16	108
Rav 4 III (_A3_)	11/05→	2AZ-FE	Petrol	2362	4	16	108
Rav 4 III (_A3_)	11/05→	2GR-FE	Petrol	3456	6	24	149
Rav 4 III (_A3_)	03/06→	1AZ-FE	Petrol	1998	4	16	72
Rav 4 III (_A3_)	03/06→	2AD-FHV	Diesel	2231	4	16	100
Rav 4 III (_A3_)	03/06→	2AD-FTV	Diesel	2231	4	16	100
Rav 4 III (_A3_)	11/08→	2AR-FE	Petrol	2494	4	16	118
Rav 4 III (_A3_)	12/08→	3ZR-FAE	Petrol	1987	4	16	94
Rav 4 III (ACA3_, ACE_, ALA3_, GSA3_, ZSA3_)	11/05→	2AZ-FE	Petrol	2362	4	16	108
Rav 4 III (ACA3_, ACE_, ALA3_, GSA3_, ZSA3_)	11/05→	2GR-FE	Petrol	3456	6	24	149
Rav 4 III (ACA3_, ACE_, ALA3_, GSA3_, ZSA3_)	03/09→	3ZR-FAE	Petrol	1987	4	16	94
Rav 4 IV (_A4_)	12/12→	1AD-FTV	Diesel	1998	4	16	71
Rav 4 IV (_A4_)	12/12→	2AD-FHV	Diesel	2231	4	16	100
Rav 4 IV (_A4_)	12/12→	2AD-FTV	Diesel	2231	4	16	100

				CC			9
Rav 4 IV (_A4_)	12/12→	2AR-FE	Petrol	2494	4	16	118
Rav 4 IV (_A4_)	12/12→	3ZR-FAE	Petrol	1987	4	16	94
Rav 4 IV (_A4_)	12/12→	3ZR-FE	Petrol	1987	4	16	94
Rav 4 IV (_A4_)	10/15→	2AR-FXE	Petrol	2494	4	16	118
Rav 4 IV (_A4_)	10/15→	2WW	Diesel	1995	4	16	84
Rav 4 IV (ZSA4_, ALA4_)	12/12→	2AR-FE	Petrol	2494	4	16	118
Rav 4 IV (ZSA4_, ALA4_)	12/12→	3ZR-FE	Petrol	1987	4	16	94
RC (_C1_)	08/14→	2GR-FSE	Petrol	3456	6	24	149
RC (_C1_)	09/14→	2AR-FSE	Petrol	2494	4	16	118
Regiusace Box (TRH2_, KDH2_)	08/04→	1KD-FTV	Diesel	2982	4	16	128
Regiusace Box (TRH2_, KDH2_)	08/04→	2KD-FTV	Diesel	2494	4	16	119
Regiusace Bus (TRH2_, KDH2_)	08/04→	1KD-FTV	Diesel	2982	4	16	128
Regiusace Bus (TRH2_, KDH2_)	08/04→	2KD-FTV	Diesel	2494	4	16	119
Rush Closed Off-Road Vehicle (F700_)	03/06→	3SZ-VE	Petrol	1495	4	16	34
Rush Closed Off-Road Vehicle (F700_)	03/06→	K3-VE	Petrol	1298	4	16	16
RX (GYL1_, GGL15, AGL10)	12/08→02/12	2GR-FE	Petrol	3456	6	24	149
RX (GYL1_, GGL15, AGL10)	12/08→10/15	1AR-FE	Petrol	2671	4	16	123
RX (GYL1_, GGL15, AGL10)	12/08→10/15	2GR-FXE	Petrol	3456	6	24	149
RX (_L1_)	12/08→10/15	2GR-FE	Petrol	3456	6	24	149
RX (_L1_)	12/08→10/15	2GR-FXE	Petrol	3456	6	24	149
RX (MCU15)	07/00→05/03	1MZ-FE	Petrol	2995	6	24	130
RX (MHU3_, GSU3_, MCU3_)	04/03→01/06	3MZ-FE	Petrol	3311	6	24	143
RX (_U3_)	04/03→12/08	3MZ-FE	Petrol	3311	6	24	143
RX (_U3_)	05/03→12/08	1MZ-FE	Petrol	2995	6	24	130
RX (_U3_)	01/06→12/08	2GR-FE	Petrol	3456	6	24	149
Sai (AZK1_)	11/09→	2AZ-FXE	Petrol	2362	4	16	108
SC (UZZ40_)	05/01→07/10	3UZ-FE	Petrol	4293	8	32	161
SC Convertible (UZZ40_)	01/01→07/10	3UZ-FE	Petrol	4293	8	32	161
SC Coupe (_ZZ3_)	08/91→06/00	1UZ-FE	Petrol	3969	8	32	153
SC Coupe (_ZZ3_)	08/91→06/00	2JZ-GE	Petrol	2997	6	24	131
Scepter Coupe (CXV15_, VCV15_)	10/93→06/96	5S-FE	Petrol	2164	4	16	103
Scepter Coupe (_V15_)	10/93→07/96	3VZ-FE	Petrol	2959	6	24	134
Scepter Coupe (_V15_)	10/93→07/96	5S-FE	Petrol	2164	4	16	103
Scepter Estate	11/92→07/96	3VZ-FE	Petrol	2959	6	24	134
Scepter Estate	11/92→09/96	2C-T	Diesel	1975	4	8	80
Scepter Estate	11/92→09/96	3S-FE	Petrol	1998	4	16	86
Scepter Estate	11/92→09/96	5S-FE	Petrol	2164	4	16	103
Scepter Saloon	11/92→08/96	3VZ-FE	Petrol	2959	6	24	134
Scepter Saloon	11/92→09/96	2C-T	Diesel	1975	4	8	80
Scepter Saloon	11/92→09/96	3S-FE	Petrol	1998	4	16	86
Scepter Saloon	11/92→09/96	5S-FE	Petrol	2164	4	16	103
Sequoia (_K6_)	09/09→07/12	1UR-FE	Petrol	4608	8	32	163
Sera Coupe (EXY1_)	03/90→11/95	5E-FHE	Petrol	1496	4	16	37
Sienna (_L1_)	08/97→12/02	1MZ-FE	Petrol	2995	6	24	130
Sienna (_L2_)	01/03→11/09	3MZ-FE	Petrol	3311	6	24	143
Sienna (_L2_)	12/06→12/09	2GR-FE	Petrol	3456	6	24	149
Sienna (_L3_)	01/10→	2GR-FE	Petrol	3456	6	24	149
Sienna (_L3_)	05/10→07/13	1AR-FE	Petrol	2672	4	16	123
Sienna Mini Cargo Van (_L2_)	01/03→08/05	3MZ-FE	Petrol	3311	6	24	143
Sienna Mini Cargo Van (_L2_)	12/06→12/09	2GR-FE	Petrol	3456	6	24	149
Sienna Mini Cargo Van (_L3_)	01/10→08/14	2GR-FE	Petrol	3456	6	24	149
Sienta (NCP8_)	05/03→05/15	1NZ-FE	Petrol	1497	4	16	27
Sienta (_P8_)	05/03→05/15	1NZ-FE	Petrol	1497	4	16	27
Sienta (_P17_)	06/15→	1NZ-FE	Petrol	1497	4	16	27
Sienta (_P17_)	06/15→	1NZ-FXE	Petrol	1497	4	16	27
Soarer Coupe (_Z1_)	09/85→08/86	7M-GTEU	Petrol	2954	6	24	137
Soarer Coupe (_Z2_)	09/86→03/91	7M-GTEU	Petrol	2954	6	24	137
Soarer Coupe (_Z3_)	09/90→09/00	1JZ-GTE	Petrol	2491	6	24	117
Soarer Coupe (_Z3_)	09/90→09/00	2JZ-GE	Petrol	2997	6	24	131
Soarer Coupe (_Z3_)	05/92→09/00	1UZ-FE	Petrol	3969	8	32	154
Solara Convertible (_V2_)	09/99→12/01	5S-FE	Petrol	2164	4	16	103
Solara Convertible (_V2_)	09/99→12/03	1MZ-FE	Petrol	2995	6	24	130
Solara Convertible (_V3_)	10/03→11/06	2AZ-FE	Petrol	2362	4	16	108
Solara Convertible (_V3_)	02/04→11/08	3MZ-FE	Petrol	3311	6	24	143
Solara Coupe (_V2_)	06/98→12/03	1MZ-FE	Petrol	2995	6	24	130
Solara Coupe (_V2_)	09/99→12/01	5S-FE	Petrol	2164	4	16	103
Solara Coupe (_V3_)	07/03→07/08	3MZ-FE	Petrol	3311	6	24	143
Solara Coupe (_V3_)	07/03→11/08	2AZ-FE	Petrol	2362	4	16	108
Soluna VIOS	07/02→08/13	5A-FE	Petrol	1498	4	16	35
Soluna VIOS (_P4_)	12/02→08/13	1NZ-FE	Petrol	1497	4	16	27
Spade (NCP14_)	08/12→	1NZ-FE	Petrol	1497	4	16	27
Spade (_P14_)	08/12→	1NR-FE	Petrol	1329	4	16	11
Sparky (S23_, S22_)	09/00→02/03	K3-VE	Petrol	1298	4	16	16
Sprinter Carib	11/87→05/92	4A-F	Petrol	1587	4	16	49
Sprinter Carib	11/87→10/01	4A-FE	Petrol	1587	4	16	50
Sprinter Carib	06/92→04/97	4E-FE	Petrol	1332	4	16	17
Sprinter Carib	11/92→10/01	7A-FE	Petrol	1762	4	16	67
Sprinter Carib	04/95→11/02	4S-FE	Petrol	1838	4	16	65









CC



9

Sprinter Carib (AE11_)	05/96→05/02	4A-FE	Petrol	1587	4	16	50
Sprinter Carib (AE11_)	04/98→07/00	3CE	Diesel	2184	4	8	101
Sprinter Carib (AL25G)	05/82→10/87	3A-U	Petrol	1452	4	8	30
Sprinter Carib (_E9_)	11/87→07/91	1C	Diesel	1840	4	8	52
Sprinter Carib (_E9_)	09/91→12/93	3E	Petrol	1456	4	12	32
Sprinter Coupe	06/83→07/87	2E-L	Petrol	1296	4	12	15
Sprinter Coupe	10/84→07/87	4A-GEC	Petrol	1587	4	16	50
Sprinter Coupe	10/84→07/87	4A-LC	Petrol	1587	4	8	48
Sprinter Hatchback	06/83→07/87	2E-L	Petrol	1296	4	12	15
Sprinter Hatchback	06/83→07/87	3A-LU	Petrol	1452	4	8	30
Sprinter Hatchback	06/83→07/87	3A-U	Petrol	1452	4	8	30
Sprinter Hatchback	06/83→07/87	4A-GE	Petrol	1587	4	16	49
Sprinter Hatchback	10/84→07/87	4A-GEC	Petrol	1587	4	16	50
Sprinter Hatchback	10/84→07/87	4A-GEU	Petrol	1587	4	16	50
Sprinter Hatchback	10/84→07/87	4A-LC	Petrol	1587	4	8	48
Sprinter Hatchback	08/87→04/92	2E	Petrol	1296	4	12	15
Sprinter Hatchback	08/87→04/92	2E-E	Petrol	1296	4	12	15
Sprinter Hatchback	08/87→05/92	5A-F	Petrol	1497	4	16	35
Sprinter Hatchback	08/87→11/00	4A-FE	Petrol	1587	4	16	50
Sprinter Hatchback	08/87→11/02	5A-FE	Petrol	1498	4	16	35
Sprinter Hatchback	06/92→11/00	4E-FE	Petrol	1332	4	16	17
Sprinter Hatchback	11/92→04/97	7A-FE	Petrol	1762	4	16	67
Sprinter Hatchback	04/95→11/02	4S-FE	Petrol	1838	4	16	65
Sprinter Hatchback (_E1_)	04/95→11/00	2C	Diesel	1975	4	8	79
Sprinter Hatchback (_E9_)	05/87→04/89	5A-F	Petrol	1497	4	16	35
Sprinter Hatchback (_E9_)	05/89→05/91	5A-FHE	Petrol	1497	4	16	35
Sprinter Saloon	06/91→08/97	5A-FE	Petrol	1498	4	16	35
Sprinter Saloon	06/91→11/00	4A-FE	Petrol	1587	4	16	50
Sprinter Saloon	06/92→11/00	4E-FE	Petrol	1332	4	16	17
Sprinter Saloon	04/95→11/02	3C-TE	Diesel	2184	4	8	101
Sprinter Saloon	04/95→11/02	4S-FE	Petrol	1838	4	16	65
Sprinter Saloon (_E1_)	06/91→04/95	4E-FE	Petrol	1332	4	16	17
Sprinter Saloon (_E1_)	06/91→07/00	4A-GE	Petrol	1587	4	16	49
Sprinter Saloon (_E1_)	06/91→11/00	2C	Diesel	1975	4	8	79
Sprinter Saloon (_E1_)	06/91→11/02	5A-FE	Petrol	1498	4	16	35
Sprinter Saloon (_E1_)	09/91→03/97	4A-FE	Petrol	1587	4	16	50
Sprinter Saloon (_E1_)	11/92→04/97	7A-FE	Petrol	1762	4	16	67
Sprinter Saloon (_E1_)	04/98→07/00	3CE	Diesel	2184	4	8	101
Sprinter Saloon (_E9_)	05/87→05/91	1C	Diesel	1840	4	8	52
Sprinter Saloon (_E9_)	05/89→05/91	4A-FE	Petrol	1587	4	16	50
Sprinter Saloon (_E9_)	05/89→05/91	5A-FHE	Petrol	1497	4	16	35
Stallion (_F5_)	08/99→05/05	1RZ	Petrol	1998	4	8	78
Stallion (_F5_)	08/99→05/05	2L	Diesel	2446	4	8	111
Stallion (_F5_)	01/00→12/04	2Y	Petrol	1812	4	8	59
Starlet (KP6_)	02/78→09/84	2K	Petrol	993	4	8	6
Starlet (KP6_)	02/78→09/84	4K	Petrol	1290	4	8	19
Starlet (KP6_)	10/78→08/82	3K-H	Petrol	1166	4	8	8
Starlet (KP6_)	09/80→12/84	4K-C	Petrol	1290	4	8	19
Starlet (_P7_)	10/84→12/89	1E-L	Petrol	999	4	12	3
Starlet (_P7_)	10/84→12/89	2E-LC	Petrol	1296	4	12	15
Starlet (_P7_)	12/86→12/89	1N	Diesel	1453	4	8	26
Starlet (_P8_)	12/89→12/92	1E	Petrol	999	4	12	2
Starlet (_P8_)	12/89→12/92	2E	Petrol	1296	4	12	15
Starlet (_P8_)	12/89→12/95	4E-FTE	Petrol	1332	4	16	18
Starlet (_P8_)	12/89→03/96	1N	Diesel	1453	4	8	26
Starlet (_P8_)	12/89→03/96	2E-E	Petrol	1296	4	12	15
Starlet (_P8_)	12/89→03/96	4E-FE	Petrol	1332	4	16	17
Starlet (_P9_)	01/96→07/99	1N	Diesel	1453	4	8	26
Starlet (_P9_)	01/96→07/99	4E-FTE	Petrol	1332	4	16	18
Starlet (_P9_)	01/96→10/99	4E-FE	Petrol	1332	4	16	17
Starlet 1000 (KP_)	11/74→08/78	2K	Petrol	993	4	8	6
Starlet 1000 Kombi (KP_)	05/76→08/78	2K	Petrol	993	4	8	6
Starlet Estate (KP6_)	02/78→09/82	3K-H	Petrol	1166	4	8	8
Starlet Estate (KP6_)	02/78→09/84	2K	Petrol	993	4	8	6
Starlet Estate (KP6_)	02/78→09/84	4K	Petrol	1290	4	8	19
Starlet Estate (KP6_)	09/82→09/84	4K-C	Petrol	1290	4	8	19
Stout Pickup (_K11_)	03/79→08/86	5R	Petrol	1997	4	8	97
Stout Pickup (YK11_, RK11_)	04/88→02/00	4Y	Petrol	2237	4	8	102
Supra (_A7_)	01/86→05/93	7M-GE	Petrol	2954	6	24	137
Supra (_A7_)	09/87→05/93	7M-GTE	Petrol	2954	6	24	137
Supra (_A7_)	08/90→05/93	1JZ-GTE	Petrol	2491	6	24	117
Supra (_A8_)	05/93→07/02	2JZ-GE	Petrol	2997	6	24	131
Supra (_A8_)	05/93→07/02	2JZ-GTE	Petrol	2997	6	24	131
T100 Pickup (_CK_)	09/92→12/94	3VZ-E	Petrol	2959	6	12	133
T100 Pickup (_CK_)	09/93→12/98	3RZ-FE	Petrol	2694	4	16	125
T100 Pickup (_CK_)	08/94→12/98	5VZ-FE	Petrol	3378	6	24	145
Tacoma Pickup (_N1_)	01/95→08/04	2RZ-FE	Petrol	2438	4	16	115
Tacoma Pickup (_N1_)	01/95→08/04	3RZ-FE	Petrol	2694	4	16	125

				CC			9
Tacoma Pickup (_N1_)	01/95→08/04	5VZ-FE	Petrol	3378	6	24	145
Tacoma Pickup (_N2_)	09/04→07/15	1GR-FE	Petrol	3956	6	24	152
Tank / Roomy (M9_)	11/16→	1KR-FE	Petrol	998	3	12	4
Tarago Box	09/89→10/99	2RZ-E	Petrol	2438	4	8	114
Tarago Box	08/98→08/04	3RZ-FE	Petrol	2694	4	16	125
Tarago Bus	09/89→10/99	2RZ-E	Petrol	2438	4	8	114
Tarago Bus	08/98→08/04	3RZ-FE	Petrol	2694	4	16	125
Tazz (E9_)	04/96→07/06	2E	Petrol	1296	4	12	15
Tazz (E9_)	04/96→07/06	4A-FE	Petrol	1587	4	16	50
Tercel (AL2_)	09/82→01/88	3A-C	Petrol	1452	4	8	24
Tercel (AL2_)	10/82→01/88	3A	Petrol	1452	4	8	30
Tercel (_L1_, _L2_)	03/79→01/88	2A	Petrol	1296	4	8	13
Tercel (_L1_, _L2_)	08/80→05/85	3A-C	Petrol	1452	4	8	24
Tercel Estate (AL2_)	08/82→10/86	3A	Petrol	1452	4	8	30
Tercel Estate (AL2_)	08/82→10/87	3A-U	Petrol	1452	4	8	30
Tercel Estate (AL2_)	08/84→12/87	3A-C	Petrol	1452	4	8	24
Tercel Estate (AL2_)	09/86→12/87	3E	Petrol	1456	4	12	32
Tercel Hatchback	11/86→09/99	1N-T	Diesel	1454	4	8	26
Tercel Hatchback	05/92→09/99	4E-FE	Petrol	1332	4	16	17
Tercel Hatchback	11/94→09/99	1N	Diesel	1453	4	8	26
Tercel Hatchback	11/94→09/99	5E-FE	Petrol	1497	4	16	36
Tercel Hatchback (EL5_)	09/94→07/99	1N-T	Diesel	1454	4	8	26
Tercel Hatchback (EL5_)	09/94→07/99	4E-FE	Petrol	1332	4	16	17
Tercel Hatchback (EL5_)	09/94→07/99	5E-FE	Petrol	1497	4	16	36
Tercel Hatchback (_L3_)	05/86→09/90	2E	Petrol	1296	4	12	15
Tercel Hatchback (_L3_)	05/86→12/90	3E	Petrol	1456	4	12	32
Tercel Hatchback (_L3_)	05/86→08/94	1N-T	Diesel	1454	4	8	26
Tercel Hatchback (_L3_)	09/90→09/94	5E-FE	Petrol	1497	4	16	36
Tercel Hatchback (_L3_)	09/90→09/94	5E-FHE	Petrol	1496	4	16	37
Tercel Saloon	05/82→10/85	3A-U	Petrol	1452	4	8	30
Tercel Saloon	11/86→10/89	3A-SU	Petrol	1452	4	8	31
Tercel Saloon	11/86→10/94	3E	Petrol	1456	4	12	32
Tercel Saloon	11/86→09/99	1N-T	Diesel	1454	4	8	26
Tercel Saloon	11/87→10/89	3E-E	Petrol	1456	4	12	32
Tercel Saloon	09/90→09/99	5E-FE	Petrol	1497	4	16	36
Tercel Saloon	05/91→09/92	2A	Petrol	1296	4	8	13
Tercel Saloon	05/92→09/99	4E-FE	Petrol	1332	4	16	17
Tercel Saloon (AL1_, AL2_)	03/79→10/85	2A	Petrol	1296	4	8	13
Tercel Saloon (AL1_, AL2_)	08/80→06/82	3A-C	Petrol	1452	4	8	24
Tercel Saloon (AL1_, AL2_)	05/82→04/86	2A-U	Petrol	1295	4	8	14
Tercel Saloon (_L5_)	09/94→06/99	2E	Petrol	1296	4	12	15
Tercel Saloon (_L5_)	09/94→07/99	1N-T	Diesel	1454	4	8	26
Tercel Saloon (_L5_)	09/94→07/99	5E-FE	Petrol	1497	4	16	36
Town Ace Box	01/92→04/95	2C	Diesel	1975	4	8	79
Town Ace Box	01/92→04/95	4Y-EC	Petrol	2237	4	8	102
Town Ace Box	04/92→09/01	3Y-C	Petrol	1998	4	8	91
Town Ace Box	05/95→09/01	3L	Diesel	2779	4	8	126
Town Ace Box	02/97→01/99	7K	Petrol	1781	4	8	68
Town Ace Box	12/98→06/04	3CE	Diesel	2184	4	8	101
Town Ace Box (KM8_, KM7_, CM8_, CM7_)	10/01→07/07	5L	Diesel	2986	4	8	135
Town Ace Box (YR3_, YR2_)	04/85→09/90	L	Diesel	2188	4	8	105
Town Ace Box (YR3_, YR2_)	04/85→12/91	2L	Diesel	2446	4	8	111
Town Ace Box (YR3_, YR2_)	09/85→12/89	4Y-EC	Petrol	2237	4	8	102
Town Ace Bus	01/92→04/95	2C	Diesel	1975	4	8	79
Town Ace Bus	01/92→04/95	2RZ-E	Petrol	2438	4	8	114
Town Ace Bus	10/93→12/99	3C-T	Diesel	2184	4	8	101
Town Ace Bus	11/94→04/95	4Y-EC	Petrol	2237	4	8	102
Town Ace Bus	05/95→09/01	3L	Diesel	2779	4	8	126
Town Ace Bus	05/95→09/01	3Y-C	Petrol	1998	4	8	91
Town Ace Bus	10/96→10/01	3S-FE	Petrol	1998	4	16	86
Town Ace Bus (CR3_, CR2_)	04/85→12/91	2L	Diesel	2446	4	8	111
Town Ace Bus (CR3_, CR2_)	04/85→12/91	L	Diesel	2188	4	8	105
Town Ace Bus (_R2_, _R3_)	01/85→12/91	3Y-EU	Petrol	1998	4	8	91
Town Ace Bus (_R2_, _R3_)	04/85→12/91	2C-T	Diesel	1975	4	8	80
Town Ace Bus (_R2_, _R3_)	08/85→07/88	4Y-EC	Petrol	2237	4	8	102
Town Ace Bus (S4_)	01/08→	3SZ-VE	Petrol	1495	4	16	34
Town Ace Bus (SR5_, SR4_, KR4_, CR5_, CR4_)	10/01→07/07	5L	Diesel	2986	4	8	135
Town Ace Bus (SR5_, SR4_, KR4_, CR5_, CR4_)	10/03→07/07	2AZ-FE	Petrol	2362	4	16	108
Town Ace Platform/Chassis (S4_)	01/08→	3SZ-VE	Petrol	1495	4	16	34
Toyoc Platform/Chassis (_U_, _Y_)	01/83→06/85	2L	Diesel	2446	4	8	111
Toyoc Platform/Chassis (_U_, _Y_)	08/88→04/95	3L	Diesel	2779	4	8	126
Toyoc Platform/Chassis (_Y1_)	08/01→06/11	5L	Diesel	2986	4	8	135
Toyoc Platform/Chassis (_Y2_)	06/11→	1KD-FTV	Diesel	2982	4	16	128
Tundra Pickup (_K3_, _K4_)	05/03→11/06	1GR-FE	Petrol	3956	6	24	152
Tundra Pickup (_K4_, _K3_)	04/99→07/03	5VZ-FE	Petrol	3378	6	24	145
Tundra Pickup (_K4_, _K3_)	05/03→11/06	1GR-FE	Petrol	3956	6	24	152
Tundra Pickup (_K5_, _K6_)	11/06→	1GR-FE	Petrol	3956	6	24	152
Tundra Pickup (_K5_, _K6_)	04/09→	1UR-FE	Petrol	4608	8	32	163



CC



9

TUV Pickup (KF_, LF_)	12/96→12/04	2L	Diesel	2446	4	8	111
TUV Pickup (KF_, LF_)	10/00→07/05	1RZ-E	Petrol	1998	4	8	78
TUV Pickup (KF_, LF_)	06/03→02/05	5L	Diesel	2986	4	8	135
TUV Pickup (KF_, LF_)	06/03→11/06	2RZ-E	Petrol	2438	4	8	114
Urban Cruiser (_P1_)	07/07→07/10	2ZR-FE	Petrol	1798	4	16	61
Urban Cruiser (_P1_)	07/07→	1NZ-FE	Petrol	1497	4	16	27
Urban Cruiser (_P1_)	01/09→04/14	1ND-TV	Diesel	1364	4	8	22
Urban Cruiser (_P1_)	01/09→	1NR-FE	Petrol	1329	4	16	11
Vanguard (_A3_)	11/05→	2AZ-FE	Petrol	2362	4	16	108
Vanguard (_A3_)	11/05→	2GR-FE	Petrol	3456	6	24	149
Venza (GGV1_, AGV1_)	11/08→	1AR-FE	Petrol	2672	4	16	123
Venza (GGV1_, AGV1_)	11/08→	2GR-FE	Petrol	3456	6	24	149
Venza (_V1_)	11/08→	1AR-FE	Petrol	2672	4	16	123
Venza (_V1_)	11/08→	2GR-FE	Petrol	3456	6	24	149
Verossa (JZX11_, GX11_)	10/00→11/03	1G-FE	Petrol	1988	6	24	76
Verossa (_X11_)	10/00→11/03	1G-FE	Petrol	1988	6	24	76
Verossa (_X11_)	10/00→11/03	1JZ-FSE	Petrol	2491	6	24	117
Verossa (_X11_)	10/00→11/03	1JZ-GTE	Petrol	2491	6	24	117
Verso (_R2_)	04/09→	1AD-FTV	Diesel	1998	4	16	71
Verso (_R2_)	04/09→	1ZR-FAE	Petrol	1598	4	16	42
Verso (_R2_)	04/09→	2AD-FHV	Diesel	2231	4	16	100
Verso (_R2_)	04/09→	2ZR-FAE	Petrol	1798	4	16	60
Verso (_R2_)	11/13→	1WW	Diesel	1598	4	16	39
Verso (ZGR2_)	06/11→	1ZR-FE	Petrol	1598	4	16	42
Verso (ZGR2_)	06/11→	2ZR-FE	Petrol	1798	4	16	61
Verso (ZGR2_)	06/11→	3ZR-FE	Petrol	1987	4	16	93
Verso S (NLP12_, NCP12_, NSP12_)	11/10→10/16	1NR-FE	Petrol	1329	4	16	11
Verso S (NLP12_, NCP12_, NSP12_)	11/10→10/16	1NZ-FE	Petrol	1497	4	16	27
Verso S (_P12_)	11/10→10/16	1ND-TV	Diesel	1364	4	8	22
Verso S (_P12_)	11/10→10/16	1NR-FE	Petrol	1329	4	16	11
Vios	10/08→05/13	1ZR-FE	Petrol	1598	4	16	43
Vios (_P4_)	10/02→10/06	1NZ-FE	Petrol	1497	4	16	27
Vios (SCP4_, NCP4_, AXP4_)	07/02→01/08	1NZ-FE	Petrol	1497	4	16	27
Vios (SCP4_, NCP4_, AXP4_)	07/02→01/08	5A-FE	Petrol	1498	4	16	35
Vios (SCP4_, NCP4_, AXP4_)	07/02→01/08	8A-FE	Petrol	1342	4	16	20
Vios/Yaris Saloon	05/13→	1NZ-FE	Petrol	1497	4	16	27
Vios/Yaris Saloon (_P9_)	08/05→	2NZ-FE	Petrol	1299	4	16	12
Vios/Yaris Saloon (_P9_)	08/07→12/13	1NZ-FE	Petrol	1497	4	16	27
Vios/Yaris Saloon (_P9_)	08/07→	2SZ-FE	Petrol	1298	4	16	16
Vios/Yaris Saloon (_P15_)	05/13→	2NZ-FE	Petrol	1299	4	16	12
Vios/Yaris Saloon (_P15_)	09/13→	1NZ-FE	Petrol	1497	4	16	27
Vios/Yaris Saloon (ZSP9_, NCP9_)	08/07→	1KR-FE	Petrol	998	3	12	4
Vios/Yaris Saloon (ZSP9_, NCP9_)	08/07→	1NZ-FE	Petrol	1497	4	16	27
Vista / Camry Saloon (_V3_, _V4_)	07/90→06/94	3S-GE	Petrol	1998	4	16	88
Vista / Camry Saloon (_V3_, _V4_)	07/90→12/94	2C-T	Diesel	1975	4	8	80
Vista / Camry Saloon (_V3_, _V4_)	07/90→06/98	4S-FE	Petrol	1838	4	16	65
Vista / Camry Saloon (_V3_, _V4_)	01/94→06/98	3C-T	Diesel	2184	4	8	101
Vista / Camry Saloon (_V3_, _V4_)	01/94→06/98	3S-FE	Petrol	1998	4	16	86
Vista Estate (CV2_, SV2_)	11/88→06/91	2C-T	Diesel	1975	4	8	80
Vista Estate (CV2_, SV2_)	11/88→06/91	3S-FE	Petrol	1998	4	16	86
Vista Estate (_V5_)	06/98→04/02	3S-FE	Petrol	1998	4	16	86
Vista Estate (_V5_)	06/98→06/03	1AZ-FSE	Petrol	1998	4	16	73
Vista Estate (_V5_)	06/98→06/03	1ZZ-FE	Petrol	1794	4	16	57
Vista Saloon (CV1_, SV1_)	06/82→06/86	1S-L	Petrol	1832	4	8	55
Vista Saloon (CV1_, SV1_)	09/83→06/86	2S-EL	Petrol	1995	4	8	82
Vista Saloon (SV2_, CV2_)	10/86→10/88	1S	Petrol	1832	4	8	53
Vista Saloon (SV2_, CV2_)	10/86→06/90	3S-FE	Petrol	1998	4	16	86
Vista Saloon (SV2_, CV2_)	10/87→06/90	2VZ-FE	Petrol	2508	6	24	121
Vista Saloon (SV2_, CV2_)	11/88→06/90	2C-T	Diesel	1975	4	8	80
Vista Saloon (SV4_, CV4_, SV3_, CV3_)	07/90→09/97	5S-FE	Petrol	2164	4	16	103
Vista Saloon (SV4_, CV4_, SV3_, CV3_)	07/90→05/98	2C-T	Diesel	1975	4	8	80
Vista Saloon (SV5_, ZV5_)	06/98→08/02	1MZ-FE	Petrol	2995	6	24	130
Vista Saloon (SV5_, ZV5_)	06/98→08/03	1AZ-FE	Petrol	1998	4	16	72
Vista Saloon (SV5_, ZV5_)	06/98→08/03	1AZ-FSE	Petrol	1998	4	16	73
Vista Saloon (SV5_, ZV5_)	06/01→08/03	2AZ-FE	Petrol	2362	4	16	108
Vista Saloon (SV5_, ZV5_)	06/02→08/03	3MZ-FE	Petrol	3311	6	24	143
Vista Saloon (_V2_)	08/86→06/90	3S-FE	Petrol	1998	4	16	86
Vista Saloon (_V2_)	08/88→06/90	3S-GE	Petrol	1998	4	16	88
Vista Saloon (_V2_)	08/88→06/90	4S-FI	Petrol	1838	4	16	66
Vista Saloon (_V5_)	06/98→04/02	3S-FE	Petrol	1998	4	16	86
Vista Saloon (_V5_)	06/98→08/03	1AZ-FE	Petrol	1998	4	16	72
Vista Saloon (_V5_)	06/98→08/03	1AZ-FSE	Petrol	1998	4	16	73
Vista Saloon (_V5_)	06/98→08/03	1ZZ-FE	Petrol	1794	4	16	57
Vista Saloon (_V5_)	06/98→08/03	3S-FSE	Petrol	1998	4	16	87
Will CYPHA (NCP7_)	05/01→07/05	1NZ-FE	Petrol	1497	4	16	27
Will CYPHA (NCP7_)	05/01→07/05	2NZ-FE	Petrol	1299	4	16	12
Will Vi (NCP19_)	01/00→12/01	2NZ-FE	Petrol	1299	4	16	12
Will VS (_E12_)	03/01→04/04	1NZ-FE	Petrol	1497	4	16	27



















CC



9

Will VS (ZZE12_, NZE12_)	03/01→04/04	1ZZ-FE	Petrol	1794	4	16	57
Windom (_V1_)	07/91→09/96	3VZ-FE	Petrol	2959	6	24	134
Windom (_V2_)	10/96→07/01	1MZ-FE	Petrol	2995	6	24	130
Windom (_V2_)	10/96→07/01	2MZ-FE	Petrol	2496	6	24	120
Windom (_V3_)	08/01→07/04	1MZ-FE	Petrol	2995	6	24	130
Wish MPV (_E1_)	04/03→03/09	1AZ-FSE	Petrol	1998	4	16	73
Wish MPV (_E1_)	04/03→03/09	1ZZ-FE	Petrol	1794	4	16	57
Wish MPV (_E1_)	12/03→12/07	1AZ-FE	Petrol	1998	4	16	72
Wish MPV (_E2_)	04/09→	3ZR-FAE	Petrol	1987	4	16	94
Wish MPV (_E2_)	04/09→	3ZR-FE	Petrol	1987	4	16	94
Wish MPV (_E2_)	04/12→	2ZR-FAE	Petrol	1798	4	16	60
Wish MPV (ZGE2_)	04/09→	2ZR-FAE	Petrol	1798	4	16	60
Wish MPV (ZGE2_)	04/09→	3ZR-FAE	Petrol	1987	4	16	94
Mark X I (GRX12_)	05/04→09/09	3GR-FSE	Petrol	2994	6	24	132
Mark X II (GRX13_)	10/09→	2GR-FSE	Petrol	3456	6	24	149
Mark X ZiO (GGA1_, ANA1_)	09/07→	2AZ-FE	Petrol	2362	4	16	108
Mark X ZiO (GGA1_, ANA1_)	09/07→	2GR-FE	Petrol	3456	6	24	149
Yaris	01/08→12/10	1ZR-FE	Petrol	1598	4	16	42
Yaris	01/08→12/10	4ZR-FE	Petrol	1598	4	16	41
Yaris	06/08→12/13	2NZ-FE	Petrol	1299	4	16	12
Yaris (NLP13_, NSP13_, NCP13_, KSP13_)	12/10→	1NZ-FE	Petrol	1497	4	16	27
Yaris (NLP13_, NSP13_, NCP13_, KSP13_)	12/10→	2NZ-FE	Petrol	1299	4	16	12
Yaris (NLP13_, NSP13_, NCP13_, KSP13_)	09/11→	1NR-FE	Petrol	1329	4	16	11
Yaris (_P1_)	04/99→09/05	1SZ-FE	Petrol	998	4	16	5
Yaris (_P1_)	08/99→09/05	2SZ-FE	Petrol	1298	4	16	16
Yaris (_P1_)	09/99→10/05	2NZ-FE	Petrol	1299	4	16	12
Yaris (_P1_)	03/00→11/05	1NZ-FE	Petrol	1497	4	16	27
Yaris (_P1_)	10/01→09/05	1ND-TV	Diesel	1364	4	8	22
Yaris (_P9_)	01/05→	1KR-FE	Petrol	998	3	12	4
Yaris (_P9_)	01/05→	2NZ-FE	Petrol	1299	4	16	12
Yaris (_P9_)	01/05→	2SZ-FE	Petrol	1298	4	16	16
Yaris (_P9_)	08/05→	1ND-TV	Diesel	1364	4	8	22
Yaris (_P9_)	08/05→	1NZ-FE	Petrol	1497	4	16	27
Yaris (_P9_)	01/07→	2ZR-FE	Petrol	1798	4	16	61
Yaris (_P9_)	11/08→	1NR-FE	Petrol	1329	4	16	11
Yaris (_P13_)	12/10→	1KR-FE	Petrol	998	3	12	4
Yaris (_P13_)	12/10→	1NZ-FE	Petrol	1497	4	16	27
Yaris (_P13_)	09/11→	1ND-TV	Diesel	1364	4	8	22
Yaris (_P13_)	09/11→	1NR-FE	Petrol	1329	4	16	11
Yaris (_P13_)	09/11→	1NR-FKE	Petrol	1329	4	16	12
Yaris (_P13_)	03/12→	1NZ-FXE	Petrol	1497	4	16	27
Yaris (_P15_)	03/14→	1NZ-FE	Petrol	1497	4	16	27
Yaris (SCP9_, NSP9_, KSP9_, NCP9_, ZSP9_)	11/05→	1NZ-FE	Petrol	1497	4	16	27
Yaris (SCP9_, NSP9_, KSP9_, NCP9_, ZSP9_)	11/05→	1ZZ-FE	Petrol	1794	4	16	57
Yaris L	10/14→	6NR-FE	Petrol	1329	4	16	12
Yaris VERSO (_P2_)	08/99→09/05	2NZ-FE	Petrol	1299	4	16	12
Yaris VERSO (_P2_)	01/00→09/05	1NZ-FE	Petrol	1497	4	16	27
Yaris VERSO (_P2_)	12/01→09/05	1ND-TV	Diesel	1364	4	8	22
Zelas Coupe (AGT20_)	08/10→	2AR-FE	Petrol	2494	4	16	118

	CC				9		CC				9
1AD-FTV	1998	4	16	Diesel	71	2AR-FE	2494	4	16	Petrol	118
1AR-FE	2671	4	16	Petrol	123	2AR-FSE	2493	4	16	Petrol	118
1AR-FE	2672	4	16	Petrol	123	2AR-FSE	2494	4	16	Petrol	118
1AR-FE	2672	4	16	Petrol	124	2AR-FXE	2493	4	16	Petrol	118
1AZ-FE	1998	4	16	Petrol	72	2AR-FXE	2494	4	16	Petrol	118
1AZ-FE	1998	4	16	Petrol	72	2A-U	1295	4	8	Petrol	14
1AZ-FE	1998	4	16	Petrol	72	2AZ-FE	2362	4	16	Petrol	106
1AZ-FSE	1998	4	16	Petrol	73	2AZ-FE	2362	4	16	Petrol	107
1C	1840	4	8	Diesel	52	2AZ-FE	2362	4	16	Petrol	108
1CD-FTV	1995	4	16	Diesel	74	2AZ-FE	2362	4	16	Petrol	108
1C-L	1839	4	8	Diesel	52	2AZ-FSE	2362	4	16	Petrol	109
1C-TL	1840	4	8	Diesel	52	2AZ-FXE	2362	4	16	Petrol	107
1E	999	4	12	Petrol	2	2AZ-FXE	2362	4	16	Petrol	108
1E-L	999	4	12	Petrol	3	2B	3197	4	8	Diesel	142
1G-E	1988	6	12	Petrol	75	2C	1975	4	8	Diesel	79
1G-FE	1988	6	24	Petrol	76	2C-E	1975	4	8	Diesel	79
1G-FE	1988	6	24	Petrol	76	2C-L	1975	4	8	Diesel	79
1G-GE	1988	6	24	Petrol	77	2C-T	1975	4	8	Diesel	80
1GR-FE	3956	6	24	Petrol	152	2C-TE	1975	4	8	Diesel	79
1GR-FE	3956	6	24	Petrol	152	2C-TL	1974	4	8	Diesel	79
1GR-FE	3956	6	24	Petrol	152	2E	1296	4	12	Petrol	15
1HD-FT	4164	6	24	Diesel	158	2E-E	1296	4	12	Petrol	15
1HD-FTE	4164	6	24	Diesel	158	2E-L	1296	4	12	Petrol	15
1HD-T	4164	6	12	Diesel	159	2E-LC	1296	4	12	Petrol	15
1H-Z	4164	6	12	Diesel	159	2F	4230	6	12	Petrol	160
1JZ-FSE	2491	6	24	Petrol	117	2GR-FE	3456	6	24	Petrol	149
1JZ-GE	2491	6	24	Petrol	117	2GR-FE	3456	6	24	Petrol	149
1JZ-GTE	2491	6	24	Petrol	117	2GR-FE	3456	6	24	Petrol	149
1KD-FTV	2982	4	16	Diesel	128	2GR-FSE	3456	6	24	Petrol	149
1KR-DE	998	3	12	Petrol	4	2GR-FSE	3456	6	24	Petrol	149
1KR-FE	998	3	12	Petrol	4	2GR-FXE	3456	6	24	Petrol	149
1KZ-T	2982	4	8	Diesel	129	2GR-FXE	3456	6	24	Petrol	149
1KZ-TE	2982	4	8	Diesel	129	2H	3980	6	12	Diesel	155
1MZ-FE	2995	6	24	Petrol	130	2J	2449	4	8	Diesel	110
1MZ-FE	2995	6	24	Petrol	130	2JZ-GE	2997	6	24	Petrol	131
1N	1453	4	8	Diesel	26	2JZ-GE	2997	6	24	Petrol	131
1ND-TV	1364	4	8	Diesel	22	2JZ-GTE	2997	6	24	Petrol	131
1NR-FE	1329	4	16	Petrol	11	2K	993	4	8	Petrol	6
1NR-FKE	1329	4	16	Petrol	12	2KD-FTV	2494	4	16	Diesel	119
1N-T	1454	4	8	Diesel	26	2L	2446	4	8	Diesel	111
1NZ-FE	1497	4	16	Petrol	27	2L-T	2446	4	8	Diesel	111
1NZ-FNE	1497	4	16	Gas	28	2L-TE	2446	4	8	Diesel	112
1NZ-FXE	1497	4	16	Petrol	27	2L-TII	2446	4	8	Diesel	113
1PZ	3470	5	10	Diesel	148	2MZ-FE	2496	6	24	Petrol	120
1RZ	1998	4	8	Petrol	78	2NZ-FE	1299	4	16	Petrol	12
1RZ-E	1998	4	8	Petrol	78	2NZ-FE	1299	4	16	Petrol	12
1S	1832	4	8	Petrol	53	2R	1490	4	8	Petrol	29
1S-EL	1832	4	8	Petrol	54	2RZ	2438	4	8	Petrol	114
1S-I	1832	4	8	Petrol	53	2RZ-E	2438	4	8	Petrol	114
1S-ILU	1832	4	8	Petrol	53	2RZ-FE	2438	4	16	Petrol	115
1S-L	1832	4	8	Petrol	55	2S	1988	6	12	Petrol	81
1S-U	1832	4	8	Petrol	56	2S	1995	4	8	Petrol	81
1SZ-FE	998	4	16	Petrol	5	2S-C	1995	4	8	Petrol	81
1UR-FE	4608	8	32	Petrol	163	2S-E	1995	4	8	Petrol	82
1UR-FE	4608	8	32	Petrol	163	2S-EL	1995	4	8	Petrol	82
1UR-FSE	4608	8	32	Petrol	163	2S-ELC	1995	4	8	Petrol	83
1UR-FSE	4608	8	32	Petrol	163	2SZ-FE	1298	4	16	Petrol	16
1UZ-FE	3969	8	32	Petrol	153	2T	1588	4	8	Petrol	44
1UZ-FE	3969	8	32	Petrol	154	2T-G	1588	4	8	Petrol	45
1VD-FTV	4461	8	32	Diesel	162	2TJ	1588	4	8	Petrol	45
1VD-FTV	4461	8	32	Diesel	162	2TZ-FE	2438	4	16	Petrol	115
1WW	1598	4	16	Diesel	39	2TZ-FZE	2438	4	16	Petrol	115
1WZ	1867	4	8	Diesel	70	2VZ-FE	2508	6	24	Petrol	121
1Y	1626	4	8	Petrol	40	2VZ-FE	2508	6	24	Petrol	121
1ZR	1598	4	16	Petrol	41	2WW	1995	4	16	Diesel	84
1ZR-FAE	1598	4	16	Petrol	42	2WZ-TV	1398	4	8	Diesel	23
1ZR-FE	1598	4	16	Petrol	42	2Y	1812	4	8	Petrol	59
1ZR-FE	1598	4	16	Petrol	42	2Y-C	1812	4	8	Petrol	59
1ZR-FE	1598	4	16	Petrol	43	2Y-U	1812	4	8	Petrol	59
1ZZ-FE	1794	4	16	Petrol	57	2ZR-FAE	1798	4	16	Petrol	60
1ZZ-FE	1794	4	16	Petrol	58	2ZR-FBE	1798	4	16	Petrol	60
2A	1296	4	8	Petrol	13	2ZR-FE	1798	4	16	Petrol	61
2AD-FHV	2231	4	16	Diesel	100	2ZR-FE	1798	4	16	Petrol	61
2AD-FHV	2231	4	16	Diesel	100	2ZR-FXE	1798	4	16	Petrol	61
2AD-FTV	2231	4	16	Diesel	100	2ZR-FXE	1798	4	16	Petrol	62
2AD-FTV	2231	4	16	Diesel	100	2ZZ-GE	1796	4	16	Petrol	63
2A-L	1296	4	8	Petrol	13	3A	1452	4	8	Petrol	30
2AR-FE	2494	4	16	Petrol	118	3A-C	1452	4	8	Petrol	24

	CC				9		CC				9
3A-LU	1452	4	8	Petrol	30	4S-FI	1838	4	16	Petrol	66
3A-SU	1452	4	8	Petrol	31	4WZ-FHV	1997	4	16	Diesel	96
3A-U	1452	4	8	Petrol	30	4WZ-FTV	1997	4	16	Diesel	96
3AZ-FE	2362	4	16	Petrol	109	4WZ-FTW	1997	4	16	Diesel	96
3AZ-FXE	2362	4	16	Petrol	109	4Y	2237	4	8	Petrol	102
3B	3432	4	8	Diesel	144	4Y-E	2237	4	8	Petrol	102
3CE	2184	4	8	Diesel	101	4Y-EC	2237	4	8	Petrol	102
3C-T	2184	4	8	Diesel	101	4ZR	1598	4	16	Petrol	41
3C-TE	2184	4	8	Diesel	101	4ZR-FE	1598	4	16	Petrol	41
3E	1456	4	12	Petrol	32	4ZZ-FE	1398	4	16	Petrol	25
3E-E	1456	4	12	Petrol	32	5A-F	1497	4	16	Petrol	35
3E-TE	1456	4	12	Petrol	33	5A-FE	1498	4	16	Petrol	35
3F	3956	6	12	Petrol	156	5A-FHE	1497	4	16	Petrol	35
3GR-FE	2995	6	24	Petrol	132	5E-FE	1497	4	16	Petrol	36
3GR-FE	2995	6	24	Petrol	132	5E-FHE	1496	4	16	Petrol	37
3GR-FSE	2994	6	24	Petrol	132	5K	1486	4	8	Petrol	38
3GR-FSE	2995	6	24	Petrol	132	5L	2986	4	8	Diesel	135
3K	1166	4	8	Petrol	8	5L-E	2986	4	8	Diesel	135
3K-B	1166	4	8	Petrol	8	5M-GE	2759	6	12	Petrol	127
3K-C	1166	4	8	Petrol	8	5R	1997	4	8	Petrol	97
3K-H	1166	4	8	Petrol	8	5S-FE	2164	4	16	Petrol	103
3KJ	1166	4	8	Petrol	9	5VZ-FE	3378	6	24	Petrol	145
3L	2779	4	8	Diesel	126	5ZR-FXE	1798	4	16	Petrol	60
3MZ-FE	3311	6	24	Petrol	143	6M-GE	2954	6	12	Petrol	136
3MZ-FE	3311	6	24	Petrol	143	6NR-FE	1329	4	16	Petrol	12
3NR-FE	1197	4	16	Petrol	10	7A-FE	1762	4	16	Petrol	67
3RZ-FE	2694	4	16	Petrol	125	7K	1781	4	8	Petrol	68
3S-FC	1998	4	16	Petrol	85	7M-GE	2954	6	24	Petrol	137
3S-FE	1998	4	16	Petrol	86	7M-GEU	2954	6	24	Petrol	138
3S-FSE	1998	4	16	Petrol	87	7M-GTE	2954	6	24	Petrol	137
3S-GE	1998	4	16	Petrol	88	7M-GTEU	2954	6	24	Petrol	137
3S-GEL	1998	4	16	Petrol	89	7ZR	1798	4	16	Petrol	60
3S-GELC	1998	4	16	Petrol	90	7ZR-FE	1798	4	16	Petrol	60
3S-GELU	1998	4	16	Petrol	88	8A-FE	1342	4	16	Petrol	20
3S-GEU	1998	4	16	Petrol	88	11B	2986	4	8	Diesel	139
3S-GTE	1998	4	16	Petrol	88	12HT	3980	6	12	Diesel	157
3SZ-VE	1495	4	16	Petrol	34	12R	1587	4	8	Petrol	51
3T	1770	4	8	Petrol	64	12RJ	1587	4	8	Petrol	51
3T-C	1770	4	8	Petrol	64	13B	3431	4	8	Diesel	146
3UZ-FE	4293	8	32	Petrol	161	13BT	3431	4	8	Diesel	147
3UZ-FE	4293	8	32	Petrol	161	16R	1808	4	8	Petrol	69
3VZ-E	2959	6	12	Petrol	133	18R	1968	4	8	Petrol	98
3VZ-FE	2959	6	24	Petrol	134	18R-G	1968	4	8	Petrol	98
3VZ-FE	2959	6	24	Petrol	134	20R	2189	4	8	Petrol	104
3WZ-HV	1560	4	8	Diesel	46	21R	1972	4	8	Petrol	99
3WZ-TV	1560	4	8	Diesel	46	21R-C	1972	4	8	Petrol	78
3Y	1998	4	8	Petrol	91	21R-U	1972	4	8	Petrol	99
3Y-C	1998	4	8	Petrol	91	22R	2367	4	8	Petrol	116
3Y-EU	1998	4	8	Petrol	91	22RE	2367	4	8	Petrol	114
3Y-P	1998	4	8	Gas	92	22REC	2367	4	8	Petrol	116
3Y-PE	1998	4	8	Gas	92	22RTEC	2367	4	8	Petrol	114
3ZR-FAE	1987	4	16	Petrol	93	B	2977	4	8	Diesel	140
3ZR-FAE	1987	4	16	Petrol	94	C 30 NE	2969	6	12	Petrol	141
3ZR-FBE	1987	4	16	Petrol	95	EJ-DE	989	3	12	Petrol	7
3ZR-FE	1987	4	16	Petrol	93	EJ-VE	989	3	12	Petrol	7
3ZR-FE	1987	4	16	Petrol	94	F	3878	6	12	Petrol	151
3ZZ-FE	1598	4	16	Petrol	47	H	3576	6	12	Diesel	150
4A	1587	4	8	Petrol	48	HC-EJ	1296	4	16	Petrol	21
4A-C	1587	4	8	Petrol	48	K3-VE	1298	4	16	Petrol	16
4A-F	1587	4	16	Petrol	49	K3-VE2	1298	4	16	Petrol	16
4A-FE	1587	4	16	Petrol	50	K3-VET	1298	4	16	Petrol	16
4A-FHE	1587	4	16	Petrol	50	K3-VT	1298	4	16	Petrol	16
4A-GE	1587	4	16	Petrol	49	KF-DET	659	3	12	Petrol	1
4A-GEC	1587	4	16	Petrol	50	KF-VE	658	3	12	Petrol	1
4A-GEL	1587	4	16	Petrol	50	L	2188	4	8	Diesel	105
4A-GELC	1587	4	16	Petrol	50						
4A-GELU	1587	4	16	Petrol	50						
4A-GEU	1587	4	16	Petrol	50						
4A-GZE	1587	4	16	Petrol	50						
4A-L	1588	4	8	Petrol	48						
4A-LC	1587	4	8	Petrol	48						
4AR-FXE	2494	4	16	Petrol	122						
4E-FE	1332	4	16	Petrol	17						
4E-FTE	1332	4	16	Petrol	18						
4K	1290	4	8	Petrol	19						
4K-C	1290	4	8	Petrol	19						
4KJ	1290	4	8	Petrol	19						
4S-FE	1838	4	16	Petrol	65						

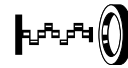
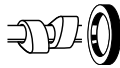

1 0.7L

Petrol

KF-DET	3 Cyl.	12 Valves	659cc	TD27470
KF-VE	3 Cyl.	12 Valves	658cc	TD27471

NA5246
42.50 x 54.50 x 6.00mm, MVQ

2 1.0L

Petrol

1E	4 Cyl.	12 Valves	999cc	TD3718
----	--------	-----------	-------	--------

PA425 (x8)
02/90→
PA425 (x4)
02/90→

NJ353
35.00 x 49.00 x 6.00mm, NBR

NJ353
35.00 x 49.00 x 6.00mm, NBR
NJ407
75.00 x 100.00 x 8.50mm, MVQ
→10/90

3 1.0L

Petrol

1E-L	4 Cyl.	12 Valves	999cc	TD3719
------	--------	-----------	-------	--------

PA425 (x12)
→01/86
PA567 (x12)
01/86→

NJ353
35.00 x 49.00 x 6.00mm, NBR

NJ353
35.00 x 49.00 x 6.00mm, NBR
NJ407
75.00 x 100.00 x 8.50mm, MVQ

4 1.0L

Petrol

1KR-DE	3 Cyl.	12 Valves	998cc	TD33695
1KR-FE	3 Cyl.	12 Valves	998cc	TD18481

NA5260
38.00 x 50.00 x 6.00mm, FPM
NA5324
74.00 x 89.00 x 8.50mm, FPM

5 1.0L

Petrol

1SZ-FE	4 Cyl.	16 Valves	998cc	TD11808
--------	--------	-----------	-------	---------

NJ288 (x2)
40.00 x 55.00 x 9.00mm, NBR

NJ353
35.00 x 49.00 x 6.00mm, NBR
NA5324
74.00 x 89.00 x 8.50mm, FPM

6 1.0L

Petrol

2K	4 Cyl.	8 Valves	993cc	TD3763
----	--------	----------	-------	--------

KH066 (x8)
→04/74
PA136 (x8)
05/74→

NJ102
38.50 x 58.00 x 11.00mm, NBR
NJ001
70.00 x 92.00 x 8.50mm, MVQ

7 1.0L

Petrol

EJ-DE	3 Cyl.	12 Valves	989cc	TD26944
EJ-VE	3 Cyl.	12 Valves	989cc	TD22445

NC048
38.00 x 52.00 x 6.00mm, FPM

NJ349
32.50 x 46.00 x 6.00mm, NBR
NJ269
58.00 x 74.00 x 10.00mm, ACM



8 1.2L Petrol

3K	4 Cyl.	8 Valves	1166cc	TD4943
3K-B	4 Cyl.	8 Valves	1166cc	TD3792
3K-C	4 Cyl.	8 Valves	1166cc	TD3794
3K-H	4 Cyl.	8 Valves	1166cc	TD4944

KH066 (x8)
→07/74
PA136 (x8)

NJ102
38.50 x 58.00 x 11.00mm, NBR
NJ001
70.00 x 92.00 x 8.50mm, MVQ

9 1.2L Petrol

3KJ	4 Cyl.	8 Valves	1166cc	TD9071
-----	--------	----------	--------	--------

NJ102
38.50 x 58.00 x 11.00mm, NBR
NJ001
70.00 x 92.00 x 8.50mm, MVQ

10 1.2L Petrol

3NR-FE	4 Cyl.	16 Valves	1197cc	TD25663
--------	--------	-----------	--------	---------

NA5088
75.00 x 107.00 x 8.00mm, FPM

11 1.3L Petrol

1NR-FE	4 Cyl.	16 Valves	1329cc	TD21740
--------	--------	-----------	--------	---------

PA5020 (x16)

NA5088
75.00 x 107.00 x 8.00mm, FPM

12 1.3L Petrol

1NR-FKE	4 Cyl.	16 Valves	1329cc	TD29228
2NZ-FE	4 Cyl.	16 Valves	1299cc	TD13088
2NZ-FE	4 Cyl.	16 Valves	1299cc	TD22018
6NR-FE	4 Cyl.	16 Valves	1329cc	TD29831

NA5088
75.00 x 107.00 x 8.00mm, FPM

13 1.3L Petrol

2A	4 Cyl.	8 Valves	1296cc	TD3745
2A-L	4 Cyl.	8 Valves	1296cc	TD4934

KJ722 (x8)

NJ353
35.00 x 49.00 x 6.00mm, NBR

NJ349
32.50 x 46.00 x 6.00mm, NBR
NJ001
70.00 x 92.00 x 8.50mm, MVQ

14 1.3L Petrol

2A-U	4 Cyl.	8 Valves	1295cc	TD34103
------	--------	----------	--------	---------

NJ353
35.00 x 49.00 x 6.00mm, NBR

NJ349
32.50 x 46.00 x 6.00mm, NBR
NJ001
70.00 x 92.00 x 8.50mm, MVQ



15 1.3L

Petrol

2E	4 Cyl.	12 Valves	1296cc	TD4935
2E-E	4 Cyl.	12 Valves	1296cc	TD4936
2E-L	4 Cyl.	12 Valves	1296cc	TD4937
2E-LC	4 Cyl.	12 Valves	1296cc	TD3756

PA425 (x12)

NJ353
35.00 x 49.00 x 6.00mm, NBR

NJ353
35.00 x 49.00 x 6.00mm, NBR
NJ407
75.00 x 100.00 x 8.50mm, MVQ

16 1.3L

Petrol

2SZ-FE	4 Cyl.	16 Valves	1298cc	TD17287
K3-VE	4 Cyl.	16 Valves	1298cc	TD24577
K3-VE2	4 Cyl.	16 Valves	1298cc	TD24625
K3-VET	4 Cyl.	16 Valves	1298cc	TD24628
K3-VT	4 Cyl.	16 Valves	1298cc	TD34154

NJ353
35.00 x 49.00 x 6.00mm, NBR
NA5324
74.00 x 89.00 x 8.50mm, FPM

17 1.3L

Petrol

4E-FE	4 Cyl.	16 Valves	1332cc	TD3833
-------	--------	-----------	--------	--------

PA425 (x16)

NJ353 (x2)
35.00 x 49.00 x 6.00mm, NBR

NJ353
35.00 x 49.00 x 6.00mm, NBR
NJ407
75.00 x 100.00 x 8.50mm, MVQ

18 1.3L

Petrol

4E-FTE	4 Cyl.	16 Valves	1332cc	TD33652
--------	--------	-----------	--------	---------

PA425 (x16)

NJ353 (x2)
35.00 x 49.00 x 6.00mm, NBR

NJ353
35.00 x 49.00 x 6.00mm, NBR

19 1.3L

Petrol

4K	4 Cyl.	8 Valves	1290cc	TD4950
4K-C	4 Cyl.	8 Valves	1290cc	TD4951
4KJ	4 Cyl.	8 Valves	1290cc	TD9072

PA136 (x8)

NJ102
38.50 x 58.00 x 11.00mm, NBR
NJ001
70.00 x 92.00 x 8.50mm, MVQ

20 1.3L

Petrol

8A-FE	4 Cyl.	16 Valves	1342cc	TD22442
-------	--------	-----------	--------	---------

PA425 (x16)

NJ353 (x2)
35.00 x 49.00 x 6.00mm, NBR

NJ349
32.50 x 46.00 x 6.00mm, NBR
NJ001
70.00 x 92.00 x 8.50mm, MVQ

21 1.3L

Petrol

HC-EJ	4 Cyl.	16 Valves	1296cc	TD22446
-------	--------	-----------	--------	---------

PA305 (x16)

NB884
38.00 x 50.00 x 5.50mm, FPM

NA5118
80.00 x 100.00 x 9.00mm, PTFE



22 1.4L Diesel

IND-TV	4 Cyl.	8 Valves	1364cc	TD16378
			NA5260 38.00 x 50.00 x 6.00mm, FPM NA5088 75.00 x 107.00 x 8.00mm, FPM	

23 1.4L Diesel

2WZ-TV	4 Cyl.	8 Valves	1398cc	TD24605
PA6072 (x8) HR5120	NA5258 27.00 x 47.00 x 7.00mm, PTFE	NA5259 40.00 x 55.00 x 6.40mm, PTFE NA5325 85.00 x 105.00 x 8.80mm, PTFE		

24 1.4L Petrol

3A-C	4 Cyl.	8 Valves	1452cc	TD3788
KJ722 (x8)	NJ353 35.00 x 49.00 x 6.00mm, NBR	NJ349 32.50 x 46.00 x 6.00mm, NBR NJ001 70.00 x 92.00 x 8.50mm, MVQ		

25 1.4L Petrol

4ZZ-FE	4 Cyl.	16 Valves	1398cc	TD14228
PA5020 (x8) PA5019 (x8)	NJ347 (x2) 38.00 x 50.00 x 8.00mm, NBR	NA5089 38.00 x 50.00 x 8.00mm, NBR NA5090 76.00 x 94.00 x 8.50mm, FPM		

26 1.5L Diesel

1N	4 Cyl.	8 Valves	1453cc	TD3729
1N-T	4 Cyl.	8 Valves	1454cc	TD27237
PA425 (x8)	NA5260 38.00 x 50.00 x 6.00mm, FPM	NA5260 38.00 x 50.00 x 6.00mm, FPM		

27 1.5L Petrol

1NZ-FE	4 Cyl.	16 Valves	1497cc	TD15499
1NZ-FXE	4 Cyl.	16 Valves	1497cc	TD15589
			NA5088 75.00 x 107.00 x 8.00mm, FPM	

28 1.5L Gas

1NZ-FNE	4 Cyl.	16 Valves	1497cc	TD25278
			NA5088 75.00 x 107.00 x 8.00mm, FPM	

29 1.5L Petrol

2R	4 Cyl.	8 Valves	1490cc	TD3769
			KV412	

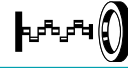

30 1.5L

Petrol

3A	4 Cyl.	8 Valves	1452cc	TD4942
3A-LU	4 Cyl.	8 Valves	1452cc	TD31666
3A-U	4 Cyl.	8 Valves	1452cc	TD22379

KJ722 (x8)

NJ353
35.00 x 49.00 x 6.00mm, NBR

NJ349
32.50 x 46.00 x 6.00mm, NBR
NJ001
70.00 x 92.00 x 8.50mm, MVQ

31 1.5L

Petrol

3A-SU	4 Cyl.	8 Valves	1452cc	TD34104
-------	--------	----------	--------	---------

NJ353
35.00 x 49.00 x 6.00mm, NBR

NJ349
32.50 x 46.00 x 6.00mm, NBR
NJ001
70.00 x 92.00 x 8.50mm, MVQ

32 1.5L

Petrol

3E	4 Cyl.	12 Valves	1456cc	TD25626
3E-E	4 Cyl.	12 Valves	1456cc	TD25627

PA567 (x12)

NJ353
35.00 x 49.00 x 6.00mm, NBR

NJ353
35.00 x 49.00 x 6.00mm, NBR
NJ360
80.00 x 100.00 x 8.50mm, MVQ

33 1.5L

Petrol

3E-TE	4 Cyl.	12 Valves	1456cc	TD25628
-------	--------	-----------	--------	---------

PA425 (x12)

NJ353
35.00 x 49.00 x 6.00mm, NBR

NJ353
35.00 x 49.00 x 6.00mm, NBR
NJ360
80.00 x 100.00 x 8.50mm, MVQ

34 1.5L

Petrol

3SZ-VE	4 Cyl.	16 Valves	1495cc	TD24576
--------	--------	-----------	--------	---------

NJ353
35.00 x 49.00 x 6.00mm, NBR
NA5324
74.00 x 89.00 x 8.50mm, FPM

35 1.5L

Petrol

5A-F	4 Cyl.	16 Valves	1497cc	TD27235
5A-FE	4 Cyl.	16 Valves	1498cc	TD20610
5A-FHE	4 Cyl.	16 Valves	1497cc	TD34195

PA425 (x16)

NJ353 (x2)
35.00 x 49.00 x 6.00mm, NBR

NJ349
32.50 x 46.00 x 6.00mm, NBR
NJ001
70.00 x 92.00 x 8.50mm, MVQ

36 1.5L

Petrol

5E-FE	4 Cyl.	16 Valves	1497cc	TD3839
-------	--------	-----------	--------	--------

PA425 (x16)

NJ353 (x2)
35.00 x 49.00 x 6.00mm, NBR

NJ353
35.00 x 49.00 x 6.00mm, NBR



37 1.5L Petrol

5E-FHE	4 Cyl.	16 Valves	1496cc	TD3840
PA425 (x16)	NJ353 35.00 x 49.00 x 6.00mm, NBR		NJ349 32.50 x 46.00 x 6.00mm, NBR NJ001 70.00 x 92.00 x 8.50mm, MVQ	

38 1.5L Petrol

5K	4 Cyl.	8 Valves	1486cc	TD4952
			NJ102 38.50 x 58.00 x 11.00mm, NBR NJ001 70.00 x 92.00 x 8.50mm, MVQ	

39 1.6L Diesel

1WW	4 Cyl.	16 Valves	1598cc	TD28734
HR5110			NA5299 55.0 x 68.0 x 8.0mm, FPM NA5298 90.00 x 104.00 x 9.00mm, FPM	

40 1.6L Petrol

1Y	4 Cyl.	8 Valves	1626cc	TD9048
PA136 (x8)			NJ344 42.00 x 60.00 x 7.00mm, NBR NJ360 80.00 x 100.00 x 8.50mm, MVQ	

41 1.6L Petrol

1ZR	4 Cyl.	16 Valves	1598cc	TD33985
4ZR	4 Cyl.	16 Valves	1598cc	TD33451
4ZR-FE	4 Cyl.	16 Valves	1598cc	TD26155
			NA5260 38.00 x 50.00 x 6.00mm, FPM NA5089 38.00 x 50.00 x 8.00mm, NBR	

42 1.6L Petrol

1ZR-FAE	4 Cyl.	16 Valves	1598cc	TD21730
1ZR-FE	4 Cyl.	16 Valves	1598cc	TD20925
1ZR-FE	4 Cyl.	16 Valves	1598cc	TD22017
PA5020 (x16)			NA5260 38.00 x 50.00 x 6.00mm, FPM NA5089 38.00 x 50.00 x 8.00mm, NBR	

43 1.6L Petrol

1ZR-FE	4 Cyl.	16 Valves	1598cc	TD21645
			NA5089 38.00 x 50.00 x 8.00mm, NBR	

44 1.6L Petrol

2T	4 Cyl.	8 Valves	1588cc	TD4940
PA136 (x8) 01/73→01/76			NJ102 38.50 x 58.00 x 11.00mm, NBR NJ044 75.00 x 100.00 x 13.00mm, MVQ	

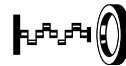
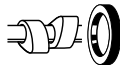

45 1.6L

Petrol

2T-G	4 Cyl.	8 Valves	1588cc	TD3778
2TJ	4 Cyl.	8 Valves	1588cc	TD9073
PA136 (x8)				NJ102 38.50 x 58.00 x 11.00mm, NBR NJ044 75.00 x 100.00 x 13.00mm, MVQ

46 1.6L

Diesel

3WZ-HV	4 Cyl.	8 Valves	1560cc	TD33590
3WZ-TV	4 Cyl.	8 Valves	1560cc	TD28203
PA6072 (x8) HR5120	NA5258 (x2) 27.00 x 47.00 x 7.00mm, PTFE			NA5259 40.00 x 55.00 x 6.40mm, PTFE NA5325 85.00 x 105.00 x 8.80mm, PTFE

47 1.6L

Petrol

3ZZ-FE	4 Cyl.	16 Valves	1598cc	TD14229
PA5020 (x8) PA5019 (x8)	NJ347 (x2) 38.00 x 50.00 x 8.00mm, NBR			NA5089 38.00 x 50.00 x 8.00mm, NBR NA5090 76.00 x 94.00 x 8.50mm, FPM

48 1.6L

Petrol

4A	4 Cyl.	8 Valves	1587cc	TD28054
4A-C	4 Cyl.	8 Valves	1587cc	TD3814
4A-L	4 Cyl.	8 Valves	1588cc	TD3831
4A-LC	4 Cyl.	8 Valves	1587cc	TD3832
KJ722 (x8)	NJ353 35.00 x 49.00 x 6.00mm, NBR			NJ349 32.50 x 46.00 x 6.00mm, NBR NJ001 70.00 x 92.00 x 8.50mm, MVQ

49 1.6L

Petrol

4A-F	4 Cyl.	16 Valves	1587cc	TD3818
4A-GE	4 Cyl.	16 Valves	1587cc	TD3824
PB313 (x8) PA425 (x8)	NJ353 (x2) 35.00 x 49.00 x 6.00mm, NBR			NJ349 32.50 x 46.00 x 6.00mm, NBR NJ001 70.00 x 92.00 x 8.50mm, MVQ

50 1.6L

Petrol

4A-FE	4 Cyl.	16 Valves	1587cc	TD3820
4A-FHE	4 Cyl.	16 Valves	1587cc	TD34100
4A-GEC	4 Cyl.	16 Valves	1587cc	TD3826
4A-GEL	4 Cyl.	16 Valves	1587cc	TD3827
4A-GELC	4 Cyl.	16 Valves	1587cc	TD3830
4A-GELU	4 Cyl.	16 Valves	1587cc	TD29807
4A-GEU	4 Cyl.	16 Valves	1587cc	TD25835
4A-GZE	4 Cyl.	16 Valves	1587cc	TD19301
PA425 (x16)	NJ353 (x2) 35.00 x 49.00 x 6.00mm, NBR			NJ349 32.50 x 46.00 x 6.00mm, NBR NJ001 70.00 x 92.00 x 8.50mm, MVQ



51 1.6L Petrol

12R	4 Cyl.	8 Valves	1587cc	TD9068
12RJ	4 Cyl.	8 Valves	1587cc	TD3705
PA021 (x8)				NJ102 38.50 x 58.00 x 11.00mm, NBR KV412

52 1.8L Diesel

1C	4 Cyl.	8 Valves	1840cc	TD3715
1C-L	4 Cyl.	8 Valves	1839cc	TD3716
1C-TL	4 Cyl.	8 Valves	1840cc	TD3717
PA136 (x8)			NJ347 38.00 x 50.00 x 8.00mm, NBR	NJ344 42.00 x 60.00 x 7.00mm, NBR NJ346 90.00 x 110.00 x 8.50mm, MVQ

53 1.8L Petrol

1S	4 Cyl.	8 Valves	1832cc	TD15709
1S-I	4 Cyl.	8 Valves	1832cc	TD34230
1S-ILU	4 Cyl.	8 Valves	1832cc	TD34098
PA136 (x8)			NB799 38.00 x 50.00 x 7.00mm, FPM	NJ344 42.00 x 60.00 x 7.00mm, NBR NJ354 85.00 x 105.00 x 10.00mm, MVQ

54 1.8L Petrol

1S-EL	4 Cyl.	8 Valves	1832cc	TD3733
			NB799 38.00 x 50.00 x 7.00mm, FPM	

55 1.8L Petrol

1S-L	4 Cyl.	8 Valves	1832cc	TD4932
			NB799 38.00 x 50.00 x 7.00mm, FPM	NJ344 42.00 x 60.00 x 7.00mm, NBR NJ354 85.00 x 105.00 x 10.00mm, MVQ

56 1.8L Petrol

1S-U	4 Cyl.	8 Valves	1832cc	TD31673
				NJ344 42.00 x 60.00 x 7.00mm, NBR NJ354 85.00 x 105.00 x 10.00mm, MVQ

57 1.8L Petrol

1ZZ-FE	4 Cyl.	16 Valves	1794cc	TD13368
PA5020 (x8) PA5019 (x8)			NJ347 (x2) 38.00 x 50.00 x 8.00mm, NBR	NA5089 38.00 x 50.00 x 8.00mm, NBR NA5090 76.00 x 94.00 x 8.50mm, FPM

58 1.8L Petrol

1ZZ-FE	4 Cyl.	16 Valves	1794cc	TD21493
PA5020 (x8) PA5019 (x8)			NB799 (x2) 38.00 x 50.00 x 7.00mm, FPM	

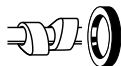

59 1.8L

Petrol

2Y	4 Cyl.	8 Valves	1812cc	TD3783
2Y-C	4 Cyl.	8 Valves	1812cc	TD3786
2Y-U	4 Cyl.	8 Valves	1812cc	TD31708

PA136 (x8)

NJ344 42.00 x 60.00 x 7.00mm, NBR
NJ360 80.00 x 100.00 x 8.50mm, MVQ

60 1.8L

Petrol

2ZR-FAE	4 Cyl.	16 Valves	1798cc	TD21731
2ZR-FBE	4 Cyl.	16 Valves	1798cc	TD28304
5ZR-FXE	4 Cyl.	16 Valves	1798cc	TD30474
7ZR	4 Cyl.	16 Valves	1798cc	TD33452
7ZR-FE	4 Cyl.	16 Valves	1798cc	TD30480

NA5260 38.00 x 50.00 x 6.00mm, FPM
NA5089 38.00 x 50.00 x 8.00mm, NBR

61 1.8L

Petrol

2ZR-FE	4 Cyl.	16 Valves	1798cc	TD30469
2ZR-FE	4 Cyl.	16 Valves	1798cc	TD19815
2ZR-FXE	4 Cyl.	16 Valves	1798cc	TD22621

PA5020 (x16)

NA5260 38.00 x 50.00 x 6.00mm, FPM
NA5089 38.00 x 50.00 x 8.00mm, NBR

62 1.8L

Petrol

2ZR-FXE	4 Cyl.	16 Valves	1798cc	TD24601
---------	--------	-----------	--------	---------

PA5020 (x16)

NA5260 38.00 x 50.00 x 6.00mm, FPM

63 1.8L

Petrol

2ZZ-GE	4 Cyl.	16 Valves	1796cc	TD13369
--------	--------	-----------	--------	---------

NB799 (x2)
38.00 x 50.00 x 7.00mm, FPM

NA5089 38.00 x 50.00 x 8.00mm, NBR
NJ215 85.00 x 105.00 x 10.00mm, FPM

64 1.8L

Petrol

3T	4 Cyl.	8 Valves	1770cc	TD4946
3T-C	4 Cyl.	8 Valves	1770cc	TD3809

PA136 (x8)

65 1.8L

Petrol

4S-FE	4 Cyl.	16 Valves	1838cc	TD22441
-------	--------	-----------	--------	---------

PA425 (x16)

NJ347 (x2)
38.00 x 50.00 x 8.00mm, NBR

NJ344 42.00 x 60.00 x 7.00mm, NBR
NJ354 85.00 x 105.00 x 10.00mm, MVQ



66 1.8L Petrol

4S-FI PA425 (x16)	4 Cyl. NB799 (x2) 38.00 x 50.00 x 7.00mm, FPM	16 Valves	1838cc	TD27236
----------------------	---	-----------	--------	---------

67 1.8L Petrol

7A-FE PA425 (x16)	4 Cyl. NJ353 (x2) 35.00 x 49.00 x 6.00mm, NBR	16 Valves	1762cc	TD3854
				NJ349 32.50 x 46.00 x 6.00mm, NBR NJ001 70.00 x 92.00 x 8.50mm, MVQ

68 1.8L Petrol

7K PA136 (x8)	4 Cyl.	8 Valves	1781cc	TD24293
				NJ102 38.50 x 58.00 x 11.00mm, NBR NJ001 70.00 x 92.00 x 8.50mm, MVQ

69 1.8L Petrol

16R	4 Cyl.	8 Valves	1808cc	TD3710
				NJ243 45.00 x 68.00 x 12.00mm, NBR NJ030 80.00 x 100.00 x 12.00mm, ACM

70 1.9L Diesel

1WZ HR569	4 Cyl. NF841 35.00 x 50.00 x 8.00mm, FPM	8 Valves	1867cc	TD14769
				NA5191 42.00 x 62.00 x 7.00mm, PTFE NA5192 90.00 x 110.00 x 7.00mm, PTFE

71 2.0L Diesel

1AD-FTV PA6055 (x16)	4 Cyl.	16 Valves	1998cc	TD20923
				NA5319 48.00 x 63.00 x 6.50mm, FPM

72 2.0L Petrol

1AZ-FE	4 Cyl.	16 Valves	1998cc	TD20998
1AZ-FE	4 Cyl.	16 Valves	1998cc	TD25209
1AZ-FE	4 Cyl. NB799 (x2) 38.00 x 50.00 x 7.00mm, FPM	16 Valves	1998cc	TD14870
				NA5089 38.00 x 50.00 x 8.00mm, NBR NK169 89.00 x 105.00 x 10.00mm, MVQ

73 2.0L Petrol

1AZ-FSE	4 Cyl. NJ347 (x2) 38.00 x 50.00 x 8.00mm, NBR	16 Valves	1998cc	TD15108
				NA5089 38.00 x 50.00 x 8.00mm, NBR NK169 89.00 x 105.00 x 10.00mm, MVQ

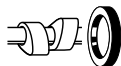

74 2.0L

Diesel

1CD-FTV	4 Cyl.	16 Valves	1995cc	TD15191
PA425 (x16)	NJ347 (x2) 38.00 x 50.00 x 8.00mm, NBR		NA5282	45.00 x 63.00 x 7.00mm, FPM

75 2.0L

Petrol

1G-E	6 Cyl.	12 Valves	1988cc	TD3721
KJ722 (x12)	NJ347 38.00 x 50.00 x 8.00mm, NBR		NJ351	45.00 x 62.00 x 8.00mm, NBR
			NJ044	75.00 x 100.00 x 13.00mm, MVQ

76 2.0L

Petrol

1G-FE	6 Cyl.	24 Valves	1988cc	TD17955
1G-FE	6 Cyl.	24 Valves	1988cc	TD15708
PA425 (x24)	NJ353 (x2) 35.00 x 49.00 x 6.00mm, NBR		NJ351	45.00 x 62.00 x 8.00mm, NBR
			NJ044	75.00 x 100.00 x 13.00mm, MVQ

77 2.0L

Petrol

1G-GE	6 Cyl.	24 Valves	1988cc	TD3724
PA567 (x24)	NJ353 (x2) 35.00 x 49.00 x 6.00mm, NBR		NJ351	45.00 x 62.00 x 8.00mm, NBR
			NJ407	75.00 x 100.00 x 8.50mm, MVQ

78 2.0L

Petrol

1RZ	4 Cyl.	8 Valves	1998cc	TD3731
1RZ-E	4 Cyl.	8 Valves	1998cc	TD24472
21R-C	4 Cyl.	8 Valves	1972cc	TD3740
PA136 (x8)				

79 2.0L

Diesel

2C	4 Cyl.	8 Valves	1975cc	TD3747
2C-E	4 Cyl.	8 Valves	1975cc	TD14768
2C-L	4 Cyl.	8 Valves	1975cc	TD3748
2C-TE	4 Cyl.	8 Valves	1975cc	TD12668
2C-TL	4 Cyl.	8 Valves	1974cc	TD3750
PA136 (x8)	NJ347 38.00 x 50.00 x 8.00mm, NBR		NJ344	42.00 x 60.00 x 7.00mm, NBR
			NJ346	90.00 x 110.00 x 8.50mm, MVQ

80 2.0L

Diesel

2C-T	4 Cyl.	8 Valves	1975cc	TD3749
PA136 (x8)	NB799 38.00 x 50.00 x 7.00mm, FPM		NJ344	42.00 x 60.00 x 7.00mm, NBR
			NJ346	90.00 x 110.00 x 8.50mm, MVQ



81 2.0L Petrol

2S	6 Cyl.	12 Valves	1988cc	TD3771
2S	4 Cyl.	8 Valves	1995cc	TD34650
2S-C	4 Cyl.	8 Valves	1995cc	TD3772
PA136 (x12)	NB799 38.00 x 50.00 x 7.00mm, FPM		NJ344 42.00 x 60.00 x 7.00mm, NBR NJ215 85.00 x 105.00 x 10.00mm, FPM	

82 2.0L Petrol

2S-E	4 Cyl.	8 Valves	1995cc	TD5192
2S-EL	4 Cyl.	8 Valves	1995cc	TD4939
PA136 (x8)	NJ347 38.00 x 50.00 x 8.00mm, NBR		NJ344 42.00 x 60.00 x 7.00mm, NBR NJ215 85.00 x 105.00 x 10.00mm, FPM	

83 2.0L Petrol

2S-ELC	4 Cyl.	8 Valves	1995cc	TD3775
PA136 (x8)	NJ347 38.00 x 50.00 x 8.00mm, NBR		NJ215 85.00 x 105.00 x 10.00mm, FPM	

84 2.0L Diesel

2WW	4 Cyl.	16 Valves	1995cc	TD31271
HR5110			NA5299 55.0 x 68.0 x 8.0mm, FPM NA5298 90.00 x 104.00 x 9.00mm, FPM	

85 2.0L Petrol

3S-FC	4 Cyl.	16 Valves	1998cc	TD23463
	NB799 (x2) 38.00 x 50.00 x 7.00mm, FPM		NJ344 42.00 x 60.00 x 7.00mm, NBR NJ215 85.00 x 105.00 x 10.00mm, FPM	

86 2.0L Petrol

3S-FE	4 Cyl.	16 Valves	1998cc	TD3798
PA425 (x16)	NB799 38.00 x 50.00 x 7.00mm, FPM		NJ344 42.00 x 60.00 x 7.00mm, NBR NJ215 85.00 x 105.00 x 10.00mm, FPM	

87 2.0L Petrol

3S-FSE	4 Cyl.	16 Valves	1998cc	TD24622
PA425 (x16)	NB799 (x2) 38.00 x 50.00 x 7.00mm, FPM		NJ344 42.00 x 60.00 x 7.00mm, NBR NJ215 85.00 x 105.00 x 10.00mm, FPM	



88 2.0L

Petrol

3S-GE	4 Cyl.	16 Valves	1998cc	TD3802
3S-GELU	4 Cyl.	16 Valves	1998cc	TD21364
3S-GEU	4 Cyl.	16 Valves	1998cc	TD21167
3S-GTE	4 Cyl.	16 Valves	1998cc	TD3797

PA425 (x16)

NJ353 (x2)
35.00 x 49.00 x 6.00mm, NBR

NJ215
85.00 x 105.00 x 10.00mm, FPM

89 2.0L

Petrol

3S-GEL	4 Cyl.	16 Valves	1998cc	TD3803
--------	--------	-----------	--------	--------

PA425 (x16)

NJ353 (x2)
35.00 x 49.00 x 6.00mm, NBR

NJ344
42.00 x 60.00 x 7.00mm, NBR
NJ215
85.00 x 105.00 x 10.00mm, FPM

90 2.0L

Petrol

3S-GELC	4 Cyl.	16 Valves	1998cc	TD3804
---------	--------	-----------	--------	--------

PA425 (x16)

NJ353 (x2)
35.00 x 49.00 x 6.00mm, NBR

91 2.0L

Petrol

3Y	4 Cyl.	8 Valves	1998cc	TD4948
3Y-C	4 Cyl.	8 Valves	1998cc	TD3813
3Y-EU	4 Cyl.	8 Valves	1998cc	TD31704

PA136 (x8)

NJ344
42.00 x 60.00 x 7.00mm, NBR
NJ360
80.00 x 100.00 x 8.50mm, MVQ

92 2.0L

Gas

3Y-P	4 Cyl.	8 Valves	1998cc	TD34207
3Y-PE	4 Cyl.	8 Valves	1998cc	TD33988

PA136 (x8)

NJ344
42.00 x 60.00 x 7.00mm, NBR
NJ360
80.00 x 100.00 x 8.50mm, MVQ

93 2.0L

Petrol

3ZR-FAE	4 Cyl.	16 Valves	1987cc	TD29865
3ZR-FE	4 Cyl.	16 Valves	1987cc	TD30475

PA5020 (x16)

NA5260
38.00 x 50.00 x 6.00mm, FPM

94 2.0L

Petrol

3ZR-FAE	4 Cyl.	16 Valves	1987cc	TD21733
3ZR-FE	4 Cyl.	16 Valves	1987cc	TD25807

PA5020 (x16)

NA5260
38.00 x 50.00 x 6.00mm, FPM
NA5089
38.00 x 50.00 x 8.00mm, NBR



95 2.0L Petrol

3ZR-FBE	4 Cyl.	16 Valves	1987cc	TD32470
				NA5260 38.00 x 50.00 x 6.00mm, FPM NA5089 38.00 x 50.00 x 8.00mm, NBR

96 2.0L Diesel

4WZ-FHV	4 Cyl.	16 Valves	1997cc	TD28205
4WZ-FTV	4 Cyl.	16 Valves	1997cc	TD28204
4WZ-FTW	4 Cyl.	16 Valves	1997cc	TD34420
HR5122	NA5035 (x2)			NA5191 42.00 x 62.00 x 7.00mm, PTFE NA5192 90.00 x 110.00 x 7.00mm, PTFE

97 2.0L Petrol

5R	4 Cyl.	8 Valves	1997cc	TD3849
KH066 (x8) 01/71→05/78 PA021 (x8) 05/78→				NJ102 38.50 x 58.00 x 11.00mm, NBR →12/75 NJ243 45.00 x 68.00 x 12.00mm, NBR 12/75→ NJ030 80.00 x 100.00 x 12.00mm, ACM 01/71→

98 2.0L Petrol

18R	4 Cyl.	8 Valves	1968cc	TD3712
18R-G	4 Cyl.	8 Valves	1968cc	TD3714
				NJ243 45.00 x 68.00 x 12.00mm, NBR NJ030 80.00 x 100.00 x 12.00mm, ACM

99 2.0L Petrol

21R	4 Cyl.	8 Valves	1972cc	TD3739
21R-U	4 Cyl.	8 Valves	1972cc	TD9045
PA136 (x8)				NJ243 45.00 x 68.00 x 12.00mm, NBR NJ030 80.00 x 100.00 x 12.00mm, ACM

100 2.2L Diesel

2AD-FHV	4 Cyl.	16 Valves	2231cc	TD18483
2AD-FHV	4 Cyl.	16 Valves	2231cc	TD18734
2AD-FTV	4 Cyl.	16 Valves	2231cc	TD24506
2AD-FTV	4 Cyl.	16 Valves	2231cc	TD18485
PA6055 (x16)				NA5319 48.00 x 63.00 x 6.50mm, FPM



101 2.2L

Diesel

3CE	4 Cyl.	8 Valves	2184cc	TD31866
3C-T	4 Cyl.	8 Valves	2184cc	TD34044
3C-TE	4 Cyl.	8 Valves	2184cc	TD12628

PA136 (x8)	NB799 38.00 x 50.00 x 7.00mm, FPM	NJ344 42.00 x 60.00 x 7.00mm, NBR NJ346 90.00 x 110.00 x 8.50mm, MVQ
------------	---	---

102 2.2L

Petrol

4Y	4 Cyl.	8 Valves	2237cc	TD3836
4Y-E	4 Cyl.	8 Valves	2237cc	TD24961
4Y-EC	4 Cyl.	8 Valves	2237cc	TD3837

PA136 (x8)		NJ344 42.00 x 60.00 x 7.00mm, NBR NJ360 80.00 x 100.00 x 8.50mm, MVQ
------------	--	---

103 2.2L

Petrol

5S-FE	4 Cyl.	16 Valves	2164cc	TD3850
-------	--------	-----------	--------	--------

PA425 (x16)	NJ347 38.00 x 50.00 x 8.00mm, NBR	NJ344 42.00 x 60.00 x 7.00mm, NBR NJ354 85.00 x 105.00 x 10.00mm, MVQ
-------------	---	--

104 2.2L

Petrol

20R	4 Cyl.	8 Valves	2189cc	TD32782
-----	--------	----------	--------	---------

		NJ243 45.00 x 68.00 x 12.00mm, NBR NJ030 80.00 x 100.00 x 12.00mm, ACM
--	--	---

105 2.2L

Diesel

L	4 Cyl.	8 Valves	2188cc	TD4955
---	--------	----------	--------	--------

PA139 (x8) →07/81	NJ358 42.00 x 60.00 x 9.00mm, NBR →07/81 NJ344 42.00 x 60.00 x 7.00mm, NBR 08/81→	NJ358 42.00 x 60.00 x 9.00mm, NBR →07/81
----------------------	--	---

106 2.4L

Petrol

2AZ-FE	4 Cyl.	16 Valves	2362cc	TD25213
--------	--------	-----------	--------	---------

	NB799 (x2) 38.00 x 50.00 x 7.00mm, FPM	NA5089 38.00 x 50.00 x 8.00mm, NBR NK169 89.00 x 105.00 x 10.00mm, MVQ
--	--	---

107 2.4L

Petrol

2AZ-FE	4 Cyl.	16 Valves	2362cc	TD21437
--------	--------	-----------	--------	---------

2AZ-FXE	4 Cyl.	16 Valves	2362cc	TD23837
---------	--------	-----------	--------	---------

PA5020 (x16)	NB799 (x2) 38.00 x 50.00 x 7.00mm, FPM	NA5089 38.00 x 50.00 x 8.00mm, NBR NK169 89.00 x 105.00 x 10.00mm, MVQ
---------------	--	---

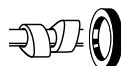

108 2.4L		Petrol			
2AZ-FE		4 Cyl.	16 Valves	2362cc	TD33041
2AZ-FE		4 Cyl.	16 Valves	2362cc	TD14788
2AZ-FXE		4 Cyl.	16 Valves	2362cc	TD19295
PA5020 (x16)		NB799 38.00 x 50.00 x 7.00mm, FPM		NA5089 (x) 38.00 x 50.00 x 8.00mm, NBR NK169 (x) 89.00 x 105.00 x 10.00mm, MVQ	

109 2.4L		Petrol			
2AZ-FSE		4 Cyl.	16 Valves	2362cc	TD18032
3AZ-FE		4 Cyl.	16 Valves	2362cc	TD30473
3AZ-FXE		4 Cyl.	16 Valves	2362cc	TD33235
				NA5089 (x) 38.00 x 50.00 x 8.00mm, NBR NK169 (x) 89.00 x 105.00 x 10.00mm, MVQ	

110 2.4L		Diesel			
2J		4 Cyl.	8 Valves	2449cc	TD3759
PA192 (x8) 08/77→12/80				NJ239 (x) 50.00 x 72.00 x 12.00mm, NBR	

111 2.4L		Diesel			
2L		4 Cyl.	8 Valves	2446cc	TD4938
2L-T		4 Cyl.	8 Valves	2446cc	TD3767
PA138 (x8) →12/88 PA136 (x8) 01/89→		NJ344 42.00 x 60.00 x 7.00mm, NBR →07/88 NJ349 32.50 x 46.00 x 6.00mm, NBR 08/88→		NJ344 (x) 42.00 x 60.00 x 7.00mm, NBR NJ215 (x) 85.00 x 105.00 x 10.00mm, FPM	

112 2.4L		Diesel			
2L-TE		4 Cyl.	8 Valves	2446cc	TD24627
PA136 (x8) →07/88		NJ344 42.00 x 60.00 x 7.00mm, NBR →07/88 NJ349 32.50 x 46.00 x 6.00mm, NBR 08/88→		NJ344 (x) 42.00 x 60.00 x 7.00mm, NBR NJ215 (x) 85.00 x 105.00 x 10.00mm, FPM	

113 2.4L		Diesel			
2L-TII		4 Cyl.	8 Valves	2446cc	TD21259
PA136 (x8)		NJ349 32.50 x 46.00 x 6.00mm, NBR		NJ344 (x) 42.00 x 60.00 x 7.00mm, NBR NJ215 (x) 85.00 x 105.00 x 10.00mm, FPM	



114 2.4L Petrol

2RZ	4 Cyl.	8 Valves	2438cc	TD26841
2RZ-E	4 Cyl.	8 Valves	2438cc	TD3770
22RE	4 Cyl.	8 Valves	2367cc	TD9070
22RTEC	4 Cyl.	8 Valves	2367cc	TD30278

PA136 (x8)				NJ200 48.00 x 68.00 x 7.00mm, NBR NK055 88.00 x 106.00 x 8.70mm, FPM
------------	--	--	--	---

115 2.4L Petrol

2RZ-FE	4 Cyl.	16 Valves	2438cc	TD9930
2TZ-FE	4 Cyl.	16 Valves	2438cc	TD3780
2TZ-FZE	4 Cyl.	16 Valves	2438cc	TD18746

PA425 (x16)				NJ200 48.00 x 68.00 x 7.00mm, NBR NK055 88.00 x 106.00 x 8.70mm, FPM
-------------	--	--	--	---

116 2.4L Petrol

22R	4 Cyl.	8 Valves	2367cc	TD4933
22REC	4 Cyl.	8 Valves	2367cc	TD3744

PA136 (x8)	NJ353 35.00 x 49.00 x 6.00mm, NBR	NJ243 45.00 x 68.00 x 12.00mm, NBR NJ360 80.00 x 100.00 x 8.50mm, MVQ
------------	---	--

117 2.5L Petrol

1JZ-FSE	6 Cyl.	24 Valves	2491cc	TD24626
1JZ-GE	6 Cyl.	24 Valves	2491cc	TD20612
1JZ-GTE	6 Cyl.	24 Valves	2491cc	TD3727

PA425 (x24)				
-------------	--	--	--	--

118 2.5L Petrol

2AR-FE	4 Cyl.	16 Valves	2494cc	TD24804
2AR-FE	4 Cyl.	16 Valves	2494cc	TD27729
2AR-FSE	4 Cyl.	16 Valves	2493cc	TD27473
2AR-FSE	4 Cyl.	16 Valves	2494cc	TD27852
2AR-FXE	4 Cyl.	16 Valves	2493cc	TD27730
2AR-FXE	4 Cyl.	16 Valves	2494cc	TD25707

PA5020 (x16)				NA5036 42.00 x 54.00 x 6.00mm, FPM NK169 89.00 x 105.00 x 10.00mm, MVQ
---------------	--	--	--	---

119 2.5L Diesel

2KD-FTV	4 Cyl.	16 Valves	2494cc	TD16332
---------	--------	-----------	--------	---------

	NJ349 (x2) 32.50 x 46.00 x 6.00mm, NBR	NJ377 32.00 x 47.00 x 6.00mm, ACM NK216 95.00 x 115.00 x 9.50mm, MVQ
--	--	---



120 2.5L Petrol

2MZ-FE	6 Cyl.	24 Valves	2496cc	TD19665
			NK050	40.00 x 55.00 x 6.00mm, ACM

121 2.5L Petrol

2VZ-FE	6 Cyl.	24 Valves	2508cc	TD24602
2VZ-FE	6 Cyl.	24 Valves	2508cc	TD3781
PA425 (x24)	NB799 (x2)		NK050	40.00 x 55.00 x 6.00mm, ACM
	38.00 x 50.00 x 7.00mm, FPM			

122 2.5L Petrol

4AR-FXE	4 Cyl.	16 Valves	2494cc	TD33377
			NA5036	42.00 x 54.00 x 6.00mm, FPM
			NK169	89.00 x 105.00 x 10.00mm, MVQ

123 2.7L Petrol

1AR-FE	4 Cyl.	16 Valves	2671cc	TD24540
1AR-FE	4 Cyl.	16 Valves	2672cc	TD24802
PA5020 (x16)			NA5036	42.00 x 54.00 x 6.00mm, FPM
			NK169	89.00 x 105.00 x 10.00mm, MVQ

124 2.7L Petrol

1AR-FE	4 Cyl.	16 Valves	2672cc	TD30326
			NA5036	42.00 x 54.00 x 6.00mm, FPM
			NK169	89.00 x 105.00 x 10.00mm, MVQ

125 2.7L Petrol

3RZ-FE	4 Cyl.	16 Valves	2694cc	TD13128
PA425 (x8)			NJ200	48.00 x 68.00 x 7.00mm, NBR
			NK055	88.00 x 106.00 x 8.70mm, FPM

126 2.8L Diesel

3L	4 Cyl.	8 Valves	2779cc	TD3796
PA136 (x8)	NJ349		NJ344	42.00 x 60.00 x 7.00mm, NBR
	32.50 x 46.00 x 6.00mm, NBR		NJ215	85.00 x 105.00 x 10.00mm, FPM

127 2.8L Petrol

5M-GE	6 Cyl.	12 Valves	2759cc	TD3847
PA136 (x12)	NJ102 (x2)		NJ344	42.00 x 60.00 x 7.00mm, NBR
	38.50 x 58.00 x 11.00mm, NBR		NJ042	48.00 x 70.00 x 12.00mm, NBR
			NJ030	80.00 x 100.00 x 12.00mm, ACM

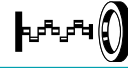

128 3.0L

Diesel

1KD-FTV	4 Cyl.	16 Valves	2982cc	TD15208
	NJ349 (x2) 32.50 x 46.00 x 6.00mm, NBR		NJ377 32.00 x 47.00 x 6.00mm, ACM	

129 3.0L

Diesel

1KZ-T	4 Cyl.	8 Valves	2982cc	TD3728
1KZ-TE	4 Cyl.	8 Valves	2982cc	TD9479
PA136 (x8)	NJ349 32.50 x 46.00 x 6.00mm, NBR		NJ377 32.00 x 47.00 x 6.00mm, ACM NK251 50.00 x 68.00 x 9.00mm, NBR	

130 3.0L

Petrol

1MZ-FE	6 Cyl.	24 Valves	2995cc	TD5545
1MZ-FE	6 Cyl.	24 Valves	2995cc	TD17949
PA5020 (x24)	NB799 (x2) 38.00 x 50.00 x 7.00mm, FPM		NK050 40.00 x 55.00 x 6.00mm, ACM	

131 3.0L

Petrol

2JZ-GE	6 Cyl.	24 Valves	2997cc	TD17957
2JZ-GE	6 Cyl.	24 Valves	2997cc	TD3761
2JZ-GTE	6 Cyl.	24 Valves	2997cc	TD3762
PA425 (x24)				

132 3.0L

Petrol

3GR-FE	6 Cyl.	24 Valves	2995cc	TD23839
3GR-FE	6 Cyl.	24 Valves	2995cc	TD23840
3GR-FSE	6 Cyl.	24 Valves	2994cc	TD19299
3GR-FSE	6 Cyl.	24 Valves	2995cc	TD18337
PA5020 (x24)				

133 3.0L

Petrol

3VZ-E	6 Cyl.	12 Valves	2959cc	TD3810
PA136 (x12)	NK180 42.00 x 55.00 x 8.00mm, FPM		NK050 40.00 x 55.00 x 6.00mm, ACM	

134 3.0L

Petrol

3VZ-FE	6 Cyl.	24 Valves	2959cc	TD4947
3VZ-FE	6 Cyl.	24 Valves	2959cc	TD17953
PA425 (x24)	NJ347 (x2) 38.00 x 50.00 x 8.00mm, NBR		NK050 40.00 x 55.00 x 6.00mm, ACM	

135 3.0L

Diesel

5L	4 Cyl.	8 Valves	2986cc	TD18745
5L-E	4 Cyl.	8 Valves	2986cc	TD23999
PA136 (x8)	NJ349 32.50 x 46.00 x 6.00mm, NBR		NJ344 42.00 x 60.00 x 7.00mm, NBR NJ215 85.00 x 105.00 x 10.00mm, FPM	

136 3.0L

Petrol

6M-GE	6 Cyl.	12 Valves	2954cc	TD3852
PA136 (x8)				



137 3.0L		Petrol		
7M-GE	6 Cyl.	24 Valves	2954cc	TD3856
7M-GTE	6 Cyl.	24 Valves	2954cc	TD3859
7M-GTEU	6 Cyl.	24 Valves	2954cc	TD29212
PA425 (x24)	NJ353 (x2) 35.00 x 49.00 x 6.00mm, NBR		NJ344 42.00 x 60.00 x 7.00mm, NBR NJ030 80.00 x 100.00 x 12.00mm, ACM	

138 3.0L		Petrol		
7M-GEU	6 Cyl.	24 Valves	2954cc	TD3858
PA425 (x24)	NJ353 (x2) 35.00 x 49.00 x 6.00mm, NBR			

139 3.0L		Diesel		
11B	4 Cyl.	8 Valves	2986cc	TD3703
PA260 (x8)			NJ239 50.00 x 72.00 x 12.00mm, NBR NJ240 95.00 x 115.00 x 12.00mm, MVQ	

140 3.0L		Diesel		
B	4 Cyl.	8 Valves	2977cc	TD9039
			NJ239 50.00 x 72.00 x 12.00mm, NBR NJ240 95.00 x 115.00 x 12.00mm, MVQ	

141 3.0L		Petrol		
C 30 NE	6 Cyl.	12 Valves	2969cc	TD31613
PA619 (x12) HR336 (x3)			NB628 45.00 x 60.00 x 9.00mm, ACM NB469 77.00 x 100.00 x 11.50mm, FPM	

142 3.2L		Diesel		
2B	4 Cyl.	8 Valves	3197cc	TD22034
			NJ239 50.00 x 72.00 x 12.00mm, NBR NJ240 95.00 x 115.00 x 12.00mm, MVQ	

143 3.3L		Petrol		
3MZ-FE	6 Cyl.	24 Valves	3311cc	TD19300
3MZ-FE	6 Cyl.	24 Valves	3311cc	TD19346
PA5020 (x24)	NB799 (x2) 38.00 x 50.00 x 7.00mm, FPM		NK050 40.00 x 55.00 x 6.00mm, ACM NA869 92.00 x 110.00 x 10.00mm, MVQ	

144 3.4L		Diesel		
3B	4 Cyl.	8 Valves	3432cc	TD3789
PA260 (x8) →08/88				

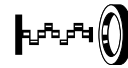
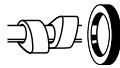

145 3.4L

Petrol

5VZ-FE	6 Cyl.	24 Valves	3378cc	TD9480
PA425 (x24)	NB799 (x2) 38.00 x 50.00 x 7.00mm, FPM		NK050 40.00 x 55.00 x 6.00mm, ACM	

146 3.4L

Diesel

13B	4 Cyl.	8 Valves	3431cc	TD3706
PA260 (x8)	NA5187 30.00 x 52.00 x 7.00mm, ACM		NJ239 50.00 x 72.00 x 12.00mm, NBR NJ240 95.00 x 115.00 x 12.00mm, MVQ	

147 3.4L

Diesel

13BT	4 Cyl.	8 Valves	3431cc	TD3707
PA260 (x8)			NJ239 50.00 x 72.00 x 12.00mm, NBR NJ240 95.00 x 115.00 x 12.00mm, MVQ	

148 3.5L

Diesel

1PZ	5 Cyl.	10 Valves	3470cc	TD3730
PA136 (x10)	NJ349 32.50 x 46.00 x 6.00mm, NBR		NJ377 32.00 x 47.00 x 6.00mm, ACM NJ349 32.50 x 46.00 x 6.00mm, NBR	

149 3.5L

Petrol

2GR-FE	6 Cyl.	24 Valves	3456cc	TD22384
2GR-FE	6 Cyl.	24 Valves	3456cc	TD19296
2GR-FE	6 Cyl.	24 Valves	3456cc	TD19345
2GR-FSE	6 Cyl.	24 Valves	3456cc	TD19908
2GR-FSE	6 Cyl.	24 Valves	3456cc	TD19909
2GR-FXE	6 Cyl.	24 Valves	3456cc	TD22886
2GR-FXE	6 Cyl.	24 Valves	3456cc	TD23440
PA5020 (x24)				

150 3.6L

Diesel

H	6 Cyl.	12 Valves	3576cc	TD15729
PA192 (x12) 08/77→			NJ239 50.00 x 72.00 x 12.00mm, NBR NJ240 95.00 x 115.00 x 12.00mm, MVQ	

151 3.9L

Petrol

F	6 Cyl.	12 Valves	3878cc	TD15728
			NJ243 45.00 x 68.00 x 12.00mm, NBR NJ055 100.00 x 120.00 x 11.00mm, MVQ	

152 4.0L

Petrol

1GR-FE	6 Cyl.	24 Valves	3956cc	TD28431
1GR-FE	6 Cyl.	24 Valves	3956cc	TD16984
1GR-FE	6 Cyl.	24 Valves	3956cc	TD26744
PA5020 (x24)				



153 4.0L Petrol

1UZ-FE	8 Cyl.	32 Valves	3969cc	TD17951
PA425 (x32)	NB799 (x2) 38.00 x 50.00 x 7.00mm, FPM		NJ344 42.00 x 60.00 x 7.00mm, NBR NJ346 90.00 x 110.00 x 8.50mm, MVQ	

154 4.0L Petrol

1UZ-FE	8 Cyl.	32 Valves	3969cc	TD3736
PA425 (x32)	NB799 (x2) 38.00 x 50.00 x 7.00mm, FPM			

155 4.0L Diesel

2H	6 Cyl.	12 Valves	3980cc	TD3758
PA192 (x12) →10/82			NJ239 50.00 x 72.00 x 12.00mm, NBR NJ240 95.00 x 115.00 x 12.00mm, MVQ	

156 4.0L Petrol

3F	6 Cyl.	12 Valves	3956cc	TD3790
PA139 (x12)			NJ993 45.00 x 68.00 x 8.50mm, ACM	

157 4.0L Diesel

12HT	6 Cyl.	12 Valves	3980cc	TD4931
			NK251 50.00 x 68.00 x 9.00mm, NBR NJ239 50.00 x 72.00 x 12.00mm, NBR NJ240 95.00 x 115.00 x 12.00mm, MVQ	

158 4.2L Diesel

1HD-FT	6 Cyl.	24 Valves	4164cc	TD5193
1HD-FTE	6 Cyl.	24 Valves	4164cc	TD9928
PA136 (x24)	NJ349 (x2) 32.50 x 46.00 x 6.00mm, NBR		NJ377 32.00 x 47.00 x 6.00mm, ACM NK216 95.00 x 115.00 x 9.50mm, MVQ	

159 4.2L Diesel

1HD-T	6 Cyl.	12 Valves	4164cc	TD3725
1H-Z	6 Cyl.	12 Valves	4164cc	TD3726
PA136 (x12)	NJ349 32.50 x 46.00 x 6.00mm, NBR		NJ377 32.00 x 47.00 x 6.00mm, ACM	

160 4.2L Petrol

2F	6 Cyl.	12 Valves	4230cc	TD3757
PA021 (x12) 08/75→10/80 PA139 (x12) 11/80→			NJ243 45.00 x 68.00 x 12.00mm, NBR NJ055 100.00 x 120.00 x 11.00mm, MVQ	

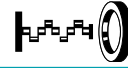

161 4.3L

Petrol

3UZ-FE	8 Cyl.	32 Valves	4293cc	TD15628
3UZ-FE	8 Cyl.	32 Valves	4293cc	TD17959
PA5020 ■ (x32)				

162 4.5L

Diesel

1VD-FTV	8 Cyl.	32 Valves	4461cc	TD23771
1VD-FTV	8 Cyl.	32 Valves	4461cc	TD34135
PA6055 (x32)				

163 4.6L

Petrol

1UR-FE	8 Cyl.	32 Valves	4608cc	TD23835
1UR-FE	8 Cyl.	32 Valves	4608cc	TD23836
1UR-FSE	8 Cyl.	32 Valves	4608cc	TD19906
1UR-FSE	8 Cyl.	32 Valves	4608cc	TD19907

NJ344 ■

42.00 x 60.00 x 7.00mm, NBR

NJ346 ■

90.00 x 110.00 x 8.50mm, MVQ



181	09/69→07/70	H	Petrol	1493	4	8	75
181	08/70→12/74	AG	Petrol	1584	4	8	81
181	09/72→12/74	AH	Petrol	1584	4	8	81
181	03/73→02/79	AL	Petrol	1584	4	8	81
181	03/73→02/79	AM	Petrol	1584	4	8	81
411,412	07/68→08/73	V	Petrol	1679	4	8	117
411,412	07/68→08/73	Z	Petrol	1679	4	8	117
411,412	09/69→08/73	W	Petrol	1679	4	8	117
411,412	07/73→03/75	AN	Petrol	1795	4	8	134
411,412	07/73→03/75	AT	Petrol	1795	4	8	134
411,412	09/73→12/74	EA	Petrol	1679	4	8	117
411,412	09/73→12/74	EC	Petrol	1795	4	8	134
412 Variant	01/72→12/73	W	Petrol	1679	4	8	117
412 Variant	07/73→03/75	AN	Petrol	1795	4	8	134
412 Variant	07/73→03/75	AT	Petrol	1795	4	8	134
1500,1600 (31)	04/61→07/73	K	Petrol	1493	4	8	75
1500,1600 (31)	08/65→07/73	T	Petrol	1584	4	8	81
1500,1600 (31)	08/65→07/73	U	Petrol	1584	4	8	81
1500,1600 Hatchback (31)	08/65→07/73	T	Petrol	1584	4	8	81
1500,1600 Hatchback (31)	08/65→07/73	U	Petrol	1584	4	8	81
1500,1600 Hatchback (31)	07/68→07/73	K	Petrol	1493	4	8	75
1500,1600 Variant (36)	04/61→07/73	K	Petrol	1493	4	8	75
1500,1600 Variant (36)	08/65→07/73	T	Petrol	1584	4	8	81
1500,1600 Variant (36)	08/65→07/73	U	Petrol	1584	4	8	81
Amarok (2HA, 2HB, S1B, S6B, S7A, S7B)	09/10→	CDBA	Diesel	1968	4	16	194
Amarok (2HA, 2HB, S1B, S6B, S7A, S7B)	09/10→	CDCA	Diesel	1968	4	16	194
Amarok (2HA, 2HB, S1B, S6B, S7A, S7B)	09/10→	CNFA	Diesel	1968	4	16	194
Amarok (2HA, 2HB, S1B, S6B, S7A, S7B)	12/10→	CFPA	Petrol	1984	4	16	195
Amarok (2HA, 2HB, S1B, S6B, S7A, S7B)	11/11→	CNEA	Diesel	1968	4	16	194
Amarok (2HA, 2HB, S1B, S6B, S7A, S7B)	11/11→	CSHA	Diesel	1968	4	16	194
Amarok (2HA, 2HB, S1B, S6B, S7A, S7B)	06/12→	CNFB	Diesel	1968	4	16	194
Amarok (2HA, 2HB, S1B, S6B, S7A, S7B)	06/16→	DDXB	Diesel	2967	6	24	257
Amarok (2HA, 2HB, S1B, S6B, S7A, S7B)	06/16→	DDXC	Diesel	2967	6	24	257
Amarok Platform/Chassis (S1B)	09/11→	CDBA	Diesel	1968	4	16	194
Amarok Platform/Chassis (S1B)	09/11→	CDCA	Diesel	1968	4	16	194
Amarok Platform/Chassis (S1B)	09/11→	CFPA	Petrol	1984	4	16	195
Amarok Platform/Chassis (S1B)	09/11→	CNEA	Diesel	1968	4	16	194
Amarok Platform/Chassis (S1B)	09/11→	CNFA	Diesel	1968	4	16	194
Amarok Platform/Chassis (S1B)	09/11→	CNFB	Diesel	1968	4	16	194
Amarok Platform/Chassis (S1B)	09/11→	CSHA	Diesel	1968	4	16	194
Ameo (631)	05/16→	CJLA	Petrol	1198	3	12	23
Ameo (631)	08/16→	CWXC	Diesel	1498	4	16	71
Arteon (3H7)	04/17→	CUAA	Diesel	1968	4	16	204
Arteon (3H7)	04/17→	DFGA	Diesel	1968	4	16	207
Arteon (3H7)	05/17→	DFHA	Diesel	1968	4	16	207
Beetle (5C1, 5C2)	04/11→	CBFA	Petrol	1984	4	16	195
Beetle (5C1, 5C2)	04/11→	CBTA	Petrol	2480	5	20	243
Beetle (5C1, 5C2)	04/11→	CBUA	Petrol	2480	5	20	243
Beetle (5C1, 5C2)	04/11→	CCCA	Petrol	2480	5	20	243
Beetle (5C1, 5C2)	04/11→	CCTA	Petrol	1984	4	16	195
Beetle (5C1, 5C2)	04/11→	CCZA	Petrol	1984	4	16	195
Beetle (5C1, 5C2)	04/11→	CFFB	Diesel	1968	4	16	194
Beetle (5C1, 5C2)	04/11→	CJAA	Diesel	1968	4	16	194
Beetle (5C1, 5C2)	07/11→	CBZB	Petrol	1197	4	8	24
Beetle (5C1, 5C2)	10/11→	CAVD	Petrol	1390	4	16	53
Beetle (5C1, 5C2)	10/11→	CAYC	Diesel	1598	4	16	105
Beetle (5C1, 5C2)	10/11→	CNWA	Petrol	1390	4	16	53
Beetle (5C1, 5C2)	10/11→	CTHD	Petrol	1390	4	16	53
Beetle (5C1, 5C2)	10/11→	CTKA	Petrol	1390	4	16	53
Beetle (5C1, 5C2)	12/13→	CPKA	Petrol	1798	4	16	147
Beetle (5C1, 5C2)	12/13→	CPRA	Petrol	1798	4	16	147
Beetle (5C1, 5C2)	06/14→	CUUA	Diesel	1968	4	16	204
Beetle (5C1, 5C2)	07/14→	CUUB	Diesel	1968	4	16	204
Beetle (5C1, 5C2)	07/14→	CVCA	Diesel	1968	4	16	204
Beetle (5C1, 5C2)	12/14→	CULC	Petrol	1984	4	16	201
Beetle (5C1, 5C2)	12/14→	CYVD	Petrol	1197	4	16	26
Beetle (5C1, 5C2)	12/14→	CZDA	Petrol	1395	4	16	64
Beetle Convertible (5C7, 5C8)	12/11→	CAVD	Petrol	1390	4	16	53
Beetle Convertible (5C7, 5C8)	12/11→	CAYC	Diesel	1598	4	16	105
Beetle Convertible (5C7, 5C8)	12/11→	CBFA	Petrol	1984	4	16	195
Beetle Convertible (5C7, 5C8)	12/11→	CBTA	Petrol	2480	5	20	243
Beetle Convertible (5C7, 5C8)	12/11→	CBUA	Petrol	2480	5	20	243
Beetle Convertible (5C7, 5C8)	12/11→	CBZB	Petrol	1197	4	8	24
Beetle Convertible (5C7, 5C8)	12/11→	CCCA	Petrol	2480	5	20	243
Beetle Convertible (5C7, 5C8)	12/11→	CCTA	Petrol	1984	4	16	195
Beetle Convertible (5C7, 5C8)	12/11→	CCZA	Petrol	1984	4	16	195
Beetle Convertible (5C7, 5C8)	12/11→	CNWA	Petrol	1390	4	16	53
Beetle Convertible (5C7, 5C8)	12/11→	CTHD	Petrol	1390	4	16	53



CC



9

Beetle Convertible (5C7, 5C8)	12/11→	CTKA	Petrol	1390	4	16	53
Beetle Convertible (5C7, 5C8)	04/12→	CFFB	Diesel	1968	4	16	194
Beetle Convertible (5C7, 5C8)	04/12→	CJAA	Diesel	1968	4	16	194
Beetle Convertible (5C7, 5C8)	12/13→	CPKA	Petrol	1798	4	16	147
Beetle Convertible (5C7, 5C8)	12/13→	CPRA	Petrol	1798	4	16	147
Beetle Convertible (5C7, 5C8)	06/14→	CUUA	Diesel	1968	4	16	204
Beetle Convertible (5C7, 5C8)	09/14→	CUUB	Diesel	1968	4	16	204
Beetle Convertible (5C7, 5C8)	09/14→	CVCA	Diesel	1968	4	16	204
Beetle Convertible (5C7, 5C8)	09/14→	DELA	Diesel	1968	4	16	204
Beetle Convertible (5C7, 5C8)	12/14→	CULC	Petrol	1984	4	16	201
Beetle Convertible (5C7, 5C8)	12/14→	CYVD	Petrol	1197	4	16	26
Beetle Convertible (5C7, 5C8)	12/14→	CZDA	Petrol	1395	4	16	64
Bora	01/08→03/16	CLS	Petrol	1598	4	16	103
Bora	11/08→12/10	CEN	Petrol	1984	4	8	180
Bora	11/08→03/16	BWH	Petrol	1595	4	8	104
Bora	06/10→03/16	CFB	Petrol	1390	4	16	53
Bora (1J2)	10/98→10/00	AGZ	Petrol	2324	5	10	221
Bora (1J2)	10/98→06/01	AHF	Diesel	1896	4	8	165
Bora (1J2)	10/98→06/01	ASV	Diesel	1896	4	8	169
Bora (1J2)	10/98→05/05	AEH	Petrol	1595	4	8	84
Bora (1J2)	10/98→05/05	AGN	Petrol	1781	4	20	132
Bora (1J2)	10/98→05/05	AGP	Diesel	1896	4	8	164
Bora (1J2)	10/98→05/05	AGR	Diesel	1896	4	8	164
Bora (1J2)	10/98→05/05	AKL	Petrol	1595	4	8	84
Bora (1J2)	10/98→05/05	ALH	Diesel	1896	4	8	164
Bora (1J2)	10/98→05/05	APF	Petrol	1595	4	8	87
Bora (1J2)	10/98→05/05	APK	Petrol	1984	4	8	180
Bora (1J2)	10/98→05/05	AQM	Diesel	1896	4	8	169
Bora (1J2)	10/98→05/05	AQY	Petrol	1984	4	8	180
Bora (1J2)	10/98→05/05	AZG	Petrol	1984	4	8	180
Bora (1J2)	10/98→05/05	AZH	Petrol	1984	4	8	180
Bora (1J2)	10/98→05/05	AZJ	Petrol	1984	4	8	180
Bora (1J2)	10/98→05/05	BAF	Petrol	1781	4	20	133
Bora (1J2)	10/98→05/05	BBW	Petrol	1984	4	8	180
Bora (1J2)	12/98→01/02	AJM	Diesel	1896	4	8	168
Bora (1J2)	12/98→01/02	AUY	Diesel	1896	4	8	168
Bora (1J2)	03/99→05/05	AQP	Petrol	2792	6	24	254
Bora (1J2)	03/99→05/05	AUE	Petrol	2792	6	24	254
Bora (1J2)	03/99→05/05	BDE	Petrol	2792	6	24	254
Bora (1J2)	03/00→05/05	AHW	Petrol	1390	4	16	45
Bora (1J2)	03/00→05/05	AKQ	Petrol	1390	4	16	43
Bora (1J2)	03/00→05/05	APE	Petrol	1390	4	16	43
Bora (1J2)	03/00→05/05	AXP	Petrol	1390	4	16	43
Bora (1J2)	03/00→05/05	BCA	Petrol	1390	4	16	43
Bora (1J2)	05/00→05/05	AGU	Petrol	1781	4	20	132
Bora (1J2)	05/00→05/05	ARL	Diesel	1896	4	8	168
Bora (1J2)	05/00→05/05	ARX	Petrol	1781	4	20	132
Bora (1J2)	05/00→05/05	ATN	Petrol	1598	4	16	94
Bora (1J2)	05/00→05/05	AUM	Petrol	1781	4	20	132
Bora (1J2)	05/00→05/05	AUS	Petrol	1598	4	16	94
Bora (1J2)	05/00→05/05	AZD	Petrol	1598	4	16	89
Bora (1J2)	05/00→05/05	BAE	Petrol	1781	4	20	133
Bora (1J2)	05/00→05/05	BCB	Petrol	1598	4	16	94
Bora (1J2)	08/00→05/05	AVU	Petrol	1595	4	8	91
Bora (1J2)	08/00→05/05	BFQ	Petrol	1595	4	8	91
Bora (1J2)	08/00→05/05	BJH	Petrol	1595	4	8	91
Bora (1J2)	09/00→05/05	ATD	Diesel	1896	4	8	168
Bora (1J2)	09/00→05/05	AXR	Diesel	1896	4	8	168
Bora (1J2)	10/00→05/05	AQN	Petrol	2324	5	20	222
Bora (1J2)	11/00→05/05	ASZ	Diesel	1896	4	8	168
Bora (1J2)	01/01→06/03	BJG	Petrol	1595	4	8	102
Bora (1J2)	01/01→09/06	BJH	Petrol	1595	4	8	91
Bora (1J2)	12/01→12/06	BAF	Petrol	1781	4	20	142
Bora (1J2)	01/02→05/05	BAD	Petrol	1598	4	16	92
Bora (1J2)	02/02→07/05	BDF	Petrol	2792	6	24	254
Bora (1J2)	03/02→05/05	AUQ	Petrol	1781	4	20	132
Bora (1J2)	03/02→05/05	AWP	Petrol	1781	4	20	133
Bora (1J2)	06/02→10/04	AWB	Petrol	1595	4	20	95
Bora (1J2)	08/02→07/05	AAA	Petrol	2792	6	12	247
Bora (1J2)	08/02→07/05	AFP	Petrol	2792	6	12	250
Bora (1J2)	08/05→12/06	BTH	Petrol	1781	4	20	131
Bora GP Saloon	07/06→12/08	BAF	Petrol	1781	4	20	142
Bora GP Saloon	07/06→12/08	BJH	Petrol	1595	4	8	91
Bora HS Hatchback	10/06→12/08	BAF	Petrol	1781	4	20	142
Bora HS Hatchback	10/06→12/08	BJH	Petrol	1595	4	8	91
Bora Variant (1J6)	05/99→10/00	AGZ	Petrol	2324	5	10	221
Bora Variant (1J6)	05/99→06/01	AHF	Diesel	1896	4	8	165
Bora Variant (1J6)	05/99→06/01	AJM	Diesel	1896	4	8	168



CC



9

Model	Year Range	Code	Fuel	CC	Wrench	Screwdriver	Price
Bora Variant (1J6)	05/99→06/01	ASV	Diesel	1896	4	8	169
Bora Variant (1J6)	05/99→06/01	AUY	Diesel	1896	4	8	168
Bora Variant (1J6)	05/99→05/05	AEH	Petrol	1595	4	8	84
Bora Variant (1J6)	05/99→05/05	AGN	Petrol	1781	4	20	132
Bora Variant (1J6)	05/99→05/05	AKL	Petrol	1595	4	8	84
Bora Variant (1J6)	05/99→05/05	APF	Petrol	1595	4	8	87
Bora Variant (1J6)	05/99→05/05	APK	Petrol	1984	4	8	180
Bora Variant (1J6)	05/99→05/05	AQP	Petrol	2792	6	24	254
Bora Variant (1J6)	05/99→05/05	AQY	Petrol	1984	4	8	180
Bora Variant (1J6)	05/99→05/05	AUE	Petrol	2792	6	24	254
Bora Variant (1J6)	05/99→05/05	AZG	Petrol	1984	4	8	180
Bora Variant (1J6)	05/99→05/05	AZH	Petrol	1984	4	8	180
Bora Variant (1J6)	05/99→05/05	AZJ	Petrol	1984	4	8	180
Bora Variant (1J6)	05/99→05/05	BDE	Petrol	2792	6	24	254
Bora Variant (1J6)	02/00→05/05	ATN	Petrol	1598	4	16	94
Bora Variant (1J6)	02/00→05/05	AUS	Petrol	1598	4	16	94
Bora Variant (1J6)	02/00→05/05	AZD	Petrol	1598	4	16	89
Bora Variant (1J6)	02/00→05/05	BCB	Petrol	1598	4	16	94
Bora Variant (1J6)	05/00→05/05	AGU	Petrol	1781	4	20	132
Bora Variant (1J6)	05/00→05/05	ARX	Petrol	1781	4	20	132
Bora Variant (1J6)	05/00→05/05	AUM	Petrol	1781	4	20	132
Bora Variant (1J6)	08/00→05/05	AVU	Petrol	1595	4	8	91
Bora Variant (1J6)	08/00→05/05	BFQ	Petrol	1595	4	8	91
Bora Variant (1J6)	09/00→12/04	AFP	Petrol	2792	6	12	250
Bora Variant (1J6)	09/00→05/05	ATD	Diesel	1896	4	8	168
Bora Variant (1J6)	09/00→05/05	AXR	Diesel	1896	4	8	168
Bora Variant (1J6)	10/00→05/05	AQN	Petrol	2324	5	20	222
Bora Variant (1J6)	11/00→05/05	ASZ	Diesel	1896	4	8	168
Bora Variant (1J6)	05/01→05/05	ARL	Diesel	1896	4	8	168
Bora Variant (1J6)	09/01→05/05	AHW	Petrol	1390	4	16	45
Bora Variant (1J6)	09/01→05/05	AXP	Petrol	1390	4	16	43
Bora Variant (1J6)	09/01→05/05	BCA	Petrol	1390	4	16	43
Bora Variant (1J6)	01/02→05/05	BAD	Petrol	1598	4	16	92
Bora Variant (1J6)	05/02→05/05	AUQ	Petrol	1781	4	20	132
Bora Variant (1J6)	07/04→05/05	AGR	Diesel	1896	4	8	164
Bora Variant (1J6)	07/04→05/05	ALH	Diesel	1896	4	8	164
Caddy Alltrack Box (SAA)	05/15→	CUUB	Diesel	1968	4	16	204
Caddy Alltrack Box (SAA)	05/15→	CUUD	Diesel	1968	4	16	204
Caddy Alltrack Box (SAA)	05/15→	CUUE	Diesel	1968	4	16	204
Caddy Alltrack Box (SAA)	05/15→	CUUF	Diesel	1968	4	16	204
Caddy Alltrack Box (SAA)	05/15→	CZCB	Petrol	1395	4	16	64
Caddy Alltrack Box (SAA)	05/15→	DFSB	Diesel	1968	4	16	207
Caddy Alltrack Box (SAA)	05/15→	DFSD	Diesel	1968	4	16	207
Caddy Alltrack Box (SAA)	05/15→	DFSE	Diesel	1968	4	16	207
Caddy Alltrack Box (SAA)	05/15→	DFSF	Diesel	1968	4	16	207
Caddy Alltrack Box (SAA)	06/15→	CPWA	Petrol	1395	4	16	64
Caddy Alltrack Box (SAA)	06/15→	CYVC	Petrol	1197	4	16	26
Caddy Alltrack Box (SAA)	11/15→	CHZG	Petrol	999	3	12	14
Caddy Alltrack Variant (SAB)	05/15→	CUUB	Diesel	1968	4	16	204
Caddy Alltrack Variant (SAB)	05/15→	CUUD	Diesel	1968	4	16	204
Caddy Alltrack Variant (SAB)	05/15→	CUUE	Diesel	1968	4	16	204
Caddy Alltrack Variant (SAB)	05/15→	CUUF	Diesel	1968	4	16	204
Caddy Alltrack Variant (SAB)	05/15→	CZCB	Petrol	1395	4	16	64
Caddy Alltrack Variant (SAB)	05/15→	DFSB	Diesel	1968	4	16	207
Caddy Alltrack Variant (SAB)	05/15→	DFSD	Diesel	1968	4	16	207
Caddy Alltrack Variant (SAB)	05/15→	DFSE	Diesel	1968	4	16	207
Caddy Alltrack Variant (SAB)	05/15→	DFSF	Diesel	1968	4	16	207
Caddy Alltrack Variant (SAB)	06/15→	CPWA	Petrol	1395	4	16	64
Caddy Alltrack Variant (SAB)	06/15→	CYVC	Petrol	1197	4	16	26
Caddy Alltrack Variant (SAB)	11/15→	CHZG	Petrol	999	3	12	14
Caddy Box	03/05→12/07	BDJ	Diesel	1968	4	8	187
Caddy Box	03/05→12/07	BRY	Petrol	1595	4	8	91
Caddy Box	03/05→12/07	BWH	Petrol	1595	4	8	104
Caddy Box (6K9, 9E7, 9E9)	09/02→09/05	ADD	Petrol	1781	4	8	125
Caddy Box (6K9, 9E7, 9E9)	10/05→06/09	1Y	Diesel	1896	4	8	153
Caddy Estate (6K9, 9E7, 9E9)	09/02→09/05	ADD	Petrol	1781	4	8	125
Caddy Estate (6K9, 9E7, 9E9)	10/05→06/09	1Y	Diesel	1896	4	8	153
Caddy I (14)	09/80→12/83	EN	Petrol	1716	4	8	118
Caddy I (14)	08/82→07/83	JB	Petrol	1457	4	8	76
Caddy I (14)	08/82→07/92	JK	Diesel	1588	4	8	111
Caddy I (14)	08/82→07/92	ME	Diesel	1588	4	8	111
Caddy I (14)	10/82→10/83	EM	Petrol	1588	4	8	79
Caddy I (14)	01/83→07/92	EW	Petrol	1595	4	8	79
Caddy I (14)	08/85→07/92	JH	Petrol	1781	4	8	121
Caddy II Box (9K9A)	11/95→05/97	1F	Petrol	1595	4	8	78
Caddy II Box (9K9A)	11/95→09/00	AEE	Petrol	1598	4	8	83
Caddy II Box (9K9A)	11/95→01/04	1Y	Diesel	1896	4	8	153
Caddy II Box (9K9A)	11/95→01/04	AEX	Petrol	1390	4	8	41



CC



9

Caddy II Box (9K9A)	11/95→01/04	AEY	Diesel	1896	4	8	161
Caddy II Box (9K9A)	11/95→01/04	APQ	Petrol	1390	4	8	50
Caddy II Box (9K9A)	11/95→01/04	AUD	Petrol	1390	4	8	47
Caddy II Box (9K9A)	11/95→01/04	AYQ	Diesel	1896	4	8	169
Caddy II Box (9K9A)	07/96→09/00	AHB	Diesel	1716	4	8	115
Caddy II Box (9K9A)	09/96→01/04	IZ	Diesel	1896	4	8	154
Caddy II Box (9K9A)	09/96→01/04	AHU	Diesel	1896	4	8	167
Caddy II Box (9K9A)	09/96→01/04	ALH	Diesel	1896	4	8	164
Caddy II Box (9K9A)	08/00→01/04	AUA	Petrol	1390	4	16	43
Caddy II Pickup (9U7)	06/96→12/00	AEE	Petrol	1598	4	8	83
Caddy II Pickup (9U7)	06/96→12/00	AEE	Diesel	1896	4	8	160
Caddy II Variant (9K9B)	11/95→05/97	TF	Petrol	1595	4	8	78
Caddy II Variant (9K9B)	11/95→01/04	TY	Diesel	1896	4	8	153
Caddy II Variant (9K9B)	11/95→01/04	AEX	Petrol	1390	4	8	41
Caddy II Variant (9K9B)	11/95→01/04	AEY	Diesel	1896	4	8	161
Caddy II Variant (9K9B)	11/95→01/04	AKV	Petrol	1390	4	8	48
Caddy II Variant (9K9B)	11/95→01/04	APQ	Petrol	1390	4	8	50
Caddy II Variant (9K9B)	11/95→01/04	AUD	Petrol	1390	4	8	47
Caddy II Variant (9K9B)	11/95→01/04	AYQ	Diesel	1896	4	8	169
Caddy II Variant (9K9B)	07/96→09/00	AHB	Diesel	1716	4	8	115
Caddy II Variant (9K9B)	10/96→01/04	AHU	Diesel	1896	4	8	167
Caddy II Variant (9K9B)	10/96→01/04	ALE	Diesel	1896	4	8	166
Caddy II Variant (9K9B)	10/96→01/04	ALH	Diesel	1896	4	8	164
Caddy II Variant (9K9B)	06/97→09/00	AEE	Petrol	1598	4	8	83
Caddy II Variant (9K9B)	08/00→01/04	AUA	Petrol	1390	4	16	43
Caddy III Box (2KA, 2KH, 2CA, 2CH)	03/04→05/06	BCA	Petrol	1390	4	16	43
Caddy III Box (2KA, 2KH, 2CA, 2CH)	03/04→08/10	BDJ	Diesel	1968	4	8	187
Caddy III Box (2KA, 2KH, 2CA, 2CH)	03/04→08/10	BST	Diesel	1968	4	8	187
Caddy III Box (2KA, 2KH, 2CA, 2CH)	04/04→08/10	BJB	Diesel	1896	4	8	171
Caddy III Box (2KA, 2KH, 2CA, 2CH)	04/04→08/10	BLS	Diesel	1896	4	8	171
Caddy III Box (2KA, 2KH, 2CA, 2CH)	04/04→05/15	BGU	Petrol	1595	4	8	91
Caddy III Box (2KA, 2KH, 2CA, 2CH)	04/04→05/15	BSE	Petrol	1595	4	8	91
Caddy III Box (2KA, 2KH, 2CA, 2CH)	04/04→05/15	BSF	Petrol	1595	4	8	91
Caddy III Box (2KA, 2KH, 2CA, 2CH)	09/05→08/10	BSU	Diesel	1896	4	8	171
Caddy III Box (2KA, 2KH, 2CA, 2CH)	04/06→05/15	BSX	Gas	1984	4	8	192
Caddy III Box (2KA, 2KH, 2CA, 2CH)	05/06→08/10	BUD	Petrol	1390	4	16	60
Caddy III Box (2KA, 2KH, 2CA, 2CH)	09/07→08/10	BMM	Diesel	1968	4	8	187
Caddy III Box (2KA, 2KH, 2CA, 2CH)	08/10→05/15	CAYD	Diesel	1598	4	16	106
Caddy III Box (2KA, 2KH, 2CA, 2CH)	08/10→05/15	CAYE	Diesel	1598	4	16	106
Caddy III Box (2KA, 2KH, 2CA, 2CH)	08/10→05/15	CFHF	Diesel	1968	4	16	194
Caddy III Box (2KA, 2KH, 2CA, 2CH)	08/10→05/15	CLCA	Diesel	1968	4	16	194
Caddy III Box (2KA, 2KH, 2CA, 2CH)	09/10→05/15	CBZA	Petrol	1197	4	8	24
Caddy III Box (2KA, 2KH, 2CA, 2CH)	09/10→05/15	CBZB	Petrol	1197	4	8	24
Caddy III Box (2KA, 2KH, 2CA, 2CH)	11/10→05/15	CFHC	Diesel	1968	4	16	194
Caddy III Box (2KA, 2KH, 2CA, 2CH)	11/10→05/15	CFHE	Diesel	1968	4	16	194
Caddy III Box (2KA, 2KH, 2CA, 2CH)	11/10→05/15	CLCB	Diesel	1968	4	16	194
Caddy III Box (2KA, 2KH, 2CA, 2CH)	05/11→05/15	CHGA	Petrol	1595	4	8	91
Caddy III Box (2KA, 2KH, 2CA, 2CH)	05/12→05/15	CFJA	Diesel	1968	4	16	194
Caddy III Variant (2KB, 2KJ, 2CB, 2CJ)	03/04→05/06	BCA	Petrol	1390	4	16	43
Caddy III Variant (2KB, 2KJ, 2CB, 2CJ)	03/04→08/10	BDJ	Diesel	1968	4	8	187
Caddy III Variant (2KB, 2KJ, 2CB, 2CJ)	03/04→08/10	BST	Diesel	1968	4	8	187
Caddy III Variant (2KB, 2KJ, 2CB, 2CJ)	04/04→08/10	BJB	Diesel	1896	4	8	171
Caddy III Variant (2KB, 2KJ, 2CB, 2CJ)	04/04→08/10	BLS	Diesel	1896	4	8	171
Caddy III Variant (2KB, 2KJ, 2CB, 2CJ)	04/04→05/15	BGU	Petrol	1595	4	8	91
Caddy III Variant (2KB, 2KJ, 2CB, 2CJ)	04/04→05/15	BSE	Petrol	1595	4	8	91
Caddy III Variant (2KB, 2KJ, 2CB, 2CJ)	04/04→05/15	BSF	Petrol	1595	4	8	91
Caddy III Variant (2KB, 2KJ, 2CB, 2CJ)	09/05→08/10	BSU	Diesel	1896	4	8	171
Caddy III Variant (2KB, 2KJ, 2CB, 2CJ)	10/05→06/09	TY	Diesel	1896	4	8	153
Caddy III Variant (2KB, 2KJ, 2CB, 2CJ)	04/06→05/15	BSX	Gas	1984	4	8	192
Caddy III Variant (2KB, 2KJ, 2CB, 2CJ)	05/06→08/10	BUD	Petrol	1390	4	16	60
Caddy III Variant (2KB, 2KJ, 2CB, 2CJ)	09/07→08/10	BMM	Diesel	1968	4	8	187
Caddy III Variant (2KB, 2KJ, 2CB, 2CJ)	08/10→05/15	CAYD	Diesel	1598	4	16	106
Caddy III Variant (2KB, 2KJ, 2CB, 2CJ)	08/10→05/15	CAYE	Diesel	1598	4	16	106
Caddy III Variant (2KB, 2KJ, 2CB, 2CJ)	08/10→05/15	CFHF	Diesel	1968	4	16	194
Caddy III Variant (2KB, 2KJ, 2CB, 2CJ)	08/10→05/15	CLCA	Diesel	1968	4	16	194
Caddy III Variant (2KB, 2KJ, 2CB, 2CJ)	09/10→05/15	CBZA	Petrol	1197	4	8	24
Caddy III Variant (2KB, 2KJ, 2CB, 2CJ)	09/10→05/15	CBZB	Petrol	1197	4	8	24
Caddy III Variant (2KB, 2KJ, 2CB, 2CJ)	11/10→05/15	CFHC	Diesel	1968	4	16	194
Caddy III Variant (2KB, 2KJ, 2CB, 2CJ)	11/10→05/15	CLCB	Diesel	1968	4	16	194
Caddy III Variant (2KB, 2KJ, 2CB, 2CJ)	05/11→05/15	CHGA	Petrol	1595	4	8	91
Caddy III Variant (2KB, 2KJ, 2CB, 2CJ)	05/12→05/15	CFJA	Diesel	1968	4	16	194
Caddy IV Box (SAA, SAH)	05/15→	CAYD	Diesel	1598	4	16	106
Caddy IV Box (SAA, SAH)	05/15→	CAYE	Diesel	1598	4	16	106
Caddy IV Box (SAA, SAH)	05/15→	CFHC	Diesel	1968	4	16	194
Caddy IV Box (SAA, SAH)	05/15→	CFHF	Diesel	1968	4	16	194
Caddy IV Box (SAA, SAH)	05/15→	CLCB	Diesel	1968	4	16	194
Caddy IV Box (SAA, SAH)	05/15→	CUUB	Diesel	1968	4	16	204
Caddy IV Box (SAA, SAH)	05/15→	CUUD	Diesel	1968	4	16	204



Caddy IV Box (SAA, SAH)	05/15→	CUUE	Diesel	1968	4	16	204
Caddy IV Box (SAA, SAH)	05/15→	CUUF	Diesel	1968	4	16	204
Caddy IV Box (SAA, SAH)	05/15→	CZCB	Petrol	1395	4	16	64
Caddy IV Box (SAA, SAH)	05/15→	DFSB	Diesel	1968	4	16	207
Caddy IV Box (SAA, SAH)	05/15→	DFSC	Diesel	1968	4	16	207
Caddy IV Box (SAA, SAH)	05/15→	DFSD	Diesel	1968	4	16	207
Caddy IV Box (SAA, SAH)	05/15→	DFSE	Diesel	1968	4	16	207
Caddy IV Box (SAA, SAH)	05/15→	DFSF	Diesel	1968	4	16	207
Caddy IV Box (SAA, SAH)	06/15→	CPWA	Petrol	1395	4	16	64
Caddy IV Box (SAA, SAH)	06/15→	CYVC	Petrol	1197	4	16	26
Caddy IV Box (SAA, SAH)	09/15→	CLCA	Diesel	1968	4	16	194
Caddy IV Box (SAA, SAH)	11/15→	CHZG	Petrol	999	3	12	14
Caddy IV Box (SAA, SAH)	11/15→	CWVA	Petrol	1598	4	16	113
Caddy IV Variant (SAB, SAJ)	05/15→	CAYD	Diesel	1598	4	16	106
Caddy IV Variant (SAB, SAJ)	05/15→	CAYE	Diesel	1598	4	16	106
Caddy IV Variant (SAB, SAJ)	05/15→	CFHC	Diesel	1968	4	16	194
Caddy IV Variant (SAB, SAJ)	05/15→	CFHF	Diesel	1968	4	16	194
Caddy IV Variant (SAB, SAJ)	05/15→	CLCB	Diesel	1968	4	16	194
Caddy IV Variant (SAB, SAJ)	05/15→	CUUB	Diesel	1968	4	16	204
Caddy IV Variant (SAB, SAJ)	05/15→	CUUD	Diesel	1968	4	16	204
Caddy IV Variant (SAB, SAJ)	05/15→	CUUE	Diesel	1968	4	16	204
Caddy IV Variant (SAB, SAJ)	05/15→	CUUF	Diesel	1968	4	16	204
Caddy IV Variant (SAB, SAJ)	05/15→	CZCB	Petrol	1395	4	16	64
Caddy IV Variant (SAB, SAJ)	05/15→	DFSB	Diesel	1968	4	16	207
Caddy IV Variant (SAB, SAJ)	05/15→	DFSD	Diesel	1968	4	16	207
Caddy IV Variant (SAB, SAJ)	05/15→	DFSE	Diesel	1968	4	16	207
Caddy IV Variant (SAB, SAJ)	05/15→	DFSF	Diesel	1968	4	16	207
Caddy IV Variant (SAB, SAJ)	06/15→	CPWA	Petrol	1395	4	16	64
Caddy IV Variant (SAB, SAJ)	06/15→	CYVC	Petrol	1197	4	16	26
Caddy IV Variant (SAB, SAJ)	09/15→	CLCA	Diesel	1968	4	16	194
Caddy IV Variant (SAB, SAJ)	11/15→	CHZG	Petrol	999	3	12	14
Caddy IV Variant (SAB, SAJ)	11/15→	CWVA	Petrol	1598	4	16	113
CC	07/10→	CEA	Petrol	1798	4	16	147
CC	07/10→	CGM	Petrol	1984	4	16	201
CC	03/12→	CNG	Petrol	2975	6	24	259
CC (358)	11/11→12/16	BLV	Petrol	3597	6	24	265
CC (358)	11/11→12/16	BWS	Petrol	3597	6	24	265
CC (358)	11/11→12/16	CBFA	Petrol	1984	4	16	195
CC (358)	11/11→12/16	CCTA	Petrol	1984	4	16	195
CC (358)	11/11→12/16	CCZB	Petrol	1984	4	16	195
CC (358)	11/11→12/16	CDAA	Petrol	1798	4	16	147
CC (358)	11/11→12/16	CDAB	Petrol	1798	4	16	147
CC (358)	11/11→12/16	CFFA	Diesel	1968	4	16	194
CC (358)	11/11→12/16	CFFB	Diesel	1968	4	16	194
CC (358)	11/11→12/16	CFGB	Diesel	1968	4	16	194
CC (358)	11/11→12/16	CKMA	Petrol	1390	4	16	66
CC (358)	11/11→12/16	CLLA	Diesel	1968	4	16	206
CC (358)	11/11→12/16	CNNA	Petrol	3597	6	24	265
CC (358)	11/11→12/16	CTHD	Petrol	1390	4	16	53
CC (358)	12/12→12/16	CFGC	Diesel	1968	4	16	194
CC (358)	05/15→12/16	CUVC	Diesel	1968	4	16	204
CC (358)	05/15→12/16	CUWA	Diesel	1968	4	16	204
CC (358)	05/15→12/16	CZDA	Petrol	1395	4	16	64
CityGolf	01/81→12/84	EP	Petrol	1297	4	8	33
CityGolf	06/96→12/99	AGN	Petrol	1781	4	20	132
CityGolf	06/96→12/99	HM	Petrol	1595	4	8	79
CityGolf	01/99→08/09	AJD	Petrol	1324	4	8	32
CityGolf	12/99→08/09	AFX	Petrol	1595	4	8	86
CityGolf	12/99→08/09	AGY	Petrol	1390	4	8	44
CityGolf	01/01→12/02	GY	Petrol	1324	4	8	34
CityGolf	02/02→08/09	BSC	Petrol	1423	4	8	59
CityGolf	09/06→12/10	BEV	Petrol	1984	4	8	180
CityGolf	06/07→08/09	BZF	Petrol	1806	4	8	125
Corrado (531)	09/88→09/93	PG	Petrol	1781	4	8	121
Corrado (531)	04/89→07/92	KR	Petrol	1781	4	16	151
Corrado (531)	08/91→12/95	9A	Petrol	1984	4	16	176
Corrado (531)	08/91→12/95	ABV	Petrol	2861	6	12	255
Corrado (531)	09/91→12/95	AAA	Petrol	2792	6	12	247
Corrado (531)	04/93→12/95	2E	Petrol	1984	4	8	175
Corrado (531)	04/93→12/95	ADY	Petrol	1984	4	8	179
Crafter 30-35 Bus (2E_)	04/06→07/11	BJJ	Diesel	2461	5	10	244
Crafter 30-35 Bus (2E_)	04/06→07/11	BJM	Diesel	2461	5	10	244
Crafter 30-35 Bus (2E_)	04/06→07/11	CEBA	Diesel	2461	5	10	244
Crafter 30-35 Bus (2E_)	04/06→07/11	CECB	Diesel	2461	5	10	244
Crafter 30-35 Bus (2E_)	04/06→05/13	BJK	Diesel	2461	5	10	244
Crafter 30-35 Bus (2E_)	04/06→05/13	BJL	Diesel	2461	5	10	244
Crafter 30-35 Bus (2E_)	04/06→05/13	CEBB	Diesel	2461	5	10	244
Crafter 30-35 Bus (2E_)	04/06→05/13	CECA	Diesel	2461	5	10	244



CC



9

Crafter 30-35 Bus (2E_)	05/11→12/16	CKTB	Diesel	1968	4	16	194
Crafter 30-35 Bus (2E_)	05/11→12/16	CKTC	Diesel	1968	4	16	194
Crafter 30-35 Bus (2E_)	05/11→12/16	CSLA	Diesel	1968	4	16	197
Crafter 30-35 Bus (2E_)	07/11→12/16	CKUB	Diesel	1968	4	16	194
Crafter 30-35 Bus (2E_)	07/11→12/16	CSNA	Diesel	1968	4	16	194
Crafter 30-35 Bus (2E_)	10/11→12/16	CKUC	Diesel	1968	4	16	194
Crafter 30-35 Bus (2E_)	11/13→12/16	CSLB	Diesel	1968	4	16	194
Crafter 30-50 Box (2E_)	04/06→07/11	BJJ	Diesel	2461	5	10	244
Crafter 30-50 Box (2E_)	04/06→07/11	BJM	Diesel	2461	5	10	244
Crafter 30-50 Box (2E_)	04/06→07/11	CEBA	Diesel	2461	5	10	244
Crafter 30-50 Box (2E_)	04/06→07/11	CECB	Diesel	2461	5	10	244
Crafter 30-50 Box (2E_)	04/06→05/13	BJK	Diesel	2461	5	10	244
Crafter 30-50 Box (2E_)	04/06→05/13	BJL	Diesel	2461	5	10	244
Crafter 30-50 Box (2E_)	04/06→05/13	CEBB	Diesel	2461	5	10	244
Crafter 30-50 Box (2E_)	04/06→05/13	CECA	Diesel	2461	5	10	244
Crafter 30-50 Box (2E_)	05/11→12/16	CKTB	Diesel	1968	4	16	194
Crafter 30-50 Box (2E_)	05/11→12/16	CKTC	Diesel	1968	4	16	194
Crafter 30-50 Box (2E_)	05/11→12/16	CSLA	Diesel	1968	4	16	197
Crafter 30-50 Box (2E_)	07/11→12/16	CKUB	Diesel	1968	4	16	194
Crafter 30-50 Box (2E_)	07/11→12/16	CSNA	Diesel	1968	4	16	194
Crafter 30-50 Box (2E_)	10/11→12/16	CKUC	Diesel	1968	4	16	194
Crafter 30-50 Box (2E_)	11/13→12/16	CSLB	Diesel	1968	4	16	194
Crafter 30-50 Box (2E_)	11/15→12/16	CSLC	Diesel	1968	4	16	197
Crafter 30-50 Platform/Chassis (2F_)	04/06→07/11	BJJ	Diesel	2461	5	10	244
Crafter 30-50 Platform/Chassis (2F_)	04/06→07/11	BJM	Diesel	2461	5	10	244
Crafter 30-50 Platform/Chassis (2F_)	04/06→07/11	CEBA	Diesel	2461	5	10	244
Crafter 30-50 Platform/Chassis (2F_)	04/06→07/11	CECB	Diesel	2461	5	10	244
Crafter 30-50 Platform/Chassis (2F_)	04/06→05/13	BJK	Diesel	2461	5	10	244
Crafter 30-50 Platform/Chassis (2F_)	04/06→05/13	BJL	Diesel	2461	5	10	244
Crafter 30-50 Platform/Chassis (2F_)	04/06→05/13	CEBB	Diesel	2461	5	10	244
Crafter 30-50 Platform/Chassis (2F_)	04/06→05/13	CECA	Diesel	2461	5	10	244
Crafter 30-50 Platform/Chassis (2F_)	05/11→12/16	CKTB	Diesel	1968	4	16	194
Crafter 30-50 Platform/Chassis (2F_)	05/11→12/16	CKTC	Diesel	1968	4	16	194
Crafter 30-50 Platform/Chassis (2F_)	07/11→12/16	CKUB	Diesel	1968	4	16	194
Crafter 30-50 Platform/Chassis (2F_)	07/11→12/16	CSNA	Diesel	1968	4	16	194
Crafter 30-50 Platform/Chassis (2F_)	10/11→12/16	CKUC	Diesel	1968	4	16	194
Crafter 30-50 Platform/Chassis (2F_)	11/13→12/16	CSLB	Diesel	1968	4	16	194
Crafter 30-50 Platform/Chassis (2F_)	11/15→12/16	CSLC	Diesel	1968	4	16	197
Crafter Box (SY_)	09/16→	DAUA	Diesel	1968	4	16	211
Crafter Box (SY_)	09/16→	DAVA	Diesel	1968	4	16	211
Crafter Box (SY_)	10/16→	DAUB	Diesel	1968	4	16	211
Crafter Bus (SY_)	09/16→	DAUA	Diesel	1968	4	16	211
Crafter Bus (SY_)	09/16→	DAVA	Diesel	1968	4	16	211
Crafter Bus (SY_)	10/16→	DAUB	Diesel	1968	4	16	211
Crafter Platform/Chassis (SZ_)	11/16→	DAUA	Diesel	1968	4	16	211
Crafter Platform/Chassis (SZ_)	11/16→	DAUB	Diesel	1968	4	16	211
Crafter Platform/Chassis (SZ_)	11/16→	DAVA	Diesel	1968	4	16	211
Derby (86)	02/77→09/81	HA	Petrol	895	4	8	2
Derby (86)	02/77→09/81	HB	Petrol	1093	4	8	17
Derby (86)	02/77→09/81	HH	Petrol	1272	4	8	35
Derby (86)	02/77→09/81	HJ	Petrol	1272	4	8	35
Derby (86C, 80)	08/81→07/83	HH	Petrol	1272	4	8	35
Derby (86C, 80)	10/81→07/83	HB	Petrol	1093	4	8	17
Derby (86C, 80)	10/81→12/84	GL	Petrol	1043	4	8	16
Derby (86C, 80)	09/82→12/84	GK	Petrol	1272	4	8	34
Derby (86C, 80)	08/83→12/84	HK	Petrol	1272	4	8	34
Derby (86C, 80)	08/83→12/84	HW	Petrol	1272	4	8	34
Derby Saloon	09/94→12/09	ADD	Petrol	1781	4	8	125
Derby Saloon	09/02→12/03	ADC	Petrol	1984	4	8	178
Eos (1F7, 1F8)	03/06→05/08	BVY	Petrol	1984	4	16	184
Eos (1F7, 1F8)	03/06→05/08	BVZ	Petrol	1984	4	16	184
Eos (1F7, 1F8)	03/06→08/15	BPY	Petrol	1984	4	16	185
Eos (1F7, 1F8)	03/06→08/15	BWA	Petrol	1984	4	16	185
Eos (1F7, 1F8)	03/06→08/15	CAWB	Petrol	1984	4	16	195
Eos (1F7, 1F8)	03/06→08/15	CBFA	Petrol	1984	4	16	195
Eos (1F7, 1F8)	03/06→08/15	CCTA	Petrol	1984	4	16	195
Eos (1F7, 1F8)	03/06→08/15	CCZA	Petrol	1984	4	16	195
Eos (1F7, 1F8)	06/06→05/08	BLF	Petrol	1598	4	16	97
Eos (1F7, 1F8)	06/06→05/08	BMM	Diesel	1968	4	8	187
Eos (1F7, 1F8)	06/06→05/09	BUB	Petrol	3189	6	24	263
Eos (1F7, 1F8)	06/06→05/09	CBRA	Petrol	3189	6	24	264
Eos (1F7, 1F8)	11/07→08/15	CAXA	Petrol	1390	4	16	53
Eos (1F7, 1F8)	05/08→08/15	CAVD	Petrol	1390	4	16	53
Eos (1F7, 1F8)	05/08→08/15	CBAB	Diesel	1968	4	16	194
Eos (1F7, 1F8)	05/08→08/15	CFFB	Diesel	1968	4	16	194
Eos (1F7, 1F8)	05/08→08/15	CTHD	Petrol	1390	4	16	53
Eos (1F7, 1F8)	05/09→11/10	CDVA	Petrol	3597	6	24	265



CC



9

Eos (1F7, 1F8)	11/09→08/15	CCZB	Petrol	1984	4	16	195
Eos (1F7, 1F8)	11/10→08/15	CFFA	Diesel	1968	4	16	194
Fox	08/14→	CNXA	Petrol	1598	4	16	109
Fox	03/15→	CWSA	Petrol	1598	4	16	109
Fox	10/15→	CFZA	Petrol	1598	4	8	98
Fox (5Z1, 5Z3)	10/03→	AQZ	Petrol	999	4	8	9
Fox (5Z1, 5Z3)	10/03→	BAH	Petrol	1598	4	8	98
Fox (5Z1, 5Z3)	10/03→	BJA	Petrol	1598	4	8	100
Fox (5Z1, 5Z3)	10/03→	BJE	Petrol	999	4	8	13
Fox (5Z1, 5Z3)	10/03→	BLH	Petrol	1598	4	8	100
Fox (5Z1, 5Z3)	10/03→	BNX	Petrol	999	4	8	9
Fox (5Z1, 5Z3)	10/03→	BPA	Petrol	1598	4	8	98
Fox (5Z1, 5Z3)	10/03→	CCNA	Petrol	999	4	8	9
Fox (5Z1, 5Z3)	10/03→	CCRA	Petrol	1598	4	8	98
Fox (5Z1, 5Z3)	10/03→	CFZA	Petrol	1598	4	8	98
Fox (5Z1, 5Z3)	04/05→	BKR	Petrol	1390	4	8	56
Fox (5Z1, 5Z3)	04/05→	BMD	Petrol	1198	3	6	22
Fox (5Z1, 5Z3)	04/05→	BNM	Diesel	1422	3	6	49
Fox (5Z1, 5Z3)	04/05→	CHFB	Petrol	1198	3	6	22
Fox (5Z1, 5Z3)	12/07→	ASY	Diesel	1896	4	8	168
Fox (5Z1, 5Z3)	04/08→	CPBA	Petrol	999	4	8	15
Fox (5Z1, 5Z3)	09/10→	CHFA	Petrol	1198	3	6	22
Fox (5Z1, 5Z3)	04/13→	CSEA	Petrol	999	3	12	14
Fox Saloon	01/87→12/90	JN	Petrol	1781	4	8	121
Fox Saloon	01/87→12/93	HM	Petrol	1595	4	8	79
Fox Saloon	10/90→12/93	ABG	Petrol	1781	4	8	121
Fox Saloon	10/90→12/93	EV	Petrol	1781	4	8	149
Fox Variant	09/86→12/90	JN	Petrol	1781	4	8	121
Gol	05/84→09/94	RM	Petrol	1781	4	8	121
Gol	09/97→09/05	AZP	Petrol	999	4	16	12
Gol	06/02→05/08	UPD	Petrol	1595	4	8	101
Gol	08/02→05/08	UNF	Petrol	1598	4	8	83
Gol	10/05→05/08	BTY	Petrol	999	4	8	9
Golf (9B3)	03/06→	BJA	Petrol	1598	4	8	100
Golf (9B3)	03/06→	BPA	Petrol	1598	4	8	98
Golf (9B3)	04/07→05/08	AUQ	Petrol	1781	4	20	132
Golf (9B3)	05/08→	CCRA	Petrol	1598	4	8	98
Golf (9B3)	06/08→	CSEA	Petrol	1984	4	8	180
Golf Alltrack (BA5)	12/14→	CJSB	Petrol	1798	4	16	147
Golf Alltrack (BA5)	12/14→	CRBC	Diesel	1968	4	16	204
Golf Alltrack (BA5)	12/14→	CRKB	Diesel	1598	4	16	107
Golf Alltrack (BA5)	12/14→	CRLB	Diesel	1968	4	16	204
Golf Alltrack (BA5)	12/14→	CUNA	Diesel	1968	4	16	204
Golf Alltrack (BA5)	12/14→	CXXB	Diesel	1598	4	16	107
Golf Alltrack (BA5)	12/14→	DCYA	Diesel	1968	4	16	207
Golf Alltrack (BA5)	12/14→	DGCA	Diesel	1968	4	16	204
Golf I (17)	04/74→12/75	FH	Petrol	1471	4	8	74
Golf I (17)	04/74→07/83	FA	Petrol	1093	4	8	17
Golf I (17)	04/74→07/83	GG	Petrol	1093	4	8	17
Golf I (17)	08/75→07/77	FT	Petrol	1588	4	8	114
Golf I (17)	08/75→02/84	EM	Petrol	1588	4	8	79
Golf I (17)	08/75→02/84	FN	Petrol	1588	4	8	114
Golf I (17)	08/75→02/84	FP	Petrol	1588	4	8	114
Golf I (17)	08/76→07/80	CK	Diesel	1471	4	8	70
Golf I (17)	08/76→07/80	FJ	Petrol	1093	4	8	17
Golf I (17)	08/76→07/82	EG	Petrol	1588	4	8	114
Golf I (17)	08/77→07/83	JB	Petrol	1457	4	8	76
Golf I (17)	08/79→07/83	GF	Petrol	1272	4	8	35
Golf I (17)	08/80→07/83	CR	Diesel	1588	4	8	111
Golf I (17)	08/80→07/83	JK	Diesel	1588	4	8	111
Golf I (17)	09/80→12/84	EN	Petrol	1716	4	8	118
Golf I (17)	03/82→07/83	CY	Diesel	1588	4	8	111
Golf I (17)	08/82→12/83	DX	Petrol	1781	4	8	121
Golf I (17)	08/82→12/83	GS	Petrol	1272	4	8	35
Golf I (17)	08/82→12/83	JJ	Petrol	1781	4	8	121
Golf I (17)	09/82→12/84	JH	Petrol	1781	4	8	121
Golf I (17)	01/83→02/84	EW	Petrol	1595	4	8	79
Golf I (17)	01/83→02/84	HN	Petrol	1595	4	8	79
Golf I Cabriolet (155)	01/79→11/83	JB	Petrol	1457	4	8	76
Golf I Cabriolet (155)	08/79→07/82	EG	Petrol	1588	4	8	114
Golf I Cabriolet (155)	08/79→07/83	EM	Petrol	1588	4	8	79
Golf I Cabriolet (155)	09/80→12/83	EN	Petrol	1716	4	8	118
Golf I Cabriolet (155)	08/82→12/89	EV	Petrol	1781	4	8	149
Golf I Cabriolet (155)	08/82→12/89	KT	Petrol	1781	4	8	149
Golf I Cabriolet (155)	08/82→12/89	PB	Petrol	1781	4	8	121
Golf I Cabriolet (155)	08/82→12/92	DX	Petrol	1781	4	8	121
Golf I Cabriolet (155)	08/83→07/86	HK	Petrol	1272	4	8	34
Golf I Cabriolet (155)	08/83→04/92	EW	Petrol	1595	4	8	79



CC



9

Golf I Cabriolet (155)	08/83→04/92	HN	Petrol	1595	4	8	79
Golf I Cabriolet (155)	08/83→09/92	EX	Petrol	1781	4	8	121
Golf I Cabriolet (155)	08/83→04/93	JH	Petrol	1781	4	8	121
Golf I Cabriolet (155)	04/86→02/90	RE	Petrol	1595	4	8	79
Golf I Cabriolet (155)	08/89→03/93	2H	Petrol	1781	4	8	121
Golf II (19E, 1G1)	08/83→10/86	GT	Petrol	1272	4	8	34
Golf II (19E, 1G1)	08/83→06/87	HK	Petrol	1272	4	8	34
Golf II (19E, 1G1)	08/83→10/91	DX	Petrol	1781	4	8	121
Golf II (19E, 1G1)	08/83→10/91	EV	Petrol	1781	4	8	149
Golf II (19E, 1G1)	08/83→10/91	GZ	Petrol	1781	4	8	121
Golf II (19E, 1G1)	08/83→10/91	JP	Diesel	1588	4	8	111
Golf II (19E, 1G1)	08/83→10/91	JR	Diesel	1588	4	8	77
Golf II (19E, 1G1)	08/83→10/91	ME	Diesel	1588	4	8	111
Golf II (19E, 1G1)	08/83→10/91	MF	Diesel	1588	4	8	77
Golf II (19E, 1G1)	08/83→10/91	PB	Petrol	1781	4	8	121
Golf II (19E, 1G1)	08/83→07/92	ABN	Petrol	1595	4	8	79
Golf II (19E, 1G1)	08/83→07/92	EZ	Petrol	1595	4	8	79
Golf II (19E, 1G1)	08/83→07/92	HM	Petrol	1595	4	8	79
Golf II (19E, 1G1)	08/83→12/92	MH	Petrol	1272	4	8	34
Golf II (19E, 1G1)	11/83→08/85	GN	Petrol	1043	4	8	16
Golf II (19E, 1G1)	08/84→10/91	GU	Petrol	1781	4	8	149
Golf II (19E, 1G1)	08/84→10/91	GX	Petrol	1781	4	8	121
Golf II (19E, 1G1)	08/84→10/91	HV	Petrol	1781	4	8	121
Golf II (19E, 1G1)	01/85→07/85	HT	Petrol	1781	4	8	121
Golf II (19E, 1G1)	01/85→12/92	RV	Petrol	1781	4	8	121
Golf II (19E, 1G1)	08/85→10/87	RD	Petrol	1781	4	8	121
Golf II (19E, 1G1)	08/85→12/87	NU	Petrol	1272	4	8	34
Golf II (19E, 1G1)	08/85→10/91	HZ	Petrol	1043	4	8	3
Golf II (19E, 1G1)	02/86→06/90	KR	Petrol	1781	4	16	151
Golf II (19E, 1G1)	02/86→10/91	PL	Petrol	1781	4	16	151
Golf II (19E, 1G1)	02/86→10/91	RF	Petrol	1595	4	8	79
Golf II (19E, 1G1)	06/86→12/92	2G	Petrol	1272	4	8	29
Golf II (19E, 1G1)	06/86→12/92	NZ	Petrol	1272	4	8	29
Golf II (19E, 1G1)	08/86→01/90	RH	Petrol	1781	4	8	121
Golf II (19E, 1G1)	08/86→07/91	EZA	Petrol	1595	4	8	79
Golf II (19E, 1G1)	08/86→12/92	PN	Petrol	1595	4	8	79
Golf II (19E, 1G1)	01/87→12/92	PF	Petrol	1781	4	8	121
Golf II (19E, 1G1)	08/87→10/91	RP	Petrol	1781	4	8	149
Golf II (19E, 1G1)	08/88→07/91	1P	Petrol	1781	4	8	121
Golf II (19E, 1G1)	08/88→12/91	1H	Petrol	1781	4	8	121
Golf II (19E, 1G1)	08/88→12/91	PG	Petrol	1781	4	8	121
Golf II (19E, 1G1)	04/89→10/91	RA	Diesel	1588	4	8	77
Golf II (19E, 1G1)	04/89→10/91	SB	Diesel	1588	4	8	77
Golf II (19E, 1G1)	08/89→10/91	1V	Diesel	1589	4	8	77
Golf II (19E, 1G1)	09/89→12/92	9A	Petrol	1984	4	16	176
Golf II Van (19E, 1G1)	08/83→07/91	JP	Diesel	1588	4	8	111
Golf II Van (19E, 1G1)	08/87→07/91	RP	Petrol	1781	4	8	149
Golf III (1H1)	08/91→07/92	2G	Petrol	1272	4	8	29
Golf III (1H1)	10/91→08/97	ABD	Petrol	1390	4	8	40
Golf III (1H1)	10/91→08/97	AEX	Petrol	1390	4	8	41
Golf III (1H1)	11/91→08/97	1Y	Diesel	1896	4	8	153
Golf III (1H1)	11/91→08/97	2E	Petrol	1984	4	8	175
Golf III (1H1)	11/91→08/97	AAM	Petrol	1781	4	8	123
Golf III (1H1)	11/91→08/97	AAZ	Diesel	1896	4	8	156
Golf III (1H1)	11/91→08/97	ABA	Petrol	1984	4	8	178
Golf III (1H1)	11/91→08/97	ABS	Petrol	1781	4	8	124
Golf III (1H1)	11/91→08/97	ACC	Petrol	1781	4	8	125
Golf III (1H1)	11/91→08/97	ADY	Petrol	1984	4	8	179
Golf III (1H1)	11/91→08/97	ADZ	Petrol	1781	4	8	128
Golf III (1H1)	11/91→08/97	AGG	Petrol	1984	4	8	178
Golf III (1H1)	11/91→08/97	AKR	Petrol	1984	4	8	181
Golf III (1H1)	01/92→09/97	AAA	Petrol	2792	6	12	247
Golf III (1H1)	08/92→08/97	ABF	Petrol	1984	4	16	176
Golf III (1H1)	09/92→08/97	ABU	Petrol	1598	4	8	80
Golf III (1H1)	09/92→08/97	AEA	Petrol	1598	4	8	83
Golf III (1H1)	09/92→08/97	AEE	Petrol	1598	4	8	83
Golf III (1H1)	09/93→08/97	1Z	Diesel	1896	4	8	154
Golf III (1H1)	09/93→08/97	AHU	Diesel	1896	4	8	167
Golf III (1H1)	09/93→08/97	ALE	Diesel	1896	4	8	166
Golf III (1H1)	10/94→08/97	ABV	Petrol	2861	6	12	255
Golf III (1H1)	07/95→08/97	AEK	Petrol	1595	4	8	85
Golf III (1H1)	07/95→08/97	AEY	Diesel	1896	4	8	161
Golf III (1H1)	07/95→08/97	AFT	Petrol	1595	4	8	82
Golf III (1H1)	07/95→08/97	AKS	Petrol	1595	4	8	82
Golf III (1H1)	08/95→09/97	AEP	Petrol	1984	4	8	181
Golf III (1H1)	04/96→08/97	AFN	Diesel	1896	4	8	162
Golf III Cabriolet (1E7)	07/93→05/98	2E	Petrol	1984	4	8	175
Golf III Cabriolet (1E7)	07/93→05/98	AAM	Petrol	1781	4	8	123



Golf III Cabriolet (1E7)	07/93→05/98	ABS	Petrol	1781	4	8	124
Golf III Cabriolet (1E7)	07/93→05/98	ADY	Petrol	1984	4	8	179
Golf III Cabriolet (1E7)	07/93→05/98	ADZ	Petrol	1781	4	8	128
Golf III Cabriolet (1E7)	07/93→05/98	AGG	Petrol	1984	4	8	178
Golf III Cabriolet (1E7)	07/93→05/98	AKR	Petrol	1984	4	8	181
Golf III Cabriolet (1E7)	10/94→05/98	AEK	Petrol	1595	4	8	85
Golf III Cabriolet (1E7)	10/94→05/98	AFT	Petrol	1595	4	8	82
Golf III Cabriolet (1E7)	10/94→05/98	AKS	Petrol	1595	4	8	82
Golf III Cabriolet (1E7)	08/95→05/98	1Z	Diesel	1896	4	8	154
Golf III Cabriolet (1E7)	08/95→05/98	AHU	Diesel	1896	4	8	167
Golf III Cabriolet (1E7)	08/95→05/98	ALE	Diesel	1896	4	8	166
Golf III Cabriolet (1E7)	07/96→05/98	AFN	Diesel	1896	4	8	162
Golf III Van (1H1)	08/91→12/97	ABS	Petrol	1781	4	8	124
Golf III Van (1H1)	08/91→12/97	ADZ	Petrol	1781	4	8	128
Golf III Variant (1H5)	07/93→04/99	1Y	Diesel	1896	4	8	153
Golf III Variant (1H5)	07/93→04/99	2E	Petrol	1984	4	8	175
Golf III Variant (1H5)	07/93→04/99	AAM	Petrol	1781	4	8	123
Golf III Variant (1H5)	07/93→04/99	AAZ	Diesel	1896	4	8	156
Golf III Variant (1H5)	07/93→04/99	ABD	Petrol	1390	4	8	40
Golf III Variant (1H5)	07/93→04/99	ABS	Petrol	1781	4	8	124
Golf III Variant (1H5)	07/93→04/99	ADY	Petrol	1984	4	8	179
Golf III Variant (1H5)	07/93→04/99	ADZ	Petrol	1781	4	8	128
Golf III Variant (1H5)	07/93→04/99	AEX	Petrol	1390	4	8	41
Golf III Variant (1H5)	07/93→04/99	AGG	Petrol	1984	4	8	178
Golf III Variant (1H5)	07/93→04/99	AKR	Petrol	1984	4	8	181
Golf III Variant (1H5)	07/93→04/99	ANN	Petrol	1781	4	8	136
Golf III Variant (1H5)	07/93→04/99	ANP	Petrol	1781	4	8	136
Golf III Variant (1H5)	07/93→04/99	APQ	Petrol	1390	4	8	50
Golf III Variant (1H5)	03/94→04/99	1Z	Diesel	1896	4	8	154
Golf III Variant (1H5)	03/94→04/99	AHU	Diesel	1896	4	8	167
Golf III Variant (1H5)	03/94→04/99	ALE	Diesel	1896	4	8	166
Golf III Variant (1H5)	07/94→04/99	AEK	Petrol	1595	4	8	85
Golf III Variant (1H5)	07/94→04/99	AFT	Petrol	1595	4	8	82
Golf III Variant (1H5)	07/94→04/99	AKS	Petrol	1595	4	8	82
Golf III Variant (1H5)	10/94→04/99	ABV	Petrol	2861	6	12	255
Golf III Variant (1H5)	07/95→04/99	AEY	Diesel	1896	4	8	161
Golf III Variant (1H5)	08/95→04/96	AEP	Petrol	1984	4	8	181
Golf III Variant (1H5)	04/96→04/99	AFN	Diesel	1896	4	8	162
Golf IV (1J1)	08/97→10/00	AGZ	Petrol	2324	5	10	221
Golf IV (1J1)	08/97→12/00	AHA	Petrol	2771	6	30	252
Golf IV (1J1)	08/97→05/04	AEH	Petrol	1595	4	8	84
Golf IV (1J1)	08/97→05/04	AHF	Diesel	1896	4	8	165
Golf IV (1J1)	08/97→05/04	AKL	Petrol	1595	4	8	84
Golf IV (1J1)	08/97→05/04	APF	Petrol	1595	4	8	87
Golf IV (1J1)	08/97→05/04	ASV	Diesel	1896	4	8	169
Golf IV (1J1)	08/97→06/05	AGN	Petrol	1781	4	20	132
Golf IV (1J1)	08/97→06/05	AGP	Diesel	1896	4	8	164
Golf IV (1J1)	08/97→06/05	AGU	Petrol	1781	4	20	132
Golf IV (1J1)	08/97→06/05	AHW	Petrol	1390	4	16	45
Golf IV (1J1)	08/97→06/05	AKQ	Petrol	1390	4	16	43
Golf IV (1J1)	08/97→06/05	APE	Petrol	1390	4	16	43
Golf IV (1J1)	08/97→06/05	AQA	Petrol	1781	4	20	132
Golf IV (1J1)	08/97→06/05	AQM	Diesel	1896	4	8	169
Golf IV (1J1)	08/97→06/05	ARZ	Petrol	1781	4	20	132
Golf IV (1J1)	08/97→06/05	AUM	Petrol	1781	4	20	132
Golf IV (1J1)	08/97→06/05	AWD	Petrol	1781	4	20	140
Golf IV (1J1)	08/97→06/05	AXP	Petrol	1390	4	16	43
Golf IV (1J1)	08/97→06/05	BAF	Petrol	1781	4	20	133
Golf IV (1J1)	08/97→06/05	BCA	Petrol	1390	4	16	43
Golf IV (1J1)	10/97→09/99	AAZ	Diesel	1896	4	8	156
Golf IV (1J1)	10/97→09/99	ACC	Petrol	1781	4	8	125
Golf IV (1J1)	10/97→05/04	AGR	Diesel	1896	4	8	164
Golf IV (1J1)	10/97→05/04	ALH	Diesel	1896	4	8	164
Golf IV (1J1)	07/98→05/04	APK	Petrol	1984	4	8	180
Golf IV (1J1)	07/98→05/04	AQY	Petrol	1984	4	8	180
Golf IV (1J1)	07/98→05/04	AZG	Petrol	1984	4	8	180
Golf IV (1J1)	07/98→05/04	BER	Petrol	1984	4	8	180
Golf IV (1J1)	07/98→06/05	AZJ	Petrol	1984	4	8	180
Golf IV (1J1)	12/98→06/01	AJM	Diesel	1896	4	8	168
Golf IV (1J1)	12/98→06/01	AUY	Diesel	1896	4	8	168
Golf IV (1J1)	03/99→06/05	AQP	Petrol	2792	6	24	254
Golf IV (1J1)	03/99→06/05	AUE	Petrol	2792	6	24	254
Golf IV (1J1)	03/99→06/05	BDE	Petrol	2792	6	24	254
Golf IV (1J1)	02/00→06/05	ARL	Diesel	1896	4	8	168
Golf IV (1J1)	02/00→06/05	ATN	Petrol	1598	4	16	94
Golf IV (1J1)	02/00→06/05	AUS	Petrol	1598	4	16	94
Golf IV (1J1)	02/00→06/05	AZD	Petrol	1598	4	16	89
Golf IV (1J1)	02/00→06/05	BCB	Petrol	1598	4	16	94



CC



9

Golf IV (1J1)	08/00→06/05	AVU	Petrol	1595	4	8	91
Golf IV (1J1)	08/00→06/05	BFQ	Petrol	1595	4	8	91
Golf IV (1J1)	08/00→06/05	BJH	Petrol	1595	4	8	91
Golf IV (1J1)	09/00→06/05	ATD	Diesel	1896	4	8	168
Golf IV (1J1)	09/00→06/05	AXR	Diesel	1896	4	8	168
Golf IV (1J1)	10/00→06/05	AQN	Petrol	2324	5	20	222
Golf IV (1J1)	10/00→06/05	AZH	Petrol	1984	4	8	180
Golf IV (1J1)	11/00→06/05	ASZ	Diesel	1896	4	8	168
Golf IV (1J1)	02/01→06/05	BAH	Petrol	1598	4	8	98
Golf IV (1J1)	02/01→06/05	BPA	Petrol	1598	4	8	98
Golf IV (1J1)	08/01→06/05	AUQ	Petrol	1781	4	20	132
Golf IV (1J1)	01/02→06/05	BAD	Petrol	1598	4	16	92
Golf IV (1J1)	03/02→06/05	BDF	Petrol	2792	6	24	254
Golf IV (1J1)	09/02→12/03	BJS	Petrol	3189	6	24	263
Golf IV (1J1)	09/02→06/05	BFH	Petrol	3189	6	24	263
Golf IV (1J1)	09/02→06/05	BML	Petrol	3189	6	24	263
Golf IV (1J1)	07/03→07/09	BAF	Petrol	1781	4	20	142
Golf IV (1J1)	08/03→01/05	AWB	Petrol	1595	4	20	96
Golf IV (1J1)	08/03→01/05	BFQ	Petrol	1595	4	8	91
Golf IV (1J1)	08/03→01/05	BJH	Petrol	1595	4	8	91
Golf IV (1J1)	08/03→06/05	AWB	Petrol	1595	4	20	95
Golf IV (1J1)	08/03→12/05	APK	Petrol	1984	4	8	180
Golf IV Cabriolet (1E7)	06/98→06/02	AAM	Petrol	1781	4	8	123
Golf IV Cabriolet (1E7)	06/98→06/02	ABA	Petrol	1984	4	8	178
Golf IV Cabriolet (1E7)	06/98→06/02	ADZ	Petrol	1781	4	8	128
Golf IV Cabriolet (1E7)	06/98→06/02	AFN	Diesel	1896	4	8	162
Golf IV Cabriolet (1E7)	06/98→06/02	AFT	Petrol	1595	4	8	82
Golf IV Cabriolet (1E7)	06/98→06/02	AGG	Petrol	1984	4	8	178
Golf IV Cabriolet (1E7)	06/98→06/02	AHU	Diesel	1896	4	8	167
Golf IV Cabriolet (1E7)	06/98→06/02	AKR	Petrol	1984	4	8	181
Golf IV Cabriolet (1E7)	06/98→06/02	AKS	Petrol	1595	4	8	82
Golf IV Cabriolet (1E7)	06/98→06/02	ALE	Diesel	1896	4	8	166
Golf IV Cabriolet (1E7)	06/98→06/02	ANN	Petrol	1781	4	8	136
Golf IV Cabriolet (1E7)	06/98→06/02	ANP	Petrol	1781	4	8	136
Golf IV Cabriolet (1E7)	06/98→06/02	ATU	Petrol	1984	4	8	183
Golf IV Cabriolet (1E7)	06/98→06/02	AVG	Diesel	1896	4	8	166
Golf IV Cabriolet (1E7)	06/98→06/02	AWF	Petrol	1984	4	8	183
Golf IV Cabriolet (1E7)	06/98→06/02	AWG	Petrol	1984	4	8	183
Golf IV Van (1J1)	05/00→09/02	AGR	Diesel	1896	4	8	164
Golf IV Van (1J1)	04/01→05/04	ASZ	Diesel	1896	4	8	168
Golf IV Variant (1J5)	05/99→06/01	AHF	Diesel	1896	4	8	165
Golf IV Variant (1J5)	05/99→06/01	AJM	Diesel	1896	4	8	168
Golf IV Variant (1J5)	05/99→06/01	ASV	Diesel	1896	4	8	169
Golf IV Variant (1J5)	05/99→04/02	AEH	Petrol	1595	4	8	84
Golf IV Variant (1J5)	05/99→04/02	AKL	Petrol	1595	4	8	84
Golf IV Variant (1J5)	05/99→04/02	APF	Petrol	1595	4	8	87
Golf IV Variant (1J5)	05/99→05/06	AGR	Diesel	1896	4	8	164
Golf IV Variant (1J5)	05/99→05/06	ALH	Diesel	1896	4	8	164
Golf IV Variant (1J5)	05/99→06/06	AGN	Petrol	1781	4	20	132
Golf IV Variant (1J5)	05/99→06/06	AGP	Diesel	1896	4	8	164
Golf IV Variant (1J5)	05/99→06/06	AGZ	Petrol	2324	5	10	221
Golf IV Variant (1J5)	05/99→06/06	AHW	Petrol	1390	4	16	45
Golf IV Variant (1J5)	05/99→06/06	AKQ	Petrol	1390	4	16	43
Golf IV Variant (1J5)	05/99→06/06	APE	Petrol	1390	4	16	43
Golf IV Variant (1J5)	05/99→06/06	APK	Petrol	1984	4	8	180
Golf IV Variant (1J5)	05/99→06/06	AQM	Diesel	1896	4	8	169
Golf IV Variant (1J5)	05/99→06/06	AQP	Petrol	2792	6	24	254
Golf IV Variant (1J5)	05/99→06/06	AQY	Petrol	1984	4	8	180
Golf IV Variant (1J5)	05/99→06/06	AUE	Petrol	2792	6	24	254
Golf IV Variant (1J5)	05/99→06/06	AXP	Petrol	1390	4	16	43
Golf IV Variant (1J5)	05/99→06/06	AZJ	Petrol	1984	4	8	180
Golf IV Variant (1J5)	05/99→06/06	BCA	Petrol	1390	4	16	43
Golf IV Variant (1J5)	05/99→06/06	BDE	Petrol	2792	6	24	254
Golf IV Variant (1J5)	08/99→06/01	AUY	Diesel	1896	4	8	168
Golf IV Variant (1J5)	02/00→06/06	ATN	Petrol	1598	4	16	94
Golf IV Variant (1J5)	02/00→06/06	AUS	Petrol	1598	4	16	94
Golf IV Variant (1J5)	02/00→06/06	AZD	Petrol	1598	4	16	89
Golf IV Variant (1J5)	02/00→06/06	BCB	Petrol	1598	4	16	94
Golf IV Variant (1J5)	05/00→06/06	AGU	Petrol	1781	4	20	132
Golf IV Variant (1J5)	05/00→06/06	AQA	Petrol	1781	4	20	132
Golf IV Variant (1J5)	05/00→06/06	ARZ	Petrol	1781	4	20	132
Golf IV Variant (1J5)	05/00→06/06	AUM	Petrol	1781	4	20	132
Golf IV Variant (1J5)	05/00→06/06	AWD	Petrol	1781	4	20	140
Golf IV Variant (1J5)	08/00→06/06	AVU	Petrol	1595	4	8	91
Golf IV Variant (1J5)	08/00→06/06	BFQ	Petrol	1595	4	8	91
Golf IV Variant (1J5)	09/00→12/04	AFP	Petrol	2792	6	12	250
Golf IV Variant (1J5)	09/00→06/06	ATD	Diesel	1896	4	8	168
Golf IV Variant (1J5)	09/00→06/06	AXR	Diesel	1896	4	8	168



CC



9

Golf IV Variant (1J5)	10/00→06/06	AQN	Petrol	2324	5	20	222
Golf IV Variant (1J5)	10/00→06/06	AZH	Petrol	1984	4	8	180
Golf IV Variant (1J5)	11/00→06/06	ASZ	Diesel	1896	4	8	168
Golf IV Variant (1J5)	06/01→06/06	ARL	Diesel	1896	4	8	168
Golf IV Variant (1J5)	01/02→06/06	BAD	Petrol	1598	4	16	92
Golf IV Variant (1J5)	02/02→06/06	BEH	Petrol	1984	4	8	180
Golf IV Variant (1J5)	05/02→06/06	AUQ	Petrol	1781	4	20	132
Golf IV Variant (1J5)	10/03→07/04	BAG	Petrol	1598	4	16	97
Golf V (1K1)	10/03→05/06	BCA	Petrol	1390	4	16	43
Golf V (1K1)	10/03→07/06	BKG	Petrol	1390	4	16	55
Golf V (1K1)	10/03→07/06	BLN	Petrol	1390	4	16	55
Golf V (1K1)	10/03→07/08	BAG	Petrol	1598	4	16	97
Golf V (1K1)	10/03→07/08	BLF	Petrol	1598	4	16	97
Golf V (1K1)	10/03→07/08	BLP	Petrol	1598	4	16	97
Golf V (1K1)	10/03→11/08	AZV	Diesel	1968	4	16	186
Golf V (1K1)	10/03→11/08	BKC	Diesel	1896	4	8	171
Golf V (1K1)	10/03→11/08	BKD	Diesel	1968	4	16	186
Golf V (1K1)	10/03→11/08	BLS	Diesel	1896	4	8	171
Golf V (1K1)	10/03→11/08	BXE	Diesel	1896	4	8	171
Golf V (1K1)	01/04→11/08	AXW	Petrol	1984	4	16	184
Golf V (1K1)	01/04→11/08	BDK	Diesel	1968	4	8	187
Golf V (1K1)	01/04→11/08	BGU	Petrol	1595	4	8	91
Golf V (1K1)	01/04→11/08	BJS	Petrol	3189	6	24	263
Golf V (1K1)	01/04→11/08	BLR	Petrol	1984	4	16	184
Golf V (1K1)	01/04→11/08	BLX	Petrol	1984	4	16	184
Golf V (1K1)	01/04→11/08	BLY	Petrol	1984	4	16	184
Golf V (1K1)	01/04→11/08	BSE	Petrol	1595	4	8	91
Golf V (1K1)	01/04→11/08	BSF	Petrol	1595	4	8	91
Golf V (1K1)	01/04→11/08	BVX	Petrol	1984	4	16	184
Golf V (1K1)	01/04→11/08	BVY	Petrol	1984	4	16	184
Golf V (1K1)	01/04→11/08	BVZ	Petrol	1984	4	16	184
Golf V (1K1)	01/04→11/08	CCSA	Petrol	1595	4	8	91
Golf V (1K1)	05/04→11/08	BRU	Diesel	1896	4	8	171
Golf V (1K1)	05/04→11/08	BXF	Diesel	1896	4	8	171
Golf V (1K1)	05/04→11/08	BXJ	Diesel	1896	4	8	171
Golf V (1K1)	08/04→11/08	BMM	Diesel	1968	4	8	187
Golf V (1K1)	10/04→02/09	AXX	Petrol	1984	4	16	185
Golf V (1K1)	10/04→02/09	BPY	Petrol	1984	4	16	185
Golf V (1K1)	10/04→02/09	BWA	Petrol	1984	4	16	185
Golf V (1K1)	10/04→02/09	CAWB	Petrol	1984	4	16	195
Golf V (1K1)	10/04→02/09	CBFA	Petrol	1984	4	16	195
Golf V (1K1)	10/04→02/09	CCTA	Petrol	1984	4	16	195
Golf V (1K1)	06/05→12/08	BGP	Petrol	2480	5	20	243
Golf V (1K1)	06/05→12/08	BGQ	Petrol	2480	5	20	243
Golf V (1K1)	08/05→11/08	BJR	Petrol	999	4	8	9
Golf V (1K1)	09/05→11/08	BUB	Petrol	3189	6	24	263
Golf V (1K1)	09/05→02/09	AVH	Petrol	1984	4	8	180
Golf V (1K1)	09/05→02/09	BEV	Petrol	1984	4	8	180
Golf V (1K1)	11/05→11/08	BLG	Petrol	1390	4	16	53
Golf V (1K1)	11/05→11/08	BMN	Diesel	1968	4	16	186
Golf V (1K1)	11/05→11/08	CBRA	Petrol	3189	6	24	264
Golf V (1K1)	05/06→11/08	BMV	Petrol	1390	4	16	53
Golf V (1K1)	05/06→11/08	BUD	Petrol	1390	4	16	60
Golf V (1K1)	08/06→11/08	BHY	Petrol	1984	4	8	180
Golf V (1K1)	08/06→11/08	CBPA	Petrol	1984	4	8	180
Golf V (1K1)	09/06→12/08	BYD	Petrol	1984	4	16	185
Golf V (1K1)	04/07→05/08	AUQ	Petrol	1781	4	20	132
Golf V (1K1)	04/07→02/09	BPA	Petrol	1598	4	8	98
Golf V (1K1)	05/07→11/08	CAXA	Petrol	1390	4	16	53
Golf V (1K1)	05/07→11/08	CBTA	Petrol	2480	5	20	243
Golf V (1K1)	05/07→11/08	CBUA	Petrol	2480	5	20	243
Golf V (1K1)	08/09→12/14	CDF	Petrol	1598	4	16	103
Golf V (1K1)	08/09→12/14	CFB	Petrol	1390	4	16	53
Golf V (1K1)	08/09→12/14	CLR	Petrol	1598	4	16	103
Golf V (1K1)	03/10→12/14	CGM	Petrol	1984	4	16	201
Golf V Variant (1K5)	06/07→07/09	AZV	Diesel	1968	4	16	186
Golf V Variant (1K5)	06/07→07/09	BGU	Petrol	1595	4	8	91
Golf V Variant (1K5)	06/07→07/09	BKD	Diesel	1968	4	16	186
Golf V Variant (1K5)	06/07→07/09	BLG	Petrol	1390	4	16	53
Golf V Variant (1K5)	06/07→07/09	BLS	Diesel	1896	4	8	171
Golf V Variant (1K5)	06/07→07/09	BMM	Diesel	1968	4	8	187
Golf V Variant (1K5)	06/07→07/09	BMV	Petrol	1390	4	16	53
Golf V Variant (1K5)	06/07→07/09	BSE	Petrol	1595	4	8	91
Golf V Variant (1K5)	06/07→07/09	BSF	Petrol	1595	4	8	91
Golf V Variant (1K5)	06/07→07/09	BTK	Petrol	2480	5	20	243
Golf V Variant (1K5)	06/07→07/09	BUD	Petrol	1390	4	16	60
Golf V Variant (1K5)	06/07→07/09	BWA	Petrol	1984	4	16	185
Golf V Variant (1K5)	06/07→07/09	BXE	Diesel	1896	4	8	171



CC



9

Golf V Variant (1K5)	06/07→07/09	CAWB	Petrol	1984	4	16	195
Golf V Variant (1K5)	06/07→07/09	CAXA	Petrol	1390	4	16	53
Golf V Variant (1K5)	06/07→07/09	CBDB	Diesel	1968	4	16	194
Golf V Variant (1K5)	06/07→07/09	CBTA	Petrol	2480	5	20	243
Golf V Variant (1K5)	06/07→07/09	CBUA	Petrol	2480	5	20	243
Golf V Variant (1K5)	06/07→07/09	CCSA	Petrol	1595	4	8	91
Golf V Variant (1K5)	06/07→07/09	CCTA	Petrol	1984	4	16	195
Golf V Variant (1K5)	01/08→07/09	CCCA	Petrol	2480	5	20	243
Golf V Variant (1K5)	07/08→07/09	CAVD	Petrol	1390	4	16	53
Golf VI (5K1)	10/08→11/12	BSE	Petrol	1595	4	8	91
Golf VI (5K1)	10/08→11/12	BSF	Petrol	1595	4	8	91
Golf VI (5K1)	10/08→11/12	CAVD	Petrol	1390	4	16	53
Golf VI (5K1)	10/08→11/12	CAXA	Petrol	1390	4	16	53
Golf VI (5K1)	10/08→11/12	CBAA	Diesel	1968	4	16	194
Golf VI (5K1)	10/08→11/12	CBDC	Diesel	1968	4	16	194
Golf VI (5K1)	10/08→11/12	CCSA	Petrol	1595	4	8	91
Golf VI (5K1)	10/08→11/12	CFFA	Diesel	1968	4	16	194
Golf VI (5K1)	10/08→11/12	CGGA	Petrol	1390	4	16	43
Golf VI (5K1)	10/08→11/12	CLCA	Diesel	1968	4	16	194
Golf VI (5K1)	10/08→11/12	CMXA	Petrol	1595	4	8	91
Golf VI (5K1)	10/08→11/12	CNWA	Petrol	1390	4	16	53
Golf VI (5K1)	10/08→11/12	CTHD	Petrol	1390	4	16	53
Golf VI (5K1)	10/08→11/12	CTKA	Petrol	1390	4	16	53
Golf VI (5K1)	10/08→05/13	CBAB	Diesel	1968	4	16	194
Golf VI (5K1)	10/08→05/13	CFFB	Diesel	1968	4	16	194
Golf VI (5K1)	10/08→05/13	CJAA	Diesel	1968	4	16	194
Golf VI (5K1)	10/08→11/13	CFEA	Petrol	1984	4	8	180
Golf VI (5K1)	11/08→11/12	CBZB	Petrol	1197	4	8	24
Golf VI (5K1)	02/09→11/12	CAYB	Diesel	1598	4	16	105
Golf VI (5K1)	02/09→11/12	CAYC	Diesel	1598	4	16	105
Golf VI (5K1)	03/09→11/12	CHGA	Petrol	1595	4	8	91
Golf VI (5K1)	04/09→11/12	CBBB	Diesel	1968	4	16	194
Golf VI (5K1)	04/09→11/12	CCZB	Petrol	1984	4	16	195
Golf VI (5K1)	04/09→11/12	CFGB	Diesel	1968	4	16	194
Golf VI (5K1)	06/09→01/11	CDAA	Petrol	1798	4	16	147
Golf VI (5K1)	06/09→11/13	CBFA	Petrol	1984	4	16	195
Golf VI (5K1)	06/09→11/13	CCTA	Petrol	1984	4	16	195
Golf VI (5K1)	06/09→11/13	CCZA	Petrol	1984	4	16	195
Golf VI (5K1)	07/09→11/13	CBTA	Petrol	2480	5	20	243
Golf VI (5K1)	07/09→11/13	CBUA	Petrol	2480	5	20	243
Golf VI (5K1)	09/09→12/10	BEV	Petrol	1984	4	8	180
Golf VI (5K1)	10/09→12/14	CDF	Petrol	1598	4	16	103
Golf VI (5K1)	10/09→12/14	CFB	Petrol	1390	4	16	53
Golf VI (5K1)	11/09→05/11	CDLA	Petrol	1984	4	16	185
Golf VI (5K1)	11/09→11/12	CDLF	Petrol	1984	4	16	185
Golf VI (5K1)	11/09→11/13	CDLC	Petrol	1984	4	16	185
Golf VI (5K1)	11/09→11/13	CRZA	Petrol	1984	4	16	208
Golf VI (5K1)	05/10→11/12	CBZA	Petrol	1197	4	8	24
Golf VI (5K1)	05/11→11/12	CDLG	Petrol	1984	4	16	185
Golf VI Convertible (517)	03/11→	CAVD	Petrol	1390	4	16	53
Golf VI Convertible (517)	03/11→	CAYC	Diesel	1598	4	16	105
Golf VI Convertible (517)	03/11→	CBZB	Petrol	1197	4	8	24
Golf VI Convertible (517)	03/11→	CNWA	Petrol	1390	4	16	53
Golf VI Convertible (517)	03/11→	CTHD	Petrol	1390	4	16	53
Golf VI Convertible (517)	03/11→	CTKA	Petrol	1390	4	16	53
Golf VI Convertible (517)	11/11→	CAXA	Petrol	1390	4	16	53
Golf VI Convertible (517)	11/11→	CCZB	Petrol	1984	4	16	195
Golf VI Convertible (517)	11/11→	CFHC	Diesel	1968	4	16	194
Golf VI Convertible (517)	01/13→	CDLA	Petrol	1984	4	16	185
Golf VI Convertible (517)	11/13→	CULC	Petrol	1984	4	16	201
Golf VI Convertible (517)	11/13→	CUUA	Diesel	1968	4	16	204
Golf VI Convertible (517)	11/13→	CUUB	Diesel	1968	4	16	204
Golf VI Convertible (517)	11/13→	CXSB	Petrol	1395	4	16	64
Golf VI Convertible (517)	11/13→	CYVD	Petrol	1197	4	16	26
Golf VI Convertible (517)	11/13→	CZCA	Petrol	1395	4	16	64
Golf VI Convertible (517)	11/13→	CZDA	Petrol	1395	4	16	64
Golf VI Variant (AJ5)	07/09→07/10	CCCA	Petrol	2480	5	20	243
Golf VI Variant (AJ5)	07/09→07/13	BSE	Petrol	1595	4	8	91
Golf VI Variant (AJ5)	07/09→07/13	BSF	Petrol	1595	4	8	91
Golf VI Variant (AJ5)	07/09→07/13	BUD	Petrol	1390	4	16	60
Golf VI Variant (AJ5)	07/09→07/13	CAVD	Petrol	1390	4	16	53
Golf VI Variant (AJ5)	07/09→07/13	CAXA	Petrol	1390	4	16	53
Golf VI Variant (AJ5)	07/09→07/13	CAYC	Diesel	1598	4	16	105
Golf VI Variant (AJ5)	07/09→07/13	CBDA	Diesel	1968	4	16	194
Golf VI Variant (AJ5)	07/09→07/13	CBDB	Diesel	1968	4	16	194
Golf VI Variant (AJ5)	07/09→07/13	CBTA	Petrol	2480	5	20	243
Golf VI Variant (AJ5)	07/09→07/13	CBUA	Petrol	2480	5	20	243
Golf VI Variant (AJ5)	07/09→07/13	CBZB	Petrol	1197	4	8	24



Golf VI Variant (AJ5)	07/09→07/13	CCSA	Petrol	1595	4	8	91	
Golf VI Variant (AJ5)	07/09→07/13	CCZA	Petrol	1984	4	16	195	
Golf VI Variant (AJ5)	07/09→07/13	CFHB	Diesel	1968	4	16	194	
Golf VI Variant (AJ5)	07/09→07/13	CFHC	Diesel	1968	4	16	194	
Golf VI Variant (AJ5)	07/09→07/13	CGGA	Petrol	1390	4	16	43	
Golf VI Variant (AJ5)	07/09→07/13	CJAA	Diesel	1968	4	16	194	
Golf VI Variant (AJ5)	07/09→07/13	CLCB	Diesel	1968	4	16	194	
Golf VI Variant (AJ5)	07/09→07/13	CMXA	Petrol	1595	4	8	91	
Golf VI Variant (AJ5)	07/09→07/13	CNWA	Petrol	1390	4	16	53	
Golf VI Variant (AJ5)	07/09→07/13	CTHD	Petrol	1390	4	16	53	
Golf VI Variant (AJ5)	07/09→07/13	CTKA	Petrol	1390	4	16	53	
Golf VI Variant (AJ5)	12/09→07/13	CAYB	Diesel	1598	4	16	105	
Golf VI Variant (AJ5)	01/10→07/13	CLCA	Diesel	1968	4	16	194	
Golf VI Variant (AJ5)	07/10→07/13	CBZA	Petrol	1197	4	8	24	
Golf VI Variant (AJ5)	09/10→12/12	BEV	Petrol	1984	4	8	180	
Golf VI Variant (AJ5)	09/10→12/12	CBPA	Petrol	1984	4	8	180	
Golf VII (5G1)	12/13→	CSS	Petrol	1395	4	16	65	
Golf VII (5G1)	06/15→	CYA	Petrol	1197	4	16	28	
Golf VII (5G1)	11/15→	CHH	Petrol	1984	4	16	201	
Golf VII (5G1)	11/15→	CUG	Petrol	1984	4	16	201	
Golf VII (5G1, BQ1, BE1, BE2)	08/12→	CHPA	Petrol	1395	4	16	64	
Golf VII (5G1, BQ1, BE1, BE2)	08/12→	CJZB	Petrol	1197	4	16	27	
Golf VII (5G1, BQ1, BE1, BE2)	08/12→	CLHA	Diesel	1598	4	16	107	
Golf VII (5G1, BQ1, BE1, BE2)	08/12→	CPTA	Petrol	1395	4	16	67	
Golf VII (5G1, BQ1, BE1, BE2)	08/12→	CRBB	Diesel	1968	4	16	204	
Golf VII (5G1, BQ1, BE1, BE2)	08/12→	CRVC	Diesel	1968	4	16	204	
Golf VII (5G1, BQ1, BE1, BE2)	08/12→	CYVA	Petrol	1197	4	16	26	
Golf VII (5G1, BQ1, BE1, BE2)	09/12→	CBTA	Petrol	2480	5	20	243	
Golf VII (5G1, BQ1, BE1, BE2)	09/12→	CBUA	Petrol	2480	5	20	243	
Golf VII (5G1, BQ1, BE1, BE2)	09/12→	CRZA	Petrol	1984	4	16	208	
Golf VII (5G1, BQ1, BE1, BE2)	11/12→	CJZA	Petrol	1197	4	16	26	
Golf VII (5G1, BQ1, BE1, BE2)	11/12→	CKFC	Diesel	1968	4	16	204	
Golf VII (5G1, BQ1, BE1, BE2)	11/12→	CMBA	Petrol	1395	4	16	64	
Golf VII (5G1, BQ1, BE1, BE2)	11/12→	CPVA	Petrol	1395	4	16	64	
Golf VII (5G1, BQ1, BE1, BE2)	11/12→	CRBC	Diesel	1968	4	16	204	
Golf VII (5G1, BQ1, BE1, BE2)	11/12→	CRLB	Diesel	1968	4	16	204	
Golf VII (5G1, BQ1, BE1, BE2)	11/12→	CRLD	Diesel	1968	4	16	207	
Golf VII (5G1, BQ1, BE1, BE2)	11/12→	CRMB	Diesel	1968	4	16	204	
Golf VII (5G1, BQ1, BE1, BE2)	11/12→	CRUA	Diesel	1968	4	16	204	
Golf VII (5G1, BQ1, BE1, BE2)	11/12→	CRVA	Diesel	1968	4	16	204	
Golf VII (5G1, BQ1, BE1, BE2)	11/12→	CXSA	Petrol	1395	4	16	64	
Golf VII (5G1, BQ1, BE1, BE2)	11/12→	CYKB	Diesel	1968	4	16	207	
Golf VII (5G1, BQ1, BE1, BE2)	11/12→	DCYA	Diesel	1968	4	16	207	
Golf VII (5G1, BQ1, BE1, BE2)	11/12→	DEJA	Diesel	1968	4	16	204	
Golf VII (5G1, BQ1, BE1, BE2)	11/12→	DEJB	Diesel	1968	4	16	204	
Golf VII (5G1, BQ1, BE1, BE2)	01/13→	CRKB	Diesel	1598	4	16	107	
Golf VII (5G1, BQ1, BE1, BE2)	01/13→	CXXB	Diesel	1598	4	16	107	
Golf VII (5G1, BQ1, BE1, BE2)	01/13→	DBKA	Diesel	1598	4	16	107	
Golf VII (5G1, BQ1, BE1, BE2)	04/13→	CHHA	Petrol	1984	4	16	201	
Golf VII (5G1, BQ1, BE1, BE2)	04/13→	CHHB	Petrol	1984	4	16	201	
Golf VII (5G1, BQ1, BE1, BE2)	04/13→	CLHB	Diesel	1598	4	16	107	
Golf VII (5G1, BQ1, BE1, BE2)	04/13→	CRKA	Diesel	1598	4	16	107	
Golf VII (5G1, BQ1, BE1, BE2)	04/13→	CUNA	Diesel	1968	4	16	204	
Golf VII (5G1, BQ1, BE1, BE2)	04/13→	CXCB	Petrol	1984	4	16	201	
Golf VII (5G1, BQ1, BE1, BE2)	04/13→	CXDA	Petrol	1984	4	16	201	
Golf VII (5G1, BQ1, BE1, BE2)	04/13→	CXXA	Diesel	1598	4	16	107	
Golf VII (5G1, BQ1, BE1, BE2)	04/13→	DDYB	Diesel	1598	4	16	107	
Golf VII (5G1, BQ1, BE1, BE2)	04/13→	DGCA	Diesel	1968	4	16	204	
Golf VII (5G1, BQ1, BE1, BE2)	06/13→	CPWA	Petrol	1395	4	16	64	
Golf VII (5G1, BQ1, BE1, BE2)	07/13→	CJAA	Diesel	1968	4	16	194	
Golf VII (5G1, BQ1, BE1, BE2)	07/13→	CNSA	Petrol	1798	4	16	147	
Golf VII (5G1, BQ1, BE1, BE2)	07/13→	CNSB	Petrol	1798	4	16	147	
Golf VII (5G1, BQ1, BE1, BE2)	11/13→	CJXB	Petrol	1984	4	16	201	
Golf VII (5G1, BQ1, BE1, BE2)	11/13→	CJXC	Petrol	1984	4	16	201	
Golf VII (5G1, BQ1, BE1, BE2)	11/13→	CNTA	Petrol	1984	4	16	201	
Golf VII (5G1, BQ1, BE1, BE2)	11/13→	CXCA	Petrol	1984	4	16	201	
Golf VII (5G1, BQ1, BE1, BE2)	12/13→	CPVB	Petrol	1395	4	16	64	
Golf VII (5G1, BQ1, BE1, BE2)	04/14→	CYVB	Petrol	1197	4	16	26	
Golf VII (5G1, BQ1, BE1, BE2)	05/14→	CUKB	Petrol	1395	4	16	64	
Golf VII (5G1, BQ1, BE1, BE2)	05/14→	CWVA	Petrol	1598	4	16	113	
Golf VII (5G1, BQ1, BE1, BE2)	05/14→	CZCA	Petrol	1395	4	16	64	
Golf VII (5G1, BQ1, BE1, BE2)	05/14→	CZDA	Petrol	1395	4	16	64	
Golf VII (5G1, BQ1, BE1, BE2)	05/14→	CZEA	Petrol	1395	4	16	67	
Golf VII (5G1, BQ1, BE1, BE2)	11/14→	CYFB	Petrol	1984	4	16	201	
Golf VII (5G1, BQ1, BE1, BE2)	05/15→	CHZD	Petrol	999	3	12	14	
Golf VII (5G1, BQ1, BE1, BE2)	02/16→	CJXE	Petrol	1984	4	16	201	
Golf VII (5G1, BQ1, BE1, BE2)	09/16→	CJXG	Petrol	1984	4	16	201	
Golf VII (5G1, BQ1, BE1, BE2)	11/16→	CHZC	Petrol	999	3	12	14	



CC



9

Golf VII (5G1, BQ1, BE1, BE2)	11/16→	DDYA	Diesel	1598	4	16	107
Golf VII (5G1, BQ1, BE1, BE2)	12/16→	CJXD	Petrol	1984	4	16	201
Golf VII (5G1, BQ1, BE1, BE2)	12/16→	DJHA	Petrol	1984	4	16	201
Golf VII (5G1, BQ1, BE1, BE2)	12/16→	DJHB	Petrol	1984	4	16	201
Golf VII (5G1, BQ1, BE1, BE2)	03/17→	DLBA	Petrol	1984	4	16	201
Golf VII Variant (BA5, BV5)	04/13→	CBTA	Petrol	2480	5	20	243
Golf VII Variant (BA5, BV5)	04/13→	CBUA	Petrol	2480	5	20	243
Golf VII Variant (BA5, BV5)	04/13→	CKFC	Diesel	1968	4	16	204
Golf VII Variant (BA5, BV5)	04/13→	CPVA	Petrol	1395	4	16	64
Golf VII Variant (BA5, BV5)	04/13→	CRBC	Diesel	1968	4	16	204
Golf VII Variant (BA5, BV5)	04/13→	CRLB	Diesel	1968	4	16	204
Golf VII Variant (BA5, BV5)	04/13→	CRUA	Diesel	1968	4	16	204
Golf VII Variant (BA5, BV5)	04/13→	DCYA	Diesel	1968	4	16	207
Golf VII Variant (BA5, BV5)	04/13→	DEJA	Diesel	1968	4	16	204
Golf VII Variant (BA5, BV5)	05/13→	CHPA	Petrol	1395	4	16	64
Golf VII Variant (BA5, BV5)	05/13→	CJZA	Petrol	1197	4	16	26
Golf VII Variant (BA5, BV5)	05/13→	CJZB	Petrol	1197	4	16	27
Golf VII Variant (BA5, BV5)	05/13→	CLHA	Diesel	1598	4	16	107
Golf VII Variant (BA5, BV5)	05/13→	CLHB	Diesel	1598	4	16	107
Golf VII Variant (BA5, BV5)	05/13→	CRKA	Diesel	1598	4	16	107
Golf VII Variant (BA5, BV5)	05/13→	CRKB	Diesel	1598	4	16	107
Golf VII Variant (BA5, BV5)	05/13→	CRLD	Diesel	1968	4	16	207
Golf VII Variant (BA5, BV5)	05/13→	CRVA	Diesel	1968	4	16	204
Golf VII Variant (BA5, BV5)	05/13→	CXSA	Petrol	1395	4	16	64
Golf VII Variant (BA5, BV5)	05/13→	CXXA	Diesel	1598	4	16	107
Golf VII Variant (BA5, BV5)	05/13→	CXXB	Diesel	1598	4	16	107
Golf VII Variant (BA5, BV5)	05/13→	CYKB	Diesel	1968	4	16	207
Golf VII Variant (BA5, BV5)	05/13→	CYVA	Petrol	1197	4	16	26
Golf VII Variant (BA5, BV5)	05/13→	DCYB	Diesel	1968	4	16	204
Golf VII Variant (BA5, BV5)	05/13→	DDYB	Diesel	1598	4	16	107
Golf VII Variant (BA5, BV5)	05/13→	DEJB	Diesel	1968	4	16	204
Golf VII Variant (BA5, BV5)	07/13→	CBPA	Petrol	1984	4	8	180
Golf VII Variant (BA5, BV5)	07/13→	CJAA	Diesel	1968	4	16	194
Golf VII Variant (BA5, BV5)	07/13→	CNSA	Petrol	1798	4	16	147
Golf VII Variant (BA5, BV5)	07/13→	CNSB	Petrol	1798	4	16	147
Golf VII Variant (BA5, BV5)	09/13→	CPWA	Petrol	1395	4	16	64
Golf VII Variant (BA5, BV5)	04/14→	CYVB	Petrol	1197	4	16	26
Golf VII Variant (BA5, BV5)	05/14→	CHPB	Petrol	1395	4	16	64
Golf VII Variant (BA5, BV5)	05/14→	CPVB	Petrol	1395	4	16	64
Golf VII Variant (BA5, BV5)	05/14→	CWVA	Petrol	1598	4	16	113
Golf VII Variant (BA5, BV5)	05/14→	CZCA	Petrol	1395	4	16	64
Golf VII Variant (BA5, BV5)	05/14→	CZDA	Petrol	1395	4	16	64
Golf VII Variant (BA5, BV5)	01/15→	CUNA	Diesel	1968	4	16	204
Golf VII Variant (BA5, BV5)	01/15→	DGCA	Diesel	1968	4	16	204
Golf VII Variant (BA5, BV5)	03/15→	CJXB	Petrol	1984	4	16	201
Golf VII Variant (BA5, BV5)	03/15→	CJXC	Petrol	1984	4	16	201
Golf VII Variant (BA5, BV5)	05/15→	CHZD	Petrol	999	3	12	14
Golf VII Variant (BA5, BV5)	11/16→	CHZC	Petrol	999	3	12	14
Golf VII Variant (BA5, BV5)	11/16→	CJSB	Petrol	1798	4	16	147
Golf VII Variant (BA5, BV5)	11/16→	DDYA	Diesel	1598	4	16	107
Golf VII Variant (BA5, BV5)	12/16→	CJXD	Petrol	1984	4	16	201
Golf VII Variant (BA5, BV5)	12/16→	DJHA	Petrol	1984	4	16	201
Golf VII Variant (BA5, BV5)	12/16→	DJHB	Petrol	1984	4	16	201
Golf PLUS (5M1, 521)	01/05→11/06	BCA	Petrol	1390	4	16	43
Golf PLUS (5M1, 521)	01/05→05/08	BLF	Petrol	1598	4	16	97
Golf PLUS (5M1, 521)	01/05→01/09	BRC	Diesel	1896	4	8	171
Golf PLUS (5M1, 521)	01/05→01/09	BLS	Diesel	1896	4	8	171
Golf PLUS (5M1, 521)	01/05→01/09	BXE	Diesel	1896	4	8	171
Golf PLUS (5M1, 521)	01/05→12/13	BKD	Diesel	1968	4	16	186
Golf PLUS (5M1, 521)	01/05→12/13	CBDB	Diesel	1968	4	16	194
Golf PLUS (5M1, 521)	01/05→12/13	CFHC	Diesel	1968	4	16	194
Golf PLUS (5M1, 521)	05/05→06/08	BLR	Petrol	1984	4	16	184
Golf PLUS (5M1, 521)	05/05→06/08	BLY	Petrol	1984	4	16	184
Golf PLUS (5M1, 521)	05/05→06/08	BVY	Petrol	1984	4	16	184
Golf PLUS (5M1, 521)	05/05→06/08	BVZ	Petrol	1984	4	16	184
Golf PLUS (5M1, 521)	05/05→12/08	BRU	Diesel	1896	4	8	171
Golf PLUS (5M1, 521)	05/05→12/08	BXF	Diesel	1896	4	8	171
Golf PLUS (5M1, 521)	05/05→12/08	BXJ	Diesel	1896	4	8	171
Golf PLUS (5M1, 521)	05/05→12/13	AZY	Diesel	1968	4	16	186
Golf PLUS (5M1, 521)	05/05→12/13	BSE	Petrol	1595	4	8	91
Golf PLUS (5M1, 521)	05/05→12/13	BSF	Petrol	1595	4	8	91
Golf PLUS (5M1, 521)	05/05→12/13	CBDA	Diesel	1968	4	16	194
Golf PLUS (5M1, 521)	05/05→12/13	CCSA	Petrol	1595	4	8	91
Golf PLUS (5M1, 521)	05/05→12/13	CFHB	Diesel	1968	4	16	194
Golf PLUS (5M1, 521)	05/05→12/13	CMXA	Petrol	1595	4	8	91
Golf PLUS (5M1, 521)	07/05→11/06	BLN	Petrol	1390	4	16	55
Golf PLUS (5M1, 521)	08/05→12/13	BJR	Petrol	999	4	8	9
Golf PLUS (5M1, 521)	12/05→05/11	BMM	Diesel	1968	4	8	187



Model	Period	Code	Fuel	CC	Gear	Power
Golf PLUS (5M1, 521)	05/06→06/08	BLG	Petrol	1390	4	53
Golf PLUS (5M1, 521)	05/06→06/08	BMV	Petrol	1390	4	53
Golf PLUS (5M1, 521)	05/06→12/13	BUD	Petrol	1390	4	60
Golf PLUS (5M1, 521)	05/06→12/13	CGGA	Petrol	1390	4	43
Golf PLUS (5M1, 521)	06/07→12/13	CAXA	Petrol	1390	4	53
Golf PLUS (5M1, 521)	06/08→12/13	CAVD	Petrol	1390	4	53
Golf PLUS (5M1, 521)	06/08→12/13	CNWA	Petrol	1390	4	53
Golf PLUS (5M1, 521)	01/09→12/13	CBDC	Diesel	1968	4	194
Golf PLUS (5M1, 521)	01/09→12/13	CLCA	Diesel	1968	4	194
Golf PLUS (5M1, 521)	02/09→12/13	CAYB	Diesel	1598	4	105
Golf PLUS (5M1, 521)	03/09→12/13	CAYC	Diesel	1598	4	105
Golf PLUS (5M1, 521)	05/09→12/13	CHGA	Petrol	1595	4	91
Golf PLUS (5M1, 521)	11/09→12/13	CBZB	Petrol	1197	4	24
Golf PLUS (5M1, 521)	05/10→12/13	CBZA	Petrol	1197	4	24
Golf Sportsvan (AM1)	02/14→	CRKA	Diesel	1598	4	107
Golf Sportsvan (AM1)	02/14→	CRKB	Diesel	1598	4	107
Golf Sportsvan (AM1)	02/14→	CRLB	Diesel	1968	4	204
Golf Sportsvan (AM1)	02/14→	CXXA	Diesel	1598	4	107
Golf Sportsvan (AM1)	02/14→	CXXB	Diesel	1598	4	107
Golf Sportsvan (AM1)	02/14→	CZDA	Petrol	1395	4	64
Golf Sportsvan (AM1)	02/14→	DBKA	Diesel	1598	4	107
Golf Sportsvan (AM1)	02/14→	DCYA	Diesel	1968	4	207
Golf Sportsvan (AM1)	02/14→	DDYB	Diesel	1598	4	107
Golf Sportsvan (AM1)	04/14→	CPVB	Petrol	1395	4	64
Golf Sportsvan (AM1)	04/14→	CYVB	Petrol	1197	4	26
Golf Sportsvan (AM1)	04/14→	CZCA	Petrol	1395	4	64
Golf Sportsvan (AM1)	05/14→	CRLD	Diesel	1968	4	207
Golf Sportsvan (AM1)	05/14→	CRVA	Diesel	1968	4	204
Golf Sportsvan (AM1)	05/14→	CWVA	Petrol	1598	4	113
Golf Sportsvan (AM1)	05/14→	CYVA	Petrol	1197	4	26
Golf Sportsvan (AM1)	05/14→	DCYB	Diesel	1968	4	204
Golf Sportsvan (AM1)	05/15→	CHZD	Petrol	999	3	14
Golf Sportsvan (AM1)	05/16→	CSS	Petrol	1395	4	65
Golf Sportsvan (AM1)	05/16→	CYA	Petrol	1197	4	28
Golf Sportsvan (AM1)	11/16→	DDYA	Diesel	1598	4	107
Golf Sportsvan (AM1)	05/17→	CHZC	Petrol	999	3	14
Gol II	06/94→09/03	UDB	Petrol	1781	4	121
Gol II	06/94→08/05	UDH	Petrol	1781	4	130
Gol II	10/94→09/96	UQG	Petrol	1984	4	214
Gol II	08/96→04/99	AZN	Petrol	999	4	9
Gol II	06/00→05/03	ASW	Petrol	999	4	11
Gol II	08/07→06/13	BNW	Petrol	999	4	9
Gol III	03/99→09/05	AZN	Petrol	999	4	9
Gol III	03/99→09/05	BJR	Petrol	999	4	9
Gol III	03/99→09/05	BWX	Petrol	1596	4	101
Gol III	05/99→08/05	AZP	Petrol	999	4	12
Gol III	09/99→08/05	UPD	Petrol	1595	4	101
Gol III	05/02→05/03	BEH	Petrol	1984	4	180
Gol III	06/02→06/05	1Y	Diesel	1896	4	153
Gol III	06/02→06/05	BGG	Diesel	1896	4	172
Gol III	05/03→08/05	BJF	Petrol	1596	4	101
Gol III	02/05→08/05	BNY	Petrol	1781	4	146
Gol IV	07/05→07/06	BTY	Petrol	999	4	9
Gol IV	07/05→05/08	BNY	Petrol	1781	4	146
Gol IV	09/05→05/08	AZN	Petrol	999	4	9
Gol IV	09/05→05/08	BJF	Petrol	1596	4	101
Gol IV	09/05→04/10	BNW	Petrol	999	4	9
Gol IV	10/05→05/08	UNF	Petrol	1598	4	83
Gol V	07/08→	CCNA	Petrol	999	4	9
Gol V	07/08→	CCRA	Petrol	1598	4	98
Gol V	07/09→	CFZA	Petrol	1598	4	98
Gol VI	08/16→	CFZA	Petrol	1598	4	98
Gran Lavida Hatchback	04/17→	CYA	Petrol	1197	4	28
Gran Santana Hatchback	09/15→	CPD	Petrol	1598	4	110
Gran Santana Hatchback	03/17→	CKA	Petrol	1395	4	65
Iltis (183)	03/79→12/88	WL	Petrol	1714	4	120
Iltis (183)	03/79→12/88	YX	Petrol	1714	4	120
Iltis (183)	08/87→12/88	1C	Diesel	1588	4	77
Jetta	10/04→12/13	BJG	Petrol	1595	4	102
Jetta	03/13→	CKAA	Petrol	1395	4	65
Jetta	03/13→	CPD	Petrol	1598	4	110
Jetta (1G2, 1J2)	05/91→12/99	ABX	Petrol	1595	4	79
Jetta CITY	09/06→12/09	BEV	Petrol	1984	4	180
Jetta CITY Saloon	09/06→12/09	BEV	Petrol	1984	4	180
Jetta I (16)	08/78→07/80	CK	Diesel	1471	4	70
Jetta I (16)	08/78→07/82	EG	Petrol	1588	4	114
Jetta I (16)	08/78→02/84	FR	Petrol	1588	4	114
Jetta I (16)	08/78→02/84	JB	Petrol	1457	4	76



CC



9

Jetta I (16)	08/79→02/84	GF	Petrol	1272	4	8	35
Jetta I (16)	08/79→02/84	GG	Petrol	1093	4	8	17
Jetta I (16)	08/80→12/84	CR	Diesel	1588	4	8	111
Jetta I (16)	08/80→12/84	JK	Diesel	1588	4	8	111
Jetta I (16)	09/80→02/84	EN	Petrol	1716	4	8	118
Jetta I (16)	08/81→07/83	EM	Petrol	1588	4	8	79
Jetta I (16)	03/82→02/84	CY	Diesel	1588	4	8	111
Jetta I (16)	08/82→07/83	EW	Petrol	1595	4	8	79
Jetta I (16)	08/82→02/84	DX	Petrol	1781	4	8	121
Jetta I (16)	08/82→02/84	GS	Petrol	1272	4	8	35
Jetta I (16)	08/82→02/84	JJ	Petrol	1781	4	8	121
Jetta I (16)	09/83→02/84	JH	Petrol	1781	4	8	121
Jetta II (19E, 1G2, 165)	01/84→10/86	GT	Petrol	1272	4	8	34
Jetta II (19E, 1G2, 165)	01/84→06/87	HK	Petrol	1272	4	8	34
Jetta II (19E, 1G2, 165)	01/84→10/91	EV	Petrol	1781	4	8	149
Jetta II (19E, 1G2, 165)	01/84→10/91	GZ	Petrol	1781	4	8	121
Jetta II (19E, 1G2, 165)	01/84→10/91	JP	Diesel	1588	4	8	111
Jetta II (19E, 1G2, 165)	01/84→10/91	JR	Diesel	1588	4	8	77
Jetta II (19E, 1G2, 165)	01/84→10/91	ME	Diesel	1588	4	8	111
Jetta II (19E, 1G2, 165)	01/84→10/91	MF	Diesel	1588	4	8	77
Jetta II (19E, 1G2, 165)	01/84→10/91	PB	Petrol	1781	4	8	121
Jetta II (19E, 1G2, 165)	01/84→12/91	MH	Petrol	1272	4	8	34
Jetta II (19E, 1G2, 165)	01/84→07/92	ABN	Petrol	1595	4	8	79
Jetta II (19E, 1G2, 165)	01/84→07/92	EZ	Petrol	1595	4	8	79
Jetta II (19E, 1G2, 165)	01/84→07/92	HM	Petrol	1595	4	8	79
Jetta II (19E, 1G2, 165)	08/84→10/91	GU	Petrol	1781	4	8	149
Jetta II (19E, 1G2, 165)	08/84→10/91	GX	Petrol	1781	4	8	121
Jetta II (19E, 1G2, 165)	08/84→10/91	HV	Petrol	1781	4	8	121
Jetta II (19E, 1G2, 165)	01/85→12/92	HT	Petrol	1781	4	8	121
Jetta II (19E, 1G2, 165)	01/85→12/92	RV	Petrol	1781	4	8	121
Jetta II (19E, 1G2, 165)	08/85→10/87	RD	Petrol	1781	4	8	121
Jetta II (19E, 1G2, 165)	03/86→10/91	RF	Petrol	1595	4	8	79
Jetta II (19E, 1G2, 165)	08/86→01/90	RH	Petrol	1781	4	8	121
Jetta II (19E, 1G2, 165)	08/86→10/91	PL	Petrol	1781	4	16	151
Jetta II (19E, 1G2, 165)	09/86→12/92	PF	Petrol	1781	4	8	121
Jetta II (19E, 1G2, 165)	10/86→10/91	PN	Petrol	1595	4	8	79
Jetta II (19E, 1G2, 165)	06/87→12/89	KR	Petrol	1781	4	16	151
Jetta II (19E, 1G2, 165)	06/87→12/91	2G	Petrol	1272	4	8	29
Jetta II (19E, 1G2, 165)	06/87→12/91	NZ	Petrol	1272	4	8	29
Jetta II (19E, 1G2, 165)	08/87→10/91	RP	Petrol	1781	4	8	149
Jetta II (19E, 1G2, 165)	08/88→07/91	1P	Petrol	1781	4	8	121
Jetta II (19E, 1G2, 165)	04/89→10/91	RA	Diesel	1588	4	8	77
Jetta II (19E, 1G2, 165)	04/89→10/91	SB	Diesel	1588	4	8	77
Jetta II (19E, 1G2, 165)	08/89→07/92	9A	Petrol	1984	4	16	176
Jetta II (19E, 1G2, 165)	01/90→10/91	1V	Diesel	1589	4	8	77
Jetta III (1K2)	08/05→10/10	BHY	Petrol	1984	4	8	180
Jetta III (1K2)	08/05→10/10	BKC	Diesel	1896	4	8	171
Jetta III (1K2)	08/05→10/10	BKD	Diesel	1968	4	16	186
Jetta III (1K2)	08/05→10/10	BLR	Petrol	1984	4	16	184
Jetta III (1K2)	08/05→10/10	BLS	Diesel	1896	4	8	171
Jetta III (1K2)	08/05→10/10	BLX	Petrol	1984	4	16	184
Jetta III (1K2)	08/05→10/10	BLY	Petrol	1984	4	16	184
Jetta III (1K2)	08/05→10/10	BRM	Diesel	1896	4	8	171
Jetta III (1K2)	08/05→10/10	BVY	Petrol	1984	4	16	184
Jetta III (1K2)	08/05→10/10	BVZ	Petrol	1984	4	16	184
Jetta III (1K2)	08/05→10/10	BXE	Diesel	1896	4	8	171
Jetta III (1K2)	08/05→10/10	CBDB	Diesel	1968	4	16	194
Jetta III (1K2)	08/05→10/10	CBEA	Diesel	1968	4	16	197
Jetta III (1K2)	08/05→10/10	CJAA	Diesel	1968	4	16	194
Jetta III (1K2)	09/05→12/07	BGQ	Petrol	2480	5	20	243
Jetta III (1K2)	09/05→12/09	BEV	Petrol	1984	4	8	180
Jetta III (1K2)	09/05→10/10	AZV	Diesel	1968	4	16	186
Jetta III (1K2)	09/05→10/10	BGP	Petrol	2480	5	20	243
Jetta III (1K2)	09/05→10/10	BLF	Petrol	1598	4	16	97
Jetta III (1K2)	09/05→10/10	BTK	Petrol	2480	5	20	243
Jetta III (1K2)	09/05→10/10	CBDA	Diesel	1968	4	16	194
Jetta III (1K2)	09/05→10/10	CBTA	Petrol	2480	5	20	243
Jetta III (1K2)	09/05→10/10	CBUA	Petrol	2480	5	20	243
Jetta III (1K2)	10/05→10/10	AXX	Petrol	1984	4	16	185
Jetta III (1K2)	10/05→10/10	BGU	Petrol	1595	4	8	91
Jetta III (1K2)	10/05→10/10	BMM	Diesel	1968	4	8	187
Jetta III (1K2)	10/05→10/10	BPY	Petrol	1984	4	16	185
Jetta III (1K2)	10/05→10/10	BSE	Petrol	1595	4	8	91
Jetta III (1K2)	10/05→10/10	BSF	Petrol	1595	4	8	91
Jetta III (1K2)	10/05→10/10	BWA	Petrol	1984	4	16	185
Jetta III (1K2)	10/05→10/10	CAWB	Petrol	1984	4	16	195
Jetta III (1K2)	10/05→10/10	CBFA	Petrol	1984	4	16	195
Jetta III (1K2)	10/05→10/10	CCSA	Petrol	1595	4	8	91



CC



9

Jetta III (1K2)	10/05→10/10	CCTA	Petrol	1984	4	16	195
Jetta III (1K2)	10/05→10/10	CCZA	Petrol	1984	4	16	195
Jetta III (1K2)	07/06→10/10	BLG	Petrol	1390	4	16	53
Jetta III (1K2)	07/06→10/10	BMV	Petrol	1390	4	16	53
Jetta III (1K2)	10/06→10/10	BMN	Diesel	1968	4	16	186
Jetta III (1K2)	10/06→10/10	CEGA	Diesel	1968	4	16	194
Jetta III (1K2)	05/07→10/10	CAXA	Petrol	1390	4	16	53
Jetta III (1K2)	03/08→10/10	CAWA	Petrol	1984	4	16	195
Jetta III (1K2)	07/08→10/10	CAVD	Petrol	1390	4	16	53
Jetta III (1K2)	07/08→10/10	CCCA	Petrol	2480	5	20	243
Jetta III (1K2)	06/09→10/10	CAYC	Diesel	1598	4	16	105
Jetta III (1K2)	10/09→10/10	AAA	Petrol	2792	6	12	247
Jetta III (1K2)	12/09→10/10	CAYB	Diesel	1598	4	16	105
Jetta III (1K2)	01/10→10/10	CLCA	Diesel	1968	4	16	194
Jetta IV (162, 163)	04/10→07/14	CAYC	Diesel	1598	4	16	105
Jetta IV (162, 163)	04/10→	CBTA	Petrol	2480	5	20	243
Jetta IV (162, 163)	04/10→	CBUA	Petrol	2480	5	20	243
Jetta IV (162, 163)	04/10→	CCCA	Petrol	2480	5	20	243
Jetta IV (162, 163)	06/10→	CBPA	Petrol	1984	4	8	180
Jetta IV (162, 163)	06/10→	CKJA	Petrol	1984	4	8	205
Jetta IV (162, 163)	10/10→	CBZB	Petrol	1197	4	8	24
Jetta IV (162, 163)	10/10→	CLCA	Diesel	1968	4	16	194
Jetta IV (162, 163)	12/10→	CBFA	Petrol	1984	4	16	195
Jetta IV (162, 163)	12/10→	CCTA	Petrol	1984	4	16	195
Jetta IV (162, 163)	12/10→	CCZA	Petrol	1984	4	16	195
Jetta IV (162, 163)	02/11→	CFFB	Diesel	1968	4	16	194
Jetta IV (162, 163)	02/11→	CFHC	Diesel	1968	4	16	194
Jetta IV (162, 163)	02/11→	CJAA	Diesel	1968	4	16	194
Jetta IV (162, 163)	02/11→	CLCB	Diesel	1968	4	16	194
Jetta IV (162, 163)	04/11→07/14	CAVA	Petrol	1390	4	16	53
Jetta IV (162, 163)	04/11→07/14	CTHA	Petrol	1390	4	16	53
Jetta IV (162, 163)	04/11→	CAVD	Petrol	1390	4	16	53
Jetta IV (162, 163)	04/11→	CNLA	Petrol	1395	4	16	64
Jetta IV (162, 163)	04/11→	CRJA	Petrol	1395	4	16	64
Jetta IV (162, 163)	04/11→	CTHD	Petrol	1390	4	16	53
Jetta IV (162, 163)	05/11→	CAXA	Petrol	1390	4	16	53
Jetta IV (162, 163)	05/11→	CMSB	Petrol	1390	4	16	53
Jetta IV (162, 163)	12/11→	CFNA	Petrol	1598	4	16	103
Jetta IV (162, 163)	12/11→	CLRA	Petrol	1598	4	16	103
Jetta IV (162, 163)	03/13→	CFNB	Petrol	1598	4	16	103
Jetta IV (162, 163)	07/14→	CPKA	Petrol	1798	4	16	147
Jetta IV (162, 163)	07/14→	CPRA	Petrol	1798	4	16	147
Jetta IV (162, 163)	08/14→	CUUB	Diesel	1968	4	16	204
Jetta IV (162, 163)	08/14→	CYVD	Petrol	1197	4	16	26
Jetta IV (162, 163)	08/14→	CZCA	Petrol	1395	4	16	64
Jetta IV (162, 163)	08/14→	CZDA	Petrol	1395	4	16	64
Jetta IV (162, 163)	08/14→	CZTA	Petrol	1395	4	16	64
Jetta IV (162, 163)	08/14→	DELA	Diesel	1968	4	16	204
Jetta IV (162, 163)	09/15→	CWVA	Petrol	1598	4	16	113
Kaefer	01/54→07/65	M51	Petrol	1192	4	8	18
Kaefer	01/60→12/85	D	Petrol	1192	4	8	18
Kaefer	01/65→07/70	F	Petrol	1285	4	8	30
Kaefer	08/65→07/70	E	Petrol	1285	4	8	30
Kaefer	08/66→11/73	H	Petrol	1493	4	8	75
Kaefer	01/70→07/75	AB	Petrol	1285	4	8	30
Kaefer	01/70→12/79	AD	Petrol	1584	4	8	81
Kaefer	08/70→07/75	AC	Petrol	1285	4	8	30
Kaefer	07/71→07/74	AE	Petrol	1584	4	8	81
Kaefer	07/71→07/74	AH	Petrol	1584	4	8	81
Kaefer	07/71→07/74	AK	Petrol	1584	4	8	81
Kaefer	08/72→07/75	AR	Petrol	1285	4	8	30
Kaefer	08/72→12/79	AJ	Petrol	1584	4	8	81
Kaefer	08/72→12/79	AS	Petrol	1584	4	8	81
Kaefer	05/73→09/92	AF	Petrol	1584	4	8	81
Kaefer	09/92→08/03	ACD	Petrol	1584	4	8	81
Kaefer	07/64→07/70	F	Petrol	1285	4	8	30
Kaefer Convertible (15)	01/66→12/70	H	Petrol	1493	4	8	75
Kaefer Convertible (15)	07/70→06/79	AD	Petrol	1584	4	8	81
Kaefer Convertible (15)	07/70→03/81	AB	Petrol	1285	4	8	30
Kaefer Convertible (15)	08/70→07/74	AC	Petrol	1285	4	8	30
Kaefer Convertible (15)	08/70→07/74	AE	Petrol	1584	4	8	81
Kaefer Convertible (15)	08/70→07/74	AF	Petrol	1584	4	8	81
Kaefer Convertible (15)	08/70→07/74	AH	Petrol	1584	4	8	81
Kaefer Convertible (15)	08/70→07/74	AK	Petrol	1584	4	8	81
Kaefer Convertible (15)	04/75→12/79	D	Petrol	1192	4	8	18
Kaefer Convertible (15)	09/75→12/80	AJ	Petrol	1584	4	8	81
Karmann Ghia Convertible (14, 34)	09/57→12/64	D	Petrol	1192	4	8	18
Karmann Ghia Convertible (14, 34)	07/64→07/74	F	Petrol	1285	4	8	30



CC



9

Karmann Ghia Convertible (14, 34)	01/66→12/69	H	Petrol	1493	4	8	75
Karmann Ghia Coupe (14, 34)	08/55→12/65	D	Petrol	1192	4	8	18
Karmann Ghia Coupe (14, 34)	01/66→12/69	H	Petrol	1493	4	8	75
Karmann Ghia Coupe (14, 34)	01/70→07/74	AD	Petrol	1584	4	8	81
Karmann Ghia Coupe (14, 34)	07/70→07/74	AB	Petrol	1285	4	8	30
Karmann Ghia Coupe (14, 34)	07/71→07/74	AL	Petrol	1584	4	8	81
Kombi Box (T2)	08/92→07/00	EZ	Petrol	1595	4	8	79
Kombi Box (T2)	05/95→12/11	CT	Petrol	1584	4	8	81
Kombi Bus (T2)	05/95→12/05	CT	Petrol	1584	4	8	81
Lamando	01/15→	CSS	Petrol	1395	4	16	65
Lavida	04/08→08/12	CEN	Petrol	1984	4	8	180
Lavida Saloon	07/15→	CYA	Petrol	1197	4	16	28
Lavida Saloon	05/16→	CSS	Petrol	1395	4	16	65
Load Up (121, 122, BL1, BL2)	12/14→	CHYA	Petrol	999	3	12	14
Load Up (121, 122, BL1, BL2)	12/14→	CPGA	Petrol	999	3	12	14
Logus	10/93→09/94	RM	Petrol	1781	4	8	121
LT 28-35 I Box (281-363)	04/75→09/83	CH	Petrol	1984	4	8	202
LT 28-35 I Box (281-363)	01/79→07/92	CP	Diesel	2383	6	12	225
LT 28-35 I Box (281-363)	01/79→07/92	DW	Diesel	2383	6	12	225
LT 28-35 I Box (281-363)	12/82→07/92	DL	Petrol	2383	6	12	224
LT 28-35 I Box (281-363)	02/86→08/92	DV	Diesel	2383	6	12	225
LT 28-35 I Box (281-363)	08/88→08/92	1G	Diesel	2383	6	12	225
LT 28-35 I Box (281-363)	07/90→05/96	1S	Diesel	2383	6	12	225
LT 28-35 I Box (281-363)	07/90→05/96	ACT	Diesel	2383	6	12	225
LT 28-35 I Box (281-363)	06/92→05/96	ACL	Diesel	2383	6	12	229
LT 28-35 I Box (281-363)	03/94→06/96	1E	Petrol	2383	6	12	224
LT 28-35 I Bus (281-363)	04/75→09/83	CH	Petrol	1984	4	8	202
LT 28-35 I Bus (281-363)	01/79→07/92	CP	Diesel	2383	6	12	225
LT 28-35 I Bus (281-363)	01/79→07/92	DW	Diesel	2383	6	12	225
LT 28-35 I Bus (281-363)	12/82→07/89	DV	Diesel	2383	6	12	225
LT 28-35 I Bus (281-363)	12/82→07/92	DL	Petrol	2383	6	12	224
LT 28-35 I Bus (281-363)	08/89→08/92	1G	Diesel	2383	6	12	225
LT 28-35 I Bus (281-363)	08/89→06/96	1E	Petrol	2383	6	12	224
LT 28-35 I Bus (281-363)	08/89→06/96	1S	Diesel	2383	6	12	225
LT 28-35 I Bus (281-363)	08/89→06/96	ACT	Diesel	2383	6	12	225
LT 28-35 I Bus (281-363)	09/92→06/96	ACL	Diesel	2383	6	12	229
LT 28-35 I Platform/Chassis (281-363)	04/75→09/83	CH	Petrol	1984	4	8	202
LT 28-35 I Platform/Chassis (281-363)	12/78→02/91	CP	Diesel	2383	6	12	225
LT 28-35 I Platform/Chassis (281-363)	12/78→07/92	DW	Diesel	2383	6	12	225
LT 28-35 I Platform/Chassis (281-363)	12/82→07/92	DL	Petrol	2383	6	12	224
LT 28-35 I Platform/Chassis (281-363)	12/82→09/93	DV	Diesel	2383	6	12	225
LT 28-35 I Platform/Chassis (281-363)	08/90→08/92	1G	Diesel	2383	6	12	225
LT 28-35 I Platform/Chassis (281-363)	08/90→06/96	1S	Diesel	2383	6	12	225
LT 28-35 I Platform/Chassis (281-363)	08/90→06/96	ACT	Diesel	2383	6	12	225
LT 28-35 I Platform/Chassis (281-363)	08/92→06/96	1E	Petrol	2383	6	12	224
LT 28-35 I Platform/Chassis (281-363)	08/92→06/96	ACL	Diesel	2383	6	12	229
LT 28-35 II Bus (2DB, 2DE, 2DK)	05/96→08/99	AHD	Diesel	2461	5	10	235
LT 28-35 II Bus (2DB, 2DE, 2DK)	05/96→07/06	AGL	Petrol	2295	4	16	220
LT 28-35 II Bus (2DB, 2DE, 2DK)	07/96→07/06	AGX	Diesel	2461	5	10	235
LT 28-35 II Bus (2DB, 2DE, 2DK)	05/99→07/06	ANJ	Diesel	2461	5	10	238
LT 28-35 II Bus (2DB, 2DE, 2DK)	05/99→07/06	APA	Diesel	2461	5	10	238
LT 28-35 II Bus (2DB, 2DE, 2DK)	05/99→07/06	AVR	Diesel	2461	5	10	238
LT 28-35 II Bus (2DB, 2DE, 2DK)	05/01→07/06	BBE	Diesel	2461	5	10	238
LT 28-35 II Bus (2DB, 2DE, 2DK)	05/01→07/06	BBF	Diesel	2461	5	10	238
LT 28-46 II Box (2DA, 2DD, 2DH)	05/96→08/99	AHD	Diesel	2461	5	10	235
LT 28-46 II Box (2DA, 2DD, 2DH)	05/96→07/06	AGL	Petrol	2295	4	16	220
LT 28-46 II Box (2DA, 2DD, 2DH)	09/96→07/06	AGX	Diesel	2461	5	10	235
LT 28-46 II Box (2DA, 2DD, 2DH)	05/99→07/06	ANJ	Diesel	2461	5	10	238
LT 28-46 II Box (2DA, 2DD, 2DH)	05/99→07/06	APA	Diesel	2461	5	10	238
LT 28-46 II Box (2DA, 2DD, 2DH)	05/99→07/06	AVR	Diesel	2461	5	10	238
LT 28-46 II Box (2DA, 2DD, 2DH)	05/01→07/06	BBE	Diesel	2461	5	10	238
LT 28-46 II Box (2DA, 2DD, 2DH)	05/01→07/06	BBF	Diesel	2461	5	10	238
LT 28-46 II Platform/Chassis (2DC, 2DF, 2DG, 2DL, 2DM)	06/96→08/99	AHD	Diesel	2461	5	10	235
LT 28-46 II Platform/Chassis (2DC, 2DF, 2DG, 2DL, 2DM)	06/96→07/06	AGL	Petrol	2295	4	16	220
LT 28-46 II Platform/Chassis (2DC, 2DF, 2DG, 2DL, 2DM)	09/96→07/06	AGX	Diesel	2461	5	10	235
LT 28-46 II Platform/Chassis (2DC, 2DF, 2DG, 2DL, 2DM)	05/99→07/06	ANJ	Diesel	2461	5	10	238
LT 28-46 II Platform/Chassis (2DC, 2DF, 2DG, 2DL, 2DM)	05/99→07/06	APA	Diesel	2461	5	10	238
LT 28-46 II Platform/Chassis (2DC, 2DF, 2DG, 2DL, 2DM)	05/99→07/06	AVR	Diesel	2461	5	10	238
LT 28-46 II Platform/Chassis (2DC, 2DF, 2DG, 2DL, 2DM)	05/01→07/06	BBE	Diesel	2461	5	10	238
LT 28-46 II Platform/Chassis (2DC, 2DF, 2DG, 2DL, 2DM)	05/01→07/06	BBF	Diesel	2461	5	10	238
LT 40-55 I Box (291-512)	04/75→09/83	CH	Petrol	1984	4	8	202
LT 40-55 I Box (291-512)	08/78→08/92	DV	Diesel	2383	6	12	225
LT 40-55 I Box (291-512)	01/79→07/92	CP	Diesel	2383	6	12	225
LT 40-55 I Box (291-512)	01/79→07/92	DW	Diesel	2383	6	12	225
LT 40-55 I Box (291-512)	12/82→07/92	DL	Petrol	2383	6	12	224
LT 40-55 I Box (291-512)	08/88→08/92	1G	Diesel	2383	6	12	225
LT 40-55 I Box (291-512)	07/90→05/96	1S	Diesel	2383	6	12	225
LT 40-55 I Box (291-512)	07/90→05/96	ACT	Diesel	2383	6	12	225



LT 40-55 I Box (291-512)	06/92→05/96	ACL	Diesel	2383	6	12	229
LT 40-55 I Box (291-512)	01/93→06/96	1E	Petrol	2383	6	12	224
LT 40-55 I Platform/Chassis (293-909)	04/75→09/83	CH	Petrol	1984	4	8	202
LT 40-55 I Platform/Chassis (293-909)	12/78→02/91	CP	Diesel	2383	6	12	225
LT 40-55 I Platform/Chassis (293-909)	12/78→02/91	DW	Diesel	2383	6	12	225
LT 40-55 I Platform/Chassis (293-909)	12/82→07/89	DL	Petrol	2383	6	12	224
LT 40-55 I Platform/Chassis (293-909)	12/82→09/93	DV	Diesel	2383	6	12	225
LT 40-55 I Platform/Chassis (293-909)	08/88→07/91	1G	Diesel	2383	6	12	225
LT 40-55 I Platform/Chassis (293-909)	08/88→06/96	1E	Petrol	2383	6	12	224
LT 40-55 I Platform/Chassis (293-909)	08/90→06/96	1S	Diesel	2383	6	12	225
LT 40-55 I Platform/Chassis (293-909)	08/90→06/96	ACT	Diesel	2383	6	12	225
LT 40-55 I Platform/Chassis (293-909)	08/92→06/96	ACL	Diesel	2383	6	12	229
Lupo (5Z1)	10/03→12/09	BPA	Petrol	1598	4	8	98
Lupo (5Z1)	01/04→12/09	BLH	Petrol	1598	4	8	100
Lupo (5Z1)	01/04→12/09	CCRA	Petrol	1598	4	8	98
Lupo (6X1, 6E1)	09/98→07/05	AER	Petrol	999	4	8	4
Lupo (6X1, 6E1)	09/98→07/05	AHW	Petrol	1390	4	16	45
Lupo (6X1, 6E1)	09/98→07/05	AKQ	Petrol	1390	4	16	43
Lupo (6X1, 6E1)	09/98→07/05	AKU	Diesel	1716	4	8	116
Lupo (6X1, 6E1)	09/98→07/05	ALD	Petrol	999	4	8	7
Lupo (6X1, 6E1)	09/98→07/05	ALL	Petrol	999	4	8	8
Lupo (6X1, 6E1)	09/98→07/05	ANV	Petrol	999	4	8	7
Lupo (6X1, 6E1)	09/98→07/05	APE	Petrol	1390	4	16	43
Lupo (6X1, 6E1)	09/98→07/05	AUA	Petrol	1390	4	16	43
Lupo (6X1, 6E1)	09/98→07/05	AUC	Petrol	999	4	8	7
Lupo (6X1, 6E1)	09/98→07/05	BBY	Petrol	1390	4	16	43
Lupo (6X1, 6E1)	10/98→05/00	AHT	Petrol	997	4	8	6
Lupo (6X1, 6E1)	01/99→07/05	AMF	Diesel	1422	3	6	49
Lupo (6X1, 6E1)	07/99→07/05	ANY	Diesel	1191	3	6	19
Lupo (6X1, 6E1)	07/99→07/05	AYZ	Diesel	1191	3	6	19
Lupo (6X1, 6E1)	08/99→07/05	AFK	Petrol	1390	4	16	43
Lupo (6X1, 6E1)	08/99→07/05	AQQ	Petrol	1390	4	16	51
Lupo (6X1, 6E1)	08/99→07/05	AUB	Petrol	1390	4	16	43
Lupo (6X1, 6E1)	09/00→07/05	AVY	Petrol	1598	4	16	92
Lupo (6X1, 6E1)	10/00→07/05	AUD	Petrol	1390	4	8	47
Lupo (6X1, 6E1)	02/01→07/05	ARR	Petrol	1390	4	16	52
Magotan (B6)	06/07→07/11	BYJ	Petrol	1798	4	16	147
Magotan (B6)	04/08→07/11	CBL	Petrol	1984	4	16	195
Magotan (B6)	01/10→07/11	CFB	Petrol	1390	4	16	53
Magotan (B7L)	07/11→	CEA	Petrol	1798	4	16	147
Magotan (B7L)	07/11→	CFB	Petrol	1390	4	16	53
Magotan (B7L)	07/11→	CGM	Petrol	1984	4	16	201
Magotan (B7L)	12/11→	CNG	Petrol	2975	6	24	259
Magotan (B8L)	07/16→	CSS	Petrol	1395	4	16	65
Magotan (B8L)	07/16→	CUG	Petrol	1984	4	16	201
Multivan V (7HM, 7HN, 7HF, 7EF, 7EM, 7EN)	04/03→11/09	AXB	Diesel	1896	4	8	168
Multivan V (7HM, 7HN, 7HF, 7EF, 7EM, 7EN)	04/03→11/09	AXC	Diesel	1896	4	8	168
Multivan V (7HM, 7HN, 7HF, 7EF, 7EM, 7EN)	04/03→11/09	AXD	Diesel	2461	5	10	241
Multivan V (7HM, 7HN, 7HF, 7EF, 7EM, 7EN)	04/03→11/09	AXE	Diesel	2461	5	10	241
Multivan V (7HM, 7HN, 7HF, 7EF, 7EM, 7EN)	04/03→11/09	BNZ	Diesel	2461	5	10	246
Multivan V (7HM, 7HN, 7HF, 7EF, 7EM, 7EN)	04/03→11/09	BPC	Diesel	2461	5	10	246
Multivan V (7HM, 7HN, 7HF, 7EF, 7EM, 7EN)	11/03→11/09	BLJ	Diesel	2461	5	10	245
Multivan V (7HM, 7HN, 7HF, 7EF, 7EM, 7EN)	11/03→08/15	AXA	Petrol	1984	4	8	180
Multivan V (7HM, 7HN, 7HF, 7EF, 7EM, 7EN)	02/04→06/04	BDL	Petrol	3189	6	24	263
Multivan V (7HM, 7HN, 7HF, 7EF, 7EM, 7EN)	02/04→11/09	BKK	Petrol	3189	6	24	263
Multivan V (7HM, 7HN, 7HF, 7EF, 7EM, 7EN)	02/04→11/09	CFLA	Petrol	3189	6	24	263
Multivan V (7HM, 7HN, 7HF, 7EF, 7EM, 7EN)	01/06→11/09	BRR	Diesel	1896	4	8	171
Multivan V (7HM, 7HN, 7HF, 7EF, 7EM, 7EN)	06/06→11/09	BRS	Diesel	1896	4	8	171
Multivan V (7HM, 7HN, 7HF, 7EF, 7EM, 7EN)	09/09→08/15	CAAA	Diesel	1968	4	16	194
Multivan V (7HM, 7HN, 7HF, 7EF, 7EM, 7EN)	09/09→08/15	CAAB	Diesel	1968	4	16	194
Multivan V (7HM, 7HN, 7HF, 7EF, 7EM, 7EN)	09/09→08/15	CAAC	Diesel	1968	4	16	194
Multivan V (7HM, 7HN, 7HF, 7EF, 7EM, 7EN)	09/09→08/15	CCHA	Diesel	1968	4	16	194
Multivan V (7HM, 7HN, 7HF, 7EF, 7EM, 7EN)	09/09→08/15	CFCA	Diesel	1968	4	16	194
Multivan V (7HM, 7HN, 7HF, 7EF, 7EM, 7EN)	05/10→08/15	CAAE	Diesel	1968	4	16	194
Multivan V (7HM, 7HN, 7HF, 7EF, 7EM, 7EN)	05/10→08/15	CCHB	Diesel	1968	4	16	194
Multivan V (7HM, 7HN, 7HF, 7EF, 7EM, 7EN)	05/11→08/15	CAAD	Diesel	1968	4	16	194
Multivan V (7HM, 7HN, 7HF, 7EF, 7EM, 7EN)	05/11→08/15	CJKA	Petrol	1984	4	16	201
Multivan V (7HM, 7HN, 7HF, 7EF, 7EM, 7EN)	07/12→08/15	CJKB	Petrol	1984	4	16	201
Multivan VI (SGF, SGM, SGN)	04/15→	CAAB	Diesel	1968	4	16	194
Multivan VI (SGF, SGM, SGN)	04/15→	CAAC	Diesel	1968	4	16	194
Multivan VI (SGF, SGM, SGN)	04/15→	CFCA	Diesel	1968	4	16	194
Multivan VI (SGF, SGM, SGN)	04/15→	CJKA	Petrol	1984	4	16	201
Multivan VI (SGF, SGM, SGN)	04/15→	CJKB	Petrol	1984	4	16	201
Multivan VI (SGF, SGM, SGN)	04/15→	CXFA	Diesel	1968	4	16	210
Multivan VI (SGF, SGM, SGN)	04/15→	CXGA	Diesel	1968	4	16	210
Multivan VI (SGF, SGM, SGN)	04/15→	CXGB	Diesel	1968	4	16	210
Multivan VI (SGF, SGM, SGN)	04/15→	CXHA	Diesel	1968	4	16	209
Multivan VI (SGF, SGM, SGN)	06/15→	CXEB	Diesel	1968	4	16	209



CC



9

Multivan VI (SGF, SGM, SGN)	05/16→	CXGC	Diesel	1968	4	16	209
Multivan VI (SGF, SGM, SGN)	05/16→	CXHB	Diesel	1968	4	16	209
New Beetle (9C1, 1C1)	01/98→06/04	ALH	Diesel	1896	4	8	164
New Beetle (9C1, 1C1)	01/98→09/10	AEG	Petrol	1984	4	8	180
New Beetle (9C1, 1C1)	01/98→09/10	APK	Petrol	1984	4	8	180
New Beetle (9C1, 1C1)	01/98→09/10	AQY	Petrol	1984	4	8	180
New Beetle (9C1, 1C1)	01/98→09/10	AVH	Petrol	1984	4	8	180
New Beetle (9C1, 1C1)	01/98→09/10	AZG	Petrol	1984	4	8	180
New Beetle (9C1, 1C1)	01/98→09/10	AZJ	Petrol	1984	4	8	180
New Beetle (9C1, 1C1)	01/98→09/10	BEJ	Petrol	1984	4	8	180
New Beetle (9C1, 1C1)	01/98→09/10	BER	Petrol	1984	4	8	180
New Beetle (9C1, 1C1)	01/98→09/10	BEV	Petrol	1984	4	8	180
New Beetle (9C1, 1C1)	01/98→09/10	BHP	Petrol	1984	4	8	180
New Beetle (9C1, 1C1)	01/98→09/10	CBPA	Petrol	1984	4	8	180
New Beetle (9C1, 1C1)	10/99→09/00	AWH	Petrol	1595	4	8	87
New Beetle (9C1, 1C1)	10/99→09/10	AGU	Petrol	1781	4	20	132
New Beetle (9C1, 1C1)	10/99→09/10	APH	Petrol	1781	4	20	133
New Beetle (9C1, 1C1)	10/99→09/10	AVC	Petrol	1781	4	20	133
New Beetle (9C1, 1C1)	10/99→09/10	AWU	Petrol	1781	4	20	133
New Beetle (9C1, 1C1)	10/99→09/10	AWV	Petrol	1781	4	20	133
New Beetle (9C1, 1C1)	10/99→09/10	BKF	Petrol	1781	4	20	133
New Beetle (9C1, 1C1)	04/00→05/01	AXJ	Petrol	3189	6	24	263
New Beetle (9C1, 1C1)	06/00→09/10	AYD	Petrol	1595	4	8	91
New Beetle (9C1, 1C1)	06/00→09/10	BFS	Petrol	1595	4	8	91
New Beetle (9C1, 1C1)	10/00→09/10	AQN	Petrol	2324	5	20	222
New Beetle (9C1, 1C1)	02/01→09/10	ATD	Diesel	1896	4	8	168
New Beetle (9C1, 1C1)	02/01→09/10	BEW	Diesel	1896	4	8	168
New Beetle (9C1, 1C1)	11/01→06/05	AWP	Petrol	1781	4	20	133
New Beetle (9C1, 1C1)	11/01→06/05	BNU	Petrol	1781	4	20	133
New Beetle (9C1, 1C1)	11/01→09/10	BCA	Petrol	1390	4	16	43
New Beetle (9C1, 1C1)	07/05→09/10	BPR	Petrol	2480	5	20	243
New Beetle (9C1, 1C1)	07/05→09/10	BPS	Petrol	2480	5	20	243
New Beetle (9C1, 1C1)	07/05→09/10	BSW	Diesel	1896	4	8	168
New Beetle Convertible (1Y7)	09/02→12/04	ALH	Diesel	1896	4	8	164
New Beetle Convertible (1Y7)	09/02→10/10	AQY	Petrol	1984	4	8	180
New Beetle Convertible (1Y7)	09/02→10/10	AZJ	Petrol	1984	4	8	180
New Beetle Convertible (1Y7)	09/02→10/10	BDC	Petrol	1984	4	8	180
New Beetle Convertible (1Y7)	09/02→10/10	BEV	Petrol	1984	4	8	180
New Beetle Convertible (1Y7)	09/02→10/10	BGD	Petrol	1984	4	8	180
New Beetle Convertible (1Y7)	01/03→09/10	AWU	Petrol	1781	4	20	133
New Beetle Convertible (1Y7)	01/03→09/10	AWV	Petrol	1781	4	20	133
New Beetle Convertible (1Y7)	01/03→09/10	BCA	Petrol	1390	4	16	43
New Beetle Convertible (1Y7)	01/03→09/10	BFS	Petrol	1595	4	8	91
New Beetle Convertible (1Y7)	01/03→09/10	BKF	Petrol	1781	4	20	133
New Beetle Convertible (1Y7)	06/03→09/10	AXR	Diesel	1896	4	8	168
New Beetle Convertible (1Y7)	07/05→09/10	BPR	Petrol	2480	5	20	243
New Beetle Convertible (1Y7)	07/05→09/10	BPS	Petrol	2480	5	20	243
New Beetle Convertible (1Y7)	07/05→09/10	BSW	Diesel	1896	4	8	168
Parati	08/02→	UDH	Petrol	1781	4	8	130
Parati I	05/82→12/95	FS	Petrol	1588	4	8	79
Parati I	08/87→07/94	JH	Petrol	1781	4	8	121
Parati I	08/91→07/94	RM	Petrol	1781	4	8	121
Parati II	08/95→07/99	AFX	Petrol	1595	4	8	86
Parati II	08/95→07/99	UDB	Petrol	1781	4	8	121
Parati II	08/95→07/99	UDH	Petrol	1781	4	8	130
Parati II	10/96→07/99	UNF	Petrol	1598	4	8	83
Parati II	10/96→07/99	UQG	Petrol	1984	4	8	214
Parati II	08/97→04/99	AZP	Petrol	999	4	16	12
Parati III	08/99→08/05	UDB	Petrol	1781	4	8	121
Parati III	08/99→08/05	UDH	Petrol	1781	4	8	130
Parati III	08/99→08/05	UNF	Petrol	1598	4	8	83
Parati III	08/99→08/05	UPD	Petrol	1595	4	8	101
Parati III	08/99→	UQG	Petrol	1984	4	8	214
Parati III	08/02→	1Y	Diesel	1896	4	8	153
Parati III	08/02→	ASW	Petrol	999	4	16	11
Parati III	08/02→	AZP	Petrol	999	4	16	12
Parati III	08/02→	BGG	Diesel	1896	4	8	172
Parati III	05/03→08/05	BWX	Petrol	1596	4	8	101
Parati III	05/03→	BJF	Petrol	1596	4	8	101
Parati IV	09/05→12/08	BNY	Petrol	1781	4	8	146
Passat (3A2, 35I)	02/88→08/96	ABS	Petrol	1781	4	8	124
Passat (3A2, 35I)	02/88→08/96	ADZ	Petrol	1781	4	8	128
Passat (3A2, 35I)	02/88→08/96	RP	Petrol	1781	4	8	149
Passat (3A2, 35I)	04/88→07/89	RF	Petrol	1595	4	8	79
Passat (3A2, 35I)	04/88→07/91	1F	Petrol	1595	4	8	78
Passat (3A2, 35I)	04/88→07/91	ABN	Petrol	1595	4	8	79
Passat (3A2, 35I)	04/88→07/91	EZ	Petrol	1595	4	8	79
Passat (3A2, 35I)	04/88→07/92	PB	Petrol	1781	4	8	121



Passat (3A2, 35I)	04/88→07/93	PF	Petrol	1781	4	8	121
Passat (3A2, 35I)	04/88→09/93	KR	Petrol	1781	4	16	151
Passat (3A2, 35I)	08/88→09/93	9A	Petrol	1984	4	16	176
Passat (3A2, 35I)	08/88→09/93	RA	Diesel	1588	4	8	77
Passat (3A2, 35I)	08/88→09/93	SB	Diesel	1588	4	8	77
Passat (3A2, 35I)	08/88→08/96	PG	Petrol	1781	4	8	121
Passat (3A2, 35I)	05/89→10/93	1Y	Diesel	1896	4	8	153
Passat (3A2, 35I)	02/90→08/96	2E	Petrol	1984	4	8	175
Passat (3A2, 35I)	02/90→08/96	ABA	Petrol	1984	4	8	178
Passat (3A2, 35I)	02/90→08/96	ADY	Petrol	1984	4	8	179
Passat (3A2, 35I)	02/90→08/96	AGG	Petrol	1984	4	8	178
Passat (3A2, 35I)	08/90→08/96	AAM	Petrol	1781	4	8	123
Passat (3A2, 35I)	03/91→08/96	AAZ	Diesel	1896	4	8	156
Passat (3A2, 35I)	06/91→08/96	AAA	Petrol	2792	6	12	247
Passat (3A2, 35I)	10/93→08/96	1Z	Diesel	1896	4	8	154
Passat (3A2, 35I)	10/93→08/96	AHU	Diesel	1896	4	8	167
Passat (3A2, 35I)	01/94→08/96	ABF	Petrol	1984	4	16	176
Passat (3A2, 35I)	10/94→08/96	AEK	Petrol	1595	4	8	85
Passat (3A2, 35I)	10/94→08/96	AFT	Petrol	1595	4	8	82
Passat (3A2, 35I)	03/95→08/96	AEP	Petrol	1984	4	8	181
Passat (3A2, 35I)	03/96→08/96	AFN	Diesel	1896	4	8	162
Passat (3B2)	08/96→11/00	ACK	Petrol	2771	6	30	249
Passat (3B2)	08/96→11/00	AHA	Petrol	2771	6	30	252
Passat (3B2)	08/96→11/00	APR	Petrol	2771	6	30	253
Passat (3B2)	08/96→11/00	AQD	Petrol	2771	6	30	253
Passat (3B2)	10/96→11/00	ADP	Petrol	1595	4	8	82
Passat (3B2)	10/96→11/00	ADR	Petrol	1781	4	20	127
Passat (3B2)	10/96→11/00	AFN	Diesel	1896	4	8	162
Passat (3B2)	10/96→11/00	AGZ	Petrol	2324	5	10	221
Passat (3B2)	10/96→11/00	AHH	Diesel	1896	4	8	166
Passat (3B2)	10/96→11/00	AHL	Petrol	1595	4	8	87
Passat (3B2)	10/96→11/00	AHU	Diesel	1896	4	8	167
Passat (3B2)	10/96→11/00	ALG	Petrol	2771	6	30	253
Passat (3B2)	10/96→11/00	ANA	Petrol	1595	4	8	87
Passat (3B2)	10/96→11/00	ANB	Petrol	1781	4	20	135
Passat (3B2)	10/96→11/00	APT	Petrol	1781	4	20	139
Passat (3B2)	10/96→11/00	APU	Petrol	1781	4	20	139
Passat (3B2)	10/96→11/00	ARG	Petrol	1781	4	20	139
Passat (3B2)	10/96→11/00	ARM	Petrol	1595	4	8	93
Passat (3B2)	10/96→11/00	AVG	Diesel	1896	4	8	166
Passat (3B2)	10/96→12/01	AEB	Petrol	1781	4	20	129
Passat (3B2)	01/97→11/00	AFY	Petrol	1781	4	20	127
Passat (3B2)	05/97→09/99	AGE	Petrol	2771	6	30	252
Passat (3B2)	07/98→11/00	AFB	Diesel	2496	6	24	234
Passat (3B2)	07/98→11/00	AKN	Diesel	2496	6	24	234
Passat (3B2)	08/98→11/00	AJM	Diesel	1896	4	8	168
Passat (3B2)	08/98→11/00	ATJ	Diesel	1896	4	8	168
Passat (3B2)	09/99→11/00	ATX	Petrol	2771	6	30	253
Passat (3B2)	09/99→11/00	BBG	Petrol	2771	6	30	253
Passat (3B2)	02/00→11/00	AVB	Diesel	1896	4	8	168
Passat (3B2)	04/00→11/00	ASU	Petrol	1984	4	8	180
Passat (3B2)	04/00→11/00	AUZ	Petrol	1984	4	8	180
Passat (3B3)	11/00→03/05	AFY	Petrol	1781	4	20	127
Passat (3B3)	11/00→05/05	AFB	Diesel	2496	6	24	234
Passat (3B3)	11/00→05/05	AKN	Diesel	2496	6	24	234
Passat (3B3)	11/00→05/05	ALZ	Petrol	1595	4	8	91
Passat (3B3)	11/00→05/05	AMX	Petrol	2771	6	30	253
Passat (3B3)	11/00→05/05	ATQ	Petrol	2771	6	30	253
Passat (3B3)	11/00→05/05	AVB	Diesel	1896	4	8	168
Passat (3B3)	11/00→05/05	AVF	Diesel	1896	4	8	168
Passat (3B3)	11/00→05/05	AWL	Petrol	1781	4	20	132
Passat (3B3)	11/00→05/05	AWT	Petrol	1781	4	20	132
Passat (3B3)	11/00→05/05	AWX	Diesel	1896	4	8	168
Passat (3B3)	11/00→05/05	AZM	Petrol	1984	4	8	180
Passat (3B3)	11/00→05/05	AZX	Petrol	2324	5	20	223
Passat (3B3)	11/00→05/05	BFF	Petrol	1984	4	8	180
Passat (3B3)	02/01→05/05	AWM	Petrol	1781	4	20	132
Passat (3B3)	09/01→09/04	BDN	Petrol	3999	8	32	267
Passat (3B3)	09/01→09/04	BDP	Petrol	3999	8	32	267
Passat (3B3)	11/01→05/05	ALT	Petrol	1984	4	20	182
Passat (3B3)	01/03→05/05	BAU	Diesel	2496	6	24	234
Passat (3B3)	01/03→05/05	BDH	Diesel	2496	6	24	234
Passat (3B3)	05/03→05/05	BDG	Diesel	2496	6	24	234
Passat (3B3)	12/03→05/05	BGW	Diesel	1968	4	8	190
Passat (3B3)	12/03→05/05	BHW	Diesel	1968	4	8	190
Passat (3C2)	03/05→06/08	BLF	Petrol	1598	4	16	97
Passat (3C2)	03/05→11/08	BKC	Diesel	1896	4	8	171
Passat (3C2)	03/05→11/08	BLS	Diesel	1896	4	8	171



CC



9

Passat (3C2)	03/05→11/08	BXE	Diesel	1896	4	8	171
Passat (3C2)	03/05→05/09	BMP	Diesel	1968	4	8	187
Passat (3C2)	03/05→07/10	BLR	Petrol	1984	4	16	184
Passat (3C2)	03/05→07/10	BLY	Petrol	1984	4	16	184
Passat (3C2)	03/05→07/10	BVY	Petrol	1984	4	16	184
Passat (3C2)	03/05→07/10	BVZ	Petrol	1984	4	16	184
Passat (3C2)	03/05→08/10	BKP	Diesel	1968	4	16	186
Passat (3C2)	03/05→08/10	CBAB	Diesel	1968	4	16	194
Passat (3C2)	03/05→11/10	BMA	Diesel	1968	4	16	186
Passat (3C2)	03/05→11/10	CBAA	Diesel	1968	4	16	194
Passat (3C2)	05/05→07/10	BSE	Petrol	1595	4	8	91
Passat (3C2)	05/05→07/10	BSF	Petrol	1595	4	8	91
Passat (3C2)	06/05→07/10	BLV	Petrol	3597	6	24	265
Passat (3C2)	07/05→07/10	AXX	Petrol	1984	4	16	185
Passat (3C2)	07/05→07/10	BPY	Petrol	1984	4	16	185
Passat (3C2)	07/05→07/10	BWA	Petrol	1984	4	16	185
Passat (3C2)	07/05→07/10	CAWB	Petrol	1984	4	16	195
Passat (3C2)	07/05→07/10	CBFA	Petrol	1984	4	16	195
Passat (3C2)	07/05→07/10	CCTA	Petrol	1984	4	16	195
Passat (3C2)	07/05→07/10	CCZA	Petrol	1984	4	16	195
Passat (3C2)	08/05→07/06	BVE	Diesel	1968	4	16	186
Passat (3C2)	08/05→05/09	BUZ	Diesel	1968	4	16	186
Passat (3C2)	08/05→07/10	BMR	Diesel	1968	4	16	186
Passat (3C2)	08/05→07/10	CBBB	Diesel	1968	4	16	194
Passat (3C2)	09/05→07/10	BLX	Petrol	1984	4	16	184
Passat (3C2)	09/05→07/10	BVX	Petrol	1984	4	16	184
Passat (3C2)	11/05→05/07	BWV	Diesel	1968	4	16	186
Passat (3C2)	11/05→07/10	AXZ	Petrol	3168	6	24	263
Passat (3C2)	04/07→07/10	BWS	Petrol	3597	6	24	265
Passat (3C2)	05/07→07/10	BZB	Petrol	1798	4	16	147
Passat (3C2)	05/07→07/10	CAXA	Petrol	1390	4	16	53
Passat (3C2)	05/07→07/10	CDAA	Petrol	1798	4	16	147
Passat (3C2)	08/07→07/10	CCTB	Petrol	1984	4	16	195
Passat (3C2)	11/08→07/10	CBDC	Diesel	1968	4	16	194
Passat (3C2)	01/09→07/10	CDGA	Petrol	1390	4	16	62
Passat (3C2)	01/09→11/10	CBAC	Diesel	1968	4	16	194
Passat (3C2)	08/09→07/10	CAYC	Diesel	1598	4	16	105
Passat (3C2)	11/09→07/10	CDAB	Petrol	1798	4	16	147
Passat (3C2)	11/09→07/10	CGYA	Petrol	1798	4	16	147
Passat (3G2)	08/14→	CUAA	Diesel	1968	4	16	204
Passat (3G2)	08/14→	DCXA	Diesel	1598	4	16	107
Passat (3G2)	08/14→	DCZA	Diesel	1598	4	16	107
Passat (3G2)	11/14→	CRLB	Diesel	1968	4	16	204
Passat (3G2)	11/14→	CZCA	Petrol	1395	4	16	64
Passat (3G2)	11/14→	CZDA	Petrol	1395	4	16	64
Passat (3G2)	11/14→	CZEA	Petrol	1395	4	16	67
Passat (3G2)	11/14→	DBGA	Diesel	1968	4	16	207
Passat (3G2)	11/14→	DDAA	Diesel	1968	4	16	204
Passat (3G2)	11/14→	DFCA	Diesel	1968	4	16	204
Passat (3G2)	11/14→	DFGA	Diesel	1968	4	16	207
Passat (3G2)	02/15→	CHHB	Petrol	1984	4	16	201
Passat (3G2)	02/15→	CJSA	Petrol	1798	4	16	147
Passat (3G2)	02/15→	CJSC	Petrol	1798	4	16	147
Passat (3G2)	02/15→	CXDA	Petrol	1984	4	16	201
Passat (3G2)	02/15→	DFEA	Diesel	1968	4	16	204
Passat (3G2)	05/15→	CJXA	Petrol	1984	4	16	201
Passat (3G2)	06/15→	CUKC	Petrol	1395	4	16	64
Passat (3G2)	07/15→	CUPA	Diesel	1968	4	16	207
Passat (32)	05/73→12/75	ZC	Petrol	1471	4	8	74
Passat (32)	05/73→01/78	ZA	Petrol	1297	4	8	38
Passat (32)	05/73→01/78	ZF	Petrol	1297	4	8	34
Passat (32)	05/73→07/80	FY	Petrol	1272	4	8	35
Passat (32)	07/73→12/75	YJ	Petrol	1471	4	8	74
Passat (32)	07/73→12/75	ZB	Petrol	1471	4	8	74
Passat (32)	08/75→07/80	FS	Petrol	1588	4	8	79
Passat (32)	08/75→07/80	YP	Petrol	1588	4	8	114
Passat (32)	09/75→12/76	YK	Petrol	1588	4	8	79
Passat (32)	09/75→07/80	YG	Petrol	1588	4	8	79
Passat (32)	09/75→12/80	YH	Petrol	1588	4	8	114
Passat (32)	08/77→07/80	CK	Diesel	1471	4	8	70
Passat (32)	08/77→07/80	YS	Petrol	1588	4	8	114
Passat (32)	01/78→07/80	FZ	Petrol	1272	4	8	35
Passat (32)	09/79→07/80	WY	Petrol	1588	4	8	79
Passat (32)	09/79→07/80	WZ	Petrol	1588	4	8	79
Passat (32)	09/80→07/81	CR	Diesel	1588	4	8	111
Passat (32B)	08/80→07/83	FY	Petrol	1272	4	8	35
Passat (32B)	08/80→07/86	EP	Petrol	1297	4	8	33
Passat (32B)	08/80→07/86	EU	Petrol	1297	4	8	34



Passat (32B)	08/80→07/86	FZ	Petrol	1272	4	8	35
Passat (32B)	08/80→03/88	CR	Diesel	1588	4	8	111
Passat (32B)	08/80→03/88	DT	Petrol	1595	4	8	79
Passat (32B)	08/80→03/88	JK	Diesel	1588	4	8	111
Passat (32B)	08/80→03/88	WV	Petrol	1588	4	8	114
Passat (32B)	08/80→03/88	YN	Petrol	1588	4	8	79
Passat (32B)	01/81→02/83	YP	Petrol	1588	4	8	114
Passat (32B)	01/81→07/83	WN	Petrol	1921	5	10	174
Passat (32B)	01/81→12/83	WE	Petrol	2144	5	10	216
Passat (32B)	09/81→12/83	WT	Petrol	1715	4	8	118
Passat (32B)	04/82→03/88	CY	Diesel	1588	4	8	111
Passat (32B)	01/83→03/88	DS	Petrol	1781	4	8	121
Passat (32B)	01/83→03/88	JN	Petrol	1781	4	8	121
Passat (32B)	01/83→03/88	JV	Petrol	1781	4	8	149
Passat (32B)	08/83→03/88	HP	Petrol	1994	5	10	213
Passat (32B)	08/83→03/88	JS	Petrol	1994	5	10	213
Passat (32B)	12/83→03/88	DZ	Petrol	1781	4	8	121
Passat (32B)	01/85→03/88	KV	Petrol	2226	5	10	219
Passat (32B)	08/85→03/88	KX	Petrol	2226	5	10	218
Passat (32B)	02/86→03/88	RL	Petrol	1595	4	8	79
Passat (32B)	05/86→03/88	RA	Diesel	1588	4	8	77
Passat (32B)	05/86→03/88	RM	Petrol	1781	4	8	121
Passat (32B)	08/87→03/88	PP	Petrol	1595	4	8	79
Passat (362)	08/10→12/14	CAXA	Petrol	1390	4	16	53
Passat (362)	08/10→12/14	CAYC	Diesel	1598	4	16	105
Passat (362)	08/10→12/14	CDAA	Petrol	1798	4	16	147
Passat (362)	08/10→12/14	CDGA	Petrol	1390	4	16	62
Passat (362)	08/10→12/14	CFFA	Diesel	1968	4	16	194
Passat (362)	08/10→12/14	CFFB	Diesel	1968	4	16	194
Passat (362)	08/10→12/14	CFGB	Diesel	1968	4	16	194
Passat (362)	08/10→12/14	CLLA	Diesel	1968	4	16	206
Passat (362)	11/10→12/14	CCZB	Petrol	1984	4	16	195
Passat (362)	11/10→12/14	CKMA	Petrol	1390	4	16	66
Passat (362)	01/11→12/14	BWS	Petrol	3597	6	24	265
Passat (362)	02/11→12/14	CDAB	Petrol	1798	4	16	147
Passat (362)	11/12→12/14	CTHD	Petrol	1390	4	16	53
Passat (362)	12/12→12/14	CFGC	Diesel	1968	4	16	194
Passat (A32)	01/11→09/15	CBTA	Petrol	2480	5	20	243
Passat (A32)	01/11→09/15	CBUA	Petrol	2480	5	20	243
Passat (A32)	04/11→06/15	CFFB	Diesel	1968	4	16	194
Passat (A32)	04/11→06/15	CKRA	Diesel	1968	4	16	197
Passat (A32)	04/11→09/15	CDVB	Petrol	3598	6	24	265
Passat (A32)	06/13→09/15	CPKA	Petrol	1798	4	16	147
Passat (A32)	06/13→09/15	CPRA	Petrol	1798	4	16	147
Passat (A32)	06/14→09/15	CVCA	Diesel	1968	4	16	204
Passat (B8)	01/16→	CSS	Petrol	1395	4	16	65
Passat Alltrack (3G5)	05/15→	CRLB	Diesel	1968	4	16	204
Passat Alltrack (3G5)	05/15→	CUAA	Diesel	1968	4	16	204
Passat Alltrack (3G5)	05/15→	CZEA	Petrol	1395	4	16	67
Passat Alltrack (3G5)	05/15→	DDAA	Diesel	1968	4	16	204
Passat Alltrack (3G5)	05/15→	DFCA	Diesel	1968	4	16	204
Passat Alltrack (3G5)	05/15→	DFEA	Diesel	1968	4	16	204
Passat Alltrack (3G5)	07/15→	CHHB	Petrol	1984	4	16	201
Passat Alltrack (3G5)	07/15→	CUPA	Diesel	1968	4	16	207
Passat Alltrack (365)	01/12→12/14	CCZB	Petrol	1984	4	16	195
Passat Alltrack (365)	01/12→12/14	CDAA	Petrol	1798	4	16	147
Passat Alltrack (365)	01/12→12/14	CDAB	Petrol	1798	4	16	147
Passat Alltrack (365)	01/12→12/14	CFFB	Diesel	1968	4	16	194
Passat Alltrack (365)	01/12→12/14	CFGB	Diesel	1968	4	16	194
Passat Alltrack (365)	01/13→12/14	CFGC	Diesel	1968	4	16	194
Passat CC (357)	05/08→05/11	CBBA	Diesel	1968	4	16	196
Passat CC (357)	06/08→05/10	BWS	Petrol	3597	6	24	265
Passat CC (357)	06/08→05/11	CBAA	Diesel	1968	4	16	194
Passat CC (357)	06/08→05/11	CFFA	Diesel	1968	4	16	194
Passat CC (357)	06/08→01/12	BLV	Petrol	3597	6	24	265
Passat CC (357)	06/08→01/12	BZB	Petrol	1798	4	16	147
Passat CC (357)	06/08→01/12	CAWB	Petrol	1984	4	16	195
Passat CC (357)	06/08→01/12	CBAB	Diesel	1968	4	16	194
Passat CC (357)	06/08→01/12	CBBB	Diesel	1968	4	16	194
Passat CC (357)	06/08→01/12	CBFA	Petrol	1984	4	16	195
Passat CC (357)	06/08→01/12	CCTA	Petrol	1984	4	16	195
Passat CC (357)	06/08→01/12	CCZA	Petrol	1984	4	16	195
Passat CC (357)	06/08→01/12	CDAA	Petrol	1798	4	16	147
Passat CC (357)	06/08→01/12	CFFB	Diesel	1968	4	16	194
Passat CC (357)	06/08→01/12	CFGB	Diesel	1968	4	16	194
Passat CC (357)	06/08→01/12	CLLA	Diesel	1968	4	16	206
Passat CC (357)	06/08→01/12	CNNA	Petrol	3597	6	24	265
Passat CC (357)	11/08→05/10	CDAB	Petrol	1798	4	16	147



CC



9

Passat CC (357)	11/08→05/10	CGYA	Petrol	1798	4	16	147
Passat CC (357)	05/09→11/10	CBAC	Diesel	1968	4	16	194
Passat CC (357)	11/10→01/12	CCZB	Petrol	1984	4	16	195
Passat CC (357)	01/11→01/12	CKMA	Petrol	1390	4	16	66
Passat Lingyu Saloon (B5)	11/05→10/12	BBG	Petrol	2771	6	30	253
Passat Lingyu Saloon (B5)	04/06→10/12	BNL	Petrol	1984	4	8	180
Passat Lingyu Saloon (B5)	04/06→10/12	BTL	Petrol	1984	4	8	180
Passat Saloon (32B)	08/84→07/85	HP	Petrol	1994	5	10	213
Passat Saloon (32B)	08/84→07/85	JS	Petrol	1994	5	10	213
Passat Saloon (32B)	08/84→03/88	JK	Diesel	1588	4	8	111
Passat Saloon (32B)	08/84→03/88	JN	Petrol	1781	4	8	121
Passat Saloon (32B)	08/84→03/88	KX	Petrol	2226	5	10	218
Passat Saloon (32B)	01/85→03/88	CY	Diesel	1588	4	8	111
Passat Saloon (32B)	01/85→03/88	DS	Petrol	1781	4	8	121
Passat Saloon (32B)	01/85→03/88	DT	Petrol	1595	4	8	79
Passat Saloon (32B)	01/85→03/88	RL	Petrol	1595	4	8	79
Passat Saloon (32B)	05/86→03/88	RM	Petrol	1781	4	8	121
Passat Saloon (32B)	08/87→03/88	PP	Petrol	1595	4	8	79
Passat Saloon (B5)	04/00→02/03	ANQ	Petrol	1781	4	20	137
Passat Saloon (B5)	01/01→04/09	AWL	Petrol	1781	4	20	137
Passat Saloon (B5)	12/01→12/06	BBG	Petrol	2771	6	30	253
Passat Saloon (B5)	02/03→04/09	BFF	Petrol	1984	4	8	180
Passat Saloon (B5)	02/03→04/09	BNL	Petrol	1984	4	8	180
Passat Variant (3A5, 35I)	02/88→05/97	ABS	Petrol	1781	4	8	124
Passat Variant (3A5, 35I)	02/88→05/97	ADZ	Petrol	1781	4	8	128
Passat Variant (3A5, 35I)	02/88→05/97	RP	Petrol	1781	4	8	149
Passat Variant (3A5, 35I)	04/88→07/89	RF	Petrol	1595	4	8	79
Passat Variant (3A5, 35I)	04/88→07/90	PF	Petrol	1781	4	8	121
Passat Variant (3A5, 35I)	04/88→07/91	1F	Petrol	1595	4	8	78
Passat Variant (3A5, 35I)	04/88→07/91	EZ	Petrol	1595	4	8	79
Passat Variant (3A5, 35I)	04/88→07/92	PB	Petrol	1781	4	8	121
Passat Variant (3A5, 35I)	04/88→09/93	KR	Petrol	1781	4	16	151
Passat Variant (3A5, 35I)	08/88→09/93	9A	Petrol	1984	4	16	176
Passat Variant (3A5, 35I)	08/88→09/93	RA	Diesel	1588	4	8	77
Passat Variant (3A5, 35I)	08/88→09/93	SB	Diesel	1588	4	8	77
Passat Variant (3A5, 35I)	08/88→05/97	PG	Petrol	1781	4	8	121
Passat Variant (3A5, 35I)	05/89→10/93	1Y	Diesel	1896	4	8	153
Passat Variant (3A5, 35I)	02/90→05/97	2E	Petrol	1984	4	8	175
Passat Variant (3A5, 35I)	02/90→05/97	ADY	Petrol	1984	4	8	179
Passat Variant (3A5, 35I)	02/90→05/97	AGG	Petrol	1984	4	8	178
Passat Variant (3A5, 35I)	08/90→05/97	AAM	Petrol	1781	4	8	123
Passat Variant (3A5, 35I)	03/91→05/97	AAZ	Diesel	1896	4	8	156
Passat Variant (3A5, 35I)	06/91→05/97	AAA	Petrol	2792	6	12	247
Passat Variant (3A5, 35I)	10/93→05/97	1Z	Diesel	1896	4	8	154
Passat Variant (3A5, 35I)	10/93→05/97	AHU	Diesel	1896	4	8	167
Passat Variant (3A5, 35I)	01/94→05/97	ABF	Petrol	1984	4	16	176
Passat Variant (3A5, 35I)	01/94→05/97	ABV	Petrol	2861	6	12	255
Passat Variant (3A5, 35I)	07/94→12/95	AEK	Petrol	1595	4	8	85
Passat Variant (3A5, 35I)	07/94→12/95	AFT	Petrol	1595	4	8	82
Passat Variant (3A5, 35I)	03/95→08/96	AEP	Petrol	1984	4	8	181
Passat Variant (3A5, 35I)	03/96→05/97	AFN	Diesel	1896	4	8	162
Passat Variant (3B5)	05/97→09/99	AGE	Petrol	2771	6	30	252
Passat Variant (3B5)	05/97→12/00	AHA	Petrol	2771	6	30	252
Passat Variant (3B5)	06/97→11/00	ACK	Petrol	2771	6	30	249
Passat Variant (3B5)	06/97→11/00	ADP	Petrol	1595	4	8	82
Passat Variant (3B5)	06/97→11/00	ADR	Petrol	1781	4	20	127
Passat Variant (3B5)	06/97→11/00	AFN	Diesel	1896	4	8	162
Passat Variant (3B5)	06/97→11/00	AFY	Petrol	1781	4	20	127
Passat Variant (3B5)	06/97→11/00	AGZ	Petrol	2324	5	10	221
Passat Variant (3B5)	06/97→11/00	AHH	Diesel	1896	4	8	166
Passat Variant (3B5)	06/97→11/00	AHL	Petrol	1595	4	8	87
Passat Variant (3B5)	06/97→11/00	AHU	Diesel	1896	4	8	167
Passat Variant (3B5)	06/97→11/00	ALG	Petrol	2771	6	30	253
Passat Variant (3B5)	06/97→11/00	ANA	Petrol	1595	4	8	87
Passat Variant (3B5)	06/97→11/00	ANB	Petrol	1781	4	20	135
Passat Variant (3B5)	06/97→11/00	APR	Petrol	2771	6	30	253
Passat Variant (3B5)	06/97→11/00	APT	Petrol	1781	4	20	139
Passat Variant (3B5)	06/97→11/00	APU	Petrol	1781	4	20	139
Passat Variant (3B5)	06/97→11/00	AQD	Petrol	2771	6	30	253
Passat Variant (3B5)	06/97→11/00	ARG	Petrol	1781	4	20	139
Passat Variant (3B5)	06/97→11/00	ARM	Petrol	1595	4	8	93
Passat Variant (3B5)	06/97→11/00	AVG	Diesel	1896	4	8	166
Passat Variant (3B5)	06/97→12/01	AEB	Petrol	1781	4	20	129
Passat Variant (3B5)	07/98→11/00	AFB	Diesel	2496	6	24	234
Passat Variant (3B5)	07/98→11/00	AKN	Diesel	2496	6	24	234
Passat Variant (3B5)	08/98→11/00	AJM	Diesel	1896	4	8	168
Passat Variant (3B5)	08/98→11/00	ATJ	Diesel	1896	4	8	168
Passat Variant (3B5)	09/99→11/00	ATX	Petrol	2771	6	30	253



CC



9

Passat Variant (3B5)	09/99→11/00	BBG	Petrol	2771	6	30	253
Passat Variant (3B5)	02/00→11/00	AVB	Diesel	1896	4	8	168
Passat Variant (3B5)	04/00→11/00	ASU	Petrol	1984	4	8	180
Passat Variant (3B5)	04/00→11/00	AUZ	Petrol	1984	4	8	180
Passat Variant (3B6)	10/00→08/05	ATQ	Petrol	2771	6	30	253
Passat Variant (3B6)	11/00→05/05	AFB	Diesel	2496	6	24	234
Passat Variant (3B6)	11/00→05/05	AKN	Diesel	2496	6	24	234
Passat Variant (3B6)	11/00→05/05	ALZ	Petrol	1595	4	8	91
Passat Variant (3B6)	11/00→05/05	AMX	Petrol	2771	6	30	253
Passat Variant (3B6)	11/00→05/05	AVB	Diesel	1896	4	8	168
Passat Variant (3B6)	11/00→05/05	AVF	Diesel	1896	4	8	168
Passat Variant (3B6)	11/00→05/05	AWT	Petrol	1781	4	20	132
Passat Variant (3B6)	11/00→05/05	AWX	Diesel	1896	4	8	168
Passat Variant (3B6)	11/00→05/05	AZM	Petrol	1984	4	8	180
Passat Variant (3B6)	11/00→05/05	AZX	Petrol	2324	5	20	223
Passat Variant (3B6)	03/01→08/05	AWM	Petrol	1781	4	20	132
Passat Variant (3B6)	09/01→09/04	BDN	Petrol	3999	8	32	267
Passat Variant (3B6)	09/01→09/04	BDP	Petrol	3999	8	32	267
Passat Variant (3B6)	11/01→05/05	ALT	Petrol	1984	4	20	182
Passat Variant (3B6)	01/03→05/05	BAU	Diesel	2496	6	24	234
Passat Variant (3B6)	01/03→05/05	BDH	Diesel	2496	6	24	234
Passat Variant (3B6)	05/03→05/05	BDG	Diesel	2496	6	24	234
Passat Variant (3B6)	12/03→05/05	BGW	Diesel	1968	4	8	190
Passat Variant (3B6)	12/03→05/05	BHW	Diesel	1968	4	8	190
Passat Variant (3C5)	08/05→02/06	BVE	Diesel	1968	4	16	186
Passat Variant (3C5)	08/05→06/08	BLF	Petrol	1598	4	16	97
Passat Variant (3C5)	08/05→11/08	BKC	Diesel	1896	4	8	171
Passat Variant (3C5)	08/05→11/08	BLS	Diesel	1896	4	8	171
Passat Variant (3C5)	08/05→11/08	BXE	Diesel	1896	4	8	171
Passat Variant (3C5)	08/05→05/09	BMP	Diesel	1968	4	8	187
Passat Variant (3C5)	08/05→05/09	BUZ	Diesel	1968	4	16	186
Passat Variant (3C5)	08/05→11/10	AXX	Petrol	1984	4	16	185
Passat Variant (3C5)	08/05→11/10	BKP	Diesel	1968	4	16	186
Passat Variant (3C5)	08/05→11/10	BLR	Petrol	1984	4	16	184
Passat Variant (3C5)	08/05→11/10	BLY	Petrol	1984	4	16	184
Passat Variant (3C5)	08/05→11/10	BMA	Diesel	1968	4	16	186
Passat Variant (3C5)	08/05→11/10	BMR	Diesel	1968	4	16	186
Passat Variant (3C5)	08/05→11/10	BPY	Petrol	1984	4	16	185
Passat Variant (3C5)	08/05→11/10	BSE	Petrol	1595	4	8	91
Passat Variant (3C5)	08/05→11/10	BSF	Petrol	1595	4	8	91
Passat Variant (3C5)	08/05→11/10	BVY	Petrol	1984	4	16	184
Passat Variant (3C5)	08/05→11/10	BVZ	Petrol	1984	4	16	184
Passat Variant (3C5)	08/05→11/10	BWA	Petrol	1984	4	16	185
Passat Variant (3C5)	08/05→11/10	CAWB	Petrol	1984	4	16	195
Passat Variant (3C5)	08/05→11/10	CBAA	Diesel	1968	4	16	194
Passat Variant (3C5)	08/05→11/10	CBAB	Diesel	1968	4	16	194
Passat Variant (3C5)	08/05→11/10	CBBB	Diesel	1968	4	16	194
Passat Variant (3C5)	08/05→11/10	CBFA	Petrol	1984	4	16	195
Passat Variant (3C5)	08/05→11/10	CCTA	Petrol	1984	4	16	195
Passat Variant (3C5)	08/05→11/10	CCZA	Petrol	1984	4	16	195
Passat Variant (3C5)	09/05→11/10	BLV	Petrol	3597	6	24	265
Passat Variant (3C5)	09/05→11/10	BLX	Petrol	1984	4	16	184
Passat Variant (3C5)	09/05→11/10	BVX	Petrol	1984	4	16	184
Passat Variant (3C5)	11/05→05/07	BWV	Diesel	1968	4	16	186
Passat Variant (3C5)	11/05→11/10	AXZ	Petrol	3168	6	24	263
Passat Variant (3C5)	04/07→11/10	BWS	Petrol	3597	6	24	265
Passat Variant (3C5)	05/07→11/10	CAXA	Petrol	1390	4	16	53
Passat Variant (3C5)	05/07→10/11	BZB	Petrol	1798	4	16	147
Passat Variant (3C5)	05/07→10/11	CDAA	Petrol	1798	4	16	147
Passat Variant (3C5)	08/07→11/10	CCTB	Petrol	1984	4	16	195
Passat Variant (3C5)	11/08→11/10	CBDC	Diesel	1968	4	16	194
Passat Variant (3C5)	01/09→11/10	CBAC	Diesel	1968	4	16	194
Passat Variant (3C5)	01/09→11/10	CDGA	Petrol	1390	4	16	62
Passat Variant (3C5)	08/09→11/10	CAYC	Diesel	1598	4	16	105
Passat Variant (3C5)	11/09→11/10	CDAB	Petrol	1798	4	16	147
Passat Variant (3C5)	11/09→11/10	CGYA	Petrol	1798	4	16	147
Passat Variant (3G5)	08/14→	CJAA	Diesel	1968	4	16	204
Passat Variant (3G5)	08/14→	DCXA	Diesel	1598	4	16	107
Passat Variant (3G5)	08/14→	DCZA	Diesel	1598	4	16	107
Passat Variant (3G5)	11/14→	CRLB	Diesel	1968	4	16	204
Passat Variant (3G5)	11/14→	CZCA	Petrol	1395	4	16	64
Passat Variant (3G5)	11/14→	CZDA	Petrol	1395	4	16	64
Passat Variant (3G5)	11/14→	CZEA	Petrol	1395	4	16	67
Passat Variant (3G5)	11/14→	DBGA	Diesel	1968	4	16	207
Passat Variant (3G5)	11/14→	DDAA	Diesel	1968	4	16	204
Passat Variant (3G5)	11/14→	DFCA	Diesel	1968	4	16	204
Passat Variant (3G5)	11/14→	DFGA	Diesel	1968	4	16	207
Passat Variant (3G5)	02/15→	CHHB	Petrol	1984	4	16	201



CC



9

Passat Variant (3G5)	02/15→	CJSA	Petrol	1798	4	16	147
Passat Variant (3G5)	02/15→	CJSC	Petrol	1798	4	16	147
Passat Variant (3G5)	02/15→	CXDA	Petrol	1984	4	16	201
Passat Variant (3G5)	02/15→	DFEA	Diesel	1968	4	16	204
Passat Variant (3G5)	05/15→	CJXA	Petrol	1984	4	16	201
Passat Variant (3G5)	06/15→	CUKC	Petrol	1395	4	16	64
Passat Variant (3G5)	07/15→	CUPA	Diesel	1968	4	16	207
Passat Variant (33)	05/73→01/78	ZA	Petrol	1297	4	8	38
Passat Variant (33)	05/73→07/80	FY	Petrol	1272	4	8	35
Passat Variant (33)	10/73→08/75	YJ	Petrol	1471	4	8	74
Passat Variant (33)	10/73→08/75	ZB	Petrol	1471	4	8	74
Passat Variant (33)	10/73→12/75	ZC	Petrol	1471	4	8	74
Passat Variant (33)	10/73→01/78	ZF	Petrol	1297	4	8	34
Passat Variant (33)	08/75→07/80	YP	Petrol	1588	4	8	114
Passat Variant (33)	09/75→12/80	YH	Petrol	1588	4	8	114
Passat Variant (33)	02/76→08/79	FS	Petrol	1588	4	8	79
Passat Variant (33)	02/76→07/80	YN	Petrol	1588	4	8	79
Passat Variant (33)	02/77→07/80	CK	Diesel	1471	4	8	70
Passat Variant (33)	06/78→07/80	YS	Petrol	1588	4	8	114
Passat Variant (33)	09/78→12/80	YK	Petrol	1588	4	8	79
Passat Variant (33)	02/79→07/80	CR	Diesel	1588	4	8	111
Passat Variant (33B)	08/80→07/83	FY	Petrol	1272	4	8	35
Passat Variant (33B)	08/80→07/86	EP	Petrol	1297	4	8	33
Passat Variant (33B)	08/80→07/86	EU	Petrol	1297	4	8	34
Passat Variant (33B)	08/80→07/86	FZ	Petrol	1272	4	8	35
Passat Variant (33B)	08/80→03/88	CR	Diesel	1588	4	8	111
Passat Variant (33B)	08/80→03/88	DT	Petrol	1595	4	8	79
Passat Variant (33B)	08/80→03/88	JK	Diesel	1588	4	8	111
Passat Variant (33B)	08/80→03/88	WV	Petrol	1588	4	8	114
Passat Variant (33B)	08/80→03/88	YN	Petrol	1588	4	8	79
Passat Variant (33B)	01/81→02/83	YP	Petrol	1588	4	8	114
Passat Variant (33B)	01/81→07/83	WN	Petrol	1921	5	10	174
Passat Variant (33B)	01/81→12/84	WE	Petrol	2144	5	10	216
Passat Variant (33B)	09/81→12/83	WT	Petrol	1715	4	8	118
Passat Variant (33B)	04/82→03/88	CY	Diesel	1588	4	8	111
Passat Variant (33B)	01/83→03/88	DS	Petrol	1781	4	8	121
Passat Variant (33B)	01/83→03/88	JN	Petrol	1781	4	8	121
Passat Variant (33B)	01/83→03/88	JV	Petrol	1781	4	8	149
Passat Variant (33B)	08/83→03/88	HP	Petrol	1994	5	10	213
Passat Variant (33B)	08/83→03/88	JS	Petrol	1994	5	10	213
Passat Variant (33B)	12/83→03/88	DZ	Petrol	1781	4	8	121
Passat Variant (33B)	08/84→07/88	HY	Petrol	2226	5	10	218
Passat Variant (33B)	09/84→12/88	KX	Petrol	2226	5	10	218
Passat Variant (33B)	01/85→03/88	KV	Petrol	2226	5	10	219
Passat Variant (33B)	08/85→12/88	JT	Petrol	2226	5	10	219
Passat Variant (33B)	02/86→03/88	RL	Petrol	1595	4	8	79
Passat Variant (33B)	05/86→03/88	RM	Petrol	1781	4	8	121
Passat Variant (33B)	08/87→03/88	PP	Petrol	1595	4	8	79
Passat Variant (365)	08/10→12/14	CAXA	Petrol	1390	4	16	53
Passat Variant (365)	08/10→12/14	CAYC	Diesel	1598	4	16	105
Passat Variant (365)	08/10→12/14	CDAA	Petrol	1798	4	16	147
Passat Variant (365)	08/10→12/14	CDGA	Petrol	1390	4	16	62
Passat Variant (365)	08/10→12/14	CFFA	Diesel	1968	4	16	194
Passat Variant (365)	08/10→12/14	CFFB	Diesel	1968	4	16	194
Passat Variant (365)	08/10→12/14	CFGB	Diesel	1968	4	16	194
Passat Variant (365)	08/10→12/14	CLLA	Diesel	1968	4	16	206
Passat Variant (365)	11/10→12/14	CCZB	Petrol	1984	4	16	195
Passat Variant (365)	11/10→12/14	CKMA	Petrol	1390	4	16	66
Passat Variant (365)	01/11→12/14	BWS	Petrol	3597	6	24	265
Passat Variant (365)	02/11→12/14	CDAB	Petrol	1798	4	16	147
Passat Variant (365)	11/12→12/14	CTHD	Petrol	1390	4	16	53
Passat Variant (365)	12/12→12/14	CFGC	Diesel	1968	4	16	194
Phaeton (3D1, 3D2, 3D3, 3D4, 3D6, 3D7, 3D8, 3D9)	04/02→05/05	AYT	Petrol	3189	6	24	263
Phaeton (3D1, 3D2, 3D3, 3D4, 3D6, 3D7, 3D8, 3D9)	04/02→05/05	BAN	Petrol	5998	12	48	273
Phaeton (3D1, 3D2, 3D3, 3D4, 3D6, 3D7, 3D8, 3D9)	04/02→11/08	BKL	Petrol	3189	6	24	263
Phaeton (3D1, 3D2, 3D3, 3D4, 3D6, 3D7, 3D8, 3D9)	05/03→03/16	BGH	Petrol	4172	8	40	270
Phaeton (3D1, 3D2, 3D3, 3D4, 3D6, 3D7, 3D8, 3D9)	05/03→03/16	BGJ	Petrol	4172	8	40	270
Phaeton (3D1, 3D2, 3D3, 3D4, 3D6, 3D7, 3D8, 3D9)	02/04→11/08	BRK	Petrol	3189	6	24	263
Phaeton (3D1, 3D2, 3D3, 3D4, 3D6, 3D7, 3D8, 3D9)	09/04→05/07	BMK	Diesel	2967	6	24	256
Phaeton (3D1, 3D2, 3D3, 3D4, 3D6, 3D7, 3D8, 3D9)	05/05→03/16	BRN	Petrol	5998	12	48	273
Phaeton (3D1, 3D2, 3D3, 3D4, 3D6, 3D7, 3D8, 3D9)	05/05→03/16	BTT	Petrol	5998	12	48	273
Phaeton (3D1, 3D2, 3D3, 3D4, 3D6, 3D7, 3D8, 3D9)	06/07→11/08	CARA	Diesel	2967	6	24	256
Phaeton (3D1, 3D2, 3D3, 3D4, 3D6, 3D7, 3D8, 3D9)	11/08→03/16	CARB	Diesel	2967	6	24	256
Phaeton (3D1, 3D2, 3D3, 3D4, 3D6, 3D7, 3D8, 3D9)	11/08→03/16	CEXA	Diesel	2967	6	24	256
Phaeton (3D1, 3D2, 3D3, 3D4, 3D6, 3D7, 3D8, 3D9)	11/08→03/16	CHNA	Petrol	3597	6	24	265
Phaeton (3D1, 3D2, 3D3, 3D4, 3D6, 3D7, 3D8, 3D9)	11/08→03/16	CMVA	Petrol	3597	6	24	265
Phaeton (3D1, 3D2, 3D3, 3D4, 3D6, 3D7, 3D8, 3D9)	11/13→03/16	CEXB	Diesel	2967	6	24	256
Phaeton (3D1, 3D2, 3D3, 3D4, 3D6, 3D7, 3D8, 3D9)	01/14→03/16	CPFA	Petrol	2975	6	24	260



Model	Year Range	Code	Fuel	CC	Power (kW)	Power (hp)	0-100 (s)
Pointer	10/93→09/94	RM	Petrol	1781	4	8	121
Pointer	06/02→	UDH	Petrol	1781	4	8	130
Pointer	12/05→	BGG	Diesel	1896	4	8	172
Pointer Pickup	10/93→09/94	RM	Petrol	1781	4	8	121
Pointer Pickup	06/02→12/10	UDH	Petrol	1781	4	8	130
Pointer Variant	09/97→03/06	UDH	Petrol	1781	4	8	130
Pointer Variant	09/99→12/02	UQG	Petrol	1984	4	8	214
Polo (6N1)	10/94→07/95	ADX	Petrol	1296	4	8	31
Polo (6N1)	10/94→09/96	AEV	Petrol	1043	4	8	5
Polo (6N1)	10/94→10/99	AEA	Petrol	1598	4	8	83
Polo (6N1)	10/94→10/99	AEE	Petrol	1598	4	8	83
Polo (6N1)	10/94→10/99	AEF	Diesel	1896	4	8	160
Polo (6N1)	10/94→10/99	AHS	Petrol	1598	4	8	88
Polo (6N1)	07/95→10/99	AEX	Petrol	1390	4	8	41
Polo (6N1)	07/95→10/99	AKV	Petrol	1390	4	8	48
Polo (6N1)	07/95→10/99	APQ	Petrol	1390	4	8	50
Polo (6N1)	04/96→10/99	AFH	Petrol	1390	4	16	42
Polo (6N1)	07/96→10/99	AGD	Diesel	1896	4	8	163
Polo (6N1)	09/96→10/99	AER	Petrol	999	4	8	4
Polo (6N1)	09/96→10/99	ALL	Petrol	999	4	8	8
Polo (6N1)	04/97→10/99	AHG	Diesel	1716	4	8	115
Polo (6N1)	08/97→10/99	AKU	Diesel	1716	4	8	116
Polo (6N1)	09/98→10/99	AJV	Petrol	1598	4	16	89
Polo (6N2)	10/99→09/01	AEF	Diesel	1896	4	8	160
Polo (6N2)	10/99→09/01	AFK	Petrol	1390	4	16	43
Polo (6N2)	10/99→09/01	AGD	Diesel	1896	4	8	163
Polo (6N2)	10/99→09/01	AHW	Petrol	1390	4	16	45
Polo (6N2)	10/99→09/01	AKK	Petrol	1390	4	8	46
Polo (6N2)	10/99→09/01	AKP	Petrol	1390	4	8	47
Polo (6N2)	10/99→09/01	AKU	Diesel	1716	4	8	116
Polo (6N2)	10/99→09/01	ALD	Petrol	999	4	8	7
Polo (6N2)	10/99→09/01	AMF	Diesel	1422	3	6	49
Polo (6N2)	10/99→09/01	ANX	Petrol	1390	4	8	50
Polo (6N2)	10/99→09/01	APE	Petrol	1390	4	16	43
Polo (6N2)	10/99→09/01	AQQ	Petrol	1390	4	16	51
Polo (6N2)	10/99→09/01	ARC	Petrol	1598	4	16	92
Polo (6N2)	10/99→09/01	ASX	Diesel	1896	4	8	166
Polo (6N2)	10/99→09/01	AUA	Petrol	1390	4	16	43
Polo (6N2)	10/99→09/01	AUB	Petrol	1390	4	16	43
Polo (6N2)	10/99→09/01	AUC	Petrol	999	4	8	7
Polo (6N2)	10/99→09/01	AUD	Petrol	1390	4	8	47
Polo (6N2)	10/99→09/01	AVY	Petrol	1598	4	16	92
Polo (6N2)	01/00→10/00	ATL	Diesel	1422	3	6	49
Polo (6R, 6C)	06/09→	CAYA	Diesel	1598	4	16	105
Polo (6R, 6C)	06/09→	CAYB	Diesel	1598	4	16	105
Polo (6R, 6C)	06/09→	CAYC	Diesel	1598	4	16	105
Polo (6R, 6C)	06/09→	CDDA	Petrol	1390	4	16	61
Polo (6R, 6C)	06/09→	CGGB	Petrol	1390	4	16	43
Polo (6R, 6C)	06/09→	CGPA	Petrol	1198	3	12	23
Polo (6R, 6C)	06/09→	CGPB	Petrol	1198	3	12	23
Polo (6R, 6C)	06/09→	CLNA	Diesel	1598	4	16	106
Polo (6R, 6C)	06/09→	CLPA	Petrol	1390	4	16	53
Polo (6R, 6C)	06/09→	CWXB	Diesel	1498	4	16	71
Polo (6R, 6C)	10/09→	CFWA	Diesel	1199	3	12	25
Polo (6R, 6C)	11/09→	CBZB	Petrol	1197	4	8	24
Polo (6R, 6C)	01/10→	CFNA	Petrol	1598	4	16	103
Polo (6R, 6C)	01/10→	CLSA	Petrol	1598	4	16	103
Polo (6R, 6C)	03/10→01/11	CMAA	Petrol	1390	4	16	43
Polo (6R, 6C)	05/10→	CAVE	Petrol	1390	4	16	53
Polo (6R, 6C)	05/10→	CFNB	Petrol	1598	4	16	103
Polo (6R, 6C)	05/10→	CTHE	Petrol	1390	4	16	53
Polo (6R, 6C)	01/11→	CNKA	Petrol	1598	4	16	103
Polo (6R, 6C)	05/11→05/14	CBZC	Petrol	1197	4	8	24
Polo (6R, 6C)	08/11→	CJLA	Petrol	1198	3	12	23
Polo (6R, 6C)	10/12→	CPTA	Petrol	1395	4	16	67
Polo (6R, 6C)	01/13→	CCRA	Petrol	1598	4	8	98
Polo (6R, 6C)	08/13→	CDLJ	Petrol	1984	4	16	185
Polo (6R, 6C)	01/14→	CHYA	Petrol	999	3	12	14
Polo (6R, 6C)	01/14→	CHYB	Petrol	999	3	12	14
Polo (6R, 6C)	01/14→	CJZD	Petrol	1197	4	16	26
Polo (6R, 6C)	02/14→	CJZC	Petrol	1197	4	16	26
Polo (6R, 6C)	02/14→	CUSB	Diesel	1422	3	12	68
Polo (6R, 6C)	03/14→	CUSA	Diesel	1422	3	12	68
Polo (6R, 6C)	03/14→	CYZB	Diesel	1422	3	12	68
Polo (6R, 6C)	05/14→	CUTA	Diesel	1422	3	12	68
Polo (6R, 6C)	05/14→	CYZA	Diesel	1422	3	12	68
Polo (6R, 6C)	05/14→	CZEA	Petrol	1395	4	16	67
Polo (6R, 6C)	07/14→	CWVA	Petrol	1598	4	16	113



CC



9

Polo (6R, 6C)	07/14→	CWVB	Petrol	1598	4	16	110
Polo (6R, 6C)	07/14→	CWXA	Diesel	1498	4	16	71
Polo (6R, 6C)	11/14→	CHZB	Petrol	999	3	12	14
Polo (6R, 6C)	11/14→	CHZC	Petrol	999	3	12	14
Polo (6R, 6C)	11/14→	DAJA	Petrol	1798	4	16	147
Polo (6R, 6C)	11/14→	DAJB	Petrol	1798	4	16	147
Polo (9N_)	10/01→06/05	AMF	Diesel	1422	3	6	49
Polo (9N_)	10/01→06/05	BAY	Diesel	1422	3	6	49
Polo (9N_)	10/01→07/07	AZQ	Petrol	1198	3	12	21
Polo (9N_)	10/01→07/07	BME	Petrol	1198	3	12	21
Polo (9N_)	10/01→05/08	AUA	Petrol	1390	4	16	43
Polo (9N_)	10/01→05/08	AUB	Petrol	1390	4	16	43
Polo (9N_)	10/01→05/08	BBY	Petrol	1390	4	16	43
Polo (9N_)	10/01→05/08	BBZ	Petrol	1390	4	16	43
Polo (9N_)	10/01→05/08	BKY	Petrol	1390	4	16	43
Polo (9N_)	10/01→11/09	ASY	Diesel	1896	4	8	168
Polo (9N_)	10/01→11/09	ATD	Diesel	1896	4	8	168
Polo (9N_)	10/01→11/09	AXR	Diesel	1896	4	8	168
Polo (9N_)	10/01→11/09	BMT	Diesel	1896	4	8	171
Polo (9N_)	01/02→05/07	AWY	Petrol	1198	3	6	20
Polo (9N_)	01/02→05/07	BMD	Petrol	1198	3	6	22
Polo (9N_)	02/02→07/06	AXU	Petrol	1390	4	16	53
Polo (9N_)	07/02→05/05	ARA	Petrol	999	4	16	10
Polo (9N_)	08/02→05/05	BAH	Petrol	1598	4	8	98
Polo (9N_)	08/02→11/09	BLM	Petrol	1390	4	8	47
Polo (9N_)	11/03→11/09	ASZ	Diesel	1896	4	8	168
Polo (9N_)	11/03→11/09	BLT	Diesel	1896	4	8	168
Polo (9N_)	10/04→01/12	BBX	Petrol	1984	4	8	180
Polo (9N_)	12/04→04/08	BPA	Petrol	1598	4	8	98
Polo (9N_)	04/05→11/09	BMS	Diesel	1422	3	6	57
Polo (9N_)	04/05→11/09	BNM	Diesel	1422	3	6	49
Polo (9N_)	04/05→11/09	BNV	Diesel	1422	3	6	49
Polo (9N_)	04/05→11/09	BWB	Diesel	1422	3	6	57
Polo (9N_)	09/05→11/09	BJX	Petrol	1781	4	20	133
Polo (9N_)	05/06→11/09	BBU	Petrol	1781	4	20	133
Polo (9N_)	05/06→11/09	BTS	Petrol	1598	4	16	103
Polo (9N_)	05/06→11/09	BUD	Petrol	1390	4	16	60
Polo (9N_)	05/07→11/09	BBM	Petrol	1198	3	6	20
Polo (9N_)	05/07→11/09	BZG	Petrol	1198	3	12	23
Polo (9N_)	05/08→01/12	CCRA	Petrol	1598	4	8	98
Polo (9N_)	10/08→01/12	CFEA	Petrol	1984	4	8	180
Polo (86)	03/75→09/81	HB	Petrol	1093	4	8	17
Polo (86)	03/75→09/81	HC	Petrol	1093	4	8	17
Polo (86)	09/75→09/81	HA	Petrol	895	4	8	2
Polo (86)	12/76→09/81	HH	Petrol	1272	4	8	35
Polo (86C, 80)	10/81→12/81	HA	Petrol	895	4	8	2
Polo (86C, 80)	10/81→07/83	HH	Petrol	1272	4	8	35
Polo (86C, 80)	10/81→10/86	GL	Petrol	1043	4	8	16
Polo (86C, 80)	10/81→09/89	HB	Petrol	1093	4	8	17
Polo (86C, 80)	08/82→07/88	GT	Petrol	1272	4	8	34
Polo (86C, 80)	08/82→07/88	HJ	Petrol	1272	4	8	35
Polo (86C, 80)	09/82→09/89	GK	Petrol	1272	4	8	34
Polo (86C, 80)	08/83→07/85	HW	Petrol	1272	4	8	34
Polo (86C, 80)	08/83→07/88	HK	Petrol	1272	4	8	34
Polo (86C, 80)	08/83→09/94	MH	Petrol	1272	4	8	34
Polo (86C, 80)	08/85→01/92	HZ	Petrol	1043	4	8	3
Polo (86C, 80)	08/86→07/90	MN	Diesel	1272	4	8	36
Polo (86C, 80)	07/87→09/94	2G	Petrol	1272	4	8	29
Polo (86C, 80)	07/87→09/94	AAV	Petrol	1272	4	8	29
Polo (86C, 80)	07/87→09/94	NZ	Petrol	1272	4	8	29
Polo (86C, 80)	08/89→09/94	AAK	Petrol	1043	4	8	3
Polo (86C, 80)	08/89→09/94	AAU	Petrol	1043	4	8	3
Polo (86C, 80)	08/89→09/94	ACM	Petrol	1043	4	8	3
Polo (86C, 80)	10/89→08/94	3F	Petrol	1272	4	8	29
Polo (86C, 80)	10/90→09/94	1W	Diesel	1398	4	8	39
Polo (AW1)	06/17→	CHYB	Petrol	999	3	12	14
Polo Box (6NF)	09/94→12/95	AEA	Petrol	1598	4	8	83
Polo Box (6NF)	10/94→12/99	AEF	Diesel	1896	4	8	160
Polo Box (6NF)	10/94→12/99	AEV	Petrol	1043	4	8	5
Polo Box (6NF)	07/96→12/99	AGD	Diesel	1896	4	8	163
Polo Box (6NF)	08/97→12/99	AKU	Diesel	1716	4	8	116
Polo Box (6NF)	05/98→12/99	AEX	Petrol	1390	4	8	41
Polo Box (6NF)	05/98→12/99	APQ	Petrol	1390	4	8	50
Polo Box (86CF)	08/92→07/94	1W	Diesel	1398	4	8	39
Polo Box (86CF)	08/92→07/94	AAU	Petrol	1043	4	8	3
Polo Box (86CF)	08/92→07/94	AAV	Petrol	1272	4	8	29
Polo CLASSIC (6KV2)	05/96→07/02	AGY	Petrol	1390	4	8	44
Polo Classic (6V2)	11/95→09/97	1F	Petrol	1595	4	8	78



Model	Year Range	Code	Fuel	CC	Gears	Doors	Price
Polo Classic (6V2)	11/95→09/01	AEE	Petrol	1598	4	8	83
Polo Classic (6V2)	11/95→09/01	ALM	Petrol	1598	4	8	90
Polo Classic (6V2)	12/95→09/01	AEH	Petrol	1595	4	8	84
Polo Classic (6V2)	12/95→09/01	AEX	Petrol	1390	4	8	41
Polo Classic (6V2)	12/95→09/01	AEY	Diesel	1896	4	8	161
Polo Classic (6V2)	12/95→09/01	AFT	Petrol	1595	4	8	82
Polo Classic (6V2)	12/95→09/01	AKK	Petrol	1390	4	8	46
Polo Classic (6V2)	12/95→09/01	AKL	Petrol	1595	4	8	84
Polo Classic (6V2)	12/95→09/01	AKV	Petrol	1390	4	8	48
Polo Classic (6V2)	12/95→09/01	ANW	Petrol	1390	4	8	46
Polo Classic (6V2)	12/95→09/01	APF	Petrol	1595	4	8	87
Polo Classic (6V2)	12/95→09/01	APQ	Petrol	1390	4	8	50
Polo Classic (6V2)	12/95→09/01	AUD	Petrol	1390	4	8	47
Polo Classic (6V2)	12/95→09/01	AUR	Petrol	1595	4	8	87
Polo Classic (6V2)	01/96→10/96	1Y	Diesel	1896	4	8	153
Polo Classic (6V2)	08/96→12/01	AER	Petrol	999	4	8	4
Polo Classic (6V2)	09/96→09/01	AGR	Diesel	1896	4	8	164
Polo Classic (6V2)	09/96→09/01	AHU	Diesel	1896	4	8	167
Polo Classic (6V2)	09/96→09/01	ALE	Diesel	1896	4	8	166
Polo Classic (6V2)	09/96→09/01	ALH	Diesel	1896	4	8	164
Polo Classic (6V2)	01/97→09/01	ABS	Petrol	1781	4	8	124
Polo Classic (6V2)	01/97→09/01	ADD	Petrol	1781	4	8	125
Polo Classic (6V2)	01/97→09/01	ADZ	Petrol	1781	4	8	128
Polo Classic (6V2)	07/97→09/01	AKW	Diesel	1716	4	8	115
Polo Classic (6V2)	01/98→08/99	ANX	Petrol	1390	4	8	50
Polo Classic (6V2)	06/98→01/02	AFN	Diesel	1896	4	8	162
Polo Classic (6V2)	06/98→01/02	ASV	Diesel	1896	4	8	169
Polo Classic (6V2)	08/99→09/01	ADC	Petrol	1984	4	8	178
Polo Classic (6V2)	08/99→01/02	AGP	Diesel	1896	4	8	164
Polo Classic (6V2)	08/99→01/02	AQM	Diesel	1896	4	8	169
Polo Classic (6V2)	10/99→09/01	APE	Petrol	1390	4	16	43
Polo Classic (6V2)	10/99→09/01	AUA	Petrol	1390	4	16	43
Polo Classic (6V2)	11/02→07/06	BAH	Petrol	1598	4	8	98
Polo CLASSIC (86C, 80)	01/85→10/86	GL	Petrol	1043	4	8	16
Polo CLASSIC (86C, 80)	01/85→07/87	HK	Petrol	1272	4	8	34
Polo CLASSIC (86C, 80)	01/85→09/94	AAK	Petrol	1043	4	8	3
Polo CLASSIC (86C, 80)	01/85→09/94	AAU	Petrol	1043	4	8	3
Polo CLASSIC (86C, 80)	01/85→09/94	HZ	Petrol	1043	4	8	3
Polo CLASSIC (86C, 80)	01/85→09/94	MH	Petrol	1272	4	8	34
Polo CLASSIC (86C, 80)	08/86→12/88	MN	Diesel	1272	4	8	36
Polo CLASSIC (86C, 80)	07/87→09/94	NZ	Petrol	1272	4	8	29
Polo CLASSIC (86C, 80)	10/90→09/94	1W	Diesel	1398	4	8	39
Polo Coupe (86C, 80)	10/81→07/83	HB	Petrol	1093	4	8	17
Polo Coupe (86C, 80)	10/81→07/83	HH	Petrol	1272	4	8	35
Polo Coupe (86C, 80)	05/82→10/86	GL	Petrol	1043	4	8	16
Polo Coupe (86C, 80)	08/82→07/88	GT	Petrol	1272	4	8	34
Polo Coupe (86C, 80)	09/82→09/89	GK	Petrol	1272	4	8	34
Polo Coupe (86C, 80)	08/83→06/87	HK	Petrol	1272	4	8	34
Polo Coupe (86C, 80)	08/83→08/94	MH	Petrol	1272	4	8	34
Polo Coupe (86C, 80)	08/85→01/92	HZ	Petrol	1043	4	8	3
Polo Coupe (86C, 80)	08/86→08/90	MN	Diesel	1272	4	8	36
Polo Coupe (86C, 80)	01/87→09/94	PY	Petrol	1272	4	8	37
Polo Coupe (86C, 80)	07/87→08/94	2G	Petrol	1272	4	8	29
Polo Coupe (86C, 80)	07/87→08/94	AAV	Petrol	1272	4	8	29
Polo Coupe (86C, 80)	07/87→08/94	NZ	Petrol	1272	4	8	29
Polo Coupe (86C, 80)	08/89→09/94	AAK	Petrol	1043	4	8	3
Polo Coupe (86C, 80)	08/89→09/94	AAU	Petrol	1043	4	8	3
Polo Coupe (86C, 80)	08/89→09/94	ACM	Petrol	1043	4	8	3
Polo Coupe (86C, 80)	10/89→09/94	3F	Petrol	1272	4	8	29
Polo Coupe (86C, 80)	08/90→09/94	1W	Diesel	1398	4	8	39
Polo Hatchback	01/02→03/06	BCC	Petrol	1390	4	16	54
Polo Hatchback (6R)	05/15→	CSS	Petrol	1395	4	16	65
Polo Jinqin Hatchback (9N3)	06/06→12/08	BCC	Petrol	1390	4	16	54
Polo Playa	01/95→10/99	ADZ	Petrol	1781	4	8	128
Polo Playa	05/96→07/02	AGY	Petrol	1390	4	8	44
Polo Playa	01/98→08/00	AFX	Petrol	1595	4	8	86
Polo Playa	05/99→05/02	ALD	Petrol	999	4	8	7
Polo Playa	10/99→10/04	AKL	Petrol	1595	4	8	84
Polo Saloon	06/03→03/06	BCC	Petrol	1390	4	16	54
Polo Saloon	11/10→	CFNB	Petrol	1598	4	16	103
Polo Saloon (9A4)	09/02→	ASY	Diesel	1896	4	8	168
Polo Saloon (9A4)	09/02→	ATD	Diesel	1896	4	8	168
Polo Saloon (9A4)	09/02→	BAH	Petrol	1598	4	8	98
Polo Saloon (9A4)	09/02→	BBX	Petrol	1984	4	8	180
Polo Saloon (9A4)	09/02→	BPA	Petrol	1598	4	8	98
Polo Saloon (9A4)	09/02→	CFEA	Petrol	1984	4	8	180
Polo Saloon (9A4)	09/02→	CFZA	Petrol	1598	4	8	98
Polo Saloon (9A4)	07/03→	BAY	Diesel	1422	3	6	49



CC



9

Polo Saloon (9A4)	07/03→	BBY	Petrol	1390	4	16	43
Polo Saloon (9A4)	07/03→	BKY	Petrol	1390	4	16	43
Polo Saloon (9A4)	11/03→	BBZ	Petrol	1390	4	16	43
Polo Saloon (9A4)	10/04→	CCRA	Petrol	1598	4	8	98
Polo Saloon (9A4)	10/05→12/08	ADD	Petrol	1781	4	8	125
Polo Saloon (9N_)	09/02→05/05	BAH	Petrol	1598	4	8	98
Polo Saloon (9N_)	07/03→12/10	ATD	Diesel	1896	4	8	168
Polo Saloon (9N_)	01/05→12/06	BCD	Petrol	1595	4	8	99
Polo Saloon (9N_)	01/07→12/10	BTS	Petrol	1598	4	16	103
Polo Saloon (60_ , 61_)	04/10→	CFWA	Diesel	1199	3	12	25
Polo Saloon (60_ , 61_)	05/10→	CFNA	Petrol	1598	4	16	103
Polo Saloon (60_ , 61_)	05/10→	CLSA	Petrol	1598	4	16	103
Polo Saloon (60_ , 61_)	07/10→	CLNA	Diesel	1598	4	16	106
Polo Saloon (60_ , 61_)	12/10→	CLPA	Petrol	1390	4	16	53
Polo Saloon (60_ , 61_)	10/13→	CBZB	Petrol	1197	4	8	24
Polo Saloon (60_ , 61_)	02/14→	CWXB	Diesel	1498	4	16	71
Polo Saloon (60_ , 61_)	08/16→	CWXC	Diesel	1498	4	16	71
Polo Van (6R)	01/14→	CHYA	Petrol	999	3	12	14
Polo Van (6R)	01/14→	CHYB	Petrol	999	3	12	14
Polo Van (6R)	01/14→	CJZD	Petrol	1197	4	16	26
Polo Van (6R)	02/14→	CJZC	Petrol	1197	4	16	26
Polo Van (6R)	02/14→	CUSB	Diesel	1422	3	12	68
Polo Van (6R)	03/14→	CUSA	Diesel	1422	3	12	68
Polo Van (6R)	03/14→	CYZB	Diesel	1422	3	12	68
Polo Van (6R)	05/14→	CZEA	Petrol	1395	4	16	67
Polo Van (6R)	11/14→	CHZB	Petrol	999	3	12	14
Polo Variant (6V5)	05/97→09/01	ADZ	Petrol	1781	4	8	128
Polo Variant (6V5)	05/97→09/01	AEE	Petrol	1598	4	8	83
Polo Variant (6V5)	05/97→09/01	AEH	Petrol	1595	4	8	84
Polo Variant (6V5)	05/97→09/01	AEX	Petrol	1390	4	8	41
Polo Variant (6V5)	05/97→09/01	AFT	Petrol	1595	4	8	82
Polo Variant (6V5)	05/97→09/01	AGR	Diesel	1896	4	8	164
Polo Variant (6V5)	05/97→09/01	AHU	Diesel	1896	4	8	167
Polo Variant (6V5)	05/97→09/01	AKK	Petrol	1390	4	8	46
Polo Variant (6V5)	05/97→09/01	AKL	Petrol	1595	4	8	84
Polo Variant (6V5)	05/97→09/01	AKV	Petrol	1390	4	8	48
Polo Variant (6V5)	05/97→09/01	ALE	Diesel	1896	4	8	166
Polo Variant (6V5)	05/97→09/01	ALH	Diesel	1896	4	8	164
Polo Variant (6V5)	05/97→09/01	ALM	Petrol	1598	4	8	90
Polo Variant (6V5)	05/97→09/01	ANW	Petrol	1390	4	8	46
Polo Variant (6V5)	05/97→09/01	APF	Petrol	1595	4	8	87
Polo Variant (6V5)	05/97→09/01	APQ	Petrol	1390	4	8	50
Polo Variant (6V5)	05/97→09/01	AUD	Petrol	1390	4	8	47
Polo Variant (6V5)	05/97→09/01	AUR	Petrol	1595	4	8	87
Polo Variant (6V5)	06/97→09/01	AEY	Diesel	1896	4	8	161
Polo Variant (6V5)	08/97→09/01	AKW	Diesel	1716	4	8	115
Polo Variant (6V5)	06/98→09/01	AFN	Diesel	1896	4	8	162
Polo Variant (6V5)	06/98→09/01	ASV	Diesel	1896	4	8	169
Polo Variant (6V5)	12/98→09/01	AKP	Petrol	1390	4	8	47
Polo Variant (6V5)	08/99→09/01	AGP	Diesel	1896	4	8	164
Polo Variant (6V5)	08/99→09/01	AQM	Diesel	1896	4	8	169
Polo Variant (6V5)	10/99→09/01	APE	Petrol	1390	4	16	43
Polo Variant (6V5)	10/99→09/01	AUA	Petrol	1390	4	16	43
Polo Vivo Hatchback	02/10→	CLPA	Petrol	1390	4	16	53
Polo Vivo Saloon	02/10→	CLPA	Petrol	1390	4	16	53
Polo Vivo Saloon	02/10→	CLSA	Petrol	1598	4	16	103
Quantum	08/89→07/90	DDR	Petrol	1984	4	8	212
Quantum	03/93→12/01	UDB	Petrol	1781	4	8	121
Routan	09/10→12/13	CJRA	Petrol	3604	6	24	266
Sagitar	02/06→12/12	BWH	Petrol	1595	4	8	104
Sagitar	04/06→04/08	BPL	Petrol	1781	4	20	131
Sagitar	07/08→12/12	BYJ	Petrol	1798	4	16	147
Sagitar	09/09→	CFB	Petrol	1390	4	16	53
Sagitar	03/12→02/15	CLR	Petrol	1598	4	16	103
Sagitar	04/13→	CGM	Petrol	1984	4	16	201
Sagitar	03/15→	CPDA	Petrol	1598	4	16	110
Sagitar	03/15→	CSS	Petrol	1395	4	16	65
Sagitar	09/16→	CYA	Petrol	1197	4	16	28
Santana	08/84→07/94	DSN	Petrol	1781	4	8	121
Santana	05/91→07/94	JN	Petrol	1781	4	8	121
Santana	02/93→09/06	UDB	Petrol	1781	4	8	121
Santana	01/95→12/99	JV	Petrol	1781	4	8	149
Santana	01/95→09/12	AFE	Petrol	1781	4	8	130
Santana	08/96→12/12	JV	Petrol	1781	4	8	150
Santana (32B)	08/81→12/82	YP	Petrol	1588	4	8	114
Santana (32B)	08/81→07/83	FZ	Petrol	1272	4	8	35
Santana (32B)	08/81→07/83	WN	Petrol	1921	5	10	174
Santana (32B)	08/81→12/84	CR	Diesel	1588	4	8	111



CC



9

Santana (32B)	08/81→12/84	DT	Petrol	1595	4	8	79
Santana (32B)	08/81→12/84	JK	Diesel	1588	4	8	111
Santana (32B)	08/81→12/84	WV	Petrol	1588	4	8	114
Santana (32B)	09/81→12/83	WT	Petrol	1715	4	8	118
Santana (32B)	12/81→12/84	CY	Diesel	1588	4	8	111
Santana (32B)	08/82→12/84	WE	Petrol	2144	5	10	216
Santana (32B)	01/83→12/84	DS	Petrol	1781	4	8	121
Santana (32B)	08/83→12/84	HP	Petrol	1994	5	10	213
Santana (32B)	08/83→12/84	JS	Petrol	1994	5	10	213
Santana (32B)	09/83→12/85	JN	Petrol	1781	4	8	121
Santana (32B)	09/84→12/85	KX	Petrol	2226	5	10	218
Santana 2000	04/95→03/04	JV	Petrol	1781	4	8	150
Santana 2000	05/98→03/04	BKU	Petrol	1781	4	8	144
Santana 3000	06/05→12/08	BKT	Petrol	1781	4	8	144
Santana 3000	05/06→10/07	BTL	Petrol	1984	4	8	180
Santana Estate	03/85→12/00	JV	Petrol	1781	4	8	150
Santana Saloon	12/12→	CKA	Petrol	1395	4	16	65
Santana Saloon	12/12→	CPD	Petrol	1598	4	16	110
Santana Vista	01/08→12/12	BTL	Petrol	1984	4	8	180
Santana Vista	01/08→12/14	BKT	Petrol	1781	4	8	144
Santana Vista	01/08→12/14	BKU	Petrol	1781	4	8	144
Saveiro I	07/85→10/89	HM	Petrol	1595	4	8	79
Saveiro I	08/90→07/96	1F	Petrol	1595	4	8	78
Saveiro I	08/90→07/96	EW	Petrol	1595	4	8	79
Saveiro I	08/91→07/96	SB	Diesel	1588	4	8	77
Saveiro I	04/93→11/96	YH	Petrol	1588	4	8	114
Saveiro II	07/97→01/00	UPD	Petrol	1595	4	8	101
Saveiro II	07/97→01/00	UQG	Petrol	1984	4	8	214
Saveiro II	07/97→11/01	UNF	Petrol	1598	4	8	83
Saveiro II	07/97→02/02	1F	Petrol	1595	4	8	78
Saveiro II	07/97→02/02	EW	Petrol	1595	4	8	79
Saveiro II	07/97→02/02	UDH	Petrol	1781	4	8	130
Saveiro II	02/98→02/02	1Y	Diesel	1896	4	8	153
Saveiro III	02/00→09/03	BWX	Petrol	1596	4	8	101
Saveiro III	02/00→09/03	UNF	Petrol	1598	4	8	83
Saveiro III	02/00→08/05	UQG	Petrol	1984	4	8	214
Saveiro III	02/00→09/05	BJF	Petrol	1596	4	8	101
Saveiro III	02/00→09/05	UDH	Petrol	1781	4	8	130
Saveiro IV	03/05→08/09	UQG	Petrol	1984	4	8	214
Saveiro IV	09/05→08/09	BNY	Petrol	1781	4	8	146
Saveiro IV	09/05→08/09	UPD	Petrol	1595	4	8	101
Saveiro V	09/09→	CCRA	Petrol	1598	4	8	98
Scirocco (53)	02/74→08/75	YJ	Petrol	1471	4	8	74
Scirocco (53)	02/74→08/75	ZB	Petrol	1471	4	8	74
Scirocco (53)	02/74→12/75	FH	Petrol	1471	4	8	74
Scirocco (53)	02/74→12/77	FD	Petrol	1471	4	8	72
Scirocco (53)	04/74→07/79	FA	Petrol	1093	4	8	17
Scirocco (53)	08/75→07/77	FT	Petrol	1588	4	8	114
Scirocco (53)	08/75→07/79	FN	Petrol	1588	4	8	114
Scirocco (53)	08/75→07/79	FP	Petrol	1588	4	8	114
Scirocco (53)	08/75→07/80	FR	Petrol	1588	4	8	114
Scirocco (53)	06/76→07/80	EG	Petrol	1588	4	8	114
Scirocco (53)	08/77→07/80	JB	Petrol	1457	4	8	76
Scirocco (53)	09/77→12/78	EH	Petrol	1457	4	8	72
Scirocco (53)	08/79→07/80	GF	Petrol	1272	4	8	35
Scirocco (53B)	08/80→07/82	EG	Petrol	1588	4	8	114
Scirocco (53B)	08/80→12/83	GF	Petrol	1272	4	8	35
Scirocco (53B)	08/80→12/83	JB	Petrol	1457	4	8	76
Scirocco (53B)	08/80→04/84	FR	Petrol	1588	4	8	114
Scirocco (53B)	09/80→12/83	EN	Petrol	1716	4	8	118
Scirocco (53B)	08/82→07/83	EM	Petrol	1588	4	8	79
Scirocco (53B)	08/82→12/89	DX	Petrol	1781	4	8	121
Scirocco (53B)	08/82→12/89	EV	Petrol	1781	4	8	149
Scirocco (53B)	08/82→12/89	JJ	Petrol	1781	4	8	121
Scirocco (53B)	08/82→12/89	PB	Petrol	1781	4	8	121
Scirocco (53B)	01/83→12/89	EW	Petrol	1595	4	8	79
Scirocco (53B)	08/83→07/84	EWA	Petrol	1595	4	8	79
Scirocco (53B)	08/83→07/84	HK	Petrol	1272	4	8	34
Scirocco (53B)	08/83→07/92	EX	Petrol	1781	4	8	121
Scirocco (53B)	09/85→07/92	PL	Petrol	1781	4	16	151
Scirocco (53B)	10/85→07/89	KR	Petrol	1781	4	16	151
Scirocco (53B)	11/85→07/92	JH	Petrol	1781	4	8	121
Scirocco (53B)	04/86→07/90	RE	Petrol	1595	4	8	79
Scirocco (137, 138)	05/08→11/09	CAWB	Petrol	1984	4	16	195
Scirocco (137, 138)	05/08→	CAVD	Petrol	1390	4	16	53
Scirocco (137, 138)	05/08→	CNWA	Petrol	1390	4	16	53
Scirocco (137, 138)	05/08→	CTHD	Petrol	1390	4	16	53
Scirocco (137, 138)	05/08→	CTKA	Petrol	1390	4	16	53









CC



9

Scirocco (137, 138)	08/08→	CAXA	Petrol	1390	4	16	53
Scirocco (137, 138)	08/08→	CBDB	Diesel	1968	4	16	194
Scirocco (137, 138)	08/08→	CFHC	Diesel	1968	4	16	194
Scirocco (137, 138)	08/08→	CMSB	Petrol	1390	4	16	53
Scirocco (137, 138)	05/09→	CBBB	Diesel	1968	4	16	194
Scirocco (137, 138)	05/09→	CFGB	Diesel	1968	4	16	194
Scirocco (137, 138)	11/09→	CCZB	Petrol	1984	4	16	195
Scirocco (137, 138)	11/09→	CDLA	Petrol	1984	4	16	185
Scirocco (137, 138)	11/09→	CDLC	Petrol	1984	4	16	185
Scirocco (137, 138)	11/10→	CFHB	Diesel	1968	4	16	194
Scirocco (137, 138)	01/13→	CFGC	Diesel	1968	4	16	194
Scirocco (137, 138)	11/13→	CULA	Petrol	1984	4	16	201
Scirocco (137, 138)	11/13→	CULC	Petrol	1984	4	16	201
Scirocco (137, 138)	11/13→	CUUB	Diesel	1968	4	16	204
Scirocco (137, 138)	11/13→	CXSB	Petrol	1395	4	16	64
Scirocco (137, 138)	11/13→	CZCA	Petrol	1395	4	16	64
Scirocco (137, 138)	05/14→	CDLK	Petrol	1984	4	16	185
Scirocco (137, 138)	05/14→	CUWA	Diesel	1968	4	16	204
Scirocco (137, 138)	05/14→	CUXA	Diesel	1968	4	16	204
Scirocco (137, 138)	07/15→	CZDA	Petrol	1395	4	16	64
Sharan (7M8, 7M9, 7M6)	09/95→04/00	AAA	Petrol	2792	6	12	247
Sharan (7M8, 7M9, 7M6)	09/95→04/00	AMY	Petrol	2792	6	12	247
Sharan (7M8, 7M9, 7M6)	09/95→03/10	IZ	Diesel	1896	4	8	154
Sharan (7M8, 7M9, 7M6)	09/95→03/10	ADY	Petrol	1984	4	8	179
Sharan (7M8, 7M9, 7M6)	09/95→03/10	AHU	Diesel	1896	4	8	167
Sharan (7M8, 7M9, 7M6)	09/95→03/10	ANU	Diesel	1896	4	8	168
Sharan (7M8, 7M9, 7M6)	09/95→03/10	ATM	Petrol	1984	4	8	180
Sharan (7M8, 7M9, 7M6)	09/96→04/00	AFN	Diesel	1896	4	8	162
Sharan (7M8, 7M9, 7M6)	09/96→04/00	AVG	Diesel	1896	4	8	166
Sharan (7M8, 7M9, 7M6)	09/97→03/10	AJH	Petrol	1781	4	20	133
Sharan (7M8, 7M9, 7M6)	09/97→03/10	AWC	Petrol	1781	4	20	133
Sharan (7M8, 7M9, 7M6)	04/00→03/10	AUY	Diesel	1896	4	8	168
Sharan (7M8, 7M9, 7M6)	04/00→03/10	AYL	Petrol	2792	6	24	254
Sharan (7M8, 7M9, 7M6)	04/00→03/10	BVK	Diesel	1896	4	8	168
Sharan (7M8, 7M9, 7M6)	11/02→03/10	ASZ	Diesel	1896	4	8	168
Sharan (7M8, 7M9, 7M6)	06/05→03/10	BTB	Diesel	1896	4	8	168
Sharan (7M8, 7M9, 7M6)	11/05→03/10	BRT	Diesel	1968	4	8	187
Sharan (7M8, 7M9, 7M6)	11/05→03/10	BVH	Diesel	1968	4	8	187
Sharan (7N)	11/11→	CDAA	Petrol	1798	4	16	147
Sharan (7N1, 7N2)	05/10→	CAVA	Petrol	1390	4	16	53
Sharan (7N1, 7N2)	05/10→	CFFA	Diesel	1968	4	16	194
Sharan (7N1, 7N2)	05/10→	CFFB	Diesel	1968	4	16	194
Sharan (7N1, 7N2)	05/10→	CNWB	Petrol	1390	4	16	53
Sharan (7N1, 7N2)	05/10→	CTHA	Petrol	1390	4	16	53
Sharan (7N1, 7N2)	08/10→	CFGB	Diesel	1968	4	16	194
Sharan (7N1, 7N2)	12/10→	CCZA	Petrol	1984	4	16	195
Sharan (7N1, 7N2)	05/11→	CFFE	Diesel	1968	4	16	194
Sharan (7N1, 7N2)	05/11→	CUVA	Diesel	1968	4	16	204
Sharan (7N1, 7N2)	05/11→	DFLD	Diesel	1968	4	16	207
Sharan (7N1, 7N2)	01/13→	CFGC	Diesel	1968	4	16	194
Sharan (7N1, 7N2)	05/15→	CUVC	Diesel	1968	4	16	204
Sharan (7N1, 7N2)	05/15→	CUWA	Diesel	1968	4	16	204
Sharan (7N1, 7N2)	05/15→	CZDA	Petrol	1395	4	16	64
Sharan (7N1, 7N2)	05/15→	DEDA	Petrol	1984	4	16	201
Sharan (7N1, 7N2)	05/15→	DFLA	Diesel	1968	4	16	207
Sharan (7N1, 7N2)	05/15→	DFMA	Diesel	1968	4	16	207
Spacefox / Space Cross	04/15→	CWSA	Petrol	1598	4	16	109
Spacefox / Space Cross	10/15→	CFZA	Petrol	1598	4	8	98
Spacefox / Space Cross (5Z6, 5Z7)	03/06→	BAH	Petrol	1598	4	8	98
Spacefox / Space Cross (5Z6, 5Z7)	03/06→	BLH	Petrol	1598	4	8	100
Spacefox / Space Cross (5Z6, 5Z7)	03/06→	BPA	Petrol	1598	4	8	98
Spacefox / Space Cross (5Z6, 5Z7)	03/06→	CCRA	Petrol	1598	4	8	98
Spacefox / Space Cross (5Z6, 5Z7)	03/06→	CFZA	Petrol	1598	4	8	98
Spacefox / Space Cross (5Z6, 5Z7)	11/07→11/10	ASY	Diesel	1896	4	8	168
Taro	04/89→09/94	2Y	Petrol	1812	4	8	122
Taro	04/89→03/97	2L	Diesel	2446	4	8	226
Taro	06/89→07/94	4Y	Petrol	2237	4	8	217
Taro	06/89→03/97	22R	Petrol	2366	4	8	227
Tiguan (5N_)	09/07→	BWK	Petrol	1390	4	16	53
Tiguan (5N_)	09/07→	CAVA	Petrol	1390	4	16	53
Tiguan (5N_)	09/07→	CAWA	Petrol	1984	4	16	195
Tiguan (5N_)	09/07→	CAWB	Petrol	1984	4	16	195
Tiguan (5N_)	09/07→	CBAB	Diesel	1968	4	16	194
Tiguan (5N_)	09/07→	CBBB	Diesel	1968	4	16	194
Tiguan (5N_)	09/07→	CCTA	Petrol	1984	4	16	195
Tiguan (5N_)	09/07→	CCZA	Petrol	1984	4	16	195
Tiguan (5N_)	09/07→	CCZC	Petrol	1984	4	16	195
Tiguan (5N_)	09/07→	CFFB	Diesel	1968	4	16	194

				CC			9
Tiguan (5N_)	09/07→	CFGB	Diesel	1968	4	16	194
Tiguan (5N_)	09/07→	CLJA	Diesel	1968	4	16	194
Tiguan (5N_)	09/07→	CTHA	Petrol	1390	4	16	53
Tiguan (5N_)	11/07→	CBAA	Diesel	1968	4	16	194
Tiguan (5N_)	11/07→	CFFA	Diesel	1968	4	16	194
Tiguan (5N_)	02/08→08/09	CBBA	Diesel	1968	4	16	196
Tiguan (5N_)	05/08→	CCTB	Petrol	1984	4	16	195
Tiguan (5N_)	05/10→	CFFD	Diesel	1968	4	16	194
Tiguan (5N_)	08/10→	CAXA	Petrol	1390	4	16	53
Tiguan (5N_)	05/11→	CAVD	Petrol	1390	4	16	53
Tiguan (5N_)	05/11→	CCZB	Petrol	1984	4	16	195
Tiguan (5N_)	05/11→	CCZD	Petrol	1984	4	16	195
Tiguan (5N_)	05/11→	CTHD	Petrol	1390	4	16	53
Tiguan (5N_)	11/12→	CFGC	Diesel	1968	4	16	194
Tiguan (5N_)	05/15→	CUVC	Diesel	1968	4	16	204
Tiguan (5N_)	05/15→	CUWA	Diesel	1968	4	16	204
Tiguan (5N_)	05/15→	CZDA	Petrol	1395	4	16	64
Tiguan (5N_)	05/15→	CZDB	Petrol	1395	4	16	64
Tiguan (5N)	09/16→	CSS	Petrol	1395	4	16	65
Tiguan (AD1)	01/16→	CZCA	Petrol	1395	4	16	64
Tiguan (AD1)	01/16→	CZPA	Petrol	1984	4	16	201
Tiguan (AD1)	01/16→	DFGA	Diesel	1968	4	16	207
Tiguan (AD1)	04/16→	DFHA	Diesel	1968	4	16	207
Tiguan (AD1)	05/16→	CUAA	Diesel	1968	4	16	204
Tiguan (AD1)	05/16→	CZDA	Petrol	1395	4	16	64
Tiguan (AD1)	05/16→	CZEA	Petrol	1395	4	16	67
Tiguan (AD1)	05/16→	DFGC	Diesel	1968	4	16	207
Tiguan (AD1)	05/16→	DGDB	Diesel	1598	4	16	107
Tiguan (AD1)	06/16→	CHHB	Petrol	1984	4	16	201
Tiguan (AD1)	06/16→	CRFD	Diesel	1968	4	16	207
Tiguan (AD1)	08/16→	CRGB	Diesel	1968	4	16	207
Tiguan (AD1)	08/16→	CYKC	Diesel	1968	4	16	207
Tiguan Allspace (BW2)	04/17→	CZDA	Petrol	1395	4	16	64
Tiguan Allspace (BW2)	04/17→	CZEA	Petrol	1395	4	16	67
Tiguan Allspace (BW2)	06/17→	CUAA	Diesel	1968	4	16	204
Tiguan Allspace (BW2)	06/17→	DFGA	Diesel	1968	4	16	207
Tiguan Allspace (BW2)	06/17→	DFHA	Diesel	1968	4	16	207
Tiguan Allspace (BW2)	07/17→	CXDA	Petrol	1984	4	16	201
Touareg (7LA, 7L6, 7L7)	10/02→11/06	AZZ	Petrol	3189	6	24	263
Touareg (7LA, 7L6, 7L7)	10/02→11/06	BAA	Petrol	3189	6	24	263
Touareg (7LA, 7L6, 7L7)	10/02→11/06	BKJ	Petrol	3189	6	24	263
Touareg (7LA, 7L6, 7L7)	10/02→11/06	BMV	Petrol	3189	6	24	263
Touareg (7LA, 7L6, 7L7)	10/02→11/06	BMX	Petrol	3189	6	24	263
Touareg (7LA, 7L6, 7L7)	10/02→11/06	BRJ	Petrol	3189	6	24	263
Touareg (7LA, 7L6, 7L7)	12/02→11/06	AXQ	Petrol	4172	8	40	268
Touareg (7LA, 7L6, 7L7)	12/02→11/06	BHX	Petrol	4172	8	40	270
Touareg (7LA, 7L6, 7L7)	01/03→05/10	BAC	Diesel	2461	5	10	241
Touareg (7LA, 7L6, 7L7)	01/03→05/10	BPE	Diesel	2461	5	10	246
Touareg (7LA, 7L6, 7L7)	08/03→05/10	BLK	Diesel	2461	5	10	245
Touareg (7LA, 7L6, 7L7)	08/03→05/10	BPD	Diesel	2461	5	10	246
Touareg (7LA, 7L6, 7L7)	08/04→05/10	BJN	Petrol	5998	12	48	273
Touareg (7LA, 7L6, 7L7)	08/04→05/10	CFRA	Petrol	5998	12	48	273
Touareg (7LA, 7L6, 7L7)	11/04→05/10	BKS	Diesel	2967	6	24	256
Touareg (7LA, 7L6, 7L7)	11/04→05/10	CATA	Diesel	2967	6	24	256
Touareg (7LA, 7L6, 7L7)	10/05→05/10	BHK	Petrol	3597	6	24	265
Touareg (7LA, 7L6, 7L7)	10/05→05/10	BHL	Petrol	3597	6	24	265
Touareg (7LA, 7L6, 7L7)	04/06→05/10	BUN	Diesel	2967	6	24	256
Touareg (7LA, 7L6, 7L7)	04/06→05/10	CASB	Diesel	2967	6	24	256
Touareg (7LA, 7L6, 7L7)	06/06→05/10	BAR	Petrol	4163	8	32	269
Touareg (7LA, 7L6, 7L7)	08/07→05/10	CBWA	Diesel	4921	10	20	272
Touareg (7LA, 7L6, 7L7)	11/07→05/10	CASA	Diesel	2967	6	24	256
Touareg (7LA, 7L6, 7L7)	11/07→05/10	CASC	Diesel	2967	6	24	256
Touareg (7P5)	01/10→	CASA	Diesel	2967	6	24	256
Touareg (7P5)	01/10→	CASD	Diesel	2967	6	24	256
Touareg (7P5)	01/10→	CJMA	Diesel	2967	6	24	257
Touareg (7P5)	01/10→	CKDA	Diesel	4134	8	32	271
Touareg (7P5)	01/10→	CNRB	Diesel	2967	6	24	257
Touareg (7P5)	01/10→	CRCD	Diesel	2967	6	24	257
Touareg (7P5)	01/10→	CVWA	Diesel	2967	6	24	261
Touareg (7P5)	04/10→	CGEA	Petrol	2995	6	24	258
Touareg (7P5)	04/10→	CGFA	Petrol	2995	6	24	258
Touareg (7P5)	04/10→	CGRA	Petrol	3597	6	24	265
Touareg (7P5)	06/10→	CATA	Diesel	2967	6	24	256
Touareg (7P5)	08/10→	CJTA	Petrol	2995	6	24	258
Touareg (7P5)	08/10→	CMTA	Petrol	3597	6	24	265
Touareg (7P5)	01/11→	CGNA	Petrol	4163	8	32	269
Touareg (7P5)	05/11→	CJGD	Diesel	2967	6	24	257
Touareg (7P5)	05/11→	CRCA	Diesel	2967	6	24	257



Touareg (7P5)	09/14→	CVVA	Diesel	2967	6	24	261
Touareg (7P5)	01/15→	CYJA	Petrol	2995	6	24	258
Touran (1T1, 1T2)	02/03→05/04	AVQ	Diesel	1896	4	8	171
Touran (1T1, 1T2)	02/03→01/07	BAG	Petrol	1598	4	16	97
Touran (1T1, 1T2)	02/03→01/07	BLF	Petrol	1598	4	16	97
Touran (1T1, 1T2)	02/03→01/07	BLP	Petrol	1598	4	16	97
Touran (1T1, 1T2)	02/03→05/10	AZV	Diesel	1968	4	16	186
Touran (1T1, 1T2)	07/03→05/10	BGU	Petrol	1595	4	8	91
Touran (1T1, 1T2)	07/03→05/10	BSE	Petrol	1595	4	8	91
Touran (1T1, 1T2)	07/03→05/10	BSF	Petrol	1595	4	8	91
Touran (1T1, 1T2)	08/03→05/10	BKC	Diesel	1896	4	8	171
Touran (1T1, 1T2)	08/03→05/10	BKD	Diesel	1968	4	16	186
Touran (1T1, 1T2)	08/03→05/10	BLS	Diesel	1896	4	8	171
Touran (1T1, 1T2)	08/03→05/10	BXE	Diesel	1896	4	8	171
Touran (1T1, 1T2)	10/03→01/07	AXW	Petrol	1984	4	16	184
Touran (1T1, 1T2)	10/03→01/07	BLR	Petrol	1984	4	16	184
Touran (1T1, 1T2)	10/03→01/07	BLX	Petrol	1984	4	16	184
Touran (1T1, 1T2)	10/03→01/07	BLY	Petrol	1984	4	16	184
Touran (1T1, 1T2)	10/03→01/07	BVY	Petrol	1984	4	16	184
Touran (1T1, 1T2)	10/03→01/07	BVZ	Petrol	1984	4	16	184
Touran (1T1, 1T2)	10/04→05/10	BJZ	Petrol	1984	4	16	191
Touran (1T1, 1T2)	11/04→05/10	BRU	Diesel	1896	4	8	171
Touran (1T1, 1T2)	11/04→05/10	BXF	Diesel	1896	4	8	171
Touran (1T1, 1T2)	11/04→05/10	BXJ	Diesel	1896	4	8	171
Touran (1T1, 1T2)	12/05→05/10	BMM	Diesel	1968	4	8	187
Touran (1T1, 1T2)	12/05→05/10	BMN	Diesel	1968	4	16	186
Touran (1T1, 1T2)	02/06→05/09	BSX	Gas	1984	4	8	192
Touran (1T1, 1T2)	02/06→05/10	BMY	Petrol	1390	4	16	53
Touran (1T1, 1T2)	02/06→05/10	CAVC	Petrol	1390	4	16	53
Touran (1T1, 1T2)	11/06→05/10	BLG	Petrol	1390	4	16	53
Touran (1T1, 1T2)	11/06→05/10	CAVB	Petrol	1390	4	16	53
Touran (1T1, 1T2)	05/09→05/10	CDGA	Petrol	1390	4	16	62
Touran (1T3)	05/10→01/13	CFJA	Diesel	1968	4	16	194
Touran (1T3)	05/10→05/15	CAVB	Petrol	1390	4	16	53
Touran (1T3)	05/10→05/15	CAVC	Petrol	1390	4	16	53
Touran (1T3)	05/10→05/15	CAYB	Diesel	1598	4	16	105
Touran (1T3)	05/10→05/15	CAYC	Diesel	1598	4	16	105
Touran (1T3)	05/10→05/15	CBZB	Petrol	1197	4	8	24
Touran (1T3)	05/10→05/15	CDGA	Petrol	1390	4	16	62
Touran (1T3)	05/10→05/15	CFHC	Diesel	1968	4	16	194
Touran (1T3)	05/10→05/15	CTHB	Petrol	1390	4	16	53
Touran (1T3)	05/10→05/15	CTHC	Petrol	1390	4	16	53
Touran (1T3)	11/10→05/15	CFHF	Diesel	1968	4	16	194
Touran (1T3)	11/10→05/15	CLCA	Diesel	1968	4	16	194
Touran (1T3)	01/13→05/15	CFJB	Diesel	1968	4	16	194
Touran (5T1)	05/15→05/16	CRKB	Diesel	1598	4	16	107
Touran (5T1)	05/15→	CYVB	Petrol	1197	4	16	26
Touran (5T1)	05/15→	CZDA	Petrol	1395	4	16	64
Touran (5T1)	05/15→	DFEA	Diesel	1968	4	16	204
Touran (5T1)	05/15→	DFGA	Diesel	1968	4	16	207
Touran (5T1)	11/15→	CJSA	Petrol	1798	4	16	147
Touran (5T1)	11/15→	CRVA	Diesel	1968	4	16	204
Touran (5T1)	11/15→	CYKB	Diesel	1968	4	16	207
Touran (5T1)	11/15→	DFEB	Diesel	1968	4	16	207
Touran (5T1)	11/15→	DFGB	Diesel	1968	4	16	207
Touran (5T1)	11/15→	DFHA	Diesel	1968	4	16	207
Touran (5T1)	05/16→	DGDA	Diesel	1598	4	16	107
Touran L (5T1)	03/16→	CSSA	Petrol	1395	4	16	65
Transporter I Box (21, 23)	02/62→12/68	H	Petrol	1493	4	8	75
Transporter I Bus (22, 24, 25, 28)	11/62→08/66	H	Petrol	1493	4	8	75
Transporter I Platform/Chassis (26)	06/66→10/70	H	Petrol	1493	4	8	75
Transporter II Box	08/70→04/79	AD	Petrol	1584	4	8	81
Transporter II Box	08/70→04/79	AE	Petrol	1584	4	8	81
Transporter II Box	08/70→04/79	AS	Petrol	1584	4	8	81
Transporter II Box	08/71→12/73	CA	Petrol	1679	4	8	117
Transporter II Box	08/71→12/73	CB	Petrol	1679	4	8	117
Transporter II Box	11/73→07/75	AP	Petrol	1795	4	8	134
Transporter II Box	08/75→07/79	CJ	Petrol	1970	4	8	203
Transporter II Box	08/75→07/79	GD	Petrol	1970	4	8	203
Transporter II Box	08/75→07/79	GE	Petrol	1970	4	8	203
Transporter II Bus	08/67→07/70	AF	Petrol	1584	4	8	81
Transporter II Bus	08/70→04/79	AD	Petrol	1584	4	8	81
Transporter II Bus	08/70→04/79	AH	Petrol	1584	4	8	81
Transporter II Bus	08/70→04/79	AS	Petrol	1584	4	8	81
Transporter II Bus	08/71→10/73	CA	Petrol	1679	4	8	117
Transporter II Bus	08/71→10/73	CB	Petrol	1679	4	8	117
Transporter II Bus	11/73→07/75	AP	Petrol	1795	4	8	134
Transporter II Bus	08/75→04/79	CJ	Petrol	1970	4	8	203



Model	Year Range	Code	Fuel	CC	Power (kW)	Power (hp)	Price
Transporter II Bus	08/75→04/79	GD	Petrol	1970	4	8	203
Transporter II Bus	08/75→04/79	GE	Petrol	1970	4	8	203
Transporter II Platform/Chassis	08/68→07/79	AD	Petrol	1584	4	8	81
Transporter II Platform/Chassis	08/68→07/79	AS	Petrol	1584	4	8	81
Transporter III Box	05/79→12/82	CT	Petrol	1584	4	8	81
Transporter III Box	05/79→04/86	CU	Petrol	1970	4	8	203
Transporter III Box	01/81→07/87	CS	Diesel	1588	4	8	111
Transporter III Box	10/82→07/92	DF	Petrol	1913	4	8	173
Transporter III Box	10/82→07/92	DG	Petrol	1913	4	8	173
Transporter III Box	08/83→02/89	GW	Petrol	1913	4	8	173
Transporter III Box	10/84→02/89	DH	Petrol	1913	4	8	173
Transporter III Box	10/84→07/92	JX	Diesel	1589	4	8	77
Transporter III Box	08/85→07/92	KY	Diesel	1716	4	8	119
Transporter III Box	08/85→07/92	MV	Petrol	2110	4	8	215
Transporter III Box	03/86→07/92	DJ	Petrol	2110	4	8	215
Transporter III Box	07/89→07/92	SS	Petrol	2110	4	8	215
Transporter III Bus	05/79→12/82	CT	Petrol	1584	4	8	81
Transporter III Bus	05/79→12/82	CU	Petrol	1970	4	8	203
Transporter III Bus	05/79→12/82	CV	Petrol	1970	4	8	203
Transporter III Bus	01/81→07/87	CS	Diesel	1588	4	8	111
Transporter III Bus	08/82→07/92	DF	Petrol	1913	4	8	173
Transporter III Bus	08/82→07/92	DG	Petrol	1913	4	8	173
Transporter III Bus	01/83→12/85	DH	Petrol	1913	4	8	173
Transporter III Bus	08/83→07/85	GW	Petrol	1913	4	8	173
Transporter III Bus	08/84→07/92	DJ	Petrol	2110	4	8	215
Transporter III Bus	08/84→07/92	JX	Diesel	1589	4	8	77
Transporter III Bus	08/85→07/92	MV	Petrol	2110	4	8	215
Transporter III Bus	10/86→07/92	KY	Diesel	1716	4	8	119
Transporter III Bus	10/86→07/92	SR	Petrol	2109	4	8	215
Transporter III Bus	08/87→07/89	SP	Petrol	1913	4	8	173
Transporter III Bus	07/89→07/92	SS	Petrol	2110	4	8	215
Transporter III Platform/Chassis	05/79→04/86	CU	Petrol	1970	4	8	203
Transporter III Platform/Chassis	01/81→07/87	CS	Diesel	1588	4	8	111
Transporter III Platform/Chassis	08/82→07/92	DG	Petrol	1913	4	8	173
Transporter III Platform/Chassis	09/82→07/92	DF	Petrol	1913	4	8	173
Transporter III Platform/Chassis	10/84→02/89	DH	Petrol	1913	4	8	173
Transporter III Platform/Chassis	10/84→07/92	JX	Diesel	1589	4	8	77
Transporter III Platform/Chassis	08/85→07/92	KY	Diesel	1716	4	8	119
Transporter III Platform/Chassis	08/85→07/92	MV	Petrol	2110	4	8	215
Transporter III Platform/Chassis	03/86→07/92	DJ	Petrol	2110	4	8	215
Transporter III Platform/Chassis	07/89→07/92	SS	Petrol	2110	4	8	215
Transporter IV Box (70XA)	07/90→12/95	TX	Diesel	1896	4	8	152
Transporter IV Box (70XA)	07/90→09/98	AAB	Diesel	2370	5	10	228
Transporter IV Box (70XA)	07/90→04/03	AAC	Petrol	1968	4	8	177
Transporter IV Box (70XA)	11/90→04/03	AAF	Petrol	2461	5	10	230
Transporter IV Box (70XA)	11/90→04/03	ACU	Petrol	2461	5	10	230
Transporter IV Box (70XA)	11/90→04/03	AEN	Petrol	2461	5	10	230
Transporter IV Box (70XA)	11/90→04/03	AEU	Petrol	2461	5	10	230
Transporter IV Box (70XA)	10/92→04/03	ABL	Diesel	1896	4	8	157
Transporter IV Box (70XA)	09/95→04/03	ACV	Diesel	2461	5	10	231
Transporter IV Box (70XA)	09/95→04/03	AUF	Diesel	2461	5	10	239
Transporter IV Box (70XA)	09/95→04/03	AXL	Diesel	2461	5	10	242
Transporter IV Box (70XA)	09/95→04/03	AYC	Diesel	2461	5	10	239
Transporter IV Box (70XA)	05/96→05/00	AES	Petrol	2792	6	12	247
Transporter IV Box (70XA)	08/96→04/03	AET	Petrol	2461	5	10	233
Transporter IV Box (70XA)	08/96→04/03	APL	Petrol	2461	5	10	233
Transporter IV Box (70XA)	08/96→04/03	AVT	Petrol	2461	5	10	240
Transporter IV Box (70XA)	08/97→04/03	AJA	Diesel	2370	5	10	228
Transporter IV Box (70XA)	12/98→04/03	AJT	Diesel	2461	5	10	231
Transporter IV Box (70XA)	12/98→04/03	AYY	Diesel	2461	5	10	239
Transporter IV Box (70XA)	06/00→04/03	AMV	Petrol	2792	6	24	254
Transporter IV Box (70XA)	09/00→04/03	AXG	Diesel	2461	5	10	236
Transporter IV Bus (70XB, 70XC, 7DB, 7DW)	01/96→04/96	AES	Petrol	2792	6	12	247
Transporter IV Bus (70XB, 70XC, 7DB, 7DW, 7DK)	09/90→12/95	TX	Diesel	1896	4	8	152
Transporter IV Bus (70XB, 70XC, 7DB, 7DW, 7DK)	09/90→09/98	AAB	Diesel	2370	5	10	228
Transporter IV Bus (70XB, 70XC, 7DB, 7DW, 7DK)	09/90→04/03	AAC	Petrol	1968	4	8	177
Transporter IV Bus (70XB, 70XC, 7DB, 7DW, 7DK)	11/90→04/03	AAF	Petrol	2461	5	10	230
Transporter IV Bus (70XB, 70XC, 7DB, 7DW, 7DK)	11/90→04/03	ACU	Petrol	2461	5	10	230
Transporter IV Bus (70XB, 70XC, 7DB, 7DW, 7DK)	11/90→04/03	AEN	Petrol	2461	5	10	230
Transporter IV Bus (70XB, 70XC, 7DB, 7DW, 7DK)	11/90→04/03	AEU	Petrol	2461	5	10	230
Transporter IV Bus (70XB, 70XC, 7DB, 7DW, 7DK)	12/90→07/92	PD	Petrol	1781	4	8	121
Transporter IV Bus (70XB, 70XC, 7DB, 7DW, 7DK)	10/92→04/03	ABL	Diesel	1896	4	8	157
Transporter IV Bus (70XB, 70XC, 7DB, 7DW, 7DK)	09/95→04/03	ACV	Diesel	2461	5	10	231
Transporter IV Bus (70XB, 70XC, 7DB, 7DW, 7DK)	09/95→04/03	AUF	Diesel	2461	5	10	239
Transporter IV Bus (70XB, 70XC, 7DB, 7DW, 7DK)	09/95→04/03	AYC	Diesel	2461	5	10	239
Transporter IV Bus (70XB, 70XC, 7DB, 7DW, 7DK)	11/95→04/00	AES	Petrol	2792	6	12	247
Transporter IV Bus (70XB, 70XC, 7DB, 7DW, 7DK)	01/96→04/03	AXL	Diesel	2461	5	10	242
Transporter IV Bus (70XB, 70XC, 7DB, 7DW, 7DK)	07/96→04/03	AET	Petrol	2461	5	10	233



CC



9

Transporter IV Bus (70XB, 70XC, 7DB, 7DW, 7DK)	07/96→04/03	APL	Petrol	2461	5	10	233
Transporter IV Bus (70XB, 70XC, 7DB, 7DW, 7DK)	07/96→04/03	AVT	Petrol	2461	5	10	240
Transporter IV Bus (70XB, 70XC, 7DB, 7DW, 7DK)	08/97→04/03	AJA	Diesel	2370	5	10	228
Transporter IV Bus (70XB, 70XC, 7DB, 7DW, 7DK)	05/98→04/03	AHY	Diesel	2461	5	10	236
Transporter IV Bus (70XB, 70XC, 7DB, 7DW, 7DK)	05/98→04/03	AJT	Diesel	2461	5	10	231
Transporter IV Bus (70XB, 70XC, 7DB, 7DW, 7DK)	05/98→04/03	AXG	Diesel	2461	5	10	236
Transporter IV Bus (70XB, 70XC, 7DB, 7DW, 7DK)	05/98→04/03	AYY	Diesel	2461	5	10	239
Transporter IV Bus (70XB, 70XC, 7DB, 7DW, 7DK)	04/00→04/03	AMV	Petrol	2792	6	24	254
Transporter IV Platform/Chassis (70XD)	07/90→12/95	1X	Diesel	1896	4	8	152
Transporter IV Platform/Chassis (70XD)	07/90→04/03	AAC	Petrol	1968	4	8	177
Transporter IV Platform/Chassis (70XD)	09/90→09/98	AAB	Diesel	2370	5	10	228
Transporter IV Platform/Chassis (70XD)	11/90→04/03	AAF	Petrol	2461	5	10	230
Transporter IV Platform/Chassis (70XD)	11/90→04/03	ACU	Petrol	2461	5	10	230
Transporter IV Platform/Chassis (70XD)	11/90→04/03	AEN	Petrol	2461	5	10	230
Transporter IV Platform/Chassis (70XD)	11/90→04/03	AEU	Petrol	2461	5	10	230
Transporter IV Platform/Chassis (70XD)	12/90→07/92	PD	Petrol	1781	4	8	121
Transporter IV Platform/Chassis (70XD)	10/92→04/03	ABL	Diesel	1896	4	8	157
Transporter IV Platform/Chassis (70XD)	09/95→04/03	ACV	Diesel	2461	5	10	231
Transporter IV Platform/Chassis (70XD)	09/95→04/03	AUF	Diesel	2461	5	10	239
Transporter IV Platform/Chassis (70XD)	09/95→04/03	AYC	Diesel	2461	5	10	239
Transporter IV Platform/Chassis (70XD)	05/96→05/00	AES	Petrol	2792	6	12	247
Transporter IV Platform/Chassis (70XD)	08/96→04/03	AET	Petrol	2461	5	10	233
Transporter IV Platform/Chassis (70XD)	08/96→04/03	APL	Petrol	2461	5	10	233
Transporter IV Platform/Chassis (70XD)	08/96→04/03	AVT	Petrol	2461	5	10	240
Transporter IV Platform/Chassis (70XD)	08/97→04/03	AJA	Diesel	2370	5	10	228
Transporter IV Platform/Chassis (70XD)	05/98→04/03	AJT	Diesel	2461	5	10	231
Transporter IV Platform/Chassis (70XD)	05/98→04/03	AXL	Diesel	2461	5	10	242
Transporter IV Platform/Chassis (70XD)	05/98→04/03	AYY	Diesel	2461	5	10	239
Transporter IV Platform/Chassis (70XD)	06/00→04/03	AMV	Petrol	2792	6	24	254
Transporter V Box (7HA, 7HH, 7EA, 7EH)	04/03→06/04	BDL	Petrol	3189	6	24	263
Transporter V Box (7HA, 7HH, 7EA, 7EH)	04/03→11/09	AXB	Diesel	1896	4	8	168
Transporter V Box (7HA, 7HH, 7EA, 7EH)	04/03→11/09	AXC	Diesel	1896	4	8	168
Transporter V Box (7HA, 7HH, 7EA, 7EH)	04/03→11/09	AXD	Diesel	2461	5	10	241
Transporter V Box (7HA, 7HH, 7EA, 7EH)	04/03→11/09	AXE	Diesel	2461	5	10	241
Transporter V Box (7HA, 7HH, 7EA, 7EH)	04/03→11/09	BNZ	Diesel	2461	5	10	246
Transporter V Box (7HA, 7HH, 7EA, 7EH)	04/03→11/09	BPC	Diesel	2461	5	10	246
Transporter V Box (7HA, 7HH, 7EA, 7EH)	11/03→11/09	BKK	Petrol	3189	6	24	263
Transporter V Box (7HA, 7HH, 7EA, 7EH)	11/03→11/09	CFLA	Petrol	3189	6	24	263
Transporter V Box (7HA, 7HH, 7EA, 7EH)	11/03→08/15	AXA	Petrol	1984	4	8	180
Transporter V Box (7HA, 7HH, 7EA, 7EH)	01/06→11/09	BRR	Diesel	1896	4	8	171
Transporter V Box (7HA, 7HH, 7EA, 7EH)	06/06→11/09	BRS	Diesel	1896	4	8	171
Transporter V Box (7HA, 7HH, 7EA, 7EH)	09/09→08/15	CAAA	Diesel	1968	4	16	194
Transporter V Box (7HA, 7HH, 7EA, 7EH)	09/09→08/15	CAAB	Diesel	1968	4	16	194
Transporter V Box (7HA, 7HH, 7EA, 7EH)	09/09→08/15	CAAC	Diesel	1968	4	16	194
Transporter V Box (7HA, 7HH, 7EA, 7EH)	09/09→08/15	CCHA	Diesel	1968	4	16	194
Transporter V Box (7HA, 7HH, 7EA, 7EH)	09/09→08/15	CFCA	Diesel	1968	4	16	194
Transporter V Box (7HA, 7HH, 7EA, 7EH)	05/10→08/15	CAAE	Diesel	1968	4	16	194
Transporter V Box (7HA, 7HH, 7EA, 7EH)	05/10→08/15	CCHB	Diesel	1968	4	16	194
Transporter V Box (7HA, 7HH, 7EA, 7EH)	05/11→08/15	CAAD	Diesel	1968	4	16	194
Transporter V Box (7HA, 7HH, 7EA, 7EH)	05/11→08/15	CJKA	Petrol	1984	4	16	201
Transporter V Box (7HA, 7HH, 7EA, 7EH)	07/12→08/15	CJKB	Petrol	1984	4	16	201
Transporter V Bus (7HB, 7HJ, 7EB, 7EJ, 7EF, 7EG, 7HF, 7EC)	04/03→11/09	AXB	Diesel	1896	4	8	168
Transporter V Bus (7HB, 7HJ, 7EB, 7EJ, 7EF, 7EG, 7HF, 7EC)	04/03→11/09	AXC	Diesel	1896	4	8	168
Transporter V Bus (7HB, 7HJ, 7EB, 7EJ, 7EF, 7EG, 7HF, 7EC)	04/03→11/09	AXD	Diesel	2461	5	10	241
Transporter V Bus (7HB, 7HJ, 7EB, 7EJ, 7EF, 7EG, 7HF, 7EC)	04/03→11/09	AXE	Diesel	2461	5	10	241
Transporter V Bus (7HB, 7HJ, 7EB, 7EJ, 7EF, 7EG, 7HF, 7EC)	04/03→11/09	BNZ	Diesel	2461	5	10	246
Transporter V Bus (7HB, 7HJ, 7EB, 7EJ, 7EF, 7EG, 7HF, 7EC)	04/03→11/09	BPC	Diesel	2461	5	10	246
Transporter V Bus (7HB, 7HJ, 7EB, 7EJ, 7EF, 7EG, 7HF, 7EC)	11/03→11/09	BKK	Petrol	3189	6	24	263
Transporter V Bus (7HB, 7HJ, 7EB, 7EJ, 7EF, 7EG, 7HF, 7EC)	11/03→11/09	BLJ	Diesel	2461	5	10	245
Transporter V Bus (7HB, 7HJ, 7EB, 7EJ, 7EF, 7EG, 7HF, 7EC)	11/03→11/09	CFLA	Petrol	3189	6	24	263
Transporter V Bus (7HB, 7HJ, 7EB, 7EJ, 7EF, 7EG, 7HF, 7EC)	11/03→08/15	AXA	Petrol	1984	4	8	180
Transporter V Bus (7HB, 7HJ, 7EB, 7EJ, 7EF, 7EG, 7HF, 7EC)	02/04→06/04	BDL	Petrol	3189	6	24	263
Transporter V Bus (7HB, 7HJ, 7EB, 7EJ, 7EF, 7EG, 7HF, 7EC)	01/06→11/09	BRR	Diesel	1896	4	8	171
Transporter V Bus (7HB, 7HJ, 7EB, 7EJ, 7EF, 7EG, 7HF, 7EC)	06/06→11/09	BRS	Diesel	1896	4	8	171
Transporter V Bus (7HB, 7HJ, 7EB, 7EJ, 7EF, 7EG, 7HF, 7EC)	09/09→08/15	CAAA	Diesel	1968	4	16	194
Transporter V Bus (7HB, 7HJ, 7EB, 7EJ, 7EF, 7EG, 7HF, 7EC)	09/09→08/15	CAAB	Diesel	1968	4	16	194
Transporter V Bus (7HB, 7HJ, 7EB, 7EJ, 7EF, 7EG, 7HF, 7EC)	09/09→08/15	CAAC	Diesel	1968	4	16	194
Transporter V Bus (7HB, 7HJ, 7EB, 7EJ, 7EF, 7EG, 7HF, 7EC)	09/09→08/15	CCHA	Diesel	1968	4	16	194
Transporter V Bus (7HB, 7HJ, 7EB, 7EJ, 7EF, 7EG, 7HF, 7EC)	09/09→08/15	CFCA	Diesel	1968	4	16	194
Transporter V Bus (7HB, 7HJ, 7EB, 7EJ, 7EF, 7EG, 7HF, 7EC)	05/10→08/15	CAAE	Diesel	1968	4	16	194
Transporter V Bus (7HB, 7HJ, 7EB, 7EJ, 7EF, 7EG, 7HF, 7EC)	05/10→08/15	CCHB	Diesel	1968	4	16	194
Transporter V Bus (7HB, 7HJ, 7EB, 7EJ, 7EF, 7EG, 7HF, 7EC)	05/11→08/15	CAAD	Diesel	1968	4	16	194
Transporter V Bus (7HB, 7HJ, 7EB, 7EJ, 7EF, 7EG, 7HF, 7EC)	05/11→08/15	CJKA	Petrol	1984	4	16	201
Transporter V Bus (7HB, 7HJ, 7EB, 7EJ, 7EF, 7EG, 7HF, 7EC)	07/12→08/15	CJKB	Petrol	1984	4	16	201
Transporter V Platform/Chassis (7JD, 7JE, 7JL, 7JY, 7JZ, 7FD)	04/03→11/09	AXB	Diesel	1896	4	8	168
Transporter V Platform/Chassis (7JD, 7JE, 7JL, 7JY, 7JZ, 7FD)	04/03→11/09	AXC	Diesel	1896	4	8	168
Transporter V Platform/Chassis (7JD, 7JE, 7JL, 7JY, 7JZ, 7FD)	04/03→11/09	AXD	Diesel	2461	5	10	241
Transporter V Platform/Chassis (7JD, 7JE, 7JL, 7JY, 7JZ, 7FD)	04/03→11/09	AXE	Diesel	2461	5	10	241



Model	Year Range	Code	Fuel	CC	Power (kW)	Power (hp)	Weight (kg)
Transporter V Platform/Chassis (7JD, 7JE, 7JL, 7JY, 7JZ, 7FD)	04/03→11/09	BNZ	Diesel	2461	5	10	246
Transporter V Platform/Chassis (7JD, 7JE, 7JL, 7JY, 7JZ, 7FD)	04/03→11/09	BPC	Diesel	2461	5	10	246
Transporter V Platform/Chassis (7JD, 7JE, 7JL, 7JY, 7JZ, 7FD)	08/03→05/06	BKK	Petrol	3189	6	24	263
Transporter V Platform/Chassis (7JD, 7JE, 7JL, 7JY, 7JZ, 7FD)	11/03→11/09	BDL	Petrol	3189	6	24	263
Transporter V Platform/Chassis (7JD, 7JE, 7JL, 7JY, 7JZ, 7FD)	11/03→05/13	AXA	Petrol	1984	4	8	180
Transporter V Platform/Chassis (7JD, 7JE, 7JL, 7JY, 7JZ, 7FD)	01/06→11/09	BRR	Diesel	1896	4	8	171
Transporter V Platform/Chassis (7JD, 7JE, 7JL, 7JY, 7JZ, 7FD)	06/06→11/09	BRS	Diesel	1896	4	8	171
Transporter V Platform/Chassis (7JD, 7JE, 7JL, 7JY, 7JZ, 7FD)	09/09→08/15	CAAA	Diesel	1968	4	16	194
Transporter V Platform/Chassis (7JD, 7JE, 7JL, 7JY, 7JZ, 7FD)	09/09→08/15	CAAB	Diesel	1968	4	16	194
Transporter V Platform/Chassis (7JD, 7JE, 7JL, 7JY, 7JZ, 7FD)	09/09→08/15	CAAC	Diesel	1968	4	16	194
Transporter V Platform/Chassis (7JD, 7JE, 7JL, 7JY, 7JZ, 7FD)	09/09→08/15	CAAC	Diesel	1968	4	16	194
Transporter V Platform/Chassis (7JD, 7JE, 7JL, 7JY, 7JZ, 7FD)	09/09→08/15	CAAE	Diesel	1968	4	16	194
Transporter V Platform/Chassis (7JD, 7JE, 7JL, 7JY, 7JZ, 7FD)	09/09→08/15	CAAE	Diesel	1968	4	16	194
Transporter V Platform/Chassis (7JD, 7JE, 7JL, 7JY, 7JZ, 7FD)	05/10→08/15	CCHB	Diesel	1968	4	16	194
Transporter V Platform/Chassis (7JD, 7JE, 7JL, 7JY, 7JZ, 7FD)	05/11→08/15	CAAD	Diesel	1968	4	16	194
Transporter V Platform/Chassis (7JD, 7JE, 7JL, 7JY, 7JZ, 7FD)	07/12→08/15	CJKB	Petrol	1984	4	16	201
Transporter VI Box (SGA, SGH)	04/15→	CAAA	Diesel	1968	4	16	194
Transporter VI Box (SGA, SGH)	04/15→	CAAB	Diesel	1968	4	16	194
Transporter VI Box (SGA, SGH)	04/15→	CAAC	Diesel	1968	4	16	194
Transporter VI Box (SGA, SGH)	04/15→	CFCA	Diesel	1968	4	16	194
Transporter VI Box (SGA, SGH)	04/15→	CJKA	Petrol	1984	4	16	201
Transporter VI Box (SGA, SGH)	04/15→	CJKB	Petrol	1984	4	16	201
Transporter VI Box (SGA, SGH)	04/15→	CXFA	Diesel	1968	4	16	210
Transporter VI Box (SGA, SGH)	04/15→	CXGA	Diesel	1968	4	16	210
Transporter VI Box (SGA, SGH)	04/15→	CXGB	Diesel	1968	4	16	210
Transporter VI Box (SGA, SGH)	04/15→	CXHA	Diesel	1968	4	16	209
Transporter VI Box (SGA, SGH)	06/15→	CXEB	Diesel	1968	4	16	209
Transporter VI Box (SGA, SGH)	05/16→	CXHB	Diesel	1968	4	16	209
Transporter VI Bus (SGB, SGG, SGJ)	04/15→	CAAA	Diesel	1968	4	16	194
Transporter VI Bus (SGB, SGG, SGJ)	04/15→	CAAB	Diesel	1968	4	16	194
Transporter VI Bus (SGB, SGG, SGJ)	04/15→	CAAC	Diesel	1968	4	16	194
Transporter VI Bus (SGB, SGG, SGJ)	04/15→	CFCA	Diesel	1968	4	16	194
Transporter VI Bus (SGB, SGG, SGJ)	04/15→	CJKA	Petrol	1984	4	16	201
Transporter VI Bus (SGB, SGG, SGJ)	04/15→	CJKB	Petrol	1984	4	16	201
Transporter VI Bus (SGB, SGG, SGJ)	04/15→	CXFA	Diesel	1968	4	16	210
Transporter VI Bus (SGB, SGG, SGJ)	04/15→	CXGA	Diesel	1968	4	16	210
Transporter VI Bus (SGB, SGG, SGJ)	04/15→	CXGB	Diesel	1968	4	16	210
Transporter VI Bus (SGB, SGG, SGJ)	04/15→	CXHA	Diesel	1968	4	16	209
Transporter VI Bus (SGB, SGG, SGJ)	06/15→	CXEB	Diesel	1968	4	16	209
Transporter VI Bus (SGB, SGG, SGJ)	05/16→	CXGC	Diesel	1968	4	16	209
Transporter VI Bus (SGB, SGG, SGJ)	05/16→	CXHB	Diesel	1968	4	16	209
Transporter VI Platform/Chassis (SFD, SFE, SFL, SFZ)	04/15→	CAAA	Diesel	1968	4	16	194
Transporter VI Platform/Chassis (SFD, SFE, SFL, SFZ)	04/15→	CAAB	Diesel	1968	4	16	194
Transporter VI Platform/Chassis (SFD, SFE, SFL, SFZ)	04/15→	CAAC	Diesel	1968	4	16	194
Transporter VI Platform/Chassis (SFD, SFE, SFL, SFZ)	04/15→	CFCA	Diesel	1968	4	16	194
Transporter VI Platform/Chassis (SFD, SFE, SFL, SFZ)	04/15→	CJKB	Petrol	1984	4	16	201
Transporter VI Platform/Chassis (SFD, SFE, SFL, SFZ)	04/15→	CXGA	Diesel	1968	4	16	210
Transporter VI Platform/Chassis (SFD, SFE, SFL, SFZ)	04/15→	CXGB	Diesel	1968	4	16	210
Transporter VI Platform/Chassis (SFD, SFE, SFL, SFZ)	08/15→	CXHA	Diesel	1968	4	16	209
Transporter VI Platform/Chassis (SFD, SFE, SFL, SFZ)	05/16→	CXEB	Diesel	1968	4	16	209
Transporter VI Platform/Chassis (SFD, SFE, SFL, SFZ)	05/16→	CXHB	Diesel	1968	4	16	209
Up (121, 122, BL1, BL2)	08/11→	CHYA	Petrol	999	3	12	14
Up (121, 122, BL1, BL2)	08/11→	CHYB	Petrol	999	3	12	14
Up (121, 122, BL1, BL2)	11/12→	CPGA	Petrol	999	3	12	14
Up (121, 122, BL1, BL2)	05/16→	CHZA	Petrol	999	3	12	14
Van Mini Passenger Van	09/07→12/09	ADD	Petrol	1781	4	8	125
Vento	01/10→12/12	CFNA	Petrol	1598	4	16	103
Vento	01/10→	CBZB	Petrol	1197	4	8	24
Vento	01/10→	CWXB	Diesel	1498	4	16	71
Vento (1H2)	11/91→07/98	AAC	Petrol	1968	4	8	177
Vento (1H2)	11/91→09/98	1Y	Diesel	1896	4	8	153
Vento (1H2)	11/91→09/98	2E	Petrol	1984	4	8	175
Vento (1H2)	11/91→09/98	AAM	Petrol	1781	4	8	123
Vento (1H2)	11/91→09/98	AAZ	Diesel	1896	4	8	156
Vento (1H2)	11/91→09/98	ABD	Petrol	1390	4	8	40
Vento (1H2)	11/91→09/98	ABS	Petrol	1781	4	8	124
Vento (1H2)	11/91→09/98	ACC	Petrol	1781	4	8	125
Vento (1H2)	11/91→09/98	ADD	Petrol	1781	4	8	125
Vento (1H2)	11/91→09/98	ADY	Petrol	1984	4	8	179
Vento (1H2)	11/91→09/98	ADZ	Petrol	1781	4	8	128
Vento (1H2)	11/91→09/98	AEX	Petrol	1390	4	8	41
Vento (1H2)	11/91→09/98	AGG	Petrol	1984	4	8	178
Vento (1H2)	11/91→09/98	AKR	Petrol	1984	4	8	181
Vento (1H2)	01/92→09/98	AAA	Petrol	2792	6	12	247
Vento (1H2)	09/92→09/98	ABU	Petrol	1598	4	8	80
Vento (1H2)	09/92→09/98	AEA	Petrol	1598	4	8	83
Vento (1H2)	09/92→09/98	AEE	Petrol	1598	4	8	83
Vento (1H2)	09/93→09/98	1Z	Diesel	1896	4	8	154
Vento (1H2)	09/93→09/98	AHU	Diesel	1896	4	8	167



















CC



















9









Model	Year Range	Code	Fuel Type	CC	Cylinders	Power (kW)	Power (hp)
Vento (1H2)	09/93→09/98	ALE	Diesel	1896	4	8	166
Vento (1H2)	10/94→09/98	AEK	Petrol	1595	4	8	85
Vento (1H2)	10/94→09/98	AFT	Petrol	1595	4	8	82
Vento (1H2)	04/96→09/98	AFN	Diesel	1896	4	8	162
Vento (1H2)	05/96→12/97	AEP	Petrol	1984	4	8	181
Vento (1H2)	04/97→09/98	AEY	Diesel	1896	4	8	161
Voyage	05/84→09/88	RM	Petrol	1781	4	8	121
Voyage	05/96→07/02	AGY	Petrol	1390	4	8	44
Voyage	06/96→09/01	1Y	Diesel	1896	4	8	153
Voyage	08/96→12/01	AER	Petrol	999	4	8	4
Voyage	09/99→09/01	1Z	Diesel	1896	4	8	154
Voyage	07/08→	CCNA	Petrol	999	4	8	9
Voyage	07/08→	CFZA	Petrol	1598	4	8	98
Voyage	10/08→	CCRA	Petrol	1598	4	8	98
XLI	02/14→	CSCA	Diesel	829	2	8	1









	CC				9		CC				9
1C	1588	4	8	Diesel	77	AEG	1984	4	8	Petrol	180
1E	2383	6	12	Petrol	224	AEH	1595	4	8	Petrol	84
1F	1595	4	8	Petrol	78	AEK	1595	4	8	Petrol	85
1G	2383	6	12	Diesel	225	AEN	2459	5	10	Petrol	232
1H	1781	4	8	Petrol	121	AEN	2461	5	10	Petrol	230
1P	1781	4	8	Petrol	121	AEP	1984	4	8	Petrol	181
1S	2383	6	12	Diesel	225	AER	999	4	8	Petrol	4
1V	1589	4	8	Diesel	77	AES	2792	6	12	Petrol	247
1W	1398	4	8	Diesel	39	AET	2461	5	10	Petrol	233
1X	1896	4	8	Diesel	152	AEU	2461	5	10	Petrol	230
1Y	1896	4	8	Diesel	153	AEV	1043	4	8	Petrol	5
1Z	1896	4	8	Diesel	154	AEX	1390	4	8	Petrol	41
2E	1984	4	8	Petrol	175	AEY	1896	4	8	Diesel	161
2G	1272	4	8	Petrol	29	AF	1584	4	8	Petrol	81
2H	1781	4	8	Petrol	121	AFB	2496	6	24	Diesel	234
2L	2446	4	8	Diesel	226	AFD	1896	4	8	Diesel	159
2Y	1812	4	8	Petrol	122	AFE	1781	4	8	Petrol	130
3F	1272	4	8	Petrol	29	AFH	1390	4	16	Petrol	42
4Y	2237	4	8	Petrol	217	AFK	1390	4	16	Petrol	43
9A	1984	4	16	Petrol	176	AFN	1896	4	8	Diesel	162
22R	2366	4	8	Petrol	227	AFP	2792	6	12	Petrol	250
28B	1896	4	8	Diesel	155	AFT	1595	4	8	Petrol	82
68A	1588	4	8	Diesel	77	AFX	1595	4	8	Petrol	86
68C	1588	4	8	Diesel	77	AFY	1781	4	20	Petrol	127
122	1192	4	8	Petrol	18	AFY	1781	4	20	Petrol	131
262	1781	4	8	Petrol	121	AG	1584	4	8	Petrol	81
496	1588	4	8	Petrol	78	AGD	1896	4	8	Diesel	163
682	1471	4	8	Diesel	69	AGE	2771	6	30	Petrol	251
685	1588	4	8	Diesel	77	AGE	2771	6	30	Petrol	252
686	1588	4	8	Diesel	77	AGG	1984	4	8	Petrol	178
AAA	2792	6	12	Petrol	247	AGL	2295	4	16	Petrol	220
AAA	2792	6	12	Petrol	248	AGN	1781	4	20	Petrol	132
AAB	2370	5	10	Diesel	228	AGP	1896	4	8	Diesel	164
AAC	1968	4	8	Petrol	177	AGR	1896	4	8	Diesel	164
AAF	2461	5	10	Petrol	230	AGU	1781	4	20	Petrol	132
AAK	1043	4	8	Petrol	3	AGX	2461	5	10	Diesel	235
AAM	1781	4	8	Petrol	123	AGY	1390	4	8	Petrol	44
AAU	1043	4	8	Petrol	3	AGZ	2324	5	10	Petrol	221
AAV	1272	4	8	Petrol	29	AH	1584	4	8	Petrol	81
AAZ	1896	4	8	Diesel	156	AHA	2771	6	30	Petrol	252
AB	1285	4	8	Petrol	30	AHB	1716	4	8	Diesel	115
ABA	1984	4	8	Petrol	178	AHD	2461	5	10	Diesel	235
ABD	1390	4	8	Petrol	40	AHF	1896	4	8	Diesel	165
ABF	1984	4	16	Petrol	176	AHG	1716	4	8	Diesel	115
ABG	1781	4	8	Petrol	121	AHH	1896	4	8	Diesel	166
ABL	1896	4	8	Diesel	157	AHL	1595	4	8	Petrol	87
ABN	1595	4	8	Petrol	79	AHS	1598	4	8	Petrol	88
ABS	1781	4	8	Petrol	124	AHT	997	4	8	Petrol	6
ABU	1598	4	8	Petrol	80	AHU	1896	4	8	Diesel	167
ABV	2861	6	12	Petrol	255	AHW	1390	4	16	Petrol	45
ABX	1595	4	8	Petrol	79	AHY	2461	5	10	Diesel	236
ABX	1595	4	8	Petrol	79	AJ	1584	4	8	Petrol	81
AC	1285	4	8	Petrol	30	AJA	2370	5	10	Diesel	228
ACC	1781	4	8	Petrol	125	AJD	1324	4	8	Petrol	32
ACD	1584	4	8	Petrol	81	AJH	1781	4	20	Petrol	133
ACK	2771	6	30	Petrol	249	AJM	1896	4	8	Diesel	168
ACL	2383	6	12	Diesel	229	AJT	2461	5	10	Diesel	231
ACM	1043	4	8	Petrol	3	AJV	1598	4	16	Petrol	89
ACT	2383	6	12	Diesel	225	AK	1584	4	8	Petrol	81
ACU	2461	5	10	Petrol	230	AKK	1390	4	8	Petrol	46
ACV	2461	5	10	Diesel	231	AKL	1595	4	8	Petrol	84
AD	1584	4	8	Petrol	81	AKN	2496	6	24	Diesel	234
ADC	1984	4	8	Petrol	178	AKP	1390	4	8	Petrol	47
ADD	1781	4	8	Petrol	125	AKQ	1390	4	16	Petrol	43
ADE	1896	4	8	Diesel	158	AKR	1984	4	8	Petrol	181
ADF	1781	4	8	Petrol	126	AKS	1595	4	8	Petrol	82
ADG	1896	4	8	Diesel	159	AKU	1716	4	8	Diesel	116
ADK	1588	4	8	Diesel	77	AKV	1390	4	8	Petrol	48
ADP	1595	4	8	Petrol	82	AKW	1716	4	8	Diesel	115
ADR	1781	4	20	Petrol	127	AL	1584	4	8	Petrol	81
ADX	1296	4	8	Petrol	31	ALD	999	4	8	Petrol	7
ADY	1984	4	8	Petrol	179	ALE	1896	4	8	Diesel	166
ADZ	1781	4	8	Petrol	128	ALG	2771	6	30	Petrol	253
AE	1584	4	8	Petrol	81	ALH	1896	4	8	Diesel	164
AEA	1598	4	8	Petrol	83	ALL	999	4	8	Petrol	8
AEB	1781	4	20	Petrol	129	ALM	1598	4	8	Petrol	90
AEE	1598	4	8	Petrol	83	ALT	1984	4	20	Petrol	182
AEF	1896	4	8	Diesel	160	ALZ	1595	4	8	Petrol	91









	CC				9		CC				9
AM	1584	4	8	Petrol	81	AUM	1781	4	20	Petrol	132
AMF	1422	3	6	Diesel	49	AUQ	1781	4	20	Petrol	132
AMV	2792	6	24	Petrol	254	AUR	1595	4	8	Petrol	87
AMX	2771	6	30	Petrol	253	AUS	1598	4	16	Petrol	94
AMY	2792	6	12	Petrol	247	AUY	1896	4	8	Diesel	168
AN	1795	4	8	Petrol	134	AUZ	1984	4	8	Petrol	180
ANA	1595	4	8	Petrol	87	AVB	1896	4	8	Diesel	168
ANB	1781	4	20	Petrol	135	AVC	1781	4	20	Petrol	133
ANC	1896	4	8	Diesel	168	AVF	1896	4	8	Diesel	168
ANF	2461	5	10	Diesel	237	AVG	1896	4	8	Diesel	166
ANG	2461	5	10	Diesel	237	AVH	1984	4	8	Petrol	180
ANH	2461	5	10	Diesel	237	AVM	1896	4	8	Diesel	168
ANJ	2461	5	10	Diesel	238	AVQ	1896	4	8	Diesel	171
ANM	1390	4	16	Petrol	43	AVR	2461	5	10	Diesel	238
ANN	1781	4	8	Petrol	136	AVT	2461	5	10	Petrol	240
ANP	1781	4	8	Petrol	136	AVU	1595	4	8	Petrol	91
ANQ	1781	4	20	Petrol	137	AVY	1598	4	16	Petrol	92
ANQ	1781	4	20	Petrol	138	AWB	1595	4	20	Petrol	95
ANU	1896	4	8	Diesel	168	AWB	1595	4	20	Petrol	96
ANV	999	4	8	Petrol	7	AWC	1781	4	20	Petrol	133
ANW	1390	4	8	Petrol	46	AWD	1781	4	20	Petrol	140
ANX	1390	4	8	Petrol	50	AWF	1984	4	8	Petrol	183
ANY	1191	3	6	Diesel	19	AWG	1984	4	8	Petrol	183
AP	1795	4	8	Petrol	134	AWH	1595	4	8	Petrol	87
APA	2461	5	10	Diesel	238	AWL	1781	4	20	Petrol	132
APE	1390	4	16	Petrol	43	AWL	1781	4	20	Petrol	137
APF	1595	4	8	Petrol	87	AWM	1781	4	20	Petrol	132
APH	1781	4	20	Petrol	133	AWP	1781	4	20	Petrol	133
APK	1984	4	8	Petrol	180	AWT	1781	4	20	Petrol	132
APK	1984	4	8	Petrol	180	AWU	1781	4	20	Petrol	133
APL	2461	5	10	Petrol	233	AWV	1781	4	20	Petrol	133
APQ	1390	4	8	Petrol	50	AWW	1781	4	20	Petrol	141
APR	2771	6	30	Petrol	253	AWX	1896	4	8	Diesel	168
APT	1781	4	20	Petrol	139	AWY	1198	3	6	Petrol	20
APU	1781	4	20	Petrol	139	AXA	1984	4	8	Petrol	180
AQA	1781	4	20	Petrol	132	AXB	1896	4	8	Diesel	168
AQD	2771	6	30	Petrol	253	AXC	1896	4	8	Diesel	168
AQM	1896	4	8	Diesel	169	AXD	2461	5	10	Diesel	241
AQN	2324	5	20	Petrol	222	AXE	2461	5	10	Diesel	241
AQP	2792	6	24	Petrol	254	AXG	2461	5	10	Diesel	236
AQQ	1390	4	16	Petrol	51	AXJ	3189	6	24	Petrol	263
AQY	1984	4	8	Petrol	180	AXL	2461	5	10	Diesel	242
AQZ	999	4	8	Petrol	9	AXP	1390	4	16	Petrol	43
AR	1285	4	8	Petrol	30	AXQ	4172	8	40	Petrol	268
ARA	999	4	16	Petrol	10	AXR	1896	4	8	Diesel	168
ARC	1598	4	16	Petrol	92	AXU	1390	4	16	Petrol	53
ARD	1896	4	8	Diesel	168	AXW	1984	4	16	Petrol	184
ARG	1781	4	20	Petrol	139	AXX	1984	4	16	Petrol	185
ARL	1896	4	8	Diesel	168	AXZ	3168	6	24	Petrol	263
ARM	1595	4	8	Petrol	93	AXZ	3168	6	24	Petrol	264
ARR	1390	4	16	Petrol	52	AYC	2461	5	10	Diesel	239
ARX	1781	4	20	Petrol	132	AYD	1595	4	8	Petrol	91
ARZ	1781	4	20	Petrol	132	AYL	2792	6	24	Petrol	254
AS	1584	4	8	Petrol	81	AYQ	1896	4	8	Diesel	169
ASU	1984	4	8	Petrol	180	AYT	3189	6	24	Petrol	263
ASV	1896	4	8	Diesel	169	AYY	2461	5	10	Diesel	239
ASW	999	4	16	Petrol	11	AYZ	1191	3	6	Diesel	19
ASX	1896	4	8	Diesel	166	AZD	1598	4	16	Petrol	89
ASY	1896	4	8	Diesel	168	AZG	1984	4	8	Petrol	180
ASZ	1896	4	8	Diesel	168	AZH	1984	4	8	Petrol	180
AT	1795	4	8	Petrol	134	AZJ	1984	4	8	Petrol	180
ATD	1896	4	8	Diesel	168	AZM	1984	4	8	Petrol	180
ATD	1896	4	8	Diesel	170	AZN	999	4	8	Petrol	9
ATE	999	4	8	Petrol	7	AZP	999	4	16	Petrol	12
ATJ	1896	4	8	Diesel	168	AZQ	1198	3	12	Petrol	21
ATL	1422	3	6	Diesel	49	AZV	1968	4	16	Diesel	186
ATM	1984	4	8	Petrol	180	AZX	2324	5	20	Petrol	223
ATN	1598	4	16	Petrol	94	AZZ	3189	6	24	Petrol	263
ATQ	2771	6	30	Petrol	253	BAA	3189	6	24	Petrol	263
ATU	1984	4	8	Petrol	183	BAC	2461	5	10	Diesel	241
ATX	2771	6	30	Petrol	253	BAD	1598	4	16	Petrol	92
ATX	2771	6	30	Petrol	253	BAE	1781	4	20	Petrol	131
AUA	1390	4	16	Petrol	43	BAE	1781	4	20	Petrol	133
AUB	1390	4	16	Petrol	43	BAF	1781	4	20	Petrol	133
AUC	999	4	8	Petrol	7	BAF	1781	4	20	Petrol	142
AUD	1390	4	8	Petrol	47	BAG	1598	4	16	Petrol	97
AUE	2792	6	24	Petrol	254	BAH	1598	4	8	Petrol	98
AUF	2461	5	10	Diesel	239	BAN	5998	12	48	Petrol	273

	CC				9		CC				9
BAR	4163	8	32	Petrol	269	BJY	1781	4	8	Petrol	101
BAU	2496	6	24	Diesel	234	BJZ	1984	4	16	Petrol	191
BAY	1422	3	6	Diesel	49	BKC	1896	4	8	Diesel	171
BBE	2461	5	10	Diesel	238	BKD	1968	4	16	Diesel	186
BBF	2461	5	10	Diesel	238	BKF	1781	4	20	Petrol	133
BBG	2771	6	30	Petrol	253	BKG	1390	4	16	Petrol	55
BBJ	2771	6	30	Petrol	253	BKJ	3189	6	24	Petrol	263
BBM	1198	3	6	Petrol	20	BKK	3189	6	24	Petrol	263
BBR	2461	5	10	Diesel	237	BKL	3189	6	24	Petrol	263
BBU	1781	4	20	Petrol	133	BKP	1968	4	16	Diesel	186
BBW	1984	4	8	Petrol	180	BKR	1390	4	8	Petrol	56
BBX	1984	4	8	Petrol	180	BKS	2967	6	24	Diesel	256
BBY	1390	4	16	Petrol	43	BKT	1781	4	8	Petrol	144
BBZ	1390	4	16	Petrol	43	BKU	1781	4	8	Petrol	144
BCA	1390	4	16	Petrol	43	BKU	1781	4	8	Petrol	145
BCB	1598	4	16	Petrol	94	BKY	1390	4	16	Petrol	43
BCC	1390	4	16	Petrol	54	BLF	1598	4	16	Petrol	97
BCD	1595	4	8	Petrol	99	BLG	1390	4	16	Petrol	53
BDC	1984	4	8	Petrol	180	BLH	1598	4	8	Petrol	100
BDE	2792	6	24	Petrol	254	BLJ	2461	5	10	Diesel	245
BDF	2792	6	24	Petrol	254	BLK	2461	5	10	Diesel	245
BDG	2496	6	24	Diesel	234	BLM	1390	4	8	Petrol	47
BDH	2496	6	24	Diesel	234	BLN	1390	4	16	Petrol	55
BDJ	1968	4	8	Diesel	187	BLP	1598	4	16	Petrol	97
BDJ	1968	4	8	Diesel	187	BLR	1984	4	16	Petrol	184
BDJ	1996	4	8	Petrol	188	BLS	1896	4	8	Diesel	171
BDK	1968	4	8	Diesel	187	BLT	1896	4	8	Diesel	168
BDL	3189	6	24	Petrol	263	BLV	3597	6	24	Petrol	265
BDN	3999	8	32	Petrol	267	BLX	1984	4	16	Petrol	184
BDP	3999	8	32	Petrol	267	BLY	1984	4	16	Petrol	184
BEF	1984	4	8	Gas	189	BMA	1968	4	16	Diesel	186
BEH	1984	4	8	Petrol	180	BMD	1198	3	6	Petrol	22
BEJ	1984	4	8	Petrol	180	BME	1198	3	12	Petrol	21
BEQ	1896	4	8	Diesel	168	BMG	1390	4	16	Petrol	53
BER	1984	4	8	Petrol	180	BMH	1598	4	16	Petrol	103
BEU	1896	4	8	Diesel	168	BMK	2967	6	24	Diesel	256
BEV	1984	4	8	Petrol	180	BML	3189	6	24	Petrol	263
BEW	1896	4	8	Diesel	168	BMM	1968	4	8	Diesel	187
BFF	1984	4	8	Petrol	180	BMN	1968	4	16	Diesel	186
BFH	1984	4	8	Petrol	180	BMP	1968	4	8	Diesel	187
BFQ	3189	6	24	Petrol	263	BMR	1968	4	16	Diesel	186
BFQ	1595	4	8	Petrol	91	BMS	1422	3	6	Diesel	57
BFS	1595	4	8	Petrol	91	BMT	1896	4	8	Diesel	171
BGC	1781	4	20	Petrol	131	BMV	3189	6	24	Petrol	263
BGD	1984	4	8	Petrol	180	BMX	3189	6	24	Petrol	263
BGG	1896	4	8	Diesel	172	BMY	1390	4	16	Petrol	53
BGH	4172	8	40	Petrol	270	BNG	1390	4	16	Petrol	58
BGJ	4172	8	40	Petrol	270	BNL	1984	4	8	Petrol	180
BGL	1896	4	8	Diesel	168	BNL	1984	4	8	Petrol	180
BGM	1896	4	8	Diesel	168	BNN	1422	3	6	Diesel	49
BGP	2480	5	20	Petrol	243	BNU	1781	4	20	Petrol	133
BGQ	2480	5	20	Petrol	243	BNV	1422	3	6	Diesel	49
BGU	1595	4	8	Petrol	91	BNW	999	4	8	Petrol	9
BGW	1968	4	8	Diesel	190	BNX	999	4	8	Petrol	9
BHG	1781	4	8	Petrol	143	BNY	1781	4	8	Petrol	146
BHK	3597	6	24	Petrol	265	BNZ	2461	5	10	Diesel	246
BHL	3597	6	24	Petrol	265	BPA	1598	4	8	Petrol	98
BHP	1984	4	8	Petrol	180	BPC	2461	5	10	Diesel	246
BHW	1968	4	8	Diesel	190	BPD	2461	5	10	Diesel	246
BHX	4172	8	40	Petrol	270	BPE	2461	5	10	Diesel	246
BHY	1984	4	8	Petrol	180	BPF	3189	6	24	Petrol	263
BJA	1598	4	8	Petrol	100	BPL	1781	4	20	Petrol	131
BJB	1896	4	8	Diesel	171	BPR	2480	5	20	Petrol	243
BJC	1896	4	8	Diesel	168	BPS	2480	5	20	Petrol	243
BJE	999	4	8	Petrol	13	BPY	1984	4	16	Petrol	185
BJF	1596	4	8	Petrol	101	BPZ	1896	4	8	Diesel	168
BJG	1595	4	8	Petrol	102	BRJ	3189	6	24	Petrol	263
BJH	1595	4	8	Petrol	91	BRK	3189	6	24	Petrol	263
BJH	1595	4	8	Petrol	91	BRM	1896	4	8	Diesel	171
BJI	1595	4	8	Petrol	91	BRN	5998	12	48	Petrol	273
BJJ	2461	5	10	Diesel	244	BRR	1896	4	8	Diesel	171
BJK	2461	5	10	Diesel	244	BRS	1896	4	8	Diesel	171
BJL	2461	5	10	Diesel	244	BRT	1968	4	8	Diesel	187
BJM	2461	5	10	Diesel	244	BRU	1896	4	8	Diesel	171
BJN	5998	12	48	Petrol	273	BRY	1595	4	8	Petrol	91
BJR	999	4	8	Petrol	9	BRY	1595	4	8	Petrol	91
BJS	3189	6	24	Petrol	263	BSA	1781	4	8	Petrol	143
BJX	1781	4	20	Petrol	133	BSC	1423	4	8	Petrol	59

	CC				9		CC				9
BSE	1595	4	8	Petrol	91	CBBB	1968	4	16	Diesel	194
BSF	1595	4	8	Petrol	91	CBDA	1968	4	16	Diesel	194
BSL	1781	4	8	Petrol	143	CBDB	1968	4	16	Diesel	194
BSP	2967	6	24	Diesel	257	CBDC	1968	4	16	Diesel	194
BST	1968	4	8	Diesel	187	CBEA	1968	4	16	Diesel	197
BSU	1896	4	8	Diesel	171	CBFA	1984	4	16	Petrol	195
BSW	1896	4	8	Diesel	168	CBHA	1968	4	8	Diesel	198
BSX	1984	4	8	Gas	192	CBJB	1968	4	8	Diesel	198
BTB	1896	4	8	Diesel	168	CBKA	1968	4	8	Diesel	199
BTH	1781	4	20	Petrol	131	CBL	1984	4	16	Petrol	195
BTK	2480	5	20	Petrol	243	CBLA	1984	4	16	Petrol	195
BTL	1984	4	8	Petrol	180	CBPA	1984	4	8	Petrol	180
BTL	1984	4	8	Petrol	180	CBR	3189	6	24	Petrol	263
BTS	1598	4	16	Petrol	103	CBRA	3189	6	24	Petrol	264
BTT	5998	12	48	Petrol	273	CBSA	1984	4	8	Gas	189
BTY	999	4	8	Petrol	9	CBTA	2480	5	20	Petrol	243
BUB	3189	6	24	Petrol	263	CBUA	2480	5	20	Petrol	243
BUD	1390	4	16	Petrol	60	CBWA	4921	10	20	Diesel	272
BUK	1896	4	8	Diesel	168	CBZA	1197	4	8	Petrol	24
BUN	2967	6	24	Diesel	256	CBZB	1197	4	8	Petrol	24
BUZ	1968	4	16	Diesel	186	CBZC	1197	4	8	Petrol	24
BVD	1968	4	16	Diesel	193	CCCA	2480	5	20	Petrol	243
BVE	1968	4	16	Diesel	186	CCHA	1968	4	16	Diesel	194
BVH	1968	4	8	Diesel	187	CCHB	1968	4	16	Diesel	194
BVK	1896	4	8	Diesel	168	CCNA	999	4	8	Petrol	9
BVX	1984	4	16	Petrol	184	CCRA	1598	4	8	Petrol	98
BVY	1984	4	16	Petrol	184	CCSA	1595	4	8	Petrol	91
BVZ	1984	4	16	Petrol	184	CCTA	1984	4	16	Petrol	195
BWA	1984	4	16	Petrol	185	CCTB	1984	4	16	Petrol	195
BWB	1422	3	6	Diesel	57	CCZA	1984	4	16	Petrol	195
BWH	1595	4	8	Petrol	104	CCZB	1984	4	16	Petrol	195
BWK	1390	4	16	Petrol	53	CCZC	1984	4	16	Petrol	195
BWS	3597	6	24	Petrol	265	CCZD	1984	4	16	Petrol	195
BWV	1968	4	16	Diesel	186	CDAA	1798	4	16	Petrol	147
BWX	1596	4	8	Petrol	101	CDAA	1798	4	16	Petrol	147
BXE	1896	4	8	Diesel	171	CDAB	1798	4	16	Petrol	147
BXF	1896	4	8	Diesel	171	CDBA	1968	4	16	Diesel	194
BXJ	1896	4	8	Diesel	171	CDCA	1968	4	16	Diesel	194
BXT	1896	4	8	Diesel	168	CDDA	1390	4	16	Petrol	61
BXV	1198	3	12	Petrol	23	CDE	1598	4	16	Petrol	103
BYD	1984	4	16	Petrol	185	CDEA	1598	4	16	Petrol	103
BYJ	1798	4	16	Petrol	147	CDF	1598	4	16	Petrol	103
BYJ	1798	4	16	Petrol	147	CDGA	1390	4	16	Petrol	62
BZB	1798	4	16	Petrol	147	CDLA	1984	4	16	Petrol	185
BZB	1798	4	16	Petrol	147	CDLC	1984	4	16	Petrol	185
BZF	1806	4	8	Petrol	125	CDLF	1984	4	16	Petrol	185
BZG	1198	3	12	Petrol	23	CDLG	1984	4	16	Petrol	185
CA	1679	4	8	Petrol	117	CDLJ	1984	4	16	Petrol	185
CAAA	1968	4	16	Diesel	194	CDLK	1984	4	16	Petrol	185
CAAB	1968	4	16	Diesel	194	CDVA	3597	6	24	Petrol	265
CAAC	1968	4	16	Diesel	194	CDVB	3598	6	24	Petrol	265
CAAD	1968	4	16	Diesel	194	CDXA	1896	4	8	Diesel	168
CAAE	1968	4	16	Diesel	194	CDXB	1896	4	8	Diesel	168
CARA	2967	6	24	Diesel	256	CE	1679	4	8	Petrol	117
CARB	2967	6	24	Diesel	256	CEA	1798	4	16	Petrol	147
CASA	2967	6	24	Diesel	256	CEA	1798	4	16	Petrol	147
CASB	2967	6	24	Diesel	256	CEAA	1798	4	16	Petrol	147
CASC	2967	6	24	Diesel	256	CEBA	2461	5	10	Diesel	244
CASD	2967	6	24	Diesel	256	CEBB	2461	5	10	Diesel	244
CATA	2967	6	24	Diesel	256	CECA	2461	5	10	Diesel	244
CAVA	1390	4	16	Petrol	53	CECB	2461	5	10	Diesel	244
CAVB	1390	4	16	Petrol	53	CED	1781	4	20	Petrol	148
CAVC	1390	4	16	Petrol	53	CEGA	1968	4	16	Diesel	194
CAVD	1390	4	16	Petrol	53	CEN	1984	4	8	Petrol	180
CAVE	1390	4	16	Petrol	53	CEN	1984	4	8	Petrol	180
CAWA	1984	4	16	Petrol	195	CENA	1984	4	16	Petrol	200
CAWB	1984	4	16	Petrol	195	CEXA	2967	6	24	Diesel	256
CAXA	1390	4	16	Petrol	53	CEXB	2967	6	24	Diesel	256
CAYA	1598	4	16	Diesel	105	CEZA	2967	6	24	Diesel	257
CAYB	1598	4	16	Diesel	105	CFB	1390	4	16	Petrol	53
CAYC	1598	4	16	Diesel	105	CFBA	1390	4	16	Petrol	63
CAYD	1598	4	16	Diesel	106	CFCA	1968	4	16	Diesel	194
CAYE	1598	4	16	Diesel	106	CFEA	1984	4	8	Petrol	180
CB	1679	4	8	Petrol	117	CFFA	1968	4	16	Diesel	194
CBAA	1968	4	16	Diesel	194	CFFB	1968	4	16	Diesel	194
CBAB	1968	4	16	Diesel	194	CFFD	1968	4	16	Diesel	194
CBAC	1968	4	16	Diesel	194	CFFE	1968	4	16	Diesel	194
CBBA	1968	4	16	Diesel	196	CFGB	1968	4	16	Diesel	194

	CC				9		CC				9
CFGC	1968	4	16	Diesel	194	CKTB	1968	4	16	Diesel	194
CFHB	1968	4	16	Diesel	194	CKTC	1968	4	16	Diesel	194
CFHC	1968	4	16	Diesel	194	CKUC	1968	4	16	Diesel	194
CFHE	1968	4	16	Diesel	194	CKUC	1968	4	16	Diesel	194
CFHF	1968	4	16	Diesel	194	CLCA	1968	4	16	Diesel	194
CFJA	1968	4	16	Diesel	194	CLCB	1968	4	16	Diesel	194
CFJB	1968	4	16	Diesel	194	CLHA	1598	4	16	Diesel	107
CFLA	3189	6	24	Petrol	263	CLHB	1598	4	16	Diesel	107
CFMA	1781	4	20	Petrol	148	CLJA	1968	4	16	Diesel	194
CFNA	1598	4	16	Petrol	103	CLLA	1968	4	16	Diesel	206
CFNB	1598	4	16	Petrol	103	CLNA	1598	4	16	Diesel	106
CFPA	1984	4	16	Petrol	195	CLPA	1390	4	16	Petrol	53
CFRA	5998	12	48	Petrol	273	CLR	1598	4	16	Petrol	103
CFWA	1199	3	12	Diesel	25	CLRA	1598	4	16	Petrol	103
CFZA	1598	4	8	Petrol	98	CLRA	1598	4	16	Petrol	103
CGEA	2995	6	24	Petrol	258	CLS	1598	4	16	Petrol	103
CGFA	2995	6	24	Petrol	258	CLSA	1598	4	16	Petrol	103
CGGA	1390	4	16	Petrol	43	CMAA	1390	4	16	Petrol	43
CGGB	1390	4	16	Petrol	43	CMBA	1395	4	16	Petrol	64
CGM	1984	4	16	Petrol	195	CMR	1595	4	8	Petrol	108
CGM	1984	4	16	Petrol	201	CMSB	1390	4	16	Petrol	53
CGMA	1984	4	16	Petrol	195	CMTA	3597	6	24	Petrol	265
CGNA	4163	8	32	Petrol	269	CMVA	3597	6	24	Petrol	265
CGPA	1198	3	12	Petrol	23	CMXA	1595	4	8	Petrol	91
CGPB	1198	3	12	Petrol	23	CNEA	1968	4	16	Diesel	194
CGRA	3597	6	24	Petrol	265	CNFA	1968	4	16	Diesel	194
CGYA	1798	4	16	Petrol	147	CNFB	1968	4	16	Diesel	194
CGZ	1984	4	8	Petrol	180	CNG	2975	6	24	Petrol	259
CH	1984	4	8	Petrol	202	CNGA	2975	6	24	Petrol	259
CHFA	1198	3	6	Petrol	22	CNKA	1598	4	16	Petrol	103
CHFB	1198	3	6	Petrol	22	CNLA	1395	4	16	Petrol	64
CHGA	1595	4	8	Petrol	91	CNNA	3597	6	24	Petrol	265
CHH	1984	4	16	Petrol	201	CNRB	2967	6	24	Diesel	257
CHHA	1984	4	16	Petrol	201	CNSA	1798	4	16	Petrol	147
CHHB	1984	4	16	Petrol	201	CNSB	1798	4	16	Petrol	147
CHNA	3597	6	24	Petrol	265	CNTA	1984	4	16	Petrol	201
CHPA	1395	4	16	Petrol	64	CNWA	1390	4	16	Petrol	53
CHPB	1395	4	16	Petrol	64	CNWB	1390	4	16	Petrol	53
CHYA	999	3	12	Petrol	14	CNXA	1598	4	16	Petrol	109
CHYB	999	3	12	Petrol	14	CP	2383	6	12	Diesel	225
CHZA	999	3	12	Petrol	14	CPBA	999	4	8	Petrol	15
CHZB	999	3	12	Petrol	14	CPD	1598	4	16	Petrol	110
CHZC	999	3	12	Petrol	14	CPD	1598	4	16	Petrol	110
CHZD	999	3	12	Petrol	14	CPDA	1598	4	16	Petrol	110
CHZG	999	3	12	Petrol	14	CPDA	1598	4	16	Petrol	110
CJ	1970	4	8	Petrol	203	CPFA	2975	6	24	Petrol	260
CJAA	1968	4	16	Diesel	194	CPGA	999	3	12	Petrol	14
CJGD	2967	6	24	Diesel	257	CPKA	1798	4	16	Petrol	147
CJKA	1984	4	16	Petrol	201	CPRA	1798	4	16	Petrol	147
CJKB	1984	4	16	Petrol	201	CPTA	1395	4	16	Petrol	67
CJLA	1198	3	12	Petrol	23	CPVA	1395	4	16	Petrol	64
CJMA	2967	6	24	Diesel	257	CPVB	1395	4	16	Petrol	64
CJRA	3604	6	24	Petrol	266	CPWA	1395	4	16	Petrol	64
CJSA	1798	4	16	Petrol	147	CR	1588	4	8	Diesel	111
CJSB	1798	4	16	Petrol	147	CRBB	1968	4	16	Diesel	204
CJSC	1798	4	16	Petrol	147	CRBC	1968	4	16	Diesel	204
CJTA	2995	6	24	Petrol	258	CRCA	2967	6	24	Diesel	257
CJXA	1984	4	16	Petrol	201	CRCD	2967	6	24	Diesel	257
CJXB	1984	4	16	Petrol	201	CRFC	1968	4	16	Diesel	204
CJXC	1984	4	16	Petrol	201	CRFD	1968	4	16	Diesel	207
CJXD	1984	4	16	Petrol	201	CRGB	1968	4	16	Diesel	207
CJXE	1984	4	16	Petrol	201	CRJA	1395	4	16	Petrol	64
CJXG	1984	4	16	Petrol	201	CRKA	1598	4	16	Diesel	107
CJZA	1197	4	16	Petrol	26	CRKB	1598	4	16	Diesel	107
CJZB	1197	4	16	Petrol	27	CRLB	1968	4	16	Diesel	204
CJZC	1197	4	16	Petrol	26	CRLD	1968	4	16	Diesel	207
CJZD	1197	4	16	Petrol	26	CRMB	1968	4	16	Diesel	204
CJZD	1197	4	16	Petrol	26	CRUA	1968	4	16	Diesel	204
CK	1471	4	8	Diesel	70	CRVA	1968	4	16	Diesel	204
CKA	1395	4	16	Petrol	65	CRVC	1968	4	16	Diesel	204
CKA	1395	4	16	Petrol	65	CRZA	1984	4	16	Petrol	208
CKAA	1395	4	16	Petrol	65	CS	1588	4	8	Diesel	111
CKAA	1395	4	16	Petrol	65	CSCA	829	2	8	Diesel	1
CKDA	4134	8	32	Diesel	271	CSEA	999	3	12	Petrol	14
CKFC	1968	4	16	Diesel	204	CSEZ	999	3	12	Petrol	14
CKJA	1984	4	8	Petrol	205	CSHA	1968	4	16	Diesel	194
CKMA	1390	4	16	Petrol	66	CSLA	1968	4	16	Diesel	197
CKRA	1968	4	16	Diesel	197	CSLB	1968	4	16	Diesel	194

	CC				9		CC				9
CSLC	1968	4	16	Diesel	197	CZ	1584	4	8	Petrol	81
CSNA	1968	4	16	Diesel	194	CZBA	1395	4	16	Petrol	64
CSS	1395	4	16	Petrol	65	CZCA	1395	4	16	Petrol	64
CSS	1395	4	16	Petrol	65	CZCB	1395	4	16	Petrol	64
CSSA	1395	4	16	Petrol	65	CZDA	1395	4	16	Petrol	64
CSSA	1395	4	16	Petrol	65	CZDB	1395	4	16	Petrol	64
CT	1584	4	8	Petrol	81	CZEA	1395	4	16	Petrol	67
CTHA	1390	4	16	Petrol	53	CZEA	1395	4	16	Petrol	67
CTHB	1390	4	16	Petrol	53	CZPA	1984	4	16	Petrol	201
CTHC	1390	4	16	Petrol	53	CZTA	1395	4	16	Petrol	64
CTHD	1390	4	16	Petrol	53	D	1192	4	8	Petrol	18
CTHE	1390	4	16	Petrol	53	DAJA	1798	4	16	Petrol	147
CTKA	1390	4	16	Petrol	53	DAJB	1798	4	16	Petrol	147
CU	1970	4	8	Petrol	203	DAUA	1968	4	16	Diesel	211
CUAA	1968	4	16	Diesel	204	DAUB	1968	4	16	Diesel	211
CUCA	1598	4	16	Gas	112	DAVA	1968	4	16	Diesel	211
CUCA	1598	4	16	Petrol	110	DBGA	1968	4	16	Diesel	207
CUG	1984	4	16	Petrol	201	DBKA	1598	4	16	Diesel	107
CUKA	1395	4	16	Petrol	64	DCXA	1598	4	16	Diesel	107
CUKB	1395	4	16	Petrol	64	DCYA	1968	4	16	Diesel	207
CUKC	1395	4	16	Petrol	64	DCYB	1968	4	16	Diesel	204
CULA	1984	4	16	Petrol	201	DCZA	1598	4	16	Diesel	107
CULC	1984	4	16	Petrol	201	DDAA	1968	4	16	Diesel	204
CUNA	1968	4	16	Diesel	204	DDR	1984	4	8	Petrol	212
CUPA	1968	4	16	Diesel	207	DDXB	2967	6	24	Diesel	257
CUSA	1422	3	12	Diesel	68	DDXC	2967	6	24	Diesel	257
CUSB	1422	3	12	Diesel	68	DDYA	1598	4	16	Diesel	107
CUTA	1422	3	12	Diesel	68	DDYB	1598	4	16	Diesel	107
CUUA	1968	4	16	Diesel	204	DEDA	1984	4	16	Petrol	201
CUUB	1968	4	16	Diesel	204	DEJA	1968	4	16	Diesel	204
CUUC	1968	4	16	Diesel	207	DEJB	1968	4	16	Diesel	204
CUUD	1968	4	16	Diesel	204	DELA	1968	4	16	Diesel	204
CUUE	1968	4	16	Diesel	204	DF	1913	4	8	Petrol	173
CUUF	1968	4	16	Diesel	204	DFCA	1968	4	16	Diesel	204
CUVA	1968	4	16	Diesel	204	DFEA	1968	4	16	Diesel	204
CUVC	1968	4	16	Diesel	204	DFEB	1968	4	16	Diesel	207
CUVE	1968	4	16	Diesel	207	DFGA	1968	4	16	Diesel	207
CUWA	1968	4	16	Diesel	204	DFGB	1968	4	16	Diesel	207
CUXA	1968	4	16	Diesel	204	DFGC	1968	4	16	Diesel	207
CV	1970	4	8	Petrol	203	DFHA	1968	4	16	Diesel	207
CVCA	1968	4	16	Diesel	204	DFLA	1968	4	16	Diesel	207
CVVA	2967	6	24	Diesel	261	DFLD	1968	4	16	Diesel	207
CVWA	2967	6	24	Diesel	261	DFMA	1968	4	16	Diesel	207
CWSA	1598	4	16	Petrol	109	DFSB	1968	4	16	Diesel	207
CWVA	1598	4	16	Petrol	113	DFSC	1968	4	16	Diesel	207
CWVB	1598	4	16	Petrol	110	DFSD	1968	4	16	Diesel	207
CWXA	1498	4	16	Diesel	71	DFSE	1968	4	16	Diesel	207
CWXB	1498	4	16	Diesel	71	DFSF	1968	4	16	Diesel	207
CWXC	1498	4	16	Diesel	71	DG	1913	4	8	Petrol	173
CXCA	1984	4	16	Petrol	201	DGCA	1968	4	16	Diesel	204
CXCB	1984	4	16	Petrol	201	DGDA	1598	4	16	Diesel	107
CXDA	1984	4	16	Petrol	201	DGDB	1598	4	16	Diesel	107
CXDB	1984	4	16	Petrol	201	DH	1913	4	8	Petrol	173
CXEB	1968	4	16	Diesel	209	DJ	2110	4	8	Petrol	215
CXFA	1968	4	16	Diesel	210	DJHA	1984	4	16	Petrol	201
CXGA	1968	4	16	Diesel	210	DJHB	1984	4	16	Petrol	201
CXGB	1968	4	16	Diesel	210	DL	2383	6	12	Petrol	224
CXGC	1968	4	16	Diesel	209	DLBA	1984	4	16	Petrol	201
CXHA	1968	4	16	Diesel	209	DS	1781	4	8	Petrol	121
CXHB	1968	4	16	Diesel	209	DSN	1781	4	8	Petrol	121
CXSA	1395	4	16	Petrol	64	DT	1595	4	8	Petrol	79
CXSB	1395	4	16	Petrol	64	DTA	1595	4	8	Petrol	79
CXXA	1598	4	16	Diesel	107	DV	2383	6	12	Diesel	225
CXXB	1598	4	16	Diesel	107	DW	2383	6	12	Diesel	225
CY	1588	4	8	Diesel	111	DX	1781	4	8	Petrol	121
CYA	1197	4	16	Petrol	28	DZ	1781	4	8	Petrol	121
CYA	1197	4	16	Petrol	28	E	1285	4	8	Petrol	30
CYFB	1984	4	16	Petrol	201	EA	1679	4	8	Petrol	117
CYJA	2995	6	24	Petrol	258	EC	1795	4	8	Petrol	134
CYKB	1968	4	16	Diesel	207	ED	1795	4	8	Petrol	134
CYKC	1968	4	16	Diesel	207	EE	1588	4	8	Petrol	114
CYVA	1197	4	16	Petrol	26	EF	1588	4	8	Petrol	79
CYVB	1197	4	16	Petrol	26	EG	1588	4	8	Petrol	114
CYVB	1197	4	16	Petrol	26	EH	1457	4	8	Petrol	72
CYVC	1197	4	16	Petrol	26	EM	1588	4	8	Petrol	79
CYVD	1197	4	16	Petrol	26	EN	1716	4	8	Petrol	118
CYZA	1422	3	12	Diesel	68	EP	1297	4	8	Petrol	33
CYZB	1422	3	12	Diesel	68	EU	1297	4	8	Petrol	34

	CC				9		CC				9
EV	1781	4	8	Petrol	149	MF	1588	4	8	Diesel	77
EW	1595	4	8	Petrol	79	MH	1272	4	8	Petrol	34
EWA	1595	4	8	Petrol	79	MN	1272	4	8	Diesel	36
EX	1781	4	8	Petrol	121	MV	2110	4	8	Petrol	215
EY	1913	4	8	Petrol	173	NU	1272	4	8	Petrol	34
EZ	1595	4	8	Petrol	79	NZ	1272	4	8	Petrol	29
EZA	1595	4	8	Petrol	79	PB	1781	4	8	Petrol	121
F	1285	4	8	Petrol	30	PD	1781	4	8	Petrol	121
FA	1093	4	8	Petrol	17	PF	1781	4	8	Petrol	121
FB	1470	4	8	Petrol	73	PG	1781	4	8	Petrol	121
FD	1471	4	8	Petrol	72	PL	1781	4	16	Petrol	151
FF	1471	4	8	Petrol	72	PN	1595	4	8	Petrol	79
FH	1471	4	8	Petrol	74	PP	1595	4	8	Petrol	79
FJ	1093	4	8	Petrol	17	PY	1272	4	8	Petrol	37
FK	1471	4	8	Petrol	73	RA	1588	4	8	Diesel	77
FN	1588	4	8	Petrol	114	RD	1781	4	8	Petrol	121
FP	1588	4	8	Petrol	114	RE	1595	4	8	Petrol	79
FR	1588	4	8	Petrol	114	RF	1595	4	8	Petrol	79
FS	1588	4	8	Petrol	79	RG	1781	4	8	Petrol	121
FT	1588	4	8	Petrol	114	RH	1781	4	8	Petrol	121
FV	1588	4	8	Petrol	114	RL	1595	4	8	Petrol	79
FY	1272	4	8	Petrol	35	RM	1781	4	8	Petrol	121
FZ	1272	4	8	Petrol	35	RP	1781	4	8	Petrol	149
GD	1970	4	8	Petrol	203	RP	1781	4	8	Petrol	150
GE	1970	4	8	Petrol	203	RV	1781	4	8	Petrol	121
GEXB	2967	6	24	Diesel	262	SB	1588	4	8	Diesel	77
GF	1272	4	8	Petrol	35	SP	1913	4	8	Petrol	173
GG	1093	4	8	Petrol	17	SR	2109	4	8	Petrol	215
GH	1457	4	8	Petrol	72	SS	2110	4	8	Petrol	215
GK	1272	4	8	Petrol	34	T	1584	4	8	Petrol	81
GL	1043	4	8	Petrol	16	U	1584	4	8	Petrol	81
GN	1043	4	8	Petrol	16	UDB	1781	4	8	Petrol	121
GS	1272	4	8	Petrol	35	UDH	1781	4	8	Petrol	130
GT	1272	4	8	Petrol	34	UNF	1598	4	8	Petrol	83
GU	1781	4	8	Petrol	149	UPD	1595	4	8	Petrol	101
GW	1913	4	8	Petrol	173	UQG	1984	4	8	Petrol	214
GX	1781	4	8	Petrol	121	V	1679	4	8	Petrol	117
GY	1324	4	8	Petrol	34	W	1679	4	8	Petrol	117
GZ	1781	4	8	Petrol	121	WE	2144	5	10	Petrol	216
H	1493	4	8	Petrol	75	WL	1714	4	8	Petrol	120
HA	895	4	8	Petrol	2	WN	1921	5	10	Petrol	174
HB	1093	4	8	Petrol	17	WP	1588	4	8	Petrol	79
HC	1093	4	8	Petrol	17	WT	1715	4	8	Petrol	118
HD	1093	4	8	Petrol	17	WV	1588	4	8	Petrol	114
HH	1272	4	8	Petrol	35	WY	1588	4	8	Petrol	79
HJ	1272	4	8	Petrol	35	WZ	1588	4	8	Petrol	79
HK	1272	4	8	Petrol	34	YG	1588	4	8	Petrol	79
HM	1595	4	8	Petrol	79	YH	1588	4	8	Petrol	114
HN	1595	4	8	Petrol	79	YJ	1471	4	8	Petrol	74
HP	1994	5	10	Petrol	213	YK	1588	4	8	Petrol	79
HS	2384	6	12	Petrol	224	YN	1588	4	8	Petrol	79
HT	1781	4	8	Petrol	121	YP	1588	4	8	Petrol	114
HV	1781	4	8	Petrol	121	YS	1588	4	8	Petrol	114
HW	1272	4	8	Petrol	34	YU	1588	4	8	Petrol	79
HY	2226	5	10	Petrol	218	YX	1714	4	8	Petrol	120
HZ	1043	4	8	Petrol	3	YY	1588	4	8	Petrol	79
JB	1457	4	8	Petrol	76	Z	1679	4	8	Petrol	117
JH	1781	4	8	Petrol	121	ZA	1297	4	8	Petrol	38
JJ	1781	4	8	Petrol	121	ZB	1471	4	8	Petrol	74
JK	1588	4	8	Diesel	111	ZC	1471	4	8	Petrol	74
JN	1781	4	8	Petrol	121	ZF	1297	4	8	Petrol	34
JP	1588	4	8	Diesel	111						
JR	1588	4	8	Diesel	77						
JS	1994	5	10	Petrol	213						
JT	2226	5	10	Petrol	219						
JU	1595	4	8	Petrol	79						
JV	1781	4	8	Petrol	149						
JV	1781	4	8	Petrol	150						
JX	1589	4	8	Diesel	77						
K	1493	4	8	Petrol	75						
KR	1781	4	16	Petrol	151						
KT	1781	4	8	Petrol	149						
KV	2226	5	10	Petrol	219						
KX	2226	5	10	Petrol	218						
KY	1716	4	8	Diesel	119						
L	1493	4	8	Petrol	75						
M51	1192	4	8	Petrol	18						
ME	1588	4	8	Diesel	111						



1 0.8L Diesel

CSCA 2 Cyl. 8 Valves 829cc TD29742

NA5106
35.00 x 48.00 x 10.00mm, PTFE

2 0.9L Petrol

HA 4 Cyl. 8 Valves 895cc TD4104

HR569

NA5001
32.00 x 47.00 x 10.00mm, FPM

NA5001 (x2)
32.00 x 47.00 x 10.00mm, FPM
NA5133
85.00 x 105.00 x 11.00mm, FPM

3 1.0L Petrol

AAK 4 Cyl. 8 Valves 1043cc TD4003

AAU 4 Cyl. 8 Valves 1043cc TD4971

ACM 4 Cyl. 8 Valves 1043cc TD4013

HZ 4 Cyl. 8 Valves 1043cc TD5012

HR569
→Ch no. 80-NW-500 000

HR816
Ch no. 80-PW-000 001 →

NA5001
32.00 x 47.00 x 10.00mm, FPM

NA5001
32.00 x 47.00 x 10.00mm, FPM
NA5133
85.00 x 105.00 x 11.00mm, FPM

4 1.0L Petrol

AER 4 Cyl. 8 Valves 999cc TD9519

HR816

NA5001
32.00 x 47.00 x 10.00mm, FPM

NA5001
32.00 x 47.00 x 10.00mm, FPM
NA5133
85.00 x 105.00 x 11.00mm, FPM
LK5006
85.00 x 131.00 x 16.00mm, PTFE

5 1.0L Petrol

AEV 4 Cyl. 8 Valves 1043cc TD4021

HR816

NA5001
32.00 x 47.00 x 10.00mm, FPM

NA5001
32.00 x 47.00 x 10.00mm, FPM
NA5133
85.00 x 105.00 x 11.00mm, FPM

6 1.0L Petrol

AHT 4 Cyl. 8 Valves 997cc TD11467

HR816

NA5306
42.00 x 58.00 x 8.00mm, ACM
01/99 →
NA5133
85.00 x 105.00 x 11.00mm, FPM
LK5006
85.00 x 131.00 x 16.00mm, PTFE

7 1.0L Petrol

ALD 4 Cyl. 8 Valves 999cc TD11468

ANV 4 Cyl. 8 Valves 999cc TD11469

ATE 4 Cyl. 8 Valves 999cc TD22625

AUC 4 Cyl. 8 Valves 999cc TD15491

PA5041 (x8)
HR817

NA5185
32.00 x 42.00 x 6.00mm, FPM

NA5185
32.00 x 42.00 x 6.00mm, FPM
LK5006
85.00 x 131.00 x 16.00mm, PTFE

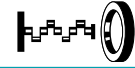

8 1.0L		Petrol			
ALL		4 Cyl.	8 Valves	999cc	TD10609
HR816		NA5001 32.00 x 47.00 x 10.00mm, FPM		NA5001 32.00 x 47.00 x 10.00mm, FPM LK5006 85.00 x 131.00 x 16.000mm, PTFE	
9 1.0L		Petrol			
AQZ		4 Cyl.	8 Valves	999cc	TD20806
AZN		4 Cyl.	8 Valves	999cc	TD25771
BJR		4 Cyl.	8 Valves	999cc	TD25199
BNW		4 Cyl.	8 Valves	999cc	TD25773
BNX		4 Cyl.	8 Valves	999cc	TD20807
BTY		4 Cyl.	8 Valves	999cc	TD25787
CCNA		4 Cyl.	8 Valves	999cc	TD20809
PA5041 (x8) HR817		NA5185 32.00 x 42.00 x 6.00mm, FPM		NA5185 32.00 x 42.00 x 6.00mm, FPM	
10 1.0L		Petrol			
ARA		4 Cyl.	16 Valves	999cc	TD20970
PA5041 (x16) HR791		NA5180 27.00 x 42.00 x 8.00mm, FPM		NA5185 32.00 x 42.00 x 6.00mm, FPM	
11 1.0L		Petrol			
ASW		4 Cyl.	16 Valves	999cc	TD25196
PA5041 (x16) HR791		NA5180 (x2) 27.00 x 42.00 x 8.00mm, FPM		NA5185 32.00 x 42.00 x 6.00mm, FPM LK5006 85.00 x 131.00 x 16.000mm, PTFE	
12 1.0L		Petrol			
AZP		4 Cyl.	16 Valves	999cc	TD25197
PA5041 (x16) HR791		NA5180 (x2) 27.00 x 42.00 x 8.00mm, FPM		NA5185 32.00 x 42.00 x 6.00mm, FPM	
13 1.0L		Petrol			
BJE		4 Cyl.	8 Valves	999cc	TD20808
PA5041 (x8)		NA5185 32.00 x 42.00 x 6.00mm, FPM		NA5185 32.00 x 42.00 x 6.00mm, FPM	
14 1.0L		Petrol			
CHYA		3 Cyl.	12 Valves	999cc	TD26238
CHYB		3 Cyl.	12 Valves	999cc	TD26239
CHZA		3 Cyl.	12 Valves	999cc	TD33442
CHZB		3 Cyl.	12 Valves	999cc	TD30245
CHZC		3 Cyl.	12 Valves	999cc	TD30266
CHZD		3 Cyl.	12 Valves	999cc	TD31431
CHZG		3 Cyl.	12 Valves	999cc	TD32528
CPGA		3 Cyl.	12 Valves	999cc	TD27210
CSEA		3 Cyl.	12 Valves	999cc	TD27848
CSEZ		3 Cyl.	12 Valves	999cc	TD31402
		NA5458 (x2) 24.00 x 39.00 x 8.00mm, PTFE/ACM NA5456 (x2) 36.00 x 46.00 x 7.00mm, PTFE/ACM			



15 1.0L

Petrol

CPBA	4 Cyl.	8 Valves	999cc	TD27847
PA5041 (x8) HR817	NA5180	27.00 x 42.00 x 8.00mm, FPM		NA5185
				32.00 x 42.00 x 6.00mm, FPM

16 1.0L

Petrol

GL	4 Cyl.	8 Valves	1043cc	TD5006
GN	4 Cyl.	8 Valves	1043cc	TD4095
HR569	NA5001	32.00 x 47.00 x 10.00mm, FPM		NA5001
				32.00 x 47.00 x 10.00mm, FPM
				NA5133
				85.00 x 105.00 x 11.00mm, FPM

17 1.1L

Petrol

FA	4 Cyl.	8 Valves	1093cc	TD5001
FJ	4 Cyl.	8 Valves	1093cc	TD4082
GG	4 Cyl.	8 Valves	1093cc	TD4093
HB	4 Cyl.	8 Valves	1093cc	TD5008
HC	4 Cyl.	8 Valves	1093cc	TD5009
HD	4 Cyl.	8 Valves	1093cc	TD21345
HR569	NA5001	32.00 x 47.00 x 10.00mm, FPM		NA5001
				32.00 x 47.00 x 10.00mm, FPM
				NA5133
				85.00 x 105.00 x 11.00mm, FPM

18 1.2L

Petrol

I22	4 Cyl.	8 Valves	1192cc	TD22607
D	4 Cyl.	8 Valves	1192cc	TD4054
M51	4 Cyl.	8 Valves	1192cc	TD24566
				NA784
				70.00 x 90.00 x 10.00mm, ACM

19 1.2L

Diesel

ANY	3 Cyl.	6 Valves	1191cc	TD12029
AYZ	3 Cyl.	6 Valves	1191cc	TD15494
HR5068	NA5124	32.00 x 47.00 x 10.00mm, PTFE/ACM		NA5106
				35.00 x 48.00 x 10.00mm, PTFE
				LK5003
				85.00 x 131.00 x 15.700mm, PTFE

20 1.2L

Petrol

AWY	3 Cyl.	6 Valves	1198cc	TD16334
BBM	3 Cyl.	6 Valves	1198cc	TD20142
PA5041 (x6) HL5002	NA5106	35.00 x 48.00 x 10.00mm, PTFE		NA5305
				85.00 x 105.00 x 11.00mm, PTFE
				01/01 →

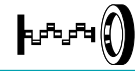
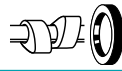

21 1.2L		Petrol		
AZQ	3 Cyl.	12 Valves	1198cc	TD16333
BME	3 Cyl.	12 Valves	1198cc	TD18156
PA5041 (x12) HR280				NA5106 35.00 x 48.00 x 10.00mm, PTFE NA5305 85.00 x 105.00 x 11.00mm, PTFE 01/01 →

22 1.2L		Petrol		
BMD	3 Cyl.	6 Valves	1198cc	TD18155
CHFA	3 Cyl.	6 Valves	1198cc	TD23101
CHFB	3 Cyl.	6 Valves	1198cc	TD24054
PA5041 (x6) HL5002				NA5106 35.00 x 48.00 x 10.00mm, PTFE NA5305 85.00 x 105.00 x 11.00mm, PTFE

23 1.2L		Petrol		
BXV	3 Cyl.	12 Valves	1198cc	TD29052
BZG	3 Cyl.	12 Valves	1198cc	TD20141
CGPA	3 Cyl.	12 Valves	1198cc	TD23102
CGPB	3 Cyl.	12 Valves	1198cc	TD23100
CJLA	3 Cyl.	12 Valves	1198cc	TD27582
PA5041 (x12) HR280				NA5106 35.00 x 48.00 x 10.00mm, PTFE NA5305 85.00 x 105.00 x 11.00mm, PTFE

24 1.2L		Petrol		
CBZA	4 Cyl.	8 Valves	1197cc	TD24312
CBZB	4 Cyl.	8 Valves	1197cc	TD23520
CBZC	4 Cyl.	8 Valves	1197cc	TD25703
PA5041 (x8) HR817		NA5124 32.00 x 47.00 x 10.00mm, PTFE/ACM		NA5124 32.00 x 47.00 x 10.00mm, PTFE/ACM

25 1.2L		Diesel		
CFWA	3 Cyl.	12 Valves	1199cc	TD23610
PA5041 (x12) HR280		NA5361 (x2) 32.00 x 47.00 x 10.00mm, PTFE		NA5106 35.00 x 48.00 x 10.00mm, PTFE

26 1.2L		Petrol		
CJZA	4 Cyl.	16 Valves	1197cc	TD27189
CJZC	4 Cyl.	16 Valves	1197cc	TD29661
CJZD	4 Cyl.	16 Valves	1197cc	TD29571
CJZD	4 Cyl.	16 Valves	1197cc	TD32208
CYVA	4 Cyl.	16 Valves	1197cc	TD29246
CYVB	4 Cyl.	16 Valves	1197cc	TD29245
CYVB	4 Cyl.	16 Valves	1197cc	TD32216
CYVC	4 Cyl.	16 Valves	1197cc	TD31237
CYVD	4 Cyl.	16 Valves	1197cc	TD31806
		NA5458 (x2) 24.00 x 39.00 x 8.00mm, PTFE/ACM		
		NA5456 (x2) 36.00 x 46.00 x 7.00mm, PTFE/ACM		



27 1.2L

Petrol

CJZB	4 Cyl.	16 Valves	1197cc	TD27190
	NA5458 24.00 x 39.00 x 8.00mm, PTFE/ACM NA5456 (x2) 36.00 x 46.00 x 7.00mm, PTFE/ACM			

28 1.2L

Petrol

CYA	4 Cyl.	16 Valves	1197cc	TD33288
CYA	4 Cyl.	16 Valves	1197cc	TD33301
	NA5458 (x2) 24.00 x 39.00 x 8.00mm, PTFE/ACM			

29 1.3L

Petrol

2G	4 Cyl.	8 Valves	1272cc	TD4964
3F	4 Cyl.	8 Valves	1272cc	TD4968
AAV	4 Cyl.	8 Valves	1272cc	TD5159
NZ	4 Cyl.	8 Valves	1272cc	TD4136
HR569	NA5001 32.00 x 47.00 x 10.00mm, FPM		NA5001 32.00 x 47.00 x 10.00mm, FPM NA5133 85.00 x 105.00 x 11.00mm, FPM	
→Ch no. 80-NW-500 000				
HR816				
Ch no. 80-PW-000 001 →				

30 1.3L

Petrol

AB	4 Cyl.	8 Valves	1285cc	TD4005
AC	4 Cyl.	8 Valves	1285cc	TD5135
AR	4 Cyl.	8 Valves	1285cc	TD4029
E	4 Cyl.	8 Valves	1285cc	TD5132
F	4 Cyl.	8 Valves	1285cc	TD4076
			NA784 70.00 x 90.00 x 10.00mm, ACM	

31 1.3L

Petrol

ADX	4 Cyl.	8 Valves	1296cc	TD4017
HR816	NA5001 32.00 x 47.00 x 10.00mm, FPM		NA5001 32.00 x 47.00 x 10.00mm, FPM NA5133 85.00 x 105.00 x 11.00mm, FPM	

32 1.3L

Petrol

AJD	4 Cyl.	8 Valves	1324cc	TD26796
HR816	NA5001 32.00 x 47.00 x 10.00mm, FPM		NA5001 32.00 x 47.00 x 10.00mm, FPM NA5133 85.00 x 105.00 x 11.00mm, FPM LK5006 85.00 x 131.00 x 16.000mm, PTFE	

33 1.3L

Petrol

EP	4 Cyl.	8 Valves	1297cc	TD5158
HR569	NA5001 32.00 x 47.00 x 10.00mm, FPM →07/83		NA5001 32.00 x 47.00 x 10.00mm, FPM NA5133 85.00 x 105.00 x 11.00mm, FPM	

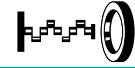
**34 1.3L****Petrol**

EU	4 Cyl.	8 Valves	1297cc	TD16428
GK	4 Cyl.	8 Valves	1272cc	TD4094
GT	4 Cyl.	8 Valves	1272cc	TD4097
GY	4 Cyl.	8 Valves	1324cc	TD26797
HK	4 Cyl.	8 Valves	1272cc	TD5011
HW	4 Cyl.	8 Valves	1272cc	TD4113
MH	4 Cyl.	8 Valves	1272cc	TD4131
NU	4 Cyl.	8 Valves	1272cc	TD4135
ZF	4 Cyl.	8 Valves	1297cc	TD5140

HR569

NA5001
 32.00 x 47.00 x 10.00mm, FPM

NA5001
 32.00 x 47.00 x 10.00mm, FPM
NA5133
 85.00 x 105.00 x 11.00mm, FPM
35 1.3L**Petrol**

FY	4 Cyl.	8 Valves	1272cc	TD5002
FZ	4 Cyl.	8 Valves	1272cc	TD5003
GF	4 Cyl.	8 Valves	1272cc	TD4092
GS	4 Cyl.	8 Valves	1272cc	TD4096
HH	4 Cyl.	8 Valves	1272cc	TD5010
HJ	4 Cyl.	8 Valves	1272cc	TD4105

HR569

NA5001 (x2)
 32.00 x 47.00 x 10.00mm, FPM

NA5001
 32.00 x 47.00 x 10.00mm, FPM
NA5133
 85.00 x 105.00 x 11.00mm, FPM
36 1.3L**Diesel**

MN	4 Cyl.	8 Valves	1272cc	TD4132
----	--------	----------	--------	--------

HR569

NA5001 (x2)
 32.00 x 47.00 x 10.00mm, FPM

NA5001
 32.00 x 47.00 x 10.00mm, FPM
NA5133
 85.00 x 105.00 x 11.00mm, FPM
37 1.3L**Petrol**

PY	4 Cyl.	8 Valves	1272cc	TD5023
----	--------	----------	--------	--------

 HR569
 →Ch no. 80N500000
 HR816
 Ch no. 80PW000001→

NA5001
 32.00 x 47.00 x 10.00mm, FPM

NA5001
 32.00 x 47.00 x 10.00mm, FPM
NA5133
 85.00 x 105.00 x 11.00mm, FPM
38 1.3L**Petrol**

ZA	4 Cyl.	8 Valves	1297cc	TD5036
----	--------	----------	--------	--------

HR569

NA5001
 32.00 x 47.00 x 10.00mm, FPM

NA5133
 85.00 x 105.00 x 11.00mm, FPM
39 1.4L**Diesel**

1W	4 Cyl.	8 Valves	1398cc	TD4959
----	--------	----------	--------	--------

 HR569
 HR816
 Ch no. 80-PW-000 001→

NA5001 (x2)
 32.00 x 47.00 x 10.00mm, FPM

NA5001
 32.00 x 47.00 x 10.00mm, FPM
NA5133
 85.00 x 105.00 x 11.00mm, FPM

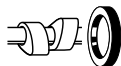

40 1.4L

Petrol

ABD	4 Cyl.	8 Valves	1390cc	TD4973
HR569 →07/92	NA5001 32.00 x 47.00 x 10.00mm, FPM	NA5001 32.00 x 47.00 x 10.00mm, FPM	NA5133 85.00 x 105.00 x 11.00mm, FPM	LK5006 85.00 x 131.00 x 16.000mm, PTFE
HR816 08/92→				

41 1.4L

Petrol

AEX	4 Cyl.	8 Valves	1390cc	TD4984	
HR816	NA5001 32.00 x 47.00 x 10.00mm, FPM	NA5185 32.00 x 42.00 x 6.00mm, FPM	NA5001 32.00 x 47.00 x 10.00mm, FPM	NA5133 85.00 x 105.00 x 11.00mm, FPM	LK5006 85.00 x 131.00 x 16.000mm, PTFE

42 1.4L

Petrol

AFH	4 Cyl.	16 Valves	1390cc	TD4986	
PA5041 (x16) HR791	NA5001 (x2) 32.00 x 47.00 x 10.00mm, FPM	NA5185 32.00 x 42.00 x 6.00mm, FPM	NA5001 32.00 x 47.00 x 10.00mm, FPM	NA5133 85.00 x 105.00 x 11.00mm, FPM	LK5006 85.00 x 131.00 x 16.000mm, PTFE

43 1.4L

Petrol

AFK	4 Cyl.	16 Valves	1390cc	TD12028
AKQ	4 Cyl.	16 Valves	1390cc	TD9454
ANM	4 Cyl.	16 Valves	1390cc	TD13470
APE	4 Cyl.	16 Valves	1390cc	TD13468
AUA	4 Cyl.	16 Valves	1390cc	TD13771
AUB	4 Cyl.	16 Valves	1390cc	TD13772
AXP	4 Cyl.	16 Valves	1390cc	TD15474
BBY	4 Cyl.	16 Valves	1390cc	TD16335
BBZ	4 Cyl.	16 Valves	1390cc	TD16540
BCA	4 Cyl.	16 Valves	1390cc	TD16386
BKY	4 Cyl.	16 Valves	1390cc	TD18154
CGGA	4 Cyl.	16 Valves	1390cc	TD20791
CGGB	4 Cyl.	16 Valves	1390cc	TD23103
CMAA	4 Cyl.	16 Valves	1390cc	TD25705
PA5041 (x16) HR791	NA5180 (x2) 27.00 x 42.00 x 8.00mm, FPM	NA5185 32.00 x 42.00 x 6.00mm, FPM		

44 1.4L

Petrol

AGY	4 Cyl.	8 Valves	1390cc	TD19871
HR816	NA5001 32.00 x 47.00 x 10.00mm, FPM	LK5006 85.00 x 131.00 x 16.000mm, PTFE		

**45 1.4L****Petrol**

AHW	4 Cyl.	16 Valves	1390cc	TD9453
PA5041 (x16) HR791	NA5180 27.00 x 42.00 x 8.00mm, FPM	NA5185	32.00 x 42.00 x 6.00mm, FPM	

46 1.4L**Petrol**

AKK	4 Cyl.	8 Valves	1390cc	TD13768
ANW	4 Cyl.	8 Valves	1390cc	TD15568
PA5041 (x8) HR817	NA5185 32.00 x 42.00 x 6.00mm, FPM	NA5185	32.00 x 42.00 x 6.00mm, FPM	
		LK5006	85.00 x 131.00 x 16.000mm, PTFE	

47 1.4L**Petrol**

AKP	4 Cyl.	8 Valves	1390cc	TD14168
AUD	4 Cyl.	8 Valves	1390cc	TD13770
BLM	4 Cyl.	8 Valves	1390cc	TD21076
PA5041 (x16) HR817	NA5185 32.00 x 42.00 x 6.00mm, FPM	NA5185	32.00 x 42.00 x 6.00mm, FPM	
		LK5006	85.00 x 131.00 x 16.000mm, PTFE	

48 1.4L**Petrol**

AKV	4 Cyl.	8 Valves	1390cc	TD9688
PA5041 (x8) HR816	NA5001 32.00 x 47.00 x 10.00mm, FPM	NA5185	32.00 x 42.00 x 6.00mm, FPM	
		NA5001	32.00 x 47.00 x 10.00mm, FPM	
		LK5006	85.00 x 131.00 x 16.000mm, PTFE	

49 1.4L**Diesel**

AMF	3 Cyl.	6 Valves	1422cc	TD12589
ATL	3 Cyl.	6 Valves	1422cc	TD21352
BAY	3 Cyl.	6 Valves	1422cc	TD16336
BNM	3 Cyl.	6 Valves	1422cc	TD18159
BNV	3 Cyl.	6 Valves	1422cc	TD18158
HR5068	NA5124 32.00 x 47.00 x 10.00mm, PTFE/ACM	NA5106	35.00 x 48.00 x 10.00mm, PTFE	
		LK5003	85.00 x 131.00 x 15.700mm, PTFE	

50 1.4L**Petrol**

ANX	4 Cyl.	8 Valves	1390cc	TD15613
APQ	4 Cyl.	8 Valves	1390cc	TD15614
HR816	NA5001 32.00 x 47.00 x 10.00mm, FPM	NA5001	32.00 x 47.00 x 10.00mm, FPM	
		LK5006	85.00 x 131.00 x 16.000mm, PTFE	

51 1.4L**Petrol**

AQQ	4 Cyl.	16 Valves	1390cc	TD13469
PA5041 (x16) HR791	NA5180 (x2) 27.00 x 42.00 x 8.00mm, FPM	NA5185	32.00 x 42.00 x 6.00mm, FPM	
		NB806	90.00 x 104.00 x 11.00mm, FPM	

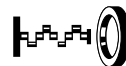
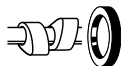

52 1.4L

Petrol

ARR	4 Cyl.	16 Valves	1390cc	TD15492
PA5041 (x16) HR791	NA5180 27.00 x 42.00 x 8.00mm, FPM	NA5185 32.00 x 42.00 x 6.00mm, FPM LK5006 85.00 x 131.00 x 16.000mm, PTFE		

53 1.4L

Petrol

AXU	4 Cyl.	16 Valves	1390cc	TD16430
BLG	4 Cyl.	16 Valves	1390cc	TD18470
BMG	4 Cyl.	16 Valves	1390cc	TD25891
BMY	4 Cyl.	16 Valves	1390cc	TD18910
BWK	4 Cyl.	16 Valves	1390cc	TD20734
CAVA	4 Cyl.	16 Valves	1390cc	TD22452
CAVB	4 Cyl.	16 Valves	1390cc	TD22173
CAVC	4 Cyl.	16 Valves	1390cc	TD22174
CAVD	4 Cyl.	16 Valves	1390cc	TD20792
CAVE	4 Cyl.	16 Valves	1390cc	TD24000
CAXA	4 Cyl.	16 Valves	1390cc	TD20606
CFB	4 Cyl.	16 Valves	1390cc	TD26156
CLPA	4 Cyl.	16 Valves	1390cc	TD26336
CMSB	4 Cyl.	16 Valves	1390cc	TD25468
CNWA	4 Cyl.	16 Valves	1390cc	TD24834
CNWB	4 Cyl.	16 Valves	1390cc	TD27017
CTHA	4 Cyl.	16 Valves	1390cc	TD26573
CTHB	4 Cyl.	16 Valves	1390cc	TD26629
CTHC	4 Cyl.	16 Valves	1390cc	TD26643
CTHD	4 Cyl.	16 Valves	1390cc	TD26574
CTHE	4 Cyl.	16 Valves	1390cc	TD27355
CTKA	4 Cyl.	16 Valves	1390cc	TD26695
PA5041 (x16) HR791		NA5106 35.00 x 48.00 x 10.00mm, PTFE		

54 1.4L

Petrol

BCC	4 Cyl.	16 Valves	1390cc	TD21636
	NA5180 (x2) 27.00 x 42.00 x 8.00mm, FPM			

55 1.4L

Petrol

BKG	4 Cyl.	16 Valves	1390cc	TD17181
BLN	4 Cyl.	16 Valves	1390cc	TD18911
PA5041 (x16) HR791		NA5106 35.00 x 48.00 x 10.00mm, PTFE LK5013 85.00 x 111.00 x 15.50mm, PTFE		

56 1.4L

Petrol

BKR	4 Cyl.	8 Valves	1390cc	TD18271
PA5041 (x16) HR817	NA5185 (x2) 32.00 x 42.00 x 6.00mm, FPM	NA5185 32.00 x 42.00 x 6.00mm, FPM		

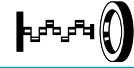
**57 1.4L****Diesel**

BMS	3 Cyl.	6 Valves	1422cc	TD18157
BWB	3 Cyl.	6 Valves	1422cc	TD20514
HR5068	NA5124 32.00 x 47.00 x 10.00mm, PTFE/ACM		NA5106 35.00 x 48.00 x 10.00mm, PTFE	

58 1.4L**Petrol**

BNG	4 Cyl.	16 Valves	1390cc	TD21639
PA5041 (x24)				

59 1.4L**Petrol**

BSC	4 Cyl.	8 Valves	1423cc	TD26798
HR569	NA5001 32.00 x 47.00 x 10.00mm, FPM		NA5001 32.00 x 47.00 x 10.00mm, FPM	
			NA5133 85.00 x 105.00 x 11.00mm, FPM	
			LK5006 85.00 x 131.00 x 16.00mm, PTFE	

60 1.4L**Petrol**

BUD	4 Cyl.	16 Valves	1390cc	TD18909
PA5041 (x16)				
HR791	NA5180 (x2) 27.00 x 42.00 x 8.00mm, FPM		NA5185 32.00 x 42.00 x 6.00mm, FPM	
			LK5013 85.00 x 111.00 x 15.50mm, PTFE →10/06	

61 1.4L**Petrol**

CDDA	4 Cyl.	16 Valves	1390cc	TD25789
PA5041 (x16)				
HR791	NA5180 (x2) 27.00 x 42.00 x 8.00mm, FPM		NA5106 35.00 x 48.00 x 10.00mm, PTFE	
	NA5106 (x2) 35.00 x 48.00 x 10.00mm, PTFE/ACM			

62 1.4L**Petrol**

CDGA	4 Cyl.	16 Valves	1390cc	TD22222
PA5041 (x16)				
			NA5106 35.00 x 48.00 x 10.00mm, PTFE	

63 1.4L**Petrol**

CFBA	4 Cyl.	16 Valves	1390cc	TD31385
PA5041 (x16)				
HR791				

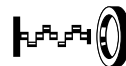
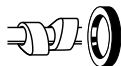

64 1.4L

Petrol

CHPA	4 Cyl.	16 Valves	1395cc	TD27194
CHPB	4 Cyl.	16 Valves	1395cc	TD27858
CMBA	4 Cyl.	16 Valves	1395cc	TD27191
CNLA	4 Cyl.	16 Valves	1395cc	TD26572
CPVA	4 Cyl.	16 Valves	1395cc	TD27201
CPVB	4 Cyl.	16 Valves	1395cc	TD29247
CPWA	4 Cyl.	16 Valves	1395cc	TD28099
CRJA	4 Cyl.	16 Valves	1395cc	TD26924
CUKA	4 Cyl.	16 Valves	1395cc	TD27192
CUKB	4 Cyl.	16 Valves	1395cc	TD29283
CUKC	4 Cyl.	16 Valves	1395cc	TD31438
CXSA	4 Cyl.	16 Valves	1395cc	TD27193
CXSB	4 Cyl.	16 Valves	1395cc	TD27857
CZBA	4 Cyl.	16 Valves	1395cc	TD28100
CZCA	4 Cyl.	16 Valves	1395cc	TD29248
CZCB	4 Cyl.	16 Valves	1395cc	TD31238
CZDA	4 Cyl.	16 Valves	1395cc	TD29249
CZDB	4 Cyl.	16 Valves	1395cc	TD31024
CZTA	4 Cyl.	16 Valves	1395cc	TD32547

NA5458 (x2)
24.00 x 39.00 x 8.00mm, PTFE/ACM
NA5456 (x2)
36.00 x 46.00 x 7.00mm, PTFE/ACM

65 1.4L

Petrol

CKA	4 Cyl.	16 Valves	1395cc	TD33368
CKA	4 Cyl.	16 Valves	1395cc	TD33370
CKAA	4 Cyl.	16 Valves	1395cc	TD30911
CKAA	4 Cyl.	16 Valves	1395cc	TD30905
CSS	4 Cyl.	16 Valves	1395cc	TD33254
CSS	4 Cyl.	16 Valves	1395cc	TD33308
CSSA	4 Cyl.	16 Valves	1395cc	TD30914
CSSA	4 Cyl.	16 Valves	1395cc	TD32172

NA5458 (x2)
24.00 x 39.00 x 8.00mm, PTFE/ACM

66 1.4L

Petrol

CKMA	4 Cyl.	16 Valves	1390cc	TD25401
PA5041 (x16) HR791	NA5106 (x2) 35.00 x 48.00 x 10.00mm, PTFE/ACM	NA5106 35.00 x 48.00 x 10.00mm, PTFE		

67 1.4L

Petrol

CPTA	4 Cyl.	16 Valves	1395cc	TD26902
CZEA	4 Cyl.	16 Valves	1395cc	TD29242
CZEA	4 Cyl.	16 Valves	1395cc	TD32215

NA5454 (x2)
28.00 x 39.00 x 7.00mm, PTFE/ACM
NA5456 (x2)
36.00 x 46.00 x 7.00mm, PTFE/ACM

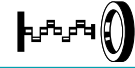

68 1.4L		Diesel			
CUSA		3 Cyl.	12 Valves	1422cc	TD29226
CUSB		3 Cyl.	12 Valves	1422cc	TD29225
CUTA		3 Cyl.	12 Valves	1422cc	TD31029
CYZA		3 Cyl.	12 Valves	1422cc	TD29243
CYZB		3 Cyl.	12 Valves	1422cc	TD31034
PA5041 (x12) HR280		NA5361 (x2) 32.00 x 47.00 x 10.00mm, PTFE			
69 1.5L		Diesel			
682		4 Cyl.	8 Valves	1471cc	TD22612
HR569		NA5001 32.00 x 47.00 x 10.00mm, FPM		NA5001 32.00 x 47.00 x 10.00mm, FPM NA5133 85.00 x 105.00 x 11.00mm, FPM	
70 1.5L		Diesel			
CK		4 Cyl.	8 Valves	1471cc	TD4046
HR569		NA5001 (x2) 32.00 x 47.00 x 10.00mm, FPM		NA5001 32.00 x 47.00 x 10.00mm, FPM NA5133 85.00 x 105.00 x 11.00mm, FPM	
71 1.5L		Diesel			
CWXA		4 Cyl.	16 Valves	1498cc	TD32523
CWXB		4 Cyl.	16 Valves	1498cc	TD32410
CWXC		4 Cyl.	16 Valves	1498cc	TD33126
PA5041 (x16) HR791		NA5124 32.00 x 47.00 x 10.00mm, PTFE/ACM →09/09 NA5361 32.00 x 47.00 x 10.00mm, PTFE 10/09→		NA5106 35.00 x 48.00 x 10.00mm, PTFE LK5019 85.00 x 131.00 x 17.25mm, PTFE/ACM	
72 1.5L		Petrol			
EH		4 Cyl.	8 Valves	1457cc	TD21347
FD		4 Cyl.	8 Valves	1471cc	TD21346
FF		4 Cyl.	8 Valves	1471cc	TD4078
GH		4 Cyl.	8 Valves	1457cc	TD22653
HR569		NA5001 32.00 x 47.00 x 10.00mm, FPM		NA5001 32.00 x 47.00 x 10.00mm, FPM NA5133 85.00 x 105.00 x 11.00mm, FPM	
73 1.5L		Petrol			
FB		4 Cyl.	8 Valves	1470cc	TD4077
FK		4 Cyl.	8 Valves	1471cc	TD4083
HR569		NA5001 32.00 x 47.00 x 10.00mm, FPM			

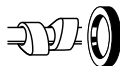

74 1.5L

Petrol

FH	4 Cyl.	8 Valves	1471cc	TD4080
YJ	4 Cyl.	8 Valves	1471cc	TD5033
ZB	4 Cyl.	8 Valves	1471cc	TD5037
ZC	4 Cyl.	8 Valves	1471cc	TD5141

HR569

NA5001
32.00 x 47.00 x 10.00mm, FPM

NA5133
85.00 x 105.00 x 11.00mm, FPM

75 1.5L

Petrol

H	4 Cyl.	8 Valves	1493cc	TD4103
K	4 Cyl.	8 Valves	1493cc	TD4122
L	4 Cyl.	8 Valves	1493cc	TD4127

NA784
70.00 x 90.00 x 10.00mm, ACM

76 1.5L

Petrol

JB	4 Cyl.	8 Valves	1457cc	TD4115
----	--------	----------	--------	--------

HR569

NA5001 (x2)
32.00 x 47.00 x 10.00mm, FPM

NA5001
32.00 x 47.00 x 10.00mm, FPM
NA5133
85.00 x 105.00 x 11.00mm, FPM

77 1.6L

Diesel

1C	4 Cyl.	8 Valves	1588cc	TD13489
1V	4 Cyl.	8 Valves	1589cc	TD3996
68A	4 Cyl.	8 Valves	1588cc	TD22615
68C	4 Cyl.	8 Valves	1588cc	TD22616
685	4 Cyl.	8 Valves	1588cc	TD22613
686	4 Cyl.	8 Valves	1588cc	TD22614
ADK	4 Cyl.	8 Valves	1588cc	TD22619
JR	4 Cyl.	8 Valves	1588cc	TD4121
JX	4 Cyl.	8 Valves	1589cc	TD5018
MF	4 Cyl.	8 Valves	1588cc	TD4130
RA	4 Cyl.	8 Valves	1588cc	TD5024
SB	4 Cyl.	8 Valves	1588cc	TD5028

HR569

NA5001
32.00 x 47.00 x 10.00mm, FPM

NA5001
32.00 x 47.00 x 10.00mm, FPM
NA5133
85.00 x 105.00 x 11.00mm, FPM

78 1.6L

Petrol

1F	4 Cyl.	8 Valves	1595cc	TD4957
496	4 Cyl.	8 Valves	1588cc	TD22610

HR569

NA5001
32.00 x 47.00 x 10.00mm, FPM

NA5001
32.00 x 47.00 x 10.00mm, FPM
NA5133
85.00 x 105.00 x 11.00mm, FPM
LK5006
85.00 x 131.00 x 16.00mm, PTFE

**79 1.6L****Petrol**

ABN	4 Cyl.	8 Valves	1595cc	TD4974
ABX	4 Cyl.	8 Valves	1595cc	TD19526
ABX	4 Cyl.	8 Valves	1595cc	TD22618
DT	4 Cyl.	8 Valves	1595cc	TD4997
DTA	4 Cyl.	8 Valves	1595cc	TD22646
EF	4 Cyl.	8 Valves	1588cc	TD4066
EM	4 Cyl.	8 Valves	1588cc	TD4068
EW	4 Cyl.	8 Valves	1595cc	TD4070
EWA	4 Cyl.	8 Valves	1595cc	TD4072
EZ	4 Cyl.	8 Valves	1595cc	TD4074
EZA	4 Cyl.	8 Valves	1595cc	TD4075
FS	4 Cyl.	8 Valves	1588cc	TD16536
HM	4 Cyl.	8 Valves	1595cc	TD9523
HN	4 Cyl.	8 Valves	1595cc	TD4107
JU	4 Cyl.	8 Valves	1595cc	TD12532
PN	4 Cyl.	8 Valves	1595cc	TD4141
PP	4 Cyl.	8 Valves	1595cc	TD5022
RE	4 Cyl.	8 Valves	1595cc	TD4145
RF	4 Cyl.	8 Valves	1595cc	TD5025
RL	4 Cyl.	8 Valves	1595cc	TD4148
WP	4 Cyl.	8 Valves	1588cc	TD17200
WY	4 Cyl.	8 Valves	1588cc	TD21343
WZ	4 Cyl.	8 Valves	1588cc	TD4171
YG	4 Cyl.	8 Valves	1588cc	TD19257
YK	4 Cyl.	8 Valves	1588cc	TD4176
YN	4 Cyl.	8 Valves	1588cc	TD5034
YU	4 Cyl.	8 Valves	1588cc	TD4177
YY	4 Cyl.	8 Valves	1588cc	TD22655

HR569 **NA5001**
32.00 x 47.00 x 10.00mm, FPM**NA5001**
32.00 x 47.00 x 10.00mm, FPM**NA5133**
85.00 x 105.00 x 11.00mm, FPM**80 1.6L****Petrol**

ABU	4 Cyl.	8 Valves	1598cc	TD4976
-----	--------	----------	--------	--------

HR569
→Ch no. 1HNW500000
HR816
Ch no. 1HPW000001→**NA5001**
32.00 x 47.00 x 10.00mm, FPM**NA5001**
32.00 x 47.00 x 10.00mm, FPM**NA5133**
85.00 x 105.00 x 11.00mm, FPM

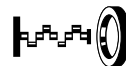
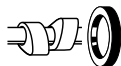

81 1.6L

Petrol

ACD	4 Cyl.	8 Valves	1584cc	TD9471
AD	4 Cyl.	8 Valves	1584cc	TD4016
AE	4 Cyl.	8 Valves	1584cc	TD5133
AF	4 Cyl.	8 Valves	1584cc	TD4022
AG	4 Cyl.	8 Valves	1584cc	TD14188
AH	4 Cyl.	8 Valves	1584cc	TD4018
AJ	4 Cyl.	8 Valves	1584cc	TD4024
AK	4 Cyl.	8 Valves	1584cc	TD5134
AL	4 Cyl.	8 Valves	1584cc	TD14189
AM	4 Cyl.	8 Valves	1584cc	TD14190
AS	4 Cyl.	8 Valves	1584cc	TD4030
CT	4 Cyl.	8 Valves	1584cc	TD4049
CZ	4 Cyl.	8 Valves	1584cc	TD4053
T	4 Cyl.	8 Valves	1584cc	TD5029
U	4 Cyl.	8 Valves	1584cc	TD5030

NA784
70.00 x 90.00 x 10.00mm, ACM

82 1.6L

Petrol

ADP	4 Cyl.	8 Valves	1595cc	TD16253
AFT	4 Cyl.	8 Valves	1595cc	TD4988
AKS	4 Cyl.	8 Valves	1595cc	TD9991

HR816

NA5001
32.00 x 47.00 x 10.00mm, FPM

NA5001
32.00 x 47.00 x 10.00mm, FPM
NA5133
85.00 x 105.00 x 11.00mm, FPM

83 1.6L

Petrol

AEA	4 Cyl.	8 Valves	1598cc	TD4019
AEE	4 Cyl.	8 Valves	1598cc	TD4981
UNF	4 Cyl.	8 Valves	1598cc	TD27042

HR816

NA5001
32.00 x 47.00 x 10.00mm, FPM

NA5001
32.00 x 47.00 x 10.00mm, FPM
NA5133
85.00 x 105.00 x 11.00mm, FPM
LK5006
85.00 x 131.00 x 16.000mm, PTFE

84 1.6L

Petrol

AEH	4 Cyl.	8 Valves	1595cc	TD9450
AKL	4 Cyl.	8 Valves	1595cc	TD9451

HR816

NA5124
32.00 x 47.00 x 10.00mm, PTFE/ACM

NB716
35.00 x 48.00 x 10.00mm, FPM
NA5106
35.00 x 48.00 x 10.00mm, PTFE
LK5008
85.00 x 131.00 x 15.700mm, PTFE

85 1.6L

Petrol

AEK	4 Cyl.	8 Valves	1595cc	TD4982
-----	--------	----------	--------	--------

HR569
→Eng no. AEK000813

HR816
Eng no. AEK000814 →

NA5001
32.00 x 47.00 x 10.00mm, FPM

NA5001
32.00 x 47.00 x 10.00mm, FPM
NA5133
85.00 x 105.00 x 11.00mm, FPM

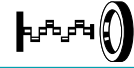
**86 1.6L****Petrol**

AFX	4 Cyl.	8 Valves	1595cc	TD19870
HR816	NA5001 32.00 x 47.00 x 10.00mm, FPM		NA5001 32.00 x 47.00 x 10.00mm, FPM LK5006 85.00 x 131.00 x 16.000mm, PTFE	

87 1.6L**Petrol**

AHL	4 Cyl.	8 Valves	1595cc	TD5556
ANA	4 Cyl.	8 Valves	1595cc	TD16254
APF	4 Cyl.	8 Valves	1595cc	TD12848
AUR	4 Cyl.	8 Valves	1595cc	TD15611
AWH	4 Cyl.	8 Valves	1595cc	TD15465
HR816	NA5124 32.00 x 47.00 x 10.00mm, PTFE/ACM		NA5106 35.00 x 48.00 x 10.00mm, PTFE LK5008 85.00 x 131.00 x 15.700mm, PTFE	

88 1.6L**Petrol**

AHS	4 Cyl.	8 Valves	1598cc	TD12948
HR816	NA5001 (x2) 32.00 x 47.00 x 10.00mm, FPM		NA5001 32.00 x 47.00 x 10.00mm, FPM NA5133 85.00 x 105.00 x 11.00mm, FPM LK5006 85.00 x 131.00 x 16.000mm, PTFE	

89 1.6L**Petrol**

AJV	4 Cyl.	16 Valves	1598cc	TD11247
AZD	4 Cyl.	16 Valves	1598cc	TD15478
PA5041 (x16) HR791	NA5180 (x2) 27.00 x 42.00 x 8.00mm, FPM		NA5185 32.00 x 42.00 x 6.00mm, FPM	

90 1.6L**Petrol**

ALM	4 Cyl.	8 Valves	1598cc	TD15610
HR816	NA5001 32.00 x 47.00 x 10.00mm, FPM →Eng no. ALM 000 706 NA5185 32.00 x 42.00 x 6.00mm, FPM Eng no. 000 707→		NA5001 32.00 x 47.00 x 10.00mm, FPM →Eng no. ALM 000 706 NA5185 32.00 x 42.00 x 6.00mm, FPM Eng no. 000 707→ LK5006 85.00 x 131.00 x 16.000mm, PTFE	



91 1.6L

Petrol

ALZ	4 Cyl.	8 Valves	1595cc	TD15148
AVU	4 Cyl.	8 Valves	1595cc	TD15475
AYD	4 Cyl.	8 Valves	1595cc	TD15466
BFQ	4 Cyl.	8 Valves	1595cc	TD18137
BFQ	4 Cyl.	8 Valves	1595cc	TD24363
BFS	4 Cyl.	8 Valves	1595cc	TD16743
BGU	4 Cyl.	8 Valves	1595cc	TD17067
BJH	4 Cyl.	8 Valves	1595cc	TD19138
BJH	4 Cyl.	8 Valves	1595cc	TD22290
BRY	4 Cyl.	8 Valves	1595cc	TD22897
BRY	4 Cyl.	8 Valves	1595cc	TD20654
BSE	4 Cyl.	8 Valves	1595cc	TD18222
BSF	4 Cyl.	8 Valves	1595cc	TD18223
CCSA	4 Cyl.	8 Valves	1595cc	TD20780
CHGA	4 Cyl.	8 Valves	1595cc	TD22180
CMXA	4 Cyl.	8 Valves	1595cc	TD24313

PA5041 (x8)
HR817

NA5124
32.00 x 47.00 x 10.00mm, PTFE/ACM

NA5106
35.00 x 48.00 x 10.00mm, PTFE
LK5008
85.00 x 131.00 x 15.700mm, PTFE

92 1.6L

Petrol

ARC	4 Cyl.	16 Valves	1598cc	TD14169
AVY	4 Cyl.	16 Valves	1598cc	TD15493
BAD	4 Cyl.	16 Valves	1598cc	TD16388

PA5041 (x16)
HR791

NA5180
27.00 x 42.00 x 8.00mm, FPM

NA5185
32.00 x 42.00 x 6.00mm, FPM

93 1.6L

Petrol

ARM	4 Cyl.	8 Valves	1595cc	TD16255
-----	--------	----------	--------	---------

HR816

NA5124
32.00 x 47.00 x 10.00mm, PTFE/ACM

NA5106
35.00 x 48.00 x 10.00mm, PTFE
LK5008
85.00 x 131.00 x 15.700mm, PTFE
LK5006
85.00 x 131.00 x 16.000mm, PTFE

94 1.6L

Petrol

ATN	4 Cyl.	16 Valves	1598cc	TD15476
AUS	4 Cyl.	16 Valves	1598cc	TD15477
BCB	4 Cyl.	16 Valves	1598cc	TD16387

PA5041 (x16)
HR791

NA5180 (x2)
27.00 x 42.00 x 8.00mm, FPM

NA5185
32.00 x 42.00 x 6.00mm, FPM
LK5006
85.00 x 131.00 x 16.000mm, PTFE

95 1.6L

Petrol

AWB	4 Cyl.	20 Valves	1595cc	TD19157
-----	--------	-----------	--------	---------

PA5041 (x20)
HR822

NA5001 (x2)
32.00 x 47.00 x 10.00mm, FPM
NA5124 (x2)
32.00 x 47.00 x 10.00mm, PTFE/ACM

NB716
35.00 x 48.00 x 10.00mm, FPM
NA5106
35.00 x 48.00 x 10.00mm, PTFE
LK5003
85.00 x 131.00 x 15.700mm, PTFE

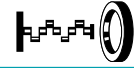
**96 1.6L****Petrol**

AWB	4 Cyl.	20 Valves	1595cc	TD21601
PA5041 (x20) HR822				

97 1.6L**Petrol**

BAG	4 Cyl.	16 Valves	1598cc	TD17048
BLF	4 Cyl.	16 Valves	1598cc	TD18100
BLP	4 Cyl.	16 Valves	1598cc	TD18202
PA5041 (x16) HR791				
			NA5106 35.00 x 48.00 x 10.00mm, PTFE	
			LK5013 85.00 x 111.00 x 15.50mm, PTFE	

98 1.6L**Petrol**

BAH	4 Cyl.	8 Valves	1598cc	TD20801
BPA	4 Cyl.	8 Valves	1598cc	TD20802
CCRA	4 Cyl.	8 Valves	1598cc	TD20810
CFZA	4 Cyl.	8 Valves	1598cc	TD24043
PA5041 (x8) HR817				
			NA5185 32.00 x 42.00 x 6.00mm, FPM	
			NA5185 32.00 x 42.00 x 6.00mm, FPM	

99 1.6L**Petrol**

BCD	4 Cyl.	8 Valves	1595cc	TD22629
PA5041 (x8)				
			NA5124 32.00 x 47.00 x 10.00mm, PTFE/ACM	
			NA5106 35.00 x 48.00 x 10.00mm, PTFE	
			LK5003 85.00 x 131.00 x 15.700mm, PTFE	

100 1.6L**Petrol**

BJA	4 Cyl.	8 Valves	1598cc	TD20811
BLH	4 Cyl.	8 Valves	1598cc	TD20803
PA5041 (x8)				
			NA5185 32.00 x 42.00 x 6.00mm, FPM	
			NA5185 32.00 x 42.00 x 6.00mm, FPM	

101 1.6L**Petrol**

BJF	4 Cyl.	8 Valves	1596cc	TD25198
BJY	4 Cyl.	8 Valves	1781cc	TD25785
BWX	4 Cyl.	8 Valves	1596cc	TD25788
UPD	4 Cyl.	8 Valves	1595cc	TD27043
HR816				
			NA5001 32.00 x 47.00 x 10.00mm, FPM	
			NA5001 32.00 x 47.00 x 10.00mm, FPM	

102 1.6L**Petrol**

BJG	4 Cyl.	8 Valves	1595cc	TD21419
PA5041 (x8)				

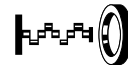
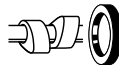

103 1.6L

Petrol

BMH	4 Cyl.	16 Valves	1598cc	TD25892
BTS	4 Cyl.	16 Valves	1598cc	TD19093
CDE	4 Cyl.	16 Valves	1598cc	TD25896
CDEA	4 Cyl.	16 Valves	1598cc	TD31215
CDF	4 Cyl.	16 Valves	1598cc	TD30493
CFNA	4 Cyl.	16 Valves	1598cc	TD25747
CFNB	4 Cyl.	16 Valves	1598cc	TD25748
CLR	4 Cyl.	16 Valves	1598cc	TD31380
CLRA	4 Cyl.	16 Valves	1598cc	TD27078
CLRA	4 Cyl.	16 Valves	1598cc	TD27418
CLS	4 Cyl.	16 Valves	1598cc	TD32828
CLSA	4 Cyl.	16 Valves	1598cc	TD25749
CNKA	4 Cyl.	16 Valves	1598cc	TD25189

PA5041 (x16)
HR791

NA5106
35.00 x 48.00 x 10.00mm, PTFE

104 1.6L

Petrol

BWH	4 Cyl.	8 Valves	1595cc	TD21421
-----	--------	----------	--------	---------

PA5041 (x8)
HR817

NA5124
32.00 x 47.00 x 10.00mm, PTFE/ACM

NA5106
35.00 x 48.00 x 10.00mm, PTFE
LK5003
85.00 x 131.00 x 15.700mm, PTFE

105 1.6L

Diesel

CAYA	4 Cyl.	16 Valves	1598cc	TD23105
CAYB	4 Cyl.	16 Valves	1598cc	TD22638
CAYC	4 Cyl.	16 Valves	1598cc	TD22639

PA5041 (x16)
HR791

NA5361 (x2)
32.00 x 47.00 x 10.00mm, PTFE
NA5124 (x2)
32.00 x 47.00 x 10.00mm, PTFE/ACM

NA5106
35.00 x 48.00 x 10.00mm, PTFE
LK5019
85.00 x 131.00 x 17.25mm, PTFE/ACM

106 1.6L

Diesel

CAYD	4 Cyl.	16 Valves	1598cc	TD24364
CAYE	4 Cyl.	16 Valves	1598cc	TD24365
CLNA	4 Cyl.	16 Valves	1598cc	TD25704

PA5041 (x16)
HR791

NA5124 (x2)
32.00 x 47.00 x 10.00mm, PTFE/ACM
→09/09
NA5361 (x2)
32.00 x 47.00 x 10.00mm, PTFE
10/09→

NA5106
35.00 x 48.00 x 10.00mm, PTFE
LK5019
85.00 x 131.00 x 17.25mm, PTFE/ACM

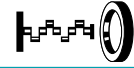

107 1.6L		Diesel			
CLHA	4 Cyl.	16 Valves	1598cc		TD27195
CLHB	4 Cyl.	16 Valves	1598cc		TD27961
CRKA	4 Cyl.	16 Valves	1598cc		TD27962
CRKB	4 Cyl.	16 Valves	1598cc		TD27963
CXXA	4 Cyl.	16 Valves	1598cc		TD28095
CXXB	4 Cyl.	16 Valves	1598cc		TD28098
DBKA	4 Cyl.	16 Valves	1598cc		TD31432
DCXA	4 Cyl.	16 Valves	1598cc		TD29841
DCZA	4 Cyl.	16 Valves	1598cc		TD32772
DDYA	4 Cyl.	16 Valves	1598cc		TD34061
DDYB	4 Cyl.	16 Valves	1598cc		TD34422
DGDA	4 Cyl.	16 Valves	1598cc		TD33103
DGDB	4 Cyl.	16 Valves	1598cc		TD33683
PA5041 (x16) HR791	NA5361 (x2) 32.00 x 47.00 x 10.00mm, PTFE		LK5017 85.00 x 130.90 x 15.75mm, PTFE		

108 1.6L		Petrol			
CMR	4 Cyl.	8 Valves	1595cc		TD25901
HR816	NA5124 32.00 x 47.00 x 10.00mm, PTFE/ACM		NA5106 35.00 x 48.00 x 10.00mm, PTFE LK5003 85.00 x 131.00 x 15.700mm, PTFE		

109 1.6L		Petrol			
CNXA	4 Cyl.	16 Valves	1598cc		TD31414
CWSA	4 Cyl.	16 Valves	1598cc		TD31413
	NA5456 (x2) 36.00 x 46.00 x 7.00mm, PTFE/ACM				

110 1.6L		Petrol			
CPD	4 Cyl.	16 Valves	1598cc		TD33367
CPD	4 Cyl.	16 Valves	1598cc		TD33369
CPDA	4 Cyl.	16 Valves	1598cc		TD30501
CPDA	4 Cyl.	16 Valves	1598cc		TD30502
CUCA	4 Cyl.	16 Valves	1598cc		TD32672
CWVB	4 Cyl.	16 Valves	1598cc		TD31028
	NA5458 (x2) 24.00 x 39.00 x 8.00mm, PTFE/ACM				

111 1.6L		Diesel			
CR	4 Cyl.	8 Valves	1588cc		TD4992
CS	4 Cyl.	8 Valves	1588cc		TD4048
CY	4 Cyl.	8 Valves	1588cc		TD4052
JK	4 Cyl.	8 Valves	1588cc		TD5013
JP	4 Cyl.	8 Valves	1588cc		TD4120
ME	4 Cyl.	8 Valves	1588cc		TD4129
HR569	NA5001 (x2) 32.00 x 47.00 x 10.00mm, FPM		NA5001 32.00 x 47.00 x 10.00mm, FPM NA5133 85.00 x 105.00 x 11.00mm, FPM		

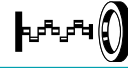

112 1.6L

Gas



CUCA 4 Cyl. 16 Valves 1598cc TD31399

NA5458 (x2)
24.00 x 39.00 x 8.00mm, PTFE/ACM
NA5456 (x2)
36.00 x 46.00 x 7.00mm, PTFE/ACM

113 1.6L

Petrol



CWVA 4 Cyl. 16 Valves 1598cc TD29250

NA5456  (x2)
36.00 x 46.00 x 7.00mm, PTFE/ACM
NA5458  (x2)
24.00 x 39.00 x 8.00mm, PTFE/ACM

114 1.6L

Petrol

EE	4 Cyl.	8 Valves	1588cc	TD4065
EG	4 Cyl.	8 Valves	1588cc	TD4999
FN	4 Cyl.	8 Valves	1588cc	TD4085
FP	4 Cyl.	8 Valves	1588cc	TD4086
FR	4 Cyl.	8 Valves	1588cc	TD4088
FT	4 Cyl.	8 Valves	1588cc	TD4089
FV	4 Cyl.	8 Valves	1588cc	TD4090
WV	4 Cyl.	8 Valves	1588cc	TD5032
YH	4 Cyl.	8 Valves	1588cc	TD4175
YP	4 Cyl.	8 Valves	1588cc	TD5035
YS	4 Cyl.	8 Valves	1588cc	TD9378

HR569 	NA5001 (x2) 32.00 x 47.00 x 10.00mm, FPM	NA5001  32.00 x 47.00 x 10.00mm, FPM NA5133  85.00 x 105.00 x 11.00mm, FPM
--	--	---

115 1.7L

Diesel





AHB	4 Cyl.	8 Valves	1716cc	TD15028
AHG	4 Cyl.	8 Valves	1716cc	TD11207
AKW	4 Cyl.	8 Valves	1716cc	TD9687

HR816 	NA5001 32.00 x 47.00 x 10.00mm, FPM	NA5001  32.00 x 47.00 x 10.00mm, FPM LK5006  85.00 x 131.00 x 16.00mm, PTFE
--	---	--

116 1.7L

Diesel

AKU 4 Cyl. 8 Valves 1716cc TD9513

HR816 	NA5001 32.00 x 47.00 x 10.00mm, FPM	NA5001  32.00 x 47.00 x 10.00mm, FPM LK5006  85.00 x 131.00 x 16.00mm, PTFE NA5133  85.00 x 105.00 x 11.00mm, FPM →Eng no. 013 000
--	---	--

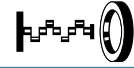

117 1.7L

Petrol

CA	4 Cyl.	8 Valves	1679cc	TD4040
CB	4 Cyl.	8 Valves	1679cc	TD5149
CE	4 Cyl.	8 Valves	1679cc	TD4041
EA	4 Cyl.	8 Valves	1679cc	TD22647
V	4 Cyl.	8 Valves	1679cc	TD5120
W	4 Cyl.	8 Valves	1679cc	TD4170
Z	4 Cyl.	8 Valves	1679cc	TD4179

NB953
75.00 x 95.00 x 12.00mm, FPM

118 1.7L

Petrol

EN	4 Cyl.	8 Valves	1716cc	TD22652
WT	4 Cyl.	8 Valves	1715cc	TD29386

HR569

NA5001
32.00 x 47.00 x 10.00mm, FPM

NA5001
32.00 x 47.00 x 10.00mm, FPM
NA5133
85.00 x 105.00 x 11.00mm, FPM

119 1.7L

Diesel

KY	4 Cyl.	8 Valves	1716cc	TD4126
----	--------	----------	--------	--------

HR569

NA5001
32.00 x 47.00 x 10.00mm, FPM

NA5001
32.00 x 47.00 x 10.00mm, FPM
NA5133
85.00 x 105.00 x 11.00mm, FPM

120 1.7L

Petrol

WL	4 Cyl.	8 Valves	1714cc	TD13488
YX	4 Cyl.	8 Valves	1714cc	TD4178

HR569

NA5001 (x2)
32.00 x 47.00 x 10.00mm, FPM

NA5001
32.00 x 47.00 x 10.00mm, FPM
NA5133
85.00 x 105.00 x 11.00mm, FPM

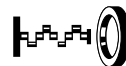
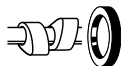

121 1.8L

Petrol

1H	4 Cyl.	8 Valves	1781cc	TD3994
1P	4 Cyl.	8 Valves	1781cc	TD3995
2H	4 Cyl.	8 Valves	1781cc	TD4965
262	4 Cyl.	8 Valves	1781cc	TD22608
ABG	4 Cyl.	8 Valves	1781cc	TD26861
DS	4 Cyl.	8 Valves	1781cc	TD4996
DSN	4 Cyl.	8 Valves	1781cc	TD25202
DX	4 Cyl.	8 Valves	1781cc	TD4063
DZ	4 Cyl.	8 Valves	1781cc	TD4998
EX	4 Cyl.	8 Valves	1781cc	TD5000
GX	4 Cyl.	8 Valves	1781cc	TD4100
GZ	4 Cyl.	8 Valves	1781cc	TD4102
HT	4 Cyl.	8 Valves	1781cc	TD4109
HV	4 Cyl.	8 Valves	1781cc	TD4111
JH	4 Cyl.	8 Valves	1781cc	TD4117
JJ	4 Cyl.	8 Valves	1781cc	TD4118
JN	4 Cyl.	8 Valves	1781cc	TD5014
PB	4 Cyl.	8 Valves	1781cc	TD9367
PD	4 Cyl.	8 Valves	1781cc	TD4138
PF	4 Cyl.	8 Valves	1781cc	TD4139
PG	4 Cyl.	8 Valves	1781cc	TD4140
RD	4 Cyl.	8 Valves	1781cc	TD4143
RG	4 Cyl.	8 Valves	1781cc	TD4146
RH	4 Cyl.	8 Valves	1781cc	TD5026
RM	4 Cyl.	8 Valves	1781cc	TD4149
RV	4 Cyl.	8 Valves	1781cc	TD4151
UDB	4 Cyl.	8 Valves	1781cc	TD28208

HR569

NA5001
32.00 x 47.00 x 10.00mm, FPM

NA5001
32.00 x 47.00 x 10.00mm, FPM
NA5133
85.00 x 105.00 x 11.00mm, FPM

122 1.8L

Petrol

2Y	4 Cyl.	8 Valves	1812cc	TD4967
----	--------	----------	--------	--------

PA136 (x8)

NJ344
42.00 x 60.00 x 7.00mm, NBR
NJ360
80.00 x 100.00 x 8.50mm, MVQ

123 1.8L

Petrol

AAM	4 Cyl.	8 Valves	1781cc	TD4004
-----	--------	----------	--------	--------

HR569
→Eng no. AAM 408 197
HR816
Eng no. AAM 408 198 →

NA5001
32.00 x 47.00 x 10.00mm, FPM

NA5001
32.00 x 47.00 x 10.00mm, FPM
NA5133
85.00 x 105.00 x 11.00mm, FPM
LK5006
85.00 x 131.00 x 16.000mm, PTFE

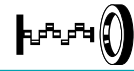
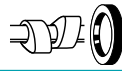
**124 1.8L****Petrol**

ABS	4 Cyl.	8 Valves	1781cc	TD4975
HR569 →Eng no. 935 645	NA5001 32.00 x 47.00 x 10.00mm, FPM	NA5001 32.00 x 47.00 x 10.00mm, FPM	NA5133 85.00 x 105.00 x 11.00mm, FPM	LK5006 85.00 x 131.00 x 16.00mm, PTFE
HR816 Eng no. 935 646 →				

125 1.8L**Petrol**

ACC	4 Cyl.	8 Valves	1781cc	TD4011
ADD	4 Cyl.	8 Valves	1781cc	TD15496
BZF	4 Cyl.	8 Valves	1806cc	TD26800
HR816	NA5001 32.00 x 47.00 x 10.00mm, FPM	NA5001 32.00 x 47.00 x 10.00mm, FPM	NA5133 85.00 x 105.00 x 11.00mm, FPM	LK5006 85.00 x 131.00 x 16.00mm, PTFE

126 1.8L**Petrol**

ADF	4 Cyl.	8 Valves	1781cc	TD21353
HR569 →Eng no. ADF 005 795	NA5001 32.00 x 47.00 x 10.00mm, FPM	NA5001 32.00 x 47.00 x 10.00mm, FPM	NA5133 85.00 x 105.00 x 11.00mm, FPM	LK5006 85.00 x 131.00 x 16.00mm, PTFE
HR816 Eng no. ADF 005 796 →				

127 1.8L**Petrol**

ADR	4 Cyl.	20 Valves	1781cc	TD5557
AFY	4 Cyl.	20 Valves	1781cc	TD16244
PA5041 (x20) HR822	NA5001 (x2) 32.00 x 47.00 x 10.00mm, FPM NA5124 (x2) 32.00 x 47.00 x 10.00mm, PTFE/ACM	NA5001 32.00 x 47.00 x 10.00mm, FPM NA5124 (x2) 32.00 x 47.00 x 10.00mm, PTFE/ACM NA5133 85.00 x 105.00 x 11.00mm, FPM LK5006 85.00 x 131.00 x 16.00mm, PTFE		

128 1.8L**Petrol**

ADZ	4 Cyl.	8 Valves	1781cc	TD4980
HR569 →Eng no. 011 565	NA5001 32.00 x 47.00 x 10.00mm, FPM	NA5001 32.00 x 47.00 x 10.00mm, FPM	NA5133 85.00 x 105.00 x 11.00mm, FPM	LK5006 85.00 x 131.00 x 16.00mm, PTFE
HR816 Eng no. 011 566 →				

129 1.8L**Petrol**

AEB	4 Cyl.	20 Valves	1781cc	TD5558
PA5041 (x20) HR822	NA5001 (x2) 32.00 x 47.00 x 10.00mm, FPM NA5124 (x2) 32.00 x 47.00 x 10.00mm, PTFE/ACM	NA5001 32.00 x 47.00 x 10.00mm, FPM NA5133 85.00 x 105.00 x 11.00mm, FPM LK5006 85.00 x 131.00 x 16.00mm, PTFE		

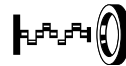
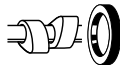

130 1.8L

Petrol

AFE	4 Cyl.	8 Valves	1781cc	TD19141
UDH	4 Cyl.	8 Valves	1781cc	TD20405
HR816	NA5001 32.00 x 47.00 x 10.00mm, FPM		NA5001 32.00 x 47.00 x 10.00mm, FPM NA5133 85.00 x 105.00 x 11.00mm, FPM	

131 1.8L

Petrol

AFY	4 Cyl.	20 Valves	1781cc	TD19531
BAE	4 Cyl.	20 Valves	1781cc	TD20649
BGC	4 Cyl.	20 Valves	1781cc	TD25889
BPL	4 Cyl.	20 Valves	1781cc	TD21422
BTH	4 Cyl.	20 Valves	1781cc	TD30118
PA5041 (x20) HR822	NA5124 (x2) 32.00 x 47.00 x 10.00mm, PTFE/ACM		NA5106 35.00 x 48.00 x 10.00mm, PTFE LK5003 85.00 x 131.00 x 15.700mm, PTFE	

132 1.8L

Petrol

AGN	4 Cyl.	20 Valves	1781cc	TD9363
AGU	4 Cyl.	20 Valves	1781cc	TD9456
AQA	4 Cyl.	20 Valves	1781cc	TD22620
ARX	4 Cyl.	20 Valves	1781cc	TD15485
ARZ	4 Cyl.	20 Valves	1781cc	TD16385
AUM	4 Cyl.	20 Valves	1781cc	TD15486
AUQ	4 Cyl.	20 Valves	1781cc	TD16420
AWL	4 Cyl.	20 Valves	1781cc	TD19134
AWM	4 Cyl.	20 Valves	1781cc	TD16423
AWT	4 Cyl.	20 Valves	1781cc	TD15149
PA5041 (x20) HR822	NA5001 (x2) 32.00 x 47.00 x 10.00mm, FPM NA5124 (x2) 32.00 x 47.00 x 10.00mm, PTFE/ACM		NB716 35.00 x 48.00 x 10.00mm, FPM NA5106 35.00 x 48.00 x 10.00mm, PTFE LK5003 85.00 x 131.00 x 15.700mm, PTFE	

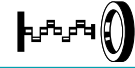

133 1.8L		Petrol			
AJH	4 Cyl.	20 Valves	1781cc		TD10887
APH	4 Cyl.	20 Valves	1781cc		TD13441
AVC	4 Cyl.	20 Valves	1781cc		TD15467
AWC	4 Cyl.	20 Valves	1781cc		TD14914
AWP	4 Cyl.	20 Valves	1781cc		TD19253
AWU	4 Cyl.	20 Valves	1781cc		TD15468
AWV	4 Cyl.	20 Valves	1781cc		TD15469
BAE	4 Cyl.	20 Valves	1781cc		TD19140
BAF	4 Cyl.	20 Valves	1781cc		TD19143
BBU	4 Cyl.	20 Valves	1781cc		TD20512
BJX	4 Cyl.	20 Valves	1781cc		TD18799
BKF	4 Cyl.	20 Valves	1781cc		TD21071
BNU	4 Cyl.	20 Valves	1781cc		TD21072
PA5041 (x20) HR822		NA5001 (x2) 32.00 x 47.00 x 10.00mm, FPM		NA5106 35.00 x 48.00 x 10.00mm, PTFE	
		NA5124 (x2) 32.00 x 47.00 x 10.00mm, PTFE/ACM		LK5003 85.00 x 131.00 x 15.700mm, PTFE	

134 1.8L		Petrol			
AN	4 Cyl.	8 Valves	1795cc		TD5130
AP	4 Cyl.	8 Valves	1795cc		TD4991
AT	4 Cyl.	8 Valves	1795cc		TD5131
EC	4 Cyl.	8 Valves	1795cc		TD22649
ED	4 Cyl.	8 Valves	1795cc		TD22651
				NB953 75.00 x 95.00 x 12.00mm, FPM	

135 1.8L		Petrol			
ANB	4 Cyl.	20 Valves	1781cc		TD16256
PA5041 (x20) HR822		NA5001 (x2) 32.00 x 47.00 x 10.00mm, FPM		NA5124 32.00 x 47.00 x 10.00mm, PTFE/ACM	
		NA5124 (x2) 32.00 x 47.00 x 10.00mm, PTFE/ACM		NA5001 32.00 x 47.00 x 10.00mm, FPM Eng no. 8D-X-200001 →	
				LK5006 85.00 x 131.00 x 16.000mm, PTFE	

136 1.8L		Petrol			
ANN	4 Cyl.	8 Valves	1781cc		TD10847
ANP	4 Cyl.	8 Valves	1781cc		TD10848
HR816		NA5001 32.00 x 47.00 x 10.00mm, FPM		NA5001 32.00 x 47.00 x 10.00mm, FPM	
				LK5006 85.00 x 131.00 x 16.000mm, PTFE	

137 1.8L		Petrol			
ANQ	4 Cyl.	20 Valves	1781cc		TD26159
AWL	4 Cyl.	20 Valves	1781cc		TD20648
PA5041 (x20)					

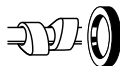

138 1.8L

Petrol

ANQ	4 Cyl.	20 Valves	1781cc	TD26500
PA5041 (x20) HR822	NA5001 (x2) 32.00 x 47.00 x 10.00mm, FPM	NA5124 (x2) 32.00 x 47.00 x 10.00mm, PTFE/ACM	NB716 35.00 x 48.00 x 10.00mm, FPM	NA5106 35.00 x 48.00 x 10.00mm, PTFE
			LK5008 85.00 x 131.00 x 15.700mm, PTFE	

139 1.8L

Petrol

APT	4 Cyl.	20 Valves	1781cc	TD11497
APU	4 Cyl.	20 Valves	1781cc	TD16257
ARG	4 Cyl.	20 Valves	1781cc	TD16237
PA5041 (x20) HR822	NA5001 (x2) 32.00 x 47.00 x 10.00mm, FPM	NA5124 (x2) 32.00 x 47.00 x 10.00mm, PTFE/ACM	NA5124 (x2) 32.00 x 47.00 x 10.00mm, PTFE/ACM	LK5006 85.00 x 131.00 x 16.000mm, PTFE

140 1.8L

Petrol

AWD	4 Cyl.	20 Valves	1781cc	TD20628
PA5041 (x20) HR822	NA5106 (x2) 35.00 x 48.00 x 10.00mm, PTFE/ACM		NA5106 35.00 x 48.00 x 10.00mm, PTFE	LK5003 85.00 x 131.00 x 15.700mm, PTFE

141 1.8L

Petrol

AWW	4 Cyl.	20 Valves	1781cc	TD20627
HR822	NA5124 32.00 x 47.00 x 10.00mm, PTFE/ACM		NA5106 35.00 x 48.00 x 10.00mm, PTFE	LK5003 85.00 x 131.00 x 15.700mm, PTFE

142 1.8L

Petrol

BAF	4 Cyl.	20 Valves	1781cc	TD20650
PA5041 (x20) HR822	NA5001 32.00 x 47.00 x 10.00mm, FPM	NA5124 32.00 x 47.00 x 10.00mm, PTFE/ACM	NA5106 35.00 x 48.00 x 10.00mm, PTFE	LK5003 85.00 x 131.00 x 15.700mm, PTFE

143 1.8L

Petrol

BHG	4 Cyl.	8 Valves	1781cc	TD25772
BSA	4 Cyl.	8 Valves	1781cc	TD25894
BSL	4 Cyl.	8 Valves	1781cc	TD25786
HR816				

144 1.8L

Petrol

BKT	4 Cyl.	8 Valves	1781cc	TD22325
BKU	4 Cyl.	8 Valves	1781cc	TD26160
HR816	NA5124 32.00 x 47.00 x 10.00mm, PTFE/ACM		NA5106 35.00 x 48.00 x 10.00mm, PTFE	LK5003 85.00 x 131.00 x 15.700mm, PTFE

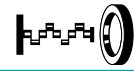
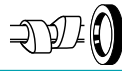

145 1.8L		Petrol			
BKU		4 Cyl.	8 Valves	1781cc	TD25890
HR816					NB716 35.00 x 48.00 x 10.00mm, FPM NA5106 35.00 x 48.00 x 10.00mm, PTFE LK5003 85.00 x 131.00 x 15.700mm, PTFE

146 1.8L		Petrol			
BNY		4 Cyl.	8 Valves	1781cc	TD25774
HR816		NA5001 32.00 x 47.00 x 10.00mm, FPM		NA5001 32.00 x 47.00 x 10.00mm, FPM	

147 1.8L		Petrol			
BYJ		4 Cyl.	16 Valves	1798cc	TD21420
BYJ		4 Cyl.	16 Valves	1798cc	TD23914
BZB		4 Cyl.	16 Valves	1798cc	TD20793
BZB		4 Cyl.	16 Valves	1798cc	TD21925
CDAA		4 Cyl.	16 Valves	1798cc	TD22641
CDAA		4 Cyl.	16 Valves	1798cc	TD27417
CDAB		4 Cyl.	16 Valves	1798cc	TD23735
CEA		4 Cyl.	16 Valves	1798cc	TD25897
CEA		4 Cyl.	16 Valves	1798cc	TD30001
CEAA		4 Cyl.	16 Valves	1798cc	TD31220
CGYA		4 Cyl.	16 Valves	1798cc	TD23736
CJSA		4 Cyl.	16 Valves	1798cc	TD30933
CJSB		4 Cyl.	16 Valves	1798cc	TD30930
CJSC		4 Cyl.	16 Valves	1798cc	TD30934
CNSA		4 Cyl.	16 Valves	1798cc	TD31405
CNSB		4 Cyl.	16 Valves	1798cc	TD31406
CPKA		4 Cyl.	16 Valves	1798cc	TD30931
CPRA		4 Cyl.	16 Valves	1798cc	TD30932
DAJA		4 Cyl.	16 Valves	1798cc	TD31027
DAJB		4 Cyl.	16 Valves	1798cc	TD29844
PA5041 (x16)					LK5016 85.00 x 164.00 x 11.00mm, PTFE
HR791					

148 1.8L		Petrol			
CED		4 Cyl.	20 Valves	1781cc	TD25898
CFMA		4 Cyl.	20 Valves	1781cc	TD29078
PA5041 (x20)		NA5124 (x2) 32.00 x 47.00 x 10.00mm, PTFE/ACM NA5106 (x2) 35.00 x 48.00 x 10.00mm, PTFE/ACM		NA5106 35.00 x 48.00 x 10.00mm, PTFE LK5003 85.00 x 131.00 x 15.700mm, PTFE	
HR822					



149 1.8L

Petrol

EV	4 Cyl.	8 Valves	1781cc	TD4069
GU	4 Cyl.	8 Valves	1781cc	TD5007
JV	4 Cyl.	8 Valves	1781cc	TD5017
KT	4 Cyl.	8 Valves	1781cc	TD4124
RP	4 Cyl.	8 Valves	1781cc	TD5027

HR569

NA5001 (x2)
32.00 x 47.00 x 10.00mm, FPM

NA5001
32.00 x 47.00 x 10.00mm, FPM
NA5133
85.00 x 105.00 x 11.00mm, FPM

150 1.8L

Petrol

JV	4 Cyl.	8 Valves	1781cc	TD23915
RP	4 Cyl.	8 Valves	1781cc	TD19538

HR569

NA5001 (x2)
32.00 x 47.00 x 10.00mm, FPM

NA5001 (x2)
32.00 x 47.00 x 10.00mm, FPM
NA5133
85.00 x 105.00 x 11.00mm, FPM

151 1.8L

Petrol

KR	4 Cyl.	16 Valves	1781cc	TD5019
PL	4 Cyl.	16 Valves	1781cc	TD5021

HR816 (x2)

NA5001 (x2)
32.00 x 47.00 x 10.00mm, FPM

NA5001
32.00 x 47.00 x 10.00mm, FPM
NA5133
85.00 x 105.00 x 11.00mm, FPM

152 1.9L

Diesel

IX	4 Cyl.	8 Valves	1896cc	TD3997
----	--------	----------	--------	--------

HR569

NA5001
32.00 x 47.00 x 10.00mm, FPM

NA5001
32.00 x 47.00 x 10.00mm, FPM
NA5133
85.00 x 105.00 x 11.00mm, FPM
LK5006
85.00 x 131.00 x 16.00mm, PTFE

153 1.9L

Diesel

IY	4 Cyl.	8 Valves	1896cc	TD4960
----	--------	----------	--------	--------

HR569
→Eng no. 580 000

HR816
Eng no. 580 001→

NA5001
32.00 x 47.00 x 10.00mm, FPM

NA5001
32.00 x 47.00 x 10.00mm, FPM
NA5133
85.00 x 105.00 x 11.00mm, FPM
LK5006
85.00 x 131.00 x 16.00mm, PTFE

154 1.9L

Diesel

IZ	4 Cyl.	8 Valves	1896cc	TD4961
----	--------	----------	--------	--------

HR569
→Eng no. 1Z-720 000

HR816
Eng no. 1Z-720 001→

NA5001
32.00 x 47.00 x 10.00mm, FPM

NA5001
32.00 x 47.00 x 10.00mm, FPM
NA5133
85.00 x 105.00 x 11.00mm, FPM
LK5006
85.00 x 131.00 x 16.00mm, PTFE

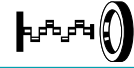
**155 1.9L****Diesel**

28B 4 Cyl. 8 Valves 1896cc TD22609

HR569 **NA5001**
32.00 x 47.00 x 10.00mm, FPM**NA5001**
32.00 x 47.00 x 10.00mm, FPM
NA5133
85.00 x 105.00 x 11.00mm, FPM**156 1.9L****Diesel**

AAZ 4 Cyl. 8 Valves 1896cc TD4972

HR569

→Eng no. AAZ-678 000

HR816

Eng no. AAZ-678 001→

NA5001
32.00 x 47.00 x 10.00mm, FPM**NA5001**
32.00 x 47.00 x 10.00mm, FPM
NA5133
85.00 x 105.00 x 11.00mm, FPM**157 1.9L****Diesel**

ABL 4 Cyl. 8 Valves 1896cc TD4009

HR569

→Eng no. 076 000

HR816

Eng no. 076 001→

NA5001
32.00 x 47.00 x 10.00mm, FPM**NA5001**
32.00 x 47.00 x 10.00mm, FPM
NA5133
85.00 x 105.00 x 11.00mm, FPM
LK5006
85.00 x 131.00 x 16.00mm, PTFE**158 1.9L****Diesel**

ADE 4 Cyl. 8 Valves 1896cc TD20097

HR816

→Eng no. ADE 003 235

HR569

Eng no. ADE 003 236→

NA5001
32.00 x 47.00 x 10.00mm, FPM**NA5001**
32.00 x 47.00 x 10.00mm, FPM
NA5133
85.00 x 105.00 x 11.00mm, FPM
LK5006
85.00 x 131.00 x 16.00mm, PTFE**159 1.9L****Diesel**

ADG 4 Cyl. 8 Valves 1896cc TD20098

AFD 4 Cyl. 8 Valves 1896cc TD16184

HR816 **NA5001**
32.00 x 47.00 x 10.00mm, FPM**NA5001**
32.00 x 47.00 x 10.00mm, FPM
NA5133
85.00 x 105.00 x 11.00mm, FPM
LK5006
85.00 x 131.00 x 16.00mm, PTFE**160 1.9L****Diesel**

AEF 4 Cyl. 8 Valves 1896cc TD4020

HR569

→Eng no. 007 000

HR816

Eng no. 007 001→

NA5001
32.00 x 47.00 x 10.00mm, FPM**NA5001**
32.00 x 47.00 x 10.00mm, FPM
NA5133
85.00 x 105.00 x 11.00mm, FPM
LK5006
85.00 x 131.00 x 16.00mm, PTFE**161 1.9L****Diesel**

AEY 4 Cyl. 8 Valves 1896cc TD4985

HR569

→Eng no. AEY 002 000

HR816

Eng no. AEY 002 001→

NA5001
32.00 x 47.00 x 10.00mm, FPM**NA5001**
32.00 x 47.00 x 10.00mm, FPM
NA5133
85.00 x 105.00 x 11.00mm, FPM
LK5006
85.00 x 131.00 x 16.00mm, PTFE

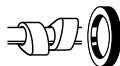

162 1.9L

Diesel

AFN	4 Cyl.	8 Valves	1896cc	TD4987
HR569	NA5001 32.00 x 47.00 x 10.00mm, FPM			NA5001 32.00 x 47.00 x 10.00mm, FPM
→Eng no. 002 000				NA5133 85.00 x 105.00 x 11.00mm, FPM
HR816				LK5006 85.00 x 131.00 x 16.000mm, PTFE
Eng no. 002 001→				

163 1.9L

Diesel

AGD	4 Cyl.	8 Valves	1896cc	TD9372
HR816	NA5001 32.00 x 47.00 x 10.00mm, FPM			NA5001 32.00 x 47.00 x 10.00mm, FPM
				NA5133 85.00 x 105.00 x 11.00mm, FPM
				→Eng no. 015 000
				LK5006 85.00 x 131.00 x 16.000mm, PTFE
				Eng no. 015 001→

164 1.9L

Diesel

AGP	4 Cyl.	8 Valves	1896cc	TD9452
AGR	4 Cyl.	8 Valves	1896cc	TD9364
ALH	4 Cyl.	8 Valves	1896cc	TD9455
HR816	NA5001 32.00 x 47.00 x 10.00mm, FPM			NB716 35.00 x 48.00 x 10.00mm, FPM
				NA5106 35.00 x 48.00 x 10.00mm, PTFE
				LK5003 85.00 x 131.00 x 15.700mm, PTFE

165 1.9L

Diesel

AHF	4 Cyl.	8 Valves	1896cc	TD9788
HR816	NA5001 32.00 x 47.00 x 10.00mm, FPM			NB716 35.00 x 48.00 x 10.00mm, FPM
				LK5003 85.00 x 131.00 x 15.700mm, PTFE

166 1.9L

Diesel

AHH	4 Cyl.	8 Valves	1896cc	TD10927
ALE	4 Cyl.	8 Valves	1896cc	TD9512
ASX	4 Cyl.	8 Valves	1896cc	TD15495
AVG	4 Cyl.	8 Valves	1896cc	TD14988
HR816	NA5001 32.00 x 47.00 x 10.00mm, FPM			NA5001 32.00 x 47.00 x 10.00mm, FPM
				LK5006 85.00 x 131.00 x 16.000mm, PTFE

167 1.9L

Diesel

AHU	4 Cyl.	8 Valves	1896cc	TD4990
HR569	NA5001 32.00 x 47.00 x 10.00mm, FPM			NA5001 32.00 x 47.00 x 10.00mm, FPM
→Eng no. 720 000				NA5133 85.00 x 105.00 x 11.00mm, FPM
HR816				LK5006 85.00 x 131.00 x 16.000mm, PTFE
Eng no. 720 001→				

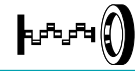
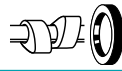

168 1.9L		Diesel		
AJM	4 Cyl.	8 Valves	1896cc	TD12588
ANC	4 Cyl.	8 Valves	1896cc	TD20491
ANU	4 Cyl.	8 Valves	1896cc	TD13443
ARD	4 Cyl.	8 Valves	1896cc	TD20099
ARL	4 Cyl.	8 Valves	1896cc	TD15484
ASY	4 Cyl.	8 Valves	1896cc	TD16338
ASZ	4 Cyl.	8 Valves	1896cc	TD16231
ATD	4 Cyl.	8 Valves	1896cc	TD15473
ATJ	4 Cyl.	8 Valves	1896cc	TD16258
AUY	4 Cyl.	8 Valves	1896cc	TD14915
AVB	4 Cyl.	8 Valves	1896cc	TD15152
AVF	4 Cyl.	8 Valves	1896cc	TD15153
AVM	4 Cyl.	8 Valves	1896cc	TD18705
AWX	4 Cyl.	8 Valves	1896cc	TD15154
AXB	4 Cyl.	8 Valves	1896cc	TD16867
AXC	4 Cyl.	8 Valves	1896cc	TD16881
AXR	4 Cyl.	8 Valves	1896cc	TD16337
BEQ	4 Cyl.	8 Valves	1896cc	TD20100
BEU	4 Cyl.	8 Valves	1896cc	TD20101
BEW	4 Cyl.	8 Valves	1896cc	TD19255
BGL	4 Cyl.	8 Valves	1896cc	TD25870
BGM	4 Cyl.	8 Valves	1896cc	TD25871
BJC	4 Cyl.	8 Valves	1896cc	TD22453
BLT	4 Cyl.	8 Valves	1896cc	TD17467
BPZ	4 Cyl.	8 Valves	1896cc	TD25766
BSW	4 Cyl.	8 Valves	1896cc	TD18771
BTB	4 Cyl.	8 Valves	1896cc	TD18232
BUK	4 Cyl.	8 Valves	1896cc	TD29051
BVK	4 Cyl.	8 Valves	1896cc	TD20489
BXT	4 Cyl.	8 Valves	1896cc	TD25869
CDXA	4 Cyl.	8 Valves	1896cc	TD23291
CDXB	4 Cyl.	8 Valves	1896cc	TD23292
HR816	NA5124 32.00 x 47.00 x 10.00mm, PTFE/ACM		NA5106 35.00 x 48.00 x 10.00mm, PTFE LK5003 85.00 x 131.00 x 15.700mm, PTFE	

169 1.9L		Diesel		
AQM	4 Cyl.	8 Valves	1896cc	TD11351
ASV	4 Cyl.	8 Valves	1896cc	TD13773
AYQ	4 Cyl.	8 Valves	1896cc	TD16863
HR816	NA5001 32.00 x 47.00 x 10.00mm, FPM		NA5106 35.00 x 48.00 x 10.00mm, PTFE LK5003 85.00 x 131.00 x 15.700mm, PTFE	

170 1.9L		Diesel		
ATD	4 Cyl.	8 Valves	1896cc	TD21920
HR816				

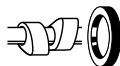

171 1.9L Diesel

AVQ	4 Cyl.	8 Valves	1896cc	TD16861
BJB	4 Cyl.	8 Valves	1896cc	TD17078
BKC	4 Cyl.	8 Valves	1896cc	TD17079
BLS	4 Cyl.	8 Valves	1896cc	TD18224
BMT	4 Cyl.	8 Valves	1896cc	TD20494
BRM	4 Cyl.	8 Valves	1896cc	TD20629
BRR	4 Cyl.	8 Valves	1896cc	TD20159
BRS	4 Cyl.	8 Valves	1896cc	TD18994
BRU	4 Cyl.	8 Valves	1896cc	TD17468
BSU	4 Cyl.	8 Valves	1896cc	TD18755
BXE	4 Cyl.	8 Valves	1896cc	TD18908
BXF	4 Cyl.	8 Valves	1896cc	TD18907
BXJ	4 Cyl.	8 Valves	1896cc	TD20493

HR816	NA5124 32.00 x 47.00 x 10.00mm, PTFE/ACM	NA5106 35.00 x 48.00 x 10.00mm, PTFE LK5012 85.00 x 132.00 x 15.70mm, PTFE
--------------	--	---

172 1.9L Diesel

BGG	4 Cyl.	8 Valves	1896cc	TD21349
-----	--------	----------	--------	---------

HR816	NA5124 32.00 x 47.00 x 10.00mm, PTFE/ACM	NA5124 32.00 x 47.00 x 10.00mm, PTFE/ACM LK5006 85.00 x 131.00 x 16.000mm, PTFE
--------------	--	--

173 1.9L Petrol

DF	4 Cyl.	8 Valves	1913cc	TD4058
DG	4 Cyl.	8 Valves	1913cc	TD4993
DH	4 Cyl.	8 Valves	1913cc	TD4994
EY	4 Cyl.	8 Valves	1913cc	TD9322
GW	4 Cyl.	8 Valves	1913cc	TD4099
SP	4 Cyl.	8 Valves	1913cc	TD4152

NB953
75.00 x 95.00 x 12.00mm, FPM

174 1.9L Petrol

WN	5 Cyl.	10 Valves	1921cc	TD5031
----	--------	-----------	--------	--------

HR615	NA5001 32.00 x 47.00 x 10.00mm, FPM	NB716 35.00 x 48.00 x 10.00mm, FPM NA5133 85.00 x 105.00 x 11.00mm, FPM
--------------	---	--

175 2.0L Petrol



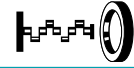

2E	4 Cyl.	8 Valves	1984cc	TD4963
----	--------	----------	--------	--------

HR569 →Eng no. 2E 565 664 HR816 Eng no. 2E 565 665→	NA5001 32.00 x 47.00 x 10.00mm, FPM	NA5001 32.00 x 47.00 x 10.00mm, FPM NA5133 85.00 x 105.00 x 11.00mm, FPM
--	---	---

**176 2.0L****Petrol**

9A	4 Cyl.	16 Valves	1984cc	TD3998
ABF	4 Cyl.	16 Valves	1984cc	TD4007
HR816  (x2)	NA5001 (x2) 32.00 x 47.00 x 10.00mm, FPM		NA5001  32.00 x 47.00 x 10.00mm, FPM NA5133  85.00 x 105.00 x 11.00mm, FPM	



177 2.0L**Petrol**

AAC	4 Cyl.	8 Valves	1968cc	TD4001
HR569  →Eng no. 70-T-200 000	NA5001 32.00 x 47.00 x 10.00mm, FPM		NA5001  32.00 x 47.00 x 10.00mm, FPM NA5133  85.00 x 105.00 x 11.00mm, FPM	
HR816  Eng no. 70-T-200 001 →				

178 2.0L**Petrol**

ABA	4 Cyl.	8 Valves	1984cc	TD22617
ADC	4 Cyl.	8 Valves	1984cc	TD15609
AGG	4 Cyl.	8 Valves	1984cc	TD4989
HR816 	NA5001 32.00 x 47.00 x 10.00mm, FPM		NA5001  32.00 x 47.00 x 10.00mm, FPM NA5133  85.00 x 105.00 x 11.00mm, FPM LK5006  85.00 x 131.00 x 16.000mm, PTFE	

179 2.0L**Petrol**

ADY	4 Cyl.	8 Valves	1984cc	TD4979
HR569  →Eng no. 000 778	NA5001 32.00 x 47.00 x 10.00mm, FPM		NA5001  32.00 x 47.00 x 10.00mm, FPM	
HR816  Eng no. 000 779 →	NA5124 32.00 x 47.00 x 10.00mm, PTFE/ACM		NA5133  85.00 x 105.00 x 11.00mm, FPM LK5006  85.00 x 131.00 x 16.000mm, PTFE	

180 2.0L**Petrol**

AEG	4 Cyl.	8 Valves	1984cc	TD13442
APK	4 Cyl.	8 Valves	1984cc	TD21602
APK	4 Cyl.	8 Valves	1984cc	TD11927
AQY	4 Cyl.	8 Valves	1984cc	TD10607
ASU	4 Cyl.	8 Valves	1984cc	TD16242
ATM	4 Cyl.	8 Valves	1984cc	TD14913
AUZ	4 Cyl.	8 Valves	1984cc	TD16243
AVH	4 Cyl.	8 Valves	1984cc	TD19258
AXA	4 Cyl.	8 Valves	1984cc	TD16866
AZG	4 Cyl.	8 Valves	1984cc	TD15470
AZH	4 Cyl.	8 Valves	1984cc	TD15479
AZJ	4 Cyl.	8 Valves	1984cc	TD16419
AZM	4 Cyl.	8 Valves	1984cc	TD15150
BBW	4 Cyl.	8 Valves	1984cc	TD22628
BBX	4 Cyl.	8 Valves	1984cc	TD21077
BDC	4 Cyl.	8 Valves	1984cc	TD16744
BEH	4 Cyl.	8 Valves	1984cc	TD16527
BEJ	4 Cyl.	8 Valves	1984cc	TD21073
BER	4 Cyl.	8 Valves	1984cc	TD18049

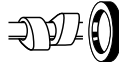

BEV	4 Cyl.	8 Valves	1984cc	TD19254
BFF	4 Cyl.	8 Valves	1984cc	TD20653
BFF	4 Cyl.	8 Valves	1984cc	TD19132
BGD	4 Cyl.	8 Valves	1984cc	TD16745
BHP	4 Cyl.	8 Valves	1984cc	TD21074
BHY	4 Cyl.	8 Valves	1984cc	TD22634
BNL	4 Cyl.	8 Valves	1984cc	TD25893
BNL	4 Cyl.	8 Valves	1984cc	TD26161
BTL	4 Cyl.	8 Valves	1984cc	TD25895
BTL	4 Cyl.	8 Valves	1984cc	TD26162
CBPA	4 Cyl.	8 Valves	1984cc	TD21075
CEN	4 Cyl.	8 Valves	1984cc	TD22330
CEN	4 Cyl.	8 Valves	1984cc	TD23413
CFEA	4 Cyl.	8 Valves	1984cc	TD27391
CGZ	4 Cyl.	8 Valves	1984cc	TD25900

HR816

NA5124
32.00 x 47.00 x 10.00mm, PTFE/ACM

NA5106
35.00 x 48.00 x 10.00mm, PTFE
LK5003
85.00 x 131.00 x 15.700mm, PTFE

181 2.0L

Petrol

AEP	4 Cyl.	8 Valves	1984cc	TD11448
AKR	4 Cyl.	8 Valves	1984cc	TD11354

HR569
→Eng no. 000 778

HR816
Eng no. 000 779→

NA5001
32.00 x 47.00 x 10.00mm, FPM

NA5001
32.00 x 47.00 x 10.00mm, FPM
NA5133
85.00 x 105.00 x 11.00mm, FPM
LK5006
85.00 x 131.00 x 16.000mm, PTFE

182 2.0L

Petrol

ALT	4 Cyl.	20 Valves	1984cc	TD17040
-----	--------	-----------	--------	---------

PA5041 (x20)
HR822

NA5124 (x2)
32.00 x 47.00 x 10.00mm, PTFE/ACM

NA5106
35.00 x 48.00 x 10.00mm, PTFE
LK5008
85.00 x 131.00 x 15.700mm, PTFE

183 2.0L

Petrol

ATU	4 Cyl.	8 Valves	1984cc	TD15490
AWF	4 Cyl.	8 Valves	1984cc	TD15488
AWG	4 Cyl.	8 Valves	1984cc	TD15489

HR816

NA5124
32.00 x 47.00 x 10.00mm, PTFE/ACM

NA5124
32.00 x 47.00 x 10.00mm, PTFE/ACM
LK5006
85.00 x 131.00 x 16.000mm, PTFE

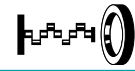

184 2.0L		Petrol			
AXW		4 Cyl.	16 Valves	1984cc	TD17081
BLR		4 Cyl.	16 Valves	1984cc	TD18134
BLX		4 Cyl.	16 Valves	1984cc	TD17985
BLY		4 Cyl.	16 Valves	1984cc	TD17986
BVX		4 Cyl.	16 Valves	1984cc	TD18912
BVY		4 Cyl.	16 Valves	1984cc	TD18468
BVZ		4 Cyl.	16 Valves	1984cc	TD18469
PA5041 (x16) HR791		NA5124 (x2) 32.00 x 47.00 x 10.00mm, PTFE/ACM		NA5106 35.00 x 48.00 x 10.00mm, PTFE LK5008 85.00 x 131.00 x 15.700mm, PTFE	

185 2.0L		Petrol			
AXX		4 Cyl.	16 Valves	1984cc	TD18540
BPY		4 Cyl.	16 Valves	1984cc	TD18883
BWA		4 Cyl.	16 Valves	1984cc	TD18541
BYD		4 Cyl.	16 Valves	1984cc	TD19430
CDLA		4 Cyl.	16 Valves	1984cc	TD22642
CDLC		4 Cyl.	16 Valves	1984cc	TD22469
CDLF		4 Cyl.	16 Valves	1984cc	TD23525
CDLG		4 Cyl.	16 Valves	1984cc	TD25853
CDLJ		4 Cyl.	16 Valves	1984cc	TD27543
CDLK		4 Cyl.	16 Valves	1984cc	TD29597
PA5041 (x16) HR791		NA5124 (x2) 32.00 x 47.00 x 10.00mm, PTFE/ACM		NA5106 35.00 x 48.00 x 10.00mm, PTFE LK5003 85.00 x 131.00 x 15.700mm, PTFE	

186 2.0L		Diesel			
AZV		4 Cyl.	16 Valves	1968cc	TD16862
BKD		4 Cyl.	16 Valves	1968cc	TD17080
BKP		4 Cyl.	16 Valves	1968cc	TD18135
BMA		4 Cyl.	16 Valves	1968cc	TD18225
BMN		4 Cyl.	16 Valves	1968cc	TD18471
BMR		4 Cyl.	16 Valves	1968cc	TD18188
BUZ		4 Cyl.	16 Valves	1968cc	TD20499
BVE		4 Cyl.	16 Valves	1968cc	TD18543
BWV		4 Cyl.	16 Valves	1968cc	TD20498
PA5041 (x16) HR791		NA5124 (x2) 32.00 x 47.00 x 10.00mm, PTFE/ACM		NA5106 35.00 x 48.00 x 10.00mm, PTFE LK5012 85.00 x 132.00 x 15.70mm, PTFE	

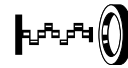
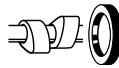

187 2.0L

Diesel

BDJ	4 Cyl.	8 Valves	1968cc	TD17358
BDJ	4 Cyl.	8 Valves	1968cc	TD34851
BDK	4 Cyl.	8 Valves	1968cc	TD17359
BMM	4 Cyl.	8 Valves	1968cc	TD18482
BMP	4 Cyl.	8 Valves	1968cc	TD18136
BRT	4 Cyl.	8 Valves	1968cc	TD19105
BST	4 Cyl.	8 Valves	1968cc	TD20501
BVH	4 Cyl.	8 Valves	1968cc	TD20520

HR816

NA5124
32.00 x 47.00 x 10.00mm, PTFE/ACM

NA5106
35.00 x 48.00 x 10.00mm, PTFE
LK5012
85.00 x 132.00 x 15.70mm, PTFE

188 2.0L

Petrol

BDJ	4 Cyl.	8 Valves	1996cc	TD21924
-----	--------	----------	--------	---------

HR816

NA5124
32.00 x 47.00 x 10.00mm, PTFE/ACM

NA5106
35.00 x 48.00 x 10.00mm, PTFE
LK5012
85.00 x 132.00 x 15.70mm, PTFE

189 2.0L

Gas

BEF	4 Cyl.	8 Valves	1984cc	TD25872
CBSA	4 Cyl.	8 Valves	1984cc	TD23562

HR816

NA5124
32.00 x 47.00 x 10.00mm, PTFE/ACM

NA5106
35.00 x 48.00 x 10.00mm, PTFE
LK5003
85.00 x 131.00 x 15.70mm, PTFE

190 2.0L

Diesel

BGW	4 Cyl.	8 Valves	1968cc	TD18539
BHW	4 Cyl.	8 Valves	1968cc	TD22177

HR816

NA5124
32.00 x 47.00 x 10.00mm, PTFE/ACM

NA5106
35.00 x 48.00 x 10.00mm, PTFE
LK5003
85.00 x 131.00 x 15.70mm, PTFE

191 2.0L

Petrol

BJZ	4 Cyl.	16 Valves	1984cc	TD22898
-----	--------	-----------	--------	---------

HR816

NA5124 (x2)
32.00 x 47.00 x 10.00mm, PTFE/ACM

NA5106
35.00 x 48.00 x 10.00mm, PTFE
LK5003
85.00 x 131.00 x 15.70mm, PTFE

192 2.0L

Gas

BSX	4 Cyl.	8 Valves	1984cc	TD19005
-----	--------	----------	--------	---------

HR816

NA5124 (x2)
32.00 x 47.00 x 10.00mm, PTFE/ACM

NA5106
35.00 x 48.00 x 10.00mm, PTFE
LK5003
85.00 x 131.00 x 15.70mm, PTFE

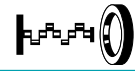
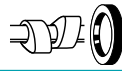
**193 2.0L****Diesel**

BVD	4 Cyl.	16 Valves	1968cc	TD18542
PA5041 (x16) HR791				NA5106 35.00 x 48.00 x 10.00mm, PTFE LK5012 85.00 x 132.00 x 15.70mm, PTFE

194 2.0L**Diesel**

CAAA	4 Cyl.	16 Valves	1968cc	TD23411
CAAB	4 Cyl.	16 Valves	1968cc	TD23412
CAAC	4 Cyl.	16 Valves	1968cc	TD23414
CAAD	4 Cyl.	16 Valves	1968cc	TD26334
CAAE	4 Cyl.	16 Valves	1968cc	TD24473
CBAA	4 Cyl.	16 Valves	1968cc	TD20798
CBAB	4 Cyl.	16 Valves	1968cc	TD20799
CBAC	4 Cyl.	16 Valves	1968cc	TD20800
CBBB	4 Cyl.	16 Valves	1968cc	TD20949
CBDA	4 Cyl.	16 Valves	1968cc	TD22715
CBDB	4 Cyl.	16 Valves	1968cc	TD21070
CBDC	4 Cyl.	16 Valves	1968cc	TD21109
CCHA	4 Cyl.	16 Valves	1968cc	TD24471
CCHB	4 Cyl.	16 Valves	1968cc	TD24474
CDBA	4 Cyl.	16 Valves	1968cc	TD24402
CDCA	4 Cyl.	16 Valves	1968cc	TD24403
CEGA	4 Cyl.	16 Valves	1968cc	TD24125
CFCA	4 Cyl.	16 Valves	1968cc	TD23421
CFFA	4 Cyl.	16 Valves	1968cc	TD23312
CFFB	4 Cyl.	16 Valves	1968cc	TD23178
CFFD	4 Cyl.	16 Valves	1968cc	TD24215
CFFE	4 Cyl.	16 Valves	1968cc	TD25739
CFGB	4 Cyl.	16 Valves	1968cc	TD23180
CFGC	4 Cyl.	16 Valves	1968cc	TD26990
CFHB	4 Cyl.	16 Valves	1968cc	TD24314
CFHC	4 Cyl.	16 Valves	1968cc	TD24315
CFHE	4 Cyl.	16 Valves	1968cc	TD25438
CFHF	4 Cyl.	16 Valves	1968cc	TD24366
CFJA	4 Cyl.	16 Valves	1968cc	TD24994
CFJB	4 Cyl.	16 Valves	1968cc	TD27973
CJAA	4 Cyl.	16 Valves	1968cc	TD23179
CKTB	4 Cyl.	16 Valves	1968cc	TD25415
CKTC	4 Cyl.	16 Valves	1968cc	TD25416
CKUB	4 Cyl.	16 Valves	1968cc	TD25417
CKUC	4 Cyl.	16 Valves	1968cc	TD25418
CLCA	4 Cyl.	16 Valves	1968cc	TD24835
CLCB	4 Cyl.	16 Valves	1968cc	TD24600
CLJA	4 Cyl.	16 Valves	1968cc	TD24963
CNEA	4 Cyl.	16 Valves	1968cc	TD26330
CNFA	4 Cyl.	16 Valves	1968cc	TD26995
CNFB	4 Cyl.	16 Valves	1968cc	TD26996

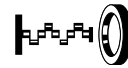
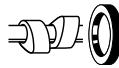

CSHA	4 Cyl.	16 Valves	1968cc	TD26331
CSLB	4 Cyl.	16 Valves	1968cc	TD28424
CSNA	4 Cyl.	16 Valves	1968cc	TD30982
PA5041 (x16) HR791	NA5361 (x2) 32.00 x 47.00 x 10.00mm, PTFE	NA5106 35.00 x 48.00 x 10.00mm, PTFE LK5019 85.00 x 131.00 x 17.25mm, PTFE/ACM		

195 2.0L Petrol

CAWA	4 Cyl.	16 Valves	1984cc	TD20733
CAWB	4 Cyl.	16 Valves	1984cc	TD20732
CBFA	4 Cyl.	16 Valves	1984cc	TD20797
CBL	4 Cyl.	16 Valves	1984cc	TD33392
CBLA	4 Cyl.	16 Valves	1984cc	TD30491
CCTA	4 Cyl.	16 Valves	1984cc	TD20795
CCTB	4 Cyl.	16 Valves	1984cc	TD20796
CCZA	4 Cyl.	16 Valves	1984cc	TD22172
CCZB	4 Cyl.	16 Valves	1984cc	TD22181
CCZC	4 Cyl.	16 Valves	1984cc	TD24964
CCZD	4 Cyl.	16 Valves	1984cc	TD25421
CFPA	4 Cyl.	16 Valves	1984cc	TD25736
CGM	4 Cyl.	16 Valves	1984cc	TD25899
CGMA	4 Cyl.	16 Valves	1984cc	TD31244
PA5041 (x16) HR791		LK5016 85.00 x 164.00 x 11.00mm, PTFE		

196 2.0L Diesel

CBBA	4 Cyl.	16 Valves	1968cc	TD21661
PA5041 (x16) HR791	NA5361 (x2) 32.00 x 47.00 x 10.00mm, PTFE NA5124 (x2) 32.00 x 47.00 x 10.00mm, PTFE/ACM	NA5106 35.00 x 48.00 x 10.00mm, PTFE LK5019 85.00 x 131.00 x 17.25mm, PTFE/ACM		

197 2.0L Diesel

CBEA	4 Cyl.	16 Valves	1968cc	TD22176
CKRA	4 Cyl.	16 Valves	1968cc	TD31393
CSLA	4 Cyl.	16 Valves	1968cc	TD33129
CSLC	4 Cyl.	16 Valves	1968cc	TD32186
PA5041 (x16) HR791	NA5361 32.00 x 47.00 x 10.00mm, PTFE	NA5106 35.00 x 48.00 x 10.00mm, PTFE LK5019 85.00 x 131.00 x 17.25mm, PTFE/ACM		

198 2.0L Diesel

CBHA	4 Cyl.	8 Valves	1968cc	TD22527
CBJB	4 Cyl.	8 Valves	1968cc	TD22525
HR816				

199 2.0L Diesel

CBKA	4 Cyl.	8 Valves	1968cc	TD22528
HR816		NA5106 35.00 x 48.00 x 10.00mm, PTFE		

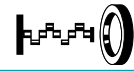
**200 2.0L****Petrol**

CENA	4 Cyl.	16 Valves	1984cc	TD31379
				NA5106 35.00 x 48.00 x 10.00mm, PTFE LK5003 85.00 x 131.00 x 15.700mm, PTFE

201 2.0L**Petrol**

CGM	4 Cyl.	16 Valves	1984cc	TD30014
CHH	4 Cyl.	16 Valves	1984cc	TD33239
CHHA	4 Cyl.	16 Valves	1984cc	TD27977
CHHB	4 Cyl.	16 Valves	1984cc	TD27976
CJKA	4 Cyl.	16 Valves	1984cc	TD26335
CJKB	4 Cyl.	16 Valves	1984cc	TD26535
CJXA	4 Cyl.	16 Valves	1984cc	TD31365
CJXB	4 Cyl.	16 Valves	1984cc	TD28283
CJXC	4 Cyl.	16 Valves	1984cc	TD28425
CJXD	4 Cyl.	16 Valves	1984cc	TD29286
CJXE	4 Cyl.	16 Valves	1984cc	TD32682
CJXG	4 Cyl.	16 Valves	1984cc	TD33682
CNTA	4 Cyl.	16 Valves	1984cc	TD29285
CUG	4 Cyl.	16 Valves	1984cc	TD33238
CULA	4 Cyl.	16 Valves	1984cc	TD29308
CULC	4 Cyl.	16 Valves	1984cc	TD27859
CXCA	4 Cyl.	16 Valves	1984cc	TD31408
CXCB	4 Cyl.	16 Valves	1984cc	TD33125
CXDA	4 Cyl.	16 Valves	1984cc	TD31415
CXDB	4 Cyl.	16 Valves	1984cc	TD33124
CYFB	4 Cyl.	16 Valves	1984cc	TD32140
CZPA	4 Cyl.	16 Valves	1984cc	TD32973
DEDA	4 Cyl.	16 Valves	1984cc	TD31370
DJHA	4 Cyl.	16 Valves	1984cc	TD34399
DJHB	4 Cyl.	16 Valves	1984cc	TD34413
DLBA	4 Cyl.	16 Valves	1984cc	TD34425
PA5041 (x16) HR791				

202 2.0L**Petrol**

CH	4 Cyl.	8 Valves	1984cc	TD4044
PB394 (x8)				NA5001 (x2) 32.00 x 47.00 x 10.00mm, FPM

203 2.0L**Petrol**

CJ	4 Cyl.	8 Valves	1970cc	TD4045
CU	4 Cyl.	8 Valves	1970cc	TD4050
CV	4 Cyl.	8 Valves	1970cc	TD4051
GD	4 Cyl.	8 Valves	1970cc	TD4091
GE	4 Cyl.	8 Valves	1970cc	TD5005
				NB953 75.00 x 95.00 x 12.00mm, FPM

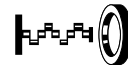
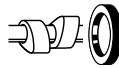

204 2.0L

Diesel

CKFC	4 Cyl.	16 Valves	1968cc	TD27197
CRBB	4 Cyl.	16 Valves	1968cc	TD27964
CRBC	4 Cyl.	16 Valves	1968cc	TD27202
CRFC	4 Cyl.	16 Valves	1968cc	TD32975
CRLB	4 Cyl.	16 Valves	1968cc	TD27196
CRMB	4 Cyl.	16 Valves	1968cc	TD27198
CRUA	4 Cyl.	16 Valves	1968cc	TD31407
CRVA	4 Cyl.	16 Valves	1968cc	TD27965
CRVC	4 Cyl.	16 Valves	1968cc	TD29264
CUAA	4 Cyl.	16 Valves	1968cc	TD29843
CUNA	4 Cyl.	16 Valves	1968cc	TD27978
CUUA	4 Cyl.	16 Valves	1968cc	TD30261
CUUB	4 Cyl.	16 Valves	1968cc	TD28213
CUUD	4 Cyl.	16 Valves	1968cc	TD31239
CUUE	4 Cyl.	16 Valves	1968cc	TD31241
CUUF	4 Cyl.	16 Valves	1968cc	TD31240
CUVA	4 Cyl.	16 Valves	1968cc	TD31371
CUVC	4 Cyl.	16 Valves	1968cc	TD30995
CUWA	4 Cyl.	16 Valves	1968cc	TD30937
CUXA	4 Cyl.	16 Valves	1968cc	TD31400
CVCA	4 Cyl.	16 Valves	1968cc	TD30260
DCYB	4 Cyl.	16 Valves	1968cc	TD34421
DDAA	4 Cyl.	16 Valves	1968cc	TD29842
DEJA	4 Cyl.	16 Valves	1968cc	TD34412
DEJB	4 Cyl.	16 Valves	1968cc	TD34423
DELA	4 Cyl.	16 Valves	1968cc	TD31807
DFCA	4 Cyl.	16 Valves	1968cc	TD31778
DFEA	4 Cyl.	16 Valves	1968cc	TD31777
DGCA	4 Cyl.	16 Valves	1968cc	TD34424

PA5041 (x16)
HR791

NA5361 (x2)
32.00 x 47.00 x 10.00mm, PTFE

LK5017
85.00 x 130.90 x 15.75mm, PTFE

205 2.0L

Petrol

CKJA	4 Cyl.	8 Valves	1984cc	TD25006
HR816				NA5106 35.00 x 48.00 x 10.00mm, PTFE LK5003 85.00 x 131.00 x 15.700mm, PTFE

206 2.0L

Diesel

CLLA	4 Cyl.	16 Valves	1968cc	TD24441
PA5041 (x16) HR791				NA5106 35.00 x 48.00 x 10.00mm, PTFE LK5019 85.00 x 131.00 x 17.25mm, PTFE/ACM
				NA5106 (x2) 35.00 x 48.00 x 10.00mm, PTFE/ACM

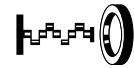
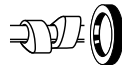
**207 2.0L****Diesel**

CRFD	4 Cyl.	16 Valves	1968cc	TD34041
CRGB	4 Cyl.	16 Valves	1968cc	TD34043
CRLD	4 Cyl.	16 Valves	1968cc	TD32536
CUPA	4 Cyl.	16 Valves	1968cc	TD32773
CUUC	4 Cyl.	16 Valves	1968cc	TD32511
CUVE	4 Cyl.	16 Valves	1968cc	TD33113
CYKB	4 Cyl.	16 Valves	1968cc	TD32295
CYKC	4 Cyl.	16 Valves	1968cc	TD34040
DBGA	4 Cyl.	16 Valves	1968cc	TD33476
DCYA	4 Cyl.	16 Valves	1968cc	TD34063
DFEB	4 Cyl.	16 Valves	1968cc	TD33492
DFGA	4 Cyl.	16 Valves	1968cc	TD32774
DFGB	4 Cyl.	16 Valves	1968cc	TD33493
DFGC	4 Cyl.	16 Valves	1968cc	TD33105
DFHA	4 Cyl.	16 Valves	1968cc	TD32468
DFLA	4 Cyl.	16 Valves	1968cc	TD33098
DFLD	4 Cyl.	16 Valves	1968cc	TD33099
DFMA	4 Cyl.	16 Valves	1968cc	TD33092
DFSB	4 Cyl.	16 Valves	1968cc	TD32527
DFSC	4 Cyl.	16 Valves	1968cc	TD32531
DFSD	4 Cyl.	16 Valves	1968cc	TD32601
DFSE	4 Cyl.	16 Valves	1968cc	TD32602
DFSF	4 Cyl.	16 Valves	1968cc	TD32532
PA5041 (x16) HR791	NA5361 32.00 x 47.00 x 10.00mm, PTFE	LK5017 85.00 x 130.90 x 15.75mm, PTFE		

208 2.0L**Petrol**

CRZA	4 Cyl.	16 Valves	1984cc	TD27628
PA5041 (x16) HR791	NA5106 35.00 x 48.00 x 10.00mm, PTFE LK5003 85.00 x 131.00 x 15.700mm, PTFE			

209 2.0L**Diesel**

CXEB	4 Cyl.	16 Valves	1968cc	TD31317
CXGC	4 Cyl.	16 Valves	1968cc	TD33460
CXHA	4 Cyl.	16 Valves	1968cc	TD31329
CXHB	4 Cyl.	16 Valves	1968cc	TD33445
NA5361 32.00 x 47.00 x 10.00mm, PTFE	LK5017 85.00 x 130.90 x 15.75mm, PTFE			

210 2.0L**Diesel**

CXFA	4 Cyl.	16 Valves	1968cc	TD31318
CXGA	4 Cyl.	16 Valves	1968cc	TD31319
CXGB	4 Cyl.	16 Valves	1968cc	TD31328
NA5361 (x2) 32.00 x 47.00 x 10.00mm, PTFE	LK5017 85.00 x 130.90 x 15.75mm, PTFE			



211 2.0L Diesel

DAUA	4 Cyl.	16 Valves	1968cc	TD34187
DAUB	4 Cyl.	16 Valves	1968cc	TD34186
DAVA	4 Cyl.	16 Valves	1968cc	TD34188

LK5017 R
85.00 x 130.90 x 15.75mm, PTFE

212 2.0L Petrol

DDR	4 Cyl.	8 Valves	1984cc	TD25201
-----	--------	----------	--------	---------

HR569

NA5001
32.00 x 47.00 x 10.00mm, FPM

NA5001 F
32.00 x 47.00 x 10.00mm, FPM
NA5133 R
85.00 x 105.00 x 11.00mm, FPM

213 2.0L Petrol

HP	5 Cyl.	10 Valves	1994cc	TD16429
JS	5 Cyl.	10 Valves	1994cc	TD5015

HR615

NA5001 (x2)
32.00 x 47.00 x 10.00mm, FPM

NB716 F
35.00 x 48.00 x 10.00mm, FPM
NA5133 R
85.00 x 105.00 x 11.00mm, FPM

214 2.0L Petrol

UQG	4 Cyl.	8 Valves	1984cc	TD27044
-----	--------	----------	--------	---------

HR816

NA5001
32.00 x 47.00 x 10.00mm, FPM

NA5001 F
32.00 x 47.00 x 10.00mm, FPM

215 2.1L Petrol

DJ	4 Cyl.	8 Valves	2110cc	TD4059
MV	4 Cyl.	8 Valves	2110cc	TD4133
SR	4 Cyl.	8 Valves	2109cc	TD4153
SS	4 Cyl.	8 Valves	2110cc	TD4154

NB953 R
75.00 x 95.00 x 12.00mm, FPM

216 2.1L Petrol

WE	5 Cyl.	10 Valves	2144cc	TD16427
----	--------	-----------	--------	---------

HR615

NA5001 (x2)
32.00 x 47.00 x 10.00mm, FPM

NB716 F
35.00 x 48.00 x 10.00mm, FPM
NA5133 R
85.00 x 105.00 x 11.00mm, FPM

217 2.2L Petrol

4Y	4 Cyl.	8 Valves	2237cc	TD4969
----	--------	----------	--------	--------

PA136 (x8)

NJ344 F
42.00 x 60.00 x 7.00mm, NBR
NJ360 R
80.00 x 100.00 x 8.50mm, MVQ

218 2.2L Petrol

HY	5 Cyl.	10 Valves	2226cc	TD21344
KX	5 Cyl.	10 Valves	2226cc	TD5020

HR615

NA5001 (x2)
32.00 x 47.00 x 10.00mm, FPM

NB716 F
35.00 x 48.00 x 10.00mm, FPM
NA5133 R
85.00 x 105.00 x 11.00mm, FPM

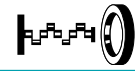
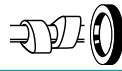

219 2.2L		Petrol			
JT		5 Cyl.	10 Valves	2226cc	TD5016
KV		5 Cyl.	10 Valves	2226cc	TD4125
HR615		NA5001 32.00 x 47.00 x 10.00mm, FPM		NB716 35.00 x 48.00 x 10.00mm, FPM NA5133 85.00 x 105.00 x 11.00mm, FPM	
220 2.3L		Petrol			
AGL		4 Cyl.	16 Valves	2295cc	TD9296
HR5085 (x4)				NB973 45.00 x 67.00 x 8.00mm, FPM	
221 2.3L		Petrol			
AGZ		5 Cyl.	10 Valves	2324cc	TD5559
HR816 (x2)				NA5106 35.00 x 48.00 x 10.00mm, PTFE NA5305 85.00 x 105.00 x 11.00mm, PTFE 01/01→	
222 2.3L		Petrol			
AQN		5 Cyl.	20 Valves	2324cc	TD15472
PA5041 (x20) HR822		NA5001 (x2) 32.00 x 47.00 x 10.00mm, FPM		NA5106 35.00 x 48.00 x 10.00mm, PTFE NA5305 85.00 x 105.00 x 11.00mm, PTFE 01/01→	
223 2.3L		Petrol			
AZX		5 Cyl.	20 Valves	2324cc	TD15151
PA5041 (x20) HR822				NA5106 35.00 x 48.00 x 10.00mm, PTFE NA5305 85.00 x 105.00 x 11.00mm, PTFE 01/01→	
224 2.4L		Petrol			
1E		6 Cyl.	12 Valves	2383cc	TD4956
DL		6 Cyl.	12 Valves	2383cc	TD4995
HS		6 Cyl.	12 Valves	2384cc	TD4108
HR805		NA5001 (x2) 32.00 x 47.00 x 10.00mm, FPM		NB716 35.00 x 48.00 x 10.00mm, FPM NA5133 85.00 x 105.00 x 11.00mm, FPM	
225 2.4L		Diesel			
1G		6 Cyl.	12 Valves	2383cc	TD3993
1S		6 Cyl.	12 Valves	2383cc	TD4958
ACT		6 Cyl.	12 Valves	2383cc	TD4014
CP		6 Cyl.	12 Valves	2383cc	TD4047
DV		6 Cyl.	12 Valves	2383cc	TD4061
DW		6 Cyl.	12 Valves	2383cc	TD4062
HR805		NA5001 (x2) 32.00 x 47.00 x 10.00mm, FPM		NB716 35.00 x 48.00 x 10.00mm, FPM NA5133 85.00 x 105.00 x 11.00mm, FPM	

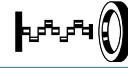

226 2.4L

Diesel

2L	4 Cyl.	8 Valves	2446cc	TD4966
PA138 (x8) →12/88	NJ349 32.50 x 46.00 x 6.00mm, NBR	NJ344	42.00 x 60.00 x 7.00mm, NBR	
PA136 (x8) 01/89→	NJ344 42.00 x 60.00 x 7.00mm, NBR	NJ215	85.00 x 105.00 x 10.00mm, FPM	

227 2.4L

Petrol

22R	4 Cyl.	8 Valves	2366cc	TD4962
PA136 (x8)	NJ353 35.00 x 49.00 x 6.00mm, NBR	NK214	35.00 x 63.00 x 10.00mm, ACM	
		NJ243	45.00 x 68.00 x 12.00mm, NBR	
		NJ360	80.00 x 100.00 x 8.50mm, MVQ	

228 2.4L

Diesel

AAB	5 Cyl.	10 Valves	2370cc	TD4000
AJA	5 Cyl.	10 Valves	2370cc	TD11049
HR615	NA5001 32.00 x 47.00 x 10.00mm, FPM	NB716	35.00 x 48.00 x 10.00mm, FPM	
		NA5133	85.00 x 105.00 x 11.00mm, FPM	

229 2.4L

Diesel

ACL	6 Cyl.	12 Valves	2383cc	TD4012
HR805	NA5001 32.00 x 47.00 x 10.00mm, FPM	NB716	35.00 x 48.00 x 10.00mm, FPM	
		NA5133	85.00 x 105.00 x 11.00mm, FPM	

230 2.5L

Petrol

AAF	5 Cyl.	10 Valves	2461cc	TD4002
ACU	5 Cyl.	10 Valves	2461cc	TD4015
AEN	5 Cyl.	10 Valves	2461cc	TD9347
AEU	5 Cyl.	10 Valves	2461cc	TD9344
HR615	NA5001 (x2) 32.00 x 47.00 x 10.00mm, FPM	NB716	35.00 x 48.00 x 10.00mm, FPM	
		NA5133	85.00 x 105.00 x 11.00mm, FPM	

231 2.5L

Diesel

ACV	5 Cyl.	10 Valves	2461cc	TD4978
AJT	5 Cyl.	10 Valves	2461cc	TD10747
HR615	NA5124 32.00 x 47.00 x 10.00mm, PTFE/ACM	NB716	35.00 x 48.00 x 10.00mm, FPM	
	NA5001 (x2) 32.00 x 47.00 x 10.00mm, FPM	NA5133	85.00 x 105.00 x 11.00mm, FPM	
		LK5006	85.00 x 131.00 x 16.00mm, PTFE	

232 2.5L

Petrol

AEN	5 Cyl.	10 Valves	2459cc	TD19528
HR615	NA5307 32.00 x 47.00 x 10.00mm, PTFE			

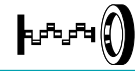
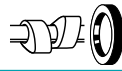
**233 2.5L****Petrol**

AET	5 Cyl.	10 Valves	2461cc	TD4983
APL	5 Cyl.	10 Valves	2461cc	TD15288
HR615	NA5001 32.00 x 47.00 x 10.00mm, FPM		NB716 35.00 x 48.00 x 10.00mm, FPM NA5133 85.00 x 105.00 x 11.00mm, FPM	

234 2.5L**Diesel**

AFB	6 Cyl.	24 Valves	2496cc	TD11499
AKN	6 Cyl.	24 Valves	2496cc	TD11498
BAU	6 Cyl.	24 Valves	2496cc	TD17046
BDG	6 Cyl.	24 Valves	2496cc	TD16985
BDH	6 Cyl.	24 Valves	2496cc	TD17047
PA5041 (x24) HR5062	NA5001 (x2) 32.00 x 47.00 x 10.00mm, FPM		NB716 35.00 x 48.00 x 10.00mm, FPM NA5349 85.00 x 105.00 x 12.00mm, PTFE/ACM	

235 2.5L**Diesel**

AGX	5 Cyl.	10 Valves	2461cc	TD9295
AHD	5 Cyl.	10 Valves	2461cc	TD9294
HR615	NA5001 32.00 x 47.00 x 10.00mm, FPM		NB716 35.00 x 48.00 x 10.00mm, FPM NA5133 85.00 x 105.00 x 11.00mm, FPM LK5006 85.00 x 131.00 x 16.000mm, PTFE	

236 2.5L**Diesel**

AHY	5 Cyl.	10 Valves	2461cc	TD10748
AXG	5 Cyl.	10 Valves	2461cc	TD17505
HR615	NA5124 32.00 x 47.00 x 10.00mm, PTFE/ACM		NB716 35.00 x 48.00 x 10.00mm, FPM LK5006 85.00 x 131.00 x 16.000mm, PTFE	

237 2.5L**Diesel**

ANF	5 Cyl.	10 Valves	2461cc	TD20502
ANG	5 Cyl.	10 Valves	2461cc	TD20503
ANH	5 Cyl.	10 Valves	2461cc	TD20504
BBR	5 Cyl.	10 Valves	2461cc	TD22627
HR615	NA5307 32.00 x 47.00 x 10.00mm, PTFE		NB716 35.00 x 48.00 x 10.00mm, FPM LK5006 85.00 x 131.00 x 16.000mm, PTFE	

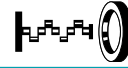

238 2.5L

Diesel

ANJ	5 Cyl.	10 Valves	2461cc	TD13446
APA	5 Cyl.	10 Valves	2461cc	TD13445
AVR	5 Cyl.	10 Valves	2461cc	TD15497
BBE	5 Cyl.	10 Valves	2461cc	TD16451
BBF	5 Cyl.	10 Valves	2461cc	TD16452

HR615

NA5124
32.00 x 47.00 x 10.00mm, PTFE/ACM
NA5001 (x2)
32.00 x 47.00 x 10.00mm, FPM

NA5106
35.00 x 48.00 x 10.00mm, PTFE
LK5006
85.00 x 131.00 x 16.000mm, PTFE

239 2.5L

Diesel

AUF	5 Cyl.	10 Valves	2461cc	TD16857
AYC	5 Cyl.	10 Valves	2461cc	TD17504
AYY	5 Cyl.	10 Valves	2461cc	TD17503

HR615

NA5124
32.00 x 47.00 x 10.00mm, PTFE/ACM
NA5001 (x2)
32.00 x 47.00 x 10.00mm, FPM

NB716
35.00 x 48.00 x 10.00mm, FPM
LK5006
85.00 x 131.00 x 16.000mm, PTFE

240 2.5L

Petrol

AVT	5 Cyl.	10 Valves	2461cc	TD15370
-----	--------	-----------	--------	---------

HR615

NA5001
32.00 x 47.00 x 10.00mm, FPM

NB716
35.00 x 48.00 x 10.00mm, FPM
LK5006
85.00 x 131.00 x 16.000mm, PTFE

241 2.5L

Diesel

AXD	5 Cyl.	10 Valves	2461cc	TD16868
AXE	5 Cyl.	10 Valves	2461cc	TD16869
BAC	5 Cyl.	10 Valves	2461cc	TD16855

HR816 (x2)
HR5085 (x3)

NA5349
85.00 x 105.00 x 12.00mm, PTFE/ACM

242 2.5L

Diesel

AXL	5 Cyl.	10 Valves	2461cc	TD18687
-----	--------	-----------	--------	---------

HR615

NA5124
32.00 x 47.00 x 10.00mm, PTFE/ACM
NA5001 (x2)
32.00 x 47.00 x 10.00mm, FPM

LK5006
85.00 x 131.00 x 16.000mm, PTFE

243 2.5L

Petrol

BGP	5 Cyl.	20 Valves	2480cc	TD20522
BGQ	5 Cyl.	20 Valves	2480cc	TD20673
BPR	5 Cyl.	20 Valves	2480cc	TD19260
BPS	5 Cyl.	20 Valves	2480cc	TD19261
BTK	5 Cyl.	20 Valves	2480cc	TD20521
CBTA	5 Cyl.	20 Valves	2480cc	TD20855
CBUA	5 Cyl.	20 Valves	2480cc	TD22542
CCCA	5 Cyl.	20 Valves	2480cc	TD22640

PA5041 (x20)
HR822

NA5349
85.00 x 105.00 x 12.00mm, PTFE/ACM

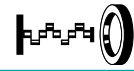
**244 2.5L****Diesel**

BJJ	5 Cyl.	10 Valves	2461cc	TD18891
BJK	5 Cyl.	10 Valves	2461cc	TD18892
BJL	5 Cyl.	10 Valves	2461cc	TD18893
BJM	5 Cyl.	10 Valves	2461cc	TD18894
CEBA	5 Cyl.	10 Valves	2461cc	TD24719
CEBB	5 Cyl.	10 Valves	2461cc	TD24720
CECA	5 Cyl.	10 Valves	2461cc	TD24721
CECB	5 Cyl.	10 Valves	2461cc	TD24722
HR615	NA5124 32.00 x 47.00 x 10.00mm, PTFE/ACM		NA5106 35.00 x 48.00 x 10.00mm, PTFE	

245 2.5L**Diesel**

BLJ	5 Cyl.	10 Valves	2461cc	TD20505
BLK	5 Cyl.	10 Valves	2461cc	TD20506
HR816 (x2)			NA5349 85.00 x 105.00 x 12.00mm, PTFE/ACM	

246 2.5L**Diesel**

BNZ	5 Cyl.	10 Valves	2461cc	TD20398
BPC	5 Cyl.	10 Valves	2461cc	TD20397
BPD	5 Cyl.	10 Valves	2461cc	TD20507
BPE	5 Cyl.	10 Valves	2461cc	TD20508
			NA5349 85.00 x 105.00 x 12.00mm, PTFE/ACM	

247 2.8L**Petrol**

AAA	6 Cyl.	12 Valves	2792cc	TD3999
AES	6 Cyl.	12 Valves	2792cc	TD9346
AMY	6 Cyl.	12 Valves	2792cc	TD17199
HR662			NB716 35.00 x 48.00 x 10.00mm, FPM NA5133 85.00 x 105.00 x 11.00mm, FPM	

248 2.8L**Petrol**

AAA	6 Cyl.	12 Valves	2792cc	TD19525
HR662				

249 2.8L**Petrol**

ACK	6 Cyl.	30 Valves	2771cc	TD5560
PA5041 (x30)	NA5001 (x4) 32.00 x 47.00 x 10.00mm, FPM		NB716 35.00 x 48.00 x 10.00mm, FPM NA5133 85.00 x 105.00 x 11.00mm, FPM NA5349 85.00 x 105.00 x 12.00mm, PTFE/ACM	

250 2.8L**Petrol**

AFP	6 Cyl.	12 Valves	2792cc	TD20532
HR662			NA5106 35.00 x 48.00 x 10.00mm, PTFE NA5305 85.00 x 105.00 x 11.00mm, PTFE	

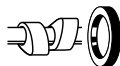

251 2.8L

Petrol

AGE	6 Cyl.	30 Valves	2771cc	TD19532
PA5041 (x30)				NB716 35.00 x 48.00 x 10.00mm, FPM NA5106 35.00 x 48.00 x 10.00mm, PTFE

252 2.8L

Petrol

AGE	6 Cyl.	30 Valves	2771cc	TD16251
AHA	6 Cyl.	30 Valves	2771cc	TD19252
PA5041 (x30)				NA5001 (x2) 32.00 x 47.00 x 10.00mm, FPM NB716 35.00 x 48.00 x 10.00mm, FPM NA5106 35.00 x 48.00 x 10.00mm, PTFE NA5349 85.00 x 105.00 x 12.00mm, PTFE/ACM

253 2.8L

Petrol

ALG	6 Cyl.	30 Valves	2771cc	TD16260
AMX	6 Cyl.	30 Valves	2771cc	TD15155
APR	6 Cyl.	30 Valves	2771cc	TD15808
AQD	6 Cyl.	30 Valves	2771cc	TD16259
ATQ	6 Cyl.	30 Valves	2771cc	TD16422
ATX	6 Cyl.	30 Valves	2771cc	TD16252
ATX	6 Cyl.	30 Valves	2771cc	TD19535
BBG	6 Cyl.	30 Valves	2771cc	TD17913
BBG	6 Cyl.	30 Valves	2771cc	TD20651
PA5041 (x30)				NA5001 (x4) 32.00 x 47.00 x 10.00mm, FPM NA5106 35.00 x 48.00 x 10.00mm, PTFE NA5349 85.00 x 105.00 x 12.00mm, PTFE/ACM

254 2.8L

Petrol

AMV	6 Cyl.	24 Valves	2792cc	TD15128
AQP	6 Cyl.	24 Valves	2792cc	TD12849
AUE	6 Cyl.	24 Valves	2792cc	TD15482
AYL	6 Cyl.	24 Valves	2792cc	TD14916
BDE	6 Cyl.	24 Valves	2792cc	TD16390
BDF	6 Cyl.	24 Valves	2792cc	TD20675
PA5041 (x24) HR5062				NA5106 35.00 x 48.00 x 10.00mm, PTFE NA5305 85.00 x 105.00 x 11.00mm, PTFE 01/01 →

255 2.9L

Petrol

ABV	6 Cyl.	12 Valves	2861cc	TD4977
HR662				NB716 35.00 x 48.00 x 10.00mm, FPM NA5133 85.00 x 105.00 x 11.00mm, FPM

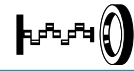
**256 3.0L****Diesel**

BKS	6 Cyl.	24 Valves	2967cc	TD18031
BMK	6 Cyl.	24 Valves	2967cc	TD18023
BUN	6 Cyl.	24 Valves	2967cc	TD21182
CARA	6 Cyl.	24 Valves	2967cc	TD22390
CARB	6 Cyl.	24 Valves	2967cc	TD22605
CASA	6 Cyl.	24 Valves	2967cc	TD20865
CASB	6 Cyl.	24 Valves	2967cc	TD22636
CASC	6 Cyl.	24 Valves	2967cc	TD22560
CASD	6 Cyl.	24 Valves	2967cc	TD24893
CATA	6 Cyl.	24 Valves	2967cc	TD22637
CEXA	6 Cyl.	24 Valves	2967cc	TD22389
CEXB	6 Cyl.	24 Valves	2967cc	TD28876

PA5041 (x24)
HR5062

NA5001 (x2)
32.00 x 47.00 x 10.00mm, FPM

NA5329
55.00 x 70.00 x 8.00mm, PTFE
NA5325
85.00 x 105.00 x 8.80mm, PTFE

257 3.0L**Diesel**

BSP	6 Cyl.	24 Valves	2967cc	TD20533
CEZA	6 Cyl.	24 Valves	2967cc	TD22561
CJGD	6 Cyl.	24 Valves	2967cc	TD24926
CJMA	6 Cyl.	24 Valves	2967cc	TD24892
CNRB	6 Cyl.	24 Valves	2967cc	TD24886
CRCA	6 Cyl.	24 Valves	2967cc	TD27356
CRCO	6 Cyl.	24 Valves	2967cc	TD32992
DDXB	6 Cyl.	24 Valves	2967cc	TD33812
DDXC	6 Cyl.	24 Valves	2967cc	TD33811

PA5041 (x24)
HR5062

NA5329
55.00 x 70.00 x 8.00mm, PTFE

258 3.0L**Petrol**

CGEA	6 Cyl.	24 Valves	2995cc	TD23931
CGFA	6 Cyl.	24 Valves	2995cc	TD23930
CJTA	6 Cyl.	24 Valves	2995cc	TD24888
CYJA	6 Cyl.	24 Valves	2995cc	TD33006

PA5041 (x24)
HR5062

NA5325
85.00 x 105.00 x 8.80mm, PTFE

259 3.0L**Petrol**

CNG	6 Cyl.	24 Valves	2975cc	TD33365
CNGA	6 Cyl.	24 Valves	2975cc	TD26925

PA5041 (x24)
HR5062

260 3.0L**Petrol**

CPFA	6 Cyl.	24 Valves	2975cc	TD31386
------	--------	-----------	--------	---------

PA5041 (x24)
HR5062

NA5305
85.00 x 105.00 x 11.00mm, PTFE

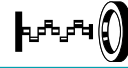

261 3.0L

Diesel

CVVA	6 Cyl.	24 Valves	2967cc	TD29745
CVWA	6 Cyl.	24 Valves	2967cc	TD30594
PA5041 (x24) HR5062				NA5329 55.00 x 70.00 x 8.00mm, PTFE NA5325 85.00 x 105.00 x 8.80mm, PTFE

262 3.0L

Diesel

GEXB	6 Cyl.	24 Valves	2967cc	TD28426
				NA5325 85.00 x 105.00 x 8.80mm, PTFE

263 3.2L

Petrol

AXJ	6 Cyl.	24 Valves	3189cc	TD15471
AXZ	6 Cyl.	24 Valves	3168cc	TD18187
AYT	6 Cyl.	24 Valves	3189cc	TD16481
AZZ	6 Cyl.	24 Valves	3189cc	TD17041
BAA	6 Cyl.	24 Valves	3189cc	TD20531
BDL	6 Cyl.	24 Valves	3189cc	TD16870
BFH	6 Cyl.	24 Valves	3189cc	TD16526
BJS	6 Cyl.	24 Valves	3189cc	TD25200
BKJ	6 Cyl.	24 Valves	3189cc	TD17042
BKK	6 Cyl.	24 Valves	3189cc	TD17186
BKL	6 Cyl.	24 Valves	3189cc	TD18024
BML	6 Cyl.	24 Valves	3189cc	TD20523
BMV	6 Cyl.	24 Valves	3189cc	TD20525
BMX	6 Cyl.	24 Valves	3189cc	TD19256
BPF	6 Cyl.	24 Valves	3189cc	TD20524
BRJ	6 Cyl.	24 Valves	3189cc	TD20526
BRK	6 Cyl.	24 Valves	3189cc	TD18025
BUB	6 Cyl.	24 Valves	3189cc	TD18472
CBR	6 Cyl.	24 Valves	3189cc	TD20023
CFLA	6 Cyl.	24 Valves	3189cc	TD20920
PA5041 (x24) HR5062				NA5106 35.00 x 48.00 x 10.00mm, PTFE NA5305 85.00 x 105.00 x 11.00mm, PTFE

264 3.2L

Petrol

AXZ	6 Cyl.	24 Valves	3168cc	TD21922
CBRA	6 Cyl.	24 Valves	3189cc	TD22178
PA5041 (x24) HR5062				NA5305 85.00 x 105.00 x 11.00mm, PTFE

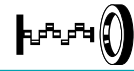
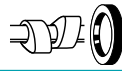
**265 3.6L****Petrol**

BHK	6 Cyl.	24 Valves	3597cc	TD18998
BHL	6 Cyl.	24 Valves	3597cc	TD18999
BLV	6 Cyl.	24 Valves	3597cc	TD19259
BWS	6 Cyl.	24 Valves	3597cc	TD19820
CDVA	6 Cyl.	24 Valves	3597cc	TD22643
CDVB	6 Cyl.	24 Valves	3598cc	TD27681
CGRA	6 Cyl.	24 Valves	3597cc	TD23925
CHNA	6 Cyl.	24 Valves	3597cc	TD22388
CMTA	6 Cyl.	24 Valves	3597cc	TD24889
CMVA	6 Cyl.	24 Valves	3597cc	TD26099
CNNA	6 Cyl.	24 Valves	3597cc	TD25469

PA5041 (x24)
HR5062

NA5305
85.00 x 105.00 x 11.00mm, PTFE

266 3.6L**Petrol**

CJRA	6 Cyl.	24 Valves	3604cc	TD26308
------	--------	-----------	--------	---------

NA5131
45.00 x 67.00 x 8.00mm, PTFE

267 4.0L**Petrol**

BDN	8 Cyl.	32 Valves	3999cc	TD16391
BDP	8 Cyl.	32 Valves	3999cc	TD16421

PA5041 (x32)
HR791 (x2)

NA5305
85.00 x 105.00 x 11.00mm, PTFE

268 4.2L**Petrol**

AXQ	8 Cyl.	40 Valves	4172cc	TD16853
-----	--------	-----------	--------	---------

PA5041 (x40)
HR822 (x2)

NA5001 (x4)
32.00 x 47.00 x 10.00mm, FPM

NA5069
55.00 x 68.00 x 8.00mm, FPM

269 4.2L**Petrol**

BAR	8 Cyl.	32 Valves	4163cc	TD20207
CGNA	8 Cyl.	32 Valves	4163cc	TD24993

PA5041 (x32)
HR791 (x2)

NA5325
85.00 x 105.00 x 8.80mm, PTFE

270 4.2L**Petrol**

BGH	8 Cyl.	40 Valves	4172cc	TD17018
BGJ	8 Cyl.	40 Valves	4172cc	TD18026
BHX	8 Cyl.	40 Valves	4172cc	TD16854

PA5041 (x40)
HR822 (x2)

NA5001
32.00 x 47.00 x 10.00mm, FPM

271 4.2L**Diesel**

CKDA	8 Cyl.	32 Valves	4134cc	TD23926
------	--------	-----------	--------	---------

PA5041 (x32)
HR791 (x2)

NA5307
32.00 x 47.00 x 10.00mm, PTFE

NF850
85.00 x 105.00 x 8.00mm, FPM

272 4.9L**Diesel**

CBWA	10 Cyl.	20 Valves	4921cc	TD21348
------	---------	-----------	--------	---------

HR816 (x3)

VOLKSWAGEN

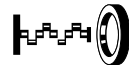
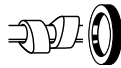







273 6.0L

Petrol

BAN	12 Cyl.	48 Valves	5998cc	TD16482
BJN	12 Cyl.	48 Valves	5998cc	TD20528
BRN	12 Cyl.	48 Valves	5998cc	TD20279
BTT	12 Cyl.	48 Valves	5998cc	TD20280
CFRA	12 Cyl.	48 Valves	5998cc	TD22644

PA5041 (x48)
HR5062  (x2)

NA5305 
85.00 x 105.00 x 11.00mm, PTFE

				CC			9
66	08/75→08/78	B 11	Petrol	1108	4	8	2
66	08/75→08/78	B 130	Petrol	1289	4	8	3
66 Estate	10/75→11/79	B 11	Petrol	1108	4	8	2
66 Estate	10/75→11/79	B 130	Petrol	1289	4	8	3
140 (142, 144)	08/68→07/74	B 20 A	Petrol	1986	4	8	28
140 (142, 144)	09/68→04/75	B 20 E	Petrol	1986	4	8	28
140 (142, 144)	11/68→09/72	B 20 B	Petrol	1986	4	8	28
140 (142, 144)	08/71→07/72	B 20 D	Petrol	1986	4	8	28
140 (142, 144)	09/72→08/75	B 20 F	Petrol	1985	4	8	28
140 Estate (145)	08/68→07/74	B 20 A	Petrol	1986	4	8	28
140 Estate (145)	08/72→07/73	B 20 E	Petrol	1986	4	8	28
140 Estate (145)	08/72→07/74	B 20 B	Petrol	1986	4	8	28
140 Estate (145)	08/72→07/74	B 20 D	Petrol	1986	4	8	28
140 Estate (145)	09/73→02/75	B 20 F	Petrol	1985	4	8	28
164	08/68→07/73	B 30 A	Petrol	2978	6	12	75
164	09/68→12/74	B 30 F	Petrol	2978	6	12	79
164	08/72→07/74	B 30 E	Petrol	2978	6	12	75
240 (P242, P244)	08/74→07/76	B 20 A	Petrol	1986	4	8	28
240 (P242, P244)	08/74→09/83	B 21 E	Petrol	2127	4	8	45
240 (P242, P244)	08/74→12/84	B 21 A	Petrol	2127	4	8	45
240 (P242, P244)	08/76→08/83	B 19 A	Petrol	1986	4	8	27
240 (P242, P244)	08/78→12/89	B 23 E	Petrol	2316	4	8	46
240 (P242, P244)	08/78→08/93	D 24	Diesel	2383	6	12	63
240 (P242, P244)	09/78→08/83	B 19 K	Petrol	1986	4	8	27
240 (P242, P244)	08/79→07/80	B 27 E	Petrol	2664	6	12	71
240 (P242, P244)	09/79→12/81	B 21 F	Petrol	2127	4	8	45
240 (P242, P244)	08/80→07/84	B 23 A	Petrol	2316	4	8	46
240 (P242, P244)	08/80→12/85	B 21 ET	Petrol	2127	4	8	45
240 (P242, P244)	09/81→07/93	B 230 F	Petrol	2316	4	8	46
240 (P242, P244)	10/82→08/84	B 19 ET	Petrol	1986	4	8	27
240 (P242, P244)	10/82→09/84	B 28 E	Petrol	2849	6	12	72
240 (P242, P244)	08/83→07/85	B 230 E	Petrol	2316	4	8	46
240 (P242, P244)	08/84→07/85	B 200 K	Petrol	1986	4	8	27
240 (P242, P244)	08/84→07/86	B 230 A	Petrol	2316	4	8	46
240 (P242, P244)	08/84→12/93	B 19 E	Petrol	1986	4	8	27
240 (P242, P244)	09/84→12/93	B 200 E	Petrol	1986	4	8	27
240 (P242, P244)	08/86→12/88	B 230 K	Petrol	2316	4	8	46
240 (P242, P244)	09/88→12/93	B 200 F	Petrol	1986	4	8	27
240 Kombi (P245)	08/74→07/75	B 20 A	Petrol	1986	4	8	28
240 Kombi (P245)	08/74→09/83	B 21 E	Petrol	2127	4	8	45
240 Kombi (P245)	08/74→07/84	B 21 A	Petrol	2127	4	8	45
240 Kombi (P245)	08/76→12/84	B 19 A	Petrol	1986	4	8	27
240 Kombi (P245)	09/78→10/80	D 20	Diesel	1986	5	10	42
240 Kombi (P245)	04/79→08/93	D 24	Diesel	2383	6	12	63
240 Kombi (P245)	08/79→07/80	B 27 E	Petrol	2664	6	12	71
240 Kombi (P245)	08/80→07/84	B 21 F	Petrol	2127	4	8	45
240 Kombi (P245)	08/80→07/84	B 23 A	Petrol	2316	4	8	46
240 Kombi (P245)	08/80→12/84	B 19 K	Petrol	1986	4	8	27
240 Kombi (P245)	08/80→07/85	B 21 ET	Petrol	2127	4	8	45
240 Kombi (P245)	08/80→12/88	B 23 E	Petrol	2316	4	8	46
240 Kombi (P245)	10/80→09/82	B 28 E	Petrol	2849	6	12	72
240 Kombi (P245)	09/81→07/93	B 230 F	Petrol	2316	4	8	46
240 Kombi (P245)	10/81→09/82	B 28 A	Petrol	2849	6	12	72
240 Kombi (P245)	10/82→05/93	B 19 ET	Petrol	1986	4	8	27
240 Kombi (P245)	08/83→07/93	B 200 E	Petrol	1986	4	8	27
240 Kombi (P245)	08/84→07/85	B 200 K	Petrol	1986	4	8	27
240 Kombi (P245)	08/84→07/85	B 230 E	Petrol	2316	4	8	46
240 Kombi (P245)	08/84→07/86	B 230 A	Petrol	2316	4	8	46
240 Kombi (P245)	09/84→12/85	B 21 FT	Petrol	2127	4	8	45
240 Kombi (P245)	08/86→12/88	B 230 K	Petrol	2316	4	8	46
240 Kombi (P245)	09/88→12/93	B 200 F	Petrol	1986	4	8	27
260 (P262, P264)	08/74→07/82	B 27 E	Petrol	2664	6	12	71
260 (P262, P264)	09/75→07/82	B 27 A	Petrol	2664	6	12	71
260 (P262, P264)	08/78→07/82	B 27 F	Petrol	2664	6	12	71
260 (P262, P264)	09/79→12/80	B 21 E	Petrol	2127	4	8	45
260 (P262, P264)	09/79→12/81	D 24	Diesel	2383	6	12	63
260 (P262, P264)	08/80→07/82	B 28 A	Petrol	2849	6	12	72
260 (P262, P264)	08/80→07/82	B 28 E	Petrol	2849	6	12	72
260 Coupe (P262)	09/75→12/79	B 27 A	Petrol	2664	6	12	71
260 Coupe (P262)	08/77→07/78	B 27 E	Petrol	2664	6	12	71
260 Coupe (P262)	09/79→12/81	B 28 F	Petrol	2849	6	12	72
260 Estate (P265)	07/75→07/82	B 27 E	Petrol	2664	6	12	71
260 Estate (P265)	08/75→12/79	B 27 A	Petrol	2664	6	12	71
260 Estate (P265)	10/78→07/82	B 27 F	Petrol	2664	6	12	71
260 Estate (P265)	09/79→12/80	D 24	Diesel	2383	6	12	63
260 Estate (P265)	08/80→07/82	B 28 F	Petrol	2849	6	12	72
340-360 (343, 345)	08/75→12/88	B 14.4 S	Petrol	1397	4	8	5
340-360 (343, 345)	08/79→08/85	B 14.3 E	Petrol	1397	4	8	5











CC



9

340-360 (343, 345)	08/80→07/84	B 19 A	Petrol	1986	4	8	27
340-360 (343, 345)	08/80→07/87	B 200 K	Petrol	1986	4	8	27
340-360 (343, 345)	08/81→07/82	B 21 E	Petrol	2127	4	8	45
340-360 (343, 345)	08/82→07/84	B 19 E	Petrol	1986	4	8	27
340-360 (343, 345)	08/84→07/88	B 200 E	Petrol	1986	4	8	27
340-360 (343, 345)	08/84→07/91	D 16	Diesel	1596	4	8	11
340-360 (343, 345)	08/85→07/91	B 17 2 K	Petrol	1721	4	8	14
340-360 (343, 345)	08/86→07/89	B 200 F	Petrol	1986	4	8	27
340-360 (343, 345)	01/89→12/90	B 13	Petrol	1289	4	8	3
340-360 Saloon (344)	08/82→07/84	B 19 A	Petrol	1986	4	8	27
340-360 Saloon (344)	01/83→12/86	B 14.3 E	Petrol	1397	4	8	5
340-360 Saloon (344)	08/83→07/84	B 19 E	Petrol	1986	4	8	27
340-360 Saloon (344)	08/83→12/88	B 14.4 S	Petrol	1397	4	8	5
340-360 Saloon (344)	08/84→07/86	B 200 E	Petrol	1986	4	8	27
340-360 Saloon (344)	08/84→07/90	B 200 K	Petrol	1986	4	8	27
340-360 Saloon (344)	08/84→07/91	D 16	Diesel	1596	4	8	11
340-360 Saloon (344)	08/85→07/91	B 17 2 K	Petrol	1721	4	8	14
340-360 Saloon (344)	08/86→07/88	B 200 EA	Petrol	1986	4	8	27
340-360 Saloon (344)	08/88→07/89	B 200 F	Petrol	1986	4	8	27
340-360 Saloon (344)	01/89→12/90	B 13	Petrol	1289	4	8	3
440 K (445)	08/88→07/89	B 18 F	Petrol	1721	4	8	14
440 K (445)	08/88→12/96	B 18 FT	Petrol	1721	4	8	14
440 K (445)	09/88→08/89	B 18 K	Petrol	1721	4	8	14
440 K (445)	09/88→08/92	B 18 KD	Petrol	1721	4	8	14
440 K (445)	09/88→12/96	B 16 F	Petrol	1596	4	8	6
440 K (445)	09/88→12/96	B 18 EP	Petrol	1721	4	8	14
440 K (445)	09/88→12/96	B 18 KP	Petrol	1721	4	8	14
440 K (445)	08/89→12/96	B 18 FP	Petrol	1721	4	8	14
440 K (445)	08/91→12/96	B 18 U	Petrol	1794	4	8	15
440 K (445)	09/91→08/93	B 16 FI	Petrol	1596	4	8	6
440 K (445)	08/92→07/96	B 20 F	Petrol	1998	4	8	29
440 K (445)	07/94→12/96	D 19 T	Diesel	1870	4	8	23
460 L (464)	09/88→07/96	B 18 KP	Petrol	1721	4	8	14
460 L (464)	08/89→07/92	B 18 E	Petrol	1721	4	8	14
460 L (464)	08/89→07/92	B 18 EP	Petrol	1721	4	8	14
460 L (464)	08/89→07/96	B 18 FT	Petrol	1721	4	8	14
460 L (464)	09/89→08/91	B 18 KD	Petrol	1721	4	8	14
460 L (464)	08/91→07/96	B 18 U	Petrol	1794	4	8	15
460 L (464)	07/92→07/96	B 16 F	Petrol	1596	4	8	6
460 L (464)	08/92→07/96	B 20 F	Petrol	1998	4	8	29
460 L (464)	07/94→07/96	D 19 T	Diesel	1870	4	8	23
480 E	04/86→07/89	B 18 E	Petrol	1721	4	8	14
480 E	08/87→07/89	B 18 F	Petrol	1721	4	8	14
480 E	08/87→07/96	B 18 FT	Petrol	1721	4	8	14
480 E	08/89→07/96	B 18 EP	Petrol	1721	4	8	14
480 E	08/92→09/95	B 20 F	Petrol	1998	4	8	29
740 (744)	04/83→07/84	B 19 E	Petrol	1986	4	8	27
740 (744)	08/83→12/85	B 23 E	Petrol	2316	4	8	46
740 (744)	12/83→07/84	B 19 ET	Petrol	1986	4	8	27
740 (744)	08/84→07/86	B 230 A	Petrol	2316	4	8	46
740 (744)	08/84→07/88	B 230 E	Petrol	2316	4	8	46
740 (744)	08/84→07/90	B 23 A	Petrol	2316	4	8	46
740 (744)	08/84→12/90	D 24 T	Diesel	2383	6	12	63
740 (744)	08/84→07/92	B 230 F	Petrol	2316	4	8	46
740 (744)	08/84→07/92	D 24	Diesel	2383	6	12	63
740 (744)	01/85→08/90	B 200 ET	Petrol	1986	4	8	27
740 (744)	08/85→12/88	B 230 ET	Petrol	2316	4	8	46
740 (744)	08/85→07/92	B 200 G	Petrol	1986	4	8	27
740 (744)	08/86→07/88	B 230 K	Petrol	2316	4	8	46
740 (744)	08/86→10/88	D 24 TIC	Diesel	2383	6	12	63
740 (744)	08/86→08/91	B 230 FT	Petrol	2316	4	8	46
740 (744)	01/87→08/88	B 200 E	Petrol	1986	4	8	27
740 (744)	08/87→08/92	B 234 F	Petrol	2316	4	16	48
740 (744)	09/87→08/90	B 204 E	Petrol	1986	4	16	30
740 (744)	09/88→08/90	B 200 K	Petrol	1986	4	8	27
740 (744)	09/89→08/91	B 230 GT	Petrol	2316	4	8	46
740 (744)	07/90→12/92	B 230 FB	Petrol	2316	4	8	46
740 (744)	09/90→08/91	B 200 FT	Petrol	1986	4	8	27
740 (744)	09/90→08/92	B 200 F	Petrol	1986	4	8	27
740 (744)	09/90→08/92	B 204 FTE	Petrol	1986	4	8	31
740 Kombi (745)	08/84→08/87	B 23 E	Petrol	2316	4	8	46
740 Kombi (745)	08/84→07/88	B 230 E	Petrol	2316	4	8	46
740 Kombi (745)	05/85→08/90	B 200 ET	Petrol	1986	4	8	27
740 Kombi (745)	08/85→07/86	B 230 A	Petrol	2316	4	8	46
740 Kombi (745)	08/85→07/88	B 230 ET	Petrol	2316	4	8	46
740 Kombi (745)	08/85→07/88	D 24	Diesel	2383	6	12	63
740 Kombi (745)	08/85→07/92	B 200 E	Petrol	1986	4	8	27
740 Kombi (745)	08/85→07/92	B 200 G	Petrol	1986	4	8	27

							
740 Kombi (745)	08/85→07/92	B 230 F	Petrol	2316	4	8	46
740 Kombi (745)	09/85→07/90	B 230 K	Petrol	2316	4	8	46
740 Kombi (745)	09/85→07/92	D 24 T	Diesel	2383	6	12	63
740 Kombi (745)	08/86→07/88	D 24 TIC	Diesel	2383	6	12	63
740 Kombi (745)	08/86→08/91	B 230 FT	Petrol	2316	4	8	46
740 Kombi (745)	08/87→08/92	B 234 F	Petrol	2316	4	16	48
740 Kombi (745)	09/87→08/90	B 204 E	Petrol	1986	4	16	30
740 Kombi (745)	09/88→08/90	B 200 K	Petrol	1986	4	8	27
740 Kombi (745)	08/89→07/91	B 200 F	Petrol	1986	4	8	27
740 Kombi (745)	08/89→08/91	B 230 GT	Petrol	2316	4	8	46
740 Kombi (745)	07/90→12/92	B 230 FB	Petrol	2316	4	8	46
740 Kombi (745)	09/90→08/91	B 200 FT	Petrol	1986	4	8	27
740 Kombi (745)	09/90→08/92	B 204 FTE	Petrol	1986	4	8	31
760 (704, 764)	08/81→07/88	B 28 E	Petrol	2849	6	12	72
760 (704, 764)	08/81→08/90	B 280 E	Petrol	2849	6	12	73
760 (704, 764)	01/82→12/87	B 28 A	Petrol	2849	6	12	72
760 (704, 764)	01/82→07/92	D 24	Diesel	2383	6	12	63
760 (704, 764)	08/82→03/86	B 23 ET	Petrol	2315	4	8	46
760 (704, 764)	08/82→07/92	D 24 T	Diesel	2383	6	12	63
760 (704, 764)	08/84→08/87	B 230 K	Petrol	2316	4	8	46
760 (704, 764)	08/84→10/88	B 230 ET	Petrol	2316	4	8	46
760 (704, 764)	05/86→08/91	B 280 F	Petrol	2849	6	12	73
760 (704, 764)	08/87→07/92	D 24 TIC	Diesel	2383	6	12	63
760 (704, 764)	09/87→07/92	B 230 FT	Petrol	2316	4	8	46
760 Kombi (704, 765)	01/82→07/92	D 24	Diesel	2383	6	12	63
760 Kombi (704, 765)	09/82→10/89	D 24 T	Diesel	2383	6	12	63
760 Kombi (704, 765)	09/82→08/91	B 280 F	Petrol	2849	6	12	73
760 Kombi (704, 765)	09/83→12/90	B 230 FT	Petrol	2316	4	8	46
760 Kombi (704, 765)	08/84→08/87	B 230 K	Petrol	2316	4	8	46
760 Kombi (704, 765)	08/84→08/90	B 230 ET	Petrol	2316	4	8	46
760 Kombi (704, 765)	08/84→08/90	B 280 E	Petrol	2849	6	12	73
760 Kombi (704, 765)	05/86→12/87	B 28 A	Petrol	2849	6	12	72
760 Kombi (704, 765)	08/86→08/90	B 28 E	Petrol	2849	6	12	72
760 Kombi (704, 765)	08/87→07/92	D 24 TIC	Diesel	2383	6	12	63
780	04/86→07/90	D 24 TIC	Diesel	2383	6	12	63
780	08/86→07/87	B 280 E	Petrol	2849	6	12	73
780	08/87→07/90	B 280 F	Petrol	2849	6	12	73
780	09/88→07/90	B 230 FT	Petrol	2316	4	8	46
850 (LS)	06/91→07/94	B 5252	Petrol	2435	5	10	59
850 (LS)	06/91→12/96	B 5204 F	Petrol	1984	5	20	38
850 (LS)	08/91→12/96	B 5254 S	Petrol	2435	5	20	61
850 (LS)	08/93→07/96	B 5234 FT	Petrol	2319	5	20	50
850 (LS)	08/93→12/96	B 5204 FT	Petrol	1984	5	20	38
850 (LS)	08/93→12/96	B 5204 T	Petrol	1984	5	20	38
850 (LS)	09/93→10/96	B 5204 T2	Petrol	1984	5	20	39
850 (LS)	09/93→10/97	B 5254 T	Petrol	2435	5	20	62
850 (LS)	08/94→12/96	B 5202 S	Petrol	1984	5	10	37
850 (LS)	08/94→12/96	B 5252 FS	Petrol	2435	5	10	59
850 (LS)	09/94→10/97	B 5234 T5	Petrol	2319	5	20	49
850 (LS)	08/95→12/96	B 5234 T4	Petrol	2319	5	20	51
850 (LS)	08/95→12/96	D 5252 T	Diesel	2461	5	10	70
850 (LS)	01/96→10/96	B 5234 FS	Petrol	2319	5	20	49
850 (LS)	04/96→10/96	B 5234 T2	Petrol	2319	5	20	49
850 Estate (LW)	08/92→07/94	B 5252	Petrol	2435	5	10	59
850 Estate (LW)	09/92→12/96	B 5254 S	Petrol	2435	5	20	61
850 Estate (LW)	02/93→12/96	B 5204 F	Petrol	1984	5	20	38
850 Estate (LW)	02/93→12/96	B 5204 FT	Petrol	1984	5	20	38
850 Estate (LW)	02/93→12/96	B 5204 T	Petrol	1984	5	20	38
850 Estate (LW)	02/93→12/96	B 5234 FT	Petrol	2319	5	20	50
850 Estate (LW)	09/93→12/96	B 5252 FS	Petrol	2435	5	10	59
850 Estate (LW)	09/93→10/97	B 5204 T2	Petrol	1984	5	20	39
850 Estate (LW)	09/93→10/97	B 5254 T	Petrol	2435	5	20	62
850 Estate (LW)	08/94→12/96	B 5202 S	Petrol	1984	5	10	37
850 Estate (LW)	09/94→10/97	B 5234 T5	Petrol	2319	5	20	49
850 Estate (LW)	08/95→12/96	B 5234 T4	Petrol	2319	5	20	51
850 Estate (LW)	08/95→12/96	D 5252 T	Diesel	2461	5	10	70
850 Estate (LW)	01/96→10/96	B 5234 FS	Petrol	2319	5	20	49
850 Estate (LW)	04/96→10/96	B 5234 T2	Petrol	2319	5	20	49
940 (944)	08/90→07/91	B 234 F	Petrol	2316	4	16	48
940 (944)	08/90→07/91	B 234 G	Petrol	2316	4	16	48
940 (944)	08/90→07/94	B 230 FT	Petrol	2316	4	8	46
940 (944)	08/90→12/94	B 200 FT	Petrol	1986	4	8	27
940 (944)	08/90→12/94	B 230 FB	Petrol	2316	4	8	46
940 (944)	08/90→12/94	B 230 G	Petrol	2316	4	8	46
940 (944)	08/90→12/94	D 24	Diesel	2383	6	12	63
940 (944)	08/90→12/94	D 24 T	Diesel	2383	6	12	63
940 (944)	08/90→12/94	D 24 TIC	Diesel	2383	6	12	63
940 (944)	09/90→04/92	B 204 E	Petrol	1986	4	16	30











CC



9

940 (944)	09/90→09/93	B 200 E	Petrol	1986	4	8	27
940 (944)	09/90→09/93	B 200 G	Petrol	1986	4	8	27
940 (944)	09/90→09/93	B 204 FT	Petrol	1986	4	16	30
940 (944)	05/91→03/95	B 230 FK	Petrol	2316	4	8	47
940 (944)	08/91→07/93	B 230 FT+	Petrol	2316	4	8	46
940 (944)	01/92→07/94	B 200 F	Petrol	1986	4	8	27
940 (944)	08/92→07/94	B 230 FD	Petrol	2316	4	8	46
940 II (944)	08/94→07/95	B 230 FD	Petrol	2316	4	8	46
940 II (944)	08/94→10/98	B 230 FB	Petrol	2316	4	8	46
940 II (944)	08/94→10/98	D 24 TIC	Diesel	2383	6	12	63
940 II (944)	08/94→12/98	B 230 FT	Petrol	2316	4	8	46
940 II (944)	10/94→05/97	B 200 GT	Petrol	1986	4	8	27
940 II (944)	10/94→05/97	B 204 FT	Petrol	1986	4	16	30
940 II (944)	11/94→12/95	B 200 G	Petrol	1986	4	8	27
940 II (944)	01/95→10/98	B 230 FK	Petrol	2316	4	8	47
940 II (944)	04/96→10/98	B 200 FT	Petrol	1986	4	8	27
940 II Estate (945)	08/94→07/95	B 230 FD	Petrol	2316	4	8	46
940 II Estate (945)	08/94→10/98	B 230 FB	Petrol	2316	4	8	46
940 II Estate (945)	08/94→10/98	B 230 FT	Petrol	2316	4	8	46
940 II Estate (945)	08/94→10/98	D 24 TIC	Diesel	2383	6	12	63
940 II Estate (945)	10/94→05/97	B 200 GT	Petrol	1986	4	8	27
940 II Estate (945)	10/94→05/97	B 204 FT	Petrol	1986	4	16	30
940 II Estate (945)	11/94→12/95	B 200 G	Petrol	1986	4	8	27
940 II Estate (945)	01/95→10/98	B 230 FK	Petrol	2316	4	8	47
940 II Estate (945)	04/96→10/98	B 200 FT	Petrol	1986	4	8	27
940 Kombi (945)	08/90→07/91	B 234 F	Petrol	2316	4	16	48
940 Kombi (945)	08/90→07/94	B 230 FT	Petrol	2316	4	8	46
940 Kombi (945)	08/90→07/94	D 24 T	Diesel	2383	6	12	63
940 Kombi (945)	08/90→12/94	B 230 FB	Petrol	2316	4	8	46
940 Kombi (945)	08/90→03/95	D 24 TIC	Diesel	2383	6	12	63
940 Kombi (945)	08/90→07/95	D 24	Diesel	2383	6	12	63
940 Kombi (945)	09/90→04/92	B 204 E	Petrol	1986	4	16	30
940 Kombi (945)	09/90→09/93	B 200 G	Petrol	1986	4	8	27
940 Kombi (945)	01/91→07/95	B 200 FT	Petrol	1986	4	8	27
940 Kombi (945)	08/91→07/93	B 230 FT+	Petrol	2316	4	8	46
940 Kombi (945)	01/92→07/94	B 200 F	Petrol	1986	4	8	27
940 Kombi (945)	08/92→07/94	B 230 FD	Petrol	2316	4	8	46
960 (964)	08/90→09/93	B 204 FT	Petrol	1986	4	16	30
960 (964)	08/90→07/94	B 6304 F	Petrol	2922	6	24	78
960 (964)	08/90→07/94	B 6304 FS	Petrol	2922	6	24	78
960 (964)	08/90→07/94	B 6304 G	Petrol	2922	6	24	78
960 (964)	09/90→05/92	B 280 F	Petrol	2849	6	12	73
960 (964)	09/90→08/93	B 204 E	Petrol	1986	4	16	30
960 (964)	09/90→08/93	B 230 FT	Petrol	2316	4	8	46
960 (964)	09/90→09/93	B 200 F	Petrol	1986	4	8	27
960 (964)	09/91→07/94	D 24 TIC	Diesel	2383	6	12	63
960 II (964)	07/94→12/96	B 6254 S	Petrol	2473	6	24	69
960 II (964)	07/94→12/96	B 6304 S	Petrol	2922	6	24	78
960 II (964)	07/94→12/96	B 6304 S2	Petrol	2922	6	24	78
960 II Estate (965)	07/94→12/96	B 6304 S2	Petrol	2922	6	24	78
960 II Estate (965)	08/94→12/96	B 6254 S	Petrol	2473	6	24	69
960 II Estate (965)	09/94→12/96	B 6304 FS2	Petrol	2922	6	24	78
960 II Estate (965)	09/94→12/96	B 6304 S	Petrol	2922	6	24	78
960 Kombi (965)	08/90→09/93	B 204 FT	Petrol	1986	4	16	30
960 Kombi (965)	08/90→07/94	B 6304 F	Petrol	2922	6	24	78
960 Kombi (965)	08/90→07/94	B 6304 S	Petrol	2922	6	24	78
960 Kombi (965)	09/90→05/92	B 280 F	Petrol	2849	6	12	73
960 Kombi (965)	09/90→08/93	B 204 E	Petrol	1986	4	16	30
960 Kombi (965)	09/90→08/93	B 230 FT	Petrol	2316	4	8	46
960 Kombi (965)	09/90→07/94	D 24 TIC	Diesel	2383	6	12	63
C30	10/06→12/12	B 4164 S3	Petrol	1596	4	16	9
C30	10/06→12/12	B 4184 S11	Petrol	1798	4	16	19
C30	10/06→12/12	B 4204 S3	Petrol	1999	4	16	35
C30	10/06→12/12	B 5244 S4	Petrol	2435	5	20	55
C30	10/06→12/12	B 5254 T3	Petrol	2521	5	20	67
C30	10/06→12/12	D 4164 T	Diesel	1560	4	16	13
C30	10/06→12/12	D 4204 T	Diesel	1997	4	16	43
C30	10/06→12/12	D 5244 T13	Diesel	2400	5	20	64
C30	10/06→12/12	D 5244 T8	Diesel	2400	5	20	64
C30	10/06→12/12	D 5244 T9	Diesel	2400	5	20	64
C30	01/07→12/12	B 4184 S8	Petrol	1798	4	16	19
C30	03/07→12/12	B 5254 T7	Petrol	2521	5	20	67
C30	10/07→12/13	B 4204 S	Petrol	1948	4	16	33
C30	01/10→12/12	B 4204 S4	Petrol	1999	4	16	35
C30	10/10→12/12	D 4162 T	Diesel	1560	4	8	12
C30	10/10→12/12	D 5204 T	Diesel	1984	5	20	44
C30	10/10→12/12	D 5204 T5	Diesel	1984	5	20	44
C70 I Convertible	03/98→10/05	B 5204 T2	Petrol	1984	5	20	39

							
C70 I Convertible	03/98→10/05	B 5204 T3	Petrol	1984	5	20	39
C70 I Convertible	03/98→10/05	B 5234 T3	Petrol	2319	5	20	49
C70 I Convertible	03/98→10/05	B 5244 T	Petrol	2435	5	20	56
C70 I Convertible	03/98→10/05	B 5254 T	Petrol	2435	5	20	62
C70 I Convertible	06/98→10/05	B 5254 S	Petrol	2435	5	20	61
C70 I Convertible	03/00→10/05	B 5204 T4	Petrol	1984	5	20	39
C70 I Convertible	07/02→10/05	B 5234 T9	Petrol	2319	5	20	49
C70 I Convertible	07/02→10/05	B 5244 T7	Petrol	2435	5	20	58
C70 I Convertible	09/04→10/05	B 5244 T5	Petrol	2401	5	20	58
C70 I Coupe	03/97→09/02	B 5204 T2	Petrol	1984	5	20	39
C70 I Coupe	03/97→09/02	B 5204 T3	Petrol	1984	5	20	39
C70 I Coupe	03/97→09/02	B 5234 T3	Petrol	2319	5	20	49
C70 I Coupe	03/97→09/02	B 5244 T	Petrol	2435	5	20	56
C70 I Coupe	03/97→09/02	B 5254 T	Petrol	2435	5	20	62
C70 I Coupe	03/99→09/02	B 5254 S	Petrol	2435	5	20	61
C70 I Coupe	05/99→09/02	B 5244 S	Petrol	2435	5	20	54
C70 I Coupe	03/00→09/02	B 5204 T4	Petrol	1984	5	20	39
C70 II Convertible	03/06→02/07	B 5254 T3	Petrol	2521	5	20	67
C70 II Convertible	03/06→10/09	B 5244 S4	Petrol	2435	5	20	55
C70 II Convertible	03/06→10/09	B 5244 S5	Petrol	2435	5	20	55
C70 II Convertible	03/06→06/13	D 5244 T13	Diesel	2400	5	20	64
C70 II Convertible	03/06→06/13	D 5244 T8	Diesel	2400	5	20	64
C70 II Convertible	03/07→10/09	B 5254 T7	Petrol	2521	5	20	67
C70 II Convertible	03/07→06/13	D 5244 T9	Diesel	2400	5	20	64
C70 II Convertible	01/08→10/09	D 4204 T	Diesel	1997	4	16	43
C70 II Convertible	10/10→06/13	D 5204 T	Diesel	1984	5	20	44
C70 II Convertible	10/10→06/13	D 5204 T5	Diesel	1984	5	20	44
C303	05/74→05/80	B 30 A	Petrol	2978	6	12	75
P 121	11/68→05/71	B 20 A	Petrol	1986	4	8	28
P 122 S Amazon	11/68→05/71	B 20 B	Petrol	1986	4	8	28
P 1800	09/69→11/73	B 20 E	Petrol	1986	4	8	28
S40 I (VS)	07/95→08/99	B 4184 S	Petrol	1731	4	16	16
S40 I (VS)	07/95→08/99	B 4184 S3	Petrol	1731	4	16	18
S40 I (VS)	07/95→08/99	D 4192 T	Diesel	1870	4	8	24
S40 I (VS)	07/95→12/03	B 4204 S	Petrol	1948	4	16	33
S40 I (VS)	07/95→12/03	B 4204 S2	Petrol	1948	4	16	34
S40 I (VS)	09/95→08/99	B 4164 S	Petrol	1588	4	16	7
S40 I (VS)	05/97→07/00	B 4194 T	Petrol	1855	4	16	21
S40 I (VS)	05/97→07/00	B 4194 T2	Petrol	1855	4	16	21
S40 I (VS)	10/97→12/03	B 4204 T	Petrol	1948	4	16	36
S40 I (VS)	03/98→12/03	B 4184 SM	Petrol	1834	4	16	20
S40 I (VS)	03/99→07/00	D 4192 T2	Diesel	1870	4	8	25
S40 I (VS)	03/99→12/03	B 4164 S2	Petrol	1587	4	16	8
S40 I (VS)	03/99→12/03	B 4184 S2	Petrol	1783	4	16	17
S40 I (VS)	03/99→	B 4184 S9	Petrol	1783	4	16	17
S40 I (VS)	07/00→06/01	B 4204 T2	Petrol	1948	4	16	34
S40 I (VS)	07/00→12/03	B 4204 T3	Petrol	1948	4	16	34
S40 I (VS)	07/00→12/03	B 4204 T5	Petrol	1948	4	16	34
S40 I (VS)	07/00→12/03	D 4192 T3	Diesel	1870	4	8	26
S40 I (VS)	07/00→12/03	D 4192 T4	Diesel	1870	4	8	26
S40 I (VS)	06/01→12/03	B 4184 S1	Petrol	1834	4	16	20
S40 I (VS)	09/02→12/03	B 4204 T4	Petrol	1948	4	16	22
S40 I (VS)	12/02→06/04	D 4204 T	Diesel	1997	4	16	43
S40 II (MS)	01/04→12/04	B 4204 T4	Petrol	1948	4	16	22
S40 II (MS)	01/04→12/07	B 5254 T3	Petrol	2521	5	20	67
S40 II (MS)	01/04→12/10	B 5244 S5	Petrol	2435	5	20	55
S40 II (MS)	01/04→12/10	D 4204 T	Diesel	1997	4	16	43
S40 II (MS)	01/04→12/12	B 5244 S4	Petrol	2435	5	20	55
S40 II (MS)	04/04→12/10	B 4184 S11	Petrol	1798	4	16	19
S40 II (MS)	01/05→12/12	B 4164 S3	Petrol	1596	4	16	9
S40 II (MS)	01/05→12/12	D 4164 T	Diesel	1560	4	16	13
S40 II (MS)	07/05→12/06	D 4204 T2	Diesel	1997	4	16	43
S40 II (MS)	01/06→12/10	B 4184 S8	Petrol	1798	4	16	19
S40 II (MS)	03/06→12/10	D 5244 T13	Diesel	2400	5	20	64
S40 II (MS)	03/06→12/10	D 5244 T8	Diesel	2400	5	20	64
S40 II (MS)	10/06→12/12	B 4204 S3	Petrol	1999	4	16	35
S40 II (MS)	03/07→12/10	D 5244 T9	Diesel	2400	5	20	64
S40 II (MS)	03/07→12/12	B 5254 T7	Petrol	2521	5	20	67
S40 II (MS)	10/09→12/12	B 4204 S4	Petrol	1999	4	16	35
S40 II (MS)	10/10→12/12	D 4162 T	Diesel	1560	4	8	12
S40 II (MS)	10/10→12/12	D 5204 T	Diesel	1984	5	20	44
S40 II (MS)	10/10→12/12	D 5204 T5	Diesel	1984	5	20	44
S60	02/04→04/10	B 5244 T5	Petrol	2401	5	20	58
S60 I	07/00→09/02	B 5234 T7	Petrol	2319	5	20	49
S60 I	07/00→04/10	B 5204 T5	Petrol	1984	5	20	40
S60 I	07/00→04/10	B 5234 T3	Petrol	2319	5	20	49
S60 I	07/00→04/10	B 5244 S2	Petrol	2435	5	20	54
S60 I	07/00→04/10	B 5244 T3	Petrol	2435	5	20	57



CC



9

S60 I	11/00→04/10	B 5244 S	Petrol	2435	5	20	54
S60 I	01/01→04/10	B 5244 T	Petrol	2435	5	20	56
S60 I	01/01→04/10	D 5244 T	Diesel	2401	5	20	64
S60 I	05/01→04/10	D 5244 T2	Diesel	2401	5	20	64
S60 I	07/01→04/10	B 5244 SG	Petrol	2435	5	20	54
S60 I	07/01→04/10	B 5244 SG2	Petrol	2435	5	20	54
S60 I	07/02→04/10	B 5254 T2	Petrol	2521	5	20	66
S60 I	01/03→04/10	B 5254 T4	Petrol	2521	5	20	68
S60 I	10/03→12/05	D 5244 T3	Diesel	2401	5	20	64
S60 I	04/04→04/10	B 5244 T5	Petrol	2401	5	20	58
S60 I	01/05→10/06	B 5244 T4	Petrol	2435	5	20	58
S60 I	03/05→04/10	D 5244 T4	Diesel	2400	5	20	64
S60 I	03/05→04/10	D 5244 T7	Diesel	2400	5	20	64
S60 I	05/05→12/06	D 5244 T6	Diesel	2401	5	20	64
S60 I	07/05→12/09	D 5244 T5	Diesel	2400	5	20	64
S60 II	04/10→12/11	B 4204 T6	Petrol	1999	4	16	35
S60 II	04/10→12/11	D 5244 T10	Diesel	2400	5	20	64
S60 II	04/10→12/14	B 4204 T7	Petrol	1999	4	16	35
S60 II	04/10→12/14	D 5204 T2	Diesel	1984	5	20	44
S60 II	04/10→12/14	D 5204 T3	Diesel	1984	5	20	44
S60 II	04/10→12/15	B 4164 T	Petrol	1596	4	16	10
S60 II	04/10→12/15	B 4164 T3	Petrol	1596	4	16	10
S60 II	04/10→12/15	B 6304 T4	Petrol	2953	6	24	80
S60 II	01/11→12/15	D 4162 T	Diesel	1560	4	8	12
S60 II	04/11→12/15	B 4164 T2	Petrol	1596	4	16	10
S60 II	04/11→12/15	D 5244 T11	Diesel	2400	5	20	64
S60 II	04/11→12/15	D 5244 T15	Diesel	2400	5	20	64
S60 II	09/11→	B 5254 T5	Petrol	2521	5	20	67
S60 II	05/12→12/15	B 5204 T8	Petrol	1984	5	20	41
S60 II	05/12→12/15	D 5204 T7	Diesel	1984	5	20	44
S60 II	11/13→03/15	B 5204 T9	Petrol	1984	5	20	41
S60 II	04/14→12/15	B 6304 T3	Petrol	2953	6	24	80
S60 II	04/14→	B 6304 T5	Petrol	2953	6	24	80
S60 II	03/15→	D 5244 T21	Diesel	2400	5	20	64
S60 II	08/15→	B 5254 T12	Petrol	2497	5	20	67
S70 (LS)	11/96→11/00	B 5234 T3	Petrol	2319	5	20	49
S70 (LS)	11/96→11/00	B 5252 FS	Petrol	2435	5	10	59
S70 (LS)	11/96→11/00	B 5254 T	Petrol	2435	5	20	62
S70 (LS)	01/97→11/00	B 5202 FS	Petrol	1984	5	10	37
S70 (LS)	01/97→11/00	B 5202 S	Petrol	1984	5	10	37
S70 (LS)	01/97→11/00	B 5204 F	Petrol	1984	5	20	38
S70 (LS)	01/97→11/00	B 5204 T	Petrol	1984	5	20	38
S70 (LS)	01/97→11/00	B 5204 T2	Petrol	1984	5	20	39
S70 (LS)	01/97→11/00	B 5204 T3	Petrol	1984	5	20	39
S70 (LS)	01/97→11/00	B 5204 T4	Petrol	1984	5	20	39
S70 (LS)	01/97→11/00	B 5234 FT+	Petrol	2319	5	20	49
S70 (LS)	01/97→11/00	B 5244 S	Petrol	2435	5	20	54
S70 (LS)	01/97→11/00	B 5244 T	Petrol	2435	5	20	56
S70 (LS)	01/97→11/00	B 5254 S	Petrol	2435	5	20	61
S70 (LS)	01/97→11/00	D 5252 T	Diesel	2461	5	10	70
S70 (LS)	07/97→09/00	B 5234 T4	Petrol	2319	5	20	51
S70 (LS)	07/97→11/00	B 5244 S2	Petrol	2435	5	20	54
S70 (LS)	07/97→11/00	B 5244 SG	Petrol	2435	5	20	54
S70 (LS)	10/98→11/00	GB 5252 S	Petrol	2435	5	10	59
S70 (LS)	04/99→09/00	B 5234 T7	Petrol	2319	5	20	49
S80 I (TS, XY)	05/98→07/06	B 6284 T	Petrol	2783	6	24	74
S80 I (TS, XY)	05/98→07/06	B 6304 S3	Petrol	2922	6	24	76
S80 I (TS, XY)	06/98→07/06	B 5204 T3	Petrol	1984	5	20	39
S80 I (TS, XY)	06/98→07/06	B 5204 T4	Petrol	1984	5	20	39
S80 I (TS, XY)	01/99→07/06	B 5244 S	Petrol	2435	5	20	54
S80 I (TS, XY)	01/99→07/06	B 5244 S2	Petrol	2435	5	20	54
S80 I (TS, XY)	01/99→07/06	D 5252 T	Diesel	2461	5	10	70
S80 I (TS, XY)	03/99→07/06	B 6294 S	Petrol	2922	6	24	76
S80 I (TS, XY)	12/99→07/06	B 5204 T5	Petrol	1984	5	20	40
S80 I (TS, XY)	04/00→08/05	B 5234 T7	Petrol	2319	5	20	49
S80 I (TS, XY)	04/00→07/06	B 5244 T3	Petrol	2435	5	20	57
S80 I (TS, XY)	06/01→07/06	B 6294 S2	Petrol	2922	6	24	77
S80 I (TS, XY)	06/01→07/06	B 6294 T	Petrol	2922	6	24	76
S80 I (TS, XY)	08/01→07/06	D 5244 T	Diesel	2401	5	20	64
S80 I (TS, XY)	09/01→07/06	B 5244 SG	Petrol	2435	5	20	54
S80 I (TS, XY)	09/01→07/06	B 5244 SG2	Petrol	2435	5	20	54
S80 I (TS, XY)	10/01→07/06	D 5244 T2	Diesel	2401	5	20	64
S80 I (TS, XY)	03/03→07/06	B 5254 T2	Petrol	2521	5	20	66
S80 I (TS, XY)	06/04→07/06	B 5244 T4	Petrol	2435	5	20	58
S80 II (AS)	03/06→	B 5254 T6	Petrol	2521	5	20	67
S80 II (AS)	03/06→	B 6324 S	Petrol	3192	6	24	81
S80 II (AS)	03/06→	D 5244 T	Diesel	2401	5	20	64
S80 II (AS)	03/06→	D 5244 T4	Diesel	2400	5	20	64



CC



9

S80 II (AS)	03/06→	D 5244 T5	Diesel	2400	5	20	64
S80 II (AS)	01/07→	B 6304 T2	Petrol	2953	6	24	80
S80 II (AS)	01/08→	B 4204 S3	Petrol	1999	4	16	35
S80 II (AS)	01/08→	B 4204 S4	Petrol	1999	4	16	35
S80 II (AS)	02/08→	D 4204 T	Diesel	1997	4	16	43
S80 II (AS)	05/08→	B 5254 T8	Petrol	2521	5	20	67
S80 II (AS)	01/10→	B 4204 T6	Petrol	1999	4	16	35
S80 II (AS)	01/10→	B 5254 T10	Petrol	2521	5	20	67
S80 II (AS)	01/10→	B 5254 T11	Petrol	2521	5	20	67
S80 II (AS)	01/10→	B 6324 S5	Petrol	3192	6	24	81
S80 II (AS)	01/10→	D 4164 T	Diesel	1560	4	16	13
S80 II (AS)	01/10→	D 5204 T2	Diesel	1984	5	20	44
S80 II (AS)	01/10→	D 5204 T3	Diesel	1984	5	20	44
S80 II (AS)	01/10→	D 5244 T10	Diesel	2400	5	20	64
S80 II (AS)	01/10→	D 5244 T14	Diesel	2400	5	20	64
S80 II (AS)	09/10→12/11	B 6324 S4	Petrol	3192	6	24	81
S80 II (AS)	10/10→	B 4164 T	Petrol	1596	4	16	10
S80 II (AS)	10/10→	B 4204 T7	Petrol	1999	4	16	35
S80 II (AS)	10/10→	B 6304 T4	Petrol	2953	6	24	80
S80 II (AS)	05/11→	B 4164 T2	Petrol	1596	4	16	10
S80 II (AS)	06/11→	D 4162 T	Diesel	1560	4	8	12
S80 II (AS)	06/11→	D 5244 T11	Diesel	2400	5	20	64
S80 II (AS)	06/11→	D 5244 T15	Diesel	2400	5	20	64
S80 II (AS)	01/12→	B 5254 T12	Petrol	2497	5	20	67
S80 II (AS)	05/12→	D 5204 T7	Diesel	1984	5	20	44
S80 II (AS)	09/12→	B 5254 T14	Petrol	2497	5	20	67
S90	11/96→10/97	B 6244 FS	Petrol	2473	6	24	69
S90	11/96→10/98	B 6254 FS	Petrol	2473	6	24	69
S90	11/96→12/98	B 6304 S2	Petrol	2922	6	24	78
S90	01/97→05/98	B 6304 G	Petrol	2922	6	24	78
V40 Estate (VW)	07/95→08/99	B 4184 S	Petrol	1731	4	16	16
V40 Estate (VW)	07/95→08/99	B 4184 S3	Petrol	1731	4	16	18
V40 Estate (VW)	07/95→08/99	D 4192 T	Diesel	1870	4	8	24
V40 Estate (VW)	07/95→06/04	B 4204 S	Petrol	1948	4	16	33
V40 Estate (VW)	07/95→06/04	B 4204 S2	Petrol	1948	4	16	34
V40 Estate (VW)	12/95→08/99	B 4164 S	Petrol	1588	4	16	7
V40 Estate (VW)	05/97→07/00	B 4194 T	Petrol	1855	4	16	21
V40 Estate (VW)	05/97→07/00	B 4194 T2	Petrol	1855	4	16	21
V40 Estate (VW)	10/97→12/00	B 4204 T	Petrol	1948	4	16	36
V40 Estate (VW)	03/98→06/04	B 4184 SM	Petrol	1834	4	16	20
V40 Estate (VW)	03/99→07/00	D 4192 T2	Diesel	1870	4	8	25
V40 Estate (VW)	03/99→06/04	B 4164 S2	Petrol	1587	4	16	8
V40 Estate (VW)	03/99→06/04	B 4184 S2	Petrol	1783	4	16	17
V40 Estate (VW)	03/99→	B 4184 S9	Petrol	1783	4	16	17
V40 Estate (VW)	07/99→06/04	B 4204 T2	Petrol	1948	4	16	34
V40 Estate (VW)	07/00→06/04	B 4204 T5	Petrol	1948	4	16	34
V40 Estate (VW)	07/00→06/04	D 4192 T3	Diesel	1870	4	8	26
V40 Estate (VW)	07/00→06/04	D 4192 T4	Diesel	1870	4	8	26
V40 Estate (VW)	06/01→06/04	B 4184 SJ	Petrol	1834	4	16	20
V40 Estate (VW)	06/01→06/04	B 4204 T3	Petrol	1948	4	16	34
V40 Estate (VW)	12/02→06/04	D 4204 T	Diesel	1997	4	16	43
V40 Estate (VW)	09/03→06/04	B 4204 T4	Petrol	1948	4	16	22
V40 Hatchback	03/12→03/15	D 5204 T6	Diesel	1984	5	20	44
V40 Hatchback	03/12→	B 4164 T	Petrol	1596	4	16	10
V40 Hatchback	03/12→	B 4164 T3	Petrol	1596	4	16	10
V40 Hatchback	03/12→	D 4162 T	Diesel	1560	4	8	12
V40 Hatchback	03/12→	D 5204 T4	Diesel	1984	5	20	44
V40 Hatchback	12/12→	B 5254 T12	Petrol	2497	5	20	67
V40 Hatchback	03/13→12/15	B 4164 T4	Petrol	1596	4	16	10
V40 Hatchback	03/13→	B 5204 T9	Petrol	1984	5	20	41
V40 Hatchback	04/13→	B 4204 T2	Petrol	1948	4	16	34
V40 Hatchback	07/13→	B 5204 T8	Petrol	1984	5	20	41
V40 Hatchback	10/13→	B 5244 S	Petrol	2435	5	20	54
V40 Hatchback	01/14→	B 5254 T14	Petrol	2497	5	20	67
V50 (MW)	12/03→12/06	D 4204 T2	Diesel	1997	4	16	43
V50 (MW)	04/04→12/07	B 5254 T3	Petrol	2521	5	20	67
V50 (MW)	04/04→12/10	B 4184 S11	Petrol	1798	4	16	19
V50 (MW)	04/04→12/10	B 5244 S4	Petrol	2435	5	20	55
V50 (MW)	04/04→12/10	B 5244 S5	Petrol	2435	5	20	55
V50 (MW)	04/04→12/10	D 4204 T	Diesel	1997	4	16	43
V50 (MW)	01/05→12/10	B 4184 S8	Petrol	1798	4	16	19
V50 (MW)	01/05→12/11	D 4164 T	Diesel	1560	4	16	13
V50 (MW)	01/05→12/12	B 4164 S3	Petrol	1596	4	16	9
V50 (MW)	03/06→12/10	D 5244 T13	Diesel	2400	5	20	64
V50 (MW)	03/06→12/10	D 5244 T8	Diesel	2400	5	20	64
V50 (MW)	10/06→12/12	B 4204 S3	Petrol	1999	4	16	35
V50 (MW)	03/07→12/12	B 5254 T7	Petrol	2521	5	20	67
V50 (MW)	05/07→12/10	D 5244 T9	Diesel	2400	5	20	64



CC



9

V50 (MW)	01/10→12/12	B 4204 S4	Petrol	1999	4	16	35
V50 (MW)	01/10→12/12	D 4162 T	Diesel	1560	4	8	12
V50 (MW)	10/10→12/12	D 5204 T	Diesel	1984	5	20	44
V50 (MW)	10/10→12/12	D 5204 T5	Diesel	1984	5	20	44
V60	07/10→12/11	D 5244 T10	Diesel	2400	5	20	64
V60	07/10→12/12	B 4204 T6	Petrol	1999	4	16	35
V60	07/10→12/14	D 5204 T2	Diesel	1984	5	20	44
V60	07/10→12/14	D 5204 T3	Diesel	1984	5	20	44
V60	07/10→	B 6304 T4	Petrol	2953	6	24	80
V60	09/10→12/15	B 4164 T	Petrol	1596	4	16	10
V60	09/10→12/15	B 4164 T3	Petrol	1596	4	16	10
V60	09/10→	B 4204 T7	Petrol	1999	4	16	35
V60	02/11→12/15	D 4162 T	Diesel	1560	4	8	12
V60	04/11→12/15	B 4164 T2	Petrol	1596	4	16	10
V60	04/11→12/15	D 5244 T11	Diesel	2400	5	20	64
V60	04/11→12/15	D 5244 T15	Diesel	2400	5	20	64
V60	05/12→12/15	D 5204 T7	Diesel	1984	5	20	44
V60	05/12→	D 5244 T17	Diesel	2400	5	20	64
V60	06/12→12/15	D82PHEV	Diesel	2400	5	20	64
V60	10/13→12/15	D 5244 T12	Diesel	2400	5	20	64
V60	10/13→	B 5204 T9	Petrol	1984	5	20	41
V60	01/14→	B 5204 T8	Petrol	1984	5	20	41
V60	04/14→12/15	B 6304 T3	Petrol	2953	6	24	80
V60	04/14→12/15	D 5244 T23	Diesel	2400	5	20	64
V60	04/14→	B 6304 T5	Petrol	2953	6	24	80
V60	07/14→	B 5254 T5	Petrol	2521	5	20	67
V60	03/15→	D87PHEV	Diesel	2400	5	20	64
V60	03/15→	D97PHEV	Diesel	2400	5	20	64
V60	03/15→	D 5244 T21	Diesel	2400	5	20	64
V60	04/15→	B 5254 T12	Petrol	2497	5	20	67
V70 I (LV)	12/95→03/00	B 5202 S	Petrol	1984	5	10	37
V70 I (LV)	12/95→03/00	B 5204 F	Petrol	1984	5	20	38
V70 I (LV)	12/95→03/00	B 5204 T	Petrol	1984	5	20	38
V70 I (LV)	12/95→03/00	B 5234 FT+	Petrol	2319	5	20	49
V70 I (LV)	12/95→03/00	B 5252 FS	Petrol	2435	5	10	59
V70 I (LV)	12/95→05/00	B 5244 S	Petrol	2435	5	20	54
V70 I (LV)	12/95→05/00	B 5254 S	Petrol	2435	5	20	61
V70 I (LV)	12/95→12/00	D 5252 T	Diesel	2461	5	10	70
V70 I (LV)	04/96→12/00	B 5244 T	Petrol	2435	5	20	56
V70 I (LV)	04/96→12/00	B 5254 T	Petrol	2435	5	20	62
V70 I (LV)	11/96→03/00	B 5204 T2	Petrol	1984	5	20	39
V70 I (LV)	11/96→12/00	B 5204 T3	Petrol	1984	5	20	39
V70 I (LV)	11/96→12/00	B 5234 T3	Petrol	2319	5	20	49
V70 I (LV)	01/97→12/00	B 5204 T4	Petrol	1984	5	20	39
V70 I (LV)	04/97→03/00	B 5234 T4	Petrol	2319	5	20	51
V70 I (LV)	05/98→12/99	GB 5252 S	Petrol	2435	5	10	59
V70 I (LV)	12/98→02/00	B 5234 T7	Petrol	2319	5	20	49
V70 I (LV)	12/98→02/00	B 5234 T8	Petrol	2319	5	20	49
V70 I (LV)	03/99→12/00	B 5244 S2	Petrol	2435	5	20	54
V70 I (LV)	03/99→12/00	B 5244 SG2	Petrol	2435	5	20	54
V70 I (LV)	03/99→12/00	B 5244 T2	Petrol	2435	5	20	55
V70 I (LV)	08/99→12/00	B 5244 SG	Petrol	2435	5	20	54
V70 II (SW)	11/99→08/03	B 5244 T3	Petrol	2435	5	20	57
V70 II (SW)	11/99→12/04	B 5234 T3	Petrol	2319	5	20	49
V70 II (SW)	11/99→08/07	B 5204 T5	Petrol	1984	5	20	40
V70 II (SW)	11/99→08/07	D 5252 T	Diesel	2461	5	10	70
V70 II (SW)	03/00→09/03	B 5254 S	Petrol	2435	5	20	61
V70 II (SW)	03/00→08/07	B 5244 S	Petrol	2435	5	20	54
V70 II (SW)	03/00→08/07	B 5244 S2	Petrol	2435	5	20	54
V70 II (SW)	09/00→12/02	B 5244 T	Petrol	2435	5	20	56
V70 II (SW)	10/00→09/04	B 5234 T7	Petrol	2319	5	20	49
V70 II (SW)	10/00→09/04	B 5234 T8	Petrol	2319	5	20	49
V70 II (SW)	01/01→12/08	D 5244 T	Diesel	2401	5	20	64
V70 II (SW)	07/01→08/07	B 5254 T2	Petrol	2521	5	20	66
V70 II (SW)	07/01→08/07	D 5244 T2	Diesel	2401	5	20	64
V70 II (SW)	09/01→08/07	B 5244 SG	Petrol	2435	5	20	54
V70 II (SW)	09/01→08/07	B 5244 SG2	Petrol	2435	5	20	54
V70 II (SW)	07/02→08/07	D 5244 T5	Diesel	2400	5	20	64
V70 II (SW)	12/02→08/07	B 5254 T4	Petrol	2521	5	20	68
V70 II (SW)	04/04→08/07	B 5244 T5	Petrol	2401	5	20	58
V70 II (SW)	04/05→12/08	D 5244 T4	Diesel	2400	5	20	64
V70 II (SW)	04/05→12/08	D 5244 T7	Diesel	2400	5	20	64
V70 II (SW)	07/05→12/08	D 5244 T6	Diesel	2401	5	20	64
V70 III (BW)	04/07→12/09	D 5244 T4	Diesel	2400	5	20	64
V70 III (BW)	04/07→12/10	B 6324 S	Petrol	3192	6	24	81
V70 III (BW)	04/07→12/10	D 5244 T5	Diesel	2400	5	20	64
V70 III (BW)	08/07→12/09	B 5254 T6	Petrol	2521	5	20	67
V70 III (BW)	08/07→12/10	B 6304 T2	Petrol	2953	6	24	80



CC



9

V70 III (BW)	10/07→12/11	B 4204 S3	Petrol	1999	4	16	35
V70 III (BW)	10/07→12/15	D 4204 T	Diesel	1997	4	16	43
V70 III (BW)	10/07→12/15	D 5204 T7	Diesel	1984	5	20	44
V70 III (BW)	10/07→12/15	D 5244 T17	Diesel	2400	5	20	64
V70 III (BW)	01/08→12/11	B 4204 S4	Petrol	1999	4	16	35
V70 III (BW)	05/08→12/09	B 5254 T8	Petrol	2521	5	20	67
V70 III (BW)	10/08→12/11	D 5244 T10	Diesel	2400	5	20	64
V70 III (BW)	04/09→12/10	D 5244 T14	Diesel	2400	5	20	64
V70 III (BW)	04/09→12/11	B 5254 T11	Petrol	2521	5	20	67
V70 III (BW)	04/09→12/12	B 5254 T10	Petrol	2521	5	20	67
V70 III (BW)	07/09→12/11	D 4164 T	Diesel	1560	4	16	13
V70 III (BW)	09/09→12/10	B 6324 S2	Petrol	3192	6	24	81
V70 III (BW)	09/09→12/11	B 4204 T6	Petrol	1999	4	16	35
V70 III (BW)	01/10→12/14	B 4204 T7	Petrol	1999	4	16	35
V70 III (BW)	01/10→12/15	B 6304 T4	Petrol	2953	6	24	80
V70 III (BW)	03/10→12/15	D 5204 T2	Diesel	1984	5	20	44
V70 III (BW)	03/10→12/15	D 5204 T3	Diesel	1984	5	20	44
V70 III (BW)	04/10→12/15	B 6324 S5	Petrol	3192	6	24	81
V70 III (BW)	10/10→12/15	B 4164 T	Petrol	1596	4	16	10
V70 III (BW)	01/11→12/15	B 4164 T2	Petrol	1596	4	16	10
V70 III (BW)	04/11→12/15	D 4162 T	Diesel	1560	4	8	12
V70 III (BW)	04/11→12/15	D 5244 T11	Diesel	2400	5	20	64
V70 III (BW)	04/11→12/15	D 5244 T15	Diesel	2400	5	20	64
V70 III (BW)	09/11→12/13	B 6324 S4	Petrol	3192	6	24	81
V70 III (BW)	04/12→12/15	B 5204 T9	Petrol	1984	5	20	41
V70 III (BW)	10/13→	D 5244 T12	Diesel	2400	5	20	64
V90 Estate	11/96→10/97	B 6244 FS	Petrol	2473	6	24	69
V90 Estate	11/96→10/98	B 6254 FS	Petrol	2473	6	24	69
V90 Estate	01/97→12/98	B 6304 G	Petrol	2922	6	24	78
V90 Estate	01/97→12/98	B 6304 S2	Petrol	2922	6	24	78
XC60	05/08→12/09	D 5244 T4	Diesel	2400	5	20	64
XC60	05/08→12/10	B 6304 T2	Petrol	2953	6	24	80
XC60	05/08→	D 5244 T16	Diesel	2400	5	20	64
XC60	05/08→	D 5244 T17	Diesel	2400	5	20	64
XC60	05/08→	D 5244 T5	Diesel	2400	5	20	64
XC60	04/09→12/10	D 5244 T14	Diesel	2400	5	20	64
XC60	07/09→12/10	B 6324 S	Petrol	3192	6	24	81
XC60	07/09→06/11	D 5244 T10	Diesel	2400	5	20	64
XC60	09/09→12/10	B 6324 S2	Petrol	3192	6	24	81
XC60	12/09→12/12	B 4204 T6	Petrol	1999	4	16	35
XC60	03/10→12/14	D 5204 T2	Diesel	1984	5	20	44
XC60	03/10→12/14	D 5204 T3	Diesel	1984	5	20	44
XC60	03/10→12/15	B 6324 S5	Petrol	3192	6	24	81
XC60	03/10→	B 6304 T4	Petrol	2953	6	24	80
XC60	09/10→12/14	B 4204 T7	Petrol	1999	4	16	35
XC60	09/10→12/15	B 6324 S4	Petrol	3192	6	24	81
XC60	04/11→	D 5244 T11	Diesel	2400	5	20	64
XC60	04/11→	D 5244 T15	Diesel	2400	5	20	64
XC60	04/12→12/15	D 5204 T7	Diesel	1984	5	20	44
XC60	10/13→12/15	D 5244 T12	Diesel	2400	5	20	64
XC60	04/14→12/15	B 6304 T3	Petrol	2953	6	24	80
XC60	04/14→12/15	D 5244 T23	Diesel	2400	5	20	64
XC60	04/14→	B 5254 T12	Petrol	2497	5	20	67
XC60	03/15→	D 5244 T20	Diesel	2400	5	20	64
XC60	03/15→	D 5244 T21	Diesel	2400	5	20	64
XC60	03/15→	D 5244 T22	Diesel	2400	5	20	64
XC70 Cross Country	10/97→03/99	B 5204 T3	Petrol	1984	5	20	39
XC70 Cross Country	11/97→09/02	B 5254 T	Petrol	2435	5	20	62
XC70 Cross Country	03/00→09/02	B 5244 T3	Petrol	2435	5	20	57
XC70 Cross Country	08/02→08/07	B 5254 T2	Petrol	2521	5	20	66
XC70 Cross Country	09/02→08/07	D 5244 T	Diesel	2401	5	20	64
XC70 Cross Country	12/05→08/07	D 5244 T4	Diesel	2400	5	20	64
XC70 II	04/07→12/09	D 5244 T4	Diesel	2400	5	20	64
XC70 II	08/07→	B 6324 S	Petrol	3192	6	24	81
XC70 II	08/07→	B 6324 S5	Petrol	3192	6	24	81
XC70 II	08/07→	D 5244 T16	Diesel	2400	5	20	64
XC70 II	08/07→	D 5244 T17	Diesel	2400	5	20	64
XC70 II	08/07→	D 5244 T5	Diesel	2400	5	20	64
XC70 II	01/08→	B 6304 T2	Petrol	2953	6	24	80
XC70 II	04/09→12/11	D 5244 T10	Diesel	2400	5	20	64
XC70 II	06/09→12/10	D 5244 T14	Diesel	2400	5	20	64
XC70 II	09/09→12/10	B 6324 S2	Petrol	3192	6	24	81
XC70 II	01/10→	B 6304 T4	Petrol	2953	6	24	80
XC70 II	04/10→12/15	D 5204 T2	Diesel	1984	5	20	44
XC70 II	04/10→12/15	D 5204 T3	Diesel	1984	5	20	44
XC70 II	09/10→12/15	B 6324 S4	Petrol	3192	6	24	81
XC70 II	04/11→12/15	D 5244 T11	Diesel	2400	5	20	64
XC70 II	04/11→12/15	D 5244 T15	Diesel	2400	5	20	64



















CC











9

Model	Period	Engine	Fuel	CC	Scissors	Pencil	Page
XC70 II	10/13→	D 5244 T12	Diesel	2400	5	20	64
XC70 II	03/15→	B 5254 T14	Petrol	2497	5	20	67
XC70 II	03/15→	D 5244 T20	Diesel	2400	5	20	64
XC70 II	08/15→	B 5254 T12	Petrol	2497	5	20	67
XC90 I	10/02→12/06	B 5254 T2	Petrol	2521	5	20	66
XC90 I	10/02→12/06	B 6294 T	Petrol	2922	6	24	76
XC90 I	10/02→12/06	D 5244 T	Diesel	2401	5	20	64
XC90 I	10/02→12/14	D 5244 T5	Diesel	2400	5	20	64
XC90 I	09/03→11/08	B 6284 T	Petrol	2783	6	24	74
XC90 I	04/05→12/10	D 5244 T4	Diesel	2400	5	20	64
XC90 I	03/06→09/14	B 6324 S	Petrol	3192	6	24	81
XC90 I	04/10→09/14	B 6324 S5	Petrol	3192	6	24	81
XC90 I	01/11→12/14	D 5244 T18	Diesel	2400	5	20	64
XC90 I	10/12→09/14	B 5254 T9	Petrol	2497	5	20	67

	CC				9		CC				9
B 10 E	1108	4	8	Petrol	1	B 230 GS	2316	4	8	Petrol	46
B 11	1108	4	8	Petrol	2	B 230 GT	2316	4	8	Petrol	46
B 13	1289	4	8	Petrol	3	B 230 K	2316	4	8	Petrol	46
B 13 E	1289	4	8	Petrol	4	B 234 F	2316	4	16	Petrol	48
B 14.3 E	1397	4	8	Petrol	5	B 234 G	2316	4	16	Petrol	48
B 14.4 S	1397	4	8	Petrol	5	B 280 E	2849	6	12	Petrol	73
B 14 OE	1397	4	8	Petrol	5	B 280 F	2849	6	12	Petrol	73
B 16 F	1596	4	8	Petrol	6	B 4164 S	1588	4	16	Petrol	7
B 16 FI	1596	4	8	Petrol	6	B 4164 S2	1587	4	16	Petrol	8
B 18 E	1721	4	8	Petrol	14	B 4164 S3	1596	4	16	Petrol	9
B 18 ED	1721	4	8	Petrol	14	B 4164 T	1596	4	16	Petrol	10
B 18 EP	1721	4	8	Petrol	14	B 4164 T2	1596	4	16	Petrol	10
B 18 F	1721	4	8	Petrol	14	B 4164 T3	1596	4	16	Petrol	10
B 18 FP	1721	4	8	Petrol	14	B 4164 T4	1596	4	16	Petrol	10
B 18 FT	1721	4	8	Petrol	14	B 4184 S	1731	4	16	Petrol	16
B 18 FTM	1721	4	8	Petrol	14	B 4184 S11	1798	4	16	Petrol	19
B 18 K	1721	4	8	Petrol	14	B 4184 S2	1783	4	16	Petrol	17
B 18 KD	1721	4	8	Petrol	14	B 4184 S3	1731	4	16	Petrol	18
B 18 KP	1721	4	8	Petrol	14	B 4184 S8	1798	4	16	Petrol	19
B 18 KPD	1721	4	8	Petrol	14	B 4184 S9	1783	4	16	Petrol	17
B 18 U	1794	4	8	Petrol	15	B 4184 SJ	1834	4	16	Petrol	20
B 19 A	1986	4	8	Petrol	27	B 4184 SM	1834	4	16	Petrol	20
B 19 E	1986	4	8	Petrol	27	B 4194 T	1855	4	16	Petrol	21
B 19 ET	1986	4	8	Petrol	27	B 4194 T2	1855	4	16	Petrol	21
B 19 K	1986	4	8	Petrol	27	B 4204 S	1948	4	16	Petrol	33
B 20 A	1986	4	8	Petrol	28	B 4204 S2	1948	4	16	Petrol	34
B 20 B	1986	4	8	Petrol	28	B 4204 S3	1999	4	16	Petrol	35
B 20 D	1986	4	8	Petrol	28	B 4204 S4	1999	4	16	Petrol	35
B 20 E	1986	4	8	Petrol	28	B 4204 T	1948	4	16	Petrol	36
B 20 F	1985	4	8	Petrol	28	B 4204 T2	1948	4	16	Petrol	34
B 20 F	1998	4	8	Petrol	29	B 4204 T3	1948	4	16	Petrol	34
B 21 A	2127	4	8	Petrol	45	B 4204 T4	1948	4	16	Petrol	22
B 21 E	2127	4	8	Petrol	45	B 4204 T5	1948	4	16	Petrol	34
B 21 ET	2127	4	8	Petrol	45	B 4204 T6	1999	4	16	Petrol	35
B 21 F	2127	4	8	Petrol	45	B 4204 T7	1999	4	16	Petrol	35
B 21 FT	2127	4	8	Petrol	45	B 5202 F	1984	5	10	Petrol	37
B 23 A	2316	4	8	Petrol	46	B 5202 FS	1984	5	10	Petrol	37
B 23 E	2316	4	8	Petrol	46	B 5202 S	1984	5	10	Petrol	37
B 23 ET	2315	4	8	Petrol	46	B 5204 F	1984	5	20	Petrol	38
B 23 F	2316	4	8	Petrol	46	B 5204 FT	1984	5	20	Petrol	38
B 23 FT	2316	4	8	Petrol	46	B 5204 S	1984	5	20	Petrol	38
B 27 A	2664	6	12	Petrol	71	B 5204 T	1984	5	20	Petrol	38
B 27 E	2664	6	12	Petrol	71	B 5204 T2	1984	5	20	Petrol	39
B 27 F	2664	6	12	Petrol	71	B 5204 T3	1984	5	20	Petrol	39
B 28 A	2849	6	12	Petrol	72	B 5204 T4	1984	5	20	Petrol	39
B 28 E	2849	6	12	Petrol	72	B 5204 T5	1984	5	20	Petrol	40
B 28 F	2849	6	12	Petrol	72	B 5204 T8	1984	5	20	Petrol	41
B 30	2978	6	12	Petrol	79	B 5204 T9	1984	5	20	Petrol	41
B 30 A	2978	6	12	Petrol	75	B 5234 F	2319	5	20	Petrol	49
B 30 E	2978	6	12	Petrol	75	B 5234 FS	2319	5	20	Petrol	49
B 30 F	2978	6	12	Petrol	79	B 5234 FT	2319	5	20	Petrol	50
B 130	1289	4	8	Petrol	3	B 5234 FT+	2319	5	20	Petrol	49
B 17 2 K	1721	4	8	Petrol	14	B 5234 T1	2319	5	20	Petrol	50
B 200 E	1986	4	8	Petrol	27	B 5234 T2	2319	5	20	Petrol	49
B 200 EA	1986	4	8	Petrol	27	B 5234 T3	2319	5	20	Petrol	49
B 200 ET	1986	4	8	Petrol	27	B 5234 T4	2319	5	20	Petrol	51
B 200 F	1986	4	8	Petrol	27	B 5234 T5	2319	5	20	Petrol	49
B 200 FT	1986	4	8	Petrol	27	B 5234 T6	2319	5	20	Petrol	52
B 200 G	1986	4	8	Petrol	27	B 5234 T7	2319	5	20	Petrol	49
B 200 GT	1986	4	8	Petrol	27	B 5234 T8	2319	5	20	Petrol	49
B 200 K	1986	4	8	Petrol	27	B 5234 T9	2319	5	20	Petrol	49
B 200 KE	1986	4	8	Petrol	27	B 5244 S	2435	5	20	Petrol	53
B 204 E	1986	4	16	Petrol	30	B 5244 S	2435	5	20	Petrol	54
B 204 FT	1986	4	16	Petrol	30	B 5244 S2	2435	5	20	Petrol	54
B 204 FTE	1986	4	8	Petrol	31	B 5244 S4	2435	5	20	Petrol	55
B 204 GT	1986	4	16	Petrol	32	B 5244 S5	2435	5	20	Petrol	55
B 230 A	2316	4	8	Petrol	46	B 5244 SG	2435	5	20	Petrol	54
B 230 E	2316	4	8	Petrol	46	B 5244 SG2	2435	5	20	Petrol	54
B 230 ET	2316	4	8	Petrol	46	B 5244 T	2435	5	20	Petrol	56
B 230 F	2316	4	8	Petrol	46	B 5244 T2	2435	5	20	Petrol	55
B 230 FB	2316	4	8	Petrol	46	B 5244 T3	2435	5	20	Petrol	57
B 230 FD	2316	4	8	Petrol	46	B 5244 T4	2435	5	20	Petrol	58
B 230 FK	2316	4	8	Petrol	47	B 5244 T5	2401	5	20	Petrol	58
B 230 FT	2316	4	8	Petrol	46	B 5244 T7	2435	5	20	Petrol	58
B 230 FT+	2316	4	8	Petrol	46	B 5252	2435	5	10	Petrol	59
B 230 FX	2316	4	8	Petrol	46	B 5252 F	2435	5	10	Petrol	59
B 230 G	2316	4	8	Petrol	46	B 5252 FS	2435	5	10	Petrol	59
B 230 GK	2316	4	8	Petrol	46	B 5252 S	2435	5	10	Petrol	65

	CC				9		CC				9
B 5254 F	2435	5	20	Petrol	60	D11C370	10840	6	24	Diesel	89
B 5254 S	2435	5	20	Petrol	61	D11C410	10800	6	24	Diesel	89
B 5254 T	2435	5	20	Petrol	62	D11C450	10800	6	24	Diesel	89
B 5254 T10	2521	5	20	Petrol	67	D12A340	12100	6	24	Diesel	91
B 5254 T11	2521	5	20	Petrol	67	D12A380	12100	6	24	Diesel	91
B 5254 T12	2497	5	20	Petrol	67	D12A420	12100	6	24	Diesel	91
B 5254 T14	2497	5	20	Petrol	67	D12C340	12100	6	24	Diesel	91
B 5254 T2	2521	5	20	Petrol	66	D12C380	12100	6	24	Diesel	91
B 5254 T3	2521	5	20	Petrol	67	D12C390	12100	6	24	Diesel	91
B 5254 T4	2521	5	20	Petrol	68	D12C420	12100	6	24	Diesel	91
B 5254 T5	2521	5	20	Petrol	67	D12C460	12100	6	24	Diesel	91
B 5254 T6	2521	5	20	Petrol	67	D12D340	12100	6	24	Diesel	91
B 5254 T7	2521	5	20	Petrol	67	D12D380	12100	6	24	Diesel	91
B 5254 T8	2521	5	20	Petrol	67	D12D390	12100	6	24	Diesel	91
B 5254 T9	2497	5	20	Petrol	67	D12D420	12100	6	24	Diesel	91
B 6244 FS	2473	6	24	Petrol	69	D12D460	12100	6	24	Diesel	91
B 6254 F	2473	6	24	Petrol	69	D12D500	12100	6	24	Diesel	91
B 6254 FS	2473	6	24	Petrol	69	D12F390	12100	6	24	Diesel	91
B 6254 G	2473	6	24	Petrol	69	D12F430	12100	6	24	Diesel	91
B 6254 S	2473	6	24	Petrol	69	D13A360	12800	6	24	Diesel	93
B 6284 T	2783	6	24	Petrol	74	D13A400	12800	6	24	Diesel	93
B 6294 S	2922	6	24	Petrol	76	D13A440	12800	6	24	Diesel	93
B 6294 S2	2922	6	24	Petrol	77	D13A480	12800	6	24	Diesel	93
B 6294 T	2922	6	24	Petrol	76	D13A520	12800	6	24	Diesel	93
B 6304 F	2922	6	24	Petrol	78	D13B360	12800	6	24	Diesel	93
B 6304 FS	2922	6	24	Petrol	78	D13B400	12800	6	24	Diesel	93
B 6304 FS2	2922	6	24	Petrol	78	D13B440	12800	6	24	Diesel	93
B 6304 G	2922	6	24	Petrol	78	D13B500	12800	6	24	Diesel	93
B 6304 S	2922	6	24	Petrol	78	D13C380	12800	6	24	Diesel	93
B 6304 S2	2922	6	24	Petrol	78	D13C420	12800	6	24	Diesel	93
B 6304 S3	2922	6	24	Petrol	76	D13C460	12800	6	24	Diesel	93
B 6304 T2	2953	6	24	Petrol	80	D13C500	12800	6	24	Diesel	93
B 6304 T3	2953	6	24	Petrol	80	D13C540	12800	6	24	Diesel	93
B 6304 T4	2953	6	24	Petrol	80	D13H440	12800	6	24	Diesel	93
B 6304 T5	2953	6	24	Petrol	80	D13K420	12800	6	24	Diesel	93
B 6324 S	3192	6	24	Petrol	81	D13K460	12800	6	24	Diesel	93
B 6324 S2	3192	6	24	Petrol	81	D13K500	12800	6	24	Diesel	93
B 6324 S4	3192	6	24	Petrol	81	D13K540	12800	6	24	Diesel	93
B 6324 S5	3192	6	24	Petrol	81	D 16	1596	4	8	Diesel	11
D6A180	5480	6	12	Diesel	82	D 16A	16123	6	12	Diesel	94
D6A210	5480	6	12	Diesel	82	D16A470	16120	6	24	Diesel	94
D6A230	5480	6	12	Diesel	82	D16A520	16120	6	24	Diesel	95
D6A250	5480	6	12	Diesel	82	D16B520	16120	6	24	Diesel	95
D7A230	6700	6	12	Diesel	83	D16C550	16120	6	24	Diesel	96
D7A260	6700	6	12	Diesel	83	D16C610	16120	6	24	Diesel	96
D7A285	6700	6	12	Diesel	83	D16E540	16120	6	24	Diesel	96
D7B230	6700	6	12	Diesel	83	D16E580	16120	6	24	Diesel	96
D7B260	6700	6	12	Diesel	83	D16E660	16120	6	24	Diesel	96
D7C215	7300	6	12	Diesel	85	D16G540	16120	6	24	Diesel	96
D7C250	7300	6	12	Diesel	85	D16G600	16120	6	24	Diesel	96
D7C290	7300	6	12	Diesel	85	D16G700	16120	6	24	Diesel	96
D7C310	7300	6	24	Diesel	85	D16G750	16120	6	24	Diesel	96
D7E240	7146	6	24	Diesel	84	D16K550	16120	6	24	Diesel	96
D7E280	7146	6	24	Diesel	84	D16K650	16120	6	24	Diesel	96
D7E290	7146	6	24	Diesel	84	D16K750	16120	6	24	Diesel	96
D7E320	7146	6	24	Diesel	84	D 19 T	1870	4	8	Diesel	23
D9A260	9364	6	24	Diesel	86	D 20	1986	5	10	Diesel	42
D9A300	9364	6	24	Diesel	86	D 24	2383	6	12	Diesel	63
D9A340	9364	6	24	Diesel	86	D 24 T	2383	6	12	Diesel	63
D9A380	9364	6	24	Diesel	86	D 24 TIC	2383	6	12	Diesel	63
D9B260	9364	6	24	Diesel	86	D82PHEV	2400	5	20	Diesel	64
D9B300	9364	6	24	Diesel	86	D87PHEV	2400	5	20	Diesel	64
D9B310	9364	6	24	Diesel	86	D97PHEV	2400	5	20	Diesel	64
D9B340	9364	6	24	Diesel	86	D 100 A	9600	6	12	Diesel	87
D9B360	9364	6	24	Diesel	86	D 100 B	9600	6	12	Diesel	87
D9B380	9364	6	24	Diesel	86	D 4162 T	1560	4	8	Diesel	12
D10A320	9600	6	12	Diesel	87	D 4164 T	1560	4	16	Diesel	13
D10A360	9600	6	12	Diesel	87	D 4192 T	1870	4	8	Diesel	24
D10B320	9600	6	12	Diesel	87	D 4192 T2	1870	4	8	Diesel	25
D10B360	9600	6	12	Diesel	87	D 4192 T3	1870	4	8	Diesel	26
D11-325	10800	6	24	Diesel	89	D 4192 T4	1870	4	8	Diesel	26
D11-355	10800	6	24	Diesel	89	D 4204 T	1997	4	16	Diesel	43
D11-365	10800	6	24	Diesel	89	D 4204 T2	1997	4	16	Diesel	43
D11-385	10800	6	24	Diesel	89	D 5204 T	1984	5	20	Diesel	44
D11-405	10800	6	24	Diesel	89	D 5204 T2	1984	5	20	Diesel	44
D11B390	10800	6	24	Diesel	89	D 5204 T3	1984	5	20	Diesel	44
D11B430	10800	6	24	Diesel	89	D 5204 T4	1984	5	20	Diesel	44
D11C330	10800	6	24	Diesel	89	D 5204 T5	1984	5	20	Diesel	44

	CC				9		CC				9
D 5204 T6	1984	5	20	Diesel	44	TD 103 ES	9600	6	12	Diesel	87
D 5204 T7	1984	5	20	Diesel	44	TD 103 KB	9600	6	12	Diesel	87
D 5244	2400	5	20	Diesel	64	TD 103 KF	9600	6	12	Diesel	87
D 5244 T	2401	5	20	Diesel	64	TD 120 A	12000	6	12	Diesel	90
D 5244 T10	2400	5	20	Diesel	64	TD 120 C	12000	6	12	Diesel	90
D 5244 T11	2400	5	20	Diesel	64	TD 120 D	11980	6	12	Diesel	90
D 5244 T12	2400	5	20	Diesel	64	TD 120 E	11980	6	12	Diesel	90
D 5244 T13	2400	5	20	Diesel	64	TD 120 F	11980	6	12	Diesel	90
D 5244 T14	2400	5	20	Diesel	64	TD 120 FA	11980	6	12	Diesel	90
D 5244 T15	2400	5	20	Diesel	64	TD 120 FB	11980	6	12	Diesel	90
D 5244 T16	2400	5	20	Diesel	64	TD 120 FC	11980	6	12	Diesel	90
D 5244 T17	2400	5	20	Diesel	64	TD 120 FTQ	11980	6	12	Diesel	90
D 5244 T18	2400	5	20	Diesel	64	TD 120 G	11980	6	12	Diesel	90
D 5244 T2	2401	5	20	Diesel	64	TD 120 GA	11980	6	12	Diesel	90
D 5244 T20	2400	5	20	Diesel	64	TD 121 F	11980	6	12	Diesel	90
D 5244 T21	2400	5	20	Diesel	64	TD 121 FA	11980	6	12	Diesel	90
D 5244 T22	2400	5	20	Diesel	64	TD 121 FB	11980	6	12	Diesel	90
D 5244 T23	2400	5	20	Diesel	64	TD 121 FC	11980	6	12	Diesel	90
D 5244 T3	2401	5	20	Diesel	64	TD 121 FD	11980	6	12	Diesel	90
D 5244 T4	2400	5	20	Diesel	64	TD 121 FE	11980	6	12	Diesel	90
D 5244 T5	2400	5	20	Diesel	64	TD 121 FF	11980	6	12	Diesel	90
D 5244 T6	2401	5	20	Diesel	64	TD 121 FG	11980	6	12	Diesel	90
D 5244 T7	2400	5	20	Diesel	64	TD 121 FH	11980	6	12	Diesel	90
D 5244 T8	2400	5	20	Diesel	64	TD 121 FK	11980	6	12	Diesel	90
D 5244 T9	2400	5	20	Diesel	64	TD 121 G	11980	6	12	Diesel	90
D 5252 T	2461	5	10	Diesel	70	TD 121 GD	11980	6	12	Diesel	90
D16500V	16120	6	24	Diesel	95	TD 122 F	11980	6	12	Diesel	90
D16550V	16120	6	24	Diesel	95	TD 122 FA	11980	6	12	Diesel	90
D16600V	16120	6	24	Diesel	95	TD 122 FAQ	11980	6	12	Diesel	90
DH10A245	9600	6	12	Diesel	87	TD 122 FBQ	11980	6	12	Diesel	90
DH10A285	9600	6	12	Diesel	87	TD 122 FCQ	11980	6	12	Diesel	90
DH10A360	9600	6	12	Diesel	87	TD 122 FH	11980	6	12	Diesel	90
DH12D340	12100	6	24	Diesel	92	TD 122 FK	11980	6	12	Diesel	90
DH12D380	12100	6	24	Diesel	92	TD 122 FKQ	11980	6	12	Diesel	90
DH12D420	12100	6	24	Diesel	92	TD 122 FL	11980	6	12	Diesel	90
DH12E340	12100	6	24	Diesel	92	TD 122 FR	11980	6	12	Diesel	90
DH12E380	12100	6	24	Diesel	92	TD 122 FS	11980	6	12	Diesel	90
DH12E420	12100	6	24	Diesel	92	TD 123 E	11980	6	12	Diesel	90
DH12E460	12100	6	24	Diesel	92	TD 123 EA	11980	6	12	Diesel	90
F8Q 768	1870	4	8	Diesel	23	TD 123 EB	11980	6	12	Diesel	90
GB 5252 S	2435	5	10	Petrol	59	TD 123 EC	11980	6	12	Diesel	90
HD 100 A	9600	6	12	Diesel	87	TD 123 ED	11980	6	12	Diesel	90
HD 100 D	9600	6	12	Diesel	87	TD 123 ES	11980	6	12	Diesel	90
TD 73 E	6700	6	12	Diesel	83	TD 162 F	16123	6	24	Diesel	95
TD 73 ES	6700	6	12	Diesel	83	TD 162 FJ	16123	6	24	Diesel	95
TD 100 A	9600	6	12	Diesel	88	TD 162 FL	16120	6	24	Diesel	95
TD 100 B	9600	6	12	Diesel	87	TD 162 FS	16123	6	24	Diesel	95
TD 100 BG	9600	6	12	Diesel	87	TD 163 ES	16123	6	24	Diesel	95
TD 100 C	9600	6	12	Diesel	87	THD 100 A	9600	6	12	Diesel	87
TD 100 CHC	9600	6	12	Diesel	87	THD 100 D	9600	6	12	Diesel	87
TD 100 F	9600	6	12	Diesel	87	THD 100 DA	9600	6	12	Diesel	87
TD 100 G	9600	6	12	Diesel	87	THD 100 DB	9600	6	12	Diesel	87
TD 100 GA	9600	6	12	Diesel	87	THD 100 DC	9600	6	12	Diesel	87
TD 101 F	9600	6	12	Diesel	87	THD 100 DD	9600	6	12	Diesel	87
TD 101 FA	9600	6	12	Diesel	87	THD 100 E	9600	6	12	Diesel	87
TD 101 FC	9600	6	12	Diesel	87	THD 100 EA	9600	6	12	Diesel	87
TD 101 FD	9600	6	12	Diesel	87	THD 100 EB	9600	6	12	Diesel	87
TD 101 G	9600	6	12	Diesel	87	THD 100 EC	9600	6	12	Diesel	87
TD 101 GA	9600	6	12	Diesel	87	THD 100 ED	9600	6	12	Diesel	87
TD 101 GB	9600	6	12	Diesel	87	THD 100 EE	9600	6	12	Diesel	87
TD 101 GE	9600	6	12	Diesel	87	THD 100 EK	9600	6	12	Diesel	87
TD 102 F	9600	6	12	Diesel	87	THD 101 B	9600	6	12	Diesel	87
TD 102 FAQ	9600	6	12	Diesel	87	THD 101 GB	9600	6	12	Diesel	87
TD 102 FBQ	9600	6	12	Diesel	87	THD 101 GC	9600	6	12	Diesel	87
TD 102 FCQ	9600	6	12	Diesel	87	THD 101 GD	9600	6	12	Diesel	87
TD 102 FD	9600	6	12	Diesel	87	THD 101 KB	9600	6	12	Diesel	87
TD 102 FDQ	9600	6	12	Diesel	87	THD 101 KC	9600	6	12	Diesel	87
TD 102 FEQ	9600	6	12	Diesel	87	THD 101 KE	9600	6	12	Diesel	87
TD 102 FF	9600	6	12	Diesel	87	THD 102 KA	9600	6	12	Diesel	87
TD 102 FGQ	9600	6	12	Diesel	87	THD 102 KB	9600	6	12	Diesel	87
TD 102 FH	9600	6	12	Diesel	87	THD 102 KD	9600	6	12	Diesel	87
TD 102 FL	9600	6	12	Diesel	87	THD 102 KE	9600	6	12	Diesel	87
TD 102 FM	9600	6	12	Diesel	87	THD 102 KF	9600	6	12	Diesel	87
TD 102 FQ	9600	6	12	Diesel	87	THD 102 KJ	9600	6	12	Diesel	87
TD 102 FS	9600	6	12	Diesel	87	THD 103 E	9600	6	12	Diesel	87
TD 102 FT	9595	6	12	Diesel	87	THD 103 ES	9600	6	12	Diesel	87
TD 103 E	9600	6	12	Diesel	87	THD 103 KB	9600	6	12	Diesel	87
TD 103 EA	9600	6	12	Diesel	87	THD 103 KD	9600	6	12	Diesel	87



CC



9



CC



9

THD 103 KF

9600

6

12

Diesel

87



1 1.1L Petrol

B 10 E 4 Cyl. 8 Valves 1108cc TD21325

NF722
35.00 x 50.00 x 10.00mm, MVQ
NF835
80.00 x 100.00 x 8.00mm, FPM/ACM

2 1.1L Petrol

B 11 4 Cyl. 8 Valves 1108cc TD3980

NF834
35.00 x 50.00 x 8.00mm, FPM
NF722
35.00 x 50.00 x 10.00mm, MVQ
NJ242
35.00 x 50.00 x 8.00mm, NBR
NF634
80.00 x 100.00 x 13.00mm, MVQ
Eng no. 100148 →

3 1.3L Petrol

B 13 4 Cyl. 8 Valves 1289cc TD3987

B 130 4 Cyl. 8 Valves 1289cc TD3904

NF834
35.00 x 50.00 x 8.00mm, FPM
NF722
35.00 x 50.00 x 10.00mm, MVQ
NJ242
35.00 x 50.00 x 8.00mm, NBR
NF634
80.00 x 100.00 x 13.00mm, MVQ
Eng no. 26918 →

4 1.3L Petrol

B 13 E 4 Cyl. 8 Valves 1289cc TD21326

NF722
35.00 x 50.00 x 10.00mm, MVQ
NF835
80.00 x 100.00 x 8.00mm, FPM/ACM

5 1.4L Petrol

B 14.3 E 4 Cyl. 8 Valves 1397cc TD3988

B 14.4 S 4 Cyl. 8 Valves 1397cc TD5142

B 14 OE 4 Cyl. 8 Valves 1397cc TD23445

HR643

NF722
35.00 x 50.00 x 10.00mm, MVQ
NF835
80.00 x 100.00 x 8.00mm, FPM/ACM

6 1.6L Petrol

B 16 F 4 Cyl. 8 Valves 1596cc TD3905

B 16 FI 4 Cyl. 8 Valves 1596cc TD21867

HR569

NF846
25.00 x 42.00 x 7.00mm, FPM/ACM
NF847
22.00 x 45.00 x 7.00mm, FPM/ACM

NF843
50.00 x 68.00 x 10.00mm, FPM/ACM
NF850
85.00 x 105.00 x 8.00mm, FPM

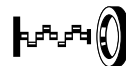
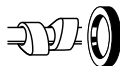
**7 1.6L****Petrol**

B 4164 S	4 Cyl.	16 Valves	1588cc	TD5549
HR816 (x2)	NA5136 (x2) 30.00 x 47.00 x 7.00mm, FPM	NA5018 35.00 x 47.00 x 5.60mm, FPM	NA5017 98.00 x 110.00 x 8.50mm, FPM	

8 1.6L**Petrol**

B 4164 S2	4 Cyl.	16 Valves	1587cc	TD13708
HR5060 →Eng no. 1818168	NA5179 (x2) 51.00 x 65.00 x 7.00mm, FPM	NA5018 35.00 x 47.00 x 5.60mm, FPM	NA5017 98.00 x 110.00 x 8.50mm, FPM	
HR5076 Eng no. 1818169→	NA5178 (x2) 45.00 x 65.00 x 7.00mm, FPM/ACM			
	NA5136 (x2) 30.00 x 47.00 x 7.00mm, FPM			

9 1.6L**Petrol**

B 4164 S3	4 Cyl.	16 Valves	1596cc	TD18513
HR808	NC048 (x2) 38.00 x 52.00 x 6.00mm, FPM	NA5137 33.00 x 47.00 x 5.00mm, FPM	LK5004 80.00 x 182.00 x 19.400mm, PTFE	
HR809				

10 1.6L**Petrol**

B 4164 T	4 Cyl.	16 Valves	1596cc	TD24673
B 4164 T2	4 Cyl.	16 Valves	1596cc	TD26061
B 4164 T3	4 Cyl.	16 Valves	1596cc	TD24674
B 4164 T4	4 Cyl.	16 Valves	1596cc	TD27991
PA6070 (x16) HR5123	NA5310 (x2) 46.00 x 56.40 x 7.00mm, FPM	NA5137 33.00 x 47.00 x 5.00mm, FPM	LK5004 80.00 x 182.00 x 19.400mm, PTFE	

11 1.6L**Diesel**

D 16	4 Cyl.	8 Valves	1596cc	TD3981
HR569	NF846 25.00 x 42.00 x 7.00mm, FPM/ACM	NF843 50.00 x 68.00 x 10.00mm, FPM/ACM	NF648 50.00 x 68.00 x 10.00mm, MVQ	
	NA5265 30.00 x 40.00 x 7.00mm, FPM	NF850 85.00 x 105.00 x 8.00mm, FPM		

12 1.6L**Diesel**

D 4162 T	4 Cyl.	8 Valves	1560cc	TD23981
HR5120	NA5258 (x2) 27.00 x 47.00 x 7.00mm, PTFE	NA5259 40.00 x 55.00 x 6.40mm, PTFE	NA5325 85.00 x 105.00 x 8.80mm, PTFE	

13 1.6L**Diesel**

D 4164 T	4 Cyl.	16 Valves	1560cc	TD20849
PA6072 (x16) HR5124	NA5258 (x2) 27.00 x 47.00 x 7.00mm, PTFE	NA5259 40.00 x 55.00 x 6.40mm, PTFE	NA5325 85.00 x 105.00 x 8.80mm, PTFE	



14 1.7L		Petrol			
B 17 2 K	4 Cyl.	8 Valves	1721cc		TD3991
B 18 E	4 Cyl.	8 Valves	1721cc		TD3907
B 18 ED	4 Cyl.	8 Valves	1721cc		TD19336
B 18 EP	4 Cyl.	8 Valves	1721cc		TD3908
B 18 F	4 Cyl.	8 Valves	1721cc		TD3909
B 18 FP	4 Cyl.	8 Valves	1721cc		TD3910
B 18 FT	4 Cyl.	8 Valves	1721cc		TD3911
B 18 FTM	4 Cyl.	8 Valves	1721cc		TD19337
B 18 K	4 Cyl.	8 Valves	1721cc		TD3912
B 18 KD	4 Cyl.	8 Valves	1721cc		TD19338
B 18 KP	4 Cyl.	8 Valves	1721cc		TD3913
B 18 KPD	4 Cyl.	8 Valves	1721cc		TD17257
HR569		NF846 25.00 x 42.00 x 7.00mm, FPM/ACM		NF843 50.00 x 68.00 x 10.00mm, FPM/ACM	
		NF847 22.00 x 45.00 x 7.00mm, FPM/ACM		NF648 50.00 x 68.00 x 10.00mm, MVQ	
				NF850 85.00 x 105.00 x 8.00mm, FPM	

15 1.8L		Petrol			
B 18 U	4 Cyl.	8 Valves	1794cc		TD3914
HR569		NF846 25.00 x 42.00 x 7.00mm, FPM/ACM		NF843 50.00 x 68.00 x 10.00mm, FPM/ACM	
		NF847 22.00 x 45.00 x 7.00mm, FPM/ACM		NF648 50.00 x 68.00 x 10.00mm, MVQ	
				NF850 85.00 x 105.00 x 8.00mm, FPM	

16 1.8L		Petrol			
B 4184 S	4 Cyl.	16 Valves	1731cc		TD5152
HR5060 →Eng no. 1818168		NA5138 (x2) 44.50 x 57.20 x 6.75mm, ACM		NA5018 35.00 x 47.00 x 5.60mm, FPM	
HR5076 Eng no. 1818169→		NA5136 (x2) 30.00 x 47.00 x 7.00mm, FPM		NA5017 98.00 x 110.00 x 8.50mm, FPM	

17 1.8L		Petrol			
B 4184 S2	4 Cyl.	16 Valves	1783cc		TD13729
B 4184 S9	4 Cyl.	16 Valves	1783cc		TD17998
HR5060 →Eng no. 1818168		NA5179 (x2) 51.00 x 65.00 x 7.00mm, FPM		NA5018 35.00 x 47.00 x 5.60mm, FPM	
HR5076 Eng no. 1818169→		NA5178 (x2) 45.00 x 65.00 x 7.00mm, FPM/ACM		NA5017 98.00 x 110.00 x 8.50mm, FPM	
		NA5136 (x2) 30.00 x 47.00 x 7.00mm, FPM			

18 1.8L		Petrol			
B 4184 S3	4 Cyl.	16 Valves	1731cc		TD13748
HR5060 →Eng no. 1818168		NA5179 51.00 x 65.00 x 7.00mm, FPM		NA5018 35.00 x 47.00 x 5.60mm, FPM	
HR5076 Eng no. 1818169→		NA5178 45.00 x 65.00 x 7.00mm, FPM/ACM		NA5017 98.00 x 110.00 x 8.50mm, FPM	
		NA5136 30.00 x 47.00 x 7.00mm, FPM			

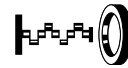
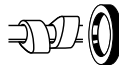
**19 1.8L****Petrol**

B 4184 S8	4 Cyl.	16 Valves	1798cc	TD20853
B 4184 S11	4 Cyl.	16 Valves	1798cc	TD18022
HR5063	NA5179 (x2) 51.00 x 65.00 x 7.00mm, FPM		NA5157 37.00 x 50.00 x 8.00mm, PTFE	
	NA5178 (x2) 45.00 x 65.00 x 7.00mm, FPM/ACM		LK5005 88.00 x 188.00 x 15.000mm, PTFE	

20 1.8L**Petrol**

B 4184 SJ	4 Cyl.	16 Valves	1834cc	TD18000
B 4184 SM	4 Cyl.	16 Valves	1834cc	TD12329
	NJ933 (x2) 35.00 x 50.00 x 8.00mm, FPM		NJ242 35.00 x 50.00 x 8.00mm, NBR	
			NK143 85.00 x 103.00 x 8.00mm, FPM	

21 1.9L**Petrol**

B 4194 T	4 Cyl.	16 Valves	1855cc	TD18003
B 4194 T2	4 Cyl.	16 Valves	1855cc	TD18004
HR5060 →Eng no. 1818168	NA5138 (x2) 44.50 x 57.20 x 6.75mm, ACM		NA5018 35.00 x 47.00 x 5.60mm, FPM	
HR5076 Eng no. 1818169→	NA5136 (x2) 30.00 x 47.00 x 7.00mm, FPM		NA5017 98.00 x 110.00 x 8.50mm, FPM	

22 1.9L**Petrol**

B 4204 T4	4 Cyl.	16 Valves	1948cc	TD29364
HR5060 →Eng no. 1818168	NA5179 (x2) 51.00 x 65.00 x 7.00mm, FPM		NA5018 35.00 x 47.00 x 5.60mm, FPM	
HR5076 Eng no. 1818169→	NA5178 (x2) 45.00 x 65.00 x 7.00mm, FPM/ACM		NA5017 98.00 x 110.00 x 8.50mm, FPM	
	NA5136 (x2) 30.00 x 47.00 x 7.00mm, FPM			

23 1.9L**Diesel**

D 19 T	4 Cyl.	8 Valves	1870cc	TD5044
F8Q 768	4 Cyl.	8 Valves	1870cc	TD19235
HR569	NF846 25.00 x 42.00 x 7.00mm, FPM/ACM		NF843 50.00 x 68.00 x 10.00mm, FPM/ACM	
			NF850 85.00 x 105.00 x 8.00mm, FPM	

24 1.9L**Diesel**

D 4192 T	4 Cyl.	8 Valves	1870cc	TD5550
HR569	NF846 25.00 x 42.00 x 7.00mm, FPM/ACM		NF843 50.00 x 68.00 x 10.00mm, FPM/ACM →04/97	
			NA5036 42.00 x 54.00 x 6.00mm, FPM 04/97→	
			NA5037 85.00 x 105.00 x 11.00mm, ACM	
			NF850 85.00 x 105.00 x 8.00mm, FPM	

**25 1.9L****Diesel**

D 4192 T2	4 Cyl.	8 Valves	1870cc	TD13728
HR816	NF846		25.00 x 42.00 x 7.00mm, FPM/ACM	NA5036
				42.00 x 54.00 x 6.00mm, FPM
				NA5037
				85.00 x 105.00 x 11.00mm, ACM

26 1.9L**Diesel**

D 4192 T3	4 Cyl.	8 Valves	1870cc	TD17997
D 4192 T4	4 Cyl.	8 Valves	1870cc	TD17996
HR816	NF846 (x2)		25.00 x 42.00 x 7.00mm, FPM/ACM	NA5036
				42.00 x 54.00 x 6.00mm, FPM
				NA5037
				85.00 x 105.00 x 11.00mm, ACM

27 2.0L**Petrol**

B 19 A	4 Cyl.	8 Valves	1986cc	TD3915
B 19 E	4 Cyl.	8 Valves	1986cc	TD3916
B 19 ET	4 Cyl.	8 Valves	1986cc	TD3917
B 19 K	4 Cyl.	8 Valves	1986cc	TD19335
B 200 E	4 Cyl.	8 Valves	1986cc	TD3925
B 200 EA	4 Cyl.	8 Valves	1986cc	TD5150
B 200 ET	4 Cyl.	8 Valves	1986cc	TD3926
B 200 F	4 Cyl.	8 Valves	1986cc	TD3927
B 200 FT	4 Cyl.	8 Valves	1986cc	TD3928
B 200 G	4 Cyl.	8 Valves	1986cc	TD3929
B 200 GT	4 Cyl.	8 Valves	1986cc	TD19344
B 200 K	4 Cyl.	8 Valves	1986cc	TD3930
B 200 KE	4 Cyl.	8 Valves	1986cc	TD21328
HR641 (x2)	NA581		52.00 x 68.00 x 10.00mm, MVQ	NA869
				92.00 x 110.00 x 10.00mm, MVQ

28 2.0L**Petrol**

B 20 A	4 Cyl.	8 Valves	1986cc	TD3919
B 20 B	4 Cyl.	8 Valves	1986cc	TD3920
B 20 D	4 Cyl.	8 Valves	1986cc	TD3921
B 20 E	4 Cyl.	8 Valves	1986cc	TD3922
B 20 F	4 Cyl.	8 Valves	1985cc	TD15068
HR801	NA869		92.00 x 110.00 x 10.00mm, MVQ	

29 2.0L**Petrol**

B 20 F	4 Cyl.	8 Valves	1998cc	TD3924
HR805	NF846		25.00 x 42.00 x 7.00mm, FPM/ACM	NF843
				50.00 x 68.00 x 10.00mm, FPM/ACM
		NF847	22.00 x 45.00 x 7.00mm, FPM/ACM	NF850
				85.00 x 105.00 x 8.00mm, FPM
				NJ354
				85.00 x 105.00 x 10.00mm, MVQ

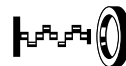
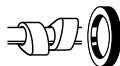

30 2.0L

Petrol

B 204 E	4 Cyl.	16 Valves	1986cc	TD3931
B 204 FT	4 Cyl.	16 Valves	1986cc	TD3932
HR816 (x2)				NA581 52.00 x 68.00 x 10.00mm, MVQ NJ354 85.00 x 105.00 x 10.00mm, MVQ NA869 92.00 x 110.00 x 10.00mm, MVQ

31 2.0L

Petrol

B 204 FTE	4 Cyl.	8 Valves	1986cc	TD21845
HR816				NA581 52.00 x 68.00 x 10.00mm, MVQ NA869 92.00 x 110.00 x 10.00mm, MVQ

32 2.0L

Petrol

B 204 GT	4 Cyl.	16 Valves	1986cc	TD3933
HR816 (x2)				NA581 52.00 x 68.00 x 10.00mm, MVQ NA869 92.00 x 110.00 x 10.00mm, MVQ

33 2.0L

Petrol

B 4204 S	4 Cyl.	16 Valves	1948cc	TD5153
HR5060 →Eng no. 1818168				NA5018 35.00 x 47.00 x 5.60mm, FPM NA5017 98.00 x 110.00 x 8.50mm, FPM
HR5076 Eng no. 1818169→	NA5138 (x2) 44.50 x 57.20 x 6.75mm, ACM NA5136 (x2) 30.00 x 47.00 x 7.00mm, FPM			

34 2.0L

Petrol

B 4204 S2	4 Cyl.	16 Valves	1948cc	TD17999
B 4204 T2	4 Cyl.	16 Valves	1948cc	TD18005
B 4204 T3	4 Cyl.	16 Valves	1948cc	TD18001
B 4204 T5	4 Cyl.	16 Valves	1948cc	TD18002
HR5060 →Eng no. 1818168				NA5018 35.00 x 47.00 x 5.60mm, FPM NA5017 98.00 x 110.00 x 8.50mm, FPM
HR5076 Eng no. 1818169→	NA5179 (x2) 51.00 x 65.00 x 7.00mm, FPM NA5178 (x2) 45.00 x 65.00 x 7.00mm, FPM/ACM NA5136 (x2) 30.00 x 47.00 x 7.00mm, FPM			

35 2.0L

Petrol

B 4204 S3	4 Cyl.	16 Valves	1999cc	TD19659
B 4204 S4	4 Cyl.	16 Valves	1999cc	TD20854
B 4204 T6	4 Cyl.	16 Valves	1999cc	TD23983
B 4204 T7	4 Cyl.	16 Valves	1999cc	TD24671
HR5063				NA5157 37.00 x 50.00 x 8.00mm, PTFE LK5005 88.00 x 188.00 x 15.000mm, PTFE

**36 2.0L****Petrol**

B 4204 T	4 Cyl.	16 Valves	1948cc	TD11287
HR5060	NA5138 (x2) 44.50 x 57.20 x 6.75mm, ACM		NA5018 35.00 x 47.00 x 5.60mm, FPM	
	NA5136 (x2) 30.00 x 47.00 x 7.00mm, FPM		NA5017 98.00 x 110.00 x 8.50mm, FPM	

37 2.0L**Petrol**

B 5202 F	5 Cyl.	10 Valves	1984cc	TD3970
B 5202 FS	5 Cyl.	10 Valves	1984cc	TD28773
B 5202 S	5 Cyl.	10 Valves	1984cc	TD5143
HR662	NA5138 (x2) 44.50 x 57.20 x 6.75mm, ACM		NA5018 35.00 x 47.00 x 5.60mm, FPM	
	NA5149 (x2) 30.00 x 54.00 x 15.00mm, FPM		NA5017 98.00 x 110.00 x 8.50mm, FPM	

38 2.0L**Petrol**

B 5204 F	5 Cyl.	20 Valves	1984cc	TD3971
B 5204 FT	5 Cyl.	20 Valves	1984cc	TD3972
B 5204 S	5 Cyl.	20 Valves	1984cc	TD23443
B 5204 T	5 Cyl.	20 Valves	1984cc	TD9893
HR662 (x2)	NA5136 (x2) 30.00 x 47.00 x 7.00mm, FPM		NA5018 35.00 x 47.00 x 5.60mm, FPM	
			NA5017 98.00 x 110.00 x 8.50mm, FPM	

39 2.0L**Petrol**

B 5204 T2	5 Cyl.	20 Valves	1984cc	TD5554
B 5204 T3	5 Cyl.	20 Valves	1984cc	TD5553
B 5204 T4	5 Cyl.	20 Valves	1984cc	TD11553
HR5113 Eng no. 1817653 →	NA5136 (x2) 30.00 x 47.00 x 7.00mm, FPM		NA5018 35.00 x 47.00 x 5.60mm, FPM	
HR662 (x2) →Eng no. 1817652			NA5017 98.00 x 110.00 x 8.50mm, FPM	

40 2.0L**Petrol**

B 5204 T5	5 Cyl.	20 Valves	1984cc	TD18006
HR5113 Eng no. 1817653 →	NA5179 (x2) 51.00 x 65.00 x 7.00mm, FPM		NA5018 35.00 x 47.00 x 5.60mm, FPM	
HR662 (x2) →Eng no. 1817652	NA5178 (x2) 45.00 x 65.00 x 7.00mm, FPM/ACM		NA5017 98.00 x 110.00 x 8.50mm, FPM	
	NA5136 (x2) 30.00 x 47.00 x 7.00mm, FPM			

41 2.0L**Petrol**

B 5204 T8	5 Cyl.	20 Valves	1984cc	TD26509
B 5204 T9	5 Cyl.	20 Valves	1984cc	TD26510
HR662 (x2)	NA5179 (x2) 51.00 x 65.00 x 7.00mm, FPM		NA5018 35.00 x 47.00 x 5.60mm, FPM	
			NA5017 98.00 x 110.00 x 8.50mm, FPM	

**42 2.0L****Diesel**

D 20	5 Cyl.	10 Valves	1986cc	TD3983
HR615	NA5001 32.00 x 47.00 x 10.00mm, FPM	NB716 35.00 x 48.00 x 10.00mm, FPM	NA5133 85.00 x 105.00 x 11.00mm, FPM	

43 2.0L**Diesel**

D 4204 T	4 Cyl.	16 Valves	1997cc	TD18993
D 4204 T2	4 Cyl.	16 Valves	1997cc	TD21826
HR5046 (x2)	NA5035 (x2) 27.00 x 47.00 x 7.00mm, FPM	NA5191 42.00 x 62.00 x 7.00mm, PTFE	NA5192 90.00 x 110.00 x 7.00mm, PTFE	

44 2.0L**Diesel**

D 5204 T	5 Cyl.	20 Valves	1984cc	TD23987
D 5204 T2	5 Cyl.	20 Valves	1984cc	TD23985
D 5204 T3	5 Cyl.	20 Valves	1984cc	TD25778
D 5204 T4	5 Cyl.	20 Valves	1984cc	TD26513
D 5204 T5	5 Cyl.	20 Valves	1984cc	TD23986
D 5204 T6	5 Cyl.	20 Valves	1984cc	TD26512
D 5204 T7	5 Cyl.	20 Valves	1984cc	TD27100
PA5041 (x20) HR822	NA5317 55.5 x 70.0 x 6.00mm, FPM	NA5018 35.00 x 47.00 x 5.60mm, FPM	NA5017 98.00 x 110.00 x 8.50mm, FPM	

45 2.1L**Petrol**

B 21 A	4 Cyl.	8 Valves	2127cc	TD3934
B 21 E	4 Cyl.	8 Valves	2127cc	TD3935
B 21 ET	4 Cyl.	8 Valves	2127cc	TD3936
B 21 F	4 Cyl.	8 Valves	2127cc	TD3937
B 21 FT	4 Cyl.	8 Valves	2127cc	TD3940
HR641 (x2)		NA581 52.00 x 68.00 x 10.00mm, MVQ	NA869 92.00 x 110.00 x 10.00mm, MVQ	

46 2.3L**Petrol**

B 23 A	4 Cyl.	8 Valves	2316cc	TD3941
B 23 E	4 Cyl.	8 Valves	2316cc	TD3942
B 23 ET	4 Cyl.	8 Valves	2315cc	TD3943
B 23 F	4 Cyl.	8 Valves	2316cc	TD3944
B 23 FT	4 Cyl.	8 Valves	2316cc	TD19262
B 230 A	4 Cyl.	8 Valves	2316cc	TD3945
B 230 E	4 Cyl.	8 Valves	2316cc	TD5038
B 230 ET	4 Cyl.	8 Valves	2316cc	TD3947
B 230 F	4 Cyl.	8 Valves	2316cc	TD3948
B 230 FB	4 Cyl.	8 Valves	2316cc	TD5157
B 230 FD	4 Cyl.	8 Valves	2316cc	TD3949
B 230 FT	4 Cyl.	8 Valves	2316cc	TD3950
B 230 FT+	4 Cyl.	8 Valves	2316cc	TD5361
B 230 FX	4 Cyl.	8 Valves	2316cc	TD21129



B 230 G	4 Cyl.	8 Valves	2316cc	TD3951
B 230 GK	4 Cyl.	8 Valves	2316cc	TD3952
B 230 GS	4 Cyl.	8 Valves	2316cc	TD3953
B 230 GT	4 Cyl.	8 Valves	2316cc	TD5039
B 230 K	4 Cyl.	8 Valves	2316cc	TD3955

HR641 (x2)

NA5016
 35.00 x 47.00 x 7.00mm, FPM/ACM

NA581
 52.00 x 68.00 x 10.00mm, MVQ
NA869
 92.00 x 110.00 x 10.00mm, MVQ
47 2.3L**Petrol**

B 230 FK	4 Cyl.	8 Valves	2316cc	TD5156
-----------------	--------	----------	--------	---------------

HR641 (x2)

NF846
 25.00 x 42.00 x 7.00mm, FPM/ACM

NA581
 52.00 x 68.00 x 10.00mm, MVQ
NA869
 92.00 x 110.00 x 10.00mm, MVQ
48 2.3L**Petrol**

B 234 F	4 Cyl.	16 Valves	2316cc	TD3956
----------------	--------	-----------	--------	---------------

B 234 G	4 Cyl.	16 Valves	2316cc	TD3957
----------------	--------	-----------	--------	---------------

HR816 (x2)

NA5016 (x2)
 35.00 x 47.00 x 7.00mm, FPM/ACM

NA581
 52.00 x 68.00 x 10.00mm, MVQ
NA869
 92.00 x 110.00 x 10.00mm, MVQ
49 2.3L**Petrol**

B 5234 F	5 Cyl.	20 Valves	2319cc	TD19269
-----------------	--------	-----------	--------	----------------

B 5234 FS	5 Cyl.	20 Valves	2319cc	TD19339
------------------	--------	-----------	--------	----------------

B 5234 FT+	5 Cyl.	20 Valves	2319cc	TD5148
-------------------	--------	-----------	--------	---------------

B 5234 T2	5 Cyl.	20 Valves	2319cc	TD19341
------------------	--------	-----------	--------	----------------

B 5234 T3	5 Cyl.	20 Valves	2319cc	TD5401
------------------	--------	-----------	--------	---------------

B 5234 T5	5 Cyl.	20 Valves	2319cc	TD19264
------------------	--------	-----------	--------	----------------

B 5234 T7	5 Cyl.	20 Valves	2319cc	TD19340
------------------	--------	-----------	--------	----------------

B 5234 T8	5 Cyl.	20 Valves	2319cc	TD19343
------------------	--------	-----------	--------	----------------

B 5234 T9	5 Cyl.	20 Valves	2319cc	TD19284
------------------	--------	-----------	--------	----------------

HR816 (x3)

NA5136 (x2)
 30.00 x 47.00 x 7.00mm, FPM

NA5018
 35.00 x 47.00 x 5.60mm, FPM
NA5017
 98.00 x 110.00 x 8.50mm, FPM
50 2.3L**Petrol**

B 5234 FT	5 Cyl.	20 Valves	2319cc	TD3973
------------------	--------	-----------	--------	---------------

B 5234 T1	5 Cyl.	20 Valves	2319cc	TD19268
------------------	--------	-----------	--------	----------------

HR662 (x2)

NA5136 (x2)
 30.00 x 47.00 x 7.00mm, FPM
NA5138 (x2)
 44.50 x 57.20 x 6.75mm, ACM

NA5018
 35.00 x 47.00 x 5.60mm, FPM
NA5017
 98.00 x 110.00 x 8.50mm, FPM

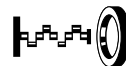
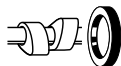
**51 2.3L****Petrol**

B 5234 T4	5 Cyl.	20 Valves	2319cc	TD17848
HR662 (x2)	NA5138 (x2) 44.50 x 57.20 x 6.75mm, ACM →12/98	NA5179 (x2) 51.00 x 65.00 x 7.00mm, FPM 01/99→	NA5018 35.00 x 47.00 x 5.60mm, FPM	NA5017 98.00 x 110.00 x 8.50mm, FPM
	NA5136 (x2) 30.00 x 47.00 x 7.00mm, FPM →12/98			
	NA5178 (x2) 45.00 x 65.00 x 7.00mm, FPM/ACM 01/99→			

52 2.3L**Petrol**

B 5234 T6	5 Cyl.	20 Valves	2319cc	TD19265
HR816 (x3)	NA5138 (x2) 44.50 x 57.20 x 6.75mm, ACM		NA5018 35.00 x 47.00 x 5.60mm, FPM	
	NA5136 (x2) 30.00 x 47.00 x 7.00mm, FPM		NA5017 98.00 x 110.00 x 8.50mm, FPM	

53 2.4L**Petrol**

B 5244 S	5 Cyl.	20 Valves	2435cc	TD24153
HR5076 Eng no. 1817653→	NA5138 (x2) 44.50 x 57.20 x 6.75mm, ACM		NA5018 35.00 x 47.00 x 5.60mm, FPM	
HR816 (x3) →Eng no. 1817652	NA5136 (x2) 30.00 x 47.00 x 7.00mm, FPM		NA5017 98.00 x 110.00 x 8.50mm, FPM	

54 2.4L**Petrol**

B 5244 S	5 Cyl.	20 Valves	2435cc	TD11552
B 5244 S2	5 Cyl.	20 Valves	2435cc	TD9847
B 5244 SG	5 Cyl.	20 Valves	2435cc	TD12328
B 5244 SG2	5 Cyl.	20 Valves	2435cc	TD17992
HR5113 Eng no. 1817653→	NA5179 (x2) 51.00 x 65.00 x 7.00mm, FPM		NA5018 35.00 x 47.00 x 5.60mm, FPM	
HR662 (x2) →Eng no. 1817652	NA5178 (x2) 45.00 x 65.00 x 7.00mm, FPM/ACM		NA5017 98.00 x 110.00 x 8.50mm, FPM	
	NA5136 (x2) 30.00 x 47.00 x 7.00mm, FPM			

55 2.4L**Petrol**

B 5244 S4	5 Cyl.	20 Valves	2435cc	TD19285
B 5244 S5	5 Cyl.	20 Valves	2435cc	TD18249
B 5244 T2	5 Cyl.	20 Valves	2435cc	TD19342
HR5113	NA5179 (x2) 51.00 x 65.00 x 7.00mm, FPM		NA5018 35.00 x 47.00 x 5.60mm, FPM	
	NA5178 (x2) 45.00 x 65.00 x 7.00mm, FPM/ACM		NA5017 98.00 x 110.00 x 8.50mm, FPM	
	NA5136 (x2) 30.00 x 47.00 x 7.00mm, FPM			

**56 2.4L****Petrol**

B 5244 T	5 Cyl.	20 Valves	2435cc	TD17995
-----------------	--------	-----------	--------	----------------

HR662 (x2)
→Eng no. 1817652
HR5076 (x2)
Eng no. 1817653→

NA5179 (x2)
51.00 x 65.00 x 7.00mm, FPM
NA5178 (x2)
45.00 x 65.00 x 7.00mm, FPM/ACM
NA5136 (x2)
30.00 x 47.00 x 7.00mm, FPM

NA5018
35.00 x 47.00 x 5.60mm, FPM
NA5017
98.00 x 110.00 x 8.50mm, FPM

57 2.4L**Petrol**

B 5244 T3	5 Cyl.	20 Valves	2435cc	TD15008
------------------	--------	-----------	--------	----------------

HR662 (x2)
→Eng no. 1817652
HR5076 (x2)
Eng no. 1817653→

NA5179
51.00 x 65.00 x 7.00mm, FPM
NA5178
45.00 x 65.00 x 7.00mm, FPM/ACM
NA5136
30.00 x 47.00 x 7.00mm, FPM

NA5018
35.00 x 47.00 x 5.60mm, FPM
NA5017
98.00 x 110.00 x 8.50mm, FPM

58 2.4L**Petrol**

B 5244 T4	5 Cyl.	20 Valves	2435cc	TD21830
------------------	--------	-----------	--------	----------------

B 5244 T5	5 Cyl.	20 Valves	2401cc	TD18547
------------------	--------	-----------	--------	----------------

B 5244 T7	5 Cyl.	20 Valves	2435cc	TD18251
------------------	--------	-----------	--------	----------------

HR816 (x3)

NA5179 (x2)
51.00 x 65.00 x 7.00mm, FPM
NA5178 (x2)
45.00 x 65.00 x 7.00mm, FPM/ACM
NA5136 (x2)
30.00 x 47.00 x 7.00mm, FPM

NA5018
35.00 x 47.00 x 5.60mm, FPM
NA5017
98.00 x 110.00 x 8.50mm, FPM

59 2.4L**Petrol**

B 5252	5 Cyl.	10 Valves	2435cc	TD5144
---------------	--------	-----------	--------	---------------

B 5252 F	5 Cyl.	10 Valves	2435cc	TD19267
-----------------	--------	-----------	--------	----------------

B 5252 FS	5 Cyl.	10 Valves	2435cc	TD21829
------------------	--------	-----------	--------	----------------

GB 5252 S	5 Cyl.	10 Valves	2435cc	TD12330
------------------	--------	-----------	--------	----------------

HR662

NA5138 (x2)
44.50 x 57.20 x 6.75mm, ACM
NA5149 (x2)
30.00 x 54.00 x 15.00mm, FPM

NA5018
35.00 x 47.00 x 5.60mm, FPM
NA5017
98.00 x 110.00 x 8.50mm, FPM

60 2.4L**Petrol**

B 5254 F	5 Cyl.	20 Valves	2435cc	TD19266
-----------------	--------	-----------	--------	----------------

HR662 (x2)

NA5136 (x2)
30.00 x 47.00 x 7.00mm, FPM
NA5138 (x2)
44.50 x 57.20 x 6.75mm, ACM

NA5018
35.00 x 47.00 x 5.60mm, FPM
NA5017
98.00 x 110.00 x 8.50mm, FPM

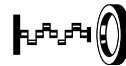
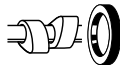
**61 2.4L****Petrol**

B 5254 S	5 Cyl.	20 Valves	2435cc	TD5147
HR662 (x2)	NA5138 (x2) 44.50 x 57.20 x 6.75mm, ACM →12/98 NA5179 (x2) 51.00 x 65.00 x 7.00mm, FPM 01/00→ NA5136 (x2) 30.00 x 47.00 x 7.00mm, FPM →12/98 NA5178 (x2) 45.00 x 65.00 x 7.00mm, FPM/ACM 01/99→			NA5018 35.00 x 47.00 x 5.60mm, FPM NA5017 98.00 x 110.00 x 8.50mm, FPM

62 2.4L**Petrol**

B 5254 T	5 Cyl.	20 Valves	2435cc	TD9366
HR662 (x2)	NA5138 (x2) 44.50 x 57.20 x 6.75mm, ACM →12/98 NA5178 (x2) 45.00 x 65.00 x 7.00mm, FPM/ACM 01/99→ NA5179 (x2) 51.00 x 65.00 x 7.00mm, FPM 01/00→ NA5136 (x2) 30.00 x 47.00 x 7.00mm, FPM →12/98			NA5018 35.00 x 47.00 x 5.60mm, FPM NA5017 98.00 x 110.00 x 8.50mm, FPM

63 2.4L**Diesel**

D 24	6 Cyl.	12 Valves	2383cc	TD3984
D 24 T	6 Cyl.	12 Valves	2383cc	TD3985
D 24 TIC	6 Cyl.	12 Valves	2383cc	TD3986
HR805	NA5001 32.00 x 47.00 x 10.00mm, FPM			NB716 35.00 x 48.00 x 10.00mm, FPM NA5133 85.00 x 105.00 x 11.00mm, FPM

64 2.4L**Diesel**

D82PHEV	5 Cyl.	20 Valves	2400cc	TD29282
D87PHEV	5 Cyl.	20 Valves	2400cc	TD31515
D97PHEV	5 Cyl.	20 Valves	2400cc	TD31059
D 5244	5 Cyl.	20 Valves	2400cc	TD20835
D 5244 T	5 Cyl.	20 Valves	2401cc	TD16325
D 5244 T2	5 Cyl.	20 Valves	2401cc	TD17990
D 5244 T3	5 Cyl.	20 Valves	2401cc	TD28023
D 5244 T4	5 Cyl.	20 Valves	2400cc	TD20081
D 5244 T5	5 Cyl.	20 Valves	2400cc	TD20833
D 5244 T6	5 Cyl.	20 Valves	2401cc	TD26862
D 5244 T7	5 Cyl.	20 Valves	2400cc	TD20834
D 5244 T8	5 Cyl.	20 Valves	2400cc	TD19660
D 5244 T9	5 Cyl.	20 Valves	2400cc	TD20851
D 5244 T10	5 Cyl.	20 Valves	2400cc	TD23621
D 5244 T11	5 Cyl.	20 Valves	2400cc	TD25185
D 5244 T12	5 Cyl.	20 Valves	2400cc	TD28501



D 5244 T13	5 Cyl.	20 Valves	2400cc	TD20850
D 5244 T14	5 Cyl.	20 Valves	2400cc	TD23623
D 5244 T15	5 Cyl.	20 Valves	2400cc	TD25186
D 5244 T16	5 Cyl.	20 Valves	2400cc	TD23624
D 5244 T17	5 Cyl.	20 Valves	2400cc	TD25779
D 5244 T18	5 Cyl.	20 Valves	2400cc	TD25007
D 5244 T20	5 Cyl.	20 Valves	2400cc	TD31057
D 5244 T21	5 Cyl.	20 Valves	2400cc	TD31031
D 5244 T22	5 Cyl.	20 Valves	2400cc	TD31056
D 5244 T23	5 Cyl.	20 Valves	2400cc	TD29584

PA5041 (x20)
HR822

NA5317
55.5 x 70.0 x 6.00mm, FPM

NA5018
35.00 x 47.00 x 5.60mm, FPM
NA5017
98.00 x 110.00 x 8.50mm, FPM

65 2.5L

Petrol

B 5252 S	5 Cyl.	10 Valves	2435cc	TD5146
HR662	NA5138 (x2) 44.50 x 57.20 x 6.75mm, ACM NA5149 (x2) 30.00 x 54.00 x 15.00mm, FPM	NA5018 35.00 x 47.00 x 5.60mm, FPM NA5017 98.00 x 110.00 x 8.50mm, FPM		

66 2.5L

Petrol

B 5254 T2	5 Cyl.	20 Valves	2521cc	TD17991
HR5113	NA5179 (x2) 51.00 x 65.00 x 7.00mm, FPM NA5178 (x2) 45.00 x 65.00 x 7.00mm, FPM/ACM NA5138 (x2) 44.50 x 57.20 x 6.75mm, ACM NA5136 (x2) 30.00 x 47.00 x 7.00mm, FPM	NA5018 35.00 x 47.00 x 5.60mm, FPM NA5017 98.00 x 110.00 x 8.50mm, FPM		

67 2.5L

Petrol

B 5254 T3	5 Cyl.	20 Valves	2521cc	TD18250
B 5254 T5	5 Cyl.	20 Valves	2521cc	TD29363
B 5254 T6	5 Cyl.	20 Valves	2521cc	TD20985
B 5254 T7	5 Cyl.	20 Valves	2521cc	TD20963
B 5254 T8	5 Cyl.	20 Valves	2521cc	TD21270
B 5254 T9	5 Cyl.	20 Valves	2497cc	TD29888
B 5254 T10	5 Cyl.	20 Valves	2521cc	TD24239
B 5254 T11	5 Cyl.	20 Valves	2521cc	TD24235
B 5254 T12	5 Cyl.	20 Valves	2497cc	TD26511
B 5254 T14	5 Cyl.	20 Valves	2497cc	TD29810
HR5113	NA5179 (x2) 51.00 x 65.00 x 7.00mm, FPM	NA5018 35.00 x 47.00 x 5.60mm, FPM NA5017 98.00 x 110.00 x 8.50mm, FPM		

68 2.5L

Petrol

B 5254 T4	5 Cyl.	20 Valves	2521cc	TD18248
HR5113	NA5136 (x2) 30.00 x 47.00 x 7.00mm, FPM	NA5018 35.00 x 47.00 x 5.60mm, FPM NA5017 98.00 x 110.00 x 8.50mm, FPM		

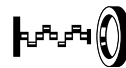
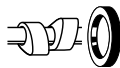

69 2.5L

Petrol

B 6244 FS	6 Cyl.	24 Valves	2473cc	TD21828
B 6254 F	6 Cyl.	24 Valves	2473cc	TD3976
B 6254 FS	6 Cyl.	24 Valves	2473cc	TD21827
B 6254 G	6 Cyl.	24 Valves	2473cc	TD23444
B 6254 S	6 Cyl.	24 Valves	2473cc	TD5154

HR800

NA5138 (x2)
44.50 x 57.20 x 6.75mm, ACM
NA5136 (x2)
30.00 x 47.00 x 7.00mm, FPM

NA5018
35.00 x 47.00 x 5.60mm, FPM
NA5017
98.00 x 110.00 x 8.50mm, FPM

70 2.5L

Diesel

D 5252 T	5 Cyl.	10 Valves	2461cc	TD5145
----------	--------	-----------	--------	--------

HR615

NA5001
32.00 x 47.00 x 10.00mm, FPM

NB716
35.00 x 48.00 x 10.00mm, FPM
NA5133
85.00 x 105.00 x 11.00mm, FPM

71 2.7L

Petrol

B 27 A	6 Cyl.	12 Valves	2664cc	TD3958
B 27 E	6 Cyl.	12 Valves	2664cc	TD3959
B 27 F	6 Cyl.	12 Valves	2664cc	TD3960

HR805

NF634
80.00 x 100.00 x 13.00mm, MVQ

72 2.8L

Petrol

B 28 A	6 Cyl.	12 Valves	2849cc	TD3962
B 28 E	6 Cyl.	12 Valves	2849cc	TD3963
B 28 F	6 Cyl.	12 Valves	2849cc	TD3964

HR805

NF634
80.00 x 100.00 x 13.00mm, MVQ

73 2.8L

Petrol

B 280 E	6 Cyl.	12 Valves	2849cc	TD3965
B 280 F	6 Cyl.	12 Valves	2849cc	TD5041

HR300 (x2)

NF634
80.00 x 100.00 x 13.00mm, MVQ

74 2.8L

Petrol

B 6284 T	6 Cyl.	24 Valves	2783cc	TD9828
----------	--------	-----------	--------	--------

HR662 (x2)
→Eng no. 1818168
HR5076 (x2)
Eng no. 1818169→

NA5179
51.00 x 65.00 x 7.00mm, FPM
NA5178
45.00 x 65.00 x 7.00mm, FPM/ACM
NA5136 (x2)
30.00 x 47.00 x 7.00mm, FPM

NA5018
35.00 x 47.00 x 5.60mm, FPM
NA5017
98.00 x 110.00 x 8.50mm, FPM

75 2.9L

Petrol

B 30 A	6 Cyl.	12 Valves	2978cc	TD3967
B 30 E	6 Cyl.	12 Valves	2978cc	TD3968

HR641 (x3)

NA581
52.00 x 68.00 x 10.00mm, MVQ
NA869
92.00 x 110.00 x 10.00mm, MVQ

**76 2.9L****Petrol**

B 6294 S	6 Cyl.	24 Valves	2922cc	TD13668
B 6294 T	6 Cyl.	24 Valves	2922cc	TD17994
B 6304 S3	6 Cyl.	24 Valves	2922cc	TD9827
HR662 (x2) →Eng no. 1818168	NA5179 51.00 x 65.00 x 7.00mm, FPM		NA5018 35.00 x 47.00 x 5.60mm, FPM	
HR5076 (x2) Eng no. 1818169→	NA5178 45.00 x 65.00 x 7.00mm, FPM/ACM		NA5017 98.00 x 110.00 x 8.50mm, FPM	
	NA5136 30.00 x 47.00 x 7.00mm, FPM			

77 2.9L**Petrol**

B 6294 S2	6 Cyl.	24 Valves	2922cc	TD17993
HR662 (x2) →Eng no. 1818168	NA5136 30.00 x 47.00 x 7.00mm, FPM		NA5018 35.00 x 47.00 x 5.60mm, FPM	
HR5076 (x2) Eng no. 1818169→			NA5017 98.00 x 110.00 x 8.50mm, FPM	

78 2.9L**Petrol**

B 6304 F	6 Cyl.	24 Valves	2922cc	TD5042
B 6304 FS	6 Cyl.	24 Valves	2922cc	TD25836
B 6304 FS2	6 Cyl.	24 Valves	2922cc	TD25837
B 6304 G	6 Cyl.	24 Valves	2922cc	TD5402
B 6304 S	6 Cyl.	24 Valves	2922cc	TD5555
B 6304 S2	6 Cyl.	24 Valves	2922cc	TD5155
HR662 (x2)	NA5138 (x2) 44.50 x 57.20 x 6.75mm, ACM		NA5018 35.00 x 47.00 x 5.60mm, FPM	
	NA5136 (x2) 30.00 x 47.00 x 7.00mm, FPM		NA5017 98.00 x 110.00 x 8.50mm, FPM	

79 3.0L**Petrol**

B 30	6 Cyl.	12 Valves	2978cc	TD23446
B 30 F	6 Cyl.	12 Valves	2978cc	TD3969
HR641 (x3)			NA581 52.00 x 68.00 x 10.00mm, MVQ	
			NA869 92.00 x 110.00 x 10.00mm, MVQ	

80 3.0L**Petrol**

B 6304 T2	6 Cyl.	24 Valves	2953cc	TD20992
B 6304 T3	6 Cyl.	24 Valves	2953cc	TD29583
B 6304 T4	6 Cyl.	24 Valves	2953cc	TD23982
B 6304 T5	6 Cyl.	24 Valves	2953cc	TD29314
HR5062				

81 3.2L**Petrol**

B 6324 S	6 Cyl.	24 Valves	3192cc	TD20082
B 6324 S2	6 Cyl.	24 Valves	3192cc	TD29362
B 6324 S4	6 Cyl.	24 Valves	3192cc	TD29357
B 6324 S5	6 Cyl.	24 Valves	3192cc	TD23984
HR5062				

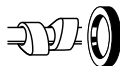

82 5.5L

Diesel

D6A180	6 Cyl.	12 Valves	5480cc	TD9219
D6A210	6 Cyl.	12 Valves	5480cc	TD9220
D6A230	6 Cyl.	12 Valves	5480cc	TD9227
D6A250	6 Cyl.	12 Valves	5480cc	TD9228

PB180 (x24)

83 6.7L

Diesel

D7A230	6 Cyl.	12 Valves	6700cc	TD29201
D7A260	6 Cyl.	12 Valves	6700cc	TD29199
D7A285	6 Cyl.	12 Valves	6700cc	TD9229
D7B230	6 Cyl.	12 Valves	6700cc	TD9242
D7B260	6 Cyl.	12 Valves	6700cc	TD9243
TD 73 E	6 Cyl.	12 Valves	6700cc	TD9233
TD 73 ES	6 Cyl.	12 Valves	6700cc	TD9236

PB180 (x24)

84 7.1L

Diesel

D7E240	6 Cyl.	24 Valves	7146cc	TD18965
D7E280	6 Cyl.	24 Valves	7146cc	TD18964
D7E290	6 Cyl.	24 Valves	7146cc	TD20460
D7E320	6 Cyl.	24 Valves	7146cc	TD18963

PB180 (x24)

NA5459

81.00 x 104.00 x 11.00mm, FPM

NA5475

130.00 x 150.00 x 12.00mm, FPM

85 7.3L

Diesel

D7C215	6 Cyl.	12 Valves	7300cc	TD18725
D7C250	6 Cyl.	12 Valves	7300cc	TD11770
D7C290	6 Cyl.	12 Valves	7300cc	TD11771
D7C310	6 Cyl.	24 Valves	7300cc	TD16726

PB180 (x24)

86 9.4L

Diesel

D9A260	6 Cyl.	24 Valves	9364cc	TD16780
D9A300	6 Cyl.	24 Valves	9364cc	TD16781
D9A340	6 Cyl.	24 Valves	9364cc	TD16782
D9A380	6 Cyl.	24 Valves	9364cc	TD16783
D9B260	6 Cyl.	24 Valves	9364cc	TD21048
D9B300	6 Cyl.	24 Valves	9364cc	TD18978
D9B310	6 Cyl.	24 Valves	9364cc	TD21049
D9B340	6 Cyl.	24 Valves	9364cc	TD18979
D9B360	6 Cyl.	24 Valves	9364cc	TD21050
D9B380	6 Cyl.	24 Valves	9364cc	TD18980

PB180 (x24)

NA5461

136.00 x 159.00 x 13.00mm, PTFE/ACM

**87 9.6L****Diesel**

D10A320	6 Cyl.	12 Valves	9600cc	TD9263
D10A360	6 Cyl.	12 Valves	9600cc	TD12047
D10B320	6 Cyl.	12 Valves	9600cc	TD16235
D10B360	6 Cyl.	12 Valves	9600cc	TD16236
D 100 A	6 Cyl.	12 Valves	9600cc	TD9204
D 100 B	6 Cyl.	12 Valves	9600cc	TD9205
DH10A245	6 Cyl.	12 Valves	9600cc	TD29181
DH10A285	6 Cyl.	12 Valves	9600cc	TD29182
DH10A360	6 Cyl.	12 Valves	9600cc	TD29183
HD 100 A	6 Cyl.	12 Valves	9600cc	TD9134
HD 100 D	6 Cyl.	12 Valves	9600cc	TD9135
TD 100 B	6 Cyl.	12 Valves	9600cc	TD9153
TD 100 BG	6 Cyl.	12 Valves	9600cc	TD21337
TD 100 C	6 Cyl.	12 Valves	9600cc	TD9251
TD 100 CHC	6 Cyl.	12 Valves	9600cc	TD21338
TD 100 F	6 Cyl.	12 Valves	9600cc	TD21339
TD 100 G	6 Cyl.	12 Valves	9600cc	TD9154
TD 100 GA	6 Cyl.	12 Valves	9600cc	TD9155
TD 101 F	6 Cyl.	12 Valves	9600cc	TD9156
TD 101 FA	6 Cyl.	12 Valves	9600cc	TD9157
TD 101 FC	6 Cyl.	12 Valves	9600cc	TD9237
TD 101 FD	6 Cyl.	12 Valves	9600cc	TD9238
TD 101 G	6 Cyl.	12 Valves	9600cc	TD9158
TD 101 GA	6 Cyl.	12 Valves	9600cc	TD9159
TD 101 GB	6 Cyl.	12 Valves	9600cc	TD9252
TD 101 GE	6 Cyl.	12 Valves	9600cc	TD21340
TD 102 F	6 Cyl.	12 Valves	9600cc	TD9160
TD 102 FAQ	6 Cyl.	12 Valves	9600cc	TD9161
TD 102 FBQ	6 Cyl.	12 Valves	9600cc	TD9162
TD 102 FCQ	6 Cyl.	12 Valves	9600cc	TD9163
TD 102 FD	6 Cyl.	12 Valves	9600cc	TD21341
TD 102 FDQ	6 Cyl.	12 Valves	9600cc	TD9164
TD 102 FEQ	6 Cyl.	12 Valves	9600cc	TD9165
TD 102 FF	6 Cyl.	12 Valves	9600cc	TD9166
TD 102 FGQ	6 Cyl.	12 Valves	9600cc	TD9167
TD 102 FH	6 Cyl.	12 Valves	9600cc	TD9168
TD 102 FL	6 Cyl.	12 Valves	9600cc	TD9169
TD 102 FM	6 Cyl.	12 Valves	9600cc	TD9170
TD 102 FQ	6 Cyl.	12 Valves	9600cc	TD26264
TD 102 FS	6 Cyl.	12 Valves	9600cc	TD9264
TD 102 FT	6 Cyl.	12 Valves	9595cc	TD9262
TD 103 E	6 Cyl.	12 Valves	9600cc	TD5900
TD 103 EA	6 Cyl.	12 Valves	9600cc	TD21342
TD 103 ES	6 Cyl.	12 Valves	9600cc	TD6247
TD 103 KB	6 Cyl.	12 Valves	9600cc	TD19062
TD 103 KF	6 Cyl.	12 Valves	9600cc	TD19063
THD 100 A	6 Cyl.	12 Valves	9600cc	TD9136
THD 100 D	6 Cyl.	12 Valves	9600cc	TD9119
THD 100 DA	6 Cyl.	12 Valves	9600cc	TD9103

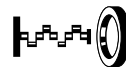
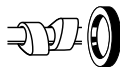

THD 100 DB	6 Cyl.	12 Valves	9600cc	TD9120
THD 100 DC	6 Cyl.	12 Valves	9600cc	TD9104
THD 100 DD	6 Cyl.	12 Valves	9600cc	TD9105
THD 100 E	6 Cyl.	12 Valves	9600cc	TD9137
THD 100 EA	6 Cyl.	12 Valves	9600cc	TD9106
THD 100 EB	6 Cyl.	12 Valves	9600cc	TD9107
THD 100 EC	6 Cyl.	12 Valves	9600cc	TD9108
THD 100 ED	6 Cyl.	12 Valves	9600cc	TD9109
THD 100 EE	6 Cyl.	12 Valves	9600cc	TD9110
THD 100 EK	6 Cyl.	12 Valves	9600cc	TD9111
THD 101 B	6 Cyl.	12 Valves	9600cc	TD23324
THD 101 GB	6 Cyl.	12 Valves	9600cc	TD9112
THD 101 GC	6 Cyl.	12 Valves	9600cc	TD9113
THD 101 GD	6 Cyl.	12 Valves	9600cc	TD9114
THD 101 KB	6 Cyl.	12 Valves	9600cc	TD9115
THD 101 KC	6 Cyl.	12 Valves	9600cc	TD9116
THD 101 KE	6 Cyl.	12 Valves	9600cc	TD9117
THD 102 KA	6 Cyl.	12 Valves	9600cc	TD23325
THD 102 KB	6 Cyl.	12 Valves	9600cc	TD23326
THD 102 KD	6 Cyl.	12 Valves	9600cc	TD9118
THD 102 KE	6 Cyl.	12 Valves	9600cc	TD26266
THD 102 KF	6 Cyl.	12 Valves	9600cc	TD9121
THD 102 KJ	6 Cyl.	12 Valves	9600cc	TD9138
THD 103 E	6 Cyl.	12 Valves	9600cc	TD23327
THD 103 ES	6 Cyl.	12 Valves	9600cc	TD23328
THD 103 KB	6 Cyl.	12 Valves	9600cc	TD9098
THD 103 KD	6 Cyl.	12 Valves	9600cc	TD9099
THD 103 KF	6 Cyl.	12 Valves	9600cc	TD9100

NB853 F
85.70 x 114.30 x 13.00mm, FPM

NB852 R
155.00 x 180.00 x 15.00mm, FPM

88 10.0L

Diesel

TD 100 A	6 Cyl.	12 Valves	9600cc	TD9152
----------	--------	-----------	--------	--------

NB853 F
85.70 x 114.30 x 13.00mm, FPM

NB852 R
155.00 x 180.00 x 15.00mm, FPM

89 10.8L

Diesel

D11-325	6 Cyl.	24 Valves	10800cc	TD22576
D11-355	6 Cyl.	24 Valves	10800cc	TD22578
D11-365	6 Cyl.	24 Valves	10800cc	TD22579
D11-385	6 Cyl.	24 Valves	10800cc	TD22580
D11-405	6 Cyl.	24 Valves	10800cc	TD22581
D11B390	6 Cyl.	24 Valves	10800cc	TD23374
D11B430	6 Cyl.	24 Valves	10800cc	TD23373
D11C330	6 Cyl.	24 Valves	10800cc	TD22373



D11C370	6 Cyl.	24 Valves	10840cc	TD22374
D11C410	6 Cyl.	24 Valves	10800cc	TD22376
D11C450	6 Cyl.	24 Valves	10800cc	TD22377

NA5461 F
136.00 x 159.00 x 13.00mm, PTFE/ACM

90 12.0L**Diesel**

TD 120 A	6 Cyl.	12 Valves	12000cc	TD9206
TD 120 C	6 Cyl.	12 Valves	12000cc	TD9171
TD 120 D	6 Cyl.	12 Valves	11980cc	TD9172
TD 120 E	6 Cyl.	12 Valves	11980cc	TD9173
TD 120 F	6 Cyl.	12 Valves	11980cc	TD9174
TD 120 FA	6 Cyl.	12 Valves	11980cc	TD9254
TD 120 FB	6 Cyl.	12 Valves	11980cc	TD9255
TD 120 FC	6 Cyl.	12 Valves	11980cc	TD9175
TD 120 FTQ	6 Cyl.	12 Valves	11980cc	TD9176
TD 120 G	6 Cyl.	12 Valves	11980cc	TD9177
TD 120 GA	6 Cyl.	12 Valves	11980cc	TD9178
TD 121 F	6 Cyl.	12 Valves	11980cc	TD9179
TD 121 FA	6 Cyl.	12 Valves	11980cc	TD9256
TD 121 FB	6 Cyl.	12 Valves	11980cc	TD9257
TD 121 FC	6 Cyl.	12 Valves	11980cc	TD9258
TD 121 FD	6 Cyl.	12 Valves	11980cc	TD9180
TD 121 FE	6 Cyl.	12 Valves	11980cc	TD9259
TD 121 FF	6 Cyl.	12 Valves	11980cc	TD9260
TD 121 FG	6 Cyl.	12 Valves	11980cc	TD9261
TD 121 FH	6 Cyl.	12 Valves	11980cc	TD9181
TD 121 FK	6 Cyl.	12 Valves	11980cc	TD9182
TD 121 G	6 Cyl.	12 Valves	11980cc	TD9183
TD 121 GD	6 Cyl.	12 Valves	11980cc	TD9143
TD 122 F	6 Cyl.	12 Valves	11980cc	TD9186
TD 122 FA	6 Cyl.	12 Valves	11980cc	TD9187
TD 122 FAQ	6 Cyl.	12 Valves	11980cc	TD9188
TD 122 FBQ	6 Cyl.	12 Valves	11980cc	TD9189
TD 122 FCQ	6 Cyl.	12 Valves	11980cc	TD9190
TD 122 FH	6 Cyl.	12 Valves	11980cc	TD9122
TD 122 FK	6 Cyl.	12 Valves	11980cc	TD9191
TD 122 FKQ	6 Cyl.	12 Valves	11980cc	TD9192
TD 122 FL	6 Cyl.	12 Valves	11980cc	TD9123
TD 122 FR	6 Cyl.	12 Valves	11980cc	TD9193
TD 122 FS	6 Cyl.	12 Valves	11980cc	TD9194
TD 123 E	6 Cyl.	12 Valves	11980cc	TD9124
TD 123 EA	6 Cyl.	12 Valves	11980cc	TD9196
TD 123 EB	6 Cyl.	12 Valves	11980cc	TD9197
TD 123 EC	6 Cyl.	12 Valves	11980cc	TD9198
TD 123 ED	6 Cyl.	12 Valves	11980cc	TD9199
TD 123 ES	6 Cyl.	12 Valves	11980cc	TD9125

NB853 F
85.70 x 114.30 x 13.00mm, FPM

NB852 R
155.00 x 180.00 x 15.00mm, FPM

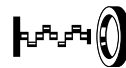
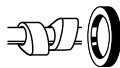

91 12.1L

Diesel

D12A340	6 Cyl.	24 Valves	12100cc	TD11727
D12A380	6 Cyl.	24 Valves	12100cc	TD9215
D12A420	6 Cyl.	24 Valves	12100cc	TD9216
D12C340	6 Cyl.	24 Valves	12100cc	TD11731
D12C380	6 Cyl.	24 Valves	12100cc	TD11728
D12C390	6 Cyl.	24 Valves	12100cc	TD26596
D12C420	6 Cyl.	24 Valves	12100cc	TD11729
D12C460	6 Cyl.	24 Valves	12100cc	TD11730
D12D340	6 Cyl.	24 Valves	12100cc	TD16784
D12D380	6 Cyl.	24 Valves	12100cc	TD16785
D12D390	6 Cyl.	24 Valves	12100cc	TD26597
D12D420	6 Cyl.	24 Valves	12100cc	TD16786
D12D460	6 Cyl.	24 Valves	12100cc	TD16787
D12D500	6 Cyl.	24 Valves	12100cc	TD16508
D12F390	6 Cyl.	24 Valves	12100cc	TD29191
D12F430	6 Cyl.	24 Valves	12100cc	TD29190

PB180 (x24)
HR801

NA5359
180.00 x 205.00 x 15.00mm, FPM

92 12.1L

Diesel

DH12D340	6 Cyl.	24 Valves	12100cc	TD16511
DH12D380	6 Cyl.	24 Valves	12100cc	TD16512
DH12D420	6 Cyl.	24 Valves	12100cc	TD16513
DH12E340	6 Cyl.	24 Valves	12100cc	TD22155
DH12E380	6 Cyl.	24 Valves	12100cc	TD22156
DH12E420	6 Cyl.	24 Valves	12100cc	TD22157
DH12E460	6 Cyl.	24 Valves	12100cc	TD22158

PB180 (x24)
HR801

NA5461
136.00 x 159.00 x 13.00mm, PTFE/ACM
NA5359
180.00 x 205.00 x 15.00mm, FPM

93 12.8L

Diesel

D13A360	6 Cyl.	24 Valves	12800cc	TD18826
D13A400	6 Cyl.	24 Valves	12800cc	TD18827
D13A440	6 Cyl.	24 Valves	12800cc	TD18828
D13A480	6 Cyl.	24 Valves	12800cc	TD18829
D13A520	6 Cyl.	24 Valves	12800cc	TD18830
D13B360	6 Cyl.	24 Valves	12800cc	TD20776
D13B400	6 Cyl.	24 Valves	12800cc	TD20777
D13B440	6 Cyl.	24 Valves	12800cc	TD20778
D13B500	6 Cyl.	24 Valves	12800cc	TD20779
D13C380	6 Cyl.	24 Valves	12800cc	TD22378
D13C420	6 Cyl.	24 Valves	12800cc	TD22150
D13C460	6 Cyl.	24 Valves	12800cc	TD22151
D13C500	6 Cyl.	24 Valves	12800cc	TD22152
D13C540	6 Cyl.	24 Valves	12800cc	TD22153
D13H440	6 Cyl.	24 Valves	12800cc	TD22154
D13K420	6 Cyl.	24 Valves	12800cc	TD28157



D13K460	6 Cyl.	24 Valves	12800cc	TD28158
D13K500	6 Cyl.	24 Valves	12800cc	TD28159
D13K540	6 Cyl.	24 Valves	12800cc	TD28160

NA5461
136.00 x 159.00 x 13.00mm, PTFE/ACM
NA5359
180.00 x 205.00 x 15.00mm, FPM

94 16.0L**Diesel**

D 16A	6 Cyl.	12 Valves	16123cc	TD9217
D16A470	6 Cyl.	24 Valves	16120cc	TD17534

PA6071 (x24)

NJ312
80.00 x 100.00 x 10.00mm, MVQ

NA5461
136.00 x 159.00 x 13.00mm, PTFE/ACM
NA5359
180.00 x 205.00 x 15.00mm, FPM

95 16.1L**Diesel**

D16A520	6 Cyl.	24 Valves	16120cc	TD11767
D16B520	6 Cyl.	24 Valves	16120cc	TD11768
D16500V	6 Cyl.	24 Valves	16120cc	TD33617
D16550V	6 Cyl.	24 Valves	16120cc	TD33618
D16600V	6 Cyl.	24 Valves	16120cc	TD33619
TD 162 F	6 Cyl.	24 Valves	16123cc	TD5901
TD 162 FJ	6 Cyl.	24 Valves	16123cc	TD6248
TD 162 FL	6 Cyl.	24 Valves	16120cc	TD6313
TD 162 FS	6 Cyl.	24 Valves	16123cc	TD6327
TD 163 ES	6 Cyl.	24 Valves	16123cc	TD9200

PA6071 (x24)

NJ312
80.00 x 100.00 x 10.00mm, MVQ

NA5461
136.00 x 159.00 x 13.00mm, PTFE/ACM
NA5359
180.00 x 205.00 x 15.00mm, FPM

96 16.1L**Diesel**

D16C550	6 Cyl.	24 Valves	16120cc	TD17170
D16C610	6 Cyl.	24 Valves	16120cc	TD17171
D16E540	6 Cyl.	24 Valves	16120cc	TD20770
D16E580	6 Cyl.	24 Valves	16120cc	TD18966
D16E660	6 Cyl.	24 Valves	16120cc	TD18967
D16G540	6 Cyl.	24 Valves	16120cc	TD21323
D16G600	6 Cyl.	24 Valves	16120cc	TD21327
D16G700	6 Cyl.	24 Valves	16120cc	TD21329
D16G750	6 Cyl.	24 Valves	16120cc	TD28558
D16K550	6 Cyl.	24 Valves	16120cc	TD31692
D16K650	6 Cyl.	24 Valves	16120cc	TD31693
D16K750	6 Cyl.	24 Valves	16120cc	TD31694









PA6063 (x24)

NJ312
80.00 x 100.00 x 10.00mm, MVQ

NA5461
136.00 x 159.00 x 13.00mm, PTFE/ACM
NA5359
180.00 x 205.00 x 15.00mm, FPM





NUMERICAL PARTS LIST









Numerische Teilenummernliste • Liste des références produits
Elenco numerico articoli • Lista de referencias

							
HL5002 MERCEDES-BENZ	645, 658	HR569 ALFA ROMEO	10, 12, 13, 14, 15, 16, 17, 19, 20	HR602 ALFA ROMEO	10, 11, 20, 21	HR662 ALFA ROMEO	23
SEAT	1070, 1071	AUDI	55, 56, 57, 58, 60, 61, 65, 66, 67, 68	CITROËN	195	AUDI	76, 78, 79
SKODA	1098, 1099	BMW	109, 110, 111, 112, 118,	FIAT	306, 307, 308, 309	BMW	112, 113, 114, 115, 117, 120, 121, 123
SMART	1112, 1113	CHRYSLER	155, 157	IVECO	472, 473, 474, 475, 476, 477, 478, 479, 480, 481	CITROËN	194, 195, 196
VOLKSWAGEN	1238, 1239	CITROËN	178, 180, 181, 184, 185, 186, 187, 188, 190, 193	LANCIA	536	DAF	217
HR280 AUDI	57	DACIA	205	OPEL	866, 868, 870	FIAT	286, 308
BMW	113, 115, 116	FIAT	276, 277, 278, 279, 280, 281, 283, 284, 285, 286, 288, 289, 290, 291, 294, 295, 296, 297, 298, 299, 300, 301, 302, 303, 304	PEUGEOT	920	FORD	404
LAND ROVER	544	FORD	374, 385	RENAULT	1009, 1010, 1011, 1012, 1013, 1015, 1018, 1020	LANCIA	528, 537
MERCEDES-BENZ	680	HONDA	428	SEAT	1087	MERCEDES-BENZ	661
OPEL	867, 868	HYUNDAI	448	HR615 ALFA ROMEO	20, 21	PEUGEOT	917, 919, 920
ROVER	1034	JEEP	500, 501	AUDI	67, 72, 74, 75, 76, 77	RENAULT	1003, 1007
SEAT	1070, 1071, 1075	LADA	517, 518	FIAT	305	VOLKSWAGEN	1283, 1284
SKODA	1098, 1099, 1102	LANCIA	525, 527, 528, 529, 530, 531, 532, 533, 534	LANCIA	535	VOLVO	1309, 1311, 1312, 1313, 1314, 1315, 1316, 1317
VOLKSWAGEN	1239, 1247	LEYLAND	549	VOLKSWAGEN	1268, 1278, 1279, 1280, 1281, 1282, 1283	HR666 MERCEDES-BENZ	670, 672
HR291 OPEL	838, 839	MITSUBISHI	744	VOLVO	1310, 1316	HR667 MERCEDES-BENZ	681, 684, 685, 691
HR299 JAGUAR	496, 497	NISSAN	781	HR618 AUSTIN	90, 91	HR668 MERCEDES-BENZ	670
MERCEDES-BENZ	668, 670, 673, 679	OPEL	855, 856	HR619 AUSTIN	90	HR752 LAND ROVER	541
HR300 CITROËN	177, 178, 179, 180, 186	PEUGEOT	898, 899, 901, 902, 903, 905, 906, 908, 909, 910, 911, 912, 913, 917, 919	HR621 LEYLAND	549	MG	722
FIAT	300	RENAULT	989, 992, 993, 994, 995, 996, 997, 999, 1000, 1003, 1006, 1008, 1009, 1014	HR629 FORD	406	OPEL	841, 844, 852
PEUGEOT	898, 899, 900, 901, 903, 905, 909, 910, 919	ROVER	1031, 1032	HR630 FORD	392, 398, 401, 403, 404, 405, 406	ROVER	1030, 1031
RENAULT	980, 983, 1014	SAAB	1041	HR632 FORD	364, 367, 369, 372, 377, 380	HR756 MERCEDES-BENZ	646, 649, 655 939
VOLVO	1316	SEAT	1069, 1070, 1071, 1072, 1075, 1076, 1079, 1080, 1081, 1082, 1084	HR635 LAND ROVER	542, 543	PUCH	939
HR336 BEDFORD	95, 96	SKODA	1105, 1106	HR636 PERKINS	874	HR757 DAEWOO	212
CHEVROLET	151	SUZUKI	1137, 1138	HR637 PERKINS	874	MERCEDES-BENZ	650, 653, 656
DAEWOO	213	TOYOTA	1177	HR638 PERKINS	876	SSANGYONG	1116
LAND ROVER	541	VOLKSWAGEN	1236, 1238, 1240, 1241, 1242, 1245, 1247, 1248, 1249, 1250, 1255, 1256, 1257, 1258, 1259, 1264, 1265, 1266, 1268, 1269, 1270, 1278	HR639 PERKINS	874, 875, 877	HR758 DAEWOO	213
OPEL	845, 850, 855, 856, 857, 861, 862, 864, 866, 867, 869, 870	HR641 VOLVO	1303, 1304, 1305, 1306	HR643 RENAULT	980, 983	MERCEDES-BENZ	659, 662, 663
TOYOTA	1187	HR643 RENAULT		VOLVO	1303	PUCH	939
HR339 AUSTIN	90	HR655 FORD		HR644 VOLVO	1307, 1310, 1311, 1316, 1317	SSANGYONG	1117, 1118
MG	722	MAN	560, 566	HR643 RENAULT	980, 983	HR759 MERCEDES-BENZ	658, 660, 662, 663
MINI	727	MAZDA	594	VOLVO	1303, 379, 383, 384, 385	PUCH	940
ROVER	1029, 1032	HR656 LAND ROVER		HR643 RENAULT	980, 983	HR760 MERCEDES-BENZ	664, 667
HR340 CITROËN	193, 194	ROVER	1029, 1030, 1033	VOLVO	1303	PUCH	940
FIAT	305, 308	HR659 FORD	379, 383, 384, 385	HR655 FORD	364, 368, 390, 392, 397	HR767 NISSAN	786
PEUGEOT	901, 904, 910, 918	HR660 ALFA ROMEO		MAN	560, 566	RENAULT	1005
HR342 BEDFORD	94	CHRYSLER	158	HR656 LAND ROVER	541	HR768 NISSAN	786
BUICK	126	DODGE	248	ROVER	1029, 1030, 1033	RENAULT	1005
CHEVROLET	139, 140, 141, 142, 143, 145, 146, 147, 148, 149	FORD	399, 405	HR659 FORD	379, 383, 384, 385	HR775 LEYLAND	549, 550
DAEWOO	209, 210, 211, 212	JEEP	502	HR660 ALFA ROMEO	22	MAN	559, 560, 561, 564, 566
FIAT	287, 289, 296	MERCEDES-BENZ	673, 675, 676, 677, 694, 695, 696	CHRYSLER	158	HR789 NISSAN	775
ISUZU	460, 461	RENAULT	1023	DODGE	248	RENAULT	979, 980, 982
LADA	518	HR661 FIAT	293	FORD	399, 405		
OPEL	839, 840, 841, 844, 845, 847, 849, 853, 854, 857, 858, 859, 862, 870	FORD	365, 368, 369, 370, 378, 383, 385	HR661 FIAT	293		
SUZUKI	1136	MAZDA	601	FORD	365, 368, 369, 370, 378, 383, 385		
HR343 BEDFORD	94, 95			MAZDA	601		
LAND ROVER	543, 544						
OPEL	844, 845, 846, 849, 852, 853						
ROVER	1034						

NUMERICAL PARTS LIST









Numerische Teilenummernliste • Liste des références produits
Elenco numerico articoli • Lista de referencias





 HR5048 ALFA ROMEO 12	 HR5062 AUDI 77, 78, 80, 81, 82, 83, 86, 87	 HR5082 CITROËN 192	 HR5097 MERCEDES-BENZ 645, 646, 648, 650, 651
BMW 114, 121, 122	BMW 113, 114, 115, 116, 117, 118, 119	FIAT 304	HR5107 BMW 117, 119
BUICK 126	CHEVROLET 151	FORD 386, 396, 399, 406	HR5110 BMW 109, 110, 112
CADILLAC 130	CHRYSLER 159	JAGUAR 496	CITROËN 180, 183
CHEVROLET 140, 141, 146	CITROËN 195, 196	LEYLAND 549	MINI 727, 728
CHRYSLER 155	DAEWOO 213	MAZDA 604, 607	PEUGEOT 902, 906
FIAT 281, 282, 283, 286, 287	DODGE 249	PEUGEOT 916	TOYOTA 1173, 1179
FORD 366	FIAT 309, 310	HR5085 AUDI 74	HR5111 CITROËN 195
LANCIA 526, 528	FORD 404	CHRYSLER 157	FORD 404
MERCEDES-BENZ 645	JEEP 502	DAEWOO 212	JAGUAR 496
MITSUBISHI 740, 741	LANCIA 537	MERCEDES-BENZ 647, 648, 649, 652, 654, 655, 661	LAND ROVER 544
OPEL 839, 842, 854, 855	LAND ROVER 544	SSANGYONG 1116	PEUGEOT 919, 920
SAAB 1041	MERCEDES-BENZ 658, 664, 666, 668	VOLKSWAGEN 1279, 1282	HR5112 FORD 388
SMART 1113	OPEL 867, 869, 871, 872	HR5087 ALFA ROMEO 15	NISSAN 775, 776, 779, 780, 781, 783, 792
SUZUKI 1135	PEUGEOT 920	BUICK 126	HR5113 FORD 401, 402
HR5050 JAGUAR 496, 497	PORSCHE 927, 928, 929, 930	CHEVROLET 141, 143, 144, 145	VOLVO 1309, 1312, 1315
HR5051 HONDA 428	RENAULT 1015, 1016	DAEWOO 210	HR5117 SCANIA 1049, 1052, 1053
LAND ROVER 541	SAAB 1044	FIAT 288, 292, 296	HR5118 RENAULT 1022
MG 723	SEAT 1087	OPEL 846, 847, 849, 853, 855	HR5119 ALFA ROMEO 13, 17, 18
ROVER 1033	SKODA 1109	SAAB 1041	CADILLAC 130
HR5052 FIAT 310	VOLKSWAGEN 1281, 1284, 1285, 1286, 1287, 1288	SUZUKI 1137	CHEVROLET 147, 148
LAND ROVER 545	VOLVO 1317	HR5088 ALFA ROMEO 10	CHRYSLER 156
ROVER 1035	HR5063 FIAT 297, 302	CHEVROLET 140	FIAT 293, 298, 299, 301, 302
HR5053 FIAT 312	FORD 382, 388, 390, 398, 401, 402	CHRYSLER 155	LANCIA 529, 532
LAND ROVER 545, 546	KIA 509	CITROËN 179	OPEL 846, 857, 859, 862
ROVER 1035, 1036	LAND ROVER 541	FIAT 281, 285	SAAB 1041, 1042
HR5054 LAND ROVER 545	MAZDA 596, 601, 603, 605, 606	FORD 367	SUZUKI 1138
ROVER 1035	NISSAN 785	LANCIA 526, 527	HR5120 CITROËN 180, 183, 184
HR5055 CHRYSLER 159	VOLVO 1306, 1308	OPEL 840, 841	FIAT 289
DAEWOO 213	HR5064 FORD 400, 401	PEUGEOT 900, 902	FORD 370, 371, 380
MERCEDES-BENZ 655, 656, 657, 660, 661, 663, 666, 667, 668, 669, 673, 678, 679, 685	LEYLAND 549	SUBARU 1125	MAZDA 595, 598
PUCH 940	HR5068 AUDI 55, 56	SUZUKI 1135	PEUGEOT 903, 907
SSANGYONG 1116, 1117, 1118	SEAT 1074	HR5092 BUICK 126	SUZUKI 1136
HR5056 MERCEDES-BENZ 646, 650, 653	SKODA 1100, 1101	CHEVROLET 141, 143	TOYOTA 1171, 1174
HR5057 MERCEDES-BENZ 664	VOLKSWAGEN 1238, 1243, 1245	DAEWOO 209, 210	VOLVO 1304
HR5060 ALFA ROMEO 14, 15, 18	HR5072 SAAB 1043, 1044	FIAT 288, 293	HR5121 BMW 116, 118
FIAT 292, 296, 302	HR5075 CHEVROLET 139	OPEL 848	LAND ROVER 545
LANCIA 529, 530, 532	DAEWOO 209	HR5094 HONDA 434	OPEL 868
VOLVO 1304, 1305, 1306, 1308, 1309	FIAT 293	HYUNDAI 450	HR5122 CITROËN 189, 192
HR5061 CHRYSLER 156, 157	HYUNDAI 444	ISUZU 463	FIAT 303, 304
DODGE 247, 248	NISSAN 774	KIA 512	FORD 394, 396
FIAT 293	SUZUKI 1134	OPEL 871	JAGUAR 496
JEEP 501	HR5076 VOLVO 1304, 1305, 1306, 1308, 1312, 1313, 1316, 1317	RENAULT 1016	LANCIA 535
MINI 727, 728	HR5077 CHRYSLER 159	SAAB 1044	LAND ROVER 541
	DODGE 249	HR5095 ALFA ROMEO 17	PEUGEOT 913, 916
	JEEP 502	CADILLAC 130	TOYOTA 1181
	HR5080 CITROËN 187, 191	FIAT 298, 299	HR5123 FORD 364, 377
	PEUGEOT 910, 914	LANCIA 532	VOLVO 1304
	HR5081 CITROËN 187, 191	OPEL 857	
	LANCIA 534	SAAB 1041	
	PEUGEOT 910, 914	HR5096 MITSUBISHI 740	
		NISSAN 774	
		OPEL 838	
		SMART 1112, 1113	
		SUZUKI 1134	

							
HR5124 CITROËN	180, 184	KJ710 CHEVROLET	148	LK5004 FIAT	294	LK5019 AUDI	59, 72
FIAT	289	FORD	367, 370, 371, 372, 374, 379, 382, 389, 390, 393, 397	FORD	366, 370, 372, 373, 375, 376, 377, 380	SEAT	1078, 1086
FORD	375	KIA	510, 511, 513	MAZDA	594, 595, 598	SKODA	1102, 1103, 1108
MAZDA	598	MAZDA	593, 594, 595, 596, 598, 600, 601, 602, 603, 604, 607	OPEL	848	VOLKSWAGEN	1247, 1254, 1274, 1276
MINI	727	NISSAN	781	LK5005 FIAT	297, 302	LK5020 CITROËN	178, 179
PEUGEOT	907	SUZUKI	1139	FORD	382, 388, 398, 402	PEUGEOT	899, 901
SUZUKI	1136	KJ722 CHEVROLET	142	LAND ROVER	541	LK5021 CITROËN	195
VOLVO	1304	TOYOTA	1169, 1171, 1172, 1174, 1178	MAZDA	601, 603, 605, 606	FORD	404
HR5125 CHEVROLET	139, 140	KS696 DAF	217	NISSAN	785	JAGUAR	496
OPEL	840	FORD	398, 402, 403	VOLVO	1306, 1308	LAND ROVER	544
HR5126 CITROËN	186, 187, 190, 191, 192	LEYLAND	550	LK5006 AUDI	58, 61, 62, 63, 65, 66, 67, 68, 74	PEUGEOT	919, 920
FIAT	303	PEUGEOT	911, 912, 915, 916, 917, 918	FORD	385, 386	LK5022 NISSAN	785, 787
LANCIA	534	SSANGYONG	1117	SEAT	1069, 1072, 1073, 1074, 1075, 1076, 1077, 1078, 1079, 1081, 1082, 1083, 1084	OPEL	861, 865
PEUGEOT	909, 910, 913, 914, 916	KT632 BEDFORD	96	SKODA	1102, 1104, 1105, 1106	RENAULT	1005, 1009
HR5127 ALFA ROMEO	17, 20	KT633 PERKINS	874	VOLKSWAGEN	1236, 1237, 1240, 1242, 1243, 1244, 1245, 1248, 1250, 1251, 1252, 1256, 1258, 1259, 1261, 1262, 1264, 1265, 1266, 1268, 1269, 1270, 1280, 1281, 1282	LV501 NISSAN	792
BUICK	127	KT636 PERKINS	874, 875, 876	LK5007 BMW	113, 116, 118	NA422 JAGUAR	497
CADILLAC	130	KT638 BEDFORD	96	LK5008 AUDI	58, 59, 62, 64, 68	MERCEDES-BENZ	673
CHEVROLET	147, 149, 150	FORD	406	SEAT	1077, 1085	NA473 AUSTIN	90, 91
FIAT	305	KV412 DAIHATSU	230	SKODA	1102, 1103, 1107	LEYLAND	549
OPEL	859, 860, 863, 865	TOYOTA	1171, 1175	VOLKSWAGEN	1250, 1251, 1252, 1262, 1270, 1271	MG	722
SAAB	1042	KV417 NISSAN	778	LK5009 LAND ROVER	543, 544	ROVER	1029
SUBARU	1127	LB955 MERCEDES-BENZ	670, 672, 681, 684, 685, 691	ROVER	1034	NA576 FORD	363, 364, 365, 367, 368, 369, 372, 377, 380
HR5128 MAZDA	595	LK5000 KIA	512	LK5012 AUDI	67, 69, 70	MAZDA	594
MITSUBISHI	740	LAND ROVER	544	CHRYSLER	157	OPEL	844
OPEL	838, 840	MG	723	DODGE	247	NA581 VOLVO	1307, 1308, 1310, 1311, 1316, 1317
SUZUKI	1134, 1135, 1136	ROVER	1032, 1034, 1035	JEEP	500	NA584 AUSTIN	90
HR5129 RENAULT	1018, 1019, 1020	LK5001 ALFA ROMEO	11, 12	LANCIA	526, 527, 528	MG	722
KG393 FIAT	276	CHRYSLER	155	OPEL	842	ROVER	1029
KH066 DAIHATSU	229, 230	DODGE	247	LK5002 LAND ROVER	541, 542	NA736 PERKINS	874
TOYOTA	1168, 1169, 1181	FIAT	279, 283, 286, 287, 288	MG	723	NA773 LEYLAND	550
KJ208 NISSAN	774, 775	JEEP	500	LK5003 AUDI	55, 56, 62, 63, 66, 67, 69, 70, 71	NA774 MG	722
KJ211 CHRYSLER	158	LANCIA	526, 527, 528	FORD	385	NA784 FIAT	289, 290
DODGE	248, 249	OPEL	842	SEAT	1074, 1080, 1082, 1083, 1084, 1085, 1086	SEAT	1070, 1076
FORD	386, 397, 398, 401, 403	LK5002 LAND ROVER	541, 542	SKODA	1100, 1104, 1105, 1106, 1107, 1108	VOLKSWAGEN	1238, 1240, 1248, 1250
HYUNDAI	445, 447, 448, 449, 450, 451	MG	723	VOLKSWAGEN	1268, 1271, 1272, 1273	NA869 TOYOTA	1187
KIA	512	LK5003 AUDI	55, 56, 62, 63, 66, 67, 69, 70, 71	LK5013 AUDI	59	VOLVO	1307, 1308, 1310, 1311, 1316, 1317
MAZDA	605, 606	FORD	385	SEAT	1074	NA933 LEYLAND	550
MITSUBISHI	740, 741, 742, 743, 744, 745, 746, 747, 748, 749	SEAT	1074, 1080, 1082, 1083, 1084, 1085, 1086	SKODA	1101, 1103		
PROTON	935	SKODA	1100, 1104, 1105, 1106, 1107, 1108	VOLKSWAGEN	1244, 1245, 1253		
KJ453 NISSAN	780	VOLKSWAGEN	1238, 1243, 1252, 1253, 1254, 1255, 1260, 1261, 1262, 1263, 1266, 1267, 1270, 1271, 1272, 1275, 1276, 1277	LK5016 AUDI	64, 71		
KJ454 NISSAN	776, 777			SEAT	1081, 1086		
KJ570 HYUNDAI	444, 445, 446, 447, 448, 449, 450, 451			SKODA	1105, 1108		
KIA	511, 512			VOLKSWAGEN	1263, 1274		
MITSUBISHI	740, 741, 742, 743, 745, 746, 749, 750			LK5017 AUDI	60, 73		
PROTON	935			MAN	558		
				SEAT	1078, 1086, 1087		
				SKODA	1104, 1109		
				VOLKSWAGEN	1255, 1276, 1277, 1278		

NUMERICAL PARTS LIST









Numerische Teilenummernliste • Liste des références produits
Elenco numerico articoli • Lista de referencias









							
NA5001 ALFA ROMEO	19, 21, 23	NA5030 CITROËN	192	NA5049 FIAT	276, 277, 278, 279, 280, 284, 286, 288, 291	NA5057 ALFA ROMEO	11, 12
AUDI	55, 56, 57, 58, 59, 60, 61, 62, 63, 65, 66, 67, 68, 72, 74, 75, 76, 77, 78, 79, 80, 83, 84, 85	FIAT	304	LANCIA	525, 526, 527, 528, 529	CHRYSLER	155
DODGE	249	FORD	386, 396, 399, 406	SAAB	1041	DODGE	247
FORD	363, 385, 386	JAGUAR	496	SEAT	1068	FIAT	279, 281, 282, 283, 286, 287, 288
LANCIA	537	LAND ROVER	542	NA5050 FIAT	281, 284, 285, 290, 291, 294, 295, 297, 299, 302	FORD	366
PORSCHE	926, 927, 928	LEYLAND	549	LADA	517, 518	JEEP	500
SEAT	1069, 1071, 1072, 1073, 1074, 1075, 1076, 1077, 1079, 1080, 1081, 1082, 1083, 1084, 1087	MAZDA	604, 607	LANCIA	528, 529, 530	LANCIA	526, 527, 528
SKODA	1102, 1104, 1105, 1106, 1109	PEUGEOT	916	SEAT	1070, 1072, 1084	OPEL	842
VOLKSWAGEN	1236, 1237, 1238, 1240, 1241, 1242, 1243, 1245, 1247, 1248, 1249, 1250, 1251, 1252, 1253, 1255, 1256, 1257, 1258, 1259, 1260, 1261, 1262, 1263, 1264, 1265, 1266, 1267, 1268, 1269, 1270, 1275, 1278, 1279, 1280, 1281, 1282, 1283, 1284, 1285, 1287	NA5031 CITROËN	192	NA5051 ALFA ROMEO	10, 14, 15, 16	NA5058 ALFA ROMEO	11, 12, 15
		FIAT	304	BEDFORD	96	CHRYSLER	155
		FORD	386, 396, 399	CHEVROLET	150	DAEWOO	213
		JAGUAR	496	CITROËN	184	FIAT	281, 282, 283, 286, 287, 296
		LANCIA	534, 535	FIAT	279, 283, 284, 285, 288, 289, 291, 292	FORD	366
		LAND ROVER	541	FORD	404	HONDA	420, 421, 422, 424
		MITSUBISHI	747	HONDA	433	KIA	512
		PEUGEOT	913, 914, 915, 916, 917	ISUZU	461, 462, 463	LANCIA	526, 527, 528, 531
		SUZUKI	1139	LANCIA	527, 528, 529	OPEL	842
		TOYOTA	1181	OPEL	857, 866, 869, 871	PEUGEOT	902
		VOLVO	1310	PEUGEOT	908, 909	NA5061 ALFA ROMEO	12
NA5013 FORD	381, 383	NA5035 CITROËN	189, 191, 192, 193	SAAB	1041	CHRYSLER	155
NA5016 CHRYSLER	155, 157	FIAT	302, 303, 304	NA5052 FIAT	283	FIAT	279, 280, 281, 282, 283, 287
DACIA	204, 205	FORD	388, 389, 394, 396	NA5053 ALFA ROMEO	12, 14, 15, 16, 17, 18, 19, 20	FORD	366
DAEWOO	213	JAGUAR	496	BUICK	126	LANCIA	526, 527, 528
JEEP	500, 501	LANCIA	534, 535	CHEVROLET	142	NA5062 FIAT	294, 295, 300
KIA	512	LAND ROVER	541	DACIA	204, 205	NA5063 ALFA ROMEO	10, 11, 12, 13, 14, 15
MAZDA	593	MITSUBISHI	744, 745	DAEWOO	209, 210	NA5064 ALFA ROMEO	10, 11, 12, 13, 14
NISSAN	774, 777, 780	NISSAN	782, 783	FIAT	276, 277, 279, 280, 281, 282, 283, 286, 287, 288, 289, 295, 296, 298, 300, 301, 302, 305	NA5065 ALFA ROMEO	10, 11, 12, 13, 14, 15, 20
PEUGEOT	912, 917	OPEL	855, 856, 860	HYUNDAI	450, 451, 452	NA5066 ALFA ROMEO	11, 13, 16, 17, 19, 20
RENAULT	982, 985, 986, 990, 991, 999, 1003, 1006, 1008	RENAULT	994, 995, 996, 997, 998, 1000, 1002	KIA	513, 514	FORD	369, 389
		SUZUKI	1138	LANCIA	525, 526, 527, 528, 530, 531, 532, 533, 534, 535, 536	NA5069 ALFA ROMEO	12, 14, 15, 16, 18, 19
		TOYOTA	1184, 1185	MITSUBISHI	749, 750	CHEVROLET	148
		VOLVO	1306, 1307	NISSAN	775, 777, 786, 788	FIAT	296, 301, 305
NA5017 FORD	401, 402	NA5037 DACIA	205	OPEL	856, 863, 868	LANCIA	530, 531, 532, 535, 536
RENAULT	1005, 1013	MITSUBISHI	744	RENAULT	979, 980, 982, 985, 991, 1007, 1013	OPEL	861, 864
VOLVO	1304, 1305, 1306, 1308, 1309, 1310, 1311, 1312, 1313, 1314, 1315, 1316, 1317	NISSAN	783	SAAB	1041	SAAB	1043
		OPEL	856, 860	SUZUKI	1137	VOLKSWAGEN	1287
NA5018 FORD	401, 402	RENAULT	994, 995, 996, 997, 998, 1000, 1002	NA5055 FIAT	289	NA5070 ALFA ROMEO	10, 12, 13, 14, 15, 16, 17, 18, 19, 20, 21
RENAULT	1005, 1013	SUZUKI	1138	IVECO	483	CADILLAC	130
VOLVO	1304, 1305, 1306, 1308, 1309, 1310, 1311, 1312, 1313, 1314, 1315, 1316, 1317	VOLVO	1306, 1307	RENAULT	1017	CHEVROLET	147
		NA5039 FIAT	310, 312	SAAB	1041	CHRYSLER	155, 156
NA5023 LAND ROVER	542	IVECO	483	SUZUKI	1137	FIAT	278, 286, 293, 296, 298, 299, 301, 302, 305, 306
NA5028 FORD	386, 396	RENAULT	1017	NA5055 FIAT	289	JEEP	500
JAGUAR	496	NA5040 FIAT	308, 309, 310, 311, 312, 313, 314, 315	IVECO	478	LANCIA	525, 528, 529, 530, 531, 532, 535, 536
		IVECO	481, 482, 483, 484, 488			OPEL	846, 856, 857, 859
		NA5041 FIAT	310, 311, 315			SAAB	1041, 1042
		IVECO	482, 483, 484, 488			SUZUKI	1137, 1138
		NA5042 FIAT	315				
		IVECO	484				
		NA5045 FIAT	276				

 NA5074 CHRYSLER 157 DAEWOO 212, 213 JEEP 502 MERCEDES-BENZ 652, 654, 655, 656, 657, 659, 661, 662, 663, 664, 667 PUCH 939 SSANGYONG 1116, 1117, 1118	 NA5106 AUDI 55, 56, 57, 58, 59, 62, 63, 64, 66, 67, 68, 69, 70, 71, 72, 76, 78, 79, 80, 83 CHRYSLER 157 DODGE 247 FORD 385, 404 JEEP 500 MITSUBISHI 746, 747 PORSCHE 928 SEAT 1070, 1071, 1074, 1077, 1078, 1080, 1082, 1083, 1084, 1085, 1086, 1087 SKODA 1098, 1099, 1100, 1101, 1102, 1103, 1104, 1105, 1106, 1107, 1108, 1109 VOLKSWAGEN 1236, 1238, 1239, 1243, 1244, 1245, 1246, 1247, 1250, 1251, 1252, 1253, 1254, 1255, 1260, 1261, 1262, 1263, 1266, 1267, 1268, 1270, 1271, 1272, 1273, 1274, 1275, 1276, 1277, 1279, 1282, 1283, 1284, 1286	 NA5120 MERCEDES-BENZ 673, 675, 676, 677, 678, 694, 695, 696 NA5121 MERCEDES-BENZ 673, 675, 676, 677, 678, 694, 695, 696, 705, 707, 710 NA5124 AUDI 55, 56, 58, 59, 62, 63, 64, 66, 67, 68, 69, 70, 71, 78 CHRYSLER 157 DODGE 247 FORD 385 JEEP 500 MITSUBISHI 746, 747 SEAT 1071, 1074, 1077, 1078, 1080, 1083, 1084, 1085 SKODA 1099, 1100, 1101, 1102, 1103, 1105, 1106, 1107, 1108 VOLKSWAGEN 1238, 1239, 1243, 1245, 1247, 1250, 1251, 1252, 1253, 1254, 1255, 1259, 1260, 1261, 1262, 1263, 1267, 1268, 1269, 1270, 1271, 1272, 1274, 1280, 1281, 1282, 1283	 NA5133 AUDI 55, 56, 57, 58, 60, 61, 62, 65, 66, 67, 68, 72, 74, 75, 76, 77, 78, 79 CHRYSLER 158 DODGE 249 FORD 385, 404 JEEP 501 MERCEDES-BENZ 661 SEAT 1069, 1071, 1072, 1073, 1075, 1076, 1077, 1079, 1080, 1081, 1082, 1084 SKODA 1098, 1099, 1100, 1102, 1104, 1105, 1106 VOLKSWAGEN 1236, 1238, 1240, 1241, 1242, 1245, 1247, 1248, 1249, 1250, 1251, 1255, 1256, 1257, 1258, 1259, 1260, 1264, 1265, 1266, 1268, 1269, 1270, 1278, 1279, 1280, 1281, 1283, 1284 VOLVO 1310, 1314, 1316 NA5136 CHEVROLET 151 CHRYSLER 158 DODGE 248, 249 JEEP 501, 502 LANCIA 536 LEYLAND 549, 550 PORSCHE 927, 930, 931 RENAULT 1005, 1013 VOLVO 1304, 1305, 1306, 1308, 1309, 1311, 1312, 1313, 1314, 1315, 1316, 1317 NA5137 FIAT 294 FORD 366, 370, 372, 373, 375, 376, 377, 380 MAZDA 594, 595, 598 OPEL 848 VOLVO 1304 NA5138 RENAULT 1005, 1013 VOLVO 1305, 1306, 1308, 1309, 1311, 1312, 1313, 1314, 1315, 1316, 1317 NA5139 CHEVROLET 147 CHRYSLER 156, 157 DAEWOO 212 DODGE 247, 248 FIAT 293 HYUNDAI 445, 449 JEEP 500, 501 MINI 727, 728 OPEL 861
NA5083 KIA 512 LAND ROVER 544 MG 723 ROVER 1032, 1034, 1035	NA5107 MERCEDES-BENZ 645, 646, 648, 651	NA5130 FORD 366, 374	NA5133 AUDI 55, 56, 57, 58, 60, 61, 62, 65, 66, 67, 68, 72, 74, 75, 76, 77, 78, 79
NA5088 DAIHATSU 229 MINI 727 SUBARU 1124, 1125 TOYOTA 1169, 1171	NA5108 ALFA ROMEO 17, 20 BUICK 126, 127 CADILLAC 130 CHEVROLET 140, 141, 147, 149, 151 CHRYSLER 157 CITROËN 188, 193, 194 DODGE 247, 248 FIAT 305, 306 HONDA 434, 435 HYUNDAI 449, 450 ISUZU 463 JEEP 500, 501 KIA 511, 512 LANCIA 536 MITSUBISHI 743, 745, 747 OPEL 838, 839, 842, 859, 860, 863, 865, 871, 872 PEUGEOT 912, 917 SAAB 1042 SUBARU 1127 SUZUKI 1134, 1135	NA5131 CHRYSLER 157, 159 DAEWOO 212, 213 DODGE 249 FIAT 310 JEEP 502 LANCIA 537 MERCEDES-BENZ 646, 647, 648, 652, 654, 656, 657, 658, 659, 660, 661, 662, 663, 664, 666, 667, 668, 669, 671, 672, 673, 676, 678, 679, 680, 685, 686, 692 PUCH 939, 940 SSANGYONG 1116, 1117, 1118 VOLKSWAGEN 1287	NA5136 CHEVROLET 151 CHRYSLER 158 DODGE 248, 249 JEEP 501, 502 LANCIA 536 LEYLAND 549, 550 PORSCHE 927, 930, 931 RENAULT 1005, 1013 VOLVO 1304, 1305, 1306, 1308, 1309, 1311, 1312, 1313, 1314, 1315, 1316, 1317
NA5089 DAIHATSU 231 HONDA 426, 427 HYUNDAI 447 OPEL 844, 851, 852 TOYOTA 1171, 1173, 1174, 1175, 1176, 1177, 1180, 1181, 1182, 1183	NA5109 MERCEDES-BENZ 645, 646, 648, 651 SMART 1112	NA5132 BMW 118, 120, 121, 122, 123 FIAT 312 LAND ROVER 546	NA5137 FIAT 294 FORD 366, 370, 372, 373, 375, 376, 377, 380 MAZDA 594, 595, 598 OPEL 848 VOLVO 1304
NA5090 OPEL 851 TOYOTA 1171, 1174, 1175	NA5110 MERCEDES-BENZ 645, 646, 648, 651 SMART 1112		NA5138 RENAULT 1005, 1013 VOLVO 1305, 1306, 1308, 1309, 1311, 1312, 1313, 1314, 1315, 1316, 1317
NA5099 BMW 109, 111	NA5111 MERCEDES-BENZ 645, 646, 648, 651 SMART 1112		NA5139 CHEVROLET 147 CHRYSLER 156, 157 DAEWOO 212 DODGE 247, 248 FIAT 293 HYUNDAI 445, 449 JEEP 500, 501 MINI 727, 728 OPEL 861
NA5103 BMW 112, 113, 116, 118, 122 LAND ROVER 541, 545, 546 MINI 728 ROVER 1033	NA5112 DACIA 204 MERCEDES-BENZ 645 NISSAN 778 RENAULT 988 SMART 1112 SUZUKI 1136 TOYOTA 1170		
NA5104 BMW 109, 110, 111, 113, 114, 116, 117, 118, 119 FIAT 309 LAND ROVER 541, 544, 545, 546 MG 723 OPEL 868 ROVER 1033			
NA5105 BMW 113, 114, 116, 117, 118, 119, 123 FIAT 312 LAND ROVER 544			

NUMERICAL PARTS LIST









Numerische Teilenummernliste • Liste des références produits
Elenco numerico articoli • Lista de referencias









							
NA5140 CHRYSLER	156, 157, 158, 159	NA5180 AUDI	56, 59	NA5191 CHEVROLET	148	NA5209 CHEVROLET	148
DODGE	247, 248, 249	SEAT	1073, 1074, 1078	CITROËN	184, 185, 186, 187, 188, 189, 190, 191, 192, 193, 195, 196	OPEL	861, 864
FIAT	293	SKODA	1101			SAAB	1043
HYUNDAI	444, 445, 446, 447, 448, 449, 450, 451, 452	VOLKSWAGEN	1237, 1238, 1242, 1243, 1244, 1245, 1251, 1252	FIAT	296, 297, 299, 301, 302, 303, 304	NA5215 DACIA	204
JEEP	500, 501	NA5181 LEYLAND	549, 550	FORD	388, 389, 393, 394, 396, 404	NISSAN	778
KIA	508, 509, 510, 512, 513, 514	MAN	558, 559, 560, 561, 564, 566	HONDA	428	RENAULT	986, 988, 990, 991
MINI	727, 728	RENAULT	1017, 1018, 1019, 1020	HYUNDAI	448	SUZUKI	1136
MITSUBISHI	749, 750	NA5185 AUDI	56, 59	JAGUAR	496	NA5223 ALFA ROMEO	10
NA5147 FORD	366, 374	SEAT	1069, 1072, 1073, 1074, 1076, 1077, 1078	LADA	518	CHEVROLET	140
NA5149 VOLVO	1309, 1313, 1315	SKODA	1101, 1102	LANCIA	534, 535	CHRYSLER	155
NA5156 MAN	559, 560, 561, 564, 566	VOLKSWAGEN	1236, 1237, 1238, 1242, 1243, 1244, 1245, 1251, 1252, 1253	LAND ROVER	541	CITROËN	179
NA5157 FIAT	297, 302	NA5187 ALFA ROMEO	16, 17, 19	LEYLAND	549	FIAT	281, 285
FORD	382, 388, 398, 402	CITROËN	184, 188	MITSUBISHI	747	FORD	367
LAND ROVER	541	FIAT	278, 279, 280, 283, 284, 285, 286, 288, 289, 290, 291, 292, 294, 295, 296, 297, 299, 300, 301, 302	PEUGEOT	908, 909, 910, 911, 912, 913, 914, 915, 916, 917, 920	LANCIA	526, 527
MAZDA	601, 603, 605, 606	LANCIA	525, 527, 528, 529, 530, 531, 532, 533	RENAULT	1015, 1016	NISSAN	780
NISSAN	785	PEUGEOT	908, 909	ROVER	1031, 1032	OPEL	840, 841
VOLVO	1306, 1308	RENAULT	1006	SUZUKI	1138, 1139	PEUGEOT	900, 902
NA5163 ALFA ROMEO	19, 20, 21, 22, 23	SAAB	1041	TOYOTA	1177, 1181	SUBARU	1125
AUDI	79	SEAT	1076, 1079, 1084	VOLVO	1310	SUZUKI	1135
FIAT	306	TOYOTA	1188	NA5192 CHEVROLET	148	NA5226 ISUZU	460
LANCIA	537	NA5190 BUICK	126	CITROËN	184, 185, 186, 187, 188, 189, 190, 191, 192, 193	SAAB	1043, 1044
NA5164 BUICK	126	CHEVROLET	139, 141, 143, 150	FIAT	297, 299, 302, 303, 304	SUBARU	1125, 1126, 1127
CHEVROLET	141, 143	CITROËN	195, 196	FORD	388, 389, 393, 394, 396	NA5230 ALFA ROMEO	10
DAEWOO	209, 210	DAEWOO	209, 210	HONDA	428	CHEVROLET	140
FIAT	288, 293	FIAT	276, 277, 278, 288, 293, 309	HYUNDAI	448	CHRYSLER	155
OPEL	848	FORD	365, 368, 369, 370, 373, 378, 379, 380, 383, 385, 386, 388, 390, 391, 392, 397, 398, 399, 405	JAGUAR	496	CITROËN	179
NA5168 CHRYSLER	159	LANCIA	537	LADA	518	FIAT	281, 285
MERCEDES-BENZ	657, 660, 661, 666, 669, 672, 673, 678, 679, 680, 685, 686, 692	OPEL	848	LANCIA	534, 535	FORD	367
PUCH	940	PEUGEOT	920	LAND ROVER	541	LANCIA	526, 527
NA5173 CHRYSLER	159	RENAULT	1015, 1016	LEYLAND	549	OPEL	840, 841
DODGE	249	SEAT	1068	MITSUBISHI	747	PEUGEOT	900, 902
JEEP	502			PEUGEOT	908, 909, 910, 911, 913, 914, 915, 916, 917	SUBARU	1125
NA5174 ALFA ROMEO	15			ROVER	1031, 1032	SUZUKI	1135
BUICK	126			SUZUKI	1138, 1139	NA5242 HONDA	428, 430, 431, 432
CHEVROLET	141, 143, 144, 145, 146			TOYOTA	1177, 1181	ISUZU	460, 461
DAEWOO	210			VOLVO	1310	ROVER	1031, 1033, 1034
FIAT	288, 292, 296			NA5196 HYUNDAI	450	NA5243 MITSUBISHI	749, 750
OPEL	846, 847, 849, 853, 854, 855			KIA	513	NA5244 MITSUBISHI	749
SAAB	1041			NA5197 FORD	403	NA5245 HONDA	431
SUZUKI	1137			KIA	513	NA5246 FORD	383, 390, 402
NA5175 FIAT	309			MAZDA	606	MAZDA	593, 595, 596, 598, 599, 600, 601, 602, 605, 606
FORD	402, 405			NA5201 DODGE	248	SUBARU	1124
MAZDA	605, 607			FIAT	305	TOYOTA	1168
NA5178 FORD	401, 402			IVECO	472	NA5255 DACIA	204
VOLVO	1304, 1305, 1306, 1308, 1309, 1312, 1313, 1314, 1315, 1316, 1317			NA5202 CITROËN	193	MERCEDES-BENZ	645
NA5179 VOLVO	1304, 1305, 1306, 1308, 1309, 1312, 1313, 1314, 1315, 1316, 1317			DODGE	248	NISSAN	778
				FIAT	305	RENAULT	988
				IVECO	472	SUZUKI	1136
						NA5256 CITROËN	190, 192
						FIAT	303
						LANCIA	534
						PEUGEOT	913, 916

 NA5257 NISSAN 783		 NA5299 BMW 110, 112, 117		 NA5325 AUDI 77, 78, 80, 81, 83, 84, 85, 86		 NA5349 AUDI 64, 76, 77, 78, 79	
OPEL 860		MINI 728		CITROËN 180, 183, 184, 185		SKODA 1109	
RENAULT 995, 1002		TOYOTA 1173, 1179		FIAT 289		VOLKSWAGEN 1281, 1282, 1283, 1284	
NA5258 ALFA ROMEO 23		NA5300 SCANIA 1048, 1049, 1052, 1054, 1055		FORD 370, 371, 375, 380		NA5350 ALFA ROMEO 15	
CITROËN 180, 183, 184		NA5305 AUDI 83, 86, 87		MAZDA 595, 598		BUICK 126	
FIAT 289		FORD 404		MINI 727		CHEVROLET 141, 143, 144, 145	
FORD 370, 371, 375, 380		IVECO 474		MITSUBISHI 743		DAEWOO 210	
MAZDA 595, 598		PORSCHE 926, 927, 928, 929, 930, 931		PEUGEOT 903, 907		FIAT 288, 296	
MINI 727		SEAT 1070, 1071, 1087		PORSCHE 927, 928		OPEL 846, 847, 849, 853, 855	
PEUGEOT 903, 907		SKODA 1098, 1099, 1109		SUZUKI 1136		SAAB 1041	
SUZUKI 1136		VOLKSWAGEN 1238, 1239, 1279, 1283, 1284, 1285, 1286, 1287, 1288		TOYOTA 1171, 1174		SUZUKI 1137	
TOYOTA 1171, 1174				VOLKSWAGEN 1285, 1286, 1287		NA5351 CHEVROLET 139, 140	
VOLVO 1304				VOLVO 1304		OPEL 840	
NA5259 CITROËN 180, 183, 184, 185, 186, 190		NA5306 SEAT 1069		NA5326 DACIA 203		NA5354 IVECO 490, 491	
FIAT 289, 303		SKODA 1098, 1100		NISSAN 774, 775		NA5355 RENAULT 1022, 1023, 1024	
FORD 370, 371, 375, 380		VOLKSWAGEN 1236		RENAULT 979, 980, 981, 982		NA5356 RENAULT 1022, 1023	
MAZDA 595, 598		NA5307 AUDI 84, 86		NA5327 CHEVROLET 146		NA5359 RENAULT 1023, 1024	
MINI 727		PORSCHE 930		OPEL 848, 849, 855		VOLVO 1322, 1323	
PEUGEOT 903, 907, 909, 913		VOLKSWAGEN 1280, 1281, 1287		NA5328 DACIA 204		NA5360 RENAULT 1023	
SUZUKI 1136		NA5310 FIAT 294		MERCEDES-BENZ 645		NA5361 AUDI 57, 59, 60, 72, 73, 86	
TOYOTA 1171, 1174		FORD 373, 376, 377		NISSAN 778, 780		SEAT 1071, 1075, 1078, 1086, 1087	
VOLVO 1304		VOLVO 1304		RENAULT 988, 991		SKODA 1099, 1102, 1103, 1104, 1108, 1109	
NA5260 CITROËN 177, 185, 186, 195, 196		NA5317 VOLVO 1310, 1315		NA5329 AUDI 78, 80, 82, 84, 86, 87		VOLKSWAGEN 1239, 1247, 1254, 1255, 1274, 1276, 1277	
DAIHATSU 228, 230		NA5318 CITROËN 195		PORSCHE 927, 928			
FIAT 309		FORD 404		VOLKSWAGEN 1285, 1286		NA5362 BMW 109	
LANCIA 537		JAGUAR 496		NA5331 CITROËN 181, 182, 185, 186		CITROËN 179, 180, 181, 182, 183, 185	
MINI 727		LAND ROVER 544		PEUGEOT 903, 904, 908, 909		FIAT 288	
OPEL 844, 852		PEUGEOT 919, 920		NA5332 MERCEDES-BENZ 645, 646, 650, 651		MINI 727, 728	
PEUGEOT 898, 908, 909, 920		NA5319 TOYOTA 1177, 1181		MITSUBISHI 742		PEUGEOT 899, 900, 902, 903, 904, 905, 906, 908, 909	
RENAULT 1015, 1016		NA5320 HONDA 426, 428, 431, 432, 433		SMART 1112, 1113		ROVER 1030	
SUBARU 1124, 1125		NA5321 ALFA ROMEO 12		NA5333 FIAT 293		NA5363 BMW 109	
TOYOTA 1168, 1171, 1173, 1176, 1180, 1181		FIAT 281, 283, 287		MERCEDES-BENZ 646		CITROËN 178, 179, 180, 182, 183	
NA5261 DACIA 203		JEEP 500		NISSAN 780, 785, 787		MINI 727, 728	
NISSAN 775		LANCIA 526		OPEL 848, 861, 865		PEUGEOT 899, 901, 902, 905, 906	
RENAULT 979, 981		NA5322 CHEVROLET 142		RENAULT 992, 1005, 1009		NA5364 CITROËN 181, 182	
NA5264 MERCEDES-BENZ 649, 653, 656, 658, 660, 661, 662, 667		DACIA 203		NA5347 ALFA ROMEO 13, 17, 18, 20, 21		PEUGEOT 899, 901, 902, 905, 906	
PUCH 939		ISUZU 457, 458		BEDFORD 95		NA5446 NISSAN 786, 788	
NA5265 VOLVO 1304		OPEL 843, 844		CADILLAC 130		OPEL 863, 868	
NA5267 BMW 123		RENAULT 979, 980, 982		CHEVROLET 147, 149, 151		RENAULT 1007, 1013	
NA5268 MERCEDES-BENZ 667, 672, 673, 676, 677, 678, 679, 685		NA5323 CITROËN 195		CHRYSLER 156		NA5447 NISSAN 786, 788	
NA5282 TOYOTA 1178		FIAT 297		FIAT 293, 298, 299, 301, 302, 306		OPEL 863, 868	
NA5293 CUMMINS 198		FORD 377, 382, 386, 387, 389, 390, 394, 397, 404		HONDA 433, 434, 435		RENAULT 1007, 1013	
DAF 217, 218		JAGUAR 496		ISUZU 457, 458, 459, 460, 462, 463		NA5448 RENAULT 995, 1002	
IVECO 482, 483, 488, 489		LAND ROVER 544		JEEP 500		NA5450 MAN 568, 569, 571, 577	
NA5294 CUMMINS 198		MAZDA 603		LANCIA 529, 532, 536		NA5451 RENAULT 1022	
DAF 217, 218		PEUGEOT 919, 920		OPEL 844, 846, 852, 856, 857, 859, 864, 871, 872		NA5452 RENAULT 1022	
IVECO 482, 483, 488, 489		NA5324 CITROËN 177		SAAB 1041, 1042		NA5453 CITROËN 181	
NA5298 BMW 109, 110, 112, 117		DAIHATSU 228, 229		SUZUKI 1137, 1138		PEUGEOT 904	
MINI 727, 728		PEUGEOT 898		NA5348 DACIA 203		NA5454 AUDI 57	
TOYOTA 1173, 1179		SUBARU 1124		NISSAN 774, 775		SEAT 1075	
		TOYOTA 1168, 1170, 1172		RENAULT 979, 980, 981, 982		VOLKSWAGEN 1246	

NUMERICAL PARTS LIST









Nummerische Teilenummernliste • Liste des références produits
Elenco numerico articoli • Lista de referencias









							
NA5455 CITROËN	186, 190	NB307 ALFA ROMEO	10	NB690 BEDFORD	95, 96	NB720 JAGUAR	496, 497
FIAT	303	FIAT	278, 279, 280, 283, 284, 285, 289, 290, 294, 295, 297, 299, 300, 302	LAND ROVER	541	MERCEDES-BENZ	668
PEUGEOT	909, 913	LADA	517, 518	OPEL	857, 861, 862, 864, 870	NB728 FIAT	276
NA5456 AUDI	55, 57, 60	LANCIA	525, 528, 530, 533	NB691 OPEL	838, 839	NB732 ALFA ROMEO	16, 17, 19, 20
SEAT	1070, 1071, 1075, 1078	SEAT	1068, 1070, 1072, 1076, 1079, 1084	NB697 BEDFORD	94	CITROËN	188
SKODA	1098, 1099, 1102, 1104	NB384 FORD	367, 371, 372	CHEVROLET	139, 141, 142, 143	FIAT	296, 297, 298, 299, 300, 301, 302
VOLKSWAGEN	1237, 1239, 1240, 1246, 1255, 1256	MAZDA	593, 594, 595, 596	DAEWOO	210	LANCIA	529, 531, 532, 533, 534
NA5457 DACIA	204	NB431 BMW	109, 110, 111, 112, 113, 114, 115, 116, 117, 118, 119, 120, 121	FIAT	296, 297	NB734 BEDFORD	94, 95
RENAULT	991	LAND ROVER	541, 546	OPEL	839, 840, 841, 843, 845, 847, 848, 849	DACIA	203
NA5458 AUDI	55, 57, 60	OPEL	867	ROVER	1033, 1034	NISSAN	774
SEAT	1070, 1071, 1075, 1078	NB432 BMW	109, 110, 111, 112	NB384 FORD	367, 371, 372	OPEL	844, 849
SKODA	1098, 1099, 1102, 1104	NB452 FORD	398	MAZDA	593, 594, 595, 596	NB742 ALFA ROMEO	16, 19
VOLKSWAGEN	1237, 1239, 1240, 1246, 1255, 1256	NB453 FORD	398	TOYOTA	1187	CITROËN	188
NA5459 DEUTZ	238, 240	NB459 PERKINS	874, 875, 876, 877	NB431 BMW	109, 110, 111, 112, 113, 114, 115, 116, 117, 118, 119, 120, 121	FIAT	285, 291, 295, 296, 297, 298, 300, 301, 302
RENAULT	1018, 1020	NB460 PERKINS	874, 875, 876, 877	LAND ROVER	541, 546	LANCIA	529, 530, 531, 532, 533, 534
VOLVO	1318	NB469 BEDFORD	95	OPEL	867	NB772 AUSTIN	91
NA5460 DAF	222	CHEVROLET	149, 151	ROVER	1033, 1034	LEYLAND	549
NA5461 RENAULT	1022, 1024	DAEWOO	213	NB432 BMW	109, 110, 111, 112	MG	722, 723
VOLVO	1318, 1321, 1322, 1323	OPEL	845, 846, 850, 855, 856, 857, 862, 866, 867, 869, 870	NB452 FORD	398	PERKINS	874
NA5462 DAF	222	SAAB	1041	NB459 PERKINS	874, 875, 876, 877	ROVER	1030, 1032, 1033
NA5463 RENAULT	1020, 1021, 1022	NB564 FORD	363, 364, 365, 372, 380, 392, 398, 399, 403, 404, 405	NB460 PERKINS	874, 875, 876, 877	NB773 AUSTIN	91
NA5464 CUMMINS	199	OPEL	851	NB469 BEDFORD	95	MG	723
DAF	222	SAAB	1041	CHEVROLET	149, 151	PERKINS	874
NA5465 DAF	217, 218	NB584 JAGUAR	497	DAEWOO	213	NB774 AUSTIN	91
NA5466 MAN	580, 582	MERCEDES-BENZ	679	OPEL	845, 846, 850, 855, 856, 857, 862, 866, 867, 869, 870	HONDA	428
NA5467 MAN	580, 582	NB586 AUSTIN	91	SAAB	1041	LAND ROVER	541
NA5469 MERCEDES-BENZ	705, 710, 712, 717, 718	MG	722, 723	SUBARU	1127	MG	723
mitsubishi	751	ROVER	1030, 1032	SUZUKI	1134, 1135, 1136	PERKINS	874
NA5470 SCANIA	1047, 1048, 1051, 1053, 1054	NB618 DAF	218	NB700 BUICK	126	ROVER	1030, 1032, 1033
NA5471 SCANIA	1048, 1049, 1052, 1054, 1055	SCANIA	1047, 1051, 1053, 1054	CADILLAC	130	NB775 AUSTIN	91
NA5472 SCANIA	1049, 1053	NB619 SCANIA	1047, 1051, 1053, 1054	CHEVROLET	143, 145, 146, 147, 148, 149, 150	HONDA	428
NA5473 SCANIA	1049, 1053	NB628 BEDFORD	95, 96	DAEWOO	211, 212, 213	LAND ROVER	541, 542, 543, 544
NA5474 RENAULT	1018, 1019, 1020, 1021, 1022, 1023	CHEVROLET	149, 151	ISUZU	460, 461	MG	722, 723
SCANIA	1047, 1048, 1051, 1053, 1054	DAEWOO	213	NISSAN	781	PERKINS	874
NA5475 DEUTZ	238, 240	LAND ROVER	541	OPEL	844, 845, 846, 847, 852, 853, 854, 858, 859, 860, 861, 862, 863, 866, 872	ROVER	1030, 1032, 1033, 1034
RENAULT	1018, 1020, 1023	OPEL	839, 843, 845, 846, 850, 855, 856, 857, 861, 862, 864, 866, 867, 869, 870	ISUZU	460, 461	NB785 FORD	379, 381, 383, 384, 385
VOLVO	1318	TOYOTA	1187	NISSAN	781	MAZDA	601
NA5478 CHEVROLET	139, 140	NB644 FIAT	301	OPEL	844, 845, 846, 847, 852, 853, 854, 858, 859, 860, 861, 862, 863, 866, 872	NB786 FORD	379
OPEL	840	LANCIA	534	SUBARU	1127	NB788 CHEVROLET	150
NA5479 DODGE	247	NB688 BEDFORD	96	SUZUKI	1138	FORD	364, 367, 368, 369, 373, 377, 378, 379, 380, 383, 384, 385, 386, 388, 391, 398, 400, 401, 406
JEEP	501	FORD	406	NB701 BEDFORD	94	MAZDA	594, 601
MERCEDES-BENZ	648, 652, 654	NB714 SAAB	1042, 1043, 1044	OPEL	844, 845, 846, 852, 853	SUZUKI	1139
NB291 AUSTIN	90	NB716 AUDI	62, 64, 66, 67, 72, 74, 75, 76, 77, 78, 79, 83, 84	NB714 SAAB	1042, 1043, 1044	NB792 BMW	115, 117, 118, 119, 120, 121
FIAT	310, 312	FORD	404	NB716 AUDI	62, 64, 66, 67, 72, 74, 75, 76, 77, 78, 79, 83, 84	FORD	379
LAND ROVER	545, 546	MERCEDES-BENZ	661	FORD	404		
ROVER	1029, 1035, 1036	SEAT	1077, 1080, 1082, 1083	MERCEDES-BENZ	661		
		SKODA	1104, 1105, 1106, 1109	SEAT	1077, 1080, 1082, 1083		
		VOLKSWAGEN	1250, 1252, 1260, 1262, 1263, 1266, 1268, 1278, 1279, 1280, 1281, 1282, 1283, 1284	SKODA	1104, 1105, 1106, 1109		
				VOLKSWAGEN	1250, 1252, 1260, 1262, 1263, 1266, 1268, 1278, 1279, 1280, 1281, 1282, 1283, 1284		
				VOLVO	1310, 1314, 1316		

							
NB799 BMW	109, 110, 112, 114, 115, 117	NB829 LAND ROVER	541	NB933 NISSAN	793, 794	NB973 DAEWOO	212, 213
		MG	722	PERKINS	874, 875, 876, 877	MERCEDES-BENZ	646, 647, 649, 650, 652, 653, 655, 656, 658, 659, 661, 662, 663, 664, 666, 667, 668, 669, 672, 673, 676, 677, 678, 679, 685
DAIHATSU	230	OPEL	841, 844, 852, 854	NB934 DEUTZ	239, 240, 241, 242, 243		
HONDA	427	ROVER	1029, 1030, 1031	IVECO	489, 490, 491, 493		
HYUNDAI	447	NB843 LAND ROVER	541	NB935 DEUTZ	239, 240, 241, 242, 243		
OPEL	851	ROVER	1032, 1033	IVECO	489, 490, 491, 493		
TOYOTA	1175, 1176, 1177, 1178, 1179, 1182, 1183, 1185, 1186, 1187, 1188, 1189	NB847 FIAT	293, 297	NB938 DEUTZ	235, 236, 237, 238, 239, 240	PUCH	939, 940
		FORD	365, 369, 370, 377, 378, 382, 383, 385, 386, 387, 389, 390, 392, 397	IVECO	483, 488	SSANGYONG	1116, 1117, 1118
NB806 ALFA ROMEO	17, 20	SAAB	1042, 1043, 1044	NB939 DEUTZ	235, 236, 237, 238, 239, 240	VOLKSWAGEN	1279
BEDFORD	94, 95	NB848 FORD	365, 369	FIAT	315	NB974 DAEWOO	212, 213
BUICK	126, 127	LAND ROVER	542, 543, 544	IVECO	483, 488, 489, 490	MERCEDES-BENZ	646, 647, 649, 650, 652, 653, 655, 656, 657, 658, 659, 660, 661, 662, 663, 664, 666, 667, 668, 669
CADILLAC	130	NB849 FIAT	310, 312	NB946 ALFA ROMEO	20, 21	PUCH	939, 940
CHEVROLET	143, 145, 146, 147, 148, 149, 150, 151	LAND ROVER	542, 543, 544, 545, 546	DAF	219, 220	SSANGYONG	1116, 1117, 1118
DAEWOO	211, 212, 213	ROVER	1035, 1036	FIAT	306, 307, 308, 317	NB975 MERCEDES-BENZ	648, 649, 650, 651, 652, 654, 655, 657, 663, 665
FIAT	305	NB852 VOLVO	1320, 1321	IVECO	472, 473, 474, 475, 476, 477, 478, 479, 480, 489, 492	PUCH	939, 940
ISUZU	460, 461	NB853 VOLVO	1320, 1321	LANCIA	528	SEAT	1087
LADA	518	NB854 FORD	400, 401	RENAULT	1009, 1010, 1011, 1012	NB977 MERCEDES-BENZ	697, 698, 699, 701, 705
OPEL	844, 849, 853, 854, 858, 859, 860, 861, 862, 863, 866, 867, 869, 871, 872	NB855 FORD	400, 401	NB947 DAF	220, 221, 222	NB978 MERCEDES-BENZ	670, 672, 681, 684, 685, 691
SAAB	1042, 1044	LEYLAND	549	NB953 PORSCHE	926	NB979 MERCEDES-BENZ	670, 676, 681, 684
SEAT	1074	NB856 FORD	400, 401	SEAT	1084	NB980 BMW	109, 110
SUBARU	1127	LEYLAND	549, 550	VOLKSWAGEN	1257, 1261, 1268, 1275, 1278	NB984 FORD	383, 384, 385
SUZUKI	1138	PEUGEOT	918	NB954 DAF	219	MAZDA	601
VOLKSWAGEN	1243	NB866 FIAT	289	NB956 DAF	221, 222	MERCEDES-BENZ	701
NB807 CHEVROLET	146	SEAT	1070, 1072, 1075, 1079	NB958 FIAT	297	SUZUKI	1139
DAEWOO	211	NB882 IVECO	489	FORD	377, 382, 386, 387, 389, 390, 392, 394	NB998 KIA	512
ISUZU	460	NB884 CHEVROLET	144, 151	MAZDA	603	LAND ROVER	541, 544
OPEL	844, 847, 853, 854, 858	DAIHATSU	229	NB959 ALFA ROMEO	14, 15, 16, 19	MG	722, 723
NB808 CITROËN	184	HONDA	425, 426, 427	CITROËN	188, 194, 195	OPEL	841, 844, 852, 854
FIAT	276, 277, 278, 285, 291, 294	LADA	518	DAF	217	ROVER	1029, 1030, 1031, 1032, 1034, 1035
LANCIA	525, 528	OPEL	851, 858, 867, 869, 871, 872	FIAT	293, 297		
PEUGEOT	908, 909	SAAB	1044	FORD	365, 369, 370, 374, 377, 378, 382, 383, 386, 387, 389, 390, 392, 394		
SEAT	1068	TOYOTA	1170	MAZDA	603		
NB814 FIAT	276, 277, 279, 281	NB928 FIAT	315, 316	PEUGEOT	917, 919		
LANCIA	525, 526	IVECO	490	NB967 LEYLAND	549, 550		
NB815 FIAT	276, 277, 279, 280, 281, 282, 283, 287	MAN	567, 568, 571, 572, 574, 575, 576, 577, 578, 579, 580, 581	MAN	559, 560, 561, 564, 566		
LANCIA	525, 526, 527	MERCEDES-BENZ	698, 699, 700, 701, 703, 704, 705, 707, 710, 711, 712, 715, 716, 717, 718, 719	NB971 MERCEDES-BENZ	660		
MERCEDES-BENZ	710	MITSUBISHI	751	PUCH	939		
NB818 FIAT	280, 281, 284, 285, 286, 288, 290, 291, 292, 294, 295, 299	NB929 MAN	567, 568, 569, 571, 572, 574, 575, 576, 577, 578, 579, 580, 581	SSANGYONG	1118		
LANCIA	527, 528, 529	MERCEDES-BENZ	698, 699, 700, 701, 703, 704, 705, 707, 710, 711, 712, 715, 716, 717, 718, 719	NB972 MERCEDES-BENZ	649		
SEAT	1072	MITSUBISHI	751				
NB825 ALFA ROMEO	17, 20	NB932 NISSAN	793, 794				
FIAT	300, 301	PERKINS	874, 875, 876, 877				
LANCIA	530, 531, 533						
NB828 LAND ROVER	541						
MG	722						
OPEL	841, 844, 852, 854						
ROVER	1029, 1030, 1031						

NUMERICAL PARTS LIST









Numerische Teilenummernliste • Liste des références produits
Elenco numerico articoli • Lista de referencias









							
NC006	ALFA ROMEO 15	NF198	RENAULT 989	NF722	DACIA 203	NF841	CHRYSLER 158
	BEDFORD 94, 95	NF387	DAF 217		RENAULT 978, 980, 983, 984		CITROËN 186, 187, 188, 192
	BUICK 126		FORD 394, 398, 403		VOLVO 1303		DODGE 248, 249
	CADILLAC 130		PEUGEOT 901, 904, 910, 911, 912, 915, 916, 917, 918	NF734	PEUGEOT 905		FIAT 299, 304, 308
	CHEVROLET 139, 140, 141, 142, 143, 144, 145, 146, 147, 148, 149, 150, 151		SSANGYONG 1117	NF741	CITROËN 193, 194		HONDA 428
	CHRYSLER 156, 157	NF535	DACIA 203	NF746	CITROËN 181, 185		HYUNDAI 448, 451
	DAEWOO 209, 210, 211, 212, 213		HYUNDAI 450, 451, 452	NF761	PEUGEOT 919		LADA 518
	DODGE 247, 248		KIA 512, 513, 514		RENAULT 1009, 1014		LANCIA 535, 536
	FIAT 287, 288, 289, 292, 296, 297	NF603	RENAULT 978, 979, 980, 983	NF776	CITROËN 194		LEYLAND 549
	HYUNDAI 444, 445, 446	NF604	RENAULT 1017		PEUGEOT 918		MITSUBISHI 742, 746, 750
	ISUZU 460, 461	NF604	RENAULT 1017	NF780	DAF 217		PEUGEOT 909, 910, 911, 915
	JEEP 500, 501	NF634	BMW 109, 111		FORD 402, 403		ROVER 1031, 1032
	KIA 508, 509, 510		CITROËN 195, 196		LEYLAND 550		SMART 1113
	LADA 518		DACIA 203		PEUGEOT 910, 912, 915, 916, 917, 918		SUZUKI 1138
	NISSAN 781		PEUGEOT 919, 920		SSANGYONG 1117		TOYOTA 1177
	OPEL 839, 840, 841, 843, 844, 845, 846, 847, 848, 849, 852, 853, 854, 855, 857, 858, 859, 860, 862, 863, 866, 867, 869, 871, 872	NF636	RENAULT 978, 979, 980, 983, 984, 986, 988, 989, 1009, 1014, 1015, 1016	NF809	CITROËN 177		NF843
	SAAB 1041, 1044		SKODA 1098, 1100	NF812	CHEVROLET 141, 143, 145		BEDFORD 95
	SUBARU 1127	NF637	VOLVO 1303, 1316		CITROËN 177, 178, 179		CHEVROLET 150
	SUZUKI 1136, 1138		ALFA ROMEO 19, 21, 22, 23		DAEWOO 209, 210, 211		CHRYSLER 155, 157
NC007	LAND ROVER 543, 544		AUDI 67	NF817	FIAT 293		CITROËN 188, 193
NC008	LAND ROVER 543, 544		BMW 110, 112, 113, 114, 115, 116, 117, 118, 120, 121, 122, 123		HYUNDAI 445, 448, 449		ISUZU 459, 460, 461, 462, 463
	ROVER 1034		CITROËN 189, 193, 194		KIA 510		JEEP 500, 501
NC009	LAND ROVER 543, 544		FIAT 305, 308		LANCIA 534		MITSUBISHI 744
	ROVER 1034		LANCIA 537		NISSAN 778		PEUGEOT 912, 917
NC015	BMW 111, 114, 116		LAND ROVER 544, 546		OPEL 861		RENAULT 989, 992, 993, 994, 995, 996, 997, 999, 1000, 1002, 1003, 1006, 1008
NC048	DAIHATSU 227, 228, 229		OPEL 867, 868		PEUGEOT 898, 899, 900, 902, 903, 904, 905, 908, 909, 910, 911, 913, 914, 916		ROVER 1030
	FIAT 277, 278	NF640	ROVER 1034		RENAULT 1009, 1010, 1011, 1012, 1013		NF844
	FORD 366, 370, 375, 380		PEUGEOT 900, 901, 904, 905		SEAT 1087		CHRYSLER 157
	HYUNDAI 450	NF641	CITROËN 177, 178, 179, 180, 181		TOYOTA 1168		CITROËN 186, 188, 190, 192, 193
	KIA 513		PEUGEOT 898, 899, 900, 901, 903, 905		VOLVO 1304		FIAT 303
	LANCIA 525		RENAULT 980, 983	NF831	RENAULT 1018, 1020, 1023		JEEP 500, 501
	MAZDA 594, 595, 598	NF648	CHRYSLER 155	NF833	ALFA ROMEO 21		MAZDA 606
	SEAT 1068		JEEP 501		FIAT 306, 307		PEUGEOT 909, 912, 913, 916, 917
	TOYOTA 1168		RENAULT 989, 992, 993		IVECO 472, 473, 474, 475		RENAULT 999, 1002, 1003, 1006, 1008
	VOLVO 1304	NF685	VOLVO 1304, 1305		RENAULT 1009, 1010, 1011, 1012, 1013		NF846
NC065	CHEVROLET 146		RENAULT 989		SEAT 1087		DACIA 205
	KIA 512	NF687	CITROËN 188, 193	NF834	DACIA 203		MITSUBISHI 744, 745
	LAND ROVER 541, 544		RENAULT 1003, 1006, 1014		RENAULT 978, 979, 981, 984		NISSAN 782, 783
	MERCEDES-BENZ 658, 660, 662, 663, 666, 673, 678, 685		SUZUKI 1134		VOLVO 1303		OPEL 855, 856
	MG 722, 723	NF692	CITROËN 180	NF835	DACIA 204, 205		RENAULT 989, 992, 993, 994, 995, 996, 997, 998, 1000, 1002
	OPEL 841, 844, 852, 854		PEUGEOT 898, 899, 900, 901, 902, 905, 906		DAF 217		SUZUKI 1138
	PUCH 940		CHRYSLER 156		NISSAN 777, 780		VOLVO 1303, 1304, 1305, 1306, 1307, 1311
	ROVER 1029, 1030, 1031, 1032, 1034, 1035		CITROËN 180		RENAULT 978, 979, 981, 982, 985, 986, 990, 991, 1015, 1016		NF847
NC086	FORD 381, 383, 384		PEUGEOT 899, 900, 901, 902, 905, 906, 909, 912		VOLVO 1303		RENAULT 992, 993, 994, 995, 1000
	SUZUKI 1139	NF695	PEUGEOT 898, 901				VOLVO 1303, 1305, 1307
NF097	PEUGEOT 918	NF715	RENAULT 1017, 1018				

							
NF850	AUDI 86	NF870	CITROËN 178, 179, 180, 181, 182, 185, 186	NJ006	HYUNDAI 444, 445, 446, 447	NJ215	DAIHATSU 231
	CHEVROLET 148, 150		FIAT 281, 288		KIA 508, 509, 510		HYUNDAI 447
	CITROËN 178, 179, 180, 181, 182, 185, 186		NISSAN 778		MITSUBISHI 740, 741, 742, 743		OPEL 852
	DACIA 205		PEUGEOT 898, 899, 900, 902, 903, 904, 905, 908, 909	NJ014	PROTON 935		TOYOTA 1176, 1179, 1180, 1183, 1185, 1186
	DAEWOO 212		ROVER 1030		BEDFORD 95, 96		VOLKSWAGEN 1280
	FIAT 281	NF883	CITROËN 195		CHEVROLET 150	NJ222	MAZDA 593
	MITSUBISHI 744, 745		FIAT 307, 309		HONDA 433		MITSUBISHI 740
	NISSAN 778, 782		IVECO 472, 473, 474, 476, 477, 478, 479, 480, 481		ISUZU 458, 459, 460, 461, 462		NISSAN 775, 790, 791, 792
	OPEL 855		OPEL 866, 868, 870	NJ021	OPEL 866, 869, 871	NJ232	ISUZU 463
	PEUGEOT 898, 899, 902, 903, 904, 905, 908, 909		PEUGEOT 920	NJ022	SSANGYONG 1116	NJ239	DAIHATSU 232
	RENAULT 989, 992, 993, 994, 995, 996, 997, 1000, 1002		RENAULT 1011, 1013, 1015		NISSAN 774, 775, 777		TOYOTA 1183, 1187, 1188, 1189
	ROVER 1030	NF885	CITROËN 195	NJ030	NISSAN 774, 775, 776, 777	NJ240	DAIHATSU 232
	VOLKSWAGEN 1287		FIAT 307, 309		SUBARU 1124, 1125		TOYOTA 1187, 1188, 1189
	VOLVO 1303, 1304, 1305, 1306, 1307		IVECO 472, 473, 474, 475, 477, 478, 479, 480, 481	NJ042	TOYOTA 1177, 1181, 1182, 1185, 1187	NJ242	CITROËN 177, 178, 179, 180, 181
NF853	FIAT 306, 307, 308		OPEL 866, 868, 870		FORD 379		DODGE 248
	IVECO 472, 473, 474, 475, 476, 477, 479, 480		PEUGEOT 920	NJ044	MAZDA 598		FIAT 306
	LANCIA 536		RENAULT 1011, 1012, 1013, 1015		TOYOTA 1185		FORD 401
	OPEL 866	NF886	FIAT 307	NJ045	DAIHATSU 230		HYUNDAI 445, 446, 447, 448, 451
	RENAULT 1009, 1010, 1011, 1012, 1013		IVECO 472, 473, 474, 475, 476, 477, 478, 479		TOYOTA 1173, 1174, 1178		MITSUBISHI 740, 741, 742, 743, 744, 745, 746, 747, 748, 749
NF857	ALFA ROMEO 10		LANCIA 528, 529	NJ050	NISSAN 777, 780, 782, 783, 784, 786, 788, 789, 790, 778		PEUGEOT 898, 899, 900, 901, 903, 905
	CHRYSLER 155	NF887	FIAT 286, 291, 292, 299	NJ055	TOYOTA 1188, 1189		PROTON 935, 936
	CITROËN 178, 185		LANCIA 528, 529	NJ056	NISSAN 777, 780, 782, 786, 788		RENAULT 980, 983
	FIAT 278	NF888	ALFA ROMEO 12, 13, 14, 15, 16, 17, 18, 19, 20, 21	NJ057	MITSUBISHI 745		VOLVO 1303, 1306
	LANCIA 525		CADILLAC 130	NJ058	FORD 386, 397, 398	NJ243	TOYOTA 1177, 1181, 1182, 1184, 1188, 1189
	PEUGEOT 898, 899, 902, 904		CHEVROLET 147		HYUNDAI 446, 447, 448, 449, 450		VOLKSWAGEN 1280
	ROVER 1030		CHRYSLER 156	NJ060	KIA 511, 512	NJ251	DODGE 248
NF858	RENAULT 1007		FIAT 286, 293, 296, 298, 299, 301, 302, 305, 306		MITSUBISHI 747, 749		FORD 401, 403
NF860	CITROËN 194		JEEP 500	NJ072	BEDFORD 95		HYUNDAI 446, 447
	NISSAN 786, 788		LANCIA 528, 529, 530, 531, 532, 535, 536		ISUZU 458, 459, 460, 461		KIA 510
	OPEL 868		OPEL 846, 856, 857, 859	NJ098	HONDA 420, 421, 423, 426, 427		MAZDA 605, 606
	RENAULT 1007, 1013		SAAB 1041, 1042		ROVER 1031		MITSUBISHI 742, 743, 744, 745, 746, 747, 748, 749
NF861	RENAULT 1007		SUZUKI 1137, 1138	NJ099	DAIHATSU 231	NJ252	HYUNDAI 444, 445, 446
NF866	CITROËN 194, 195	NJ001	CHEVROLET 142, 145		FORD 367, 372		KIA 508
	DAF 217		DAIHATSU 229, 230	NJ102	MAZDA 593, 594, 595, 596		MITSUBISHI 740, 741, 742
	FIAT 308		OPEL 844		NISSAN 229, 230		PROTON 935
	PEUGEOT 917, 919		TOYOTA 1168, 1169, 1170, 1171, 1172, 1173, 1174, 1177		TOYOTA 1168, 1169, 1170, 1173, 1174, 1175, 1177, 1181, 1185		SUBARU 1124
NF867	CITROËN 194, 195, 196		NISSAN 776, 777	NJ134	HONDA 428, 430, 431, 432	NJ254	HONDA 420, 421, 423, 424, 425, 426, 427, 429, 431
	DAF 217	NJ004	NISSAN 776, 777		ISUZU 460, 461		ROVER 1031
	FIAT 308, 309	NJ005	DODGE 248	NJ158	ROVER 1031, 1033, 1034	NJ258	MITSUBISHI 750
	LANCIA 537		FIAT 305		BEDFORD 96	NJ265	BEDFORD 96
	PEUGEOT 917, 919, 920		FORD 386, 401		CHEVROLET 150		ISUZU 459, 460, 461
	RENAULT 1015, 1016		HYUNDAI 444, 445, 446, 447, 448, 449, 450		HONDA 434		OPEL 863
NF869	CITROËN 187, 195, 196		IVECO 472		ISUZU 459, 462, 463	NJ267	ISUZU 461
	PEUGEOT 911, 919, 920		KIA 511, 512		OPEL 857, 861, 865, 871		OPEL 863
	RENAULT 1014, 1016		MITSUBISHI 740, 741, 742, 743, 745, 746, 747, 748, 749	NJ200	SAAB 1044	NJ268	BEDFORD 94
			PROTON 935, 936		TOYOTA 1184, 1185		DAIHATSU 227, 228
							OPEL 838

NUMERICAL PARTS LIST









Numerische Teilenummernliste • Liste des références produits
Elenco numerico articoli • Lista de referencias









							
NJ269	BEDFORD 94 DAIHATSU 227, 228, 229 OPEL 838 TOYOTA 1168	NJ323	BEDFORD 95, 96 CHEVROLET 149 HONDA 433 ISUZU 458, 459, 460, 461, 462 OPEL 852, 857, 862, 864, 865	NJ346	TOYOTA 1175, 1178, 1182, 1189, 1190	NJ446	CHEVROLET 142 ISUZU 457, 458 OPEL 844
NJ270	DAIHATSU 228	NJ324	BEDFORD 94 CHEVROLET 148 DAIHATSU 227, 228 FORD 373, 374, 380, 381, 382, 383, 389, 390, 393, 396, 397 HYUNDAI 444 KIA 508, 509, 510, 511 MAZDA 596, 597, 598, 599, 600, 601, 602, 603, 604 NISSAN 781, 784 OPEL 838 SUZUKI 1139	NJ347	DAIHATSU 230, 231 OPEL 852 TOYOTA 1171, 1174, 1175, 1176, 1177, 1178, 1179, 1182, 1186	NJ448	FORD 366, 371, 372, 373, 374, 381, 390, 393, 397, 402 KIA 508, 509, 511 MAZDA 593, 594, 596, 597, 598, 599, 600, 601, 602, 603, 604, 605, 606 SUZUKI 1139
NJ276	DAIHATSU 231	NJ325	CHEVROLET 148 FORD 374, 382, 389, 390, 396, 397 KIA 510, 511 MAZDA 598, 600, 601, 602, 603, 604, 605 NISSAN 781, 784 SUZUKI 1139	NJ349	CHEVROLET 142, 145 DAIHATSU 227, 228, 229, 230 OPEL 844 TOYOTA 1168, 1169, 1170, 1171, 1172, 1173, 1174, 1177, 1183, 1184, 1185, 1186, 1188, 1189 VOLKSWAGEN 1280	NJ449	CHEVROLET 142, 144 HONDA 426 ISUZU 457, 458 MAZDA 596, 597 MERCEDES-BENZ 645 NISSAN 776, 778 OPEL 843, 844, 850, 851 RENAULT 978 SMART 1112
NJ280	FORD 388 NISSAN 779, 781, 783	NJ330	KIA 512 MAZDA 605, 607	NJ351	TOYOTA 1178	NJ450	OPEL 851
NJ283	OPEL 871 RENAULT 1016 SAAB 1044	NJ336	BEDFORD 94 CHEVROLET 144 DAEWOO 209 HYUNDAI 444 LEYLAND 549 OPEL 838 SUBARU 1124 SUZUKI 1133, 1134, 1135, 1136, 1137, 1138, 1139	NJ353	CHEVROLET 142, 145 DAIHATSU 229, 230 NISSAN 776, 779 SUBARU 1124 TOYOTA 1168, 1169, 1170, 1171, 1172, 1173, 1174, 1177, 1178, 1180, 1184, 1187 VOLKSWAGEN 1280	NJ454	ISUZU 457
NJ284	FORD 388 MAZDA 593 MITSUBISHI 740 NISSAN 774, 775, 776, 777, 779, 781, 782, 783, 785, 786, 788, 789, 791, 793 RENAULT 978, 988, 1005, 1010, 1012 SUZUKI 1139	NJ337	BEDFORD 94 BUICK 127 CADILLAC 130 CHEVROLET 139, 140, 144, 148 DAEWOO 209 FIAT 293 HYUNDAI 444 OPEL 838 SUBARU 1125 SUZUKI 1133, 1134, 1135, 1136, 1137, 1138, 1139	NJ354	DAIHATSU 231 TOYOTA 1175, 1176, 1182 VOLVO 1307, 1308	NJ496	MITSUBISHI 750, 751
NJ285	FORD 388 NISSAN 779, 780, 781, 783, 790, 791, 792	NJ360	DAIHATSU 229, 230, 231 TOYOTA 1172, 1173, 1176, 1180, 1182, 1184 VOLKSWAGEN 1258, 1278, 1280	NJ355	DAIHATSU 231 TOYOTA 1175, 1176, 1182 VOLVO 1307, 1308	NJ497	MITSUBISHI 750
NJ286	NISSAN 777	NJ363	NISSAN 775, 776	NJ356	DAIHATSU 231 TOYOTA 1175, 1176, 1182 VOLVO 1307, 1308	NJ498	ISUZU 463
NJ287	FORD 399 LADA 517 NISSAN 774, 776, 777, 779, 783, 784, 785, 786, 787, 789, 790 OPEL 843, 848	NJ364	NISSAN 775, 776	NJ358	TOYOTA 1182	NJ499	FORD 366, 371, 372, 373, 374, 380, 381 KIA 508, 509, 510 MAZDA 593, 594, 595, 596, 597, 598, 599, 600
NJ288	NISSAN 776, 777, 779 OPEL 848 TOYOTA 1168	NJ366	NISSAN 780, 781, 791	NJ359	NISSAN 786, 789	NJ675	ROVER 1035
NJ311	HONDA 428, 429	NJ369	NISSAN 786, 789	NJ377	BUICK 127 CADILLAC 130 CHEVROLET 139, 140, 144, 147, 148 DAEWOO 209 FIAT 293 HYUNDAI 444 OPEL 841 SUBARU 1124, 1125 SUZUKI 1133, 1134, 1135, 1136, 1137, 1138 TOYOTA 1184, 1186, 1188, 1189	NJ765	MAZDA 593 MITSUBISHI 740 NISSAN 774, 775, 776, 777, 779, 780, 781, 782, 783, 784, 785, 789, 790, 791, 792
NJ312	HONDA 420, 421, 422, 423, 424, 425, 426, 427, 428, 429, 430, 431, 432 ISUZU 460, 461 ROVER 1029, 1031 VOLVO 1323	NJ370	BUICK 127 CADILLAC 130 CHEVROLET 139, 140, 144, 147, 148 DAEWOO 209 FIAT 293 HYUNDAI 444 OPEL 841 SUBARU 1124, 1125 SUZUKI 1133, 1134, 1135, 1136, 1137, 1138 TOYOTA 1184, 1186, 1188, 1189	NJ378	CHEVROLET 144 SUBARU 1124 SUZUKI 1134, 1135, 1136, 1137	NJ790	ISUZU 464
NJ313	HONDA 420, 421, 422, 423, 424, 425, 426, 427, 428, 429 ROVER 1029, 1031	NJ371	BEDFORD 94 BUICK 127 CADILLAC 130 CHEVROLET 139, 140, 144, 148 DAEWOO 209 FIAT 293 HYUNDAI 444 OPEL 838 SUBARU 1125 SUZUKI 1133, 1134, 1135, 1136, 1137, 1138, 1139	NJ381	HONDA 421, 422, 423, 424, 425, 426 ROVER 1029, 1031	NJ829	FORD 404 ISUZU 462 NISSAN 789, 790, 792, 793 RENAULT 1014
NJ321	BEDFORD 96 ISUZU 458, 459, 460, 461, 462 OPEL 857, 861, 865, 870	NJ374	SUBARU 1126	NJ407	TOYOTA 1168, 1170, 1178	NJ831	FORD 404 ISUZU 462 NISSAN 789, 790, 792, 793 RENAULT 1014
NJ322	BEDFORD 95, 96 CHEVROLET 149, 150 HONDA 433 ISUZU 458, 459, 460, 462, 463 OPEL 852, 857, 862, 864, 866, 869, 871	NJ344	DAIHATSU 230, 231 TOYOTA 1173, 1175, 1176, 1178, 1179, 1180, 1182, 1183, 1185, 1186, 1187, 1189, 1190 VOLKSWAGEN 1258, 1278, 1280			NJ846	SUBARU 1124

							
NJ933	DODGE 248	NK143	CHRYSLER 157	PA136	DAIHATSU 229, 230, 231	PA425	CHEVROLET 145
	FIAT 305, 306		CITROËN 188, 193, 194		TOYOTA 1168, 1169, 1170, 1173, 1174, 1175, 1176, 1177, 1178, 1179, 1180, 1181, 1182, 1183, 1184, 1185, 1186, 1188, 1189		DAIHATSU 230, 231
	FORD 386, 397, 398, 401		DODGE 247, 248				FORD 381
	HONDA 429, 433, 434, 435		FIAT 305, 306				HYUNDAI 444, 445, 446, 447, 449
	HYUNDAI 444, 445, 446, 447, 448, 449, 450, 451		HYUNDAI 448, 449, 450				ISUZU 460
	IVECO 472		IVECO 472				KIA 508, 509, 510, 511
	KIA 508, 509, 510, 511, 512		JEEP 500, 501				MAZDA 594, 599, 600, 601
	MITSUBISHI 740, 741, 742, 743, 744, 745, 746, 747, 748, 749		KIA 511, 512	PA138	TOYOTA 1183		MITSUBISHI 742, 748
	NISSAN 774, 776		LANCIA 536		VOLKSWAGEN 1280		OPEL 844
	PEUGEOT 900, 905		MITSUBISHI 743, 744, 745, 746, 747, 748, 749	PA139	TOYOTA 1182, 1189		SAAB 1043, 1044
	PROTON 935, 936		PEUGEOT 912, 917	PA192	TOYOTA 1183, 1188, 1189		SUBARU 1125, 1126, 1127
	RENAULT 978		PROTON 935, 936	PA203	NISSAN 774, 776, 777, 779		SUZUKI 1135, 1138, 1139
	ROVER 1035		VOLVO 1306		OPEL 848		TOYOTA 1168, 1170, 1171, 1172, 1173, 1174, 1176, 1177, 1178, 1179, 1180, 1182, 1184, 1185, 1186, 1187, 1188, 1189
	VOLVO 1306	NK158	FORD 372, 380, 381	PA208	ISUZU 463		
NJ943	ISUZU 459		HYUNDAI 447	PA229	DAF 217		
NJ951	ALFA ROMEO 22		KIA 508, 509, 510		FORD 394, 398, 402, 403		
NJ978	KIA 513		MAZDA 594, 596, 597, 598		LEYLAND 550		
	MAZDA 607	NK169	DAIHATSU 231		PEUGEOT 911, 912, 915, 917, 918	PA525	MITSUBISHI 750
NJ982	HONDA 429, 431		TOYOTA 1177, 1182, 1183, 1184, 1185	PA260	DAIHATSU 231, 232		PA528
NJ985	KIA 513		TOYOTA 1186		TOYOTA 1187, 1188		HONDA 421, 423, 424, 426, 428, 429, 433
	MAZDA 607	NK180	TOYOTA 1186	PA286	HONDA 420, 421		ROVER 1029, 1035
NJ993	TOYOTA 1189	NK205	FORD 383, 390	PA305	BEDFORD 94		PA531
NK035	KIA 513		MAZDA 600, 602		DAEWOO 209		HONDA 421, 423, 424, 426, 429
	MAZDA 607	NK209	DAIHATSU 229, 230		DAIHATSU 229, 230		ROVER 1029
NK050	TOYOTA 1185, 1186, 1187, 1188	NK214	DAIHATSU 230		OPEL 838		PA565
NK055	TOYOTA 1184, 1185		VOLKSWAGEN 1280		SUZUKI 1133, 1134, 1135, 1137		BEDFORD 94
NK102	HONDA 420	NK216	TOYOTA 1184, 1189		TOYOTA 1170		BUICK 126
NK103	CHEVROLET 144	NK251	HYUNDAI 450	PA313	HONDA 426, 429		CHEVROLET 139, 140, 141, 142, 143, 145, 146, 147, 148, 149
	HONDA 426		KIA 513	PA378	FORD 404, 406		DAEWOO 209, 210, 211, 212
	ISUZU 457, 458		TOYOTA 1186, 1189		ISUZU 462		FIAT 287, 289, 296
	MAZDA 597	NP067	FIAT 307		NISSAN 787, 789, 790, 792, 793		ISUZU 460, 461
	OPEL 843, 850, 851		IVECO 472, 473, 474, 475, 476, 477, 478, 479, 480, 481		RENAULT 1014		LADA 518
	RENAULT 978, 979, 985		LANCIA 534	PA387	BEDFORD 94		OPEL 839, 840, 841, 844, 845, 847, 849, 853, 854, 857, 858, 859, 862, 870
NK106	FORD 399		PEUGEOT 920		DAIHATSU 227, 228		SUZUKI 1136
	MAZDA 601	NP068	ALFA ROMEO 20, 21	PA418	OPEL 838		TOYOTA 1168, 1172, 1178
	MITSUBISHI 744		CITROËN 195		BEDFORD 96		PA606
	NISSAN 780, 782, 783, 784, 785, 786, 787, 788		FIAT 306, 307, 308, 309		CHEVROLET 150, 151		MAZDA 607
	RENAULT 992, 1003, 1005, 1010		IVECO 472, 473, 474, 475, 476, 477, 478, 479, 480, 481		HONDA 433		PA619
	SUZUKI 1138, 1139		LANCIA 534, 536		ISUZU 461, 462		BEDFORD 95
NK117	ISUZU 460		OPEL 866, 868, 870		OPEL 863, 866, 869, 871		CHEVROLET 151
	SAAB 1043, 1044		PEUGEOT 920				DAEWOO 213
	SUBARU 1125, 1126, 1127		RENAULT 1009, 1010, 1011, 1012, 1013, 1015				LAND ROVER 541
NK139	ISUZU 460		SEAT 1087				OPEL 845, 850, 852, 853, 855, 856, 857, 861, 862, 864, 866, 867, 869, 870
	SAAB 1043, 1044		OPEL 866, 868, 870				TOYOTA 1187
	SUBARU 1125, 1126, 1127	PA021	PEUGEOT 920				PA658
			RENAULT 1009, 1010, 1011, 1012, 1013, 1015				CHEVROLET 142
			SEAT 1087				ISUZU 457, 458, 459
		PA079	RENAULT 1009, 1010, 1011, 1012, 1013, 1015				MAZDA 597
			TOYOTA 1175, 1181, 1189				OPEL 843, 850, 851
			FORD 388, 399				PA815
			ISUZU 463				MERCEDES-BENZ 648, 649, 650, 651, 652, 653, 654, 655, 656, 657, 658, 660, 661, 662, 663, 665
			NISSAN 775, 776, 779, 780, 781, 783, 786, 787, 789, 790, 791, 792				PUCH 939, 940
			OPEL 871				SEAT 1087
			RENAULT 1005, 1016				PA858
							PEUGEOT 904



























































































NUMERICAL PARTS LIST

Numerische Teilenummernliste • Liste des références produits
Elenco numerico articoli • Lista de referencias



























































































							
PA874	ISUZU 463	PA5025	ALFA ROMEO 12	PA5041	SAAB 1043, 1044	PB180	DAEWOO 213
	MITSUBISHI 750		BMW 114, 121, 122, 123		SEAT 1069, 1070, 1071, 1073, 1074, 1075, 1077, 1078, 1080, 1081, 1085, 1086, 1087		DEUTZ 235, 236, 237, 238, 239, 240, 241
	NISSAN 777, 779, 781, 782, 785, 786, 788, 789, 791, 792, 793		BUICK 126		SKODA 1098, 1099, 1101, 1102, 1103, 1104, 1105, 1107, 1108, 1109		FORD 363, 364, 365, 368, 373, 378, 379, 381, 383, 384, 385, 386, 388, 391, 392, 398, 399, 401, 403, 404, 405, 406
	RENAULT 1005, 1010, 1013, 1017		CADILLAC 130		SMART 1112, 1113		KIA 512
	SUZUKI 1139, 1140		CHEVROLET 140, 141, 146		SUBARU 1127		MAZDA 601
PA883	FORD 366, 371, 382, 390, 396		CHRYSLER 155		SUZUKI 1136, 1138		MERCEDES-BENZ 673, 675, 676, 677, 694, 695, 696
	KIA 508, 509, 513		FIAT 281, 282, 283, 286, 287		VOLKSWAGEN 1236, 1237, 1238, 1239, 1242, 1243, 1244, 1245, 1246, 1247, 1251, 1252, 1253, 1254, 1255, 1259, 1260, 1261, 1262, 1263, 1270, 1271, 1273, 1274, 1275, 1276, 1277, 1279, 1281, 1282, 1283, 1284, 1285, 1286, 1287, 1288		VOLVO 1318, 1322
	MAZDA 593, 594, 596, 597, 599, 600, 602, 604, 606, 607		FORD 366		VOLVO 1310, 1315		PB224
PA928	BUICK 127		LANCIA 526, 528	PA5033	FORD 366, 374		MAN 567, 568, 571, 572, 574, 575, 577, 578, 579, 580, 581
	CADILLAC 130		MERCEDES-BENZ 645		AUDI 55, 56, 57, 59, 60, 61, 62, 63, 64, 65, 68, 69, 70, 71, 72, 73, 76, 77, 78, 79, 80, 81, 82, 83, 84, 85, 86, 87		MERCEDES-BENZ 698, 699, 700, 701, 703, 704, 705, 707, 711, 715, 716, 717, 718, 719
	CHEVROLET 139, 140, 142, 144, 148		MITSUBISHI 740, 741		BMW 110, 111, 113, 114, 115, 116, 117, 118, 119, 120, 121, 122, 123		PB313
	DAEWOO 209		OPEL 838, 839, 842, 854, 855		BUICK 126		FORD 373, 374, 380, 383, 390, 402
	FIAT 293		SAAB 1041		CADILLAC 130		ISUZU 463
	HYUNDAI 444		SMART 1112, 1113		CHEVROLET 142, 143, 144, 145, 146, 147, 148, 149, 150, 151		KIA 509, 510, 512
	MAZDA 593		SUZUKI 1134, 1135		CHRYSLER 157, 158		MAZDA 596, 597, 598, 599, 600, 601, 602, 603, 605, 606
	NISSAN 774		PA5041		CITROËN 185, 186, 191, 195, 196		TOYOTA 1174
	OPEL 838		AUDI 55, 56, 57, 59, 60, 61, 62, 63, 64, 65, 68, 69, 70, 71, 72, 73, 76, 77, 78, 79, 80, 81, 82, 83, 84, 85, 86, 87		DACIA 204		PB314
	SUBARU 1124, 1125		BMW 110, 111, 113, 114, 115, 116, 117, 118, 119, 120, 121, 122, 123		DAEWOO 211, 212, 213		CHEVROLET 147
	SUZUKI 1133, 1134, 1135, 1136, 1137		BUICK 126		DODGE 247, 249		FORD 372, 373, 374, 380, 383, 390, 402, 403
PA933	BEDFORD 95, 96		CADILLAC 130		FIAT 293, 297, 309, 312		ISUZU 463
	CHEVROLET 149		CHEVROLET 142, 143, 144, 145, 146, 147, 148, 149, 150, 151		FORD 404		KIA 509, 510, 512, 513
	FORD 399		CHRYSLER 157, 158		HONDA 426		MAZDA 596, 597, 598, 599, 600, 601, 602, 603, 605, 606
	HONDA 433		CITROËN 185, 186, 191, 195, 196		ISUZU 461		TOYOTA 1174
	ISUZU 458, 459, 460, 461, 462		DACIA 204		JEEP 500, 501, 502		PB354
	LEYLAND 549		DAEWOO 211, 212, 213		LANCIA 536, 537		HONDA 420, 421, 422, 423, 424, 425, 426, 427, 428, 430, 431, 432, 433, 434, 435, 436
	NISSAN 777, 780, 782, 783, 784, 785, 786, 787, 788, 789, 790, 791, 792		DODGE 247, 249		LAND ROVER 544, 546		ROVER 1031, 1033, 1034
	OPEL 852, 857, 861, 862, 864, 865		FIAT 293, 297, 309, 312		MERCEDES-BENZ 645, 646, 647, 648, 650, 651, 652, 653, 654, 658, 659, 664, 666, 668, 671, 676, 680, 686, 692		PB355
PA952	DAIHATSU 229, 230		FORD 404		MITSUBISHI 742, 746, 747		HONDA 420, 421, 422, 423, 424, 425, 426, 427, 428, 430, 431, 432, 433, 434, 435, 436
	PA5013		HONDA 426		NISSAN 778, 780, 786, 788		ISUZU 460, 461
	DACIA 204		ISUZU 461		OPEL 843, 847, 848, 851, 854, 860, 861, 863, 864, 866, 867, 868, 869, 871, 872		ROVER 1031, 1033
	NISSAN 780, 783		JEEP 500, 501, 502		PEUGEOT 908, 909, 914, 920		SUBARU 1127
	OPEL 860		LANCIA 536, 537		PORSCHE 926, 927, 928, 929, 930, 931, 932		PB356
	RENAULT 986, 990, 991, 995, 1002		LAND ROVER 544, 546		RENAULT 988, 992, 1007, 1013, 1015, 1016		HONDA 420, 421, 422, 423, 424, 425, 426, 427, 428, 430, 431, 432, 433, 434, 435, 436
PA5016	BMW 113, 116, 118, 121		MERCEDES-BENZ 645, 646, 647, 648, 650, 651, 652, 653, 654, 658, 659, 664, 666, 668, 671, 676, 680, 686, 692		ROVER 1031, 1034		ISUZU 460, 461
	LAND ROVER 541, 545		MITSUBISHI 742, 746, 747		PB172		ROVER 1031, 1033
	MG 723		NISSAN 778, 780, 786, 788		MERCEDES-BENZ 670, 672, 681, 684, 685, 691		SUBARU 1127
	OPEL 868		OPEL 843, 847, 848, 851, 854, 860, 861, 863, 864, 866, 867, 868, 869, 871, 872		PB177		HONDA 420, 421, 422, 423, 424, 425, 426, 427, 428, 430, 431, 432, 433, 434, 435, 436
	ROVER 1033		PEUGEOT 908, 909, 914, 920		MERCEDES-BENZ 670, 672, 681, 684, 685, 691		ISUZU 460, 461
PA5019	OPEL 851		PORSCHE 926, 927, 928, 929, 930, 931, 932		PB177		ROVER 1031, 1033
	SUBARU 1124		RENAULT 988, 992, 1007, 1013, 1015, 1016		MERCEDES-BENZ 670, 672, 681, 684, 685, 691		SUBARU 1127
	TOYOTA 1171, 1174, 1175		ROVER 1034				
PA5020	DAIHATSU 231						
	OPEL 844, 851, 852, 872						
	SUBARU 1124						
	TOYOTA 1169, 1171, 1173, 1174, 1175, 1176, 1180, 1182, 1183, 1184, 1185, 1186, 1187, 1188, 1190						

							
PB394	AUDI	57, 61, 67, 74					
	DAEWOO	212, 213					
	MAN	569, 571, 575, 577, 578, 580, 582					
	MERCEDES-BENZ	649, 650, 652, 653, 655, 656, 657, 658, 659, 660, 662, 663, 664, 667, 669, 672, 676, 677, 678, 679, 707, 710, 712, 717, 718					
	PORSCHE	926					
	PUCH	939, 940					
	SSANGYONG	1116, 1117, 1118					
	VOLKSWAGEN	1275					
PB681	DACIA	203					
	MAZDA	593, 601					
	MERCEDES-BENZ	645					
	MITSUBISHI	740, 744					
	NISSAN	774, 775, 776, 777, 779, 780, 781, 782, 785					
	RENAULT	978, 979, 982, 985, 988, 992, 1003					
	SMART	1112					
	SUZUKI	1139					

































































































OIL SEALS BY REFERENCE

▲ Payen		mm		mm		mm				▲ Payen		mm		mm		mm			
LK5000	89.00	x	116.00	x	10.20	FPM	840S SP		NA5036	42.00	x	54.00	x	6.00	FPM	827S W			
LK5001	74.00	x	141.00 / 187.50	x	17.00	FPM	SP		NA5037	85.00	x	105.00	x	11.00	ACM	827S W			
LK5002	136.00	x	153.00	x	21.00	PTFE	841S		NA5039	95.00	x	120.00	x	13.00	FPM	822 S			
LK5003	85.00	x	131.00	x	15.70	PTFE	841S SP		NA5040	110.00	x	135.00	x	13.00	FPM	823S			
LK5004	80.00	x	182.00	x	19.40	PTFE	841N LS SP		NA5041	42.00	x	65.00	x	12.00	ACM	829S W			
LK5005	88.00	x	188.00	x	15.00	PTFE	841 SP		NA5045	53.00	x	68.00	x	10.00	ACM	827N			
LK5006	85.00	x	131.00	x	16.00	PTFE	841S		NA5049	64.00	x	80.00	x	8.00	ACM	822S			
LK5007	90.00	x	173.00	x	24.00	PTFE	841S		NA5050	70.00	x	90.00	x	10.00	ACM	827S			
LK5008	85.00	x	131.00	x	15.70	PTFE	841S SP		NA5051	40.00	x	56.00	x	7.00	FPM	827N			
LK5009	99.00	x	118.00	x	16.50	PTFE	841S		NA5053	30.00	x	42.00	x	7.00	FPM	827S W			
LK5012	132.00	x	153.00	x	15.70	PTFE	841S		NA5055	70.00	x	90.00	x	10.00	FPM	829S W			
LK5013	85.00	x	111.00	x	15.50	PTFE	841		NA5057	27.00	x	37.00	x	7.00	FPM	829S W			
LK5016	85.00	x	164.00 / 156.20	x	11.00	PTFE	841S		NA5058	40.00	x	55.00	x	7.00	FPM	827S			
LK5017	85.00	x	130.90 / 170.00	x	15.75	PTFE	841S		NA5061	74.00	x	88.00	x	8.00	FPM	829S W			
LK5020	85.00	x	154.00 / 160.00	x	9.50	PTFE / AEM	841S		NA5062	74.00	x	90.00	x	10.00	ACM	829S W			
LK5021	92.00	x	235.00 / 220.00	x	22.00	PTFE / ACM	841S		NA5063	40.00	x	56.00	x	10.00	ACM	822S			
LK5022	94.00	x	161.00 / 193.00	x	10.00	PTFE / AEM	841S		NA5064	35.00	x	58.00	x	10.00	ACM	827S W			
NA162	34.90	x	49.50	x	13.10	NBR + LEATHER	822S		NA5065	62.00	x	80.00	x	12.00	ACM	822N			
NA187	22.23	x	35.70	x	9.53	NBR	827N SP		NA5066	35.00	x	50.00	x	10.00	ACM	827S W			
NA195	28.00	x	40.00	x	8.00	NBR	827S		NA5069	55.00	x	68.00	x	8.00	FPM	829S W			
NA294	42.90	x	63.50	x	9.52	NBR	827N		NA5070	31.00	x	41.00	x	7.00	FPM	829S W			
NA301	34.90	x	53.90	x	7.90	NBR	827N		NA5074	93.00	x	133.50	x	15.50	PTFE	841S SP			
NA380	45.00	x	62.00	x	10.00	NBR	827N		NA5083	32.50	x	45.00	x	7.70	FPM	827S			
NA422	50.80	x	69.90	x	12.70	NBR	827S DD		NA5089	38.00	x	50.00	x	8.00	NBR	827S			
NA448	48.00	x	62.00	x	8.00	NBR	827N		NA5090	76.00	x	94.00	x	8.50	FPM	827S			
NA473	39.70	x	59.00	x	9.50	NBR	827S		NA5099	44.00	x	60.00	x	10.00	PTFE	829S W			
NA5001	32.00	x	47.00	x	10.00	FPM	827S DD W		NA5101	66.70	x	88.90	x	9.50	MVQ	827N W			
NA5013	30.00	x	50.00	x	7.50	PTFE	829S		NA5103	55.00	x	68.00	x	8.00	PTFE	829S W			
NA5016	35.00	x	47.00	x	7.00	FPM / ACM	827N W		NA5104	90.00	x	110.00	x	12.00	PTFE	829S W			
NA5017	98.00	x	110.00	x	8.50	FPM	827S		NA5105	48.00	x	65.00	x	10.00	PTFE	829S W			
NA5018	35.00	x	47.00	x	5.60	FPM	827S		NA5106	35.00	x	48.00	x	10.00	PTFE	827S W			
NA5023	50.00	x	65.00	x	8.00 / 9.30	FPM	829S W		NA5107	90.00	x	167.00	x	10.50	PTFE	841S SP			
NA5028	36.00	x	50.00	x	7.00	PTFE / ACM	827S		NA5108	42.00	x	55.00	x	7.00	FPM / ACM	827S W			
NA5030	106.00	x	190.00 / 196.00	x	15.20	FPM	841S		NA5109	40.00	x	62.00	x	8.00	PTFE	827S W			
NA5031	50.00	x	86.50	x	13.70	PTFE	827S W		NA5118	80.00	x	100.00	x	9.00	PTFE	827S DD W			
NA5035	27.00	x	47.00	x	7.00	FPM	827S W		NA5120	78.00	x	104.00	x	11.00	ACM	829S DD W			
									NA5121	115.00	x	140.00	x	13.00	PTFE	829S W			
									NA5124	32.00	x	47.00	x	10.00	PTFE / ACM	827SW			
									NA5130	79.00	x	196.00	x	21.50	PTFE	841			
									NA5131	45.00	x	67.00	x	8.00	PTFE	827S W			
									NA5132	100.00	x	125.00	x	13.00	FPM	829S W			
									NA5133	85.00	x	105.00	x	11.00	FPM	829S W			
									NA5136	30.00	x	47.00	x	7.00	FPM	827N DD			
									NA5137	32.90	x	47.40	x	5.00	FPM	827S W			































































































OIL SEALS BY REFERENCE

▲ Payen		mm		mm		mm				▲ Payen		mm		mm		mm			
NA5138	44.50	x	57.20	x	6.75	ACM	827S		NA5258	27.00	x	47.00	x	7.00	PTFE	827S W			
NA5139	32.00	x	45.00	x	6.00	FPM	829S		NA5259	40.00	x	55.00	x	6.40	PTFE	827S W			
NA5140	91.00	x	111.00	x	10.00	FPM	823S		NA5260	38.00	x	50.00	x	6.00	FPM	827S W			
NA5147	40.00	x	62.00	x	7.40	PTFE	827S W		NA5261	28.00	x	47.00	x	8.00	PTFE / ACM	827SW			
NA5149	30.00	x	54.00	x	15.00 / 19.30	FPM	827N		NA5262	143.00	x	165.00	x	10.00	NBR	824S			
NA5156	66.00	x	90.00	x	12.00	PTFE	829S W		NA5263	15.00	x	21.00	x	5.00	NBR	822SK			
NA5157	37.00	x	50.00	x	8.00	PTFE	827S W		NA5264	45.00	x	67.00	x	13.00	FPM	827 SSP			
NA5163	32.00	x	47.00	x	10.00	FPM	827S W		NA5266	93.00	x	114.00	x	14.00	FPM	829S W			
NA5168	93.00	x	114.00	x	11.50	PTFE	827S W		NA5267	55.00	x	72.00	x	10.00	FPM	829S W			
NA5171	145.00	x	175.00	x	14.00	NBR	829S W		NA5268	100.00	x	124.00	x	13.00	FPM	829S W			
NA5173	100.00	x	120.00	x	9.50	FPM	829S		NA5269	115.00	x	140.00	x	10.00	FPM	827 N			
NA5174	31.50	x	42.00	x	7.00	FPM	829S W		NA5270	58.00	x	81.20	x	5.00	FPM	827N			
NA5175	91.00	x	108.00	x	9.50	NBR	829N		NA5271	18.00	x	32.00	x	6.00	ACM	827S			
NA5178	45.00	x	65.00	x	7.00	FPM / ACM	827S W		NA5282	45.00	x	63.00	x	7.00	FPM	827SDD			
NA5179	51.00	x	65.00	x	7.00	FPM	827S W		NA5293	70.00	x	100.00	x	16.00	PTFE				
NA5180	27.00	x	42.00	x	8.00	FPM	827S W		NA5294	130.00	x	155.00	x	16.00	PTFE				
NA5181	110.00	x	130.00	x	13.00	PTFE	829S W		NA5298	90.00	x	104.00	x	9.00	FKM	829S W			
NA5185	32.00	x	42.00	x	6.00 / 7.00	FPM	829S W		NA5299	55.00	x	68.00	x	8.00	FPM	829S W			
NA5187	30.00	x	52.00	x	7.00	ACM	827S		NA5300	120.00	x	140.00	x	12.00	PTFE				
NA5190	42.00	x	56.00	x	7.00	FPM	827SS W		NA5305	85.00	x	105.00	x	11.00	PTFE	829S W			
NA5191	42.00	x	62.00	x	7.00	PTFE	829S W		NA5306	42.00	x	58.00	x	8.00	ACM	827S W			
NA5192	90.00	x	110.00	x	7.00	PTFE	829S W		NA5307	32.00	x	47.00	x	10.00	PTFE	827S W			
NA5196	90.00	x	110.00	x	9.00	ACM	827S		NA5310	46.00	x	56.40	x	7.00	FPM	827S W			
NA5197	53.00	x	69.85	x	11.00	MVQ	827S		NA5317	55.50	x	70.00	x	6.00	FPM	ASW			
NA5201	34.00	x	60.00	x	10.00	FPM	829S W		NA5318	26.00	x	45.00	x	8.00	FPM	ASW			
NA5202	50.00	x	80.00	x	14.00	FPM	SP		NA5319	48.00	x	63.00	x	6.50	FPM	ASL			
NA5204	29.90	x	47.00	x	11.30	PTFE / ACM	827SW		NA5320	43.00	x	58.00	x	7.00	ACM	827S			
NA5205	40.00	x	58.00	x	10.00	FPM / ACM	827S DD W		NA5321	31.00	x	55.00	x	7.00	FKM	829S W			
NA5209	99.00	x	114.00	x	11.00	FPM	827S		NA5322	32.00	x	44.00	x	6.00	ACM	827S			
NA5215	28.00	x	42.00	x	5.00	FPM	827S W		NA5323	35.00	x	50.00	x	7.00	PTFE	827S W			
NA5223	40.00	x	52.00	x	7.00	FPM	829S W		NA5324	74.00	x	89.00	x	8.50	FKM	827S			
NA5226	33.00	x	49.00	x	8.00	FPM	ASL		NA5325	85.00	x	105.00	x	8.80	PTFE	827S W			
NA5230	78.00	x	100.00	x	9.00	PTFE	827S W		NA5326	32.00	x	44.00	x	6.00	PTFE	827S W			
NA5238	85.00	x	120.00	x	10.00	FPM	841S		NA5327	80.00	x	98.00	x	14.50	PTFE	827N W			
NA5242	40.00	x	52.00	x	7.00	FPM	827S		NA5328	28.00	x	42.00	x	6.00	PTFE / ACM	827SW			
NA5243	50.00	x	74.00	x	11.00	FPM	827S		NA5329	55.00	x	70.00	x	8.00	PTFE	827S W			
NA5244	91.00	x	114.00	x	12.00	FPM	827S		NA5330	48.00	x	62.00	x	8.00	FKM	827S			
NA5245	29.00	x	43.00	x	8.00	ACM	827S		NA5331	42.00	x	66.00	x	7.00	PTFE / ACM	ASW			
NA5246	42.50	x	54.50	x	6.00	MVQ	0		NA5332	50.00	x	81.00	x	11.45	FPM	827S W			
NA5255	35.00	x	47.00	x	7.00	PTFE / ACM	827SW		NA5333	48.00	x	81.00	x	11.50	PTFE / PA	ASL			
NA5256	40.00	x	55.00	x	6.50	FPM	827S W		NA5347	30.00	x	45.00	x	7.00	FPM	829S W			
NA5257	28.00	x	47.00	x	5.50	FPM	827S W		NA5348	70.00	x	86.00	x	7.00	PTFE	827S W			
									NA5349	85.00	x	105.00	x	12.00	PTFE	829S W			
									NA5350	80.00	x	98.00	x	14.70	PTFE	827S W			



































































































OIL SEALS BY REFERENCE

▲ Payen		mm		mm		mm				▲ Payen		mm		mm		mm			
NA5351	36.00	x	50.00	x	6.00	FPM	827S												
NA5354	130.00	x	160.00	x	13.00	VMQ	SP												
NA5355	153.00	x	171.45	x	11.00	PTFE	823S												
NA5356	82.50	x	101.60	x	12.00	PTFE	SP												
NA5357	54.50	x	67.50	x	6.50	PTFE	SP												
NA5358	12.00	x	24.00	x	6.00	FPM	827N												
NA5359	180.00	x	205.00	x	15.00	FPM	829S W												
NA5360	45.00	x	62.00	x	8.00	ACM	829S W												
NA5361	32.00	x	47.00	x	10.00	PTFE	SP												
NA5362	85.00	x	105.00	x	8.00	PTFE	827S W												
NA5363	61.00	x	75.00	x	8.00	PTFE	827S W												
NA5364	36.00	x	50.00	x	8.00	PTFE / ACM	827SW												
NA543	47.60	x	66.70	x	10.80	ACM	822N												
NA5446	60.00	x	75.00	x	7.00	FPM / ACM	827S W												
NA5447	70.00	x	85.00	x	7.00	FPM / ACM	827S W												
NA5448	34.00	x	47.00	x	5.50	FPM	827S W												
NA5449	23.00	x	36.00	x	6.00 / 7.00	NBR	827N W												
NA5450	100.00	x	130.00	x	12.00	PTFE / ACM	829SW												
NA5451	90.00	x	120.00	x	11.00	PTFE	827S W												
NA5452	160.00	x	190.00	x	13.00	PTFE / ACM	827SW												
NA5453	24.00	x	50.00	x	8.00	PTFE / ACM	827SW												
NA5454	28.00	x	39.00	x	7.00	PTFE / ACM	827SP												
NA5455	39.00	x	50.00	x	7.00	PTFE / ACM	827SP												
NA5456	36.00	x	46.00	x	7.00	PTFE / ACM	827SP												
NA5457	33.00	x	42.00	x	6.00	PTFE / AEM	827SW												
NA5458	24.00	x	39.00	x	8.00	PTFE / AEM	827SW												
NA5459	81.00	x	104.00	x	11.00	FPM	829SW												
NA5460	134.00	x	161.00	x	16.00	PTFE / ACM	829SBONDED												
NA5461	139.00	x	159.00	x	13.00	PTFE / ACM	827SP												
NA5462	165.00	x	191.00	x	16.00	PTFE / ACM	829SBONDED												
NA5463	150.00	x	172.00	x	13.00	PTFE / ACM	SP												
NA5464	152.50	x	171.50	x	11.00	PTFE	SP												
NA5465	130.00	x	150.00	x	14.80	PTFE	SP												
NA5466	139.00	x	164.00	x	12.00	PTFE / ACM	SP												
NA5467	110.00	x	130.00	x	12.00	PTFE / ACM	827SP												
NA5468	55.00	x	75.00	x	8.00	FPM	822N												
NA5469	100.00	x	130.00	x	11.00	PTFE / ACM	827SP												
NA5470	130.00	x	160.00	x	13.00	PTFE / ACM	827SP												
NA5471	145.00	x	175.00	x	13.00	PTFE / FPM	SP												
NA5472	155.00	x	185.00	x	13.00	PTFE / FPM	SP												
NA5473	135.00	x	153.00	x	13.00	PTFE	SP												
NA5474	80.00	x	100.00	x	13.00	PTFE / ACM	827BSLHALF-RIBBED												
NA5475	130.00	x	150.00	x	13.00	FPM	827S W												
NA5476	60.00	x	74.00	x	8.00	ACM	829S												
NA5477	48.00	x	62.00	x	7.00	ACM	827SW												
NA5478	60.00	x	80.00	x	8.00	FPM	829S												
NA5479	60.00	x	75.00	x	8.00	FPM	827SP (NO SPRING)												
NA567	44.50	x	63.50	x	9.52	ACM	827N												
NA576	36.50	x	52.30	x	8.00	MVQ	827S W												
NA579	36.50	x	52.70	x	7.90	NBR	827S DD W												
NA580	41.30	x	60.30	x	9.52	NBR	827S												
NA581	52.00	x	68.00	x	10.00	MVQ	827S W												
NA583	39.70	x	72.60	x	8.13	ACM	822N SP												
NA584	55.00	x	70.00	x	10.00	MVQ	827N												
NA585	40.00	x	55.00	x	8.00	PTFE	827S												
NA611	63.50	x	90.00	x	12.70	LEATHER	824 SP												
NA652	58.70	x	85.10	x	7.90	NBR	827N												
NA736	57.20	x	76.20	x	12.70	NBR + LEATHER	822S SP												
NA764	60.30	x	82.90	x	11.50	ACM	822N												
NA773	55.50	x	73.00	x	12.70	NBR	827S												
NA774	73.00	x	92.10	x	9.50	MVQ	827N												
NA784	70.00	x	90.00	x	10.00	ACM	827N												
NA853	87.30	x	120.60	x	12.70	NBR	822 SP												
NA869	92.00	x	110.00	x	10.00	MVQ	827N												
NA933	127.00	x	146.10	x	11.10	ACM	827N												
NA965	122.20	x	141.00	x	11.80	MVQ	827S												
NA987	63.50	x	83.40	x	7.92	NBR	827N DD												
NB064	14.30	x	29.36	x	19.84	NBR	0												
NB077	15.90	x	39.30	x	11.70	NBR	SP												
NB083	15.00	x	25.40	x	5.20	NBR	827S SP												
NB291	82.60	x	98.70	x	12.70	MVQ	827N												
NB307	40.00	x	56.00	x	7.00	ACM	827 NW												
NB384	40.00	x	55.00	x	8.00	NBR	827S												
NB431	90.00	x	110.00	x	12.00	FPM	829S W												
NB432	35.00	x	55.00	x	12.00	ACM	827S W												
NB450	40.00	x	52.00	x	7.50	NBR	827S												
NB452	66.70	x	85.70	x	9.52	MVQ	827N												
NB453	47.60	x	67.00	x	11.10	MVQ	827N W												
NB459	60.30	x	79.50	x	9.50	MVQ	827N												
NB460	133.30	x	158.70	x	12.70	MVQ	827N												
NB469	77.00	x	100.00	x	11.50	FPM	829S												
NB564	60.45	x	76.18	x	10.00	FPM / FELT	827S W												
NB567	40.00	x	52.00	x	6.00	NBR	827S DD W												
NB575	40.00	x	52.00	x	8.50	NBR	827S DD W												
NB584	54.00	x	73.00	x	12.40	NBR	827N DD												

































































































OIL SEALS BY REFERENCE

▲ Payen		mm		mm		mm				▲ Payen		mm		mm		mm			
NB586	30.00	x	40.00	x	7.00	MVQ	827S		NB848	100.00	x	120.00	x	11.00	PTFE	829N W			
NB596	55.00	x	70.00	x	6.00	NBR	827S SP		NB849	48.70	x	63.50	x	8.00	FPM	827S			
NB619	130.00	x	160.00	x	15.00	FPM	829SW		NB852	155.00	x	180.00	x	15.00	FPM	829S W			
NB628	45.00	x	60.00	x	8.00 / 9.00	ACM	827S W		NB853	85.70	x	114.30	x	13.00	FPM	829S W			
NB638	130.00	x	150.00	x	13.00	FPM	827S W		NB854	79.00	x	99.00	x	9.50	PTFE	829S W			
NB644	74.00	x	90.00	x	10.00	NBR	829 S W		NB855	67.00	x	86.00	x	9.50	PTFE	829S W			
NB655	50.00	x	65.00	x	9.75	NBR	827S DD		NB856	47.62	x	66.50	x	11.00	PTFE	827N W			
NB684	31.80	x	47.60	x	9.52	NBR	827S DD		NB882	70.00	x	90.00	x	15.00	FPM	0			
NB688	66.70	x	89.60	x	9.50	MVQ	827SW		NB884	38.00	x	50.00	x	8.00	FPM	829S W			
NB690	81.00	x	100.10	x	11.50	FPM	827S		NB928	105.00	x	130.00	x	12.00	FPM	829S W			
NB691	54.00	x	82.00	x	9.00	ACM	827S		NB929	120.00	x	140.00	x	13.00	FPM	829S W			
NB694	40.00	x	56.00	x	10.00	ACM	827N		NB932	60.33	x	79.40	x	9.50	FPM	827S			
NB697	26.00	x	42.00	x	8.00	FPM	827S W		NB933	133.35	x	158.75	x	12.63	FPM	827SW			
NB698	80.00	x	98.00	x	10.00	FPM	827S W		NB934	100.00	x	120.00	x	15.00	FPM	829S W			
NB700	31.00	x	50.00	x	8.00	MVQ	827S		NB935	105.00	x	130.00	x	15.00	FPM	829S W			
NB701	86.00	x	104.00	x	11.00	FPM	827S		NB938	65.00	x	85.00	x	13.00	FPM	827SW			
NB714	48.00	x	66.70	x	10.00	MVQ	827S W		NB939	115.00	x	140.00	x	16.00	FPM	823S			
NB716	35.00	x	48.00	x	10.00	FPM	829S W		NB946	70.00	x	90.00	x	10.00	FPM	829S W			
NB732	74.00	x	90.00	x	10.00	FPM	829S W		NB947	154.00	x	180.00	x	12.00	FPM	829SW			
NB734	35.00	x	50.00	x	8.00	FPM	829S		NB954	125.00	x	150.00	x	12.00	FPM	829 S W			
NB742	30.00	x	43.00	x	8.00	ACM	829S W		NB956	100.00	x	124.00	x	12.00	FPM	829S W			
NB772	88.90	x	104.80	x	9.52	MVQ	827S W		NB958	42.00	x	53.00	x	7.00	FPM	827S W			
NB773	46.00	x	60.00	x	7.00	FPM	827N		NB959	35.00	x	50.00	x	7.00	FPM	827S W			
NB774	35.00	x	45.00	x	7.00 / 8.00	FPM	827S		NB966	120.00	x	140.00	x	13.00	PTFE / ACM	827SW			
NB775	40.00	x	52.00	x	7.00	FPM	827N DD		NB967	66.00	x	90.00	x	12.00	FPM	823S			
NB785	28.00	x	38.00	x	7.00	FPM	827S		NB971	45.00	x	67.00	x	10.00	FPM	829S W			
NB786	42.00	x	58.00	x	11.00	FPM	827S		NB972	93.00	x	117.00	x	12.00	FPM	823S			
NB788	79.40	x	95.30	x	11.10	PTFE	829S W		NB973	45.00	x	67.00	x	8.00	FPM	829S W			
NB792	42.00	x	62.00	x	12.00	FPM	829S W		NB974	93.00	x	114.00	x	13.00	FPM	827S W			
NB799	38.00	x	50.00	x	7.00	FPM	827S DD W		NB975	45.00	x	74.50	x	12.00	FPM	827S W SP			
NB806	90.00	x	104.00	x	11.00	FPM	829S		NB977	75.00	x	100.00	x	13.00	FPM	822S SP			
NB807	55.00	x	70.10	x	8.00	FPM	827S		NB978	65.00	x	90.00	x	13.00	FPM	829N W			
NB808	64.00	x	80.00	x	8.00	FPM	829S W		NB979	65.00	x	90.00	x	15.00	FPM	823N			
NB814	70.00	x	88.00	x	8.00	FPM	829S W		NB980	42.00	x	52.00	x	7.50	FPM	829S W			
NB815	23.00	x	35.00	x	7.00	FPM	829S		NB984	66.67	x	89.30	x	10.00	FPM	827S W			
NB818	40.00	x	56.00	x	7.00	ACM	822N		NB998	30.00	x	40.00	x	7.00	FPM	827S W			
NB825	30.00	x	43.00	x	8.00	FPM	829S W		NCD006	35.00	x	48.00	x	7.00	MVQ	829S W			
NB828	27.50	x	39.50	x	7.00	FPM	827S		NCD007	57.00	x	71.00	x	9.50	FPM	827S			
NB829	79.95	x	116.00 / 126.00	x	11.50	FPM	829S W		NCD008	47.00	x	62.00	x	10.00	FPM	827N			
NB843	88.90	x	145.00	x	12.00	FPM	840N SP		NCD009	57.00	x	74.00	x	8.50	NBR	827SS DD			
NB847	88.00	x	108.00	x	11.00	FPM	827S W		NCD015	44.00	x	60.00	x	10.00	FPM	827S W			
									NCD44	40.00	x	138.00	x	11.60 / 22.20	FPM	840S			
									NCD48	38.00	x	52.00	x	6.00	FPM	827S W			



























































































OIL SEALS BY REFERENCE

▲ Payen		mm		mm		mm				▲ Payen		mm		mm		mm			
NCO65	30.00	x	40.00	x	7.00	FPM	827S W		NF339	25.00	x	47.00	x	8.00	NBR	827N			
NCO86	79.80	x	184.00	x	18.80	PTFE	841S		NF349	15.00	x	32.00	x	7.00	NBR	827N			
NFO01	68.00	x	90.00	x	10.00	NBR	827N		NF356	60.00	x	75.00	x	8.00	NBR	827N			
NFO20	22.00	x	40.00	x	8.00	NBR	827 N		NF369	35.00	x	50.00	x	8.00	NBR	827N			
NFO24	30.00	x	48.00	x	8.00	NBR	827N		NF376	20.00	x	40.00	x	7.00	NBR	827 N			
NFO26	32.00	x	52.00	x	10.00	NBR	827 N		NF387	42.00	x	60.00	x	10.00	NBR	827N			
NFO27	35.00	x	62.00	x	10.00	NBR	827N		NF387	42.00	x	60.00	x	10.00	NBR	827N			
NFO32	40.00	x	62.00	x	10.00	NBR	827N DD		NF391	55.00	x	70.00	x	8.00	ACM	827S			
NFO36	45.00	x	62.00	x	8.00	NBR	822S DD		NF395	75.00	x	100.00	x	10.00	NBR	827N			
NFO37	45.00	x	62.00	x	12.00	NBR	822N DD		NF415	72.00	x	100.00	x	12.00	NBR	827 S			
NFO44	60.00	x	80.00	x	12.00	NBR	827 N		NF449	48.00	x	72.00	x	10.00	NBR	827N			
NFO62	55.00	x	72.00	x	10.00	NBR	827 N		NF470	35.00	x	54.00	x	10.00	NBR	827 N			
NFO70	27.00	x	42.00	x	10.00	NBR	827N		NF475	40.00	x	60.00	x	10.00	NBR	827N			
NFO72	32.00	x	47.00	x	8.00	NBR	827N DD		NF477	40.00	x	62.00	x	8.00	NBR	827N			
NFO96	35.00	x	52.00	x	10.00	NBR	824N DD		NF505	31.00	x	42.00	x	8.00	NBR	827N DD			
NFO97	45.00	x	62.00	x	10.00	NBR	827S DD		NF514	115.00	x	150.00	x	13.00	NBR	827N			
NF110	55.00	x	80.00	x	8.00	NBR	827N DD		NF528	54.00	x	81.00	x	10.00	NBR	827S DD			
NF115	45.00	x	62.00	x	10.00	NBR	827N DD		NF532	170.00	x	200.00	x	15.00	NBR	827S			
NF126	35.00	x	52.00	x	8.00	NBR	827 N		NF535	30.00	x	42.00	x	8.00	NBR	827N			
NF134	15.00	x	30.00	x	7.00	NBR	827 N		NF535	30.00	x	42.00	x	8.00	NBR	827N			
NF136	20.00	x	30.00	x	4.50	NBR	827 N		NF536	20.00	x	40.00	x	8.00	NBR	827S			
NF140	25.00	x	52.00	x	8.00	NBR	827N		NF539	40.00	x	52.00	x	7.00	NBR	827N			
NF152	20.00	x	30.00	x	7.00	NBR	827 N		NF545	17.00	x	28.00	x	7.00	NBR	822 N			
NF155	12.00	x	22.00	x	7.00	NBR	827N		NF549	160.00	x	190.00	x	15.00	NBR	827S			
NF177	70.00	x	90.00	x	10.00	NBR	827 N		NF550	140.00	x	160.00	x	13.00	NBR	822N			
NF178	70.00	x	100.00	x	13.00	NBR	827S		NF603	95.00	x	120.00	x	13.00	MVQ	827N DD			
NF183	155.00	x	180.00	x	15.00	NBR	827N		NF604	50.00	x	70.00	x	10.00	MVQ	827 N			
NF185	42.00	x	62.00	x	10.00	NBR	822N DD		NF611	65.00	x	85.00	x	12.00	MVQ	827S			
NF198	40.00	x	55.00	x	8.00	NBR	827N DD		NF630	110.00	x	130.00	x	13.00	MVQ	827 N			
NF200	30.00	x	40.00	x	7.00	NBR	827N		NF634	80.00	x	100.00	x	13.00	MVQ	827N			
NF209	30.00	x	52.00	x	10.00	NBR	827N		NF636	55.00	x	70.00	x	10.00	MVQ	0			
NF213	35.00	x	50.00	x	10.00	NBR	827 N		NF637	48.00	x	65.00	x	10.00	FPM	829S W			
NF217	40.00	x	65.00	x	10.00	NBR	827N		NF640	60.50	x	78.00	x	9.00	MVQ	827N			
NF219	42.00	x	65.00	x	10.00	NBR	827 N		NF640	60.50	x	78.00	x	9.00	MVQ	827N			
NF223	58.00	x	80.00	x	10.00	NBR	827N		NF641	78.00	x	100.00	x	10.00	MVQ	827N			
NF235	40.00	x	62.00	x	10.00	NBR	827S		NF648	50.00	x	68.00	x	10.00	MVQ	827N			
NF242	20.00	x	47.00	x	7.00	NBR	827 N		NF653	150.00	x	172.00	x	18.00	MVQ	827 N W			
NF249	50.00	x	68.00	x	10.00	NBR	827S		NF663	55.00	x	68.00	x	8.00	FPM	827 N			
NF257	35.00	x	55.00	x	10.00	NBR	827N		NF685	45.00	x	60.00	x	10.00	ACM	827N			
NF310	115.00	x	140.00	x	13.00	NBR	824N		NF687	35.00	x	47.00	x	7.00	FPM	827S W			
NF316	60.00	x	80.00	x	12.00	NBR	827 N		NF692	71.00	x	88.00	x	8.00	MVQ	827N W			
NF320	140.00	x	170.00	x	15.00	NBR	827N		NF694	40.00	x	58.00	x	8.00	ACM	827N			
NF325	50.00	x	72.00	x	12.00	NBR	827S		NF695	40.00	x	58.00	x	8.00	ACM	827N			
NF334	40.00	x	58.00	x	10.00	NBR	827S		NF715	110.00	x	130.00	x	13.00	MVQ	SP			





































































































OIL SEALS BY REFERENCE

▲ Payen		mm		mm		mm				▲ Payen		mm		mm		mm				
NF718	35.00	x	50.00	x	10.00	NBR	827 S		NF861	46.00	x	59.00	x	7.00	FPM	827S W				
NF720	32.00	x	52.00	x	7.00	MVQ	827N		NF866	64.00	x	88.00	x	6.00	FPM / ACM	827S				
NF722	35.00	x	50.00	x	10.00	MVQ	827S		NF867	98.00	x	120.00	x	7.00	FPM / ACM	827S				
NF734	45.00	x	62.00	x	10.00	MVQ	827S DD W		NF869	32.00	x	45.00	x	8.00	FPM	827N W				
NF741	29.00	x	46.00	x	10.00	ACM	827N		NF870	42.00	x	66.00	x	6.00	FPM / ACM	827S W				
NF746	36.00	x	50.00	x	7.00	ACM	827N		NF875	7.00	x	13.50	x	1.20	Brass	0				
NF756	45.00	x	60.00	x	6.50	NBR	827N		NF881	43.00	x	59.00	x	10.00	FPM	827S				
NF761	42.00	x	62.00	x	10.00	FPM / ACM	827S		NF882	35.00	x	54.00	x	11.00	FPM	827S				
NF776	75.00	x	90.00	x	11.50	FPM / ACM	827SW		NF882	35.00	x	54.00	x	11.00	FPM	827S				
NF778	48.00	x	72.00	x	10.00	FPM	827S		NF883	114.00	x	171.00 / 177.00	x	13.00	FPM	840S				
NF780	45.00	x	60.00	x	7.00	ACM	827S W		NF885	70.00	x	159.00 / 179.00	x	16.00	FPM	840S				
NF790	42.00	x	62.00	x	7.00	NBR	827 N		NF886	100.00	x	179.00	x	15.80	FPM	840S				
NF791	27.95	x	56.00	x	7.00	ACM	827S		NF887	64.00	x	112.50	x	20.00	FPM	840				
NF792	29.80	x	47.00	x	9.90	NBR	827S		NF888	93.00	x	139.70 / 172.00	x	12.00	FPM	840S				
NF800	100.00	x	130.00	x	13.00	NBR	827S		NJ001	70.00	x	92.00	x	8.50	MVQ	827S				
NF806	28.50	x	38.00	x	6.00	NBR	827S		NJ002	38.00	x	74.00	x	11.50	NBR	822 S				
NF808	36.00	x	50.00	x	8.00	ACM	SP		NJ004	60.00	x	82.00	x	12.00	FPM / ACM	827S				
NF809	56.00	x	69.00	x	10.00	FPM	827S W		NJ005	44.00	x	60.00	x	7.00	NBR	827S				
NF810	57.50	x	70.00	x	10.00	MVQ	827S W		NJ006	72.00	x	96.00	x	9.00	MVQ	827S				
NF812	30.00	x	42.00	x	8.00	ACM	827N		NJ007	44.00	x	65.00	x	11.00	NBR	827S				
NF814	36.00	x	54.00	x	11.00	NBR	827S DD		NJ011	40.00	x	52.00	x	7.00	FPM	822S DD				
NF817	36.00	x	50.00	x	7.00	FPM	827S W		NJ014	50.00	x	68.00	x	9.00	NBR	827S				
NF824	40.00	x	58.00	x	10.00	NBR	827S W		NJ015	40.00	x	52.00	x	6.00	NBR	822 S				
NF825	32.00	x	50.00	x	10.00	FPM	827S W		NJ021	60.00	x	82.00	x	12.00	FPM / ACM	827S				
NF826	29.90	x	47.00	x	11.30	ACM	827S W SP		NJ022	38.00	x	55.00	x	9.00	FPM / ACM	827S				
NF833	90.00	x	115.00	x	13.00	FPM	829S W		NJ026	25.00	x	35.00	x	6.00	NBR	822 N				
NF834	35.00	x	50.00	x	8.00	FPM	827S		NJ030	80.00	x	100.00	x	12.00	ACM	827S				
NF835	80.00	x	100.00	x	8.00	FPM / ACM	827S W		NJ033	38.00	x	52.00	x	9.50	NBR	827 S				
NF836	40.00	x	58.00	x	11.30	ACM	827S DD W SP		NJ036	41.00	x	56.00	x	7.00	NBR	822N				
NF840	150.00	x	172.00	x	13.00	PTFE	SP		NJ042	48.00	x	70.00	x	12.00	NBR	827SS				
NF841	35.00	x	50.00	x	8.00	FPM	827N DD		NJ043	40.00	x	75.00	x	12.00	NBR	827 S				
NF843	50.00	x	68.00	x	10.00	FPM / ACM	827S W		NJ044	75.00	x	100.00	x	13.00	MVQ	827S				
NF844	90.00	x	110.00	x	11.00	FPM / ACM	827S W		NJ045	48.00	x	70.00	x	9.00	NBR	827N				
NF846	25.00	x	42.00	x	7.00	FPM / ACM	827S W		NJ052	42.00	x	55.00	x	7.00	NBR	822S DD				
NF847	22.00	x	45.00	x	7.00	FPM / ACM	827S W		NJ055	100.00	x	120.00	x	11.00	MVQ	827S DD				
NF849	30.00	x	40.00	x	7.00	MVQ	827S W		NJ056	80.00	x	100.00	x	13.00	MVQ	827S				
NF850	85.00	x	105.00	x	8.00	FPM	827S W		NJ058	80.00	x	96.00	x	9.00	NBR	827S SP				
NF851	25.00	x	40.00	x	7.00	FPM / ACM	827S W		NJ060	82.00	x	105.00	x	13.00	MVQ	SP				
NF853	100.00	x	118.00	x	10.00	FPM	829S W		NJ062	62.00	x	85.00	x	10.00	NBR	824 S				
NF853	100.00	x	118.00	x	10.00	FPM	829S W		NJ064	47.50	x	70.70	x	9.00	NBR	827 S				
NF856	32.00	x	44.00	x	6.00	FPM	827S W		NJ066	48.00	x	62.00	x	7.00	NBR	824S				
NF857	85.00	x	105.00	x	9.00	FPM / ACM	827S W													
NF858	33.00	x	43.00	x	6.00	FPM	827S W													
NF860	93.00	x	108.00	x	7.00	FPM / ACM	827S W													



































































































OIL SEALS BY REFERENCE

▲ Payen		mm		mm		mm				▲ Payen		mm		mm		mm			
NJ068	52.00	x	65.00	x	9.00	NBR	824 N		NJ220	38.00	x	49.00	x	8.00	NBR	827 SS			
NJ069	50.00	x	68.00	x	9.00	NBR	824 S		NJ222	40.00	x	52.00	x	7.00	FPM	829S W			
NJ070	50.00	x	70.00	x	9.00	NBR	822 S		NJ225	70.00	x	88.00	x	9.00	NBR				
NJ071	42.00	x	62.00	x	9.00	NBR	827 S		NJ232	100.00	x	135.00	x	15.00	MVQ	SP			
NJ072	35.00	x	50.00	x	8.00	NBR	827S		NJ233	70.00	x	92.00	x	12.00	NBR	827 S			
NJ080	35.00	x	50.00	x	11.00	NBR	827 S		NJ239	50.00	x	72.00	x	12.00	NBR	827SS			
NJ082	48.00	x	62.00	x	13.00	NBR	827S SP		NJ240	95.00	x	115.00	x	12.00	MVQ	827S			
NJ084	24.00	x	40.00	x	8.00	NBR	827 S		NJ242	35.00	x	50.00	x	8.00	NBR	827S			
NJ088	38.00	x	52.00	x	6.00	NBR	827 S		NJ243	45.00	x	68.00	x	12.00	NBR	827S			
NJ090	47.00	x	62.00	x	9.00	NBR	822 N		NJ251	80.00	x	96.00	x	9.00	MVQ	827S			
NJ096	38.00	x	55.00	x	8.00	NBR	827 S		NJ252	30.00	x	46.00	x	7.00	NBR	827S			
NJ098	95.00	x	110.00	x	11.00	MVQ	827S		NJ254	27.00	x	43.00	x	9.00	NBR	827S			
NJ099	70.00	x	88.00	x	12.00	MVQ	827S		NJ255	17.00	x	28.00	x	7.00	NBR	827S			
NJ100	48.00	x	70.00	x	9.50	NBR	827 S		NJ258	55.00	x	78.00	x	12.00	NBR	827S			
NJ101	33.00	x	55.00	x	9.50	NBR	822 N		NJ265	82.00	x	105.00	x	13.00	MVQ	827SS			
NJ102	38.50	x	58.00	x	11.00	NBR	827S		NJ267	42.00	x	55.00	x	9.00	NBR	827SS			
NJ106	40.00	x	62.00	x	10.00	NBR	827S DD		NJ268	32.00	x	48.00	x	7.00	NBR	827SS			
NJ118	25.00	x	38.00	x	7.00	NBR	827 S		NJ269	58.00	x	74.00	x	10.00	ACM	827S			
NJ119	25.00	x	40.00	x	7.00	NBR	822 N		NJ270	28.00	x	42.00	x	8.00	NBR	827S DD			
NJ122	42.00	x	72.00	x	10.00	NBR	827 S		NJ274	35.00	x	55.00	x	11.00	NBR	827S DD			
NJ125	34.00	x	44.00	x	10.00	NBR	SP		NJ280	33.00	x	47.00	x	8.00	NBR	827S			
NJ127	38.00	x	52.00	x	7.00	NBR	SP		NJ283	36.00	x	50.00	x	8.00	NBR	827S			
NJ132	56.00	x	78.00	x	6.50	NBR	SP		NJ284	84.00	x	104.00	x	11.00	MVQ	827S W			
NJ133	56.00	x	68.00	x	8.00	NBR	SP		NJ285	34.00	x	48.00	x	8.00	NBR	827S			
NJ134	28.00	x	42.00	x	8.00	MVQ	827S		NJ286	36.00	x	49.00	x	7.00	NBR	827S			
NJ140	61.00	x	76.00	x	10.00	NBR	822 S		NJ287	80.00	x	100.00	x	10.00	MVQ	827S			
NJ141	66.00	x	80.00	x	9.00	NBR	824 S		NJ288	40.00	x	55.00	x	9.00	NBR	827SS			
NJ144	23.50	x	40.00	x	7.50	NBR	827S		NJ298	65.00	x	88.00	x	12.00	NBR	827SS			
NJ145	33.00	x	44.00	x	10.00	NBR	822S		NJ304	25.00	x	45.00	x	10.00	NBR	827 S			
NJ151	29.00	x	50.00	x	9.00	ACM	0		NJ312	80.00	x	100.00	x	10.00	MVQ	827S			
NJ154	89.00	x	109.00	x	9.00	MVQ	827 S		NJ313	29.00	x	45.00	x	8.00	ACM	827S			
NJ158	95.00	x	118.00	x	10.00	ACM	827S		NJ321	28.00	x	47.00	x	8.00	NBR	827N W			
NJ161	35.00	x	56.00	x	8.00	ACM	827 S		NJ322	95.00	x	118.00	x	10.00	NBR	827S			
NJ165	35.00	x	62.00	x	8.00	ACM	827 SS		NJ323	40.00	x	56.00	x	7.00	NBR	827SS			
NJ186	33.00	x	59.00	x	11.00	NBR	827S		NJ324	34.00	x	48.00	x	7.00	ACM	827S			
NJ190	40.00	x	56.00	x	8.00	ACM	827 S		NJ325	90.00	x	110.00	x	9.00	MVQ	827S			
NJ199	49.00	x	62.00	x	8.00	NBR	SP		NJ336	32.00	x	47.00	x	8.00	NBR	827S			
NJ200	48.00	x	68.00	x	7.00	NBR	827SS		NJ337	60.00	x	80.00	x	8.00	NBR	827S			
NJ207	27.00	x	49.00	x	7.50	ACM	827N		NJ341	38.00	x	59.00	x	9.00	NBR	827S			
NJ212	37.00	x	58.00	x	10.00	NBR	SP		NJ344	42.00	x	60.00	x	7.00	NBR	827S			
NJ213	39.00	x	59.00	x	11.00	NBR	827S		NJ346	90.00	x	110.00	x	8.50	MVQ	827S			
NJ215	85.00	x	105.00	x	10.00	FPM	823S		NJ347	38.00	x	50.00	x	8.00	NBR	827S			
NJ217	50.00	x	80.00	x	16.50	ACM	827 S		NJ349	32.50	x	46.00	x	6.00	NBR	827S			
NJ219	51.00	x	72.00	x	9.50	NBR	SP		NJ351	45.00	x	62.00	x	8.00	NBR	827S			































































OIL SEALS BY REFERENCE

▲ Payen		mm		mm		mm				▲ Payen		mm		mm		mm			
NJ353	35.00	x	49.00	x	6.00	NBR	827S		NJ500	68.00	x	90.00	x	12.00	NBR	822S			
NJ354	85.00	x	105.00	x	10.00	MVQ	827S		NJ511	100.00	x	114.00	x	12.00	NBR	822 S			
NJ358	42.00	x	60.00	x	9.00	NBR	827S		NJ520	33.00	x	44.00	x	8.00	NBR	822S			
NJ360	80.00	x	100.00	x	8.50	MVQ	827SS		NJ523	48.00	x	82.00	x	12.00	NBR	822S			
NJ363	38.00	x	54.00	x	7.00	NBR	827S		NJ525	68.00	x	90.00	x	10.00	NBR	824 S			
NJ364	75.00	x	94.00	x	10.00	MVQ	827SS		NJ527	42.00	x	62.00	x	7.00	NBR	827 S			
NJ368	33.00	x	47.00	x	7.00	NBR	827SS		NJ536	40.00	x	54.00	x	8.00	NBR	827 S			
NJ369	58.00	x	80.00	x	12.00	ACM	827SS		NJ537	52.00	x	68.00	x	7.00	NBR	SP			
NJ373	28.00	x	40.00	x	8.00	NBR	827S		NJ538	50.00	x	66.50	x	13.00	NBR	827 S			
NJ377	32.00	x	47.00	x	6.00	ACM	827S		NJ539	50.00	x	65.00	x	10.00	NBR	822 S			
NJ378	68.00	x	86.00	x	8.00	ACM	827S		NJ540	36.00	x	62.00	x	14.00	NBR	822 S			
NJ381	31.00	x	46.00	x	8.00	NBR	827S		NJ553	38.00	x	50.30	x	10.00	NBR	822S SP			
NJ382	45.00	x	75.00	x	12.00	NBR	822 S		NJ557	48.00	x	62.00	x	7.00	NBR	824 S			
NJ385	70.00	x	112.00	x	14.00	NBR	0		NJ562	48.00	x	62.00	x	9.00	NBR	822 S			
NJ390	68.00	x	88.00	x	10.00	NBR	824S		NJ569	40.00	x	74.00	x	10.00	NBR	822 S			
NJ391	138.00	x	152.00	x	12.00	NBR	0		NJ571	80.00	x	113.00	x	12.00	NBR	SP			
NJ397	70.00	x	112.00	x	10.00	NBR	SP		NJ575	35.00	x	67.00	x	12.00	NBR	827 S			
NJ399	30.00	x	45.00	x	8.00	NBR	827 N		NJ577	40.00	x	52.00	x	8.00	NBR	827 S			
NJ407	75.00	x	100.00	x	8.50	MVQ	827S		NJ585	58.00	x	103.00	x	11.00	NBR	822 S			
NJ413	45.00	x	63.00	x	7.00	NBR	822S		NJ588	55.00	x	78.00	x	12.00	NBR	0			
NJ415	35.00	x	48.00	x	8.00	NBR	827 S		NJ603	55.00	x	70.00	x	9.00	NBR	827 S			
NJ416	32.00	x	45.00	x	8.00	NBR	822S		NJ606	32.00	x	52.00	x	11.00	NBR	827 SS			
NJ419	42.00	x	54.00	x	8.00	NBR	822S DD		NJ607	35.00	x	55.00	x	11.00	NBR	822S			
NJ420	101.00	x	114.00	x	10.00	NBR	822S		NJ609	38.00	x	58.00	x	11.00	NBR	822 S			
NJ426	29.00	x	36.00	x	8.00	NBR	822 S		NJ610	25.00	x	35.00	x	6.00	NBR	827S			
NJ427	38.00	x	45.00	x	8.00	NBR	822S		NJ611	30.00	x	45.00	x	6.00	NBR	827 S			
NJ429	50.00	x	65.00	x	9.00	NBR	822S		NJ612	36.00	x	52.00	x	10.00	NBR	827 SS			
NJ439	28.60	x	43.00	x	6.50	NBR	822S		NJ614	28.00	x	38.00	x	7.00	NBR	822 N			
NJ441	40.00	x	75.00	x	12.00	ACM	827 S		NJ617	25.00	x	37.00	x	8.00	NBR	827 SS			
NJ444	19.00	x	32.00	x	8.00	NBR	827 S		NJ621	17.00	x	30.00	x	7.00	NBR	827 S			
NJ446	87.00	x	100.00	x	8.00	MVQ	827N		NJ634	40.00	x	58.00	x	8.00	NBR	827 SS			
NJ448	30.00	x	44.00	x	7.00	NBR	827S		NJ635	25.00	x	40.00	x	8.00	NBR	827 N			
NJ449	40.00	x	52.00	x	6.00	NBR	827S		NJ637	40.00	x	56.00	x	8.00	NBR	827 S			
NJ450	45.00	x	68.00	x	12.00	NBR	827S DD		NJ639	52.00	x	68.00	x	13.00	NBR	827S DD			
NJ452	35.00	x	56.00	x	9.00	NBR	827S SP		NJ645	52.00	x	70.00	x	8.50	ACM	827SS			
NJ454	30.00	x	45.00	x	8.00	NBR	827S DD		NJ649	18.00	x	35.00	x	8.00	NBR	822 S			
NJ472	76.00	x	102.00	x	9.50	NBR	SP		NJ650	83.00	x	100.00	x	9.00	ACM	827S			
NJ474	52.00	x	72.00	x	7.50	NBR	822 S		NJ651	38.00	x	62.00	x	8.00	NBR	827S SP			
NJ475	40.00	x	60.00	x	10.00	NBR	822 S		NJ654	20.00	x	32.00	x	5.00	ACM	827S			
NJ484	27.00	x	43.00	x	9.00	NBR	827 SS		NJ655	20.00	x	30.00	x	7.00	NBR	827S			
NJ489	155.00	x	180.00	x	17.00	NBR	822 S		NJ659	52.00	x	66.00	x	9.00	NBR	827 N			
NJ490	85.00	x	110.00	x	13.00	NBR	827 S		NJ661	66.00	x	85.00	x	8.00	NBR	824S SP			
NJ492	45.00	x	58.00	x	9.00	NBR	822S		NJ674	90.00	x	110.00	x	13.00	MVQ	827 SS			
NJ497	100.00	x	123.00	x	12.50	MVQ	827SS		NJ675	80.00	x	98.00	x	10.00	NBR	827SS			



































































































OIL SEALS BY REFERENCE

▲ Payen		mm		mm		mm				▲ Payen		mm		mm		mm				
NJ678	50.00	x	70.00	x	7.00	NBR	824 S		NJ849	26.00	x	38.00	x	8.00	NBR	827 S				
NJ687	38.00	x	58.00	x	11.00	NBR	827 S		NJ855	28.00	x	38.00	x	10.00	NBR	827 N				
NJ689	40.00	x	56.00	x	10.00	NBR	SP		NJ856	38.00	x	60.00	x	8.00	NBR	827 S				
NJ695	57.00	x	79.00	x	9.00	NBR	SP		NJ858	19.00	x	38.00	x	7.00	NBR	827 S				
NJ701	50.00	x	68.00	x	7.00	NBR	SP		NJ860	34.00	x	54.00	x	9.00	ACM	827 S				
NJ702	38.00	x	44.00	x	17.50	NBR	0		NJ861	35.00	x	55.00	x	9.00	NBR	827 S				
NJ704	33.50	x	54.00	x	9.00	NBR	827 S		NJ864	48.00	x	74.00	x	10.00	NBR	827 S				
NJ705	34.00	x	63.00	x	9.00	NBR	827 S		NJ867	52.00	x	66.00	x	7.50	NBR	822 S				
NJ706	37.50	x	50.00	x	6.00	ACM	827S		NJ868	56.00	x	73.00	x	8.00	NBR	822 S				
NJ713	37.00	x	57.00	x	10.00	NBR	827 S		NJ872	32.00	x	40.00	x	5.00	NBR	827 N				
NJ717	154.00	x	172.00	x	14.00	NBR	822 S		NJ873	91.00	x	111.00	x	9.00	FPM	827SS				
NJ719	38.50	x	58.00	x	8.50	NBR	827S		NJ874	37.00	x	50.00	x	6.00	ACM	827S				
NJ737	73.00	x	90.00	x	8.00	NBR	822 S		NJ875	32.00	x	44.00	x	6.00	ACM	827S				
NJ739	45.00	x	72.00	x	12.00	NBR	822 S		NJ877	16.00	x	28.00	x	15.00	NBR	SP				
NJ743	35.00	x	48.00	x	7.00	NBR	827 S		NJ879	65.00	x	88.00	x	10.00	NBR	SP				
NJ748	39.00	x	52.00	x	6.00	NBR	822S SP		NJ880	65.00	x	88.00	x	8.50	NBR	SP				
NJ749	35.00	x	56.00	x	9.00	NBR	827 S		NJ886	65.00	x	90.00	x	10.00	NBR	827 S				
NJ755	127.00	x	146.00	x	10.00	NBR	822 S		NJ887	38.00	x	62.00	x	11.00	NBR	822 S				
NJ758	20.00	x	35.00	x	5.50	NBR	827S		NJ888	33.00	x	44.00	x	7.00	NBR	822 S				
NJ761	35.00	x	62.00	x	9.50	NBR	827 S		NJ892	52.00	x	70.00	x	9.00	NBR	822 S				
NJ765	40.00	x	52.00	x	7.00	NBR	827S		NJ909	60.00	x	75.00	x	11.50	NBR	SP				
NJ768	45.00	x	80.00	x	10.00	ACM	827 S		NJ913	18.50	x	32.00	x	7.00	NBR	827 S				
NJ777	35.00	x	76.00	x	9.00	NBR	827S SP		NJ915	35.00	x	56.00	x	8.00	NBR	827 S				
NJ778	22.00	x	35.00	x	7.00	NBR	827 S		NJ921	45.00	x	68.00	x	12.50	NBR	827S SP				
NJ779	27.00	x	42.00	x	7.00	NBR	827 S		NJ933	35.00	x	50.00	x	8.00	FPM	827S				
NJ790	120.00	x	153.00	x	15.00	MVQ	827 N		NJ939	117.50	x	174.00	x	15.00	NBR	SP				
NJ793	20.00	x	38.00	x	7.00	NBR	827 N		NJ939	117.50	x	174.00	x	15.00	NBR	SP				
NJ794	38.00	x	49.30	x	9.00	NBR	822 S		NJ942	49.00	x	100.00	x	8.00	NBR	SP				
NJ797	35.00	x	55.00	x	10.00	NBR	SP		NJ945	22.20	x	35.00	x	7.00	NBR	827 S				
NJ802	46.00	x	94.50	x	18.00	NBR	SP		NJ946	32.00	x	52.00	x	7.00	ACM	827 S				
NJ806	26.00	x	38.00	x	8.00	NBR	827 N		NJ949	58.00	x	75.00	x	7.50	NBR	SP				
NJ807	8.00	x	16.00	x	6.00	NBR	827 S		NJ951	32.00	x	50.00	x	8.00	FPM	829S W				
NJ808	51.00	x	63.00	x	8.50	NBR	822 S		NJ961	40.00	x	72.00	x	10.00	NBR	SP				
NJ811	42.00	x	58.00	x	7.00	NBR	822 S		NJ962	32.00	x	42.00	x	10.00	NBR	SP				
NJ820	65.00	x	90.00	x	13.00	NBR	822 S		NJ963	18.00	x	30.00	x	7.00	ACM	827S				
NJ822	40.00	x	65.00	x	10.00	NBR	822 S		NJ966	75.50	x	108.00	x	10.00	NBR	SP				
NJ825	52.00	x	72.00	x	8.00	NBR	822 S		NJ985	35.00	x	49.60	x	11.00	NBR	827S				
NJ829	86.00	x	100.00	x	10.00	MVQ	827S		NJ986	19.00	x	35.00	x	7.00	NBR	827 S				
NJ830	25.00	x	35.00	x	7.00	NBR	822 S		NJ991	48.00	x	62.00	x	9.00	NBR	827 N				
NJ831	58.00	x	80.00	x	10.00	NBR	827S		NJ992	54.00	x	69.00	x	7.50	NBR	827 S				
NJ832	20.00	x	35.00	x	7.00	NBR	827 SS		NJ995	52.00	x	75.00	x	7.50	NBR	822 S				
NJ838	56.00	x	72.00	x	8.00	NBR	827S DD		NJ996	54.00	x	66.00	x	7.50 / 10.00	NBR	822S				
NJ844	43.00	x	54.00	x	6.00	NBR	824S DD													
NJ846	38.50	x	53.00	x	8.00	NBR	827SS													





































































































OIL SEALS BY REFERENCE

▲ Payen		mm		mm		mm				▲ Payen		mm		mm		mm				
NJ998	63.00	x	90.00	x	7.00 / 9.20		NBR	822S		NK205	89.00	x	109.00	x	9.00 / 10.30		MVQ	827S		
NK009	59.00	x	75.00	x	10.00		NBR	822S		NK208	69.00	x	86.00	x	7.00		NBR	SP		
NK012	45.00	x	59.00	x	8.00		NBR	SP		NK212	56.00	x	76.00	x	5.00 / 12.30		NBR	SP		
NK020	127.00	x	147.00	x	11.00		NBR	822 S												
NK021	57.00	x	124.00	x	13.00		NBR	SP		NK214	35.00	x	63.00	x	10.00 / 16.50		ACM	822S SP		
NK034	58.00	x	68.00	x	11.00		NBR	SP												
NK035	75.00	x	93.00	x	9.00		MVQ	827SS		NK216	95.00	x	115.00	x	9.50		MVQ	827SS		
NK036	17.00	x	30.00	x	8.00		NBR	822 S		NK216	95.00	x	115.00	x	9.50		MVQ	827SS		
NK038	46.00	x	101.80	x	11.00		NBR	SP		NK233	25.00	x	35.00	x	6.00		NBR	827SS		
NK050	40.00	x	55.00	x	6.00		ACM	827SS		NK251	50.00	x	68.00	x	9.00		NBR	827S		
NK052	48.00	x	62.00	x	9.00		ACM	827 SS		NK265	40.00	x	72.00	x	11.00 / 18.50		NBR	827S SP		
NK054	56.00	x	75.00	x	6.50		NBR	822 S												
NK055	88.00	x	106.00	x	8.70		FPM	827S		NP067	50.00	x	70.00	x	10.00		FPM	829S W		
NK066	40.00	x	76.00	x	9.00		ACM	827 S		NP068	55.00	x	70.00	x	8.00		FPM	827S W		
NK072	15.00	x	32.00	x	7.50		NBR	827 S												
NK073	19.00	x	30.00	x	8.00		NBR	822 N												
NK074	35.00	x	52.00	x	10.00		NBR	827 S												
NK076	40.00	x	58.00	x	11.00		ACM	827 SS												
NK080	25.00	x	38.00	x	7.00		NBR	827 S												
NK084	43.00	x	60.00	x	9.00		ACM	827 SS												
NK086	27.00	x	40.00	x	8.00		NBR	827 S												
NK095	16.00	x	30.00	x	7.00		NBR	827 S												
NK096	51.00	x	63.00	x	7.50		NBR	822 S												
NK098	52.00	x	68.00	x	7.50		NBR	822 S												
NK099	56.00	x	75.00	x	8.00		NBR	822 S												
NK103	87.00	x	100.00	x	8.50		FPM	827S												
NK105	50.00	x	65.00	x	8.00		ACM	827 S												
NK106	46.00	x	58.00	x	7.00		ACM	827S												
NK117	32.00	x	45.00	x	8.00		ACM	0												
NK122	35.00	x	50.00	x	9.50		NBR	SP												
NK133	12.00	x	22.00	x	7.00		ACM	827 S												
NK137	25.00	x	42.00	x	7.00		ACM	827 S												
NK139	86.00	x	103.00	x	10.00		MVQ	824 S												
NK143	85.00	x	103.00	x	8.00		FPM	827S												
NK146	50.00	x	65.00	x	8.00		NBR	SP												
NK150	40.50	x	52.60	x	6.00		ACM	827 S												
NK158	37.00	x	50.50	x	7.00		ACM	827S												
NK162	54.00	x	76.00	x	8.00		NBR	SP												
NK168	38.00	x	58.00	x	11.00		NBR	827 S												
NK169	89.50	x	105.00	x	10.00		MVQ	827 S												
NK170	92.00	x	110.00	x	10.00		FPM	SP												
NK180	42.00	x	55.00	x	8.00		MVQ	827SS												
NK198	34.00	x	54.00	x	9.00		ACM	827 SS												





































































































OIL SEALS BY SIZE

 mm	 mm	 mm					 mm	 mm	 mm								
7.00	x	13.50	x	1.20	Brass	0		NF875	23.50	x	40.00	x	7.50	NBR	827S		NJ144
8.00	x	16.00	x	6.00	NBR	827 S		NJ807	24.00	x	39.00	x	8.00	PTFE / AEM	827SW		NA5458
12.00	x	22.00	x	7.00	NBR	827N		NF155	24.00	x	40.00	x	8.00	NBR	827 S		NJ084
12.00	x	22.00	x	7.00	ACM	827 S		NK133	24.00	x	50.00	x	8.00	PTFE / ACM	827SW		NA5453
12.00	x	24.00	x	6.00	FPM	827N		NA5358	25.00	x	35.00	x	6.00	NBR	822 N		NJ026
14.30	x	29.36	x	19.84	NBR	0		NB064	25.00	x	35.00	x	6.00	NBR	827S		NJ610
15.00	x	21.00	x	5.00	NBR	822SK		NA5263	25.00	x	35.00	x	6.00	NBR	827SS		NK233
15.00	x	25.40	x	5.20	NBR	827S SP		NB083	25.00	x	35.00	x	7.00	NBR	822 S		NJ830
15.00	x	30.00	x	7.00	NBR	827 N		NF134	25.00	x	37.00	x	8.00	NBR	827 SS		NJ617
15.00	x	32.00	x	7.00	NBR	827N		NF349	25.00	x	38.00	x	7.00	NBR	827 S		NJ118
15.00	x	32.00	x	7.50	NBR	827 S		NK072	25.00	x	38.00	x	7.00	NBR	827 S		NK080
15.90	x	39.30	x	11.70	NBR	SP		NB077	25.00	x	40.00	x	7.00	FPM / ACM	827S W		NF851
16.00	x	28.00	x	15.00	NBR	SP		NJ877	25.00	x	40.00	x	7.00	NBR	822 N		NJ119
16.00	x	30.00	x	7.00	NBR	827 S		NK095	25.00	x	40.00	x	8.00	NBR	827 N		NJ635
17.00	x	28.00	x	7.00	NBR	822 N		NF545	25.00	x	42.00	x	7.00	FPM / ACM	827S W		NF846
17.00	x	28.00	x	7.00	NBR	827S		NJ255	25.00	x	42.00	x	7.00	ACM	827 S		NK137
17.00	x	30.00	x	7.00	NBR	827 S		NJ621	25.00	x	45.00	x	10.00	NBR	827 S		NJ304
17.00	x	30.00	x	8.00	NBR	822 S		NK036	25.00	x	47.00	x	8.00	NBR	827N		NF339
18.00	x	30.00	x	7.00	ACM	827S		NJ963	25.00	x	52.00	x	8.00	NBR	827N		NF140
18.00	x	32.00	x	6.00	ACM	827S		NA5271	26.00	x	38.00	x	8.00	NBR	827 N		NJ806
18.00	x	35.00	x	8.00	NBR	822 S		NJ649	26.00	x	38.00	x	8.00	NBR	827 S		NJ849
18.50	x	32.00	x	7.00	NBR	827 S		NJ913	26.00	x	42.00	x	8.00	FPM	827S W		NB697
19.00	x	30.00	x	8.00	NBR	822 N		NK073	26.00	x	45.00	x	8.00	FPM	ASW		NA5318
19.00	x	32.00	x	8.00	NBR	827 S		NJ444	27.00	x	37.00	x	7.00	FPM	829S W		NA5057
19.00	x	35.00	x	7.00	NBR	827 S		NJ986	27.00	x	40.00	x	8.00	NBR	827 S		NK086
19.00	x	38.00	x	7.00	NBR	827 S		NJ858	27.00	x	42.00	x	7.00	NBR	827 S		NJ779
20.00	x	30.00	x	4.50	NBR	827 N		NF136	27.00	x	42.00	x	8.00	FPM	827S W		NA5180
20.00	x	30.00	x	7.00	NBR	827 N		NF152	27.00	x	42.00	x	10.00	NBR	827N		NF070
20.00	x	30.00	x	7.00	NBR	827S		NJ655	27.00	x	43.00	x	9.00	NBR	827S		NJ254
20.00	x	32.00	x	5.00	ACM	827S		NJ654	27.00	x	43.00	x	9.00	NBR	827 SS		NJ484
20.00	x	35.00	x	5.50	NBR	827S		NJ758	27.00	x	47.00	x	7.00	FPM	827S W		NA5035
20.00	x	35.00	x	7.00	NBR	827 SS		NJ832	27.00	x	47.00	x	7.00	PTFE	827S W		NA5258
20.00	x	38.00	x	7.00	NBR	827 N		NJ793	27.00	x	49.00	x	7.50	ACM	827N		NJ207
20.00	x	40.00	x	7.00	NBR	827 N		NF376	27.50	x	39.50	x	7.00	FPM	827S		NB828
20.00	x	40.00	x	8.00	NBR	827S		NF536	27.95	x	56.00	x	7.00	ACM	827S		NF791
20.00	x	47.00	x	7.00	NBR	827 N		NF242	28.00	x	38.00	x	7.00	FPM	827S		NB785
22.00	x	35.00	x	7.00	NBR	827 S		NJ778	28.00	x	38.00	x	7.00	NBR	822 N		NJ614
22.00	x	40.00	x	8.00	NBR	827 N		NF020	28.00	x	38.00	x	10.00	NBR	827 N		NJ855
22.00	x	45.00	x	7.00	FPM / ACM	827S W		NF847	28.00	x	39.00	x	7.00	PTFE / ACM	827SP		NA5454
22.20	x	35.00	x	7.00	NBR	827 S		NJ945	28.00	x	40.00	x	8.00	NBR	827S		NA195
22.23	x	35.70	x	9.53	NBR	827N SP		NA187	28.00	x	40.00	x	8.00	NBR	827S		NJ373
23.00	x	35.00	x	7.00	FPM	829S		NB815	28.00	x	42.00	x	5.00	FPM	827S W		NA5215
23.00	x	36.00	x	6.00 / 7.00	NBR	827N W		NA5449	28.00	x	42.00	x	6.00	PTFE / ACM	827SW		NA5328
									28.00	x	42.00	x	8.00	MVQ	827S		NJ134































































































OIL SEALS BY SIZE

																	
28.00	x	42.00	x	8.00	NBR	827S DD		NJ270	32.00	x	40.00	x	5.00	NBR	827 N		NJ872
28.00	x	47.00	x	5.50	FPM	827S W		NA5257	32.00	x	42.00	x	6.00 / 7.00	FPM	829S W		NA5185
28.00	x	47.00	x	8.00	PTFE / ACM	827SW		NA5261									
28.00	x	47.00	x	8.00	NBR	827N W		NJ321	32.00	x	42.00	x	10.00	NBR	SP		NJ962
28.50	x	38.00	x	6.00	NBR	827S		NF806	32.00	x	44.00	x	6.00	ACM	827S		NA5322
28.60	x	43.00	x	6.50	NBR	822S		NJ439	32.00	x	44.00	x	6.00	PTFE	827S W		NA5326
29.00	x	36.00	x	8.00	NBR	822 S		NJ426	32.00	x	44.00	x	6.00	FPM	827S W		NF856
29.00	x	43.00	x	8.00	ACM	827S		NA5245	32.00	x	44.00	x	6.00	ACM	827S		NJ875
29.00	x	45.00	x	8.00	ACM	827S		NJ313	32.00	x	45.00	x	6.00	FPM	829S		NA5139
29.00	x	46.00	x	10.00	ACM	827N		NF741	32.00	x	45.00	x	8.00	FPM	827N W		NF869
29.00	x	50.00	x	9.00	ACM	0		NJ151	32.00	x	45.00	x	8.00	NBR	822S		NJ416
29.80	x	47.00	x	9.90	NBR	827S		NF792	32.00	x	45.00	x	8.00	ACM	0		NK117
29.90	x	47.00	x	11.30	PTFE / ACM	827SW		NA5204	32.00	x	47.00	x	6.00	ACM	827S		NJ377
29.90	x	47.00	x	11.30	ACM	827S W SP		NF826	32.00	x	47.00	x	8.00	NBR	827N DD		NF072
30.00	x	40.00	x	7.00	MVQ	827S		NB586	32.00	x	47.00	x	8.00	NBR	827S		NJ336
30.00	x	40.00	x	7.00	FPM	827S W		NB998	32.00	x	47.00	x	10.00	FPM	827S DD W		NA5001
30.00	x	40.00	x	7.00	FPM	827S W		NC065	32.00	x	47.00	x	10.00	PTFE / ACM	827SW		NA5124
30.00	x	40.00	x	7.00	NBR	827N		NF200	32.00	x	47.00	x	10.00	FPM	827S W		NA5163
30.00	x	40.00	x	7.00	MVQ	827S W		NF849	32.00	x	47.00	x	10.00	PTFE	827S W		NA5307
30.00	x	42.00	x	7.00	FPM	827S W		NA5053	32.00	x	47.00	x	10.00	PTFE	SP		NA5361
30.00	x	42.00	x	8.00	NBR	827N		NF535	32.00	x	48.00	x	7.00	NBR	827SS		NJ268
30.00	x	42.00	x	8.00	ACM	827N		NF812	32.00	x	50.00	x	8.00	FPM	829S W		NJ951
30.00	x	43.00	x	8.00	ACM	829S W		NB742	32.00	x	50.00	x	10.00	FPM	827S W		NF825
30.00	x	43.00	x	8.00	FPM	829S W		NB825	32.00	x	52.00	x	7.00	MVQ	827N		NF720
30.00	x	44.00	x	7.00	NBR	827S		NJ448	32.00	x	52.00	x	7.00	ACM	827 S		NJ946
30.00	x	45.00	x	6.00	NBR	827 S		NJ611	32.00	x	52.00	x	10.00	NBR	827 N		NF026
30.00	x	45.00	x	7.00	FPM	829S W		NA5347	32.00	x	52.00	x	11.00	NBR	827 SS		NJ606
30.00	x	45.00	x	8.00	NBR	827 N		NJ399	32.50	x	45.00	x	7.70	FPM	827S		NA5083
30.00	x	45.00	x	8.00	NBR	827S DD		NJ454	32.50	x	46.00	x	6.00	NBR	827S		NJ349
30.00	x	46.00	x	7.00	NBR	827S		NJ252	32.90	x	47.40	x	5.00	FPM	827S W		NA5137
30.00	x	47.00	x	7.00	FPM	827N DD		NA5136	33.00	x	42.00	x	6.00	PTFE / AEM	827SW		NA5457
30.00	x	48.00	x	8.00	NBR	827N		NF024	33.00	x	43.00	x	6.00	FPM	827S W		NF858
30.00	x	50.00	x	7.50	PTFE	829S		NA5013	33.00	x	44.00	x	7.00	NBR	822 S		NJ888
30.00	x	52.00	x	7.00	ACM	827S		NA5187	33.00	x	44.00	x	8.00	NBR	822S		NJ520
30.00	x	52.00	x	10.00	NBR	827N		NF209	33.00	x	44.00	x	10.00	NBR	822S		NJ145
30.00	x	54.00	x	15.00 / 19.30	FPM	827N		NA5149	33.00	x	47.00	x	7.00	NBR	827SS		NJ368
									33.00	x	47.00	x	8.00	NBR	827S		NJ280
31.00	x	41.00	x	7.00	FPM	829S W		NA5070	33.00	x	49.00	x	8.00	FPM	ASL		NA5226
31.00	x	42.00	x	8.00	NBR	827N DD		NF505	33.00	x	55.00	x	9.50	NBR	822 N		NJ101
31.00	x	46.00	x	8.00	NBR	827S		NJ381	33.00	x	59.00	x	11.00	NBR	827S		NJ186
31.00	x	50.00	x	8.00	MVQ	827S		NB700	33.50	x	54.00	x	9.00	NBR	827 S		NJ704
31.00	x	55.00	x	7.00	FKM	829S W		NA5321	34.00	x	44.00	x	10.00	NBR	SP		NJ125
31.50	x	42.00	x	7.00	FPM	829S W		NA5174	34.00	x	47.00	x	5.50	FPM	827S W		NA5448
31.80	x	47.60	x	9.52	NBR	827S DD		NB684	34.00	x	48.00	x	7.00	ACM	827S		NJ324







































































































OIL SEALS BY SIZE

 mm	 mm	 mm					 mm	 mm	 mm								
34.00	x	48.00	x	8.00	NBR	827S		NJ285	35.00	x	55.00	x	11.00	NBR	822S		NJ607
34.00	x	54.00	x	9.00	ACM	827 S		NJ860	35.00	x	55.00	x	12.00	ACM	827S W		NB432
34.00	x	54.00	x	9.00	ACM	827 SS		NK198	35.00	x	56.00	x	8.00	ACM	827 S		NJ161
34.00	x	60.00	x	10.00	FPM	829S W		NA5201	35.00	x	56.00	x	8.00	NBR	827 S		NJ915
34.00	x	63.00	x	9.00	NBR	827 S		NJ705	35.00	x	56.00	x	9.00	NBR	827S SP		NJ452
34.90	x	49.50	x	13.10	NBR + LEATHER	822S		NA162	35.00	x	56.00	x	9.00	NBR	827 S		NJ749
34.90	x	53.90	x	7.90	NBR	827N		NA301	35.00	x	58.00	x	10.00	ACM	827S W		NA5064
35.00	x	45.00	x	7.00 / 8.00	FPM	827S		NB774	35.00	x	62.00	x	8.00	ACM	827 SS		NJ165
									35.00	x	62.00	x	9.50	NBR	827 S		NJ761
35.00	x	47.00	x	5.60	FPM	827S		NA5018	35.00	x	62.00	x	10.00	NBR	827N		NF027
35.00	x	47.00	x	7.00	FPM / ACM	827N W		NA5016	35.00	x	63.00	x	10.00 / 16.50	ACM	822S SP		NK214
35.00	x	47.00	x	7.00	PTFE / ACM	827SW		NA5255									
35.00	x	47.00	x	7.00	FPM	827S W		NF687	35.00	x	67.00	x	12.00	NBR	827 S		NJ575
35.00	x	48.00	x	7.00	MVQ	829S W		NC006	35.00	x	76.00	x	9.00	NBR	827S SP		NJ777
35.00	x	48.00	x	7.00	NBR	827 S		NJ743	36.00	x	46.00	x	7.00	PTFE / ACM	827SP		NA5456
35.00	x	48.00	x	8.00	NBR	827 S		NJ415	36.00	x	49.00	x	7.00	NBR	827S		NJ286
35.00	x	48.00	x	10.00	PTFE	827S W		NA5106	36.00	x	50.00	x	6.00	FPM	827S		NA5351
35.00	x	48.00	x	10.00	FPM	829S W		NB716	36.00	x	50.00	x	7.00	PTFE / ACM	827S		NA5028
35.00	x	49.00	x	6.00	NBR	827S		NJ353	36.00	x	50.00	x	7.00	ACM	827N		NF746
35.00	x	49.60	x	11.00	NBR	827S		NJ985	36.00	x	50.00	x	7.00	FPM	827S W		NF817
35.00	x	50.00	x	7.00	PTFE	827S W		NA5323	36.00	x	50.00	x	8.00	PTFE / ACM	827SW		NA5364
35.00	x	50.00	x	7.00	FPM	827S W		NB959	36.00	x	50.00	x	8.00	ACM	SP		NF808
35.00	x	50.00	x	8.00	FPM	829S		NB734	36.00	x	50.00	x	8.00	NBR	827S		NJ283
35.00	x	50.00	x	8.00	NBR	827N		NF369	36.00	x	52.00	x	10.00	NBR	827 SS		NJ612
35.00	x	50.00	x	8.00	FPM	827S		NF834	36.00	x	54.00	x	11.00	NBR	827S DD		NF814
35.00	x	50.00	x	8.00	FPM	827N DD		NF841	36.00	x	62.00	x	14.00	NBR	822 S		NJ540
35.00	x	50.00	x	8.00	NBR	827S		NJ072	36.50	x	52.30	x	8.00	MVQ	827S W		NA576
35.00	x	50.00	x	8.00	NBR	827S		NJ242	36.50	x	52.70	x	7.90	NBR	827S DD W		NA579
35.00	x	50.00	x	8.00	FPM	827S		NJ933	37.00	x	50.00	x	6.00	ACM	827S		NJ874
35.00	x	50.00	x	9.50	NBR	SP		NK122	37.00	x	50.00	x	8.00	PTFE	827S W		NA5157
35.00	x	50.00	x	10.00	ACM	827S W		NA5066	37.00	x	50.50	x	7.00	ACM	827S		NK158
35.00	x	50.00	x	10.00	NBR	827 N		NF213	37.00	x	57.00	x	10.00	NBR	827 S		NJ713
35.00	x	50.00	x	10.00	NBR	827 S		NF718	37.00	x	58.00	x	10.00	NBR	SP		NJ212
35.00	x	50.00	x	10.00	MVQ	827S		NF722	37.50	x	50.00	x	6.00	ACM	827S		NJ706
35.00	x	50.00	x	11.00	NBR	827 S		NJ080	38.00	x	44.00	x	17.50	NBR	0		NJ702
35.00	x	52.00	x	8.00	NBR	827 N		NF126	38.00	x	45.00	x	8.00	NBR	822S		NJ427
35.00	x	52.00	x	10.00	NBR	824N DD		NF096	38.00	x	49.00	x	8.00	NBR	827 SS		NJ220
35.00	x	52.00	x	10.00	NBR	827 S		NK074	38.00	x	49.30	x	9.00	NBR	822 S		NJ794
35.00	x	54.00	x	10.00	NBR	827 N		NF470	38.00	x	50.00	x	6.00	FPM	827S W		NA5260
35.00	x	54.00	x	11.00	FPM	827S		NF882	38.00	x	50.00	x	7.00	FPM	827S DD W		NB799
35.00	x	55.00	x	9.00	NBR	827 S		NJ861	38.00	x	50.00	x	8.00	NBR	827S		NA5089
35.00	x	55.00	x	10.00	NBR	827N		NF257	38.00	x	50.00	x	8.00	FPM	829S W		NB884
35.00	x	55.00	x	10.00	NBR	SP		NJ797	38.00	x	50.00	x	8.00	NBR	827S		NJ347
35.00	x	55.00	x	11.00	NBR	827S DD		NJ274	38.00	x	50.30	x	10.00	NBR	822S SP		NJ553































































































OIL SEALS BY SIZE

																	
38.00	x	52.00	x	6.00	FPM	827S W		NC048	40.00	x	55.00	x	9.00	NBR	827SS		NJ288
38.00	x	52.00	x	6.00	NBR	827 S		NJ088	40.00	x	56.00	x	7.00	FPM	827N		NA5051
38.00	x	52.00	x	7.00	NBR	SP		NJ127	40.00	x	56.00	x	7.00	ACM	827 NW		NB307
38.00	x	52.00	x	9.50	NBR	827 S		NJ033	40.00	x	56.00	x	7.00	ACM	822N		NB818
38.00	x	54.00	x	7.00	NBR	827S		NJ363	40.00	x	56.00	x	7.00	NBR	827SS		NJ323
38.00	x	55.00	x	8.00	NBR	827 S		NJ096	40.00	x	56.00	x	8.00	ACM	827 S		NJ190
38.00	x	55.00	x	9.00	FPM / ACM	827S		NJ022	40.00	x	56.00	x	8.00	NBR	827 S		NJ637
38.00	x	58.00	x	11.00	NBR	822 S		NJ609	40.00	x	56.00	x	10.00	ACM	822S		NA5063
38.00	x	58.00	x	11.00	NBR	827 S		NJ687	40.00	x	56.00	x	10.00	ACM	827N		NB694
38.00	x	58.00	x	11.00	NBR	827 S		NK168	40.00	x	56.00	x	10.00	NBR	SP		NJ689
38.00	x	59.00	x	9.00	NBR	827S		NJ341	40.00	x	58.00	x	8.00	ACM	827N		NF694
38.00	x	60.00	x	8.00	NBR	827 S		NJ856	40.00	x	58.00	x	8.00	ACM	827N		NF695
38.00	x	62.00	x	8.00	NBR	827S SP		NJ651	40.00	x	58.00	x	8.00	NBR	827 SS		NJ634
38.00	x	62.00	x	11.00	NBR	822 S		NJ887	40.00	x	58.00	x	10.00	FPM / ACM	827S DD W		NA5205
38.00	x	74.00	x	11.50	NBR	822 S		NJ002	40.00	x	58.00	x	10.00	NBR	827S		NF334
38.50	x	53.00	x	8.00	NBR	827SS		NJ846	40.00	x	58.00	x	10.00	NBR	827S W		NF824
38.50	x	58.00	x	8.50	NBR	827S		NJ719	40.00	x	58.00	x	11.00	ACM	827 SS		NK076
38.50	x	58.00	x	11.00	NBR	827S		NJ102	40.00	x	58.00	x	11.30	ACM	827S DD W SP		NF836
39.00	x	50.00	x	7.00	PTFE / ACM	827SP		NA5455	40.00	x	60.00	x	10.00	NBR	827N		NF475
39.00	x	52.00	x	6.00	NBR	822S SP		NJ748	40.00	x	60.00	x	10.00	NBR	822 S		NJ475
39.00	x	59.00	x	11.00	NBR	827S		NJ213	40.00	x	62.00	x	7.40	PTFE	827S W		NA5147
39.70	x	59.00	x	9.50	NBR	827S		NA473	40.00	x	62.00	x	8.00	PTFE	827S W		NA5109
39.70	x	72.60	x	8.13	ACM	822N SP		NA583	40.00	x	62.00	x	8.00	NBR	827N		NF477
40.00	x	52.00	x	6.00	NBR	827S DD W		NB567	40.00	x	62.00	x	10.00	NBR	827N DD		NF032
40.00	x	52.00	x	6.00	NBR	822 S		NJ015	40.00	x	62.00	x	10.00	NBR	827S		NF235
40.00	x	52.00	x	6.00	NBR	827S		NJ449	40.00	x	62.00	x	10.00	NBR	827S DD		NJ106
40.00	x	52.00	x	7.00	FPM	829S W		NA5223	40.00	x	65.00	x	10.00	NBR	827N		NF217
40.00	x	52.00	x	7.00	FPM	827S		NA5242	40.00	x	65.00	x	10.00	NBR	822 S		NJ822
40.00	x	52.00	x	7.00	FPM	827N DD		NB775	40.00	x	72.00	x	10.00	NBR	SP		NJ961
40.00	x	52.00	x	7.00	NBR	827N		NF539	40.00	x	72.00	x	11.00 / 18.50	NBR	827S SP		NK265
40.00	x	52.00	x	7.00	FPM	822S DD		NJ011									
40.00	x	52.00	x	7.00	FPM	829S W		NJ222	40.00	x	74.00	x	10.00	NBR	822 S		NJ569
40.00	x	52.00	x	7.00	NBR	827S		NJ765	40.00	x	75.00	x	12.00	NBR	827 S		NJ043
40.00	x	52.00	x	7.50	NBR	827S		NB450	40.00	x	75.00	x	12.00	ACM	827 S		NJ441
40.00	x	52.00	x	8.00	NBR	827 S		NJ577	40.00	x	76.00	x	9.00	ACM	827 S		NK066
40.00	x	52.00	x	8.50	NBR	827S DD W		NB575	40.00	x	138.00	x	11.60 / 22.20	FPM	840S		NC044
40.00	x	54.00	x	8.00	NBR	827 S		NJ536									
40.00	x	55.00	x	6.00	ACM	827SS		NK050	40.50	x	52.60	x	6.00	ACM	827 S		NK150
40.00	x	55.00	x	6.40	PTFE	827S W		NA5259	41.00	x	56.00	x	7.00	NBR	822N		NJ036
40.00	x	55.00	x	6.50	FPM	827S W		NA5256	41.30	x	60.30	x	9.52	NBR	827S		NA580
40.00	x	55.00	x	7.00	FPM	827S		NA5058	42.00	x	52.00	x	7.50	FPM	829S W		NB980
40.00	x	55.00	x	8.00	PTFE	827S		NA585	42.00	x	53.00	x	7.00	FPM	827S W		NB958
40.00	x	55.00	x	8.00	NBR	827S		NB384	42.00	x	54.00	x	6.00	FPM	827S W		NA5036
40.00	x	55.00	x	8.00	NBR	827N DD		NF198	42.00	x	54.00	x	8.00	NBR	822S DD		NJ419





































































































OIL SEALS BY SIZE

																	
42.00	x	55.00	x	7.00	FPM / ACM	827S W		NA5108	45.00	x	62.00	x	8.00	NBR	827S		NJ351
42.00	x	55.00	x	7.00	NBR	822S DD		NJ052	45.00	x	62.00	x	10.00	NBR	827N		NA380
42.00	x	55.00	x	8.00	MVQ	827SS		NK180	45.00	x	62.00	x	10.00	NBR	827S DD		NF097
42.00	x	55.00	x	9.00	NBR	827SS		NJ267	45.00	x	62.00	x	10.00	NBR	827N DD		NF115
42.00	x	56.00	x	7.00	FPM	827SS W		NA5190	45.00	x	62.00	x	10.00	MVQ	827S DD W		NF734
42.00	x	58.00	x	7.00	NBR	822 S		NJ811	45.00	x	62.00	x	12.00	NBR	822N DD		NF037
42.00	x	58.00	x	8.00	ACM	827S W		NA5306	45.00	x	63.00	x	7.00	FPM	827SDD		NA5282
42.00	x	58.00	x	11.00	FPM	827S		NB786	45.00	x	63.00	x	7.00	NBR	822S		NJ413
42.00	x	60.00	x	7.00	NBR	827S		NJ344	45.00	x	65.00	x	7.00	FPM / ACM	827S W		NA5178
42.00	x	60.00	x	9.00	NBR	827S		NJ358	45.00	x	67.00	x	8.00	PTFE	827S W		NA5131
42.00	x	60.00	x	10.00	NBR	827N		NF387	45.00	x	67.00	x	8.00	FPM	829S W		NB973
42.00	x	62.00	x	7.00	PTFE	829S W		NA5191	45.00	x	67.00	x	10.00	FPM	829S W		NB971
42.00	x	62.00	x	7.00	NBR	827 N		NF790	45.00	x	67.00	x	13.00	FPM	827 SSP		NA5264
42.00	x	62.00	x	7.00	NBR	827 S		NJ527	45.00	x	68.00	x	12.00	NBR	827S		NJ243
42.00	x	62.00	x	9.00	NBR	827 S		NJ071	45.00	x	68.00	x	12.00	NBR	827S DD		NJ450
42.00	x	62.00	x	10.00	NBR	822N DD		NF185	45.00	x	68.00	x	12.50	NBR	827S SP		NJ921
42.00	x	62.00	x	10.00	FPM / ACM	827S		NF761	45.00	x	72.00	x	12.00	NBR	822 S		NJ739
42.00	x	62.00	x	12.00	FPM	829S W		NB792	45.00	x	74.50	x	12.00	FPM	827S W SP		NB975
42.00	x	65.00	x	10.00	NBR	827 N		NF219	45.00	x	75.00	x	12.00	NBR	822 S		NJ382
42.00	x	65.00	x	12.00	ACM	829S W		NA5041	45.00	x	80.00	x	10.00	ACM	827 S		NJ768
42.00	x	66.00	x	6.00	FPM / ACM	827S W		NF870	46.00	x	56.40	x	7.00	FPM	827S W		NA5310
42.00	x	66.00	x	7.00	PTFE / ACM	ASW		NA5331	46.00	x	58.00	x	7.00	ACM	827S		NK106
42.00	x	72.00	x	10.00	NBR	827 S		NJ122	46.00	x	59.00	x	7.00	FPM	827S W		NF861
42.50	x	54.50	x	6.00	MVQ	0		NA5246	46.00	x	60.00	x	7.00	FPM	827N		NB773
42.90	x	63.50	x	9.52	NBR	827N		NA294	46.00	x	94.50	x	18.00	NBR	SP		NJ802
43.00	x	54.00	x	6.00	NBR	824S DD		NJ844	46.00	x	101.80	x	11.00	NBR	SP		NK038
43.00	x	58.00	x	7.00	ACM	827S		NA5320	47.00	x	62.00	x	9.00	NBR	822 N		NJ090
43.00	x	59.00	x	10.00	FPM	827S		NF881	47.00	x	62.00	x	10.00	FPM	827N		NC008
43.00	x	60.00	x	9.00	ACM	827 SS		NK084	47.50	x	70.70	x	9.00	NBR	827 S		NJ064
44.00	x	60.00	x	7.00	NBR	827S		NJ005	47.60	x	66.70	x	10.80	ACM	822N		NA543
44.00	x	60.00	x	10.00	PTFE	829S W		NA5099	47.60	x	67.00	x	11.10	MVQ	827N W		NB453
44.00	x	60.00	x	10.00	FPM	827S W		NC015	47.62	x	66.50	x	11.00	PTFE	827N W		NB856
44.00	x	65.00	x	11.00	NBR	827S		NJ007	48.00	x	62.00	x	7.00	ACM	827SW		NA5477
44.50	x	57.20	x	6.75	ACM	827S		NA5138	48.00	x	62.00	x	7.00	NBR	824S		NJ066
44.50	x	63.50	x	9.52	ACM	827N		NA567	48.00	x	62.00	x	7.00	NBR	824 S		NJ557
45.00	x	58.00	x	9.00	NBR	822S		NJ492	48.00	x	62.00	x	8.00	NBR	827N		NA448
45.00	x	59.00	x	8.00	NBR	SP		NK012	48.00	x	62.00	x	8.00	FKM	827S		NA5330
45.00	x	60.00	x	6.50	NBR	827N		NF756	48.00	x	62.00	x	9.00	NBR	822 S		NJ562
45.00	x	60.00	x	7.00	ACM	827S W		NF780	48.00	x	62.00	x	9.00	NBR	827 N		NJ991
45.00	x	60.00	x	8.00 / 9.00	ACM	827S W		NB628	48.00	x	62.00	x	9.00	ACM	827 SS		NK052
45.00	x	60.00	x	10.00	ACM	827N		NF685	48.00	x	62.00	x	13.00	NBR	827S SP		NJ082
45.00	x	62.00	x	8.00	ACM	829S W		NA5360	48.00	x	63.00	x	6.50	FPM	ASL		NA5319
45.00	x	62.00	x	8.00	NBR	822S DD		NF036	48.00	x	65.00	x	10.00	PTFE	829S W		NA5105
45.00	x	62.00	x	8.00	NBR	822S DD		NF036	48.00	x	65.00	x	10.00	FPM	829S W		NF637



















































































OIL SEALS BY SIZE

																	
48.00	x	66.70	x	10.00	MVQ	827S W		NB714	52.00	x	65.00	x	9.00	NBR	824 N		NJ068
48.00	x	68.00	x	7.00	NBR	827SS		NJ200	52.00	x	66.00	x	7.50	NBR	822 S		NJ867
48.00	x	70.00	x	9.00	NBR	827N		NJ045	52.00	x	66.00	x	9.00	NBR	827 N		NJ659
48.00	x	70.00	x	9.50	NBR	827 S		NJ100	52.00	x	68.00	x	7.00	NBR	SP		NJ537
48.00	x	70.00	x	12.00	NBR	827SS		NJ042	52.00	x	68.00	x	7.50	NBR	822 S		NK098
48.00	x	72.00	x	10.00	NBR	827N		NF449	52.00	x	68.00	x	10.00	MVQ	827S W		NA581
48.00	x	72.00	x	10.00	FPM	827S		NF778	52.00	x	68.00	x	13.00	NBR	827S DD		NJ639
48.00	x	74.00	x	10.00	NBR	827 S		NJ864	52.00	x	70.00	x	8.50	ACM	827SS		NJ645
48.00	x	81.00	x	11.50	PTFE / PA	ASL		NA5333	52.00	x	70.00	x	9.00	NBR	822 S		NJ892
48.00	x	82.00	x	12.00	NBR	822S		NJ523	52.00	x	72.00	x	7.50	NBR	822 S		NJ474
48.70	x	63.50	x	8.00	FPM	827S		NB849	52.00	x	72.00	x	8.00	NBR	822 S		NJ825
49.00	x	62.00	x	8.00	NBR	SP		NJ199	52.00	x	75.00	x	7.50	NBR	822 S		NJ995
49.00	x	100.00	x	8.00	NBR	SP		NJ942	53.00	x	68.00	x	10.00	ACM	827N		NA5045
50.00	x	65.00	x	8.00	ACM	827 S		NK105	53.00	x	69.85	x	11.00	MVQ	827S		NA5197
50.00	x	65.00	x	8.00	NBR	SP		NK146	54.00	x	66.00	x	7.50 / 10.00	NBR	822S		NJ996
50.00	x	65.00	x	8.00 / 9.30	FPM	829S W		NA5023									
50.00	x	65.00	x	9.00	NBR	822S		NJ429	54.00	x	73.00	x	12.40	NBR	827N DD		NB584
50.00	x	65.00	x	9.75	NBR	827S DD		NB655	54.00	x	76.00	x	8.00	NBR	SP		NK162
50.00	x	65.00	x	10.00	NBR	822 S		NJ539	54.00	x	81.00	x	10.00	NBR	827S DD		NF528
50.00	x	66.50	x	13.00	NBR	827 S		NJ538	54.00	x	82.00	x	9.00	ACM	827S		NB691
50.00	x	68.00	x	7.00	NBR	SP		NJ701	54.50	x	67.50	x	6.50	PTFE	SP	S S	NA5357
50.00	x	68.00	x	9.00	NBR	827S		NJ014	55.00	x	68.00	x	8.00	FPM	829S W		NA5069
50.00	x	68.00	x	9.00	NBR	824 S		NJ069	55.00	x	68.00	x	8.00	PTFE	829S W		NA5103
50.00	x	68.00	x	9.00	NBR	827S		NK251	55.00	x	68.00	x	8.00	FPM	829S W		NA5299
50.00	x	68.00	x	10.00	NBR	827S		NF249	55.00	x	68.00	x	8.00	FPM	827 N		NF663
50.00	x	68.00	x	10.00	MVQ	827N		NF648	55.00	x	70.00	x	6.00	NBR	827S SP		NB596
50.00	x	68.00	x	10.00	FPM / ACM	827S W		NF843	55.00	x	70.00	x	8.00	PTFE	827S W		NA5329
50.00	x	70.00	x	7.00	NBR	824 S		NJ678	55.00	x	70.00	x	8.00	ACM	827S		NF391
50.00	x	70.00	x	9.00	NBR	822 S		NJ070	55.00	x	70.00	x	8.00	FPM	827S W		NP068
50.00	x	70.00	x	10.00	MVQ	827 N		NF604	55.00	x	70.00	x	9.00	NBR	827 S		NJ603
50.00	x	70.00	x	10.00	FPM	829S W		NP067	55.00	x	70.00	x	10.00	MVQ	827N		NA584
50.00	x	72.00	x	12.00	NBR	827S		NF325	55.00	x	70.00	x	10.00	MVQ	0		NF636
50.00	x	72.00	x	12.00	NBR	827SS		NJ239	55.00	x	70.10	x	8.00	FPM	827S		NB807
50.00	x	74.00	x	11.00	FPM	827S		NA5243	55.00	x	72.00	x	10.00	FPM	829S W		NA5267
50.00	x	80.00	x	14.00	FPM	SP		NA5202	55.00	x	72.00	x	10.00	NBR	827 N		NF062
50.00	x	80.00	x	16.50	ACM	827 S		NJ217	55.00	x	75.00	x	8.00	FPM	822N		NA5468
50.00	x	81.00	x	11.45	FPM	827S W		NA5332	55.00	x	78.00	x	12.00	NBR	827S		NJ258
50.00	x	86.50	x	13.70	PTFE	827S W		NA5031	55.00	x	78.00	x	12.00	NBR	0		NJ588
50.80	x	69.90	x	12.70	NBR	827S DD		NA422	55.00	x	80.00	x	8.00	NBR	827N DD		NF110
51.00	x	63.00	x	7.50	NBR	822 S		NK096	55.50	x	70.00	x	6.00	FPM	ASW		NA5317
51.00	x	63.00	x	8.50	NBR	822 S		NJ808	55.50	x	73.00	x	12.70	NBR	827S		NA773
51.00	x	65.00	x	7.00	FPM	827S W		NA5179	56.00	x	68.00	x	8.00	NBR	SP		NJ133
51.00	x	72.00	x	9.50	NBR	SP		NJ219	56.00	x	69.00	x	10.00	FPM	827S W		NF809

OIL SEALS BY SIZE

																	
56.00	x	72.00	x	8.00	NBR	827S DD		NJ838	63.00	x	90.00	x	7.00 / 9.20	NBR	822S		NJ998
56.00	x	73.00	x	8.00	NBR	822 S		NJ868	63.50	x	83.40	x	7.92	NBR	827N DD		NA987
56.00	x	75.00	x	6.50	NBR	822 S		NK054	63.50	x	90.00	x	12.70	LEATHER	824 SP		NA611
56.00	x	75.00	x	8.00	NBR	822 S		NK099	64.00	x	80.00	x	8.00	ACM	822S		NA5049
56.00	x	76.00	x	5.00 / 12.30	NBR	SP		NK212	64.00	x	80.00	x	8.00	FPM	829S W		NB808
56.00	x	78.00	x	6.50	NBR	SP		NJ132	64.00	x	88.00	x	6.00	FPM / ACM	827S		NF866
57.00	x	71.00	x	9.50	FPM	827S		NC007	64.00	x	112.50	x	20.00	FPM	840		NF887
57.00	x	74.00	x	8.50	NBR	827SS DD		NC009	65.00	x	85.00	x	12.00	MVQ	827S		NF611
57.00	x	79.00	x	9.00	NBR	SP		NJ695	65.00	x	85.00	x	13.00	FPM	827SW		NB938
57.00	x	124.00	x	13.00	NBR	SP		NK021	65.00	x	88.00	x	8.50	NBR	SP		NJ880
57.20	x	76.20	x	12.70	NBR + LEATHER	822S SP		NA736	65.00	x	88.00	x	10.00	NBR	SP		NJ879
57.50	x	70.00	x	10.00	MVQ	827S W		NF810	65.00	x	88.00	x	12.00	NBR	827SS		NJ298
58.00	x	68.00	x	11.00	NBR	SP		NK034	65.00	x	90.00	x	10.00	NBR	827 S		NJ886
58.00	x	74.00	x	10.00	ACM	827S		NJ269	65.00	x	90.00	x	13.00	FPM	829N W		NB978
58.00	x	75.00	x	7.50	NBR	SP		NJ949	65.00	x	90.00	x	13.00	NBR	822 S		NJ820
58.00	x	80.00	x	10.00	NBR	827N		NF223	65.00	x	90.00	x	15.00	FPM	823N		NB979
58.00	x	80.00	x	10.00	NBR	827S		NJ831	66.00	x	80.00	x	9.00	NBR	824 S		NJ141
58.00	x	80.00	x	12.00	ACM	827SS		NJ369	66.00	x	85.00	x	8.00	NBR	824S SP		NJ661
58.00	x	81.20	x	5.00	FPM	827N		NA5270	66.00	x	90.00	x	12.00	PTFE	829S W		NA5156
58.00	x	103.00	x	11.00	NBR	822 S		NJ585	66.00	x	90.00	x	12.00	FPM	823S		NB967
58.70	x	85.10	x	7.90	NBR	827N		NA652	66.67	x	89.30	x	10.00	FPM	827S W		NB984
59.00	x	75.00	x	10.00	NBR	822S		NK009	66.70	x	85.70	x	9.52	MVQ	827N		NB452
60.00	x	74.00	x	8.00	ACM	829S		NA5476	66.70	x	88.90	x	9.50	MVQ	827N W		NA5101
60.00	x	75.00	x	7.00	FPM / ACM	827S W		NA5446	66.70	x	89.60	x	9.50	MVQ	827SW		NB688
60.00	x	75.00	x	8.00	FPM	827SP (NO SPRING)		NA5479	67.00	x	86.00	x	9.50	PTFE	829S W		NB855
60.00	x	75.00	x	8.00	NBR	827N		NF356	68.00	x	86.00	x	8.00	ACM	827S		NJ378
60.00	x	75.00	x	11.50	NBR	SP		NJ909	68.00	x	88.00	x	10.00	NBR	824S		NJ390
60.00	x	75.00	x	11.50	NBR	SP		NJ909	68.00	x	90.00	x	10.00	NBR	827N		NF001
60.00	x	80.00	x	8.00	FPM	829S		NA5478	68.00	x	90.00	x	10.00	NBR	824 S		NJ525
60.00	x	80.00	x	8.00	NBR	827S		NJ337	68.00	x	90.00	x	12.00	NBR	822S		NJ500
60.00	x	80.00	x	12.00	NBR	827 N		NF044	69.00	x	86.00	x	7.00	NBR	SP		NK208
60.00	x	80.00	x	12.00	NBR	827 N		NF316	70.00	x	85.00	x	7.00	FPM / ACM	827S W		NA5447
60.00	x	82.00	x	12.00	FPM / ACM	827S		NJ004	70.00	x	86.00	x	7.00	PTFE	827S W		NA5348
60.00	x	82.00	x	12.00	FPM / ACM	827S		NJ021	70.00	x	88.00	x	8.00	FPM	829S W		NB814
60.30	x	79.50	x	9.50	MVQ	827N		NB459	70.00	x	88.00	x	9.00	NBR			NJ225
60.30	x	82.90	x	11.50	ACM	822N		NA764	70.00	x	88.00	x	12.00	MVQ	827S		NJ099
60.33	x	79.40	x	9.50	FPM	827S		NB932	70.00	x	90.00	x	10.00	ACM	827S		NA5050
60.45	x	76.18	x	10.00	FPM / FELT	827S W		NB564	70.00	x	90.00	x	10.00	FPM	829S W		NA5055
60.50	x	78.00	x	9.00	MVQ	827N		NF640	70.00	x	90.00	x	10.00	ACM	827N		NA784
61.00	x	75.00	x	8.00	PTFE	827S W		NA5363	70.00	x	90.00	x	10.00	FPM	829S W		NB946
61.00	x	76.00	x	10.00	NBR	822 S		NJ140	70.00	x	90.00	x	10.00	NBR	827 N		NF177
62.00	x	80.00	x	12.00	ACM	822N		NA5065	70.00	x	90.00	x	15.00	FPM	0		NB882
62.00	x	85.00	x	10.00	NBR	824 S		NJ062	70.00	x	92.00	x	8.50	MVQ	827S		NJ001































































OIL SEALS BY SIZE

																	
70.00	x	92.00	x	12.00	NBR	827 S		NJ233	80.00	x	98.00	x	14.70	PTFE	827S W		NA5350
70.00	x	100.00	x	13.00	NBR	827S		NF178	80.00	x	100.00	x	8.00	FPM / ACM	827S W		NF835
70.00	x	100.00	x	16.00	PTFE			NA5293	80.00	x	100.00	x	8.50	MVQ	827SS		NJ360
70.00	x	112.00	x	10.00	NBR	SP		NJ397	80.00	x	100.00	x	9.00	PTFE	827S DD W		NA5118
70.00	x	112.00	x	14.00	NBR	O		NJ385	80.00	x	100.00	x	10.00	MVQ	827S		NJ287
70.00	x	159.00 / 179.00	x	16.00	FPM	840S		NF885	80.00	x	100.00	x	10.00	MVQ	827S		NJ312
									80.00	x	100.00	x	12.00	ACM	827S		NJ030
71.00	x	88.00	x	8.00	MVQ	827N W		NF692	80.00	x	100.00	x	13.00	PTFE / ACM	827BSLHALF-RIBBED		NA5474
72.00	x	96.00	x	9.00	MVQ	827S		NJ006									
72.00	x	100.00	x	12.00	NBR	827 S		NF415	80.00	x	100.00	x	13.00	MVQ	827N		NF634
73.00	x	90.00	x	8.00	NBR	822 S		NJ737	80.00	x	100.00	x	13.00	MVQ	827S		NJ056
73.00	x	92.10	x	9.50	MVQ	827N		NA774	80.00	x	113.00	x	12.00	NBR	SP		NJ571
74.00	x	88.00	x	8.00	FPM	829S W		NA5061	80.00	x	182.00	x	19.40	PTFE	841N LS SP		LK5004
74.00	x	89.00	x	8.50	FKM	827S		NA5324	81.00	x	100.10	x	11.50	FPM	827S		NB690
74.00	x	90.00	x	10.00	ACM	829S W		NA5062	81.00	x	104.00	x	11.00	FPM	829SW		NA5459
74.00	x	90.00	x	10.00	NBR	829 S W		NB644	82.00	x	105.00	x	13.00	MVQ	SP		NJ060
74.00	x	90.00	x	10.00	FPM	829S W		NB732	82.00	x	105.00	x	13.00	MVQ	827SS		NJ265
74.00	x	141.00 / 187.50	x	17.00	FPM	SP		LK5001	82.50	x	101.60	x	12.00	PTFE	SP		NA5356
									82.60	x	98.70	x	12.70	MVQ	827N		NB291
75.00	x	90.00	x	11.50	FPM / ACM	827SW		NF776	83.00	x	100.00	x	9.00	ACM	827S		NJ650
75.00	x	93.00	x	9.00	MVQ	827SS		NK035	84.00	x	104.00	x	11.00	MVQ	827S W		NJ284
75.00	x	94.00	x	10.00	MVQ	827SS		NJ364	85.00	x	103.00	x	8.00	FPM	827S		NK143
75.00	x	100.00	x	8.50	MVQ	827S		NJ407	85.00	x	105.00	x	8.00	PTFE	827S W		NA5362
75.00	x	100.00	x	10.00	NBR	827N		NF395	85.00	x	105.00	x	8.00	FPM	827S W		NF850
75.00	x	100.00	x	13.00	FPM	822S SP		NB977	85.00	x	105.00	x	8.80	PTFE	827S W		NA5325
75.00	x	100.00	x	13.00	MVQ	827S		NJ044	85.00	x	105.00	x	9.00	FPM / ACM	827S W		NF857
75.50	x	108.00	x	10.00	NBR	SP		NJ966	85.00	x	105.00	x	10.00	FPM	823S		NJ215
76.00	x	94.00	x	8.50	FPM	827S		NA5090	85.00	x	105.00	x	10.00	MVQ	827S		NJ354
76.00	x	102.00	x	9.50	NBR	SP		NJ472	85.00	x	105.00	x	11.00	ACM	827S W		NA5037
77.00	x	100.00	x	11.50	FPM	829S		NB469	85.00	x	105.00	x	11.00	FPM	829S W		NA5133
78.00	x	100.00	x	9.00	PTFE	827S W		NA5230	85.00	x	105.00	x	11.00	PTFE	829S W		NA5305
78.00	x	100.00	x	10.00	MVQ	827N		NF641	85.00	x	105.00	x	12.00	PTFE	829S W		NA5349
78.00	x	104.00	x	11.00	ACM	829S DD W		NA5120	85.00	x	110.00	x	13.00	NBR	827 S		NJ490
79.00	x	99.00	x	9.50	PTFE	829S W		NB854	85.00	x	111.00	x	15.50	PTFE	841		LK5013
79.00	x	196.00	x	21.50	PTFE	841		NA5130	85.00	x	120.00	x	10.00	FPM	841S		NA5238
79.40	x	95.30	x	11.10	PTFE	829S W		NB788	85.00	x	130.90 / 170.00	x	15.75	PTFE	841S		LK5017
79.80	x	184.00	x	18.80	PTFE	841S		NC086									
79.95	x	116.00 / 126.00	x	11.50	FPM	829S W		NB829	85.00	x	131.00	x	15.70	PTFE	841S SP		LK5003
									85.00	x	131.00	x	15.70	PTFE	841S SP		LK5008
80.00	x	96.00	x	9.00	NBR	827S SP		NJ058	85.00	x	131.00	x	16.00	PTFE	841S		LK5006
80.00	x	96.00	x	9.00	MVQ	827S		NJ251	85.00	x	154.00 / 160.00	x	9.50	PTFE / AEM	841S		LK5020
80.00	x	98.00	x	10.00	FPM	827S W		NB698									
80.00	x	98.00	x	10.00	NBR	827SS		NJ675	85.00	x	164.00 / 156.20	x	11.00	PTFE	841S		LK5016
80.00	x	98.00	x	14.50	PTFE	827N W		NA5327									

























































































OIL SEALS BY SIZE

85.70	x	114.30	x	13.00	FPM	829S W		NB853	93.00	x	133.50	x	15.50	PTFE	841S SP		NA5074
86.00	x	100.00	x	10.00	MVQ	827S		NJ829	93.00	x	139.70 / 172.00	x	12.00	FPM	840S		NF888
86.00	x	103.00	x	10.00	MVQ	824 S		NK139									
86.00	x	104.00	x	11.00	FPM	827S		NB701	94.00	x	161.00 / 193.00	x	10.00	PTFE / AEM	841S		LK5022
87.00	x	100.00	x	8.00	MVQ	827N		NJ446									
87.00	x	100.00	x	8.50	FPM	827S		NK103	95.00	x	110.00	x	11.00	MVQ	827S		NJ098
87.30	x	120.60	x	12.70	NBR	822 SP		NA853	95.00	x	115.00	x	9.50	MVQ	827SS		NK216
88.00	x	106.00	x	8.70	FPM	827S		NK055	95.00	x	115.00	x	12.00	MVQ	827S		NJ240
88.00	x	108.00	x	11.00	FPM	827S W		NB847	95.00	x	118.00	x	10.00	ACM	827S		NJ158
88.00	x	188.00	x	15.00	PTFE	841 SP		LK5005	95.00	x	118.00	x	10.00	NBR	827S		NJ322
88.90	x	104.80	x	9.52	MVQ	827S W		NB772	95.00	x	120.00	x	13.00	FPM	822 S		NA5039
88.90	x	145.00	x	12.00	FPM	840N SP		NB843	95.00	x	120.00	x	13.00	MVQ	827N DD		NF603
89.00	x	109.00	x	9.00	MVQ	827 S		NJ154	98.00	x	110.00	x	8.50	FPM	827S		NA5017
89.00	x	109.00	x	9.00 / 10.30	MVQ	827S		NK205	98.00	x	120.00	x	7.00	FPM / ACM	827S		NF867
									99.00	x	114.00	x	11.00	FPM	827S		NA5209
89.00	x	116.00	x	10.20	FPM	840S SP		LK5000	99.00	x	118.00	x	16.50	PTFE	841S		LK5009
89.50	x	105.00	x	10.00	MVQ	827 S		NK169	100.00	x	114.00	x	12.00	NBR	822 S		NJ511
90.00	x	104.00	x	9.00	FKM	829S W		NA5298	100.00	x	118.00	x	10.00	FPM	829S W		NF853
90.00	x	104.00	x	11.00	FPM	829S		NB806	100.00	x	120.00	x	9.50	FPM	829S		NA5173
90.00	x	110.00	x	7.00	PTFE	829S W		NA5192	100.00	x	120.00	x	11.00	PTFE	829N W		NB848
90.00	x	110.00	x	8.50	MVQ	827S		NJ346	100.00	x	120.00	x	11.00	MVQ	827S DD		NJ055
90.00	x	110.00	x	9.00	ACM	827S		NA5196	100.00	x	120.00	x	15.00	FPM	829S W		NB934
90.00	x	110.00	x	9.00	MVQ	827S		NJ325	100.00	x	123.00	x	12.50	MVQ	827SS		NJ497
90.00	x	110.00	x	11.00	FPM / ACM	827S W		NF844	100.00	x	124.00	x	12.00	FPM	829S W		NB956
90.00	x	110.00	x	12.00	PTFE	829S W		NA5104	100.00	x	124.00	x	13.00	FPM	829S W		NA5268
90.00	x	110.00	x	12.00	FPM	829S W		NB431	100.00	x	125.00	x	13.00	FPM	829S W		NA5132
90.00	x	110.00	x	13.00	MVQ	827 SS		NJ674	100.00	x	130.00	x	11.00	PTFE / ACM	827SP		NA5469
90.00	x	115.00	x	13.00	FPM	829S W		NF833	100.00	x	130.00	x	12.00	PTFE / ACM	829SW		NA5450
90.00	x	120.00	x	11.00	PTFE	827S W		NA5451	100.00	x	130.00	x	13.00	NBR	827S		NF800
90.00	x	167.00	x	10.50	PTFE	841S SP		NA5107	100.00	x	135.00	x	15.00	MVQ	SP		NJ232
90.00	x	173.00	x	24.00	PTFE	841S		LK5007	100.00	x	179.00	x	15.80	FPM	840S		NF886
91.00	x	108.00	x	9.50	NBR	829N		NA5175	101.00	x	114.00	x	10.00	NBR	822S		NJ420
91.00	x	111.00	x	9.00	FPM	827SS		NJ873	105.00	x	130.00	x	12.00	FPM	829S W		NB928
91.00	x	111.00	x	10.00	FPM	823S		NA5140	105.00	x	130.00	x	15.00	FPM	829S W		NB935
91.00	x	114.00	x	12.00	FPM	827S		NA5244	106.00	x	190.00 / 196.00	x	15.20	FPM	841S		NA5030
92.00	x	110.00	x	10.00	MVQ	827N		NA869									
92.00	x	110.00	x	10.00	FPM	SP		NK170	110.00	x	130.00	x	12.00	PTFE / ACM	827SP		NA5467
92.00	x	235.00 / 220.00	x	22.00	PTFE / ACM	841S		LK5021	110.00	x	130.00	x	13.00	PTFE	829S W		NA5181
									110.00	x	130.00	x	13.00	MVQ	827 N		NF630
93.00	x	108.00	x	7.00	FPM / ACM	827S W		NF860	110.00	x	130.00	x	13.00	MVQ	SP		NF715
93.00	x	114.00	x	11.50	PTFE	827S W		NA5168	110.00	x	135.00	x	13.00	FPM	823S		NA5040
93.00	x	114.00	x	13.00	FPM	827S W		NB974	114.00	x	171.00 / 177.00	x	13.00	FPM	840S		NF883
93.00	x	114.00	x	14.00	FPM	829S W		NA5266									
93.00	x	117.00	x	12.00	FPM	823S		NB972	115.00	x	140.00	x	10.00	FPM	827 N		NA5269



























































































OIL SEALS BY SIZE

 mm	 mm	 mm					 mm	 mm	 mm								
115.00	x	140.00	x	13.00	PTFE	829S W		NA5121	155.00	x	180.00	x	17.00	NBR	822 S		NJ489
115.00	x	140.00	x	13.00	NBR	824N		NF310	155.00	x	185.00	x	13.00	PTFE / FPM	SP		NA5472
115.00	x	140.00	x	16.00	FPM	823S		NB939	160.00	x	190.00	x	13.00	PTFE / ACM	827SW		NA5452
115.00	x	150.00	x	13.00	NBR	827N		NF514	160.00	x	190.00	x	15.00	NBR	827S		NF549
117.50	x	174.00	x	15.00	NBR	SP		NJ939	165.00	x	191.00	x	16.00	PTFE / ACM	829SBONDED		NA5462
120.00	x	140.00	x	12.00	PTFE			NA5300	170.00	x	200.00	x	15.00	NBR	827S		NF532
120.00	x	140.00	x	13.00	FPM	829S W		NB929	180.00	x	205.00	x	15.00	FPM	829S W		NA5359
120.00	x	140.00	x	13.00	PTFE / ACM	827SW		NB966									
120.00	x	153.00	x	15.00	MVQ	827 N		NJ790									
122.20	x	141.00	x	11.80	MVQ	827S		NA965									
125.00	x	150.00	x	12.00	FPM	829 S W		NB954									
127.00	x	146.00	x	10.00	NBR	822 S		NJ755									
127.00	x	146.10	x	11.10	ACM	827N		NA933									
127.00	x	147.00	x	11.00	NBR	822 S		NK020									
130.00	x	150.00	x	13.00	FPM	827S W		NA5475									
130.00	x	150.00	x	13.00	FPM	827S W		NB638									
130.00	x	150.00	x	14.80	PTFE	SP		NA5465									
130.00	x	155.00	x	16.00	PTFE			NA5294									
130.00	x	160.00	x	13.00	VMQ	SP		NA5354									
130.00	x	160.00	x	13.00	PTFE / ACM	827SP		NA5470									
130.00	x	160.00	x	15.00	FPM	829SW		NB619									
132.00	x	153.00	x	15.70	PTFE	841S		LK5012									
133.30	x	158.70	x	12.70	MVQ	827N		NB460									
133.35	x	158.75	x	12.63	FPM	827SW		NB933									
134.00	x	161.00	x	16.00	PTFE / ACM	829SBONDED		NA5460									
135.00	x	153.00	x	13.00	PTFE	SP		NA5473									
136.00	x	153.00	x	21.00	PTFE	841S		LK5002									
138.00	x	152.00	x	12.00	NBR	0		NJ391									
139.00	x	159.00	x	13.00	PTFE / ACM	827SP		NA5461									
139.00	x	164.00	x	12.00	PTFE / ACM	SP		NA5466									
140.00	x	160.00	x	13.00	NBR	822N		NF550									
140.00	x	170.00	x	15.00	NBR	827N		NF320									
143.00	x	165.00	x	10.00	NBR	824S		NA5262									
145.00	x	175.00	x	13.00	PTFE / FPM	SP		NA5471									
145.00	x	175.00	x	14.00	NBR	829S W		NA5171									
150.00	x	172.00	x	13.00	PTFE / ACM	SP		NA5463									
150.00	x	172.00	x	13.00	PTFE	SP		NF840									
150.00	x	172.00	x	18.00	MVQ	827 N W		NF653									
152.50	x	171.50	x	11.00	PTFE	SP		NA5464									
153.00	x	171.45	x	11.00	PTFE	823S		NA5355									
154.00	x	172.00	x	14.00	NBR	822 S		NJ717									
154.00	x	180.00	x	12.00	FPM	829SW		NB947									
155.00	x	180.00	x	15.00	FPM	829S W		NB852									
155.00	x	180.00	x	15.00	NBR	827N		NF183									

DIFFERENTIAL SEALS BY REFERENCE

▲ Payen		mm		mm		mm				▲ Payen		mm		mm		mm			
NA5001	32.00	x	47.00	x	10.00	FPM	827S DD W												
NA5204	29.90	x	47.00	x	11.30	PTFE / ACM	827S RD W												
NA5205	40.00	x	58.00	x	10.00	FPM / ACM	827S DD W												
NA5238	85.00	x	120.00	x	10.00	FPM	841S												
NA5476	60.00	x	74.00	x	8.00	ACM	829S												
NA5477	48.00	x	62.00	x	7.00	ACM	827SW												
NB684	31.80	x	47.60	x	9.52	NBR	827S DD												
NC048	38.00	x	52.00	x	6.00	FPM	827S RD W												
NF032	40.00	x	62.00	x	10.00	NBR	827N DD												
NF044	60.00	x	80.00	x	12.00	NBR	827 N												
NF062	55.00	x	72.00	x	10.00	NBR	827 N												
NF096	35.00	x	52.00	x	10.00	NBR	824N DD												
NF097	45.00	x	62.00	x	10.00	NBR	827S DD												
NF115	45.00	x	62.00	x	10.00	NBR	827N DD												
NF242	20.00	x	47.00	x	7.00	NBR	827 N												
NF334	40.00	x	58.00	x	10.00	NBR	827S												
NF369	35.00	x	50.00	x	8.00	NBR	827N												
NF505	31.00	x	42.00	x	8.00	NBR	827N DD												
NF775	36.00	x	54.00	x	7.50	ACM	827S DD												
NF779	95.00	x	120.00	x	11.30	NBR	822S												
NF791	27.95	x	56.00	x	7.00	ACM	827S RD												
NF792	29.80	x	47.00	x	9.90	NBR	827S												
NF814	36.00	x	54.00	x	11.00	NBR	827S DD												
NF824	40.00	x	58.00	x	10.00	NBR	827S LD W												
NF825	32.00	x	50.00	x	10.00	FPM	827S RD W												
NF826	29.90	x	47.00	x	11.30	ACM	827S RD W SP												
NF836	40.00	x	58.00	x	11.30	ACM	827S DD W SP												
NF841	35.00	x	50.00	x	8.00	FPM	827N DD												
NF881	43.00	x	59.00	x	10.00	FPM	827S LD												
NF882	35.00	x	54.00	x	11.00	FPM	827S RD												
NJ002	38.00	x	74.00	x	11.50	NBR	822 S												
NJ011	40.00	x	52.00	x	7.00	FPM	822S DD												
NJ017	38.00	x	65.00	x	12.00	NBR	822 S												
NJ036	41.00	x	56.00	x	7.00	NBR	822N												
NJ042	48.00	x	70.00	x	12.00	NBR	827SS RD												
NJ052	42.00	x	55.00	x	7.00	NBR	822S DD												
NJ071	42.00	x	62.00	x	9.00	NBR	827 S												
NJ090	47.00	x	62.00	x	9.00	NBR	822 N												
NJ117	32.00	x	52.00	x	11.00	NBR	827 S												
NJ152	35.00	x	58.00	x	10.00	NBR	SP												
NJ161	35.00	x	56.00	x	8.00	ACM	827 S												
NJ165	35.00	x	62.00	x	8.00	ACM	827 SS												
NJ190	40.00	x	56.00	x	8.00	ACM	827 S												
NJ382	45.00	x	75.00	x	12.00	NBR	822 S												
NJ492	45.00	x	58.00	x	9.00	NBR	822S												
NJ520	33.00	x	44.00	x	8.00	NBR	822S												
NJ539	50.00	x	65.00	x	10.00	NBR	822 S												
NJ540	36.00	x	62.00	x	14.00	NBR	822 S												
NJ575	35.00	x	67.00	x	12.00	NBR	827 S												
NJ607	35.00	x	55.00	x	11.00	NBR	822SRD												
NJ610	25.00	x	35.00	x	6.00	NBR	827S RD												
NJ637	40.00	x	56.00	x	8.00	NBR	827 S												
NJ659	52.00	x	66.00	x	9.00	NBR	827 N												
NJ687	38.00	x	58.00	x	11.00	NBR	827 S												
NJ689	40.00	x	56.00	x	10.00	NBR	SP												
NJ702	38.00	x	44.00	x	17.50	NBR	0												
NJ704	33.50	x	54.00	x	9.00	NBR	827 S												
NJ705	34.00	x	63.00	x	9.00	NBR	827 S												
NJ731	35.00	x	62.00	x	8.00	ACM	827 S												
NJ732	38.00	x	54.00	x	8.00	ACM	827 S												
NJ739	45.00	x	72.00	x	12.00	NBR	822 S												
NJ749	35.00	x	56.00	x	9.00	NBR	827 S												
NJ761	35.00	x	62.00	x	9.50	NBR	827 S												
NJ777	35.00	x	76.00	x	9.00	NBR	827SRD SP												
NJ813	40.00	x	64.00	x	12.00	NBR	822 S												
NJ859	30.00	x	42.00	x	8.00	NBR	827 SS												
NJ861	35.00	x	55.00	x	9.00	NBR	827 S												
NJ887	38.00	x	62.00	x	11.00	NBR	822 S												
NJ915	35.00	x	56.00	x	8.00	NBR	827 S												
NK066	40.00	x	76.00	x	9.00	ACM	827 S												
NK110	35.00	x	52.00	x	9.50	NBR	827 S												
NK117	32.00	x	45.00	x	8.00	ACM	0												
NK122	35.00	x	50.00	x	9.50	NBR	SP												
NK178	35.00	x	63.00	x	9.00	ACM	827 SS												
NK180	42.00	x	55.00	x	8.00	MVQ	827SS RD												
NK195	50.00	x	75.00	x	9.00	NBR	SP												
NK198	34.00	x	54.00	x	9.00	ACM	827 SS												
NK214	35.00	x	63.00	x	10.00 / 16.50	ACM	822S SP												
NK265	40.00	x	72.00	x	11.00 / 18.50	NBR	827S SP												

DIFFERENTIAL SEALS BY SIZE

																	
20.00	x	47.00	x	7.00	NBR	827 N		NF242	38.00	x	62.00	x	11.00	NBR	822 S		NJ887
25.00	x	35.00	x	6.00	NBR	827S RD		NJ610	38.00	x	65.00	x	12.00	NBR	822 S		NJ017
27.95	x	56.00	x	7.00	ACM	827S RD		NF791	38.00	x	74.00	x	11.50	NBR	822 S		NJ002
29.80	x	47.00	x	9.90	NBR	827S		NF792	40.00	x	52.00	x	7.00	FPM	822S DD		NJ011
29.90	x	47.00	x	11.30	PTFE / ACM	827S RD W		NA5204	40.00	x	56.00	x	8.00	ACM	827 S		NJ190
29.90	x	47.00	x	11.30	ACM	827S RD W SP		NF826	40.00	x	56.00	x	8.00	NBR	827 S		NJ637
30.00	x	42.00	x	8.00	NBR	827 SS		NJ859	40.00	x	56.00	x	10.00	NBR	SP		NJ689
31.00	x	42.00	x	8.00	NBR	827N DD		NF505	40.00	x	58.00	x	10.00	FPM / ACM	827S DD W		NA5205
31.80	x	47.60	x	9.52	NBR	827S DD		NB684	40.00	x	58.00	x	10.00	NBR	827S		NF334
32.00	x	45.00	x	8.00	ACM	O		NK117	40.00	x	58.00	x	10.00	NBR	827S LD W		NF824
32.00	x	47.00	x	10.00	FPM	827S DD W		NA5001	40.00	x	58.00	x	11.30	ACM	827S DD W SP		NF836
32.00	x	50.00	x	10.00	FPM	827S RD W		NF825	40.00	x	62.00	x	10.00	NBR	827N DD		NF032
32.00	x	52.00	x	11.00	NBR	827 S		NJ117	40.00	x	64.00	x	12.00	NBR	822 S		NJ813
33.00	x	44.00	x	8.00	NBR	822S		NJ520	40.00	x	72.00	x	11.00 / 18.50	NBR	827S SP		NK265
33.50	x	54.00	x	9.00	NBR	827 S		NJ704									
34.00	x	54.00	x	9.00	ACM	827 SS		NK198	40.00	x	76.00	x	9.00	ACM	827 S		NK066
34.00	x	63.00	x	9.00	NBR	827 S		NJ705	41.00	x	56.00	x	7.00	NBR	822N		NJ036
35.00	x	50.00	x	8.00	NBR	827N		NF369	42.00	x	55.00	x	7.00	NBR	822S DD		NJ052
35.00	x	50.00	x	8.00	FPM	827N DD		NF841	42.00	x	55.00	x	8.00	MVQ	827SS RD		NK180
35.00	x	50.00	x	9.50	NBR	SP		NK122	42.00	x	62.00	x	9.00	NBR	827 S		NJ071
35.00	x	52.00	x	9.50	NBR	827 S		NK110	43.00	x	59.00	x	10.00	FPM	827S LD		NF881
35.00	x	52.00	x	10.00	NBR	824N DD		NF096	45.00	x	58.00	x	9.00	NBR	822S		NJ492
35.00	x	54.00	x	11.00	FPM	827S RD		NF882	45.00	x	62.00	x	10.00	NBR	827S DD		NF097
35.00	x	55.00	x	9.00	NBR	827 S		NJ861	45.00	x	62.00	x	10.00	NBR	827N DD		NF115
35.00	x	55.00	x	11.00	NBR	822SRD		NJ607	45.00	x	72.00	x	12.00	NBR	822 S		NJ739
35.00	x	56.00	x	8.00	ACM	827 S		NJ161	45.00	x	75.00	x	12.00	NBR	822 S		NJ382
35.00	x	56.00	x	8.00	NBR	827 S		NJ915	47.00	x	62.00	x	9.00	NBR	822 N		NJ090
35.00	x	56.00	x	9.00	NBR	827 S		NJ749	48.00	x	62.00	x	7.00	ACM	827SW		NA5477
35.00	x	58.00	x	10.00	NBR	SP		NJ152	48.00	x	70.00	x	12.00	NBR	827SS RD		NJ042
35.00	x	62.00	x	8.00	ACM	827 SS		NJ165	50.00	x	65.00	x	10.00	NBR	822 S		NJ539
35.00	x	62.00	x	8.00	ACM	827 S		NJ731	50.00	x	75.00	x	9.00	NBR	SP		NK195
35.00	x	62.00	x	9.50	NBR	827 S		NJ761	52.00	x	66.00	x	9.00	NBR	827 N		NJ659
35.00	x	63.00	x	9.00	ACM	827 SS		NK178	55.00	x	72.00	x	10.00	NBR	827 N		NF062
35.00	x	63.00	x	10.00 / 16.50	ACM	822S SP		NK214	60.00	x	74.00	x	8.00	ACM	829S		NA5476
									60.00	x	80.00	x	12.00	NBR	827 N		NF044
35.00	x	67.00	x	12.00	NBR	827 S		NJ575	85.00	x	120.00	x	10.00	FPM	841S		NA5238
35.00	x	76.00	x	9.00	NBR	827SRD SP		NJ777	95.00	x	120.00	x	11.30	NBR	822S		NF779
36.00	x	54.00	x	7.50	ACM	827S DD		NF775									
36.00	x	54.00	x	11.00	NBR	827S DD		NF814									
36.00	x	62.00	x	14.00	NBR	822 S		NJ540									
38.00	x	44.00	x	17.50	NBR	O		NJ702									
38.00	x	52.00	x	6.00	FPM	827S RD W		NC048									
38.00	x	54.00	x	8.00	ACM	827 S		NJ732									
38.00	x	58.00	x	11.00	NBR	827 S		NJ687									

OIL SEAL SETS

APPLICATION	SET	CRANKSHAFT SEAL	CAMSHAFT SEAL	AUXILIARY SHAFT SEAL	QTY in the BOX
ALFA ROMEO					
1.4 1.6 1.8 16V 145 / 146 / 147 / 155 / 156 / GTV / Spider	HL5030	NA5070 - 31x41x7mm	NA5053 - 30x42x7mm	NA5069 - 55x68x8mm	3
AUTOBIANCHI					
1.0 Fire Y 10	HL5024	NB815 - 23x35x7mm	NA5053 - 30x42x7mm	-	2
DACIA					
1.4 1.6 E7J K7J K7M Logan / Solenza	HL5015	NF823 - 35x47x7mm	NA5053 - 30x42x7mm	-	2
FIAT					
750 1.0 1.1 1.1Mpi / Spi 1.2 Mpi Cinquecento / Doblo / Palio / Panda / Punto / Seicento / Strada / Tipo / Uno	HL5024	NB815 - 23x35x7mm	NA5053 - 30x42x7mm	-	2
1.4 12V 1.9 DS / JTD 2.4 TD / JTD Brava / Bravo / Cromia / Doblo / Idea / Marea / Multipla / Palio / Punto / Stilo / Strada	HL5031	NA5070 - 31x41x7mm	NA5053 - 30x42x7mm	-	2
1.8 2.0 2.0 T XU Ducato / Ulysse	HL5019	NA5191 - 42x62x7mm	NF817 - 36x50x7mm	-	2
1.8 16v 1.8 MPI 2.0 2.4 20V Barchetta / Bravo / Coupé / Marea / Punto / Stilo	HL5030	NA5070 - 31x41x7mm	NA5053 - 30x42x7mm	NA5069 - 55x68x8mm	3
1.8 D 1.9 D / TD 2.1 TD Ducato / Scudo / Ulysse I	HL5012	NA5191 - 42x62x7mm	NB959 - 35x50x7mm	-	2
2.0 16V Scudo / Ulysse	HL5037	NA5256 - 40x55x6.5mm	NF817 - 36x50x7mm	NF817 - 36x50x7mm	3
2.0 JTD Ducato / Scudo / Ulysse I	HL5016	NA5191 - 42x62x7mm	NA5035 - 27x47x7mm	NA5035 - 27x47x7mm	3
2.5 D 2.5 Tdi 2.8 DS 2.8 JTD 2.8 Tdi Sofim Ducato	HL5032	NF885 - 70x159x16mm	NP068 - 55x70x8mm	-	2
FORD					
1.4 TDCi 1.6 TDCi Fiesta / Focus / Fusion	HL5033	NA5259 - 40x55x6.4mm	NA5258 - 27x47x7mm	-	2
1.8 D / TD Escort / Fiesta / Mondeo / Orion / Sierra	HL5018	NB984 - 66.6x89.3x10mm	NB785 - 28x38x7mm	-	2
1.9 Tdi Galaxy →04 / 00	HL5020	NA5001 - 32x47x10mm	NA5001 - 32x47x10mm	NA5001 - 32x47x10mm	3
1.9 Tdi Galaxy 04 / 00→	HL5034	NA5106 - 35x48x10mm	NA5124 - 32x47x10mm	-	2
LANCIA					
1.1 Spi 1.2 Spi 176B2 188A4 840A3 Y / Ypsilon	HL5019	NA5191 - 42x62x7mm	NF817 - 36x50x7mm	-	2
1.4 Spi Y	HL5031	NA5070 - 31x41x7mm	NA5053 - 30x42x7mm	-	2
1.8 MPI 16V 183A1 Dedra / Delta / Lybra	HL5030	NA5070 - 31x41x7mm	NA5053 - 30x42x7mm	NA5069 - 55x68x8mm	3
2.0 T RGX Zeta	HL5024	NB815 - 23x35x7mm	NA5053 - 30x42x7mm	-	2
2.0 16V RFN Phedra / Zeta	HL5037	NA5256 - 40x55x6.5mm	NF817 - 36x50x7mm	NF817 - 36x50x7mm	3
2.0 2.4 20V Kappa / Lybra / Thesis	HL5030	NA5070 - 31x41x7mm	NA5053 - 30x42x7mm	NA5069 - 55x68x8mm	3
1.9 2.4 JTD 2.4 TDS Kappa / Lybra / Musa / Thesis	HL5031	NA5070 - 31x41x7mm	NA5053 - 30x42x7mm	-	2
2.0 JTD RHZ Zeta	HL5016	NA5191 - 42x62x7mm	NA5035 - 27x47x7mm	NA5035 - 27x47x7mm	3
2.1 TD P8C Zeta	HL5012	NA5191 - 42x62x7mm	NB959 - 35x50x7mm	-	2
OPEL					
1.9 CDTi 2.2 2.5 DTi 16V Z19DT G9T G9U Astra / Movano / Signum / Vectra / Vivaro / Zafira	HL5031	NA5070 - 31x41x7mm	NA5053 - 30x42x7mm	-	2
2.5 D SBU Arena / Movano	HL5032	NF885 - 70x159x16mm	NP068 - 55x70x8mm	-	2
PSA (Peugeot - Citroën)					
1.0 1.1 1.2 1.3 1.4 1.6 8V AX / Berlingo / BX / C15 / C2 / C3 Saxo / Xsara / ZX / 106 / 1007 / 205 / 206 / 306 / 309 / 405 / Partner	HL5011	NF870 - 42x66x6mm	NF817 - 36x50x7mm	-	2
1.4 1.4 D 1.5 D 1.6 TU3D / F TU5D / F AX / BX / C15 / SaxoXsara / ZX / 106 / 205 / 206 / 306 / 309 / 405	HL5011	NF870 - 42x66x6mm	NF817 - 36x50x7mm	-	
1.6 1.8 1.9 2.0 XU5 XU7 XU9 XU10 Berlingo / BX / Evasion / Jumper / Jumpy / Visa / Xantia / XM / Xsara / ZX / 205 / 305 / 306 / 309 / 405 / 406 / 605 / 806 / Boxer / Expert / Partner	HL5019	NA5191 - 42x62x7mm	NF817 - 36x50x7mm	-	2
1.6 16V TU5J4 TU5JP4 Berlingo / C2 / C3 / C4 / Saxo / Xsara / Picasso / 1007 / 106 / 206 / 307 / Partner	HL5038	NF870 - 42x66x6mm	NA5260 - 38x50x6mm	-	2
1.8 2.0 EW7J4 EW10J4 / S C4 / C5 / C8 / Evasion / Jumper / Picasso / Xsara / 206 / 307 / 406 / 407 / 607 / 806 / 807 / Expert	HL5037	NA5256 - 40x55x6.5mm	NF817 - 36x50x7mm	NF817 - 36x50x7mm	3
1.4 HDi 1.6 HDi DV4 / DV6 Berlingo / C1 / C2 / C3 / C4 / C5 / Picasso / Xsara / 1007 / 107 / 206 / 207 / 307 / 308 / 407 / Expert	HL5033	NA5259 - 40x55x6.4mm	NA5258 - 27x47x7mm	-	2
1.8 D / TD 1.9 D / TD XUD7 XUD9 →12 / 93 Horizon BX / C15 / C25 / Visa / XM / ZX / 205 / 305 / 309 / 405 / 605 / J5	HL5010	NA5191 - 42x62x7mm	NF841 - 35x50x8mm	-	2
1.8 D / TD 1.9 D / TD 1.9 HDi DW8 / B XUD7 / 9 01 / 94→ Berlingo / C15 / Evasion / Jumper / Jumpy / Xantia / Xsara / 206 / 306 / 406 / 806 / Boxer / Expert / Partner	HL5012	NA5191 - 42x62x7mm	NB959 - 35x50x7mm	-	2
2.0 HDi 2.2 HDi DW10TD / ATED / BTED DW12TED Berlingo / C5 / Evasion / Jumpy / Jumper / Xantia / Xsara / 206 / 306 / 307 / 406 / 607 / 806 / 807 / Boxer / Expert / Partner	HL5016	NA5191 - 42x62x7mm	NA5035 - 27x47x7mm	NA5035 - 27x47x7mm	3

OIL SEAL SETS

APPLICATION	SET	CRANKSHAFT SEAL	CAMSHAFT SEAL	AUXILIARY SHAFT SEAL	QTY in the BOX
PSA (Peugeot - Citroën)					
2.0 XU10 2C / J2 / J2TE Evasion / Jumper / Xantia / Xsara / XM / ZX / 306 / 405 / 406 / 605 / 806 / Boxer	HL5019	NA5191 - 42x62x7mm	NF817 - 36x50x7mm	-	2
2.0 2.2 J6R J6T ZEJ ZDJ CX / 505	HL5014	NF843 - 50x68x10mm	NF823 - 35x47x7mm	NF849 - 30x40x7mm	3
2.5 D / TD M25 U25 CRD93 / LS CX / C25 / J5	HL5022	NF776 - 75x90x11.5mm	NF741 - 29x46x10mm	-	2
2.5 D / TD / TDi DJ5 DJ5T DJ5TED Boxer / Jumper	HL5027	NF866 - 64x88x6mm	NB959 - 35x50x7mm	-	2
2.8 D / TD 2.8 HDi Sofim Jumper / Boxer	HL5032	NF885 - 70x159x16mm	NP068 - 55x70x8mm	-	2
RENAULT					
1.1 1.2 1.4 1.6 E5F E7F E6J E7J K7M Clio / Express / Kangoo / Megane / Rapid / R19 / Scenic / Thalia	HL5015	NF823 - 35x47x7mm	NA5053 - 30x42x7mm	-	2
1.1 D7F Clio / Kangoo / Twingo	HL5021	NF856 - 32x44x6mm	NA5053 - 30x42x7mm	-	2
1.2 16V D4F Clio / Kangoo / Modus / Thalia / Twingo → 10 / 05	HL5036	NF856 - 32x44x6mm	NA5261 - 28x47x8mm	NA5053 - 30x42x7mm	3
1.4 16V 1.6 16V K4J / M Clio / Kangoo / Laguna / Megane / Modus / Nevada / Scenic / Thalia	HL5029	NF823 - 35x47x7mm	NA5215 - 28x42x5mm	NA5215 - 28x42x5mm	3
1.6 D 1.9 D / TD F8M F8Q → 07 / 97 Clio / Express / Megane / Rapid / R19 / R21 / Scenic	HL5013	NF843 - 50x68x10mm	NF846 - 25x42x7mm	NF849 - 30x40x7mm	3
1.7 1.8 2.0 F1N F2N F3N F3P F3R → 05 / 97 Super 5 / Clio / Espace / Laguna / Megane / R9 / R11 / R19 / R21 / Trafic	HL5013	NF843 - 50x68x10mm	NF846 - 25x42x7mm	NF849 - 30x40x7mm	3
1.8 16V 2.0 16V F4P / R F5R Avantime / Clio / Espace / Laguna / Megane / Nevada / Scenic / Trafic / Vel Satis	HL5039	NA5036 - 42x54x6mm	NA5257 - 28x47x5.5mm	-	2
2.0 2.2 J5R J6R(829) J7R J7T Espace / Fuego / Master / R18 / R20 / R21 / R25 / Safrane / Trafic	HL5014	NF843 - 50x68x10mm	NF823 - 35x47x7mm	NF849 - 30x40x7mm	3
1.5 dCi K9K Clio / Kangoo / Megane / Modus / Scenic	HL5026	NA5255 - 35x47x7mm	NA5215 - 28x42x5mm	NA5215 - 28x42x5mm	3
1.9 dCi / dTi F9Q Clio / Espace / Kangoo / Laguna / Master / Megane / Nevada / Scenic / Thalia / Trafic	HL5017	NA5036 - 42x54x6mm	NF846 - 25x42x7mm	-	2
2.1 D / TD 85Z J8S Cherokee / Espace / Fuego / Master / R18 / R20 / R21 / R25 / R30 / Safrane / Trafic	HL5014	NF843 - 50x68x10mm	NF823 - 35x47x7mm	NF849 - 30x40x7mm	3
2.2 D / TD G8T Espace / Laguna / Safrane	HL5023	NF861 - 46x59x7mm	NF858 - 33x43x7mm	-	2
2.2 dCi 2.5 dCi G9T / U Avantime / Espace / Laguna / Master / Trafic / Vel Satis	HL5035	NF861 - 46x59x7mm	NA5053 - 30x42x7mm	NA5053 - 30x42x7mm	3
2.5 D S8U Master / Trafic	HL5032	NF885 - 70x159x16mm	NP068 - 55x70x8mm	-	2
ROVER					
18 TD XUD7 200 / 400 → 10 / 95	HL5012	NA5191 - 42x62x7mm	NB959 - 35x50x7mm	-	2
VAG (Volkswagen, Audi, SEAT, Skoda)					
0.8 0.9 1.0 1.1 1.3 1.4 1.5 1.6 1.7 1.8 2.0 Essence 8V 80 / 90 / 100 / A4 / A6 / Alhambra / Caddy / Cordoba / Corrado / Felicia / Golf / Ibiza / Inca / Jetta / Octavia / Passat / Polo / Scirocco / Sharan / Toledo / Transporter / Vento	HL5020	NA5001 - 32x47x10mm	NA5001 - 32x47x10mm	NA5001 - 32x47x10mm	3
1.6 1.8 1.9 2.0 2.1 2.2 2.5 A3 / Alhambra / Altea / Beetle / Bora / Caddy / Cordoba / Golf / Ibiza / Jetta / León / Passat / Octavia / Sharan / Superb / Toledo / Touran / Transporter	HL5034	NA5106 - 35x48x10mm	NA5124 - 32x47x10mm	-	2
1.4 D 1.5 1.6 D / TD 1.7 Sdi 1.9 D / TD / Sdi / Tdi 80 / 90 / A4 / A6 / Alhambra / Arosa / Caddy / Cordoba / Felicia / Golf / Ibiza / Inca / Jetta / Lupo / Passat / Polo / Santana / Scirocco / Sharan / Toledo / Transporter / Vento	HL5020	NA5001 - 32x47x10mm	NA5001 - 32x47x10mm	NA5001 - 32x47x10mm	3
1.2 Tdi 1.4 Tdi 1.9 Sdi 1.9 Tdi 2.0 Sdi 2.0 Tdi 2.4 D 2.5 D 2.5 Tdi A2 / A3 / A4 / A6 / Alhambra / Altea / Arosa / Beetle / Bora / Caddy / Cordoba / Fabia / Fox / Golf / Ibiza / Jetta / León / LT / Lupo / Octavia / Passat / Polo / Sharan / Superb / Toledo / Touran / Transporter	HL5034	NA5106 - 35x48x10mm	NA5124 - 32x47x10mm	-	2
1.6 1.8 20V 2.0 Fsi 16V 2.0 20V A3 / A4 / A6 / TT / Alhambra / Altea / Beetle / Bora / Cordoba / Golf / Ibiza / Jetta / León / Octavia / Passat / Sharan / Toledo / Touran	HL5040	NA5106 - 35x48x10mm	NA5124 - 32x47x10mm	NA5124 - 32x47x10mm	3
2.0 Tdi 16V 2.5 Tdi V6 24V A3 / A4 / A6 / Altea / Golf / Jetta / León / Passat / Toledo / Touran	HL5040	NA5106 - 35x48x10mm	NA5124 - 32x47x10mm	NA5124 - 32x47x10mm	3
5 Cyl: 2.1 2.1 Tbo 2.2 2.2 Tbo 200 / Coupé	HL5034	NA5106 - 35x48x10mm	NA5124 - 32x47x10mm	-	2
5 Cyl: 1.9 2.0 2.0 D / TD 2.1 2.2 2. Tbo 2.3 2.4 D 2.5 Tdi 80 / 90 / 100 / 200	HL5040	NA5106 - 35x48x10mm	NA5124 - 32x47x10mm	NA5124 - 32x47x10mm	3
2.4 V6 2.6 V6 2.7 V6 2.8 V6 80 / 100 / A4 / A6 / A8 / Beetle / Bora / Golf / Jetta / Passat / Sharan / Superb / Touran	HL5040	NA5106 - 35x48x10mm	NA5124 - 32x47x10mm	NA5124 - 32x47x10mm	3
VOLVO					
1.6 1.7 1.8 1.9 D 2.0 340 / 360 / 440 / 460 / 480 / S40 / V40	HL5013	NF843 - 50x68x10mm	NF846 - 25x42x7mm	NF849 - 30x40x7mm	3
2.0D 2.4D 2.5D 240 / 740 / 760 / 850 / 940 / 960 / S70 / S80 / V70	HL5034	NA5106 - 35x48x10mm	NA5124 - 32x47x10mm	-	2

O-RING SEALS BY REFERENCE

▲ Payen	INNER DIAMETER	THICKNESS	QTY	▲ Payen	INNER DIAMETER	THICKNESS	QTY
HR618	4.0	3.0	8	LA5078	26.6	3.5	10
KH066	6.0	3.5	100	LA5081	31.3	3.5	10
LA5023	4.9	1.9	20	LA5084	36.1	3.5	5
LA5024	5.7	1.9	20	LA5085	37.7	3.5	5
LA5025	7.2	1.9	20	LA5087	7.5	3.25	50
LA5026	8.9	1.9	20	LA5106	16.7	2.5	20
LA5027	12.1	2.7	10	LA5109	10.0	3.0	20
LA5028	15.1	2.7	20	LA5113	6.3	2.4	20
LA5030	18.3	3.6	20	LA5114	38.9	2.7	10
LA5031	19.8	3.6	20	LA5116	20.3	2.6	10
LA5032	21.3	3.6	10	LA5120	18.0	2.0	5
LA5033	23.0	3.6	10	LA5124	18.7	1.8	5
LA5037	29.3	3.6	10	LA5128	126.0	3.0	10
LA5040	34.1	3.6	10	LA5139	58.6	7.0	20
LA5042	37.3	3.6	10	LA5143	13.0	2.5	20
LA5044	10.6	5.3	20	LA5235	144.0	3.8	100
LA5045	43.8	5.3	20	LA5236	144.0	4.0	50
LA5046	46.6	5.3	20	LA5244	33.0	3.5	100
LA5054	75.6	5.3	10	PA173	13.6	2.7	20
LA5057	88.3	5.3	10	PA326	18.4	2.7	5
LA5067	10.8	2.6	10	PA714	99.0	3.0	10
LA5068	12.4	2.6	10	KJ760	54.0	2.0	500
LA5070	15.5	2.6	10	PB047	137.5	3.5	12
LA5072	18.7	2.6	10				

O-RING SEALS BY SIZE

INNER DIAMETER	THICKNESS	QTY	▲ Payen	INNER DIAMETER	THICKNESS	QTY	▲ Payen
4.0	3.0	8	HR618	20.3	2.6	10	LA5116
4.9	1.9	20	LA5023	21.3	3.6	10	LA5032
5.7	1.9	20	LA5024	23.0	3.6	10	LA5033
6.0	3.5	100	KH066	26.6	3.5	10	LA5078
6.3	2.4	20	LA5113	29.3	3.6	10	LA5037
7.2	1.9	20	LA5025	31.3	3.5	10	LA5081
7.5	3.25	50	LA5087	33.0	3.5	100	LA5244
8.9	1.9	20	LA5026	34.1	3.6	10	LA5040
10.0	3.0	20	LA5109	36.1	3.5	5	LA5084
10.6	5.3	20	LA5044	37.3	3.6	10	LA5042
10.8	2.6	10	LA5067	37.7	3.5	5	LA5085
12.1	2.7	10	LA5027	38.9	2.7	10	LA5114
12.4	2.6	10	LA5068	43.8	5.3	20	LA5045
13.0	2.5	20	LA5143	46.6	5.3	20	LA5046
13.6	2.7	20	PA173	54.0	2.0	500	KJ760
15.1	2.7	20	LA5028	58.6	7.0	20	LA5139
15.5	2.6	10	LA5070	75.6	5.3	10	LA5054
16.7	2.5	20	LA5106	88.3	5.3	10	LA5057
18.0	2.0	5	LA5120	99.0	3.0	10	PA714
18.3	3.6	20	LA5030	126.0	3.0	10	LA5128
18.4	2.7	5	PA326	137.5	3.5	12	PB047
18.7	1.8	5	LA5124	144.0	3.8	100	LA5235
18.7	2.6	10	LA5072	144.0	4.0	50	LA5236
19.8	3.6	20	LA5031				

WASHERS BY REFERENCE

▲ Payen	INNER DIAMETER	OUTER DIAMETER	THICKNESS	QTY	MATERIAL	TYPE	▲ Payen	INNER DIAMETER	OUTER DIAMETER	THICKNESS	QTY	MATERIAL	TYPE
KG5009	14.1	19	2.5	100	COPPER	FIBRE FILLED	KG5091	16.2	20	1	100	COPPER	
KG5010	5.1	13.5	1.3	25	PA		KG5092	10.2	17	1	100	COPPER	
KG5011	14	21	1.5	25	BONDED WASHER		KG5093	12.5	20	0.8	100	COPPER	
KG5012	16	23	1.5	25	BONDED WASHER		KG5094	8	12	1	100	COPPER	
KG5019	9.2	14	2	100	COPPER	FIBRE FILLED	KG5095	12.2	18	1	100	COPPER	
KG5020	14.1	19	2.5	100	COPPER	FIBRE FILLED	KG5096	17	21	1	100	COPPER	
KG5021	18.1	24	3	100	COPPER	FIBRE FILLED	KG5097	12.5	19	1.5	100	COPPER	
KG5022	24.2	30	3	100	COPPER	FIBRE FILLED	KG5098	18.5	23	1	100	COPPER	
KG5023	25	32	2	100	COPPER	FIBRE FILLED	KG5099	14	21	0.8	100	COPPER	
KG5026	24.4	32	2	100	COPPER	FIBRE FILLED	KG5100	14.5	21	1.5	100	COPPER	
KG5027	10.2	16	2	100	COPPER	FIBRE FILLED	KG5101	5.2	8	1	100	COPPER	
KG5030	14.3	19	2	100	COPPER	FIBRE FILLED	KG5102	8.5	17	1	100	COPPER	
KG5033	12	16	2	100	COPPER	FIBRE FILLED	KG5103	7.2	11	1	100	COPPER	
KG5034	16.3	24	3	50	COPPER	FIBRE FILLED	KG5104	16.2	21.5	1	100	COPPER	
KG5035	21	26	2	100	COPPER	FIBRE FILLED	KG5105	10.2	15	1	100	COPPER	
KG5036	22.3	26.8	2	100	COPPER	FIBRE FILLED	KG5106	22.2	30	1.5	100	COPPER	
KG5039	6.2	10	2	100	COPPER	FIBRE FILLED	KG5108	8.2	14	1	100	COPPER	
KG5040	7.2	11	2	100	COPPER	FIBRE FILLED	KG5109	12.2	21.5	1	100	COPPER	
KG5042	20.4	26	2	100	COPPER	FIBRE FILLED	KG5110	14.2	20	1	100	COPPER	
KG5043	27.4	35	2	100	COPPER	FIBRE FILLED	KG5111	26.1	32	1	100	COPPER	
KG5045	33.4	41	2	100	COPPER	FIBRE FILLED	KG5112	10.3	15.8	1	100	COPPER	
KG5050	26	32	2	100	COPPER	FIBRE FILLED	KG5113	14	18	2	100	COPPER	
KG5055	22.4	29	2	100	SPECIAL		KG5114	6.5	12	1	100	COPPER	
KG5058	18.3	24	2	100	SPECIAL		KG5115	9.2	20	1	100	COPPER	
KG5059	9.3	20	1	100	COPPER		KG5116	8.3	16	1	100	COPPER	
KG5060	8	13	1	25	BONDED WASHER		KG5117	6.2	10	1	100	COPPER	
KG5062	12	19	1.5	25	BONDED WASHER		KG5118	15	24	1	100	COPPER	
KG5063	22	31	2	25	BONDED WASHER		KG5119	16.5	24	1.5	100	COPPER	
KG5064	5.3	20.2	2.6	20	COPPER	INJECTOR	KG5120	30.5	36	2	100	COPPER	
KG5066	5.5	13.8	1.3	20	PA		KG5121	14.4	19	2	100	COPPER	
KG5067	4	9.5 / 10.8	1.3	20	PA		KG5122	14.2	21.8	2	100	COPPER	
KG5068	17.2	21	2	20	COPPER	INJECTOR	KG5124	12.1	15.7	1	100	COPPER	
KG5072	10.8	17.5	4.5 / 55	20	COPPER	INJECTOR	KG5125	20.5	28	2	100	COPPER	
KG5073	12	19.6	0.9	20	RETOUR		KG5126	18.5	26	2	100	COPPER	
KG5074	11.2	20	1	100	COPPER		KG5128	18.5	24	1	100	COPPER	
KG5075	10.8	19	1	100	COPPER		KG5130	10.2	20	1	100	COPPER	
KG5076	8.2	14	1.5	100	COPPER		KG5131	11.2	16	1	100	COPPER	
KG5077	10.5	18	2	100	COPPER		KG5132	13.1	19.8	1	100	COPPER	
KG5078	9.5	20	1.5	100	COPPER		KG5133	36	42	2	100	COPPER	
KG5079	24	29	1	100	COPPER		KG5134	13.7	18.5	1	100	COPPER	
KG5081	12.2	17	2	100	COPPER		KG5135	22.5	27	1	100	COPPER	
KG5082	10	15	3.5	100	COPPER		KG5136	16.5	20.5	2	100	COPPER	
KG5083	11	20	1.5	100	COPPER		KG5137	24.4	32	1.5	100	COPPER	
KG5084	27.3	34	2	100	COPPER		KG5140	28.2	35	1.5	100	COPPER	
KG5086	23.4	31	1	100	COPPER		KG5141	24	29	1.5	100	COPPER	
KG5087	14.7	21.4	1.95	100	COPPER		KG5144	14.3	18	1.5	100	COPPER	
KG5088	17	19.9	1.5	50	COPPER		KG5145	12.5	18	2	100	COPPER	
KG5089	14	19	1	100	COPPER		KG5146	10	16	1.5	100	COPPER	
KG5090	20.1	26	1	100	COPPER		KG5147	14.1	20.5	1.5	100	COPPER	

WASHERS BY REFERENCE

▲ Payen	INNER DIAMETER	OUTER DIAMETER	THICKNESS	QTY	MATERIAL	TYPE	▲ Payen	INNER DIAMETER	OUTER DIAMETER	THICKNESS	QTY	MATERIAL	TYPE
KG5148	22.1	26.9	1.5	100	COPPER		KG5210	22.4	30	1	100	COPPER	
KG5149	8.1	11.5	1	100	COPPER		KG5213	21	27	1	100	COPPER	
KG5150	9.7	14.2	1.8	100	COPPER		KG5214	8	16	2	100	COPPER	
KG5151	14.5	21.4	2.3	100	COPPER		KG5215	26.3	33	3	100	COPPER	
KG5152	17.6	21.4	0.5	50	COPPER		KG5217	22.5	29	1.5	100	COPPER	
KG5153	9.8	21	2	100	COPPER		KG5218	14.2	18	1.5	100	COPPER	
KG5155	16	20	1.5	100	COPPER		KG5219	10.2	13.9	1	100	COPPER	
KG5157	10.1	20.8	2	100	COPPER		KG5220	14.5	21.3	1.5	100	COPPER	
KG5158	18.3	24	1.5	100	COPPER		KG5221	8.2	12	1.5	100	COPPER	
KG5159	5	10	1.5	100	COPPER		KG5222	21.2	25.5	1	100	COPPER	
KG5160	11	16	1.5	100	COPPER		KG5224	16.2	21.5	2	100	COPPER	
KG5161	16.2	22	1.5	100	COPPER		KG5225	22	26	1	100	COPPER	
KG5162	12.2	15.9	1.5	100	COPPER		KG5226	32	42	1	100	COPPER	
KG5163	10.1	14.5	1	100	COPPER		KG5227	14.1	18	1	100	COPPER	
KG5164	13	18	1	100	COPPER		KG5228	13.2	18	1.5	100	COPPER	
KG5165	14.2	19.5	1	100	COPPER		KG5229	22.7	26.8	2	100	COPPER	
KG5167	10	19.5	2	100	COPPER		KG5230	24	32.5	2	100	COPPER	
KG5169	20.2	25	1.5	100	COPPER		KG5231	18.2	22	1.5	100	COPPER	
KG5170	8	13	1.5	100	COPPER		KG5235	14.5	21	1.8	100	COPPER	
KG5173	9.2	14	1.2	100	COPPER		KG5239	10.2	17	2	100	COPPER	
KG5175	10.2	13	1	100	COPPER		KG5242	12	16	1.6	100	ALUMINIUM	
KG5176	18.2	26	1.5	100	COPPER		KG5244	14.1	18	1	100	ALUMINIUM	
KG5178	22	29	1	100	COPPER		KG5245	16	24	1	100	ALUMINIUM	
KG5179	9.5	18	2	100	COPPER		KG5247	22.5	29	1.5	100	ALUMINIUM	
KG5180	9.5	20	1	100	COPPER		KG5248	14.3	19	1.5	50	ALUMINIUM	
KG5181	9.5	17.5	1.5	100	COPPER		KG5249	14.9	22.2	2	25	PA	
KG5182	18.2	23	1.5	100	COPPER		KG5250	13.2	20	2	50	ALUMINIUM	
KG5183	12.5	20	1	100	COPPER		KG5252	4	7	0.05	100	STEEL	
KG5184	22	28	1.5	100	COPPER		KG5253	4	7	0.1	100	STEEL	
KG5185	10.2	13.5	1.5	100	COPPER		KG5254	4.9	9.5	0.05	100	STEEL	
KG5186	17	22	1.5	100	COPPER		KG5255	4.9	9.5	0.1	100	STEEL	
KG5187	15	20	1	100	COPPER		KG5257	5	9	0.05	100	STEEL	
KG5188	36.4	45	2	100	COPPER		KG5259	5	9	0.2	100	STEEL	
KG5190	12	22	1	100	COPPER		KG5260	5.5	11.5	0.05	100	STEEL	
KG5191	16.2	22.9	1.5	100	COPPER		KG5262	5.5	11.5	0.2	100	STEEL	
KG5192	24	30	1	100	COPPER		KG5263	6	10	0.05	100	STEEL	
KG5193	26	30	1.5	100	COPPER		KG5266	6.5	11	0.05	100	STEEL	
KG5194	21.5	25	2	100	COPPER		KG5267	6.5	11	0.1	100	STEEL	
KG5195	20	26	1.5	100	COPPER		KG5270	7.5	13	0.2	100	STEEL	
KG5197	15.5	20	2	100	COPPER		KG5272	8.2	14	0.1	50	STEEL	
KG5198	6	9.4	0.8	100	COPPER		KG5276	6	10	1	100	FIBRE	
KG5199	13	19	1.5	100	COPPER		KG5277	12	18	1	100	FIBRE	
KG5200	24.5	32	2	100	COPPER		KG5278	8.2	14	1	100	FIBRE	
KG5202	12	16	1	100	COPPER		KG5280	13	18	1	100	FIBRE	
KG5203	13	20.4	1.5	100	COPPER		KG5286	14.4	20	2	100	FIBRE	
KG5204	10	14	0.8	100	COPPER		KG5287	12.5	20	2	100	FIBRE	
KG5206	12.5	16.8	1	100	COPPER		KG5288	14.3	19	1.5	100	FIBRE	
KG5207	16	23.6	1.5	100	COPPER		KG5290	20.4	27	3	100	FIBRE	
KG5209	12	20	1.5	100	COPPER		KG5291	16	22	2	100	FIBRE	

WASHERS BY REFERENCE

▲ Payen	INNER DIAMETER	OUTER DIAMETER	THICKNESS	QTY	MATERIAL	TYPE
KG5292	14.5	22	2	100	FIBRE	
KG5294	14.2	20	1.5	100	FIBRE	
KG5296	14	18	2	100	FIBRE	
KG5297	4.2	8	1	100	FIBRE	
KG5298	5	9	1	100	FIBRE	
KG5299	10	16	1	100	FIBRE	
KG5300	11	16	1	100	FIBRE	
KG5301	20.5	26	1.5	100	FIBRE	
KG5308	10.2	16	1.5	100	FIBRE	
KG5338	10	21	1.5	1000	COPPER	
KG5339	7.4	15	1.5	100	COPPER	INJECTOR
KG5340	7.4	15	1.5	25	COPPER	INJECTOR
KG5341	18.4 / 18.8	26	1.5	50	BONDED WASHER	
KG5342	7.3	15	1.56	10	COPPER	
KG5343	12	18	2	100	COPPER	OIL FEED
KG5344	7	16	2	25	COPPER	
KG5345	12	20	1.5	100	COPPER	
KG5346	18	26	1.5	100	COPPER	
KG5347	7 / 7.5	15	2	4	COPPER	INJECTOR
KG5348	12	21	2	25	ALUMINIUM	OIL DRAIN PLUG
KJ647	18.3	23.8	2.2	100	COPPER	FIBRE FILLED
KJ779	12.3	17.9	1.4	500	COPPER	
PA348	15.3	21	1.2	100	COPPER	
PA400	12.5	18	1.5	100	COPPER	
PB852	16.7	24	1.5	25	BONDED WASHER	
PB853	22.2	26.9	2	100	COPPER	FIBRE FILLED

WASHERS BY SIZE

INNER DIAMETER	OUTER DIAMETER	THICKNESS	QTY	MATERIAL	TYPE	▲ Payen	INNER DIAMETER	OUTER DIAMETER	THICKNESS	QTY	MATERIAL	TYPE	▲ Payen
4	7	0.05	100	STEEL		KG5252	9.5	18	2	100	COPPER		KG5179
4	7	0.1	100	STEEL		KG5253	9.5	20	1	100	COPPER		KG5180
4	9.5/10.8	1.3	20	PA		KG5067	9.5	20	1.5	100	COPPER		KG5078
4.2	8	1	100	FIBRE		KG5297	9.7	14.2	1.8	100	COPPER		KG5150
4.9	9.5	0.05	100	STEEL		KG5254	9.8	21	2	100	COPPER		KG5153
4.9	9.5	0.1	100	STEEL		KG5255	10	14	0.8	100	COPPER		KG5204
5	9	0.05	100	STEEL		KG5257	10	15	3.5	100	COPPER		KG5082
5	9	0.2	100	STEEL		KG5259	10	16	1	100	FIBRE		KG5299
5	9	1	100	FIBRE		KG5298	10	16	1.5	100	COPPER		KG5146
5	10	1.5	100	COPPER		KG5159	10	19.5	2	100	COPPER		KG5167
5.1	13.5	1.3	25	PA		KG5010	10	21	1.5	1000	COPPER		KG5338
5.2	8	1	100	COPPER		KG5101	10.1	14.5	1	100	COPPER		KG5163
5.3	20.2	2.6	20	COPPER	INJECTOR	KG5064	10.1	20.8	2	100	COPPER		KG5157
5.5	11.5	0.05	100	STEEL		KG5260	10.2	13	1	100	COPPER		KG5175
5.5	11.5	0.2	100	STEEL		KG5262	10.2	13.5	1.5	100	COPPER		KG5185
5.5	13.8	1.3	20	PA		KG5066	10.2	13.9	1	100	COPPER		KG5219
6	9.4	0.8	100	COPPER		KG5198	10.2	15	1	100	COPPER		KG5105
6	10	0.05	100	STEEL		KG5263	10.2	16	1.5	100	FIBRE		KG5308
6	10	1	100	FIBRE		KG5276	10.2	16	2	100	COPPER	FIBRE FILLED	KG5027
6.2	10	1	100	COPPER		KG5117	10.2	17	1	100	COPPER		KG5092
6.2	10	2	100	COPPER	FIBRE FILLED	KG5039	10.2	17	2	100	COPPER		KG5239
6.5	11	0.05	100	STEEL		KG5266	10.2	20	1	100	COPPER		KG5130
6.5	11	0.1	100	STEEL		KG5267	10.3	15.8	1	100	COPPER		KG5112
6.5	12	1	100	COPPER		KG5114	10.5	18	2	100	COPPER		KG5077
7	16	2	25	COPPER		KG5344	10.8	17.5	4.5/55	20	COPPER	INJECTOR	KG5072
7/7.5	15	2	4	COPPER	INJECTOR	KG5347	10.8	19	1	100	COPPER		KG5075
7.2	11	1	100	COPPER		KG5103	11	16	1	100	FIBRE		KG5300
7.2	11	2	100	COPPER	FIBRE FILLED	KG5040	11	16	1.5	100	COPPER		KG5160
7.3	15	1.56	10	COPPER		KG5342	11	20	1.5	100	COPPER		KG5083
7.4	15	1.5	100	COPPER	INJECTOR	KG5339	11.2	16	1	100	COPPER		KG5131
7.4	15	1.5	25	COPPER	INJECTOR	KG5340	11.2	20	1	100	COPPER		KG5074
7.5	13	0.2	100	STEEL		KG5270	12	16	1	100	COPPER		KG5202
8	12	1	100	COPPER		KG5094	12	16	1.6	100	ALUMINIUM		KG5242
8	13	1	25	BONDED WASHER		KG5060	12	16	2	100	COPPER	FIBRE FILLED	KG5033
8	13	1.5	100	COPPER		KG5170	12	18	1	100	FIBRE		KG5277
8	16	2	100	COPPER		KG5214	12	18	2	100	COPPER	OIL FEED	KG5343
8.1	11.5	1	100	COPPER		KG5149	12	19	1.5	25	BONDED WASHER		KG5062
8.2	12	1.5	100	COPPER		KG5221	12	19.6	0.9	20	RETOUR		KG5073
8.2	14	0.1	50	STEEL		KG5272	12	20	1.5	100	COPPER		KG5345
8.2	14	1	100	COPPER		KG5108	12	20	1.5	100	COPPER		KG5209
8.2	14	1	100	FIBRE		KG5278	12	21	2	25	ALUMINIUM	OIL DRAIN PLUG	KG5348
8.2	14	1.5	100	COPPER		KG5076	12	22	1	100	COPPER		KG5190
8.3	16	1	100	COPPER		KG5116	12.1	15.7	1	100	COPPER		KG5124
8.5	17	1	100	COPPER		KG5102	12.2	15.9	1.5	100	COPPER		KG5162
9.2	14	1.2	100	COPPER		KG5173	12.2	17	2	100	COPPER		KG5081
9.2	14	2	100	COPPER	FIBRE FILLED	KG5019	12.2	18	1	100	COPPER		KG5095
9.2	20	1	100	COPPER		KG5115	12.2	21.5	1	100	COPPER		KG5109
9.3	20	1	100	COPPER		KG5059	12.3	17.9	1.4	500	COPPER		KJ779
9.5	17.5	1.5	100	COPPER		KG5181	12.5	16.8	1	100	COPPER		KG5206

WASHERS BY SIZE

INNER DIAMETER	OUTER DIAMETER	THICKNESS	QTY	MATERIAL	TYPE	▲ Payen	INNER DIAMETER	OUTER DIAMETER	THICKNESS	QTY	MATERIAL	TYPE	▲ Payen
12.5	18	1.5	100	COPPER		PA400	16	23	1.5	25	BONDED WASHER		KG5012
12.5	18	2	100	COPPER		KG5145	16	23.6	1.5	100	COPPER		KG5207
12.5	19	1.5	100	COPPER		KG5097	16	24	1	100	ALUMINIUM		KG5245
12.5	20	0.8	100	COPPER		KG5093	16.2	20	1	100	COPPER		KG5091
12.5	20	1	100	COPPER		KG5183	16.2	21.5	1	100	COPPER		KG5104
12.5	20	2	100	FIBRE		KG5287	16.2	21.5	2	100	COPPER		KG5224
13	18	1	100	COPPER		KG5164	16.2	22	1.5	100	COPPER		KG5161
13	18	1	100	FIBRE		KG5280	16.2	22.9	1.5	100	COPPER		KG5191
13	19	1.5	100	COPPER		KG5199	16.3	24	3	50	COPPER	FIBRE FILLED	KG5034
13	20.4	1.5	100	COPPER		KG5203	16.5	20.5	2	100	COPPER		KG5136
13.1	19.8	1	100	COPPER		KG5132	16.5	24	1.5	100	COPPER		KG5119
13.2	18	1.5	100	COPPER		KG5228	16.7	24	1.5	25	BONDED WASHER		PB852
13.2	20	2	50	ALUMINIUM		KG5250	17	19.9	1.5	50	COPPER		KG5088
13.7	18.5	1	100	COPPER		KG5134	17	21	1	100	COPPER		KG5096
14	18	2	100	COPPER		KG5113	17	22	1.5	100	COPPER		KG5186
14	18	2	100	FIBRE		KG5296	17.2	21	2	20	COPPER	INJECTOR	KG5068
14	19	1	100	COPPER		KG5089	17.6	21.4	0.5	50	COPPER		KG5152
14	21	0.8	100	COPPER		KG5099	18	26	1.5	100	COPPER		KG5346
14	21	1.5	25	BONDED WASHER		KG5011	18.1	24	3	100	COPPER	FIBRE FILLED	KG5021
14.1	18	1	100	COPPER		KG5227	18.2	22	1.5	100	COPPER		KG5231
14.1	18	1	100	ALUMINIUM		KG5244	18.2	23	1.5	100	COPPER		KG5182
14.1	19	2.5	100	COPPER	FIBRE FILLED	KG5009	18.2	26	1.5	100	COPPER		KG5176
14.1	19	2.5	100	COPPER	FIBRE FILLED	KG5020	18.3	23.8	2.2	100	COPPER	FIBRE FILLED	KJ647
14.1	20.5	1.5	100	COPPER		KG5147	18.3	24	1.5	100	COPPER		KG5158
14.2	18	1.5	100	COPPER		KG5218	18.3	24	2	100	SPECIAL		KG5058
14.2	19.5	1	100	COPPER		KG5165	18.4 / 18.8	26	1.5	50	BONDED WASHER		KG5341
14.2	20	1	100	COPPER		KG5110	18.5	23	1	100	COPPER		KG5098
14.2	20	1.5	100	FIBRE		KG5294	18.5	24	1	100	COPPER		KG5128
14.2	21.8	2	100	COPPER		KG5122	18.5	26	2	100	COPPER		KG5126
14.3	18	1.5	100	COPPER		KG5144	20	26	1.5	100	COPPER		KG5195
14.3	19	1.5	50	ALUMINIUM		KG5248	20.1	26	1	100	COPPER		KG5090
14.3	19	1.5	100	FIBRE		KG5288	20.2	25	1.5	100	COPPER		KG5169
14.3	19	2	100	COPPER	FIBRE FILLED	KG5030	20.4	26	2	100	COPPER	FIBRE FILLED	KG5042
14.4	19	2	100	COPPER		KG5121	20.4	27	3	100	FIBRE		KG5290
14.4	20	2	100	FIBRE		KG5286	20.5	26	1.5	100	FIBRE		KG5301
14.5	21	1.5	100	COPPER		KG5100	20.5	28	2	100	COPPER		KG5125
14.5	21	1.8	100	COPPER		KG5235	21	26	2	100	COPPER	FIBRE FILLED	KG5035
14.5	21.3	1.5	100	COPPER		KG5220	21	27	1	100	COPPER		KG5213
14.5	21.4	2.3	100	COPPER		KG5151	21.2	25.5	1	100	COPPER		KG5222
14.5	22	2	100	FIBRE		KG5292	21.5	25	2	100	COPPER		KG5194
14.7	21.4	1.95	100	COPPER		KG5087	22	26	1	100	COPPER		KG5225
14.9	22.2	2	25	PA		KG5249	22	28	1.5	100	COPPER		KG5184
15	20	1	100	COPPER		KG5187	22	29	1	100	COPPER		KG5178
15	24	1	100	COPPER		KG5118	22	31	2	25	BONDED WASHER		KG5063
15.3	21	1.2	100	COPPER		PA348	22.1	26.9	1.5	100	COPPER		KG5148
15.5	20	2	100	COPPER		KG5197	22.2	26.9	2	100	COPPER	FIBRE FILLED	PB853
16	20	1.5	100	COPPER		KG5155	22.2	30	1.5	100	COPPER		KG5106
16	22	2	100	FIBRE		KG5291	22.3	26.8	2	100	COPPER	FIBRE FILLED	KG5036

WASHERS BY SIZE

INNER DIAMETER	OUTER DIAMETER	THICKNESS	QTY	MATERIAL	TYPE	▲ Payen®
22.4	29	2	100	SPECIAL		KG5055
22.4	30	1	100	COPPER		KG5210
22.5	27	1	100	COPPER		KG5135
22.5	29	1.5	100	ALUMINIUM		KG5247
22.5	29	1.5	100	COPPER		KG5217
22.7	26.8	2	100	COPPER		KG5229
23.4	31	1	100	COPPER		KG5086
24	29	1	100	COPPER		KG5079
24	29	1.5	100	COPPER		KG5141
24	30	1	100	COPPER		KG5192
24	32.5	2	100	COPPER		KG5230
24.2	30	3	100	COPPER	FIBRE FILLED	KG5022
24.4	32	1.5	100	COPPER		KG5137
24.4	32	2	100	COPPER	FIBRE FILLED	KG5026
24.5	32	2	100	COPPER		KG5200
25	32	2	100	COPPER	FIBRE FILLED	KG5023
26	30	1.5	100	COPPER		KG5193
26	32	2	100	COPPER	FIBRE FILLED	KG5050
26.1	32	1	100	COPPER		KG5111
26.3	33	3	100	COPPER		KG5215
27.3	34	2	100	COPPER		KG5084
27.4	35	2	100	COPPER	FIBRE FILLED	KG5043
28.2	35	1.5	100	COPPER		KG5140
30.5	36	2	100	COPPER		KG5120
32	42	1	100	COPPER		KG5226
33.4	41	2	100	COPPER	FIBRE FILLED	KG5045
36	42	2	100	COPPER		KG5133
36.4	45	2	100	COPPER		KG5188



ENGINE PART NUMBERING SYSTEM



TOP ENGINE

	PREFIX	NUMBER	SUFFIX/SIZE	FULL PART NUMBER EXAMPLE
Engine Valve	V	94168	None	V94168
Valve Guide	VAG	96215	None or B ⁽¹⁾	VAG96215
Valve Seat Insert	VS	6344	None	VS6344
Camshaft	CAM	376	None	CAM376
Camshaft Kit	CKS	2373	None	CKS2373
Cam Follower	FOL	101	None	FOL101

⁽¹⁾ "B" indicates BRONZE valve guide.



BEARINGS

SETS	COMPONENTS	*TYPE
01-3040/4 STD Quantity (pairs: bearings; pieces: washers, bushings)	01-3040 Material	1 Conrod bearing
01-3040/4 STD Size	01-3040 Type*	2 Main bearing
H821/5 STD Main bearing	01-3040 Reference	3 Camshaft bush/bearing
A123/4 STD Thrust washer	02-3823H Flanged	4 Thrust washer
N110/5 SEMI Camshaft bush/bearing		5 Small end bushing
		7 Auxiliary bushing



RINGS & LINERS

PISTON RINGS		CYLINDER LINERS	
08 - 114900 - 00 Catalogue reference		14 - 451160 - 00 Catalogue reference	
08 - 114900 - 00 Ring set assembly		14 - 451160 - 00 Cylinder liner without seals	
08 - 114900 - 00 Reference		15 - 451160 - 00 Cylinder liner with seals	
08 - 114900 - 00 Size* (See Nüral pistons table)	*If imperial in the past, it continues to be imperial	14 - 451160 - 00 Liner type ⁽¹⁾	⁽¹⁾ 01 - 19 = Dry liner
08 - 114900 - 00 Version		14 - 451160 - 00 Serial number	⁽²⁾ 20 - 99 = Wet liner
		14 - 451160 - 00 Size ⁽²⁾	⁽²⁾ 0 = STD
		14 - 451160 - 00 Version	1 = 1st oversize
			2 = 2nd oversize



FITTED WITH GOETZE RINGS

PISTONS

Size	Metric	Imperial	Size	Metric	Imperial	Size	Metric	Imperial
00	STD		08	0.60 mm		16	2.00 mm	
03	0.125 mm		09	0.75 mm	.030	17	2.286 mm	.090
04	0.20 mm		10	0.80 mm		20	0.70 mm	
05	0.25 mm	.010	11	1.00 mm	.040	21	0.65 mm	
06	0.40 mm		13	1.25 mm		22	0.30 mm	
07	0.50 mm	.020	14	1.50 mm	.060			



GASKETS

2 LETTERS PREFIX FOR GASKETS AND SEALS – 3 LETTERS PREFIX FOR HEADBOLTS

AA - BZ Cylinder head gaskets	HM Valve cover sets	KG - KJ Washers
CA - DZ Head sets	HR Valve stem seals sets	KK - LZ Miscellaneous joints
EA - EZ Conversion sets	JA - JD Manifold gaskets	LA - LJ O-rings
FA - GZ Full sets	JE - JF Exhaust pipe joints	LK - LN Integrated seal and housing
HA Manifold sets	JH - JJ Sump gaskets	NA - NZ Dynamic oil seals
HBS Headbolt sets	JM - JP Valve cover gaskets	PA - PB Valve stem seals multipacks
HC Oil sump sets	JR - JS Timing case gaskets	
HL Miscellaneous sets	KA Water pump gaskets	

ENGINE EXPERTISE
BY FEDERAL-MOGUL
MOTORPARTS





CHECK OUT OUR CATALOGUES



CATAE902 - Belts and Timing Belt kits

CATAE1301 - Valves and Components

CATAE1501 - Camshaft, Kits and Components

CATPA1201 - Cylinder Headbolts

CATPA1401 - Gaskets, Oil Seals and Cylinder Headbolts

CATPA1801 - Oil Seals



CATGY1601
Engine Bearings



CATGT1401
Piston Rings



CATGT1501
Liners



CATNU1601
Pistons



Combined E&S catalogues per vehicle makes:

CATMX1301 - Audi / Seat / Skoda / Volkswagen

CATMX1402 - PSA Renault

CATMX1403 - BMW / Mini / Mercedes-Benz / Smart / Porsche

CATMX1501 - Alfa / Fiat / Lancia / Iveco

CATMX1601 - Ford - Jaguar - Land Rover - Opel - Saab

Visit www.fmmotorparts.eu
Online catalogue website. Available 24/7

You can obtain these catalogues through your Federal-Mogul sales representative
or through your local distributor

CAMPUS

Federal-Mogul Motorparts' Technical Portal



ENHANCE YOUR KNOWLEDGE AND SKILLS

- ▶ Comprehensive interactive training modules
- ▶ 9 languages
- ▶ Accessible online using your PC or tablet and offline via an iPad app
- ▶ Free registration
- ▶ Technical Resource Center: diagnostic & troubleshooting documents
- ▶ Free Registration & Available 24/7
- ▶ Latest Automotive News
- ▶ Personal Training Scoreboard
- ▶ Follow Federal Mogul Events!
- ▶ F-M Campus Newsletter. Sign up & Keep up with the latest trainings & automotive news

For additional information:

 www.fmcampus.eu

 info@fmcampus.eu

 @FMCampus_EMEA

 F-M Campus



Used in more than
120 countries!

CONTENT FOR MY CAMPUS

- ▶ Generic Training
- ▶ Brake Training
- ▶ Chassis Training
- ▶ Engine parts Training
- ▶ Wheel-end Bearing Training
- ▶ Filter Training
- ▶ Installation Guides
- ▶ Technical Tips
- ▶ Diagnostic Aids
- ▶ Sales Arguments
- ▶ Technical Posters

Federal-Mogul Global Aftermarket EMEA bvba

Prins Boudewijnlaan 5 • 2550 Kontich • Belgium

Central Distribution Centre

Schoondonkweg 17 • 2830 Willebroek • Belgium

Phone +32 (0) 3450 83 10 • Fax +32 (0) 3450 83 38

Federal-Mogul Italy Srl • Aftermarket Division

Via Enrico Fermi 8 • 37135 Verona • Italy

Phone +39 045 828 13 11 • Fax +39 045 828 14 00

Federal-Mogul Aftermarket GmbH

Albert-Ruprecht-Strasse 2 • 71636 Ludwigsburg • Germany

Phone +49 (0) 7141-64865-8230 • Fax +49 (0) 7141-64865-8390

Federal-Mogul Aftermarket UK Limited

Greyhound Drive • Bradford • BD7 1NQ • U.K.

Phone +44 (0) 800 970 0203 • Fax +44 (0) 1274 848282

Federal-Mogul Aftermarket España S.A.

Calle Alcarria, nº 2 • 28823 Coslada • Madrid • Spain

Phone + 34 91 746 1900 • Fax + 34 91 746 18 90

Federal-Mogul Aftermarket France SAS

60-62, rue Danjou • 92517 Boulogne-Billancourt Cedex • France

Phone +33 (0) 1 46 94 27 00 • Fax +33 (0) 1 46 94 27 01

Service Commande de stock :

Phone +33 (0) 810 000 029 • Fax +32 (0) 34 50 80 26

Service Commande express :

Phone +33 (0) 810 000 029 • Fax +32 (0) 34 50 80 26

Federal-Mogul Motorparts Serbia*

Spanskih Boraca 22 • 11070 Novi Beograd • Serbia

Phone +381 11 31 31 918 • Fax +381 11 31 31 848

Federal-Mogul Aftermarket Southern Africa (PTY) Ltd

33 Western Boulevard • 2092 City West Johannesburg • South Africa

Phone +27 (0) 11 630 3000 • Fax +27 (0) 11 630 3106

Federal Mogul Powertrain Otomotiv A.S. (Aftermarket Division)

Meclis-i Mebusan Cad. No: 53 Dereli İş Merkezi 34427 • Fındıklı / İstanbul • Türkiye

Phone +90 212 292 6313 • Fax +90 212 292 6260

Federal-Mogul VCS OOO

Smolnaya street 24D, 13th floor • 125445 Moscow • Russia

Phone +7 495 221 50 60 • Fax +7 495 221 50 64

Federal-Mogul Aftermarket Egypt Ltd.

3 El Yemen St., Giza • 12311 Egypt • P.O. Box: 391 Dokki • Egypt

Phone +202 333 85 725 • Fax +202 374 84 147

Federal-Mogul Motorparts Sharjah*

Sharjah Airport International Free Zone (Saif-Zone)

Building X3 • Phone 20, 21, 22 • P.O.Box. 120548 • Sharjah • UAE

Phone +971 6 557 8870 • Fax +971 6 557 8941

* Branch office of Federal-Mogul Global Aftermarket EMEA, bvba



BERU® is a Registered Trademark of Borg Warner Ludwigsburg GmbH

