



THE GASKETS PROFESSIONALS TRUST™

**CATALOG NO.
900-16**

April 2016
Supersedes No. 900-11
Dated October 2011

MASTER GASKET CATALOG

Passenger Cars and Light Duty Trucks 1991-2016



INDUSTRY LEADING COVERAGE

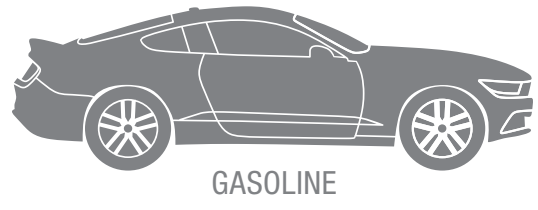

GASOLINE

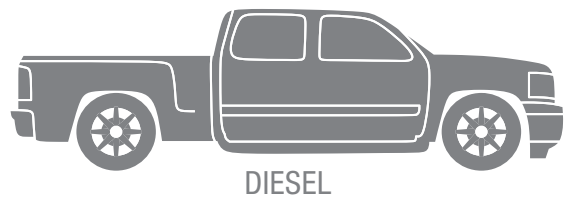

DIESEL

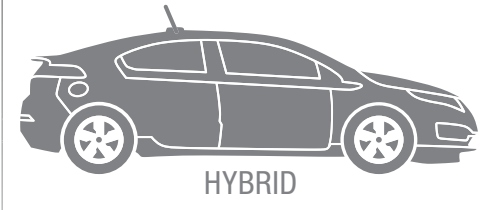

HYBRID

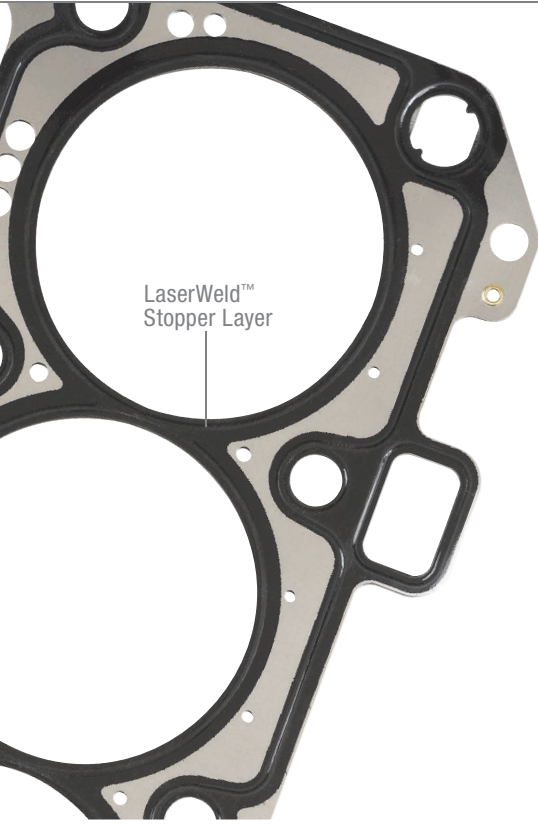

LaserWeld™
Stopper Layer

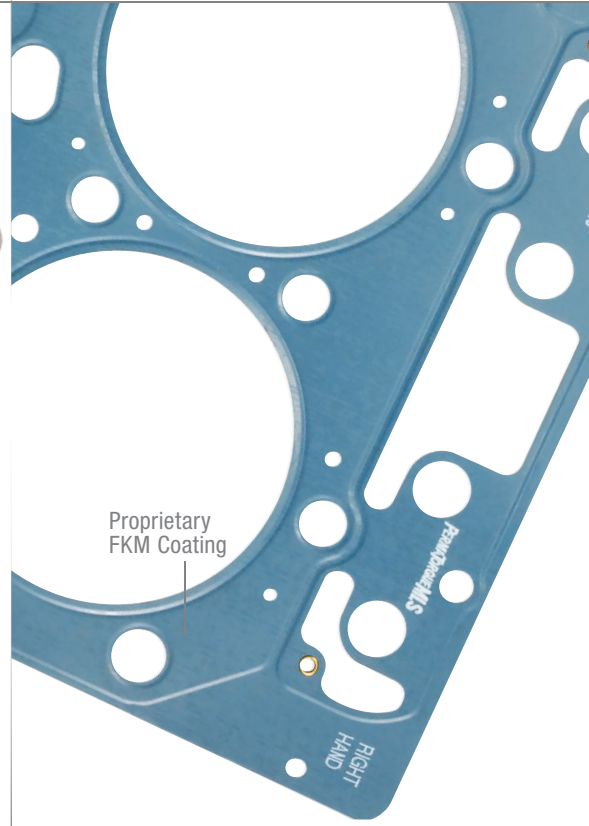

Proprietary
FKM Coating

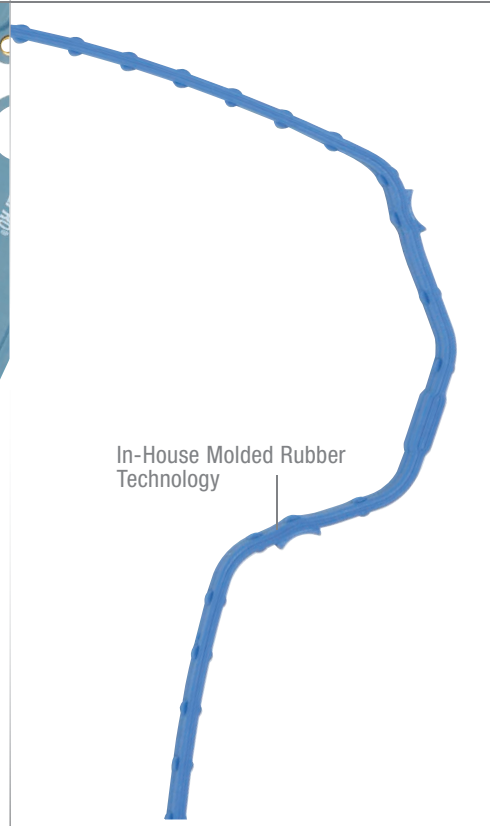

In-House Molded Rubber
Technology

PROBLEM SOLVER TECHNOLOGIES

TECHNOLOGIES ENGINEERED TO ADDRESS SEALING CONCERNS UNIQUE TO EVERY APPLICATION



#PartsMatter





TOUGH GASKETS FOR TOUGH TRUCKS

LIGHT TRUCK ENGINE PROGRAM

Light-duty commercial vehicle owners drive their engines hard. For these demanding applications, Fel-Pro[®] offers gaskets designed to seal engines pushed to these punishing extremes.

Innovations like those found in Fel-Pro PermaTorque[®] MLS head gaskets ensure engine sealing reliability under the higher temperatures and increased cylinder pressures brought on by tough workloads and harsh operating environments.

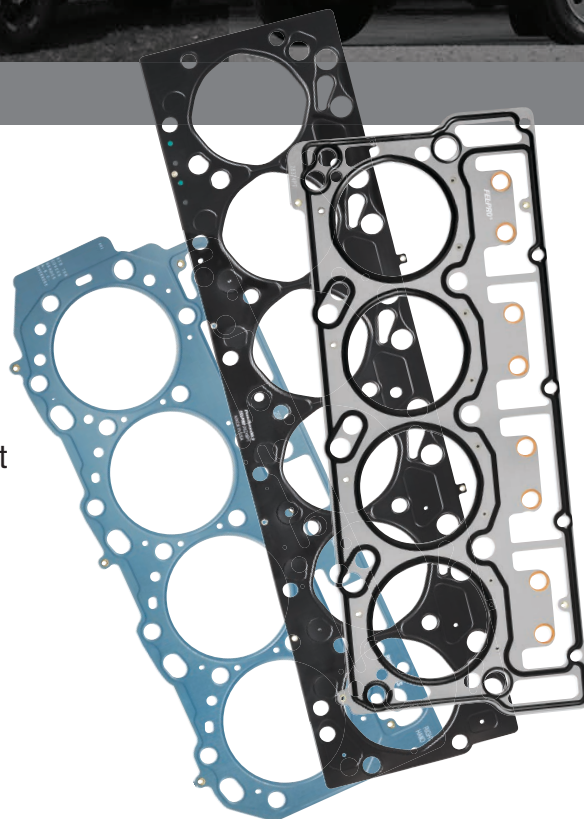

DIESEL

Dodge / Ram	Ford		GM
5.9L L6 24V Cummins Turbo Diesel	6.0L V8 32V Power Stroke Diesel	6.4L V8 32V Power Stroke Diesel	6.6L V8 32V Duramax Diesel

GASOLINE

Dodge / Ram	Ford			GM		Toyota	
5.7L V8 16V Hemi	4.6L V8 16V Triton	5.4L V8 16V Triton	5.4L V8 24V Triton	5.3L V8 16V LS	6.0L V8 16V LS	4.7L V8 32V	5.7L V8 32V i-FORCE

USING THE CATALOG

Table of Contents I
 Manufacturer Index II
 Part Number Identification III
 How To Use This Catalog (English)..... IV
 How To Use This Catalog (Français) VI
 How To Use This Catalog (Español)..... VIII
 Abbreviations X
 English to French/Spanish Glossary..... XII
 Model Cross Reference XIV

ENGINE GASKET LISTINGS

Engine Gaskets Catalog Listings 1
 Engine Gaskets Numerical Listings 1181

DRIVETRAIN GASKET LISTINGS

Drivetrain Gaskets Catalog Listings1219
 Drivetrain Gaskets Diagram Chart.....1254
 Axle Housing Cover &
 Differential Carrier Silhouettes 1255
 Rear Axle Flange Silhouettes 1259
 Power Take-Off (PTO) Silhouettes1260
 Automatic Transmission Oil Pan Silhouettes 1261

BULK MATERIALS/STOCKING AIDS/HARDWARE

FEL-PRO O-Rings1269
 Water Outlet Gasket Assortment WO 20-08.... 1270
 Exhaust Flange Gasket Assortment EX 20-08.... 1271
 FEL-PRO Packings1272
 FEL-PRO Stocking Aids 1272
 FEL-PRO Sheet Materials 1273
 Engine\$aver® Hardware 1277
 Harmonic Balancer &
 Crankshaft Repair Sleeves 1278

GASKET TECHNICAL INFORMATION

Measuring System Conversions1275
 Cylinder Head Gasket Installation Tips1279
 Gasket and Seal Locations (V6)1281
 Gasket and Seal Locations (L4)1282
 Gasket and Seal Locations (Fuel Injection)1283
 Important Instructions and Warranty1284

ALL INFORMATION CONTAINED IN THIS FEL-PRO® CATALOG IS BASED ON THE LATEST DATA AVAILABLE AT THE TIME OF PRINTING. ALTHOUGH CARE HAS BEEN TAKEN TO ENSURE THE ACCURACY OF THE DATA COMPILED IN THIS CATALOG, FEDERAL-MOGUL® DOES NOT ASSUME LIABILITY FOR ERRORS OR OMISSIONS .

LIMITATION OF REMEDIES

IF ANY FEDERAL-MOGUL PRODUCT OR FEL-PRO PRODUCT IS DEFECTIVE, BUYER'S EXCLUSIVE REMEDY IS REIMBURSEMENT OF THE SALES PRICE OF THE GOOD. IN NO EVENT SHALL FEDERAL-MOGUL OR FEL-PRO BE LIABLE FOR INCIDENTAL OR CONSEQUENTIAL DAMAGES.

LA POSITION FEL-PRO EN CE QUI CONCERNE LES PRODUITS DÉFECTUEUX

EN CAS OÙ LES PRODUITS FEDERAL-MOGUL OU FEL-PRO SOIENT DÉFECTUEUX, L'ACHETEUR AURA LE DROIT D'ÊTRE REMBOURSI SEULEMENT POUR LE PRIX DES PRODUITS DÉFECTUEUX. ON NE PEUT JAMAIS RENDRE FEDERAL-MOGUL OU FEL-PRO RESPONSABLE DE DOMMAGES QUI SOIENT LA RESULTAT DES PRODUITS DÉFECTUEUX.

GARANTIA

SI CUALQUIER PRODUCTO FEDERAL-MOGUL O FEL-PRO RESULTA DEFECTUOSO, EL COMPRADOR EXCLUSIVAMENTE RECIBIRA COMO REEMBOLSO EL PRECIO DE VENTA DEL ARTICULO. EN NINGUN CASO FEDERAL-MOGUL O FEL-PRO SERA RESPONSABLE POR DAÑOS INCIDENTALES O DE CONSECUENCIA.

MANUFACTURER INDEX

A

AC Cobra	1
Acura Car	See Honda Car
Acura SUV's	See Honda Truck
AM General Truck	3
Asuna Car	See GM Car
Asuna SUV's	See GMC Truck
Audi Car	7
Audi SUV's	See Audi Truck
Audi Truck	31
Avanti	35

B

Bentley	See Rolls-Royce
BMW Car	40
BMW SUV's	See BMW Truck
BMW Truck	57
Buick Car	See GM Car
Buick Minivans	See GMC Truck
Buick SUV's	See GMC Truck

C

Cadillac Car	See GM Car
Cadillac SUV's	See GMC Truck
Callaway	60
Chevrolet Car	See GM Car
Chevrolet Minivans	See GMC Truck
Chevrolet SUV's	See GMC Truck
Chevrolet Truck	See GMC Truck
Chrysler Car	61
Chrysler Minivans	See Dodge Truck
Chrysler Motor Home	See Dodge Truck
Chrysler SUV's	See Dodge Truck
Chrysler Truck	See Dodge Truck

D

Daewoo Car	133
DeTomaso	136
Dodge Car	See Chrysler Car
Dodge Minivans	See Dodge Truck
Dodge SUV's	See Dodge Truck
Dodge Truck	137

E

Eagle	See Chrysler Car
Excalibur	204

F

Ford Car	205
Ford Minivans	See Ford Truck
Ford SUV's	See Ford Truck
Ford Truck	276
Freightliner Truck	359

G

Geo Car	See GM Car
Geo SUV's	See GMC Truck
GM Car	360
GMC Minivans	See GMC Truck
GMC SUV's	See GMC Truck
GMC Truck	476
Grumman Truck	592

H

Honda Car	595
Honda Minivans	See Honda Truck
Honda SUV's	See Honda Truck
Honda Truck	652

Hummer SUV's (1992-2001)	See AM General Truck
Hummer SUV's (2002-2010)	See GMC Truck
Hyundai Car	675
Hyundai Minivans	See Hyundai Truck
Hyundai SUV's	See Hyundai Truck
Hyundai Truck	701

I

Infiniti Car	See Nissan Car
Infiniti SUV's	See Nissan Truck
Isuzu Car	710
Isuzu Minivans	See Isuzu Truck
Isuzu SUV's	See Isuzu Truck
Isuzu Truck	713

J

Jaguar	734
Jeep Truck	736

K

Kia Car	759
Kia Minivans	See Kia Truck
Kia SUV's	See Kia Truck
Kia Truck	777

L

LaForza SUV's	See LaForza Truck
LaForza Truck	788
Land Rover SUV's	See Land Rover Truck
Land Rover Truck	790
Lexus Car	See Toyota Car
Lexus SUV's	See Toyota Truck
Lincoln Car	See Ford Car
Lincoln SUV's	See Ford Truck
Lincoln Truck	See Ford Truck
Lotus	797

M

Maybach	See Mercedes-Benz Car
Mazda Car	801
Mazda Minivans	See Mazda Truck
Mazda SUV's	See Mazda Truck
Mazda Truck	827
Mercedes-Benz Car	852
Mercedes Benz SUV's - See Mercedes-Benz Truck	
Mercedes-Benz Truck	882
Mercury Car	See Ford Car
Mercury Minivans	See Ford Truck
Mercury SUV's	See Ford Truck
Mini	See BMW Car
Mitsubishi Car	888
Mitsubishi Minivans	See Mitsubishi Truck
Mitsubishi SUV's	See Mitsubishi Truck
Mitsubishi Truck	914
Morgan	927
Mosler	928

N

Nissan Car	929
Nissan Minivans	See Nissan Truck
Nissan SUV's	See Nissan Truck
Nissan Truck	954

O

Oldsmobile Car	See GM Car
Oldsmobile Minivans	See GMC Truck
Oldsmobile SUV's	See GMC Truck

P

Panoz	975
Passport Car	See GM Car
Peugeot	976
Plymouth Car	See Chrysler Car
Plymouth Minivans	See Dodge Truck
Pontiac Car	See GM Car
Pontiac Minivans	See GMC Truck
Pontiac SUV's	See GMC Truck
Porsche Car	977
Porsche SUV's	See Porsche Truck
Porsche Truck	978

Q

Qvale	See DeTomaso
-------	--------------

R

Rolls-Royce	979
-------------	-----

S

Saab Car	980
Saab SUV's	See Saab Truck
Saab Truck	993
Saturn Car	See GM Car
Saturn Minivans	See GMC Truck
Saturn SUV's	See GMC Truck
Scion Car	See Toyota Car
Shelby	See AC Cobra
Smart Car	See Mercedes-Benz Car
Sterling	997
Subaru Car	998
Subaru SUV's	See Subaru Truck
Subaru Truck	1019
Suzuki Car	1026
Suzuki SUV's	See Suzuki Truck
Suzuki Truck	1033

T

Toyota Car	1040
Toyota Minivans	See Toyota Truck
Toyota SUV's	See Toyota Truck
Toyota Truck	1078

V

Volvo Car	1108
Volvo SUV's	See Volvo Truck
Volvo Truck	1132
VPG Truck	1135
VW Car	1135
VW Minivans	See VW Truck
VW SUV's	See VW Truck
VW Truck	1167

W

Winnebago Truck	1175
Workhorse Truck	1176

**PREFIXES (Letters appearing before Numbers)
IDENTIFY SET OR PART TYPE**

(No Prefix)	Head Gasket or Spacer Shim
B	Rear Main Seal Set
S	Semi-Circular Plug Set
C	Conversion Set (Use with HS set to equal FS set)
P	Head Bolt Set or Miscellaneous Set
C	Full Set (Complete Engine Overhaul)
BIS	Head Installation Set
BS	Head Set (Valve Grinding)
RSB	Head Set with Head Bolts
HST	Head Set (Premium Valve Grinding)
HSU	Head Set without Head Gasket
HSUB	Head Set without Head Gasket with Head Bolts
MIK	Intake Manifold Installation Set
MS	Intake, Exhaust, Intake & Exhaust, or Upper Intake (Plenum) Manifold Set
OS	Oil Pan Set
PS	Push Rod Cover Set
RDS	Axle Housing Cover Set or Differential Carrier Set
SS	Intake, Exhaust, Intake & Exhaust, or Auxiliary Valve Stem Seal Set
TCS	Timing Cover Set, Camshaft Front Seal Set, Auxiliary Shaft Seal Set, or Crankshaft Front Seal Set
TOS	Automatic Transmission/Transaxle Oil Pan Set
TS	Manual Transmission Set
VS	Valve Cover Set

**SUFFIXES (Letters appearing after Numbers)
IDENTIFY GASKET MATERIAL OR DESIGN**

A	Fiber
AC	Cork-Rubber (Extra Thick)
AD	Felcoid® or Felcoid/Plus®
B	Retorque Type (Head Gasket or Manifold Set)
BS	Fiber-Faced (Head Gasket)
C	Copper-Fiber (Head Gasket)
CS	Copper-Steel-Fiber
D	Felcoid® or Felcoid/Plus®
F	Cork-Rubber
K	Fiber
PT	PermaTorque® or PermaTorqueMLS®
R	Fel-CoPrene® (Rubber)
RR	Rubber O-Ring
S	Steel-Fiber
SB	Shim-Replacement (Retorque Type)
SBX	Shim-Replacement (Retorque Type-Extra Heavy) PermaTorque
SD	Severe Duty®
SH	Shim-Embossed Steel
SP	.020" Thick, Dead Soft Copper HeadSaver® Spacer Shim (Use with conventional FEL-PRO® head gaskets where additional thickness is required)
T	PermaDryPlus®
WS	Stainless Steel Shim

This master catalog contains gasket set listings for domestic and imported passenger car and light-duty truck engine applications. All Minivan and SUV (Sport Utility Vehicle) coverage is included in the appropriate manufacturer's Truck section only. Both engine and drivetrain applications are included in this publication.

All manufacturers are arranged in alphabetical sequence with the manufacturer's name appearing in bold-face type at the outer margins of each page. The Manufacturer Index at the front of this catalog will help to easily locate the desired manufacturer. Each manufacturer listing also includes information on all separate model lines and which engines are available for particular years. In order to simplify the overall catalog, the following manufacturers' sections have consolidated engine data, model data, and gasket entries:

Manufacturer Section	Includes Engines and Models	Manufacturer Section	Includes Engines and Models
AM General Truck	AM General, Hummer	GMC Truck	Buick, Cadillac, Chevrolet, Geo, GMC, Hummer, Oldsmobile, Pontiac, Saturn
American Motors Car	AMC, Hudson, Nash, Rambler	Honda Car	Acura, Honda
BMW Car	BMW, Mini	Honda Truck	Acura, Honda
British Leyland	Austin, Austin-Healey, Jensen, Metropolitan, MG, Morris, Riley	International Truck	International, Navistar
Chrysler Car	Chrysler, DeSoto, Dodge, Eagle, Plymouth	Jeep Truck	Jeep, Willys
Dodge Truck	Chrysler, Dodge, Fargo, Plymouth	Kaiser	Frazer, Henry J, Kaiser
Fiat	Bertone, Fiat, Lancia, Pinninfarina	Nissan Car	Datsun, Infiniti, Nissan
Ford Car	Edsel, Ford, Lincoln, Mercury, Merkur	Nissan Truck	Datsun, Infiniti, Nissan
Ford Truck	Ford, Lincoln, Mercury	Studebaker Car	Packard, Studebaker
GM Car	Buick, Cadillac, Chevrolet, Geo, Oldsmobile, Pontiac, Saturn	Toyota Car	Lexus, Scion, Toyota
		Toyota Truck	Lexus, Toyota

Each manufacturer listing has **four** distinct sections.

The **first** section, found at the beginning of each listing, is a complete index of all engines included in that manufacturer. The engines are arranged in ascending order by displacement, either by CID or CC as appropriate.

The **second** section is a complete index of all engine codes used for imported engines found in that manufacturer. This will aid in identifying the often similar variations within an import engine family.

The **third** section is comprehensive model data for that manufacturer, including all available engine/model year combinations for each vehicle line. The models are sorted in alphabetical order under each individual marque, and include domestic VIN codes and import engine codes to aid identification of the correct engine.

Mazda Truck (Incl. Minivans and SUV's)

Engine Finding Index							
Engine	Years	Code	Line No.	Engine	Years	Code	Line No.
2.0L 1988cc DOHC L4 (16 Valve), 84.8mm Bore	2001-04	YF	1	3.0L 2954cc SOHC V6 (18 Valve), 90mm Bore	1991-93	JE	12
2.2L 2184cc SOHC L4 (8 Valve), 86mm Bore	1991-93	F2G	2	3.0L 2954cc SOHC V6 (18 Valve), 90mm Bore	1994-99	JE-E	13
2.2L 2184cc SOHC L4 (8 Valve), 86mm Bore	1991-93	F2L	3	3.0L 2967cc DOHC V6 (24 Valve), 89mm Bore	2002-05	ADJ	14
2.3L 2261cc DOHC L4 (16 Valve), 87.5mm Bore	2001-09	4	4	3.0L 2967cc DOHC V6 (24 Valve), 89mm Bore	2001-08	AJ	15
2.3L 2261cc DOHC L4 (16 Valve), 87.5mm Bore	2005-08	MZR	5	3.0L 2982cc OHV V6 (12 Valve), 89mm Bore	1999-08	8U	16
2.3L 2261cc DOHC L4 (16 Valve), 87.5mm Bore	2008	MZR	6	3.0L 2982cc OHV V6 (12 Valve), 89mm Bore	1999-03	8U	17
2.3L 2261cc DOHC L4 (16 Valve), 87.5mm Bore	2007-09	MZR-T	7	3.5L 3496cc DOHC V6 (24 Valve), 92.5mm Bore	2007	MZI	18
2.3L 2302cc SOHC L4 (8 Valve), 96mm Bore	1994-97	8A	8	4.0L 4015cc OHV V6 (12 Valve), 100.4mm Bore	1994-00	8X	19
2.5L 2495cc DOHC V6 (24 Valve), 81.6mm Bore	2000-01	GY	9	4.0L 4015cc OHV V6 (12 Valve), 100.4mm Bore	1991-93	ZZL	20
2.5L 2503cc SOHC L4 (8 Valve), 96mm Bore	1998-01	10	10	4.0L 4015cc SOHC V6 (12 Valve), 100.4mm Bore	2001-09	21	21
2.6L 2606cc SOHC L4 (12 Valve), 92mm Bore	1991-94	G6	11				

Engine Code Index							
Engine Code	Engine Description	Line No.	Engine Code	Engine Description	Line No.	Engine Code	Line No.
ADJ	3.0L 2967cc DOHC V6 (24 Valve), 89mm Bore	14	MZR	2.3L 2261cc DOHC L4 (16 Valve), 87.5mm Bore	5		
AJ	3.0L 2967cc DOHC V6 (24 Valve), 89mm Bore	15	MZR	2.3L 2261cc DOHC L4 (16 Valve), 87.5mm Bore	6		
F2G	2.2L 2184cc SOHC L4 (8 Valve), 86mm Bore	2	MZR-T	2.3L 2261cc DOHC L4 (16 Valve), 87.5mm Bore	7		
F2L	2.2L 2184cc SOHC L4 (8 Valve), 86mm Bore	3	YF	2.0L 1988cc DOHC L4 (16 Valve), 84.8mm Bore	1		
G6	2.6L 2606cc SOHC L4 (12 Valve), 92mm Bore	11	ZZL	4.0L 4015cc OHV V6 (12 Valve), 100.4mm Bore	20		
GY	2.5L 2495cc DOHC V6 (24 Valve), 81.6mm Bore	9	8A	2.3L 2302cc SOHC L4 (8 Valve), 96mm Bore	8		
JE	3.0L 2954cc SOHC V6 (18 Valve), 90mm Bore	12	8U	3.0L 2982cc OHV V6 (12 Valve), 89mm Bore	16		
JE-E	3.0L 2954cc SOHC V6 (18 Valve), 90mm Bore	13	8U	3.0L 2982cc OHV V6 (12 Valve), 89mm Bore	17		
MZI	3.5L 3496cc DOHC V6 (24 Valve), 92.5mm Bore	18	8X	4.0L 4015cc OHV V6 (12 Valve), 100.4mm Bore	19		

Model Index								
Engine	(VIN Code/Eng. Code)	Years	Engine	(VIN Code/Eng. Code)	Years	Engine	(VIN Code/Eng. Code)	Years
Mazda Truck								
B1600 (Mini-Pickup)								
L4 1586cc 1.6L SOHC (NA)		72-76						
B1800 (Mini-Pickup)								
L4 1796cc 1.8L SOHC (VB)		77-78						
B2000 (Mini-Pickup)								
L4 1970cc 2.0L SOHC (MA)		79-84						
B2200 (Mini-Pickup)								
L4 2184cc 2.2L SOHC (8 Valve) (F2G)		90-93	L4 2184cc 2.2L SOHC (8 Valve) (F2L)		87-93	L4 2209cc 2.2L OHV Diesel (S2)		82-84
B2300 (2WD Compact Pickup)								
L4 2261cc 2.3L DOHC (16 Valve) (D)		01-10						
B2300 (4WD Compact Pickup)								
L4 2302cc 2.3L SOHC (8A)		94-97						
B2500 (2WD Compact Pickup)								
L4 2503cc 2.5L SOHC (C)		98-01						

The **fourth** section of each manufacturer listing includes all engine gaskets available for that manufacturer. The engines are arranged in one running sequence, in ascending numerical order by displacement. Domestic manufacturers are arranged by CID size and imported manufacturers are arranged by CC size. The header block for each engine contains detailed information on liter designation, engine size, valvetrain layout, cylinder configuration, bore size, and model years available. Complete VIN Codes and Engine Codes are also included to aid engine identification. Following the header block all available gaskets are shown in this sequence:

Gasket Group	Set Type or Part Type	Gasket Group	Set Type or Part Type
Cylinder Head	Head Gasket, Spacer Shim, Head Set, Head Installation Set, Head Bolt Set, Dowel Pins	Valve Cover Set	Valve Cover Set, Semi-Circular Plug Set, Grommet Set, Spark Plug Tube Seal Set
Full Set	Full Set	Push Rod Cover Set	Push Rod Cover Set
Conversion Set	Conversion Set	Valve Stem Seal Set	Valve Stem Seal Set
Manifold – Int. & Exh.	Intake Manifold Set, Upper Intake (Plenum) Set, Intake & Exhaust Manifold Set, Exhaust Manifold Set	Water Outlet	Water Outlet, Thermostat Housing, Water Bypass
Exhaust Pipe Flange	Exhaust Flange, Exhaust Crossover, Heat Riser, Catalytic Converter, Exhaust Flange Bolt & Spring Kit	Water Pump	Water Pump, Water Pump Plate
Fuel Pump	Fuel Pump Mounting, Fuel Pump Plate, Fuel Pump Bowl	Timing Cover Set	Timing Cover Set, Sleeve 'N' Seal® Timing Cover Set, Camshaft Front Seal Set, Auxiliary Shaft Seal Set, Crankshaft Front Seal Set, Timing Cover Repair Sleeve & Installation Tool
Oil Pan	Oil Pan Set, Oil Pan Drain Plug	Miscellaneous Gaskets	Air Cleaner, Carburetor, Fuel Injection, Throttle Body, Distributor, EGR Valve, Oil Pump, Oil Filter, Oil Cooler
Crankshaft Rear Seal	Rear Main Seal Set, Crankshaft Repair Sleeve & Installation Tool		

For each individual entry, part numbers are shown in bold type and model years are listed in descending order (newest year first). If there is more than one entry for any part type, the parts will be listed by newest year covered first. The "Description" column contains detailed notes on exact application information, gasket designs, premium gasket materials included, and if an additional set is required to complete the repair job.

Mazda Truck (Incl. Minivans and SUV's)

3		1993 - 1991; 2.2L 2184cc SOHC L4 (8 Valve), 86mm Bore; 2 Bbl.; Gasoline; Naturally Aspirated Mazda Eng.; Eng. Code F2L			3
QTY	CYLINDER HEAD	YEARS	PART NO.	DESCRIPTION	
1	Head Gasket	93-91	9572 PT		
1	Head Set	93-91	HS 9572 PT-1	PermaDry® molded rubber valve cover gskt. incl.; Premium valve stem seals incl.	
1	Head Installation Set	93-91	HIS 9572 PT-1	Exh. pipe flange not incl.; PermaDry® molded rubber valve cover gskt. incl.	
QTY	CONVERSION SET	YEARS	PART NO.	DESCRIPTION	
1	Gasket Conversion Set	93-91	CS 9513	RTV sealant incl. for Upper oil pan gskt.	
QTY	MANIFOLD - INT. & EXH.	YEARS	PART NO.	DESCRIPTION	
1	Int. Manifold Gasket Set	93-91	MS 93248	Upper set incl.	
1	Exh. Manifold Gasket Set	93-91	MS 93353		
QTY	EXHAUST PIPE FLANGE	YEARS	PART NO.	DESCRIPTION	
1	Exhaust Pipe Gasket	93-91	60286	Flange	
2	Exhaust Pipe Gasket	93-91	60620	Converter	
QTY	FUEL PUMP	YEARS	PART NO.	DESCRIPTION	
2	Fuel Pump Mounting Gasket	93-91	72611		

A complete numerical listing of all the engine gasket part numbers included in this catalog appears at the end of the last manufacturer section. It references every appearance of each part number in this catalog, coded by manufacturer abbreviation and line number of each section where it appears. An abbreviations list of all the manufacturers may be found on the next page.

All domestic and imported passenger car and light-duty truck drivetrain gaskets are cataloged in a separate section at the rear of this catalog. All axle and transmission gaskets are listed under their appropriate vehicle manufacturers and the manufacturers are listed in alphabetical order. A comprehensive silhouette chart follows the gasket listings. The chart includes all axle housing cover, differential carrier, axle flange, and automatic transmission oil pan silhouettes for each manufacturer. All imported vehicle silhouettes are together in a single section for ease of reference. The silhouettes will aid you in selecting the correct gasket for your customers, especially if they do not know the ring gear, model name, or model number of the axle or transmission being serviced.

Ce catalogue contient des listes de jeux de joints destinés aux moteurs de voitures de tourisme et camionnettes américaines et importées. Tout ce qui concerne les Minivans et SUV (véhicules sport/loisir) se trouve uniquement dans la section Camionnettes du constructeur correspondant. Les joints utilisés dans les moteurs comme dans les organes de transmission sont inclus dans ce document.

Tous les constructeurs sont classés par ordre alphabétique et leur nom apparaît en caractères gras en bordure de chaque page. L'index des constructeurs figurant au début de ce catalogue facilite la localisation du constructeur désiré. La liste correspondant à chaque constructeur inclut également des informations sur toutes les différentes gammes de modèles et sur les moteurs disponibles pour des années de fabrication particulières. En vue de simplifier la présentation générale du catalogue, les informations concernant les moteurs, les modèles et les joints ont été regroupées dans les sections correspondant aux constructeurs suivants :

Section Constructeur	Inclut les moteurs et modèles	Section Constructeur	Inclut les moteurs et modèles
AM General Truck	AM General, Hummer	GMC Truck	Buick, Cadillac, Chevrolet, Geo, GMC, Hummer, Oldsmobile
American Motors Car	AMC, Hudson, Nash, Rambler	Honda Car	Acura, Honda
BMW Car	BMW, Mini	Honda Truck	Acura, Honda
British Leyland	Austin, Austin-Healey, Jensen, Metropolitan, MG, Morris, Riley	International Truck	International, Navistar
Chrysler Car	Chrysler, DeSoto, Dodge, Eagle, Plymouth	Jeep Truck	Jeep, Willys
Dodge Truck	Chrysler, Dodge, Fargo, Plymouth	Kaiser	Frazer, Henry J, Kaiser
Fiat	Bertone, Fiat, Lancia, Pinninfarina	Nissan Car	Datsun, Infiniti, Nissan
Ford Car	Edsel, Ford, Lincoln, Mercury, Merkur	Nissan Truck	Datsun, Infiniti, Nissan
Ford Truck	Ford, Lincoln, Mercury	Studebaker Car	Packard, Studebaker
GM Car	Buick, Cadillac, Chevrolet, Geo, Oldsmobile, Pontiac, Saturn	Toyota Car	Lexus, Scion, Toyota
		Toyota Truck	Lexus, Toyota

La liste pour chaque constructeur comporte **quatre** sections distinctes.

La **première** section, qui se trouve au début de chaque liste, consiste en un index complet de tous les moteurs inclus pour ce constructeur. Les moteurs sont classés par ordre de cylindrée croissante exprimée en po^3 ou en cm^3 suivant le cas.

La **deuxième** section consiste en un index complet de tous les codes de moteurs utilisés pour les moteurs importés par ce fabricant. Cela aide à identifier les variations souvent similaires que l'on trouve dans une gamme de moteurs importés.

La **troisième** section donne des informations complètes sur les modèles de ce fabricant, y compris toutes les combinaisons moteur/année de fabrication pour chaque gamme de véhicule. Les modèles sont classés par ordre alphabétique pour chaque marque individuelle, et sont accompagnés des codes de numéro d'identification de véhicule américains et des codes de moteurs importés pour faciliter l'identification du moteur correct.

La **quatrième** section de la liste pour chaque constructeur inclut tous les joints de moteurs disponibles pour ce constructeur. Les moteurs sont classés par ordre continu croissant de cylindrées. Les constructeurs américains sont classés par ordre de cylindrées exprimées en po³ et les constructeurs étrangers par ordre de cylindrées exprimées en cm³. L'en-tête pour chaque moteur donne des informations détaillées sur la désignation en litres, la cylindrée, la configuration de la commande des soupapes, la disposition des cylindres, l'alésage et les années de fabrication disponibles. Des codes complets de numéro d'identification de véhicule et de moteurs sont également inclus pour faciliter l'identification des moteurs. À la suite de l'en-tête, tous les joints disponibles apparaissent dans l'ordre suivant :

Groupe de joints	Type de jeu ou de pièce	Groupe de joints	Type de jeu ou de pièce
Culasse	Joint de culasse, cale d'espacement, jeu pour culasse, jeu de boulons de culasse, goujons d'assemblage	Jeu pour cache-soupapes	Jeu pour cache-soupapes, jeu pour bouchon en demi-cercle, jeu pour rondelles, jeu de joints pour tubes de bougies
Jeu complet	Jeu complet	Jeu pour couvercle de tiges de poussoirs	Jeu pour couvercle de tiges de poussoirs
Jeu pour conversion	Jeu pour conversion	Jeu de joints pour tiges de soupapes	Jeu de joints pour tiges de soupapes
Collecteur – adm. & éch.	Jeu pour collecteur d'admission, jeu pour collecteur supérieur d'air d'aspiration, jeu pour collecteurs d'admission et d'échappement, jeu pour collecteur d'échappement	Sortie d'eau	Sortie d'eau, boîtier de thermostat, dérivation d'eau
Bride de tuyau d'échappement	Bride d'échappement, tuyau de liaison d'échappement, réchauffeur de combustible, convertisseur catalytique, jeu de boulons et ressorts d'échappement	Pompe à eau	Pompe à eau, plaque de pompe à eau
Pompe à carburant	Fixation de pompe à carburant, plaque de pompe à carburant, cuve de pompe à carburant	Jeu pour carter de distribution	Jeu pour carter de distribution, jeu Sleeve 'N' Seal® pour carter de distribution, jeu de joints avant d'arbre à cames, jeu de joints pour arbre auxiliaire, jeu de joints avant de vilebrequin, manchon et outil de pose pour réparation de carter de distribution
Carter d'huile	Jeu pour carter d'huile, bouchon de vidange de carter d'huile	Joints divers	Filtre à air, carburateur, injection de carburant, carter de papillon, allumeur, soupape de recirculation des gaz d'échappement, pompe à huile, filtre à huile, refroidisseur d'huile
Joint arrière de vilebrequin	Jeu de joints de palier arrière, manchon et outil de pose pour réparation de vilebrequin		

Pour chaque entrée individuelle, les numéros de pièces sont indiqués en caractères gras et les années de fabrication énumérées à rebours (en commençant par l'année la plus récente). S'il y a plusieurs entrées pour un type de pièce quelconque, les pièces sont énumérées en commençant par l'année concernée la plus récente. La colonne « Description » contient des notes détaillées sur les applications exactes, les modèles de joints, les matières de qualité supérieures incorporées aux joints, et indiquent si un jeu supplémentaire est nécessaire pour compléter le travail de réparation.

Une liste numérique complète de tous les numéros de pièce des joints pour moteurs que contient ce catalogue apparaît à la fin de la dernière section Constructeur. Elle fait référence à toutes les apparitions de chaque numéro de pièce dans ce catalogue, codées par abréviation de constructeur et numéro de ligne de chaque section où il apparaît. Une liste des abréviations pour tous les constructeurs se trouve à la page suivante.

Tous les joints pour organes de transmission des voitures de tourisme et camionnettes américaines et importées sont répertoriés dans une section distincte à la fin de ce catalogue. Tous les joints pour essieux et transmissions sont énumérés dans la rubrique consacrée aux constructeurs de véhicules correspondants et les constructeurs sont classés par ordre alphabétique. Un tableau complet de silhouettes suit les listes de joints. Il inclut toutes les silhouettes de couvercles de carter d'essieu, de coquilles de différentiel, de flasques d'essieu et de carters d'huile de boîte automatique pour chaque constructeur. Toutes les silhouettes de véhicules importés sont regroupées dans une même section pour qu'il soit plus facile de s'y référer. Les silhouettes vous aideront à choisir le joint correct pour vos clients, en particulier s'ils ne connaissent pas la couronne ni le nom ou le numéro de modèle de l'essieu ou de la transmission en cours de réparation.

Este catálogo original contiene listas de juegos de empaques para aplicaciones de motores de automóviles de pasajeros y camiones ligeros nacionales y de importación. Las minifurgonetas y SUV (vehículos utilitarios deportivos) se incluyen solamente en la sección del fabricante de camiones correspondiente. En esta publicación se incluyen aplicaciones de motores y sistemas de transmisión.

Todos los fabricantes están en orden alfabético y el nombre de los mismos aparece en negrita en los márgenes exteriores de cada página. El índice de fabricantes de la parte delantera de este catálogo permitirá localizar fácilmente al fabricante deseado. La lista de cada fabricante incluye también información sobre gamas separadas de modelos y qué motores están disponibles para ciertos años en particular. A fin de simplificar todo el catálogo, las siguientes secciones de fabricantes han consolidado los datos de motores, datos de modelos y empaquetaduras:

Sección del fabricante	Incluye motores y modelos	Sección del fabricante	Incluye motores y modelos
AM General Truck	AM General, Hummer	GMC Truck	Buick, Cadillac, Chevrolet, Geo, GMC, Hummer, Oldsmobile, Pontiac, Saturn
American Motors Car	AMC, Hudson, Nash, Rambler	Honda Car	Acura, Honda
BMW Car	BMW, Mini	Honda Truck	Acura, Honda
British Leyland	Austin, Austin-Healey, Jensen, Metropolitan, MG, Morris, Riley	International Truck	International, Navistar
Chrysler Car	Chrysler, DeSoto, Dodge, Eagle, Plymouth	Jeep Truck	Jeep, Willys
Dodge Truck	Chrysler, Dodge, Fargo, Plymouth	Kaiser	Frazer, Henry J, Kaiser
Fiat	Bertone, Fiat, Lancia, Pinninfarina	Nissan Car	Datsun, Infiniti, Nissan
Ford Car	Edsel, Ford, Lincoln, Mercury, Merkur	Nissan Truck	Datsun, Infiniti, Nissan
Ford Truck	Ford, Lincoln, Mercury	Studebaker Car	Packard, Studebaker
GM Car	Buick, Cadillac, Chevrolet, Geo, Oldsmobile, Pontiac, Saturn	Toyota Car	Lexus, Scion, Toyota
		Toyota Truck	Lexus, Toyota

La lista de cada uno de los fabricantes tiene **cuatro** funciones distintas.

La **primera** sección, ubicada al principio de cada lista, constituye un índice completo de todos los motores de ese fabricante. Los motores están colocados en orden ascendente por cilindrada, ya sea en pulgadas cúbicas o centímetros cúbicos.

La **segunda** sección es un índice completo de todos los códigos de motor usados para motores de importación encontrados en ese fabricante. Esto ayudará a identificar las variantes, a menudo similares, dentro de una familia de motores de importación.

La **tercera** sección consta de datos completos para el modelo de ese fabricante, incluidas todas las combinaciones de motores/años de modelos para cada gama de vehículos. Los modelos están clasificados por orden alfabético por marcas, e incluyen códigos nacionales VIN y códigos de motores de importación como ayuda para identificar el motor correcto.

La **cuarta** sección de la lista de cada fabricante incluye todos los juegos de empaques de motor disponibles para ese fabricante. Los motores están clasificados orden ascendente por cilindradas. Los fabricantes nacionales están clasificados por cilindrada en pulgadas cúbicas y los fabricantes de modelos de importación están clasificados por cilindrada en centímetros cúbicos. El título de cada motor contiene información detallada sobre la designación en litros, tamaño del motor, disposición del tren de válvulas, configuración de los cilindros, calibre y años de modelos disponibles. También se incluyen códigos VIN y códigos de motor completos como ayuda para identificar el motor. A continuación del título del motor se indican todos los juegos de empaques disponibles en este orden:

Grupo de empaquetaduras	Tipo de juego o Tipo de pieza	Grupo de empaquetaduras	Tipo de juego o Tipo de pieza
Cilindro	Empaquetadura de cilindro, calce espaciador, juego de cilindro, juego de pernos de cilindro, pasadores de espiga	Juego de tapas de válvula	Juego de tapas de válvula, juego de taponos semicirculares, juego de arandelas de goma, juego de sellos de tubo de bujías
Juego completo	Juego completo	Juego de tapas de varillas de empuje	Juego de tapas de varillas de empuje
Juego de conversión	Juego de conversión	Juego de sellos de válvula	Juego de sellos de válvula
Múltiple de adm. y esc.	Juego de múltiple de admisión, juego de (cámara de aire) admisión superior, juego de múltiple de admisión y escape, juego de múltiple de escape	Salida de agua	Salida de agua, caja de termostato, derivación de agua
Pestaña de tubo de escape	Pestaña de escape, tubo transversal de escape, camisa de calefacción, convertidor catalítico, juego de pernos y resortes de escape	Bomba de agua	Bomba de agua, placa de bomba de agua
Bomba de combustible	Montaje de bomba de combustible, placa de bomba de combustible, taza de bomba de combustible	Juego de tapas de sincronización	Juego de tapas de sincronización, juego de tapas de sincronización Sleeve 'N' Seal® , juego de sellos delanteros del árbol de levas, juego de sellos del eje auxiliar, juego de sellos delanteros del cigüeñal, manguito de reparación y herramienta de instalación de la tapa de sincronización
Colector de aceite	Juego de colector de aceite, tapón de drenaje de colector de aceite	Empaquetaduras varias	Filtro de aire, carburador, inyección de combustible, cuerpo de acelerador, distribuidor, válvula de recirculación de los gases de escape, bomba de aceite, filtro de aceite, enfriador de aceite
Sello trasero del cigüeñal	Juego de sellos traseros de los cojinetes de bancada, manguito de reparación y herramienta de instalación del cigüeñal		

Por cada apartado individual, se muestran los números de pieza en negrita y los años de modelos se indican en orden descendente (el año más reciente primero). Si hay más de un apartado para cualquier tipo de pieza, las piezas se indican primero para el año más reciente. La columna "Descripción" contiene notas detalladas sobre la información exacta de la aplicación, diseños de empaquetadura, materiales de calidad óptima de empaquetaduras incluidos, y si se necesita un juego adicional para completar el trabajo de reparación.

Al final de la última sección de fabricantes se incluye una lista numérica completa de todos los números de pieza de empaquetaduras de motor incluidas en este catálogo. Hace referencia a cada uno de los aspectos de cada número de pieza de este catálogo, codificado por abreviatura de fabricante y el número de línea de cada sección donde aparece. En la página siguiente aparece una lista de abreviaturas de todos los fabricantes.

Todas las empaquetaduras del sistema de transmisión de automóviles de pasajeros y camiones ligeros nacionales y de importación están catalogados en una sección separada en la parte de atrás de este catálogo. Todas las empaquetaduras de ejes y transmisiones se indican bajo el fabricante del vehículo correspondiente y los fabricantes se indican en orden alfabético. A continuación de las listas de empaquetaduras aparece un cuadro completo de siluetas. El cuadro incluye todas las siluetas de tapas de cajas de ejes, portadiferenciales, pestañas de ejes y colector de aceite de transmisiones automáticas por cada fabricante. Todas las siluetas de vehículos de importación aparecen juntas en una sola sección para facilitar su referencia. Las siluetas ayudan a seleccionar la empaquetadura correcta para sus clientes, especialmente si no saben cuál es la corona, nombre del modelo o número del modelo del eje o transmisión cuyo servicio se está efectuando.

ABBREVIATIONS

Abbr.	English	French	Spanish	Abbr.	English	French	Spanish
A/C	Air conditioning	Climatiseur	Acondicionador de aire	Gov.	Governor	Régulateur	Regulador
AC	Air-cooled	Refroidissement d'air	Enfriado por aire	Gskt.	Gasket	Joint	Empaquetadura
A.I.R.	Air Injection Reactor	Reacteur d'injection d'air	Reactor a inyección por aire	GVW	Gross vehicle weight	Poids de véhicule total	Peso de vehículo total
Alt.	Altitude	Altitude	Altitud	H/D	Heavy duty	Poids lourd	Trabajo pesado
Alum.	Aluminum	Aluminium	Aluminio	Hemi.	Hemispherical	Hémisphérique	Hemisférico
A/R	As required	Autant qu'il faut	Como sea necesario	Hi-Alt.	High altitude	Haute altitude	Alto altitud
A/T	Automatic transmission	Transmission automatique	Transmisión automático	Hi-Comp.	High compression	Haute fonctionnement	Alta compresión
Aux.	Auxiliary	Auxiliaire	Auxiliar	Hi-Perf.	High performance	Haute performance	Alto rendimiento
Avail.	Available	Disponible	Disponible	Hi-Temp.	High temperature	Haute température	Alto temperatura
AWD	All wheel drive	Traction sur toutes les roues	Tracción en todas las ruedas	H.O.	High Output	Haute rendement	De poder
Bbl.	Barrel	Corps	Cuerpo	HP	Horsepower	Cheval-vapeur	Caballos de fuerza
Brg.	Bearing	Palier	Cojinete	HSC	High Swirl Combustion (Ford only)	Combustion à tourbillonnement élève	Combustión de altomovimiento espiral
Cam.	Camshaft	Arbre à cames	Árbol de levas	Hsg.	Housing	Boîte	Caja
Carb.	Carburetor	Carburateur	Carburador	ID	Inside diameter	Diamètre intérieur	Diámetro interior
cc	Cubic centimeters	Centimètre cube	Centímetro cúbico	IDI	Indirect injection	Injection indirect	Inyección indirecto
CFI	Central Fuel Injection (Ford only)	Injection centralisée	Inyección central	Incl.	Includes	Comporte	Incluso
CFI	Crossfire Injection (GM only)	Injection croisée	Inyección de fuego cruzado	Int.	Intake	Admission	Admisión
C.I.	Cast iron	Fonte	Hierro colado	L	Liter	Litre	Litro
CI	Cubic inch displacement	Cylindrée	Cilindrada	Lb.	Pound	Livre	Libra
CID	Cubic inch displacement	Cylindrée	Cilindrada	L/D	Light duty	Service léger	Servicio liviano
CNG	Compressed natural gas	Gas de naturel compression	Gas de natural compresión	L.H.	Left hand	Coté gauche	Mano izquierda
Com.	Commercial	Commercial	Comercial	LPG	Liquid propane gas	Gaz de pétrole liquéfié	Gas de petróleo líquido
Cont.	Continued	Suite	Continuación	Mani.	Manifold	Collecteur	Múltiple
CPI	Central Port Injection (GM only)	Injection avec in injecteur central	Inyección por punto central	Max.	Maximum	Maximum	Máximo
Cvr.	Cover	Couvercle	Cubierta	M/D	Medium duty	Service moyen	Servicio mediano
Cyl.	Cylinder	Cylindre	Cilindro	MFI	Multi-point fuel injection	Injection de carburant multipoint	Inyección de combustible multipunto
Cyl. Hd.	Cylinder head	Culasse	Culata de cilindros	MFI	Multi-port fuel injection	Injection de carburant multiport	Inyección de combustible multiples aberturas
Dbl.	Double	Double	Doble	mm	Millimeter	Millimètre	Milímetro
DEFI	Digital Electronic Fuel Injection (GM only)	Injection électronique digital	Inyección electrónica digital	MPI	Multi-point fuel injection	Injection par rampe à orifices multiples	Inyección de tubo multiple
DI	Direct injection	Injection direct	Inyección directo	M/T	Manual transmission	Transmission manuel	Transmisión manual
Dia.	Diameter	Diamètre	Diámetro	Mtg.	Mounting	Montage	Montaje
Diff.	Differential	Différentiel	Diferencial	N/A	Not available	Pas disponible	No disponible
DOHC	Double overhead cam	Arbre à cames (double) en haut	Doble árboles de levas	No.	Number	Numéro	Número
E.E.C.	Exhaust emission control	Controle des emissions de l'échappement	Control de emisión de los gases de escape	N/R	Not required	Pas nécessaire	No se requiere
EFE	Early Fuel Evaporation (GM only)	Evaporation carburant tôt	Evaporación combustible temprano	OD	Outside diameter	Diamètre extérieur	Diámetro exterior
EFI	Electronic fuel injection	Injection électronique	Inyección electrónica	OEM	Original Equipment Manufacturer	Fabricant d'équipements d'origine	Fabricante de equipo original
EGR	Exhaust gas recirculation	Recyclage des gaz d'échappement	Recirculación de los gases del escape	OHC	Overhead cam	Arbre à cames en haut	Culata de árbol de levas
Eng.	Engine	Moteur	Motor	OHV	Overhead valve	Soupape en haut	Válvula de árbol de levas
EP	Exhaust pipe	Tayau d'échappement	Tubo de escape de gases	Opt.	Optional	Facultatif	Opcional
Evap.	Evaporation	Evaporation	Evaporación	O/S	Oversize	Classer trop	Sobretamaño
Exc.	Except	Sauf	Excepto	PFI	Port Fuel Injection (Ford only)	Injection de carburant multiport	Inyección de combustible multiples aberturas
Exh.	Exhaust	Échappement	Escape	Pkg.	Package	Paquet	Paquete
FI	Fuel injection	Injection d'essence	Inyección de combustible	Prod.	Production	Production	Producción
Flg.	Flange	Bride	Brida	PTFE	Polytetrafluoroethylene	Polytetrafluoroethylene	Polytetrafluoroethylene
Frt.	Front	Avant	Frente	PTO	Power take-off	Pouvoir accessoire	Poder accesorio
FWD	Front wheel drive	Traction avant	Tracción delantera	Req'd.	Required	Nécessaire	Requerido
				Ret.	Retainer	Retenue	Retén
				R.H.	Right hand	Coté droit	Mano derecha
				RTV	Room Temperature Vulcanizer	Vulcanisation à la température	Vulcanización a temperatura ambiente

Abbr.	English	French	Spanish
RWD	Rear wheel drive	Propulsion arrière	Tracción trasera
S/C	Supercharged	Surcompression	Sobrealimentar
S.D. (GM only)	Super Duty	Service super	Servicio superior
SEFI (Ford only)	Sequential Fuel Injection	Injection séquentielle de carburant	Inyección de combustible secuencial
Ser.	Series	Série	Serie
Ser. No.	Serial number	Numéro	Número de serie
SFI (GM only)	Sequential Fuel Injection	Injection séquentielle de carburant	Inyección de combustible secuencial
Sgl.	Single	Seul	Sencillo
SHO (Ford only)	Super High Output	Super haute performance	Superior alto rendimiento
SOHC	Single overhead cam	Came en tête unique	Leva superior única
Spec.	Special	Spécial	Especial
Std.	Standard	Standard	Estándar
TBI	Throttle body injection	Injection de mélange dans le papillon des gaz	Inyección de la válvula reguladora
TE (Ford only)	Thermactor Emission	Emission thermactique	Emisión térmica
TPI (GM only)	Tuned Port Injection	Injection de carburant multiport	Inyección de combustible multiples aberturas
Trans.	Transmission	Transmission	Transmisión
Turbo	Turbocharged	Turbo-compresseur	Turboalimentador
V	Barrel carburetor	Corps carburateur	Cuerpo carburador
VIN	Vehicle Identification Number	Numéro d'identification du véhicule	Número de identificación del vehículo
w/	With	Avec	Con
WC	Water-cooled	Refroidissement par eau	Enfriado por agua
w/o	Without	Sans	Sin
2WD	Two-wheel drive	Traction sur deux les roues	Tracción en dos las ruedas
4WD	Four-wheel drive	Traction sur quatre les roues	Tracción en cuatro las ruedas

ENGLISH TO FRENCH / SPANISH GLOSSARY

English	French / Spanish	English	French / Spanish	English	French / Spanish
above	au-dessus/ arriba	cooler	refroidisseur/ heladera	fuel pump	bol de pompe à carburant/
adapter	adaptateur/ adaptador	cooling	refroidissement/ enfriado	bowl	taza de bomba de
after	après/ después	cork	liège/ corcho		combustible
agricultural	agriculture/ agrícola	coupe	coupé/ cupé	full	plein/ lleno
air cleaner	épureur d'air/ depurador	cover	couvercle/ cubierta	gas	gaz/ gasolina
	de aire	crankcase	carter/ caja del cigüeñal	gasket	joint/ empaquetadura
air-cooled	refroidissement d'air/ enfriado por aire	crankshaft	vilebrequin/ árbol cigüeñal	gear	engrenage/ engranaje
all	tout/ todo	crossflow	courant traversal/ corriente	glass bowl	bol en verre/ taza de vidrio
alloy	alliage/ aleación		transversal	governor	régulateur/ regulador
altitude	altitude/ altitud	crossover	coude de croisement/ curva de pase	grommet	rondelle/ arandela
aluminum	aluminium/ aluminio	cubic	centimètre cube/ centímetro cúbico	hand	main/ mano
application	application/ aplicación	centimeters	centimètre/ centímetro	head	culasse/ culata
aspirate	aspire/ aspirar	cubic inch	cylindrique/ cilindrada	head gasket	joint de culasse/ empaque
assortment	assortiment/ variedad	displacement			de culata
automatic	automatique/ automático	cylinder	cylindre/ cilindro	heat	chaleur/ calor
auxiliary	auxiliaire/ auxiliar	cylinder head	culasse/ culata de cilindros	heat riser	réchauffeur/ camisa de
available	disponible/ disponible	damper	amortisseur/ registro		calefacción
axle	essieu/ eje	data	données/ datos	heat shield	défecteur de chaleur/ protección contra el calor
back	arrière/ parte posterior	design	dessin/ diseño	heavy duty	poids lourd/ trabajo pesado
backing	réglette/ tira de respaldo	diameter	diamètre/ diámetro	heavy truck	camion poids lourd/ camión
barrel	corps/ cuerpo	differential	différentiel/ diferencial		pesado
bath tub	baignoire/ bañera	displacement	déplacement/ desplazamiento	high	haute/ alto
bearing	palier/ cojinete	distributor	distributeur/ distribuidor	hi-lift	haut levée/ cierre alto
before	avant/ antes	divider	compas de mesure/ compás de división	hole	trou/ hueco
below	au-dessous/ abajo	does not	ne contient pas/ no incluye	housing	boîte/ caja
between	entre/ entre	contain		identification	identification/ identificación
block	bloc/ bloque	domestic	domestique/ doméstico	imported	d'importation/ importado
body	corps/ cuerpo	double	double/ doble	improved	amélioré/ mejora
bolt	boulon/ tornillo	drain	évacuation/ desagüe	inches	pouces/ pulgadas
booster	survolteur/ reforzador	drive	entraînement/ control	including	comporte/ incluso
bore	alesage/ alesaje	drivetrain	train d'engrenage/ tren	industrial	industriel/ industrial
bowl	cuve/ tazón		propulsor	injection	injection/ inyección
box	boîte/ cajón	dual	double/ doble	inlet	arrivée/ admisión
brake	frein/ freno	early	tôt/ temprano	inner	intérieur/ interior
built	construit/ construido	elbow	coude/ codo	install	installer/ instalar
bulk materials	materiaux en vrac/ materiales en cantidad	embossed	en relief/ realizado	insulator	isolant/ aislador
bypass	derivation/ derivación	emissions	emissions/ emisión	intake	admission/ admisión
camshaft	arbre à cames/ árbol de levas	encased	renfermé/ encajado	interchange	échange/ intercambio
cap	chapeau/ tapa	end	extrémité/ extremidad	internal	intéme/ interno
carburetor	carbureteur/ carburador	engine	moteur/ motor	inventory	inventaire/ inventario
carrier	appui/ conductor	evaporative	évaporatif/ evaporativo	kerosene	kérosène/ keroseno
cast iron	fonte/ hierro colado	except	sauf/ excepto	kit	nécessaire/ juego
catalog	catalogue/ catálogo	exhaust	échappement/ escape	large	grand/ grande
catalytic	convertisseur catalytique/ convertidor catalítico	explanation	explication/ explicación	late	récent/ reciente
center	centre/ centro	export	export/ exportación	leaf spring	ressort à lames/ muelle de
chamber	chambre/ cámara	external	externe/ externo		hojas
change	changement/ cambio	feet	pieds/ pies	left	gauche/ izquierda
chart	tableau/ cuadro	felt	feutre/ fieltro	length	longueur/ longitud
choke	étrangleur/ estrangulador	fiber	corde/ fibra	light duty	service léger/ servicio liviano
clamped	serré/ fijado	filter	filtre/ filtrar	light truck	camion léger/ camión
closed	fermé/ cerrado	final	dernier/ último		liviano
clutch	embrayage/ embrague	flange	bride/ brida	lip	rebord/ reborde
code	code/ código	flat	plat/ plano	listing	inscription/ inscripción
column	colonne/ columna	floor	sol/ piso	long	long/ largo
combination	combinaison/ combinación	fluid	liquide/ fluido	low	bas/ bajo
combustion	combustion/ combustión	flywheel	volant/ volante	lower	inférieur/ inferior
commercial	commercial/ comercial	from	de/ desde	main	principal/ principal
complete	complet/ completo	front	avant/ frente	manifold	collecteur/ múltiple
contained in	incorporé dans/ incorporado en	fuel	carburant/ combustible	manual	manuel/ manual
continued	suite/ continuación	fuel pump	pompe à carburant/ bomba de combustible	material	matériel/ material
converter	convertisseur/ convertidor			medium duty	service moyen/ servicio
					mediano
				medium truck	camion moyen/ camión
					mediano
				millimeters	millimètre/ milímetro

English	French / Spanish	English	French / Spanish	English	French / Spanish
miscellaneous	divers / varios	rear	arrière / trasero	temperature	température / temperatura
model	modèle / modelo	rear axle	plateau d'entraînement de	thermostat	thermostat / termostato
molded	moulé / moldeado	flange	l'essieu arrière/ pestaña del	thicker	plus épais/ más espeso
month	mois / mes		eje trasero	thin	mince/ delgado
mounting	montage / montaje	rear main seal	joint d'arrêt d'huile du palier	throttle	papillon / regulador
narrow	étroit / estrecho		arrière/ retén del cojinete	timing cover	couvercle du distributeur/
not available	pas disponible/ no		de bancada trasero		cubierta de regulación
	disponible	rear wheel	plaquette de support de	to	à / a
not included	pas compris / no incluido	backing plate	roues arrière/ contraplato	ton	tonne / tonelada
not required	pas nécessaire / no se		de la rueda trasera	towing	remorquage / remolque
	requiere	refaced	rectifié/ refrentado	tractor	tracteur / tractor
number	numéro / número	regular	régulier / regular	trailer	remorque / remolque
oil	huile / aceite	relief	de sûreté/ relieve	transaxle	essieu transversal/ transeje
oil cooler	refroidisseur d'huile/	replaced	remplacé/ repuesto	transmission	transmission / transmisión
	enfriador de aceite	required	nécessaire/ requerido	treated paper	papier traité/ papel tratado
oil filter	filtre d'huile/ filtro de aceite	resonator	silencieux auxiliaire/	truck	camion / camión
oil pan	carter à l'huile/ colector de		resonador	tube	tuyau / tubo
	aceite	retainer	arrêt / retén	turbocharged	turbo-compresseur/
oil pump	pompe à l'huile/ bomba de	right	droite/ derecho		turbolimentador
	aceite	ring	bague / anillo	type	type / tipo
only	seulement / solamente	ring gear	couronne dentée/ corona	typical	typique / típico
open	ouvert / abierto	riser	tuyau vertical/ tubo	umbrella	parapluie / paraguas
optional	facultatif / opcional		ascendante	unit	unité / unidad
opposite	opposé / opuesto	rocker arm	culbuteur/ balancín	universal joint	cardan / junta universal
O-ring	joint torique/ junta de orillo	rolls	rouleaux/ rollos	upper	haut/ superior
outer	extérieur / exterior	rope	corde/ cuerda	vacuum	vide/ vacío
outlet	sortie / salida	rubber	caoutchouc / caucho	valve	soupape / válvula
output	rendement / rendimiento	seal	joint/ retén	valve cover	couvercle des soupapes/
overdrive	vitesse surmultipliée/	section	partie/ sección		cubierta de válvula
	superdirecta	sedan	conduite/ sedán	valve stem	tige de soupape/ varilla de
overhaul	réviser / arreglar	see	voir / véase		válvula
overhead	de culasse/ de culata	separate	individuel/ individual	valve stem	joint d'arrêt d'huile pour tige
package	paquet/ paquete	serial number	numéro / número de série	seal	de soupape/ retén del
packing	emballage / embalaje	series	série / serie		varilla de válvula
pad	tampon/ cojin almohadilla	set	ensemble/ conjunto	vehicle	véhicule / vehículo
page	page / página	shaft	arbre / árbol	ventilation	ventilateur/ ventilación
pan	carter / colector	sheet	tôle / hoja	venturi	corps/ cuerpo
part	pièce / pieza	shell	paroi / casco	water	eau / agua
part number	numéro de pièce / número	shield	protecteur / protector	water bypass	derivation d'eau/
	de pieza	shift	change / cambio		derivación de agua
passenger	passager / pasajero	shim	cale / calzo	water-cooled	refroidissement par eau/
passenger car	voiture de tourisme/	short	court / corto		enfriado por agua
	automóvil	shoulder	épaule / respaldo	water outlet	sortie d'eau/ salida del
performance	fonctionnement /	side	côté / lado		agua
	funcionamiento	silencer	silencieux/ silenciador	water pump	pompe à eau/ bomba de
piece	pièce / pieza	single	seul / sencillo		agua
pipe	tuyau / tubo	size	dimension / tamaño	wide	large / ancho
plate	plaque / placa	sleeve	manche / manga	width	largeur / anchura
plenum	chambre de distribution de	small	petit / pequeño	with	avec / con
	chaleur/ cámara de pleno	spacer	entretoise / espaciador	without	sans / sin
plug	bouchon / tapón	spark plug	bougie / buja de encendido	wound	enroule / bobinado
police car	voiture de police/ automóvil	spark plug	joint pour tuyau de bougie/	yards	yards / yardas
	policial	tube seal	retén del tubo de bujía	year	année / año
positive	positif / positivo	special	spécial / especial		
pound	livre / libra	speed	vitesse / velocidad		
power	puissance / fuerza	spring	ressort / resorte		
premium	super / superior	stamped	estampe / estampado		
pressed	estampé / apretado	standard	standard / estándar		
pressure	pression / presión	station wagon	familiale / camioneta		
prior	antérieur / anterior	steel	acier / acero		
pump	pompe / bomba	straight	rectiligne / derecho		
push rod	tige-poussoir / levanta	stud	tige / perno		
	válvula	supercharged	surcompression /		
racing	emballement /		sobrealimentar		
	embalamiento	swirl	tourbillonnement /		
ratio	rapport / relación		movimiento espiral		

MODEL CROSS REFERENCE

A								
A	Ford Car	ActiveHybrid X6	AD100	BMW Truck	Aura Hybrid	GM Car	B2PW Series	Dodge Truck
A	Ford Truck	Ramcharger		Dodge Truck	Aurora	GM Car	B300	Dodge Truck
A.C. 289	AC Cobra	AD150		Dodge Truck	Avalanche 1500	GMC Truck	B3000	Mazda Truck
A.C. 427	AC Cobra	Ramcharger			Avalanche 2500	GMC Truck	B350	Dodge Truck
A.C. 428	AC Cobra	AD150S		Dodge Truck	Avalon	Toyota Car	B3500	Dodge Truck
A100	Dodge Truck	Ramcharger			Avalon Hybrid	Toyota Car	B3500 Series	GMC Truck
A100	International Truck	Adventurer		Chrysler Car	Avanti	Studebaker Car	B3B Series	Dodge Truck
A102	International Truck	Aerio		Suzuki Car	Avanti II		B3C Series	Dodge Truck
A108	Dodge Truck	Aero 8		Morgan	Avenger	Chrysler Car	B3D Series	Dodge Truck
A11	Checker	Aero Ace		Willys Car	Aveo	GM Car	B3DU Series	Dodge Truck
A110	International Truck	Aero Comet		Willys Car	Aveo 5	GM Car	B3E Series	Dodge Truck
A112	International Truck	Aero Eagle		Willys Car	Aviator	Ford Truck	B3EU Series	Dodge Truck
A11E	Checker	Aero Falcon		Willys Car	AW100	Dodge Truck	B3F Series	Dodge Truck
A12	Checker	Aero Lark		Willys Car	Ramcharger		B3G Series	Dodge Truck
A120	International Truck	Aero Wing		Willys Car	AW150	Dodge Truck	B3H Series	Dodge Truck
A122	International Truck	Aerobus		Checker	Ramcharger		B3J Series	Dodge Truck
A12E	Checker	Aerostar		Ford Truck	AW150S	Dodge Truck	B3K Series	Dodge Truck
A12W	Checker	AG Series		Ford Truck	Ramcharger		B3PW Series	Dodge Truck
A130	International Truck	AJ Series		GMC Truck	Axiom	Isuzu Truck	B4000	Mazda Truck
A132	International Truck	AK Series		GMC Truck	Axxess	Nissan Truck	B4B Series	Dodge Truck
A2	Checker	AL Series		GMC Truck	Azera	Hyundai Car	B4C Series	Dodge Truck
A3	Audi Car	Alero		GM Car	Aztek	GM Truck	B4D Series	Dodge Truck
A3	Checker	Allante		GM Car			B4DU Series	Dodge Truck
A3 Quattro	Audi Car	Alliance		American Motors	B	Ford Car	B4E Series	Dodge Truck
A30	British Leyland	Alliance		Renault	B	Ford Truck	B4EU Series	Dodge Truck
A35	British Leyland	Allroad Quattro		Audi Car	B100	Dodge Truck	B4F Series	Dodge Truck
A4	Audi Car	Allroad Quattro		Audi Truck	B100	International Truck	B4G Series	Dodge Truck
A4	Checker	Allstate		Kaiser	B102	International Truck	B4H Series	Dodge Truck
A4 Quattro	Audi Car	Allure		GM Car	B110	International Truck	B4J Series	Dodge Truck
A40	British Leyland	Alpina B7		BMW Car	B110	Nissan Car	B4K Series	Dodge Truck
A40 Series	British Leyland	Alpina B7L		BMW Car	B112	International Truck	B4PW Series	Dodge Truck
A5	Audi Car	Alpina Roadster		BMW Car	B120	International Truck	B9 Tribeca	Subaru Truck
A5	Checker	Alpine		Sunbeam	B122	International Truck	Baja	Subaru Truck
A5 Quattro	Audi Car	Altima		Nissan Car	B130	International Truck	Barracuda	Chrysler Car
A50 Series	British Leyland	Altima Hybrid		Nissan Car	B132	International Truck	Bavaria	BMW Car
A55	British Leyland	AM Series		GMC Truck	B150	Dodge Truck	BB	Ford Truck
A6	Audi Car	AM120		International Truck	B1500	Dodge Truck	Beaumont	GM Car
A6	Checker	AM130		International Truck	B1600	Mazda Truck	Beauville	GMC Truck
A6 Allroad Quattro	Audi Truck	AM132		International Truck	B1800	Mazda Truck	Beetle	VW Car
A6 Quattro	Audi Car	AM150		International Truck	B1B Series	Dodge Truck	Bel Air	GM Car
A60	British Leyland	AM80		International Truck	B1C Series	Dodge Truck	Belvedere	Chrysler Car
A7	Audi Car	Amanti		Kia Car	B1D Series	Dodge Truck	Beretta	GM Car
A7	Checker	Ambassador		American Motors	B1DU Series	Dodge Truck	Bermuda	Willys Car
A8	Audi Car	America		British Leyland	B1E Series	Dodge Truck	Beta	Fiat
A8	Checker	America		Chrysler Car	B1EU Series	Dodge Truck	BG Series	GMC Truck
A8 Quattro	Audi Car	American		American Motors	B1F Series	Dodge Truck	Biscayne	GM Car
A8B	Checker	Americar		Jeep Truck	B1G Series	Dodge Truck	BJ Series	GMC Truck
A8L Quattro	Audi Car	Americar		Willys Car	B1H Series	Dodge Truck	BK Series	GMC Truck
A9	Checker	Amigo		Isuzu Truck	B1J Series	Dodge Truck	BL Series	GMC Truck
A9L	Checker	AMX		American Motors	B1K Series	Dodge Truck	Blackhawk	Stutz
AA	Ford Truck	AN Series		GMC Truck	B1PW Series	Dodge Truck	Blackwood	Ford Truck
AB120	International Truck	Apollo		GM Car	B200	Dodge Truck	Blazer	GMC Truck
AB1200	International Truck	APV		GMC Truck	B2000	Mazda Truck	BM Series	GMC Truck
AB140	International Truck	Aries		Chrysler Car	B210	Nissan Car	BN Series	GMC Truck
AB1400	International Truck	Armada		Nissan Truck	B2200	Mazda Truck	Bobcat	Ford Car
AC100 Series	GMC Truck	Arnage		Rolls-Royce	B2300	Mazda Truck	Bonaventure	GMC Truck
AC150 Series	GMC Truck	Arrow		Chrysler Car	B250	Dodge Truck	Bonneville	GM Car
AC250 Series	GMC Truck	Arrow		Dodge Truck	B2500	Dodge Truck	Borrego	Kia Truck
AC300 Series	GMC Truck	Ascender		Isuzu Truck	B2500	Mazda Truck	Boxster	Porsche Car
Acadia	GMC Truck	Ascender EXT		Isuzu Truck	B2600	Mazda Truck	Brat	Subaru Truck
Acadian	GM Car	Aspen		Chrysler Car	B2B Series	Dodge Truck	Brava	Fiat
Accent	Hyundai Car	Aspen		Dodge Truck	B2C Series	Dodge Truck	Bravada	GMC Truck
Acclaim	Chrysler Car	Aspen Hybrid		Dodge Truck	B2D Series	Dodge Truck	Breeze	Chrysler Car
Accord	Honda Car	Aspire		Ford Car	B2DU Series	Dodge Truck	Briarwood	Jeep Truck
Accord Crosstour	Honda Truck	Astra		GM Car	B2E Series	Dodge Truck	Bronco	Ford Truck
Accord Hybrid	Honda Car	Astre		GM Car	B2EU Series	Dodge Truck	Bronco II	Ford Truck
Achieva	GM Car	Astro		GMC Truck	B2F Series	Dodge Truck	Brookwood Wagon	GM Car
ActiveHybrid 3	BMW Car	ATS		GM Car	B2G Series	Dodge Truck	Brougham	GM Car
ActiveHybrid 5	BMW Car	Aura		GM Car	B2H Series	Dodge Truck	Brougham	Jeep Truck
ActiveHybrid 7	BMW Car	Aura Green Line Hybrid		GM Car	B2J Series	Dodge Truck	BRZ	Subaru Car
					B2K Series	Dodge Truck		

MODEL CROSS REFERENCE

C		C63 AMG	Mercedes-Benz Car	Citation	GM Car	Cooper Coupe	BMW Car
C-Max Hybrid	Ford Car	C70	Volvo Car	Civic	Honda Car	Cooper Paceman	BMW Car
C10	GMC Truck	C900 Series	International Truck	Civic Hybrid	Honda Car	Cooper S Clubman	BMW Car
C10 Suburban	GMC Truck	Caballero	GMC Truck	Civic Wagon	Honda Car	Cooper S	BMW Car
C100 Series	International Truck	Cabrio	VW Car	CJ-2A	Jeep Truck	Convertible	
C1000 Series	International Truck	Cabrio	Yugo	CJ-3A	Jeep Truck	Cooper S	BMW Car
C110 Series	International Truck	Cabriolet	Audi Car	CJ-3B	Jeep Truck	Countryman	
C1100 Series	International Truck	Cabriolet	VW Car	CJ-5	Jeep Truck	Cooper S Coupe	BMW Car
C12	Callaway	Calais	GM Car	CJ-5A	Jeep Truck	Cooper S John	BMW Car
C120 Series	International Truck	Caliber	Chrysler Car	CJ-6	Jeep Truck	Cooper Works	
C1200 Series	International Truck	Camaro	GM Car	CJ-6A	Jeep Truck	Cooper S	BMW Car
C130 Series	International Truck	Cambridge	British Leyland	CJ-7	Jeep Truck	Paceman	
C1300 Series	International Truck	Cambridge	Chrysler Car	CJ-8	Jeep Truck	Cordia	Mitsubishi Car
C1500	GMC Truck	Camper	VW Truck	CK Series	GMC Truck	Cordoba	Chrysler Car
C1500 Suburban	GMC Truck	Camry	Toyota Car	CL500	Mercedes-Benz Car	Corolla	Toyota Car
C16	Chrysler Car	Camry All-Trac	Toyota Car	CL55 AMG	Mercedes-Benz Car	Corolla All-Trac	Toyota Car
C18	Chrysler Car	Camry Hybrid	Toyota Car	CL550	Mercedes-Benz Car	Corolla FX	Toyota Car
C1B Series	Dodge Truck	Canyon	GMC Truck	CL600	Mercedes-Benz Car	Corona	Toyota Car
C1C Series	Dodge Truck	Capri	Ford Car	CL63 AMG	Mercedes-Benz Car	Corona Mark II	Toyota Car
C1D Series	Dodge Truck	Caprice	GM Car	CL65 AMG	Mercedes-Benz Car	Coronet	Chrysler Car
C1DU Series	Dodge Truck	Caprice Classic	GM Car	Classic	American Motors	Corrado	VW Car
C1E Series	Dodge Truck	Caprice PPV	GM Car	Classic	GM Car	Corsair	Ford Car
C1EU Series	Dodge Truck	Captiva Sport	GMC Truck	Classic 98	GM Car	Corsair	Kaiser
C1G Series	Dodge Truck	Caravan	Dodge Truck	Clipper DeLuxe	Studebaker Car	Corsica	GM Car
C1H Series	Dodge Truck	Caravelle	Chrysler Car	Clipper Special	Studebaker Car	Corvair	GM Car
C1J Series	Dodge Truck	Caribbean	Studebaker Car	Clipper Wagon	Studebaker Car	Corvair	GMC Truck
C1K Series	Dodge Truck	Carina	Toyota Car	CLK320	Mercedes-Benz Car	Corvan	GMC Truck
C1PW Series	Dodge Truck	Carolina	Kaiser	CLK350	Mercedes-Benz Car	Corvette	GM Car
C1R Series	Dodge Truck	Cartier	Ford Car	CLK430	Mercedes-Benz Car	Cosmo	Mazda Car
C1T Series	Dodge Truck	Catalina	GM Car	CLK500	Mercedes-Benz Car	Cosmopolitan	Ford Car
C1V Series	Dodge Truck	Catera	GM Car	CLK55 AMG	Mercedes-Benz Car	Cougar	Ford Car
C20	GMC Truck	Cavalier	GM Car	CLK550	Mercedes-Benz Car	Coupe	Audi Car
C20 Suburban	GMC Truck	Cavalier	Studebaker Car	CLK63 AMG	Mercedes-Benz Car	Coupe	Volvo Car
C22	Chrysler Car	Cayenne	Porsche Truck	CLS500	Mercedes-Benz Car	Coupe Quattro	Audi Car
C220	Mercedes-Benz Car	Cayenne Hybrid	Porsche Truck	CLS55 AMG	Mercedes-Benz Car	Courier	Elva
C230	Mercedes-Benz Car	Cayman	Porsche Car	CLS550	Mercedes-Benz Car	Courier	Ford Truck
C240	Mercedes-Benz Car	CB300	Dodge Truck	CLS63 AMG	Mercedes-Benz Car	Cowley	British Leyland
C25	Chrysler Car	CB350	Dodge Truck	CM110 Series	International Truck	CR-V	Honda Truck
C250	Mercedes-Benz Car	CC	VW Car	CM75 Series	International Truck	CR-Z Hybrid	Honda Car
C2500	GMC Truck	CC100 Series	GMC Truck	CM80 Series	International Truck	Cranbrook	Chrysler Car
C2500 Suburban	GMC Truck	CC101 Series	GMC Truck	Coachbuilder	GM Car	Cressida	Toyota Car
C28	Chrysler Car	CC102 Series	GMC Truck	Wagon		Crestline	Ford Car
C280	Mercedes-Benz Car	CC150 Series	GMC Truck	Cobalt	GM Car	Crestliner	Ford Car
C30	GMC Truck	CC250 Series	GMC Truck	Colorado	GMC Truck	Crocket	Chrysler Car
C30	Volvo Car	CC260 Series	GMC Truck	Colt	Chrysler Car	Crossfire	Chrysler Car
C300	Mercedes-Benz Car	CC300 Series	GMC Truck	Colt Vista	Chrysler Car	Crosstour	Honda Truck
C32 AMG	Mercedes-Benz Car	Celebrity	GM Car	Colt Wagon	Chrysler Car	Crown	Toyota Car
C320	Mercedes-Benz Car	Celeste	Chrysler Car	Comanche	Jeep Truck	Crown Imperial	Chrysler Car
C34	Chrysler Car	Celica	Toyota Car	Comet	Ford Car	Crown Victoria	Ford Car
C350	Mercedes-Benz Car	Celica All-Trac	Toyota Car	Commander	Jeep Truck	Cruiser	Studebaker Car
C3500	GMC Truck	Centurion	GM Car	Commander	Studebaker Car	Cruze	GM Car
C36 AMG	Mercedes-Benz Car	Century	GM Car	Commando	Jeep Truck	CRX	Honda Car
C3B Series	Dodge Truck	Challenger	Chrysler Car	Commercial	GM Car	CTS	GM Car
C3C Series	Dodge Truck	Challenger	Studebaker Car	Chassis		CTS-V	GM Car
C3D Series	Dodge Truck	Champ	Chrysler Car	Commodore	American Motors	Cube	Nissan Car
C3F Series	Dodge Truck	Champion	Studebaker Car	Commuter	Ford Car	Cuda	Chrysler Car
C3G Series	Dodge Truck	Charade	Daihatsu Car	Compass	Jeep Truck	Custom	Chrysler Car
C3H Series	Dodge Truck	Charger	Chrysler Car	Concord	American Motors	Custom	Ford Car
C3J Series	Dodge Truck	Cherokee	Jeep Truck	Concord	Chrysler Car	Custom	Kaiser
C3K Series	Dodge Truck	Chevelle	GM Car	Concorde	Chrysler Car	Custom	Willys Car
C3PW Series	Dodge Truck	Chevette	GM Car	Concours	GM Car	Custom 300	Ford Car
C3R Series	Dodge Truck	Chevy II	GM Car	Conquest	Chrysler Car	Custom 500	Ford Car
C3T Series	Dodge Truck	Chief	Jeep Truck	Continental	Cunningham	Custom 880	Chrysler Car
C3V Series	Dodge Truck	Chieftain	GM Car	Continental	Ford Car	Custom Cruiser	GM Car
C3Y Series	Dodge Truck	Chieftain Sedan	GMC Truck	Continental	Rolls-Royce	Customline	Ford Car
C43 AMG	Mercedes-Benz Car	Delivery		Contour	Ford Car	Cutlass	GM Car
C4B Series	Dodge Truck	Ciera	GM Car	Cooper Clubman	BMW Car	Cutlass Calais	GM Car
C4C Series	Dodge Truck	Cimarron	GM Car	Cooper	BMW Car	Cutlass Ciera	GM Car
C4D Series	Dodge Truck	Cinco	Kia Car	Convertible		Cutlass Supreme	GM Car
C4PW Series	Dodge Truck	Cirrus	Chrysler Car	Cooper	BMW Car	CX-5	Mazda Truck
C55 AMG	Mercedes-Benz Car	Citation	Ford Car	Countryman		CX-7	Mazda Truck

MODEL CROSS REFERENCE

C		D		E		F	
CX-9	Mazda Truck	Durango Hybrid	Dodge Truck	Envoy Denali XL	GMC Truck	F2B	Dodge Truck
Cyclone	Ford Car	Duster	Chrysler Car	Envoy XL	GMC Truck	F3	Ford Truck
		Dynamic 88	GM Car	Envoy XUV	GMC Truck	F350	Ford Truck
		Dynasty	Chrysler Car	Eos	VW Car	F350 Super Duty	Ford Truck
D100	Dodge Truck			EP3100 Series	GMC Truck	F3B	Dodge Truck
D1000 Series	International Truck	E-Class	Chrysler Car	Epica	GM Car	F4-134 Truck	Jeep Truck
D110	Dodge Truck	E10 Series	Studebaker Truck	Equator	Suzuki Truck	F450	Ford Truck
D1100 Series	International Truck	E100	Ford Truck	Equinox	GMC Truck	F450 Super Duty	Ford Truck
D1200 Series	International Truck	E12 Series	Studebaker Truck	Equus	Hyundai Car	F4B	Dodge Truck
D1300 Series	International Truck	E150	Ford Truck	ER3600 Series	GMC Truck	F53	Ford Truck
D150	Dodge Truck	E200	Ford Truck	ES 250	Toyota Car	F550	Ford Truck
D1500 Series	GMC Truck	E250	Ford Truck	ES 300	Toyota Car	F550 Super Duty	Ford Truck
D150S	Dodge Truck	E300	Ford Truck	ES 300h Hybrid	Toyota Car	F59	Ford Truck
D2 Series	Dodge Truck	E300D	Mercedes-Benz Car	ES 330	Toyota Car	FA-134 Truck	Jeep Truck
D200	Dodge Truck	E300TD	Mercedes-Benz Car	ES 350	Toyota Car	Facel II	Facel Vega
D21	Nissan Truck	E320	Mercedes-Benz Car	ES3800 Series	GMC Truck	Facel III	Facel Vega
D210	Dodge Truck	E350	Ford Truck	Escalade	GMC Truck	Fairlane	Ford Car
D250	Dodge Truck	E350	Mercedes-Benz Car	Escalade ESV	GMC Truck	Fairmont	Ford Car
D2551 Series	GMC Truck	E350 Super Duty	Ford Truck	Escalade EXT	GMC Truck	Falcon	Ford Car
D300	Dodge Truck	E400 Hybrid	Mercedes-Benz Car	Escalade Hybrid	GMC Truck	Fastback	VW Car
D350	Dodge Truck	E420	Mercedes-Benz Car	Escape	Ford Truck	FB Series	GMC Truck
D50	Dodge Truck	E430	Mercedes-Benz Car	Escape Hybrid	Ford Truck	FC Series	GMC Truck
D500	Chrysler Car	E450 Super Duty	Ford Truck	Escort	Ford Car	FC-150	Jeep Truck
D5415 Series	GMC Truck	E5 Series	Studebaker Truck	Escort ZX2	Ford Car	FC-170	Jeep Truck
D5615 Series	GMC Truck	E500	Mercedes-Benz Car	Esperante	Panoz	FC-170HD	Jeep Truck
D5715 Series	GMC Truck	E55 AMG	Mercedes-Benz Car	Estate Wagon	GM Car	FC100 Series	GMC Truck
D5815 Series	GMC Truck	E550	Mercedes-Benz Car	Esteem	Suzuki Car	FC100-22 Series	GMC Truck
D900 Series	International Truck	E63 AMG	Mercedes-Benz Car	EuroVan	VW Truck	FC101 Series	GMC Truck
Dakota	Dodge Truck	E7 Series	Studebaker Truck	Evolution	Mitsubishi Car	FC102 Series	GMC Truck
Darrin	Darrin	Eagle	American Motors	Evora	Lotus	FC150 Series	GMC Truck
Darrin	Kaiser	EB Series	GMC Truck	EX35	Nissan Truck	FC152 Series	GMC Truck
Dart	Chrysler Car	EB16.4	VW Car	EX37	Nissan Truck	FC1B	Dodge Truck
Dasher	VW Car	EC Series	GMC Truck	Excel	Hyundai Car	FC1C	Dodge Truck
Daytona	Chrysler Car	EC100 Series	GMC Truck	Excellence	Facel Vega	FC250 Series	GMC Truck
Daytona	Studebaker Car	EC101 Series	GMC Truck	Excursion	Ford Truck	FC251 Series	GMC Truck
Defender	Land Rover Truck	EC102 Series	GMC Truck	Executive	GM Car	FC252 Series	GMC Truck
Defender 110	Land Rover Truck	EC150 Series	GMC Truck	Executive	Chrysler Car	FC253 Series	GMC Truck
Defender 90	Land Rover Truck	EC152 Series	GMC Truck	Limousine		FC280 Series	GMC Truck
Del Ray	GM Car	EC250 Series	GMC Truck	Executive Sedan	Chrysler Car	FC281 Series	GMC Truck
Del Sol	Honda Car	EC251 Series	GMC Truck	Exige	Lotus	FC283 Series	GMC Truck
Delmont 88	GM Car	EC252 Series	GMC Truck	EXP	Ford Car	FC3B	Dodge Truck
Delta 88	GM Car	EC280 Series	GMC Truck	Expedition	Ford Truck	FC3C	Dodge Truck
DeLuxe	Chrysler Car	EC282 Series	GMC Truck	Expedition EL	Ford Truck	FC4B	Dodge Truck
DeLuxe	Ford Car	EC283 Series	GMC Truck	Explorer	Ford Truck	FC4C	Dodge Truck
DeLuxe	Kaiser	Echo	Toyota Car	Explorer Sport	Ford Truck	FD1	Dodge Truck
DeLuxe 88	GM Car	Eclipse	Mitsubishi Car	Explorer Sport	Ford Truck	FE	Subaru Car
DeLuxe Eight	Studebaker Car	Econoline	Ford Truck	Trac		FE1	Dodge Truck
Denali	GMC Truck	Edge	Ford Truck	Expo	Mitsubishi Car	FE2	Dodge Truck
Denali XL	GMC Truck	Edsel	Ford Car	Expo LRV	Mitsubishi Car	FE439	Mitsubishi Truck
DeVille	GM Car	EF241 Series	GMC Truck	Express 1500	GMC Truck	FE449	Mitsubishi Truck
DeVille	Panther	EF242 Series	GMC Truck	Express 2500	GMC Truck	FE639	Mitsubishi Truck
Diamante	Mitsubishi Car	Eight	GM Car	Express 3500	GMC Truck	Festiva	Ford Car
Dictator	Studebaker Car	Eighty Eight	GM Car			FG1	Dodge Truck
Diplomat	Chrysler Car	EJ1500 Series	GMC Truck	F-134 Truck	Jeep Truck	FG2	Dodge Truck
Discovery	Land Rover Truck	El Camino	GMC Truck	F-37	GM Car	FG439	Mitsubishi Truck
Dispatcher	Jeep Truck	Elan	Lotus	F-38	GM Car	FG639	Mitsubishi Truck
DJ Series	GMC Truck	Elantra	Hyundai Car	F-39	GM Car	FH1	Dodge Truck
DJ-3A	Jeep Truck	Elantra Touring	Hyundai Car	F-40	GM Car	FH2	Dodge Truck
DJ-5	AM General Truck	Eldorado	GM Car	F-85	GM Car	Fiero	GM Car
DJ-5	Jeep Truck	Electra	GM Car	F-Type	Jaguar	Fiesta	Ford Car
DJ-6	Jeep Truck	Element	Honda Truck	F1	Ford Truck	Fifth Avenue	Chrysler Car
DL	Subaru Car	Elise	Lotus	F10	Nissan Car	Firebird	GM Car
DL	Volvo Car	Elite	Ford Car	F100	Dodge Truck	Firedome	Chrysler Car
DMC-12	DeLorean	Enclave	GMC Truck	F100	Ford Truck	Fireflite	Chrysler Car
DP Series	GMC Truck	Encore	American Motors	F150	Ford Truck	Firefly	GM Car
DR Series	GMC Truck	Encore	GMC Truck	F150 Heritage	Ford Truck	Firenza	GM Car
Dragon	Kaiser	Encore	Renault	F1B	Dodge Truck	Firesweep	Chrysler Car
DS Series	GMC Truck	Endeavor	Mitsubishi Truck	F2	Ford Truck	Fit	Honda Car
DTS	GM Car	Entourage	Hyundai Truck	F250	Ford Truck	Five Hundred	Ford Car
Duplex	Stutz	Envoy	GMC Truck	F250 Super Duty	Ford Truck	FJ	Jeep Truck
Durango	Dodge Truck	Envoy Denali	GMC Truck	F2553 Series	GMC Truck	FJ Cruiser	Toyota Truck

MODEL CROSS REFERENCE

F						I	
FJ-3	Jeep Truck	G20	Nissan Car	Grifo	Iso		
FJ-3A	Jeep Truck	G25	GMC Truck	GS 300	Toyota Car	i-280	Isuzu Truck
FJ-8	AM General Truck	G25	Nissan Car	GS 350	Toyota Car	i-290	Isuzu Truck
FJ-9	AM General Truck	G2500	GMC Truck	GS 400	Toyota Car	i-350	Isuzu Truck
FJ1	Dodge Truck	G2553 Series	GMC Truck	GS 430	Toyota Car	i-370	Isuzu Truck
FJ1500 Series	GMC Truck	G25X	Nissan Car	GS 450h Hybrid	Toyota Car	I-Mark	Isuzu Car
FJ2	Dodge Truck	G3	GM Car	GS 460	Toyota Car	I1000 Series	GMC Truck
FK1	Dodge Truck	G30	GMC Truck	GS3800 Series	GMC Truck	I1500 Series	GMC Truck
FK2	Dodge Truck	G35	GMC Truck	GT	Apollo	I2500 Series	GMC Truck
FK6	Dodge Truck	G35	Nissan Car	GT	Ford Car	I30	Nissan Car
FK8	Dodge Truck	G3500	GMC Truck	GT	GM Car	I35	Nissan Car
FL1	Dodge Truck	G35X	Nissan Car	GT	Marcos	I3500 Series	GMC Truck
FL2	Dodge Truck	G37	Nissan Car	GT	Opel	ILX	Honda Car
FL6	Dodge Truck	G37X	Nissan Car	GT	Puma	ILX Hybrid	Honda Car
FL8	Dodge Truck	G5	GM Car	GT America	Bizzarrini	Impala	GM Car
Fleetline	GM Car	G500	Mercedes-Benz Truck	GT-R	Nissan Car	Imperial	Chrysler Car
Fleetmaster	GM Car	G55 AMG	Mercedes-Benz Truck	GT3700 Series	GMC Truck	Impreza	Subaru Car
Fleetwood	GM Car	G550	Mercedes-Benz Truck	GT6	Triumph	Impreza WRX	Subaru Car
Flex	Ford Truck	G6	GM Car	GTA	American Motors	Impulse	Isuzu Car
Flight Hawk	Studebaker Car	G63 AMG	Mercedes-Benz Truck	GTI	VW Car	Insight Hybrid	Honda Car
FM1	Dodge Truck	G8	GM Car	GTO	GM Car	Integra	Honda Car
FN1	Dodge Truck	Galant	Chrysler Car	GTV	Alfa-Romeo	Interceptor	British Leyland
FO1	Dodge Truck	Galant	Mitsubishi Car	GTX	Chrysler Car	Intrepid	Chrysler Car
FO2	Dodge Truck	Galant Sigma	Mitsubishi Car	GU3900 Series	GMC Truck	Intrigue	GM Car
Focus	Ford Car	Galaxie	Ford Car	GV Series	Yugo	Invicta	GM Car
Ford 300	Ford Car	GB Series	GMC Truck	GVX	Yugo	Ion 1	GM Car
Forenza	Suzuki Car	GC Series	GMC Truck	GX 460	Toyota Truck	Ion 2	GM Car
Forester	Subaru Truck	GD Series	GMC Truck	GX 470	Toyota Truck	Ion 3	GM Car
Forester XT	Subaru Truck	GE Series	GMC Truck			Ion Red Line	GM Car
Forsa	Suzuki Car	Genesis Coupe	Hyundai Car	H	Dodge Truck	IPL G	Nissan Car
Forte	Kia Car	Genesis Sedan	Hyundai Car	H1	GMC Truck	iQ Coupe	Toyota Car
Forte 5	Kia Car	GF	Subaru Car	H2 SUT Pickup	GMC Truck	IS 250	Toyota Car
Forte Koup	Kia Car	Ghost	Rollis-Royce	H2 SUV Wagon	GMC Truck	IS 250 C	Toyota Car
ForTwo	Mercedes-Benz Car	GJ1508 Series	GMC Truck	H2553 Series	GMC Truck	IS 300	Toyota Car
Fox	Audi Car	GK1	Gordon-Keeble	H3 Wagon	GMC Truck	IS 350	Toyota Car
Fox	VW Car	GL	Subaru Car	H3100 Series	GMC Truck	IS 350 C	Toyota Car
FP1	Dodge Truck	GL	Volvo Car	H3T Pickup	GMC Truck	IS F	Toyota Car
FP152 Series	GMC Truck	GL-10	Subaru Car	H3x Wagon	GMC Truck	Isuzu by Opel	Opel
FP2	Dodge Truck	GL320	Mercedes-Benz Truck	H5431 Series	GMC Truck	IT	Gordon-Keeble
FP3100 Series	GMC Truck	GL350	Mercedes-Benz Truck	Hardbody	Nissan Truck		
FR-S Coupe	Toyota Car	GL450	Mercedes-Benz Truck	Hatchback	Subaru Car	J-10	Jeep Truck
FR3600 Series	GMC Truck	GL550	Mercedes-Benz Truck	Hawk	Studebaker Car	J-100 Wagoneer	Jeep Truck
Freelander	Land Rover Truck	GL63 AMG	Mercedes-Benz Truck	HB Series	GMC Truck	J-20	Jeep Truck
Freestar	Ford Truck	Gladiator	Jeep Truck	HC	Dodge Truck	J-200 Gladiator	Jeep Truck
Freestyle	Ford Truck	GLC	Mazda Car	HC Series	GMC Truck	J-210 Gladiator	Jeep Truck
Frontier	Nissan Truck	GLF	Subaru Car	HCL	Dodge Truck	J-220 Gladiator	Jeep Truck
FS3800 Series	GMC Truck	GLI	VW Car	HD Series	GMC Truck	J-230 Gladiator	Jeep Truck
FT3700 Series	GMC Truck	GLK250	Mercedes-Benz Truck	HE Series	GMC Truck	J-2500 Gladiator	Jeep Truck
FU3900 Series	GMC Truck	GLK350	Mercedes-Benz Truck	Henry J	Kaiser	J-2600 Gladiator	Jeep Truck
Fuego	Renault	Golden Hawk	Studebaker Car	Herald	Triumph	J-2700 Gladiator	Jeep Truck
Fury	Chrysler Car	Golden Rocket 88	GM Car	HHR	GMC Truck	J-2800 Gladiator	Jeep Truck
Fusion	Ford Car	Golf	VW Car	HHR Panel	GMC Truck	J-300 Gladiator	Jeep Truck
Fusion Hybrid	Ford Car	GP3100 Series	GMC Truck	Hi-Lux	Toyota Truck	J-310 Gladiator	Jeep Truck
Futuramic 98	GM Car	GR3600 Series	GMC Truck	Highlander	Toyota Truck	J-320 Gladiator	Jeep Truck
FVS	Facel Vega	Gran Fury	Chrysler Car	Highlander Hybrid	Toyota Truck	J-330 Gladiator	Jeep Truck
FW100	Dodge Truck	Gran Sport	GM Car	HJ1500 Series	GMC Truck	J-3500 Gladiator	Jeep Truck
FX16	Toyota Car	Granada	Ford Car	HK500	Facel Vega	J-3600 Gladiator	Jeep Truck
FX35	Nissan Truck	Grand Am	GM Car	Hombre	Isuzu Truck	J-3700 Gladiator	Jeep Truck
FX37	Nissan Truck	Grand Caravan	Dodge Truck	Honcho	Jeep Truck	J-3800 Gladiator	Jeep Truck
FX45	Nissan Truck	Grand Cherokee	Jeep Truck	Horizon	Chrysler Car	J-4500 Gladiator	Jeep Truck
FX50	Nissan Truck	Grand Marquis	Ford Car	Hornet	American Motors	J-4600 Gladiator	Jeep Truck
		Grand Prix	GM Car	HP3100 Series	GMC Truck	J-4700 Gladiator	Jeep Truck
		Grand Safari	GM Car	HPE	Fiat	J-4800 Gladiator	Jeep Truck
		Wagon		HR3600 Series	GMC Truck	J-72	Panther
G	Dodge Truck	Grand Ville	GM Car	HS 250h Hybrid	Toyota Car	J1	Allard
G-39	GM Car	Grand Vitera	Suzuki Truck	HS3800 Series	GMC Truck	J2	Allard
G-40	GM Car	Grand Voyager	Dodge Truck	HT3700 Series	GMC Truck	J2000	GM Car
G10	GMC Truck	Grand Wagoneer	Jeep Truck	HU3900 Series	GMC Truck	J2553 Series	GMC Truck
G1000	GMC Truck	Greenbriar	GMC Truck	Hummer	AM General Truck	J30	Nissan Car
G15	GMC Truck	Gremlin	American Motors	Hummer	GMC Truck	J3600 Series	GMC Truck
G1500	GMC Truck	Griffith	Griffith	Hunter	Aro Truck	J5	Studebaker Truck
G20	GMC Truck						

MODEL CROSS REFERENCE

J		K		L		M	
J5436 Series	GMC Truck	KJ1500 Series	GMC Truck	Liberty	Jeep Truck	Mainline	Ford Car
Javelin	American Motors	Korando	Daewoo Truck	Limited	GM Car	Malibu	GM Car
JB Series	GMC Truck	KP Series	GMC Truck	Limousine	Stutz	Malibu Classic	GM Car
JC Series	GMC Truck	KP3100 Series	GMC Truck	LLV	Grumman Truck	Malibu Hybrid	GM Car
JD Series	GMC Truck	KR3600 Series	GMC Truck	LM120	International Truck	Malibu Maxx	GM Car
Jeepster	Jeep Truck	KS3800 Series	GMC Truck	LM121	International Truck	Manhunga	DeTomaso
Jeepster	Willys Car	KT3700 Series	GMC Truck	LM122	International Truck	Manhattan	Kaiser
Jeepster	Jeep Truck	KU3900 Series	GMC Truck	LM150	International Truck	Manta	Opel
Commando				LM151	International Truck	Marathon	Checker
Jetfire	GM Car	L	Allard	LM153	International Truck	Marauder	Ford Car
Jetstar 88	GM Car	L-37	GM Car	LN-7		Marina	British Leyland
Jetstar I	GM Car	L-38	GM Car	Loyale	Subaru Car	Mariner	Ford Truck
Jetta	VW Car	L-39	GM Car	LR2	Land Rover Truck	Mariner Hybrid	Ford Truck
Jetta Hybrid	VW Car	L-40	GM Car	LR3	Land Rover Truck	Mark II	Ford Car
Jimmy	GMC Truck	L100	GM Car	LR4	Land Rover Truck	Mark III	Ford Car
JJ1500 Series	GMC Truck	L110	International Truck	LS		Mark IV	Ford Car
Journey	Dodge Truck	L111	International Truck	LS		Mark LT	Ford Truck
JP3100 Series	GMC Truck	L112	International Truck	LS 400	Toyota Car	Mark V	Ford Car
JP3600 Series	GMC Truck	L120	International Truck	LS 430	Toyota Car	Mark VI	Ford Car
JR3600 Series	GMC Truck	L130	International Truck	LS 460	Toyota Car	Mark VII	Ford Car
JS3800 Series	GMC Truck	L150	International Truck	LS 460 L	Toyota Car	Mark VIII	Ford Car
JT3700 Series	GMC Truck	L151	International Truck	LS 600h L Hybrid	Toyota Car	Marlin	American Motors
JU3900 Series	GMC Truck	L153	International Truck	LS1	GM Car	Marquis	Ford Car
Juke	Nissan Truck	L200	GM Car	LS2	GM Car	Master	GM Car
Justy	Subaru Car	L2553 Series	GMC Truck	LTD	Ford Car	Matador	American Motors
JX35	Nissan Truck	L300	GM Car	LTD Crown	Ford Car	Matador	Chrysler Car
		L3500 Series	GMC Truck	Victoria		Matrix	Toyota Car
		L3800 Series	GMC Truck	LTD II	Ford Car	Maverick	Ford Car
K	Dodge Truck	L5	Studebaker Truck	Lucerne	GM Car	Maxima	Nissan Car
K1	Allard	L5438 Series	GMC Truck	Lumina	GM Car	Mayfair	Studebaker Car
K10	GMC Truck	L6	BMW Car	Lumina APV	GMC Truck	MazdaSpeed 3	Mazda Car
K10 Suburban	GMC Truck	L6-226 Truck	Jeep Truck	Lumina MiniVan	GMC Truck	MazdaSpeed 6	Mazda Car
K1000	GMC Truck	L6.4	Dual-Ghia	LUV	GMC Truck	MB	Jeep Truck
K1500	GMC Truck	L7	BMW Car	LW1	GM Car	MC Series	Dodge Truck
K1500 Suburban	GMC Truck	LaCrosse	GM Car	LW2	GM Car	MD15 Series	Dodge Truck
K2	Allard	LaForza	LaForza Truck	LW200	GM Car	MD16 Series	Dodge Truck
K20	GMC Truck	Lancer	Chrysler Car	LW300	GM Car	MD20 Series	Dodge Truck
K20 Series	Dodge Truck	Lancer	Mitsubishi Car	LX 450	Toyota Truck	MD21 Series	Dodge Truck
K20 Suburban	GMC Truck	Lancer Evolution	Mitsubishi Car	LX 470	Toyota Truck	MDX	Honda Truck
K20X Series	Dodge Truck	Land Cruiser	Studebaker Car	LX 570	Toyota Truck	Meadowbrook	Chrysler Car
K2500	GMC Truck	Landulet	Mercedes-Benz Car	Lynx	Ford Car	Medallist	Ford Car
K2500 Suburban	GMC Truck	Landcruiser	Toyota Truck			Medallion	Chrysler Car
K2553 Series	GMC Truck	Lanos	Daewoo Car	M	Allard	Medallion	Renault
K3	Allard	Laredo	Jeep Truck	M1100	International Truck	Meteor	Ford Car
K30	GMC Truck	Lark	Jeep Truck	M1200	International Truck	Metro	GM Car
K30 Series	Dodge Truck	Lark	Studebaker Car	M1400	International Truck	Metro	International Truck
K3500	GMC Truck	Laser	Chrysler Car	M2553 Series	GMC Truck	Metro-Mite	International Truck
K3700 Series	GMC Truck	Laser	Ford Car	M3	BMW Car	Metroette	International Truck
K5	Studebaker Truck	Laurentian	GM Car	M30	Nissan Car	Metropolitan	British Leyland
K5437 Series	GMC Truck	LB140	International Truck	M300	Dodge Truck	MGA	British Leyland
Kadett	Opel	LC Series	Dodge Truck	M35	Nissan Car	MGB	British Leyland
Kallista	Panther	Le Car	Renault	M35h Hybrid	Nissan Car	Miata	Mazda Car
Karmann Ghia	VW Car	LE Series	Dodge Truck	M35X	Nissan Car	Miata	Mazda Car
Kary Van	Dodge Truck	Le Sharo/Phasar	Winnebago Truck	M37	Nissan Car	MazdaSpeed	
KB Series	GMC Truck	LE15 Series	Dodge Truck	M37X	Nissan Car	Microbus	VW Truck
KC Series	Dodge Truck	LE16 Series	Dodge Truck	M3900 Series	GMC Truck	Midget	British Leyland
KC Series	GMC Truck	LE17 Series	Dodge Truck	M400	Ford Truck	Mighty Max	Mitsubishi Truck
KCL Series	Dodge Truck	LE20 Series	Dodge Truck	M45	Nissan Car	Milan	Ford Car
KD Series	GMC Truck	LE21 Series	Dodge Truck	M45X	Nissan Car	Milan Hybrid	Ford Car
KF Series	GMC Truck	LE22 Series	Dodge Truck	M5	BMW Car	Milano	Alfa-Romeo
KH Series	GMC Truck	LeBaron	Chrysler Car	M5 Series	Studebaker Truck	Millenia	Mazda Car
KH15 Series	Dodge Truck	Legacy	Subaru Car	M5439 Series	GMC Truck	Mini 1000	British Leyland
KH16 Series	Dodge Truck	Leganza	Daewoo Car	M56	Nissan Car	Mini 850	British Leyland
KH17 Series	Dodge Truck	Legend	Honda Car	M56X	Nissan Car	Mini Cooper	British Leyland
KH18 Series	Dodge Truck	Lele	Iso	M6	BMW Car	Mini Cooper	BMW Car
KH20 Series	Dodge Truck	LeMans	GM Car	M700	International Truck	Clubman	
KH21 Series	Dodge Truck	LeSabre	GM Car	M800	International Truck	Mini Cooper	BMW Car
KH22 Series	Dodge Truck	LF	Dodge Truck	MA	Jeep Truck	Convertible	
KH23 Series	Dodge Truck	LFA	Toyota Car	MA1200 Series	International Truck	Mini Cooper	BMW Car
Kingswood Wagon	GM Car	LHS	Chrysler Car	Magnette	British Leyland	Countryman	
Kizashi	Suzuki Car	LI3500 Series	GMC Truck	Magnum	Chrysler Car	Mini Cooper Coupe	BMW Car

MODEL CROSS REFERENCE

M		Mystique	Ford Car	P30 Parcel	GMC Truck	PM150-24 Series	GMC Truck
Mini Cooper	BMW Car			Delivery		Parcel Delivery	
Paceman				P300	Dodge Truck	PM250 Series	GMC Truck
Mini Cooper S	British Leyland	Navajo	Mazda Truck	P32 Custom	Workhorse Truck	Polara	Chrysler Car
Mini Cooper S	BMW Car	Navigator	Ford Truck	Chassis		Police Car	Studebaker Car
Clubman		Navigator L	Ford Truck	P35 Parcel	GMC Truck	Pony	Hyundai Car
Mini Cooper S	BMW Car	Neon	Chrysler Car	Delivery		Power Hawk	Studebaker Car
Convertible		New Beetle	VW Car	P350	Ford Truck	Power Ram 50	Dodge Truck
Mini Cooper S	BMW Car	New Beetle Cabrio	VW Car	P3500 Motor	GMC Truck	Powermaster	Chrysler Car
Countryman		New Yorker	Chrysler Car	Home Chassis		Precis	Mitsubishi Car
Mini Cooper S	BMW Car	Newport	Chrysler Car	P3500 Parcel	GMC Truck	Prelude	Honda Car
Coupe		Ninety Eight	GM Car	Delivery		Premier	Chrysler Car
Mini Cooper S	BMW Car	Nitro	Dodge Truck	P400	Ford Truck	Premiere	Ford Car
John Cooper		Nomad	GM Car	P500	Ford Truck	President	Studebaker Car
Works		Nova	GM Car	P7	Dodge Truck	Previa	Toyota Truck
Mini Cooper S	BMW Car	NPR	Isuzu Truck	P9	Dodge Truck	Prius c Hybrid	Toyota Car
Paceman		NSX	Honda Car	Pacer	American Motors	Prius Hybrid	Toyota Car
Mini Moke	British Leyland	Nubira	Daewoo Car	Pacer	Ford Car	Prius v Hybrid	Toyota Car
Mini-Ram Van	Dodge Truck	NV1500	Nissan Truck	Pacifica	Dodge Truck	Prizm	GM Car
Minor	British Leyland	NV200	Nissan Truck	Palm Beach	Allard	Probe	Ford Car
Minor	Fairthorpe	NV2500	Nissan Truck	Panamera	Porsche Car	Protege	Mazda Car
Mirada	Chrysler Car	NV3500	Nissan Truck	Panamera Hybrid	Porsche Car	Protege 5	Mazda Car
Mirage	Mitsubishi Car	NX1600	Nissan Car	Panel Express	GMC Truck	Protege	Mazda Car
Mizer	Mazda Car	NX2000	Nissan Car	Pantera	DeTomaso	MazdaSpeed	
MK	Dodge Truck			Parisienne	GM Car	Prowler	Chrysler Car
MKS	Ford Car	Oasis	Isuzu Truck	Park Avenue	GM Car	PT Cruiser	Chrysler Car
MKT	Ford Truck	Odyssey	Honda Truck	Park Avenue Ultra	GM Car	Convertible	
MKX	Ford Truck	Omega	GM Car	Park Lane	Ford Car	PT Cruiser	Dodge Truck
MKZ	Ford Car	Omega	Omega	Park Ward	Rolls-Royce	Hatchback	
MKZ Hybrid	Ford Car	Omni	Chrysler Car	Parkwood	GM Car	PT105	Dodge Truck
ML320	Mercedes-Benz Truck	Optima	GM Car	Paseo	Toyota Car	PT125	Dodge Truck
ML350	Mercedes-Benz Truck	Optima	Kia Car	Passat	VW Car	PT50	Dodge Truck
ML430	Mercedes-Benz Truck	Optima Hybrid	Kia Car	Passat Syncro	VW Car	PT57	Dodge Truck
ML450 Hybrid	Mercedes-Benz Truck	Optra	GM Car	Passat W8	VW Car	PT81	Dodge Truck
ML500	Mercedes-Benz Truck	Orlando	GMC Truck	Passport	Honda Truck	Pulsar	Nissan Car
ML55 AMG	Mercedes-Benz Truck	Outback	Subaru Car	Pathfinder	GM Car	Pursuit	GM Car
ML550	Mercedes-Benz Truck	Outback Sedan	Subaru Car	Pathfinder	Nissan Truck	PV444	Volvo Car
ML63 AMG	Mercedes-Benz Truck	Outback Sport	Subaru Car	Pathfinder Armada	Nissan Truck	PV544	Volvo Car
Model A	Ford Car	Wagon		Patrician	Studebaker Car	PW100 Trailduster	Dodge Truck
Model B	Ford Car	Outback Wagon	Subaru Car	Patriot	Jeep Truck	PW150 Trailduster	Dodge Truck
Model T	Ford Car	Outlander	Mitsubishi Truck	PB100 Voyager	Dodge Truck		
Monaco	Chrysler Car	Outlander Sport	Mitsubishi Truck	PB1000	GMC Truck	Q45	Nissan Car
Monarch	Ford Car	Outlook	GMC Truck	PB150 Voyager	Dodge Truck	Q5	Audi Truck
Montana	GMC Truck	Oxford	British Leyland	PB1500	GMC Truck	Q5 Hybrid	Audi Truck
Montana SV6	GMC Truck			PB200 Voyager	Dodge Truck	Q7	Audi Truck
Montclair	Ford Car	P'up	Isuzu Truck	PB250 Voyager	Dodge Truck	Quantum	VW Car
Monte Carlo	Allard	P1	Dodge Truck	PB2500	GMC Truck	Quantum Syncro	VW Car
Monte Carlo	GM Car	P10 Parcel	GMC Truck	PB300 Voyager	Dodge Truck	Quattro	Audi Car
Montego	Ford Car	Delivery		PB350 Voyager	Dodge Truck	Quest	Nissan Truck
Monterey	Ford Car	P100	Dodge Truck	PD100 Trailduster	Dodge Truck	QX4	Nissan Truck
Monterey	Ford Truck	P100	Ford Truck	PD150 Trailduster	Dodge Truck	QX56	Nissan Truck
Montero	Mitsubishi Truck	P1000 Parcel	GMC Truck	Phaeton	VW Car		
Montero Sport	Mitsubishi Truck	Delivery		Phantom	Rolls-Royce	R10	GMC Truck
Monza	GM Car	P11	Dodge Truck	Phoenix	Chrysler Car	R10 Suburban	GMC Truck
Mountaineer	Ford Truck	P11D	Dodge Truck	Phoenix	GM Car	R100	International Truck
MPV	Mazda Truck	P12	Dodge Truck	Pickup	Ford Truck	R102	International Truck
MR2	Toyota Car	P14C	Dodge Truck	Pickup	Isuzu Truck	R110	International Truck
MR2 Spyder	Toyota Car	P14S	Dodge Truck	Pickup	Mitsubishi Truck	R111	International Truck
MS1210 Series	International Truck	P150 Series	GMC Truck	Pickup	Nissan Truck	R112	International Truck
MT900	Mosler	Parcel Delivery		Pickup	Toyota Truck	R120	International Truck
Multi Wagon	Nissan Car	P150-22 Series	GMC Truck	Pickup	VW Truck	R121	International Truck
Murano	Nissan Truck	Parcel Delivery		Pilot	Honda Truck	R122	International Truck
Mustang	Ford Car	P1500 Parcel	GMC Truck	Pinto	Ford Car	R130	International Truck
Mustang Cobra	Ford Car	Delivery		Pioneer	Chrysler Car	R131	International Truck
Mustang GT	Ford Car	P1800	Volvo Car	PJ	Dodge Truck	R132	International Truck
Mustang II	Ford Car	P20 Parcel	GMC Truck	Plaza	Chrysler Car	R1500	Dodge Truck
MX-3	Mazda Car	Delivery		Plus 8	Morgan	R1500	GMC Truck
MX-5 Miata	Mazda Car	P200	Dodge Truck	PM150 Series	GMC Truck	R1500 Suburban	GMC Truck
MX-5 Miata	Mazda Car	P2500 Parcel	GMC Truck	PM150 Series	GMC Truck	R18i	Renault
MazdaSpeed		Delivery		Parcel Delivery		R20	GMC Truck
MX-6	Mazda Car	P30 Motor Home	GMC Truck	PM150-22 Series	GMC Truck	R20 Suburban	GMC Truck
		Chassis		Parcel Delivery			

MODEL CROSS REFERENCE

R		RM122	International Truck	S63 AMG	Mercedes-Benz Car	Series II	Excalibur
R2500	Dodge Truck	RM300	Dodge Truck	S65 AMG	Mercedes-Benz Car	Series III	Excalibur
R2500	GMC Truck	RM350	Dodge Truck	S7	Audi Car	Series IV	Excalibur
R2500 Suburban	GMC Truck	Road Runner	Chrysler Car	S7	Chrysler Car	Series V	Excalibur
R30	GMC Truck	Roadmaster	GM Car	S7 Quattro	Audi Car	Seven	Lotus
R320	Mercedes-Benz Truck	Roadster	Panoz	S70	Volvo Car	Seville	GM Car
R350	Mercedes-Benz Truck	Rocky	Daihatsu Truck	S70 AWD	Volvo Car	Shadow	Chrysler Car
R3500	Dodge Truck	Rodeo	Isuzu Truck	S8	Chrysler Car	Shelby Charger	Chrysler Car
R3500	GMC Truck	Rodeo Sport	Isuzu Truck	S8 Quattro	Audi Car	Shelby Cobra	AC Cobra
R5	Renault	Rogue	American Motors	S80	Volvo Car	Shelby Daytona	Chrysler Car
R500	Mercedes-Benz Truck	Rogue	Nissan Truck	S80 AWD	Volvo Car	Shelby GT	Ford Car
R63 AMG	Mercedes-Benz Truck	Rondo	Kia Car	S90	Volvo Car	Shelby Lancer	Chrysler Car
R8 Quattro	Audi Car	Routan	VW Truck	SA120	International Truck	Shelby Shadow	Chrysler Car
RA120	International Truck	Royal	Chrysler Car	SA122	International Truck	Sidekick	Suzuki Truck
RA121	International Truck	Royale	GM Car	SA310	Suzuki Car	Sidekick Sport	Suzuki Truck
RA122	International Truck	RS4 Quattro	Audi Car	Sable	Ford Car	Sienna	Toyota Truck
Rabbit	VW Car	RS5 Quattro	Audi Car	Safari	Allard	Sierra	Chrysler Car
Rabbit	VW Truck	RS6 Quattro	Audi Car	Safari	GMC Truck	Sierra	GMC Truck
Raider	Dodge Truck	RSX	Honda Car	Safari Wagon	GM Car	Sierra 1500	GMC Truck
Raider	Mitsubishi Truck	RX	Subaru Car	Samurai	Suzuki Truck	Sierra 1500	GMC Truck
Rainier	GMC Truck	RX 300	Toyota Truck	Santa Fe	Hyundai Truck	Classic	
Ram 1500	Dodge Truck	RX 330	Toyota Truck	Santa Fe Sport	Hyundai Truck	Sierra 1500	GMC Truck
Ram 2500	Dodge Truck	RX 350	Toyota Truck	Sapporo	Chrysler Car	Classic Denali	
Ram 3500	Dodge Truck	RX 400h Hybrid	Toyota Truck	Saratoga	Chrysler Car	Sierra 1500	GMC Truck
Ram 50	Dodge Truck	RX 450h Hybrid	Toyota Truck	Satellite	Chrysler Car	Classic Hybrid	
Ram C/V	Dodge Truck	RX-2	Mazda Car	Savanna 1500	GMC Truck	Sierra 1500 Denali	GMC Truck
Ram Van 1500	Dodge Truck	RX-3	Mazda Car	Savanna 2500	GMC Truck	Sierra 1500 Hybrid	GMC Truck
Ram Van 2500	Dodge Truck	RX-4	Mazda Car	Savanna 3500	GMC Truck	Sierra 2500	GMC Truck
Ram Van 3500	Dodge Truck	RX-7	Mazda Car	Savoy	Chrysler Car	Sierra 2500	GMC Truck
Ram Wagon 1500	Dodge Truck	RX-8	Mazda Car	SC	GM Car	Classic	
Ram Wagon 2500	Dodge Truck			SC 300	Toyota Car	Sierra 2500HD	GMC Truck
Ram Wagon 3500	Dodge Truck	S-10	GMC Truck	SC 400	Toyota Car	Sierra 3500	GMC Truck
Rambler	American Motors	S-10 Blazer	GMC Truck	SC 430	Toyota Car	Sierra 3500	GMC Truck
Ramcharger	Dodge Truck	S-15	GMC Truck	SC1	GM Car	Classic	
Rampage	Dodge Truck	S-15 Jimmy	GMC Truck	SC2	GM Car	Sierra Classic	GMC Truck
Ranchero	Ford Truck	S-55	Ford Car	Scamp	Chrysler Car	1500	
Range Rover	Land Rover Truck	S-Series	GM Truck	Scamp	Dodge Truck	Sierra Classic	GMC Truck
Range Rover	Land Rover Truck	S-Type	Jaguar	Scimitar	Reliant	2500	
Evoque		S10	Chrysler Car	Scirocco	VW Car	Sierra Classic	GMC Truck
Range Rover	Land Rover Truck	S100	International Truck	Scorpio	Ford Car	3500	
Sport		S102	International Truck	Scorpion	Fiat	Sierra Hybrid	GMC Truck
Ranger	Ford Car	S110	International Truck	Scoupe	Hyundai Car	Sigma	Mitsubishi Car
Ranger	Ford Truck	S112	International Truck	Scout	International Truck	Silhouette	GMC Truck
RAV4	Toyota Truck	S120	International Truck	Scrambler	Jeep Truck	Silver Hawk	Studebaker Car
RC Series	Dodge Truck	S130	International Truck	SE	GM Car	Silver Seraph	Rolls-Royce
RD15 Series	Dodge Truck	S132	International Truck	Sebring	Chrysler Car	Silver Streak	GM Car
RD16 Series	Dodge Truck	S2000	Honda Car	Sebring	Chrysler Car	Silverado 1500	GMC Truck
RD20 Series	Dodge Truck	S3	Chrysler Car	Convertible		Silverado 1500	GMC Truck
RD21 Series	Dodge Truck	S320	Mercedes-Benz Car	Sebring Coupe	Chrysler Car	Classic	
RDX	Honda Truck	S350	Mercedes-Benz Car	Sebring Sedan	Chrysler Car	Silverado 1500	GMC Truck
Reatta	GM Car	S350TD	Mercedes-Benz Car	Sedan	Subaru Car	Classic Hybrid	
Rebel	American Motors	S4	Audi Car	Sedan Delivery	Ford Truck	Silverado 1500	GMC Truck
Regal	GM Car	S4 Fidia	Iso	Sedona	Kia Truck	Hybrid	
Regency	GM Car	S4 Quattro	Audi Car	Seneca	Chrysler Car	Silverado 2500	GMC Truck
Relay	GMC Truck	S40	Volvo Car	Sentra	Nissan Car	Silverado 2500	GMC Truck
Relay 1	GMC Truck	S40 AWD	Volvo Car	Sephia	Kia Car	Classic	
Relay 2	GMC Truck	S400 Hybrid	Mercedes-Benz Car	Sequoia	Toyota Truck	Silverado 2500HD	GMC Truck
Relay 3	GMC Truck	S420	Mercedes-Benz Car	Series 1	AC Cobra	Silverado 3500	GMC Truck
Reliant	Chrysler Car	S430	Mercedes-Benz Car	Series 60	GM Car	Silverado 3500	GMC Truck
Rendezvous	GMC Truck	S5	Audi Car	Series 61	GM Car	Classic	
Renegade	Jeep Truck	S5	Chrysler Car	Series 62	GM Car	Silverado Classic	GMC Truck
Reno	Suzuki Car	S5 Quattro	Audi Car	Series 63	GM Car	1500	
Rialta	Winnebago Truck	S500	Mercedes-Benz Car	Series 65	GM Car	Silverado Classic	GMC Truck
Ridgeline	Honda Truck	S55 AMG	Mercedes-Benz Car	Series 67	GM Car	2500	
Rio	Kia Car	S550	Mercedes-Benz Car	Series 70	GM Car	Silverado Classic	GMC Truck
Rio 5	Kia Car	S6	Audi Car	Fleetwood		3500	
Riviera	GM Car	S6	Chrysler Car	Series 72	GM Car	Silverado Hybrid	GMC Truck
Rivolta	Iso	S6 Quattro	Audi Car	Fleetwood		Six	GM Car
RL	Honda Car	S60	Volvo Car	Series 75	GM Car	Sixty Special	GM Car
RM120	International Truck	S60 AWD	Volvo Car	Fleetwood		SJ413	Suzuki Truck
RM121	International Truck	S600	Mercedes-Benz Car	Series I	Excalibur	Sky	GM Car

MODEL CROSS REFERENCE

S		SRX	GMC Truck	T155 Series	GMC Truck	Trooper	Isuzu Truck
Sky Hawk	Studebaker Car	SSR	GMC Truck	T16L Suburban	GMC Truck	Trooper II	Isuzu Truck
Sky Red Line	GM Car	St. Regis	Chrysler Car	Tacoma	Toyota Truck	Truck	Jeep Truck
Skyhawk	GM Car	Standard	Ford Car	Tahoe	GMC Truck	TSX	Honda Car
Skylark	GM Car	Standard	GM Car	Tahoe Hybrid	GMC Truck	TT	Audi Car
SL	GM Car	Standard	Kaiser	Talon	Chrysler Car	TT	Ford Truck
SL1	GM Car	Standard Eight	Studebaker Car	Tasmin	TVR	TT Quattro	Audi Car
SL2	GM Car	Stanza	Nissan Car	Taurus	Ford Car	TTS	Audi Car
SL320	Mercedes-Benz Car	Stanza Wagon	Nissan Car	Taurus SHO	Ford Car	TTS Quattro	Audi Car
SL500	Mercedes-Benz Car	Star Chief	GM Car	Taurus X	Ford Truck	Tucson	Hyundai Truck
SL55 AMG	Mercedes-Benz Car	Starfire	GM Car	Taxi	Studebaker Car	Tundra	Toyota Truck
SL550	Mercedes-Benz Car	Starfire 98	GM Car	Taxicab	Checker	Turismo	Chrysler Car
SL600	Mercedes-Benz Car	Starion	Mitsubishi Car	tC Coupe	Toyota Car	Turnpike Cruiser	Ford Car
SL63 AMG	Mercedes-Benz Car	Starlet	Toyota Car	TC Maserati	Chrysler Car	Tuscan	TVR
SL65 AMG	Mercedes-Benz Car	Statesman	American Motors	TC Series	Dodge Truck	Typhoon	American Motors
SLK230	Mercedes-Benz Car	Station Sedan	Willys Car	TC3	Chrysler Car	Typhoon	GMC Truck
SLK250	Mercedes-Benz Car	Station Wagon	Willys Car	TD Series	Dodge Truck	U	
SLK280	Mercedes-Benz Car	Stealth	Chrysler Car	TD15 Series	Dodge Truck	Ultra	GM Car
SLK300	Mercedes-Benz Car	Stellar	Hyundai Car	TD20 Series	Dodge Truck	Universal	Jeep Truck
SLK32 AMG	Mercedes-Benz Car	Storm	GM Car	TD21 Series	Dodge Truck	Uplander	GMC Truck
SLK320	Mercedes-Benz Car	Strada	Fiat	TDI	VW Car	Utility Wagon	Jeep Truck
SLK350	Mercedes-Benz Car	Strato-Chief	GM Car	Tempest	GM Car	V	
SLK55 AMG	Mercedes-Benz Car	Stratus	Chrysler Car	Tempo	Ford Car	V10	GMC Truck
SLR McLaren	Mercedes-Benz Car	Stratus Coupe	Chrysler Car	Tercel	Toyota Car	V10 Suburban	GMC Truck
SLS AMG	Mercedes-Benz Car	Stratus Sedan	Chrysler Car	Tercel Wagon	Toyota Car	V1500	GMC Truck
SLX	Honda Truck	Streamliner	GM Car	Terrain	GMC Truck	V1500 Suburban	GMC Truck
SM120	International Truck	Streamliner Sedan	GMC Truck	Terraza	GMC Truck	V20	GMC Truck
SM122	International Truck	Delivery		Texan	Chrysler Car	V20 Suburban	GMC Truck
SM130	International Truck	STS	GM Car	Thing	VW Car	V2500	GMC Truck
SM132	International Truck	STS-V	GM Car	Thunderbird	Ford Car	V2500 Suburban	GMC Truck
Solara	Toyota Car	Styleline	GM Car	Tiburon	Hyundai Car	V30	GMC Truck
Solstice	GM Car	Stylemaster	GM Car	Tiger	Sunbeam	V3500	GMC Truck
Somerset	GM Car	Stylus	Isuzu Car	Tiguan	VW Truck	V40	Volvo Car
Sonata	Hyundai Car	Suburban	GMC Truck	Titan	Nissan Truck	V50	Volvo Car
Sonata Hybrid	Hyundai Car	Suburban 1500	GMC Truck	TL	Honda Car	V50 AWD	Volvo Car
Sonic	GM Car	Suburban 2500	GMC Truck	Topaz	Ford Car	V70	Volvo Car
Sonoma	GMC Truck	Summit	Chrysler Car	Torino	Ford Car	V70 AWD	Volvo Car
Sonoma Jimmy	GMC Truck	Summit Wagon	Chrysler Car	Toronado	GM Car	V70 XC	Volvo Car
Sorento	Kia Truck	Sunbird	GM Car	Torpedo	GM Car	V70 XC AWD	Volvo Car
Soul	Kia Car	Sunburst	GM Car	Torrent	GMC Truck	V8 Quattro	Audi Car
Space Wagon	Mitsubishi Car	Sundance	Chrysler Car	Touareg	VW Truck	V90	Volvo Car
Space Wagon	Mitsubishi Truck	Sunfire	GM Car	Touareg Hybrid	VW Truck	VA Series	GMC Truck
Spark	GM Car	SunRunner	GMC Truck	Town & Country	Chrysler Car	Vagabond	Kaiser
Special	Chrysler Car	Super 88	GM Car	Town & Country	Dodge Truck	Valiant	Chrysler Car
Special	GM Car	Super Beetle	VW Car	Town Car	Ford Car	Van	Mitsubishi Truck
Special	Kaiser	Super Chief	GM Car	Townsmen Wagon	GM Car	Van	Nissan Truck
Spectra	Kia Car	Super Clipper	Studebaker Car	TR250	Triumph	Van Wagon	Toyota Truck
Spectra 5	Kia Car	Super DeLuxe	Ford Car	TR6	Triumph	Vanagon	VW Truck
Spectrum	GM Car	Super DeLuxe	Studebaker Car	TR7	Triumph	Vanagon Syncro	VW Truck
Spider	Alfa-Romeo	Eight		TR8	Triumph	Vanden Plas	Jaguar
Spirit	American Motors	Super Eight	Studebaker Car	Tracer	Ford Car	Vandura	GMC Truck
Spirit	Chrysler Car	Super V8	Jaguar	Tracker	GMC Truck	VC Series	Dodge Truck
Spitfire	Triumph	Superba	Checker	TrailBlazer	GMC Truck	VD Series	Dodge Truck
Sport Utility Sedan	Subaru Car	Supra	Toyota Car	TrailBlazer EXT	GMC Truck	VD15 Series	Dodge Truck
Sport Wagon	GM Car	SV1	Bricklin	TrailBlazer SS	GMC Truck	VD20 Series	Dodge Truck
Sportage	Kia Truck	SV6	GMC Truck	Trailduster	Dodge Truck	VD21 Series	Dodge Truck
Sportwagen	VW Car	SVX	Subaru Car	Trans Am	GM Car	Vega	GM Car
Sportwagon	Renault	SW1	GM Car	Trans Sport	GMC Truck	Vega Panel	GMC Truck
SPR60	Turner	SW2	GM Car	Transit Connect	Ford Truck	Delivery	
Spring	Siata	Swift	Suzuki Car	Transmode Motor	GMC Truck	VehiCROSS	Isuzu Truck
Sprint	GM Car	SX4	Suzuki Car	Home		Veloster	Hyundai Car
Sprint	GMC Truck	Syclone	GMC Truck	Transporter	VW Truck	Ventura	GM Car
Sprinter 2500	Dodge Truck	T		Travelall	International Truck	Ventura II	GM Car
Sprinter 2500	Freightliner Truck	T	Ford Car	Traveler	Kaiser	Venture	GMC Truck
Sprinter 2500	Mercedes-Benz Truck	T	Ford Truck	Traverse	GMC Truck	Venza	Toyota Truck
Sprinter 3500	Dodge Truck	T100	Toyota Truck	Trax	GMC Truck	Veracruz	Hyundai Truck
Sprinter 3500	Freightliner Truck	T1000	GM Car	Tredia	Mitsubishi Car	Verano	GM Car
Sprinter 3500	Mercedes-Benz Truck	T145 Series	GMC Truck	Tribeca	Subaru Truck	Verona	Suzuki Car
Sprite	British Leyland	T14A Series	GMC Truck	Tribute	Mazda Truck	Versa	Nissan Car
Spyder	Fiat	T14B Series	GMC Truck	Tribute Hybrid	Mazda Truck	Versailles	Ford Car
Squareback	VW Car	T15 Series	GMC Truck	Trofeo	GM Car	Vibe	GM Car

MODEL CROSS REFERENCE

V		XFR-S	Jaguar
Vigor	Honda Car	XG300	Hyundai Car
Villager	Ford Car	XG350	Hyundai Car
Villager	Ford Truck	XJ	Jaguar
Viper	Chrysler Car	XJ-L	Jaguar
Virginian	Kaiser	XJ6	Jaguar
Vision	Chrysler Car	XJ8	Jaguar
Vista	Chrysler Car	XJ8-L	Jaguar
Vista	GM Car	XJR	Jaguar
Vista Cruiser	GM Car	XK	Jaguar
Vista Wagon	Chrysler Car	XK8	Jaguar
Vitara	Suzuki Truck	XKE	Jaguar
Volare	Chrysler Car	XKR	Jaguar
Volt Hybrid	GM Car	XKR-S	Jaguar
Voyager	Dodge Truck	XL-7	Suzuki Truck
Vue	GMC Truck	XLR	GM Car
Vue Green Line	GMC Truck	XLR-V	GM Car
Hybrid		XR4Ti	Ford Car
Vue Red Line	GMC Truck	XR7	Ford Car
Vue Single Mode	GMC Truck	XT	Subaru Car
Hybrid		XT6	Subaru Car
Vue Two Mode	GMC Truck	Xterra	Nissan Truck
Hybrid		XTS	GM Car
VX-4	Isuzu Truck	XV Crosstrek	Subaru Car
W		Y	
W100	Dodge Truck	Yaris	Toyota Car
W110	Dodge Truck	Yeoman	GM Car
W150	Dodge Truck	YJ Series	Jeep Truck
W150S	Dodge Truck	YR Series	GMC Truck
W200	Dodge Truck	Yukon	GMC Truck
W250	Dodge Truck	Yukon Denali	GMC Truck
W300	Dodge Truck	Yukon Denali	GMC Truck
W350	Dodge Truck	Hybrid	
W4S042	GMC Truck	Yukon Hybrid	GMC Truck
W800	Winnebago Truck	Yukon XL 1500	GMC Truck
WA Series	GMC Truck	Yukon XL 2500	GMC Truck
Wagon	Mitsubishi Truck	Yukon XL Denali	GMC Truck
Wagonaire	Studebaker Car	Z	
Wagoneer	Jeep Truck	Z24	GM Car
Wave	GM Car	Z28	GM Car
Wave 5	GM Car	Z3	BMW Car
Wayfarer	Chrysler Car	Z4	BMW Car
WC Series	Dodge Truck	Z8	BMW Car
WD15 Series	Dodge Truck	Zagato	Fiat
WD20 Series	Dodge Truck	ZDX	Honda Truck
WD21 Series	Dodge Truck	Zephyr	Ford Car
WDX Series	Dodge Truck		
Wildcat	GM Car		
Windsor	Chrysler Car		
Windstar	Ford Truck		
WM300	Dodge Truck		
Wrangler	Jeep Truck		
Wrangler Unlimited	Jeep Truck		
WRX	Subaru Car		
X			
X-90	Suzuki Truck		
X-Trail	Nissan Truck		
X-Type	Jaguar		
X1	BMW Truck		
X1/9	Fiat		
X3	BMW Truck		
X5	BMW Truck		
X6	BMW Truck		
xA Hatchback	Toyota Car		
xB Wagon	Toyota Car		
XC60	Volvo Truck		
XC70	Volvo Car		
XC90	Volvo Truck		
xD Hatchback	Toyota Car		
XF	Jaguar		
XFR	Jaguar		

NUMERICAL MODEL CROSS REFERENCE

01A	Ford Car	1900	Opel	2R5 Series	Studebaker Truck	335d	BMW Car
024	Chrysler Car	190E	Mercedes-Benz Car	2R6 Series	Studebaker Truck	335i	BMW Car
02A	Ford Car	19A	Ford Car	3.0CL	Honda Car	335is	BMW Car
09A	Ford Car	1CM	Ford Car	3.0CS	BMW Car	335xi	BMW Car
0CM	Ford Car	1GA	Ford Car	3.0CSi	BMW Car	3400 Series	GMC Truck
1.5	British Leyland	1M	BMW Car	3.0S	BMW Car	3500	Rover Car
1.6EL	Honda Car	2	Mazda Car	3.0Si	BMW Car	3500 Series	GMC Truck
1.7EL	Honda Car	2.2CL	Honda Car	3.2CL	Honda Car	3500S	Rover Car
100	Audi Car	2.3CL	Honda Car	3.2TL	Honda Car	350SD	Mercedes-Benz Car
100 Quattro	Audi Car	2.5TL	Honda Car	3.5RL	Honda Car	350SDL	Mercedes-Benz Car
100 Series	GMC Truck	200	Audi Car	300	Chrysler Car	350SL	Mercedes-Benz Car
100 Series	International Truck	200	Chrysler Car	300 Eight	Studebaker Car	350Z	Nissan Car
100 Skylark	GM Car	200 DeLuxe Eight	Studebaker Car	3000GT	Mitsubishi Car	3600 Series	GMC Truck
100 Travelall	International Truck	200 Eight	Studebaker Car	3000M	TVR	3700 Series	GMC Truck
100-22 Series	GMC Truck	200 Quattro	Audi Car	300B	Chrysler Car	370Z	Nissan Car
100-24 Series	GMC Truck	200 Series	International Truck	300C	Chrysler Car	375 Series	Monteverdi
1000	GM Car	200 Travelall	International Truck	300CD	Mercedes-Benz Car	38	Jeep Truck
1000	Nissan Car	2000	BMW Car	300CDT	Mercedes-Benz Car	38	Willys Car
1000 Series	GMC Truck	2000 GTX	Chrysler Car	300CE	Mercedes-Benz Car	3800 Series	GMC Truck
1000 Series	International Truck	2000CS	BMW Car	300D	Chrysler Car	39	Jeep Truck
1010 Series	International Truck	2000Ti	BMW Car	300D	Mercedes-Benz Car	39	Willys Car
102 Series	GMC Truck	2002	BMW Car	300E	Chrysler Car	3A	GMC Truck
102-22	GMC Truck	2002 Turbo	BMW Car	300E	Mercedes-Benz Car	3B	GMC Truck
1100	British Leyland	2002Ti	BMW Car	300F	Chrysler Car	3C	GMC Truck
1100 Series	GMC Truck	200CS	Siata	300G	Chrysler Car	3D	GMC Truck
1100 Series	International Truck	200SX	Nissan Car	300H	Chrysler Car	3E	GMC Truck
1110 Series	International Truck	210	Nissan Car	300J	Chrysler Car	3E1 Series	Studebaker Truck
11A	Ford Car	210 Series	GM Car	300K	Chrysler Car	3E11 Series	Studebaker Truck
1200	Nissan Car	DeLuxe		300L	Chrysler Car	3E11D Series	Studebaker Truck
1200 Series	International Truck	21A	Ford Car	300M	Chrysler Car	3E12 Series	Studebaker Truck
1210 Series	International Truck	240	Dual-Ghia	300S	Chrysler Car	3E12D Series	Studebaker Truck
122	Volvo Car	240 Series	Volvo Car	300SD	Mercedes-Benz Car	3E5 Series	Studebaker Truck
124	Fiat	240D	Mercedes-Benz Car	300SE	Mercedes-Benz Car	3E6 Series	Studebaker Truck
124 Spider	Fiat	240SX	Nissan Car	300SEL	Mercedes-Benz Car	3E6D Series	Studebaker Truck
128	Fiat	240Z	Nissan Car	300SL	Mercedes-Benz Car	3E7 Series	Studebaker Truck
128i	BMW Car	242	Volvo Car	300TD	Mercedes-Benz Car	3E7D Series	Studebaker Truck
1300	British Leyland	244	Volvo Car	300TE	Mercedes-Benz Car	3F	GMC Truck
1300	Nissan Car	245	Volvo Car	300ZX	Nissan Car	3G	GMC Truck
1300 Series	International Truck	250 Eight	Studebaker Car	302SC	Aurora	3i	Mazda Car
131	Fiat	250 Series	GMC Truck	310	Nissan Car	3R10 Series	Studebaker Truck
1310 Motor Home	International Truck	250-22 Series	GMC Truck	3100 Series	GMC Truck	3R11 Series	Studebaker Truck
Chassis		250-24 Series	GMC Truck	318i	BMW Car	3R5 Series	Studebaker Truck
1310 Series	International Truck	2500	TVR	318iC	BMW Car	3R6 Series	Studebaker Truck
135i	BMW Car	2500 Series	GMC Truck	318is	BMW Car	3s	Mazda Car
135is	BMW Car	253 Series	GMC Truck	318ti	BMW Car	4-4-2	GM Car
142	Volvo Car	253-22	GMC Truck	3200 Series	GMC Truck	4/4	Morgan
144	Volvo Car	260Z	Nissan Car	320i	BMW Car	40	Ford Car
145	Volvo Car	262	Volvo Car	320xi	BMW Car	40 Special	GM Car
15/50	British Leyland	264	Volvo Car	323	Mazda Car	400	Bristol
150 Series	GMC Truck	265	Volvo Car	323Ci	BMW Car	400	Chrysler Car
150 Series	International Truck	280	Mercedes-Benz Car	323i	BMW Car	400 Patrician	Studebaker Car
150 Series Special	GM Car	2800	BMW Car	323iC	BMW Car	4000	Audi Car
150 Travelall	International Truck	2800CS	BMW Car	323is	BMW Car	4000 Quattro	Audi Car
150-22 Series	GMC Truck	280C	Mercedes-Benz Car	325	BMW Car	400E	Mercedes-Benz Car
150-24 Series	GMC Truck	280CE	Mercedes-Benz Car	325Ci	BMW Car	400SE	Mercedes-Benz Car
1500	British Leyland	280E	Mercedes-Benz Car	325e	BMW Car	400SEL	Mercedes-Benz Car
1500 Series	GMC Truck	280i	TVR	325es	BMW Car	401	Bristol
1600	Fiat	280S	Mercedes-Benz Car	325i	BMW Car	402	Bristol
1600	Subaru Car	280SE	Mercedes-Benz Car	325iC	BMW Car	403	Bristol
164	Alfa-Romeo	280SEC	Mercedes-Benz Car	325is	BMW Car	404	Bristol
164	Volvo Car	280SEL	Mercedes-Benz Car	325ix	BMW Car	405	Bristol
164L	Alfa-Romeo	280Z	Nissan Car	325xi	BMW Car	405	Peugeot
164S	Alfa-Romeo	280ZX	Nissan Car	328Ci	BMW Car	406	Bristol
18	Ford Car	29A	Ford Car	328i	BMW Car	407	Bristol
1800	BMW Car	2E12 Series	Studebaker Truck	328iC	BMW Car	408	Bristol
1800	British Leyland	2E5 Series	Studebaker Truck	328is	BMW Car	409	Bristol
1800	Fiat	2E7 Series	Studebaker Truck	328xi	BMW Car	40A	Ford Car
1800	Subaru Car	2GA	Ford Car	330Ci	BMW Car	410	Bristol
1800	Volvo Car	2M	Ford Car	330i	BMW Car	411	Bristol
1802	BMW Car	2R10 Series	Studebaker Truck	330iC	BMW Car	411	VW Car
18i	Renault	2R11 Series	Studebaker Truck	330xi	BMW Car	412	Bristol

NUMERICAL MODEL CROSS REFERENCE

412	VW Car	530iT	BMW Car	70	GM Car	900	Saab Car
420SEL	Mercedes-Benz Car	530xi	BMW Car	70 Roadmaster	GM Car	9000	Saab Car
440	Willys Car	533i	BMW Car	700 Limited	GM Car	9000S	Saab Car
440 Truck	Jeep Truck	535i	BMW Car	710	Nissan Car	900A Series	International Truck
440 Utility	Jeep Truck	535i GT	BMW Car	720	Nissan Truck	900S	Saab Car
4400 LeSabre	GM Car	535is	BMW Car	733i	BMW Car	908B Series	International Truck
440P Truck	Jeep Truck	535xi	BMW Car	735i	BMW Car	908C Series	International Truck
441	Willys Car	535xi GT	BMW Car	735iL	BMW Car	911	Porsche Car
441 Truck	Jeep Truck	540	British Leyland	74	Ford Car	911 Carrera	Porsche Car
441 Utility	Jeep Truck	540i	BMW Car	740 Series	Volvo Car	911 Targa	Porsche Car
442	Willys Car	540iT	BMW Car	740i	BMW Car	911 Turbo	Porsche Car
442 Truck	Jeep Truck	545i	BMW Car	740iL	BMW Car	912E	Porsche Car
442 Utility	Jeep Truck	550i	BMW Car	740Li	BMW Car	914	Porsche Car
450 SS	Monteverdi	550i GT	BMW Car	740Lxi	BMW Car	91A	Ford Car
450SEL	Mercedes-Benz Car	550xi	BMW Car	745i	BMW Car	924	Porsche Car
450SL	Mercedes-Benz Car	550xi GT	BMW Car	745Li	BMW Car	924S	Porsche Car
450SLC	Mercedes-Benz Car	560	British Leyland	75 Roadmaster	GM Car	929	Mazda Car
454 Truck	Jeep Truck	560SEC	Mercedes-Benz Car	750i	BMW Car	929S	Mazda Car
46	Ford Car	560SEL	Mercedes-Benz Car	750iL	BMW Car	92A	Ford Car
4600 Invicta	GM Car	57	Mercedes-Benz Car	750Li	BMW Car	940 Series	Volvo Car
463 Truck	Jeep Truck	57L Series	Studebaker Car	750Lxi	BMW Car	944	Porsche Car
4700 Electra	GM Car	58L Series	Studebaker Car	750xi	BMW Car	944S	Porsche Car
473 Truck	Jeep Truck	5E11 Series	Studebaker Truck	76	GM Car	950	Turner
473D Truck	Jeep Truck	5E12 Series	Studebaker Truck	760 Series	Volvo Car	96	GM Car
473E Truck	Jeep Truck	5E12D Series	Studebaker Truck	760i	BMW Car	960 Series	Volvo Car
473SD Truck	Jeep Truck	5E5 Series	Studebaker Truck	760Li	BMW Car	968	Porsche Car
475 Truck	Jeep Truck	5E6 Series	Studebaker Truck	770	Amphicar	98	GM Car
475SD Truck	Jeep Truck	5E7 Series	Studebaker Truck	78	Ford Car	99	Saab Car
48	Ford Car	5E7D Series	Studebaker Truck	78	GM Car	99A	Ford Car
48	Jeep Truck	6-230 Truck	Jeep Truck	780 Series	Volvo Car	9CM	Ford Car
48	Willys Car	6-230 Utility	Jeep Truck	79M	Ford Car		
4800 Electra	GM Car	60	GM Car	7E10 Series	Studebaker Truck		
4E1 Series	Studebaker Truck	60 Century	GM Car	7E12 Series	Studebaker Truck		
4E11 Series	Studebaker Truck	600	Chrysler Car	7E12D Series	Studebaker Truck		
4E11D Series	Studebaker Truck	6000	GM Car	7E5 Series	Studebaker Truck		
4E12 Series	Studebaker Truck	6000 STE	GM Car	7E7 Series	Studebaker Truck		
4E12D Series	Studebaker Truck	600SEC	Mercedes-Benz Car	80	Audi Car		
4E2 Series	Studebaker Truck	600SEL	Mercedes-Benz Car	80	GM Car		
4E2D Series	Studebaker Truck	603	Bristol	80 Quattro	Audi Car		
4E3 Series	Studebaker Truck	604	Peugeot	80 Roadmaster	GM Car		
4E3D Series	Studebaker Truck	610	Nissan Car	803	Turner		
4E7 Series	Studebaker Truck	616	Mazda Car	808	Mazda Car		
4E7D Series	Studebaker Truck	618	Mazda Car	810	Nissan Car		
4Runner	Toyota Truck	62	Mercedes-Benz Car	81A	Ford Car		
5	Mazda Car	620	Nissan Truck	825	Sterling		
50 Super	GM Car	626	Mazda Car	827	Sterling		
500	Dual-Ghia	630CSi	BMW Car	82A	Ford Car		
500	Fiat	633CSi	BMW Car	840Ci	BMW Car		
500 Abarth	Fiat	635CSi	BMW Car	850	Fiat		
500 Turbo	Fiat	640i	BMW Car	850 Series	Volvo Car		
5000	Audi Car	640i Gran Coupe	BMW Car	850Ci	BMW Car		
5000 Quattro	Audi Car	645Ci	BMW Car	850CSi	BMW Car		
500c	Fiat	650Ci	BMW Car	850i	BMW Car		
500E	Mercedes-Benz Car	650i	BMW Car	88	GM Car		
500M	Kurtis	650i Gran Coupe	BMW Car	89M	Ford Car		
500SEC	Mercedes-Benz Car	650xi	BMW Car	8E10 Series	Studebaker Truck		
500SEL	Mercedes-Benz Car	650xi Gran Coupe	BMW Car	8E12 Series	Studebaker Truck		
500SL	Mercedes-Benz Car	654 Truck	Jeep Truck	8E12D Series	Studebaker Truck		
504	Peugeot	66	GM Car	8E5 Series	Studebaker Truck		
505	Peugeot	68	Ford Car	8E7 Series	Studebaker Truck		
510	Nissan Car	68	GM Car	8E7D Series	Studebaker Truck		
520i	BMW Car	685 Truck	Jeep Truck	9-2X	Saab Car		
521	Nissan Truck	69M	Ford Car	9-3	Saab Car		
524td	BMW Car	6E10 Series	Studebaker Truck	9-3X	Saab Car		
525i	BMW Car	6E12 Series	Studebaker Truck	9-4X	Saab Truck		
525iT	BMW Car	6E12D Series	Studebaker Truck	9-5	Saab Car		
525xi	BMW Car	6E5 Series	Studebaker Truck	9-7X	Saab Truck		
528e	BMW Car	6E7 Series	Studebaker Truck	90	Audi Car		
528i	BMW Car	6E7D Series	Studebaker Truck	90 Limited	GM Car		
528xi	BMW Car	6i	Mazda Car	90 Quattro	Audi Car		
530i	BMW Car	6s	Mazda Car	90 Roadmaster	GM Car		

AC Cobra (Incl. AC Cobra, Shelby)

Engine Finding Index

Engine	Years	Code	Line No.
4.0L 244 (3995cc) DOHC V8 (32 Valve) 87mm Bore Northstar; MFI; Gasoline; Naturally Aspirated GMC Eng.; Oldsmobile	2000-99		1
4.0L 244 (3995cc) DOHC V8 (32 Valve) 87mm Bore Northstar; MFI; Gasoline; Supercharged GMC Eng.; Oldsmobile	2002-01		2

Model Index

Engine (VIN Code / Eng. Code)	Year	Engine (VIN Code / Eng. Code)	Year	Engine (VIN Code / Eng. Code)	Year
AC Cobra		AC Cobra (cont.)		Shelby	
A.C. 289		Shelby Cobra		Series 1	
V8 289CI 4.7L OHV	68-66	V8 260CI 4.3L OHV (F)	64-62	V8 244CI 4.0L DOHC (32 Valve)	00-99
A.C. 427		V8 289CI 4.7L OHV (K)	68-63	V8 244CI 4.0L DOHC Supercharged (32 Valve)	02-01
V8 427CI 7.0L OHV	66	V8 427CI 7.0L OHV (R)	67-64		
A.C. 428		V8 428CI 7.0L OHV (R)	68-66		
V8 428CI 7.0L OHV	73-67				

1 2000 - 1999; 4.0L 244 (3995cc) DOHC V8 (32 Valve) 87mm Bore Northstar 1 MFI; Gasoline; Naturally Aspirated GMC Eng.; Oldsmobile

QTY	CYLINDER HEAD	YEARS	PART NO.	DESCRIPTION
1	Head Gasket	2000-99	26152 PT	Loc. L.H.; Head bolts not incl.; Head bolt replacement recommended
1	Head Gasket	2000-99	26153 PT	Loc. R.H.; Head bolts not incl.; Head bolt replacement recommended
1	Head Set	2000	HS 26152 PT-1	Head bolts & exh. pipe packing not incl.; Head bolt replacement recommended; Must be used w/TCS 46013; PermaDry® molded rubber valve cover gskts. incl.; Premium valve stem seals incl.
1	Head Set	1999	HS 26152 PT	Head bolts & exh. pipe packing not incl.; Head bolt replacement recommended; Must be used w/TCS 46018; PermaDry® molded rubber valve cover gskts. incl.; Premium valve stem seals incl.
2	Head Bolt Set	2000	ES 72187	Head bolts w/Washers; Replacement recommended
2	Head Bolt Set	1999	ES 72186	Head bolts w/Washers; Replacement recommended
QTY	CONVERSION SET	YEARS	PART NO.	DESCRIPTION
1	Gasket Conversion Set	2000	CS 26150-3	PermaDry® molded rubber oil pan gskt. incl.
1	Gasket Conversion Set	1999	CS 26150-2	PermaDry® molded rubber oil pan gskt. incl.
QTY	MANIFOLD - INT. & EXH.	YEARS	PART NO.	DESCRIPTION
1	Int. Manifold Gasket Set	2000	MS 93313	
1	Int. Manifold Gasket Set	1999	MS 93222	
1	Exh. Manifold Gasket Set	2000	MS 93371	
1	Exh. Manifold Gasket Set	1999	MS 93455	
QTY	EXHAUST PIPE FLANGE	YEARS	PART NO.	DESCRIPTION
1	Exhaust Pipe Gasket	2000-99	61009	Loc. Rear
1	Exhaust Pipe Gasket	2000	61009	Loc. L.H.; Pipe to manifold
1	Exhaust Pipe Gasket	2000	61129	Loc. R.H.; Pipe to manifold; Old design; Superseded - When depleted use 61431
1	Exhaust Pipe Gasket	2000	61431	Loc. R.H.; Pipe to manifold; Improved design
1	Exhaust Pipe Gasket	1999	61009	Pipe to manifold
QTY	OIL PAN	YEARS	PART NO.	DESCRIPTION
1	Oil Pan Gasket Set	2000-99	OS 30704 R	PermaDry® molded rubber gskt. incl.
QTY	CRANKSHAFT REAR SEAL	YEARS	PART NO.	DESCRIPTION
1	Rear Main Seal Set	2000-99	BS 40670	2nd Design; 12.0mm thick; PTFE Rubber; One-piece
QTY	VALVE COVER	YEARS	PART NO.	DESCRIPTION
1	Valve Cover Gasket Set	2000	VS 50526 R	w/Grommets & Spark plug tube seals; PermaDry® molded rubber gskts. incl.
1	Valve Cover Gasket Set	1999	VS 50524 R	w/Grommets & Spark plug tube seals; PermaDry® molded rubber gskts. incl.
QTY	VALVE STEM SEAL SET	YEARS	PART NO.	DESCRIPTION
2	Valve Stem Seal Set	2000	SS 71042	Premium valve stem seals incl.
2	Valve Stem Seal Set	1999	SS 71146	Premium valve stem seals incl.
QTY	WATER OUTLET GASKET	YEARS	PART NO.	DESCRIPTION
1	Water Outlet Gasket	2000-99	35346	Water Outlet
QTY	WATER PUMP	YEARS	PART NO.	DESCRIPTION
2	Water Pump Gasket	2000-99	35656	Loc. Lower; To block
1	Water Pump Gasket	2000-99	35794	Body cover; Improved design
2	Water Pump Gasket	2000	35659	Loc. Upper; To block
2	Water Pump Gasket	1999	35658	Loc. Upper; To block
QTY	TIMING COVER	YEARS	PART NO.	DESCRIPTION
1	Timing Cover Gasket	2000-99	72673	New Part Number - Check for Availability
1	Crankshaft Front Seal Set	2000	TCS 46013	
1	Crankshaft Front Seal Set	1999	TCS 46018	
1	Camshaft Rear Seal Set	2000-99	TCS 46011	
QTY	CARB & FUEL INJECTION	YEARS	PART NO.	DESCRIPTION
1	Throttle Body Gasket	2000	61125	

AC Cobra (Incl. AC Cobra, Shelby) (Cont.)

1		2000 - 1999; 4.0L 244 (3995cc) DOHC V8 (32 Valve) 87mm Bore Northstar			1	
(cont.)		MFI; Gasoline; Naturally Aspirated GMC Eng.; Oldsmobile			(cont.)	
QTY	CARB & FUEL INJECTION	YEARS	PART NO.	DESCRIPTION		
1	Throttle Body Gasket	1999	61111	Throttle body to spacer		
1	Throttle Body Gasket	1999	61113	Spacer to manifold		
QTY	EXHAUST GAS RECIRCULATION	YEARS	PART NO.	DESCRIPTION		
1	EGR Gasket	2000	70914	Valve		
1	EGR Gasket	1999	70788	Valve		
2		2002 - 2001; 4.0L 244 (3995cc) DOHC V8 (32 Valve) 87mm Bore Northstar			2	
		MFI; Gasoline; Supercharged GMC Eng.; Oldsmobile				
QTY	CYLINDER HEAD	YEARS	PART NO.	DESCRIPTION		
1	Head Gasket	2002-01	26152 PT	Loc. L.H.; Head bolts not incl.; Head bolt replacement recommended		
1	Head Gasket	2002-01	26153 PT	Loc. R.H.; Head bolts not incl.; Head bolt replacement recommended		
1	Head Set	2002	HS 26152 PT-2	Head bolts & exh. pipe packing not incl.; Head bolt replacement recommended; Must be used w/TCS 46013; PermaDry® molded rubber valve cover gskts. incl.; Premium valve stem seals incl.		
1	Head Set	2001	HS 26152 PT-1	Head bolts & exh. pipe packing not incl.; Head bolt replacement recommended; Must be used w/TCS 46013; PermaDry® molded rubber valve cover gskts. incl.; Premium valve stem seals incl.		
2	Head Bolt Set	2002-01	ES 72187	Head bolts w/Washers; Replacement recommended		
QTY	CONVERSION SET	YEARS	PART NO.	DESCRIPTION		
1	Gasket Conversion Set	2002-01	CS 26150-3	PermaDry® molded rubber oil pan gskt. incl.		
QTY	MANIFOLD - INT. & EXH.	YEARS	PART NO.	DESCRIPTION		
1	Int. Manifold Gasket Set	2002-01	MS 93313			
1	Exh. Manifold Gasket Set	2002-01	MS 93371			
QTY	EXHAUST PIPE FLANGE	YEARS	PART NO.	DESCRIPTION		
1	Exhaust Pipe Gasket	2002-01	61009	Loc. L.H.; Pipe to manifold		
1	Exhaust Pipe Gasket	2002-01	61009	Loc. Rear		
1	Exhaust Pipe Gasket	2002-01	61129	Loc. R.H.; Pipe to manifold; Old design; Superseded - When depleted use 61431		
1	Exhaust Pipe Gasket	2002-01	61431	Loc. R.H.; Pipe to manifold; Improved design		
QTY	OIL PAN	YEARS	PART NO.	DESCRIPTION		
1	Oil Pan Gasket Set	2002-01	OS 30704 R	PermaDry® molded rubber gskt. incl.		
QTY	CRANKSHAFT REAR SEAL	YEARS	PART NO.	DESCRIPTION		
1	Rear Main Seal Set	2002-01	BS 40670	2nd Design; 12.0mm thick; PTFE Rubber; One-piece		
QTY	VALVE COVER	YEARS	PART NO.	DESCRIPTION		
1	Valve Cover Gasket Set	2002-01	VS 50526 R	w/Grommets & Spark plug tube seals; PermaDry® molded rubber gskts. incl.		
QTY	VALVE STEM SEAL SET	YEARS	PART NO.	DESCRIPTION		
2	Valve Stem Seal Set	2002	SS 71043	Premium valve stem seals incl.		
2	Valve Stem Seal Set	2001	SS 71042	Premium valve stem seals incl.		
QTY	WATER OUTLET GASKET	YEARS	PART NO.	DESCRIPTION		
1	Water Outlet Gasket	2002-01	35346	Water Outlet		
QTY	WATER PUMP	YEARS	PART NO.	DESCRIPTION		
2	Water Pump Gasket	2002-01	35656	Loc. Lower; To block		
2	Water Pump Gasket	2002-01	35659	Loc. Upper; To block		
1	Water Pump Gasket	2002-01	35794	Body cover; Improved design		
QTY	TIMING COVER	YEARS	PART NO.	DESCRIPTION		
1	Timing Cover Gasket	2002-01	72673	New Part Number - Check for Availability		
1	Crankshaft Front Seal Set	2002-01	TCS 46013			
1	Camshaft Rear Seal Set	2002-01	TCS 46011			
QTY	CARB & FUEL INJECTION	YEARS	PART NO.	DESCRIPTION		
1	Throttle Body Gasket	2002-01	61125			
QTY	EXHAUST GAS RECIRCULATION	YEARS	PART NO.	DESCRIPTION		
1	EGR Gasket	2002-01	70914	Valve		

Acura Car - See Honda Car

Acura SUV's - See Honda Truck

AM General Truck (Incl. SUV's)

Engine Finding Index

Engine	Years	Code	Line No.
5.7L 350 (5736cc) OHV V8 (16 Valve) 4" Bore; CPI; Gasoline; Naturally Aspirated GMC Eng.; Chevrolet	1997-96	D	1
5.7L 350 (5736cc) OHV V8 (16 Valve) 4" Bore; TBI; Gasoline; Naturally Aspirated GMC Eng.; Chevrolet	1995-94	D	2
6.2L 379 (6211cc) OHV V8 (16 Valve) 101mm Bore; MFI; Diesel; Naturally Aspirated GMC Eng.; Chevrolet	1994-92	X	3
6.5L 395 (6468cc) OHV Turbo V8 (16 Valve) 103mm Bore; MFI; Diesel; Turbo GMC Eng.; Chevrolet	2001-96	Z	4
6.5L 395 (6468cc) OHV V8 (16 Valve) 103mm Bore; MFI; Diesel; Naturally Aspirated GMC Eng.; Chevrolet	2000-94	Y	5

Model Index

Engine (VIN Code / Eng. Code)	Year	Engine (VIN Code / Eng. Code)	Year	Engine (VIN Code / Eng. Code)	Year
AM General Truck		AM General Truck (cont.)		AM General Truck (cont.)	
DJ-5		DJ-5 (cont.)		FJ-9 (cont.)	
L4 134CI 2.2L (F-Head) (F)	71-70	L6 258CI 4.2L (C)	79	L6 258CI 4.2L (A)	79-77
L4 134CI 2.2L (F-Head) (J)	69	FJ-8		Hummer (4WD Full-Size SUV)	
L4 150CI 2.46L OHV (U)	84-83	L6 232CI 3.8L (E)	76-73	V8 350CI 5.7L (D)	97-94
L4 151CI 2.5L OHV (B)	83-80	L6 258CI 4.2L (A)	76-74	V8 379CI 6.2L Diesel (X)	94-92
L4 1984cc 2.0L SOHC (G)	79	FJ-9		V8 395CI 6.5L Diesel (Y)	00-94
L6 232CI 3.8L (G)	78-72	L4 1984cc 2.0L SOHC (G)	79	V8 395CI 6.5L Turbo-Diesel (Z)	01-96
L6 258CI 4.2L (A)	78-74	L6 232CI 3.8L (E)	78-77		

1

**1997 - 1996; 5.7L 350 (5736cc) OHV V8 (16 Valve) 4" Bore
CPI; Gasoline; Naturally Aspirated GMC Eng.; Chevrolet; VIN Code D**

1

QTY	CYLINDER HEAD	YEARS	PART NO.	DESCRIPTION
2	Head Gasket	1997-96	501 SD	Head bolts not incl.; Head bolt replacement recommended; PermaTorque Severe Duty®
2	Head Gasket	1997-96	7733 PT-2	Head bolts not incl.; Head bolt replacement recommended; PermaTorque®
2	Head Gasket Spacer Shim	1997-96	7733 SP	HeadSaver®
1	Head Set	1997-96	HS 7733 PT-16	Head bolts & exh. pipe packing not incl.; Head bolt replacement recommended; PermaDry® molded rubber valve cover gskts. incl.; Premium valve stem seals incl.
1	Head Set	1997-96	HST 7733 PT-16	Head bolts & exh. pipe packing not incl.; Head bolt replacement recommended; PermaTorque Severe Duty® head gskts. incl.; PermaDryPlus® int. manifold gskts. incl.; PermaDry® molded rubber valve cover gskts. incl.; Premium valve stem seals incl.
2	Head Bolt Set	1997-96	ES 72856	Replacement recommended
QTY	CONVERSION SET	YEARS	PART NO.	DESCRIPTION
1	Gasket Conversion Set	1997-96	CS 8510-1	Plastic timing cover not incl.; PermaDry® molded rubber oil pan gskt. incl.
QTY	MANIFOLD - INT. & EXH.	YEARS	PART NO.	DESCRIPTION
1	Int. Manifold Gasket Set	1997-96	MS 90131	Lower set; Upper set incl.; Manifold bolts not incl.; Manifold bolt replacement recommended
1	Int. Manifold Gasket Set	1997-96	MS 90131-2	Lower set only; Upper set not incl.; Manifold bolts not incl.; Manifold bolt replacement recommended
1	Int. Manifold Gasket Set	1997-96	MS 98000 T	Single valve cover gskt. incl.; Upper set incl.; PermaDryPlus® int. manifold gskts. incl.; When servicing second valve cover use VS 50293R if required; Manifold bolts not incl.; Manifold bolt replacement recommended
1	Plenum Gasket Set	1997-96	MS 90269	Upper set
1	Int. Manifold Bolt Set	1997-96	ES 72224	Loc. Lower; Replacement recommended
1	Exh. Manifold Gasket Set	1997-96	MS 94054	
QTY	EXHAUST PIPE FLANGE	YEARS	PART NO.	DESCRIPTION
2	Exhaust Pipe Gasket	1997-96	61014	Pipe to manifold
1	Exhaust Pipe Gasket	1997-96	61559	Converter; 3-bolt
1	Exhaust Pipe Gasket	1997-96	61561	Converter; 2-bolt
1	Exhaust Pipe Gasket	1997-96	61683	Exh. connector; New Part Number - Check for Availability
QTY	FUEL PUMP	YEARS	PART NO.	DESCRIPTION
1	Fuel Pump Mounting Gasket	1997-96	5182	Plate
QTY	OIL PAN	YEARS	PART NO.	DESCRIPTION
1	Oil Pan Gasket Set	1997-96	OS 34500 R	PermaDry® molded rubber gskt. incl.
1	Drain Plug Gasket	1997-96	70820	
QTY	CRANKSHAFT REAR SEAL	YEARS	PART NO.	DESCRIPTION
1	Rear Main Seal Set	1997-96	BS 40656	PTFE Rubber; One-piece; Improved design
QTY	VALVE COVER	YEARS	PART NO.	DESCRIPTION
1	Valve Cover Gasket Set	1997-96	VS 50088 R	Services both covers; PermaDry® molded rubber gskts. incl.
2	Valve Cover Gasket Set	1997-96	VS 50293 R	Services one cover only; PermaDry® molded rubber gskt. incl.
QTY	VALVE STEM SEAL SET	YEARS	PART NO.	DESCRIPTION
1	Valve Stem Seal Set	1997-96	SS 72861	Loc. Int. & Exh.; Premium valve stem seals incl.; Improved design
QTY	THERMOSTAT HOUSING	YEARS	PART NO.	DESCRIPTION
1	O-Ring	1997-96	35710	Thermostat Housing; 1.954" ID; Improved design
QTY	WATER PUMP	YEARS	PART NO.	DESCRIPTION
1	Water Pump Gasket	1997-96	13032	To plate

AM General Truck (Incl. SUV's) (Cont.)

1		1997 - 1996; 5.7L 350 (5736cc) OHV V8 (16 Valve) 4" Bore			1	
(cont.)		CPI; Gasoline; Naturally Aspirated GMC Eng.; Chevrolet; VIN Code D			(cont.)	
QTY	WATER PUMP	YEARS	PART NO.	DESCRIPTION		
2	Water Pump Gasket	1997-96	5152	To block		
QTY	TIMING COVER	YEARS	PART NO.	DESCRIPTION		
1	Timing Cover Set	1997-96	TCS 46093	Eng. w/2.42" OD timing cover seal; Must be used w/OS 34500R		
QTY	CARB & FUEL INJECTION	YEARS	PART NO.	DESCRIPTION		
1	Throttle Body Gasket	1997-96	61036			
QTY	DISTRIBUTOR MOUNTING	YEARS	PART NO.	DESCRIPTION		
1	Distributor Mounting Gasket	1997-96	70194			
QTY	EXHAUST GAS RECIRCULATION	YEARS	PART NO.	DESCRIPTION		
1	EGR Gasket	1997-96	70789			
QTY	OIL PUMP RETAINER	YEARS	PART NO.	DESCRIPTION		
1	Oil Pump Shaft Guide	1997-96	72665	Distributor to oil pump shaft retainer		
QTY	OIL COOLER	YEARS	PART NO.	DESCRIPTION		
1	Oil Cooler Mounting Set	1997-96	ES 72671			
2		1995 - 1994; 5.7L 350 (5736cc) OHV V8 (16 Valve) 4" Bore			2	
(cont.)		TBI; Gasoline; Naturally Aspirated GMC Eng.; Chevrolet; VIN Code D			(cont.)	
QTY	CYLINDER HEAD	YEARS	PART NO.	DESCRIPTION		
2	Head Gasket	1995-94	501 SD	Head bolts not incl.; Head bolt replacement recommended; PermaTorque Severe Duty®		
2	Head Gasket	1995-94	7733 PT-2	Head bolts not incl.; Head bolt replacement recommended; PermaTorque®		
2	Head Gasket Spacer Shim	1995-94	7733 SP	HeadSaver®		
1	Head Set	1995-94	HS 7733 PT-15	Exh. valve stem seals for H/D not incl.; Head bolts & exh. pipe packing not incl.; Head bolt replacement recommended; PermaDry® molded rubber valve cover gskts. incl.; Premium valve stem seals incl.		
2	Head Bolt Set	1995-94	ES 72856	Replacement recommended		
QTY	CONVERSION SET	YEARS	PART NO.	DESCRIPTION		
1	Gasket Conversion Set	1995-94	CS 8510	PermaDry® molded rubber oil pan gskt. incl.		
QTY	MANIFOLD - INT. & EXH.	YEARS	PART NO.	DESCRIPTION		
1	Int. Manifold Gasket Set	1995-94	MS 93317			
1	Exh. Manifold Gasket Set	1995-94	MS 9275 B			
QTY	EXHAUST PIPE FLANGE	YEARS	PART NO.	DESCRIPTION		
2	Exhaust Pipe Gasket	1995-94	60584	Packing; 2 1/2" ID Steel sleeve to manifold; 2 1/4" ID Gasket to pipe		
2	Exhaust Pipe Gasket	1995-94	60718	Packing; 2 3/32" ID Steel sleeve		
QTY	FUEL PUMP	YEARS	PART NO.	DESCRIPTION		
1	Fuel Pump Mounting Gasket	1995-94	5182	Plate		
1	Fuel Pump Mounting Gasket	1995-94	6579	May also be used as a fuel pump block-off plate gasket if desired		
QTY	OIL PAN	YEARS	PART NO.	DESCRIPTION		
1	Oil Pan Gasket Set	1995-94	OS 34500 R	PermaDry® molded rubber gskt. incl.		
1	Drain Plug Gasket	1995-94	70822			
QTY	CRANKSHAFT REAR SEAL	YEARS	PART NO.	DESCRIPTION		
1	Rear Main Seal Set	1995-94	BS 40520	Rubber; One-piece		
1	Rear Main Seal Set	1995-94	BS 40626	PTFE Rubber; One-piece		
1	Repair Sleeve	1995-94	16258	Crankshaft; Use w/installation tool		
1	Repair Sleeve Tool	1995-94	16301	Crankshaft		
QTY	VALVE COVER	YEARS	PART NO.	DESCRIPTION		
1	Valve Cover Gasket Set	1995-94	VS 50088 R	Services both covers; PermaDry® molded rubber gskts. incl.		
2	Valve Cover Gasket Set	1995-94	VS 50293 R	Services one cover only; PermaDry® molded rubber gskt. incl.		
QTY	VALVE STEM SEAL SET	YEARS	PART NO.	DESCRIPTION		
1	Valve Stem Seal Set	1995-94	SS 72525	Loc. Exh.; H/D; Premium valve stem seals incl.		
1	Valve Stem Seal Set	1995-94	SS 72526	Loc. Exh.; Exc. H/D; Premium valve stem seals incl.		
1	Valve Stem Seal Set	1995-94	SS 72527	Loc. Int.; Premium valve stem seals incl.		
1	Valve Stem Seal Set	1995-94	SS 72877	Loc. Exh.; Exc. H/D; Opt. Hi-Temp. premium valve stem seals incl.		
1	Valve Stem Seal Set	1995-94	SS 72883	Loc. Exh.; H/D; Opt. Hi-Temp. premium valve stem seals incl.		
QTY	THERMOSTAT HOUSING	YEARS	PART NO.	DESCRIPTION		
1	O-Ring	1995-94	35710	Thermostat Housing; 1.954" ID; Improved design		
QTY	WATER OUTLET GASKET	YEARS	PART NO.	DESCRIPTION		
1	Water Outlet Gasket	1995-94	35062	Water Outlet; 1 13/16" ID		
1	Water Outlet Gasket	1995-94	35562 T	Water Outlet; 1 13/16" ID; PermaDryPlus®		
QTY	WATER PUMP	YEARS	PART NO.	DESCRIPTION		
1	Water Pump Gasket	1995-94	13032	To plate		
2	Water Pump Gasket	1995-94	5152	To block		
QTY	TIMING COVER	YEARS	PART NO.	DESCRIPTION		
1	Timing Cover Set	1995-94	TCS 45121	w/o Sleeve 'N' Seal®; Must be used w/OS 34500R		

AM General Truck (Incl. SUV's) (Cont.)

2		1995 - 1994; 5.7L 350 (5736cc) OHV V8 (16 Valve) 4" Bore			2	
(cont.)		TBI; Gasoline; Naturally Aspirated GMC Eng.; Chevrolet; VIN Code D			(cont.)	
QTY	TIMING COVER	YEARS	PART NO.	DESCRIPTION		
1	Timing Set w/Sleeve & Seal	1995-94	TCS 45265	w/Sleeve 'N' Seal®; Must be used w/OS 34500R		
1	Repair Sleeve	1995-94	16202	Timing Cover; Use w/installation tool		
1	Repair Sleeve Tool	1995-94	16312	Timing Cover		
QTY	AIR CLEANER MOUNTING	YEARS	PART NO.	DESCRIPTION		
1	Air Cleaner Gasket	1995-94	60038	5 1/32" ID		
QTY	CARB & FUEL INJECTION	YEARS	PART NO.	DESCRIPTION		
1	Throttle Body Gasket	1995-94	60903			
QTY	DISTRIBUTOR MOUNTING	YEARS	PART NO.	DESCRIPTION		
1	Distributor Mounting Gasket	1995-94	70194			
QTY	EXHAUST GAS RECIRCULATION	YEARS	PART NO.	DESCRIPTION		
1	EGR Gasket	1995-94	70978			
QTY	OIL PUMP RETAINER	YEARS	PART NO.	DESCRIPTION		
1	Oil Pump Shaft Guide	1995-94	72665	Distributor to oil pump shaft retainer		
QTY	OIL COOLER	YEARS	PART NO.	DESCRIPTION		
1	Oil Cooler Mounting Set	1995-94	ES 72671			
3		1994 - 1992; 6.2L 379 (6211cc) OHV V8 (16 Valve) 101mm Bore			3	
(cont.)		MFI; Diesel; Naturally Aspirated GMC Eng.; Chevrolet; VIN Code X			(cont.)	
QTY	CYLINDER HEAD	YEARS	PART NO.	DESCRIPTION		
2	Head Gasket	1994-92	8726 PT	Standard thickness; Head bolts not incl.; Head bolt replacement recommended		
2	Head Gasket	1994-92	9128 PT	.010" thicker for use when block is refaced; Head bolts not incl.; Head bolt replacement recommended		
1	Head Set w/o Head Gasket	1994-92	HSU 8726	L/D eng.; Head gsks., head bolts, exh. pipe packing, positive control exh. valve stem seals not incl.; Head bolt replacement recommended		
1	Head Set w/o Head Gasket	1994-92	HSU 8726-1	H/D eng.; Head gsks., head bolts, exh. pipe packing, positive control exh. valve stem seals not incl.; Head bolt replacement recommended		
2	Head Bolt Set	1994-92	ES 72724	Replacement recommended		
QTY	CONVERSION SET	YEARS	PART NO.	DESCRIPTION		
1	Gasket Conversion Set	1994-92	CS 8726-2			
QTY	MANIFOLD - INT. & EXH.	YEARS	PART NO.	DESCRIPTION		
1	Int. Manifold Gasket Set	1994-92	MS 91585	L/D eng.		
1	Int. Manifold Gasket Set	1994-92	MS 91586	H/D eng.		
1	Exh. Manifold Gasket Set	1994-92	MS 91587			
QTY	EXHAUST PIPE FLANGE	YEARS	PART NO.	DESCRIPTION		
2	Exhaust Pipe Gasket	1994-93	60718	Packing; 2 3/32" ID Steel sleeve		
2	Exhaust Pipe Gasket	1992	60556	Packing; 1 3/4" ID		
QTY	FUEL PUMP	YEARS	PART NO.	DESCRIPTION		
1	Fuel Pump Mounting Gasket	1994-92	5182	Plate		
1	Fuel Pump Mounting Gasket	1994-92	6579	May also be used as a fuel pump block-off plate gasket if desired		
1	Fuel Pump Mounting Gasket	1994-92	70150	Injection pump mounting		
QTY	OIL PAN	YEARS	PART NO.	DESCRIPTION		
1	Oil Pan Gasket Set	1994-92	OS 34406			
1	Drain Plug Gasket	1994-92	70822			
QTY	CRANKSHAFT REAR SEAL	YEARS	PART NO.	DESCRIPTION		
1	Rear Main Seal Set	1994-92	BS 40604	Rubber; One-piece		
QTY	VALVE COVER	YEARS	PART NO.	DESCRIPTION		
1	Valve Cover Gasket Set	1994-92	VS 50228 C			
QTY	VALVE STEM SEAL SET	YEARS	PART NO.	DESCRIPTION		
1	Valve Stem Seal Set	1994-92	SS 5112	Loc. Int. & Exh.; O-ring		
1	Valve Stem Seal Set	1994-92	SS 72711	Loc. Exh.; Positive control; Premium valve stem seals incl.		
QTY	WATER OUTLET GASKET	YEARS	PART NO.	DESCRIPTION		
2	Water Outlet Gasket	1994-92	35357	Water Crossover		
1	Thermostat Gasket	1994-92	35271	Water Outlet		
QTY	WATER PUMP	YEARS	PART NO.	DESCRIPTION		
1	Water Pump Mounting Set	1994-92	ES 72674			
QTY	TIMING COVER	YEARS	PART NO.	DESCRIPTION		
1	Timing Cover Set	1994-92	TCS 45554	w/o Sleeve 'N' Seal®		
1	Timing Set w/Sleeve & Seal	1994-92	TCS 45686	w/Sleeve 'N' Seal®		
1	Repair Sleeve	1994-92	16209	Timing Cover; Use w/installation tool		
1	Repair Sleeve Tool	1994-92	16311	Timing Cover		
QTY	AIR CLEANER MOUNTING	YEARS	PART NO.	DESCRIPTION		
1	Air Cleaner Gasket	1994-92	60555			

AM General Truck (Incl. SUV's) (Cont.)

4		2001 - 1996; 6.5L 395 (6468cc) OHV Turbo V8 (16 Valve) 103mm Bore			4
		MFI; Diesel; Turbo GMC Eng.; Chevrolet; VIN Code Z			
QTY	CYLINDER HEAD	YEARS	PART NO.	DESCRIPTION	
2	Head Gasket	2001-96	9521 PT	.010" thicker for use when block is refaced; Head bolts not incl.; Head bolt replacement recommended	
2	Head Gasket	2001-96	9701 PT	Standard thickness; Head bolts not incl.; Head bolt replacement recommended	
1	Head Set w/o Head Gasket	2001-96	HSU 8726	Head gskts., head bolts, exh. pipe packing, positive control exh. valve stem seals not incl.; Upper int. manifold gskt. not incl.; Head bolt replacement recommended	
2	Head Bolt Set	2001-96	ES 72724	Replacement recommended	
QTY	CONVERSION SET	YEARS	PART NO.	DESCRIPTION	
1	Gasket Conversion Set	2001-96	CS 8726-2		
QTY	MANIFOLD - INT. & EXH.	YEARS	PART NO.	DESCRIPTION	
1	Int. Manifold Gasket Set	2001-96	MS 91585	Lower set	
1	Plenum Gasket Set	2001-96	MS 90176-1	Upper set	
1	Exh. Manifold Gasket Set	2001-96	MS 91587		
QTY	EXHAUST PIPE FLANGE	YEARS	PART NO.	DESCRIPTION	
2	Exhaust Pipe Gasket	2001-96	60556	Pipe to manifold; 1 3/4" ID	
2	Exhaust Pipe Gasket	2001-96	60718	Crossover; 2 3/32" ID Steel sleeve	
QTY	FUEL PUMP	YEARS	PART NO.	DESCRIPTION	
1	Fuel Pump Mounting Gasket	2001-96	5182	Plate	
1	Fuel Pump Mounting Gasket	2001-96	6579	May also be used as a fuel pump block-off plate gasket if desired	
1	Fuel Pump Mounting Gasket	2001-96	70150	Injection pump mounting	
QTY	OIL PAN	YEARS	PART NO.	DESCRIPTION	
1	Oil Pan Gasket Set	2001-96	OS 34406		
1	Drain Plug Gasket	2001-96	70822		
QTY	CRANKSHAFT REAR SEAL	YEARS	PART NO.	DESCRIPTION	
1	Rear Main Seal Set	2001-96	BS 40604	Rubber; One-piece	
QTY	VALVE COVER	YEARS	PART NO.	DESCRIPTION	
1	Valve Cover Gasket Set	2001-96	VS 50228 C		
QTY	VALVE STEM SEAL SET	YEARS	PART NO.	DESCRIPTION	
1	Valve Stem Seal Set	2001-96	SS 5112	Loc. Int. & Exh.; O-ring	
1	Valve Stem Seal Set	2001-96	SS 72711	Loc. Exh.; Positive control; Premium valve stem seals incl.	
QTY	THERMOSTAT HOUSING	YEARS	PART NO.	DESCRIPTION	
1	Thermostat Gasket	1996	35271	Thermostat Housing	
2	O-Ring	2001-97	35710	Thermostat Housing; 1.954" ID; Improved design	
QTY	WATER OUTLET GASKET	YEARS	PART NO.	DESCRIPTION	
2	Water Outlet Gasket	2001-96	35357	Water Crossover	
QTY	WATER PUMP	YEARS	PART NO.	DESCRIPTION	
1	Water Pump Mounting Set	2001-96	ES 72674		
QTY	TIMING COVER	YEARS	PART NO.	DESCRIPTION	
1	Timing Cover Set	2001-96	TCS 45554	w/o Sleeve 'N' Seal®	
1	Timing Set w/Sleeve & Seal	2001-96	TCS 45686	w/Sleeve 'N' Seal®	
1	Repair Sleeve	2001-96	16209	Timing Cover; Use w/installation tool	
1	Repair Sleeve Tool	2001-96	16311	Timing Cover	
QTY	EXHAUST GAS RECIRCULATION	YEARS	PART NO.	DESCRIPTION	
1	EGR Gasket	2001-96	70781		
5		2000 - 1994; 6.5L 395 (6468cc) OHV V8 (16 Valve) 103mm Bore			5
		MFI; Diesel; Naturally Aspirated GMC Eng.; Chevrolet; VIN Code Y			
QTY	CYLINDER HEAD	YEARS	PART NO.	DESCRIPTION	
2	Head Gasket	2000-94	9521 PT	.010" thicker for use when block is refaced; Head bolts not incl.; Head bolt replacement recommended	
2	Head Gasket	2000-94	9701 PT	Standard thickness; Head bolts not incl.; Head bolt replacement recommended	
1	Head Set w/o Head Gasket	2000-94	HSU 8726	Head gskts., head bolts, exh. pipe packing, positive control exh. valve stem seals not incl.; Head bolt replacement recommended	
2	Head Bolt Set	2000-94	ES 72724	Replacement recommended	
QTY	CONVERSION SET	YEARS	PART NO.	DESCRIPTION	
1	Gasket Conversion Set	2000-94	CS 8726-2		
QTY	MANIFOLD - INT. & EXH.	YEARS	PART NO.	DESCRIPTION	
1	Int. Manifold Gasket Set	2000-94	MS 91585	Lower set	
1	Exh. Manifold Gasket Set	2000-94	MS 91587		
QTY	EXHAUST PIPE FLANGE	YEARS	PART NO.	DESCRIPTION	
2	Exhaust Pipe Gasket	2000-94	60556	Pipe to manifold; 1 3/4" ID	

AM General Truck (Incl. SUV's) (Cont.)

5 (cont.)	2000 - 1994; 6.5L 395 (6468cc) OHV V8 (16 Valve) 103mm Bore				5 (cont.)
MFI; Diesel; Naturally Aspirated GMC Eng.; Chevrolet; VIN Code Y					
QTY	EXHAUST PIPE FLANGE	YEARS	PART NO.	DESCRIPTION	
2	Exhaust Pipe Gasket	2000-94	60718	Crossover; 2 3/32" ID Steel sleeve	
QTY	FUEL PUMP	YEARS	PART NO.	DESCRIPTION	
1	Fuel Pump Mounting Gasket	2000-94	5182	Plate	
1	Fuel Pump Mounting Gasket	2000-94	6579	May also be used as a fuel pump block-off plate gasket if desired	
1	Fuel Pump Mounting Gasket	2000-94	70150	Injection pump mounting	
QTY	OIL PAN	YEARS	PART NO.	DESCRIPTION	
1	Oil Pan Gasket Set	2000-94	OS 34406		
1	Drain Plug Gasket	2000-94	70822		
QTY	CRANKSHAFT REAR SEAL	YEARS	PART NO.	DESCRIPTION	
1	Rear Main Seal Set	2000-94	BS 40604	Rubber; One-piece	
QTY	VALVE COVER	YEARS	PART NO.	DESCRIPTION	
1	Valve Cover Gasket Set	2000-94	VS 50228 C		
QTY	VALVE STEM SEAL SET	YEARS	PART NO.	DESCRIPTION	
1	Valve Stem Seal Set	2000-94	SS 5112	Loc. Int. & Exh.; O-ring	
1	Valve Stem Seal Set	2000-94	SS 72711	Loc. Exh.; Positive control; Premium valve stem seals incl.	
QTY	THERMOSTAT HOUSING	YEARS	PART NO.	DESCRIPTION	
1	Thermostat Gasket	1996-94	35271	Thermostat Housing	
2	O-Ring	2000-97	35710	Thermostat Housing; 1.954" ID; Improved design	
QTY	WATER OUTLET GASKET	YEARS	PART NO.	DESCRIPTION	
2	Water Outlet Gasket	2000-94	35357	Water Crossover	
QTY	WATER PUMP	YEARS	PART NO.	DESCRIPTION	
1	Water Pump Mounting Set	2000-94	ES 72674		
QTY	TIMING COVER	YEARS	PART NO.	DESCRIPTION	
1	Timing Cover Set	2000-94	TCS 45554	w/o Sleeve 'N' Seal®	
1	Timing Set w/Sleeve & Seal	2000-94	TCS 45686	w/Sleeve 'N' Seal®	
1	Repair Sleeve	2000-94	16209	Timing Cover; Use w/installation tool	
1	Repair Sleeve Tool	2000-94	16311	Timing Cover	
QTY	AIR CLEANER MOUNTING	YEARS	PART NO.	DESCRIPTION	
1	Air Cleaner Gasket	2000-94	60555		

Asuna Car - See GM Car
Asuna SUV's - See GMC Truck
Audi Car

Engine Finding Index				
Engine	Years	Code	Line No.	
1.8L 108.6 (1780cc) DOHC L4 (20 Valve) 81mm Bore; MFI; Gasoline; Turbo - Intercooled VW Eng.	2000-97	AEB	1	
1.8L 108.6 (1780cc) DOHC L4 (20 Valve) 81mm Bore; MFI; Gasoline; Turbo - Intercooled VW Eng.	2006-01	AMB	2	
1.8L 108.6 (1780cc) DOHC L4 (20 Valve) 81mm Bore; MFI; Gasoline; Turbo - Intercooled VW Eng.	2005-00	AMU	3	
1.8L 108.6 (1780cc) DOHC L4 (20 Valve) 81mm Bore; MFI; Gasoline; Turbo - Intercooled VW Eng.	2005-00	ATC	4	
1.8L 108.6 (1780cc) DOHC L4 (20 Valve) 81mm Bore; MFI; Gasoline; Turbo - Intercooled VW Eng.	2000	ATW	5	
1.8L 108.6 (1780cc) DOHC L4 (20 Valve) 81mm Bore; MFI; Gasoline; Turbo - Intercooled VW Eng.	2005-01	AWM	6	
1.8L 108.6 (1780cc) DOHC L4 (20 Valve) 81mm Bore; MFI; Gasoline; Turbo - Intercooled VW Eng.	2006-00	AWP	7	
1.8L 108.6 (1780cc) DOHC L4 (20 Valve) 81mm Bore; MFI; Gasoline; Turbo - Intercooled VW Eng.	2006-03	BEA	8	
2.0L 121 (1984cc) DOHC L4 (16 Valve) 82.5mm Bore; DI; Gasoline; Turbo - Intercooled VW Eng.	2013-05	BPG	9	
2.0L 121 (1984cc) DOHC L4 (16 Valve) 82.5mm Bore; DI; Gasoline; Turbo - Intercooled VW Eng.	2013-06	BPY	10	
2.0L 121 (1984cc) DOHC L4 (16 Valve) 82.5mm Bore; DI; Gasoline; Turbo - Intercooled VW Eng.	2013-07	BWT	11	
2.0L 121 (1984cc) DOHC L4 (16 Valve) 82.5mm Bore; DI; Gasoline; Turbo - Intercooled VW Eng.	2013-12	CAEB	12	
2.0L 121 (1984cc) DOHC L4 (16 Valve) 82.5mm Bore; DI; Gasoline; Turbo - Intercooled VW Eng.	2013-12	CBFA	13	
2.0L 121 (1984cc) DOHC L4 (16 Valve) 82.5mm Bore; DI; Gasoline; Turbo - Intercooled VW Eng.	2013-12	CCTA	14	
2.0L 121 (1984cc) DOHC L4 (16 Valve) 82.5mm Bore; DI; Gasoline; Turbo - Intercooled VW Eng.	2013-12	CDMA	15	
2.0L 121 (1984cc) DOHC L4 (16 Valve) 82.5mm Bore; DI; Gasoline; Turbo - Intercooled VW Eng.	2013-12	CESA	16	
2.0L 121 (1984cc) DOHC L4 (16 Valve) 82.5mm Bore; DI; Gasoline; Turbo - Intercooled VW Eng.	2013-12	CETA	17	
2.2L 135.8 (2226cc) SOHC L5 (10 Valve) 81mm Bore; MFI; Gasoline; Turbo - Intercooled Audi Eng.	1991	MC	18	
2.3L 140.8 (2309cc) DOHC L5 (20 Valve) 82.5mm Bore; MFI; Gasoline; Naturally Aspirated Audi Eng.	1992-91	7A	19	
2.3L 140.8 (2309cc) SOHC L5 (10 Valve) 82.5mm Bore; MFI; Gasoline; Naturally Aspirated Audi Eng.	1991	NF	20	
2.3L 140.8 (2309cc) SOHC L5 (10 Valve) 82.5mm Bore; MFI; Gasoline; Naturally Aspirated Audi Eng.	1992-91	NG	21	
2.7L 163 (2671cc) DOHC V6 (30 Valve) 81mm Bore; MFI; Gasoline; Turbo - Intercooled Audi Eng.	2002-00	APB	22	
2.7L 163 (2671cc) DOHC V6 (30 Valve) 81mm Bore; MFI; Gasoline; Turbo - Intercooled Audi Eng.	2004-03	BEL	23	

Audi Car (Cont.)

Engine Finding Index (Cont.)

Engine	Years	Code	Line No.
2.8L 169 (2771cc) DOHC V6 (30 Valve) 82.5mm Bore; MFI; Gasoline; Naturally Aspirated Audi Eng.	2001-97	AHA	24
2.8L 169 (2771cc) DOHC V6 (30 Valve) 82.5mm Bore; MFI; Gasoline; Naturally Aspirated Audi Eng.	2001-00	ATQ	25
2.8L 169 (2771cc) SOHC V6 (12 Valve) 82.5mm Bore; MFI; Gasoline; Naturally Aspirated Audi Eng.	1998-92	AAH	26
2.8L 169 (2771cc) SOHC V6 (12 Valve) 82.5mm Bore; MFI; Gasoline; Naturally Aspirated Audi Eng.	1998-94	AFC	27
3.0L 181.6 (2976cc) DOHC V6 (30 Valve) 82.5mm Bore; MFI; Gasoline; Naturally Aspirated Audi Eng.	2005-02	AVK	28
3.0L 181.6 (2976cc) DOHC V6 (30 Valve) 82.5mm Bore; MFI; Gasoline; Naturally Aspirated Audi Eng.	2006-05	BGN	29
3.0L 182.8 (2995cc) DOHC V6 (24 Valve) 84.5mm Bore; DI; Gasoline; Supercharged - Intercooled Audi Eng.	2011-09	CAJA	30
3.0L 182.8 (2995cc) DOHC V6 (24 Valve) 84.5mm Bore; DI; Gasoline; Supercharged - Intercooled Audi Eng.	2013-12	CAKA	31
3.0L 182.8 (2995cc) DOHC V6 (24 Valve) 84.5mm Bore; DI; Gasoline; Supercharged - Intercooled Audi Eng.	2013-12	CCAA	32
3.0L 182.8 (2995cc) DOHC V6 (24 Valve) 84.5mm Bore; DI; Gasoline; Supercharged - Intercooled Audi Eng.	2013-10	CCBA	33
3.0L 182.8 (2995cc) DOHC V6 (24 Valve) 84.5mm Bore; DI; Gasoline; Supercharged - Intercooled Audi Eng.	2013-12	CGXB	34
3.0L 182.8 (2995cc) DOHC V6 (24 Valve) 84.5mm Bore; DI; Gasoline; Supercharged - Intercooled Audi Eng.	2013	CGXC	35
3.0L 182.8 (2995cc) DOHC V6 (24 Valve) 84.5mm Bore; DI; Gasoline; Supercharged - Intercooled Audi Eng.	2013	CTUA	36
3.0L 182.8 (2995cc) DOHC V6 (24 Valve) 84.5mm Bore; DI; Gasoline; Supercharged - Intercooled Audi Eng.	2013	CTUB	37
3.1L 188 (3123cc) DOHC V6 (30 Valve) 84.5mm Bore; DI; Gasoline; Naturally Aspirated Audi Eng.	2011-05	BKH	38
3.2L 195 (3189cc) DOHC V6 (24 Valve) 84mm Bore; MFI; Gasoline; Naturally Aspirated VW Eng.	2009-04	BHE	39
3.2L 195 (3189cc) DOHC V6 (24 Valve) 84mm Bore; MFI; Gasoline; Naturally Aspirated VW Eng.	2009-06	BUB	40
4.2L 254.5 (4163cc) DOHC V8 (40 Valve) 84.5mm Bore; DI; Gasoline; Naturally Aspirated Audi Eng.	2008-04	BFM	41
4.2L 254.5 (4163cc) DOHC V8 (40 Valve) 84.5mm Bore; DI; Gasoline; Naturally Aspirated Audi Eng.	2007-06	BGK	42
4.2L 254.5 (4163cc) DOHC V8 (40 Valve) 84.5mm Bore; DI; Gasoline; Naturally Aspirated Audi Eng.	2012-04	BHF	43
4.2L 254.5 (4163cc) DOHC V8 (40 Valve) 84.5mm Bore; DI; Gasoline; Naturally Aspirated Audi Eng.	2008-05	BNK	44
4.2L 254.5 (4163cc) DOHC V8 (40 Valve) 84.5mm Bore; DI; Gasoline; Naturally Aspirated Audi Eng.	2009-06	BNS	45
4.2L 254.5 (4163cc) DOHC V8 (40 Valve) 84.5mm Bore; DI; Gasoline; Naturally Aspirated Audi Eng.	2011-07	BVJ	46
4.2L 254.5 (4163cc) DOHC V8 (40 Valve) 84.5mm Bore; DI; Gasoline; Naturally Aspirated Audi Eng.	2013-08	BYH	47
4.2L 254.5 (4172cc) DOHC V8 (32 Valve) 84.5mm Bore; MFI; Gasoline; Naturally Aspirated Audi Eng.	1994-92	ABH	48
4.2L 254.5 (4172cc) DOHC V8 (32 Valve) 84.5mm Bore; MFI; Gasoline; Naturally Aspirated Audi Eng.	2000-97	ABZ	49
4.2L 254.5 (4172cc) DOHC V8 (32 Valve) 84.5mm Bore; MFI; Gasoline; Naturally Aspirated Audi Eng.	2000	ART	50
4.2L 254.5 (4172cc) DOHC V8 (32 Valve) 84.5mm Bore; MFI; Gasoline; Naturally Aspirated Audi Eng.	2004-01	AWN	51
4.2L 254.5 (4172cc) DOHC V8 (40 Valve) 84.5mm Bore; MFI; Gasoline; Naturally Aspirated Audi Eng.	2004-00	AKB	52
4.2L 254.5 (4172cc) DOHC V8 (40 Valve) 84.5mm Bore; MFI; Gasoline; Naturally Aspirated Audi Eng.	2004-01	AUX	53
4.2L 254.5 (4172cc) DOHC V8 (40 Valve) 84.5mm Bore; MFI; Gasoline; Naturally Aspirated Audi Eng.	2003-01	AYS	54
4.2L 254.5 (4172cc) DOHC V8 (40 Valve) 84.5mm Bore; MFI; Gasoline; Naturally Aspirated Audi Eng.	2004-02	BBD	55
4.2L 254.5 (4172cc) DOHC V8 (40 Valve) 84.5mm Bore; MFI; Gasoline; Turbo - Intercooled Audi Eng.	2004-03	BCY	56

Engine Code Index

Code	Engine	Line No.
7A	2.3L 140.8 (2309cc) DOHC L5 (20 Valve) 82.5mm Bore; MFI; Gasoline; Naturally Aspirated Audi Eng.	19
AAH	2.8L 169 (2771cc) SOHC V6 (12 Valve) 82.5mm Bore; MFI; Gasoline; Naturally Aspirated Audi Eng.	26
ABH	4.2L 254.5 (4172cc) DOHC V8 (32 Valve) 84.5mm Bore; MFI; Gasoline; Naturally Aspirated Audi Eng.	48
ABZ	4.2L 254.5 (4172cc) DOHC V8 (32 Valve) 84.5mm Bore; MFI; Gasoline; Naturally Aspirated Audi Eng.	49
AEB	1.8L 108.6 (1780cc) DOHC L4 (20 Valve) 81mm Bore; MFI; Gasoline; Turbo - Intercooled VW Eng.	1
AFC	2.8L 169 (2771cc) SOHC V6 (12 Valve) 82.5mm Bore; MFI; Gasoline; Naturally Aspirated Audi Eng.	27
AHA	2.8L 169 (2771cc) DOHC V6 (30 Valve) 82.5mm Bore; MFI; Gasoline; Naturally Aspirated Audi Eng.	24
AKB	4.2L 254.5 (4172cc) DOHC V8 (40 Valve) 84.5mm Bore; MFI; Gasoline; Naturally Aspirated Audi Eng.	52
AMB	1.8L 108.6 (1780cc) DOHC L4 (20 Valve) 81mm Bore; MFI; Gasoline; Turbo - Intercooled VW Eng.	2
AMU	1.8L 108.6 (1780cc) DOHC L4 (20 Valve) 81mm Bore; MFI; Gasoline; Turbo - Intercooled VW Eng.	3
APB	2.7L 163 (2671cc) DOHC V6 (30 Valve) 81mm Bore; MFI; Gasoline; Turbo - Intercooled Audi Eng.	22
ART	4.2L 254.5 (4172cc) DOHC V8 (32 Valve) 84.5mm Bore; MFI; Gasoline; Naturally Aspirated Audi Eng.	50
ATC	1.8L 108.6 (1780cc) DOHC L4 (20 Valve) 81mm Bore; MFI; Gasoline; Turbo - Intercooled VW Eng.	4
ATQ	2.8L 169 (2771cc) DOHC V6 (30 Valve) 82.5mm Bore; MFI; Gasoline; Naturally Aspirated Audi Eng.	25
ATW	1.8L 108.6 (1780cc) DOHC L4 (20 Valve) 81mm Bore; MFI; Gasoline; Turbo - Intercooled VW Eng.	5
AUX	4.2L 254.5 (4172cc) DOHC V8 (40 Valve) 84.5mm Bore; MFI; Gasoline; Naturally Aspirated Audi Eng.	53
AVK	3.0L 181.6 (2976cc) DOHC V6 (30 Valve) 82.5mm Bore; MFI; Gasoline; Naturally Aspirated Audi Eng.	28
AWM	1.8L 108.6 (1780cc) DOHC L4 (20 Valve) 81mm Bore; MFI; Gasoline; Turbo - Intercooled VW Eng.	6
AWN	4.2L 254.5 (4172cc) DOHC V8 (32 Valve) 84.5mm Bore; MFI; Gasoline; Naturally Aspirated Audi Eng.	51
AWP	1.8L 108.6 (1780cc) DOHC L4 (20 Valve) 81mm Bore; MFI; Gasoline; Turbo - Intercooled VW Eng.	7
AYS	4.2L 254.5 (4172cc) DOHC V8 (40 Valve) 84.5mm Bore; MFI; Gasoline; Naturally Aspirated Audi Eng.	54
BBD	4.2L 254.5 (4172cc) DOHC V8 (40 Valve) 84.5mm Bore; MFI; Gasoline; Naturally Aspirated Audi Eng.	55
BCY	4.2L 254.5 (4172cc) DOHC V8 (40 Valve) 84.5mm Bore; MFI; Gasoline; Turbo - Intercooled Audi Eng.	56
BEA	1.8L 108.6 (1780cc) DOHC L4 (20 Valve) 81mm Bore; MFI; Gasoline; Turbo - Intercooled VW Eng.	8
BEL	2.7L 163 (2671cc) DOHC V6 (30 Valve) 81mm Bore; MFI; Gasoline; Turbo - Intercooled Audi Eng.	23
BFM	4.2L 254.5 (4163cc) DOHC V8 (40 Valve) 84.5mm Bore; DI; Gasoline; Naturally Aspirated Audi Eng.	41
BGK	4.2L 254.5 (4163cc) DOHC V8 (40 Valve) 84.5mm Bore; DI; Gasoline; Naturally Aspirated Audi Eng.	42
BGN	3.0L 181.6 (2976cc) DOHC V6 (30 Valve) 82.5mm Bore; MFI; Gasoline; Naturally Aspirated Audi Eng.	29

Engine Code Index (Cont.)		
Code	Engine	Line No.
BHE	3.2L 195 (3189cc) DOHC V6 (24 Valve) 84mm Bore; MFI; Gasoline; Naturally Aspirated VW Eng.	39
BHF	4.2L 254.5 (4163cc) DOHC V8 (40 Valve) 84.5mm Bore; DI; Gasoline; Naturally Aspirated Audi Eng.	43
BKH	3.1L 188 (3123cc) DOHC V6 (30 Valve) 84.5mm Bore; DI; Gasoline; Naturally Aspirated Audi Eng.	38
BNK	4.2L 254.5 (4163cc) DOHC V8 (40 Valve) 84.5mm Bore; DI; Gasoline; Naturally Aspirated Audi Eng.	44
BNS	4.2L 254.5 (4163cc) DOHC V8 (40 Valve) 84.5mm Bore; DI; Gasoline; Naturally Aspirated Audi Eng.	45
BPG	2.0L 121 (1984cc) DOHC L4 (16 Valve) 82.5mm Bore; DI; Gasoline; Turbo - Intercooled VW Eng.	9
BPY	2.0L 121 (1984cc) DOHC L4 (16 Valve) 82.5mm Bore; DI; Gasoline; Turbo - Intercooled VW Eng.	10
BUB	3.2L 195 (3189cc) DOHC V6 (24 Valve) 84mm Bore; MFI; Gasoline; Naturally Aspirated VW Eng.	40
BVJ	4.2L 254.5 (4163cc) DOHC V8 (40 Valve) 84.5mm Bore; DI; Gasoline; Naturally Aspirated Audi Eng.	46
BWT	2.0L 121 (1984cc) DOHC L4 (16 Valve) 82.5mm Bore; DI; Gasoline; Turbo - Intercooled VW Eng.	11
BYH	4.2L 254.5 (4163cc) DOHC V8 (40 Valve) 84.5mm Bore; DI; Gasoline; Naturally Aspirated Audi Eng.	47
CAEB	2.0L 121 (1984cc) DOHC L4 (16 Valve) 82.5mm Bore; DI; Gasoline; Turbo - Intercooled VW Eng.	12
CAJA	3.0L 182.8 (2995cc) DOHC V6 (24 Valve) 84.5mm Bore; DI; Gasoline; Supercharged - Intercooled Audi Eng.	30
CAKA	3.0L 182.8 (2995cc) DOHC V6 (24 Valve) 84.5mm Bore; DI; Gasoline; Supercharged - Intercooled Audi Eng.	31
CBFA	2.0L 121 (1984cc) DOHC L4 (16 Valve) 82.5mm Bore; DI; Gasoline; Turbo - Intercooled VW Eng.	13
CCAA	3.0L 182.8 (2995cc) DOHC V6 (24 Valve) 84.5mm Bore; DI; Gasoline; Supercharged - Intercooled Audi Eng.	32
CCBA	3.0L 182.8 (2995cc) DOHC V6 (24 Valve) 84.5mm Bore; DI; Gasoline; Supercharged - Intercooled Audi Eng.	33
CCTA	2.0L 121 (1984cc) DOHC L4 (16 Valve) 82.5mm Bore; DI; Gasoline; Turbo - Intercooled VW Eng.	14
CDMA	2.0L 121 (1984cc) DOHC L4 (16 Valve) 82.5mm Bore; DI; Gasoline; Turbo - Intercooled VW Eng.	15
CESA	2.0L 121 (1984cc) DOHC L4 (16 Valve) 82.5mm Bore; DI; Gasoline; Turbo - Intercooled VW Eng.	16
CETA	2.0L 121 (1984cc) DOHC L4 (16 Valve) 82.5mm Bore; DI; Gasoline; Turbo - Intercooled VW Eng.	17
CGXB	3.0L 182.8 (2995cc) DOHC V6 (24 Valve) 84.5mm Bore; DI; Gasoline; Supercharged - Intercooled Audi Eng.	34
CGXC	3.0L 182.8 (2995cc) DOHC V6 (24 Valve) 84.5mm Bore; DI; Gasoline; Supercharged - Intercooled Audi Eng.	35
CTUA	3.0L 182.8 (2995cc) DOHC V6 (24 Valve) 84.5mm Bore; DI; Gasoline; Supercharged - Intercooled Audi Eng.	36
CTUB	3.0L 182.8 (2995cc) DOHC V6 (24 Valve) 84.5mm Bore; DI; Gasoline; Supercharged - Intercooled Audi Eng.	37
MC	2.2L 135.8 (2226cc) SOHC L5 (10 Valve) 81mm Bore; MFI; Gasoline; Turbo - Intercooled Audi Eng.	18
NF	2.3L 140.8 (2309cc) SOHC L5 (10 Valve) 82.5mm Bore; MFI; Gasoline; Naturally Aspirated Audi Eng.	20
NG	2.3L 140.8 (2309cc) SOHC L5 (10 Valve) 82.5mm Bore; MFI; Gasoline; Naturally Aspirated Audi Eng.	21

Model Index

Engine (VIN Code / Eng. Code)	Year	Engine (VIN Code / Eng. Code)	Year	Engine (VIN Code / Eng. Code)	Year
Audi		Audi (cont.)		Audi (cont.)	
100		80 (cont.)		A4 (cont.)	
L5 2309cc 2.3L SOHC (10 Valve) (NF)	91-89	L5 2309cc 2.3L SOHC (10 Valve) (NG)	92-88	L4 1984cc 2.0L DOHC Turbo (16 Valve) (CAEB)	13-12
V6 2771cc 2.8L SOHC (12 Valve) (AAH)	94-92	L5 2309cc 2.3L SOHC (10 Valve) (NG)	92-88	V6 2771cc 2.8L DOHC (30 Valve) (AHA)	01-98
L5 2309cc 2.3L SOHC (10 Valve) (NF)	91-89	90		V6 2771cc 2.8L DOHC (30 Valve) (ATQ)	01-00
V6 2771cc 2.8L SOHC (12 Valve) (AAH)	94-92	L4 1984cc 2.0L SOHC (8 Valve) (3A)	90-88	V6 2771cc 2.8L SOHC (12 Valve) (AFC)	97-96
200		L5 2309cc 2.3L SOHC (10 Valve) (NG)	92-88	V6 2976cc 3.0L DOHC (30 Valve) (AVK)	05-02
L5 2226cc 2.2L SOHC Turbo (10 Valve) (MC)	91-89	V6 2771cc 2.8L SOHC (12 Valve) (AAH)	95-93	V6 2976cc 3.0L DOHC (30 Valve) (BGN)	06-05
L5 2226cc 2.2L DOHC Turbo (20 Valve) (3B)	91-90	L5 2309cc 2.3L DOHC (20 Valve) (7A)	92-89	V6 3123cc 3.2L DOHC (30 Valve) (BKH)	09-05
L5 2226cc 2.2L SOHC Turbo (10 Valve) (MC)	90-89	L5 2309cc 2.3L SOHC (10 Valve) (NG)	90-88	A4 Quattro	
4000		V6 2771cc 2.8L SOHC (12 Valve) (AAH)	95-93	L4 1780cc 1.8L DOHC Turbo (20 Valve) (AEB)	00-97
L4 1588cc 1.6L SOHC (YG)	80	A3		L4 1780cc 1.8L DOHC Turbo (20 Valve) (AMB)	06-01
L4 1588cc 1.6L SOHC Diesel (CR)	82	L4 1969cc 2.0L DOHC Turbo-Diesel (16 Valve) (CBEA)	13-10	L4 1780cc 1.8L DOHC Turbo (20 Valve) (AWM)	05-01
L4 1588cc 1.6L SOHC Diesel (JK)	83	L4 1969cc 2.0L DOHC Turbo-Diesel (16 Valve) (CJAA)	13	L4 1984cc 2.0L DOHC Turbo (16 Valve) (BPG)	07-05
L4 1588cc 1.6L SOHC Turbo-Diesel (CY)	83-82	L4 1984cc 2.0L DOHC Turbo (16 Valve) (BPY)	13-06	L4 1984cc 2.0L DOHC Turbo (16 Valve) (BWT)	13-07
L4 1715cc 1.7L SOHC (WT)	83-81	L4 1984cc 2.0L DOHC Turbo (16 Valve) (CBFA)	13-12	L4 1984cc 2.0L DOHC Turbo (16 Valve) (CAEB)	13-12
L4 1780cc 1.8L SOHC (8 Valve) (JN)	84	A3 Quattro		V6 2771cc 2.8L DOHC (30 Valve) (AHA)	01-98
L4 1780cc 1.8L SOHC (8 Valve) (MG)	87-85	L4 1984cc 2.0L DOHC Turbo (16 Valve) (BPY)	13-09	V6 2771cc 2.8L DOHC (30 Valve) (ATQ)	01-00
L5 2144cc 2.1L SOHC (WE)	84-80	L4 1984cc 2.0L DOHC Turbo (16 Valve) (CCTA)	13-12	V6 2771cc 2.8L SOHC (12 Valve) (AFC)	97-96
L5 2226cc 2.2L SOHC (10 Valve) (JT)	87-84	V6 3189cc 3.2L DOHC (24 Valve) (BUB)	09-06	V6 2976cc 3.0L DOHC (30 Valve) (AVK)	05-02
5000		A4		V6 2976cc 3.0L DOHC (30 Valve) (BGN)	06-05
L5 1986cc 2.0L SOHC Diesel (CN)	82-79	L4 1780cc 1.8L DOHC Turbo (20 Valve) (AEB)	00-97	V6 3123cc 3.2L DOHC (30 Valve) (BKH)	09-05
L5 1986cc 2.0L SOHC Turbo-Diesel (DE)	85-82	L4 1780cc 1.8L DOHC Turbo (20 Valve) (AMB)	06-01	A5	
L5 2144cc 2.1L SOHC (WD)	83-78	L4 1780cc 1.8L DOHC Turbo (20 Valve) (AWM)	05-01	L4 1984cc 2.0L DOHC Turbo (16 Valve) (BWT)	13-10
L5 2144cc 2.1L SOHC (WE)	85-78	L4 1984cc 2.0L DOHC Turbo (16 Valve) (BPG)	07-05	L4 1984cc 2.0L DOHC Turbo (16 Valve) (CAEB)	13-12
L5 2144cc 2.1L SOHC Turbo (KH)	85-80	L4 1984cc 2.0L DOHC Turbo (16 Valve) (BWT)	13-07	V6 3123cc 3.2L DOHC (30 Valve) (BKH)	10-08
L5 2226cc 2.2L SOHC (10 Valve) (KZ)	87-85	80			
L5 2226cc 2.2L SOHC Turbo (10 Valve) (MC)	88-86	L4 1984cc 2.0L SOHC (8 Valve) (3A)	90-88		
L5 2309cc 2.3L SOHC (10 Valve) (NF)	88				
L5 2144cc 2.1L SOHC (WD)	83				
L5 2144cc 2.1L SOHC (WE)	85-83				
L5 2144cc 2.1L SOHC (WU)	85-84				
L5 2144cc 2.1L SOHC Turbo (KH)	85-82				
L5 2226cc 2.2L SOHC (10 Valve) (KZ)	87-85				
L5 2226cc 2.2L SOHC Turbo (10 Valve) (MC)	88-86				
L5 2309cc 2.3L SOHC (10 Valve) (NF)	88				

Audi Car (Cont.)

Model Index (Cont.)

Engine (VIN Code / Eng. Code)	Year	Engine (VIN Code / Eng. Code)	Year	Engine (VIN Code / Eng. Code)	Year
Audi (cont.)		Audi (cont.)		Audi (cont.)	
A5 Quattro		A8 Quattro (cont.)		S4 Quattro (cont.)	
L4 1984cc 2.0L DOHC Turbo (16 Valve) (BWT)	13-10	V8 4163cc 4.2L DOHC (40 Valve) (BFM)	08-04	V6 2671cc 2.7L DOHC Turbo (30 Valve) (BEL)	03
L4 1984cc 2.0L DOHC Turbo (16 Valve) (CAEB)	13-12	V8 4163cc 4.2L DOHC (40 Valve) (BGK)	08-06	V6 2995cc 3.0L DOHC Supercharged (24 Valve) (CCBA)	13-10
V6 3123cc 3.2L DOHC (30 Valve) (BKH)	10-08	V8 4163cc 4.2L DOHC (40 Valve) (BVJ)	10-07	V6 2995cc 3.0L DOHC Supercharged (24 Valve) (CGXC)	13
A6		V8 4163cc 4.2L DOHC (40 Valve) (CDRA)	12-11	V8 4163cc 4.2L DOHC (40 Valve) (BHF)	09-04
L4 1984cc 2.0L DOHC Turbo (16 Valve) (CAEB)	13-12	V8 4172cc 4.2L DOHC (32 Valve) (ABZ)	99-97	S5 Quattro	
V6 2771cc 2.8L DOHC (30 Valve) (AHA)	01-98	V8 4172cc 4.2L DOHC (40 Valve) (AKB)	04-00	V6 2995cc 3.0L DOHC Supercharged (24 Valve) (CAKA)	13-12
V6 2771cc 2.8L DOHC (30 Valve) (ATQ)	01-00	V8 4172cc 4.2L DOHC (40 Valve) (AUX)	04-01	V6 2995cc 3.0L DOHC Supercharged (24 Valve) (CCBA)	13-10
V6 2771cc 2.8L SOHC (12 Valve) (AFC)	97-95	A8L Quattro		V6 2995cc 3.0L DOHC Supercharged (24 Valve) (CGXC)	13
V6 2976cc 3.0L DOHC (30 Valve) (AVK)	04-02	V6 2995cc 3.0L DOHC Supercharged (24 Valve) (CTUB)	13	V8 4163cc 4.2L DOHC (40 Valve) (BHF)	12-08
V6 2995cc 3.0L DOHC Supercharged (24 Valve) (CAJA)	11-09	V8 3991cc 4.0L DOHC Turbo (32 Valve) (CEUC)	13	V8 4163cc 4.2L DOHC (40 Valve) (CAUA)	12
V6 2995cc 3.0L DOHC Supercharged (24 Valve) (CCAA)	13-12	V8 4163cc 4.2L DOHC (40 Valve) (BFM)	08-04	S6	
V6 2995cc 3.0L DOHC Supercharged (24 Valve) (CGXB)	13-12	V8 4163cc 4.2L DOHC (40 Valve) (BGK)	08-06	L5 2226cc 2.2L DOHC Turbo (20 Valve) (MC)	
V6 2995cc 3.0L DOHC Supercharged (24 Valve) (CTUA)	13	V8 4163cc 4.2L DOHC (40 Valve) (BVJ)	10-07	S6 Quattro	
V6 3123cc 3.2L DOHC (30 Valve) (BKH)	11-05	V8 4163cc 4.2L DOHC (40 Valve) (CDRA)	12-11	V10 5204cc 5.2L DOHC (40 Valve) (BSA)	09-07
A6 Quattro		V8 4172cc 4.2L DOHC (40 Valve) (AKB)	04-00	V10 5204cc 5.2L DOHC (40 Valve) (BXA)	11-07
L4 1984cc 2.0L DOHC Turbo (16 Valve) (CAEB)	13-12	V8 4172cc 4.2L DOHC (40 Valve) (AUX)	04-01	V8 3991cc 4.0L DOHC Turbo (32 Valve) (CEUC)	13
V6 2671cc 2.7L DOHC Turbo (30 Valve) (APB)	02-00	W12 5998cc 6.0L DOHC (48 Valve) (BSB)	09-05	V8 4172cc 4.2L DOHC (40 Valve) (AUX)	04-02
V6 2671cc 2.7L DOHC Turbo (30 Valve) (BEL)	04-03	W12 6299cc 6.3L DOHC (48 Valve) (CEJA)	13-11	V8 4172cc 4.2L DOHC (40 Valve) (BBD)	04-02
V6 2771cc 2.8L DOHC (30 Valve) (AHA)	01-98	Allroad Quattro		S7 Quattro	
V6 2771cc 2.8L DOHC (30 Valve) (ATQ)	01-00	L4 1984cc 2.0L DOHC Turbo (16 Valve) (BWT)	13	V8 3991cc 4.0L DOHC Turbo (32 Valve) (CEUC)	13
V6 2771cc 2.8L SOHC (12 Valve) (AFC)	97-95	L4 1984cc 2.0L DOHC Turbo (16 Valve) (CAEB)	13	S8 Quattro	
V6 2976cc 3.0L DOHC (30 Valve) (AVK)	04-02	Cabriolet		V10 5204cc 5.2L DOHC (40 Valve) (BSM)	09-07
V6 2995cc 3.0L DOHC Supercharged (24 Valve) (CAJA)	11-09	V6 2771cc 2.8L SOHC (12 Valve) (AAH)	98-94	V8 3991cc 4.0L DOHC Turbo (32 Valve) (CGTA)	13
V6 2995cc 3.0L DOHC Supercharged (24 Valve) (CCAA)	13-12	Coupe		V8 4172cc 4.2L DOHC (40 Valve) (AYS)	03-01
V6 2995cc 3.0L DOHC Supercharged (24 Valve) (CGXB)	13-12	L5 2144cc 2.1L SOHC (WE)	84-81	TT	
V6 2995cc 3.0L DOHC Supercharged (24 Valve) (CTUA)	13	L5 2226cc 2.2L SOHC (10 Valve) (KX)	87-84	L4 1780cc 1.8L DOHC Turbo (20 Valve) (AMU)	05-00
V6 3123cc 3.2L DOHC (30 Valve) (BKH)	09-05	Coupe Quattro		L4 1780cc 1.8L DOHC Turbo (20 Valve) (ATC)	05-00
V8 4163cc 4.2L DOHC (40 Valve) (BNK)	06-05	L5 2226cc 2.2L SOHC Turbo (10 Valve) (MC)	90-89	L4 1780cc 1.8L DOHC Turbo (20 Valve) (AWP)	06-00
V8 4163cc 4.2L DOHC (40 Valve) (BVJ)	11-07	L5 2309cc 2.3L DOHC (20 Valve) (7A)	92-89	L4 1780cc 1.8L DOHC Turbo (20 Valve) (BEA)	06-03
V8 4172cc 4.2L DOHC (32 Valve) (ART)	00	Fox		L4 1984cc 2.0L DOHC Turbo (16 Valve) (BPG)	13-08
V8 4172cc 4.2L DOHC (32 Valve) (AWN)	04-01	L4 1471cc 1.5L SOHC (XV)	74	L4 1984cc 2.0L DOHC Turbo (16 Valve) (BWT)	13-08
A7		L4 1471cc 1.5L SOHC (XW)	74	L4 1984cc 2.0L DOHC Turbo (16 Valve) (CESA)	13-12
V6 2995cc 3.0L DOHC Supercharged (24 Valve) (CAJA)	11	L4 1471cc 1.5L SOHC (XY)	74	L4 1984cc 2.0L DOHC Turbo (16 Valve) (CETA)	13-12
V6 2995cc 3.0L DOHC Supercharged (24 Valve) (CCAA)	13-12	L4 1471cc 1.5L SOHC (XZ)	74	TT Quattro	
V6 2995cc 3.0L DOHC Supercharged (24 Valve) (CGXB)	13-12	L4 1471cc 1.5L SOHC (ZD)	73	L4 1780cc 1.8L DOHC Turbo (20 Valve) (AMU)	05-00
V6 2995cc 3.0L DOHC Supercharged (24 Valve) (CTUA)	13	L4 1471cc 1.5L SOHC (ZE)	73	L4 1780cc 1.8L DOHC Turbo (20 Valve) (ATC)	05-00
A8		L4 1588cc 1.6L SOHC (YG)	79-75	L4 1780cc 1.8L DOHC Turbo (20 Valve) (AWP)	06-00
V8 3697cc 3.7L DOHC (32 Valve) (AEW)	99-97	L4 1588cc 1.6L SOHC (YH)	79-75	L4 1780cc 1.8L DOHC Turbo (20 Valve) (BEA)	06-03
V8 4172cc 4.2L DOHC (32 Valve) (ABZ)	99-97	L4 1588cc 1.6L SOHC (YK)	76	L4 1984cc 2.0L DOHC Turbo (16 Valve) (BPG)	13-08
A8 Quattro		L4 1588cc 1.6L SOHC (YM)	76-75	L4 1984cc 2.0L DOHC Turbo (16 Valve) (CESA)	13-12
V6 2995cc 3.0L DOHC Supercharged (24 Valve) (CCBA)	13	R8 Quattro		L4 1780cc 1.8L DOHC Turbo (20 Valve) (AMU)	05-00
V6 2995cc 3.0L DOHC Supercharged (24 Valve) (CTUB)	13	V10 5204cc 5.2L DOHC (40 Valve) (BUJ)	13-10	L4 1780cc 1.8L DOHC Turbo (20 Valve) (ATC)	05-00
V8 3697cc 3.7L DOHC (32 Valve) (AEW)	99-97	V10 5204cc 5.2L DOHC (40 Valve) (CEH)	13-12	L4 1780cc 1.8L DOHC Turbo (20 Valve) (AWP)	06-00
V8 3991cc 4.0L DOHC Turbo (32 Valve) (CEUC)	13	V10 5204cc 5.2L DOHC (40 Valve) (CMPA)	13-12	L4 1780cc 1.8L DOHC Turbo (20 Valve) (BEA)	06-03
A8 Quattro		V8 4163cc 4.2L DOHC (40 Valve) (BYH)	13-08	L4 1984cc 2.0L DOHC Turbo (16 Valve) (BPG)	13-08
V6 2995cc 3.0L DOHC Supercharged (24 Valve) (CCBA)	13	V8 4163cc 4.2L DOHC (40 Valve) (CNDA)	13-12	L4 1984cc 2.0L DOHC Turbo (16 Valve) (BWT)	13-08
V6 2995cc 3.0L DOHC Supercharged (24 Valve) (CTUB)	13	RS4 Quattro		L4 1984cc 2.0L DOHC Turbo (16 Valve) (CESA)	13-12
V8 3697cc 3.7L DOHC (32 Valve) (AEW)	99-97	V8 4163cc 4.2L DOHC (40 Valve) (BNS)	09-06	TT Quattro	
V8 3991cc 4.0L DOHC Turbo (32 Valve) (CEUC)	13	RS5 Quattro		L4 1780cc 1.8L DOHC Turbo (20 Valve) (AMU)	05-00
A8 Quattro		V8 4163cc 4.2L DOHC (40 Valve) (CFSA)	13	L4 1780cc 1.8L DOHC Turbo (20 Valve) (ATC)	05-00
V6 2995cc 3.0L DOHC Supercharged (24 Valve) (CCBA)	13	RS6 Quattro		L4 1780cc 1.8L DOHC Turbo (20 Valve) (AWP)	06-00
V6 2995cc 3.0L DOHC Supercharged (24 Valve) (CTUB)	13	V8 4172cc 4.2L DOHC Turbo (40 Valve) (BCY)	03	L4 1780cc 1.8L DOHC Turbo (20 Valve) (BEA)	06-03
V8 3697cc 3.7L DOHC (32 Valve) (AEW)	99-97	S4		L4 1984cc 2.0L DOHC Turbo (16 Valve) (BPG)	13-08
V8 3991cc 4.0L DOHC Turbo (32 Valve) (CEUC)	13	L5 2226cc 2.2L DOHC Turbo (20 Valve) (3B)	94-92	L4 1984cc 2.0L DOHC Turbo (16 Valve) (BWT)	13-08
A8 Quattro		S4 Quattro		L4 1984cc 2.0L DOHC Turbo (16 Valve) (CESA)	13-12
V6 2995cc 3.0L DOHC Supercharged (24 Valve) (CCBA)	13	V6 2671cc 2.7L DOHC Turbo (30 Valve) (APB)	02-00		

Model Index (Cont.)					
Engine (VIN Code / Eng. Code)	Year	Engine (VIN Code / Eng. Code)	Year	Engine (VIN Code / Eng. Code)	Year
Audi (cont.)					
TT Quattro (cont.)					
L4 1984cc 2.0L DOHC Turbo (16 Valve) (CETA)	13-12				
L5 2480cc 2.5L DOHC Turbo (20 Valve) (CEPB)	13-12				
V6 3189cc 3.2L DOHC (24 Valve) (BHE)	09-04				
TTS Quattro					
L4 1984cc 2.0L DOHC Turbo (16 Valve) (BPG)	13-09				
L4 1984cc 2.0L DOHC Turbo (16 Valve) (BWT)	13-09				
L4 1984cc 2.0L DOHC Turbo (16 Valve) (CDMA)	13-12				
V8 Quattro					
V8 3562cc 3.6L DOHC (32 Valve) (PT)	91-90				
V8 4172cc 4.2L DOHC (32 Valve) (ABH)	94-92				

Audi Car (Cont.)

1		2000 - 1997; 1.8L 108.6 (1780cc) DOHC L4 (20 Valve) 81mm Bore			1
		MFI; Gasoline; Turbo - Intercooled VW Eng.; Eng. Code AEB			
QTY	CYLINDER HEAD	YEARS	PART NO.	DESCRIPTION	
1	Head Gasket	2000-97	26182 PT	Head bolts not incl.; Head bolt replacement recommended; PermaTorqueMLS®	
1	Head Set	2000-97	HS 26182 PT	Head bolts not incl.; Head bolt replacement recommended; PermaDry® molded rubber valve cover gskt. incl.; Premium valve stem seals incl.	
1	Head Bolt Set	2000-97	ES 71172	Replacement recommended	
QTY	CONVERSION SET	YEARS	PART NO.	DESCRIPTION	
1	Gasket Conversion Set	2000-97	CS 26182-2	PermaDry® molded rubber oil pan gskt. incl.	
QTY	MANIFOLD - INT. & EXH.	YEARS	PART NO.	DESCRIPTION	
1	Int. Manifold Gasket Set	2000-97	MS 96151		
1	Exh. Manifold Gasket Set	2000-97	MS 96116		
QTY	EXHAUST PIPE FLANGE	YEARS	PART NO.	DESCRIPTION	
1	Exhaust Pipe Gasket	2000-97	61171	Flange	
QTY	OIL PAN	YEARS	PART NO.	DESCRIPTION	
1	Oil Pan Gasket Set	2000-97	OS 30791 R	PermaDry® molded rubber gskt. incl.	
QTY	CRANKSHAFT REAR SEAL	YEARS	PART NO.	DESCRIPTION	
1	Rear Main Seal Set	2000-97	BS 40187	w/7mm bolt holes; PTFE Rubber; One-piece	
1	Rear Main Seal Set	2000-97	BS 40724	w/6mm bolt holes; PTFE Rubber; One-piece	
QTY	VALVE COVER	YEARS	PART NO.	DESCRIPTION	
1	Valve Cover Gasket Set	2000-97	VS 50531 R	w/Spark plug tube seals; PermaDry® molded rubber gskt. incl.	
QTY	VALVE STEM SEAL SET	YEARS	PART NO.	DESCRIPTION	
1	Valve Stem Seal Set	2000-97	SS 71074	Premium valve stem seals incl.	
QTY	THERMOSTAT HOUSING	YEARS	PART NO.	DESCRIPTION	
1	O-Ring	2000-97	25598	Thermostat Housing	
QTY	WATER PUMP	YEARS	PART NO.	DESCRIPTION	
1	Water Pump Gasket	2000-97	35549		
QTY	TIMING COVER	YEARS	PART NO.	DESCRIPTION	
1	Crankshaft Front Seal Set	2000-97	TCS 46021		
1	Camshaft Front Seal Set	2000-97	TCS 46005		
QTY	CARB & FUEL INJECTION	YEARS	PART NO.	DESCRIPTION	
2	Fuel Injector O-Ring Set	2000-97	ES 70599	Improved design	
1	Throttle Body Gasket	2000-97	61092		
QTY	OIL FILTER MOUNTING	YEARS	PART NO.	DESCRIPTION	
1	Oil Filter Adapter Gasket	2000-97	72969	Oil filter adapter; New Part Number - Check for Availability	
QTY	OIL COOLER	YEARS	PART NO.	DESCRIPTION	
1	Oil Cooler Gasket	2000-97	72485	Oil cooler O-ring; New Part Number - Check for Availability	
2		2006 - 2001; 1.8L 108.6 (1780cc) DOHC L4 (20 Valve) 81mm Bore			2
		MFI; Gasoline; Turbo - Intercooled VW Eng.; Eng. Code AMB			
QTY	CYLINDER HEAD	YEARS	PART NO.	DESCRIPTION	
1	Head Gasket	2006-01	26182 PT	Head bolts not incl.; Head bolt replacement recommended; PermaTorqueMLS®	
1	Head Set	2006-01	HS 26182 PT	Head bolts not incl.; Head bolt replacement recommended; PermaDry® molded rubber valve cover gskt. incl.; Premium valve stem seals incl.	
1	Head Bolt Set	2006-01	ES 71193	Replacement recommended	
QTY	CONVERSION SET	YEARS	PART NO.	DESCRIPTION	
1	Gasket Conversion Set	2006-01	CS 26182-2	Crankshaft front seal not incl.; PermaDry® molded rubber oil pan gskt. incl.	
QTY	MANIFOLD - INT. & EXH.	YEARS	PART NO.	DESCRIPTION	
1	Int. Manifold Gasket Set	2006-01	MS 96151		
1	Exh. Manifold Gasket Set	2006-01	MS 96116		
QTY	EXHAUST PIPE FLANGE	YEARS	PART NO.	DESCRIPTION	
1	Exhaust Pipe Gasket	2006-01	61197	Turbo inlet	
1	Exhaust Pipe Gasket	2006-01	61198	Flange	
QTY	OIL PAN	YEARS	PART NO.	DESCRIPTION	
1	Oil Pan Gasket Set	2006-01	OS 30736	PermaDry® molded rubber gskt. incl.	
QTY	CRANKSHAFT REAR SEAL	YEARS	PART NO.	DESCRIPTION	
1	Rear Main Seal Set	2006-01	BS 40187	w/7mm bolt holes; PTFE Rubber; One-piece	
1	Rear Main Seal Set	2006-01	BS 40724	w/6mm bolt holes; PTFE Rubber; One-piece	
QTY	VALVE COVER	YEARS	PART NO.	DESCRIPTION	
1	Valve Cover Gasket Set	2006-01	VS 50531 R	w/Spark plug tube seals; PermaDry® molded rubber gskt. incl.	
QTY	VALVE STEM SEAL SET	YEARS	PART NO.	DESCRIPTION	
1	Valve Stem Seal Set	2006-01	SS 71074	Premium valve stem seals incl.	
QTY	THERMOSTAT HOUSING	YEARS	PART NO.	DESCRIPTION	
1	O-Ring	2006-03	35716	Thermostat Housing	

2		2006 - 2001; 1.8L 108.6 (1780cc) DOHC L4 (20 Valve) 81mm Bore			2	
(cont.)		MFI; Gasoline; Turbo - Intercooled VW Eng.; Eng. Code AMB			(cont.)	
QTY	THERMOSTAT HOUSING	YEARS	PART NO.	DESCRIPTION		
1	O-Ring	2002-01	25598	Thermostat Housing		
QTY	WATER PUMP	YEARS	PART NO.	DESCRIPTION		
1	Water Pump Gasket	2006-01	35549			
QTY	TIMING COVER	YEARS	PART NO.	DESCRIPTION		
1	Crankshaft Front Seal Set	2006-01	TCS 45038			
1	Camshaft Front Seal Set	2006-01	TCS 46005			
QTY	CARB & FUEL INJECTION	YEARS	PART NO.	DESCRIPTION		
2	Fuel Injector O-Ring Set	2006-01	ES 70599	Improved design		
1	Throttle Body Gasket	2006-01	61330			
QTY	EXHAUST GAS RECIRCULATION	YEARS	PART NO.	DESCRIPTION		
2	EGR Gasket	2006-01	72803	Air pump gskt.; New Part Number - Check for Availability		
QTY	OIL FILTER MOUNTING	YEARS	PART NO.	DESCRIPTION		
1	Oil Filter Adapter Gasket	2006-01	72969	Oil filter adapter; New Part Number - Check for Availability		
QTY	OIL COOLER	YEARS	PART NO.	DESCRIPTION		
1	Oil Cooler Gasket	2006-01	72485	Oil cooler O-ring; New Part Number - Check for Availability		
3		2005 - 2000; 1.8L 108.6 (1780cc) DOHC L4 (20 Valve) 81mm Bore			3	
		MFI; Gasoline; Turbo - Intercooled VW Eng.; Eng. Code AMU				
QTY	CYLINDER HEAD	YEARS	PART NO.	DESCRIPTION		
1	Head Gasket	2005-00	26182 PT	Head bolts not incl.; Head bolt replacement recommended; PermaTorqueMLS®		
1	Head Set	2005-00	HS 26182 PT	Head bolts not incl.; Head bolt replacement recommended; PermaDry® molded rubber valve cover gskt. incl.; Premium valve stem seals incl.		
1	Head Bolt Set	2005-00	ES 71193	Replacement recommended		
QTY	CONVERSION SET	YEARS	PART NO.	DESCRIPTION		
1	Gasket Conversion Set	2005-00	CS 26182	Crankshaft front seal not incl.; PermaDry® molded rubber oil pan gskt. incl.		
QTY	MANIFOLD - INT. & EXH.	YEARS	PART NO.	DESCRIPTION		
1	Int. Manifold Gasket Set	2005-00	MS 96151			
1	Exh. Manifold Gasket Set	2005-00	MS 96116			
QTY	EXHAUST PIPE FLANGE	YEARS	PART NO.	DESCRIPTION		
1	Exhaust Pipe Gasket	2005-00	61171	Flange		
1	Exhaust Pipe Gasket	2005-00	61197	Turbo inlet		
QTY	OIL PAN	YEARS	PART NO.	DESCRIPTION		
1	Oil Pan Gasket Set	2005-00	OS 30708 R	PermaDry® molded rubber gskt. incl.		
QTY	CRANKSHAFT REAR SEAL	YEARS	PART NO.	DESCRIPTION		
1	Rear Main Seal Set	2005-00	BS 40187	w/7mm bolt holes; PTFE Rubber; One-piece		
1	Rear Main Seal Set	2005-00	BS 40724	w/6mm bolt holes; PTFE Rubber; One-piece		
QTY	VALVE COVER	YEARS	PART NO.	DESCRIPTION		
1	Valve Cover Gasket Set	2005-00	VS 50531 R	w/Spark plug tube seals; PermaDry® molded rubber gskt. incl.		
QTY	VALVE STEM SEAL SET	YEARS	PART NO.	DESCRIPTION		
1	Valve Stem Seal Set	2005-00	SS 71074	Premium valve stem seals incl.		
QTY	THERMOSTAT HOUSING	YEARS	PART NO.	DESCRIPTION		
1	O-Ring	2005-03	35716	Thermostat Housing		
1	O-Ring	2002-00	25598	Thermostat Housing		
QTY	WATER PUMP	YEARS	PART NO.	DESCRIPTION		
1	Water Pump Gasket	2005-00	35549			
QTY	TIMING COVER	YEARS	PART NO.	DESCRIPTION		
1	Crankshaft Front Seal Set	2005-00	TCS 45038			
1	Camshaft Front Seal Set	2005-00	TCS 46005			
QTY	CARB & FUEL INJECTION	YEARS	PART NO.	DESCRIPTION		
2	Fuel Injector O-Ring Set	2005-00	ES 70599	Improved design		
1	Throttle Body Gasket	2005-00	61092			
QTY	OIL FILTER MOUNTING	YEARS	PART NO.	DESCRIPTION		
1	Oil Filter Adapter Gasket	2005-00	72969	Oil filter adapter; New Part Number - Check for Availability		
QTY	OIL COOLER	YEARS	PART NO.	DESCRIPTION		
1	Oil Cooler Gasket	2005-00	72485	Oil cooler O-ring; New Part Number - Check for Availability		
4		2005 - 2000; 1.8L 108.6 (1780cc) DOHC L4 (20 Valve) 81mm Bore			4	
		MFI; Gasoline; Turbo - Intercooled VW Eng.; Eng. Code ATC				
QTY	CYLINDER HEAD	YEARS	PART NO.	DESCRIPTION		
1	Head Gasket	2005-00	26182 PT	Head bolts not incl.; Head bolt replacement recommended; PermaTorqueMLS®		

Audi Car (Cont.)

4		2005 - 2000; 1.8L 108.6 (1780cc) DOHC L4 (20 Valve) 81mm Bore			4	
(cont.)		MFI; Gasoline; Turbo - Intercooled VW Eng.; Eng. Code ATC			(cont.)	
QTY	CYLINDER HEAD	YEARS	PART NO.	DESCRIPTION		
1	Head Set	2005-00	HS 26182 PT	Head bolts not incl.; Head bolt replacement recommended; PermaDry® molded rubber valve cover gskt. incl.; Premium valve stem seals incl.		
1	Head Bolt Set	2005-00	ES 71193	Replacement recommended		
QTY	CONVERSION SET	YEARS	PART NO.	DESCRIPTION		
1	Gasket Conversion Set	2005-00	CS 26182	Crankshaft front seal not incl.; PermaDry® molded rubber oil pan gskt. incl.		
QTY	MANIFOLD - INT. & EXH.	YEARS	PART NO.	DESCRIPTION		
1	Int. Manifold Gasket Set	2005-00	MS 96151			
1	Exh. Manifold Gasket Set	2005-00	MS 96116			
QTY	EXHAUST PIPE FLANGE	YEARS	PART NO.	DESCRIPTION		
1	Exhaust Pipe Gasket	2005-00	61171	Flange		
1	Exhaust Pipe Gasket	2005-00	61197	Turbo inlet		
QTY	OIL PAN	YEARS	PART NO.	DESCRIPTION		
1	Oil Pan Gasket Set	2005-00	OS 30708 R	PermaDry® molded rubber gskt. incl.		
QTY	CRANKSHAFT REAR SEAL	YEARS	PART NO.	DESCRIPTION		
1	Rear Main Seal Set	2005-00	BS 40187	w/7mm bolt holes; PTFE Rubber; One-piece		
1	Rear Main Seal Set	2005-00	BS 40724	w/6mm bolt holes; PTFE Rubber; One-piece		
QTY	VALVE COVER	YEARS	PART NO.	DESCRIPTION		
1	Valve Cover Gasket Set	2005-00	VS 50531 R	w/Spark plug tube seals; PermaDry® molded rubber gskt. incl.		
QTY	VALVE STEM SEAL SET	YEARS	PART NO.	DESCRIPTION		
1	Valve Stem Seal Set	2005-00	SS 71074	Premium valve stem seals incl.		
QTY	THERMOSTAT HOUSING	YEARS	PART NO.	DESCRIPTION		
1	O-Ring	2005-03	35716	Thermostat Housing		
1	O-Ring	2002-00	25598	Thermostat Housing		
QTY	WATER PUMP	YEARS	PART NO.	DESCRIPTION		
1	Water Pump Gasket	2005-00	35549			
QTY	TIMING COVER	YEARS	PART NO.	DESCRIPTION		
1	Crankshaft Front Seal Set	2005-00	TCS 45038			
1	Camshaft Front Seal Set	2005-00	TCS 46005			
QTY	CARB & FUEL INJECTION	YEARS	PART NO.	DESCRIPTION		
2	Fuel Injector O-Ring Set	2005-00	ES 70599	Improved design		
1	Throttle Body Gasket	2005-00	61092			
QTY	OIL FILTER MOUNTING	YEARS	PART NO.	DESCRIPTION		
1	Oil Filter Adapter Gasket	2005-00	72969	Oil filter adapter; New Part Number - Check for Availability		
QTY	OIL COOLER	YEARS	PART NO.	DESCRIPTION		
1	Oil Cooler Gasket	2005-00	72485	Oil cooler O-ring; New Part Number - Check for Availability		
5		2000; 1.8L 108.6 (1780cc) DOHC L4 (20 Valve) 81mm Bore			5	
(cont.)		MFI; Gasoline; Turbo - Intercooled VW Eng.; Eng. Code ATW			(cont.)	
QTY	CYLINDER HEAD	YEARS	PART NO.	DESCRIPTION		
1	Head Gasket	2000	26182 PT	Head bolts not incl.; Head bolt replacement recommended; PermaTorqueMLS®		
1	Head Set	2000	HS 26182 PT	Head bolts not incl.; Head bolt replacement recommended; PermaDry® molded rubber valve cover gskt. incl.; Premium valve stem seals incl.		
1	Head Bolt Set	2000	ES 71172	Replacement recommended		
QTY	CONVERSION SET	YEARS	PART NO.	DESCRIPTION		
1	Gasket Conversion Set	2000	CS 26182-2	PermaDry® molded rubber oil pan gskt. incl.		
QTY	MANIFOLD - INT. & EXH.	YEARS	PART NO.	DESCRIPTION		
1	Int. Manifold Gasket Set	2000	MS 96151			
1	Exh. Manifold Gasket Set	2000	MS 96116			
QTY	EXHAUST PIPE FLANGE	YEARS	PART NO.	DESCRIPTION		
1	Exhaust Pipe Gasket	2000	61171	Flange		
QTY	OIL PAN	YEARS	PART NO.	DESCRIPTION		
1	Oil Pan Gasket Set	2000	OS 30791 R	PermaDry® molded rubber gskt. incl.		
QTY	CRANKSHAFT REAR SEAL	YEARS	PART NO.	DESCRIPTION		
1	Rear Main Seal Set	2000	BS 40187	w/7mm bolt holes; PTFE Rubber; One-piece		
1	Rear Main Seal Set	2000	BS 40724	w/6mm bolt holes; PTFE Rubber; One-piece		
QTY	VALVE COVER	YEARS	PART NO.	DESCRIPTION		
1	Valve Cover Gasket Set	2000	VS 50531 R	w/Spark plug tube seals; PermaDry® molded rubber gskt. incl.		
QTY	VALVE STEM SEAL SET	YEARS	PART NO.	DESCRIPTION		
1	Valve Stem Seal Set	2000	SS 71074	Premium valve stem seals incl.		
QTY	THERMOSTAT HOUSING	YEARS	PART NO.	DESCRIPTION		
1	O-Ring	2000	25598	Thermostat Housing		
QTY	WATER PUMP	YEARS	PART NO.	DESCRIPTION		
1	Water Pump Gasket	2000	35549			

5 (cont.)		2000; 1.8L 108.6 (1780cc) DOHC L4 (20 Valve) 81mm Bore			5 (cont.)
		MFI; Gasoline; Turbo - Intercooled VW Eng.; Eng. Code ATW			
QTY	TIMING COVER	YEARS	PART NO.	DESCRIPTION	
1	Crankshaft Front Seal Set	2000	TCS 46021		
1	Camshaft Front Seal Set	2000	TCS 46005		
QTY	CARB & FUEL INJECTION	YEARS	PART NO.	DESCRIPTION	
2	Fuel Injector O-Ring Set	2000	ES 70599	Improved design	
1	Throttle Body Gasket	2000	61092		
QTY	EXHAUST GAS RECIRCULATION	YEARS	PART NO.	DESCRIPTION	
2	EGR Gasket	2000	72803	Air pump gskt.; New Part Number - Check for Availability	
QTY	OIL FILTER MOUNTING	YEARS	PART NO.	DESCRIPTION	
1	Oil Filter Adapter Gasket	2000	72969	Oil filter adapter; New Part Number - Check for Availability	
QTY	OIL COOLER	YEARS	PART NO.	DESCRIPTION	
1	Oil Cooler Gasket	2000	72485	Oil cooler O-ring; New Part Number - Check for Availability	
6		2005 - 2001; 1.8L 108.6 (1780cc) DOHC L4 (20 Valve) 81mm Bore			6
		MFI; Gasoline; Turbo - Intercooled VW Eng.; Eng. Code AWM			
QTY	CYLINDER HEAD	YEARS	PART NO.	DESCRIPTION	
1	Head Gasket	2005-01	26182 PT	Head bolts not incl.; Head bolt replacement recommended; PermaTorqueMLS®	
1	Head Set	2005-01	HS 26182 PT	Head bolts not incl.; Head bolt replacement recommended; PermaDry® molded rubber valve cover gskt. incl.; Premium valve stem seals incl.	
1	Head Bolt Set	2005-01	ES 71193	Replacement recommended	
QTY	CONVERSION SET	YEARS	PART NO.	DESCRIPTION	
1	Gasket Conversion Set	2005-01	CS 26182-2	Crankshaft front seal not incl.; PermaDry® molded rubber oil pan gskt. incl.	
QTY	MANIFOLD - INT. & EXH.	YEARS	PART NO.	DESCRIPTION	
1	Int. Manifold Gasket Set	2005-01	MS 96151		
1	Exh. Manifold Gasket Set	2005-01	MS 96116		
QTY	EXHAUST PIPE FLANGE	YEARS	PART NO.	DESCRIPTION	
1	Exhaust Pipe Gasket	2005-01	61197	Turbo inlet	
1	Exhaust Pipe Gasket	2005-01	61198	Flange	
QTY	OIL PAN	YEARS	PART NO.	DESCRIPTION	
1	Oil Pan Gasket Set	2005-01	OS 30736	PermaDry® molded rubber gskt. incl.	
QTY	CRANKSHAFT REAR SEAL	YEARS	PART NO.	DESCRIPTION	
1	Rear Main Seal Set	2005-01	BS 40187	w/7mm bolt holes; PTFE Rubber; One-piece	
1	Rear Main Seal Set	2005-01	BS 40724	w/6mm bolt holes; PTFE Rubber; One-piece	
QTY	VALVE COVER	YEARS	PART NO.	DESCRIPTION	
1	Valve Cover Gasket Set	2005-01	VS 50531 R	w/Spark plug tube seals; PermaDry® molded rubber gskt. incl.	
QTY	VALVE STEM SEAL SET	YEARS	PART NO.	DESCRIPTION	
1	Valve Stem Seal Set	2005-01	SS 71074	Premium valve stem seals incl.	
QTY	THERMOSTAT HOUSING	YEARS	PART NO.	DESCRIPTION	
1	O-Ring	2005-01	35705	Thermostat Housing	
QTY	WATER PUMP	YEARS	PART NO.	DESCRIPTION	
1	Water Pump Gasket	2005-01	35549		
QTY	TIMING COVER	YEARS	PART NO.	DESCRIPTION	
1	Crankshaft Front Seal Set	2005-01	TCS 45038		
1	Camshaft Front Seal Set	2005-01	TCS 46005		
QTY	CARB & FUEL INJECTION	YEARS	PART NO.	DESCRIPTION	
2	Fuel Injector O-Ring Set	2005-01	ES 70599	Improved design	
1	Throttle Body Gasket	2005-01	61092		
QTY	EXHAUST GAS RECIRCULATION	YEARS	PART NO.	DESCRIPTION	
2	EGR Gasket	2005-01	72803	Air pump gskt.; New Part Number - Check for Availability	
QTY	OIL FILTER MOUNTING	YEARS	PART NO.	DESCRIPTION	
1	Oil Filter Adapter Gasket	2005-01	72969	Oil filter adapter; New Part Number - Check for Availability	
QTY	OIL COOLER	YEARS	PART NO.	DESCRIPTION	
1	Oil Cooler Gasket	2005-01	72485	Oil cooler O-ring; New Part Number - Check for Availability	
7		2006 - 2000; 1.8L 108.6 (1780cc) DOHC L4 (20 Valve) 81mm Bore			7
		MFI; Gasoline; Turbo - Intercooled VW Eng.; Eng. Code AWP			
QTY	CYLINDER HEAD	YEARS	PART NO.	DESCRIPTION	
1	Head Gasket	2006-00	26182 PT	Head bolts not incl.; Head bolt replacement recommended; PermaTorqueMLS®	
1	Head Set	2006-00	HS 26182 PT	Head bolts not incl.; Head bolt replacement recommended; PermaDry® molded rubber valve cover gskt. incl.; Premium valve stem seals incl.	
1	Head Bolt Set	2006-00	ES 71193	Replacement recommended	

Audi Car (Cont.)

7		2006 - 2000; 1.8L 108.6 (1780cc) DOHC L4 (20 Valve) 81mm Bore			7
(cont.)		MFI; Gasoline; Turbo - Intercooled VW Eng.; Eng. Code AWP			(cont.)
QTY	CONVERSION SET	YEARS	PART NO.	DESCRIPTION	
1	Gasket Conversion Set	2006-00	CS 26182	Crankshaft front seal not incl.; PermaDry® molded rubber oil pan gskt. incl.	
QTY	MANIFOLD - INT. & EXH.	YEARS	PART NO.	DESCRIPTION	
1	Int. Manifold Gasket Set	2006-00	MS 96151		
1	Exh. Manifold Gasket Set	2006-00	MS 96116		
QTY	EXHAUST PIPE FLANGE	YEARS	PART NO.	DESCRIPTION	
1	Exhaust Pipe Gasket	2006-00	61197	Flange	
QTY	OIL PAN	YEARS	PART NO.	DESCRIPTION	
1	Oil Pan Gasket Set	2006-00	OS 30708 R	PermaDry® molded rubber gskt. incl.	
QTY	CRANKSHAFT REAR SEAL	YEARS	PART NO.	DESCRIPTION	
1	Rear Main Seal Set	2006-00	BS 40187	w/7mm bolt holes; PTFE Rubber; One-piece	
1	Rear Main Seal Set	2006-00	BS 40724	w/6mm bolt holes; PTFE Rubber; One-piece	
QTY	VALVE COVER	YEARS	PART NO.	DESCRIPTION	
1	Valve Cover Gasket Set	2006-00	VS 50531 R	w/Spark plug tube seals; PermaDry® molded rubber gskt. incl.	
QTY	VALVE STEM SEAL SET	YEARS	PART NO.	DESCRIPTION	
1	Valve Stem Seal Set	2006-00	SS 71074	Premium valve stem seals incl.	
QTY	THERMOSTAT HOUSING	YEARS	PART NO.	DESCRIPTION	
1	Thermostat Gasket	2006-00	35744	Thermostat Housing; Thermostat seal	
1	Thermostat Gasket	2006-00	35750	Thermostat Housing; Thermostat O-ring	
QTY	WATER PUMP	YEARS	PART NO.	DESCRIPTION	
1	Water Pump Gasket	2006-00	35549		
1	O-Ring	2006-00	35675	Water Pump; Housing	
QTY	TIMING COVER	YEARS	PART NO.	DESCRIPTION	
1	Crankshaft Front Seal Set	2006-00	TCS 45038		
1	Camshaft Front Seal Set	2006-00	TCS 46005		
QTY	CARB & FUEL INJECTION	YEARS	PART NO.	DESCRIPTION	
2	Fuel Injector O-Ring Set	2006-00	ES 70599	Improved design	
1	Throttle Body Gasket	2006-00	61092		
QTY	OIL FILTER MOUNTING	YEARS	PART NO.	DESCRIPTION	
1	Oil Filter Adapter Gasket	2006-00	72969	Oil filter adapter; New Part Number - Check for Availability	
QTY	OIL COOLER	YEARS	PART NO.	DESCRIPTION	
1	Oil Cooler Gasket	2006-00	72485	Oil cooler O-ring; New Part Number - Check for Availability	
8		2006 - 2003; 1.8L 108.6 (1780cc) DOHC L4 (20 Valve) 81mm Bore			8
		MFI; Gasoline; Turbo - Intercooled VW Eng.; Eng. Code BEA			
QTY	CYLINDER HEAD	YEARS	PART NO.	DESCRIPTION	
1	Head Gasket	2006-03	26182 PT	Head bolts not incl.; Head bolt replacement recommended; PermaTorqueMLS®	
1	Head Set	2006-03	HS 26182 PT	Head bolts not incl.; Head bolt replacement recommended; PermaDry® molded rubber valve cover gskt. incl.; Premium valve stem seals incl.	
1	Head Bolt Set	2006-03	ES 71193	Replacement recommended	
QTY	CONVERSION SET	YEARS	PART NO.	DESCRIPTION	
1	Gasket Conversion Set	2006-03	CS 26182	Crankshaft front seal not incl.; PermaDry® molded rubber oil pan gskt. incl.	
QTY	MANIFOLD - INT. & EXH.	YEARS	PART NO.	DESCRIPTION	
1	Int. Manifold Gasket Set	2006-03	MS 96151		
1	Exh. Manifold Gasket Set	2006-03	MS 96116		
QTY	EXHAUST PIPE FLANGE	YEARS	PART NO.	DESCRIPTION	
1	Exhaust Pipe Gasket	2006-03	61197	Flange	
QTY	OIL PAN	YEARS	PART NO.	DESCRIPTION	
1	Oil Pan Gasket Set	2006-03	OS 30708 R	PermaDry® molded rubber gskt. incl.	
QTY	CRANKSHAFT REAR SEAL	YEARS	PART NO.	DESCRIPTION	
1	Rear Main Seal Set	2006-03	BS 40187	w/7mm bolt holes; PTFE Rubber; One-piece	
1	Rear Main Seal Set	2006-03	BS 40724	w/6mm bolt holes; PTFE Rubber; One-piece	
QTY	VALVE COVER	YEARS	PART NO.	DESCRIPTION	
1	Valve Cover Gasket Set	2006-03	VS 50531 R	w/Spark plug tube seals; PermaDry® molded rubber gskt. incl.	
QTY	VALVE STEM SEAL SET	YEARS	PART NO.	DESCRIPTION	
1	Valve Stem Seal Set	2006-03	SS 71074	Premium valve stem seals incl.	
QTY	THERMOSTAT HOUSING	YEARS	PART NO.	DESCRIPTION	
1	Thermostat Gasket	2006-03	35744	Thermostat Housing; Thermostat seal	
1	Thermostat Gasket	2006-03	35750	Thermostat Housing; Thermostat O-ring	
QTY	WATER PUMP	YEARS	PART NO.	DESCRIPTION	
1	Water Pump Gasket	2006-03	35549		
1	O-Ring	2006-03	35675	Water Pump; Housing	
QTY	TIMING COVER	YEARS	PART NO.	DESCRIPTION	
1	Crankshaft Front Seal Set	2006-03	TCS 45038		

8		2006 - 2003; 1.8L 108.6 (1780cc) DOHC L4 (20 Valve) 81mm Bore			8
(cont.)		MFI; Gasoline; Turbo - Intercooled VW Eng.; Eng. Code BEA			(cont.)
QTY	TIMING COVER	YEARS	PART NO.	DESCRIPTION	
1	Camshaft Front Seal Set	2006-03	TCS 46005		
QTY	CARB & FUEL INJECTION	YEARS	PART NO.	DESCRIPTION	
2	Fuel Injector O-Ring Set	2006-03	ES 70599	Improved design	
1	Throttle Body Gasket	2006-03	61092		
QTY	OIL FILTER MOUNTING	YEARS	PART NO.	DESCRIPTION	
1	Oil Filter Adapter Gasket	2006-03	72969	Oil filter adapter; New Part Number - Check for Availability	
QTY	OIL COOLER	YEARS	PART NO.	DESCRIPTION	
1	Oil Cooler Gasket	2006-03	72485	Oil cooler O-ring; New Part Number - Check for Availability	
9		2013 - 2005; 2.0L 121 (1984cc) DOHC L4 (16 Valve) 82.5mm Bore			9
		DI; Gasoline; Turbo - Intercooled VW Eng.; Eng. Code BPG			
QTY	CYLINDER HEAD	YEARS	PART NO.	DESCRIPTION	
1	Head Gasket	2013-12	26547 PT	w/Timing chain; Head bolts not incl.; Head bolt replacement recommended; PermaTorqueMLS®; New Part Number - Check for Availability	
1	Head Gasket	2011-08	26455 PT	w/Timing chain; Head bolts not incl.; Head bolt replacement recommended; PermaTorqueMLS®	
1	Head Gasket	2007-05	26318 PT	w/Timing belt; Head bolts not incl.; Head bolt replacement recommended; PermaTorqueMLS®	
1	Head Set	2011-08	HS 26455 PT	w/Timing chain; Head bolts not incl.; Head bolt replacement recommended; RTV sealant incl. for Lower valve cover housing; PermaDry® molded rubber valve cover gskt. incl.; Premium valve stem seals incl.	
1	Head Set	2007-05	HS 26318 PT	w/Timing belt; Head bolts not incl.; Head bolt replacement recommended; PermaDry® molded rubber valve cover gskt. incl.; Premium valve stem seals incl.; Consolidated design	
QTY	CONVERSION SET	YEARS	PART NO.	DESCRIPTION	
1	Gasket Conversion Set	2012-08	CS 26455	RTV sealant incl. for oil pan gskt.; New Part Number - Check for Availability	
1	Gasket Conversion Set	2007-05	CS 26318	RTV sealant incl. for oil pan gskt.	
QTY	MANIFOLD - INT. & EXH.	YEARS	PART NO.	DESCRIPTION	
1	Int. Manifold Gasket Set	2011-05	MS 96780		
1	Exh. Manifold Gasket Set	2011-05	MS 96784		
QTY	EXHAUST PIPE FLANGE	YEARS	PART NO.	DESCRIPTION	
1	Exhaust Pipe Gasket	2011-05	61458	Flange	
1	Exhaust Pipe Gasket	2011-05	61458	Turbo inlet	
QTY	OIL PAN	YEARS	PART NO.	DESCRIPTION	
1	Oil Pan Gasket Set	2012-05	OS 30821		
QTY	CRANKSHAFT REAR SEAL	YEARS	PART NO.	DESCRIPTION	
1	Rear Main Seal Set	2012-08	BS 40725	PTFE Rubber; One-piece; New Part Number - Check for Availability	
1	Rear Main Seal Set	2007-05	BS 40187	PTFE Rubber; One-piece	
QTY	VALVE COVER	YEARS	PART NO.	DESCRIPTION	
1	Valve Cover Gasket Set	2011-08	VS 50762 R	w/Timing chain; RTV sealant incl. for Lower valve cover housing; PermaDry® molded rubber gskt. incl.	
1	Valve Cover Gasket Set	2007-05	VS 50685 R	w/Timing belt; w/Spark plug tube seals; PermaDry® molded rubber gskt. incl.	
QTY	VALVE STEM SEAL SET	YEARS	PART NO.	DESCRIPTION	
1	Valve Stem Seal Set	2011-05	SS 71074-1	Premium valve stem seals incl.	
QTY	THERMOSTAT HOUSING	YEARS	PART NO.	DESCRIPTION	
1	Thermostat Gasket	2011-05	35838	Thermostat Housing; Thermostat housing O-ring	
1	O-Ring	2011-05	35924	Thermostat Housing; Thermostat seal	
QTY	WATER PUMP	YEARS	PART NO.	DESCRIPTION	
1	Water Pump Gasket	2012-08	35872	Housing	
1	O-Ring	2007-05	35675	Water Pump; Housing	
QTY	TIMING COVER	YEARS	PART NO.	DESCRIPTION	
1	Crankshaft Front Seal Set	2012-08	TCS 46138		
1	Crankshaft Front Seal Set	2007-05	TCS 45038		
1	Camshaft Front Seal Set	2011-05	TCS 46005		
QTY	CARB & FUEL INJECTION	YEARS	PART NO.	DESCRIPTION	
1	Throttle Body Gasket	2011-05	61462		
QTY	OIL COOLER	YEARS	PART NO.	DESCRIPTION	
1	Oil Cooler Gasket	2012-05	72485	Oil cooler O-ring; New Part Number - Check for Availability	

Audi Car (Cont.)

10		2013 - 2006; 2.0L 121 (1984cc) DOHC L4 (16 Valve) 82.5mm Bore			10
		DI; Gasoline; Turbo - Intercooled VW Eng.; Eng. Code BPY			
QTY	CYLINDER HEAD	YEARS	PART NO.	DESCRIPTION	
1	Head Gasket	2013-12	26547 PT	w/Timing chain; Head bolts not incl.; Head bolt replacement recommended; PermaTorqueMLS®; New Part Number - Check for Availability	
1	Head Gasket	2011-08	26455 PT	w/Timing chain; Head bolts not incl.; Head bolt replacement recommended; PermaTorqueMLS®	
1	Head Gasket	2007-06	26318 PT	w/Timing belt; Head bolts not incl.; Head bolt replacement recommended; PermaTorqueMLS®	
1	Head Set	2011-08	HS 26455 PT	w/Timing chain; Head bolts not incl.; Head bolt replacement recommended; RTV sealant incl. for Lower valve cover housing; PermaDry® molded rubber valve cover gskt. incl.; Premium valve stem seals incl.	
1	Head Set	2007-06	HS 26318 PT	w/Timing belt; Head bolts not incl.; Head bolt replacement recommended; PermaDry® molded rubber valve cover gskt. incl.; Premium valve stem seals incl.; Consolidated design	
QTY	CONVERSION SET	YEARS	PART NO.	DESCRIPTION	
1	Gasket Conversion Set	2012-08	CS 26455	RTV sealant incl. for oil pan gskt.; New Part Number - Check for Availability	
1	Gasket Conversion Set	2007-06	CS 26318	RTV sealant incl. for oil pan gskt.	
QTY	MANIFOLD - INT. & EXH.	YEARS	PART NO.	DESCRIPTION	
1	Int. Manifold Gasket Set	2011-06	MS 96780		
1	Exh. Manifold Gasket Set	2011-06	MS 96784		
QTY	EXHAUST PIPE FLANGE	YEARS	PART NO.	DESCRIPTION	
1	Exhaust Pipe Gasket	2011-06	61458	Flange	
1	Exhaust Pipe Gasket	2011-06	61458	Turbo inlet	
QTY	OIL PAN	YEARS	PART NO.	DESCRIPTION	
1	Oil Pan Gasket Set	2012-06	OS 30821		
QTY	CRANKSHAFT REAR SEAL	YEARS	PART NO.	DESCRIPTION	
1	Rear Main Seal Set	2012-08	BS 40725	PTFE Rubber; One-piece; New Part Number - Check for Availability	
1	Rear Main Seal Set	2007-06	BS 40187	PTFE Rubber; One-piece	
QTY	VALVE COVER	YEARS	PART NO.	DESCRIPTION	
1	Valve Cover Gasket Set	2011-08	VS 50762 R	w/Timing chain; RTV sealant incl. for Lower valve cover housing; PermaDry® molded rubber gskt. incl.	
1	Valve Cover Gasket Set	2007-06	VS 50685 R	w/Timing belt; w/Spark plug tube seals; PermaDry® molded rubber gskt. incl.	
QTY	VALVE STEM SEAL SET	YEARS	PART NO.	DESCRIPTION	
1	Valve Stem Seal Set	2011-06	SS 71074-1	Premium valve stem seals incl.	
QTY	THERMOSTAT HOUSING	YEARS	PART NO.	DESCRIPTION	
1	Thermostat Gasket	2011-06	35838	Thermostat Housing; Thermostat housing O-ring	
1	O-Ring	2011-06	35924	Thermostat Housing; Thermostat seal	
QTY	WATER PUMP	YEARS	PART NO.	DESCRIPTION	
1	Water Pump Gasket	2012-08	35872	Housing	
1	O-Ring	2007-06	35675	Water Pump; Housing	
QTY	TIMING COVER	YEARS	PART NO.	DESCRIPTION	
1	Crankshaft Front Seal Set	2012-08	TCS 46138		
1	Crankshaft Front Seal Set	2007-06	TCS 45038		
1	Camshaft Front Seal Set	2011-06	TCS 46005		
QTY	CARB & FUEL INJECTION	YEARS	PART NO.	DESCRIPTION	
1	Throttle Body Gasket	2011-06	61462		
QTY	OIL COOLER	YEARS	PART NO.	DESCRIPTION	
1	Oil Cooler Gasket	2012-06	72485	Oil cooler O-ring; New Part Number - Check for Availability	
11		2013 - 2007; 2.0L 121 (1984cc) DOHC L4 (16 Valve) 82.5mm Bore			11
		DI; Gasoline; Turbo - Intercooled VW Eng.; Eng. Code BWT			
QTY	CYLINDER HEAD	YEARS	PART NO.	DESCRIPTION	
1	Head Gasket	2013-12	26547 PT	w/Timing chain; Head bolts not incl.; Head bolt replacement recommended; PermaTorqueMLS®; New Part Number - Check for Availability	
1	Head Gasket	2011-08	26455 PT	w/Timing chain; Head bolts not incl.; Head bolt replacement recommended; PermaTorqueMLS®	
1	Head Gasket	2009-07	26318 PT	w/Timing belt; Head bolts not incl.; Head bolt replacement recommended; PermaTorqueMLS®	
1	Head Set	2011-08	HS 26455 PT	w/Timing chain; Head bolts not incl.; Head bolt replacement recommended; RTV sealant incl. for Lower valve cover housing; PermaDry® molded rubber valve cover gskt. incl.; Premium valve stem seals incl.	
1	Head Set	2009-07	HS 26318 PT	w/Timing belt; Head bolts not incl.; Head bolt replacement recommended; PermaDry® molded rubber valve cover gskt. incl.; Premium valve stem seals incl.; Consolidated design	

11		2013 - 2007; 2.0L 121 (1984cc) DOHC L4 (16 Valve) 82.5mm Bore			11	
(cont.)		DI; Gasoline; Turbo - Intercooled VW Eng.; Eng. Code BWT			(cont.)	
QTY	CONVERSION SET	YEARS	PART NO.	DESCRIPTION		
1	Gasket Conversion Set	2012-08	CS 26455	RTV sealant incl. for oil pan gskt.; New Part Number - Check for Availability		
1	Gasket Conversion Set	2007	CS 26318	RTV sealant incl. for oil pan gskt.		
QTY	MANIFOLD - INT. & EXH.	YEARS	PART NO.	DESCRIPTION		
1	Int. Manifold Gasket Set	2011-07	MS 96780			
1	Exh. Manifold Gasket Set	2011-07	MS 96784			
QTY	EXHAUST PIPE FLANGE	YEARS	PART NO.	DESCRIPTION		
1	Exhaust Pipe Gasket	2011-07	61458	Flange		
1	Exhaust Pipe Gasket	2011-07	61458	Turbo inlet		
QTY	OIL PAN	YEARS	PART NO.	DESCRIPTION		
1	Oil Pan Gasket Set	2012-07	OS 30821			
QTY	CRANKSHAFT REAR SEAL	YEARS	PART NO.	DESCRIPTION		
1	Rear Main Seal Set	2012-08	BS 40725	PTFE Rubber; One-piece; New Part Number - Check for Availability		
1	Rear Main Seal Set	2007	BS 40187	PTFE Rubber; One-piece		
QTY	VALVE COVER	YEARS	PART NO.	DESCRIPTION		
1	Valve Cover Gasket Set	2011-08	VS 50762 R	w/Timing chain; RTV sealant incl. for Lower valve cover housing; PermaDry® molded rubber gskt. incl.		
1	Valve Cover Gasket Set	2009-07	VS 50685 R	w/Timing belt; w/Spark plug tube seals; PermaDry® molded rubber gskt. incl.		
QTY	VALVE STEM SEAL SET	YEARS	PART NO.	DESCRIPTION		
1	Valve Stem Seal Set	2011-07	SS 71074-1	Premium valve stem seals incl.		
QTY	THERMOSTAT HOUSING	YEARS	PART NO.	DESCRIPTION		
1	Thermostat Gasket	2011-07	35838	Thermostat Housing; Thermostat housing O-ring		
1	O-Ring	2011-07	35924	Thermostat Housing; Thermostat seal		
QTY	WATER PUMP	YEARS	PART NO.	DESCRIPTION		
1	Water Pump Gasket	2012-08	35872	Housing		
1	O-Ring	2007	35675	Water Pump; Housing		
QTY	TIMING COVER	YEARS	PART NO.	DESCRIPTION		
1	Crankshaft Front Seal Set	2012-08	TCS 46138			
1	Crankshaft Front Seal Set	2007	TCS 45038			
1	Camshaft Front Seal Set	2011-07	TCS 46005			
QTY	CARB & FUEL INJECTION	YEARS	PART NO.	DESCRIPTION		
1	Throttle Body Gasket	2011-07	61462			
QTY	OIL COOLER	YEARS	PART NO.	DESCRIPTION		
1	Oil Cooler Gasket	2012-07	72485	Oil cooler O-ring; New Part Number - Check for Availability		
12		2013 - 2012; 2.0L 121 (1984cc) DOHC L4 (16 Valve) 82.5mm Bore			12	
(cont.)		DI; Gasoline; Turbo - Intercooled VW Eng.; Eng. Code CAEB			(cont.)	
QTY	CYLINDER HEAD	YEARS	PART NO.	DESCRIPTION		
1	Head Gasket	2013-12	26547 PT	Head bolts not incl.; Head bolt replacement recommended; PermaTorqueMLS®; New Part Number - Check for Availability		
QTY	CONVERSION SET	YEARS	PART NO.	DESCRIPTION		
1	Gasket Conversion Set	2012	CS 26455	RTV sealant incl. for oil pan gskt.; New Part Number - Check for Availability		
QTY	OIL PAN	YEARS	PART NO.	DESCRIPTION		
1	Oil Pan Gasket Set	2012	OS 30821			
QTY	CRANKSHAFT REAR SEAL	YEARS	PART NO.	DESCRIPTION		
1	Rear Main Seal Set	2012	BS 40725	PTFE Rubber; One-piece; New Part Number - Check for Availability		
QTY	WATER PUMP	YEARS	PART NO.	DESCRIPTION		
1	Water Pump Gasket	2012	35872			
QTY	TIMING COVER	YEARS	PART NO.	DESCRIPTION		
1	Crankshaft Front Seal Set	2012	TCS 46138			
QTY	OIL COOLER	YEARS	PART NO.	DESCRIPTION		
1	Oil Cooler Gasket	2012	72485	Oil cooler O-ring; New Part Number - Check for Availability		
13		2013 - 2012; 2.0L 121 (1984cc) DOHC L4 (16 Valve) 82.5mm Bore			13	
(cont.)		DI; Gasoline; Turbo - Intercooled VW Eng.; Eng. Code CBFA			(cont.)	
QTY	CYLINDER HEAD	YEARS	PART NO.	DESCRIPTION		
1	Head Gasket	2013-12	26547 PT	Head bolts not incl.; Head bolt replacement recommended; PermaTorqueMLS®; New Part Number - Check for Availability		
QTY	CONVERSION SET	YEARS	PART NO.	DESCRIPTION		
1	Gasket Conversion Set	2012	CS 26455	RTV sealant incl. for oil pan gskt.; New Part Number - Check for Availability		
QTY	OIL PAN	YEARS	PART NO.	DESCRIPTION		
1	Oil Pan Gasket Set	2012	OS 30821			

Audi Car (Cont.)

13		2013 - 2012; 2.0L 121 (1984cc) DOHC L4 (16 Valve) 82.5mm Bore			13
(cont.)		DI; Gasoline; Turbo - Intercooled VW Eng.; Eng. Code CBFA			(cont.)
QTY	CRANKSHAFT REAR SEAL	YEARS	PART NO.	DESCRIPTION	
1	Rear Main Seal Set	2012	BS 40725	PTFE Rubber; One-piece; New Part Number - Check for Availability	
QTY	WATER PUMP	YEARS	PART NO.	DESCRIPTION	
1	Water Pump Gasket	2012	35872	Housing	
QTY	TIMING COVER	YEARS	PART NO.	DESCRIPTION	
1	Crankshaft Front Seal Set	2012	TCS 46138		
QTY	OIL COOLER	YEARS	PART NO.	DESCRIPTION	
1	Oil Cooler Gasket	2012	72485	Oil cooler O-ring; New Part Number - Check for Availability	
14		2013 - 2012; 2.0L 121 (1984cc) DOHC L4 (16 Valve) 82.5mm Bore			14
		DI; Gasoline; Turbo - Intercooled VW Eng.; Eng. Code CCTA			
QTY	CYLINDER HEAD	YEARS	PART NO.	DESCRIPTION	
1	Head Gasket	2013-12	26547 PT	Head bolts not incl.; Head bolt replacement recommended; PermaTorqueMLS®; New Part Number - Check for Availability	
QTY	CONVERSION SET	YEARS	PART NO.	DESCRIPTION	
1	Gasket Conversion Set	2012	CS 26455	RTV sealant incl. for oil pan gskt.; New Part Number - Check for Availability	
QTY	OIL PAN	YEARS	PART NO.	DESCRIPTION	
1	Oil Pan Gasket Set	2012	OS 30821		
QTY	CRANKSHAFT REAR SEAL	YEARS	PART NO.	DESCRIPTION	
1	Rear Main Seal Set	2012	BS 40725	PTFE Rubber; One-piece; New Part Number - Check for Availability	
QTY	WATER PUMP	YEARS	PART NO.	DESCRIPTION	
1	Water Pump Gasket	2012	35872	Housing	
QTY	TIMING COVER	YEARS	PART NO.	DESCRIPTION	
1	Crankshaft Front Seal Set	2012	TCS 46138		
QTY	OIL COOLER	YEARS	PART NO.	DESCRIPTION	
1	Oil Cooler Gasket	2012	72485	Oil cooler O-ring; New Part Number - Check for Availability	
15		2013 - 2012; 2.0L 121 (1984cc) DOHC L4 (16 Valve) 82.5mm Bore			15
		DI; Gasoline; Turbo - Intercooled VW Eng.; Eng. Code CDMA			
QTY	CYLINDER HEAD	YEARS	PART NO.	DESCRIPTION	
1	Head Gasket	2013-12	26547 PT	Head bolts not incl.; Head bolt replacement recommended; PermaTorqueMLS®; New Part Number - Check for Availability	
QTY	CONVERSION SET	YEARS	PART NO.	DESCRIPTION	
1	Gasket Conversion Set	2012	CS 26455	RTV sealant incl. for oil pan gskt.; New Part Number - Check for Availability	
QTY	OIL PAN	YEARS	PART NO.	DESCRIPTION	
1	Oil Pan Gasket Set	2012	OS 30821		
QTY	CRANKSHAFT REAR SEAL	YEARS	PART NO.	DESCRIPTION	
1	Rear Main Seal Set	2012	BS 40725	PTFE Rubber; One-piece; New Part Number - Check for Availability	
QTY	WATER PUMP	YEARS	PART NO.	DESCRIPTION	
1	Water Pump Gasket	2012	35872	Housing	
QTY	TIMING COVER	YEARS	PART NO.	DESCRIPTION	
1	Crankshaft Front Seal Set	2012	TCS 46138		
QTY	OIL COOLER	YEARS	PART NO.	DESCRIPTION	
1	Oil Cooler Gasket	2012	72485	Oil cooler O-ring; New Part Number - Check for Availability	
16		2013 - 2012; 2.0L 121 (1984cc) DOHC L4 (16 Valve) 82.5mm Bore			16
		DI; Gasoline; Turbo - Intercooled VW Eng.; Eng. Code CESA			
QTY	CYLINDER HEAD	YEARS	PART NO.	DESCRIPTION	
1	Head Gasket	2013-12	26547 PT	Head bolts not incl.; Head bolt replacement recommended; PermaTorqueMLS®; New Part Number - Check for Availability	
QTY	CONVERSION SET	YEARS	PART NO.	DESCRIPTION	
1	Gasket Conversion Set	2012	CS 26455	RTV sealant incl. for oil pan gskt.; New Part Number - Check for Availability	
QTY	OIL PAN	YEARS	PART NO.	DESCRIPTION	
1	Oil Pan Gasket Set	2012	OS 30821		
QTY	CRANKSHAFT REAR SEAL	YEARS	PART NO.	DESCRIPTION	
1	Rear Main Seal Set	2012	BS 40725	PTFE Rubber; One-piece; New Part Number - Check for Availability	
QTY	WATER PUMP	YEARS	PART NO.	DESCRIPTION	
1	Water Pump Gasket	2012	35872	Housing	
QTY	TIMING COVER	YEARS	PART NO.	DESCRIPTION	
1	Crankshaft Front Seal Set	2012	TCS 46138		
QTY	OIL COOLER	YEARS	PART NO.	DESCRIPTION	
1	Oil Cooler Gasket	2012	72485	Oil cooler O-ring; New Part Number - Check for Availability	

17		2013 - 2012; 2.0L 121 (1984cc) DOHC L4 (16 Valve) 82.5mm Bore DI; Gasoline; Turbo - Intercooled VW Eng.; Eng. Code CETA			17
QTY	CYLINDER HEAD	YEARS	PART NO.	DESCRIPTION	
1	Head Gasket	2013-12	26547 PT	Head bolts not incl.; Head bolt replacement recommended; PermaTorqueMLS®; New Part Number - Check for Availability	
QTY	CONVERSION SET	YEARS	PART NO.	DESCRIPTION	
1	Gasket Conversion Set	2012	CS 26455	RTV sealant incl. for oil pan gskt.; New Part Number - Check for Availability	
QTY	OIL PAN	YEARS	PART NO.	DESCRIPTION	
1	Oil Pan Gasket Set	2012	OS 30821		
QTY	CRANKSHAFT REAR SEAL	YEARS	PART NO.	DESCRIPTION	
1	Rear Main Seal Set	2012	BS 40725	PTFE Rubber; One-piece; New Part Number - Check for Availability	
QTY	WATER PUMP	YEARS	PART NO.	DESCRIPTION	
1	Water Pump Gasket	2012	35872	Housing	
QTY	TIMING COVER	YEARS	PART NO.	DESCRIPTION	
1	Crankshaft Front Seal Set	2012	TCS 46138		
QTY	OIL COOLER	YEARS	PART NO.	DESCRIPTION	
1	Oil Cooler Gasket	2012	72485	Oil cooler O-ring; New Part Number - Check for Availability	
18		1991; 2.2L 135.8 (2226cc) SOHC L5 (10 Valve) 81mm Bore MFI; Gasoline; Turbo - Intercooled Audi Eng.; Eng. Code MC			18
QTY	CYLINDER HEAD	YEARS	PART NO.	DESCRIPTION	
1	Head Gasket	1991	9282 B	Head bolts not incl.; Head bolt replacement recommended	
QTY	MANIFOLD - INT. & EXH.	YEARS	PART NO.	DESCRIPTION	
1	Exh. Manifold Gasket Set	1991	MS 94063		
QTY	CRANKSHAFT REAR SEAL	YEARS	PART NO.	DESCRIPTION	
1	Rear Main Seal Set	1991	BS 40427	Rubber; One-piece; Improved design	
QTY	VALVE COVER	YEARS	PART NO.	DESCRIPTION	
1	Valve Cover Gasket Set	1991	VS 50236 C	w/Semi-circular plug	
QTY	THERMOSTAT HOUSING	YEARS	PART NO.	DESCRIPTION	
1	Water Outlet Gasket	1991	25589	Thermostat Housing; O-ring; New Improved design	
1	Thermostat Gasket	1991	25615	Thermostat Housing	
1	O-Ring	1991	35327	Thermostat Housing; Old design	
1	O-Ring	1991	35763	Thermostat Housing; Improved design	
QTY	TIMING COVER	YEARS	PART NO.	DESCRIPTION	
1	Camshaft Front Seal Set	1991	TCS 45357		
QTY	CARB & FUEL INJECTION	YEARS	PART NO.	DESCRIPTION	
1	Throttle Body Gasket	1991	23623		
19		1992 - 1991; 2.3L 140.8 (2309cc) DOHC L5 (20 Valve) 82.5mm Bore MFI; Gasoline; Naturally Aspirated Audi Eng.; Eng. Code 7A			19
QTY	CRANKSHAFT REAR SEAL	YEARS	PART NO.	DESCRIPTION	
1	Rear Main Seal Set	1992-91	BS 40427	Rubber; One-piece; Improved design	
QTY	VALVE COVER	YEARS	PART NO.	DESCRIPTION	
2	Semi-Circular Plug	1992-91	CP 75002	Valve Cover	
QTY	THERMOSTAT HOUSING	YEARS	PART NO.	DESCRIPTION	
1	Water Outlet Gasket	1992-91	25589	Thermostat Housing; O-ring; New Improved design	
1	O-Ring	1992-91	35327	Thermostat Housing; Old design	
1	O-Ring	1992-91	35763	Thermostat Housing; Improved design	
QTY	TIMING COVER	YEARS	PART NO.	DESCRIPTION	
2	Camshaft Front Seal Set	1992-91	TCS 45357		
QTY	CARB & FUEL INJECTION	YEARS	PART NO.	DESCRIPTION	
1	Throttle Body Gasket	1992-91	23623		
QTY	EXHAUST GAS RECIRCULATION	YEARS	PART NO.	DESCRIPTION	
1	EGR Gasket	1992-91	70982		
20		1991; 2.3L 140.8 (2309cc) SOHC L5 (10 Valve) 82.5mm Bore MFI; Gasoline; Naturally Aspirated Audi Eng.; Eng. Code NF			20
QTY	MANIFOLD - INT. & EXH.	YEARS	PART NO.	DESCRIPTION	
1	Int. Manifold Gasket Set	1991	MS 94073		
1	Exh. Manifold Gasket Set	1991	MS 94063		
QTY	EXHAUST PIPE FLANGE	YEARS	PART NO.	DESCRIPTION	
1	Exhaust Pipe Gasket	1991	60708	Flange	
QTY	CRANKSHAFT REAR SEAL	YEARS	PART NO.	DESCRIPTION	
1	Rear Main Seal Set	1991	BS 40427	Rubber; One-piece; Improved design	
QTY	VALVE COVER	YEARS	PART NO.	DESCRIPTION	
1	Valve Cover Gasket Set	1991	VS 50236 C	w/Semi-circular plug	

Audi Car (Cont.)

20 (cont.)		1991; 2.3L 140.8 (2309cc) SOHC L5 (10 Valve) 82.5mm Bore			20 (cont.)
		MFI; Gasoline; Naturally Aspirated Audi Eng.; Eng. Code NF			
QTY	THERMOSTAT HOUSING	YEARS	PART NO.	DESCRIPTION	
1	Water Outlet Gasket	1991	25589	Thermostat Housing; O-ring; New Improved design	
1	Thermostat Gasket	1991	25615	Thermostat Housing	
1	O-Ring	1991	35327	Thermostat Housing; Old design	
1	O-Ring	1991	35763	Thermostat Housing; Improved design	
QTY	TIMING COVER	YEARS	PART NO.	DESCRIPTION	
1	Camshaft Front Seal Set	1991	TCS 45357		
QTY	CARB & FUEL INJECTION	YEARS	PART NO.	DESCRIPTION	
1	Throttle Body Gasket	1991	23623		
21		1992 - 1991; 2.3L 140.8 (2309cc) SOHC L5 (10 Valve) 82.5mm Bore			21
		MFI; Gasoline; Naturally Aspirated Audi Eng.; Eng. Code NG			
QTY	MANIFOLD - INT. & EXH.	YEARS	PART NO.	DESCRIPTION	
1	Int. Manifold Gasket Set	1992-91	MS 94073		
1	Exh. Manifold Gasket Set	1992-91	MS 94063		
QTY	EXHAUST PIPE FLANGE	YEARS	PART NO.	DESCRIPTION	
1	Exhaust Pipe Gasket	1992-91	60708	Flange	
QTY	CRANKSHAFT REAR SEAL	YEARS	PART NO.	DESCRIPTION	
1	Rear Main Seal Set	1992-91	BS 40427	Rubber; One-piece; Improved design	
QTY	VALVE COVER	YEARS	PART NO.	DESCRIPTION	
1	Valve Cover Gasket Set	1992-91	VS 50236 C	w/Semi-circular plug	
QTY	THERMOSTAT HOUSING	YEARS	PART NO.	DESCRIPTION	
1	Water Outlet Gasket	1992-91	25589	Thermostat Housing; O-ring; New Improved design	
1	Thermostat Gasket	1992-91	25615	Thermostat Housing	
1	O-Ring	1992-91	35327	Thermostat Housing; Old design	
1	O-Ring	1992-91	35763	Thermostat Housing; Improved design	
QTY	TIMING COVER	YEARS	PART NO.	DESCRIPTION	
1	Camshaft Front Seal Set	1992-91	TCS 45357		
QTY	CARB & FUEL INJECTION	YEARS	PART NO.	DESCRIPTION	
1	Throttle Body Gasket	1992-91	23623		
22		2002 - 2000; 2.7L 163 (2671cc) DOHC V6 (30 Valve) 81mm Bore			22
		MFI; Gasoline; Turbo - Intercooled Audi Eng.; Eng. Code APB			
QTY	CYLINDER HEAD	YEARS	PART NO.	DESCRIPTION	
2	Head Gasket	2002-00	26607 PT	Head bolts not incl.; Head bolt replacement recommended; PermaTorqueMLS®; New Part Number - Check for Availability	
2	Head Set	2002-00	HS 26607 PT	Head bolts not incl.; Head bolt replacement recommended; PermaDry® molded rubber valve cover gskt. incl.; Premium valve stem seals incl.; New Part Number - Check for Availability	
1	Head Bolt Set	2002-00	ES 72870	OEM style; Replacement recommended; New Part Number - Check for Availability	
QTY	MANIFOLD - INT. & EXH.	YEARS	PART NO.	DESCRIPTION	
1	Int. Manifold Gasket Set	2002-00	MS 97314	Lower set; New Part Number - Check for Availability	
1	Exh. Manifold Gasket Set	2002-00	MS 96882		
QTY	VALVE COVER	YEARS	PART NO.	DESCRIPTION	
1	Valve Cover Gasket Set	2002-00	VS 50702 R	w/Spark plug tube seals; PermaDry® molded rubber gskts. incl.	
QTY	VALVE STEM SEAL SET	YEARS	PART NO.	DESCRIPTION	
1	Valve Stem Seal Set	2002-00	SS 71074-2	Premium valve stem seals incl.	
QTY	THERMOSTAT HOUSING	YEARS	PART NO.	DESCRIPTION	
1	Water Outlet Gasket	2002-00	25589	Thermostat Housing; Thermostat O-ring; New Improved design	
1	O-Ring	2002-00	35763	Thermostat Housing; Thermostat O-ring; Improved design	
QTY	WATER PUMP	YEARS	PART NO.	DESCRIPTION	
1	Water Pump Gasket	2002-00	35829		
QTY	TIMING COVER	YEARS	PART NO.	DESCRIPTION	
1	Crankshaft Front Seal Set	2002-00	TCS 45038-1		
2	Camshaft Front Seal Set	2002-00	ES 72806	Camshaft circular plug; New Part Number - Check for Availability	
2	Camshaft Rear Seal Set	2002	TCS 46186	Exc. Audi S4 Avant, Base; From Chassis No. 4B-2-040-001; New Part Number - Check for Availability	
QTY	EXHAUST GAS RECIRCULATION	YEARS	PART NO.	DESCRIPTION	
2	EGR Gasket	2002-00	72803	Air pump gskt.; New Part Number - Check for Availability	

23		2004 - 2003; 2.7L 163 (2671cc) DOHC V6 (30 Valve) 81mm Bore			23
		MFI; Gasoline; Turbo - Intercooled Audi Eng.; Eng. Code BEL			
QTY	CYLINDER HEAD	YEARS	PART NO.	DESCRIPTION	
2	Head Gasket	2004-03	26607 PT	Head bolts not incl.; Head bolt replacement recommended; PermaTorqueMLS®; New Part Number - Check for Availability	
2	Head Set	2004-03	HS 26607 PT	Head bolts not incl.; Head bolt replacement recommended; PermaDry® molded rubber valve cover gskt. incl.; Premium valve stem seals incl.; New Part Number - Check for Availability	
1	Head Bolt Set	2004-03	ES 72870	OEM style; Replacement recommended; New Part Number - Check for Availability	
QTY	MANIFOLD - INT. & EXH.	YEARS	PART NO.	DESCRIPTION	
1	Int. Manifold Gasket Set	2004-03	MS 97314	Lower set; New Part Number - Check for Availability	
1	Exh. Manifold Gasket Set	2004-03	MS 96882		
QTY	VALVE COVER	YEARS	PART NO.	DESCRIPTION	
1	Valve Cover Gasket Set	2004-03	VS 50702 R	w/Spark plug tube seals; PermaDry® molded rubber gskts. incl.	
QTY	VALVE STEM SEAL SET	YEARS	PART NO.	DESCRIPTION	
1	Valve Stem Seal Set	2004-03	SS 71074-2	Premium valve stem seals incl.	
QTY	THERMOSTAT HOUSING	YEARS	PART NO.	DESCRIPTION	
1	Water Outlet Gasket	2004-03	25589	Thermostat Housing; Thermostat O-ring; New Improved design	
1	O-Ring	2004-03	35763	Thermostat Housing; Thermostat O-ring; Improved design	
QTY	WATER PUMP	YEARS	PART NO.	DESCRIPTION	
1	Water Pump Gasket	2003	35829	Audi S4 Avant, Base	
QTY	TIMING COVER	YEARS	PART NO.	DESCRIPTION	
1	Crankshaft Front Seal Set	2004-03	TCS 45038-1		
2	Camshaft Front Seal Set	2004-03	ES 72806	Camshaft circular plug; New Part Number - Check for Availability	
2	Camshaft Rear Seal Set	2004-03	TCS 46186	New Part Number - Check for Availability	
QTY	EXHAUST GAS RECIRCULATION	YEARS	PART NO.	DESCRIPTION	
2	EGR Gasket	2004-03	72803	Air pump gskt.; New Part Number - Check for Availability	
24		2001 - 1997; 2.8L 169 (2771cc) DOHC V6 (30 Valve) 82.5mm Bore			24
		MFI; Gasoline; Naturally Aspirated Audi Eng.; Eng. Code AHA			
QTY	CYLINDER HEAD	YEARS	PART NO.	DESCRIPTION	
2	Head Gasket	2001-97	26328 PT	Head bolts not incl.; Head bolt replacement recommended; PermaTorqueMLS®	
1	Head Set	2001-97	HS 26328 PT	Head bolts not incl.; Head bolt replacement recommended; PermaDry® molded rubber valve cover gskts. incl.; Premium valve stem seals incl.	
1	Head Bolt Set	2001-97	ES 72870	OEM style; Replacement recommended; New Part Number - Check for Availability	
QTY	CONVERSION SET	YEARS	PART NO.	DESCRIPTION	
1	Gasket Conversion Set	2001-97	CS 26328	RTV sealant incl. for Upper oil pan gskt.	
QTY	MANIFOLD - INT. & EXH.	YEARS	PART NO.	DESCRIPTION	
1	Int. Manifold Gasket Set	2001-97	MS 96890		
1	Exh. Manifold Gasket Set	2001-00	MS 96882		
1	Exh. Manifold Gasket Set	1999-97	MS 97276	New Part Number - Check for Availability	
QTY	EXHAUST PIPE FLANGE	YEARS	PART NO.	DESCRIPTION	
2	Exhaust Pipe Gasket	2001-97	61171	Flange	
QTY	OIL PAN	YEARS	PART NO.	DESCRIPTION	
1	Oil Pan Gasket Set	2001-97	OS 30779	RTV sealant incl. for Upper oil pan gskt.	
QTY	CRANKSHAFT REAR SEAL	YEARS	PART NO.	DESCRIPTION	
1	Rear Main Seal Set	2001-97	BS 40704	PTFE Rubber; One-piece	
QTY	VALVE COVER	YEARS	PART NO.	DESCRIPTION	
1	Valve Cover Gasket Set	2001-97	VS 50702 R	w/Spark plug tube seals; PermaDry® molded rubber gskts. incl.	
QTY	VALVE STEM SEAL SET	YEARS	PART NO.	DESCRIPTION	
1	Valve Stem Seal Set	2001-97	SS 71074-2	Premium valve stem seals incl.	
QTY	THERMOSTAT HOUSING	YEARS	PART NO.	DESCRIPTION	
1	Water Outlet Gasket	2001-97	25589	Thermostat Housing; Thermostat O-ring; New Improved design	
1	O-Ring	2001-97	35327	Thermostat Housing; Thermostat O-ring; Old design	
1	O-Ring	2001-97	35763	Thermostat Housing; Thermostat O-ring; Improved design	
QTY	WATER PUMP	YEARS	PART NO.	DESCRIPTION	
1	Water Pump Gasket	2001-97	35829		
QTY	TIMING COVER	YEARS	PART NO.	DESCRIPTION	
1	Crankshaft Front Seal Set	2001-97	TCS 45038-1		
2	Camshaft Front Seal Set	2001-97	ES 72806	Camshaft circular plug; New Part Number - Check for Availability	
QTY	CARB & FUEL INJECTION	YEARS	PART NO.	DESCRIPTION	
3	Fuel Injector O-Ring Set	2001-97	ES 70599	Improved design	
1	Throttle Body Gasket	2001-97	61491		

Audi Car (Cont.)

24 (cont.)		2001 - 1997; 2.8L 169 (2771cc) DOHC V6 (30 Valve) 82.5mm Bore			24 (cont.)
MFI; Gasoline; Naturally Aspirated Audi Eng.; Eng. Code AHA					
QTY	EXHAUST GAS RECIRCULATION	YEARS	PART NO.	DESCRIPTION	
4	EGR Gasket	2001-97	72803	Air pump gskt.; New Part Number - Check for Availability	
25		2001 - 2000; 2.8L 169 (2771cc) DOHC V6 (30 Valve) 82.5mm Bore			25
MFI; Gasoline; Naturally Aspirated Audi Eng.; Eng. Code ATQ					
QTY	CYLINDER HEAD	YEARS	PART NO.	DESCRIPTION	
2	Head Gasket	2001-00	26328 PT	Head bolts not incl.; Head bolt replacement recommended; PermaTorqueMLS®	
1	Head Set	2001-00	HS 26328 PT	Head bolts not incl.; Head bolt replacement recommended; PermaDry® molded rubber valve cover gskts. incl.; Premium valve stem seals incl.	
1	Head Bolt Set	2001-00	ES 72870	OEM style; Replacement recommended; New Part Number - Check for Availability	
QTY	CONVERSION SET	YEARS	PART NO.	DESCRIPTION	
1	Gasket Conversion Set	2001-00	CS 26328	RTV sealant incl. for Upper oil pan gskt.	
QTY	MANIFOLD - INT. & EXH.	YEARS	PART NO.	DESCRIPTION	
1	Int. Manifold Gasket Set	2001-00	MS 96890		
1	Exh. Manifold Gasket Set	2001-00	MS 96882		
QTY	EXHAUST PIPE FLANGE	YEARS	PART NO.	DESCRIPTION	
2	Exhaust Pipe Gasket	2001-00	61171	Flange	
QTY	OIL PAN	YEARS	PART NO.	DESCRIPTION	
1	Oil Pan Gasket Set	2001-00	OS 30779	RTV sealant incl. for Upper oil pan gskt.	
QTY	CRANKSHAFT REAR SEAL	YEARS	PART NO.	DESCRIPTION	
1	Rear Main Seal Set	2001-00	BS 40704	PTFE Rubber; One-piece	
QTY	VALVE COVER	YEARS	PART NO.	DESCRIPTION	
1	Valve Cover Gasket Set	2001-00	VS 50702 R	w/Spark plug tube seals; PermaDry® molded rubber gskts. incl.	
QTY	VALVE STEM SEAL SET	YEARS	PART NO.	DESCRIPTION	
1	Valve Stem Seal Set	2001-00	SS 71074-2	Premium valve stem seals incl.	
QTY	THERMOSTAT HOUSING	YEARS	PART NO.	DESCRIPTION	
1	Water Outlet Gasket	2001-00	25589	Thermostat Housing; Thermostat O-ring; New Improved design	
1	O-Ring	2001-00	35327	Thermostat Housing; Thermostat O-ring; Old design	
1	O-Ring	2001-00	35763	Thermostat Housing; Thermostat O-ring; Improved design	
QTY	WATER PUMP	YEARS	PART NO.	DESCRIPTION	
1	Water Pump Gasket	2001-00	35829		
QTY	TIMING COVER	YEARS	PART NO.	DESCRIPTION	
1	Crankshaft Front Seal Set	2001-00	TCS 45038-1		
2	Camshaft Front Seal Set	2001-00	ES 72806	Camshaft circular plug; New Part Number - Check for Availability	
QTY	CARB & FUEL INJECTION	YEARS	PART NO.	DESCRIPTION	
3	Fuel Injector O-Ring Set	2001-00	ES 70599	Improved design	
1	Throttle Body Gasket	2001-00	61491		
QTY	EXHAUST GAS RECIRCULATION	YEARS	PART NO.	DESCRIPTION	
4	EGR Gasket	2001-00	72803	Air pump gskt.; New Part Number - Check for Availability	
26		1998 - 1992; 2.8L 169 (2771cc) SOHC V6 (12 Valve) 82.5mm Bore			26
MFI; Gasoline; Naturally Aspirated Audi Eng.; Eng. Code AAH					
QTY	CYLINDER HEAD	YEARS	PART NO.	DESCRIPTION	
1	Head Bolt Set	1998-92	ES 72958	Head bolts w/Washers; Replacement recommended; New Part Number - Check for Availability	
QTY	OIL PAN	YEARS	PART NO.	DESCRIPTION	
1	Oil Pan Gasket Set	1998-96	OS 30864	Loc. Upper; From Chassis No. 8G-S-001-303; New Part Number - Check for Availability	
1	Oil Pan Gasket Set	1998-96	OS 30865	Loc. Lower; From Chassis No. 8G-S-001-303; New Part Number - Check for Availability	
1	Oil Pan Gasket Set	1995	OS 30864	Audi A6 Avant, Base; Loc. Upper; From Chassis No. 4A-S-026-716; New Part Number - Check for Availability	
1	Oil Pan Gasket Set	1995	OS 30864	Exc. Audi A6 Avant, Base, Cabriolet Base; Loc. Upper; From Chassis No. 8C-S-025-821; New Part Number - Check for Availability	
1	Oil Pan Gasket Set	1995	OS 30864	Audi Cabriolet Base; Loc. Upper; From Chassis No. 8G-S-001-303; New Part Number - Check for Availability	
1	Oil Pan Gasket Set	1995	OS 30865	Audi A6 Avant, Base; Loc. Lower; From Chassis No. 4A-S-026-716; New Part Number - Check for Availability	
1	Oil Pan Gasket Set	1995	OS 30865	Exc. Audi A6 Avant, Base, Cabriolet Base; Loc. Lower; From Chassis No. 8C-S-025-821; New Part Number - Check for Availability	
1	Oil Pan Gasket Set	1995	OS 30865	Audi Cabriolet Base; Loc. Lower; From Chassis No. 8G-S-001-303; New Part Number - Check for Availability	

26 (cont.)		1998 - 1992; 2.8L 169 (2771cc) SOHC V6 (12 Valve) 82.5mm Bore			26 (cont.)
MFI; Gasoline; Naturally Aspirated Audi Eng.; Eng. Code AAH					
QTY	OIL PAN	YEARS	PART NO.	DESCRIPTION	
1	Oil Pan Gasket Set	1994-93	OS 30864	Audi 90 CS, S, 90 Quattro CS; Loc. Upper; From Chassis No. 8C-S-025-821; New Part Number - Check for Availability	
1	Oil Pan Gasket Set	1994-93	OS 30865	Audi 90 CS, S, 90 Quattro CS; Loc. Lower; From Chassis No. 8C-S-025-821; New Part Number - Check for Availability	
1	Oil Pan Gasket Set	1994	OS 30864	Audi Cabriolet Base; Loc. Upper; From Chassis No. 8G-S-001-303; New Part Number - Check for Availability	
1	Oil Pan Gasket Set	1994	OS 30865	Audi Cabriolet Base; Loc. Lower; From Chassis No. 8G-S-001-303; New Part Number - Check for Availability	
QTY	VALVE COVER	YEARS	PART NO.	DESCRIPTION	
1	Valve Cover Gasket Set	1998-92	VS 50787 R	PermaDry® molded rubber gskts. incl.	
QTY	TIMING COVER	YEARS	PART NO.	DESCRIPTION	
2	Camshaft Front Seal Set	1998-92	ES 72806	Camshaft circular plug; New Part Number - Check for Availability	
27		1998 - 1994; 2.8L 169 (2771cc) SOHC V6 (12 Valve) 82.5mm Bore			27
MFI; Gasoline; Naturally Aspirated Audi Eng.; Eng. Code AFC					
QTY	CYLINDER HEAD	YEARS	PART NO.	DESCRIPTION	
1	Head Bolt Set	1998-94	ES 72958	Head bolts w/Washers; Replacement recommended; New Part Number - Check for Availability	
QTY	OIL PAN	YEARS	PART NO.	DESCRIPTION	
1	Oil Pan Gasket Set	1998-96	OS 30864	Loc. Upper; New Part Number - Check for Availability	
1	Oil Pan Gasket Set	1998-96	OS 30865	Loc. Lower; New Part Number - Check for Availability	
1	Oil Pan Gasket Set	1995-94	OS 30864	Loc. Upper; From Chassis No. 4A-S-026-716; New Part Number - Check for Availability	
1	Oil Pan Gasket Set	1995-94	OS 30865	Loc. Lower; From Chassis No. 4A-S-026-716; New Part Number - Check for Availability	
QTY	VALVE COVER	YEARS	PART NO.	DESCRIPTION	
1	Valve Cover Gasket Set	1998-94	VS 50787 R	PermaDry® molded rubber gskts. incl.	
QTY	TIMING COVER	YEARS	PART NO.	DESCRIPTION	
2	Camshaft Front Seal Set	1998-94	ES 72806	Camshaft circular plug; New Part Number - Check for Availability	
28		2005 - 2002; 3.0L 181.6 (2976cc) DOHC V6 (30 Valve) 82.5mm Bore			28
MFI; Gasoline; Naturally Aspirated Audi Eng.; Eng. Code AVK					
QTY	CYLINDER HEAD	YEARS	PART NO.	DESCRIPTION	
2	Head Gasket	2005-02	26608 PT	Head bolts not incl.; Head bolt replacement recommended; PermaTorqueMLS®; New Part Number - Check for Availability	
2	Head Set	2005-02	HS 26608 PT	Head bolts not incl.; Head bolt replacement recommended; PermaDry® molded rubber valve cover gskt. incl.; Premium valve stem seals incl.; New Part Number - Check for Availability	
1	Head Bolt Set	2005-02	ES 72834	Replacement recommended; New Part Number - Check for Availability	
QTY	MANIFOLD - INT. & EXH.	YEARS	PART NO.	DESCRIPTION	
1	Int. Manifold Gasket Set	2005-02	MS 96890		
1	Exh. Manifold Gasket Set	2005-02	MS 96882		
QTY	VALVE COVER	YEARS	PART NO.	DESCRIPTION	
2	Valve Cover Gasket Set	2005-02	VS 50857 R	w/Spark plug tube seals; PermaDry® molded rubber gskt. incl.; New Part Number - Check for Availability	
QTY	VALVE STEM SEAL SET	YEARS	PART NO.	DESCRIPTION	
1	Valve Stem Seal Set	2005-02	SS 71074-2	Premium valve stem seals incl.	
QTY	TIMING COVER	YEARS	PART NO.	DESCRIPTION	
4	Camshaft Front Seal Set	2005-02	TCS 46184	New Part Number - Check for Availability	
QTY	CARB & FUEL INJECTION	YEARS	PART NO.	DESCRIPTION	
1	Throttle Body Gasket	2005-02	61491		
QTY	EXHAUST GAS RECIRCULATION	YEARS	PART NO.	DESCRIPTION	
4	EGR Gasket	2005-02	72803	Air pump gskt.; New Part Number - Check for Availability	
29		2006 - 2005; 3.0L 181.6 (2976cc) DOHC V6 (30 Valve) 82.5mm Bore			29
MFI; Gasoline; Naturally Aspirated Audi Eng.; Eng. Code BGN					
QTY	CYLINDER HEAD	YEARS	PART NO.	DESCRIPTION	
2	Head Gasket	2006-05	26608 PT	Head bolts not incl.; Head bolt replacement recommended; PermaTorqueMLS®; New Part Number - Check for Availability	
2	Head Set	2006-05	HS 26608 PT	Head bolts not incl.; Head bolt replacement recommended; PermaDry® molded rubber valve cover gskt. incl.; Premium valve stem seals incl.; New Part Number - Check for Availability	
1	Head Bolt Set	2006-05	ES 72834	Replacement recommended; New Part Number - Check for Availability	
QTY	MANIFOLD - INT. & EXH.	YEARS	PART NO.	DESCRIPTION	
1	Int. Manifold Gasket Set	2006-05	MS 96890		

Audi Car (Cont.)

29 (cont.)	2006 - 2005; 3.0L 181.6 (2976cc) DOHC V6 (30 Valve) 82.5mm Bore			29 (cont.)
MFI; Gasoline; Naturally Aspirated Audi Eng.; Eng. Code BGN				
QTY	MANIFOLD - INT. & EXH.	YEARS	PART NO.	DESCRIPTION
1	Exh. Manifold Gasket Set	2006-05	MS 96882	
QTY	VALVE COVER	YEARS	PART NO.	DESCRIPTION
2	Valve Cover Gasket Set	2006-05	VS 50857 R	w/Spark plug tube seals; PermaDry® molded rubber gskt. incl.; New Part Number - Check for Availability
QTY	VALVE STEM SEAL SET	YEARS	PART NO.	DESCRIPTION
1	Valve Stem Seal Set	2006-05	SS 71074-2	Premium valve stem seals incl.
QTY	TIMING COVER	YEARS	PART NO.	DESCRIPTION
4	Camshaft Front Seal Set	2006-05	TCS 46184	New Part Number - Check for Availability
QTY	CARB & FUEL INJECTION	YEARS	PART NO.	DESCRIPTION
1	Throttle Body Gasket	2006-05	61491	
QTY	EXHAUST GAS RECIRCULATION	YEARS	PART NO.	DESCRIPTION
4	EGR Gasket	2006-05	72803	Air pump gskt.; New Part Number - Check for Availability
30	2011 - 2009; 3.0L 182.8 (2995cc) DOHC V6 (24 Valve) 84.5mm Bore			30
DI; Gasoline; Supercharged - Intercooled Audi Eng.; Eng. Code CAJA				
QTY	VALVE COVER	YEARS	PART NO.	DESCRIPTION
1	Valve Cover Gasket Set	2011-09	VS 50865 R	w/Spark plug tube seals; PermaDry® molded rubber gskts. incl.; New Part Number - Check for Availability
31	2013 - 2012; 3.0L 182.8 (2995cc) DOHC V6 (24 Valve) 84.5mm Bore			31
DI; Gasoline; Supercharged - Intercooled Audi Eng.; Eng. Code CAKA				
QTY	VALVE COVER	YEARS	PART NO.	DESCRIPTION
1	Valve Cover Gasket Set	2013-12	VS 50865 R	w/Spark plug tube seals; PermaDry® molded rubber gskts. incl.; New Part Number - Check for Availability
32	2013 - 2012; 3.0L 182.8 (2995cc) DOHC V6 (24 Valve) 84.5mm Bore			32
DI; Gasoline; Supercharged - Intercooled Audi Eng.; Eng. Code CCAA				
QTY	VALVE COVER	YEARS	PART NO.	DESCRIPTION
1	Valve Cover Gasket Set	2013-12	VS 50865 R	w/Spark plug tube seals; PermaDry® molded rubber gskts. incl.; New Part Number - Check for Availability
33	2013 - 2010; 3.0L 182.8 (2995cc) DOHC V6 (24 Valve) 84.5mm Bore			33
DI; Gasoline; Supercharged - Intercooled Audi Eng.; Eng. Code CCBA				
QTY	VALVE COVER	YEARS	PART NO.	DESCRIPTION
1	Valve Cover Gasket Set	2013-10	VS 50865 R	w/Spark plug tube seals; PermaDry® molded rubber gskts. incl.; New Part Number - Check for Availability
34	2013 - 2012; 3.0L 182.8 (2995cc) DOHC V6 (24 Valve) 84.5mm Bore			34
DI; Gasoline; Supercharged - Intercooled Audi Eng.; Eng. Code CGXB				
QTY	VALVE COVER	YEARS	PART NO.	DESCRIPTION
1	Valve Cover Gasket Set	2013-12	VS 50865 R	w/Spark plug tube seals; PermaDry® molded rubber gskts. incl.; New Part Number - Check for Availability
35	2013; 3.0L 182.8 (2995cc) DOHC V6 (24 Valve) 84.5mm Bore			35
DI; Gasoline; Supercharged - Intercooled Audi Eng.; Eng. Code CGXC				
QTY	VALVE COVER	YEARS	PART NO.	DESCRIPTION
1	Valve Cover Gasket Set	2013	VS 50865 R	w/Spark plug tube seals; PermaDry® molded rubber gskts. incl.; New Part Number - Check for Availability
36	2013; 3.0L 182.8 (2995cc) DOHC V6 (24 Valve) 84.5mm Bore			36
DI; Gasoline; Supercharged - Intercooled Audi Eng.; Eng. Code CTUA				
QTY	VALVE COVER	YEARS	PART NO.	DESCRIPTION
1	Valve Cover Gasket Set	2013	VS 50865 R	w/Spark plug tube seals; PermaDry® molded rubber gskts. incl.; New Part Number - Check for Availability
37	2013; 3.0L 182.8 (2995cc) DOHC V6 (24 Valve) 84.5mm Bore			37
DI; Gasoline; Supercharged - Intercooled Audi Eng.; Eng. Code CTUB				
QTY	VALVE COVER	YEARS	PART NO.	DESCRIPTION
1	Valve Cover Gasket Set	2013	VS 50865 R	w/Spark plug tube seals; PermaDry® molded rubber gskts. incl.; New Part Number - Check for Availability

38		2011 - 2005; 3.1L 188 (3123cc) DOHC V6 (30 Valve) 84.5mm Bore			38
DI; Gasoline; Naturally Aspirated Audi Eng.; Eng. Code BKH					
QTY	VALVE COVER	YEARS	PART NO.	DESCRIPTION	
1	Valve Cover Gasket Set	2011	VS 50865 R	w/Spark plug tube seals; PermaDry® molded rubber gskts. incl.; New Part Number - Check for Availability	
1	Valve Cover Gasket Set	2010-05	VS 50866 R	w/Spark plug tube seals; PermaDry® molded rubber gskts. incl.; New Part Number - Check for Availability	
39		2009 - 2004; 3.2L 195 (3189cc) DOHC V6 (24 Valve) 84mm Bore			39
MFI; Gasoline; Naturally Aspirated VW Eng.; Eng. Code BHE					
QTY	CYLINDER HEAD	YEARS	PART NO.	DESCRIPTION	
1	Head Gasket	2009-08	26648 PT	Head bolts not incl.; Head bolt replacement recommended; PermaTorqueMLS®; New Part Number - Check for Availability	
1	Head Gasket	2006-04	26648 PT	Head bolts not incl.; Head bolt replacement recommended; PermaTorqueMLS®; New Part Number - Check for Availability	
QTY	OIL FILTER MOUNTING	YEARS	PART NO.	DESCRIPTION	
1	Oil Filter Adapter Gasket	2009-08	72980	Loc. Front; Oil filter adapter seal; New Part Number - Check for Availability	
1	Oil Filter Adapter Gasket	2006-04	72980	Loc. Front; Oil filter adapter seal; New Part Number - Check for Availability	
40		2009 - 2006; 3.2L 195 (3189cc) DOHC V6 (24 Valve) 84mm Bore			40
MFI; Gasoline; Naturally Aspirated VW Eng.; Eng. Code BUB					
QTY	CYLINDER HEAD	YEARS	PART NO.	DESCRIPTION	
1	Head Gasket	2009-06	26648 PT	Head bolts not incl.; Head bolt replacement recommended; PermaTorqueMLS®; New Part Number - Check for Availability	
QTY	TIMING COVER	YEARS	PART NO.	DESCRIPTION	
2	Camshaft Front Seal Set	2009-06	TCS 46183	New Part Number - Check for Availability	
QTY	OIL FILTER MOUNTING	YEARS	PART NO.	DESCRIPTION	
1	Oil Filter Adapter Gasket	2009-06	72980	Loc. Front; Oil filter adapter seal; New Part Number - Check for Availability	
41		2008 - 2004; 4.2L 254.5 (4163cc) DOHC V8 (40 Valve) 84.5mm Bore			41
DI; Gasoline; Naturally Aspirated Audi Eng.; Eng. Code BFM					
QTY	CYLINDER HEAD	YEARS	PART NO.	DESCRIPTION	
1	Head Gasket	2008-04	26616 PT	Loc. L.H.; Head bolts not incl.; Head bolt replacement recommended; PermaTorqueMLS®; New Part Number - Check for Availability	
1	Head Gasket	2008-04	26629 PT	Loc. R.H.; Head bolts not incl.; Head bolt replacement recommended; PermaTorqueMLS®; New Part Number - Check for Availability	
42		2007 - 2006; 4.2L 254.5 (4163cc) DOHC V8 (40 Valve) 84.5mm Bore			42
DI; Gasoline; Naturally Aspirated Audi Eng.; Eng. Code BGK					
QTY	CYLINDER HEAD	YEARS	PART NO.	DESCRIPTION	
1	Head Gasket	2007-06	26616 PT	Loc. L.H.; Head bolts not incl.; Head bolt replacement recommended; PermaTorqueMLS®; New Part Number - Check for Availability	
1	Head Gasket	2007-06	26629 PT	Loc. R.H.; Head bolts not incl.; Head bolt replacement recommended; PermaTorqueMLS®; New Part Number - Check for Availability	
43		2012 - 2004; 4.2L 254.5 (4163cc) DOHC V8 (40 Valve) 84.5mm Bore			43
DI; Gasoline; Naturally Aspirated Audi Eng.; Eng. Code BHF					
QTY	CYLINDER HEAD	YEARS	PART NO.	DESCRIPTION	
1	Head Gasket	2012-04	26616 PT	Loc. L.H.; Head bolts not incl.; Head bolt replacement recommended; PermaTorqueMLS®; New Part Number - Check for Availability	
1	Head Gasket	2012-04	26629 PT	Loc. R.H.; Head bolts not incl.; Head bolt replacement recommended; PermaTorqueMLS®; New Part Number - Check for Availability	
44		2008 - 2005; 4.2L 254.5 (4163cc) DOHC V8 (40 Valve) 84.5mm Bore			44
DI; Gasoline; Naturally Aspirated Audi Eng.; Eng. Code BNK					
QTY	CYLINDER HEAD	YEARS	PART NO.	DESCRIPTION	
1	Head Gasket	2008-05	26616 PT	Loc. L.H.; Head bolts not incl.; Head bolt replacement recommended; PermaTorqueMLS®; New Part Number - Check for Availability	
1	Head Gasket	2008-05	26629 PT	Loc. R.H.; Head bolts not incl.; Head bolt replacement recommended; PermaTorqueMLS®; New Part Number - Check for Availability	
45		2009 - 2006; 4.2L 254.5 (4163cc) DOHC V8 (40 Valve) 84.5mm Bore			45
DI; Gasoline; Naturally Aspirated Audi Eng.; Eng. Code BNS					
QTY	CYLINDER HEAD	YEARS	PART NO.	DESCRIPTION	
1	Head Gasket	2009-06	26616 PT	Loc. L.H.; Head bolts not incl.; Head bolt replacement recommended; PermaTorqueMLS®; New Part Number - Check for Availability	

Audi Car (Cont.)

45 (cont.)	2009 - 2006; 4.2L 254.5 (4163cc) DOHC V8 (40 Valve) 84.5mm Bore			45 (cont.)
DI; Gasoline; Naturally Aspirated Audi Eng.; Eng. Code BNS				
QTY	CYLINDER HEAD	YEARS	PART NO.	DESCRIPTION
1	Head Gasket	2009-06	26629 PT	Loc. R.H.; Head bolts not incl.; Head bolt replacement recommended; PermaTorqueMLS®; New Part Number - Check for Availability
46	2011 - 2007; 4.2L 254.5 (4163cc) DOHC V8 (40 Valve) 84.5mm Bore			46
DI; Gasoline; Naturally Aspirated Audi Eng.; Eng. Code BVJ				
QTY	CYLINDER HEAD	YEARS	PART NO.	DESCRIPTION
1	Head Gasket	2011-07	26616 PT	Loc. L.H.; Head bolts not incl.; Head bolt replacement recommended; PermaTorqueMLS®; New Part Number - Check for Availability
1	Head Gasket	2011-07	26629 PT	Loc. R.H.; Head bolts not incl.; Head bolt replacement recommended; PermaTorqueMLS®; New Part Number - Check for Availability
47	2013 - 2008; 4.2L 254.5 (4163cc) DOHC V8 (40 Valve) 84.5mm Bore			47
DI; Gasoline; Naturally Aspirated Audi Eng.; Eng. Code BYH				
QTY	CYLINDER HEAD	YEARS	PART NO.	DESCRIPTION
1	Head Gasket	2013-08	26616 PT	Loc. L.H.; Head bolts not incl.; Head bolt replacement recommended; PermaTorqueMLS®; New Part Number - Check for Availability
1	Head Gasket	2013-08	26629 PT	Loc. R.H.; Head bolts not incl.; Head bolt replacement recommended; PermaTorqueMLS®; New Part Number - Check for Availability
48	1994 - 1992; 4.2L 254.5 (4172cc) DOHC V8 (32 Valve) 84.5mm Bore			48
MFI; Gasoline; Naturally Aspirated Audi Eng.; Eng. Code ABH				
QTY	CYLINDER HEAD	YEARS	PART NO.	DESCRIPTION
1	Head Gasket	1994-92	26618 PT	Loc. L.H.; Head bolts not incl.; Head bolt replacement recommended; New Part Number - Check for Availability
1	Head Gasket	1994-92	26631 PT	Loc. R.H.; Head bolts not incl.; Head bolt replacement recommended; New Part Number - Check for Availability
1	Head Set	1994-92	HS 26671 PT	Valve stem seals & head bolts not incl.; Head bolt replacement recommended; PermaDry® molded rubber valve cover gskts. incl.; New Part Number - Check for Availability
QTY	OIL PAN	YEARS	PART NO.	DESCRIPTION
1	Oil Pan Gasket Set	1994-92	OS 30857 PR	Loc. Upper; New Part Number - Check for Availability
1	Oil Pan Gasket Set	1994-92	OS 30858	Loc. Lower; New Part Number - Check for Availability
QTY	VALVE COVER	YEARS	PART NO.	DESCRIPTION
2	Valve Cover Gasket Set	1994-92	VS 50850 R	w/Semi-circular plug & Spark plug tube seals; PermaDry® molded rubber gskt. incl.; New Part Number - Check for Availability
49	2000 - 1997; 4.2L 254.5 (4172cc) DOHC V8 (32 Valve) 84.5mm Bore			49
MFI; Gasoline; Naturally Aspirated Audi Eng.; Eng. Code ABZ				
QTY	CYLINDER HEAD	YEARS	PART NO.	DESCRIPTION
1	Head Gasket	2000-97	26618 PT	Loc. L.H.; Head bolts not incl.; Head bolt replacement recommended; New Part Number - Check for Availability
1	Head Gasket	2000-97	26631 PT	Loc. R.H.; Head bolts not incl.; Head bolt replacement recommended; New Part Number - Check for Availability
1	Head Set	2000-97	HS 26672 PT	Valve stem seals & head bolts not incl.; Head bolt replacement recommended; PermaDry® molded rubber valve cover gskts. incl.; New Part Number - Check for Availability
QTY	MANIFOLD - INT. & EXH.	YEARS	PART NO.	DESCRIPTION
1	Exh. Manifold Gasket Set	2000-97	MS 97270	New Part Number - Check for Availability
QTY	OIL PAN	YEARS	PART NO.	DESCRIPTION
1	Oil Pan Gasket Set	2000-97	OS 30857 PR	Loc. Upper; New Part Number - Check for Availability
1	Oil Pan Gasket Set	2000-97	OS 30858	Loc. Lower; New Part Number - Check for Availability
QTY	VALVE COVER	YEARS	PART NO.	DESCRIPTION
2	Valve Cover Gasket Set	2000-97	VS 50850 R	w/Semi-circular plug & Spark plug tube seals; PermaDry® molded rubber gskt. incl.; New Part Number - Check for Availability
50	2000; 4.2L 254.5 (4172cc) DOHC V8 (32 Valve) 84.5mm Bore			50
MFI; Gasoline; Naturally Aspirated Audi Eng.; Eng. Code ART				
QTY	CYLINDER HEAD	YEARS	PART NO.	DESCRIPTION
1	Head Gasket	2000	26615 PT	Loc. L.H.; Head bolts not incl.; Head bolt replacement recommended; PermaTorqueMLS®; New Part Number - Check for Availability
1	Head Gasket	2000	26628 PT	Loc. R.H.; Head bolts not incl.; Head bolt replacement recommended; PermaTorqueMLS®; New Part Number - Check for Availability

50 (cont.)		2000; 4.2L 254.5 (4172cc) DOHC V8 (32 Valve) 84.5mm Bore			50 (cont.)
MFI; Gasoline; Naturally Aspirated Audi Eng.; Eng. Code ART					
QTY	CYLINDER HEAD	YEARS	PART NO.	DESCRIPTION	
1	Head Set	2000	HS 26669 PT	Valve stem seals & head bolts not incl.; Head bolt replacement recommended; PermaDry® molded rubber valve cover gskts. incl.; New Part Number - Check for Availability	
QTY	MANIFOLD - INT. & EXH.	YEARS	PART NO.	DESCRIPTION	
1	Int. Manifold Gasket Set	2000	MS 97302	Lower set; New Part Number - Check for Availability	
1	Exh. Manifold Gasket Set	2000	MS 97269	New Part Number - Check for Availability	
QTY	VALVE COVER	YEARS	PART NO.	DESCRIPTION	
2	Valve Cover Gasket Set	2000	VS 50851 R	w/Semi-circular plug & Grommets & Spark plug tube seals; PermaDry® molded rubber gskt. incl.; New Part Number - Check for Availability	
51		2004 - 2001; 4.2L 254.5 (4172cc) DOHC V8 (32 Valve) 84.5mm Bore			51
MFI; Gasoline; Naturally Aspirated Audi Eng.; Eng. Code AWN					
QTY	CYLINDER HEAD	YEARS	PART NO.	DESCRIPTION	
1	Head Gasket	2004-01	26615 PT	Loc. L.H.; Head bolts not incl.; Head bolt replacement recommended; PermaTorqueMLS®; New Part Number - Check for Availability	
1	Head Gasket	2004-01	26628 PT	Loc. R.H.; Head bolts not incl.; Head bolt replacement recommended; PermaTorqueMLS®; New Part Number - Check for Availability	
1	Head Set	2004-01	HS 26669 PT	Valve stem seals & head bolts not incl.; Head bolt replacement recommended; PermaDry® molded rubber valve cover gskts. incl.; New Part Number - Check for Availability	
QTY	MANIFOLD - INT. & EXH.	YEARS	PART NO.	DESCRIPTION	
1	Int. Manifold Gasket Set	2004-01	MS 97302	Lower set; New Part Number - Check for Availability	
1	Exh. Manifold Gasket Set	2004-01	MS 97269	New Part Number - Check for Availability	
QTY	VALVE COVER	YEARS	PART NO.	DESCRIPTION	
2	Valve Cover Gasket Set	2004-01	VS 50851 R	w/Semi-circular plug & Grommets & Spark plug tube seals; PermaDry® molded rubber gskt. incl.; New Part Number - Check for Availability	
52		2004 - 2000; 4.2L 254.5 (4172cc) DOHC V8 (40 Valve) 84.5mm Bore			52
MFI; Gasoline; Naturally Aspirated Audi Eng.; Eng. Code AKB					
QTY	CYLINDER HEAD	YEARS	PART NO.	DESCRIPTION	
1	Head Gasket	2004-00	26615 PT	Loc. L.H.; Head bolts not incl.; Head bolt replacement recommended; PermaTorqueMLS®; New Part Number - Check for Availability	
1	Head Gasket	2004-00	26628 PT	Loc. R.H.; Head bolts not incl.; Head bolt replacement recommended; PermaTorqueMLS®; New Part Number - Check for Availability	
1	Head Set	2004-00	HS 26669 PT	Valve stem seals & head bolts not incl.; Head bolt replacement recommended; PermaDry® molded rubber valve cover gskts. incl.; New Part Number - Check for Availability	
2	Head Bolt Set	2004-00	ES 72827	Replacement recommended; New Part Number - Check for Availability	
QTY	MANIFOLD - INT. & EXH.	YEARS	PART NO.	DESCRIPTION	
1	Int. Manifold Gasket Set	2004-00	MS 97302	Lower set; New Part Number - Check for Availability	
1	Exh. Manifold Gasket Set	2004-00	MS 97269	New Part Number - Check for Availability	
QTY	VALVE COVER	YEARS	PART NO.	DESCRIPTION	
2	Valve Cover Gasket Set	2004-00	VS 50851 R	w/Semi-circular plug & Grommets & Spark plug tube seals; PermaDry® molded rubber gskt. incl.; New Part Number - Check for Availability	
QTY	TIMING COVER	YEARS	PART NO.	DESCRIPTION	
4	Camshaft Front Seal Set	2004-00	ES 72806	Camshaft circular plug; New Part Number - Check for Availability	
53		2004 - 2001; 4.2L 254.5 (4172cc) DOHC V8 (40 Valve) 84.5mm Bore			53
MFI; Gasoline; Naturally Aspirated Audi Eng.; Eng. Code AUX					
QTY	CYLINDER HEAD	YEARS	PART NO.	DESCRIPTION	
1	Head Gasket	2004-01	26615 PT	Loc. L.H.; Head bolts not incl.; Head bolt replacement recommended; PermaTorqueMLS®; New Part Number - Check for Availability	
1	Head Gasket	2004-01	26628 PT	Loc. R.H.; Head bolts not incl.; Head bolt replacement recommended; PermaTorqueMLS®; New Part Number - Check for Availability	
1	Head Set	2004-01	HS 26669 PT	Valve stem seals & head bolts not incl.; Head bolt replacement recommended; PermaDry® molded rubber valve cover gskts. incl.; New Part Number - Check for Availability	
2	Head Bolt Set	2004-01	ES 72827	Replacement recommended; New Part Number - Check for Availability	
QTY	MANIFOLD - INT. & EXH.	YEARS	PART NO.	DESCRIPTION	
1	Int. Manifold Gasket Set	2004-01	MS 97302	Lower set; New Part Number - Check for Availability	
1	Exh. Manifold Gasket Set	2004-01	MS 97269	New Part Number - Check for Availability	
QTY	VALVE COVER	YEARS	PART NO.	DESCRIPTION	
2	Valve Cover Gasket Set	2004-01	VS 50851 R	w/Semi-circular plug & Grommets & Spark plug tube seals; PermaDry® molded rubber gskt. incl.; New Part Number - Check for Availability	

Audi Car (Cont.)

53 (cont.)	2004 - 2001; 4.2L 254.5 (4172cc) DOHC V8 (40 Valve) 84.5mm Bore			53 (cont.)
MFI; Gasoline; Naturally Aspirated Audi Eng.; Eng. Code AUX				
QTY	TIMING COVER	YEARS	PART NO.	DESCRIPTION
4	Camshaft Front Seal Set	2004-01	ES 72806	Camshaft circular plug; New Part Number - Check for Availability
54	2003 - 2001; 4.2L 254.5 (4172cc) DOHC V8 (40 Valve) 84.5mm Bore			54
MFI; Gasoline; Naturally Aspirated Audi Eng.; Eng. Code AYS				
QTY	CYLINDER HEAD	YEARS	PART NO.	DESCRIPTION
1	Head Gasket	2003-01	26615 PT	Loc. L.H.; Head bolts not incl.; Head bolt replacement recommended; PermaTorqueMLS®; New Part Number - Check for Availability
1	Head Gasket	2003-01	26628 PT	Loc. R.H.; Head bolts not incl.; Head bolt replacement recommended; PermaTorqueMLS®; New Part Number - Check for Availability
1	Head Set	2003-01	HS 26669 PT	Valve stem seals & head bolts not incl.; Head bolt replacement recommended; PermaDry® molded rubber valve cover gskts. incl.; New Part Number - Check for Availability
2	Head Bolt Set	2003-01	ES 72827	Replacement recommended; New Part Number - Check for Availability
QTY	MANIFOLD - INT. & EXH.	YEARS	PART NO.	DESCRIPTION
1	Int. Manifold Gasket Set	2003-01	MS 97302	Lower set; New Part Number - Check for Availability
1	Exh. Manifold Gasket Set	2003-01	MS 97269	New Part Number - Check for Availability
QTY	VALVE COVER	YEARS	PART NO.	DESCRIPTION
2	Valve Cover Gasket Set	2003-01	VS 50851 R	w/Semi-circular plug & Grommets & Spark plug tube seals; PermaDry® molded rubber gskt. incl.; New Part Number - Check for Availability
QTY	TIMING COVER	YEARS	PART NO.	DESCRIPTION
4	Camshaft Front Seal Set	2003-01	ES 72806	Camshaft circular plug; New Part Number - Check for Availability
55	2004 - 2002; 4.2L 254.5 (4172cc) DOHC V8 (40 Valve) 84.5mm Bore			55
MFI; Gasoline; Naturally Aspirated Audi Eng.; Eng. Code BBD				
QTY	CYLINDER HEAD	YEARS	PART NO.	DESCRIPTION
1	Head Gasket	2004-02	26615 PT	Loc. L.H.; Head bolts not incl.; Head bolt replacement recommended; PermaTorqueMLS®; New Part Number - Check for Availability
1	Head Gasket	2004-02	26628 PT	Loc. R.H.; Head bolts not incl.; Head bolt replacement recommended; PermaTorqueMLS®; New Part Number - Check for Availability
1	Head Set	2004-02	HS 26669 PT	Valve stem seals & head bolts not incl.; Head bolt replacement recommended; PermaDry® molded rubber valve cover gskts. incl.; New Part Number - Check for Availability
2	Head Bolt Set	2004-02	ES 72827	Replacement recommended; New Part Number - Check for Availability
QTY	MANIFOLD - INT. & EXH.	YEARS	PART NO.	DESCRIPTION
1	Int. Manifold Gasket Set	2004-02	MS 97302	Lower set; New Part Number - Check for Availability
1	Exh. Manifold Gasket Set	2004-02	MS 97269	New Part Number - Check for Availability
QTY	VALVE COVER	YEARS	PART NO.	DESCRIPTION
2	Valve Cover Gasket Set	2004-02	VS 50851 R	w/Semi-circular plug & Grommets & Spark plug tube seals; PermaDry® molded rubber gskt. incl.; New Part Number - Check for Availability
QTY	TIMING COVER	YEARS	PART NO.	DESCRIPTION
4	Camshaft Front Seal Set	2004-02	ES 72806	Camshaft circular plug; New Part Number - Check for Availability
56	2004 - 2003; 4.2L 254.5 (4172cc) DOHC V8 (40 Valve) 84.5mm Bore			56
MFI; Gasoline; Turbo - Intercooled Audi Eng.; Eng. Code BCY				
QTY	CYLINDER HEAD	YEARS	PART NO.	DESCRIPTION
1	Head Gasket	2004-03	26617 PT	Loc. L.H.; Head bolts not incl.; Head bolt replacement recommended; PermaTorqueMLS®; New Part Number - Check for Availability
1	Head Gasket	2004-03	26630 PT	Loc. R.H.; Head bolts not incl.; Head bolt replacement recommended; PermaTorqueMLS®; New Part Number - Check for Availability
2	Head Bolt Set	2004-03	ES 72827	Replacement recommended; New Part Number - Check for Availability
QTY	MANIFOLD - INT. & EXH.	YEARS	PART NO.	DESCRIPTION
1	Int. Manifold Gasket Set	2004-03	MS 97303	Lower set; New Part Number - Check for Availability
1	Exh. Manifold Gasket Set	2004-03	MS 97269	New Part Number - Check for Availability
QTY	VALVE COVER	YEARS	PART NO.	DESCRIPTION
2	Valve Cover Gasket Set	2004-03	VS 50851 R	w/Semi-circular plug & Grommets & Spark plug tube seals; PermaDry® molded rubber gskt. incl.; New Part Number - Check for Availability
QTY	TIMING COVER	YEARS	PART NO.	DESCRIPTION
4	Camshaft Front Seal Set	2004-03	ES 72806	Camshaft circular plug; New Part Number - Check for Availability

**Audi SUV's - See Audi Truck
Audi Truck (Incl. SUV's)**

Engine Finding Index				
<i>Engine</i>	<i>Years</i>	<i>Code</i>	<i>Line No.</i>	
2.0L 121 (1984cc) DOHC L4 (16 Valve) 82.5mm Bore; DI; Gasoline; Turbo - Intercooled VW Eng.	2013-11	CAEB	1	
2.7L 163 (2671cc) DOHC V6 (30 Valve) 81mm Bore; MFI; Gasoline; Turbo - Intercooled Audi Eng.	2002-01	APB	2	
2.7L 163 (2671cc) DOHC V6 (30 Valve) 81mm Bore; MFI; Gasoline; Turbo - Intercooled Audi Eng.	2005-03	BEL	3	
3.0L 181.6 (2967cc) DOHC Turbo - Intercooled V6 (24 Valve) 83mm Bore; DI; Diesel; Turbo - Intercooled Audi Eng.	2012-09	CATA	4	
3.0L 181.6 (2967cc) DOHC Turbo - Intercooled V6 (24 Valve) 83mm Bore; DI; Diesel; Turbo - Intercooled Audi Eng.	2013	CNRB	5	
3.0L 182.8 (2995cc) DOHC V6 (24 Valve) 84.5mm Bore; DI; Gasoline; Supercharged - Intercooled Audi Eng.	2013-11	CCFC	6	
3.0L 182.8 (2995cc) DOHC V6 (24 Valve) 84.5mm Bore; DI; Gasoline; Supercharged - Intercooled Audi Eng.	2013-11	CJTC	7	
3.0L 182.8 (2995cc) DOHC V6 (24 Valve) 84.5mm Bore; DI; Gasoline; Supercharged - Intercooled Audi Eng.	2013-12	CJWB	8	
3.0L 182.8 (2995cc) DOHC V6 (24 Valve) 84.5mm Bore; DI; Gasoline; Supercharged - Intercooled Audi Eng.	2013-12	CJWC	9	
3.0L 182.8 (2995cc) DOHC V6 (24 Valve) 84.5mm Bore; DI; Gasoline; Supercharged - Intercooled Audi Eng.	2013-12	CJWE	10	
3.0L 182.8 (2995cc) DOHC V6 (24 Valve) 84.5mm Bore; DI; Gasoline; Supercharged - Intercooled Audi Eng.	2013	CTUC	11	
3.0L 182.8 (2995cc) DOHC V6 (24 Valve) 84.5mm Bore; DI; Gasoline; Supercharged - Intercooled Audi Eng.	2013	CTWA	12	
3.0L 182.8 (2995cc) DOHC V6 (24 Valve) 84.5mm Bore; DI; Gasoline; Supercharged - Intercooled Audi Eng.	2013	CTWB	13	
3.1L 188 (3123cc) DOHC V6 (30 Valve) 84.5mm Bore; DI; Gasoline; Naturally Aspirated Audi Eng.	2012-09	BKH	14	
3.1L 188 (3123cc) DOHC V6 (30 Valve) 84.5mm Bore; DI; Gasoline; Naturally Aspirated Audi Eng.	2012	CALA	15	
3.1L 188 (3123cc) DOHC V6 (30 Valve) 84.5mm Bore; DI; Gasoline; Naturally Aspirated Audi Eng.	2012	CALB	16	
4.2L 254.5 (4163cc) DOHC V8 (40 Valve) 84.5mm Bore; DI; Gasoline; Naturally Aspirated Audi Eng.	2010-07	BAR	17	
4.2L 254.5 (4172cc) DOHC V8 (40 Valve) 84.5mm Bore; MFI; Gasoline; Naturally Aspirated Audi Eng.	2005-03	BAS	18	

Engine Code Index				
<i>Code</i>	<i>Engine</i>	<i>Line No.</i>		
APB	2.7L 163 (2671cc) DOHC V6 (30 Valve) 81mm Bore; MFI; Gasoline; Turbo - Intercooled Audi Eng.	2		
BAR	4.2L 254.5 (4163cc) DOHC V8 (40 Valve) 84.5mm Bore; DI; Gasoline; Naturally Aspirated Audi Eng.	17		
BAS	4.2L 254.5 (4172cc) DOHC V8 (40 Valve) 84.5mm Bore; MFI; Gasoline; Naturally Aspirated Audi Eng.	18		
BEL	2.7L 163 (2671cc) DOHC V6 (30 Valve) 81mm Bore; MFI; Gasoline; Turbo - Intercooled Audi Eng.	3		
BKH	3.1L 188 (3123cc) DOHC V6 (30 Valve) 84.5mm Bore; DI; Gasoline; Naturally Aspirated Audi Eng.	14		
CAEB	2.0L 121 (1984cc) DOHC L4 (16 Valve) 82.5mm Bore; DI; Gasoline; Turbo - Intercooled VW Eng.	1		
CALA	3.1L 188 (3123cc) DOHC V6 (30 Valve) 84.5mm Bore; DI; Gasoline; Naturally Aspirated Audi Eng.	15		
CALB	3.1L 188 (3123cc) DOHC V6 (30 Valve) 84.5mm Bore; DI; Gasoline; Naturally Aspirated Audi Eng.	16		
CATA	3.0L 181.6 (2967cc) DOHC Turbo - Intercooled V6 (24 Valve) 83mm Bore; DI; Diesel; Turbo - Intercooled Audi Eng.	4		
CCFC	3.0L 182.8 (2995cc) DOHC V6 (24 Valve) 84.5mm Bore; DI; Gasoline; Supercharged - Intercooled Audi Eng.	6		
CJTC	3.0L 182.8 (2995cc) DOHC V6 (24 Valve) 84.5mm Bore; DI; Gasoline; Supercharged - Intercooled Audi Eng.	7		
CJWB	3.0L 182.8 (2995cc) DOHC V6 (24 Valve) 84.5mm Bore; DI; Gasoline; Supercharged - Intercooled Audi Eng.	8		
CJWC	3.0L 182.8 (2995cc) DOHC V6 (24 Valve) 84.5mm Bore; DI; Gasoline; Supercharged - Intercooled Audi Eng.	9		
CJWE	3.0L 182.8 (2995cc) DOHC V6 (24 Valve) 84.5mm Bore; DI; Gasoline; Supercharged - Intercooled Audi Eng.	10		
CNRB	3.0L 181.6 (2967cc) DOHC Turbo - Intercooled V6 (24 Valve) 83mm Bore; DI; Diesel; Turbo - Intercooled Audi Eng.	5		
CTUC	3.0L 182.8 (2995cc) DOHC V6 (24 Valve) 84.5mm Bore; DI; Gasoline; Supercharged - Intercooled Audi Eng.	11		
CTWA	3.0L 182.8 (2995cc) DOHC V6 (24 Valve) 84.5mm Bore; DI; Gasoline; Supercharged - Intercooled Audi Eng.	12		
CTWB	3.0L 182.8 (2995cc) DOHC V6 (24 Valve) 84.5mm Bore; DI; Gasoline; Supercharged - Intercooled Audi Eng.	13		

Model Index					
<i>Engine (VIN Code / Eng. Code)</i>	<i>Year</i>	<i>Engine (VIN Code / Eng. Code)</i>	<i>Year</i>	<i>Engine (VIN Code / Eng. Code)</i>	<i>Year</i>
Audi Truck		Audi Truck (cont.)		Audi Truck (cont.)	
A6 Allroad Quattro (AWD Mid-Size SUV)		Q5 Hybrid (AWD Compact SUV)		Q7 (AWD Mid-Size SUV) (cont.)	
V6 2671cc 2.7L DOHC Turbo (30 Valve) (APB)	02-01	L4 1984cc 2.0L DOHC Turbo (16 Valve) (CHJA)	13	V6 2995cc 3.0L DOHC Supercharged (24 Valve) (CJWC)	13-12
V6 2671cc 2.7L DOHC Turbo (30 Valve) (BEL)	05-03	Q7 (AWD Mid-Size SUV)		V6 2995cc 3.0L DOHC Supercharged (24 Valve) (CJWE)	13-12
V8 4172cc 4.2L DOHC (40 Valve) (BAS)	05-03	V6 2967cc 3.0L DOHC Turbo-Diesel (24 Valve) (CATA)	12-09	V6 2995cc 3.0L DOHC Supercharged (24 Valve) (CTWA)	13
Q5 (AWD Compact SUV)		V6 2967cc 3.0L DOHC Turbo-Diesel (24 Valve) (CNRB)	13	V6 2995cc 3.0L DOHC Supercharged (24 Valve) (CTWB)	13
L4 1984cc 2.0L DOHC Turbo (16 Valve) (CAEB)	13-11	V6 2995cc 3.0L DOHC Supercharged (24 Valve) (CCFC)	13-11	V6 3597cc 3.6L DOHC (24 Valve) (BHL)	10-07
V6 2995cc 3.0L DOHC Supercharged (24 Valve) (CTUC)	13	V6 2995cc 3.0L DOHC Supercharged (24 Valve) (CJTC)	13-11	V6 3597cc 3.6L DOHC (24 Valve) (BLV)	10-07
V6 3123cc 3.2L DOHC (30 Valve) (BKH)	12-09	V6 2995cc 3.0L DOHC Supercharged (24 Valve) (CJWB)	13-12	V8 4163cc 4.2L DOHC (40 Valve) (BAR)	10-07
V6 3123cc 3.2L DOHC (30 Valve) (CALA)	12				
V6 3123cc 3.2L DOHC (30 Valve) (CALB)	12				

1	2013 - 2011; 2.0L 121 (1984cc) DOHC L4 (16 Valve) 82.5mm Bore DI; Gasoline; Turbo - Intercooled VW Eng.; Eng. Code CAEB				1
QTY	CYLINDER HEAD	YEARS	PART NO.	DESCRIPTION	
1	Head Gasket	2013-12	26547 PT	w/Timing chain; Head bolts not incl.; Head bolt replacement recommended; PermaTorqueMLS®; New Part Number - Check for Availability	
1	Head Gasket	2011	26455 PT	w/Timing chain; Head bolts not incl.; Head bolt replacement recommended; PermaTorqueMLS®	

Audi Truck (Incl. SUV's) (Cont.)

1		2013 - 2011; 2.0L 121 (1984cc) DOHC L4 (16 Valve) 82.5mm Bore			1
(cont.)		DI; Gasoline; Turbo - Intercooled VW Eng.; Eng. Code CAEB			(cont.)
QTY	CYLINDER HEAD	YEARS	PART NO.	DESCRIPTION	
1	Head Set	2011	HS 26455 PT	w/Timing chain; Head bolts not incl.; Head bolt replacement recommended; RTV sealant incl. for Lower valve cover housing; PermaDry® molded rubber valve cover gskt. incl.; Premium valve stem seals incl.	
QTY	CONVERSION SET	YEARS	PART NO.	DESCRIPTION	
1	Gasket Conversion Set	2012-11	CS 26455	RTV sealant incl. for oil pan gskt.; New Part Number - Check for Availability	
QTY	MANIFOLD - INT. & EXH.	YEARS	PART NO.	DESCRIPTION	
1	Int. Manifold Gasket Set	2011	MS 96780		
1	Exh. Manifold Gasket Set	2011	MS 96784		
QTY	EXHAUST PIPE FLANGE	YEARS	PART NO.	DESCRIPTION	
1	Exhaust Pipe Gasket	2011	61458	Flange	
1	Exhaust Pipe Gasket	2011	61458	Turbo inlet	
QTY	OIL PAN	YEARS	PART NO.	DESCRIPTION	
1	Oil Pan Gasket Set	2012-11	OS 30821		
QTY	CRANKSHAFT REAR SEAL	YEARS	PART NO.	DESCRIPTION	
1	Rear Main Seal Set	2012-11	BS 40725	PTFE Rubber; One-piece; New Part Number - Check for Availability	
QTY	VALVE COVER	YEARS	PART NO.	DESCRIPTION	
1	Valve Cover Gasket Set	2011	VS 50762 R	w/Timing chain; RTV sealant incl. for Lower valve cover housing; PermaDry® molded rubber gskt. incl.	
QTY	VALVE STEM SEAL SET	YEARS	PART NO.	DESCRIPTION	
1	Valve Stem Seal Set	2011	SS 71074-1	Premium valve stem seals incl.	
QTY	THERMOSTAT HOUSING	YEARS	PART NO.	DESCRIPTION	
1	Thermostat Gasket	2011	35838	Thermostat Housing; Thermostat housing O-ring	
1	O-Ring	2011	35924	Thermostat Housing; Thermostat seal	
QTY	WATER PUMP	YEARS	PART NO.	DESCRIPTION	
1	Water Pump Gasket	2012-11	35872	Housing	
QTY	TIMING COVER	YEARS	PART NO.	DESCRIPTION	
1	Crankshaft Front Seal Set	2012-11	TCS 46138		
1	Camshaft Front Seal Set	2011	TCS 46005		
QTY	CARB & FUEL INJECTION	YEARS	PART NO.	DESCRIPTION	
1	Throttle Body Gasket	2011	61462		
QTY	OIL COOLER	YEARS	PART NO.	DESCRIPTION	
1	Oil Cooler Gasket	2012-11	72485	Oil cooler O-ring; New Part Number - Check for Availability	
2		2002 - 2001; 2.7L 163 (2671cc) DOHC V6 (30 Valve) 81mm Bore			2
(cont.)		MFI; Gasoline; Turbo - Intercooled Audi Eng.; Eng. Code APB			(cont.)
QTY	CYLINDER HEAD	YEARS	PART NO.	DESCRIPTION	
2	Head Gasket	2002-01	26607 PT	Head bolts not incl.; Head bolt replacement recommended; PermaTorqueMLS®; New Part Number - Check for Availability	
2	Head Set	2002-01	HS 26607 PT	Head bolts not incl.; Head bolt replacement recommended; PermaDry® molded rubber valve cover gskt. incl.; Premium valve stem seals incl.; New Part Number - Check for Availability	
1	Head Bolt Set	2002-01	ES 72870	OEM style; Replacement recommended; New Part Number - Check for Availability	
QTY	MANIFOLD - INT. & EXH.	YEARS	PART NO.	DESCRIPTION	
1	Int. Manifold Gasket Set	2002-01	MS 97314	Lower set; New Part Number - Check for Availability	
1	Exh. Manifold Gasket Set	2002-01	MS 96882		
QTY	VALVE COVER	YEARS	PART NO.	DESCRIPTION	
1	Valve Cover Gasket Set	2002-01	VS 50702 R	w/Spark plug tube seals; PermaDry® molded rubber gskts. incl.	
QTY	VALVE STEM SEAL SET	YEARS	PART NO.	DESCRIPTION	
1	Valve Stem Seal Set	2002-01	SS 71074-2	Premium valve stem seals incl.	
QTY	THERMOSTAT HOUSING	YEARS	PART NO.	DESCRIPTION	
1	Water Outlet Gasket	2002-01	25589	Thermostat Housing; Thermostat O-ring; New Improved design	
1	O-Ring	2002-01	35763	Thermostat Housing; Thermostat O-ring; Improved design	
QTY	WATER PUMP	YEARS	PART NO.	DESCRIPTION	
1	Water Pump Gasket	2002-01	35829		
QTY	TIMING COVER	YEARS	PART NO.	DESCRIPTION	
1	Crankshaft Front Seal Set	2002-01	TCS 45038-1		
2	Camshaft Front Seal Set	2002-01	ES 72806	Camshaft circular plug; New Part Number - Check for Availability	
2	Camshaft Rear Seal Set	2002	TCS 46186	From Chassis No. 4B-2-045-001; New Part Number - Check for Availability	
QTY	EXHAUST GAS RECIRCULATION	YEARS	PART NO.	DESCRIPTION	
2	EGR Gasket	2002-01	72803	Air pump gskt.; New Part Number - Check for Availability	

Audi Truck (Incl. SUV's) (Cont.)

3	2005 - 2003; 2.7L 163 (2671cc) DOHC V6 (30 Valve) 81mm Bore MFI; Gasoline; Turbo - Intercooled Audi Eng.; Eng. Code BEL				3
QTY	CYLINDER HEAD	YEARS	PART NO.	DESCRIPTION	
2	Head Gasket	2005-03	26607 PT	Head bolts not incl.; Head bolt replacement recommended; PermaTorqueMLS®; New Part Number - Check for Availability	
2	Head Set	2005-03	HS 26607 PT	Head bolts not incl.; Head bolt replacement recommended; PermaDry® molded rubber valve cover gskt. incl.; Premium valve stem seals incl.; New Part Number - Check for Availability	
1	Head Bolt Set	2005-03	ES 72870	OEM style; Replacement recommended; New Part Number - Check for Availability	
QTY	MANIFOLD - INT. & EXH.	YEARS	PART NO.	DESCRIPTION	
1	Int. Manifold Gasket Set	2005-03	MS 97314	Lower set; New Part Number - Check for Availability	
1	Exh. Manifold Gasket Set	2005-03	MS 96882		
QTY	VALVE COVER	YEARS	PART NO.	DESCRIPTION	
1	Valve Cover Gasket Set	2005-03	VS 50702 R	w/Spark plug tube seals; PermaDry® molded rubber gskts. incl.	
QTY	VALVE STEM SEAL SET	YEARS	PART NO.	DESCRIPTION	
1	Valve Stem Seal Set	2005-03	SS 71074-2	Premium valve stem seals incl.	
QTY	THERMOSTAT HOUSING	YEARS	PART NO.	DESCRIPTION	
1	Water Outlet Gasket	2005-03	25589	Thermostat Housing; Thermostat O-ring; New Improved design	
1	O-Ring	2005-03	35763	Thermostat Housing; Thermostat O-ring; Improved design	
QTY	WATER PUMP	YEARS	PART NO.	DESCRIPTION	
1	Water Pump Gasket	2005-03	35829		
QTY	TIMING COVER	YEARS	PART NO.	DESCRIPTION	
1	Crankshaft Front Seal Set	2005-03	TCS 45038-1		
2	Camshaft Front Seal Set	2005-03	ES 72806	Camshaft circular plug; New Part Number - Check for Availability	
2	Camshaft Rear Seal Set	2005-03	TCS 46186	New Part Number - Check for Availability	
QTY	EXHAUST GAS RECIRCULATION	YEARS	PART NO.	DESCRIPTION	
2	EGR Gasket	2005-03	72803	Air pump gskt.; New Part Number - Check for Availability	
4	2012 - 2009; 3.0L 181.6 (2967cc) DOHC Turbo - Intercooled V6 (24 Valve) 83mm Bore DI; Diesel; Turbo - Intercooled Audi Eng.; Eng. Code CATA				4
QTY	TIMING COVER	YEARS	PART NO.	DESCRIPTION	
2	Camshaft Front Seal Set	2012-09	ES 72806	Camshaft circular plug; New Part Number - Check for Availability	
5	2013; 3.0L 181.6 (2967cc) DOHC Turbo - Intercooled V6 (24 Valve) 83mm Bore DI; Diesel; Turbo - Intercooled Audi Eng.; Eng. Code CNRB				5
QTY	TIMING COVER	YEARS	PART NO.	DESCRIPTION	
2	Camshaft Front Seal Set	2013	ES 72806	Camshaft circular plug; New Part Number - Check for Availability	
6	2013 - 2011; 3.0L 182.8 (2995cc) DOHC V6 (24 Valve) 84.5mm Bore DI; Gasoline; Supercharged - Intercooled Audi Eng.; Eng. Code CCFC				6
QTY	VALVE COVER	YEARS	PART NO.	DESCRIPTION	
1	Valve Cover Gasket Set	2013-11	VS 50865 R	w/Spark plug tube seals; PermaDry® molded rubber gskts. incl.; New Part Number - Check for Availability	
7	2013 - 2011; 3.0L 182.8 (2995cc) DOHC V6 (24 Valve) 84.5mm Bore DI; Gasoline; Supercharged - Intercooled Audi Eng.; Eng. Code CJTC				7
QTY	VALVE COVER	YEARS	PART NO.	DESCRIPTION	
1	Valve Cover Gasket Set	2013-11	VS 50865 R	w/Spark plug tube seals; PermaDry® molded rubber gskts. incl.; New Part Number - Check for Availability	
8	2013 - 2012; 3.0L 182.8 (2995cc) DOHC V6 (24 Valve) 84.5mm Bore DI; Gasoline; Supercharged - Intercooled Audi Eng.; Eng. Code CJWB				8
QTY	VALVE COVER	YEARS	PART NO.	DESCRIPTION	
1	Valve Cover Gasket Set	2013-12	VS 50865 R	w/Spark plug tube seals; PermaDry® molded rubber gskts. incl.; New Part Number - Check for Availability	
9	2013 - 2012; 3.0L 182.8 (2995cc) DOHC V6 (24 Valve) 84.5mm Bore DI; Gasoline; Supercharged - Intercooled Audi Eng.; Eng. Code CJWC				9
QTY	VALVE COVER	YEARS	PART NO.	DESCRIPTION	
1	Valve Cover Gasket Set	2013-12	VS 50865 R	w/Spark plug tube seals; PermaDry® molded rubber gskts. incl.; New Part Number - Check for Availability	

Audi Truck (Incl. SUV's) (Cont.)

10	2013 - 2012; 3.0L 182.8 (2995cc) DOHC V6 (24 Valve) 84.5mm Bore			10
DI; Gasoline; Supercharged - Intercooled Audi Eng.; Eng. Code CJWE				
QTY	VALVE COVER	YEARS	PART NO.	DESCRIPTION
1	Valve Cover Gasket Set	2013-12	VS 50865 R	w/Spark plug tube seals; PermaDry® molded rubber gskts. incl.; New Part Number - Check for Availability
11	2013; 3.0L 182.8 (2995cc) DOHC V6 (24 Valve) 84.5mm Bore			11
DI; Gasoline; Supercharged - Intercooled Audi Eng.; Eng. Code CTUC				
QTY	VALVE COVER	YEARS	PART NO.	DESCRIPTION
1	Valve Cover Gasket Set	2013	VS 50865 R	w/Spark plug tube seals; PermaDry® molded rubber gskts. incl.; New Part Number - Check for Availability
12	2013; 3.0L 182.8 (2995cc) DOHC V6 (24 Valve) 84.5mm Bore			12
DI; Gasoline; Supercharged - Intercooled Audi Eng.; Eng. Code CTWA				
QTY	VALVE COVER	YEARS	PART NO.	DESCRIPTION
1	Valve Cover Gasket Set	2013	VS 50865 R	w/Spark plug tube seals; PermaDry® molded rubber gskts. incl.; New Part Number - Check for Availability
13	2013; 3.0L 182.8 (2995cc) DOHC V6 (24 Valve) 84.5mm Bore			13
DI; Gasoline; Supercharged - Intercooled Audi Eng.; Eng. Code CTWB				
QTY	VALVE COVER	YEARS	PART NO.	DESCRIPTION
1	Valve Cover Gasket Set	2013	VS 50865 R	w/Spark plug tube seals; PermaDry® molded rubber gskts. incl.; New Part Number - Check for Availability
14	2012 - 2009; 3.1L 188 (3123cc) DOHC V6 (30 Valve) 84.5mm Bore			14
DI; Gasoline; Naturally Aspirated Audi Eng.; Eng. Code BKH				
QTY	VALVE COVER	YEARS	PART NO.	DESCRIPTION
1	Valve Cover Gasket Set	2012-11	VS 50865 R	w/Spark plug tube seals; PermaDry® molded rubber gskts. incl.; New Part Number - Check for Availability
1	Valve Cover Gasket Set	2010-09	VS 50866 R	w/Spark plug tube seals; PermaDry® molded rubber gskts. incl.; New Part Number - Check for Availability
15	2012; 3.1L 188 (3123cc) DOHC V6 (30 Valve) 84.5mm Bore			15
DI; Gasoline; Naturally Aspirated Audi Eng.; Eng. Code CALA				
QTY	VALVE COVER	YEARS	PART NO.	DESCRIPTION
1	Valve Cover Gasket Set	2012	VS 50865 R	w/Spark plug tube seals; PermaDry® molded rubber gskts. incl.; New Part Number - Check for Availability
16	2012; 3.1L 188 (3123cc) DOHC V6 (30 Valve) 84.5mm Bore			16
DI; Gasoline; Naturally Aspirated Audi Eng.; Eng. Code CALB				
QTY	VALVE COVER	YEARS	PART NO.	DESCRIPTION
1	Valve Cover Gasket Set	2012	VS 50865 R	w/Spark plug tube seals; PermaDry® molded rubber gskts. incl.; New Part Number - Check for Availability
17	2010 - 2007; 4.2L 254.5 (4163cc) DOHC V8 (40 Valve) 84.5mm Bore			17
DI; Gasoline; Naturally Aspirated Audi Eng.; Eng. Code BAR				
QTY	CYLINDER HEAD	YEARS	PART NO.	DESCRIPTION
1	Head Gasket	2010-07	26616 PT	Loc. L.H.; Head bolts not incl.; Head bolt replacement recommended; PermaTorqueMLS®; New Part Number - Check for Availability
1	Head Gasket	2010-07	26629 PT	Loc. R.H.; Head bolts not incl.; Head bolt replacement recommended; PermaTorqueMLS®; New Part Number - Check for Availability
18	2005 - 2003; 4.2L 254.5 (4172cc) DOHC V8 (40 Valve) 84.5mm Bore			18
MFI; Gasoline; Naturally Aspirated Audi Eng.; Eng. Code BAS				
QTY	CYLINDER HEAD	YEARS	PART NO.	DESCRIPTION
1	Head Gasket	2005-03	26615 PT	Loc. L.H.; Head bolts not incl.; Head bolt replacement recommended; PermaTorqueMLS®; New Part Number - Check for Availability
1	Head Gasket	2005-03	26628 PT	Loc. R.H.; Head bolts not incl.; Head bolt replacement recommended; PermaTorqueMLS®; New Part Number - Check for Availability
1	Head Set	2005-03	HS 26669 PT	Valve stem seals & head bolts not incl.; Head bolt replacement recommended; PermaDry® molded rubber valve cover gskts. incl.; New Part Number - Check for Availability
2	Head Bolt Set	2005-03	ES 72827	Replacement recommended; New Part Number - Check for Availability
QTY	MANIFOLD - INT. & EXH.	YEARS	PART NO.	DESCRIPTION
1	Int. Manifold Gasket Set	2005-03	MS 97302	Lower set; New Part Number - Check for Availability
1	Exh. Manifold Gasket Set	2005-03	MS 97269	New Part Number - Check for Availability

Audi Truck (Incl. SUV's) (Cont.)

18 (cont.)	2005 - 2003; 4.2L 254.5 (4172cc) DOHC V8 (40 Valve) 84.5mm Bore	18 (cont.)	
MFI; Gasoline; Naturally Aspirated Audi Eng.; Eng. Code BAS			
QTY VALVE COVER	YEARS	PART NO.	DESCRIPTION
2 Valve Cover Gasket Set	2005-03	VS 50851 R	w/Semi-circular plug & Grommets & Spark plug tube seals; PermaDry® molded rubber gskt. incl.; New Part Number - Check for Availability
QTY TIMING COVER	YEARS	PART NO.	DESCRIPTION
4 Camshaft Front Seal Set	2005-03	ES 72806	Camshaft circular plug; New Part Number - Check for Availability

Avanti II

Engine Finding Index			
Engine	Years	Code	Line No.
4.0L 244 (4015cc) SOHC V6 (12 Valve) 100.4mm Bore; MFI; Gasoline; Naturally Aspirated Ford Eng.	2007-06	N	1
4.6L 281 (4605cc) SOHC V8 (24 Valve) 90.2mm Bore Triton; MFI; Gasoline; Naturally Aspirated Ford Eng.	2007-05	H	2
5.0L 305 (4999cc) OHV V8 (16 Valve) 3.736" Bore; TBI; Gasoline; Naturally Aspirated GMC Eng.; Chevrolet	1991	E	3
5.0L 305 (4999cc) OHV V8 (16 Valve) 3.736" Bore; TBI; Gasoline; Naturally Aspirated GMC Eng.; Chevrolet	1991	H	4
5.0L 305 (4999cc) OHV V8 (16 Valve) 3.736" Bore; TPI; Gasoline; Naturally Aspirated GMC Eng.; Chevrolet	1991	H	5
5.7L 346 (5665cc) OHV V8 (16 Valve) 99mm Bore LS-1; MFI; Gasoline; Naturally Aspirated GMC Eng.; Chevrolet	2004-01	G	6

Model Index					
Engine (VIN Code / Eng. Code)	Year	Engine (VIN Code / Eng. Code)	Year	Engine (VIN Code / Eng. Code)	Year
Avanti		Avanti (cont.)		Avanti (cont.)	
Avanti II		Avanti II (cont.)		Avanti II (cont.)	
V6 244CI 4.0L SOHC (N)	07-06	V8 327CI 5.3L	69-65	V8 350CI 5.7L (L)	80-77
V8 281CI 4.6L SOHC (24 Valve) (H)	07-05	V8 346CI 5.7L (G)	04-01	V8 400CI 6.6L (U)	78-73
V8 305CI 5.0L (E)	91-88	V8 350CI 5.7L	71-69		
V8 305CI 5.0L (H)	91-81	V8 350CI 5.7L (K)	72		

1	2007 - 2006; 4.0L 244 (4015cc) SOHC V6 (12 Valve) 100.4mm Bore	1	
MFI; Gasoline; Naturally Aspirated Ford Eng.; VIN Code N			
QTY CYLINDER HEAD	YEARS	PART NO.	DESCRIPTION
1 Head Gasket	2007-06	26300 PT	Loc. L.H.; Head bolts not incl.; Head bolt replacement required; PermaTorqueMLS® LaserWeld® Technology; Improved design
1 Head Gasket	2007-06	26301 PT	Loc. R.H.; Head bolts not incl.; Head bolt replacement required; PermaTorqueMLS® LaserWeld® Technology; Improved design
1 Head Set	2007-06	HS 26300 PT-1	Head bolts not incl.; Head bolt replacement required; PermaDry® molded rubber valve cover gskts. incl.; Premium valve stem seals incl.
2 Head Bolt Set	2007-06	ES 72171	Replacement required
QTY CONVERSION SET	YEARS	PART NO.	DESCRIPTION
1 Gasket Conversion Set	2007-06	CS 9293-1	PermaDry® molded rubber oil pan gskt. incl.
QTY MANIFOLD - INT. & EXH.	YEARS	PART NO.	DESCRIPTION
1 Int. Manifold Gasket Set	2007-06	MS 96669	Lower set; Upper set incl.
1 Exh. Manifold Gasket Set	2007-06	MS 90779	
QTY OIL PAN	YEARS	PART NO.	DESCRIPTION
1 Oil Pan Gasket Set	2007-06	OS 30687 R	Loc. Lower; PermaDry® molded rubber gskt. incl.
1 Oil Pan Gasket Set	2007-06	OS 34309 R	Loc. Upper; PermaDry® molded rubber gskt. incl.
QTY CRANKSHAFT REAR SEAL	YEARS	PART NO.	DESCRIPTION
1 Rear Main Seal Set	2007-06	BS 40619	Wear sleeve incl.; Rubber; One-piece
1 Rear Main Seal Set	2007-06	BS 40647	PTFE Rubber; One-piece
QTY VALVE COVER	YEARS	PART NO.	DESCRIPTION
1 Valve Cover Gasket Set	2007-06	VS 50646 R	w/Grommets; PermaDry® molded rubber gskts. incl.
QTY VALVE STEM SEAL SET	YEARS	PART NO.	DESCRIPTION
1 Valve Stem Seal Set	2007-06	SS 70858	Premium valve stem seals incl.
QTY THERMOSTAT HOUSING	YEARS	PART NO.	DESCRIPTION
1 Thermostat Gasket	2007-06	35673	Thermostat Housing; Thermostat housing to manifold
1 O-Ring	2007-06	35617	Thermostat Housing
QTY WATER PUMP	YEARS	PART NO.	DESCRIPTION
1 Water Pump Gasket	2007-06	35474	
QTY TIMING COVER	YEARS	PART NO.	DESCRIPTION
1 Timing Cover Set	2007-06	TCS 46061	
QTY CARB & FUEL INJECTION	YEARS	PART NO.	DESCRIPTION
3 Fuel Injector O-Ring Set	2007-06	ES 70599	Improved design
1 Throttle Body Gasket	2007-06	61356	Mounting
1 Throttle Body Gasket	2007-06	72302	Air bypass valve
QTY EXHAUST GAS RECIRCULATION	YEARS	PART NO.	DESCRIPTION
1 EGR Gasket	2007-06	71176	Valve
1 EGR Gasket	2007-06	71202	Tube seal

Avanti II (Cont.)

1		2007 - 2006; 4.0L 244 (4015cc) SOHC V6 (12 Valve) 100.4mm Bore			1	
(cont.)		MFI; Gasoline; Naturally Aspirated Ford Eng.; VIN Code N			(cont.)	
QTY	OIL COOLER	YEARS	PART NO.	DESCRIPTION		
1	Oil Cooler Gasket	2007-06	72796	Oil cooler O-ring; New Part Number - Check for Availability		
2		2007 - 2005; 4.6L 281 (4605cc) SOHC V8 (24 Valve) 90.2mm Bore Triton			2	
(cont.)		MFI; Gasoline; Naturally Aspirated Ford Eng.; VIN Code H			(cont.)	
QTY	CYLINDER HEAD	YEARS	PART NO.	DESCRIPTION		
1	Head Gasket	2007-05	26308 PT	Loc. R.H.; Head bolts not incl.; Head bolt replacement recommended; PermaTorqueMLS®		
1	Head Gasket	2007-05	26309 PT	Loc. L.H.; Head bolts not incl.; Head bolt replacement recommended; PermaTorqueMLS®		
1	Head Set	2007	HS 26308 PT-1	Head bolts not incl.; Head bolt replacement recommended; PermaDry® molded rubber valve cover gskts. incl.; Premium valve stem seals incl.		
1	Head Set	2006-05	HS 26308 PT	Head bolts not incl.; Head bolt replacement recommended; PermaDry® molded rubber valve cover gskts. incl.; Premium valve stem seals incl.		
2	Head Bolt Set	2007-05	ES 71328	Head bolts w/Washers; Replacement recommended; Improved design		
2	Head Bolt Set	2007-05	ES 72798	Head bolts w/Washers; Replacement recommended; May use ES 71328 instead; Old design		
QTY	CONVERSION SET	YEARS	PART NO.	DESCRIPTION		
1	Gasket Conversion Set	2007-05	CS 9790-5	PermaDry® molded rubber oil pan gskt. incl.; Consolidated design		
QTY	MANIFOLD - INT. & EXH.	YEARS	PART NO.	DESCRIPTION		
1	Int. Manifold Gasket Set	2007-05	MS 96687-1	Lower set		
1	Exh. Manifold Gasket Set	2007-05	MS 96679			
QTY	OIL PAN	YEARS	PART NO.	DESCRIPTION		
1	Oil Pan Gasket Set	2007-05	OS 30725 R	PermaDry® molded rubber gskt. incl.; Improved design		
1	Drain Plug Gasket	2007-05	72515			
QTY	CRANKSHAFT REAR SEAL	YEARS	PART NO.	DESCRIPTION		
1	Rear Main Seal Set	2007-05	BS 40620	Rubber; One-piece; Improved design		
1	Rear Main Seal Set	2007-05	BS 40644	PTFE Rubber; One-piece		
1	Repair Sleeve	2007-05	16255-1	Crankshaft; 1.105" - 1.135" sleeve length; Use w/installation tool; Improved design		
1	Repair Sleeve Tool	2007-05	16306	Crankshaft		
QTY	VALVE COVER	YEARS	PART NO.	DESCRIPTION		
1	Valve Cover Gasket Set	2007	VS 50687 R	w/Grommets; PermaDry® molded rubber gskts. incl.		
1	Valve Cover Gasket Set	2006-05	VS 50664 R	w/Grommets; PermaDry® molded rubber gskts. incl.		
1	Grommet Set	2007-05	ES 71426	Valve Cover; VCT seals set; New Part Number - Check for Availability		
QTY	VALVE STEM SEAL SET	YEARS	PART NO.	DESCRIPTION		
1	Valve Stem Seal Set	2007-05	SS 72921-1	Premium valve stem seals incl.		
QTY	THERMOSTAT HOUSING	YEARS	PART NO.	DESCRIPTION		
1	Water Outlet Gasket	2007-05	35489	Thermostat Housing; Thermostat seal		
QTY	WATER OUTLET GASKET	YEARS	PART NO.	DESCRIPTION		
1	Water Outlet Gasket	2007-05	35792	Water Crossover; Loc. R.H.		
1	Water Outlet Gasket	2007	35835	Water Crossover; Loc. L.H.		
1	Water Outlet Gasket	2006-05	35793	Water Crossover; Loc. L.H.		
QTY	WATER PUMP	YEARS	PART NO.	DESCRIPTION		
1	Water Pump Gasket	2007-05	35478			
2	O-Ring	2007-05	413	Water Pump; Water pump bypass pipe O-ring		
QTY	TIMING COVER	YEARS	PART NO.	DESCRIPTION		
1	Timing Cover Set	2007-05	TCS 46072	Repair sleeve not incl.; May use TCS 46072-1 instead; Old design; Superseded - When depleted use TCS 46072-1		
1	Timing Cover Set	2007-05	TCS 46072-1	Repair sleeve not incl.; Consolidated design		
1	Crankshaft Front Seal Set	2007-05	TCS 46117			
QTY	CARB & FUEL INJECTION	YEARS	PART NO.	DESCRIPTION		
2	Fuel Injector O-Ring Set	2007-05	ES 70599	Lower set; Injectors to cylinder head; Improved design		
1	Throttle Body Gasket	2007-05	61426	Mounting		
QTY	OIL FILTER MOUNTING	YEARS	PART NO.	DESCRIPTION		
1	Oil Filter Adapter Gasket	2007-05	70801			
3		1991; 5.0L 305 (4999cc) OHV V8 (16 Valve) 3.736" Bore			3	
(cont.)		TBI; Gasoline; Naturally Aspirated GMC Eng.; Chevrolet; VIN Code E			(cont.)	
QTY	CYLINDER HEAD	YEARS	PART NO.	DESCRIPTION		
2	Head Gasket	1991	505 SD	Head bolts not incl.; Head bolt replacement recommended; PermaTorque Severe Duty®		
2	Head Gasket	1991	8510 PT	Head bolts not incl.; Head bolt replacement recommended; PermaTorque®		

3 (cont.)		1991; 5.0L 305 (4999cc) OHV V8 (16 Valve) 3.736" Bore			3 (cont.)
TBI; Gasoline; Naturally Aspirated GMC Eng.; Chevrolet; VIN Code E					
QTY	CYLINDER HEAD	YEARS	PART NO.	DESCRIPTION	
1	Head Set	1991	HS 8510 PT-4	Head bolts not incl.; Head bolt replacement recommended; PermaDry® molded rubber valve cover gskts. incl.; Premium valve stem seals incl.	
2	Head Bolt Set	1991	ES 72856	Replacement recommended	
QTY	CONVERSION SET	YEARS	PART NO.	DESCRIPTION	
1	Gasket Conversion Set	1991	CS 8510	PermaDry® molded rubber oil pan gskt. incl.	
QTY	MANIFOLD - INT. & EXH.	YEARS	PART NO.	DESCRIPTION	
1	Int. Manifold Gasket Set	1991	MS 93317		
1	Exh. Manifold Gasket Set	1991	MS 9275 B		
QTY	FUEL PUMP	YEARS	PART NO.	DESCRIPTION	
1	Fuel Pump Mounting Gasket	1991	5182	Plate	
1	Fuel Pump Mounting Gasket	1991	6579	May also be used as a fuel pump block-off plate gasket if desired	
QTY	OIL PAN	YEARS	PART NO.	DESCRIPTION	
1	Oil Pan Gasket Set	1991	OS 34500 R	PermaDry® molded rubber gskt. incl.	
1	Drain Plug Gasket	1991	70822		
QTY	CRANKSHAFT REAR SEAL	YEARS	PART NO.	DESCRIPTION	
1	Rear Main Seal Set	1991	BS 40520	Rubber; One-piece	
1	Rear Main Seal Set	1991	BS 40626	PTFE Rubber; One-piece	
1	Repair Sleeve	1991	16258	Crankshaft; Use w/installation tool	
1	Repair Sleeve Tool	1991	16301	Crankshaft	
QTY	VALVE COVER	YEARS	PART NO.	DESCRIPTION	
1	Valve Cover Gasket Set	1991	VS 50088 R	Services both covers; PermaDry® molded rubber gskts. incl.	
2	Valve Cover Gasket Set	1991	VS 50293 R	Services one cover only; PermaDry® molded rubber gskt. incl.	
QTY	VALVE STEM SEAL SET	YEARS	PART NO.	DESCRIPTION	
1	Valve Stem Seal Set	1991	SS 72526	Loc. Exh.; Premium valve stem seals incl.	
1	Valve Stem Seal Set	1991	SS 72527	Loc. Int.; Premium valve stem seals incl.	
1	Valve Stem Seal Set	1991	SS 72877	Loc. Exh.; Opt. Hi-Temp. premium valve stem seals incl.	
QTY	WATER OUTLET GASKET	YEARS	PART NO.	DESCRIPTION	
1	Water Outlet Gasket	1991	35062	Water Outlet; 1 13/16" ID	
1	Water Outlet Gasket	1991	35562 T	Water Outlet; 1 13/16" ID; PermaDryPlus®	
QTY	WATER PUMP	YEARS	PART NO.	DESCRIPTION	
1	Water Pump Gasket	1991	13032	To plate	
2	Water Pump Gasket	1991	5152	To block	
QTY	TIMING COVER	YEARS	PART NO.	DESCRIPTION	
1	Timing Cover Set	1991	TCS 45121	w/o Sleeve 'N' Seal®; Must be used w/OS 34500R	
1	Timing Set w/Sleeve & Seal	1991	TCS 45265	w/Sleeve 'N' Seal®; Must be used w/OS 34500R	
1	Repair Sleeve	1991	16202	Timing Cover; Use w/installation tool	
1	Repair Sleeve Tool	1991	16312	Timing Cover	
QTY	AIR CLEANER MOUNTING	YEARS	PART NO.	DESCRIPTION	
1	Air Cleaner Gasket	1991	60038	5 1/32" ID	
QTY	CARB & FUEL INJECTION	YEARS	PART NO.	DESCRIPTION	
1	Throttle Body Gasket	1991	60903		
QTY	DISTRIBUTOR MOUNTING	YEARS	PART NO.	DESCRIPTION	
1	Distributor Mounting Gasket	1991	70194		
QTY	EXHAUST GAS RECIRCULATION	YEARS	PART NO.	DESCRIPTION	
1	EGR Gasket	1991	70978		
QTY	OIL PUMP RETAINER	YEARS	PART NO.	DESCRIPTION	
1	Oil Pump Shaft Guide	1991	72665	Distributor to oil pump shaft retainer	
4		1991; 5.0L 305 (4999cc) OHV V8 (16 Valve) 3.736" Bore			4
TBI; Gasoline; Naturally Aspirated GMC Eng.; Chevrolet; VIN Code H					
QTY	CYLINDER HEAD	YEARS	PART NO.	DESCRIPTION	
2	Head Gasket	1991	505 SD	Head bolts not incl.; Head bolt replacement recommended; PermaTorque Severe Duty®	
2	Head Gasket	1991	8510 PT	Head bolts not incl.; Head bolt replacement recommended; PermaTorque®	
1	Head Set	1991	HS 8510 PT-4	Head bolts not incl.; Head bolt replacement recommended; PermaDry® molded rubber valve cover gskts. incl.; Premium valve stem seals incl.	
2	Head Bolt Set	1991	ES 72856	Replacement recommended	
QTY	CONVERSION SET	YEARS	PART NO.	DESCRIPTION	
1	Gasket Conversion Set	1991	CS 8510	PermaDry® molded rubber oil pan gskt. incl.	
QTY	MANIFOLD - INT. & EXH.	YEARS	PART NO.	DESCRIPTION	
1	Int. Manifold Gasket Set	1991	MS 93317		
1	Exh. Manifold Gasket Set	1991	MS 9275 B		

Avanti II (Cont.)

4		1991; 5.0L 305 (4999cc) OHV V8 (16 Valve) 3.736" Bore			4	
(cont.)		TBI; Gasoline; Naturally Aspirated GMC Eng.; Chevrolet; VIN Code H			(cont.)	
QTY	FUEL PUMP	YEARS	PART NO.	DESCRIPTION		
1	Fuel Pump Mounting Gasket	1991	5182	Plate		
1	Fuel Pump Mounting Gasket	1991	6579	May also be used as a fuel pump block-off plate gasket if desired		
QTY	OIL PAN	YEARS	PART NO.	DESCRIPTION		
1	Oil Pan Gasket Set	1991	OS 34500 R	PermaDry® molded rubber gskt. incl.		
1	Drain Plug Gasket	1991	70822			
QTY	CRANKSHAFT REAR SEAL	YEARS	PART NO.	DESCRIPTION		
1	Rear Main Seal Set	1991	BS 40520	Rubber; One-piece		
1	Rear Main Seal Set	1991	BS 40626	PTFE Rubber; One-piece		
1	Repair Sleeve	1991	16258	Crankshaft; Use w/installation tool		
1	Repair Sleeve Tool	1991	16301	Crankshaft		
QTY	VALVE COVER	YEARS	PART NO.	DESCRIPTION		
1	Valve Cover Gasket Set	1991	VS 50088 R	Services both covers; PermaDry® molded rubber gskts. incl.		
2	Valve Cover Gasket Set	1991	VS 50293 R	Services one cover only; PermaDry® molded rubber gskt. incl.		
QTY	VALVE STEM SEAL SET	YEARS	PART NO.	DESCRIPTION		
1	Valve Stem Seal Set	1991	SS 72526	Loc. Exh.; Premium valve stem seals incl.		
1	Valve Stem Seal Set	1991	SS 72527	Loc. Int.; Premium valve stem seals incl.		
1	Valve Stem Seal Set	1991	SS 72877	Loc. Exh.; Opt. Hi-Temp. premium valve stem seals incl.		
QTY	WATER OUTLET GASKET	YEARS	PART NO.	DESCRIPTION		
1	Water Outlet Gasket	1991	35062	Water Outlet; 1 13/16" ID		
1	Water Outlet Gasket	1991	35562 T	Water Outlet; 1 13/16" ID; PermaDryPlus®		
QTY	WATER PUMP	YEARS	PART NO.	DESCRIPTION		
1	Water Pump Gasket	1991	13032	To plate		
2	Water Pump Gasket	1991	5152	To block		
QTY	TIMING COVER	YEARS	PART NO.	DESCRIPTION		
1	Timing Cover Set	1991	TCS 45121	w/o Sleeve 'N' Seal®; Must be used w/OS 34500R		
1	Timing Set w/Sleeve & Seal	1991	TCS 45265	w/Sleeve 'N' Seal®; Must be used w/OS 34500R		
1	Repair Sleeve	1991	16202	Timing Cover; Use w/installation tool		
1	Repair Sleeve Tool	1991	16312	Timing Cover		
QTY	AIR CLEANER MOUNTING	YEARS	PART NO.	DESCRIPTION		
1	Air Cleaner Gasket	1991	60038	5 1/32" ID		
QTY	CARB & FUEL INJECTION	YEARS	PART NO.	DESCRIPTION		
1	Throttle Body Gasket	1991	60903			
QTY	DISTRIBUTOR MOUNTING	YEARS	PART NO.	DESCRIPTION		
1	Distributor Mounting Gasket	1991	70194			
QTY	EXHAUST GAS RECIRCULATION	YEARS	PART NO.	DESCRIPTION		
1	EGR Gasket	1991	70978			
QTY	OIL PUMP RETAINER	YEARS	PART NO.	DESCRIPTION		
1	Oil Pump Shaft Guide	1991	72665	Distributor to oil pump shaft retainer		
5		1991; 5.0L 305 (4999cc) OHV V8 (16 Valve) 3.736" Bore			5	
(cont.)		TPI; Gasoline; Naturally Aspirated GMC Eng.; Chevrolet; VIN Code H			(cont.)	
QTY	CYLINDER HEAD	YEARS	PART NO.	DESCRIPTION		
2	Head Gasket	1991	505 SD	Head bolts not incl.; Head bolt replacement recommended; PermaTorque Severe Duty®		
2	Head Gasket	1991	8510 PT	Head bolts not incl.; Head bolt replacement recommended; PermaTorque®		
1	Head Set	1991	HS 8510 PT-5	Head bolts not incl.; Head bolt replacement recommended; PermaDry® molded rubber valve cover gskts. incl.; Premium valve stem seals incl.		
2	Head Bolt Set	1991	ES 72856	Replacement recommended		
QTY	CONVERSION SET	YEARS	PART NO.	DESCRIPTION		
1	Gasket Conversion Set	1991	CS 8510	PermaDry® molded rubber oil pan gskt. incl.		
QTY	MANIFOLD - INT. & EXH.	YEARS	PART NO.	DESCRIPTION		
1	Int. Manifold Gasket Set	1991	MS 93035-1	Upper set incl.		
1	Plenum Gasket Set	1991	MS 93160	Upper set		
1	Exh. Manifold Gasket Set	1991	MS 9275 B			
QTY	FUEL PUMP	YEARS	PART NO.	DESCRIPTION		
1	Fuel Pump Mounting Gasket	1991	5182	Plate		
1	Fuel Pump Mounting Gasket	1991	6579	May also be used as a fuel pump block-off plate gasket if desired		
QTY	OIL PAN	YEARS	PART NO.	DESCRIPTION		
1	Oil Pan Gasket Set	1991	OS 34500 R	PermaDry® molded rubber gskt. incl.		
1	Drain Plug Gasket	1991	70822			
QTY	CRANKSHAFT REAR SEAL	YEARS	PART NO.	DESCRIPTION		
1	Rear Main Seal Set	1991	BS 40520	Rubber; One-piece		

5		1991; 5.0L 305 (4999cc) OHV V8 (16 Valve) 3.736" Bore			5	
(cont.)		TPI; Gasoline; Naturally Aspirated GMC Eng.; Chevrolet; VIN Code H			(cont.)	
QTY	CRANKSHAFT REAR SEAL	YEARS	PART NO.	DESCRIPTION		
1	Rear Main Seal Set	1991	BS 40626	PTFE Rubber; One-piece		
1	Repair Sleeve	1991	16258	Crankshaft; Use w/installation tool		
1	Repair Sleeve Tool	1991	16301	Crankshaft		
QTY	VALVE COVER	YEARS	PART NO.	DESCRIPTION		
1	Valve Cover Gasket Set	1991	VS 50088 R	Services both covers; PermaDry® molded rubber gskts. incl.		
2	Valve Cover Gasket Set	1991	VS 50293 R	Services one cover only; PermaDry® molded rubber gskt. incl.		
QTY	VALVE STEM SEAL SET	YEARS	PART NO.	DESCRIPTION		
1	Valve Stem Seal Set	1991	SS 72526	Loc. Exh.; Premium valve stem seals incl.		
1	Valve Stem Seal Set	1991	SS 72527	Loc. Int.; Premium valve stem seals incl.		
1	Valve Stem Seal Set	1991	SS 72877	Loc. Exh.; Opt. Hi-Temp. premium valve stem seals incl.		
QTY	WATER OUTLET GASKET	YEARS	PART NO.	DESCRIPTION		
1	Water Outlet Gasket	1991	35062	Water Outlet; 1 13/16" ID		
1	Water Outlet Gasket	1991	35562 T	Water Outlet; 1 13/16" ID; PermaDryPlus®		
QTY	WATER PUMP	YEARS	PART NO.	DESCRIPTION		
1	Water Pump Gasket	1991	13032	To plate		
2	Water Pump Gasket	1991	5152	To block		
QTY	TIMING COVER	YEARS	PART NO.	DESCRIPTION		
1	Timing Cover Set	1991	TCS 45121	w/o Sleeve 'N' Seal®; Must be used w/OS 34500R		
1	Timing Set w/Sleeve & Seal	1991	TCS 45265	w/Sleeve 'N' Seal®; Must be used w/OS 34500R		
1	Repair Sleeve	1991	16202	Timing Cover; Use w/installation tool		
1	Repair Sleeve Tool	1991	16312	Timing Cover		
QTY	CARB & FUEL INJECTION	YEARS	PART NO.	DESCRIPTION		
4	Fuel Injector O-Ring Set	1991	ES 70599	Improved design		
1	Throttle Body Gasket	1991	60826			
QTY	DISTRIBUTOR MOUNTING	YEARS	PART NO.	DESCRIPTION		
1	Distributor Mounting Gasket	1991	70194			
QTY	EXHAUST GAS RECIRCULATION	YEARS	PART NO.	DESCRIPTION		
1	EGR Gasket	1991	70954			
QTY	OIL PUMP RETAINER	YEARS	PART NO.	DESCRIPTION		
1	Oil Pump Shaft Guide	1991	72665	Distributor to oil pump shaft retainer		
6		2004 - 2001; 5.7L 346 (5665cc) OHV V8 (16 Valve) 99mm Bore LS-1			6	
(cont.)		MFI; Gasoline; Naturally Aspirated GMC Eng.; Chevrolet; VIN Code G			(cont.)	
QTY	CYLINDER HEAD	YEARS	PART NO.	DESCRIPTION		
2	Head Gasket	2004-02	26190 PT	Head bolts not incl.; Head bolt replacement recommended; PermaTorqueMLS® LaserWeld® Technology		
2	Head Gasket	2001	9284 PT	Head bolts not incl.; Head bolt replacement recommended		
1	Head Set	2004-02	HS 26190 PT	Head bolts not incl.; Head bolt replacement recommended; PermaDry® molded rubber valve cover gskts. incl.; Premium valve stem seals incl.		
1	Head Set	2001	HS 9284 PT-2	Head bolts not incl.; Head bolt replacement recommended; PermaDry® molded rubber valve cover gskts. incl.; Premium valve stem seals incl.		
2	Head Bolt Set	2004-01	ES 72173	1st Design; Replacement recommended		
2	Head Bolt Set	2004	ES 72220	2nd Design; Replacement recommended		
QTY	CONVERSION SET	YEARS	PART NO.	DESCRIPTION		
1	Gasket Conversion Set	2004-01	CS 9284	Lower oil pan gskt. not incl.; PermaDry® molded rubber oil pan gskt. incl.		
QTY	MANIFOLD - INT. & EXH.	YEARS	PART NO.	DESCRIPTION		
1	Int. Manifold Gasket Set	2004-01	MS 92438			
1	Int. Manifold Gasket Set	2004-01	MS 92465	Lifter valley cover set		
1	Exh. Manifold Gasket Set	2004-01	MS 92904			
QTY	EXHAUST PIPE FLANGE	YEARS	PART NO.	DESCRIPTION		
1	Exhaust Pipe Gasket	2004-01	60988	Loc. R.H.; Pipe to manifold		
1	Exhaust Pipe Gasket	2004-01	61077	Loc. L.H.; Pipe to manifold		
QTY	OIL PAN	YEARS	PART NO.	DESCRIPTION		
1	Oil Pan Gasket Set	2004-01	OS 30693 R	Loc. Upper; PermaDry® molded rubber gskt. incl.		
1	Oil Pan Gasket Set	2004-01	OS 30703 R	Loc. Lower; PermaDry® molded rubber gskt. incl.		
QTY	CRANKSHAFT REAR SEAL	YEARS	PART NO.	DESCRIPTION		
1	Rear Main Seal Set	2004-01	BS 40640	PTFE Rubber; One-piece		
1	Repair Sleeve	2004-01	16228	Crankshaft; Narrow lip; .780" sleeve length; Requires crankshaft machining due to clearance issues; Use w/installation tool		
1	Repair Sleeve	2004-01	16229	Crankshaft; Wide lip; 1.156" sleeve length; Requires crankshaft machining due to clearance issues; Use w/installation tool		
1	Repair Sleeve Tool	2004-01	16329	Crankshaft		
QTY	VALVE COVER	YEARS	PART NO.	DESCRIPTION		
1	Valve Cover Gasket Set	2004-01	VS 50504 R	w/o Grommets; PermaDry® molded rubber gskts. incl.		

Avanti II (Cont.)

6 (cont.)		2004 - 2001; 5.7L 346 (5665cc) OHV V8 (16 Valve) 99mm Bore LS-1			6 (cont.)	
MFI; Gasoline; Naturally Aspirated GMC Eng.; Chevrolet; VIN Code G						
QTY	VALVE COVER	YEARS	PART NO.	DESCRIPTION		
1	Valve Cover Gasket Set	2004-01	VS 50504 R-1	w/Grommets; PermaDry® molded rubber gskts. incl.; New Part Number - Check for Availability		
1	Grommet Set	2004-01	ES 72233	Valve Cover		
QTY	VALVE STEM SEAL SET	YEARS	PART NO.	DESCRIPTION		
1	Valve Stem Seal Set	2004-02	SS 71039	Premium valve stem seals incl.		
1	Valve Stem Seal Set	2001	SS 70945	Premium valve stem seals incl.		
QTY	THERMOSTAT HOUSING	YEARS	PART NO.	DESCRIPTION		
1	Thermostat Gasket	2003-01	35632	Thermostat Housing; Thermostat O-ring		
1	O-Ring	2004	35720	Thermostat Housing		
QTY	WATER PUMP	YEARS	PART NO.	DESCRIPTION		
2	Water Pump Gasket	2004-01	35635			
1	O-Ring	2004-01	35633	Water Pump		
1	Water Pump Mounting Set	2004-01	ES 73010	Mounting gasket set; New Part Number - Check for Availability		
QTY	TIMING COVER	YEARS	PART NO.	DESCRIPTION		
1	Timing Cover Set	2004-01	TCS 45993	Must be used w/OS 30693R or w/OS 30703R		
QTY	CARB & FUEL INJECTION	YEARS	PART NO.	DESCRIPTION		
1	Throttle Body Gasket	2004-01	61069			
QTY	EXHAUST GAS RECIRCULATION	YEARS	PART NO.	DESCRIPTION		
1	EGR Gasket	2004-01	70895	Pipe; O-ring		
1	EGR Gasket	2004-01	70914	Valve		
1	EGR Gasket	2004-01	70947	Pipe		
QTY	OIL FILTER MOUNTING	YEARS	PART NO.	DESCRIPTION		
1	Oil Cooler Gasket	2004-01	72462	Oil Filter; Center tube; Dual round port		
QTY	OIL PUMP COVER	YEARS	PART NO.	DESCRIPTION		
1	O-Ring	2004-01	72401	Oil Pump; Inlet tube		
QTY	OIL COOLER	YEARS	PART NO.	DESCRIPTION		
1	Oil Cooler Gasket	2004-01	72435	Oval port		
1	Oil Cooler Gasket	2004-01	72462	Dual round port		

Bentley - See Rolls-Royce

BMW Car (Incl. BMW, Glas, Isetta, Mini)

Engine Finding Index				
Engine	Years	Code	Line No.	
1.6L 97.5 (1598cc) DOHC L4 (16 Valve) 77mm Bore; MFI; Gasoline; Naturally Aspirated BMW Eng.	2012-07	N12B16	1	
1.6L 97.5 (1598cc) DOHC L4 (16 Valve) 77mm Bore; MFI; Gasoline; Turbo - Intercooled BMW Eng.	2013-07	N14B16	2	
1.6L 97.5 (1598cc) DOHC L4 (16 Valve) 77mm Bore; MFI; Gasoline; Naturally Aspirated BMW Eng.	2012-07	N45B16	3	
1.6L 97.5 (1598cc) DOHC L4 (16 Valve) 77mm Bore; MFI; Gasoline; Turbo - Intercooled BMW Eng.	2012-07	N45B16T	4	
1.6L 97.5 (1598cc) DOHC L4 (16 Valve) 77mm Bore VVT; DI; Gasoline; Naturally Aspirated BMW Eng.	2013-11	N16B16	5	
1.6L 97.5 (1598cc) DOHC L4 (16 Valve) 77mm Bore VVT; DI; Gasoline; Turbo - Intercooled BMW Eng.	2013-11	N18B16	6	
1.6L 98 (1598cc) SOHC L4 (16 Valve) 77mm Bore; MFI; Gasoline; Naturally Aspirated Tritec Eng.	2009-02	W10B16	7	
1.6L 98 (1598cc) SOHC L4 (16 Valve) 77mm Bore; MFI; Gasoline; Supercharged Tritec Eng.	2009-02	W11B16	8	
1.8L 109.5 (1796cc) DOHC L4 (16 Valve) 84mm Bore; MFI; Gasoline; Naturally Aspirated BMW Eng.	1995-91	M42B18	9	
1.9L 115.7 (1895cc) DOHC L4 (16 Valve) 85mm Bore; MFI; Gasoline; Naturally Aspirated BMW Eng.	1999-96	M44B19	10	
2.0L 121.4 (1991cc) DOHC L6 (24 Valve) 80mm Bore; MFI; Gasoline; Naturally Aspirated BMW Eng.	1995-93	M50B20	11	
2.5L 152.2 (2494cc) DOHC L6 (24 Valve) 84mm Bore; MFI; Gasoline; Naturally Aspirated BMW Eng.	1995-91	M50B25	12	
2.5L 152.2 (2494cc) DOHC L6 (24 Valve) 84mm Bore; MFI; Gasoline; Naturally Aspirated BMW Eng.	2000-98	M52B25	13	
2.5L 152.2 (2494cc) DOHC L6 (24 Valve) 84mm Bore; MFI; Gasoline; Naturally Aspirated BMW Eng.	2006-01	M54B25	14	
2.5L 152.2 (2494cc) SOHC L6 (12 Valve) 84mm Bore; MFI; Gasoline; Naturally Aspirated BMW Eng.	1993-91	M20B25	15	
2.8L 170 (2793cc) DOHC L6 (24 Valve) 84mm Bore; MFI; Gasoline; Naturally Aspirated BMW Eng.	2000-96	M52B28	16	
3.0L 181.8 (2979cc) DOHC L6 (24 Valve) 84mm Bore; MFI; Gasoline; Naturally Aspirated BMW Eng.	2006-01	M54B30	17	
3.0L 181.8 (2979cc) DOHC L6 (24 Valve) 84mm Bore; MFI; Gasoline; Turbo - Intercooled BMW Eng.	2013-07	N54B30	18	
3.0L 182 (2993cc) DOHC Turbo - Intercooled L6 (24 Valve) 90mm Bore; DI; Diesel; Turbo - Intercooled BMW Eng.	2013-09	M57T2D30	19	
3.0L 182.4 (2990cc) DOHC L6 (24 Valve) 86mm Bore; MFI; Gasoline; Naturally Aspirated BMW Eng.	1995-94	S50B30	20	
3.0L 182.8 (2996cc) DOHC L6 (24 Valve) 85mm Bore; MFI; Gasoline; Naturally Aspirated BMW Eng.	2010-06	N52B30	21	
3.0L 182.8 (2997cc) DOHC V8 (32 Valve) 84mm Bore; MFI; Gasoline; Naturally Aspirated BMW Eng.	1995-94	M60B30	22	
3.2L 192 (3152cc) DOHC L6 (24 Valve) 86.4mm Bore; MFI; Gasoline; Naturally Aspirated BMW Eng.	2000-96	S52B32	23	
3.2L 198 (3246cc) DOHC L6 (24 Valve) 87mm Bore; MFI; Gasoline; Naturally Aspirated BMW Eng.	2009-01	S54B32	24	
3.4L 209.2 (3430cc) SOHC L6 (12 Valve) 92mm Bore; MFI; Gasoline; Naturally Aspirated BMW Eng.	1993-91	M30B34	25	
4.0L 242.9 (3982cc) DOHC V8 (32 Valve) 89mm Bore; MFI; Gasoline; Naturally Aspirated BMW Eng.	1995-93	M60B40	26	

BMW Car (Incl. BMW, Glas, Isetta, Mini) (Cont.)

Engine Finding Index (Cont.)

Engine	Years	Code	Line No.
4.0L 244 (3999cc) DOHC V8 (32 Valve) 92mm Bore; MFI; Gasoline; Naturally Aspirated BMW Eng.	2013-08	S65B40	27
4.4L 268.4 (4398cc) DOHC V8 (32 Valve) 92mm Bore; MFI; Gasoline; Naturally Aspirated BMW Eng.	2003-96	M62B44	28
4.8L 294.3 (4837cc) DOHC V8 (32 Valve) 93mm Bore; MFI; Gasoline; Naturally Aspirated BMW Eng.	2005-03	S62B48	29
4.9L 301 (4941cc) DOHC V8 (32 Valve) 94mm Bore; MFI; Gasoline; Naturally Aspirated BMW Eng.	2003-00	S62B50	30
5.0L 304 (4999cc) DOHC V10 (40 Valve) 92mm Bore; MFI; Gasoline; Naturally Aspirated BMW Eng.	2010-06	S85B50	31

Engine Code Index

Code	Engine	Line No.
M20B25	2.5L 152.2 (2494cc) SOHC L6 (12 Valve) 84mm Bore; MFI; Gasoline; Naturally Aspirated BMW Eng.	15
M30B34	3.4L 209.2 (3430cc) SOHC L6 (12 Valve) 92mm Bore; MFI; Gasoline; Naturally Aspirated BMW Eng.	25
M42B18	1.8L 109.5 (1796cc) DOHC L4 (16 Valve) 84mm Bore; MFI; Gasoline; Naturally Aspirated BMW Eng.	9
M44B19	1.9L 115.7 (1895cc) DOHC L4 (16 Valve) 85mm Bore; MFI; Gasoline; Naturally Aspirated BMW Eng.	10
M50B20	2.0L 121.4 (1991cc) DOHC L6 (24 Valve) 80mm Bore; MFI; Gasoline; Naturally Aspirated BMW Eng.	11
M50B25	2.5L 152.2 (2494cc) DOHC L6 (24 Valve) 84mm Bore; MFI; Gasoline; Naturally Aspirated BMW Eng.	12
M52B25	2.5L 152.2 (2494cc) DOHC L6 (24 Valve) 84mm Bore; MFI; Gasoline; Naturally Aspirated BMW Eng.	13
M52B28	2.8L 170 (2793cc) DOHC L6 (24 Valve) 84mm Bore; MFI; Gasoline; Naturally Aspirated BMW Eng.	16
M54B25	2.5L 152.2 (2494cc) DOHC L6 (24 Valve) 84mm Bore; MFI; Gasoline; Naturally Aspirated BMW Eng.	14
M54B30	3.0L 181.8 (2979cc) DOHC L6 (24 Valve) 84mm Bore; MFI; Gasoline; Naturally Aspirated BMW Eng.	17
M57T2D30	3.0L 182 (2993cc) DOHC Turbo - Intercooled L6 (24 Valve) 90mm Bore; DI; Diesel; Turbo - Intercooled BMW Eng.	19
M60B30	3.0L 182.8 (2997cc) DOHC V8 (32 Valve) 84mm Bore; MFI; Gasoline; Naturally Aspirated BMW Eng.	22
M60B40	4.0L 242.9 (3982cc) DOHC V8 (32 Valve) 89mm Bore; MFI; Gasoline; Naturally Aspirated BMW Eng.	26
M62B44	4.4L 268.4 (4398cc) DOHC V8 (32 Valve) 92mm Bore; MFI; Gasoline; Naturally Aspirated BMW Eng.	28
N12B16	1.6L 97.5 (1598cc) DOHC L4 (16 Valve) 77mm Bore; MFI; Gasoline; Naturally Aspirated BMW Eng.	1
N14B16	1.6L 97.5 (1598cc) DOHC L4 (16 Valve) 77mm Bore; MFI; Gasoline; Turbo - Intercooled BMW Eng.	2
N16B16	1.6L 97.5 (1598cc) DOHC L4 (16 Valve) 77mm Bore VVT; DI; Gasoline; Naturally Aspirated BMW Eng.	5
N18B16	1.6L 97.5 (1598cc) DOHC L4 (16 Valve) 77mm Bore VVT; DI; Gasoline; Turbo - Intercooled BMW Eng.	6
N45B16	1.6L 97.5 (1598cc) DOHC L4 (16 Valve) 77mm Bore; MFI; Gasoline; Naturally Aspirated BMW Eng.	3
N45B16T	1.6L 97.5 (1598cc) DOHC L4 (16 Valve) 77mm Bore; MFI; Gasoline; Turbo - Intercooled BMW Eng.	4
N52B30	3.0L 182.8 (2996cc) DOHC L6 (24 Valve) 85mm Bore; MFI; Gasoline; Naturally Aspirated BMW Eng.	21
N54B30	3.0L 181.8 (2979cc) DOHC L6 (24 Valve) 84mm Bore; MFI; Gasoline; Turbo - Intercooled BMW Eng.	18
S50B30	3.0L 182.4 (2990cc) DOHC L6 (24 Valve) 86mm Bore; MFI; Gasoline; Naturally Aspirated BMW Eng.	20
S52B32	3.2L 192 (3152cc) DOHC L6 (24 Valve) 86.4mm Bore; MFI; Gasoline; Naturally Aspirated BMW Eng.	23
S54B32	3.2L 198 (3246cc) DOHC L6 (24 Valve) 87mm Bore; MFI; Gasoline; Naturally Aspirated BMW Eng.	24
S62B48	4.8L 294.3 (4837cc) DOHC V8 (32 Valve) 93mm Bore; MFI; Gasoline; Naturally Aspirated BMW Eng.	29
S62B50	4.9L 301 (4941cc) DOHC V8 (32 Valve) 94mm Bore; MFI; Gasoline; Naturally Aspirated BMW Eng.	30
S65B40	4.0L 244 (3999cc) DOHC V8 (32 Valve) 92mm Bore; MFI; Gasoline; Naturally Aspirated BMW Eng.	27
S85B50	5.0L 304 (4999cc) DOHC V10 (40 Valve) 92mm Bore; MFI; Gasoline; Naturally Aspirated BMW Eng.	31
W10B16	1.6L 98 (1598cc) SOHC L4 (16 Valve) 77mm Bore; MFI; Gasoline; Naturally Aspirated Tritec Eng.	7
W11B16	1.6L 98 (1598cc) SOHC L4 (16 Valve) 77mm Bore; MFI; Gasoline; Supercharged Tritec Eng.	8

Model Index

Engine (VIN Code / Eng. Code)	Year	Engine (VIN Code / Eng. Code)	Year	Engine (VIN Code / Eng. Code)	Year
BMW		BMW (cont.)		BMW (cont.)	
128i		2002Tii (cont.)		318ti (cont.)	
L6 2996cc 3.0L DOHC (24 Valve) (N51B30)	13-12	L4 1990cc 2.0L SOHC (121)	74-71	L4 1895cc 1.9L DOHC (16 Valve) (M44B19)	99-96
L6 2996cc 3.0L DOHC (24 Valve) (N52B30)	13-08	2800		320i	
135i		L6 2788cc 2.8L SOHC (M30B28)	71-69	L4 1766cc 1.8L SOHC (M10B18)	83-80
L6 2979cc 3.0L DOHC Turbo (24 Valve) (N54B30)	10-08	L6 2788cc 2.8L SOHC (M30B28)	71-70	L4 1990cc 2.0L SOHC (M10B20)	79-77
L6 2979cc 3.0L DOHC Turbo (24 Valve) (N55B30)	13-11	3.0CS		L4 1997cc 2.0L DOHC Turbo (16 Valve) (N20B20)	13
L6 2985cc 3.0L SOHC (M30B30)	74-71	L6 2985cc 3.0L SOHC (M30B30)	74-71	320xi	
135is		3.0CSi		L4 1997cc 2.0L DOHC Turbo (16 Valve) (N20B20)	13
L6 2979cc 3.0L DOHC Turbo (24 Valve) (N54B30)	13	3.0S		323Ci	
L6 2985cc 3.0L SOHC (M30B30)	74-71	L6 2985cc 3.0L SOHC (M30B30)	74-71	L6 2494cc 2.5L DOHC (24 Valve) (M52B25)	00
1800		3.0Si		323i	
L4 1766cc 1.8L SOHC (M10B18)	71-68	L6 2985cc 3.0L SOHC (M30B30)	76-75	L6 2494cc 2.5L DOHC (24 Valve) (M52B25)	00-98
1802		318i		323iC	
L4 1766cc 1.8L SOHC (M10B18)	71	L4 1766cc 1.8L SOHC (M10B18)	85-84	L6 2494cc 2.5L DOHC (24 Valve) (M52B25)	00-98
1M		L4 1796cc 1.8L DOHC (16 Valve) (M42B18)	95-91	323is	
L6 2979cc 3.0L DOHC Turbo (24 Valve) (N54B30)	12-11	L4 1895cc 1.9L DOHC (16 Valve) (M44B19)	98-96	L6 2494cc 2.5L DOHC (24 Valve) (M52B25)	99-98
2000		318iC		325	
L4 1990cc 2.0L SOHC (121)	70-66	L4 1796cc 1.8L DOHC (16 Valve) (M42B18)	95-93	L6 2693cc 2.7L SOHC (M20B27)	88-85
L4 1990cc 2.0L SOHC (121)	68-66	L4 1895cc 1.9L DOHC (16 Valve) (M44B19)	97-96	L6 2494cc 2.5L DOHC (24 Valve) (M54B25)	06-01
L4 1990cc 2.0L SOHC (121)	68-66	318is		L6 2693cc 2.7L SOHC (M20B27)	88-83
2002		L4 1796cc 1.8L DOHC (16 Valve) (M42B18)	95-91	L6 2693cc 2.7L SOHC (M20B27)	88-85
L4 1990cc 2.0L SOHC (121)	76-69	L4 1895cc 1.9L DOHC (16 Valve) (M44B19)	97-96	L6 2494cc 2.5L DOHC (24 Valve) (M50B25)	95-92
L4 1990cc 2.0L SOHC Turbo (121)	74-73	318ti		L6 2494cc 2.5L DOHC (24 Valve) (M54B25)	05-01
		L4 1796cc 1.8L DOHC (16 Valve) (M42B18)	95		

BMW Car (Incl. BMW, Glas, Isetta, Mini) (Cont.)

Model Index (Cont.)

Engine (VIN Code / Eng. Code)	Year	Engine (VIN Code / Eng. Code)	Year	Engine (VIN Code / Eng. Code)	Year
BMW (cont.)		BMW (cont.)		BMW (cont.)	
325i (cont.)		525iT (cont.)		550xi	
L6 2494cc 2.5L SOHC (12 Valve) (M20B25)	91-87	L6 2494cc 2.5L DOHC (24 Valve) (M54B25)	03-01	V8 4395cc 4.4L DOHC Turbo (32 Valve) (N63B44)	13-11
L6 2996cc 3.0L DOHC (24 Valve) (N52B30)	06	525xi		550xi GT	
L6 2494cc 2.5L DOHC (24 Valve) (M50B25)	95-94	L6 2996cc 3.0L DOHC (24 Valve) (N52B30)	07-06	V8 4395cc 4.4L DOHC Turbo (32 Valve) (N63B44)	13-10
L6 2494cc 2.5L DOHC (24 Valve) (M54B25)	06-01	528e		630CSi	
L6 2494cc 2.5L SOHC (12 Valve) (M20B25)	93-87	L6 2693cc 2.7L SOHC (M20B27)	88-82	L6 2985cc 3.0L SOHC (M30B30)	78-77
L6 2494cc 2.5L DOHC (24 Valve) (M50B25)	95-92	528i		633CSi	
L6 2494cc 2.5L SOHC (12 Valve) (M20B25)	91-87	L4 1997cc 2.0L DOHC Turbo (16 Valve) (N20B20)	13-12	L6 3210cc 3.2L SOHC (M30B32)	84-78
L6 2494cc 2.5L SOHC (12 Valve) (M20B25)	91-87	L6 2788cc 2.8L SOHC (M30B28)	81-79	635CSi	
L6 2494cc 2.5L DOHC (24 Valve) (M54B25)	05-01	L6 2793cc 2.8L DOHC (24 Valve) (M52B28)	00-97	L6 3430cc 3.4L SOHC (M30B34)	90-85
L6 2996cc 3.0L DOHC (24 Valve) (N52B30)	06	L6 2996cc 3.0L DOHC (24 Valve) (N52B30)	11-08	640i	
328Ci		528xi		640i Gran Coupe	
L6 2793cc 2.8L DOHC (24 Valve) (M52B28)	00	L4 1997cc 2.0L DOHC Turbo (16 Valve) (N20B20)	13-12	L6 2979cc 3.0L DOHC Turbo (24 Valve) (N55B30)	13
328i		L6 2996cc 3.0L DOHC (24 Valve) (N52B30)	10-08	645Ci	
L4 1997cc 2.0L DOHC Turbo (16 Valve) (N20B20)	13-12	530i		650Ci	
L6 2793cc 2.8L DOHC (24 Valve) (M52B28)	00-96	L6 2979cc 3.0L DOHC (24 Valve) (M54B30)	05-01	V8 4398cc 4.4L DOHC (32 Valve) (N62B44)	05-04
L6 2996cc 3.0L DOHC (24 Valve) (N51B30)	13-12	L6 2985cc 3.0L SOHC (M30B30)	78-75	650i	
L6 2996cc 3.0L DOHC (24 Valve) (N52B30)	13-07	L6 2996cc 3.0L DOHC (24 Valve) (N52B30)	07-06	V8 4799cc 4.8L DOHC (32 Valve) (N62B48)	10-06
328iC		V8 2997cc 3.0L DOHC (32 Valve) (M60B30)	95-94	650i	
L6 2793cc 2.8L DOHC (24 Valve) (M52B28)	00-96	530iT		650xi	
328is		V8 2997cc 3.0L DOHC (32 Valve) (M60B30)	95-94	V8 4395cc 4.4L DOHC Turbo (32 Valve) (N63B44)	13-12
L6 2793cc 2.8L DOHC (24 Valve) (M52B28)	99-96	530xi		V8 4799cc 4.8L DOHC (32 Valve) (N62B48)	10-06
328xi		L6 2996cc 3.0L DOHC (24 Valve) (N52B30)	07-06	650i Gran Coupe	
L4 1997cc 2.0L DOHC Turbo (16 Valve) (N20B20)	13-12	533i		V8 4395cc 4.4L DOHC Turbo (32 Valve) (N63B44)	13
L6 2996cc 3.0L DOHC (24 Valve) (N51B30)	13-12	L6 3210cc 3.2L SOHC (M30B32)	84-83	650xi	
L6 2996cc 3.0L DOHC (24 Valve) (N52B30)	13-07	535i		650xi Gran Coupe	
330Ci		L6 2979cc 3.0L DOHC Turbo (24 Valve) (N54B30)	10-08	V8 4395cc 4.4L DOHC Turbo (32 Valve) (N63B44)	13-12
L6 2979cc 3.0L DOHC (24 Valve) (M54B30)	06-01	L6 2979cc 3.0L DOHC Turbo (24 Valve) (N55B30)	13-11	733i	
330i		L6 3430cc 3.4L SOHC (M30B34)	93-85	L6 3210cc 3.2L SOHC (M30B32)	84-78
L6 2979cc 3.0L DOHC (24 Valve) (M54B30)	05-01	535i GT		735i	
L6 2996cc 3.0L DOHC (24 Valve) (N52B30)	06	L6 2979cc 3.0L DOHC Turbo (24 Valve) (N54B30)	10	L6 3430cc 3.4L SOHC (M30B34)	92-85
330iC		L6 2979cc 3.0L DOHC Turbo (24 Valve) (N55B30)	13-11	735iL	
L6 2979cc 3.0L DOHC (24 Valve) (M54B30)	06-01	535is		L6 3430cc 3.4L SOHC (M30B34)	92-88
330xi		L6 3430cc 3.4L SOHC (M30B34)	88	740i	
L6 2979cc 3.0L DOHC (24 Valve) (M54B30)	05-01	535xi		L6 2979cc 3.0L DOHC Turbo (24 Valve) (N54B30)	13-11
L6 2996cc 3.0L DOHC (24 Valve) (N52B30)	06	L6 2979cc 3.0L DOHC Turbo (24 Valve) (N54B30)	10-08	L6 2979cc 3.0L DOHC Turbo (24 Valve) (N54B30)	13-11
335d		L6 2979cc 3.0L DOHC Turbo (24 Valve) (N55B30)	13-11	V8 3982cc 4.0L DOHC (32 Valve) (M60B40)	95-93
L6 2993cc 3.0L DOHC Turbo-Diesel (24 Valve) (M57T2D30)	13-09	535xi GT		V8 4398cc 4.4L DOHC (32 Valve) (M62B44)	01-96
335i		L6 2979cc 3.0L DOHC Turbo (24 Valve) (N54B30)	10	740iL	
L6 2979cc 3.0L DOHC Turbo (24 Valve) (N54B30)	10-07	L6 2979cc 3.0L DOHC Turbo (24 Valve) (N55B30)	13-11	V8 3982cc 4.0L DOHC (32 Valve) (M60B40)	95-93
L6 2979cc 3.0L DOHC Turbo (24 Valve) (N55B30)	13-11	540i		V8 4398cc 4.4L DOHC (32 Valve) (M62B44)	01-96
335is		L6 2979cc 3.0L DOHC Turbo (24 Valve) (N54B30)	10-07	740Li	
L6 2979cc 3.0L DOHC Turbo (24 Valve) (N54B30)	13-11	L6 2979cc 3.0L DOHC Turbo (24 Valve) (N55B30)	13-11	L6 2979cc 3.0L DOHC Turbo (24 Valve) (N54B30)	13-11
335xi		540iT		745i	
L6 2979cc 3.0L DOHC Turbo (24 Valve) (N54B30)	10-07	V8 4398cc 4.4L DOHC (32 Valve) (M62B44)	03-99	V8 4398cc 4.4L DOHC (32 Valve) (N62B44)	05-02
L6 2979cc 3.0L DOHC Turbo (24 Valve) (N55B30)	13-11	545i		745Li	
520i		V8 4395cc 4.4L DOHC Turbo (32 Valve) (N63B44)	13-11	750i	
L4 1766cc 1.8L SOHC (M10B18)	81-80	V8 4799cc 4.8L DOHC (32 Valve) (N62B48)	10-06	V8 4395cc 4.4L DOHC Turbo (32 Valve) (N63B44)	13-09
L4 1990cc 2.0L SOHC (M10B20)	79-77	550i		V8 4799cc 4.8L DOHC (32 Valve) (N62B48)	08-06
524td		V8 4395cc 4.4L DOHC Turbo (32 Valve) (N63B44)	13-11	750iL	
L6 2443cc 2.4L SOHC Turbo-Diesel (M21D24)	86-85	V8 4398cc 4.4L DOHC (32 Valve) (M62B44)	05-04	V12 4988cc 5.0L SOHC (24 Valve) (M70B50)	94-88
525i		540i		V12 5379cc 5.4L SOHC (24 Valve) (M73B54)	01-95
L6 2494cc 2.5L DOHC (24 Valve) (M50B25)	95-91	V8 4398cc 4.4L DOHC (32 Valve) (M62B44)	03-99		
L6 2494cc 2.5L DOHC (24 Valve) (M54B25)	05-01	540iT			
L6 2494cc 2.5L SOHC (12 Valve) (M20B25)	90-89	V8 4398cc 4.4L DOHC (32 Valve) (M62B44)	03-99		
L6 2996cc 3.0L DOHC (24 Valve) (N52B30)	07-06	545i			
525iT		V8 4398cc 4.4L DOHC (32 Valve) (M62B44)	05-04		
L6 2494cc 2.5L DOHC (24 Valve) (M50B25)	95-91	550i			

BMW Car (Incl. BMW, Glas, Isetta, Mini) (Cont.)

Model Index (Cont.)					
Engine (VIN Code / Eng. Code)	Year	Engine (VIN Code / Eng. Code)	Year	Engine (VIN Code / Eng. Code)	Year
BMW (cont.)		BMW (cont.)		Mini (cont.)	
750Li		M5 (cont.)		Cooper S John Cooper Works	
V8 4395cc 4.4L DOHC Turbo (32 Valve) (N63B44)	13-09	V8 4395cc 4.4L DOHC Turbo (32 Valve) (S63B44)	13-12	L4 1598cc 1.6L DOHC Turbo (16 Valve) (N14B16)	13-08
V8 4799cc 4.8L DOHC (32 Valve) (N62B48)	08-06	V8 4941cc 4.9L DOHC (32 Valve) (S62B50)	03-00	L4 1598cc 1.6L SOHC Supercharged (16 Valve) (W11B16)	08-04
750Lxi		M6		Cooper S Paceman	
V8 4395cc 4.4L DOHC Turbo (32 Valve) (N63B44)	13-10	L6 3453cc 3.5L DOHC (24 Valve) (S38B35)	89-87	L4 1598cc 1.6L DOHC Turbo (16 Valve) (N18B16)	13
750xi		V10 4999cc 5.0L DOHC (40 Valve) (S85B50)	10-06		
V8 4395cc 4.4L DOHC Turbo (32 Valve) (N63B44)	13-10	V8 4395cc 4.4L DOHC Turbo (32 Valve) (S63B44)	13-12		
760i		Z3			
V12 5972cc 6.0L DOHC (48 Valve) (N73B60)	06-05	L4 1895cc 1.9L DOHC (16 Valve) (M44B19)	98-96		
760Li		L6 2494cc 2.5L DOHC (24 Valve) (M52B25)	00-99		
V12 5972cc 6.0L DOHC (48 Valve) (N73B60)	08-03	L6 2494cc 2.5L DOHC (24 Valve) (M54B25)	02-01		
V12 5972cc 6.0L DOHC Turbo (48 Valve) (N74B60)	13-10	L6 2793cc 2.8L DOHC (24 Valve) (M52B28)	00-97		
840Ci		L6 2979cc 3.0L DOHC (24 Valve) (M54B30)	02-01		
V8 3982cc 4.0L DOHC (32 Valve) (M60B40)	95-94	L6 3152cc 3.2L DOHC (24 Valve) (S52B32)	00-98		
V8 4398cc 4.4L DOHC (32 Valve) (M62B44)	97-96	L6 3245cc 3.2L DOHC (24 Valve) (S54B32)	02-01		
850Ci		Z4			
V12 4988cc 5.0L SOHC (24 Valve) (M70B50)	94-93	L4 1997cc 2.0L DOHC Turbo (16 Valve) (N20B20)	13-12		
V12 5379cc 5.4L SOHC (24 Valve) (M73B54)	97-95	L6 2494cc 2.5L DOHC (24 Valve) (M54B25)	06-03		
850CSi		L6 2979cc 3.0L DOHC (24 Valve) (M54B30)	06-03		
V12 5576cc 5.6L SOHC (24 Valve) (S70B56)	95-94	L6 2979cc 3.0L DOHC Turbo (24 Valve) (N54B30)	13-10		
850i		L6 2996cc 3.0L DOHC (24 Valve) (N52B30)	11-06		
V12 4988cc 5.0L SOHC (24 Valve) (M70B50)	92-90	L6 3245cc 3.2L DOHC (24 Valve) (S54B32)	09-06		
ActiveHybrid3		Z8			
L6 2979cc 3.0L DOHC Turbo (24 Valve) (N55B30)	13	V8 4941cc 4.9L DOHC (32 Valve) (S62B50)	03-00		
ActiveHybrid5		Mini			
L6 2979cc 3.0L DOHC Turbo (24 Valve) (N55B30)	13-12	Cooper Clubman			
ActiveHybrid7		L4 1598cc 1.6L DOHC (16 Valve) (N12B16)	10-08		
L6 2979cc 3.0L DOHC Turbo (24 Valve) (N55B30)	13	L4 1598cc 1.6L DOHC (16 Valve) (N16B16)	13-11		
V8 4395cc 4.4L DOHC Turbo (32 Valve) (N63B44)	13-10	Cooper Convertible			
Alpina B7		L4 1598cc 1.6L DOHC (16 Valve) (N12B16)	10-09		
V8 4395cc 4.4L DOHC Turbo (32 Valve) (N63B44)	13-11	L4 1598cc 1.6L DOHC (16 Valve) (N16B16)	13-11		
V8 4395cc 4.4L DOHC Turbo (32 Valve) (N63B44)	09	L4 1598cc 1.6L SOHC (16 Valve) (W10B16)	09-05		
V8 4398cc 4.4L DOHC Supercharged (32 Valve) (N62B44S)	08-07	Cooper Countryman			
Alpina B7L		L4 1598cc 1.6L DOHC (16 Valve) (N16B16)	13-11		
V8 4395cc 4.4L DOHC Turbo (32 Valve) (N63B44)	13-11	Cooper Coupe			
Alpina Roadster		L4 1598cc 1.6L DOHC (16 Valve) (N12B16)	10-07		
V8 4837cc 4.8L DOHC (32 Valve) (S62B48)	04-03	L4 1598cc 1.6L DOHC (16 Valve) (N16B16)	13-11		
Bavaria		L4 1598cc 1.6L SOHC (16 Valve) (W10B16)	06-02		
L6 2788cc 2.8L SOHC (M30B28)	71	Cooper Paceman			
L6 2985cc 3.0L SOHC (M30B30)	74-72	L4 1598cc 1.6L DOHC (16 Valve) (N16B16)	13		
L6		Cooper S Clubman			
L6 3430cc 3.4L SOHC (M30B34)	88-87	L4 1598cc 1.6L DOHC Turbo (16 Valve) (N14B16)	10-08		
L7		L4 1598cc 1.6L DOHC Turbo (16 Valve) (N18B16)	13-11		
L6 3430cc 3.4L SOHC (M30B34)	87-86	L4 1598cc 1.6L SOHC Supercharged (16 Valve) (W11B16)	09-05		
M3		Cooper S Countryman			
L4 2302cc 2.3L DOHC (16 Valve) (S14B23)	91-88	L4 1598cc 1.6L DOHC Turbo (16 Valve) (N18B16)	13-11		
L6 2990cc 3.0L DOHC (24 Valve) (S50B30)	95-94	Cooper S Coupe			
L6 3152cc 3.2L DOHC (24 Valve) (S52B32)	00-96	L4 1598cc 1.6L DOHC Turbo (16 Valve) (N14B16)	10-07		
L6 3245cc 3.2L DOHC (24 Valve) (S54B32)	06-01	L4 1598cc 1.6L DOHC Turbo (16 Valve) (N18B16)	13-11		
V8 3999cc 4.0L DOHC (32 Valve) (S65B40)	13-08	L4 1598cc 1.6L SOHC Supercharged (16 Valve) (W11B16)	06-02		
M5					
L6 3453cc 3.5L DOHC (24 Valve) (S38B35)	88-87				
L6 3535cc 3.5L DOHC (24 Valve) (S38B35)	93-91				
V10 4999cc 5.0L DOHC (40 Valve) (S85B50)	10-06				

BMW Car (Incl. BMW, Glas, Isetta, Mini) (Cont.)

1		2012 - 2007; 1.6L 97.5 (1598cc) DOHC L4 (16 Valve) 77mm Bore			1
		MFI; Gasoline; Naturally Aspirated BMW Eng.; Eng. Code N12B16			
QTY	CYLINDER HEAD	YEARS	PART NO.	DESCRIPTION	
1	Head Gasket	2012-07	26453 PT	Head bolts not incl.; Head bolt replacement recommended; 1.20mm thick; PermaTorqueMLS®	
1	Head Gasket	2012-07	26458 PT	Head bolts not incl.; Head bolt replacement recommended; .90mm thick; PermaTorqueMLS®	
1	Head Set	2012-07	HS 26453 PT	Head gskt. 1.20mm thick; Head bolts not incl.; Head bolt replacement recommended; PermaDry® molded rubber valve cover gskt. incl.; Premium valve stem seals incl.; New Part Number - Check for Availability	
1	Head Set	2012-07	HS 26458 PT	Head gskt. .90mm thick; Head bolts not incl.; Head bolt replacement recommended; PermaDry® molded rubber valve cover gskt. incl.; Premium valve stem seals incl.; New Part Number - Check for Availability	
1	Head Set w/o Head Gasket	2012-07	HSU 26453	Head gskt. & head bolts not incl.; Head bolt replacement recommended; PermaDry® molded rubber valve cover gskt. incl.; Premium valve stem seals incl.; New Part Number - Check for Availability	
1	Head Bolt Set	2012-07	ES 72451	Head bolts w/Washers; Replacement recommended; New Part Number - Check for Availability	
QTY	CONVERSION SET	YEARS	PART NO.	DESCRIPTION	
1	Gasket Conversion Set	2012-07	CS 26453	New Part Number - Check for Availability	
QTY	MANIFOLD - INT. & EXH.	YEARS	PART NO.	DESCRIPTION	
1	Int. Manifold Gasket Set	2012-07	MS 97101		
1	Exh. Manifold Gasket Set	2012-07	MS 97105		
QTY	OIL PAN	YEARS	PART NO.	DESCRIPTION	
1	Oil Pan Gasket Set	2012-07	OS 30820		
QTY	CRANKSHAFT REAR SEAL	YEARS	PART NO.	DESCRIPTION	
1	Rear Main Seal Set	2012-07	BS 40721	Rubber; One-piece	
QTY	VALVE COVER	YEARS	PART NO.	DESCRIPTION	
1	Valve Cover Gasket Set	2012-07	VS 50763 R	w/Grommets & Spark plug tube seals; PermaDry® molded rubber gskt. incl.	
QTY	VALVE STEM SEAL SET	YEARS	PART NO.	DESCRIPTION	
1	Valve Stem Seal Set	2012-07	SS 72930	Premium valve stem seals incl.	
QTY	THERMOSTAT HOUSING	YEARS	PART NO.	DESCRIPTION	
1	Thermostat Gasket	2012-07	35963	Thermostat Housing; Thermostat O-ring; New Part Number - Check for Availability	
QTY	WATER PUMP	YEARS	PART NO.	DESCRIPTION	
1	Water Pump Gasket	2012-07	35922	Thermostat housing to block	
1	Water Pump Gasket	2012-07	35966	Mounting; New Part Number - Check for Availability	
QTY	TIMING COVER	YEARS	PART NO.	DESCRIPTION	
1	Crankshaft Front Seal Set	2012-07	TCS 46127		
4	Camshaft Front Seal Set	2012-07	TCS 46149	New Part Number - Check for Availability	
QTY	CARB & FUEL INJECTION	YEARS	PART NO.	DESCRIPTION	
1	Throttle Body Gasket	2012-07	61605		
2		2013 - 2007; 1.6L 97.5 (1598cc) DOHC L4 (16 Valve) 77mm Bore			2
		MFI; Gasoline; Turbo - Intercooled BMW Eng.; Eng. Code N14B16			
QTY	CYLINDER HEAD	YEARS	PART NO.	DESCRIPTION	
1	Head Gasket	2012-07	26454 PT	Head bolts not incl.; Head bolt replacement recommended; .90mm thick; PermaTorqueMLS®	
1	Head Gasket	2012-07	26457 PT	Head bolts not incl.; Head bolt replacement recommended; 1.20mm thick; PermaTorqueMLS®	
1	Head Set w/o Head Gasket	2012-07	HSU 26454	Head gskt. & head bolts not incl.; Head bolt replacement recommended; PermaDry® molded rubber valve cover gskt. incl.; Premium valve stem seals incl.; New Part Number - Check for Availability	
1	Head Bolt Set	2012-07	ES 72451	Head bolts w/Washers; Replacement recommended; New Part Number - Check for Availability	
QTY	CONVERSION SET	YEARS	PART NO.	DESCRIPTION	
1	Gasket Conversion Set	2012-07	CS 26453	New Part Number - Check for Availability	
QTY	MANIFOLD - INT. & EXH.	YEARS	PART NO.	DESCRIPTION	
1	Int. Manifold Gasket Set	2012-07	MS 97101		
1	Exh. Manifold Gasket Set	2012-07	MS 97103		
QTY	OIL PAN	YEARS	PART NO.	DESCRIPTION	
1	Oil Pan Gasket Set	2012-07	OS 30820		
QTY	CRANKSHAFT REAR SEAL	YEARS	PART NO.	DESCRIPTION	
1	Rear Main Seal Set	2012-07	BS 40721	Rubber; One-piece	
QTY	VALVE COVER	YEARS	PART NO.	DESCRIPTION	
1	Valve Cover Gasket Set	2012-07	VS 50761 R	w/Grommets & Spark plug tube seals; PermaDry® molded rubber gskt. incl.	

BMW Car (Incl. BMW, Glas, Isetta, Mini) (Cont.)

2 (cont.)	2013 - 2007; 1.6L 97.5 (1598cc) DOHC L4 (16 Valve) 77mm Bore				2 (cont.)
MFI; Gasoline; Turbo - Intercooled BMW Eng.; Eng. Code N14B16					
QTY	VALVE STEM SEAL SET	YEARS	PART NO.	DESCRIPTION	
1	Valve Stem Seal Set	2012-07	SS 72930	Premium valve stem seals incl.	
QTY	THERMOSTAT HOUSING	YEARS	PART NO.	DESCRIPTION	
1	Thermostat Gasket	2012-07	35963	Thermostat Housing; Thermostat O-ring; New Part Number - Check for Availability	
QTY	WATER PUMP	YEARS	PART NO.	DESCRIPTION	
1	Water Pump Gasket	2012-07	35922	Thermostat housing to block	
1	Water Pump Gasket	2012-07	35966	Mounting; New Part Number - Check for Availability	
QTY	TIMING COVER	YEARS	PART NO.	DESCRIPTION	
1	Crankshaft Front Seal Set	2012-07	TCS 46127		
4	Camshaft Front Seal Set	2013-07	TCS 46149	New Part Number - Check for Availability	
QTY	CARB & FUEL INJECTION	YEARS	PART NO.	DESCRIPTION	
1	Throttle Body Gasket	2012-07	61608		
3	2012 - 2007; 1.6L 97.5 (1598cc) DOHC L4 (16 Valve) 77mm Bore				3
MFI; Gasoline; Naturally Aspirated BMW Eng.; Eng. Code N45B16					
QTY	CYLINDER HEAD	YEARS	PART NO.	DESCRIPTION	
1	Head Gasket	2012-07	26453 PT	Head bolts not incl.; Head bolt replacement recommended; 1.20mm thick; PermaTorqueMLS®	
1	Head Gasket	2012-07	26458 PT	Head bolts not incl.; Head bolt replacement recommended; .90mm thick; PermaTorqueMLS®	
1	Head Set	2012-07	HS 26453 PT	Head gskt. 1.20mm thick; Head bolts not incl.; Head bolt replacement recommended; PermaDry® molded rubber valve cover gskt. incl.; Premium valve stem seals incl.; New Part Number - Check for Availability	
1	Head Set	2012-07	HS 26458 PT	Head gskt. .90mm thick; Head bolts not incl.; Head bolt replacement recommended; PermaDry® molded rubber valve cover gskt. incl.; Premium valve stem seals incl.; New Part Number - Check for Availability	
1	Head Set w/o Head Gasket	2012-07	HSU 26453	Head gskt. & head bolts not incl.; Head bolt replacement recommended; PermaDry® molded rubber valve cover gskt. incl.; Premium valve stem seals incl.; New Part Number - Check for Availability	
1	Head Bolt Set	2012-07	ES 72451	Head bolts w/Washers; Replacement recommended; New Part Number - Check for Availability	
QTY	CONVERSION SET	YEARS	PART NO.	DESCRIPTION	
1	Gasket Conversion Set	2012-07	CS 26453	New Part Number - Check for Availability	
QTY	MANIFOLD - INT. & EXH.	YEARS	PART NO.	DESCRIPTION	
1	Int. Manifold Gasket Set	2012-07	MS 97101		
1	Exh. Manifold Gasket Set	2012-07	MS 97105		
QTY	OIL PAN	YEARS	PART NO.	DESCRIPTION	
1	Oil Pan Gasket Set	2012-07	OS 30820		
QTY	CRANKSHAFT REAR SEAL	YEARS	PART NO.	DESCRIPTION	
1	Rear Main Seal Set	2012-07	BS 40721	Rubber; One-piece	
QTY	VALVE COVER	YEARS	PART NO.	DESCRIPTION	
1	Valve Cover Gasket Set	2012-07	VS 50763 R	w/Grommets & Spark plug tube seals; PermaDry® molded rubber gskt. incl.	
QTY	VALVE STEM SEAL SET	YEARS	PART NO.	DESCRIPTION	
1	Valve Stem Seal Set	2012-07	SS 72930	Premium valve stem seals incl.	
QTY	THERMOSTAT HOUSING	YEARS	PART NO.	DESCRIPTION	
1	Thermostat Gasket	2012-07	35963	Thermostat Housing; Thermostat O-ring; New Part Number - Check for Availability	
QTY	WATER PUMP	YEARS	PART NO.	DESCRIPTION	
1	Water Pump Gasket	2012-07	35922	Thermostat housing to block	
1	Water Pump Gasket	2012-07	35966	Mounting; New Part Number - Check for Availability	
QTY	TIMING COVER	YEARS	PART NO.	DESCRIPTION	
1	Crankshaft Front Seal Set	2012-07	TCS 46127		
4	Camshaft Front Seal Set	2012-07	TCS 46149	New Part Number - Check for Availability	
QTY	CARB & FUEL INJECTION	YEARS	PART NO.	DESCRIPTION	
1	Throttle Body Gasket	2012-07	61605		
4	2012 - 2007; 1.6L 97.5 (1598cc) DOHC L4 (16 Valve) 77mm Bore				4
MFI; Gasoline; Turbo - Intercooled BMW Eng.; Eng. Code N45B16T					
QTY	CYLINDER HEAD	YEARS	PART NO.	DESCRIPTION	
1	Head Gasket	2012-07	26454 PT	Head bolts not incl.; Head bolt replacement recommended; .90mm thick; PermaTorqueMLS®	
1	Head Gasket	2012-07	26457 PT	Head bolts not incl.; Head bolt replacement recommended; 1.20mm thick; PermaTorqueMLS®	

BMW Car (Incl. BMW, Glas, Isetta, Mini) (Cont.)

4		2012 - 2007; 1.6L 97.5 (1598cc) DOHC L4 (16 Valve) 77mm Bore			4	
(cont.)		MFI; Gasoline; Turbo - Intercooled BMW Eng.; Eng. Code N45B16T			(cont.)	
QTY	CYLINDER HEAD	YEARS	PART NO.	DESCRIPTION		
1	Head Set w/o Head Gasket	2012-07	HSU 26454	Head gskt. & head bolts not incl.; Head bolt replacement recommended; PermaDry® molded rubber valve cover gskt. incl.; Premium valve stem seals incl.; New Part Number - Check for Availability		
1	Head Bolt Set	2012-07	ES 72451	Head bolts w/Washers; Replacement recommended; New Part Number - Check for Availability		
QTY	CONVERSION SET	YEARS	PART NO.	DESCRIPTION		
1	Gasket Conversion Set	2012-07	CS 26453	New Part Number - Check for Availability		
QTY	MANIFOLD - INT. & EXH.	YEARS	PART NO.	DESCRIPTION		
1	Int. Manifold Gasket Set	2012-07	MS 97101			
1	Exh. Manifold Gasket Set	2012-07	MS 97103			
QTY	OIL PAN	YEARS	PART NO.	DESCRIPTION		
1	Oil Pan Gasket Set	2012-07	OS 30820			
QTY	CRANKSHAFT REAR SEAL	YEARS	PART NO.	DESCRIPTION		
1	Rear Main Seal Set	2012-07	BS 40721	Rubber; One-piece		
QTY	VALVE COVER	YEARS	PART NO.	DESCRIPTION		
1	Valve Cover Gasket Set	2012-07	VS 50761 R	w/Grommets & Spark plug tube seals; PermaDry® molded rubber gskt. incl.		
QTY	VALVE STEM SEAL SET	YEARS	PART NO.	DESCRIPTION		
1	Valve Stem Seal Set	2012-07	SS 72930	Premium valve stem seals incl.		
QTY	THERMOSTAT HOUSING	YEARS	PART NO.	DESCRIPTION		
1	Thermostat Gasket	2012-07	35963	Thermostat Housing; Thermostat O-ring; New Part Number - Check for Availability		
QTY	WATER PUMP	YEARS	PART NO.	DESCRIPTION		
1	Water Pump Gasket	2012-07	35922	Thermostat housing to block		
1	Water Pump Gasket	2012-07	35966	Mounting; New Part Number - Check for Availability		
QTY	TIMING COVER	YEARS	PART NO.	DESCRIPTION		
1	Crankshaft Front Seal Set	2012-07	TCS 46127			
4	Camshaft Front Seal Set	2012-07	TCS 46149	New Part Number - Check for Availability		
QTY	CARB & FUEL INJECTION	YEARS	PART NO.	DESCRIPTION		
1	Throttle Body Gasket	2012-07	61608			
5		2013 - 2011; 1.6L 97.5 (1598cc) DOHC L4 (16 Valve) 77mm Bore VVT			5	
(cont.)		DI; Gasoline; Naturally Aspirated BMW Eng.; Eng. Code N16B16			(cont.)	
QTY	CYLINDER HEAD	YEARS	PART NO.	DESCRIPTION		
1	Head Bolt Set	2012-11	ES 72451	Head bolts w/Washers; Replacement recommended; New Part Number - Check for Availability		
QTY	CONVERSION SET	YEARS	PART NO.	DESCRIPTION		
1	Gasket Conversion Set	2012-11	CS 26453	New Part Number - Check for Availability		
QTY	MANIFOLD - INT. & EXH.	YEARS	PART NO.	DESCRIPTION		
1	Exh. Manifold Gasket Set	2012-11	MS 97189	New Part Number - Check for Availability		
QTY	OIL PAN	YEARS	PART NO.	DESCRIPTION		
1	Oil Pan Gasket Set	2012-11	OS 30820			
QTY	CRANKSHAFT REAR SEAL	YEARS	PART NO.	DESCRIPTION		
1	Rear Main Seal Set	2012-11	BS 40721	Rubber; One-piece		
QTY	THERMOSTAT HOUSING	YEARS	PART NO.	DESCRIPTION		
1	Thermostat Gasket	2012-11	35963	Thermostat Housing; Thermostat O-ring; New Part Number - Check for Availability		
QTY	WATER PUMP	YEARS	PART NO.	DESCRIPTION		
1	Water Pump Gasket	2012-11	35922	Thermostat housing to block		
1	Water Pump Gasket	2012-11	35966	Mounting; New Part Number - Check for Availability		
QTY	TIMING COVER	YEARS	PART NO.	DESCRIPTION		
1	Crankshaft Front Seal Set	2012-11	TCS 46127			
4	Camshaft Front Seal Set	2013-11	TCS 46149	New Part Number - Check for Availability		
6		2013 - 2011; 1.6L 97.5 (1598cc) DOHC L4 (16 Valve) 77mm Bore VVT			6	
(cont.)		DI; Gasoline; Turbo - Intercooled BMW Eng.; Eng. Code N18B16			(cont.)	
QTY	CYLINDER HEAD	YEARS	PART NO.	DESCRIPTION		
1	Head Bolt Set	2012-11	ES 72451	Head bolts w/Washers; Replacement recommended; New Part Number - Check for Availability		
QTY	CONVERSION SET	YEARS	PART NO.	DESCRIPTION		
1	Gasket Conversion Set	2012-11	CS 26453	New Part Number - Check for Availability		
QTY	MANIFOLD - INT. & EXH.	YEARS	PART NO.	DESCRIPTION		
1	Exh. Manifold Gasket Set	2012-11	MS 97189	New Part Number - Check for Availability		
QTY	OIL PAN	YEARS	PART NO.	DESCRIPTION		
1	Oil Pan Gasket Set	2012-11	OS 30820			

BMW Car (Incl. BMW, Glas, Isetta, Mini) (Cont.)

6		2013 - 2011; 1.6L 97.5 (1598cc) DOHC L4 (16 Valve) 77mm Bore VVT			6
(cont.)		DI; Gasoline; Turbo - Intercooled BMW Eng.; Eng. Code N18B16			(cont.)
QTY	CRANKSHAFT REAR SEAL	YEARS	PART NO.	DESCRIPTION	
1	Rear Main Seal Set	2012-11	BS 40721	Rubber; One-piece	
QTY	VALVE COVER	YEARS	PART NO.	DESCRIPTION	
1	Valve Cover Gasket Set	2012-11	VS 50788 R	w/Spark plug tube seals; PermaDry® molded rubber gskt. incl.; New Part Number - Check for Availability	
QTY	THERMOSTAT HOUSING	YEARS	PART NO.	DESCRIPTION	
1	Thermostat Gasket	2012-11	35963	Thermostat Housing; Thermostat O-ring; New Part Number - Check for Availability	
QTY	WATER PUMP	YEARS	PART NO.	DESCRIPTION	
1	Water Pump Gasket	2012-11	35922	Thermostat housing to block	
1	Water Pump Gasket	2012-11	35966	Mounting; New Part Number - Check for Availability	
QTY	TIMING COVER	YEARS	PART NO.	DESCRIPTION	
1	Crankshaft Front Seal Set	2012-11	TCS 46127		
4	Camshaft Front Seal Set	2013-11	TCS 46149	New Part Number - Check for Availability	
7		2009 - 2002; 1.6L 98 (1598cc) SOHC L4 (16 Valve) 77mm Bore			7
		MFI; Gasoline; Naturally Aspirated Tritec Eng.; Eng. Code W10B16			
QTY	CYLINDER HEAD	YEARS	PART NO.	DESCRIPTION	
1	Head Gasket	2009-02	26382 PT	Head bolts not incl.; Head bolt replacement recommended; PermaTorqueMLS®	
1	Head Set	2009-02	HS 26382 PT	Head bolts not incl.; Head bolt replacement recommended; PermaDry® molded rubber valve cover gskt. incl.; Premium valve stem seals incl.	
1	Head Bolt Set	2009-02	ES 72272	Head bolts w/Washers; Replacement recommended	
QTY	CONVERSION SET	YEARS	PART NO.	DESCRIPTION	
1	Gasket Conversion Set	2009-02	CS 26382	PermaDry® molded rubber oil pan gskt. incl.	
QTY	MANIFOLD - INT. & EXH.	YEARS	PART NO.	DESCRIPTION	
1	Int. Manifold Gasket Set	2009-02	MS 97005		
1	Exh. Manifold Gasket Set	2009-02	MS 97003		
QTY	EXHAUST PIPE FLANGE	YEARS	PART NO.	DESCRIPTION	
1	Exhaust Pipe Gasket	2009-02	61665	Flange	
QTY	OIL PAN	YEARS	PART NO.	DESCRIPTION	
1	Oil Pan Gasket Set	2009-02	OS 30800 R	PermaDry® molded rubber gskt. incl.	
QTY	CRANKSHAFT REAR SEAL	YEARS	PART NO.	DESCRIPTION	
1	Rear Main Seal Set	2009-02	BS 40710	Rubber; One-piece	
QTY	VALVE COVER	YEARS	PART NO.	DESCRIPTION	
1	Valve Cover Gasket Set	2009-02	VS 50731 R	PermaDry® molded rubber gskt. incl.	
QTY	VALVE STEM SEAL SET	YEARS	PART NO.	DESCRIPTION	
1	Valve Stem Seal Set	2009-02	SS 71292	Premium valve stem seals incl.	
QTY	THERMOSTAT HOUSING	YEARS	PART NO.	DESCRIPTION	
1	Thermostat Gasket	2009-02	35964	Thermostat Housing; Thermostat seal; New Part Number - Check for Availability	
QTY	WATER OUTLET GASKET	YEARS	PART NO.	DESCRIPTION	
1	Water Outlet Gasket	2009-02	35965	Water Outlet; Water inlet; New Part Number - Check for Availability	
QTY	TIMING COVER	YEARS	PART NO.	DESCRIPTION	
1	Timing Cover Set	2009-02	TCS 46105		
QTY	CARB & FUEL INJECTION	YEARS	PART NO.	DESCRIPTION	
1	Throttle Body Gasket	2009-02	61529		
8		2009 - 2002; 1.6L 98 (1598cc) SOHC L4 (16 Valve) 77mm Bore			8
		MFI; Gasoline; Supercharged Tritec Eng.; Eng. Code W11B16			
QTY	CYLINDER HEAD	YEARS	PART NO.	DESCRIPTION	
1	Head Gasket	2009-02	26382 PT	Head bolts not incl.; Head bolt replacement recommended; PermaTorqueMLS®	
1	Head Set	2009-02	HS 26382 PT-1	Head bolts not incl.; Head bolt replacement recommended; PermaDry® molded rubber valve cover gskt. incl.; Premium valve stem seals incl.	
1	Head Bolt Set	2009-02	ES 72272	Head bolts w/Washers; Replacement recommended	
QTY	CONVERSION SET	YEARS	PART NO.	DESCRIPTION	
1	Gasket Conversion Set	2009-02	CS 26382	PermaDry® molded rubber oil pan gskt. incl.	
QTY	MANIFOLD - INT. & EXH.	YEARS	PART NO.	DESCRIPTION	
1	Int. Manifold Gasket Set	2009-02	MS 97001		
1	Exh. Manifold Gasket Set	2009-02	MS 97003		
QTY	EXHAUST PIPE FLANGE	YEARS	PART NO.	DESCRIPTION	
1	Exhaust Pipe Gasket	2009-02	61665	Flange	

BMW Car (Incl. BMW, Glas, Isetta, Mini) (Cont.)

8 (cont.)	2009 - 2002; 1.6L 98 (1598cc) SOHC L4 (16 Valve) 77mm Bore			8 (cont.)
MFI; Gasoline; Supercharged Tritec Eng.; Eng. Code W11B16				
QTY	OIL PAN	YEARS	PART NO.	DESCRIPTION
1	Oil Pan Gasket Set	2009-02	OS 30800 R	PermaDry® molded rubber gskt. incl.
QTY	CRANKSHAFT REAR SEAL	YEARS	PART NO.	DESCRIPTION
1	Rear Main Seal Set	2009-02	BS 40710	Rubber; One-piece
QTY	VALVE COVER	YEARS	PART NO.	DESCRIPTION
1	Valve Cover Gasket Set	2009-02	VS 50731 R	PermaDry® molded rubber gskt. incl.
QTY	VALVE STEM SEAL SET	YEARS	PART NO.	DESCRIPTION
1	Valve Stem Seal Set	2009-02	SS 71292	Premium valve stem seals incl.
QTY	THERMOSTAT HOUSING	YEARS	PART NO.	DESCRIPTION
1	Thermostat Gasket	2009-02	35964	Thermostat Housing; Thermostat seal; New Part Number - Check for Availability
QTY	WATER OUTLET GASKET	YEARS	PART NO.	DESCRIPTION
1	Water Outlet Gasket	2009-02	35965	Water Outlet; Water inlet; New Part Number - Check for Availability
QTY	TIMING COVER	YEARS	PART NO.	DESCRIPTION
1	Timing Cover Set	2009-02	TCS 46105	
QTY	CARB & FUEL INJECTION	YEARS	PART NO.	DESCRIPTION
1	Throttle Body Gasket	2009-02	61532	
9	1995 - 1991; 1.8L 109.5 (1796cc) DOHC L4 (16 Valve) 84mm Bore			9
MFI; Gasoline; Naturally Aspirated BMW Eng.; Eng. Code M42B18				
QTY	CYLINDER HEAD	YEARS	PART NO.	DESCRIPTION
1	Head Set	1995-94	HS 26247 PT	Head bolts not incl.; Head bolt replacement recommended; PermaDry® molded rubber valve cover gskt. incl.; Premium valve stem seals incl.
1	Head Set	1993	HS 26246 PT	Head bolts not incl.; Head bolt replacement recommended; PermaDry® molded rubber valve cover gskt. incl.; Premium valve stem seals incl.
1	Head Set	1992-91	HS 26254 PT	Head bolts not incl.; Head bolt replacement recommended; PermaDry® molded rubber valve cover gskt. incl.; Premium valve stem seals incl.
1	Head Bolt Set	1995-91	ES 72838	Replacement recommended; New Part Number - Check for Availability
QTY	CONVERSION SET	YEARS	PART NO.	DESCRIPTION
1	Gasket Conversion Set	1993-91	CS 26246	PermaDry® molded rubber oil pan gskt. incl.
QTY	VALVE COVER	YEARS	PART NO.	DESCRIPTION
1	Valve Cover Gasket Set	1995-91	VS 50798 R	w/Grommets & Spark plug tube seals; PermaDry® molded rubber gskt. incl.; New Part Number - Check for Availability
10	1999 - 1996; 1.9L 115.7 (1895cc) DOHC L4 (16 Valve) 85mm Bore			10
MFI; Gasoline; Naturally Aspirated BMW Eng.; Eng. Code M44B19				
QTY	CYLINDER HEAD	YEARS	PART NO.	DESCRIPTION
1	Head Gasket	1999-96	26585 PT	Head bolts not incl.; Head bolt replacement recommended; 1.75mm thick; New Part Number - Check for Availability
1	Head Set	1999-96	HS 26253 PT	Head bolts not incl.; Head bolt replacement recommended; PermaDry® molded rubber valve cover gskt. incl.; Premium valve stem seals incl.
1	Head Bolt Set	1999-96	ES 72838	Replacement recommended; New Part Number - Check for Availability
QTY	CONVERSION SET	YEARS	PART NO.	DESCRIPTION
1	Gasket Conversion Set	1999-96	CS 26253	PermaDry® molded rubber oil pan gskt. incl.
QTY	MANIFOLD - INT. & EXH.	YEARS	PART NO.	DESCRIPTION
1	Int. Manifold Gasket Set	1999-96	MS 97315	Lower set; Upper set incl.; New Part Number - Check for Availability
1	Exh. Manifold Gasket Set	1999-98	MS 97282	New Part Number - Check for Availability
1	Exh. Manifold Gasket Set	1997-96	MS 97282	From 09/01/96; New Part Number - Check for Availability
QTY	VALVE COVER	YEARS	PART NO.	DESCRIPTION
1	Valve Cover Gasket Set	1999-96	VS 50798 R	w/Grommets & Spark plug tube seals; PermaDry® molded rubber gskt. incl.; New Part Number - Check for Availability
QTY	EXHAUST GAS RECIRCULATION	YEARS	PART NO.	DESCRIPTION
1	EGR Gasket	1999-96	72996	Air pump check valve; New Part Number - Check for Availability
11	1995 - 1993; 2.0L 121.4 (1991cc) DOHC L6 (24 Valve) 80mm Bore			11
MFI; Gasoline; Naturally Aspirated BMW Eng.; Eng. Code M50B20				
QTY	CYLINDER HEAD	YEARS	PART NO.	DESCRIPTION
1	Head Bolt Set	1995-93	ES 72440	Head bolts w/Washers; Replacement recommended; New Part Number - Check for Availability
12	1995 - 1991; 2.5L 152.2 (2494cc) DOHC L6 (24 Valve) 84mm Bore			12
MFI; Gasoline; Naturally Aspirated BMW Eng.; Eng. Code M50B25				
QTY	CYLINDER HEAD	YEARS	PART NO.	DESCRIPTION
1	Head Gasket	1995-91	26252 PT	Head bolts not incl.; Head bolt replacement recommended; 1.75mm thick

BMW Car (Incl. BMW, Glas, Isetta, Mini) (Cont.)

12 (cont.)		1995 - 1991; 2.5L 152.2 (2494cc) DOHC L6 (24 Valve) 84mm Bore			12 (cont.)
		MFI; Gasoline; Naturally Aspirated BMW Eng.; Eng. Code M50B25			
QTY	CYLINDER HEAD	YEARS	PART NO.	DESCRIPTION	
1	Head Gasket	1995-91	26264 PT	Head bolts not incl.; Head bolt replacement recommended; 2.05mm thick	
1	Head Set	1995-93	HS 26252 PT	Head gskt. 1.75mm thick; Head bolts not incl.; Head bolt replacement recommended; PermaDry® molded rubber valve cover gskt. incl.; Premium valve stem seals incl.	
1	Head Set	1992-91	HS 26252 PT-1	Head gskt. 1.75mm thick; Head bolts not incl.; Head bolt replacement recommended; PermaDry® molded rubber valve cover gskt. incl.; Premium valve stem seals incl.	
1	Head Bolt Set	1995-91	ES 72440	Head bolts w/Washers; Replacement recommended; New Part Number - Check for Availability	
QTY	CONVERSION SET	YEARS	PART NO.	DESCRIPTION	
1	Gasket Conversion Set	1995-91	CS 26252	PermaDry® molded rubber oil pan gskt. incl.	
QTY	MANIFOLD - INT. & EXH.	YEARS	PART NO.	DESCRIPTION	
1	Int. Manifold Gasket Set	1995-91	MS 96432		
1	Exh. Manifold Gasket Set	1995-91	MS 96555		
QTY	EXHAUST PIPE FLANGE	YEARS	PART NO.	DESCRIPTION	
2	Exhaust Pipe Gasket	1995-91	61371	Flange	
QTY	OIL PAN	YEARS	PART NO.	DESCRIPTION	
1	Oil Pan Gasket Set	1995-91	OS 30747 R	PermaDry® molded rubber gskt. incl.	
QTY	CRANKSHAFT REAR SEAL	YEARS	PART NO.	DESCRIPTION	
1	Rear Main Seal Set	1995-91	BS 40681	Rubber; One-piece	
QTY	VALVE COVER	YEARS	PART NO.	DESCRIPTION	
1	Valve Cover Gasket Set	1995-93	VS 50619 R	w/Spark plug tube seals; PermaDry® molded rubber gskt. incl.	
1	Valve Cover Gasket Set	1992-91	VS 50600 R	w/Spark plug tube seals; PermaDry® molded rubber gskt. incl.	
QTY	VALVE STEM SEAL SET	YEARS	PART NO.	DESCRIPTION	
1	Valve Stem Seal Set	1995-93	SS 72915	Premium valve stem seals incl.	
1	Valve Stem Seal Set	1992-91	SS 72682-3	Premium valve stem seals incl.	
QTY	THERMOSTAT HOUSING	YEARS	PART NO.	DESCRIPTION	
1	Water Outlet Gasket	1995-91	25589	Thermostat Housing; Aluminum housing; O-ring; New Improved design	
1	Thermostat Gasket	1995-93	35761	Thermostat Housing; Plastic housing	
1	Thermostat Gasket	1992-91	35782	Thermostat Housing; Thermostat housing to block	
1	O-Ring	1995-91	35763	Thermostat Housing; Aluminum housing; Improved design	
QTY	WATER PUMP	YEARS	PART NO.	DESCRIPTION	
1	Water Pump Gasket	1995-91	36066	Water pump housing O-ring; New Part Number - Check for Availability	
QTY	TIMING COVER	YEARS	PART NO.	DESCRIPTION	
1	Crankshaft Front Seal Set	1995-91	TCS 46047		
13		2000 - 1998; 2.5L 152.2 (2494cc) DOHC L6 (24 Valve) 84mm Bore			13
		MFI; Gasoline; Naturally Aspirated BMW Eng.; Eng. Code M52B25			
QTY	CYLINDER HEAD	YEARS	PART NO.	DESCRIPTION	
1	Head Gasket	2000-99	26245 PT	Head bolts not incl.; Head bolt replacement recommended; .70mm thick; PermaTorqueMLS®	
1	Head Gasket	1998	26252 PT	Head bolts not incl.; Head bolt replacement recommended; 1.75mm thick	
1	Head Set	2000-99	HS 26245 PT-1	Exh. manifold gskts. & head bolts not incl.; Head bolt replacement recommended; PermaDry® molded rubber valve cover gskt. incl.; Premium valve stem seals incl.	
1	Head Set	1998	HS 26252 PT-2	Head bolts not incl.; Head bolt replacement recommended; PermaDry® molded rubber valve cover gskt. incl.; Premium valve stem seals incl.	
1	Head Bolt Set	2000-98	ES 72440	Cast iron block; Head bolts w/Washers; Replacement recommended; New Part Number - Check for Availability	
1	Head Bolt Set	2000-98	ES 72943	Aluminum block; Replacement recommended; New Part Number - Check for Availability	
QTY	CONVERSION SET	YEARS	PART NO.	DESCRIPTION	
1	Gasket Conversion Set	2000-99	CS 26245	PermaDry® molded rubber oil pan gskt. incl.	
1	Gasket Conversion Set	1998	CS 26251	PermaDry® molded rubber oil pan gskt. incl.	
QTY	MANIFOLD - INT. & EXH.	YEARS	PART NO.	DESCRIPTION	
1	Int. Manifold Gasket Set	2000-99	MS 96431		
1	Int. Manifold Gasket Set	1998	MS 96430		
1	Exh. Manifold Gasket Set	2000-99	MS 96521		
1	Exh. Manifold Gasket Set	1998	MS 96553		
QTY	EXHAUST PIPE FLANGE	YEARS	PART NO.	DESCRIPTION	
2	Exhaust Pipe Gasket	2000-98	61371	Flange	
QTY	OIL PAN	YEARS	PART NO.	DESCRIPTION	
1	Oil Pan Gasket Set	2000-98	OS 30747 R	PermaDry® molded rubber gskt. incl.	

BMW Car (Incl. BMW, Glas, Isetta, Mini) (Cont.)

13 (cont.)		2000 - 1998; 2.5L 152.2 (2494cc) DOHC L6 (24 Valve) 84mm Bore			13 (cont.)
MFI; Gasoline; Naturally Aspirated BMW Eng.; Eng. Code M52B25					
QTY	CRANKSHAFT REAR SEAL	YEARS	PART NO.	DESCRIPTION	
1	Rear Main Seal Set	2000-98	BS 40681	Rubber; One-piece	
QTY	VALVE COVER	YEARS	PART NO.	DESCRIPTION	
1	Valve Cover Gasket Set	2000-99	VS 50626 R	w/Spark plug tube seals; PermaDry® molded rubber gskt. incl.	
1	Valve Cover Gasket Set	1998	VS 50601 R	w/Spark plug tube seals; PermaDry® molded rubber gskt. incl.	
1	Grommet Set	2000-98	ES 72490	Valve Cover; New Part Number - Check for Availability	
QTY	VALVE STEM SEAL SET	YEARS	PART NO.	DESCRIPTION	
1	Valve Stem Seal Set	2000-98	SS 72915	Premium valve stem seals incl.	
QTY	THERMOSTAT HOUSING	YEARS	PART NO.	DESCRIPTION	
1	Thermostat Gasket	2000-98	35761	Thermostat Housing; Plastic housing	
QTY	WATER OUTLET GASKET	YEARS	PART NO.	DESCRIPTION	
4	Water Outlet Gasket	2000-98	36058	Water Outlet; Water inlet pipe seal; New Part Number - Check for Availability	
QTY	WATER PUMP	YEARS	PART NO.	DESCRIPTION	
1	Water Pump Gasket	2000-98	36066	Water pump housing O-ring; New Part Number - Check for Availability	
QTY	TIMING COVER	YEARS	PART NO.	DESCRIPTION	
1	Crankshaft Front Seal Set	2000-99	TCS 46048-1		
1	Crankshaft Front Seal Set	1998	TCS 46047		
QTY	OIL FILTER MOUNTING	YEARS	PART NO.	DESCRIPTION	
1	Oil Filter Adapter Gasket	2000-98	72491	Oil filter mounting; New Part Number - Check for Availability	
14		2006 - 2001; 2.5L 152.2 (2494cc) DOHC L6 (24 Valve) 84mm Bore			14
MFI; Gasoline; Naturally Aspirated BMW Eng.; Eng. Code M54B25					
QTY	CYLINDER HEAD	YEARS	PART NO.	DESCRIPTION	
1	Head Gasket	2006-01	26245 PT	Head bolts not incl.; Head bolt replacement recommended; .70mm thick; PermaTorqueMLS®	
1	Head Gasket	2006-01	26275 PT	Head bolts not incl.; Head bolt replacement recommended; 1.00mm thick; PermaTorqueMLS®	
1	Head Set	2006-01	HS 26245 PT	Head gskt. .70mm thick; Exh. manifold gskts. & head bolts not incl.; Head bolt replacement recommended; PermaDry® molded rubber valve cover gskt. incl.; Premium valve stem seals incl.	
1	Head Bolt Set	2006-01	ES 72440	Cast iron block; Head bolts w/Washers; Replacement recommended; New Part Number - Check for Availability	
1	Head Bolt Set	2006-01	ES 72943	Aluminum block; Replacement recommended; New Part Number - Check for Availability	
QTY	CONVERSION SET	YEARS	PART NO.	DESCRIPTION	
1	Gasket Conversion Set	2006-01	CS 26245	PermaDry® molded rubber oil pan gskt. incl.	
QTY	MANIFOLD - INT. & EXH.	YEARS	PART NO.	DESCRIPTION	
1	Int. Manifold Gasket Set	2006-01	MS 96431		
1	Exh. Manifold Gasket Set	2006-01	MS 96521		
QTY	OIL PAN	YEARS	PART NO.	DESCRIPTION	
1	Oil Pan Gasket Set	2006-01	OS 30747 R	PermaDry® molded rubber gskt. incl.	
QTY	CRANKSHAFT REAR SEAL	YEARS	PART NO.	DESCRIPTION	
1	Rear Main Seal Set	2006-01	BS 40681	Rubber; One-piece	
QTY	VALVE COVER	YEARS	PART NO.	DESCRIPTION	
1	Valve Cover Gasket Set	2006-04	VS 50631 R	w/Spark plug tube seals; PermaDry® molded rubber gskt. incl.	
1	Valve Cover Gasket Set	2003-02	VS 50626 R	To 08/31/02; w/Spark plug tube seals; PermaDry® molded rubber gskt. incl.	
1	Valve Cover Gasket Set	2003-02	VS 50631 R	From 09/01/02; w/Spark plug tube seals; PermaDry® molded rubber gskt. incl.	
1	Valve Cover Gasket Set	2001	VS 50626 R	w/Spark plug tube seals; PermaDry® molded rubber gskt. incl.	
1	Grommet Set	2006-01	ES 72490	Valve Cover; New Part Number - Check for Availability	
QTY	VALVE STEM SEAL SET	YEARS	PART NO.	DESCRIPTION	
1	Valve Stem Seal Set	2006-01	SS 72915	Premium valve stem seals incl.	
QTY	THERMOSTAT HOUSING	YEARS	PART NO.	DESCRIPTION	
1	Thermostat Gasket	2006-01	35761	Thermostat Housing; Plastic housing	
QTY	WATER OUTLET GASKET	YEARS	PART NO.	DESCRIPTION	
4	Water Outlet Gasket	2006-01	36058	Water Outlet; Water inlet pipe seal; New Part Number - Check for Availability	
QTY	WATER PUMP	YEARS	PART NO.	DESCRIPTION	
1	Water Pump Gasket	2006-01	36066	Water pump housing O-ring; New Part Number - Check for Availability	
QTY	TIMING COVER	YEARS	PART NO.	DESCRIPTION	
1	Crankshaft Front Seal Set	2006-01	TCS 46048		
QTY	OIL FILTER MOUNTING	YEARS	PART NO.	DESCRIPTION	
1	Oil Filter Adapter Gasket	2006-01	72491	Oil filter mounting; New Part Number - Check for Availability	

BMW Car (Incl. BMW, Glas, Isetta, Mini) (Cont.)

15		1993 - 1991; 2.5L 152.2 (2494cc) SOHC L6 (12 Valve) 84mm Bore			15
MFI; Gasoline; Naturally Aspirated BMW Eng.; Eng. Code M20B25					
QTY	CYLINDER HEAD	YEARS	PART NO.	DESCRIPTION	
1	Head Gasket	1993-91	9397 B	Head bolts not incl.; Head bolt replacement recommended	
1	Head Set	1993-91	HS 9397 B-1	Head bolts not incl.; Head bolt replacement recommended; PermaDry® molded rubber valve cover gskt. incl.; Premium valve stem seals incl.	
QTY	CONVERSION SET	YEARS	PART NO.	DESCRIPTION	
1	Gasket Conversion Set	1993-91	CS 9397		
QTY	MANIFOLD - INT. & EXH.	YEARS	PART NO.	DESCRIPTION	
1	Int. Manifold Gasket Set	1993-91	MS 94070		
1	Exh. Manifold Gasket Set	1993-91	MS 93028		
QTY	OIL PAN	YEARS	PART NO.	DESCRIPTION	
1	Oil Pan Gasket Set	1993-91	OS 30527 C		
QTY	CRANKSHAFT REAR SEAL	YEARS	PART NO.	DESCRIPTION	
1	Rear Main Seal Set	1993-91	BS 40494	Rubber; One-piece	
QTY	VALVE COVER	YEARS	PART NO.	DESCRIPTION	
1	Valve Cover Gasket Set	1993-91	VS 50279 B	PermaDry® molded rubber gskt. incl.	
QTY	VALVE STEM SEAL SET	YEARS	PART NO.	DESCRIPTION	
1	Valve Stem Seal Set	1993-91	SS 72682	Premium valve stem seals incl.; Improved design	
QTY	THERMOSTAT HOUSING	YEARS	PART NO.	DESCRIPTION	
1	Water Outlet Gasket	1993-91	25589	Thermostat Housing; O-ring; New Improved design	
1	O-Ring	1993-91	35327	Thermostat Housing; Old design	
1	O-Ring	1993-91	35763	Thermostat Housing; Improved design	
QTY	WATER OUTLET GASKET	YEARS	PART NO.	DESCRIPTION	
1	Water Outlet Gasket	1993-91	35550	Water Outlet	
QTY	WATER PUMP	YEARS	PART NO.	DESCRIPTION	
1	Water Pump Gasket	1993-91	35326		
16		2000 - 1996; 2.8L 170 (2793cc) DOHC L6 (24 Valve) 84mm Bore			16
MFI; Gasoline; Naturally Aspirated BMW Eng.; Eng. Code M52B28					
QTY	CYLINDER HEAD	YEARS	PART NO.	DESCRIPTION	
1	Head Gasket	2000-99	26245 PT	Head bolts not incl.; Head bolt replacement recommended; .70mm thick; PermaTorqueMLS®	
1	Head Gasket	1998-96	26252 PT	Head bolts not incl.; Head bolt replacement recommended; 1.75mm thick	
1	Head Gasket	1998-96	26264 PT	Head bolts not incl.; Head bolt replacement recommended; 2.05mm thick	
1	Head Set	2000-99	HS 26245 PT-1	Exh. manifold gskts. & head bolts not incl.; Head bolt replacement recommended; PermaDry® molded rubber valve cover gskt. incl.; Premium valve stem seals incl.	
1	Head Set	1998-96	HS 26252 PT-2	Head bolts not incl.; Head bolt replacement recommended; PermaDry® molded rubber valve cover gskt. incl.; Premium valve stem seals incl.	
1	Head Bolt Set	2000-96	ES 72440	Cast iron block; Head bolts w/Washers; Replacement recommended; New Part Number - Check for Availability	
1	Head Bolt Set	2000-96	ES 72943	Aluminum block; Replacement recommended; New Part Number - Check for Availability	
QTY	CONVERSION SET	YEARS	PART NO.	DESCRIPTION	
1	Gasket Conversion Set	2000-99	CS 26245	PermaDry® molded rubber oil pan gskt. incl.	
1	Gasket Conversion Set	1998-96	CS 26251	PermaDry® molded rubber oil pan gskt. incl.	
QTY	MANIFOLD - INT. & EXH.	YEARS	PART NO.	DESCRIPTION	
1	Int. Manifold Gasket Set	2000-99	MS 96431		
1	Int. Manifold Gasket Set	1998-96	MS 96430		
1	Exh. Manifold Gasket Set	2000-99	MS 96521		
1	Exh. Manifold Gasket Set	1998-96	MS 96553		
QTY	EXHAUST PIPE FLANGE	YEARS	PART NO.	DESCRIPTION	
2	Exhaust Pipe Gasket	2000-96	61371	Flange	
QTY	OIL PAN	YEARS	PART NO.	DESCRIPTION	
1	Oil Pan Gasket Set	2000-96	OS 30747 R	PermaDry® molded rubber gskt. incl.	
QTY	CRANKSHAFT REAR SEAL	YEARS	PART NO.	DESCRIPTION	
1	Rear Main Seal Set	2000-96	BS 40681	Rubber; One-piece	
QTY	VALVE COVER	YEARS	PART NO.	DESCRIPTION	
1	Valve Cover Gasket Set	2000-99	VS 50626 R	w/Spark plug tube seals; PermaDry® molded rubber gskt. incl.	
1	Valve Cover Gasket Set	1998-96	VS 50601 R	w/Spark plug tube seals; PermaDry® molded rubber gskt. incl.	
1	Grommet Set	2000-96	ES 72490	Valve Cover; New Part Number - Check for Availability	
QTY	VALVE STEM SEAL SET	YEARS	PART NO.	DESCRIPTION	
1	Valve Stem Seal Set	2000-96	SS 72915	Premium valve stem seals incl.	
QTY	THERMOSTAT HOUSING	YEARS	PART NO.	DESCRIPTION	
1	Water Outlet Gasket	2000-96	25589	Thermostat Housing; Aluminum housing; O-ring; New Improved design	

BMW Car (Incl. BMW, Glas, Isetta, Mini) (Cont.)

16 (cont.)		2000 - 1996; 2.8L 170 (2793cc) DOHC L6 (24 Valve) 84mm Bore			16 (cont.)
		MFI; Gasoline; Naturally Aspirated BMW Eng.; Eng. Code M52B28			
QTY	THERMOSTAT HOUSING	YEARS	PART NO.	DESCRIPTION	
1	Thermostat Gasket	2000-96	35761	Thermostat Housing; Plastic housing	
1	O-Ring	2000-96	35763	Thermostat Housing; Aluminum housing; Improved design	
QTY	WATER OUTLET GASKET	YEARS	PART NO.	DESCRIPTION	
4	Water Outlet Gasket	2000-96	36058	Water Outlet; Water inlet pipe seal; New Part Number - Check for Availability	
QTY	WATER PUMP	YEARS	PART NO.	DESCRIPTION	
1	Water Pump Gasket	2000-96	36066	Water pump housing O-ring; New Part Number - Check for Availability	
QTY	TIMING COVER	YEARS	PART NO.	DESCRIPTION	
1	Crankshaft Front Seal Set	2000-99	TCS 46048-1		
1	Crankshaft Front Seal Set	1998-96	TCS 46047		
QTY	EXHAUST GAS RECIRCULATION	YEARS	PART NO.	DESCRIPTION	
1	EGR Gasket	2000-96	72996	Air pump check valve; New Part Number - Check for Availability	
QTY	OIL FILTER MOUNTING	YEARS	PART NO.	DESCRIPTION	
1	Oil Filter Adapter Gasket	2000-96	72491	Oil filter mounting; New Part Number - Check for Availability	
17		2006 - 2001; 3.0L 181.8 (2979cc) DOHC L6 (24 Valve) 84mm Bore			17
		MFI; Gasoline; Naturally Aspirated BMW Eng.; Eng. Code M54B30			
QTY	CYLINDER HEAD	YEARS	PART NO.	DESCRIPTION	
1	Head Gasket	2006-01	26245 PT	Head bolts not incl.; Head bolt replacement recommended; .70mm thick; PermaTorqueMLS®	
1	Head Gasket	2006-01	26275 PT	Head bolts not incl.; Head bolt replacement recommended; 1.00mm thick; PermaTorqueMLS®	
1	Head Set	2006-01	HS 26245 PT	Head gskt. .70mm thick; Exh. manifold gskts. & head bolts not incl.; Head bolt replacement recommended; PermaDry® molded rubber valve cover gskt. incl.; Premium valve stem seals incl.	
1	Head Bolt Set	2006-01	ES 72440	Cast iron block; Head bolts w/Washers; Replacement recommended; New Part Number - Check for Availability	
1	Head Bolt Set	2006-01	ES 72943	Aluminum block; Replacement recommended; New Part Number - Check for Availability	
QTY	CONVERSION SET	YEARS	PART NO.	DESCRIPTION	
1	Gasket Conversion Set	2006-01	CS 26245	PermaDry® molded rubber oil pan gskt. incl.	
QTY	MANIFOLD - INT. & EXH.	YEARS	PART NO.	DESCRIPTION	
1	Int. Manifold Gasket Set	2006-01	MS 96431		
1	Exh. Manifold Gasket Set	2006-01	MS 96521		
QTY	OIL PAN	YEARS	PART NO.	DESCRIPTION	
1	Oil Pan Gasket Set	2006-01	OS 30747 R	PermaDry® molded rubber gskt. incl.	
QTY	CRANKSHAFT REAR SEAL	YEARS	PART NO.	DESCRIPTION	
1	Rear Main Seal Set	2006-01	BS 40681	Rubber; One-piece	
QTY	VALVE COVER	YEARS	PART NO.	DESCRIPTION	
1	Valve Cover Gasket Set	2006-04	VS 50631 R	w/Spark plug tube seals; PermaDry® molded rubber gskt. incl.	
1	Valve Cover Gasket Set	2003-02	VS 50626 R	To 08/31/02; w/Spark plug tube seals; PermaDry® molded rubber gskt. incl.	
1	Valve Cover Gasket Set	2003-02	VS 50631 R	From 09/01/02; w/Spark plug tube seals; PermaDry® molded rubber gskt. incl.	
1	Valve Cover Gasket Set	2001	VS 50626 R	w/Spark plug tube seals; PermaDry® molded rubber gskt. incl.	
1	Grommet Set	2006-01	ES 72490	Valve Cover; New Part Number - Check for Availability	
QTY	VALVE STEM SEAL SET	YEARS	PART NO.	DESCRIPTION	
1	Valve Stem Seal Set	2006-01	SS 72915	Premium valve stem seals incl.	
QTY	THERMOSTAT HOUSING	YEARS	PART NO.	DESCRIPTION	
1	Thermostat Gasket	2006-01	35761	Thermostat Housing; Plastic housing	
QTY	WATER OUTLET GASKET	YEARS	PART NO.	DESCRIPTION	
4	Water Outlet Gasket	2006-01	36058	Water Outlet; Water inlet pipe seal; New Part Number - Check for Availability	
QTY	WATER PUMP	YEARS	PART NO.	DESCRIPTION	
1	Water Pump Gasket	2006-01	36066	Water pump housing O-ring; New Part Number - Check for Availability	
QTY	TIMING COVER	YEARS	PART NO.	DESCRIPTION	
1	Crankshaft Front Seal Set	2006-01	TCS 46048-1		
QTY	OIL FILTER MOUNTING	YEARS	PART NO.	DESCRIPTION	
1	Oil Filter Adapter Gasket	2006-01	72491	Oil filter mounting; New Part Number - Check for Availability	
18		2013 - 2007; 3.0L 181.8 (2979cc) DOHC L6 (24 Valve) 84mm Bore			18
		MFI; Gasoline; Turbo - Intercooled BMW Eng.; Eng. Code N54B30			
QTY	VALVE COVER	YEARS	PART NO.	DESCRIPTION	
1	Valve Cover Gasket Set	2013-07	VS 50867 R	w/Spark plug tube seals; PermaDry® molded rubber gskt. incl.; New Part Number - Check for Availability	

BMW Car (Incl. BMW, Glas, Isetta, Mini) (Cont.)

19		2013 - 2009; 3.0L 182 (2993cc) DOHC Turbo - Intercooled L6 (24 Valve) 90mm Bore			19	
		DI; Diesel; Turbo - Intercooled BMW Eng.; Eng. Code M57T2D30				
QTY	VALVE COVER	YEARS	PART NO.	DESCRIPTION		
1	Valve Cover Gasket Set	2013-09	VS 50864 R	w/Injector tube & Glow plug tube seals; PermaDry® molded rubber gskt. incl.; New Part Number - Check for Availability		
20		1995 - 1994; 3.0L 182.4 (2990cc) DOHC L6 (24 Valve) 86mm Bore			20	
		MFI; Gasoline; Naturally Aspirated BMW Eng.; Eng. Code S50B30				
QTY	CYLINDER HEAD	YEARS	PART NO.	DESCRIPTION		
1	Head Gasket	1995-94	26606 PT	Head bolts not incl.; Head bolt replacement recommended; New Part Number - Check for Availability		
21		2010 - 2006; 3.0L 182.8 (2996cc) DOHC L6 (24 Valve) 85mm Bore			21	
		MFI; Gasoline; Naturally Aspirated BMW Eng.; Eng. Code N52B30				
QTY	CYLINDER HEAD	YEARS	PART NO.	DESCRIPTION		
1	Head Gasket	2010-06	26656 PT	Head bolts not incl.; Head bolt replacement recommended; 1.20mm thick; PermaTorqueMLS®; New Part Number - Check for Availability		
QTY	MANIFOLD - INT. & EXH.	YEARS	PART NO.	DESCRIPTION		
1	Int. Manifold Gasket Set	2010-06	MS 97316	Lower set; New Part Number - Check for Availability		
QTY	OIL PAN	YEARS	PART NO.	DESCRIPTION		
1	Oil Pan Gasket Set	2010-06	OS 30869 R	PermaDry® molded rubber gskt. incl.; New Part Number - Check for Availability		
QTY	VALVE COVER	YEARS	PART NO.	DESCRIPTION		
1	Valve Cover Gasket Set	2010-08	VS 50859 R	w/Spark plug tube seals; PermaDry® molded rubber gskt. incl.; New Part Number - Check for Availability		
1	Valve Cover Gasket Set	2007	VS 50859 R	BMW Z4 Coupe 3.0si, Roadster 3.0i, Roadster 3.0si; From 10/01/06; w/Spark plug tube seals; PermaDry® molded rubber gskt. incl.; New Part Number - Check for Availability		
1	Valve Cover Gasket Set	2007	VS 50859 R	BMW 328i Base, 328xi Base; w/Spark plug tube seals; PermaDry® molded rubber gskt. incl.; New Part Number - Check for Availability		
1	Valve Cover Gasket Set	2007	VS 50860 R	BMW Z4 Coupe 3.0si, Roadster 3.0i, Roadster 3.0si; To 09/30/06; Valve cover bolts not incl.; Valve cover bolt replacement required; w/Spark plug tube seals; PermaDry® molded rubber gskt. incl.; New Part Number - Check for Availability		
1	Valve Cover Gasket Set	2007	VS 50860 R	BMW 525i Base, 525xi Base, 530i Base, 530xi Base; Valve cover bolts not incl.; Valve cover bolt replacement required; w/Spark plug tube seals; PermaDry® molded rubber gskt. incl.; New Part Number - Check for Availability		
1	Valve Cover Gasket Set	2006	VS 50860 R	Valve cover bolts not incl.; Valve cover bolt replacement required; w/Spark plug tube seals; PermaDry® molded rubber gskt. incl.; New Part Number - Check for Availability		
QTY	THERMOSTAT HOUSING	YEARS	PART NO.	DESCRIPTION		
1	Water Outlet Gasket	2010-06	36057	Thermostat Housing; Thermostat housing O-ring; New Part Number - Check for Availability		
QTY	WATER OUTLET GASKET	YEARS	PART NO.	DESCRIPTION		
1	Water Outlet Gasket	2010-06	36056	Water Outlet; Water inlet pipe from water pump housing; O-ring; New Part Number - Check for Availability		
1	Water Outlet Gasket	2010-06	36057	Water Outlet; Water inlet pipe seal; New Part Number - Check for Availability		
22		1995 - 1994; 3.0L 182.8 (2997cc) DOHC V8 (32 Valve) 84mm Bore			22	
		MFI; Gasoline; Naturally Aspirated BMW Eng.; Eng. Code M60B30				
QTY	CYLINDER HEAD	YEARS	PART NO.	DESCRIPTION		
1	Head Set w/o Head Gasket	1995-94	HSU 26339	Head gskts. & head bolts not incl.; Head bolt replacement recommended; PermaDry® molded rubber valve cover gskts. incl.; Premium valve stem seals incl.		
2	Head Bolt Set	1995-94	ES 72439	Head bolts w/Washers; Replacement recommended; New Part Number - Check for Availability		
QTY	CONVERSION SET	YEARS	PART NO.	DESCRIPTION		
1	Gasket Conversion Set	1995-94	CS 26339	PermaDry® molded rubber oil pan gskt. incl.		
QTY	MANIFOLD - INT. & EXH.	YEARS	PART NO.	DESCRIPTION		
1	Int. Manifold Gasket Set	1995-94	MS 97187	Lower set		
1	Exh. Manifold Gasket Set	1995-94	MS 97274	New Part Number - Check for Availability		
QTY	OIL PAN	YEARS	PART NO.	DESCRIPTION		
1	Oil Pan Gasket Set	1995-94	OS 30866 R	Loc. Lower; PermaDry® molded rubber gskt. incl.; New Part Number - Check for Availability		

BMW Car (Incl. BMW, Glas, Isetta, Mini) (Cont.)

22		1995 - 1994; 3.0L 182.8 (2997cc) DOHC V8 (32 Valve) 84mm Bore			22	
(cont.)		MFI; Gasoline; Naturally Aspirated BMW Eng.; Eng. Code M60B30			(cont.)	
QTY	VALVE COVER	YEARS	PART NO.	DESCRIPTION		
1	Valve Cover Gasket Set	1995-94	VS 50792 R	Loc. R.H.; w/Spark plug tube seals; PermaDry® molded rubber gskts. incl.; New Part Number - Check for Availability		
1	Valve Cover Gasket Set	1995-94	VS 50793 R	Loc. L.H.; w/Spark plug tube seals; PermaDry® molded rubber gskts. incl.		
QTY	WATER OUTLET GASKET	YEARS	PART NO.	DESCRIPTION		
2	Water Outlet Gasket	1995-94	36053	Water Outlet; Water crossover pipe; New Part Number - Check for Availability		
2	Water Outlet Gasket	1995-94	36054	Water Outlet; Water inlet pipe seal; 34.2mm ID; New Part Number - Check for Availability		
2	Water Outlet Gasket	1995-94	36055	Water Outlet; Water inlet pipe seal; 19.5mm ID; New Part Number - Check for Availability		
QTY	EXHAUST GAS RECIRCULATION	YEARS	PART NO.	DESCRIPTION		
1	EGR Gasket	1995-94	72996	Air pump check valve; New Part Number - Check for Availability		
23		2000 - 1996; 3.2L 192 (3152cc) DOHC L6 (24 Valve) 86.4mm Bore			23	
(cont.)		MFI; Gasoline; Naturally Aspirated BMW Eng.; Eng. Code S52B32			(cont.)	
QTY	CYLINDER HEAD	YEARS	PART NO.	DESCRIPTION		
1	Head Gasket	2000-96	26606 PT	Head bolts not incl.; Head bolt replacement recommended; New Part Number - Check for Availability		
QTY	WATER OUTLET GASKET	YEARS	PART NO.	DESCRIPTION		
2	Water Outlet Gasket	2000-96	36059	Water Outlet; Water inlet pipe seal; New Part Number - Check for Availability		
QTY	WATER PUMP	YEARS	PART NO.	DESCRIPTION		
1	Water Pump Gasket	2000-96	36066	Water pump housing O-ring; New Part Number - Check for Availability		
QTY	OIL FILTER MOUNTING	YEARS	PART NO.	DESCRIPTION		
1	Oil Filter Adapter Gasket	2000-96	72491	Oil filter mounting; New Part Number - Check for Availability		
24		2009 - 2001; 3.2L 198 (3246cc) DOHC L6 (24 Valve) 87mm Bore			24	
(cont.)		MFI; Gasoline; Naturally Aspirated BMW Eng.; Eng. Code S54B32			(cont.)	
QTY	VALVE COVER	YEARS	PART NO.	DESCRIPTION		
1	Valve Cover Gasket Set	2009-01	VS 50868 R	w/Spark plug tube seals; PermaDry® molded rubber gskt. incl.; New Part Number - Check for Availability		
QTY	OIL FILTER MOUNTING	YEARS	PART NO.	DESCRIPTION		
1	Oil Filter Adapter Gasket	2009-01	72491	Oil filter mounting; New Part Number - Check for Availability		
25		1993 - 1991; 3.4L 209.2 (3430cc) SOHC L6 (12 Valve) 92mm Bore			25	
(cont.)		MFI; Gasoline; Naturally Aspirated BMW Eng.; Eng. Code M30B34			(cont.)	
QTY	CYLINDER HEAD	YEARS	PART NO.	DESCRIPTION		
1	Head Gasket	1993-91	26580 PT	Head bolts not incl.; Head bolt replacement recommended; New Part Number - Check for Availability		
1	Head Set	1993-91	HS 9759 PT	Head bolts not incl.; Head bolt replacement recommended; PermaDry® molded rubber valve cover gskt. incl.; Premium valve stem seals incl.		
QTY	CONVERSION SET	YEARS	PART NO.	DESCRIPTION		
1	Gasket Conversion Set	1993-91	CS 9759			
QTY	OIL PAN	YEARS	PART NO.	DESCRIPTION		
1	Oil Pan Gasket Set	1993-91	OS 30851	New Part Number - Check for Availability		
QTY	CRANKSHAFT REAR SEAL	YEARS	PART NO.	DESCRIPTION		
1	Rear Main Seal Set	1993-91	BS 40412-1	Rubber; One-piece		
QTY	VALVE COVER	YEARS	PART NO.	DESCRIPTION		
1	Valve Cover Gasket Set	1993-91	VS 50278 B	PermaDry® molded rubber gskt. incl.		
QTY	THERMOSTAT HOUSING	YEARS	PART NO.	DESCRIPTION		
1	Thermostat Gasket	1993-91	35434	Thermostat Housing		
1	O-Ring	1993-91	35547	Thermostat Housing		
26		1995 - 1993; 4.0L 242.9 (3982cc) DOHC V8 (32 Valve) 89mm Bore			26	
(cont.)		MFI; Gasoline; Naturally Aspirated BMW Eng.; Eng. Code M60B40			(cont.)	
QTY	CYLINDER HEAD	YEARS	PART NO.	DESCRIPTION		
1	Head Gasket	1995-93	26339 PT	Loc. L.H.; Head bolts not incl.; Head bolt replacement recommended; 2.03mm thick		
1	Head Gasket	1995-93	26342 PT	Loc. L.H.; Head bolts not incl.; Head bolt replacement recommended; 1.74mm thick		
1	Head Gasket	1995-93	26343 PT	Loc. R.H.; Head bolts not incl.; Head bolt replacement recommended; 1.74mm thick		
1	Head Gasket	1995-93	26344 PT	Loc. R.H.; Head bolts not incl.; Head bolt replacement recommended; 2.03mm thick		

BMW Car (Incl. BMW, Glas, Isetta, Mini) (Cont.)

26 (cont.)		1995 - 1993; 4.0L 242.9 (3982cc) DOHC V8 (32 Valve) 89mm Bore			26 (cont.)
MFI; Gasoline; Naturally Aspirated BMW Eng.; Eng. Code M60B40					
QTY	CYLINDER HEAD	YEARS	PART NO.	DESCRIPTION	
1	Head Set w/o Head Gasket	1995-93	HSU 26339	Head gskts. & head bolts not incl.; Head bolt replacement recommended; PermaDry® molded rubber valve cover gskts. incl.; Premium valve stem seals incl.	
2	Head Bolt Set	1995-93	ES 72439	Head bolts w/Washers; Replacement recommended; New Part Number - Check for Availability	
QTY	CONVERSION SET	YEARS	PART NO.	DESCRIPTION	
1	Gasket Conversion Set	1995-93	CS 26339	PermaDry® molded rubber oil pan gskt. incl.	
QTY	MANIFOLD - INT. & EXH.	YEARS	PART NO.	DESCRIPTION	
1	Int. Manifold Gasket Set	1995-93	MS 97187	Lower set	
1	Exh. Manifold Gasket Set	1995-93	MS 97274	New Part Number - Check for Availability	
QTY	OIL PAN	YEARS	PART NO.	DESCRIPTION	
1	Oil Pan Gasket Set	1995-93	OS 30866 R	Loc. Lower; PermaDry® molded rubber gskt. incl.; New Part Number - Check for Availability	
QTY	VALVE COVER	YEARS	PART NO.	DESCRIPTION	
1	Valve Cover Gasket Set	1995-93	VS 50792 R	Loc. R.H.; w/Spark plug tube seals; PermaDry® molded rubber gskts. incl.; New Part Number - Check for Availability	
1	Valve Cover Gasket Set	1995-93	VS 50793 R	Loc. L.H.; w/Spark plug tube seals; PermaDry® molded rubber gskts. incl.	
QTY	WATER OUTLET GASKET	YEARS	PART NO.	DESCRIPTION	
2	Water Outlet Gasket	1995-93	36053	Water Outlet; Water crossover pipe; New Part Number - Check for Availability	
2	Water Outlet Gasket	1995-93	36054	Water Outlet; Water inlet pipe seal; 34.2mm ID; New Part Number - Check for Availability	
2	Water Outlet Gasket	1995-93	36055	Water Outlet; Water inlet pipe seal; 19.5mm ID; New Part Number - Check for Availability	
27		2013 - 2008; 4.0L 244 (3999cc) DOHC V8 (32 Valve) 92mm Bore			27
MFI; Gasoline; Naturally Aspirated BMW Eng.; Eng. Code S65B40					
QTY	WATER PUMP	YEARS	PART NO.	DESCRIPTION	
1	Water Pump Gasket	2013-08	36066	Water pump housing O-ring; New Part Number - Check for Availability	
28		2003 - 1996; 4.4L 268.4 (4398cc) DOHC V8 (32 Valve) 92mm Bore			28
MFI; Gasoline; Naturally Aspirated BMW Eng.; Eng. Code M62B44					
QTY	CYLINDER HEAD	YEARS	PART NO.	DESCRIPTION	
1	Head Gasket	2003-99	26345 PT	Loc. R.H.; Head bolts not incl.; Head bolt replacement recommended; 1.74mm thick; PermaTorqueMLS®	
1	Head Gasket	2003-99	26346 PT	Loc. L.H.; Head bolts not incl.; Head bolt replacement recommended; 1.74mm thick; PermaTorqueMLS®	
1	Head Gasket	1998	26345 PT	Loc. R.H.; From 10/01/97; Head bolts not incl.; Head bolt replacement recommended; 1.74mm thick; PermaTorqueMLS®	
1	Head Gasket	1998	26346 PT	Loc. L.H.; From 10/01/97; Head bolts not incl.; Head bolt replacement recommended; 1.74mm thick; PermaTorqueMLS®	
1	Head Gasket	1998	26355 PT	Loc. R.H.; To 09/30/97; Head bolts not incl.; Head bolt replacement recommended	
1	Head Gasket	1998	26356 PT	Loc. L.H.; To 09/30/97; Head bolts not incl.; Head bolt replacement recommended	
1	Head Gasket	1997-96	26355 PT	Loc. R.H.; Head bolts not incl.; Head bolt replacement recommended	
1	Head Gasket	1997-96	26356 PT	Loc. L.H.; Head bolts not incl.; Head bolt replacement recommended	
1	Head Set w/o Head Gasket	2003-96	HSU 26345	Head gskts. & head bolts not incl.; Head bolt replacement recommended; PermaDry® molded rubber valve cover gskts. incl.; Premium valve stem seals incl.	
2	Head Bolt Set	2003-96	ES 72439	Head bolts w/Washers; Replacement recommended; New Part Number - Check for Availability	
QTY	CONVERSION SET	YEARS	PART NO.	DESCRIPTION	
1	Gasket Conversion Set	2003-96	CS 26339	PermaDry® molded rubber oil pan gskt. incl.	
QTY	MANIFOLD - INT. & EXH.	YEARS	PART NO.	DESCRIPTION	
1	Int. Manifold Gasket Set	2003-96	MS 97187	Lower set	
1	Exh. Manifold Gasket Set	2003-96	MS 97274	New Part Number - Check for Availability	
QTY	OIL PAN	YEARS	PART NO.	DESCRIPTION	
1	Oil Pan Gasket Set	2003-96	OS 30866 R	Loc. Lower; PermaDry® molded rubber gskt. incl.; New Part Number - Check for Availability	
QTY	VALVE COVER	YEARS	PART NO.	DESCRIPTION	
1	Valve Cover Gasket Set	2003-00	VS 50790 R	Loc. R.H.; w/Spark plug tube seals; PermaDry® molded rubber gskt. incl.	
1	Valve Cover Gasket Set	2003-00	VS 50791 R	Loc. L.H.; w/Spark plug tube seals; PermaDry® molded rubber gskt. incl.	

BMW Car (Incl. BMW, Glas, Isetta, Mini) (Cont.)

28 (cont.)		2003 - 1996; 4.4L 268.4 (4398cc) DOHC V8 (32 Valve) 92mm Bore			28 (cont.)
MFI; Gasoline; Naturally Aspirated BMW Eng.; Eng. Code M62B44					
QTY	VALVE COVER	YEARS	PART NO.	DESCRIPTION	
1	Valve Cover Gasket Set	1999-98	VS 50790 R	Loc. R.H.; From 09/01/98; w/Spark plug tube seals; PermaDry® molded rubber gskt. incl.	
1	Valve Cover Gasket Set	1999-98	VS 50791 R	Loc. L.H.; From 09/01/98; w/Spark plug tube seals; PermaDry® molded rubber gskt. incl.	
1	Valve Cover Gasket Set	1999-98	VS 50792 R	Loc. R.H.; To 08/31/98; w/Spark plug tube seals; PermaDry® molded rubber gskts. incl.; New Part Number - Check for Availability	
1	Valve Cover Gasket Set	1999-98	VS 50793 R	Loc. L.H.; To 08/31/98; w/Spark plug tube seals; PermaDry® molded rubber gskts. incl.	
1	Valve Cover Gasket Set	1997-96	VS 50792 R	Loc. R.H.; w/Spark plug tube seals; PermaDry® molded rubber gskts. incl.; New Part Number - Check for Availability	
1	Valve Cover Gasket Set	1997-96	VS 50793 R	Loc. L.H.; w/Spark plug tube seals; PermaDry® molded rubber gskts. incl.	
QTY	WATER OUTLET GASKET	YEARS	PART NO.	DESCRIPTION	
2	Water Outlet Gasket	2003-96	36053	Water Outlet; Water crossover pipe; New Part Number - Check for Availability	
2	Water Outlet Gasket	2003-96	36054	Water Outlet; Water inlet pipe seal; 34.2mm ID; New Part Number - Check for Availability	
2	Water Outlet Gasket	2003-96	36055	Water Outlet; Water inlet pipe seal; 19.5mm ID; New Part Number - Check for Availability	
QTY	EXHAUST GAS RECIRCULATION	YEARS	PART NO.	DESCRIPTION	
1	EGR Gasket	2003-96	72996	Air pump check valve; New Part Number - Check for Availability	
29		2005 - 2003; 4.8L 294.3 (4837cc) DOHC V8 (32 Valve) 93mm Bore			29
MFI; Gasoline; Naturally Aspirated BMW Eng.; Eng. Code S62B48					
QTY	CYLINDER HEAD	YEARS	PART NO.	DESCRIPTION	
1	Head Gasket	2005-03	26620 PT	Loc. L.H.; Head bolts not incl.; Head bolt replacement recommended; 1.95mm thick; PermaTorqueMLS®; New Part Number - Check for Availability	
1	Head Gasket	2005-03	26621 PT	Loc. L.H.; Head bolts not incl.; Head bolt replacement recommended; 1.65mm thick; PermaTorqueMLS®; New Part Number - Check for Availability	
1	Head Gasket	2005-03	26633 PT	Loc. R.H.; Head bolts not incl.; Head bolt replacement recommended; 1.65mm thick; PermaTorqueMLS®; New Part Number - Check for Availability	
1	Head Gasket	2005-03	26634 PT	Loc. R.H.; Head bolts not incl.; Head bolt replacement recommended; 1.95mm thick; PermaTorqueMLS®; New Part Number - Check for Availability	
2	Head Bolt Set	2005-03	ES 72439	Head bolts w/Washers; Replacement recommended; New Part Number - Check for Availability	
QTY	MANIFOLD - INT. & EXH.	YEARS	PART NO.	DESCRIPTION	
1	Exh. Manifold Gasket Set	2005-03	MS 97274	New Part Number - Check for Availability	
QTY	VALVE COVER	YEARS	PART NO.	DESCRIPTION	
1	Valve Cover Gasket Set	2005-03	VS 50790 R	Loc. R.H.; w/Spark plug tube seals; PermaDry® molded rubber gskt. incl.	
1	Valve Cover Gasket Set	2005-03	VS 50791 R	Loc. L.H.; w/Spark plug tube seals; PermaDry® molded rubber gskt. incl.	
30		2003 - 2000; 4.9L 301 (4941cc) DOHC V8 (32 Valve) 94mm Bore			30
MFI; Gasoline; Naturally Aspirated BMW Eng.; Eng. Code S62B50					
QTY	CYLINDER HEAD	YEARS	PART NO.	DESCRIPTION	
2	Head Bolt Set	2003-00	ES 72439	Head bolts w/Washers; Replacement recommended; New Part Number - Check for Availability	
QTY	VALVE COVER	YEARS	PART NO.	DESCRIPTION	
1	Valve Cover Gasket Set	2003-00	VS 50862 R	Loc. R.H. Lower; w/Spark plug tube seals; PermaDry® molded rubber gskt. incl.; New Part Number - Check for Availability	
1	Valve Cover Gasket Set	2003-00	VS 50863 R	Loc. L.H. Lower; w/Spark plug tube seals; PermaDry® molded rubber gskt. incl.; New Part Number - Check for Availability	
31		2010 - 2006; 5.0L 304 (4999cc) DOHC V10 (40 Valve) 92mm Bore			31
MFI; Gasoline; Naturally Aspirated BMW Eng.; Eng. Code S85B50					
QTY	WATER PUMP	YEARS	PART NO.	DESCRIPTION	
1	Water Pump Gasket	2010-06	36066	Water pump housing O-ring; New Part Number - Check for Availability	

**BMW SUV's - See BMW Truck
BMW Truck (Incl. SUV'S)**

Engine Finding Index					
Engine	Years	Code	Line No.		
2.5L 152.2 (2494cc) DOHC L6 (24 Valve) 84mm Bore; MFI; Gasoline; Naturally Aspirated BMW Eng.	2006-04	M54B25	1		
3.0L 181.8 (2979cc) DOHC L6 (24 Valve) 84mm Bore; MFI; Gasoline; Naturally Aspirated BMW Eng.	2006-01	M54B30	2		
3.0L 181.8 (2979cc) DOHC L6 (24 Valve) 84mm Bore; MFI; Gasoline; Turbo - Intercooled BMW Eng.	2011-08	N54B30	3		
3.0L 182 (2993cc) DOHC Turbo - Intercooled L6 (24 Valve) 90mm Bore; DI; Diesel; Turbo - Intercooled BMW Eng.	2013-09	M57T2D30	4		
3.0L 182.8 (2996cc) DOHC L6 (24 Valve) 85mm Bore; MFI; Gasoline; Naturally Aspirated BMW Eng.	2010-07	N52B30	5		
4.4L 268.4 (4398cc) DOHC V8 (32 Valve) 92mm Bore; MFI; Gasoline; Naturally Aspirated BMW Eng.	2004-00	M62B44	6		
4.6L 281.9 (4619cc) DOHC V8 (32 Valve) 93mm Bore; MFI; Gasoline; Naturally Aspirated BMW Eng.	2003-02	M62B46	7		
4.8L 293 (4799cc) DOHC V8 (32 Valve) 93mm Bore; MFI; Gasoline; Naturally Aspirated BMW Eng.	2006-04	N62B48	8		
Engine Code Index					
Code	Engine				Line No.
M54B25	2.5L 152.2 (2494cc) DOHC L6 (24 Valve) 84mm Bore; MFI; Gasoline; Naturally Aspirated BMW Eng.				1
M54B30	3.0L 181.8 (2979cc) DOHC L6 (24 Valve) 84mm Bore; MFI; Gasoline; Naturally Aspirated BMW Eng.				2
M57T2D30	3.0L 182 (2993cc) DOHC Turbo - Intercooled L6 (24 Valve) 90mm Bore; DI; Diesel; Turbo - Intercooled BMW Eng.				4
M62B44	4.4L 268.4 (4398cc) DOHC V8 (32 Valve) 92mm Bore; MFI; Gasoline; Naturally Aspirated BMW Eng.				6
M62B46	4.6L 281.9 (4619cc) DOHC V8 (32 Valve) 93mm Bore; MFI; Gasoline; Naturally Aspirated BMW Eng.				7
N52B30	3.0L 182.8 (2996cc) DOHC L6 (24 Valve) 85mm Bore; MFI; Gasoline; Naturally Aspirated BMW Eng.				5
N54B30	3.0L 181.8 (2979cc) DOHC L6 (24 Valve) 84mm Bore; MFI; Gasoline; Turbo - Intercooled BMW Eng.				3
N62B48	4.8L 293 (4799cc) DOHC V8 (32 Valve) 93mm Bore; MFI; Gasoline; Naturally Aspirated BMW Eng.				8
Model Index					
Engine (VIN Code / Eng. Code)	Year	Engine (VIN Code / Eng. Code)	Year	Engine (VIN Code / Eng. Code)	Year
BMW Truck		BMW Truck (cont.)		BMW Truck (cont.)	
ActiveHybrid X6 (AWD Mid-Size SUV)		X3 (AWD Compact SUV) (cont.)		X5 (AWD Mid-Size SUV) (cont.)	
V8 4395cc 4.4L DOHC Turbo (32 Valve) (N63B44)	11-10	L6 2979cc 3.0L DOHC (24 Valve) (M54B30)	06-04	V8 4398cc 4.4L DOHC (32 Valve) (M62B44)	03-00
		L6 2979cc 3.0L DOHC Turbo (24 Valve) (N55B30)	13-11	V8 4398cc 4.4L DOHC (32 Valve) (N62B44)	07-04
		L6 2996cc 3.0L DOHC (24 Valve) (N52B30)	12-07	V8 4619cc 4.6L DOHC (32 Valve) (M62B46)	03-02
L4 1997cc 2.0L DOHC Turbo (16 Valve) (N20B20)	13			V8 4799cc 4.8L DOHC (32 Valve) (N62B48)	10-04
		X5 (AWD Mid-Size SUV)		X6 (AWD Mid-Size SUV)	
		L6 2979cc 3.0L DOHC (24 Valve) (M54B30)	06-01	L6 2979cc 3.0L DOHC Turbo (24 Valve) (N54B30)	10-08
L4 1997cc 2.0L DOHC Turbo (16 Valve) (N20B20)	13	L6 2979cc 3.0L DOHC Turbo (24 Valve) (N55B30)	13-11	L6 2979cc 3.0L DOHC Turbo (24 Valve) (N55B30)	13-11
L6 2979cc 3.0L DOHC Turbo (24 Valve) (N55B30)	13-11	L6 2993cc 3.0L DOHC Turbo-Diesel (24 Valve) (M57T2D30)	13-09	V8 4395cc 4.4L DOHC Turbo (32 Valve) (N63B44)	13-08
L6 2996cc 3.0L DOHC (24 Valve) (N52B30)	12-11	L6 2996cc 3.0L DOHC (24 Valve) (N52B30)	10-07	V8 4395cc 4.4L DOHC Turbo (32 Valve) (S63B44)	13-10
		X3 (AWD Compact SUV)			
L4 1997cc 2.0L DOHC Turbo (16 Valve) (N20B20)	13	V8 4395cc 4.4L DOHC Turbo (32 Valve) (N63B44)	13-11	V8 4395cc 4.4L DOHC Turbo (32 Valve) (S63B44)	13-10
L6 2494cc 2.5L DOHC (24 Valve) (M54B25)	05-04	V8 4395cc 4.4L DOHC Turbo (32 Valve) (S63B44)	13-10		
1	2006 - 2004; 2.5L 152.2 (2494cc) DOHC L6 (24 Valve) 84mm Bore MFI; Gasoline; Naturally Aspirated BMW Eng.; Eng. Code M54B25				1
QTY	CYLINDER HEAD	YEARS	PART NO.	DESCRIPTION	
1	Head Gasket	2006-04	26245 PT	Head bolts not incl.; Head bolt replacement recommended; .70mm thick; PermaTorqueMLS®	
1	Head Gasket	2006-04	26275 PT	Head bolts not incl.; Head bolt replacement recommended; 1.00mm thick; PermaTorqueMLS®	
1	Head Set	2006-04	HS 26245 PT	Head gskt. .70mm thick; Exh. manifold gskts. & head bolts not incl.; Head bolt replacement recommended; PermaDry® molded rubber valve cover gskt. incl.; Premium valve stem seals incl.	
1	Head Bolt Set	2006-04	ES 72440	Cast iron block; Head bolts w/Washers; Replacement recommended; New Part Number - Check for Availability	
1	Head Bolt Set	2006-04	ES 72943	Aluminum block; Replacement recommended; New Part Number - Check for Availability	
QTY	CONVERSION SET	YEARS	PART NO.	DESCRIPTION	
1	Gasket Conversion Set	2006-04	CS 26245	PermaDry® molded rubber oil pan gskt. incl.	
QTY	MANIFOLD - INT. & EXH.	YEARS	PART NO.	DESCRIPTION	
1	Int. Manifold Gasket Set	2006-04	MS 96431		
1	Exh. Manifold Gasket Set	2006-04	MS 96521		
QTY	OIL PAN	YEARS	PART NO.	DESCRIPTION	
1	Oil Pan Gasket Set	2006-04	OS 30747 R	PermaDry® molded rubber gskt. incl.	
QTY	CRANKSHAFT REAR SEAL	YEARS	PART NO.	DESCRIPTION	
1	Rear Main Seal Set	2006-04	BS 40681	Rubber; One-piece	
QTY	VALVE COVER	YEARS	PART NO.	DESCRIPTION	
1	Valve Cover Gasket Set	2006-04	VS 50631 R	w/Spark plug tube seals; PermaDry® molded rubber gskt. incl.	

BMW Truck (Incl. SUV'S) (Cont.)

1		2006 - 2004; 2.5L 152.2 (2494cc) DOHC L6 (24 Valve) 84mm Bore			1
(cont.)		MFI; Gasoline; Naturally Aspirated BMW Eng.; Eng. Code M54B25			(cont.)
QTY	VALVE COVER	YEARS	PART NO.	DESCRIPTION	
1	Grommet Set	2006-04	ES 72490	Valve Cover; New Part Number - Check for Availability	
QTY	VALVE STEM SEAL SET	YEARS	PART NO.	DESCRIPTION	
1	Valve Stem Seal Set	2006-04	SS 72915	Premium valve stem seals incl.	
QTY	THERMOSTAT HOUSING	YEARS	PART NO.	DESCRIPTION	
1	Thermostat Gasket	2006-04	35761	Thermostat Housing; Plastic housing	
QTY	WATER OUTLET GASKET	YEARS	PART NO.	DESCRIPTION	
4	Water Outlet Gasket	2006-04	36058	Water Outlet; Water inlet pipe seal; New Part Number - Check for Availability	
QTY	WATER PUMP	YEARS	PART NO.	DESCRIPTION	
1	Water Pump Gasket	2006-04	36066	Water pump housing O-ring; New Part Number - Check for Availability	
QTY	TIMING COVER	YEARS	PART NO.	DESCRIPTION	
1	Crankshaft Front Seal Set	2006-04	TCS 46048		
QTY	OIL FILTER MOUNTING	YEARS	PART NO.	DESCRIPTION	
1	Oil Filter Adapter Gasket	2006-04	72491	Oil filter mounting; New Part Number - Check for Availability	
2		2006 - 2001; 3.0L 181.8 (2979cc) DOHC L6 (24 Valve) 84mm Bore			2
(cont.)		MFI; Gasoline; Naturally Aspirated BMW Eng.; Eng. Code M54B30			(cont.)
QTY	CYLINDER HEAD	YEARS	PART NO.	DESCRIPTION	
1	Head Gasket	2006-01	26245 PT	Head bolts not incl.; Head bolt replacement recommended; .70mm thick; PermaTorqueMLS®	
1	Head Gasket	2006-01	26275 PT	Head bolts not incl.; Head bolt replacement recommended; 1.00mm thick; PermaTorqueMLS®	
1	Head Set	2006-01	HS 26245 PT	Head gskt. .70mm thick; Exh. manifold gskts. & head bolts not incl.; Head bolt replacement recommended; PermaDry® molded rubber valve cover gskt. incl.; Premium valve stem seals incl.	
1	Head Bolt Set	2006-01	ES 72440	Cast iron block; Head bolts w/Washers; Replacement recommended; New Part Number - Check for Availability	
1	Head Bolt Set	2006-01	ES 72943	Aluminum block; Replacement recommended; New Part Number - Check for Availability	
QTY	CONVERSION SET	YEARS	PART NO.	DESCRIPTION	
1	Gasket Conversion Set	2006-01	CS 26245	PermaDry® molded rubber oil pan gskt. incl.	
QTY	MANIFOLD - INT. & EXH.	YEARS	PART NO.	DESCRIPTION	
1	Int. Manifold Gasket Set	2006-01	MS 96431		
1	Exh. Manifold Gasket Set	2006-01	MS 96521		
QTY	OIL PAN	YEARS	PART NO.	DESCRIPTION	
1	Oil Pan Gasket Set	2006-01	OS 30747 R	PermaDry® molded rubber gskt. incl.	
QTY	CRANKSHAFT REAR SEAL	YEARS	PART NO.	DESCRIPTION	
1	Rear Main Seal Set	2006-01	BS 40681	Rubber; One-piece	
QTY	VALVE COVER	YEARS	PART NO.	DESCRIPTION	
1	Valve Cover Gasket Set	2006-04	VS 50631 R	w/Spark plug tube seals; PermaDry® molded rubber gskt. incl.	
1	Valve Cover Gasket Set	2003-02	VS 50626 R	To 08/31/02; w/Spark plug tube seals; PermaDry® molded rubber gskt. incl.	
1	Valve Cover Gasket Set	2003-02	VS 50631 R	From 09/01/02; w/Spark plug tube seals; PermaDry® molded rubber gskt. incl.	
1	Valve Cover Gasket Set	2001	VS 50626 R	w/Spark plug tube seals; PermaDry® molded rubber gskt. incl.	
1	Grommet Set	2006-01	ES 72490	Valve Cover; New Part Number - Check for Availability	
QTY	VALVE STEM SEAL SET	YEARS	PART NO.	DESCRIPTION	
1	Valve Stem Seal Set	2006-01	SS 72915	Premium valve stem seals incl.	
QTY	THERMOSTAT HOUSING	YEARS	PART NO.	DESCRIPTION	
1	Thermostat Gasket	2006-01	35761	Thermostat Housing; Plastic housing	
QTY	WATER OUTLET GASKET	YEARS	PART NO.	DESCRIPTION	
4	Water Outlet Gasket	2006-01	36058	Water Outlet; Water inlet pipe seal; New Part Number - Check for Availability	
QTY	WATER PUMP	YEARS	PART NO.	DESCRIPTION	
1	Water Pump Gasket	2006-01	36066	Water pump housing O-ring; New Part Number - Check for Availability	
QTY	TIMING COVER	YEARS	PART NO.	DESCRIPTION	
1	Crankshaft Front Seal Set	2006-01	TCS 46048-1		
QTY	OIL FILTER MOUNTING	YEARS	PART NO.	DESCRIPTION	
1	Oil Filter Adapter Gasket	2006-01	72491	Oil filter mounting; New Part Number - Check for Availability	
3		2011 - 2008; 3.0L 181.8 (2979cc) DOHC L6 (24 Valve) 84mm Bore			3
(cont.)		MFI; Gasoline; Turbo - Intercooled BMW Eng.; Eng. Code N54B30			(cont.)
QTY	VALVE COVER	YEARS	PART NO.	DESCRIPTION	
1	Valve Cover Gasket Set	2011-08	VS 50867 R	w/Spark plug tube seals; PermaDry® molded rubber gskt. incl.; New Part Number - Check for Availability	

4		2013 - 2009; 3.0L 182 (2993cc) DOHC Turbo - Intercooled L6 (24 Valve) 90mm Bore			4
		DI; Diesel; Turbo - Intercooled BMW Eng.; Eng. Code M57T2D30			
QTY	VALVE COVER	YEARS	PART NO.	DESCRIPTION	
1	Valve Cover Gasket Set	2013-09	VS 50864 R	w/Injector tube & Glow plug tube seals; PermaDry® molded rubber gskt. incl.; New Part Number - Check for Availability	
5		2010 - 2007; 3.0L 182.8 (2996cc) DOHC L6 (24 Valve) 85mm Bore			5
		MFI; Gasoline; Naturally Aspirated BMW Eng.; Eng. Code N52B30			
QTY	CYLINDER HEAD	YEARS	PART NO.	DESCRIPTION	
1	Head Gasket	2010-07	26656 PT	Head bolts not incl.; Head bolt replacement recommended; 1.20mm thick; PermaTorqueMLS®; New Part Number - Check for Availability	
QTY	MANIFOLD - INT. & EXH.	YEARS	PART NO.	DESCRIPTION	
1	Int. Manifold Gasket Set	2010-07	MS 97316	Lower set; New Part Number - Check for Availability	
QTY	OIL PAN	YEARS	PART NO.	DESCRIPTION	
1	Oil Pan Gasket Set	2010-07	OS 30869 R	PermaDry® molded rubber gskt. incl.; New Part Number - Check for Availability	
QTY	VALVE COVER	YEARS	PART NO.	DESCRIPTION	
1	Valve Cover Gasket Set	2010-07	VS 50859 R	w/Spark plug tube seals; PermaDry® molded rubber gskt. incl.; New Part Number - Check for Availability	
QTY	THERMOSTAT HOUSING	YEARS	PART NO.	DESCRIPTION	
1	Water Outlet Gasket	2010-07	36057	Thermostat Housing; Thermostat housing O-ring; New Part Number - Check for Availability	
QTY	WATER OUTLET GASKET	YEARS	PART NO.	DESCRIPTION	
1	Water Outlet Gasket	2010-07	36056	Water Outlet; Water inlet pipe from water pump housing; O-ring; New Part Number - Check for Availability	
1	Water Outlet Gasket	2010-07	36057	Water Outlet; Water inlet pipe seal; New Part Number - Check for Availability	
6		2004 - 2000; 4.4L 268.4 (4398cc) DOHC V8 (32 Valve) 92mm Bore			6
		MFI; Gasoline; Naturally Aspirated BMW Eng.; Eng. Code M62B44			
QTY	CYLINDER HEAD	YEARS	PART NO.	DESCRIPTION	
1	Head Gasket	2004-00	26345 PT	Loc. R.H.; Head bolts not incl.; Head bolt replacement recommended; 1.74mm thick; PermaTorqueMLS®	
1	Head Gasket	2004-00	26346 PT	Loc. L.H.; Head bolts not incl.; Head bolt replacement recommended; 1.74mm thick; PermaTorqueMLS®	
1	Head Set w/o Head Gasket	2004-00	HSU 26345	Head gskts. & head bolts not incl.; Head bolt replacement recommended; PermaDry® molded rubber valve cover gskts. incl.; Premium valve stem seals incl.	
2	Head Bolt Set	2004-00	ES 72439	Head bolts w/Washers; Replacement recommended; New Part Number - Check for Availability	
QTY	CONVERSION SET	YEARS	PART NO.	DESCRIPTION	
1	Gasket Conversion Set	2004-00	CS 26339	PermaDry® molded rubber oil pan gskt. incl.	
QTY	MANIFOLD - INT. & EXH.	YEARS	PART NO.	DESCRIPTION	
1	Int. Manifold Gasket Set	2004-00	MS 97187	Lower set	
1	Exh. Manifold Gasket Set	2004-00	MS 97274	New Part Number - Check for Availability	
QTY	OIL PAN	YEARS	PART NO.	DESCRIPTION	
1	Oil Pan Gasket Set	2004-00	OS 30867 R	Loc. Upper; PermaDry® molded rubber gskt. incl.; New Part Number - Check for Availability	
1	Oil Pan Gasket Set	2004-00	OS 30868	Loc. Lower; New Part Number - Check for Availability	
QTY	VALVE COVER	YEARS	PART NO.	DESCRIPTION	
1	Valve Cover Gasket Set	2004-00	VS 50790 R	Loc. R.H.; w/Spark plug tube seals; PermaDry® molded rubber gskt. incl.	
1	Valve Cover Gasket Set	2004-00	VS 50791 R	Loc. L.H.; w/Spark plug tube seals; PermaDry® molded rubber gskt. incl.	
QTY	WATER OUTLET GASKET	YEARS	PART NO.	DESCRIPTION	
2	Water Outlet Gasket	2004-00	36053	Water Outlet; Water crossover pipe; New Part Number - Check for Availability	
2	Water Outlet Gasket	2004-00	36054	Water Outlet; Water inlet pipe seal; 34.2mm ID; New Part Number - Check for Availability	
2	Water Outlet Gasket	2004-00	36055	Water Outlet; Water inlet pipe seal; 19.5mm ID; New Part Number - Check for Availability	
QTY	EXHAUST GAS RECIRCULATION	YEARS	PART NO.	DESCRIPTION	
1	EGR Gasket	2004-00	72996	Air pump check valve; New Part Number - Check for Availability	
7		2003 - 2002; 4.6L 281.9 (4619cc) DOHC V8 (32 Valve) 93mm Bore			7
		MFI; Gasoline; Naturally Aspirated BMW Eng.; Eng. Code M62B46			
QTY	CYLINDER HEAD	YEARS	PART NO.	DESCRIPTION	
1	Head Gasket	2003-02	26620 PT	Loc. L.H.; Head bolts not incl.; Head bolt replacement recommended; 1.95mm thick; PermaTorqueMLS®; New Part Number - Check for Availability	

BMW Truck (Incl. SUV'S) (Cont.)

7		2003 - 2002; 4.6L 281.9 (4619cc) DOHC V8 (32 Valve) 93mm Bore			7	
(cont.)		MFI; Gasoline; Naturally Aspirated BMW Eng.; Eng. Code M62B46			(cont.)	
QTY	CYLINDER HEAD	YEARS	PART NO.	DESCRIPTION		
1	Head Gasket	2003-02	26621 PT	Loc. L.H.; Head bolts not incl.; Head bolt replacement recommended; 1.65mm thick; PermaTorqueMLS®; New Part Number - Check for Availability		
1	Head Gasket	2003-02	26633 PT	Loc. R.H.; Head bolts not incl.; Head bolt replacement recommended; 1.65mm thick; PermaTorqueMLS®; New Part Number - Check for Availability		
1	Head Gasket	2003-02	26634 PT	Loc. R.H.; Head bolts not incl.; Head bolt replacement recommended; 1.95mm thick; PermaTorqueMLS®; New Part Number - Check for Availability		
2	Head Bolt Set	2003-02	ES 72439	Head bolts w/Washers; Replacement recommended; New Part Number - Check for Availability		
QTY	MANIFOLD - INT. & EXH.	YEARS	PART NO.	DESCRIPTION		
1	Int. Manifold Gasket Set	2003-02	MS 97187	Lower set		
1	Exh. Manifold Gasket Set	2003-02	MS 97274	New Part Number - Check for Availability		
QTY	OIL PAN	YEARS	PART NO.	DESCRIPTION		
1	Oil Pan Gasket Set	2003-02	OS 30867 R	Loc. Upper; PermaDry® molded rubber gskt. incl.; New Part Number - Check for Availability		
1	Oil Pan Gasket Set	2003-02	OS 30868	Loc. Lower; New Part Number - Check for Availability		
QTY	VALVE COVER	YEARS	PART NO.	DESCRIPTION		
1	Valve Cover Gasket Set	2003-02	VS 50790 R	Loc. R.H.; w/Spark plug tube seals; PermaDry® molded rubber gskt. incl.		
1	Valve Cover Gasket Set	2003-02	VS 50791 R	Loc. L.H.; w/Spark plug tube seals; PermaDry® molded rubber gskt. incl.		
QTY	WATER OUTLET GASKET	YEARS	PART NO.	DESCRIPTION		
2	Water Outlet Gasket	2003-02	36053	Water Outlet; Water crossover pipe; New Part Number - Check for Availability		
2	Water Outlet Gasket	2003-02	36054	Water Outlet; Water inlet pipe seal; 34.2mm ID; New Part Number - Check for Availability		
2	Water Outlet Gasket	2003-02	36055	Water Outlet; Water inlet pipe seal; 19.5mm ID; New Part Number - Check for Availability		
QTY	EXHAUST GAS RECIRCULATION	YEARS	PART NO.	DESCRIPTION		
1	EGR Gasket	2003-02	72996	Air pump check valve; New Part Number - Check for Availability		
8		2006 - 2004; 4.8L 293 (4799cc) DOHC V8 (32 Valve) 93mm Bore			8	
		MFI; Gasoline; Naturally Aspirated BMW Eng.; Eng. Code N62B48				
QTY	MANIFOLD - INT. & EXH.	YEARS	PART NO.	DESCRIPTION		
1	Exh. Manifold Gasket Set	2006-04	MS 97274	New Part Number - Check for Availability		

Buick Car - See GM Car

Buick Minivans - See GMC Truck

Buick SUV's - See GMC Truck

Cadillac Car - See GM Car

Cadillac SUV's - See GMC Truck

Callaway

Engine Finding Index

<i>Engine</i>	<i>Years</i>	<i>Code</i>	<i>Line No.</i>
5.7L 346 (5665cc) OHV V8 (16 Valve) 99mm Bore LS-1; MFI; Gasoline; Naturally Aspirated GMC Eng.; Chevrolet	1999	G	1

Model Index

<i>Engine (VIN Code / Eng. Code)</i>	<i>Year</i>	<i>Engine (VIN Code / Eng. Code)</i>	<i>Year</i>	<i>Engine (VIN Code / Eng. Code)</i>	<i>Year</i>
Callaway		Callaway (cont.)			
		C12			
		V8 346CI 5.7L OHV (G)	99		

1		1999; 5.7L 346 (5665cc) OHV V8 (16 Valve) 99mm Bore LS-1			1	
		MFI; Gasoline; Naturally Aspirated GMC Eng.; Chevrolet; VIN Code G				
QTY	CYLINDER HEAD	YEARS	PART NO.	DESCRIPTION		
2	Head Gasket	1999	9284 PT	Head bolts not incl.; Head bolt replacement recommended		
1	Head Set	1999	HS 9284 PT-1	Head bolts not incl.; Head bolt replacement recommended; PermaDry® molded rubber valve cover gskts. incl.; Premium valve stem seals incl.		
2	Head Bolt Set	1999	ES 72173	Replacement recommended		
QTY	CONVERSION SET	YEARS	PART NO.	DESCRIPTION		
1	Gasket Conversion Set	1999	CS 9284	PermaDry® molded rubber oil pan gskt. incl.		

1		1999; 5.7L 346 (5665cc) OHV V8 (16 Valve) 99mm Bore LS-1			1
(cont.)		MFI; Gasoline; Naturally Aspirated GMC Eng.; Chevrolet; VIN Code G			(cont.)
QTY	MANIFOLD - INT. & EXH.	YEARS	PART NO.	DESCRIPTION	
1	Int. Manifold Gasket Set	1999	MS 92438		
1	Int. Manifold Gasket Set	1999	MS 92465	Lifter valley cover set	
1	Exh. Manifold Gasket Set	1999	MS 92467		
QTY	EXHAUST PIPE FLANGE	YEARS	PART NO.	DESCRIPTION	
1	Exhaust Pipe Gasket	1999	60988	Loc. R.H.; Pipe to manifold	
1	Exhaust Pipe Gasket	1999	61077	Loc. L.H.; Pipe to manifold	
QTY	OIL PAN	YEARS	PART NO.	DESCRIPTION	
1	Oil Pan Gasket Set	1999	OS 30693 R	PermaDry® molded rubber gskt. incl.	
QTY	CRANKSHAFT REAR SEAL	YEARS	PART NO.	DESCRIPTION	
1	Rear Main Seal Set	1999	BS 40640	PTFE Rubber; One-piece	
1	Repair Sleeve	1999	16228	Crankshaft; Narrow lip; .780" sleeve length; Requires crankshaft machining due to clearance issues; Use w/installation tool	
1	Repair Sleeve	1999	16229	Crankshaft; Wide lip; 1.156" sleeve length; Requires crankshaft machining due to clearance issues; Use w/installation tool	
1	Repair Sleeve Tool	1999	16329	Crankshaft	
QTY	VALVE COVER	YEARS	PART NO.	DESCRIPTION	
1	Valve Cover Gasket Set	1999	VS 50504 R	w/o Grommets; PermaDry® molded rubber gskts. incl.	
1	Valve Cover Gasket Set	1999	VS 50504 R-1	w/Grommets; PermaDry® molded rubber gskts. incl.; New Part Number - Check for Availability	
1	Grommet Set	1999	ES 72233	Valve Cover	
QTY	VALVE STEM SEAL SET	YEARS	PART NO.	DESCRIPTION	
1	Valve Stem Seal Set	1999	SS 70945	Premium valve stem seals incl.	
QTY	THERMOSTAT HOUSING	YEARS	PART NO.	DESCRIPTION	
1	Thermostat Gasket	1999	35632	Thermostat Housing; Thermostat O-ring	
QTY	WATER PUMP	YEARS	PART NO.	DESCRIPTION	
2	Water Pump Gasket	1999	35635		
1	O-Ring	1999	35633	Water Pump	
1	Water Pump Mounting Set	1999	ES 73010	Mounting gasket set; New Part Number - Check for Availability	
QTY	TIMING COVER	YEARS	PART NO.	DESCRIPTION	
1	Timing Cover Set	1999	TCS 45993	Must be used w/OS 30693R	
QTY	CARB & FUEL INJECTION	YEARS	PART NO.	DESCRIPTION	
1	Throttle Body Gasket	1999	61069		
QTY	EXHAUST GAS RECIRCULATION	YEARS	PART NO.	DESCRIPTION	
1	EGR Gasket	1999	70895	Pipe; O-ring	
1	EGR Gasket	1999	70914	Valve	
1	EGR Gasket	1999	70947	Pipe	
QTY	OIL FILTER MOUNTING	YEARS	PART NO.	DESCRIPTION	
1	Oil Cooler Gasket	1999	72462	Oil Filter; Center tube; Dual round port	
QTY	OIL PUMP COVER	YEARS	PART NO.	DESCRIPTION	
1	O-Ring	1999	72401	Oil Pump; Inlet tube	
QTY	OIL COOLER	YEARS	PART NO.	DESCRIPTION	
1	Oil Cooler Gasket	1999	72435	Oval port	
1	Oil Cooler Gasket	1999	72462	Dual round port	

Chevrolet Car - See GM Car
Chevrolet Minivans - See GMC Truck
Chevrolet SUV's - See GMC Truck
Chevrolet Truck - See GMC Truck

Chrysler Car (Incl. Chrysler, DeSoto, Dodge, Eagle, Plymouth)

Engine Finding Index				
Engine	Years	Code	Line No.	
1.5L 89.6 (1468cc) SOHC L4 (12 Valve) 75.5mm Bore; MFI; Gasoline; Naturally Aspirated Mitsubishi Eng.	1996-91	A	1	
1.5L 89.6 (1468cc) SOHC L4 (12 Valve) 75.5mm Bore; MFI; Gasoline; Naturally Aspirated Mitsubishi Eng.	1991	K	2	
1.5L 89.6 (1468cc) SOHC L4 (12 Valve) 75.5mm Bore; MFI; Gasoline; Naturally Aspirated Mitsubishi Eng.	1996-91	Q	3	
1.5L 89.6 (1468cc) SOHC L4 (8 Valve) 75.5mm Bore; 2 Bbl.; Gasoline; Naturally Aspirated Mitsubishi Eng.	1991	Q	4	
1.8L 107.1 (1755cc) SOHC L4 (8 Valve) 80.6mm Bore; MFI; Gasoline; Naturally Aspirated Mitsubishi Eng.	1994-93	B	5	
1.8L 107.1 (1755cc) SOHC L4 (8 Valve) 80.6mm Bore; MFI; Gasoline; Naturally Aspirated Mitsubishi Eng.	1992-91	T	6	

Chrysler Car (Incl. Chrysler, DeSoto, Dodge, Eagle, Plymouth) (Cont.)

Engine Finding Index (Cont.)

Engine	Years	Code	Line No.
1.8L 109.7 (1798cc) DOHC L4 (16 Valve) 86mm Bore; MFI; Gasoline; Naturally Aspirated Chrysler Eng.	2009-07	C	7
1.8L 111.8 (1834cc) SOHC L4 (16 Valve) 81mm Bore; MFI; Gasoline; Naturally Aspirated Mitsubishi Eng.	1996-92	C	8
1.8L 111.8 (1834cc) SOHC L4 (16 Valve) 81mm Bore; MFI; Gasoline; Naturally Aspirated Mitsubishi Eng.	1992	D	9
2.0L 122 (1996cc) DOHC L4 (16 Valve) 87.5mm Bore; MFI; Gasoline; Naturally Aspirated Chrysler Eng.	1999-95	B	10
2.0L 122 (1996cc) DOHC L4 (16 Valve) 87.5mm Bore; MFI; Gasoline; Naturally Aspirated Chrysler Eng.	1999-95	Y	11
2.0L 122 (1996cc) DOHC L4 (16 Valve) 87.5mm Bore; MFI; Gasoline; Naturally Aspirated Chrysler Eng.	2004-02	Y	12
2.0L 122 (1996cc) SOHC L4 (16 Valve) 87.5mm Bore; MFI; Gasoline; Naturally Aspirated Chrysler Eng.	2005-95	C	13
2.0L 122 (1996cc) SOHC L4 (16 Valve) 87.5mm Bore H.O.; MFI; Gasoline; Naturally Aspirated Chrysler Eng.	2005-01	F	14
2.0L 122 (1997cc) DOHC L4 (16 Valve) 85mm Bore; MFI; Gasoline; Naturally Aspirated Mitsubishi Eng.	1994-93	E	15
2.0L 122 (1997cc) DOHC L4 (16 Valve) 85mm Bore; MFI; Gasoline; Turbo - Intercooled Mitsubishi Eng.	1998-93	F	16
2.0L 122 (1997cc) DOHC L4 (16 Valve) 85mm Bore; MFI; Gasoline; Naturally Aspirated Mitsubishi Eng.	1993-91	R	17
2.0L 122 (1997cc) DOHC L4 (16 Valve) 85mm Bore; MFI; Gasoline; Turbo - Intercooled Mitsubishi Eng.	1992-91	U	18
2.0L 122 (1997cc) SOHC L4 (16 Valve) 85mm Bore; MFI; Gasoline; Naturally Aspirated Mitsubishi Eng.	1993	D	19
2.0L 122 (1997cc) SOHC L4 (16 Valve) 85mm Bore; MFI; Gasoline; Naturally Aspirated Mitsubishi Eng.	1993	V	20
2.0L 122 (1997cc) SOHC L4 (8 Valve) 85mm Bore; MFI; Gasoline; Naturally Aspirated Mitsubishi Eng.	1992-91	V	21
2.0L 122 (1997cc) SOHC L4 (8 Valve) 85mm Bore; MFI; Gasoline; Naturally Aspirated Mitsubishi Eng.	1991	V	22
2.0L 122 (1998cc) DOHC L4 (16 Valve) 86mm Bore; MFI; Gasoline; Naturally Aspirated Chrysler Eng.	2012-10	A	23
2.0L 122 (1998cc) DOHC L4 (16 Valve) 86mm Bore; MFI; Gasoline; Naturally Aspirated Chrysler Eng.	2012-07	B	24
2.2L 135 (2212cc) SOHC L4 (8 Valve) 87.5mm Bore; TBI; Gasoline; Naturally Aspirated Chrysler Eng.	1994-91	D	25
2.4L 143.4 (2351cc) SOHC L4 (16 Valve) 86.5mm Bore; MFI; Gasoline; Naturally Aspirated Mitsubishi Eng.	2005-93	G	26
2.4L 143.4 (2351cc) SOHC L4 (8 Valve) 86.5mm Bore; MFI; Gasoline; Naturally Aspirated Mitsubishi Eng.	1992	W	27
2.4L 144 (2360cc) DOHC L4 (16 Valve) 88mm Bore; MFI; Gasoline; Naturally Aspirated Chrysler Eng.	2013-09	B	28
2.4L 144 (2360cc) DOHC L4 (16 Valve) 88mm Bore; MFI; Gasoline; Naturally Aspirated Chrysler Eng.	2011-07	C	29
2.4L 144 (2360cc) DOHC L4 (16 Valve) 88mm Bore; MFI; Gasoline; Turbo - Intercooled Chrysler Eng.	2010-08	F	30
2.4L 144 (2360cc) DOHC L4 (16 Valve) 88mm Bore; MFI; Gasoline; Naturally Aspirated Chrysler Eng.	2013-07	K	31
2.4L 144 (2360cc) DOHC L4 (16 Valve) 88mm Bore; MFI; Gasoline; Turbo - Intercooled Chrysler Eng.	2010-08	K	32
2.4L 148 (2429cc) DOHC L4 (16 Valve) 87.5mm Bore; MFI; Gasoline; Turbo - Intercooled Chrysler Eng.	2008-04	E	33
2.4L 148 (2429cc) DOHC L4 (16 Valve) 87.5mm Bore; MFI; Gasoline; Turbo - Intercooled Chrysler Eng.	2003	G	34
2.4L 148 (2429cc) DOHC L4 (16 Valve) 87.5mm Bore; MFI; Gasoline; Naturally Aspirated Chrysler Eng.	2006-04	J	35
2.4L 148 (2429cc) DOHC L4 (16 Valve) 87.5mm Bore; MFI; Gasoline; Turbo - Intercooled Chrysler Eng.	2007-04	S	36
2.4L 148 (2429cc) DOHC L4 (16 Valve) 87.5mm Bore; MFI; Gasoline; Naturally Aspirated Chrysler Eng.	2008-95	X	37
2.5L 152.2 (2497cc) SOHC V6 (24 Valve) 83.5mm Bore; MFI; Gasoline; Naturally Aspirated Mitsubishi Eng.	2000-95	H	38
2.5L 152.2 (2497cc) SOHC V6 (24 Valve) 83.5mm Bore; MFI; Gasoline; Naturally Aspirated Mitsubishi Eng.	2000-95	N	39
2.5L 153 (2507cc) SOHC L4 (8 Valve) 87.5mm Bore; MFI; Gasoline; Turbo Chrysler Eng.	1992-91	J	40
2.5L 153 (2507cc) SOHC L4 (8 Valve) 87.5mm Bore; TBI; Gasoline; Naturally Aspirated Chrysler Eng.	1995-91	K	41
2.5L 153 (2507cc) SOHC L4 (8 Valve) 87.5mm Bore; MFI; Flex Fuel; Naturally Aspirated Chrysler Eng.	1994-93	V	42
2.7L 167 (2736cc) DOHC V6 (24 Valve) 86mm Bore; MFI; Flex Fuel; Naturally Aspirated Chrysler Eng.	2011-10	D	43
2.7L 167 (2736cc) DOHC V6 (24 Valve) 86mm Bore; MFI; Gasoline; Naturally Aspirated Chrysler Eng.	2011-98	R	44
2.7L 167 (2736cc) DOHC V6 (24 Valve) 86mm Bore; MFI; Flex Fuel; Naturally Aspirated Chrysler Eng.	2009-03	T	45
2.7L 167 (2736cc) DOHC V6 (24 Valve) 86mm Bore; MFI; Gasoline; Naturally Aspirated Chrysler Eng.	2005-00	U	46
3.0L 181.1 (2972cc) DOHC V6 (24 Valve) 91.1mm Bore; MFI; Gasoline; Naturally Aspirated Mitsubishi Eng.	1992-91	B	47
3.0L 181.1 (2972cc) DOHC V6 (24 Valve) 91.1mm Bore; MFI; Gasoline; Turbo - Intercooled Mitsubishi Eng.	1992-91	C	48
3.0L 181.1 (2972cc) DOHC V6 (24 Valve) 91.1mm Bore; MFI; Gasoline; Naturally Aspirated Mitsubishi Eng.	1996-93	J	49
3.0L 181.1 (2972cc) DOHC V6 (24 Valve) 91.1mm Bore; MFI; Gasoline; Turbo - Intercooled Mitsubishi Eng.	1996-93	K	50
3.0L 181.1 (2972cc) SOHC V6 (12 Valve) 91.1mm Bore; MFI; Gasoline; Naturally Aspirated Mitsubishi Eng.	1995-91	3	51
3.0L 181.1 (2972cc) SOHC V6 (12 Valve) 91.1mm Bore; MFI; Gasoline; Naturally Aspirated Mitsubishi Eng.	1996-93	H	52
3.0L 181.1 (2972cc) SOHC V6 (12 Valve) 91.1mm Bore; MFI; Gasoline; Naturally Aspirated Mitsubishi Eng.	1992-91	S	53
3.0L 181.1 (2972cc) SOHC V6 (24 Valve) 91.1mm Bore; MFI; Gasoline; Naturally Aspirated Mitsubishi Eng.	2005-01	H	54
3.0L 182 (2970cc) SOHC V6 (12 Valve) 93mm Bore; MFI; Gasoline; Naturally Aspirated Volvo Eng.	1992-91	U	55
3.2L 195.1 (3199cc) SOHC V6 (18 Valve) 89.9mm Bore; MFI; Gasoline; Naturally Aspirated Mercedes-Benz Eng.	2008-04	L	56
3.2L 195.1 (3199cc) SOHC V6 (18 Valve) 89.9mm Bore; MFI; Gasoline; Supercharged Mercedes-Benz Eng.	2006-05	N	57
3.2L 197 (3231cc) SOHC V6 (24 Valve) 92mm Bore; MFI; Gasoline; Naturally Aspirated Chrysler Eng.	2001-98	J	58
3.3L 201 (3302cc) OHV V6 (12 Valve) 93mm Bore; MFI; Gasoline; Naturally Aspirated Chrysler Eng.	1993-91	R	59
3.3L 201 (3302cc) OHV V6 (12 Valve) 93mm Bore; MFI; Gasoline; Naturally Aspirated Chrysler Eng.	1997-93	T	60
3.3L 201 (3302cc) OHV V6 (12 Valve) 93mm Bore; MFI; Flex Fuel; Naturally Aspirated Chrysler Eng.	1996-94	U	61
3.5L 215 (3518cc) SOHC V6 (24 Valve) 96mm Bore; MFI; Gasoline; Naturally Aspirated Chrysler Eng.	1998-93	F	62
3.5L 215 (3518cc) SOHC V6 (24 Valve) 96mm Bore; MFI; Gasoline; Naturally Aspirated Chrysler Eng.	2010-98	G	63
3.5L 215 (3518cc) SOHC V6 (24 Valve) 96mm Bore; MFI; Gasoline; Naturally Aspirated Chrysler Eng.	2004-02	K	64
3.5L 215 (3518cc) SOHC V6 (24 Valve) 96mm Bore; MFI; Gasoline; Naturally Aspirated Chrysler Eng.	2011-02	M	65
3.5L 215 (3518cc) SOHC V6 (24 Valve) 96mm Bore; MFI; Gasoline; Naturally Aspirated Chrysler Eng.	2011-00	V	66
3.6L 219.9 (3604cc) DOHC V6 (24 Valve) 96mm Bore Pentastar VVT; MFI; Flex Fuel; Naturally Aspirated Chrysler Eng.	2013-11	G	67
3.8L 231 (3785cc) OHV V6 (12 Valve) 96mm Bore; MFI; Gasoline; Naturally Aspirated Chrysler Eng.	1993-91	L	68
5.7L 345 (5654cc) OHV V8 (16 Valve) 99.5mm Bore Hemi; MFI; Flex Fuel; Naturally Aspirated Chrysler Eng.	2013-12	2	69
5.7L 345 (5654cc) OHV V8 (16 Valve) 99.5mm Bore Hemi; MFI; Gasoline; Naturally Aspirated Chrysler Eng.	2008-06	2	70

Chrysler Car (Incl. Chrysler, DeSoto, Dodge, Eagle, Plymouth) (Cont.)

Engine Finding Index (Cont.)

Engine	Years	Code	Line No.
5.7L 345 (5654cc) OHV V8 (16 Valve) 99.5mm Bore Hemi; MFI; Gasoline; Naturally Aspirated Chrysler Eng.	2008-05	H	71
5.7L 345 (5654cc) OHV V8 (16 Valve) 99.5mm Bore Hemi; MFI; Gasoline; Naturally Aspirated Chrysler Eng.	2013-09	T	72
6.1L 370 (6059cc) OHV V8 (16 Valve) 103mm Bore Hemi; MFI; Gasoline; Naturally Aspirated Chrysler Eng.	2010-05	W	73
8.3L 505 (8277cc) OHV V10 (20 Valve) 102.4mm Bore; MFI; Gasoline; Naturally Aspirated Chrysler Eng.	2007-03	Z	74
8.4L 512 (8354cc) OHV V10 (20 Valve) 103mm Bore; MFI; Gasoline; Naturally Aspirated Chrysler Eng.	2009-08	Z	75

Engine Code Index

Code	Engine	Line No.
112.947	3.2L 195.1 (3199cc) SOHC V6 (18 Valve) 89.9mm Bore; MFI; Gasoline; Naturally Aspirated Mercedes-Benz Eng.	56
112.960	3.2L 195.1 (3199cc) SOHC V6 (18 Valve) 89.9mm Bore; MFI; Gasoline; Supercharged Mercedes-Benz Eng.	57
4G15	1.5L 89.6 (1468cc) SOHC L4 (12 Valve) 75.5mm Bore; MFI; Gasoline; Naturally Aspirated Mitsubishi Eng.	1
4G15	1.5L 89.6 (1468cc) SOHC L4 (12 Valve) 75.5mm Bore; MFI; Gasoline; Naturally Aspirated Mitsubishi Eng.	2
4G15	1.5L 89.6 (1468cc) SOHC L4 (12 Valve) 75.5mm Bore; MFI; Gasoline; Naturally Aspirated Mitsubishi Eng.	3
4G37	1.8L 107.1 (1755cc) SOHC L4 (8 Valve) 80.6mm Bore; MFI; Gasoline; Naturally Aspirated Mitsubishi Eng.	5
4G37	1.8L 107.1 (1755cc) SOHC L4 (8 Valve) 80.6mm Bore; MFI; Gasoline; Naturally Aspirated Mitsubishi Eng.	6
4G63	2.0L 122 (1997cc) DOHC L4 (16 Valve) 85mm Bore; MFI; Gasoline; Naturally Aspirated Mitsubishi Eng.	15
4G63	2.0L 122 (1997cc) DOHC L4 (16 Valve) 85mm Bore; MFI; Gasoline; Naturally Aspirated Mitsubishi Eng.	17
4G63	2.0L 122 (1997cc) SOHC L4 (16 Valve) 85mm Bore; MFI; Gasoline; Naturally Aspirated Mitsubishi Eng.	19
4G63	2.0L 122 (1997cc) SOHC L4 (16 Valve) 85mm Bore; MFI; Gasoline; Naturally Aspirated Mitsubishi Eng.	20
4G63	2.0L 122 (1997cc) SOHC L4 (8 Valve) 85mm Bore; MFI; Gasoline; Naturally Aspirated Mitsubishi Eng.	21
4G63-T	2.0L 122 (1997cc) DOHC L4 (16 Valve) 85mm Bore; MFI; Gasoline; Turbo - Intercooled Mitsubishi Eng.	16
4G63-T	2.0L 122 (1997cc) DOHC L4 (16 Valve) 85mm Bore; MFI; Gasoline; Turbo - Intercooled Mitsubishi Eng.	18
4G64	2.4L 143.4 (2351cc) SOHC L4 (16 Valve) 86.5mm Bore; MFI; Gasoline; Naturally Aspirated Mitsubishi Eng.	26
4G64	2.4L 143.4 (2351cc) SOHC L4 (8 Valve) 86.5mm Bore; MFI; Gasoline; Naturally Aspirated Mitsubishi Eng.	27
4G93	1.8L 111.8 (1834cc) SOHC L4 (16 Valve) 81mm Bore; MFI; Gasoline; Naturally Aspirated Mitsubishi Eng.	8
4G93	1.8L 111.8 (1834cc) SOHC L4 (16 Valve) 81mm Bore; MFI; Gasoline; Naturally Aspirated Mitsubishi Eng.	9
6G72	3.0L 181.1 (2972cc) DOHC V6 (24 Valve) 91.1mm Bore; MFI; Gasoline; Naturally Aspirated Mitsubishi Eng.	47
6G72	3.0L 181.1 (2972cc) DOHC V6 (24 Valve) 91.1mm Bore; MFI; Gasoline; Naturally Aspirated Mitsubishi Eng.	49
6G72	3.0L 181.1 (2972cc) SOHC V6 (12 Valve) 91.1mm Bore; MFI; Gasoline; Naturally Aspirated Mitsubishi Eng.	51
6G72	3.0L 181.1 (2972cc) SOHC V6 (12 Valve) 91.1mm Bore; MFI; Gasoline; Naturally Aspirated Mitsubishi Eng.	52
6G72	3.0L 181.1 (2972cc) SOHC V6 (12 Valve) 91.1mm Bore; MFI; Gasoline; Naturally Aspirated Mitsubishi Eng.	53
6G72	3.0L 181.1 (2972cc) SOHC V6 (24 Valve) 91.1mm Bore; MFI; Gasoline; Naturally Aspirated Mitsubishi Eng.	54
6G72-T	3.0L 181.1 (2972cc) DOHC V6 (24 Valve) 91.1mm Bore; MFI; Gasoline; Turbo - Intercooled Mitsubishi Eng.	48
6G72-T	3.0L 181.1 (2972cc) DOHC V6 (24 Valve) 91.1mm Bore; MFI; Gasoline; Turbo - Intercooled Mitsubishi Eng.	50
6G73	2.5L 152.2 (2497cc) SOHC V6 (24 Valve) 83.5mm Bore; MFI; Gasoline; Naturally Aspirated Mitsubishi Eng.	38
6G73	2.5L 152.2 (2497cc) SOHC V6 (24 Valve) 83.5mm Bore; MFI; Gasoline; Naturally Aspirated Mitsubishi Eng.	39
A588	2.0L 122 (1996cc) DOHC L4 (16 Valve) 87.5mm Bore; MFI; Gasoline; Naturally Aspirated Chrysler Eng.	11
G15B	1.5L 89.6 (1468cc) SOHC L4 (8 Valve) 75.5mm Bore; 2 Bbl.; Gasoline; Naturally Aspirated Mitsubishi Eng.	4
G63B	2.0L 122 (1997cc) SOHC L4 (8 Valve) 85mm Bore; MFI; Gasoline; Naturally Aspirated Mitsubishi Eng.	22
PRV	3.0L 182 (2970cc) SOHC V6 (12 Valve) 93mm Bore; MFI; Gasoline; Naturally Aspirated Volvo Eng.	55

Model Index

Engine (VIN Code / Eng. Code)	Year	Engine (VIN Code / Eng. Code)	Year	Engine (VIN Code / Eng. Code)	Year
Chrysler		Chrysler (cont.)		Chrysler (cont.)	
200		300C (cont.)		C25	
L4 2360cc 2.4L DOHC (16 Valve) (B)	13-11	V8 345CI 5.7L (Hemi) (H)	08-05	L6 241.5CI 4.0L (L-Head)	40
L4 2360cc 2.4L DOHC (16 Valve) (K)	13-11	V8 345CI 5.7L (Hemi) (T)	13-09	C28	
V6 167CI 2.7L DOHC (24 Valve) (R)	11	V8 345CI 5.7L (Hemi) (Flex Fuel) (2)	13-12	L6 241.5CI 4.0L (L-Head)	41
V6 167CI 2.7L DOHC (24 Valve) (Flex Fuel) (D)	11	V8 370CI 6.1L (Hemi) (W)	10-05	C34	
V6 215CI 3.5L SOHC (24 Valve) (M)	11	V8 392CI 6.4L	57	L6 251.6CI 4.1L (L-Head)	42
V6 215CI 3.5L SOHC (24 Valve) (V)	11	V8 392CI 6.4L (Hemi) (J)	13-12	Cirrus	
V6 220CI 3.6L DOHC (24 Valve) (Flex Fuel) (G)	13-11	V8 392CI 6.4L	58	L4 122CI 2.0L SOHC (16 Valve) (C)	00
300		V8 413CI 6.7L	59	L4 148CI 2.4L DOHC (16 Valve) (X)	97-95
V6 167CI 2.7L DOHC (24 Valve) (R)	10-05	V8 413CI 6.7L	60	L4 148CI 2.4L DOHC (16 Valve) (X)	00
V6 167CI 2.7L DOHC (24 Valve) (Flex Fuel) (D)	10	V8 413CI 6.7L	61	V6 2497cc 2.5L SOHC (24 Valve) (H)	00-95
V6 215CI 3.5L SOHC (24 Valve) (G)	10-05	V8 413CI 6.7L	62	Concorde	
V6 215CI 3.5L SOHC (24 Valve) (V)	10	V8 413CI 6.7L	63	V6 167CI 2.7L DOHC (24 Valve) (R)	04-98
V6 220CI 3.6L DOHC (24 Valve) (Flex Fuel) (G)	13-11	V8 413CI 6.7L	64	V6 197CI 3.2L SOHC (24 Valve) (J)	01-98
V8 331CI 5.4L	55	V8 413CI 6.7L	65	V6 201CI 3.3L OHV (T)	96-93
V8 383CI 6.3L	66-62	V6 215CI 3.5L SOHC (24 Valve) (G)	04-99	V6 215CI 3.5L SOHC (24 Valve) (F)	97-93
V8 413CI 6.7L	65-62	V6 215CI 3.5L SOHC (24 Valve) (K)	04-02	V6 215CI 3.5L SOHC (24 Valve) (G)	04-02
V8 440CI 7.2L	71-66	V8 345CI 5.7L (Hemi) (T)	13-12	V6 215CI 3.5L SOHC (24 Valve) (M)	04-02
V8 354CI 5.8L	56	V8 345CI 5.7L (Hemi) (Flex Fuel) (2)	13-12	Conquest	
V6 220CI 3.6L DOHC (24 Valve) (Flex Fuel) (G)	13	C16		L4 2555cc 2.6L SOHC Turbo (H)	86-84
		C18		L4 2555cc 2.6L SOHC Turbo (N)	89-87
		C22		Cordoba	
		L6 241.5CI 4.0L (L-Head)	38	L6 225CI 3.7L (C)	80
		L6 241.5CI 4.0L (L-Head)	39	L6 225CI 3.7L (E)	82-81

Chrysler Car (Incl. Chrysler, DeSoto, Dodge, Eagle, Plymouth) (Cont.)

Model Index (Cont.)					
Engine (VIN Code / Eng. Code)	Year	Engine (VIN Code / Eng. Code)	Year	Engine (VIN Code / Eng. Code)	Year
Chrysler (cont.)		Chrysler (cont.)		Chrysler (cont.)	
Cordoba (cont.)		Intrepid (Canada)		Newport	
L6 225CI 3.7L (H)	83	V6 167CI 2.7L DOHC (24 Valve) (R)	04-98	L6 225CI 3.7L (C)	80
L6 225CI 3.7L (J)	83	V6 197CI 3.2L SOHC (24 Valve) (J)	01-98	L6 225CI 3.7L (D)	80-79
V8 318CI 5.2L (G)	80-75	V6 201CI 3.3L OHV (T)	97-93	L6 225CI 3.7L (E)	82-81
V8 318CI 5.2L (K)	82-81	V6 215CI 3.5L SOHC (24 Valve) (F)	97-93	L6 225CI 3.7L (F)	82-81
V8 318CI 5.2L (P)	83	V6 215CI 3.5L SOHC (24 Valve) (G)	04-00	L6 225CI 3.7L (H)	83
V8 360CI 5.9L (J)	79	V6 215CI 3.5L SOHC (24 Valve) (V)	04-00	L6 251.6CI 4.1L (L-Head)	51-50
V8 360CI 5.9L (K)	80-75	Laser		L6 265CI 4.3L (L-Head)	54-52
V8 400CI 6.6L (M)	76-75	L4 135CI 2.2L SOHC (D)	86-84	V8 301CI 4.9L	55
V8 400CI 6.6L (N)	78-75	L4 135CI 2.2L SOHC Turbo (E)	86-84	V8 318CI 5.2L (G)	80-79
V8 400CI 6.6L (P)	76-75	L4 153CI 2.5L SOHC (K)	86	V8 318CI 5.2L (K)	81
Crossfire		LeBaron (FWD)		V8 318CI 5.2L (L)	81
V6 3199cc 3.2L SOHC (18 Valve) (L)	08-04	L4 135CI 2.2L SOHC (B)	82	V8 318CI 5.2L (M)	81
V6 3199cc 3.2L SOHC Supercharged (18 Valve) (N)	06-05	L4 135CI 2.2L SOHC (C)	85-83	V8 318CI 5.2L (N)	81
Crown Imperial		L4 135CI 2.2L SOHC (D)	89-85	V8 331CI 5.4L	56
L8 323.5CI 5.3L (L-Head)	50-46	L4 135CI 2.2L SOHC Turbo (C)	90	V8 354CI 5.8L	58-57
V8 331CI 5.4L	55-51	L4 135CI 2.2L SOHC Turbo (E)	89-84	V8 360CI 5.9L (K)	80-71
V8 354CI 5.8L	56	L4 153CI 2.5L SOHC (K)	93-86	V8 361CI 5.9L	64-61
V8 392CI 6.4L	58-57	L4 153CI 2.5L SOHC Turbo (J)	92-89	V8 383CI 6.3L	71-65
V8 413CI 6.7L	65-59	L4 2555cc 2.6L SOHC (D)	82	V8 383CI 6.3L	60-59
Daytona (Canada)		L4 2555cc 2.6L SOHC (G)	85-83	V8 400CI 6.6L (M)	76-72
L4 135CI 2.2L DOHC Turbo (A)	93-92	V6 2972cc 3.0L SOHC (12 Valve) (3)	95-90	V8 400CI 6.6L (N)	78-76
L4 135CI 2.2L SOHC (D)	86-84	LeBaron (RWD)		V8 413CI 6.7L	60-59
L4 135CI 2.2L SOHC Turbo (C)	90	L6 225CI 3.7L (C)	80-79	V8 440CI 7.2L	69-66
L4 135CI 2.2L SOHC Turbo (E)	89-84	L6 225CI 3.7L (D)	80-77	V8 440CI 7.2L (T)	78-70
L4 153CI 2.5L SOHC (K)	93-86	L6 225CI 3.7L (E)	81	Prowler	
L4 153CI 2.5L SOHC Turbo (J)	92-89	V8 318CI 5.2L (G)	80-77	V6 215CI 3.5L SOHC (24 Valve) (G)	02-01
V6 2972cc 3.0L SOHC (12 Valve) (3)	93-90	V8 318CI 5.2L (K)	81	PT Cruiser Convertible	
Dynasty (Canada)		V8 360CI 5.9L (J)	79	L4 148CI 2.4L DOHC (16 Valve) (X)	08-04
L4 153CI 2.5L SOHC (K)	93-88	V8 360CI 5.9L (K)	80-77	L4 148CI 2.4L DOHC Turbo (16 Valve) (E)	08-04
V6 201CI 3.3L OHV (R)	93-90	LHS		L4 148CI 2.4L DOHC Turbo (16 Valve) (S)	07-04
V6 2972cc 3.0L SOHC (12 Valve) (3)	93-88	V6 215CI 3.5L SOHC (24 Valve) (F)	97-93	Royal	
E-Class		V6 215CI 3.5L SOHC (24 Valve) (G)	01-99	L6 217.8CI 3.6L (L-Head)	37
L4 135CI 2.2L SOHC (D)	84-83	New Yorker (FWD)		L6 241.5CI 4.0L (L-Head)	41-38
L4 135CI 2.2L SOHC Turbo (E)	84	L4 135CI 2.2L SOHC (B)	82	L6 251.6CI 4.1L (L-Head)	50-46
L4 2555cc 2.6L SOHC (G)	84-83	L4 135CI 2.2L SOHC (C)	85-83	L6 251.6CI 4.1L (L-Head)	42
Executive Limousine		L4 135CI 2.2L SOHC (D)	88-85	Saratoga	
L4 135CI 2.2L SOHC (D)	86-85	L4 135CI 2.2L SOHC Turbo (E)	88-84	L8 323.5CI 5.3L (L-Head)	50-46
L4 135CI 2.2L SOHC Turbo (E)	86-85	L4 153CI 2.5L SOHC (K)	88-86	V8 331CI 5.4L	52-51
L4 153CI 2.5L SOHC (K)	86	L4 2555cc 2.6L SOHC (D)	82	V8 354CI 5.8L	58-57
L4 2555cc 2.6L SOHC (G)	85	L4 2555cc 2.6L SOHC (G)	85-83	V8 383CI 6.3L	60-59
Executive Sedan		V6 201CI 3.3L OHV (R)	93-90	Sebring Convertible	
L4 135CI 2.2L SOHC (D)	84-83	V6 215CI 3.5L SOHC (24 Valve) (F)	96-94	L4 148CI 2.4L DOHC (16 Valve) (X)	98-96
L4 135CI 2.2L SOHC Turbo (E)	84	V6 231CI 3.8L OHV (L)	93-91	L4 148CI 2.4L DOHC (16 Valve) (X)	06-02
L4 2555cc 2.6L SOHC (G)	84-83	V6 2972cc 3.0L SOHC (12 Valve) (3)	89-88	L4 2360cc 2.4L DOHC (16 Valve) (B)	10-09
Fifth Avenue (FWD)		New Yorker (RWD)		L4 2360cc 2.4L DOHC (16 Valve) (K)	08
V6 201CI 3.3L OHV (R)	93-90	L6 225CI 3.7L (E)	82-81	V6 167CI 2.7L DOHC (24 Valve) (R)	10-08
V6 231CI 3.8L OHV (L)	93-91	L6 225CI 3.7L (H)	83	V6 167CI 2.7L DOHC (24 Valve) (R)	06-05
Fifth Avenue (RWD)		L8 323.5CI 5.3L (L-Head)	50-46	V6 167CI 2.7L DOHC (24 Valve) (U)	04-01
L6 225CI 3.7L (H)	83	V8 318CI 5.2L (G)	80-79	V6 167CI 2.7L DOHC (24 Valve) (Flex Fuel)	10
L6 225CI 3.7L (J)	83	V8 318CI 5.2L (K)	82-81	(D)	
V8 318CI 5.2L (4)	89-83	V8 318CI 5.2L (L)	82-81	V6 215CI 3.5L SOHC (24 Valve) (M)	10-08
V8 318CI 5.2L (P)	89-83	V8 318CI 5.2L (M)	81	V6 215CI 3.5L SOHC (24 Valve) (V)	10
Imperial (FWD)		V8 318CI 5.2L (N)	81	V6 2497cc 2.5L SOHC (24 Valve) (H)	00-96
V6 201CI 3.3L OHV (R)	90	V8 318CI 5.2L (P)	83	Sebring Coupe	
V6 231CI 3.8L OHV (L)	93-91	V8 318CI 5.2L (P)	83	L4 122CI 2.0L DOHC (16 Valve) (Y)	99-95
Imperial (RWD)		V8 331CI 5.4L	55-51	L4 2351cc 2.4L SOHC (16 Valve) (G)	05-01
L8 323.5CI 5.3L (L-Head)	50-46	V8 354CI 5.8L	56	V6 2497cc 2.5L SOHC (24 Valve) (N)	00-95
V8 318CI 5.2L (J)	82-81	V8 360CI 5.9L (J)	79	V6 2972cc 3.0L SOHC (24 Valve) (H)	05-01
V8 318CI 5.2L (N)	83	V8 360CI 5.9L (K)	80-77	Sebring Sedan	
V8 331CI 5.4L	55-51	V8 383CI 6.3L	71-66	L4 148CI 2.4L DOHC (16 Valve) (X)	06-01
V8 354CI 5.8L	56	V8 392CI 6.4L	58-57	L4 2360cc 2.4L DOHC (16 Valve) (B)	10-09
V8 392CI 6.4L	58-57	V8 400CI 6.6L (M)	76-72	L4 2360cc 2.4L DOHC (16 Valve) (K)	08-07
V8 413CI 6.7L	65-59	V8 400CI 6.6L (N)	78-75	V6 167CI 2.7L DOHC (24 Valve) (R)	10-07
V8 413CI 6.7L	65-59	V8 413CI 6.7L	65-59	V6 167CI 2.7L DOHC (24 Valve) (R)	10-07
V8 440CI 7.2L	69-66	V8 440CI 7.2L	69-66	V6 167CI 2.7L DOHC (24 Valve) (U)	06-01
V8 440CI 7.2L	75-66	V8 440CI 7.2L (T)	78-70	V6 167CI 2.7L DOHC (24 Valve) (Flex Fuel)	10

(D)

Chrysler Car (Incl. Chrysler, DeSoto, Dodge, Eagle, Plymouth) (Cont.)

Model Index (Cont.)					
Engine (VIN Code / Eng. Code)	Year	Engine (VIN Code / Eng. Code)	Year	Engine (VIN Code / Eng. Code)	Year
Chrysler (cont.)		DeSoto (cont.)		Dodge (cont.)	
Sebring Sedan (cont.)		Firesweep		Caliber (cont.)	
V6 167CI 2.7L DOHC (24 Valve) (Flex Fuel) (T)	09-03	V8 325CI 5.3L	57	L4 2360cc 2.4L DOHC (16 Valve) (C)	11-07
V6 215CI 3.5L SOHC (24 Valve) (M)	10-07	V8 350CI 5.7L	58	L4 2360cc 2.4L DOHC (16 Valve) (K)	10-07
V6 215CI 3.5L SOHC (24 Valve) (V)	10	V8 361CI 5.9L	59-58	L4 2360cc 2.4L DOHC Turbo (16 Valve) (K)	09-08
TC Maserati		Powermaster		Caliber (cont.)	
L4 135CI 2.2L DOHC (A)	91-88	L6 251.6CI 4.1L (L-Head)	54-53	L4 2360cc 2.4L DOHC Turbo (16 Valve) (T)	10-09
L4 135CI 2.2L DOHC Turbo (A)	91-89	S10		Celeste (Puerto Rico)	
V6 2972cc 3.0L SOHC (12 Valve) (S)	91-90	L6 236.6CI 3.9L (L-Head)	42	L4 1597cc 1.6L SOHC (8 Valve) (K)	80-76
Town & Country (FWD)		S3		L4 1995cc 2.0L SOHC (U)	79-76
L4 135CI 2.2L SOHC (B)	82	L6 228.1CI 3.7L (L-Head)	37	L4 2555cc 2.6L SOHC (F)	80-78
L4 135CI 2.2L SOHC (D)	88-83	S5		Challenger (Domestic)	
L4 135CI 2.2L SOHC Turbo (E)	88-84	L6 228.1CI 3.7L (L-Head)	38	L6 225CI 3.7L	74-70
L4 153CI 2.5L SOHC (K)	88-86	S6		V8 318CI 5.2L	74-70
L4 2555cc 2.6L SOHC (D)	82	L6 228.1CI 3.7L (L-Head)	39	V8 340CI 5.6L	73-70
L4 2555cc 2.6L SOHC (G)	85-83	S7		V8 360CI 5.9L	74-71
Town & Country (RWD)		S8		V8 383CI 6.3L	71-70
L6 251.6CI 4.1L (L-Head)	48-46	L6 228.1CI 3.7L (L-Head)	41	V8 400CI 6.6L	74-72
L8 323.5CI 5.3L (L-Head)	48-46	Dodge		V8 426CI 7.0L	71-70
V8 383CI 6.3L	71-70	024		V8 440CI 7.2L	74-70
V8 400CI 6.6L (M)	76-72	L4 135CI 2.2L SOHC (B)	82-81	Challenger (Import)	
V8 400CI 6.6L (N)	78-75	L4 1715cc 1.7L SOHC (A)	82-81	L4 1597cc 1.6L SOHC (8 Valve) (K)	79-78
V8 440CI 7.2L (T)	78-70	400		L4 1597cc 1.6L SOHC (8 Valve) (Z)	79-78
Windsor		L4 135CI 2.2L SOHC (B)	82	L4 1995cc 2.0L SOHC (U)	79-78
L6 241.5CI 4.0L (L-Head)	41-39	L4 135CI 2.2L SOHC (C)	83	L4 2555cc 2.6L SOHC (7)	83-81
L6 251.6CI 4.1L (L-Head)	51-46	L4 2555cc 2.6L SOHC (D)	82	L4 2555cc 2.6L SOHC (F)	80-78
L6 251.6CI 4.1L (L-Head)	42	L4 2555cc 2.6L SOHC (G)	83	Challenger (RWD)	
L6 265CI 4.3L (L-Head)	54-52	600		V6 215CI 3.5L SOHC (24 Valve) (G)	10-09
V8 301CI 4.9L	55	L4 135CI 2.2L SOHC (D)	89-83	V6 215CI 3.5L SOHC (24 Valve) (V)	10
V8 331CI 5.4L	56	L4 135CI 2.2L SOHC Turbo (E)	88-84	V6 220CI 3.6L DOHC (24 Valve) (Flex Fuel) (G)	13-11
V8 354CI 5.8L	58-57	L4 153CI 2.5L SOHC (K)	89-86	V8 345CI 5.7L (Hemi) (T)	13-09
V8 383CI 6.3L	61-59	L4 153CI 2.5L SOHC Turbo (J)	89	V8 345CI 5.7L (Hemi) (Flex Fuel) (2)	13-12
V8 413CI 6.7L	61-59	L4 2555cc 2.6L SOHC (G)	85-83	V8 370CI 6.1L (Hemi) (W)	10-08
DeSoto		Aries		V8 392CI 6.4L (Hemi) (B)	11
Adventurer		L4 135CI 2.2L SOHC (B)	82-81	V8 392CI 6.4L (Hemi) (J)	13-12
V8 341CI 5.6L	56	L4 135CI 2.2L SOHC (C)	85-83	Charger (FWD)	
V8 345CI 5.6L	57	L4 135CI 2.2L SOHC (D)	89-86	L4 135CI 2.2L SOHC (B)	82-81
V8 361CI 5.9L	61	L4 153CI 2.5L SOHC (K)	89-86	L4 135CI 2.2L SOHC (C)	87-83
V8 361CI 5.9L	58	L4 2555cc 2.6L SOHC (D)	82-81	L4 135CI 2.2L SOHC Turbo (E)	87-85
V8 383CI 6.3L	60-59	L4 2555cc 2.6L SOHC (G)	85-83	L4 1592cc 1.6L OHV (A)	86-83
Custom		Aspen		L4 1715cc 1.7L SOHC (A)	83-82
L6 217.8CI 3.6L (L-Head)	37	L6 225CI 3.7L (C)	80-76	Charger (RWD)	
L6 236.6CI 3.9L (L-Head)	50-46	L6 225CI 3.7L (D)	80-77	L6 225CI 3.7L	69
L6 236.6CI 3.9L (L-Head)	42	V8 318CI 5.2L (G)	80-76	L6 225CI 3.7L (C)	78-70
L6 241.5CI 4.0L (L-Head)	41-38	V8 360CI 5.9L (J)	79	V6 167CI 2.7L DOHC (24 Valve) (R)	10-06
L6 251.6CI 4.1L (L-Head)	52-51	V8 360CI 5.9L (K)	80-76	V6 167CI 2.7L DOHC (24 Valve) (Flex Fuel) (D)	10
DeLuxe		V8 360CI 5.9L (L)	80-77	V6 215CI 3.5L SOHC (24 Valve) (G)	10-06
L6 217.8CI 3.6L (L-Head)	37	Avenger		V6 215CI 3.5L SOHC (24 Valve) (V)	10
L6 236.6CI 3.9L (L-Head)	50-46	L4 122CI 2.0L DOHC (16 Valve) (Y)	99-95	V6 220CI 3.6L DOHC (24 Valve) (Flex Fuel) (G)	13-11
L6 236.6CI 3.9L (L-Head)	42	L4 2360cc 2.4L DOHC (16 Valve) (B)	13-09	V8 318CI 5.2L	69-67
L6 241.5CI 4.0L (L-Head)	41-38	L4 2360cc 2.4L DOHC (16 Valve) (K)	13-07	V8 318CI 5.2L (G)	78-70
L6 251.6CI 4.1L (L-Head)	52-51	V6 167CI 2.7L DOHC (24 Valve) (R)	10-07	V8 340CI 5.6L	73-70
Firedome		V6 167CI 2.7L DOHC (24 Valve) (Flex Fuel) (D)	10	V8 345CI 5.7L (Hemi) (H)	08-06
V8 276CI 4.5L	54-52	V6 167CI 2.7L DOHC (24 Valve) (Flex Fuel) (T)	09-07	V8 345CI 5.7L (Hemi) (T)	13-09
V8 291CI 4.8L	55	V6 215CI 3.5L SOHC (24 Valve) (M)	10-07	V8 345CI 5.7L (Hemi) (Flex Fuel) (2)	13-12
V8 330CI 5.4L	56	V6 215CI 3.5L SOHC (24 Valve) (V)	10	V8 360CI 5.9L (K)	78-71
V8 341CI 5.6L	57	V6 220CI 3.6L DOHC (24 Valve) (Flex Fuel) (G)	13-11	V8 361CI 5.9L	66
V8 361CI 5.9L	58	V6 2497cc 2.5L SOHC (24 Valve) (N)	00-95	V8 370CI 6.1L (Hemi) (W)	10-06
V8 383CI 6.3L	59	Caliber		V8 383CI 6.3L	71-66
Fireflite		L4 1798cc 1.8L DOHC (16 Valve) (C)	09-07	V8 392CI 6.4L (Hemi) (J)	13-12
V8 291CI 4.8L	55	L4 1998cc 2.0L DOHC (16 Valve) (A)	12-10	V8 400CI 6.6L (M)	76-72
V8 330CI 5.4L	56	L4 1998cc 2.0L DOHC (16 Valve) (B)	12-07	V8 400CI 6.6L (N)	78-74
V8 341CI 5.6L	57	L4 2360cc 2.4L DOHC (16 Valve) (B)	11-09	V8 426CI 7.0L	71-67
V8 361CI 5.9L	61-60	Caliber		V8 440CI 7.2L	74-67
V8 361CI 5.9L	58	024			
V8 383CI 6.3L	59	400			

Chrysler Car (Incl. Chrysler, DeSoto, Dodge, Eagle, Plymouth) (Cont.)

Model Index (Cont.)					
Engine (VIN Code / Eng. Code)	Year	Engine (VIN Code / Eng. Code)	Year	Engine (VIN Code / Eng. Code)	Year
Dodge (cont.)		Dodge (cont.)		Dodge (cont.)	
Colt (FWD)		Custom (cont.)		Intrepid (cont.)	
L4 1410cc 1.4L SOHC (2)	83-81	V8 361CI 5.9L	59	V6 197CI 3.2L SOHC (24 Valve) (J)	01-98
L4 1410cc 1.4L SOHC (A)	84	Custom 880		V6 201CI 3.3L OHV (T)	97-93
L4 1410cc 1.4L SOHC (J)	80-79	V8 361CI 5.9L	64-62	V6 215CI 3.5L SOHC (24 Valve) (F)	97-93
L4 1468cc 1.5L SOHC (12 Valve) (A)	94-91	V8 383CI 6.3L	65-62	V6 215CI 3.5L SOHC (24 Valve) (G)	04-00
L4 1468cc 1.5L SOHC (12 Valve) (Q)	94-91	V8 413CI 6.7L	65	V6 215CI 3.5L SOHC (24 Valve) (M)	04-02
L4 1468cc 1.5L SOHC (8 Valve) (K)	88-85	V8 426CI 7.0L	65	V6 215CI 3.5L SOHC (24 Valve) (V)	04-00
L4 1468cc 1.5L SOHC (8 Valve) (Q)	91-85	D500		Lancer (FWD)	
L4 1468cc 1.5L SOHC (8 Valve) (X)	90-89	V8 315CI 5.1L	56	L4 135CI 2.2L SOHC (D)	89-85
L4 1595cc 1.6L DOHC (16 Valve) (Y)	90	V8 325CI 5.3L	57	L4 135CI 2.2L SOHC Turbo (E)	89-85
L4 1595cc 1.6L DOHC Turbo (16 Valve) (Z)	89	V8 350CI 5.7L	58	L4 153CI 2.5L SOHC (K)	89-86
L4 1597cc 1.6L SOHC (8 Valve) (3)	83-81	V8 354CI 5.8L	57	L4 153CI 2.5L SOHC Turbo (J)	89
L4 1597cc 1.6L SOHC (8 Valve) (B)	84	V8 361CI 5.9L	58	L4 2555cc 2.6L SOHC (G)	85
L4 1597cc 1.6L SOHC (8 Valve) (K)	80-79	V8 383CI 6.3L	61-59	Lancer (RWD)	
L4 1597cc 1.6L SOHC Turbo (8 Valve) (F)	90-84	Dart (FWD)		L6 170CI 2.8L	62-61
L4 1834cc 1.8L SOHC (16 Valve) (C)	94-93	L4 1368cc 1.4L SOHC Turbo (16 Valve) (H)	13	L6 225CI 3.7L	62-61
Colt (RWD)		L4 1995cc 2.0L DOHC (16 Valve) (A)	13	V8 270CI 4.4L	55
L4 1597cc 1.6L SOHC (8 Valve) (K)	80-71	L4 2360cc 2.4L SOHC (16 Valve) (B)	13	V8 315CI 5.1L	56
L4 1995cc 2.0L SOHC (U)	79-74	Dart (RWD)		V8 325CI 5.3L	57
L4 2555cc 2.6L SOHC (F)	80-78	L6 170CI 2.8L	69-60	Magnum	
Colt Vista		L6 198CI 3.2L	74-70	V6 167CI 2.7L DOHC (24 Valve) (R)	08-05
L4 1834cc 1.8L SOHC (16 Valve) (C)	94-92	L6 225CI 3.7L	69-60	V6 215CI 3.5L SOHC (24 Valve) (G)	08-05
L4 1997cc 2.0L SOHC (8 Valve) (D)	88-84	L6 225CI 3.7L (C)	76-70	V6 215CI 3.5L SOHC (24 Valve) (V)	08-05
L4 1997cc 2.0L SOHC (8 Valve) (V)	91-89	V8 273CI 4.5L	69-64	V8 318CI 5.2L (G)	79-78
L4 2351cc 2.4L SOHC (16 Valve) (G)	94-93	V8 318CI 5.2L	71-68	V8 345CI 5.7L (Hemi) (H)	08-05
L4 2351cc 2.4L SOHC (8 Valve) (W)	92	V8 318CI 5.2L (G)	76-72	V8 360CI 5.9L (J)	79
Colt Vista AWD		V8 340CI 5.6L	73-68	V8 360CI 5.9L (K)	78
L4 1834cc 1.8L SOHC (16 Valve) (C)	94-92	V8 360CI 5.9L (K)	76-71	V8 370CI 6.1L (Hemi) (W)	08-06
L4 1997cc 2.0L SOHC (8 Valve) (D)	88-84	V8 361CI 5.9L	62-60	V8 400CI 6.6L (N)	78
L4 1997cc 2.0L SOHC (8 Valve) (V)	91-89	V8 383CI 6.3L	69-68	Matador	
L4 2351cc 2.4L SOHC (16 Valve) (G)	94-93	Daytona		V8 361CI 5.9L	60
L4 2351cc 2.4L SOHC (8 Valve) (W)	92	L4 135CI 2.2L DOHC Turbo (A)	93-92	V8 383CI 6.3L	60
Colt Wagon AWD		L4 135CI 2.2L SOHC (D)	86-84	Meadowbrook	
L4 1755cc 1.8L SOHC (8 Valve) (T)	90-89	L4 135CI 2.2L SOHC Turbo (C)	90	L6 230CI 3.8L (L-Head)	54-49
Conquest		L4 135CI 2.2L SOHC Turbo (E)	89-84	V8 241.4CI 4.0L	54
L4 2555cc 2.6L SOHC Turbo (H)	86-84	L4 153CI 2.5L SOHC (K)	93-86	Mirada	
L4 2555cc 2.6L SOHC Turbo (N)	89-87	L4 153CI 2.5L SOHC Turbo (J)	92-89	L6 225CI 3.7L (C)	80
Coronet		V6 2972cc 3.0L SOHC (12 Valve) (3)	93-90	L6 225CI 3.7L (E)	82-81
L6 217.8CI 3.6L (L-Head)	48-34	DeLuxe		L6 225CI 3.7L (H)	83
L6 225CI 3.7L	69-63	L6 217.8CI 3.6L (L-Head)	42-34	L6 225CI 3.7L (J)	83
L6 225CI 3.7L (C)	76-70	L6 230CI 3.8L (L-Head)	48-46	V8 318CI 5.2L (G)	80
L6 230CI 3.8L (L-Head)	59-49	L6 230CI 3.8L (L-Head)	42	V8 318CI 5.2L (K)	82-81
V8 241.4CI 4.0L	54-53	Diplomat		V8 318CI 5.2L (P)	83
V8 270CI 4.4L	56-55	L6 225CI 3.7L (C)	80-79	V8 360CI 5.9L (L)	80
V8 273CI 4.5L	68-65	L6 225CI 3.7L (D)	80-77	Monaco (FWD)	
V8 315CI 5.1L	56	L6 225CI 3.7L (E)	82-81	V6 2970cc 3.0L SOHC (U)	92-90
V8 318CI 5.2L	69-65	L6 225CI 3.7L (F)	82-81	Monaco (RWD)	
V8 318CI 5.2L (G)	76-70	L6 225CI 3.7L (H)	83	L6 225CI 3.7L (C)	76-70
V8 325CI 5.3L	58-57	L6 225CI 3.7L (J)	83	L6 225CI 3.7L (D)	78-77
V8 326CI 5.3L	59	V8 318CI 5.2L (4)	89-84	V8 318CI 5.2L (G)	78-70
V8 340CI 5.6L	73-70	V8 318CI 5.2L (G)	80-77	V8 360CI 5.9L (K)	78-71
V8 360CI 5.9L (K)	76-71	V8 318CI 5.2L (J)	82-81	V8 383CI 6.3L	71-65
V8 361CI 5.9L	66-63	V8 318CI 5.2L (K)	82-81	V8 400CI 6.6L (M)	76-72
V8 383CI 6.3L	71-59	V8 318CI 5.2L (L)	82-81	V8 400CI 6.6L (N)	78-74
V8 400CI 6.6L (M)	76-72	V8 318CI 5.2L (M)	82-81	V8 413CI 6.7L	65
V8 400CI 6.6L (N)	76-74	V8 318CI 5.2L (N)	82-81	V8 426CI 7.0L	66-65
V8 426CI 7.0L	71-65	V8 318CI 5.2L (P)	89-83	V8 440CI 7.2L	69-66
V8 440CI 7.2L	76-67	V8 318CI 5.2L (S)	89-83	V8 440CI 7.2L (T)	78-70
Custom		V8 360CI 5.9L (J)	79	Neon	
L6 217.8CI 3.6L (L-Head)	42-41	V8 360CI 5.9L (K)	80-77	L4 122CI 2.0L DOHC (16 Valve) (B)	99-95
L6 230CI 3.8L (L-Head)	48-46	Dynasty		L4 122CI 2.0L DOHC (16 Valve) (Y)	99-95
L6 230CI 3.8L (L-Head)	42	L4 153CI 2.5L SOHC (K)	93-88	L4 122CI 2.0L SOHC (16 Valve) (C)	06-95
V8 270CI 4.4L	55	V6 201CI 3.3L OHV (R)	93-90	L4 122CI 2.0L SOHC (16 Valve) (F)	05-01
V8 315CI 5.1L	56	V6 2972cc 3.0L SOHC (12 Valve) (3)	93-88	L4 148CI 2.4L DOHC Turbo (16 Valve) (G)	03
V8 325CI 5.3L	58-57	Intrepid		L4 148CI 2.4L DOHC Turbo (16 Valve) (S)	06-04
V8 350CI 5.7L	58	V6 167CI 2.7L DOHC (24 Valve) (R)	04-98		

Chrysler Car (Incl. Chrysler, DeSoto, Dodge, Eagle, Plymouth) (Cont.)

Model Index (Cont.)					
Engine (VIN Code / Eng. Code)	Year	Engine (VIN Code / Eng. Code)	Year	Engine (VIN Code / Eng. Code)	Year
Dodge (cont.)		Dodge (cont.)		Eagle (cont.)	
Omni		Sierra (cont.)		Galant (Canada) (cont.)	
L4 135CI 2.2L SOHC (8)	86-85	V8 361CI 5.9L	59	L4 2351cc 2.4L SOHC (16 Valve) (G)	94
L4 135CI 2.2L SOHC (B)	82-81	V8 383CI 6.3L	59	Medallion	
L4 135CI 2.2L SOHC (C)	87-83	Special		L4 2165cc 2.2L SOHC (F)	89-88
L4 135CI 2.2L SOHC (D)	90-88	L6 217.8CI 3.6L (L-Head)	40-39	Premier	
L4 135CI 2.2L SOHC (F)	86-83	Spirit		L4 150CI 2.46L OHV (H)	89
L4 135CI 2.2L SOHC Turbo (E)	86-85	L4 135CI 2.2L DOHC Turbo (A)	92-91	L4 150CI 2.46L OHV (Z)	88
L4 1592cc 1.6L OHV (A)	86-83	L4 153CI 2.5L SOHC (K)	95-89	V6 2970cc 3.0L SOHC (J)	88
L4 1715cc 1.7L SOHC (A)	82-78	L4 153CI 2.5L SOHC Turbo (J)	92-89	V6 2970cc 3.0L SOHC (U)	92-89
L4 1715cc 1.7L SOHC (B)	83	V6 2972cc 3.0L SOHC (12 Valve) (3)	95-89	Summit	
Phoenix		St. Regis		L4 1468cc 1.5L SOHC (12 Valve) (A)	96-91
L6 225CI 3.7L	61-60	L6 225CI 3.7L (C)	80	L4 1468cc 1.5L SOHC (8 Valve) (X)	90-89
V8 361CI 5.9L	61-60	L6 225CI 3.7L (D)	80-79	L4 1595cc 1.6L DOHC (16 Valve) (Y)	90-89
Pioneer		L6 225CI 3.7L (E)	81	L4 1834cc 1.8L SOHC (16 Valve) (C)	96-93
L6 225CI 3.7L	61-60	L6 225CI 3.7L (F)	81	Summit Wagon	
V8 318CI 5.2L	61-60	V8 318CI 5.2L (G)	80-79	L4 1834cc 1.8L SOHC (16 Valve) (C)	96-92
V8 361CI 5.9L	61	V8 318CI 5.2L (K)	81	L4 2351cc 2.4L SOHC (16 Valve) (G)	96-93
Polara		V8 318CI 5.2L (L)	81	L4 2351cc 2.4L SOHC (8 Valve) (W)	92
L6 225CI 3.7L	73-63	V8 360CI 5.9L (K)	80-79	Summit Wagon AWD	
V8 318CI 5.2L	73-63	Stealth		L4 1834cc 1.8L SOHC (16 Valve) (C)	93-92
V8 340CI 5.6L	73-72	V6 2972cc 3.0L DOHC (24 Valve) (B)	92-91	L4 2351cc 2.4L SOHC (16 Valve) (G)	96-93
V8 360CI 5.9L	73-71	V6 2972cc 3.0L DOHC (24 Valve) (J)	96-93	L4 2351cc 2.4L SOHC (8 Valve) (W)	92
V8 361CI 5.9L	62-60	V6 2972cc 3.0L SOHC (12 Valve) (H)	96-93	Talon	
V8 383CI 6.3L	71-60	V6 2972cc 3.0L SOHC (12 Valve) (S)	92-91	L4 122CI 2.0L DOHC (16 Valve) (Y)	98-95
V8 400CI 6.6L	73-72	Stealth AWD		L4 1755cc 1.8L SOHC (8 Valve) (B)	94-93
V8 413CI 6.7L	65	V6 2972cc 3.0L DOHC Turbo (24 Valve) (C)	92-91	L4 1997cc 2.0L DOHC (16 Valve) (E)	94-93
V8 426CI 7.0L	66-63	V6 2972cc 3.0L DOHC Turbo (24 Valve) (K)	96-93	L4 1997cc 2.0L DOHC (16 Valve) (R)	92-89
V8 440CI 7.2L	73-66	Stratus		L4 1997cc 2.0L DOHC Turbo (16 Valve) (F)	98-93
Royal		L4 122CI 2.0L SOHC (16 Valve) (C)	00-95	L4 1997cc 2.0L DOHC Turbo (16 Valve) (U)	92-89
V8 241.4CI 4.0L	54	L4 148CI 2.4L DOHC (16 Valve) (X)	00-95	Talon AWD	
V8 270CI 4.4L	55	V6 2497cc 2.5L SOHC (24 Valve) (H)	00-95	L4 1997cc 2.0L DOHC Turbo (16 Valve) (F)	98-93
V8 315CI 5.1L	56	Stratus Coupe		L4 1997cc 2.0L DOHC Turbo (16 Valve) (U)	92-89
V8 325CI 5.3L	58-57	L4 2351cc 2.4L SOHC (16 Valve) (G)	05-01	Vision	
V8 350CI 5.7L	58	V6 2972cc 3.0L SOHC (24 Valve) (H)	05-01	V6 201CI 3.3L OHV (T)	97-93
V8 361CI 5.9L	59	Stratus Sedan		V6 215CI 3.5L SOHC (24 Valve) (F)	97-93
V8 383CI 6.3L	59	L4 148CI 2.4L DOHC (16 Valve) (X)	06-01	Vista (Canada)	
Seneca		V6 167CI 2.7L DOHC (24 Valve) (R)	06-05	L4 1468cc 1.5L SOHC (12 Valve) (A)	94-91
L6 225CI 3.7L	61-60	V6 167CI 2.7L DOHC (24 Valve) (U)	04-01	L4 1468cc 1.5L SOHC (8 Valve) (X)	90-88
V8 318CI 5.2L	61-60	V6 167CI 2.7L DOHC (24 Valve) (Flex Fuel)	06-03	L4 1595cc 1.6L DOHC Turbo (16 Valve) (Z)	90-89
V8 361CI 5.9L	61	(T)		L4 1597cc 1.6L SOHC Turbo (8 Valve) (F)	88
Shadow		Texan		Vista Wagon (Canada)	
L4 135CI 2.2L SOHC (D)	94-87	V8 315CI 5.1L	56	L4 1997cc 2.0L SOHC (8 Valve) (D)	88-84
L4 135CI 2.2L SOHC Turbo (C)	90	Viper		L4 1997cc 2.0L SOHC (8 Valve) (V)	91-89
L4 135CI 2.2L SOHC Turbo (E)	89-87	V10 488CI 8.0L (E)	02-92	Vista Wagon AWD (Canada)	
L4 153CI 2.5L SOHC (K)	94-87	V10 505CI 8.3L (Z)	07-03	L4 1997cc 2.0L SOHC (8 Valve) (D)	88-84
L4 153CI 2.5L SOHC Turbo (J)	92-89	V10 512CI 8.4L (Z)	13	L4 1997cc 2.0L SOHC (8 Valve) (V)	91-89
V6 2972cc 3.0L SOHC (12 Valve) (3)	94-92	V10 512CI 8.4L (Z)	10-08	Plymouth	
Shelby Charger		Wayfarer		Acclaim	
L4 135CI 2.2L SOHC (C)	84-83	L6 230CI 3.8L (L-Head)	52-49	L4 153CI 2.5L SOHC (K)	95-89
L4 135CI 2.2L SOHC Turbo (E)	87-85	Eagle		L4 153CI 2.5L SOHC Turbo (J)	90-89
Shelby Daytona		2000 GTX (Canada)		V6 2972cc 3.0L SOHC (12 Valve) (3)	95-89
L4 135CI 2.2L SOHC Turbo (C)	90	L4 1997cc 2.0L DOHC (16 Valve) (R)	92-89	Arrow	
L4 135CI 2.2L SOHC Turbo (E)	89	L4 1997cc 2.0L DOHC Turbo (16 Valve) (U)	92-89	L4 1597cc 1.6L SOHC (8 Valve) (K)	80-75
L4 153CI 2.5L SOHC Turbo (J)	91	L4 1997cc 2.0L SOHC (16 Valve) (D)	93	L4 1597cc 1.6L SOHC (8 Valve) (Z)	80-78
Shelby Lancer		L4 1997cc 2.0L SOHC (16 Valve) (V)	93	L4 1995cc 2.0L SOHC (U)	79-75
L4 135CI 2.2L SOHC Turbo (E)	89-88	L4 1997cc 2.0L SOHC (8 Valve) (V)	92-89	L4 2555cc 2.6L SOHC (F)	80-79
Shelby Shadow		L4 2351cc 2.4L SOHC (16 Valve) (G)	94	Barracuda	
L4 135CI 2.2L SOHC Turbo (C)	90	2000 GTX AWD (Canada)		L6 170CI 2.8L	65-64
L4 135CI 2.2L SOHC Turbo (E)	89	L4 1997cc 2.0L DOHC Turbo (16 Valve) (F)	94-93	L6 198CI 3.2L	73-70
Sierra		L4 1997cc 2.0L DOHC Turbo (16 Valve) (U)	92-89	L6 225CI 3.7L	74-64
V8 241.4CI 4.0L	54	Galant (Canada)		V8 273CI 4.5L	68-64
V8 270CI 4.4L	56-55	L4 1997cc 2.0L DOHC (16 Valve) (R)	92-89	V8 318CI 5.2L	74-68
V8 315CI 5.1L	56	L4 1997cc 2.0L DOHC Turbo (16 Valve) (U)	92-89	V8 340CI 5.6L	73-68
V8 325CI 5.3L	58-57	L4 1997cc 2.0L SOHC (16 Valve) (D)	93	V8 360CI 5.9L	74-71
V8 326CI 5.3L	59	L4 1997cc 2.0L SOHC (16 Valve) (V)	93	V8 383CI 6.3L	71-67
V8 350CI 5.7L	58	L4 1997cc 2.0L SOHC (8 Valve) (V)	92-89	V8 426CI 7.0L	71-70

Chrysler Car (Incl. Chrysler, DeSoto, Dodge, Eagle, Plymouth) (Cont.)

Model Index (Cont.)					
Engine (VIN Code / Eng. Code)	Year	Engine (VIN Code / Eng. Code)	Year	Engine (VIN Code / Eng. Code)	Year
Plymouth (cont.)		Plymouth (cont.)		Plymouth (cont.)	
Barracuda (cont.)		Colt Wagon AWD		Gran Fury (Full-Size) (cont.)	
V8 440CI 7.2L	71-70	L4 1755cc 1.8L SOHC (8 Valve) (T)	90-89	V8 440CI 7.2L (T)	78-72
Belvedere		Concord		Horizon	
L6 217.8CI 3.6L (L-Head)	54	L6 217.8CI 3.6L (L-Head)	52-51	L4 135CI 2.2L SOHC (8)	86-85
L6 225CI 3.7L	70-60	Conquest		L4 135CI 2.2L SOHC (B)	82-81
L6 230CI 3.8L (L-Head)	59-54	L4 2555cc 2.6L SOHC Turbo (H)	86-84	L4 135CI 2.2L SOHC (C)	87-83
V8 241.4CI 4.0L	55	L4 2555cc 2.6L SOHC Turbo (N)	89-87	L4 135CI 2.2L SOHC (D)	90-88
V8 260CI 4.3L	55	Cranbrook		L4 135CI 2.2L SOHC (F)	86-83
V8 273CI 4.5L	68-65	L6 217.8CI 3.6L (L-Head)	53-51	L4 1592cc 1.6L OHV (A)	86-83
V8 277CI 4.5L	56	Cuda		L4 1715cc 1.7L SOHC (A)	82-78
V8 301CI 4.9L	57	V8 318CI 5.2L	74-68	L4 1715cc 1.7L SOHC (B)	83
V8 303CI 5.0L	56	V8 340CI 5.6L	73-68	Lancer (Puerto Rico)	
V8 313CI 5.1L	58-57	V8 360CI 5.9L	74-71	L4 1597cc 1.6L SOHC (8 Valve) (K)	80-78
V8 318CI 5.2L	70-58	V8 383CI 6.3L	71-68	L4 2555cc 2.6L SOHC (F)	80-78
V8 340CI 5.6L	70	V8 426CI 7.0L	71-70	Laser	
V8 350CI 5.7L	58	V8 440CI 7.2L	71-70	L4 1755cc 1.8L SOHC (8 Valve) (B)	94-93
V8 361CI 5.9L	66-59	DeLuxe		L4 1755cc 1.8L SOHC (8 Valve) (T)	92-89
V8 383CI 6.3L	70-60	L6 201.3CI 3.3L (L-Head)	41-35	L4 1997cc 2.0L DOHC (16 Valve) (E)	94-93
V8 426CI 7.0L	70-63	L6 217.8CI 3.6L (L-Head)	51-46	L4 1997cc 2.0L DOHC (16 Valve) (R)	92-89
V8 440CI 7.2L	70-67	L6 217.8CI 3.6L (L-Head)	42	L4 1997cc 2.0L DOHC Turbo (16 Valve) (F)	94-93
Breeze		Duster		L4 1997cc 2.0L DOHC Turbo (16 Valve) (U)	92-89
L4 122CI 2.0L SOHC (16 Valve) (C)	00-96	L6 198CI 3.2L	74-70	Laser AWD	
L4 148CI 2.4L DOHC (16 Valve) (X)	00-98	L6 225CI 3.7L (C)	76-70	L4 1997cc 2.0L DOHC Turbo (16 Valve) (F)	94-93
Cambridge		V8 318CI 5.2L (G)	76-70	L4 1997cc 2.0L DOHC Turbo (16 Valve) (U)	92-89
L6 217.8CI 3.6L (L-Head)	53-51	V8 340CI 5.6L	73-70	Neon	
Caravelle (FWD)		V8 360CI 5.9L (K)	76-74	L4 122CI 2.0L DOHC (16 Valve) (B)	99-95
L4 135CI 2.2L SOHC (D)	89-85	V8 383CI 6.3L	71-70	L4 122CI 2.0L DOHC (16 Valve) (Y)	99-95
L4 135CI 2.2L SOHC Turbo (E)	88-85	Fury (Full-Size)		L4 122CI 2.0L SOHC (16 Valve) (C)	00-95
L4 153CI 2.5L SOHC (K)	89-86	L6 225CI 3.7L	74-60	Plaza	
L4 153CI 2.5L SOHC Turbo (J)	89	V8 301CI 4.9L	57	L6 217.8CI 3.6L (L-Head)	54
L4 2555cc 2.6L SOHC (G)	85	V8 303CI 5.0L	56	L6 230CI 3.8L (L-Head)	58-54
Caravelle (RWD)		V8 313CI 5.1L	58-57	V8 241.4CI 4.0L	55
V8 318CI 5.2L (G)	80-78	V8 318CI 5.2L	74-57	V8 260CI 4.3L	55
V8 318CI 5.2L (K)	82-81	V8 350CI 5.7L	58	V8 270CI 4.4L	56
V8 318CI 5.2L (P)	87-83	V8 360CI 5.9L	74-71	V8 277CI 4.5L	57
Champ		V8 361CI 5.9L	64-59	V8 318CI 5.2L	58
L4 1410cc 1.4L SOHC (2)	82-81	V8 383CI 6.3L	71-59	Prowler	
L4 1410cc 1.4L SOHC (J)	80-79	V8 400CI 6.6L	74-72	V6 215CI 3.5L SOHC (24 Valve) (F)	98-97
L4 1597cc 1.6L SOHC (8 Valve) (3)	82-81	V8 426CI 7.0L	65-63	V6 215CI 3.5L SOHC (24 Valve) (G)	01-99
L4 1597cc 1.6L SOHC (8 Valve) (K)	80-79	V8 440CI 7.2L	74-66	Reliant	
Colt		Fury (Mid-Size)		L4 135CI 2.2L SOHC (B)	82-81
L4 1410cc 1.4L SOHC (2)	83	L6 225CI 3.7L (C)	76-75	L4 135CI 2.2L SOHC (C)	87-83
L4 1410cc 1.4L SOHC (A)	84	L6 225CI 3.7L (D)	78-77	L4 135CI 2.2L SOHC (D)	89-88
L4 1468cc 1.5L SOHC (12 Valve) (A)	94-91	V8 318CI 5.2L (G)	78-75	L4 153CI 2.5L SOHC (K)	89-86
L4 1468cc 1.5L SOHC (12 Valve) (Q)	94-91	V8 360CI 5.9L (K)	78-75	L4 2555cc 2.6L SOHC (D)	82-81
L4 1468cc 1.5L SOHC (8 Valve) (K)	88-85	V8 400CI 6.6L (M)	76-75	L4 2555cc 2.6L SOHC (G)	85-83
L4 1468cc 1.5L SOHC (8 Valve) (Q)	91-85	V8 400CI 6.6L (N)	78-77	Road Runner	
L4 1468cc 1.5L SOHC (8 Valve) (X)	90-89	V8 400CI 6.6L (P)	76-75	V8 318CI 5.2L (G)	75-70
L4 1595cc 1.6L DOHC (16 Valve) (Y)	90	V8 440CI 7.2L (T)	78-75	V8 340CI 5.6L	73-68
L4 1595cc 1.6L DOHC Turbo (16 Valve) (Z)	89	Gran Fury (Full-Size)		V8 360CI 5.9L (K)	75-74
L4 1597cc 1.6L SOHC (8 Valve) (3)	83	L6 225CI 3.7L (C)	80	V8 383CI 6.3L	71-67
L4 1597cc 1.6L SOHC (8 Valve) (B)	84	L6 225CI 3.7L (E)	82-81	V8 400CI 6.6L (M)	75-72
L4 1597cc 1.6L SOHC Turbo (8 Valve) (F)	90-84	L6 225CI 3.7L (H)	83	V8 400CI 6.6L (P)	75-72
L4 1834cc 1.8L SOHC (16 Valve) (C)	94-93	L6 225CI 3.7L (J)	83	V8 426CI 7.0L	71-68
Colt Vista		V8 318CI 5.2L (4)	89-83	V8 440CI 7.2L	75-68
L4 1834cc 1.8L SOHC (16 Valve) (C)	94-92	V8 318CI 5.2L (G)	80-72	Sapporo	
L4 1997cc 2.0L SOHC (8 Valve) (D)	88-84	V8 318CI 5.2L (K)	82-81	L4 1597cc 1.6L SOHC (8 Valve) (K)	79-78
L4 1997cc 2.0L SOHC (8 Valve) (V)	91-89	V8 318CI 5.2L (L)	82-81	L4 1597cc 1.6L SOHC (8 Valve) (Z)	79-78
L4 2351cc 2.4L SOHC (16 Valve) (G)	94-93	V8 318CI 5.2L (M)	81	L4 1995cc 2.0L SOHC (U)	79-78
L4 2351cc 2.4L SOHC (8 Valve) (W)	92	V8 318CI 5.2L (N)	81	L4 2555cc 2.6L SOHC (7)	83-81
Colt Vista AWD		V8 318CI 5.2L (P)	89-83	L4 2555cc 2.6L SOHC (F)	80-78
L4 1834cc 1.8L SOHC (16 Valve) (C)	94-92	V8 318CI 5.2L (S)	89-83	Satellite	
L4 1997cc 2.0L SOHC (8 Valve) (D)	88-84	V8 360CI 5.9L (K)	80-72	L6 225CI 3.7L	74-65
L4 1997cc 2.0L SOHC (8 Valve) (V)	91-89	V8 400CI 6.6L (M)	76-72	V8 273CI 4.5L	68-65
L4 2351cc 2.4L SOHC (16 Valve) (G)	94-93	V8 400CI 6.6L (N)	78-76	V8 318CI 5.2L	74-65
L4 2351cc 2.4L SOHC (8 Valve) (W)	92	V8 400CI 6.6L (P)	75	V8 340CI 5.6L	73-68

Chrysler Car (Incl. Chrysler, DeSoto, Dodge, Eagle, Plymouth) (Cont.)

Model Index (Cont.)					
Engine (VIN Code / Eng. Code)	Year	Engine (VIN Code / Eng. Code)	Year	Engine (VIN Code / Eng. Code)	Year
Plymouth (cont.)					
Satellite (cont.)					
V8 360CI 5.9L	74-71				
V8 361CI 5.9L	66-65				
V8 383CI 6.3L	71-65				
V8 400CI 6.6L	74-72				
V8 426CI 7.0L	71-65				
V8 440CI 7.2L	74-67				
Savoy					
L6 217.8CI 3.6L (L-Head)	54				
L6 225CI 3.7L	64-60				
L6 230CI 3.8L (L-Head)	59-54				
V8 241.4CI 4.0L	55				
V8 260CI 4.3L	55				
V8 270CI 4.4L	56				
V8 301CI 4.9L	57				
V8 303CI 5.0L	56				
V8 313CI 5.1L	58-57				
V8 318CI 5.2L	64-58				
V8 350CI 5.7L	58				
V8 361CI 5.9L	64-59				
V8 383CI 6.3L	64-59				
V8 426CI 7.0L	64-63				
Scamp					
L6 198CI 3.2L	74-71				
L6 225CI 3.7L (C)	76-71				
V8 318CI 5.2L (G)	76-71				
Sundance					
L4 135CI 2.2L SOHC (D)	94-87				
L4 135CI 2.2L SOHC Turbo (C)	90				
L4 135CI 2.2L SOHC Turbo (E)	89-87				
L4 153CI 2.5L SOHC (K)	94-87				
L4 153CI 2.5L SOHC Turbo (J)	92-89				
V6 2972cc 3.0L SOHC (12 Valve) (3)	94-92				
TC3					
L4 135CI 2.2L SOHC (B)	82-81				
L4 1715cc 1.7L SOHC (A)	82-81				
Turismo					
L4 135CI 2.2L SOHC (8)	86-85				
L4 135CI 2.2L SOHC (B)	82				
L4 135CI 2.2L SOHC (C)	87-83				
L4 135CI 2.2L SOHC (F)	86-83				
L4 1592cc 1.6L OHV (A)	86-83				
L4 1715cc 1.7L SOHC (A)	82				
L4 1715cc 1.7L SOHC (B)	83				
Valiant					
L6 170CI 2.8L	69-60				
L6 198CI 3.2L	74-70				
L6 225CI 3.7L	69-62				
L6 225CI 3.7L (C)	76-70				
V8 273CI 4.5L	69-64				
V8 318CI 5.2L	69-68				
V8 318CI 5.2L (G)	76-70				
V8 340CI 5.6L	73-68				
V8 360CI 5.9L (K)	76-71				
V8 360CI 5.9L (L)	76				
V8 383CI 6.3L	71-70				
Volare					
L6 225CI 3.7L (C)	80-76				
L6 225CI 3.7L (D)	80-77				
V8 318CI 5.2L (G)	80-76				
V8 360CI 5.9L (K)	80-76				

Chrysler Car (Incl. Chrysler, DeSoto, Dodge, Eagle, Plymouth) (Cont.)

1		1996 - 1991; 1.5L 89.6 (1468cc) SOHC L4 (12 Valve) 75.5mm Bore			1
MFI; Gasoline; Naturally Aspirated Mitsubishi Eng.; VIN Code A, Eng. Code 4G15					
QTY	CYLINDER HEAD	YEARS	PART NO.	DESCRIPTION	
1	Head Gasket	1996-91	9758 PT		
1	Head Set	1996-91	HS 9758 PT	PermaDry® molded rubber valve cover gskt. incl.; Premium valve stem seals incl.	
1	Head Installation Set	1996-91	HIS 9758 PT	Exh. pipe flange not incl.; PermaDry® molded rubber valve cover gskt. incl.	
1	Head Bolt Set	1996-95	ES 71206	9mm Head bolts; Head bolts w/Washers; Replacement recommended	
QTY	CONVERSION SET	YEARS	PART NO.	DESCRIPTION	
1	Gasket Conversion Set	1996-95	CS 26184		
1	Gasket Conversion Set	1994-91	CS 8767-1		
QTY	MANIFOLD - INT. & EXH.	YEARS	PART NO.	DESCRIPTION	
1	Int. Manifold Gasket Set	1996-91	MS 94789		
1	Exh. Manifold Gasket Set	1996-91	MS 94763		
QTY	EXHAUST PIPE FLANGE	YEARS	PART NO.	DESCRIPTION	
1	Exhaust Pipe Gasket	1996-93	60496-1	Loc. Front; Exh. connector	
1	Exhaust Pipe Gasket	1996-93	60620	Flange	
1	Exhaust Pipe Gasket	1996-93	60620	Loc. Rear; Exh. connector	
2	Exhaust Pipe Gasket	1992-91	60620	Exh. connector; 1 or 2 Req'd.	
1	Exhaust Pipe Gasket	1992-91	60680	Flange	
QTY	OIL PAN	YEARS	PART NO.	DESCRIPTION	
1	Oil Pan Gasket Set	1996-91	OS 30414 C		
QTY	CRANKSHAFT REAR SEAL	YEARS	PART NO.	DESCRIPTION	
1	Rear Main Seal Set	1996-95	BS 40672	Rubber; One-piece	
1	Rear Main Seal Set	1994-91	BS 40097-1	Rubber; One-piece	
1	Repair Sleeve	1996-91	16275	Crankshaft; Use w/installation tool	
QTY	VALVE COVER	YEARS	PART NO.	DESCRIPTION	
1	Valve Cover Gasket Set	1996-91	VS 50382 R	PermaDry® molded rubber gskt. incl.	
QTY	VALVE STEM SEAL SET	YEARS	PART NO.	DESCRIPTION	
1	Valve Stem Seal Set	1996-91	SS 72805	Premium valve stem seals incl.	
QTY	WATER OUTLET GASKET	YEARS	PART NO.	DESCRIPTION	
1	Water Outlet Gasket	1996-91	35336	Water Outlet	
QTY	WATER PUMP	YEARS	PART NO.	DESCRIPTION	
1	Water Pump Gasket	1996-91	35225		
1	Water Pump Gasket	1996-91	ES 72872	O-ring	
QTY	TIMING COVER	YEARS	PART NO.	DESCRIPTION	
1	Crankshaft Front Seal Set	1996-95	TCS 46027		
1	Crankshaft Front Seal Set	1994-91	TCS 45482-1		
1	Camshaft Front Seal Set	1996-91	TCS 45483		
QTY	AIR CLEANER MOUNTING	YEARS	PART NO.	DESCRIPTION	
1	Air Cleaner Gasket	1992-91	60756	Air flow sensor	
QTY	CARB & FUEL INJECTION	YEARS	PART NO.	DESCRIPTION	
1	Fuel Injector O-Ring Set	1996-91	ES 70600		
1	Throttle Body Gasket	1996-93	60968		
1	Throttle Body Gasket	1992-91	60855		
QTY	EXHAUST GAS RECIRCULATION	YEARS	PART NO.	DESCRIPTION	
1	EGR Gasket	1996-95	70152		
1	EGR Gasket	1994-92	70152	California	
1	EGR Gasket	1991	70152		
2		1991; 1.5L 89.6 (1468cc) SOHC L4 (12 Valve) 75.5mm Bore			2
MFI; Gasoline; Naturally Aspirated Mitsubishi Eng.; VIN Code K, Eng. Code 4G15					
QTY	CYLINDER HEAD	YEARS	PART NO.	DESCRIPTION	
1	Head Gasket	1991	9758 PT		
1	Head Set	1991	HS 9758 PT	PermaDry® molded rubber valve cover gskt. incl.; Premium valve stem seals incl.	
1	Head Installation Set	1991	HIS 9758 PT	Exh. pipe flange not incl.; PermaDry® molded rubber valve cover gskt. incl.	
QTY	CONVERSION SET	YEARS	PART NO.	DESCRIPTION	
1	Gasket Conversion Set	1991	CS 8767-1		
QTY	MANIFOLD - INT. & EXH.	YEARS	PART NO.	DESCRIPTION	
1	Int. Manifold Gasket Set	1991	MS 94789		
1	Exh. Manifold Gasket Set	1991	MS 94763		
QTY	EXHAUST PIPE FLANGE	YEARS	PART NO.	DESCRIPTION	
2	Exhaust Pipe Gasket	1991	60620	Exh. connector; 1 or 2 Req'd.	
1	Exhaust Pipe Gasket	1991	60680	Flange	
QTY	OIL PAN	YEARS	PART NO.	DESCRIPTION	
1	Oil Pan Gasket Set	1991	OS 30414 C		

Chrysler Car (Incl. Chrysler, DeSoto, Dodge, Eagle, Plymouth) (Cont.)

2 (cont.)		1991; 1.5L 89.6 (1468cc) SOHC L4 (12 Valve) 75.5mm Bore			2 (cont.)
		MFI; Gasoline; Naturally Aspirated Mitsubishi Eng.; VIN Code K, Eng. Code 4G15			
QTY	CRANKSHAFT REAR SEAL	YEARS	PART NO.	DESCRIPTION	
1	Rear Main Seal Set	1991	BS 40097-1	Rubber; One-piece	
1	Repair Sleeve	1991	16275	Crankshaft; Use w/installation tool	
QTY	VALVE COVER	YEARS	PART NO.	DESCRIPTION	
1	Valve Cover Gasket Set	1991	VS 50382 R	PermaDry® molded rubber gskt. incl.	
QTY	VALVE STEM SEAL SET	YEARS	PART NO.	DESCRIPTION	
1	Valve Stem Seal Set	1991	SS 72805	Premium valve stem seals incl.	
QTY	WATER OUTLET GASKET	YEARS	PART NO.	DESCRIPTION	
1	Water Outlet Gasket	1991	35336	Water Outlet	
QTY	WATER PUMP	YEARS	PART NO.	DESCRIPTION	
1	Water Pump Gasket	1991	35225		
1	Water Pump Gasket	1991	ES 72872	O-ring	
QTY	TIMING COVER	YEARS	PART NO.	DESCRIPTION	
1	Crankshaft Front Seal Set	1991	TCS 45482-1		
1	Camshaft Front Seal Set	1991	TCS 45483		
QTY	AIR CLEANER MOUNTING	YEARS	PART NO.	DESCRIPTION	
1	Air Cleaner Gasket	1991	60756	Air flow sensor	
QTY	CARB & FUEL INJECTION	YEARS	PART NO.	DESCRIPTION	
1	Fuel Injector O-Ring Set	1991	ES 70600		
1	Throttle Body Gasket	1991	60855		
QTY	EXHAUST GAS RECIRCULATION	YEARS	PART NO.	DESCRIPTION	
1	EGR Gasket	1991	70152		
3		1996 - 1991; 1.5L 89.6 (1468cc) SOHC L4 (12 Valve) 75.5mm Bore			3
		MFI; Gasoline; Naturally Aspirated Mitsubishi Eng.; VIN Code Q, Eng. Code 4G15			
QTY	CYLINDER HEAD	YEARS	PART NO.	DESCRIPTION	
1	Head Gasket	1996-91	9758 PT		
1	Head Set	1996-91	HS 9758 PT	PermaDry® molded rubber valve cover gskt. incl.; Premium valve stem seals incl.	
1	Head Installation Set	1996-91	HIS 9758 PT	Exh. pipe flange not incl.; PermaDry® molded rubber valve cover gskt. incl.	
1	Head Bolt Set	1996-95	ES 71206	9mm Head bolts; Head bolts w/Washers; Replacement recommended	
QTY	CONVERSION SET	YEARS	PART NO.	DESCRIPTION	
1	Gasket Conversion Set	1996-95	CS 26184		
1	Gasket Conversion Set	1994-91	CS 8767-1		
QTY	MANIFOLD - INT. & EXH.	YEARS	PART NO.	DESCRIPTION	
1	Int. Manifold Gasket Set	1996-91	MS 94789		
1	Exh. Manifold Gasket Set	1996-91	MS 94763		
QTY	EXHAUST PIPE FLANGE	YEARS	PART NO.	DESCRIPTION	
1	Exhaust Pipe Gasket	1996-93	60496-1	Loc. Front; Exh. connector	
1	Exhaust Pipe Gasket	1996-93	60620	Flange	
1	Exhaust Pipe Gasket	1996-93	60620	Loc. Rear; Exh. connector	
2	Exhaust Pipe Gasket	1992-91	60620	Exh. connector; 1 or 2 Req'd.	
1	Exhaust Pipe Gasket	1992-91	60680	Flange	
QTY	OIL PAN	YEARS	PART NO.	DESCRIPTION	
1	Oil Pan Gasket Set	1996-91	OS 30414 C		
QTY	CRANKSHAFT REAR SEAL	YEARS	PART NO.	DESCRIPTION	
1	Rear Main Seal Set	1996-95	BS 40672	Rubber; One-piece	
1	Rear Main Seal Set	1994-91	BS 40097-1	Rubber; One-piece	
1	Repair Sleeve	1996-91	16275	Crankshaft; Use w/installation tool	
QTY	VALVE COVER	YEARS	PART NO.	DESCRIPTION	
1	Valve Cover Gasket Set	1996-91	VS 50382 R	PermaDry® molded rubber gskt. incl.	
QTY	VALVE STEM SEAL SET	YEARS	PART NO.	DESCRIPTION	
1	Valve Stem Seal Set	1996-91	SS 72805	Premium valve stem seals incl.	
QTY	WATER OUTLET GASKET	YEARS	PART NO.	DESCRIPTION	
1	Water Outlet Gasket	1996-91	35336	Water Outlet	
QTY	WATER PUMP	YEARS	PART NO.	DESCRIPTION	
1	Water Pump Gasket	1996-91	35225		
1	Water Pump Gasket	1996-91	ES 72872	O-ring	
QTY	TIMING COVER	YEARS	PART NO.	DESCRIPTION	
1	Crankshaft Front Seal Set	1996-95	TCS 46027		
1	Crankshaft Front Seal Set	1994-91	TCS 45482-1		
1	Camshaft Front Seal Set	1996-91	TCS 45483		
QTY	AIR CLEANER MOUNTING	YEARS	PART NO.	DESCRIPTION	
1	Air Cleaner Gasket	1992-91	60756	Air flow sensor	

Chrysler Car (Incl. Chrysler, DeSoto, Dodge, Eagle, Plymouth) (Cont.)

3		1996 - 1991; 1.5L 89.6 (1468cc) SOHC L4 (12 Valve) 75.5mm Bore			3	
(cont.)		MFI; Gasoline; Naturally Aspirated Mitsubishi Eng.; VIN Code Q, Eng. Code 4G15			(cont.)	
QTY	CARB & FUEL INJECTION	YEARS	PART NO.	DESCRIPTION		
1	Fuel Injector O-Ring Set	1996-91	ES 70600			
1	Throttle Body Gasket	1996-93	60968			
1	Throttle Body Gasket	1992-91	60855			
QTY	EXHAUST GAS RECIRCULATION	YEARS	PART NO.	DESCRIPTION		
1	EGR Gasket	1996-95	70152			
1	EGR Gasket	1994-92	70152	California		
1	EGR Gasket	1991	70152			
4		1991; 1.5L 89.6 (1468cc) SOHC L4 (8 Valve) 75.5mm Bore			4	
		2 Bbl.; Gasoline; Naturally Aspirated Mitsubishi Eng.; VIN Code Q, Eng. Code G15B				
QTY	CYLINDER HEAD	YEARS	PART NO.	DESCRIPTION		
1	Head Gasket	1991	9352 PT	PermaTorque®		
1	Head Set	1991	HS 9352 PT	PermaDry® molded rubber valve cover gskt. incl.; Premium valve stem seals incl.		
QTY	CONVERSION SET	YEARS	PART NO.	DESCRIPTION		
1	Gasket Conversion Set	1991	CS 8767-1			
QTY	MANIFOLD - INT. & EXH.	YEARS	PART NO.	DESCRIPTION		
1	Int. Manifold Gasket Set	1991	MS 90968			
1	Exh. Manifold Gasket Set	1991	MS 90967			
QTY	EXHAUST PIPE FLANGE	YEARS	PART NO.	DESCRIPTION		
1	Exhaust Pipe Gasket	1991	60680	Flange		
QTY	FUEL PUMP	YEARS	PART NO.	DESCRIPTION		
2	Fuel Pump Mounting Gasket	1991	35226-1	1 or 2 Req'd.		
QTY	OIL PAN	YEARS	PART NO.	DESCRIPTION		
1	Oil Pan Gasket Set	1991	OS 30414 C			
QTY	CRANKSHAFT REAR SEAL	YEARS	PART NO.	DESCRIPTION		
1	Rear Main Seal Set	1991	BS 40097-1	Rubber; One-piece		
1	Repair Sleeve	1991	16275	Crankshaft; Use w/installation tool		
QTY	VALVE COVER	YEARS	PART NO.	DESCRIPTION		
1	Valve Cover Gasket Set	1991	VS 50195 R	PermaDry® molded rubber gskt. incl.		
QTY	VALVE STEM SEAL SET	YEARS	PART NO.	DESCRIPTION		
1	Valve Stem Seal Set	1991	SS 72524	Loc. Int. & Exh.; Premium valve stem seals incl.		
1	Valve Stem Seal Set	1991	SS 72681	Loc. Aux.; Premium valve stem seals incl.		
QTY	WATER OUTLET GASKET	YEARS	PART NO.	DESCRIPTION		
1	Water Outlet Gasket	1991	35336	Water Outlet		
QTY	WATER PUMP	YEARS	PART NO.	DESCRIPTION		
1	Water Pump Gasket	1991	35225			
1	Water Pump Gasket	1991	ES 72872	O-ring		
QTY	TIMING COVER	YEARS	PART NO.	DESCRIPTION		
1	Crankshaft Front Seal Set	1991	TCS 45482-1			
1	Camshaft Front Seal Set	1991	TCS 45483			
QTY	CARB & FUEL INJECTION	YEARS	PART NO.	DESCRIPTION		
1	Carb. Mounting Gasket	1991	60739	Carb. to heater		
1	Carb. Mounting Gasket	1991	60740	Heater to manifold		
QTY	EXHAUST GAS RECIRCULATION	YEARS	PART NO.	DESCRIPTION		
1	EGR Gasket	1991	70152			
5		1994 - 1993; 1.8L 107.1 (1755cc) SOHC L4 (8 Valve) 80.6mm Bore			5	
		MFI; Gasoline; Naturally Aspirated Mitsubishi Eng.; VIN Code B, Eng. Code 4G37				
QTY	CYLINDER HEAD	YEARS	PART NO.	DESCRIPTION		
1	Head Gasket	1994-93	9846 PT	Head bolts not incl.; Head bolt replacement recommended		
1	Head Set	1994-93	HS 9846 B	Head bolts not incl.; Head bolt replacement recommended; PermaDry® molded rubber valve cover gskt. incl.; Premium valve stem seals incl.		
1	Head Bolt Set	1994-93	ES 71174	10mm Head bolts; Replacement recommended		
1	Head Bolt Set	1994-93	ES 71175	12mm Head bolts; Replacement recommended		
QTY	CONVERSION SET	YEARS	PART NO.	DESCRIPTION		
1	Gasket Conversion Set	1994-93	CS 9846			
QTY	MANIFOLD - INT. & EXH.	YEARS	PART NO.	DESCRIPTION		
1	Int. Manifold Gasket Set	1994-93	MS 94630	Upper set incl.		
1	Exh. Manifold Gasket Set	1994-93	MS 94631			
QTY	EXHAUST PIPE FLANGE	YEARS	PART NO.	DESCRIPTION		
1	Exhaust Pipe Gasket	1994-93	60496-1	Loc. Front; Exh. connector		

Chrysler Car (Incl. Chrysler, DeSoto, Dodge, Eagle, Plymouth) (Cont.)

5		1994 - 1993; 1.8L 107.1 (1755cc) SOHC L4 (8 Valve) 80.6mm Bore			5
(cont.)		MFI; Gasoline; Naturally Aspirated Mitsubishi Eng.; VIN Code B, Eng. Code 4G37			(cont.)
QTY	EXHAUST PIPE FLANGE	YEARS	PART NO.	DESCRIPTION	
1	Exhaust Pipe Gasket	1994-93	60620	Loc. Rear; Exh. connector	
1	Exhaust Pipe Gasket	1994-93	60680	Flange	
QTY	OIL PAN	YEARS	PART NO.	DESCRIPTION	
1	Oil Pan Gasket Set	1994-93	OS 30397 A		
QTY	CRANKSHAFT REAR SEAL	YEARS	PART NO.	DESCRIPTION	
1	Rear Main Seal Set	1994-93	BS 40097-1	Rubber; One-piece	
1	Repair Sleeve	1994-93	16275	Crankshaft; Use w/installation tool	
QTY	VALVE COVER	YEARS	PART NO.	DESCRIPTION	
1	Valve Cover Gasket Set	1994-93	VS 50103 R	w/Semi-circular plug & Grommets; PermaDry® molded rubber gskt. incl.	
1	Valve Cover Gasket Set	1994-93	VS 50203 R	w/o Semi-circular plug & Grommets; PermaDry® molded rubber gskt. incl.	
1	Grommet Set	1994-93	ES 70342	Valve Cover	
1	Semi-Circular Plug	1994-93	CP 75001	Valve Cover	
QTY	VALVE STEM SEAL SET	YEARS	PART NO.	DESCRIPTION	
1	Valve Stem Seal Set	1994-93	SS 70598	Premium valve stem seals incl.; Improved design	
QTY	WATER OUTLET GASKET	YEARS	PART NO.	DESCRIPTION	
1	Water Outlet Gasket	1994-93	35336	Water Outlet	
QTY	WATER PUMP	YEARS	PART NO.	DESCRIPTION	
1	Water Pump Gasket	1994-93	35479		
1	Water Pump Gasket	1994-93	ES 72872	O-ring	
QTY	TIMING COVER	YEARS	PART NO.	DESCRIPTION	
1	Crankshaft Front Seal Set	1994-93	TCS 45910	Must be used w/OS 30397A	
1	Camshaft Front Seal Set	1994-93	TCS 45483		
QTY	AIR CLEANER MOUNTING	YEARS	PART NO.	DESCRIPTION	
1	Air Cleaner Gasket	1994-93	60756	Air flow sensor	
QTY	CARB & FUEL INJECTION	YEARS	PART NO.	DESCRIPTION	
1	Fuel Injector O-Ring Set	1994-93	ES 70600		
1	Throttle Body Gasket	1994-93	60855		
QTY	EXHAUST GAS RECIRCULATION	YEARS	PART NO.	DESCRIPTION	
1	EGR Gasket	1994-93	70152	California	
6		1992 - 1991; 1.8L 107.1 (1755cc) SOHC L4 (8 Valve) 80.6mm Bore			6
(cont.)		MFI; Gasoline; Naturally Aspirated Mitsubishi Eng.; VIN Code T, Eng. Code 4G37			(cont.)
QTY	CYLINDER HEAD	YEARS	PART NO.	DESCRIPTION	
1	Head Gasket	1992-91	9846 PT	Head bolts not incl.; Head bolt replacement recommended	
1	Head Set	1992-91	HS 9846 B	Head bolts not incl.; Head bolt replacement recommended; PermaDry® molded rubber valve cover gskt. incl.; Premium valve stem seals incl.	
1	Head Bolt Set	1992-91	ES 71174	10mm Head bolts; Replacement recommended	
1	Head Bolt Set	1992-91	ES 71175	12mm Head bolts; Replacement recommended	
QTY	CONVERSION SET	YEARS	PART NO.	DESCRIPTION	
1	Gasket Conversion Set	1992-91	CS 9846		
QTY	MANIFOLD - INT. & EXH.	YEARS	PART NO.	DESCRIPTION	
1	Int. Manifold Gasket Set	1992-91	MS 94630	Upper set incl.	
1	Exh. Manifold Gasket Set	1992-91	MS 94631		
QTY	EXHAUST PIPE FLANGE	YEARS	PART NO.	DESCRIPTION	
1	Exhaust Pipe Gasket	1992-91	60496-1	Loc. Front; Exh. connector	
1	Exhaust Pipe Gasket	1992-91	60620	Loc. Rear; Exh. connector	
1	Exhaust Pipe Gasket	1992-91	60680	Flange	
QTY	OIL PAN	YEARS	PART NO.	DESCRIPTION	
1	Oil Pan Gasket Set	1992-91	OS 30397 A		
QTY	CRANKSHAFT REAR SEAL	YEARS	PART NO.	DESCRIPTION	
1	Rear Main Seal Set	1992-91	BS 40097-1	Rubber; One-piece	
1	Repair Sleeve	1992-91	16275	Crankshaft; Use w/installation tool	
QTY	VALVE COVER	YEARS	PART NO.	DESCRIPTION	
1	Valve Cover Gasket Set	1992-91	VS 50103 R	w/Semi-circular plug & Grommets; PermaDry® molded rubber gskt. incl.	
1	Valve Cover Gasket Set	1992-91	VS 50203 R	w/o Semi-circular plug & Grommets; PermaDry® molded rubber gskt. incl.	
1	Grommet Set	1992-91	ES 70342	Valve Cover	
1	Semi-Circular Plug	1992-91	CP 75001	Valve Cover	
QTY	VALVE STEM SEAL SET	YEARS	PART NO.	DESCRIPTION	
1	Valve Stem Seal Set	1992-91	SS 70598	Premium valve stem seals incl.; Improved design	
QTY	WATER OUTLET GASKET	YEARS	PART NO.	DESCRIPTION	
1	Water Outlet Gasket	1992-91	35336	Water Outlet	
QTY	WATER PUMP	YEARS	PART NO.	DESCRIPTION	
1	Water Pump Gasket	1992-91	35479		

Chrysler Car (Incl. Chrysler, DeSoto, Dodge, Eagle, Plymouth) (Cont.)

6		1992 - 1991; 1.8L 107.1 (1755cc) SOHC L4 (8 Valve) 80.6mm Bore			6
(cont.)		MFI; Gasoline; Naturally Aspirated Mitsubishi Eng.; VIN Code T, Eng. Code 4G37			(cont.)
QTY	WATER PUMP	YEARS	PART NO.	DESCRIPTION	
1	Water Pump Gasket	1992-91	ES 72872	O-ring	
QTY	TIMING COVER	YEARS	PART NO.	DESCRIPTION	
1	Crankshaft Front Seal Set	1992-91	TCS 45910	Must be used w/OS 30397A	
1	Camshaft Front Seal Set	1992-91	TCS 45483		
QTY	AIR CLEANER MOUNTING	YEARS	PART NO.	DESCRIPTION	
1	Air Cleaner Gasket	1992-91	60756	Air flow sensor	
QTY	CARB & FUEL INJECTION	YEARS	PART NO.	DESCRIPTION	
1	Fuel Injector O-Ring Set	1992-91	ES 70600		
1	Throttle Body Gasket	1992-91	60855		
QTY	EXHAUST GAS RECIRCULATION	YEARS	PART NO.	DESCRIPTION	
1	EGR Gasket	1992	70152	California	
1	EGR Gasket	1991	70152		
7		2009 - 2007; 1.8L 109.7 (1798cc) DOHC L4 (16 Valve) 86mm Bore			7
		MFI; Gasoline; Naturally Aspirated Chrysler Eng.; VIN Code C			
QTY	CYLINDER HEAD	YEARS	PART NO.	DESCRIPTION	
1	Head Gasket	2009-07	26360 PT	Head bolts not incl.; Head bolt replacement recommended; PermaTorqueMLS®; Old design	
1	Head Gasket	2009-07	26557 PT	Head bolts not incl.; Head bolt replacement recommended; PermaTorqueMLS®; Improved design; New Part Number - Check for Availability	
1	Head Set	2009-07	HS 26360 PT	Head bolts not incl.; Head bolt replacement recommended; PermaDry® molded rubber valve cover gskt. incl.; Premium valve stem seals incl.	
1	Head Bolt Set	2009-07	ES 72256	Head bolts w/Washers; Replacement recommended; Old design; Superseded - When depleted use ES 72267	
1	Head Bolt Set	2009-07	ES 72267	Head bolts w/Washers; Replacement recommended; Improved design	
QTY	CONVERSION SET	YEARS	PART NO.	DESCRIPTION	
1	Gasket Conversion Set	2009-07	CS 26332-1	RTV sealant incl. for oil pan gskt.	
QTY	MANIFOLD - INT. & EXH.	YEARS	PART NO.	DESCRIPTION	
1	Int. Manifold Gasket Set	2009-07	MS 96840		
1	Exh. Manifold Gasket Set	2009-07	MS 96902		
QTY	EXHAUST PIPE FLANGE	YEARS	PART NO.	DESCRIPTION	
1	Exhaust Pipe Gasket	2009-07	61002	Pipe to manifold	
1	Exhaust Pipe Gasket	2009-07	61506	Converter; 2.975" ID	
1	Exhaust Pipe Gasket	2009-07	61524	Converter; 2.757" ID	
QTY	OIL PAN	YEARS	PART NO.	DESCRIPTION	
1	Oil Pan Gasket Set	2009-07	OS 30782	RTV sealant incl. for oil pan gskt.; Improved design	
QTY	CRANKSHAFT REAR SEAL	YEARS	PART NO.	DESCRIPTION	
1	Rear Main Seal Set	2009-07	BS 40663	Rubber; One-piece	
QTY	VALVE COVER	YEARS	PART NO.	DESCRIPTION	
1	Valve Cover Gasket Set	2009-07	VS 50698 R	w/o Grommets & w/Spark plug tube seals; PermaDry® molded rubber gskt. incl.	
1	Grommet Set	2009-07	ES 72252-1	Valve Cover	
QTY	VALVE STEM SEAL SET	YEARS	PART NO.	DESCRIPTION	
1	Valve Stem Seal Set	2009-07	SS 71268	Premium valve stem seals incl.	
QTY	THERMOSTAT HOUSING	YEARS	PART NO.	DESCRIPTION	
1	Thermostat Gasket	2009-07	35826	Thermostat seal	
QTY	WATER OUTLET GASKET	YEARS	PART NO.	DESCRIPTION	
1	Water Outlet Gasket	2009-07	35837	Outlet	
QTY	WATER PUMP	YEARS	PART NO.	DESCRIPTION	
1	Water Pump Gasket	2009-07	35813	Inlet; Improved design	
1	Water Pump Gasket	2009-07	35813	Mounting; Improved design	
1	Water Pump Gasket	2009-07	35822	Mounting; Old design	
1	Water Pump Gasket	2009-07	36005	Cover; New Part Number - Check for Availability	
QTY	TIMING COVER	YEARS	PART NO.	DESCRIPTION	
1	Crankshaft Front Seal Set	2009-07	TCS 46098		
2	Camshaft Front Seal Set	2009-07	TCS 45961		
1	Camshaft Sensor Seal	2009-07	70725		
QTY	CARB & FUEL INJECTION	YEARS	PART NO.	DESCRIPTION	
2	Fuel Injector O-Ring Set	2009-07	ES 70599	Improved design	
1	Throttle Body Gasket	2009-07	61480	Mounting	
QTY	EXHAUST GAS RECIRCULATION	YEARS	PART NO.	DESCRIPTION	
1	EGR Gasket	2009-07	70720	Valve	

Chrysler Car (Incl. Chrysler, DeSoto, Dodge, Eagle, Plymouth) (Cont.)

8		1996 - 1992; 1.8L 111.8 (1834cc) SOHC L4 (16 Valve) 81mm Bore			8
MFI; Gasoline; Naturally Aspirated Mitsubishi Eng.; VIN Code C, Eng. Code 4G93					
QTY	CYLINDER HEAD	YEARS	PART NO.	DESCRIPTION	
1	Head Gasket	1996-92	9887 PT	Head bolts not incl.; Head bolt replacement recommended	
1	Head Set	1996-95	HS 9887 PT	Head bolts & California Wagon exh. pipe flange not incl.; Head bolt replacement recommended; PermaDry® molded rubber valve cover gskt. incl.; Premium valve stem seals incl.; Consolidated design	
1	Head Set	1994-92	HS 9887 PT	Canada; Head bolts not incl.; Head bolt replacement recommended; PermaDry® molded rubber valve cover gskt. incl.; Premium valve stem seals incl.; Consolidated design	
1	Head Set	1994-92	HS 9887 PT	Exc. Canada; Head bolts not incl.; Head bolt replacement recommended; PermaDry® molded rubber valve cover gskt. incl.; Premium valve stem seals incl.; Consolidated design	
1	Head Bolt Set	1996-92	ES 71209	Replacement recommended	
QTY	CONVERSION SET	YEARS	PART NO.	DESCRIPTION	
1	Gasket Conversion Set	1996-92	CS 9887		
QTY	MANIFOLD - INT. & EXH.	YEARS	PART NO.	DESCRIPTION	
1	Int. Manifold Gasket Set	1996-92	MS 95313		
1	Exh. Manifold Gasket Set	1996-92	MS 95314		
QTY	EXHAUST PIPE FLANGE	YEARS	PART NO.	DESCRIPTION	
1	Exhaust Pipe Gasket	1996-93	60496-1	Loc. Front; Exh. connector	
1	Exhaust Pipe Gasket	1996-93	60620	Loc. Rear; Exh. connector	
2	Exhaust Pipe Gasket	1996-94	60620	Eagle Summit Base, DL, ES, ESI, LX; Exh. connector; Wagon	
1	Exhaust Pipe Gasket	1996-95	60496-1	Eagle Summit Base, DL, ES, ESI, LX; Flange; California; Wagon	
1	Exhaust Pipe Gasket	1996-95	60680	Eagle Summit Base, DL, ES, ESI; Flange; California; Coupe	
1	Exhaust Pipe Gasket	1996-95	60680	Eagle Summit Base, ES, ESI, LX; Flange; California; Sedan	
1	Exhaust Pipe Gasket	1996-95	60680	Eagle Summit Base, DL, ES, ESI, LX; Flange; Exc. California	
2	Exhaust Pipe Gasket	1994-92	60620	Dodge Colt Vista, Vista SE Plymouth Colt Vista, Vista SE; Exh. connector	
1	Exhaust Pipe Gasket	1994-92	60680	Flange	
2	Exhaust Pipe Gasket	1993	60620	Eagle Summit Base, DL, ES, LX; Exh. connector; Wagon	
2	Exhaust Pipe Gasket	1992	60620	Eagle Summit Base, DL, LX; Exh. connector; Wagon	
QTY	OIL PAN	YEARS	PART NO.	DESCRIPTION	
1	Oil Pan Gasket Set	1996-92	OS 30655 C		
QTY	CRANKSHAFT REAR SEAL	YEARS	PART NO.	DESCRIPTION	
1	Rear Main Seal Set	1996-92	BS 40648	Rubber; One-piece	
1	Repair Sleeve	1996-92	16275	Crankshaft; Use w/installation tool	
QTY	VALVE COVER	YEARS	PART NO.	DESCRIPTION	
1	Valve Cover Gasket Set	1996-92	VS 50415 R	w/Spark plug tube seals; PermaDry® molded rubber gskt. incl.	
1	Spark Plug Tube Seal Set	1996-92	ES 72120	Valve Cover	
QTY	VALVE STEM SEAL SET	YEARS	PART NO.	DESCRIPTION	
1	Valve Stem Seal Set	1996-92	SS 70660	Premium valve stem seals incl.; Improved design	
QTY	THERMOSTAT HOUSING	YEARS	PART NO.	DESCRIPTION	
1	Thermostat Gasket	1996-92	35554	Thermostat Housing; Seal	
QTY	WATER OUTLET GASKET	YEARS	PART NO.	DESCRIPTION	
1	Water Outlet Gasket	1996-95	35336	Exc. Eagle Summit Base, DL, ES, ESI, LX; Water Outlet	
1	Water Outlet Gasket	1996-95	35336	Eagle Summit Base, DL, ES, ESI; Water Outlet; Coupe	
1	Water Outlet Gasket	1996-95	35336	Eagle Summit Base, ES, ESI, LX; Water Outlet; Sedan	
1	O-Ring	1996-95	35524	Eagle Summit Base, DL, ES, ESI, LX; Water Outlet; Wagon	
1	O-Ring	1994-92	35524	Water Outlet	
QTY	WATER PUMP	YEARS	PART NO.	DESCRIPTION	
1	Water Pump Gasket	1996-92	35551		
QTY	TIMING COVER	YEARS	PART NO.	DESCRIPTION	
1	Crankshaft Front Seal Set	1996-92	TCS 45931	Must be used w/OS 30655C	
1	Camshaft Front Seal Set	1996-92	TCS 45483		
QTY	CARB & FUEL INJECTION	YEARS	PART NO.	DESCRIPTION	
1	Fuel Injector O-Ring Set	1996-92	ES 70600		
1	Throttle Body Gasket	1996-93	60966		
1	Throttle Body Gasket	1992	60855		
QTY	EXHAUST GAS RECIRCULATION	YEARS	PART NO.	DESCRIPTION	
1	EGR Gasket	1996-95	70152		
1	EGR Gasket	1994-92	70152	California	
9		1992; 1.8L 111.8 (1834cc) SOHC L4 (16 Valve) 81mm Bore			9
MFI; Gasoline; Naturally Aspirated Mitsubishi Eng.; VIN Code D, Eng. Code 4G93					
QTY	CYLINDER HEAD	YEARS	PART NO.	DESCRIPTION	
1	Head Gasket	1992	9887 PT	Head bolts not incl.; Head bolt replacement recommended	

Chrysler Car (Incl. Chrysler, DeSoto, Dodge, Eagle, Plymouth) (Cont.)

9		1992; 1.8L 111.8 (1834cc) SOHC L4 (16 Valve) 81mm Bore			9	
(cont.)		MFI; Gasoline; Naturally Aspirated Mitsubishi Eng.; VIN Code D, Eng. Code 4G93			(cont.)	
QTY	CYLINDER HEAD	YEARS	PART NO.	DESCRIPTION		
1	Head Set	1992	HS 9887 PT	Canada; Head bolts not incl.; Head bolt replacement recommended; PermaDry® molded rubber valve cover gskt. incl.; Premium valve stem seals incl.; Consolidated design		
1	Head Set	1992	HS 9887 PT	Exc. Canada; Head bolts not incl.; Head bolt replacement recommended; PermaDry® molded rubber valve cover gskt. incl.; Premium valve stem seals incl.; Consolidated design		
1	Head Bolt Set	1992	ES 71209	Replacement recommended		
QTY	CONVERSION SET	YEARS	PART NO.	DESCRIPTION		
1	Gasket Conversion Set	1992	CS 9887			
QTY	MANIFOLD - INT. & EXH.	YEARS	PART NO.	DESCRIPTION		
1	Int. Manifold Gasket Set	1992	MS 95313			
1	Exh. Manifold Gasket Set	1992	MS 95314			
QTY	EXHAUST PIPE FLANGE	YEARS	PART NO.	DESCRIPTION		
2	Exhaust Pipe Gasket	1992	60620	Dodge Colt Vista, Vista SE Plymouth Colt Vista, Vista SE; Exh. connector		
2	Exhaust Pipe Gasket	1992	60620	Eagle Summit Base, DL, LX; Exh. connector; Wagon		
1	Exhaust Pipe Gasket	1992	60680	Flange		
QTY	OIL PAN	YEARS	PART NO.	DESCRIPTION		
1	Oil Pan Gasket Set	1992	OS 30655 C			
QTY	CRANKSHAFT REAR SEAL	YEARS	PART NO.	DESCRIPTION		
1	Rear Main Seal Set	1992	BS 40648	Rubber; One-piece		
1	Repair Sleeve	1992	16275	Crankshaft; Use w/installation tool		
QTY	VALVE COVER	YEARS	PART NO.	DESCRIPTION		
1	Valve Cover Gasket Set	1992	VS 50415 R	w/Spark plug tube seals; PermaDry® molded rubber gskt. incl.		
1	Spark Plug Tube Seal Set	1992	ES 72120	Valve Cover		
QTY	VALVE STEM SEAL SET	YEARS	PART NO.	DESCRIPTION		
1	Valve Stem Seal Set	1992	SS 70660	Premium valve stem seals incl.; Improved design		
QTY	THERMOSTAT HOUSING	YEARS	PART NO.	DESCRIPTION		
1	Thermostat Gasket	1992	35554	Thermostat Housing; Seal		
QTY	WATER OUTLET GASKET	YEARS	PART NO.	DESCRIPTION		
1	O-Ring	1992	35524	Water Outlet		
QTY	WATER PUMP	YEARS	PART NO.	DESCRIPTION		
1	Water Pump Gasket	1992	35551			
QTY	TIMING COVER	YEARS	PART NO.	DESCRIPTION		
1	Crankshaft Front Seal Set	1992	TCS 45931	Must be used w/OS 30655C		
1	Camshaft Front Seal Set	1992	TCS 45483			
QTY	CARB & FUEL INJECTION	YEARS	PART NO.	DESCRIPTION		
1	Fuel Injector O-Ring Set	1992	ES 70600			
1	Throttle Body Gasket	1992	60855			
QTY	EXHAUST GAS RECIRCULATION	YEARS	PART NO.	DESCRIPTION		
1	EGR Gasket	1992	70152	California		
10		1999 - 1995; 2.0L 122 (1996cc) DOHC L4 (16 Valve) 87.5mm Bore			10	
		MFI; Gasoline; Naturally Aspirated Chrysler Eng.; VIN Code B				
QTY	CYLINDER HEAD	YEARS	PART NO.	DESCRIPTION		
1	Head Gasket	1999-95	26501 PT	.010" thicker for use when head is refaced; Head bolts not incl.; Head bolt replacement recommended; PermaTorqueMLS®		
1	Head Gasket	1999-95	9922 PT	Head bolts not incl.; Head bolt replacement recommended; PermaTorqueMLS®		
1	Head Set	1999-95	HS 9922 PT	Head bolts not incl.; Head bolt replacement recommended; PermaDry® molded rubber valve cover gskt. incl.; Premium valve stem seals incl.		
1	Head Installation Set	1999-95	HIS 9922 PT	Head bolts & exh. pipe to manifold gskt. not incl.; Head bolt replacement recommended; PermaDry® molded rubber valve cover gskt. incl.		
1	Head Bolt Set	1999-95	ES 72166	Head bolts w/Washers; Replacement recommended		
QTY	CONVERSION SET	YEARS	PART NO.	DESCRIPTION		
1	Gasket Conversion Set	1999-95	CS 9922	PermaDry® molded rubber oil pan gskt. incl.		
QTY	MANIFOLD - INT. & EXH.	YEARS	PART NO.	DESCRIPTION		
1	Int. Manifold Gasket Set	1999-95	MS 95660-2	Upper set incl.		
1	Exh. Manifold Gasket Set	1999-95	MS 95692			
QTY	EXHAUST PIPE FLANGE	YEARS	PART NO.	DESCRIPTION		
1	Exhaust Pipe Gasket	1999-98	61002	Pipe to manifold		
1	Exhaust Pipe Gasket	1997-95	60810	Pipe to manifold		
QTY	OIL PAN	YEARS	PART NO.	DESCRIPTION		
1	Oil Pan Gasket Set	1999-95	OS 30673 R	PermaDry® molded rubber gskt. incl.		

Chrysler Car (Incl. Chrysler, DeSoto, Dodge, Eagle, Plymouth) (Cont.)

10 (cont.)		1999 - 1995; 2.0L 122 (1996cc) DOHC L4 (16 Valve) 87.5mm Bore			10 (cont.)
		MFI; Gasoline; Naturally Aspirated Chrysler Eng.; VIN Code B			
QTY	CRANKSHAFT REAR SEAL	YEARS	PART NO.	DESCRIPTION	
1	Rear Main Seal Set	1999-95	BS 40182	Rubber; One-piece	
1	Rear Main Seal Set	1999-95	BS 40627	PTFE Rubber; One-piece	
QTY	VALVE COVER	YEARS	PART NO.	DESCRIPTION	
1	Valve Cover Gasket Set	1999-95	VS 50455 R	w/Spark plug tube seals; PermaDry® molded rubber gskt. incl.	
1	Spark Plug Tube Seal Set	1999-95	ES 72753	Valve Cover; New Part Number - Check for Availability	
QTY	VALVE STEM SEAL SET	YEARS	PART NO.	DESCRIPTION	
1	Valve Stem Seal Set	1999-95	SS 72871	Premium valve stem seals incl.	
QTY	THERMOSTAT HOUSING	YEARS	PART NO.	DESCRIPTION	
1	Thermostat Gasket	1999-95	35588	Thermostat Housing; Thermostat seal	
QTY	WATER PUMP	YEARS	PART NO.	DESCRIPTION	
1	Water Pump Gasket	1999-95	35131	Seal	
1	Water Pump Gasket	1999-95	35586	O-ring	
QTY	TIMING COVER	YEARS	PART NO.	DESCRIPTION	
1	Crankshaft Front Seal Set	1999-95	TCS 45962		
2	Camshaft Front Seal Set	1999-95	TCS 45961		
1	Camshaft Sensor Seal	1999-95	70725		
1	Repair Sleeve	1999-95	16224	Timing Cover; Use w/installation tool	
1	Repair Sleeve Tool	1999-95	16325	Timing Cover	
QTY	CARB & FUEL INJECTION	YEARS	PART NO.	DESCRIPTION	
2	Fuel Injector O-Ring Set	1999-95	ES 70599	Improved design	
1	Throttle Body Gasket	1999-95	61000	Plastic Int. manifold	
QTY	EXHAUST GAS RECIRCULATION	YEARS	PART NO.	DESCRIPTION	
1	EGR Gasket	1999-95	70720	Valve	
1	EGR Gasket	1999-95	70721	Tube flange	
11		1999 - 1995; 2.0L 122 (1996cc) DOHC L4 (16 Valve) 87.5mm Bore			11
		MFI; Gasoline; Naturally Aspirated Chrysler Eng.; VIN Code Y, Eng. Code A588			
QTY	CYLINDER HEAD	YEARS	PART NO.	DESCRIPTION	
1	Head Gasket	1999-95	26501 PT	.010" thicker for use when head is refaced; Head bolts not incl.; Head bolt replacement recommended; PermaTorqueMLS®	
1	Head Gasket	1999-95	9922 PT	Head bolts not incl.; Head bolt replacement recommended; PermaTorqueMLS®	
1	Head Set	1999-95	HS 9922 PT	Head bolts not incl.; Head bolt replacement recommended; PermaDry® molded rubber valve cover gskt. incl.; Premium valve stem seals incl.	
1	Head Installation Set	1999-95	HIS 9922 PT	Head bolts & exh. pipe to manifold gskt. not incl.; Head bolt replacement recommended; PermaDry® molded rubber valve cover gskt. incl.	
1	Head Bolt Set	1999-95	ES 72166	Head bolts w/Washers; Replacement recommended	
QTY	CONVERSION SET	YEARS	PART NO.	DESCRIPTION	
1	Gasket Conversion Set	1999-95	CS 9922	PermaDry® molded rubber oil pan gskt. incl.	
QTY	MANIFOLD - INT. & EXH.	YEARS	PART NO.	DESCRIPTION	
1	Int. Manifold Gasket Set	1999	MS 95660-1	Chrysler Sebring LX Dodge Avenger Base, ES; Upper set incl.	
1	Int. Manifold Gasket Set	1999	MS 95660-2	Exc. Chrysler Sebring LX Dodge Avenger Base, ES; Upper set incl.	
1	Int. Manifold Gasket Set	1998-96	MS 95660-1	Chrysler Sebring LX Dodge Avenger Base, ES Eagle Talon Base, ESi; Upper set incl.	
1	Int. Manifold Gasket Set	1998-97	MS 95660-2	Exc. Chrysler Sebring LX Dodge Avenger Base, ES Eagle Talon Base, ESi; Upper set incl.	
1	Int. Manifold Gasket Set	1996	MS 95660-2	Dodge Neon Base, Highline, Sport Plymouth Neon Base, Highline, Sport; Upper set incl.	
1	Int. Manifold Gasket Set	1995	MS 95660-1	Chrysler Sebring LX Dodge Avenger Base, ES Eagle Talon ESi; Upper set incl.	
1	Int. Manifold Gasket Set	1995	MS 95660-2	Exc. Chrysler Sebring LX Dodge Avenger Base, ES Eagle Talon ESi; Upper set incl.	
1	Exh. Manifold Gasket Set	1999-95	MS 95692		
QTY	EXHAUST PIPE FLANGE	YEARS	PART NO.	DESCRIPTION	
1	Exhaust Pipe Gasket	1999	60810	Chrysler Sebring LX Dodge Avenger Base, ES; Pipe to manifold	
1	Exhaust Pipe Gasket	1999	61002	Exc. Chrysler Sebring LX Dodge Avenger Base, ES; Pipe to manifold	
1	Exhaust Pipe Gasket	1998	60810	Chrysler Sebring LX Dodge Avenger Base, ES Eagle Talon Base, ESi; Pipe to manifold	
1	Exhaust Pipe Gasket	1998	61002	Exc. Chrysler Sebring LX Dodge Avenger Base, ES Eagle Talon Base, ESi; Pipe to manifold	
1	Exhaust Pipe Gasket	1997-95	60810	Pipe to manifold	
QTY	OIL PAN	YEARS	PART NO.	DESCRIPTION	
1	Oil Pan Gasket Set	1999-95	OS 30673 R	PermaDry® molded rubber gskt. incl.	

Chrysler Car (Incl. Chrysler, DeSoto, Dodge, Eagle, Plymouth) (Cont.)

11 (cont.)		1999 - 1995; 2.0L 122 (1996cc) DOHC L4 (16 Valve) 87.5mm Bore			11 (cont.)
MFI; Gasoline; Naturally Aspirated Chrysler Eng.; VIN Code Y, Eng. Code A588					
QTY	CRANKSHAFT REAR SEAL	YEARS	PART NO.	DESCRIPTION	
1	Rear Main Seal Set	1999-95	BS 40182	Rubber; One-piece	
1	Rear Main Seal Set	1999-95	BS 40627	PTFE Rubber; One-piece	
QTY	VALVE COVER	YEARS	PART NO.	DESCRIPTION	
1	Valve Cover Gasket Set	1999-95	VS 50455 R	w/Spark plug tube seals; PermaDry® molded rubber gskt. incl.	
1	Spark Plug Tube Seal Set	1999-95	ES 72753	Valve Cover; New Part Number - Check for Availability	
QTY	VALVE STEM SEAL SET	YEARS	PART NO.	DESCRIPTION	
1	Valve Stem Seal Set	1999-95	SS 72871	Premium valve stem seals incl.	
QTY	THERMOSTAT HOUSING	YEARS	PART NO.	DESCRIPTION	
1	Thermostat Gasket	1999-95	35588	Thermostat Housing; Thermostat seal	
1	Thermostat Gasket	1999	35585	Chrysler Sebring LX Dodge Avenger Base, ES; Thermostat Housing	
1	Thermostat Gasket	1998-96	35585	Chrysler Sebring LX Dodge Avenger Base, ES Eagle Talon Base, ESi; Thermostat Housing	
1	Thermostat Gasket	1995	35585	Chrysler Sebring LX Dodge Avenger Base, ES Eagle Talon ESi; Thermostat Housing	
QTY	WATER OUTLET GASKET	YEARS	PART NO.	DESCRIPTION	
1	Water Outlet Gasket	1999	35365	Chrysler Sebring LX Dodge Avenger Base, ES; Water Outlet; Water outlet connection	
1	Water Outlet Gasket	1998-96	35365	Chrysler Sebring LX Dodge Avenger Base, ES Eagle Talon Base, ESi; Water Outlet; Water outlet connection	
1	Water Outlet Gasket	1995	35365	Chrysler Sebring LX Dodge Avenger Base, ES Eagle Talon ESi; Water Outlet; Water outlet connection	
QTY	WATER PUMP	YEARS	PART NO.	DESCRIPTION	
1	Water Pump Gasket	1999-95	35131	Seal	
1	Water Pump Gasket	1999-95	35586	O-ring	
QTY	TIMING COVER	YEARS	PART NO.	DESCRIPTION	
1	Crankshaft Front Seal Set	1999-95	TCS 45962		
2	Camshaft Front Seal Set	1999-95	TCS 45961		
1	Camshaft Sensor Seal	1999-95	70725		
1	Repair Sleeve	1999-95	16224	Timing Cover; Use w/installation tool	
1	Repair Sleeve Tool	1999-95	16325	Timing Cover	
QTY	CARB & FUEL INJECTION	YEARS	PART NO.	DESCRIPTION	
2	Fuel Injector O-Ring Set	1999-95	ES 70599	Improved design	
1	Throttle Body Gasket	1999	61000	Exc. Chrysler Sebring LX Dodge Avenger Base, ES; Plastic Int. manifold	
1	Throttle Body Gasket	1999	61001	Chrysler Sebring LX Dodge Avenger Base, ES; Aluminum Int. manifold	
1	Throttle Body Gasket	1998-96	61001	Chrysler Sebring LX Dodge Avenger Base, ES Eagle Talon Base, ESi; Aluminum Int. manifold	
1	Throttle Body Gasket	1998-97	61000	Exc. Chrysler Sebring LX Dodge Avenger Base, ES Eagle Talon Base, ESi; Plastic Int. manifold	
1	Throttle Body Gasket	1996	61000	Dodge Neon Base, Highline, Sport Plymouth Neon Base, Highline, Sport; Plastic Int. manifold	
1	Throttle Body Gasket	1995	61000	Exc. Chrysler Sebring LX Dodge Avenger Base, ES Eagle Talon ESi; Plastic Int. manifold	
1	Throttle Body Gasket	1995	61001	Chrysler Sebring LX Dodge Avenger Base, ES Eagle Talon ESi; Aluminum Int. manifold	
QTY	EXHAUST GAS RECIRCULATION	YEARS	PART NO.	DESCRIPTION	
1	EGR Gasket	1999-95	70720	Valve	
1	EGR Gasket	1999-95	70721	Tube flange	
12		2004 - 2002; 2.0L 122 (1996cc) DOHC L4 (16 Valve) 87.5mm Bore			12
MFI; Gasoline; Naturally Aspirated Chrysler Eng.; VIN Code Y					
QTY	CYLINDER HEAD	YEARS	PART NO.	DESCRIPTION	
1	Head Gasket	2004-02	26202 PT	Head bolts not incl.; Head bolt replacement recommended; PermaTorqueMLS® LaserWeld® Technology; Improved design	
1	Head Gasket	2004-02	26206 PT	Head bolts not incl.; Head bolt replacement recommended; PermaTorqueMLS®; Old design	
1	Head Set	2004-02	HS 26206 PT	Head bolts not incl.; Head bolt replacement recommended; PermaDry® molded rubber valve cover gskt. incl.; Premium valve stem seals incl.	
1	Head Bolt Set	2004-02	ES 72166	Head bolts w/Washers; Replacement recommended	
QTY	CONVERSION SET	YEARS	PART NO.	DESCRIPTION	
1	Gasket Conversion Set	2004-02	CS 9922	PermaDry® molded rubber oil pan gskt. incl.	
QTY	MANIFOLD - INT. & EXH.	YEARS	PART NO.	DESCRIPTION	
1	Int. Manifold Gasket Set	2004-02	MS 92888		
1	Exh. Manifold Gasket Set	2004-02	MS 92846		

Chrysler Car (Incl. Chrysler, DeSoto, Dodge, Eagle, Plymouth) (Cont.)

12 (cont.)		2004 - 2002; 2.0L 122 (1996cc) DOHC L4 (16 Valve) 87.5mm Bore			12 (cont.)
		MFI; Gasoline; Naturally Aspirated Chrysler Eng.; VIN Code Y			
QTY	EXHAUST PIPE FLANGE	YEARS	PART NO.	DESCRIPTION	
1	Exhaust Pipe Gasket	2004-02	61002	Pipe to manifold	
QTY	OIL PAN	YEARS	PART NO.	DESCRIPTION	
1	Oil Pan Gasket Set	2004-02	OS 30673 R	PermaDry® molded rubber gskt. incl.	
QTY	CRANKSHAFT REAR SEAL	YEARS	PART NO.	DESCRIPTION	
1	Rear Main Seal Set	2004-02	BS 40182	Rubber; One-piece	
1	Rear Main Seal Set	2004-02	BS 40627	PTFE Rubber; One-piece	
QTY	VALVE COVER	YEARS	PART NO.	DESCRIPTION	
1	Valve Cover Gasket Set	2004-02	VS 50459 R	w/Spark plug tube seals; PermaDry® molded rubber gskt. incl.	
1	Spark Plug Tube Seal Set	2004-02	ES 72947	Valve Cover; New Part Number - Check for Availability	
QTY	VALVE STEM SEAL SET	YEARS	PART NO.	DESCRIPTION	
1	Valve Stem Seal Set	2004-02	SS 72871	Premium valve stem seals incl.	
QTY	THERMOSTAT HOUSING	YEARS	PART NO.	DESCRIPTION	
1	Thermostat Gasket	2004-02	35588	Thermostat Housing; Thermostat seal	
1	Thermostat Gasket	2004-02	35681	Thermostat Housing	
QTY	WATER PUMP	YEARS	PART NO.	DESCRIPTION	
1	Water Pump Gasket	2004-02	35131	Seal	
1	Water Pump Gasket	2004-02	35586	O-ring	
QTY	TIMING COVER	YEARS	PART NO.	DESCRIPTION	
1	Crankshaft Front Seal Set	2004-02	TCS 45962		
2	Camshaft Front Seal Set	2004-02	TCS 45961		
1	Camshaft Sensor Seal	2004-02	70725		
1	Repair Sleeve	2004-02	16224	Timing Cover; Use w/installation tool	
1	Repair Sleeve Tool	2004-02	16325	Timing Cover	
QTY	CARB & FUEL INJECTION	YEARS	PART NO.	DESCRIPTION	
2	Fuel Injector O-Ring Set	2004-02	ES 70599	Improved design	
1	Throttle Body Gasket	2004-02	61098	Mounting	
QTY	EXHAUST GAS RECIRCULATION	YEARS	PART NO.	DESCRIPTION	
1	EGR Gasket	2004-02	70720	Valve	
1	EGR Gasket	2004-02	70721	Tube flange	
13		2005 - 1995; 2.0L 122 (1996cc) SOHC L4 (16 Valve) 87.5mm Bore			13
		MFI; Gasoline; Naturally Aspirated Chrysler Eng.; VIN Code C			
QTY	CYLINDER HEAD	YEARS	PART NO.	DESCRIPTION	
1	Head Gasket	2005-95	26500 PT	.010" thicker for use when head is refaced; Head bolts not incl.; Head bolt replacement recommended; PermaTorqueMLS®	
1	Head Gasket	2005-95	9036 PT	Head bolts not incl.; Head bolt replacement recommended; PermaTorqueMLS®	
1	Head Set	2005-00	HS 9036 PT-2	Head bolts not incl.; Head bolt replacement recommended; PermaDry® molded rubber valve cover gskt. incl.; Premium valve stem seals incl.	
1	Head Set	1999	HS 9036 PT-1	Exc. Dodge Stratus Base, ES Plymouth Breeze Base, Espresso; Plastic Int. manifold gskt. & head bolts not incl.; Head bolt replacement recommended; PermaDry® molded rubber valve cover gskt. incl.; Premium valve stem seals incl.	
1	Head Set	1999	HS 9036 PT-1	Dodge Stratus Base, ES Plymouth Breeze Base, Espresso; To 04/08/99; w/Stamped steel valve cover; Plastic Int. manifold gskt. & head bolts not incl.; Head bolt replacement recommended; PermaDry® molded rubber valve cover gskt. incl.; Premium valve stem seals incl.	
1	Head Set	1999	HS 9036 PT-2	Dodge Stratus Base, ES Plymouth Breeze Base, Espresso; From 04/09/99; w/Plastic valve cover; Head bolts not incl.; Head bolt replacement recommended; PermaDry® molded rubber valve cover gskt. incl.; Premium valve stem seals incl.	
1	Head Set	1998-96	HS 9036 PT-1	Plastic Int. manifold gskt. & head bolts not incl.; Head bolt replacement recommended; PermaDry® molded rubber valve cover gskt. incl.; Premium valve stem seals incl.	
1	Head Set	1995	HS 9036 PT	Plastic Int. manifold gskt. & head bolts not incl.; Head bolt replacement recommended; PermaDry® molded rubber valve cover gskt. incl.; Premium valve stem seals incl.	
1	Head Installation Set	1999-96	HIS 9036 PT-1	Plastic Int. manifold gskt., head bolts, exh. pipe to manifold gskt. not incl.; Head bolt replacement recommended; PermaDry® molded rubber valve cover gskt. incl.	
1	Head Installation Set	1995	HIS 9036 PT	Plastic Int. manifold gskt., head bolts, exh. pipe to manifold gskt. not incl.; Head bolt replacement recommended; PermaDry® molded rubber valve cover gskt. incl.	
1	Head Bolt Set	2005-95	ES 72157	Head bolts w/Washers; Replacement recommended	

Chrysler Car (Incl. Chrysler, DeSoto, Dodge, Eagle, Plymouth) (Cont.)

13 (cont.)		2005 - 1995; 2.0L 122 (1996cc) SOHC L4 (16 Valve) 87.5mm Bore			13 (cont.)
MFI; Gasoline; Naturally Aspirated Chrysler Eng.; VIN Code C					
QTY	CONVERSION SET	YEARS	PART NO.	DESCRIPTION	
1	Gasket Conversion Set	2005-95	CS 9036	PermaDry® molded rubber oil pan gskt. incl.	
QTY	MANIFOLD - INT. & EXH.	YEARS	PART NO.	DESCRIPTION	
1	Int. Manifold Gasket Set	2005-97	MS 95695		
1	Int. Manifold Gasket Set	1996-95	MS 90708	Aluminum Int. manifold	
1	Int. Manifold Gasket Set	1996-95	MS 95695	Plastic Int. manifold	
1	Exh. Manifold Gasket Set	2005-95	MS 95674		
QTY	EXHAUST PIPE FLANGE	YEARS	PART NO.	DESCRIPTION	
1	Exhaust Pipe Gasket	2005-00	61002	Pipe to manifold	
1	Exhaust Pipe Gasket	1999-95	60810	Pipe to manifold; Round gskt.	
1	Exhaust Pipe Gasket	1999-95	61002	Pipe to manifold; Square 4-bolt gskt.	
QTY	OIL PAN	YEARS	PART NO.	DESCRIPTION	
1	Oil Pan Gasket Set	2005-95	OS 30673 R	PermaDry® molded rubber gskt. incl.	
QTY	CRANKSHAFT REAR SEAL	YEARS	PART NO.	DESCRIPTION	
1	Rear Main Seal Set	2005-95	BS 40182	Rubber; One-piece	
1	Rear Main Seal Set	2005-95	BS 40627	PTFE Rubber; One-piece	
QTY	VALVE COVER	YEARS	PART NO.	DESCRIPTION	
1	Valve Cover Gasket Set	2005-00	VS 50507 R	w/Grommets & Spark plug tube seals; PermaDry® molded rubber gskt. incl.	
1	Valve Cover Gasket Set	1999	VS 50457 R	Dodge Stratus Base, ES Plymouth Breeze Base, Espresso; To 04/08/99; w/Stamped steel valve cover; w/Grommets & Spark plug tube seals; PermaDry® molded rubber gskt. incl.	
1	Valve Cover Gasket Set	1999	VS 50457 R	Exc. Dodge Stratus Base, ES Plymouth Breeze Base, Espresso; w/Grommets & Spark plug tube seals; PermaDry® molded rubber gskt. incl.	
1	Valve Cover Gasket Set	1999	VS 50507 R	Dodge Stratus Base, ES Plymouth Breeze Base, Espresso; From 04/09/99; w/Plastic valve cover; w/Grommets & Spark plug tube seals; PermaDry® molded rubber gskt. incl.	
1	Valve Cover Gasket Set	1998-96	VS 50457 R	w/Grommets & Spark plug tube seals; PermaDry® molded rubber gskt. incl.	
1	Valve Cover Gasket Set	1995	VS 50456 R	w/Grommets & Spark plug tube seals; PermaDry® molded rubber gskt. incl.	
1	Spark Plug Tube Seal Set	2005-96	ES 72523	Valve Cover; New Part Number - Check for Availability	
QTY	VALVE STEM SEAL SET	YEARS	PART NO.	DESCRIPTION	
1	Valve Stem Seal Set	2005-95	SS 72871	Premium valve stem seals incl.	
QTY	THERMOSTAT HOUSING	YEARS	PART NO.	DESCRIPTION	
1	Thermostat Gasket	2005-95	35588	Thermostat Housing; Thermostat seal	
1	Thermostat Gasket	2005-04	35681	Thermostat Housing	
QTY	WATER PUMP	YEARS	PART NO.	DESCRIPTION	
1	Water Pump Gasket	2005-95	35131	Seal	
1	Water Pump Gasket	2005-95	35586	O-ring	
QTY	TIMING COVER	YEARS	PART NO.	DESCRIPTION	
1	Crankshaft Front Seal Set	2005-95	TCS 45962		
1	Camshaft Front Seal Set	2005-95	TCS 45961		
1	Camshaft Sensor Seal	2005-95	70725		
1	Repair Sleeve	2005-95	16224	Timing Cover; Use w/installation tool	
1	Repair Sleeve Tool	2005-95	16325	Timing Cover	
QTY	CARB & FUEL INJECTION	YEARS	PART NO.	DESCRIPTION	
2	Fuel Injector O-Ring Set	2005-95	ES 70599	Improved design	
1	Throttle Body Gasket	2005-97	61003		
1	Throttle Body Gasket	1996-95	61001	Aluminum Int. manifold	
1	Throttle Body Gasket	1996-95	61003	Plastic Int. manifold	
QTY	EXHAUST GAS RECIRCULATION	YEARS	PART NO.	DESCRIPTION	
1	EGR Gasket	2005-95	70720	Valve	
1	EGR Gasket	2005-95	70721	Tube flange	
14		2005 - 2001; 2.0L 122 (1996cc) SOHC L4 (16 Valve) 87.5mm Bore H.O.			14
MFI; Gasoline; Naturally Aspirated Chrysler Eng.; VIN Code F					
QTY	CYLINDER HEAD	YEARS	PART NO.	DESCRIPTION	
1	Head Gasket	2005-01	26500 PT	.010" thicker for use when head is refaced; Head bolts not incl.; Head bolt replacement recommended; PermaTorqueMLS®	
1	Head Gasket	2005-01	9036 PT	Head bolts not incl.; Head bolt replacement recommended; PermaTorqueMLS®	
1	Head Set	2005-01	HS 9036 PT-3	Head bolts not incl.; Head bolt replacement recommended; PermaDry® molded rubber valve cover gskt. incl.; Premium valve stem seals incl.	
1	Head Bolt Set	2005-01	ES 72157	Head bolts w/Washers; Replacement recommended	
QTY	CONVERSION SET	YEARS	PART NO.	DESCRIPTION	
1	Gasket Conversion Set	2005-01	CS 9036	PermaDry® molded rubber oil pan gskt. incl.	
QTY	MANIFOLD - INT. & EXH.	YEARS	PART NO.	DESCRIPTION	
1	Int. Manifold Gasket Set	2005-01	MS 96163		

Chrysler Car (Incl. Chrysler, DeSoto, Dodge, Eagle, Plymouth) (Cont.)

14 (cont.)		2005 - 2001; 2.0L 122 (1996cc) SOHC L4 (16 Valve) 87.5mm Bore H.O. MFI; Gasoline; Naturally Aspirated Chrysler Eng.; VIN Code F			14 (cont.)
QTY	MANIFOLD - INT. & EXH.	YEARS	PART NO.	DESCRIPTION	
1	Exh. Manifold Gasket Set	2005-01	MS 96172		
QTY	EXHAUST PIPE FLANGE	YEARS	PART NO.	DESCRIPTION	
1	Exhaust Pipe Gasket	2005-01	61002	Pipe to manifold	
QTY	OIL PAN	YEARS	PART NO.	DESCRIPTION	
1	Oil Pan Gasket Set	2005-01	OS 30673 R	PermaDry® molded rubber gskt. incl.	
QTY	CRANKSHAFT REAR SEAL	YEARS	PART NO.	DESCRIPTION	
1	Rear Main Seal Set	2005-01	BS 40182	Rubber; One-piece	
1	Rear Main Seal Set	2005-01	BS 40627	PTFE Rubber; One-piece	
QTY	VALVE COVER	YEARS	PART NO.	DESCRIPTION	
1	Valve Cover Gasket Set	2005-01	VS 50507 R	w/Grommets & Spark plug tube seals; PermaDry® molded rubber gskt. incl.	
1	Spark Plug Tube Seal Set	2005-01	ES 72523	Valve Cover; New Part Number - Check for Availability	
QTY	VALVE STEM SEAL SET	YEARS	PART NO.	DESCRIPTION	
1	Valve Stem Seal Set	2005-01	SS 72871	Premium valve stem seals incl.	
QTY	THERMOSTAT HOUSING	YEARS	PART NO.	DESCRIPTION	
1	Thermostat Gasket	2005-01	35588	Thermostat Housing; Thermostat seal	
1	Thermostat Gasket	2005-04	35681	Thermostat Housing	
QTY	WATER PUMP	YEARS	PART NO.	DESCRIPTION	
1	Water Pump Gasket	2005-01	35131	Seal	
1	Water Pump Gasket	2005-01	35586	O-ring	
QTY	TIMING COVER	YEARS	PART NO.	DESCRIPTION	
1	Crankshaft Front Seal Set	2005-01	TCS 45962		
1	Camshaft Front Seal Set	2005-01	TCS 45961		
1	Camshaft Sensor Seal	2005-01	70725		
1	Repair Sleeve	2005-01	16224	Timing Cover; Use w/installation tool	
1	Repair Sleeve Tool	2005-01	16325	Timing Cover	
QTY	CARB & FUEL INJECTION	YEARS	PART NO.	DESCRIPTION	
2	Fuel Injector O-Ring Set	2005-01	ES 70599	Improved design	
1	Throttle Body Gasket	2005-01	61003		
QTY	EXHAUST GAS RECIRCULATION	YEARS	PART NO.	DESCRIPTION	
1	EGR Gasket	2005-01	70720	Valve	
1	EGR Gasket	2005-01	70721	Tube flange	
15		1994 - 1993; 2.0L 122 (1997cc) DOHC L4 (16 Valve) 85mm Bore MFI; Gasoline; Naturally Aspirated Mitsubishi Eng.; VIN Code E, Eng. Code 4G63			15
QTY	CYLINDER HEAD	YEARS	PART NO.	DESCRIPTION	
1	Head Gasket	1994-93	9627 PT	Head bolts not incl.; Head bolt replacement recommended	
1	Head Set	1994-93	HS 9627 PT-1	Head bolts & exh. pipe flange not incl.; Head bolt replacement recommended; PermaDry® molded rubber valve cover gskt. incl.; Premium valve stem seals incl.	
1	Head Bolt Set	1994-93	ES 71175	Replacement recommended	
QTY	CONVERSION SET	YEARS	PART NO.	DESCRIPTION	
1	Gasket Conversion Set	1994-93	CS 9086-1		
QTY	MANIFOLD - INT. & EXH.	YEARS	PART NO.	DESCRIPTION	
1	Int. Manifold Gasket Set	1994-93	MS 94328		
1	Exh. Manifold Gasket Set	1994-93	MS 95470		
QTY	EXHAUST PIPE FLANGE	YEARS	PART NO.	DESCRIPTION	
1	Exhaust Pipe Gasket	1994-93	60496-1	Loc. Front; Exh. connector	
1	Exhaust Pipe Gasket	1994-93	60620	Loc. Rear; Exh. connector	
1	Exhaust Pipe Gasket	1994-93	60680	Flange	
QTY	OIL PAN	YEARS	PART NO.	DESCRIPTION	
1	Oil Pan Gasket Set	1994-93	OS 30665 C		
QTY	CRANKSHAFT REAR SEAL	YEARS	PART NO.	DESCRIPTION	
1	Rear Main Seal Set	1994-93	BS 40648	Rubber; One-piece	
1	Repair Sleeve	1994-93	16275	Crankshaft; Use w/installation tool	
QTY	VALVE COVER	YEARS	PART NO.	DESCRIPTION	
1	Valve Cover Gasket Set	1994-93	VS 50434 R	w/Semi-circular plug & Spark plug tube seals; PermaDry® molded rubber gskt. incl.	
1	Semi-Circular Plug	1994-93	CP 75013	Valve Cover	
1	Spark Plug Tube Seal Set	1994-93	ES 72845	Valve Cover	
QTY	VALVE STEM SEAL SET	YEARS	PART NO.	DESCRIPTION	
1	Valve Stem Seal Set	1994-93	SS 70359	Premium valve stem seals incl.	
QTY	WATER OUTLET GASKET	YEARS	PART NO.	DESCRIPTION	
1	Water Outlet Gasket	1994-93	35336	Water Outlet	

Chrysler Car (Incl. Chrysler, DeSoto, Dodge, Eagle, Plymouth) (Cont.)

15		1994 - 1993; 2.0L 122 (1997cc) DOHC L4 (16 Valve) 85mm Bore			15
(cont.)		MFI; Gasoline; Naturally Aspirated Mitsubishi Eng.; VIN Code E, Eng. Code 4G63			(cont.)
QTY	WATER PUMP	YEARS	PART NO.	DESCRIPTION	
1	Water Pump Gasket	1994-93	35273		
1	Water Pump Gasket	1994-93	ES 72872	O-ring	
QTY	TIMING COVER	YEARS	PART NO.	DESCRIPTION	
1	Crankshaft Front Seal Set	1994-93	TCS 45941	Must be used w/OS 30665C	
2	Camshaft Front Seal Set	1994-93	TCS 45483		
QTY	AIR CLEANER MOUNTING	YEARS	PART NO.	DESCRIPTION	
1	Air Cleaner Gasket	1994-93	60756	Air flow sensor	
QTY	CARB & FUEL INJECTION	YEARS	PART NO.	DESCRIPTION	
1	Fuel Injector O-Ring Set	1994-93	ES 70600		
1	Throttle Body Gasket	1994-93	60879		
QTY	EXHAUST GAS RECIRCULATION	YEARS	PART NO.	DESCRIPTION	
1	EGR Gasket	1994-93	70152		
16		1998 - 1993; 2.0L 122 (1997cc) DOHC L4 (16 Valve) 85mm Bore			16
		MFI; Gasoline; Turbo - Intercooled Mitsubishi Eng.; VIN Code F, Eng. Code 4G63-T			
QTY	CYLINDER HEAD	YEARS	PART NO.	DESCRIPTION	
1	Head Gasket	1998-93	9627 PT	Head bolts not incl.; Head bolt replacement recommended	
1	Head Set	1998-95	HS 9627 PT-3	Turbo mounting gsks., head bolts, exh. pipe flange not incl.; Head bolt replacement recommended; PermaDry® molded rubber valve cover gskt. incl.; Premium valve stem seals incl.	
1	Head Set	1994-93	HS 9627 PT-1	Turbo mounting gsks., head bolts, exh. pipe flange not incl.; Head bolt replacement recommended; PermaDry® molded rubber valve cover gskt. incl.; Premium valve stem seals incl.	
1	Head Bolt Set	1998-95	ES 71177	Head bolts w/Washers; Replacement recommended	
1	Head Bolt Set	1994-93	ES 71175	Replacement recommended	
QTY	CONVERSION SET	YEARS	PART NO.	DESCRIPTION	
1	Gasket Conversion Set	1998-93	CS 9086-1		
QTY	MANIFOLD - INT. & EXH.	YEARS	PART NO.	DESCRIPTION	
1	Int. Manifold Gasket Set	1998-95	MS 91837		
1	Int. Manifold Gasket Set	1994-93	MS 94328		
1	Exh. Manifold Gasket Set	1998-93	MS 95470		
QTY	EXHAUST PIPE FLANGE	YEARS	PART NO.	DESCRIPTION	
2	Exhaust Pipe Gasket	1998-95	60496-1	Exh. connector	
1	Exhaust Pipe Gasket	1998-95	61080	Flange	
1	Exhaust Pipe Gasket	1994-93	60496-1	Flange	
1	Exhaust Pipe Gasket	1994-93	60496-1	Loc. Front; Exh. connector	
1	Exhaust Pipe Gasket	1994-93	60620	Loc. Rear; Exh. connector	
QTY	OIL PAN	YEARS	PART NO.	DESCRIPTION	
1	Oil Pan Gasket Set	1998-93	OS 30665 C		
QTY	CRANKSHAFT REAR SEAL	YEARS	PART NO.	DESCRIPTION	
1	Rear Main Seal Set	1998-93	BS 40648	Rubber; One-piece	
1	Repair Sleeve	1998-93	16275	Crankshaft; Use w/installation tool	
QTY	VALVE COVER	YEARS	PART NO.	DESCRIPTION	
1	Valve Cover Gasket Set	1998-93	VS 50434 R	w/Semi-circular plug & Spark plug tube seals; PermaDry® molded rubber gskt. incl.	
1	Semi-Circular Plug	1998-93	CP 75013	Valve Cover	
1	Spark Plug Tube Seal Set	1998-93	ES 72845	Valve Cover	
QTY	VALVE STEM SEAL SET	YEARS	PART NO.	DESCRIPTION	
1	Valve Stem Seal Set	1998-93	SS 70359	Premium valve stem seals incl.	
QTY	WATER OUTLET GASKET	YEARS	PART NO.	DESCRIPTION	
1	Water Outlet Gasket	1994-93	35336	Water Outlet	
1	O-Ring	1998-95	35524	Water Outlet	
QTY	WATER PUMP	YEARS	PART NO.	DESCRIPTION	
1	Water Pump Gasket	1998-93	ES 72872	O-ring	
1	Water Pump Gasket	1998-95	35003		
1	Water Pump Gasket	1994-93	35273		
QTY	TIMING COVER	YEARS	PART NO.	DESCRIPTION	
1	Crankshaft Front Seal Set	1998-93	TCS 45941	Must be used w/OS 30665C	
2	Camshaft Front Seal Set	1998-93	TCS 45483		
QTY	AIR CLEANER MOUNTING	YEARS	PART NO.	DESCRIPTION	
1	Air Cleaner Gasket	1994-93	60756	Air flow sensor	
QTY	CARB & FUEL INJECTION	YEARS	PART NO.	DESCRIPTION	
1	Fuel Injector O-Ring Set	1998-93	ES 70600		
1	Throttle Body Gasket	1998-95	60870		

Chrysler Car (Incl. Chrysler, DeSoto, Dodge, Eagle, Plymouth) (Cont.)

16		1998 - 1993; 2.0L 122 (1997cc) DOHC L4 (16 Valve) 85mm Bore			16
(cont.)		MFI; Gasoline; Turbo - Intercooled Mitsubishi Eng.; VIN Code F, Eng. Code 4G63-T			(cont.)
QTY	CARB & FUEL INJECTION	YEARS	PART NO.	DESCRIPTION	
1	Throttle Body Gasket	1994-93	60879		
QTY	EXHAUST GAS RECIRCULATION	YEARS	PART NO.	DESCRIPTION	
1	EGR Gasket	1998-93	70152		
QTY	TURBO MOUNTING SET	YEARS	PART NO.	DESCRIPTION	
1	Turbo Mtg. Gasket Set	1998-93	ES 72787		
17		1993 - 1991; 2.0L 122 (1997cc) DOHC L4 (16 Valve) 85mm Bore			17
(cont.)		MFI; Gasoline; Naturally Aspirated Mitsubishi Eng.; VIN Code R, Eng. Code 4G63			(cont.)
QTY	CYLINDER HEAD	YEARS	PART NO.	DESCRIPTION	
1	Head Gasket	1993-91	9627 PT	Head bolts not incl.; Head bolt replacement recommended	
1	Head Set	1993	HS 9627 PT-1	Head bolts & exh. pipe flange not incl.; Head bolt replacement recommended; PermaDry® molded rubber valve cover gskt. incl.; Premium valve stem seals incl.	
1	Head Set	1992-91	HS 9627 PT	Head bolts & exh. pipe flange not incl.; Head bolt replacement recommended; PermaDry® molded rubber valve cover gskt. incl.; Premium valve stem seals incl.	
1	Head Bolt Set	1993-91	ES 71175	Replacement recommended	
QTY	CONVERSION SET	YEARS	PART NO.	DESCRIPTION	
1	Gasket Conversion Set	1993	CS 9086-1		
1	Gasket Conversion Set	1992-91	CS 9086		
QTY	MANIFOLD - INT. & EXH.	YEARS	PART NO.	DESCRIPTION	
1	Int. Manifold Gasket Set	1993-91	MS 94328		
1	Exh. Manifold Gasket Set	1993-91	MS 95470		
QTY	EXHAUST PIPE FLANGE	YEARS	PART NO.	DESCRIPTION	
1	Exhaust Pipe Gasket	1993-91	60496-1	Loc. Front; Exh. connector	
1	Exhaust Pipe Gasket	1993-91	60620	Loc. Rear; Exh. connector	
1	Exhaust Pipe Gasket	1993-91	60680	Flange	
QTY	FUEL PUMP	YEARS	PART NO.	DESCRIPTION	
1	Fuel Pump Mounting Gasket	1992-91	35226-1		
QTY	OIL PAN	YEARS	PART NO.	DESCRIPTION	
1	Oil Pan Gasket Set	1993	OS 30665 C		
1	Oil Pan Gasket Set	1992-91	OS 30460 A		
QTY	CRANKSHAFT REAR SEAL	YEARS	PART NO.	DESCRIPTION	
1	Rear Main Seal Set	1993	BS 40648	Rubber; One-piece	
1	Rear Main Seal Set	1992-91	BS 40408-1	Rubber; One-piece	
1	Repair Sleeve	1993-91	16275	Crankshaft; Use w/installation tool	
QTY	VALVE COVER	YEARS	PART NO.	DESCRIPTION	
1	Valve Cover Gasket Set	1993	VS 50434 R	w/Semi-circular plug & Spark plug tube seals; PermaDry® molded rubber gskt. incl.	
1	Valve Cover Gasket Set	1992-91	VS 50041 R	w/Semi-circular plug & Spark plug tube seals; PermaDry® molded rubber gskt. incl.	
1	Semi-Circular Plug	1993-91	CP 75013	Valve Cover	
1	Spark Plug Tube Seal Set	1993	ES 72845	Valve Cover	
QTY	VALVE STEM SEAL SET	YEARS	PART NO.	DESCRIPTION	
1	Valve Stem Seal Set	1993-91	SS 70359	Premium valve stem seals incl.	
QTY	WATER OUTLET GASKET	YEARS	PART NO.	DESCRIPTION	
1	Water Outlet Gasket	1993-91	35336	Water Outlet	
QTY	WATER PUMP	YEARS	PART NO.	DESCRIPTION	
1	Water Pump Gasket	1993-91	35273		
1	Water Pump Gasket	1993-91	ES 72872	O-ring	
QTY	TIMING COVER	YEARS	PART NO.	DESCRIPTION	
1	Crankshaft Front Seal Set	1993	TCS 45941	Must be used w/OS 30665C	
1	Crankshaft Front Seal Set	1992-91	TCS 45565-1	Must be used w/OS 30460A	
2	Camshaft Front Seal Set	1993-91	TCS 45483		
QTY	AIR CLEANER MOUNTING	YEARS	PART NO.	DESCRIPTION	
1	Air Cleaner Gasket	1993-91	60756	Air flow sensor	
QTY	CARB & FUEL INJECTION	YEARS	PART NO.	DESCRIPTION	
1	Fuel Injector O-Ring Set	1993-91	ES 70600		
1	Throttle Body Gasket	1993-91	60879		
QTY	EXHAUST GAS RECIRCULATION	YEARS	PART NO.	DESCRIPTION	
1	EGR Gasket	1993-91	70152		

Chrysler Car (Incl. Chrysler, DeSoto, Dodge, Eagle, Plymouth) (Cont.)

18		1992 - 1991; 2.0L 122 (1997cc) DOHC L4 (16 Valve) 85mm Bore			18
MFI; Gasoline; Turbo - Intercooled Mitsubishi Eng.; VIN Code U, Eng. Code 4G63-T					
QTY	CYLINDER HEAD	YEARS	PART NO.	DESCRIPTION	
1	Head Gasket	1992-91	9627 PT	Head bolts not incl.; Head bolt replacement recommended	
1	Head Set	1992-91	HS 9627 PT	Turbo mounting gsks., head bolts, exh. pipe flange not incl.; Head bolt replacement recommended; PermaDry® molded rubber valve cover gskt. incl.; Premium valve stem seals incl.	
1	Head Bolt Set	1992-91	ES 71175	Replacement recommended	
QTY	CONVERSION SET	YEARS	PART NO.	DESCRIPTION	
1	Gasket Conversion Set	1992-91	CS 9086		
QTY	MANIFOLD - INT. & EXH.	YEARS	PART NO.	DESCRIPTION	
1	Int. Manifold Gasket Set	1992-91	MS 94328		
1	Exh. Manifold Gasket Set	1992-91	MS 95470		
QTY	EXHAUST PIPE FLANGE	YEARS	PART NO.	DESCRIPTION	
1	Exhaust Pipe Gasket	1992-91	60496-1	Flange	
1	Exhaust Pipe Gasket	1992-91	60496-1	Loc. Front; Exh. connector	
1	Exhaust Pipe Gasket	1992-91	60620	Loc. Rear; Exh. connector	
QTY	FUEL PUMP	YEARS	PART NO.	DESCRIPTION	
1	Fuel Pump Mounting Gasket	1992-91	35226-1		
QTY	OIL PAN	YEARS	PART NO.	DESCRIPTION	
1	Oil Pan Gasket Set	1992-91	OS 30460 A		
QTY	CRANKSHAFT REAR SEAL	YEARS	PART NO.	DESCRIPTION	
1	Rear Main Seal Set	1992-91	BS 40408-1	Rubber; One-piece	
1	Repair Sleeve	1992-91	16275	Crankshaft; Use w/installation tool	
QTY	VALVE COVER	YEARS	PART NO.	DESCRIPTION	
1	Valve Cover Gasket Set	1992-91	VS 50041 R	w/Semi-circular plug & Spark plug tube seals; PermaDry® molded rubber gskt. incl.	
1	Semi-Circular Plug	1992-91	CP 75013	Valve Cover	
QTY	VALVE STEM SEAL SET	YEARS	PART NO.	DESCRIPTION	
1	Valve Stem Seal Set	1992-91	SS 70359	Premium valve stem seals incl.	
QTY	WATER OUTLET GASKET	YEARS	PART NO.	DESCRIPTION	
1	Water Outlet Gasket	1992-91	35336	Water Outlet	
QTY	WATER PUMP	YEARS	PART NO.	DESCRIPTION	
1	Water Pump Gasket	1992-91	35273		
1	Water Pump Gasket	1992-91	ES 72872	O-ring	
QTY	TIMING COVER	YEARS	PART NO.	DESCRIPTION	
1	Crankshaft Front Seal Set	1992-91	TCS 45565-1	Must be used w/OS 30460A	
2	Camshaft Front Seal Set	1992-91	TCS 45483		
QTY	AIR CLEANER MOUNTING	YEARS	PART NO.	DESCRIPTION	
1	Air Cleaner Gasket	1992-91	60756	Air flow sensor	
QTY	CARB & FUEL INJECTION	YEARS	PART NO.	DESCRIPTION	
1	Fuel Injector O-Ring Set	1992-91	ES 70600		
1	Throttle Body Gasket	1992-91	60879		
QTY	EXHAUST GAS RECIRCULATION	YEARS	PART NO.	DESCRIPTION	
1	EGR Gasket	1992-91	70152		
QTY	TURBO MOUNTING SET	YEARS	PART NO.	DESCRIPTION	
1	Turbo Mtg. Gasket Set	1992-91	ES 72787		
19		1993; 2.0L 122 (1997cc) SOHC L4 (16 Valve) 85mm Bore			19
MFI; Gasoline; Naturally Aspirated Mitsubishi Eng.; VIN Code D, Eng. Code 4G63					
QTY	CYLINDER HEAD	YEARS	PART NO.	DESCRIPTION	
1	Head Gasket	1993	9932 PT		
1	Head Set	1993	HS 9932 PT	PermaDry® molded rubber valve cover gskt. incl.; Premium valve stem seals incl.; Consolidated design	
QTY	CONVERSION SET	YEARS	PART NO.	DESCRIPTION	
1	Gasket Conversion Set	1993	CS 9086-1		
QTY	MANIFOLD - INT. & EXH.	YEARS	PART NO.	DESCRIPTION	
1	Int. Manifold Gasket Set	1993	MS 95471		
1	Exh. Manifold Gasket Set	1993	MS 95470		
QTY	EXHAUST PIPE FLANGE	YEARS	PART NO.	DESCRIPTION	
1	Exhaust Pipe Gasket	1993	60496-1	Loc. Front; Exh. connector	
1	Exhaust Pipe Gasket	1993	60620	Loc. Rear; Exh. connector	
1	Exhaust Pipe Gasket	1993	60680	Flange	
QTY	OIL PAN	YEARS	PART NO.	DESCRIPTION	
1	Oil Pan Gasket Set	1993	OS 30665 C		

Chrysler Car (Incl. Chrysler, DeSoto, Dodge, Eagle, Plymouth) (Cont.)

19 (cont.)		1993; 2.0L 122 (1997cc) SOHC L4 (16 Valve) 85mm Bore			19 (cont.)
		MFI; Gasoline; Naturally Aspirated Mitsubishi Eng.; VIN Code D, Eng. Code 4G63			
QTY	CRANKSHAFT REAR SEAL	YEARS	PART NO.	DESCRIPTION	
1	Rear Main Seal Set	1993	BS 40648	Rubber; One-piece	
1	Repair Sleeve	1993	16275	Crankshaft; Use w/installation tool	
QTY	VALVE COVER	YEARS	PART NO.	DESCRIPTION	
1	Valve Cover Gasket Set	1993	VS 50435 R	w/Spark plug tube seals; PermaDry® molded rubber gskt. incl.	
1	Spark Plug Tube Seal Set	1993	ES 72120	Valve Cover	
QTY	VALVE STEM SEAL SET	YEARS	PART NO.	DESCRIPTION	
1	Valve Stem Seal Set	1993	SS 70660	Premium valve stem seals incl.; Improved design	
QTY	WATER OUTLET GASKET	YEARS	PART NO.	DESCRIPTION	
1	O-Ring	1993	35524	Water Outlet	
QTY	WATER PUMP	YEARS	PART NO.	DESCRIPTION	
1	Water Pump Gasket	1993	35003		
1	Water Pump Gasket	1993	ES 72872	O-ring	
QTY	TIMING COVER	YEARS	PART NO.	DESCRIPTION	
1	Crankshaft Front Seal Set	1993	TCS 45941	Must be used w/OS 30665C	
1	Camshaft Front Seal Set	1993	TCS 45483		
QTY	AIR CLEANER MOUNTING	YEARS	PART NO.	DESCRIPTION	
1	Air Cleaner Gasket	1993	60756	Air flow sensor	
QTY	CARB & FUEL INJECTION	YEARS	PART NO.	DESCRIPTION	
1	Fuel Injector O-Ring Set	1993	ES 70600		
1	Throttle Body Gasket	1993	60870		
QTY	EXHAUST GAS RECIRCULATION	YEARS	PART NO.	DESCRIPTION	
1	EGR Gasket	1993	70152		
20		1993; 2.0L 122 (1997cc) SOHC L4 (16 Valve) 85mm Bore			20
		MFI; Gasoline; Naturally Aspirated Mitsubishi Eng.; VIN Code V, Eng. Code 4G63			
QTY	CYLINDER HEAD	YEARS	PART NO.	DESCRIPTION	
1	Head Gasket	1993	9932 PT		
1	Head Set	1993	HS 9932 PT	PermaDry® molded rubber valve cover gskt. incl.; Premium valve stem seals incl.; Consolidated design	
QTY	CONVERSION SET	YEARS	PART NO.	DESCRIPTION	
1	Gasket Conversion Set	1993	CS 9086-1		
QTY	MANIFOLD - INT. & EXH.	YEARS	PART NO.	DESCRIPTION	
1	Int. Manifold Gasket Set	1993	MS 95471		
1	Exh. Manifold Gasket Set	1993	MS 95470		
QTY	EXHAUST PIPE FLANGE	YEARS	PART NO.	DESCRIPTION	
1	Exhaust Pipe Gasket	1993	60496-1	Loc. Front; Exh. connector	
1	Exhaust Pipe Gasket	1993	60620	Loc. Rear; Exh. connector	
1	Exhaust Pipe Gasket	1993	60680	Flange	
QTY	OIL PAN	YEARS	PART NO.	DESCRIPTION	
1	Oil Pan Gasket Set	1993	OS 30665 C		
QTY	CRANKSHAFT REAR SEAL	YEARS	PART NO.	DESCRIPTION	
1	Rear Main Seal Set	1993	BS 40648	Rubber; One-piece	
1	Repair Sleeve	1993	16275	Crankshaft; Use w/installation tool	
QTY	VALVE COVER	YEARS	PART NO.	DESCRIPTION	
1	Valve Cover Gasket Set	1993	VS 50435 R	w/Spark plug tube seals; PermaDry® molded rubber gskt. incl.	
1	Spark Plug Tube Seal Set	1993	ES 72120	Valve Cover	
QTY	VALVE STEM SEAL SET	YEARS	PART NO.	DESCRIPTION	
1	Valve Stem Seal Set	1993	SS 70660	Premium valve stem seals incl.; Improved design	
QTY	WATER OUTLET GASKET	YEARS	PART NO.	DESCRIPTION	
1	O-Ring	1993	35524	Water Outlet	
QTY	WATER PUMP	YEARS	PART NO.	DESCRIPTION	
1	Water Pump Gasket	1993	35003		
1	Water Pump Gasket	1993	ES 72872	O-ring	
QTY	TIMING COVER	YEARS	PART NO.	DESCRIPTION	
1	Crankshaft Front Seal Set	1993	TCS 45941	Must be used w/OS 30665C	
1	Camshaft Front Seal Set	1993	TCS 45483		
QTY	AIR CLEANER MOUNTING	YEARS	PART NO.	DESCRIPTION	
1	Air Cleaner Gasket	1993	60756	Air flow sensor	
QTY	CARB & FUEL INJECTION	YEARS	PART NO.	DESCRIPTION	
1	Fuel Injector O-Ring Set	1993	ES 70600		
1	Throttle Body Gasket	1993	60870		
QTY	EXHAUST GAS RECIRCULATION	YEARS	PART NO.	DESCRIPTION	
1	EGR Gasket	1993	70152		

Chrysler Car (Incl. Chrysler, DeSoto, Dodge, Eagle, Plymouth) (Cont.)

21		1992 - 1991; 2.0L 122 (1997cc) SOHC L4 (8 Valve) 85mm Bore			21
MFI; Gasoline; Naturally Aspirated Mitsubishi Eng.; VIN Code V, Eng. Code 4G63					
QTY	CYLINDER HEAD	YEARS	PART NO.	DESCRIPTION	
1	Head Gasket	1992-91	9086 PT		
1	Head Set	1992-91	HS 9086 B-1	Exh. pipe flange not incl.; PermaDry® molded rubber valve cover gskt. incl.; Premium valve stem seals incl.	
QTY	CONVERSION SET	YEARS	PART NO.	DESCRIPTION	
1	Gasket Conversion Set	1992-91	CS 9086		
QTY	MANIFOLD - INT. & EXH.	YEARS	PART NO.	DESCRIPTION	
1	Int. Manifold Gasket Set	1992-91	MS 91657	Lower set; Upper set not incl.	
1	Exh. Manifold Gasket Set	1992-91	MS 92029		
QTY	EXHAUST PIPE FLANGE	YEARS	PART NO.	DESCRIPTION	
1	Exhaust Pipe Gasket	1992-91	60496-1	Loc. Front; Exh. connector	
1	Exhaust Pipe Gasket	1992-91	60620	Loc. Rear; Exh. connector	
1	Exhaust Pipe Gasket	1992-91	60680	Flange	
QTY	FUEL PUMP	YEARS	PART NO.	DESCRIPTION	
1	Fuel Pump Mounting Gasket	1992-91	35226-1		
QTY	OIL PAN	YEARS	PART NO.	DESCRIPTION	
1	Oil Pan Gasket Set	1992-91	OS 30460 A		
QTY	CRANKSHAFT REAR SEAL	YEARS	PART NO.	DESCRIPTION	
1	Rear Main Seal Set	1992-91	BS 40408-1	Rubber; One-piece	
1	Repair Sleeve	1992-91	16275	Crankshaft; Use w/installation tool	
QTY	VALVE COVER	YEARS	PART NO.	DESCRIPTION	
1	Valve Cover Gasket Set	1992-91	VS 50132 R	w/Semi-circular plug & Grommets; PermaDry® molded rubber gskt. incl.	
1	Valve Cover Gasket Set	1992-91	VS 50234 R	w/o Semi-circular plug & Grommets; PermaDry® molded rubber gskt. incl.	
1	Grommet Set	1992-91	ES 70342	Valve Cover	
1	Semi-Circular Plug	1992-91	CP 75001	Valve Cover	
QTY	VALVE STEM SEAL SET	YEARS	PART NO.	DESCRIPTION	
1	Valve Stem Seal Set	1992-91	SS 72630	Loc. Int. & Exh.; Premium valve stem seals incl.	
QTY	WATER OUTLET GASKET	YEARS	PART NO.	DESCRIPTION	
1	Water Outlet Gasket	1992-91	35336	Water Outlet	
QTY	WATER PUMP	YEARS	PART NO.	DESCRIPTION	
1	Water Pump Gasket	1992-91	35273		
1	Water Pump Gasket	1992-91	ES 72872	O-ring	
QTY	TIMING COVER	YEARS	PART NO.	DESCRIPTION	
1	Timing Cover Dust Seal Set	1992-91	ES 72772		
1	Crankshaft Front Seal Set	1992-91	TCS 45565-1	Must be used w/OS 30460A	
1	Camshaft Front Seal Set	1992-91	TCS 45483		
QTY	AIR CLEANER MOUNTING	YEARS	PART NO.	DESCRIPTION	
1	Air Cleaner Gasket	1992-91	60756	Air flow sensor	
QTY	CARB & FUEL INJECTION	YEARS	PART NO.	DESCRIPTION	
1	Fuel Injector O-Ring Set	1992-91	ES 70600		
1	Throttle Body Gasket	1992-91	60681		
QTY	EXHAUST GAS RECIRCULATION	YEARS	PART NO.	DESCRIPTION	
1	EGR Gasket	1992-91	70152		
22		1991; 2.0L 122 (1997cc) SOHC L4 (8 Valve) 85mm Bore			22
MFI; Gasoline; Naturally Aspirated Mitsubishi Eng.; VIN Code V, Eng. Code G63B					
QTY	CYLINDER HEAD	YEARS	PART NO.	DESCRIPTION	
1	Head Gasket	1991	9086 PT		
1	Head Set	1991	HS 9086 B-1	Exh. pipe flange not incl.; PermaDry® molded rubber valve cover gskt. incl.; Premium valve stem seals incl.	
QTY	CONVERSION SET	YEARS	PART NO.	DESCRIPTION	
1	Gasket Conversion Set	1991	CS 9086		
QTY	MANIFOLD - INT. & EXH.	YEARS	PART NO.	DESCRIPTION	
1	Int. Manifold Gasket Set	1991	MS 91657	Lower set; Upper set not incl.	
1	Exh. Manifold Gasket Set	1991	MS 92029		
QTY	EXHAUST PIPE FLANGE	YEARS	PART NO.	DESCRIPTION	
1	Exhaust Pipe Gasket	1991	60496-1	Loc. Front; Exh. connector	
1	Exhaust Pipe Gasket	1991	60620	Loc. Rear; Exh. connector	
1	Exhaust Pipe Gasket	1991	60680	Flange	
QTY	FUEL PUMP	YEARS	PART NO.	DESCRIPTION	
1	Fuel Pump Mounting Gasket	1991	35226-1		
QTY	OIL PAN	YEARS	PART NO.	DESCRIPTION	
1	Oil Pan Gasket Set	1991	OS 30460 A		

Chrysler Car (Incl. Chrysler, DeSoto, Dodge, Eagle, Plymouth) (Cont.)

22 (cont.)		1991; 2.0L 122 (1997cc) SOHC L4 (8 Valve) 85mm Bore			22 (cont.)
		MFI; Gasoline; Naturally Aspirated Mitsubishi Eng.; VIN Code V, Eng. Code G63B			
QTY	CRANKSHAFT REAR SEAL	YEARS	PART NO.	DESCRIPTION	
1	Rear Main Seal Set	1991	BS 40408-1	Rubber; One-piece	
1	Repair Sleeve	1991	16275	Crankshaft; Use w/installation tool	
QTY	VALVE COVER	YEARS	PART NO.	DESCRIPTION	
1	Valve Cover Gasket Set	1991	VS 50132 R	w/Semi-circular plug & Grommets; PermaDry® molded rubber gskt. incl.	
1	Valve Cover Gasket Set	1991	VS 50234 R	w/o Semi-circular plug & Grommets; PermaDry® molded rubber gskt. incl.	
1	Grommet Set	1991	ES 70342	Valve Cover	
1	Semi-Circular Plug	1991	CP 75001	Valve Cover	
QTY	VALVE STEM SEAL SET	YEARS	PART NO.	DESCRIPTION	
1	Valve Stem Seal Set	1991	SS 72630	Loc. Int. & Exh.; Premium valve stem seals incl.	
QTY	WATER OUTLET GASKET	YEARS	PART NO.	DESCRIPTION	
1	Water Outlet Gasket	1991	35336	Water Outlet	
QTY	WATER PUMP	YEARS	PART NO.	DESCRIPTION	
1	Water Pump Gasket	1991	35273		
1	Water Pump Gasket	1991	ES 72872	O-ring	
QTY	TIMING COVER	YEARS	PART NO.	DESCRIPTION	
1	Timing Cover Dust Seal Set	1991	ES 72772		
1	Crankshaft Front Seal Set	1991	TCS 45565-1	Must be used w/OS 30460A	
1	Camshaft Front Seal Set	1991	TCS 45483		
QTY	AIR CLEANER MOUNTING	YEARS	PART NO.	DESCRIPTION	
1	Air Cleaner Gasket	1991	60756	Air flow sensor	
QTY	CARB & FUEL INJECTION	YEARS	PART NO.	DESCRIPTION	
1	Fuel Injector O-Ring Set	1991	ES 70600		
1	Throttle Body Gasket	1991	60681		
QTY	EXHAUST GAS RECIRCULATION	YEARS	PART NO.	DESCRIPTION	
1	EGR Gasket	1991	70152		
23		2012 - 2010; 2.0L 122 (1998cc) DOHC L4 (16 Valve) 86mm Bore			23
		MFI; Gasoline; Naturally Aspirated Chrysler Eng.; VIN Code A			
QTY	CYLINDER HEAD	YEARS	PART NO.	DESCRIPTION	
1	Head Gasket	2012-10	26360 PT	Head bolts not incl.; Head bolt replacement recommended; PermaTorqueMLS®; Old design	
1	Head Gasket	2012-10	26557 PT	Head bolts not incl.; Head bolt replacement recommended; PermaTorqueMLS®; Improved design; New Part Number - Check for Availability	
1	Head Set	2012-10	HS 26360 PT	Head bolts not incl.; Head bolt replacement recommended; PermaDry® molded rubber valve cover gskt. incl.; Premium valve stem seals incl.	
1	Head Bolt Set	2012-10	ES 72267	Head bolts w/Washers; Replacement recommended; Improved design	
1	Head Bolt Set	2012-10	ES 72256	Head bolts w/Washers; Replacement recommended; Old design; Superseded - When depleted use ES 72267	
QTY	CONVERSION SET	YEARS	PART NO.	DESCRIPTION	
1	Gasket Conversion Set	2012-10	CS 26332-1	RTV sealant incl. for oil pan gskt.	
QTY	MANIFOLD - INT. & EXH.	YEARS	PART NO.	DESCRIPTION	
1	Int. Manifold Gasket Set	2012-10	MS 96840		
1	Exh. Manifold Gasket Set	2012-10	MS 96902		
QTY	EXHAUST PIPE FLANGE	YEARS	PART NO.	DESCRIPTION	
1	Exhaust Pipe Gasket	2012-10	61002	Pipe to manifold	
1	Exhaust Pipe Gasket	2012-10	61506	Converter; 2.975" ID	
1	Exhaust Pipe Gasket	2012-10	61524	Converter; 2.757" ID	
QTY	OIL PAN	YEARS	PART NO.	DESCRIPTION	
1	Oil Pan Gasket Set	2012-10	OS 30782	RTV sealant incl. for oil pan gskt.; Improved design	
QTY	CRANKSHAFT REAR SEAL	YEARS	PART NO.	DESCRIPTION	
1	Rear Main Seal Set	2012-10	BS 40663	Rubber; One-piece	
QTY	VALVE COVER	YEARS	PART NO.	DESCRIPTION	
1	Valve Cover Gasket Set	2012-10	VS 50698 R	w/o Grommets & w/Spark plug tube seals; PermaDry® molded rubber gskt. incl.	
1	Grommet Set	2012-10	ES 72252-1	Valve Cover	
QTY	VALVE STEM SEAL SET	YEARS	PART NO.	DESCRIPTION	
1	Valve Stem Seal Set	2012-10	SS 71268	Premium valve stem seals incl.	
QTY	THERMOSTAT HOUSING	YEARS	PART NO.	DESCRIPTION	
1	Thermostat Gasket	2012-10	35826	Thermostat seal	
QTY	WATER OUTLET GASKET	YEARS	PART NO.	DESCRIPTION	
1	Water Outlet Gasket	2012-10	35837	Outlet	

Chrysler Car (Incl. Chrysler, DeSoto, Dodge, Eagle, Plymouth) (Cont.)

23 (cont.)		2012 - 2010; 2.0L 122 (1998cc) DOHC L4 (16 Valve) 86mm Bore			23 (cont.)
MFI; Gasoline; Naturally Aspirated Chrysler Eng.; VIN Code A					
QTY	WATER PUMP	YEARS	PART NO.	DESCRIPTION	
1	Water Pump Gasket	2012-10	35813	Inlet; Improved design	
1	Water Pump Gasket	2012-10	35813	Mounting; Improved design	
1	Water Pump Gasket	2012-10	35822	Mounting; Old design	
1	Water Pump Gasket	2012-10	36005	Cover; New Part Number - Check for Availability	
QTY	TIMING COVER	YEARS	PART NO.	DESCRIPTION	
1	Crankshaft Front Seal Set	2012-10	TCS 46098		
2	Camshaft Front Seal Set	2012-10	TCS 45961		
1	Camshaft Sensor Seal	2012-10	70725		
QTY	CARB & FUEL INJECTION	YEARS	PART NO.	DESCRIPTION	
2	Fuel Injector O-Ring Set	2012-10	ES 70599	Improved design	
1	Throttle Body Gasket	2012-10	61480	Mounting	
QTY	EXHAUST GAS RECIRCULATION	YEARS	PART NO.	DESCRIPTION	
1	EGR Gasket	2012-10	70720	Valve	
24		2012 - 2007; 2.0L 122 (1998cc) DOHC L4 (16 Valve) 86mm Bore			24
MFI; Gasoline; Naturally Aspirated Chrysler Eng.; VIN Code B					
QTY	CYLINDER HEAD	YEARS	PART NO.	DESCRIPTION	
1	Head Gasket	2012-07	26360 PT	Head bolts not incl.; Head bolt replacement recommended; PermaTorqueMLS®; Old design	
1	Head Gasket	2012-07	26557 PT	Head bolts not incl.; Head bolt replacement recommended; PermaTorqueMLS®; Improved design; New Part Number - Check for Availability	
1	Head Set	2012-07	HS 26360 PT	Head bolts not incl.; Head bolt replacement recommended; PermaDry® molded rubber valve cover gskt. incl.; Premium valve stem seals incl.	
1	Head Bolt Set	2012-07	ES 72256	Head bolts w/Washers; Replacement recommended; Old design; Superseded - When depleted use ES 72267	
1	Head Bolt Set	2012-07	ES 72267	Head bolts w/Washers; Replacement recommended; Improved design	
QTY	CONVERSION SET	YEARS	PART NO.	DESCRIPTION	
1	Gasket Conversion Set	2012-07	CS 26332-1	RTV sealant incl. for oil pan gskt.	
QTY	MANIFOLD - INT. & EXH.	YEARS	PART NO.	DESCRIPTION	
1	Int. Manifold Gasket Set	2012-07	MS 96840		
1	Exh. Manifold Gasket Set	2012-07	MS 96902		
QTY	EXHAUST PIPE FLANGE	YEARS	PART NO.	DESCRIPTION	
1	Exhaust Pipe Gasket	2012-07	61002	Pipe to manifold	
1	Exhaust Pipe Gasket	2012-07	61506	Converter; 2.975" ID	
1	Exhaust Pipe Gasket	2012-07	61524	Converter; 2.757" ID	
QTY	OIL PAN	YEARS	PART NO.	DESCRIPTION	
1	Oil Pan Gasket Set	2012-07	OS 30782	RTV sealant incl. for oil pan gskt.; Improved design	
QTY	CRANKSHAFT REAR SEAL	YEARS	PART NO.	DESCRIPTION	
1	Rear Main Seal Set	2012-07	BS 40663	Rubber; One-piece	
QTY	VALVE COVER	YEARS	PART NO.	DESCRIPTION	
1	Valve Cover Gasket Set	2012-07	VS 50698 R	w/o Grommets & w/Spark plug tube seals; PermaDry® molded rubber gskt. incl.	
1	Grommet Set	2012-07	ES 72252-1	Valve Cover	
QTY	VALVE STEM SEAL SET	YEARS	PART NO.	DESCRIPTION	
1	Valve Stem Seal Set	2012-07	SS 71268	Premium valve stem seals incl.	
QTY	THERMOSTAT HOUSING	YEARS	PART NO.	DESCRIPTION	
1	Thermostat Gasket	2012-07	35826	Thermostat seal	
QTY	WATER OUTLET GASKET	YEARS	PART NO.	DESCRIPTION	
1	Water Outlet Gasket	2012-07	35837	Outlet	
QTY	WATER PUMP	YEARS	PART NO.	DESCRIPTION	
1	Water Pump Gasket	2012-07	35813	Inlet; Improved design	
1	Water Pump Gasket	2012-07	35813	Mounting; Improved design	
1	Water Pump Gasket	2012-07	35822	Mounting; Old design	
1	Water Pump Gasket	2012-07	36005	Cover; New Part Number - Check for Availability	
QTY	TIMING COVER	YEARS	PART NO.	DESCRIPTION	
1	Crankshaft Front Seal Set	2012-07	TCS 46098		
2	Camshaft Front Seal Set	2012-07	TCS 45961		
1	Camshaft Sensor Seal	2012-07	70725		
QTY	CARB & FUEL INJECTION	YEARS	PART NO.	DESCRIPTION	
2	Fuel Injector O-Ring Set	2012-07	ES 70599	Improved design	
1	Throttle Body Gasket	2012-07	61480	Mounting	
QTY	EXHAUST GAS RECIRCULATION	YEARS	PART NO.	DESCRIPTION	
1	EGR Gasket	2012-07	70720	Valve	

Chrysler Car (Incl. Chrysler, DeSoto, Dodge, Eagle, Plymouth) (Cont.)

25		1994 - 1991; 2.2L 135 (2212cc) SOHC L4 (8 Valve) 87.5mm Bore TBI; Gasoline; Naturally Aspirated Chrysler Eng.; VIN Code D			25
QTY	CYLINDER HEAD	YEARS	PART NO.	DESCRIPTION	
1	Head Gasket	1994-91	9296 PT	Head bolts not incl.; Head bolt replacement recommended; PermaTorque®	
1	Head Gasket Spacer Shim	1994-91	9296 SP	HeadSaver®	
1	Head Set	1994	HS 9296 PT-2	w/Stamped steel valve cover; Head bolts, exh. pipe packing, camshaft rear seal plug not incl.; Head bolt replacement recommended; Premium valve stem seals incl.	
1	Head Set	1994	HS 9296 PT-3	w/Aluminum valve cover; Head bolts, exh. pipe packing, camshaft rear seal plug not incl.; Head bolt replacement recommended; PermaDry® molded rubber valve cover gskt. incl.; Premium valve stem seals incl.	
1	Head Set	1994	HS 9296 PT-3	w/Plastic valve cover; Head bolts, exh. pipe packing, camshaft rear seal plug not incl.; Head bolt replacement recommended; PermaDry® molded rubber valve cover gskt. incl.; Premium valve stem seals incl.	
1	Head Set	1993-91	HS 9296 PT-2	Head bolts, exh. pipe packing, camshaft rear seal plug not incl.; Head bolt replacement recommended; Premium valve stem seals incl.	
1	Head Set w/Head Bolts	1994	HSB 9296 PT-2	w/Stamped steel valve cover; w/11mm Head bolts w/o Washers; Washers are req'd.; Exh. pipe packing & camshaft rear seal plug not incl.; Premium valve stem seals incl.	
1	Head Set w/Head Bolts	1993-91	HSB 9296 PT-2	w/11mm Head bolts w/o Washers; Washers are req'd.; Exh. pipe packing & camshaft rear seal plug not incl.; Premium valve stem seals incl.	
1	Head Installation Set	1994	HIS 9296 PT-2	w/Stamped steel valve cover; Head bolts, exh. pipe packing, camshaft rear seal plug not incl.; Head bolt replacement recommended	
1	Head Installation Set	1993-91	HIS 9296 PT-2	Head bolts, exh. pipe packing, camshaft rear seal plug not incl.; Head bolt replacement recommended	
1	Head Bolt Set	1994-91	ES 72723	11mm Head bolts w/o Washers; Washers are req'd.; Replacement recommended	
1	Head Bolt Washer Set	1994-91	ES 72176	11mm Head bolts; Replacement recommended	
QTY	CONVERSION SET	YEARS	PART NO.	DESCRIPTION	
1	Gasket Conversion Set	1994-91	CS 8763-2	PermaDry® molded rubber oil pan gskt. incl.	
QTY	MANIFOLD - INT. & EXH.	YEARS	PART NO.	DESCRIPTION	
1	Int. & Exh. Gasket Set	1994-91	MS 90947		
QTY	EXHAUST PIPE FLANGE	YEARS	PART NO.	DESCRIPTION	
1	Exhaust Pipe Gasket	1994-91	60632	Pipe to manifold	
1	Exh. Flange Bolt & Spring Kit	1994-91	ES 72143		
QTY	FUEL PUMP	YEARS	PART NO.	DESCRIPTION	
2	Fuel Pump Mounting Gasket	1994-91	70627	May also be used as a fuel pump block-off plate gasket if desired	
QTY	OIL PAN	YEARS	PART NO.	DESCRIPTION	
1	Oil Pan Gasket Set	1994-91	OS 30612 R	PermaDry® molded rubber gskt. incl.	
1	Oil Pan Gasket Set	1994-91	OS 30612 T	PermaDryPlus®; Oil Pan SnapUps® incl.	
1	Drain Plug Gasket	1994-91	70822		
QTY	CRANKSHAFT REAR SEAL	YEARS	PART NO.	DESCRIPTION	
1	Rear Main Seal Set	1994-91	BS 40168-1	Rubber; One-piece	
1	Rear Main Seal Set	1994-91	BS 40627	PTFE Rubber; One-piece	
1	Repair Sleeve Tool	1994-91	16300	Crankshaft	
QTY	VALVE COVER	YEARS	PART NO.	DESCRIPTION	
1	Valve Cover Gasket Set	1994	VS 50205 C	w/Stamped steel valve cover; Cork	
1	Valve Cover Gasket Set	1994	VS 50205 T	w/Stamped steel valve cover; PermaDryPlus®	
1	Valve Cover Gasket Set	1994	VS 50334 R	w/Aluminum valve cover; PermaDry® molded rubber gskt. incl.	
1	Valve Cover Gasket Set	1994	VS 50334 R	w/Plastic valve cover; PermaDry® molded rubber gskt. incl.	
1	Valve Cover Gasket Set	1993-91	VS 50205 C	Cork	
1	Valve Cover Gasket Set	1993-91	VS 50205 T	PermaDryPlus®	
QTY	VALVE STEM SEAL SET	YEARS	PART NO.	DESCRIPTION	
1	Valve Stem Seal Set	1994-91	SS 72522	Premium valve stem seals incl.	
QTY	WATER OUTLET GASKET	YEARS	PART NO.	DESCRIPTION	
1	Water Outlet Gasket	1994-91	35286	Water Outlet	
1	Water Outlet Gasket	1994-91	35286 T	Water Outlet; PermaDryPlus®	
QTY	WATER PUMP	YEARS	PART NO.	DESCRIPTION	
1	Water Pump Gasket	1994-91	35444		
1	O-Ring	1994-91	35224	Water Pump	
QTY	TIMING COVER	YEARS	PART NO.	DESCRIPTION	
1	Timing Cover Set	1994-91	TCS 45495	Camshaft; Front seal set	
1	Crankshaft Front Seal Set	1994-91	TCS 45131		
1	Auxiliary Shaft Seal Set	1994-91	TCS 45026		
1	Camshaft Rear Seal Plug Set	1994-91	TCS 45833		
QTY	CARB & FUEL INJECTION	YEARS	PART NO.	DESCRIPTION	
1	Throttle Body Gasket	1994-91	60743		

Chrysler Car (Incl. Chrysler, DeSoto, Dodge, Eagle, Plymouth) (Cont.)

25 (cont.)		1994 - 1991; 2.2L 135 (2212cc) SOHC L4 (8 Valve) 87.5mm Bore			25 (cont.)
TBI; Gasoline; Naturally Aspirated Chrysler Eng.; VIN Code D					
QTY	DISTRIBUTOR MOUNTING	YEARS	PART NO.	DESCRIPTION	
1	O-Ring	1994-91	70799	Distributor Mounting	
QTY	EXHAUST GAS RECIRCULATION	YEARS	PART NO.	DESCRIPTION	
1	EGR Gasket	1994-91	70561		
26		2005 - 1993; 2.4L 143.4 (2351cc) SOHC L4 (16 Valve) 86.5mm Bore			26
MFI; Gasoline; Naturally Aspirated Mitsubishi Eng.; VIN Code G, Eng. Code 4G64					
QTY	CYLINDER HEAD	YEARS	PART NO.	DESCRIPTION	
1	Head Gasket	2005-01	26172 PT	Head bolts not incl.; Head bolt replacement recommended; PermaTorqueMLS® LaserWeld® Technology	
1	Head Gasket	1996-93	9932 PT	Head bolts not incl.; Head bolt replacement recommended	
1	Head Set	2005-01	HS 26172 PT	Head bolts not incl.; Head bolt replacement recommended; PermaDry® molded rubber valve cover gskt. incl.; Premium valve stem seals incl.	
1	Head Set	1996-95	HS 9932 PT	Eagle Summit DL, LX; California; AWD; Head bolts not incl.; Head bolt replacement recommended; PermaDry® molded rubber valve cover gskt. incl.; Premium valve stem seals incl.; Consolidated design	
1	Head Set	1996-95	HS 9932 PT	California; FWD; Head bolts & exh. pipe flange not incl.; Head bolt replacement recommended; PermaDry® molded rubber valve cover gskt. incl.; Premium valve stem seals incl.; Consolidated design	
1	Head Set	1996-95	HS 9932 PT	Exc. California; Head bolts not incl.; Head bolt replacement recommended; PermaDry® molded rubber valve cover gskt. incl.; Premium valve stem seals incl.; Consolidated design	
1	Head Set	1994-93	HS 9932 PT	Head bolts not incl.; Head bolt replacement recommended; PermaDry® molded rubber valve cover gskt. incl.; Premium valve stem seals incl.; Consolidated design	
1	Head Bolt Set	2005-01	ES 71177	Head bolts w/Washers; Replacement recommended	
QTY	CONVERSION SET	YEARS	PART NO.	DESCRIPTION	
1	Gasket Conversion Set	2005-01	CS 26172		
1	Gasket Conversion Set	1996-93	CS 9086-1		
QTY	MANIFOLD - INT. & EXH.	YEARS	PART NO.	DESCRIPTION	
1	Int. Manifold Gasket Set	2005-01	MS 96075		
1	Int. Manifold Gasket Set	1996-93	MS 95471		
1	Exh. Manifold Gasket Set	2005-01	MS 95470		
1	Exh. Manifold Gasket Set	1996-93	MS 95470		
QTY	EXHAUST PIPE FLANGE	YEARS	PART NO.	DESCRIPTION	
2	Exhaust Pipe Gasket	2005-01	60496-1	Converter	
2	Exhaust Pipe Gasket	2005-01	60817	Pipe to manifold	
1	Exhaust Pipe Gasket	2005-01	61080	Pipe to muffler	
2	Exhaust Pipe Gasket	1996-93	60496-1	Exh. connector	
1	Exhaust Pipe Gasket	1996-95	60496-1	Flange; California; FWD	
1	Exhaust Pipe Gasket	1996-95	60680	Eagle Summit DL, LX; Flange; California; AWD	
1	Exhaust Pipe Gasket	1996-95	60680	Flange; Exc. California	
1	Exhaust Pipe Gasket	1994-93	60680	Flange	
QTY	OIL PAN	YEARS	PART NO.	DESCRIPTION	
1	Oil Pan Gasket Set	2005-01	OS 30715		
1	Oil Pan Gasket Set	1996-93	OS 30665 C		
QTY	CRANKSHAFT REAR SEAL	YEARS	PART NO.	DESCRIPTION	
1	Rear Main Seal Set	2005-01	BS 40648	Rubber; One-piece	
1	Rear Main Seal Set	1996-93	BS 40648	Rubber; One-piece	
1	Repair Sleeve	2005-01	16275	Crankshaft; Use w/installation tool	
1	Repair Sleeve	1996-93	16275	Crankshaft; Use w/installation tool	
QTY	VALVE COVER	YEARS	PART NO.	DESCRIPTION	
1	Valve Cover Gasket Set	2005-01	VS 50562 R	w/Spark plug tube seals; PermaDry® molded rubber gskt. incl.	
1	Valve Cover Gasket Set	1996-93	VS 50435 R	w/Spark plug tube seals; PermaDry® molded rubber gskt. incl.	
1	Spark Plug Tube Seal Set	2005-01	ES 72120	Valve Cover	
1	Spark Plug Tube Seal Set	1996-93	ES 72120	Valve Cover	
QTY	VALVE STEM SEAL SET	YEARS	PART NO.	DESCRIPTION	
1	Valve Stem Seal Set	2005-01	SS 70660	Premium valve stem seals incl.; Improved design	
1	Valve Stem Seal Set	1996-93	SS 70660	Premium valve stem seals incl.; Improved design	
QTY	THERMOSTAT HOUSING	YEARS	PART NO.	DESCRIPTION	
2	Thermostat Gasket	2005-01	35589	Thermostat Housing; Thermostat case to head	
1	O-Ring	2005-01	35524	Thermostat Housing	
QTY	WATER OUTLET GASKET	YEARS	PART NO.	DESCRIPTION	
2	Water Outlet Gasket	2005-01	35959	Water Outlet; Water pipe; O-ring	

Chrysler Car (Incl. Chrysler, DeSoto, Dodge, Eagle, Plymouth) (Cont.)

26 (cont.)		2005 - 1993; 2.4L 143.4 (2351cc) SOHC L4 (16 Valve) 86.5mm Bore			26 (cont.)
MFI; Gasoline; Naturally Aspirated Mitsubishi Eng.; VIN Code G, Eng. Code 4G64					
QTY	WATER OUTLET GASKET	YEARS	PART NO.	DESCRIPTION	
1	Water Outlet Gasket	1993	35336	Water Outlet	
1	O-Ring	1996-93	35524	Water Outlet	
QTY	WATER PUMP	YEARS	PART NO.	DESCRIPTION	
1	Water Pump Gasket	2005-01	35003		
1	Water Pump Gasket	2005-01	ES 72872	O-ring	
1	Water Pump Gasket	1996-93	ES 72872	O-ring	
1	Water Pump Gasket	1996-94	35003		
1	Water Pump Gasket	1993	35273		
QTY	TIMING COVER	YEARS	PART NO.	DESCRIPTION	
1	Crankshaft Front Seal Set	2005-01	TCS 46024	Must be used w/OS 30715	
1	Crankshaft Front Seal Set	1996-93	TCS 45941	Must be used w/OS 30665C	
1	Camshaft Front Seal Set	2005-01	TCS 45483		
1	Camshaft Front Seal Set	1996-93	TCS 45483		
QTY	CARB & FUEL INJECTION	YEARS	PART NO.	DESCRIPTION	
1	Fuel Injector O-Ring Set	2005-01	ES 70600		
1	Fuel Injector O-Ring Set	1996-93	ES 70600		
1	Throttle Body Gasket	2005-01	60889		
1	Throttle Body Gasket	1996-93	60889		
QTY	EXHAUST GAS RECIRCULATION	YEARS	PART NO.	DESCRIPTION	
1	EGR Gasket	2005-01	70152		
1	EGR Gasket	1996-93	70152		
27		1992; 2.4L 143.4 (2351cc) SOHC L4 (8 Valve) 86.5mm Bore			27
MFI; Gasoline; Naturally Aspirated Mitsubishi Eng.; VIN Code W, Eng. Code 4G64					
QTY	CYLINDER HEAD	YEARS	PART NO.	DESCRIPTION	
1	Head Gasket	1992	9388 PT		
1	Head Set	1992	HS 9388 PT-2	PermaDry® molded rubber valve cover gskt. incl.; Premium valve stem seals incl.	
QTY	CONVERSION SET	YEARS	PART NO.	DESCRIPTION	
1	Gasket Conversion Set	1992	CS 9388-1		
QTY	MANIFOLD - INT. & EXH.	YEARS	PART NO.	DESCRIPTION	
1	Int. Manifold Gasket Set	1992	MS 92964-4	Lower set; Upper set incl.	
1	Exh. Manifold Gasket Set	1992	MS 92029		
QTY	EXHAUST PIPE FLANGE	YEARS	PART NO.	DESCRIPTION	
2	Exhaust Pipe Gasket	1992	60620	Exh. connector	
1	Exhaust Pipe Gasket	1992	60680	Flange	
QTY	OIL PAN	YEARS	PART NO.	DESCRIPTION	
1	Oil Pan Gasket Set	1992	OS 30460 A		
QTY	CRANKSHAFT REAR SEAL	YEARS	PART NO.	DESCRIPTION	
1	Rear Main Seal Set	1992	BS 40408-1	Rubber; One-piece	
1	Repair Sleeve	1992	16275	Crankshaft; Use w/installation tool	
QTY	VALVE COVER	YEARS	PART NO.	DESCRIPTION	
1	Valve Cover Gasket Set	1992	VS 50132 R	w/Semi-circular plug & Grommets; PermaDry® molded rubber gskt. incl.	
1	Valve Cover Gasket Set	1992	VS 50234 R	w/o Semi-circular plug & Grommets; PermaDry® molded rubber gskt. incl.	
1	Grommet Set	1992	ES 70342	Valve Cover	
1	Semi-Circular Plug	1992	CP 75001	Valve Cover	
QTY	VALVE STEM SEAL SET	YEARS	PART NO.	DESCRIPTION	
1	Valve Stem Seal Set	1992	SS 72630	Loc. Int. & Exh.; Premium valve stem seals incl.	
1	Valve Stem Seal Set	1992	SS 72681	Loc. Aux.; Premium valve stem seals incl.	
QTY	WATER OUTLET GASKET	YEARS	PART NO.	DESCRIPTION	
1	Water Outlet Gasket	1992	35336	Water Outlet	
QTY	WATER PUMP	YEARS	PART NO.	DESCRIPTION	
1	Water Pump Gasket	1992	35273		
1	Water Pump Gasket	1992	ES 72872	O-ring	
QTY	TIMING COVER	YEARS	PART NO.	DESCRIPTION	
1	Camshaft Front Seal Set	1992	TCS 45483		
QTY	CARB & FUEL INJECTION	YEARS	PART NO.	DESCRIPTION	
1	Fuel Injector O-Ring Set	1992	ES 70600		
1	Throttle Body Gasket	1992	60855		
QTY	EXHAUST GAS RECIRCULATION	YEARS	PART NO.	DESCRIPTION	
1	EGR Gasket	1992	70152		

Chrysler Car (Incl. Chrysler, DeSoto, Dodge, Eagle, Plymouth) (Cont.)

28		2013 - 2009; 2.4L 144 (2360cc) DOHC L4 (16 Valve) 88mm Bore			28
MFI; Gasoline; Naturally Aspirated Chrysler Eng.; VIN Code B					
QTY	CYLINDER HEAD	YEARS	PART NO.	DESCRIPTION	
1	Head Gasket	2013-09	26332 PT	Head bolts not incl.; Head bolt replacement recommended; PermaTorqueMLS®; Old design	
1	Head Gasket	2013-09	26557 PT	Head bolts not incl.; Head bolt replacement recommended; PermaTorqueMLS®; Improved design; New Part Number - Check for Availability	
1	Head Set	2013-09	HS 26332 PT	Eng. I.D. Code "ED3"; w/o PZEV; Head bolts not incl.; Head bolt replacement recommended; PermaDry® molded rubber valve cover gskt. incl.; Premium valve stem seals incl.	
1	Head Set	2013-09	HS 26332 PT-1	Eng. I.D. Code "EDG"; w/PZEV; Head bolts not incl.; Head bolt replacement recommended; PermaDry® molded rubber valve cover gskt. incl.; Premium valve stem seals incl.	
1	Head Bolt Set	2013-09	ES 72267	Head bolts w/Washers; Replacement recommended; Improved design	
QTY	CONVERSION SET	YEARS	PART NO.	DESCRIPTION	
1	Gasket Conversion Set	2013-09	CS 26332	RTV sealant incl. for oil pan gskt.	
QTY	MANIFOLD - INT. & EXH.	YEARS	PART NO.	DESCRIPTION	
1	Int. Manifold Gasket Set	2013-09	MS 96840		
1	Exh. Manifold Gasket Set	2013-09	MS 96902	Eng. I.D. Code "ED3"; w/o PZEV	
1	Exh. Manifold Gasket Set	2013-09	MS 96961	Eng. I.D. Code "EDG"; w/PZEV	
QTY	EXHAUST PIPE FLANGE	YEARS	PART NO.	DESCRIPTION	
1	Exhaust Pipe Gasket	2013-09	61002	Pipe to manifold	
1	Exhaust Pipe Gasket	2013-09	61506	Converter; 2.975" ID	
1	Exhaust Pipe Gasket	2013-09	61524	Converter; 2.757" ID	
QTY	OIL PAN	YEARS	PART NO.	DESCRIPTION	
1	Oil Pan Gasket Set	2013-09	OS 30782	RTV sealant incl. for oil pan gskt.; Improved design	
QTY	CRANKSHAFT REAR SEAL	YEARS	PART NO.	DESCRIPTION	
1	Rear Main Seal Set	2013-09	BS 40684	Retainer w/Seal; PTFE Rubber; One-piece; Improved design	
1	Rear Main Seal Set	2013-09	BS 40703	Rubber; One-piece; Old design; Superseded - When depleted use BS 40684	
QTY	VALVE COVER	YEARS	PART NO.	DESCRIPTION	
1	Valve Cover Gasket Set	2013-09	VS 50698 R	w/o Grommets & w/Spark plug tube seals; PermaDry® molded rubber gskt. incl.	
1	Grommet Set	2013-09	ES 72252-1	Valve Cover	
QTY	VALVE STEM SEAL SET	YEARS	PART NO.	DESCRIPTION	
1	Valve Stem Seal Set	2013-09	SS 71268	Premium valve stem seals incl.	
QTY	THERMOSTAT HOUSING	YEARS	PART NO.	DESCRIPTION	
1	Thermostat Gasket	2013-09	35826	Thermostat Housing; Thermostat seal	
QTY	WATER OUTLET GASKET	YEARS	PART NO.	DESCRIPTION	
1	Water Outlet Gasket	2013-09	35837	Water Outlet; Outlet	
QTY	WATER PUMP	YEARS	PART NO.	DESCRIPTION	
1	Water Pump Gasket	2013-09	35813	Inlet; Improved design	
1	Water Pump Gasket	2013-09	35813	Mounting; Improved design	
1	Water Pump Gasket	2013-09	35822	Mounting; Old design	
1	Water Pump Gasket	2013-09	36005	Cover; New Part Number - Check for Availability	
QTY	TIMING COVER	YEARS	PART NO.	DESCRIPTION	
1	Crankshaft Front Seal Set	2013-09	TCS 46098		
2	Camshaft Front Seal Set	2013-09	TCS 45961		
1	Camshaft Sensor Seal	2013-09	70725		
QTY	CARB & FUEL INJECTION	YEARS	PART NO.	DESCRIPTION	
2	Fuel Injector O-Ring Set	2013-09	ES 70599	Improved design	
1	Throttle Body Gasket	2013-09	61480	Mounting	
QTY	EXHAUST GAS RECIRCULATION	YEARS	PART NO.	DESCRIPTION	
1	EGR Gasket	2013-09	70720	Valve	
29		2011 - 2007; 2.4L 144 (2360cc) DOHC L4 (16 Valve) 88mm Bore			29
MFI; Gasoline; Naturally Aspirated Chrysler Eng.; VIN Code C					
QTY	CYLINDER HEAD	YEARS	PART NO.	DESCRIPTION	
1	Head Gasket	2011-07	26332 PT	Head bolts not incl.; Head bolt replacement recommended; PermaTorqueMLS®; Old design	
1	Head Gasket	2011-07	26557 PT	Head bolts not incl.; Head bolt replacement recommended; PermaTorqueMLS®; Improved design; New Part Number - Check for Availability	
1	Head Set	2011-07	HS 26332 PT	Head bolts not incl.; Head bolt replacement recommended; PermaDry® molded rubber valve cover gskt. incl.; Premium valve stem seals incl.	
1	Head Bolt Set	2011-07	ES 72267	Head bolts w/Washers; Replacement recommended; Improved design	

Chrysler Car (Incl. Chrysler, DeSoto, Dodge, Eagle, Plymouth) (Cont.)

29 (cont.)		2011 - 2007; 2.4L 144 (2360cc) DOHC L4 (16 Valve) 88mm Bore			29 (cont.)
		MFI; Gasoline; Naturally Aspirated Chrysler Eng.; VIN Code C			
QTY	CONVERSION SET	YEARS	PART NO.	DESCRIPTION	
1	Gasket Conversion Set	2011-07	CS 26332	RTV sealant incl. for oil pan gskt.	
QTY	MANIFOLD - INT. & EXH.	YEARS	PART NO.	DESCRIPTION	
1	Int. Manifold Gasket Set	2011-07	MS 96840		
1	Exh. Manifold Gasket Set	2011-07	MS 96902		
QTY	EXHAUST PIPE FLANGE	YEARS	PART NO.	DESCRIPTION	
1	Exhaust Pipe Gasket	2011-07	61002	Pipe to manifold	
1	Exhaust Pipe Gasket	2011-07	61506	Converter; 2.975" ID	
1	Exhaust Pipe Gasket	2011-07	61524	Converter; 2.757" ID	
QTY	OIL PAN	YEARS	PART NO.	DESCRIPTION	
1	Oil Pan Gasket Set	2011-07	OS 30782	RTV sealant incl. for oil pan gskt.; Improved design	
QTY	CRANKSHAFT REAR SEAL	YEARS	PART NO.	DESCRIPTION	
1	Rear Main Seal Set	2011-07	BS 40684	Retainer w/Seal; PTFE Rubber; One-piece; Improved design	
1	Rear Main Seal Set	2011-07	BS 40703	Rubber; One-piece; Old design; Superseded - When depleted use BS 40684	
QTY	VALVE COVER	YEARS	PART NO.	DESCRIPTION	
1	Valve Cover Gasket Set	2011-07	VS 50698 R	w/o Grommets & w/Spark plug tube seals; PermaDry® molded rubber gskt. incl.	
1	Grommet Set	2011-07	ES 72252-1	Valve Cover	
QTY	VALVE STEM SEAL SET	YEARS	PART NO.	DESCRIPTION	
1	Valve Stem Seal Set	2011-07	SS 71268	Premium valve stem seals incl.	
QTY	THERMOSTAT HOUSING	YEARS	PART NO.	DESCRIPTION	
1	Thermostat Gasket	2011-07	35826	Thermostat Housing; Thermostat seal	
QTY	WATER OUTLET GASKET	YEARS	PART NO.	DESCRIPTION	
1	Water Outlet Gasket	2011-07	35837	Water Outlet; Outlet	
QTY	WATER PUMP	YEARS	PART NO.	DESCRIPTION	
1	Water Pump Gasket	2011-07	35813	Inlet; Improved design	
1	Water Pump Gasket	2011-07	35813	Mounting; Improved design	
1	Water Pump Gasket	2011-07	35822	Mounting; Old design	
1	Water Pump Gasket	2011-07	36005	Cover; New Part Number - Check for Availability	
QTY	TIMING COVER	YEARS	PART NO.	DESCRIPTION	
1	Crankshaft Front Seal Set	2011-07	TCS 46098		
2	Camshaft Front Seal Set	2011-07	TCS 45961		
1	Camshaft Sensor Seal	2011-07	70725		
QTY	CARB & FUEL INJECTION	YEARS	PART NO.	DESCRIPTION	
2	Fuel Injector O-Ring Set	2011-07	ES 70599	Improved design	
1	Throttle Body Gasket	2011-07	61480	Mounting	
QTY	EXHAUST GAS RECIRCULATION	YEARS	PART NO.	DESCRIPTION	
1	EGR Gasket	2011-07	70720	Valve	
30		2010 - 2008; 2.4L 144 (2360cc) DOHC L4 (16 Valve) 88mm Bore			30
		MFI; Gasoline; Turbo - Intercooled Chrysler Eng.; VIN Code F			
QTY	CYLINDER HEAD	YEARS	PART NO.	DESCRIPTION	
1	Head Gasket	2010-08	26465 PT	Head bolts not incl.; Head bolt replacement recommended; PermaTorqueMLS®; New Part Number - Check for Availability	
1	Head Set	2010-08	HS 26465 PT	Head bolts not incl.; Head bolt replacement recommended; PermaDry® molded rubber valve cover gskt. incl.; Premium valve stem seals incl.; New Part Number - Check for Availability	
1	Head Bolt Set	2010-08	ES 72267	Head bolts w/Washers; Replacement recommended; Improved design	
QTY	CONVERSION SET	YEARS	PART NO.	DESCRIPTION	
1	Gasket Conversion Set	2010-08	CS 26332	RTV sealant incl. for oil pan gskt.	
QTY	MANIFOLD - INT. & EXH.	YEARS	PART NO.	DESCRIPTION	
1	Int. Manifold Gasket Set	2010-08	MS 96840		
1	Exh. Manifold Gasket Set	2010-08	MS 97112		
QTY	EXHAUST PIPE FLANGE	YEARS	PART NO.	DESCRIPTION	
1	Exhaust Pipe Gasket	2010-08	61002	Pipe to manifold	
1	Exhaust Pipe Gasket	2010-08	61506	Converter; 2.975" ID	
1	Exhaust Pipe Gasket	2010-08	61524	Converter; 2.757" ID	
QTY	OIL PAN	YEARS	PART NO.	DESCRIPTION	
1	Oil Pan Gasket Set	2010-08	OS 30782	RTV sealant incl. for oil pan gskt.; Improved design	
QTY	CRANKSHAFT REAR SEAL	YEARS	PART NO.	DESCRIPTION	
1	Rear Main Seal Set	2010-08	BS 40684	Retainer w/Seal; PTFE Rubber; One-piece; Improved design	
1	Rear Main Seal Set	2010-08	BS 40703	Rubber; One-piece; Old design; Superseded - When depleted use BS 40684	

Chrysler Car (Incl. Chrysler, DeSoto, Dodge, Eagle, Plymouth) (Cont.)

30 (cont.)		2010 - 2008; 2.4L 144 (2360cc) DOHC L4 (16 Valve) 88mm Bore MFI; Gasoline; Turbo - Intercooled Chrysler Eng.; VIN Code F			30 (cont.)
QTY	VALVE COVER	YEARS	PART NO.	DESCRIPTION	
1	Valve Cover Gasket Set	2010-08	VS 50698 R	w/o Grommets & w/Spark plug tube seals; PermaDry® molded rubber gskt. incl.	
1	Grommet Set	2010-08	ES 72252-1	Valve Cover	
QTY	VALVE STEM SEAL SET	YEARS	PART NO.	DESCRIPTION	
1	Valve Stem Seal Set	2010-08	SS 71268	Premium valve stem seals incl.	
QTY	THERMOSTAT HOUSING	YEARS	PART NO.	DESCRIPTION	
1	Thermostat Gasket	2010-08	35826	Thermostat Housing; Thermostat seal	
QTY	WATER OUTLET GASKET	YEARS	PART NO.	DESCRIPTION	
1	Water Outlet Gasket	2010-08	35837	Water Outlet; Outlet	
QTY	WATER PUMP	YEARS	PART NO.	DESCRIPTION	
1	Water Pump Gasket	2010-08	35813	Inlet; Improved design	
1	Water Pump Gasket	2010-08	35813	Mounting; Improved design	
1	Water Pump Gasket	2010-08	35822	Mounting; Old design	
1	Water Pump Gasket	2010-08	36005	Cover; New Part Number - Check for Availability	
QTY	TIMING COVER	YEARS	PART NO.	DESCRIPTION	
1	Crankshaft Front Seal Set	2010-08	TCS 46098		
2	Camshaft Front Seal Set	2010-08	TCS 45961		
1	Camshaft Sensor Seal	2010-08	70725		
QTY	CARB & FUEL INJECTION	YEARS	PART NO.	DESCRIPTION	
2	Fuel Injector O-Ring Set	2010-08	ES 70599	Improved design	
1	Throttle Body Gasket	2010-08	61480	Mounting	
QTY	EXHAUST GAS RECIRCULATION	YEARS	PART NO.	DESCRIPTION	
1	EGR Gasket	2010-08	70720	Valve	
31		2013 - 2007; 2.4L 144 (2360cc) DOHC L4 (16 Valve) 88mm Bore MFI; Gasoline; Naturally Aspirated Chrysler Eng.; VIN Code K			31
QTY	CYLINDER HEAD	YEARS	PART NO.	DESCRIPTION	
1	Head Gasket	2013-07	26332 PT	Head bolts not incl.; Head bolt replacement recommended; PermaTorqueMLS®; Old design	
1	Head Gasket	2013-07	26557 PT	Head bolts not incl.; Head bolt replacement recommended; PermaTorqueMLS®; Improved design; New Part Number - Check for Availability	
1	Head Set	2013-07	HS 26332 PT	Eng. I.D. Code "ED3"; w/o PZEV; Head bolts not incl.; Head bolt replacement recommended; PermaDry® molded rubber valve cover gskt. incl.; Premium valve stem seals incl.	
1	Head Set	2013-07	HS 26332 PT-1	Eng. I.D. Code "EDG"; w/PZEV; Head bolts not incl.; Head bolt replacement recommended; PermaDry® molded rubber valve cover gskt. incl.; Premium valve stem seals incl.	
1	Head Bolt Set	2013-07	ES 72267	Head bolts w/Washers; Replacement recommended; Improved design	
QTY	CONVERSION SET	YEARS	PART NO.	DESCRIPTION	
1	Gasket Conversion Set	2013-07	CS 26332	RTV sealant incl. for oil pan gskt.	
QTY	MANIFOLD - INT. & EXH.	YEARS	PART NO.	DESCRIPTION	
1	Int. Manifold Gasket Set	2013-07	MS 96840		
1	Exh. Manifold Gasket Set	2013-07	MS 96902	Eng. I.D. Code "ED3"; w/o PZEV	
1	Exh. Manifold Gasket Set	2013-07	MS 96961	Eng. I.D. Code "EDG"; w/PZEV	
QTY	EXHAUST PIPE FLANGE	YEARS	PART NO.	DESCRIPTION	
1	Exhaust Pipe Gasket	2013-07	61002	Pipe to manifold	
1	Exhaust Pipe Gasket	2013-07	61506	Converter; 2.975" ID	
1	Exhaust Pipe Gasket	2013-07	61524	Converter; 2.757" ID	
QTY	OIL PAN	YEARS	PART NO.	DESCRIPTION	
1	Oil Pan Gasket Set	2013-07	OS 30782	RTV sealant incl. for oil pan gskt.; Improved design	
QTY	CRANKSHAFT REAR SEAL	YEARS	PART NO.	DESCRIPTION	
1	Rear Main Seal Set	2013-07	BS 40684	Retainer w/Seal; PTFE Rubber; One-piece; Improved design	
1	Rear Main Seal Set	2013-07	BS 40703	Rubber; One-piece; Old design; Superseded - When depleted use BS 40684	
QTY	VALVE COVER	YEARS	PART NO.	DESCRIPTION	
1	Valve Cover Gasket Set	2013-07	VS 50698 R	w/o Grommets & w/Spark plug tube seals; PermaDry® molded rubber gskt. incl.	
1	Grommet Set	2013-07	ES 72252-1	Valve Cover	
QTY	VALVE STEM SEAL SET	YEARS	PART NO.	DESCRIPTION	
1	Valve Stem Seal Set	2013-07	SS 71268	Premium valve stem seals incl.	
QTY	THERMOSTAT HOUSING	YEARS	PART NO.	DESCRIPTION	
1	Thermostat Gasket	2013-07	35826	Thermostat Housing; Thermostat seal	
QTY	WATER OUTLET GASKET	YEARS	PART NO.	DESCRIPTION	
1	Water Outlet Gasket	2013-07	35837	Water Outlet; Outlet	

Chrysler Car (Incl. Chrysler, DeSoto, Dodge, Eagle, Plymouth) (Cont.)

31 (cont.)		2013 - 2007; 2.4L 144 (2360cc) DOHC L4 (16 Valve) 88mm Bore			31 (cont.)
		MFI; Gasoline; Naturally Aspirated Chrysler Eng.; VIN Code K			
QTY	WATER PUMP	YEARS	PART NO.	DESCRIPTION	
1	Water Pump Gasket	2013-07	35813	Inlet; Improved design	
1	Water Pump Gasket	2013-07	35813	Mounting; Improved design	
1	Water Pump Gasket	2013-07	35822	Mounting; Old design	
1	Water Pump Gasket	2013-07	36005	Cover; New Part Number - Check for Availability	
QTY	TIMING COVER	YEARS	PART NO.	DESCRIPTION	
1	Crankshaft Front Seal Set	2013-07	TCS 46098		
2	Camshaft Front Seal Set	2013-07	TCS 45961		
1	Camshaft Sensor Seal	2013-07	70725		
QTY	CARB & FUEL INJECTION	YEARS	PART NO.	DESCRIPTION	
2	Fuel Injector O-Ring Set	2013-07	ES 70599	Improved design	
1	Throttle Body Gasket	2013-07	61480	Mounting	
QTY	EXHAUST GAS RECIRCULATION	YEARS	PART NO.	DESCRIPTION	
1	EGR Gasket	2013-07	70720	Valve	
32		2010 - 2008; 2.4L 144 (2360cc) DOHC L4 (16 Valve) 88mm Bore			32
		MFI; Gasoline; Turbo - Intercooled Chrysler Eng.; VIN Code K			
QTY	CYLINDER HEAD	YEARS	PART NO.	DESCRIPTION	
1	Head Gasket	2010-08	26465 PT	Head bolts not incl.; Head bolt replacement recommended; PermaTorqueMLS®; New Part Number - Check for Availability	
1	Head Set	2010-08	HS 26465 PT	Head bolts not incl.; Head bolt replacement recommended; PermaDry® molded rubber valve cover gskt. incl.; Premium valve stem seals incl.; New Part Number - Check for Availability	
1	Head Bolt Set	2010-08	ES 72267	Head bolts w/Washers; Replacement recommended; Improved design	
QTY	CONVERSION SET	YEARS	PART NO.	DESCRIPTION	
1	Gasket Conversion Set	2010-08	CS 26332	RTV sealant incl. for oil pan gskt.	
QTY	MANIFOLD - INT. & EXH.	YEARS	PART NO.	DESCRIPTION	
1	Int. Manifold Gasket Set	2010-08	MS 96840		
1	Exh. Manifold Gasket Set	2010-08	MS 97112		
QTY	EXHAUST PIPE FLANGE	YEARS	PART NO.	DESCRIPTION	
1	Exhaust Pipe Gasket	2010-08	61002	Pipe to manifold	
1	Exhaust Pipe Gasket	2010-08	61506	Converter; 2.975" ID	
1	Exhaust Pipe Gasket	2010-08	61524	Converter; 2.757" ID	
QTY	OIL PAN	YEARS	PART NO.	DESCRIPTION	
1	Oil Pan Gasket Set	2010-08	OS 30782	RTV sealant incl. for oil pan gskt.; Improved design	
QTY	CRANKSHAFT REAR SEAL	YEARS	PART NO.	DESCRIPTION	
1	Rear Main Seal Set	2010-08	BS 40684	Retainer w/Seal; PTFE Rubber; One-piece; Improved design	
1	Rear Main Seal Set	2010-08	BS 40703	Rubber; One-piece; Old design; Superseded - When depleted use BS 40684	
QTY	VALVE COVER	YEARS	PART NO.	DESCRIPTION	
1	Valve Cover Gasket Set	2010-08	VS 50698 R	w/o Grommets & w/Spark plug tube seals; PermaDry® molded rubber gskt. incl.	
1	Grommet Set	2010-08	ES 72252-1	Valve Cover	
QTY	VALVE STEM SEAL SET	YEARS	PART NO.	DESCRIPTION	
1	Valve Stem Seal Set	2010-08	SS 71268	Premium valve stem seals incl.	
QTY	THERMOSTAT HOUSING	YEARS	PART NO.	DESCRIPTION	
1	Thermostat Gasket	2010-08	35826	Thermostat Housing; Thermostat seal	
QTY	WATER OUTLET GASKET	YEARS	PART NO.	DESCRIPTION	
1	Water Outlet Gasket	2010-08	35837	Water Outlet; Outlet	
QTY	WATER PUMP	YEARS	PART NO.	DESCRIPTION	
1	Water Pump Gasket	2010-08	35813	Inlet; Improved design	
1	Water Pump Gasket	2010-08	35813	Mounting; Improved design	
1	Water Pump Gasket	2010-08	35822	Mounting; Old design	
1	Water Pump Gasket	2010-08	36005	Cover; New Part Number - Check for Availability	
QTY	TIMING COVER	YEARS	PART NO.	DESCRIPTION	
1	Crankshaft Front Seal Set	2010-08	TCS 46098		
2	Camshaft Front Seal Set	2010-08	TCS 45961		
1	Camshaft Sensor Seal	2010-08	70725		
QTY	CARB & FUEL INJECTION	YEARS	PART NO.	DESCRIPTION	
2	Fuel Injector O-Ring Set	2010-08	ES 70599	Improved design	
1	Throttle Body Gasket	2010-08	61480	Mounting	
QTY	EXHAUST GAS RECIRCULATION	YEARS	PART NO.	DESCRIPTION	
1	EGR Gasket	2010-08	70720	Valve	

Chrysler Car (Incl. Chrysler, DeSoto, Dodge, Eagle, Plymouth) (Cont.)

33		2008 - 2004; 2.4L 148 (2429cc) DOHC L4 (16 Valve) 87.5mm Bore			33
MFI; Gasoline; Turbo - Intercooled Chrysler Eng.; VIN Code E					
QTY	CYLINDER HEAD	YEARS	PART NO.	DESCRIPTION	
1	Head Gasket	2008-04	26202 PT	Head bolts not incl.; Head bolt replacement recommended; PermaTorqueMLS® LaserWeld® Technology; Improved design	
1	Head Set	2008-04	HS 26202 PT	Head bolts not incl.; Head bolt replacement recommended; PermaDry® molded rubber valve cover gskt. incl.; Premium valve stem seals incl.	
1	Head Bolt Set	2008-04	ES 71028	Head bolts w/Washers; Replacement recommended	
QTY	CONVERSION SET	YEARS	PART NO.	DESCRIPTION	
1	Gasket Conversion Set	2008-04	CS 26202	PermaDry® molded rubber oil pan gskt. incl.	
QTY	MANIFOLD - INT. & EXH.	YEARS	PART NO.	DESCRIPTION	
1	Int. Manifold Gasket Set	2008-04	MS 96198	Upper set incl.	
1	Exh. Manifold Gasket Set	2008-04	MS 92846		
QTY	EXHAUST PIPE FLANGE	YEARS	PART NO.	DESCRIPTION	
1	Exhaust Pipe Gasket	2008-04	61002	Pipe to manifold	
QTY	OIL PAN	YEARS	PART NO.	DESCRIPTION	
1	Oil Pan Gasket Set	2008-04	OS 30728 R	PermaDry® molded rubber gskt. incl.	
QTY	CRANKSHAFT REAR SEAL	YEARS	PART NO.	DESCRIPTION	
1	Rear Main Seal Set	2008-04	BS 40182	Rubber; One-piece	
1	Rear Main Seal Set	2008-04	BS 40627	PTFE Rubber; One-piece	
QTY	VALVE COVER	YEARS	PART NO.	DESCRIPTION	
1	Valve Cover Gasket Set	2008-04	VS 50459 R	w/Spark plug tube seals; PermaDry® molded rubber gskt. incl.	
1	Semi-Circular Plug	2008-04	ES 72357	Valve Cover	
1	Spark Plug Tube Seal Set	2008-04	ES 72947	Valve Cover; New Part Number - Check for Availability	
QTY	VALVE STEM SEAL SET	YEARS	PART NO.	DESCRIPTION	
1	Valve Stem Seal Set	2008-04	SS 72871	Premium valve stem seals incl.	
QTY	THERMOSTAT HOUSING	YEARS	PART NO.	DESCRIPTION	
1	Thermostat Gasket	2008-04	35588	Thermostat Housing; Thermostat seal	
1	Thermostat Gasket	2008-04	35681	Thermostat Housing	
QTY	WATER PUMP	YEARS	PART NO.	DESCRIPTION	
1	Water Pump Gasket	2008-04	35586	O-ring	
1	Water Pump Gasket	2008-04	35587	Seal	
QTY	TIMING COVER	YEARS	PART NO.	DESCRIPTION	
1	Crankshaft Front Seal Set	2008-04	TCS 45962		
2	Camshaft Front Seal Set	2008-04	TCS 45961		
1	Camshaft Sensor Seal	2008-04	70725		
1	Repair Sleeve	2008-04	16224	Timing Cover; Use w/installation tool	
1	Repair Sleeve Tool	2008-04	16325	Timing Cover	
QTY	CARB & FUEL INJECTION	YEARS	PART NO.	DESCRIPTION	
2	Fuel Injector O-Ring Set	2008-04	ES 70599	Improved design	
1	Throttle Body Gasket	2008-04	61228	Mounting	
1	Throttle Body Gasket	2008-04	61237	O-ring	
1	Throttle Body Gasket	2008-04	61324	Idle air control; 21mm ID	
1	Throttle Body Gasket	2008-04	61326	Idle air control; 30mm ID	
QTY	EXHAUST GAS RECIRCULATION	YEARS	PART NO.	DESCRIPTION	
1	EGR Gasket	2008-04	70720	Valve	

34		2003; 2.4L 148 (2429cc) DOHC L4 (16 Valve) 87.5mm Bore			34
MFI; Gasoline; Turbo - Intercooled Chrysler Eng.; VIN Code G					
QTY	CYLINDER HEAD	YEARS	PART NO.	DESCRIPTION	
1	Head Gasket	2003	26202 PT	Head bolts not incl.; Head bolt replacement recommended; PermaTorqueMLS® LaserWeld® Technology; Improved design	
1	Head Set	2003	HS 26202 PT	Head bolts not incl.; Head bolt replacement recommended; PermaDry® molded rubber valve cover gskt. incl.; Premium valve stem seals incl.	
1	Head Bolt Set	2003	ES 71028	Head bolts w/Washers; Replacement recommended	
QTY	CONVERSION SET	YEARS	PART NO.	DESCRIPTION	
1	Gasket Conversion Set	2003	CS 26202	PermaDry® molded rubber oil pan gskt. incl.	
QTY	MANIFOLD - INT. & EXH.	YEARS	PART NO.	DESCRIPTION	
1	Int. Manifold Gasket Set	2003	MS 96198	Upper set incl.	
1	Exh. Manifold Gasket Set	2003	MS 92846		
QTY	EXHAUST PIPE FLANGE	YEARS	PART NO.	DESCRIPTION	
1	Exhaust Pipe Gasket	2003	61002	Pipe to manifold	
QTY	OIL PAN	YEARS	PART NO.	DESCRIPTION	
1	Oil Pan Gasket Set	2003	OS 30728 R	PermaDry® molded rubber gskt. incl.	
QTY	CRANKSHAFT REAR SEAL	YEARS	PART NO.	DESCRIPTION	
1	Rear Main Seal Set	2003	BS 40182	Rubber; One-piece	

Chrysler Car (Incl. Chrysler, DeSoto, Dodge, Eagle, Plymouth) (Cont.)

34 (cont.)		2003; 2.4L 148 (2429cc) DOHC L4 (16 Valve) 87.5mm Bore			34 (cont.)
		MFI; Gasoline; Turbo - Intercooled Chrysler Eng.; VIN Code G			
QTY	CRANKSHAFT REAR SEAL	YEARS	PART NO.	DESCRIPTION	
1	Rear Main Seal Set	2003	BS 40627	PTFE Rubber; One-piece	
QTY	VALVE COVER	YEARS	PART NO.	DESCRIPTION	
1	Valve Cover Gasket Set	2003	VS 50459 R	w/Spark plug tube seals; PermaDry® molded rubber gskt. incl.	
1	Semi-Circular Plug	2003	ES 72357	Valve Cover	
1	Spark Plug Tube Seal Set	2003	ES 72947	Valve Cover; New Part Number - Check for Availability	
QTY	VALVE STEM SEAL SET	YEARS	PART NO.	DESCRIPTION	
1	Valve Stem Seal Set	2003	SS 72871	Premium valve stem seals incl.	
QTY	THERMOSTAT HOUSING	YEARS	PART NO.	DESCRIPTION	
1	Thermostat Gasket	2003	35588	Thermostat Housing; Thermostat seal	
1	Thermostat Gasket	2003	35681	Thermostat Housing	
QTY	WATER PUMP	YEARS	PART NO.	DESCRIPTION	
1	Water Pump Gasket	2003	35586	O-ring	
1	Water Pump Gasket	2003	35587	Seal	
QTY	TIMING COVER	YEARS	PART NO.	DESCRIPTION	
1	Crankshaft Front Seal Set	2003	TCS 45962		
2	Camshaft Front Seal Set	2003	TCS 45961		
1	Camshaft Sensor Seal	2003	70725		
1	Repair Sleeve	2003	16224	Timing Cover; Use w/installation tool	
1	Repair Sleeve Tool	2003	16325	Timing Cover	
QTY	CARB & FUEL INJECTION	YEARS	PART NO.	DESCRIPTION	
2	Fuel Injector O-Ring Set	2003	ES 70599	Improved design	
1	Throttle Body Gasket	2003	61228	Mounting	
1	Throttle Body Gasket	2003	61237	O-ring	
1	Throttle Body Gasket	2003	61324	Idle air control; 21mm ID	
1	Throttle Body Gasket	2003	61326	Idle air control; 30mm ID	
QTY	EXHAUST GAS RECIRCULATION	YEARS	PART NO.	DESCRIPTION	
1	EGR Gasket	2003	70720	Valve	
35		2006 - 2004; 2.4L 148 (2429cc) DOHC L4 (16 Valve) 87.5mm Bore			35
		MFI; Gasoline; Naturally Aspirated Chrysler Eng.; VIN Code J			
QTY	CYLINDER HEAD	YEARS	PART NO.	DESCRIPTION	
1	Head Gasket	2006-05	26202 PT	Head bolts not incl.; Head bolt replacement recommended; PermaTorqueMLS® LaserWeld® Technology; Improved design	
1	Head Gasket	2004	26202 PT	w/8-bolt valve cover; Head bolts not incl.; Head bolt replacement recommended; PermaTorqueMLS® LaserWeld® Technology; Improved design	
1	Head Gasket	2004	26202 PT	w/9-bolt valve cover; Head bolts not incl.; Head bolt replacement recommended; PermaTorqueMLS® LaserWeld® Technology; Improved design	
1	Head Gasket	2004	26206 PT	w/8-bolt valve cover; Head bolts not incl.; Head bolt replacement recommended; PermaTorqueMLS®; Old design	
1	Head Set	2006-05	HS 26202 PT-1	Head bolts not incl.; Head bolt replacement recommended; PermaDry® molded rubber valve cover gskt. incl.; Premium valve stem seals incl.	
1	Head Set	2004	HS 26202 PT-1	w/9-bolt valve cover; Head bolts not incl.; Head bolt replacement recommended; PermaDry® molded rubber valve cover gskt. incl.; Premium valve stem seals incl.	
1	Head Set	2004	HS 26206 PT	w/8-bolt valve cover; Head bolts not incl.; Head bolt replacement recommended; PermaDry® molded rubber valve cover gskt. incl.; Premium valve stem seals incl.	
1	Head Bolt Set	2006-04	ES 71028	Head bolts w/Washers; Replacement recommended	
QTY	CONVERSION SET	YEARS	PART NO.	DESCRIPTION	
1	Gasket Conversion Set	2006-04	CS 9924	PermaDry® molded rubber oil pan gskt. incl.	
QTY	MANIFOLD - INT. & EXH.	YEARS	PART NO.	DESCRIPTION	
1	Int. Manifold Gasket Set	2006-04	MS 92888		
1	Exh. Manifold Gasket Set	2006-04	MS 92846		
QTY	EXHAUST PIPE FLANGE	YEARS	PART NO.	DESCRIPTION	
1	Exhaust Pipe Gasket	2006-04	61002	Pipe to manifold	
QTY	OIL PAN	YEARS	PART NO.	DESCRIPTION	
1	Oil Pan Gasket Set	2006-04	OS 30676 R	PermaDry® molded rubber gskt. incl.	
QTY	CRANKSHAFT REAR SEAL	YEARS	PART NO.	DESCRIPTION	
1	Rear Main Seal Set	2006-04	BS 40182	Rubber; One-piece	
1	Rear Main Seal Set	2006-04	BS 40627	PTFE Rubber; One-piece	
QTY	VALVE COVER	YEARS	PART NO.	DESCRIPTION	
1	Valve Cover Gasket Set	2006-05	VS 50518 R	w/Spark plug tube seals; PermaDry® molded rubber gskt. incl.	

Chrysler Car (Incl. Chrysler, DeSoto, Dodge, Eagle, Plymouth) (Cont.)

35 (cont.)		2006 - 2004; 2.4L 148 (2429cc) DOHC L4 (16 Valve) 87.5mm Bore			35 (cont.)
MFI; Gasoline; Naturally Aspirated Chrysler Eng.; VIN Code J					
QTY	VALVE COVER	YEARS	PART NO.	DESCRIPTION	
1	Valve Cover Gasket Set	2004	VS 50459 R	w/8-bolt valve cover; w/Spark plug tube seals; PermaDry® molded rubber gskt. incl.	
1	Valve Cover Gasket Set	2004	VS 50518 R	w/9-bolt valve cover; w/Spark plug tube seals; PermaDry® molded rubber gskt. incl.	
1	Semi-Circular Plug	2006-04	ES 72357	Valve Cover	
1	Spark Plug Tube Seal Set	2004	ES 72947	Valve Cover; w/8-bolt valve cover; New Part Number - Check for Availability	
QTY	VALVE STEM SEAL SET	YEARS	PART NO.	DESCRIPTION	
1	Valve Stem Seal Set	2006-04	SS 72871	Premium valve stem seals incl.	
QTY	THERMOSTAT HOUSING	YEARS	PART NO.	DESCRIPTION	
1	Thermostat Gasket	2006-04	35588	Thermostat Housing; Thermostat seal	
1	Thermostat Gasket	2006-04	35681	Thermostat Housing	
QTY	WATER PUMP	YEARS	PART NO.	DESCRIPTION	
1	Water Pump Gasket	2006-04	35586	O-ring	
1	Water Pump Gasket	2006-04	35587	Seal	
QTY	TIMING COVER	YEARS	PART NO.	DESCRIPTION	
1	Crankshaft Front Seal Set	2006-04	TCS 45962		
2	Camshaft Front Seal Set	2006-04	TCS 45961		
1	Camshaft Sensor Seal	2006-04	70725		
1	Repair Sleeve	2006-04	16224	Timing Cover; Use w/installation tool	
1	Repair Sleeve Tool	2006-04	16325	Timing Cover	
QTY	CARB & FUEL INJECTION	YEARS	PART NO.	DESCRIPTION	
2	Fuel Injector O-Ring Set	2006-04	ES 70599	Improved design	
1	Throttle Body Gasket	2006-04	61098	Mounting	
1	Throttle Body Gasket	2006-04	61324	Idle air control; 21mm ID	
1	Throttle Body Gasket	2006-04	61326	Idle air control; 30mm ID	
QTY	EXHAUST GAS RECIRCULATION	YEARS	PART NO.	DESCRIPTION	
1	EGR Gasket	2006-04	70720	Valve	
1	EGR Gasket	2006-05	72218	Mounting	
36		2007 - 2004; 2.4L 148 (2429cc) DOHC L4 (16 Valve) 87.5mm Bore			36
MFI; Gasoline; Turbo - Intercooled Chrysler Eng.; VIN Code S					
QTY	CYLINDER HEAD	YEARS	PART NO.	DESCRIPTION	
1	Head Gasket	2007-04	26202 PT	Head bolts not incl.; Head bolt replacement recommended; PermaTorqueMLS® LaserWeld® Technology; Improved design	
1	Head Set	2007-04	HS 26202 PT	Head bolts not incl.; Head bolt replacement recommended; PermaDry® molded rubber valve cover gskt. incl.; Premium valve stem seals incl.	
1	Head Bolt Set	2007-04	ES 71028	Head bolts w/Washers; Replacement recommended	
QTY	CONVERSION SET	YEARS	PART NO.	DESCRIPTION	
1	Gasket Conversion Set	2007-04	CS 26202	PermaDry® molded rubber oil pan gskt. incl.	
QTY	MANIFOLD - INT. & EXH.	YEARS	PART NO.	DESCRIPTION	
1	Int. Manifold Gasket Set	2007-04	MS 96198	Upper set incl.	
1	Exh. Manifold Gasket Set	2007-04	MS 92846		
QTY	EXHAUST PIPE FLANGE	YEARS	PART NO.	DESCRIPTION	
1	Exhaust Pipe Gasket	2007-04	61002	Pipe to manifold	
QTY	OIL PAN	YEARS	PART NO.	DESCRIPTION	
1	Oil Pan Gasket Set	2007-04	OS 30728 R	PermaDry® molded rubber gskt. incl.	
QTY	CRANKSHAFT REAR SEAL	YEARS	PART NO.	DESCRIPTION	
1	Rear Main Seal Set	2007-04	BS 40182	Rubber; One-piece	
1	Rear Main Seal Set	2007-04	BS 40627	PTFE Rubber; One-piece	
QTY	VALVE COVER	YEARS	PART NO.	DESCRIPTION	
1	Valve Cover Gasket Set	2007-04	VS 50459 R	w/Spark plug tube seals; PermaDry® molded rubber gskt. incl.	
1	Semi-Circular Plug	2007-04	ES 72357	Valve Cover	
1	Spark Plug Tube Seal Set	2007-04	ES 72947	Valve Cover; New Part Number - Check for Availability	
QTY	VALVE STEM SEAL SET	YEARS	PART NO.	DESCRIPTION	
1	Valve Stem Seal Set	2007-04	SS 72871	Premium valve stem seals incl.	
QTY	THERMOSTAT HOUSING	YEARS	PART NO.	DESCRIPTION	
1	Thermostat Gasket	2007-04	35588	Thermostat Housing; Thermostat seal	
1	Thermostat Gasket	2007-04	35681	Thermostat Housing	
QTY	WATER PUMP	YEARS	PART NO.	DESCRIPTION	
1	Water Pump Gasket	2007-04	35586	O-ring	
1	Water Pump Gasket	2007-04	35587	Seal	
QTY	TIMING COVER	YEARS	PART NO.	DESCRIPTION	
1	Crankshaft Front Seal Set	2007-04	TCS 45962		
2	Camshaft Front Seal Set	2007-04	TCS 45961		

Chrysler Car (Incl. Chrysler, DeSoto, Dodge, Eagle, Plymouth) (Cont.)

36 (cont.)		2007 - 2004; 2.4L 148 (2429cc) DOHC L4 (16 Valve) 87.5mm Bore			36 (cont.)
MFI; Gasoline; Turbo - Intercooled Chrysler Eng.; VIN Code S					
QTY	TIMING COVER	YEARS	PART NO.	DESCRIPTION	
1	Camshaft Sensor Seal	2007-04	70725		
1	Repair Sleeve	2007-04	16224	Timing Cover; Use w/installation tool	
1	Repair Sleeve Tool	2007-04	16325	Timing Cover	
QTY	CARB & FUEL INJECTION	YEARS	PART NO.	DESCRIPTION	
2	Fuel Injector O-Ring Set	2007-04	ES 70599	Improved design	
1	Throttle Body Gasket	2007-04	61228	Mounting	
1	Throttle Body Gasket	2007-04	61237	O-ring	
1	Throttle Body Gasket	2007-04	61324	Idle air control; 21mm ID	
1	Throttle Body Gasket	2007-04	61326	Idle air control; 30mm ID	
QTY	EXHAUST GAS RECIRCULATION	YEARS	PART NO.	DESCRIPTION	
1	EGR Gasket	2007-04	70720	Valve	
37		2008 - 1995; 2.4L 148 (2429cc) DOHC L4 (16 Valve) 87.5mm Bore			37
MFI; Gasoline; Naturally Aspirated Chrysler Eng.; VIN Code X					
QTY	CYLINDER HEAD	YEARS	PART NO.	DESCRIPTION	
1	Head Gasket	2008-05	26202 PT	Head bolts not incl.; Head bolt replacement recommended; PermaTorqueMLS® LaserWeld® Technology; Improved design	
1	Head Gasket	2004	26202 PT	w/8-bolt valve cover; Head bolts not incl.; Head bolt replacement recommended; PermaTorqueMLS® LaserWeld® Technology; Improved design	
1	Head Gasket	2004	26202 PT	w/9-bolt valve cover; Head bolts not incl.; Head bolt replacement recommended; PermaTorqueMLS® LaserWeld® Technology; Improved design	
1	Head Gasket	2004	26206 PT	w/8-bolt valve cover; Head bolts not incl.; Head bolt replacement recommended; PermaTorqueMLS®; Old design	
1	Head Gasket	2003-02	26202 PT	Head bolts not incl.; Head bolt replacement recommended; PermaTorqueMLS® LaserWeld® Technology; Improved design	
1	Head Gasket	2003-02	26206 PT	Head bolts not incl.; Head bolt replacement recommended; PermaTorqueMLS®; Old design	
1	Head Gasket	2001-95	26502 PT	.010" thicker for use when head is refaced; Head bolts not incl.; Head bolt replacement recommended; PermaTorqueMLS®	
1	Head Gasket	2001-95	9924 PT	Head bolts not incl.; Head bolt replacement recommended; PermaTorqueMLS®	
1	Head Set	2008-05	HS 26202 PT-1	Head bolts not incl.; Head bolt replacement recommended; PermaDry® molded rubber valve cover gskt. incl.; Premium valve stem seals incl.	
1	Head Set	2004	HS 26202 PT-1	w/9-bolt valve cover; Head bolts not incl.; Head bolt replacement recommended; PermaDry® molded rubber valve cover gskt. incl.; Premium valve stem seals incl.	
1	Head Set	2004	HS 26206 PT	w/8-bolt valve cover; Head bolts not incl.; Head bolt replacement recommended; PermaDry® molded rubber valve cover gskt. incl.; Premium valve stem seals incl.	
1	Head Set	2003-02	HS 26206 PT	Head bolts not incl.; Head bolt replacement recommended; PermaDry® molded rubber valve cover gskt. incl.; Premium valve stem seals incl.	
1	Head Set	2001	HS 9924 PT-1	Head bolts not incl.; Head bolt replacement recommended; PermaDry® molded rubber valve cover gskt. incl.; Premium valve stem seals incl.	
1	Head Set	2000-95	HS 9924 PT	Head bolts not incl.; Head bolt replacement recommended; PermaDry® molded rubber valve cover gskt. incl.; Premium valve stem seals incl.	
1	Head Installation Set	2000-95	HIS 9924 PT	Head bolts & exh. pipe to manifold gskt. not incl.; Head bolt replacement recommended; PermaDry® molded rubber valve cover gskt. incl.	
1	Head Bolt Set	2008-95	ES 71028	Head bolts w/Washers; Replacement recommended	
QTY	CONVERSION SET	YEARS	PART NO.	DESCRIPTION	
1	Gasket Conversion Set	2008-95	CS 9924	PermaDry® molded rubber oil pan gskt. incl.	
QTY	MANIFOLD - INT. & EXH.	YEARS	PART NO.	DESCRIPTION	
1	Int. Manifold Gasket Set	2008-01	MS 92888		
1	Int. Manifold Gasket Set	2000-95	MS 95660	Lower set; Upper set incl.	
1	Plenum Gasket Set	2000-95	MS 90546	Upper set	
1	Exh. Manifold Gasket Set	2008-01	MS 92846		
1	Exh. Manifold Gasket Set	2000-95	MS 95692		
QTY	EXHAUST PIPE FLANGE	YEARS	PART NO.	DESCRIPTION	
1	Exhaust Pipe Gasket	2008-95	61002	Pipe to manifold	
QTY	OIL PAN	YEARS	PART NO.	DESCRIPTION	
1	Oil Pan Gasket Set	2008-95	OS 30676 R	PermaDry® molded rubber gskt. incl.	
QTY	CRANKSHAFT REAR SEAL	YEARS	PART NO.	DESCRIPTION	
1	Rear Main Seal Set	2008-95	BS 40182	Rubber; One-piece	

Chrysler Car (Incl. Chrysler, DeSoto, Dodge, Eagle, Plymouth) (Cont.)

37 (cont.)		2008 - 1995; 2.4L 148 (2429cc) DOHC L4 (16 Valve) 87.5mm Bore			37 (cont.)
MFI; Gasoline; Naturally Aspirated Chrysler Eng.; VIN Code X					
QTY	CRANKSHAFT REAR SEAL	YEARS	PART NO.	DESCRIPTION	
1	Rear Main Seal Set	2008-95	BS 40627	PTFE Rubber; One-piece	
QTY	VALVE COVER	YEARS	PART NO.	DESCRIPTION	
1	Valve Cover Gasket Set	2008-05	VS 50518 R	w/Spark plug tube seals; PermaDry® molded rubber gskt. incl.	
1	Valve Cover Gasket Set	2004	VS 50459 R	w/8-bolt valve cover; w/Spark plug tube seals; PermaDry® molded rubber gskt. incl.	
1	Valve Cover Gasket Set	2004	VS 50518 R	w/9-bolt valve cover; w/Spark plug tube seals; PermaDry® molded rubber gskt. incl.	
1	Valve Cover Gasket Set	2003-95	VS 50459 R	w/Spark plug tube seals; PermaDry® molded rubber gskt. incl.	
1	Semi-Circular Plug	2008-95	ES 72357	Valve Cover	
1	Spark Plug Tube Seal Set	2004	ES 72947	Valve Cover; w/8-bolt valve cover; New Part Number - Check for Availability	
1	Spark Plug Tube Seal Set	2003-95	ES 72947	Valve Cover; New Part Number - Check for Availability	
QTY	VALVE STEM SEAL SET	YEARS	PART NO.	DESCRIPTION	
1	Valve Stem Seal Set	2008-95	SS 72871	Premium valve stem seals incl.	
QTY	THERMOSTAT HOUSING	YEARS	PART NO.	DESCRIPTION	
1	Water Outlet Gasket	2001-95	35286	Thermostat Housing; 2-bolt	
1	Water Outlet Gasket	2001-95	35286 T	Thermostat Housing; 2-bolt; PermaDryPlus®	
1	Thermostat Gasket	2008-95	35588	Thermostat Housing; Thermostat seal	
1	Thermostat Gasket	2008-01	35681	Thermostat Housing; 3-bolt	
QTY	WATER PUMP	YEARS	PART NO.	DESCRIPTION	
1	Water Pump Gasket	2008-95	35586	O-ring	
1	Water Pump Gasket	2008-95	35587	Seal	
QTY	TIMING COVER	YEARS	PART NO.	DESCRIPTION	
1	Crankshaft Front Seal Set	2008-95	TCS 45962		
2	Camshaft Front Seal Set	2008-95	TCS 45961		
1	Camshaft Sensor Seal	2008-95	70725		
1	Repair Sleeve	2008-95	16224	Timing Cover; Use w/installation tool	
1	Repair Sleeve Tool	2008-95	16325	Timing Cover	
QTY	CARB & FUEL INJECTION	YEARS	PART NO.	DESCRIPTION	
2	Fuel Injector O-Ring Set	2008-95	ES 70599	Improved design	
1	Throttle Body Gasket	2008-01	61098	Mounting	
1	Throttle Body Gasket	2008-03	61324	Idle air control; 21mm ID	
1	Throttle Body Gasket	2008-03	61326	Idle air control; 30mm ID	
1	Throttle Body Gasket	2000-96	60744	Mounting	
1	Throttle Body Gasket	1995	60999	Mounting	
QTY	EXHAUST GAS RECIRCULATION	YEARS	PART NO.	DESCRIPTION	
1	EGR Gasket	2008-95	70720	Valve	
1	EGR Gasket	2008-05	72218	Mounting	
1	EGR Gasket	2004-95	70721	Tube flange	
38		2000 - 1995; 2.5L 152.2 (2497cc) SOHC V6 (24 Valve) 83.5mm Bore			38
MFI; Gasoline; Naturally Aspirated Mitsubishi Eng.; VIN Code H, Eng. Code 6G73					
QTY	CYLINDER HEAD	YEARS	PART NO.	DESCRIPTION	
2	Head Gasket	2000-98	9158 PT	Head bolts not incl.; Head bolt replacement recommended; PermaTorqueMLS®	
2	Head Gasket	1997-95	9037 PT	Head bolts not incl.; Head bolt replacement recommended	
1	Head Set	2000-98	HS 9158 PT	Head bolts & exh. pipe flange not incl.; Head bolt replacement recommended; PermaDry® molded rubber valve cover gskts. incl.; Premium valve stem seals incl.	
1	Head Set	1997-95	HS 9037 PT	Head bolts & exh. pipe flange not incl.; Head bolt replacement recommended; PermaDry® molded rubber valve cover gskts. incl.; Premium valve stem seals incl.	
1	Head Bolt Set	2000-95	ES 72859	Head bolts w/Washers; Replacement recommended	
QTY	CONVERSION SET	YEARS	PART NO.	DESCRIPTION	
1	Gasket Conversion Set	2000-95	CS 9037		
QTY	MANIFOLD - INT. & EXH.	YEARS	PART NO.	DESCRIPTION	
1	Int. Manifold Gasket Set	2000-95	MS 95709	Lower set; Upper set incl.	
1	Plenum Gasket Set	2000-95	MS 95708	Upper set	
1	Exh. Manifold Gasket Set	2000-95	MS 95711		
QTY	EXHAUST PIPE FLANGE	YEARS	PART NO.	DESCRIPTION	
1	Exhaust Pipe Gasket	2000-95	60917	Pipe to muffler	
2	Exhaust Pipe Gasket	2000-96	60496-1	Chrysler Sebring JX, JXi; Converter	
1	Exhaust Pipe Gasket	2000-96	60496-1	Chrysler Sebring JX, JXi; Flange	
1	Exhaust Pipe Gasket	2000-96	61002	Exc. Chrysler Sebring JX, JXi; Converter	

Chrysler Car (Incl. Chrysler, DeSoto, Dodge, Eagle, Plymouth) (Cont.)

38 (cont.)		2000 - 1995; 2.5L 152.2 (2497cc) SOHC V6 (24 Valve) 83.5mm Bore			38 (cont.)
MFI; Gasoline; Naturally Aspirated Mitsubishi Eng.; VIN Code H, Eng. Code 6G73					
QTY	EXHAUST PIPE FLANGE	YEARS	PART NO.	DESCRIPTION	
1	Exhaust Pipe Gasket	2000-96	61049	Exc. Chrysler Sebring JX, JXi; Flange	
1	Exhaust Pipe Gasket	1995	61002	Converter	
1	Exhaust Pipe Gasket	1995	61049	Flange	
QTY	OIL PAN	YEARS	PART NO.	DESCRIPTION	
1	Oil Pan Gasket Set	2000-95	OS 30672 C		
QTY	CRANKSHAFT REAR SEAL	YEARS	PART NO.	DESCRIPTION	
1	Rear Main Seal Set	2000-95	BS 40562	Rubber; One-piece	
1	Rear Main Seal Set	2000-95	BS 40627	PTFE Rubber; One-piece	
QTY	VALVE COVER	YEARS	PART NO.	DESCRIPTION	
1	Valve Cover Gasket Set	2000-95	VS 50461 R	w/Spark plug tube seals; PermaDry® molded rubber gskts. incl.	
1	Spark Plug Tube Seal Set	2000-95	ES 72120-1	Valve Cover	
QTY	VALVE STEM SEAL SET	YEARS	PART NO.	DESCRIPTION	
1	Valve Stem Seal Set	2000-95	SS 70795	Premium valve stem seals incl.	
QTY	THERMOSTAT HOUSING	YEARS	PART NO.	DESCRIPTION	
1	Thermostat Gasket	2000-95	35589	Thermostat Housing; Thermostat case to head	
1	Thermostat Gasket	2000-96	35650	Exc. Chrysler Sebring JX, JXi; Thermostat Housing	
1	Thermostat Gasket	1995	35650	Thermostat Housing	
QTY	WATER OUTLET GASKET	YEARS	PART NO.	DESCRIPTION	
1	Water Outlet Gasket	2000-95	35520	Water Outlet; Inlet	
2	Water Outlet Gasket	2000-95	35959	Water Outlet; Water pipe; O-ring	
1	O-Ring	2000-95	35555	Water Outlet	
QTY	WATER PUMP	YEARS	PART NO.	DESCRIPTION	
1	Water Pump Gasket	2000-95	35584		
QTY	TIMING COVER	YEARS	PART NO.	DESCRIPTION	
1	Crankshaft Front Seal Set	2000-95	TCS 45965		
2	Camshaft Front Seal Set	2000-95	TCS 45483		
QTY	CARB & FUEL INJECTION	YEARS	PART NO.	DESCRIPTION	
2	Fuel Injector O-Ring Set	2000-95	ES 70600		
1	Throttle Body Gasket	2000-95	60999		
QTY	EXHAUST GAS RECIRCULATION	YEARS	PART NO.	DESCRIPTION	
2	EGR Gasket	2000-95	70721	Tube flange	
1	EGR Gasket	2000-96	70561	Chrysler Sebring JX, JXi; Valve	
1	EGR Gasket	2000-96	70720	Exc. Chrysler Sebring JX, JXi; Valve	
1	EGR Gasket	1995	70720	Valve	
39		2000 - 1995; 2.5L 152.2 (2497cc) SOHC V6 (24 Valve) 83.5mm Bore			39
MFI; Gasoline; Naturally Aspirated Mitsubishi Eng.; VIN Code N, Eng. Code 6G73					
QTY	CYLINDER HEAD	YEARS	PART NO.	DESCRIPTION	
2	Head Gasket	2000-98	9158 PT	Head bolts not incl.; Head bolt replacement recommended; PermaTorqueMLS®	
2	Head Gasket	1997-95	9037 PT	Head bolts not incl.; Head bolt replacement recommended	
1	Head Set	2000-98	HS 9158 PT	Head bolts & exh. pipe flange not incl.; Head bolt replacement recommended; PermaDry® molded rubber valve cover gskts. incl.; Premium valve stem seals incl.	
1	Head Set	1997-95	HS 9037 PT	Head bolts & exh. pipe flange not incl.; Head bolt replacement recommended; PermaDry® molded rubber valve cover gskts. incl.; Premium valve stem seals incl.	
1	Head Bolt Set	2000-95	ES 72859	Head bolts w/Washers; Replacement recommended	
QTY	CONVERSION SET	YEARS	PART NO.	DESCRIPTION	
1	Gasket Conversion Set	2000-95	CS 9037		
QTY	MANIFOLD - INT. & EXH.	YEARS	PART NO.	DESCRIPTION	
1	Int. Manifold Gasket Set	2000-95	MS 95709	Lower set; Upper set incl.	
1	Plenum Gasket Set	2000-95	MS 95708	Upper set	
1	Exh. Manifold Gasket Set	2000-95	MS 95711		
QTY	EXHAUST PIPE FLANGE	YEARS	PART NO.	DESCRIPTION	
2	Exhaust Pipe Gasket	2000-95	60496-1	Converter	
1	Exhaust Pipe Gasket	2000-95	60496-1	Flange	
1	Exhaust Pipe Gasket	2000-95	60917	Pipe to muffler	
QTY	OIL PAN	YEARS	PART NO.	DESCRIPTION	
1	Oil Pan Gasket Set	2000-95	OS 30672 C		
QTY	CRANKSHAFT REAR SEAL	YEARS	PART NO.	DESCRIPTION	
1	Rear Main Seal Set	2000-95	BS 40562	Rubber; One-piece	
1	Rear Main Seal Set	2000-95	BS 40627	PTFE Rubber; One-piece	

Chrysler Car (Incl. Chrysler, DeSoto, Dodge, Eagle, Plymouth) (Cont.)

39 (cont.)		2000 - 1995; 2.5L 152.2 (2497cc) SOHC V6 (24 Valve) 83.5mm Bore			39 (cont.)
MFI; Gasoline; Naturally Aspirated Mitsubishi Eng.; VIN Code N, Eng. Code 6G73					
QTY	VALVE COVER	YEARS	PART NO.	DESCRIPTION	
1	Valve Cover Gasket Set	2000-95	VS 50461 R	w/Spark plug tube seals; PermaDry® molded rubber gskts. incl.	
1	Spark Plug Tube Seal Set	2000-95	ES 72120-1	Valve Cover	
QTY	VALVE STEM SEAL SET	YEARS	PART NO.	DESCRIPTION	
1	Valve Stem Seal Set	2000-95	SS 70795	Premium valve stem seals incl.	
QTY	THERMOSTAT HOUSING	YEARS	PART NO.	DESCRIPTION	
1	Thermostat Gasket	2000-95	35589	Thermostat Housing; Thermostat case to head	
QTY	WATER OUTLET GASKET	YEARS	PART NO.	DESCRIPTION	
1	Water Outlet Gasket	2000-95	35520	Water Outlet; Inlet	
2	Water Outlet Gasket	2000-95	35959	Water Outlet; Water pipe; O-ring	
1	O-Ring	2000-95	35555	Water Outlet	
QTY	WATER PUMP	YEARS	PART NO.	DESCRIPTION	
1	Water Pump Gasket	2000-95	35584		
QTY	TIMING COVER	YEARS	PART NO.	DESCRIPTION	
1	Crankshaft Front Seal Set	2000-95	TCS 45965		
2	Camshaft Front Seal Set	2000-95	TCS 45483		
QTY	CARB & FUEL INJECTION	YEARS	PART NO.	DESCRIPTION	
2	Fuel Injector O-Ring Set	2000-95	ES 70600		
1	Throttle Body Gasket	2000-95	60999		
QTY	EXHAUST GAS RECIRCULATION	YEARS	PART NO.	DESCRIPTION	
1	EGR Gasket	2000-95	70561	Valve	
2	EGR Gasket	2000-95	70721	Tube flange	
40		1992 - 1991; 2.5L 153 (2507cc) SOHC L4 (8 Valve) 87.5mm Bore			40
MFI; Gasoline; Turbo Chrysler Eng.; VIN Code J					
QTY	CYLINDER HEAD	YEARS	PART NO.	DESCRIPTION	
1	Head Gasket	1992-91	9296 PT	Head bolts not incl.; Head bolt replacement recommended; PermaTorque®	
1	Head Gasket Spacer Shim	1992-91	9296 SP	HeadSaver®	
1	Head Set	1992-91	HS 9296 PT-1	Head bolts & exh. pipe packing not incl.; Head bolt replacement recommended; PermaDry® molded rubber valve cover gskt. incl.; Premium valve stem seals incl.	
1	Head Set w/Head Bolts	1992-91	HSB 9296 PT-1	w/Head bolts w/o Washers; Washers are req'd.; Exh. pipe packing not incl.; PermaDry® molded rubber valve cover gskt. incl.; Premium valve stem seals incl.	
1	Head Bolt Set	1992-91	ES 72723	Head bolts w/o Washers; Washers are req'd.; Replacement recommended	
1	Head Bolt Washer Set	1992-91	ES 72176	Replacement recommended	
QTY	CONVERSION SET	YEARS	PART NO.	DESCRIPTION	
1	Gasket Conversion Set	1992-91	CS 8763-2	PermaDry® molded rubber oil pan gskt. incl.	
QTY	MANIFOLD - INT. & EXH.	YEARS	PART NO.	DESCRIPTION	
1	Int. & Exh. Gasket Set	1992-91	MS 90947		
QTY	EXHAUST PIPE FLANGE	YEARS	PART NO.	DESCRIPTION	
1	Exhaust Pipe Gasket	1992-91	60810	Pipe to manifold	
1	Exh. Flange Bolt & Spring Kit	1992-91	ES 72143		
QTY	FUEL PUMP	YEARS	PART NO.	DESCRIPTION	
2	Fuel Pump Mounting Gasket	1992-91	70627	May also be used as a fuel pump block-off plate gasket if desired	
QTY	OIL PAN	YEARS	PART NO.	DESCRIPTION	
1	Oil Pan Gasket Set	1992-91	OS 30612 R	PermaDry® molded rubber gskt. incl.	
1	Oil Pan Gasket Set	1992-91	OS 30612 T	PermaDryPlus®; Oil Pan SnapUps® incl.	
1	Drain Plug Gasket	1992-91	70822		
QTY	CRANKSHAFT REAR SEAL	YEARS	PART NO.	DESCRIPTION	
1	Rear Main Seal Set	1992-91	BS 40168-1	Rubber; One-piece	
1	Rear Main Seal Set	1992-91	BS 40627	PTFE Rubber; One-piece	
1	Repair Sleeve Tool	1992-91	16300	Crankshaft	
QTY	VALVE COVER	YEARS	PART NO.	DESCRIPTION	
1	Valve Cover Gasket Set	1992-91	VS 50334 R	PermaDry® molded rubber gskt. incl.	
QTY	VALVE STEM SEAL SET	YEARS	PART NO.	DESCRIPTION	
1	Valve Stem Seal Set	1992-91	SS 72522	Premium valve stem seals incl.	
QTY	WATER OUTLET GASKET	YEARS	PART NO.	DESCRIPTION	
1	Water Outlet Gasket	1992-91	35286	Water Outlet	
1	Water Outlet Gasket	1992-91	35286 T	Water Outlet; PermaDryPlus®	
QTY	WATER PUMP	YEARS	PART NO.	DESCRIPTION	
1	Water Pump Gasket	1992-91	35444		
1	O-Ring	1992-91	35224	Water Pump	

Chrysler Car (Incl. Chrysler, DeSoto, Dodge, Eagle, Plymouth) (Cont.)

40 (cont.)		1992 - 1991; 2.5L 153 (2507cc) SOHC L4 (8 Valve) 87.5mm Bore			40 (cont.)
		MFI; Gasoline; Turbo Chrysler Eng.; VIN Code J			
QTY	TIMING COVER	YEARS	PART NO.	DESCRIPTION	
1	Timing Cover Set	1992-91	TCS 45495	Camshaft; Front seal set	
1	Crankshaft Front Seal Set	1992-91	TCS 45131		
1	Auxiliary Shaft Seal Set	1992-91	TCS 45026		
1	Camshaft Rear Seal Plug Set	1992-91	TCS 45833		
QTY	CARB & FUEL INJECTION	YEARS	PART NO.	DESCRIPTION	
2	Fuel Injector O-Ring Set	1992-91	ES 70599	Improved design	
1	Throttle Body Gasket	1992-91	60700		
QTY	DISTRIBUTOR MOUNTING	YEARS	PART NO.	DESCRIPTION	
1	O-Ring	1992-91	70799	Distributor Mounting	
QTY	EXHAUST GAS RECIRCULATION	YEARS	PART NO.	DESCRIPTION	
1	EGR Gasket	1992-91	70561	California	
41		1995 - 1991; 2.5L 153 (2507cc) SOHC L4 (8 Valve) 87.5mm Bore			41
		TBI; Gasoline; Naturally Aspirated Chrysler Eng.; VIN Code K			
QTY	CYLINDER HEAD	YEARS	PART NO.	DESCRIPTION	
1	Head Gasket	1995-91	9296 PT	Head bolts not incl.; Head bolt replacement recommended; PermaTorque®	
1	Head Gasket Spacer Shim	1995-91	9296 SP	HeadSaver®	
1	Head Set	1995-91	HS 9296 PT-2	w/Stamped steel valve cover; Head bolts, exh. pipe packing, camshaft rear seal plug not incl.; Head bolt replacement recommended; Premium valve stem seals incl.	
1	Head Set	1995-91	HS 9296 PT-3	w/Aluminum valve cover; Head bolts, exh. pipe packing, camshaft rear seal plug not incl.; Head bolt replacement recommended; PermaDry® molded rubber valve cover gskt. incl.; Premium valve stem seals incl.	
1	Head Set w/Head Bolts	1995-91	HSB 9296 PT-2	w/Stamped steel valve cover; w/Head bolts w/o Washers; Washers are req'd.; Exh. pipe packing & camshaft rear seal plug not incl.; Premium valve stem seals incl.	
1	Head Installation Set	1995-91	HIS 9296 PT-2	w/Stamped steel valve cover; Head bolts, exh. pipe packing, camshaft rear seal plug not incl.; Head bolt replacement recommended	
1	Head Bolt Set	1995-91	ES 72723	Head bolts w/o Washers; Washers are req'd.; Replacement recommended	
1	Head Bolt Washer Set	1995-91	ES 72176	Replacement recommended	
QTY	CONVERSION SET	YEARS	PART NO.	DESCRIPTION	
1	Gasket Conversion Set	1995-91	CS 8763-2	PermaDry® molded rubber oil pan gskt. incl.	
QTY	MANIFOLD - INT. & EXH.	YEARS	PART NO.	DESCRIPTION	
1	Int. & Exh. Gasket Set	1995-91	MS 90947		
QTY	EXHAUST PIPE FLANGE	YEARS	PART NO.	DESCRIPTION	
1	Exhaust Pipe Gasket	1995-91	60632	Pipe to manifold	
1	Exh. Flange Bolt & Spring Kit	1995-91	ES 72143		
QTY	FUEL PUMP	YEARS	PART NO.	DESCRIPTION	
2	Fuel Pump Mounting Gasket	1995-91	70627	May also be used as a fuel pump block-off plate gasket if desired	
QTY	OIL PAN	YEARS	PART NO.	DESCRIPTION	
1	Oil Pan Gasket Set	1995-91	OS 30612 R	PermaDry® molded rubber gskt. incl.	
1	Oil Pan Gasket Set	1995-91	OS 30612 T	PermaDryPlus®; Oil Pan SnapUps® incl.	
1	Drain Plug Gasket	1995-91	70822		
QTY	CRANKSHAFT REAR SEAL	YEARS	PART NO.	DESCRIPTION	
1	Rear Main Seal Set	1995-91	BS 40168-1	Rubber; One-piece	
1	Rear Main Seal Set	1995-91	BS 40627	PTFE Rubber; One-piece	
1	Repair Sleeve Tool	1995-91	16300	Crankshaft	
QTY	VALVE COVER	YEARS	PART NO.	DESCRIPTION	
1	Valve Cover Gasket Set	1995-91	VS 50205 C	w/Stamped steel valve cover; Cork	
1	Valve Cover Gasket Set	1995-91	VS 50205 T	w/Stamped steel valve cover; PermaDryPlus®	
1	Valve Cover Gasket Set	1995-91	VS 50334 R	w/Aluminum valve cover; PermaDry® molded rubber gskt. incl.	
QTY	VALVE STEM SEAL SET	YEARS	PART NO.	DESCRIPTION	
1	Valve Stem Seal Set	1995-91	SS 72522	Premium valve stem seals incl.	
QTY	WATER OUTLET GASKET	YEARS	PART NO.	DESCRIPTION	
1	Water Outlet Gasket	1995-91	35286	Water Outlet	
1	Water Outlet Gasket	1995-91	35286 T	Water Outlet; PermaDryPlus®	
QTY	WATER PUMP	YEARS	PART NO.	DESCRIPTION	
1	Water Pump Gasket	1995-91	35444		
1	O-Ring	1995-91	35224	Water Pump	
QTY	TIMING COVER	YEARS	PART NO.	DESCRIPTION	
1	Timing Cover Set	1995-91	TCS 45495	Camshaft; Front seal set	
1	Crankshaft Front Seal Set	1995-91	TCS 45131		
1	Auxiliary Shaft Seal Set	1995-91	TCS 45026		
1	Camshaft Rear Seal Plug Set	1995-91	TCS 45833		

Chrysler Car (Incl. Chrysler, DeSoto, Dodge, Eagle, Plymouth) (Cont.)

41 (cont.)		1995 - 1991; 2.5L 153 (2507cc) SOHC L4 (8 Valve) 87.5mm Bore			41 (cont.)
TBI; Gasoline; Naturally Aspirated Chrysler Eng.; VIN Code K					
QTY	CARB & FUEL INJECTION	YEARS	PART NO.	DESCRIPTION	
1	Throttle Body Gasket	1995-91	60743		
QTY	DISTRIBUTOR MOUNTING	YEARS	PART NO.	DESCRIPTION	
1	O-Ring	1995-91	70799	Distributor Mounting	
QTY	EXHAUST GAS RECIRCULATION	YEARS	PART NO.	DESCRIPTION	
1	EGR Gasket	1995-91	70561		
42		1994 - 1993; 2.5L 153 (2507cc) SOHC L4 (8 Valve) 87.5mm Bore			42
MFI; Flex Fuel; Naturally Aspirated Chrysler Eng.; VIN Code V					
QTY	CYLINDER HEAD	YEARS	PART NO.	DESCRIPTION	
1	Head Gasket	1994-93	9296 PT	Head bolts not incl.; Head bolt replacement recommended; PermaTorque®	
1	Head Gasket Spacer Shim	1994-93	9296 SP	HeadSaver®	
1	Head Set	1994-93	HS 9296 PT-2	w/Stamped steel valve cover; Head bolts, exh. pipe packing, camshaft rear seal plug not incl.; Head bolt replacement recommended; Premium valve stem seals incl.	
1	Head Set	1994-93	HS 9296 PT-3	w/Aluminum valve cover; Head bolts, exh. pipe packing, camshaft rear seal plug not incl.; Head bolt replacement recommended; PermaDry® molded rubber valve cover gskt. incl.; Premium valve stem seals incl.	
1	Head Set w/Head Bolts	1994-93	HSB 9296 PT-2	w/Stamped steel valve cover; w/Head bolts w/o Washers; Washers are req'd.; Exh. pipe packing & camshaft rear seal plug not incl.; Premium valve stem seals incl.	
1	Head Installation Set	1994-93	HIS 9296 PT-2	w/Stamped steel valve cover; Head bolts, exh. pipe packing, camshaft rear seal plug not incl.; Head bolt replacement recommended	
1	Head Bolt Set	1994-93	ES 72723	Head bolts w/o Washers; Washers are req'd.; Replacement recommended	
1	Head Bolt Washer Set	1994-93	ES 72176	Replacement recommended	
QTY	CONVERSION SET	YEARS	PART NO.	DESCRIPTION	
1	Gasket Conversion Set	1994-93	CS 8763-2	PermaDry® molded rubber oil pan gskt. incl.	
QTY	MANIFOLD - INT. & EXH.	YEARS	PART NO.	DESCRIPTION	
1	Int. & Exh. Gasket Set	1994-93	MS 90947		
QTY	EXHAUST PIPE FLANGE	YEARS	PART NO.	DESCRIPTION	
1	Exhaust Pipe Gasket	1994-93	60632	Pipe to manifold	
1	Exh. Flange Bolt & Spring Kit	1994-93	ES 72143		
QTY	FUEL PUMP	YEARS	PART NO.	DESCRIPTION	
2	Fuel Pump Mounting Gasket	1994-93	70627	May also be used as a fuel pump block-off plate gasket if desired	
QTY	OIL PAN	YEARS	PART NO.	DESCRIPTION	
1	Oil Pan Gasket Set	1994-93	OS 30612 R	PermaDry® molded rubber gskt. incl.	
1	Oil Pan Gasket Set	1994-93	OS 30612 T	PermaDryPlus®; Oil Pan SnapUps® incl.	
1	Drain Plug Gasket	1994-93	70822		
QTY	CRANKSHAFT REAR SEAL	YEARS	PART NO.	DESCRIPTION	
1	Rear Main Seal Set	1994-93	BS 40168-1	Rubber; One-piece	
1	Rear Main Seal Set	1994-93	BS 40627	PTFE Rubber; One-piece	
1	Repair Sleeve Tool	1994-93	16300	Crankshaft	
QTY	VALVE COVER	YEARS	PART NO.	DESCRIPTION	
1	Valve Cover Gasket Set	1994-93	VS 50205 C	w/Stamped steel valve cover; Cork	
1	Valve Cover Gasket Set	1994-93	VS 50205 T	w/Stamped steel valve cover; PermaDryPlus®	
1	Valve Cover Gasket Set	1994-93	VS 50334 R	w/Aluminum valve cover; PermaDry® molded rubber gskt. incl.	
QTY	VALVE STEM SEAL SET	YEARS	PART NO.	DESCRIPTION	
1	Valve Stem Seal Set	1994-93	SS 72522	Premium valve stem seals incl.	
QTY	WATER OUTLET GASKET	YEARS	PART NO.	DESCRIPTION	
1	Water Outlet Gasket	1994-93	35286	Water Outlet	
1	Water Outlet Gasket	1994-93	35286 T	Water Outlet; PermaDryPlus®	
QTY	WATER PUMP	YEARS	PART NO.	DESCRIPTION	
1	Water Pump Gasket	1994-93	35444		
1	O-Ring	1994-93	35224	Water Pump	
QTY	TIMING COVER	YEARS	PART NO.	DESCRIPTION	
1	Timing Cover Set	1994-93	TCS 45495	Camshaft; Front seal set	
1	Crankshaft Front Seal Set	1994-93	TCS 45131		
1	Auxiliary Shaft Seal Set	1994-93	TCS 45026		
1	Camshaft Rear Seal Plug Set	1994-93	TCS 45833		
QTY	CARB & FUEL INJECTION	YEARS	PART NO.	DESCRIPTION	
1	Throttle Body Gasket	1994-93	60700		
QTY	DISTRIBUTOR MOUNTING	YEARS	PART NO.	DESCRIPTION	
1	O-Ring	1994-93	70799	Distributor Mounting	
QTY	EXHAUST GAS RECIRCULATION	YEARS	PART NO.	DESCRIPTION	
1	EGR Gasket	1994-93	70561		

Chrysler Car (Incl. Chrysler, DeSoto, Dodge, Eagle, Plymouth) (Cont.)

43		2011 - 2010; 2.7L 167 (2736cc) DOHC V6 (24 Valve) 86mm Bore MFI; Flex Fuel; Naturally Aspirated Chrysler Eng.; VIN Code D			43
QTY	CYLINDER HEAD	YEARS	PART NO.	DESCRIPTION	
1	Head Gasket	2010	9514 PT	Loc. L.H.; Head bolts not incl.; Head bolt replacement recommended; PermaTorqueMLS®	
1	Head Gasket	2010	9517 PT	Loc. R.H.; Head bolts not incl.; Head bolt replacement recommended; PermaTorqueMLS®	
1	Head Set	2010	HS 9514 PT-1	Head bolts not incl.; Head bolt replacement recommended; PermaDry® molded rubber valve cover gskts. incl.; Premium valve stem seals incl.	
2	Head Bolt Set	2010	ES 72897	Head bolts w/Washers; Replacement recommended	
QTY	CONVERSION SET	YEARS	PART NO.	DESCRIPTION	
1	Gasket Conversion Set	2010	CS 9514-2	PermaDry® molded rubber oil pan gskt. incl.; New Part Number - Check for Availability	
QTY	MANIFOLD - INT. & EXH.	YEARS	PART NO.	DESCRIPTION	
1	Int. Manifold Gasket Set	2010	MS 91473	Lower set; Upper set incl.	
1	Plenum Gasket Set	2010	MS 91476	Upper set	
1	Exh. Manifold Gasket Set	2010	MS 91483		
QTY	EXHAUST PIPE FLANGE	YEARS	PART NO.	DESCRIPTION	
1	Exhaust Pipe Gasket	2010	61002	Pipe to manifold	
1	Exhaust Pipe Gasket	2010	61283	Converter	
2	Exhaust Pipe Gasket	2010	61494	Crossover	
QTY	OIL PAN	YEARS	PART NO.	DESCRIPTION	
1	Oil Pan Gasket Set	2010	OS 30818 R	PermaDry® molded rubber gskt. incl.; New Part Number - Check for Availability	
QTY	CRANKSHAFT REAR SEAL	YEARS	PART NO.	DESCRIPTION	
1	Rear Main Seal Set	2010	BS 40690	Rubber; One-piece	
QTY	VALVE COVER	YEARS	PART NO.	DESCRIPTION	
1	Valve Cover Gasket Set	2010	VS 50520 R	w/o Grommets & w/Spark plug tube seals; PermaDry® molded rubber gskts. incl.	
2	Grommet Set	2010	ES 71105	Valve Cover	
1	Spark Plug Tube Seal Set	2010	ES 72948	Valve Cover; New Part Number - Check for Availability	
QTY	VALVE STEM SEAL SET	YEARS	PART NO.	DESCRIPTION	
2	Valve Stem Seal Set	2010	SS 72871-1	Premium valve stem seals incl.	
QTY	THERMOSTAT HOUSING	YEARS	PART NO.	DESCRIPTION	
1	Thermostat Gasket	2010	35770	Thermostat Housing; Thermostat seal	
QTY	WATER OUTLET GASKET	YEARS	PART NO.	DESCRIPTION	
1	Water Outlet Gasket	2011-10	36001	Water Outlet; Water outlet; Square shape; New Part Number - Check for Availability	
1	Water Outlet Gasket	2011-10	36002	Water Outlet; Water outlet; Oval shape; New Part Number - Check for Availability	
QTY	WATER PUMP	YEARS	PART NO.	DESCRIPTION	
1	Water Pump Gasket	2010	35904		
QTY	TIMING COVER	YEARS	PART NO.	DESCRIPTION	
1	Timing Cover Set	2010	TCS 45035		
1	Crankshaft Front Seal Set	2010	TCS 46164	New Part Number - Check for Availability	
1	Repair Sleeve	2010	16224	Timing Cover; Use w/installation tool	
1	Repair Sleeve Tool	2010	16325	Timing Cover	
QTY	CARB & FUEL INJECTION	YEARS	PART NO.	DESCRIPTION	
3	Fuel Injector O-Ring Set	2010	ES 70599	Improved design	
1	Throttle Body Gasket	2010	61324	Idle air control; 21mm ID	
1	Throttle Body Gasket	2010	61326	Idle air control; 30mm ID	
1	Throttle Body Gasket	2010	61389	Mounting	
QTY	EXHAUST GAS RECIRCULATION	YEARS	PART NO.	DESCRIPTION	
2	EGR Gasket	2010	70693	Tube flange	
2	EGR Gasket	2010	70696	Exc. Chrysler 300 Base, LX, Touring Dodge Charger SE; Tube seal	
1	EGR Gasket	2010	71185	Valve	
2	EGR Gasket	2010	72928	Chrysler 300 Base, LX, Touring Dodge Charger SE; Tube seal	
44		2011 - 1998; 2.7L 167 (2736cc) DOHC V6 (24 Valve) 86mm Bore MFI; Gasoline; Naturally Aspirated Chrysler Eng.; VIN Code R			44
QTY	CYLINDER HEAD	YEARS	PART NO.	DESCRIPTION	
1	Head Gasket	2010-98	9514 PT	Loc. L.H.; Head bolts not incl.; Head bolt replacement recommended; PermaTorqueMLS®	
1	Head Gasket	2010-98	9517 PT	Loc. R.H.; Head bolts not incl.; Head bolt replacement recommended; PermaTorqueMLS®	

Chrysler Car (Incl. Chrysler, DeSoto, Dodge, Eagle, Plymouth) (Cont.)

44 (cont.)		2011 - 1998; 2.7L 167 (2736cc) DOHC V6 (24 Valve) 86mm Bore			44 (cont.)
MFI; Gasoline; Naturally Aspirated Chrysler Eng.; VIN Code R					
QTY	CYLINDER HEAD	YEARS	PART NO.	DESCRIPTION	
1	Head Set	2010-01	HS 9514 PT-1	Head bolts not incl.; Head bolt replacement recommended; PermaDry® molded rubber valve cover gskts. incl.; Premium valve stem seals incl.	
1	Head Set	2000-98	HS 9514 PT	Head bolts not incl.; Head bolt replacement recommended; PermaDry® molded rubber valve cover gskts. incl.; Premium valve stem seals incl.	
2	Head Bolt Set	2010-98	ES 72897	Head bolts w/Washers; Replacement recommended	
QTY	CONVERSION SET	YEARS	PART NO.	DESCRIPTION	
1	Gasket Conversion Set	2010-08	CS 9514-1	PermaDry® molded rubber oil pan gskt. incl.	
1	Gasket Conversion Set	2007-06	CS 9514	Exc. Chrysler 300 Base Dodge Charger Base, SE, Magnum SE; PermaDry® molded rubber oil pan gskt. incl.	
1	Gasket Conversion Set	2007-06	CS 9514-1	Chrysler 300 Base Dodge Charger Base, SE, Magnum SE; PermaDry® molded rubber oil pan gskt. incl.	
1	Gasket Conversion Set	2005	CS 9514	Exc. Chrysler 300 Base Dodge Magnum SE; PermaDry® molded rubber oil pan gskt. incl.	
1	Gasket Conversion Set	2005	CS 9514-1	Chrysler 300 Base Dodge Magnum SE; PermaDry® molded rubber oil pan gskt. incl.	
1	Gasket Conversion Set	2004-98	CS 9514	PermaDry® molded rubber oil pan gskt. incl.	
QTY	MANIFOLD - INT. & EXH.	YEARS	PART NO.	DESCRIPTION	
1	Int. Manifold Gasket Set	2010-98	MS 91473	Lower set; Upper set incl.	
1	Plenum Gasket Set	2010-98	MS 91476	Upper set	
1	Exh. Manifold Gasket Set	2010-98	MS 91483		
QTY	EXHAUST PIPE FLANGE	YEARS	PART NO.	DESCRIPTION	
1	Exhaust Pipe Gasket	2010-02	61283	Converter	
2	Exhaust Pipe Gasket	2010-07	61494	Crossover	
1	Exhaust Pipe Gasket	2010-08	61002	Pipe to manifold	
1	Exhaust Pipe Gasket	2007-06	61002	Exc. Chrysler 300 Base Dodge Charger Base, SE, Magnum SE; Pipe to manifold	
1	Exhaust Pipe Gasket	2006-02	61284	Crossover	
1	Exhaust Pipe Gasket	2005	61002	Exc. Chrysler 300 Base Dodge Magnum SE; Pipe to manifold	
1	Exhaust Pipe Gasket	2004	61002	Exc. Chrysler Concorde LX, Intrepid Base, SE Dodge Intrepid SE; Pipe to manifold	
1	Exhaust Pipe Gasket	2003	61002	Exc. Chrysler Concorde LX, Intrepid Base, ES, SE Dodge Intrepid SE; Pipe to manifold	
1	Exhaust Pipe Gasket	2002	61002	Exc. Chrysler Concorde LX, Intrepid Base Dodge Intrepid SE; Pipe to manifold	
QTY	OIL PAN	YEARS	PART NO.	DESCRIPTION	
1	Oil Pan Gasket Set	2010-98	OS 30689 R	PermaDry® molded rubber gskt. incl.	
QTY	CRANKSHAFT REAR SEAL	YEARS	PART NO.	DESCRIPTION	
1	Rear Main Seal Set	2010-08	BS 40690	Rubber; One-piece	
1	Rear Main Seal Set	2007-06	BS 40657	Exc. Chrysler 300 Base Dodge Charger Base, SE, Magnum SE; Rubber; One-piece	
1	Rear Main Seal Set	2007-06	BS 40690	Chrysler 300 Base Dodge Charger Base, SE, Magnum SE; Rubber; One-piece	
1	Rear Main Seal Set	2005	BS 40657	Exc. Chrysler 300 Base Dodge Magnum SE; Rubber; One-piece	
1	Rear Main Seal Set	2005	BS 40690	Chrysler 300 Base Dodge Magnum SE; Rubber; One-piece	
1	Rear Main Seal Set	2004-98	BS 40657	Rubber; One-piece	
QTY	VALVE COVER	YEARS	PART NO.	DESCRIPTION	
1	Valve Cover Gasket Set	2010-01	VS 50520 R	w/o Grommets & w/Spark plug tube seals; PermaDry® molded rubber gskts. incl.	
1	Valve Cover Gasket Set	2000-98	VS 50496 R	w/o Grommets & w/Spark plug tube seals; PermaDry® molded rubber gskts. incl.	
2	Grommet Set	2010-98	ES 71105	Valve Cover	
1	Spark Plug Tube Seal Set	2010-98	ES 72948	Valve Cover; New Part Number - Check for Availability	
QTY	VALVE STEM SEAL SET	YEARS	PART NO.	DESCRIPTION	
2	Valve Stem Seal Set	2010-98	SS 72871-1	Premium valve stem seals incl.	
QTY	THERMOSTAT HOUSING	YEARS	PART NO.	DESCRIPTION	
1	Thermostat Gasket	2010-08	35770	Thermostat Housing; Thermostat seal	
1	Thermostat Gasket	2007-06	35660	Exc. Chrysler 300 Base Dodge Charger Base, SE, Magnum SE; Thermostat Housing; Thermostat seal	
1	Thermostat Gasket	2007-06	35770	Chrysler 300 Base Dodge Charger Base, SE, Magnum SE; Thermostat Housing; Thermostat seal	
1	Thermostat Gasket	2005	35660	Exc. Chrysler 300 Base Dodge Magnum SE; Thermostat Housing; Thermostat seal	
1	Thermostat Gasket	2005	35770	Chrysler 300 Base Dodge Magnum SE; Thermostat Housing; Thermostat seal	

Chrysler Car (Incl. Chrysler, DeSoto, Dodge, Eagle, Plymouth) (Cont.)

44 (cont.)		2011 - 1998; 2.7L 167 (2736cc) DOHC V6 (24 Valve) 86mm Bore			44 (cont.)
		MFI; Gasoline; Naturally Aspirated Chrysler Eng.; VIN Code R			
QTY	THERMOSTAT HOUSING	YEARS	PART NO.	DESCRIPTION	
1	Thermostat Gasket	2004-98	35660	Thermostat Housing; Thermostat seal	
QTY	WATER OUTLET GASKET	YEARS	PART NO.	DESCRIPTION	
1	Water Outlet Gasket	2011-09	36001	Water Outlet; Water outlet; Square shape; New Part Number - Check for Availability	
1	Water Outlet Gasket	2011-09	36002	Water Outlet; Water outlet; Oval shape; New Part Number - Check for Availability	
QTY	WATER PUMP	YEARS	PART NO.	DESCRIPTION	
1	Water Pump Gasket	2010-08	35904		
1	Water Pump Gasket	2007-98	35652		
QTY	TIMING COVER	YEARS	PART NO.	DESCRIPTION	
1	Timing Cover Set	2010-98	TCS 45035		
1	Crankshaft Front Seal Set	2010-98	TCS 46164	New Part Number - Check for Availability	
1	Repair Sleeve	2010-98	16224	Timing Cover; Use w/installation tool	
1	Repair Sleeve Tool	2010-98	16325	Timing Cover	
QTY	CARB & FUEL INJECTION	YEARS	PART NO.	DESCRIPTION	
3	Fuel Injector O-Ring Set	2010-98	ES 70599	Improved design	
1	Throttle Body Gasket	2010-03	61324	Idle air control; 21mm ID	
1	Throttle Body Gasket	2010-03	61326	Idle air control; 30mm ID	
1	Throttle Body Gasket	2010-08	61389	Mounting	
1	Throttle Body Gasket	2007-06	61107	Exc. Chrysler 300 Base Dodge Charger Base, SE, Magnum SE; Mounting	
1	Throttle Body Gasket	2007-06	61389	Chrysler 300 Base Dodge Charger Base, SE, Magnum SE; Mounting	
1	Throttle Body Gasket	2005	61107	Exc. Chrysler 300 Base Dodge Magnum SE; Mounting	
1	Throttle Body Gasket	2005	61389	Chrysler 300 Base Dodge Magnum SE; Mounting	
1	Throttle Body Gasket	2004-98	61107	Mounting	
QTY	EXHAUST GAS RECIRCULATION	YEARS	PART NO.	DESCRIPTION	
2	EGR Gasket	2010-98	70693	Tube flange	
1	EGR Gasket	2010-05	71185	Valve	
2	EGR Gasket	2010	70696	Exc. Chrysler 300 Base, LX, Touring Dodge Charger SE; Tube seal	
2	EGR Gasket	2010	72928	Chrysler 300 Base, LX, Touring Dodge Charger SE; Tube seal	
2	EGR Gasket	2009	70696	Exc. Chrysler 300 Base, LX Dodge Charger Base, SE; Tube seal	
2	EGR Gasket	2009	72928	Chrysler 300 Base, LX Dodge Charger Base, SE; Tube seal	
2	EGR Gasket	2008	70696	Exc. Chrysler 300 Base, LX Dodge Charger Base, SE, Magnum SE; Tube seal	
2	EGR Gasket	2008	72928	Chrysler 300 Base, LX Dodge Charger Base, SE, Magnum SE; Tube seal	
2	EGR Gasket	2007-06	70696	Exc. Chrysler 300 Base Dodge Charger Base, SE, Magnum SE; Tube seal	
2	EGR Gasket	2007-06	72928	Chrysler 300 Base Dodge Charger Base, SE, Magnum SE; Tube seal	
2	EGR Gasket	2005	70696	Exc. Chrysler 300 Base Dodge Magnum SE; Tube seal	
2	EGR Gasket	2005	72928	Chrysler 300 Base Dodge Magnum SE; Tube seal	
2	EGR Gasket	2004-98	70696	Tube seal	
45		2009 - 2003; 2.7L 167 (2736cc) DOHC V6 (24 Valve) 86mm Bore			45
		MFI; Flex Fuel; Naturally Aspirated Chrysler Eng.; VIN Code T			
QTY	CYLINDER HEAD	YEARS	PART NO.	DESCRIPTION	
1	Head Gasket	2009-03	9514 PT	Loc. L.H.; Head bolts not incl.; Head bolt replacement recommended; PermaTorqueMLS®	
1	Head Gasket	2009-03	9517 PT	Loc. R.H.; Head bolts not incl.; Head bolt replacement recommended; PermaTorqueMLS®	
1	Head Set	2009-03	HS 9514 PT-1	Head bolts not incl.; Head bolt replacement recommended; PermaDry® molded rubber valve cover gskts. incl.; Premium valve stem seals incl.	
2	Head Bolt Set	2009-03	ES 72897	Head bolts w/Washers; Replacement recommended	
QTY	CONVERSION SET	YEARS	PART NO.	DESCRIPTION	
1	Gasket Conversion Set	2009-08	CS 9514-1	PermaDry® molded rubber oil pan gskt. incl.	
1	Gasket Conversion Set	2007-05	CS 9514	Exc. Dodge Magnum SE; PermaDry® molded rubber oil pan gskt. incl.	
1	Gasket Conversion Set	2007-05	CS 9514-1	Dodge Magnum SE; PermaDry® molded rubber oil pan gskt. incl.	
1	Gasket Conversion Set	2004-03	CS 9514	PermaDry® molded rubber oil pan gskt. incl.	
QTY	MANIFOLD - INT. & EXH.	YEARS	PART NO.	DESCRIPTION	
1	Int. Manifold Gasket Set	2009-03	MS 91473	Lower set; Upper set incl.	
1	Plenum Gasket Set	2009-03	MS 91476	Upper set	
1	Exh. Manifold Gasket Set	2009-03	MS 91483		
QTY	EXHAUST PIPE FLANGE	YEARS	PART NO.	DESCRIPTION	
1	Exhaust Pipe Gasket	2009-03	61283	Converter	
2	Exhaust Pipe Gasket	2009-07	61494	Crossover	
1	Exhaust Pipe Gasket	2009-08	61002	Pipe to manifold	
1	Exhaust Pipe Gasket	2007-05	61002	Exc. Dodge Magnum SE; Pipe to manifold	

Chrysler Car (Incl. Chrysler, DeSoto, Dodge, Eagle, Plymouth) (Cont.)

45 (cont.)		2009 - 2003; 2.7L 167 (2736cc) DOHC V6 (24 Valve) 86mm Bore			45 (cont.)
MFI; Flex Fuel; Naturally Aspirated Chrysler Eng.; VIN Code T					
QTY	EXHAUST PIPE FLANGE	YEARS	PART NO.	DESCRIPTION	
1	Exhaust Pipe Gasket	2006-03	61284	Crossover	
1	Exhaust Pipe Gasket	2004-03	61002	Pipe to manifold	
QTY	OIL PAN	YEARS	PART NO.	DESCRIPTION	
1	Oil Pan Gasket Set	2009-03	OS 30689 R	PermaDry® molded rubber gskt. incl.	
QTY	CRANKSHAFT REAR SEAL	YEARS	PART NO.	DESCRIPTION	
1	Rear Main Seal Set	2009-08	BS 40690	Rubber; One-piece	
1	Rear Main Seal Set	2007-05	BS 40657	Exc. Dodge Magnum SE; Rubber; One-piece	
1	Rear Main Seal Set	2007-05	BS 40690	Dodge Magnum SE; Rubber; One-piece	
1	Rear Main Seal Set	2004-03	BS 40657	Rubber; One-piece	
QTY	VALVE COVER	YEARS	PART NO.	DESCRIPTION	
1	Valve Cover Gasket Set	2009-03	VS 50520 R	w/o Grommets & w/Spark plug tube seals; PermaDry® molded rubber gskts. incl.	
2	Grommet Set	2009-03	ES 71105	Valve Cover	
1	Spark Plug Tube Seal Set	2009-03	ES 72948	Valve Cover; New Part Number - Check for Availability	
QTY	VALVE STEM SEAL SET	YEARS	PART NO.	DESCRIPTION	
2	Valve Stem Seal Set	2009-03	SS 72871-1	Premium valve stem seals incl.	
QTY	THERMOSTAT HOUSING	YEARS	PART NO.	DESCRIPTION	
1	Thermostat Gasket	2009-08	35770	Thermostat Housing; Thermostat seal	
1	Thermostat Gasket	2007-05	35660	Exc. Dodge Magnum SE; Thermostat Housing; Thermostat seal	
1	Thermostat Gasket	2007-05	35770	Dodge Magnum SE; Thermostat Housing; Thermostat seal	
1	Thermostat Gasket	2004-03	35660	Thermostat Housing; Thermostat seal	
QTY	WATER OUTLET GASKET	YEARS	PART NO.	DESCRIPTION	
1	Water Outlet Gasket	2009	36001	Water Outlet; Water outlet; Square shape; New Part Number - Check for Availability	
1	Water Outlet Gasket	2009	36002	Water Outlet; Water outlet; Oval shape; New Part Number - Check for Availability	
QTY	WATER PUMP	YEARS	PART NO.	DESCRIPTION	
1	Water Pump Gasket	2009-08	35904		
1	Water Pump Gasket	2007-03	35652		
QTY	TIMING COVER	YEARS	PART NO.	DESCRIPTION	
1	Timing Cover Set	2009-03	TCS 45035		
1	Crankshaft Front Seal Set	2009-03	TCS 46164	New Part Number - Check for Availability	
1	Repair Sleeve	2009-03	16224	Timing Cover; Use w/installation tool	
1	Repair Sleeve Tool	2009-03	16325	Timing Cover	
QTY	CARB & FUEL INJECTION	YEARS	PART NO.	DESCRIPTION	
3	Fuel Injector O-Ring Set	2009-03	ES 70599	Improved design	
1	Throttle Body Gasket	2009-03	61324	Idle air control; 21mm ID	
1	Throttle Body Gasket	2009-03	61326	Idle air control; 30mm ID	
1	Throttle Body Gasket	2009-08	61389	Mounting	
1	Throttle Body Gasket	2007-05	61107	Exc. Dodge Magnum SE; Mounting	
1	Throttle Body Gasket	2007-05	61389	Dodge Magnum SE; Mounting	
1	Throttle Body Gasket	2004-03	61107	Mounting	
QTY	EXHAUST GAS RECIRCULATION	YEARS	PART NO.	DESCRIPTION	
2	EGR Gasket	2009-03	70693	Tube flange	
1	EGR Gasket	2009-05	71185	Valve	
2	EGR Gasket	2009	70696	Tube seal	
2	EGR Gasket	2008-05	70696	Exc. Dodge Magnum SE; Tube seal	
2	EGR Gasket	2008-05	72928	Dodge Magnum SE; Tube seal	
2	EGR Gasket	2004-03	70696	Tube seal	
46		2005 - 2000; 2.7L 167 (2736cc) DOHC V6 (24 Valve) 86mm Bore			46
MFI; Gasoline; Naturally Aspirated Chrysler Eng.; VIN Code U					
QTY	CYLINDER HEAD	YEARS	PART NO.	DESCRIPTION	
1	Head Gasket	2005-00	9514 PT	Loc. L.H.; Head bolts not incl.; Head bolt replacement recommended; PermaTorqueMLS®	
1	Head Gasket	2005-00	9517 PT	Loc. R.H.; Head bolts not incl.; Head bolt replacement recommended; PermaTorqueMLS®	
1	Head Set	2005-01	HS 9514 PT-1	Head bolts not incl.; Head bolt replacement recommended; PermaDry® molded rubber valve cover gskts. incl.; Premium valve stem seals incl.	
1	Head Set	2000	HS 9514 PT	Head bolts not incl.; Head bolt replacement recommended; PermaDry® molded rubber valve cover gskts. incl.; Premium valve stem seals incl.	
2	Head Bolt Set	2005-00	ES 72897	Head bolts w/Washers; Replacement recommended	
QTY	CONVERSION SET	YEARS	PART NO.	DESCRIPTION	
1	Gasket Conversion Set	2005-00	CS 9514	PermaDry® molded rubber oil pan gskt. incl.	

Chrysler Car (Incl. Chrysler, DeSoto, Dodge, Eagle, Plymouth) (Cont.)

46 (cont.)		2005 - 2000; 2.7L 167 (2736cc) DOHC V6 (24 Valve) 86mm Bore			46 (cont.)
		MFI; Gasoline; Naturally Aspirated Chrysler Eng.; VIN Code U			
QTY	MANIFOLD - INT. & EXH.	YEARS	PART NO.	DESCRIPTION	
1	Int. Manifold Gasket Set	2005-00	MS 91473	Lower set; Upper set incl.	
1	Plenum Gasket Set	2005-00	MS 91476	Upper set	
1	Exh. Manifold Gasket Set	2005-00	MS 91483		
QTY	EXHAUST PIPE FLANGE	YEARS	PART NO.	DESCRIPTION	
1	Exhaust Pipe Gasket	2005-02	61002	Pipe to manifold	
1	Exhaust Pipe Gasket	2005-02	61283	Converter	
1	Exhaust Pipe Gasket	2005-02	61284	Crossover	
QTY	OIL PAN	YEARS	PART NO.	DESCRIPTION	
1	Oil Pan Gasket Set	2005-00	OS 30689 R	PermaDry® molded rubber gskt. incl.	
QTY	CRANKSHAFT REAR SEAL	YEARS	PART NO.	DESCRIPTION	
1	Rear Main Seal Set	2005-00	BS 40657	Rubber; One-piece	
QTY	VALVE COVER	YEARS	PART NO.	DESCRIPTION	
1	Valve Cover Gasket Set	2005-01	VS 50520 R	w/o Grommets & w/Spark plug tube seals; PermaDry® molded rubber gskts. incl.	
1	Valve Cover Gasket Set	2000	VS 50496 R	w/o Grommets & w/Spark plug tube seals; PermaDry® molded rubber gskts. incl.	
2	Grommet Set	2005-00	ES 71105	Valve Cover	
1	Spark Plug Tube Seal Set	2005-00	ES 72948	Valve Cover; New Part Number - Check for Availability	
QTY	VALVE STEM SEAL SET	YEARS	PART NO.	DESCRIPTION	
2	Valve Stem Seal Set	2005-00	SS 72871-1	Premium valve stem seals incl.	
QTY	THERMOSTAT HOUSING	YEARS	PART NO.	DESCRIPTION	
1	Thermostat Gasket	2005-00	35660	Thermostat Housing; Thermostat seal	
QTY	WATER PUMP	YEARS	PART NO.	DESCRIPTION	
1	Water Pump Gasket	2005-00	35652		
QTY	TIMING COVER	YEARS	PART NO.	DESCRIPTION	
1	Timing Cover Set	2005-00	TCS 45035		
1	Crankshaft Front Seal Set	2005-00	TCS 46164	New Part Number - Check for Availability	
1	Repair Sleeve	2005-00	16224	Timing Cover; Use w/installation tool	
1	Repair Sleeve Tool	2005-00	16325	Timing Cover	
QTY	CARB & FUEL INJECTION	YEARS	PART NO.	DESCRIPTION	
3	Fuel Injector O-Ring Set	2005-00	ES 70599	Improved design	
1	Throttle Body Gasket	2005-00	61107	Mounting	
1	Throttle Body Gasket	2005-03	61324	Idle air control; 21mm ID	
1	Throttle Body Gasket	2005-03	61326	Idle air control; 30mm ID	
QTY	EXHAUST GAS RECIRCULATION	YEARS	PART NO.	DESCRIPTION	
2	EGR Gasket	2005-00	70693	Tube flange	
2	EGR Gasket	2005-00	70696	Tube seal	
1	EGR Gasket	2005	71185	Valve	
47		1992 - 1991; 3.0L 181.1 (2972cc) DOHC V6 (24 Valve) 91.1mm Bore			47
		MFI; Gasoline; Naturally Aspirated Mitsubishi Eng.; VIN Code B, Eng. Code 6G72			
QTY	CYLINDER HEAD	YEARS	PART NO.	DESCRIPTION	
2	Head Gasket	1992-91	26186 PT	Head bolts not incl.; Head bolt replacement recommended; PermaTorqueMLS® LaserWeld® Technology; Improved design	
2	Head Gasket	1992-91	9842 PT	Head bolts not incl.; Head bolt replacement recommended; Old design	
1	Head Set	1992-91	HS 9842 PT	Head bolts not incl.; Head bolt replacement recommended; PermaDry® molded rubber valve cover gskts. incl.; Premium valve stem seals incl.	
1	Head Bolt Set	1992-91	ES 72859	Head bolts w/Washers; Replacement recommended	
QTY	CONVERSION SET	YEARS	PART NO.	DESCRIPTION	
1	Gasket Conversion Set	1992-91	CS 9842		
QTY	MANIFOLD - INT. & EXH.	YEARS	PART NO.	DESCRIPTION	
1	Int. Manifold Gasket Set	1992-91	MS 94946	Lower set; Upper set incl.	
1	Plenum Gasket Set	1992-91	MS 95008	Upper set	
1	Exh. Manifold Gasket Set	1992-91	MS 95082		
QTY	EXHAUST PIPE FLANGE	YEARS	PART NO.	DESCRIPTION	
2	Exhaust Pipe Gasket	1992-91	60496-1	Converter	
2	Exhaust Pipe Gasket	1992-91	60496-1	Pipe to manifold	
1	Exhaust Pipe Gasket	1992-91	60917	Pipe to muffler	
QTY	OIL PAN	YEARS	PART NO.	DESCRIPTION	
1	Oil Pan Gasket Set	1992-91	OS 30570 C	Cork	
1	Oil Pan Gasket Set	1992-91	OS 30570 T	PermaDryPlus®; Oil Pan SnapUps® incl.	
QTY	CRANKSHAFT REAR SEAL	YEARS	PART NO.	DESCRIPTION	
1	Rear Main Seal Set	1992-91	BS 40562	Rubber; One-piece	

Chrysler Car (Incl. Chrysler, DeSoto, Dodge, Eagle, Plymouth) (Cont.)

47 (cont.)		1992 - 1991; 3.0L 181.1 (2972cc) DOHC V6 (24 Valve) 91.1mm Bore			47 (cont.)
MFI; Gasoline; Naturally Aspirated Mitsubishi Eng.; VIN Code B, Eng. Code 6G72					
QTY	CRANKSHAFT REAR SEAL	YEARS	PART NO.	DESCRIPTION	
1	Rear Main Seal Set	1992-91	BS 40627	PTFE Rubber; One-piece	
1	Repair Sleeve Tool	1992-91	16300	Crankshaft	
QTY	VALVE COVER	YEARS	PART NO.	DESCRIPTION	
1	Valve Cover Gasket Set	1992-91	VS 50390 R	w/Spark plug tube seals; PermaDry® molded rubber gskts. incl.	
4	Circular Plug	1992-91	CP 75023	Valve Cover	
1	Spark Plug Tube Seal Set	1992-91	ES 72812	Valve Cover	
QTY	VALVE STEM SEAL SET	YEARS	PART NO.	DESCRIPTION	
2	Valve Stem Seal Set	1992-91	SS 72805	Premium valve stem seals incl.	
QTY	THERMOSTAT HOUSING	YEARS	PART NO.	DESCRIPTION	
2	Thermostat Gasket	1992-91	35313	Thermostat Housing; Thermostat case to head	
QTY	WATER OUTLET GASKET	YEARS	PART NO.	DESCRIPTION	
1	Water Outlet Gasket	1992-91	35336	Water Outlet	
1	Water Outlet Gasket	1992-91	35520	Water Outlet; Inlet	
2	Water Outlet Gasket	1992-91	35959	Water Outlet; Water pipe; O-ring	
QTY	WATER PUMP	YEARS	PART NO.	DESCRIPTION	
1	Water Pump Gasket	1992-91	35495		
QTY	TIMING COVER	YEARS	PART NO.	DESCRIPTION	
1	Crankshaft Front Seal Set	1992-91	TCS 45911		
4	Camshaft Front Seal Set	1992-91	TCS 45901	Must be used w/VS 50390R	
QTY	CARB & FUEL INJECTION	YEARS	PART NO.	DESCRIPTION	
2	Fuel Injector O-Ring Set	1992-91	ES 70600		
1	Throttle Body Gasket	1992-91	60879		
QTY	EXHAUST GAS RECIRCULATION	YEARS	PART NO.	DESCRIPTION	
1	EGR Gasket	1992-91	70568		
48		1992 - 1991; 3.0L 181.1 (2972cc) DOHC V6 (24 Valve) 91.1mm Bore			48
MFI; Gasoline; Turbo - Intercooled Mitsubishi Eng.; VIN Code C, Eng. Code 6G72-T					
QTY	CYLINDER HEAD	YEARS	PART NO.	DESCRIPTION	
2	Head Gasket	1992-91	26186 PT	Head bolts not incl.; Head bolt replacement recommended; PermaTorqueMLS® LaserWeld® Technology; Improved design	
1	Head Set	1992-91	HS 26186 PT	Turbo mounting gskts. & head bolts not incl.; Head bolt replacement recommended; PermaDry® molded rubber valve cover gskts. incl.; Premium valve stem seals incl.	
1	Head Bolt Set	1992-91	ES 72859	Head bolts w/Washers; Replacement recommended	
QTY	CONVERSION SET	YEARS	PART NO.	DESCRIPTION	
1	Gasket Conversion Set	1992-91	CS 26186-1		
QTY	MANIFOLD - INT. & EXH.	YEARS	PART NO.	DESCRIPTION	
1	Int. Manifold Gasket Set	1992-91	MS 94946	Lower set; Upper set incl.	
1	Plenum Gasket Set	1992-91	MS 95008	Upper set	
1	Exh. Manifold Gasket Set	1992-91	MS 95082		
QTY	EXHAUST PIPE FLANGE	YEARS	PART NO.	DESCRIPTION	
2	Exhaust Pipe Gasket	1992-91	60496-1	Converter	
2	Exhaust Pipe Gasket	1992-91	60496-1	Pipe to manifold	
QTY	OIL PAN	YEARS	PART NO.	DESCRIPTION	
1	Oil Pan Gasket Set	1992-91	OS 30570 C	Cork	
1	Oil Pan Gasket Set	1992-91	OS 30570 T	PermaDryPlus®; Oil Pan SnapUps® incl.	
QTY	CRANKSHAFT REAR SEAL	YEARS	PART NO.	DESCRIPTION	
1	Rear Main Seal Set	1992-91	BS 40660	Rubber; One-piece	
QTY	VALVE COVER	YEARS	PART NO.	DESCRIPTION	
1	Valve Cover Gasket Set	1992-91	VS 50390 R	w/Spark plug tube seals; PermaDry® molded rubber gskts. incl.	
4	Circular Plug	1992-91	CP 75023	Valve Cover	
1	Spark Plug Tube Seal Set	1992-91	ES 72812	Valve Cover	
QTY	VALVE STEM SEAL SET	YEARS	PART NO.	DESCRIPTION	
2	Valve Stem Seal Set	1992-91	SS 72805	Premium valve stem seals incl.	
QTY	THERMOSTAT HOUSING	YEARS	PART NO.	DESCRIPTION	
2	Thermostat Gasket	1992-91	35313	Thermostat Housing; Thermostat case to head	
QTY	WATER OUTLET GASKET	YEARS	PART NO.	DESCRIPTION	
1	Water Outlet Gasket	1992-91	35336	Water Outlet	
1	Water Outlet Gasket	1992-91	35520	Water Outlet; Inlet	
2	Water Outlet Gasket	1992-91	35959	Water Outlet; Water pipe; O-ring	
QTY	WATER PUMP	YEARS	PART NO.	DESCRIPTION	
1	Water Pump Gasket	1992-91	35495		
QTY	TIMING COVER	YEARS	PART NO.	DESCRIPTION	
1	Crankshaft Front Seal Set	1992-91	TCS 45911		

Chrysler Car (Incl. Chrysler, DeSoto, Dodge, Eagle, Plymouth) (Cont.)

48		1992 - 1991; 3.0L 181.1 (2972cc) DOHC V6 (24 Valve) 91.1mm Bore			48
(cont.)		MFI; Gasoline; Turbo - Intercooled Mitsubishi Eng.; VIN Code C, Eng. Code 6G72-T			(cont.)
QTY	TIMING COVER	YEARS	PART NO.	DESCRIPTION	
4	Camshaft Front Seal Set	1992-91	TCS 45901	Must be used w/VS 50390R	
QTY	CARB & FUEL INJECTION	YEARS	PART NO.	DESCRIPTION	
2	Fuel Injector O-Ring Set	1992-91	ES 70600		
1	Throttle Body Gasket	1992-91	60879		
QTY	EXHAUST GAS RECIRCULATION	YEARS	PART NO.	DESCRIPTION	
1	EGR Gasket	1992-91	70152		
QTY	TURBO MOUNTING SET	YEARS	PART NO.	DESCRIPTION	
1	Turbo Mtg. Gasket Set	1992-91	ES 72817		
49		1996 - 1993; 3.0L 181.1 (2972cc) DOHC V6 (24 Valve) 91.1mm Bore			49
(cont.)		MFI; Gasoline; Naturally Aspirated Mitsubishi Eng.; VIN Code J, Eng. Code 6G72			(cont.)
QTY	CYLINDER HEAD	YEARS	PART NO.	DESCRIPTION	
2	Head Gasket	1996-93	26186 PT	Head bolts not incl.; Head bolt replacement recommended; PermaTorqueMLS® LaserWeld® Technology; Improved design	
2	Head Gasket	1993	9842 PT	Head bolts not incl.; Head bolt replacement recommended; Old design	
1	Head Set	1996	HS 26186 PT-1	Head bolts not incl.; Head bolt replacement recommended; PermaDry® molded rubber valve cover gskts. incl.; Premium valve stem seals incl.	
1	Head Set	1995	HS 26186 PT	To 10/03/94; Head bolts not incl.; Head bolt replacement recommended; PermaDry® molded rubber valve cover gskts. incl.; Premium valve stem seals incl.	
1	Head Set	1995	HS 26186 PT-1	From 10/04/94; Head bolts not incl.; Head bolt replacement recommended; PermaDry® molded rubber valve cover gskts. incl.; Premium valve stem seals incl.	
1	Head Set	1994	HS 26186 PT	Head bolts not incl.; Head bolt replacement recommended; PermaDry® molded rubber valve cover gskts. incl.; Premium valve stem seals incl.	
1	Head Set	1993	HS 9842 PT	Head bolts not incl.; Head bolt replacement recommended; PermaDry® molded rubber valve cover gskts. incl.; Premium valve stem seals incl.	
1	Head Bolt Set	1996-93	ES 72859	Head bolts w/Washers; Replacement recommended	
QTY	CONVERSION SET	YEARS	PART NO.	DESCRIPTION	
1	Gasket Conversion Set	1996-93	CS 26186	RTV sealant incl. for oil pan gskt.	
QTY	MANIFOLD - INT. & EXH.	YEARS	PART NO.	DESCRIPTION	
1	Int. Manifold Gasket Set	1996-93	MS 94946	Lower set; Upper set incl.	
1	Plenum Gasket Set	1996-93	MS 95008	Upper set	
1	Exh. Manifold Gasket Set	1996-93	MS 95082		
QTY	EXHAUST PIPE FLANGE	YEARS	PART NO.	DESCRIPTION	
2	Exhaust Pipe Gasket	1996-93	60496-1	Pipe to manifold	
1	Exhaust Pipe Gasket	1996-93	60917	Pipe to muffler	
1	Exhaust Pipe Gasket	1996-94	60496-1	Loc. R.H.; Converter	
1	Exhaust Pipe Gasket	1996-94	61268	Loc. L.H.; Converter	
2	Exhaust Pipe Gasket	1993	60496-1	Converter	
QTY	CRANKSHAFT REAR SEAL	YEARS	PART NO.	DESCRIPTION	
1	Rear Main Seal Set	1996-93	BS 40660	Rubber; One-piece	
1	Repair Sleeve Tool	1996-93	16300	Crankshaft	
QTY	VALVE COVER	YEARS	PART NO.	DESCRIPTION	
1	Valve Cover Gasket Set	1996-93	VS 50390 R	w/Spark plug tube seals; PermaDry® molded rubber gskts. incl.	
4	Circular Plug	1996-93	CP 75023	Valve Cover	
1	Spark Plug Tube Seal Set	1996-93	ES 72812	Valve Cover	
QTY	VALVE STEM SEAL SET	YEARS	PART NO.	DESCRIPTION	
1	Valve Stem Seal Set	1996	SS 71179	Premium valve stem seals incl.	
1	Valve Stem Seal Set	1995	SS 71179	From 10/04/94; Premium valve stem seals incl.	
2	Valve Stem Seal Set	1995	SS 72805	To 10/03/94; Premium valve stem seals incl.	
2	Valve Stem Seal Set	1994-93	SS 72805	Premium valve stem seals incl.	
QTY	THERMOSTAT HOUSING	YEARS	PART NO.	DESCRIPTION	
2	Thermostat Gasket	1996-93	35313	Thermostat Housing; Thermostat case to head	
QTY	WATER OUTLET GASKET	YEARS	PART NO.	DESCRIPTION	
1	Water Outlet Gasket	1993	35336	Water Outlet	
1	Water Outlet Gasket	1993	35520	Water Outlet; Inlet	
2	Water Outlet Gasket	1993	35959	Water Outlet; Water pipe; O-ring	
QTY	WATER PUMP	YEARS	PART NO.	DESCRIPTION	
1	Water Pump Gasket	1996-93	35495		
QTY	TIMING COVER	YEARS	PART NO.	DESCRIPTION	
1	Crankshaft Front Seal Set	1996-93	TCS 45911		
4	Camshaft Front Seal Set	1996-93	TCS 45901	Must be used w/VS 50390R	
QTY	CARB & FUEL INJECTION	YEARS	PART NO.	DESCRIPTION	
2	Fuel Injector O-Ring Set	1996-93	ES 70600		

Chrysler Car (Incl. Chrysler, DeSoto, Dodge, Eagle, Plymouth) (Cont.)

49		1996 - 1993; 3.0L 181.1 (2972cc) DOHC V6 (24 Valve) 91.1mm Bore			49
(cont.)		MFI; Gasoline; Naturally Aspirated Mitsubishi Eng.; VIN Code J, Eng. Code 6G72			(cont.)
QTY	CARB & FUEL INJECTION	YEARS	PART NO.	DESCRIPTION	
1	Throttle Body Gasket	1996-93	60879		
QTY	EXHAUST GAS RECIRCULATION	YEARS	PART NO.	DESCRIPTION	
1	EGR Gasket	1996-93	70568		
50		1996 - 1993; 3.0L 181.1 (2972cc) DOHC V6 (24 Valve) 91.1mm Bore			50
		MFI; Gasoline; Turbo - Intercooled Mitsubishi Eng.; VIN Code K, Eng. Code 6G72-T			
QTY	CYLINDER HEAD	YEARS	PART NO.	DESCRIPTION	
2	Head Gasket	1996-93	26186 PT	Head bolts not incl.; Head bolt replacement recommended; PermaTorqueMLS® LaserWeld® Technology; Improved design	
1	Head Set	1996	HS 26186 PT-1	Turbo mounting gsks. & head bolts not incl.; Head bolt replacement recommended; PermaDry® molded rubber valve cover gsks. incl.; Premium valve stem seals incl.	
1	Head Set	1995	HS 26186 PT	To 10/03/94; Turbo mounting gsks. & head bolts not incl.; Head bolt replacement recommended; PermaDry® molded rubber valve cover gsks. incl.; Premium valve stem seals incl.	
1	Head Set	1995	HS 26186 PT-1	From 10/04/94; Turbo mounting gsks. & head bolts not incl.; Head bolt replacement recommended; PermaDry® molded rubber valve cover gsks. incl.; Premium valve stem seals incl.	
1	Head Set	1994-93	HS 26186 PT	Turbo mounting gsks. & head bolts not incl.; Head bolt replacement recommended; PermaDry® molded rubber valve cover gsks. incl.; Premium valve stem seals incl.	
1	Head Bolt Set	1996-93	ES 72859	Head bolts w/Washers; Replacement recommended	
QTY	CONVERSION SET	YEARS	PART NO.	DESCRIPTION	
1	Gasket Conversion Set	1996-93	CS 26186	RTV sealant incl. for oil pan gskt.	
QTY	MANIFOLD - INT. & EXH.	YEARS	PART NO.	DESCRIPTION	
1	Int. Manifold Gasket Set	1996-93	MS 94946	Lower set; Upper set incl.	
1	Plenum Gasket Set	1996-93	MS 95008	Upper set	
1	Exh. Manifold Gasket Set	1996-93	MS 95082		
QTY	EXHAUST PIPE FLANGE	YEARS	PART NO.	DESCRIPTION	
2	Exhaust Pipe Gasket	1996-93	60496-1	Pipe to manifold	
1	Exhaust Pipe Gasket	1996-94	60496-1	Loc. R.H.; Converter	
1	Exhaust Pipe Gasket	1996-94	61268	Loc. L.H.; Converter	
2	Exhaust Pipe Gasket	1993	60496-1	Converter	
QTY	CRANKSHAFT REAR SEAL	YEARS	PART NO.	DESCRIPTION	
1	Rear Main Seal Set	1996-93	BS 40660	Rubber; One-piece	
QTY	VALVE COVER	YEARS	PART NO.	DESCRIPTION	
1	Valve Cover Gasket Set	1996-93	VS 50390 R	w/Spark plug tube seals; PermaDry® molded rubber gsks. incl.	
4	Circular Plug	1996-93	CP 75023	Valve Cover	
1	Spark Plug Tube Seal Set	1996-93	ES 72812	Valve Cover	
QTY	VALVE STEM SEAL SET	YEARS	PART NO.	DESCRIPTION	
1	Valve Stem Seal Set	1996	SS 71179	Premium valve stem seals incl.	
1	Valve Stem Seal Set	1995	SS 71179	From 10/04/94; Premium valve stem seals incl.	
2	Valve Stem Seal Set	1995	SS 72805	To 10/03/94; Premium valve stem seals incl.	
2	Valve Stem Seal Set	1994-93	SS 72805	Premium valve stem seals incl.	
QTY	THERMOSTAT HOUSING	YEARS	PART NO.	DESCRIPTION	
2	Thermostat Gasket	1996-93	35313	Thermostat Housing; Thermostat case to head	
QTY	WATER OUTLET GASKET	YEARS	PART NO.	DESCRIPTION	
1	Water Outlet Gasket	1993	35336	Water Outlet	
1	Water Outlet Gasket	1993	35520	Water Outlet; Inlet	
QTY	WATER PUMP	YEARS	PART NO.	DESCRIPTION	
1	Water Pump Gasket	1996-93	35495		
QTY	TIMING COVER	YEARS	PART NO.	DESCRIPTION	
1	Crankshaft Front Seal Set	1996-93	TCS 45911		
4	Camshaft Front Seal Set	1996-93	TCS 45901	Must be used w/VS 50390R	
QTY	CARB & FUEL INJECTION	YEARS	PART NO.	DESCRIPTION	
2	Fuel Injector O-Ring Set	1996-93	ES 70600		
1	Throttle Body Gasket	1996-93	60879		
QTY	EXHAUST GAS RECIRCULATION	YEARS	PART NO.	DESCRIPTION	
1	EGR Gasket	1996-93	70152		
QTY	TURBO MOUNTING SET	YEARS	PART NO.	DESCRIPTION	
1	Turbo Mtg. Gasket Set	1996-93	ES 72817		

Chrysler Car (Incl. Chrysler, DeSoto, Dodge, Eagle, Plymouth) (Cont.)

51		1995 - 1991; 3.0L 181.1 (2972cc) SOHC V6 (12 Valve) 91.1mm Bore			51
		MFI; Gasoline; Naturally Aspirated Mitsubishi Eng.; VIN Code 3, Eng. Code 6G72			
QTY	CYLINDER HEAD	YEARS	PART NO.	DESCRIPTION	
2	Head Gasket	1995-91	9112 PT	Head bolts not incl.; Head bolt replacement recommended	
1	Head Set	1995-91	HS 9112 PT	Head bolts & exh. pipe to manifold gskt. not incl.; Head bolt replacement recommended; PermaDry® molded rubber valve cover gskts. incl.; Premium valve stem seals incl.	
1	Head Installation Set	1995-91	HIS 9112 PT	Head bolts, exh. pipe to manifold gskt., exh. crossover gskt. not incl.; Head bolt replacement recommended; PermaDry® molded rubber valve cover gskts. incl.	
1	Head Bolt Set	1995-91	ES 72859	Head bolts w/Washers; Replacement recommended	
QTY	CONVERSION SET	YEARS	PART NO.	DESCRIPTION	
1	Gasket Conversion Set	1995-91	CS 9112		
QTY	MANIFOLD - INT. & EXH.	YEARS	PART NO.	DESCRIPTION	
1	Int. Manifold Gasket Set	1995-91	MS 93795	Upper set incl.	
1	Plenum Gasket Set	1995-91	MS 93796	Upper set	
1	Exh. Manifold Gasket Set	1995-91	MS 93797		
QTY	EXHAUST PIPE FLANGE	YEARS	PART NO.	DESCRIPTION	
1	Exhaust Pipe Gasket	1995-91	60810	Pipe to manifold	
2	Exhaust Pipe Gasket	1995-94	60978	Crossover	
2	Exhaust Pipe Gasket	1993-91	60738	Crossover	
1	Exh. Flange Bolt & Spring Kit	1995-91	ES 72143		
QTY	OIL PAN	YEARS	PART NO.	DESCRIPTION	
1	Oil Pan Gasket Set	1995-91	OS 30570 C	Cork	
1	Oil Pan Gasket Set	1995-91	OS 30570 T	PermaDryPlus®; Oil Pan SnapUps® incl.	
QTY	CRANKSHAFT REAR SEAL	YEARS	PART NO.	DESCRIPTION	
1	Rear Main Seal Set	1995-91	BS 40562	Rubber; One-piece	
1	Rear Main Seal Set	1995-91	BS 40627	PTFE Rubber; One-piece	
1	Repair Sleeve Tool	1995-91	16300	Crankshaft	
QTY	VALVE COVER	YEARS	PART NO.	DESCRIPTION	
1	Valve Cover Gasket Set	1995-91	VS 50026 R-1	w/o Circular plugs & Grommets; PermaDry® molded rubber gskts. incl.	
1	Valve Cover Gasket Set	1995-91	VS 50173 R	w/Circular plugs & Grommets; PermaDry® molded rubber gskts. incl.	
2	Grommet Set	1995-91	ES 70342	Valve Cover	
2	Circular Plug	1995-91	CP 75018	Valve Cover	
QTY	VALVE STEM SEAL SET	YEARS	PART NO.	DESCRIPTION	
1	Valve Stem Seal Set	1995-91	SS 70710	Premium valve stem seals incl.; Improved design	
QTY	WATER OUTLET GASKET	YEARS	PART NO.	DESCRIPTION	
1	Water Outlet Gasket	1995-91	35336	Water Outlet	
QTY	WATER PUMP	YEARS	PART NO.	DESCRIPTION	
1	Water Pump Gasket	1995-91	35399	To block	
1	Water Pump Gasket	1995-91	35468	Inlet	
1	Water Pump Gasket	1995-91	35603	To cover	
1	Water Pump Gasket	1995-91	ES 72872	O-ring	
QTY	TIMING COVER	YEARS	PART NO.	DESCRIPTION	
1	Timing Cover Dust Seal Set	1995-91	TCS 45835		
1	Crankshaft Front Seal Set	1995-91	TCS 45750		
2	Camshaft Front Seal Set	1995-91	TCS 45483		Must be used w/VS 50173R or w/VS 50026R-1
QTY	CARB & FUEL INJECTION	YEARS	PART NO.	DESCRIPTION	
1	Fuel Injector O-Ring Set	1995-91	ES 70260		
1	Throttle Body Gasket	1995-91	60700		
QTY	EXHAUST GAS RECIRCULATION	YEARS	PART NO.	DESCRIPTION	
1	EGR Gasket	1995-93	70561		
1	EGR Mounting Set	1995-91	ES 72122		
52		1996 - 1993; 3.0L 181.1 (2972cc) SOHC V6 (12 Valve) 91.1mm Bore			52
		MFI; Gasoline; Naturally Aspirated Mitsubishi Eng.; VIN Code H, Eng. Code 6G72			
QTY	CYLINDER HEAD	YEARS	PART NO.	DESCRIPTION	
2	Head Gasket	1996-93	9112 PT	Head bolts not incl.; Head bolt replacement recommended	
1	Head Set	1996-93	HS 9112 PT-2	Head bolts & exh. pipe to manifold gskt. not incl.; Head bolt replacement recommended; PermaDry® molded rubber valve cover gskts. incl.; Premium valve stem seals incl.	
1	Head Bolt Set	1996-93	ES 72859	Head bolts w/Washers; Replacement recommended	
QTY	CONVERSION SET	YEARS	PART NO.	DESCRIPTION	
1	Gasket Conversion Set	1996-93	CS 9112		
QTY	MANIFOLD - INT. & EXH.	YEARS	PART NO.	DESCRIPTION	
1	Int. Manifold Gasket Set	1996-93	MS 93795-3	Upper set incl.	
1	Exh. Manifold Gasket Set	1996-93	MS 93797		

Chrysler Car (Incl. Chrysler, DeSoto, Dodge, Eagle, Plymouth) (Cont.)

52 (cont.)		1996 - 1993; 3.0L 181.1 (2972cc) SOHC V6 (12 Valve) 91.1mm Bore			52 (cont.)
MFI; Gasoline; Naturally Aspirated Mitsubishi Eng.; VIN Code H, Eng. Code 6G72					
QTY	EXHAUST PIPE FLANGE	YEARS	PART NO.	DESCRIPTION	
1	Exhaust Pipe Gasket	1996-93	60496-1	Converter	
2	Exhaust Pipe Gasket	1996-93	60496-1	Pipe to manifold	
QTY	OIL PAN	YEARS	PART NO.	DESCRIPTION	
1	Oil Pan Gasket Set	1996-93	OS 30570 C	Cork	
1	Oil Pan Gasket Set	1996-93	OS 30570 T	PermaDryPlus®; Oil Pan SnapUps® incl.	
QTY	CRANKSHAFT REAR SEAL	YEARS	PART NO.	DESCRIPTION	
1	Rear Main Seal Set	1996-93	BS 40562	Rubber; One-piece	
1	Rear Main Seal Set	1996-93	BS 40627	PTFE Rubber; One-piece	
1	Repair Sleeve Tool	1996-93	16300	Crankshaft	
QTY	VALVE COVER	YEARS	PART NO.	DESCRIPTION	
1	Valve Cover Gasket Set	1996-93	VS 50026 R-1	w/o Circular plugs & Grommets; PermaDry® molded rubber gskts. incl.	
1	Valve Cover Gasket Set	1996-93	VS 50173 R	w/Circular plugs & Grommets; PermaDry® molded rubber gskts. incl.	
2	Grommet Set	1996-93	ES 70342	Valve Cover	
2	Circular Plug	1996-93	CP 75018	Valve Cover	
QTY	VALVE STEM SEAL SET	YEARS	PART NO.	DESCRIPTION	
1	Valve Stem Seal Set	1996-93	SS 70710	Premium valve stem seals incl.; Improved design	
QTY	WATER OUTLET GASKET	YEARS	PART NO.	DESCRIPTION	
1	Water Outlet Gasket	1996-93	35336	Water Outlet	
QTY	WATER PUMP	YEARS	PART NO.	DESCRIPTION	
1	Water Pump Gasket	1996-93	35399	To block	
1	Water Pump Gasket	1996-93	35468	Inlet	
1	Water Pump Gasket	1996-93	35603	To cover	
1	Water Pump Gasket	1996-93	ES 72872	O-ring	
QTY	TIMING COVER	YEARS	PART NO.	DESCRIPTION	
1	Crankshaft Front Seal Set	1996-93	TCS 45750		
2	Camshaft Front Seal Set	1996-93	TCS 45483	Must be used w/VS 50173R or w/VS 50026R-1	
QTY	CARB & FUEL INJECTION	YEARS	PART NO.	DESCRIPTION	
2	Fuel Injector O-Ring Set	1996-93	ES 70600		
1	Throttle Body Gasket	1996-95	60889		
1	Throttle Body Gasket	1994-93	60870		
QTY	EXHAUST GAS RECIRCULATION	YEARS	PART NO.	DESCRIPTION	
1	EGR Gasket	1996-94	70152		
1	EGR Gasket	1993	70152	California	
53		1992 - 1991; 3.0L 181.1 (2972cc) SOHC V6 (12 Valve) 91.1mm Bore			53
MFI; Gasoline; Naturally Aspirated Mitsubishi Eng.; VIN Code S, Eng. Code 6G72					
QTY	CYLINDER HEAD	YEARS	PART NO.	DESCRIPTION	
2	Head Gasket	1992-91	9112 PT	Head bolts not incl.; Head bolt replacement recommended	
1	Head Set	1992	HS 9112 PT-2	Head bolts & exh. pipe to manifold gskt. not incl.; Head bolt replacement recommended; PermaDry® molded rubber valve cover gskts. incl.; Premium valve stem seals incl.	
1	Head Set	1991	HS 9112 PT	Exc. Dodge Stealth Base; Head bolts & exh. pipe to manifold gskt. not incl.; Head bolt replacement recommended; PermaDry® molded rubber valve cover gskts. incl.; Premium valve stem seals incl.	
1	Head Set	1991	HS 9112 PT-2	Dodge Stealth Base; Head bolts & exh. pipe to manifold gskt. not incl.; Head bolt replacement recommended; PermaDry® molded rubber valve cover gskts. incl.; Premium valve stem seals incl.	
1	Head Installation Set	1991	HIS 9112 PT	Exc. Dodge Stealth Base; Head bolts, exh. pipe to manifold gskt., exh. crossover gskt. not incl.; Head bolt replacement recommended; PermaDry® molded rubber valve cover gskts. incl.	
1	Head Bolt Set	1992-91	ES 72859	Head bolts w/Washers; Replacement recommended	
QTY	CONVERSION SET	YEARS	PART NO.	DESCRIPTION	
1	Gasket Conversion Set	1992-91	CS 9112		
QTY	MANIFOLD - INT. & EXH.	YEARS	PART NO.	DESCRIPTION	
1	Int. Manifold Gasket Set	1992	MS 93795-3	Upper set incl.	
1	Int. Manifold Gasket Set	1991	MS 93795	Exc. Dodge Stealth Base; Upper set incl.	
1	Int. Manifold Gasket Set	1991	MS 93795-3	Dodge Stealth Base; Upper set incl.	
1	Plenum Gasket Set	1991	MS 93796	Exc. Dodge Stealth Base; Upper set	
1	Exh. Manifold Gasket Set	1992-91	MS 93797		
QTY	EXHAUST PIPE FLANGE	YEARS	PART NO.	DESCRIPTION	
1	Exhaust Pipe Gasket	1992	60496-1	Converter	
2	Exhaust Pipe Gasket	1992	60496-1	Pipe to manifold	
1	Exhaust Pipe Gasket	1991	60496-1	Dodge Stealth Base; Converter	

Chrysler Car (Incl. Chrysler, DeSoto, Dodge, Eagle, Plymouth) (Cont.)

53 (cont.)		1992 - 1991; 3.0L 181.1 (2972cc) SOHC V6 (12 Valve) 91.1mm Bore			53 (cont.)
		MFI; Gasoline; Naturally Aspirated Mitsubishi Eng.; VIN Code S, Eng. Code 6G72			
QTY	EXHAUST PIPE FLANGE	YEARS	PART NO.	DESCRIPTION	
2	Exhaust Pipe Gasket	1991	60496-1	Dodge Stealth Base; Pipe to manifold	
2	Exhaust Pipe Gasket	1991	60738	Exc. Dodge Stealth Base; Crossover	
1	Exhaust Pipe Gasket	1991	60810	Exc. Dodge Stealth Base; Pipe to manifold	
1	Exh. Flange Bolt & Spring Kit	1991	ES 72143	Exc. Dodge Stealth Base	
QTY	OIL PAN	YEARS	PART NO.	DESCRIPTION	
1	Oil Pan Gasket Set	1992-91	OS 30570 C	Cork	
1	Oil Pan Gasket Set	1992-91	OS 30570 T	PermaDryPlus®; Oil Pan SnapUps® incl.	
QTY	CRANKSHAFT REAR SEAL	YEARS	PART NO.	DESCRIPTION	
1	Rear Main Seal Set	1992-91	BS 40562	Rubber; One-piece	
1	Rear Main Seal Set	1992-91	BS 40627	PTFE Rubber; One-piece	
1	Repair Sleeve Tool	1992-91	16300	Crankshaft	
QTY	VALVE COVER	YEARS	PART NO.	DESCRIPTION	
1	Valve Cover Gasket Set	1992-91	VS 50026 R-1	w/o Circular plugs & Grommets; PermaDry® molded rubber gskts. incl.	
1	Valve Cover Gasket Set	1992-91	VS 50173 R	w/Circular plugs & Grommets; PermaDry® molded rubber gskts. incl.	
2	Grommet Set	1992-91	ES 70342	Valve Cover	
2	Circular Plug	1992-91	CP 75018	Valve Cover	
QTY	VALVE STEM SEAL SET	YEARS	PART NO.	DESCRIPTION	
1	Valve Stem Seal Set	1992-91	SS 70710	Premium valve stem seals incl.; Improved design	
QTY	WATER OUTLET GASKET	YEARS	PART NO.	DESCRIPTION	
1	Water Outlet Gasket	1992-91	35336	Water Outlet	
QTY	WATER PUMP	YEARS	PART NO.	DESCRIPTION	
1	Water Pump Gasket	1992-91	35399	To block	
1	Water Pump Gasket	1992-91	35468	Inlet	
1	Water Pump Gasket	1992-91	35603	To cover	
1	Water Pump Gasket	1992-91	ES 72872	O-ring	
QTY	TIMING COVER	YEARS	PART NO.	DESCRIPTION	
1	Timing Cover Dust Seal Set	1991	TCS 45835	Exc. Dodge Stealth Base	
1	Crankshaft Front Seal Set	1992-91	TCS 45750		
2	Camshaft Front Seal Set	1992-91	TCS 45483	Must be used w/VS 50173R or w/VS 50026R-1	
QTY	CARB & FUEL INJECTION	YEARS	PART NO.	DESCRIPTION	
2	Fuel Injector O-Ring Set	1992	ES 70600		
1	Fuel Injector O-Ring Set	1991	ES 70260	Exc. Dodge Stealth Base	
2	Fuel Injector O-Ring Set	1991	ES 70600	Dodge Stealth Base	
1	Throttle Body Gasket	1992	60870		
1	Throttle Body Gasket	1991	60700	Exc. Dodge Stealth Base	
1	Throttle Body Gasket	1991	60870	Dodge Stealth Base	
QTY	EXHAUST GAS RECIRCULATION	YEARS	PART NO.	DESCRIPTION	
1	EGR Gasket	1992	70152	California	
1	EGR Gasket	1991	70152	Dodge Stealth Base; California	
1	EGR Mounting Set	1991	ES 72122	Exc. Dodge Stealth Base	
54		2005 - 2001; 3.0L 181.1 (2972cc) SOHC V6 (24 Valve) 91.1mm Bore			54
		MFI; Gasoline; Naturally Aspirated Mitsubishi Eng.; VIN Code H, Eng. Code 6G72			
QTY	CYLINDER HEAD	YEARS	PART NO.	DESCRIPTION	
2	Head Gasket	2005-01	9537 PT	Head bolts not incl.; Head bolt replacement recommended; PermaTorqueMLS® LaserWeld® Technology	
1	Head Set	2005-01	HS 9537 PT	Head bolts not incl.; Head bolt replacement recommended; PermaDry® molded rubber valve cover gskts. incl.; Premium valve stem seals incl.	
1	Head Bolt Set	2005-01	ES 72859	Head bolts w/Washers; Replacement recommended	
QTY	CONVERSION SET	YEARS	PART NO.	DESCRIPTION	
1	Gasket Conversion Set	2005-01	CS 9537	RTV sealant incl. for Upper oil pan gskt.	
QTY	MANIFOLD - INT. & EXH.	YEARS	PART NO.	DESCRIPTION	
1	Int. Manifold Gasket Set	2005-01	MS 95709	Lower set; Upper set incl.	
1	Plenum Gasket Set	2005-01	MS 95708	Upper set	
1	Exh. Manifold Gasket Set	2005-01	MS 95711		
QTY	EXHAUST PIPE FLANGE	YEARS	PART NO.	DESCRIPTION	
1	Exhaust Pipe Gasket	2005-01	60917	Pipe to muffler	
2	Exhaust Pipe Gasket	2005-01	61234	Converter	
1	Exhaust Pipe Gasket	2005-01	61236	Loc. Rear; Pipe to manifold	
1	Exhaust Pipe Gasket	2005-03	60817	Loc. Front; Pipe to manifold	
1	Exhaust Pipe Gasket	2002-01	60496-1	Loc. Front; Pipe to manifold	
QTY	OIL PAN	YEARS	PART NO.	DESCRIPTION	
1	Oil Pan Gasket Set	2005-01	OS 30707	Loc. Lower	

Chrysler Car (Incl. Chrysler, DeSoto, Dodge, Eagle, Plymouth) (Cont.)

54		2005 - 2001; 3.0L 181.1 (2972cc) SOHC V6 (24 Valve) 91.1mm Bore			54
(cont.)		MFI; Gasoline; Naturally Aspirated Mitsubishi Eng.; VIN Code H, Eng. Code 6G72			(cont.)
QTY	CRANKSHAFT REAR SEAL	YEARS	PART NO.	DESCRIPTION	
1	Rear Main Seal Set	2005-01	BS 40660	Rubber; One-piece	
QTY	VALVE COVER	YEARS	PART NO.	DESCRIPTION	
1	Valve Cover Gasket Set	2005-01	VS 50461 R	w/Spark plug tube seals; PermaDry® molded rubber gskts. incl.	
1	Spark Plug Tube Seal Set	2005-01	ES 72120-1	Valve Cover	
QTY	VALVE STEM SEAL SET	YEARS	PART NO.	DESCRIPTION	
1	Valve Stem Seal Set	2005-01	SS 70795	Premium valve stem seals incl.	
QTY	THERMOSTAT HOUSING	YEARS	PART NO.	DESCRIPTION	
1	Water Outlet Gasket	2005-01	35520	Thermostat Housing; Adapter to head	
2	Thermostat Gasket	2005-01	35589	Thermostat Housing; Thermostat case to head	
2	Thermostat Gasket	2005-01	35667	Thermostat Housing; Outlet to head	
1	O-Ring	2005-01	35555	Thermostat Housing; Thermostat O-ring	
QTY	WATER OUTLET GASKET	YEARS	PART NO.	DESCRIPTION	
2	Water Outlet Gasket	2005-01	35959	Water Outlet; Water pipe; O-ring	
QTY	WATER PUMP	YEARS	PART NO.	DESCRIPTION	
1	Water Pump Gasket	2005-01	35584		
QTY	TIMING COVER	YEARS	PART NO.	DESCRIPTION	
1	Crankshaft Front Seal Set	2005-01	TCS 45965		
2	Camshaft Front Seal Set	2005-01	TCS 45483		
QTY	CARB & FUEL INJECTION	YEARS	PART NO.	DESCRIPTION	
2	Fuel Injector O-Ring Set	2005-01	ES 70600		
1	Throttle Body Gasket	2005-01	60879		
QTY	EXHAUST GAS RECIRCULATION	YEARS	PART NO.	DESCRIPTION	
1	EGR Gasket	2005-01	70152		
55		1992 - 1991; 3.0L 182 (2970cc) SOHC V6 (12 Valve) 93mm Bore			55
		MFI; Gasoline; Naturally Aspirated Volvo Eng.; VIN Code U, Eng. Code PRV			
QTY	EXHAUST PIPE FLANGE	YEARS	PART NO.	DESCRIPTION	
1	Exhaust Pipe Gasket	1992-91	60292	Converter	
QTY	WATER OUTLET GASKET	YEARS	PART NO.	DESCRIPTION	
1	Water Outlet Gasket	1992-91	35384	Water Outlet	
QTY	EXHAUST GAS RECIRCULATION	YEARS	PART NO.	DESCRIPTION	
1	EGR Gasket	1992-91	70253		
56		2008 - 2004; 3.2L 195.1 (3199cc) SOHC V6 (18 Valve) 89.9mm Bore			56
		MFI; Gasoline; Naturally Aspirated Mercedes-Benz Eng.; VIN Code L, Eng. Code 112.947			
QTY	CYLINDER HEAD	YEARS	PART NO.	DESCRIPTION	
1	Head Gasket	2008-04	26433 PT	Loc. L.H.; Head bolts not incl.; Head bolt replacement recommended; PermaTorqueMLS®	
1	Head Gasket	2008-04	26434 PT	Loc. R.H.; Head bolts not incl.; Head bolt replacement recommended; PermaTorqueMLS®	
1	Head Set	2008-04	HS 26433 PT	Head bolts not incl.; Head bolt replacement recommended; PermaDry® molded rubber valve cover gskts. incl.; Premium valve stem seals incl.	
2	Head Bolt Set	2008-04	ES 71307	Replacement recommended	
QTY	CONVERSION SET	YEARS	PART NO.	DESCRIPTION	
1	Gasket Conversion Set	2008-04	CS 26433	RTV sealant incl. for oil pan gskt.	
QTY	MANIFOLD - INT. & EXH.	YEARS	PART NO.	DESCRIPTION	
1	Int. Manifold Gasket Set	2008-04	MS 97091		
1	Exh. Manifold Gasket Set	2008-04	MS 97095		
QTY	EXHAUST PIPE FLANGE	YEARS	PART NO.	DESCRIPTION	
2	Exhaust Pipe Gasket	2008-04	61590	Flange; New Part Number - Check for Availability	
QTY	OIL PAN	YEARS	PART NO.	DESCRIPTION	
1	Oil Pan Gasket Set	2008-04	OS 30813	RTV sealant incl. for oil pan gskt.	
QTY	CRANKSHAFT REAR SEAL	YEARS	PART NO.	DESCRIPTION	
1	Rear Main Seal Set	2008-04	BS 40720	Rubber; One-piece	
QTY	VALVE COVER	YEARS	PART NO.	DESCRIPTION	
1	Valve Cover Gasket Set	2008-04	VS 50758 R	PermaDry® molded rubber gskts. incl.	
QTY	VALVE STEM SEAL SET	YEARS	PART NO.	DESCRIPTION	
1	Valve Stem Seal Set	2008-04	SS 72919-2	Premium valve stem seals incl.	
QTY	THERMOSTAT HOUSING	YEARS	PART NO.	DESCRIPTION	
1	O-Ring	2008-04	35908	Thermostat Housing; Thermostat seal	
QTY	WATER PUMP	YEARS	PART NO.	DESCRIPTION	
1	Water Pump Gasket	2008-04	35910		

Chrysler Car (Incl. Chrysler, DeSoto, Dodge, Eagle, Plymouth) (Cont.)

56 (cont.)		2008 - 2004; 3.2L 195.1 (3199cc) SOHC V6 (18 Valve) 89.9mm Bore			56 (cont.)
MFI; Gasoline; Naturally Aspirated Mercedes-Benz Eng.; VIN Code L, Eng. Code 112.947					
QTY	TIMING COVER	YEARS	PART NO.	DESCRIPTION	
1	Crankshaft Front Seal Set	2008-04	TCS 46123	Mounting set	
1	Crankshaft Front Seal Set	2008-04	TCS 46188	Seal only; New Part Number - Check for Availability	
QTY	CARB & FUEL INJECTION	YEARS	PART NO.	DESCRIPTION	
3	Fuel Injector O-Ring Set	2008-04	ES 70599	Improved design	
1	Throttle Body Gasket	2008-04	61594		
QTY	EXHAUST GAS RECIRCULATION	YEARS	PART NO.	DESCRIPTION	
1	EGR Gasket	2008-04	72361		
57		2006 - 2005; 3.2L 195.1 (3199cc) SOHC V6 (18 Valve) 89.9mm Bore			57
MFI; Gasoline; Supercharged Mercedes-Benz Eng.; VIN Code N, Eng. Code 112.960					
QTY	CYLINDER HEAD	YEARS	PART NO.	DESCRIPTION	
1	Head Gasket	2006-05	26433 PT	Loc. L.H.; Head bolts not incl.; Head bolt replacement recommended; PermaTorqueMLS®	
1	Head Gasket	2006-05	26434 PT	Loc. R.H.; Head bolts not incl.; Head bolt replacement recommended; PermaTorqueMLS®	
1	Head Set	2006-05	HS 26433 PT	Head bolts not incl.; Head bolt replacement recommended; PermaDry® molded rubber valve cover gsks. incl.; Premium valve stem seals incl.	
2	Head Bolt Set	2006-05	ES 71307	Replacement recommended	
QTY	CONVERSION SET	YEARS	PART NO.	DESCRIPTION	
1	Gasket Conversion Set	2006-05	CS 26433	RTV sealant incl. for oil pan gskt.	
QTY	MANIFOLD - INT. & EXH.	YEARS	PART NO.	DESCRIPTION	
1	Int. Manifold Gasket Set	2006-05	MS 97091		
1	Exh. Manifold Gasket Set	2006-05	MS 97095		
QTY	EXHAUST PIPE FLANGE	YEARS	PART NO.	DESCRIPTION	
2	Exhaust Pipe Gasket	2006-05	61590	Flange; New Part Number - Check for Availability	
QTY	OIL PAN	YEARS	PART NO.	DESCRIPTION	
1	Oil Pan Gasket Set	2006-05	OS 30813	RTV sealant incl. for oil pan gskt.	
QTY	CRANKSHAFT REAR SEAL	YEARS	PART NO.	DESCRIPTION	
1	Rear Main Seal Set	2006-05	BS 40720	Rubber; One-piece	
QTY	VALVE COVER	YEARS	PART NO.	DESCRIPTION	
1	Valve Cover Gasket Set	2006-05	VS 50758 R	PermaDry® molded rubber gsks. incl.	
QTY	VALVE STEM SEAL SET	YEARS	PART NO.	DESCRIPTION	
1	Valve Stem Seal Set	2006-05	SS 72919-2	Premium valve stem seals incl.	
QTY	THERMOSTAT HOUSING	YEARS	PART NO.	DESCRIPTION	
1	O-Ring	2006-05	35908	Thermostat Housing; Thermostat seal	
QTY	WATER PUMP	YEARS	PART NO.	DESCRIPTION	
1	Water Pump Gasket	2006-05	35910		
QTY	TIMING COVER	YEARS	PART NO.	DESCRIPTION	
1	Crankshaft Front Seal Set	2006-05	TCS 46123	Mounting set	
1	Crankshaft Front Seal Set	2006-05	TCS 46188	Seal only; New Part Number - Check for Availability	
QTY	CARB & FUEL INJECTION	YEARS	PART NO.	DESCRIPTION	
3	Fuel Injector O-Ring Set	2006-05	ES 70599	Improved design	
1	Throttle Body Gasket	2006-05	61594		
QTY	EXHAUST GAS RECIRCULATION	YEARS	PART NO.	DESCRIPTION	
1	EGR Gasket	2006-05	72361		
58		2001 - 1998; 3.2L 197 (3231cc) SOHC V6 (24 Valve) 92mm Bore			58
MFI; Gasoline; Naturally Aspirated Chrysler Eng.; VIN Code J					
QTY	CYLINDER HEAD	YEARS	PART NO.	DESCRIPTION	
1	Head Gasket	2001-98	9425 PT	Loc. L.H.; Head bolts not incl.; Head bolt replacement recommended; PermaTorqueMLS®	
1	Head Gasket	2001-98	9455 PT	Loc. R.H.; Head bolts not incl.; Head bolt replacement recommended; PermaTorqueMLS®	
1	Head Set	2001-98	HS 9425 PT	Head bolts not incl.; Head bolt replacement recommended; PermaDry® molded rubber valve cover gsks. incl.; Premium valve stem seals incl.	
2	Head Bolt Set	2001-98	ES 72895	Head bolts w/Washers; Replacement recommended	
QTY	CONVERSION SET	YEARS	PART NO.	DESCRIPTION	
1	Gasket Conversion Set	2001-98	CS 9425	PermaDry® molded rubber oil pan gskt. incl.; Old design	
1	Gasket Conversion Set	2001-98	CS 9505	PermaDry® molded rubber oil pan gskt. incl.; Improved design	
QTY	MANIFOLD - INT. & EXH.	YEARS	PART NO.	DESCRIPTION	
1	Int. Manifold Gasket Set	2001-98	MS 92165	Upper set incl.	
1	Plenum Gasket Set	2001-98	MS 91990	Upper set	
1	Exh. Manifold Gasket Set	2001-98	MS 95446		

Chrysler Car (Incl. Chrysler, DeSoto, Dodge, Eagle, Plymouth) (Cont.)

58 (cont.)		2001 - 1998; 3.2L 197 (3231cc) SOHC V6 (24 Valve) 92mm Bore			58 (cont.)
MFI; Gasoline; Naturally Aspirated Chrysler Eng.; VIN Code J					
QTY	OIL PAN	YEARS	PART NO.	DESCRIPTION	
1	Oil Pan Gasket Set	2001-98	OS 30692 R	PermaDry® molded rubber gskt. incl.	
QTY	CRANKSHAFT REAR SEAL	YEARS	PART NO.	DESCRIPTION	
1	Rear Main Seal Set	2001-98	BS 40657	Rubber; One-piece	
QTY	VALVE COVER	YEARS	PART NO.	DESCRIPTION	
1	Valve Cover Gasket Set	2001-98	VS 50501 R	w/o Grommets & w/Spark plug tube seals; PermaDry® molded rubber gskts. incl.	
2	Grommet Set	2001-98	ES 71071	Valve Cover; May use ES 71105-1 instead; Old design; Superseded - When depleted use ES 71105-1	
2	Grommet Set	2001-98	ES 71105-1	Valve Cover; Improved design	
QTY	VALVE STEM SEAL SET	YEARS	PART NO.	DESCRIPTION	
2	Valve Stem Seal Set	2001-98	SS 72842	Premium valve stem seals incl.	
QTY	THERMOSTAT HOUSING	YEARS	PART NO.	DESCRIPTION	
1	Thermostat Gasket	2001-98	35631	Thermostat Housing	
QTY	WATER PUMP	YEARS	PART NO.	DESCRIPTION	
1	Water Pump Gasket	2001-98	35499	Improved design	
QTY	TIMING COVER	YEARS	PART NO.	DESCRIPTION	
1	Crankshaft Front Seal Set	2001-98	TCS 45992	Must be used w/OS 30692R	
2	Camshaft Front Seal Set	2001-98	TCS 45939		
QTY	CARB & FUEL INJECTION	YEARS	PART NO.	DESCRIPTION	
1	Throttle Body Gasket	2001-98	61068		
QTY	EXHAUST GAS RECIRCULATION	YEARS	PART NO.	DESCRIPTION	
1	EGR Gasket	2001-98	70720	Valve	
2	EGR Gasket	2001-98	70721	Tube flange	
2	EGR Gasket	2001-98	72928	Tube seal	
59		1993 - 1991; 3.3L 201 (3302cc) OHV V6 (12 Valve) 93mm Bore			59
MFI; Gasoline; Naturally Aspirated Chrysler Eng.; VIN Code R					
QTY	CYLINDER HEAD	YEARS	PART NO.	DESCRIPTION	
1	Head Gasket	1993-91	9673 PT-1	Loc. R.H.; Head bolts not incl.; Head bolt replacement recommended; Improved design	
1	Head Gasket	1993-91	9676 PT-1	Loc. L.H.; Head bolts not incl.; Head bolt replacement recommended; Improved design	
1	Head Set	1993-91	HS 9673 PT	Int. manifold gskt., head bolts, exh. pipe to manifold gskt. not incl.; Head bolt replacement recommended; PermaDry® molded rubber valve cover gskts. incl.; Premium valve stem seals incl.	
1	Head Installation Set	1993-91	HIS 9673 PT	Int. manifold gskt., head bolts, exh. pipe to manifold gskt., exh. crossover gskt. not incl.; Head bolt replacement recommended; PermaDry® molded rubber valve cover gskts. incl.	
1	Head Bolt Set	1993-91	ES 72849	Head bolts w/o Washers; Washers are req'd.; Replacement recommended	
1	Head Bolt Washer Set	1993-91	ES 72176-1	Replacement recommended	
QTY	CONVERSION SET	YEARS	PART NO.	DESCRIPTION	
1	Gasket Conversion Set	1993-91	CS 9673-2	PermaDry® molded rubber oil pan gskt. incl.	
QTY	MANIFOLD - INT. & EXH.	YEARS	PART NO.	DESCRIPTION	
1	Valley Pan Gasket Set	1993-91	MS 96042	Upper set incl.	
1	Plenum Gasket Set	1993-91	MS 94566	Upper set	
1	Exh. Manifold Gasket Set	1993-91	MS 94666		
QTY	EXHAUST PIPE FLANGE	YEARS	PART NO.	DESCRIPTION	
1	Exhaust Pipe Gasket	1993-91	60810	Pipe to manifold	
2	Exhaust Pipe Gasket	1993-91	60860	Crossover	
1	Exh. Flange Bolt & Spring Kit	1993-91	ES 72143		
QTY	OIL PAN	YEARS	PART NO.	DESCRIPTION	
1	Oil Pan Gasket Set	1993-91	OS 30622 R	PermaDry® molded rubber gskt. incl.	
1	Drain Plug Gasket	1993-91	70822		
QTY	CRANKSHAFT REAR SEAL	YEARS	PART NO.	DESCRIPTION	
1	Rear Main Seal Set	1993-91	BS 40168-1	Rubber; One-piece	
1	Rear Main Seal Set	1993-91	BS 40627	PTFE Rubber; One-piece	
1	Repair Sleeve Tool	1993-91	16300	Crankshaft	
QTY	VALVE COVER	YEARS	PART NO.	DESCRIPTION	
1	Valve Cover Gasket Set	1993-91	VS 50339 R	Must be used w/MS 94566; PermaDry® molded rubber gskts. incl.; .200" thick	
QTY	VALVE STEM SEAL SET	YEARS	PART NO.	DESCRIPTION	
1	Valve Stem Seal Set	1993-91	SS 72783	Premium valve stem seals incl.	
QTY	WATER OUTLET GASKET	YEARS	PART NO.	DESCRIPTION	
1	Water Outlet Gasket	1993-91	35286	Water Outlet	

Chrysler Car (Incl. Chrysler, DeSoto, Dodge, Eagle, Plymouth) (Cont.)

59 (cont.)		1993 - 1991; 3.3L 201 (3302cc) OHV V6 (12 Valve) 93mm Bore			59 (cont.)
		MFI; Gasoline; Naturally Aspirated Chrysler Eng.; VIN Code R			
QTY	WATER OUTLET GASKET	YEARS	PART NO.	DESCRIPTION	
1	Water Outlet Gasket	1993-91	35286 T	Water Outlet; PermaDryPlus®	
QTY	WATER PUMP	YEARS	PART NO.	DESCRIPTION	
1	Water Pump Gasket	1993-91	35446		
QTY	TIMING COVER	YEARS	PART NO.	DESCRIPTION	
1	Timing Cover Set	1993-91	TCS 45893-1	Must be used w/OS 30622R	
1	Crankshaft Front Seal Set	1993-91	TCS 46194	New Part Number - Check for Availability	
1	Repair Sleeve Tool	1993-91	16326	Timing Cover	
QTY	CARB & FUEL INJECTION	YEARS	PART NO.	DESCRIPTION	
3	Fuel Injector O-Ring Set	1993-91	ES 70599	Improved design	
1	Throttle Body Gasket	1993-91	60744	Mounting	
QTY	EXHAUST GAS RECIRCULATION	YEARS	PART NO.	DESCRIPTION	
1	EGR Gasket	1993-91	70561	Valve	
60		1997 - 1993; 3.3L 201 (3302cc) OHV V6 (12 Valve) 93mm Bore			60
		MFI; Gasoline; Naturally Aspirated Chrysler Eng.; VIN Code T			
QTY	CYLINDER HEAD	YEARS	PART NO.	DESCRIPTION	
1	Head Gasket	1997-93	9673 PT-1	Loc. R.H.; Head bolts not incl.; Head bolt replacement recommended; Improved design	
1	Head Gasket	1997-93	9676 PT-1	Loc. L.H.; Head bolts not incl.; Head bolt replacement recommended; Improved design	
1	Head Set	1997-93	HS 9673 PT	Int. manifold gskt., head bolts, exh. pipe to manifold gskt. not incl.; Head bolt replacement recommended; PermaDry® molded rubber valve cover gskts. incl.; Premium valve stem seals incl.	
1	Head Installation Set	1997-93	HIS 9673 PT	Int. manifold gskt., head bolts, exh. pipe to manifold gskt., exh. crossover gskt. not incl.; Head bolt replacement recommended; PermaDry® molded rubber valve cover gskts. incl.	
2	Head Bolt Set	1997	ES 72163	Head bolts w/Washers; Replacement recommended	
1	Head Bolt Set	1996-93	ES 72849	Head bolts w/o Washers; Washers are req'd.; Replacement recommended	
1	Head Bolt Washer Set	1996-93	ES 72176-1	Replacement recommended	
QTY	CONVERSION SET	YEARS	PART NO.	DESCRIPTION	
1	Gasket Conversion Set	1997-93	CS 9673-2	PermaDry® molded rubber oil pan gskt. incl.	
QTY	MANIFOLD - INT. & EXH.	YEARS	PART NO.	DESCRIPTION	
1	Valley Pan Gasket Set	1997-93	MS 96042	Upper set incl.	
1	Plenum Gasket Set	1997-93	MS 94566	Upper set	
1	Exh. Manifold Gasket Set	1997-93	MS 94666		
QTY	EXHAUST PIPE FLANGE	YEARS	PART NO.	DESCRIPTION	
1	Exh. Flange Bolt & Spring Kit	1995-93	ES 72143		
QTY	OIL PAN	YEARS	PART NO.	DESCRIPTION	
1	Oil Pan Gasket Set	1997-93	OS 30622 R	PermaDry® molded rubber gskt. incl.	
1	Drain Plug Gasket	1997-93	70822		
QTY	CRANKSHAFT REAR SEAL	YEARS	PART NO.	DESCRIPTION	
1	Rear Main Seal Set	1997-93	BS 40168-1	Rubber; One-piece	
1	Rear Main Seal Set	1997-93	BS 40627	PTFE Rubber; One-piece	
1	Repair Sleeve Tool	1997-93	16300	Crankshaft	
QTY	VALVE COVER	YEARS	PART NO.	DESCRIPTION	
1	Valve Cover Gasket Set	1997-93	VS 50339 R	Must be used w/MS 94566; PermaDry® molded rubber gskts. incl.; .200" thick	
QTY	VALVE STEM SEAL SET	YEARS	PART NO.	DESCRIPTION	
1	Valve Stem Seal Set	1997-93	SS 72783	Premium valve stem seals incl.	
QTY	WATER OUTLET GASKET	YEARS	PART NO.	DESCRIPTION	
1	Water Outlet Gasket	1997-93	35286	Water Outlet	
1	Water Outlet Gasket	1997-93	35286 T	Water Outlet; PermaDryPlus®	
QTY	WATER PUMP	YEARS	PART NO.	DESCRIPTION	
1	Water Pump Gasket	1997-93	35446		
QTY	TIMING COVER	YEARS	PART NO.	DESCRIPTION	
1	Timing Cover Set	1997-93	TCS 45893-1	Must be used w/OS 30622R	
1	Crankshaft Front Seal Set	1997-93	TCS 46194	New Part Number - Check for Availability	
1	Repair Sleeve Tool	1997-93	16326	Timing Cover	
QTY	CARB & FUEL INJECTION	YEARS	PART NO.	DESCRIPTION	
3	Fuel Injector O-Ring Set	1997-93	ES 70599	Improved design	
1	Throttle Body Gasket	1997-93	60744	Mounting	
QTY	EXHAUST GAS RECIRCULATION	YEARS	PART NO.	DESCRIPTION	
1	EGR Gasket	1997-93	70561	Valve	

Chrysler Car (Incl. Chrysler, DeSoto, Dodge, Eagle, Plymouth) (Cont.)

61		1996 - 1994; 3.3L 201 (3302cc) OHV V6 (12 Valve) 93mm Bore			61
MFI; Flex Fuel; Naturally Aspirated Chrysler Eng.; VIN Code U					
QTY	CYLINDER HEAD	YEARS	PART NO.	DESCRIPTION	
1	Head Gasket	1996-94	9673 PT-1	Loc. R.H.; Head bolts not incl.; Head bolt replacement recommended; Improved design	
1	Head Gasket	1996-94	9676 PT-1	Loc. L.H.; Head bolts not incl.; Head bolt replacement recommended; Improved design	
1	Head Set	1996-94	HS 9673 PT	Int. manifold gskt., head bolts, exh. pipe to manifold gskt. not incl.; Head bolt replacement recommended; PermaDry® molded rubber valve cover gskts. incl.; Premium valve stem seals incl.	
1	Head Installation Set	1996-94	HIS 9673 PT	Int. manifold gskt., head bolts, exh. pipe to manifold gskt., exh. crossover gskt. not incl.; Head bolt replacement recommended; PermaDry® molded rubber valve cover gskts. incl.	
1	Head Bolt Set	1996-94	ES 72849	Head bolts w/o Washers; Washers are req'd.; Replacement recommended	
1	Head Bolt Washer Set	1996-94	ES 72176-1	Replacement recommended	
QTY	CONVERSION SET	YEARS	PART NO.	DESCRIPTION	
1	Gasket Conversion Set	1996-94	CS 9673-2	PermaDry® molded rubber oil pan gskt. incl.	
QTY	MANIFOLD - INT. & EXH.	YEARS	PART NO.	DESCRIPTION	
1	Valley Pan Gasket Set	1996-94	MS 96042	Upper set incl.	
1	Plenum Gasket Set	1996-94	MS 94566	Upper set	
1	Exh. Manifold Gasket Set	1996-94	MS 94666		
QTY	EXHAUST PIPE FLANGE	YEARS	PART NO.	DESCRIPTION	
1	Exh. Flange Bolt & Spring Kit	1995-94	ES 72143		
QTY	OIL PAN	YEARS	PART NO.	DESCRIPTION	
1	Oil Pan Gasket Set	1996-94	OS 30622 R	PermaDry® molded rubber gskt. incl.	
1	Drain Plug Gasket	1996-94	70822		
QTY	CRANKSHAFT REAR SEAL	YEARS	PART NO.	DESCRIPTION	
1	Rear Main Seal Set	1996-94	BS 40168-1	Rubber; One-piece	
1	Rear Main Seal Set	1996-94	BS 40627	PTFE Rubber; One-piece	
1	Repair Sleeve Tool	1996-94	16300	Crankshaft	
QTY	VALVE COVER	YEARS	PART NO.	DESCRIPTION	
1	Valve Cover Gasket Set	1996-94	VS 50339 R	Must be used w/MS 94566; PermaDry® molded rubber gskts. incl.; .200" thick	
QTY	VALVE STEM SEAL SET	YEARS	PART NO.	DESCRIPTION	
1	Valve Stem Seal Set	1996-94	SS 72783	Premium valve stem seals incl.	
QTY	WATER OUTLET GASKET	YEARS	PART NO.	DESCRIPTION	
1	Water Outlet Gasket	1996-94	35286	Water Outlet	
1	Water Outlet Gasket	1996-94	35286 T	Water Outlet; PermaDryPlus®	
QTY	WATER PUMP	YEARS	PART NO.	DESCRIPTION	
1	Water Pump Gasket	1996-94	35446		
QTY	TIMING COVER	YEARS	PART NO.	DESCRIPTION	
1	Timing Cover Set	1996-94	TCS 45893-1	Must be used w/OS 30622R	
1	Crankshaft Front Seal Set	1996-94	TCS 46194	New Part Number - Check for Availability	
1	Repair Sleeve Tool	1996-94	16326	Timing Cover	
QTY	CARB & FUEL INJECTION	YEARS	PART NO.	DESCRIPTION	
3	Fuel Injector O-Ring Set	1996-94	ES 70599	Improved design	
1	Throttle Body Gasket	1996-94	60744	Mounting	
QTY	EXHAUST GAS RECIRCULATION	YEARS	PART NO.	DESCRIPTION	
1	EGR Gasket	1996-94	70561	Valve	

62		1998 - 1993; 3.5L 215 (3518cc) SOHC V6 (24 Valve) 96mm Bore			62
MFI; Gasoline; Naturally Aspirated Chrysler Eng.; VIN Code F					
QTY	CYLINDER HEAD	YEARS	PART NO.	DESCRIPTION	
1	Head Gasket	1998	26208 PT	Loc. R.H.; Head bolts not incl.; Head bolt replacement recommended; PermaTorqueMLS® LaserWeld® Technology; Improved design	
1	Head Gasket	1998	26209 PT	Loc. L.H.; Head bolts not incl.; Head bolt replacement recommended; PermaTorqueMLS® LaserWeld® Technology; Improved design	
1	Head Gasket	1998	9505 PT	Loc. R.H.; Head bolts not incl.; Head bolt replacement recommended; PermaTorqueMLS®; May use 26208PT instead; Old design; Superseded - When depleted use 26208 PT	
1	Head Gasket	1998	9507 PT	Loc. L.H.; Head bolts not incl.; Head bolt replacement recommended; PermaTorqueMLS®; May use 26209PT instead; Old design	
1	Head Gasket	1997-93	9926 PT	Loc. L.H.; Head bolts not incl.; Head bolt replacement recommended	
1	Head Gasket	1997-93	9927 PT	Loc. R.H.; Head bolts not incl.; Head bolt replacement recommended	

Chrysler Car (Incl. Chrysler, DeSoto, Dodge, Eagle, Plymouth) (Cont.)

62 (cont.)		1998 - 1993; 3.5L 215 (3518cc) SOHC V6 (24 Valve) 96mm Bore			62 (cont.)
		MFI; Gasoline; Naturally Aspirated Chrysler Eng.; VIN Code F			
QTY	CYLINDER HEAD	YEARS	PART NO.	DESCRIPTION	
1	Head Set	1998	HS 26208 PT	Head bolts not incl.; Head bolt replacement recommended; PermaDry® molded rubber valve cover gskts. incl.; Premium valve stem seals incl.; Improved design	
1	Head Set	1998	HS 9505 PT	Head bolts not incl.; Head bolt replacement recommended; PermaDry® molded rubber valve cover gskts. incl.; Premium valve stem seals incl.; Old design	
1	Head Set	1997-93	HS 9926 PT	Head bolts not incl.; Head bolt replacement recommended; PermaDry® molded rubber valve cover gskts. incl.; Premium valve stem seals incl.	
2	Head Bolt Set	1998	ES 72895	Head bolts w/Washers; Replacement recommended	
1	Head Bolt Set	1997-93	ES 72138	Replacement recommended	
QTY	CONVERSION SET	YEARS	PART NO.	DESCRIPTION	
1	Gasket Conversion Set	1998	CS 9505	PermaDry® molded rubber oil pan gskt. incl.; Improved design	
1	Gasket Conversion Set	1997-93	CS 9926	PermaDry® molded rubber oil pan gskt. incl.	
QTY	MANIFOLD - INT. & EXH.	YEARS	PART NO.	DESCRIPTION	
1	Int. Manifold Gasket Set	1998	MS 92165	Upper set incl.	
1	Int. Manifold Gasket Set	1997-93	MS 95444	Upper set incl.	
1	Plenum Gasket Set	1998	MS 91990	Upper set	
1	Plenum Gasket Set	1997-93	MS 95445	Upper set	
1	Exh. Manifold Gasket Set	1998-93	MS 95446		
QTY	OIL PAN	YEARS	PART NO.	DESCRIPTION	
1	Oil Pan Gasket Set	1998	OS 30692 R	PermaDry® molded rubber gskt. incl.	
1	Oil Pan Gasket Set	1997-93	OS 34212 R	One-piece gskt. & windage tray assembly; PermaDry® molded rubber gskt. incl.	
1	Drain Plug Gasket	1998-93	70822		
QTY	CRANKSHAFT REAR SEAL	YEARS	PART NO.	DESCRIPTION	
1	Rear Main Seal Set	1998-93	BS 40168-1	Rubber; One-piece	
1	Rear Main Seal Set	1998-93	BS 40627	PTFE Rubber; One-piece	
1	Repair Sleeve Tool	1998-93	16300	Crankshaft	
QTY	VALVE COVER	YEARS	PART NO.	DESCRIPTION	
1	Valve Cover Gasket Set	1998	VS 50501 R	w/o Grommets & w/Spark plug tube seals; PermaDry® molded rubber gskts. incl.	
1	Valve Cover Gasket Set	1997-93	VS 50429 R	w/Spark plug tube seals; PermaDry® molded rubber gskts. incl.	
2	Grommet Set	1998	ES 71071	Valve Cover; May use ES 71105-1 instead; Old design; Superseded - When depleted use ES 71105-1	
2	Grommet Set	1998	ES 71105-1	Valve Cover; Improved design	
QTY	VALVE STEM SEAL SET	YEARS	PART NO.	DESCRIPTION	
2	Valve Stem Seal Set	1998-93	SS 72842	Premium valve stem seals incl.	
QTY	THERMOSTAT HOUSING	YEARS	PART NO.	DESCRIPTION	
1	Thermostat Gasket	1998	35631	Thermostat Housing	
QTY	WATER OUTLET GASKET	YEARS	PART NO.	DESCRIPTION	
1	Water Outlet Gasket	1997-93	35286	Water Outlet	
1	Water Outlet Gasket	1997-93	35286 T	Water Outlet; PermaDryPlus®	
QTY	WATER PUMP	YEARS	PART NO.	DESCRIPTION	
1	Water Pump Gasket	1998-93	35499	Improved design	
QTY	TIMING COVER	YEARS	PART NO.	DESCRIPTION	
1	Timing Cover Set	1997-93	TCS 45950	Must be used w/OS 34212R	
1	Crankshaft Front Seal Set	1998	TCS 45992	Must be used w/OS 30692R	
1	Crankshaft Front Seal Set	1997-93	TCS 46194	New Part Number - Check for Availability	
2	Camshaft Front Seal Set	1998-93	TCS 45939		
QTY	CARB & FUEL INJECTION	YEARS	PART NO.	DESCRIPTION	
2	Fuel Injector O-Ring Set	1998	ES 70599	Improved design	
1	Fuel Injector O-Ring Set	1997-93	ES 70743		
1	Throttle Body Gasket	1998	61068		
2	Throttle Body Gasket	1997-93	60976		
QTY	EXHAUST GAS RECIRCULATION	YEARS	PART NO.	DESCRIPTION	
1	EGR Gasket	1998-93	70720	Valve	
2	EGR Gasket	1998-93	70721	Tube flange	
2	EGR Gasket	1998	72928	Tube seal	
63		2010 - 1998; 3.5L 215 (3518cc) SOHC V6 (24 Valve) 96mm Bore			63
		MFI; Gasoline; Naturally Aspirated Chrysler Eng.; VIN Code G			
QTY	CYLINDER HEAD	YEARS	PART NO.	DESCRIPTION	
1	Head Gasket	2010-98	26208 PT	Loc. R.H.; Head bolts not incl.; Head bolt replacement recommended; PermaTorqueMLS® LaserWeld® Technology; Improved design	

Chrysler Car (Incl. Chrysler, DeSoto, Dodge, Eagle, Plymouth) (Cont.)

63 (cont.)		2010 - 1998; 3.5L 215 (3518cc) SOHC V6 (24 Valve) 96mm Bore			63 (cont.)
MFI; Gasoline; Naturally Aspirated Chrysler Eng.; VIN Code G					
QTY	CYLINDER HEAD	YEARS	PART NO.	DESCRIPTION	
1	Head Gasket	2010-98	26209 PT	Loc. L.H.; Head bolts not incl.; Head bolt replacement recommended; PermaTorqueMLS® LaserWeld® Technology; Improved design	
1	Head Gasket	2002-98	9505 PT	Loc. R.H.; Head bolts not incl.; Head bolt replacement recommended; PermaTorqueMLS®; May use 26208PT instead; Old design; Superseded - When depleted use 26208 PT	
1	Head Gasket	2002-98	9507 PT	Loc. L.H.; Head bolts not incl.; Head bolt replacement recommended; PermaTorqueMLS®; May use 26209PT instead; Old design	
1	Head Set	2010-07	HS 26208 PT-2	Head bolts not incl.; Head bolt replacement recommended; PermaDry® molded rubber valve cover gsks. incl.; Premium valve stem seals incl.	
1	Head Set	2006-98	HS 26208 PT	Head bolts not incl.; Head bolt replacement recommended; PermaDry® molded rubber valve cover gsks. incl.; Premium valve stem seals incl.; Improved design	
1	Head Set	2002-98	HS 9505 PT	Head bolts not incl.; Head bolt replacement recommended; PermaDry® molded rubber valve cover gsks. incl.; Premium valve stem seals incl.; Old design	
2	Head Bolt Set	2010-98	ES 72895	Head bolts w/Washers; Replacement recommended	
QTY	CONVERSION SET	YEARS	PART NO.	DESCRIPTION	
1	Gasket Conversion Set	2010-05	CS 9505-2	One-piece rear main retainer w/Seal not incl.; PermaDry® molded rubber oil pan gskt. incl.	
1	Gasket Conversion Set	2004-98	CS 9505	PermaDry® molded rubber oil pan gskt. incl.; Improved design	
QTY	MANIFOLD - INT. & EXH.	YEARS	PART NO.	DESCRIPTION	
1	Int. Manifold Gasket Set	2010-98	MS 92165	Upper set incl.	
1	Plenum Gasket Set	2010-98	MS 91990	Upper set	
1	Exh. Manifold Gasket Set	2010-98	MS 95446		
QTY	EXHAUST PIPE FLANGE	YEARS	PART NO.	DESCRIPTION	
1	Exhaust Pipe Gasket	2010-04	61266	Converter	
1	Exhaust Pipe Gasket	2010	61261	Flange	
1	Exhaust Pipe Gasket	2009-07	61261	Exc. Chrysler Sebring Limited Dodge Avenger R/T; Flange	
1	Exhaust Pipe Gasket	2009-07	61495	Chrysler Sebring Limited Dodge Avenger R/T; Flange	
1	Exhaust Pipe Gasket	2006-04	61261	Flange	
QTY	OIL PAN	YEARS	PART NO.	DESCRIPTION	
1	Oil Pan Gasket Set	2010-05	OS 30754 R	PermaDry® molded rubber gskt. incl.	
1	Oil Pan Gasket Set	2004-98	OS 30692 R	PermaDry® molded rubber gskt. incl.	
1	Drain Plug Gasket	2010-98	70822		
QTY	CRANKSHAFT REAR SEAL	YEARS	PART NO.	DESCRIPTION	
1	Rear Main Seal Set	2010-98	BS 40168-1	w/Aluminum housing; w/Separate seal; Rubber; One-piece	
1	Rear Main Seal Set	2010-98	BS 40627	w/Aluminum housing; w/Separate seal; PTFE Rubber; One-piece	
1	Rear Main Seal Set	2010-05	BS 40734	w/Steel housing; Retainer w/Seal; Rubber; One-piece; New Part Number - Check for Availability	
1	Repair Sleeve Tool	2010-98	16300	Crankshaft	
QTY	VALVE COVER	YEARS	PART NO.	DESCRIPTION	
1	Valve Cover Gasket Set	2010-07	VS 50689 R	w/o Grommets & w/Spark plug tube seals; PermaDry® molded rubber gsks. incl.	
1	Valve Cover Gasket Set	2006-98	VS 50501 R	w/o Grommets & w/Spark plug tube seals; PermaDry® molded rubber gsks. incl.	
2	Grommet Set	2010-98	ES 71071	Valve Cover; May use ES 71105-1 instead; Old design; Superseded - When depleted use ES 71105-1	
2	Grommet Set	2010-98	ES 71105-1	Valve Cover; Improved design	
QTY	VALVE STEM SEAL SET	YEARS	PART NO.	DESCRIPTION	
2	Valve Stem Seal Set	2010-98	SS 72842	Premium valve stem seals incl.	
QTY	THERMOSTAT HOUSING	YEARS	PART NO.	DESCRIPTION	
1	Thermostat Gasket	2010-07	35631	Thermostat Housing; Cast aluminum housing	
1	Thermostat Gasket	2006-98	35631	Thermostat Housing	
QTY	WATER PUMP	YEARS	PART NO.	DESCRIPTION	
1	Water Pump Gasket	2010-05	35785	Mounting	
1	Water Pump Gasket	2010-07	35813	Inlet; Improved design	
1	Water Pump Gasket	2004-98	35499	Improved design	
QTY	TIMING COVER	YEARS	PART NO.	DESCRIPTION	
1	Crankshaft Front Seal Set	2010-05	TCS 46147	Must be used w/OS 30754R; Improved design	
1	Crankshaft Front Seal Set	2004-98	TCS 45992	Must be used w/OS 30692R	
2	Camshaft Front Seal Set	2010-98	TCS 45939		
QTY	CARB & FUEL INJECTION	YEARS	PART NO.	DESCRIPTION	
2	Fuel Injector O-Ring Set	2010-98	ES 70599	Improved design	

Chrysler Car (Incl. Chrysler, DeSoto, Dodge, Eagle, Plymouth) (Cont.)

63 (cont.)		2010 - 1998; 3.5L 215 (3518cc) SOHC V6 (24 Valve) 96mm Bore			63 (cont.)
		MFI; Gasoline; Naturally Aspirated Chrysler Eng.; VIN Code G			
QTY	CARB & FUEL INJECTION	YEARS	PART NO.	DESCRIPTION	
1	Throttle Body Gasket	2010-04	61324	Idle air control; 21mm ID	
1	Throttle Body Gasket	2010-04	61326	Idle air control; 30mm ID	
1	Throttle Body Gasket	2010-05	61389	Mounting	
1	Throttle Body Gasket	2004-98	61068	Mounting	
QTY	EXHAUST GAS RECIRCULATION	YEARS	PART NO.	DESCRIPTION	
2	EGR Gasket	2010-98	70721	Tube flange	
2	EGR Gasket	2010-98	72928	Tube seal	
1	EGR Gasket	2010	71185	Valve	
1	EGR Gasket	2009-07	71185	Exc. Chrysler Sebring Limited Dodge Avenger R/T; Valve	
1	EGR Gasket	2009-07	72305	Chrysler Sebring Limited Dodge Avenger R/T; Valve	
1	EGR Gasket	2006-05	71185	Valve	
1	EGR Gasket	2004-98	70720	Valve	
64		2004 - 2002; 3.5L 215 (3518cc) SOHC V6 (24 Valve) 96mm Bore			64
		MFI; Gasoline; Naturally Aspirated Chrysler Eng.; VIN Code K			
QTY	CYLINDER HEAD	YEARS	PART NO.	DESCRIPTION	
1	Head Gasket	2004-02	26208 PT	Loc. R.H.; Head bolts not incl.; Head bolt replacement recommended; PermaTorqueMLS® LaserWeld® Technology; Improved design	
1	Head Gasket	2004-02	26209 PT	Loc. L.H.; Head bolts not incl.; Head bolt replacement recommended; PermaTorqueMLS® LaserWeld® Technology; Improved design	
1	Head Gasket	2002	9505 PT	Loc. R.H.; Head bolts not incl.; Head bolt replacement recommended; PermaTorqueMLS®; May use 26208PT instead; Old design; Superseded - When depleted use 26208 PT	
1	Head Gasket	2002	9507 PT	Loc. L.H.; Head bolts not incl.; Head bolt replacement recommended; PermaTorqueMLS®; May use 26209PT instead; Old design	
1	Head Set	2004-02	HS 26208 PT	Head bolts not incl.; Head bolt replacement recommended; PermaDry® molded rubber valve cover gsks. incl.; Premium valve stem seals incl.; Improved design	
1	Head Set	2002	HS 9505 PT	Head bolts not incl.; Head bolt replacement recommended; PermaDry® molded rubber valve cover gsks. incl.; Premium valve stem seals incl.; Old design	
2	Head Bolt Set	2004-02	ES 72895	Head bolts w/Washers; Replacement recommended	
QTY	CONVERSION SET	YEARS	PART NO.	DESCRIPTION	
1	Gasket Conversion Set	2004-02	CS 9505	PermaDry® molded rubber oil pan gskt. incl.; Improved design	
QTY	MANIFOLD - INT. & EXH.	YEARS	PART NO.	DESCRIPTION	
1	Int. Manifold Gasket Set	2004-02	MS 92165	Upper set incl.	
1	Plenum Gasket Set	2004-02	MS 91990	Upper set	
1	Exh. Manifold Gasket Set	2004-02	MS 95446		
QTY	EXHAUST PIPE FLANGE	YEARS	PART NO.	DESCRIPTION	
1	Exhaust Pipe Gasket	2004	61261	Flange	
1	Exhaust Pipe Gasket	2004	61266	Converter	
QTY	OIL PAN	YEARS	PART NO.	DESCRIPTION	
1	Oil Pan Gasket Set	2004-02	OS 30692 R	PermaDry® molded rubber gskt. incl.	
1	Drain Plug Gasket	2004-02	70822		
QTY	CRANKSHAFT REAR SEAL	YEARS	PART NO.	DESCRIPTION	
1	Rear Main Seal Set	2004-02	BS 40168-1	w/Aluminum housing; w/Separate seal; Rubber; One-piece	
1	Rear Main Seal Set	2004-02	BS 40627	w/Aluminum housing; w/Separate seal; PTFE Rubber; One-piece	
1	Repair Sleeve Tool	2004-02	16300	Crankshaft	
QTY	VALVE COVER	YEARS	PART NO.	DESCRIPTION	
1	Valve Cover Gasket Set	2004-02	VS 50501 R	w/o Grommets & w/Spark plug tube seals; PermaDry® molded rubber gsks. incl.	
2	Grommet Set	2004-02	ES 71071	Valve Cover; May use ES 71105-1 instead; Old design; Superseded - When depleted use ES 71105-1	
2	Grommet Set	2004-02	ES 71105-1	Valve Cover; Improved design	
QTY	VALVE STEM SEAL SET	YEARS	PART NO.	DESCRIPTION	
2	Valve Stem Seal Set	2004-02	SS 72842	Premium valve stem seals incl.	
QTY	THERMOSTAT HOUSING	YEARS	PART NO.	DESCRIPTION	
1	Thermostat Gasket	2004-02	35631	Thermostat Housing	
QTY	WATER PUMP	YEARS	PART NO.	DESCRIPTION	
1	Water Pump Gasket	2004-02	35499	Improved design	
QTY	TIMING COVER	YEARS	PART NO.	DESCRIPTION	
1	Crankshaft Front Seal Set	2004-02	TCS 45992	Must be used w/OS 30692R	
2	Camshaft Front Seal Set	2004-02	TCS 45939		

Chrysler Car (Incl. Chrysler, DeSoto, Dodge, Eagle, Plymouth) (Cont.)

64 (cont.)		2004 - 2002; 3.5L 215 (3518cc) SOHC V6 (24 Valve) 96mm Bore			64 (cont.)
MFI; Gasoline; Naturally Aspirated Chrysler Eng.; VIN Code K					
QTY	CARB & FUEL INJECTION	YEARS	PART NO.	DESCRIPTION	
2	Fuel Injector O-Ring Set	2004-02	ES 70599	Improved design	
1	Throttle Body Gasket	2004-02	61068	Mounting	
1	Throttle Body Gasket	2004	61324	Idle air control; 21mm ID	
1	Throttle Body Gasket	2004	61326	Idle air control; 30mm ID	
QTY	EXHAUST GAS RECIRCULATION	YEARS	PART NO.	DESCRIPTION	
1	EGR Gasket	2004-02	70720	Valve	
2	EGR Gasket	2004-02	70721	Tube flange	
2	EGR Gasket	2004-02	72928	Tube seal	
65		2011 - 2002; 3.5L 215 (3518cc) SOHC V6 (24 Valve) 96mm Bore			65
MFI; Gasoline; Naturally Aspirated Chrysler Eng.; VIN Code M					
QTY	CYLINDER HEAD	YEARS	PART NO.	DESCRIPTION	
1	Head Gasket	2011-07	26208 PT	Loc. R.H.; Head bolts not incl.; Head bolt replacement recommended; PermaTorqueMLS® LaserWeld® Technology; Improved design	
1	Head Gasket	2011-07	26209 PT	Loc. L.H.; Head bolts not incl.; Head bolt replacement recommended; PermaTorqueMLS® LaserWeld® Technology; Improved design	
1	Head Gasket	2004-02	26208 PT	Loc. R.H.; Head bolts not incl.; Head bolt replacement recommended; PermaTorqueMLS® LaserWeld® Technology; Improved design	
1	Head Gasket	2004-02	26209 PT	Loc. L.H.; Head bolts not incl.; Head bolt replacement recommended; PermaTorqueMLS® LaserWeld® Technology; Improved design	
1	Head Gasket	2002	9505 PT	Loc. R.H.; Head bolts not incl.; Head bolt replacement recommended; PermaTorqueMLS®; May use 26208PT instead; Old design; Superseded - When depleted use 26208 PT	
1	Head Gasket	2002	9507 PT	Loc. L.H.; Head bolts not incl.; Head bolt replacement recommended; PermaTorqueMLS®; May use 26209PT instead; Old design	
1	Head Set	2011	HS 26208 PT-3	Head bolts not incl.; Head bolt replacement recommended; PermaDry® molded rubber valve cover gskts. incl.; Premium valve stem seals incl.; New Part Number - Check for Availability	
1	Head Set	2010-07	HS 26208 PT-2	Head bolts not incl.; Head bolt replacement recommended; PermaDry® molded rubber valve cover gskts. incl.; Premium valve stem seals incl.	
1	Head Set	2004-02	HS 26208 PT	Head bolts not incl.; Head bolt replacement recommended; PermaDry® molded rubber valve cover gskts. incl.; Premium valve stem seals incl.; Improved design	
1	Head Set	2002	HS 9505 PT	Head bolts not incl.; Head bolt replacement recommended; PermaDry® molded rubber valve cover gskts. incl.; Premium valve stem seals incl.; Old design	
2	Head Bolt Set	2011-07	ES 72895	Head bolts w/Washers; Replacement recommended	
2	Head Bolt Set	2004-02	ES 72895	Head bolts w/Washers; Replacement recommended	
QTY	CONVERSION SET	YEARS	PART NO.	DESCRIPTION	
1	Gasket Conversion Set	2011-07	CS 9505-2	One-piece rear main retainer w/Seal not incl.; PermaDry® molded rubber oil pan gskt. incl.	
1	Gasket Conversion Set	2004-02	CS 9505	PermaDry® molded rubber oil pan gskt. incl.; Improved design	
QTY	MANIFOLD - INT. & EXH.	YEARS	PART NO.	DESCRIPTION	
1	Int. Manifold Gasket Set	2011-07	MS 92165-1	Upper set incl.	
1	Int. Manifold Gasket Set	2004-02	MS 92165	Upper set incl.	
1	Plenum Gasket Set	2011-07	MS 96324	Upper set	
1	Plenum Gasket Set	2004-02	MS 91990	Upper set	
1	Exh. Manifold Gasket Set	2011-07	MS 95446		
1	Exh. Manifold Gasket Set	2004-02	MS 95446		
QTY	EXHAUST PIPE FLANGE	YEARS	PART NO.	DESCRIPTION	
1	Exhaust Pipe Gasket	2011-07	61266	Converter	
1	Exhaust Pipe Gasket	2011-07	61495	Flange	
1	Exhaust Pipe Gasket	2004	61261	Flange	
1	Exhaust Pipe Gasket	2004	61266	Converter	
QTY	OIL PAN	YEARS	PART NO.	DESCRIPTION	
1	Oil Pan Gasket Set	2011-07	OS 30754 R	PermaDry® molded rubber gskt. incl.	
1	Oil Pan Gasket Set	2004-02	OS 30692 R	PermaDry® molded rubber gskt. incl.	
1	Drain Plug Gasket	2011-07	70822		
1	Drain Plug Gasket	2004-02	70822		
QTY	CRANKSHAFT REAR SEAL	YEARS	PART NO.	DESCRIPTION	
1	Rear Main Seal Set	2011-07	BS 40168-1	w/Aluminum housing; w/Separate seal; Rubber; One-piece	
1	Rear Main Seal Set	2011-07	BS 40627	w/Aluminum housing; w/Separate seal; PTFE Rubber; One-piece	
1	Rear Main Seal Set	2011-07	BS 40734	w/Steel housing; Retainer w/Seal; Rubber; One-piece; New Part Number - Check for Availability	

Chrysler Car (Incl. Chrysler, DeSoto, Dodge, Eagle, Plymouth) (Cont.)

65 (cont.)		2011 - 2002; 3.5L 215 (3518cc) SOHC V6 (24 Valve) 96mm Bore			65 (cont.)
		MFI; Gasoline; Naturally Aspirated Chrysler Eng.; VIN Code M			
QTY	CRANKSHAFT REAR SEAL	YEARS	PART NO.	DESCRIPTION	
1	Rear Main Seal Set	2004-02	BS 40168-1	w/Aluminum housing; w/Separate seal; Rubber; One-piece	
1	Rear Main Seal Set	2004-02	BS 40627	w/Aluminum housing; w/Separate seal; PTFE Rubber; One-piece	
1	Repair Sleeve Tool	2011-07	16300	Crankshaft	
1	Repair Sleeve Tool	2004-02	16300	Crankshaft	
QTY	VALVE COVER	YEARS	PART NO.	DESCRIPTION	
1	Valve Cover Gasket Set	2011-07	VS 50689 R	w/o Grommets & w/Spark plug tube seals; PermaDry® molded rubber gskts. incl.	
1	Valve Cover Gasket Set	2004-02	VS 50501 R	w/o Grommets & w/Spark plug tube seals; PermaDry® molded rubber gskts. incl.	
1	Grommet Set	2011	ES 71451	Valve Cover; New Part Number - Check for Availability	
2	Grommet Set	2010-07	ES 71071	Valve Cover; May use ES 71105-1 instead; Old design; Superseded - When depleted use ES 71105-1	
2	Grommet Set	2010-07	ES 71105-1	Valve Cover; Improved design	
2	Grommet Set	2004-02	ES 71071	Valve Cover; May use ES 71105-1 instead; Old design; Superseded - When depleted use ES 71105-1	
2	Grommet Set	2004-02	ES 71105-1	Valve Cover; Improved design	
QTY	VALVE STEM SEAL SET	YEARS	PART NO.	DESCRIPTION	
2	Valve Stem Seal Set	2011-07	SS 72842	Premium valve stem seals incl.	
2	Valve Stem Seal Set	2004-02	SS 72842	Premium valve stem seals incl.	
QTY	THERMOSTAT HOUSING	YEARS	PART NO.	DESCRIPTION	
1	Thermostat Gasket	2011-07	35631	Thermostat Housing	
1	Thermostat Gasket	2004-02	35631	Thermostat Housing	
QTY	WATER PUMP	YEARS	PART NO.	DESCRIPTION	
1	Water Pump Gasket	2011-07	35785	Mounting	
1	Water Pump Gasket	2011-07	35813	Inlet; Improved design	
1	Water Pump Gasket	2004-02	35499	Improved design	
QTY	TIMING COVER	YEARS	PART NO.	DESCRIPTION	
1	Crankshaft Front Seal Set	2011-07	TCS 46147	Must be used w/OS 30754R; Improved design	
1	Crankshaft Front Seal Set	2004-02	TCS 45992	Must be used w/OS 30692R	
2	Camshaft Front Seal Set	2011-07	TCS 45939		
2	Camshaft Front Seal Set	2004-02	TCS 45939		
QTY	CARB & FUEL INJECTION	YEARS	PART NO.	DESCRIPTION	
2	Fuel Injector O-Ring Set	2011-07	ES 70599	Improved design	
2	Fuel Injector O-Ring Set	2004-02	ES 70599	Improved design	
1	Throttle Body Gasket	2011-07	61324	Idle air control; 21mm ID	
1	Throttle Body Gasket	2011-07	61326	Idle air control; 30mm ID	
1	Throttle Body Gasket	2011-07	61389	Mounting	
1	Throttle Body Gasket	2004-02	61068	Mounting	
1	Throttle Body Gasket	2004	61324	Idle air control; 21mm ID	
1	Throttle Body Gasket	2004	61326	Idle air control; 30mm ID	
QTY	EXHAUST GAS RECIRCULATION	YEARS	PART NO.	DESCRIPTION	
2	EGR Gasket	2011-07	70721	Tube flange	
1	EGR Gasket	2011-07	72305	Valve	
2	EGR Gasket	2011-07	72928	Tube seal	
1	EGR Gasket	2004-02	70720	Valve	
2	EGR Gasket	2004-02	70721	Tube flange	
2	EGR Gasket	2004-02	72928	Tube seal	
66		2011 - 2000; 3.5L 215 (3518cc) SOHC V6 (24 Valve) 96mm Bore			66
		MFI; Gasoline; Naturally Aspirated Chrysler Eng.; VIN Code V			
QTY	CYLINDER HEAD	YEARS	PART NO.	DESCRIPTION	
1	Head Gasket	2011-10	26208 PT	Loc. R.H.; Head bolts not incl.; Head bolt replacement recommended; PermaTorqueMLS® LaserWeld® Technology; Improved design	
1	Head Gasket	2011-10	26209 PT	Loc. L.H.; Head bolts not incl.; Head bolt replacement recommended; PermaTorqueMLS® LaserWeld® Technology; Improved design	
1	Head Gasket	2008-00	26208 PT	Loc. R.H.; Head bolts not incl.; Head bolt replacement recommended; PermaTorqueMLS® LaserWeld® Technology; Improved design	
1	Head Gasket	2008-00	26209 PT	Loc. L.H.; Head bolts not incl.; Head bolt replacement recommended; PermaTorqueMLS® LaserWeld® Technology; Improved design	
1	Head Gasket	2002-00	9505 PT	Loc. R.H.; Head bolts not incl.; Head bolt replacement recommended; PermaTorqueMLS®; May use 26208PT instead; Old design; Superseded - When depleted use 26208 PT	
1	Head Gasket	2002-00	9507 PT	Loc. L.H.; Head bolts not incl.; Head bolt replacement recommended; PermaTorqueMLS®; May use 26209PT instead; Old design	

Chrysler Car (Incl. Chrysler, DeSoto, Dodge, Eagle, Plymouth) (Cont.)

66 (cont.)		2011 - 2000; 3.5L 215 (3518cc) SOHC V6 (24 Valve) 96mm Bore MFI; Gasoline; Naturally Aspirated Chrysler Eng.; VIN Code V			66 (cont.)
QTY	CYLINDER HEAD	YEARS	PART NO.	DESCRIPTION	
1	Head Set	2011	HS 26208 PT-3	Head bolts not incl.; Head bolt replacement recommended; PermaDry® molded rubber valve cover gskts. incl.; Premium valve stem seals incl.; New Part Number - Check for Availability	
1	Head Set	2010	HS 26208 PT-2	Exc. Chrysler Sebring Limited Dodge Avenger R/T; Head bolts not incl.; Head bolt replacement recommended; PermaDry® molded rubber valve cover gskts. incl.; Premium valve stem seals incl.	
1	Head Set	2010	HS 26208 PT-3	Chrysler Sebring Limited Dodge Avenger R/T; Head bolts not incl.; Head bolt replacement recommended; PermaDry® molded rubber valve cover gskts. incl.; Premium valve stem seals incl.; New Part Number - Check for Availability	
1	Head Set	2008-07	HS 26208 PT-2	Head bolts not incl.; Head bolt replacement recommended; PermaDry® molded rubber valve cover gskts. incl.; Premium valve stem seals incl.	
1	Head Set	2006-00	HS 26208 PT	Head bolts not incl.; Head bolt replacement recommended; PermaDry® molded rubber valve cover gskts. incl.; Premium valve stem seals incl.; Improved design	
1	Head Set	2002-00	HS 9505 PT	Head bolts not incl.; Head bolt replacement recommended; PermaDry® molded rubber valve cover gskts. incl.; Premium valve stem seals incl.; Old design	
2	Head Bolt Set	2011-10	ES 72895	Head bolts w/Washers; Replacement recommended	
2	Head Bolt Set	2008-00	ES 72895	Head bolts w/Washers; Replacement recommended	
QTY	CONVERSION SET	YEARS	PART NO.	DESCRIPTION	
1	Gasket Conversion Set	2011-10	CS 9505-2	One-piece rear main retainer w/Seal not incl.; PermaDry® molded rubber oil pan gskt. incl.	
1	Gasket Conversion Set	2008-05	CS 9505-2	One-piece rear main retainer w/Seal not incl.; PermaDry® molded rubber oil pan gskt. incl.	
1	Gasket Conversion Set	2004-00	CS 9505	PermaDry® molded rubber oil pan gskt. incl.; Improved design	
QTY	MANIFOLD - INT. & EXH.	YEARS	PART NO.	DESCRIPTION	
1	Int. Manifold Gasket Set	2011	MS 92165-1	Upper set incl.	
1	Int. Manifold Gasket Set	2010	MS 92165	Exc. Chrysler Sebring Limited Dodge Avenger R/T; Upper set incl.	
1	Int. Manifold Gasket Set	2010	MS 92165-1	Chrysler Sebring Limited Dodge Avenger R/T; Upper set incl.	
1	Int. Manifold Gasket Set	2008-00	MS 92165	Upper set incl.	
1	Plenum Gasket Set	2011	MS 96324	Upper set	
1	Plenum Gasket Set	2010	MS 91990	Exc. Chrysler Sebring Limited Dodge Avenger R/T; Upper set	
1	Plenum Gasket Set	2010	MS 96324	Chrysler Sebring Limited Dodge Avenger R/T; Upper set	
1	Plenum Gasket Set	2008-00	MS 91990	Upper set	
1	Exh. Manifold Gasket Set	2011-10	MS 95446		
1	Exh. Manifold Gasket Set	2008-00	MS 95446		
QTY	EXHAUST PIPE FLANGE	YEARS	PART NO.	DESCRIPTION	
1	Exhaust Pipe Gasket	2011-10	61266	Converter	
1	Exhaust Pipe Gasket	2011	61495	Flange	
1	Exhaust Pipe Gasket	2010	61261	Exc. Chrysler Sebring Limited Dodge Avenger R/T; Flange	
1	Exhaust Pipe Gasket	2010	61495	Chrysler Sebring Limited Dodge Avenger R/T; Flange	
1	Exhaust Pipe Gasket	2008-04	61261	Flange	
1	Exhaust Pipe Gasket	2008-04	61266	Converter	
QTY	OIL PAN	YEARS	PART NO.	DESCRIPTION	
1	Oil Pan Gasket Set	2011-10	OS 30754 R	PermaDry® molded rubber gskt. incl.	
1	Oil Pan Gasket Set	2008-05	OS 30754 R	PermaDry® molded rubber gskt. incl.	
1	Oil Pan Gasket Set	2004-00	OS 30692 R	PermaDry® molded rubber gskt. incl.	
1	Drain Plug Gasket	2011-10	70822		
1	Drain Plug Gasket	2008-00	70822		
QTY	CRANKSHAFT REAR SEAL	YEARS	PART NO.	DESCRIPTION	
1	Rear Main Seal Set	2011-10	BS 40168-1	w/Aluminum housing; w/Separate seal; Rubber; One-piece	
1	Rear Main Seal Set	2011-10	BS 40627	w/Aluminum housing; w/Separate seal; PTFE Rubber; One-piece	
1	Rear Main Seal Set	2011-10	BS 40734	w/Steel housing; Retainer w/Seal; Rubber; One-piece; New Part Number - Check for Availability	
1	Rear Main Seal Set	2008-00	BS 40168-1	w/Aluminum housing; w/Separate seal; Rubber; One-piece	
1	Rear Main Seal Set	2008-00	BS 40627	w/Aluminum housing; w/Separate seal; PTFE Rubber; One-piece	
1	Rear Main Seal Set	2008-05	BS 40734	w/Steel housing; Retainer w/Seal; Rubber; One-piece; New Part Number - Check for Availability	
1	Repair Sleeve Tool	2011-10	16300	Crankshaft	
1	Repair Sleeve Tool	2008-00	16300	Crankshaft	
QTY	VALVE COVER	YEARS	PART NO.	DESCRIPTION	
1	Valve Cover Gasket Set	2011-10	VS 50689 R	w/o Grommets & w/Spark plug tube seals; PermaDry® molded rubber gskts. incl.	

Chrysler Car (Incl. Chrysler, DeSoto, Dodge, Eagle, Plymouth) (Cont.)

66 (cont.)		2011 - 2000; 3.5L 215 (3518cc) SOHC V6 (24 Valve) 96mm Bore			66 (cont.)
		MFI; Gasoline; Naturally Aspirated Chrysler Eng.; VIN Code V			
QTY	VALVE COVER	YEARS	PART NO.	DESCRIPTION	
1	Valve Cover Gasket Set	2008-07	VS 50689 R	w/o Grommets & w/Spark plug tube seals; PermaDry® molded rubber gskts. incl.	
1	Valve Cover Gasket Set	2006-00	VS 50501 R	w/o Grommets & w/Spark plug tube seals; PermaDry® molded rubber gskts. incl.	
1	Grommet Set	2011	ES 71451	Valve Cover; New Part Number - Check for Availability	
2	Grommet Set	2010	ES 71071	Exc. Chrysler Sebring Limited Dodge Avenger R/T; Valve Cover; May use ES 71105-1 instead; Old design; Superseded - When depleted use ES 71105-1	
2	Grommet Set	2010	ES 71105-1	Exc. Chrysler Sebring Limited Dodge Avenger R/T; Valve Cover; Improved design	
1	Grommet Set	2010	ES 71451	Chrysler Sebring Limited Dodge Avenger R/T; Valve Cover; New Part Number - Check for Availability	
2	Grommet Set	2008-00	ES 71071	Valve Cover; May use ES 71105-1 instead; Old design; Superseded - When depleted use ES 71105-1	
2	Grommet Set	2008-00	ES 71105-1	Valve Cover; Improved design	
QTY	VALVE STEM SEAL SET	YEARS	PART NO.	DESCRIPTION	
2	Valve Stem Seal Set	2011-10	SS 72842	Premium valve stem seals incl.	
2	Valve Stem Seal Set	2008-00	SS 72842	Premium valve stem seals incl.	
QTY	THERMOSTAT HOUSING	YEARS	PART NO.	DESCRIPTION	
1	Thermostat Gasket	2011	35631	Thermostat Housing	
1	Thermostat Gasket	2010	35631	Thermostat Housing; Cast aluminum housing	
1	Thermostat Gasket	2008-07	35631	Thermostat Housing; Cast aluminum housing	
1	Thermostat Gasket	2006-00	35631	Thermostat Housing	
QTY	WATER PUMP	YEARS	PART NO.	DESCRIPTION	
1	Water Pump Gasket	2011-10	35785	Mounting	
1	Water Pump Gasket	2011-10	35813	Inlet; Improved design	
1	Water Pump Gasket	2008-05	35785	Mounting	
1	Water Pump Gasket	2008-07	35813	Inlet; Improved design	
1	Water Pump Gasket	2004-00	35499	Improved design	
QTY	TIMING COVER	YEARS	PART NO.	DESCRIPTION	
1	Crankshaft Front Seal Set	2011-10	TCS 46147	Must be used w/OS 30754R; Improved design	
1	Crankshaft Front Seal Set	2008-05	TCS 46147	Must be used w/OS 30754R; Improved design	
1	Crankshaft Front Seal Set	2004-00	TCS 45992	Must be used w/OS 30692R	
2	Camshaft Front Seal Set	2011-10	TCS 45939		
2	Camshaft Front Seal Set	2008-00	TCS 45939		
QTY	CARB & FUEL INJECTION	YEARS	PART NO.	DESCRIPTION	
2	Fuel Injector O-Ring Set	2011-10	ES 70599	Improved design	
2	Fuel Injector O-Ring Set	2008-00	ES 70599	Improved design	
1	Throttle Body Gasket	2011-10	61324	Idle air control; 21mm ID	
1	Throttle Body Gasket	2011-10	61326	Idle air control; 30mm ID	
1	Throttle Body Gasket	2011-10	61389	Mounting	
1	Throttle Body Gasket	2008-04	61324	Idle air control; 21mm ID	
1	Throttle Body Gasket	2008-04	61326	Idle air control; 30mm ID	
1	Throttle Body Gasket	2008-05	61389	Mounting	
1	Throttle Body Gasket	2004-00	61068	Mounting	
QTY	EXHAUST GAS RECIRCULATION	YEARS	PART NO.	DESCRIPTION	
2	EGR Gasket	2011-10	70721	Tube flange	
2	EGR Gasket	2011-10	72928	Tube seal	
1	EGR Gasket	2011	72305	Valve	
1	EGR Gasket	2010	71185	Exc. Chrysler Sebring Limited Dodge Avenger R/T; Valve	
1	EGR Gasket	2010	72305	Chrysler Sebring Limited Dodge Avenger R/T; Valve	
2	EGR Gasket	2008-00	70721	Tube flange	
2	EGR Gasket	2008-00	72928	Tube seal	
1	EGR Gasket	2008-05	71185	Valve	
1	EGR Gasket	2004-00	70720	Valve	
67		2013 - 2011; 3.6L 219.9 (3604cc) DOHC V6 (24 Valve) 96mm Bore Pentastar VVT			67
		MFI; Flex Fuel; Naturally Aspirated Chrysler Eng.; VIN Code G			
QTY	CYLINDER HEAD	YEARS	PART NO.	DESCRIPTION	
1	Head Gasket	2013-11	26541 PT	Loc. R.H.; Head bolts not incl.; Head bolt replacement recommended; PermaTorqueMLS®; New Part Number - Check for Availability	
1	Head Gasket	2013-11	26542 PT	Loc. L.H.; Head bolts not incl.; Head bolt replacement recommended; PermaTorqueMLS®; New Part Number - Check for Availability	

Chrysler Car (Incl. Chrysler, DeSoto, Dodge, Eagle, Plymouth) (Cont.)

67		2013 - 2011; 3.6L 219.9 (3604cc) DOHC V6 (24 Valve) 96mm Bore Pentastar VVT			67	
(cont.)		MFI; Flex Fuel; Naturally Aspirated Chrysler Eng.; VIN Code G			(cont.)	
QTY	CYLINDER HEAD	YEARS	PART NO.	DESCRIPTION		
1	Head Set	2013-11	HS 26541 PT	Head bolts not incl.; Head bolt replacement recommended; PermaDry® molded rubber valve cover gskts. incl.; Premium valve stem seals incl.; New Part Number - Check for Availability		
2	Head Bolt Set	2013-11	ES 72467	Replacement recommended; New Part Number - Check for Availability		
QTY	MANIFOLD - INT. & EXH.	YEARS	PART NO.	DESCRIPTION		
1	Int. Manifold Gasket Set	2013-11	MS 97204	Lower set; Upper set incl.; New Part Number - Check for Availability		
1	Plenum Gasket Set	2013-11	MS 97205	Upper set; New Part Number - Check for Availability		
1	Exh. Manifold Gasket Set	2013-11	MS 97197	New Part Number - Check for Availability		
QTY	EXHAUST PIPE FLANGE	YEARS	PART NO.	DESCRIPTION		
2	Exhaust Pipe Gasket	2013-11	61494	Crossover		
QTY	OIL PAN	YEARS	PART NO.	DESCRIPTION		
1	Oil Pan Gasket Set	2013-12	OS 30833	Chrysler 200 Limited, LX, S, Touring Dodge Avenger Canada Value Package, Lux, R/T, SE, SXT, SXT Plus; Loc. Lower; New Part Number - Check for Availability		
1	Oil Pan Gasket Set	2013-12	OS 30835	Exc. Chrysler 200 Limited, LX, S, Touring Dodge Avenger Canada Value Package, Lux, R/T, SE, SXT, SXT Plus; Loc. Lower; New Part Number - Check for Availability		
1	Oil Pan Gasket Set	2011	OS 30833	Exc. Chrysler 300 Base, Limited, LX, Touring Dodge Challenger Rallye, SE, Charger SE, SXT; Loc. Lower; New Part Number - Check for Availability		
1	Oil Pan Gasket Set	2011	OS 30835	Chrysler 300 Base, Limited, LX, Touring Dodge Challenger Rallye, SE, Charger SE, SXT; Loc. Lower; New Part Number - Check for Availability		
QTY	CRANKSHAFT REAR SEAL	YEARS	PART NO.	DESCRIPTION		
1	Rear Main Seal Set	2013-11	BS 40737	Rubber; One-piece; New Part Number - Check for Availability		
QTY	VALVE COVER	YEARS	PART NO.	DESCRIPTION		
1	Valve Cover Gasket Set	2013-11	VS 50805 R	w/Spark plug tube seals; PermaDry® molded rubber gskts. incl.; New Part Number - Check for Availability		
QTY	VALVE STEM SEAL SET	YEARS	PART NO.	DESCRIPTION		
1	Valve Stem Seal Set	2013-11	SS 71074-3	Premium valve stem seals incl.; New Part Number - Check for Availability		
QTY	THERMOSTAT HOUSING	YEARS	PART NO.	DESCRIPTION		
1	Thermostat Gasket	2013-11	35974	Thermostat Housing; Thermostat gskt.; New Part Number - Check for Availability		
QTY	WATER OUTLET GASKET	YEARS	PART NO.	DESCRIPTION		
1	Water Outlet Gasket	2013-11	35975	Water Outlet; Water outlet crossover; New Part Number - Check for Availability		
QTY	WATER PUMP	YEARS	PART NO.	DESCRIPTION		
1	Water Pump Gasket	2013-11	35982	New Part Number - Check for Availability		
QTY	TIMING COVER	YEARS	PART NO.	DESCRIPTION		
1	Timing Cover Set	2013-11	TCS 46162	New Part Number - Check for Availability		
QTY	CARB & FUEL INJECTION	YEARS	PART NO.	DESCRIPTION		
1	Throttle Body Gasket	2013-11	61679	New Part Number - Check for Availability		
68		1993 - 1991; 3.8L 231 (3785cc) OHV V6 (12 Valve) 96mm Bore			68	
		MFI; Gasoline; Naturally Aspirated Chrysler Eng.; VIN Code L				
QTY	CYLINDER HEAD	YEARS	PART NO.	DESCRIPTION		
1	Head Gasket	1993-91	9535 PT	Loc. L.H.; Head bolts not incl.; Head bolt replacement recommended; Improved design		
1	Head Gasket	1993-91	9536 PT	Loc. R.H.; Head bolts not incl.; Head bolt replacement recommended; Improved design		
1	Head Set	1993-91	HS 9830 PT	Int. manifold gskt., head bolts, exh. pipe to manifold gskt. not incl.; Head bolt replacement recommended; PermaDry® molded rubber valve cover gskts. incl.; Premium valve stem seals incl.		
1	Head Bolt Set	1993-91	ES 72849	Head bolts w/o Washers; Washers are req'd.; Replacement recommended		
1	Head Bolt Washer Set	1993-91	ES 72176-1	Replacement recommended		
QTY	CONVERSION SET	YEARS	PART NO.	DESCRIPTION		
1	Gasket Conversion Set	1993-91	CS 9673-2	PermaDry® molded rubber oil pan gskt. incl.		
QTY	MANIFOLD - INT. & EXH.	YEARS	PART NO.	DESCRIPTION		
1	Valley Pan Gasket Set	1993-91	MS 96042	Upper set incl.		
1	Plenum Gasket Set	1993-91	MS 94566	Upper set		
1	Exh. Manifold Gasket Set	1993-91	MS 94666			
QTY	EXHAUST PIPE FLANGE	YEARS	PART NO.	DESCRIPTION		
1	Exhaust Pipe Gasket	1993-91	60810	Pipe to manifold		
2	Exhaust Pipe Gasket	1993-91	60860	Crossover		
1	Exh. Flange Bolt & Spring Kit	1993-91	ES 72143			

Chrysler Car (Incl. Chrysler, DeSoto, Dodge, Eagle, Plymouth) (Cont.)

68 (cont.)		1993 - 1991; 3.8L 231 (3785cc) OHV V6 (12 Valve) 96mm Bore			68 (cont.)
		MFI; Gasoline; Naturally Aspirated Chrysler Eng.; VIN Code L			
QTY	OIL PAN	YEARS	PART NO.	DESCRIPTION	
1	Oil Pan Gasket Set	1993-91	OS 30622 R	PermaDry® molded rubber gskt. incl.	
1	Drain Plug Gasket	1993-91	70822		
QTY	CRANKSHAFT REAR SEAL	YEARS	PART NO.	DESCRIPTION	
1	Rear Main Seal Set	1993-91	BS 40168-1	Rubber; One-piece	
1	Rear Main Seal Set	1993-91	BS 40627	PTFE Rubber; One-piece	
1	Repair Sleeve Tool	1993-91	16300	Crankshaft	
QTY	VALVE COVER	YEARS	PART NO.	DESCRIPTION	
1	Valve Cover Gasket Set	1993-91	VS 50339 R	Must be used w/MS 94566; PermaDry® molded rubber gskts. incl.; .200" thick	
QTY	VALVE STEM SEAL SET	YEARS	PART NO.	DESCRIPTION	
1	Valve Stem Seal Set	1993-91	SS 72783	Premium valve stem seals incl.	
QTY	WATER OUTLET GASKET	YEARS	PART NO.	DESCRIPTION	
1	Water Outlet Gasket	1993-91	35286	Water Outlet	
1	Water Outlet Gasket	1993-91	35286 T	Water Outlet; PermaDryPlus®	
QTY	WATER PUMP	YEARS	PART NO.	DESCRIPTION	
1	Water Pump Gasket	1993-91	35446		
QTY	TIMING COVER	YEARS	PART NO.	DESCRIPTION	
1	Timing Cover Set	1993-91	TCS 45893-1	Must be used w/OS 30622R	
1	Crankshaft Front Seal Set	1993-91	TCS 46194	New Part Number - Check for Availability	
1	Repair Sleeve Tool	1993-91	16326	Timing Cover	
QTY	CARB & FUEL INJECTION	YEARS	PART NO.	DESCRIPTION	
3	Fuel Injector O-Ring Set	1993-91	ES 70599	Improved design	
1	Throttle Body Gasket	1993-91	60744	Mounting	
QTY	EXHAUST GAS RECIRCULATION	YEARS	PART NO.	DESCRIPTION	
1	EGR Gasket	1993-91	70561	Valve	
69		2013 - 2012; 5.7L 345 (5654cc) OHV V8 (16 Valve) 99.5mm Bore Hemi			69
		MFI; Flex Fuel; Naturally Aspirated Chrysler Eng.; VIN Code 2			
QTY	CYLINDER HEAD	YEARS	PART NO.	DESCRIPTION	
1	Head Gasket	2012	26423 PT	Loc. L.H.; Head bolts not incl.; Head bolt replacement recommended; PermaTorqueMLS®	
1	Head Gasket	2012	26426 PT	Loc. R.H.; Head bolts not incl.; Head bolt replacement recommended; PermaTorqueMLS®	
1	Head Set	2012	HS 26423 PT	Head bolts not incl.; Head bolt replacement recommended; PermaDry® molded rubber valve cover gskts. incl.; Premium valve stem seals incl.	
2	Head Bolt Set	2012	ES 72200	Head bolts w/Washers; Replacement recommended	
QTY	CONVERSION SET	YEARS	PART NO.	DESCRIPTION	
1	Gasket Conversion Set	2012	CS 26284-1	PermaDry® molded rubber oil pan gskt. incl.	
QTY	MANIFOLD - INT. & EXH.	YEARS	PART NO.	DESCRIPTION	
1	Int. Manifold Gasket Set	2012	MS 97089		
1	Exh. Manifold Gasket Set	2012	MS 97083		
QTY	EXHAUST PIPE FLANGE	YEARS	PART NO.	DESCRIPTION	
1	Exhaust Pipe Gasket	2012	61240	Flange	
2	Exhaust Pipe Gasket	2012	61710	Pipe to manifold; New Part Number - Check for Availability	
QTY	OIL PAN	YEARS	PART NO.	DESCRIPTION	
1	Oil Pan Gasket Set	2012	OS 30761 R	PermaDry® molded rubber gskt. incl.	
QTY	CRANKSHAFT REAR SEAL	YEARS	PART NO.	DESCRIPTION	
1	Rear Main Seal Set	2012	BS 40684	Retainer w/Seal; PTFE Rubber; One-piece; Improved design	
1	Rear Main Seal Set	2012	BS 40735	Rubber; One-piece; New Part Number - Check for Availability	
1	Repair Sleeve	2012	16230	Crankshaft; Use w/installation tool	
1	Repair Sleeve Tool	2012	16328	Crankshaft	
QTY	VALVE COVER	YEARS	PART NO.	DESCRIPTION	
1	Valve Cover Gasket Set	2012	VS 50625 R	w/Spark plug tube seals; PermaDry® molded rubber gskts. incl.	
QTY	VALVE STEM SEAL SET	YEARS	PART NO.	DESCRIPTION	
1	Valve Stem Seal Set	2012	SS 72929	Premium valve stem seals incl.	
QTY	THERMOSTAT HOUSING	YEARS	PART NO.	DESCRIPTION	
1	Thermostat Gasket	2012	35840	Thermostat Housing; Thermostat housing	
QTY	WATER PUMP	YEARS	PART NO.	DESCRIPTION	
1	Water Pump Gasket	2012	35907		
QTY	TIMING COVER	YEARS	PART NO.	DESCRIPTION	
1	Timing Cover Set	2013-12	TCS 46169	Improved design; New Part Number - Check for Availability	
1	Timing Cover Set	2012	TCS 46049	Old design	

Chrysler Car (Incl. Chrysler, DeSoto, Dodge, Eagle, Plymouth) (Cont.)

69 (cont.)		2013 - 2012; 5.7L 345 (5654cc) OHV V8 (16 Valve) 99.5mm Bore Hemi			69 (cont.)
MFI; Flex Fuel; Naturally Aspirated Chrysler Eng.; VIN Code 2					
QTY	CARB & FUEL INJECTION	YEARS	PART NO.	DESCRIPTION	
2	Fuel Injector O-Ring Set	2012	ES 70599	Improved design	
1	Throttle Body Gasket	2012	61372	Loc. Lower	
1	Throttle Body Gasket	2012	61586	Loc. Upper	
QTY	EXHAUST GAS RECIRCULATION	YEARS	PART NO.	DESCRIPTION	
2	EGR Gasket	2012	70721	Tube flange	
1	EGR Gasket	2012	71221	Valve	
2	EGR Gasket	2012	72535	Tube gskt.; New Part Number - Check for Availability	
2	EGR Gasket	2012	72928	Tube seal	
70		2008 - 2006; 5.7L 345 (5654cc) OHV V8 (16 Valve) 99.5mm Bore Hemi			70
MFI; Gasoline; Naturally Aspirated Chrysler Eng.; VIN Code 2					
QTY	CYLINDER HEAD	YEARS	PART NO.	DESCRIPTION	
1	Head Gasket	2008-06	26284 PT	Loc. L.H.; Head bolts not incl.; Head bolt replacement recommended; PermaTorqueMLS®	
1	Head Gasket	2008-06	26286 PT	Loc. R.H.; Head bolts not incl.; Head bolt replacement recommended; PermaTorqueMLS®	
1	Head Set	2008-06	HS 26284 PT-1	Head bolts not incl.; Head bolt replacement recommended; RTV sealant incl. for thermostat gskt.; PermaDry® molded rubber valve cover gskts. incl.; Premium valve stem seals incl.; Improved design	
1	Head Set	2006	HS 26284 PT	Head bolts not incl.; Head bolt replacement recommended; RTV sealant incl. for thermostat gskt.; PermaDry® molded rubber valve cover gskts. incl.; Premium valve stem seals incl.; Old design	
2	Head Bolt Set	2008-06	ES 72200	Head bolts w/Washers; Replacement recommended	
QTY	CONVERSION SET	YEARS	PART NO.	DESCRIPTION	
1	Gasket Conversion Set	2008-06	CS 26284-1	PermaDry® molded rubber oil pan gskt. incl.	
QTY	MANIFOLD - INT. & EXH.	YEARS	PART NO.	DESCRIPTION	
1	Int. Manifold Gasket Set	2008-06	MS 96574		
1	Exh. Manifold Gasket Set	2008-06	MS 96905	Consolidated design	
1	Exh. Manifold Gasket Set	2006	MS 96532	May use MS 96905 instead; Old design	
QTY	EXHAUST PIPE FLANGE	YEARS	PART NO.	DESCRIPTION	
1	Exhaust Pipe Gasket	2008-06	61240	Flange	
QTY	OIL PAN	YEARS	PART NO.	DESCRIPTION	
1	Oil Pan Gasket Set	2008-06	OS 30761 R	PermaDry® molded rubber gskt. incl.	
QTY	CRANKSHAFT REAR SEAL	YEARS	PART NO.	DESCRIPTION	
1	Rear Main Seal Set	2008-06	BS 40684	Retainer w/Seal; PTFE Rubber; One-piece; Improved design	
1	Rear Main Seal Set	2008-06	BS 40735	Rubber; One-piece; New Part Number - Check for Availability	
1	Repair Sleeve	2008-06	16230	Crankshaft; Use w/installation tool	
1	Repair Sleeve Tool	2008-06	16328	Crankshaft	
QTY	VALVE COVER	YEARS	PART NO.	DESCRIPTION	
1	Valve Cover Gasket Set	2008-06	VS 50625 R	w/Spark plug tube seals; PermaDry® molded rubber gskts. incl.	
QTY	VALVE STEM SEAL SET	YEARS	PART NO.	DESCRIPTION	
1	Valve Stem Seal Set	2008-06	SS 72914	Premium valve stem seals incl.	
QTY	THERMOSTAT HOUSING	YEARS	PART NO.	DESCRIPTION	
1	Thermostat Gasket	2008-06	35840	Thermostat Housing; Thermostat housing	
QTY	WATER PUMP	YEARS	PART NO.	DESCRIPTION	
1	Water Pump Gasket	2008-06	35783		
QTY	TIMING COVER	YEARS	PART NO.	DESCRIPTION	
1	Timing Cover Set	2008-06	TCS 46049	Old design	
1	Timing Cover Set	2008-06	TCS 46169	Improved design; New Part Number - Check for Availability	
QTY	CARB & FUEL INJECTION	YEARS	PART NO.	DESCRIPTION	
2	Fuel Injector O-Ring Set	2008-06	ES 70599	Improved design	
1	Throttle Body Gasket	2008-06	61372	Loc. Lower	
1	Throttle Body Gasket	2008-06	61415	Loc. Upper	
QTY	EXHAUST GAS RECIRCULATION	YEARS	PART NO.	DESCRIPTION	
2	EGR Gasket	2008-06	70721	Tube flange	
1	EGR Gasket	2008-06	71221	Valve	
2	EGR Gasket	2008-06	72928	Tube seal	
71		2008 - 2005; 5.7L 345 (5654cc) OHV V8 (16 Valve) 99.5mm Bore Hemi			71
MFI; Gasoline; Naturally Aspirated Chrysler Eng.; VIN Code H					
QTY	CYLINDER HEAD	YEARS	PART NO.	DESCRIPTION	
1	Head Gasket	2008-05	26284 PT	Loc. L.H.; Head bolts not incl.; Head bolt replacement recommended; PermaTorqueMLS®	

Chrysler Car (Incl. Chrysler, DeSoto, Dodge, Eagle, Plymouth) (Cont.)

71 (cont.)		2008 - 2005; 5.7L 345 (5654cc) OHV V8 (16 Valve) 99.5mm Bore Hemi			71 (cont.)
		MFI; Gasoline; Naturally Aspirated Chrysler Eng.; VIN Code H			
QTY	CYLINDER HEAD	YEARS	PART NO.	DESCRIPTION	
1	Head Gasket	2008-05	26286 PT	Loc. R.H.; Head bolts not incl.; Head bolt replacement recommended; PermaTorqueMLS®	
1	Head Set	2008-05	HS 26284 PT-1	Head bolts not incl.; Head bolt replacement recommended; RTV sealant incl. for thermostat gskt.; PermaDry® molded rubber valve cover gskts. incl.; Premium valve stem seals incl.; Improved design	
1	Head Set	2006-05	HS 26284 PT	Head bolts not incl.; Head bolt replacement recommended; RTV sealant incl. for thermostat gskt.; PermaDry® molded rubber valve cover gskts. incl.; Premium valve stem seals incl.; Old design	
2	Head Bolt Set	2008-05	ES 72200	Head bolts w/Washers; Replacement recommended	
QTY	CONVERSION SET	YEARS	PART NO.	DESCRIPTION	
1	Gasket Conversion Set	2008-05	CS 26284-1	PermaDry® molded rubber oil pan gskt. incl.	
QTY	MANIFOLD - INT. & EXH.	YEARS	PART NO.	DESCRIPTION	
1	Int. Manifold Gasket Set	2008-05	MS 96574		
1	Exh. Manifold Gasket Set	2008-05	MS 96905	Consolidated design	
1	Exh. Manifold Gasket Set	2006-05	MS 96532	May use MS 96905 instead; Old design	
QTY	EXHAUST PIPE FLANGE	YEARS	PART NO.	DESCRIPTION	
1	Exhaust Pipe Gasket	2008-05	61240	Flange	
QTY	OIL PAN	YEARS	PART NO.	DESCRIPTION	
1	Oil Pan Gasket Set	2008-05	OS 30761 R	PermaDry® molded rubber gskt. incl.	
QTY	CRANKSHAFT REAR SEAL	YEARS	PART NO.	DESCRIPTION	
1	Rear Main Seal Set	2008-05	BS 40684	Retainer w/Seal; PTFE Rubber; One-piece; Improved design	
1	Rear Main Seal Set	2008-05	BS 40735	Rubber; One-piece; New Part Number - Check for Availability	
1	Repair Sleeve	2008-05	16230	Crankshaft; Use w/installation tool	
1	Repair Sleeve Tool	2008-05	16328	Crankshaft	
QTY	VALVE COVER	YEARS	PART NO.	DESCRIPTION	
1	Valve Cover Gasket Set	2008-05	VS 50625 R	w/Spark plug tube seals; PermaDry® molded rubber gskts. incl.	
QTY	VALVE STEM SEAL SET	YEARS	PART NO.	DESCRIPTION	
1	Valve Stem Seal Set	2008-05	SS 72914	Premium valve stem seals incl.	
QTY	THERMOSTAT HOUSING	YEARS	PART NO.	DESCRIPTION	
1	Thermostat Gasket	2008-05	35840	Thermostat Housing; Thermostat housing	
QTY	WATER PUMP	YEARS	PART NO.	DESCRIPTION	
1	Water Pump Gasket	2008-05	35783		
QTY	TIMING COVER	YEARS	PART NO.	DESCRIPTION	
1	Timing Cover Set	2008-05	TCS 46049	Old design	
1	Timing Cover Set	2008-05	TCS 46169	Improved design; New Part Number - Check for Availability	
QTY	CARB & FUEL INJECTION	YEARS	PART NO.	DESCRIPTION	
2	Fuel Injector O-Ring Set	2008-05	ES 70599	Improved design	
1	Throttle Body Gasket	2008-05	61372	Loc. Lower	
1	Throttle Body Gasket	2008-05	61415	Loc. Upper	
QTY	EXHAUST GAS RECIRCULATION	YEARS	PART NO.	DESCRIPTION	
2	EGR Gasket	2008-05	70721	Tube flange	
1	EGR Gasket	2008-05	71221	Valve	
2	EGR Gasket	2008-05	72928	Tube seal	
72		2013 - 2009; 5.7L 345 (5654cc) OHV V8 (16 Valve) 99.5mm Bore Hemi			72
		MFI; Gasoline; Naturally Aspirated Chrysler Eng.; VIN Code T			
QTY	CYLINDER HEAD	YEARS	PART NO.	DESCRIPTION	
1	Head Gasket	2012-09	26423 PT	Loc. L.H.; Head bolts not incl.; Head bolt replacement recommended; PermaTorqueMLS®	
1	Head Gasket	2012-09	26426 PT	Loc. R.H.; Head bolts not incl.; Head bolt replacement recommended; PermaTorqueMLS®	
1	Head Set	2012-09	HS 26423 PT	Head bolts not incl.; Head bolt replacement recommended; PermaDry® molded rubber valve cover gskts. incl.; Premium valve stem seals incl.	
2	Head Bolt Set	2012-09	ES 72200	Head bolts w/Washers; Replacement recommended	
QTY	CONVERSION SET	YEARS	PART NO.	DESCRIPTION	
1	Gasket Conversion Set	2012-09	CS 26284-1	PermaDry® molded rubber oil pan gskt. incl.	
QTY	MANIFOLD - INT. & EXH.	YEARS	PART NO.	DESCRIPTION	
1	Int. Manifold Gasket Set	2012-09	MS 97089		
1	Exh. Manifold Gasket Set	2012-09	MS 97083		
QTY	EXHAUST PIPE FLANGE	YEARS	PART NO.	DESCRIPTION	
1	Exhaust Pipe Gasket	2012-09	61240	Flange	
2	Exhaust Pipe Gasket	2012-09	61710	Pipe to manifold; New Part Number - Check for Availability	
QTY	OIL PAN	YEARS	PART NO.	DESCRIPTION	
1	Oil Pan Gasket Set	2012-09	OS 30761 R	PermaDry® molded rubber gskt. incl.	

Chrysler Car (Incl. Chrysler, DeSoto, Dodge, Eagle, Plymouth) (Cont.)

72 (cont.)		2013 - 2009; 5.7L 345 (5654cc) OHV V8 (16 Valve) 99.5mm Bore Hemi			72 (cont.)
MFI; Gasoline; Naturally Aspirated Chrysler Eng.; VIN Code T					
QTY	CRANKSHAFT REAR SEAL	YEARS	PART NO.	DESCRIPTION	
1	Rear Main Seal Set	2012-09	BS 40684	Retainer w/Seal; PTFE Rubber; One-piece; Improved design	
1	Rear Main Seal Set	2012-09	BS 40735	Rubber; One-piece; New Part Number - Check for Availability	
1	Repair Sleeve	2012-09	16230	Crankshaft; Use w/installation tool	
1	Repair Sleeve Tool	2012-09	16328	Crankshaft	
QTY	VALVE COVER	YEARS	PART NO.	DESCRIPTION	
1	Valve Cover Gasket Set	2012-09	VS 50625 R	w/Spark plug tube seals; PermaDry® molded rubber gskts. incl.	
QTY	VALVE STEM SEAL SET	YEARS	PART NO.	DESCRIPTION	
1	Valve Stem Seal Set	2012-09	SS 72929	Premium valve stem seals incl.	
QTY	THERMOSTAT HOUSING	YEARS	PART NO.	DESCRIPTION	
1	Thermostat Gasket	2012-09	35840	Thermostat Housing; Thermostat housing	
QTY	WATER PUMP	YEARS	PART NO.	DESCRIPTION	
1	Water Pump Gasket	2012-09	35907		
QTY	TIMING COVER	YEARS	PART NO.	DESCRIPTION	
1	Timing Cover Set	2013-09	TCS 46169	Improved design; New Part Number - Check for Availability	
1	Timing Cover Set	2012-09	TCS 46049	Old design	
QTY	CARB & FUEL INJECTION	YEARS	PART NO.	DESCRIPTION	
2	Fuel Injector O-Ring Set	2012-09	ES 70599	Improved design	
1	Throttle Body Gasket	2012-09	61372	Loc. Lower	
1	Throttle Body Gasket	2012-09	61586	Loc. Upper	
QTY	EXHAUST GAS RECIRCULATION	YEARS	PART NO.	DESCRIPTION	
2	EGR Gasket	2012-09	70721	Tube flange	
1	EGR Gasket	2012-09	71221	Valve	
2	EGR Gasket	2012-09	72535	Tube gskt.; New Part Number - Check for Availability	
2	EGR Gasket	2012-09	72928	Tube seal	
73		2010 - 2005; 6.1L 370 (6059cc) OHV V8 (16 Valve) 103mm Bore Hemi			73
MFI; Gasoline; Naturally Aspirated Chrysler Eng.; VIN Code W					
QTY	CYLINDER HEAD	YEARS	PART NO.	DESCRIPTION	
2	Head Gasket	2010-05	26366 PT	Head bolts not incl.; Head bolt replacement recommended; PermaTorqueMLS®	
1	Head Set	2010-05	HS 26366 PT	Head bolts not incl.; Head bolt replacement recommended; PermaDry® molded rubber valve cover gskts. incl.; Premium valve stem seals incl.	
2	Head Bolt Set	2010-05	ES 72200	Head bolts w/Washers; Replacement recommended	
QTY	CONVERSION SET	YEARS	PART NO.	DESCRIPTION	
1	Gasket Conversion Set	2010-05	CS 26366	PermaDry® molded rubber oil pan gskt. incl.	
QTY	MANIFOLD - INT. & EXH.	YEARS	PART NO.	DESCRIPTION	
1	Int. Manifold Gasket Set	2010-05	MS 96916	Lower set; Upper set incl.	
1	Exh. Manifold Gasket Set	2010-05	MS 96964		
QTY	OIL PAN	YEARS	PART NO.	DESCRIPTION	
1	Oil Pan Gasket Set	2010-05	OS 30795 R	PermaDry® molded rubber gskt. incl.	
QTY	CRANKSHAFT REAR SEAL	YEARS	PART NO.	DESCRIPTION	
1	Rear Main Seal Set	2010-05	BS 40684	Retainer w/Seal; PTFE Rubber; One-piece; Improved design	
1	Rear Main Seal Set	2010-05	BS 40735	Rubber; One-piece; New Part Number - Check for Availability	
1	Repair Sleeve	2010-05	16230	Crankshaft; Use w/installation tool	
1	Repair Sleeve Tool	2010-05	16328	Crankshaft	
QTY	VALVE COVER	YEARS	PART NO.	DESCRIPTION	
1	Valve Cover Gasket Set	2010-05	VS 50625 R	w/Spark plug tube seals; PermaDry® molded rubber gskts. incl.	
QTY	VALVE STEM SEAL SET	YEARS	PART NO.	DESCRIPTION	
1	Valve Stem Seal Set	2010-05	SS 72914-1	Premium valve stem seals incl.	
QTY	THERMOSTAT HOUSING	YEARS	PART NO.	DESCRIPTION	
1	O-Ring	2010-05	35857	Thermostat Housing; Thermostat seal	
QTY	WATER PUMP	YEARS	PART NO.	DESCRIPTION	
1	Water Pump Gasket	2010-05	35783		
QTY	TIMING COVER	YEARS	PART NO.	DESCRIPTION	
1	Timing Cover Set	2010-05	TCS 46049	Old design	
1	Timing Cover Set	2010-05	TCS 46169	Improved design; New Part Number - Check for Availability	
QTY	CARB & FUEL INJECTION	YEARS	PART NO.	DESCRIPTION	
2	Fuel Injector O-Ring Set	2010-05	ES 70599	Improved design	
1	Throttle Body Gasket	2010-05	61324	Idle air control; 21mm ID	
1	Throttle Body Gasket	2010-05	61372	Mounting	

Chrysler Car (Incl. Chrysler, DeSoto, Dodge, Eagle, Plymouth) (Cont.)

74		2007 - 2003; 8.3L 505 (8277cc) OHV V10 (20 Valve) 102.4mm Bore MFI; Gasoline; Naturally Aspirated Chrysler Eng.; VIN Code Z			74
QTY	CYLINDER HEAD	YEARS	PART NO.	DESCRIPTION	
2	Head Gasket	2007-03	26283 PT	Head bolts not incl.; Head bolt replacement recommended; PermaTorqueMLS®	
1	Head Set	2007-03	HS 26283 PT	Head bolts not incl.; Head bolt replacement recommended; PermaDry® molded rubber valve cover gskts. incl.; Premium valve stem seals incl.	
2	Head Bolt Set	2007-03	ES 72209	Head bolts w/Washers; Replacement recommended	
QTY	CONVERSION SET	YEARS	PART NO.	DESCRIPTION	
1	Gasket Conversion Set	2007-03	CS 26283		
QTY	MANIFOLD - INT. & EXH.	YEARS	PART NO.	DESCRIPTION	
1	Int. Manifold Gasket Set	2007-03	MS 96638	Lower set	
1	Exh. Manifold Gasket Set	2007-03	MS 96632		
QTY	OIL PAN	YEARS	PART NO.	DESCRIPTION	
1	Oil Pan Gasket Set	2007-03	OS 30755		
1	Drain Plug Gasket	2007-03	70822		
QTY	CRANKSHAFT REAR SEAL	YEARS	PART NO.	DESCRIPTION	
1	Rear Main Seal Set	2007-03	BS 40688	Rubber; One-piece	
QTY	VALVE COVER	YEARS	PART NO.	DESCRIPTION	
1	Valve Cover Gasket Set	2007-03	VS 50636 R	PermaDry® molded rubber gskts. incl.	
QTY	VALVE STEM SEAL SET	YEARS	PART NO.	DESCRIPTION	
1	Valve Stem Seal Set	2007-03	SS 72860	Premium valve stem seals incl.	
QTY	THERMOSTAT HOUSING	YEARS	PART NO.	DESCRIPTION	
1	Thermostat Gasket	2007-03	35773	Thermostat Housing; Thermostat seal	
1	Thermostat Gasket	2007-03	35799	Thermostat Housing; Seal	
QTY	WATER PUMP	YEARS	PART NO.	DESCRIPTION	
1	Water Pump Gasket	2007-03	35775		
QTY	TIMING COVER	YEARS	PART NO.	DESCRIPTION	
1	Timing Cover Set	2007-03	TCS 46057		
QTY	CARB & FUEL INJECTION	YEARS	PART NO.	DESCRIPTION	
3	Fuel Injector O-Ring Set	2007-03	ES 70599	Improved design	
1	Throttle Body Gasket	2007-03	61393		
75		2009 - 2008; 8.4L 512 (8354cc) OHV V10 (20 Valve) 103mm Bore MFI; Gasoline; Naturally Aspirated Chrysler Eng.; VIN Code Z			75
QTY	CONVERSION SET	YEARS	PART NO.	DESCRIPTION	
1	Gasket Conversion Set	2009-08	CS 26283		
QTY	OIL PAN	YEARS	PART NO.	DESCRIPTION	
1	Oil Pan Gasket Set	2009-08	OS 30755		
1	Drain Plug Gasket	2009-08	70822		
QTY	CRANKSHAFT REAR SEAL	YEARS	PART NO.	DESCRIPTION	
1	Rear Main Seal Set	2009-08	BS 40688	Rubber; One-piece	
QTY	THERMOSTAT HOUSING	YEARS	PART NO.	DESCRIPTION	
1	Thermostat Gasket	2009-08	35773	Thermostat Housing; Thermostat seal	
1	Thermostat Gasket	2009-08	35799	Thermostat Housing; Seal	
QTY	WATER PUMP	YEARS	PART NO.	DESCRIPTION	
1	Water Pump Gasket	2009-08	35775		
QTY	TIMING COVER	YEARS	PART NO.	DESCRIPTION	
1	Timing Cover Set	2009-08	TCS 46057		

Chrysler Minivans - See Dodge Truck
Chrysler Motor Home - See Dodge Truck
Chrysler SUV's - See Dodge Truck
Chrysler Truck - See Dodge Truck
Daewoo Car

Engine Finding Index				
Engine	Years	Code	Line No.	
1.6L 97.5 (1598cc) DOHC L4 (16 Valve) 79mm Bore; MFI; Gasoline; Naturally Aspirated Opel Eng.	2002-98	A16DMS	1	
2.0L 122 (1998cc) DOHC L4 (16 Valve) 86mm Bore; MFI; Gasoline; Naturally Aspirated Opel Eng.	2002-98	A20DMS	2	

Daewoo Car (Cont.)

Engine Finding Index (Cont.)

Engine	Years	Code	Line No.
2.2L 134.1 (2198cc) DOHC L4 (16 Valve) 86mm Bore; MFI; Gasoline; Naturally Aspirated Opel Eng.	2002-98	A22DMS	3

Engine Code Index			
Code	Engine	Line No.	
A16DMS	1.6L 97.5 (1598cc) DOHC L4 (16 Valve) 79mm Bore; MFI; Gasoline; Naturally Aspirated Opel Eng.	1	
A20DMS	2.0L 122 (1998cc) DOHC L4 (16 Valve) 86mm Bore; MFI; Gasoline; Naturally Aspirated Opel Eng.	2	
A22DMS	2.2L 134.1 (2198cc) DOHC L4 (16 Valve) 86mm Bore; MFI; Gasoline; Naturally Aspirated Opel Eng.	3	

Model Index					
Engine (VIN Code / Eng. Code)	Year	Engine (VIN Code / Eng. Code)	Year	Engine (VIN Code / Eng. Code)	Year
Daewoo		Daewoo (cont.)		Daewoo (cont.)	
Lanos		Leganza		Nubira	
L4 1598cc 1.6L DOHC (16 Valve) (A16DMS)	02-99	L4 2198cc 2.2L DOHC (16 Valve) (A22DMS)	02-99	L4 1998cc 2.0L DOHC (16 Valve) (A20DMS)	02-99

1 2002 - 1998; 1.6L 97.5 (1598cc) DOHC L4 (16 Valve) 79mm Bore MFI; Gasoline; Naturally Aspirated Opel Eng.; Eng. Code A16DMS 1				
QTY	CYLINDER HEAD	YEARS	PART NO.	DESCRIPTION
1	Head Gasket	2002-98	26385 PT	Head bolts not incl.; Head bolt replacement recommended
1	Head Set	2002	HS 26385 PT-1	Head bolts not incl.; Head bolt replacement recommended; PermaDry® molded rubber valve cover gskt. incl.; Premium valve stem seals incl.
1	Head Set	2001-98	HS 26385 PT	Head bolts not incl.; Head bolt replacement recommended; PermaDry® molded rubber valve cover gskt. incl.; Premium valve stem seals incl.
1	Head Bolt Set	2002-98	ES 72244	Head bolts w/Washers; Replacement recommended
QTY	CONVERSION SET	YEARS	PART NO.	DESCRIPTION
1	Gasket Conversion Set	2002-98	CS 26385	
QTY	MANIFOLD - INT. & EXH.	YEARS	PART NO.	DESCRIPTION
1	Int. Manifold Gasket Set	2002-98	MS 97004	Lower set
1	Plenum Gasket Set	2002-98	MS 97006	Upper set
1	Exh. Manifold Gasket Set	2002-98	MS 96942	
QTY	EXHAUST PIPE FLANGE	YEARS	PART NO.	DESCRIPTION
1	Exhaust Pipe Gasket	2002-98	61171	Converter
1	Exhaust Pipe Gasket	2002-00	61473	Flange
1	Exhaust Pipe Gasket	1999	61473	From 11/01/98; Flange
1	Exhaust Pipe Gasket	1999	62555	To 10/31/98; Flange
1	Exhaust Pipe Gasket	1998	62555	Flange
QTY	OIL PAN	YEARS	PART NO.	DESCRIPTION
1	Oil Pan Gasket Set	2002-98	OS 30801 C	
QTY	CRANKSHAFT REAR SEAL	YEARS	PART NO.	DESCRIPTION
1	Rear Main Seal Set	2002-98	BS 40535	Rubber; One-piece; Improved design
QTY	VALVE COVER	YEARS	PART NO.	DESCRIPTION
1	Valve Cover Gasket Set	2002	VS 50730 R	w/Grommets; PermaDry® molded rubber gskt. incl.
1	Valve Cover Gasket Set	2001-98	VS 50732 R	w/Semi-circular plugs & Grommets; PermaDry® molded rubber gskt. incl.
QTY	VALVE STEM SEAL SET	YEARS	PART NO.	DESCRIPTION
1	Valve Stem Seal Set	2002-98	SS 72924	Premium valve stem seals incl.
QTY	THERMOSTAT HOUSING	YEARS	PART NO.	DESCRIPTION
1	Thermostat Gasket	2002-00	35862	Thermostat seal
1	Thermostat Gasket	1999-98	35862	From 09/01/98; Thermostat seal
1	O-Ring	1999-98	35410	Thermostat Housing; To 08/31/98; Thermostat seal
QTY	WATER PUMP	YEARS	PART NO.	DESCRIPTION
1	Water Pump Gasket	2002-98	35411	
QTY	TIMING COVER	YEARS	PART NO.	DESCRIPTION
1	Crankshaft Front Seal Set	2002-98	TCS 46110	
1	Camshaft Front Seal Set	2002-98	TCS 46116	
QTY	CARB & FUEL INJECTION	YEARS	PART NO.	DESCRIPTION
1	Fuel Injector O-Ring Set	2002-98	ES 70599	Lower set; Injectors to cylinder head; Improved design
1	Fuel Injector O-Ring Set	2002-98	ES 70599	Upper set; Injectors to fuel rail; Improved design
1	Fuel Injector O-Ring Set	2002-98	ES 71192	Upper set; Injectors to fuel rail; Old design
1	Throttle Body Gasket	2002-98	61533	
QTY	EXHAUST GAS RECIRCULATION	YEARS	PART NO.	DESCRIPTION
1	EGR Gasket	2002-98	70789	Valve
1	EGR Gasket	2002-98	71287	Pipe
1	EGR Gasket	2002-98	72293	Adapter

2		2002 - 1998; 2.0L 122 (1998cc) DOHC L4 (16 Valve) 86mm Bore			2
		MFI; Gasoline; Naturally Aspirated Opel Eng.; Eng. Code A20DMS			
QTY	CYLINDER HEAD	YEARS	PART NO.	DESCRIPTION	
1	Head Gasket	2002-98	26317 PT	Head bolts not incl.; Head bolt replacement recommended	
1	Head Set	2002-98	HS 26317 PT	Head bolts not incl.; Head bolt replacement recommended; PermaDry® molded rubber valve cover gskt. incl.; Premium valve stem seals incl.	
1	Head Bolt Set	2002-98	ES 72906-1	Head bolts w/Washers; Replacement recommended	
QTY	CONVERSION SET	YEARS	PART NO.	DESCRIPTION	
1	Gasket Conversion Set	2002-98	CS 26317	RTV sealant incl. for oil pan gskt.	
QTY	MANIFOLD - INT. & EXH.	YEARS	PART NO.	DESCRIPTION	
1	Int. Manifold Gasket Set	2002-98	MS 96859		
1	Exh. Manifold Gasket Set	2002-98	MS 96815		
QTY	EXHAUST PIPE FLANGE	YEARS	PART NO.	DESCRIPTION	
1	Exhaust Pipe Gasket	2002-98	61473	Ring	
1	Exhaust Pipe Gasket	2002-98	61475	Exh. connector; 3-bolt	
1	Exhaust Pipe Gasket	2002-98	61488	Exh. connector; 2-bolt	
QTY	CRANKSHAFT REAR SEAL	YEARS	PART NO.	DESCRIPTION	
1	Rear Main Seal Set	2002-98	BS 40555	Rubber; One-piece	
QTY	VALVE COVER	YEARS	PART NO.	DESCRIPTION	
1	Valve Cover Gasket Set	2002-98	VS 50692 R	w/Grommets & Spark plug tube seals; PermaDry® molded rubber gskt. incl.	
QTY	VALVE STEM SEAL SET	YEARS	PART NO.	DESCRIPTION	
1	Valve Stem Seal Set	2002-98	SS 71163-1	Premium valve stem seals incl.	
QTY	THERMOSTAT HOUSING	YEARS	PART NO.	DESCRIPTION	
1	Thermostat Gasket	2002-98	35820	Thermostat Housing; Thermostat seal	
QTY	WATER OUTLET GASKET	YEARS	PART NO.	DESCRIPTION	
1	Water Outlet Gasket	2002-98	35821	Water Outlet	
QTY	WATER PUMP	YEARS	PART NO.	DESCRIPTION	
1	Water Pump Gasket	2002-98	35302	O-ring	
QTY	TIMING COVER	YEARS	PART NO.	DESCRIPTION	
1	Crankshaft Front Seal Set	2002-98	TCS 46097		
1	Camshaft Front Seal Set	2002-98	TCS 46094		
QTY	CARB & FUEL INJECTION	YEARS	PART NO.	DESCRIPTION	
2	Fuel Injector O-Ring Set	2002-98	ES 70599	Improved design	
1	Throttle Body Gasket	2002-98	61384		
QTY	EXHAUST GAS RECIRCULATION	YEARS	PART NO.	DESCRIPTION	
1	EGR Gasket	2002-98	71269	Valve	
1	EGR Gasket	2002-98	71270	Adapter	
3		2002 - 1998; 2.2L 134.1 (2198cc) DOHC L4 (16 Valve) 86mm Bore			3
		MFI; Gasoline; Naturally Aspirated Opel Eng.; Eng. Code A22DMS			
QTY	CYLINDER HEAD	YEARS	PART NO.	DESCRIPTION	
1	Head Gasket	2002-98	26317 PT	Head bolts not incl.; Head bolt replacement recommended	
1	Head Set	2002-98	HS 26317 PT	Head bolts not incl.; Head bolt replacement recommended; PermaDry® molded rubber valve cover gskt. incl.; Premium valve stem seals incl.	
1	Head Bolt Set	2002-98	ES 72906-1	Head bolts w/Washers; Replacement recommended	
QTY	CONVERSION SET	YEARS	PART NO.	DESCRIPTION	
1	Gasket Conversion Set	2002-98	CS 26317	RTV sealant incl. for oil pan gskt.	
QTY	MANIFOLD - INT. & EXH.	YEARS	PART NO.	DESCRIPTION	
1	Int. Manifold Gasket Set	2002-98	MS 96859		
1	Exh. Manifold Gasket Set	2002-98	MS 96815		
QTY	EXHAUST PIPE FLANGE	YEARS	PART NO.	DESCRIPTION	
1	Exhaust Pipe Gasket	2002-98	61473	Ring	
1	Exhaust Pipe Gasket	2002-98	61475	Exh. connector; 3-bolt	
1	Exhaust Pipe Gasket	2002-98	61488	Exh. connector; 2-bolt	
QTY	CRANKSHAFT REAR SEAL	YEARS	PART NO.	DESCRIPTION	
1	Rear Main Seal Set	2002-98	BS 40555	Rubber; One-piece	
QTY	VALVE COVER	YEARS	PART NO.	DESCRIPTION	
1	Valve Cover Gasket Set	2002-98	VS 50692 R	w/Grommets & Spark plug tube seals; PermaDry® molded rubber gskt. incl.	
QTY	VALVE STEM SEAL SET	YEARS	PART NO.	DESCRIPTION	
1	Valve Stem Seal Set	2002-98	SS 71163-1	Premium valve stem seals incl.	
QTY	THERMOSTAT HOUSING	YEARS	PART NO.	DESCRIPTION	
1	Thermostat Gasket	2002-98	35820	Thermostat Housing; Thermostat seal	
QTY	WATER OUTLET GASKET	YEARS	PART NO.	DESCRIPTION	
1	Water Outlet Gasket	2002-98	35821	Water Outlet	
QTY	WATER PUMP	YEARS	PART NO.	DESCRIPTION	
1	Water Pump Gasket	2002-98	35302	O-ring	

Daewoo Car (Cont.)

3 (cont.)		2002 - 1998; 2.2L 134.1 (2198cc) DOHC L4 (16 Valve) 86mm Bore MFI; Gasoline; Naturally Aspirated Opel Eng.; Eng. Code A22DMS			3 (cont.)
QTY	TIMING COVER	YEARS	PART NO.	DESCRIPTION	
1	Crankshaft Front Seal Set	2002-98	TCS 46097		
1	Camshaft Front Seal Set	2002-98	TCS 46094		
QTY	CARB & FUEL INJECTION	YEARS	PART NO.	DESCRIPTION	
2	Fuel Injector O-Ring Set	2002-98	ES 70599	Improved design	
1	Throttle Body Gasket	2002-98	61384		
QTY	EXHAUST GAS RECIRCULATION	YEARS	PART NO.	DESCRIPTION	
1	EGR Gasket	2002-98	71269	Valve	
1	EGR Gasket	2002-98	71270	Adapter	

DeTomaso (Incl. DeTomaso, Qvale)

Engine Finding Index					
Engine	Years	Code	Line No.		
4.6L 281 (4605cc) DOHC V8 (32 Valve) 90.2mm Bore Intech; MFI; Gasoline; Naturally Aspirated Ford Eng.	2002-00	V	1		
Model Index					
Engine (VIN Code / Eng. Code)	Year	Engine (VIN Code / Eng. Code)	Year	Engine (VIN Code / Eng. Code)	Year
DeTomaso		DeTomaso (cont.)		Qvale	
Mangusta		Pantera		Mangusta	
V8 289CI 4.7L OHV (K)	67	V8 351CI 5.8L OHV (Cleveland) (H)	74-71	V8 281CI 4.6L DOHC (32 Valve) (V)	02-00
V8 302CI 5.0L OHV (F)	72-67	V8 351CI 5.8L OHV (Windsor) (G)	89-81		
V8 302CI 5.0L OHV (G)	71-69				
1		2002 - 2000; 4.6L 281 (4605cc) DOHC V8 (32 Valve) 90.2mm Bore Intech MFI; Gasoline; Naturally Aspirated Ford Eng.; VIN Code V			1
QTY	CYLINDER HEAD	YEARS	PART NO.	DESCRIPTION	
1	Head Gasket	2002-00	9790 PT-2	Loc. R.H.; Head bolts not incl.; Head bolt replacement recommended; PermaTorqueMLS®; Improved design	
1	Head Gasket	2002-00	9792 PT-2	Loc. L.H.; Head bolts not incl.; Head bolt replacement recommended; PermaTorqueMLS®; Improved design	
1	Head Set	2002-00	HS 9790 PT-3	Int. manifold upper & lower gskts., valve cover gskts., head bolts not incl.; Head bolt replacement recommended; Premium valve stem seals incl.	
2	Head Bolt Set	2002-00	ES 71328	Head bolts w/Washers; Replacement recommended; Improved design	
2	Head Bolt Set	2002-00	ES 72798	Head bolts w/Washers; Replacement recommended; May use ES 71328 instead; Old design	
QTY	CONVERSION SET	YEARS	PART NO.	DESCRIPTION	
1	Gasket Conversion Set	2002-00	CS 9790-4	PermaDry® molded rubber oil pan gskt. incl.; Consolidated design	
QTY	MANIFOLD - INT. & EXH.	YEARS	PART NO.	DESCRIPTION	
1	Int. Manifold Gasket Set	2002-00	MS 92562	Lower set	
1	Plenum Gasket Set	2002-00	MS 95925-2	Upper set	
1	Exh. Manifold Gasket Set	2002-00	MS 95949		
QTY	EXHAUST PIPE FLANGE	YEARS	PART NO.	DESCRIPTION	
1	Exhaust Pipe Gasket	2002-00	61203	Flange	
QTY	OIL PAN	YEARS	PART NO.	DESCRIPTION	
1	Oil Pan Gasket Set	2002-00	OS 30725 R	PermaDry® molded rubber gskt. incl.; Improved design	
1	Drain Plug Gasket	2002-00	72515		
QTY	CRANKSHAFT REAR SEAL	YEARS	PART NO.	DESCRIPTION	
1	Rear Main Seal Set	2002-00	BS 40620	Rubber; One-piece; Improved design	
1	Rear Main Seal Set	2002-00	BS 40644	PTFE Rubber; One-piece	
1	Repair Sleeve	2002-00	16255-1	Crankshaft; 1.105" - 1.135" sleeve length; Use w/installation tool; Improved design	
1	Repair Sleeve Tool	2002-00	16306	Crankshaft	
QTY	VALVE COVER	YEARS	PART NO.	DESCRIPTION	
1	Valve Cover Gasket Set	2002-00	VS 50477 R	w/Grommets & Spark plug tube seals; PermaDry® molded rubber gskts. incl.; Improved design	
QTY	VALVE STEM SEAL SET	YEARS	PART NO.	DESCRIPTION	
1	Valve Stem Seal Set	2002-00	SS 72888	Premium valve stem seals incl.	
QTY	WATER OUTLET GASKET	YEARS	PART NO.	DESCRIPTION	
1	Water Outlet Gasket	2002-00	35489	Water Outlet	
QTY	WATER PUMP	YEARS	PART NO.	DESCRIPTION	
1	Water Pump Gasket	2002-00	35478		
2	O-Ring	2002-00	413	Water Pump; Water pump bypass pipe O-ring	
QTY	TIMING COVER	YEARS	PART NO.	DESCRIPTION	
1	Timing Cover Set	2002-00	TCS 45980	Repair sleeve not incl.	
1	Crankshaft Front Seal Set	2002-00	TCS 46114		

DeTomaso (Incl. DeTomaso, Qvale) (Cont.)

1 (cont.)	2002 - 2000; 4.6L 281 (4605cc) DOHC V8 (32 Valve) 90.2mm Bore Intech MFI; Gasoline; Naturally Aspirated Ford Eng.; VIN Code V				1 (cont.)
QTY	TIMING COVER	YEARS	PART NO.	DESCRIPTION	
1	Repair Sleeve	2002-00	16207	Timing Cover; Use w/installation tool	
1	Repair Sleeve Tool	2002-00	16310	Timing Cover	
QTY	CARB & FUEL INJECTION	YEARS	PART NO.	DESCRIPTION	
4	Fuel Injector O-Ring Set	2002-00	ES 70599	Improved design	
1	Throttle Body Gasket	2002-00	61042	Mounting	
1	Throttle Body Gasket	2002-00	71216	Air bypass valve	
QTY	EXHAUST GAS RECIRCULATION	YEARS	PART NO.	DESCRIPTION	
1	EGR Gasket	2002-00	70149		
QTY	OIL FILTER MOUNTING	YEARS	PART NO.	DESCRIPTION	
1	Oil Filter Adapter Gasket	2002-00	70415		

Dodge Car - See Chrysler Car

Dodge Minivans - See Dodge Truck

Dodge SUV's - See Dodge Truck

Dodge Truck (Incl. Minivans and SUV's)

Engine Finding Index				
Engine	Years	Code	Line No.	
2.0L 122 (1996cc) DOHC L4 (16 Valve) 87.5mm Bore; MFI; Gasoline; Naturally Aspirated Chrysler Eng.	2004-02	9	1	
2.4L 143.4 (2351cc) SOHC L4 (8 Valve) 86.5mm Bore; MFI; Gasoline; Naturally Aspirated Mitsubishi Eng.	1993	G	2	
2.4L 143.4 (2351cc) SOHC L4 (8 Valve) 86.5mm Bore; MFI; Gasoline; Naturally Aspirated Mitsubishi Eng.	1992-91	W	3	
2.4L 144 (2360cc) DOHC L4 (16 Valve) 88mm Bore; MFI; Gasoline; Naturally Aspirated Chrysler Eng.	2013-10	B	4	
2.4L 144 (2360cc) DOHC L4 (16 Valve) 88mm Bore; MFI; Gasoline; Naturally Aspirated Chrysler Eng.	2013-09	T	5	
2.4L 148 (2429cc) DOHC L4 (16 Valve) 87.5mm Bore; MFI; Gasoline; Turbo - Intercooled Chrysler Eng.	2009-04	8	6	
2.4L 148 (2429cc) DOHC L4 (16 Valve) 87.5mm Bore; MFI; Gasoline; Naturally Aspirated Chrysler Eng.	2010	9	7	
2.4L 148 (2429cc) DOHC L4 (16 Valve) 87.5mm Bore; MFI; Gasoline; Naturally Aspirated Chrysler Eng.	2010-96	B	8	
2.4L 148 (2429cc) DOHC L4 (16 Valve) 87.5mm Bore; MFI; Gasoline; Turbo - Intercooled Chrysler Eng.	2008-04	E	9	
2.4L 148 (2429cc) DOHC L4 (16 Valve) 87.5mm Bore; MFI; Gasoline; Turbo - Intercooled Chrysler Eng.	2009-03	G	10	
2.4L 148 (2429cc) DOHC L4 (16 Valve) 87.5mm Bore; MFI; Gasoline; Turbo - Intercooled Chrysler Eng.	2007-04	S	11	
2.4L 148 (2429cc) DOHC L4 (16 Valve) 87.5mm Bore; MFI; Gasoline; Naturally Aspirated Chrysler Eng.	2008-04	X	12	
2.5L 150 (2464cc) OHV L4 (8 Valve) 3.875" Bore; MFI; Gasoline; Naturally Aspirated AMC Eng.	2002-96	P	13	
2.5L 153 (2507cc) SOHC L4 (8 Valve) 87.5mm Bore; TBI; Gasoline; Naturally Aspirated Chrysler Eng.	1995-91	G	14	
2.5L 153 (2507cc) SOHC L4 (8 Valve) 87.5mm Bore; TBI; Gasoline; Naturally Aspirated Chrysler Eng.	1995-91	K	15	
2.7L 164 (2686cc) DOHC Turbo - Intercooled L5 (20 Valve) 88mm Bore; MFI; Diesel; Turbo - Intercooled Mercedes-Benz Eng.	2007-06	4	16	
2.7L 164 (2686cc) DOHC Turbo - Intercooled L5 (20 Valve) 88mm Bore; MFI; Diesel; Turbo - Intercooled Mercedes-Benz Eng.	2005-03	C	17	
3.0L 181.1 (2972cc) SOHC V6 (12 Valve) 91.1mm Bore; MFI; Gasoline; Naturally Aspirated Mitsubishi Eng.	2000-91	3	18	
3.0L 181.1 (2972cc) SOHC V6 (12 Valve) 91.1mm Bore; MFI; Gasoline; Naturally Aspirated Mitsubishi Eng.	1992-91	S	19	
3.0L 182.2 (2987cc) DOHC Turbo - Intercooled V6 (24 Valve) 83mm Bore Bluetec; DI; Diesel; Turbo - Intercooled Mercedes-Benz Eng.	2010-07	4	20	
3.0L 182.2 (2987cc) DOHC Turbo - Intercooled V6 (24 Valve) 83mm Bore Bluetec; DI; Diesel; Turbo - Intercooled Mercedes-Benz Eng.	2010-07	5	21	
3.3L 201 (3302cc) OHV V6 (12 Valve) 93mm Bore; MFI; Flex Fuel; Naturally Aspirated Chrysler Eng.	2009-01	3	22	
3.3L 201 (3302cc) OHV V6 (12 Valve) 93mm Bore; MFI; Flex Fuel; Naturally Aspirated Chrysler Eng.	2010	E	23	
3.3L 201 (3302cc) OHV V6 (12 Valve) 93mm Bore; MFI; Flex Fuel; Naturally Aspirated Chrysler Eng.	2009-98	G	24	
3.3L 201 (3302cc) OHV V6 (12 Valve) 93mm Bore; MFI; Gasoline; Naturally Aspirated Chrysler Eng.	2010-08	H	25	
3.3L 201 (3302cc) OHV V6 (12 Valve) 93mm Bore; MFI; Natural Gas; Naturally Aspirated Chrysler Eng.	1996-94	J	26	
3.3L 201 (3302cc) OHV V6 (12 Valve) 93mm Bore; MFI; Natural Gas; Naturally Aspirated Chrysler Eng.	1996-94	P	27	
3.3L 201 (3302cc) OHV V6 (12 Valve) 93mm Bore; MFI; Gasoline; Naturally Aspirated Chrysler Eng.	2010-91	R	28	
3.3L 201 (3302cc) OHV V6 (12 Valve) 93mm Bore; MFI; Flex Fuel; Naturally Aspirated Chrysler Eng.	2004	S	29	
3.5L 213.4 (3498cc) DOHC V6 (24 Valve) 92.9mm Bore; MFI; Gasoline; Naturally Aspirated Mercedes-Benz Eng.	2010-07	6	30	
3.5L 215 (3518cc) SOHC V6 (24 Valve) 96mm Bore; MFI; Gasoline; Naturally Aspirated Chrysler Eng.	2006-04	4	31	
3.5L 215 (3518cc) SOHC V6 (24 Valve) 96mm Bore; MFI; Gasoline; Naturally Aspirated Chrysler Eng.	2010-09	S	32	
3.5L 215 (3518cc) SOHC V6 (24 Valve) 96mm Bore; MFI; Gasoline; Naturally Aspirated Chrysler Eng.	2010	V	33	
3.6L 219.9 (3604cc) DOHC V6 (24 Valve) 96mm Bore Pentastar VVT; MFI; Flex Fuel; Naturally Aspirated Chrysler Eng.	2013-11	G	34	
3.7L 226 (3704cc) SOHC V6 (12 Valve) 93mm Bore; MFI; Gasoline; Naturally Aspirated Chrysler Eng.	2012-02	K	35	
3.8L 231 (3785cc) OHV V6 (12 Valve) 96mm Bore; MFI; Flex Fuel; Naturally Aspirated Chrysler Eng.	2010	1	36	
3.8L 231 (3785cc) OHV V6 (12 Valve) 96mm Bore; MFI; Gasoline; Naturally Aspirated Chrysler Eng.	2010-94	L	37	
3.8L 231 (3785cc) OHV V6 (12 Valve) 96mm Bore; MFI; Gasoline; Naturally Aspirated Chrysler Eng.	2010-08	P	38	
3.9L 239 (3916cc) OHV V6 (12 Valve) 3.9063" Bore; MFI; Gasoline; Naturally Aspirated Chrysler Eng.	2003-92	X	39	
3.9L 239 (3916cc) OHV V6 (12 Valve) 3.9063" Bore; TBI; Gasoline; Naturally Aspirated Chrysler Eng.	1991	X	40	
4.0L 241.1 (3952cc) SOHC V6 (24 Valve) 96mm Bore; MFI; Gasoline; Naturally Aspirated Chrysler Eng.	2011-07	X	41	
4.7L 287 (4703cc) SOHC V8 (16 Valve) 93mm Bore; MFI; Gasoline; Naturally Aspirated Chrysler Eng.	2012-00	N	42	

Dodge Truck (Incl. Minivans and SUV's) (Cont.)

Engine Finding Index (Cont.)

Engine	Years	Code	Line No.
4.7L 287 (4703cc) SOHC V8 (16 Valve) 93mm Bore; MFI; Flex Fuel; Naturally Aspirated Chrysler Eng.	2012-04	P	43
4.7L 287 (4703cc) SOHC V8 (16 Valve) 93mm Bore H.O.; MFI; Gasoline; Naturally Aspirated Chrysler Eng.	2007-05	J	44
5.2L 318 (5212cc) OHV V8 (16 Valve) 3.9063" Bore; MFI; Natural Gas; Naturally Aspirated Chrysler Eng.	2003-92	T	45
5.2L 318 (5212cc) OHV V8 (16 Valve) 3.9063" Bore; MFI; Gasoline; Naturally Aspirated Chrysler Eng.	2003-92	Y	46
5.2L 318 (5212cc) OHV V8 (16 Valve) 3.9063" Bore; TBI; Gasoline; Naturally Aspirated Chrysler Eng.	1991	Y	47
5.7L 345 (5654cc) OHV V8 (16 Valve) 99.5mm Bore Hemi; MFI; Gasoline; Naturally Aspirated Chrysler Eng.	2008-06	2	48
5.7L 345 (5654cc) OHV V8 (16 Valve) 99.5mm Bore Hemi; MFI; Natural Gas; Naturally Aspirated Chrysler Eng.	2013-12	2	49
5.7L 345 (5654cc) OHV V8 (16 Valve) 99.5mm Bore Hemi; MFI; Gasoline; Naturally Aspirated Chrysler Eng.	2008-07	8	50
5.7L 345 (5654cc) OHV V8 (16 Valve) 99.5mm Bore Hemi; MFI; Gasoline; Naturally Aspirated Chrysler Eng.	2008-03	D	51
5.7L 345 (5654cc) OHV V8 (16 Valve) 99.5mm Bore Hemi; MFI; Gasoline; Naturally Aspirated Chrysler Eng.	2013-09	T	52
5.7L 345 (5654cc) OHV V8 (16 Valve) 99.5mm Bore Hemi; MFI; Hybrid (Gas/Electric); Naturally Aspirated Chrysler Eng.	2009	T	53
5.9L 359 (5882cc) OHV Turbo - Intercooled L6 (12 Valve) 102mm Bore; MFI; Diesel; Turbo - Intercooled Cummins Eng.	1991	8	54
5.9L 359 (5882cc) OHV Turbo - Intercooled L6 (12 Valve) 102mm Bore; MFI; Diesel; Turbo - Intercooled Cummins Eng.	1996-91	C	55
5.9L 359 (5882cc) OHV Turbo - Intercooled L6 (12 Valve) 102mm Bore; MFI; Diesel; Turbo - Intercooled Cummins Eng.	1999-97	D	56
5.9L 359 (5882cc) OHV Turbo - Intercooled L6 (24 Valve) 102mm Bore; MFI; Diesel; Turbo - Intercooled Cummins Eng.	2005-98	6	57
5.9L 359 (5882cc) OHV Turbo - Intercooled L6 (24 Valve) 102mm Bore; MFI; Diesel; Turbo - Intercooled Cummins Eng.	2004-98	7	58
5.9L 359 (5882cc) OHV Turbo - Intercooled L6 (24 Valve) 102mm Bore H.O.; MFI; Diesel; Turbo - Intercooled Cummins Eng.	2010	7	59
5.9L 359 (5882cc) OHV Turbo - Intercooled L6 (24 Valve) 102mm Bore H.O.; MFI; Diesel; Turbo - Intercooled Cummins Eng.	2010-02	C	60
5.9L 360 (5900cc) OHV V8 (16 Valve) 4" Bore H/D; MFI; Gasoline; Naturally Aspirated Chrysler Eng.	2002-93	5	61
5.9L 360 (5900cc) OHV V8 (16 Valve) 4" Bore H/D; TBI; Gasoline; Naturally Aspirated Chrysler Eng.	1992-91	5	62
5.9L 360 (5900cc) OHV V8 (16 Valve) 4" Bore L/D; MFI; Gasoline; Naturally Aspirated Chrysler Eng.	2003-93	Z	63
5.9L 360 (5900cc) OHV V8 (16 Valve) 4" Bore L/D; TBI; Gasoline; Naturally Aspirated Chrysler Eng.	1992-91	Z	64
6.7L 408 (6691cc) OHV Turbo - Intercooled L6 (24 Valve) 107mm Bore H.O.; MFI; Diesel; Turbo - Intercooled Cummins Eng.	2010-07	A	65
6.7L 408 (6691cc) OHV Turbo - Intercooled L6 (24 Valve) 107mm Bore H.O.; MFI; Diesel; Turbo - Intercooled Cummins Eng.	2011-09	L	66
8.0L 488 (7994cc) OHV V10 (20 Valve) 101.6mm Bore; MFI; Gasoline; Naturally Aspirated Chrysler Eng.	2004-94	W	67
8.3L 505 (8277cc) OHV V10 (20 Valve) 102.4mm Bore; MFI; Gasoline; Naturally Aspirated Chrysler Eng.	2006-04	H	68

Engine Code Index

Code	Engine	Line No.
272.963	3.5L 213.4 (3498cc) DOHC V6 (24 Valve) 92.9mm Bore; MFI; Gasoline; Naturally Aspirated Mercedes-Benz Eng.	30
4G64	2.4L 143.4 (2351cc) SOHC L4 (8 Valve) 86.5mm Bore; MFI; Gasoline; Naturally Aspirated Mitsubishi Eng.	2
4G64	2.4L 143.4 (2351cc) SOHC L4 (8 Valve) 86.5mm Bore; MFI; Gasoline; Naturally Aspirated Mitsubishi Eng.	3
602.984	2.7L 164 (2686cc) DOHC Turbo - Intercooled L5 (20 Valve) 88mm Bore; MFI; Diesel; Turbo - Intercooled Mercedes-Benz Eng.	16
602.984	2.7L 164 (2686cc) DOHC Turbo - Intercooled L5 (20 Valve) 88mm Bore; MFI; Diesel; Turbo - Intercooled Mercedes-Benz Eng.	17
6BTA5.9	5.9L 359 (5882cc) OHV Turbo - Intercooled L6 (12 Valve) 102mm Bore; MFI; Diesel; Turbo - Intercooled Cummins Eng.	54
6BTA5.9	5.9L 359 (5882cc) OHV Turbo - Intercooled L6 (12 Valve) 102mm Bore; MFI; Diesel; Turbo - Intercooled Cummins Eng.	55
6BTA5.9	5.9L 359 (5882cc) OHV Turbo - Intercooled L6 (12 Valve) 102mm Bore; MFI; Diesel; Turbo - Intercooled Cummins Eng.	56
6BTA5.9	5.9L 359 (5882cc) OHV Turbo - Intercooled L6 (24 Valve) 102mm Bore; MFI; Diesel; Turbo - Intercooled Cummins Eng.	57
6BTA5.9	5.9L 359 (5882cc) OHV Turbo - Intercooled L6 (24 Valve) 102mm Bore; MFI; Diesel; Turbo - Intercooled Cummins Eng.	58
6BTA5.9	5.9L 359 (5882cc) OHV Turbo - Intercooled L6 (24 Valve) 102mm Bore H.O.; MFI; Diesel; Turbo - Intercooled Cummins Eng.	59
6BTA5.9	5.9L 359 (5882cc) OHV Turbo - Intercooled L6 (24 Valve) 102mm Bore H.O.; MFI; Diesel; Turbo - Intercooled Cummins Eng.	60
6G72	3.0L 181.1 (2972cc) SOHC V6 (12 Valve) 91.1mm Bore; MFI; Gasoline; Naturally Aspirated Mitsubishi Eng.	18
6G72	3.0L 181.1 (2972cc) SOHC V6 (12 Valve) 91.1mm Bore; MFI; Gasoline; Naturally Aspirated Mitsubishi Eng.	19
ISB6.7-305	6.7L 408 (6691cc) OHV Turbo - Intercooled L6 (24 Valve) 107mm Bore H.O.; MFI; Diesel; Turbo - Intercooled Cummins Eng.	65
ISB6.7-350	6.7L 408 (6691cc) OHV Turbo - Intercooled L6 (24 Valve) 107mm Bore H.O.; MFI; Diesel; Turbo - Intercooled Cummins Eng.	66
OM642	3.0L 182.2 (2987cc) DOHC Turbo - Intercooled V6 (24 Valve) 83mm Bore Bluetec; DI; Diesel; Turbo - Intercooled Mercedes-Benz Eng.	20
OM642	3.0L 182.2 (2987cc) DOHC Turbo - Intercooled V6 (24 Valve) 83mm Bore Bluetec; DI; Diesel; Turbo - Intercooled Mercedes-Benz Eng.	21

Model Index

Engine (VIN Code / Eng. Code)	Year	Engine (VIN Code / Eng. Code)	Year	Engine (VIN Code / Eng. Code)	Year
Chrysler Truck		Chrysler Truck (cont.)		Chrysler Truck (cont.)	
Aspen (2WD Mid-Size SUV)		Pacifica (FWD Mid-Size SUV) (cont.)		Town & Country (FWD Minivan) (cont.)	
V8 287CI 4.7L SOHC (N)	09-07	V6 231CI 3.8L OHV (L)	08-05	V6 231CI 3.8L OHV (P)	10-08
V8 287CI 4.7L SOHC (Flex Fuel) (P)	09-07	V6 241CI 4.0L SOHC (24 Valve) (X)	08-07	V6 231CI 3.8L OHV (Flex Fuel) (1)	10
V8 345CI 5.7L (Hemi) (2)	08-07	PT Cruiser Hatchback		V6 241CI 4.0L SOHC (24 Valve) (X)	10-08
V8 345CI 5.7L (Hemi) (T)	09	L4 148CI 2.4L DOHC (16 Valve) (9)	10	V6 2972cc 3.0L SOHC (12 Valve) (3)	89
Aspen (4WD Mid-Size SUV)		L4 148CI 2.4L DOHC (16 Valve) (B)	10-01	Voyager (FWD Minivan)	
V8 287CI 4.7L SOHC (N)	09-07	L4 148CI 2.4L DOHC Turbo (16 Valve) (G)	09-03	L4 148CI 2.4L DOHC (16 Valve) (B)	03-00
V8 287CI 4.7L SOHC (Flex Fuel) (P)	09-07	Town & Country (AWD Minivan)		V6 201CI 3.3L OHV (R)	03-00
V8 345CI 5.7L (Hemi) (2)	08-07	V6 201CI 3.3L OHV (R)	93-92	V6 2972cc 3.0L SOHC (12 Valve) (3)	00
V8 345CI 5.7L (Hemi) (T)	09	V6 231CI 3.8L OHV (L)	04-94	Dodge Truck	
Aspen Hybrid (4WD Mid-Size SUV)		Town & Country (FWD Minivan)		A100 (Compact Van)	
V8 345CI 5.7L (Hemi) (T)	09	V6 201CI 3.3L OHV (H)	10-08	L6 170CI 2.8L	69-64
Pacifica (AWD Mid-Size SUV)		V6 201CI 3.3L OHV (R)	10-90	L6 198CI 3.2L	73-70
V6 215CI 3.5L SOHC (24 Valve) (4)	06-04	V6 201CI 3.3L OHV (Flex Fuel) (E)	10	L6 225CI 3.7L	70-64
V6 241CI 4.0L SOHC (24 Valve) (X)	08-07	V6 220CI 3.6L DOHC (24 Valve) (Flex Fuel) (G)	13-11	V8 273CI 4.5L	68-64
Pacifica (FWD Mid-Size SUV)		V6 231CI 3.8L OHV (L)	10-94	V8 318CI 5.2L	70-67

Dodge Truck (Incl. Minivans and SUV's) (Cont.)

Model Index (Cont.)					
Engine (VIN Code / Eng. Code)	Year	Engine (VIN Code / Eng. Code)	Year	Engine (VIN Code / Eng. Code)	Year
Dodge Truck (cont.)		Dodge Truck (cont.)		Dodge Truck (cont.)	
AD100 (Ramcharger Full-Size SUV)		B150 (Full-Size Van) (cont.)		B2DU Series (Route Van)	
L6 225CI 3.7L (B)	78-74	V8 318CI 5.2L (Y)	94-88	L6 230CI 3.8L (L-Head)	50
L6 225CI 3.7L (N)	80-79	V8 318CI 5.2L (Natural Gas) (T)	94	B2EU Series (Route Van)	
L6 225CI 3.7L (X)	75	V8 360CI 5.9L (W)	88	L6 230CI 3.8L (L-Head)	50
V8 318CI 5.2L (E)	80-74	V8 360CI 5.9L (Z)	94-89	B2F Series	
V8 318CI 5.2L (G)	75	B1500 (Full-Size Van)		L6 236.6CI 3.9L (L-Head)	50
V8 318CI 5.2L (P)	82-79	V6 239CI 3.9L (X)	03-95	B2G Series	
V8 318CI 5.2L (R)	82-81	V8 318CI 5.2L (Y)	03-95	L6 236.6CI 3.9L (L-Head)	50
V8 318CI 5.2L (T)	87-83	V8 318CI 5.2L (Natural Gas) (T)	03-95	B2H Series	
V8 318CI 5.2L (U)	83	V8 360CI 5.9L (Z)	03-95	L6 236.6CI 3.9L (L-Head)	50
V8 318CI 5.2L (Y)	89-88	B1B Series		B2J Series	
V8 360CI 5.9L (F)	79-74	L6 217.8CI 3.6L (L-Head)	49-48	L6 251.6CI 4.1L (L-Head)	50
V8 360CI 5.9L (T)	80-74	B1C Series		B2K Series	
V8 360CI 5.9L (W)	88-84	L6 217.8CI 3.6L (L-Head)	49-48	L6 251.6CI 4.1L (L-Head)	50
V8 360CI 5.9L (Z)	89	B1D Series		B2PW Series (Power Wagon)	
V8 400CI 6.6L (J)	78-74	L6 230CI 3.8L (L-Head)	49-48	L6 230CI 3.8L (L-Head)	50
V8 440CI 7.2L (A)	78-74	B1DU Series (Route Van)		B300 (Full-Size Van)	
V8 440CI 7.2L (D)	78-74	L6 230CI 3.8L (L-Head)	49-48	L6 225CI 3.7L (B)	79-71
AD150 (Ramcharger Full-Size SUV)		B1EU Series (Route Van)		L6 225CI 3.7L (N)	80-79
V8 318CI 5.2L (P)	82-81	L6 230CI 3.8L (L-Head)	49-48	V8 318CI 5.2L (E)	80-71
V8 318CI 5.2L (R)	82-81	B1F Series		V8 318CI 5.2L (P)	80-79
V8 318CI 5.2L (T)	87-83	L6 236.6CI 3.9L (L-Head)	49-48	V8 360CI 5.9L (F)	80-72
V8 318CI 5.2L (U)	83	B1G Series		V8 360CI 5.9L (S)	80-79
V8 318CI 5.2L (Y)	93-88	L6 236.6CI 3.9L (L-Head)	49-48	V8 360CI 5.9L (T)	80-74
V8 360CI 5.9L (W)	88-84	B1H Series		V8 360CI 5.9L (V)	80-76
V8 360CI 5.9L (Z)	93-89	L6 236.6CI 3.9L (L-Head)	49-48	V8 400CI 6.6L (J)	78-76
AD150S (Ramcharger Full-Size SUV)		B1J Series		V8 440CI 7.2L (D)	78-76
V8 318CI 5.2L (Y)	93-90	L6 251.6CI 4.1L (L-Head)	49-48	B350 (Full-Size Van)	
V8 360CI 5.9L (Z)	93-90	B1K Series		V6 239CI 3.9L (X)	90-88
AW100 (Ramcharger Full-Size SUV)		L6 251.6CI 4.1L (L-Head)	49-48	V8 318CI 5.2L (P)	82-81
L6 225CI 3.7L (B)	78-74	B1PW Series (Power Wagon)		V8 318CI 5.2L (R)	82-81
L6 225CI 3.7L (X)	75	L6 230CI 3.8L (L-Head)	49-48	V8 318CI 5.2L (T)	87-83
V8 318CI 5.2L (E)	80-74	B200 (Full-Size Van)		V8 318CI 5.2L (U)	83
V8 318CI 5.2L (G)	75	L6 198CI 3.2L	73-70	V8 318CI 5.2L (Y)	94-88
V8 318CI 5.2L (P)	80-79	L6 225CI 3.7L (B)	79-71	V8 318CI 5.2L (Natural Gas) (T)	94-92
V8 360CI 5.9L (F)	79-74	L6 225CI 3.7L (N)	80-79	V8 360CI 5.9L (1)	87
V8 360CI 5.9L (T)	80-74	V8 318CI 5.2L (E)	80-71	V8 360CI 5.9L (S)	82-81
V8 400CI 6.6L (J)	78-74	V8 318CI 5.2L (P)	80-79	V8 360CI 5.9L (T)	82-81
V8 440CI 7.2L (A)	78-74	V8 360CI 5.9L (F)	79-72	V8 360CI 5.9L (U)	82
V8 440CI 7.2L (D)	78-74	V8 360CI 5.9L (L)	75	V8 360CI 5.9L (V)	85-83
AW150 (Ramcharger Full-Size SUV)		V8 360CI 5.9L (S)	79	V8 360CI 5.9L (W)	88-83
V8 318CI 5.2L (P)	82-81	V8 360CI 5.9L (T)	80-74	V8 360CI 5.9L (Z)	94-89
V8 318CI 5.2L (R)	82-81	V8 400CI 6.6L (J)	78-76	B3500 (Full-Size Van)	
V8 318CI 5.2L (T)	87-83	V8 440CI 7.2L (D)	78-76	V8 318CI 5.2L (Y)	03-95
V8 318CI 5.2L (U)	83	B250 (Full-Size Van)		V8 318CI 5.2L (Natural Gas) (T)	95
V8 318CI 5.2L (Y)	93-88	L6 225CI 3.7L (E)	82-81	V8 360CI 5.9L (Z)	03-95
V8 360CI 5.9L (W)	88-84	L6 225CI 3.7L (H)	87-83	B3B Series	
V8 360CI 5.9L (Z)	93-89	V6 239CI 3.9L (X)	94-88	L6 217.8CI 3.6L (L-Head)	52-51
AW150S (Ramcharger Full-Size SUV)		V8 318CI 5.2L (P)	82-81	B3C Series	
V8 318CI 5.2L (Y)	93-90	V8 318CI 5.2L (R)	82-81	L6 217.8CI 3.6L (L-Head)	52-51
V8 360CI 5.9L (Z)	93-90	V8 318CI 5.2L (T)	87-83	B3D Series	
B100 (Full-Size Van)		V8 318CI 5.2L (Y)	94-88	L6 230CI 3.8L (L-Head)	52-51
L6 198CI 3.2L	73-70	V8 318CI 5.2L (Natural Gas) (T)	94-92	B3DU Series (Route Van)	
L6 225CI 3.7L (B)	79-71	V8 360CI 5.9L (W)	88-84	L6 230CI 3.8L (L-Head)	52-51
L6 225CI 3.7L (N)	80-79	V8 360CI 5.9L (Z)	94-89	B3EU Series (Route Van)	
V8 318CI 5.2L (E)	80-71	B2500 (Full-Size Van)		L6 230CI 3.8L (L-Head)	52-51
V8 318CI 5.2L (P)	80-79	V6 239CI 3.9L (X)	03-95	B3F Series	
V8 360CI 5.9L (F)	78-72	V8 318CI 5.2L (Y)	03-95	L6 236.6CI 3.9L (L-Head)	52-51
V8 360CI 5.9L (T)	78-74	V8 318CI 5.2L (Natural Gas) (T)	95	B3G Series	
B150 (Full-Size Van)		V8 360CI 5.9L (Z)	03-95	L6 236.6CI 3.9L (L-Head)	52-51
L6 225CI 3.7L (E)	82-81	B2B Series		B3H Series	
L6 225CI 3.7L (H)	87-83	L6 217.8CI 3.6L (L-Head)	50	L6 236.6CI 3.9L (L-Head)	52-51
V6 239CI 3.9L (X)	94-88	B2C Series		B3J Series	
V8 318CI 5.2L (P)	82-81	L6 217.8CI 3.6L (L-Head)	50	L6 251.6CI 4.1L (L-Head)	52-51
V8 318CI 5.2L (R)	82-81	B2D Series		B3K Series	
V8 318CI 5.2L (T)	87-83	L6 230CI 3.8L (L-Head)	50	L6 251.6CI 4.1L (L-Head)	52-51

Dodge Truck (Incl. Minivans and SUV's) (Cont.)

Model Index (Cont.)

Engine (VIN Code / Eng. Code)	Year	Engine (VIN Code / Eng. Code)	Year	Engine (VIN Code / Eng. Code)	Year
Dodge Truck (cont.)		Dodge Truck (cont.)		Dodge Truck (cont.)	
B3PW Series (Power Wagon)		C3B Series		Caravan (FWD Minivan) (cont.)	
L6 230CI 3.8L (L-Head)	52-51	L6 230CI 3.8L (L-Head)	55	L4 153CI 2.5L SOHC Turbo (J)	90-89
B4B Series		V8 259.2CI 4.3L	56-55	L4 2555cc 2.6L SOHC (G)	87-84
L6 217.8CI 3.6L (L-Head)	53	V8 270CI 4.4L	56-55	V6 201CI 3.3L OHV (H)	10-08
B4C Series		C3C Series		V6 201CI 3.3L OHV (R)	10-90
L6 217.8CI 3.6L (L-Head)	53	L6 230CI 3.8L (L-Head)	55	V6 201CI 3.3L OHV (Flex Fuel) (E)	10
B4D Series		V8 259.2CI 4.3L	56-55	V6 220CI 3.6L DOHC (24 Valve) (Flex Fuel) (G)	13-11
L6 230CI 3.8L (L-Head)	53	V8 270CI 4.4L	56-55	V6 231CI 3.8L OHV (L)	10-94
B4DU Series (Route Van)		C3D Series		V6 231CI 3.8L OHV (P)	10-08
L6 230CI 3.8L (L-Head)	53	L6 230CI 3.8L (L-Head)	55	V6 231CI 3.8L OHV (Flex Fuel) (1)	10
B4EU Series (Route Van)		V8 259.2CI 4.3L	56-55	V6 241CI 4.0L SOHC (24 Valve) (X)	10-08
L6 230CI 3.8L (L-Head)	53	V8 270CI 4.4L	56-55	V6 2972cc 3.0L SOHC (12 Valve) (3)	00-87
B4F Series		C3F Series		CB300 (Kary Van)	
L6 236.6CI 3.9L (L-Head)	53	V8 259.2CI 4.3L	56-55	L6 225CI 3.7L (B)	80-73
L6 251.6CI 4.1L (L-Head)	53	V8 270CI 4.4L	56-55	L6 225CI 3.7L (N)	79
B4G Series		C3G Series		V8 318CI 5.2L (E)	80-73
L6 236.6CI 3.9L (L-Head)	53	L6 251.6CI 4.1L (L-Head)	56-55	V8 318CI 5.2L (P)	80-79
L6 251.6CI 4.1L (L-Head)	53	L6 265CI 4.3L (L-Head)	56-55	V8 360CI 5.9L (F)	77-73
B4H Series		V8 259.2CI 4.3L	56-55	V8 360CI 5.9L (K)	80-78
L6 236.6CI 3.9L (L-Head)	53	V8 270CI 4.4L	56-55	V8 360CI 5.9L (T)	80-79
L6 251.6CI 4.1L (L-Head)	53	C3H Series		V8 360CI 5.9L (V)	80
B4J Series		L6 251.6CI 4.1L (L-Head)	56-55	V8 400CI 6.6L (J)	78-76
L6 236.6CI 3.9L (L-Head)	53	L6 265CI 4.3L (L-Head)	56-55	V8 440CI 7.2L (D)	78-76
L6 251.6CI 4.1L (L-Head)	53	V8 259.2CI 4.3L	56-55	CB350 (Kary Van)	
B4K Series		V8 270CI 4.4L	56-55	V8 318CI 5.2L (P)	81
L6 236.6CI 3.9L (L-Head)	53	C3J Series		V8 318CI 5.2L (R)	81
L6 251.6CI 4.1L (L-Head)	53	L6 251.6CI 4.1L (L-Head)	56-55	V8 360CI 5.9L (T)	81
B4PW Series (Power Wagon)		L6 265CI 4.3L (L-Head)	56-55	D100 (Full-Size Pickup)	
L6 230CI 3.8L (L-Head)	53	V8 259.2CI 4.3L	56-55	L6 170CI 2.8L	66-61
C1B Series		V8 270CI 4.4L	56-55	L6 198CI 3.2L	73-70
L6 217.8CI 3.6L (L-Head)	54	C3K Series		L6 225CI 3.7L	65-61
V8 241.4CI 4.0L	54	L6 251.6CI 4.1L (L-Head)	56-55	L6 225CI 3.7L (B)	79-66
C1C Series		L6 265CI 4.3L (L-Head)	56-55	L6 225CI 3.7L (C)	75-74
L6 217.8CI 3.6L (L-Head)	54	V8 259.2CI 4.3L	56-55	L6 225CI 3.7L (H)	87-86
V8 241.4CI 4.0L	54	V8 270CI 4.4L	56-55	L6 225CI 3.7L (N)	79
C1D Series		C3PW Series (Power Wagon)		L6 230CI 3.8L (L-Head)	60-57
L6 230CI 3.8L (L-Head)	54	L6 230CI 3.8L (L-Head)	55	V6 239CI 3.9L (X)	89-88
V8 241.4CI 4.0L	54	C3R Series		V8 303CI 5.0L	57
C1DU Series (Route Van)		V8 331CI 5.4L	56-55	V8 313CI 5.1L	63-58
L6 230CI 3.8L (L-Head)	54	C3T Series		V8 315CI 5.1L	59-57
C1EU Series (Route Van)		V8 331CI 5.4L	56-55	V8 318CI 5.2L	65-59
L6 230CI 3.8L (L-Head)	54	C3V Series		V8 318CI 5.2L (E)	79-66
C1G Series		V8 331CI 5.4L	56-55	V8 318CI 5.2L (P)	79
L6 251.6CI 4.1L (L-Head)	54	C3Y Series		V8 318CI 5.2L (T)	87-86
L6 265CI 4.3L (L-Head)	54	V8 331CI 5.4L	56-55	V8 318CI 5.2L (Y)	89-88
V8 241.4CI 4.0L	54	C4B Series		V8 360CI 5.9L (F)	79-72
C1H Series		L6 230CI 3.8L (L-Head)	56	V8 360CI 5.9L (K)	75
L6 251.6CI 4.1L (L-Head)	54	V8 259.2CI 4.3L	56	V8 360CI 5.9L (T)	79-74
L6 265CI 4.3L (L-Head)	54	V8 270CI 4.4L	56	V8 360CI 5.9L (V)	78-76
V8 241.4CI 4.0L	54	C4C Series		V8 360CI 5.9L (W)	88-86
C1J Series		L6 230CI 3.8L (L-Head)	56	V8 360CI 5.9L (Z)	89
L6 251.6CI 4.1L (L-Head)	54	V8 259.2CI 4.3L	56	V8 383CI 6.3L (J)	71-67
L6 265CI 4.3L (L-Head)	54	V8 270CI 4.4L	56	V8 400CI 6.6L (J)	78-72
V8 241.4CI 4.0L	54	C4D Series		V8 440CI 7.2L (A)	78-74
C1K Series		L6 230CI 3.8L (L-Head)	56	V8 440CI 7.2L (D)	78-74
L6 251.6CI 4.1L (L-Head)	54	V8 259.2CI 4.3L	56	D150 (Full-Size Pickup)	
L6 265CI 4.3L (L-Head)	54	V8 270CI 4.4L	56	L6 225CI 3.7L (B)	79-78
V8 241.4CI 4.0L	54	C4PW Series (Power Wagon)		L6 225CI 3.7L (E)	82-81
C1PW Series (Power Wagon)		L6 230CI 3.8L (L-Head)	56	L6 225CI 3.7L (H)	87-83
L6 230CI 3.8L (L-Head)	54	Caravan (AWD Minivan)		L6 225CI 3.7L (M)	83
C1R Series		V6 201CI 3.3L OHV (R)	94-91	L6 225CI 3.7L (N)	80-79
V8 331CI 5.4L	54	V6 231CI 3.8L OHV (L)	04-94	L6 225CI 3.7L (W)	82
C1T Series		Caravan (FWD Minivan)		L6 225CI 3.7L (X)	78
V8 331CI 5.4L	54	L4 135CI 2.2L SOHC (C)	87-84	V6 239CI 3.9L (X)	93-88
C1V Series		L4 148CI 2.4L DOHC (16 Valve) (B)	07-96	V8 318CI 5.2L (E)	80-78
V8 331CI 5.4L	54	L4 153CI 2.5L SOHC (K)	95-87		

Dodge Truck (Incl. Minivans and SUV's) (Cont.)

Model Index (Cont.)					
Engine (VIN Code / Eng. Code)	Year	Engine (VIN Code / Eng. Code)	Year	Engine (VIN Code / Eng. Code)	Year
Dodge Truck (cont.)		Dodge Truck (cont.)		Dodge Truck (cont.)	
D150 (Full-Size Pickup) (cont.)		D300 (Full-Size Pickup) (cont.)		Durango (4WD Mid-Size SUV)	
V8 318CI 5.2L (P)	82-79	V8 313CI 5.1L	63-58	V6 220CI 3.6L DOHC (24 Valve) (Flex Fuel)	13-11
V8 318CI 5.2L (R)	82-81	V8 315CI 5.1L	59-57	(G)	
V8 318CI 5.2L (T)	87-83	V8 318CI 5.2L (E)	80-70	V6 239CI 3.9L (X)	99-97
V8 318CI 5.2L (U)	83	V8 318CI 5.2L (P)	80-79	V8 287CI 4.7L SOHC (N)	09-00
V8 318CI 5.2L (Y)	93-88	V8 360CI 5.9L (F)	78-72	V8 287CI 4.7L SOHC (Flex Fuel) (P)	09-06
V8 360CI 5.9L (1)	87	V8 360CI 5.9L (T)	80-79	V8 318CI 5.2L (Y)	00-97
V8 360CI 5.9L (F)	79-78	V8 360CI 5.9L (V)	80-76	V8 345CI 5.7L (Hemi) (2)	08-06
V8 360CI 5.9L (S)	81-79	V8 383CI 6.3L (J)	71-67	V8 345CI 5.7L (Hemi) (D)	06-04
V8 360CI 5.9L (T)	82-79	V8 400CI 6.6L (J)	78-72	V8 345CI 5.7L (Hemi) (T)	13-11
V8 360CI 5.9L (W)	88-84	V8 440CI 7.2L (D)	78-72	V8 345CI 5.7L (Hemi) (T)	09
V8 360CI 5.9L (Z)	93-89			V8 360CI 5.9L (Z)	03-97
V8 400CI 6.6L (J)	78	D350 (Full-Size Pickup)		Durango Hybrid (4WD Mid-Size SUV)	
V8 440CI 7.2L (A)	78	L6 359CI 5.9L Turbo-Diesel (8)	91-89	V8 345CI 5.7L (Hemi) (T)	09
V8 440CI 7.2L (D)	78	L6 359CI 5.9L Turbo-Diesel (C)	93-91	Journey (AWD Mid-Size SUV)	
		V8 318CI 5.2L (P)	82-81	V6 215CI 3.5L SOHC (24 Valve) (S)	10-09
D150S (Full-Size Pickup)		V8 318CI 5.2L (R)	82-81	V6 215CI 3.5L SOHC (24 Valve) (V)	10
V6 239CI 3.9L (X)	93-90	V8 318CI 5.2L (U)	83	V6 220CI 3.6L DOHC (24 Valve) (Flex Fuel)	13-11
V8 318CI 5.2L (Y)	93-90	V8 360CI 5.9L (1)	87	(G)	
V8 360CI 5.9L (Z)	93-90	V8 360CI 5.9L (5)	93-87	Journey (FWD Mid-Size SUV)	
D2 Series		V8 360CI 5.9L (T)	82-81	L4 2360cc 2.4L DOHC (16 Valve) (B)	13-10
L6 217.8CI 3.6L (L-Head)	36	V8 360CI 5.9L (U)	82	L4 2360cc 2.4L DOHC (16 Valve) (T)	13-09
D200 (Full-Size Pickup)		V8 360CI 5.9L (V)	85-81	V6 215CI 3.5L SOHC (24 Valve) (S)	10-09
L6 225CI 3.7L	65-61	V8 360CI 5.9L (W)	87-83	V6 215CI 3.5L SOHC (24 Valve) (V)	10
L6 225CI 3.7L (B)	79-66	V8 360CI 5.9L (Z)	93-89	V6 220CI 3.6L DOHC (24 Valve) (Flex Fuel)	13-11
L6 225CI 3.7L (C)	75-74	D50 (Mini-Pickup)		(G)	
L6 225CI 3.7L (N)	80-79	L4 1995cc 2.0L SOHC (5)	81	K20 Series	
L6 230CI 3.8L (L-Head)	60-57	L4 1995cc 2.0L SOHC (U)	80-79	L6 217.8CI 3.6L (L-Head)	34
V8 303CI 5.0L	57	L4 2555cc 2.6L SOHC (7)	81	K20X Series	
V8 313CI 5.1L	63-58	L4 2555cc 2.6L SOHC (W)	80-79	L6 217.8CI 3.6L (L-Head)	34
V8 315CI 5.1L	59-57	Dakota (2WD Mid-Size Pickup)		K30 Series	
V8 318CI 5.2L (E)	80-70	L4 135CI 2.2L SOHC (C)	88-87	L6 217.8CI 3.6L (L-Head)	34
V8 318CI 5.2L (P)	80-79	L4 150CI 2.46L OHV (P)	02-96	KC Series	
V8 360CI 5.9L (F)	79-72	L4 153CI 2.5L SOHC (G)	95-89	L6 201.3CI 3.3L (L-Head)	35-34
V8 360CI 5.9L (K)	75	V6 226CI 3.7L SOHC (12 Valve) (K)	11-04	KCL Series	
V8 360CI 5.9L (T)	80-79	V6 239CI 3.9L (M)	87	L6 201.3CI 3.3L (L-Head)	35-34
V8 360CI 5.9L (V)	76	V6 239CI 3.9L (X)	03-88	KH15 Series	
V8 383CI 6.3L (J)	71-67	V8 287CI 4.7L SOHC (J)	07-05	L6 201.3CI 3.3L (L-Head)	35
V8 400CI 6.6L (J)	78-72	V8 287CI 4.7L SOHC (N)	11-00	KH16 Series	
V8 440CI 7.2L (A)	78-74	V8 287CI 4.7L SOHC (Flex Fuel) (P)	11-07	L6 201.3CI 3.3L (L-Head)	35
V8 440CI 7.2L (D)	78-74	V8 318CI 5.2L (Y)	99-99	KH17 Series	
		V8 360CI 5.9L (Z)	03-98	L6 201.3CI 3.3L (L-Head)	35
D250 (Full-Size Pickup)		Dakota (4WD Mid-Size Pickup)		KH18 Series	
L6 225CI 3.7L (E)	82-81	L4 153CI 2.5L SOHC (G)	93-89	L6 201.3CI 3.3L (L-Head)	35
L6 225CI 3.7L (H)	87-83	V6 226CI 3.7L SOHC (12 Valve) (K)	11-04	KH20 Series	
L6 359CI 5.9L Turbo-Diesel (8)	91-89	V6 239CI 3.9L (M)	87	L6 201.3CI 3.3L (L-Head)	35
L6 359CI 5.9L Turbo-Diesel (C)	93-91	V6 239CI 3.9L (X)	03-88	KH21 Series	
V6 239CI 3.9L (X)	93-88	V8 287CI 4.7L SOHC (J)	07-05	L6 201.3CI 3.3L (L-Head)	35
V8 318CI 5.2L (P)	82-81	V8 287CI 4.7L SOHC (N)	11-00	KH22 Series	
V8 318CI 5.2L (R)	82-81	V8 287CI 4.7L SOHC (Flex Fuel) (P)	11-07	L6 201.3CI 3.3L (L-Head)	35
V8 318CI 5.2L (T)	87-83	V8 318CI 5.2L (Y)	99-91	KH23 Series	
V8 318CI 5.2L (U)	83	V8 360CI 5.9L (Z)	03-98	L6 201.3CI 3.3L (L-Head)	35
V8 318CI 5.2L (Y)	93-88	Durango (2WD Mid-Size SUV)		LC Series	
V8 360CI 5.9L (1)	87	V6 220CI 3.6L DOHC (24 Valve) (Flex Fuel)	13-11	L6 201.3CI 3.3L (L-Head)	36
V8 360CI 5.9L (5)	93-87	(G)		LE15 Series	
V8 360CI 5.9L (S)	81	V6 226CI 3.7L SOHC (12 Valve) (K)	09-04	L6 201.3CI 3.3L (L-Head)	36
V8 360CI 5.9L (T)	82-81	V6 239CI 3.9L (X)	99-97	LE16 Series	
V8 360CI 5.9L (U)	82	V8 287CI 4.7L SOHC (N)	09-00	L6 201.3CI 3.3L (L-Head)	36
V8 360CI 5.9L (W)	88-84	V8 287CI 4.7L SOHC (Flex Fuel) (P)	09-06	LE17 Series	
V8 360CI 5.9L (Z)	93-89	V8 318CI 5.2L (Y)	00-97	L6 201.3CI 3.3L (L-Head)	36
D300 (Full-Size Pickup)		V8 345CI 5.7L (Hemi) (2)	08-06	LE20 Series	
L6 225CI 3.7L	65-61	V8 345CI 5.7L (Hemi) (D)	06-04	L6 201.3CI 3.3L (L-Head)	36
L6 225CI 3.7L (B)	78-66	V8 345CI 5.7L (Hemi) (T)	13-11	LE21 Series	
L6 225CI 3.7L (C)	77-74	V8 345CI 5.7L (Hemi) (T)	09	L6 201.3CI 3.3L (L-Head)	36
L6 230CI 3.8L (L-Head)	60-57	V8 360CI 5.9L (Z)	03-97	LE22 Series	
L6 251.6CI 4.1L (L-Head)	60-57			L6 201.3CI 3.3L (L-Head)	36
L6 265CI 4.3L (L-Head)	60-57			LE22 Series	
V8 303CI 5.0L	57			L6 201.3CI 3.3L (L-Head)	36

Dodge Truck (Incl. Minivans and SUV's) (Cont.)

Model Index (Cont.)

Engine (VIN Code / Eng. Code)	Year	Engine (VIN Code / Eng. Code)	Year	Engine (VIN Code / Eng. Code)	Year
Dodge Truck (cont.)		Dodge Truck (cont.)		Dodge Truck (cont.)	
M300 (Motor Home Chassis)		R1500 (4WD Full-Size Pickup) (cont.)		R3500 (4WD Full-Size Pickup) (cont.)	
V8 318CI 5.2L (E)	75-70	V8 345CI 5.7L (Hemi) (D)	08-03	V8 345CI 5.7L (Hemi) (Natural Gas) (2)	13-12
V8 360CI 5.9L (F)	79-76	V8 345CI 5.7L (Hemi) (T)	13-09	V8 360CI 5.9L (5)	94
V8 360CI 5.9L (T)	79-76	V8 360CI 5.9L (Z)	02-94	V8 360CI 5.9L (Z)	02-94
MC Series		R2500 (2WD Full-Size Pickup)		Raider (2WD Compact SUV)	
L6 217.8CI 3.6L (L-Head)	37	L6 359CI 5.9L Turbo-Diesel (6)	05-98	L4 2555cc 2.6L SOHC (E)	89-87
MD15 Series		L6 359CI 5.9L Turbo-Diesel (7)	10	Raider (4WD Compact SUV)	
L6 217.8CI 3.6L (L-Head)	37	L6 359CI 5.9L Turbo-Diesel (7)	04-98	L4 2555cc 2.6L SOHC (E)	89-87
MD16 Series		L6 359CI 5.9L Turbo-Diesel (C)	96-94	V6 2972cc 3.0L SOHC (12 Valve) (S)	89
L6 217.8CI 3.6L (L-Head)	37	L6 359CI 5.9L Turbo-Diesel (C)	10-02	Ram 50 (Mini-Pickup)	
MD20 Series		L6 359CI 5.9L Turbo-Diesel (D)	98-97	L4 1995cc 2.0L SOHC (5)	82
L6 217.8CI 3.6L (L-Head)	37	L6 408CI 6.7L Turbo-Diesel (A)	09-07	L4 1997cc 2.0L SOHC (8 Valve) (D)	89-83
MD21 Series		L6 408CI 6.7L Turbo-Diesel (L)	13-09	L4 2346cc 2.3L SOHC Turbo-Diesel (9)	83
L6 217.8CI 3.6L (L-Head)	37	V10 488CI 8.0L (W)	04-94	L4 2346cc 2.3L SOHC Turbo-Diesel (J)	86-84
Mini-Ram Van (FWD Minivan)		V8 287CI 4.7L SOHC (N)	06-02	L4 2351cc 2.4L SOHC (8 Valve) (G)	93
L4 135CI 2.2L SOHC (C)	87-84	V8 318CI 5.2L (Y)	02-94	L4 2351cc 2.4L SOHC (8 Valve) (W)	92-90
L4 153CI 2.5L SOHC (K)	95-87	V8 345CI 5.7L (Hemi) (2)	08-06	L4 2555cc 2.6L SOHC (7)	83-82
L4 153CI 2.5L SOHC Turbo (J)	90-89	V8 345CI 5.7L (Hemi) (D)	08-03	L4 2555cc 2.6L SOHC (E)	89-84
L4 2555cc 2.6L SOHC (G)	87-84	V8 345CI 5.7L (Hemi) (T)	13-09	V6 2972cc 3.0L SOHC (12 Valve) (S)	92-90
V6 201CI 3.3L OHV (R)	95-91	V8 345CI 5.7L (Hemi) (Natural Gas) (2)	13-12	Ram C/V (FWD Minivan)	
V6 231CI 3.8L OHV (L)	95-94	V8 360CI 5.9L (Z)	02-94	V6 220CI 3.6L DOHC (24 Valve) (Flex Fuel)	13-12
V6 2972cc 3.0L SOHC (12 Valve) (3)	95-87	R2500 (4WD Full-Size Pickup)		(G)	
Nitro (2WD Mid-Size SUV)		L6 359CI 5.9L Turbo-Diesel (6)	05-98	Rampage (Mini-Pickup)	
V6 226CI 3.7L SOHC (12 Valve) (K)	11-07	L6 359CI 5.9L Turbo-Diesel (7)	10	L4 135CI 2.2L SOHC (B)	82
V6 241CI 4.0L SOHC (24 Valve) (X)	11-07	L6 359CI 5.9L Turbo-Diesel (7)	04-98	L4 135CI 2.2L SOHC (C)	84-83
Nitro (4WD Mid-Size SUV)		L6 359CI 5.9L Turbo-Diesel (C)	96-94	L4 1715cc 1.7L SOHC (A)	83-82
V6 226CI 3.7L SOHC (12 Valve) (K)	11-07	L6 359CI 5.9L Turbo-Diesel (C)	10-02	L4 1715cc 1.7L SOHC (B)	83
V6 241CI 4.0L SOHC (24 Valve) (X)	11-07	L6 359CI 5.9L Turbo-Diesel (D)	98-97	RC Series	
P100 (Parcel Delivery)		L6 408CI 6.7L Turbo-Diesel (A)	09-07	L6 217.8CI 3.6L (L-Head)	38
L6 170CI 2.8L	66-61	L6 408CI 6.7L Turbo-Diesel (L)	13-09	RD15 Series	
L6 225CI 3.7L	66-62	V10 488CI 8.0L (W)	04-94	L6 217.8CI 3.6L (L-Head)	38
P200 (Parcel Delivery)		V8 287CI 4.7L SOHC (N)	06-02	RD16 Series	
L6 170CI 2.8L	66-61	V8 318CI 5.2L (Y)	02-94	L6 217.8CI 3.6L (L-Head)	38
L6 225CI 3.7L	74-61	V8 345CI 5.7L (Hemi) (2)	08-06	RD20 Series	
P300 (Parcel Delivery)		V8 345CI 5.7L (Hemi) (D)	08-03	L6 217.8CI 3.6L (L-Head)	38
L6 225CI 3.7L	77-61	V8 345CI 5.7L (Hemi) (T)	13-09	RD21 Series	
L6 230CI 3.8L (L-Head)	60-57	V8 345CI 5.7L (Hemi) (Natural Gas) (2)	13-12	L6 217.8CI 3.6L (L-Head)	38
Power Ram 50 (Mini-Pickup)		V8 360CI 5.9L (Z)	02-94	RM300 (Motor Home Chassis)	
L4 1997cc 2.0L SOHC (8 Valve) (D)	89-83	R3500 (2WD Full-Size Pickup)		V8 318CI 5.2L (E)	74-73
L4 2346cc 2.3L SOHC Turbo-Diesel (9)	83	L6 359CI 5.9L Turbo-Diesel (6)	05-98	V8 440CI 7.2L (A)	74-73
L4 2346cc 2.3L SOHC Turbo-Diesel (J)	86-84	L6 359CI 5.9L Turbo-Diesel (7)	10	RM350 (Motor Home Chassis)	
L4 2351cc 2.4L SOHC (8 Valve) (G)	93	L6 359CI 5.9L Turbo-Diesel (7)	04-98	V8 318CI 5.2L (E)	74-73
L4 2351cc 2.4L SOHC (8 Valve) (W)	92-90	L6 359CI 5.9L Turbo-Diesel (C)	96-94	V8 440CI 7.2L (A)	74-73
L4 2555cc 2.6L SOHC (7)	83-82	L6 359CI 5.9L Turbo-Diesel (C)	10-02	Sprinter 2500 (Mid-Size Van)	
L4 2555cc 2.6L SOHC (E)	89-84	L6 359CI 5.9L Turbo-Diesel (D)	98-97	L5 2686cc 2.7L DOHC Turbo-Diesel (4)	07-06
V6 2972cc 3.0L SOHC (12 Valve) (S)	92-90	L6 408CI 6.7L Turbo-Diesel (A)	09-07	L5 2686cc 2.7L DOHC Turbo-Diesel (C)	05-03
R1500 (2WD Full-Size Pickup)		L6 408CI 6.7L Turbo-Diesel (L)	13-09	V6 2987cc 3.0L DOHC Turbo-Diesel (24 Valve) (4)	10-07
V10 505CI 8.3L (H)	06-04	V10 488CI 8.0L (W)	04-94	V6 2987cc 3.0L DOHC Turbo-Diesel (24 Valve) (5)	10-07
V6 220CI 3.6L DOHC (24 Valve) (Flex Fuel) (G)	13	V8 345CI 5.7L (Hemi) (2)	08-06	V6 3498cc 3.5L DOHC (24 Valve) (6)	10-07
V6 226CI 3.7L SOHC (12 Valve) (K)	12-02	V8 345CI 5.7L (Hemi) (D)	08-03	Sprinter 3500 (Mid-Size Van)	
V6 239CI 3.9L (X)	01-94	V8 345CI 5.7L (Hemi) (T)	13-09	L5 2686cc 2.7L DOHC Turbo-Diesel (4)	07-06
V8 287CI 4.7L SOHC (N)	13-02	V8 345CI 5.7L (Hemi) (Natural Gas) (2)	13-12	L5 2686cc 2.7L DOHC Turbo-Diesel (C)	05-03
V8 287CI 4.7L SOHC (Flex Fuel) (P)	13-04	V8 360CI 5.9L (Z)	02-94	V6 2987cc 3.0L DOHC Turbo-Diesel (24 Valve) (4)	10-07
V8 318CI 5.2L (Y)	02-94	R3500 (4WD Full-Size Pickup)		V6 2987cc 3.0L DOHC Turbo-Diesel (24 Valve) (5)	10-07
V8 345CI 5.7L (Hemi) (2)	08-06	L6 359CI 5.9L Turbo-Diesel (6)	05-98	V6 3498cc 3.5L DOHC (24 Valve) (6)	10-07
V8 345CI 5.7L (Hemi) (D)	08-03	L6 359CI 5.9L Turbo-Diesel (7)	10	TC Series	
V8 345CI 5.7L (Hemi) (T)	13-09	L6 359CI 5.9L Turbo-Diesel (7)	04-98	L6 201.3CI 3.3L (L-Head)	39
V8 360CI 5.9L (Z)	02-94	L6 359CI 5.9L Turbo-Diesel (C)	96-94	TD15 Series	
R1500 (4WD Full-Size Pickup)		L6 359CI 5.9L Turbo-Diesel (C)	10-02	L6 217.8CI 3.6L (L-Head)	39
V6 220CI 3.6L DOHC (24 Valve) (Flex Fuel) (G)	13	L6 359CI 5.9L Turbo-Diesel (D)	98-97	TD20 Series	
V8 287CI 4.7L SOHC (N)	13-02	L6 408CI 6.7L Turbo-Diesel (A)	09-07	L6 217.8CI 3.6L (L-Head)	39
V8 287CI 4.7L SOHC (Flex Fuel) (P)	13-04	L6 408CI 6.7L Turbo-Diesel (L)	13-09		
V8 318CI 5.2L (Y)	02-94	V10 488CI 8.0L (W)	04-94		
V8 345CI 5.7L (Hemi) (2)	08-06	V8 345CI 5.7L (Hemi) (2)	08-06		
V8 345CI 5.7L (Hemi) (D)	08-03	V8 345CI 5.7L (Hemi) (D)	08-03		
V8 345CI 5.7L (Hemi) (T)	13-09	V8 345CI 5.7L (Hemi) (T)	13-09		

Dodge Truck (Incl. Minivans and SUV's) (Cont.)

Model Index (Cont.)					
Engine (VIN Code / Eng. Code)		Year	Engine (VIN Code / Eng. Code)		Year
Dodge Truck (cont.)			Dodge Truck (cont.)		Fargo Truck
TD21 Series			W200 (Full-Size Pickup) (cont.)		A100 (Compact Van)
L6 217.8CI 3.6L (L-Head)		39	V8 383CI 6.3L (J)		71-67
VC Series			V8 400CI 6.6L (J)		78-76
L6 201.3CI 3.3L (L-Head)		40	V8 440CI 7.2L (A)		78-75
VD15 Series			V8 440CI 7.2L (D)		78-75
L6 217.8CI 3.6L (L-Head)		40	W250 (Full-Size Pickup)		L6 170CI 2.8L (A)
VD20 Series			L6 359CI 5.9L Turbo-Diesel (8)		91-89
L6 217.8CI 3.6L (L-Head)		40	L6 359CI 5.9L Turbo-Diesel (C)		93-91
VD21 Series			V6 239CI 3.9L (X)		93-88
L6 217.8CI 3.6L (L-Head)		40	V8 318CI 5.2L (P)		82-81
W100 (Full-Size Pickup)			V8 318CI 5.2L (R)		82-81
L6 225CI 3.7L		65-61	V8 318CI 5.2L (T)		87-83
L6 225CI 3.7L (B)		77-66	V8 318CI 5.2L (U)		83
L6 225CI 3.7L (H)		87-86	V8 318CI 5.2L (Y)		93-88
L6 230CI 3.8L (L-Head)		60-57	V8 360CI 5.9L (1)		87
V6 239CI 3.9L (X)		89-88	V8 360CI 5.9L (5)		93-87
V8 315CI 5.1L		59-57	V8 360CI 5.9L (T)		81
V8 318CI 5.2L (E)		77-70	V8 360CI 5.9L (W)		88-84
V8 318CI 5.2L (T)		87-86	V8 360CI 5.9L (Z)		93-89
V8 318CI 5.2L (Y)		89-88	W300 (Full-Size Pickup)		V8 318CI 5.2L (E)
V8 360CI 5.9L (F)		77-72	L6 225CI 3.7L		65-63
V8 360CI 5.9L (W)		88-86	L6 225CI 3.7L (B)		78-66
V8 360CI 5.9L (Z)		89	L6 230CI 3.8L (L-Head)		59-57
V8 383CI 6.3L (J)		71-67	L6 251.6CI 4.1L (L-Head)		62-57
V8 400CI 6.6L (J)		77-76	L6 265CI 4.3L (L-Head)		60-57
V8 440CI 7.2L (A)		77-74	V8 313CI 5.1L		63-60
V8 440CI 7.2L (D)		77-74	V8 315CI 5.1L		59-57
W150 (Full-Size Pickup)			V8 318CI 5.2L (E)		78-70
L6 225CI 3.7L (B)		79-78	V8 360CI 5.9L (F)		78-72
L6 225CI 3.7L (E)		82-81	V8 360CI 5.9L (T)		80-79
L6 225CI 3.7L (H)		87-83	V8 383CI 6.3L (J)		71-70
L6 225CI 3.7L (M)		83	V8 400CI 6.6L (J)		78-76
L6 225CI 3.7L (N)		80-79	V8 440CI 7.2L (D)		78-75
L6 225CI 3.7L (W)		82	W350 (Full-Size Pickup)		L6 225CI 3.7L (B)
L6 225CI 3.7L (X)		79-78	L6 359CI 5.9L Turbo-Diesel (8)		91-89
V6 239CI 3.9L (X)		93-88	L6 359CI 5.9L Turbo-Diesel (C)		93-91
V8 318CI 5.2L (E)		80-78	V8 318CI 5.2L (R)		82
V8 318CI 5.2L (P)		82-79	V8 318CI 5.2L (U)		83
V8 318CI 5.2L (R)		82-81	V8 360CI 5.9L (1)		87
V8 318CI 5.2L (T)		87-83	V8 360CI 5.9L (5)		93-87
V8 318CI 5.2L (U)		83	V8 360CI 5.9L (T)		82-81
V8 318CI 5.2L (Y)		93-88	V8 360CI 5.9L (U)		82
V8 360CI 5.9L (1)		87	V8 360CI 5.9L (W)		87-83
V8 360CI 5.9L (F)		79-78	V8 360CI 5.9L (Z)		93-89
V8 360CI 5.9L (S)		81-79	WC Series		L6 225CI 3.7L (B)
V8 360CI 5.9L (T)		81-79	L6 201.3CI 3.3L (L-Head)		41
V8 360CI 5.9L (W)		88-84	L6 217.8CI 3.6L (L-Head)		47-46
V8 360CI 5.9L (Z)		93-89	L6 217.8CI 3.6L (L-Head)		42
V8 400CI 6.6L (J)		78	WD15 Series		L6 225CI 3.7L (B)
V8 440CI 7.2L (A)		78	L6 217.8CI 3.6L (L-Head)		47-46
V8 440CI 7.2L (D)		78	L6 217.8CI 3.6L (L-Head)		42-41
W150S (Full-Size Pickup)			WD20 Series		V8 383CI 6.3L (J)
V6 239CI 3.9L (X)		93-90	L6 217.8CI 3.6L (L-Head)		41
V8 318CI 5.2L (Y)		93-90	L6 230CI 3.8L (L-Head)		47-46
V8 360CI 5.9L (Z)		93-90	L6 230CI 3.8L (L-Head)		42
W200 (Full-Size Pickup)			WD21 Series		V8 313CI 5.1L
L6 225CI 3.7L		65-61	L6 217.8CI 3.6L (L-Head)		41
L6 225CI 3.7L (B)		79-66	L6 230CI 3.8L (L-Head)		47-46
L6 225CI 3.7L (N)		80	L6 230CI 3.8L (L-Head)		42
L6 230CI 3.8L (L-Head)		60-57	WDX Series (Power Wagon)		L6 225CI 3.7L
V8 315CI 5.1L		59-57	L6 230CI 3.8L (L-Head)		47-46
V8 318CI 5.2L (E)		80-70	WM300 (Power Wagon)		L6 251.6CI 4.1L (L-Head)
V8 318CI 5.2L (P)		80-79	L6 230CI 3.8L (L-Head)		60-58
V8 360CI 5.9L (F)		79-72	L6 251.6CI 4.1L (L-Head)		65-57
V8 360CI 5.9L (S)		79	L6 265CI 4.3L (L-Head)		60-57
V8 360CI 5.9L (T)		80-79	V8 313CI 5.1L		63-60
					V8 318CI 5.2L
					F100 (Pickup)
					L6 225CI 3.7L
					L6 251.6CI 4.1L (L-Head)
					V8 313CI 5.1L
					V8 318CI 5.2L
					F1B (Pickup)
					L6 217.8CI 3.6L (L-Head)
					F2B (Pickup)
					L6 217.8CI 3.6L (L-Head)

Dodge Truck (Incl. Minivans and SUV's) (Cont.)

Model Index (Cont.)					
Engine (VIN Code / Eng. Code)	Year	Engine (VIN Code / Eng. Code)	Year	Engine (VIN Code / Eng. Code)	Year
Fargo Truck (cont.)		Fargo Truck (cont.)		Fargo Truck (cont.)	
F3B (Pickup)		FK6 (Panel Delivery)		W100 (4WD Full-Size Pickup) (cont.)	
L6 217.8CI 3.6L (L-Head)	52-51	L6 251.6CI 4.1L (L-Head)	57	V8 318CI 5.2L (E)	72-66
F4B (Pickup)		FK6 (Pickup)		V8 383CI 6.3L (J)	71-67
L6 217.8CI 3.6L (L-Head)	53	L6 251.6CI 4.1L (L-Head)	57	V8 400CI 6.6L (J)	72
FC1B (Panel Delivery)		FK8 (Panel Delivery)		W100 (4WD Panel Delivery)	
L6 228.1CI 3.7L (L-Head)	54	V8 303CI 5.0L	57	L6 225CI 3.7L (B)	67-66
V8 241.4CI 4.0L	54	FK8 (Pickup)		V8 318CI 5.2L (E)	67-66
FC1B (Pickup)		V8 303CI 5.0L	57	V8 383CI 6.3L (J)	67
L6 228.1CI 3.7L (L-Head)	54	FL1 (Panel Delivery)		W110 (4WD Full-Size Pickup)	
V8 241.4CI 4.0L	54	L6 217.8CI 3.6L (L-Head)	47-46	L6 225CI 3.7L (B)	72-69
FC1C (Pickup)		L6 217.8CI 3.6L (L-Head)	42	V8 318CI 5.2L (E)	72-69
L6 228.1CI 3.7L (L-Head)	54	FL1 (Pickup)		V8 383CI 6.3L (J)	71-69
V8 241.4CI 4.0L	54	L6 217.8CI 3.6L (L-Head)	47-46	V8 400CI 6.6L (J)	72
FC3B (Panel Delivery)		L6 217.8CI 3.6L (L-Head)	42	W200 (4WD Full-Size Pickup)	
L6 251.6CI 4.1L (L-Head)	55	FL2 (Pickup)		L6 225CI 3.7L (B)	72-66
V8 241.4CI 4.0L	55	L6 228.1CI 3.7L (L-Head)	47-46	V8 318CI 5.2L (E)	72-66
FC3B (Pickup)		L6 228.1CI 3.7L (L-Head)	42	V8 383CI 6.3L (J)	71-67
L6 251.6CI 4.1L (L-Head)	55	FL6 (Panel Delivery)		V8 400CI 6.6L (J)	72
V8 241.4CI 4.0L	55	L6 251.6CI 4.1L (L-Head)	58	Plymouth Truck	
FC3C (Pickup)		FL6 (Pickup)		Arrow (Mini-Pickup)	
L6 251.6CI 4.1L (L-Head)	55	L6 251.6CI 4.1L (L-Head)	58	L4 1995cc 2.0L SOHC (5)	82-81
V8 241.4CI 4.0L	55	FL8 (Panel Delivery)		L4 1995cc 2.0L SOHC (U)	80-79
FC4B (Panel Delivery)		V8 313CI 5.1L	58	L4 2555cc 2.6L SOHC (7)	82-81
L6 251.6CI 4.1L (L-Head)	56	FL8 (Pickup)		L4 2555cc 2.6L SOHC (W)	80-79
V8 270CI 4.4L	56	V8 313CI 5.1L	58	P1 (Sedan Delivery)	
FC4B (Pickup)		FM1 (Panel Delivery)		L6 201.3CI 3.3L (L-Head)	36
L6 251.6CI 4.1L (L-Head)	56	L6 217.8CI 3.6L (L-Head)	49-48	P11 (Sedan Delivery)	
V8 270CI 4.4L	56	FM1 (Pickup)		L6 201.3CI 3.3L (L-Head)	41
FC4C (Pickup)		L6 217.8CI 3.6L (L-Head)	49-48	P11D (Sedan Delivery)	
L6 251.6CI 4.1L (L-Head)	56	FN1 (Panel Delivery)		L6 201.3CI 3.3L (L-Head)	41
V8 270CI 4.4L	56	L6 217.8CI 3.6L (L-Head)	50	P12 (Sedan Delivery)	
FD1 (Pickup)		FN1 (Pickup)		L6 201.3CI 3.3L (L-Head)	41
L6 201.3CI 3.3L (L-Head)	36	L6 217.8CI 3.6L (L-Head)	50	P14C (Sedan Delivery)	
FE1 (Panel Delivery)		FO1 (Panel Delivery)		L6 217.8CI 3.6L (L-Head)	42
L6 217.8CI 3.6L (L-Head)	37	L6 217.8CI 3.6L (L-Head)	52-51	P14S (Sedan Delivery)	
FE1 (Pickup)		FO1 (Pickup)		L6 217.8CI 3.6L (L-Head)	42
L6 217.8CI 3.6L (L-Head)	37	L6 217.8CI 3.6L (L-Head)	52-51	P7 (Sedan Delivery)	
FE1 (Sedan Delivery)		FO2 (Pickup)		L6 201.3CI 3.3L (L-Head)	39
L6 217.8CI 3.6L (L-Head)	37	L6 228.1CI 3.7L (L-Head)	52-51	P9 (Sedan Delivery)	
FE2 (Pickup)		FP1 (Panel Delivery)		L6 201.3CI 3.3L (L-Head)	40
L6 217.8CI 3.6L (L-Head)	37	L6 217.8CI 3.6L (L-Head)	53	PB100 (Voyager Full-Size Van)	
FG1 (Panel Delivery)		FP1 (Pickup)		L6 225CI 3.7L (B)	80-74
L6 217.8CI 3.6L (L-Head)	38	L6 217.8CI 3.6L (L-Head)	53	V8 318CI 5.2L (E)	80-74
FG1 (Pickup)		FP2 (Pickup)		V8 318CI 5.2L (P)	82-81
L6 217.8CI 3.6L (L-Head)	38	L6 228.1CI 3.7L (L-Head)	53	V8 318CI 5.2L (R)	82-81
FG1 (Sedan Delivery)		FW100 (4WD Panel Delivery)		V8 318CI 5.2L (T)	83
L6 217.8CI 3.6L (L-Head)	38	L6 225CI 3.7L	65-61	V8 318CI 5.2L (U)	83
FG2 (Pickup)		L6 251.6CI 4.1L (L-Head)	60-59	V8 360CI 5.9L (F)	78-74
L6 217.8CI 3.6L (L-Head)	38	V8 313CI 5.1L	64-59	PB150 (Voyager Full-Size Van)	
FH1 (Panel Delivery)		V8 318CI 5.2L	65	L6 225CI 3.7L (E)	82-81
L6 201.3CI 3.3L (L-Head)	39	FW100 (4WD Pickup)		L6 225CI 3.7L (H)	83
FH1 (Pickup)		L6 225CI 3.7L	65-61	V8 318CI 5.2L (P)	82-81
L6 201.3CI 3.3L (L-Head)	39	L6 251.6CI 4.1L (L-Head)	60-59	V8 318CI 5.2L (R)	82-81
FH2 (Pickup)		V8 313CI 5.1L	64-59	V8 318CI 5.2L (T)	83
L6 217.8CI 3.6L (L-Head)	39	V8 318CI 5.2L	65	PB200 (Voyager Full-Size Van)	
FJ1 (Panel Delivery)		P100 (Parcel Delivery)		L6 225CI 3.7L (B)	80-74
L6 201.3CI 3.3L (L-Head)	40	L6 225CI 3.7L (B)	69-66	V8 318CI 5.2L (E)	80-74
FJ1 (Pickup)		P200 (Parcel Delivery)		V8 360CI 5.9L (F)	80-74
L6 201.3CI 3.3L (L-Head)	40	L6 225CI 3.7L	65-61	V8 400CI 6.6L (J)	78-76
FJ2 (Pickup)		L6 225CI 3.7L (B)	71-66	V8 440CI 7.2L (A)	78-77
L6 217.8CI 3.6L (L-Head)	40	L6 251.6CI 4.1L (L-Head)	60-59	V8 440CI 7.2L (D)	78-77
FK1 (Panel Delivery)		P300 (Parcel Delivery)		PB250 (Voyager Full-Size Van)	
L6 217.8CI 3.6L (L-Head)	41	L6 225CI 3.7L	65-61	L6 225CI 3.7L (H)	83-81
FK1 (Pickup)		L6 225CI 3.7L (B)	71-66	V8 318CI 5.2L (P)	82-81
L6 217.8CI 3.6L (L-Head)	41	L6 251.6CI 4.1L (L-Head)	60-59	V8 318CI 5.2L (R)	82-81
FK2 (Pickup)		W100 (4WD Full-Size Pickup)		V8 318CI 5.2L (T)	83
L6 217.8CI 3.6L (L-Head)	41	L6 225CI 3.7L (B)	72-66		

Dodge Truck (Incl. Minivans and SUV's) (Cont.)

Model Index (Cont.)					
Engine (VIN Code / Eng. Code)	Year	Engine (VIN Code / Eng. Code)	Year	Engine (VIN Code / Eng. Code)	Year
Plymouth Truck (cont.)		Plymouth Truck (cont.)			
PB250 (Voyager Full-Size Van) (cont.)		Voyager (FWD Minivan) (cont.)			
V8 318CI 5.2L (U)	83	V6 231CI 3.8L OHV (L)	99-94		
PB300 (Voyager Full-Size Van)		V6 2972cc 3.0L SOHC (12 Valve) (3)	99-87		
V8 318CI 5.2L (E)	80-74				
V8 360CI 5.9L (F)	80-74				
V8 400CI 6.6L (J)	78-76				
V8 440CI 7.2L (A)	78-77				
V8 440CI 7.2L (D)	78-77				
PB350 (Voyager Full-Size Van)					
V8 318CI 5.2L (P)	82-81				
V8 318CI 5.2L (R)	82-81				
V8 318CI 5.2L (T)	83				
V8 318CI 5.2L (U)	83				
V8 360CI 5.9L (S)	82-81				
V8 360CI 5.9L (U)	83-81				
PD100 (2WD Trailduster Full-Size SUV)					
L6 225CI 3.7L (B)	80-74				
V8 318CI 5.2L (E)	80-74				
V8 360CI 5.9L (F)	80-74				
V8 400CI 6.6L (J)	78-74				
V8 440CI 7.2L (D)	78-74				
PD150 (2WD Trailduster Full-Size SUV)					
V8 318CI 5.2L (P)	82-81				
V8 318CI 5.2L (U)	83				
PJ (Sedan Delivery)					
L6 201.3CI 3.3L (L-Head)	35				
PT105 (Pickup)					
L6 201.3CI 3.3L (L-Head)	40				
PT125 (Pickup)					
L6 201.3CI 3.3L (L-Head)	41				
PT50 (Pickup)					
L6 201.3CI 3.3L (L-Head)	37				
PT50 (Sedan Delivery)					
L6 201.3CI 3.3L (L-Head)	37				
PT57 (Pickup)					
L6 201.3CI 3.3L (L-Head)	38				
PT57 (Sedan Delivery)					
L6 201.3CI 3.3L (L-Head)	38				
PT81 (Pickup)					
L6 201.3CI 3.3L (L-Head)	39				
PW100 (4WD Trailduster Full-Size SUV)					
L6 225CI 3.7L (B)	80-74				
L6 225CI 3.7L (E)	82-81				
V8 318CI 5.2L (E)	80-74				
V8 360CI 5.9L (F)	80-74				
V8 400CI 6.6L (J)	78-74				
V8 440CI 7.2L (A)	78-74				
V8 440CI 7.2L (D)	78-74				
PW150 (4WD Trailduster Full-Size SUV)					
V8 318CI 5.2L (P)	82-81				
V8 318CI 5.2L (U)	83				
Scamp (Mini-Pickup)					
L4 135CI 2.2L SOHC (C)	84-83				
L4 1715cc 1.7L SOHC (A)	83				
L4 1715cc 1.7L SOHC (B)	83				
Voyager (AWD Minivan)					
V6 201CI 3.3L OHV (R)	94-91				
V6 231CI 3.8L OHV (L)	99-94				
Voyager (FWD Minivan)					
L4 135CI 2.2L SOHC (C)	86-84				
L4 135CI 2.2L SOHC (D)	87				
L4 148CI 2.4L DOHC (16 Valve) (B)	99-96				
L4 153CI 2.5L SOHC (K)	95-87				
L4 153CI 2.5L SOHC Turbo (J)	90-89				
L4 2555cc 2.6L SOHC (G)	87-84				
V6 201CI 3.3L OHV (R)	99-91				

Dodge Truck (Incl. Minivans and SUV's) (Cont.)

1		2004 - 2002; 2.0L 122 (1996cc) DOHC L4 (16 Valve) 87.5mm Bore MFI; Gasoline; Naturally Aspirated Chrysler Eng.; VIN Code 9			1
QTY	CYLINDER HEAD	YEARS	PART NO.	DESCRIPTION	
1	Head Gasket	2004-02	26202 PT	Head bolts not incl.; Head bolt replacement recommended; PermaTorqueMLS® LaserWeld® Technology; Improved design	
1	Head Gasket	2004-02	26206 PT	Head bolts not incl.; Head bolt replacement recommended; PermaTorqueMLS®; Old design	
1	Head Set	2004-02	HS 26206 PT-1	Head bolts not incl.; Head bolt replacement recommended; PermaDry® molded rubber valve cover gskt. incl.; Premium valve stem seals incl.	
1	Head Bolt Set	2004-02	ES 72166	Head bolts w/Washers; Replacement recommended	
QTY	CONVERSION SET	YEARS	PART NO.	DESCRIPTION	
1	Gasket Conversion Set	2004-02	CS 9922	PermaDry® molded rubber oil pan gskt. incl.	
QTY	MANIFOLD - INT. & EXH.	YEARS	PART NO.	DESCRIPTION	
1	Int. Manifold Gasket Set	2004-02	MS 93219	Lower set; Upper set incl.	
1	Plenum Gasket Set	2004-02	MS 93220	Upper set	
1	Exh. Manifold Gasket Set	2004-02	MS 92846		
QTY	EXHAUST PIPE FLANGE	YEARS	PART NO.	DESCRIPTION	
1	Exhaust Pipe Gasket	2004-02	61002	Pipe to manifold	
QTY	OIL PAN	YEARS	PART NO.	DESCRIPTION	
1	Oil Pan Gasket Set	2004-02	OS 30673 R	PermaDry® molded rubber gskt. incl.	
QTY	CRANKSHAFT REAR SEAL	YEARS	PART NO.	DESCRIPTION	
1	Rear Main Seal Set	2004-02	BS 40182	Rubber; One-piece	
1	Rear Main Seal Set	2004-02	BS 40627	PTFE Rubber; One-piece	
QTY	VALVE COVER	YEARS	PART NO.	DESCRIPTION	
1	Valve Cover Gasket Set	2004-02	VS 50518 R	w/Spark plug tube seals; PermaDry® molded rubber gskt. incl.	
QTY	VALVE STEM SEAL SET	YEARS	PART NO.	DESCRIPTION	
1	Valve Stem Seal Set	2004-02	SS 72871	Premium valve stem seals incl.	
QTY	THERMOSTAT HOUSING	YEARS	PART NO.	DESCRIPTION	
1	Thermostat Gasket	2004-02	35588	Thermostat Housing; Thermostat seal	
1	Thermostat Gasket	2004-02	35681	Thermostat Housing	
QTY	WATER PUMP	YEARS	PART NO.	DESCRIPTION	
1	Water Pump Gasket	2004-02	35131	Seal	
1	Water Pump Gasket	2004-02	35586	O-ring	
QTY	TIMING COVER	YEARS	PART NO.	DESCRIPTION	
1	Crankshaft Front Seal Set	2004-02	TCS 45962		
2	Camshaft Front Seal Set	2004-02	TCS 45961		
1	Camshaft Sensor Seal	2004-02	70725		
1	Repair Sleeve	2004-02	16224	Timing Cover; Use w/installation tool	
1	Repair Sleeve Tool	2004-02	16325	Timing Cover	
QTY	CARB & FUEL INJECTION	YEARS	PART NO.	DESCRIPTION	
2	Fuel Injector O-Ring Set	2004-02	ES 70599	Improved design	
1	Throttle Body Gasket	2004-02	61214	Mounting	
QTY	EXHAUST GAS RECIRCULATION	YEARS	PART NO.	DESCRIPTION	
1	EGR Gasket	2004-02	70720	Valve	
1	EGR Gasket	2004-02	70721	Tube flange	
1	EGR Gasket	2004-02	72928	Tube seal	
2		1993; 2.4L 143.4 (2351cc) SOHC L4 (8 Valve) 86.5mm Bore MFI; Gasoline; Naturally Aspirated Mitsubishi Eng.; VIN Code G, Eng. Code 4G64			2
QTY	CYLINDER HEAD	YEARS	PART NO.	DESCRIPTION	
1	Head Gasket	1993	9388 PT		
1	Head Set	1993	HS 9388 PT-3	Exh. pipe flange not incl.; PermaDry® molded rubber valve cover gskt. incl.; Premium valve stem seals incl.	
QTY	CONVERSION SET	YEARS	PART NO.	DESCRIPTION	
1	Gasket Conversion Set	1993	CS 9086-2		
QTY	MANIFOLD - INT. & EXH.	YEARS	PART NO.	DESCRIPTION	
1	Int. Manifold Gasket Set	1993	MS 92964-3	Lower set; Upper set incl.	
1	Exh. Manifold Gasket Set	1993	MS 94841		
QTY	EXHAUST PIPE FLANGE	YEARS	PART NO.	DESCRIPTION	
1	Exhaust Pipe Gasket	1993	60496-1	Flange	
2	Exhaust Pipe Gasket	1993	60620	Converter	
QTY	OIL PAN	YEARS	PART NO.	DESCRIPTION	
1	Oil Pan Gasket Set	1993	OS 30665 C		
QTY	CRANKSHAFT REAR SEAL	YEARS	PART NO.	DESCRIPTION	
1	Rear Main Seal Set	1993	BS 40648	Rubber; One-piece	

Dodge Truck (Incl. Minivans and SUV's) (Cont.)

2 (cont.)	1993; 2.4L 143.4 (2351cc) SOHC L4 (8 Valve) 86.5mm Bore				2 (cont.)
MFI; Gasoline; Naturally Aspirated Mitsubishi Eng.; VIN Code G, Eng. Code 4G64					
QTY	CRANKSHAFT REAR SEAL	YEARS	PART NO.	DESCRIPTION	
1	Repair Sleeve	1993	16275	Crankshaft; Use w/installation tool	
QTY	VALVE COVER	YEARS	PART NO.	DESCRIPTION	
1	Valve Cover Gasket Set	1993	VS 50132 R	w/Semi-circular plug & Grommets; PermaDry® molded rubber gskt. incl.	
1	Valve Cover Gasket Set	1993	VS 50234 R	w/o Semi-circular plug & Grommets; PermaDry® molded rubber gskt. incl.	
1	Grommet Set	1993	ES 70342	Valve Cover	
1	Semi-Circular Plug	1993	CP 75001	Valve Cover	
QTY	VALVE STEM SEAL SET	YEARS	PART NO.	DESCRIPTION	
1	Valve Stem Seal Set	1993	SS 70598	Loc. Int. & Exh.; Premium valve stem seals incl.; Improved design	
QTY	THERMOSTAT HOUSING	YEARS	PART NO.	DESCRIPTION	
1	Thermostat Gasket	1993	35523	Thermostat Housing; Case to manifold	
QTY	WATER OUTLET GASKET	YEARS	PART NO.	DESCRIPTION	
1	Water Outlet Gasket	1993	35336	Water Outlet	
QTY	WATER PUMP	YEARS	PART NO.	DESCRIPTION	
1	Water Pump Gasket	1993	35273		
1	Water Pump Gasket	1993	ES 72872	O-ring	
QTY	TIMING COVER	YEARS	PART NO.	DESCRIPTION	
1	Crankshaft Front Seal Set	1993	TCS 45946	Must be used w/OS 30665C	
1	Camshaft Front Seal Set	1993	TCS 45483		
QTY	CARB & FUEL INJECTION	YEARS	PART NO.	DESCRIPTION	
1	Fuel Injector O-Ring Set	1993	ES 70600		
1	Throttle Body Gasket	1993	60855	Exc. California	
1	Throttle Body Gasket	1993	60966	California	
QTY	EXHAUST GAS RECIRCULATION	YEARS	PART NO.	DESCRIPTION	
1	EGR Gasket	1993	70152		
3	1992 - 1991; 2.4L 143.4 (2351cc) SOHC L4 (8 Valve) 86.5mm Bore				3
MFI; Gasoline; Naturally Aspirated Mitsubishi Eng.; VIN Code W, Eng. Code 4G64					
QTY	CYLINDER HEAD	YEARS	PART NO.	DESCRIPTION	
1	Head Gasket	1992-91	9388 PT		
1	Head Set	1992-91	HS 9388 PT	PermaDry® molded rubber valve cover gskt. incl.; Premium valve stem seals incl.	
QTY	CONVERSION SET	YEARS	PART NO.	DESCRIPTION	
1	Gasket Conversion Set	1992-91	CS 9388-1		
QTY	MANIFOLD - INT. & EXH.	YEARS	PART NO.	DESCRIPTION	
1	Int. Manifold Gasket Set	1992-91	MS 92964-3	Lower set; Upper set incl.	
1	Exh. Manifold Gasket Set	1992-91	MS 92029		
QTY	EXHAUST PIPE FLANGE	YEARS	PART NO.	DESCRIPTION	
1	Exhaust Pipe Gasket	1992-91	60494	Flange	
2	Exhaust Pipe Gasket	1992-91	60620	Converter	
QTY	OIL PAN	YEARS	PART NO.	DESCRIPTION	
1	Oil Pan Gasket Set	1992-91	OS 30460 A		
QTY	CRANKSHAFT REAR SEAL	YEARS	PART NO.	DESCRIPTION	
1	Rear Main Seal Set	1992-91	BS 40408-1	Rubber; One-piece	
1	Repair Sleeve	1992-91	16275	Crankshaft; Use w/installation tool	
QTY	VALVE COVER	YEARS	PART NO.	DESCRIPTION	
1	Valve Cover Gasket Set	1992-91	VS 50132 R	w/Semi-circular plug & Grommets; PermaDry® molded rubber gskt. incl.	
1	Valve Cover Gasket Set	1992-91	VS 50234 R	w/o Semi-circular plug & Grommets; PermaDry® molded rubber gskt. incl.	
1	Grommet Set	1992-91	ES 70342	Valve Cover	
1	Semi-Circular Plug	1992-91	CP 75001	Valve Cover	
QTY	VALVE STEM SEAL SET	YEARS	PART NO.	DESCRIPTION	
1	Valve Stem Seal Set	1992-91	SS 72630	Loc. Int. & Exh.; Premium valve stem seals incl.	
1	Valve Stem Seal Set	1992-91	SS 72681	Loc. Aux.; Premium valve stem seals incl.	
QTY	THERMOSTAT HOUSING	YEARS	PART NO.	DESCRIPTION	
1	Thermostat Gasket	1992-91	35523	Thermostat Housing; Case to manifold	
QTY	WATER OUTLET GASKET	YEARS	PART NO.	DESCRIPTION	
1	Water Outlet Gasket	1992-91	35336	Water Outlet	
QTY	WATER PUMP	YEARS	PART NO.	DESCRIPTION	
1	Water Pump Gasket	1992-91	35273		
1	Water Pump Gasket	1992-91	ES 72872	O-ring	
QTY	TIMING COVER	YEARS	PART NO.	DESCRIPTION	
1	Crankshaft Front Seal Set	1992-91	TCS 45565-1	Must be used w/OS 30460A	
1	Camshaft Front Seal Set	1992-91	TCS 45483		
QTY	CARB & FUEL INJECTION	YEARS	PART NO.	DESCRIPTION	
1	Fuel Injector O-Ring Set	1992-91	ES 70600		

Dodge Truck (Incl. Minivans and SUV's) (Cont.)

3		1992 - 1991; 2.4L 143.4 (2351cc) SOHC L4 (8 Valve) 86.5mm Bore			3
(cont.)		MFI; Gasoline; Naturally Aspirated Mitsubishi Eng.; VIN Code W, Eng. Code 4G64			(cont.)
QTY	CARB & FUEL INJECTION	YEARS	PART NO.	DESCRIPTION	
1	Throttle Body Gasket	1992-91	60855		
QTY	EXHAUST GAS RECIRCULATION	YEARS	PART NO.	DESCRIPTION	
1	EGR Gasket	1992-91	70152		
4		2013 - 2010; 2.4L 144 (2360cc) DOHC L4 (16 Valve) 88mm Bore			4
		MFI; Gasoline; Naturally Aspirated Chrysler Eng.; VIN Code B			
QTY	CYLINDER HEAD	YEARS	PART NO.	DESCRIPTION	
1	Head Gasket	2013-10	26332 PT	Head bolts not incl.; Head bolt replacement recommended; PermaTorqueMLS®; Old design	
1	Head Gasket	2013-10	26557 PT	Head bolts not incl.; Head bolt replacement recommended; PermaTorqueMLS®; Improved design; New Part Number - Check for Availability	
1	Head Set	2013-10	HS 26332 PT	Head bolts not incl.; Head bolt replacement recommended; PermaDry® molded rubber valve cover gskt. incl.; Premium valve stem seals incl.	
1	Head Bolt Set	2013-10	ES 72267	Head bolts w/Washers; Replacement recommended; Improved design	
QTY	CONVERSION SET	YEARS	PART NO.	DESCRIPTION	
1	Gasket Conversion Set	2013-10	CS 26332	RTV sealant incl. for oil pan gskt.	
QTY	MANIFOLD - INT. & EXH.	YEARS	PART NO.	DESCRIPTION	
1	Int. Manifold Gasket Set	2013-10	MS 96840		
1	Exh. Manifold Gasket Set	2013-10	MS 96902		
QTY	EXHAUST PIPE FLANGE	YEARS	PART NO.	DESCRIPTION	
1	Exhaust Pipe Gasket	2013-10	61002	Pipe to manifold	
1	Exhaust Pipe Gasket	2013-10	61506	Converter; 2.975" ID	
1	Exhaust Pipe Gasket	2013-10	61524	Converter; 2.757" ID	
QTY	OIL PAN	YEARS	PART NO.	DESCRIPTION	
1	Oil Pan Gasket Set	2013-10	OS 30782	RTV sealant incl. for oil pan gskt.; Improved design	
QTY	CRANKSHAFT REAR SEAL	YEARS	PART NO.	DESCRIPTION	
1	Rear Main Seal Set	2013-10	BS 40684	Retainer w/Seal; PTFE Rubber; One-piece; Improved design	
1	Rear Main Seal Set	2013-10	BS 40703	Rubber; One-piece; Old design; Superseded - When depleted use BS 40684	
QTY	VALVE COVER	YEARS	PART NO.	DESCRIPTION	
1	Valve Cover Gasket Set	2013-10	VS 50698 R	w/o Grommets & w/Spark plug tube seals; PermaDry® molded rubber gskt. incl.	
1	Grommet Set	2013-10	ES 72252-1	Valve Cover	
QTY	VALVE STEM SEAL SET	YEARS	PART NO.	DESCRIPTION	
1	Valve Stem Seal Set	2013-10	SS 71268	Premium valve stem seals incl.	
QTY	THERMOSTAT HOUSING	YEARS	PART NO.	DESCRIPTION	
1	Thermostat Gasket	2013-10	35826	Thermostat Housing; Thermostat seal	
QTY	WATER OUTLET GASKET	YEARS	PART NO.	DESCRIPTION	
1	Water Outlet Gasket	2013-10	35837	Water Outlet; Outlet	
QTY	WATER PUMP	YEARS	PART NO.	DESCRIPTION	
1	Water Pump Gasket	2013-10	35813	Inlet; Improved design	
1	Water Pump Gasket	2013-10	35813	Mounting; Improved design	
1	Water Pump Gasket	2013-10	35822	Mounting; Old design	
1	Water Pump Gasket	2013-10	36005	Cover; New Part Number - Check for Availability	
QTY	TIMING COVER	YEARS	PART NO.	DESCRIPTION	
1	Crankshaft Front Seal Set	2013-10	TCS 46098		
2	Camshaft Front Seal Set	2013-10	TCS 45961		
1	Camshaft Sensor Seal	2013-10	70725		
QTY	CARB & FUEL INJECTION	YEARS	PART NO.	DESCRIPTION	
2	Fuel Injector O-Ring Set	2013-10	ES 70599	Improved design	
1	Throttle Body Gasket	2013-10	61480	Mounting	
QTY	EXHAUST GAS RECIRCULATION	YEARS	PART NO.	DESCRIPTION	
1	EGR Gasket	2013-10	70720	Valve	
5		2013 - 2009; 2.4L 144 (2360cc) DOHC L4 (16 Valve) 88mm Bore			5
		MFI; Gasoline; Naturally Aspirated Chrysler Eng.; VIN Code T			
QTY	CYLINDER HEAD	YEARS	PART NO.	DESCRIPTION	
1	Head Gasket	2013-09	26332 PT	Head bolts not incl.; Head bolt replacement recommended; PermaTorqueMLS®; Old design	
1	Head Gasket	2013-09	26557 PT	Head bolts not incl.; Head bolt replacement recommended; PermaTorqueMLS®; Improved design; New Part Number - Check for Availability	

Dodge Truck (Incl. Minivans and SUV's) (Cont.)

5 (cont.)		2013 - 2009; 2.4L 144 (2360cc) DOHC L4 (16 Valve) 88mm Bore			5 (cont.)
		MFI; Gasoline; Naturally Aspirated Chrysler Eng.; VIN Code T			
QTY	CYLINDER HEAD	YEARS	PART NO.	DESCRIPTION	
1	Head Set	2013-09	HS 26332 PT	Head bolts not incl.; Head bolt replacement recommended; PermaDry® molded rubber valve cover gskt. incl.; Premium valve stem seals incl.	
1	Head Bolt Set	2013-09	ES 72267	Head bolts w/Washers; Replacement recommended; Improved design	
QTY	CONVERSION SET	YEARS	PART NO.	DESCRIPTION	
1	Gasket Conversion Set	2013-09	CS 26332	RTV sealant incl. for oil pan gskt.	
QTY	MANIFOLD - INT. & EXH.	YEARS	PART NO.	DESCRIPTION	
1	Int. Manifold Gasket Set	2013-09	MS 96840		
1	Exh. Manifold Gasket Set	2013-09	MS 96902		
QTY	EXHAUST PIPE FLANGE	YEARS	PART NO.	DESCRIPTION	
1	Exhaust Pipe Gasket	2013-09	61002	Pipe to manifold	
1	Exhaust Pipe Gasket	2013-09	61506	Converter; 2.975" ID	
1	Exhaust Pipe Gasket	2013-09	61524	Converter; 2.757" ID	
QTY	OIL PAN	YEARS	PART NO.	DESCRIPTION	
1	Oil Pan Gasket Set	2013-09	OS 30782	RTV sealant incl. for oil pan gskt.; Improved design	
QTY	CRANKSHAFT REAR SEAL	YEARS	PART NO.	DESCRIPTION	
1	Rear Main Seal Set	2013-09	BS 40684	Retainer w/Seal; PTFE Rubber; One-piece; Improved design	
1	Rear Main Seal Set	2013-09	BS 40703	Rubber; One-piece; Old design; Superseded - When depleted use BS 40684	
QTY	VALVE COVER	YEARS	PART NO.	DESCRIPTION	
1	Valve Cover Gasket Set	2013-09	VS 50698 R	w/o Grommets & w/Spark plug tube seals; PermaDry® molded rubber gskt. incl.	
1	Grommet Set	2013-09	ES 72252-1	Valve Cover	
QTY	VALVE STEM SEAL SET	YEARS	PART NO.	DESCRIPTION	
1	Valve Stem Seal Set	2013-09	SS 71268	Premium valve stem seals incl.	
QTY	THERMOSTAT HOUSING	YEARS	PART NO.	DESCRIPTION	
1	Thermostat Gasket	2013-09	35826	Thermostat Housing; Thermostat seal	
QTY	WATER OUTLET GASKET	YEARS	PART NO.	DESCRIPTION	
1	Water Outlet Gasket	2013-09	35837	Water Outlet; Outlet	
QTY	WATER PUMP	YEARS	PART NO.	DESCRIPTION	
1	Water Pump Gasket	2013-09	35813	Inlet; Improved design	
1	Water Pump Gasket	2013-09	35813	Mounting; Improved design	
1	Water Pump Gasket	2013-09	35822	Mounting; Old design	
1	Water Pump Gasket	2013-09	36005	Cover; New Part Number - Check for Availability	
QTY	TIMING COVER	YEARS	PART NO.	DESCRIPTION	
1	Crankshaft Front Seal Set	2013-09	TCS 46098		
2	Camshaft Front Seal Set	2013-09	TCS 45961		
1	Camshaft Sensor Seal	2013-09	70725		
QTY	CARB & FUEL INJECTION	YEARS	PART NO.	DESCRIPTION	
2	Fuel Injector O-Ring Set	2013-09	ES 70599	Improved design	
1	Throttle Body Gasket	2013-09	61480	Mounting	
QTY	EXHAUST GAS RECIRCULATION	YEARS	PART NO.	DESCRIPTION	
1	EGR Gasket	2013-09	70720	Valve	
6		2009 - 2004; 2.4L 148 (2429cc) DOHC L4 (16 Valve) 87.5mm Bore			6
		MFI; Gasoline; Turbo - Intercooled Chrysler Eng.; VIN Code 8			
QTY	CYLINDER HEAD	YEARS	PART NO.	DESCRIPTION	
1	Head Gasket	2009-04	26202 PT	Head bolts not incl.; Head bolt replacement recommended; PermaTorqueMLS® LaserWeld® Technology; Improved design	
1	Head Set	2009-04	HS 26202 PT	Head bolts not incl.; Head bolt replacement recommended; PermaDry® molded rubber valve cover gskt. incl.; Premium valve stem seals incl.	
1	Head Bolt Set	2009-04	ES 71028	Head bolts w/Washers; Replacement recommended	
QTY	CONVERSION SET	YEARS	PART NO.	DESCRIPTION	
1	Gasket Conversion Set	2009-04	CS 26202	PermaDry® molded rubber oil pan gskt. incl.	
QTY	MANIFOLD - INT. & EXH.	YEARS	PART NO.	DESCRIPTION	
1	Int. Manifold Gasket Set	2009-04	MS 96198	Upper set incl.	
1	Exh. Manifold Gasket Set	2009-04	MS 92846		
QTY	EXHAUST PIPE FLANGE	YEARS	PART NO.	DESCRIPTION	
1	Exhaust Pipe Gasket	2009-04	61002	Pipe to manifold	
QTY	OIL PAN	YEARS	PART NO.	DESCRIPTION	
1	Oil Pan Gasket Set	2009-04	OS 30728 R	PermaDry® molded rubber gskt. incl.	
QTY	CRANKSHAFT REAR SEAL	YEARS	PART NO.	DESCRIPTION	
1	Rear Main Seal Set	2009-04	BS 40182	Rubber; One-piece	
1	Rear Main Seal Set	2009-04	BS 40627	PTFE Rubber; One-piece	

Dodge Truck (Incl. Minivans and SUV's) (Cont.)

6		2009 - 2004; 2.4L 148 (2429cc) DOHC L4 (16 Valve) 87.5mm Bore			6	
(cont.)		MFI; Gasoline; Turbo - Intercooled Chrysler Eng.; VIN Code 8			(cont.)	
QTY	VALVE COVER	YEARS	PART NO.	DESCRIPTION		
1	Valve Cover Gasket Set	2009-04	VS 50459 R	w/Spark plug tube seals; PermaDry® molded rubber gskt. incl.		
1	Semi-Circular Plug	2009-04	ES 72357	Valve Cover		
1	Spark Plug Tube Seal Set	2009-04	ES 72947	Valve Cover; New Part Number - Check for Availability		
QTY	VALVE STEM SEAL SET	YEARS	PART NO.	DESCRIPTION		
1	Valve Stem Seal Set	2009-04	SS 72871	Premium valve stem seals incl.		
QTY	THERMOSTAT HOUSING	YEARS	PART NO.	DESCRIPTION		
1	Thermostat Gasket	2009-04	35588	Thermostat Housing; Thermostat seal		
1	Thermostat Gasket	2009-04	35681	Thermostat Housing		
QTY	WATER PUMP	YEARS	PART NO.	DESCRIPTION		
1	Water Pump Gasket	2009-04	35586	O-ring		
1	Water Pump Gasket	2009-04	35587	Seal		
QTY	TIMING COVER	YEARS	PART NO.	DESCRIPTION		
1	Crankshaft Front Seal Set	2009-04	TCS 45962			
2	Camshaft Front Seal Set	2009-04	TCS 45961			
1	Camshaft Sensor Seal	2009-04	70725			
1	Repair Sleeve	2009-04	16224	Timing Cover; Use w/installation tool		
1	Repair Sleeve Tool	2009-04	16325	Timing Cover		
QTY	CARB & FUEL INJECTION	YEARS	PART NO.	DESCRIPTION		
2	Fuel Injector O-Ring Set	2009-04	ES 70599	Improved design		
1	Throttle Body Gasket	2009-04	61237	O-ring		
1	Throttle Body Gasket	2009-04	61248	Mounting		
1	Throttle Body Gasket	2009-04	61324	Idle air control; 21mm ID		
1	Throttle Body Gasket	2009-04	61326	Idle air control; 30mm ID		
QTY	EXHAUST GAS RECIRCULATION	YEARS	PART NO.	DESCRIPTION		
1	EGR Gasket	2009-04	70720	Valve		
7		2010; 2.4L 148 (2429cc) DOHC L4 (16 Valve) 87.5mm Bore			7	
(cont.)		MFI; Gasoline; Naturally Aspirated Chrysler Eng.; VIN Code 9			(cont.)	
QTY	CYLINDER HEAD	YEARS	PART NO.	DESCRIPTION		
1	Head Gasket	2010	26202 PT	Head bolts not incl.; Head bolt replacement recommended; PermaTorqueMLS® LaserWeld® Technology; Improved design		
1	Head Set	2010	HS 26202 PT-3	Head bolts not incl.; Head bolt replacement recommended; PermaDry® molded rubber valve cover gskt. incl.; Premium valve stem seals incl.		
1	Head Bolt Set	2010	ES 71028	Head bolts w/Washers; Replacement recommended		
QTY	CONVERSION SET	YEARS	PART NO.	DESCRIPTION		
1	Gasket Conversion Set	2010	CS 26202	PermaDry® molded rubber oil pan gskt. incl.		
QTY	MANIFOLD - INT. & EXH.	YEARS	PART NO.	DESCRIPTION		
1	Int. Manifold Gasket Set	2010	MS 93219	Lower set; Upper set incl.		
1	Plenum Gasket Set	2010	MS 93220	Upper set		
1	Exh. Manifold Gasket Set	2010	MS 92846			
QTY	EXHAUST PIPE FLANGE	YEARS	PART NO.	DESCRIPTION		
1	Exhaust Pipe Gasket	2010	61002	Pipe to manifold		
1	Exhaust Pipe Gasket	2010	61229	Converter		
QTY	OIL PAN	YEARS	PART NO.	DESCRIPTION		
1	Oil Pan Gasket Set	2010	OS 30728 R	PermaDry® molded rubber gskt. incl.		
QTY	CRANKSHAFT REAR SEAL	YEARS	PART NO.	DESCRIPTION		
1	Rear Main Seal Set	2010	BS 40182	Rubber; One-piece		
1	Rear Main Seal Set	2010	BS 40627	PTFE Rubber; One-piece		
QTY	VALVE COVER	YEARS	PART NO.	DESCRIPTION		
1	Valve Cover Gasket Set	2010	VS 50518 R	w/Spark plug tube seals; PermaDry® molded rubber gskt. incl.		
1	Semi-Circular Plug	2010	ES 72357	Valve Cover		
QTY	VALVE STEM SEAL SET	YEARS	PART NO.	DESCRIPTION		
1	Valve Stem Seal Set	2010	SS 72871	Premium valve stem seals incl.		
QTY	THERMOSTAT HOUSING	YEARS	PART NO.	DESCRIPTION		
1	Thermostat Gasket	2010	35588	Thermostat Housing; Thermostat seal		
1	Thermostat Gasket	2010	35681	Thermostat Housing		
QTY	WATER PUMP	YEARS	PART NO.	DESCRIPTION		
1	Water Pump Gasket	2010	35586	O-ring		
1	Water Pump Gasket	2010	35587	Seal		
QTY	TIMING COVER	YEARS	PART NO.	DESCRIPTION		
1	Crankshaft Front Seal Set	2010	TCS 45962			
2	Camshaft Front Seal Set	2010	TCS 45961			
1	Camshaft Sensor Seal	2010	70725			

Dodge Truck (Incl. Minivans and SUV's) (Cont.)

7 (cont.)		2010; 2.4L 148 (2429cc) DOHC L4 (16 Valve) 87.5mm Bore			7 (cont.)
		MFI; Gasoline; Naturally Aspirated Chrysler Eng.; VIN Code 9			
QTY	TIMING COVER	YEARS	PART NO.	DESCRIPTION	
1	Repair Sleeve	2010	16224	Timing Cover; Use w/installation tool	
1	Repair Sleeve Tool	2010	16325	Timing Cover	
QTY	CARB & FUEL INJECTION	YEARS	PART NO.	DESCRIPTION	
2	Fuel Injector O-Ring Set	2010	ES 70599	Improved design	
1	Throttle Body Gasket	2010	61214	Mounting	
1	Throttle Body Gasket	2010	61324	Idle air control; 21mm ID	
1	Throttle Body Gasket	2010	61326	Idle air control; 30mm ID	
QTY	EXHAUST GAS RECIRCULATION	YEARS	PART NO.	DESCRIPTION	
1	EGR Gasket	2010	70720	Valve	
8		2010 - 1996; 2.4L 148 (2429cc) DOHC L4 (16 Valve) 87.5mm Bore			8
		MFI; Gasoline; Naturally Aspirated Chrysler Eng.; VIN Code B			
QTY	CYLINDER HEAD	YEARS	PART NO.	DESCRIPTION	
1	Head Gasket	2010-02	26202 PT	Head bolts not incl.; Head bolt replacement recommended; PermaTorqueMLS® LaserWeld® Technology; Improved design	
1	Head Gasket	2004-02	26206 PT	Head bolts not incl.; Head bolt replacement recommended; PermaTorqueMLS®; Old design	
1	Head Gasket	2001	26502 PT	Chrysler Voyager Base Dodge Caravan Base, SE; .010" thicker for use when head is refaced; Head bolts not incl.; Head bolt replacement recommended; PermaTorqueMLS®	
1	Head Gasket	2001	9924 PT	Chrysler Voyager Base Dodge Caravan Base, SE; Head bolts not incl.; Head bolt replacement recommended; PermaTorqueMLS®	
1	Head Gasket	2001	9946 PT	Exc. Chrysler Voyager Base Dodge Caravan Base, SE; Head bolts not incl.; Head bolt replacement recommended; PermaTorqueMLS®	
1	Head Gasket	2000-96	26502 PT	.010" thicker for use when head is refaced; Head bolts not incl.; Head bolt replacement recommended; PermaTorqueMLS®	
1	Head Gasket	2000-96	9924 PT	Head bolts not incl.; Head bolt replacement recommended; PermaTorqueMLS®	
1	Head Set	2010-08	HS 26202 PT-3	Head bolts not incl.; Head bolt replacement recommended; PermaDry® molded rubber valve cover gskt. incl.; Premium valve stem seals incl.	
1	Head Set	2007-05	HS 26202 PT-2	Dodge Caravan SE; Head bolts not incl.; Head bolt replacement recommended; PermaDry® molded rubber valve cover gskt. incl.; Premium valve stem seals incl.	
1	Head Set	2007-05	HS 26202 PT-3	Exc. Dodge Caravan SE; Head bolts not incl.; Head bolt replacement recommended; PermaDry® molded rubber valve cover gskt. incl.; Premium valve stem seals incl.	
1	Head Set	2004-03	HS 26206 PT-1	Chrysler PT Cruiser Base, Limited, Touring; Head bolts not incl.; Head bolt replacement recommended; PermaDry® molded rubber valve cover gskt. incl.; Premium valve stem seals incl.	
1	Head Set	2004	HS 26206 PT-2	Chrysler Voyager Base, LX Dodge Caravan SE; Head bolts not incl.; Head bolt replacement recommended; PermaDry® molded rubber valve cover gskt. incl.; Premium valve stem seals incl.	
1	Head Set	2003	HS 26206 PT-2	Exc. Chrysler PT Cruiser Base, Limited, Touring; Head bolts not incl.; Head bolt replacement recommended; PermaDry® molded rubber valve cover gskt. incl.; Premium valve stem seals incl.	
1	Head Set	2002	HS 26206 PT-1	Exc. Chrysler Voyager Base, LX Dodge Caravan eC, SE; Head bolts not incl.; Head bolt replacement recommended; PermaDry® molded rubber valve cover gskt. incl.; Premium valve stem seals incl.	
1	Head Set	2002	HS 26206 PT-2	Chrysler Voyager Base, LX Dodge Caravan eC, SE; Head bolts not incl.; Head bolt replacement recommended; PermaDry® molded rubber valve cover gskt. incl.; Premium valve stem seals incl.	
1	Head Set	2001	HS 9924 PT-2	Chrysler Voyager Base Dodge Caravan Base, SE; Head bolts not incl.; Head bolt replacement recommended; PermaDry® molded rubber valve cover gskt. incl.; Premium valve stem seals incl.	
1	Head Set	2001	HS 9946 PT	Exc. Chrysler Voyager Base Dodge Caravan Base, SE; Head bolts not incl.; Head bolt replacement recommended; PermaDry® molded rubber valve cover gskt. incl.; Premium valve stem seals incl.	
1	Head Set	2000-96	HS 9924 PT	Head bolts not incl.; Head bolt replacement recommended; PermaDry® molded rubber valve cover gskt. incl.; Premium valve stem seals incl.	
1	Head Installation Set	2000-96	HIS 9924 PT	Head bolts & exh. pipe to manifold gskt. not incl.; Head bolt replacement recommended; PermaDry® molded rubber valve cover gskt. incl.	
1	Head Bolt Set	2010-96	ES 71028	Head bolts w/Washers; Replacement recommended	
QTY	CONVERSION SET	YEARS	PART NO.	DESCRIPTION	
1	Gasket Conversion Set	2010-08	CS 26202	PermaDry® molded rubber oil pan gskt. incl.	

Dodge Truck (Incl. Minivans and SUV's) (Cont.)

8 (cont.)		2010 - 1996; 2.4L 148 (2429cc) DOHC L4 (16 Valve) 87.5mm Bore MFI; Gasoline; Naturally Aspirated Chrysler Eng.; VIN Code B			8 (cont.)
QTY	CONVERSION SET	YEARS	PART NO.	DESCRIPTION	
1	Gasket Conversion Set	2007-05	CS 26202	Exc. Dodge Caravan SE; PermaDry® molded rubber oil pan gskt. incl.	
1	Gasket Conversion Set	2007-05	CS 9924	Dodge Caravan SE; PermaDry® molded rubber oil pan gskt. incl.	
1	Gasket Conversion Set	2004-03	CS 26202	Chrysler PT Cruiser Base, Limited, Touring; PermaDry® molded rubber oil pan gskt. incl.	
1	Gasket Conversion Set	2004	CS 9924	Chrysler Voyager Base, LX Dodge Caravan SE; PermaDry® molded rubber oil pan gskt. incl.	
1	Gasket Conversion Set	2003	CS 9924	Exc. Chrysler PT Cruiser Base, Limited, Touring; PermaDry® molded rubber oil pan gskt. incl.	
1	Gasket Conversion Set	2002	CS 9924	Chrysler Voyager Base, LX Dodge Caravan eC, SE; PermaDry® molded rubber oil pan gskt. incl.	
1	Gasket Conversion Set	2002	CS 9946	Exc. Chrysler Voyager Base, LX Dodge Caravan eC, SE; PermaDry® molded rubber oil pan gskt. incl.	
1	Gasket Conversion Set	2001	CS 9924	Chrysler Voyager Base Dodge Caravan Base, SE; PermaDry® molded rubber oil pan gskt. incl.	
1	Gasket Conversion Set	2001	CS 9946	Exc. Chrysler Voyager Base Dodge Caravan Base, SE; PermaDry® molded rubber oil pan gskt. incl.	
1	Gasket Conversion Set	2000-96	CS 9924	PermaDry® molded rubber oil pan gskt. incl.	
QTY	MANIFOLD - INT. & EXH.	YEARS	PART NO.	DESCRIPTION	
1	Int. Manifold Gasket Set	2010-08	MS 93219	Lower set; Upper set incl.	
1	Int. Manifold Gasket Set	2007-05	MS 92532	Dodge Caravan SE; Lower set; Upper set incl.	
1	Int. Manifold Gasket Set	2007-05	MS 93219	Exc. Dodge Caravan SE; Lower set; Upper set incl.	
1	Int. Manifold Gasket Set	2004-03	MS 93219	Chrysler PT Cruiser Base, Limited, Touring; Lower set; Upper set incl.	
1	Int. Manifold Gasket Set	2004	MS 92532	Chrysler Voyager Base, LX Dodge Caravan SE; Lower set; Upper set incl.	
1	Int. Manifold Gasket Set	2003	MS 92532	Exc. Chrysler PT Cruiser Base, Limited, Touring; Lower set; Upper set incl.	
1	Int. Manifold Gasket Set	2002	MS 92532	Chrysler Voyager Base, LX Dodge Caravan eC, SE; Lower set; Upper set incl.	
1	Int. Manifold Gasket Set	2002	MS 93219	Exc. Chrysler Voyager Base, LX Dodge Caravan eC, SE; Lower set; Upper set incl.	
1	Int. Manifold Gasket Set	2001	MS 92532	Chrysler Voyager Base Dodge Caravan Base, SE; Lower set; Upper set incl.	
1	Int. Manifold Gasket Set	2001	MS 93219	Exc. Chrysler Voyager Base Dodge Caravan Base, SE; Lower set; Upper set incl.	
1	Int. Manifold Gasket Set	2000-96	MS 95660	Lower set; Upper set incl.	
1	Plenum Gasket Set	2010-08	MS 93220	Upper set	
1	Plenum Gasket Set	2007-05	MS 93220	Exc. Dodge Caravan SE; Upper set	
1	Plenum Gasket Set	2007-05	MS 96912	Dodge Caravan SE; Upper set; New Part Number - Check for Availability	
1	Plenum Gasket Set	2004-03	MS 93220	Chrysler PT Cruiser Base, Limited, Touring; Upper set	
1	Plenum Gasket Set	2004	MS 96912	Chrysler Voyager Base, LX Dodge Caravan SE; Upper set; New Part Number - Check for Availability	
1	Plenum Gasket Set	2003	MS 96912	Exc. Chrysler PT Cruiser Base, Limited, Touring; Upper set; New Part Number - Check for Availability	
1	Plenum Gasket Set	2002	MS 93220	Exc. Chrysler Voyager Base, LX Dodge Caravan eC, SE; Upper set	
1	Plenum Gasket Set	2002	MS 96912	Chrysler Voyager Base, LX Dodge Caravan eC, SE; Upper set; New Part Number - Check for Availability	
1	Plenum Gasket Set	2001	MS 93220	Exc. Chrysler Voyager Base Dodge Caravan Base, SE; Upper set	
1	Plenum Gasket Set	2001	MS 96912	Chrysler Voyager Base Dodge Caravan Base, SE; Upper set; New Part Number - Check for Availability	
1	Plenum Gasket Set	2000-96	MS 90546	Upper set	
1	Exh. Manifold Gasket Set	2010-01	MS 92846		
1	Exh. Manifold Gasket Set	2000-96	MS 95692		
QTY	EXHAUST PIPE FLANGE	YEARS	PART NO.	DESCRIPTION	
1	Exhaust Pipe Gasket	2010-96	61002	Pipe to manifold	
1	Exhaust Pipe Gasket	2010-02	61229	Converter	
QTY	OIL PAN	YEARS	PART NO.	DESCRIPTION	
1	Oil Pan Gasket Set	2010-08	OS 30728 R	PermaDry® molded rubber gskt. incl.	
1	Oil Pan Gasket Set	2007-05	OS 30676 R	Dodge Caravan SE; PermaDry® molded rubber gskt. incl.	
1	Oil Pan Gasket Set	2007-05	OS 30728 R	Exc. Dodge Caravan SE; PermaDry® molded rubber gskt. incl.	
1	Oil Pan Gasket Set	2004-03	OS 30728 R	Chrysler PT Cruiser Base, Limited, Touring; PermaDry® molded rubber gskt. incl.	
1	Oil Pan Gasket Set	2004	OS 30676 R	Chrysler Voyager Base, LX Dodge Caravan SE; PermaDry® molded rubber gskt. incl.	
1	Oil Pan Gasket Set	2003	OS 30676 R	Exc. Chrysler PT Cruiser Base, Limited, Touring; PermaDry® molded rubber gskt. incl.	
1	Oil Pan Gasket Set	2002	OS 30676 R	Chrysler Voyager Base, LX Dodge Caravan eC, SE; PermaDry® molded rubber gskt. incl.	

Dodge Truck (Incl. Minivans and SUV's) (Cont.)

8 (cont.)	2010 - 1996; 2.4L 148 (2429cc) DOHC L4 (16 Valve) 87.5mm Bore MFI; Gasoline; Naturally Aspirated Chrysler Eng.; VIN Code B				8 (cont.)
QTY	OIL PAN	YEARS	PART NO.	DESCRIPTION	
1	Oil Pan Gasket Set	2002	OS 30701 R	Exc. Chrysler Voyager Base, LX Dodge Caravan eC, SE; PermaDry® molded rubber gskt. incl.	
1	Oil Pan Gasket Set	2001	OS 30701 R	Exc. Chrysler Voyager Base Dodge Caravan Base, SE; PermaDry® molded rubber gskt. incl.	
1	Oil Pan Gasket Set	2001	OS 30676 R	Chrysler Voyager Base Dodge Caravan Base, SE; PermaDry® molded rubber gskt. incl.	
1	Oil Pan Gasket Set	2000-96	OS 30676 R	PermaDry® molded rubber gskt. incl.	
QTY	CRANKSHAFT REAR SEAL	YEARS	PART NO.	DESCRIPTION	
1	Rear Main Seal Set	2010-96	BS 40182	Rubber; One-piece	
1	Rear Main Seal Set	2010-96	BS 40627	PTFE Rubber; One-piece	
QTY	VALVE COVER	YEARS	PART NO.	DESCRIPTION	
1	Valve Cover Gasket Set	2010-08	VS 50518 R	w/Spark plug tube seals; PermaDry® molded rubber gskt. incl.	
1	Valve Cover Gasket Set	2007-05	VS 50459 R	Dodge Caravan SE; w/Spark plug tube seals; PermaDry® molded rubber gskt. incl.	
1	Valve Cover Gasket Set	2007-05	VS 50518 R	Exc. Dodge Caravan SE; w/Spark plug tube seals; PermaDry® molded rubber gskt. incl.	
1	Valve Cover Gasket Set	2004-03	VS 50518 R	Chrysler PT Cruiser Base, Limited, Touring; w/Spark plug tube seals; PermaDry® molded rubber gskt. incl.	
1	Valve Cover Gasket Set	2004	VS 50459 R	Chrysler Voyager Base, LX Dodge Caravan SE; w/Spark plug tube seals; PermaDry® molded rubber gskt. incl.	
1	Valve Cover Gasket Set	2003	VS 50459 R	Exc. Chrysler PT Cruiser Base, Limited, Touring; w/Spark plug tube seals; PermaDry® molded rubber gskt. incl.	
1	Valve Cover Gasket Set	2002	VS 50459 R	Chrysler Voyager Base, LX Dodge Caravan eC, SE; w/Spark plug tube seals; PermaDry® molded rubber gskt. incl.	
1	Valve Cover Gasket Set	2002	VS 50518 R	Exc. Chrysler Voyager Base, LX Dodge Caravan eC, SE; w/Spark plug tube seals; PermaDry® molded rubber gskt. incl.	
1	Valve Cover Gasket Set	2001	VS 50459 R	Chrysler Voyager Base Dodge Caravan Base, SE; w/Spark plug tube seals; PermaDry® molded rubber gskt. incl.	
1	Valve Cover Gasket Set	2001	VS 50518 R	Exc. Chrysler Voyager Base Dodge Caravan Base, SE; w/Spark plug tube seals; PermaDry® molded rubber gskt. incl.	
1	Valve Cover Gasket Set	2000-96	VS 50459 R	w/Spark plug tube seals; PermaDry® molded rubber gskt. incl.	
1	Semi-Circular Plug	2010-96	ES 72357	Valve Cover	
1	Spark Plug Tube Seal Set	2007-05	ES 72947	Dodge Caravan SE; Valve Cover; New Part Number - Check for Availability	
1	Spark Plug Tube Seal Set	2004	ES 72947	Chrysler Voyager Base, LX Dodge Caravan SE; Valve Cover; New Part Number - Check for Availability	
1	Spark Plug Tube Seal Set	2003	ES 72947	Exc. Chrysler PT Cruiser Base, Limited, Touring; Valve Cover; New Part Number - Check for Availability	
1	Spark Plug Tube Seal Set	2002	ES 72947	Chrysler Voyager Base, LX Dodge Caravan eC, SE; Valve Cover; New Part Number - Check for Availability	
1	Spark Plug Tube Seal Set	2001	ES 72947	Chrysler Voyager Base Dodge Caravan Base, SE; Valve Cover; New Part Number - Check for Availability	
1	Spark Plug Tube Seal Set	2000-96	ES 72947	Valve Cover; New Part Number - Check for Availability	
QTY	VALVE STEM SEAL SET	YEARS	PART NO.	DESCRIPTION	
1	Valve Stem Seal Set	2010-96	SS 72871	Premium valve stem seals incl.	
QTY	THERMOSTAT HOUSING	YEARS	PART NO.	DESCRIPTION	
1	Water Outlet Gasket	2007-05	35286	Dodge Caravan SE; Thermostat Housing	
1	Water Outlet Gasket	2007-05	35286 T	Dodge Caravan SE; Thermostat Housing; PermaDryPlus®	
1	Water Outlet Gasket	2004	35286	Chrysler Voyager Base, LX Dodge Caravan SE; Thermostat Housing	
1	Water Outlet Gasket	2004	35286 T	Chrysler Voyager Base, LX Dodge Caravan SE; Thermostat Housing; PermaDryPlus®	
1	Water Outlet Gasket	2003	35286	Exc. Chrysler PT Cruiser Base, Limited, Touring; Thermostat Housing	
1	Water Outlet Gasket	2003	35286 T	Exc. Chrysler PT Cruiser Base, Limited, Touring; Thermostat Housing; PermaDryPlus®	
1	Water Outlet Gasket	2002	35286	Chrysler Voyager Base, LX Dodge Caravan eC, SE; Thermostat Housing	
1	Water Outlet Gasket	2002	35286 T	Chrysler Voyager Base, LX Dodge Caravan eC, SE; Thermostat Housing; PermaDryPlus®	
1	Water Outlet Gasket	2001	35286	Chrysler Voyager Base Dodge Caravan Base, SE; Thermostat Housing	
1	Water Outlet Gasket	2001	35286 T	Chrysler Voyager Base Dodge Caravan Base, SE; Thermostat Housing; PermaDryPlus®	
1	Water Outlet Gasket	2000-96	35286	Thermostat Housing	
1	Water Outlet Gasket	2000-96	35286 T	Thermostat Housing; PermaDryPlus®	
1	Thermostat Gasket	2010-96	35588	Thermostat Housing; Thermostat seal	
1	Thermostat Gasket	2010-08	35681	Thermostat Housing	
1	Thermostat Gasket	2007-05	35681	Exc. Dodge Caravan SE; Thermostat Housing	

Dodge Truck (Incl. Minivans and SUV's) (Cont.)

8		2010 - 1996; 2.4L 148 (2429cc) DOHC L4 (16 Valve) 87.5mm Bore			8	
(cont.)		MFI; Gasoline; Naturally Aspirated Chrysler Eng.; VIN Code B			(cont.)	
QTY	THERMOSTAT HOUSING	YEARS	PART NO.	DESCRIPTION		
1	Thermostat Gasket	2004-03	35681	Chrysler PT Cruiser Base, Limited, Touring; Thermostat Housing		
1	Thermostat Gasket	2002	35681	Exc. Chrysler Voyager Base, LX Dodge Caravan eC, SE; Thermostat Housing		
1	Thermostat Gasket	2001	35681	Exc. Chrysler Voyager Base Dodge Caravan Base, SE; Thermostat Housing		
QTY	WATER OUTLET GASKET	YEARS	PART NO.	DESCRIPTION		
1	Thermostat Gasket	2004	35651	Chrysler Voyager Base, LX Dodge Caravan SE; Water Outlet		
1	Thermostat Gasket	2003	35651	Exc. Chrysler PT Cruiser Base, Limited, Touring; Water Outlet		
1	Thermostat Gasket	2002	35651	Chrysler Voyager Base, LX Dodge Caravan eC, SE; Water Outlet		
QTY	WATER PUMP	YEARS	PART NO.	DESCRIPTION		
1	Water Pump Gasket	2010-96	35586	O-ring		
1	Water Pump Gasket	2010-96	35587	Seal		
QTY	TIMING COVER	YEARS	PART NO.	DESCRIPTION		
1	Crankshaft Front Seal Set	2010-96	TCS 45962			
2	Camshaft Front Seal Set	2010-96	TCS 45961			
1	Camshaft Sensor Seal	2010-96	70725			
1	Repair Sleeve	2010-96	16224	Timing Cover; Use w/installation tool		
1	Repair Sleeve Tool	2010-96	16325	Timing Cover		
QTY	CARB & FUEL INJECTION	YEARS	PART NO.	DESCRIPTION		
2	Fuel Injector O-Ring Set	2010-96	ES 70599	Improved design		
1	Throttle Body Gasket	2010-03	61324	Idle air control; 21mm ID		
1	Throttle Body Gasket	2010-03	61326	Idle air control; 30mm ID		
1	Throttle Body Gasket	2010-08	61214	Mounting		
1	Throttle Body Gasket	2007-05	61214	Exc. Dodge Caravan SE; Mounting		
1	Throttle Body Gasket	2007-05	61228	Dodge Caravan SE; Mounting		
1	Throttle Body Gasket	2004-03	61214	Chrysler PT Cruiser Base, Limited, Touring; Mounting		
1	Throttle Body Gasket	2004	61228	Chrysler Voyager Base, LX Dodge Caravan SE; Mounting		
1	Throttle Body Gasket	2003	61228	Exc. Chrysler PT Cruiser Base, Limited, Touring; Mounting		
1	Throttle Body Gasket	2002	60744	Chrysler Voyager Base, LX Dodge Caravan eC, SE; Mounting		
1	Throttle Body Gasket	2002	61214	Exc. Chrysler Voyager Base, LX Dodge Caravan eC, SE; Mounting		
1	Throttle Body Gasket	2001	60744	Chrysler Voyager Base Dodge Caravan Base, SE; Mounting		
1	Throttle Body Gasket	2001	61214	Exc. Chrysler Voyager Base Dodge Caravan Base, SE; Mounting		
1	Throttle Body Gasket	2000-96	60744	Mounting		
QTY	EXHAUST GAS RECIRCULATION	YEARS	PART NO.	DESCRIPTION		
1	EGR Gasket	2010-96	70720	Valve		
1	EGR Gasket	2007-05	71182	Dodge Caravan SE; Tube flange		
1	EGR Gasket	2004-03	70721	Chrysler PT Cruiser Base, Limited, Touring; Tube flange		
1	EGR Gasket	2004-03	72928	Chrysler PT Cruiser Base, Limited, Touring; Tube seal		
1	EGR Gasket	2004	71182	Chrysler Voyager Base, LX Dodge Caravan SE; Tube flange		
1	EGR Gasket	2003	71182	Exc. Chrysler PT Cruiser Base, Limited, Touring; Tube flange		
1	EGR Gasket	2002	70721	Exc. Chrysler Voyager Base, LX Dodge Caravan eC, SE; Tube flange		
1	EGR Gasket	2002	71182	Chrysler Voyager Base, LX Dodge Caravan eC, SE; Tube flange		
1	EGR Gasket	2002	72928	Exc. Chrysler Voyager Base, LX Dodge Caravan eC, SE; Tube seal		
1	EGR Gasket	2001-96	70721	Tube flange		
1	EGR Gasket	2001	72928	Exc. Chrysler Voyager Base Dodge Caravan Base, SE; Tube seal		
9		2008 - 2004; 2.4L 148 (2429cc) DOHC L4 (16 Valve) 87.5mm Bore			9	
		MFI; Gasoline; Turbo - Intercooled Chrysler Eng.; VIN Code E				
QTY	CYLINDER HEAD	YEARS	PART NO.	DESCRIPTION		
1	Head Gasket	2008-04	26202 PT	Head bolts not incl.; Head bolt replacement recommended; PermaTorqueMLS® LaserWeld® Technology; Improved design		
1	Head Set	2008-04	HS 26202 PT	Head bolts not incl.; Head bolt replacement recommended; PermaDry® molded rubber valve cover gskt. incl.; Premium valve stem seals incl.		
1	Head Bolt Set	2008-04	ES 71028	Head bolts w/Washers; Replacement recommended		
QTY	CONVERSION SET	YEARS	PART NO.	DESCRIPTION		
1	Gasket Conversion Set	2008-04	CS 26202	PermaDry® molded rubber oil pan gskt. incl.		
QTY	MANIFOLD - INT. & EXH.	YEARS	PART NO.	DESCRIPTION		
1	Int. Manifold Gasket Set	2008-04	MS 96198	Upper set incl.		
1	Exh. Manifold Gasket Set	2008-04	MS 92846			
QTY	EXHAUST PIPE FLANGE	YEARS	PART NO.	DESCRIPTION		
1	Exhaust Pipe Gasket	2008-04	61002	Pipe to manifold		
QTY	OIL PAN	YEARS	PART NO.	DESCRIPTION		
1	Oil Pan Gasket Set	2008-04	OS 30728 R	PermaDry® molded rubber gskt. incl.		
QTY	CRANKSHAFT REAR SEAL	YEARS	PART NO.	DESCRIPTION		
1	Rear Main Seal Set	2008-04	BS 40182	Rubber; One-piece		

Dodge Truck (Incl. Minivans and SUV's) (Cont.)

9		2008 - 2004; 2.4L 148 (2429cc) DOHC L4 (16 Valve) 87.5mm Bore			9
(cont.)		MFI; Gasoline; Turbo - Intercooled Chrysler Eng.; VIN Code E			(cont.)
QTY	CRANKSHAFT REAR SEAL	YEARS	PART NO.	DESCRIPTION	
1	Rear Main Seal Set	2008-04	BS 40627	PTFE Rubber; One-piece	
QTY	VALVE COVER	YEARS	PART NO.	DESCRIPTION	
1	Valve Cover Gasket Set	2008-04	VS 50459 R	w/Spark plug tube seals; PermaDry® molded rubber gskt. incl.	
1	Semi-Circular Plug	2008-04	ES 72357	Valve Cover	
1	Spark Plug Tube Seal Set	2008-04	ES 72947	Valve Cover; New Part Number - Check for Availability	
QTY	VALVE STEM SEAL SET	YEARS	PART NO.	DESCRIPTION	
1	Valve Stem Seal Set	2008-04	SS 72871	Premium valve stem seals incl.	
QTY	THERMOSTAT HOUSING	YEARS	PART NO.	DESCRIPTION	
1	Thermostat Gasket	2008-04	35588	Thermostat Housing; Thermostat seal	
1	Thermostat Gasket	2008-04	35681	Thermostat Housing	
QTY	WATER PUMP	YEARS	PART NO.	DESCRIPTION	
1	Water Pump Gasket	2008-04	35586	O-ring	
1	Water Pump Gasket	2008-04	35587	Seal	
QTY	TIMING COVER	YEARS	PART NO.	DESCRIPTION	
1	Crankshaft Front Seal Set	2008-04	TCS 45962		
2	Camshaft Front Seal Set	2008-04	TCS 45961		
1	Camshaft Sensor Seal	2008-04	70725		
1	Repair Sleeve	2008-04	16224	Timing Cover; Use w/installation tool	
1	Repair Sleeve Tool	2008-04	16325	Timing Cover	
QTY	CARB & FUEL INJECTION	YEARS	PART NO.	DESCRIPTION	
2	Fuel Injector O-Ring Set	2008-04	ES 70599	Improved design	
1	Throttle Body Gasket	2008-04	61228	Mounting	
1	Throttle Body Gasket	2008-04	61237	O-ring	
1	Throttle Body Gasket	2008-04	61324	Idle air control; 21mm ID	
1	Throttle Body Gasket	2008-04	61326	Idle air control; 30mm ID	
QTY	EXHAUST GAS RECIRCULATION	YEARS	PART NO.	DESCRIPTION	
1	EGR Gasket	2008-04	70720	Valve	
10		2009 - 2003; 2.4L 148 (2429cc) DOHC L4 (16 Valve) 87.5mm Bore			10
(cont.)		MFI; Gasoline; Turbo - Intercooled Chrysler Eng.; VIN Code G			(cont.)
QTY	CYLINDER HEAD	YEARS	PART NO.	DESCRIPTION	
1	Head Gasket	2009-03	26202 PT	Head bolts not incl.; Head bolt replacement recommended; PermaTorqueMLS® LaserWeld® Technology; Improved design	
1	Head Set	2009-03	HS 26202 PT	Head bolts not incl.; Head bolt replacement recommended; PermaDry® molded rubber valve cover gskt. incl.; Premium valve stem seals incl.	
1	Head Bolt Set	2009-03	ES 71028	Head bolts w/Washers; Replacement recommended	
QTY	CONVERSION SET	YEARS	PART NO.	DESCRIPTION	
1	Gasket Conversion Set	2009-03	CS 26202	PermaDry® molded rubber oil pan gskt. incl.	
QTY	MANIFOLD - INT. & EXH.	YEARS	PART NO.	DESCRIPTION	
1	Int. Manifold Gasket Set	2009-03	MS 96198	Upper set incl.	
1	Exh. Manifold Gasket Set	2009-03	MS 92846		
QTY	EXHAUST PIPE FLANGE	YEARS	PART NO.	DESCRIPTION	
1	Exhaust Pipe Gasket	2009-03	61002	Pipe to manifold	
QTY	OIL PAN	YEARS	PART NO.	DESCRIPTION	
1	Oil Pan Gasket Set	2009-03	OS 30728 R	PermaDry® molded rubber gskt. incl.	
QTY	CRANKSHAFT REAR SEAL	YEARS	PART NO.	DESCRIPTION	
1	Rear Main Seal Set	2009-03	BS 40182	Rubber; One-piece	
1	Rear Main Seal Set	2009-03	BS 40627	PTFE Rubber; One-piece	
QTY	VALVE COVER	YEARS	PART NO.	DESCRIPTION	
1	Valve Cover Gasket Set	2009-03	VS 50459 R	w/Spark plug tube seals; PermaDry® molded rubber gskt. incl.	
1	Semi-Circular Plug	2009-03	ES 72357	Valve Cover	
1	Spark Plug Tube Seal Set	2009-03	ES 72947	Valve Cover; New Part Number - Check for Availability	
QTY	VALVE STEM SEAL SET	YEARS	PART NO.	DESCRIPTION	
1	Valve Stem Seal Set	2009-03	SS 72871	Premium valve stem seals incl.	
QTY	THERMOSTAT HOUSING	YEARS	PART NO.	DESCRIPTION	
1	Thermostat Gasket	2009-03	35588	Thermostat Housing; Thermostat seal	
1	Thermostat Gasket	2009-03	35681	Thermostat Housing	
QTY	WATER PUMP	YEARS	PART NO.	DESCRIPTION	
1	Water Pump Gasket	2009-03	35586	O-ring	
1	Water Pump Gasket	2009-03	35587	Seal	
QTY	TIMING COVER	YEARS	PART NO.	DESCRIPTION	
1	Crankshaft Front Seal Set	2009-03	TCS 45962		
2	Camshaft Front Seal Set	2009-03	TCS 45961		

Dodge Truck (Incl. Minivans and SUV's) (Cont.)

10 (cont.)		2009 - 2003; 2.4L 148 (2429cc) DOHC L4 (16 Valve) 87.5mm Bore MFI; Gasoline; Turbo - Intercooled Chrysler Eng.; VIN Code G			10 (cont.)
QTY	TIMING COVER	YEARS	PART NO.	DESCRIPTION	
1	Camshaft Sensor Seal	2009-03	70725		
1	Repair Sleeve	2009-03	16224	Timing Cover; Use w/installation tool	
1	Repair Sleeve Tool	2009-03	16325	Timing Cover	
QTY	CARB & FUEL INJECTION	YEARS	PART NO.	DESCRIPTION	
2	Fuel Injector O-Ring Set	2009-03	ES 70599	Improved design	
1	Throttle Body Gasket	2009-03	61237	O-ring	
1	Throttle Body Gasket	2009-03	61248	Mounting	
1	Throttle Body Gasket	2009-03	61324	Idle air control; 21mm ID	
1	Throttle Body Gasket	2009-03	61326	Idle air control; 30mm ID	
QTY	EXHAUST GAS RECIRCULATION	YEARS	PART NO.	DESCRIPTION	
1	EGR Gasket	2009-03	70720	Valve	
11		2007 - 2004; 2.4L 148 (2429cc) DOHC L4 (16 Valve) 87.5mm Bore MFI; Gasoline; Turbo - Intercooled Chrysler Eng.; VIN Code S			11
QTY	CYLINDER HEAD	YEARS	PART NO.	DESCRIPTION	
1	Head Gasket	2007-04	26202 PT	Head bolts not incl.; Head bolt replacement recommended; PermaTorqueMLS® LaserWeld® Technology; Improved design	
1	Head Set	2007-04	HS 26202 PT	Head bolts not incl.; Head bolt replacement recommended; PermaDry® molded rubber valve cover gskt. incl.; Premium valve stem seals incl.	
1	Head Bolt Set	2007-04	ES 71028	Head bolts w/Washers; Replacement recommended	
QTY	CONVERSION SET	YEARS	PART NO.	DESCRIPTION	
1	Gasket Conversion Set	2007-04	CS 26202	PermaDry® molded rubber oil pan gskt. incl.	
QTY	MANIFOLD - INT. & EXH.	YEARS	PART NO.	DESCRIPTION	
1	Int. Manifold Gasket Set	2007-04	MS 96198	Upper set incl.	
1	Exh. Manifold Gasket Set	2007-04	MS 92846		
QTY	EXHAUST PIPE FLANGE	YEARS	PART NO.	DESCRIPTION	
1	Exhaust Pipe Gasket	2007-04	61002	Pipe to manifold	
QTY	OIL PAN	YEARS	PART NO.	DESCRIPTION	
1	Oil Pan Gasket Set	2007-04	OS 30728 R	PermaDry® molded rubber gskt. incl.	
QTY	CRANKSHAFT REAR SEAL	YEARS	PART NO.	DESCRIPTION	
1	Rear Main Seal Set	2007-04	BS 40182	Rubber; One-piece	
1	Rear Main Seal Set	2007-04	BS 40627	PTFE Rubber; One-piece	
QTY	VALVE COVER	YEARS	PART NO.	DESCRIPTION	
1	Valve Cover Gasket Set	2007-04	VS 50459 R	w/Spark plug tube seals; PermaDry® molded rubber gskt. incl.	
1	Semi-Circular Plug	2007-04	ES 72357	Valve Cover	
1	Spark Plug Tube Seal Set	2007-04	ES 72947	Valve Cover; New Part Number - Check for Availability	
QTY	VALVE STEM SEAL SET	YEARS	PART NO.	DESCRIPTION	
1	Valve Stem Seal Set	2007-04	SS 72871	Premium valve stem seals incl.	
QTY	THERMOSTAT HOUSING	YEARS	PART NO.	DESCRIPTION	
1	Thermostat Gasket	2007-04	35588	Thermostat Housing; Thermostat seal	
1	Thermostat Gasket	2007-04	35681	Thermostat Housing	
QTY	WATER PUMP	YEARS	PART NO.	DESCRIPTION	
1	Water Pump Gasket	2007-04	35586	O-ring	
1	Water Pump Gasket	2007-04	35587	Seal	
QTY	TIMING COVER	YEARS	PART NO.	DESCRIPTION	
1	Crankshaft Front Seal Set	2007-04	TCS 45962		
2	Camshaft Front Seal Set	2007-04	TCS 45961		
1	Camshaft Sensor Seal	2007-04	70725		
1	Repair Sleeve	2007-04	16224	Timing Cover; Use w/installation tool	
1	Repair Sleeve Tool	2007-04	16325	Timing Cover	
QTY	CARB & FUEL INJECTION	YEARS	PART NO.	DESCRIPTION	
2	Fuel Injector O-Ring Set	2007-04	ES 70599	Improved design	
1	Throttle Body Gasket	2007-04	61228	Mounting	
1	Throttle Body Gasket	2007-04	61237	O-ring	
1	Throttle Body Gasket	2007-04	61324	Idle air control; 21mm ID	
1	Throttle Body Gasket	2007-04	61326	Idle air control; 30mm ID	
QTY	EXHAUST GAS RECIRCULATION	YEARS	PART NO.	DESCRIPTION	
1	EGR Gasket	2007-04	70720	Valve	

Dodge Truck (Incl. Minivans and SUV's) (Cont.)

12		2008 - 2004; 2.4L 148 (2429cc) DOHC L4 (16 Valve) 87.5mm Bore			12
MFI; Gasoline; Naturally Aspirated Chrysler Eng.; VIN Code X					
QTY	CYLINDER HEAD	YEARS	PART NO.	DESCRIPTION	
1	Head Gasket	2008-04	26202 PT	Head bolts not incl.; Head bolt replacement recommended; PermaTorqueMLS® LaserWeld® Technology; Improved design	
1	Head Gasket	2004	26206 PT	Head bolts not incl.; Head bolt replacement recommended; PermaTorqueMLS®; Old design	
1	Head Set	2008-05	HS 26202 PT-1	Head bolts not incl.; Head bolt replacement recommended; PermaDry® molded rubber valve cover gskt. incl.; Premium valve stem seals incl.	
1	Head Set	2004	HS 26206 PT	Head bolts not incl.; Head bolt replacement recommended; PermaDry® molded rubber valve cover gskt. incl.; Premium valve stem seals incl.	
1	Head Bolt Set	2008-04	ES 71028	Head bolts w/Washers; Replacement recommended	
QTY	CONVERSION SET	YEARS	PART NO.	DESCRIPTION	
1	Gasket Conversion Set	2008-04	CS 9924	PermaDry® molded rubber oil pan gskt. incl.	
QTY	MANIFOLD - INT. & EXH.	YEARS	PART NO.	DESCRIPTION	
1	Int. Manifold Gasket Set	2008-04	MS 92888		
1	Exh. Manifold Gasket Set	2008-04	MS 92846		
QTY	EXHAUST PIPE FLANGE	YEARS	PART NO.	DESCRIPTION	
1	Exhaust Pipe Gasket	2008-04	61002	Pipe to manifold	
QTY	OIL PAN	YEARS	PART NO.	DESCRIPTION	
1	Oil Pan Gasket Set	2008-04	OS 30676 R	PermaDry® molded rubber gskt. incl.	
QTY	CRANKSHAFT REAR SEAL	YEARS	PART NO.	DESCRIPTION	
1	Rear Main Seal Set	2008-04	BS 40182	Rubber; One-piece	
1	Rear Main Seal Set	2008-04	BS 40627	PTFE Rubber; One-piece	
QTY	VALVE COVER	YEARS	PART NO.	DESCRIPTION	
1	Valve Cover Gasket Set	2008-05	VS 50518 R	w/Spark plug tube seals; PermaDry® molded rubber gskt. incl.	
1	Valve Cover Gasket Set	2004	VS 50459 R	w/Spark plug tube seals; PermaDry® molded rubber gskt. incl.	
1	Semi-Circular Plug	2008-04	ES 72357	Valve Cover	
1	Spark Plug Tube Seal Set	2004	ES 72947	Valve Cover; New Part Number - Check for Availability	
QTY	VALVE STEM SEAL SET	YEARS	PART NO.	DESCRIPTION	
1	Valve Stem Seal Set	2008-04	SS 72871	Premium valve stem seals incl.	
QTY	THERMOSTAT HOUSING	YEARS	PART NO.	DESCRIPTION	
1	Thermostat Gasket	2008-04	35588	Thermostat Housing; Thermostat seal	
1	Thermostat Gasket	2008-04	35681	Thermostat Housing	
QTY	WATER PUMP	YEARS	PART NO.	DESCRIPTION	
1	Water Pump Gasket	2008-04	35586	O-ring	
1	Water Pump Gasket	2008-04	35587	Seal	
QTY	TIMING COVER	YEARS	PART NO.	DESCRIPTION	
1	Crankshaft Front Seal Set	2008-04	TCS 45962		
2	Camshaft Front Seal Set	2008-04	TCS 45961		
1	Camshaft Sensor Seal	2008-04	70725		
1	Repair Sleeve	2008-04	16224	Timing Cover; Use w/installation tool	
1	Repair Sleeve Tool	2008-04	16325	Timing Cover	
QTY	CARB & FUEL INJECTION	YEARS	PART NO.	DESCRIPTION	
2	Fuel Injector O-Ring Set	2008-04	ES 70599	Improved design	
1	Throttle Body Gasket	2008-04	61098	Mounting	
1	Throttle Body Gasket	2008-04	61324	Idle air control; 21mm ID	
1	Throttle Body Gasket	2008-04	61326	Idle air control; 30mm ID	
QTY	EXHAUST GAS RECIRCULATION	YEARS	PART NO.	DESCRIPTION	
1	EGR Gasket	2008-04	70720	Valve	
1	EGR Gasket	2008-05	72218	Mounting	
1	EGR Gasket	2004	70721	Tube flange	
1	EGR Gasket	2004	72928	Tube seal	
13		2002 - 1996; 2.5L 150 (2464cc) OHV L4 (8 Valve) 3.875" Bore			13
MFI; Gasoline; Naturally Aspirated AMC Eng.; VIN Code P					
QTY	CYLINDER HEAD	YEARS	PART NO.	DESCRIPTION	
1	Head Gasket	2002-96	9196 PT	Head bolts not incl.; Head bolt replacement recommended	
1	Head Set	2002-97	HS 9196 PT-5	Head bolts not incl.; Head bolt replacement recommended; PermaDry® molded rubber valve cover gskt. incl.; Premium valve stem seals incl.	
1	Head Set	1996	HS 9196 PT-3	Premium valve stem seals incl.	
1	Head Bolt Set	2002-97	ES 72896	Replacement recommended	
QTY	CONVERSION SET	YEARS	PART NO.	DESCRIPTION	
1	Gasket Conversion Set	2002-96	CS 9196-2	PermaDry® molded rubber oil pan gskt. incl.	
QTY	MANIFOLD - INT. & EXH.	YEARS	PART NO.	DESCRIPTION	
1	Int. & Exh. Gasket Set	2002-96	MS 92100		

Dodge Truck (Incl. Minivans and SUV's) (Cont.)

13 (cont.)		2002 - 1996; 2.5L 150 (2464cc) OHV L4 (8 Valve) 3.875" Bore			13 (cont.)
MFI; Gasoline; Naturally Aspirated AMC Eng.; VIN Code P					
QTY	EXHAUST PIPE FLANGE	YEARS	PART NO.	DESCRIPTION	
1	Exhaust Pipe Gasket	2002-96	60836	Packing	
QTY	OIL PAN	YEARS	PART NO.	DESCRIPTION	
1	Oil Pan Gasket Set	2002-96	OS 34007 R	PermaDry® molded rubber gskt. incl.	
QTY	CRANKSHAFT REAR SEAL	YEARS	PART NO.	DESCRIPTION	
1	Rear Main Seal Set	2002-96	BS 40578	Rubber; One-piece; Improved design	
1	Repair Sleeve Tool	2002-96	16304	Crankshaft	
QTY	VALVE COVER	YEARS	PART NO.	DESCRIPTION	
1	Valve Cover Gasket Set	2002-97	VS 50502 R	PermaDry® molded rubber gskt. incl.	
1	Valve Cover Gasket Set	1996	VS 50430 C	Cork	
QTY	VALVE STEM SEAL SET	YEARS	PART NO.	DESCRIPTION	
1	Valve Stem Seal Set	2002-96	SS 72854	Premium valve stem seals incl.	
QTY	THERMOSTAT HOUSING	YEARS	PART NO.	DESCRIPTION	
1	Thermostat Gasket	2002-99	35630	Thermostat Housing	
QTY	WATER OUTLET GASKET	YEARS	PART NO.	DESCRIPTION	
1	Water Outlet Gasket	1998-97	35024	Water Outlet	
1	Water Outlet Gasket	1996	35286	Water Outlet	
1	Water Outlet Gasket	1996	35286 T	Water Outlet; PermaDryPlus®	
QTY	WATER PUMP	YEARS	PART NO.	DESCRIPTION	
1	Water Pump Gasket	2002-99	35629		
1	Water Pump Gasket	1998-97	35582		
1	Water Pump Gasket	1996	35444		
1	O-Ring	1996	35224	Water Pump; Housing	
QTY	TIMING COVER	YEARS	PART NO.	DESCRIPTION	
1	Timing Cover Set	2002-96	TCS 45117	w/o Sleeve 'N' Seal®; Must be used w/OS 34007R	
1	Timing Set w/Sleeve & Seal	2002-96	TCS 45458	w/Sleeve 'N' Seal®; Must be used w/OS 34007R	
1	Repair Sleeve	2002-96	16210	Timing Cover; Use w/installation tool	
1	Repair Sleeve Tool	2002-96	16312	Timing Cover	
QTY	CARB & FUEL INJECTION	YEARS	PART NO.	DESCRIPTION	
2	Fuel Injector O-Ring Set	2002-96	ES 70599	Improved design	
1	Throttle Body Gasket	2002-96	60948		
QTY	DISTRIBUTOR MOUNTING	YEARS	PART NO.	DESCRIPTION	
1	Distributor Mounting Gasket	2002-96	70051	1 11/32" OD	
QTY	EXHAUST GAS RECIRCULATION	YEARS	PART NO.	DESCRIPTION	
1	EGR Gasket	2002-96	70561		
14		1995 - 1991; 2.5L 153 (2507cc) SOHC L4 (8 Valve) 87.5mm Bore			14
TBI; Gasoline; Naturally Aspirated Chrysler Eng.; VIN Code G					
QTY	CYLINDER HEAD	YEARS	PART NO.	DESCRIPTION	
1	Head Gasket	1995-91	9296 PT	Head bolts not incl.; Head bolt replacement recommended; PermaTorque®	
1	Head Gasket Spacer Shim	1995-91	9296 SP	HeadSaver®	
1	Head Set	1995-91	HS 9296 PT-2	w/Stamped steel valve cover; Head bolts, exh. pipe packing, camshaft rear seal plug not incl.; Head bolt replacement recommended; Premium valve stem seals incl.	
1	Head Set	1995-91	HS 9296 PT-3	w/Aluminum valve cover; Head bolts, exh. pipe packing, camshaft rear seal plug not incl.; Head bolt replacement recommended; PermaDry® molded rubber valve cover gskt. incl.; Premium valve stem seals incl.	
1	Head Set w/Head Bolts	1995-91	HSB 9296 PT-2	w/Stamped steel valve cover; w/Head bolts w/o Washers; Washers are req'd.; Exh. pipe packing & camshaft rear seal plug not incl.; Premium valve stem seals incl.	
1	Head Installation Set	1995-91	HIS 9296 PT-2	w/Stamped steel valve cover; Head bolts, exh. pipe packing, camshaft rear seal plug not incl.; Head bolt replacement recommended	
1	Head Bolt Set	1995-91	ES 72723	Head bolts w/o Washers; Washers are req'd.; Replacement recommended	
1	Head Bolt Washer Set	1995-91	ES 72176	Replacement recommended	
QTY	CONVERSION SET	YEARS	PART NO.	DESCRIPTION	
1	Gasket Conversion Set	1995-91	CS 8763-2	PermaDry® molded rubber oil pan gskt. incl.	
QTY	MANIFOLD - INT. & EXH.	YEARS	PART NO.	DESCRIPTION	
1	Int. & Exh. Gasket Set	1995-91	MS 90947		
QTY	FUEL PUMP	YEARS	PART NO.	DESCRIPTION	
2	Fuel Pump Mounting Gasket	1995-91	70627	May also be used as a fuel pump block-off plate gasket if desired	
QTY	OIL PAN	YEARS	PART NO.	DESCRIPTION	
1	Oil Pan Gasket Set	1995-91	OS 30612 R	PermaDry® molded rubber gskt. incl.	
1	Oil Pan Gasket Set	1995-91	OS 30612 T	PermaDryPlus®; Oil Pan SnapUps® incl.	
1	Drain Plug Gasket	1995-91	70822		

Dodge Truck (Incl. Minivans and SUV's) (Cont.)

14 (cont.)		1995 - 1991; 2.5L 153 (2507cc) SOHC L4 (8 Valve) 87.5mm Bore			14 (cont.)
TBI; Gasoline; Naturally Aspirated Chrysler Eng.; VIN Code G					
QTY	CRANKSHAFT REAR SEAL	YEARS	PART NO.	DESCRIPTION	
1	Rear Main Seal Set	1995-91	BS 40168-1	Rubber; One-piece	
1	Rear Main Seal Set	1995-91	BS 40627	PTFE Rubber; One-piece	
1	Repair Sleeve Tool	1995-91	16300	Crankshaft	
QTY	VALVE COVER	YEARS	PART NO.	DESCRIPTION	
1	Valve Cover Gasket Set	1995-91	VS 50205 C	w/Stamped steel valve cover; Cork	
1	Valve Cover Gasket Set	1995-91	VS 50205 T	w/Stamped steel valve cover; PermaDryPlus®	
1	Valve Cover Gasket Set	1995-91	VS 50334 R	w/Aluminum valve cover; PermaDry® molded rubber gskt. incl.	
QTY	VALVE STEM SEAL SET	YEARS	PART NO.	DESCRIPTION	
1	Valve Stem Seal Set	1995-91	SS 72522	Premium valve stem seals incl.	
QTY	WATER OUTLET GASKET	YEARS	PART NO.	DESCRIPTION	
1	Water Outlet Gasket	1995-91	35286	Water Outlet	
1	Water Outlet Gasket	1995-91	35286 T	Water Outlet; PermaDryPlus®	
QTY	WATER PUMP	YEARS	PART NO.	DESCRIPTION	
1	Water Pump Gasket	1995-91	35444		
1	O-Ring	1995-91	35224	Water Pump	
QTY	TIMING COVER	YEARS	PART NO.	DESCRIPTION	
1	Timing Cover Set	1995-91	TCS 45495	Camshaft; Front seal set	
1	Crankshaft Front Seal Set	1995-91	TCS 45131		
1	Auxiliary Shaft Seal Set	1995-91	TCS 45026		
1	Camshaft Rear Seal Plug Set	1995-91	TCS 45833		
QTY	CARB & FUEL INJECTION	YEARS	PART NO.	DESCRIPTION	
1	Throttle Body Gasket	1995-91	60743		
QTY	DISTRIBUTOR MOUNTING	YEARS	PART NO.	DESCRIPTION	
1	O-Ring	1995-91	70799	Distributor Mounting	
QTY	EXHAUST GAS RECIRCULATION	YEARS	PART NO.	DESCRIPTION	
1	EGR Gasket	1995-91	70561		
15		1995 - 1991; 2.5L 153 (2507cc) SOHC L4 (8 Valve) 87.5mm Bore			15
TBI; Gasoline; Naturally Aspirated Chrysler Eng.; VIN Code K					
QTY	CYLINDER HEAD	YEARS	PART NO.	DESCRIPTION	
1	Head Gasket	1995-91	9296 PT	Head bolts not incl.; Head bolt replacement recommended; PermaTorque®	
1	Head Gasket Spacer Shim	1995-91	9296 SP	HeadSaver®	
1	Head Set	1995-91	HS 9296 PT-2	w/Stamped steel valve cover; Head bolts, exh. pipe packing, camshaft rear seal plug not incl.; Head bolt replacement recommended; Premium valve stem seals incl.	
1	Head Set	1995-91	HS 9296 PT-3	w/Aluminum valve cover; Head bolts, exh. pipe packing, camshaft rear seal plug not incl.; Head bolt replacement recommended; PermaDry® molded rubber valve cover gskt. incl.; Premium valve stem seals incl.	
1	Head Set w/Head Bolts	1995-91	HSB 9296 PT-2	w/Stamped steel valve cover; w/Head bolts w/o Washers; Washers are req'd.; Exh. pipe packing & camshaft rear seal plug not incl.; Premium valve stem seals incl.	
1	Head Installation Set	1995-91	HIS 9296 PT-2	w/Stamped steel valve cover; Head bolts, exh. pipe packing, camshaft rear seal plug not incl.; Head bolt replacement recommended	
1	Head Bolt Set	1995-91	ES 72723	Head bolts w/o Washers; Washers are req'd.; Replacement recommended	
1	Head Bolt Washer Set	1995-91	ES 72176	Replacement recommended	
QTY	CONVERSION SET	YEARS	PART NO.	DESCRIPTION	
1	Gasket Conversion Set	1995-91	CS 8763-2	PermaDry® molded rubber oil pan gskt. incl.	
QTY	MANIFOLD - INT. & EXH.	YEARS	PART NO.	DESCRIPTION	
1	Int. & Exh. Gasket Set	1995-91	MS 90947		
QTY	EXHAUST PIPE FLANGE	YEARS	PART NO.	DESCRIPTION	
1	Exhaust Pipe Gasket	1995-91	60632	Pipe to manifold	
1	Exh. Flange Bolt & Spring Kit	1995-91	ES 72143		
QTY	FUEL PUMP	YEARS	PART NO.	DESCRIPTION	
2	Fuel Pump Mounting Gasket	1995-91	70627	May also be used as a fuel pump block-off plate gasket if desired	
QTY	OIL PAN	YEARS	PART NO.	DESCRIPTION	
1	Oil Pan Gasket Set	1995-91	OS 30612 R	PermaDry® molded rubber gskt. incl.	
1	Oil Pan Gasket Set	1995-91	OS 30612 T	PermaDryPlus®; Oil Pan SnapUps® incl.	
1	Drain Plug Gasket	1995-91	70822		
QTY	CRANKSHAFT REAR SEAL	YEARS	PART NO.	DESCRIPTION	
1	Rear Main Seal Set	1995-91	BS 40168-1	Rubber; One-piece	
1	Rear Main Seal Set	1995-91	BS 40627	PTFE Rubber; One-piece	
1	Repair Sleeve Tool	1995-91	16300	Crankshaft	
QTY	VALVE COVER	YEARS	PART NO.	DESCRIPTION	
1	Valve Cover Gasket Set	1995-91	VS 50205 C	w/Stamped steel valve cover; Cork	

Dodge Truck (Incl. Minivans and SUV's) (Cont.)

15 (cont.)		1995 - 1991; 2.5L 153 (2507cc) SOHC L4 (8 Valve) 87.5mm Bore			15 (cont.)
TBI; Gasoline; Naturally Aspirated Chrysler Eng.; VIN Code K					
QTY	VALVE COVER	YEARS	PART NO.	DESCRIPTION	
1	Valve Cover Gasket Set	1995-91	VS 50205 T	w/Stamped steel valve cover; PermaDryPlus®	
1	Valve Cover Gasket Set	1995-91	VS 50334 R	w/Aluminum valve cover; PermaDry® molded rubber gskt. incl.	
QTY	VALVE STEM SEAL SET	YEARS	PART NO.	DESCRIPTION	
1	Valve Stem Seal Set	1995-91	SS 72522	Premium valve stem seals incl.	
QTY	WATER OUTLET GASKET	YEARS	PART NO.	DESCRIPTION	
1	Water Outlet Gasket	1995-91	35286	Water Outlet	
1	Water Outlet Gasket	1995-91	35286 T	Water Outlet; PermaDryPlus®	
QTY	WATER PUMP	YEARS	PART NO.	DESCRIPTION	
1	Water Pump Gasket	1995-91	35444		
1	O-Ring	1995-91	35224	Water Pump	
QTY	TIMING COVER	YEARS	PART NO.	DESCRIPTION	
1	Timing Cover Set	1995-91	TCS 45495	Camshaft; Front seal set	
1	Crankshaft Front Seal Set	1995-91	TCS 45131		
1	Auxiliary Shaft Seal Set	1995-91	TCS 45026		
1	Camshaft Rear Seal Plug Set	1995-91	TCS 45833		
QTY	CARB & FUEL INJECTION	YEARS	PART NO.	DESCRIPTION	
1	Throttle Body Gasket	1995-91	60743		
QTY	DISTRIBUTOR MOUNTING	YEARS	PART NO.	DESCRIPTION	
1	O-Ring	1995-91	70799	Distributor Mounting	
QTY	EXHAUST GAS RECIRCULATION	YEARS	PART NO.	DESCRIPTION	
1	EGR Gasket	1995-91	70561		
16		2007 - 2006; 2.7L 164 (2686cc) DOHC Turbo - Intercooled L5 (20 Valve) 88mm Bore			16
MFI; Diesel; Turbo - Intercooled Mercedes-Benz Eng.; VIN Code 4, Eng. Code 602.984					
QTY	CYLINDER HEAD	YEARS	PART NO.	DESCRIPTION	
1	Head Gasket	2007-06	26319 PT	Head bolts not incl.; Head bolt replacement recommended; PermaTorqueMLS®	
1	Head Set	2007-06	HS 26319 PT	Head bolts not incl.; Head bolt replacement recommended; PermaDry® molded rubber valve cover gskt. incl.; Premium valve stem seals incl.	
1	Head Bolt Set	2007-06	ES 71233	Replacement recommended	
QTY	CONVERSION SET	YEARS	PART NO.	DESCRIPTION	
1	Gasket Conversion Set	2007-06	CS 26319		
QTY	MANIFOLD - INT. & EXH.	YEARS	PART NO.	DESCRIPTION	
1	Int. Manifold Gasket Set	2007-06	MS 96779		
1	Exh. Manifold Gasket Set	2007-06	MS 96785		
QTY	OIL PAN	YEARS	PART NO.	DESCRIPTION	
1	Oil Pan Gasket Set	2007-06	OS 30769		
QTY	CRANKSHAFT REAR SEAL	YEARS	PART NO.	DESCRIPTION	
1	Rear Main Seal Set	2007-06	BS 40699	Rubber; One-piece	
QTY	VALVE COVER	YEARS	PART NO.	DESCRIPTION	
1	Valve Cover Gasket Set	2007-06	VS 50680 R	w/Grommets & Spark plug tube seals; PermaDry® molded rubber gskt. incl.	
QTY	VALVE STEM SEAL SET	YEARS	PART NO.	DESCRIPTION	
1	Valve Stem Seal Set	2007-06	SS 72919-1	Premium valve stem seals incl.	
QTY	THERMOSTAT HOUSING	YEARS	PART NO.	DESCRIPTION	
1	O-Ring	2007-06	35803	Thermostat Housing; Seal	
QTY	WATER OUTLET GASKET	YEARS	PART NO.	DESCRIPTION	
1	O-Ring	2007-06	35805	Water Outlet	
QTY	WATER PUMP	YEARS	PART NO.	DESCRIPTION	
1	Water Pump Gasket	2007-06	35810		
QTY	TIMING COVER	YEARS	PART NO.	DESCRIPTION	
1	Crankshaft Front Seal Set	2007-06	TCS 46086	Mounting set	
1	Crankshaft Front Seal Set	2007-06	TCS 46188	Seal only; New Part Number - Check for Availability	
QTY	EXHAUST GAS RECIRCULATION	YEARS	PART NO.	DESCRIPTION	
1	EGR Gasket	2007-06	72219		
17		2005 - 2003; 2.7L 164 (2686cc) DOHC Turbo - Intercooled L5 (20 Valve) 88mm Bore			17
MFI; Diesel; Turbo - Intercooled Mercedes-Benz Eng.; VIN Code C, Eng. Code 602.984					
QTY	CYLINDER HEAD	YEARS	PART NO.	DESCRIPTION	
1	Head Gasket	2005-03	26319 PT	Head bolts not incl.; Head bolt replacement recommended; PermaTorqueMLS®	
1	Head Set	2005-03	HS 26319 PT	Head bolts not incl.; Head bolt replacement recommended; PermaDry® molded rubber valve cover gskt. incl.; Premium valve stem seals incl.	

Dodge Truck (Incl. Minivans and SUV's) (Cont.)

17		2005 - 2003; 2.7L 164 (2686cc) DOHC Turbo - Intercooled L5 (20 Valve) 88mm Bore			17
(cont.)		MFI; Diesel; Turbo - Intercooled Mercedes-Benz Eng.; VIN Code C, Eng. Code 602.984			(cont.)
QTY	CYLINDER HEAD	YEARS	PART NO.	DESCRIPTION	
1	Head Bolt Set	2005-03	ES 71233	Replacement recommended	
QTY	CONVERSION SET	YEARS	PART NO.	DESCRIPTION	
1	Gasket Conversion Set	2005-03	CS 26319		
QTY	MANIFOLD - INT. & EXH.	YEARS	PART NO.	DESCRIPTION	
1	Int. Manifold Gasket Set	2005-03	MS 96779		
1	Exh. Manifold Gasket Set	2005-03	MS 96785		
QTY	OIL PAN	YEARS	PART NO.	DESCRIPTION	
1	Oil Pan Gasket Set	2005-03	OS 30769		
QTY	CRANKSHAFT REAR SEAL	YEARS	PART NO.	DESCRIPTION	
1	Rear Main Seal Set	2005-03	BS 40699	Rubber; One-piece	
QTY	VALVE COVER	YEARS	PART NO.	DESCRIPTION	
1	Valve Cover Gasket Set	2005-03	VS 50680 R	w/Grommets & Spark plug tube seals; PermaDry® molded rubber gskt. incl.	
QTY	VALVE STEM SEAL SET	YEARS	PART NO.	DESCRIPTION	
1	Valve Stem Seal Set	2005-03	SS 72919-1	Premium valve stem seals incl.	
QTY	THERMOSTAT HOUSING	YEARS	PART NO.	DESCRIPTION	
1	O-Ring	2005-03	35803	Thermostat Housing; Seal	
QTY	WATER OUTLET GASKET	YEARS	PART NO.	DESCRIPTION	
1	O-Ring	2005-03	35805	Water Outlet	
QTY	WATER PUMP	YEARS	PART NO.	DESCRIPTION	
1	Water Pump Gasket	2005-03	35810		
QTY	TIMING COVER	YEARS	PART NO.	DESCRIPTION	
1	Crankshaft Front Seal Set	2005-03	TCS 46086	Mounting set	
1	Crankshaft Front Seal Set	2005-03	TCS 46188	Seal only; New Part Number - Check for Availability	
QTY	EXHAUST GAS RECIRCULATION	YEARS	PART NO.	DESCRIPTION	
1	EGR Gasket	2005-03	72219		
18		2000 - 1991; 3.0L 181.1 (2972cc) SOHC V6 (12 Valve) 91.1mm Bore			18
(cont.)		MFI; Gasoline; Naturally Aspirated Mitsubishi Eng.; VIN Code 3, Eng. Code 6G72			(cont.)
QTY	CYLINDER HEAD	YEARS	PART NO.	DESCRIPTION	
2	Head Gasket	2000-91	9112 PT	Head bolts not incl.; Head bolt replacement recommended	
1	Head Set	2000-99	HS 9112 PT-3	Head bolts & exh. pipe to manifold gskt. not incl.; Head bolt replacement recommended; PermaDry® molded rubber valve cover gskts. incl.; Premium valve stem seals incl.	
1	Head Set	1998-91	HS 9112 PT	Head bolts & exh. pipe to manifold gskt. not incl.; Head bolt replacement recommended; PermaDry® molded rubber valve cover gskts. incl.; Premium valve stem seals incl.	
1	Head Installation Set	1998-91	HIS 9112 PT	Head bolts, exh. pipe to manifold gskt., exh. crossover gskt. not incl.; Head bolt replacement recommended; PermaDry® molded rubber valve cover gskts. incl.	
1	Head Bolt Set	2000-91	ES 72859	Head bolts w/Washers; Replacement recommended	
QTY	CONVERSION SET	YEARS	PART NO.	DESCRIPTION	
1	Gasket Conversion Set	2000-91	CS 9112		
QTY	MANIFOLD - INT. & EXH.	YEARS	PART NO.	DESCRIPTION	
1	Int. Manifold Gasket Set	2000-91	MS 93795	Upper set incl.	
1	Plenum Gasket Set	2000-91	MS 93796	Upper set	
1	Exh. Manifold Gasket Set	2000	MS 91815-1		
1	Exh. Manifold Gasket Set	1999	MS 91815		
1	Exh. Manifold Gasket Set	1998-91	MS 93797		
QTY	EXHAUST PIPE FLANGE	YEARS	PART NO.	DESCRIPTION	
2	Exhaust Pipe Gasket	2000-94	60978	Crossover	
1	Exhaust Pipe Gasket	2000-96	61072	Pipe to manifold	
1	Exhaust Pipe Gasket	1995-91	60810	Pipe to manifold	
2	Exhaust Pipe Gasket	1993-91	60738	Crossover	
1	Exh. Flange Bolt & Spring Kit	1995-91	ES 72143		
QTY	OIL PAN	YEARS	PART NO.	DESCRIPTION	
1	Oil Pan Gasket Set	2000-91	OS 30570 C	Cork	
1	Oil Pan Gasket Set	2000-91	OS 30570 T	PermaDryPlus®; Oil Pan SnapUps® incl.	
QTY	CRANKSHAFT REAR SEAL	YEARS	PART NO.	DESCRIPTION	
1	Rear Main Seal Set	2000-91	BS 40562	Rubber; One-piece	
1	Rear Main Seal Set	2000-91	BS 40627	PTFE Rubber; One-piece	
1	Repair Sleeve Tool	2000-91	16300	Crankshaft	
QTY	VALVE COVER	YEARS	PART NO.	DESCRIPTION	
1	Valve Cover Gasket Set	2000-91	VS 50026 R-1	w/o Circular plugs & Grommets; PermaDry® molded rubber gskts. incl.	

Dodge Truck (Incl. Minivans and SUV's) (Cont.)

18		2000 - 1991; 3.0L 181.1 (2972cc) SOHC V6 (12 Valve) 91.1mm Bore			18	
(cont.)		MFI; Gasoline; Naturally Aspirated Mitsubishi Eng.; VIN Code 3, Eng. Code 6G72			(cont.)	
QTY	VALVE COVER	YEARS	PART NO.	DESCRIPTION		
1	Valve Cover Gasket Set	2000-91	VS 50173 R	w/Circular plugs & Grommets; PermaDry® molded rubber gskts. incl.		
2	Grommet Set	2000-91	ES 70342	Valve Cover		
2	Circular Plug	2000-91	CP 75018	Valve Cover		
QTY	VALVE STEM SEAL SET	YEARS	PART NO.	DESCRIPTION		
1	Valve Stem Seal Set	2000-91	SS 70710	Premium valve stem seals incl.; Improved design		
QTY	WATER OUTLET GASKET	YEARS	PART NO.	DESCRIPTION		
1	Water Outlet Gasket	2000-91	35336	Water Outlet		
QTY	WATER PUMP	YEARS	PART NO.	DESCRIPTION		
1	Water Pump Gasket	2000-91	35399	To block		
1	Water Pump Gasket	2000-91	35468	Inlet		
1	Water Pump Gasket	2000-91	35603	To cover		
1	Water Pump Gasket	2000-91	ES 72872	O-ring		
QTY	TIMING COVER	YEARS	PART NO.	DESCRIPTION		
1	Timing Cover Dust Seal Set	2000-91	TCS 45835			
1	Crankshaft Front Seal Set	2000-91	TCS 45750			
2	Camshaft Front Seal Set	2000-91	TCS 45483	Must be used w/VS 50173R or w/VS 50026R-1		
QTY	CARB & FUEL INJECTION	YEARS	PART NO.	DESCRIPTION		
1	Fuel Injector O-Ring Set	2000-91	ES 70260			
1	Throttle Body Gasket	2000-91	60700			
QTY	EXHAUST GAS RECIRCULATION	YEARS	PART NO.	DESCRIPTION		
1	EGR Gasket	2000-93	70561	Valve		
1	EGR Mounting Set	2000-91	ES 72122			
19		1992 - 1991; 3.0L 181.1 (2972cc) SOHC V6 (12 Valve) 91.1mm Bore			19	
		MFI; Gasoline; Naturally Aspirated Mitsubishi Eng.; VIN Code S, Eng. Code 6G72				
QTY	CYLINDER HEAD	YEARS	PART NO.	DESCRIPTION		
2	Head Gasket	1992-91	9112 PT	Head bolts not incl.; Head bolt replacement recommended		
1	Head Set	1992-91	HS 9112 PT-1	Head bolts not incl.; Head bolt replacement recommended; PermaDry® molded rubber valve cover gskts. incl.; Premium valve stem seals incl.		
1	Head Bolt Set	1992-91	ES 72859	Head bolts w/Washers; Replacement recommended		
QTY	CONVERSION SET	YEARS	PART NO.	DESCRIPTION		
1	Gasket Conversion Set	1992-91	CS 9112			
QTY	MANIFOLD - INT. & EXH.	YEARS	PART NO.	DESCRIPTION		
1	Int. Manifold Gasket Set	1992-91	MS 93795-2	Upper set incl.		
1	Exh. Manifold Gasket Set	1992-91	MS 93797			
QTY	EXHAUST PIPE FLANGE	YEARS	PART NO.	DESCRIPTION		
2	Exhaust Pipe Gasket	1992-91	60496-1	Pipe to manifold		
1	Exh. Flange Bolt & Spring Kit	1992-91	ES 72143			
QTY	OIL PAN	YEARS	PART NO.	DESCRIPTION		
1	Oil Pan Gasket Set	1992-91	OS 30570 C	Cork		
1	Oil Pan Gasket Set	1992-91	OS 30570 T	PermaDryPlus®; Oil Pan SnapUps® incl.		
QTY	CRANKSHAFT REAR SEAL	YEARS	PART NO.	DESCRIPTION		
1	Rear Main Seal Set	1992-91	BS 40562	Rubber; One-piece		
1	Rear Main Seal Set	1992-91	BS 40627	PTFE Rubber; One-piece		
1	Repair Sleeve Tool	1992-91	16300	Crankshaft		
QTY	VALVE COVER	YEARS	PART NO.	DESCRIPTION		
1	Valve Cover Gasket Set	1992-91	VS 50026 R-1	w/o Circular plugs & Grommets; PermaDry® molded rubber gskts. incl.		
1	Valve Cover Gasket Set	1992-91	VS 50173 R	w/Circular plugs & Grommets; PermaDry® molded rubber gskts. incl.		
2	Grommet Set	1992-91	ES 70342	Valve Cover		
2	Circular Plug	1992-91	CP 75018	Valve Cover		
QTY	VALVE STEM SEAL SET	YEARS	PART NO.	DESCRIPTION		
1	Valve Stem Seal Set	1992-91	SS 70710	Premium valve stem seals incl.; Improved design		
QTY	WATER OUTLET GASKET	YEARS	PART NO.	DESCRIPTION		
1	Water Outlet Gasket	1992-91	35336	Water Outlet		
QTY	WATER PUMP	YEARS	PART NO.	DESCRIPTION		
1	Water Pump Gasket	1992-91	35399	To block		
1	Water Pump Gasket	1992-91	35468	Inlet		
1	Water Pump Gasket	1992-91	35603	To cover		
1	Water Pump Gasket	1992-91	ES 72872	O-ring		
QTY	TIMING COVER	YEARS	PART NO.	DESCRIPTION		
1	Timing Cover Dust Seal Set	1992-91	TCS 45835			
1	Crankshaft Front Seal Set	1992-91	TCS 45750			
2	Camshaft Front Seal Set	1992-91	TCS 45483	Must be used w/VS 50173R or w/VS 50026R-1		
QTY	CARB & FUEL INJECTION	YEARS	PART NO.	DESCRIPTION		
1	Fuel Injector O-Ring Set	1992-91	ES 70260			

Dodge Truck (Incl. Minivans and SUV's) (Cont.)

19		1992 - 1991; 3.0L 181.1 (2972cc) SOHC V6 (12 Valve) 91.1mm Bore			19
(cont.)		MFI; Gasoline; Naturally Aspirated Mitsubishi Eng.; VIN Code S, Eng. Code 6G72			(cont.)
QTY	CARB & FUEL INJECTION	YEARS	PART NO.	DESCRIPTION	
1	Throttle Body Gasket	1992-91	60870		
QTY	EXHAUST GAS RECIRCULATION	YEARS	PART NO.	DESCRIPTION	
1	EGR Gasket	1992-91	70152		
20		2010 - 2007; 3.0L 182.2 (2987cc) DOHC Turbo - Intercooled V6 (24 Valve) 83mm Bore Bluetec			20
		DI; Diesel; Turbo - Intercooled Mercedes-Benz Eng.; VIN Code 4, Eng. Code OM642			
QTY	TIMING COVER	YEARS	PART NO.	DESCRIPTION	
1	Crankshaft Front Seal Set	2010-07	TCS 46188	New Part Number - Check for Availability	
21		2010 - 2007; 3.0L 182.2 (2987cc) DOHC Turbo - Intercooled V6 (24 Valve) 83mm Bore Bluetec			21
		DI; Diesel; Turbo - Intercooled Mercedes-Benz Eng.; VIN Code 5, Eng. Code OM642			
QTY	TIMING COVER	YEARS	PART NO.	DESCRIPTION	
1	Crankshaft Front Seal Set	2010-07	TCS 46188	New Part Number - Check for Availability	
22		2009 - 2001; 3.3L 201 (3302cc) OHV V6 (12 Valve) 93mm Bore			22
		MFI; Flex Fuel; Naturally Aspirated Chrysler Eng.; VIN Code 3			
QTY	CYLINDER HEAD	YEARS	PART NO.	DESCRIPTION	
1	Head Gasket	2009-01	9978 PT	Loc. L.H.; Head bolts not incl.; Head bolt replacement recommended; PermaTorqueMLS®	
1	Head Gasket	2009-01	9981 PT	Loc. R.H.; Head bolts not incl.; Head bolt replacement recommended; PermaTorqueMLS®	
1	Head Set	2009-04	HS 9978 PT-1	w/Plastic valve covers; Int. manifold gskt., head bolts, exh. pipe to manifold gskt. not incl.; Head bolt replacement recommended; PermaDry® molded rubber valve cover gskts. incl.; Premium valve stem seals incl.	
1	Head Set	2004	HS 9978 PT	w/Stamped steel valve covers; Int. manifold gskt., head bolts, exh. pipe to manifold gskt. not incl.; Head bolt replacement recommended; PermaDry® molded rubber valve cover gskts. incl.; Premium valve stem seals incl.	
1	Head Set	2003-01	HS 9978 PT	Int. manifold gskt., head bolts, exh. pipe to manifold gskt. not incl.; Head bolt replacement recommended; PermaDry® molded rubber valve cover gskts. incl.; Premium valve stem seals incl.	
2	Head Bolt Set	2009-01	ES 72163	Head bolts w/Washers; Replacement recommended	
QTY	CONVERSION SET	YEARS	PART NO.	DESCRIPTION	
1	Gasket Conversion Set	2009	CS 26326-1	PermaDry® molded rubber oil pan gskt. incl.	
1	Gasket Conversion Set	2008-01	CS 9673-2	PermaDry® molded rubber oil pan gskt. incl.	
QTY	MANIFOLD - INT. & EXH.	YEARS	PART NO.	DESCRIPTION	
1	Int. Manifold Gasket Set	2009-01	MS 92808-1	Upper set incl.	
1	Plenum Gasket Set	2009-01	MS 96176	Upper set	
1	Exh. Manifold Gasket Set	2009-01	MS 94666		
QTY	EXHAUST PIPE FLANGE	YEARS	PART NO.	DESCRIPTION	
2	Exhaust Pipe Gasket	2009-01	61213	Crossover; May use 61453 instead; Old design	
2	Exhaust Pipe Gasket	2009-01	61453	Crossover; Improved design	
1	Exhaust Pipe Gasket	2009-02	61229	Converter	
1	Exhaust Pipe Gasket	2009-08	61701	Connector; New Part Number - Check for Availability	
QTY	OIL PAN	YEARS	PART NO.	DESCRIPTION	
1	Oil Pan Gasket Set	2009-01	OS 30622 R	PermaDry® molded rubber gskt. incl.	
1	Drain Plug Gasket	2002-01	70822		
QTY	CRANKSHAFT REAR SEAL	YEARS	PART NO.	DESCRIPTION	
1	Rear Main Seal Set	2009	BS 40713	Rubber; One-piece	
1	Rear Main Seal Set	2008-01	BS 40168-1	Rubber; One-piece	
1	Rear Main Seal Set	2008-01	BS 40627	PTFE Rubber; One-piece	
1	Repair Sleeve Tool	2008-01	16300	Crankshaft	
QTY	VALVE COVER	YEARS	PART NO.	DESCRIPTION	
1	Valve Cover Gasket Set	2009-04	VS 50599 R	w/Plastic valve covers; w/Grommets; PermaDry® molded rubber gskts. incl.	
1	Valve Cover Gasket Set	2004	VS 50513 R	w/Stamped steel valve covers; w/Grommets; PermaDry® molded rubber gskts. incl.	
1	Valve Cover Gasket Set	2003-01	VS 50513 R	w/Grommets; PermaDry® molded rubber gskts. incl.	
1	Grommet Set	2004	ES 72768	Valve Cover; w/Stamped steel valve covers; New Part Number - Check for Availability	
1	Grommet Set	2003-01	ES 72768	Valve Cover; New Part Number - Check for Availability	
QTY	VALVE STEM SEAL SET	YEARS	PART NO.	DESCRIPTION	
1	Valve Stem Seal Set	2009-01	SS 71035	Premium valve stem seals incl.	
QTY	THERMOSTAT HOUSING	YEARS	PART NO.	DESCRIPTION	
1	Thermostat Gasket	2009-01	35651	Thermostat Housing; Thermostat gskt.	

Dodge Truck (Incl. Minivans and SUV's) (Cont.)

22 (cont.)		2009 - 2001; 3.3L 201 (3302cc) OHV V6 (12 Valve) 93mm Bore			22 (cont.)
MFI; Flex Fuel; Naturally Aspirated Chrysler Eng.; VIN Code 3					
QTY	THERMOSTAT HOUSING	YEARS	PART NO.	DESCRIPTION	
1	O-Ring	2009-08	35861	Thermostat Housing; Thermostat seal	
QTY	WATER OUTLET GASKET	YEARS	PART NO.	DESCRIPTION	
1	Water Outlet Gasket	2009-06	35286	Water Outlet	
1	Water Outlet Gasket	2009-06	35286 T	Water Outlet; PermaDryPlus®	
QTY	WATER PUMP	YEARS	PART NO.	DESCRIPTION	
1	Water Pump Gasket	2009-02	35586	O-ring	
1	Water Pump Gasket	2009-02	35691	Seal to front cover	
1	Water Pump Gasket	2009-07	35780	Gskt.	
1	Water Pump Gasket	2001	35446		
QTY	TIMING COVER	YEARS	PART NO.	DESCRIPTION	
1	Timing Cover Set	2009	TCS 46023-1	Must be used w/OS 30622R	
1	Timing Cover Set	2008-07	TCS 46134	Must be used w/OS 30622R	
1	Timing Cover Set	2006-02	TCS 46023	Must be used w/OS 30622R	
1	Timing Cover Set	2001	TCS 45893-1	Must be used w/OS 30622R	
1	Timing Cover Gasket	2009-07	72706	New Part Number - Check for Availability	
1	Timing Cover Gasket	2006-02	72704	New Part Number - Check for Availability	
1	Crankshaft Front Seal Set	2008-01	TCS 46194	New Part Number - Check for Availability	
1	Repair Sleeve Tool	2008-01	16326	Timing Cover	
QTY	CARB & FUEL INJECTION	YEARS	PART NO.	DESCRIPTION	
3	Fuel Injector O-Ring Set	2009-01	ES 70599	Improved design	
1	Throttle Body Gasket	2009-02	61324	Idle air control; 21mm ID	
1	Throttle Body Gasket	2009-02	61326	Idle air control; 30mm ID	
1	Throttle Body Gasket	2009-08	61467	Mounting; Flush mount	
1	Throttle Body Gasket	2009-08	61700	Mounting; Recessed lip; New Part Number - Check for Availability	
1	Throttle Body Gasket	2007-01	61230	Seal	
1	Throttle Body Gasket	2007-01	61232	Mounting	
QTY	EXHAUST GAS RECIRCULATION	YEARS	PART NO.	DESCRIPTION	
2	EGR Gasket	2009-01	70696	Tube seal	
2	EGR Gasket	2009-01	70721	Tube flange	
1	EGR Gasket	2009-02	71185	Valve	
1	EGR Gasket	2001	70720	Valve	
23		2010; 3.3L 201 (3302cc) OHV V6 (12 Valve) 93mm Bore			23
MFI; Flex Fuel; Naturally Aspirated Chrysler Eng.; VIN Code E					
QTY	CYLINDER HEAD	YEARS	PART NO.	DESCRIPTION	
1	Head Gasket	2010	9978 PT	Loc. L.H.; Head bolts not incl.; Head bolt replacement recommended; PermaTorqueMLS®	
1	Head Gasket	2010	9981 PT	Loc. R.H.; Head bolts not incl.; Head bolt replacement recommended; PermaTorqueMLS®	
1	Head Set	2010	HS 9978 PT-1	w/Plastic valve covers; Int. manifold gskt., head bolts, exh. pipe to manifold gskt. not incl.; Head bolt replacement recommended; PermaDry® molded rubber valve cover gskts. incl.; Premium valve stem seals incl.	
2	Head Bolt Set	2010	ES 72163	Head bolts w/Washers; Replacement recommended	
QTY	CONVERSION SET	YEARS	PART NO.	DESCRIPTION	
1	Gasket Conversion Set	2010	CS 26326-1	PermaDry® molded rubber oil pan gskt. incl.	
QTY	MANIFOLD - INT. & EXH.	YEARS	PART NO.	DESCRIPTION	
1	Int. Manifold Gasket Set	2010	MS 92808-1	Upper set incl.	
1	Plenum Gasket Set	2010	MS 96176	Upper set	
1	Exh. Manifold Gasket Set	2010	MS 94666		
QTY	EXHAUST PIPE FLANGE	YEARS	PART NO.	DESCRIPTION	
2	Exhaust Pipe Gasket	2010	61213	Crossover; May use 61453 instead; Old design	
1	Exhaust Pipe Gasket	2010	61229	Converter	
2	Exhaust Pipe Gasket	2010	61453	Crossover; Improved design	
1	Exhaust Pipe Gasket	2010	61701	Connector; New Part Number - Check for Availability	
QTY	OIL PAN	YEARS	PART NO.	DESCRIPTION	
1	Oil Pan Gasket Set	2010	OS 30622 R	PermaDry® molded rubber gskt. incl.	
QTY	CRANKSHAFT REAR SEAL	YEARS	PART NO.	DESCRIPTION	
1	Rear Main Seal Set	2010	BS 40713	Rubber; One-piece	
QTY	VALVE COVER	YEARS	PART NO.	DESCRIPTION	
1	Valve Cover Gasket Set	2010	VS 50599 R	w/Plastic valve covers; w/Grommets; PermaDry® molded rubber gskts. incl.	
QTY	VALVE STEM SEAL SET	YEARS	PART NO.	DESCRIPTION	
1	Valve Stem Seal Set	2010	SS 71035	Premium valve stem seals incl.	
QTY	THERMOSTAT HOUSING	YEARS	PART NO.	DESCRIPTION	
1	Thermostat Gasket	2010	35651	Thermostat Housing; Thermostat gskt.	

Dodge Truck (Incl. Minivans and SUV's) (Cont.)

23 (cont.)		2010; 3.3L 201 (3302cc) OHV V6 (12 Valve) 93mm Bore			23 (cont.)
MFI; Flex Fuel; Naturally Aspirated Chrysler Eng.; VIN Code E					
QTY	THERMOSTAT HOUSING	YEARS	PART NO.	DESCRIPTION	
1	O-Ring	2010	35861	Thermostat Housing; Thermostat seal	
QTY	WATER OUTLET GASKET	YEARS	PART NO.	DESCRIPTION	
1	Water Outlet Gasket	2010	35286	Water Outlet	
1	Water Outlet Gasket	2010	35286 T	Water Outlet; PermaDryPlus®	
QTY	WATER PUMP	YEARS	PART NO.	DESCRIPTION	
1	Water Pump Gasket	2010	35586	O-ring	
1	Water Pump Gasket	2010	35691	Seal to front cover	
1	Water Pump Gasket	2010	35780	Gskt.	
QTY	TIMING COVER	YEARS	PART NO.	DESCRIPTION	
1	Timing Cover Set	2010	TCS 46023-1	Must be used w/OS 30622R	
1	Timing Cover Gasket	2010	72706	New Part Number - Check for Availability	
QTY	CARB & FUEL INJECTION	YEARS	PART NO.	DESCRIPTION	
3	Fuel Injector O-Ring Set	2010	ES 70599	Improved design	
1	Throttle Body Gasket	2010	61324	Idle air control; 21mm ID	
1	Throttle Body Gasket	2010	61326	Idle air control; 30mm ID	
1	Throttle Body Gasket	2010	61467	Mounting; Flush mount	
1	Throttle Body Gasket	2010	61700	Mounting; Recessed lip; New Part Number - Check for Availability	
QTY	EXHAUST GAS RECIRCULATION	YEARS	PART NO.	DESCRIPTION	
2	EGR Gasket	2010	70696	Tube seal	
2	EGR Gasket	2010	70721	Tube flange	
1	EGR Gasket	2010	71185	Valve	
24		2009 - 1998; 3.3L 201 (3302cc) OHV V6 (12 Valve) 93mm Bore			24
MFI; Flex Fuel; Naturally Aspirated Chrysler Eng.; VIN Code G					
QTY	CYLINDER HEAD	YEARS	PART NO.	DESCRIPTION	
1	Head Gasket	2009-06	9978 PT	Loc. L.H.; Head bolts not incl.; Head bolt replacement recommended; PermaTorqueMLS®	
1	Head Gasket	2009-06	9981 PT	Loc. R.H.; Head bolts not incl.; Head bolt replacement recommended; PermaTorqueMLS®	
1	Head Gasket	2001	9978 PT	Loc. L.H.; Head bolts not incl.; Head bolt replacement recommended; PermaTorqueMLS®	
1	Head Gasket	2001	9981 PT	Loc. R.H.; Head bolts not incl.; Head bolt replacement recommended; PermaTorqueMLS®	
1	Head Gasket	2000-98	9673 PT-1	Loc. R.H.; Head bolts not incl.; Head bolt replacement recommended; Improved design	
1	Head Gasket	2000-98	9676 PT-1	Loc. L.H.; Head bolts not incl.; Head bolt replacement recommended; Improved design	
1	Head Set	2009-06	HS 9978 PT-1	w/Plastic valve covers; Int. manifold gskt., head bolts, exh. pipe to manifold gskt. not incl.; Head bolt replacement recommended; PermaDry® molded rubber valve cover gskts. incl.; Premium valve stem seals incl.	
1	Head Set	2001	HS 9978 PT	Int. manifold gskt., head bolts, exh. pipe to manifold gskt. not incl.; Head bolt replacement recommended; PermaDry® molded rubber valve cover gskts. incl.; Premium valve stem seals incl.	
1	Head Set	2000-98	HS 9673 PT	w/o Isolated valve covers; 9/32" diameter valve cover bolt holes; Int. manifold gskt., head bolts, exh. pipe to manifold gskt. not incl.; Head bolt replacement recommended; PermaDry® molded rubber valve cover gskts. incl.; Premium valve stem seals incl.	
1	Head Set	2000-98	HS 9673 PT-1	w/Isolated valve covers; 29/64" diameter valve cover bolt holes; Int. manifold gskt., head bolts, exh. pipe to manifold gskt. not incl.; Head bolt replacement recommended; PermaDry® molded rubber valve cover gskts. incl.; Premium valve stem seals incl.	
2	Head Bolt Set	2009-06	ES 72163	Head bolts w/Washers; Replacement recommended	
2	Head Bolt Set	2001-98	ES 72163	Head bolts w/Washers; Replacement recommended	
QTY	CONVERSION SET	YEARS	PART NO.	DESCRIPTION	
1	Gasket Conversion Set	2009	CS 26326-1	PermaDry® molded rubber oil pan gskt. incl.	
1	Gasket Conversion Set	2008-06	CS 9673-2	PermaDry® molded rubber oil pan gskt. incl.	
1	Gasket Conversion Set	2001-98	CS 9673-2	PermaDry® molded rubber oil pan gskt. incl.	
QTY	MANIFOLD - INT. & EXH.	YEARS	PART NO.	DESCRIPTION	
1	Int. Manifold Gasket Set	2009-06	MS 92808-1	Upper set incl.	
1	Int. Manifold Gasket Set	2001	MS 92808-1	Upper set incl.	
1	Valley Pan Gasket Set	2000-98	MS 96042	Upper set incl.	
1	Plenum Gasket Set	2009-06	MS 96176	Upper set	
1	Plenum Gasket Set	2001	MS 96176	Upper set	
1	Plenum Gasket Set	2000-98	MS 94566	Upper set	
1	Exh. Manifold Gasket Set	2009-06	MS 94666		

Dodge Truck (Incl. Minivans and SUV's) (Cont.)

24 (cont.)		2009 - 1998; 3.3L 201 (3302cc) OHV V6 (12 Valve) 93mm Bore			24 (cont.)
		MFI; Flex Fuel; Naturally Aspirated Chrysler Eng.; VIN Code G			
QTY	MANIFOLD - INT. & EXH.	YEARS	PART NO.	DESCRIPTION	
1	Exh. Manifold Gasket Set	2001-98	MS 94666		
QTY	EXHAUST PIPE FLANGE	YEARS	PART NO.	DESCRIPTION	
2	Exhaust Pipe Gasket	2009-06	61213	Crossover; May use 61453 instead; Old design	
1	Exhaust Pipe Gasket	2009-06	61229	Converter	
2	Exhaust Pipe Gasket	2009-06	61453	Crossover; Improved design	
1	Exhaust Pipe Gasket	2009-08	61701	Connector; New Part Number - Check for Availability	
2	Exhaust Pipe Gasket	2001	61213	Crossover; May use 61453 instead; Old design	
2	Exhaust Pipe Gasket	2001	61453	Crossover; Improved design	
2	Exhaust Pipe Gasket	2000-98	60860	Crossover	
1	Exhaust Pipe Gasket	2000-98	61002	Pipe to manifold	
QTY	OIL PAN	YEARS	PART NO.	DESCRIPTION	
1	Oil Pan Gasket Set	2009-06	OS 30622 R	PermaDry® molded rubber gskt. incl.	
1	Oil Pan Gasket Set	2001-98	OS 30622 R	PermaDry® molded rubber gskt. incl.	
1	Drain Plug Gasket	2001-98	70822		
QTY	CRANKSHAFT REAR SEAL	YEARS	PART NO.	DESCRIPTION	
1	Rear Main Seal Set	2009	BS 40713	Rubber; One-piece	
1	Rear Main Seal Set	2008-06	BS 40168-1	Rubber; One-piece	
1	Rear Main Seal Set	2008-06	BS 40627	PTFE Rubber; One-piece	
1	Rear Main Seal Set	2001-98	BS 40168-1	Rubber; One-piece	
1	Rear Main Seal Set	2001-98	BS 40627	PTFE Rubber; One-piece	
1	Repair Sleeve Tool	2008-06	16300	Crankshaft	
1	Repair Sleeve Tool	2001-98	16300	Crankshaft	
QTY	VALVE COVER	YEARS	PART NO.	DESCRIPTION	
1	Valve Cover Gasket Set	2009-06	VS 50599 R	w/Plastic valve covers; w/Grommets; PermaDry® molded rubber gskts. incl.	
1	Valve Cover Gasket Set	2001	VS 50513 R	w/Grommets; PermaDry® molded rubber gskts. incl.	
1	Valve Cover Gasket Set	2000-98	VS 50339 R	w/o Isolated valve covers; 9/32" diameter valve cover bolt holes; Must be used w/MS 94566; PermaDry® molded rubber gskts. incl.; .200" thick	
1	Valve Cover Gasket Set	2000-98	VS 50449 R	w/Isolated valve covers; 29/64" diameter valve cover bolt holes; Must be used w/MS 94566; w/o Grommets; PermaDry® molded rubber gskts. incl.; .474" thick	
1	Grommet Set	2001	ES 72768	Valve Cover; New Part Number - Check for Availability	
1	Grommet Set	2000-98	ES 72768	Valve Cover; w/Isolated valve covers; 29/64" diameter valve cover bolt holes; New Part Number - Check for Availability	
QTY	VALVE STEM SEAL SET	YEARS	PART NO.	DESCRIPTION	
1	Valve Stem Seal Set	2009-06	SS 71035	Premium valve stem seals incl.	
1	Valve Stem Seal Set	2001	SS 71035	Premium valve stem seals incl.	
1	Valve Stem Seal Set	2000-98	SS 72783	Premium valve stem seals incl.	
QTY	THERMOSTAT HOUSING	YEARS	PART NO.	DESCRIPTION	
1	Thermostat Gasket	2009-06	35651	Thermostat Housing; Thermostat gskt.	
1	Thermostat Gasket	2001	35651	Thermostat Housing; Thermostat gskt.	
1	O-Ring	2009-08	35861	Thermostat Housing; Thermostat seal	
QTY	WATER OUTLET GASKET	YEARS	PART NO.	DESCRIPTION	
1	Water Outlet Gasket	2009-06	35286	Water Outlet	
1	Water Outlet Gasket	2009-06	35286 T	Water Outlet; PermaDryPlus®	
1	Water Outlet Gasket	2000-98	35286	Water Outlet	
1	Water Outlet Gasket	2000-98	35286 T	Water Outlet; PermaDryPlus®	
QTY	WATER PUMP	YEARS	PART NO.	DESCRIPTION	
1	Water Pump Gasket	2009-06	35586	O-ring	
1	Water Pump Gasket	2009-06	35691	Seal to front cover	
1	Water Pump Gasket	2009-07	35780	Gskt.	
1	Water Pump Gasket	2001-98	35446		
QTY	TIMING COVER	YEARS	PART NO.	DESCRIPTION	
1	Timing Cover Set	2009	TCS 46023-1	Must be used w/OS 30622R	
1	Timing Cover Set	2008-07	TCS 46134	Must be used w/OS 30622R	
1	Timing Cover Set	2006	TCS 46023	Must be used w/OS 30622R	
1	Timing Cover Set	2001-98	TCS 45893-1	Must be used w/OS 30622R	
1	Timing Cover Gasket	2009-07	72706	New Part Number - Check for Availability	
1	Timing Cover Gasket	2006	72704	New Part Number - Check for Availability	
1	Crankshaft Front Seal Set	2008-06	TCS 46194	New Part Number - Check for Availability	
1	Crankshaft Front Seal Set	2001-98	TCS 46194	New Part Number - Check for Availability	
1	Repair Sleeve Tool	2008-06	16326	Timing Cover	
1	Repair Sleeve Tool	2001-98	16326	Timing Cover	
QTY	CARB & FUEL INJECTION	YEARS	PART NO.	DESCRIPTION	
3	Fuel Injector O-Ring Set	2009-06	ES 70599	Improved design	

Dodge Truck (Incl. Minivans and SUV's) (Cont.)

24 (cont.)		2009 - 1998; 3.3L 201 (3302cc) OHV V6 (12 Valve) 93mm Bore			24 (cont.)
MFI; Flex Fuel; Naturally Aspirated Chrysler Eng.; VIN Code G					
QTY	CARB & FUEL INJECTION	YEARS	PART NO.	DESCRIPTION	
3	Fuel Injector O-Ring Set	2001-98	ES 70599	Improved design	
1	Throttle Body Gasket	2009-06	61324	Idle air control; 21mm ID	
1	Throttle Body Gasket	2009-06	61326	Idle air control; 30mm ID	
1	Throttle Body Gasket	2009-08	61467	Mounting; Flush mount	
1	Throttle Body Gasket	2009-08	61700	Mounting; Recessed lip; New Part Number - Check for Availability	
1	Throttle Body Gasket	2007-06	61230	Seal	
1	Throttle Body Gasket	2007-06	61232	Mounting	
1	Throttle Body Gasket	2001	61230	Seal	
1	Throttle Body Gasket	2001	61232	Mounting	
1	Throttle Body Gasket	2000-98	60744	Mounting	
QTY	EXHAUST GAS RECIRCULATION	YEARS	PART NO.	DESCRIPTION	
2	EGR Gasket	2009-06	70696	Tube seal	
2	EGR Gasket	2009-06	70721	Tube flange	
1	EGR Gasket	2009-06	71185	Valve	
2	EGR Gasket	2001	70696	Tube seal	
1	EGR Gasket	2001	70720	Valve	
2	EGR Gasket	2001	70721	Tube flange	
1	EGR Gasket	2000-98	70561	Valve	
25		2010 - 2008; 3.3L 201 (3302cc) OHV V6 (12 Valve) 93mm Bore			25
MFI; Gasoline; Naturally Aspirated Chrysler Eng.; VIN Code H					
QTY	CYLINDER HEAD	YEARS	PART NO.	DESCRIPTION	
1	Head Gasket	2010-08	9981 PT	Loc. R.H.; Head bolts not incl.; Head bolt replacement recommended; PermaTorqueMLS®	
1	Head Gasket	2010	9978 PT	Dodge Grand Caravan Cargo, SE; Loc. L.H.; Head bolts not incl.; Head bolt replacement recommended; PermaTorqueMLS®	
1	Head Gasket	2009-08	9978 PT	Loc. L.H.; Head bolts not incl.; Head bolt replacement recommended; PermaTorqueMLS®	
1	Head Set	2010-08	HS 9978 PT-1	w/Plastic valve covers; Int. manifold gskt., head bolts, exh. pipe to manifold gskt. not incl.; Head bolt replacement recommended; PermaDry® molded rubber valve cover gskts. incl.; Premium valve stem seals incl. Head bolts w/Washers; Replacement recommended	
2	Head Bolt Set	2010-08	ES 72163		
QTY	CONVERSION SET	YEARS	PART NO.	DESCRIPTION	
1	Gasket Conversion Set	2010-09	CS 26326-1	PermaDry® molded rubber oil pan gskt. incl.	
1	Gasket Conversion Set	2008	CS 9673-2	PermaDry® molded rubber oil pan gskt. incl.	
QTY	MANIFOLD - INT. & EXH.	YEARS	PART NO.	DESCRIPTION	
1	Int. Manifold Gasket Set	2010-08	MS 92808-1	Upper set incl.	
1	Plenum Gasket Set	2010-08	MS 96176	Upper set	
1	Exh. Manifold Gasket Set	2010-08	MS 94666		
QTY	EXHAUST PIPE FLANGE	YEARS	PART NO.	DESCRIPTION	
2	Exhaust Pipe Gasket	2010-08	61213	Crossover; May use 61453 instead; Old design	
1	Exhaust Pipe Gasket	2010-08	61229	Converter	
2	Exhaust Pipe Gasket	2010-08	61453	Crossover; Improved design	
1	Exhaust Pipe Gasket	2010-08	61701	Connector; New Part Number - Check for Availability	
QTY	OIL PAN	YEARS	PART NO.	DESCRIPTION	
1	Oil Pan Gasket Set	2010-08	OS 30622 R	PermaDry® molded rubber gskt. incl.	
QTY	CRANKSHAFT REAR SEAL	YEARS	PART NO.	DESCRIPTION	
1	Rear Main Seal Set	2010-09	BS 40713	Rubber; One-piece	
1	Rear Main Seal Set	2008	BS 40168-1	Rubber; One-piece	
1	Rear Main Seal Set	2008	BS 40627	PTFE Rubber; One-piece	
1	Repair Sleeve Tool	2008	16300	Crankshaft	
QTY	VALVE COVER	YEARS	PART NO.	DESCRIPTION	
1	Valve Cover Gasket Set	2010-08	VS 50599 R	w/Plastic valve covers; w/Grommets; PermaDry® molded rubber gskts. incl.	
QTY	VALVE STEM SEAL SET	YEARS	PART NO.	DESCRIPTION	
1	Valve Stem Seal Set	2010-08	SS 71035	Premium valve stem seals incl.	
QTY	THERMOSTAT HOUSING	YEARS	PART NO.	DESCRIPTION	
1	Thermostat Gasket	2010-08	35651	Thermostat Housing; Thermostat gskt.	
1	O-Ring	2010-08	35861	Thermostat Housing; Thermostat seal	
QTY	WATER OUTLET GASKET	YEARS	PART NO.	DESCRIPTION	
1	Water Outlet Gasket	2010-08	35286	Water Outlet	
1	Water Outlet Gasket	2010-08	35286 T	Water Outlet; PermaDryPlus®	
QTY	WATER PUMP	YEARS	PART NO.	DESCRIPTION	
1	Water Pump Gasket	2010-08	35586	O-ring	

Dodge Truck (Incl. Minivans and SUV's) (Cont.)

25 (cont.)		2010 - 2008; 3.3L 201 (3302cc) OHV V6 (12 Valve) 93mm Bore			25 (cont.)
MFI; Gasoline; Naturally Aspirated Chrysler Eng.; VIN Code H					
QTY	WATER PUMP	YEARS	PART NO.	DESCRIPTION	
1	Water Pump Gasket	2010-08	35691	Seal to front cover	
1	Water Pump Gasket	2010-08	35780	Gskt.	
QTY	TIMING COVER	YEARS	PART NO.	DESCRIPTION	
1	Timing Cover Set	2010-09	TCS 46023-1	Must be used w/OS 30622R	
1	Timing Cover Set	2008	TCS 46134	Must be used w/OS 30622R	
1	Timing Cover Gasket	2010-08	72706	New Part Number - Check for Availability	
1	Crankshaft Front Seal Set	2008	TCS 46194	New Part Number - Check for Availability	
1	Repair Sleeve Tool	2008	16326	Timing Cover	
QTY	CARB & FUEL INJECTION	YEARS	PART NO.	DESCRIPTION	
3	Fuel Injector O-Ring Set	2010-08	ES 70599	Improved design	
1	Throttle Body Gasket	2010-08	61324	Idle air control; 21mm ID	
1	Throttle Body Gasket	2010-08	61326	Idle air control; 30mm ID	
1	Throttle Body Gasket	2010-08	61467	Mounting; Flush mount	
1	Throttle Body Gasket	2010-08	61700	Mounting; Recessed lip; New Part Number - Check for Availability	
QTY	EXHAUST GAS RECIRCULATION	YEARS	PART NO.	DESCRIPTION	
2	EGR Gasket	2010-08	70696	Tube seal	
2	EGR Gasket	2010-08	70721	Tube flange	
1	EGR Gasket	2010-08	71185	Valve	
26		1996 - 1994; 3.3L 201 (3302cc) OHV V6 (12 Valve) 93mm Bore			26
MFI; Natural Gas; Naturally Aspirated Chrysler Eng.; VIN Code J					
QTY	CYLINDER HEAD	YEARS	PART NO.	DESCRIPTION	
1	Head Gasket	1996-94	9673 PT-1	Loc. R.H.; Head bolts not incl.; Head bolt replacement recommended; Improved design	
1	Head Gasket	1996-94	9676 PT-1	Loc. L.H.; Head bolts not incl.; Head bolt replacement recommended; Improved design	
1	Head Set	1996-94	HS 9673 PT	Int. manifold gskt., head bolts, exh. pipe to manifold gskt. not incl.; Head bolt replacement recommended; PermaDry® molded rubber valve cover gskts. incl.; Premium valve stem seals incl.	
1	Head Installation Set	1996-94	HIS 9673 PT	Int. manifold gskt., head bolts, exh. pipe to manifold gskt., exh. crossover gskt. not incl.; Head bolt replacement recommended; PermaDry® molded rubber valve cover gskts. incl.	
1	Head Bolt Set	1996-94	ES 72849	Head bolts w/o Washers; Washers are req'd.; Replacement recommended	
1	Head Bolt Washer Set	1996-94	ES 72176-1	Replacement recommended	
QTY	CONVERSION SET	YEARS	PART NO.	DESCRIPTION	
1	Gasket Conversion Set	1996-94	CS 9673-2	PermaDry® molded rubber oil pan gskt. incl.	
QTY	MANIFOLD - INT. & EXH.	YEARS	PART NO.	DESCRIPTION	
1	Valley Pan Gasket Set	1996-94	MS 96042	Upper set incl.	
1	Plenum Gasket Set	1996-94	MS 94566	Upper set	
1	Exh. Manifold Gasket Set	1996-94	MS 94666		
QTY	EXHAUST PIPE FLANGE	YEARS	PART NO.	DESCRIPTION	
2	Exhaust Pipe Gasket	1996-94	60860	Crossover	
1	Exhaust Pipe Gasket	1996	61002	Pipe to manifold	
1	Exhaust Pipe Gasket	1995-94	60810	Pipe to manifold	
1	Exh. Flange Bolt & Spring Kit	1995-94	ES 72143		
QTY	OIL PAN	YEARS	PART NO.	DESCRIPTION	
1	Oil Pan Gasket Set	1996-94	OS 30622 R	PermaDry® molded rubber gskt. incl.	
1	Drain Plug Gasket	1996-94	70822		
QTY	CRANKSHAFT REAR SEAL	YEARS	PART NO.	DESCRIPTION	
1	Rear Main Seal Set	1996-94	BS 40168-1	Rubber; One-piece	
1	Rear Main Seal Set	1996-94	BS 40627	PTFE Rubber; One-piece	
1	Repair Sleeve Tool	1996-94	16300	Crankshaft	
QTY	VALVE COVER	YEARS	PART NO.	DESCRIPTION	
1	Valve Cover Gasket Set	1996-94	VS 50339 R	Must be used w/MS 94566; PermaDry® molded rubber gskts. incl.; .200" thick	
QTY	VALVE STEM SEAL SET	YEARS	PART NO.	DESCRIPTION	
1	Valve Stem Seal Set	1996-94	SS 72783	Premium valve stem seals incl.	
QTY	WATER OUTLET GASKET	YEARS	PART NO.	DESCRIPTION	
1	Water Outlet Gasket	1996-94	35286	Water Outlet	
1	Water Outlet Gasket	1996-94	35286 T	Water Outlet; PermaDryPlus®	
QTY	WATER PUMP	YEARS	PART NO.	DESCRIPTION	
1	Water Pump Gasket	1996-94	35446		
QTY	TIMING COVER	YEARS	PART NO.	DESCRIPTION	
1	Timing Cover Set	1996-94	TCS 45893-1	Must be used w/OS 30622R	

Dodge Truck (Incl. Minivans and SUV's) (Cont.)

26 (cont.)		1996 - 1994; 3.3L 201 (3302cc) OHV V6 (12 Valve) 93mm Bore			26 (cont.)
MFI; Natural Gas; Naturally Aspirated Chrysler Eng.; VIN Code J					
QTY	TIMING COVER	YEARS	PART NO.	DESCRIPTION	
1	Crankshaft Front Seal Set	1996-94	TCS 46194	New Part Number - Check for Availability	
1	Repair Sleeve Tool	1996-94	16326	Timing Cover	
QTY	CARB & FUEL INJECTION	YEARS	PART NO.	DESCRIPTION	
3	Fuel Injector O-Ring Set	1996-94	ES 70599	Improved design	
1	Throttle Body Gasket	1996-94	60744	Mounting	
QTY	EXHAUST GAS RECIRCULATION	YEARS	PART NO.	DESCRIPTION	
1	EGR Gasket	1996-94	70561	Valve	
27		1996 - 1994; 3.3L 201 (3302cc) OHV V6 (12 Valve) 93mm Bore			27
MFI; Natural Gas; Naturally Aspirated Chrysler Eng.; VIN Code P					
QTY	CYLINDER HEAD	YEARS	PART NO.	DESCRIPTION	
1	Head Gasket	1996-94	9673 PT-1	Loc. R.H.; Head bolts not incl.; Head bolt replacement recommended; Improved design	
1	Head Gasket	1996-94	9676 PT-1	Loc. L.H.; Head bolts not incl.; Head bolt replacement recommended; Improved design	
1	Head Set	1996-94	HS 9673 PT	Int. manifold gskt., head bolts, exh. pipe to manifold gskt. not incl.; Head bolt replacement recommended; PermaDry® molded rubber valve cover gskts. incl.; Premium valve stem seals incl.	
1	Head Installation Set	1996-94	HIS 9673 PT	Int. manifold gskt., head bolts, exh. pipe to manifold gskt., exh. crossover gskt. not incl.; Head bolt replacement recommended; PermaDry® molded rubber valve cover gskts. incl.	
1	Head Bolt Set	1996-94	ES 72849	Head bolts w/o Washers; Washers are req'd.; Replacement recommended	
1	Head Bolt Washer Set	1996-94	ES 72176-1	Replacement recommended	
QTY	CONVERSION SET	YEARS	PART NO.	DESCRIPTION	
1	Gasket Conversion Set	1996-94	CS 9673-2	PermaDry® molded rubber oil pan gskt. incl.	
QTY	MANIFOLD - INT. & EXH.	YEARS	PART NO.	DESCRIPTION	
1	Valley Pan Gasket Set	1996-94	MS 96042	Upper set incl.	
1	Plenum Gasket Set	1996-94	MS 94566	Upper set	
1	Exh. Manifold Gasket Set	1996-94	MS 94666		
QTY	EXHAUST PIPE FLANGE	YEARS	PART NO.	DESCRIPTION	
2	Exhaust Pipe Gasket	1996-94	60860	Crossover	
1	Exhaust Pipe Gasket	1996	61002	Pipe to manifold	
1	Exhaust Pipe Gasket	1995-94	60810	Pipe to manifold	
1	Exh. Flange Bolt & Spring Kit	1995-94	ES 72143		
QTY	OIL PAN	YEARS	PART NO.	DESCRIPTION	
1	Oil Pan Gasket Set	1996-94	OS 30622 R	PermaDry® molded rubber gskt. incl.	
1	Drain Plug Gasket	1996-94	70822		
QTY	CRANKSHAFT REAR SEAL	YEARS	PART NO.	DESCRIPTION	
1	Rear Main Seal Set	1996-94	BS 40168-1	Rubber; One-piece	
1	Rear Main Seal Set	1996-94	BS 40627	PTFE Rubber; One-piece	
1	Repair Sleeve Tool	1996-94	16300	Crankshaft	
QTY	VALVE COVER	YEARS	PART NO.	DESCRIPTION	
1	Valve Cover Gasket Set	1996-94	VS 50339 R	Must be used w/MS 94566; PermaDry® molded rubber gskts. incl.; .200" thick	
QTY	VALVE STEM SEAL SET	YEARS	PART NO.	DESCRIPTION	
1	Valve Stem Seal Set	1996-94	SS 72783	Premium valve stem seals incl.	
QTY	WATER OUTLET GASKET	YEARS	PART NO.	DESCRIPTION	
1	Water Outlet Gasket	1996-94	35286	Water Outlet	
1	Water Outlet Gasket	1996-94	35286 T	Water Outlet; PermaDryPlus®	
QTY	WATER PUMP	YEARS	PART NO.	DESCRIPTION	
1	Water Pump Gasket	1996-94	35446		
QTY	TIMING COVER	YEARS	PART NO.	DESCRIPTION	
1	Timing Cover Set	1996-94	TCS 45893-1	Must be used w/OS 30622R	
1	Crankshaft Front Seal Set	1996-94	TCS 46194	New Part Number - Check for Availability	
1	Repair Sleeve Tool	1996-94	16326	Timing Cover	
QTY	CARB & FUEL INJECTION	YEARS	PART NO.	DESCRIPTION	
3	Fuel Injector O-Ring Set	1996-94	ES 70599	Improved design	
1	Throttle Body Gasket	1996-94	60744	Mounting	
QTY	EXHAUST GAS RECIRCULATION	YEARS	PART NO.	DESCRIPTION	
1	EGR Gasket	1996-94	70561	Valve	

Dodge Truck (Incl. Minivans and SUV's) (Cont.)

28		2010 - 1991; 3.3L 201 (3302cc) OHV V6 (12 Valve) 93mm Bore			28
		MFI; Gasoline; Naturally Aspirated Chrysler Eng.; VIN Code R			
QTY	CYLINDER HEAD	YEARS	PART NO.	DESCRIPTION	
1	Head Gasket	2010-01	9978 PT	Loc. L.H.; Head bolts not incl.; Head bolt replacement recommended; PermaTorqueMLS®	
1	Head Gasket	2010-01	9981 PT	Loc. R.H.; Head bolts not incl.; Head bolt replacement recommended; PermaTorqueMLS®	
1	Head Gasket	2000-91	9673 PT-1	Loc. R.H.; Head bolts not incl.; Head bolt replacement recommended; Improved design	
1	Head Gasket	2000-91	9676 PT-1	Loc. L.H.; Head bolts not incl.; Head bolt replacement recommended; Improved design	
1	Head Set	2010-04	HS 9978 PT-1	w/Plastic valve covers; Int. manifold gskt., head bolts, exh. pipe to manifold gskt. not incl.; Head bolt replacement recommended; PermaDry® molded rubber valve cover gskts. incl.; Premium valve stem seals incl.	
1	Head Set	2004	HS 9978 PT	w/Stamped steel valve covers; Int. manifold gskt., head bolts, exh. pipe to manifold gskt. not incl.; Head bolt replacement recommended; PermaDry® molded rubber valve cover gskts. incl.; Premium valve stem seals incl.	
1	Head Set	2003-01	HS 9978 PT	Int. manifold gskt., head bolts, exh. pipe to manifold gskt. not incl.; Head bolt replacement recommended; PermaDry® molded rubber valve cover gskts. incl.; Premium valve stem seals incl.	
1	Head Set	2000-98	HS 9673 PT	w/o Isolated valve covers; 9/32" diameter valve cover bolt holes; Int. manifold gskt., head bolts, exh. pipe to manifold gskt. not incl.; Head bolt replacement recommended; PermaDry® molded rubber valve cover gskts. incl.; Premium valve stem seals incl.	
1	Head Set	2000-98	HS 9673 PT-1	w/Isolated valve covers; 29/64" diameter valve cover bolt holes; Int. manifold gskt., head bolts, exh. pipe to manifold gskt. not incl.; Head bolt replacement recommended; PermaDry® molded rubber valve cover gskts. incl.; Premium valve stem seals incl.	
1	Head Set	1997-91	HS 9673 PT	Int. manifold gskt., head bolts, exh. pipe to manifold gskt. not incl.; Head bolt replacement recommended; PermaDry® molded rubber valve cover gskts. incl.; Premium valve stem seals incl.	
1	Head Installation Set	1997-91	HIS 9673 PT	Int. manifold gskt., head bolts, exh. pipe to manifold gskt., exh. crossover gskt. not incl.; Head bolt replacement recommended; PermaDry® molded rubber valve cover gskts. incl.	
2	Head Bolt Set	2010-97	ES 72163	Head bolts w/Washers; Replacement recommended	
1	Head Bolt Set	1996-91	ES 72849	Head bolts w/o Washers; Washers are req'd.; Replacement recommended	
1	Head Bolt Washer Set	1996-91	ES 72176-1	Replacement recommended	
QTY	CONVERSION SET	YEARS	PART NO.	DESCRIPTION	
1	Gasket Conversion Set	2010-09	CS 26326-1	PermaDry® molded rubber oil pan gskt. incl.	
1	Gasket Conversion Set	2008-91	CS 9673-2	PermaDry® molded rubber oil pan gskt. incl.	
QTY	MANIFOLD - INT. & EXH.	YEARS	PART NO.	DESCRIPTION	
1	Int. Manifold Gasket Set	2010-01	MS 92808-1	Upper set incl.	
1	Valley Pan Gasket Set	2000-91	MS 96042	Upper set incl.	
1	Plenum Gasket Set	2010-01	MS 96176	Upper set	
1	Plenum Gasket Set	2000-91	MS 94566	Upper set	
1	Exh. Manifold Gasket Set	2010-91	MS 94666		
QTY	EXHAUST PIPE FLANGE	YEARS	PART NO.	DESCRIPTION	
2	Exhaust Pipe Gasket	2010-01	61213	Crossover; May use 61453 instead; Old design	
2	Exhaust Pipe Gasket	2010-01	61453	Crossover; Improved design	
1	Exhaust Pipe Gasket	2010-02	61229	Converter	
1	Exhaust Pipe Gasket	2010-08	61701	Connector; New Part Number - Check for Availability	
2	Exhaust Pipe Gasket	2000-91	60860	Crossover	
1	Exhaust Pipe Gasket	2000-96	61002	Pipe to manifold	
1	Exhaust Pipe Gasket	1995-91	60810	Pipe to manifold	
1	Exh. Flange Bolt & Spring Kit	1995-91	ES 72143		
QTY	OIL PAN	YEARS	PART NO.	DESCRIPTION	
1	Oil Pan Gasket Set	2010-91	OS 30622 R	PermaDry® molded rubber gskt. incl.	
1	Drain Plug Gasket	2002-91	70822		
QTY	CRANKSHAFT REAR SEAL	YEARS	PART NO.	DESCRIPTION	
1	Rear Main Seal Set	2010-09	BS 40713	Rubber; One-piece	
1	Rear Main Seal Set	2008-91	BS 40168-1	Rubber; One-piece	
1	Rear Main Seal Set	2008-91	BS 40627	PTFE Rubber; One-piece	
1	Repair Sleeve Tool	2008-91	16300	Crankshaft	
QTY	VALVE COVER	YEARS	PART NO.	DESCRIPTION	
1	Valve Cover Gasket Set	2010-04	VS 50599 R	w/Plastic valve covers; w/Grommets; PermaDry® molded rubber gskts. incl.	
1	Valve Cover Gasket Set	2004	VS 50513 R	w/Stamped steel valve covers; w/Grommets; PermaDry® molded rubber gskts. incl.	

Dodge Truck (Incl. Minivans and SUV's) (Cont.)

28 (cont.)		2010 - 1991; 3.3L 201 (3302cc) OHV V6 (12 Valve) 93mm Bore			28 (cont.)
		MFI; Gasoline; Naturally Aspirated Chrysler Eng.; VIN Code R			
QTY	VALVE COVER	YEARS	PART NO.	DESCRIPTION	
1	Valve Cover Gasket Set	2003-01	VS 50513 R	w/Grommets; PermaDry® molded rubber gsks. incl.	
1	Valve Cover Gasket Set	2000-98	VS 50339 R	w/o Isolated valve covers; 9/32" diameter valve cover bolt holes; Must be used w/MS 94566; PermaDry® molded rubber gsks. incl.; .200" thick	
1	Valve Cover Gasket Set	2000-98	VS 50449 R	w/Isolated valve covers; 29/64" diameter valve cover bolt holes; Must be used w/MS 94566; w/o Grommets; PermaDry® molded rubber gsks. incl.; .474" thick	
1	Valve Cover Gasket Set	1997-91	VS 50339 R	Must be used w/MS 94566; PermaDry® molded rubber gsks. incl.; .200" thick	
1	Grommet Set	2004	ES 72768	Valve Cover; w/Stamped steel valve covers; New Part Number - Check for Availability	
1	Grommet Set	2003-01	ES 72768	Valve Cover; New Part Number - Check for Availability	
1	Grommet Set	2000-98	ES 72768	Valve Cover; w/Isolated valve covers; 29/64" diameter valve cover bolt holes; New Part Number - Check for Availability	
QTY	VALVE STEM SEAL SET	YEARS	PART NO.	DESCRIPTION	
1	Valve Stem Seal Set	2010-01	SS 71035	Premium valve stem seals incl.	
1	Valve Stem Seal Set	2000-91	SS 72783	Premium valve stem seals incl.	
QTY	THERMOSTAT HOUSING	YEARS	PART NO.	DESCRIPTION	
1	Thermostat Gasket	2010-01	35651	Thermostat Housing; Thermostat gskt.	
1	O-Ring	2010-08	35861	Thermostat Housing; Thermostat seal	
QTY	WATER OUTLET GASKET	YEARS	PART NO.	DESCRIPTION	
1	Water Outlet Gasket	2010-06	35286	Water Outlet	
1	Water Outlet Gasket	2010-06	35286 T	Water Outlet; PermaDryPlus®	
1	Water Outlet Gasket	2000-91	35286	Water Outlet	
1	Water Outlet Gasket	2000-91	35286 T	Water Outlet; PermaDryPlus®	
QTY	WATER PUMP	YEARS	PART NO.	DESCRIPTION	
1	Water Pump Gasket	2010-02	35586	O-ring	
1	Water Pump Gasket	2010-02	35691	Seal to front cover	
1	Water Pump Gasket	2010-07	35780	Gskt.	
1	Water Pump Gasket	2001-91	35446		
QTY	TIMING COVER	YEARS	PART NO.	DESCRIPTION	
1	Timing Cover Set	2010-09	TCS 46023-1	Must be used w/OS 30622R	
1	Timing Cover Set	2008-07	TCS 46134	Must be used w/OS 30622R	
1	Timing Cover Set	2006-02	TCS 46023	Must be used w/OS 30622R	
1	Timing Cover Set	2001-91	TCS 45893-1	Must be used w/OS 30622R	
1	Timing Cover Gasket	2010-07	72706	New Part Number - Check for Availability	
1	Timing Cover Gasket	2006-02	72704	New Part Number - Check for Availability	
1	Crankshaft Front Seal Set	2008-91	TCS 46194	New Part Number - Check for Availability	
1	Repair Sleeve Tool	2008-91	16326	Timing Cover	
QTY	CARB & FUEL INJECTION	YEARS	PART NO.	DESCRIPTION	
3	Fuel Injector O-Ring Set	2010-91	ES 70599	Improved design	
1	Throttle Body Gasket	2010-02	61324	Idle air control; 21mm ID	
1	Throttle Body Gasket	2010-02	61326	Idle air control; 30mm ID	
1	Throttle Body Gasket	2010-08	61467	Mounting; Flush mount	
1	Throttle Body Gasket	2010-08	61700	Mounting; Recessed lip; New Part Number - Check for Availability	
1	Throttle Body Gasket	2007-01	61230	Seal	
1	Throttle Body Gasket	2007-01	61232	Mounting	
1	Throttle Body Gasket	2000-91	60744	Mounting	
QTY	EXHAUST GAS RECIRCULATION	YEARS	PART NO.	DESCRIPTION	
2	EGR Gasket	2010-01	70696	Tube seal	
2	EGR Gasket	2010-01	70721	Tube flange	
1	EGR Gasket	2010-02	71185	Valve	
1	EGR Gasket	2001	70720	Valve	
1	EGR Gasket	2000-91	70561	Valve	
29		2004; 3.3L 201 (3302cc) OHV V6 (12 Valve) 93mm Bore			29
		MFI; Flex Fuel; Naturally Aspirated Chrysler Eng.; VIN Code S			
QTY	CYLINDER HEAD	YEARS	PART NO.	DESCRIPTION	
1	Head Gasket	2004	9978 PT	Loc. L.H.; Head bolts not incl.; Head bolt replacement recommended; PermaTorqueMLS®	
1	Head Gasket	2004	9981 PT	Loc. R.H.; Head bolts not incl.; Head bolt replacement recommended; PermaTorqueMLS®	
1	Head Set	2004	HS 9978 PT	w/Stamped steel valve covers; Int. manifold gskt., head bolts, exh. pipe to manifold gskt. not incl.; Head bolt replacement recommended; PermaDry® molded rubber valve cover gsks. incl.; Premium valve stem seals incl.	

Dodge Truck (Incl. Minivans and SUV's) (Cont.)

29 (cont.)		2004; 3.3L 201 (3302cc) OHV V6 (12 Valve) 93mm Bore			29 (cont.)
MFI; Flex Fuel; Naturally Aspirated Chrysler Eng.; VIN Code S					
QTY	CYLINDER HEAD	YEARS	PART NO.	DESCRIPTION	
1	Head Set	2004	HS 9978 PT-1	w/Plastic valve covers; Int. manifold gskt., head bolts, exh. pipe to manifold gskt. not incl.; Head bolt replacement recommended; PermaDry® molded rubber valve cover gskts. incl.; Premium valve stem seals incl.	
2	Head Bolt Set	2004	ES 72163	Head bolts w/Washers; Replacement recommended	
QTY	CONVERSION SET	YEARS	PART NO.	DESCRIPTION	
1	Gasket Conversion Set	2004	CS 9673-2	PermaDry® molded rubber oil pan gskt. incl.	
QTY	MANIFOLD - INT. & EXH.	YEARS	PART NO.	DESCRIPTION	
1	Int. Manifold Gasket Set	2004	MS 92808-1	Upper set incl.	
1	Plenum Gasket Set	2004	MS 96176	Upper set	
1	Exh. Manifold Gasket Set	2004	MS 94666		
QTY	EXHAUST PIPE FLANGE	YEARS	PART NO.	DESCRIPTION	
2	Exhaust Pipe Gasket	2004	61213	Crossover; May use 61453 instead; Old design	
1	Exhaust Pipe Gasket	2004	61229	Converter	
2	Exhaust Pipe Gasket	2004	61453	Crossover; Improved design	
QTY	OIL PAN	YEARS	PART NO.	DESCRIPTION	
1	Oil Pan Gasket Set	2004	OS 30622 R	PermaDry® molded rubber gskt. incl.	
QTY	CRANKSHAFT REAR SEAL	YEARS	PART NO.	DESCRIPTION	
1	Rear Main Seal Set	2004	BS 40168-1	Rubber; One-piece	
1	Rear Main Seal Set	2004	BS 40627	PTFE Rubber; One-piece	
1	Repair Sleeve Tool	2004	16300	Crankshaft	
QTY	VALVE COVER	YEARS	PART NO.	DESCRIPTION	
1	Valve Cover Gasket Set	2004	VS 50513 R	w/Stamped steel valve covers; w/Grommets; PermaDry® molded rubber gskts. incl.	
1	Valve Cover Gasket Set	2004	VS 50599 R	w/Plastic valve covers; w/Grommets; PermaDry® molded rubber gskts. incl.	
1	Grommet Set	2004	ES 72768	Valve Cover; w/Stamped steel valve covers; New Part Number - Check for Availability	
QTY	VALVE STEM SEAL SET	YEARS	PART NO.	DESCRIPTION	
1	Valve Stem Seal Set	2004	SS 71035	Premium valve stem seals incl.	
QTY	THERMOSTAT HOUSING	YEARS	PART NO.	DESCRIPTION	
1	Thermostat Gasket	2004	35651	Thermostat Housing	
QTY	WATER PUMP	YEARS	PART NO.	DESCRIPTION	
1	Water Pump Gasket	2004	35586	O-ring	
1	Water Pump Gasket	2004	35691	Seal to front cover	
QTY	TIMING COVER	YEARS	PART NO.	DESCRIPTION	
1	Timing Cover Set	2004	TCS 46023	Must be used w/OS 30622R	
1	Timing Cover Gasket	2004	72704	New Part Number - Check for Availability	
1	Crankshaft Front Seal Set	2004	TCS 46194	New Part Number - Check for Availability	
1	Repair Sleeve Tool	2004	16326	Timing Cover	
QTY	CARB & FUEL INJECTION	YEARS	PART NO.	DESCRIPTION	
3	Fuel Injector O-Ring Set	2004	ES 70599	Improved design	
1	Throttle Body Gasket	2004	61230	Seal	
1	Throttle Body Gasket	2004	61232	Mounting	
1	Throttle Body Gasket	2004	61324	Idle air control; 21mm ID	
1	Throttle Body Gasket	2004	61326	Idle air control; 30mm ID	
QTY	EXHAUST GAS RECIRCULATION	YEARS	PART NO.	DESCRIPTION	
2	EGR Gasket	2004	70696	Tube seal	
2	EGR Gasket	2004	70721	Tube flange	
1	EGR Gasket	2004	71185	Valve	
30		2010 - 2007; 3.5L 213.4 (3498cc) DOHC V6 (24 Valve) 92.9mm Bore			30
MFI; Gasoline; Naturally Aspirated Mercedes-Benz Eng.; VIN Code 6, Eng. Code 272.963					
QTY	CYLINDER HEAD	YEARS	PART NO.	DESCRIPTION	
1	Head Gasket	2010-07	26610 PT	Loc. L.H.; Head bolts not incl.; Head bolt replacement recommended; PermaTorqueMLS®; New Part Number - Check for Availability	
1	Head Gasket	2010-07	26623 PT	Loc. R.H.; Head bolts not incl.; Head bolt replacement recommended; PermaTorqueMLS®; New Part Number - Check for Availability	
1	Head Set	2010-07	HS 26610 PT	Head bolts not incl.; Head bolt replacement recommended; RTV sealant incl. for valve cover gskts.; Premium valve stem seals incl.; New Part Number - Check for Availability	
QTY	CONVERSION SET	YEARS	PART NO.	DESCRIPTION	
1	Gasket Conversion Set	2010-07	CS 26610	RTV sealant incl. for oil pan gskt.; New Part Number - Check for Availability	
QTY	MANIFOLD - INT. & EXH.	YEARS	PART NO.	DESCRIPTION	
1	Int. Manifold Gasket Set	2010-07	MS 97292	Lower set; New Part Number - Check for Availability	

Dodge Truck (Incl. Minivans and SUV's) (Cont.)

30 (cont.)		2010 - 2007; 3.5L 213.4 (3498cc) DOHC V6 (24 Valve) 92.9mm Bore			30 (cont.)
MFI; Gasoline; Naturally Aspirated Mercedes-Benz Eng.; VIN Code 6, Eng. Code 272.963					
QTY	MANIFOLD - INT. & EXH.	YEARS	PART NO.	DESCRIPTION	
1	Exh. Manifold Gasket Set	2010-07	MS 97263	New Part Number - Check for Availability	
QTY	OIL COOLER	YEARS	PART NO.	DESCRIPTION	
1	Oil Cooler Gasket	2010-07	72979	Oil cooler to housing; New Part Number - Check for Availability	
31		2006 - 2004; 3.5L 215 (3518cc) SOHC V6 (24 Valve) 96mm Bore			31
MFI; Gasoline; Naturally Aspirated Chrysler Eng.; VIN Code 4					
QTY	CYLINDER HEAD	YEARS	PART NO.	DESCRIPTION	
1	Head Gasket	2006-04	26208 PT	Loc. R.H.; Head bolts not incl.; Head bolt replacement recommended; PermaTorqueMLS® LaserWeld® Technology; Improved design	
1	Head Gasket	2006-04	26209 PT	Loc. L.H.; Head bolts not incl.; Head bolt replacement recommended; PermaTorqueMLS® LaserWeld® Technology; Improved design	
1	Head Set	2006-04	HS 26208 PT-1	Head bolts not incl.; Head bolt replacement recommended; PermaDry® molded rubber valve cover gskts. incl.; Premium valve stem seals incl.	
2	Head Bolt Set	2006-04	ES 72895	Head bolts w/Washers; Replacement recommended	
QTY	CONVERSION SET	YEARS	PART NO.	DESCRIPTION	
1	Gasket Conversion Set	2006-05	CS 26208	One-piece rear main retainer w/Seal not incl.; PermaDry® molded rubber oil pan gskt. incl.	
1	Gasket Conversion Set	2004	CS 9505-1	PermaDry® molded rubber oil pan gskt. incl.	
QTY	MANIFOLD - INT. & EXH.	YEARS	PART NO.	DESCRIPTION	
1	Int. Manifold Gasket Set	2006-04	MS 92165-1	Upper set incl.	
1	Plenum Gasket Set	2006-04	MS 96324	Upper set	
1	Exh. Manifold Gasket Set	2006-04	MS 95446		
QTY	EXHAUST PIPE FLANGE	YEARS	PART NO.	DESCRIPTION	
1	Exhaust Pipe Gasket	2006-04	61017	Crossover; 2.265" ID x 3.015" OD	
1	Exhaust Pipe Gasket	2006-04	61261	Flange	
1	Exhaust Pipe Gasket	2006-04	61266	Converter	
QTY	OIL PAN	YEARS	PART NO.	DESCRIPTION	
1	Oil Pan Gasket Set	2006-05	OS 30760 R	PermaDry® molded rubber gskt. incl.	
1	Oil Pan Gasket Set	2004	OS 30733 R	PermaDry® molded rubber gskt. incl.	
1	Drain Plug Gasket	2006-04	70822		
QTY	CRANKSHAFT REAR SEAL	YEARS	PART NO.	DESCRIPTION	
1	Rear Main Seal Set	2006-04	BS 40168-1	w/Aluminum housing; w/Separate seal; Rubber; One-piece	
1	Rear Main Seal Set	2006-04	BS 40627	w/Aluminum housing; w/Separate seal; PTFE Rubber; One-piece	
1	Rear Main Seal Set	2006-05	BS 40734	w/Steel housing; Retainer w/Seal; Rubber; One-piece; New Part Number - Check for Availability	
1	Repair Sleeve Tool	2006-04	16300	Crankshaft	
QTY	VALVE COVER	YEARS	PART NO.	DESCRIPTION	
1	Valve Cover Gasket Set	2006-04	VS 50501 R	w/o Grommets & w/Spark plug tube seals; PermaDry® molded rubber gskts. incl.	
2	Grommet Set	2006-04	ES 71071	Valve Cover; May use ES 71105-1 instead; Old design; Superseded - When depleted use ES 71105-1	
2	Grommet Set	2006-04	ES 71105-1	Valve Cover; Improved design	
QTY	VALVE STEM SEAL SET	YEARS	PART NO.	DESCRIPTION	
2	Valve Stem Seal Set	2006-04	SS 72842	Premium valve stem seals incl.	
QTY	THERMOSTAT HOUSING	YEARS	PART NO.	DESCRIPTION	
1	Thermostat Gasket	2006-04	35631	Thermostat Housing; Thermostat seal	
1	Thermostat Gasket	2006-04	35651	Thermostat Housing	
QTY	WATER PUMP	YEARS	PART NO.	DESCRIPTION	
1	Water Pump Gasket	2006-05	35785		
1	Water Pump Gasket	2004	35499	Improved design	
QTY	TIMING COVER	YEARS	PART NO.	DESCRIPTION	
1	Crankshaft Front Seal Set	2006-05	TCS 46147	Must be used w/OS 30760R; Improved design	
1	Crankshaft Front Seal Set	2004	TCS 45992	Must be used w/OS 30733R	
2	Camshaft Front Seal Set	2006-04	TCS 45939		
QTY	CARB & FUEL INJECTION	YEARS	PART NO.	DESCRIPTION	
2	Fuel Injector O-Ring Set	2006-04	ES 70599	Improved design	
1	Throttle Body Gasket	2006-04	61230	Seal	
1	Throttle Body Gasket	2006-04	61324	Idle air control; 21mm ID	
1	Throttle Body Gasket	2006-04	61326	Idle air control; 30mm ID	
QTY	EXHAUST GAS RECIRCULATION	YEARS	PART NO.	DESCRIPTION	
2	EGR Gasket	2006-04	70721	Tube flange	
1	EGR Gasket	2006-04	71185	Valve	
2	EGR Gasket	2006-04	72928	Tube seal	

Dodge Truck (Incl. Minivans and SUV's) (Cont.)

32		2010 - 2009; 3.5L 215 (3518cc) SOHC V6 (24 Valve) 96mm Bore			32	
MFI; Gasoline; Naturally Aspirated Chrysler Eng.; VIN Code S						
QTY	CYLINDER HEAD	YEARS	PART NO.	DESCRIPTION		
1	Head Gasket	2010-09	26208 PT	Loc. R.H.; Head bolts not incl.; Head bolt replacement recommended; PermaTorqueMLS® LaserWeld® Technology; Improved design		
1	Head Gasket	2010-09	26209 PT	Loc. L.H.; Head bolts not incl.; Head bolt replacement recommended; PermaTorqueMLS® LaserWeld® Technology; Improved design		
1	Head Set	2010-09	HS 26208 PT-2	Head bolts not incl.; Head bolt replacement recommended; PermaDry® molded rubber valve cover gskts. incl.; Premium valve stem seals incl.		
2	Head Bolt Set	2010-09	ES 72895	Head bolts w/Washers; Replacement recommended		
QTY	CONVERSION SET	YEARS	PART NO.	DESCRIPTION		
1	Gasket Conversion Set	2010-09	CS 9505-2	One-piece rear main retainer w/Seal not incl.; PermaDry® molded rubber oil pan gskt. incl.		
QTY	MANIFOLD - INT. & EXH.	YEARS	PART NO.	DESCRIPTION		
1	Int. Manifold Gasket Set	2010-09	MS 92165-1	Upper set incl.		
1	Plenum Gasket Set	2010-09	MS 96324	Upper set		
1	Exh. Manifold Gasket Set	2010-09	MS 95446			
QTY	EXHAUST PIPE FLANGE	YEARS	PART NO.	DESCRIPTION		
1	Exhaust Pipe Gasket	2010-09	61266	Converter		
1	Exhaust Pipe Gasket	2010-09	61495	Flange		
QTY	OIL PAN	YEARS	PART NO.	DESCRIPTION		
1	Oil Pan Gasket Set	2010-09	OS 30754 R	PermaDry® molded rubber gskt. incl.		
1	Drain Plug Gasket	2010-09	70822			
QTY	CRANKSHAFT REAR SEAL	YEARS	PART NO.	DESCRIPTION		
1	Rear Main Seal Set	2010-09	BS 40168-1	w/Aluminum housing; w/Separate seal; Rubber; One-piece		
1	Rear Main Seal Set	2010-09	BS 40627	w/Aluminum housing; w/Separate seal; PTFE Rubber; One-piece		
1	Rear Main Seal Set	2010-09	BS 40734	w/Steel housing; Retainer w/Seal; Rubber; One-piece; New Part Number - Check for Availability		
1	Repair Sleeve Tool	2010-09	16300	Crankshaft		
QTY	VALVE COVER	YEARS	PART NO.	DESCRIPTION		
1	Valve Cover Gasket Set	2010-09	VS 50689 R	w/o Grommets & w/Spark plug tube seals; PermaDry® molded rubber gskts. incl.		
2	Grommet Set	2010-09	ES 71071	Valve Cover; May use ES 71105-1 instead; Old design; Superseded - When depleted use ES 71105-1		
2	Grommet Set	2010-09	ES 71105-1	Valve Cover; Improved design		
QTY	VALVE STEM SEAL SET	YEARS	PART NO.	DESCRIPTION		
2	Valve Stem Seal Set	2010-09	SS 72842	Premium valve stem seals incl.		
QTY	THERMOSTAT HOUSING	YEARS	PART NO.	DESCRIPTION		
1	Thermostat Gasket	2010-09	35631	Thermostat Housing		
QTY	WATER PUMP	YEARS	PART NO.	DESCRIPTION		
1	Water Pump Gasket	2010-09	35785	Mounting		
1	Water Pump Gasket	2010-09	35813	Inlet; Improved design		
QTY	TIMING COVER	YEARS	PART NO.	DESCRIPTION		
1	Crankshaft Front Seal Set	2010-09	TCS 46147	Must be used w/OS 30754R; Improved design		
2	Camshaft Front Seal Set	2010-09	TCS 45939			
QTY	CARB & FUEL INJECTION	YEARS	PART NO.	DESCRIPTION		
2	Fuel Injector O-Ring Set	2010-09	ES 70599	Improved design		
1	Throttle Body Gasket	2010-09	61324	Idle air control; 21mm ID		
1	Throttle Body Gasket	2010-09	61326	Idle air control; 30mm ID		
1	Throttle Body Gasket	2010-09	61389	Mounting		
QTY	EXHAUST GAS RECIRCULATION	YEARS	PART NO.	DESCRIPTION		
2	EGR Gasket	2010-09	70721	Tube flange		
1	EGR Gasket	2010-09	72305	Valve		
2	EGR Gasket	2010-09	72928	Tube seal		
33		2010; 3.5L 215 (3518cc) SOHC V6 (24 Valve) 96mm Bore			33	
MFI; Gasoline; Naturally Aspirated Chrysler Eng.; VIN Code V						
QTY	CYLINDER HEAD	YEARS	PART NO.	DESCRIPTION		
1	Head Gasket	2010	26208 PT	Loc. R.H.; Head bolts not incl.; Head bolt replacement recommended; PermaTorqueMLS® LaserWeld® Technology; Improved design		
1	Head Gasket	2010	26209 PT	Loc. L.H.; Head bolts not incl.; Head bolt replacement recommended; PermaTorqueMLS® LaserWeld® Technology; Improved design		
1	Head Set	2010	HS 26208 PT-3	Head bolts not incl.; Head bolt replacement recommended; PermaDry® molded rubber valve cover gskts. incl.; Premium valve stem seals incl.; New Part Number - Check for Availability		
2	Head Bolt Set	2010	ES 72895	Head bolts w/Washers; Replacement recommended		

Dodge Truck (Incl. Minivans and SUV's) (Cont.)

33 (cont.)		2010; 3.5L 215 (3518cc) SOHC V6 (24 Valve) 96mm Bore			33 (cont.)
MFI; Gasoline; Naturally Aspirated Chrysler Eng.; VIN Code V					
QTY	CONVERSION SET	YEARS	PART NO.	DESCRIPTION	
1	Gasket Conversion Set	2010	CS 9505-2	One-piece rear main retainer w/Seal not incl.; PermaDry® molded rubber oil pan gskt. incl.	
QTY	MANIFOLD - INT. & EXH.	YEARS	PART NO.	DESCRIPTION	
1	Int. Manifold Gasket Set	2010	MS 92165-1	Upper set incl.	
1	Plenum Gasket Set	2010	MS 96324	Upper set	
1	Exh. Manifold Gasket Set	2010	MS 95446		
QTY	EXHAUST PIPE FLANGE	YEARS	PART NO.	DESCRIPTION	
1	Exhaust Pipe Gasket	2010	61266	Converter	
1	Exhaust Pipe Gasket	2010	61495	Flange	
QTY	OIL PAN	YEARS	PART NO.	DESCRIPTION	
1	Oil Pan Gasket Set	2010	OS 30754 R	PermaDry® molded rubber gskt. incl.	
1	Drain Plug Gasket	2010	70822		
QTY	CRANKSHAFT REAR SEAL	YEARS	PART NO.	DESCRIPTION	
1	Rear Main Seal Set	2010	BS 40168-1	w/Aluminum housing; w/Separate seal; Rubber; One-piece	
1	Rear Main Seal Set	2010	BS 40627	w/Aluminum housing; w/Separate seal; PTFE Rubber; One-piece	
1	Rear Main Seal Set	2010	BS 40734	w/Steel housing; Retainer w/Seal; Rubber; One-piece; New Part Number - Check for Availability	
1	Repair Sleeve Tool	2010	16300	Crankshaft	
QTY	VALVE COVER	YEARS	PART NO.	DESCRIPTION	
1	Valve Cover Gasket Set	2010	VS 50689 R	w/o Grommets & w/Spark plug tube seals; PermaDry® molded rubber gskts. incl.	
1	Grommet Set	2010	ES 71451	Valve Cover; New Part Number - Check for Availability	
QTY	VALVE STEM SEAL SET	YEARS	PART NO.	DESCRIPTION	
2	Valve Stem Seal Set	2010	SS 72842	Premium valve stem seals incl.	
QTY	THERMOSTAT HOUSING	YEARS	PART NO.	DESCRIPTION	
1	Thermostat Gasket	2010	35631	Thermostat Housing	
QTY	WATER PUMP	YEARS	PART NO.	DESCRIPTION	
1	Water Pump Gasket	2010	35785	Mounting	
1	Water Pump Gasket	2010	35813	Inlet; Improved design	
QTY	TIMING COVER	YEARS	PART NO.	DESCRIPTION	
1	Crankshaft Front Seal Set	2010	TCS 46147	Must be used w/OS 30754R; Improved design	
2	Camshaft Front Seal Set	2010	TCS 45939		
QTY	CARB & FUEL INJECTION	YEARS	PART NO.	DESCRIPTION	
2	Fuel Injector O-Ring Set	2010	ES 70599	Improved design	
1	Throttle Body Gasket	2010	61324	Idle air control; 21mm ID	
1	Throttle Body Gasket	2010	61326	Idle air control; 30mm ID	
1	Throttle Body Gasket	2010	61389	Mounting	
QTY	EXHAUST GAS RECIRCULATION	YEARS	PART NO.	DESCRIPTION	
2	EGR Gasket	2010	70721	Tube flange	
1	EGR Gasket	2010	72305	Valve	
2	EGR Gasket	2010	72928	Tube seal	
34		2013 - 2011; 3.6L 219.9 (3604cc) DOHC V6 (24 Valve) 96mm Bore Pentastar VVT			34
MFI; Flex Fuel; Naturally Aspirated Chrysler Eng.; VIN Code G					
QTY	CYLINDER HEAD	YEARS	PART NO.	DESCRIPTION	
1	Head Gasket	2013-11	26541 PT	Loc. R.H.; Head bolts not incl.; Head bolt replacement recommended; PermaTorqueMLS®; New Part Number - Check for Availability	
1	Head Gasket	2013-11	26542 PT	Loc. L.H.; Head bolts not incl.; Head bolt replacement recommended; PermaTorqueMLS®; New Part Number - Check for Availability	
1	Head Set	2013-11	HS 26541 PT	Head bolts not incl.; Head bolt replacement recommended; PermaDry® molded rubber valve cover gskts. incl.; Premium valve stem seals incl.; New Part Number - Check for Availability	
2	Head Bolt Set	2013-11	ES 72467	Replacement recommended; New Part Number - Check for Availability	
QTY	MANIFOLD - INT. & EXH.	YEARS	PART NO.	DESCRIPTION	
1	Int. Manifold Gasket Set	2013-11	MS 97204	Lower set; Upper set incl.; New Part Number - Check for Availability	
1	Plenum Gasket Set	2013-11	MS 97205	Upper set; New Part Number - Check for Availability	
1	Exh. Manifold Gasket Set	2013-11	MS 97197	New Part Number - Check for Availability	
QTY	EXHAUST PIPE FLANGE	YEARS	PART NO.	DESCRIPTION	
2	Exhaust Pipe Gasket	2013-11	61494	Crossover	
QTY	OIL PAN	YEARS	PART NO.	DESCRIPTION	
1	Oil Pan Gasket Set	2013	OS 30833	Exc. Dodge Durango Citadel, Crew, Crew Lux, Crew Plus, Special Service, SXT; Loc. Lower; New Part Number - Check for Availability	

Dodge Truck (Incl. Minivans and SUV's) (Cont.)

34		2013 - 2011; 3.6L 219.9 (3604cc) DOHC V6 (24 Valve) 96mm Bore Pentastar VVT			34	
(cont.)		MFI; Flex Fuel; Naturally Aspirated Chrysler Eng.; VIN Code G			(cont.)	
QTY	OIL PAN	YEARS	PART NO.	DESCRIPTION		
1	Oil Pan Gasket Set	2013	OS 30834	Dodge Durango Citadel, Crew, Crew Lux, Crew Plus, Special Service, SXT; Loc. Lower; New Part Number - Check for Availability		
1	Oil Pan Gasket Set	2012	OS 30833	Exc. Dodge Durango Citadel, Crew, Crew Lux, Crew Plus, Heat, SXT; Loc. Lower; New Part Number - Check for Availability		
1	Oil Pan Gasket Set	2012	OS 30834	Dodge Durango Citadel, Crew, Crew Lux, Crew Plus, Heat, SXT; Loc. Lower; New Part Number - Check for Availability		
1	Oil Pan Gasket Set	2011	OS 30833	Exc. Dodge Durango Citadel, Crew, Crew Lux, Express; Loc. Lower; New Part Number - Check for Availability		
1	Oil Pan Gasket Set	2011	OS 30834	Dodge Durango Citadel, Crew, Crew Lux, Express; Loc. Lower; New Part Number - Check for Availability		
QTY	CRANKSHAFT REAR SEAL	YEARS	PART NO.	DESCRIPTION		
1	Rear Main Seal Set	2013-11	BS 40737	Rubber; One-piece; New Part Number - Check for Availability		
QTY	VALVE COVER	YEARS	PART NO.	DESCRIPTION		
1	Valve Cover Gasket Set	2013-11	VS 50805 R	w/Spark plug tube seals; PermaDry® molded rubber gskts. incl.; New Part Number - Check for Availability		
QTY	VALVE STEM SEAL SET	YEARS	PART NO.	DESCRIPTION		
1	Valve Stem Seal Set	2013-11	SS 71074-3	Premium valve stem seals incl.; New Part Number - Check for Availability		
QTY	THERMOSTAT HOUSING	YEARS	PART NO.	DESCRIPTION		
1	Thermostat Gasket	2013-11	35974	Thermostat Housing; Thermostat gskt.; New Part Number - Check for Availability		
QTY	WATER OUTLET GASKET	YEARS	PART NO.	DESCRIPTION		
1	Water Outlet Gasket	2013-11	35975	Water Outlet; Water outlet crossover; New Part Number - Check for Availability		
QTY	WATER PUMP	YEARS	PART NO.	DESCRIPTION		
1	Water Pump Gasket	2013-11	35982	New Part Number - Check for Availability		
QTY	TIMING COVER	YEARS	PART NO.	DESCRIPTION		
1	Timing Cover Set	2013-11	TCS 46162	New Part Number - Check for Availability		
QTY	CARB & FUEL INJECTION	YEARS	PART NO.	DESCRIPTION		
1	Throttle Body Gasket	2013-11	61679	New Part Number - Check for Availability		
35		2012 - 2002; 3.7L 226 (3704cc) SOHC V6 (12 Valve) 93mm Bore			35	
		MFI; Gasoline; Naturally Aspirated Chrysler Eng.; VIN Code K				
QTY	CYLINDER HEAD	YEARS	PART NO.	DESCRIPTION		
2	Head Gasket	2012-02	26229 PT	Head bolts not incl.; Head bolt replacement recommended; PermaTorqueMLS®		
1	Head Set	2012-05	HS 26229 PT-1	w/Plastic valve covers; Head bolts not incl.; Head bolt replacement recommended; Must be used w/TCS 46022; PermaDry® molded rubber valve cover gskts. incl.; Premium valve stem seals incl.		
1	Head Set	2005	HS 26229 PT	w/Stamped steel valve covers; Head bolts not incl.; Head bolt replacement recommended; Must be used w/TCS 46022; PermaDry® molded rubber valve cover gskts. incl.; Premium valve stem seals incl.		
1	Head Set	2004-02	HS 26229 PT	Head bolts not incl.; Head bolt replacement recommended; Must be used w/TCS 46022; PermaDry® molded rubber valve cover gskts. incl.; Premium valve stem seals incl.		
2	Head Bolt Set	2012-02	ES 71129-1	Head bolts w/Washers; Replacement recommended		
QTY	CONVERSION SET	YEARS	PART NO.	DESCRIPTION		
1	Gasket Conversion Set	2012-02	CS 26229	PermaDry® molded rubber oil pan gskt. incl.		
QTY	MANIFOLD - INT. & EXH.	YEARS	PART NO.	DESCRIPTION		
1	Int. Manifold Gasket Set	2012-02	MS 93205-1			
1	Exh. Manifold Gasket Set	2012-02	MS 96344-1	Improved design		
1	Exh. Manifold Gasket Set	2006-02	MS 96344	Old design		
QTY	EXHAUST PIPE FLANGE	YEARS	PART NO.	DESCRIPTION		
1	Exhaust Pipe Gasket	2012-02	61240	Flange		
1	Exhaust Pipe Gasket	2012-02	61289	Ring		
QTY	OIL PAN	YEARS	PART NO.	DESCRIPTION		
1	Oil Pan Gasket Set	2012-02	OS 30743 R	PermaDry® molded rubber gskt. incl.		
QTY	CRANKSHAFT REAR SEAL	YEARS	PART NO.	DESCRIPTION		
1	Rear Main Seal Set	2012-02	BS 40186	Rubber; One-piece		
1	Repair Sleeve	2012-02	16230	Crankshaft; Use w/installation tool		
1	Repair Sleeve Tool	2012-02	16328	Crankshaft		
QTY	VALVE COVER	YEARS	PART NO.	DESCRIPTION		
1	Valve Cover Gasket Set	2012-05	VS 50652 R	w/Plastic valve covers; w/Grommets; PermaDry® molded rubber gskts. incl.		

Dodge Truck (Incl. Minivans and SUV's) (Cont.)

35 (cont.)		2012 - 2002; 3.7L 226 (3704cc) SOHC V6 (12 Valve) 93mm Bore			35 (cont.)
		MFI; Gasoline; Naturally Aspirated Chrysler Eng.; VIN Code K			
QTY	VALVE COVER	YEARS	PART NO.	DESCRIPTION	
1	Valve Cover Gasket Set	2005	VS 50594 R	w/Stamped steel valve covers; w/Grommets; PermaDry® molded rubber gskts. incl.	
1	Valve Cover Gasket Set	2004-02	VS 50594 R	w/Grommets; PermaDry® molded rubber gskts. incl.	
QTY	VALVE STEM SEAL SET	YEARS	PART NO.	DESCRIPTION	
1	Valve Stem Seal Set	2012-02	SS 71041-1	Premium valve stem seals incl.	
QTY	THERMOSTAT HOUSING	YEARS	PART NO.	DESCRIPTION	
1	Thermostat Gasket	2012-02	35692	Thermostat Housing; Thermostat seal	
QTY	WATER PUMP	YEARS	PART NO.	DESCRIPTION	
1	Water Pump Gasket	2012-02	35655		
QTY	TIMING COVER	YEARS	PART NO.	DESCRIPTION	
1	Timing Cover Set	2012-02	TCS 46022		
QTY	CARB & FUEL INJECTION	YEARS	PART NO.	DESCRIPTION	
2	Fuel Injector O-Ring Set	2012-02	ES 70599	Improved design	
1	Throttle Body Gasket	2012-02	61324	Idle air control; 21mm ID	
1	Throttle Body Gasket	2012-02	61326	Idle air control; 30mm ID	
1	Throttle Body Gasket	2012	61702	Mounting; New Part Number - Check for Availability	
1	Throttle Body Gasket	2011	61467	Exc. Dodge Nitro Heat, Ram 1500 Pickup ST, SXT; Mounting	
1	Throttle Body Gasket	2011	61702	Dodge Nitro Heat, Ram 1500 Pickup ST, SXT; Mounting; New Part Number - Check for Availability	
1	Throttle Body Gasket	2010	61467	Exc. Dodge Nitro SE, SXT, Ram 1500 Pickup ST, SXT; Mounting	
1	Throttle Body Gasket	2010	61702	Dodge Nitro SE, SXT, Ram 1500 Pickup ST, SXT; Mounting; New Part Number - Check for Availability	
1	Throttle Body Gasket	2009	61467	Exc. Dodge Durango SE, SLT, SXT, Nitro SE, SLT, Ram 1500 Pickup ST, SXT; Mounting	
1	Throttle Body Gasket	2009	61702	Dodge Durango SE, SLT, SXT, Nitro SE, SLT, Ram 1500 Pickup ST, SXT; Mounting; New Part Number - Check for Availability	
1	Throttle Body Gasket	2008-07	61467	Mounting	
1	Throttle Body Gasket	2006-02	61225	Mounting	
QTY	EXHAUST GAS RECIRCULATION	YEARS	PART NO.	DESCRIPTION	
2	EGR Gasket	2012-05	70721	Tube flange	
1	EGR Gasket	2012-05	72251	Valve	
36		2010; 3.8L 231 (3785cc) OHV V6 (12 Valve) 96mm Bore			36
		MFI; Flex Fuel; Naturally Aspirated Chrysler Eng.; VIN Code 1			
QTY	CYLINDER HEAD	YEARS	PART NO.	DESCRIPTION	
1	Head Gasket	2010	9996 PT	Loc. R.H.; Head bolts not incl.; Head bolt replacement recommended; PermaTorqueMLS®	
1	Head Gasket	2010	9997 PT	Loc. L.H.; Head bolts not incl.; Head bolt replacement recommended; PermaTorqueMLS®	
1	Head Set	2010	HS 9996 PT-2	w/Plastic valve covers; Int. manifold gskt., head bolts, exh. pipe to manifold gskt. not incl.; Head bolt replacement recommended; PermaDry® molded rubber valve cover gskts. incl.; Premium valve stem seals incl.	
2	Head Bolt Set	2010	ES 72163	Head bolts w/Washers; Replacement recommended	
QTY	CONVERSION SET	YEARS	PART NO.	DESCRIPTION	
1	Gasket Conversion Set	2010	CS 26326-1	PermaDry® molded rubber oil pan gskt. incl.	
QTY	MANIFOLD - INT. & EXH.	YEARS	PART NO.	DESCRIPTION	
1	Int. Manifold Gasket Set	2010	MS 92808-1	Upper set incl.	
1	Plenum Gasket Set	2010	MS 96176	Upper set	
1	Exh. Manifold Gasket Set	2010	MS 94666		
QTY	EXHAUST PIPE FLANGE	YEARS	PART NO.	DESCRIPTION	
2	Exhaust Pipe Gasket	2010	61213	Crossover; May use 61453 instead; Old design	
1	Exhaust Pipe Gasket	2010	61229	Converter	
2	Exhaust Pipe Gasket	2010	61453	Crossover; Improved design	
1	Exhaust Pipe Gasket	2010	61701	Connector; New Part Number - Check for Availability	
QTY	OIL PAN	YEARS	PART NO.	DESCRIPTION	
1	Oil Pan Gasket Set	2010	OS 30622 R	PermaDry® molded rubber gskt. incl.	
QTY	CRANKSHAFT REAR SEAL	YEARS	PART NO.	DESCRIPTION	
1	Rear Main Seal Set	2010	BS 40713	Rubber; One-piece	
QTY	VALVE COVER	YEARS	PART NO.	DESCRIPTION	
1	Valve Cover Gasket Set	2010	VS 50599 R	w/Plastic valve covers; w/Grommets; PermaDry® molded rubber gskts. incl.	
QTY	VALVE STEM SEAL SET	YEARS	PART NO.	DESCRIPTION	
1	Valve Stem Seal Set	2010	SS 71035	Premium valve stem seals incl.	
QTY	THERMOSTAT HOUSING	YEARS	PART NO.	DESCRIPTION	
1	Thermostat Gasket	2010	35651	Thermostat Housing; Thermostat gskt.	

Dodge Truck (Incl. Minivans and SUV's) (Cont.)

36 (cont.)		2010; 3.8L 231 (3785cc) OHV V6 (12 Valve) 96mm Bore			36 (cont.)
MFI; Flex Fuel; Naturally Aspirated Chrysler Eng.; VIN Code 1					
QTY	THERMOSTAT HOUSING	YEARS	PART NO.	DESCRIPTION	
1	O-Ring	2010	35861	Thermostat Housing; Thermostat seal	
QTY	WATER OUTLET GASKET	YEARS	PART NO.	DESCRIPTION	
1	Water Outlet Gasket	2010	35286	Water Outlet	
1	Water Outlet Gasket	2010	35286 T	Water Outlet; PermaDryPlus®	
QTY	WATER PUMP	YEARS	PART NO.	DESCRIPTION	
1	Water Pump Gasket	2010	35586	O-ring	
1	Water Pump Gasket	2010	35691	Seal to front cover	
1	Water Pump Gasket	2010	35780	Gskt.	
QTY	TIMING COVER	YEARS	PART NO.	DESCRIPTION	
1	Timing Cover Set	2010	TCS 46023-1	Must be used w/OS 30622R	
1	Timing Cover Gasket	2010	72706	New Part Number - Check for Availability	
QTY	CARB & FUEL INJECTION	YEARS	PART NO.	DESCRIPTION	
3	Fuel Injector O-Ring Set	2010	ES 70599	Improved design	
1	Throttle Body Gasket	2010	61324	Idle air control; 21mm ID	
1	Throttle Body Gasket	2010	61326	Idle air control; 30mm ID	
1	Throttle Body Gasket	2010	61467	Mounting; Flush mount	
1	Throttle Body Gasket	2010	61700	Mounting; Recessed lip; New Part Number - Check for Availability	
QTY	EXHAUST GAS RECIRCULATION	YEARS	PART NO.	DESCRIPTION	
2	EGR Gasket	2010	70696	Tube seal	
2	EGR Gasket	2010	70721	Tube flange	
1	EGR Gasket	2010	71185	Valve	
37		2010 - 1994; 3.8L 231 (3785cc) OHV V6 (12 Valve) 96mm Bore			37
MFI; Gasoline; Naturally Aspirated Chrysler Eng.; VIN Code L					
QTY	CYLINDER HEAD	YEARS	PART NO.	DESCRIPTION	
1	Head Gasket	2010-01	9997 PT	Loc. L.H.; Head bolts not incl.; Head bolt replacement recommended; PermaTorqueMLS®	
1	Head Gasket	2010-01	9996 PT	Loc. R.H.; Head bolts not incl.; Head bolt replacement recommended; PermaTorqueMLS®	
1	Head Gasket	2000-94	9535 PT	Loc. L.H.; Head bolts not incl.; Head bolt replacement recommended; Improved design	
1	Head Gasket	2000-94	9536 PT	Loc. R.H.; Head bolts not incl.; Head bolt replacement recommended; Improved design	
1	Head Set	2010-04	HS 9996 PT-2	w/Plastic valve covers; Int. manifold gskt., head bolts, exh. pipe to manifold gskt. not incl.; Head bolt replacement recommended; PermaDry® molded rubber valve cover gskts. incl.; Premium valve stem seals incl.	
1	Head Set	2004	HS 9996 PT-1	w/Stamped steel valve covers; Int. manifold gskt., head bolts, exh. pipe to manifold gskt. not incl.; Head bolt replacement recommended; PermaDry® molded rubber valve cover gskts. incl.; Premium valve stem seals incl.	
1	Head Set	2003-02	HS 9996 PT-1	Int. manifold gskt., head bolts, exh. pipe to manifold gskt. not incl.; Head bolt replacement recommended; PermaDry® molded rubber valve cover gskts. incl.; Premium valve stem seals incl.	
1	Head Set	2001	HS 9996 PT	Int. manifold gskt., head bolts, exh. pipe to manifold gskt. not incl.; Head bolt replacement recommended; PermaDry® molded rubber valve cover gskts. incl.; Premium valve stem seals incl.	
1	Head Set	2000-98	HS 9535 PT	w/Isolated valve covers; 29/64" diameter valve cover bolt holes; Int. manifold gskt., head bolts, exh. pipe to manifold gskt. not incl.; Head bolt replacement recommended; PermaDry® molded rubber valve cover gskts. incl.; Premium valve stem seals incl.	
1	Head Set	2000-98	HS 9830 PT	w/o Isolated valve covers; 9/32" diameter valve cover bolt holes; Int. manifold gskt., head bolts, exh. pipe to manifold gskt. not incl.; Head bolt replacement recommended; PermaDry® molded rubber valve cover gskts. incl.; Premium valve stem seals incl.	
1	Head Set	1997-94	HS 9830 PT	Int. manifold gskt., head bolts, exh. pipe to manifold gskt. not incl.; Head bolt replacement recommended; PermaDry® molded rubber valve cover gskts. incl.; Premium valve stem seals incl.	
2	Head Bolt Set	2010-97	ES 72163	Head bolts w/Washers; Replacement recommended	
1	Head Bolt Set	1996-94	ES 72849	Head bolts w/o Washers; Washers are req'd.; Replacement recommended	
1	Head Bolt Washer Set	1996-94	ES 72176-1	Replacement recommended	
QTY	CONVERSION SET	YEARS	PART NO.	DESCRIPTION	
1	Gasket Conversion Set	2010-09	CS 26326-1	PermaDry® molded rubber oil pan gskt. incl.	
1	Gasket Conversion Set	2008-94	CS 9673-2	PermaDry® molded rubber oil pan gskt. incl.	
QTY	MANIFOLD - INT. & EXH.	YEARS	PART NO.	DESCRIPTION	
1	Int. Manifold Gasket Set	2010-02	MS 92808-1	Upper set incl.	

Dodge Truck (Incl. Minivans and SUV's) (Cont.)

37 (cont.)	2010 - 1994; 3.8L 231 (3785cc) OHV V6 (12 Valve) 96mm Bore				37 (cont.)
QTY	MANIFOLD - INT. & EXH.	YEARS	PART NO.	DESCRIPTION	
1	Int. Manifold Gasket Set	2001	MS 92808	Upper set incl.	
1	Valley Pan Gasket Set	2000-94	MS 96042	Upper set incl.	
1	Plenum Gasket Set	2010-02	MS 96176	Upper set	
1	Plenum Gasket Set	2001	MS 92947	Upper set	
1	Plenum Gasket Set	2000-94	MS 94566	Upper set	
1	Exh. Manifold Gasket Set	2010-94	MS 94666		
QTY	EXHAUST PIPE FLANGE	YEARS	PART NO.	DESCRIPTION	
2	Exhaust Pipe Gasket	2010-01	61213	Crossover; May use 61453 instead; Old design	
2	Exhaust Pipe Gasket	2010-01	61453	Crossover; Improved design	
1	Exhaust Pipe Gasket	2010-02	61229	Converter	
1	Exhaust Pipe Gasket	2010-08	61701	Connector; New Part Number - Check for Availability	
2	Exhaust Pipe Gasket	2000-94	60860	Crossover	
1	Exhaust Pipe Gasket	2000-96	61002	Pipe to manifold	
1	Exhaust Pipe Gasket	1995-94	60810	Pipe to manifold	
1	Exh. Flange Bolt & Spring Kit	1995-94	ES 72143		
QTY	OIL PAN	YEARS	PART NO.	DESCRIPTION	
1	Oil Pan Gasket Set	2010-94	OS 30622 R	PermaDry® molded rubber gskt. incl.	
1	Drain Plug Gasket	2002-94	70822		
QTY	CRANKSHAFT REAR SEAL	YEARS	PART NO.	DESCRIPTION	
1	Rear Main Seal Set	2010-09	BS 40713	Rubber; One-piece	
1	Rear Main Seal Set	2008-94	BS 40168-1	Rubber; One-piece	
1	Rear Main Seal Set	2008-94	BS 40627	PTFE Rubber; One-piece	
1	Repair Sleeve Tool	2008-94	16300	Crankshaft	
QTY	VALVE COVER	YEARS	PART NO.	DESCRIPTION	
1	Valve Cover Gasket Set	2010-04	VS 50599 R	w/Plastic valve covers; w/Grommets; PermaDry® molded rubber gskts. incl.	
1	Valve Cover Gasket Set	2004	VS 50513 R	w/Stamped steel valve covers; w/Grommets; PermaDry® molded rubber gskts. incl.	
1	Valve Cover Gasket Set	2003-01	VS 50513 R	w/Grommets; PermaDry® molded rubber gskts. incl.	
1	Valve Cover Gasket Set	2000-98	VS 50339 R	w/o Isolated valve covers; 9/32" diameter valve cover bolt holes; Must be used w/MS 94566; PermaDry® molded rubber gskts. incl.; .200" thick	
1	Valve Cover Gasket Set	2000-98	VS 50449 R	w/Isolated valve covers; 29/64" diameter valve cover bolt holes; Must be used w/MS 94566; w/o Grommets; PermaDry® molded rubber gskts. incl.; .474" thick	
1	Valve Cover Gasket Set	1997-94	VS 50339 R	Must be used w/MS 94566; PermaDry® molded rubber gskts. incl.; .200" thick	
1	Grommet Set	2004	ES 72768	Valve Cover; w/Stamped steel valve covers; New Part Number - Check for Availability	
1	Grommet Set	2003-01	ES 72768	Valve Cover; New Part Number - Check for Availability	
1	Grommet Set	2000-98	ES 72768	Valve Cover; w/Isolated valve covers; 29/64" diameter valve cover bolt holes; New Part Number - Check for Availability	
QTY	VALVE STEM SEAL SET	YEARS	PART NO.	DESCRIPTION	
1	Valve Stem Seal Set	2010-01	SS 71035	Premium valve stem seals incl.	
1	Valve Stem Seal Set	2000-94	SS 72783	Premium valve stem seals incl.	
QTY	THERMOSTAT HOUSING	YEARS	PART NO.	DESCRIPTION	
1	Thermostat Gasket	2010-09	35651	Thermostat Housing; Thermostat gskt.	
1	Thermostat Gasket	2008	35631	Chrysler Pacifica Base, LX; Thermostat Housing; Thermostat seal	
1	Thermostat Gasket	2008	35651	Exc. Chrysler Pacifica Base, LX; Thermostat Housing; Thermostat gskt.	
1	Thermostat Gasket	2007-05	35631	Chrysler Pacifica Base; Thermostat Housing; Thermostat seal	
1	Thermostat Gasket	2007-05	35651	Exc. Chrysler Pacifica Base; Thermostat Housing; Thermostat gskt.	
1	Thermostat Gasket	2004-01	35651	Thermostat Housing; Thermostat gskt.	
1	O-Ring	2010-09	35861	Thermostat Housing; Thermostat seal	
1	O-Ring	2008	35861	Exc. Chrysler Pacifica Base, LX; Thermostat Housing; Thermostat seal	
QTY	WATER OUTLET GASKET	YEARS	PART NO.	DESCRIPTION	
1	Water Outlet Gasket	2010-09	35286	Water Outlet	
1	Water Outlet Gasket	2010-09	35286 T	Water Outlet; PermaDryPlus®	
1	Water Outlet Gasket	2008	35286	Exc. Chrysler Pacifica Base, LX; Water Outlet	
1	Water Outlet Gasket	2008	35286 T	Exc. Chrysler Pacifica Base, LX; Water Outlet; PermaDryPlus®	
1	Water Outlet Gasket	2007-06	35286	Exc. Chrysler Pacifica Base; Water Outlet	
1	Water Outlet Gasket	2007-06	35286 T	Exc. Chrysler Pacifica Base; Water Outlet; PermaDryPlus®	
1	Water Outlet Gasket	2000-94	35286	Water Outlet	
1	Water Outlet Gasket	2000-94	35286 T	Water Outlet; PermaDryPlus®	
QTY	WATER PUMP	YEARS	PART NO.	DESCRIPTION	
1	Water Pump Gasket	2010-02	35691	Seal to front cover	
1	Water Pump Gasket	2010-09	35586	O-ring	

Dodge Truck (Incl. Minivans and SUV's) (Cont.)

37 (cont.)		2010 - 1994; 3.8L 231 (3785cc) OHV V6 (12 Valve) 96mm Bore			37 (cont.)
MFI; Gasoline; Naturally Aspirated Chrysler Eng.; VIN Code L					
QTY	WATER PUMP	YEARS	PART NO.	DESCRIPTION	
1	Water Pump Gasket	2010-09	35780	Gskt.	
1	Water Pump Gasket	2008	35586	Exc. Chrysler Pacifica Base, LX; O-ring	
1	Water Pump Gasket	2008	35780	Chrysler Pacifica Base, LX	
1	Water Pump Gasket	2008	35780	Exc. Chrysler Pacifica Base, LX; Gskt.	
1	Water Pump Gasket	2007-05	35586	Exc. Chrysler Pacifica Base; O-ring	
1	Water Pump Gasket	2007-05	35780	Chrysler Pacifica Base	
1	Water Pump Gasket	2007	35780	Exc. Chrysler Pacifica Base; Gskt.	
1	Water Pump Gasket	2004-02	35586	O-ring	
1	Water Pump Gasket	2001-94	35446		
QTY	TIMING COVER	YEARS	PART NO.	DESCRIPTION	
1	Timing Cover Set	2010-09	TCS 46023-1	Must be used w/OS 30622R	
1	Timing Cover Set	2008-07	TCS 46134	Must be used w/OS 30622R	
1	Timing Cover Set	2006-02	TCS 46023	Must be used w/OS 30622R	
1	Timing Cover Set	2001-94	TCS 45893-1	Must be used w/OS 30622R	
1	Timing Cover Gasket	2010-07	72706	New Part Number - Check for Availability	
1	Timing Cover Gasket	2006-02	72704	New Part Number - Check for Availability	
1	Crankshaft Front Seal Set	2008-94	TCS 46194	New Part Number - Check for Availability	
1	Repair Sleeve Tool	2008-94	16326	Timing Cover	
QTY	CARB & FUEL INJECTION	YEARS	PART NO.	DESCRIPTION	
3	Fuel Injector O-Ring Set	2010-94	ES 70599	Improved design	
1	Throttle Body Gasket	2010-02	61324	Idle air control; 21mm ID	
1	Throttle Body Gasket	2010-02	61326	Idle air control; 30mm ID	
1	Throttle Body Gasket	2010-08	61467	Mounting; Flush mount	
1	Throttle Body Gasket	2010-08	61700	Mounting; Recessed lip; New Part Number - Check for Availability	
1	Throttle Body Gasket	2007-01	61230	Seal	
1	Throttle Body Gasket	2007-01	61232	Mounting	
1	Throttle Body Gasket	2000	61108	Mounting	
1	Throttle Body Gasket	1999-94	60744	Mounting	
QTY	EXHAUST GAS RECIRCULATION	YEARS	PART NO.	DESCRIPTION	
2	EGR Gasket	2010-01	70696	Tube seal	
1	EGR Gasket	2010-02	71185	Valve	
2	EGR Gasket	2010-03	70721	Tube flange	
1	EGR Gasket	2002-01	70721	Loc. Lower; Tube flange	
1	EGR Gasket	2002-01	71182	Loc. Upper; Tube flange	
1	EGR Gasket	2001	70720	Valve	
1	EGR Gasket	2000-94	70561	Valve	
38		2010 - 2008; 3.8L 231 (3785cc) OHV V6 (12 Valve) 96mm Bore			38
MFI; Gasoline; Naturally Aspirated Chrysler Eng.; VIN Code P					
QTY	CYLINDER HEAD	YEARS	PART NO.	DESCRIPTION	
1	Head Gasket	2010-08	9996 PT	Loc. R.H.; Head bolts not incl.; Head bolt replacement recommended; PermaTorqueMLS®	
1	Head Gasket	2010-08	9997 PT	Loc. L.H.; Head bolts not incl.; Head bolt replacement recommended; PermaTorqueMLS®	
1	Head Set	2010-08	HS 9996 PT-2	w/Plastic valve covers; Int. manifold gskt., head bolts, exh. pipe to manifold gskt. not incl.; Head bolt replacement recommended; PermaDry® molded rubber valve cover gskts. incl.; Premium valve stem seals incl.	
2	Head Bolt Set	2010-08	ES 72163	Head bolts w/Washers; Replacement recommended	
QTY	CONVERSION SET	YEARS	PART NO.	DESCRIPTION	
1	Gasket Conversion Set	2010-09	CS 26326-1	PermaDry® molded rubber oil pan gskt. incl.	
1	Gasket Conversion Set	2008	CS 9673-2	PermaDry® molded rubber oil pan gskt. incl.	
QTY	MANIFOLD - INT. & EXH.	YEARS	PART NO.	DESCRIPTION	
1	Int. Manifold Gasket Set	2010-08	MS 92808-1	Upper set incl.	
1	Plenum Gasket Set	2010-08	MS 96176	Upper set	
1	Exh. Manifold Gasket Set	2010-08	MS 94666		
QTY	EXHAUST PIPE FLANGE	YEARS	PART NO.	DESCRIPTION	
2	Exhaust Pipe Gasket	2010-08	61213	Crossover; May use 61453 instead; Old design	
1	Exhaust Pipe Gasket	2010-08	61229	Converter	
2	Exhaust Pipe Gasket	2010-08	61453	Crossover; Improved design	
1	Exhaust Pipe Gasket	2010-08	61701	Connector; New Part Number - Check for Availability	
QTY	OIL PAN	YEARS	PART NO.	DESCRIPTION	
1	Oil Pan Gasket Set	2010-08	OS 30622 R	PermaDry® molded rubber gskt. incl.	
QTY	CRANKSHAFT REAR SEAL	YEARS	PART NO.	DESCRIPTION	
1	Rear Main Seal Set	2010-09	BS 40713	Rubber; One-piece	

Dodge Truck (Incl. Minivans and SUV's) (Cont.)

38 (cont.)		2010 - 2008; 3.8L 231 (3785cc) OHV V6 (12 Valve) 96mm Bore			38 (cont.)
MFI; Gasoline; Naturally Aspirated Chrysler Eng.; VIN Code P					
QTY	CRANKSHAFT REAR SEAL	YEARS	PART NO.	DESCRIPTION	
1	Rear Main Seal Set	2008	BS 40168-1	Rubber; One-piece	
1	Rear Main Seal Set	2008	BS 40627	PTFE Rubber; One-piece	
1	Repair Sleeve Tool	2008	16300	Crankshaft	
QTY	VALVE COVER	YEARS	PART NO.	DESCRIPTION	
1	Valve Cover Gasket Set	2010-08	VS 50599 R	w/Plastic valve covers; w/Grommets; PermaDry® molded rubber gsks. incl.	
QTY	VALVE STEM SEAL SET	YEARS	PART NO.	DESCRIPTION	
1	Valve Stem Seal Set	2010-08	SS 71035	Premium valve stem seals incl.	
QTY	THERMOSTAT HOUSING	YEARS	PART NO.	DESCRIPTION	
1	Thermostat Gasket	2010-08	35651	Thermostat Housing; Thermostat gskt.	
1	O-Ring	2010-08	35861	Thermostat Housing; Thermostat seal	
QTY	WATER OUTLET GASKET	YEARS	PART NO.	DESCRIPTION	
1	Water Outlet Gasket	2010-08	35286	Water Outlet	
1	Water Outlet Gasket	2010-08	35286 T	Water Outlet; PermaDryPlus®	
QTY	WATER PUMP	YEARS	PART NO.	DESCRIPTION	
1	Water Pump Gasket	2010-08	35586	O-ring	
1	Water Pump Gasket	2010-08	35691	Seal to front cover	
1	Water Pump Gasket	2010-08	35780	Gskt.	
QTY	TIMING COVER	YEARS	PART NO.	DESCRIPTION	
1	Timing Cover Set	2010-09	TCS 46023-1	Must be used w/OS 30622R	
1	Timing Cover Set	2008	TCS 46134	Must be used w/OS 30622R	
1	Timing Cover Gasket	2010-08	72706	New Part Number - Check for Availability	
1	Crankshaft Front Seal Set	2008	TCS 46194	New Part Number - Check for Availability	
1	Repair Sleeve Tool	2008	16326	Timing Cover	
QTY	CARB & FUEL INJECTION	YEARS	PART NO.	DESCRIPTION	
3	Fuel Injector O-Ring Set	2010-08	ES 70599	Improved design	
1	Throttle Body Gasket	2010-08	61324	Idle air control; 21mm ID	
1	Throttle Body Gasket	2010-08	61326	Idle air control; 30mm ID	
1	Throttle Body Gasket	2010-08	61467	Mounting; Flush mount	
1	Throttle Body Gasket	2010-08	61700	Mounting; Recessed lip; New Part Number - Check for Availability	
QTY	EXHAUST GAS RECIRCULATION	YEARS	PART NO.	DESCRIPTION	
2	EGR Gasket	2010-08	70696	Tube seal	
2	EGR Gasket	2010-08	70721	Tube flange	
1	EGR Gasket	2010-08	71185	Valve	
39		2003 - 1992; 3.9L 239 (3916cc) OHV V6 (12 Valve) 3.9063" Bore			39
MFI; Gasoline; Naturally Aspirated Chrysler Eng.; VIN Code X					
QTY	CYLINDER HEAD	YEARS	PART NO.	DESCRIPTION	
2	Head Gasket	2003-92	518 SD	Head bolts not incl.; Head bolt replacement recommended; PermaTorque Severe Duty®	
2	Head Gasket	2003-92	9910 PT	Head bolts not incl.; Head bolt replacement recommended; PermaTorque®	
1	Head Set	2003-98	HS 9910 PT-1	Head bolts not incl.; Head bolt replacement recommended; PermaDry® molded rubber valve cover gsks. incl.; Premium valve stem seals incl.	
1	Head Set	1997-92	HS 9910 PT	Head bolts not incl.; Head bolt replacement recommended; PermaDry® molded rubber valve cover gsks. incl.; Premium valve stem seals incl.	
1	Head Bolt Set	2003-94	ES 71038	Replacement recommended	
QTY	CONVERSION SET	YEARS	PART NO.	DESCRIPTION	
1	Gasket Conversion Set	2003-97	CS 9910-1	PermaDry® molded rubber oil pan gskt. incl.; PermaDryPlus® timing cover gskt. incl.	
1	Gasket Conversion Set	1996-92	CS 9910	PermaDry® molded rubber oil pan gskt. incl.	
QTY	MANIFOLD - INT. & EXH.	YEARS	PART NO.	DESCRIPTION	
1	Int. Manifold Gasket Set	2003-98	MS 95315-1	Lower set; Upper set incl.; Manifold bolts not incl.; Manifold bolt replacement recommended	
1	Int. Manifold Gasket Set	1997-92	MS 95315	Lower set; Upper set incl.; Manifold bolts not incl.; Manifold bolt replacement recommended	
1	Int. Manifold Bolt Set	2003-92	ES 72169	Int. manifold bolts w/Washers; Replacement recommended	
1	Exh. Manifold Gasket Set	2003-92	MS 95463		
QTY	OIL PAN	YEARS	PART NO.	DESCRIPTION	
1	Oil Pan Gasket Set	2003-92	OS 34503 R	PermaDry® molded rubber gskt. incl.	
1	Drain Plug Gasket	2003-92	70822		
QTY	CRANKSHAFT REAR SEAL	YEARS	PART NO.	DESCRIPTION	
1	Rear Main Seal Set	2003-92	BS 40181	Rubber; Two-piece	
QTY	VALVE COVER	YEARS	PART NO.	DESCRIPTION	
1	Valve Cover Gasket Set	2003-92	VS 50420 R	PermaDry® molded rubber gsks. incl.	

Dodge Truck (Incl. Minivans and SUV's) (Cont.)

39 (cont.)		2003 - 1992; 3.9L 239 (3916cc) OHV V6 (12 Valve) 3.9063" Bore			39 (cont.)
MFI; Gasoline; Naturally Aspirated Chrysler Eng.; VIN Code X					
QTY	VALVE STEM SEAL SET	YEARS	PART NO.	DESCRIPTION	
1	Valve Stem Seal Set	2003-92	SS 72835	Loc. Int. & Exh.; Premium valve stem seals incl.	
QTY	WATER OUTLET GASKET	YEARS	PART NO.	DESCRIPTION	
1	Water Outlet Gasket	2003-92	35064	Water Outlet	
QTY	WATER PUMP	YEARS	PART NO.	DESCRIPTION	
1	Water Pump Gasket	2003-92	35540		
QTY	TIMING COVER	YEARS	PART NO.	DESCRIPTION	
1	Timing Cover Set	2003-97	TCS 45996	w/o Sleeve 'N' Seal®; Must be used w/OS 34503R; PermaDryPlus® timing cover gskt. incl.	
1	Timing Cover Set	1996-92	TCS 45952	w/o Sleeve 'N' Seal®; Must be used w/OS 34503R	
1	Timing Set w/Sleeve & Seal	2003-97	TCS 45999	w/Sleeve 'N' Seal®; Must be used w/OS 34503R; PermaDryPlus® timing cover gskt. incl.	
1	Timing Set w/Sleeve & Seal	1996-92	TCS 45949	w/Sleeve 'N' Seal®; Must be used w/OS 34503R	
1	Crankshaft Front Seal Set	2003-92	TCS 46198	New Part Number - Check for Availability	
1	Repair Sleeve	2003-92	16201	Timing Cover; Use w/installation tool	
QTY	AIR CLEANER MOUNTING	YEARS	PART NO.	DESCRIPTION	
1	Air Cleaner Gasket	2003-02	61216		
1	Air Cleaner Gasket	2001-92	60038	5 1/32" ID	
QTY	CARB & FUEL INJECTION	YEARS	PART NO.	DESCRIPTION	
3	Fuel Injector O-Ring Set	2003-92	ES 70599	Improved design	
1	Throttle Body Gasket	2003-92	60958-1		
QTY	EXHAUST GAS RECIRCULATION	YEARS	PART NO.	DESCRIPTION	
1	EGR Gasket	2003-92	70561		
QTY	OIL FILTER MOUNTING	YEARS	PART NO.	DESCRIPTION	
1	Oil Filter Adapter Gasket	2003-92	70522		
40		1991; 3.9L 239 (3916cc) OHV V6 (12 Valve) 3.9063" Bore			40
TBI; Gasoline; Naturally Aspirated Chrysler Eng.; VIN Code X					
QTY	CYLINDER HEAD	YEARS	PART NO.	DESCRIPTION	
2	Head Gasket	1991	517 SD	PermaTorque Severe Duty®	
2	Head Gasket	1991	9111 PT	PermaTorque®	
1	Head Set	1991	HS 9111 PT-2	PermaDry® molded rubber valve cover gskts. incl.; Premium valve stem seals incl.	
QTY	CONVERSION SET	YEARS	PART NO.	DESCRIPTION	
1	Gasket Conversion Set	1991	CS 9111		
QTY	MANIFOLD - INT. & EXH.	YEARS	PART NO.	DESCRIPTION	
1	Int. Manifold Gasket Set	1991	MS 93789		
1	Exh. Manifold Gasket Set	1991	MS 93791		
QTY	OIL PAN	YEARS	PART NO.	DESCRIPTION	
1	Oil Pan Gasket Set	1991	OS 30569 C	Cork	
1	Drain Plug Gasket	1991	70822		
QTY	CRANKSHAFT REAR SEAL	YEARS	PART NO.	DESCRIPTION	
1	Rear Main Seal Set	1991	BS 40245	Rubber; Two-piece	
QTY	VALVE COVER	YEARS	PART NO.	DESCRIPTION	
1	Valve Cover Gasket Set	1991	VS 50436 R	PermaDry® molded rubber gskts. incl.	
QTY	VALVE STEM SEAL SET	YEARS	PART NO.	DESCRIPTION	
1	Valve Stem Seal Set	1991	SS 72729	Loc. Int. & Exh.; Premium valve stem seals incl.	
QTY	WATER OUTLET GASKET	YEARS	PART NO.	DESCRIPTION	
1	Water Outlet Gasket	1991	35064	Water Outlet	
QTY	WATER PUMP	YEARS	PART NO.	DESCRIPTION	
1	Water Pump Gasket	1991	6584		
QTY	TIMING COVER	YEARS	PART NO.	DESCRIPTION	
1	Timing Cover Set	1991	TCS 45790	w/o Sleeve 'N' Seal®	
1	Timing Set w/Sleeve & Seal	1991	TCS 45789	w/Sleeve 'N' Seal®	
1	Repair Sleeve	1991	16201	Timing Cover; Use w/installation tool	
QTY	AIR CLEANER MOUNTING	YEARS	PART NO.	DESCRIPTION	
1	Air Cleaner Gasket	1991	60038	5 1/32" ID	
QTY	CARB & FUEL INJECTION	YEARS	PART NO.	DESCRIPTION	
1	Throttle Body Gasket	1991	60821		
QTY	EXHAUST GAS RECIRCULATION	YEARS	PART NO.	DESCRIPTION	
1	EGR Gasket	1991	70561		
QTY	OIL FILTER MOUNTING	YEARS	PART NO.	DESCRIPTION	
1	Oil Filter Adapter Gasket	1991	70522		

Dodge Truck (Incl. Minivans and SUV's) (Cont.)

41		2011 - 2007; 4.0L 241.1 (3952cc) SOHC V6 (24 Valve) 96mm Bore			41
MFI; Gasoline; Naturally Aspirated Chrysler Eng.; VIN Code X					
QTY	CYLINDER HEAD	YEARS	PART NO.	DESCRIPTION	
1	Head Gasket	2011-07	26208 PT	Loc. R.H.; Head bolts not incl.; Head bolt replacement recommended; PermaTorqueMLS® LaserWeld® Technology; Improved design	
1	Head Gasket	2011-07	26209 PT	Loc. L.H.; Head bolts not incl.; Head bolt replacement recommended; PermaTorqueMLS® LaserWeld® Technology; Improved design	
1	Head Gasket	2011-07	26368 PT	Loc. R.H.; Head bolts not incl.; Head bolt replacement recommended; PermaTorqueMLS®; May use 26208PT instead; Old design; Superseded - When depleted use 26208 PT	
1	Head Gasket	2011-07	26369 PT	Loc. L.H.; Head bolts not incl.; Head bolt replacement recommended; PermaTorqueMLS®; May use 26209PT instead; Old design; Superseded - When depleted use 26209 PT	
1	Head Set	2011-07	HS 26368 PT	Head bolts not incl.; Head bolt replacement recommended; PermaDry® molded rubber valve cover gskts. incl.; Premium valve stem seals incl.	
2	Head Bolt Set	2011-07	ES 72895	Head bolts w/Washers; Replacement recommended	
QTY	CONVERSION SET	YEARS	PART NO.	DESCRIPTION	
1	Gasket Conversion Set	2011-07	CS 9505-2	One-piece rear main retainer w/Seal not incl.; PermaDry® molded rubber oil pan gskt. incl.	
QTY	MANIFOLD - INT. & EXH.	YEARS	PART NO.	DESCRIPTION	
1	Int. Manifold Gasket Set	2011-07	MS 92165-1	Upper set incl.	
1	Plenum Gasket Set	2011-07	MS 96324	Upper set	
1	Exh. Manifold Gasket Set	2011-07	MS 95446		
QTY	EXHAUST PIPE FLANGE	YEARS	PART NO.	DESCRIPTION	
1	Exhaust Pipe Gasket	2011-07	61495	Flange	
QTY	OIL PAN	YEARS	PART NO.	DESCRIPTION	
1	Oil Pan Gasket Set	2011-07	OS 30754 R	PermaDry® molded rubber gskt. incl.	
1	Drain Plug Gasket	2011-07	70822		
QTY	CRANKSHAFT REAR SEAL	YEARS	PART NO.	DESCRIPTION	
1	Rear Main Seal Set	2011-07	BS 40168-1	w/Aluminum housing; w/Separate seal; Rubber; One-piece	
1	Rear Main Seal Set	2011-07	BS 40627	w/Aluminum housing; w/Separate seal; PTFE Rubber; One-piece	
1	Rear Main Seal Set	2011-07	BS 40734	w/Steel housing; Retainer w/Seal; Rubber; One-piece; New Part Number - Check for Availability	
1	Repair Sleeve Tool	2011-07	16300	Crankshaft	
QTY	VALVE COVER	YEARS	PART NO.	DESCRIPTION	
1	Valve Cover Gasket Set	2011-07	VS 50689 R	w/o Grommets & w/Spark plug tube seals; PermaDry® molded rubber gskts. incl.	
2	Grommet Set	2011-07	ES 71071	Valve Cover; May use ES 71105-1 instead; Old design; Superseded - When depleted use ES 71105-1	
2	Grommet Set	2011-07	ES 71105-1	Valve Cover; Improved design	
QTY	VALVE STEM SEAL SET	YEARS	PART NO.	DESCRIPTION	
2	Valve Stem Seal Set	2011-07	SS 72842	Premium valve stem seals incl.	
QTY	THERMOSTAT HOUSING	YEARS	PART NO.	DESCRIPTION	
1	O-Ring	2011-07	35861	Thermostat Housing; Thermostat seal	
QTY	WATER PUMP	YEARS	PART NO.	DESCRIPTION	
1	Water Pump Gasket	2011-07	35499	O-ring; Improved design	
1	Water Pump Gasket	2011-07	35785	Mounting	
QTY	TIMING COVER	YEARS	PART NO.	DESCRIPTION	
1	Crankshaft Front Seal Set	2011-07	TCS 45992-1	Must be used w/OS 30754R; Old design	
1	Crankshaft Front Seal Set	2011-07	TCS 46147	Must be used w/OS 30754R; Improved design	
2	Camshaft Front Seal Set	2011-07	TCS 45939		
QTY	CARB & FUEL INJECTION	YEARS	PART NO.	DESCRIPTION	
2	Fuel Injector O-Ring Set	2011-07	ES 70599	Improved design	
1	Throttle Body Gasket	2011-07	61324	Idle air control; 21mm ID	
1	Throttle Body Gasket	2011-07	61326	Idle air control; 30mm ID	
1	Throttle Body Gasket	2011-07	61389	Mounting	
QTY	EXHAUST GAS RECIRCULATION	YEARS	PART NO.	DESCRIPTION	
2	EGR Gasket	2011-07	70721	Tube flange	
1	EGR Gasket	2011-07	71185	Valve	
2	EGR Gasket	2011-07	72928	Tube seal	
42		2012 - 2000; 4.7L 287 (4703cc) SOHC V8 (16 Valve) 93mm Bore			42
MFI; Gasoline; Naturally Aspirated Chrysler Eng.; VIN Code N					
QTY	CYLINDER HEAD	YEARS	PART NO.	DESCRIPTION	
2	Head Gasket	2012-00	26157 PT	Head bolts not incl.; Head bolt replacement recommended; PermaTorqueMLS®	

Dodge Truck (Incl. Minivans and SUV's) (Cont.)

42 (cont.)		2012 - 2000; 4.7L 287 (4703cc) SOHC V8 (16 Valve) 93mm Bore			42 (cont.)
MFI; Gasoline; Naturally Aspirated Chrysler Eng.; VIN Code N					
QTY	CYLINDER HEAD	YEARS	PART NO.	DESCRIPTION	
1	Head Set	2012-08	HS 26157 PT-2	Unified valve spring/seal not incl.; Head bolts not incl.; Head bolt replacement recommended; Must be used w/TCS 46022; PermaDry® molded rubber valve cover gskts. incl.; Premium valve stem seals incl.	
1	Head Set	2007-04	HS 26157 PT-1	Head bolts not incl.; Head bolt replacement recommended; Must be used w/TCS 46022; PermaDry® molded rubber valve cover gskts. incl.; Premium valve stem seals incl.	
1	Head Set	2003-02	HS 26157 PT	Head bolts not incl.; Head bolt replacement recommended; Must be used w/TCS 46000 or TCS 46022; PermaDry® molded rubber valve cover gskts. incl.; Premium valve stem seals incl.	
1	Head Set	2001-00	HS 26157 PT	Head bolts not incl.; Head bolt replacement recommended; Must be used w/TCS 46000; PermaDry® molded rubber valve cover gskts. incl.; Premium valve stem seals incl.	
2	Head Bolt Set	2012-00	ES 71129	Head bolts w/Washers; Replacement recommended	
QTY	CONVERSION SET	YEARS	PART NO.	DESCRIPTION	
1	Gasket Conversion Set	2012-04	CS 26157	RTV sealant incl. for timing cover gskt.; PermaDry® molded rubber oil pan gskt. incl.	
1	Gasket Conversion Set	2003-02	CS 26157	1st Design; w/Timing cover gskt.; PermaDry® molded rubber oil pan gskt. incl.	
1	Gasket Conversion Set	2003-02	CS 26157	2nd Design; w/o Timing cover gskt.; RTV sealant incl. for timing cover gskt.; PermaDry® molded rubber oil pan gskt. incl.	
1	Gasket Conversion Set	2001-00	CS 26157	PermaDry® molded rubber oil pan gskt. incl.	
QTY	MANIFOLD - INT. & EXH.	YEARS	PART NO.	DESCRIPTION	
1	Int. Manifold Gasket Set	2012-08	MS 96998		
1	Int. Manifold Gasket Set	2007-00	MS 93205		
1	Exh. Manifold Gasket Set	2012-08	MS 96994		
1	Exh. Manifold Gasket Set	2007-00	MS 93217		
QTY	OIL PAN	YEARS	PART NO.	DESCRIPTION	
1	Oil Pan Gasket Set	2012-00	OS 30709 R	w/Windage tray; PermaDry® molded rubber gskt. incl.	
QTY	CRANKSHAFT REAR SEAL	YEARS	PART NO.	DESCRIPTION	
1	Rear Main Seal Set	2012-00	BS 40186	Rubber; One-piece	
1	Repair Sleeve	2012-00	16230	Crankshaft; Use w/installation tool	
1	Repair Sleeve Tool	2012-00	16328	Crankshaft	
QTY	VALVE COVER	YEARS	PART NO.	DESCRIPTION	
1	Valve Cover Gasket Set	2012-08	VS 50733 R	w/Grommets; PermaDry® molded rubber gskts. incl.	
1	Valve Cover Gasket Set	2007-04	VS 50577 R	w/Grommets; PermaDry® molded rubber gskts. incl.	
1	Valve Cover Gasket Set	2003-00	VS 50521 R	w/Grommets; PermaDry® molded rubber gskts. incl.	
QTY	VALVE STEM SEAL SET	YEARS	PART NO.	DESCRIPTION	
1	Valve Stem Seal Set	2012-08	SS 71041	Replaces unified valve spring/seal; Premium valve stem seals incl.	
1	Valve Stem Seal Set	2012-08	SS 72446	Unified valve spring/seal; Premium valve stem seals incl.; New Part Number - Check for Availability	
1	Valve Stem Seal Set	2007-00	SS 71041	Premium valve stem seals incl.	
QTY	THERMOSTAT HOUSING	YEARS	PART NO.	DESCRIPTION	
1	Thermostat Gasket	2012-00	35692	Thermostat Housing; Thermostat seal	
QTY	WATER PUMP	YEARS	PART NO.	DESCRIPTION	
1	Water Pump Gasket	2012-00	35655		
QTY	TIMING COVER	YEARS	PART NO.	DESCRIPTION	
1	Timing Cover Set	2012-04	TCS 46022	RTV sealant incl. for timing cover gskt.	
1	Timing Cover Set	2003-02	TCS 46000	1st Design; w/Timing cover gskt.	
1	Timing Cover Set	2003-02	TCS 46022	2nd Design; w/o Timing cover gskt.; RTV sealant incl. for timing cover gskt.	
1	Timing Cover Set	2001-00	TCS 46000		
QTY	AIR CLEANER MOUNTING	YEARS	PART NO.	DESCRIPTION	
1	Air Cleaner Gasket	2012-00	61216		
QTY	CARB & FUEL INJECTION	YEARS	PART NO.	DESCRIPTION	
2	Fuel Injector O-Ring Set	2012-00	ES 70599	Lower set; Injectors to cylinder head; Improved design	
2	Fuel Injector O-Ring Set	2012-00	ES 70599	Upper set; Injectors to fuel rail; Improved design	
1	Throttle Body Gasket	2012-03	61324	Idle air control; 21mm ID	
1	Throttle Body Gasket	2012-03	61326	Idle air control; 30mm ID	
1	Throttle Body Gasket	2012-08	61438	Mounting	
1	Throttle Body Gasket	2007-00	61182	Loc. Lower; Mounting	
1	Throttle Body Gasket	2007-06	61398	Dodge Durango Adventurer, Limited, SLT, SXT, Ram 1500 Pickup Laramie, SLT, SLT TRX, SLT TRX4, ST, TRX, TRX4; Loc. Upper; Mounting	
1	Throttle Body Gasket	2005	61398	Exc. Dodge Dakota Laramie, SLT, Sport, ST; Loc. Upper; Mounting	
1	Throttle Body Gasket	2001-00	60948	Dodge Dakota Base, SLT, Sport; Loc. Upper; Mounting	

Dodge Truck (Incl. Minivans and SUV's) (Cont.)

42 (cont.)	2012 - 2000; 4.7L 287 (4703cc) SOHC V8 (16 Valve) 93mm Bore				42 (cont.)
MFI; Gasoline; Naturally Aspirated Chrysler Eng.; VIN Code N					
QTY	EXHAUST GAS RECIRCULATION	YEARS	PART NO.	DESCRIPTION	
2	EGR Gasket	2012-04	70721	Tube flange	
2	EGR Gasket	2012-04	72928	Tube seal	
1	EGR Gasket	2012-08	71221	Valve	
1	EGR Gasket	2012-08	72251	Flange	
1	EGR Gasket	2007-04	71238	Valve	
1	EGR Gasket	2007-04	71240	Flange	
43	2012 - 2004; 4.7L 287 (4703cc) SOHC V8 (16 Valve) 93mm Bore				43
MFI; Flex Fuel; Naturally Aspirated Chrysler Eng.; VIN Code P					
QTY	CYLINDER HEAD	YEARS	PART NO.	DESCRIPTION	
2	Head Gasket	2012-04	26157 PT	Head bolts not incl.; Head bolt replacement recommended; PermaTorqueMLS®	
1	Head Set	2012-08	HS 26157 PT-2	Unified valve spring/seal not incl.; Head bolts not incl.; Head bolt replacement recommended; Must be used w/TCS 46022; PermaDry® molded rubber valve cover gskts. incl.; Premium valve stem seals incl.	
1	Head Set	2007-04	HS 26157 PT-1	Head bolts not incl.; Head bolt replacement recommended; Must be used w/TCS 46022; PermaDry® molded rubber valve cover gskts. incl.; Premium valve stem seals incl.	
2	Head Bolt Set	2012-04	ES 71129	Head bolts w/Washers; Replacement recommended	
QTY	CONVERSION SET	YEARS	PART NO.	DESCRIPTION	
1	Gasket Conversion Set	2012-04	CS 26157	RTV sealant incl. for timing cover gskt.; PermaDry® molded rubber oil pan gskt. incl.	
QTY	MANIFOLD - INT. & EXH.	YEARS	PART NO.	DESCRIPTION	
1	Int. Manifold Gasket Set	2012-08	MS 96998		
1	Int. Manifold Gasket Set	2007-04	MS 93205		
1	Exh. Manifold Gasket Set	2012-08	MS 96994		
1	Exh. Manifold Gasket Set	2007-04	MS 93217		
QTY	OIL PAN	YEARS	PART NO.	DESCRIPTION	
1	Oil Pan Gasket Set	2012-04	OS 30709 R	w/Windage tray; PermaDry® molded rubber gskt. incl.	
QTY	CRANKSHAFT REAR SEAL	YEARS	PART NO.	DESCRIPTION	
1	Rear Main Seal Set	2012-04	BS 40186	Rubber; One-piece	
1	Repair Sleeve	2012-04	16230	Crankshaft; Use w/installation tool	
1	Repair Sleeve Tool	2012-04	16328	Crankshaft	
QTY	VALVE COVER	YEARS	PART NO.	DESCRIPTION	
1	Valve Cover Gasket Set	2012-08	VS 50733 R	w/Grommets; PermaDry® molded rubber gskts. incl.	
1	Valve Cover Gasket Set	2007-04	VS 50577 R	w/Grommets; PermaDry® molded rubber gskts. incl.	
QTY	VALVE STEM SEAL SET	YEARS	PART NO.	DESCRIPTION	
1	Valve Stem Seal Set	2012-08	SS 71041	Replaces unified valve spring/seal; Premium valve stem seals incl.	
1	Valve Stem Seal Set	2012-08	SS 72446	Unified valve spring/seal; Premium valve stem seals incl.; New Part Number - Check for Availability	
1	Valve Stem Seal Set	2007-04	SS 71041	Premium valve stem seals incl.	
QTY	THERMOSTAT HOUSING	YEARS	PART NO.	DESCRIPTION	
1	Thermostat Gasket	2012-04	35692	Thermostat seal	
QTY	WATER PUMP	YEARS	PART NO.	DESCRIPTION	
1	Water Pump Gasket	2012-04	35655		
QTY	TIMING COVER	YEARS	PART NO.	DESCRIPTION	
1	Timing Cover Set	2012-04	TCS 46022	RTV sealant incl. for timing cover gskt.	
QTY	AIR CLEANER MOUNTING	YEARS	PART NO.	DESCRIPTION	
1	Air Cleaner Gasket	2012-04	61216		
QTY	CARB & FUEL INJECTION	YEARS	PART NO.	DESCRIPTION	
2	Fuel Injector O-Ring Set	2012-04	ES 70599	Lower set; Injectors to cylinder head; Improved design	
2	Fuel Injector O-Ring Set	2012-04	ES 70599	Upper set; Injectors to fuel rail; Improved design	
1	Throttle Body Gasket	2012-04	61324	Idle air control; 21mm ID	
1	Throttle Body Gasket	2012-04	61326	Idle air control; 30mm ID	
1	Throttle Body Gasket	2012-08	61438	Mounting	
1	Throttle Body Gasket	2007-04	61182	Loc. Lower; Mounting	
1	Throttle Body Gasket	2007	61398	Dodge Durango Adventurer, Limited, SLT, SXT, Ram 1500 Pickup Laramie, SLT, SLT TRX, SLT TRX4, ST, TRX, TRX4; Loc. Upper; Mounting	
1	Throttle Body Gasket	2006-05	61398	Loc. Upper; Mounting	
QTY	EXHAUST GAS RECIRCULATION	YEARS	PART NO.	DESCRIPTION	
2	EGR Gasket	2012-04	70721	Tube flange	
2	EGR Gasket	2012-04	72928	Tube seal	
1	EGR Gasket	2012-08	71221	Valve	

Dodge Truck (Incl. Minivans and SUV's) (Cont.)

43		2012 - 2004; 4.7L 287 (4703cc) SOHC V8 (16 Valve) 93mm Bore			43	
(cont.)		MFI; Flex Fuel; Naturally Aspirated Chrysler Eng.; VIN Code P			(cont.)	
QTY	EXHAUST GAS RECIRCULATION	YEARS	PART NO.	DESCRIPTION		
1	EGR Gasket	2012-08	72251	Flange		
1	EGR Gasket	2007-04	71238	Valve		
1	EGR Gasket	2007-04	71240	Flange		
44		2007 - 2005; 4.7L 287 (4703cc) SOHC V8 (16 Valve) 93mm Bore H.O.			44	
		MFI; Gasoline; Naturally Aspirated Chrysler Eng.; VIN Code J				
QTY	CYLINDER HEAD	YEARS	PART NO.	DESCRIPTION		
2	Head Gasket	2007-05	26157 PT	Head bolts not incl.; Head bolt replacement recommended; PermaTorqueMLS®		
1	Head Set	2007-05	HS 26157 PT-1	Head bolts not incl.; Head bolt replacement recommended; Must be used w/TCS 46022; PermaDry® molded rubber valve cover gskts. incl.; Premium valve stem seals incl.		
2	Head Bolt Set	2007-05	ES 71129	Head bolts w/Washers; Replacement recommended		
QTY	CONVERSION SET	YEARS	PART NO.	DESCRIPTION		
1	Gasket Conversion Set	2007-05	CS 26157	RTV sealant incl. for timing cover gskt.; PermaDry® molded rubber oil pan gskt. incl.		
QTY	MANIFOLD - INT. & EXH.	YEARS	PART NO.	DESCRIPTION		
1	Int. Manifold Gasket Set	2007-05	MS 93205			
1	Exh. Manifold Gasket Set	2007-05	MS 93217			
QTY	OIL PAN	YEARS	PART NO.	DESCRIPTION		
1	Oil Pan Gasket Set	2007-05	OS 30709 R	w/Windage tray; PermaDry® molded rubber gskt. incl.		
QTY	CRANKSHAFT REAR SEAL	YEARS	PART NO.	DESCRIPTION		
1	Rear Main Seal Set	2007-05	BS 40186	Rubber; One-piece		
1	Repair Sleeve	2007-05	16230	Crankshaft; Use w/installation tool		
1	Repair Sleeve Tool	2007-05	16328	Crankshaft		
QTY	VALVE COVER	YEARS	PART NO.	DESCRIPTION		
1	Valve Cover Gasket Set	2007-05	VS 50577 R	w/Grommets; PermaDry® molded rubber gskts. incl.		
QTY	VALVE STEM SEAL SET	YEARS	PART NO.	DESCRIPTION		
1	Valve Stem Seal Set	2007-05	SS 71041	Premium valve stem seals incl.		
QTY	THERMOSTAT HOUSING	YEARS	PART NO.	DESCRIPTION		
1	Thermostat Gasket	2007-05	35692	Thermostat Housing; Thermostat seal		
QTY	WATER PUMP	YEARS	PART NO.	DESCRIPTION		
1	Water Pump Gasket	2007-05	35655			
QTY	TIMING COVER	YEARS	PART NO.	DESCRIPTION		
1	Timing Cover Set	2007-05	TCS 46022	RTV sealant incl. for timing cover gskt.		
QTY	AIR CLEANER MOUNTING	YEARS	PART NO.	DESCRIPTION		
1	Air Cleaner Gasket	2007-05	61216			
QTY	CARB & FUEL INJECTION	YEARS	PART NO.	DESCRIPTION		
2	Fuel Injector O-Ring Set	2007-05	ES 70599	Lower set; Injectors to cylinder head; Improved design		
2	Fuel Injector O-Ring Set	2007-05	ES 70599	Upper set; Injectors to fuel rail; Improved design		
1	Throttle Body Gasket	2007-05	61182	Loc. Lower; Mounting		
1	Throttle Body Gasket	2007-05	61324	Idle air control; 21mm ID		
1	Throttle Body Gasket	2007-05	61326	Idle air control; 30mm ID		
QTY	EXHAUST GAS RECIRCULATION	YEARS	PART NO.	DESCRIPTION		
2	EGR Gasket	2007-05	70721	Tube flange		
1	EGR Gasket	2007-05	71238	Valve		
1	EGR Gasket	2007-05	71240	Flange		
2	EGR Gasket	2007-05	72928	Tube seal		
45		2003 - 1992; 5.2L 318 (5212cc) OHV V8 (16 Valve) 3.9063" Bore			45	
		MFI; Natural Gas; Naturally Aspirated Chrysler Eng.; VIN Code T				
QTY	CYLINDER HEAD	YEARS	PART NO.	DESCRIPTION		
2	Head Gasket	2003-92	26179 PT	Head bolts not incl.; Head bolt replacement recommended; PermaTorque®		
2	Head Gasket	2003-92	540 SD	Head bolts not incl.; Head bolt replacement recommended; PermaTorque Severe Duty®		
1	Head Set	2003-98	HS 26179 PT-2	Head bolts not incl.; Head bolt replacement recommended; PermaDry® molded rubber valve cover gskts. incl.; Premium valve stem seals incl.		
1	Head Set	1997-92	HS 26179 PT-1	Head bolts not incl.; Head bolt replacement recommended; PermaDry® molded rubber valve cover gskts. incl.; Premium valve stem seals incl.		
1	Head Bolt Set	2003-94	ES 71038-1	Replacement recommended		
QTY	CONVERSION SET	YEARS	PART NO.	DESCRIPTION		
1	Gasket Conversion Set	2003-97	CS 9898-3	PermaDry® molded rubber oil pan gskt. incl.; PermaDryPlus® timing cover gskt. incl.		

Dodge Truck (Incl. Minivans and SUV's) (Cont.)

45 (cont.)	2003 - 1992; 5.2L 318 (5212cc) OHV V8 (16 Valve) 3.9063" Bore				45 (cont.)
MFI; Natural Gas; Naturally Aspirated Chrysler Eng.; VIN Code T					
QTY	CONVERSION SET	YEARS	PART NO.	DESCRIPTION	
1	Gasket Conversion Set	1996-92	CS 9898	PermaDry® molded rubber oil pan gskt. incl.	
QTY	MANIFOLD - INT. & EXH.	YEARS	PART NO.	DESCRIPTION	
1	Int. Manifold Gasket Set	2003-98	MS 95392-1	Lower set; Upper set incl.; Manifold bolts not incl.; Manifold bolt replacement recommended	
1	Int. Manifold Gasket Set	1997-92	MS 95392	Lower set; Upper set incl.; Manifold bolts not incl.; Manifold bolt replacement recommended	
1	Plenum Gasket Set	2003-92	MS 95462	Upper set	
1	Int. Manifold Bolt Set	2003-92	ES 72169	Int. manifold bolts w/Washers; Replacement recommended	
1	Exh. Manifold Gasket Set	2003-92	MS 95480		
QTY	OIL PAN	YEARS	PART NO.	DESCRIPTION	
1	Oil Pan Gasket Set	2003-92	OS 34408 R	PermaDry® molded rubber gskt. incl.	
1	Drain Plug Gasket	2003-92	70822		
QTY	CRANKSHAFT REAR SEAL	YEARS	PART NO.	DESCRIPTION	
1	Rear Main Seal Set	2003-92	BS 40181	Rubber; Two-piece	
QTY	VALVE COVER	YEARS	PART NO.	DESCRIPTION	
1	Valve Cover Gasket Set	2003-92	VS 50419 R	PermaDry® molded rubber gskts. incl.	
QTY	VALVE STEM SEAL SET	YEARS	PART NO.	DESCRIPTION	
1	Valve Stem Seal Set	2003-92	SS 72844	Loc. Int. & Exh.; Premium valve stem seals incl.	
QTY	WATER OUTLET GASKET	YEARS	PART NO.	DESCRIPTION	
1	Water Outlet Gasket	2003-92	35064	Water Outlet	
QTY	WATER PUMP	YEARS	PART NO.	DESCRIPTION	
1	Water Pump Gasket	2003-92	35540		
QTY	TIMING COVER	YEARS	PART NO.	DESCRIPTION	
1	Timing Cover Set	2003-97	TCS 45996	w/o Sleeve 'N' Seal®; Must be used w/OS 34408R; PermaDryPlus® timing cover gskt. incl.	
1	Timing Cover Set	1996-92	TCS 45952	w/o Sleeve 'N' Seal®; Must be used w/OS 34408R	
1	Timing Set w/Sleeve & Seal	2003-97	TCS 45999	w/Sleeve 'N' Seal®; Must be used w/OS 34408R; PermaDryPlus® timing cover gskt. incl.	
1	Timing Set w/Sleeve & Seal	1996-92	TCS 45949	w/Sleeve 'N' Seal®; Must be used w/OS 34408R	
1	Crankshaft Front Seal Set	2003-92	TCS 46198	New Part Number - Check for Availability	
1	Repair Sleeve	2003-92	16201	Timing Cover; Use w/installation tool	
QTY	AIR CLEANER MOUNTING	YEARS	PART NO.	DESCRIPTION	
1	Air Cleaner Gasket	2003-02	61216		
1	Air Cleaner Gasket	2001-92	60038	5 1/32" ID	
QTY	CARB & FUEL INJECTION	YEARS	PART NO.	DESCRIPTION	
4	Fuel Injector O-Ring Set	2003-92	ES 70599	Improved design	
1	Throttle Body Gasket	2003-92	60958-1		
QTY	EXHAUST GAS RECIRCULATION	YEARS	PART NO.	DESCRIPTION	
1	EGR Gasket	2003-92	70561		
QTY	OIL FILTER MOUNTING	YEARS	PART NO.	DESCRIPTION	
1	Oil Filter Adapter Gasket	2003-92	70522		
46	2003 - 1992; 5.2L 318 (5212cc) OHV V8 (16 Valve) 3.9063" Bore				46
MFI; Gasoline; Naturally Aspirated Chrysler Eng.; VIN Code Y					
QTY	CYLINDER HEAD	YEARS	PART NO.	DESCRIPTION	
2	Head Gasket	2003-92	26179 PT	Head bolts not incl.; Head bolt replacement recommended; PermaTorque®	
2	Head Gasket	2003-92	540 SD	Head bolts not incl.; Head bolt replacement recommended; PermaTorque Severe Duty®	
1	Head Set	2003-98	HS 26179 PT-2	Head bolts not incl.; Head bolt replacement recommended; PermaDry® molded rubber valve cover gskts. incl.; Premium valve stem seals incl.	
1	Head Set	1997-92	HS 26179 PT-1	Head bolts not incl.; Head bolt replacement recommended; PermaDry® molded rubber valve cover gskts. incl.; Premium valve stem seals incl.	
1	Head Bolt Set	2003-94	ES 71038-1	Replacement recommended	
QTY	CONVERSION SET	YEARS	PART NO.	DESCRIPTION	
1	Gasket Conversion Set	2003-97	CS 9898-3	PermaDry® molded rubber oil pan gskt. incl.; PermaDryPlus® timing cover gskt. incl.	
1	Gasket Conversion Set	1996-92	CS 9898	PermaDry® molded rubber oil pan gskt. incl.	
QTY	MANIFOLD - INT. & EXH.	YEARS	PART NO.	DESCRIPTION	
1	Int. Manifold Gasket Set	2003-98	MS 95392-1	Lower set; Upper set incl.; Manifold bolts not incl.; Manifold bolt replacement recommended	
1	Int. Manifold Gasket Set	1997-92	MS 95392	Lower set; Upper set incl.; Manifold bolts not incl.; Manifold bolt replacement recommended	
1	Plenum Gasket Set	2003-92	MS 95462	Upper set	

Dodge Truck (Incl. Minivans and SUV's) (Cont.)

46 (cont.)		2003 - 1992; 5.2L 318 (5212cc) OHV V8 (16 Valve) 3.9063" Bore			46 (cont.)
MFI; Gasoline; Naturally Aspirated Chrysler Eng.; VIN Code Y					
QTY	MANIFOLD - INT. & EXH.	YEARS	PART NO.	DESCRIPTION	
1	Int. Manifold Bolt Set	2003-92	ES 72169	Int. manifold bolts w/Washers; Replacement recommended	
1	Exh. Manifold Gasket Set	2003-92	MS 95480		
QTY	OIL PAN	YEARS	PART NO.	DESCRIPTION	
1	Oil Pan Gasket Set	2003-92	OS 34408 R	PermaDry® molded rubber gskt. incl.	
1	Drain Plug Gasket	2003-92	70822		
QTY	CRANKSHAFT REAR SEAL	YEARS	PART NO.	DESCRIPTION	
1	Rear Main Seal Set	2003-92	BS 40181	Rubber; Two-piece	
QTY	VALVE COVER	YEARS	PART NO.	DESCRIPTION	
1	Valve Cover Gasket Set	2003-92	VS 50419 R	PermaDry® molded rubber gskts. incl.	
QTY	VALVE STEM SEAL SET	YEARS	PART NO.	DESCRIPTION	
1	Valve Stem Seal Set	2003-92	SS 72844	Loc. Int. & Exh.; Premium valve stem seals incl.	
QTY	WATER OUTLET GASKET	YEARS	PART NO.	DESCRIPTION	
1	Water Outlet Gasket	2003-92	35064	Water Outlet	
QTY	WATER PUMP	YEARS	PART NO.	DESCRIPTION	
1	Water Pump Gasket	2003-92	35540		
QTY	TIMING COVER	YEARS	PART NO.	DESCRIPTION	
1	Timing Cover Set	2003-97	TCS 45996	w/o Sleeve 'N' Seal®; Must be used w/OS 34408R; PermaDryPlus® timing cover gskt. incl.	
1	Timing Cover Set	1996-92	TCS 45952	w/o Sleeve 'N' Seal®; Must be used w/OS 34408R	
1	Timing Set w/Sleeve & Seal	2003-97	TCS 45999	w/Sleeve 'N' Seal®; Must be used w/OS 34408R; PermaDryPlus® timing cover gskt. incl.	
1	Timing Set w/Sleeve & Seal	1996-92	TCS 45949	w/Sleeve 'N' Seal®; Must be used w/OS 34408R	
1	Crankshaft Front Seal Set	2003-92	TCS 46198	New Part Number - Check for Availability	
1	Repair Sleeve	2003-92	16201	Timing Cover; Use w/installation tool	
QTY	AIR CLEANER MOUNTING	YEARS	PART NO.	DESCRIPTION	
1	Air Cleaner Gasket	2003-02	61216		
1	Air Cleaner Gasket	2001-92	60038	5 1/32" ID	
QTY	CARB & FUEL INJECTION	YEARS	PART NO.	DESCRIPTION	
4	Fuel Injector O-Ring Set	2003-92	ES 70599	Improved design	
1	Throttle Body Gasket	2003-92	60958-1		
QTY	EXHAUST GAS RECIRCULATION	YEARS	PART NO.	DESCRIPTION	
1	EGR Gasket	2003-92	70561		
QTY	OIL FILTER MOUNTING	YEARS	PART NO.	DESCRIPTION	
1	Oil Filter Adapter Gasket	2003-92	70522		
47		1991; 5.2L 318 (5212cc) OHV V8 (16 Valve) 3.9063" Bore			47
TBI; Gasoline; Naturally Aspirated Chrysler Eng.; VIN Code Y					
QTY	CYLINDER HEAD	YEARS	PART NO.	DESCRIPTION	
2	Head Gasket	1991	26179 PT	Head bolts not incl.; Head bolt replacement recommended; PermaTorque®	
2	Head Gasket	1991	540 SD	Head bolts not incl.; Head bolt replacement recommended; PermaTorque Severe Duty®	
1	Head Set	1991	HS 26179 PT	Head bolts not incl.; Head bolt replacement recommended; Premium valve stem seals incl.; Consolidated design	
QTY	CONVERSION SET	YEARS	PART NO.	DESCRIPTION	
1	Gasket Conversion Set	1991	CS 8553		
QTY	MANIFOLD - INT. & EXH.	YEARS	PART NO.	DESCRIPTION	
1	Int. Manifold Gasket Set	1991	MS 94964		
1	Exh. Manifold Gasket Set	1991	MS 90460		
QTY	OIL PAN	YEARS	PART NO.	DESCRIPTION	
1	Oil Pan Gasket Set	1991	OS 6566 C-2	Cork	
1	Drain Plug Gasket	1991	70822		
QTY	CRANKSHAFT REAR SEAL	YEARS	PART NO.	DESCRIPTION	
1	Rear Main Seal Set	1991	BS 40245	Rubber; Two-piece	
QTY	VALVE COVER	YEARS	PART NO.	DESCRIPTION	
1	Valve Cover Gasket Set	1991	VS 50184 R	Hi-Temp.; Rubber coated fiber	
QTY	VALVE STEM SEAL SET	YEARS	PART NO.	DESCRIPTION	
1	Valve Stem Seal Set	1991	SS 72730	Loc. Int. & Exh.; Premium valve stem seals incl.	
QTY	WATER OUTLET GASKET	YEARS	PART NO.	DESCRIPTION	
1	Water Outlet Gasket	1991	35064	Water Outlet	
QTY	WATER PUMP	YEARS	PART NO.	DESCRIPTION	
1	Water Pump Gasket	1991	35540	Dodge Dakota Base, LE, S, SE, Sport	
1	Water Pump Gasket	1991	6584	Exc. Dodge Dakota Base, LE, S, SE, Sport	

Dodge Truck (Incl. Minivans and SUV's) (Cont.)

47 (cont.)		1991; 5.2L 318 (5212cc) OHV V8 (16 Valve) 3.9063" Bore			47 (cont.)
		TBI; Gasoline; Naturally Aspirated Chrysler Eng.; VIN Code Y			
QTY	TIMING COVER	YEARS	PART NO.	DESCRIPTION	
1	Timing Cover Set	1991	TCS 6563-1	w/o Sleeve 'N' Seal®	
1	Timing Set w/Sleeve & Seal	1991	TCS 45284	w/Sleeve 'N' Seal®	
1	Repair Sleeve	1991	16201	Timing Cover; Use w/installation tool	
QTY	AIR CLEANER MOUNTING	YEARS	PART NO.	DESCRIPTION	
1	Air Cleaner Gasket	1991	60038	5 1/32" ID	
QTY	CARB & FUEL INJECTION	YEARS	PART NO.	DESCRIPTION	
1	Throttle Body Gasket	1991	60821		
QTY	EXHAUST GAS RECIRCULATION	YEARS	PART NO.	DESCRIPTION	
1	EGR Gasket	1991	70561		
QTY	OIL FILTER MOUNTING	YEARS	PART NO.	DESCRIPTION	
1	Oil Filter Adapter Gasket	1991	70522		
48		2008 - 2006; 5.7L 345 (5654cc) OHV V8 (16 Valve) 99.5mm Bore Hemi			48
		MFI; Gasoline; Naturally Aspirated Chrysler Eng.; VIN Code 2			
QTY	CYLINDER HEAD	YEARS	PART NO.	DESCRIPTION	
1	Head Gasket	2008-06	26284 PT	Loc. L.H.; Head bolts not incl.; Head bolt replacement recommended; PermaTorqueMLS®	
1	Head Gasket	2008-06	26286 PT	Loc. R.H.; Head bolts not incl.; Head bolt replacement recommended; PermaTorqueMLS®	
1	Head Set	2008-06	HS 26284 PT-1	Head bolts not incl.; Head bolt replacement recommended; RTV sealant incl. for thermostat gskt.; PermaDry® molded rubber valve cover gskts. incl.; Premium valve stem seals incl.; Improved design	
1	Head Set	2006	HS 26284 PT	Head bolts not incl.; Head bolt replacement recommended; RTV sealant incl. for thermostat gskt.; PermaDry® molded rubber valve cover gskts. incl.; Premium valve stem seals incl.; Old design	
2	Head Bolt Set	2008-06	ES 72200	Head bolts w/Washers; Replacement recommended	
QTY	CONVERSION SET	YEARS	PART NO.	DESCRIPTION	
1	Gasket Conversion Set	2008-06	CS 26284	PermaDry® molded rubber oil pan gskt. incl.	
QTY	MANIFOLD - INT. & EXH.	YEARS	PART NO.	DESCRIPTION	
1	Int. Manifold Gasket Set	2008-06	MS 96574		
1	Exh. Manifold Gasket Set	2008-06	MS 96905	Consolidated design	
1	Exh. Manifold Gasket Set	2006	MS 96532	May use MS 96905 instead; Old design	
QTY	EXHAUST PIPE FLANGE	YEARS	PART NO.	DESCRIPTION	
1	Exhaust Pipe Gasket	2008-07	61240	Exc. Chrysler Aspen Limited E, Limited J Dodge Durango Adventurer, Limited, SLT; Flange	
1	Exhaust Pipe Gasket	2006	61240	Exc. Dodge Durango Adventurer, Limited, SLT; Flange	
QTY	OIL PAN	YEARS	PART NO.	DESCRIPTION	
1	Oil Pan Gasket Set	2008-06	OS 30750 R	PermaDry® molded rubber gskt. incl.	
QTY	CRANKSHAFT REAR SEAL	YEARS	PART NO.	DESCRIPTION	
1	Rear Main Seal Set	2008-06	BS 40684	Retainer w/Seal; PTFE Rubber; One-piece; Improved design	
1	Rear Main Seal Set	2008-06	BS 40735	Rubber; One-piece; New Part Number - Check for Availability	
1	Repair Sleeve	2008-06	16230	Crankshaft; Use w/installation tool	
1	Repair Sleeve Tool	2008-06	16328	Crankshaft	
QTY	VALVE COVER	YEARS	PART NO.	DESCRIPTION	
1	Valve Cover Gasket Set	2008-06	VS 50625 R	w/Spark plug tube seals; PermaDry® molded rubber gskts. incl.	
QTY	VALVE STEM SEAL SET	YEARS	PART NO.	DESCRIPTION	
1	Valve Stem Seal Set	2008-06	SS 72914	Premium valve stem seals incl.	
QTY	THERMOSTAT HOUSING	YEARS	PART NO.	DESCRIPTION	
1	Thermostat Gasket	2008-06	35840	Thermostat Housing; Thermostat housing	
QTY	WATER PUMP	YEARS	PART NO.	DESCRIPTION	
1	Water Pump Gasket	2008-06	35760		
QTY	TIMING COVER	YEARS	PART NO.	DESCRIPTION	
1	Timing Cover Set	2008-06	TCS 46049	Old design	
1	Timing Cover Set	2008-06	TCS 46169	Improved design; New Part Number - Check for Availability	
QTY	CARB & FUEL INJECTION	YEARS	PART NO.	DESCRIPTION	
2	Fuel Injector O-Ring Set	2008-06	ES 70599	Improved design	
1	Throttle Body Gasket	2008-06	61372	Loc. Lower	
1	Throttle Body Gasket	2008-06	61415	Loc. Upper	
QTY	EXHAUST GAS RECIRCULATION	YEARS	PART NO.	DESCRIPTION	
2	EGR Gasket	2008-06	70721	Tube flange	
1	EGR Gasket	2008-06	71221	Valve	
2	EGR Gasket	2008-06	72928	Tube seal	

Dodge Truck (Incl. Minivans and SUV's) (Cont.)

49		2013 - 2012; 5.7L 345 (5654cc) OHV V8 (16 Valve) 99.5mm Bore Hemi			49
MFI; Natural Gas; Naturally Aspirated Chrysler Eng.; VIN Code 2					
QTY	CYLINDER HEAD	YEARS	PART NO.	DESCRIPTION	
1	Head Gasket	2012	26423 PT	Loc. L.H.; Head bolts not incl.; Head bolt replacement recommended; PermaTorqueMLS®	
1	Head Gasket	2012	26426 PT	Loc. R.H.; Head bolts not incl.; Head bolt replacement recommended; PermaTorqueMLS®	
1	Head Set	2012	HS 26423 PT	Head bolts not incl.; Head bolt replacement recommended; PermaDry® molded rubber valve cover gskts. incl.; Premium valve stem seals incl.	
2	Head Bolt Set	2012	ES 72200	Head bolts w/Washers; Replacement recommended	
QTY	CONVERSION SET	YEARS	PART NO.	DESCRIPTION	
1	Gasket Conversion Set	2012	CS 26284	PermaDry® molded rubber oil pan gskt. incl.	
QTY	MANIFOLD - INT. & EXH.	YEARS	PART NO.	DESCRIPTION	
1	Int. Manifold Gasket Set	2012	MS 97089		
1	Exh. Manifold Gasket Set	2012	MS 97083		
QTY	EXHAUST PIPE FLANGE	YEARS	PART NO.	DESCRIPTION	
1	Exhaust Pipe Gasket	2012	61240	Flange	
2	Exhaust Pipe Gasket	2012	61710	Pipe to manifold; New Part Number - Check for Availability	
QTY	OIL PAN	YEARS	PART NO.	DESCRIPTION	
1	Oil Pan Gasket Set	2012	OS 30750 R	PermaDry® molded rubber gskt. incl.	
QTY	CRANKSHAFT REAR SEAL	YEARS	PART NO.	DESCRIPTION	
1	Rear Main Seal Set	2012	BS 40684	Retainer w/Seal; PTFE Rubber; One-piece; Improved design	
1	Rear Main Seal Set	2012	BS 40735	Rubber; One-piece; New Part Number - Check for Availability	
1	Repair Sleeve	2012	16230	Crankshaft; Use w/installation tool	
1	Repair Sleeve Tool	2012	16328	Crankshaft	
QTY	VALVE COVER	YEARS	PART NO.	DESCRIPTION	
1	Valve Cover Gasket Set	2012	VS 50625 R	w/Spark plug tube seals; PermaDry® molded rubber gskts. incl.	
QTY	VALVE STEM SEAL SET	YEARS	PART NO.	DESCRIPTION	
1	Valve Stem Seal Set	2012	SS 72929	Premium valve stem seals incl.	
QTY	THERMOSTAT HOUSING	YEARS	PART NO.	DESCRIPTION	
1	Thermostat Gasket	2012	35840	Thermostat Housing; Thermostat housing	
QTY	WATER PUMP	YEARS	PART NO.	DESCRIPTION	
1	Water Pump Gasket	2012	35907		
QTY	TIMING COVER	YEARS	PART NO.	DESCRIPTION	
1	Timing Cover Set	2013-12	TCS 46169	Improved design; New Part Number - Check for Availability	
1	Timing Cover Set	2012	TCS 46049	Old design	
QTY	CARB & FUEL INJECTION	YEARS	PART NO.	DESCRIPTION	
2	Fuel Injector O-Ring Set	2012	ES 70599	Improved design	
1	Throttle Body Gasket	2012	61372	Loc. Lower	
1	Throttle Body Gasket	2012	61586	Loc. Upper	
QTY	EXHAUST GAS RECIRCULATION	YEARS	PART NO.	DESCRIPTION	
2	EGR Gasket	2012	70721	Tube flange	
1	EGR Gasket	2012	71221	Valve	
2	EGR Gasket	2012	72535	Tube gskt.; New Part Number - Check for Availability	
2	EGR Gasket	2012	72928	Tube seal	
50		2008 - 2007; 5.7L 345 (5654cc) OHV V8 (16 Valve) 99.5mm Bore Hemi			50
MFI; Gasoline; Naturally Aspirated Chrysler Eng.; VIN Code 8					
QTY	CYLINDER HEAD	YEARS	PART NO.	DESCRIPTION	
1	Head Gasket	2008-07	26284 PT	Loc. L.H.; Head bolts not incl.; Head bolt replacement recommended; PermaTorqueMLS®	
1	Head Gasket	2008-07	26286 PT	Loc. R.H.; Head bolts not incl.; Head bolt replacement recommended; PermaTorqueMLS®	
1	Head Set	2008-07	HS 26284 PT-1	Head bolts not incl.; Head bolt replacement recommended; RTV sealant incl. for thermostat gskt.; PermaDry® molded rubber valve cover gskts. incl.; Premium valve stem seals incl.; Improved design	
2	Head Bolt Set	2008-07	ES 72200	Head bolts w/Washers; Replacement recommended	
QTY	CONVERSION SET	YEARS	PART NO.	DESCRIPTION	
1	Gasket Conversion Set	2008-07	CS 26284	PermaDry® molded rubber oil pan gskt. incl.	
QTY	MANIFOLD - INT. & EXH.	YEARS	PART NO.	DESCRIPTION	
1	Int. Manifold Gasket Set	2008-07	MS 96574		
1	Exh. Manifold Gasket Set	2008-07	MS 96905	Consolidated design	
QTY	OIL PAN	YEARS	PART NO.	DESCRIPTION	
1	Oil Pan Gasket Set	2008-07	OS 30750 R	PermaDry® molded rubber gskt. incl.	
QTY	CRANKSHAFT REAR SEAL	YEARS	PART NO.	DESCRIPTION	
1	Rear Main Seal Set	2008-07	BS 40684	Retainer w/Seal; PTFE Rubber; One-piece; Improved design	

Dodge Truck (Incl. Minivans and SUV's) (Cont.)

50 (cont.)	2008 - 2007; 5.7L 345 (5654cc) OHV V8 (16 Valve) 99.5mm Bore Hemi				50 (cont.)
MFI; Gasoline; Naturally Aspirated Chrysler Eng.; VIN Code 8					
QTY	CRANKSHAFT REAR SEAL	YEARS	PART NO.	DESCRIPTION	
1	Rear Main Seal Set	2008-07	BS 40735	Rubber; One-piece; New Part Number - Check for Availability	
1	Repair Sleeve	2008-07	16230	Crankshaft; Use w/installation tool	
1	Repair Sleeve Tool	2008-07	16328	Crankshaft	
QTY	VALVE COVER	YEARS	PART NO.	DESCRIPTION	
1	Valve Cover Gasket Set	2008-07	VS 50625 R	w/Spark plug tube seals; PermaDry® molded rubber gsks. incl.	
QTY	VALVE STEM SEAL SET	YEARS	PART NO.	DESCRIPTION	
1	Valve Stem Seal Set	2008-07	SS 72914	Premium valve stem seals incl.	
QTY	THERMOSTAT HOUSING	YEARS	PART NO.	DESCRIPTION	
1	Thermostat Gasket	2008-07	35840	Thermostat Housing; Thermostat housing	
QTY	WATER PUMP	YEARS	PART NO.	DESCRIPTION	
1	Water Pump Gasket	2008-07	35760		
QTY	TIMING COVER	YEARS	PART NO.	DESCRIPTION	
1	Timing Cover Set	2008-07	TCS 46049	Old design	
1	Timing Cover Set	2008-07	TCS 46169	Improved design; New Part Number - Check for Availability	
QTY	CARB & FUEL INJECTION	YEARS	PART NO.	DESCRIPTION	
2	Fuel Injector O-Ring Set	2008-07	ES 70599	Improved design	
1	Throttle Body Gasket	2008-07	61372	Loc. Lower	
1	Throttle Body Gasket	2008-07	61415	Loc. Upper	
QTY	EXHAUST GAS RECIRCULATION	YEARS	PART NO.	DESCRIPTION	
2	EGR Gasket	2008-07	70721	Tube flange	
1	EGR Gasket	2008-07	71221	Valve	
2	EGR Gasket	2008-07	72928	Tube seal	
51	2008 - 2003; 5.7L 345 (5654cc) OHV V8 (16 Valve) 99.5mm Bore Hemi				51
MFI; Gasoline; Naturally Aspirated Chrysler Eng.; VIN Code D					
QTY	CYLINDER HEAD	YEARS	PART NO.	DESCRIPTION	
1	Head Gasket	2008-03	26284 PT	Loc. L.H.; Head bolts not incl.; Head bolt replacement recommended; PermaTorqueMLS®	
1	Head Gasket	2008-03	26286 PT	Loc. R.H.; Head bolts not incl.; Head bolt replacement recommended; PermaTorqueMLS®	
1	Head Set	2008-03	HS 26284 PT-1	Head bolts not incl.; Head bolt replacement recommended; RTV sealant incl. for thermostat gskt.; PermaDry® molded rubber valve cover gsks. incl.; Premium valve stem seals incl.; Improved design	
1	Head Set	2006-03	HS 26284 PT	Head bolts not incl.; Head bolt replacement recommended; RTV sealant incl. for thermostat gskt.; PermaDry® molded rubber valve cover gsks. incl.; Premium valve stem seals incl.; Old design	
2	Head Bolt Set	2008-03	ES 72200	Head bolts w/Washers; Replacement recommended	
QTY	CONVERSION SET	YEARS	PART NO.	DESCRIPTION	
1	Gasket Conversion Set	2008-03	CS 26284	PermaDry® molded rubber oil pan gskt. incl.	
QTY	MANIFOLD - INT. & EXH.	YEARS	PART NO.	DESCRIPTION	
1	Int. Manifold Gasket Set	2008-03	MS 96574		
1	Exh. Manifold Gasket Set	2008-03	MS 96905	Consolidated design	
1	Exh. Manifold Gasket Set	2006-03	MS 96532	May use MS 96905 instead; Old design	
QTY	EXHAUST PIPE FLANGE	YEARS	PART NO.	DESCRIPTION	
1	Exhaust Pipe Gasket	2008-07	61240	Flange	
1	Exhaust Pipe Gasket	2006	61240	Exc. Dodge Durango Adventurer, Limited, SLT; Flange	
1	Exhaust Pipe Gasket	2005	61240	Exc. Dodge Durango Adventurer, Limited, SLT, ST; Flange	
1	Exhaust Pipe Gasket	2004	61240	Exc. Dodge Durango Limited, SLT, ST; Flange	
1	Exhaust Pipe Gasket	2003	61240	Flange	
QTY	OIL PAN	YEARS	PART NO.	DESCRIPTION	
1	Oil Pan Gasket Set	2008-03	OS 30750 R	PermaDry® molded rubber gskt. incl.	
QTY	CRANKSHAFT REAR SEAL	YEARS	PART NO.	DESCRIPTION	
1	Rear Main Seal Set	2008-03	BS 40684	Retainer w/Seal; PTFE Rubber; One-piece; Improved design	
1	Rear Main Seal Set	2008-03	BS 40735	Rubber; One-piece; New Part Number - Check for Availability	
1	Repair Sleeve	2008-03	16230	Crankshaft; Use w/installation tool	
1	Repair Sleeve Tool	2008-03	16328	Crankshaft	
QTY	VALVE COVER	YEARS	PART NO.	DESCRIPTION	
1	Valve Cover Gasket Set	2008-03	VS 50625 R	w/Spark plug tube seals; PermaDry® molded rubber gsks. incl.	
QTY	VALVE STEM SEAL SET	YEARS	PART NO.	DESCRIPTION	
1	Valve Stem Seal Set	2008-03	SS 72914	Premium valve stem seals incl.	
QTY	THERMOSTAT HOUSING	YEARS	PART NO.	DESCRIPTION	
1	Thermostat Gasket	2008-03	35840	Thermostat Housing; Thermostat housing	
QTY	WATER PUMP	YEARS	PART NO.	DESCRIPTION	
1	Water Pump Gasket	2008-03	35760		

Dodge Truck (Incl. Minivans and SUV's) (Cont.)

51		2008 - 2003; 5.7L 345 (5654cc) OHV V8 (16 Valve) 99.5mm Bore Hemi			51
(cont.)		MFI; Gasoline; Naturally Aspirated Chrysler Eng.; VIN Code D			(cont.)
QTY	TIMING COVER	YEARS	PART NO.	DESCRIPTION	
1	Timing Cover Set	2008-03	TCS 46049	Old design	
1	Timing Cover Set	2008-03	TCS 46169	Improved design; New Part Number - Check for Availability	
QTY	CARB & FUEL INJECTION	YEARS	PART NO.	DESCRIPTION	
2	Fuel Injector O-Ring Set	2008-03	ES 70599	Improved design	
1	Throttle Body Gasket	2008-03	61372	Loc. Lower	
1	Throttle Body Gasket	2008-03	61415	Loc. Upper	
QTY	EXHAUST GAS RECIRCULATION	YEARS	PART NO.	DESCRIPTION	
2	EGR Gasket	2008-03	70721	Tube flange	
1	EGR Gasket	2008-03	71221	Valve	
2	EGR Gasket	2008-03	72928	Tube seal	
52		2013 - 2009; 5.7L 345 (5654cc) OHV V8 (16 Valve) 99.5mm Bore Hemi			52
(cont.)		MFI; Gasoline; Naturally Aspirated Chrysler Eng.; VIN Code T			(cont.)
QTY	CYLINDER HEAD	YEARS	PART NO.	DESCRIPTION	
1	Head Gasket	2012-09	26423 PT	Loc. L.H.; Head bolts not incl.; Head bolt replacement recommended; PermaTorqueMLS®	
1	Head Gasket	2012-09	26426 PT	Loc. R.H.; Head bolts not incl.; Head bolt replacement recommended; PermaTorqueMLS®	
1	Head Set	2012-09	HS 26423 PT	Head bolts not incl.; Head bolt replacement recommended; PermaDry® molded rubber valve cover gsks. incl.; Premium valve stem seals incl.	
2	Head Bolt Set	2012-09	ES 72200	Head bolts w/Washers; Replacement recommended	
QTY	CONVERSION SET	YEARS	PART NO.	DESCRIPTION	
1	Gasket Conversion Set	2012-09	CS 26284	PermaDry® molded rubber oil pan gskt. incl.	
QTY	MANIFOLD - INT. & EXH.	YEARS	PART NO.	DESCRIPTION	
1	Int. Manifold Gasket Set	2012-09	MS 97089		
1	Exh. Manifold Gasket Set	2012-09	MS 97083		
QTY	EXHAUST PIPE FLANGE	YEARS	PART NO.	DESCRIPTION	
2	Exhaust Pipe Gasket	2012-09	61710	Pipe to manifold; New Part Number - Check for Availability	
1	Exhaust Pipe Gasket	2012	61240	Exc. Dodge Durango Citadel, Crew, Crew Lux, Crew Plus, R/T; Flange	
1	Exhaust Pipe Gasket	2012	61451	Dodge Durango Citadel, Crew, Crew Lux, Crew Plus, R/T; Loc. R.H.; Converter	
1	Exhaust Pipe Gasket	2011	61240	Exc. Dodge Durango R/T; Flange	
1	Exhaust Pipe Gasket	2011	61451	Dodge Durango R/T; Loc. R.H.; Converter	
1	Exhaust Pipe Gasket	2010	61240	Flange	
1	Exhaust Pipe Gasket	2009	61240	Exc. Chrysler Aspen Limited E, Limited J Dodge Durango Adventurer, Limited, SLT; Flange	
1	Exhaust Pipe Gasket	2009	61451	Loc. R.H.; Converter	
QTY	OIL PAN	YEARS	PART NO.	DESCRIPTION	
1	Oil Pan Gasket Set	2012-09	OS 30750 R	PermaDry® molded rubber gskt. incl.	
QTY	CRANKSHAFT REAR SEAL	YEARS	PART NO.	DESCRIPTION	
1	Rear Main Seal Set	2012-09	BS 40684	Retainer w/Seal; PTFE Rubber; One-piece; Improved design	
1	Rear Main Seal Set	2012-09	BS 40735	Rubber; One-piece; New Part Number - Check for Availability	
1	Repair Sleeve	2012-09	16230	Crankshaft; Use w/installation tool	
1	Repair Sleeve Tool	2012-09	16328	Crankshaft	
QTY	VALVE COVER	YEARS	PART NO.	DESCRIPTION	
1	Valve Cover Gasket Set	2012-09	VS 50625 R	w/Spark plug tube seals; PermaDry® molded rubber gsks. incl.	
QTY	VALVE STEM SEAL SET	YEARS	PART NO.	DESCRIPTION	
1	Valve Stem Seal Set	2012-09	SS 72929	Premium valve stem seals incl.	
QTY	THERMOSTAT HOUSING	YEARS	PART NO.	DESCRIPTION	
1	Thermostat Gasket	2012-09	35840	Thermostat Housing; Thermostat housing	
QTY	WATER PUMP	YEARS	PART NO.	DESCRIPTION	
1	Water Pump Gasket	2012-09	35907		
QTY	TIMING COVER	YEARS	PART NO.	DESCRIPTION	
1	Timing Cover Set	2013-09	TCS 46169	Improved design; New Part Number - Check for Availability	
1	Timing Cover Set	2012-09	TCS 46049	Old design	
QTY	CARB & FUEL INJECTION	YEARS	PART NO.	DESCRIPTION	
2	Fuel Injector O-Ring Set	2012-09	ES 70599	Improved design	
1	Throttle Body Gasket	2012-09	61372	Loc. Lower	
1	Throttle Body Gasket	2012-09	61586	Loc. Upper	
QTY	EXHAUST GAS RECIRCULATION	YEARS	PART NO.	DESCRIPTION	
2	EGR Gasket	2012-09	70721	Tube flange	
1	EGR Gasket	2012-09	71221	Valve	
2	EGR Gasket	2012-09	72535	Tube gskt.; New Part Number - Check for Availability	

Dodge Truck (Incl. Minivans and SUV's) (Cont.)

52		2013 - 2009; 5.7L 345 (5654cc) OHV V8 (16 Valve) 99.5mm Bore Hemi			52
(cont.)		MFI; Gasoline; Naturally Aspirated Chrysler Eng.; VIN Code T			(cont.)
QTY	EXHAUST GAS RECIRCULATION	YEARS	PART NO.	DESCRIPTION	
2	EGR Gasket	2012-09	72928	Tube seal	
53		2009; 5.7L 345 (5654cc) OHV V8 (16 Valve) 99.5mm Bore Hemi			53
(cont.)		MFI; Hybrid (Gas/Electric); Naturally Aspirated Chrysler Eng.; VIN Code T			(cont.)
QTY	CYLINDER HEAD	YEARS	PART NO.	DESCRIPTION	
1	Head Gasket	2009	26423 PT	Loc. L.H.; Head bolts not incl.; Head bolt replacement recommended; PermaTorqueMLS®	
1	Head Gasket	2009	26426 PT	Loc. R.H.; Head bolts not incl.; Head bolt replacement recommended; PermaTorqueMLS®	
1	Head Set	2009	HS 26423 PT	Head bolts not incl.; Head bolt replacement recommended; PermaDry® molded rubber valve cover gskts. incl.; Premium valve stem seals incl.	
2	Head Bolt Set	2009	ES 72200	Head bolts w/Washers; Replacement recommended	
QTY	CONVERSION SET	YEARS	PART NO.	DESCRIPTION	
1	Gasket Conversion Set	2009	CS 26284	PermaDry® molded rubber oil pan gskt. incl.	
QTY	MANIFOLD - INT. & EXH.	YEARS	PART NO.	DESCRIPTION	
1	Int. Manifold Gasket Set	2009	MS 97089		
1	Exh. Manifold Gasket Set	2009	MS 97083		
QTY	EXHAUST PIPE FLANGE	YEARS	PART NO.	DESCRIPTION	
1	Exhaust Pipe Gasket	2009	61451	Loc. R.H.; Converter	
2	Exhaust Pipe Gasket	2009	61710	Pipe to manifold; New Part Number - Check for Availability	
QTY	OIL PAN	YEARS	PART NO.	DESCRIPTION	
1	Oil Pan Gasket Set	2009	OS 30750 R	PermaDry® molded rubber gskt. incl.	
QTY	CRANKSHAFT REAR SEAL	YEARS	PART NO.	DESCRIPTION	
1	Rear Main Seal Set	2009	BS 40684	Retainer w/Seal; PTFE Rubber; One-piece; Improved design	
1	Rear Main Seal Set	2009	BS 40735	Rubber; One-piece; New Part Number - Check for Availability	
1	Repair Sleeve	2009	16230	Crankshaft; Use w/installation tool	
1	Repair Sleeve Tool	2009	16328	Crankshaft	
QTY	VALVE COVER	YEARS	PART NO.	DESCRIPTION	
1	Valve Cover Gasket Set	2009	VS 50625 R	w/Spark plug tube seals; PermaDry® molded rubber gskts. incl.	
QTY	VALVE STEM SEAL SET	YEARS	PART NO.	DESCRIPTION	
1	Valve Stem Seal Set	2009	SS 72929	Premium valve stem seals incl.	
QTY	THERMOSTAT HOUSING	YEARS	PART NO.	DESCRIPTION	
1	Thermostat Gasket	2009	35840	Thermostat Housing; Thermostat housing	
QTY	WATER PUMP	YEARS	PART NO.	DESCRIPTION	
1	Water Pump Gasket	2009	35907		
QTY	TIMING COVER	YEARS	PART NO.	DESCRIPTION	
1	Timing Cover Set	2009	TCS 46049	Old design	
1	Timing Cover Set	2009	TCS 46169	Improved design; New Part Number - Check for Availability	
QTY	CARB & FUEL INJECTION	YEARS	PART NO.	DESCRIPTION	
2	Fuel Injector O-Ring Set	2009	ES 70599	Improved design	
1	Throttle Body Gasket	2009	61372	Loc. Lower	
1	Throttle Body Gasket	2009	61586	Loc. Upper	
QTY	EXHAUST GAS RECIRCULATION	YEARS	PART NO.	DESCRIPTION	
2	EGR Gasket	2009	70721	Tube flange	
1	EGR Gasket	2009	71221	Valve	
2	EGR Gasket	2009	72535	Tube gskt.; New Part Number - Check for Availability	
2	EGR Gasket	2009	72928	Tube seal	
54		1991; 5.9L 359 (5882cc) OHV Turbo - Intercooled L6 (12 Valve) 102mm Bore			54
(cont.)		MFI; Diesel; Turbo - Intercooled Cummins Eng.; VIN Code 8, Eng. Code 6BTA5.9			(cont.)
QTY	CYLINDER HEAD	YEARS	PART NO.	DESCRIPTION	
1	Head Gasket	1991	9313 PT	Standard; Head bolts not incl.; Head bolt replacement recommended; .061" thickness; Improved design	
1	Head Gasket	1991	9332 PT	Standard; Head bolts not incl.; Head bolt replacement recommended; .061" thickness; Old design	
1	Head Gasket	1991	9523 PT	Head bolts not incl.; Head bolt replacement recommended; .081" thickness; .50mm oversize thickness	
1	Head Gasket	1991	9534 PT	Head bolts not incl.; Head bolt replacement recommended; .071" thickness; .25mm oversize thickness	
1	Head Set w/o Head Gasket	1991	HSU 9332	Head gskt. & head bolts not incl.; Head bolt replacement recommended; PermaDry® molded rubber valve cover gskts. incl.; Premium valve stem seals incl.	
QTY	CONVERSION SET	YEARS	PART NO.	DESCRIPTION	
1	Gasket Conversion Set	1991	CS 9332		

Dodge Truck (Incl. Minivans and SUV's) (Cont.)

54		1991; 5.9L 359 (5882cc) OHV Turbo - Intercooled L6 (12 Valve) 102mm Bore			54	
(cont.)		MFI; Diesel; Turbo - Intercooled Cummins Eng.; VIN Code 8, Eng. Code 6BTA5.9			(cont.)	
QTY	MANIFOLD - INT. & EXH.	YEARS	PART NO.	DESCRIPTION		
1	Int. Manifold Gasket Set	1991	MS 95087	Lower set; Upper set incl.		
1	Plenum Gasket Set	1991	MS 97248	Upper set; New Part Number - Check for Availability		
1	Exh. Manifold Gasket Set	1991	MS 92089			
QTY	EXHAUST PIPE FLANGE	YEARS	PART NO.	DESCRIPTION		
1	Exhaust Pipe Gasket	1991	60928	Pipe to manifold		
QTY	OIL PAN	YEARS	PART NO.	DESCRIPTION		
1	Oil Pan Gasket Set	1991	OS 34102			
QTY	CRANKSHAFT REAR SEAL	YEARS	PART NO.	DESCRIPTION		
1	Rear Main Seal Set	1991	BS 40633	PTFE Rubber; One-piece		
1	Repair Sleeve	1991	16274	Crankshaft; Use w/installation tool		
1	Repair Sleeve Tool	1991	16319	Crankshaft		
QTY	VALVE COVER	YEARS	PART NO.	DESCRIPTION		
6	Valve Cover Gasket Set	1991	VS 50396 R	w/Grommet; PermaDry® molded rubber gskt. incl.; Improved design		
1	Valve Cover Gasket Set	1991	VS 50396 R-1	Complete set; w/Grommets; PermaDry® molded rubber gskts. incl.; Improved design; New Part Number - Check for Availability		
QTY	PUSH ROD COVER	YEARS	PART NO.	DESCRIPTION		
1	Push Rod Cover Gasket Set	1991	PS 50397 R	w/Grommets; PermaDry® molded rubber gskt. incl.		
QTY	VALVE STEM SEAL SET	YEARS	PART NO.	DESCRIPTION		
1	Valve Stem Seal Set	1991	SS 70819-1	Premium valve stem seals incl.		
QTY	THERMOSTAT HOUSING	YEARS	PART NO.	DESCRIPTION		
1	O-Ring	1991	35526	Thermostat Housing		
QTY	WATER PUMP	YEARS	PART NO.	DESCRIPTION		
1	Water Pump Gasket	1991	35525			
QTY	TIMING COVER	YEARS	PART NO.	DESCRIPTION		
1	Timing Cover Set	1991	TCS 45902			
1	Crankshaft Front Seal Set	1991	TCS 46174	New Part Number - Check for Availability		
1	Repair Sleeve	1991	16219	Timing Cover; Use w/installation tool		
1	Repair Sleeve Tool	1991	16318	Timing Cover		
55		1996 - 1991; 5.9L 359 (5882cc) OHV Turbo - Intercooled L6 (12 Valve) 102mm Bore			55	
(cont.)		MFI; Diesel; Turbo - Intercooled Cummins Eng.; VIN Code C, Eng. Code 6BTA5.9			(cont.)	
QTY	CYLINDER HEAD	YEARS	PART NO.	DESCRIPTION		
1	Head Gasket	1996-91	9313 PT	Standard; Head bolts not incl.; Head bolt replacement recommended; .061" thickness; Improved design		
1	Head Gasket	1996-91	9332 PT	Standard; Head bolts not incl.; Head bolt replacement recommended; .061" thickness; Old design		
1	Head Gasket	1996-91	9523 PT	Head bolts not incl.; Head bolt replacement recommended; .081" thickness; .50mm oversize thickness		
1	Head Gasket	1996-91	9534 PT	Head bolts not incl.; Head bolt replacement recommended; .071" thickness; .25mm oversize thickness		
1	Head Set w/o Head Gasket	1996-91	HSU 9332	Head gskt. & head bolts not incl.; Head bolt replacement recommended; PermaDry® molded rubber valve cover gskts. incl.; Premium valve stem seals incl.		
QTY	CONVERSION SET	YEARS	PART NO.	DESCRIPTION		
1	Gasket Conversion Set	1996-94	CS 9313			
1	Gasket Conversion Set	1993-91	CS 9332			
QTY	MANIFOLD - INT. & EXH.	YEARS	PART NO.	DESCRIPTION		
1	Int. Manifold Gasket Set	1996-91	MS 95087	Lower set; Upper set incl.		
1	Plenum Gasket Set	1996-91	MS 97248	Upper set; New Part Number - Check for Availability		
1	Exh. Manifold Gasket Set	1996-91	MS 92089			
QTY	EXHAUST PIPE FLANGE	YEARS	PART NO.	DESCRIPTION		
1	Exhaust Pipe Gasket	1993-91	60928	Pipe to manifold		
QTY	OIL PAN	YEARS	PART NO.	DESCRIPTION		
1	Oil Pan Gasket Set	1996-94	OS 30694			
1	Oil Pan Gasket Set	1993-91	OS 34102			
QTY	CRANKSHAFT REAR SEAL	YEARS	PART NO.	DESCRIPTION		
1	Rear Main Seal Set	1996-94	BS 40650	PTFE Rubber; One-piece; Improved design		
1	Rear Main Seal Set	1993-91	BS 40633	PTFE Rubber; One-piece		
1	Repair Sleeve	1996-91	16274	Crankshaft; Use w/installation tool		
1	Repair Sleeve Tool	1996-91	16319	Crankshaft		
QTY	VALVE COVER	YEARS	PART NO.	DESCRIPTION		
6	Valve Cover Gasket Set	1996-91	VS 50396 R	w/Grommet; PermaDry® molded rubber gskt. incl.; Improved design		

Dodge Truck (Incl. Minivans and SUV's) (Cont.)

55		1996 - 1991; 5.9L 359 (5882cc) OHV Turbo - Intercooled L6 (12 Valve) 102mm Bore			55
(cont.)		MFI; Diesel; Turbo - Intercooled Cummins Eng.; VIN Code C, Eng. Code 6BTA5.9			(cont.)
QTY	VALVE COVER	YEARS	PART NO.	DESCRIPTION	
1	Valve Cover Gasket Set	1996-91	VS 50396 R-1	Complete set; w/Grommets; PermaDry® molded rubber gskts. incl.; Improved design; New Part Number - Check for Availability	
QTY	PUSH ROD COVER	YEARS	PART NO.	DESCRIPTION	
1	Push Rod Cover Gasket Set	1996-91	PS 50397 R	w/Grommets; PermaDry® molded rubber gskt. incl.	
QTY	VALVE STEM SEAL SET	YEARS	PART NO.	DESCRIPTION	
1	Valve Stem Seal Set	1996-91	SS 70819-1	Premium valve stem seals incl.	
QTY	THERMOSTAT HOUSING	YEARS	PART NO.	DESCRIPTION	
1	Thermostat Gasket	1996-94	35639	Thermostat Housing	
1	O-Ring	1993-91	35526	Thermostat Housing	
QTY	WATER PUMP	YEARS	PART NO.	DESCRIPTION	
1	Water Pump Gasket	1996-91	35525		
QTY	TIMING COVER	YEARS	PART NO.	DESCRIPTION	
1	Timing Cover Set	1996-94	TCS 46001		
1	Timing Cover Set	1993-91	TCS 45902		
1	Crankshaft Front Seal Set	1996-91	TCS 46174	New Part Number - Check for Availability	
1	Repair Sleeve	1996-91	16219	Timing Cover; Use w/installation tool	
1	Repair Sleeve Tool	1996-91	16318	Timing Cover	
56		1999 - 1997; 5.9L 359 (5882cc) OHV Turbo - Intercooled L6 (12 Valve) 102mm Bore			56
(cont.)		MFI; Diesel; Turbo - Intercooled Cummins Eng.; VIN Code D, Eng. Code 6BTA5.9			(cont.)
QTY	CYLINDER HEAD	YEARS	PART NO.	DESCRIPTION	
1	Head Gasket	1999-97	9313 PT	Standard; Head bolts not incl.; Head bolt replacement recommended; .061" thickness; Improved design	
1	Head Gasket	1999-97	9523 PT	Head bolts not incl.; Head bolt replacement recommended; .081" thickness; .50mm oversize thickness	
1	Head Gasket	1999-97	9534 PT	Head bolts not incl.; Head bolt replacement recommended; .071" thickness; .25mm oversize thickness	
1	Head Set	1999-98	HS 9313 PT-1	Head bolts not incl.; Head bolt replacement recommended; PermaDry® molded rubber valve cover gskts. incl.; Premium valve stem seals incl.	
1	Head Set	1997	HS 9313 PT	Head bolts not incl.; Head bolt replacement recommended; PermaDry® molded rubber valve cover gskts. incl.; Premium valve stem seals incl.	
QTY	CONVERSION SET	YEARS	PART NO.	DESCRIPTION	
1	Gasket Conversion Set	1999-97	CS 9313		
QTY	MANIFOLD - INT. & EXH.	YEARS	PART NO.	DESCRIPTION	
1	Int. Manifold Gasket Set	1999-97	MS 95087	Lower set; Upper set incl.	
1	Plenum Gasket Set	1999-97	MS 97248	Upper set; New Part Number - Check for Availability	
1	Exh. Manifold Gasket Set	1999-97	MS 92089		
QTY	OIL PAN	YEARS	PART NO.	DESCRIPTION	
1	Oil Pan Gasket Set	1999-97	OS 30694		
QTY	CRANKSHAFT REAR SEAL	YEARS	PART NO.	DESCRIPTION	
1	Rear Main Seal Set	1999-97	BS 40650	PTFE Rubber; One-piece; Improved design	
1	Repair Sleeve	1999-97	16274	Crankshaft; Use w/installation tool	
1	Repair Sleeve Tool	1999-97	16319	Crankshaft	
QTY	VALVE COVER	YEARS	PART NO.	DESCRIPTION	
6	Valve Cover Gasket Set	1999-97	VS 50396 R	w/Grommet; PermaDry® molded rubber gskt. incl.; Improved design	
1	Valve Cover Gasket Set	1999-97	VS 50396 R-1	Complete set; w/Grommets; PermaDry® molded rubber gskts. incl.; Improved design; New Part Number - Check for Availability	
6	Valve Cover Gasket Set	1999-98	VS 50505 R	PermaDry® molded rubber gskt. incl.; Old design	
QTY	PUSH ROD COVER	YEARS	PART NO.	DESCRIPTION	
1	Push Rod Cover Gasket Set	1999-97	PS 50397 R	w/Grommets; PermaDry® molded rubber gskt. incl.	
QTY	VALVE STEM SEAL SET	YEARS	PART NO.	DESCRIPTION	
1	Valve Stem Seal Set	1999-97	SS 70819-1	Premium valve stem seals incl.	
QTY	THERMOSTAT HOUSING	YEARS	PART NO.	DESCRIPTION	
1	Thermostat Gasket	1999-97	35639	Thermostat Housing	
QTY	WATER PUMP	YEARS	PART NO.	DESCRIPTION	
1	Water Pump Gasket	1999-97	35525		
QTY	TIMING COVER	YEARS	PART NO.	DESCRIPTION	
1	Timing Cover Set	1999-97	TCS 46001		
1	Crankshaft Front Seal Set	1999-97	TCS 46174	New Part Number - Check for Availability	
1	Repair Sleeve	1999-97	16219	Timing Cover; Use w/installation tool	
1	Repair Sleeve Tool	1999-97	16318	Timing Cover	

Dodge Truck (Incl. Minivans and SUV's) (Cont.)

57		2005 - 1998; 5.9L 359 (5882cc) OHV Turbo - Intercooled L6 (24 Valve) 102mm Bore MFI; Diesel; Turbo - Intercooled Cummins Eng.; VIN Code 6, Eng. Code 6BTA5.9			57
QTY	CYLINDER HEAD	YEARS	PART NO.	DESCRIPTION	
1	Head Gasket	2005-03	26216 PT	Piston protrusion less than .30mm; Head bolts not incl.; Head bolt replacement recommended; PermaTorqueMLS® LaserWeld® Technology	
1	Head Gasket	2005-03	26218 PT	Piston protrusion over .30mm; Head bolts not incl.; Head bolt replacement recommended; PermaTorqueMLS® LaserWeld® Technology	
1	Head Gasket	2002-98	9522 PT	Head bolts not incl.; Head bolt replacement recommended; .061" thickness	
1	Head Set	2005-03	HS 26218 PT	Piston protrusion over .30mm; Upper valve cover gskt. & head bolts not incl.; Head bolt replacement recommended; PermaDry® molded rubber Lower valve cover gskt. incl.; Premium valve stem seals incl.	
1	Head Set	2002-98	HS 9522 PT	Head bolts not incl.; Head bolt replacement recommended; PermaDry® molded rubber valve cover gskt. incl.; Premium valve stem seals incl.	
1	Head Bolt Set	2005-98	ES 72193	Replacement recommended	
QTY	CONVERSION SET	YEARS	PART NO.	DESCRIPTION	
1	Gasket Conversion Set	2005-03	CS 26218		
1	Gasket Conversion Set	2002-98	CS 9522		
QTY	MANIFOLD - INT. & EXH.	YEARS	PART NO.	DESCRIPTION	
1	Int. Manifold Gasket Set	2005-03	MS 96279	Lower set; Upper set incl.	
1	Int. Manifold Gasket Set	2002-98	MS 95087	Lower set; Upper set incl.	
1	Plenum Gasket Set	2005-98	MS 97248	Upper set; New Part Number - Check for Availability	
1	Exh. Manifold Gasket Set	2005	MS 96677		
1	Exh. Manifold Gasket Set	2004	MS 92492	To 01/03/04	
1	Exh. Manifold Gasket Set	2004	MS 96677	From 01/04/04	
1	Exh. Manifold Gasket Set	2003-98	MS 92492		
QTY	OIL PAN	YEARS	PART NO.	DESCRIPTION	
1	Oil Pan Gasket Set	2005-03	OS 30738		
1	Oil Pan Gasket Set	2002-98	OS 30694		
QTY	CRANKSHAFT REAR SEAL	YEARS	PART NO.	DESCRIPTION	
1	Rear Main Seal Set	2005-98	BS 40650	PTFE Rubber; One-piece; Improved design	
1	Rear Main Seal Set	2005-04	BS 40692	PTFE Rubber; One-piece; Old design	
1	Repair Sleeve	2005-98	16274	Crankshaft; Use w/installation tool	
1	Repair Sleeve Tool	2005-98	16319	Crankshaft	
QTY	VALVE COVER	YEARS	PART NO.	DESCRIPTION	
1	Valve Cover Gasket Set	2005-03	VS 50582 R	Loc. Upper; w/Grommets; PermaDry® molded rubber gskt. incl.	
1	Valve Cover Gasket Set	2005-03	VS 50589 R	Loc. Lower; PermaDry® molded rubber gskt. incl.	
1	Valve Cover Gasket Set	2002-98	VS 50506 R	w/Grommets; PermaDry® molded rubber gskt. incl.	
1	Grommet Set	2005-03	ES 72720	Valve Cover; Loc. Upper; Optional set; Isolator bolt w/Integral grommet; New Part Number - Check for Availability	
QTY	PUSH ROD COVER	YEARS	PART NO.	DESCRIPTION	
1	Push Rod Cover Gasket Set	2002-98	PS 50397 R	w/Grommets; PermaDry® molded rubber gskt. incl.	
QTY	VALVE STEM SEAL SET	YEARS	PART NO.	DESCRIPTION	
1	Valve Stem Seal Set	2005-03	SS 71186	Premium valve stem seals incl.	
1	Valve Stem Seal Set	2002-98	SS 70937	Premium valve stem seals incl.	
QTY	THERMOSTAT HOUSING	YEARS	PART NO.	DESCRIPTION	
1	Thermostat Gasket	2005-03	35703	Thermostat Housing; Thermostat seal	
1	Thermostat Gasket	2002-98	35639	Thermostat Housing	
QTY	WATER PUMP	YEARS	PART NO.	DESCRIPTION	
1	Water Pump Gasket	2005-98	35525		
QTY	TIMING COVER	YEARS	PART NO.	DESCRIPTION	
1	Timing Cover Set	2005-03	TCS 46031		
1	Timing Cover Set	2002-98	TCS 45994		
1	Crankshaft Front Seal Set	2005-98	TCS 46174	New Part Number - Check for Availability	
1	Repair Sleeve	2005-98	16219	Timing Cover; Use w/installation tool	
1	Repair Sleeve Tool	2005-98	16318	Timing Cover	
QTY	CARB & FUEL INJECTION	YEARS	PART NO.	DESCRIPTION	
1	Fuel Injector O-Ring Set	2002-98	72773	Fuel heater seal; New Part Number - Check for Availability	
1	Fuel Injector O-Ring Set	2002-98	ES 72773	Fuel heater service kit; New Part Number - Check for Availability	
QTY	OIL COOLER	YEARS	PART NO.	DESCRIPTION	
1	Oil Cooler Mounting Set	2005-03	ES 72376		
58		2004 - 1998; 5.9L 359 (5882cc) OHV Turbo - Intercooled L6 (24 Valve) 102mm Bore MFI; Diesel; Turbo - Intercooled Cummins Eng.; VIN Code 7, Eng. Code 6BTA5.9			58
QTY	CYLINDER HEAD	YEARS	PART NO.	DESCRIPTION	
1	Head Gasket	2004-03	26216 PT	Piston protrusion less than .30mm; Head bolts not incl.; Head bolt replacement recommended; PermaTorqueMLS® LaserWeld® Technology	

Dodge Truck (Incl. Minivans and SUV's) (Cont.)

58 (cont.)		2004 - 1998; 5.9L 359 (5882cc) OHV Turbo - Intercooled L6 (24 Valve) 102mm Bore MFI; Diesel; Turbo - Intercooled Cummins Eng.; VIN Code 7, Eng. Code 6BTA5.9			58 (cont.)
QTY	CYLINDER HEAD	YEARS	PART NO.	DESCRIPTION	
1	Head Gasket	2004-03	26218 PT	Piston protrusion over .30mm; Head bolts not incl.; Head bolt replacement recommended; PermaTorqueMLS® LaserWeld® Technology	
1	Head Gasket	2002-98	9522 PT	Head bolts not incl.; Head bolt replacement recommended; .061" thickness	
1	Head Set	2004-03	HS 26218 PT	Piston protrusion over .30mm; Upper valve cover gskt. & head bolts not incl.; Head bolt replacement recommended; PermaDry® molded rubber Lower valve cover gskt. incl.; Premium valve stem seals incl.	
1	Head Set	2002-98	HS 9522 PT	Head bolts not incl.; Head bolt replacement recommended; PermaDry® molded rubber valve cover gskt. incl.; Premium valve stem seals incl.	
1	Head Bolt Set	2004-98	ES 72193	Replacement recommended	
QTY	CONVERSION SET	YEARS	PART NO.	DESCRIPTION	
1	Gasket Conversion Set	2004-03	CS 26218		
1	Gasket Conversion Set	2002-98	CS 9522		
QTY	MANIFOLD - INT. & EXH.	YEARS	PART NO.	DESCRIPTION	
1	Int. Manifold Gasket Set	2004-03	MS 96279	Lower set; Upper set incl.	
1	Int. Manifold Gasket Set	2002-98	MS 95087	Lower set; Upper set incl.	
1	Plenum Gasket Set	2004-98	MS 97248	Upper set; New Part Number - Check for Availability	
1	Exh. Manifold Gasket Set	2004	MS 92492	To 01/03/04	
1	Exh. Manifold Gasket Set	2004	MS 96677	From 01/04/04	
1	Exh. Manifold Gasket Set	2003-98	MS 92492		
QTY	OIL PAN	YEARS	PART NO.	DESCRIPTION	
1	Oil Pan Gasket Set	2004-03	OS 30738		
1	Oil Pan Gasket Set	2002-98	OS 30694		
QTY	CRANKSHAFT REAR SEAL	YEARS	PART NO.	DESCRIPTION	
1	Rear Main Seal Set	2004-98	BS 40650	PTFE Rubber; One-piece; Improved design	
1	Rear Main Seal Set	2004	BS 40692	PTFE Rubber; One-piece; Old design	
1	Repair Sleeve	2004-98	16274	Crankshaft; Use w/installation tool	
1	Repair Sleeve Tool	2004-98	16319	Crankshaft	
QTY	VALVE COVER	YEARS	PART NO.	DESCRIPTION	
1	Valve Cover Gasket Set	2004-03	VS 50582 R	Loc. Upper; w/Grommets; PermaDry® molded rubber gskt. incl.	
1	Valve Cover Gasket Set	2004-03	VS 50589 R	Loc. Lower; PermaDry® molded rubber gskt. incl.	
1	Valve Cover Gasket Set	2002-98	VS 50506 R	w/Grommets; PermaDry® molded rubber gskt. incl.	
1	Grommet Set	2004-03	ES 72720	Valve Cover; Loc. Upper; Optional set; Isolator bolt w/Integral grommet; New Part Number - Check for Availability	
QTY	PUSH ROD COVER	YEARS	PART NO.	DESCRIPTION	
1	Push Rod Cover Gasket Set	2002-98	PS 50397 R	w/Grommets; PermaDry® molded rubber gskt. incl.	
QTY	VALVE STEM SEAL SET	YEARS	PART NO.	DESCRIPTION	
1	Valve Stem Seal Set	2004-03	SS 71186	Premium valve stem seals incl.	
1	Valve Stem Seal Set	2002-98	SS 70937	Premium valve stem seals incl.	
QTY	THERMOSTAT HOUSING	YEARS	PART NO.	DESCRIPTION	
1	Thermostat Gasket	2004-03	35703	Thermostat Housing; Thermostat seal	
1	Thermostat Gasket	2002-98	35639	Thermostat Housing	
QTY	WATER PUMP	YEARS	PART NO.	DESCRIPTION	
1	Water Pump Gasket	2004-98	35525		
QTY	TIMING COVER	YEARS	PART NO.	DESCRIPTION	
1	Timing Cover Set	2004-03	TCS 46031		
1	Timing Cover Set	2002-98	TCS 45994		
1	Crankshaft Front Seal Set	2004-98	TCS 46174	New Part Number - Check for Availability	
1	Repair Sleeve	2004-98	16219	Timing Cover; Use w/installation tool	
1	Repair Sleeve Tool	2004-98	16318	Timing Cover	
QTY	CARB & FUEL INJECTION	YEARS	PART NO.	DESCRIPTION	
1	Fuel Injector O-Ring Set	2002-98	72773	Fuel heater seal; New Part Number - Check for Availability	
1	Fuel Injector O-Ring Set	2002-98	ES 72773	Fuel heater service kit; New Part Number - Check for Availability	
QTY	OIL COOLER	YEARS	PART NO.	DESCRIPTION	
1	Oil Cooler Mounting Set	2004-03	ES 72376		
59		2010; 5.9L 359 (5882cc) OHV Turbo - Intercooled L6 (24 Valve) 102mm Bore H.O. MFI; Diesel; Turbo - Intercooled Cummins Eng.; VIN Code 7, Eng. Code 6BTA5.9			59
QTY	CYLINDER HEAD	YEARS	PART NO.	DESCRIPTION	
1	Head Gasket	2010	26216 PT	Piston protrusion less than .30mm; Head bolts not incl.; Head bolt replacement recommended; PermaTorqueMLS® LaserWeld® Technology	
1	Head Gasket	2010	26218 PT	Piston protrusion over .30mm; Head bolts not incl.; Head bolt replacement recommended; PermaTorqueMLS® LaserWeld® Technology	

Dodge Truck (Incl. Minivans and SUV's) (Cont.)

59		2010; 5.9L 359 (5882cc) OHV Turbo - Intercooled L6 (24 Valve) 102mm Bore H.O.			59	
(cont.)		MFI; Diesel; Turbo - Intercooled Cummins Eng.; VIN Code 7, Eng. Code 6BTA5.9			(cont.)	
QTY	CYLINDER HEAD	YEARS	PART NO.	DESCRIPTION		
1	Head Set	2010	HS 26218 PT	Piston protrusion over .30mm; Upper valve cover gskt. & head bolts not incl.; Head bolt replacement recommended; PermaDry® molded rubber Lower valve cover gskt. incl.; Premium valve stem seals incl.		
1	Head Bolt Set	2010	ES 72193	Replacement recommended		
QTY	CONVERSION SET	YEARS	PART NO.	DESCRIPTION		
1	Gasket Conversion Set	2010	CS 26218			
QTY	MANIFOLD - INT. & EXH.	YEARS	PART NO.	DESCRIPTION		
1	Int. Manifold Gasket Set	2010	MS 96279	Lower set; Upper set incl.		
1	Plenum Gasket Set	2010	MS 97248	Upper set; New Part Number - Check for Availability		
1	Exh. Manifold Gasket Set	2010	MS 96677			
QTY	OIL PAN	YEARS	PART NO.	DESCRIPTION		
1	Oil Pan Gasket Set	2010	OS 30738			
QTY	CRANKSHAFT REAR SEAL	YEARS	PART NO.	DESCRIPTION		
1	Rear Main Seal Set	2010	BS 40650	PTFE Rubber; One-piece; Improved design		
1	Rear Main Seal Set	2010	BS 40692	PTFE Rubber; One-piece; Old design		
1	Repair Sleeve	2010	16274	Crankshaft; Use w/installation tool		
1	Repair Sleeve Tool	2010	16319	Crankshaft		
QTY	VALVE COVER	YEARS	PART NO.	DESCRIPTION		
1	Valve Cover Gasket Set	2010	VS 50589 R	Loc. Lower; PermaDry® molded rubber gskt. incl.		
1	Valve Cover Gasket Set	2010	VS 50668 R	Loc. Upper; w/Grommets; PermaDry® molded rubber gskt. incl.		
1	Grommet Set	2010	ES 72720	Valve Cover; Loc. Upper; Optional set; Isolator bolt w/Integral grommet; New Part Number - Check for Availability		
QTY	VALVE STEM SEAL SET	YEARS	PART NO.	DESCRIPTION		
1	Valve Stem Seal Set	2010	SS 71186	Premium valve stem seals incl.		
QTY	THERMOSTAT HOUSING	YEARS	PART NO.	DESCRIPTION		
1	Thermostat Gasket	2010	35703	Thermostat Housing; Thermostat seal		
QTY	WATER PUMP	YEARS	PART NO.	DESCRIPTION		
1	Water Pump Gasket	2010	35525			
QTY	TIMING COVER	YEARS	PART NO.	DESCRIPTION		
1	Timing Cover Set	2010	TCS 46031			
1	Crankshaft Front Seal Set	2010	TCS 46174	New Part Number - Check for Availability		
1	Repair Sleeve	2010	16219	Timing Cover; Use w/installation tool		
1	Repair Sleeve Tool	2010	16318	Timing Cover		
QTY	OIL COOLER	YEARS	PART NO.	DESCRIPTION		
1	Oil Cooler Mounting Set	2010	ES 72376			
60		2010 - 2002; 5.9L 359 (5882cc) OHV Turbo - Intercooled L6 (24 Valve) 102mm Bore H.O.			60	
(cont.)		MFI; Diesel; Turbo - Intercooled Cummins Eng.; VIN Code C, Eng. Code 6BTA5.9			(cont.)	
QTY	CYLINDER HEAD	YEARS	PART NO.	DESCRIPTION		
1	Head Gasket	2010-03	26216 PT	Piston protrusion less than .30mm; Head bolts not incl.; Head bolt replacement recommended; PermaTorqueMLS® LaserWeld® Technology		
1	Head Gasket	2010-03	26218 PT	Piston protrusion over .30mm; Head bolts not incl.; Head bolt replacement recommended; PermaTorqueMLS® LaserWeld® Technology		
1	Head Gasket	2002	9522 PT	Head bolts not incl.; Head bolt replacement recommended; .061" thickness		
1	Head Set	2010-03	HS 26218 PT	Piston protrusion over .30mm; Upper valve cover gskt. & head bolts not incl.; Head bolt replacement recommended; PermaDry® molded rubber Lower valve cover gskt. incl.; Premium valve stem seals incl.		
1	Head Set	2002	HS 9522 PT	Head bolts not incl.; Head bolt replacement recommended; PermaDry® molded rubber valve cover gskt. incl.; Premium valve stem seals incl.		
1	Head Bolt Set	2010-02	ES 72193	Replacement recommended		
QTY	CONVERSION SET	YEARS	PART NO.	DESCRIPTION		
1	Gasket Conversion Set	2010-03	CS 26218			
1	Gasket Conversion Set	2002	CS 9522			
QTY	MANIFOLD - INT. & EXH.	YEARS	PART NO.	DESCRIPTION		
1	Int. Manifold Gasket Set	2010-03	MS 96279	Lower set; Upper set incl.		
1	Int. Manifold Gasket Set	2002	MS 95087	Lower set; Upper set incl.		
1	Plenum Gasket Set	2010-02	MS 97248	Upper set; New Part Number - Check for Availability		
1	Exh. Manifold Gasket Set	2010-05	MS 96677			
1	Exh. Manifold Gasket Set	2004	MS 92492	To 01/03/04		
1	Exh. Manifold Gasket Set	2004	MS 96677	From 01/04/04		
1	Exh. Manifold Gasket Set	2003-02	MS 92492			
QTY	OIL PAN	YEARS	PART NO.	DESCRIPTION		
1	Oil Pan Gasket Set	2010-03	OS 30738			
1	Oil Pan Gasket Set	2002	OS 30694			

Dodge Truck (Incl. Minivans and SUV's) (Cont.)

60 (cont.)		2010 - 2002; 5.9L 359 (5882cc) OHV Turbo - Intercooled L6 (24 Valve) 102mm Bore H.O. MFI; Diesel; Turbo - Intercooled Cummins Eng.; VIN Code C, Eng. Code 6BTA5.9			60 (cont.)
QTY	CRANKSHAFT REAR SEAL	YEARS	PART NO.	DESCRIPTION	
1	Rear Main Seal Set	2010-02	BS 40650	PTFE Rubber; One-piece; Improved design	
1	Rear Main Seal Set	2010-04	BS 40692	PTFE Rubber; One-piece; Old design	
1	Repair Sleeve	2010-02	16274	Crankshaft; Use w/installation tool	
1	Repair Sleeve Tool	2010-02	16319	Crankshaft	
QTY	VALVE COVER	YEARS	PART NO.	DESCRIPTION	
1	Valve Cover Gasket Set	2010-03	VS 50589 R	Loc. Lower; PermaDry® molded rubber gskt. incl.	
1	Valve Cover Gasket Set	2010-06	VS 50668 R	Loc. Upper; w/Grommets; PermaDry® molded rubber gskt. incl.	
1	Valve Cover Gasket Set	2005-03	VS 50582 R	Loc. Upper; w/Grommets; PermaDry® molded rubber gskt. incl.	
1	Valve Cover Gasket Set	2002	VS 50506 R	w/Grommets; PermaDry® molded rubber gskt. incl.	
1	Grommet Set	2010-03	ES 72720	Valve Cover; Loc. Upper; Optional set; Isolator bolt w/Integral grommet; New Part Number - Check for Availability	
QTY	PUSH ROD COVER	YEARS	PART NO.	DESCRIPTION	
1	Push Rod Cover Gasket Set	2002	PS 50397 R	w/Grommets; PermaDry® molded rubber gskt. incl.	
QTY	VALVE STEM SEAL SET	YEARS	PART NO.	DESCRIPTION	
1	Valve Stem Seal Set	2010-03	SS 71186	Premium valve stem seals incl.	
1	Valve Stem Seal Set	2002	SS 70937	Premium valve stem seals incl.	
QTY	THERMOSTAT HOUSING	YEARS	PART NO.	DESCRIPTION	
1	Thermostat Gasket	2010-03	35703	Thermostat Housing; Thermostat seal	
1	Thermostat Gasket	2002	35639	Thermostat Housing	
QTY	WATER PUMP	YEARS	PART NO.	DESCRIPTION	
1	Water Pump Gasket	2010-02	35525		
QTY	TIMING COVER	YEARS	PART NO.	DESCRIPTION	
1	Timing Cover Set	2010-03	TCS 46031		
1	Timing Cover Set	2002	TCS 45994		
1	Crankshaft Front Seal Set	2010-02	TCS 46174	New Part Number - Check for Availability	
1	Repair Sleeve	2010-02	16219	Timing Cover; Use w/installation tool	
1	Repair Sleeve Tool	2010-02	16318	Timing Cover	
QTY	CARB & FUEL INJECTION	YEARS	PART NO.	DESCRIPTION	
1	Fuel Injector O-Ring Set	2002	72773	Fuel heater seal; New Part Number - Check for Availability	
1	Fuel Injector O-Ring Set	2002	ES 72773	Fuel heater service kit; New Part Number - Check for Availability	
QTY	OIL COOLER	YEARS	PART NO.	DESCRIPTION	
1	Oil Cooler Mounting Set	2010-03	ES 72376		
61		2002 - 1993; 5.9L 360 (5900cc) OHV V8 (16 Valve) 4" Bore H/D MFI; Gasoline; Naturally Aspirated Chrysler Eng.; VIN Code 5			61
QTY	CYLINDER HEAD	YEARS	PART NO.	DESCRIPTION	
2	Head Gasket	2002-93	519 SD	Head bolts not incl.; Head bolt replacement recommended; PermaTorque Severe Duty®	
2	Head Gasket	2002-93	9898 PT	Head bolts not incl.; Head bolt replacement recommended; PermaTorque®; Improved design	
1	Head Set	2002-98	HS 9898 PT-2	Head bolts not incl.; Head bolt replacement recommended; PermaDry® molded rubber valve cover gskts. incl.; Premium valve stem seals incl.; Consolidated design	
1	Head Set	2002-98	HS 9920 PT	Head bolts not incl.; Head bolt replacement recommended; PermaDry® molded rubber valve cover gskts. incl.; Premium valve stem seals incl.; May use HS 9898PT-2 instead; Old design; Superseded - When depleted use HS 9898 PT-2	
1	Head Set	1997-93	HS 9898 PT-1	Head bolts not incl.; Head bolt replacement recommended; PermaDry® molded rubber valve cover gskts. incl.; Premium valve stem seals incl.	
1	Head Bolt Set	2002-94	ES 71038-1	Replacement recommended	
QTY	CONVERSION SET	YEARS	PART NO.	DESCRIPTION	
1	Gasket Conversion Set	2002-97	CS 9898-2	PermaDry® molded rubber oil pan gskt. incl.; PermaDryPlus® timing cover gskt. incl.	
1	Gasket Conversion Set	1996-93	CS 9898-1	PermaDry® molded rubber oil pan gskt. incl.	
QTY	MANIFOLD - INT. & EXH.	YEARS	PART NO.	DESCRIPTION	
1	Int. Manifold Gasket Set	2002-98	MS 95392-1	Lower set; Upper set incl.; Manifold bolts not incl.; Manifold bolt replacement recommended	
1	Int. Manifold Gasket Set	1997-93	MS 95392	Lower set; Upper set incl.; Manifold bolts not incl.; Manifold bolt replacement recommended	
1	Plenum Gasket Set	2002-93	MS 95462	Upper set	
1	Int. Manifold Bolt Set	2002-93	ES 72169	Int. manifold bolts w/Washers; Replacement recommended	
1	Exh. Manifold Gasket Set	2002-93	MS 95480		
QTY	OIL PAN	YEARS	PART NO.	DESCRIPTION	
1	Oil Pan Gasket Set	2002-93	OS 34409 R	PermaDry® molded rubber gskt. incl.	

Dodge Truck (Incl. Minivans and SUV's) (Cont.)

61 (cont.)		2002 - 1993; 5.9L 360 (5900cc) OHV V8 (16 Valve) 4" Bore H/D			61 (cont.)
		MFI; Gasoline; Naturally Aspirated Chrysler Eng.; VIN Code 5			
QTY	OIL PAN	YEARS	PART NO.	DESCRIPTION	
1	Drain Plug Gasket	2002-93	70822		
QTY	CRANKSHAFT REAR SEAL	YEARS	PART NO.	DESCRIPTION	
1	Rear Main Seal Set	2002-93	BS 40651	Viton®; Two-piece	
QTY	VALVE COVER	YEARS	PART NO.	DESCRIPTION	
1	Valve Cover Gasket Set	2002-93	VS 50419 R	PermaDry® molded rubber gskts. incl.	
QTY	VALVE STEM SEAL SET	YEARS	PART NO.	DESCRIPTION	
1	Valve Stem Seal Set	2002-93	SS 72844	Loc. Int. & Exh.; Premium valve stem seals incl.	
QTY	WATER OUTLET GASKET	YEARS	PART NO.	DESCRIPTION	
1	Water Outlet Gasket	2002-93	35064	Water Outlet	
QTY	WATER PUMP	YEARS	PART NO.	DESCRIPTION	
1	Water Pump Gasket	2002-93	35540		
QTY	TIMING COVER	YEARS	PART NO.	DESCRIPTION	
1	Timing Cover Set	2002-97	TCS 45996	w/o Sleeve 'N' Seal®; Must be used w/OS 34409R; PermaDryPlus® timing cover gskt. incl.	
1	Timing Cover Set	1996-93	TCS 45952	w/o Sleeve 'N' Seal®; Must be used w/OS 34409R	
1	Timing Set w/Sleeve & Seal	2002-97	TCS 45999	w/Sleeve 'N' Seal®; Must be used w/OS 34409R; PermaDryPlus® timing cover gskt. incl.	
1	Timing Set w/Sleeve & Seal	1996-93	TCS 45949	w/Sleeve 'N' Seal®; Must be used w/OS 34409R	
1	Crankshaft Front Seal Set	2002-93	TCS 46198	New Part Number - Check for Availability	
1	Repair Sleeve	2002-93	16201	Timing Cover; Use w/installation tool	
QTY	AIR CLEANER MOUNTING	YEARS	PART NO.	DESCRIPTION	
1	Air Cleaner Gasket	2002	61216		
1	Air Cleaner Gasket	2001-93	60038	5 1/32" ID	
QTY	CARB & FUEL INJECTION	YEARS	PART NO.	DESCRIPTION	
4	Fuel Injector O-Ring Set	2002-93	ES 70599	Improved design	
1	Throttle Body Gasket	2002-93	60958-1		
QTY	EXHAUST GAS RECIRCULATION	YEARS	PART NO.	DESCRIPTION	
1	EGR Gasket	2002-93	70561		
QTY	OIL FILTER MOUNTING	YEARS	PART NO.	DESCRIPTION	
1	Oil Filter Adapter Gasket	2002-93	70522		
62		1992 - 1991; 5.9L 360 (5900cc) OHV V8 (16 Valve) 4" Bore H/D			62
		TBI; Gasoline; Naturally Aspirated Chrysler Eng.; VIN Code 5			
QTY	CYLINDER HEAD	YEARS	PART NO.	DESCRIPTION	
2	Head Gasket	1992-91	521 SD	PermaTorque Severe Duty®	
2	Head Gasket	1992-91	8553 PT	PermaTorque®	
2	Head Gasket Spacer Shim	1992-91	8553 SP	HeadSaver®	
1	Head Set	1992-91	HS 8553 PT-15	Premium valve stem seals incl.	
QTY	CONVERSION SET	YEARS	PART NO.	DESCRIPTION	
1	Gasket Conversion Set	1992	CS 9898-1	PermaDry® molded rubber oil pan gskt. incl.	
1	Gasket Conversion Set	1991	CS 8359-2	PermaDry® molded rubber oil pan gskt. incl.	
QTY	MANIFOLD - INT. & EXH.	YEARS	PART NO.	DESCRIPTION	
1	Int. Manifold Gasket Set	1992-91	MS 94377		
1	Exh. Manifold Gasket Set	1992-91	MS 90460		
QTY	OIL PAN	YEARS	PART NO.	DESCRIPTION	
1	Oil Pan Gasket Set	1992-91	OS 34409 R	PermaDry® molded rubber gskt. incl.	
1	Drain Plug Gasket	1992-91	70822		
QTY	CRANKSHAFT REAR SEAL	YEARS	PART NO.	DESCRIPTION	
1	Rear Main Seal Set	1992-91	BS 40651	Viton®; Two-piece	
QTY	VALVE COVER	YEARS	PART NO.	DESCRIPTION	
1	Valve Cover Gasket Set	1992-91	VS 50184 R	Hi-Temp.; Rubber coated fiber	
QTY	VALVE STEM SEAL SET	YEARS	PART NO.	DESCRIPTION	
1	Valve Stem Seal Set	1992-91	SS 72730	Loc. Int. & Exh.; Premium valve stem seals incl.	
QTY	WATER OUTLET GASKET	YEARS	PART NO.	DESCRIPTION	
1	Water Outlet Gasket	1992-91	35064	Water Outlet	
QTY	WATER PUMP	YEARS	PART NO.	DESCRIPTION	
1	Water Pump Gasket	1992-91	6584		
QTY	TIMING COVER	YEARS	PART NO.	DESCRIPTION	
1	Timing Cover Set	1992	TCS 45952	w/o Sleeve 'N' Seal®; Must be used w/OS 34409R	
1	Timing Cover Set	1991	TCS 6563-1	w/o Sleeve 'N' Seal®	
1	Timing Set w/Sleeve & Seal	1992	TCS 45949	w/Sleeve 'N' Seal®; Must be used w/OS 34409R	
1	Timing Set w/Sleeve & Seal	1991	TCS 45284	w/Sleeve 'N' Seal®	

Dodge Truck (Incl. Minivans and SUV's) (Cont.)

62 (cont.)		1992 - 1991; 5.9L 360 (5900cc) OHV V8 (16 Valve) 4" Bore H/D			62 (cont.)
		TBI; Gasoline; Naturally Aspirated Chrysler Eng.; VIN Code 5			
QTY	TIMING COVER	YEARS	PART NO.	DESCRIPTION	
1	Crankshaft Front Seal Set	1992	TCS 46198	New Part Number - Check for Availability	
1	Repair Sleeve	1992-91	16201	Timing Cover; Use w/installation tool	
QTY	AIR CLEANER MOUNTING	YEARS	PART NO.	DESCRIPTION	
1	Air Cleaner Gasket	1992-91	60038	5 1/32" ID	
QTY	EXHAUST GAS RECIRCULATION	YEARS	PART NO.	DESCRIPTION	
1	EGR Gasket	1992-91	70561		
QTY	OIL FILTER MOUNTING	YEARS	PART NO.	DESCRIPTION	
1	Oil Filter Adapter Gasket	1992-91	70522		
63		2003 - 1993; 5.9L 360 (5900cc) OHV V8 (16 Valve) 4" Bore L/D			63
		MFI; Gasoline; Naturally Aspirated Chrysler Eng.; VIN Code Z			
QTY	CYLINDER HEAD	YEARS	PART NO.	DESCRIPTION	
2	Head Gasket	2003-93	519 SD	Head bolts not incl.; Head bolt replacement recommended; PermaTorque Severe Duty®	
2	Head Gasket	2003-93	9898 PT	Head bolts not incl.; Head bolt replacement recommended; PermaTorque®; Improved design	
1	Head Set	2003-98	HS 9898 PT-2	Head bolts not incl.; Head bolt replacement recommended; PermaDry® molded rubber valve cover gskts. incl.; Premium valve stem seals incl.; Consolidated design	
1	Head Set	2003-98	HS 9920 PT	Head bolts not incl.; Head bolt replacement recommended; PermaDry® molded rubber valve cover gskts. incl.; Premium valve stem seals incl.; May use HS 9898PT-2 instead; Old design; Superseded - When depleted use HS 9898 PT-2	
1	Head Set	1997-93	HS 9898 PT-1	Head bolts not incl.; Head bolt replacement recommended; PermaDry® molded rubber valve cover gskts. incl.; Premium valve stem seals incl.	
1	Head Bolt Set	2003-94	ES 71038-1	Replacement recommended	
QTY	CONVERSION SET	YEARS	PART NO.	DESCRIPTION	
1	Gasket Conversion Set	2003-97	CS 9898-2	PermaDry® molded rubber oil pan gskt. incl.; PermaDryPlus® timing cover gskt. incl.	
1	Gasket Conversion Set	1996-93	CS 9898-1	PermaDry® molded rubber oil pan gskt. incl.	
QTY	MANIFOLD - INT. & EXH.	YEARS	PART NO.	DESCRIPTION	
1	Int. Manifold Gasket Set	2003-98	MS 95392-1	Lower set; Upper set incl.; Manifold bolts not incl.; Manifold bolt replacement recommended	
1	Int. Manifold Gasket Set	1997-93	MS 95392	Lower set; Upper set incl.; Manifold bolts not incl.; Manifold bolt replacement recommended	
1	Plenum Gasket Set	2003-93	MS 95462	Upper set	
1	Int. Manifold Bolt Set	2003-93	ES 72169	Int. manifold bolts w/Washers; Replacement recommended	
1	Exh. Manifold Gasket Set	2003-93	MS 95480		
QTY	OIL PAN	YEARS	PART NO.	DESCRIPTION	
1	Oil Pan Gasket Set	2003-93	OS 34409 R	PermaDry® molded rubber gskt. incl.	
1	Drain Plug Gasket	2003-93	70822		
QTY	CRANKSHAFT REAR SEAL	YEARS	PART NO.	DESCRIPTION	
1	Rear Main Seal Set	2003-93	BS 40651	Viton®; Two-piece	
QTY	VALVE COVER	YEARS	PART NO.	DESCRIPTION	
1	Valve Cover Gasket Set	2003-93	VS 50419 R	PermaDry® molded rubber gskts. incl.	
QTY	VALVE STEM SEAL SET	YEARS	PART NO.	DESCRIPTION	
1	Valve Stem Seal Set	2003-93	SS 72844	Loc. Int. & Exh.; Premium valve stem seals incl.	
QTY	WATER OUTLET GASKET	YEARS	PART NO.	DESCRIPTION	
1	Water Outlet Gasket	2003-93	35064	Water Outlet	
QTY	WATER PUMP	YEARS	PART NO.	DESCRIPTION	
1	Water Pump Gasket	2003-93	35540		
QTY	TIMING COVER	YEARS	PART NO.	DESCRIPTION	
1	Timing Cover Set	2003-97	TCS 45996	w/o Sleeve 'N' Seal®; Must be used w/OS 34409R; PermaDryPlus® timing cover gskt. incl.	
1	Timing Cover Set	1996-93	TCS 45952	w/o Sleeve 'N' Seal®; Must be used w/OS 34409R	
1	Timing Set w/Sleeve & Seal	2003-97	TCS 45999	w/Sleeve 'N' Seal®; Must be used w/OS 34409R; PermaDryPlus® timing cover gskt. incl.	
1	Timing Set w/Sleeve & Seal	1996-93	TCS 45949	w/Sleeve 'N' Seal®; Must be used w/OS 34409R	
1	Crankshaft Front Seal Set	2003-93	TCS 46198	New Part Number - Check for Availability	
1	Repair Sleeve	2003-93	16201	Timing Cover; Use w/installation tool	
QTY	AIR CLEANER MOUNTING	YEARS	PART NO.	DESCRIPTION	
1	Air Cleaner Gasket	2003-02	61216		
1	Air Cleaner Gasket	2001-93	60038	5 1/32" ID	

Dodge Truck (Incl. Minivans and SUV's) (Cont.)

63		2003 - 1993; 5.9L 360 (5900cc) OHV V8 (16 Valve) 4" Bore L/D			63	
(cont.)		MFI; Gasoline; Naturally Aspirated Chrysler Eng.; VIN Code Z			(cont.)	
QTY	CARB & FUEL INJECTION	YEARS	PART NO.	DESCRIPTION		
4	Fuel Injector O-Ring Set	2003-93	ES 70599	Improved design		
1	Throttle Body Gasket	2003-93	60958-1			
QTY	EXHAUST GAS RECIRCULATION	YEARS	PART NO.	DESCRIPTION		
1	EGR Gasket	2003-93	70561			
QTY	OIL FILTER MOUNTING	YEARS	PART NO.	DESCRIPTION		
1	Oil Filter Adapter Gasket	2003-93	70522			
64		1992 - 1991; 5.9L 360 (5900cc) OHV V8 (16 Valve) 4" Bore L/D			64	
		TBI; Gasoline; Naturally Aspirated Chrysler Eng.; VIN Code Z				
QTY	CYLINDER HEAD	YEARS	PART NO.	DESCRIPTION		
2	Head Gasket	1992-91	521 SD	PermaTorque Severe Duty®		
2	Head Gasket	1992-91	8553 PT	PermaTorque®		
2	Head Gasket Spacer Shim	1992-91	8553 SP	HeadSaver®		
1	Head Set	1992-91	HS 8553 PT-15	Premium valve stem seals incl.		
QTY	CONVERSION SET	YEARS	PART NO.	DESCRIPTION		
1	Gasket Conversion Set	1992	CS 9898-1	PermaDry® molded rubber oil pan gsckt. incl.		
1	Gasket Conversion Set	1991	CS 8359-2	PermaDry® molded rubber oil pan gsckt. incl.		
QTY	MANIFOLD - INT. & EXH.	YEARS	PART NO.	DESCRIPTION		
1	Int. Manifold Gasket Set	1992-91	MS 94377			
1	Exh. Manifold Gasket Set	1992-91	MS 90460			
QTY	OIL PAN	YEARS	PART NO.	DESCRIPTION		
1	Oil Pan Gasket Set	1992-91	OS 34409 R	PermaDry® molded rubber gsckt. incl.		
1	Drain Plug Gasket	1992-91	70822			
QTY	CRANKSHAFT REAR SEAL	YEARS	PART NO.	DESCRIPTION		
1	Rear Main Seal Set	1992-91	BS 40651	Viton®; Two-piece		
QTY	VALVE COVER	YEARS	PART NO.	DESCRIPTION		
1	Valve Cover Gasket Set	1992-91	VS 50184 R	Hi-Temp.; Rubber coated fiber		
QTY	VALVE STEM SEAL SET	YEARS	PART NO.	DESCRIPTION		
1	Valve Stem Seal Set	1992-91	SS 72730	Loc. Int. & Exh.; Premium valve stem seals incl.		
QTY	WATER OUTLET GASKET	YEARS	PART NO.	DESCRIPTION		
1	Water Outlet Gasket	1992-91	35064	Water Outlet		
QTY	WATER PUMP	YEARS	PART NO.	DESCRIPTION		
1	Water Pump Gasket	1992-91	6584			
QTY	TIMING COVER	YEARS	PART NO.	DESCRIPTION		
1	Timing Cover Set	1992	TCS 45952	w/o Sleeve 'N' Seal®; Must be used w/OS 34409R		
1	Timing Cover Set	1991	TCS 6563-1	w/o Sleeve 'N' Seal®		
1	Timing Set w/Sleeve & Seal	1992	TCS 45949	w/Sleeve 'N' Seal®; Must be used w/OS 34409R		
1	Timing Set w/Sleeve & Seal	1991	TCS 45284	w/Sleeve 'N' Seal®		
1	Crankshaft Front Seal Set	1992	TCS 46198	New Part Number - Check for Availability		
1	Repair Sleeve	1992-91	16201	Timing Cover; Use w/installation tool		
QTY	AIR CLEANER MOUNTING	YEARS	PART NO.	DESCRIPTION		
1	Air Cleaner Gasket	1992-91	60038	5 1/32" ID		
QTY	EXHAUST GAS RECIRCULATION	YEARS	PART NO.	DESCRIPTION		
1	EGR Gasket	1992-91	70561			
QTY	OIL FILTER MOUNTING	YEARS	PART NO.	DESCRIPTION		
1	Oil Filter Adapter Gasket	1992-91	70522			
65		2010 - 2007; 6.7L 408 (6691cc) OHV Turbo - Intercooled L6 (24 Valve) 107mm Bore H.O.			65	
		MFI; Diesel; Turbo - Intercooled Cummins Eng.; VIN Code A, Eng. Code ISB6.7-305				
QTY	CYLINDER HEAD	YEARS	PART NO.	DESCRIPTION		
1	Head Bolt Set	2010-07	ES 72193	Replacement recommended		
QTY	MANIFOLD - INT. & EXH.	YEARS	PART NO.	DESCRIPTION		
1	Int. Manifold Gasket Set	2010-07	MS 96279			
1	Exh. Manifold Gasket Set	2010-07	MS 96677			
QTY	OIL PAN	YEARS	PART NO.	DESCRIPTION		
1	Oil Pan Gasket Set	2010-07	OS 30738			
QTY	CRANKSHAFT REAR SEAL	YEARS	PART NO.	DESCRIPTION		
1	Rear Main Seal Set	2010-07	BS 40650	PTFE Rubber; One-piece; Improved design		
1	Repair Sleeve	2010-07	16274	Crankshaft; Use w/installation tool		
1	Repair Sleeve Tool	2010-07	16319	Crankshaft		
QTY	VALVE COVER	YEARS	PART NO.	DESCRIPTION		
1	Valve Cover Gasket Set	2010-07	VS 50589 R	Loc. Lower; PermaDry® molded rubber gsckt. incl.		

Dodge Truck (Incl. Minivans and SUV's) (Cont.)

65		2010 - 2007; 6.7L 408 (6691cc) OHV Turbo - Intercooled L6 (24 Valve) 107mm Bore H.O.			65
(cont.)		MFI; Diesel; Turbo - Intercooled Cummins Eng.; VIN Code A, Eng. Code ISB6.7-305			(cont.)
QTY	VALVE COVER	YEARS	PART NO.	DESCRIPTION	
1	Valve Cover Gasket Set	2010-07	VS 50668 R	Loc. Upper; w/Grommets; PermaDry® molded rubber gskt. incl.	
QTY	VALVE STEM SEAL SET	YEARS	PART NO.	DESCRIPTION	
1	Valve Stem Seal Set	2010-07	SS 71186	Premium valve stem seals incl.	
QTY	THERMOSTAT HOUSING	YEARS	PART NO.	DESCRIPTION	
1	Thermostat Gasket	2010-07	35703	Thermostat Housing; Thermostat seal	
QTY	WATER PUMP	YEARS	PART NO.	DESCRIPTION	
1	Water Pump Gasket	2010-07	35525		
QTY	TIMING COVER	YEARS	PART NO.	DESCRIPTION	
1	Timing Cover Set	2010-07	TCS 46031		
1	Repair Sleeve	2010-07	16219	Timing Cover; Use w/installation tool	
1	Repair Sleeve Tool	2010-07	16318	Timing Cover	
66		2011 - 2009; 6.7L 408 (6691cc) OHV Turbo - Intercooled L6 (24 Valve) 107mm Bore H.O.			66
(cont.)		MFI; Diesel; Turbo - Intercooled Cummins Eng.; VIN Code L, Eng. Code ISB6.7-350			(cont.)
QTY	CYLINDER HEAD	YEARS	PART NO.	DESCRIPTION	
1	Head Bolt Set	2011-09	ES 72193	Replacement recommended	
QTY	MANIFOLD - INT. & EXH.	YEARS	PART NO.	DESCRIPTION	
1	Int. Manifold Gasket Set	2011-09	MS 96279		
1	Exh. Manifold Gasket Set	2011-09	MS 96677		
QTY	OIL PAN	YEARS	PART NO.	DESCRIPTION	
1	Oil Pan Gasket Set	2011-09	OS 30738		
QTY	CRANKSHAFT REAR SEAL	YEARS	PART NO.	DESCRIPTION	
1	Rear Main Seal Set	2011-09	BS 40650	PTFE Rubber; One-piece; Improved design	
1	Repair Sleeve	2011-09	16274	Crankshaft; Use w/installation tool	
1	Repair Sleeve Tool	2011-09	16319	Crankshaft	
QTY	VALVE COVER	YEARS	PART NO.	DESCRIPTION	
1	Valve Cover Gasket Set	2011-09	VS 50589 R	Loc. Lower; PermaDry® molded rubber gskt. incl.	
1	Valve Cover Gasket Set	2011-09	VS 50668 R	Loc. Upper; w/Grommets; PermaDry® molded rubber gskt. incl.	
QTY	VALVE STEM SEAL SET	YEARS	PART NO.	DESCRIPTION	
1	Valve Stem Seal Set	2011-09	SS 71186	Premium valve stem seals incl.	
QTY	THERMOSTAT HOUSING	YEARS	PART NO.	DESCRIPTION	
1	Thermostat Gasket	2011-09	35703	Thermostat Housing; Thermostat seal	
QTY	WATER PUMP	YEARS	PART NO.	DESCRIPTION	
1	Water Pump Gasket	2011-09	35525		
QTY	TIMING COVER	YEARS	PART NO.	DESCRIPTION	
1	Timing Cover Set	2011-09	TCS 46031		
1	Repair Sleeve	2011-09	16219	Timing Cover; Use w/installation tool	
1	Repair Sleeve Tool	2011-09	16318	Timing Cover	
67		2004 - 1994; 8.0L 488 (7994cc) OHV V10 (20 Valve) 101.6mm Bore			67
(cont.)		MFI; Gasoline; Naturally Aspirated Chrysler Eng.; VIN Code W			(cont.)
QTY	CYLINDER HEAD	YEARS	PART NO.	DESCRIPTION	
2	Head Gasket	2004-94	9034 PT	Head bolts not incl.; Head bolt replacement recommended	
1	Head Set	2004-94	HS 9034 PT	Head bolts not incl.; Head bolt replacement recommended; PermaDry® molded rubber valve cover gskts. incl.; Premium valve stem seals incl.	
1	Head Bolt Set	2004-94	ES 72894	Short bolts only; Must be used w/ES 72904; Replacement recommended	
1	Head Bolt Set	2004-94	ES 72904	Long bolts only; Must be used w/ES 72894; Replacement recommended	
QTY	CONVERSION SET	YEARS	PART NO.	DESCRIPTION	
1	Gasket Conversion Set	2004-94	CS 9034	PermaDry® molded rubber oil pan gskt. incl.	
QTY	MANIFOLD - INT. & EXH.	YEARS	PART NO.	DESCRIPTION	
1	Int. Manifold Gasket Set	2004-94	MS 92542	Lower set; Upper set incl.	
1	Plenum Gasket Set	2004-94	MS 97229	Upper set; New Part Number - Check for Availability	
1	Exh. Manifold Gasket Set	2004-94	MS 92544		
QTY	OIL PAN	YEARS	PART NO.	DESCRIPTION	
1	Oil Pan Gasket Set	2004-94	OS 30695 R	PermaDry® molded rubber gskt. incl.	
QTY	CRANKSHAFT REAR SEAL	YEARS	PART NO.	DESCRIPTION	
1	Rear Main Seal Set	2004-94	BS 40658	Rubber; One-piece	
QTY	VALVE COVER	YEARS	PART NO.	DESCRIPTION	
1	Valve Cover Gasket Set	2004-94	VS 50508 R	PermaDry® molded rubber gskts. incl.	
QTY	VALVE STEM SEAL SET	YEARS	PART NO.	DESCRIPTION	
2	Valve Stem Seal Set	2004-94	SS 72808	Premium valve stem seals incl.	
QTY	THERMOSTAT HOUSING	YEARS	PART NO.	DESCRIPTION	
1	Thermostat Gasket	2004-94	35647	Thermostat Housing	

Dodge Truck (Incl. Minivans and SUV's) (Cont.)

67 (cont.)		2004 - 1994; 8.0L 488 (7994cc) OHV V10 (20 Valve) 101.6mm Bore			67 (cont.)
MFI; Gasoline; Naturally Aspirated Chrysler Eng.; VIN Code W					
QTY	WATER PUMP	YEARS	PART NO.	DESCRIPTION	
1	O-Ring	2004-94	35641	Water Pump	
QTY	TIMING COVER	YEARS	PART NO.	DESCRIPTION	
1	Timing Cover Set	2004-94	TCS 45995		
QTY	AIR CLEANER MOUNTING	YEARS	PART NO.	DESCRIPTION	
1	Air Cleaner Gasket	2004-94	61282		
QTY	CARB & FUEL INJECTION	YEARS	PART NO.	DESCRIPTION	
3	Fuel Injector O-Ring Set	2004-94	ES 70599	Improved design	
1	Throttle Body Gasket	2004-94	61078		
68		2006 - 2004; 8.3L 505 (8277cc) OHV V10 (20 Valve) 102.4mm Bore			68
MFI; Gasoline; Naturally Aspirated Chrysler Eng.; VIN Code H					
QTY	CYLINDER HEAD	YEARS	PART NO.	DESCRIPTION	
2	Head Gasket	2006-04	26283 PT	Head bolts not incl.; Head bolt replacement recommended; PermaTorqueMLS®	
1	Head Set	2006-04	HS 26283 PT	Head bolts not incl.; Head bolt replacement recommended; PermaDry® molded rubber valve cover gskts. incl.; Premium valve stem seals incl.	
2	Head Bolt Set	2006-04	ES 72209	Head bolts w/Washers; Replacement recommended	
QTY	CONVERSION SET	YEARS	PART NO.	DESCRIPTION	
1	Gasket Conversion Set	2006-04	CS 26283		
QTY	MANIFOLD - INT. & EXH.	YEARS	PART NO.	DESCRIPTION	
1	Int. Manifold Gasket Set	2006-04	MS 96638	Lower set	
1	Exh. Manifold Gasket Set	2006-04	MS 96632		
QTY	OIL PAN	YEARS	PART NO.	DESCRIPTION	
1	Oil Pan Gasket Set	2006-04	OS 30755		
1	Drain Plug Gasket	2006-04	70822		
QTY	CRANKSHAFT REAR SEAL	YEARS	PART NO.	DESCRIPTION	
1	Rear Main Seal Set	2006-04	BS 40688	Rubber; One-piece	
QTY	VALVE COVER	YEARS	PART NO.	DESCRIPTION	
1	Valve Cover Gasket Set	2006-04	VS 50636 R	PermaDry® molded rubber gskts. incl.	
QTY	VALVE STEM SEAL SET	YEARS	PART NO.	DESCRIPTION	
1	Valve Stem Seal Set	2006-04	SS 72860	Premium valve stem seals incl.	
QTY	THERMOSTAT HOUSING	YEARS	PART NO.	DESCRIPTION	
1	Thermostat Gasket	2006-04	35773	Thermostat Housing; Thermostat seal	
1	Thermostat Gasket	2006-04	35799	Thermostat Housing; Seal	
QTY	WATER PUMP	YEARS	PART NO.	DESCRIPTION	
1	Water Pump Gasket	2006-04	35775		
QTY	TIMING COVER	YEARS	PART NO.	DESCRIPTION	
1	Timing Cover Set	2006-04	TCS 46057		
QTY	CARB & FUEL INJECTION	YEARS	PART NO.	DESCRIPTION	
3	Fuel Injector O-Ring Set	2006-04	ES 70599	Improved design	
1	Throttle Body Gasket	2006-04	61393		

Eagle - See Chrysler Car

Excalibur

Engine Finding Index

Engine	Years	Code	Line No.		
5.7L 350 (5736cc) OHV V8 (16 Valve) 4" Bore LT-1; MFI; Gasoline; Naturally Aspirated GMC Eng.; Chevrolet	1996-93		1		
Model Index					
Engine (VIN Code / Eng. Code)	Year	Engine (VIN Code / Eng. Code)	Year	Engine (VIN Code / Eng. Code)	Year
Excalibur		Excalibur (cont.)		Excalibur (cont.)	
Series I		Series III		Series V	
V8 289CI 4.7L	65	V8 350CI 5.7L	79	V8 305CI 5.0L	90-87
V8 327CI 5.3L	69-65	V8 454CI 7.4L	79-75	V8 350CI 5.7L	96-93
Series II		Series IV		V8 350CI 5.7L	90-87
V8 350CI 5.7L	71-70	V8 305CI 5.0L	86-80		
V8 454CI 7.4L	74-72	V8 350CI 5.7L	86		
1		1996 - 1993; 5.7L 350 (5736cc) OHV V8 (16 Valve) 4" Bore LT-1			1
MFI; Gasoline; Naturally Aspirated GMC Eng.; Chevrolet					
QTY	CYLINDER HEAD	YEARS	PART NO.	DESCRIPTION	
2	Head Gasket	1996-93	9966 PT	Head bolts not incl.; Head bolt replacement recommended	

1 (cont.)		1996 - 1993; 5.7L 350 (5736cc) OHV V8 (16 Valve) 4" Bore LT-1 MFI; Gasoline; Naturally Aspirated GMC Eng.; Chevrolet			1 (cont.)
QTY	CYLINDER HEAD	YEARS	PART NO.	DESCRIPTION	
1	Head Set	1996-93	HS 9966 PT	Exc. Corvette engine; Head bolts not incl.; Head bolt replacement recommended; PermaDry® molded rubber valve cover gskts. incl.; Premium valve stem seals incl.	
1	Head Set	1996-93	HS 9966 PT-2	Corvette engine; Head bolts & exh. pipe packing not incl.; Head bolt replacement recommended; PermaDry® molded rubber valve cover gskts. incl.; Premium valve stem seals incl.; Consolidated design	
2	Head Bolt Set	1996-93	ES 72856	Replacement recommended	
QTY	CONVERSION SET	YEARS	PART NO.	DESCRIPTION	
1	Gasket Conversion Set	1996-93	CS 9966	PermaDry® molded rubber oil pan gskt. incl.	
QTY	MANIFOLD - INT. & EXH.	YEARS	PART NO.	DESCRIPTION	
1	Int. Manifold Gasket Set	1996-93	MS 95580		
1	Exh. Manifold Gasket Set	1996-93	MS 95573-1	Corvette engine; Improved design	
1	Exh. Manifold Gasket Set	1996-93	MS 95585	Exc. Corvette engine	
QTY	EXHAUST PIPE FLANGE	YEARS	PART NO.	DESCRIPTION	
2	Exhaust Pipe Gasket	1996-93	60988	Exc. Corvette engine	
QTY	OIL PAN	YEARS	PART NO.	DESCRIPTION	
1	Oil Pan Gasket Set	1996-93	OS 34500 R	PermaDry® molded rubber gskt. incl.	
1	Drain Plug Gasket	1996-93	70822		
QTY	CRANKSHAFT REAR SEAL	YEARS	PART NO.	DESCRIPTION	
1	Rear Main Seal Set	1996-93	BS 40520	Rubber; One-piece	
1	Rear Main Seal Set	1996-93	BS 40626	PTFE Rubber; One-piece	
1	Repair Sleeve	1996-93	16258	Crankshaft; Use w/installation tool	
1	Repair Sleeve Tool	1996-93	16301	Crankshaft	
QTY	VALVE COVER	YEARS	PART NO.	DESCRIPTION	
1	Valve Cover Gasket Set	1996-93	VS 50088 R	Exc. Corvette engine; Services both covers; PermaDry® molded rubber gskts. incl.	
2	Valve Cover Gasket Set	1996-93	VS 50293 R	Exc. Corvette engine; Services one cover only; PermaDry® molded rubber gskt. incl.	
1	Valve Cover Gasket Set	1996-93	VS 50443 R	Corvette engine; w/Grommets; PermaDry® molded rubber gskts. incl.	
QTY	VALVE STEM SEAL SET	YEARS	PART NO.	DESCRIPTION	
1	Valve Stem Seal Set	1996-93	SS 72861	Premium valve stem seals incl.; Improved design	
QTY	WATER OUTLET GASKET	YEARS	PART NO.	DESCRIPTION	
1	O-Ring	1996-93	35710	Water Outlet; 1.954" ID; Improved design	
QTY	WATER PUMP	YEARS	PART NO.	DESCRIPTION	
2	Water Pump Gasket	1996-93	35072		
QTY	TIMING COVER	YEARS	PART NO.	DESCRIPTION	
1	Timing Cover Set	1996-95	TCS 45956	Must be used w/OS 34500R	
1	Timing Cover Set	1994	TCS 45953	Corvette engine; Must be used w/OS 34500R	
1	Timing Cover Set	1994	TCS 45956	Exc. Corvette engine; Must be used w/OS 34500R	
1	Timing Cover Set	1993	TCS 45953	Must be used w/OS 34500R	
1	Repair Sleeve	1996-93	16202	Timing Cover; Use w/installation tool	
1	Repair Sleeve Tool	1996-93	16312	Timing Cover	
QTY	CARB & FUEL INJECTION	YEARS	PART NO.	DESCRIPTION	
4	Fuel Injector O-Ring Set	1996-93	ES 70599	Improved design	
1	Throttle Body Gasket	1996-93	60655		
QTY	EXHAUST GAS RECIRCULATION	YEARS	PART NO.	DESCRIPTION	
1	EGR Gasket	1996-93	70978		
QTY	OIL PUMP RETAINER	YEARS	PART NO.	DESCRIPTION	
1	Oil Pump Shaft Guide	1996-93	72665	Distributor to oil pump shaft retainer	
QTY	OIL COOLER	YEARS	PART NO.	DESCRIPTION	
1	Oil Cooler Mounting Set	1996-93	ES 70687		

Ford Car (Incl. Edsel, Ford, Lincoln, Mercury, Merkur)

Engine Finding Index				
Engine	Years	Code	Line No.	
1.3L 80.8 (1324cc) SOHC L4 (8 Valve) 71mm Bore; MFI; Gasoline; Naturally Aspirated Mazda Eng.	1997-91	H	1	
1.6L 97.5 (1597cc) DOHC L4 (16 Valve) 78mm Bore; MFI; Gasoline; Turbo - Intercooled Mazda Eng.	1994-91	6	2	
1.6L 97.5 (1597cc) DOHC L4 (16 Valve) 78mm Bore; MFI; Gasoline; Naturally Aspirated Mazda Eng.	1994-91	Z	3	
1.8L 112.2 (1839cc) DOHC L4 (16 Valve) 83mm Bore; MFI; Gasoline; Naturally Aspirated Mazda Eng.	1996-91	8	4	

Ford Car (Incl. Edsel, Ford, Lincoln, Mercury, Merkur) (Cont.)

Engine Finding Index (Cont.)

Engine	Years	Code	Line No.
1.9L 114 (1868cc) SOHC L4 (8 Valve) 82mm Bore; MFI; Gasoline; Naturally Aspirated Ford Eng.	1996-91	J	5
2.0L 121 (1988cc) DOHC L4 (16 Valve) 84.8mm Bore Zetec; MFI; Gasoline; Naturally Aspirated Ford Eng.	2004-95	3	6
2.0L 121 (1988cc) DOHC L4 (16 Valve) 84.8mm Bore Zetec; MFI; Flex Fuel; Naturally Aspirated Ford Eng.	2000-95	Z	7
2.0L 121 (1988cc) DOHC L4 (16 Valve) 84.8mm Bore Zetec H.O.; MFI; Gasoline; Naturally Aspirated Ford Eng.	2004-02	5	8
2.0L 121 (1988cc) SOHC L4 (8 Valve) 84.8mm Bore; MFI; Gasoline; Naturally Aspirated Ford Eng.	2004-97	P	9
2.0L 121.5 (1991cc) DOHC L4 (16 Valve) 83mm Bore; MFI; Gasoline; Naturally Aspirated Mazda Eng.	1997-93	A	10
2.0L 122 (1999cc) DOHC L4 (16 Valve) 87.5mm Bore Duratec; MFI; Gasoline; Naturally Aspirated Ford Eng.	2011-05	N	11
2.0L 122 (1999cc) DOHC L4 (16 Valve) 87.5mm Bore Duratec VVT; DI; Flex Fuel; Naturally Aspirated Ford Eng.	2013-12	2	12
2.0L 122 (1999cc) DOHC L4 (16 Valve) 87.5mm Bore Duratec VVT; MFI; Hybrid (Gas/Electric); Naturally Aspirated Ford Eng.	2013	U	13
2.0L 122 (1999cc) DOHC L4 (16 Valve) 87.5mm Bore EcoBoost Duratec VVT; DI; Gasoline; Turbo - Intercooled Ford Eng.	2013-12	9	14
2.2L 133 (2184cc) SOHC L4 (12 Valve) 86mm Bore; MFI; Gasoline; Naturally Aspirated Mazda Eng.	1992-91	C	15
2.2L 133 (2184cc) SOHC L4 (12 Valve) 86mm Bore; MFI; Gasoline; Turbo - Intercooled Mazda Eng.	1992-91	L	16
2.3L 138 (2261cc) DOHC L4 (16 Valve) 87.5mm Bore Duratec PZEV; MFI; Gasoline; Naturally Aspirated Ford Eng.	2009-03	Z	17
2.3L 140 (2302cc) SOHC L4 (8 Valve) 96mm Bore; MFI; Gasoline; Naturally Aspirated Ford Eng.	1993-91	M	18
2.3L 140 (2306cc) OHV L4 (8 Valve) 3.68" Bore HSC; MFI; Gasoline; Naturally Aspirated Ford Eng.	1994-91	X	19
2.3L 140 (2306cc) OHV L4 (8 Valve) 3.68" Bore HSC H.O.; MFI; Gasoline; Naturally Aspirated Ford Eng.	1991	S	20
2.5L 151.8 (2488cc) DOHC L4 (16 Valve) 89mm Bore Duratec PZEV; MFI; Hybrid (Gas/Electric); Naturally Aspirated Ford Eng.	2012-10	3	21
2.5L 151.8 (2488cc) DOHC L4 (16 Valve) 89mm Bore Duratec PZEV; MFI; Gasoline; Naturally Aspirated Ford Eng.	2012-10	A	22
2.5L 151.8 (2488cc) DOHC L4 (16 Valve) 89mm Bore Duratec VVT; MFI; Gasoline; Naturally Aspirated Ford Eng.	2013	7	23
2.5L 152 (2495cc) DOHC V6 (24 Valve) 81.6mm Bore Duratec; MFI; Gasoline; Naturally Aspirated Ford Eng.	2002-01	L	24
2.5L 152 (2495cc) DOHC V6 (24 Valve) 81.6mm Bore Duratec H.O.; MFI; Gasoline; Naturally Aspirated Ford Eng.	2002-01	G	25
2.5L 152 (2497cc) DOHC V6 (24 Valve) 84.5mm Bore; MFI; Gasoline; Naturally Aspirated Mazda Eng.	1997-93	B	26
2.5L 153 (2507cc) OHV L4 (8 Valve) 3.68" Bore HSC; MFI; Gasoline; Naturally Aspirated Ford Eng.	1991	N	27
2.5L 155 (2544cc) DOHC V6 (24 Valve) 82.4mm Bore Duratec; MFI; Gasoline; Naturally Aspirated Ford Eng.	2000-95	L	28
2.5L 155 (2544cc) DOHC V6 (24 Valve) 82.4mm Bore Duratec H.O.; MFI; Gasoline; Naturally Aspirated Ford Eng.	2000-98	G	29
3.0L 181 (2967cc) DOHC V6 (24 Valve) 89mm Bore Duratec; MFI; Gasoline; Naturally Aspirated Ford Eng.	2009-05	1	30
3.0L 181 (2967cc) DOHC V6 (24 Valve) 89mm Bore Duratec; MFI; Flex Fuel; Naturally Aspirated Ford Eng.	2012-10	G	31
3.0L 181 (2967cc) DOHC V6 (24 Valve) 89mm Bore Duratec; MFI; Gasoline; Naturally Aspirated Ford Eng.	2005-96	S	32
3.0L 183 (2982cc) DOHC V6 (24 Valve) 89mm Bore SHO; MFI; Gasoline; Naturally Aspirated Yamaha Eng.	1995-91	Y	33
3.0L 183 (2982cc) OHV V6 (12 Valve) 89mm Bore Vulcan; MFI; Flex Fuel; Naturally Aspirated Ford Eng.	1998-93	1	34
3.0L 183 (2982cc) OHV V6 (12 Valve) 89mm Bore Vulcan; MFI; Flex Fuel; Naturally Aspirated Ford Eng.	2007-96	2	35
3.0L 183 (2982cc) OHV V6 (12 Valve) 89mm Bore Vulcan; MFI; Gasoline; Naturally Aspirated Ford Eng.	2007-91	U	36
3.2L 195 (3152cc) DOHC V6 (24 Valve) 92mm Bore SHO; MFI; Gasoline; Naturally Aspirated Yamaha Eng.	1995-93	P	37
3.5L 213.3 (3496cc) DOHC V6 (24 Valve) 92.5mm Bore Duratec Cyclone; MFI; Gasoline; Naturally Aspirated Ford Eng.	2012-10	C	38
3.5L 213.3 (3496cc) DOHC V6 (24 Valve) 92.5mm Bore Duratec Cyclone; MFI; Gasoline; Naturally Aspirated Ford Eng.	2012-07	T	39
3.5L 213.3 (3496cc) DOHC V6 (24 Valve) 92.5mm Bore Duratec Cyclone; MFI; Gasoline; Naturally Aspirated Ford Eng.	2012-08	W	40
3.5L 213.3 (3496cc) DOHC V6 (24 Valve) 92.5mm Bore Duratec Cyclone VVT; MFI; Flex Fuel; Naturally Aspirated Ford Eng.	2013	8	41
3.5L 213.3 (3496cc) DOHC V6 (24 Valve) 92.5mm Bore EcoBoost Duratec VVT; DI; Gasoline; Turbo - Intercooled Ford Eng.	2013-10	T	42
3.7L 227 (3721cc) DOHC V6 (24 Valve) 95.5mm Bore Duratec Cyclone; MFI; Gasoline; Naturally Aspirated Ford Eng.	2012-09	R	43
3.7L 227 (3721cc) DOHC V6 (24 Valve) 95.5mm Bore Duratec Cyclone VVT; MFI; Gasoline; Naturally Aspirated Ford Eng.	2013	K	44
3.7L 227 (3721cc) DOHC V6 (24 Valve) 95.5mm Bore Duratec Cyclone VVT; MFI; Gasoline; Naturally Aspirated Ford Eng.	2013-11	M	45
3.8L 232 (3797cc) OHV V6 (12 Valve) 96.8mm Bore; MFI; Gasoline; Naturally Aspirated Ford Eng.	2004-91	4	46
3.8L 232 (3797cc) OHV V6 (12 Valve) 96.8mm Bore; MFI; Gasoline; Supercharged Ford Eng.	1995-91	R	47
3.9L 238 (3887cc) OHV V6 (12 Valve) 96.8mm Bore; MFI; Gasoline; Naturally Aspirated Ford Eng.	2004	6	48
3.9L 241 (3949cc) DOHC V8 (32 Valve) 86mm Bore; MFI; Gasoline; Naturally Aspirated Jaguar Eng.	2006-00	A	49
4.0L 244 (4015cc) SOHC V6 (12 Valve) 100.4mm Bore; MFI; Gasoline; Naturally Aspirated Ford Eng.	2010-05	N	50
4.6L 281 (4605cc) DOHC V8 (32 Valve) 90.2mm Bore Intech; MFI; Gasoline; Naturally Aspirated Ford Eng.	2004-03	R	51
4.6L 281 (4605cc) DOHC V8 (32 Valve) 90.2mm Bore Intech; MFI; Gasoline; Naturally Aspirated Ford Eng.	2004-93	V	52
4.6L 281 (4605cc) DOHC V8 (32 Valve) 90.2mm Bore Intech; MFI; Gasoline; Supercharged Ford Eng.	2004-03	Y	53
4.6L 281 (4605cc) SOHC V8 (16 Valve) 90.2mm Bore Triton; MFI; Natural Gas; Naturally Aspirated Ford Eng.	2011-96	9	54
4.6L 281 (4605cc) SOHC V8 (16 Valve) 90.2mm Bore Triton; MFI; Flex Fuel; Naturally Aspirated Ford Eng.	2011-06	V	55
4.6L 281 (4605cc) SOHC V8 (16 Valve) 90.2mm Bore Triton Romeo; MFI; Gasoline; Naturally Aspirated Ford Eng.	2011-91	W	56
4.6L 281 (4605cc) SOHC V8 (16 Valve) 90.2mm Bore Triton Windsor; MFI; Gasoline; Naturally Aspirated Ford Eng.	2000-96	6	57
4.6L 281 (4605cc) SOHC V8 (16 Valve) 90.2mm Bore Triton Windsor; MFI; Gasoline; Naturally Aspirated Ford Eng.	2004-96	X	58
4.6L 281 (4605cc) SOHC V8 (24 Valve) 90.2mm Bore Triton; MFI; Gasoline; Naturally Aspirated Ford Eng.	2010-05	H	59
5.0L 302 (4950cc) OHV V8 (16 Valve) 4" Bore; MFI; Gasoline; Naturally Aspirated Ford Eng.	1991	F	60
5.0L 302 (4950cc) OHV V8 (16 Valve) 4" Bore Cobra; MFI; Gasoline; Naturally Aspirated Ford Eng.	1995-93	D	61
5.0L 302 (4950cc) OHV V8 (16 Valve) 4" Bore H.O.; MFI; Gasoline; Naturally Aspirated Ford Eng.	1993-91	E	62
5.0L 302 (4950cc) OHV V8 (16 Valve) 4" Bore H.O.; MFI; Gasoline; Naturally Aspirated Ford Eng.	1995-91	T	63
5.0L 302.1 (4951cc) DOHC V8 (32 Valve) 92.2mm Bore Triton Coyote VVT; MFI; Gasoline; Naturally Aspirated Ford Eng.	2013-11	F	64
5.0L 302.1 (4951cc) DOHC V8 (32 Valve) 92.2mm Bore Triton Road Runner VVT; MFI; Gasoline; Naturally Aspirated Ford Eng.	2013-12	U	65
5.4L 330 (5408cc) DOHC V8 (32 Valve) 90.2mm Bore Intech Windsor; MFI; Gasoline; Naturally Aspirated Ford Eng.	2001-99	H	66
5.4L 330 (5408cc) DOHC V8 (32 Valve) 90.2mm Bore Triton Condor; MFI; Gasoline; Supercharged - Intercooled Ford Eng.	2005	G	67
5.4L 330 (5408cc) DOHC V8 (32 Valve) 90.2mm Bore Triton Condor; MFI; Gasoline; Supercharged - Intercooled Ford Eng.	2012-06	S	68

Ford Car (Incl. Edsel, Ford, Lincoln, Mercury, Merkur) (Cont.)

Engine Finding Index (Cont.)					
Engine	Years	Code	Line No.		
5.8L 351 (5753cc) OHV V8 (16 Valve) 4" Bore Windsor; 2 Bbl.; Gasoline; Naturally Aspirated Ford Eng.	1991	G	69		
5.8L 351 (5753cc) OHV V8 (16 Valve) 4" Bore Windsor Cobra; MFI; Gasoline; Naturally Aspirated Ford Eng.	1996-95	C	70		
Engine Code Index					
Code	Engine	Line No.			
B3	1.3L 80.8 (1324cc) SOHC L4 (8 Valve) 71mm Bore; MFI; Gasoline; Naturally Aspirated Mazda Eng.	1			
B6-T	1.6L 97.5 (1597cc) DOHC L4 (16 Valve) 78mm Bore; MFI; Gasoline; Turbo - Intercooled Mazda Eng.	2			
B6-ZE	1.6L 97.5 (1597cc) DOHC L4 (16 Valve) 78mm Bore; MFI; Gasoline; Naturally Aspirated Mazda Eng.	3			
BP-ZE	1.8L 112.2 (1839cc) DOHC L4 (16 Valve) 83mm Bore; MFI; Gasoline; Naturally Aspirated Mazda Eng.	4			
F2	2.2L 133 (2184cc) SOHC L4 (12 Valve) 86mm Bore; MFI; Gasoline; Naturally Aspirated Mazda Eng.	15			
F2-T	2.2L 133 (2184cc) SOHC L4 (12 Valve) 86mm Bore; MFI; Gasoline; Turbo - Intercooled Mazda Eng.	16			
FS-DE	2.0L 121.5 (1991cc) DOHC L4 (16 Valve) 83mm Bore; MFI; Gasoline; Naturally Aspirated Mazda Eng.	10			
KL-ZE	2.5L 152 (2497cc) DOHC V6 (24 Valve) 84.5mm Bore; MFI; Gasoline; Naturally Aspirated Mazda Eng.	26			
Model Index					
Engine (VIN Code / Eng. Code)	Year	Engine (VIN Code / Eng. Code)	Year	Engine (VIN Code / Eng. Code)	Year
Edsel		Ford (cont.)		Ford (cont.)	
Citation		78		Custom (cont.)	
V8 410CI 6.7L	58	V8 221CI 3.6L (L-Head)	37	V8 332CI 5.4L	59-58
Corsair		81A		V8 351CI 5.8L (Cleveland)	74-70
V8 332CI 5.4L	59	V8 221CI 3.6L (L-Head)	38	V8 351CI 5.8L (Modified) (H)	79-75
V8 410CI 6.7L	58	82A		V8 351CI 5.8L (Windsor)	74-69
Edsel		V8 136CI 2.3L (L-Head)	38	V8 352CI 5.8L	66-58
L6 223CI 3.6L	60-59	91A		V8 390CI 6.4L	71-64
V8 292CI 4.8L	60-59	V8 221CI 3.6L (L-Head)	39	V8 400CI 6.6L (S)	79-71
V8 332CI 5.4L	59	92A		V8 427CI 7.0L	68-64
V8 352CI 5.8L	60	V8 136CI 2.3L (L-Head)	39	V8 428CI 7.0L	70-66
V8 361CI 5.9L	59-58	A		V8 429CI 7.0L	73-69
V8 410CI 6.7L	58	L4 200CI 3.3L (L-Head)	31-28	V8 460CI 7.5L (A)	78-72
Pacer		Aspire		Customline	
V8 361CI 5.9L	59-58	L4 1324cc 1.3L SOHC (H)	97-94	L6 215CI 3.5L	53-52
Ranger		B		L6 223CI 3.6L	56-54
L6 223CI 3.6L	60-59	L4 200CI 3.3L (L-Head)	32	V8 239.4CI 3.9L (L-Head)	53-52
V8 292CI 4.8L	60-59	C-Max Hybrid		V8 239CI 3.9L (OHV)	54
V8 352CI 5.8L	60	L4 1999cc 2.0L DOHC (16 Valve) (U)	13	V8 272CI 4.4L	56-55
V8 361CI 5.9L	59-58	Contour		DeLuxe	
Villager		L4 1988cc 2.0L DOHC (16 Valve) (3)	99-95	L6 226CI 3.7L (L-Head)	51-47
L6 223CI 3.6L	60-59	V6 2544cc 2.5L DOHC (24 Valve) (G)	00-97	V8 221CI 3.6L (L-Head)	42-32
V8 292CI 4.8L	60-59	V6 2544cc 2.5L DOHC (24 Valve) (L)	00-95	V8 239.4CI 3.9L (L-Head)	51-46
V8 352CI 5.8L	60	Crestline		Escort	
V8 361CI 5.9L	59-58	L6 215CI 3.5L	53-52	L4 114CI 1.9L SOHC (9)	90-85
Ford		L6 223CI 3.6L	54	L4 114CI 1.9L SOHC (J)	96-85
01A		V8 239.4CI 3.9L (L-Head)	53-52	L4 1839cc 1.8L DOHC (16 Valve) (8)	96-91
V8 221CI 3.6L (L-Head)	40	V8 239CI 3.9L (OHV)	54	L4 1988cc 2.0L DOHC (16 Valve) (3)	03-97
02A		Crestliner		L4 1988cc 2.0L SOHC (8 Valve) (P)	01-97
V8 136CI 2.3L (L-Head)	40	L6 226CI 3.7L (L-Head)	51	L4 1998cc 2.0L SOHC Diesel (H)	87-84
11A		V8 239.4CI 3.9L (L-Head)	51	L4 98CI 1.6L SOHC (2)	85-81
V8 221CI 3.6L (L-Head)	41	Crown Victoria		L4 98CI 1.6L SOHC (4)	85-83
18		V8 255CI 4.2L (D)	82-80	L4 98CI 1.6L SOHC (5)	85-83
V8 221CI 3.6L (L-Head)	32	V8 281CI 4.6L SOHC (16 Valve) (6)	00-96	L4 98CI 1.6L SOHC (7)	83
1GA		V8 281CI 4.6L SOHC (16 Valve) (W)	97-92	L4 98CI 1.6L SOHC Turbo (8)	85-84
L6 226CI 3.7L (L-Head)	41	V8 281CI 4.6L SOHC (16 Valve) (W)	11-01	Escort ZX2	
21A		V8 281CI 4.6L SOHC (Flex Fuel) (V)	11-06	L4 1988cc 2.0L DOHC (16 Valve) (3)	03-97
V8 221CI 3.6L (L-Head)	42	V8 281CI 4.6L SOHC (Natural Gas) (9)	11-96	EXP	
2GA		V8 302CI 5.0L (F)	91-80	L4 114CI 1.9L SOHC (9)	88-85
L6 226CI 3.7L (L-Head)	42	V8 351CI 5.8L (Windsor) (G)	91-80	L4 114CI 1.9L SOHC (J)	88-85
40		Custom		L4 98CI 1.6L SOHC (2)	84-82
V8 221CI 3.6L (L-Head)	33	L6 215CI 3.5L	53-52	L4 98CI 1.6L SOHC (4)	85-82
L4 200CI 3.3L (L-Head)	34	L6 223CI 3.6L	64-54	L4 98CI 1.6L SOHC (5)	84-83
V8 221CI 3.6L (L-Head)	34	L6 226CI 3.7L (L-Head)	51-49	L4 98CI 1.6L SOHC Turbo (8)	85-84
46		L6 240CI 3.9L	72-65	Fairlane	
L4 200CI 3.3L (L-Head)	33	V8 239.4CI 3.9L (L-Head)	51-49	L6 170CI 2.8L	66-62
48		V8 255CI 4.2L (D)	80	L6 200CI 3.3L	68-63
V8 221CI 3.6L (L-Head)	35	V8 272CI 4.4L	57-55	L6 223CI 3.6L	61-55
68		V8 289CI 4.7L	67-64	L6 250CI 4.1L	70-69
V8 221CI 3.6L (L-Head)	36	V8 292CI 4.8L	60-55	V8 221CI 3.6L	63-62
74		V8 302CI 5.0L (F)	80-68	V8 260CI 4.3L	64-62
V8 136CI 2.3L (L-Head)	37	V8 312CI 5.1L	57-56	V8 272CI 4.4L	57-55

Ford Car (Incl. Edsel, Ford, Lincoln, Mercury, Merkur) (Cont.)

Model Index (Cont.)					
Engine (VIN Code / Eng. Code)	Year	Engine (VIN Code / Eng. Code)	Year	Engine (VIN Code / Eng. Code)	Year
Ford (cont.)		Ford (cont.)		Ford (cont.)	
Fairlane (cont.)		Fusion (cont.)		LTD (Mid-Size) (cont.)	
V8 289CI 4.7L	68-63	L4 2488cc 2.5L DOHC (16 Valve) (A)	12-10	V6 232CI 3.8L (C)	85-84
V8 292CI 4.8L	61-55	V6 213CI 3.5L DOHC (24 Valve) (C)	12-10	V8 302CI 5.0L (F)	86-83
V8 302CI 5.0L	70-68	V6 2967cc 3.0L DOHC (24 Valve) (1)	09-06	LTD Crown Victoria (Full-Size)	
V8 312CI 5.1L	57-56	V6 2967cc 3.0L DOHC (24 Valve) (Flex Fuel)	12-10	V8 302CI 5.0L (F)	91-83
V8 332CI 5.4L	59-58	(G)		V8 351CI 5.8L (Windsor) (G)	91-83
V8 351CI 5.8L (Cleveland)	70	Fusion Hybrid		LTD II (Mid-Size)	
V8 351CI 5.8L (Windsor)	70-69	L4 1999cc 2.0L DOHC (16 Valve) (U)	13	V8 302CI 5.0L (F)	79-77
V8 352CI 5.8L	61-58	L4 2488cc 2.5L DOHC (16 Valve) (3)	12-10	V8 351CI 5.8L (Modified) (H)	79-77
V8 390CI 6.4L	69-61	Galaxie		V8 351CI 5.8L (Windsor) (H)	79-77
V8 427CI 7.0L	68-64	L6 223CI 3.6L	64-59	V8 400CI 6.6L (S)	78-77
V8 428CI 7.0L	69-68	L6 240CI 3.9L	72-65	Mainline	
V8 429CI 7.0L	70	V8 260CI 4.3L	63	L6 215CI 3.5L	53-52
Fairmont		V8 289CI 4.7L	67-63	L6 223CI 3.6L	56-54
L4 140CI 2.3L SOHC (A)	83-80	V8 292CI 4.8L	62-59	V8 239.4CI 3.9L (L-Head)	53-52
L4 140CI 2.3L SOHC (Y)	79-78	V8 302CI 5.0L	74-68	V8 239CI 3.9L (OHV)	54
L4 140CI 2.3L SOHC Turbo (W)	80	V8 351CI 5.8L (Cleveland)	74-70	V8 272CI 4.4L	56-55
L6 200CI 3.3L (B)	82-80	V8 351CI 5.8L (Windsor)	74-69	Maverick	
L6 200CI 3.3L (T)	79-78	V8 352CI 5.8L	66-59	L6 170CI 2.8L	72-70
L6 200CI 3.3L (X)	83	V8 390CI 6.4L	71-61	L6 200CI 3.3L (T)	77-70
V8 255CI 4.2L (D)	82-80	V8 400CI 6.6L	74-71	L6 250CI 4.1L (L)	77-70
V8 302CI 5.0L (F)	79-78	V8 406CI 6.6L	63-62	V8 302CI 5.0L (F)	77-71
Falcon		V8 427CI 7.0L	68-63	Mustang	
L6 144CI 2.4L	64-60	V8 428CI 7.0L	70-66	L4 140CI 2.3L SOHC (A)	90-80
L6 170CI 2.8L	69-61	V8 429CI 7.0L	73-69	L4 140CI 2.3L SOHC (M)	93-91
L6 200CI 3.3L	70-64	V8 460CI 7.5L	74-72	L4 140CI 2.3L SOHC (Y)	79-74
L6 250CI 4.1L	70	Granada		L4 140CI 2.3L SOHC Turbo (D)	83
V8 221CI 3.6L	63-62	L4 140CI 2.3L SOHC (A)	82-81	L4 140CI 2.3L SOHC Turbo (T)	86-85
V8 260CI 4.3L	65-62	L4 140CI 2.3L SOHC (LPG) (6)	82	L4 140CI 2.3L SOHC Turbo (W)	85-79
V8 289CI 4.7L	68-65	L6 200CI 3.3L (B)	82-80	L6 170CI 2.8L	65-64
V8 302CI 5.0L	70-68	L6 200CI 3.3L (T)	79-75	L6 200CI 3.3L	70-65
V8 351CI 5.8L (Cleveland)	70	L6 250CI 4.1L (C)	80	L6 200CI 3.3L (B)	82-80
V8 351CI 5.8L (Windsor)	70-69	L6 250CI 4.1L (L)	79-75	L6 200CI 3.3L (T)	79
V8 429CI 7.0L	70	V6 232CI 3.8L (3)	82	L6 250CI 4.1L	73-69
Festiva		V8 255CI 4.2L (D)	82-80	V6 171CI 2.8L (Z)	79-74
L4 1324cc 1.3L SOHC (H)	94-89	V8 302CI 5.0L (F)	80-75	V6 227CI 3.7L DOHC (24 Valve) (M)	13-11
L4 1324cc 1.3L SOHC (K)	89-88	V8 351CI 5.8L (Windsor) (H)	77-75	V6 232CI 3.8L (3)	86-83
Fiesta (Domestic)		GT		V6 232CI 3.8L (4)	04-94
L4 1596cc 1.6L DOHC (16 Valve) (J)	13-11	V8 330CI 5.4L DOHC Supercharged (32 Valve) (G)	05	V6 238CI 3.9L (6)	04
Fiesta (Import)		V8 330CI 5.4L DOHC Supercharged (32 Valve) (S)	06	V6 244CI 4.0L SOHC (N)	10-05
L4 1598cc 1.6L OHV (3036E)	80-78	Laser (Import)		V8 255CI 4.2L (D)	82-80
Five Hundred		L4 1597cc 1.6L SOHC (8 Valve) (5)	89-88	V8 260CI 4.3L	65-64
V6 2967cc 3.0L DOHC (24 Valve) (1)	07-05	L4 1597cc 1.6L SOHC (8 Valve) (7)	87	V8 281CI 4.6L DOHC (32 Valve) (R)	04-03
Five Hundred AWD		LTD (Full-Size)		V8 281CI 4.6L DOHC (32 Valve) (V)	01-96
V6 2967cc 3.0L DOHC (24 Valve) (1)	07-05	V8 255CI 4.2L (D)	82-80	V8 281CI 4.6L DOHC Supercharged (32 Valve) (Y)	04-03
Focus		V8 289CI 4.7L	68-65	V8 281CI 4.6L SOHC (16 Valve) (X)	04-96
L4 1988cc 2.0L DOHC (16 Valve) (3)	04-00	V8 302CI 5.0L (F)	82-68	V8 281CI 4.6L SOHC (24 Valve) (H)	10-05
L4 1988cc 2.0L DOHC (16 Valve) (5)	04-02	V8 351CI 5.8L (Cleveland)	74-70	V8 289CI 4.7L	68-64
L4 1988cc 2.0L SOHC (8 Valve) (P)	04-00	V8 351CI 5.8L (Modified) (H)	79-75	V8 302CI 5.0L (D)	95-93
L4 1999cc 2.0L DOHC (16 Valve) (N)	11-05	V8 351CI 5.8L (Windsor) (G)	82-80	V8 302CI 5.0L (E)	93-85
L4 1999cc 2.0L DOHC (16 Valve) (Flex Fuel)	13-12	V8 351CI 5.8L (Windsor) (H)	79-69	V8 302CI 5.0L (F)	82-68
(2)		V8 352CI 5.8L	66-65	V8 302CI 5.0L (M)	85-83
L4 1999cc 2.0L DOHC Turbo (16 Valve) (9)	13-12	V8 390CI 6.4L	71-65	V8 302CI 5.0L (T)	95-93
L4 2261cc 2.3L DOHC (16 Valve) (Z)	07-03	V8 400CI 6.6L (S)	79-71	V8 302CI 5.0L DOHC (32 Valve) (F)	13-11
Ford 300		V8 427CI 7.0L	68-65	V8 302CI 5.0L DOHC (32 Valve) (U)	13-12
L6 223CI 3.6L	63	V8 428CI 7.0L	70-66	V8 330CI 5.4L DOHC (32 Valve) (H)	01-99
V8 260CI 4.3L	63	V8 429CI 7.0L	73-69	V8 330CI 5.4L DOHC Supercharged (32 Valve) (S)	12-07
V8 289CI 4.7L	63	V8 460CI 7.5L (A)	78-72	V8 351CI 5.8L (Cleveland)	73-70
V8 352CI 5.8L	63	V8 460CI 7.5L (C)	78-73	V8 351CI 5.8L (Windsor)	73-69
V8 390CI 6.4L	63	LTD (Mid-Size)		V8 351CI 5.8L (Windsor) (C)	96-95
V8 427CI 7.0L	63	L4 140CI 2.3L SOHC (A)	86-83	V8 355CI 5.8L DOHC Supercharged (32 Valve) (Z)	13
Fusion		L4 140CI 2.3L SOHC (LPG) (6)	85-83	V8 390CI 6.4L	69-67
L4 1596cc 1.6L DOHC Turbo (16 Valve) (R)	13	L6 200CI 3.3L (X)	83	V8 427CI 7.0L	68
L4 1999cc 2.0L DOHC Turbo (16 Valve) (9)	13	V6 232CI 3.8L (3)	86-83		
L4 2261cc 2.3L DOHC (16 Valve) (Z)	09-06				
L4 2488cc 2.5L DOHC (16 Valve) (7)	13				

Ford Car (Incl. Edsel, Ford, Lincoln, Mercury, Merkur) (Cont.)

Model Index (Cont.)					
Engine (VIN Code / Eng. Code)	Year	Engine (VIN Code / Eng. Code)	Year	Engine (VIN Code / Eng. Code)	Year
Ford (cont.)		Ford (cont.)		Lincoln (cont.)	
Mustang (cont.)		Thunderbird (cont.)		Mark VI	
V8 428CI 7.0L	70-68	V8 400CI 6.6L (S)	78-71	V8 302CI 5.0L (F)	83-80
V8 429CI 7.0L	71-69	V8 428CI 7.0L	67-66	V8 351CI 5.8L (Windsor) (G)	83-80
Pinto		V8 429CI 7.0L	73-68	Mark VII	
L4 140CI 2.3L SOHC (A)	80	V8 430CI 7.0L	60-59	L6 2443cc 2.4L SOHC Turbo-Diesel (L)	85-84
L4 140CI 2.3L SOHC (Y)	79-74	V8 460CI 7.5L (A)	76-72	V8 302CI 5.0L (E)	92-87
L4 1599cc 1.6L OHV (W)	73-71	Torino		V8 302CI 5.0L (F)	87-84
L4 1993cc 2.0L SOHC (X)	74-71	L6 200CI 3.3L	68	V8 302CI 5.0L (M)	86-85
V6 171CI 2.8L (Z)	79-75	L6 250CI 4.1L	74-69	Mark VIII	
Probe		V8 289CI 4.7L	68	V8 281CI 4.6L DOHC (32 Valve) (V)	98-93
L4 1991cc 2.0L DOHC (16 Valve) (A)	97-93	V8 302CI 5.0L (F)	76-68	MKS	
L4 2184cc 2.2L SOHC (C)	92-89	V8 351CI 5.8L (Cleveland)	74-70	V6 213CI 3.5L DOHC Turbo (24 Valve) (T)	13-10
L4 2184cc 2.2L SOHC Turbo (L)	92-89	V8 351CI 5.8L (Modified) (H)	76-75	V6 227CI 3.7L DOHC (24 Valve) (K)	13
V6 183CI 3.0L OHV (U)	92-90	V8 351CI 5.8L (Windsor) (H)	76-69	V6 227CI 3.7L DOHC (24 Valve) (R)	12-09
V6 2497cc 2.5L DOHC (24 Valve) (B)	97-93	V8 390CI 6.4L	69-68	MKZ	
Standard		V8 400CI 6.6L (S)	76-72	L4 1999cc 2.0L DOHC Turbo (16 Valve) (9)	13
L6 226CI 3.7L (L-Head)	49	V8 427CI 7.0L	68	V6 213CI 3.5L DOHC (24 Valve) (C)	12-10
V8 239.4CI 3.9L (L-Head)	49	V8 428CI 7.0L	70-68	V6 213CI 3.5L DOHC (24 Valve) (T)	12-07
Super DeLuxe		V8 429CI 7.0L	73-70	V6 227CI 3.7L DOHC (24 Valve) (K)	13
V8 239.4CI 3.9L (L-Head)	48-46	V8 460CI 7.5L (C)	76-73	MKZ Hybrid	
T		Lincoln		L4 1999cc 2.0L DOHC (16 Valve) (U)	13
L4 177CI 2.9L (L-Head)	27-09	Capri		L4 2488cc 2.5L DOHC (16 Valve) (3)	12-11
Taurus		V8 317.5CI 5.2L	54-52	Premiere	
L4 153CI 2.5L OHV (HSC) (D)	90-86	V8 341CI 5.6L	55	V8 368CI 6.0L	57-56
L4 153CI 2.5L OHV (HSC) (N)	91	V8 368CI 6.0L	57-56	V8 430CI 7.0L	65-58
L4 1999cc 2.0L DOHC Turbo (16 Valve) (9)	13	V8 430CI 7.0L	65-58	Town Car	
V6 183CI 3.0L DOHC (24 Valve) (Y)	95-89	Continental (FWD)		V8 281CI 4.6L SOHC (16 Valve) (6)	00-96
V6 183CI 3.0L OHV (U)	07-86	V6 232CI 3.8L (4)	95-88	V8 281CI 4.6L SOHC (16 Valve) (W)	95-91
V6 183CI 3.0L OHV (Flex Fuel) (2)	07-00	V8 281CI 4.6L DOHC (32 Valve) (V)	02-95	V8 281CI 4.6L SOHC (16 Valve) (W)	11-01
V6 195CI 3.2L DOHC (24 Valve) (P)	95-93	Continental (RWD)		V8 281CI 4.6L SOHC (Flex Fuel) (V)	11-06
V6 213CI 3.5L DOHC (24 Valve) (W)	12-08	L6 2443cc 2.4L SOHC Turbo-Diesel (L)	85-84	V8 302CI 5.0L (F)	90-80
V6 213CI 3.5L DOHC (24 Valve) (Flex Fuel) (8)	13	V12 292CI 4.8L	42-41	V8 351CI 5.8L (Windsor) (G)	84-80
V6 213CI 3.5L DOHC Turbo (24 Valve) (T)	13-10	V12 305CI 5.0L	42	Versailles	
V6 232CI 3.8L (4)	95-88	V6 232CI 3.8L (3)	82	V8 255CI 4.2L (D)	80
V6 2967cc 3.0L DOHC (24 Valve) (S)	05-96	V8 302CI 5.0L (F)	87-80	V8 302CI 5.0L (F)	80-77
V8 207CI 3.4L DOHC (32 Valve) (N)	99-96	V8 317.5CI 5.2L	54-52	V8 351CI 5.8L (Windsor) (H)	78-77
Tempo		V8 336.7CI 5.5L	51-49	Zephyr (FWD)	
L4 140CI 2.3L OHV (HSC) (R)	84	V8 341CI 5.6L	55	V6 2967cc 3.0L DOHC (24 Valve) (1)	06
L4 140CI 2.3L OHV (HSC) (S)	91-85	V8 351CI 5.8L (Windsor) (G)	84-80	Zephyr (RWD)	
L4 140CI 2.3L OHV (HSC) (X)	94-85	V8 368CI 6.0L	57-56	V12 267.3CI 4.4L	39-36
L4 1998cc 2.0L SOHC Diesel (H)	86-84	V8 400CI 6.6L (S)	79-77	V12 292CI 4.8L	41-40
V6 183CI 3.0L OHV (U)	94-92	V8 430CI 7.0L	65-58	V12 305CI 5.0L	42
Tempo AWD		V8 460CI 7.5L (A)	78-68	Mercury	
L4 140CI 2.3L OHV (HSC) (S)	91-87	V8 462CI 7.6L	68-66	09A	
Thunderbird		Cosmopolitan		V8 239.4CI 3.9L (L-Head)	40
L4 140CI 2.3L SOHC Turbo (W)	88-83	V8 317.5CI 5.2L	54-52	0CM	
L6 200CI 3.3L (B)	82-80	V8 336.7CI 5.5L	51-49	V8 255.4CI 4.2L (L-Head)	50
V6 232CI 3.8L (3)	87-82	V8 341CI 5.6L	55	19A	
V6 232CI 3.8L (4)	97-87	Custom		V8 239.4CI 3.9L (L-Head)	41
V6 232CI 3.8L Supercharged (C)	89	V12 292CI 4.8L	41	1CM	
V6 232CI 3.8L Supercharged (R)	95-89	V12 305CI 5.0L	42	V8 255.4CI 4.2L (L-Head)	51
V8 255CI 4.2L (D)	82-80	LS		29A	
V8 272CI 4.4L	57-55	V6 2967cc 3.0L DOHC (24 Valve) (S)	05-00	V8 239.4CI 3.9L (L-Head)	42
V8 281CI 4.6L SOHC (16 Valve) (W)	97-94	V8 3949cc 3.9L DOHC (32 Valve) (A)	06-00	2M	
V8 292CI 4.8L	57-55	Mark II		V8 255.4CI 4.2L (L-Head)	52
V8 302CI 5.0L (F)	90-77	V8 368CI 6.0L	57-56	69M	
V8 302CI 5.0L (T)	93-91	Mark III		V8 239.4CI 3.9L (L-Head)	46
V8 312CI 5.1L	57-56	V8 430CI 7.0L	58	79M	
V8 312CI 5.1L Supercharged	57	V8 460CI 7.5L	71-68	V8 239.4CI 3.9L (L-Head)	47
V8 332CI 5.4L	59-58	Mark IV		89M	
V8 351CI 5.8L (Modified) (H)	79-77	V8 430CI 7.0L	59	V8 239.4CI 3.9L (L-Head)	48
V8 351CI 5.8L (Windsor) (H)	79-77	V8 460CI 7.5L (A)	76-72	99A	
V8 352CI 5.8L	60-58	Mark V		V8 239.4CI 3.9L (L-Head)	39
V8 390CI 6.4L	68-61	V8 400CI 6.6L (S)	79-77	9CM	
V8 3949cc 3.9L DOHC (32 Valve) (A)	05-02	V8 430CI 7.0L	60	V8 255.4CI 4.2L (L-Head)	49
		V8 460CI 7.5L (A)	78-77	Bobcat	

L4 140CI 2.3L SOHC (A) 80

Ford Car (Incl. Edsel, Ford, Lincoln, Mercury, Merkur) (Cont.)

Model Index (Cont.)					
Engine (VIN Code / Eng. Code)	Year	Engine (VIN Code / Eng. Code)	Year	Engine (VIN Code / Eng. Code)	Year
Mercury (cont.)		Mercury (cont.)		Mercury (cont.)	
Bobcat (cont.)		Cougar (RWD) (cont.)		Marquis (Mid-Size) (cont.)	
L4 140CI 2.3L SOHC (Y)	79-74	V8 400CI 6.6L (S)	78-73	L4 140CI 2.3L SOHC (LPG) (6)	85-83
L4 1993cc 2.0L SOHC (X)	74	V8 427CI 7.0L	68	L6 200CI 3.3L (X)	83
V6 171CI 2.8L (Z)	79-75	V8 428CI 7.0L	70-68	V6 232CI 3.8L (3)	86-83
Capri (FWD) (Import)		V8 429CI 7.0L	71-69	V6 232CI 3.8L (C)	85-84
L4 1597cc 1.6L DOHC (16 Valve) (Z)	94-91	V8 460CI 7.5L (A)	76-73	V8 302CI 5.0L (F)	86-83
L4 1597cc 1.6L DOHC Turbo (16 Valve) (6)	94-91	Custom		Medalist	
Capri (RWD) (Domestic)		V8 255.4CI 4.2L (L-Head)	53-52	V8 312CI 5.1L	58-56
L4 140CI 2.3L SOHC (A)	86-80	V8 256CI 4.2L (OHV)	54	Meteor	
L4 140CI 2.3L SOHC (Y)	79	V8 292CI 4.8L	55	L6 170CI 2.8L	63-62
L4 140CI 2.3L SOHC Turbo (D)	83	V8 312CI 5.1L	56	L6 200CI 3.3L	63
L4 140CI 2.3L SOHC Turbo (W)	84-79	Cyclone		L6 223CI 3.6L	61
L6 200CI 3.3L (B)	82-80	V8 289CI 4.7L	68-64	L6 240CI 3.9L	72-65
V6 171CI 2.8L (Z)	79	V8 302CI 5.0L	70-68	V8 221CI 3.6L	63-62
V6 232CI 3.8L (3)	86-83	V8 351CI 5.8L (Cleveland)	70	V8 260CI 4.3L	65-62
V8 255CI 4.2L (D)	82-80	V8 351CI 5.8L (Windsor)	70-69	V8 289CI 4.7L	68-63
V8 302CI 5.0L (F)	83-79	V8 390CI 6.4L	70-65	V8 292CI 4.8L	62-61
V8 302CI 5.0L (M)	86-84	V8 427CI 7.0L	68-67	V8 302CI 5.0L	72-68
Capri (RWD) (Import)		V8 428CI 7.0L	70-68	V8 351CI 5.8L (Cleveland)	74-70
L4 140CI 2.3L SOHC (Y)	78-74	V8 429CI 7.0L	70-69	V8 351CI 5.8L (Modified) (H)	76-75
L4 1599cc 1.6L OHV (L)	72-71	Grand Marquis		V8 352CI 5.8L	65-61
L4 1599cc 1.6L OHV (W)	73-71	V8 255CI 4.2L (D)	82-80	V8 390CI 6.4L	70-61
L4 1993cc 2.0L SOHC (X)	74-71	V8 281CI 4.6L DOHC (32 Valve) (V)	04-03	V8 400CI 6.6L (S)	76-71
V6 171CI 2.8L (Z)	78-74	V8 281CI 4.6L SOHC (16 Valve) (6)	00-96	V8 428CI 7.0L	70-66
V6 2551cc 2.6L OHV (U)	73-72	V8 281CI 4.6L SOHC (16 Valve) (W)	97-92	V8 429CI 7.0L	73-69
Comet		V8 281CI 4.6L SOHC (16 Valve) (W)	11-01	V8 460CI 7.5L (A)	76-72
L6 144CI 2.4L	63-60	V8 281CI 4.6L SOHC (Flex Fuel) (V)	11-06	Milan	
L6 170CI 2.8L	72-61	V8 281CI 4.6L SOHC (Natural Gas) (9)	11-96	L4 2261cc 2.3L DOHC (16 Valve) (Z)	09-06
L6 200CI 3.3L (T)	77-64	V8 302CI 5.0L (F)	91-80	L4 2488cc 2.5L DOHC (16 Valve) (A)	11-10
L6 250CI 4.1L (L)	77-69	V8 351CI 5.8L (Windsor) (G)	91-80	V6 2967cc 3.0L DOHC (24 Valve) (1)	09-06
V8 221CI 3.6L	63-62	LN-7		V6 2967cc 3.0L DOHC (24 Valve) (Flex Fuel)	11-10
V8 260CI 4.3L	65-62	L4 98CI 1.6L SOHC (2)	83-82	(G)	
V8 289CI 4.7L	68-63	L4 98CI 1.6L SOHC (4)	83-82	Milan Hybrid	
V8 302CI 5.0L (F)	77-68	L4 98CI 1.6L SOHC (5)	83	L4 2488cc 2.5L DOHC (16 Valve) (3)	11-10
V8 351CI 5.8L (Cleveland)	70	Lynx		Monarch	
V8 351CI 5.8L (Windsor)	70-69	L4 114CI 1.9L SOHC (9)	87-85	L4 140CI 2.3L SOHC (A)	82-81
V8 390CI 6.4L	70-65	L4 114CI 1.9L SOHC (J)	87-85	L6 200CI 3.3L (B)	82-80
V8 427CI 7.0L	68-67	L4 1998cc 2.0L SOHC Diesel (H)	87-84	L6 200CI 3.3L (T)	79-75
V8 428CI 7.0L	70-68	L4 98CI 1.6L SOHC (2)	85-81	L6 250CI 4.1L (C)	80
V8 429CI 7.0L	70	L4 98CI 1.6L SOHC (4)	85-83	L6 250CI 4.1L (L)	79-75
Commuter		L4 98CI 1.6L SOHC (5)	85-83	V8 255CI 4.2L (D)	82-80
V8 390CI 6.4L	68-64	L4 98CI 1.6L SOHC (7)	83	V8 302CI 5.0L (F)	80-75
V8 410CI 6.7L	67-66	L4 98CI 1.6L SOHC Turbo (8)	85-84	V8 351CI 5.8L (Windsor) (H)	77-75
V8 428CI 7.0L	68-66	Marauder		Montclair	
Cougar (FWD)		V8 281CI 4.6L DOHC (32 Valve) (V)	04-03	V8 292CI 4.8L	55
L4 1988cc 2.0L DOHC (16 Valve) (3)	02-99	V8 390CI 6.4L	70-63	V8 312CI 5.1L	60-57
V6 2495cc 2.5L DOHC (24 Valve) (G)	02-01	V8 410CI 6.7L	67-66	V8 383CI 6.3L	60-58
V6 2495cc 2.5L DOHC (24 Valve) (L)	02-01	V8 427CI 7.0L	68-63	V8 390CI 6.4L	68-64
V6 2544cc 2.5L DOHC (24 Valve) (G)	00	V8 428CI 7.0L	70-66	V8 410CI 6.7L	67-66
V6 2544cc 2.5L DOHC (24 Valve) (L)	00-99	V8 429CI 7.0L	70-69	V8 427CI 7.0L	68-64
Cougar (RWD)		Marquis (Full-Size)		V8 428CI 7.0L	68-66
L4 140CI 2.3L SOHC Turbo (W)	88-83	V8 255CI 4.2L (D)	82-80	V8 430CI 7.0L	60-58
L6 200CI 3.3L (B)	82-80	V8 302CI 5.0L (F)	82-80	Montego (AWD)	
V6 232CI 3.8L (3)	87-82	V8 351CI 5.8L (Cleveland)	74-70	V6 2967cc 3.0L DOHC (24 Valve) (1)	07-05
V6 232CI 3.8L (4)	97-87	V8 351CI 5.8L (Modified) (H)	79-75	Montego (FWD)	
V6 232CI 3.8L Supercharged (C)	89	V8 351CI 5.8L (Windsor) (G)	82-80	V6 2967cc 3.0L DOHC (24 Valve) (1)	07-05
V6 232CI 3.8L Supercharged (R)	90-89	V8 351CI 5.8L (Windsor) (H)	79	Montego (RWD)	
V8 255CI 4.2L (D)	82-80	V8 390CI 6.4L	70-68	L6 200CI 3.3L	68
V8 281CI 4.6L SOHC (16 Valve) (W)	97-94	V8 400CI 6.6L (S)	78-71	L6 250CI 4.1L	74-69
V8 289CI 4.7L	68-67	V8 410CI 6.7L	67	V8 289CI 4.7L	68
V8 302CI 5.0L (F)	90-68	V8 428CI 7.0L	70-67	V8 302CI 5.0L	74-68
V8 302CI 5.0L (T)	93-91	V8 429CI 7.0L	73-69	V8 351CI 5.8L (Cleveland)	74-70
V8 351CI 5.8L (Cleveland)	74-70	V8 460CI 7.5L (A)	78-72	V8 351CI 5.8L (Modified) (H)	76-75
V8 351CI 5.8L (Modified) (H)	79-75	V8 460CI 7.5L (C)	78-73	V8 351CI 5.8L (Windsor) (H)	76-69
V8 351CI 5.8L (Windsor) (H)	79-69	Marquis (Mid-Size)		V8 390CI 6.4L	69-68
V8 390CI 6.4L	70-67	L4 140CI 2.3L SOHC (A)	86-83	V8 400CI 6.6L (S)	76-72

Ford Car (Incl. Edsel, Ford, Lincoln, Mercury, Merkur) (Cont.)

Model Index (Cont.)					
Engine (VIN Code / Eng. Code)	Year	Engine (VIN Code / Eng. Code)	Year	Engine (VIN Code / Eng. Code)	Year
Mercury (cont.)		Mercury (cont.)			
Montego (RWD) (cont.)		Zephyr (cont.)			
V8 427CI 7.0L	68	L4 140CI 2.3L SOHC (Y)	79-78		
V8 428CI 7.0L	69-68	L4 140CI 2.3L SOHC Turbo (W)	80		
V8 429CI 7.0L	73-70	L6 200CI 3.3L (B)	82-80		
V8 460CI 7.5L (A)	76-73	L6 200CI 3.3L (T)	79-78		
Monterey		L6 200CI 3.3L (X)	83		
L6 223CI 3.6L	62-61	V8 255CI 4.2L (D)	82-80		
V8 255.4CI 4.2L (L-Head)	53-52	V8 302CI 5.0L (F)	79-78		
V8 256CI 4.2L (OHV)	54	Merkur			
V8 292CI 4.8L	62-61	Scorpio			
V8 292CI 4.8L	55	V6 177CI 2.9L (V)	90-88		
V8 312CI 5.1L	60-56	XR4Ti			
V8 351CI 5.8L (Cleveland)	74-70	L4 140CI 2.3L SOHC Turbo (T)	89-85		
V8 351CI 5.8L (Modified) (H)	76-75				
V8 352CI 5.8L	65-61				
V8 383CI 6.3L	60-58				
V8 390CI 6.4L	70-61				
V8 400CI 6.6L (S)	76-71				
V8 406CI 6.6L	63-62				
V8 410CI 6.7L	67-66				
V8 427CI 7.0L	68-63				
V8 428CI 7.0L	70-66				
V8 429CI 7.0L	73-69				
V8 430CI 7.0L	60-58				
V8 460CI 7.5L (A)	76-72				
Mystique					
L4 1988cc 2.0L DOHC (16 Valve) (3)	00-95				
V6 2544cc 2.5L DOHC (24 Valve) (L)	00-95				
Park Lane					
V8 312CI 5.1L	60-58				
V8 383CI 6.3L	60-58				
V8 390CI 6.4L	67-64				
V8 410CI 6.7L	67-66				
V8 427CI 7.0L	67-64				
V8 428CI 7.0L	67-66				
V8 430CI 7.0L	60-58				
S-55					
V8 428CI 7.0L	67-66				
Sable					
L4 153CI 2.5L OHV (HSC) (D)	90-86				
V6 183CI 3.0L OHV (U)	07-86				
V6 183CI 3.0L OHV (Flex Fuel) (2)	07-00				
V6 213CI 3.5L DOHC (24 Valve) (W)	09-08				
V6 232CI 3.8L (4)	95-88				
V6 2967cc 3.0L DOHC (24 Valve) (S)	05-96				
Topaz					
L4 140CI 2.3L OHV (HSC) (R)	84				
L4 140CI 2.3L OHV (HSC) (S)	91-85				
L4 140CI 2.3L OHV (HSC) (X)	94-85				
L4 1998cc 2.0L SOHC Diesel (H)	86-84				
V6 183CI 3.0L OHV (U)	94-92				
Topaz AWD					
L4 140CI 2.3L OHV (HSC) (S)	91-88				
Tracer (Domestic)					
L4 114CI 1.9L SOHC (J)	96-91				
L4 1839cc 1.8L DOHC (16 Valve) (8)	96-91				
L4 1988cc 2.0L SOHC (8 Valve) (P)	99-97				
Tracer (Import)					
L4 1597cc 1.6L SOHC (8 Valve) (5)	89-88				
L4 1597cc 1.6L SOHC (8 Valve) (7)	87				
Turnpike Cruiser					
V8 368CI 6.0L	57				
V8 383CI 6.3L	58				
V8 430CI 7.0L	58				
Zephyr					
L4 140CI 2.3L SOHC (A)	83-80				

Ford Car (Incl. Edsel, Ford, Lincoln, Mercury, Merkur) (Cont.)

1		1997 - 1991; 1.3L 80.8 (1324cc) SOHC L4 (8 Valve) 71mm Bore			1
MFI; Gasoline; Naturally Aspirated Mazda Eng.; VIN Code H, Eng. Code B3					
QTY	CYLINDER HEAD	YEARS	PART NO.	DESCRIPTION	
1	Head Gasket	1997-91	9555 PT		
1	Head Set	1997-94	HS 9555 B-1	PermaDry® molded rubber valve cover gskt. incl.; Premium valve stem seals incl.	
1	Head Set	1993-91	HS 9555 B	PermaDry® molded rubber valve cover gskt. incl.; Premium valve stem seals incl.	
QTY	CONVERSION SET	YEARS	PART NO.	DESCRIPTION	
1	Gasket Conversion Set	1997-94	CS 9691-3	RTV sealant incl. for oil pan gskt.	
1	Gasket Conversion Set	1993	CS 9691-2	PermaDry® molded rubber oil pan gskt. incl.	
1	Gasket Conversion Set	1992	CS 9461	To 01/31/92; PermaDry® molded rubber oil pan gskt. incl.	
1	Gasket Conversion Set	1992	CS 9691-2	From 02/01/92; PermaDry® molded rubber oil pan gskt. incl.	
1	Gasket Conversion Set	1991	CS 9461	PermaDry® molded rubber oil pan gskt. incl.	
QTY	MANIFOLD - INT. & EXH.	YEARS	PART NO.	DESCRIPTION	
1	Int. Manifold Gasket Set	1997-94	MS 94028-2	Upper set incl.	
1	Int. Manifold Gasket Set	1993-91	MS 94028-1	Upper set incl.	
1	Exh. Manifold Gasket Set	1997-94	MS 95627	w/Heat shield	
1	Exh. Manifold Gasket Set	1993-91	MS 94027	w/o Heat shield	
QTY	EXHAUST PIPE FLANGE	YEARS	PART NO.	DESCRIPTION	
1	Exhaust Pipe Gasket	1997-91	60286	Flange	
1	Exhaust Pipe Gasket	1997-91	60690	Loc. Front; Converter	
1	Exhaust Pipe Gasket	1997-94	60620	Loc. Rear; Converter; w/A/T	
1	Exhaust Pipe Gasket	1993-91	60620	Loc. Rear; Converter	
QTY	OIL PAN	YEARS	PART NO.	DESCRIPTION	
1	Oil Pan Gasket Set	1997-94	OS 30633 R	RTV Black silicone w/Rubber end seals	
1	Oil Pan Gasket Set	1993-91	OS 30548 R	PermaDry® molded rubber gskt. incl.	
QTY	CRANKSHAFT REAR SEAL	YEARS	PART NO.	DESCRIPTION	
1	Rear Main Seal Set	1997-91	BS 40634	Rubber; One-piece	
QTY	VALVE COVER	YEARS	PART NO.	DESCRIPTION	
1	Valve Cover Gasket Set	1997-94	VS 50439 R	PermaDry® molded rubber gskt. incl.	
1	Valve Cover Gasket Set	1993-91	VS 50309 R	w/Grommets; PermaDry® molded rubber gskt. incl.	
QTY	VALVE STEM SEAL SET	YEARS	PART NO.	DESCRIPTION	
1	Valve Stem Seal Set	1997-91	SS 72680	Premium valve stem seals incl.	
QTY	WATER OUTLET GASKET	YEARS	PART NO.	DESCRIPTION	
1	Water Outlet Gasket	1997-91	35251	Water Outlet	
QTY	WATER PUMP	YEARS	PART NO.	DESCRIPTION	
1	Water Pump Gasket	1997-91	35456	Cover	
1	Water Pump Gasket	1997-91	35457	Inlet	
QTY	TIMING COVER	YEARS	PART NO.	DESCRIPTION	
1	Timing Cover Dust Seal Set	1993-91	ES 72765		
1	Crankshaft Front Seal Set	1997-94	TCS 45921	Must be used w/OS 30633R	
1	Crankshaft Front Seal Set	1993	TCS 45921	Must be used w/OS 30548R	
1	Crankshaft Front Seal Set	1992	TCS 45722	To 01/31/92; Must be used w/OS 30548R	
1	Crankshaft Front Seal Set	1992	TCS 45921	From 02/01/92; Must be used w/OS 30548R	
1	Crankshaft Front Seal Set	1991	TCS 45722	Must be used w/OS 30548R	
1	Camshaft Front Seal Set	1997-91	TCS 45724		
QTY	CARB & FUEL INJECTION	YEARS	PART NO.	DESCRIPTION	
1	Fuel Injector O-Ring Set	1997-91	ES 70600		
1	Throttle Body Gasket	1997-94	60989		
1	Throttle Body Gasket	1993-91	60697		
QTY	DISTRIBUTOR MOUNTING	YEARS	PART NO.	DESCRIPTION	
1	O-Ring	1997-91	35608	Distributor Mounting	
QTY	EXHAUST GAS RECIRCULATION	YEARS	PART NO.	DESCRIPTION	
1	EGR Gasket	1997-94	70431		
1	EGR Gasket	1993-91	70254	Pulse air tube	
2		1994 - 1991; 1.6L 97.5 (1597cc) DOHC L4 (16 Valve) 78mm Bore			2
MFI; Gasoline; Turbo - Intercooled Mazda Eng.; VIN Code 6, Eng. Code B6-T					
QTY	CYLINDER HEAD	YEARS	PART NO.	DESCRIPTION	
1	Head Gasket	1994-91	9691 PT		
1	Head Set	1994-91	HS 9691 PT-2	PermaDry® molded rubber valve cover gskt. incl.; Premium valve stem seals incl.	
QTY	CONVERSION SET	YEARS	PART NO.	DESCRIPTION	
1	Gasket Conversion Set	1994-92	CS 9691-3	RTV sealant incl. for oil pan gskt.	
1	Gasket Conversion Set	1991	CS 9691	To 11/30/90; RTV sealant incl. for oil pan gskt.	

Ford Car (Incl. Edsel, Ford, Lincoln, Mercury, Merkur) (Cont.)

2 (cont.)		1994 - 1991; 1.6L 97.5 (1597cc) DOHC L4 (16 Valve) 78mm Bore			2 (cont.)
		MFI; Gasoline; Turbo - Intercooled Mazda Eng.; VIN Code 6, Eng. Code B6-T			
QTY	CONVERSION SET	YEARS	PART NO.	DESCRIPTION	
1	Gasket Conversion Set	1991	CS 9691-3	From 12/01/90; RTV sealant incl. for oil pan gskt.	
QTY	MANIFOLD - INT. & EXH.	YEARS	PART NO.	DESCRIPTION	
1	Int. Manifold Gasket Set	1994-91	MS 94537		
1	Exh. Manifold Gasket Set	1994-91	MS 94532		
QTY	EXHAUST PIPE FLANGE	YEARS	PART NO.	DESCRIPTION	
1	Exhaust Pipe Gasket	1994-91	60620	Loc. Front; Converter	
1	Exhaust Pipe Gasket	1994-91	60620	Loc. Rear; Converter	
1	Exhaust Pipe Gasket	1994-91	60800	Loc. Front; Converter; Packing	
1	Exhaust Pipe Gasket	1994-91	60940	Flange	
QTY	FUEL PUMP	YEARS	PART NO.	DESCRIPTION	
1	Fuel Pump Mounting Gasket	1994-91	70030		
QTY	OIL PAN	YEARS	PART NO.	DESCRIPTION	
1	Oil Pan Gasket Set	1994-91	OS 30633 R	RTV Black silicone w/Rubber end seals	
QTY	CRANKSHAFT REAR SEAL	YEARS	PART NO.	DESCRIPTION	
1	Rear Main Seal Set	1994-91	BS 40634	Rubber; One-piece	
QTY	VALVE COVER	YEARS	PART NO.	DESCRIPTION	
1	Valve Cover Gasket Set	1994-91	VS 50361 R	w/o Grommets & w/Spark plug tube seals; PermaDry® molded rubber gskt. incl.	
1	Grommet Set	1994-91	ES 72210	Valve Cover	
QTY	VALVE STEM SEAL SET	YEARS	PART NO.	DESCRIPTION	
1	Valve Stem Seal Set	1994-91	SS 72782	Premium valve stem seals incl.	
QTY	WATER OUTLET GASKET	YEARS	PART NO.	DESCRIPTION	
1	Water Outlet Gasket	1994-91	35251	Water Outlet	
QTY	WATER PUMP	YEARS	PART NO.	DESCRIPTION	
1	Water Pump Gasket	1994-91	35456	Cover	
1	Water Pump Gasket	1994-91	35457	Inlet	
QTY	TIMING COVER	YEARS	PART NO.	DESCRIPTION	
1	Crankshaft Front Seal Set	1994-92	TCS 45921	Must be used w/OS 30633R	
1	Crankshaft Front Seal Set	1991	TCS 45722	To 11/30/90; Must be used w/OS 30633R	
1	Crankshaft Front Seal Set	1991	TCS 45921	From 12/01/90; Must be used w/OS 30633R	
1	Camshaft Front Seal Set	1994-91	TCS 45860		
QTY	CARB & FUEL INJECTION	YEARS	PART NO.	DESCRIPTION	
1	Fuel Injector O-Ring Set	1994-91	ES 70600		
1	Throttle Body Gasket	1994-91	60697		
QTY	TURBO MOUNTING SET	YEARS	PART NO.	DESCRIPTION	
1	Turbo Mtg. Gasket Set	1994-91	ES 70511		
3		1994 - 1991; 1.6L 97.5 (1597cc) DOHC L4 (16 Valve) 78mm Bore			3
		MFI; Gasoline; Naturally Aspirated Mazda Eng.; VIN Code Z, Eng. Code B6-ZE			
QTY	CYLINDER HEAD	YEARS	PART NO.	DESCRIPTION	
1	Head Gasket	1994-91	9691 PT		
1	Head Set	1994-91	HS 9691 PT-1	PermaDry® molded rubber valve cover gskt. incl.; Premium valve stem seals incl.	
QTY	CONVERSION SET	YEARS	PART NO.	DESCRIPTION	
1	Gasket Conversion Set	1994-92	CS 9691-2	PermaDry® molded rubber oil pan gskt. incl.	
1	Gasket Conversion Set	1991	CS 9691-2	From 12/01/90; PermaDry® molded rubber oil pan gskt. incl.	
QTY	MANIFOLD - INT. & EXH.	YEARS	PART NO.	DESCRIPTION	
1	Int. Manifold Gasket Set	1994-91	MS 94537		
1	Exh. Manifold Gasket Set	1994-91	MS 94532		
QTY	EXHAUST PIPE FLANGE	YEARS	PART NO.	DESCRIPTION	
1	Exhaust Pipe Gasket	1994-91	60286	Flange	
1	Exhaust Pipe Gasket	1994-91	60620	Loc. Front; Converter	
1	Exhaust Pipe Gasket	1994-91	60620	Loc. Rear; Converter	
1	Exhaust Pipe Gasket	1994-91	60800	Loc. Front; Converter; Packing	
QTY	FUEL PUMP	YEARS	PART NO.	DESCRIPTION	
1	Fuel Pump Mounting Gasket	1994-91	70030		
QTY	OIL PAN	YEARS	PART NO.	DESCRIPTION	
1	Oil Pan Gasket Set	1994-91	OS 30548 R	PermaDry® molded rubber gskt. incl.	
QTY	CRANKSHAFT REAR SEAL	YEARS	PART NO.	DESCRIPTION	
1	Rear Main Seal Set	1994-91	BS 40634	Rubber; One-piece	
QTY	VALVE COVER	YEARS	PART NO.	DESCRIPTION	
1	Valve Cover Gasket Set	1994-91	VS 50361 R	w/o Grommets & w/Spark plug tube seals; PermaDry® molded rubber gskt. incl.	

Ford Car (Incl. Edsel, Ford, Lincoln, Mercury, Merkur) (Cont.)

3		1994 - 1991; 1.6L 97.5 (1597cc) DOHC L4 (16 Valve) 78mm Bore			3
(cont.)		MFI; Gasoline; Naturally Aspirated Mazda Eng.; VIN Code Z, Eng. Code B6-ZE			(cont.)
QTY	VALVE COVER	YEARS	PART NO.	DESCRIPTION	
1	Grommet Set	1994-91	ES 72210	Valve Cover	
QTY	VALVE STEM SEAL SET	YEARS	PART NO.	DESCRIPTION	
1	Valve Stem Seal Set	1994-91	SS 72782	Premium valve stem seals incl.	
QTY	WATER OUTLET GASKET	YEARS	PART NO.	DESCRIPTION	
1	Water Outlet Gasket	1994-91	35251	Water Outlet	
QTY	WATER PUMP	YEARS	PART NO.	DESCRIPTION	
1	Water Pump Gasket	1994-91	35456	Cover	
1	Water Pump Gasket	1994-91	35457	Inlet	
QTY	TIMING COVER	YEARS	PART NO.	DESCRIPTION	
1	Crankshaft Front Seal Set	1994-92	TCS 45921	Must be used w/OS 30548R	
1	Crankshaft Front Seal Set	1991	TCS 45722	To 11/30/90; Must be used w/OS 30548R	
1	Crankshaft Front Seal Set	1991	TCS 45921	From 12/01/90; Must be used w/OS 30548R	
1	Camshaft Front Seal Set	1994-91	TCS 45860		
QTY	CARB & FUEL INJECTION	YEARS	PART NO.	DESCRIPTION	
1	Fuel Injector O-Ring Set	1994-91	ES 70600		
1	Throttle Body Gasket	1994-91	60697		
4		1996 - 1991; 1.8L 112.2 (1839cc) DOHC L4 (16 Valve) 83mm Bore			4
		MFI; Gasoline; Naturally Aspirated Mazda Eng.; VIN Code 8, Eng. Code BP-ZE			
QTY	CYLINDER HEAD	YEARS	PART NO.	DESCRIPTION	
1	Head Gasket	1996-91	9717 PT	Head bolts not incl.; Head bolt replacement recommended; PermaTorqueMLS®	
1	Head Set	1996-94	HS 9717 PT-1	Head bolts not incl.; Head bolt replacement recommended; PermaDry® molded rubber valve cover gskt. incl.; Premium valve stem seals incl.	
1	Head Set	1993-91	HS 9717 PT	Head bolts not incl.; Head bolt replacement recommended; PermaDry® molded rubber valve cover gskt. incl.; Premium valve stem seals incl.	
1	Head Bolt Set	1996-91	ES 72846	Replacement recommended; New Part Number - Check for Availability	
QTY	CONVERSION SET	YEARS	PART NO.	DESCRIPTION	
1	Gasket Conversion Set	1996-92	CS 9696-1	RTV sealant incl. for oil pan gskt.	
1	Gasket Conversion Set	1991	CS 9696-1	From 02/01/91; RTV sealant incl. for oil pan gskt.	
QTY	MANIFOLD - INT. & EXH.	YEARS	PART NO.	DESCRIPTION	
1	Int. Manifold Gasket Set	1996-91	MS 94612	Upper set incl.	
1	Exh. Manifold Gasket Set	1996-91	MS 94611		
QTY	EXHAUST PIPE FLANGE	YEARS	PART NO.	DESCRIPTION	
1	Exhaust Pipe Gasket	1996-91	60620	Loc. Rear; Converter	
1	Exhaust Pipe Gasket	1996-91	60798	Flange	
1	Exhaust Pipe Gasket	1996-91	60867	Loc. Front; Converter	
QTY	OIL PAN	YEARS	PART NO.	DESCRIPTION	
1	Oil Pan Gasket Set	1996-91	OS 30631 R	RTV Black silicone w/Rubber end seals	
QTY	CRANKSHAFT REAR SEAL	YEARS	PART NO.	DESCRIPTION	
1	Rear Main Seal Set	1996-91	BS 40634	Rubber; One-piece	
QTY	VALVE COVER	YEARS	PART NO.	DESCRIPTION	
1	Valve Cover Gasket Set	1996-91	VS 50569 R	w/Spark plug tube seals; PermaDry® molded rubber gskt. incl.; Improved design	
QTY	VALVE STEM SEAL SET	YEARS	PART NO.	DESCRIPTION	
1	Valve Stem Seal Set	1996-94	SS 72802	Premium valve stem seals incl.	
1	Valve Stem Seal Set	1993-91	SS 72782	Premium valve stem seals incl.	
QTY	WATER OUTLET GASKET	YEARS	PART NO.	DESCRIPTION	
1	Water Outlet Gasket	1996-91	35251	Water Outlet	
QTY	WATER PUMP	YEARS	PART NO.	DESCRIPTION	
1	Water Pump Gasket	1996-91	35456	Cover	
1	Water Pump Gasket	1996-93	35567	Inlet	
1	Water Pump Gasket	1992	35457	To 09/01/91; Inlet	
1	Water Pump Gasket	1992	35567	From 09/01/91; Inlet	
1	Water Pump Gasket	1991	35457	Inlet	
QTY	TIMING COVER	YEARS	PART NO.	DESCRIPTION	
1	Crankshaft Front Seal Set	1996-92	TCS 45921	Must be used w/OS 30631R	
1	Crankshaft Front Seal Set	1991	TCS 45722	To 01/31/91; Must be used w/OS 30631R	
1	Crankshaft Front Seal Set	1991	TCS 45921	From 02/01/91; Must be used w/OS 30631R	
1	Camshaft Front Seal Set	1996-91	TCS 45860		
QTY	CARB & FUEL INJECTION	YEARS	PART NO.	DESCRIPTION	
1	Fuel Injector O-Ring Set	1996-91	ES 70600		
1	Throttle Body Gasket	1996-91	60874		

Ford Car (Incl. Edsel, Ford, Lincoln, Mercury, Merkur) (Cont.)

4		1996 - 1991; 1.8L 112.2 (1839cc) DOHC L4 (16 Valve) 83mm Bore			4
(cont.)		MFI; Gasoline; Naturally Aspirated Mazda Eng.; VIN Code 8, Eng. Code BP-ZE			(cont.)
QTY	DISTRIBUTOR MOUNTING	YEARS	PART NO.	DESCRIPTION	
1	O-Ring	1996-91	35608	Distributor Mounting	
QTY	EXHAUST GAS RECIRCULATION	YEARS	PART NO.	DESCRIPTION	
1	EGR Gasket	1996-94	70431		
5		1996 - 1991; 1.9L 114 (1868cc) SOHC L4 (8 Valve) 82mm Bore			5
(cont.)		MFI; Gasoline; Naturally Aspirated Ford Eng.; VIN Code J			(cont.)
QTY	CYLINDER HEAD	YEARS	PART NO.	DESCRIPTION	
1	Head Gasket	1996-91	9309 PT-2	Head bolts not incl.; Head bolt replacement required; PermaTorque®	
1	Head Gasket Spacer Shim	1996-91	9309 SP-2	HeadSaver®	
1	Head Set	1996-94	HS 9309 PT-1	w/Head bolts; Mexico Int. manifold gskt. not incl.; PermaDryPlus® valve cover gskt. incl.; Premium valve stem seals incl.	
1	Head Set	1993-92	HS 9309 PT-1	w/Head bolts; PermaDryPlus® valve cover gskt. incl.; Premium valve stem seals incl.	
1	Head Set	1991	HS 9309 PT-1	From 05/02/91; w/Head bolts; PermaDryPlus® valve cover gskt. incl.; Premium valve stem seals incl.	
1	Head Set	1991	HS 9309 PT-1	To 05/01/91; w/Head bolts; Valve stem seals not incl.; PermaDryPlus® valve cover gskt. incl.	
1	Head Installation Set	1996-94	HIS 9309 PT-1	w/Head bolts; Mexico Int. manifold gskt. not incl.; PermaDryPlus® valve cover gskt. incl.	
1	Head Installation Set	1993-91	HIS 9309 PT-1	w/Head bolts; PermaDryPlus® valve cover gskt. incl.	
1	Head Bolt Set	1996-91	ES 72672	Replacement required	
QTY	CONVERSION SET	YEARS	PART NO.	DESCRIPTION	
1	Gasket Conversion Set	1996-94	CS 9309-2	PermaDry® molded rubber oil pan gskt. incl.	
1	Gasket Conversion Set	1993	CS 9309-1	To 02/09/93; PermaDry® molded rubber oil pan gskt. incl.	
1	Gasket Conversion Set	1993	CS 9309-2	From 02/10/93; PermaDry® molded rubber oil pan gskt. incl.	
1	Gasket Conversion Set	1992-91	CS 9309-1	PermaDry® molded rubber oil pan gskt. incl.	
QTY	MANIFOLD - INT. & EXH.	YEARS	PART NO.	DESCRIPTION	
1	Int. Manifold Gasket Set	1996-94	MS 93935	Exc. Mexico	
1	Int. Manifold Gasket Set	1993-91	MS 93935		
1	Exh. Manifold Gasket Set	1996-91	MS 92057		
QTY	EXHAUST PIPE FLANGE	YEARS	PART NO.	DESCRIPTION	
1	Exhaust Pipe Gasket	1996-91	60831	Converter	
1	Exh. Flange Bolt & Spring Kit	1994-91	ES 72142		
QTY	OIL PAN	YEARS	PART NO.	DESCRIPTION	
1	Oil Pan Gasket Set	1996-94	OS 30915 R	PermaDry® molded rubber gskt. incl.	
1	Oil Pan Gasket Set	1993	OS 30536 R	To 02/09/93; PermaDry® molded rubber gskt. incl.	
1	Oil Pan Gasket Set	1993	OS 30915 R	From 02/10/93; PermaDry® molded rubber gskt. incl.	
1	Oil Pan Gasket Set	1992-91	OS 30536 R	PermaDry® molded rubber gskt. incl.	
1	Drain Plug Gasket	1996-91	72515		
QTY	CRANKSHAFT REAR SEAL	YEARS	PART NO.	DESCRIPTION	
1	Rear Main Seal Set	1996-91	BS 40158	Rubber; One-piece	
1	Rear Main Seal Set	1996-91	BS 40646	PTFE Rubber; One-piece	
QTY	VALVE COVER	YEARS	PART NO.	DESCRIPTION	
1	Valve Cover Gasket Set	1996-91	VS 50369	Replaces OEM molded rubber bead; w/Grommets; PermaDryPlus® gskt. incl.	
QTY	VALVE STEM SEAL SET	YEARS	PART NO.	DESCRIPTION	
1	Valve Stem Seal Set	1996-92	SS 70654	Premium valve stem seals incl.	
1	Valve Stem Seal Set	1991	SS 70654	From 05/02/91; Premium valve stem seals incl.	
1	Valve Stem Seal Set	1991	SS 72514-2	To 05/01/91; Premium valve stem seals incl.	
QTY	THERMOSTAT HOUSING	YEARS	PART NO.	DESCRIPTION	
1	Thermostat Gasket	1996-91	35477	Thermostat Housing	
QTY	WATER PUMP	YEARS	PART NO.	DESCRIPTION	
1	Water Pump Gasket	1996-91	35607	Cover; Improved design	
QTY	TIMING COVER	YEARS	PART NO.	DESCRIPTION	
1	Crankshaft Front Seal Set	1996-91	TCS 45472-1	Must be used w/OS 30536R or w/OS 30915R; Repair sleeve not incl.	
1	Camshaft Front Seal Set	1996-91	TCS 45473		
1	Repair Sleeve Tool	1996-91	16303	Timing Cover	
QTY	CARB & FUEL INJECTION	YEARS	PART NO.	DESCRIPTION	
1	Fuel Injector O-Ring Set	1996-91	ES 70599	Improved design	
1	Throttle Body Gasket	1996-91	71216	Air bypass valve	
1	Throttle Body Gasket	1996-95	60995	Mounting	
1	Throttle Body Gasket	1994-91	60944	Mounting	
QTY	EXHAUST GAS RECIRCULATION	YEARS	PART NO.	DESCRIPTION	
1	EGR Gasket	1996-91	70149		

Ford Car (Incl. Edsel, Ford, Lincoln, Mercury, Merkur) (Cont.)

6		2004 - 1995; 2.0L 121 (1988cc) DOHC L4 (16 Valve) 84.8mm Bore Zetec			6
MFI; Gasoline; Naturally Aspirated Ford Eng.; VIN Code 3					
QTY	CYLINDER HEAD	YEARS	PART NO.	DESCRIPTION	
1	Head Gasket	2004	26174 PT	Head bolts not incl.; Head bolt replacement required; PermaTorqueMLS®	
1	Head Gasket	2003	26174 PT	Exc. Ford Escort ZX2; Engineering No. XS7G-6051D1 stamped on head gskt.; Head bolts not incl.; Head bolt replacement required; PermaTorqueMLS®	
1	Head Gasket	2003	9005 PT-1	Exc. Ford Escort ZX2; Engineering No. XS7G-6051C1 stamped on head gskt.; Head bolts not incl.; Head bolt replacement required; PermaTorqueMLS®	
1	Head Gasket	2003	9005 PT-1	Ford Escort ZX2; Head bolts not incl.; Head bolt replacement required; PermaTorqueMLS®	
1	Head Gasket	2002	26174 PT	Ford Focus S2, SE, Street, ZTS, ZTW, ZX3, ZX5; Engineering No. XS7G-6051D1 stamped on head gskt.; Head bolts not incl.; Head bolt replacement required; PermaTorqueMLS®	
1	Head Gasket	2002	9005 PT-1	Ford Focus S2, SE, Street, ZTS, ZTW, ZX3, ZX5; Engineering No. XS7G-6051C1 stamped on head gskt.; Head bolts not incl.; Head bolt replacement required; PermaTorqueMLS®	
1	Head Gasket	2002	9005 PT-1	Exc. Ford Focus S2, SE, Street, ZTS, ZTW, ZX3, ZX5; Head bolts not incl.; Head bolt replacement required; PermaTorqueMLS®	
1	Head Gasket	2001	26174 PT	Ford Focus S2, SE, Street, ZTS, ZX3; Engineering No. XS7G-6051D1 stamped on head gskt.; Head bolts not incl.; Head bolt replacement required; PermaTorqueMLS®	
1	Head Gasket	2001	9005 PT-1	Ford Focus S2, SE, Street, ZTS, ZX3; Engineering No. XS7G-6051C1 stamped on head gskt.; Head bolts not incl.; Head bolt replacement required; PermaTorqueMLS®	
1	Head Gasket	2001	9005 PT-1	Exc. Ford Focus S2, SE, Street, ZTS, ZX3; Head bolts not incl.; Head bolt replacement required; PermaTorqueMLS®	
1	Head Gasket	2000	26174 PT	Ford Focus SE, Sony Limited Edition, ZTS, ZX3; Engineering No. XS7G-6051D1 stamped on head gskt.; Head bolts not incl.; Head bolt replacement required; PermaTorqueMLS®	
1	Head Gasket	2000	9005 PT-1	Ford Focus SE, Sony Limited Edition, ZTS, ZX3; Engineering No. XS7G-6051C1 stamped on head gskt.; Head bolts not incl.; Head bolt replacement required; PermaTorqueMLS®	
1	Head Gasket	2000	9005 PT-1	Exc. Ford Focus SE, Sony Limited Edition, ZTS, ZX3; Head bolts not incl.; Head bolt replacement required; PermaTorqueMLS®	
1	Head Gasket	1999-95	9005 PT	Head bolts not incl.; Head bolt replacement required; PermaTorqueMLS®	
1	Head Set	2004	HS 26174 PT	Head bolts not incl.; Head bolt replacement required; PermaDry® molded rubber valve cover gskt. incl.; Premium valve stem seals incl.	
1	Head Set	2003-00	HS 9005 PT-3	Ford Escort ZX2; Head bolts not incl.; Head bolt replacement required; PermaDry® molded rubber valve cover gskt. incl.; Premium valve stem seals incl.	
1	Head Set	2003	HS 26174 PT	Exc. Ford Escort ZX2; Engineering No. XS7G-6051D1 stamped on head gskt.; Int. manifold gskt. w/Round port w/tab not incl.; Head bolts not incl.; Head bolt replacement required; PermaDry® molded rubber valve cover gskt. incl.; Premium valve stem seals incl.	
1	Head Set	2003	HS 9005 PT-5	Exc. Ford Escort ZX2; Engineering No. XS7G-6051C1 stamped on head gskt.; Int. manifold gskt. w/Round port w/tab not incl.; Head bolts not incl.; Head bolt replacement required; PermaDry® molded rubber valve cover gskt. incl.; Premium valve stem seals incl.	
1	Head Set	2002-00	HS 9005 PT-10	Ford Cougar Base Mercury Cougar Base; Head bolts not incl.; Head bolt replacement required; PermaDry® molded rubber valve cover gskt. incl.; Premium valve stem seals incl.	
1	Head Set	2002	HS 26174 PT	Ford Focus S2, SE, Street, ZTS, ZTW, ZX3, ZX5; Engineering No. XS7G-6051D1 stamped on head gskt.; Int. manifold gskt. w/Round port w/tab not incl.; Head bolts not incl.; Head bolt replacement required; PermaDry® molded rubber valve cover gskt. incl.; Premium valve stem seals incl.	
1	Head Set	2002	HS 9005 PT-5	Ford Focus S2, SE, Street, ZTS, ZTW, ZX3, ZX5; Engineering No. XS7G-6051C1 stamped on head gskt.; Int. manifold gskt. w/Round port w/tab not incl.; Head bolts not incl.; Head bolt replacement required; PermaDry® molded rubber valve cover gskt. incl.; Premium valve stem seals incl.	
1	Head Set	2001	HS 26174 PT	Ford Focus S2, SE, Street, ZTS, ZX3; Engineering No. XS7G-6051D1 stamped on head gskt.; Int. manifold gskt. w/Round port w/tab not incl.; Head bolts not incl.; Head bolt replacement required; PermaDry® molded rubber valve cover gskt. incl.; Premium valve stem seals incl.	

Ford Car (Incl. Edsel, Ford, Lincoln, Mercury, Merkur) (Cont.)

6 (cont.)		2004 - 1995; 2.0L 121 (1988cc) DOHC L4 (16 Valve) 84.8mm Bore Zetec			6 (cont.)
MFI; Gasoline; Naturally Aspirated Ford Eng.; VIN Code 3					
QTY	CYLINDER HEAD	YEARS	PART NO.	DESCRIPTION	
1	Head Set	2001	HS 9005 PT-5	Ford Focus S2, SE, Street, ZTS, ZX3; Engineering No. XS7G-6051C1 stamped on head gskt.; Int. manifold gskt. w/Round port w/tab not incl.; Head bolts not incl.; Head bolt replacement required; PermaDry® molded rubber valve cover gskt. incl.; Premium valve stem seals incl.	
1	Head Set	2000	HS 26174 PT	Ford Focus SE, Sony Limited Edition, ZTS, ZX3; From 12/21/99; Engineering No. XS7G-6051D1 stamped on head gskt.; Int. manifold gskt. w/Round port w/tab not incl.; Head bolts not incl.; Head bolt replacement required; PermaDry® molded rubber valve cover gskt. incl.; Premium valve stem seals incl.	
1	Head Set	2000	HS 9005 PT-11	Ford Contour LX, SE Mercury Mystique GS, LS; Head bolts not incl.; Head bolt replacement required; PermaDry® molded rubber valve cover gskt. incl.; Premium valve stem seals incl.	
1	Head Set	2000	HS 9005 PT-4	Ford Focus SE, Sony Limited Edition, ZTS, ZX3; To 12/20/99; Engineering No. XS7G-6051C1 stamped on head gskt.; Int. manifold gskt. w/Round port w/tab not incl.; Head bolts not incl.; Head bolt replacement required; PermaDry® molded rubber valve cover gskt. incl.; Premium valve stem seals incl.	
1	Head Set	2000	HS 9005 PT-5	Ford Focus SE, Sony Limited Edition, ZTS, ZX3; From 12/21/99; Engineering No. XS7G-6051C1 stamped on head gskt.; Int. manifold gskt. w/Round port w/tab not incl.; Head bolts not incl.; Head bolt replacement required; PermaDry® molded rubber valve cover gskt. incl.; Premium valve stem seals incl.	
1	Head Set	1999	HS 9005 PT-2	Ford Escort ZX2 Cool Coupe, ZX2 Hot Coupe; Head bolts & exh. pipe packing not incl.; Head bolt replacement required; PermaDry® molded rubber valve cover gskt. incl.; Premium valve stem seals incl.	
1	Head Set	1999	HS 9005 PT-9	Mercury Cougar Base; From 05/25/99; Int. manifold gskt. not incl.; Head bolts not incl.; Head bolt replacement required; PermaDry® molded rubber valve cover gskt. incl.; Premium valve stem seals incl.	
1	Head Set	1999	HS 9005 PT-9	Ford Contour LX, SE; Head bolts not incl.; Head bolt replacement required; PermaDry® molded rubber valve cover gskt. incl.; Premium valve stem seals incl.	
1	Head Set	1999	HS 9005 PT-9	Mercury Mystique GS, LS; Head bolts not incl.; Head bolt replacement required; PermaDry® molded rubber valve cover gskt. incl.; Premium valve stem seals incl.	
1	Head Set	1999	HS 9005 PT-9	Mercury Cougar Base; To 05/24/99; Head bolts not incl.; Head bolt replacement required; PermaDry® molded rubber valve cover gskt. incl.; Premium valve stem seals incl.	
1	Head Set	1998	HS 9005 PT-2	Ford Escort ZX2 Cool Coupe, ZX2 Hot Coupe; Head bolts & exh. pipe packing not incl.; Head bolt replacement required; PermaDry® molded rubber valve cover gskt. incl.; Premium valve stem seals incl.	
1	Head Set	1998	HS 9005 PT-2	Ford Contour Base, GL, LX, SE; To 02/08/98; Head bolts & exh. pipe packing not incl.; Head bolt replacement required; PermaDry® molded rubber valve cover gskt. incl.; Premium valve stem seals incl.	
1	Head Set	1998	HS 9005 PT-2	Mercury Mystique GS, LS, Spree; To 02/08/98; Head bolts & exh. pipe packing not incl.; Head bolt replacement required; PermaDry® molded rubber valve cover gskt. incl.; Premium valve stem seals incl.	
1	Head Set	1998	HS 9005 PT-9	Exc. Ford Escort ZX2 Cool Coupe, ZX2 Hot Coupe; From 02/09/98; Head bolts not incl.; Head bolt replacement required; PermaDry® molded rubber valve cover gskt. incl.; Premium valve stem seals incl.	
1	Head Set	1997	HS 9005 PT-1	Head bolts not incl.; Head bolt replacement required; PermaDry® molded rubber valve cover gskt. incl.; Premium valve stem seals incl.	
1	Head Set	1996	HS 9005 PT	To 03/13/96; Head bolts not incl.; Head bolt replacement required; PermaDry® molded rubber valve cover gskt. incl.; Premium valve stem seals incl.	
1	Head Set	1996	HS 9005 PT-1	From 03/14/96; Head bolts not incl.; Head bolt replacement required; PermaDry® molded rubber valve cover gskt. incl.; Premium valve stem seals incl.	
1	Head Set	1995	HS 9005 PT	Head bolts not incl.; Head bolt replacement required; PermaDry® molded rubber valve cover gskt. incl.; Premium valve stem seals incl.	
1	Head Bolt Set	2004-95	ES 72175	Replacement required	
QTY	CONVERSION SET	YEARS	PART NO.	DESCRIPTION	
1	Gasket Conversion Set	2004	CS 9005-2	Lower oil pan gskt. incl.; PermaDry® molded rubber oil pan gskt. incl.	
1	Gasket Conversion Set	2003	CS 9005-1	Ford Escort ZX2; RTV sealant not incl. for Lower oil pan gskt.; PermaDry® molded rubber oil pan gskt. incl.; Consolidated design	

Ford Car (Incl. Edsel, Ford, Lincoln, Mercury, Merkur) (Cont.)

6 (cont.)		2004 - 1995; 2.0L 121 (1988cc) DOHC L4 (16 Valve) 84.8mm Bore Zetec			6 (cont.)
MFI; Gasoline; Naturally Aspirated Ford Eng.; VIN Code 3					
QTY	CONVERSION SET	YEARS	PART NO.	DESCRIPTION	
1	Gasket Conversion Set	2003	CS 9005-2	Exc. Ford Escort ZX2; Lower oil pan gskt. incl.; PermaDry® molded rubber oil pan gskt. incl.	
1	Gasket Conversion Set	2002	CS 9005-1	Exc. Ford Focus S2, SE, Street, ZTS, ZTW, ZX3, ZX5; RTV sealant not incl. for Lower oil pan gskt.; PermaDry® molded rubber oil pan gskt. incl.; Consolidated design	
1	Gasket Conversion Set	2002	CS 9005-2	Ford Focus S2, SE, Street, ZTS, ZTW, ZX3, ZX5; Lower oil pan gskt. incl.; PermaDry® molded rubber oil pan gskt. incl.	
1	Gasket Conversion Set	2001	CS 9005-1	Exc. Ford Focus S2, SE, Street, ZTS, ZX3; RTV sealant not incl. for Lower oil pan gskt.; PermaDry® molded rubber oil pan gskt. incl.; Consolidated design	
1	Gasket Conversion Set	2001	CS 9005-2	Ford Focus S2, SE, Street, ZTS, ZX3; Lower oil pan gskt. incl.; PermaDry® molded rubber oil pan gskt. incl.	
1	Gasket Conversion Set	2000	CS 9005-1	Exc. Ford Focus SE, Sony Limited Edition, ZTS, ZX3; RTV sealant not incl. for Lower oil pan gskt.; PermaDry® molded rubber oil pan gskt. incl.; Consolidated design	
1	Gasket Conversion Set	2000	CS 9005-2	Ford Focus SE, Sony Limited Edition, ZTS, ZX3; Lower oil pan gskt. incl.; PermaDry® molded rubber oil pan gskt. incl.	
1	Gasket Conversion Set	1999-98	CS 9005-1	RTV sealant not incl. for Lower oil pan gskt.; PermaDry® molded rubber oil pan gskt. incl.; Consolidated design	
1	Gasket Conversion Set	1997-95	CS 9005-1	PermaDry® molded rubber oil pan gskt. incl.; Consolidated design	
QTY	MANIFOLD - INT. & EXH.	YEARS	PART NO.	DESCRIPTION	
1	Int. Manifold Gasket Set	2004	MS 96763	Square port w/o tab	
1	Int. Manifold Gasket Set	2003-00	MS 90891	Ford Escort ZX2; Irregular port w/tab	
1	Int. Manifold Gasket Set	2003-01	MS 96763	Exc. Ford Escort ZX2; Square port w/o tab	
1	Int. Manifold Gasket Set	2003	MS 96765	Exc. Ford Escort ZX2; Round port w/tab	
1	Int. Manifold Gasket Set	2002	MS 96765	Ford Focus S2, SE, Street, ZTS, ZTW, ZX3, ZX5; Round port w/tab	
1	Int. Manifold Gasket Set	2001	MS 96765	Ford Focus S2, SE, Street, ZTS, ZX3; Round port w/tab	
1	Int. Manifold Gasket Set	2000	MS 96763	Exc. Ford Contour LX, SE, Escort ZX2 Mercury Mystique GS, LS; Square port w/o tab	
1	Int. Manifold Gasket Set	2000	MS 96765	Exc. Ford Cougar Base, Escort ZX2 Mercury Cougar Base; Round port w/tab	
1	Int. Manifold Gasket Set	1999	MS 90891	Ford Escort ZX2 Cool Coupe, ZX2 Hot Coupe; Irregular port w/tab	
1	Int. Manifold Gasket Set	1999	MS 96763	Mercury Cougar Base; From 05/25/99; Square port w/o tab	
1	Int. Manifold Gasket Set	1999	MS 96765	Ford Contour LX, SE; Round port w/tab	
1	Int. Manifold Gasket Set	1999	MS 96765	Mercury Mystique GS, LS; Round port w/tab	
1	Int. Manifold Gasket Set	1999	MS 96765	Mercury Cougar Base; To 05/24/99; Round port w/tab	
1	Int. Manifold Gasket Set	1998	MS 90891	Ford Escort ZX2 Cool Coupe, ZX2 Hot Coupe; Irregular port w/tab	
1	Int. Manifold Gasket Set	1998	MS 90891	Ford Contour Base, GL, LX, SE; To 02/08/98; Irregular port w/tab	
1	Int. Manifold Gasket Set	1998	MS 90891	Mercury Mystique GS, LS, Spree; To 02/08/98; Irregular port w/tab	
1	Int. Manifold Gasket Set	1998	MS 96765	Exc. Ford Escort ZX2 Cool Coupe, ZX2 Hot Coupe; From 02/09/98; Round port w/tab	
1	Int. Manifold Gasket Set	1997-95	MS 95725		
1	Exh. Manifold Gasket Set	2004	MS 94427		
1	Exh. Manifold Gasket Set	2003	MS 94427	Exc. Ford Escort ZX2	
1	Exh. Manifold Gasket Set	2003	MS 95702	Ford Escort ZX2	
1	Exh. Manifold Gasket Set	2002	MS 94427	Ford Focus S2, SE, Street, ZTS, ZTW, ZX3, ZX5	
1	Exh. Manifold Gasket Set	2002	MS 95702	Exc. Ford Focus S2, SE, Street, ZTS, ZTW, ZX3, ZX5	
1	Exh. Manifold Gasket Set	2001	MS 94427	Ford Focus S2, SE, Street, ZTS, ZX3	
1	Exh. Manifold Gasket Set	2001	MS 95702	Exc. Ford Focus S2, SE, Street, ZTS, ZX3	
1	Exh. Manifold Gasket Set	2000	MS 94427	Ford Focus SE, Sony Limited Edition, ZTS, ZX3	
1	Exh. Manifold Gasket Set	2000	MS 95702	Exc. Ford Focus SE, Sony Limited Edition, ZTS, ZX3	
1	Exh. Manifold Gasket Set	1999-95	MS 95702		
QTY	EXHAUST PIPE FLANGE	YEARS	PART NO.	DESCRIPTION	
1	Exhaust Pipe Gasket	2004	61191	Pipe to manifold	
1	Exhaust Pipe Gasket	2003-00	61062	Ford Escort ZX2; Pipe to manifold	
1	Exhaust Pipe Gasket	2003	61191	Exc. Ford Escort ZX2; Pipe to manifold	
1	Exhaust Pipe Gasket	2002	61191	Ford Focus S2, SE, Street, ZTS, ZTW, ZX3, ZX5; Pipe to manifold	
1	Exhaust Pipe Gasket	2001	61191	Ford Focus S2, SE, Street, ZTS, ZX3; Pipe to manifold	
1	Exhaust Pipe Gasket	2000-99	61059	Ford Contour LX, SE Mercury Mystique GS, LS; Pipe to manifold	
1	Exhaust Pipe Gasket	2000	61191	Ford Focus SE, Sony Limited Edition, ZTS, ZX3; Pipe to manifold	
1	Exhaust Pipe Gasket	1999-98	61062	Ford Escort ZX2 Cool Coupe, ZX2 Hot Coupe; Pipe to manifold	
1	Exhaust Pipe Gasket	1998	61059	Exc. Ford Escort ZX2 Cool Coupe, ZX2 Hot Coupe; Pipe to manifold	
1	Exhaust Pipe Gasket	1997-95	61004	Pipe to manifold	
QTY	OIL PAN	YEARS	PART NO.	DESCRIPTION	
1	Oil Pan Gasket Set	2004	OS 30711 R	Loc. Upper; PermaDry® molded rubber gskt. incl.	

Ford Car (Incl. Edsel, Ford, Lincoln, Mercury, Merkur) (Cont.)

6 (cont.)		2004 - 1995; 2.0L 121 (1988cc) DOHC L4 (16 Valve) 84.8mm Bore Zetec			6 (cont.)
QTY OIL PAN		YEARS	PART NO.	DESCRIPTION	
1	Oil Pan Gasket Set	2004	OS 30831	Loc. Lower	
1	Oil Pan Gasket Set	2003	OS 30686 R	Ford Escort ZX2; Loc. Upper; RTV sealant not incl. for Lower oil pan gskt.; PermaDry® molded rubber gskt. incl.; Improved design	
1	Oil Pan Gasket Set	2003	OS 30711 R	Exc. Ford Escort ZX2; Loc. Upper; PermaDry® molded rubber gskt. incl.	
1	Oil Pan Gasket Set	2003	OS 30831	Exc. Ford Escort ZX2; Loc. Lower	
1	Oil Pan Gasket Set	2002	OS 30686 R	Exc. Ford Focus S2, SE, Street, ZTS, ZTW, ZX3, ZX5; Loc. Upper; RTV sealant not incl. for Lower oil pan gskt.; PermaDry® molded rubber gskt. incl.; Improved design	
1	Oil Pan Gasket Set	2002	OS 30711 R	Ford Focus S2, SE, Street, ZTS, ZTW, ZX3, ZX5; Loc. Upper; PermaDry® molded rubber gskt. incl.	
1	Oil Pan Gasket Set	2002	OS 30831	Ford Focus S2, SE, Street, ZTS, ZTW, ZX3, ZX5; Loc. Lower	
1	Oil Pan Gasket Set	2001	OS 30686 R	Exc. Ford Focus S2, SE, Street, ZTS, ZX3; Loc. Upper; RTV sealant not incl. for Lower oil pan gskt.; PermaDry® molded rubber gskt. incl.; Improved design	
1	Oil Pan Gasket Set	2001	OS 30711 R	Ford Focus S2, SE, Street, ZTS, ZX3; Loc. Upper; PermaDry® molded rubber gskt. incl.	
1	Oil Pan Gasket Set	2001	OS 30831	Ford Focus S2, SE, Street, ZTS, ZX3; Loc. Lower	
1	Oil Pan Gasket Set	2000	OS 30686 R	Exc. Ford Focus SE, Sony Limited Edition, ZTS, ZX3; Loc. Upper; RTV sealant not incl. for Lower oil pan gskt.; PermaDry® molded rubber gskt. incl.; Improved design	
1	Oil Pan Gasket Set	2000	OS 30711 R	Ford Focus SE, Sony Limited Edition, ZTS, ZX3; Loc. Upper; PermaDry® molded rubber gskt. incl.	
1	Oil Pan Gasket Set	2000	OS 30831	Ford Focus SE, Sony Limited Edition, ZTS, ZX3; Loc. Lower	
1	Oil Pan Gasket Set	1999-98	OS 30686 R	Loc. Upper; RTV sealant not incl. for Lower oil pan gskt.; PermaDry® molded rubber gskt. incl.; Improved design	
1	Oil Pan Gasket Set	1997-95	OS 30686 R	PermaDry® molded rubber gskt. incl.; Improved design	
1	Drain Plug Gasket	2004-95	72515		
QTY CRANKSHAFT REAR SEAL		YEARS	PART NO.	DESCRIPTION	
1	Rear Main Seal Set	2004-95	BS 40618	Rubber; One-piece	
1	Rear Main Seal Set	2004-95	BS 40646	PTFE Rubber; One-piece	
QTY VALVE COVER		YEARS	PART NO.	DESCRIPTION	
1	Valve Cover Gasket Set	2004	VS 50553 R	PermaDry® molded rubber gskt. incl.	
1	Valve Cover Gasket Set	2003	VS 50489 R	Ford Escort ZX2; w/Grommets; PermaDry® molded rubber gskt. incl.	
1	Valve Cover Gasket Set	2003	VS 50553 R	Exc. Ford Escort ZX2; PermaDry® molded rubber gskt. incl.	
1	Valve Cover Gasket Set	2002	VS 50489 R	Exc. Ford Focus S2, SE, Street, ZTS, ZTW, ZX3, ZX5; w/Grommets; PermaDry® molded rubber gskt. incl.	
1	Valve Cover Gasket Set	2002	VS 50553 R	Ford Focus S2, SE, Street, ZTS, ZTW, ZX3, ZX5; PermaDry® molded rubber gskt. incl.	
1	Valve Cover Gasket Set	2001	VS 50489 R	Exc. Ford Focus S2, SE, Street, ZTS, ZX3; w/Grommets; PermaDry® molded rubber gskt. incl.	
1	Valve Cover Gasket Set	2001	VS 50553 R	Ford Focus S2, SE, Street, ZTS, ZX3; PermaDry® molded rubber gskt. incl.	
1	Valve Cover Gasket Set	2000	VS 50489 R	Exc. Ford Focus SE, Sony Limited Edition, ZTS, ZX3; w/Grommets; PermaDry® molded rubber gskt. incl.	
1	Valve Cover Gasket Set	2000	VS 50552 R	Ford Focus SE, Sony Limited Edition, ZTS, ZX3; To 12/20/99; w/Grommets; PermaDry® molded rubber gskt. incl.	
1	Valve Cover Gasket Set	2000	VS 50553 R	Ford Focus SE, Sony Limited Edition, ZTS, ZX3; From 12/21/99; PermaDry® molded rubber gskt. incl.	
1	Valve Cover Gasket Set	1999-98	VS 50489 R	w/Grommets; PermaDry® molded rubber gskt. incl.	
1	Valve Cover Gasket Set	1997-95	VS 50460 R	w/Grommets; PermaDry® molded rubber gskt. incl.	
QTY VALVE STEM SEAL SET		YEARS	PART NO.	DESCRIPTION	
1	Valve Stem Seal Set	2004-97	SS 72889	Premium valve stem seals incl.; Improved design	
1	Valve Stem Seal Set	1996	SS 72873	To 03/13/96; Premium valve stem seals incl.	
1	Valve Stem Seal Set	1996	SS 72889	From 03/14/96; Premium valve stem seals incl.; Improved design	
1	Valve Stem Seal Set	1995	SS 72873	Premium valve stem seals incl.	
QTY THERMOSTAT HOUSING		YEARS	PART NO.	DESCRIPTION	
1	Water Outlet Gasket	2004	35404	Thermostat Housing; Thermostat seal	
1	Thermostat Gasket	2004	35707	Thermostat Housing; Thermostat housing to head	
1	Thermostat Gasket	2003-95	35284	Thermostat Housing; Thermostat seal	
1	Thermostat Gasket	2003-95	35606	Thermostat Housing; Thermostat housing to head	
QTY WATER PUMP		YEARS	PART NO.	DESCRIPTION	
1	Water Pump Gasket	2004-98	35619	Housing to block	
1	Water Pump Gasket	1997-95	35282		
1	O-Ring	2004-98	35717	Water Pump; Housing O-ring	
QTY TIMING COVER		YEARS	PART NO.	DESCRIPTION	
1	Crankshaft Front Seal Set	2004	TCS 46015	Must be used w/OS 30711R	

Ford Car (Incl. Edsel, Ford, Lincoln, Mercury, Merkur) (Cont.)

6		2004 - 1995; 2.0L 121 (1988cc) DOHC L4 (16 Valve) 84.8mm Bore Zetec			6	
(cont.)		MFI; Gasoline; Naturally Aspirated Ford Eng.; VIN Code 3			(cont.)	
QTY	TIMING COVER	YEARS	PART NO.	DESCRIPTION		
1	Crankshaft Front Seal Set	2003	TCS 46003	Ford Escort ZX2; Must be used w/OS 30686R		
1	Crankshaft Front Seal Set	2003	TCS 46015	Exc. Ford Escort ZX2; Must be used w/OS 30711R		
1	Crankshaft Front Seal Set	2002	TCS 46003	Exc. Ford Focus S2, SE, Street, ZTS, ZTW, ZX3, ZX5; Must be used w/OS 30686R		
1	Crankshaft Front Seal Set	2002	TCS 46015	Ford Focus S2, SE, Street, ZTS, ZTW, ZX3, ZX5; Must be used w/OS 30711R		
1	Crankshaft Front Seal Set	2001	TCS 46003	Exc. Ford Focus S2, SE, Street, ZTS, ZX3; Must be used w/OS 30686R		
1	Crankshaft Front Seal Set	2001	TCS 46015	Ford Focus S2, SE, Street, ZTS, ZX3; Must be used w/OS 30711R		
1	Crankshaft Front Seal Set	2000	TCS 46003	Exc. Ford Focus SE, Sony Limited Edition, ZTS, ZX3; Must be used w/OS 30686R		
1	Crankshaft Front Seal Set	2000	TCS 46015	Ford Focus SE, Sony Limited Edition, ZTS, ZX3; Must be used w/OS 30711R		
1	Crankshaft Front Seal Set	1999-98	TCS 46003	Must be used w/OS 30686R		
1	Crankshaft Front Seal Set	1997-95	TCS 45964	Must be used w/OS 30686R		
1	Camshaft Front Seal Set	2004	TCS 45963			
1	Camshaft Front Seal Set	2003	TCS 45963	Exc. Ford Escort ZX2		
1	Camshaft Front Seal Set	2003	TCS 45985	Ford Escort ZX2		
1	Camshaft Front Seal Set	2002	TCS 45963	Ford Focus S2, SE, Street, ZTS, ZTW, ZX3, ZX5		
1	Camshaft Front Seal Set	2002	TCS 45985	Exc. Ford Focus S2, SE, Street, ZTS, ZTW, ZX3, ZX5		
1	Camshaft Front Seal Set	2001	TCS 45963	Ford Focus S2, SE, Street, ZTS, ZX3		
1	Camshaft Front Seal Set	2001	TCS 45985	Exc. Ford Focus S2, SE, Street, ZTS, ZX3		
1	Camshaft Front Seal Set	2000	TCS 45963	Ford Focus SE, Sony Limited Edition, ZTS, ZX3		
1	Camshaft Front Seal Set	2000	TCS 45985	Exc. Ford Focus SE, Sony Limited Edition, ZTS, ZX3		
1	Camshaft Front Seal Set	1999-98	TCS 45985			
1	Camshaft Front Seal Set	1997-95	TCS 45963			
QTY	CARB & FUEL INJECTION	YEARS	PART NO.	DESCRIPTION		
2	Fuel Injector O-Ring Set	2004-95	ES 70599	Improved design		
1	Throttle Body Gasket	2004	61159			
1	Throttle Body Gasket	2003	61105	Ford Escort ZX2		
1	Throttle Body Gasket	2003	61159	Exc. Ford Escort ZX2		
1	Throttle Body Gasket	2002	61105	Exc. Ford Focus S2, SE, Street, ZTS, ZTW, ZX3, ZX5		
1	Throttle Body Gasket	2002	61159	Ford Focus S2, SE, Street, ZTS, ZTW, ZX3, ZX5		
1	Throttle Body Gasket	2001	61105	Exc. Ford Focus S2, SE, Street, ZTS, ZX3		
1	Throttle Body Gasket	2001	61159	Ford Focus S2, SE, Street, ZTS, ZX3		
1	Throttle Body Gasket	2000	61105	Exc. Ford Focus SE, Sony Limited Edition, ZTS, ZX3		
1	Throttle Body Gasket	2000	61159	Ford Focus SE, Sony Limited Edition, ZTS, ZX3		
1	Throttle Body Gasket	1999-96	61105			
1	Throttle Body Gasket	1995	61005			
QTY	EXHAUST GAS RECIRCULATION	YEARS	PART NO.	DESCRIPTION		
1	EGR Gasket	2004-95	70149			
7		2000 - 1995; 2.0L 121 (1988cc) DOHC L4 (16 Valve) 84.8mm Bore Zetec			7	
		MFI; Flex Fuel; Naturally Aspirated Ford Eng.; VIN Code Z				
QTY	CYLINDER HEAD	YEARS	PART NO.	DESCRIPTION		
1	Head Gasket	2000	9005 PT-1	Head bolts not incl.; Head bolt replacement required; PermaTorqueMLS®		
1	Head Gasket	1999-95	9005 PT	Head bolts not incl.; Head bolt replacement required; PermaTorqueMLS®		
1	Head Set	2000	HS 9005 PT-11	Head bolts not incl.; Head bolt replacement required; PermaDry® molded rubber valve cover gskt. incl.; Premium valve stem seals incl.		
1	Head Set	1999	HS 9005 PT-9	Head bolts not incl.; Head bolt replacement required; PermaDry® molded rubber valve cover gskt. incl.; Premium valve stem seals incl.		
1	Head Set	1998	HS 9005 PT-2	To 02/08/98; Head bolts & exh. pipe packing not incl.; Head bolt replacement required; PermaDry® molded rubber valve cover gskt. incl.; Premium valve stem seals incl.		
1	Head Set	1998	HS 9005 PT-9	From 02/09/98; Head bolts not incl.; Head bolt replacement required; PermaDry® molded rubber valve cover gskt. incl.; Premium valve stem seals incl.		
1	Head Set	1997	HS 9005 PT-1	Head bolts not incl.; Head bolt replacement required; PermaDry® molded rubber valve cover gskt. incl.; Premium valve stem seals incl.		
1	Head Set	1996	HS 9005 PT	To 03/13/96; Head bolts not incl.; Head bolt replacement required; PermaDry® molded rubber valve cover gskt. incl.; Premium valve stem seals incl.		
1	Head Set	1996	HS 9005 PT-1	From 03/14/96; Head bolts not incl.; Head bolt replacement required; PermaDry® molded rubber valve cover gskt. incl.; Premium valve stem seals incl.		

Ford Car (Incl. Edsel, Ford, Lincoln, Mercury, Merkur) (Cont.)

7 (cont.)	2000 - 1995; 2.0L 121 (1988cc) DOHC L4 (16 Valve) 84.8mm Bore Zetec			7 (cont.)
MFI; Flex Fuel; Naturally Aspirated Ford Eng.; VIN Code Z				
QTY	CYLINDER HEAD	YEARS	PART NO.	DESCRIPTION
1	Head Set	1995	HS 9005 PT	Head bolts not incl.; Head bolt replacement required; PermaDry® molded rubber valve cover gskt. incl.; Premium valve stem seals incl.
1	Head Bolt Set	2000-95	ES 72175	Replacement required
QTY	CONVERSION SET	YEARS	PART NO.	DESCRIPTION
1	Gasket Conversion Set	2000-98	CS 9005-1	RTV sealant not incl. for Lower oil pan gskt.; PermaDry® molded rubber oil pan gskt. incl.; Consolidated design
1	Gasket Conversion Set	1997-95	CS 9005-1	PermaDry® molded rubber oil pan gskt. incl.; Consolidated design
QTY	MANIFOLD - INT. & EXH.	YEARS	PART NO.	DESCRIPTION
1	Int. Manifold Gasket Set	2000-99	MS 96765	Round port w/tab
1	Int. Manifold Gasket Set	1998	MS 90891	To 02/08/98; Irregular port w/tab
1	Int. Manifold Gasket Set	1998	MS 96765	From 02/09/98; Round port w/tab
1	Int. Manifold Gasket Set	1997-95	MS 95725	
1	Exh. Manifold Gasket Set	2000-95	MS 95702	
QTY	EXHAUST PIPE FLANGE	YEARS	PART NO.	DESCRIPTION
1	Exhaust Pipe Gasket	2000-98	61059	Pipe to manifold
1	Exhaust Pipe Gasket	1997-95	61004	Pipe to manifold
QTY	OIL PAN	YEARS	PART NO.	DESCRIPTION
1	Oil Pan Gasket Set	2000-98	OS 30686 R	Loc. Upper; RTV sealant not incl. for Lower oil pan gskt.; PermaDry® molded rubber gskt. incl.; Improved design
1	Oil Pan Gasket Set	1997-95	OS 30686 R	PermaDry® molded rubber gskt. incl.; Improved design
1	Drain Plug Gasket	2000-95	72515	
QTY	CRANKSHAFT REAR SEAL	YEARS	PART NO.	DESCRIPTION
1	Rear Main Seal Set	2000-95	BS 40618	Rubber; One-piece
1	Rear Main Seal Set	2000-95	BS 40646	PTFE Rubber; One-piece
QTY	VALVE COVER	YEARS	PART NO.	DESCRIPTION
1	Valve Cover Gasket Set	2000-98	VS 50489 R	w/Grommets; PermaDry® molded rubber gskt. incl.
1	Valve Cover Gasket Set	1997-95	VS 50460 R	w/Grommets; PermaDry® molded rubber gskt. incl.
QTY	VALVE STEM SEAL SET	YEARS	PART NO.	DESCRIPTION
1	Valve Stem Seal Set	2000-97	SS 72889	Premium valve stem seals incl.; Improved design
1	Valve Stem Seal Set	1996	SS 72873	To 03/13/96; Premium valve stem seals incl.
1	Valve Stem Seal Set	1996	SS 72889	From 03/14/96; Premium valve stem seals incl.; Improved design
1	Valve Stem Seal Set	1995	SS 72873	Premium valve stem seals incl.
QTY	THERMOSTAT HOUSING	YEARS	PART NO.	DESCRIPTION
1	Thermostat Gasket	2000-95	35284	Thermostat Housing; Thermostat seal
1	Thermostat Gasket	2000-95	35606	Thermostat Housing; Thermostat housing to head
QTY	WATER PUMP	YEARS	PART NO.	DESCRIPTION
1	Water Pump Gasket	2000-98	35619	Housing to block
1	Water Pump Gasket	1997-95	35282	
1	O-Ring	2000-98	35717	Water Pump; Housing O-ring
QTY	TIMING COVER	YEARS	PART NO.	DESCRIPTION
1	Crankshaft Front Seal Set	2000-98	TCS 46003	Must be used w/OS 30686R
1	Crankshaft Front Seal Set	1997-95	TCS 45964	Must be used w/OS 30686R
1	Camshaft Front Seal Set	2000-98	TCS 45985	
1	Camshaft Front Seal Set	1997-95	TCS 45963	
QTY	CARB & FUEL INJECTION	YEARS	PART NO.	DESCRIPTION
2	Fuel Injector O-Ring Set	2000-95	ES 70599	Improved design
1	Throttle Body Gasket	2000-96	61105	
1	Throttle Body Gasket	1995	61005	
QTY	EXHAUST GAS RECIRCULATION	YEARS	PART NO.	DESCRIPTION
1	EGR Gasket	2000-95	70149	
8	2004 - 2002; 2.0L 121 (1988cc) DOHC L4 (16 Valve) 84.8mm Bore Zetec H.O.			8
MFI; Gasoline; Naturally Aspirated Ford Eng.; VIN Code 5				
QTY	CYLINDER HEAD	YEARS	PART NO.	DESCRIPTION
1	Head Gasket	2004	9005 PT-1	Head bolts not incl.; Head bolt replacement required; PermaTorqueMLS®
1	Head Gasket	2003-02	9005 PT	Head bolts not incl.; Head bolt replacement required; PermaTorqueMLS®
1	Head Set	2004	HS 9005 PT-8	Head bolts not incl.; Head bolt replacement required; PermaDry® molded rubber valve cover gskt. incl.; Premium valve stem seals incl.
1	Head Set	2003-02	HS 9005 PT-7	Head bolts not incl.; Head bolt replacement required; PermaDry® molded rubber valve cover gskt. incl.; Premium valve stem seals incl.
1	Head Bolt Set	2004-02	ES 72175	Replacement required
QTY	CONVERSION SET	YEARS	PART NO.	DESCRIPTION
1	Gasket Conversion Set	2004-02	CS 9005-2	Lower oil pan gskt. incl.; PermaDry® molded rubber oil pan gskt. incl.

Ford Car (Incl. Edsel, Ford, Lincoln, Mercury, Merkur) (Cont.)

8		2004 - 2002; 2.0L 121 (1988cc) DOHC L4 (16 Valve) 84.8mm Bore Zetec H.O.			8	
(cont.)		MFI; Gasoline; Naturally Aspirated Ford Eng.; VIN Code 5			(cont.)	
QTY	MANIFOLD - INT. & EXH.	YEARS	PART NO.	DESCRIPTION		
1	Int. Manifold Gasket Set	2004-02	MS 96266	Round port w/o tab		
1	Exh. Manifold Gasket Set	2004-02	MS 94427			
QTY	EXHAUST PIPE FLANGE	YEARS	PART NO.	DESCRIPTION		
1	Exhaust Pipe Gasket	2004-02	61251	Pipe to manifold		
QTY	OIL PAN	YEARS	PART NO.	DESCRIPTION		
1	Oil Pan Gasket Set	2004-02	OS 30711 R	Loc. Upper; PermaDry® molded rubber gskt. incl.		
1	Oil Pan Gasket Set	2004-02	OS 30831	Loc. Lower		
1	Drain Plug Gasket	2004-02	72515			
QTY	CRANKSHAFT REAR SEAL	YEARS	PART NO.	DESCRIPTION		
1	Rear Main Seal Set	2004-02	BS 40618	Rubber; One-piece		
1	Rear Main Seal Set	2004-02	BS 40646	PTFE Rubber; One-piece		
QTY	VALVE COVER	YEARS	PART NO.	DESCRIPTION		
1	Valve Cover Gasket Set	2004-02	VS 50581 R	w/Grommets; PermaDry® molded rubber gskt. incl.		
QTY	VALVE STEM SEAL SET	YEARS	PART NO.	DESCRIPTION		
1	Valve Stem Seal Set	2004-02	SS 72889	Premium valve stem seals incl.; Improved design		
QTY	THERMOSTAT HOUSING	YEARS	PART NO.	DESCRIPTION		
1	Water Outlet Gasket	2004	35404	Thermostat Housing; Thermostat seal		
1	Thermostat Gasket	2004	35707	Thermostat Housing; Thermostat housing to head		
1	Thermostat Gasket	2003-02	35284	Thermostat Housing; Thermostat seal		
1	Thermostat Gasket	2003-02	35606	Thermostat Housing; Thermostat housing to head		
QTY	WATER PUMP	YEARS	PART NO.	DESCRIPTION		
1	Water Pump Gasket	2004-02	35619	Housing to block		
1	O-Ring	2004-02	35717	Water Pump; Housing O-ring		
QTY	TIMING COVER	YEARS	PART NO.	DESCRIPTION		
1	Crankshaft Front Seal Set	2004-02	TCS 46015	Must be used w/OS 30711R		
1	Camshaft Front Seal Set	2004-02	TCS 45985			
QTY	CARB & FUEL INJECTION	YEARS	PART NO.	DESCRIPTION		
2	Fuel Injector O-Ring Set	2004-02	ES 70599	Improved design		
1	Throttle Body Gasket	2004-02	61253			
QTY	EXHAUST GAS RECIRCULATION	YEARS	PART NO.	DESCRIPTION		
1	EGR Gasket	2004-02	70149			
9		2004 - 1997; 2.0L 121 (1988cc) SOHC L4 (8 Valve) 84.8mm Bore			9	
		MFI; Gasoline; Naturally Aspirated Ford Eng.; VIN Code P				
QTY	CYLINDER HEAD	YEARS	PART NO.	DESCRIPTION		
1	Head Gasket	2004-00	9539 PT	Head bolts not incl.; Head bolt replacement required; PermaTorqueMLS®		
1	Head Gasket	1999-97	9309 PT-2	Head bolts not incl.; Head bolt replacement required; PermaTorque®		
1	Head Gasket Spacer Shim	1999-97	9309 SP-2	HeadSaver®		
1	Head Set	2004-03	HS 9539 PT-1	Head bolts not incl.; Head bolt replacement required; PermaDryPlus® valve cover gskt. incl.; Premium valve stem seals incl.		
1	Head Set	2002-01	HS 9539 PT	Ford Escort SE; Head bolts not incl.; Head bolt replacement required; PermaDryPlus® valve cover gskt. incl.; Premium valve stem seals incl.		
1	Head Set	2002-01	HS 9539 PT-1	Ford Focus LX, SE; Head bolts not incl.; Head bolt replacement required; PermaDryPlus® valve cover gskt. incl.; Premium valve stem seals incl.		
1	Head Set	2000	HS 9539 PT	Ford Escort LX; Head bolts not incl.; Head bolt replacement required; PermaDryPlus® valve cover gskt. incl.; Premium valve stem seals incl.		
1	Head Set	2000	HS 9539 PT-1	Exc. Ford Escort LX; Head bolts not incl.; Head bolt replacement required; PermaDryPlus® valve cover gskt. incl.; Premium valve stem seals incl.		
1	Head Set	1999-97	HS 9309 PT-2	w/Head bolts; PermaDryPlus® valve cover gskt. incl.; Premium valve stem seals incl.		
1	Head Bolt Set	2004-97	ES 72672	Replacement required		
QTY	CONVERSION SET	YEARS	PART NO.	DESCRIPTION		
1	Gasket Conversion Set	2004-97	CS 9309-2	PermaDry® molded rubber oil pan gskt. incl.		
QTY	MANIFOLD - INT. & EXH.	YEARS	PART NO.	DESCRIPTION		
1	Int. Manifold Gasket Set	2004-03	MS 94432	Upper set incl.		
1	Int. Manifold Gasket Set	2002-01	MS 95918	Ford Escort SE; Upper set incl.		
1	Int. Manifold Gasket Set	2002-01	MS 94432	Ford Focus LX, SE; Upper set incl.		
1	Int. Manifold Gasket Set	2000	MS 94432	Exc. Ford Escort LX; Upper set incl.		
1	Int. Manifold Gasket Set	2000	MS 95918	Ford Escort LX; Upper set incl.		
1	Int. Manifold Gasket Set	1999-97	MS 95918	Upper set incl.		
1	Exh. Manifold Gasket Set	2004-97	MS 92057			
QTY	EXHAUST PIPE FLANGE	YEARS	PART NO.	DESCRIPTION		
1	Exhaust Pipe Gasket	2004-97	60512	Pipe to manifold; Improved design		

Ford Car (Incl. Edsel, Ford, Lincoln, Mercury, Merkur) (Cont.)

9 (cont.)	2004 - 1997; 2.0L 121 (1988cc) SOHC L4 (8 Valve) 84.8mm Bore				9 (cont.)
QTY	EXHAUST PIPE FLANGE	YEARS	PART NO.	DESCRIPTION	
1	Exhaust Pipe Gasket	2002-01	60924	Ford Escort SE; Converter	
1	Exhaust Pipe Gasket	2000	60924	Ford Escort LX; Converter	
1	Exhaust Pipe Gasket	1999-98	60924	Ford Escort LX, SE, Sport; Converter	
1	Exhaust Pipe Gasket	1997	60924	Ford Escort Base, LX, Sport; Converter	
QTY	OIL PAN	YEARS	PART NO.	DESCRIPTION	
1	Oil Pan Gasket Set	2004-97	OS 30915 R	PermaDry® molded rubber gskt. incl.	
1	Drain Plug Gasket	2004-01	71067		
1	Drain Plug Gasket	2000	71067	Exc. Ford Escort LX	
1	Drain Plug Gasket	2000	72515	Ford Escort LX	
1	Drain Plug Gasket	1999-97	72515		
QTY	CRANKSHAFT REAR SEAL	YEARS	PART NO.	DESCRIPTION	
1	Rear Main Seal Set	2004-97	BS 40158	Rubber; One-piece	
1	Rear Main Seal Set	2004-97	BS 40646	PTFE Rubber; One-piece	
QTY	VALVE COVER	YEARS	PART NO.	DESCRIPTION	
1	Valve Cover Gasket Set	2004-98	VS 50476 R	w/Grommets; PermaDryPlus® gskt. incl.	
1	Valve Cover Gasket Set	1997	VS 50369	w/Grommets; PermaDryPlus® gskt. incl.	
QTY	VALVE STEM SEAL SET	YEARS	PART NO.	DESCRIPTION	
1	Valve Stem Seal Set	2004-97	SS 70654	Premium valve stem seals incl.	
QTY	THERMOSTAT HOUSING	YEARS	PART NO.	DESCRIPTION	
1	Thermostat Gasket	2004-03	35624	Thermostat Housing	
1	Thermostat Gasket	2002-01	35477	Ford Escort SE; Thermostat Housing	
1	Thermostat Gasket	2002-01	35624	Ford Focus LX, SE; Thermostat Housing	
1	Thermostat Gasket	2000	35477	Ford Escort LX; Thermostat Housing	
1	Thermostat Gasket	2000	35624	Exc. Ford Escort LX; Thermostat Housing	
1	Thermostat Gasket	1999-97	35477	Thermostat Housing	
QTY	WATER PUMP	YEARS	PART NO.	DESCRIPTION	
1	Water Pump Gasket	2004-03	35661		
1	Water Pump Gasket	2002-01	35607	Ford Escort SE; Improved design	
1	Water Pump Gasket	2002-01	35661	Ford Focus LX, SE	
1	Water Pump Gasket	2000	35607	Ford Escort LX; Improved design	
1	Water Pump Gasket	2000	35661	Exc. Ford Escort LX	
1	Water Pump Gasket	1999-97	35607	Improved design	
QTY	TIMING COVER	YEARS	PART NO.	DESCRIPTION	
1	Crankshaft Front Seal Set	2004-97	TCS 45472-1	Must be used w/OS 30915R; Repair sleeve not incl.	
1	Camshaft Front Seal Set	2004-97	TCS 45473		
1	Repair Sleeve Tool	2004-97	16303	Timing Cover	
QTY	CARB & FUEL INJECTION	YEARS	PART NO.	DESCRIPTION	
2	Fuel Injector O-Ring Set	2004-97	ES 70599	Improved design	
1	Throttle Body Gasket	2004-97	71216	Air bypass valve	
1	Throttle Body Gasket	2004-03	61157	Mounting	
1	Throttle Body Gasket	2002-01	61043	Ford Escort SE; Mounting	
1	Throttle Body Gasket	2002-01	61157	Ford Focus LX, SE; Mounting	
1	Throttle Body Gasket	2000	61043	Ford Escort LX; Mounting	
1	Throttle Body Gasket	2000	61157	Exc. Ford Escort LX; Mounting	
1	Throttle Body Gasket	1999-97	61043	Mounting	
QTY	EXHAUST GAS RECIRCULATION	YEARS	PART NO.	DESCRIPTION	
1	EGR Gasket	2004-97	70149	Valve	
1	EGR Gasket	2004-97	70697	Pipe	
10	1997 - 1993; 2.0L 121.5 (1991cc) DOHC L4 (16 Valve) 83mm Bore				10
QTY	CYLINDER HEAD	YEARS	PART NO.	DESCRIPTION	
1	Head Gasket	1997-93	9711 PT	Head bolts not incl.; Head bolt replacement required; PermaTorqueMLS®	
1	Head Set	1997-93	HS 9711 PT	Head bolts not incl.; Head bolt replacement required; PermaDry® molded rubber valve cover gskt. incl.; Premium valve stem seals incl.	
1	Head Bolt Set	1997-93	ES 74020	Replacement required	
QTY	CONVERSION SET	YEARS	PART NO.	DESCRIPTION	
1	Gasket Conversion Set	1997-93	CS 9711	RTV sealant incl. for Upper oil pan gskt.	
QTY	MANIFOLD - INT. & EXH.	YEARS	PART NO.	DESCRIPTION	
1	Int. Manifold Gasket Set	1997-93	MS 96149	Lower set; Improved design	
1	Exh. Manifold Gasket Set	1997-93	MS 95425		
QTY	EXHAUST PIPE FLANGE	YEARS	PART NO.	DESCRIPTION	
1	Exhaust Pipe Gasket	1997-93	60831	Loc. Front; Converter	

Ford Car (Incl. Edsel, Ford, Lincoln, Mercury, Merkur) (Cont.)

10 (cont.)		1997 - 1993; 2.0L 121.5 (1991cc) DOHC L4 (16 Valve) 83mm Bore			10 (cont.)	
MFI; Gasoline; Naturally Aspirated Mazda Eng.; VIN Code A, Eng. Code FS-DE						
QTY	EXHAUST PIPE FLANGE	YEARS	PART NO.	DESCRIPTION		
1	Exhaust Pipe Gasket	1997-93	60868	Loc. Rear; Converter		
1	Exhaust Pipe Gasket	1997-93	60967	Flange		
QTY	OIL PAN	YEARS	PART NO.	DESCRIPTION		
1	Oil Pan Gasket Set	1997-93	OS 30908 C	Loc. Lower		
1	Drain Plug Gasket	1997-93	72515			
QTY	CRANKSHAFT REAR SEAL	YEARS	PART NO.	DESCRIPTION		
1	Rear Main Seal Set	1997-93	BS 40667	Rubber; One-piece		
QTY	VALVE COVER	YEARS	PART NO.	DESCRIPTION		
1	Valve Cover Gasket Set	1997-93	VS 50428 R	w/Spark plug tube seals; PermaDry® molded rubber gskt. incl.		
QTY	VALVE STEM SEAL SET	YEARS	PART NO.	DESCRIPTION		
1	Valve Stem Seal Set	1997-93	SS 72802	Premium valve stem seals incl.		
QTY	WATER OUTLET GASKET	YEARS	PART NO.	DESCRIPTION		
1	Water Outlet Gasket	1997-93	35570	Water Outlet; Coolant housing to head; Must be used w/11760		
1	Water Pump Gasket	1997-93	11760	Water Outlet; Thermostat housing to head; Must be used w/35570		
QTY	WATER PUMP	YEARS	PART NO.	DESCRIPTION		
1	Water Pump Gasket	1997-93	35569	Mounting		
QTY	TIMING COVER	YEARS	PART NO.	DESCRIPTION		
1	Crankshaft Front Seal Set	1997-93	TCS 45936	Oil pump mounting seals incl.; Oil cooler mounting seals incl.		
1	Crankshaft Front Seal Set	1997-93	TCS 46165	Crankshaft front seal only; New Part Number - Check for Availability		
1	Camshaft Front Seal Set	1997-93	TCS 45860			
QTY	CARB & FUEL INJECTION	YEARS	PART NO.	DESCRIPTION		
1	Throttle Body Gasket	1997-93	60964			
QTY	DISTRIBUTOR MOUNTING	YEARS	PART NO.	DESCRIPTION		
1	O-Ring	1997-93	418	Distributor Mounting		
QTY	EXHAUST GAS RECIRCULATION	YEARS	PART NO.	DESCRIPTION		
1	EGR Gasket	1997-93	70431			
11		2011 - 2005; 2.0L 122 (1999cc) DOHC L4 (16 Valve) 87.5mm Bore Duratec				11
MFI; Gasoline; Naturally Aspirated Ford Eng.; VIN Code N						
QTY	CYLINDER HEAD	YEARS	PART NO.	DESCRIPTION		
1	Head Gasket	2011-05	26250 PT	Head bolts not incl.; Head bolt replacement recommended; PermaTorqueMLS® LaserWeld® Technology		
1	Head Set	2011-08	HS 26250 PT-4	Head bolts not incl.; Head bolt replacement recommended; PermaDry® molded rubber valve cover gskt. incl.; Premium valve stem seals incl.; Consolidated design		
1	Head Set	2007-05	HS 26250 PT-4	Exc. California; Head bolts not incl.; Head bolt replacement recommended; PermaDry® molded rubber valve cover gskt. incl.; Premium valve stem seals incl.; Consolidated design		
1	Head Set	2007	HS 26250 PT-5	California; Head bolts not incl.; Head bolt replacement recommended; PermaDry® molded rubber valve cover gskt. incl.; Premium valve stem seals incl.		
1	Head Set	2006-05	HS 26250 PT-3	California; Head bolts not incl.; Head bolt replacement recommended; PermaDry® molded rubber valve cover gskt. incl.; Premium valve stem seals incl.		
1	Head Bolt Set	2011-05	ES 72207	Replacement recommended		
QTY	CONVERSION SET	YEARS	PART NO.	DESCRIPTION		
1	Gasket Conversion Set	2011-05	CS 26250	RTV sealant incl. for oil pan gskt.		
QTY	MANIFOLD - INT. & EXH.	YEARS	PART NO.	DESCRIPTION		
1	Int. Manifold Gasket Set	2011-05	MS 96634			
1	Exh. Manifold Gasket Set	2011-08	MS 96656	Gskt. w/Heat shield		
1	Exh. Manifold Gasket Set	2007-05	MS 96656	Exc. California; Gskt. w/Heat shield		
1	Exh. Manifold Gasket Set	2007	MS 96892	California		
1	Exh. Manifold Gasket Set	2006-05	MS 96663	California		
QTY	EXHAUST PIPE FLANGE	YEARS	PART NO.	DESCRIPTION		
1	Exhaust Pipe Gasket	2011-08	61486	Ring; Exc. California		
1	Exhaust Pipe Gasket	2011-09	61236	Ring; California		
1	Exhaust Pipe Gasket	2008	61406	Ring; California		
1	Exhaust Pipe Gasket	2007-05	61406	Ring		
QTY	CRANKSHAFT REAR SEAL	YEARS	PART NO.	DESCRIPTION		
1	Rear Main Seal Set	2011-05	BS 40689	PTFE Rubber; One-piece		
QTY	VALVE COVER	YEARS	PART NO.	DESCRIPTION		
1	Valve Cover Gasket Set	2011-05	VS 50639 R	PermaDry® molded rubber gskt. incl.; Old design		
1	Valve Cover Gasket Set	2011-05	VS 50639 R-1	PermaDry® molded rubber gskt. incl.; Improved design		

Ford Car (Incl. Edsel, Ford, Lincoln, Mercury, Merkur) (Cont.)

11 (cont.)		2011 - 2005; 2.0L 122 (1999cc) DOHC L4 (16 Valve) 87.5mm Bore Duratec MFI; Gasoline; Naturally Aspirated Ford Eng.; VIN Code N			11 (cont.)
QTY	VALVE STEM SEAL SET	YEARS	PART NO.	DESCRIPTION	
1	Valve Stem Seal Set	2011-05	SS 72917	Premium valve stem seals incl.	
QTY	THERMOSTAT HOUSING	YEARS	PART NO.	DESCRIPTION	
1	Thermostat Gasket	2011-05	35771	Thermostat Housing; Thermostat housing to head	
1	Thermostat Gasket	2011-05	35776	Thermostat seal	
1	Thermostat Gasket	2011-05	35833	Thermostat Housing; Thermostat housing to block	
QTY	WATER PUMP	YEARS	PART NO.	DESCRIPTION	
1	O-Ring	2011-05	35772	Water Pump	
QTY	TIMING COVER	YEARS	PART NO.	DESCRIPTION	
1	Crankshaft Front Seal Set	2011-05	TCS 46059	Old design	
1	Crankshaft Front Seal Set	2011-05	TCS 46132	Improved design	
QTY	CARB & FUEL INJECTION	YEARS	PART NO.	DESCRIPTION	
2	Fuel Injector O-Ring Set	2011-05	ES 70599	Improved design	
1	Throttle Body Gasket	2011-09	61391		
1	Throttle Body Gasket	2008-05	61253		
QTY	EXHAUST GAS RECIRCULATION	YEARS	PART NO.	DESCRIPTION	
1	EGR Gasket	2011-05	71227	Connector seal	
1	EGR Gasket	2011	71224	Valve	
1	EGR Gasket	2010-05	71223	Valve	
QTY	OIL FILTER MOUNTING	YEARS	PART NO.	DESCRIPTION	
1	Oil Filter Adapter Gasket	2011-05	72949	Oil filter adapter; New Part Number - Check for Availability	
QTY	OIL PUMP COVER	YEARS	PART NO.	DESCRIPTION	
1	Oil Pump Gasket	2011-05	72705	Oil pump body; New Part Number - Check for Availability	
QTY	CYLINDER BLOCK	YEARS	PART NO.	DESCRIPTION	
1	Crankcase Breather Gasket	2011-05	72950	Cylinder Block; Crankcase vent cover seal; New Part Number - Check for Availability	
12		2013 - 2012; 2.0L 122 (1999cc) DOHC L4 (16 Valve) 87.5mm Bore Duratec VVT DI; Flex Fuel; Naturally Aspirated Ford Eng.; VIN Code 2			12
QTY	CYLINDER HEAD	YEARS	PART NO.	DESCRIPTION	
1	Head Bolt Set	2013-12	ES 72207	Replacement recommended	
QTY	CRANKSHAFT REAR SEAL	YEARS	PART NO.	DESCRIPTION	
1	Rear Main Seal Set	2013-12	BS 40689	PTFE Rubber; One-piece	
QTY	VALVE STEM SEAL SET	YEARS	PART NO.	DESCRIPTION	
1	Valve Stem Seal Set	2013-12	SS 72917	Premium valve stem seals incl.	
QTY	THERMOSTAT HOUSING	YEARS	PART NO.	DESCRIPTION	
1	Thermostat Gasket	2013-12	35771	Thermostat Housing; Thermostat housing to head	
1	Thermostat Gasket	2013-12	35833	Thermostat Housing; Thermostat housing to block	
1	Thermostat Gasket	2013-12	35839	Thermostat Housing; Thermostat seal	
QTY	WATER PUMP	YEARS	PART NO.	DESCRIPTION	
1	O-Ring	2013-12	35772	Water Pump	
QTY	TIMING COVER	YEARS	PART NO.	DESCRIPTION	
1	Crankshaft Front Seal Set	2013-12	TCS 46132	Improved design	
QTY	CARB & FUEL INJECTION	YEARS	PART NO.	DESCRIPTION	
2	Fuel Injector O-Ring Set	2013-12	ES 70599	Improved design	
1	Throttle Body Gasket	2013-12	61377		
13		2013; 2.0L 122 (1999cc) DOHC L4 (16 Valve) 87.5mm Bore Duratec VVT MFI; Hybrid (Gas/Electric); Naturally Aspirated Ford Eng.; VIN Code U			13
QTY	CYLINDER HEAD	YEARS	PART NO.	DESCRIPTION	
1	Head Bolt Set	2013	ES 72207	Replacement recommended	
QTY	EXHAUST PIPE FLANGE	YEARS	PART NO.	DESCRIPTION	
1	Exhaust Pipe Gasket	2013	61731	Converter; New Part Number - Check for Availability	
1	Exhaust Pipe Gasket	2013	61732	Pipe to muffler; New Part Number - Check for Availability	
QTY	CRANKSHAFT REAR SEAL	YEARS	PART NO.	DESCRIPTION	
1	Rear Main Seal Set	2013	BS 40689	PTFE Rubber; One-piece	
QTY	VALVE STEM SEAL SET	YEARS	PART NO.	DESCRIPTION	
1	Valve Stem Seal Set	2013	SS 72917	Premium valve stem seals incl.	
QTY	THERMOSTAT HOUSING	YEARS	PART NO.	DESCRIPTION	
1	Thermostat Gasket	2013	35771	Thermostat Housing; Thermostat housing to head	
1	Thermostat Gasket	2013	35833	Thermostat Housing; Thermostat housing to block	
1	Thermostat Gasket	2013	35991	Thermostat Housing; Thermostat seal; New Part Number - Check for Availability	

Ford Car (Incl. Edsel, Ford, Lincoln, Mercury, Merkur) (Cont.)

13		2013; 2.0L 122 (1999cc) DOHC L4 (16 Valve) 87.5mm Bore Duratec VVT			13	
(cont.)		MFI; Hybrid (Gas/Electric); Naturally Aspirated Ford Eng.; VIN Code U			(cont.)	
QTY	WATER PUMP	YEARS	PART NO.	DESCRIPTION		
1	O-Ring	2013	35772	Water Pump		
QTY	TIMING COVER	YEARS	PART NO.	DESCRIPTION		
1	Crankshaft Front Seal Set	2013	TCS 46132	Improved design		
QTY	CARB & FUEL INJECTION	YEARS	PART NO.	DESCRIPTION		
2	Fuel Injector O-Ring Set	2013	ES 70599	Improved design		
1	Throttle Body Gasket	2013	61377			
14		2013 - 2012; 2.0L 122 (1999cc) DOHC L4 (16 Valve) 87.5mm Bore EcoBoost Duratec VVT			14	
		DI; Gasoline; Turbo - Intercooled Ford Eng.; VIN Code 9				
QTY	EXHAUST PIPE FLANGE	YEARS	PART NO.	DESCRIPTION		
1	Exhaust Pipe Gasket	2013-12	61236	Loc. Rear; Secondary converter		
QTY	CRANKSHAFT REAR SEAL	YEARS	PART NO.	DESCRIPTION		
1	Rear Main Seal Set	2013-12	BS 40689	PTFE Rubber; One-piece		
QTY	VALVE STEM SEAL SET	YEARS	PART NO.	DESCRIPTION		
1	Valve Stem Seal Set	2013-12	SS 72917	Premium valve stem seals incl.		
QTY	THERMOSTAT HOUSING	YEARS	PART NO.	DESCRIPTION		
1	Thermostat Gasket	2013-12	35839	Thermostat Housing; Thermostat seal		
QTY	WATER PUMP	YEARS	PART NO.	DESCRIPTION		
1	O-Ring	2013-12	35772	Water Pump		
QTY	TIMING COVER	YEARS	PART NO.	DESCRIPTION		
1	Crankshaft Front Seal Set	2013-12	TCS 46132	Improved design		
QTY	CARB & FUEL INJECTION	YEARS	PART NO.	DESCRIPTION		
1	Throttle Body Gasket	2013-12	61377			
15		1992 - 1991; 2.2L 133 (2184cc) SOHC L4 (12 Valve) 86mm Bore			15	
		MFI; Gasoline; Naturally Aspirated Mazda Eng.; VIN Code C, Eng. Code F2				
QTY	CYLINDER HEAD	YEARS	PART NO.	DESCRIPTION		
1	Head Gasket	1992-91	9572 PT			
1	Head Set	1992-91	HS 9572 PT-2	Exh. manifold heat shield not incl.; PermaDry® molded rubber valve cover gskt. incl.; Premium valve stem seals incl.		
1	Head Installation Set	1992-91	HIS 9572 PT-2	Exh. manifold heat shield & exh. pipe flange not incl.; PermaDry® molded rubber valve cover gskt. incl.		
QTY	CONVERSION SET	YEARS	PART NO.	DESCRIPTION		
1	Gasket Conversion Set	1992-91	CS 9513	RTV sealant incl. for Upper oil pan gskt.		
QTY	MANIFOLD - INT. & EXH.	YEARS	PART NO.	DESCRIPTION		
1	Int. Manifold Gasket Set	1992-91	MS 94199	Upper set incl.		
1	Exh. Manifold Gasket Set	1992-91	MS 94197			
QTY	EXHAUST PIPE FLANGE	YEARS	PART NO.	DESCRIPTION		
1	Exhaust Pipe Gasket	1992-91	60620	Loc. Rear; Converter		
1	Exhaust Pipe Gasket	1992-91	60665	Flange		
1	Exhaust Pipe Gasket	1992-91	60800	Loc. Front; Converter; w/M/T		
1	Exhaust Pipe Gasket	1992-91	60868	Loc. Front; Converter; w/A/T		
QTY	FUEL PUMP	YEARS	PART NO.	DESCRIPTION		
2	Fuel Pump Mounting Gasket	1992-91	72611			
QTY	OIL PAN	YEARS	PART NO.	DESCRIPTION		
1	Oil Pan Gasket Set	1992-91	OS 30467 C	Loc. Lower		
QTY	CRANKSHAFT REAR SEAL	YEARS	PART NO.	DESCRIPTION		
1	Rear Main Seal Set	1992-91	BS 40421	Rubber; One-piece		
1	Repair Sleeve Tool	1992-91	16300	Crankshaft		
QTY	VALVE COVER	YEARS	PART NO.	DESCRIPTION		
1	Valve Cover Gasket Set	1992-91	VS 50027 R	PermaDry® molded rubber gskt. incl.		
QTY	VALVE STEM SEAL SET	YEARS	PART NO.	DESCRIPTION		
1	Valve Stem Seal Set	1992-91	SS 72680-1	Premium valve stem seals incl.		
QTY	WATER OUTLET GASKET	YEARS	PART NO.	DESCRIPTION		
1	Water Outlet Gasket	1992-91	35251	Water Outlet		
QTY	WATER PUMP	YEARS	PART NO.	DESCRIPTION		
1	Water Pump Gasket	1992-91	35458			
QTY	TIMING COVER	YEARS	PART NO.	DESCRIPTION		
1	Timing Cover Set	1992-91	TCS 45723	Camshaft; Front seal set		
1	Timing Cover Set	1992-91	TCS 45723	Crankshaft; Front seal set		
1	Timing Cover Dust Seal Set	1992-91	ES 72855			
1	Repair Sleeve	1992-91	16272	Timing Cover; Use w/installation tool		
QTY	CARB & FUEL INJECTION	YEARS	PART NO.	DESCRIPTION		
1	Fuel Injector O-Ring Set	1992-91	ES 70600			

Ford Car (Incl. Edsel, Ford, Lincoln, Mercury, Merkur) (Cont.)

15		1992 - 1991; 2.2L 133 (2184cc) SOHC L4 (12 Valve) 86mm Bore			15	
(cont.)		MFI; Gasoline; Naturally Aspirated Mazda Eng.; VIN Code C, Eng. Code F2			(cont.)	
QTY	CARB & FUEL INJECTION	YEARS	PART NO.	DESCRIPTION		
1	Throttle Body Gasket	1992-91	60862			
QTY	EXHAUST GAS RECIRCULATION	YEARS	PART NO.	DESCRIPTION		
1	EGR Gasket	1992-91	72606	w/A/T		
16		1992 - 1991; 2.2L 133 (2184cc) SOHC L4 (12 Valve) 86mm Bore			16	
		MFI; Gasoline; Turbo - Intercooled Mazda Eng.; VIN Code L, Eng. Code F2-T				
QTY	CYLINDER HEAD	YEARS	PART NO.	DESCRIPTION		
1	Head Gasket	1992-91	9572 PT			
1	Head Set	1992-91	HS 9572 PT	Exh. manifold heat shield not incl.; PermaDry® molded rubber valve cover gskt. incl.; Premium valve stem seals incl.		
QTY	CONVERSION SET	YEARS	PART NO.	DESCRIPTION		
1	Gasket Conversion Set	1992-91	CS 9513	RTV sealant incl. for Upper oil pan gskt.		
QTY	MANIFOLD - INT. & EXH.	YEARS	PART NO.	DESCRIPTION		
1	Int. Manifold Gasket Set	1992-91	MS 94199	Upper set incl.		
1	Exh. Manifold Gasket Set	1992-91	MS 94197			
1	Exh. Manifold Gasket Set	1992-91	MS 94213	Heat shield		
QTY	EXHAUST PIPE FLANGE	YEARS	PART NO.	DESCRIPTION		
1	Exhaust Pipe Gasket	1992-91	60620	Loc. Rear; Converter		
1	Exhaust Pipe Gasket	1992-91	60798	Flange		
1	Exhaust Pipe Gasket	1992-91	60800	Loc. Front; Converter		
QTY	FUEL PUMP	YEARS	PART NO.	DESCRIPTION		
2	Fuel Pump Mounting Gasket	1992-91	72611			
QTY	OIL PAN	YEARS	PART NO.	DESCRIPTION		
1	Oil Pan Gasket Set	1992-91	OS 30467 C	Loc. Lower		
QTY	CRANKSHAFT REAR SEAL	YEARS	PART NO.	DESCRIPTION		
1	Rear Main Seal Set	1992-91	BS 40421	Rubber; One-piece		
1	Repair Sleeve Tool	1992-91	16300	Crankshaft		
QTY	VALVE COVER	YEARS	PART NO.	DESCRIPTION		
1	Valve Cover Gasket Set	1992-91	VS 50027 R	PermaDry® molded rubber gskt. incl.		
QTY	VALVE STEM SEAL SET	YEARS	PART NO.	DESCRIPTION		
1	Valve Stem Seal Set	1992-91	SS 72680-1	Premium valve stem seals incl.		
QTY	WATER OUTLET GASKET	YEARS	PART NO.	DESCRIPTION		
1	Water Outlet Gasket	1992-91	35251	Water Outlet		
QTY	WATER PUMP	YEARS	PART NO.	DESCRIPTION		
1	Water Pump Gasket	1992-91	35458			
QTY	TIMING COVER	YEARS	PART NO.	DESCRIPTION		
1	Timing Cover Set	1992-91	TCS 45723	Camshaft; Front seal set		
1	Timing Cover Set	1992-91	TCS 45723	Crankshaft; Front seal set		
1	Timing Cover Dust Seal Set	1992-91	ES 72855			
1	Repair Sleeve	1992-91	16272	Timing Cover; Use w/installation tool		
QTY	CARB & FUEL INJECTION	YEARS	PART NO.	DESCRIPTION		
1	Fuel Injector O-Ring Set	1992-91	ES 70600			
1	Throttle Body Gasket	1992-91	60862			
QTY	EXHAUST GAS RECIRCULATION	YEARS	PART NO.	DESCRIPTION		
1	EGR Gasket	1992-91	70122			
17		2009 - 2003; 2.3L 138 (2261cc) DOHC L4 (16 Valve) 87.5mm Bore Duratec PZEV			17	
		MFI; Gasoline; Naturally Aspirated Ford Eng.; VIN Code Z				
QTY	CYLINDER HEAD	YEARS	PART NO.	DESCRIPTION		
1	Head Gasket	2009-08	26316 PT	Head bolts not incl.; Head bolt replacement recommended; PermaTorqueMLS®		
1	Head Gasket	2007-06	26250 PT	Ford Focus ZX4 ST; Head bolts not incl.; Head bolt replacement recommended; PermaTorqueMLS® LaserWeld® Technology		
1	Head Gasket	2007-06	26316 PT	Exc. Ford Focus ZX4 ST; Head bolts not incl.; Head bolt replacement recommended; PermaTorqueMLS®		
1	Head Gasket	2005-03	26250 PT	Head bolts not incl.; Head bolt replacement recommended; PermaTorqueMLS® LaserWeld® Technology		
1	Head Set	2009-08	HS 26316 PT	Exc. California; Head bolts not incl.; Head bolt replacement recommended; PermaDry® molded rubber valve cover gskt. incl.; Premium valve stem seals incl.		
1	Head Set	2009-08	HS 26316 PT-1	California; Head bolts not incl.; Head bolt replacement recommended; PermaDry® molded rubber valve cover gskt. incl.; Premium valve stem seals incl.		

Ford Car (Incl. Edsel, Ford, Lincoln, Mercury, Merkur) (Cont.)

17 (cont.)		2009 - 2003; 2.3L 138 (2261cc) DOHC L4 (16 Valve) 87.5mm Bore Duratec PZEV MFI; Gasoline; Naturally Aspirated Ford Eng.; VIN Code Z			17 (cont.)
QTY	CYLINDER HEAD	YEARS	PART NO.	DESCRIPTION	
1	Head Set	2007-06	HS 26316 PT	Exc. Ford Focus ZX4 ST; Exc. California; Head bolts not incl.; Head bolt replacement recommended; PermaDry® molded rubber valve cover gskt. incl.; Premium valve stem seals incl.	
1	Head Set	2007-06	HS 26316 PT-1	Exc. Ford Focus ZX4 ST; California; Head bolts not incl.; Head bolt replacement recommended; PermaDry® molded rubber valve cover gskt. incl.; Premium valve stem seals incl.	
1	Head Set	2007	HS 26250 PT-4	Ford Focus ZX4 ST; Head bolts not incl.; Head bolt replacement recommended; PermaDry® molded rubber valve cover gskt. incl.; Premium valve stem seals incl.; Consolidated design	
1	Head Set	2006	HS 26250 PT-3	Ford Focus ZX4 ST; Head bolts not incl.; Head bolt replacement recommended; PermaDry® molded rubber valve cover gskt. incl.; Premium valve stem seals incl.	
1	Head Set	2005	HS 26250 PT-3	Head bolts not incl.; Head bolt replacement recommended; PermaDry® molded rubber valve cover gskt. incl.; Premium valve stem seals incl.	
1	Head Set	2004	HS 26250 PT-2	To 04/04/04; Head bolts not incl.; Head bolt replacement recommended; PermaDry® molded rubber valve cover gskt. incl.; Premium valve stem seals incl.	
1	Head Set	2004	HS 26250 PT-3	From 04/05/04; Head bolts not incl.; Head bolt replacement recommended; PermaDry® molded rubber valve cover gskt. incl.; Premium valve stem seals incl.	
1	Head Set	2003	HS 26250 PT-2	Head bolts not incl.; Head bolt replacement recommended; PermaDry® molded rubber valve cover gskt. incl.; Premium valve stem seals incl.	
1	Head Bolt Set	2009-03	ES 72207	Replacement recommended	
QTY	CONVERSION SET	YEARS	PART NO.	DESCRIPTION	
1	Gasket Conversion Set	2009-03	CS 26250	RTV sealant incl. for oil pan gskt.	
QTY	MANIFOLD - INT. & EXH.	YEARS	PART NO.	DESCRIPTION	
1	Int. Manifold Gasket Set	2009-03	MS 96634		
1	Exh. Manifold Gasket Set	2009-08	MS 96655	Exc. California	
1	Exh. Manifold Gasket Set	2009-08	MS 96663	California	
1	Exh. Manifold Gasket Set	2007-06	MS 96655	Exc. Ford Focus ZX4 ST; Exc. California	
1	Exh. Manifold Gasket Set	2007-06	MS 96663	Exc. Ford Focus ZX4 ST; California	
1	Exh. Manifold Gasket Set	2007	MS 96656	Ford Focus ZX4 ST; Gskt. w/Heat shield	
1	Exh. Manifold Gasket Set	2006	MS 96663	Ford Focus ZX4 ST	
1	Exh. Manifold Gasket Set	2005-03	MS 96663		
QTY	EXHAUST PIPE FLANGE	YEARS	PART NO.	DESCRIPTION	
1	Exhaust Pipe Gasket	2009-08	61406	Ring	
1	Exhaust Pipe Gasket	2007	61406	Exc. Ford Focus ZX4 ST; Ring	
1	Exhaust Pipe Gasket	2007	61486	Ford Focus ZX4 ST; Ring	
1	Exhaust Pipe Gasket	2006-03	61406	Ring	
QTY	CRANKSHAFT REAR SEAL	YEARS	PART NO.	DESCRIPTION	
1	Rear Main Seal Set	2009-03	BS 40689	PTFE Rubber; One-piece	
QTY	VALVE COVER	YEARS	PART NO.	DESCRIPTION	
1	Valve Cover Gasket Set	2009-05	VS 50639 R-1	PermaDry® molded rubber gskt. incl.; Improved design	
1	Valve Cover Gasket Set	2007-06	VS 50639 R	Ford Focus ZX4 ST; PermaDry® molded rubber gskt. incl.; Old design	
1	Valve Cover Gasket Set	2005	VS 50639 R	PermaDry® molded rubber gskt. incl.; Old design	
1	Valve Cover Gasket Set	2004	VS 50638 R	To 04/04/04; PermaDry® molded rubber gskt. incl.	
1	Valve Cover Gasket Set	2004	VS 50639 R	From 04/05/04; PermaDry® molded rubber gskt. incl.; Old design	
1	Valve Cover Gasket Set	2004	VS 50639 R-1	From 04/05/04; PermaDry® molded rubber gskt. incl.; Improved design	
1	Valve Cover Gasket Set	2003	VS 50638 R	PermaDry® molded rubber gskt. incl.	
1	Grommet Set	2009-08	ES 73008	Valve Cover; VCT seal set; New Part Number - Check for Availability	
1	Grommet Set	2007-06	ES 73008	Exc. Ford Focus ZX4 ST; Valve Cover; VCT seal set; New Part Number - Check for Availability	
QTY	VALVE STEM SEAL SET	YEARS	PART NO.	DESCRIPTION	
1	Valve Stem Seal Set	2009-03	SS 72917	Premium valve stem seals incl.	
QTY	THERMOSTAT HOUSING	YEARS	PART NO.	DESCRIPTION	
1	Thermostat Gasket	2009-03	35833	Thermostat Housing; Thermostat housing to block	
1	Thermostat Gasket	2009-08	35839	Thermostat Housing; Thermostat seal	
1	Thermostat Gasket	2007	35771	Ford Focus ZX4 ST; Thermostat Housing; Thermostat housing to head	
1	Thermostat Gasket	2007	35776	Ford Focus ZX4 ST; Thermostat Housing; Thermostat seal	
1	Thermostat Gasket	2007	35776	Exc. Ford Focus ZX4 ST; Thermostat Housing; To 12/03/06; Thermostat seal	
1	Thermostat Gasket	2007	35839	Exc. Ford Focus ZX4 ST; Thermostat Housing; From 12/04/06; Thermostat seal	
1	Thermostat Gasket	2006-03	35776	Thermostat Housing; Thermostat seal	

Ford Car (Incl. Edsel, Ford, Lincoln, Mercury, Merkur) (Cont.)

17		2009 - 2003; 2.3L 138 (2261cc) DOHC L4 (16 Valve) 87.5mm Bore Duratec PZEV			17
(cont.)		MFI; Gasoline; Naturally Aspirated Ford Eng.; VIN Code Z			(cont.)
QTY	THERMOSTAT HOUSING	YEARS	PART NO.	DESCRIPTION	
1	Thermostat Gasket	2006	35771	Ford Focus ZX4 ST; Thermostat Housing; Thermostat housing to head	
1	Thermostat Gasket	2006	35771	Exc. Ford Focus ZX4 ST; Thermostat Housing; To 12/04/05; Thermostat housing to head	
1	Thermostat Gasket	2005-03	35771	Thermostat Housing; Thermostat housing to head	
QTY	WATER PUMP	YEARS	PART NO.	DESCRIPTION	
1	O-Ring	2009-03	35772	Water Pump; O-ring	
QTY	TIMING COVER	YEARS	PART NO.	DESCRIPTION	
1	Crankshaft Front Seal Set	2009-03	TCS 46059	Old design	
1	Crankshaft Front Seal Set	2009-03	TCS 46132	Improved design	
QTY	CARB & FUEL INJECTION	YEARS	PART NO.	DESCRIPTION	
2	Fuel Injector O-Ring Set	2009-03	ES 70599	Improved design	
1	Throttle Body Gasket	2009-08	61413	Mounting	
1	Throttle Body Gasket	2007-06	61356	Ford Focus ZX4 ST; Mounting	
1	Throttle Body Gasket	2007-06	61413	Exc. Ford Focus ZX4 ST; Mounting	
1	Throttle Body Gasket	2005-03	61356	Mounting	
QTY	EXHAUST GAS RECIRCULATION	YEARS	PART NO.	DESCRIPTION	
1	EGR Gasket	2009-03	71227	Connector seal	
1	EGR Gasket	2009-08	71224	Valve	
1	EGR Gasket	2007-06	71223	Ford Focus ZX4 ST; Valve	
1	EGR Gasket	2007-06	71224	Exc. Ford Focus ZX4 ST; Valve	
1	EGR Gasket	2005-03	71223	Valve	
QTY	OIL FILTER MOUNTING	YEARS	PART NO.	DESCRIPTION	
1	Oil Filter Adapter Gasket	2009-03	72949	Oil filter adapter; New Part Number - Check for Availability	
QTY	OIL PUMP COVER	YEARS	PART NO.	DESCRIPTION	
1	Oil Pump Gasket	2009-03	72705	Oil pump body; New Part Number - Check for Availability	
QTY	CYLINDER BLOCK	YEARS	PART NO.	DESCRIPTION	
1	Crankcase Breather Gasket	2009-03	72950	Cylinder Block; Crankcase vent cover seal; New Part Number - Check for Availability	
QTY	OIL COOLER	YEARS	PART NO.	DESCRIPTION	
1	Oil Cooler Gasket	2009-03	72709	Oil cooler mounting; Plastic carrier gskt. w/Silicone beading; New Part Number - Check for Availability	
18		1993 - 1991; 2.3L 140 (2302cc) SOHC L4 (8 Valve) 96mm Bore			18
		MFI; Gasoline; Naturally Aspirated Ford Eng.; VIN Code M			
QTY	CYLINDER HEAD	YEARS	PART NO.	DESCRIPTION	
1	Head Gasket	1993-91	8993 PT-1	Head bolts not incl.; Head bolt replacement recommended; PermaTorque®	
1	Head Gasket Spacer Shim	1993-91	8471 SP	HeadSaver®	
1	Head Set	1993-91	HS 8993 PT-6	Head bolts not incl.; Head bolt replacement recommended; PermaDry® molded rubber valve cover gskt. incl.; Premium valve stem seals incl.	
1	Head Installation Set	1993-91	HIS 8993 PT-6	Head bolts not incl.; Head bolt replacement recommended; PermaDry® molded rubber valve cover gskt. incl.	
1	Head Bolt Set	1993-91	ES 72137	Replacement recommended	
QTY	CONVERSION SET	YEARS	PART NO.	DESCRIPTION	
1	Gasket Conversion Set	1993	CS 8471-5	PermaDry® molded rubber oil pan gskt. incl.	
1	Gasket Conversion Set	1992-91	CS 8471-3	PermaDry® molded rubber oil pan gskt. incl.	
QTY	MANIFOLD - INT. & EXH.	YEARS	PART NO.	DESCRIPTION	
1	Int. Manifold Gasket Set	1993-91	MS 93391	Lower set; Upper set incl.	
1	Plenum Gasket Set	1993-91	MS 94263	Upper set	
1	Exh. Manifold Gasket Set	1993-91	MS 92424		
QTY	EXHAUST PIPE FLANGE	YEARS	PART NO.	DESCRIPTION	
1	Exh. Flange Bolt & Spring Kit	1993-91	ES 72142		
QTY	OIL PAN	YEARS	PART NO.	DESCRIPTION	
1	Oil Pan Gasket Set	1993	OS 30914 R	PermaDry® molded rubber gskt. incl.	
1	Oil Pan Gasket Set	1992-91	OS 30545 R	PermaDry® one-piece molded rubber gskt. incl.	
1	Drain Plug Gasket	1993-91	72515		
QTY	CRANKSHAFT REAR SEAL	YEARS	PART NO.	DESCRIPTION	
1	Rear Main Seal Set	1993-91	BS 40620	Rubber; One-piece; Improved design	
1	Rear Main Seal Set	1993-91	BS 40644	PTFE Rubber; One-piece	
1	Repair Sleeve	1993-91	16255-1	Crankshaft; 1.105" - 1.135" sleeve length; Use w/installation tool; Improved design	
1	Repair Sleeve Tool	1993-91	16306	Crankshaft	
QTY	VALVE COVER	YEARS	PART NO.	DESCRIPTION	
1	Valve Cover Gasket Set	1993-91	VS 50043 R-1	Int. manifold upper set incl.; PermaDry® molded rubber gskt. incl.	

Ford Car (Incl. Edsel, Ford, Lincoln, Mercury, Merkur) (Cont.)

18		1993 - 1991; 2.3L 140 (2302cc) SOHC L4 (8 Valve) 96mm Bore			18	
(cont.)		MFI; Gasoline; Naturally Aspirated Ford Eng.; VIN Code M			(cont.)	
QTY	VALVE STEM SEAL SET	YEARS	PART NO.	DESCRIPTION		
1	Valve Stem Seal Set	1993-91	SS 72683	Loc. Int. & Exh.; Premium valve stem seals incl.		
QTY	THERMOSTAT HOUSING	YEARS	PART NO.	DESCRIPTION		
1	Water Outlet Gasket	1993-91	35114	Thermostat Housing		
1	Water Outlet Gasket	1993-91	35114 T	Thermostat Housing; PermaDryPlus®		
QTY	WATER PUMP	YEARS	PART NO.	DESCRIPTION		
1	Water Pump Gasket	1993-91	35381			
QTY	TIMING COVER	YEARS	PART NO.	DESCRIPTION		
1	Timing Cover Dust Seal Set	1993-91	ES 72734			
1	Crankshaft Front Seal Set	1993	TCS 45940	Must be used w/OS 30914R		
1	Crankshaft Front Seal Set	1992-91	TCS 45107	Must be used w/OS 30545R		
1	Camshaft Front Seal Set	1993-91	TCS 45108			
1	Auxiliary Shaft Seal Set	1993-91	TCS 45109			
QTY	CARB & FUEL INJECTION	YEARS	PART NO.	DESCRIPTION		
1	Fuel Injector O-Ring Set	1993-91	ES 70599	Improved design		
1	Throttle Body Gasket	1993-91	60847	Mounting		
1	Throttle Body Gasket	1993-91	71216	Air bypass valve		
QTY	EXHAUST GAS RECIRCULATION	YEARS	PART NO.	DESCRIPTION		
1	EGR Gasket	1993-91	72649			
19		1994 - 1991; 2.3L 140 (2306cc) OHV L4 (8 Valve) 3.68" Bore HSC			19	
		MFI; Gasoline; Naturally Aspirated Ford Eng.; VIN Code X				
QTY	CYLINDER HEAD	YEARS	PART NO.	DESCRIPTION		
1	Head Gasket	1994-91	9814 PT			
1	Head Set	1994-91	HS 9814 PT	Premium valve stem seals incl.		
1	Head Installation Set	1994-91	HIS 9814 PT	Exh. pipe to manifold gskt. not incl.		
QTY	CONVERSION SET	YEARS	PART NO.	DESCRIPTION		
1	Gasket Conversion Set	1994-91	CS 9195-3	One-piece oil pan gskt. not incl.; RTV sealant incl. for oil pan gskt.		
QTY	MANIFOLD - INT. & EXH.	YEARS	PART NO.	DESCRIPTION		
1	Int. Manifold Gasket Set	1994-91	MS 93483	Lower set; Upper set incl.		
1	Plenum Gasket Set	1994-91	MS 94032	Upper set		
1	Exh. Manifold Gasket Set	1994-91	MS 94758			
QTY	EXHAUST PIPE FLANGE	YEARS	PART NO.	DESCRIPTION		
1	Exhaust Pipe Gasket	1994-91	60583	Converter		
1	Exhaust Pipe Gasket	1994-91	60639	Pipe to manifold		
1	Exh. Flange Bolt & Spring Kit	1994-91	ES 72142			
QTY	OIL PAN	YEARS	PART NO.	DESCRIPTION		
1	Drain Plug Gasket	1994-91	72515			
QTY	CRANKSHAFT REAR SEAL	YEARS	PART NO.	DESCRIPTION		
1	Rear Main Seal Set	1994-91	BS 40452	Rubber; One-piece		
1	Rear Main Seal Set	1994-91	BS 40646	PTFE Rubber; One-piece		
QTY	VALVE COVER	YEARS	PART NO.	DESCRIPTION		
1	Valve Cover Gasket Set	1994-91	VS 50399	w/Grommets; Replaces OEM molded rubber bead; Cork-Lam®		
QTY	VALVE STEM SEAL SET	YEARS	PART NO.	DESCRIPTION		
1	Valve Stem Seal Set	1994-91	SS 72683	Loc. Int. & Exh.; Premium valve stem seals incl.		
QTY	WATER OUTLET GASKET	YEARS	PART NO.	DESCRIPTION		
1	Water Outlet Gasket	1994-91	35114	Water Outlet		
1	Water Outlet Gasket	1994-91	35114 T	Water Outlet; PermaDryPlus®		
QTY	WATER PUMP	YEARS	PART NO.	DESCRIPTION		
1	Water Pump Gasket	1994-91	35362	To block		
1	Water Pump Gasket	1994-91	35558	To cover		
1	Water Pump Mounting Set	1994-91	ES 70711			
QTY	TIMING COVER	YEARS	PART NO.	DESCRIPTION		
1	Timing Cover Set	1994-91	TCS 45626			
QTY	CARB & FUEL INJECTION	YEARS	PART NO.	DESCRIPTION		
1	Fuel Injector O-Ring Set	1994-91	ES 70599	Improved design		
1	Throttle Body Gasket	1994-91	60844	Mounting		
1	Throttle Body Gasket	1994-91	71216	Air bypass valve		
QTY	EXHAUST GAS RECIRCULATION	YEARS	PART NO.	DESCRIPTION		
1	EGR Gasket	1994-91	70149			
20		1991; 2.3L 140 (2306cc) OHV L4 (8 Valve) 3.68" Bore HSC H.O.			20	
		MFI; Gasoline; Naturally Aspirated Ford Eng.; VIN Code S				
QTY	CYLINDER HEAD	YEARS	PART NO.	DESCRIPTION		
1	Head Gasket	1991	9814 PT			

Ford Car (Incl. Edsel, Ford, Lincoln, Mercury, Merkur) (Cont.)

20 (cont.)		1991; 2.3L 140 (2306cc) OHV L4 (8 Valve) 3.68" Bore HSC H.O. MFI; Gasoline; Naturally Aspirated Ford Eng.; VIN Code S			20 (cont.)
QTY	CYLINDER HEAD	YEARS	PART NO.	DESCRIPTION	
1	Head Set	1991	HS 9814 PT	Premium valve stem seals incl.	
1	Head Installation Set	1991	HIS 9814 PT	Exh. pipe to manifold gskt. not incl.	
QTY	CONVERSION SET	YEARS	PART NO.	DESCRIPTION	
1	Gasket Conversion Set	1991	CS 9195-3	One-piece oil pan gskt. not incl.; RTV sealant incl. for oil pan gskt.	
QTY	MANIFOLD - INT. & EXH.	YEARS	PART NO.	DESCRIPTION	
1	Int. Manifold Gasket Set	1991	MS 93483	Lower set; Upper set incl.	
1	Plenum Gasket Set	1991	MS 94032	Upper set	
1	Exh. Manifold Gasket Set	1991	MS 94758		
QTY	EXHAUST PIPE FLANGE	YEARS	PART NO.	DESCRIPTION	
1	Exhaust Pipe Gasket	1991	60583	Converter	
1	Exhaust Pipe Gasket	1991	60639	Pipe to manifold	
1	Exh. Flange Bolt & Spring Kit	1991	ES 72142		
QTY	OIL PAN	YEARS	PART NO.	DESCRIPTION	
1	Drain Plug Gasket	1991	72515		
QTY	CRANKSHAFT REAR SEAL	YEARS	PART NO.	DESCRIPTION	
1	Rear Main Seal Set	1991	BS 40452	Rubber; One-piece	
1	Rear Main Seal Set	1991	BS 40646	PTFE Rubber; One-piece	
QTY	VALVE COVER	YEARS	PART NO.	DESCRIPTION	
1	Valve Cover Gasket Set	1991	VS 50399	w/Grommets; Replaces OEM molded rubber bead; Cork-Lam®	
QTY	VALVE STEM SEAL SET	YEARS	PART NO.	DESCRIPTION	
1	Valve Stem Seal Set	1991	SS 72683	Loc. Int. & Exh.; Premium valve stem seals incl.	
QTY	WATER OUTLET GASKET	YEARS	PART NO.	DESCRIPTION	
1	Water Outlet Gasket	1991	35114	Water Outlet	
1	Water Outlet Gasket	1991	35114 T	Water Outlet; PermaDryPlus®	
QTY	WATER PUMP	YEARS	PART NO.	DESCRIPTION	
1	Water Pump Gasket	1991	35362	To block	
1	Water Pump Gasket	1991	35558	To cover	
1	Water Pump Mounting Set	1991	ES 70711		
QTY	TIMING COVER	YEARS	PART NO.	DESCRIPTION	
1	Timing Cover Set	1991	TCS 45626		
QTY	CARB & FUEL INJECTION	YEARS	PART NO.	DESCRIPTION	
1	Fuel Injector O-Ring Set	1991	ES 70599	Improved design	
1	Throttle Body Gasket	1991	60844	Mounting	
1	Throttle Body Gasket	1991	71216	Air bypass valve	
QTY	EXHAUST GAS RECIRCULATION	YEARS	PART NO.	DESCRIPTION	
1	EGR Gasket	1991	70149		
21		2012 - 2010; 2.5L 151.8 (2488cc) DOHC L4 (16 Valve) 89mm Bore Duratec PZEV MFI; Hybrid (Gas/Electric); Naturally Aspirated Ford Eng.; VIN Code 3			21
QTY	CYLINDER HEAD	YEARS	PART NO.	DESCRIPTION	
1	Head Gasket	2012-11	26521 PT	Head bolts not incl.; Head bolt replacement recommended; PermaTorqueMLS®; New Part Number - Check for Availability	
1	Head Gasket	2010	26522 PT	Head bolts not incl.; Head bolt replacement recommended; PermaTorqueMLS®; New Part Number - Check for Availability	
1	Head Set	2012-11	HS 26521 PT	Head bolts not incl.; Head bolt replacement recommended; PermaDry® molded rubber valve cover gskt. incl.; Premium valve stem seals incl.; New Part Number - Check for Availability	
1	Head Set	2010	HS 26522 PT	Head bolts not incl.; Head bolt replacement recommended; PermaDry® molded rubber valve cover gskt. incl.; Premium valve stem seals incl.; New Part Number - Check for Availability	
1	Head Bolt Set	2012-10	ES 72207	Replacement recommended	
QTY	CONVERSION SET	YEARS	PART NO.	DESCRIPTION	
1	Gasket Conversion Set	2012-10	CS 26521	RTV sealant incl. for oil pan gskt.; New Part Number - Check for Availability	
QTY	MANIFOLD - INT. & EXH.	YEARS	PART NO.	DESCRIPTION	
1	Int. Manifold Gasket Set	2012-10	MS 97160	New Part Number - Check for Availability	
1	Exh. Manifold Gasket Set	2012-10	MS 96901		
QTY	EXHAUST PIPE FLANGE	YEARS	PART NO.	DESCRIPTION	
1	Exhaust Pipe Gasket	2012-10	61406	Converter	
1	Exhaust Pipe Gasket	2012-10	61406	Ring	
QTY	CRANKSHAFT REAR SEAL	YEARS	PART NO.	DESCRIPTION	
1	Rear Main Seal Set	2012-10	BS 40689	PTFE Rubber; One-piece	
QTY	VALVE COVER	YEARS	PART NO.	DESCRIPTION	
1	Valve Cover Gasket Set	2012-10	VS 50639 R-1	PermaDry® molded rubber gskt. incl.; Improved design	

Ford Car (Incl. Edsel, Ford, Lincoln, Mercury, Merkur) (Cont.)

21		2012 - 2010; 2.5L 151.8 (2488cc) DOHC L4 (16 Valve) 89mm Bore Duratec PZEV			21	
(cont.)		MFI; Hybrid (Gas/Electric); Naturally Aspirated Ford Eng.; VIN Code 3			(cont.)	
QTY	VALVE COVER	YEARS	PART NO.	DESCRIPTION		
1	Grommet Set	2012-10	ES 73008	Valve Cover; VCT seal set; New Part Number - Check for Availability		
QTY	VALVE STEM SEAL SET	YEARS	PART NO.	DESCRIPTION		
1	Valve Stem Seal Set	2012-10	SS 72917	Premium valve stem seals incl.		
QTY	THERMOSTAT HOUSING	YEARS	PART NO.	DESCRIPTION		
1	Thermostat Gasket	2012-10	35771	Thermostat Housing; Thermostat housing to head		
1	Thermostat Gasket	2012-10	35839	Thermostat Housing; Thermostat seal		
QTY	WATER PUMP	YEARS	PART NO.	DESCRIPTION		
1	O-Ring	2012-10	35772	Water Pump		
QTY	TIMING COVER	YEARS	PART NO.	DESCRIPTION		
1	Crankshaft Front Seal Set	2012-10	TCS 46151			
QTY	CARB & FUEL INJECTION	YEARS	PART NO.	DESCRIPTION		
2	Fuel Injector O-Ring Set	2012-10	ES 70599	Improved design		
1	Throttle Body Gasket	2012-10	61595	Mounting		
QTY	EXHAUST GAS RECIRCULATION	YEARS	PART NO.	DESCRIPTION		
1	EGR Gasket	2012-10	71224	Valve		
1	EGR Gasket	2012-10	71227	Connector seal		
QTY	OIL FILTER MOUNTING	YEARS	PART NO.	DESCRIPTION		
1	Oil Filter Adapter Gasket	2012-10	72949	Oil filter adapter; New Part Number - Check for Availability		
QTY	CYLINDER BLOCK	YEARS	PART NO.	DESCRIPTION		
1	Crankcase Breather Gasket	2012-10	72950	Cylinder Block; Crankcase vent cover seal; New Part Number - Check for Availability		
22		2012 - 2010; 2.5L 151.8 (2488cc) DOHC L4 (16 Valve) 89mm Bore Duratec PZEV			22	
		MFI; Gasoline; Naturally Aspirated Ford Eng.; VIN Code A				
QTY	CYLINDER HEAD	YEARS	PART NO.	DESCRIPTION		
1	Head Gasket	2012-11	26521 PT	Head bolts not incl.; Head bolt replacement recommended; PermaTorqueMLS®; New Part Number - Check for Availability		
1	Head Gasket	2010	26522 PT	Head bolts not incl.; Head bolt replacement recommended; PermaTorqueMLS®; New Part Number - Check for Availability		
1	Head Set	2012-11	HS 26521 PT	Head bolts not incl.; Head bolt replacement recommended; PermaDry® molded rubber valve cover gskt. incl.; Premium valve stem seals incl.; New Part Number - Check for Availability		
1	Head Set	2010	HS 26522 PT	Head bolts not incl.; Head bolt replacement recommended; PermaDry® molded rubber valve cover gskt. incl.; Premium valve stem seals incl.; New Part Number - Check for Availability		
1	Head Bolt Set	2012-10	ES 72207	Replacement recommended		
QTY	CONVERSION SET	YEARS	PART NO.	DESCRIPTION		
1	Gasket Conversion Set	2012-10	CS 26521	RTV sealant incl. for oil pan gskt.; New Part Number - Check for Availability		
QTY	MANIFOLD - INT. & EXH.	YEARS	PART NO.	DESCRIPTION		
1	Int. Manifold Gasket Set	2012-10	MS 97160	New Part Number - Check for Availability		
1	Exh. Manifold Gasket Set	2012-10	MS 96901			
QTY	EXHAUST PIPE FLANGE	YEARS	PART NO.	DESCRIPTION		
1	Exhaust Pipe Gasket	2012-10	61406	Converter		
1	Exhaust Pipe Gasket	2012-10	61406	Ring		
QTY	CRANKSHAFT REAR SEAL	YEARS	PART NO.	DESCRIPTION		
1	Rear Main Seal Set	2012-10	BS 40689	PTFE Rubber; One-piece		
QTY	VALVE COVER	YEARS	PART NO.	DESCRIPTION		
1	Valve Cover Gasket Set	2012-10	VS 50639 R-1	PermaDry® molded rubber gskt. incl.; Improved design		
1	Grommet Set	2012-10	ES 73008	Valve Cover; VCT seal set; New Part Number - Check for Availability		
QTY	VALVE STEM SEAL SET	YEARS	PART NO.	DESCRIPTION		
1	Valve Stem Seal Set	2012-10	SS 72917	Premium valve stem seals incl.		
QTY	THERMOSTAT HOUSING	YEARS	PART NO.	DESCRIPTION		
1	Thermostat Gasket	2012-10	35833	Thermostat Housing; Thermostat housing to head		
1	Thermostat Gasket	2012-10	35839	Thermostat Housing; Thermostat seal		
QTY	WATER PUMP	YEARS	PART NO.	DESCRIPTION		
1	O-Ring	2012-10	35772	Water Pump		
QTY	TIMING COVER	YEARS	PART NO.	DESCRIPTION		
1	Crankshaft Front Seal Set	2012-10	TCS 46151			
QTY	CARB & FUEL INJECTION	YEARS	PART NO.	DESCRIPTION		
2	Fuel Injector O-Ring Set	2012-10	ES 70599	Improved design		
1	Throttle Body Gasket	2012-10	61595	Mounting		
QTY	EXHAUST GAS RECIRCULATION	YEARS	PART NO.	DESCRIPTION		
1	EGR Gasket	2012-10	71224	Valve		

Ford Car (Incl. Edsel, Ford, Lincoln, Mercury, Merkur) (Cont.)

22		2012 - 2010; 2.5L 151.8 (2488cc) DOHC L4 (16 Valve) 89mm Bore Duratec PZEV			22
(cont.)		MFI; Gasoline; Naturally Aspirated Ford Eng.; VIN Code A			(cont.)
QTY	EXHAUST GAS RECIRCULATION	YEARS	PART NO.	DESCRIPTION	
1	EGR Gasket	2012-10	71227	Connector seal	
QTY	OIL FILTER MOUNTING	YEARS	PART NO.	DESCRIPTION	
1	Oil Filter Adapter Gasket	2012-10	72949	Oil filter adapter; New Part Number - Check for Availability	
QTY	CYLINDER BLOCK	YEARS	PART NO.	DESCRIPTION	
1	Crankcase Breather Gasket	2012-10	72950	Cylinder Block; Crankcase vent cover seal; New Part Number - Check for Availability	
23		2013; 2.5L 151.8 (2488cc) DOHC L4 (16 Valve) 89mm Bore Duratec VVT			23
(cont.)		MFI; Gasoline; Naturally Aspirated Ford Eng.; VIN Code 7			(cont.)
QTY	CONVERSION SET	YEARS	PART NO.	DESCRIPTION	
1	Gasket Conversion Set	2013	CS 26521	RTV sealant incl. for oil pan gskt.; New Part Number - Check for Availability	
QTY	CRANKSHAFT REAR SEAL	YEARS	PART NO.	DESCRIPTION	
1	Rear Main Seal Set	2013	BS 40689	PTFE Rubber; One-piece	
QTY	WATER PUMP	YEARS	PART NO.	DESCRIPTION	
1	O-Ring	2013	35772	Water Pump	
QTY	TIMING COVER	YEARS	PART NO.	DESCRIPTION	
1	Crankshaft Front Seal Set	2013	TCS 46151		
QTY	OIL FILTER MOUNTING	YEARS	PART NO.	DESCRIPTION	
1	Oil Filter Adapter Gasket	2013	72949	Oil filter adapter; New Part Number - Check for Availability	
QTY	CYLINDER BLOCK	YEARS	PART NO.	DESCRIPTION	
1	Crankcase Breather Gasket	2013	72950	Cylinder Block; Crankcase vent cover seal; New Part Number - Check for Availability	
24		2002 - 2001; 2.5L 152 (2495cc) DOHC V6 (24 Valve) 81.6mm Bore Duratec			24
(cont.)		MFI; Gasoline; Naturally Aspirated Ford Eng.; VIN Code L			(cont.)
QTY	CYLINDER HEAD	YEARS	PART NO.	DESCRIPTION	
1	Head Gasket	2002-01	26165 PT	Loc. L.H.; Head bolts not incl.; Head bolt replacement required; PermaTorqueMLS®	
1	Head Gasket	2002-01	26166 PT	Loc. R.H.; Head bolts not incl.; Head bolt replacement required; PermaTorqueMLS®	
1	Head Set	2002-01	HS 26165 PT	Head bolts not incl.; Head bolt replacement required; PermaDry® molded rubber valve cover gskts. incl.; Premium valve stem seals incl.	
2	Head Bolt Set	2002-01	ES 72159	Head bolts w/Washers; Replacement required	
QTY	CONVERSION SET	YEARS	PART NO.	DESCRIPTION	
1	Gasket Conversion Set	2002-01	CS 9038-1	PermaDry® molded rubber oil pan gskt. incl.; Consolidated design	
QTY	MANIFOLD - INT. & EXH.	YEARS	PART NO.	DESCRIPTION	
1	Int. Manifold Gasket Set	2002-01	MS 95726	Lower set; Upper set incl.	
1	Plenum Gasket Set	2002-01	MS 95727	Upper set	
1	Exh. Manifold Gasket Set	2002-01	MS 95715		
QTY	OIL PAN	YEARS	PART NO.	DESCRIPTION	
1	Oil Pan Gasket Set	2002-01	OS 30697 R	PermaDry® molded rubber gskt. incl.; Improved design	
1	Drain Plug Gasket	2002-01	72515		
QTY	CRANKSHAFT REAR SEAL	YEARS	PART NO.	DESCRIPTION	
1	Rear Main Seal Set	2002-01	BS 40620	Rubber; One-piece; Improved design	
1	Rear Main Seal Set	2002-01	BS 40644	PTFE Rubber; One-piece	
QTY	VALVE COVER	YEARS	PART NO.	DESCRIPTION	
1	Valve Cover Gasket Set	2002-01	VS 50462 R	w/Grommets & Spark plug tube seals; PermaDry® molded rubber gskts. incl.	
QTY	VALVE STEM SEAL SET	YEARS	PART NO.	DESCRIPTION	
1	Valve Stem Seal Set	2002-01	SS 72873-1	Premium valve stem seals incl.	
QTY	WATER OUTLET GASKET	YEARS	PART NO.	DESCRIPTION	
1	Water Outlet Gasket	2002-01	35489	Water Outlet	
QTY	WATER PUMP	YEARS	PART NO.	DESCRIPTION	
1	Water Pump Gasket	2002-01	35663	Improved design	
QTY	TIMING COVER	YEARS	PART NO.	DESCRIPTION	
1	Timing Cover Set	2002-01	TCS 45967	Must be used w/OS 30697R; Old design	
1	Timing Cover Set	2002-01	TCS 46016	Must be used w/OS 30697R; Improved design	
1	Crankshaft Front Seal Set	2002-01	TCS 46114		
2	Camshaft Rear Seal Set	2002-01	TCS 45966		
QTY	CARB & FUEL INJECTION	YEARS	PART NO.	DESCRIPTION	
2	Fuel Injector O-Ring Set	2002-01	ES 70599	Improved design	
1	Throttle Body Gasket	2002-01	61006	Mounting	
1	Throttle Body Gasket	2002-01	71216	Air bypass valve	
QTY	EXHAUST GAS RECIRCULATION	YEARS	PART NO.	DESCRIPTION	
1	EGR Gasket	2002-01	70149		

Ford Car (Incl. Edsel, Ford, Lincoln, Mercury, Merkur) (Cont.)

25		2002 - 2001; 2.5L 152 (2495cc) DOHC V6 (24 Valve) 81.6mm Bore Duratec H.O.			25
MFI; Gasoline; Naturally Aspirated Ford Eng.; VIN Code G					
QTY	CYLINDER HEAD	YEARS	PART NO.	DESCRIPTION	
1	Head Gasket	2002-01	26165 PT	Loc. L.H.; Head bolts not incl.; Head bolt replacement required; PermaTorqueMLS®	
1	Head Gasket	2002-01	26166 PT	Loc. R.H.; Head bolts not incl.; Head bolt replacement required; PermaTorqueMLS®	
1	Head Set	2002-01	HS 26165 PT	Head bolts not incl.; Head bolt replacement required; PermaDry® molded rubber valve cover gskts. incl.; Premium valve stem seals incl.	
2	Head Bolt Set	2002-01	ES 72159	Head bolts w/Washers; Replacement required	
QTY	CONVERSION SET	YEARS	PART NO.	DESCRIPTION	
1	Gasket Conversion Set	2002-01	CS 9038-1	PermaDry® molded rubber oil pan gskt. incl.; Consolidated design	
QTY	MANIFOLD - INT. & EXH.	YEARS	PART NO.	DESCRIPTION	
1	Int. Manifold Gasket Set	2002-01	MS 95726	Lower set; Upper set incl.	
1	Plenum Gasket Set	2002-01	MS 95727	Upper set	
1	Exh. Manifold Gasket Set	2002-01	MS 95715		
QTY	OIL PAN	YEARS	PART NO.	DESCRIPTION	
1	Oil Pan Gasket Set	2002-01	OS 30697 R	PermaDry® molded rubber gskt. incl.; Improved design	
1	Drain Plug Gasket	2002-01	72515		
QTY	CRANKSHAFT REAR SEAL	YEARS	PART NO.	DESCRIPTION	
1	Rear Main Seal Set	2002-01	BS 40620	Rubber; One-piece; Improved design	
1	Rear Main Seal Set	2002-01	BS 40644	PTFE Rubber; One-piece	
QTY	VALVE COVER	YEARS	PART NO.	DESCRIPTION	
1	Valve Cover Gasket Set	2002-01	VS 50462 R	w/Grommets & Spark plug tube seals; PermaDry® molded rubber gskts. incl.	
QTY	VALVE STEM SEAL SET	YEARS	PART NO.	DESCRIPTION	
1	Valve Stem Seal Set	2002-01	SS 72873-1	Premium valve stem seals incl.	
QTY	WATER OUTLET GASKET	YEARS	PART NO.	DESCRIPTION	
1	Water Outlet Gasket	2002-01	35489	Water Outlet	
QTY	WATER PUMP	YEARS	PART NO.	DESCRIPTION	
1	Water Pump Gasket	2002-01	35663	Improved design	
QTY	TIMING COVER	YEARS	PART NO.	DESCRIPTION	
1	Timing Cover Set	2002-01	TCS 45967	Must be used w/OS 30697R; Old design	
1	Timing Cover Set	2002-01	TCS 46016	Must be used w/OS 30697R; Improved design	
1	Crankshaft Front Seal Set	2002-01	TCS 46114		
2	Camshaft Rear Seal Set	2002-01	TCS 45966		
QTY	CARB & FUEL INJECTION	YEARS	PART NO.	DESCRIPTION	
2	Fuel Injector O-Ring Set	2002-01	ES 70599	Improved design	
1	Throttle Body Gasket	2002-01	61189	Mounting	
1	Throttle Body Gasket	2002-01	71216	Air bypass valve	
QTY	EXHAUST GAS RECIRCULATION	YEARS	PART NO.	DESCRIPTION	
1	EGR Gasket	2002-01	70149		
26		1997 - 1993; 2.5L 152 (2497cc) DOHC V6 (24 Valve) 84.5mm Bore			26
MFI; Gasoline; Naturally Aspirated Mazda Eng.; VIN Code B, Eng. Code KL-ZE					
QTY	CYLINDER HEAD	YEARS	PART NO.	DESCRIPTION	
1	Head Gasket	1997-93	9921 PT	Loc. L.H.; Head bolts not incl.; Head bolt replacement recommended; PermaTorqueMLS®	
1	Head Gasket	1997-93	9923 PT	Loc. R.H.; Head bolts not incl.; Head bolt replacement recommended; PermaTorqueMLS®	
1	Head Set	1997-96	HS 9921 PT-1	Head bolts & exh. pipe flange not incl.; Head bolt replacement recommended; PermaDry® molded rubber valve cover gskts. incl.; Premium valve stem seals incl.	
1	Head Set	1995-93	HS 9921 PT	Head bolts & exh. pipe flange not incl.; Head bolt replacement recommended; PermaDry® molded rubber valve cover gskts. incl.; Premium valve stem seals incl.	
2	Head Bolt Set	1997-93	ES 72475	Replacement recommended; New Part Number - Check for Availability	
QTY	CONVERSION SET	YEARS	PART NO.	DESCRIPTION	
1	Gasket Conversion Set	1997-93	CS 9921		
QTY	MANIFOLD - INT. & EXH.	YEARS	PART NO.	DESCRIPTION	
1	Int. Manifold Gasket Set	1997-93	MS 95422		
1	Exh. Manifold Gasket Set	1997-93	MS 95428		
QTY	EXHAUST PIPE FLANGE	YEARS	PART NO.	DESCRIPTION	
2	Exhaust Pipe Gasket	1997-93	60868	Converter	
1	Exhaust Pipe Gasket	1997-93	60967	Flange	
QTY	OIL PAN	YEARS	PART NO.	DESCRIPTION	
1	Oil Pan Gasket Set	1997-93	OS 30909 C		

Ford Car (Incl. Edsel, Ford, Lincoln, Mercury, Merkur) (Cont.)

26 (cont.)		1997 - 1993; 2.5L 152 (2497cc) DOHC V6 (24 Valve) 84.5mm Bore			26 (cont.)
MFI; Gasoline; Naturally Aspirated Mazda Eng.; VIN Code B, Eng. Code KL-ZE					
QTY	CRANKSHAFT REAR SEAL	YEARS	PART NO.	DESCRIPTION	
1	Rear Main Seal Set	1997-93	BS 40387	Rubber; One-piece	
QTY	VALVE COVER	YEARS	PART NO.	DESCRIPTION	
1	Valve Cover Gasket Set	1997-96	VS 50426 R-1	w/Isolators & Spark plug tube seals; Must be used with MS 95422; PermaDry® molded rubber gskts. incl.	
1	Valve Cover Gasket Set	1995-93	VS 50426 R	w/Isolators & Grommets & Spark plug tube seals; Must be used w/MS 95422; PermaDry® molded rubber gskts. incl.	
1	Grommet Set	1995-93	ES 70718	Valve Cover	
1	Isolator Set	1997-96	ES 70747	Valve Cover	
1	Isolator Set	1995-93	ES 70719	Valve Cover	
1	Circular Plug	1997-93	ES 72756	Valve Cover; Camshaft plug seal set; New Part Number - Check for Availability	
QTY	VALVE STEM SEAL SET	YEARS	PART NO.	DESCRIPTION	
1	Valve Stem Seal Set	1997-93	SS 72802-1	Premium valve stem seals incl.	
QTY	THERMOSTAT HOUSING	YEARS	PART NO.	DESCRIPTION	
1	Water Outlet Gasket	1997-93	35251	Thermostat Housing; Thermostat cover	
QTY	WATER OUTLET GASKET	YEARS	PART NO.	DESCRIPTION	
1	Water Crossover Mounting Set	1997-93	ES 70717		
QTY	WATER PUMP	YEARS	PART NO.	DESCRIPTION	
1	Water Pump Gasket	1997-93	35578		
QTY	TIMING COVER	YEARS	PART NO.	DESCRIPTION	
1	Crankshaft Front Seal Set	1997-93	TCS 45936	Oil pump mounting seals incl.; Oil cooler mounting seals incl.	
1	Crankshaft Front Seal Set	1997-93	TCS 46165	Crankshaft front seal only; New Part Number - Check for Availability	
2	Camshaft Front Seal Set	1997-93	TCS 45724		
QTY	CARB & FUEL INJECTION	YEARS	PART NO.	DESCRIPTION	
1	Fuel Injector O-Ring Set	1997-93	ES 70713		
1	Throttle Body Gasket	1997-93	60965		
QTY	EXHAUST GAS RECIRCULATION	YEARS	PART NO.	DESCRIPTION	
1	EGR Gasket	1996	70714	To 01/18/96	
1	EGR Gasket	1995-93	70714		
QTY	OIL FILTER MOUNTING	YEARS	PART NO.	DESCRIPTION	
1	Oil Filter Adapter Gasket	1997-93	70716		
27		1991; 2.5L 153 (2507cc) OHV L4 (8 Valve) 3.68" Bore HSC			27
MFI; Gasoline; Naturally Aspirated Ford Eng.; VIN Code N					
QTY	CYLINDER HEAD	YEARS	PART NO.	DESCRIPTION	
1	Head Gasket	1991	9814 PT		
QTY	CONVERSION SET	YEARS	PART NO.	DESCRIPTION	
1	Gasket Conversion Set	1991	CS 9195-3	One-piece oil pan gskt. not incl.; RTV sealant incl. for oil pan gskt.	
QTY	MANIFOLD - INT. & EXH.	YEARS	PART NO.	DESCRIPTION	
1	Exh. Manifold Gasket Set	1991	MS 94758		
QTY	EXHAUST PIPE FLANGE	YEARS	PART NO.	DESCRIPTION	
1	Exhaust Pipe Gasket	1991	60583	Converter	
QTY	OIL PAN	YEARS	PART NO.	DESCRIPTION	
1	Drain Plug Gasket	1991	72515		
QTY	CRANKSHAFT REAR SEAL	YEARS	PART NO.	DESCRIPTION	
1	Rear Main Seal Set	1991	BS 40452	Rubber; One-piece	
1	Rear Main Seal Set	1991	BS 40646	PTFE Rubber; One-piece	
QTY	VALVE COVER	YEARS	PART NO.	DESCRIPTION	
1	Valve Cover Gasket Set	1991	VS 50399	w/Grommets; Replaces OEM molded rubber bead; Cork-Lam®	
QTY	VALVE STEM SEAL SET	YEARS	PART NO.	DESCRIPTION	
1	Valve Stem Seal Set	1991	SS 72683	Loc. Int. & Exh.; Premium valve stem seals incl.	
QTY	WATER OUTLET GASKET	YEARS	PART NO.	DESCRIPTION	
1	Water Outlet Gasket	1991	35114	Water Outlet	
1	Water Outlet Gasket	1991	35114 T	Water Outlet; PermaDryPlus®	
QTY	WATER PUMP	YEARS	PART NO.	DESCRIPTION	
1	Water Pump Gasket	1991	35362	To block	
1	Water Pump Gasket	1991	35558	To cover	
1	Water Pump Mounting Set	1991	ES 70711		
QTY	TIMING COVER	YEARS	PART NO.	DESCRIPTION	
1	Timing Cover Set	1991	TCS 45626		
QTY	CARB & FUEL INJECTION	YEARS	PART NO.	DESCRIPTION	
1	Fuel Injector O-Ring Set	1991	ES 70599	Improved design	

Ford Car (Incl. Edsel, Ford, Lincoln, Mercury, Merkur) (Cont.)

27		1991; 2.5L 153 (2507cc) OHV L4 (8 Valve) 3.68" Bore HSC			27	
(cont.)		MFI; Gasoline; Naturally Aspirated Ford Eng.; VIN Code N			(cont.)	
QTY	CARB & FUEL INJECTION	YEARS	PART NO.	DESCRIPTION		
1	Throttle Body Gasket	1991	60844	Mounting		
1	Throttle Body Gasket	1991	71216	Air bypass valve		
QTY	EXHAUST GAS RECIRCULATION	YEARS	PART NO.	DESCRIPTION		
1	EGR Gasket	1991	70149			
28		2000 - 1995; 2.5L 155 (2544cc) DOHC V6 (24 Valve) 82.4mm Bore Duratec			28	
		MFI; Gasoline; Naturally Aspirated Ford Eng.; VIN Code L				
QTY	CYLINDER HEAD	YEARS	PART NO.	DESCRIPTION		
1	Head Gasket	2000-95	9038 PT	Loc. L.H.; Head bolts not incl.; Head bolt replacement required; PermaTorqueMLS®		
1	Head Gasket	2000-95	9039 PT	Loc. R.H.; Head bolts not incl.; Head bolt replacement required; PermaTorqueMLS®		
1	Head Set	2000-95	HS 9038 PT	Head bolts not incl.; Head bolt replacement required; PermaDry® molded rubber valve cover gskts. incl.; Premium valve stem seals incl.		
2	Head Bolt Set	2000-95	ES 72159	Head bolts w/Washers; Replacement required		
QTY	CONVERSION SET	YEARS	PART NO.	DESCRIPTION		
1	Gasket Conversion Set	2000-95	CS 9038-1	PermaDry® molded rubber oil pan gskt. incl.; Consolidated design		
QTY	MANIFOLD - INT. & EXH.	YEARS	PART NO.	DESCRIPTION		
1	Int. Manifold Gasket Set	2000-95	MS 95726	Lower set; Upper set incl.		
1	Plenum Gasket Set	2000-95	MS 95727	Upper set		
1	Exh. Manifold Gasket Set	2000-95	MS 95715			
QTY	OIL PAN	YEARS	PART NO.	DESCRIPTION		
1	Oil Pan Gasket Set	2000-95	OS 30697 R	PermaDry® molded rubber gskt. incl.; Improved design		
1	Drain Plug Gasket	2000-95	72515			
QTY	CRANKSHAFT REAR SEAL	YEARS	PART NO.	DESCRIPTION		
1	Rear Main Seal Set	2000-95	BS 40620	Rubber; One-piece; Improved design		
1	Rear Main Seal Set	2000-95	BS 40644	PTFE Rubber; One-piece		
QTY	VALVE COVER	YEARS	PART NO.	DESCRIPTION		
1	Valve Cover Gasket Set	2000-95	VS 50462 R	w/Grommets & Spark plug tube seals; PermaDry® molded rubber gskts. incl.		
QTY	VALVE STEM SEAL SET	YEARS	PART NO.	DESCRIPTION		
1	Valve Stem Seal Set	2000-95	SS 72873-1	Premium valve stem seals incl.		
QTY	WATER OUTLET GASKET	YEARS	PART NO.	DESCRIPTION		
1	Water Outlet Gasket	2000-95	35489	Water Outlet		
QTY	WATER PUMP	YEARS	PART NO.	DESCRIPTION		
1	Water Pump Gasket	2000-99	35663	Improved design		
1	Water Pump Gasket	1998	35282	To 09/30/97		
1	Water Pump Gasket	1998	35663	From 10/01/97; Improved design		
1	Water Pump Gasket	1997-95	35282			
QTY	TIMING COVER	YEARS	PART NO.	DESCRIPTION		
1	Timing Cover Set	2000-95	TCS 45967	Must be used w/OS 30697R; Old design		
1	Timing Cover Set	2000-95	TCS 46016	Must be used w/OS 30697R; Improved design		
1	Crankshaft Front Seal Set	2000-95	TCS 46114			
2	Camshaft Rear Seal Set	2000-95	TCS 45966			
QTY	CARB & FUEL INJECTION	YEARS	PART NO.	DESCRIPTION		
2	Fuel Injector O-Ring Set	2000-95	ES 70599	Improved design		
1	Throttle Body Gasket	2000-95	61006	Mounting		
1	Throttle Body Gasket	2000-95	71216	Air bypass valve		
QTY	EXHAUST GAS RECIRCULATION	YEARS	PART NO.	DESCRIPTION		
1	EGR Gasket	2000-95	70149			
29		2000 - 1998; 2.5L 155 (2544cc) DOHC V6 (24 Valve) 82.4mm Bore Duratec H.O.			29	
		MFI; Gasoline; Naturally Aspirated Ford Eng.; VIN Code G				
QTY	CYLINDER HEAD	YEARS	PART NO.	DESCRIPTION		
1	Head Gasket	2000-98	9038 PT	Loc. L.H.; Head bolts not incl.; Head bolt replacement required; PermaTorqueMLS®		
1	Head Gasket	2000-98	9039 PT	Loc. R.H.; Head bolts not incl.; Head bolt replacement required; PermaTorqueMLS®		
1	Head Set	2000-98	HS 9038 PT	Head bolts not incl.; Head bolt replacement required; PermaDry® molded rubber valve cover gskts. incl.; Premium valve stem seals incl.		
2	Head Bolt Set	2000-98	ES 72159	Head bolts w/Washers; Replacement required		
QTY	CONVERSION SET	YEARS	PART NO.	DESCRIPTION		
1	Gasket Conversion Set	2000-98	CS 9038-1	PermaDry® molded rubber oil pan gskt. incl.; Consolidated design		
QTY	MANIFOLD - INT. & EXH.	YEARS	PART NO.	DESCRIPTION		
1	Int. Manifold Gasket Set	2000-98	MS 95726	Lower set; Upper set incl.		

Ford Car (Incl. Edsel, Ford, Lincoln, Mercury, Merkur) (Cont.)

29 (cont.)		2000 - 1998; 2.5L 155 (2544cc) DOHC V6 (24 Valve) 82.4mm Bore Duratec H.O.			29 (cont.)
		MFI; Gasoline; Naturally Aspirated Ford Eng.; VIN Code G			
QTY	MANIFOLD - INT. & EXH.	YEARS	PART NO.	DESCRIPTION	
1	Plenum Gasket Set	2000-98	MS 95727	Upper set	
1	Exh. Manifold Gasket Set	2000-98	MS 95715		
QTY	OIL PAN	YEARS	PART NO.	DESCRIPTION	
1	Oil Pan Gasket Set	2000-98	OS 30697 R	PermaDry® molded rubber gskt. incl.; Improved design	
1	Drain Plug Gasket	2000-98	72515		
QTY	CRANKSHAFT REAR SEAL	YEARS	PART NO.	DESCRIPTION	
1	Rear Main Seal Set	2000-98	BS 40620	Rubber; One-piece; Improved design	
1	Rear Main Seal Set	2000-98	BS 40644	PTFE Rubber; One-piece	
QTY	VALVE COVER	YEARS	PART NO.	DESCRIPTION	
1	Valve Cover Gasket Set	2000-98	VS 50462 R	w/Grommets & Spark plug tube seals; PermaDry® molded rubber gskts. incl.	
QTY	VALVE STEM SEAL SET	YEARS	PART NO.	DESCRIPTION	
1	Valve Stem Seal Set	2000-98	SS 72873-1	Premium valve stem seals incl.	
QTY	WATER OUTLET GASKET	YEARS	PART NO.	DESCRIPTION	
1	Water Outlet Gasket	2000-98	35489	Water Outlet	
QTY	WATER PUMP	YEARS	PART NO.	DESCRIPTION	
1	Water Pump Gasket	2000-99	35663	Improved design	
1	Water Pump Gasket	1998	35282	To 09/30/97	
1	Water Pump Gasket	1998	35663	From 10/01/97; Improved design	
QTY	TIMING COVER	YEARS	PART NO.	DESCRIPTION	
1	Timing Cover Set	2000-98	TCS 45967	Must be used w/OS 30697R; Old design	
1	Timing Cover Set	2000-98	TCS 46016	Must be used w/OS 30697R; Improved design	
1	Crankshaft Front Seal Set	2000-98	TCS 46114		
2	Camshaft Rear Seal Set	2000-98	TCS 45966		
QTY	CARB & FUEL INJECTION	YEARS	PART NO.	DESCRIPTION	
2	Fuel Injector O-Ring Set	2000-98	ES 70599	Improved design	
1	Throttle Body Gasket	2000-98	71216	Air bypass valve	
1	Throttle Body Gasket	2000	61075	Ford Contour SVT; Mounting	
1	Throttle Body Gasket	2000	61189	Exc. Ford Contour SVT; Mounting	
1	Throttle Body Gasket	1999-98	61075	Mounting	
QTY	EXHAUST GAS RECIRCULATION	YEARS	PART NO.	DESCRIPTION	
1	EGR Gasket	2000-98	70149		

30		2009 - 2005; 3.0L 181 (2967cc) DOHC V6 (24 Valve) 89mm Bore Duratec			30
		MFI; Gasoline; Naturally Aspirated Ford Eng.; VIN Code 1			
QTY	CYLINDER HEAD	YEARS	PART NO.	DESCRIPTION	
1	Head Gasket	2009-05	26212 PT	Loc. R.H.; Head bolts not incl.; Head bolt replacement required; PermaTorqueMLS®	
1	Head Gasket	2009-08	26233 PT	Loc. L.H.; Head bolts not incl.; Head bolt replacement required; PermaTorqueMLS®	
1	Head Gasket	2007	26207 PT	Exc. Ford Fusion SE, SEL Mercury Milan Base, Premier; Loc. L.H.; Head bolts not incl.; Head bolt replacement required; PermaTorqueMLS®	
1	Head Gasket	2007	26233 PT	Ford Fusion SE, SEL Mercury Milan Base, Premier; Loc. L.H.; Head bolts not incl.; Head bolt replacement required; PermaTorqueMLS®	
1	Head Gasket	2006	26207 PT	Ford Five Hundred Limited, SE, SEL Mercury Montego Luxury, Premier; Loc. L.H.; Head bolts not incl.; Head bolt replacement required; PermaTorqueMLS®	
1	Head Gasket	2006	26233 PT	Ford Fusion SE, SEL Lincoln Zephyr Base Mercury Milan Base, Premier; Loc. L.H.; Head bolts not incl.; Head bolt replacement required; PermaTorqueMLS®	
1	Head Gasket	2005	26207 PT	Loc. L.H.; Head bolts not incl.; Head bolt replacement required; PermaTorqueMLS®	
1	Head Set	2009-08	HS 26233 PT-1	Head bolts not incl.; Head bolt replacement required; PermaDry® molded rubber valve cover gskts. incl.; Premium valve stem seals incl.	
1	Head Set	2007	HS 26207 PT-2	Exc. Ford Fusion SE, SEL Mercury Milan Base, Premier; Head bolts not incl.; Head bolt replacement required; PermaDry® molded rubber valve cover gskts. incl.; Premium valve stem seals incl.	
1	Head Set	2007	HS 26233 PT-1	Ford Fusion SE, SEL Mercury Milan Base, Premier; Head bolts not incl.; Head bolt replacement required; PermaDry® molded rubber valve cover gskts. incl.; Premium valve stem seals incl.	
1	Head Set	2006	HS 26207 PT-2	Ford Five Hundred Limited, SE, SEL Mercury Montego Luxury, Premier; Head bolts not incl.; Head bolt replacement required; PermaDry® molded rubber valve cover gskts. incl.; Premium valve stem seals incl.	

Ford Car (Incl. Edsel, Ford, Lincoln, Mercury, Merkur) (Cont.)

30 (cont.)		2009 - 2005; 3.0L 181 (2967cc) DOHC V6 (24 Valve) 89mm Bore Duratec			30 (cont.)
MFI; Gasoline; Naturally Aspirated Ford Eng.; VIN Code 1					
QTY	CYLINDER HEAD	YEARS	PART NO.	DESCRIPTION	
1	Head Set	2006	HS 26233 PT-1	Ford Fusion SE, SEL Lincoln Zephyr Base Mercury Milan Base, Premier; Head bolts not incl.; Head bolt replacement required; PermaDry® molded rubber valve cover gskts. incl.; Premium valve stem seals incl.	
1	Head Set	2005	HS 26207 PT-2	Head bolts not incl.; Head bolt replacement required; PermaDry® molded rubber valve cover gskts. incl.; Premium valve stem seals incl.	
2	Head Bolt Set	2009-05	ES 72159	Head bolts w/Washers; Replacement required	
QTY	CONVERSION SET	YEARS	PART NO.	DESCRIPTION	
1	Gasket Conversion Set	2009-05	CS 9038-2	PermaDry® molded rubber oil pan gskt. incl.	
QTY	MANIFOLD - INT. & EXH.	YEARS	PART NO.	DESCRIPTION	
1	Int. Manifold Gasket Set	2009-05	MS 92586-1	Lower set; Upper set incl.	
1	Plenum Gasket Set	2009-05	MS 96252	Upper set	
1	Exh. Manifold Gasket Set	2009-05	MS 95715		
QTY	EXHAUST PIPE FLANGE	YEARS	PART NO.	DESCRIPTION	
1	Exhaust Pipe Gasket	2009-08	61403	Converter; 2-bolt	
1	Exhaust Pipe Gasket	2009-08	61403	Loc. R.H.; Ring	
1	Exhaust Pipe Gasket	2009-08	61430	Loc. L.H.; Ring; May use 61525 instead; Old design; Superseded - When depleted use 61525	
1	Exhaust Pipe Gasket	2009-08	61525	Loc. L.H.; Ring; Improved design	
1	Exhaust Pipe Gasket	2007	61183	Exc. Ford Fusion SE, SEL Mercury Milan Base, Premier; Converter	
2	Exhaust Pipe Gasket	2007	61402	Exc. Ford Fusion SE, SEL Mercury Milan Base, Premier; Ring	
1	Exhaust Pipe Gasket	2007	61403	Ford Fusion SE, SEL Mercury Milan Base, Premier; Converter; 2-bolt	
1	Exhaust Pipe Gasket	2007	61403	Ford Fusion SE, SEL Mercury Milan Base, Premier; Loc. R.H.; Ring	
1	Exhaust Pipe Gasket	2007	61430	Ford Fusion SE, SEL Mercury Milan Base, Premier; Loc. L.H.; Ring; May use 61525 instead; Old design; Superseded - When depleted use 61525	
1	Exhaust Pipe Gasket	2007	61525	Ford Fusion SE, SEL Mercury Milan Base, Premier; Loc. L.H.; Ring; Improved design	
1	Exhaust Pipe Gasket	2006	61183	Ford Five Hundred Limited, SE, SEL Mercury Montego Luxury, Premier; Converter	
2	Exhaust Pipe Gasket	2006	61402	Ford Five Hundred Limited, SE, SEL Mercury Montego Luxury, Premier; Ring	
1	Exhaust Pipe Gasket	2006	61403	Ford Fusion SE, SEL Lincoln Zephyr Base Mercury Milan Base, Premier; Converter; 2-bolt	
1	Exhaust Pipe Gasket	2006	61403	Ford Fusion SE, SEL Lincoln Zephyr Base Mercury Milan Base, Premier; Loc. R.H.; Ring	
1	Exhaust Pipe Gasket	2006	61430	Ford Fusion SE, SEL Lincoln Zephyr Base Mercury Milan Base, Premier; Loc. L.H.; Ring; May use 61525 instead; Old design; Superseded - When depleted use 61525	
1	Exhaust Pipe Gasket	2006	61525	Ford Fusion SE, SEL Lincoln Zephyr Base Mercury Milan Base, Premier; Loc. L.H.; Ring; Improved design	
1	Exhaust Pipe Gasket	2005	61183	Converter	
2	Exhaust Pipe Gasket	2005	61402	Ring	
QTY	OIL PAN	YEARS	PART NO.	DESCRIPTION	
1	Oil Pan Gasket Set	2009-05	OS 30729 R	Loc. Lower; PermaDry® molded rubber gskt. incl.	
1	Drain Plug Gasket	2009-05	72515		
QTY	CRANKSHAFT REAR SEAL	YEARS	PART NO.	DESCRIPTION	
1	Rear Main Seal Set	2009-05	BS 40620	Rubber; One-piece; Improved design	
1	Rear Main Seal Set	2009-05	BS 40644	PTFE Rubber; One-piece	
QTY	VALVE COVER	YEARS	PART NO.	DESCRIPTION	
1	Valve Cover Gasket Set	2009-08	VS 50644 R	w/Grommets & Spark plug tube seals; PermaDry® molded rubber gskts. incl.	
1	Valve Cover Gasket Set	2007	VS 50629 R	Exc. Ford Fusion SE, SEL Mercury Milan Base, Premier; w/Grommets & Spark plug tube seals; PermaDry® molded rubber gskts. incl.	
1	Valve Cover Gasket Set	2007	VS 50644 R	Ford Fusion SE, SEL Mercury Milan Base, Premier; w/Grommets & Spark plug tube seals; PermaDry® molded rubber gskts. incl.	
1	Valve Cover Gasket Set	2006	VS 50644 R	Ford Fusion SE, SEL Lincoln Zephyr Base Mercury Milan Base, Premier; w/Grommets & Spark plug tube seals; PermaDry® molded rubber gskts. incl.	
1	Valve Cover Gasket Set	2006	VS 50629 R	Ford Five Hundred Limited, SE, SEL Mercury Montego Luxury, Premier; w/Grommets & Spark plug tube seals; PermaDry® molded rubber gskts. incl.	
1	Valve Cover Gasket Set	2005	VS 50629 R	w/Grommets & Spark plug tube seals; PermaDry® molded rubber gskts. incl.	
QTY	VALVE STEM SEAL SET	YEARS	PART NO.	DESCRIPTION	
1	Valve Stem Seal Set	2009-05	SS 72873-1	Premium valve stem seals incl.	
QTY	THERMOSTAT HOUSING	YEARS	PART NO.	DESCRIPTION	
1	Water Outlet Gasket	2007	35489	Exc. Ford Fusion SE, SEL Mercury Milan Base, Premier; Thermostat Housing; Thermostat housing to block	

Ford Car (Incl. Edsel, Ford, Lincoln, Mercury, Merkur) (Cont.)

30 (cont.)	2009 - 2005; 3.0L 181 (2967cc) DOHC V6 (24 Valve) 89mm Bore Duratec				30 (cont.)
MFI; Gasoline; Naturally Aspirated Ford Eng.; VIN Code 1					
QTY	THERMOSTAT HOUSING	YEARS	PART NO.	DESCRIPTION	
1	Water Outlet Gasket	2006	35489	Ford Five Hundred Limited, SE, SEL Mercury Montego Luxury, Premier; Thermostat Housing; Thermostat housing to block	
1	Water Outlet Gasket	2005	35489	Thermostat Housing; Thermostat housing to block	
1	O-Ring	2007	35836	Exc. Ford Fusion SE, SEL Mercury Milan Base, Premier; Thermostat Housing; Thermostat seal	
1	O-Ring	2006	35836	Ford Five Hundred Limited, SE, SEL Mercury Montego Luxury, Premier; Thermostat Housing; Thermostat seal	
1	O-Ring	2005	35836	Thermostat Housing; Thermostat seal	
QTY	WATER OUTLET GASKET	YEARS	PART NO.	DESCRIPTION	
1	Water Outlet Gasket	2009-05	35489	Water Outlet	
QTY	TIMING COVER	YEARS	PART NO.	DESCRIPTION	
1	Timing Cover Set	2009-05	TCS 46016	Must be used w/OS 30729R; Improved design	
1	Crankshaft Front Seal Set	2009-05	TCS 46114		
1	Camshaft Rear Seal Set	2009-05	TCS 46071		
QTY	CARB & FUEL INJECTION	YEARS	PART NO.	DESCRIPTION	
1	Throttle Body Gasket	2009-05	72302	Air bypass valve	
1	Throttle Body Gasket	2009-08	61158	Mounting	
1	Throttle Body Gasket	2007	61158	Ford Fusion SE, SEL Mercury Milan Base, Premier; Mounting	
1	Throttle Body Gasket	2007	61377	Exc. Ford Fusion SE, SEL Mercury Milan Base, Premier; Mounting	
1	Throttle Body Gasket	2006	61158	Ford Fusion SE, SEL Lincoln Zephyr Base Mercury Milan Base, Premier; Mounting	
1	Throttle Body Gasket	2006	61377	Ford Five Hundred Limited, SE, SEL Mercury Montego Luxury, Premier; Mounting	
1	Throttle Body Gasket	2005	61377	Mounting	
QTY	EXHAUST GAS RECIRCULATION	YEARS	PART NO.	DESCRIPTION	
1	EGR Gasket	2009-08	70149	Valve	
1	EGR Gasket	2007	70149	Ford Fusion SE, SEL Mercury Milan Base, Premier; Valve	
1	EGR Gasket	2007	71176	Exc. Ford Fusion SE, SEL Mercury Milan Base, Premier; Valve	
1	EGR Gasket	2006	70149	Ford Fusion SE, SEL Lincoln Zephyr Base Mercury Milan Base, Premier; Valve	
1	EGR Gasket	2006	71176	Ford Five Hundred Limited, SE, SEL Mercury Montego Luxury, Premier; Valve	
1	EGR Gasket	2005	71176	Valve	
31	2012 - 2010; 3.0L 181 (2967cc) DOHC V6 (24 Valve) 89mm Bore Duratec				31
MFI; Flex Fuel; Naturally Aspirated Ford Eng.; VIN Code G					
QTY	CYLINDER HEAD	YEARS	PART NO.	DESCRIPTION	
1	Head Gasket	2012-10	26545 PT	Loc. L.H.; Head bolts not incl.; Head bolt replacement required; PermaTorqueMLS®; New Part Number - Check for Availability	
1	Head Gasket	2012-10	26546 PT	Loc. R.H.; Head bolts not incl.; Head bolt replacement required; PermaTorqueMLS®; New Part Number - Check for Availability	
1	Head Set	2012-10	HS 26545 PT	Head bolts not incl.; Head bolt replacement required; PermaDry® molded rubber valve cover gskts. incl.; Premium valve stem seals incl.; New Part Number - Check for Availability	
QTY	CONVERSION SET	YEARS	PART NO.	DESCRIPTION	
1	Gasket Conversion Set	2012-10	CS 9038-2	PermaDry® molded rubber oil pan gskt. incl.	
QTY	MANIFOLD - INT. & EXH.	YEARS	PART NO.	DESCRIPTION	
1	Int. Manifold Gasket Set	2012-10	MS 97193	Lower set; Upper set incl.; New Part Number - Check for Availability	
1	Plenum Gasket Set	2012-10	MS 97194	Upper set; New Part Number - Check for Availability	
1	Exh. Manifold Gasket Set	2012-10	MS 95715		
QTY	EXHAUST PIPE FLANGE	YEARS	PART NO.	DESCRIPTION	
1	Exhaust Pipe Gasket	2012-10	60641	Secondary converter	
1	Exhaust Pipe Gasket	2012-10	61525	Loc. Front; Exh. connector; Improved design	
2	Exhaust Pipe Gasket	2012-10	61684	Flange; New Part Number - Check for Availability	
QTY	OIL PAN	YEARS	PART NO.	DESCRIPTION	
1	Oil Pan Gasket Set	2012-10	OS 30729 R	PermaDry® molded rubber gskt. incl.	
1	Drain Plug Gasket	2012-10	71067		
QTY	CRANKSHAFT REAR SEAL	YEARS	PART NO.	DESCRIPTION	
1	Rear Main Seal Set	2012-10	BS 40620	Rubber; One-piece; Improved design	
1	Rear Main Seal Set	2012-10	BS 40644	PTFE Rubber; One-piece	
QTY	VALVE COVER	YEARS	PART NO.	DESCRIPTION	
1	Valve Cover Gasket Set	2012-10	VS 50801 R	w/Grommets & Spark plug tube seals; PermaDry® molded rubber gskts. incl.; New Part Number - Check for Availability	

Ford Car (Incl. Edsel, Ford, Lincoln, Mercury, Merkur) (Cont.)

31 (cont.)		2012 - 2010; 3.0L 181 (2967cc) DOHC V6 (24 Valve) 89mm Bore Duratec			31 (cont.)
MFI; Flex Fuel; Naturally Aspirated Ford Eng.; VIN Code G					
QTY	VALVE COVER	YEARS	PART NO.	DESCRIPTION	
1	Grommet Set	2012-10	ES 71426	Valve Cover; VCT seals set; New Part Number - Check for Availability	
QTY	VALVE STEM SEAL SET	YEARS	PART NO.	DESCRIPTION	
1	Valve Stem Seal Set	2012-10	SS 72873-1	Premium valve stem seals incl.	
QTY	THERMOSTAT HOUSING	YEARS	PART NO.	DESCRIPTION	
1	Thermostat Gasket	2012-10	35971	Thermostat Housing; Thermostat gskt.; New Part Number - Check for Availability	
QTY	WATER OUTLET GASKET	YEARS	PART NO.	DESCRIPTION	
1	Water Outlet Gasket	2012-10	35489	Water Outlet	
QTY	WATER PUMP	YEARS	PART NO.	DESCRIPTION	
1	Water Pump Gasket	2012-10	35973	Housing to block; New Part Number - Check for Availability	
1	Water Pump Gasket	2012-10	35976	Mounting; New Part Number - Check for Availability	
QTY	TIMING COVER	YEARS	PART NO.	DESCRIPTION	
1	Timing Cover Set	2012-10	TCS 46016	Must be used w/OS 30729R; Improved design	
1	Crankshaft Front Seal Set	2012-10	TCS 46114		
1	Camshaft Rear Seal Set	2012-10	TCS 46071		
QTY	CARB & FUEL INJECTION	YEARS	PART NO.	DESCRIPTION	
2	Fuel Injector O-Ring Set	2012-10	ES 70599	Improved design	
1	Throttle Body Gasket	2012-10	61377	Mounting	
1	Throttle Body Gasket	2012-10	72302	Air bypass valve	
QTY	EXHAUST GAS RECIRCULATION	YEARS	PART NO.	DESCRIPTION	
1	EGR Gasket	2012-10	70149	Valve	
2	EGR Gasket	2012-10	71278	Tube seal	
32		2005 - 1996; 3.0L 181 (2967cc) DOHC V6 (24 Valve) 89mm Bore Duratec			32
MFI; Gasoline; Naturally Aspirated Ford Eng.; VIN Code S					
QTY	CYLINDER HEAD	YEARS	PART NO.	DESCRIPTION	
1	Head Gasket	2005	26207 PT	Exc. Lincoln LS Base, Luxury, Premium, Sport, Ultimate; Loc. L.H.; Head bolts not incl.; Head bolt replacement required; PermaTorqueMLS®	
1	Head Gasket	2005	26212 PT	Exc. Lincoln LS Base, Luxury, Premium, Sport, Ultimate; Loc. R.H.; Head bolts not incl.; Head bolt replacement required; PermaTorqueMLS®	
1	Head Gasket	2005	26281 PT	Lincoln LS Base, Luxury, Premium, Sport, Ultimate; Loc. R.H.; Head bolts not incl.; Head bolt replacement recommended; PermaTorqueMLS®	
1	Head Gasket	2004	26207 PT	Exc. Lincoln LS Base; Loc. L.H.; Head bolts not incl.; Head bolt replacement required; PermaTorqueMLS®	
1	Head Gasket	2004	26212 PT	Exc. Lincoln LS Base; Loc. R.H.; Head bolts not incl.; Head bolt replacement required; PermaTorqueMLS®	
1	Head Gasket	2004	26281 PT	Lincoln LS Base; Loc. R.H.; Head bolts not incl.; Head bolt replacement recommended; PermaTorqueMLS®	
1	Head Gasket	2003-01	9540 PT	Exc. Lincoln LS Base, LSE; Loc. L.H.; Head bolts not incl.; Head bolt replacement required; PermaTorqueMLS®	
1	Head Gasket	2003-01	9541 PT	Exc. Lincoln LS Base, LSE; Loc. R.H.; Head bolts not incl.; Head bolt replacement required; PermaTorqueMLS®	
1	Head Gasket	2003	26281 PT	Lincoln LS Base, LSE; Loc. R.H.; Head bolts not incl.; Head bolt replacement recommended; PermaTorqueMLS®	
1	Head Gasket	2002-01	26248 PT	Lincoln LS Base, LSE; Loc. L.H.; Head bolts not incl.; Head bolt replacement recommended; PermaTorqueMLS®	
1	Head Gasket	2002-01	26249 PT	Lincoln LS Base, LSE; Loc. R.H.; Head bolts not incl.; Head bolt replacement recommended; PermaTorqueMLS®	
1	Head Gasket	2000	26248 PT	Lincoln LS Base; Loc. L.H.; Head bolts not incl.; Head bolt replacement recommended; PermaTorqueMLS®	
1	Head Gasket	2000	26249 PT	Lincoln LS Base; Loc. R.H.; Head bolts not incl.; Head bolt replacement recommended; PermaTorqueMLS®	
1	Head Gasket	2000	9540 PT	Exc. Lincoln LS Base; Loc. L.H.; Head bolts not incl.; Head bolt replacement required; PermaTorqueMLS®	
1	Head Gasket	2000	9541 PT	Exc. Lincoln LS Base; Loc. R.H.; Head bolts not incl.; Head bolt replacement required; PermaTorqueMLS®	
1	Head Gasket	1999	9540 PT	Loc. L.H.; Head bolts not incl.; Head bolt replacement required; PermaTorqueMLS®	
1	Head Gasket	1999	9541 PT	Loc. R.H.; Head bolts not incl.; Head bolt replacement required; PermaTorqueMLS®	
1	Head Gasket	1998-96	9481 PT	Loc. L.H.; Head bolts not incl.; Head bolt replacement required; PermaTorqueMLS®	
1	Head Gasket	1998-96	9482 PT	Loc. R.H.; Head bolts not incl.; Head bolt replacement required; PermaTorqueMLS®	

Ford Car (Incl. Edsel, Ford, Lincoln, Mercury, Merkur) (Cont.)

32 (cont.)		2005 - 1996; 3.0L 181 (2967cc) DOHC V6 (24 Valve) 89mm Bore Duratec			32 (cont.)
		MFI; Gasoline; Naturally Aspirated Ford Eng.; VIN Code S			
QTY	CYLINDER HEAD	YEARS	PART NO.	DESCRIPTION	
1	Head Set	2005	HS 26207 PT	Exc. Lincoln LS Base, Luxury, Premium, Sport, Ultimate; Head bolts not incl.; Head bolt replacement required; PermaDry® molded rubber valve cover gskts. incl.; Premium valve stem seals incl.	
1	Head Set	2004	HS 26207 PT	Exc. Lincoln LS Base; Head bolts not incl.; Head bolt replacement required; PermaDry® molded rubber valve cover gskts. incl.; Premium valve stem seals incl.	
1	Head Set	2003	HS 9540 PT-4	Exc. Lincoln LS Base, LSE; Head bolts not incl.; Head bolt replacement required; PermaDry® molded rubber valve cover gskts. incl.; Premium valve stem seals incl.	
1	Head Set	2002-01	HS 26248 PT	Lincoln LS Base, LSE; Int. manifold upper & lower gskts. not incl.; Head bolts not incl.; Head bolt replacement recommended; PermaDry® molded rubber valve cover gskts. incl.; Premium valve stem seals incl.	
1	Head Set	2002-01	HS 9540 PT-2	Exc. Lincoln LS Base, LSE; Head bolts not incl.; Head bolt replacement required; PermaDry® molded rubber valve cover gskts. incl.; Premium valve stem seals incl.	
1	Head Set	2000	HS 26248 PT	Lincoln LS Base; Int. manifold upper & lower gskts. not incl.; Head bolts not incl.; Head bolt replacement recommended; PermaDry® molded rubber valve cover gskts. incl.; Premium valve stem seals incl.	
1	Head Set	2000	HS 9540 PT-1	Exc. Lincoln LS Base; Head bolts not incl.; Head bolt replacement required; PermaDry® molded rubber valve cover gskts. incl.; Premium valve stem seals incl.	
1	Head Set	1999	HS 9540 PT	Head bolts not incl.; Head bolt replacement required; PermaDry® molded rubber valve cover gskts. incl.; Premium valve stem seals incl.	
1	Head Set	1998-96	HS 9481 PT	Head bolts not incl.; Head bolt replacement required; PermaDry® molded rubber valve cover gskts. incl.; Premium valve stem seals incl.	
2	Head Bolt Set	2005	ES 72159	Exc. Lincoln LS Base, Luxury, Premium, Sport, Ultimate; Head bolts w/Washers; Replacement required	
2	Head Bolt Set	2005	ES 72208	Lincoln LS Base, Luxury, Premium, Sport, Ultimate; Head bolts w/Washers; Replacement recommended	
2	Head Bolt Set	2004	ES 72159	Exc. Lincoln LS Base; Head bolts w/Washers; Replacement required	
2	Head Bolt Set	2004	ES 72208	Lincoln LS Base; Head bolts w/Washers; Replacement recommended	
2	Head Bolt Set	2003-01	ES 72159	Exc. Lincoln LS Base, LSE; Head bolts w/Washers; Replacement required	
2	Head Bolt Set	2003-01	ES 72208	Lincoln LS Base, LSE; Head bolts w/Washers; Replacement recommended	
2	Head Bolt Set	2000	ES 72159	Exc. Lincoln LS Base; Head bolts w/Washers; Replacement required	
2	Head Bolt Set	2000	ES 72208	Lincoln LS Base; Head bolts w/Washers; Replacement recommended	
2	Head Bolt Set	1999-96	ES 72159	Head bolts w/Washers; Replacement required	
QTY	CONVERSION SET	YEARS	PART NO.	DESCRIPTION	
1	Gasket Conversion Set	2005	CS 26248	Lincoln LS Base, Luxury, Premium, Sport, Ultimate; PermaDry® molded rubber oil pan gskt. incl.	
1	Gasket Conversion Set	2005	CS 9038-2	Exc. Lincoln LS Base, Luxury, Premium, Sport, Ultimate; PermaDry® molded rubber oil pan gskt. incl.	
1	Gasket Conversion Set	2004	CS 26248	Lincoln LS Base; PermaDry® molded rubber oil pan gskt. incl.	
1	Gasket Conversion Set	2004	CS 9038-2	Exc. Lincoln LS Base; PermaDry® molded rubber oil pan gskt. incl.	
1	Gasket Conversion Set	2003-01	CS 26248	Lincoln LS Base, LSE; PermaDry® molded rubber oil pan gskt. incl.	
1	Gasket Conversion Set	2003-01	CS 9038-1	Exc. Lincoln LS Base, LSE; PermaDry® molded rubber oil pan gskt. incl.; Consolidated design	
1	Gasket Conversion Set	2000	CS 26248	Lincoln LS Base; PermaDry® molded rubber oil pan gskt. incl.	
1	Gasket Conversion Set	2000	CS 9038-1	Exc. Lincoln LS Base; PermaDry® molded rubber oil pan gskt. incl.; Consolidated design	
1	Gasket Conversion Set	1999-96	CS 9038-1	PermaDry® molded rubber oil pan gskt. incl.; Consolidated design	
QTY	MANIFOLD - INT. & EXH.	YEARS	PART NO.	DESCRIPTION	
1	Int. Manifold Gasket Set	2005	MS 92586-1	Exc. Lincoln LS Base, Luxury, Premium, Sport, Ultimate; Lower set; Upper set incl.	
1	Int. Manifold Gasket Set	2005	MS 96485	Lincoln LS Base, Luxury, Premium, Sport, Ultimate; Lower set	
1	Int. Manifold Gasket Set	2004	MS 92586-1	Exc. Lincoln LS Base; Lower set; Upper set incl.	
1	Int. Manifold Gasket Set	2004	MS 96485	Lincoln LS Base; Lower set	
1	Int. Manifold Gasket Set	2003-02	MS 96485	Lincoln LS Base, LSE; Lower set	
1	Int. Manifold Gasket Set	2003	MS 96081	Exc. Lincoln LS Base, LSE; Lower set; Upper set incl.	
1	Int. Manifold Gasket Set	2002-01	MS 92586	Exc. Lincoln LS Base, LSE; Lower set; Upper set incl.	
1	Int. Manifold Gasket Set	2001	MS 96475	Lincoln LS Base, LSE; Lower set	
1	Int. Manifold Gasket Set	2000	MS 92586	Exc. Lincoln LS Base; Lower set; Upper set incl.	
1	Int. Manifold Gasket Set	2000	MS 96475	Lincoln LS Base; Lower set	
1	Int. Manifold Gasket Set	1999-96	MS 95726	Lower set; Upper set incl.	
1	Plenum Gasket Set	2005	MS 96252	Exc. Lincoln LS Base, Luxury, Premium, Sport, Ultimate; Upper set	
1	Plenum Gasket Set	2005	MS 96496	Lincoln LS Base, Luxury, Premium, Sport, Ultimate; Upper set	

Ford Car (Incl. Edsel, Ford, Lincoln, Mercury, Merkur) (Cont.)

32 (cont.)		2005 - 1996; 3.0L 181 (2967cc) DOHC V6 (24 Valve) 89mm Bore Duratec			32 (cont.)
MFI; Gasoline; Naturally Aspirated Ford Eng.; VIN Code S					
QTY	MANIFOLD - INT. & EXH.	YEARS	PART NO.	DESCRIPTION	
1	Plenum Gasket Set	2004	MS 96252	Exc. Lincoln LS Base; Upper set	
1	Plenum Gasket Set	2004	MS 96496	Lincoln LS Base; Upper set	
1	Plenum Gasket Set	2003-01	MS 92587	Exc. Lincoln LS Base, LSE; Upper set	
1	Plenum Gasket Set	2003-02	MS 96496	Lincoln LS Base, LSE; Upper set	
1	Plenum Gasket Set	2001	MS 96483	Lincoln LS Base, LSE; Upper set	
1	Plenum Gasket Set	2000	MS 92587	Exc. Lincoln LS Base; Upper set	
1	Plenum Gasket Set	2000	MS 96483	Lincoln LS Base; Upper set	
1	Plenum Gasket Set	1999-96	MS 95727	Upper set	
1	Exh. Manifold Gasket Set	2005-96	MS 95715		
QTY	EXHAUST PIPE FLANGE	YEARS	PART NO.	DESCRIPTION	
1	Exhaust Pipe Gasket	2005	61315	Exc. Lincoln LS Base, Luxury, Premium, Sport, Ultimate; Ring	
1	Exhaust Pipe Gasket	2004	61315	Exc. Lincoln LS Base; Ring	
1	Exhaust Pipe Gasket	2003-02	61315	Exc. Lincoln LS Base, LSE; Ring	
1	Exhaust Pipe Gasket	2001	61076	Exc. Lincoln LS Base, LSE; Ring	
1	Exhaust Pipe Gasket	2000	61076	Exc. Lincoln LS Base; Ring	
QTY	OIL PAN	YEARS	PART NO.	DESCRIPTION	
1	Oil Pan Gasket Set	2005	OS 30697 R	Lincoln LS Base, Luxury, Premium, Sport, Ultimate; Loc. Lower; PermaDry® molded rubber gskt. incl.; Improved design	
1	Oil Pan Gasket Set	2005	OS 30729 R	Exc. Lincoln LS Base, Luxury, Premium, Sport, Ultimate; Loc. Lower; PermaDry® molded rubber gskt. incl.	
1	Oil Pan Gasket Set	2004	OS 30697 R	Lincoln LS Base; Loc. Lower; PermaDry® molded rubber gskt. incl.; Improved design	
1	Oil Pan Gasket Set	2004	OS 30729 R	Exc. Lincoln LS Base; Loc. Lower; PermaDry® molded rubber gskt. incl.	
1	Oil Pan Gasket Set	2003-96	OS 30697 R	Loc. Lower; PermaDry® molded rubber gskt. incl.; Improved design	
1	Drain Plug Gasket	2005	72515	Exc. Lincoln LS Base, Luxury, Premium, Sport, Ultimate	
1	Drain Plug Gasket	2004	72515	Exc. Lincoln LS Base	
1	Drain Plug Gasket	2003-01	72515	Exc. Lincoln LS Base, LSE	
1	Drain Plug Gasket	2000	72515	Exc. Lincoln LS Base	
1	Drain Plug Gasket	1999-96	72515		
QTY	CRANKSHAFT REAR SEAL	YEARS	PART NO.	DESCRIPTION	
1	Rear Main Seal Set	2005-96	BS 40620	Rubber; One-piece; Improved design	
1	Rear Main Seal Set	2005-96	BS 40644	PTFE Rubber; One-piece	
QTY	VALVE COVER	YEARS	PART NO.	DESCRIPTION	
1	Valve Cover Gasket Set	2005	VS 50579 R	Exc. Lincoln LS Base, Luxury, Premium, Sport, Ultimate; w/Grommets & Spark plug tube seals; PermaDry® molded rubber gskts. incl.	
1	Valve Cover Gasket Set	2005	VS 50612 R	Lincoln LS Base, Luxury, Premium, Sport, Ultimate; w/Grommets & Spark plug tube seals; PermaDry® molded rubber gskts. incl.	
1	Valve Cover Gasket Set	2004	VS 50579 R	Exc. Lincoln LS Base; w/Grommets & Spark plug tube seals; PermaDry® molded rubber gskts. incl.	
1	Valve Cover Gasket Set	2004	VS 50612 R	Lincoln LS Base; w/Grommets & Spark plug tube seals; PermaDry® molded rubber gskts. incl.	
1	Valve Cover Gasket Set	2003-01	VS 50551 R	Exc. Lincoln LS Base, LSE; w/Grommets & Spark plug tube seals; PermaDry® molded rubber gskts. incl.	
1	Valve Cover Gasket Set	2003	VS 50612 R	Lincoln LS Base, LSE; w/Grommets & Spark plug tube seals; PermaDry® molded rubber gskts. incl.	
1	Valve Cover Gasket Set	2002-01	VS 50610 R	Lincoln LS Base, LSE; w/Grommets & Spark plug tube seals; PermaDry® molded rubber gskts. incl.	
1	Valve Cover Gasket Set	2000	VS 50510 R	Exc. Lincoln LS Base; w/Grommets & Spark plug tube seals; PermaDry® molded rubber gskts. incl.	
1	Valve Cover Gasket Set	2000	VS 50610 R	Lincoln LS Base; w/Grommets & Spark plug tube seals; PermaDry® molded rubber gskts. incl.	
1	Valve Cover Gasket Set	1999-96	VS 50509 R	w/Grommets & Spark plug tube seals; PermaDry® molded rubber gskts. incl.	
QTY	VALVE STEM SEAL SET	YEARS	PART NO.	DESCRIPTION	
1	Valve Stem Seal Set	2005	SS 72873-1	Exc. Lincoln LS Base, Luxury, Premium, Sport, Ultimate; Premium valve stem seals incl.	
1	Valve Stem Seal Set	2005	SS 72911	Lincoln LS Base, Luxury, Premium, Sport, Ultimate; Premium valve stem seals incl.	
1	Valve Stem Seal Set	2004	SS 72873-1	Exc. Lincoln LS Base; Premium valve stem seals incl.	
1	Valve Stem Seal Set	2004	SS 72911	Lincoln LS Base; Premium valve stem seals incl.	
1	Valve Stem Seal Set	2003-01	SS 72873-1	Exc. Lincoln LS Base, LSE; Premium valve stem seals incl.	
1	Valve Stem Seal Set	2003-01	SS 72911	Lincoln LS Base, LSE; Premium valve stem seals incl.	
1	Valve Stem Seal Set	2000	SS 72873-1	Exc. Lincoln LS Base; Premium valve stem seals incl.	
1	Valve Stem Seal Set	2000	SS 72911	Lincoln LS Base; Premium valve stem seals incl.	
1	Valve Stem Seal Set	1999-96	SS 72873-1	Premium valve stem seals incl.	

Ford Car (Incl. Edsel, Ford, Lincoln, Mercury, Merkur) (Cont.)

32 (cont.)		2005 - 1996; 3.0L 181 (2967cc) DOHC V6 (24 Valve) 89mm Bore Duratec			32 (cont.)
		MFI; Gasoline; Naturally Aspirated Ford Eng.; VIN Code S			
QTY	THERMOSTAT HOUSING	YEARS	PART NO.	DESCRIPTION	
1	Water Outlet Gasket	2005	35489	Lincoln LS Base, Luxury, Premium, Sport, Ultimate; Thermostat Housing; Thermostat seal	
1	Water Outlet Gasket	2004	35489	Lincoln LS Base; Thermostat Housing; Thermostat seal	
1	Water Outlet Gasket	2003-01	35489	Lincoln LS Base, LSE; Thermostat Housing; Thermostat seal	
1	Water Outlet Gasket	2000	35489	Lincoln LS Base; Thermostat Housing; Thermostat seal	
1	Thermostat Gasket	2005	35742	Lincoln LS Base, Luxury, Premium, Sport, Ultimate; Thermostat Housing	
1	Thermostat Gasket	2004	35742	Lincoln LS Base; Thermostat Housing	
1	Thermostat Gasket	2003-01	35742	Lincoln LS Base, LSE; Thermostat Housing	
1	Thermostat Gasket	2000	35742	Lincoln LS Base; Thermostat Housing	
QTY	WATER OUTLET GASKET	YEARS	PART NO.	DESCRIPTION	
1	Water Outlet Gasket	2005-96	35489	Water Outlet	
QTY	WATER PUMP	YEARS	PART NO.	DESCRIPTION	
1	Water Pump Gasket	2005	35663	Exc. Lincoln LS Base, Luxury, Premium, Sport, Ultimate; Improved design	
1	Water Pump Gasket	2005	35751	Lincoln LS Base, Luxury, Premium, Sport, Ultimate	
1	Water Pump Gasket	2004	35663	Exc. Lincoln LS Base; Improved design	
1	Water Pump Gasket	2004	35751	Lincoln LS Base	
1	Water Pump Gasket	2003-01	35751	Lincoln LS Base, LSE	
1	Water Pump Gasket	2003-02	35663	Exc. Lincoln LS Base, LSE; Improved design	
1	Water Pump Gasket	2001	35640	Exc. Lincoln LS Base, LSE	
1	Water Pump Gasket	2000	35640	Exc. Lincoln LS Base	
1	Water Pump Gasket	2000	35751	Lincoln LS Base	
1	Water Pump Gasket	1999-96	35640		
QTY	TIMING COVER	YEARS	PART NO.	DESCRIPTION	
1	Timing Cover Set	2005	TCS 46016	Exc. Lincoln LS Base, Luxury, Premium, Sport, Ultimate; Must be used w/OS 30729R; Improved design	
1	Timing Cover Set	2005	TCS 46054	Lincoln LS Base, Luxury, Premium, Sport, Ultimate; Must be used w/OS 30697R	
1	Timing Cover Set	2004	TCS 46016	Exc. Lincoln LS Base; Must be used w/OS 30729R; Improved design	
1	Timing Cover Set	2004	TCS 46054	Lincoln LS Base; Must be used w/OS 30697R	
1	Timing Cover Set	2003-01	TCS 46016	Exc. Lincoln LS Base, LSE; Must be used w/OS 30697R; Improved design	
1	Timing Cover Set	2003-01	TCS 46054	Lincoln LS Base, LSE; Must be used w/OS 30697R	
1	Timing Cover Set	2002-01	TCS 45967	Exc. Lincoln LS Base, LSE; Must be used w/OS 30697R; Old design	
1	Timing Cover Set	2000	TCS 45967	Exc. Lincoln LS Base; Must be used w/OS 30697R; Old design	
1	Timing Cover Set	2000	TCS 46016	Exc. Lincoln LS Base; Must be used w/OS 30697R; Improved design	
1	Timing Cover Set	2000	TCS 46054	Lincoln LS Base; Must be used w/OS 30697R	
1	Timing Cover Set	1999-96	TCS 45967	Must be used w/OS 30697R; Old design	
1	Timing Cover Set	1999-96	TCS 46016	Must be used w/OS 30697R; Improved design	
1	Crankshaft Front Seal Set	2005-96	TCS 46114		
1	Camshaft Rear Seal Set	2005	TCS 45966	Exc. Lincoln LS Base, Luxury, Premium, Sport, Ultimate	
1	Camshaft Rear Seal Set	2004	TCS 45966	Exc. Lincoln LS Base	
1	Camshaft Rear Seal Set	2003	TCS 45966	Exc. Lincoln LS Base, LSE	
QTY	CARB & FUEL INJECTION	YEARS	PART NO.	DESCRIPTION	
2	Fuel Injector O-Ring Set	2005-96	ES 70599	Improved design	
1	Throttle Body Gasket	2005-00	72302	Air bypass valve	
1	Throttle Body Gasket	2005	61158	Exc. Lincoln LS Base, Luxury, Premium, Sport, Ultimate; Mounting	
1	Throttle Body Gasket	2005	61356	Lincoln LS Base, Luxury, Premium, Sport, Ultimate; Mounting	
1	Throttle Body Gasket	2004	61158	Exc. Lincoln LS Base; Mounting	
1	Throttle Body Gasket	2004	61356	Lincoln LS Base; Mounting	
1	Throttle Body Gasket	2003-01	61158	Exc. Lincoln LS Base, LSE; Mounting	
1	Throttle Body Gasket	2003	61356	Lincoln LS Base, LSE; Mounting	
1	Throttle Body Gasket	2002-01	61355	Lincoln LS Base, LSE; Mounting	
1	Throttle Body Gasket	2000	61158	Exc. Lincoln LS Base; Mounting	
1	Throttle Body Gasket	2000	61355	Lincoln LS Base; Mounting	
1	Throttle Body Gasket	1999-96	61075	Mounting	
1	Throttle Body Gasket	1999-96	71216	Air bypass valve	
QTY	EXHAUST GAS RECIRCULATION	YEARS	PART NO.	DESCRIPTION	
1	EGR Gasket	2005	70149	Exc. Lincoln LS Base, Luxury, Premium, Sport, Ultimate; Valve	
1	EGR Gasket	2005	70948	Exc. Lincoln LS Base, Luxury, Premium, Sport, Ultimate; Tube	
1	EGR Gasket	2005	71176	Lincoln LS Base, Luxury, Premium, Sport, Ultimate; Valve	
1	EGR Gasket	2004	70149	Exc. Lincoln LS Base; Valve	
1	EGR Gasket	2004	70948	Exc. Lincoln LS Base; Tube	
1	EGR Gasket	2004	71176	Lincoln LS Base; Valve	
1	EGR Gasket	2003-01	70948	Exc. Lincoln LS Base, LSE; Tube	
1	EGR Gasket	2003	70149	Exc. Lincoln LS Base, LSE; Valve	

Ford Car (Incl. Edsel, Ford, Lincoln, Mercury, Merkur) (Cont.)

32		2005 - 1996; 3.0L 181 (2967cc) DOHC V6 (24 Valve) 89mm Bore Duratec			32	
(cont.)		MFI; Gasoline; Naturally Aspirated Ford Eng.; VIN Code S			(cont.)	
QTY	EXHAUST GAS RECIRCULATION	YEARS	PART NO.	DESCRIPTION		
1	EGR Gasket	2003	71176	Lincoln LS Base, LSE; Valve		
1	EGR Gasket	2002-96	70149	Valve		
1	EGR Gasket	2000	70948	Exc. Lincoln LS Base; Tube		
1	EGR Gasket	1999-96	70948	Tube		
33		1995 - 1991; 3.0L 183 (2982cc) DOHC V6 (24 Valve) 89mm Bore SHO			33	
		MFI; Gasoline; Naturally Aspirated Yamaha Eng.; VIN Code Y				
QTY	CYLINDER HEAD	YEARS	PART NO.	DESCRIPTION		
1	Head Bolt Set	1995-91	ES 74030	Replacement recommended		
QTY	CONVERSION SET	YEARS	PART NO.	DESCRIPTION		
1	Gasket Conversion Set	1995-91	CS 9821	RTV sealant incl. for oil pan gskt.		
QTY	MANIFOLD - INT. & EXH.	YEARS	PART NO.	DESCRIPTION		
1	Int. Manifold Gasket Set	1995-91	MS 94831	Lower set; Upper set incl.		
1	Exh. Manifold Gasket Set	1995-91	MS 94802			
QTY	EXHAUST PIPE FLANGE	YEARS	PART NO.	DESCRIPTION		
1	Exhaust Pipe Gasket	1995-91	60641	Converter		
1	Exh. Flange Bolt & Spring Kit	1995-91	ES 72142			
QTY	OIL PAN	YEARS	PART NO.	DESCRIPTION		
1	Oil Pan Gasket Set	1995-91	OS 30636 R	RTV Black silicone w/Rubber end seals		
1	Drain Plug Gasket	1995-91	72515			
QTY	CRANKSHAFT REAR SEAL	YEARS	PART NO.	DESCRIPTION		
1	Rear Main Seal Set	1995-91	BS 40623	Rubber; One-piece		
QTY	VALVE COVER	YEARS	PART NO.	DESCRIPTION		
1	Valve Cover Gasket Set	1995-91	VS 50378 R	w/Spark plug tube seals; Must be used w/MS 94831; PermaDry® molded rubber gskts. incl.		
QTY	VALVE STEM SEAL SET	YEARS	PART NO.	DESCRIPTION		
1	Valve Stem Seal Set	1995-91	SS 72807	Loc. Int.; Premium valve stem seals incl.		
1	Valve Stem Seal Set	1995-91	SS 72830	Loc. Exh.; Premium valve stem seals incl.		
QTY	THERMOSTAT HOUSING	YEARS	PART NO.	DESCRIPTION		
1	Thermostat Gasket	1995-91	35485	Thermostat Housing; Thermostat seal		
QTY	WATER OUTLET GASKET	YEARS	PART NO.	DESCRIPTION		
1	Water Crossover Mounting Set	1995-91	ES 70426			
QTY	WATER PUMP	YEARS	PART NO.	DESCRIPTION		
1	Water Pump Mounting Set	1995-91	ES 70425			
QTY	TIMING COVER	YEARS	PART NO.	DESCRIPTION		
1	Crankshaft Front Seal Set	1995-91	TCS 45871			
1	Camshaft Front Seal Set	1995-91	TCS 45870			
QTY	CARB & FUEL INJECTION	YEARS	PART NO.	DESCRIPTION		
2	Fuel Injector O-Ring Set	1995-91	ES 70600			
1	Throttle Body Gasket	1995-91	60896	Mounting		
1	Throttle Body Gasket	1995-91	71216	Air bypass valve		
34		1998 - 1993; 3.0L 183 (2982cc) OHV V6 (12 Valve) 89mm Bore Vulcan			34	
		MFI; Flex Fuel; Naturally Aspirated Ford Eng.; VIN Code 1				
QTY	CYLINDER HEAD	YEARS	PART NO.	DESCRIPTION		
2	Head Gasket	1998-93	9885 PT	Head bolts not incl.; Head bolt replacement recommended		
1	Head Set	1998-96	HS 9885 PT-3	Head bolts not incl.; Head bolt replacement recommended; PermaDry® molded rubber valve cover gskts. incl.; Premium valve stem seals incl.; Consolidated design		
1	Head Set	1995-93	HS 9885 PT	Head bolts not incl.; Head bolt replacement recommended; PermaDry® molded rubber valve cover gskts. incl.; Premium valve stem seals incl.		
1	Head Bolt Set	1998	ES 72136	To 07/13/98; Replacement recommended		
2	Head Bolt Set	1998	ES 72174	From 07/14/98; Replacement required		
1	Head Bolt Set	1997-93	ES 72136	Replacement recommended		
QTY	CONVERSION SET	YEARS	PART NO.	DESCRIPTION		
1	Gasket Conversion Set	1998-93	CS 9368-2	PermaDry® molded rubber oil pan gskt. incl.		
QTY	MANIFOLD - INT. & EXH.	YEARS	PART NO.	DESCRIPTION		
1	Int. Manifold Gasket Set	1998-93	MS 95372	Lower set; Upper set incl.; Must be used w/VS 50374R		
1	Plenum Gasket Set	1998-93	MS 93491	Upper set		
1	Exh. Manifold Gasket Set	1998-96	MS 95939	Improved design		
1	Exh. Manifold Gasket Set	1995-93	MS 93850			
QTY	EXHAUST PIPE FLANGE	YEARS	PART NO.	DESCRIPTION		
1	Exhaust Pipe Gasket	1995-93	60641	Converter		

Ford Car (Incl. Edsel, Ford, Lincoln, Mercury, Merkur) (Cont.)

34 (cont.)		1998 - 1993; 3.0L 183 (2982cc) OHV V6 (12 Valve) 89mm Bore Vulcan			34 (cont.)
MFI; Flex Fuel; Naturally Aspirated Ford Eng.; VIN Code 1					
QTY	OIL PAN	YEARS	PART NO.	DESCRIPTION	
1	Oil Pan Gasket Set	1998-93	OS 30620 R	PermaDry® molded rubber gskt. incl.	
1	Oil Pan Gasket Set	1998-93	OS 30717 R	Oil pan bolts incl.; PermaDryPlus®	
1	Oil Pan Bolt Set	1998-93	ES 72214		
1	Drain Plug Gasket	1998-93	72515		
QTY	CRANKSHAFT REAR SEAL	YEARS	PART NO.	DESCRIPTION	
1	Rear Main Seal Set	1998-93	BS 40158	Rubber; One-piece	
1	Rear Main Seal Set	1998-93	BS 40646	PTFE Rubber; One-piece	
QTY	VALVE COVER	YEARS	PART NO.	DESCRIPTION	
1	Valve Cover Gasket Set	1998-93	VS 50374 R	w/o Grommets; PermaDry® molded rubber gskts. incl.	
2	Grommet Set	1998-93	ES 72180	Valve Cover	
QTY	VALVE STEM SEAL SET	YEARS	PART NO.	DESCRIPTION	
1	Valve Stem Seal Set	1998-93	SS 70819	Premium valve stem seals incl.; Improved design	
QTY	WATER OUTLET GASKET	YEARS	PART NO.	DESCRIPTION	
1	Water Outlet Gasket	1998-93	35377	Water Outlet	
QTY	WATER PUMP	YEARS	PART NO.	DESCRIPTION	
1	Water Pump Gasket	1998-93	35379		
QTY	TIMING COVER	YEARS	PART NO.	DESCRIPTION	
1	Timing Cover Set	1998-93	TCS 45771	w/o Sleeve 'N' Seal®; Must be used w/OS 30620R or w/OS 30717R	
1	Timing Set w/Sleeve & Seal	1998-93	TCS 45973	w/Sleeve 'N' Seal®; Must be used w/OS 30620R or w/OS 30717R	
1	Repair Sleeve	1998-93	16217	Timing Cover; Use w/installation tool	
1	Repair Sleeve Tool	1998-93	16310	Timing Cover	
QTY	CARB & FUEL INJECTION	YEARS	PART NO.	DESCRIPTION	
2	Fuel Injector O-Ring Set	1998-93	ES 70599	Improved design	
1	Throttle Body Gasket	1998-93	71216	Air bypass valve	
1	Throttle Body Gasket	1998-96	61073	Mounting	
QTY	EXHAUST GAS RECIRCULATION	YEARS	PART NO.	DESCRIPTION	
1	EGR Gasket	1998-93	70149		
35		2007 - 1996; 3.0L 183 (2982cc) OHV V6 (12 Valve) 89mm Bore Vulcan			35
MFI; Flex Fuel; Naturally Aspirated Ford Eng.; VIN Code 2					
QTY	CYLINDER HEAD	YEARS	PART NO.	DESCRIPTION	
2	Head Gasket	2007-96	9885 PT	Head bolts not incl.; Head bolt replacement recommended	
1	Head Set	2007-01	HS 9885 PT-5	Head bolts not incl.; Head bolt replacement required; PermaDry® molded rubber valve cover gskts. incl.; Premium valve stem seals incl.	
1	Head Set	2000-99	HS 9885 PT-3	To 07/26/99; Head bolts not incl.; Head bolt replacement required; PermaDry® molded rubber valve cover gskts. incl.; Premium valve stem seals incl.; Consolidated design	
1	Head Set	2000-99	HS 9885 PT-4	From 07/27/99; Head bolts not incl.; Head bolt replacement required; PermaDry® molded rubber valve cover gskts. incl.; Premium valve stem seals incl.	
1	Head Set	1998-96	HS 9885 PT-3	Head bolts not incl.; Head bolt replacement recommended; PermaDry® molded rubber valve cover gskts. incl.; Premium valve stem seals incl.; Consolidated design	
2	Head Bolt Set	2007-00	ES 72174	Replacement required	
1	Head Bolt Set	1999-98	ES 72136	To 07/13/98; Replacement recommended	
2	Head Bolt Set	1999-98	ES 72174	From 07/14/98; Replacement required	
1	Head Bolt Set	1997-96	ES 72136	Replacement recommended	
QTY	CONVERSION SET	YEARS	PART NO.	DESCRIPTION	
1	Gasket Conversion Set	2007-02	CS 9368-3	PermaDry® molded rubber oil pan gskt. incl.	
1	Gasket Conversion Set	2001-96	CS 9368-2	PermaDry® molded rubber oil pan gskt. incl.	
QTY	MANIFOLD - INT. & EXH.	YEARS	PART NO.	DESCRIPTION	
1	Int. Manifold Gasket Set	2007-01	MS 95372-1	Lower set; Upper set incl.; Must be used w/VS 50374R	
1	Int. Manifold Gasket Set	2000-96	MS 95372	Lower set; Upper set incl.; Must be used w/VS 50374R	
1	Plenum Gasket Set	2007-01	MS 94429	Upper set	
1	Plenum Gasket Set	2000-96	MS 93491	Upper set	
1	Exh. Manifold Gasket Set	2007-96	MS 95939	Improved design	
QTY	EXHAUST PIPE FLANGE	YEARS	PART NO.	DESCRIPTION	
1	Exhaust Pipe Gasket	2007-02	61183	Ring	
QTY	OIL PAN	YEARS	PART NO.	DESCRIPTION	
1	Oil Pan Gasket Set	2007-02	OS 30712 R	PermaDry® molded rubber gskt. incl.	
1	Oil Pan Gasket Set	2001-96	OS 30620 R	PermaDry® molded rubber gskt. incl.	
1	Oil Pan Gasket Set	2001-96	OS 30717 R	Oil pan bolts incl.; PermaDryPlus®	
1	Oil Pan Bolt Set	2001-96	ES 72214		
1	Drain Plug Gasket	2007-96	72515		

Ford Car (Incl. Edsel, Ford, Lincoln, Mercury, Merkur) (Cont.)

35 (cont.)		2007 - 1996; 3.0L 183 (2982cc) OHV V6 (12 Valve) 89mm Bore Vulcan			35 (cont.)
MFI; Flex Fuel; Naturally Aspirated Ford Eng.; VIN Code 2					
QTY	CRANKSHAFT REAR SEAL	YEARS	PART NO.	DESCRIPTION	
1	Rear Main Seal Set	2007-96	BS 40158	Rubber; One-piece	
1	Rear Main Seal Set	2007-96	BS 40646	PTFE Rubber; One-piece	
QTY	VALVE COVER	YEARS	PART NO.	DESCRIPTION	
1	Valve Cover Gasket Set	2007-96	VS 50374 R	w/o Grommets; PermaDry® molded rubber gskts. incl.	
2	Grommet Set	2007-96	ES 72180	Valve Cover	
QTY	VALVE STEM SEAL SET	YEARS	PART NO.	DESCRIPTION	
1	Valve Stem Seal Set	2007-01	SS 70964	Premium valve stem seals incl.	
1	Valve Stem Seal Set	2000-99	SS 70819	To 07/26/99; Premium valve stem seals incl.; Improved design	
1	Valve Stem Seal Set	2000-99	SS 70964	From 07/27/99; Premium valve stem seals incl.	
1	Valve Stem Seal Set	1998-96	SS 70819	Premium valve stem seals incl.; Improved design	
QTY	WATER OUTLET GASKET	YEARS	PART NO.	DESCRIPTION	
1	Water Outlet Gasket	2007-96	35377	Water Outlet	
QTY	WATER PUMP	YEARS	PART NO.	DESCRIPTION	
1	Water Pump Gasket	2007-96	35379		
QTY	TIMING COVER	YEARS	PART NO.	DESCRIPTION	
1	Timing Cover Set	2007-96	TCS 45771	w/o Sleeve 'N' Seal®; Must be used w/OS 30620R or w/OS 30712R or w/OS 30717R	
1	Timing Set w/Sleeve & Seal	2007-96	TCS 45973	w/Sleeve 'N' Seal®; Must be used w/OS 30620R or w/OS 30712R or w/OS 30717R	
1	Repair Sleeve	2007-96	16217	Timing Cover; Use w/installation tool	
1	Repair Sleeve Tool	2007-96	16310	Timing Cover	
QTY	CARB & FUEL INJECTION	YEARS	PART NO.	DESCRIPTION	
2	Fuel Injector O-Ring Set	2007-96	ES 70599	Improved design	
1	Throttle Body Gasket	2007-01	61160	Mounting	
1	Throttle Body Gasket	2007-01	71428	Air bypass valve; New Part Number - Check for Availability	
1	Throttle Body Gasket	2000-96	61073	Mounting	
1	Throttle Body Gasket	2000-96	71216	Air bypass valve	
QTY	EXHAUST GAS RECIRCULATION	YEARS	PART NO.	DESCRIPTION	
1	EGR Gasket	2007-96	70149		
36		2007 - 1991; 3.0L 183 (2982cc) OHV V6 (12 Valve) 89mm Bore Vulcan			36
MFI; Gasoline; Naturally Aspirated Ford Eng.; VIN Code U					
QTY	CYLINDER HEAD	YEARS	PART NO.	DESCRIPTION	
2	Head Gasket	2007-91	9885 PT	Head bolts not incl.; Head bolt replacement recommended	
1	Head Set	2007-01	HS 9885 PT-5	Head bolts not incl.; Head bolt replacement required; PermaDry® molded rubber valve cover gskts. incl.; Premium valve stem seals incl.	
1	Head Set	2000-99	HS 9885 PT-3	To 07/26/99; Head bolts not incl.; Head bolt replacement required; PermaDry® molded rubber valve cover gskts. incl.; Premium valve stem seals incl.; Consolidated design	
1	Head Set	2000-99	HS 9885 PT-4	From 07/27/99; Head bolts not incl.; Head bolt replacement required; PermaDry® molded rubber valve cover gskts. incl.; Premium valve stem seals incl.	
1	Head Set	1998-96	HS 9885 PT-3	Head bolts not incl.; Head bolt replacement recommended; PermaDry® molded rubber valve cover gskts. incl.; Premium valve stem seals incl.; Consolidated design	
1	Head Set	1995-91	HS 9885 PT	Head bolts not incl.; Head bolt replacement recommended; PermaDry® molded rubber valve cover gskts. incl.; Premium valve stem seals incl.	
2	Head Bolt Set	2007-00	ES 72174	Replacement required	
1	Head Bolt Set	1999-98	ES 72136	To 07/13/98; Replacement recommended	
2	Head Bolt Set	1999-98	ES 72174	From 07/14/98; Replacement required	
1	Head Bolt Set	1997-91	ES 72136	Replacement recommended	
QTY	CONVERSION SET	YEARS	PART NO.	DESCRIPTION	
1	Gasket Conversion Set	2007-02	CS 9368-3	PermaDry® molded rubber oil pan gskt. incl.	
1	Gasket Conversion Set	2001-91	CS 9368-2	PermaDry® molded rubber oil pan gskt. incl.	
QTY	MANIFOLD - INT. & EXH.	YEARS	PART NO.	DESCRIPTION	
1	Int. Manifold Gasket Set	2007-01	MS 95372-1	Lower set; Upper set incl.; Must be used w/VS 50374R	
1	Int. Manifold Gasket Set	2000-91	MS 95372	Lower set; Upper set incl.; Must be used w/VS 50374R	
1	Plenum Gasket Set	2007-01	MS 94429	Upper set	
1	Plenum Gasket Set	2000-91	MS 93491	Upper set	
1	Exh. Manifold Gasket Set	2007-96	MS 95939	Improved design	
1	Exh. Manifold Gasket Set	1995-91	MS 93850		
QTY	EXHAUST PIPE FLANGE	YEARS	PART NO.	DESCRIPTION	
1	Exhaust Pipe Gasket	2007-02	61183	Ring	

Ford Car (Incl. Edsel, Ford, Lincoln, Mercury, Merkur) (Cont.)

36 (cont.)		2007 - 1991; 3.0L 183 (2982cc) OHV V6 (12 Valve) 89mm Bore Vulcan			36 (cont.)
MFI; Gasoline; Naturally Aspirated Ford Eng.; VIN Code U					
QTY	EXHAUST PIPE FLANGE	YEARS	PART NO.	DESCRIPTION	
1	Exhaust Pipe Gasket	1995	60641	Converter	
1	Exhaust Pipe Gasket	1994-93	60583	Ford Tempo GL, LX Mercury Topaz GS, GS AWD; Converter	
1	Exhaust Pipe Gasket	1994-93	60641	Ford Taurus GL, LX Mercury Sable GS, LS; Converter	
1	Exhaust Pipe Gasket	1992-91	60583	Ford Probe LX, SE; Loc. Front; Converter	
1	Exhaust Pipe Gasket	1992-91	60831	Ford Probe LX, SE; Loc. Rear; Converter	
1	Exhaust Pipe Gasket	1992	60583	Exc. Ford Probe LX, SE, Taurus GL, L, LX Mercury Sable GS, LS; Converter	
1	Exhaust Pipe Gasket	1992	60641	Ford Taurus GL, L, LX Mercury Sable GS, LS; Converter	
1	Exhaust Pipe Gasket	1991	60641	Exc. Ford Probe LX, SE; Converter	
QTY	OIL PAN	YEARS	PART NO.	DESCRIPTION	
1	Oil Pan Gasket Set	2007-02	OS 30712 R	PermaDry® molded rubber gskt. incl.	
1	Oil Pan Gasket Set	2001-91	OS 30620 R	PermaDry® molded rubber gskt. incl.	
1	Oil Pan Gasket Set	2001-91	OS 30717 R	Oil pan bolts incl.; PermaDryPlus®	
1	Oil Pan Bolt Set	2001-91	ES 72214		
1	Drain Plug Gasket	2007-91	72515		
QTY	CRANKSHAFT REAR SEAL	YEARS	PART NO.	DESCRIPTION	
1	Rear Main Seal Set	2007-91	BS 40158	Rubber; One-piece	
1	Rear Main Seal Set	2007-91	BS 40646	PTFE Rubber; One-piece	
QTY	VALVE COVER	YEARS	PART NO.	DESCRIPTION	
1	Valve Cover Gasket Set	2007-91	VS 50374 R	w/o Grommets; PermaDry® molded rubber gskts. incl.	
2	Grommet Set	2007-91	ES 72180	Valve Cover	
QTY	VALVE STEM SEAL SET	YEARS	PART NO.	DESCRIPTION	
1	Valve Stem Seal Set	2007-01	SS 70964	Premium valve stem seals incl.	
1	Valve Stem Seal Set	2000-99	SS 70819	To 07/26/99; Premium valve stem seals incl.; Improved design	
1	Valve Stem Seal Set	2000-99	SS 70964	From 07/27/99; Premium valve stem seals incl.	
1	Valve Stem Seal Set	1998-91	SS 70819	Premium valve stem seals incl.; Improved design	
QTY	WATER OUTLET GASKET	YEARS	PART NO.	DESCRIPTION	
1	Water Outlet Gasket	2007-91	35377	Water Outlet	
QTY	WATER PUMP	YEARS	PART NO.	DESCRIPTION	
1	Water Pump Gasket	2007-95	35379		
1	Water Pump Gasket	1994-93	35379	Ford Taurus GL, LX Mercury Sable GS, LS	
1	Water Pump Gasket	1994-93	35460	Ford Tempo GL, LX Mercury Topaz GS, GS AWD	
1	Water Pump Gasket	1992	35379	Ford Taurus GL, L, LX Mercury Sable GS, LS	
1	Water Pump Gasket	1992	35460	Exc. Ford Taurus GL, L, LX Mercury Sable GS, LS	
1	Water Pump Gasket	1991	35379	Exc. Ford Probe LX, SE	
1	Water Pump Gasket	1991	35460	Ford Probe LX, SE	
QTY	TIMING COVER	YEARS	PART NO.	DESCRIPTION	
1	Timing Cover Set	2007-91	TCS 45771	w/o Sleeve 'N' Seal®; Must be used w/OS 30620R or w/OS 30712R or w/OS 30717R or w/OS 34505R	
1	Timing Set w/Sleeve & Seal	2007-91	TCS 45973	w/Sleeve 'N' Seal®; Must be used w/OS 30620R or w/OS 30712R or w/OS 30717R or w/OS 34505R	
1	Repair Sleeve	2007-91	16217	Timing Cover; Use w/installation tool	
1	Repair Sleeve Tool	2007-91	16310	Timing Cover	
QTY	CARB & FUEL INJECTION	YEARS	PART NO.	DESCRIPTION	
2	Fuel Injector O-Ring Set	2007-91	ES 70599	Improved design	
1	Throttle Body Gasket	2007-01	61160	Mounting	
1	Throttle Body Gasket	2007-01	71428	Air bypass tube; New Part Number - Check for Availability	
1	Throttle Body Gasket	2000-91	71216	Air bypass valve	
1	Throttle Body Gasket	2000-96	61073	Mounting	
QTY	EXHAUST GAS RECIRCULATION	YEARS	PART NO.	DESCRIPTION	
1	EGR Gasket	2007-91	70149		
37		1995 - 1993; 3.2L 195 (3152cc) DOHC V6 (24 Valve) 92mm Bore SHO			37
MFI; Gasoline; Naturally Aspirated Yamaha Eng.; VIN Code P					
QTY	CYLINDER HEAD	YEARS	PART NO.	DESCRIPTION	
1	Head Bolt Set	1995-93	ES 74030	Replacement recommended	
QTY	CONVERSION SET	YEARS	PART NO.	DESCRIPTION	
1	Gasket Conversion Set	1995-93	CS 9821	RTV sealant incl. for oil pan gskt.	
QTY	MANIFOLD - INT. & EXH.	YEARS	PART NO.	DESCRIPTION	
1	Int. Manifold Gasket Set	1995-93	MS 94831	Lower set; Upper set incl.	
1	Exh. Manifold Gasket Set	1995-93	MS 94802		
QTY	EXHAUST PIPE FLANGE	YEARS	PART NO.	DESCRIPTION	
1	Exhaust Pipe Gasket	1995-93	60641	Converter	
1	Exh. Flange Bolt & Spring Kit	1995-93	ES 72142		

Ford Car (Incl. Edsel, Ford, Lincoln, Mercury, Merkur) (Cont.)

37 (cont.)		1995 - 1993; 3.2L 195 (3152cc) DOHC V6 (24 Valve) 92mm Bore SHO			37 (cont.)	
MFI; Gasoline; Naturally Aspirated Yamaha Eng.; VIN Code P						
QTY	OIL PAN	YEARS	PART NO.	DESCRIPTION		
1	Oil Pan Gasket Set	1995-93	OS 30636 R	RTV Black silicone w/Rubber end seals		
1	Drain Plug Gasket	1995-93	72515			
QTY	CRANKSHAFT REAR SEAL	YEARS	PART NO.	DESCRIPTION		
1	Rear Main Seal Set	1995-93	BS 40623	Rubber; One-piece		
QTY	VALVE COVER	YEARS	PART NO.	DESCRIPTION		
1	Valve Cover Gasket Set	1995-93	VS 50378 R	w/Spark plug tube seals; Must be used w/MS 94831; PermaDry® molded rubber gskts. incl.		
QTY	VALVE STEM SEAL SET	YEARS	PART NO.	DESCRIPTION		
1	Valve Stem Seal Set	1995-93	SS 72807	Loc. Int.; Premium valve stem seals incl.		
1	Valve Stem Seal Set	1995-93	SS 72830	Loc. Exh.; Premium valve stem seals incl.		
QTY	THERMOSTAT HOUSING	YEARS	PART NO.	DESCRIPTION		
1	Thermostat Gasket	1995-93	35485	Thermostat Housing; Thermostat seal		
QTY	WATER OUTLET GASKET	YEARS	PART NO.	DESCRIPTION		
1	Water Crossover Mounting Set	1995-93	ES 70426			
QTY	WATER PUMP	YEARS	PART NO.	DESCRIPTION		
1	Water Pump Mounting Set	1995-93	ES 70425			
QTY	TIMING COVER	YEARS	PART NO.	DESCRIPTION		
1	Crankshaft Front Seal Set	1995-93	TCS 45871			
1	Camshaft Front Seal Set	1995-93	TCS 45870			
QTY	CARB & FUEL INJECTION	YEARS	PART NO.	DESCRIPTION		
2	Fuel Injector O-Ring Set	1995-93	ES 70600			
1	Throttle Body Gasket	1995-93	60896	Mounting		
1	Throttle Body Gasket	1995-93	71216	Air bypass valve		
38		2012 - 2010; 3.5L 213.3 (3496cc) DOHC V6 (24 Valve) 92.5mm Bore Duratec Cyclone				38
MFI; Gasoline; Naturally Aspirated Ford Eng.; VIN Code C						
QTY	CYLINDER HEAD	YEARS	PART NO.	DESCRIPTION		
1	Head Gasket	2012-10	26487 PT	Loc. L.H.; Head bolts not incl.; Head bolt replacement recommended; PermaTorqueMLS®		
1	Head Gasket	2012-10	26488 PT	Loc. R.H.; Head bolts not incl.; Head bolt replacement recommended; PermaTorqueMLS®		
1	Head Set	2012-10	HS 26487 PT	Head bolts not incl.; Head bolt replacement recommended; PermaDry® molded rubber valve cover gskts. incl.; Premium valve stem seals incl.; New Part Number - Check for Availability		
2	Head Bolt Set	2012-10	ES 71324	Replacement recommended; New Part Number - Check for Availability		
QTY	CONVERSION SET	YEARS	PART NO.	DESCRIPTION		
1	Gasket Conversion Set	2012-10	CS 26487	RTV sealant incl. for oil pan gskt.; New Part Number - Check for Availability		
QTY	MANIFOLD - INT. & EXH.	YEARS	PART NO.	DESCRIPTION		
1	Int. Manifold Gasket Set	2012-10	MS 97118	Lower set; Upper set incl.; New Part Number - Check for Availability		
1	Plenum Gasket Set	2012-10	MS 97120	Upper set		
1	Exh. Manifold Gasket Set	2012-10	MS 97121			
QTY	EXHAUST PIPE FLANGE	YEARS	PART NO.	DESCRIPTION		
1	Exhaust Pipe Gasket	2012-10	61236	Loc. Rear No. 1; Converter		
1	Exhaust Pipe Gasket	2012-10	61525	Loc. Rear No. 2; Converter; Improved design		
2	Exhaust Pipe Gasket	2012-10	61620	Loc. Front; Ring		
1	Exhaust Pipe Gasket	2012-10	61622	Exh. connector		
QTY	CRANKSHAFT REAR SEAL	YEARS	PART NO.	DESCRIPTION		
1	Rear Main Seal Set	2012-10	BS 40729	Rubber; One-piece		
QTY	VALVE COVER	YEARS	PART NO.	DESCRIPTION		
1	Valve Cover Gasket Set	2012-10	VS 50767 R	w/Grommets & Spark plug tube seals; PermaDry® molded rubber gskts. incl.; New Part Number - Check for Availability		
QTY	VALVE STEM SEAL SET	YEARS	PART NO.	DESCRIPTION		
1	Valve Stem Seal Set	2012-10	SS 71327	Premium valve stem seals incl.		
QTY	THERMOSTAT HOUSING	YEARS	PART NO.	DESCRIPTION		
1	Thermostat Gasket	2012-10	35934	Thermostat case		
QTY	WATER OUTLET GASKET	YEARS	PART NO.	DESCRIPTION		
1	Water Outlet Gasket	2012-10	35489	Thermostat seal		
QTY	WATER PUMP	YEARS	PART NO.	DESCRIPTION		
1	Water Pump Gasket	2012-10	35930	Loc. Outer		
1	Water Pump Gasket	2012-10	35932	Loc. Inner		
QTY	TIMING COVER	YEARS	PART NO.	DESCRIPTION		
1	Crankshaft Front Seal Set	2012-10	TCS 46117			

Ford Car (Incl. Edsel, Ford, Lincoln, Mercury, Merkur) (Cont.)

38		2012 - 2010; 3.5L 213.3 (3496cc) DOHC V6 (24 Valve) 92.5mm Bore Duratec Cyclone			38
(cont.)		MFI; Gasoline; Naturally Aspirated Ford Eng.; VIN Code C			(cont.)
QTY	CARB & FUEL INJECTION	YEARS	PART NO.	DESCRIPTION	
2	Fuel Injector O-Ring Set	2012-10	ES 70599	Upper set; Injectors to fuel rail; Improved design	
1	Throttle Body Gasket	2012-10	61466		
QTY	OIL FILTER MOUNTING	YEARS	PART NO.	DESCRIPTION	
1	Oil Filter Adapter Gasket	2012-10	71318	Oil filter adapter; New Part Number - Check for Availability	
QTY	OIL COOLER	YEARS	PART NO.	DESCRIPTION	
1	Oil Cooler Gasket	2012-10	71319	Oil cooler O-ring; New Part Number - Check for Availability	
39		2012 - 2007; 3.5L 213.3 (3496cc) DOHC V6 (24 Valve) 92.5mm Bore Duratec Cyclone			39
		MFI; Gasoline; Naturally Aspirated Ford Eng.; VIN Code T			
QTY	CYLINDER HEAD	YEARS	PART NO.	DESCRIPTION	
1	Head Gasket	2012-07	26487 PT	Loc. L.H.; Head bolts not incl.; Head bolt replacement recommended; PermaTorqueMLS®	
1	Head Gasket	2012-07	26488 PT	Loc. R.H.; Head bolts not incl.; Head bolt replacement recommended; PermaTorqueMLS®	
1	Head Set	2012-07	HS 26487 PT	Head bolts not incl.; Head bolt replacement recommended; PermaDry® molded rubber valve cover gskts. incl.; Premium valve stem seals incl.; New Part Number - Check for Availability	
2	Head Bolt Set	2012-10	ES 71324	Replacement recommended; New Part Number - Check for Availability	
2	Head Bolt Set	2009	ES 71320	To 02/01/09; Replacement recommended	
2	Head Bolt Set	2009	ES 71324	From 02/02/09; Replacement recommended; New Part Number - Check for Availability	
2	Head Bolt Set	2008-07	ES 71320	Replacement recommended	
QTY	CONVERSION SET	YEARS	PART NO.	DESCRIPTION	
1	Gasket Conversion Set	2012-07	CS 26487	RTV sealant incl. for oil pan gskt.; New Part Number - Check for Availability	
QTY	MANIFOLD - INT. & EXH.	YEARS	PART NO.	DESCRIPTION	
1	Int. Manifold Gasket Set	2012-07	MS 97118	Lower set; Upper set incl.; New Part Number - Check for Availability	
1	Plenum Gasket Set	2012-07	MS 97120	Upper set	
1	Exh. Manifold Gasket Set	2012-07	MS 97121		
QTY	EXHAUST PIPE FLANGE	YEARS	PART NO.	DESCRIPTION	
1	Exhaust Pipe Gasket	2012-07	61236	Loc. Rear No. 1; Converter	
1	Exhaust Pipe Gasket	2012-07	61525	Loc. Rear No. 2; Converter; Improved design	
2	Exhaust Pipe Gasket	2012-07	61620	Loc. Front; Ring	
1	Exhaust Pipe Gasket	2012-07	61622	Exh. connector	
QTY	CRANKSHAFT REAR SEAL	YEARS	PART NO.	DESCRIPTION	
1	Rear Main Seal Set	2012-07	BS 40729	Rubber; One-piece	
QTY	VALVE COVER	YEARS	PART NO.	DESCRIPTION	
1	Valve Cover Gasket Set	2012-07	VS 50767 R	w/Grommets & Spark plug tube seals; PermaDry® molded rubber gskts. incl.; New Part Number - Check for Availability	
QTY	VALVE STEM SEAL SET	YEARS	PART NO.	DESCRIPTION	
1	Valve Stem Seal Set	2012-07	SS 71327	Premium valve stem seals incl.	
QTY	THERMOSTAT HOUSING	YEARS	PART NO.	DESCRIPTION	
1	Thermostat Gasket	2012-07	35934	Thermostat case	
QTY	WATER OUTLET GASKET	YEARS	PART NO.	DESCRIPTION	
1	Water Outlet Gasket	2012-07	35489	Thermostat seal	
QTY	WATER PUMP	YEARS	PART NO.	DESCRIPTION	
1	Water Pump Gasket	2012-07	35930	Loc. Outer	
1	Water Pump Gasket	2012-07	35932	Loc. Inner	
QTY	TIMING COVER	YEARS	PART NO.	DESCRIPTION	
1	Crankshaft Front Seal Set	2012-07	TCS 46117		
QTY	CARB & FUEL INJECTION	YEARS	PART NO.	DESCRIPTION	
2	Fuel Injector O-Ring Set	2012-07	ES 70599	Upper set; Injectors to fuel rail; Improved design	
1	Throttle Body Gasket	2012-07	61466		
QTY	OIL FILTER MOUNTING	YEARS	PART NO.	DESCRIPTION	
1	Oil Filter Adapter Gasket	2012-10	71318	Oil filter adapter; New Part Number - Check for Availability	
1	Oil Filter Adapter Gasket	2009-07	71312	Oil filter adapter; New Part Number - Check for Availability	
QTY	OIL COOLER	YEARS	PART NO.	DESCRIPTION	
1	Oil Cooler Gasket	2012-10	71319	Oil cooler O-ring; New Part Number - Check for Availability	
1	Oil Cooler Gasket	2009-07	71316	Oil cooler O-ring; New Part Number - Check for Availability	

Ford Car (Incl. Edsel, Ford, Lincoln, Mercury, Merkur) (Cont.)

40		2012 - 2008; 3.5L 213.3 (3496cc) DOHC V6 (24 Valve) 92.5mm Bore Duratec Cyclone			40
MFI; Gasoline; Naturally Aspirated Ford Eng.; VIN Code W					
QTY	CYLINDER HEAD	YEARS	PART NO.	DESCRIPTION	
1	Head Gasket	2012-08	26487 PT	Loc. L.H.; Head bolts not incl.; Head bolt replacement recommended; PermaTorqueMLS®	
1	Head Gasket	2012-08	26488 PT	Loc. R.H.; Head bolts not incl.; Head bolt replacement recommended; PermaTorqueMLS®	
1	Head Set	2012-08	HS 26487 PT	Head bolts not incl.; Head bolt replacement recommended; PermaDry® molded rubber valve cover gskts. incl.; Premium valve stem seals incl.; New Part Number - Check for Availability	
2	Head Bolt Set	2012-10	ES 71324	Replacement recommended; New Part Number - Check for Availability	
2	Head Bolt Set	2009	ES 71320	To 02/01/09; Replacement recommended	
2	Head Bolt Set	2009	ES 71324	From 02/02/09; Replacement recommended; New Part Number - Check for Availability	
2	Head Bolt Set	2008	ES 71320	Replacement recommended	
QTY	CONVERSION SET	YEARS	PART NO.	DESCRIPTION	
1	Gasket Conversion Set	2012-08	CS 26487	RTV sealant incl. for oil pan gskt.; New Part Number - Check for Availability	
QTY	MANIFOLD - INT. & EXH.	YEARS	PART NO.	DESCRIPTION	
1	Int. Manifold Gasket Set	2012-08	MS 97118	Lower set; Upper set incl.; New Part Number - Check for Availability	
1	Plenum Gasket Set	2012-08	MS 97120	Upper set	
1	Exh. Manifold Gasket Set	2012-08	MS 97121		
QTY	EXHAUST PIPE FLANGE	YEARS	PART NO.	DESCRIPTION	
1	Exhaust Pipe Gasket	2012-08	61236	Loc. Rear No. 1; Converter	
1	Exhaust Pipe Gasket	2012-08	61525	Loc. Rear No. 2; Converter; Improved design	
2	Exhaust Pipe Gasket	2012-08	61620	Loc. Front; Ring	
1	Exhaust Pipe Gasket	2012-08	61622	Exh. connector	
1	Exhaust Pipe Gasket	2012-08	61623	Converter	
QTY	CRANKSHAFT REAR SEAL	YEARS	PART NO.	DESCRIPTION	
1	Rear Main Seal Set	2012-08	BS 40729	Rubber; One-piece	
QTY	VALVE COVER	YEARS	PART NO.	DESCRIPTION	
1	Valve Cover Gasket Set	2012-08	VS 50767 R	w/Grommets & Spark plug tube seals; PermaDry® molded rubber gskts. incl.; New Part Number - Check for Availability	
QTY	VALVE STEM SEAL SET	YEARS	PART NO.	DESCRIPTION	
1	Valve Stem Seal Set	2012-08	SS 71327	Premium valve stem seals incl.	
QTY	THERMOSTAT HOUSING	YEARS	PART NO.	DESCRIPTION	
1	Thermostat Gasket	2012-08	35934	Thermostat case	
QTY	WATER OUTLET GASKET	YEARS	PART NO.	DESCRIPTION	
1	Water Outlet Gasket	2012-08	35489	Thermostat seal	
QTY	WATER PUMP	YEARS	PART NO.	DESCRIPTION	
1	Water Pump Gasket	2012-08	35930	Loc. Outer	
1	Water Pump Gasket	2012-08	35932	Loc. Inner	
QTY	TIMING COVER	YEARS	PART NO.	DESCRIPTION	
1	Crankshaft Front Seal Set	2012-08	TCS 46117		
QTY	CARB & FUEL INJECTION	YEARS	PART NO.	DESCRIPTION	
2	Fuel Injector O-Ring Set	2012-08	ES 70599	Upper set; Injectors to fuel rail; Improved design	
1	Throttle Body Gasket	2012-08	61466		
QTY	OIL FILTER MOUNTING	YEARS	PART NO.	DESCRIPTION	
1	Oil Filter Adapter Gasket	2012-10	71318	Oil filter adapter; New Part Number - Check for Availability	
1	Oil Filter Adapter Gasket	2009-08	71312	Oil filter adapter; New Part Number - Check for Availability	
QTY	OIL COOLER	YEARS	PART NO.	DESCRIPTION	
1	Oil Cooler Gasket	2012-10	71319	Oil cooler O-ring; New Part Number - Check for Availability	
1	Oil Cooler Gasket	2009-08	71316	Oil cooler O-ring; New Part Number - Check for Availability	
41		2013; 3.5L 213.3 (3496cc) DOHC V6 (24 Valve) 92.5mm Bore Duratec Cyclone VVT			41
MFI; Flex Fuel; Naturally Aspirated Ford Eng.; VIN Code 8					
QTY	CYLINDER HEAD	YEARS	PART NO.	DESCRIPTION	
1	Head Gasket	2013	26487 PT	Loc. L.H.; Head bolts not incl.; Head bolt replacement recommended; PermaTorqueMLS®	
1	Head Gasket	2013	26488 PT	Loc. R.H.; Head bolts not incl.; Head bolt replacement recommended; PermaTorqueMLS®	
2	Head Bolt Set	2013	ES 71324	Replacement recommended; New Part Number - Check for Availability	
QTY	CONVERSION SET	YEARS	PART NO.	DESCRIPTION	
1	Gasket Conversion Set	2013	CS 26487	RTV sealant incl. for oil pan gskt.; New Part Number - Check for Availability	
QTY	MANIFOLD - INT. & EXH.	YEARS	PART NO.	DESCRIPTION	
1	Int. Manifold Gasket Set	2013	MS 97118-1	Lower set; Upper set incl.; New Part Number - Check for Availability	
1	Plenum Gasket Set	2013	MS 97214	Upper set; New Part Number - Check for Availability	

Ford Car (Incl. Edsel, Ford, Lincoln, Mercury, Merkur) (Cont.)

41 (cont.)	2013; 3.5L 213.3 (3496cc) DOHC V6 (24 Valve) 92.5mm Bore Duratec Cyclone VVT				41 (cont.)
MFI; Flex Fuel; Naturally Aspirated Ford Eng.; VIN Code 8					
QTY	EXHAUST PIPE FLANGE	YEARS	PART NO.	DESCRIPTION	
1	Exhaust Pipe Gasket	2013	61236	Loc. Rear No. 1; Converter	
1	Exhaust Pipe Gasket	2013	61525	Loc. Rear No. 2; Converter; Improved design	
2	Exhaust Pipe Gasket	2013	61620	Loc. Front; Ring	
QTY	CRANKSHAFT REAR SEAL	YEARS	PART NO.	DESCRIPTION	
1	Rear Main Seal Set	2013	BS 40729	Rubber; One-piece	
QTY	VALVE STEM SEAL SET	YEARS	PART NO.	DESCRIPTION	
1	Valve Stem Seal Set	2013	SS 71327	Premium valve stem seals incl.	
QTY	THERMOSTAT HOUSING	YEARS	PART NO.	DESCRIPTION	
1	Thermostat Gasket	2013	35934	Thermostat case	
QTY	WATER OUTLET GASKET	YEARS	PART NO.	DESCRIPTION	
1	Water Outlet Gasket	2013	35489	Thermostat seal	
QTY	WATER PUMP	YEARS	PART NO.	DESCRIPTION	
1	Water Pump Gasket	2013	35930	Loc. Outer	
1	Water Pump Gasket	2013	35932	Loc. Inner	
QTY	TIMING COVER	YEARS	PART NO.	DESCRIPTION	
1	Crankshaft Front Seal Set	2013	TCS 46117		
QTY	CARB & FUEL INJECTION	YEARS	PART NO.	DESCRIPTION	
2	Fuel Injector O-Ring Set	2013	ES 70599	Upper set; Injectors to fuel rail; Improved design	
1	Throttle Body Gasket	2013	61466		
QTY	OIL FILTER MOUNTING	YEARS	PART NO.	DESCRIPTION	
1	Oil Filter Adapter Gasket	2013	71318	Oil filter adapter; New Part Number - Check for Availability	
QTY	OIL COOLER	YEARS	PART NO.	DESCRIPTION	
1	Oil Cooler Gasket	2013	71319	Oil cooler O-ring; New Part Number - Check for Availability	
42	2013 - 2010; 3.5L 213.3 (3496cc) DOHC V6 (24 Valve) 92.5mm Bore EcoBoost Duratec VVT				42
DI; Gasoline; Turbo - Intercooled Ford Eng.; VIN Code T					
QTY	MANIFOLD - INT. & EXH.	YEARS	PART NO.	DESCRIPTION	
1	Exh. Manifold Gasket Set	2013-10	MS 97218	New Part Number - Check for Availability	
43	2012 - 2009; 3.7L 227 (3721cc) DOHC V6 (24 Valve) 95.5mm Bore Duratec Cyclone				43
MFI; Gasoline; Naturally Aspirated Ford Eng.; VIN Code R					
QTY	CYLINDER HEAD	YEARS	PART NO.	DESCRIPTION	
1	Head Gasket	2012-09	26543 PT	Loc. R.H.; Head bolts not incl.; Head bolt replacement recommended; PermaTorqueMLS®; New Part Number - Check for Availability	
1	Head Gasket	2012-09	26544 PT	Loc. L.H.; Head bolts not incl.; Head bolt replacement recommended; PermaTorqueMLS®; New Part Number - Check for Availability	
1	Head Set	2010-09	HS 26543 PT-1	Head bolts not incl.; Head bolt replacement recommended; PermaDry® molded rubber valve cover gsks. incl.; Premium valve stem seals incl.; New Part Number - Check for Availability	
2	Head Bolt Set	2012-09	ES 71324	Replacement recommended; New Part Number - Check for Availability	
QTY	CONVERSION SET	YEARS	PART NO.	DESCRIPTION	
1	Gasket Conversion Set	2012-09	CS 26543	RTV sealant incl. for oil pan gskt.; New Part Number - Check for Availability	
QTY	MANIFOLD - INT. & EXH.	YEARS	PART NO.	DESCRIPTION	
1	Int. Manifold Gasket Set	2012-09	MS 97118	Lower set; Upper set incl.; New Part Number - Check for Availability	
1	Plenum Gasket Set	2012-09	MS 97120	Upper set	
1	Exh. Manifold Gasket Set	2012-11	MS 97217	New Part Number - Check for Availability	
1	Exh. Manifold Gasket Set	2010-09	MS 97121		
QTY	EXHAUST PIPE FLANGE	YEARS	PART NO.	DESCRIPTION	
2	Exhaust Pipe Gasket	2012-09	61236	Loc. Rear No. 1; Converter	
1	Exhaust Pipe Gasket	2012-09	61406	Exh. connector	
1	Exhaust Pipe Gasket	2012-09	61525	Loc. Rear No. 2; Converter; Improved design	
2	Exhaust Pipe Gasket	2012-09	61622	Flange	
QTY	CRANKSHAFT REAR SEAL	YEARS	PART NO.	DESCRIPTION	
1	Rear Main Seal Set	2012-09	BS 40729	Rubber; One-piece	
QTY	VALVE COVER	YEARS	PART NO.	DESCRIPTION	
1	Valve Cover Gasket Set	2012-09	VS 50767 R	w/Grommets & Spark plug tube seals; PermaDry® molded rubber gsks. incl.; New Part Number - Check for Availability	
QTY	VALVE STEM SEAL SET	YEARS	PART NO.	DESCRIPTION	
1	Valve Stem Seal Set	2012-09	SS 71327	Premium valve stem seals incl.	
QTY	THERMOSTAT HOUSING	YEARS	PART NO.	DESCRIPTION	
1	Thermostat Gasket	2012-09	35934	Thermostat case	
QTY	WATER OUTLET GASKET	YEARS	PART NO.	DESCRIPTION	
1	Water Outlet Gasket	2012-09	35489	Thermostat seal	

Ford Car (Incl. Edsel, Ford, Lincoln, Mercury, Merkur) (Cont.)

43		2012 - 2009; 3.7L 227 (3721cc) DOHC V6 (24 Valve) 95.5mm Bore Duratec Cyclone			43
(cont.)		MFI; Gasoline; Naturally Aspirated Ford Eng.; VIN Code R			(cont.)
QTY	WATER PUMP	YEARS	PART NO.	DESCRIPTION	
1	Water Pump Gasket	2012-09	35930	Loc. Outer	
1	Water Pump Gasket	2012-09	35932	Loc. Inner	
QTY	TIMING COVER	YEARS	PART NO.	DESCRIPTION	
1	Crankshaft Front Seal Set	2012-09	TCS 46117		
QTY	CARB & FUEL INJECTION	YEARS	PART NO.	DESCRIPTION	
2	Fuel Injector O-Ring Set	2012-09	ES 70599	Upper set; Injectors to fuel rail; Improved design	
1	Throttle Body Gasket	2012-09	61466		
QTY	OIL FILTER MOUNTING	YEARS	PART NO.	DESCRIPTION	
1	Oil Filter Adapter Gasket	2012-09	71318	Oil filter adapter; New Part Number - Check for Availability	
QTY	OIL COOLER	YEARS	PART NO.	DESCRIPTION	
1	Oil Cooler Gasket	2012-09	71319	Oil cooler O-ring; New Part Number - Check for Availability	
44		2013; 3.7L 227 (3721cc) DOHC V6 (24 Valve) 95.5mm Bore Duratec Cyclone VVT			44
		MFI; Gasoline; Naturally Aspirated Ford Eng.; VIN Code K			
QTY	CYLINDER HEAD	YEARS	PART NO.	DESCRIPTION	
1	Head Gasket	2013	26543 PT	Loc. R.H.; Head bolts not incl.; Head bolt replacement recommended; PermaTorqueMLS®; New Part Number - Check for Availability	
1	Head Gasket	2013	26544 PT	Loc. L.H.; Head bolts not incl.; Head bolt replacement recommended; PermaTorqueMLS®; New Part Number - Check for Availability	
2	Head Bolt Set	2013	ES 71324	Replacement recommended; New Part Number - Check for Availability	
QTY	CONVERSION SET	YEARS	PART NO.	DESCRIPTION	
1	Gasket Conversion Set	2013	CS 26543	RTV sealant incl. for oil pan gskt.; New Part Number - Check for Availability	
QTY	MANIFOLD - INT. & EXH.	YEARS	PART NO.	DESCRIPTION	
1	Int. Manifold Gasket Set	2013	MS 97118-1	Lower set; Upper set incl.; New Part Number - Check for Availability	
1	Plenum Gasket Set	2013	MS 97214	Upper set; New Part Number - Check for Availability	
1	Exh. Manifold Gasket Set	2013	MS 97217	New Part Number - Check for Availability	
QTY	EXHAUST PIPE FLANGE	YEARS	PART NO.	DESCRIPTION	
2	Exhaust Pipe Gasket	2013	61236	Loc. Rear; Converter	
2	Exhaust Pipe Gasket	2013	61620	Loc. Front; Ring	
QTY	CRANKSHAFT REAR SEAL	YEARS	PART NO.	DESCRIPTION	
1	Rear Main Seal Set	2013	BS 40729	Rubber; One-piece	
QTY	VALVE COVER	YEARS	PART NO.	DESCRIPTION	
1	Valve Cover Gasket Set	2013	VS 50814 R	w/Grommets & Spark plug tube seals; PermaDry® molded rubber gskts. incl.; New Part Number - Check for Availability	
QTY	VALVE STEM SEAL SET	YEARS	PART NO.	DESCRIPTION	
1	Valve Stem Seal Set	2013	SS 71327	Premium valve stem seals incl.	
QTY	THERMOSTAT HOUSING	YEARS	PART NO.	DESCRIPTION	
1	Thermostat Gasket	2013	35934	Thermostat case	
QTY	WATER OUTLET GASKET	YEARS	PART NO.	DESCRIPTION	
1	Water Outlet Gasket	2013	35489	Thermostat seal	
QTY	WATER PUMP	YEARS	PART NO.	DESCRIPTION	
1	Water Pump Gasket	2013	35930	Loc. Outer	
1	Water Pump Gasket	2013	35932	Loc. Inner	
1	Water Pump Gasket	2013	35994	New Part Number - Check for Availability	
QTY	TIMING COVER	YEARS	PART NO.	DESCRIPTION	
1	Crankshaft Front Seal Set	2013	TCS 46117		
QTY	CARB & FUEL INJECTION	YEARS	PART NO.	DESCRIPTION	
2	Fuel Injector O-Ring Set	2013	ES 70599	Upper set; Injectors to fuel rail; Improved design	
1	Throttle Body Gasket	2013	61466		
QTY	OIL FILTER MOUNTING	YEARS	PART NO.	DESCRIPTION	
1	Oil Filter Adapter Gasket	2013	71318	Oil filter adapter; New Part Number - Check for Availability	
QTY	OIL COOLER	YEARS	PART NO.	DESCRIPTION	
1	Oil Cooler Gasket	2013	71319	Oil cooler O-ring; New Part Number - Check for Availability	
45		2013 - 2011; 3.7L 227 (3721cc) DOHC V6 (24 Valve) 95.5mm Bore Duratec Cyclone VVT			45
		MFI; Gasoline; Naturally Aspirated Ford Eng.; VIN Code M			
QTY	CYLINDER HEAD	YEARS	PART NO.	DESCRIPTION	
1	Head Gasket	2013-11	26543 PT	Loc. R.H.; Head bolts not incl.; Head bolt replacement recommended; PermaTorqueMLS®; New Part Number - Check for Availability	
1	Head Gasket	2013-11	26544 PT	Loc. L.H.; Head bolts not incl.; Head bolt replacement recommended; PermaTorqueMLS®; New Part Number - Check for Availability	

Ford Car (Incl. Edsel, Ford, Lincoln, Mercury, Merkur) (Cont.)

45 (cont.)		2013 - 2011; 3.7L 227 (3721cc) DOHC V6 (24 Valve) 95.5mm Bore Duratec Cyclone VVT			45 (cont.)
MFI; Gasoline; Naturally Aspirated Ford Eng.; VIN Code M					
QTY	CYLINDER HEAD	YEARS	PART NO.	DESCRIPTION	
1	Head Set	2013-11	HS 26543 PT	Head bolts not incl.; Head bolt replacement recommended; PermaDry® molded rubber valve cover gsks. incl.; Premium valve stem seals incl.; New Part Number - Check for Availability	
2	Head Bolt Set	2013-11	ES 71324	Replacement recommended; New Part Number - Check for Availability	
QTY	CONVERSION SET	YEARS	PART NO.	DESCRIPTION	
1	Gasket Conversion Set	2013-11	CS 26543-1	RTV sealant incl. for oil pan gskt.; New Part Number - Check for Availability	
QTY	MANIFOLD - INT. & EXH.	YEARS	PART NO.	DESCRIPTION	
1	Int. Manifold Gasket Set	2013-11	MS 97118-1	Lower set; Upper set incl.; New Part Number - Check for Availability	
1	Plenum Gasket Set	2013-11	MS 97214	Upper set; New Part Number - Check for Availability	
1	Exh. Manifold Gasket Set	2013-11	MS 97216	New Part Number - Check for Availability	
QTY	EXHAUST PIPE FLANGE	YEARS	PART NO.	DESCRIPTION	
2	Exhaust Pipe Gasket	2013-11	61236	Loc. Rear; Converter	
QTY	CRANKSHAFT REAR SEAL	YEARS	PART NO.	DESCRIPTION	
1	Rear Main Seal Set	2013-11	BS 40729	Rubber; One-piece	
QTY	VALVE COVER	YEARS	PART NO.	DESCRIPTION	
1	Valve Cover Gasket Set	2013-11	VS 50814 R	w/Grommets & Spark plug tube seals; PermaDry® molded rubber gsks. incl.; New Part Number - Check for Availability	
QTY	VALVE STEM SEAL SET	YEARS	PART NO.	DESCRIPTION	
1	Valve Stem Seal Set	2013-11	SS 71327	Premium valve stem seals incl.	
QTY	THERMOSTAT HOUSING	YEARS	PART NO.	DESCRIPTION	
1	Thermostat Gasket	2013-11	35934	Thermostat Housing; Thermostat case	
1	Thermostat Gasket	2013-11	35991	Thermostat Housing; Thermostat seal; New Part Number - Check for Availability	
QTY	WATER PUMP	YEARS	PART NO.	DESCRIPTION	
1	Water Pump Gasket	2013-11	35989	Timing chain driven water pump; New Part Number - Check for Availability	
1	Water Pump Gasket	2013-11	35990	Serpentine belt driven water pump; New Part Number - Check for Availability	
1	Water Pump Gasket	2013-11	35996	Loc. Inner; New Part Number - Check for Availability	
1	Water Pump Gasket	2013-11	35997	Loc. Outer; New Part Number - Check for Availability	
QTY	TIMING COVER	YEARS	PART NO.	DESCRIPTION	
1	Timing Cover Set	2013-11	TCS 46182	New Part Number - Check for Availability	
1	Crankshaft Front Seal Set	2013-11	TCS 46117		
QTY	CARB & FUEL INJECTION	YEARS	PART NO.	DESCRIPTION	
2	Fuel Injector O-Ring Set	2013-11	ES 70599	Upper set; Injectors to fuel rail; Improved design	
1	Throttle Body Gasket	2013-11	61466		
QTY	OIL FILTER MOUNTING	YEARS	PART NO.	DESCRIPTION	
1	Oil Filter Adapter Gasket	2013-11	71318	Oil filter adapter; New Part Number - Check for Availability	
QTY	OIL COOLER	YEARS	PART NO.	DESCRIPTION	
1	Oil Cooler Gasket	2013-11	71319	Oil cooler O-ring; New Part Number - Check for Availability	
46		2004 - 1991; 3.8L 232 (3797cc) OHV V6 (12 Valve) 96.8mm Bore			46
MFI; Gasoline; Naturally Aspirated Ford Eng.; VIN Code 4					
QTY	CYLINDER HEAD	YEARS	PART NO.	DESCRIPTION	
1	Head Gasket	2004-99	26505 PT	Loc. L.H.; .010" thicker for use when head is refaced; Head bolts not incl.; Head bolt replacement required; PermaTorqueMLS®	
1	Head Gasket	2004-99	26506 PT	Loc. R.H.; .010" thicker for use when head is refaced; Head bolts not incl.; Head bolt replacement required; PermaTorqueMLS®	
1	Head Gasket	2004-99	9250 PT	Loc. L.H.; Head bolts not incl.; Head bolt replacement required; PermaTorqueMLS®	
1	Head Gasket	2004-99	9253 PT	Loc. R.H.; Head bolts not incl.; Head bolt replacement required; PermaTorqueMLS®	
1	Head Gasket	1998-97	9262 PT	Loc. L.H.; Head bolts not incl.; Head bolt replacement required; PermaTorqueMLS®	
1	Head Gasket	1998-97	9263 PT	Loc. R.H.; Head bolts not incl.; Head bolt replacement required; PermaTorqueMLS®	
2	Head Gasket	1996	8857 PT-1	Head bolts not incl.; Head bolt replacement required; PermaTorque®	
2	Head Gasket	1995	8857 PT-1	Exc. Ford Taurus GL, LX, SE Mercury Sable GS, LS; Head bolts not incl.; Head bolt replacement required; PermaTorque®	
2	Head Gasket	1995	9560 PT	Ford Taurus GL, LX, SE Mercury Sable GS, LS; Head bolts not incl.; Head bolt replacement required; PermaTorque®	
2	Head Gasket	1994	8857 PT-1	Ford Mustang Base, Thunderbird LX Mercury Cougar XR-7; Head bolts not incl.; Head bolt replacement required; PermaTorque®	
2	Head Gasket	1994	9560 PT	Exc. Ford Mustang Base, Thunderbird LX Mercury Cougar XR-7; Head bolts not incl.; Head bolt replacement required; PermaTorque®	

Ford Car (Incl. Edsel, Ford, Lincoln, Mercury, Merkur) (Cont.)

46 (cont.)		2004 - 1991; 3.8L 232 (3797cc) OHV V6 (12 Valve) 96.8mm Bore			46 (cont.)
MFI; Gasoline; Naturally Aspirated Ford Eng.; VIN Code 4					
QTY	CYLINDER HEAD	YEARS	PART NO.	DESCRIPTION	
2	Head Gasket	1993	8857 PT-1	Ford Thunderbird LX Mercury Cougar XR-7; Head bolts not incl.; Head bolt replacement required; PermaTorque®	
2	Head Gasket	1993	9560 PT	Exc. Ford Thunderbird LX Mercury Cougar XR-7; Head bolts not incl.; Head bolt replacement required; PermaTorque®	
2	Head Gasket	1992-91	8857 PT-1	Ford Thunderbird Base, LX Mercury Cougar LS, XR-7; Head bolts not incl.; Head bolt replacement required; PermaTorque®	
2	Head Gasket	1992-91	9560 PT	Exc. Ford Thunderbird Base, LX Mercury Cougar LS, XR-7; Head bolts not incl.; Head bolt replacement required; PermaTorque®	
2	Head Gasket Spacer Shim	1996	8857 SP-1	HeadSaver®	
2	Head Gasket Spacer Shim	1995	8857 SP-1	Exc. Ford Taurus GL, LX, SE Mercury Sable GS, LS; HeadSaver®	
2	Head Gasket Spacer Shim	1995	9560 SP	Ford Taurus GL, LX, SE Mercury Sable GS, LS; HeadSaver®	
2	Head Gasket Spacer Shim	1994	8857 SP-1	Ford Mustang Base, Thunderbird LX Mercury Cougar XR-7; HeadSaver®	
2	Head Gasket Spacer Shim	1994	9560 SP	Exc. Ford Mustang Base, Thunderbird LX Mercury Cougar XR-7; HeadSaver®	
2	Head Gasket Spacer Shim	1993	8857 SP-1	Ford Thunderbird LX Mercury Cougar XR-7; HeadSaver®	
2	Head Gasket Spacer Shim	1993	9560 SP	Exc. Ford Thunderbird LX Mercury Cougar XR-7; HeadSaver®	
2	Head Gasket Spacer Shim	1992-91	8857 SP-1	Ford Thunderbird Base, LX Mercury Cougar LS, XR-7; HeadSaver®	
2	Head Gasket Spacer Shim	1992-91	9560 SP	Exc. Ford Thunderbird Base, LX Mercury Cougar LS, XR-7; HeadSaver®	
1	Head Set	2004-99	HS 9250 PT-2	Head bolts not incl.; Head bolt replacement required; PermaDry® molded rubber valve cover gskts. incl.; Premium valve stem seals incl.; PermaDry® molded rubber valve cover gskts. incl.; Premium valve stem seals incl.	
1	Head Set	1998-97	HS 9262 PT	Head bolts not incl.; Head bolt replacement required; PermaDry® molded rubber valve cover gskts. incl.; Premium valve stem seals incl.	
1	Head Set	1996	HS 8857 PT-8	Head bolts not incl.; Head bolt replacement required; PermaDry® molded rubber valve cover gskts. incl.; Premium valve stem seals incl.	
1	Head Set	1995-94	HS 8857 PT-6	Ford Thunderbird LX Mercury Cougar XR-7; Head bolts not incl.; Head bolt replacement required; PermaDry® molded rubber valve cover gskts. incl.; Premium valve stem seals incl.	
1	Head Set	1995-94	HS 8857 PT-7	Ford Mustang Base; Head bolts not incl.; Head bolt replacement required; PermaDry® molded rubber valve cover gskts. incl.; Premium valve stem seals incl.	
1	Head Set	1995	HS 9560 PT-2	Ford Taurus GL, LX, SE Mercury Sable GS, LS; Head bolts not incl.; Head bolt replacement required; PermaDry® molded rubber valve cover gskts. incl.; Premium valve stem seals incl.	
1	Head Set	1994	HS 9560 PT-2	Exc. Ford Mustang Base, Thunderbird LX Mercury Cougar XR-7; Head bolts not incl.; Head bolt replacement required; PermaDry® molded rubber valve cover gskts. incl.; Premium valve stem seals incl.	
1	Head Set	1993	HS 8857 PT-5	Ford Thunderbird LX Mercury Cougar XR-7; Head bolts not incl.; Head bolt replacement required; PermaDry® molded rubber valve cover gskts. incl.; Premium valve stem seals incl.	
1	Head Set	1993	HS 9560 PT-1	Exc. Ford Thunderbird LX Mercury Cougar XR-7; Head bolts not incl.; Head bolt replacement required; PermaDry® molded rubber valve cover gskts. incl.; Premium valve stem seals incl.	
1	Head Set	1992-91	HS 8857 PT-5	Ford Thunderbird Base, LX Mercury Cougar LS, XR-7; Head bolts not incl.; Head bolt replacement required; PermaDry® molded rubber valve cover gskts. incl.; Premium valve stem seals incl.	
1	Head Set	1992-91	HS 9560 PT-1	Exc. Ford Thunderbird Base, LX Mercury Cougar LS, XR-7; Head bolts not incl.; Head bolt replacement required; PermaDry® molded rubber valve cover gskts. incl.; Premium valve stem seals incl.	
1	Head Installation Set	1995	HIS 9560 PT-2	Ford Taurus GL, LX, SE Mercury Sable GS, LS; Head bolts not incl.; Head bolt replacement required; PermaDry® molded rubber valve cover gskts. incl.	
1	Head Installation Set	1994	HIS 9560 PT-2	Exc. Ford Mustang Base, Thunderbird LX Mercury Cougar XR-7; Head bolts not incl.; Head bolt replacement required; PermaDry® molded rubber valve cover gskts. incl.	
1	Head Installation Set	1993	HIS 8857 PT-5	Ford Thunderbird LX Mercury Cougar XR-7; Head bolts not incl.; Head bolt replacement required; PermaDry® molded rubber valve cover gskts. incl.	
1	Head Installation Set	1993	HIS 9560 PT-1	Exc. Ford Thunderbird LX Mercury Cougar XR-7; Head bolts not incl.; Head bolt replacement required; PermaDry® molded rubber valve cover gskts. incl.	
1	Head Installation Set	1992-91	HIS 8857 PT-5	Ford Thunderbird Base, LX Mercury Cougar LS, XR-7; Head bolts not incl.; Head bolt replacement required; PermaDry® molded rubber valve cover gskts. incl.	

Ford Car (Incl. Edsel, Ford, Lincoln, Mercury, Merkur) (Cont.)

46 (cont.)		2004 - 1991; 3.8L 232 (3797cc) OHV V6 (12 Valve) 96.8mm Bore			46 (cont.)
		MFI; Gasoline; Naturally Aspirated Ford Eng.; VIN Code 4			
QTY	CYLINDER HEAD	YEARS	PART NO.	DESCRIPTION	
1	Head Installation Set	1992-91	HIS 9560 PT-1	Exc. Ford Thunderbird Base, LX Mercury Cougar LS, XR-7; Head bolts not incl.; Head bolt replacement required; PermaDry® molded rubber valve cover gsks. incl.	
2	Head Bolt Set	2004-97	ES 72160	Replacement required	
2	Head Bolt Set	1996	ES 72156	Replacement required	
2	Head Bolt Set	1995-91	ES 72131	Replacement required	
QTY	CONVERSION SET	YEARS	PART NO.	DESCRIPTION	
1	Gasket Conversion Set	2004-01	CS 9250-1	RTV sealant incl. for oil pan gskt.; PermaDryPlus® timing cover gskt. incl.	
1	Gasket Conversion Set	2000	CS 9250	RTV sealant incl. for oil pan gskt.; PermaDryPlus® timing cover gskt. incl.	
1	Gasket Conversion Set	1999-94	CS 8857-6	RTV sealant incl. for oil pan gskt.; PermaDryPlus® timing cover gskt. incl.	
1	Gasket Conversion Set	1993-91	CS 8857-5	RTV sealant incl. for oil pan gskt.; PermaDryPlus® timing cover gskt. incl.	
QTY	MANIFOLD - INT. & EXH.	YEARS	PART NO.	DESCRIPTION	
1	Int. Manifold Gasket Set	2004-99	MS 95985	Lower set	
1	Int. Manifold Gasket Set	2004-99	MS 98011 T-2	Lower set; Upper set incl.; PermaDryPlus® int. manifold gsks. incl.	
1	Int. Manifold Gasket Set	1998-96	MS 95731	Lower set; Upper set incl.	
1	Int. Manifold Gasket Set	1995-91	MS 94045	Lower set; Upper set incl.	
1	Plenum Gasket Set	2004-99	MS 95981	Upper set	
1	Plenum Gasket Set	1998-91	MS 94046	Upper set	
1	Exh. Manifold Gasket Set	2004-99	MS 95968		
1	Exh. Manifold Gasket Set	1998-96	MS 95528		
1	Exh. Manifold Gasket Set	1995-94	MS 91346	Exc. Ford Mustang Base	
1	Exh. Manifold Gasket Set	1995-94	MS 95528	Ford Mustang Base	
1	Exh. Manifold Gasket Set	1993-91	MS 91346		
QTY	EXHAUST PIPE FLANGE	YEARS	PART NO.	DESCRIPTION	
1	Exhaust Pipe Gasket	1996	60885	Converter	
1	Exhaust Pipe Gasket	1995	60641	Converter; Dual exh.	
1	Exhaust Pipe Gasket	1995	60885	Converter; Single exh.	
1	Exhaust Pipe Gasket	1994-91	60641	Exc. Lincoln Continental Base, Executive, Signature; Converter; Dual exh.	
1	Exhaust Pipe Gasket	1994-91	60885	Lincoln Continental Base, Executive, Signature; Converter	
1	Exhaust Pipe Gasket	1994-91	60885	Exc. Lincoln Continental Base, Executive, Signature; Converter; Single exh.	
1	Exh. Flange Bolt & Spring Kit	2001-91	ES 72142		
QTY	OIL PAN	YEARS	PART NO.	DESCRIPTION	
1	Oil Pan Gasket Set	2004-01	OS 30702 R	RTV Black silicone w/Rubber end seal	
1	Oil Pan Gasket Set	2000-91	OS 30625 R	RTV Black silicone w/Rubber end seal	
1	Drain Plug Gasket	2004-91	72515		
QTY	CRANKSHAFT REAR SEAL	YEARS	PART NO.	DESCRIPTION	
1	Rear Main Seal Set	2004-91	BS 40620	Rubber; One-piece; Improved design	
1	Rear Main Seal Set	2004-91	BS 40644	PTFE Rubber; One-piece	
1	Repair Sleeve	2004-91	16250	Crankshaft; Use w/installation tool	
1	Repair Sleeve Tool	2004-91	16300	Crankshaft	
QTY	VALVE COVER	YEARS	PART NO.	DESCRIPTION	
1	Valve Cover Gasket Set	2004-94	VS 50441 R	w/Grommets; PermaDry® molded rubber gsks. incl.	
1	Valve Cover Gasket Set	2004-94	VS 50441 R-1	w/o Grommets; PermaDry® molded rubber gsks. incl.	
1	Valve Cover Gasket Set	1993-91	VS 50070 R	Services both covers; PermaDry® molded rubber gsks. incl.	
2	Valve Cover Gasket Set	1993-91	VS 50321 R	Services one cover only; PermaDry® molded rubber gskt. incl.	
QTY	VALVE STEM SEAL SET	YEARS	PART NO.	DESCRIPTION	
1	Valve Stem Seal Set	2004-99	SS 70864-1	Loc. Int. & Exh.; Premium valve stem seals incl.	
1	Valve Stem Seal Set	1998-96	SS 72875-1	Loc. Int. & Exh.; Premium valve stem seals incl.	
2	Valve Stem Seal Set	1995-91	SS 72708	Loc. Int. & Exh.; Premium valve stem seals incl.	
QTY	THERMOSTAT HOUSING	YEARS	PART NO.	DESCRIPTION	
1	Water Outlet Gasket	1996	35390	Thermostat Housing; w/o Notch	
1	Water Outlet Gasket	1996	35390 T	Thermostat Housing; w/o Notch; PermaDryPlus®	
1	Thermostat Gasket	1996	35706	Thermostat Housing; Seal; w/Notch	
QTY	WATER OUTLET GASKET	YEARS	PART NO.	DESCRIPTION	
1	Water Outlet Gasket	2004-97	35390	Water Outlet	
1	Water Outlet Gasket	2004-97	35390 T	Water Outlet; PermaDryPlus®	
1	Water Outlet Gasket	1995-91	35390	Water Outlet	
1	Water Outlet Gasket	1995-91	35390 T	Water Outlet; PermaDryPlus®	
QTY	WATER PUMP	YEARS	PART NO.	DESCRIPTION	
1	Water Pump Gasket	2004-96	35431		
1	Water Pump Gasket	1995-91	35414		
2	O-Ring	2004-91	413	Water Pump; Water pump bypass pipe O-ring	
1	O-Ring	1995	35608	Ford Taurus GL, LX, SE Mercury Sable GS, LS; Water Pump; Inlet tube	

Ford Car (Incl. Edsel, Ford, Lincoln, Mercury, Merkur) (Cont.)

46 (cont.)		2004 - 1991; 3.8L 232 (3797cc) OHV V6 (12 Valve) 96.8mm Bore			46 (cont.)
MFI; Gasoline; Naturally Aspirated Ford Eng.; VIN Code 4					
QTY	WATER PUMP	YEARS	PART NO.	DESCRIPTION	
1	O-Ring	1994	35608	Exc. Ford Mustang Base, Thunderbird LX Mercury Cougar XR-7; Water Pump; Inlet tube	
1	O-Ring	1993	35608	Exc. Ford Thunderbird LX Mercury Cougar XR-7; Water Pump; Inlet tube	
1	O-Ring	1992-91	35608	Exc. Ford Thunderbird Base, LX Mercury Cougar LS, XR-7; Water Pump; Inlet tube	
QTY	TIMING COVER	YEARS	PART NO.	DESCRIPTION	
1	Timing Cover Set	2004-00	TCS 45984	PermaDryPlus® timing cover gskt. incl.	
1	Timing Cover Set	1999-94	TCS 45951	PermaDryPlus® timing cover gskt. incl.	
1	Timing Cover Set	1993-91	TCS 45826	w/o Sleeve 'N' Seal®; PermaDryPlus® timing cover gskt. incl.	
1	Timing Cover Gasket	2004-91	72754	PermaDryPlus® timing cover gskt. incl.; New Part Number - Check for Availability	
1	Timing Set w/Sleeve & Seal	1993-91	TCS 45878	w/Sleeve 'N' Seal®; PermaDryPlus® timing cover gskt. incl.	
1	Repair Sleeve	1993-91	16213	Timing Cover; Use w/installation tool	
1	Repair Sleeve Tool	1993-91	16310	Timing Cover	
QTY	CARB & FUEL INJECTION	YEARS	PART NO.	DESCRIPTION	
2	Fuel Injector O-Ring Set	2004-91	ES 70599	Improved design	
1	Throttle Body Gasket	2004-91	71216	Air bypass valve	
1	Throttle Body Gasket	2004-99	61052	Mounting	
1	Throttle Body Gasket	1998-94	60913	Mounting	
1	Throttle Body Gasket	1993-91	60843	Mounting	
QTY	EXHAUST GAS RECIRCULATION	YEARS	PART NO.	DESCRIPTION	
1	EGR Gasket	2004-91	70149		
QTY	OIL COOLER	YEARS	PART NO.	DESCRIPTION	
1	Oil Cooler Gasket	2004-94	72655	Oil cooler seal; New Part Number - Check for Availability	
47		1995 - 1991; 3.8L 232 (3797cc) OHV V6 (12 Valve) 96.8mm Bore			47
MFI; Gasoline; Supercharged Ford Eng.; VIN Code R					
QTY	CYLINDER HEAD	YEARS	PART NO.	DESCRIPTION	
2	Head Gasket	1995-91	9642 PT-1	Head bolts not incl.; Head bolt replacement required; PermaTorque®	
1	Head Set	1995-94	HS 9642 PT-1	Head bolts not incl.; Head bolt replacement required; PermaDry® molded rubber valve cover gskts. incl.; Premium valve stem seals incl.	
1	Head Set	1993-91	HS 9642 PT	Head bolts not incl.; Head bolt replacement required; PermaDry® molded rubber valve cover gskts. incl.; Premium valve stem seals incl.	
2	Head Bolt Set	1995-91	ES 72131	Replacement required	
QTY	CONVERSION SET	YEARS	PART NO.	DESCRIPTION	
1	Gasket Conversion Set	1995-94	CS 8857-6	RTV sealant incl. for oil pan gskt.; PermaDryPlus® timing cover gskt. incl.	
1	Gasket Conversion Set	1993-91	CS 8857-5	RTV sealant incl. for oil pan gskt.; PermaDryPlus® timing cover gskt. incl.	
QTY	MANIFOLD - INT. & EXH.	YEARS	PART NO.	DESCRIPTION	
1	Int. Manifold Gasket Set	1995-91	MS 94045-1	Lower set; Upper set incl.	
1	Exh. Manifold Gasket Set	1995-91	MS 91346		
QTY	EXHAUST PIPE FLANGE	YEARS	PART NO.	DESCRIPTION	
1	Exhaust Pipe Gasket	1995-91	60641	Converter; Dual exh.	
1	Exhaust Pipe Gasket	1995-91	60885	Converter; Single exh.	
1	Exh. Flange Bolt & Spring Kit	1995-91	ES 72142		
QTY	OIL PAN	YEARS	PART NO.	DESCRIPTION	
1	Oil Pan Gasket Set	1995-91	OS 30625 R	RTV Black silicone w/Rubber end seal	
1	Drain Plug Gasket	1995-91	72515		
QTY	CRANKSHAFT REAR SEAL	YEARS	PART NO.	DESCRIPTION	
1	Rear Main Seal Set	1995-91	BS 40620	Rubber; One-piece; Improved design	
1	Rear Main Seal Set	1995-91	BS 40644	PTFE Rubber; One-piece	
1	Repair Sleeve	1995-91	16250	Crankshaft; Use w/installation tool	
1	Repair Sleeve Tool	1995-91	16300	Crankshaft	
QTY	VALVE COVER	YEARS	PART NO.	DESCRIPTION	
1	Valve Cover Gasket Set	1995-94	VS 50441 R	w/Grommets; PermaDry® molded rubber gskts. incl.	
1	Valve Cover Gasket Set	1995-94	VS 50441 R-1	w/o Grommets; PermaDry® molded rubber gskts. incl.	
1	Valve Cover Gasket Set	1993-91	VS 50070 R	Services both covers; PermaDry® molded rubber gskts. incl.	
2	Valve Cover Gasket Set	1993-91	VS 50321 R	Services one cover only; PermaDry® molded rubber gskt. incl.	
QTY	VALVE STEM SEAL SET	YEARS	PART NO.	DESCRIPTION	
2	Valve Stem Seal Set	1995-91	SS 72708	Loc. Int. & Exh.; Premium valve stem seals incl.	
QTY	WATER OUTLET GASKET	YEARS	PART NO.	DESCRIPTION	
1	Water Outlet Gasket	1995-91	35459	Water Outlet	
QTY	WATER PUMP	YEARS	PART NO.	DESCRIPTION	
1	Water Pump Gasket	1995-91	35414		

Ford Car (Incl. Edsel, Ford, Lincoln, Mercury, Merkur) (Cont.)

47 (cont.)		1995 - 1991; 3.8L 232 (3797cc) OHV V6 (12 Valve) 96.8mm Bore			47 (cont.)
		MFI; Gasoline; Supercharged Ford Eng.; VIN Code R			
QTY	WATER PUMP	YEARS	PART NO.	DESCRIPTION	
2	O-Ring	1995-91	413	Water Pump; Water pump bypass pipe O-ring	
QTY	TIMING COVER	YEARS	PART NO.	DESCRIPTION	
1	Timing Cover Set	1995-94	TCS 45951	PermaDryPlus® timing cover gskt. incl.	
1	Timing Cover Set	1993-91	TCS 45826	w/o Sleeve 'N' Seal®; PermaDryPlus® timing cover gskt. incl.	
1	Timing Cover Gasket	1995-91	72754	PermaDryPlus® timing cover gskt. incl.; New Part Number - Check for Availability	
1	Timing Set w/Sleeve & Seal	1993-91	TCS 45878	w/Sleeve 'N' Seal®; PermaDryPlus® timing cover gskt. incl.	
1	Repair Sleeve	1993-91	16213	Timing Cover; Use w/installation tool	
1	Repair Sleeve Tool	1993-91	16310	Timing Cover	
QTY	CARB & FUEL INJECTION	YEARS	PART NO.	DESCRIPTION	
2	Fuel Injector O-Ring Set	1995-91	ES 70599	Improved design	
1	Throttle Body Gasket	1995-91	60859	Mounting	
1	Throttle Body Gasket	1995-91	71216	Air bypass valve	
QTY	EXHAUST GAS RECIRCULATION	YEARS	PART NO.	DESCRIPTION	
1	EGR Gasket	1995-91	70149		
QTY	OIL COOLER	YEARS	PART NO.	DESCRIPTION	
1	Oil Cooler Gasket	1995-94	72655	Oil cooler seal; New Part Number - Check for Availability	
48		2004; 3.9L 238 (3887cc) OHV V6 (12 Valve) 96.8mm Bore			48
		MFI; Gasoline; Naturally Aspirated Ford Eng.; VIN Code 6			
QTY	CYLINDER HEAD	YEARS	PART NO.	DESCRIPTION	
1	Head Gasket	2004	26505 PT	Loc. L.H.; .010" thicker for use when head is refaced; Head bolts not incl.; Head bolt replacement required; PermaTorqueMLS®	
1	Head Gasket	2004	26506 PT	Loc. R.H.; .010" thicker for use when head is refaced; Head bolts not incl.; Head bolt replacement required; PermaTorqueMLS®	
1	Head Gasket	2004	9250 PT	Loc. L.H.; Head bolts not incl.; Head bolt replacement required; PermaTorqueMLS®	
1	Head Gasket	2004	9253 PT	Loc. R.H.; Head bolts not incl.; Head bolt replacement required; PermaTorqueMLS®	
1	Head Set	2004	HS 9250 PT-2	Head bolts not incl.; Head bolt replacement required; PermaDry® molded rubber valve cover gskts. incl.; Premium valve stem seals incl.; PermaDry® molded rubber valve cover gskts. incl.; Premium valve stem seals incl.	
2	Head Bolt Set	2004	ES 72160	Replacement required	
QTY	CONVERSION SET	YEARS	PART NO.	DESCRIPTION	
1	Gasket Conversion Set	2004	CS 9250-1	RTV sealant incl. for oil pan gskt.; PermaDryPlus® timing cover gskt. incl.	
QTY	MANIFOLD - INT. & EXH.	YEARS	PART NO.	DESCRIPTION	
1	Int. Manifold Gasket Set	2004	MS 95985	Lower set	
1	Int. Manifold Gasket Set	2004	MS 98011 T-2	Lower set; Upper set incl.; PermaDryPlus® int. manifold gskts. incl.	
1	Plenum Gasket Set	2004	MS 95981	Upper set	
1	Exh. Manifold Gasket Set	2004	MS 95968		
QTY	OIL PAN	YEARS	PART NO.	DESCRIPTION	
1	Oil Pan Gasket Set	2004	OS 30702 R	RTV Black silicone w/Rubber end seal	
1	Drain Plug Gasket	2004	72515		
QTY	CRANKSHAFT REAR SEAL	YEARS	PART NO.	DESCRIPTION	
1	Rear Main Seal Set	2004	BS 40620	Rubber; One-piece; Improved design	
1	Rear Main Seal Set	2004	BS 40644	PTFE Rubber; One-piece	
1	Repair Sleeve	2004	16250	Crankshaft; Use w/installation tool	
1	Repair Sleeve Tool	2004	16300	Crankshaft	
QTY	VALVE COVER	YEARS	PART NO.	DESCRIPTION	
1	Valve Cover Gasket Set	2004	VS 50441 R	w/Grommets; PermaDry® molded rubber gskts. incl.	
1	Valve Cover Gasket Set	2004	VS 50441 R-1	w/o Grommets; PermaDry® molded rubber gskts. incl.	
QTY	VALVE STEM SEAL SET	YEARS	PART NO.	DESCRIPTION	
1	Valve Stem Seal Set	2004	SS 70864-1	Premium valve stem seals incl.	
QTY	WATER OUTLET GASKET	YEARS	PART NO.	DESCRIPTION	
1	Water Outlet Gasket	2004	35390	Water Outlet	
1	Water Outlet Gasket	2004	35390 T	Water Outlet; PermaDryPlus®	
QTY	WATER PUMP	YEARS	PART NO.	DESCRIPTION	
1	Water Pump Gasket	2004	35431		
2	O-Ring	2004	413	Water Pump; Water pump bypass pipe O-ring	
QTY	TIMING COVER	YEARS	PART NO.	DESCRIPTION	
1	Timing Cover Set	2004	TCS 45984	PermaDryPlus® timing cover gskt. incl.	
1	Timing Cover Gasket	2004	72754	PermaDryPlus® timing cover gskt. incl.; New Part Number - Check for Availability	

Ford Car (Incl. Edsel, Ford, Lincoln, Mercury, Merkur) (Cont.)

48 (cont.)		2004; 3.9L 238 (3887cc) OHV V6 (12 Valve) 96.8mm Bore			48 (cont.)
		MFI; Gasoline; Naturally Aspirated Ford Eng.; VIN Code 6			
QTY	CARB & FUEL INJECTION	YEARS	PART NO.	DESCRIPTION	
2	Fuel Injector O-Ring Set	2004	ES 70599	Improved design	
1	Throttle Body Gasket	2004	61052	Mounting	
1	Throttle Body Gasket	2004	72302	Air bypass valve	
QTY	EXHAUST GAS RECIRCULATION	YEARS	PART NO.	DESCRIPTION	
1	EGR Gasket	2004	70149		
QTY	OIL COOLER	YEARS	PART NO.	DESCRIPTION	
1	Oil Cooler Gasket	2004	72655	Oil cooler seal; New Part Number - Check for Availability	
49		2006 - 2000; 3.9L 241 (3949cc) DOHC V8 (32 Valve) 86mm Bore			49
		MFI; Gasoline; Naturally Aspirated Jaguar Eng.; VIN Code A			
QTY	CYLINDER HEAD	YEARS	PART NO.	DESCRIPTION	
1	Head Gasket	2006-00	26361 PT	Loc. L.H.; Head bolts not incl.; Head bolt replacement recommended; PermaTorqueMLS®	
1	Head Gasket	2006-00	26364 PT	Loc. R.H.; Head bolts not incl.; Head bolt replacement recommended; PermaTorqueMLS®	
1	Head Set	2006-03	HS 26361 PT-1	Head bolts not incl.; Head bolt replacement recommended; PermaDry® molded rubber valve cover gskts. incl.; Premium valve stem seals incl.	
1	Head Set	2002-00	HS 26361 PT	Head bolts not incl.; Head bolt replacement recommended; PermaDry® molded rubber valve cover gskts. incl.; Premium valve stem seals incl.	
2	Head Bolt Set	2006-00	ES 72262	Head bolts w/Washers; Replacement recommended	
QTY	CONVERSION SET	YEARS	PART NO.	DESCRIPTION	
1	Gasket Conversion Set	2006-00	CS 26361	1st Design oil pump mounting gskt. not incl.; PermaDry® molded rubber oil pan gskt. incl.	
QTY	MANIFOLD - INT. & EXH.	YEARS	PART NO.	DESCRIPTION	
1	Int. Manifold Gasket Set	2006-03	MS 96923	Lower set	
1	Int. Manifold Gasket Set	2002-00	MS 96936	Lower set	
1	Exh. Manifold Gasket Set	2006-03	MS 96925		
1	Exh. Manifold Gasket Set	2002-00	MS 96922		
QTY	OIL PAN	YEARS	PART NO.	DESCRIPTION	
1	Oil Pan Gasket Set	2006-00	OS 30790 R	PermaDry® molded rubber gskt. incl.	
QTY	CRANKSHAFT REAR SEAL	YEARS	PART NO.	DESCRIPTION	
1	Rear Main Seal Set	2006-00	BS 40706	Rubber; One-piece	
QTY	VALVE COVER	YEARS	PART NO.	DESCRIPTION	
1	Valve Cover Gasket Set	2006-00	VS 50724 R	w/Grommets & Spark plug tube seals; PermaDry® molded rubber gskts. incl.	
QTY	VALVE STEM SEAL SET	YEARS	PART NO.	DESCRIPTION	
1	Valve Stem Seal Set	2006-00	SS 72922	Premium valve stem seals incl.	
QTY	THERMOSTAT HOUSING	YEARS	PART NO.	DESCRIPTION	
1	Thermostat Gasket	2006-03	35848	Thermostat seal	
1	Thermostat Gasket	2002-00	35847	Thermostat seal	
QTY	WATER OUTLET GASKET	YEARS	PART NO.	DESCRIPTION	
1	Water Crossover Mounting Set	2006-00	ES 72738	Thermostat Housing; New Part Number - Check for Availability	
QTY	WATER PUMP	YEARS	PART NO.	DESCRIPTION	
1	Water Pump Gasket	2006-03	35846		
1	Water Pump Gasket	2002-00	35845		
QTY	TIMING COVER	YEARS	PART NO.	DESCRIPTION	
1	Crankshaft Front Seal Set	2006-00	TCS 46103	1st Design oil pump mounting gskt. not incl.	
QTY	CARB & FUEL INJECTION	YEARS	PART NO.	DESCRIPTION	
2	Fuel Injector O-Ring Set	2006-00	ES 70599	Improved design	
1	Throttle Body Gasket	2006-03	61510		
1	Throttle Body Gasket	2002-00	61516		
QTY	EXHAUST GAS RECIRCULATION	YEARS	PART NO.	DESCRIPTION	
1	EGR Gasket	2006-03	71176	Valve	
1	EGR Gasket	2002-00	70149	Valve	
50		2010 - 2005; 4.0L 244 (4015cc) SOHC V6 (12 Valve) 100.4mm Bore			50
		MFI; Gasoline; Naturally Aspirated Ford Eng.; VIN Code N			
QTY	CYLINDER HEAD	YEARS	PART NO.	DESCRIPTION	
1	Head Gasket	2010-05	26300 PT	Loc. L.H.; Head bolts not incl.; Head bolt replacement required; PermaTorqueMLS® LaserWeld® Technology; Improved design	
1	Head Gasket	2010-05	26301 PT	Loc. R.H.; Head bolts not incl.; Head bolt replacement required; PermaTorqueMLS® LaserWeld® Technology; Improved design	
1	Head Set	2010-05	HS 26300 PT-1	Head bolts not incl.; Head bolt replacement required; PermaDry® molded rubber valve cover gskts. incl.; Premium valve stem seals incl.	

Ford Car (Incl. Edsel, Ford, Lincoln, Mercury, Merkur) (Cont.)

50 (cont.)	2010 - 2005; 4.0L 244 (4015cc) SOHC V6 (12 Valve) 100.4mm Bore			50 (cont.)
MFI; Gasoline; Naturally Aspirated Ford Eng.; VIN Code N				
QTY	CYLINDER HEAD	YEARS	PART NO.	DESCRIPTION
2	Head Bolt Set	2010-05	ES 72171	Replacement required
QTY	CONVERSION SET	YEARS	PART NO.	DESCRIPTION
1	Gasket Conversion Set	2010-05	CS 9293-1	PermaDry® molded rubber oil pan gskt. incl.
QTY	MANIFOLD - INT. & EXH.	YEARS	PART NO.	DESCRIPTION
1	Int. Manifold Gasket Set	2010-05	MS 96669	Lower set; Upper set incl.
1	Exh. Manifold Gasket Set	2010-05	MS 90779	
QTY	OIL PAN	YEARS	PART NO.	DESCRIPTION
1	Oil Pan Gasket Set	2010-05	OS 30687 R	Loc. Lower; PermaDry® molded rubber gskt. incl.
1	Oil Pan Gasket Set	2010-05	OS 34309 R	Loc. Upper; PermaDry® molded rubber gskt. incl.
QTY	CRANKSHAFT REAR SEAL	YEARS	PART NO.	DESCRIPTION
1	Rear Main Seal Set	2010-05	BS 40619	Wear sleeve incl.; Rubber; One-piece
1	Rear Main Seal Set	2010-05	BS 40647	PTFE Rubber; One-piece
QTY	VALVE COVER	YEARS	PART NO.	DESCRIPTION
1	Valve Cover Gasket Set	2010-05	VS 50646 R	w/Grommets; PermaDry® molded rubber gskts. incl.
QTY	VALVE STEM SEAL SET	YEARS	PART NO.	DESCRIPTION
1	Valve Stem Seal Set	2010-05	SS 70858	Premium valve stem seals incl.
QTY	THERMOSTAT HOUSING	YEARS	PART NO.	DESCRIPTION
1	Thermostat Gasket	2010-05	35673	Thermostat Housing; Thermostat housing to manifold
1	O-Ring	2010-05	35617	Thermostat Housing
QTY	WATER PUMP	YEARS	PART NO.	DESCRIPTION
1	Water Pump Gasket	2010-05	35474	
QTY	TIMING COVER	YEARS	PART NO.	DESCRIPTION
1	Timing Cover Set	2010-05	TCS 46061	
QTY	CARB & FUEL INJECTION	YEARS	PART NO.	DESCRIPTION
3	Fuel Injector O-Ring Set	2010-05	ES 70599	Improved design
1	Throttle Body Gasket	2010-05	61356	Mounting
1	Throttle Body Gasket	2010-05	72302	Air bypass valve
QTY	EXHAUST GAS RECIRCULATION	YEARS	PART NO.	DESCRIPTION
1	EGR Gasket	2010-05	71176	Valve
1	EGR Gasket	2010-05	71202	Tube seal
QTY	OIL COOLER	YEARS	PART NO.	DESCRIPTION
1	Oil Cooler Gasket	2010-05	72796	Oil cooler O-ring; New Part Number - Check for Availability
51	2004 - 2003; 4.6L 281 (4605cc) DOHC V8 (32 Valve) 90.2mm Bore Intech			51
MFI; Gasoline; Naturally Aspirated Ford Eng.; VIN Code R				
QTY	CYLINDER HEAD	YEARS	PART NO.	DESCRIPTION
1	Head Gasket	2004-03	26188 PT	Loc. L.H.; Head bolts not incl.; Head bolt replacement recommended; PermaTorqueMLS® LaserWeld® Technology
1	Head Gasket	2004-03	26217 PT	Loc. R.H.; Head bolts not incl.; Head bolt replacement recommended; PermaTorqueMLS® LaserWeld® Technology
1	Head Set	2004-03	HS 26188 PT	Head bolts not incl.; Head bolt replacement recommended; PermaDry® molded rubber valve cover gskts. incl.; Premium valve stem seals incl.
2	Head Bolt Set	2004-03	ES 71328	Head bolts w/Washers; Replacement recommended; Improved design
2	Head Bolt Set	2004-03	ES 72798	Head bolts w/Washers; Replacement recommended; May use ES 71328 instead; Old design
QTY	CONVERSION SET	YEARS	PART NO.	DESCRIPTION
1	Gasket Conversion Set	2004-03	CS 9790-4	PermaDry® molded rubber oil pan gskt. incl.; Consolidated design
QTY	MANIFOLD - INT. & EXH.	YEARS	PART NO.	DESCRIPTION
1	Int. Manifold Gasket Set	2004-03	MS 96139	Lower set; Upper set incl.
1	Plenum Gasket Set	2004-03	MS 96108	Upper set
1	Exh. Manifold Gasket Set	2004-03	MS 95949	
QTY	EXHAUST PIPE FLANGE	YEARS	PART NO.	DESCRIPTION
1	Exhaust Pipe Gasket	2004-03	61203	Flange
QTY	OIL PAN	YEARS	PART NO.	DESCRIPTION
1	Oil Pan Gasket Set	2004-03	OS 30725 R	PermaDry® molded rubber gskt. incl.; Improved design
1	Drain Plug Gasket	2004-03	72515	
QTY	CRANKSHAFT REAR SEAL	YEARS	PART NO.	DESCRIPTION
1	Rear Main Seal Set	2004-03	BS 40620	Rubber; One-piece; Improved design
1	Rear Main Seal Set	2004-03	BS 40644	PTFE Rubber; One-piece
1	Repair Sleeve	2004-03	16255-1	Crankshaft; 1.105" - 1.135" sleeve length; Use w/installation tool; Improved design
1	Repair Sleeve Tool	2004-03	16306	Crankshaft

Ford Car (Incl. Edsel, Ford, Lincoln, Mercury, Merkur) (Cont.)

51		2004 - 2003; 4.6L 281 (4605cc) DOHC V8 (32 Valve) 90.2mm Bore Intech			51	
(cont.)		MFI; Gasoline; Naturally Aspirated Ford Eng.; VIN Code R			(cont.)	
QTY	VALVE COVER	YEARS	PART NO.	DESCRIPTION		
1	Valve Cover Gasket Set	2004-03	VS 50477 R	w/Grommets & Spark plug tube seals; PermaDry® molded rubber gskts. incl.; Improved design		
QTY	VALVE STEM SEAL SET	YEARS	PART NO.	DESCRIPTION		
1	Valve Stem Seal Set	2004-03	SS 72888	Premium valve stem seals incl.		
QTY	WATER OUTLET GASKET	YEARS	PART NO.	DESCRIPTION		
1	Water Outlet Gasket	2004-03	35489	Water Outlet		
QTY	WATER PUMP	YEARS	PART NO.	DESCRIPTION		
1	Water Pump Gasket	2004-03	35478			
2	O-Ring	2004-03	413	Water Pump; Water pump bypass pipe O-ring		
QTY	TIMING COVER	YEARS	PART NO.	DESCRIPTION		
1	Timing Cover Set	2004-03	TCS 45980	Repair sleeve not incl.		
1	Crankshaft Front Seal Set	2004-03	TCS 46114			
1	Repair Sleeve	2004-03	16207	Timing Cover; Use w/installation tool		
1	Repair Sleeve Tool	2004-03	16310	Timing Cover		
QTY	CARB & FUEL INJECTION	YEARS	PART NO.	DESCRIPTION		
4	Fuel Injector O-Ring Set	2004-03	ES 70599	Improved design		
1	Throttle Body Gasket	2004-03	61042	Mounting		
1	Throttle Body Gasket	2004-03	71216	Air bypass valve		
QTY	EXHAUST GAS RECIRCULATION	YEARS	PART NO.	DESCRIPTION		
1	EGR Gasket	2004-03	70149			
QTY	OIL FILTER MOUNTING	YEARS	PART NO.	DESCRIPTION		
1	Oil Filter Adapter Gasket	2004	70415	To 05/11/04		
1	Oil Filter Adapter Gasket	2004	70801	From 05/12/04		
1	Oil Filter Adapter Gasket	2003	70415			
52		2004 - 1993; 4.6L 281 (4605cc) DOHC V8 (32 Valve) 90.2mm Bore Intech			52	
		MFI; Gasoline; Naturally Aspirated Ford Eng.; VIN Code V				
QTY	CYLINDER HEAD	YEARS	PART NO.	DESCRIPTION		
1	Head Gasket	2004-93	9790 PT-2	Loc. R.H.; Head bolts not incl.; Head bolt replacement recommended; PermaTorqueMLS®; Improved design		
1	Head Gasket	2004-93	9792 PT-2	Loc. L.H.; Head bolts not incl.; Head bolt replacement recommended; PermaTorqueMLS®; Improved design		
1	Head Set	2004-95	HS 9790 PT-3	Int. manifold upper & lower gskts., valve cover gskts., head bolts not incl.; Head bolt replacement recommended; Premium valve stem seals incl.		
1	Head Set	1994-93	HS 9790 PT-6	Head bolts not incl.; Head bolt replacement recommended; PermaDry® molded rubber valve cover gskts. incl.; Premium valve stem seals incl.		
2	Head Bolt Set	2004-93	ES 71328	Head bolts w/Washers; Replacement recommended; Improved design		
2	Head Bolt Set	2004-93	ES 72798	Head bolts w/Washers; Replacement recommended; May use ES 71328 instead; Old design		
QTY	CONVERSION SET	YEARS	PART NO.	DESCRIPTION		
1	Gasket Conversion Set	2004-93	CS 9790-4	PermaDry® molded rubber oil pan gskt. incl.; Consolidated design		
QTY	MANIFOLD - INT. & EXH.	YEARS	PART NO.	DESCRIPTION		
1	Int. Manifold Gasket Set	2004-03	MS 96139-1	Lower set; Upper set incl.		
1	Int. Manifold Gasket Set	2002-99	MS 92562	Lower set		
1	Int. Manifold Gasket Set	1998-97	MS 95736	Lincoln Mark VIII Base, LSC; Lower set		
1	Int. Manifold Gasket Set	1998-97	MS 95833	Ford Mustang Cobra, SVT Cobra; Lower set		
1	Int. Manifold Gasket Set	1998	MS 95694	Lincoln Continental Base; Lower set		
1	Int. Manifold Gasket Set	1997	MS 95714	Lincoln Continental Spinnaker Edition; Lower set		
1	Int. Manifold Gasket Set	1996	MS 95714	Exc. Ford Mustang SVT Cobra; Lower set		
1	Int. Manifold Gasket Set	1996	MS 95833	Ford Mustang SVT Cobra; Lower set		
1	Int. Manifold Gasket Set	1995-93	MS 95714	Lower set		
1	Plenum Gasket Set	2004-03	MS 96108	Upper set		
1	Plenum Gasket Set	2002	MS 95841	Exc. Ford Mustang Cobra; Upper set		
1	Plenum Gasket Set	2001-98	MS 95841	Lincoln Continental Base; Upper set		
1	Plenum Gasket Set	2001-99	MS 95925-2	Exc. Lincoln Continental Base; Upper set		
1	Plenum Gasket Set	1998-97	MS 95925	Lincoln Mark VIII Base, LSC; Upper set		
1	Plenum Gasket Set	1998-97	MS 95925-1	Ford Mustang Cobra, SVT Cobra; Upper set		
1	Plenum Gasket Set	1997	MS 95924	Lincoln Continental Spinnaker Edition; Upper set		
1	Plenum Gasket Set	1996	MS 95924	Lincoln Continental Anniversary, Spinnaker Edition; Upper set		
1	Plenum Gasket Set	1996	MS 95925	Lincoln Mark VIII Anniversary, LSC; Upper set		
1	Plenum Gasket Set	1996	MS 95925-1	Ford Mustang SVT Cobra; Upper set		
1	Plenum Gasket Set	1995-93	MS 95924	Upper set		
1	Exh. Manifold Gasket Set	2004-93	MS 95949			
QTY	EXHAUST PIPE FLANGE	YEARS	PART NO.	DESCRIPTION		
1	Exhaust Pipe Gasket	2004-03	61203	Flange		

Ford Car (Incl. Edsel, Ford, Lincoln, Mercury, Merkur) (Cont.)

52 (cont.)	2004 - 1993; 4.6L 281 (4605cc) DOHC V8 (32 Valve) 90.2mm Bore Intech				52 (cont.)
MFI; Gasoline; Naturally Aspirated Ford Eng.; VIN Code V					
QTY	EXHAUST PIPE FLANGE	YEARS	PART NO.	DESCRIPTION	
1	Exhaust Pipe Gasket	2002	61201	Exc. Ford Mustang Cobra; Flange	
1	Exhaust Pipe Gasket	2002	61203	Ford Mustang Cobra; Flange	
1	Exhaust Pipe Gasket	2001-98	61201	Lincoln Continental Base; Flange	
1	Exhaust Pipe Gasket	2001-98	61203	Exc. Lincoln Continental Base; Flange	
1	Exhaust Pipe Gasket	1997	61201	Lincoln Continental Spinnaker Edition; Flange	
1	Exhaust Pipe Gasket	1997	61203	Exc. Lincoln Continental Spinnaker Edition; Flange	
1	Exhaust Pipe Gasket	1996	61201	Lincoln Continental Anniversary, Spinnaker Edition; Flange	
1	Exhaust Pipe Gasket	1996	61203	Exc. Lincoln Continental Anniversary, Spinnaker Edition; Flange	
1	Exhaust Pipe Gasket	1995	61201	Exc. Lincoln Mark VIII Base, LSC; Flange	
QTY	OIL PAN	YEARS	PART NO.	DESCRIPTION	
1	Oil Pan Gasket Set	2004-93	OS 30725 R	PermaDry® molded rubber gskt. incl.; Improved design	
1	Drain Plug Gasket	2004-93	72515		
QTY	CRANKSHAFT REAR SEAL	YEARS	PART NO.	DESCRIPTION	
1	Rear Main Seal Set	2004-93	BS 40620	Rubber; One-piece; Improved design	
1	Rear Main Seal Set	2004-93	BS 40644	PTFE Rubber; One-piece	
1	Repair Sleeve	2004-93	16255-1	Crankshaft; 1.105" - 1.135" sleeve length; Use w/installation tool; Improved design	
1	Repair Sleeve Tool	2004-93	16306	Crankshaft	
QTY	VALVE COVER	YEARS	PART NO.	DESCRIPTION	
1	Valve Cover Gasket Set	2004-99	VS 50477 R	w/Grommets & Spark plug tube seals; PermaDry® molded rubber gskts. incl.; Improved design	
1	Valve Cover Gasket Set	1998-97	VS 50477 R	Exc. Ford Mustang Cobra, SVT Cobra; w/Grommets & Spark plug tube seals; PermaDry® molded rubber gskts. incl.; Improved design	
1	Valve Cover Gasket Set	1998-97	VS 50479 R	Ford Mustang Cobra, SVT Cobra; w/Grommets & Spark plug tube seals; PermaDry® molded rubber gskts. incl.	
1	Valve Cover Gasket Set	1996-93	VS 50479 R	w/Grommets & Spark plug tube seals; PermaDry® molded rubber gskts. incl.	
QTY	VALVE STEM SEAL SET	YEARS	PART NO.	DESCRIPTION	
1	Valve Stem Seal Set	2004-95	SS 72888	Premium valve stem seals incl.	
2	Valve Stem Seal Set	1994-93	SS 70857	Premium valve stem seals incl.	
QTY	WATER OUTLET GASKET	YEARS	PART NO.	DESCRIPTION	
1	Water Outlet Gasket	2004-93	35489	Water Outlet	
QTY	WATER PUMP	YEARS	PART NO.	DESCRIPTION	
1	Water Pump Gasket	2004-93	35478		
2	O-Ring	2004-93	413	Water Pump; Water pump bypass pipe O-ring	
QTY	TIMING COVER	YEARS	PART NO.	DESCRIPTION	
1	Timing Cover Set	2004-93	TCS 45980	Repair sleeve not incl.	
1	Crankshaft Front Seal Set	2004-93	TCS 46114		
1	Repair Sleeve	2004-93	16207	Timing Cover; Use w/installation tool	
1	Repair Sleeve Tool	2004-93	16310	Timing Cover	
QTY	CARB & FUEL INJECTION	YEARS	PART NO.	DESCRIPTION	
4	Fuel Injector O-Ring Set	2004-93	ES 70599	Improved design	
1	Throttle Body Gasket	2004-93	71216	Air bypass valve	
1	Throttle Body Gasket	2004-03	61042	Mounting	
1	Throttle Body Gasket	2002	61041	Exc. Ford Mustang Cobra; Mounting	
1	Throttle Body Gasket	2002	61042	Ford Mustang Cobra; Mounting	
1	Throttle Body Gasket	2001-98	61041	Lincoln Continental Base; Mounting	
1	Throttle Body Gasket	2001-98	61042	Exc. Lincoln Continental Base; Mounting	
1	Throttle Body Gasket	1997	61041	Lincoln Continental Spinnaker Edition; Mounting	
1	Throttle Body Gasket	1997	61042	Exc. Lincoln Continental Spinnaker Edition; Mounting	
1	Throttle Body Gasket	1996	61041	Exc. Ford Mustang SVT Cobra; Mounting	
1	Throttle Body Gasket	1996	61141	Ford Mustang SVT Cobra; Mounting	
1	Throttle Body Gasket	1995-93	61041	Mounting	
QTY	EXHAUST GAS RECIRCULATION	YEARS	PART NO.	DESCRIPTION	
1	EGR Gasket	2002-93	70149		
QTY	OIL FILTER MOUNTING	YEARS	PART NO.	DESCRIPTION	
1	Oil Filter Adapter Gasket	2004-03	70801		
1	Oil Filter Adapter Gasket	2002-93	70415		
53	2004 - 2003; 4.6L 281 (4605cc) DOHC V8 (32 Valve) 90.2mm Bore Intech				53
MFI; Gasoline; Supercharged Ford Eng.; VIN Code Y					
QTY	CYLINDER HEAD	YEARS	PART NO.	DESCRIPTION	
1	Head Gasket	2004-03	26187 PT	Loc. L.H.; Head bolts not incl.; Head bolt replacement recommended; PermaTorqueMLS®	

Ford Car (Incl. Edsel, Ford, Lincoln, Mercury, Merkur) (Cont.)

53 (cont.)		2004 - 2003; 4.6L 281 (4605cc) DOHC V8 (32 Valve) 90.2mm Bore Intech			53 (cont.)
		MFI; Gasoline; Supercharged Ford Eng.; VIN Code Y			
QTY	CYLINDER HEAD	YEARS	PART NO.	DESCRIPTION	
1	Head Gasket	2004-03	26222 PT	Loc. R.H.; Head bolts not incl.; Head bolt replacement recommended; PermaTorqueMLS®	
1	Head Set	2004-03	HS 26187 PT	Head bolts not incl.; Head bolt replacement recommended; PermaDry® molded rubber valve cover gskts. incl.; Premium valve stem seals incl.	
2	Head Bolt Set	2004-03	ES 71173	Head bolts w/Washers; Replacement recommended	
QTY	CONVERSION SET	YEARS	PART NO.	DESCRIPTION	
1	Gasket Conversion Set	2004-03	CS 9790-4	PermaDry® molded rubber oil pan gskt. incl.; Consolidated design	
QTY	MANIFOLD - INT. & EXH.	YEARS	PART NO.	DESCRIPTION	
1	Int. Manifold Gasket Set	2004-03	MS 96114	Lower set	
1	Plenum Gasket Set	2004-03	MS 96110	Upper set	
1	Exh. Manifold Gasket Set	2004-03	MS 95949		
QTY	EXHAUST PIPE FLANGE	YEARS	PART NO.	DESCRIPTION	
1	Exhaust Pipe Gasket	2004-03	61203	Flange	
QTY	OIL PAN	YEARS	PART NO.	DESCRIPTION	
1	Oil Pan Gasket Set	2004-03	OS 30725 R	PermaDry® molded rubber gskt. incl.; Improved design	
1	Drain Plug Gasket	2004-03	72515		
QTY	CRANKSHAFT REAR SEAL	YEARS	PART NO.	DESCRIPTION	
1	Rear Main Seal Set	2004-03	BS 40620	Rubber; One-piece; Improved design	
1	Rear Main Seal Set	2004-03	BS 40644	PTFE Rubber; One-piece	
1	Repair Sleeve	2004-03	16255-1	Crankshaft; 1.105" - 1.135" sleeve length; Use w/installation tool; Improved design	
1	Repair Sleeve Tool	2004-03	16306	Crankshaft	
QTY	VALVE COVER	YEARS	PART NO.	DESCRIPTION	
1	Valve Cover Gasket Set	2004-03	VS 50477 R	w/Grommets & Spark plug tube seals; PermaDry® molded rubber gskts. incl.; Improved design	
QTY	VALVE STEM SEAL SET	YEARS	PART NO.	DESCRIPTION	
1	Valve Stem Seal Set	2004-03	SS 72888	Premium valve stem seals incl.	
QTY	WATER OUTLET GASKET	YEARS	PART NO.	DESCRIPTION	
1	Water Outlet Gasket	2004-03	35489	Water Outlet	
QTY	WATER PUMP	YEARS	PART NO.	DESCRIPTION	
1	Water Pump Gasket	2004-03	35478		
2	O-Ring	2004-03	413	Water Pump; Water pump bypass pipe O-ring	
QTY	TIMING COVER	YEARS	PART NO.	DESCRIPTION	
1	Timing Cover Set	2004-03	TCS 45980-1	Repair sleeve not incl.	
1	Crankshaft Front Seal Set	2004-03	TCS 46114		
1	Repair Sleeve	2004-03	16207	Timing Cover; Use w/installation tool	
1	Repair Sleeve Tool	2004-03	16310	Timing Cover	
QTY	CARB & FUEL INJECTION	YEARS	PART NO.	DESCRIPTION	
4	Fuel Injector O-Ring Set	2004-03	ES 70599	Improved design	
1	Throttle Body Gasket	2004-03	61042	Throttle body to spacer	
1	Throttle Body Gasket	2004-03	61202	Spacer to manifold	
1	Throttle Body Gasket	2004-03	71216	Air bypass valve	
QTY	EXHAUST GAS RECIRCULATION	YEARS	PART NO.	DESCRIPTION	
1	EGR Gasket	2004-03	70149		
QTY	OIL FILTER MOUNTING	YEARS	PART NO.	DESCRIPTION	
1	Oil Filter Adapter Gasket	2004-03	70415		
54		2011 - 1996; 4.6L 281 (4605cc) SOHC V8 (16 Valve) 90.2mm Bore Triton			54
		MFI; Natural Gas; Naturally Aspirated Ford Eng.; VIN Code 9			
QTY	CYLINDER HEAD	YEARS	PART NO.	DESCRIPTION	
1	Head Gasket	2011-09	26482 PT	Loc. L.H.; Head bolts not incl.; Head bolt replacement recommended; PermaTorqueMLS®	
1	Head Gasket	2011-09	26483 PT	Loc. R.H.; Head bolts not incl.; Head bolt replacement recommended; PermaTorqueMLS®	
1	Head Gasket	2008-96	9790 PT-2	Loc. R.H.; Head bolts not incl.; Head bolt replacement recommended; PermaTorqueMLS®; Improved design	
1	Head Gasket	2008-96	9792 PT-2	Loc. L.H.; Head bolts not incl.; Head bolt replacement recommended; PermaTorqueMLS®; Improved design	
1	Head Set	2011-09	HS 26482 PT	Head bolts not incl.; Head bolt replacement recommended; PermaDry® molded rubber valve cover gskts. incl.; Premium valve stem seals incl.; New Part Number - Check for Availability	
1	Head Set	2008-04	HS 9792 PT-8	Head bolts not incl.; Head bolt replacement recommended; PermaDry® molded rubber valve cover gskts. incl.; Premium valve stem seals incl.	

Ford Car (Incl. Edsel, Ford, Lincoln, Mercury, Merkur) (Cont.)

54 (cont.)	2011 - 1996; 4.6L 281 (4605cc) SOHC V8 (16 Valve) 90.2mm Bore Triton MFI; Natural Gas; Naturally Aspirated Ford Eng.; VIN Code 9			54 (cont.)
QTY	CYLINDER HEAD	YEARS	PART NO.	DESCRIPTION
1	Head Set	2003	HS 9792 PT-6	Head bolts not incl.; Head bolt replacement recommended; PermaDry® molded rubber valve cover gskts. incl.; Premium valve stem seals incl.
1	Head Set	2002-01	HS 9790 PT-16	Head bolts not incl.; Head bolt replacement recommended; PermaDry® molded rubber valve cover gskts. incl.; Premium valve stem seals incl.
1	Head Set	2000-96	HS 9790 PT-7	Head bolts not incl.; Head bolt replacement recommended; PermaDry® molded rubber valve cover gskts. incl.; Premium valve stem seals incl.; Consolidated design
2	Head Bolt Set	2011-96	ES 71328	Head bolts w/Washers; Replacement recommended; Improved design
2	Head Bolt Set	2011-96	ES 72798	Head bolts w/Washers; Replacement recommended; May use ES 71328 instead; Old design
QTY	CONVERSION SET	YEARS	PART NO.	DESCRIPTION
1	Gasket Conversion Set	2011-96	CS 9790-4	PermaDry® molded rubber oil pan gskt. incl.; Consolidated design
QTY	MANIFOLD - INT. & EXH.	YEARS	PART NO.	DESCRIPTION
1	Int. Manifold Gasket Set	2011-04	MS 96281	Lower set
1	Int. Manifold Gasket Set	2003-01	MS 92121-3	Lower set
1	Int. Manifold Gasket Set	2003-01	MS 98008 T-1	Lower set; Upper set incl.; PermaDryPlus® int. manifold gskts. incl.
1	Int. Manifold Gasket Set	2000-96	MS 95728-2	Lower set; Upper set incl.
1	Int. Manifold Gasket Set	2000-96	MS 98007 T-1	Lower set; Upper set incl.; PermaDryPlus® int. manifold gskts. incl.
1	Plenum Gasket Set	2000-96	MS 90762	Upper set
1	Exh. Manifold Gasket Set	2011-96	MS 92568	Improved design
QTY	EXHAUST PIPE FLANGE	YEARS	PART NO.	DESCRIPTION
1	Exhaust Pipe Gasket	2011-96	60924	Converter
QTY	OIL PAN	YEARS	PART NO.	DESCRIPTION
1	Oil Pan Gasket Set	2011-96	OS 30725 R	PermaDry® molded rubber gskt. incl.; Improved design
1	Drain Plug Gasket	2011-96	72515	
QTY	CRANKSHAFT REAR SEAL	YEARS	PART NO.	DESCRIPTION
1	Rear Main Seal Set	2011-96	BS 40620	Rubber; One-piece; Improved design
1	Rear Main Seal Set	2011-96	BS 40644	PTFE Rubber; One-piece
1	Repair Sleeve	2011-96	16255-1	Crankshaft; 1.105" - 1.135" sleeve length; Use w/installation tool; Improved design
1	Repair Sleeve Tool	2011-96	16306	Crankshaft
QTY	VALVE COVER	YEARS	PART NO.	DESCRIPTION
1	Valve Cover Gasket Set	2011-03	VS 50564 R	w/Grommets; PermaDry® molded rubber gskts. incl.
1	Valve Cover Gasket Set	2002-96	VS 50377 R	w/Grommets; PermaDry® molded rubber gskts. incl.
1	Valve Cover Gasket Set	2002-96	VS 50377 R-1	w/o Grommets; PermaDry® molded rubber gskts. incl.
QTY	VALVE STEM SEAL SET	YEARS	PART NO.	DESCRIPTION
1	Valve Stem Seal Set	2011-96	SS 72891	Premium valve stem seals incl.; Improved design
QTY	WATER OUTLET GASKET	YEARS	PART NO.	DESCRIPTION
1	Water Outlet Gasket	2011-96	35489	Water Outlet
1	Water Outlet Gasket	2011-03	35957	Water Crossover; Loc. R.H.; New Part Number - Check for Availability
1	Water Outlet Gasket	2011-03	35958	Water Crossover; Loc. L.H.; New Part Number - Check for Availability
QTY	WATER PUMP	YEARS	PART NO.	DESCRIPTION
1	Water Pump Gasket	2011-96	35478	
2	O-Ring	2011-96	413	Water Pump; Water pump bypass pipe O-ring
QTY	TIMING COVER	YEARS	PART NO.	DESCRIPTION
1	Timing Cover Set	2011-96	TCS 45869-1	Repair sleeve not incl.
1	Crankshaft Front Seal Set	2011-96	TCS 46114	
1	Repair Sleeve	2011-96	16207	Timing Cover; Use w/installation tool
1	Repair Sleeve Tool	2011-96	16310	Timing Cover
QTY	CARB & FUEL INJECTION	YEARS	PART NO.	DESCRIPTION
4	Fuel Injector O-Ring Set	2011-96	ES 70599	Improved design
1	Throttle Body Gasket	2011-96	61050	Throttle body to spacer
1	Throttle Body Gasket	2011-96	71216	Air bypass valve
1	Throttle Body Gasket	2011-01	61096	Spacer to manifold
1	Throttle Body Gasket	2000-96	61063	Spacer to manifold
QTY	EXHAUST GAS RECIRCULATION	YEARS	PART NO.	DESCRIPTION
1	EGR Gasket	2011-03	71176	
1	EGR Gasket	2002-96	70149	
QTY	OIL FILTER MOUNTING	YEARS	PART NO.	DESCRIPTION
1	Oil Filter Adapter Gasket	2011-98	70415	w/o Oil cooler
1	Oil Filter Adapter Gasket	2011-98	70801	w/Oil cooler
1	Oil Filter Adapter Gasket	1997-96	70415	

Ford Car (Incl. Edsel, Ford, Lincoln, Mercury, Merkur) (Cont.)

55		2011 - 2006; 4.6L 281 (4605cc) SOHC V8 (16 Valve) 90.2mm Bore Triton			55
MFI; Flex Fuel; Naturally Aspirated Ford Eng.; VIN Code V					
QTY	CYLINDER HEAD	YEARS	PART NO.	DESCRIPTION	
1	Head Gasket	2011-09	26482 PT	Loc. L.H.; Head bolts not incl.; Head bolt replacement recommended; PermaTorqueMLS®	
1	Head Gasket	2011-09	26483 PT	Loc. R.H.; Head bolts not incl.; Head bolt replacement recommended; PermaTorqueMLS®	
1	Head Gasket	2008-06	9790 PT-2	Loc. R.H.; Head bolts not incl.; Head bolt replacement recommended; PermaTorqueMLS®; Improved design	
1	Head Gasket	2008-06	9792 PT-2	Loc. L.H.; Head bolts not incl.; Head bolt replacement recommended; PermaTorqueMLS®; Improved design	
1	Head Set	2011-09	HS 26482 PT	Head bolts not incl.; Head bolt replacement recommended; PermaDry® molded rubber valve cover gskts. incl.; Premium valve stem seals incl.; New Part Number - Check for Availability	
1	Head Set	2008-06	HS 9792 PT-8	Head bolts not incl.; Head bolt replacement recommended; PermaDry® molded rubber valve cover gskts. incl.; Premium valve stem seals incl.	
2	Head Bolt Set	2011-06	ES 71328	Head bolts w/Washers; Replacement recommended; Improved design	
2	Head Bolt Set	2011-06	ES 72798	Head bolts w/Washers; Replacement recommended; May use ES 71328 instead; Old design	
QTY	CONVERSION SET	YEARS	PART NO.	DESCRIPTION	
1	Gasket Conversion Set	2011-06	CS 9790-4	PermaDry® molded rubber oil pan gskt. incl.; Consolidated design	
QTY	MANIFOLD - INT. & EXH.	YEARS	PART NO.	DESCRIPTION	
1	Int. Manifold Gasket Set	2011-06	MS 96281	Lower set	
1	Exh. Manifold Gasket Set	2011-06	MS 92568	Improved design	
QTY	EXHAUST PIPE FLANGE	YEARS	PART NO.	DESCRIPTION	
1	Exhaust Pipe Gasket	2011-06	60924	Converter	
QTY	OIL PAN	YEARS	PART NO.	DESCRIPTION	
1	Oil Pan Gasket Set	2011-06	OS 30725 R	PermaDry® molded rubber gskt. incl.; Improved design	
1	Drain Plug Gasket	2011-06	72515		
QTY	CRANKSHAFT REAR SEAL	YEARS	PART NO.	DESCRIPTION	
1	Rear Main Seal Set	2011-06	BS 40620	Rubber; One-piece; Improved design	
1	Rear Main Seal Set	2011-06	BS 40644	PTFE Rubber; One-piece	
1	Repair Sleeve	2011-06	16255-1	Crankshaft; 1.105" - 1.135" sleeve length; Use w/installation tool; Improved design	
1	Repair Sleeve Tool	2011-06	16306	Crankshaft	
QTY	VALVE COVER	YEARS	PART NO.	DESCRIPTION	
1	Valve Cover Gasket Set	2011-06	VS 50564 R	w/Grommets; PermaDry® molded rubber gskts. incl.	
QTY	VALVE STEM SEAL SET	YEARS	PART NO.	DESCRIPTION	
1	Valve Stem Seal Set	2011-06	SS 72891	Premium valve stem seals incl.; Improved design	
QTY	WATER OUTLET GASKET	YEARS	PART NO.	DESCRIPTION	
1	Water Outlet Gasket	2011-06	35489	Water Outlet	
1	Water Outlet Gasket	2011-06	35957	Water Crossover; Loc. R.H.; New Part Number - Check for Availability	
1	Water Outlet Gasket	2011-06	35958	Water Crossover; Loc. L.H.; New Part Number - Check for Availability	
QTY	WATER PUMP	YEARS	PART NO.	DESCRIPTION	
1	Water Pump Gasket	2011-06	35478		
2	O-Ring	2011-06	413	Water Pump; Water pump bypass pipe O-ring	
QTY	TIMING COVER	YEARS	PART NO.	DESCRIPTION	
1	Timing Cover Set	2011-06	TCS 45869-1	Repair sleeve not incl.	
1	Crankshaft Front Seal Set	2011-06	TCS 46114		
1	Repair Sleeve	2011-06	16207	Timing Cover; Use w/installation tool	
1	Repair Sleeve Tool	2011-06	16310	Timing Cover	
QTY	CARB & FUEL INJECTION	YEARS	PART NO.	DESCRIPTION	
4	Fuel Injector O-Ring Set	2011-06	ES 70599	Improved design	
1	Throttle Body Gasket	2011-06	61050	Throttle body to spacer	
1	Throttle Body Gasket	2011-06	61096	Spacer to manifold	
1	Throttle Body Gasket	2011-06	71216	Air bypass valve	
QTY	EXHAUST GAS RECIRCULATION	YEARS	PART NO.	DESCRIPTION	
1	EGR Gasket	2011-06	71176		
QTY	OIL FILTER MOUNTING	YEARS	PART NO.	DESCRIPTION	
1	Oil Filter Adapter Gasket	2011-06	70415	w/o Oil cooler	
1	Oil Filter Adapter Gasket	2011-06	70801	w/Oil cooler	
56		2011 - 1991; 4.6L 281 (4605cc) SOHC V8 (16 Valve) 90.2mm Bore Triton Romeo			56
MFI; Gasoline; Naturally Aspirated Ford Eng.; VIN Code W					
QTY	CYLINDER HEAD	YEARS	PART NO.	DESCRIPTION	
1	Head Gasket	2011-09	26482 PT	Loc. L.H.; Head bolts not incl.; Head bolt replacement recommended; PermaTorqueMLS®	

Ford Car (Incl. Edsel, Ford, Lincoln, Mercury, Merkur) (Cont.)

56 (cont.)		2011 - 1991; 4.6L 281 (4605cc) SOHC V8 (16 Valve) 90.2mm Bore Triton Romeo			56 (cont.)
		MFI; Gasoline; Naturally Aspirated Ford Eng.; VIN Code W			
QTY	CYLINDER HEAD	YEARS	PART NO.	DESCRIPTION	
1	Head Gasket	2011-09	26483 PT	Loc. R.H.; Head bolts not incl.; Head bolt replacement recommended; PermaTorqueMLS®	
1	Head Gasket	2008-91	9790 PT-2	Loc. R.H.; Head bolts not incl.; Head bolt replacement recommended; PermaTorqueMLS®; Improved design	
1	Head Gasket	2008-91	9792 PT-2	Loc. L.H.; Head bolts not incl.; Head bolt replacement recommended; PermaTorqueMLS®; Improved design	
1	Head Set	2011-09	HS 26482 PT	Head bolts not incl.; Head bolt replacement recommended; PermaDry® molded rubber valve cover gsks. incl.; Premium valve stem seals incl.; New Part Number - Check for Availability	
1	Head Set	2008-05	HS 9792 PT-8	Head bolts not incl.; Head bolt replacement recommended; PermaDry® molded rubber valve cover gsks. incl.; Premium valve stem seals incl.	
1	Head Set	2004	HS 9792 PT-6	Lincoln Town Car Executive, Executive L, Signature, Ultimate, Ultimate L; Head bolts not incl.; Head bolt replacement recommended; PermaDry® molded rubber valve cover gsks. incl.; Premium valve stem seals incl.	
1	Head Set	2004	HS 9792 PT-8	Exc. Lincoln Town Car Executive, Executive L, Signature, Ultimate, Ultimate L; Head bolts not incl.; Head bolt replacement recommended; PermaDry® molded rubber valve cover gsks. incl.; Premium valve stem seals incl.	
1	Head Set	2003	HS 9792 PT-6	Head bolts not incl.; Head bolt replacement recommended; PermaDry® molded rubber valve cover gsks. incl.; Premium valve stem seals incl.	
1	Head Set	2002-01	HS 9790 PT-16	Head bolts not incl.; Head bolt replacement recommended; PermaDry® molded rubber valve cover gsks. incl.; Premium valve stem seals incl.	
1	Head Set	2000-96	HS 9790 PT-7	Head bolts not incl.; Head bolt replacement recommended; PermaDry® molded rubber valve cover gsks. incl.; Premium valve stem seals incl.; Consolidated design	
1	Head Set	1995	HS 9790 PT	Ford Thunderbird LX Mercury Cougar XR-7; Valve stem seals & head bolts not incl.; Head bolt replacement recommended; PermaDry® molded rubber valve cover gsks. incl.	
1	Head Set	1995	HS 9790 PT-7	Exc. Ford Thunderbird LX Mercury Cougar XR-7; Head bolts not incl.; Head bolt replacement recommended; PermaDry® molded rubber valve cover gsks. incl.; Premium valve stem seals incl.; Consolidated design	
1	Head Set	1994-91	HS 9790 PT	Police valve stem seals & head bolts not incl.; Head bolt replacement recommended; PermaDry® molded rubber valve cover gsks. incl.; Premium valve stem seals incl.	
2	Head Bolt Set	2011-91	ES 71328	Head bolts w/Washers; Replacement recommended; Improved design	
2	Head Bolt Set	2011-91	ES 72798	Head bolts w/Washers; Replacement recommended; May use ES 71328 instead; Old design	
QTY	CONVERSION SET	YEARS	PART NO.	DESCRIPTION	
1	Gasket Conversion Set	2011-91	CS 9790-4	PermaDry® molded rubber oil pan gskt. incl.; Consolidated design	
QTY	MANIFOLD - INT. & EXH.	YEARS	PART NO.	DESCRIPTION	
1	Int. Manifold Gasket Set	2011-05	MS 96281	Lower set	
1	Int. Manifold Gasket Set	2004	MS 92121-3	Lincoln Town Car Executive, Executive L, Signature, Ultimate, Ultimate L; Lower set	
1	Int. Manifold Gasket Set	2004	MS 96281	Exc. Lincoln Town Car Executive, Executive L, Signature, Ultimate, Ultimate L; Lower set	
1	Int. Manifold Gasket Set	2004	MS 98008 T-1	Lincoln Town Car Executive, Executive L, Signature, Ultimate, Ultimate L; Lower set; Upper set incl.; PermaDryPlus® int. manifold gsks. incl.	
1	Int. Manifold Gasket Set	2003-01	MS 92121-3	Lower set	
1	Int. Manifold Gasket Set	2003-01	MS 98008 T-1	Lower set; Upper set incl.; PermaDryPlus® int. manifold gsks. incl.	
1	Int. Manifold Gasket Set	2000-96	MS 95728-2	Lower set; Upper set incl.	
1	Int. Manifold Gasket Set	2000-96	MS 98007 T-1	Lower set; Upper set incl.; PermaDryPlus® int. manifold gsks. incl.	
1	Int. Manifold Gasket Set	1995	MS 94801	Ford Thunderbird LX Mercury Cougar XR-7; Lower set; Upper set incl.	
1	Int. Manifold Gasket Set	1995	MS 95728	Exc. Ford Thunderbird LX Mercury Cougar XR-7; Lower set; Upper set incl.	
1	Int. Manifold Gasket Set	1995	MS 98007 T-1	Exc. Ford Thunderbird LX Mercury Cougar XR-7; Lower set; Upper set incl.; PermaDryPlus® int. manifold gsks. incl.	
1	Int. Manifold Gasket Set	1994-91	MS 94801	Lower set; Upper set incl.	
1	Plenum Gasket Set	2000-96	MS 90762	Upper set	
1	Plenum Gasket Set	1995-91	MS 94800	Upper set	
1	Exh. Manifold Gasket Set	2011-91	MS 92568	Improved design	
QTY	EXHAUST PIPE FLANGE	YEARS	PART NO.	DESCRIPTION	
1	Exhaust Pipe Gasket	2011-91	60924	Converter	
QTY	OIL PAN	YEARS	PART NO.	DESCRIPTION	
1	Oil Pan Gasket Set	2011-91	OS 30725 R	PermaDry® molded rubber gskt. incl.; Improved design	
1	Drain Plug Gasket	2011-91	72515		
QTY	CRANKSHAFT REAR SEAL	YEARS	PART NO.	DESCRIPTION	
1	Rear Main Seal Set	2011-91	BS 40620	Rubber; One-piece; Improved design	

Ford Car (Incl. Edsel, Ford, Lincoln, Mercury, Merkur) (Cont.)

56 (cont.)		2011 - 1991; 4.6L 281 (4605cc) SOHC V8 (16 Valve) 90.2mm Bore Triton Romeo			56 (cont.)
MFI; Gasoline; Naturally Aspirated Ford Eng.; VIN Code W					
QTY	CRANKSHAFT REAR SEAL	YEARS	PART NO.	DESCRIPTION	
1	Rear Main Seal Set	2011-91	BS 40644	PTFE Rubber; One-piece	
1	Repair Sleeve	2011-91	16255-1	Crankshaft; 1.105" - 1.135" sleeve length; Use w/installation tool; Improved design	
1	Repair Sleeve Tool	2011-91	16306	Crankshaft	
QTY	VALVE COVER	YEARS	PART NO.	DESCRIPTION	
1	Valve Cover Gasket Set	2011-03	VS 50564 R	w/Grommets; PermaDry® molded rubber gskts. incl.	
1	Valve Cover Gasket Set	2002-91	VS 50377 R	w/Grommets; PermaDry® molded rubber gskts. incl.	
1	Valve Cover Gasket Set	2002-91	VS 50377 R-1	w/o Grommets; PermaDry® molded rubber gskts. incl.	
QTY	VALVE STEM SEAL SET	YEARS	PART NO.	DESCRIPTION	
1	Valve Stem Seal Set	2011-95	SS 72891	Premium valve stem seals incl.; Improved design	
1	Valve Stem Seal Set	1994-91	SS 72799	Exc. Police; Premium valve stem seals incl.	
1	Valve Stem Seal Set	1994-91	SS 72891	Police; Premium valve stem seals incl.; Improved design	
QTY	WATER OUTLET GASKET	YEARS	PART NO.	DESCRIPTION	
1	Water Outlet Gasket	2011-91	35489	Water Outlet	
1	Water Outlet Gasket	2011-03	35957	Water Crossover; Loc. R.H.; New Part Number - Check for Availability	
1	Water Outlet Gasket	2011-03	35958	Water Crossover; Loc. L.H.; New Part Number - Check for Availability	
QTY	WATER PUMP	YEARS	PART NO.	DESCRIPTION	
1	Water Pump Gasket	2011-91	35478		
2	O-Ring	2011-91	413	Water Pump; Water pump bypass pipe O-ring	
QTY	TIMING COVER	YEARS	PART NO.	DESCRIPTION	
1	Timing Cover Set	2011-96	TCS 45869-1	Repair sleeve not incl.	
1	Timing Cover Set	1995-91	TCS 45869	Repair sleeve not incl.	
1	Crankshaft Front Seal Set	2011-91	TCS 46114		
1	Repair Sleeve	2011-91	16207	Timing Cover; Use w/installation tool	
1	Repair Sleeve Tool	2011-91	16310	Timing Cover	
QTY	CARB & FUEL INJECTION	YEARS	PART NO.	DESCRIPTION	
4	Fuel Injector O-Ring Set	2011-91	ES 70599	Improved design	
1	Throttle Body Gasket	2011-91	71216	Air bypass valve	
1	Throttle Body Gasket	2011-96	61050	Throttle body to spacer	
1	Throttle Body Gasket	2011-01	61096	Spacer to manifold	
1	Throttle Body Gasket	2000-96	61063	Spacer to manifold	
1	Throttle Body Gasket	1995-91	60894		
QTY	EXHAUST GAS RECIRCULATION	YEARS	PART NO.	DESCRIPTION	
1	EGR Gasket	2011-03	71176		
1	EGR Gasket	2002-91	70149		
QTY	OIL FILTER MOUNTING	YEARS	PART NO.	DESCRIPTION	
1	Oil Filter Adapter Gasket	2011-91	70415	w/o Oil cooler	
1	Oil Filter Adapter Gasket	2011-91	70801	w/Oil cooler	
57		2000 - 1996; 4.6L 281 (4605cc) SOHC V8 (16 Valve) 90.2mm Bore Triton Windsor			57
MFI; Gasoline; Naturally Aspirated Ford Eng.; VIN Code 6					
QTY	CYLINDER HEAD	YEARS	PART NO.	DESCRIPTION	
1	Head Gasket	2000-96	9790 PT-2	Loc. R.H.; Head bolts not incl.; Head bolt replacement recommended; PermaTorqueMLS®; Improved design	
1	Head Gasket	2000-96	9792 PT-2	Loc. L.H.; Head bolts not incl.; Head bolt replacement recommended; PermaTorqueMLS®; Improved design	
1	Head Set	2000-99	HS 9792 PT-1	Head bolts not incl.; Head bolt replacement recommended; PermaDry® molded rubber valve cover gskts. incl.; Premium valve stem seals incl.	
1	Head Set	1998-96	HS 9792 PT	Head bolts not incl.; Head bolt replacement recommended; PermaDry® molded rubber valve cover gskts. incl.; Premium valve stem seals incl.; Old design; Superseded - When depleted use HS 9790 PT-7	
2	Head Bolt Set	2000-96	ES 71328	Head bolts w/Washers; Replacement recommended; Improved design	
2	Head Bolt Set	2000-96	ES 72798	Head bolts w/Washers; Replacement recommended; May use ES 71328 instead; Old design	
QTY	CONVERSION SET	YEARS	PART NO.	DESCRIPTION	
1	Gasket Conversion Set	2000-99	CS 9790-5	PermaDry® molded rubber oil pan gskt. incl.; Consolidated design	
1	Gasket Conversion Set	1998-96	CS 9790-4	PermaDry® molded rubber oil pan gskt. incl.; Consolidated design	
QTY	MANIFOLD - INT. & EXH.	YEARS	PART NO.	DESCRIPTION	
1	Int. Manifold Gasket Set	2000-99	MS 92121	Lower set	
1	Int. Manifold Gasket Set	1998-96	MS 95728-2	Lower set; Upper set incl.	
1	Int. Manifold Gasket Set	1998-96	MS 98007 T-1	Lower set; Upper set incl.; PermaDryPlus® int. manifold gskts. incl.	
1	Plenum Gasket Set	1998-96	MS 90762	Upper set	
1	Exh. Manifold Gasket Set	2000-96	MS 92568	Improved design	

Ford Car (Incl. Edsel, Ford, Lincoln, Mercury, Merkur) (Cont.)

57		2000 - 1996; 4.6L 281 (4605cc) SOHC V8 (16 Valve) 90.2mm Bore Triton Windsor			57
(cont.)		MFI; Gasoline; Naturally Aspirated Ford Eng.; VIN Code 6			(cont.)
QTY	EXHAUST PIPE FLANGE	YEARS	PART NO.	DESCRIPTION	
1	Exhaust Pipe Gasket	2000-96	60924	Converter	
QTY	OIL PAN	YEARS	PART NO.	DESCRIPTION	
1	Oil Pan Gasket Set	2000-96	OS 30725 R	PermaDry® molded rubber gskt. incl.; Improved design	
1	Drain Plug Gasket	2000-96	72515		
QTY	CRANKSHAFT REAR SEAL	YEARS	PART NO.	DESCRIPTION	
1	Rear Main Seal Set	2000-96	BS 40620	Rubber; One-piece; Improved design	
1	Rear Main Seal Set	2000-96	BS 40644	PTFE Rubber; One-piece	
1	Repair Sleeve	2000-96	16255-1	Crankshaft; 1.105" - 1.135" sleeve length; Use w/installation tool; Improved design	
1	Repair Sleeve Tool	2000-96	16306	Crankshaft	
QTY	VALVE COVER	YEARS	PART NO.	DESCRIPTION	
1	Valve Cover Gasket Set	2000-96	VS 50481 R	w/o Grommets; PermaDry® molded rubber gskts. incl.	
1	Grommet Set	2000-96	ES 71189	Valve Cover	
QTY	VALVE STEM SEAL SET	YEARS	PART NO.	DESCRIPTION	
1	Valve Stem Seal Set	2000-96	SS 72891	Premium valve stem seals incl.; Improved design	
QTY	WATER OUTLET GASKET	YEARS	PART NO.	DESCRIPTION	
1	Water Outlet Gasket	2000-96	35489	Water Outlet	
QTY	WATER PUMP	YEARS	PART NO.	DESCRIPTION	
1	Water Pump Gasket	2000-96	35478		
2	O-Ring	2000-96	413	Water Pump; Water pump bypass pipe O-ring	
QTY	TIMING COVER	YEARS	PART NO.	DESCRIPTION	
1	Timing Cover Set	2000-99	TCS 45869-2	Repair sleeve not incl.	
1	Timing Cover Set	1998-96	TCS 45869-1	Repair sleeve not incl.	
1	Crankshaft Front Seal Set	2000-99	TCS 46117		
1	Crankshaft Front Seal Set	1998-96	TCS 46114		
1	Repair Sleeve	2000-96	16207	Timing Cover; Use w/installation tool	
1	Repair Sleeve Tool	2000-96	16310	Timing Cover	
QTY	CARB & FUEL INJECTION	YEARS	PART NO.	DESCRIPTION	
4	Fuel Injector O-Ring Set	2000-96	ES 70599	Improved design	
1	Throttle Body Gasket	2000-96	61050	Throttle body to spacer	
1	Throttle Body Gasket	2000-96	71216	Air bypass valve	
1	Throttle Body Gasket	2000-99	61096	Spacer to manifold	
1	Throttle Body Gasket	1998-96	61063	Spacer to manifold	
QTY	EXHAUST GAS RECIRCULATION	YEARS	PART NO.	DESCRIPTION	
1	EGR Gasket	2000-96	70149		
QTY	OIL FILTER MOUNTING	YEARS	PART NO.	DESCRIPTION	
1	Oil Filter Adapter Gasket	2000-96	70801		
58		2004 - 1996; 4.6L 281 (4605cc) SOHC V8 (16 Valve) 90.2mm Bore Triton Windsor			58
		MFI; Gasoline; Naturally Aspirated Ford Eng.; VIN Code X			
QTY	CYLINDER HEAD	YEARS	PART NO.	DESCRIPTION	
1	Head Gasket	2004-96	9790 PT-2	Loc. R.H.; Head bolts not incl.; Head bolt replacement recommended; PermaTorqueMLS®; Improved design	
1	Head Gasket	2004-96	9792 PT-2	Loc. L.H.; Head bolts not incl.; Head bolt replacement recommended; PermaTorqueMLS®; Improved design	
1	Head Set	2004-02	HS 9792 PT-6	Head bolts not incl.; Head bolt replacement recommended; PermaDry® molded rubber valve cover gskts. incl.; Premium valve stem seals incl.	
1	Head Set	2001	HS 9790 PT-16	Ford Mustang GT; Head bolts not incl.; Head bolt replacement recommended; PermaDry® molded rubber valve cover gskts. incl.; Premium valve stem seals incl.	
1	Head Set	2001	HS 9790 PT-16	Exc. Ford Mustang GT; Int. manifold gskts. & head bolts not incl.; Head bolt replacement recommended; PermaDry® molded rubber valve cover gskts. incl.; Premium valve stem seals incl.	
1	Head Set	2000-99	HS 9792 PT-1	Head bolts not incl.; Head bolt replacement recommended; PermaDry® molded rubber valve cover gskts. incl.; Premium valve stem seals incl.	
1	Head Set	1998-96	HS 9790 PT-7	Head bolts not incl.; Head bolt replacement recommended; PermaDry® molded rubber valve cover gskts. incl.; Premium valve stem seals incl.; Consolidated design	
1	Head Set	1998-96	HS 9792 PT	Head bolts not incl.; Head bolt replacement recommended; PermaDry® molded rubber valve cover gskts. incl.; Premium valve stem seals incl.; Old design; Superseded - When depleted use HS 9790 PT-7	
2	Head Bolt Set	2004-96	ES 71328	Head bolts w/Washers; Replacement recommended; Improved design	

Ford Car (Incl. Edsel, Ford, Lincoln, Mercury, Merkur) (Cont.)

58 (cont.)		2004 - 1996; 4.6L 281 (4605cc) SOHC V8 (16 Valve) 90.2mm Bore Triton Windsor MFI; Gasoline; Naturally Aspirated Ford Eng.; VIN Code X			58 (cont.)
QTY	CYLINDER HEAD	YEARS	PART NO.	DESCRIPTION	
2	Head Bolt Set	2004-96	ES 72798	Head bolts w/Washers; Replacement recommended; May use ES 71328 instead; Old design	
QTY	CONVERSION SET	YEARS	PART NO.	DESCRIPTION	
1	Gasket Conversion Set	2004-99	CS 9790-5	PermaDry® molded rubber oil pan gskt. incl.; Consolidated design	
1	Gasket Conversion Set	1998-96	CS 9790-4	PermaDry® molded rubber oil pan gskt. incl.; Consolidated design	
QTY	MANIFOLD - INT. & EXH.	YEARS	PART NO.	DESCRIPTION	
1	Int. Manifold Gasket Set	2004-02	MS 92121-3	Lower set	
1	Int. Manifold Gasket Set	2004-02	MS 98008 T-1	Lower set; Upper set incl.; PermaDryPlus® int. manifold gskts. incl.	
1	Int. Manifold Gasket Set	2001	MS 92121-3	Ford Mustang GT; Lower set	
1	Int. Manifold Gasket Set	2001	MS 92121-4	Exc. Ford Mustang GT; Lower set; Upper set incl.	
1	Int. Manifold Gasket Set	2001	MS 98008 T-1	Ford Mustang GT; Lower set; Upper set incl.; PermaDryPlus® int. manifold gskts. incl.	
1	Int. Manifold Gasket Set	2000-99	MS 92121	Lower set	
1	Int. Manifold Gasket Set	1998-96	MS 95728-2	Lower set; Upper set incl.	
1	Int. Manifold Gasket Set	1998-96	MS 98007 T-1	Lower set; Upper set incl.; PermaDryPlus® int. manifold gskts. incl.	
1	Plenum Gasket Set	1998-96	MS 90762	Upper set	
1	Exh. Manifold Gasket Set	2004-96	MS 92568	Improved design	
QTY	EXHAUST PIPE FLANGE	YEARS	PART NO.	DESCRIPTION	
1	Exhaust Pipe Gasket	2004-96	60924	Converter	
1	Exhaust Pipe Gasket	2004-96	61203	Flange	
QTY	OIL PAN	YEARS	PART NO.	DESCRIPTION	
1	Oil Pan Gasket Set	2004-96	OS 30725 R	PermaDry® molded rubber gskt. incl.; Improved design	
1	Drain Plug Gasket	2004-96	72515		
QTY	CRANKSHAFT REAR SEAL	YEARS	PART NO.	DESCRIPTION	
1	Rear Main Seal Set	2004-96	BS 40620	Rubber; One-piece; Improved design	
1	Rear Main Seal Set	2004-96	BS 40644	PTFE Rubber; One-piece	
1	Repair Sleeve	2004-96	16255-1	Crankshaft; 1.105" - 1.135" sleeve length; Use w/installation tool; Improved design	
1	Repair Sleeve Tool	2004-96	16306	Crankshaft	
QTY	VALVE COVER	YEARS	PART NO.	DESCRIPTION	
1	Valve Cover Gasket Set	2004-02	VS 50564 R	w/Grommets; PermaDry® molded rubber gskts. incl.	
1	Valve Cover Gasket Set	2001	VS 50377 R	w/Grommets; PermaDry® molded rubber gskts. incl.	
1	Valve Cover Gasket Set	2001	VS 50377 R-1	w/o Grommets; PermaDry® molded rubber gskts. incl.	
1	Valve Cover Gasket Set	2000-99	VS 50481 R	w/o Grommets; PermaDry® molded rubber gskts. incl.	
1	Valve Cover Gasket Set	1998-96	VS 50377 R	w/Grommets; PermaDry® molded rubber gskts. incl.	
1	Valve Cover Gasket Set	1998-96	VS 50377 R-1	w/o Grommets; PermaDry® molded rubber gskts. incl.	
1	Grommet Set	2000-99	ES 71189	Valve Cover	
QTY	VALVE STEM SEAL SET	YEARS	PART NO.	DESCRIPTION	
1	Valve Stem Seal Set	2004-96	SS 72891	Premium valve stem seals incl.; Improved design	
QTY	WATER OUTLET GASKET	YEARS	PART NO.	DESCRIPTION	
1	Water Outlet Gasket	2004-96	35489	Water Outlet	
QTY	WATER PUMP	YEARS	PART NO.	DESCRIPTION	
1	Water Pump Gasket	2004-96	35478		
2	O-Ring	2004-96	413	Water Pump; Water pump bypass pipe O-ring	
QTY	TIMING COVER	YEARS	PART NO.	DESCRIPTION	
1	Timing Cover Set	2004-99	TCS 45869-2	Repair sleeve not incl.	
1	Timing Cover Set	1998-96	TCS 45869-1	Repair sleeve not incl.	
1	Crankshaft Front Seal Set	2004-99	TCS 46117		
1	Crankshaft Front Seal Set	1998-96	TCS 46114		
1	Repair Sleeve	2004-96	16207	Timing Cover; Use w/installation tool	
1	Repair Sleeve Tool	2004-96	16310	Timing Cover	
QTY	CARB & FUEL INJECTION	YEARS	PART NO.	DESCRIPTION	
4	Fuel Injector O-Ring Set	2004-96	ES 70599	Improved design	
1	Throttle Body Gasket	2004-96	71216	Air bypass valve	
1	Throttle Body Gasket	2004-02	61050	Throttle body to spacer	
1	Throttle Body Gasket	2004-02	61096	Spacer to manifold	
1	Throttle Body Gasket	2001	61042	Exc. Ford Mustang GT; Throttle body to spacer	
1	Throttle Body Gasket	2001	61050	Ford Mustang GT; Throttle body to spacer	
1	Throttle Body Gasket	2001	61096	Ford Mustang GT; Spacer to manifold	
1	Throttle Body Gasket	2001	61204	Exc. Ford Mustang GT; Spacer to manifold	
1	Throttle Body Gasket	2000-96	61050	Throttle body to spacer	
1	Throttle Body Gasket	2000-99	61096	Spacer to manifold	
1	Throttle Body Gasket	1998-96	61063	Spacer to manifold	
QTY	EXHAUST GAS RECIRCULATION	YEARS	PART NO.	DESCRIPTION	
1	EGR Gasket	2004-96	70149		

Ford Car (Incl. Edsel, Ford, Lincoln, Mercury, Merkur) (Cont.)

58		2004 - 1996; 4.6L 281 (4605cc) SOHC V8 (16 Valve) 90.2mm Bore Triton Windsor			58
(cont.)		MFI; Gasoline; Naturally Aspirated Ford Eng.; VIN Code X			(cont.)
QTY	OIL FILTER MOUNTING	YEARS	PART NO.	DESCRIPTION	
1	Oil Filter Adapter Gasket	2004-96	70801		
59		2010 - 2005; 4.6L 281 (4605cc) SOHC V8 (24 Valve) 90.2mm Bore Triton			59
(cont.)		MFI; Gasoline; Naturally Aspirated Ford Eng.; VIN Code H			(cont.)
QTY	CYLINDER HEAD	YEARS	PART NO.	DESCRIPTION	
1	Head Gasket	2010-05	26308 PT	Loc. R.H.; Head bolts not incl.; Head bolt replacement recommended; PermaTorqueMLS®	
1	Head Gasket	2010-05	26309 PT	Loc. L.H.; Head bolts not incl.; Head bolt replacement recommended; PermaTorqueMLS®	
1	Head Set	2010-09	HS 26308 PT-2	Head bolts not incl.; Head bolt replacement recommended; PermaDry® molded rubber valve cover gskts. incl.; Premium valve stem seals incl.; New Part Number - Check for Availability	
1	Head Set	2008-07	HS 26308 PT-1	Head bolts not incl.; Head bolt replacement recommended; PermaDry® molded rubber valve cover gskts. incl.; Premium valve stem seals incl.	
1	Head Set	2006-05	HS 26308 PT	Head bolts not incl.; Head bolt replacement recommended; PermaDry® molded rubber valve cover gskts. incl.; Premium valve stem seals incl.	
2	Head Bolt Set	2010-05	ES 71328	Head bolts w/Washers; Replacement recommended; Improved design	
2	Head Bolt Set	2010-05	ES 72798	Head bolts w/Washers; Replacement recommended; May use ES 71328 instead; Old design	
QTY	CONVERSION SET	YEARS	PART NO.	DESCRIPTION	
1	Gasket Conversion Set	2010-05	CS 9790-5	PermaDry® molded rubber oil pan gskt. incl.; Consolidated design	
QTY	MANIFOLD - INT. & EXH.	YEARS	PART NO.	DESCRIPTION	
1	Int. Manifold Gasket Set	2010-09	MS 97181	Lower set; New Part Number - Check for Availability	
1	Int. Manifold Gasket Set	2008-05	MS 96687-1	Lower set	
1	Exh. Manifold Gasket Set	2010-05	MS 96679		
QTY	OIL PAN	YEARS	PART NO.	DESCRIPTION	
1	Oil Pan Gasket Set	2010-05	OS 30725 R	PermaDry® molded rubber gskt. incl.; Improved design	
1	Drain Plug Gasket	2010-05	72515		
QTY	CRANKSHAFT REAR SEAL	YEARS	PART NO.	DESCRIPTION	
1	Rear Main Seal Set	2010-05	BS 40620	Rubber; One-piece; Improved design	
1	Rear Main Seal Set	2010-05	BS 40644	PTFE Rubber; One-piece	
1	Repair Sleeve	2010-05	16255-1	Crankshaft; 1.105" - 1.135" sleeve length; Use w/installation tool; Improved design	
1	Repair Sleeve Tool	2010-05	16306	Crankshaft	
QTY	VALVE COVER	YEARS	PART NO.	DESCRIPTION	
1	Valve Cover Gasket Set	2010-07	VS 50687 R	w/Grommets; PermaDry® molded rubber gskts. incl.	
1	Valve Cover Gasket Set	2006-05	VS 50664 R	w/Grommets; PermaDry® molded rubber gskts. incl.	
1	Grommet Set	2010-05	ES 71426	Valve Cover; VCT seals set; New Part Number - Check for Availability	
QTY	VALVE STEM SEAL SET	YEARS	PART NO.	DESCRIPTION	
1	Valve Stem Seal Set	2010-05	SS 72921-1	Premium valve stem seals incl.	
QTY	THERMOSTAT HOUSING	YEARS	PART NO.	DESCRIPTION	
1	Water Outlet Gasket	2010-05	35489	Thermostat Housing; Thermostat seal	
QTY	WATER OUTLET GASKET	YEARS	PART NO.	DESCRIPTION	
1	Water Outlet Gasket	2010-05	35792	Water Crossover; Loc. R.H.	
1	Water Outlet Gasket	2010-07	35835	Water Crossover; Loc. L.H.	
1	Water Outlet Gasket	2006-05	35793	Water Crossover; Loc. L.H.	
QTY	WATER PUMP	YEARS	PART NO.	DESCRIPTION	
1	Water Pump Gasket	2010-05	35478		
2	O-Ring	2010-05	413	Water Pump; Water pump bypass pipe O-ring	
QTY	TIMING COVER	YEARS	PART NO.	DESCRIPTION	
1	Timing Cover Set	2010-05	TCS 46072	Repair sleeve not incl.; May use TCS 46072-1 instead; Old design; Superseded - When depleted use TCS 46072-1	
1	Timing Cover Set	2010-05	TCS 46072-1	Repair sleeve not incl.; Consolidated design	
1	Crankshaft Front Seal Set	2010-05	TCS 46117		
QTY	CARB & FUEL INJECTION	YEARS	PART NO.	DESCRIPTION	
2	Fuel Injector O-Ring Set	2010-05	ES 70599	Lower set; Injectors to cylinder head; Improved design	
1	Throttle Body Gasket	2010-05	61426	Mounting	
QTY	OIL FILTER MOUNTING	YEARS	PART NO.	DESCRIPTION	
1	Oil Filter Adapter Gasket	2010-05	70801		
60		1991; 5.0L 302 (4950cc) OHV V8 (16 Valve) 4" Bore			60
(cont.)		MFI; Gasoline; Naturally Aspirated Ford Eng.; VIN Code F			(cont.)
QTY	CYLINDER HEAD	YEARS	PART NO.	DESCRIPTION	
2	Head Gasket	1991	8548 PT-2	Head bolts not incl.; Head bolt replacement recommended; PermaTorque®	

Ford Car (Incl. Edsel, Ford, Lincoln, Mercury, Merkur) (Cont.)

60 (cont.)		1991; 5.0L 302 (4950cc) OHV V8 (16 Valve) 4" Bore			60 (cont.)	
MFI; Gasoline; Naturally Aspirated Ford Eng.; VIN Code F						
QTY	CYLINDER HEAD	YEARS	PART NO.	DESCRIPTION		
2	Head Gasket	1991	9333 PT-1	Hi-Perf. eng.; Head bolts not incl.; Head bolt replacement recommended		
2	Head Gasket Spacer Shim	1991	8548 SP-1	HeadSaver®		
1	Head Set	1991	HS 9280 PT-3	Head bolts not incl.; Head bolt replacement recommended; Premium valve stem seals incl.		
QTY	CONVERSION SET	YEARS	PART NO.	DESCRIPTION		
1	Gasket Conversion Set	1991	CS 8548-2	Water pump to plate gskts. not incl.; Multi-piece oil pan gskt. incl.		
1	Gasket Conversion Set	1991	CS 8548-9	Water pump to plate gskts. not incl.; PermaDry® molded rubber oil pan gskt. incl.		
QTY	MANIFOLD - INT. & EXH.	YEARS	PART NO.	DESCRIPTION		
1	Int. Manifold Gasket Set	1991	MS 93334	Lower set; Upper set incl.		
1	Plenum Gasket Set	1991	MS 94555	Upper set		
1	Exh. Manifold Gasket Set	1991	MS 90000			
QTY	EXHAUST PIPE FLANGE	YEARS	PART NO.	DESCRIPTION		
2	Exhaust Pipe Gasket	1991	60924	Converter; 1 or 2 Req'd.		
1	Exh. Flange Bolt & Spring Kit	1991	ES 72142			
QTY	OIL PAN	YEARS	PART NO.	DESCRIPTION		
1	Oil Pan Gasket Set	1991	OS 13260 C	Multi-piece; Cork		
1	Oil Pan Gasket Set	1991	OS 34508 R	PermaDry® one-piece molded rubber gskt. incl.; Improved design		
1	Drain Plug Gasket	1991	70822			
QTY	CRANKSHAFT REAR SEAL	YEARS	PART NO.	DESCRIPTION		
1	Rear Main Seal Set	1991	BS 40620	Rubber; One-piece; Improved design		
1	Rear Main Seal Set	1991	BS 40644	PTFE Rubber; One-piece		
1	Repair Sleeve	1991	16250	Crankshaft; Use w/installation tool		
1	Repair Sleeve Tool	1991	16300	Crankshaft		
QTY	VALVE COVER	YEARS	PART NO.	DESCRIPTION		
1	Valve Cover Gasket Set	1991	VS 13264 T	Must be used w/MS 94555; PermaDryPlus®; Improved design		
1	Valve Cover Gasket Set	1991	VS 50029 C	Must be used w/MS 94555; Hi-Temp.; w/Compression stops		
QTY	VALVE STEM SEAL SET	YEARS	PART NO.	DESCRIPTION		
2	Valve Stem Seal Set	1991	SS 72683	Loc. Int. & Exh.; Premium valve stem seals incl.		
QTY	WATER OUTLET GASKET	YEARS	PART NO.	DESCRIPTION		
1	Water Outlet Gasket	1991	35440	Water Outlet		
QTY	WATER PUMP	YEARS	PART NO.	DESCRIPTION		
1	Water Pump Gasket	1991	35211	Plate to block		
1	Water Pump Gasket	1991	35475	Pump to plate		
QTY	TIMING COVER	YEARS	PART NO.	DESCRIPTION		
1	Timing Cover Set	1991	TCS 45449	w/o Sleeve 'N' Seal®; Eng. w/one-piece oil pan gskt. must be used w/OS 34508R; Water pump to plate gskts. not incl.		
1	Timing Set w/Sleeve & Seal	1991	TCS 45450	w/Sleeve 'N' Seal®; Eng. w/one-piece oil pan gskt. must be used w/OS 34508R; Water pump to plate gskts. not incl.		
1	Repair Sleeve	1991	16213	Timing Cover; Use w/installation tool		
1	Repair Sleeve Tool	1991	16310	Timing Cover		
QTY	CARB & FUEL INJECTION	YEARS	PART NO.	DESCRIPTION		
2	Fuel Injector O-Ring Set	1991	ES 70599	Improved design		
1	Throttle Body Gasket	1991	70261	Throttle body to EGR valve		
1	Throttle Body Gasket	1991	71216	Air bypass valve		
1	Throttle Body Gasket	1991	72540	EGR valve to plenum		
QTY	DISTRIBUTOR MOUNTING	YEARS	PART NO.	DESCRIPTION		
1	O-Ring	1991	5511	Distributor Mounting		
QTY	EXHAUST GAS RECIRCULATION	YEARS	PART NO.	DESCRIPTION		
1	EGR Gasket	1991	70020			
QTY	OIL PUMP COVER	YEARS	PART NO.	DESCRIPTION		
1	Oil Pump Gasket	1991	72516	Inlet tube		
61		1995 - 1993; 5.0L 302 (4950cc) OHV V8 (16 Valve) 4" Bore Cobra				61
MFI; Gasoline; Naturally Aspirated Ford Eng.; VIN Code D						
QTY	CYLINDER HEAD	YEARS	PART NO.	DESCRIPTION		
2	Head Gasket	1995-93	8548 PT-2	Head bolts not incl.; Head bolt replacement recommended; PermaTorque®		
2	Head Gasket	1995-93	9333 PT-1	Hi-Perf. eng.; Head bolts not incl.; Head bolt replacement recommended		
2	Head Gasket Spacer Shim	1995-93	8548 SP-1	HeadSaver®		
1	Head Set	1995-93	HS 9280 PT-3	Int. manifold gskts. & head bolts not incl.; Head bolt replacement recommended; Premium valve stem seals incl.		
2	Head Bolt Set	1995-93	ES 72155	Flanged hex head; Replacement required		
1	Dowel Pin	1995-94	ES 70744	Cylinder Head; Cyl. head alignment		

Ford Car (Incl. Edsel, Ford, Lincoln, Mercury, Merkur) (Cont.)

61 (cont.)		1995 - 1993; 5.0L 302 (4950cc) OHV V8 (16 Valve) 4" Bore Cobra			61 (cont.)	
MFI; Gasoline; Naturally Aspirated Ford Eng.; VIN Code D						
QTY	CYLINDER HEAD	YEARS	PART NO.	DESCRIPTION		
1	Dowel Pin	1993	ES 70744	Cylinder Head; From 05/09/93; Cyl. head alignment		
QTY	CONVERSION SET	YEARS	PART NO.	DESCRIPTION		
1	Gasket Conversion Set	1995-93	CS 8548-9	Water pump to plate gskts. not incl.; PermaDry® molded rubber oil pan gskt. incl.		
1	Gasket Conversion Set	1994-93	CS 8548-2	Water pump to plate gskts. not incl.; Multi-piece oil pan gskt. incl.		
QTY	MANIFOLD - INT. & EXH.	YEARS	PART NO.	DESCRIPTION		
1	Int. Manifold Gasket Set	1995-93	MS 95952	Lower set; Upper set incl.		
1	Plenum Gasket Set	1995-93	MS 95953	Upper set		
1	Exh. Manifold Gasket Set	1995-93	MS 90000			
QTY	EXHAUST PIPE FLANGE	YEARS	PART NO.	DESCRIPTION		
2	Exhaust Pipe Gasket	1994-93	60924	Converter; 1 or 2 Req'd.		
1	Exh. Flange Bolt & Spring Kit	1995-93	ES 72142			
QTY	OIL PAN	YEARS	PART NO.	DESCRIPTION		
1	Oil Pan Gasket Set	1995-93	OS 34508 R	PermaDry® one-piece molded rubber gskt. incl.; Improved design		
1	Oil Pan Gasket Set	1994-93	OS 13260 C	Multi-piece; Cork		
1	Drain Plug Gasket	1995-93	70822			
QTY	CRANKSHAFT REAR SEAL	YEARS	PART NO.	DESCRIPTION		
1	Rear Main Seal Set	1995-93	BS 40620	Rubber; One-piece; Improved design		
1	Rear Main Seal Set	1995-93	BS 40644	PTFE Rubber; One-piece		
1	Repair Sleeve	1995-93	16250	Crankshaft; Use w/installation tool		
1	Repair Sleeve Tool	1995-93	16300	Crankshaft		
QTY	VALVE COVER	YEARS	PART NO.	DESCRIPTION		
1	Valve Cover Gasket Set	1995-93	VS 13264 T	Must be used w/MS 95953; PermaDryPlus®; Improved design		
1	Valve Cover Gasket Set	1995-93	VS 50029 C	Must be used w/MS 95953; Hi-Temp.; w/Compression stops		
QTY	VALVE STEM SEAL SET	YEARS	PART NO.	DESCRIPTION		
2	Valve Stem Seal Set	1995-93	SS 72683	Loc. Int. & Exh.; Premium valve stem seals incl.		
QTY	WATER OUTLET GASKET	YEARS	PART NO.	DESCRIPTION		
1	Water Outlet Gasket	1995-93	35440	Water Outlet		
QTY	WATER PUMP	YEARS	PART NO.	DESCRIPTION		
1	Water Pump Gasket	1995-93	35380	Pump to plate		
1	Water Pump Gasket	1995-94	35352	Plate to block		
1	Water Pump Gasket	1993	35211	Plate to block		
QTY	TIMING COVER	YEARS	PART NO.	DESCRIPTION		
1	Timing Cover Set	1995-93	TCS 45449	w/o Sleeve 'N' Seal®; Eng. w/one-piece oil pan gskt. must be used w/OS 34508R; Water pump to plate gskts. not incl.		
1	Timing Set w/Sleeve & Seal	1995-93	TCS 45450	w/Sleeve 'N' Seal®; Eng. w/one-piece oil pan gskt. must be used w/OS 34508R; Water pump to plate gskts. not incl.		
1	Repair Sleeve	1995-93	16213	Timing Cover; Use w/installation tool		
1	Repair Sleeve Tool	1995-93	16310	Timing Cover		
QTY	CARB & FUEL INJECTION	YEARS	PART NO.	DESCRIPTION		
2	Fuel Injector O-Ring Set	1995-93	ES 70599	Improved design		
1	Throttle Body Gasket	1995-93	71216	Air bypass valve		
1	Throttle Body Gasket	1995-93	72543	EGR valve to plenum		
1	Throttle Body Gasket	1995-94	60859	Throttle body to EGR valve		
1	Throttle Body Gasket	1993	70262	Throttle body to EGR valve		
QTY	DISTRIBUTOR MOUNTING	YEARS	PART NO.	DESCRIPTION		
1	O-Ring	1995-93	5511	Distributor Mounting		
QTY	EXHAUST GAS RECIRCULATION	YEARS	PART NO.	DESCRIPTION		
1	EGR Gasket	1995-93	70020			
QTY	OIL PUMP COVER	YEARS	PART NO.	DESCRIPTION		
1	Oil Pump Gasket	1995-93	72516	Inlet tube		
62		1993 - 1991; 5.0L 302 (4950cc) OHV V8 (16 Valve) 4" Bore H.O.			62	
MFI; Gasoline; Naturally Aspirated Ford Eng.; VIN Code E						
QTY	CYLINDER HEAD	YEARS	PART NO.	DESCRIPTION		
2	Head Gasket	1993-91	8548 PT-2	Head bolts not incl.; Head bolt replacement recommended; PermaTorque®		
2	Head Gasket	1993-91	9333 PT-1	Hi-Perf. eng.; Head bolts not incl.; Head bolt replacement recommended		
2	Head Gasket Spacer Shim	1993-91	8548 SP-1	HeadSaver®		
1	Head Set	1993-91	HS 9280 PT-3	Head bolts not incl.; Head bolt replacement recommended; Premium valve stem seals incl.		
2	Head Bolt Set	1993-92	ES 72155	Flanged hex head; Replacement required		
1	Dowel Pin	1993	ES 70744	Cylinder Head; From 05/09/93; Cyl. head alignment		
QTY	CONVERSION SET	YEARS	PART NO.	DESCRIPTION		
1	Gasket Conversion Set	1993-91	CS 8548-2	Water pump to plate gskts. not incl.; Multi-piece oil pan gskt. incl.		

Ford Car (Incl. Edsel, Ford, Lincoln, Mercury, Merkur) (Cont.)

62 (cont.)		1993 - 1991; 5.0L 302 (4950cc) OHV V8 (16 Valve) 4" Bore H.O.			62 (cont.)
MFI; Gasoline; Naturally Aspirated Ford Eng.; VIN Code E					
QTY	CONVERSION SET	YEARS	PART NO.	DESCRIPTION	
1	Gasket Conversion Set	1993-91	CS 8548-9	Water pump to plate gskts. not incl.; PermaDry® molded rubber oil pan gskt. incl.	
QTY	MANIFOLD - INT. & EXH.	YEARS	PART NO.	DESCRIPTION	
1	Int. Manifold Gasket Set	1993-91	MS 93334	Lower set; Upper set incl.	
1	Plenum Gasket Set	1993-91	MS 94555	Upper set	
1	Exh. Manifold Gasket Set	1993-91	MS 90000		
QTY	EXHAUST PIPE FLANGE	YEARS	PART NO.	DESCRIPTION	
2	Exhaust Pipe Gasket	1993-91	60924	Converter; 1 or 2 Req'd.	
1	Exh. Flange Bolt & Spring Kit	1993-91	ES 72142		
QTY	OIL PAN	YEARS	PART NO.	DESCRIPTION	
1	Oil Pan Gasket Set	1993-91	OS 13260 C	Multi-piece; Cork	
1	Oil Pan Gasket Set	1993-91	OS 34508 R	PermaDry® one-piece molded rubber gskt. incl.; Improved design	
1	Drain Plug Gasket	1993-91	70822		
QTY	CRANKSHAFT REAR SEAL	YEARS	PART NO.	DESCRIPTION	
1	Rear Main Seal Set	1993-91	BS 40620	Rubber; One-piece; Improved design	
1	Rear Main Seal Set	1993-91	BS 40644	PTFE Rubber; One-piece	
1	Repair Sleeve	1993-91	16250	Crankshaft; Use w/installation tool	
1	Repair Sleeve Tool	1993-91	16300	Crankshaft	
QTY	VALVE COVER	YEARS	PART NO.	DESCRIPTION	
1	Valve Cover Gasket Set	1993-91	VS 13264 T	Must be used w/MS 94555; PermaDryPlus®; Improved design	
1	Valve Cover Gasket Set	1993-91	VS 50029 C	Must be used w/MS 94555; Hi-Temp.; w/Compression stops	
QTY	VALVE STEM SEAL SET	YEARS	PART NO.	DESCRIPTION	
2	Valve Stem Seal Set	1993-91	SS 72683	Loc. Int. & Exh.; Premium valve stem seals incl.	
QTY	WATER OUTLET GASKET	YEARS	PART NO.	DESCRIPTION	
1	Water Outlet Gasket	1993-91	35440	Water Outlet	
QTY	WATER PUMP	YEARS	PART NO.	DESCRIPTION	
1	Water Pump Gasket	1993-91	35211	Plate to block	
1	Water Pump Gasket	1993	35380	Pump to plate	
1	Water Pump Gasket	1992-91	35380	Ford Mustang GT, LX; Pump to plate	
1	Water Pump Gasket	1992-91	35475	Exc. Ford Mustang GT, LX; Pump to plate	
QTY	TIMING COVER	YEARS	PART NO.	DESCRIPTION	
1	Timing Cover Set	1993-91	TCS 45449	w/o Sleeve 'N' Seal®; Eng. w/one-piece oil pan gskt. must be used w/OS 34508R; Water pump to plate gskts. not incl.	
1	Timing Set w/Sleeve & Seal	1993-91	TCS 45450	w/Sleeve 'N' Seal®; Eng. w/one-piece oil pan gskt. must be used w/OS 34508R; Water pump to plate gskts. not incl.	
1	Repair Sleeve	1993-91	16213	Timing Cover; Use w/installation tool	
1	Repair Sleeve Tool	1993-91	16310	Timing Cover	
QTY	CARB & FUEL INJECTION	YEARS	PART NO.	DESCRIPTION	
2	Fuel Injector O-Ring Set	1993-91	ES 70599	Improved design	
1	Throttle Body Gasket	1993-91	70262	Throttle body to EGR valve	
1	Throttle Body Gasket	1993-91	71216	Air bypass valve	
1	Throttle Body Gasket	1993-91	72543	EGR valve to plenum	
QTY	DISTRIBUTOR MOUNTING	YEARS	PART NO.	DESCRIPTION	
1	O-Ring	1993-91	5511	Distributor Mounting	
QTY	EXHAUST GAS RECIRCULATION	YEARS	PART NO.	DESCRIPTION	
1	EGR Gasket	1993-91	70020		
QTY	OIL PUMP COVER	YEARS	PART NO.	DESCRIPTION	
1	Oil Pump Gasket	1993-91	72516	Inlet tube	
63		1995 - 1991; 5.0L 302 (4950cc) OHV V8 (16 Valve) 4" Bore H.O.			63
MFI; Gasoline; Naturally Aspirated Ford Eng.; VIN Code T					
QTY	CYLINDER HEAD	YEARS	PART NO.	DESCRIPTION	
2	Head Gasket	1995-91	8548 PT-2	Head bolts not incl.; Head bolt replacement recommended; PermaTorque®	
2	Head Gasket	1995-91	9333 PT-1	Hi-Perf. eng.; Head bolts not incl.; Head bolt replacement recommended	
2	Head Gasket Spacer Shim	1995-91	8548 SP-1	HeadSaver®	
1	Head Set	1995-91	HS 9280 PT-3	Head bolts not incl.; Head bolt replacement recommended; Premium valve stem seals incl.	
2	Head Bolt Set	1995-92	ES 72155	Flanged hex head; Replacement required	
1	Dowel Pin	1995-94	ES 70744	Cylinder Head; Cyl. head alignment	
1	Dowel Pin	1993	ES 70744	Cylinder Head; From 05/09/93; Cyl. head alignment	
QTY	CONVERSION SET	YEARS	PART NO.	DESCRIPTION	
1	Gasket Conversion Set	1995-91	CS 8548-9	Water pump to plate gskts. not incl.; PermaDry® molded rubber oil pan gskt. incl.	

Ford Car (Incl. Edsel, Ford, Lincoln, Mercury, Merkur) (Cont.)

63 (cont.)		1995 - 1991; 5.0L 302 (4950cc) OHV V8 (16 Valve) 4" Bore H.O.			63 (cont.)
MFI; Gasoline; Naturally Aspirated Ford Eng.; VIN Code T					
QTY	CONVERSION SET	YEARS	PART NO.	DESCRIPTION	
1	Gasket Conversion Set	1994-91	CS 8548-2	Water pump to plate gskts. not incl.; Multi-piece oil pan gskt. incl.	
QTY	MANIFOLD - INT. & EXH.	YEARS	PART NO.	DESCRIPTION	
1	Int. Manifold Gasket Set	1995-91	MS 93334	Lower set; Upper set incl.	
1	Plenum Gasket Set	1995-91	MS 94555	Upper set	
1	Exh. Manifold Gasket Set	1995-91	MS 90000		
QTY	EXHAUST PIPE FLANGE	YEARS	PART NO.	DESCRIPTION	
2	Exhaust Pipe Gasket	1994-91	60924	Converter; 1 or 2 Req'd.	
1	Exh. Flange Bolt & Spring Kit	1995-91	ES 72142		
QTY	OIL PAN	YEARS	PART NO.	DESCRIPTION	
1	Oil Pan Gasket Set	1995-91	OS 34508 R	PermaDry® one-piece molded rubber gskt. incl.; Improved design	
1	Oil Pan Gasket Set	1994-91	OS 13260 C	Multi-piece; Cork	
1	Drain Plug Gasket	1995-91	70822		
QTY	CRANKSHAFT REAR SEAL	YEARS	PART NO.	DESCRIPTION	
1	Rear Main Seal Set	1995-91	BS 40620	Rubber; One-piece; Improved design	
1	Rear Main Seal Set	1995-91	BS 40644	PTFE Rubber; One-piece	
1	Repair Sleeve	1995-91	16250	Crankshaft; Use w/installation tool	
1	Repair Sleeve Tool	1995-91	16300	Crankshaft	
QTY	VALVE COVER	YEARS	PART NO.	DESCRIPTION	
1	Valve Cover Gasket Set	1995-91	VS 13264 T	Must be used w/MS 94555; PermaDryPlus®; Improved design	
1	Valve Cover Gasket Set	1995-91	VS 50029 C	Must be used w/MS 94555; Hi-Temp.; w/Compression stops	
QTY	VALVE STEM SEAL SET	YEARS	PART NO.	DESCRIPTION	
2	Valve Stem Seal Set	1995-91	SS 72683	Loc. Int. & Exh.; Premium valve stem seals incl.	
QTY	WATER OUTLET GASKET	YEARS	PART NO.	DESCRIPTION	
1	Water Outlet Gasket	1995-91	35440	Water Outlet	
QTY	WATER PUMP	YEARS	PART NO.	DESCRIPTION	
1	Water Pump Gasket	1995-91	35380	Pump to plate	
1	Water Pump Gasket	1995-94	35352	Plate to block	
1	Water Pump Gasket	1993	35211	Ford Mustang GT, LX; Plate to block	
1	Water Pump Gasket	1993	35352	Exc. Ford Mustang GT, LX; Plate to block	
1	Water Pump Gasket	1992-91	35352	Plate to block	
QTY	TIMING COVER	YEARS	PART NO.	DESCRIPTION	
1	Timing Cover Set	1995-91	TCS 45449	w/o Sleeve 'N' Seal®; Eng. w/one-piece oil pan gskt. must be used w/OS 34508R; Water pump to plate gskts. not incl.	
1	Timing Set w/Sleeve & Seal	1995-91	TCS 45450	w/Sleeve 'N' Seal®; Eng. w/one-piece oil pan gskt. must be used w/OS 34508R; Water pump to plate gskts. not incl.	
1	Repair Sleeve	1995-91	16213	Timing Cover; Use w/installation tool	
1	Repair Sleeve Tool	1995-91	16310	Timing Cover	
QTY	CARB & FUEL INJECTION	YEARS	PART NO.	DESCRIPTION	
2	Fuel Injector O-Ring Set	1995-91	ES 70599	Improved design	
1	Throttle Body Gasket	1995-91	71216	Air bypass valve	
1	Throttle Body Gasket	1995-94	60859	Throttle body to EGR valve	
1	Throttle Body Gasket	1995-94	72543	EGR valve to plenum	
1	Throttle Body Gasket	1993	60859	Exc. Ford Mustang GT, LX; Throttle body to plenum	
1	Throttle Body Gasket	1993	70261	Exc. Ford Mustang GT, LX; Throttle body to EGR valve	
1	Throttle Body Gasket	1993	70262	Ford Mustang GT, LX; Throttle body to EGR valve	
1	Throttle Body Gasket	1993	72540	Exc. Ford Mustang GT, LX; EGR valve to plenum	
1	Throttle Body Gasket	1993	72543	Ford Mustang GT, LX; EGR valve to plenum	
1	Throttle Body Gasket	1992-91	60859	Throttle body to plenum	
1	Throttle Body Gasket	1992-91	70261	Throttle body to EGR valve	
1	Throttle Body Gasket	1992-91	72540	EGR valve to plenum	
QTY	DISTRIBUTOR MOUNTING	YEARS	PART NO.	DESCRIPTION	
1	O-Ring	1995-91	5511	Distributor Mounting	
QTY	EXHAUST GAS RECIRCULATION	YEARS	PART NO.	DESCRIPTION	
1	EGR Gasket	1995-91	70020		
QTY	OIL PUMP COVER	YEARS	PART NO.	DESCRIPTION	
1	Oil Pump Gasket	1995-91	72516	Inlet tube	
64		2013 - 2011; 5.0L 302.1 (4951cc) DOHC V8 (32 Valve) 92.2mm Bore Triton Coyote VVT			64
MFI; Gasoline; Naturally Aspirated Ford Eng.; VIN Code F					
QTY	CYLINDER HEAD	YEARS	PART NO.	DESCRIPTION	
1	Head Gasket	2013-11	26550 PT	Loc. L.H.; Head bolts not incl.; Head bolt replacement recommended; PermaTorqueMLS®; New Part Number - Check for Availability	

Ford Car (Incl. Edsel, Ford, Lincoln, Mercury, Merkur) (Cont.)

64		2013 - 2011; 5.0L 302.1 (4951cc) DOHC V8 (32 Valve) 92.2mm Bore Triton Coyote VVT			64	
(cont.)		MFI; Gasoline; Naturally Aspirated Ford Eng.; VIN Code F			(cont.)	
QTY	CYLINDER HEAD	YEARS	PART NO.	DESCRIPTION		
1	Head Gasket	2013-11	26551 PT	Loc. R.H.; Head bolts not incl.; Head bolt replacement recommended; PermaTorqueMLS®; New Part Number - Check for Availability		
1	Head Set	2013-11	HS 26550 PT	Head bolts not incl.; Head bolt replacement recommended; PermaDry® molded rubber valve cover gskts. incl.; Premium valve stem seals incl.; New Part Number - Check for Availability		
2	Head Bolt Set	2013-11	ES 72479	11mm Head bolts; Head bolts w/Washers; Replacement recommended; New Part Number - Check for Availability		
2	Head Bolt Set	2013-11	ES 72480	12mm Head bolts; Head bolts w/Washers; Replacement recommended; New Part Number - Check for Availability		
QTY	CONVERSION SET	YEARS	PART NO.	DESCRIPTION		
1	Gasket Conversion Set	2013-11	CS 26550	PermaDry® molded rubber oil pan gskt. incl.; New Part Number - Check for Availability		
QTY	MANIFOLD - INT. & EXH.	YEARS	PART NO.	DESCRIPTION		
1	Int. Manifold Gasket Set	2013-11	MS 97215	Lower set; New Part Number - Check for Availability		
1	Exh. Manifold Gasket Set	2013-11	MS 97219	New Part Number - Check for Availability		
QTY	OIL PAN	YEARS	PART NO.	DESCRIPTION		
1	Oil Pan Gasket Set	2013-11	OS 30840 R	PermaDry® molded rubber gskt. incl.; New Part Number - Check for Availability		
QTY	CRANKSHAFT REAR SEAL	YEARS	PART NO.	DESCRIPTION		
1	Rear Main Seal Set	2013-11	BS 40729	Rubber; One-piece		
QTY	VALVE COVER	YEARS	PART NO.	DESCRIPTION		
1	Valve Cover Gasket Set	2013-11	VS 50811 R	w/Grommets & Spark plug tube seals; PermaDry® molded rubber gskts. incl.; New Part Number - Check for Availability		
QTY	VALVE STEM SEAL SET	YEARS	PART NO.	DESCRIPTION		
1	Valve Stem Seal Set	2013-11	SS 72936	Premium valve stem seals incl.; New Part Number - Check for Availability		
QTY	THERMOSTAT HOUSING	YEARS	PART NO.	DESCRIPTION		
1	Thermostat Gasket	2013-11	35984	Thermostat Housing; Thermostat housing O-ring; New Part Number - Check for Availability		
1	Thermostat Gasket	2013-11	35991	Thermostat Housing; Thermostat seal; New Part Number - Check for Availability		
QTY	WATER OUTLET GASKET	YEARS	PART NO.	DESCRIPTION		
1	Water Outlet Gasket	2013-11	35993	Water Outlet; Water outlet connection; New Part Number - Check for Availability		
QTY	WATER PUMP	YEARS	PART NO.	DESCRIPTION		
1	Water Pump Gasket	2013-11	35478			
QTY	TIMING COVER	YEARS	PART NO.	DESCRIPTION		
1	Timing Cover Set	2013-11	TCS 46159	Repair sleeve not incl.; New Part Number - Check for Availability		
1	Crankshaft Front Seal Set	2013-11	TCS 46117			
QTY	CARB & FUEL INJECTION	YEARS	PART NO.	DESCRIPTION		
4	Fuel Injector O-Ring Set	2013-11	ES 70599	Improved design		
1	Throttle Body Gasket	2013-11	61698	Mounting; New Part Number - Check for Availability		
65		2013 - 2012; 5.0L 302.1 (4951cc) DOHC V8 (32 Valve) 92.2mm Bore Triton Road Runner VVT			65	
(cont.)		MFI; Gasoline; Naturally Aspirated Ford Eng.; VIN Code U			(cont.)	
QTY	CYLINDER HEAD	YEARS	PART NO.	DESCRIPTION		
1	Head Gasket	2013-12	26552 PT	Loc. L.H.; Head bolts not incl.; Head bolt replacement recommended; PermaTorqueMLS®; New Part Number - Check for Availability		
1	Head Gasket	2013-12	26553 PT	Loc. R.H.; Head bolts not incl.; Head bolt replacement recommended; PermaTorqueMLS®; New Part Number - Check for Availability		
2	Head Bolt Set	2013-12	ES 72479	11mm Head bolts; Head bolts w/Washers; Replacement recommended; New Part Number - Check for Availability		
2	Head Bolt Set	2013-12	ES 72480	12mm Head bolts; Head bolts w/Washers; Replacement recommended; New Part Number - Check for Availability		
QTY	CONVERSION SET	YEARS	PART NO.	DESCRIPTION		
1	Gasket Conversion Set	2013-12	CS 26550	PermaDry® molded rubber oil pan gskt. incl.; New Part Number - Check for Availability		
QTY	MANIFOLD - INT. & EXH.	YEARS	PART NO.	DESCRIPTION		
1	Int. Manifold Gasket Set	2013-12	MS 97215	Lower set; New Part Number - Check for Availability		
1	Exh. Manifold Gasket Set	2013-12	MS 97219	New Part Number - Check for Availability		
QTY	OIL PAN	YEARS	PART NO.	DESCRIPTION		
1	Oil Pan Gasket Set	2013-12	OS 30840 R	PermaDry® molded rubber gskt. incl.; New Part Number - Check for Availability		
QTY	CRANKSHAFT REAR SEAL	YEARS	PART NO.	DESCRIPTION		
1	Rear Main Seal Set	2013-12	BS 40729	Rubber; One-piece		

Ford Car (Incl. Edsel, Ford, Lincoln, Mercury, Merkur) (Cont.)

65		2013 - 2012; 5.0L 302.1 (4951cc) DOHC V8 (32 Valve) 92.2mm Bore Triton Road Runner VVT			65
(cont.)		MFI; Gasoline; Naturally Aspirated Ford Eng.; VIN Code U			(cont.)
QTY	VALVE COVER	YEARS	PART NO.	DESCRIPTION	
1	Valve Cover Gasket Set	2013-12	VS 50811 R	w/Grommets & Spark plug tube seals; PermaDry® molded rubber gsks. incl.; New Part Number - Check for Availability	
QTY	VALVE STEM SEAL SET	YEARS	PART NO.	DESCRIPTION	
1	Valve Stem Seal Set	2013-12	SS 72936	Premium valve stem seals incl.; New Part Number - Check for Availability	
QTY	THERMOSTAT HOUSING	YEARS	PART NO.	DESCRIPTION	
1	Thermostat Gasket	2013-12	35984	Thermostat Housing; Thermostat housing O-ring; New Part Number - Check for Availability	
1	Thermostat Gasket	2013-12	35991	Thermostat Housing; Thermostat seal; New Part Number - Check for Availability	
QTY	WATER OUTLET GASKET	YEARS	PART NO.	DESCRIPTION	
1	Water Outlet Gasket	2013-12	35993	Water Outlet; Water outlet connection; New Part Number - Check for Availability	
QTY	WATER PUMP	YEARS	PART NO.	DESCRIPTION	
1	Water Pump Gasket	2013-12	35478		
QTY	TIMING COVER	YEARS	PART NO.	DESCRIPTION	
1	Timing Cover Set	2013-12	TCS 46159	Repair sleeve not incl.; New Part Number - Check for Availability	
1	Crankshaft Front Seal Set	2013-12	TCS 46117		
QTY	CARB & FUEL INJECTION	YEARS	PART NO.	DESCRIPTION	
4	Fuel Injector O-Ring Set	2013-12	ES 70599	Improved design	
1	Throttle Body Gasket	2013-12	61698	Mounting; New Part Number - Check for Availability	
66		2001 - 1999; 5.4L 330 (5408cc) DOHC V8 (32 Valve) 90.2mm Bore Intech Windsor			66
		MFI; Gasoline; Naturally Aspirated Ford Eng.; VIN Code H			
QTY	WATER PUMP	YEARS	PART NO.	DESCRIPTION	
2	O-Ring	2001-99	413	Water Pump; Water pump bypass pipe O-ring	
QTY	TIMING COVER	YEARS	PART NO.	DESCRIPTION	
1	Crankshaft Front Seal Set	2001-99	TCS 46117		
67		2005; 5.4L 330 (5408cc) DOHC V8 (32 Valve) 90.2mm Bore Triton Condor			67
		MFI; Gasoline; Supercharged - Intercooled Ford Eng.; VIN Code G			
QTY	CYLINDER HEAD	YEARS	PART NO.	DESCRIPTION	
1	Head Gasket	2005	9790 PT-2	Loc. R.H.; Head bolts not incl.; Head bolt replacement recommended; PermaTorqueMLS®; Improved design	
1	Head Gasket	2005	9792 PT-2	Loc. L.H.; Head bolts not incl.; Head bolt replacement recommended; PermaTorqueMLS®; Improved design	
QTY	WATER PUMP	YEARS	PART NO.	DESCRIPTION	
2	O-Ring	2005	413	Water Pump; Water pump bypass pipe O-ring	
68		2012 - 2006; 5.4L 330 (5408cc) DOHC V8 (32 Valve) 90.2mm Bore Triton Condor			68
		MFI; Gasoline; Supercharged - Intercooled Ford Eng.; VIN Code S			
QTY	CYLINDER HEAD	YEARS	PART NO.	DESCRIPTION	
1	Head Gasket	2012-06	9790 PT-2	Loc. R.H.; Head bolts not incl.; Head bolt replacement recommended; PermaTorqueMLS®; Improved design	
1	Head Gasket	2012-06	9792 PT-2	Loc. L.H.; Head bolts not incl.; Head bolt replacement recommended; PermaTorqueMLS®; Improved design	
QTY	WATER PUMP	YEARS	PART NO.	DESCRIPTION	
2	O-Ring	2012-06	413	Water Pump; Water pump bypass pipe O-ring	
69		1991; 5.8L 351 (5753cc) OHV V8 (16 Valve) 4" Bore Windsor			69
		2 Bbl.; Gasoline; Naturally Aspirated Ford Eng.; VIN Code G			
QTY	CYLINDER HEAD	YEARS	PART NO.	DESCRIPTION	
2	Head Gasket	1991	8548 PT-2	PermaTorque®	
2	Head Gasket	1991	9333 PT-1	Hi-Perf. eng.	
2	Head Gasket Spacer Shim	1991	8548 SP-1	HeadSaver®	
1	Head Set	1991	HS 8548 PT-9	Premium valve stem seals incl.	
QTY	CONVERSION SET	YEARS	PART NO.	DESCRIPTION	
1	Gasket Conversion Set	1991	CS 8548-7	Water pump to plate gskt. not incl.; Multi-piece oil pan gskt. incl.	
QTY	MANIFOLD - INT. & EXH.	YEARS	PART NO.	DESCRIPTION	
1	Int. Manifold Gasket Set	1991	MS 90361		
1	Exh. Manifold Gasket Set	1991	MS 90000		
QTY	EXHAUST PIPE FLANGE	YEARS	PART NO.	DESCRIPTION	
2	Exhaust Pipe Gasket	1991	60924	Converter	
QTY	OIL PAN	YEARS	PART NO.	DESCRIPTION	
1	Oil Pan Gasket Set	1991	OS 30214 C	Multi-piece; Cork	

Ford Car (Incl. Edsel, Ford, Lincoln, Mercury, Merkur) (Cont.)

69 (cont.)		1991; 5.8L 351 (5753cc) OHV V8 (16 Valve) 4" Bore Windsor 2 Bbl.; Gasoline; Naturally Aspirated Ford Eng.; VIN Code G			69 (cont.)
QTY	OIL PAN	YEARS	PART NO.	DESCRIPTION	
1	Oil Pan Gasket Set	1991	OS 30616 R	PermaDry® one-piece molded rubber gskt. incl.	
1	Drain Plug Gasket	1991	70822		
QTY	CRANKSHAFT REAR SEAL	YEARS	PART NO.	DESCRIPTION	
1	Rear Main Seal Set	1991	BS 40592	Rubber; One-piece	
1	Rear Main Seal Set	1991	BS 40645	PTFE Rubber; One-piece	
1	Repair Sleeve	1991	16251	Crankshaft; Use w/installation tool	
1	Repair Sleeve Tool	1991	16301	Crankshaft	
QTY	VALVE COVER	YEARS	PART NO.	DESCRIPTION	
1	Valve Cover Gasket Set	1991	VS 13264 T	PermaDryPlus®; Improved design	
1	Valve Cover Gasket Set	1991	VS 50029 C	Hi-Temp.; w/Compression stops	
QTY	VALVE STEM SEAL SET	YEARS	PART NO.	DESCRIPTION	
1	Valve Stem Seal Set	1991	SS 70070	Loc. Int.; Premium valve stem seals incl.	
1	Valve Stem Seal Set	1991	SS 70373	Loc. Exh.; Premium valve stem seals incl.	
QTY	WATER OUTLET GASKET	YEARS	PART NO.	DESCRIPTION	
1	Water Outlet Gasket	1991	35440	Water Outlet	
QTY	WATER PUMP	YEARS	PART NO.	DESCRIPTION	
1	Water Pump Gasket	1991	35211	Plate to block	
1	Water Pump Gasket	1991	35380	Pump to plate	
QTY	TIMING COVER	YEARS	PART NO.	DESCRIPTION	
1	Timing Cover Set	1991	TCS 45449	w/o Sleeve 'N' Seal®; Eng. w/one-piece oil pan gskt. must be used w/OS 30616R; Water pump to plate gskt. not incl.	
1	Timing Set w/Sleeve & Seal	1991	TCS 45450	w/Sleeve 'N' Seal®; Eng. w/one-piece oil pan gskt. must be used w/OS 30616R; Water pump to plate gskt. not incl.	
1	Repair Sleeve	1991	16213	Timing Cover; Use w/installation tool	
1	Repair Sleeve Tool	1991	16310	Timing Cover	
QTY	AIR CLEANER MOUNTING	YEARS	PART NO.	DESCRIPTION	
1	Air Cleaner Gasket	1991	60379	5 3/8" ID	
QTY	CARB & FUEL INJECTION	YEARS	PART NO.	DESCRIPTION	
1	Carb. Mounting Gasket	1991	60529	Phenolic spacer; .630" thick	
QTY	DISTRIBUTOR MOUNTING	YEARS	PART NO.	DESCRIPTION	
1	O-Ring	1991	5511	Distributor Mounting	
QTY	EXHAUST GAS RECIRCULATION	YEARS	PART NO.	DESCRIPTION	
1	EGR Gasket	1991	70020		
QTY	OIL PUMP COVER	YEARS	PART NO.	DESCRIPTION	
1	Oil Pump Gasket	1991	72607		
70		1996 - 1995; 5.8L 351 (5753cc) OHV V8 (16 Valve) 4" Bore Windsor Cobra MFI; Gasoline; Naturally Aspirated Ford Eng.; VIN Code C			70
QTY	DISTRIBUTOR MOUNTING	YEARS	PART NO.	DESCRIPTION	
1	O-Ring	1996-95	5511	Distributor Mounting	

Ford Minivans - See Ford Truck

Ford SUV's - See Ford Truck

Ford Truck (Incl. Minivans and SUV's)

Engine Finding Index				
Engine	Years	Code	Line No.	
2.0L 121 (1988cc) DOHC L4 (16 Valve) 84.8mm Bore Zetec; MFI; Gasoline; Naturally Aspirated Ford Eng.	2004-01	B	1	
2.0L 122 (1999cc) DOHC L4 (16 Valve) 87.5mm Bore Duratec; MFI; Gasoline; Naturally Aspirated Ford Eng.	2013-10	N	2	
2.0L 122 (1999cc) DOHC L4 (16 Valve) 87.5mm Bore EcoBoost Duratec VVT; DI; Gasoline; Turbo - Intercooled Ford Eng.	2013-11	9	3	
2.3L 138 (2261cc) DOHC L4 (16 Valve) 87.5mm Bore Duratec; MFI; Gasoline; Naturally Aspirated Ford Eng.	2011-01	D	4	
2.3L 138 (2261cc) DOHC L4 (16 Valve) 87.5mm Bore Duratec; MFI; Hybrid (Gas/Electric); Naturally Aspirated Ford Eng.	2008-05	H	5	
2.3L 138 (2261cc) DOHC L4 (16 Valve) 87.5mm Bore Duratec PZEV; MFI; Gasoline; Naturally Aspirated Ford Eng.	2008-05	Z	6	
2.3L 140 (2302cc) SOHC L4 (8 Valve) 96mm Bore; MFI; Gasoline; Naturally Aspirated Ford Eng.	1997-91	A	7	
2.5L 151.8 (2488cc) DOHC L4 (16 Valve) 89mm Bore Duratec; MFI; Hybrid (Gas/Electric); Naturally Aspirated Ford Eng.	2012-09	3	8	
2.5L 151.8 (2488cc) DOHC L4 (16 Valve) 89mm Bore Duratec PZEV; MFI; Gasoline; Naturally Aspirated Ford Eng.	2012-09	7	9	
2.5L 151.8 (2488cc) DOHC L4 (16 Valve) 89mm Bore Duratec VVT; MFI; Gasoline; Naturally Aspirated Ford Eng.	2013	7	10	
2.5L 153 (2503cc) SOHC L4 (8 Valve) 96mm Bore; MFI; Gasoline; Naturally Aspirated Ford Eng.	2001-98	C	11	
2.9L 177 (2935cc) OHV V6 (12 Valve) 93mm Bore; MFI; Gasoline; Naturally Aspirated Ford Eng.	1992-91	T	12	

Ford Truck (Incl. Minivans and SUV's) (Cont.)

Engine Finding Index (Cont.)			
<i>Engine</i>	<i>Years</i>	<i>Code</i>	<i>Line No.</i>
3.0L 181 (2960cc) SOHC V6 (12 Valve) 87mm Bore; MFI; Gasoline; Naturally Aspirated Nissan Eng.	1998-97	1	13
3.0L 181 (2960cc) SOHC V6 (12 Valve) 87mm Bore; MFI; Gasoline; Naturally Aspirated Nissan Eng.	1996-93	W	14
3.0L 181 (2967cc) DOHC V6 (24 Valve) 89mm Bore Duratec; MFI; Gasoline; Naturally Aspirated Ford Eng.	2008-01	1	15
3.0L 181 (2967cc) DOHC V6 (24 Valve) 89mm Bore Duratec VVT; MFI; Flex Fuel; Naturally Aspirated Ford Eng.	2012-11	G	16
3.0L 181 (2967cc) DOHC V6 (24 Valve) 89mm Bore Duratec VVT; MFI; Gasoline; Naturally Aspirated Ford Eng.	2012-09	G	17
3.0L 183 (2982cc) OHV V6 (12 Valve) 89mm Bore Vulcan; MFI; Gasoline; Naturally Aspirated Ford Eng.	2008-91	U	18
3.0L 183 (2982cc) OHV V6 (12 Valve) 89mm Bore Vulcan; MFI; Flex Fuel; Naturally Aspirated Ford Eng.	2008-99	V	19
3.3L 199.8 (3274cc) SOHC V6 (12 Valve) 91.5mm Bore; MFI; Gasoline; Naturally Aspirated Nissan Eng.	2002-99	T	20
3.5L 213.3 (3496cc) DOHC V6 (24 Valve) 92.5mm Bore Duratec Cyclone; MFI; Gasoline; Naturally Aspirated Ford Eng.	2012-07	C	21
3.5L 213.3 (3496cc) DOHC V6 (24 Valve) 92.5mm Bore Duratec Cyclone; MFI; Gasoline; Naturally Aspirated Ford Eng.	2009-08	W	22
3.5L 213.3 (3496cc) DOHC V6 (24 Valve) 92.5mm Bore Duratec Cyclone VVT; MFI; Gasoline; Naturally Aspirated Ford Eng.	2013-11	8	23
3.5L 213.3 (3496cc) DOHC V6 (24 Valve) 92.5mm Bore Duratec Cyclone VVT; MFI; Gasoline; Naturally Aspirated Ford Eng.	2013-11	C	24
3.5L 213.3 (3496cc) DOHC V6 (24 Valve) 92.5mm Bore EcoBoost Duratec VVT; DI; Gasoline; Turbo - Intercooled Ford Eng.	2013-10	T	25
3.7L 227 (3721cc) DOHC V6 (24 Valve) 95.5mm Bore Duratec Cyclone; MFI; Gasoline; Naturally Aspirated Ford Eng.	2012-10	R	26
3.7L 227 (3721cc) DOHC V6 (24 Valve) 95.5mm Bore Duratec Cyclone VVT; MFI; Gasoline; Naturally Aspirated Ford Eng.	2013-11	K	27
3.7L 227 (3721cc) DOHC V6 (24 Valve) 95.5mm Bore Duratec Cyclone VVT; MFI; Flex Fuel; Naturally Aspirated Ford Eng.	2013-11	M	28
3.8L 232 (3797cc) OHV V6 (12 Valve) 96.8mm Bore; MFI; Gasoline; Naturally Aspirated Ford Eng.	2003-95	4	29
3.9L 238 (3887cc) OHV V6 (12 Valve) 96.8mm Bore; MFI; Gasoline; Naturally Aspirated Ford Eng.	2007-04	6	30
4.0L 244 (4015cc) OHV V6 (12 Valve) 100.4mm Bore; MFI; Gasoline; Naturally Aspirated Ford Eng.	2001-91	X	31
4.0L 244 (4015cc) SOHC V6 (12 Valve) 100.4mm Bore; MFI; Gasoline; Naturally Aspirated Ford Eng.	2011-97	E	32
4.0L 244 (4015cc) SOHC V6 (12 Valve) 100.4mm Bore; MFI; Flex Fuel; Naturally Aspirated Ford Eng.	2010-00	K	33
4.2L 256 (4196cc) OHV V6 (12 Valve) 96.8mm Bore; MFI; Gasoline; Naturally Aspirated Ford Eng.	2008-97	2	34
4.6L 281 (4605cc) DOHC V8 (32 Valve) 90.2mm Bore Intech; MFI; Gasoline; Naturally Aspirated Ford Eng.	2005	A	35
4.6L 281 (4605cc) DOHC V8 (32 Valve) 90.2mm Bore Intech; MFI; Gasoline; Naturally Aspirated Ford Eng.	2004-03	H	36
4.6L 281 (4605cc) SOHC V8 (16 Valve) 90.2mm Bore Triton; MFI; Flex Fuel; Naturally Aspirated Ford Eng.	2013-06	V	37
4.6L 281 (4605cc) SOHC V8 (16 Valve) 90.2mm Bore Triton Romeo; MFI; Gasoline; Naturally Aspirated Ford Eng.	2013-97	W	38
4.6L 281 (4605cc) SOHC V8 (16 Valve) 90.2mm Bore Triton Windsor; MFI; Gasoline; Naturally Aspirated Ford Eng.	2003-97	6	39
4.6L 281 (4605cc) SOHC V8 (24 Valve) 90.2mm Bore Triton; MFI; Gasoline; Naturally Aspirated Ford Eng.	2010-06	8	40
4.9L 300 (4917cc) OHV L6 (12 Valve) 4" Bore; MFI; Gasoline; Naturally Aspirated Ford Eng.	1996-91	9	41
4.9L 300 (4917cc) OHV L6 (12 Valve) 4" Bore; MFI; Gasoline; Naturally Aspirated Ford Eng.	1997-91	Y	42
4.9L 300 (4917cc) OHV L6 (12 Valve) 4" Bore; MFI; Bi-Fuel; Naturally Aspirated Ford Eng.	1997-94	Z	43
5.0L 302 (4950cc) OHV V8 (16 Valve) 4" Bore; MFI; Gasoline; Naturally Aspirated Ford Eng.	1996-91	N	44
5.0L 302 (4950cc) OHV V8 (16 Valve) 4" Bore; MFI; Gasoline; Naturally Aspirated Ford Eng.	2001-96	P	45
5.0L 302 (4950cc) OHV V8 (16 Valve) 4" Bore; MFI; Gasoline; Naturally Aspirated Ford Eng.	1992-91	Y	46
5.0L 302.1 (4951cc) DOHC V8 (32 Valve) 92.2mm Bore Triton Coyote VVT; MFI; Flex Fuel; Naturally Aspirated Ford Eng.	2013-11	F	47
5.4L 330 (5408cc) DOHC V8 (32 Valve) 90.2mm Bore Intech Windsor; MFI; Gasoline; Naturally Aspirated Ford Eng.	2004-99	A	48
5.4L 330 (5408cc) DOHC V8 (32 Valve) 90.2mm Bore Intech Windsor; MFI; Gasoline; Naturally Aspirated Ford Eng.	2005-02	R	49
5.4L 330 (5408cc) SOHC V8 (16 Valve) 90.2mm Bore Triton Windsor; MFI; Gasoline; Supercharged Ford Eng.	2004-99	3	50
5.4L 330 (5408cc) SOHC V8 (16 Valve) 90.2mm Bore Triton Windsor; MFI; Gasoline; Naturally Aspirated Ford Eng.	2013-97	L	51
5.4L 330 (5408cc) SOHC V8 (16 Valve) 90.2mm Bore Triton Windsor; MFI; Natural Gas; Naturally Aspirated Ford Eng.	2013-97	M	52
5.4L 330 (5408cc) SOHC V8 (16 Valve) 90.2mm Bore Triton Windsor; MFI; Gasoline; Naturally Aspirated Ford Eng.	2004-01	W	53
5.4L 330 (5408cc) SOHC V8 (16 Valve) 90.2mm Bore Triton Windsor; MFI; Bi-Fuel; Naturally Aspirated Ford Eng.	2013-97	Z	54
5.4L 330 (5408cc) SOHC V8 (24 Valve) 90.2mm Bore Triton Windsor; MFI; Flex Fuel; Naturally Aspirated Ford Eng.	2013-09	5	55
5.4L 330 (5408cc) SOHC V8 (24 Valve) 90.2mm Bore Triton Windsor; MFI; Gasoline; Naturally Aspirated Ford Eng.	2013-04	5	56
5.4L 330 (5408cc) SOHC V8 (24 Valve) 90.2mm Bore Triton Windsor; MFI; Gasoline; Supercharged Ford Eng.	2010-08	5	57
5.4L 330 (5408cc) SOHC V8 (24 Valve) 90.2mm Bore Triton Windsor; MFI; Flex Fuel; Naturally Aspirated Ford Eng.	2010-06	V	58
5.8L 351 (5753cc) OHV V8 (16 Valve) 4" Bore Windsor; MFI; Gasoline; Naturally Aspirated Ford Eng.	1998-91	H	59
5.8L 351 (5753cc) OHV V8 (16 Valve) 4" Bore Windsor Lightning; MFI; Gasoline; Naturally Aspirated Ford Eng.	1996-93	R	60
6.0L 365 (5982cc) OHV Turbo - Intercooled V8 (32 Valve) 95mm Bore Power Stroke; DI; Diesel; Turbo - Intercooled International Eng.	2011-03	P	61
6.2L 378.9 (6210cc) SOHC V8 (16 Valve) 102mm Bore Triton Boss VVT; MFI; Flex Fuel; Naturally Aspirated Ford Eng.	2013-11	6	62
6.2L 378.9 (6210cc) SOHC V8 (16 Valve) 102mm Bore Triton Boss VVT; MFI; Gasoline; Naturally Aspirated Ford Eng.	2013-10	6	63
6.4L 390 (6391cc) OHV Turbo - Intercooled V8 (32 Valve) 98mm Bore Power Stroke; DI; Diesel; Turbo - Intercooled International Eng.	2011-08	R	64
6.7L 405.8 (6651cc) OHV Turbo - Intercooled V8 (32 Valve) 99mm Bore Power Stroke; DI; Diesel; Turbo - Intercooled Ford Eng.	2013-11	T	65
6.8L 415 (6751cc) SOHC V10 (20 Valve) 90.2mm Bore Triton; MFI; Gasoline; Naturally Aspirated Ford Eng.	2013-97	S	66
6.8L 415 (6751cc) SOHC V10 (30 Valve) 90.2mm Bore Triton; MFI; Gasoline; Naturally Aspirated Ford Eng.	2013-05	Y	67
7.3L 444 (7277cc) OHV Turbo V8 (16 Valve) 4.11" Bore; IDI; Diesel; Turbo International Eng.	1993-92	C	68
7.3L 444 (7277cc) OHV Turbo V8 (16 Valve) 4.11" Bore; IDI; Diesel; Turbo International Eng.	1994	K	69
7.3L 444 (7277cc) OHV Turbo V8 (16 Valve) 4.11" Bore Power Stroke; DI; Diesel; Turbo International Eng.	2003-94	F	70
7.3L 444 (7277cc) OHV V8 (16 Valve) 4.11" Bore; IDI; Diesel; Naturally Aspirated International Eng.	1995-91	M	71
7.5L 460 (7539cc) OHV V8 (16 Valve) 4.36" Bore; MFI; Gasoline; Naturally Aspirated Ford Eng.	1998-91	G	72
Engine Code Index			
<i>Code</i>	<i>Engine</i>		
VG30E	3.0L 181 (2960cc) SOHC V6 (12 Valve) 87mm Bore; MFI; Gasoline; Naturally Aspirated Nissan Eng.		<i>Line No.</i> 13

Ford Truck (Incl. Minivans and SUV's) (Cont.)

Engine Code Index (Cont.)

Code	Engine	Line No.			
VG30E	3.0L 181 (2960cc) SOHC V6 (12 Valve) 87mm Bore; MFI; Gasoline; Naturally Aspirated Nissan Eng.	14			
VG33E	3.3L 199.8 (3274cc) SOHC V6 (12 Valve) 91.5mm Bore; MFI; Gasoline; Naturally Aspirated Nissan Eng.	20			
Model Index					
Engine (VIN Code / Eng. Code)	Year	Engine (VIN Code / Eng. Code)	Year	Engine (VIN Code / Eng. Code)	Year
Ford Truck		Ford Truck (cont.)		Ford Truck (cont.)	
A		E100 (Econoline Van) (cont.)		E350 (Econoline Van) (cont.)	
L4 200CI 3.3L (L-Head)	31-28	V8 400CI 6.6L (Z)	82-80	L6 300CI 4.9L (E)	82-80
AA		E150 (Econoline Van)		L6 300CI 4.9L (Y)	96-87
L4 200CI 3.3L (L-Head)	31-28	L6 300CI 4.9L (B)	86-75	V10 415CI 6.8L SOHC (20 Valve) (S)	13-97
Aerostar (2WD Minivan)		L6 300CI 4.9L (C)	78	V8 302CI 5.0L (F)	85-81
L4 140CI 2.3L SOHC (A)	87-86	L6 300CI 4.9L (E)	82-80	V8 302CI 5.0L (N)	96-86
V6 171CI 2.8L (S)	86	L6 300CI 4.9L (Y)	96-87	V8 330CI 5.4L SOHC (16 Valve) (L)	13-97
V6 183CI 3.0L OHV (U)	97-86	V6 256CI 4.2L (Z)	06-97	V8 330CI 5.4L SOHC (Flex Fuel) (Z)	13-97
V6 244CI 4.0L OHV (X)	97-90	V8 281CI 4.6L SOHC (16 Valve) (6)	00-97	V8 330CI 5.4L SOHC (Natural Gas) (M)	13-97
Aerostar (4WD Minivan)		V8 281CI 4.6L SOHC (16 Valve) (W)	13-01	V8 351CI 5.8L (Modified) (G)	82-80
V6 183CI 3.0L OHV (U)	97-90	V8 302CI 5.0L (G)	79	V8 351CI 5.8L (Windsor) (G)	85-80
V6 244CI 4.0L OHV (X)	97-90	V8 302CI 5.0L (H)	85-80	V8 351CI 5.8L (Windsor) (H)	96-84
B		V8 302CI 5.0L (N)	96-86	V8 351CI 5.8L (Windsor) (H)	79-75
L4 200CI 3.3L (L-Head)	34-32	V8 330CI 5.4L SOHC (16 Valve) (L)	13-97	V8 365CI 6.0L Turbo-Diesel DI (P)	11-04
BB		V8 330CI 5.4L SOHC (Flex Fuel) (Z)	13-97	V8 400CI 6.6L (Z)	82-80
L4 200CI 3.3L (L-Head)	34-32	V8 330CI 5.4L SOHC (Natural Gas) (M)	13-97	V8 420CI 6.9L Diesel (1)	87-83
Bronco (Full-Size SUV)		V8 351CI 5.8L (Modified) (G)	82-80	V8 444CI 7.3L Diesel IDI (M)	95-88
L6 170CI 2.8L	72-66	V8 351CI 5.8L (Windsor) (G)	85-80	V8 444CI 7.3L Turbo-Diesel DI (F)	03-94
L6 200CI 3.3L	74-73	V8 351CI 5.8L (Windsor) (H)	96-84	V8 444CI 7.3L Turbo-Diesel IDI (C)	93-92
L6 300CI 4.9L (B)	86-83	V8 351CI 5.8L (Windsor) (H)	79-75	V8 444CI 7.3L Turbo-Diesel IDI (K)	94
L6 300CI 4.9L (E)	82-80	V8 351CI 5.8L (Windsor) (W)	80	V8 460CI 7.5L (A)	79-75
L6 300CI 4.9L (Y)	96-87	V8 400CI 6.6L (Z)	82-80	V8 460CI 7.5L (G)	98-88
V8 289CI 4.7L	68-66	E200 (Econoline Van)		V8 460CI 7.5L (L)	87-80
V8 302CI 5.0L (F)	84-80	L6 170CI 2.8L	70-69	E350 Super Duty (Econoline Van)	
V8 302CI 5.0L (G)	79-69	L6 240CI 3.9L	74-69	V10 415CI 6.8L SOHC (20 Valve) (S)	13-98
V8 302CI 5.0L (N)	96-85	L6 300CI 4.9L	74-72	V8 330CI 5.4L SOHC (16 Valve) (L)	13-98
V8 302CI 5.0L (Y)	92-87	V8 302CI 5.0L	74-69	V8 365CI 6.0L Turbo-Diesel DI (P)	11-04
V8 351CI 5.8L (Modified) (G)	82-80	E250 (Econoline Van)		V8 444CI 7.3L Turbo-Diesel DI (F)	03-98
V8 351CI 5.8L (Modified) (H)	79-77	L6 300CI 4.9L (B)	86-75	E450 Super Duty (Econoline Van)	
V8 351CI 5.8L (Windsor) (G)	85-80	L6 300CI 4.9L (E)	82-80	V10 415CI 6.8L SOHC (20 Valve) (S)	13-98
V8 351CI 5.8L (Windsor) (H)	96-84	L6 300CI 4.9L (Y)	96-87	V8 330CI 5.4L SOHC (16 Valve) (L)	13-98
V8 351CI 5.8L (Windsor) (H)	79-78	V10 415CI 6.8L SOHC (20 Valve) (S)	13-97	V8 365CI 6.0L Turbo-Diesel DI (P)	11-04
V8 400CI 6.6L (S)	79-78	V6 256CI 4.2L (Z)	06-97	V8 444CI 7.3L Turbo-Diesel DI (F)	03-98
V8 400CI 6.6L (Z)	82-80	V8 281CI 4.6L SOHC (16 Valve) (6)	00-97	Edge (AWD Mid-Size SUV)	
Bronco II (2WD Compact SUV)		V8 281CI 4.6L SOHC (16 Valve) (W)	13-01	V6 213CI 3.5L DOHC (24 Valve) (C)	13-11
L4 2346cc 2.3L SOHC Turbo-Diesel (E)	87-85	V8 302CI 5.0L (F)	85-80	V6 213CI 3.5L DOHC (24 Valve) (C)	10-07
V6 171CI 2.8L (S)	85-83	V8 302CI 5.0L (G)	79	V6 227CI 3.7L DOHC (24 Valve) (K)	13-11
V6 177CI 2.9L (T)	91-86	V8 302CI 5.0L (N)	96-86	Edge (FWD Mid-Size SUV)	
V6 244CI 4.0L OHV (X)	91-90	V8 330CI 5.4L SOHC (16 Valve) (L)	13-97	L4 1999cc 2.0L DOHC Turbo (16 Valve) (9)	13-11
Bronco II (4WD Compact SUV)		V8 330CI 5.4L SOHC (Flex Fuel) (Z)	13-97	V6 213CI 3.5L DOHC (24 Valve) (C)	13-11
L4 2346cc 2.3L SOHC Turbo-Diesel (E)	87-85	V8 330CI 5.4L SOHC (Natural Gas) (M)	13-97	V6 213CI 3.5L DOHC (24 Valve) (C)	10-07
V6 171CI 2.8L (S)	85-83	V8 351CI 5.8L (Modified) (G)	82-80	V6 227CI 3.7L DOHC (24 Valve) (K)	13-11
V6 177CI 2.9L (T)	91-86	V8 351CI 5.8L (Windsor) (G)	85-80	Escape (AWD Compact SUV)	
V6 244CI 4.0L OHV (X)	91-90	V8 351CI 5.8L (Windsor) (H)	96-84	L4 1596cc 1.6L DOHC Turbo (16 Valve) (X)	13
Courier (Mini-Pickup)		V8 351CI 5.8L (Windsor) (H)	79-75	L4 1988cc 2.0L DOHC (16 Valve) (B)	04-01
L4 140CI 2.3L SOHC (2)	82-81	V8 365CI 6.0L Turbo-Diesel DI (P)	11-05	L4 1999cc 2.0L DOHC Turbo (16 Valve) (9)	13
L4 140CI 2.3L SOHC (B)	80-77	V8 400CI 6.6L (Z)	82-80	L4 2261cc 2.3L DOHC (16 Valve) (Z)	08-05
L4 1796cc 1.8L SOHC (A)	78-72	V8 420CI 6.9L Diesel (1)	87-83	L4 2488cc 2.5L DOHC (16 Valve) (7)	13-09
L4 1970cc 2.0L SOHC (1)	82-79	V8 444CI 7.3L Diesel IDI (M)	95-88	V6 2967cc 3.0L DOHC (24 Valve) (1)	08-01
E100 (Econoline Van)		V8 444CI 7.3L Turbo-Diesel DI (F)	03-94	V6 2967cc 3.0L DOHC (24 Valve) (G)	12-09
L6 144CI 2.4L	64-61	V8 444CI 7.3L Turbo-Diesel IDI (C)	93-92	V6 2967cc 3.0L DOHC (24 Valve) (Flex Fuel) (G)	12-11
L6 170CI 2.8L	70-61	V8 444CI 7.3L Turbo-Diesel IDI (K)	94	Escape (FWD Compact SUV)	
L6 240CI 3.9L	74-65	V8 460CI 7.5L (A)	79-75	L4 1596cc 1.6L DOHC Turbo (16 Valve) (X)	13
L6 300CI 4.9L (B)	79-73	V8 460CI 7.5L (G)	98-88	L4 1988cc 2.0L DOHC (16 Valve) (B)	04-01
L6 300CI 4.9L (C)	78	V8 460CI 7.5L (L)	87-80	L4 1999cc 2.0L DOHC Turbo (16 Valve) (9)	13
L6 300CI 4.9L (E)	82-80	E300 (Econoline Van)		L4 2261cc 2.3L DOHC (16 Valve) (Z)	08-05
L6 300CI 4.9L (Y)	83	L6 170CI 2.8L	70-69	L4 2488cc 2.5L DOHC (16 Valve) (7)	13-09
V8 302CI 5.0L (F)	83-80	L6 240CI 3.9L	74-69	V6 2967cc 3.0L DOHC (24 Valve) (1)	08-01
V8 302CI 5.0L (G)	79-69	L6 300CI 4.9L	74-72	V6 2967cc 3.0L DOHC (24 Valve) (G)	12-09
V8 351CI 5.8L (Modified) (G)	82-80	V8 302CI 5.0L	74-69	V6 2967cc 3.0L DOHC (24 Valve) (Flex Fuel) (G)	12-11
V8 351CI 5.8L (Windsor) (G)	83-80	E350 (Econoline Van)		(G)	
V8 351CI 5.8L (Windsor) (H)	79-75	L6 300CI 4.9L (B)	86-75		

Ford Truck (Incl. Minivans and SUV's) (Cont.)

Model Index (Cont.)					
Engine (VIN Code / Eng. Code)	Year	Engine (VIN Code / Eng. Code)	Year	Engine (VIN Code / Eng. Code)	Year
Ford Truck (cont.)		Ford Truck (cont.)		Ford Truck (cont.)	
Escape Hybrid (AWD Compact SUV)		F100 (2WD Full-Size Pickup) (cont.)		F150 (2WD Full-Size Pickup) (cont.)	
L4 2261cc 2.3L DOHC (16 Valve) (H)	08-05	V8 292CI 4.8L	64-58	V8 351CI 5.8L (Windsor) (R)	96-93
L4 2488cc 2.5L DOHC (16 Valve) (3)	12-09	V8 302CI 5.0L (F)	83-80	V8 360CI 5.9L (H)	76-75
Escape Hybrid (FWD Compact SUV)		V8 302CI 5.0L (G)	79-69	V8 379CI 6.2L SOHC (16 Valve) (6)	13-10
L4 2261cc 2.3L DOHC (16 Valve) (H)	08-05	V8 351CI 5.8L (Modified) (G)	82-80	V8 390CI 6.4L (M)	76-75
L4 2488cc 2.5L DOHC (16 Valve) (3)	12-09	V8 351CI 5.8L (Modified) (H)	79-77	V8 400CI 6.6L (S)	79-77
Excursion (2WD Full-Size SUV)		V8 351CI 5.8L (Windsor) (G)	83-80	V8 400CI 6.6L (Z)	82-80
V10 415CI 6.8L SOHC (20 Valve) (S)	05-00	V8 351CI 5.8L (Windsor) (H)	79-77	V8 460CI 7.5L (A)	79-75
V8 330CI 5.4L SOHC (16 Valve) (L)	05-00	V8 352CI 5.8L	67-65	F150 (4WD Full-Size Pickup)	
V8 365CI 6.0L Turbo-Diesel DI (P)	05-03	V8 360CI 5.9L (Y)	76-68	L6 300CI 4.9L (B)	86-75
V8 444CI 7.3L Turbo-Diesel DI (F)	03-00	V8 390CI 6.4L (H)	76-68	L6 300CI 4.9L (C)	78
Excursion (4WD Full-Size SUV)		V8 400CI 6.6L (S)	79-77	L6 300CI 4.9L (E)	82-80
V10 415CI 6.8L SOHC (20 Valve) (S)	05-00	V8 400CI 6.6L (Z)	82-80	L6 300CI 4.9L (Y)	96-87
V8 330CI 5.4L SOHC (16 Valve) (L)	05-00	V8 460CI 7.5L (A)	79-77	V6 213CI 3.5L DOHC Turbo (24 Valve) (T)	13-11
V8 365CI 6.0L Turbo-Diesel DI (P)	05-03	V8 460CI 7.5L (J)	76-73	V6 227CI 3.7L DOHC (24 Valve) (Flex Fuel)	13-11
V8 444CI 7.3L Turbo-Diesel DI (F)	03-00	F100 (4WD Full-Size Pickup)		(M)	
Expedition (2WD Full-Size SUV)		L6 223CI 3.6L	64-59	V6 232CI 3.8L (3)	83-82
V8 281CI 4.6L SOHC (16 Valve) (6)	00-97	L6 240CI 3.9L	74-65	V6 256CI 4.2L (2)	08-97
V8 281CI 4.6L SOHC (16 Valve) (W)	04-01	L6 262CI 4.3L	64-61	V8 281CI 4.6L SOHC (16 Valve) (6)	00-97
V8 330CI 5.4L SOHC (16 Valve) (L)	04-97	L6 300CI 4.9L (B)	83-65	V8 281CI 4.6L SOHC (16 Valve) (W)	10-97
V8 330CI 5.4L SOHC (24 Valve) (5)	13-05	V8 292CI 4.8L	64-59	V8 281CI 4.6L SOHC (24 Valve) (8)	10-09
V8 330CI 5.4L SOHC (Flex Fuel) (5)	13-09	V8 302CI 5.0L (F)	83-80	V8 302CI 5.0L (F)	85-80
Expedition (4WD Full-Size SUV)		V8 302CI 5.0L (G)	79-69	V8 302CI 5.0L (G)	79-75
V8 281CI 4.6L SOHC (16 Valve) (6)	00-97	V8 351CI 5.8L (Modified) (G)	82-80	V8 302CI 5.0L (N)	96-85
V8 281CI 4.6L SOHC (16 Valve) (W)	04-01	V8 351CI 5.8L (Modified) (H)	79-77	V8 302CI 5.0L DOHC (32 Valve) (Flex Fuel)	13-11
V8 330CI 5.4L SOHC (16 Valve) (L)	04-97	V8 351CI 5.8L (Windsor) (G)	83-80	(F)	
V8 330CI 5.4L SOHC (24 Valve) (5)	13-05	V8 351CI 5.8L (Windsor) (H)	79-77	V8 330CI 5.4L SOHC (16 Valve) (L)	06-97
V8 330CI 5.4L SOHC (Flex Fuel) (5)	13-09	V8 352CI 5.8L	67-65	V8 330CI 5.4L SOHC (24 Valve) (5)	10-04
Explorer (2WD Mid-Size SUV)		V8 360CI 5.9L (Y)	76-68	V8 330CI 5.4L SOHC (Flex Fuel) (V)	10-06
V6 244CI 4.0L OHV (X)	01-91	V8 390CI 6.4L (H)	76-68	V8 330CI 5.4L SOHC (Flex Fuel) (Z)	05-97
V6 244CI 4.0L SOHC (E)	10-97	V8 400CI 6.6L (S)	79-77	V8 330CI 5.4L SOHC (Natural Gas) (M)	08-97
V8 281CI 4.6L SOHC (16 Valve) (W)	05-02	V8 400CI 6.6L (Z)	82-80	V8 330CI 5.4L SOHC Supercharged (16	04-99
V8 281CI 4.6L SOHC (24 Valve) (8)	10-06	V8 460CI 7.5L (A)	79-77	Valve) (3)	
V8 302CI 5.0L (P)	01-96	V8 460CI 7.5L (J)	76-73	V8 351CI 5.8L (Modified) (G)	82-80
Explorer (4WD Mid-Size SUV)		F150 (2WD Full-Size Pickup)		V8 351CI 5.8L (Modified) (H)	79-77
V6 244CI 4.0L OHV (X)	01-91	L6 300CI 4.9L (B)	86-75	V8 351CI 5.8L (Windsor) (G)	85-80
V6 244CI 4.0L SOHC (E)	10-97	L6 300CI 4.9L (C)	78	V8 351CI 5.8L (Windsor) (H)	98-84
V8 281CI 4.6L SOHC (16 Valve) (W)	05-02	L6 300CI 4.9L (E)	82-80	V8 351CI 5.8L (Windsor) (H)	79-77
V8 281CI 4.6L SOHC (24 Valve) (8)	10-06	L6 300CI 4.9L (Y)	96-87	V8 351CI 5.8L (Windsor) (R)	96-93
V8 302CI 5.0L (P)	01-96	V6 213CI 3.5L DOHC Turbo (24 Valve) (T)	13-11	V8 360CI 5.9L (Y)	76-75
Explorer (AWD Mid-Size SUV)		V6 227CI 3.7L DOHC (24 Valve) (Flex Fuel)	13-11	V8 379CI 6.2L SOHC (16 Valve) (6)	13-10
V6 213CI 3.5L DOHC (24 Valve) (8)	13-11	(M)		V8 390CI 6.4L (M)	76-75
V6 213CI 3.5L DOHC Turbo (24 Valve) (T)	13	V6 232CI 3.8L (3)	83-82	V8 400CI 6.6L (S)	79-77
Explorer (FWD Mid-Size SUV)		V6 256CI 4.2L (2)	08-97	V8 400CI 6.6L (Z)	82-80
L4 1999cc 2.0L DOHC Turbo (16 Valve) (9)	13-11	V8 281CI 4.6L SOHC (16 Valve) (6)	00-97	V8 460CI 7.5L (A)	79-75
V6 213CI 3.5L DOHC (24 Valve) (8)	13-11	V8 281CI 4.6L SOHC (16 Valve) (W)	10-97	F2 (Full-Size Pickup)	
F1 (Full-Size Pickup)		V8 281CI 4.6L SOHC (24 Valve) (8)	10-09	L6 215CI 3.5L	52
L6 215CI 3.5L	52	V8 302CI 5.0L (F)	85-80	L6 226CI 3.7L (L-Head)	51-48
L6 226CI 3.7L (L-Head)	51-48	V8 302CI 5.0L (G)	79-75	V8 239.4CI 3.9L (L-Head)	52-48
V8 239.4CI 3.9L (L-Head)	52-48	V8 302CI 5.0L (N)	96-85	V8 255.4CI 4.2L (L-Head)	52-48
V8 255.4CI 4.2L (L-Head)	52-48	V8 302CI 5.0L DOHC (32 Valve) (Flex Fuel)	13-11	F250 (2WD Full-Size Pickup)	
F100 (2WD Full-Size Pickup)		(F)		L6 215CI 3.5L	53
L6 215CI 3.5L	53	V8 330CI 5.4L SOHC (16 Valve) (L)	06-97	L6 223CI 3.6L	64-54
L6 223CI 3.6L	64-54	V8 330CI 5.4L SOHC (24 Valve) (5)	10-04	L6 240CI 3.9L	74-65
L6 240CI 3.9L	74-65	V8 330CI 5.4L SOHC (Flex Fuel) (V)	10-06	L6 262CI 4.3L	64-61
L6 262CI 4.3L	64-61	V8 330CI 5.4L SOHC (Flex Fuel) (Z)	05-97	L6 300CI 4.9L (B)	79-65
L6 300CI 4.9L (B)	83-65	V8 330CI 5.4L SOHC (Natural Gas) (M)	08-97	L6 300CI 4.9L (E)	82-80
L6 300CI 4.9L (C)	78	V8 330CI 5.4L SOHC Supercharged (16	04-99	L6 300CI 4.9L (Y)	97-83
L6 300CI 4.9L (E)	82-80	Valve) (3)		V10 415CI 6.8L SOHC (20 Valve) (S)	06-99
V6 232CI 3.8L (3)	83-82	V8 330CI 5.4L SOHC Supercharged (24	10-08	V10 415CI 6.8L SOHC (30 Valve) (Y)	10-05
V8 239.4CI 3.9L (L-Head)	53	Valve) (5)		V8 239.4CI 3.9L (L-Head)	53
V8 239CI 3.9L (OHV)	55-54	V8 351CI 5.8L (Modified) (G)	82-80	V8 239CI 3.9L (OHV)	55-54
V8 255.4CI 4.2L (L-Head)	54-53	V8 351CI 5.8L (Modified) (H)	79-77	V8 255.4CI 4.2L (L-Head)	54-53
V8 255CI 4.2L (D)	82-81	V8 351CI 5.8L (Windsor) (G)	85-80	V8 256CI 4.2L (OHV)	55-54
V8 256CI 4.2L (OHV)	55-54	V8 351CI 5.8L (Windsor) (H)	98-84	V8 272CI 4.4L	58-56
V8 272CI 4.4L	58-56	V8 351CI 5.8L (Windsor) (H)	79-77	V8 281CI 4.6L SOHC (16 Valve) (6)	00-97

Ford Truck (Incl. Minivans and SUV's) (Cont.)

Model Index (Cont.)					
Engine (VIN Code / Eng. Code)	Year	Engine (VIN Code / Eng. Code)	Year	Engine (VIN Code / Eng. Code)	Year
Ford Truck (cont.)		Ford Truck (cont.)		Ford Truck (cont.)	
F250 (2WD Full-Size Pickup) (cont.)		F250 (4WD Full-Size Pickup) (cont.)		F350 (2WD Full-Size Pickup) (cont.)	
V8 281CI 4.6L SOHC (16 Valve) (W)	10-97	V8 400CI 6.6L (Z)	82-80	V8 351CI 5.8L (Windsor) (H)	98-84
V8 292CI 4.8L	64-58	V8 406CI 6.7L Turbo-Diesel DI (T)	13-11	V8 351CI 5.8L (Windsor) (H)	79-77
V8 302CI 5.0L (F)	85-80	V8 420CI 6.9L Diesel (1)	87-83	V8 352CI 5.8L	67-65
V8 302CI 5.0L (G)	79-69	V8 444CI 7.3L Diesel IDI (M)	95-88	V8 360CI 5.9L (Y)	76-68
V8 302CI 5.0L (N)	96-85	V8 444CI 7.3L Turbo-Diesel DI (F)	03-94	V8 365CI 6.0L Turbo-Diesel DI (P)	08-03
V8 330CI 5.4L SOHC (16 Valve) (L)	06-97	V8 444CI 7.3L Turbo-Diesel IDI (C)	93-92	V8 379CI 6.2L SOHC (16 Valve) (Flex Fuel)	13-11
V8 330CI 5.4L SOHC (24 Valve) (5)	10-05	V8 444CI 7.3L Turbo-Diesel IDI (K)	94		
V8 330CI 5.4L SOHC (Flex Fuel) (Z)	05-97	V8 460CI 7.5L (A)	79-76	V8 390CI 6.4L (H)	76-68
V8 330CI 5.4L SOHC (Natural Gas) (M)	08-97	V8 460CI 7.5L (G)	98-88	V8 390CI 6.4L Turbo-Diesel DI (R)	10-08
V8 351CI 5.8L (Modified) (G)	82-80	V8 460CI 7.5L (J)	79-76	V8 400CI 6.6L (S)	79-77
V8 351CI 5.8L (Modified) (H)	79-77	V8 460CI 7.5L (L)	87-80	V8 400CI 6.6L (Z)	82-80
V8 351CI 5.8L (Windsor) (G)	85-80	F250 Super Duty (2WD Full-Size Pickup)		V8 406CI 6.7L Turbo-Diesel DI (T)	13-11
V8 351CI 5.8L (Windsor) (H)	98-84	V10 415CI 6.8L SOHC (20 Valve) (S)	06-98	V8 420CI 6.9L Diesel (1)	87-83
V8 351CI 5.8L (Windsor) (H)	79-77	V10 415CI 6.8L SOHC (30 Valve) (Y)	10-05	V8 444CI 7.3L Diesel IDI (M)	95-88
V8 352CI 5.8L	67-65	V8 330CI 5.4L SOHC (16 Valve) (L)	06-98	V8 444CI 7.3L Turbo-Diesel DI (F)	03-94
V8 360CI 5.9L (Y)	76-68	V8 330CI 5.4L SOHC (24 Valve) (5)	10-05	V8 444CI 7.3L Turbo-Diesel IDI (C)	93-92
V8 365CI 6.0L Turbo-Diesel DI (P)	08-03	V8 330CI 5.4L SOHC (Flex Fuel) (Z)	05-98	V8 444CI 7.3L Turbo-Diesel IDI (K)	94
V8 379CI 6.2L SOHC (16 Valve) (Flex Fuel)	13-11	V8 330CI 5.4L SOHC (Natural Gas) (M)	08-98	V8 460CI 7.5L (A)	79-73
(6)		V8 365CI 6.0L Turbo-Diesel DI (P)	08-03	V8 460CI 7.5L (G)	98-88
V8 390CI 6.4L (H)	76-68	V8 379CI 6.2L SOHC (16 Valve) (Flex Fuel)	13-11	V8 460CI 7.5L (J)	79-76
V8 390CI 6.4L Turbo-Diesel DI (R)	10-08	(6)		V8 460CI 7.5L (L)	87-80
V8 400CI 6.6L (S)	79-77	V8 390CI 6.4L Turbo-Diesel DI (R)	10-08	F350 (4WD Full-Size Pickup)	
V8 400CI 6.6L (Z)	82-80	V8 406CI 6.7L Turbo-Diesel DI (T)	13-11	L6 223CI 3.6L	64-59
V8 406CI 6.7L Turbo-Diesel DI (T)	13-11	V8 444CI 7.3L Turbo-Diesel DI (F)	03-98	L6 240CI 3.9L	74-65
V8 420CI 6.9L Diesel (1)	87-83	F250 Super Duty (4WD Full-Size Pickup)		L6 262CI 4.3L	64-61
V8 444CI 7.3L Diesel IDI (M)	95-88	V10 415CI 6.8L SOHC (20 Valve) (S)	06-98	L6 300CI 4.9L (B)	86-65
V8 444CI 7.3L Turbo-Diesel DI (F)	03-94	V10 415CI 6.8L SOHC (30 Valve) (Y)	10-05	L6 300CI 4.9L (E)	82-80
V8 444CI 7.3L Turbo-Diesel IDI (C)	93-92	V8 330CI 5.4L SOHC (16 Valve) (L)	06-98	L6 300CI 4.9L (Y)	97-87
V8 444CI 7.3L Turbo-Diesel IDI (K)	94	V8 330CI 5.4L SOHC (24 Valve) (5)	10-05	V10 415CI 6.8L SOHC (20 Valve) (S)	06-99
V8 460CI 7.5L (A)	79-73	V8 330CI 5.4L SOHC (Flex Fuel) (Z)	05-98	V10 415CI 6.8L SOHC (30 Valve) (Y)	10-05
V8 460CI 7.5L (G)	98-88	V8 330CI 5.4L SOHC (Natural Gas) (M)	08-98	V8 292CI 4.8L	64-59
V8 460CI 7.5L (J)	79-73	V8 365CI 6.0L Turbo-Diesel DI (P)	08-03	V8 330CI 5.4L SOHC (16 Valve) (L)	06-97
V8 460CI 7.5L (L)	87-80	V8 379CI 6.2L SOHC (16 Valve) (Flex Fuel)	13-11	V8 330CI 5.4L SOHC (24 Valve) (5)	10-05
F250 (4WD Full-Size Pickup)		(6)		V8 330CI 5.4L SOHC (Flex Fuel) (Z)	05-97
L6 223CI 3.6L	64-59	V8 390CI 6.4L Turbo-Diesel DI (R)	10-08	V8 330CI 5.4L SOHC (Natural Gas) (M)	08-97
L6 240CI 3.9L	74-65	V8 406CI 6.7L Turbo-Diesel DI (T)	13-11	V8 351CI 5.8L (Modified) (G)	82-80
L6 262CI 4.3L	64-61	V8 444CI 7.3L Turbo-Diesel DI (F)	03-98	V8 351CI 5.8L (Modified) (H)	79-77
L6 300CI 4.9L (B)	79-65	F3 (Full-Size Pickup)		V8 351CI 5.8L (Windsor) (G)	85-80
L6 300CI 4.9L (E)	82-80	L6 215CI 3.5L	52	V8 351CI 5.8L (Windsor) (H)	98-84
L6 300CI 4.9L (Y)	97-83	L6 226CI 3.7L (L-Head)	51-48	V8 351CI 5.8L (Windsor) (H)	79-77
V10 415CI 6.8L SOHC (20 Valve) (S)	06-99	V8 239.4CI 3.9L (L-Head)	52-48	V8 352CI 5.8L	67-65
V10 415CI 6.8L SOHC (30 Valve) (Y)	10-05	V8 255.4CI 4.2L (L-Head)	52-48	V8 360CI 5.9L (Y)	76-68
V8 281CI 4.6L SOHC (16 Valve) (6)	00-97	F350 (2WD Full-Size Pickup)		V8 365CI 6.0L Turbo-Diesel DI (P)	08-03
V8 281CI 4.6L SOHC (16 Valve) (W)	10-97	L6 215CI 3.5L	53	V8 379CI 6.2L SOHC (16 Valve) (Flex Fuel)	13-11
V8 292CI 4.8L	64-59	L6 223CI 3.6L	64-54	(6)	
V8 302CI 5.0L (F)	85-80	L6 240CI 3.9L	74-65	V8 390CI 6.4L (H)	76-68
V8 302CI 5.0L (G)	79-69	L6 262CI 4.3L	64-61	V8 390CI 6.4L Turbo-Diesel DI (R)	10-08
V8 302CI 5.0L (N)	96-85	L6 300CI 4.9L (B)	86-65	V8 400CI 6.6L (S)	79-77
V8 330CI 5.4L SOHC (16 Valve) (L)	06-97	L6 300CI 4.9L (E)	82-80	V8 400CI 6.6L (Z)	82-80
V8 330CI 5.4L SOHC (24 Valve) (5)	10-05	L6 300CI 4.9L (Y)	97-87	V8 406CI 6.7L Turbo-Diesel DI (T)	13-11
V8 330CI 5.4L SOHC (Flex Fuel) (Z)	05-97	V10 415CI 6.8L SOHC (20 Valve) (S)	06-99	V8 420CI 6.9L Diesel (1)	87-83
V8 330CI 5.4L SOHC (Natural Gas) (M)	08-97	V10 415CI 6.8L SOHC (30 Valve) (Y)	10-05	V8 444CI 7.3L Diesel IDI (M)	95-88
V8 351CI 5.8L (Modified) (G)	82-80	V8 239.4CI 3.9L (L-Head)	53	V8 444CI 7.3L Turbo-Diesel DI (F)	03-94
V8 351CI 5.8L (Modified) (H)	79-77	V8 239CI 3.9L (OHV)	55-54	V8 444CI 7.3L Turbo-Diesel IDI (C)	93-92
V8 351CI 5.8L (Windsor) (G)	85-80	V8 255.4CI 4.2L (L-Head)	54-53	V8 444CI 7.3L Turbo-Diesel IDI (K)	94
V8 351CI 5.8L (Windsor) (H)	98-84	V8 256CI 4.2L (OHV)	55-54	V8 460CI 7.5L (A)	79-73
V8 351CI 5.8L (Windsor) (H)	79-77	V8 272CI 4.4L	58-56	V8 460CI 7.5L (G)	98-88
V8 352CI 5.8L	67-65	V8 292CI 4.8L	64-58	V8 460CI 7.5L (J)	79-76
V8 360CI 5.9L (Y)	76-68	V8 330CI 5.4L SOHC (16 Valve) (L)	06-97	V8 460CI 7.5L (L)	87-80
V8 365CI 6.0L Turbo-Diesel DI (P)	08-03	V8 330CI 5.4L SOHC (24 Valve) (5)	10-05	F350 Super Duty (2WD Full-Size Pickup)	
V8 379CI 6.2L SOHC (16 Valve) (Flex Fuel)	13-11	V8 330CI 5.4L SOHC (Flex Fuel) (Z)	05-97	V10 415CI 6.8L SOHC (20 Valve) (S)	10-98
(6)		V8 330CI 5.4L SOHC (Natural Gas) (M)	08-97	V10 415CI 6.8L SOHC (30 Valve) (Y)	13-05
V8 390CI 6.4L (H)	76-68	V8 351CI 5.8L (Modified) (G)	82-80	V8 330CI 5.4L SOHC (16 Valve) (L)	06-98
V8 390CI 6.4L Turbo-Diesel DI (R)	10-08	V8 351CI 5.8L (Modified) (H)	79-77	V8 330CI 5.4L SOHC (24 Valve) (5)	10-05
V8 400CI 6.6L (S)	79-77	V8 351CI 5.8L (Windsor) (G)	85-80	V8 330CI 5.4L SOHC (Flex Fuel) (Z)	05-98

Ford Truck (Incl. Minivans and SUV's) (Cont.)

Model Index (Cont.)					
Engine (VIN Code / Eng. Code)	Year	Engine (VIN Code / Eng. Code)	Year	Engine (VIN Code / Eng. Code)	Year
Ford Truck (cont.)		Ford Truck (cont.)		Ford Truck (cont.)	
F350 Super Duty (2WD Full-Size Pickup) (cont.)		F550 (4WD Full-Size Pickup)		P350 (Parcel Delivery) (cont.)	
V8 330CI 5.4L SOHC (Natural Gas) (M)	08-98	V10 415CI 6.8L SOHC (20 Valve) (S)	10-99	L6 300CI 4.9L (B)	76-65
V8 365CI 6.0L Turbo-Diesel DI (P)	08-03	V10 415CI 6.8L SOHC (30 Valve) (Y)	13-05	V8 272CI 4.4L	58-57
V8 379CI 6.2L SOHC (16 Valve) (Flex Fuel) (6)	13-11	V8 365CI 6.0L Turbo-Diesel DI (P)	08-03	V8 292CI 4.8L	64-58
V8 390CI 6.4L Turbo-Diesel DI (R)	11-08	V8 379CI 6.2L SOHC (16 Valve) (Flex Fuel) (6)	13-11	V8 302CI 5.0L (G)	76
V8 406CI 6.7L Turbo-Diesel DI (T)	13-11	V8 390CI 6.4L Turbo-Diesel DI (R)	11-08	V8 352CI 5.8L	65
V8 444CI 7.3L Turbo-Diesel DI (F)	03-98	V8 406CI 6.7L Turbo-Diesel DI (T)	13-11	P400 (Parcel Delivery)	
F350 Super Duty (4WD Full-Size Pickup)		V8 444CI 7.3L Turbo-Diesel DI (F)	03-99	L6 300CI 4.9L (B)	76-75
V10 415CI 6.8L SOHC (20 Valve) (S)	10-98	F550 Super Duty (2WD Full-Size Pickup)		V8 302CI 5.0L (G)	76-75
V10 415CI 6.8L SOHC (30 Valve) (Y)	13-05	V10 415CI 6.8L SOHC (20 Valve) (S)	10-99	V8 400CI 6.6L (S)	76-75
V8 330CI 5.4L SOHC (16 Valve) (L)	06-98	V10 415CI 6.8L SOHC (30 Valve) (Y)	13-05	P500 (Parcel Delivery)	
V8 330CI 5.4L SOHC (24 Valve) (5)	10-05	V8 330CI 5.4L SOHC (16 Valve) (L)	06-99	L6 300CI 4.9L (B)	77-75
V8 330CI 5.4L SOHC (Flex Fuel) (Z)	05-98	V8 330CI 5.4L SOHC (24 Valve) (5)	10-05	V8 302CI 5.0L (G)	77-75
V8 330CI 5.4L SOHC (Natural Gas) (M)	08-98	V8 365CI 6.0L Turbo-Diesel DI (P)	08-03	V8 400CI 6.6L (S)	77-75
V8 365CI 6.0L Turbo-Diesel DI (P)	08-03	V8 379CI 6.2L SOHC (16 Valve) (Flex Fuel) (6)	13-11	Pickup	
V8 379CI 6.2L SOHC (16 Valve) (Flex Fuel) (6)	13-11	V8 390CI 6.4L Turbo-Diesel DI (R)	11-08	L4 119.7CI 2.0L (L-Head)	42-41
V8 390CI 6.4L Turbo-Diesel DI (R)	11-08	V8 406CI 6.7L Turbo-Diesel DI (T)	13-11	L6 226CI 3.7L (L-Head)	47-46
V8 406CI 6.7L Turbo-Diesel DI (T)	13-11	V8 444CI 7.3L Turbo-Diesel DI (F)	03-99	L6 226CI 3.7L (L-Head)	42-41
V8 444CI 7.3L Turbo-Diesel DI (F)	03-98	F550 Super Duty (4WD Full-Size Pickup)		V8 136CI 2.3L (L-Head)	40-37
F450 Super Duty (2WD Full-Size Pickup)		V10 415CI 6.8L SOHC (20 Valve) (S)	10-99	V8 221CI 3.6L (L-Head)	42-32
V10 415CI 6.8L SOHC (20 Valve) (S)	10-98	V10 415CI 6.8L SOHC (30 Valve) (Y)	13-05	V8 239.4CI 3.9L (L-Head)	47-46
V10 415CI 6.8L SOHC (30 Valve) (Y)	13-05	V8 330CI 5.4L SOHC (16 Valve) (L)	06-99	V8 239.4CI 3.9L (L-Head)	42-39
V8 330CI 5.4L SOHC (16 Valve) (L)	06-98	V8 330CI 5.4L SOHC (24 Valve) (5)	10-05	Ranchero (Pickup)	
V8 330CI 5.4L SOHC (24 Valve) (5)	10-05	V8 365CI 6.0L Turbo-Diesel DI (P)	08-03	L6 144CI 2.4L	64-60
V8 365CI 6.0L Turbo-Diesel DI (P)	08-03	V8 379CI 6.2L SOHC (16 Valve) (Flex Fuel) (6)	13-11	L6 170CI 2.8L	65-61
V8 379CI 6.2L SOHC (16 Valve) (Flex Fuel) (6)	13-11	V8 390CI 6.4L Turbo-Diesel DI (R)	11-08	L6 200CI 3.3L	68-64
V8 390CI 6.4L Turbo-Diesel DI (R)	11-08	V8 406CI 6.7L Turbo-Diesel DI (T)	13-11	L6 223CI 3.6L	59-57
V8 406CI 6.7L Turbo-Diesel DI (T)	13-11	V8 444CI 7.3L Turbo-Diesel DI (F)	03-99	L6 250CI 4.1L	74-69
V8 444CI 7.3L Diesel IDI (M)	95-88	F59 (Stripped Chassis)		V8 260CI 4.3L	64-62
V8 444CI 7.3L Turbo-Diesel DI (F)	03-94	V8 444CI 7.3L Diesel IDI (M)	94-88	V8 272CI 4.4L	57
V8 444CI 7.3L Turbo-Diesel IDI (C)	93-92	V8 444CI 7.3L Turbo-Diesel DI (F)	97-94	V8 289CI 4.7L	68-65
V8 444CI 7.3L Turbo-Diesel IDI (K)	94	V8 444CI 7.3L Turbo-Diesel IDI (C)	93-92	V8 292CI 4.8L	59-57
V8 460CI 7.5L (G)	98-88	V8 444CI 7.3L Turbo-Diesel IDI (K)	94	V8 302CI 5.0L (F)	79-68
F450 Super Duty (4WD Full-Size Pickup)		Flex (AWD Mid-Size SUV)		V8 351CI 5.8L (Cleveland)	74-70
V10 415CI 6.8L SOHC (20 Valve) (S)	10-98	V6 213CI 3.5L DOHC (24 Valve) (8)	13	V8 351CI 5.8L (Modified) (H)	79-75
V10 415CI 6.8L SOHC (30 Valve) (Y)	13-05	V6 213CI 3.5L DOHC (24 Valve) (C)	12-09	V8 351CI 5.8L (Windsor) (H)	79-69
V8 330CI 5.4L SOHC (16 Valve) (L)	06-98	V6 213CI 3.5L DOHC Turbo (24 Valve) (T)	13-10	V8 352CI 5.8L	66-65
V8 330CI 5.4L SOHC (24 Valve) (5)	10-05	Flex (FWD Mid-Size SUV)		V8 352CI 5.8L	59-57
V8 365CI 6.0L Turbo-Diesel DI (P)	08-03	V6 213CI 3.5L DOHC (24 Valve) (8)	13	V8 390CI 6.4L	69-67
V8 379CI 6.2L SOHC (16 Valve) (Flex Fuel) (6)	13-11	V6 213CI 3.5L DOHC (24 Valve) (C)	12-09	V8 400CI 6.6L (S)	79-72
V8 390CI 6.4L Turbo-Diesel DI (R)	11-08	Freestar (FWD Minivan)		V8 428CI 7.0L	69-68
V8 406CI 6.7L Turbo-Diesel DI (T)	13-11	V6 238CI 3.9L (6)	07-04	V8 429CI 7.0L	73-70
V8 444CI 7.3L Diesel IDI (M)	95-88	V6 256CI 4.2L (2)	07-04	V8 460CI 7.5L (A)	77-74
V8 444CI 7.3L Turbo-Diesel DI (F)	03-94	Freestyle (AWD Mid-Size SUV)		Ranger (2WD Compact Pickup)	
V8 444CI 7.3L Turbo-Diesel IDI (C)	93-92	V6 2967cc 3.0L DOHC (24 Valve) (1)	07-05	L4 122CI 2.0L SOHC (C)	88-83
V8 444CI 7.3L Turbo-Diesel IDI (K)	94	Freestyle (FWD Mid-Size SUV)		L4 140CI 2.3L SOHC (A)	97-83
V8 460CI 7.5L (G)	98-88	V6 2967cc 3.0L DOHC (24 Valve) (1)	07-05	L4 153CI 2.5L SOHC (C)	01-98
F53 (Motor Home Chassis)		M400 (Motor Home Chassis)		L4 2209cc 2.2L OHV Diesel (P)	84-83
V10 415CI 6.8L SOHC (20 Valve) (S)	13-98	V8 360CI 5.9L	73	L4 2261cc 2.3L DOHC (16 Valve) (D)	11-01
V10 415CI 6.8L SOHC (30 Valve) (Y)	13-05	V8 390CI 6.4L	73-72	L4 2346cc 2.3L SOHC Turbo-Diesel (E)	87-85
V8 365CI 6.0L Turbo-Diesel DI (P)	11-03	P100 (Parcel Delivery)		V6 171CI 2.8L (S)	85-83
V8 444CI 7.3L Turbo-Diesel DI (F)	03-94	L6 144CI 2.4L	64-60	V6 177CI 2.9L (T)	92-86
V8 460CI 7.5L (G)	98-88	L6 170CI 2.8L	70-61	V6 183CI 3.0L OHV (U)	08-90
F550 (2WD Full-Size Pickup)		L6 223CI 3.6L	64-57	V6 183CI 3.0L OHV (Flex Fuel) (V)	08-01
V10 415CI 6.8L SOHC (20 Valve) (S)	10-99	L6 240CI 3.9L	73-68	V6 244CI 4.0L OHV (X)	00-90
V10 415CI 6.8L SOHC (30 Valve) (Y)	13-05	L6 300CI 4.9L	73-68	V6 244CI 4.0L SOHC (E)	11-01
V8 365CI 6.0L Turbo-Diesel DI (P)	08-03	P350 (Parcel Delivery)		Ranger (4WD Compact Pickup)	
V8 379CI 6.2L SOHC (16 Valve) (Flex Fuel) (6)	13-11	L4 3611cc 3.6L OHV Diesel	66-63	L4 140CI 2.3L SOHC (A)	97-83
V8 390CI 6.4L Turbo-Diesel DI (R)	11-08	L6 170CI 2.8L	70-61	L4 2346cc 2.3L SOHC Turbo-Diesel (E)	87-85
V8 406CI 6.7L Turbo-Diesel DI (T)	13-11	L6 215CI 3.5L	53-52	V6 171CI 2.8L (S)	85-83
V8 444CI 7.3L Turbo-Diesel DI (F)	03-99	L6 223CI 3.6L	64-54	V6 177CI 2.9L (T)	92-86
		L6 240CI 3.9L	74-65	V6 183CI 3.0L OHV (U)	08-90

Ford Truck (Incl. Minivans and SUV's) (Cont.)

Model Index (Cont.)					
Engine (VIN Code / Eng. Code)	Year	Engine (VIN Code / Eng. Code)	Year	Engine (VIN Code / Eng. Code)	Year
Ford Truck (cont.)		Lincoln Truck (cont.)			
Ranger (4WD Compact Pickup) (cont.)		Navigator (4WD Full-Size SUV) (cont.)			
V6 183CI 3.0L OHV (Flex Fuel) (V)	08-01	V8 330CI 5.4L SOHC (Flex Fuel) (V)	13-09		
V6 244CI 4.0L OHV (X)	00-90	Mercury Truck			
V6 244CI 4.0L SOHC (E)	11-01	Mariner (AWD Compact SUV)			
Sedan Delivery		L4 2261cc 2.3L DOHC (16 Valve) (Z)	08-05		
L4 119.7CI 2.0L (L-Head)	42-41	L4 2488cc 2.5L DOHC (16 Valve) (7)	11-09		
L6 226CI 3.7L (L-Head)	47-46	V6 2967cc 3.0L DOHC (24 Valve) (1)	08-05		
L6 226CI 3.7L (L-Head)	42-41	V6 2967cc 3.0L DOHC (24 Valve) (G)	11-09		
V8 136CI 2.3L (L-Head)	40-37	Mariner (FWD Compact SUV)			
V8 221CI 3.6L (L-Head)	42-32	L4 2261cc 2.3L DOHC (16 Valve) (Z)	08-05		
V8 239.4CI 3.9L (L-Head)	47-46	L4 2488cc 2.5L DOHC (16 Valve) (7)	11-09		
V8 239.4CI 3.9L (L-Head)	42-39	V6 2967cc 3.0L DOHC (24 Valve) (1)	08-05		
T		V6 2967cc 3.0L DOHC (24 Valve) (G)	11-09		
L4 177CI 2.9L (L-Head)	27-09	Mariner Hybrid (AWD Compact SUV)			
Taurus X (AWD Mid-Size SUV)		L4 2261cc 2.3L DOHC (16 Valve) (H)	08-06		
V6 213CI 3.5L DOHC (24 Valve) (W)	09-08	L4 2488cc 2.5L DOHC (16 Valve) (3)	11-09		
Taurus X (FWD Mid-Size SUV)		Mariner Hybrid (FWD Compact SUV)			
V6 213CI 3.5L DOHC (24 Valve) (W)	09-08	L4 2261cc 2.3L DOHC (16 Valve) (H)	08-06		
Transit Connect (FWD Minivan)		L4 2488cc 2.5L DOHC (16 Valve) (3)	11-09		
L4 1999cc 2.0L DOHC (16 Valve) (N)	13-10	Monterey (FWD Minivan)			
TT		V6 256CI 4.2L (2)	07-04		
L4 177CI 2.9L (L-Head)	27-17	Mountaineer (2WD Mid-Size SUV)			
Windstar (FWD Minivan)		V6 244CI 4.0L SOHC (E)	10-97		
V6 183CI 3.0L OHV (U)	00-95	V8 281CI 4.6L SOHC (16 Valve) (W)	05-02		
V6 232CI 3.8L (4)	03-95	V8 281CI 4.6L SOHC (24 Valve) (8)	10-06		
Lincoln Truck		V8 302CI 5.0L (P)	01-97		
Aviator (2WD Mid-Size SUV)		Mountaineer (4WD Mid-Size SUV)			
V8 281CI 4.6L DOHC (32 Valve) (A)	05	V6 244CI 4.0L SOHC (E)	10-97		
V8 281CI 4.6L DOHC (32 Valve) (H)	04-03	V8 281CI 4.6L SOHC (16 Valve) (W)	05-02		
Aviator (AWD Mid-Size SUV)		V8 281CI 4.6L SOHC (24 Valve) (8)	10-06		
V8 281CI 4.6L DOHC (32 Valve) (A)	05	V8 302CI 5.0L (P)	01-97		
V8 281CI 4.6L DOHC (32 Valve) (H)	04-03	Villager (FWD Minivan)			
Blackwood (2WD Full-Size Pickup)		V6 2960cc 3.0L SOHC (12 Valve) (1)	98-97		
V8 330CI 5.4L DOHC (32 Valve) (A)	02-01	V6 2960cc 3.0L SOHC (12 Valve) (W)	96-93		
Mark LT (2WD Full-Size Pickup)		V6 3274cc 3.3L SOHC (12 Valve) (T)	02-99		
V8 330CI 5.4L SOHC (24 Valve) (5)	08-06				
Mark LT (4WD Full-Size Pickup)					
V8 330CI 5.4L SOHC (24 Valve) (5)	08-06				
MKT (AWD Mid-Size SUV)					
V6 213CI 3.5L DOHC Turbo (24 Valve) (T)	13-10				
V6 227CI 3.7L DOHC (24 Valve) (K)	13				
V6 227CI 3.7L DOHC (24 Valve) (R)	12-10				
MKT (FWD Mid-Size SUV)					
V6 227CI 3.7L DOHC (24 Valve) (K)	13				
V6 227CI 3.7L DOHC (24 Valve) (R)	12-10				
MKX (AWD Mid-Size SUV)					
V6 213CI 3.5L DOHC (24 Valve) (C)	10-07				
V6 227CI 3.7L DOHC (24 Valve) (K)	13-11				
MKX (FWD Mid-Size SUV)					
V6 213CI 3.5L DOHC (24 Valve) (C)	10-07				
V6 227CI 3.7L DOHC (24 Valve) (K)	13-11				
Navigator (2WD Full-Size SUV)					
V8 330CI 5.4L DOHC (32 Valve) (A)	01-99				
V8 330CI 5.4L DOHC (32 Valve) (R)	04-02				
V8 330CI 5.4L SOHC (16 Valve) (L)	99-97				
V8 330CI 5.4L SOHC (24 Valve) (5)	13-05				
V8 330CI 5.4L SOHC (Flex Fuel) (V)	13-09				
Navigator (4WD Full-Size SUV)					
V8 330CI 5.4L DOHC (32 Valve) (A)	01-99				
V8 330CI 5.4L DOHC (32 Valve) (R)	04-02				
V8 330CI 5.4L SOHC (16 Valve) (L)	99-97				
V8 330CI 5.4L SOHC (24 Valve) (5)	13-05				

Ford Truck (Incl. Minivans and SUV's) (Cont.)

1				
2004 - 2001; 2.0L 121 (1988cc) DOHC L4 (16 Valve) 84.8mm Bore Zetec				
MFI; Gasoline; Naturally Aspirated Ford Eng.; VIN Code B				
1				
QTY	CYLINDER HEAD	YEARS	PART NO.	DESCRIPTION
1	Head Gasket	2004	9005 PT-1	Head bolts not incl.; Head bolt replacement required; PermaTorqueMLS®
1	Head Gasket	2003-02	9005 PT	To 07/06/02; Head bolts not incl.; Head bolt replacement required; PermaTorqueMLS®
1	Head Gasket	2003-02	9005 PT-1	From 07/07/02; Head bolts not incl.; Head bolt replacement required; PermaTorqueMLS®
1	Head Gasket	2001	9005 PT	Head bolts not incl.; Head bolt replacement required; PermaTorqueMLS®
1	Head Set	2004	HS 9005 PT-5	Head bolts not incl.; Head bolt replacement required; PermaDry® molded rubber valve cover gskt. incl.; Premium valve stem seals incl.
1	Head Set	2003-02	HS 9005 PT-5	From 07/07/02; Head bolts not incl.; Head bolt replacement required; PermaDry® molded rubber valve cover gskt. incl.; Premium valve stem seals incl.
1	Head Set	2003-02	HS 9005 PT-6	To 07/06/02; Head bolts not incl.; Head bolt replacement required; PermaDry® molded rubber valve cover gskt. incl.; Premium valve stem seals incl.
1	Head Set	2001	HS 9005 PT-6	Head bolts not incl.; Head bolt replacement required; PermaDry® molded rubber valve cover gskt. incl.; Premium valve stem seals incl.
1	Head Bolt Set	2004-01	ES 72175	Replacement required
QTY	CONVERSION SET	YEARS	PART NO.	DESCRIPTION
1	Gasket Conversion Set	2004-01	CS 9005-2	Lower oil pan gskt. incl.; PermaDry® molded rubber oil pan gskt. incl.
QTY	MANIFOLD - INT. & EXH.	YEARS	PART NO.	DESCRIPTION
1	Int. Manifold Gasket Set	2004-01	MS 96763	Square port w/o tab
1	Exh. Manifold Gasket Set	2004-01	MS 94427	
QTY	EXHAUST PIPE FLANGE	YEARS	PART NO.	DESCRIPTION
1	Exhaust Pipe Gasket	2004-01	61191	Pipe to manifold
1	Exhaust Pipe Gasket	2004-01	61192	Loc. Front; Converter
1	Exhaust Pipe Gasket	2004-01	61194	Loc. Rear; Converter
QTY	OIL PAN	YEARS	PART NO.	DESCRIPTION
1	Oil Pan Gasket Set	2004-01	OS 30711 R	Loc. Upper; PermaDry® molded rubber gskt. incl.
1	Oil Pan Gasket Set	2004-01	OS 30831	Loc. Lower
1	Drain Plug Gasket	2004-01	72515	
QTY	CRANKSHAFT REAR SEAL	YEARS	PART NO.	DESCRIPTION
1	Rear Main Seal Set	2004-01	BS 40618	Rubber; One-piece
1	Rear Main Seal Set	2004-01	BS 40646	PTFE Rubber; One-piece
QTY	VALVE COVER	YEARS	PART NO.	DESCRIPTION
1	Valve Cover Gasket Set	2004-01	VS 50553 R	PermaDry® molded rubber gskt. incl.
QTY	VALVE STEM SEAL SET	YEARS	PART NO.	DESCRIPTION
1	Valve Stem Seal Set	2004-01	SS 72889	Premium valve stem seals incl.; Improved design
QTY	WATER OUTLET GASKET	YEARS	PART NO.	DESCRIPTION
1	Water Outlet Gasket	2004-01	35404	Water Outlet
QTY	WATER PUMP	YEARS	PART NO.	DESCRIPTION
1	Water Pump Gasket	2004-01	35619	
QTY	TIMING COVER	YEARS	PART NO.	DESCRIPTION
1	Crankshaft Front Seal Set	2004-01	TCS 46015	Must be used w/OS 30711R
1	Camshaft Front Seal Set	2004-01	TCS 45963	
QTY	CARB & FUEL INJECTION	YEARS	PART NO.	DESCRIPTION
2	Fuel Injector O-Ring Set	2004-01	ES 70599	Improved design
1	Throttle Body Gasket	2004-01	61159	
QTY	EXHAUST GAS RECIRCULATION	YEARS	PART NO.	DESCRIPTION
1	EGR Gasket	2004-01	70697	
2				
2013 - 2010; 2.0L 122 (1999cc) DOHC L4 (16 Valve) 87.5mm Bore Duratec				
MFI; Gasoline; Naturally Aspirated Ford Eng.; VIN Code N				
2				
QTY	CYLINDER HEAD	YEARS	PART NO.	DESCRIPTION
1	Head Gasket	2012-10	26250 PT	Head bolts not incl.; Head bolt replacement recommended; PermaTorqueMLS® LaserWeld® Technology
1	Head Set	2012-10	HS 26250 PT-8	Head bolts not incl.; Head bolt replacement recommended; PermaDry® molded rubber valve cover gskt. incl.; Premium valve stem seals incl.
1	Head Bolt Set	2013-10	ES 72207	Replacement recommended
QTY	CONVERSION SET	YEARS	PART NO.	DESCRIPTION
1	Gasket Conversion Set	2012-10	CS 26250	RTV sealant incl. for oil pan gskt.
QTY	MANIFOLD - INT. & EXH.	YEARS	PART NO.	DESCRIPTION
1	Int. Manifold Gasket Set	2012-10	MS 96634	
1	Exh. Manifold Gasket Set	2013-10	MS 96901	Gskt. w/Heat shield

Ford Truck (Incl. Minivans and SUV's) (Cont.)

2		2013 - 2010; 2.0L 122 (1999cc) DOHC L4 (16 Valve) 87.5mm Bore Duratec			2	
(cont.)		MFI; Gasoline; Naturally Aspirated Ford Eng.; VIN Code N			(cont.)	
QTY	EXHAUST PIPE FLANGE	YEARS	PART NO.	DESCRIPTION		
1	Exhaust Pipe Gasket	2012-10	61650	Flange; New Part Number - Check for Availability		
1	Exhaust Pipe Gasket	2012-10	61686	Converter; New Part Number - Check for Availability		
QTY	CRANKSHAFT REAR SEAL	YEARS	PART NO.	DESCRIPTION		
1	Rear Main Seal Set	2013-10	BS 40689	PTFE Rubber; One-piece		
QTY	VALVE COVER	YEARS	PART NO.	DESCRIPTION		
1	Valve Cover Gasket Set	2012-10	VS 50639 R-1	PermaDry® molded rubber gskt. incl.; Improved design		
QTY	VALVE STEM SEAL SET	YEARS	PART NO.	DESCRIPTION		
1	Valve Stem Seal Set	2013-10	SS 72917	Premium valve stem seals incl.		
QTY	THERMOSTAT HOUSING	YEARS	PART NO.	DESCRIPTION		
1	Thermostat Gasket	2013-10	35771	Thermostat Housing; Thermostat housing to head		
1	Thermostat Gasket	2013-10	35833	Thermostat Housing; Thermostat housing to block		
1	Thermostat Gasket	2013-10	35839	Thermostat Housing; Thermostat seal		
QTY	WATER PUMP	YEARS	PART NO.	DESCRIPTION		
1	O-Ring	2013-10	35772	Water Pump		
QTY	TIMING COVER	YEARS	PART NO.	DESCRIPTION		
1	Crankshaft Front Seal Set	2013-10	TCS 46132	Improved design		
QTY	CARB & FUEL INJECTION	YEARS	PART NO.	DESCRIPTION		
2	Fuel Injector O-Ring Set	2013-10	ES 70599	Improved design		
1	Throttle Body Gasket	2012-10	61391	Mounting		
QTY	EXHAUST GAS RECIRCULATION	YEARS	PART NO.	DESCRIPTION		
1	EGR Gasket	2012-10	71224	Valve		
1	EGR Gasket	2012-10	71226	Tube seal		
1	EGR Gasket	2012-10	71227	Connector seal		
QTY	OIL FILTER MOUNTING	YEARS	PART NO.	DESCRIPTION		
1	Oil Filter Adapter Gasket	2012-10	72949	Oil filter adapter; New Part Number - Check for Availability		
QTY	OIL PUMP COVER	YEARS	PART NO.	DESCRIPTION		
1	Oil Pump Gasket	2012-10	72705	Oil pump body; New Part Number - Check for Availability		
QTY	CYLINDER BLOCK	YEARS	PART NO.	DESCRIPTION		
1	Crankcase Breather Gasket	2012-10	72950	Cylinder Block; Crankcase vent cover seal; New Part Number - Check for Availability		
QTY	OIL COOLER	YEARS	PART NO.	DESCRIPTION		
1	Oil Cooler Gasket	2013-10	72709	Oil cooler mounting; Plastic carrier gskt. w/Silicone beading; New Part Number - Check for Availability		
3		2013 - 2011; 2.0L 122 (1999cc) DOHC L4 (16 Valve) 87.5mm Bore EcoBoost Duratec VVT			3	
(cont.)		DI; Gasoline; Turbo - Intercooled Ford Eng.; VIN Code 9			(cont.)	
QTY	EXHAUST PIPE FLANGE	YEARS	PART NO.	DESCRIPTION		
1	Exhaust Pipe Gasket	2013-11	61236	Loc. Rear; Secondary converter		
QTY	CRANKSHAFT REAR SEAL	YEARS	PART NO.	DESCRIPTION		
1	Rear Main Seal Set	2013-11	BS 40689	PTFE Rubber; One-piece		
QTY	VALVE STEM SEAL SET	YEARS	PART NO.	DESCRIPTION		
1	Valve Stem Seal Set	2013-11	SS 72917	Premium valve stem seals incl.		
QTY	THERMOSTAT HOUSING	YEARS	PART NO.	DESCRIPTION		
1	Thermostat Gasket	2013-11	35839	Thermostat Housing; Thermostat seal		
QTY	WATER PUMP	YEARS	PART NO.	DESCRIPTION		
1	O-Ring	2013-11	35772	Water Pump		
QTY	TIMING COVER	YEARS	PART NO.	DESCRIPTION		
1	Crankshaft Front Seal Set	2013-11	TCS 46132	Improved design		
QTY	CARB & FUEL INJECTION	YEARS	PART NO.	DESCRIPTION		
1	Throttle Body Gasket	2013-11	61377			
4		2011 - 2001; 2.3L 138 (2261cc) DOHC L4 (16 Valve) 87.5mm Bore Duratec			4	
(cont.)		MFI; Gasoline; Naturally Aspirated Ford Eng.; VIN Code D			(cont.)	
QTY	CYLINDER HEAD	YEARS	PART NO.	DESCRIPTION		
1	Head Gasket	2011-01	26250 PT	Head bolts not incl.; Head bolt replacement recommended; PermaTorqueMLS® LaserWeld® Technology		
1	Head Set	2011-04	HS 26250 PT-1	Head bolts not incl.; Head bolt replacement recommended; PermaDry® molded rubber valve cover gskt. incl.; Premium valve stem seals incl.		
1	Head Set	2003-02	HS 26250 PT	Head bolts not incl.; Head bolt replacement recommended; PermaDry® molded rubber valve cover gskt. incl.; Premium valve stem seals incl.		

Ford Truck (Incl. Minivans and SUV's) (Cont.)

4		2011 - 2001; 2.3L 138 (2261cc) DOHC L4 (16 Valve) 87.5mm Bore Duratec			4
(cont.)		MFI; Gasoline; Naturally Aspirated Ford Eng.; VIN Code D			(cont.)
QTY	CYLINDER HEAD	YEARS	PART NO.	DESCRIPTION	
1	Head Set	2001	HS 26250 PT	From 02/01/01; Head bolts not incl.; Head bolt replacement recommended; PermaDry® molded rubber valve cover gskt. incl.; Premium valve stem seals incl.	
1	Head Set	2001	HS 26250 PT	To 01/31/01; Exh. manifold gskt. & head bolts not incl.; Head bolt replacement recommended; PermaDry® molded rubber valve cover gskt. incl.; Premium valve stem seals incl.	
1	Head Bolt Set	2011-01	ES 72207	Replacement recommended	
QTY	CONVERSION SET	YEARS	PART NO.	DESCRIPTION	
1	Gasket Conversion Set	2011-01	CS 26250	RTV sealant incl. for oil pan gskt.	
QTY	MANIFOLD - INT. & EXH.	YEARS	PART NO.	DESCRIPTION	
1	Int. Manifold Gasket Set	2011-01	MS 96634		
1	Exh. Manifold Gasket Set	2011-02	MS 96655		
1	Exh. Manifold Gasket Set	2001	MS 96655	From 02/01/01	
1	Exh. Manifold Gasket Set	2001	MS 96656	To 01/31/01; Gskt. w/Heat shield	
QTY	EXHAUST PIPE FLANGE	YEARS	PART NO.	DESCRIPTION	
1	Exhaust Pipe Gasket	2011-01	60641	Converter	
QTY	CRANKSHAFT REAR SEAL	YEARS	PART NO.	DESCRIPTION	
1	Rear Main Seal Set	2011-01	BS 40689	PTFE Rubber; One-piece	
QTY	VALVE COVER	YEARS	PART NO.	DESCRIPTION	
1	Valve Cover Gasket Set	2011-04	VS 50639 R	PermaDry® molded rubber gskt. incl.; Old design	
1	Valve Cover Gasket Set	2011-04	VS 50639 R-1	PermaDry® molded rubber gskt. incl.; Improved design	
1	Valve Cover Gasket Set	2003-01	VS 50638 R	PermaDry® molded rubber gskt. incl.	
QTY	VALVE STEM SEAL SET	YEARS	PART NO.	DESCRIPTION	
1	Valve Stem Seal Set	2011-01	SS 72917	Premium valve stem seals incl.	
QTY	THERMOSTAT HOUSING	YEARS	PART NO.	DESCRIPTION	
1	Thermostat Gasket	2011-01	35771	Thermostat Housing; Thermostat housing to head	
1	Thermostat Gasket	2011-01	35776	Thermostat Housing; Thermostat seal	
QTY	WATER PUMP	YEARS	PART NO.	DESCRIPTION	
1	O-Ring	2011-01	35772	Water Pump	
QTY	TIMING COVER	YEARS	PART NO.	DESCRIPTION	
1	Crankshaft Front Seal Set	2011-01	TCS 46059	Old design	
1	Crankshaft Front Seal Set	2011-01	TCS 46132	Improved design	
QTY	CARB & FUEL INJECTION	YEARS	PART NO.	DESCRIPTION	
2	Fuel Injector O-Ring Set	2011-01	ES 70599	Improved design	
1	Throttle Body Gasket	2011-01	61253		
QTY	EXHAUST GAS RECIRCULATION	YEARS	PART NO.	DESCRIPTION	
1	EGR Gasket	2011-01	71224	Valve	
1	EGR Gasket	2011-01	71226	Tube seal	
QTY	OIL FILTER MOUNTING	YEARS	PART NO.	DESCRIPTION	
1	Oil Filter Adapter Gasket	2011-01	72949	Oil filter adapter; New Part Number - Check for Availability	
QTY	OIL PUMP COVER	YEARS	PART NO.	DESCRIPTION	
1	Oil Pump Gasket	2011-01	72705	Oil pump body; New Part Number - Check for Availability	
QTY	CYLINDER BLOCK	YEARS	PART NO.	DESCRIPTION	
1	Crankcase Breather Gasket	2011-01	72950	Cylinder Block; Crankcase vent cover seal; New Part Number - Check for Availability	
QTY	OIL COOLER	YEARS	PART NO.	DESCRIPTION	
1	Oil Cooler Gasket	2011-01	72709	Oil cooler mounting; Plastic carrier gskt. w/Silicone beading; New Part Number - Check for Availability	
5		2008 - 2005; 2.3L 138 (2261cc) DOHC L4 (16 Valve) 87.5mm Bore Duratec			5
(cont.)		MFI; Hybrid (Gas/Electric); Naturally Aspirated Ford Eng.; VIN Code H			(cont.)
QTY	CYLINDER HEAD	YEARS	PART NO.	DESCRIPTION	
1	Head Gasket	2008-05	26250 PT	Head bolts not incl.; Head bolt replacement recommended; PermaTorqueMLS® LaserWeld® Technology	
1	Head Set	2008-07	HS 26250 PT-1	Exh. manifold gskt. & head bolts not incl.; Head bolt replacement recommended; PermaDry® molded rubber valve cover gskt. incl.; Premium valve stem seals incl.	
1	Head Set	2006-05	HS 26250 PT-1	Head bolts not incl.; Head bolt replacement recommended; PermaDry® molded rubber valve cover gskt. incl.; Premium valve stem seals incl.	
1	Head Bolt Set	2008-05	ES 72207	Replacement recommended	
QTY	CONVERSION SET	YEARS	PART NO.	DESCRIPTION	
1	Gasket Conversion Set	2008-05	CS 26250	RTV sealant incl. for oil pan gskt.	
QTY	MANIFOLD - INT. & EXH.	YEARS	PART NO.	DESCRIPTION	
1	Int. Manifold Gasket Set	2008-05	MS 96634		

Ford Truck (Incl. Minivans and SUV's) (Cont.)

5		2008 - 2005; 2.3L 138 (2261cc) DOHC L4 (16 Valve) 87.5mm Bore Duratec			5	
(cont.)		MFI; Hybrid (Gas/Electric); Naturally Aspirated Ford Eng.; VIN Code H			(cont.)	
QTY	MANIFOLD - INT. & EXH.	YEARS	PART NO.	DESCRIPTION		
1	Exh. Manifold Gasket Set	2008-07	MS 96901			
1	Exh. Manifold Gasket Set	2006-05	MS 96655			
QTY	EXHAUST PIPE FLANGE	YEARS	PART NO.	DESCRIPTION		
1	Exhaust Pipe Gasket	2008-05	61395	Flange		
1	Exhaust Pipe Gasket	2008-05	61396	Converter		
QTY	CRANKSHAFT REAR SEAL	YEARS	PART NO.	DESCRIPTION		
1	Rear Main Seal Set	2008-05	BS 40689	PTFE Rubber; One-piece		
QTY	VALVE COVER	YEARS	PART NO.	DESCRIPTION		
1	Valve Cover Gasket Set	2008-05	VS 50639 R	PermaDry® molded rubber gskt. incl.; Old design		
1	Valve Cover Gasket Set	2008-05	VS 50639 R-1	PermaDry® molded rubber gskt. incl.; Improved design		
QTY	VALVE STEM SEAL SET	YEARS	PART NO.	DESCRIPTION		
1	Valve Stem Seal Set	2008-05	SS 72917	Premium valve stem seals incl.		
QTY	THERMOSTAT HOUSING	YEARS	PART NO.	DESCRIPTION		
1	Thermostat Gasket	2008-05	35771	Thermostat Housing; Thermostat housing to head		
1	Thermostat Gasket	2008-05	35776	Thermostat Housing; Thermostat seal		
QTY	WATER PUMP	YEARS	PART NO.	DESCRIPTION		
1	O-Ring	2008-05	35772	Water Pump		
QTY	TIMING COVER	YEARS	PART NO.	DESCRIPTION		
1	Crankshaft Front Seal Set	2008-05	TCS 46059	Old design		
1	Crankshaft Front Seal Set	2008-05	TCS 46132	Improved design		
QTY	CARB & FUEL INJECTION	YEARS	PART NO.	DESCRIPTION		
2	Fuel Injector O-Ring Set	2008-05	ES 70599	Improved design		
1	Throttle Body Gasket	2008-05	61391			
QTY	EXHAUST GAS RECIRCULATION	YEARS	PART NO.	DESCRIPTION		
1	EGR Gasket	2008-05	71223	Valve		
1	EGR Gasket	2008-05	71226	Tube seal		
1	EGR Gasket	2008-05	71227	Connector seal		
QTY	OIL FILTER MOUNTING	YEARS	PART NO.	DESCRIPTION		
1	Oil Filter Adapter Gasket	2008-05	72949	Oil filter adapter; New Part Number - Check for Availability		
QTY	OIL PUMP COVER	YEARS	PART NO.	DESCRIPTION		
1	Oil Pump Gasket	2008-05	72705	Oil pump body; New Part Number - Check for Availability		
QTY	CYLINDER BLOCK	YEARS	PART NO.	DESCRIPTION		
1	Crankcase Breather Gasket	2008-05	72950	Cylinder Block; Crankcase vent cover seal; New Part Number - Check for Availability		
QTY	OIL COOLER	YEARS	PART NO.	DESCRIPTION		
1	Oil Cooler Gasket	2008-05	72709	Oil cooler mounting; Plastic carrier gskt. w/Silicone beading; New Part Number - Check for Availability		
6		2008 - 2005; 2.3L 138 (2261cc) DOHC L4 (16 Valve) 87.5mm Bore Duratec PZEV			6	
(cont.)		MFI; Gasoline; Naturally Aspirated Ford Eng.; VIN Code Z			(cont.)	
QTY	CYLINDER HEAD	YEARS	PART NO.	DESCRIPTION		
1	Head Gasket	2008-05	26250 PT	Head bolts not incl.; Head bolt replacement recommended; PermaTorqueMLS® LaserWeld® Technology		
1	Head Set	2008-07	HS 26250 PT-1	Exh. manifold gskt. & head bolts not incl.; Head bolt replacement recommended; PermaDry® molded rubber valve cover gskt. incl.; Premium valve stem seals incl.		
1	Head Set	2006-05	HS 26250 PT-1	Head bolts not incl.; Head bolt replacement recommended; PermaDry® molded rubber valve cover gskt. incl.; Premium valve stem seals incl.		
1	Head Bolt Set	2008-05	ES 72207	Replacement recommended		
QTY	CONVERSION SET	YEARS	PART NO.	DESCRIPTION		
1	Gasket Conversion Set	2008-05	CS 26250	RTV sealant incl. for oil pan gskt.		
QTY	MANIFOLD - INT. & EXH.	YEARS	PART NO.	DESCRIPTION		
1	Int. Manifold Gasket Set	2008-05	MS 96634			
1	Exh. Manifold Gasket Set	2008-07	MS 96901			
1	Exh. Manifold Gasket Set	2006-05	MS 96655			
QTY	EXHAUST PIPE FLANGE	YEARS	PART NO.	DESCRIPTION		
1	Exhaust Pipe Gasket	2008-05	61395	Flange		
1	Exhaust Pipe Gasket	2008-05	61396	Converter		
QTY	CRANKSHAFT REAR SEAL	YEARS	PART NO.	DESCRIPTION		
1	Rear Main Seal Set	2008-05	BS 40689	PTFE Rubber; One-piece		
QTY	VALVE COVER	YEARS	PART NO.	DESCRIPTION		
1	Valve Cover Gasket Set	2008-05	VS 50639 R	PermaDry® molded rubber gskt. incl.; Old design		

Ford Truck (Incl. Minivans and SUV's) (Cont.)

6 (cont.)		2008 - 2005; 2.3L 138 (2261cc) DOHC L4 (16 Valve) 87.5mm Bore Duratec PZEV			6 (cont.)
		MFI; Gasoline; Naturally Aspirated Ford Eng.; VIN Code Z			
QTY	VALVE COVER	YEARS	PART NO.	DESCRIPTION	
1	Valve Cover Gasket Set	2008-05	VS 50639 R-1	PermaDry® molded rubber gskt. incl.; Improved design	
QTY	VALVE STEM SEAL SET	YEARS	PART NO.	DESCRIPTION	
1	Valve Stem Seal Set	2008-05	SS 72917	Premium valve stem seals incl.	
QTY	THERMOSTAT HOUSING	YEARS	PART NO.	DESCRIPTION	
1	Thermostat Gasket	2008-05	35771	Thermostat Housing; Thermostat housing to head	
1	Thermostat Gasket	2008-05	35776	Thermostat Housing; Thermostat seal	
QTY	WATER PUMP	YEARS	PART NO.	DESCRIPTION	
1	O-Ring	2008-05	35772	Water Pump	
QTY	TIMING COVER	YEARS	PART NO.	DESCRIPTION	
1	Crankshaft Front Seal Set	2008-05	TCS 46059	Old design	
1	Crankshaft Front Seal Set	2008-05	TCS 46132	Improved design	
QTY	CARB & FUEL INJECTION	YEARS	PART NO.	DESCRIPTION	
2	Fuel Injector O-Ring Set	2008-05	ES 70599	Improved design	
1	Throttle Body Gasket	2008-05	61253		
QTY	EXHAUST GAS RECIRCULATION	YEARS	PART NO.	DESCRIPTION	
1	EGR Gasket	2008-05	71223	Valve	
1	EGR Gasket	2008-05	71226	Tube seal	
1	EGR Gasket	2008-05	71227	Connector seal	
QTY	OIL FILTER MOUNTING	YEARS	PART NO.	DESCRIPTION	
1	Oil Filter Adapter Gasket	2008-05	72949	Oil filter adapter; New Part Number - Check for Availability	
QTY	OIL PUMP COVER	YEARS	PART NO.	DESCRIPTION	
1	Oil Pump Gasket	2008-05	72705	Oil pump body; New Part Number - Check for Availability	
QTY	CYLINDER BLOCK	YEARS	PART NO.	DESCRIPTION	
1	Crankcase Breather Gasket	2008-05	72950	Cylinder Block; Crankcase vent cover seal; New Part Number - Check for Availability	
QTY	OIL COOLER	YEARS	PART NO.	DESCRIPTION	
1	Oil Cooler Gasket	2008-05	72709	Oil cooler mounting; Plastic carrier gskt. w/Silicone beading; New Part Number - Check for Availability	
7		1997 - 1991; 2.3L 140 (2302cc) SOHC L4 (8 Valve) 96mm Bore			7
		MFI; Gasoline; Naturally Aspirated Ford Eng.; VIN Code A			
QTY	CYLINDER HEAD	YEARS	PART NO.	DESCRIPTION	
1	Head Gasket	1997-91	8993 PT-1	Head bolts not incl.; Head bolt replacement recommended; PermaTorque®	
1	Head Gasket Spacer Shim	1997-91	8471 SP	HeadSaver®	
1	Head Set	1997-95	HS 8993 PT-7	Head bolts not incl.; Head bolt replacement recommended; PermaDry® molded rubber valve cover gskt. incl.; Premium valve stem seals incl.	
1	Head Set	1994-91	HS 8993 PT-6	Head bolts not incl.; Head bolt replacement recommended; PermaDry® molded rubber valve cover gskt. incl.; Premium valve stem seals incl.	
1	Head Installation Set	1994-91	HIS 8993 PT-6	Head bolts not incl.; Head bolt replacement recommended; PermaDry® molded rubber valve cover gskt. incl.	
1	Head Bolt Set	1997-91	ES 72137	Replacement recommended	
QTY	CONVERSION SET	YEARS	PART NO.	DESCRIPTION	
1	Gasket Conversion Set	1997-95	CS 8471-6	PermaDry® molded rubber oil pan gskt. incl.	
1	Gasket Conversion Set	1994-93	CS 8471-5	PermaDry® molded rubber oil pan gskt. incl.	
1	Gasket Conversion Set	1992-91	CS 8471-3	PermaDry® molded rubber oil pan gskt. incl.	
QTY	MANIFOLD - INT. & EXH.	YEARS	PART NO.	DESCRIPTION	
1	Int. Manifold Gasket Set	1997-95	MS 93391-1	Lower set; Upper set incl.	
1	Int. Manifold Gasket Set	1994-91	MS 93391	Lower set; Upper set incl.	
1	Plenum Gasket Set	1997-95	MS 95737		
1	Plenum Gasket Set	1994-91	MS 94263		
1	Exh. Manifold Gasket Set	1997-91	MS 92424		
QTY	EXHAUST PIPE FLANGE	YEARS	PART NO.	DESCRIPTION	
1	Exhaust Pipe Gasket	1997-91	60641	Converter	
QTY	OIL PAN	YEARS	PART NO.	DESCRIPTION	
1	Oil Pan Gasket Set	1997-93	OS 30914 R	PermaDry® molded rubber gskt. incl.	
1	Oil Pan Gasket Set	1992-91	OS 30545 R	PermaDry® one-piece molded rubber gskt. incl.	
1	Drain Plug Gasket	1997-91	72515		
QTY	CRANKSHAFT REAR SEAL	YEARS	PART NO.	DESCRIPTION	
1	Rear Main Seal Set	1997-91	BS 40620	Rubber; One-piece; Improved design	
1	Rear Main Seal Set	1997-91	BS 40644	PTFE Rubber; One-piece	
1	Repair Sleeve	1997-91	16255-1	Crankshaft; 1.105" - 1.135" sleeve length; Use w/installation tool; Improved design	
1	Repair Sleeve Tool	1997-91	16306	Crankshaft	

Ford Truck (Incl. Minivans and SUV's) (Cont.)

7 (cont.)		1997 - 1991; 2.3L 140 (2302cc) SOHC L4 (8 Valve) 96mm Bore			7 (cont.)
MFI; Gasoline; Naturally Aspirated Ford Eng.; VIN Code A					
QTY	VALVE COVER	YEARS	PART NO.	DESCRIPTION	
1	Valve Cover Gasket Set	1997-95	VS 50043 R-2	Int. manifold upper set incl.; PermaDry® molded rubber gskt. incl.	
1	Valve Cover Gasket Set	1994-91	VS 50043 R-1	Int. manifold upper set incl.; PermaDry® molded rubber gskt. incl.	
QTY	VALVE STEM SEAL SET	YEARS	PART NO.	DESCRIPTION	
1	Valve Stem Seal Set	1997-95	SS 72875	Premium valve stem seals incl.	
1	Valve Stem Seal Set	1994-91	SS 72683	Premium valve stem seals incl.	
QTY	WATER OUTLET GASKET	YEARS	PART NO.	DESCRIPTION	
1	Water Outlet Gasket	1997-91	35114	Water Outlet	
1	Water Outlet Gasket	1997-91	35114 T	Water Outlet; PermaDryPlus®	
QTY	WATER PUMP	YEARS	PART NO.	DESCRIPTION	
1	Water Pump Gasket	1994-91	35381		
1	O-Ring	1997-95	35634	Water Pump; Improved design	
QTY	TIMING COVER	YEARS	PART NO.	DESCRIPTION	
1	Timing Cover Dust Seal Set	1997-91	ES 72734		
1	Crankshaft Front Seal Set	1997-93	TCS 45940	Must be used w/OS 30914R	
1	Crankshaft Front Seal Set	1992-91	TCS 45107	Must be used w/OS 30545R	
1	Camshaft Front Seal Set	1997-91	TCS 45108		
1	Auxiliary Shaft Seal Set	1997-91	TCS 45109		
QTY	CARB & FUEL INJECTION	YEARS	PART NO.	DESCRIPTION	
1	Fuel Injector O-Ring Set	1997-91	ES 70599	Improved design	
1	Throttle Body Gasket	1997-91	60847	Mounting	
1	Throttle Body Gasket	1997-91	71216	Air bypass valve	
QTY	EXHAUST GAS RECIRCULATION	YEARS	PART NO.	DESCRIPTION	
1	EGR Gasket	1997-95	70149		
1	EGR Gasket	1994-91	72649		
8		2012 - 2009; 2.5L 151.8 (2488cc) DOHC L4 (16 Valve) 89mm Bore Duratec			8
MFI; Hybrid (Gas/Electric); Naturally Aspirated Ford Eng.; VIN Code 3					
QTY	CYLINDER HEAD	YEARS	PART NO.	DESCRIPTION	
1	Head Gasket	2012-09	26522 PT	Head bolts not incl.; Head bolt replacement recommended; PermaTorqueMLS®; New Part Number - Check for Availability	
1	Head Set	2012-09	HS 26522 PT	Head bolts not incl.; Head bolt replacement recommended; PermaDry® molded rubber valve cover gskt. incl.; Premium valve stem seals incl.; New Part Number - Check for Availability	
1	Head Bolt Set	2012-09	ES 72207	Replacement recommended	
QTY	CONVERSION SET	YEARS	PART NO.	DESCRIPTION	
1	Gasket Conversion Set	2012-09	CS 26521	RTV sealant incl. for oil pan gskt.; New Part Number - Check for Availability	
QTY	MANIFOLD - INT. & EXH.	YEARS	PART NO.	DESCRIPTION	
1	Int. Manifold Gasket Set	2012-09	MS 97160	New Part Number - Check for Availability	
1	Exh. Manifold Gasket Set	2012-09	MS 96901		
QTY	EXHAUST PIPE FLANGE	YEARS	PART NO.	DESCRIPTION	
1	Exhaust Pipe Gasket	2012-09	61395	Flange	
1	Exhaust Pipe Gasket	2012-09	61406	Converter	
QTY	CRANKSHAFT REAR SEAL	YEARS	PART NO.	DESCRIPTION	
1	Rear Main Seal Set	2012-09	BS 40689	PTFE Rubber; One-piece	
QTY	VALVE COVER	YEARS	PART NO.	DESCRIPTION	
1	Valve Cover Gasket Set	2012-09	VS 50639 R-1	PermaDry® molded rubber gskt. incl.; Improved design	
1	Grommet Set	2012-09	ES 73008	Valve Cover; VCT seal set; New Part Number - Check for Availability	
QTY	VALVE STEM SEAL SET	YEARS	PART NO.	DESCRIPTION	
1	Valve Stem Seal Set	2012-09	SS 72917	Premium valve stem seals incl.	
QTY	THERMOSTAT HOUSING	YEARS	PART NO.	DESCRIPTION	
1	Thermostat Gasket	2012-09	35771	Thermostat Housing; Thermostat housing to head	
1	Thermostat Gasket	2012-09	35776	Thermostat Housing; Thermostat seal	
QTY	WATER PUMP	YEARS	PART NO.	DESCRIPTION	
1	O-Ring	2012-09	35772	Water Pump	
QTY	TIMING COVER	YEARS	PART NO.	DESCRIPTION	
1	Crankshaft Front Seal Set	2012-09	TCS 46151		
QTY	CARB & FUEL INJECTION	YEARS	PART NO.	DESCRIPTION	
2	Fuel Injector O-Ring Set	2012-09	ES 70599	Improved design	
1	Throttle Body Gasket	2012-09	61595	Mounting	
QTY	EXHAUST GAS RECIRCULATION	YEARS	PART NO.	DESCRIPTION	
1	EGR Gasket	2012-09	71224	Valve	
1	EGR Gasket	2012-09	71227	Connector seal	

Ford Truck (Incl. Minivans and SUV's) (Cont.)

8		2012 - 2009; 2.5L 151.8 (2488cc) DOHC L4 (16 Valve) 89mm Bore Duratec			8
(cont.)		MFI; Hybrid (Gas/Electric); Naturally Aspirated Ford Eng.; VIN Code 3			(cont.)
QTY	OIL FILTER MOUNTING	YEARS	PART NO.	DESCRIPTION	
1	Oil Filter Adapter Gasket	2012-09	72949	Oil filter adapter; New Part Number - Check for Availability	
QTY	CYLINDER BLOCK	YEARS	PART NO.	DESCRIPTION	
1	Crankcase Breather Gasket	2012-09	72950	Cylinder Block; Crankcase vent cover seal; New Part Number - Check for Availability	
9		2012 - 2009; 2.5L 151.8 (2488cc) DOHC L4 (16 Valve) 89mm Bore Duratec PZEV			9
		MFI; Gasoline; Naturally Aspirated Ford Eng.; VIN Code 7			
QTY	CYLINDER HEAD	YEARS	PART NO.	DESCRIPTION	
1	Head Gasket	2012-09	26522 PT	Head bolts not incl.; Head bolt replacement recommended; PermaTorqueMLS®; New Part Number - Check for Availability	
1	Head Set	2012-09	HS 26522 PT	Head bolts not incl.; Head bolt replacement recommended; PermaDry® molded rubber valve cover gskt. incl.; Premium valve stem seals incl.; New Part Number - Check for Availability	
1	Head Bolt Set	2012-09	ES 72207	Replacement recommended	
QTY	CONVERSION SET	YEARS	PART NO.	DESCRIPTION	
1	Gasket Conversion Set	2012-09	CS 26521	RTV sealant incl. for oil pan gskt.; New Part Number - Check for Availability	
QTY	MANIFOLD - INT. & EXH.	YEARS	PART NO.	DESCRIPTION	
1	Int. Manifold Gasket Set	2012-09	MS 97160	New Part Number - Check for Availability	
1	Exh. Manifold Gasket Set	2012-09	MS 96901		
QTY	EXHAUST PIPE FLANGE	YEARS	PART NO.	DESCRIPTION	
1	Exhaust Pipe Gasket	2012-09	61406	Converter	
1	Exhaust Pipe Gasket	2012-09	61406	Ring	
QTY	CRANKSHAFT REAR SEAL	YEARS	PART NO.	DESCRIPTION	
1	Rear Main Seal Set	2012-09	BS 40689	PTFE Rubber; One-piece	
QTY	VALVE COVER	YEARS	PART NO.	DESCRIPTION	
1	Valve Cover Gasket Set	2012-09	VS 50639 R-1	PermaDry® molded rubber gskt. incl.; Improved design	
1	Grommet Set	2012-09	ES 73008	Valve Cover; VCT seal set; New Part Number - Check for Availability	
QTY	VALVE STEM SEAL SET	YEARS	PART NO.	DESCRIPTION	
1	Valve Stem Seal Set	2012-09	SS 72917	Premium valve stem seals incl.	
QTY	THERMOSTAT HOUSING	YEARS	PART NO.	DESCRIPTION	
1	Thermostat Gasket	2012-09	35776	Thermostat Housing; Thermostat seal	
1	Thermostat Gasket	2012-09	35833	Thermostat Housing; Thermostat housing to head	
QTY	WATER PUMP	YEARS	PART NO.	DESCRIPTION	
1	O-Ring	2012-09	35772	Water Pump	
QTY	TIMING COVER	YEARS	PART NO.	DESCRIPTION	
1	Crankshaft Front Seal Set	2012-09	TCS 46151		
QTY	CARB & FUEL INJECTION	YEARS	PART NO.	DESCRIPTION	
2	Fuel Injector O-Ring Set	2012-09	ES 70599	Improved design	
1	Throttle Body Gasket	2012-09	61595	Mounting	
QTY	EXHAUST GAS RECIRCULATION	YEARS	PART NO.	DESCRIPTION	
1	EGR Gasket	2012-09	71224	Valve	
1	EGR Gasket	2012-09	71227	Connector seal	
QTY	OIL FILTER MOUNTING	YEARS	PART NO.	DESCRIPTION	
1	Oil Filter Adapter Gasket	2012-09	72949	Oil filter adapter; New Part Number - Check for Availability	
QTY	CYLINDER BLOCK	YEARS	PART NO.	DESCRIPTION	
1	Crankcase Breather Gasket	2012-09	72950	Cylinder Block; Crankcase vent cover seal; New Part Number - Check for Availability	
10		2013; 2.5L 151.8 (2488cc) DOHC L4 (16 Valve) 89mm Bore Duratec VVT			10
		MFI; Gasoline; Naturally Aspirated Ford Eng.; VIN Code 7			
QTY	CONVERSION SET	YEARS	PART NO.	DESCRIPTION	
1	Gasket Conversion Set	2013	CS 26521	RTV sealant incl. for oil pan gskt.; New Part Number - Check for Availability	
QTY	CRANKSHAFT REAR SEAL	YEARS	PART NO.	DESCRIPTION	
1	Rear Main Seal Set	2013	BS 40689	PTFE Rubber; One-piece	
QTY	WATER PUMP	YEARS	PART NO.	DESCRIPTION	
1	O-Ring	2013	35772	Water Pump	
QTY	TIMING COVER	YEARS	PART NO.	DESCRIPTION	
1	Crankshaft Front Seal Set	2013	TCS 46151		
QTY	OIL FILTER MOUNTING	YEARS	PART NO.	DESCRIPTION	
1	Oil Filter Adapter Gasket	2013	72949	Oil filter adapter; New Part Number - Check for Availability	
QTY	CYLINDER BLOCK	YEARS	PART NO.	DESCRIPTION	
1	Crankcase Breather Gasket	2013	72950	Cylinder Block; Crankcase vent cover seal; New Part Number - Check for Availability	

Ford Truck (Incl. Minivans and SUV's) (Cont.)

11		2001 - 1998; 2.5L 153 (2503cc) SOHC L4 (8 Valve) 96mm Bore			11
MFI; Gasoline; Naturally Aspirated Ford Eng.; VIN Code C					
QTY	CYLINDER HEAD	YEARS	PART NO.	DESCRIPTION	
1	Head Gasket	2001-98	8993 PT-1	Head bolts not incl.; Head bolt replacement recommended; PermaTorque®	
1	Head Gasket Spacer Shim	2001-98	8471 SP	HeadSaver®	
1	Head Set	2001-99	HS 8993 PT-8	Head bolts not incl.; Head bolt replacement recommended; PermaDry® molded rubber valve cover gskt. incl.; Premium valve stem seals incl.	
1	Head Set	1998	HS 8993 PT-7	Head bolts not incl.; Head bolt replacement recommended; PermaDry® molded rubber valve cover gskt. incl.; Premium valve stem seals incl.	
1	Head Bolt Set	2001-98	ES 72137	Replacement recommended	
QTY	CONVERSION SET	YEARS	PART NO.	DESCRIPTION	
1	Gasket Conversion Set	2001-98	CS 8471-7	PermaDry® molded rubber oil pan gskt. incl.	
QTY	MANIFOLD - INT. & EXH.	YEARS	PART NO.	DESCRIPTION	
1	Int. Manifold Gasket Set	2001-98	MS 93391-1	Lower set; Upper set incl.	
1	Plenum Gasket Set	2001-98	MS 95737	Upper set	
1	Exh. Manifold Gasket Set	2001-98	MS 92424		
QTY	OIL PAN	YEARS	PART NO.	DESCRIPTION	
1	Oil Pan Gasket Set	2001-98	OS 30814 R	PermaDry® molded rubber gskt. incl.	
1	Drain Plug Gasket	2001-98	72515		
QTY	CRANKSHAFT REAR SEAL	YEARS	PART NO.	DESCRIPTION	
1	Rear Main Seal Set	2001-98	BS 40620	Rubber; One-piece; Improved design	
1	Rear Main Seal Set	2001-98	BS 40644	PTFE Rubber; One-piece	
1	Repair Sleeve	2001-98	16255-1	Crankshaft; 1.105" - 1.135" sleeve length; Use w/installation tool; Improved design	
1	Repair Sleeve Tool	2001-98	16306	Crankshaft	
QTY	VALVE COVER	YEARS	PART NO.	DESCRIPTION	
1	Valve Cover Gasket Set	2001-98	VS 50043 R-2	Int. manifold upper set incl.; PermaDry® molded rubber gskt. incl.	
QTY	VALVE STEM SEAL SET	YEARS	PART NO.	DESCRIPTION	
1	Valve Stem Seal Set	2001-99	SS 70864	Std. Top-Hat Design; Premium valve stem seals incl.	
1	Valve Stem Seal Set	2001-99	SS 72875	Opt. Positive type seal; w/.600" OD; Premium valve stem seals incl.	
1	Valve Stem Seal Set	1998	SS 72875	Premium valve stem seals incl.	
QTY	THERMOSTAT HOUSING	YEARS	PART NO.	DESCRIPTION	
1	Thermostat Gasket	2001-98	35625	Thermostat Housing; Thermostat seal	
QTY	WATER PUMP	YEARS	PART NO.	DESCRIPTION	
1	O-Ring	2001-98	35634	Water Pump; Improved design	
QTY	TIMING COVER	YEARS	PART NO.	DESCRIPTION	
1	Crankshaft Front Seal Set	2001-98	TCS 45940	Must be used w/OS 30914R	
1	Camshaft Front Seal Set	2001-98	TCS 45108		
1	Auxiliary Shaft Seal Set	2001-98	TCS 45109		
QTY	CARB & FUEL INJECTION	YEARS	PART NO.	DESCRIPTION	
1	Fuel Injector O-Ring Set	2001-98	ES 70599	Improved design	
1	Throttle Body Gasket	2001-98	60847	Mounting	
1	Throttle Body Gasket	2001-98	71216	Air bypass valve	
QTY	EXHAUST GAS RECIRCULATION	YEARS	PART NO.	DESCRIPTION	
1	EGR Gasket	2001-98	70149		
12		1992 - 1991; 2.9L 177 (2935cc) OHV V6 (12 Valve) 93mm Bore			12
MFI; Gasoline; Naturally Aspirated Ford Eng.; VIN Code T					
QTY	CYLINDER HEAD	YEARS	PART NO.	DESCRIPTION	
1	Head Gasket	1992-91	9510 PT	Loc. R.H.; Head bolts not incl.; Head bolt replacement recommended	
1	Head Gasket	1992-91	9511 PT	Loc. L.H.; Head bolts not incl.; Head bolt replacement recommended	
1	Head Set	1992-91	HS 9510 PT-2	Head bolts not incl.; Head bolt replacement recommended; Premium valve stem seals incl.	
1	Head Installation Set	1992-91	HIS 9510 PT-2	Head bolts not incl.; Head bolt replacement recommended	
1	Head Bolt Set	1992-91	ES 72794	Replacement recommended	
QTY	CONVERSION SET	YEARS	PART NO.	DESCRIPTION	
1	Gasket Conversion Set	1992-91	CS 9510	PermaDry® molded rubber oil pan gskt. incl.	
QTY	MANIFOLD - INT. & EXH.	YEARS	PART NO.	DESCRIPTION	
1	Int. Manifold Gasket Set	1992-91	MS 93771	Lower set; Upper set incl.	
1	Plenum Gasket Set	1992-91	MS 93754	Upper set	
1	Exh. Manifold Gasket Set	1992-91	MS 93849		
QTY	EXHAUST PIPE FLANGE	YEARS	PART NO.	DESCRIPTION	
1	Exhaust Pipe Gasket	1992-91	60641	Converter to muffler	
1	Exhaust Pipe Gasket	1992-91	60796	Inlet pipe to converter	
QTY	OIL PAN	YEARS	PART NO.	DESCRIPTION	
1	Oil Pan Gasket Set	1992-91	OS 30571 R	PermaDry® molded rubber gskt. incl.	
1	Drain Plug Gasket	1992-91	72515		

Ford Truck (Incl. Minivans and SUV's) (Cont.)

12 (cont.)		1992 - 1991; 2.9L 177 (2935cc) OHV V6 (12 Valve) 93mm Bore MFI; Gasoline; Naturally Aspirated Ford Eng.; VIN Code T			12 (cont.)
QTY	CRANKSHAFT REAR SEAL	YEARS	PART NO.	DESCRIPTION	
1	Rear Main Seal Set	1992-91	BS 40419	Rubber; One-piece	
1	Rear Main Seal Set	1992-91	BS 40647	PTFE Rubber; One-piece	
QTY	VALVE COVER	YEARS	PART NO.	DESCRIPTION	
1	Valve Cover Gasket Set	1992-91	VS 50312 C	Cork; Improved design	
1	Valve Cover Gasket Set	1992-91	VS 50312 R	Rubber; Old design; Superseded - When depleted use VS 50312 C	
1	Valve Cover Gasket Set	1992-91	VS 50312 T	PermaDryPlus®	
QTY	VALVE STEM SEAL SET	YEARS	PART NO.	DESCRIPTION	
1	Valve Stem Seal Set	1992-91	SS 72686	Premium valve stem seals incl.	
QTY	WATER OUTLET GASKET	YEARS	PART NO.	DESCRIPTION	
1	Water Outlet Gasket	1992-91	35404	Water Outlet	
QTY	WATER PUMP	YEARS	PART NO.	DESCRIPTION	
1	Water Pump Gasket	1992-91	35400		
QTY	TIMING COVER	YEARS	PART NO.	DESCRIPTION	
1	Timing Cover Set	1992-91	TCS 45791	w/o Sleeve 'N' Seal®; Must be used w/OS 30571R	
1	Timing Set w/Sleeve & Seal	1992-91	TCS 45290	w/Sleeve 'N' Seal®; Must be used w/OS 30571R	
QTY	CARB & FUEL INJECTION	YEARS	PART NO.	DESCRIPTION	
2	Fuel Injector O-Ring Set	1992-91	ES 70599	Improved design	
1	Throttle Body Gasket	1992-91	60844	Mounting	
1	Throttle Body Gasket	1992-91	71216	Air bypass valve	
QTY	EXHAUST GAS RECIRCULATION	YEARS	PART NO.	DESCRIPTION	
1	EGR Gasket	1992-91	70149		
QTY	OIL FILTER MOUNTING	YEARS	PART NO.	DESCRIPTION	
1	O-Ring	1992-91	413	Oil Filter Mounting	
1	Oil Filter Adapter Gasket	1992-91	72625	.103" width; 2.450" ID	
1	Oil Filter Adapter Gasket	1992-91	72884	.141" width; 2.482" ID	
13		1998 - 1997; 3.0L 181 (2960cc) SOHC V6 (12 Valve) 87mm Bore MFI; Gasoline; Naturally Aspirated Nissan Eng.; VIN Code 1, Eng. Code VG30E			13
QTY	CYLINDER HEAD	YEARS	PART NO.	DESCRIPTION	
2	Head Gasket	1998-97	9571 PT	Improved design	
1	Head Set	1998-97	HS 9972 PT	PermaDry® molded rubber valve cover gskts. incl.; Premium valve stem seals incl.	
QTY	CONVERSION SET	YEARS	PART NO.	DESCRIPTION	
1	Gasket Conversion Set	1998-97	CS 9228-1	RTV sealant incl. for oil pan gskt.	
QTY	MANIFOLD - INT. & EXH.	YEARS	PART NO.	DESCRIPTION	
1	Int. Manifold Gasket Set	1998-97	MS 92270-4	Lower set; Upper set incl.	
1	Plenum Gasket Set	1998-97	MS 92273	Upper set	
1	Exh. Manifold Gasket Set	1998-97	MS 95583		
QTY	EXHAUST PIPE FLANGE	YEARS	PART NO.	DESCRIPTION	
2	Exhaust Pipe Gasket	1998-97	60568	Pipe to manifold	
2	Exhaust Pipe Gasket	1998-97	60674	Converter	
QTY	OIL PAN	YEARS	PART NO.	DESCRIPTION	
1	Oil Pan Gasket Set	1998-97	OS 30591	RTV Black silicone w/Rubber end seals	
QTY	CRANKSHAFT REAR SEAL	YEARS	PART NO.	DESCRIPTION	
1	Rear Main Seal Set	1998-97	BS 40628	Rubber; One-piece	
QTY	VALVE COVER	YEARS	PART NO.	DESCRIPTION	
1	Valve Cover Gasket Set	1998-97	VS 50251 R	w/o Grommets; PermaDry® molded rubber gskts. incl.	
1	Valve Cover Gasket Set	1998-97	VS 50251 R-1	w/Grommets; PermaDry® molded rubber gskts. incl.	
1	Grommet Set	1998-97	ES 72840	Valve Cover	
QTY	VALVE STEM SEAL SET	YEARS	PART NO.	DESCRIPTION	
1	Valve Stem Seal Set	1998-97	SS 72868	Premium valve stem seals incl.	
QTY	THERMOSTAT HOUSING	YEARS	PART NO.	DESCRIPTION	
1	Thermostat Gasket	1998-97	35312	Thermostat Housing; Loc. L.H. Inner; Thermostat housing to manifold	
1	Thermostat Gasket	1998-97	35368	Thermostat Housing; Loc. R.H.; Connection pipe	
1	Thermostat Gasket	1998-97	35497	Thermostat Housing; Loc. L.H. Outer	
QTY	WATER PUMP	YEARS	PART NO.	DESCRIPTION	
1	Water Pump Gasket	1998-97	35415	Improved design	
QTY	TIMING COVER	YEARS	PART NO.	DESCRIPTION	
1	Timing Cover Dust Seal Set	1998-97	TCS 45834		
1	Crankshaft Front Seal Set	1998-97	TCS 45935		
2	Camshaft Front Seal Set	1998-97	TCS 45635		
QTY	CARB & FUEL INJECTION	YEARS	PART NO.	DESCRIPTION	
1	Throttle Body Gasket	1998-97	61058		

Ford Truck (Incl. Minivans and SUV's) (Cont.)

13 (cont.)	1998 - 1997; 3.0L 181 (2960cc) SOHC V6 (12 Valve) 87mm Bore			13 (cont.)
MFI; Gasoline; Naturally Aspirated Nissan Eng.; VIN Code 1, Eng. Code VG30E				
QTY	DISTRIBUTOR MOUNTING	YEARS	PART NO.	DESCRIPTION
1	O-Ring	1998-97	417	Distributor Mounting
QTY	EXHAUST GAS RECIRCULATION	YEARS	PART NO.	DESCRIPTION
2	EGR Gasket	1998-97	70712	
14	1996 - 1993; 3.0L 181 (2960cc) SOHC V6 (12 Valve) 87mm Bore			14
MFI; Gasoline; Naturally Aspirated Nissan Eng.; VIN Code W, Eng. Code VG30E				
QTY	CYLINDER HEAD	YEARS	PART NO.	DESCRIPTION
2	Head Gasket	1996-93	9571 PT	Improved design
1	Head Set	1996-94	HS 9972 PT	PermaDry® molded rubber valve cover gskts. incl.; Premium valve stem seals incl.
1	Head Set	1993	HS 9571 PT-3	PermaDry® molded rubber valve cover gskts. incl.; Premium valve stem seals incl.
QTY	CONVERSION SET	YEARS	PART NO.	DESCRIPTION
1	Gasket Conversion Set	1996-93	CS 9228-1	RTV sealant incl. for oil pan gskt.
QTY	MANIFOLD - INT. & EXH.	YEARS	PART NO.	DESCRIPTION
1	Int. Manifold Gasket Set	1996-93	MS 92270-4	Lower set; Upper set incl.
1	Plenum Gasket Set	1996-93	MS 92273	Upper set
1	Exh. Manifold Gasket Set	1996-94	MS 95583	
1	Exh. Manifold Gasket Set	1993	MS 92272	
QTY	EXHAUST PIPE FLANGE	YEARS	PART NO.	DESCRIPTION
2	Exhaust Pipe Gasket	1996-93	60674	Converter
2	Exhaust Pipe Gasket	1996-94	60568	Pipe to manifold
2	Exhaust Pipe Gasket	1993	60811	Pipe to manifold
QTY	OIL PAN	YEARS	PART NO.	DESCRIPTION
1	Oil Pan Gasket Set	1996-93	OS 30591	RTV Black silicone w/Rubber end seals
QTY	CRANKSHAFT REAR SEAL	YEARS	PART NO.	DESCRIPTION
1	Rear Main Seal Set	1996-93	BS 40628	Rubber; One-piece
QTY	VALVE COVER	YEARS	PART NO.	DESCRIPTION
1	Valve Cover Gasket Set	1996-93	VS 50251 R	w/o Grommets; PermaDry® molded rubber gskts. incl.
1	Valve Cover Gasket Set	1996-93	VS 50251 R-1	w/Grommets; PermaDry® molded rubber gskts. incl.
1	Grommet Set	1996-93	ES 72840	Valve Cover
QTY	VALVE STEM SEAL SET	YEARS	PART NO.	DESCRIPTION
1	Valve Stem Seal Set	1996-93	SS 72868	Premium valve stem seals incl.
QTY	THERMOSTAT HOUSING	YEARS	PART NO.	DESCRIPTION
1	Thermostat Gasket	1996-93	35312	Thermostat Housing; Loc. L.H. Inner; Thermostat housing to manifold
1	Thermostat Gasket	1996-93	35368	Thermostat Housing; Loc. R.H.; Connection pipe
1	Thermostat Gasket	1996-93	35497	Thermostat Housing; Loc. L.H. Outer
QTY	WATER PUMP	YEARS	PART NO.	DESCRIPTION
1	Water Pump Gasket	1996-93	35415	Improved design
QTY	TIMING COVER	YEARS	PART NO.	DESCRIPTION
1	Timing Cover Dust Seal Set	1996-93	TCS 45834	
1	Crankshaft Front Seal Set	1996-93	TCS 45935	
2	Camshaft Front Seal Set	1996-93	TCS 45635	
QTY	CARB & FUEL INJECTION	YEARS	PART NO.	DESCRIPTION
1	Throttle Body Gasket	1996-93	61058	
QTY	DISTRIBUTOR MOUNTING	YEARS	PART NO.	DESCRIPTION
1	O-Ring	1996-93	417	Distributor Mounting
QTY	EXHAUST GAS RECIRCULATION	YEARS	PART NO.	DESCRIPTION
2	EGR Gasket	1996-93	70712	
15	2008 - 2001; 3.0L 181 (2967cc) DOHC V6 (24 Valve) 89mm Bore Duratec			15
MFI; Gasoline; Naturally Aspirated Ford Eng.; VIN Code 1				
QTY	CYLINDER HEAD	YEARS	PART NO.	DESCRIPTION
1	Head Gasket	2008-05	26212 PT	Loc. R.H.; Head bolts not incl.; Head bolt replacement required; PermaTorqueMLS®
1	Head Gasket	2008	26233 PT	Loc. L.H.; Head bolts not incl.; Head bolt replacement required; PermaTorqueMLS®
1	Head Gasket	2007	26207 PT	Ford Freestyle Limited, SEL; Loc. L.H.; Head bolts not incl.; Head bolt replacement required; PermaTorqueMLS®
1	Head Gasket	2007	26233 PT	Exc. Ford Freestyle Limited, SEL; Loc. L.H.; Head bolts not incl.; Head bolt replacement required; PermaTorqueMLS®
1	Head Gasket	2006-05	26207 PT	Ford Freestyle Limited, SE, SEL; Loc. L.H.; Head bolts not incl.; Head bolt replacement required; PermaTorqueMLS®

Ford Truck (Incl. Minivans and SUV's) (Cont.)

15 (cont.)	2008 - 2001; 3.0L 181 (2967cc) DOHC V6 (24 Valve) 89mm Bore Duratec MFI; Gasoline; Naturally Aspirated Ford Eng.; VIN Code 1				15 (cont.)
QTY	CYLINDER HEAD	YEARS	PART NO.	DESCRIPTION	
1	Head Gasket	2006-05	26233 PT	Exc. Ford Freestyle Limited, SE, SEL; Loc. L.H.; Head bolts not incl.; Head bolt replacement required; PermaTorqueMLS®	
1	Head Gasket	2004-01	9541 PT	Loc. R.H.; Head bolts not incl.; Head bolt replacement required; PermaTorqueMLS®	
1	Head Gasket	2004	26207 PT	Loc. L.H.; From 12/15/03; Head bolts not incl.; Head bolt replacement required; PermaTorqueMLS®	
1	Head Gasket	2004	9540 PT	Loc. L.H.; To 12/14/03; Head bolts not incl.; Head bolt replacement required; PermaTorqueMLS®	
1	Head Gasket	2003-01	9540 PT	Loc. L.H.; Head bolts not incl.; Head bolt replacement required; PermaTorqueMLS®	
1	Head Set	2008	HS 26233 PT-5	Head bolts not incl.; Head bolt replacement required; PermaDry® molded rubber valve cover gskts. incl.; Premium valve stem seals incl.	
1	Head Set	2007	HS 26207 PT-2	Ford Freestyle Limited, SEL; Head bolts not incl.; Head bolt replacement required; PermaDry® molded rubber valve cover gskts. incl.; Premium valve stem seals incl.	
1	Head Set	2007	HS 26233 PT-5	Exc. Ford Freestyle Limited, SEL; Head bolts not incl.; Head bolt replacement required; PermaDry® molded rubber valve cover gskts. incl.; Premium valve stem seals incl.	
1	Head Set	2006-05	HS 26207 PT-2	Ford Freestyle Limited, SE, SEL; Head bolts not incl.; Head bolt replacement required; PermaDry® molded rubber valve cover gskts. incl.; Premium valve stem seals incl.	
1	Head Set	2006	HS 26233 PT	Exc. Ford Freestyle Limited, SE, SEL; To 01/18/06; Head bolts not incl.; Head bolt replacement required; PermaDry® molded rubber valve cover gskts. incl.; Premium valve stem seals incl.	
1	Head Set	2006	HS 26233 PT-5	Exc. Ford Freestyle Limited, SE, SEL; From 01/19/06; Head bolts not incl.; Head bolt replacement required; PermaDry® molded rubber valve cover gskts. incl.; Premium valve stem seals incl.	
1	Head Set	2005	HS 26233 PT	Exc. Ford Freestyle Limited, SE, SEL; Head bolts not incl.; Head bolt replacement required; PermaDry® molded rubber valve cover gskts. incl.; Premium valve stem seals incl.	
1	Head Set	2004	HS 26207 PT-1	From 12/15/03; Head bolts not incl.; Head bolt replacement required; PermaDry® molded rubber valve cover gskts. incl.; Premium valve stem seals incl.	
1	Head Set	2004	HS 9540 PT-3	To 12/14/03; Head bolts not incl.; Head bolt replacement required; PermaDry® molded rubber valve cover gskts. incl.; Premium valve stem seals incl.	
1	Head Set	2003-01	HS 9540 PT-3	Head bolts not incl.; Head bolt replacement required; PermaDry® molded rubber valve cover gskts. incl.; Premium valve stem seals incl.	
2	Head Bolt Set	2008-01	ES 72159	Head bolts w/Washers; Replacement required	
QTY	CONVERSION SET	YEARS	PART NO.	DESCRIPTION	
1	Gasket Conversion Set	2008-05	CS 9038-2	PermaDry® molded rubber oil pan gskt. incl.	
1	Gasket Conversion Set	2004-03	CS 9038-1	To 07/17/03; Oil pan gskt. w/Bolt holes; PermaDry® molded rubber oil pan gskt. incl.; Consolidated design	
1	Gasket Conversion Set	2004-03	CS 9038-2	From 07/18/03; Oil pan gskt. w/o Bolt holes; PermaDry® molded rubber oil pan gskt. incl.	
1	Gasket Conversion Set	2002-01	CS 9038-1	PermaDry® molded rubber oil pan gskt. incl.; Consolidated design	
QTY	MANIFOLD - INT. & EXH.	YEARS	PART NO.	DESCRIPTION	
1	Int. Manifold Gasket Set	2008-05	MS 92586-1	Lower set; Upper set incl.	
1	Int. Manifold Gasket Set	2004-01	MS 96124	Lower set; Upper set incl.	
1	Plenum Gasket Set	2008-05	MS 96252	Upper set	
1	Plenum Gasket Set	2004-01	MS 96124-1	Upper set	
1	Exh. Manifold Gasket Set	2008-01	MS 95715		
QTY	EXHAUST PIPE FLANGE	YEARS	PART NO.	DESCRIPTION	
2	Exhaust Pipe Gasket	2008	61194	Converter	
2	Exhaust Pipe Gasket	2008	61395	Flange	
1	Exhaust Pipe Gasket	2007	61183	Ford Freestyle Limited, SEL; Converter	
2	Exhaust Pipe Gasket	2007	61194	Exc. Ford Freestyle Limited, SEL; Converter	
2	Exhaust Pipe Gasket	2007	61395	Exc. Ford Freestyle Limited, SEL; Flange	
2	Exhaust Pipe Gasket	2007	61402	Ford Freestyle Limited, SEL; Ring	
1	Exhaust Pipe Gasket	2006-05	61183	Ford Freestyle Limited, SE, SEL; Converter	
2	Exhaust Pipe Gasket	2006-05	61395	Exc. Ford Freestyle Limited, SE, SEL; Flange	
2	Exhaust Pipe Gasket	2006-05	61396	Exc. Ford Freestyle Limited, SE, SEL; Converter	
2	Exhaust Pipe Gasket	2006-05	61402	Ford Freestyle Limited, SE, SEL; Ring	
2	Exhaust Pipe Gasket	2004-01	61194	Flange	
QTY	OIL PAN	YEARS	PART NO.	DESCRIPTION	
1	Oil Pan Gasket Set	2008-05	OS 30729 R	PermaDry® molded rubber gskt. incl.	

Ford Truck (Incl. Minivans and SUV's) (Cont.)

15 (cont.)		2008 - 2001; 3.0L 181 (2967cc) DOHC V6 (24 Valve) 89mm Bore Duratec MFI; Gasoline; Naturally Aspirated Ford Eng.; VIN Code 1			15 (cont.)
QTY	OIL PAN	YEARS	PART NO.	DESCRIPTION	
1	Oil Pan Gasket Set	2004-03	OS 30697 R	To 07/17/03; Gskt. w/Bolt holes; PermaDry® molded rubber gskt. incl.; Improved design	
1	Oil Pan Gasket Set	2004-03	OS 30729 R	From 07/18/03; Gskt. w/o Bolt holes; PermaDry® molded rubber gskt. incl.	
1	Oil Pan Gasket Set	2002-01	OS 30697 R	PermaDry® molded rubber gskt. incl.; Improved design	
1	Drain Plug Gasket	2008-04	71067		
1	Drain Plug Gasket	2003-01	72515		
QTY	CRANKSHAFT REAR SEAL	YEARS	PART NO.	DESCRIPTION	
1	Rear Main Seal Set	2008-01	BS 40620	Rubber; One-piece; Improved design	
1	Rear Main Seal Set	2008-01	BS 40644	PTFE Rubber; One-piece	
QTY	VALVE COVER	YEARS	PART NO.	DESCRIPTION	
1	Valve Cover Gasket Set	2008	VS 50708 R	w/Grommets & Spark plug tube seals; PermaDry® molded rubber gskts. incl.	
1	Valve Cover Gasket Set	2007	VS 50629 R	Ford Freestyle Limited, SEL; w/Grommets & Spark plug tube seals; PermaDry® molded rubber gskts. incl.	
1	Valve Cover Gasket Set	2007	VS 50708 R	Exc. Ford Freestyle Limited, SEL; w/Grommets & Spark plug tube seals; PermaDry® molded rubber gskts. incl.	
1	Valve Cover Gasket Set	2006-05	VS 50629 R	Ford Freestyle Limited, SE, SEL; w/Grommets & Spark plug tube seals; PermaDry® molded rubber gskts. incl.	
1	Valve Cover Gasket Set	2006	VS 50579 R	Exc. Ford Freestyle Limited, SE, SEL; To 01/18/06; w/Grommets & Spark plug tube seals; PermaDry® molded rubber gskts. incl.	
1	Valve Cover Gasket Set	2006	VS 50708 R	Exc. Ford Freestyle Limited, SE, SEL; From 01/19/06; w/Grommets & Spark plug tube seals; PermaDry® molded rubber gskts. incl.	
1	Valve Cover Gasket Set	2005	VS 50579 R	Exc. Ford Freestyle Limited, SE, SEL; w/Grommets & Spark plug tube seals; PermaDry® molded rubber gskts. incl.	
1	Valve Cover Gasket Set	2004-01	VS 50551 R	w/Grommets & Spark plug tube seals; PermaDry® molded rubber gskts. incl.	
QTY	VALVE STEM SEAL SET	YEARS	PART NO.	DESCRIPTION	
1	Valve Stem Seal Set	2008-01	SS 72873-1	Premium valve stem seals incl.	
QTY	WATER OUTLET GASKET	YEARS	PART NO.	DESCRIPTION	
1	Water Outlet Gasket	2008-01	35489	Water Outlet	
QTY	WATER PUMP	YEARS	PART NO.	DESCRIPTION	
1	Water Pump Gasket	2008	35663	Improved design	
1	Water Pump Gasket	2007	35663	Exc. Ford Freestyle Limited, SEL; Improved design	
1	Water Pump Gasket	2006-05	35663	Exc. Ford Freestyle Limited, SE, SEL; Improved design	
1	Water Pump Gasket	2004-02	35663	Improved design	
1	Water Pump Gasket	2001	35640		
QTY	TIMING COVER	YEARS	PART NO.	DESCRIPTION	
1	Timing Cover Set	2008-05	TCS 46016	Must be used w/OS 30729R; Improved design	
1	Timing Cover Set	2004-01	TCS 45967	Must be used w/OS 30697R or w/OS 30729R; Old design	
1	Timing Cover Set	2004-01	TCS 46016	Must be used w/OS 30697R or w/OS 30729R; Improved design	
1	Crankshaft Front Seal Set	2008-01	TCS 46114		
1	Camshaft Rear Seal Set	2008-07	TCS 46071		
1	Camshaft Rear Seal Set	2006-05	TCS 45966	Exc. Ford Freestyle Limited, SE, SEL	
1	Camshaft Rear Seal Set	2006-05	TCS 46071	Ford Freestyle Limited, SE, SEL	
1	Camshaft Rear Seal Set	2004-01	TCS 45966		
QTY	CARB & FUEL INJECTION	YEARS	PART NO.	DESCRIPTION	
2	Fuel Injector O-Ring Set	2008-01	ES 70599	Improved design	
1	Throttle Body Gasket	2008-01	72302	Air bypass valve	
1	Throttle Body Gasket	2008	61158	Mounting	
1	Throttle Body Gasket	2007	61158	Exc. Ford Freestyle Limited, SEL; Mounting	
1	Throttle Body Gasket	2007	61377	Ford Freestyle Limited, SEL; Mounting	
1	Throttle Body Gasket	2006-05	61158	Exc. Ford Freestyle Limited, SE, SEL; Mounting	
1	Throttle Body Gasket	2006-05	61377	Ford Freestyle Limited, SE, SEL; Mounting	
1	Throttle Body Gasket	2004-01	61158	Mounting	
QTY	EXHAUST GAS RECIRCULATION	YEARS	PART NO.	DESCRIPTION	
2	EGR Gasket	2008-01	71278	Tube seal	
1	EGR Gasket	2008	70149	Valve	
1	EGR Gasket	2007	70149	Exc. Ford Freestyle Limited, SEL; Valve	
1	EGR Gasket	2007	71176	Ford Freestyle Limited, SEL; Valve	
1	EGR Gasket	2006-05	70149	Exc. Ford Freestyle Limited, SE, SEL; Valve	
1	EGR Gasket	2006-05	71176	Ford Freestyle Limited, SE, SEL; Valve	
1	EGR Gasket	2004-01	70149	Valve	

Ford Truck (Incl. Minivans and SUV's) (Cont.)

16		2012 - 2011; 3.0L 181 (2967cc) DOHC V6 (24 Valve) 89mm Bore Duratec VVT			16
MFI; Flex Fuel; Naturally Aspirated Ford Eng.; VIN Code G					
QTY	CYLINDER HEAD	YEARS	PART NO.	DESCRIPTION	
1	Head Gasket	2012-11	26545 PT	Loc. L.H.; Head bolts not incl.; Head bolt replacement required; PermaTorqueMLS®; New Part Number - Check for Availability	
1	Head Gasket	2012-11	26546 PT	Loc. R.H.; Head bolts not incl.; Head bolt replacement required; PermaTorqueMLS®; New Part Number - Check for Availability	
1	Head Set	2012-11	HS 26545 PT	Head bolts not incl.; Head bolt replacement required; PermaDry® molded rubber valve cover gskts. incl.; Premium valve stem seals incl.; New Part Number - Check for Availability	
QTY	CONVERSION SET	YEARS	PART NO.	DESCRIPTION	
1	Gasket Conversion Set	2012-11	CS 9038-2	PermaDry® molded rubber oil pan gskt. incl.	
QTY	MANIFOLD - INT. & EXH.	YEARS	PART NO.	DESCRIPTION	
1	Int. Manifold Gasket Set	2012-11	MS 97193	Lower set; Upper set incl.; New Part Number - Check for Availability	
1	Plenum Gasket Set	2012-11	MS 97194	Upper set; New Part Number - Check for Availability	
1	Exh. Manifold Gasket Set	2012-11	MS 95715		
QTY	EXHAUST PIPE FLANGE	YEARS	PART NO.	DESCRIPTION	
1	Exhaust Pipe Gasket	2012-11	60641	Secondary converter	
1	Exhaust Pipe Gasket	2012-11	60714	Loc. Front; Exh. connector	
2	Exhaust Pipe Gasket	2012-11	61684	Flange; New Part Number - Check for Availability	
QTY	OIL PAN	YEARS	PART NO.	DESCRIPTION	
1	Oil Pan Gasket Set	2012-11	OS 30729 R	PermaDry® molded rubber gskt. incl.	
1	Drain Plug Gasket	2012-11	71067		
QTY	CRANKSHAFT REAR SEAL	YEARS	PART NO.	DESCRIPTION	
1	Rear Main Seal Set	2012-11	BS 40620	Rubber; One-piece; Improved design	
1	Rear Main Seal Set	2012-11	BS 40644	PTFE Rubber; One-piece	
QTY	VALVE COVER	YEARS	PART NO.	DESCRIPTION	
1	Valve Cover Gasket Set	2012-11	VS 50801 R	w/Grommets & Spark plug tube seals; PermaDry® molded rubber gskts. incl.; New Part Number - Check for Availability	
1	Grommet Set	2012-11	ES 71426	Valve Cover; VCT seals set; New Part Number - Check for Availability	
QTY	VALVE STEM SEAL SET	YEARS	PART NO.	DESCRIPTION	
1	Valve Stem Seal Set	2012-11	SS 72873-1	Premium valve stem seals incl.	
QTY	THERMOSTAT HOUSING	YEARS	PART NO.	DESCRIPTION	
1	Thermostat Gasket	2012-11	35971	Thermostat Housing; Thermostat gskt.; New Part Number - Check for Availability	
QTY	WATER OUTLET GASKET	YEARS	PART NO.	DESCRIPTION	
1	Water Outlet Gasket	2012-11	35489	Water Outlet	
QTY	WATER PUMP	YEARS	PART NO.	DESCRIPTION	
1	Water Pump Gasket	2012-11	35973	Housing to block; New Part Number - Check for Availability	
1	Water Pump Gasket	2012-11	35976	Mounting; New Part Number - Check for Availability	
QTY	TIMING COVER	YEARS	PART NO.	DESCRIPTION	
1	Timing Cover Set	2012-11	TCS 46016	Must be used w/OS 30729R; Improved design	
1	Crankshaft Front Seal Set	2012-11	TCS 46114		
1	Camshaft Rear Seal Set	2012-11	TCS 46071		
QTY	CARB & FUEL INJECTION	YEARS	PART NO.	DESCRIPTION	
2	Fuel Injector O-Ring Set	2012-11	ES 70599	Improved design	
1	Throttle Body Gasket	2012-11	61377	Mounting	
1	Throttle Body Gasket	2012-11	72302	Air bypass valve	
QTY	EXHAUST GAS RECIRCULATION	YEARS	PART NO.	DESCRIPTION	
1	EGR Gasket	2012-11	70149	Valve	
2	EGR Gasket	2012-11	71278	Tube seal	
17		2012 - 2009; 3.0L 181 (2967cc) DOHC V6 (24 Valve) 89mm Bore Duratec VVT			17
MFI; Gasoline; Naturally Aspirated Ford Eng.; VIN Code G					
QTY	CYLINDER HEAD	YEARS	PART NO.	DESCRIPTION	
1	Head Gasket	2012-10	26545 PT	Loc. L.H.; Head bolts not incl.; Head bolt replacement required; PermaTorqueMLS®; New Part Number - Check for Availability	
1	Head Gasket	2012-10	26546 PT	Loc. R.H.; Head bolts not incl.; Head bolt replacement required; PermaTorqueMLS®; New Part Number - Check for Availability	
1	Head Gasket	2009	26212 PT	Loc. R.H.; Head bolts not incl.; Head bolt replacement required; PermaTorqueMLS®	
1	Head Gasket	2009	26233 PT	Loc. L.H.; Head bolts not incl.; Head bolt replacement required; PermaTorqueMLS®	
1	Head Set	2012-10	HS 26545 PT	Head bolts not incl.; Head bolt replacement required; PermaDry® molded rubber valve cover gskts. incl.; Premium valve stem seals incl.; New Part Number - Check for Availability	

Ford Truck (Incl. Minivans and SUV's) (Cont.)

17		2012 - 2009; 3.0L 181 (2967cc) DOHC V6 (24 Valve) 89mm Bore Duratec VVT			17	
(cont.)		MFI; Gasoline; Naturally Aspirated Ford Eng.; VIN Code G			(cont.)	
QTY	CYLINDER HEAD	YEARS	PART NO.	DESCRIPTION		
2	Head Bolt Set	2009	ES 72159	Head bolts w/Washers; Replacement required		
QTY	CONVERSION SET	YEARS	PART NO.	DESCRIPTION		
1	Gasket Conversion Set	2012-09	CS 9038-2	PermaDry® molded rubber oil pan gskt. incl.		
QTY	MANIFOLD - INT. & EXH.	YEARS	PART NO.	DESCRIPTION		
1	Int. Manifold Gasket Set	2012-09	MS 97193	Lower set; Upper set incl.; New Part Number - Check for Availability		
1	Plenum Gasket Set	2012-09	MS 97194	Upper set; New Part Number - Check for Availability		
1	Exh. Manifold Gasket Set	2012-09	MS 95715			
QTY	EXHAUST PIPE FLANGE	YEARS	PART NO.	DESCRIPTION		
1	Exhaust Pipe Gasket	2012-09	60641	Secondary converter		
1	Exhaust Pipe Gasket	2012-09	60714	Loc. Front; Exh. connector		
2	Exhaust Pipe Gasket	2012-09	61684	Flange; New Part Number - Check for Availability		
2	Exhaust Pipe Gasket	2009	61194	Converter		
QTY	OIL PAN	YEARS	PART NO.	DESCRIPTION		
1	Oil Pan Gasket Set	2012-09	OS 30729 R	PermaDry® molded rubber gskt. incl.		
1	Drain Plug Gasket	2012-09	71067			
QTY	CRANKSHAFT REAR SEAL	YEARS	PART NO.	DESCRIPTION		
1	Rear Main Seal Set	2012-09	BS 40620	Rubber; One-piece; Improved design		
1	Rear Main Seal Set	2012-09	BS 40644	PTFE Rubber; One-piece		
QTY	VALVE COVER	YEARS	PART NO.	DESCRIPTION		
1	Valve Cover Gasket Set	2012-09	VS 50801 R	w/Grommets & Spark plug tube seals; PermaDry® molded rubber gskts. incl.; New Part Number - Check for Availability		
1	Grommet Set	2012-09	ES 71426	Valve Cover; VCT seals set; New Part Number - Check for Availability		
QTY	VALVE STEM SEAL SET	YEARS	PART NO.	DESCRIPTION		
1	Valve Stem Seal Set	2012-09	SS 72873-1	Premium valve stem seals incl.		
QTY	THERMOSTAT HOUSING	YEARS	PART NO.	DESCRIPTION		
1	Thermostat Gasket	2012-09	35971	Thermostat Housing; Thermostat gskt.; New Part Number - Check for Availability		
QTY	WATER OUTLET GASKET	YEARS	PART NO.	DESCRIPTION		
1	Water Outlet Gasket	2012-09	35489	Water Outlet		
QTY	WATER PUMP	YEARS	PART NO.	DESCRIPTION		
1	Water Pump Gasket	2012-09	35973	Housing to block; New Part Number - Check for Availability		
1	Water Pump Gasket	2012-09	35976	Mounting; New Part Number - Check for Availability		
QTY	TIMING COVER	YEARS	PART NO.	DESCRIPTION		
1	Timing Cover Set	2012-09	TCS 46016	Must be used w/OS 30729R; Improved design		
1	Crankshaft Front Seal Set	2012-09	TCS 46114			
1	Camshaft Rear Seal Set	2012-09	TCS 46071			
QTY	CARB & FUEL INJECTION	YEARS	PART NO.	DESCRIPTION		
2	Fuel Injector O-Ring Set	2012-09	ES 70599	Improved design		
1	Throttle Body Gasket	2012-09	61377	Mounting		
1	Throttle Body Gasket	2012-09	72302	Air bypass valve		
QTY	EXHAUST GAS RECIRCULATION	YEARS	PART NO.	DESCRIPTION		
1	EGR Gasket	2012-09	70149	Valve		
2	EGR Gasket	2012-09	71278	Tube seal		
18		2008 - 1991; 3.0L 183 (2982cc) OHV V6 (12 Valve) 89mm Bore Vulcan			18	
(cont.)		MFI; Gasoline; Naturally Aspirated Ford Eng.; VIN Code U			(cont.)	
QTY	CYLINDER HEAD	YEARS	PART NO.	DESCRIPTION		
1	Head Gasket	2008-01	9902 PT	Loc. L.H.; Head bolts not incl.; Head bolt replacement recommended		
1	Head Gasket	2008-01	9903 PT	Loc. R.H.; Head bolts not incl.; Head bolt replacement recommended		
2	Head Gasket	2000-99	9885 PT	Exc. Ford Ranger XL, XLT; Head bolts not incl.; Head bolt replacement recommended		
1	Head Gasket	2000-99	9902 PT	Ford Ranger XL, XLT; Loc. L.H.; Head bolts not incl.; Head bolt replacement recommended		
1	Head Gasket	2000-99	9903 PT	Ford Ranger XL, XLT; Loc. R.H.; Head bolts not incl.; Head bolt replacement recommended		
1	Head Gasket	1998	9902 PT	Ford Ranger Splash, Super, XL, XLT; Loc. L.H.; Head bolts not incl.; Head bolt replacement recommended		
1	Head Gasket	1998	9903 PT	Ford Ranger Splash, Super, XL, XLT; Loc. R.H.; Head bolts not incl.; Head bolt replacement recommended		
2	Head Gasket	1998	9885 PT	Exc. Ford Ranger Splash, Super, XL, XLT; Head bolts not incl.; Head bolt replacement recommended		
2	Head Gasket	1997-95	9885 PT	Ford Windstar Base, GL, LX; Head bolts not incl.; Head bolt replacement recommended		

Ford Truck (Incl. Minivans and SUV's) (Cont.)

18 (cont.)		2008 - 1991; 3.0L 183 (2982cc) OHV V6 (12 Valve) 89mm Bore Vulcan			18 (cont.)
		MFI; Gasoline; Naturally Aspirated Ford Eng.; VIN Code U			
QTY	CYLINDER HEAD	YEARS	PART NO.	DESCRIPTION	
1	Head Gasket	1997-95	9902 PT	Exc. Ford Windstar Base, GL, LX; Loc. L.H.; Head bolts not incl.; Head bolt replacement recommended	
1	Head Gasket	1997-95	9903 PT	Exc. Ford Windstar Base, GL, LX; Loc. R.H.; Head bolts not incl.; Head bolt replacement recommended	
1	Head Gasket	1994-91	9902 PT	Loc. L.H.; Head bolts not incl.; Head bolt replacement recommended	
1	Head Gasket	1994-91	9903 PT	Loc. R.H.; Head bolts not incl.; Head bolt replacement recommended	
1	Head Set	2008-02	HS 9902 PT-5	Head bolts not incl.; Head bolt replacement required; PermaDry® molded rubber valve cover gskts. incl.; Premium valve stem seals incl.	
1	Head Set	2001	HS 9902 PT-4	Head bolts not incl.; Head bolt replacement required; PermaDry® molded rubber valve cover gskts. incl.; Premium valve stem seals incl.	
1	Head Set	2000-99	HS 9885 PT-3	Exc. Ford Ranger XL, XLT; To 07/26/99; Head bolts not incl.; Head bolt replacement required; PermaDry® molded rubber valve cover gskts. incl.; Premium valve stem seals incl.; Consolidated design	
1	Head Set	2000-99	HS 9885 PT-4	Exc. Ford Ranger XL, XLT; From 07/27/99; Head bolts not incl.; Head bolt replacement required; PermaDry® molded rubber valve cover gskts. incl.; Premium valve stem seals incl.	
1	Head Set	2000-99	HS 9902 PT-3	Ford Ranger XL, XLT; To 07/26/99; Head bolts not incl.; Head bolt replacement required; PermaDry® molded rubber valve cover gskts. incl.; Premium valve stem seals incl.; Consolidated design	
1	Head Set	2000-99	HS 9902 PT-4	Ford Ranger XL, XLT; From 07/27/99; Head bolts not incl.; Head bolt replacement required; PermaDry® molded rubber valve cover gskts. incl.; Premium valve stem seals incl.	
1	Head Set	1998	HS 9885 PT-3	Exc. Ford Ranger Splash, Super, XL, XLT; Head bolts not incl.; Head bolt replacement recommended; PermaDry® molded rubber valve cover gskts. incl.; Premium valve stem seals incl.; Consolidated design	
1	Head Set	1998	HS 9902 PT-3	Ford Ranger Splash, Super, XL, XLT; Head bolts not incl.; Head bolt replacement recommended; PermaDry® molded rubber valve cover gskts. incl.; Premium valve stem seals incl.; Consolidated design	
1	Head Set	1997-96	HS 9885 PT-3	Ford Windstar Base, GL, LX; Head bolts not incl.; Head bolt replacement recommended; PermaDry® molded rubber valve cover gskts. incl.; Premium valve stem seals incl.; Consolidated design	
1	Head Set	1997-96	HS 9902 PT-3	Exc. Ford Windstar Base, GL, LX; Head bolts not incl.; Head bolt replacement recommended; PermaDry® molded rubber valve cover gskts. incl.; Premium valve stem seals incl.; Consolidated design	
1	Head Set	1995	HS 9885 PT	Ford Windstar Base, GL, LX; Head bolts not incl.; Head bolt replacement recommended; PermaDry® molded rubber valve cover gskts. incl.; Premium valve stem seals incl.	
1	Head Set	1995	HS 9902 PT	Exc. Ford Windstar Base, GL, LX; Head bolts not incl.; Head bolt replacement recommended; PermaDry® molded rubber valve cover gskts. incl.; Premium valve stem seals incl.	
1	Head Set	1994-92	HS 9902 PT	Head bolts not incl.; Head bolt replacement recommended; PermaDry® molded rubber valve cover gskts. incl.; Premium valve stem seals incl.	
1	Head Set	1991	HS 9368 PT	Exc. Ford Ranger Custom, S, Sport, STX, Super, XLT; w/Eng. I.D. Codes IG-576, 577-BA; w/Stamped steel valve covers; Head bolts not incl.; Head bolt replacement recommended; PermaDry® molded rubber valve cover gskts. incl.; Premium valve stem seals incl.	
1	Head Set	1991	HS 9902 PT	Ford Ranger Custom, S, Sport, STX, Super, XLT; w/Cast Aluminum valve covers; Head bolts not incl.; Head bolt replacement recommended; PermaDry® molded rubber valve cover gskts. incl.; Premium valve stem seals incl.	
1	Head Set	1991	HS 9902 PT	Exc. Ford Ranger Custom, S, Sport, STX, Super, XLT; w/Eng. I.D. Codes IG-576, 577-AA, CA; w/Cast Aluminum valve covers; Head bolts not incl.; Head bolt replacement recommended; PermaDry® molded rubber valve cover gskts. incl.; Premium valve stem seals incl.	
2	Head Bolt Set	2008-00	ES 72174	Replacement required	
1	Head Bolt Set	1999-98	ES 72136	To 07/13/98; Replacement recommended	
2	Head Bolt Set	1999-98	ES 72174	From 07/14/98; Replacement required	
1	Head Bolt Set	1997-91	ES 72136	Replacement recommended	
QTY	CONVERSION SET	YEARS	PART NO.	DESCRIPTION	
1	Gasket Conversion Set	2008-02	CS 9368-3	PermaDry® molded rubber oil pan gskt. incl.	
1	Gasket Conversion Set	2001-91	CS 9368-2	PermaDry® molded rubber oil pan gskt. incl.	
QTY	MANIFOLD - INT. & EXH.	YEARS	PART NO.	DESCRIPTION	
1	Int. Manifold Gasket Set	2008-02	MS 95372-1	Lower set; Upper set incl.; Must be used w/VS 50374R	
1	Int. Manifold Gasket Set	2001-92	MS 95372	Lower set; Upper set incl.; Must be used w/VS 50374R	
1	Int. Manifold Gasket Set	1991	MS 95372	Lower set; Upper set incl.; Must be used w/VS 50066R or w/VS 50374R	

Ford Truck (Incl. Minivans and SUV's) (Cont.)

18 (cont.)		2008 - 1991; 3.0L 183 (2982cc) OHV V6 (12 Valve) 89mm Bore Vulcan MFI; Gasoline; Naturally Aspirated Ford Eng.; VIN Code U			18 (cont.)
QTY	MANIFOLD - INT. & EXH.	YEARS	PART NO.	DESCRIPTION	
1	Plenum Gasket Set	2008-02	MS 94429	Upper set	
1	Plenum Gasket Set	2001-91	MS 93491	Upper set	
1	Exh. Manifold Gasket Set	2008-96	MS 95939	Improved design	
1	Exh. Manifold Gasket Set	1995-91	MS 93850		
QTY	EXHAUST PIPE FLANGE	YEARS	PART NO.	DESCRIPTION	
1	Exhaust Pipe Gasket	2008-01	60641	Converter to muffler	
1	Exhaust Pipe Gasket	2008-01	61407	Inlet pipe to converter	
1	Exhaust Pipe Gasket	2008-02	61183	Ring	
1	Exhaust Pipe Gasket	2000-99	60641	Ford Ranger XL, XLT; Converter to muffler	
1	Exhaust Pipe Gasket	2000-99	60885	Exc. Ford Ranger XL, XLT; Converter to muffler	
1	Exhaust Pipe Gasket	1998	60641	Ford Ranger Splash, Super, XL, XLT; Converter to muffler	
1	Exhaust Pipe Gasket	1998	60885	Exc. Ford Ranger Splash, Super, XL, XLT; Converter to muffler	
1	Exhaust Pipe Gasket	1997-95	60885	Ford Windstar Base, GL, LX; Converter to muffler	
1	Exhaust Pipe Gasket	1997-96	60679	Ford Aerostar Base, XLT, XLT Plus, XLT Sport; Converter to muffler	
1	Exhaust Pipe Gasket	1997-96	60713	Ford Aerostar Base, XLT, XLT Plus, XLT Sport; Inlet pipe to converter	
1	Exhaust Pipe Gasket	1997	60641	Ford Ranger Splash, Sport, STX, Super, XL, XLT; Converter to muffler	
1	Exhaust Pipe Gasket	1996	60641	Ford Ranger Splash, STX, Super, XL, XLT; Converter to muffler	
1	Exhaust Pipe Gasket	1995	60641	Ford Ranger Splash, STX, Super, XL, XL Sport, XLT; Converter to muffler	
1	Exhaust Pipe Gasket	1995	60679	Exc. Ford Ranger Splash, STX, Super, XL, XL Sport, XLT, Windstar Base, GL, LX; Converter to muffler	
1	Exhaust Pipe Gasket	1995	60713	Exc. Ford Ranger Splash, STX, Super, XL, XL Sport, XLT, Windstar Base, GL, LX; Inlet pipe to converter	
1	Exhaust Pipe Gasket	1994	60641	Ford Ranger Splash, STX, Super, XL, XLT; Converter to muffler	
1	Exhaust Pipe Gasket	1994	60679	Exc. Ford Ranger Splash, STX, Super, XL, XLT; Converter to muffler	
1	Exhaust Pipe Gasket	1994	60713	Exc. Ford Ranger Splash, STX, Super, XL, XLT; Inlet pipe to converter	
1	Exhaust Pipe Gasket	1994	60796	Ford Ranger Splash, STX, Super, XL, XLT; Inlet pipe to converter	
1	Exhaust Pipe Gasket	1993	60641	Ford Ranger Splash, Sport, STX, Super, XL, XLT; Converter to muffler	
1	Exhaust Pipe Gasket	1993	60679	Exc. Ford Ranger Splash, Sport, STX, Super, XL, XLT; Converter to muffler	
1	Exhaust Pipe Gasket	1993	60713	Exc. Ford Ranger Splash, Sport, STX, Super, XL, XLT; Inlet pipe to converter	
1	Exhaust Pipe Gasket	1993	60796	Ford Ranger Splash, Sport, STX, Super, XL, XLT; Inlet pipe to converter	
1	Exhaust Pipe Gasket	1992	60641	Ford Ranger Base, Custom, S, Sport, STX, Super, XLT; Converter to muffler	
1	Exhaust Pipe Gasket	1992	60679	Exc. Ford Ranger Base, Custom, S, Sport, STX, Super, XLT; Converter to muffler	
1	Exhaust Pipe Gasket	1992	60713	Exc. Ford Ranger Base, Custom, S, Sport, STX, Super, XLT; Inlet pipe to converter	
1	Exhaust Pipe Gasket	1992	60796	Ford Ranger Base, Custom, S, Sport, STX, Super, XLT; Inlet pipe to converter	
1	Exhaust Pipe Gasket	1991	60641	Ford Ranger Custom, S, Sport, STX, Super, XLT; Converter to muffler	
1	Exhaust Pipe Gasket	1991	60679	Exc. Ford Ranger Custom, S, Sport, STX, Super, XLT; Converter to muffler	
1	Exhaust Pipe Gasket	1991	60713	Exc. Ford Ranger Custom, S, Sport, STX, Super, XLT; Inlet pipe to converter	
1	Exhaust Pipe Gasket	1991	60796	Ford Ranger Custom, S, Sport, STX, Super, XLT; Inlet pipe to converter	
QTY	OIL PAN	YEARS	PART NO.	DESCRIPTION	
1	Oil Pan Gasket Set	2008-02	OS 30712 R	PermaDry® molded rubber gskt. incl.	
1	Oil Pan Gasket Set	2001-91	OS 30620 R	PermaDry® molded rubber gskt. incl.	
1	Oil Pan Gasket Set	2001-91	OS 30717 R	Oil pan bolts incl.; PermaDryPlus®	
1	Oil Pan Bolt Set	2001-91	ES 72214		
1	Drain Plug Gasket	2008-91	72515		
QTY	CRANKSHAFT REAR SEAL	YEARS	PART NO.	DESCRIPTION	
1	Rear Main Seal Set	2008-91	BS 40158	Rubber; One-piece	
1	Rear Main Seal Set	2008-91	BS 40646	PTFE Rubber; One-piece	
QTY	VALVE COVER	YEARS	PART NO.	DESCRIPTION	
1	Valve Cover Gasket Set	2008-92	VS 50374 R	w/o Grommets; PermaDry® molded rubber gskts. incl.	
1	Valve Cover Gasket Set	1991	VS 50066 R	Exc. Ford Ranger Custom, S, Sport, STX, Super, XLT; w/Eng. I.D. Codes IG-576, 577-BA; w/Stamped steel valve covers; w/o Grommets; PermaDry® molded rubber gskts. incl.	
1	Valve Cover Gasket Set	1991	VS 50374 R	Ford Ranger Custom, S, Sport, STX, Super, XLT; w/Cast Aluminum valve covers; w/o Grommets; PermaDry® molded rubber gskts. incl.	
1	Valve Cover Gasket Set	1991	VS 50374 R	Exc. Ford Ranger Custom, S, Sport, STX, Super, XLT; w/Eng. I.D. Codes IG-576, 577-AA, CA; w/Cast Aluminum valve covers; w/o Grommets; PermaDry® molded rubber gskts. incl.	
2	Grommet Set	2008-91	ES 72180	Valve Cover	
QTY	VALVE STEM SEAL SET	YEARS	PART NO.	DESCRIPTION	
1	Valve Stem Seal Set	2008-01	SS 70964	Premium valve stem seals incl.	

Ford Truck (Incl. Minivans and SUV's) (Cont.)

18 (cont.)	2008 - 1991; 3.0L 183 (2982cc) OHV V6 (12 Valve) 89mm Bore Vulcan				18 (cont.)
MFI; Gasoline; Naturally Aspirated Ford Eng.; VIN Code U					
QTY	VALVE STEM SEAL SET	YEARS	PART NO.	DESCRIPTION	
1	Valve Stem Seal Set	2000-99	SS 70819	To 07/26/99; Premium valve stem seals incl.; Improved design	
1	Valve Stem Seal Set	2000-99	SS 70964	From 07/27/99; Premium valve stem seals incl.	
1	Valve Stem Seal Set	1998-91	SS 70819	Premium valve stem seals incl.; Improved design	
QTY	WATER OUTLET GASKET	YEARS	PART NO.	DESCRIPTION	
1	Water Outlet Gasket	2008-01	35390	Water Outlet	
1	Water Outlet Gasket	2008-01	35390 T	Water Outlet; PermaDryPlus®	
1	Water Outlet Gasket	2000-99	35377	Exc. Ford Ranger XL, XLT; Water Outlet	
1	Water Outlet Gasket	2000-99	35390	Ford Ranger XL, XLT; Water Outlet	
1	Water Outlet Gasket	2000-99	35390 T	Ford Ranger XL, XLT; Water Outlet; PermaDryPlus®	
1	Water Outlet Gasket	1998	35377	Exc. Ford Ranger Splash, Super, XL, XLT; Water Outlet	
1	Water Outlet Gasket	1998	35390	Ford Ranger Splash, Super, XL, XLT; Water Outlet	
1	Water Outlet Gasket	1998	35390 T	Ford Ranger Splash, Super, XL, XLT; Water Outlet; PermaDryPlus®	
1	Water Outlet Gasket	1997-95	35377	Ford Windstar Base, GL, LX; Water Outlet	
1	Water Outlet Gasket	1997-95	35390	Exc. Ford Windstar Base, GL, LX; Water Outlet	
1	Water Outlet Gasket	1997-95	35390 T	Exc. Ford Windstar Base, GL, LX; Water Outlet; PermaDryPlus®	
1	Water Outlet Gasket	1994-91	35390	Water Outlet	
1	Water Outlet Gasket	1994-91	35390 T	Water Outlet; PermaDryPlus®	
QTY	WATER PUMP	YEARS	PART NO.	DESCRIPTION	
1	Water Pump Gasket	2008-91	35379		
QTY	TIMING COVER	YEARS	PART NO.	DESCRIPTION	
1	Timing Cover Set	2008-91	TCS 45771	w/o Sleeve 'N' Seal®; Must be used w/OS 30620R or w/OS 30712R or w/OS 30717R or w/OS 34505R	
1	Timing Set w/Sleeve & Seal	2008-91	TCS 45973	w/Sleeve 'N' Seal®; Must be used w/OS 30620R or w/OS 30712R or w/OS 30717R or w/OS 34505R	
1	Repair Sleeve	2008-91	16217	Timing Cover; Use w/installation tool	
1	Repair Sleeve Tool	2008-91	16310	Timing Cover	
QTY	CARB & FUEL INJECTION	YEARS	PART NO.	DESCRIPTION	
2	Fuel Injector O-Ring Set	2008-91	ES 70599	Improved design	
1	Throttle Body Gasket	2008-02	61160	Mounting	
1	Throttle Body Gasket	2008-02	71428	Air bypass valve; New Part Number - Check for Availability	
1	Throttle Body Gasket	2001-91	60913	Mounting	
1	Throttle Body Gasket	2001-91	71216	Air bypass valve	
QTY	EXHAUST GAS RECIRCULATION	YEARS	PART NO.	DESCRIPTION	
1	EGR Gasket	2008-98	70149		
1	EGR Gasket	1997-96	70149	Exc. Ford Aerostar Base, XLT, XLT Plus, XLT Sport	
1	EGR Gasket	1997-96	72649	Ford Aerostar Base, XLT, XLT Plus, XLT Sport	
1	EGR Gasket	1995	70149	Ford Ranger Splash, STX, Super, XL, XL Sport, XLT, Windstar Base, GL, LX	
1	EGR Gasket	1995	72649	Exc. Ford Ranger Splash, STX, Super, XL, XL Sport, XLT, Windstar Base, GL, LX	
1	EGR Gasket	1994	70149	Ford Ranger Splash, STX, Super, XL, XLT	
1	EGR Gasket	1994	72649	Exc. Ford Ranger Splash, STX, Super, XL, XLT	
1	EGR Gasket	1993	70149	Ford Ranger Splash, Sport, STX, Super, XL, XLT	
1	EGR Gasket	1993	72649	Exc. Ford Ranger Splash, Sport, STX, Super, XL, XLT	
1	EGR Gasket	1992	70149	Ford Ranger Base, Custom, S, Sport, STX, Super, XLT	
1	EGR Gasket	1992	72649	Exc. Ford Ranger Base, Custom, S, Sport, STX, Super, XLT	
1	EGR Gasket	1991	70149	Ford Ranger Custom, S, Sport, STX, Super, XLT	
1	EGR Gasket	1991	72649	Exc. Ford Ranger Custom, S, Sport, STX, Super, XLT	
19	2008 - 1999; 3.0L 183 (2982cc) OHV V6 (12 Valve) 89mm Bore Vulcan				19
MFI; Flex Fuel; Naturally Aspirated Ford Eng.; VIN Code V					
QTY	CYLINDER HEAD	YEARS	PART NO.	DESCRIPTION	
1	Head Gasket	2008-99	9902 PT	Loc. L.H.; Head bolts not incl.; Head bolt replacement recommended	
1	Head Gasket	2008-99	9903 PT	Loc. R.H.; Head bolts not incl.; Head bolt replacement recommended	
1	Head Set	2008-02	HS 9902 PT-5	Head bolts not incl.; Head bolt replacement required; PermaDry® molded rubber valve cover gskts. incl.; Premium valve stem seals incl.	
1	Head Set	2001	HS 9902 PT-4	Head bolts not incl.; Head bolt replacement required; PermaDry® molded rubber valve cover gskts. incl.; Premium valve stem seals incl.	
1	Head Set	2000-99	HS 9902 PT-3	To 07/26/99; Head bolts not incl.; Head bolt replacement required; PermaDry® molded rubber valve cover gskts. incl.; Premium valve stem seals incl.; Consolidated design	
1	Head Set	2000-99	HS 9902 PT-4	From 07/27/99; Head bolts not incl.; Head bolt replacement required; PermaDry® molded rubber valve cover gskts. incl.; Premium valve stem seals incl.	

Ford Truck (Incl. Minivans and SUV's) (Cont.)

19 (cont.)		2008 - 1999; 3.0L 183 (2982cc) OHV V6 (12 Valve) 89mm Bore Vulcan			19 (cont.)
MFI; Flex Fuel; Naturally Aspirated Ford Eng.; VIN Code V					
QTY	CYLINDER HEAD	YEARS	PART NO.	DESCRIPTION	
2	Head Bolt Set	2008-00	ES 72174	Replacement required	
1	Head Bolt Set	1999	ES 72136	To 07/13/98; Replacement recommended	
2	Head Bolt Set	1999	ES 72174	From 07/14/98; Replacement required	
QTY	CONVERSION SET	YEARS	PART NO.	DESCRIPTION	
1	Gasket Conversion Set	2008-02	CS 9368-3	PermaDry® molded rubber oil pan gskt. incl.	
1	Gasket Conversion Set	2001-99	CS 9368-2	PermaDry® molded rubber oil pan gskt. incl.	
QTY	MANIFOLD - INT. & EXH.	YEARS	PART NO.	DESCRIPTION	
1	Int. Manifold Gasket Set	2008-02	MS 95372-1	Lower set; Upper set incl.; Must be used w/VS 50374R	
1	Int. Manifold Gasket Set	2001-99	MS 95372	Lower set; Upper set incl.; Must be used w/VS 50374R	
1	Plenum Gasket Set	2008-02	MS 94429	Upper set	
1	Plenum Gasket Set	2001-99	MS 93491	Upper set	
1	Exh. Manifold Gasket Set	2008-99	MS 95939	Improved design	
QTY	EXHAUST PIPE FLANGE	YEARS	PART NO.	DESCRIPTION	
1	Exhaust Pipe Gasket	2008-99	60641	Converter to muffler	
1	Exhaust Pipe Gasket	2008-01	61407	Inlet pipe to converter	
1	Exhaust Pipe Gasket	2008-02	61183	Ring	
QTY	OIL PAN	YEARS	PART NO.	DESCRIPTION	
1	Oil Pan Gasket Set	2008-02	OS 30712 R	PermaDry® molded rubber gskt. incl.	
1	Oil Pan Gasket Set	2001-99	OS 30620 R	PermaDry® molded rubber gskt. incl.	
1	Oil Pan Gasket Set	2001-99	OS 30717 R	Oil pan bolts incl.; PermaDryPlus®	
1	Oil Pan Bolt Set	2001-99	ES 72214		
1	Drain Plug Gasket	2008-99	72515		
QTY	CRANKSHAFT REAR SEAL	YEARS	PART NO.	DESCRIPTION	
1	Rear Main Seal Set	2008-99	BS 40158	Rubber; One-piece	
1	Rear Main Seal Set	2008-99	BS 40646	PTFE Rubber; One-piece	
QTY	VALVE COVER	YEARS	PART NO.	DESCRIPTION	
1	Valve Cover Gasket Set	2008-99	VS 50374 R	w/o Grommets; PermaDry® molded rubber gskts. incl.	
2	Grommet Set	2008-99	ES 72180	Valve Cover	
QTY	VALVE STEM SEAL SET	YEARS	PART NO.	DESCRIPTION	
1	Valve Stem Seal Set	2008-01	SS 70964	Premium valve stem seals incl.	
1	Valve Stem Seal Set	2000-99	SS 70819	To 07/26/99; Premium valve stem seals incl.; Improved design	
1	Valve Stem Seal Set	2000-99	SS 70964	From 07/27/99; Premium valve stem seals incl.	
QTY	WATER OUTLET GASKET	YEARS	PART NO.	DESCRIPTION	
1	Water Outlet Gasket	2008-99	35390	Water Outlet	
1	Water Outlet Gasket	2008-99	35390 T	Water Outlet; PermaDryPlus®	
QTY	WATER PUMP	YEARS	PART NO.	DESCRIPTION	
1	Water Pump Gasket	2008-99	35379		
QTY	TIMING COVER	YEARS	PART NO.	DESCRIPTION	
1	Timing Cover Set	2008-99	TCS 45771	w/o Sleeve 'N' Seal®; Must be used w/OS 30620R or w/OS 30712R or w/OS 30717R	
1	Timing Set w/Sleeve & Seal	2008-99	TCS 45973	w/Sleeve 'N' Seal®; Must be used w/OS 30620R or w/OS 30712R or w/OS 30717R	
1	Repair Sleeve	2008-99	16217	Timing Cover; Use w/installation tool	
1	Repair Sleeve Tool	2008-99	16310	Timing Cover	
QTY	CARB & FUEL INJECTION	YEARS	PART NO.	DESCRIPTION	
2	Fuel Injector O-Ring Set	2008-99	ES 70599	Improved design	
1	Throttle Body Gasket	2008-02	61160	Mounting	
1	Throttle Body Gasket	2008-02	71428	Air bypass valve; New Part Number - Check for Availability	
1	Throttle Body Gasket	2001-99	60913	Mounting	
1	Throttle Body Gasket	2001-99	71216	Air bypass valve	
QTY	EXHAUST GAS RECIRCULATION	YEARS	PART NO.	DESCRIPTION	
1	EGR Gasket	2008-99	70149		
20		2002 - 1999; 3.3L 199.8 (3274cc) SOHC V6 (12 Valve) 91.5mm Bore			20
MFI; Gasoline; Naturally Aspirated Nissan Eng.; VIN Code T, Eng. Code VG33E					
QTY	CYLINDER HEAD	YEARS	PART NO.	DESCRIPTION	
2	Head Gasket	2002-99	26219 PT	Head bolts not incl.; Head bolt replacement recommended	
1	Head Set	2002-99	HS 26219 PT	Head bolts not incl.; Head bolt replacement recommended; PermaDry® molded rubber valve cover gskts. incl.; Premium valve stem seals incl.	
2	Head Bolt Set	2002-99	ES 72194	Head bolts w/Washers; Replacement recommended	
QTY	CONVERSION SET	YEARS	PART NO.	DESCRIPTION	
1	Gasket Conversion Set	2002-99	CS 26219	RTV sealant incl. for oil pan gskt.	
QTY	MANIFOLD - INT. & EXH.	YEARS	PART NO.	DESCRIPTION	
1	Int. Manifold Gasket Set	2002-99	MS 92270-3	Lower set; Upper set incl.	

Ford Truck (Incl. Minivans and SUV's) (Cont.)

20 (cont.)	2002 - 1999; 3.3L 199.8 (3274cc) SOHC V6 (12 Valve) 91.5mm Bore				20 (cont.)
MFI; Gasoline; Naturally Aspirated Nissan Eng.; VIN Code T, Eng. Code VG33E					
QTY	MANIFOLD - INT. & EXH.	YEARS	PART NO.	DESCRIPTION	
1	Plenum Gasket Set	2002-99	MS 92273-3	Upper set	
1	Exh. Manifold Gasket Set	2002-99	MS 96300		
QTY	EXHAUST PIPE FLANGE	YEARS	PART NO.	DESCRIPTION	
2	Exhaust Pipe Gasket	2002-99	60568	Pipe to manifold; Exc. California	
2	Exhaust Pipe Gasket	2002-99	60674	Converter	
2	Exhaust Pipe Gasket	2002-99	60777	Pipe to manifold; California	
2	Exhaust Pipe Gasket	2002-99	61303	Crossover	
QTY	OIL PAN	YEARS	PART NO.	DESCRIPTION	
1	Oil Pan Gasket Set	2002-99	OS 30591	RTV Black silicone w/Rubber end seals	
QTY	CRANKSHAFT REAR SEAL	YEARS	PART NO.	DESCRIPTION	
1	Rear Main Seal Set	2002-99	BS 40609	Rubber; One-piece	
QTY	VALVE COVER	YEARS	PART NO.	DESCRIPTION	
1	Valve Cover Gasket Set	2002-99	VS 50251 R	w/o Grommets; PermaDry® molded rubber gskts. incl.	
1	Valve Cover Gasket Set	2002-99	VS 50251 R-1	w/Grommets; PermaDry® molded rubber gskts. incl.	
1	Grommet Set	2002-99	ES 72840	Valve Cover	
QTY	VALVE STEM SEAL SET	YEARS	PART NO.	DESCRIPTION	
1	Valve Stem Seal Set	2002-99	SS 72629	Premium valve stem seals incl.	
QTY	THERMOSTAT HOUSING	YEARS	PART NO.	DESCRIPTION	
1	Thermostat Gasket	2002-99	35312	Thermostat Housing; Thermostat housing to manifold	
1	Thermostat Gasket	2002-99	35368	Thermostat Housing; Connection pipe	
1	Thermostat Gasket	2002-99	35497	Thermostat Housing	
QTY	WATER PUMP	YEARS	PART NO.	DESCRIPTION	
1	Water Pump Gasket	2002-99	35415	Improved design	
QTY	TIMING COVER	YEARS	PART NO.	DESCRIPTION	
1	Crankshaft Front Seal Set	2002-99	TCS 46033	Must be used w/OS 30591	
2	Camshaft Front Seal Set	2002-99	TCS 45635		
QTY	CARB & FUEL INJECTION	YEARS	PART NO.	DESCRIPTION	
1	Throttle Body Gasket	2002-99	61274		
QTY	DISTRIBUTOR MOUNTING	YEARS	PART NO.	DESCRIPTION	
1	O-Ring	2002-99	417	Distributor Mounting	
QTY	EXHAUST GAS RECIRCULATION	YEARS	PART NO.	DESCRIPTION	
1	EGR Gasket	2002-99	71197	Spacer to manifold	
1	EGR Gasket	2002-99	72521	Valve to spacer	
21	2012 - 2007; 3.5L 213.3 (3496cc) DOHC V6 (24 Valve) 92.5mm Bore Duratec Cyclone				21
MFI; Gasoline; Naturally Aspirated Ford Eng.; VIN Code C					
QTY	CYLINDER HEAD	YEARS	PART NO.	DESCRIPTION	
1	Head Gasket	2012-07	26487 PT	Loc. L.H.; Head bolts not incl.; Head bolt replacement recommended; PermaTorqueMLS®	
1	Head Gasket	2012-07	26488 PT	Loc. R.H.; Head bolts not incl.; Head bolt replacement recommended; PermaTorqueMLS®	
1	Head Set	2012-07	HS 26487 PT	Head bolts not incl.; Head bolt replacement recommended; PermaDry® molded rubber valve cover gskts. incl.; Premium valve stem seals incl.; New Part Number - Check for Availability	
2	Head Bolt Set	2012-10	ES 71324	Replacement recommended; New Part Number - Check for Availability	
2	Head Bolt Set	2009	ES 71320	To 02/01/09; Replacement recommended	
2	Head Bolt Set	2009	ES 71324	From 02/02/09; Replacement recommended; New Part Number - Check for Availability	
2	Head Bolt Set	2008-07	ES 71320	Replacement recommended	
QTY	CONVERSION SET	YEARS	PART NO.	DESCRIPTION	
1	Gasket Conversion Set	2012-07	CS 26487	RTV sealant incl. for oil pan gskt.; New Part Number - Check for Availability	
QTY	MANIFOLD - INT. & EXH.	YEARS	PART NO.	DESCRIPTION	
1	Int. Manifold Gasket Set	2012-07	MS 97118	Lower set; Upper set incl.; New Part Number - Check for Availability	
1	Plenum Gasket Set	2012-07	MS 97120	Upper set	
1	Exh. Manifold Gasket Set	2012-07	MS 97121		
QTY	EXHAUST PIPE FLANGE	YEARS	PART NO.	DESCRIPTION	
1	Exhaust Pipe Gasket	2012-07	61236	Loc. Rear No. 1; Converter	
1	Exhaust Pipe Gasket	2012-07	61525	Loc. Rear No. 2; Converter; Improved design	
2	Exhaust Pipe Gasket	2012-07	61620	Loc. Front; Ring	
1	Exhaust Pipe Gasket	2012-07	61621	Exh. connector	
QTY	CRANKSHAFT REAR SEAL	YEARS	PART NO.	DESCRIPTION	
1	Rear Main Seal Set	2012-07	BS 40729	Rubber; One-piece	

Ford Truck (Incl. Minivans and SUV's) (Cont.)

21		2012 - 2007; 3.5L 213.3 (3496cc) DOHC V6 (24 Valve) 92.5mm Bore Duratec Cyclone			21
(cont.)		MFI; Gasoline; Naturally Aspirated Ford Eng.; VIN Code C			(cont.)
QTY	VALVE COVER	YEARS	PART NO.	DESCRIPTION	
1	Valve Cover Gasket Set	2012-07	VS 50767 R	w/Grommets & Spark plug tube seals; PermaDry® molded rubber gskts. incl.; New Part Number - Check for Availability	
QTY	VALVE STEM SEAL SET	YEARS	PART NO.	DESCRIPTION	
1	Valve Stem Seal Set	2012-07	SS 71327	Premium valve stem seals incl.	
QTY	THERMOSTAT HOUSING	YEARS	PART NO.	DESCRIPTION	
1	Thermostat Gasket	2012-07	35934	Thermostat case	
QTY	WATER OUTLET GASKET	YEARS	PART NO.	DESCRIPTION	
1	Water Outlet Gasket	2012-07	35489	Thermostat seal	
QTY	WATER PUMP	YEARS	PART NO.	DESCRIPTION	
1	Water Pump Gasket	2012-07	35930	Loc. Outer	
1	Water Pump Gasket	2012-07	35932	Loc. Inner	
QTY	TIMING COVER	YEARS	PART NO.	DESCRIPTION	
1	Crankshaft Front Seal Set	2012-07	TCS 46117		
QTY	CARB & FUEL INJECTION	YEARS	PART NO.	DESCRIPTION	
2	Fuel Injector O-Ring Set	2012-07	ES 70599	Upper set; Injectors to fuel rail; Improved design	
1	Throttle Body Gasket	2012-07	61466		
QTY	OIL FILTER MOUNTING	YEARS	PART NO.	DESCRIPTION	
1	Oil Filter Adapter Gasket	2012-10	71318	Oil filter adapter; New Part Number - Check for Availability	
1	Oil Filter Adapter Gasket	2009	71312	To 01/16/09; Oil filter adapter; New Part Number - Check for Availability	
1	Oil Filter Adapter Gasket	2009	71318	From 01/17/09; Oil filter adapter; New Part Number - Check for Availability	
1	Oil Filter Adapter Gasket	2008-07	71312	Oil filter adapter; New Part Number - Check for Availability	
QTY	OIL COOLER	YEARS	PART NO.	DESCRIPTION	
1	Oil Cooler Gasket	2012-10	71319	Oil cooler O-ring; New Part Number - Check for Availability	
1	Oil Cooler Gasket	2009	71316	To 01/16/09; Oil cooler O-ring; New Part Number - Check for Availability	
1	Oil Cooler Gasket	2009	71319	From 01/17/09; Oil cooler O-ring; New Part Number - Check for Availability	
1	Oil Cooler Gasket	2008-07	71316	Oil cooler O-ring; New Part Number - Check for Availability	
22		2009 - 2008; 3.5L 213.3 (3496cc) DOHC V6 (24 Valve) 92.5mm Bore Duratec Cyclone			22
		MFI; Gasoline; Naturally Aspirated Ford Eng.; VIN Code W			
QTY	CYLINDER HEAD	YEARS	PART NO.	DESCRIPTION	
1	Head Gasket	2009-08	26487 PT	Loc. L.H.; Head bolts not incl.; Head bolt replacement recommended; PermaTorqueMLS®	
1	Head Gasket	2009-08	26488 PT	Loc. R.H.; Head bolts not incl.; Head bolt replacement recommended; PermaTorqueMLS®	
1	Head Set	2009-08	HS 26487 PT	Head bolts not incl.; Head bolt replacement recommended; PermaDry® molded rubber valve cover gskts. incl.; Premium valve stem seals incl.; New Part Number - Check for Availability	
2	Head Bolt Set	2009	ES 71320	To 02/01/09; Replacement recommended	
2	Head Bolt Set	2009	ES 71324	From 02/02/09; Replacement recommended; New Part Number - Check for Availability	
2	Head Bolt Set	2008	ES 71320	Replacement recommended	
QTY	CONVERSION SET	YEARS	PART NO.	DESCRIPTION	
1	Gasket Conversion Set	2009-08	CS 26487	RTV sealant incl. for oil pan gskt.; New Part Number - Check for Availability	
QTY	MANIFOLD - INT. & EXH.	YEARS	PART NO.	DESCRIPTION	
1	Int. Manifold Gasket Set	2009-08	MS 97118	Lower set; Upper set incl.; New Part Number - Check for Availability	
1	Plenum Gasket Set	2009-08	MS 97120	Upper set	
1	Exh. Manifold Gasket Set	2009-08	MS 97121		
QTY	EXHAUST PIPE FLANGE	YEARS	PART NO.	DESCRIPTION	
1	Exhaust Pipe Gasket	2009-08	61236	Loc. Rear No. 1; Converter	
1	Exhaust Pipe Gasket	2009-08	61525	Loc. Rear No. 2; Converter; Improved design	
2	Exhaust Pipe Gasket	2009-08	61620	Loc. Front; Ring	
1	Exhaust Pipe Gasket	2009-08	61622	Exh. connector	
1	Exhaust Pipe Gasket	2009-08	61623	Converter	
QTY	CRANKSHAFT REAR SEAL	YEARS	PART NO.	DESCRIPTION	
1	Rear Main Seal Set	2009-08	BS 40729	Rubber; One-piece	
QTY	VALVE COVER	YEARS	PART NO.	DESCRIPTION	
1	Valve Cover Gasket Set	2009-08	VS 50767 R	w/Grommets & Spark plug tube seals; PermaDry® molded rubber gskts. incl.; New Part Number - Check for Availability	
QTY	VALVE STEM SEAL SET	YEARS	PART NO.	DESCRIPTION	
1	Valve Stem Seal Set	2009-08	SS 71327	Premium valve stem seals incl.	
QTY	THERMOSTAT HOUSING	YEARS	PART NO.	DESCRIPTION	
1	Thermostat Gasket	2009-08	35934	Thermostat case	
QTY	WATER OUTLET GASKET	YEARS	PART NO.	DESCRIPTION	
1	Water Outlet Gasket	2009-08	35489	Thermostat seal	

Ford Truck (Incl. Minivans and SUV's) (Cont.)

22		2009 - 2008; 3.5L 213.3 (3496cc) DOHC V6 (24 Valve) 92.5mm Bore Duratec Cyclone			22
(cont.)		MFI; Gasoline; Naturally Aspirated Ford Eng.; VIN Code W			(cont.)
QTY	WATER PUMP	YEARS	PART NO.	DESCRIPTION	
1	Water Pump Gasket	2009-08	35930	Loc. Outer	
1	Water Pump Gasket	2009-08	35932	Loc. Inner	
QTY	TIMING COVER	YEARS	PART NO.	DESCRIPTION	
1	Crankshaft Front Seal Set	2009-08	TCS 46117		
QTY	CARB & FUEL INJECTION	YEARS	PART NO.	DESCRIPTION	
2	Fuel Injector O-Ring Set	2009-08	ES 70599	Upper set; Injectors to fuel rail; Improved design	
1	Throttle Body Gasket	2009-08	61466		
QTY	OIL FILTER MOUNTING	YEARS	PART NO.	DESCRIPTION	
1	Oil Filter Adapter Gasket	2008	71312	Oil filter adapter; New Part Number - Check for Availability	
QTY	OIL COOLER	YEARS	PART NO.	DESCRIPTION	
1	Oil Cooler Gasket	2009-08	71316	Oil cooler O-ring; New Part Number - Check for Availability	
23		2013 - 2011; 3.5L 213.3 (3496cc) DOHC V6 (24 Valve) 92.5mm Bore Duratec Cyclone VVT			23
(cont.)		MFI; Gasoline; Naturally Aspirated Ford Eng.; VIN Code 8			(cont.)
QTY	CYLINDER HEAD	YEARS	PART NO.	DESCRIPTION	
1	Head Gasket	2013-11	26487 PT	Loc. L.H.; Head bolts not incl.; Head bolt replacement recommended; PermaTorqueMLS®	
1	Head Gasket	2013-11	26488 PT	Loc. R.H.; Head bolts not incl.; Head bolt replacement recommended; PermaTorqueMLS®	
2	Head Bolt Set	2013-11	ES 71324	Replacement recommended; New Part Number - Check for Availability	
QTY	CONVERSION SET	YEARS	PART NO.	DESCRIPTION	
1	Gasket Conversion Set	2013-11	CS 26487	RTV sealant incl. for oil pan gskt.; New Part Number - Check for Availability	
QTY	MANIFOLD - INT. & EXH.	YEARS	PART NO.	DESCRIPTION	
1	Int. Manifold Gasket Set	2013-11	MS 97118-1	Lower set; Upper set incl.; New Part Number - Check for Availability	
1	Plenum Gasket Set	2013-11	MS 97214	Upper set; New Part Number - Check for Availability	
1	Exh. Manifold Gasket Set	2013-11	MS 97217	New Part Number - Check for Availability	
QTY	EXHAUST PIPE FLANGE	YEARS	PART NO.	DESCRIPTION	
1	Exhaust Pipe Gasket	2013-11	61236	Loc. Rear No. 1; Converter	
1	Exhaust Pipe Gasket	2013-11	61525	Loc. Rear No. 2; Converter; Improved design	
2	Exhaust Pipe Gasket	2013-11	61620	Loc. Front; Ring	
QTY	CRANKSHAFT REAR SEAL	YEARS	PART NO.	DESCRIPTION	
1	Rear Main Seal Set	2013-11	BS 40729	Rubber; One-piece	
QTY	VALVE STEM SEAL SET	YEARS	PART NO.	DESCRIPTION	
1	Valve Stem Seal Set	2013-11	SS 71327	Premium valve stem seals incl.	
QTY	THERMOSTAT HOUSING	YEARS	PART NO.	DESCRIPTION	
1	Thermostat Gasket	2013-11	35934	Thermostat case	
QTY	WATER OUTLET GASKET	YEARS	PART NO.	DESCRIPTION	
1	Water Outlet Gasket	2013-11	35489	Thermostat seal	
QTY	WATER PUMP	YEARS	PART NO.	DESCRIPTION	
1	Water Pump Gasket	2013-11	35930	Loc. Outer	
1	Water Pump Gasket	2013-11	35932	Loc. Inner	
QTY	TIMING COVER	YEARS	PART NO.	DESCRIPTION	
1	Crankshaft Front Seal Set	2013-11	TCS 46117		
QTY	CARB & FUEL INJECTION	YEARS	PART NO.	DESCRIPTION	
2	Fuel Injector O-Ring Set	2013-11	ES 70599	Upper set; Injectors to fuel rail; Improved design	
1	Throttle Body Gasket	2013-11	61466		
QTY	OIL FILTER MOUNTING	YEARS	PART NO.	DESCRIPTION	
1	Oil Filter Adapter Gasket	2013-11	71318	Oil filter adapter; New Part Number - Check for Availability	
QTY	OIL COOLER	YEARS	PART NO.	DESCRIPTION	
1	Oil Cooler Gasket	2013-11	71319	Oil cooler O-ring; New Part Number - Check for Availability	
24		2013 - 2011; 3.5L 213.3 (3496cc) DOHC V6 (24 Valve) 92.5mm Bore Duratec Cyclone VVT			24
(cont.)		MFI; Gasoline; Naturally Aspirated Ford Eng.; VIN Code C			(cont.)
QTY	CYLINDER HEAD	YEARS	PART NO.	DESCRIPTION	
1	Head Gasket	2013-11	26487 PT	Loc. L.H.; Head bolts not incl.; Head bolt replacement recommended; PermaTorqueMLS®	
1	Head Gasket	2013-11	26488 PT	Loc. R.H.; Head bolts not incl.; Head bolt replacement recommended; PermaTorqueMLS®	
2	Head Bolt Set	2013-11	ES 71324	Replacement recommended; New Part Number - Check for Availability	
QTY	CONVERSION SET	YEARS	PART NO.	DESCRIPTION	
1	Gasket Conversion Set	2013-11	CS 26487	RTV sealant incl. for oil pan gskt.; New Part Number - Check for Availability	
QTY	MANIFOLD - INT. & EXH.	YEARS	PART NO.	DESCRIPTION	
1	Int. Manifold Gasket Set	2013-11	MS 97118-1	Lower set; Upper set incl.; New Part Number - Check for Availability	

Ford Truck (Incl. Minivans and SUV's) (Cont.)

24		2013 - 2011; 3.5L 213.3 (3496cc) DOHC V6 (24 Valve) 92.5mm Bore Duratec Cyclone VVT			24	
(cont.)		MFI; Gasoline; Naturally Aspirated Ford Eng.; VIN Code C			(cont.)	
QTY	MANIFOLD - INT. & EXH.	YEARS	PART NO.	DESCRIPTION		
1	Plenum Gasket Set	2013-11	MS 97214	Upper set; New Part Number - Check for Availability		
1	Exh. Manifold Gasket Set	2013-11	MS 97217	New Part Number - Check for Availability		
QTY	EXHAUST PIPE FLANGE	YEARS	PART NO.	DESCRIPTION		
1	Exhaust Pipe Gasket	2013-11	61236	Loc. Rear No. 1; Converter		
1	Exhaust Pipe Gasket	2013-11	61525	Loc. Rear No. 2; Converter; Improved design		
2	Exhaust Pipe Gasket	2013-11	61620	Loc. Front; Ring		
QTY	CRANKSHAFT REAR SEAL	YEARS	PART NO.	DESCRIPTION		
1	Rear Main Seal Set	2013-11	BS 40729	Rubber; One-piece		
QTY	VALVE STEM SEAL SET	YEARS	PART NO.	DESCRIPTION		
1	Valve Stem Seal Set	2013-11	SS 71327	Premium valve stem seals incl.		
QTY	THERMOSTAT HOUSING	YEARS	PART NO.	DESCRIPTION		
1	Thermostat Gasket	2013-11	35934	Thermostat case		
QTY	WATER OUTLET GASKET	YEARS	PART NO.	DESCRIPTION		
1	Water Outlet Gasket	2013-11	35489	Thermostat seal		
QTY	WATER PUMP	YEARS	PART NO.	DESCRIPTION		
1	Water Pump Gasket	2013-11	35930	Loc. Outer		
1	Water Pump Gasket	2013-11	35932	Loc. Inner		
QTY	TIMING COVER	YEARS	PART NO.	DESCRIPTION		
1	Crankshaft Front Seal Set	2013-11	TCS 46117			
QTY	CARB & FUEL INJECTION	YEARS	PART NO.	DESCRIPTION		
2	Fuel Injector O-Ring Set	2013-11	ES 70599	Upper set; Injectors to fuel rail; Improved design		
1	Throttle Body Gasket	2013-11	61466			
QTY	OIL FILTER MOUNTING	YEARS	PART NO.	DESCRIPTION		
1	Oil Filter Adapter Gasket	2013-11	71318	Oil filter adapter; New Part Number - Check for Availability		
QTY	OIL COOLER	YEARS	PART NO.	DESCRIPTION		
1	Oil Cooler Gasket	2013-11	71319	Oil cooler O-ring; New Part Number - Check for Availability		
25		2013 - 2010; 3.5L 213.3 (3496cc) DOHC V6 (24 Valve) 92.5mm Bore EcoBoost Duratec VVT			25	
		DI; Gasoline; Turbo - Intercooled Ford Eng.; VIN Code T				
QTY	MANIFOLD - INT. & EXH.	YEARS	PART NO.	DESCRIPTION		
1	Exh. Manifold Gasket Set	2013	MS 97218	Exc. Ford F-150 Pickup FX2, FX4, King Ranch, Lariat, Limited, Platinum, STX, XL, XLT; New Part Number - Check for Availability		
1	Exh. Manifold Gasket Set	2012-11	MS 97218	Ford Flex Limited, SEL, Titanium Lincoln MKT EcoBoost; New Part Number - Check for Availability		
1	Exh. Manifold Gasket Set	2010	MS 97218	New Part Number - Check for Availability		
26		2012 - 2010; 3.7L 227 (3721cc) DOHC V6 (24 Valve) 95.5mm Bore Duratec Cyclone			26	
		MFI; Gasoline; Naturally Aspirated Ford Eng.; VIN Code R				
QTY	CYLINDER HEAD	YEARS	PART NO.	DESCRIPTION		
1	Head Gasket	2012-10	26543 PT	Loc. R.H.; Head bolts not incl.; Head bolt replacement recommended; PermaTorqueMLS®; New Part Number - Check for Availability		
1	Head Gasket	2012-10	26544 PT	Loc. L.H.; Head bolts not incl.; Head bolt replacement recommended; PermaTorqueMLS®; New Part Number - Check for Availability		
1	Head Set	2010	HS 26543 PT-1	Head bolts not incl.; Head bolt replacement recommended; PermaDry® molded rubber valve cover gskts. incl.; Premium valve stem seals incl.; New Part Number - Check for Availability		
2	Head Bolt Set	2012-10	ES 71324	Replacement recommended; New Part Number - Check for Availability		
QTY	CONVERSION SET	YEARS	PART NO.	DESCRIPTION		
1	Gasket Conversion Set	2012-10	CS 26543	RTV sealant incl. for oil pan gskt.; New Part Number - Check for Availability		
QTY	MANIFOLD - INT. & EXH.	YEARS	PART NO.	DESCRIPTION		
1	Int. Manifold Gasket Set	2012-10	MS 97118	Lower set; Upper set incl.; New Part Number - Check for Availability		
1	Plenum Gasket Set	2012-10	MS 97120	Upper set		
1	Exh. Manifold Gasket Set	2012-11	MS 97217	New Part Number - Check for Availability		
1	Exh. Manifold Gasket Set	2010	MS 97121			
QTY	EXHAUST PIPE FLANGE	YEARS	PART NO.	DESCRIPTION		
2	Exhaust Pipe Gasket	2012-10	61236	Loc. Rear No. 1; Converter		
1	Exhaust Pipe Gasket	2012-10	61406	Exh. connector		
1	Exhaust Pipe Gasket	2012-10	61525	Loc. Rear No. 2; Converter; Improved design		
2	Exhaust Pipe Gasket	2012-10	61622	Flange		
QTY	CRANKSHAFT REAR SEAL	YEARS	PART NO.	DESCRIPTION		
1	Rear Main Seal Set	2012-10	BS 40729	Rubber; One-piece		
QTY	VALVE COVER	YEARS	PART NO.	DESCRIPTION		
1	Valve Cover Gasket Set	2012-10	VS 50767 R	w/Grommets & Spark plug tube seals; PermaDry® molded rubber gskts. incl.; New Part Number - Check for Availability		

Ford Truck (Incl. Minivans and SUV's) (Cont.)

26		2012 - 2010; 3.7L 227 (3721cc) DOHC V6 (24 Valve) 95.5mm Bore Duratec Cyclone			26
(cont.)		MFI; Gasoline; Naturally Aspirated Ford Eng.; VIN Code R			(cont.)
QTY	VALVE STEM SEAL SET	YEARS	PART NO.	DESCRIPTION	
1	Valve Stem Seal Set	2012-10	SS 71327	Premium valve stem seals incl.	
QTY	THERMOSTAT HOUSING	YEARS	PART NO.	DESCRIPTION	
1	Thermostat Gasket	2012-10	35934	Thermostat case	
QTY	WATER OUTLET GASKET	YEARS	PART NO.	DESCRIPTION	
1	Water Outlet Gasket	2012-10	35489	Thermostat seal	
QTY	WATER PUMP	YEARS	PART NO.	DESCRIPTION	
1	Water Pump Gasket	2012-10	35930	Loc. Outer	
1	Water Pump Gasket	2012-10	35932	Loc. Inner	
QTY	TIMING COVER	YEARS	PART NO.	DESCRIPTION	
1	Crankshaft Front Seal Set	2012-10	TCS 46117		
QTY	CARB & FUEL INJECTION	YEARS	PART NO.	DESCRIPTION	
2	Fuel Injector O-Ring Set	2012-10	ES 70599	Upper set; Injectors to fuel rail; Improved design	
1	Throttle Body Gasket	2012-10	61466		
QTY	OIL FILTER MOUNTING	YEARS	PART NO.	DESCRIPTION	
1	Oil Filter Adapter Gasket	2012-10	71318	Oil filter adapter; New Part Number - Check for Availability	
QTY	OIL COOLER	YEARS	PART NO.	DESCRIPTION	
1	Oil Cooler Gasket	2012-10	71319	Oil cooler O-ring; New Part Number - Check for Availability	
27		2013 - 2011; 3.7L 227 (3721cc) DOHC V6 (24 Valve) 95.5mm Bore Duratec Cyclone VVT			27
		MFI; Gasoline; Naturally Aspirated Ford Eng.; VIN Code K			
QTY	CYLINDER HEAD	YEARS	PART NO.	DESCRIPTION	
1	Head Gasket	2013-11	26543 PT	Loc. R.H.; Head bolts not incl.; Head bolt replacement recommended; PermaTorqueMLS®; New Part Number - Check for Availability	
1	Head Gasket	2013-11	26544 PT	Loc. L.H.; Head bolts not incl.; Head bolt replacement recommended; PermaTorqueMLS®; New Part Number - Check for Availability	
2	Head Bolt Set	2013-11	ES 71324	Replacement recommended; New Part Number - Check for Availability	
QTY	CONVERSION SET	YEARS	PART NO.	DESCRIPTION	
1	Gasket Conversion Set	2013-11	CS 26543	RTV sealant incl. for oil pan gskt.; New Part Number - Check for Availability	
QTY	MANIFOLD - INT. & EXH.	YEARS	PART NO.	DESCRIPTION	
1	Int. Manifold Gasket Set	2013-11	MS 97118-1	Lower set; Upper set incl.; New Part Number - Check for Availability	
1	Plenum Gasket Set	2013-11	MS 97214	Upper set; New Part Number - Check for Availability	
1	Exh. Manifold Gasket Set	2013-11	MS 97217	New Part Number - Check for Availability	
QTY	EXHAUST PIPE FLANGE	YEARS	PART NO.	DESCRIPTION	
2	Exhaust Pipe Gasket	2013-11	61236	Loc. Rear; Converter	
2	Exhaust Pipe Gasket	2013-11	61620	Loc. Front; Ring	
QTY	CRANKSHAFT REAR SEAL	YEARS	PART NO.	DESCRIPTION	
1	Rear Main Seal Set	2013-11	BS 40729	Rubber; One-piece	
QTY	VALVE COVER	YEARS	PART NO.	DESCRIPTION	
1	Valve Cover Gasket Set	2013-11	VS 50814 R	w/Grommets & Spark plug tube seals; PermaDry® molded rubber gskts. incl.; New Part Number - Check for Availability	
QTY	VALVE STEM SEAL SET	YEARS	PART NO.	DESCRIPTION	
1	Valve Stem Seal Set	2013-11	SS 71327	Premium valve stem seals incl.	
QTY	THERMOSTAT HOUSING	YEARS	PART NO.	DESCRIPTION	
1	Thermostat Gasket	2013-11	35934	Thermostat case	
QTY	WATER OUTLET GASKET	YEARS	PART NO.	DESCRIPTION	
1	Water Outlet Gasket	2013-11	35489	Thermostat seal	
QTY	WATER PUMP	YEARS	PART NO.	DESCRIPTION	
1	Water Pump Gasket	2013-11	35930	Loc. Outer	
1	Water Pump Gasket	2013-11	35932	Loc. Inner	
1	Water Pump Gasket	2013-11	35994	New Part Number - Check for Availability	
QTY	TIMING COVER	YEARS	PART NO.	DESCRIPTION	
1	Crankshaft Front Seal Set	2013-11	TCS 46117		
QTY	CARB & FUEL INJECTION	YEARS	PART NO.	DESCRIPTION	
2	Fuel Injector O-Ring Set	2013-11	ES 70599	Upper set; Injectors to fuel rail; Improved design	
1	Throttle Body Gasket	2013-11	61466		
QTY	OIL FILTER MOUNTING	YEARS	PART NO.	DESCRIPTION	
1	Oil Filter Adapter Gasket	2013-11	71318	Oil filter adapter; New Part Number - Check for Availability	
QTY	OIL COOLER	YEARS	PART NO.	DESCRIPTION	
1	Oil Cooler Gasket	2013-11	71319	Oil cooler O-ring; New Part Number - Check for Availability	

Ford Truck (Incl. Minivans and SUV's) (Cont.)

28		2013 - 2011; 3.7L 227 (3721cc) DOHC V6 (24 Valve) 95.5mm Bore Duratec Cyclone VVT			28
MFI; Flex Fuel; Naturally Aspirated Ford Eng.; VIN Code M					
QTY	CYLINDER HEAD	YEARS	PART NO.	DESCRIPTION	
1	Head Gasket	2013-11	26543 PT	Loc. R.H.; Head bolts not incl.; Head bolt replacement recommended; PermaTorqueMLS®; New Part Number - Check for Availability	
1	Head Gasket	2013-11	26544 PT	Loc. L.H.; Head bolts not incl.; Head bolt replacement recommended; PermaTorqueMLS®; New Part Number - Check for Availability	
1	Head Set	2013-11	HS 26543 PT	Head bolts not incl.; Head bolt replacement recommended; PermaDry® molded rubber valve cover gskts. incl.; Premium valve stem seals incl.; New Part Number - Check for Availability	
2	Head Bolt Set	2013-11	ES 71324	Replacement recommended; New Part Number - Check for Availability	
QTY	CONVERSION SET	YEARS	PART NO.	DESCRIPTION	
1	Gasket Conversion Set	2013-11	CS 26543-1	RTV sealant incl. for oil pan gskt.; New Part Number - Check for Availability	
QTY	MANIFOLD - INT. & EXH.	YEARS	PART NO.	DESCRIPTION	
1	Int. Manifold Gasket Set	2013-11	MS 97118-1	Lower set; Upper set incl.; New Part Number - Check for Availability	
1	Plenum Gasket Set	2013-11	MS 97214	Upper set; New Part Number - Check for Availability	
1	Exh. Manifold Gasket Set	2013-11	MS 97216	New Part Number - Check for Availability	
QTY	EXHAUST PIPE FLANGE	YEARS	PART NO.	DESCRIPTION	
2	Exhaust Pipe Gasket	2013-11	61236	Loc. Rear; Converter	
QTY	CRANKSHAFT REAR SEAL	YEARS	PART NO.	DESCRIPTION	
1	Rear Main Seal Set	2013-11	BS 40729	Rubber; One-piece	
QTY	VALVE COVER	YEARS	PART NO.	DESCRIPTION	
1	Valve Cover Gasket Set	2013-11	VS 50814 R	w/Grommets & Spark plug tube seals; PermaDry® molded rubber gskts. incl.; New Part Number - Check for Availability	
QTY	VALVE STEM SEAL SET	YEARS	PART NO.	DESCRIPTION	
1	Valve Stem Seal Set	2013-11	SS 71327	Premium valve stem seals incl.	
QTY	THERMOSTAT HOUSING	YEARS	PART NO.	DESCRIPTION	
1	Thermostat Gasket	2013-11	35934	Thermostat Housing; Thermostat case	
1	Thermostat Gasket	2013-11	35991	Thermostat Housing; Thermostat seal; New Part Number - Check for Availability	
QTY	WATER PUMP	YEARS	PART NO.	DESCRIPTION	
1	Water Pump Gasket	2013-11	35989	Timing chain driven water pump; New Part Number - Check for Availability	
1	Water Pump Gasket	2013-11	35990	Serpentine belt driven water pump; New Part Number - Check for Availability	
1	Water Pump Gasket	2013-11	35996	Loc. Inner; New Part Number - Check for Availability	
1	Water Pump Gasket	2013-11	35997	Loc. Outer; New Part Number - Check for Availability	
QTY	TIMING COVER	YEARS	PART NO.	DESCRIPTION	
1	Timing Cover Set	2013-11	TCS 46182	New Part Number - Check for Availability	
1	Crankshaft Front Seal Set	2013-11	TCS 46117		
QTY	CARB & FUEL INJECTION	YEARS	PART NO.	DESCRIPTION	
2	Fuel Injector O-Ring Set	2013-11	ES 70599	Upper set; Injectors to fuel rail; Improved design	
1	Throttle Body Gasket	2013-11	61466		
QTY	OIL FILTER MOUNTING	YEARS	PART NO.	DESCRIPTION	
1	Oil Filter Adapter Gasket	2013-11	71318	Oil filter adapter; New Part Number - Check for Availability	
QTY	OIL COOLER	YEARS	PART NO.	DESCRIPTION	
1	Oil Cooler Gasket	2013-11	71319	Oil cooler O-ring; New Part Number - Check for Availability	
29		2003 - 1995; 3.8L 232 (3797cc) OHV V6 (12 Valve) 96.8mm Bore			29
MFI; Gasoline; Naturally Aspirated Ford Eng.; VIN Code 4					
QTY	CYLINDER HEAD	YEARS	PART NO.	DESCRIPTION	
1	Head Gasket	2003-97	26505 PT	Loc. L.H.; .010" thicker for use when head is refaced; Head bolts not incl.; Head bolt replacement required; PermaTorqueMLS®	
1	Head Gasket	2003-97	26506 PT	Loc. R.H.; .010" thicker for use when head is refaced; Head bolts not incl.; Head bolt replacement required; PermaTorqueMLS®	
1	Head Gasket	2003-97	9250 PT	Loc. L.H.; Head bolts not incl.; Head bolt replacement required; PermaTorqueMLS®	
1	Head Gasket	2003-97	9253 PT	Loc. R.H.; Head bolts not incl.; Head bolt replacement required; PermaTorqueMLS®	
2	Head Gasket	1996	26200 PT	Head bolts not incl.; Head bolt replacement required; PermaTorqueMLS®	
2	Head Gasket	1996	9234 PT	Head bolts not incl.; Head bolt replacement required; PermaTorque®	
2	Head Gasket	1995	9560 PT	Head bolts not incl.; Head bolt replacement required; PermaTorque®	
2	Head Gasket Spacer Shim	1995	9560 SP	HeadSaver®	
1	Head Set	2003-99	HS 9250 PT-4	Head bolts not incl.; Head bolt replacement required; PermaDry® molded rubber valve cover gskts. incl.; Premium valve stem seals incl.	
1	Head Set	1998	HS 9250 PT-1	To 01/14/98; 3mm thick int. manifold gskts.; Head bolts not incl.; Head bolt replacement required; PermaDry® molded rubber valve cover gskts. incl.; Premium valve stem seals incl.	

Ford Truck (Incl. Minivans and SUV's) (Cont.)

29 (cont.)		2003 - 1995; 3.8L 232 (3797cc) OHV V6 (12 Valve) 96.8mm Bore			29 (cont.)
		MFI; Gasoline; Naturally Aspirated Ford Eng.; VIN Code 4			
QTY	CYLINDER HEAD	YEARS	PART NO.	DESCRIPTION	
1	Head Set	1998	HS 9250 PT-3	From 01/15/98; Head bolts not incl.; Head bolt replacement required; PermaDry® molded rubber valve cover gskts. incl.; Premium valve stem seals incl.	
1	Head Set	1998	HS 9250 PT-3	To 01/14/98; 4mm thick int. manifold gskts.; Head bolts not incl.; Head bolt replacement required; PermaDry® molded rubber valve cover gskts. incl.; Premium valve stem seals incl.	
1	Head Set	1997	HS 9250 PT-1	3mm thick int. manifold gskts.; Head bolts not incl.; Head bolt replacement required; PermaDry® molded rubber valve cover gskts. incl.; Premium valve stem seals incl.	
1	Head Set	1997	HS 9250 PT-3	4mm thick int. manifold gskts.; Head bolts not incl.; Head bolt replacement required; PermaDry® molded rubber valve cover gskts. incl.; Premium valve stem seals incl.	
1	Head Set	1996	HS 9234 PT	3mm thick int. manifold gskts.; Head bolts not incl.; Head bolt replacement required; PermaDry® molded rubber valve cover gskts. incl.; Premium valve stem seals incl.	
1	Head Set	1996	HS 9234 PT-1	4mm thick int. manifold gskts.; Head bolts not incl.; Head bolt replacement required; PermaDry® molded rubber valve cover gskts. incl.; Premium valve stem seals incl.	
1	Head Set	1995	HS 9560 PT-2	Head bolts not incl.; Head bolt replacement required; PermaDry® molded rubber valve cover gskts. incl.; Premium valve stem seals incl.	
1	Head Installation Set	1996	HIS 9234 PT	3mm thick int. manifold gskts.; Head bolts not incl.; Head bolt replacement required; PermaDry® molded rubber valve cover gskts. incl.	
1	Head Installation Set	1995	HIS 9560 PT-2	Head bolts not incl.; Head bolt replacement required; PermaDry® molded rubber valve cover gskts. incl.	
2	Head Bolt Set	2003-98	ES 72160	Replacement required	
2	Head Bolt Set	1997-96	ES 72156	Replacement required	
2	Head Bolt Set	1995	ES 72131	Replacement required	
QTY	CONVERSION SET	YEARS	PART NO.	DESCRIPTION	
1	Gasket Conversion Set	2003-01	CS 9250-1	RTV sealant incl. for oil pan gskt.; PermaDryPlus® timing cover gskt. incl.	
1	Gasket Conversion Set	2000-99	CS 9250	RTV sealant incl. for oil pan gskt.; PermaDryPlus® timing cover gskt. incl.	
1	Gasket Conversion Set	1998-95	CS 8857-6	RTV sealant incl. for oil pan gskt.; PermaDryPlus® timing cover gskt. incl.	
QTY	MANIFOLD - INT. & EXH.	YEARS	PART NO.	DESCRIPTION	
1	Int. Manifold Gasket Set	2003-99	MS 95985-2	Lower set; Upper set incl.; Must be used w/ES 72204	
1	Int. Manifold Gasket Set	2003-99	MS 98011 T-1	Lower set; Int. manifold isolators & Upper set incl.; PermaDryPlus® int. manifold gskts. incl.	
1	Int. Manifold Gasket Set	1998	MS 95932	To 01/14/98; 3mm thick int. manifold gskts.; Lower set; Upper set incl.	
1	Int. Manifold Gasket Set	1998	MS 95985-1	From 01/15/98; Lower set; Upper set incl.	
1	Int. Manifold Gasket Set	1998	MS 95985-1	To 01/14/98; 4mm thick int. manifold gskts.; Lower set; Upper set incl.	
1	Int. Manifold Gasket Set	1998	MS 98009 T	To 01/14/98; 3mm thick int. manifold gskts.; Lower set; Upper set incl.; PermaDryPlus® int. manifold gskts. incl.	
1	Int. Manifold Gasket Set	1998	MS 98011 T	From 01/15/98; Lower set; Upper set incl.; PermaDryPlus® int. manifold gskts. incl.	
1	Int. Manifold Gasket Set	1998	MS 98011 T	To 01/14/98; 4mm thick int. manifold gskts.; Lower set; Upper set incl.; PermaDryPlus® int. manifold gskts. incl.	
1	Int. Manifold Gasket Set	1997-96	MS 95932	3mm thick int. manifold gskts.; Lower set; Upper set incl.	
1	Int. Manifold Gasket Set	1997-96	MS 95985-1	4mm thick int. manifold gskts.; Lower set; Upper set incl.	
1	Int. Manifold Gasket Set	1997-96	MS 98009 T	3mm thick int. manifold gskts.; Lower set; Upper set incl.; PermaDryPlus® int. manifold gskts. incl.	
1	Int. Manifold Gasket Set	1997-96	MS 98011 T	4mm thick int. manifold gskts.; Lower set; Upper set incl.; PermaDryPlus® int. manifold gskts. incl.	
1	Int. Manifold Gasket Set	1995	MS 94045	Lower set; Upper set incl.	
1	Plenum Gasket Set	2003-99	MS 90812	Upper set	
1	Plenum Gasket Set	1998-96	MS 95934	Upper set	
1	Plenum Gasket Set	1995	MS 94046	Upper set	
1	Intake Manifold Isolator Grommet Set	2003-99	ES 72204	Replacement required	
1	Exh. Manifold Gasket Set	2003-96	MS 95968		
1	Exh. Manifold Gasket Set	1995	MS 91346		
QTY	EXHAUST PIPE FLANGE	YEARS	PART NO.	DESCRIPTION	
1	Exhaust Pipe Gasket	2001-95	60885	Converter to muffler	
1	Exh. Flange Bolt & Spring Kit	2001-95	ES 72142		
QTY	OIL PAN	YEARS	PART NO.	DESCRIPTION	
1	Oil Pan Gasket Set	2003-01	OS 30702 R	RTV Black silicone w/Rubber end seal	
1	Oil Pan Gasket Set	2000-95	OS 30625 R	RTV Black silicone w/Rubber end seal	
1	Drain Plug Gasket	2003-95	72515		

Ford Truck (Incl. Minivans and SUV's) (Cont.)

29 (cont.)		2003 - 1995; 3.8L 232 (3797cc) OHV V6 (12 Valve) 96.8mm Bore			29 (cont.)
MFI; Gasoline; Naturally Aspirated Ford Eng.; VIN Code 4					
QTY	CRANKSHAFT REAR SEAL	YEARS	PART NO.	DESCRIPTION	
1	Rear Main Seal Set	2003-95	BS 40620	Rubber; One-piece; Improved design	
1	Rear Main Seal Set	2003-95	BS 40644	PTFE Rubber; One-piece	
1	Repair Sleeve	2003-95	16250	Crankshaft; Use w/installation tool	
1	Repair Sleeve Tool	2003-95	16300	Crankshaft	
QTY	VALVE COVER	YEARS	PART NO.	DESCRIPTION	
1	Valve Cover Gasket Set	2003-95	VS 50441 R	w/Grommets; PermaDry® molded rubber gskts. incl.	
1	Valve Cover Gasket Set	2003-95	VS 50441 R-1	w/o Grommets; PermaDry® molded rubber gskts. incl.	
QTY	VALVE STEM SEAL SET	YEARS	PART NO.	DESCRIPTION	
1	Valve Stem Seal Set	2003-99	SS 70864-1	Premium valve stem seals incl.	
1	Valve Stem Seal Set	1998-96	SS 72875-1	Premium valve stem seals incl.	
2	Valve Stem Seal Set	1995	SS 72708	Premium valve stem seals incl.	
QTY	THERMOSTAT HOUSING	YEARS	PART NO.	DESCRIPTION	
1	Water Outlet Gasket	1997-96	35390	Thermostat Housing; w/o Notch	
1	Water Outlet Gasket	1997-96	35390 T	Thermostat Housing; w/o Notch; PermaDryPlus®	
1	O-Ring	1997-96	35708	Thermostat Housing; Seal; w/Notch	
QTY	WATER OUTLET GASKET	YEARS	PART NO.	DESCRIPTION	
1	Water Outlet Gasket	2003-98	35390	Water Outlet	
1	Water Outlet Gasket	2003-98	35390 T	Water Outlet; PermaDryPlus®	
1	Water Outlet Gasket	1995	35390	Water Outlet	
1	Water Outlet Gasket	1995	35390 T	Water Outlet; PermaDryPlus®	
QTY	WATER PUMP	YEARS	PART NO.	DESCRIPTION	
1	Water Pump Gasket	2003-96	35431		
1	Water Pump Gasket	1995	35414		
2	O-Ring	2003-95	413	Water Pump; Water pump bypass pipe O-ring	
QTY	TIMING COVER	YEARS	PART NO.	DESCRIPTION	
1	Timing Cover Set	2003-99	TCS 45984	PermaDryPlus® timing cover gskt. incl.	
1	Timing Cover Set	1998-95	TCS 45951	PermaDryPlus® timing cover gskt. incl.	
1	Timing Cover Gasket	2003-95	72754	PermaDryPlus® timing cover gskt. incl.; New Part Number - Check for Availability	
QTY	CARB & FUEL INJECTION	YEARS	PART NO.	DESCRIPTION	
2	Fuel Injector O-Ring Set	2003-95	ES 70599	Improved design	
1	Throttle Body Gasket	2003-95	60913	Gskt.	
1	Throttle Body Gasket	2003-95	61046	O-ring	
1	Throttle Body Gasket	2003-96	71428	Air bypass valve; New Part Number - Check for Availability	
1	Throttle Body Gasket	1995	71216	Air bypass valve	
QTY	EXHAUST GAS RECIRCULATION	YEARS	PART NO.	DESCRIPTION	
1	EGR Gasket	2003-95	70149		
QTY	OIL COOLER	YEARS	PART NO.	DESCRIPTION	
1	Oil Cooler Gasket	2003-95	72655	Oil cooler seal; New Part Number - Check for Availability	
30		2007 - 2004; 3.9L 238 (3887cc) OHV V6 (12 Valve) 96.8mm Bore			30
MFI; Gasoline; Naturally Aspirated Ford Eng.; VIN Code 6					
QTY	CYLINDER HEAD	YEARS	PART NO.	DESCRIPTION	
1	Head Gasket	2007-04	26505 PT	Loc. L.H.; .010" thicker for use when head is refaced; Head bolts not incl.; Head bolt replacement required; PermaTorqueMLS®	
1	Head Gasket	2007-04	26506 PT	Loc. R.H.; .010" thicker for use when head is refaced; Head bolts not incl.; Head bolt replacement required; PermaTorqueMLS®	
1	Head Gasket	2007-04	9250 PT	Loc. L.H.; Head bolts not incl.; Head bolt replacement required; PermaTorqueMLS®	
1	Head Gasket	2007-04	9253 PT	Loc. R.H.; Head bolts not incl.; Head bolt replacement required; PermaTorqueMLS®	
1	Head Set	2007-05	HS 9250 PT-7	Head bolts not incl.; Head bolt replacement required; PermaDry® molded rubber valve cover gskts. incl.; Premium valve stem seals incl.	
1	Head Set	2004	HS 9250 PT-6	Head bolts not incl.; Head bolt replacement required; PermaDry® molded rubber valve cover gskts. incl.; Premium valve stem seals incl.	
2	Head Bolt Set	2007-04	ES 72160	Replacement required	
QTY	CONVERSION SET	YEARS	PART NO.	DESCRIPTION	
1	Gasket Conversion Set	2007-04	CS 9250-1	RTV sealant incl. for oil pan gskt.; PermaDryPlus® timing cover gskt. incl.	
QTY	MANIFOLD - INT. & EXH.	YEARS	PART NO.	DESCRIPTION	
1	Int. Manifold Gasket Set	2007-05	MS 96451	Lower set; Upper set incl.	
1	Int. Manifold Gasket Set	2004	MS 95985	Lower set	
1	Int. Manifold Gasket Set	2004	MS 95985-3	Lower set; Upper set incl.; Must be used w/ES 72204	
1	Plenum Gasket Set	2007-04	MS 96239	Upper set	

Ford Truck (Incl. Minivans and SUV's) (Cont.)

30 (cont.)	2007 - 2004; 3.9L 238 (3887cc) OHV V6 (12 Valve) 96.8mm Bore				30 (cont.)
MFI; Gasoline; Naturally Aspirated Ford Eng.; VIN Code 6					
QTY	MANIFOLD - INT. & EXH.	YEARS	PART NO.	DESCRIPTION	
1	Intake Manifold Isolator Grommet Set	2004	ES 72204	Replacement required	
1	Exh. Manifold Gasket Set	2007-04	MS 95968		
QTY	OIL PAN	YEARS	PART NO.	DESCRIPTION	
1	Oil Pan Gasket Set	2007-04	OS 30702 R	RTV Black silicone w/Rubber end seal	
1	Drain Plug Gasket	2007-04	72515		
QTY	CRANKSHAFT REAR SEAL	YEARS	PART NO.	DESCRIPTION	
1	Rear Main Seal Set	2007-04	BS 40620	Rubber; One-piece; Improved design	
1	Rear Main Seal Set	2007-04	BS 40644	PTFE Rubber; One-piece	
1	Repair Sleeve	2007-04	16250	Crankshaft; Use w/installation tool	
1	Repair Sleeve Tool	2007-04	16300	Crankshaft	
QTY	VALVE COVER	YEARS	PART NO.	DESCRIPTION	
1	Valve Cover Gasket Set	2007-04	VS 50441 R	w/Grommets; PermaDry® molded rubber gskts. incl.	
1	Valve Cover Gasket Set	2007-04	VS 50441 R-1	w/o Grommets; PermaDry® molded rubber gskts. incl.	
QTY	VALVE STEM SEAL SET	YEARS	PART NO.	DESCRIPTION	
1	Valve Stem Seal Set	2007-04	SS 70864-1	Premium valve stem seals incl.	
QTY	WATER OUTLET GASKET	YEARS	PART NO.	DESCRIPTION	
1	Water Outlet Gasket	2007-04	35390	Water Outlet	
1	Water Outlet Gasket	2007-04	35390 T	Water Outlet; PermaDryPlus®	
QTY	WATER PUMP	YEARS	PART NO.	DESCRIPTION	
1	Water Pump Gasket	2007-04	35431		
2	O-Ring	2007-04	413	Water Pump; Water pump bypass pipe O-ring	
QTY	TIMING COVER	YEARS	PART NO.	DESCRIPTION	
1	Timing Cover Set	2007-04	TCS 45984	PermaDryPlus® timing cover gskt. incl.	
1	Timing Cover Gasket	2007-04	72754	PermaDryPlus® timing cover gskt. incl.; New Part Number - Check for Availability	
QTY	CARB & FUEL INJECTION	YEARS	PART NO.	DESCRIPTION	
2	Fuel Injector O-Ring Set	2007-04	ES 70599	Improved design	
1	Throttle Body Gasket	2007-04	61046	O-ring	
1	Throttle Body Gasket	2007-04	72302	Air bypass valve	
QTY	EXHAUST GAS RECIRCULATION	YEARS	PART NO.	DESCRIPTION	
1	EGR Gasket	2007-04	71176		
QTY	OIL COOLER	YEARS	PART NO.	DESCRIPTION	
1	Oil Cooler Gasket	2007-04	72655	Oil cooler seal; New Part Number - Check for Availability	
31	2001 - 1991; 4.0L 244 (4015cc) OHV V6 (12 Valve) 100.4mm Bore				31
MFI; Gasoline; Naturally Aspirated Ford Eng.; VIN Code X					
QTY	CYLINDER HEAD	YEARS	PART NO.	DESCRIPTION	
1	Head Gasket	2001-91	544 SD	Loc. L.H.; Head bolts not incl.; Head bolt replacement recommended; PermaTorque Severe Duty®	
1	Head Gasket	2001-91	545 SD	Loc. R.H.; Head bolts not incl.; Head bolt replacement recommended; PermaTorque Severe Duty®	
1	Head Gasket	2001-91	9724 PT-2	Loc. L.H.; Head bolts not incl.; Head bolt replacement recommended; PermaTorque®; Improved design	
1	Head Gasket	2001-91	9725 PT-2	Loc. R.H.; Head bolts not incl.; Head bolt replacement recommended; PermaTorque®; Improved design	
1	Head Set	2001-97	HS 9081 PT-1	Head bolts not incl.; Head bolt replacement recommended; PermaDryPlus® int. manifold gskts. incl.; Premium valve stem seals incl.	
1	Head Set	2001-97	HST 9081 PT-1	Head bolts not incl.; Head bolt replacement recommended; PermaTorque Severe Duty® head gskts. incl.; PermaDryPlus® int. manifold gskts. incl.; PermaDryPlus® molded rubber valve cover gskts. incl.; Premium valve stem seals incl.	
1	Head Set	1996-95	HS 9081 PT	Upper int. manifold gskts. & head bolts not incl.; Head bolt replacement recommended; PermaDryPlus® int. manifold gskts. incl.; Premium valve stem seals incl.	
1	Head Set	1994-91	HS 9724 PT-1	Head bolts not incl.; Head bolt replacement recommended; Premium valve stem seals incl.	
1	Head Installation Set	1996	HIS 9081 PT	Upper int. manifold gskts. & head bolts not incl.; Head bolt replacement recommended; PermaDryPlus® int. manifold gskts. incl.	
1	Head Installation Set	1995	HIS 9081 PT	Head bolts not incl.; Head bolt replacement recommended; PermaDryPlus® int. manifold gskts. incl.	
1	Head Installation Set	1994-91	HIS 9724 PT-1	Head bolts not incl.; Head bolt replacement recommended	
1	Head Bolt Set	2001-91	ES 72794	Replacement recommended	
QTY	CONVERSION SET	YEARS	PART NO.	DESCRIPTION	
1	Gasket Conversion Set	2001-95	CS 9724-1	PermaDry® molded rubber oil pan gskt. incl.	

Ford Truck (Incl. Minivans and SUV's) (Cont.)

31 (cont.)		2001 - 1991; 4.0L 244 (4015cc) OHV V6 (12 Valve) 100.4mm Bore			31 (cont.)
MFI; Gasoline; Naturally Aspirated Ford Eng.; VIN Code X					
QTY	CONVERSION SET	YEARS	PART NO.	DESCRIPTION	
1	Gasket Conversion Set	1994	CS 9724-1	Rear main brg. seal not incl.; PermaDry® molded rubber oil pan gskt. incl.	
1	Gasket Conversion Set	1993-91	CS 9724	PermaDry® molded rubber oil pan gskt. incl.	
QTY	MANIFOLD - INT. & EXH.	YEARS	PART NO.	DESCRIPTION	
1	Int. Manifold Gasket Set	2001-97	MS 90728	Lower set; Must be used w/VS 50368C or w/VS 50368T	
1	Int. Manifold Gasket Set	2001-98	MS 98006 T	Valve cover gskts. & Upper set incl.; PermaDryPlus® int. manifold gskts. incl.	
1	Int. Manifold Gasket Set	1997-91	MS 98005 T	Valve cover gskts. & Upper set incl.; PermaDryPlus® int. manifold gskts. incl.	
1	Int. Manifold Gasket Set	1996	MS 95739	Lower set; Must be used w/VS 50368C or w/VS 50368T	
1	Int. Manifold Gasket Set	1995	MS 94682-1	Lower set; Upper set incl.; Must be used w/VS 50368C or w/VS 50368T	
1	Int. Manifold Gasket Set	1994-91	MS 94682	Lower set; Upper set incl.; Must be used w/VS 50368C or w/VS 50368T	
1	Plenum Gasket Set	2001-98	MS 90732	Upper set	
1	Plenum Gasket Set	1997-96	MS 90733	Upper set	
1	Plenum Gasket Set	1995-91	MS 94683	Upper set	
1	Exh. Manifold Gasket Set	2001-97	MS 95960		
1	Exh. Manifold Gasket Set	1996-91	MS 94764		
QTY	EXHAUST PIPE FLANGE	YEARS	PART NO.	DESCRIPTION	
1	Exhaust Pipe Gasket	2001-98	60641	Converter to muffler	
1	Exhaust Pipe Gasket	1997	60641	Ford Explorer Eddie Bauer, Limited, Sport, XL, XLT, Ranger Splash, Sport, STX, Super, XL, XLT; Converter to muffler	
1	Exhaust Pipe Gasket	1997	60679	Ford Aerostar Base, XLT, XLT 4WD, XLT E4WD, XLT Plus, XLT Plus 4WD, XLT Plus E4WD, XLT Sport; Converter to muffler	
1	Exhaust Pipe Gasket	1996	60641	Ford Explorer Eddie Bauer, Limited, Sport, XL, XLT, Ranger Splash, STX, Super, XL, XLT; Converter to muffler	
1	Exhaust Pipe Gasket	1996	60679	Exc. Ford Explorer Eddie Bauer, Limited, Sport, XL, XLT, Ranger Splash, STX, Super, XL, XLT; Converter to muffler	
1	Exhaust Pipe Gasket	1995	60641	Exc. Ford Aerostar Base, Base 4WD, XLT, XLT 4WD, XLT E4WD, XLT Plus, XLT Plus 4WD, XLT Plus E4WD, XLT Sport; Converter to muffler	
1	Exhaust Pipe Gasket	1995	60679	Ford Aerostar Base, Base 4WD, XLT, XLT 4WD, XLT E4WD, XLT Plus, XLT Plus 4WD, XLT Plus E4WD, XLT Sport; Converter to muffler	
1	Exhaust Pipe Gasket	1994	60641	Ford Explorer Eddie Bauer, Limited, XL, XLT, Ranger Splash, STX, Super, XL, XLT; Converter to muffler	
1	Exhaust Pipe Gasket	1994	60679	Exc. Ford Explorer Eddie Bauer, Limited, XL, XLT, Ranger Splash, STX, Super, XL, XLT; Converter to muffler	
1	Exhaust Pipe Gasket	1994	60796	Ford Explorer Eddie Bauer, Limited, XL, XLT, Ranger Splash, STX, Super, XL, XLT; Inlet pipe to converter	
1	Exhaust Pipe Gasket	1993	60641	Ford Explorer Eddie Bauer, Limited, XL, XLT, Ranger Splash, Sport, STX, Super, XL, XLT; Converter to muffler	
1	Exhaust Pipe Gasket	1993	60679	Exc. Ford Explorer Eddie Bauer, Limited, XL, XLT, Ranger Splash, Sport, STX, Super, XL, XLT; Converter to muffler	
1	Exhaust Pipe Gasket	1993	60796	Ford Explorer Eddie Bauer, Limited, XL, XLT, Ranger Splash, Sport, STX, Super, XL, XLT; Inlet pipe to converter	
1	Exhaust Pipe Gasket	1992	60641	Ford Explorer Eddie Bauer, Sport, XL, XLT, Ranger Base, Custom, S, Sport, STX, Super, XLT; Converter to muffler	
1	Exhaust Pipe Gasket	1992	60679	Exc. Ford Explorer Eddie Bauer, Sport, XL, XLT, Ranger Base, Custom, S, Sport, STX, Super, XLT; Converter to muffler	
1	Exhaust Pipe Gasket	1992	60796	Ford Explorer Eddie Bauer, Sport, XL, XLT, Ranger Base, Custom, S, Sport, STX, Super, XLT; Inlet pipe to converter	
1	Exhaust Pipe Gasket	1991	60641	Ford Explorer Eddie Bauer, Sport, XL, XLT, Ranger Custom, S, Sport, STX, Super, XLT; Converter to muffler	
1	Exhaust Pipe Gasket	1991	60679	Exc. Ford Explorer Eddie Bauer, Sport, XL, XLT, Ranger Custom, S, Sport, STX, Super, XLT; Converter to muffler	
1	Exhaust Pipe Gasket	1991	60796	Ford Explorer Eddie Bauer, Sport, XL, XLT, Ranger Custom, S, Sport, STX, Super, XLT; Inlet pipe to converter	
QTY	OIL PAN	YEARS	PART NO.	DESCRIPTION	
1	Oil Pan Gasket Set	2001-94	OS 34309 R	PermaDry® molded rubber gskt. incl.	
1	Oil Pan Gasket Set	1993-91	OS 30634 R	PermaDry® molded rubber gskt. incl.	
1	Drain Plug Gasket	2001-91	72515		
QTY	CRANKSHAFT REAR SEAL	YEARS	PART NO.	DESCRIPTION	
1	Rear Main Seal Set	2001-91	BS 40647	PTFE Rubber; One-piece	
1	Rear Main Seal Set	2001-95	BS 40619	Wear sleeve incl.; Rubber; One-piece	
1	Rear Main Seal Set	1994-91	BS 40419	Rubber; One-piece	
QTY	VALVE COVER	YEARS	PART NO.	DESCRIPTION	
1	Valve Cover Gasket Set	2001-96	VS 50368 C	Int. manifold upper set not incl.; Cork	

Ford Truck (Incl. Minivans and SUV's) (Cont.)

31 (cont.)		2001 - 1991; 4.0L 244 (4015cc) OHV V6 (12 Valve) 100.4mm Bore			31 (cont.)
MFI; Gasoline; Naturally Aspirated Ford Eng.; VIN Code X					
QTY	VALVE COVER	YEARS	PART NO.	DESCRIPTION	
1	Valve Cover Gasket Set	2001-96	VS 50368 T	Int. manifold upper set not incl.; PermaDryPlus®	
1	Valve Cover Gasket Set	1995-91	VS 50368 C	Int. manifold upper set incl.; Cork	
1	Valve Cover Gasket Set	1995-91	VS 50368 T	Int. manifold upper set incl.; PermaDryPlus®	
QTY	VALVE STEM SEAL SET	YEARS	PART NO.	DESCRIPTION	
1	Valve Stem Seal Set	2001-91	SS 72686	Premium valve stem seals incl.	
QTY	WATER OUTLET GASKET	YEARS	PART NO.	DESCRIPTION	
1	Water Outlet Gasket	2001-91	35404	Water Outlet	
QTY	WATER PUMP	YEARS	PART NO.	DESCRIPTION	
1	Water Pump Gasket	2001-91	35474		
QTY	TIMING COVER	YEARS	PART NO.	DESCRIPTION	
1	Timing Cover Set	2001-94	TCS 45867	w/o Sleeve 'N' Seal®; Must be used w/OS 34309R	
1	Timing Cover Set	1993-91	TCS 45867	w/o Sleeve 'N' Seal®; Must be used w/OS 30634R	
1	Timing Set w/Sleeve & Seal	2001-94	TCS 45291	w/Sleeve 'N' Seal®; Must be used w/OS 34309R	
1	Timing Set w/Sleeve & Seal	1993-91	TCS 45291	w/Sleeve 'N' Seal®; Must be used w/OS 30634R	
QTY	CARB & FUEL INJECTION	YEARS	PART NO.	DESCRIPTION	
3	Fuel Injector O-Ring Set	2001-91	ES 70599	Improved design	
1	Throttle Body Gasket	2001-91	71216	Air bypass valve	
1	Throttle Body Gasket	2001-95	61055	O-ring	
1	Throttle Body Gasket	1995-91	60886	Gskt.	
QTY	EXHAUST GAS RECIRCULATION	YEARS	PART NO.	DESCRIPTION	
1	EGR Gasket	2001-93	70149		
2	EGR Gasket	1997-95	72266	Tube seal	
QTY	OIL FILTER MOUNTING	YEARS	PART NO.	DESCRIPTION	
1	Oil Filter Adapter Gasket	2001-91	72884	.141" width; 2.482" ID	
32		2011 - 1997; 4.0L 244 (4015cc) SOHC V6 (12 Valve) 100.4mm Bore			32
MFI; Gasoline; Naturally Aspirated Ford Eng.; VIN Code E					
QTY	CYLINDER HEAD	YEARS	PART NO.	DESCRIPTION	
1	Head Gasket	2011-97	26300 PT	Loc. L.H.; Head bolts not incl.; Head bolt replacement required; PermaTorqueMLS® LaserWeld® Technology; Improved design	
1	Head Gasket	2011-97	26301 PT	Loc. R.H.; Head bolts not incl.; Head bolt replacement required; PermaTorqueMLS® LaserWeld® Technology; Improved design	
1	Head Set	2011-04	HS 26300 PT	Head bolts not incl.; Head bolt replacement required; PermaDry® molded rubber valve cover gskts. incl.; Premium valve stem seals incl.	
1	Head Set	2003-02	HS 9293 PT-2	Head bolts not incl.; Head bolt replacement required; PermaDry® molded rubber valve cover gskts. incl.; Premium valve stem seals incl.	
1	Head Set	2001	HS 9293 PT	Ford Explorer Sport, Explorer Sport Trac Base; To 07/23/00; Head bolts not incl.; Head bolt replacement required; PermaDry® molded rubber valve cover gskts. incl.; Premium valve stem seals incl.	
1	Head Set	2001	HS 9293 PT-1	Exc. Ford Explorer Sport, Explorer Sport Trac Base, Ranger Edge, XL, XLT; Head bolts not incl.; Head bolt replacement required; PermaDry® molded rubber valve cover gskts. incl.; Premium valve stem seals incl.	
1	Head Set	2001	HS 9293 PT-2	Ford Explorer Sport, Explorer Sport Trac Base; From 07/24/00; Head bolts not incl.; Head bolt replacement required; PermaDry® molded rubber valve cover gskts. incl.; Premium valve stem seals incl.	
1	Head Set	2001	HS 9293 PT-2	Ford Ranger Edge, XL, XLT; Head bolts not incl.; Head bolt replacement required; PermaDry® molded rubber valve cover gskts. incl.; Premium valve stem seals incl.	
1	Head Set	2000	HS 9293 PT	Exc. Ford Explorer Eddie Bauer, Limited, Postal, Sport; Head bolts not incl.; Head bolt replacement required; PermaDry® molded rubber valve cover gskts. incl.; Premium valve stem seals incl.	
1	Head Set	2000	HS 9293 PT	Ford Explorer Eddie Bauer, Limited, Postal; Head bolts not incl.; Head bolt replacement required; PermaDry® molded rubber valve cover gskts. incl.; Premium valve stem seals incl.	
1	Head Set	2000	HS 9293 PT	Ford Explorer Sport; To 07/23/00; Head bolts not incl.; Head bolt replacement required; PermaDry® molded rubber valve cover gskts. incl.; Premium valve stem seals incl.	
1	Head Set	2000	HS 9293 PT-2	Ford Explorer Sport; From 07/24/00; Head bolts not incl.; Head bolt replacement required; PermaDry® molded rubber valve cover gskts. incl.; Premium valve stem seals incl.	
1	Head Set	1999-97	HS 9293 PT	Head bolts not incl.; Head bolt replacement required; PermaDry® molded rubber valve cover gskts. incl.; Premium valve stem seals incl.	
2	Head Bolt Set	2011-97	ES 72171	Replacement required	
QTY	CONVERSION SET	YEARS	PART NO.	DESCRIPTION	
1	Gasket Conversion Set	2011-05	CS 9293-1	PermaDry® molded rubber oil pan gskt. incl.	

Ford Truck (Incl. Minivans and SUV's) (Cont.)

32 (cont.)		2011 - 1997; 4.0L 244 (4015cc) SOHC V6 (12 Valve) 100.4mm Bore MFI; Gasoline; Naturally Aspirated Ford Eng.; VIN Code E			32 (cont.)
QTY	CONVERSION SET	YEARS	PART NO.	DESCRIPTION	
1	Gasket Conversion Set	2004	CS 9293	To 02/28/04; PermaDry® molded rubber oil pan gskt. incl.	
1	Gasket Conversion Set	2004	CS 9293-1	From 03/01/04; PermaDry® molded rubber oil pan gskt. incl.	
1	Gasket Conversion Set	2003-97	CS 9293	PermaDry® molded rubber oil pan gskt. incl.	
QTY	MANIFOLD - INT. & EXH.	YEARS	PART NO.	DESCRIPTION	
1	Int. Manifold Gasket Set	2011-02	MS 96123	Lower set	
1	Int. Manifold Gasket Set	2001	MS 90890	Ford Explorer Eddie Bauer, Limited, Postal; Lower set; Upper set incl.	
1	Int. Manifold Gasket Set	2001	MS 90890	Ford Explorer XL Fleet, XLS, XLT; Lower set; Upper set incl.	
1	Int. Manifold Gasket Set	2001	MS 90890	Mercury Mountaineer Base; Lower set; Upper set incl.	
1	Int. Manifold Gasket Set	2001	MS 90890	Ford Explorer Sport; To 07/23/00; Lower set; Upper set incl.	
1	Int. Manifold Gasket Set	2001	MS 90890	Ford Explorer Sport Trac Base; To 07/23/00; Lower set; Upper set incl.	
1	Int. Manifold Gasket Set	2001	MS 96123	Ford Explorer Sport, Explorer Sport Trac Base; From 07/24/00; Lower set	
1	Int. Manifold Gasket Set	2001	MS 96123	Ford Ranger Edge, XL, XLT; Lower set	
1	Int. Manifold Gasket Set	2000	MS 90890	Exc. Ford Explorer Eddie Bauer, Limited, Postal, Sport; Lower set; Upper set incl.	
1	Int. Manifold Gasket Set	2000	MS 90890	Ford Explorer Eddie Bauer, Limited, Postal; Lower set; Upper set incl.	
1	Int. Manifold Gasket Set	2000	MS 90890	Ford Explorer Sport; To 07/23/00; Lower set; Upper set incl.	
1	Int. Manifold Gasket Set	2000	MS 96123	Ford Explorer Sport; From 07/24/00; Lower set	
1	Int. Manifold Gasket Set	1999-97	MS 90890	Lower set; Upper set incl.	
1	Exh. Manifold Gasket Set	2011-97	MS 90779		
QTY	EXHAUST PIPE FLANGE	YEARS	PART NO.	DESCRIPTION	
1	Exhaust Pipe Gasket	2011	60641	Loc. Rear; Converter	
1	Exhaust Pipe Gasket	2011	61407	Loc. Front; Converter	
1	Exhaust Pipe Gasket	2010	60641	Exc. Ford Ranger Sport, XL, XLT; Converter	
1	Exhaust Pipe Gasket	2010	60641	Ford Ranger Sport, XL, XLT; Loc. Rear; Converter	
1	Exhaust Pipe Gasket	2010	61407	Ford Ranger Sport, XL, XLT; Loc. Front; Converter	
1	Exhaust Pipe Gasket	2009-06	60641	Exc. Ford Ranger FX4, Sport, STX, XL, XLT; Converter	
1	Exhaust Pipe Gasket	2009-06	60641	Ford Ranger FX4, Sport, STX, XL, XLT; Loc. Rear; Converter	
1	Exhaust Pipe Gasket	2009-06	61407	Ford Ranger FX4, Sport, STX, XL, XLT; Loc. Front; Converter	
1	Exhaust Pipe Gasket	2005	60641	Exc. Ford Ranger Edge, FX4, XL, XLT; Converter	
1	Exhaust Pipe Gasket	2005	60641	Ford Ranger Edge, FX4, XL, XLT; Loc. Rear; Converter	
1	Exhaust Pipe Gasket	2005	61407	Ford Ranger Edge, FX4, XL, XLT; Loc. Front; Converter	
1	Exhaust Pipe Gasket	2004	60641	Exc. Ford Ranger Edge, Tremor, XL, XLT; Converter	
1	Exhaust Pipe Gasket	2004	60641	Ford Ranger Edge, Tremor, XL, XLT; Loc. Rear; Converter	
1	Exhaust Pipe Gasket	2004	61407	Ford Ranger Edge, Tremor, XL, XLT; Loc. Front; Converter	
1	Exhaust Pipe Gasket	2003-01	60641	Ford Ranger Edge, XL, XLT; Loc. Rear; Converter	
1	Exhaust Pipe Gasket	2003-01	61407	Ford Ranger Edge, XL, XLT; Loc. Front; Converter	
1	Exhaust Pipe Gasket	2003-02	60641	Exc. Ford Ranger Edge, XL, XLT; Converter	
1	Exhaust Pipe Gasket	2001	61061	Exc. Ford Ranger Edge, XL, XLT; Converter	
1	Exhaust Pipe Gasket	2000-97	61061	Converter	
QTY	OIL PAN	YEARS	PART NO.	DESCRIPTION	
1	Oil Pan Gasket Set	2011-97	OS 30687 R	Loc. Lower; PermaDry® molded rubber gskt. incl.	
1	Oil Pan Gasket Set	2011-97	OS 34309 R	Loc. Upper; PermaDry® molded rubber gskt. incl.	
QTY	CRANKSHAFT REAR SEAL	YEARS	PART NO.	DESCRIPTION	
1	Rear Main Seal Set	2011-97	BS 40619	Wear sleeve incl.; Rubber; One-piece	
1	Rear Main Seal Set	2011-97	BS 40647	PTFE Rubber; One-piece	
QTY	VALVE COVER	YEARS	PART NO.	DESCRIPTION	
1	Valve Cover Gasket Set	2011-02	VS 50529 R	w/Grommets; PermaDry® molded rubber gskts. incl.	
1	Valve Cover Gasket Set	2001	VS 50491 R	Ford Explorer Sport, Explorer Sport Trac Base; To 07/23/00; PermaDry® molded rubber gskts. incl.	
1	Valve Cover Gasket Set	2001	VS 50529 R	Ford Explorer Sport; From 07/24/00; w/Grommets; PermaDry® molded rubber gskts. incl.	
1	Valve Cover Gasket Set	2001	VS 50529 R	Ford Explorer Sport Trac Base; From 07/24/00; w/Grommets; PermaDry® molded rubber gskts. incl.	
1	Valve Cover Gasket Set	2001	VS 50529 R	Ford Explorer Eddie Bauer, Limited, Postal; w/Grommets; PermaDry® molded rubber gskts. incl.	
1	Valve Cover Gasket Set	2001	VS 50529 R	Ford Explorer XL Fleet, XLS, XLT; w/Grommets; PermaDry® molded rubber gskts. incl.	
1	Valve Cover Gasket Set	2001	VS 50529 R	Ford Ranger Edge, XL, XLT Mercury Mountaineer Base; w/Grommets; PermaDry® molded rubber gskts. incl.	
1	Valve Cover Gasket Set	2000	VS 50491 R	Exc. Ford Explorer Eddie Bauer, Limited, Postal, Sport; PermaDry® molded rubber gskts. incl.	
1	Valve Cover Gasket Set	2000	VS 50491 R	Ford Explorer Eddie Bauer, Limited, Postal; PermaDry® molded rubber gskts. incl.	
1	Valve Cover Gasket Set	2000	VS 50491 R	Ford Explorer Sport; To 07/23/00; PermaDry® molded rubber gskts. incl.	

Ford Truck (Incl. Minivans and SUV's) (Cont.)

32 (cont.)		2011 - 1997; 4.0L 244 (4015cc) SOHC V6 (12 Valve) 100.4mm Bore			32 (cont.)
MFI; Gasoline; Naturally Aspirated Ford Eng.; VIN Code E					
QTY	VALVE COVER	YEARS	PART NO.	DESCRIPTION	
1	Valve Cover Gasket Set	2000	VS 50529 R	Ford Explorer Sport; From 07/24/00; w/Grommets; PermaDry® molded rubber gskts. incl.	
1	Valve Cover Gasket Set	1999-97	VS 50491 R	PermaDry® molded rubber gskts. incl.	
QTY	VALVE STEM SEAL SET	YEARS	PART NO.	DESCRIPTION	
1	Valve Stem Seal Set	2011-97	SS 70858	Premium valve stem seals incl.	
QTY	THERMOSTAT HOUSING	YEARS	PART NO.	DESCRIPTION	
1	Thermostat Gasket	2011-02	35673	Thermostat Housing; Thermostat housing to manifold	
1	Thermostat Gasket	2001-00	35673	Thermostat Housing; From 07/24/00; Thermostat housing to manifold	
1	O-Ring	2011	35327	Thermostat Housing; Old design	
1	O-Ring	2010-97	35617	Thermostat Housing	
QTY	WATER PUMP	YEARS	PART NO.	DESCRIPTION	
1	Water Pump Gasket	2011-97	35474		
QTY	TIMING COVER	YEARS	PART NO.	DESCRIPTION	
1	Timing Cover Set	2011-05	TCS 46061		
1	Timing Cover Set	2004	TCS 45986	To 02/28/04	
1	Timing Cover Set	2004	TCS 46061	From 03/01/04	
1	Timing Cover Set	2003-97	TCS 45986		
QTY	CARB & FUEL INJECTION	YEARS	PART NO.	DESCRIPTION	
3	Fuel Injector O-Ring Set	2011-97	ES 70599	Improved design	
1	Throttle Body Gasket	2011-97	72302	Air bypass valve	
1	Throttle Body Gasket	2011-02	61347	Throttle body to spacer; Gskt.	
1	Throttle Body Gasket	2011	61208		
1	Throttle Body Gasket	2010	61208	Ford Explorer Sport Trac Limited, XLT, Ranger Sport, XL, XLT	
1	Throttle Body Gasket	2009-07	61208	Ford Explorer Sport Trac Limited, XLT, Ranger FX4, Sport, STX, XL, XLT	
1	Throttle Body Gasket	2006	61208	Ford Ranger FX4, Sport, STX, XL, XLT	
1	Throttle Body Gasket	2005	61208	Ford Explorer Sport Trac Adrenalin, XLS, XLT, Ranger Edge, FX4, XL, XLT	
1	Throttle Body Gasket	2004	61208	Mercury Mountaineer Base, Convenience, Luxury, Premier; To 08/03/03	
1	Throttle Body Gasket	2004	61208	Ford Explorer Sport Trac XLS, XLT, Ranger Edge, Tremor, XL, XLT	
1	Throttle Body Gasket	2004	61208	Ford Explorer Eddie Bauer, Limited, NBX, XLS, XLS Sport, XLT, XLT Sport; To 08/03/03	
1	Throttle Body Gasket	2003	61208	Ford Explorer Sport Trac XLS, XLT, Ranger Edge, XL, XLT	
1	Throttle Body Gasket	2003	61208	Ford Explorer Eddie Bauer, Limited, Postal, Sport, Sport XLS, Sport XLT, XLS, XLT; To 08/03/03	
1	Throttle Body Gasket	2003	61208	Mercury Mountaineer Base, Convenience, Luxury, Premier; To 08/03/03	
1	Throttle Body Gasket	2002	61208		
1	Throttle Body Gasket	2001-97	61056	Spacer to manifold; O-ring	
1	Throttle Body Gasket	2001-97	61057	Throttle body to spacer; Gskt.	
QTY	EXHAUST GAS RECIRCULATION	YEARS	PART NO.	DESCRIPTION	
1	EGR Gasket	2011-97	71202	Tube seal	
1	EGR Gasket	2011	70149	Valve	
1	EGR Gasket	2010	70149	Ford Ranger Sport, XL, XLT; Valve	
1	EGR Gasket	2010	71176	Exc. Ford Ranger Sport, XL, XLT; Valve	
1	EGR Gasket	2009-06	70149	Ford Ranger FX4, Sport, STX, XL, XLT; Valve	
1	EGR Gasket	2009-06	71176	Exc. Ford Ranger FX4, Sport, STX, XL, XLT; Valve	
1	EGR Gasket	2005	70149	Ford Explorer Sport Trac Adrenalin, XLS, XLT, Ranger Edge, FX4, XL, XLT; Valve	
1	EGR Gasket	2005	71176	Exc. Ford Explorer Sport Trac Adrenalin, XLS, XLT, Ranger Edge, FX4, XL, XLT; Valve	
1	EGR Gasket	2004	70149	Ford Explorer Sport Trac XLS, XLT, Ranger Edge, Tremor, XL, XLT; Valve	
1	EGR Gasket	2004	71176	Exc. Ford Explorer Sport Trac XLS, XLT, Ranger Edge, Tremor, XL, XLT; Valve	
1	EGR Gasket	2003-97	70149	Valve	
QTY	OIL COOLER	YEARS	PART NO.	DESCRIPTION	
1	Oil Cooler Gasket	2011-97	72796	Oil cooler O-ring; New Part Number - Check for Availability	
33		2010 - 2000; 4.0L 244 (4015cc) SOHC V6 (12 Valve) 100.4mm Bore			33
MFI; Flex Fuel; Naturally Aspirated Ford Eng.; VIN Code K					
QTY	CYLINDER HEAD	YEARS	PART NO.	DESCRIPTION	
1	Head Gasket	2010-00	26300 PT	Loc. L.H.; Head bolts not incl.; Head bolt replacement required; PermaTorqueMLS® LaserWeld® Technology; Improved design	
1	Head Gasket	2010-00	26301 PT	Loc. R.H.; Head bolts not incl.; Head bolt replacement required; PermaTorqueMLS® LaserWeld® Technology; Improved design	
1	Head Set	2010-04	HS 26300 PT	Head bolts not incl.; Head bolt replacement required; PermaDry® molded rubber valve cover gskts. incl.; Premium valve stem seals incl.	

Ford Truck (Incl. Minivans and SUV's) (Cont.)

33 (cont.)		2010 - 2000; 4.0L 244 (4015cc) SOHC V6 (12 Valve) 100.4mm Bore			33 (cont.)
MFI; Flex Fuel; Naturally Aspirated Ford Eng.; VIN Code K					
QTY	CYLINDER HEAD	YEARS	PART NO.	DESCRIPTION	
1	Head Set	2003-02	HS 9293 PT-2	Head bolts not incl.; Head bolt replacement required; PermaDry® molded rubber valve cover gskts. incl.; Premium valve stem seals incl.	
1	Head Set	2001	HS 9293 PT	Ford Explorer Sport, Explorer Sport Trac Base; To 07/23/00; Head bolts not incl.; Head bolt replacement required; PermaDry® molded rubber valve cover gskts. incl.; Premium valve stem seals incl.	
1	Head Set	2001	HS 9293 PT-1	Exc. Ford Explorer Sport, Explorer Sport Trac Base; Head bolts not incl.; Head bolt replacement required; PermaDry® molded rubber valve cover gskts. incl.; Premium valve stem seals incl.	
1	Head Set	2001	HS 9293 PT-2	Ford Explorer Sport, Explorer Sport Trac Base; From 07/24/00; Head bolts not incl.; Head bolt replacement required; PermaDry® molded rubber valve cover gskts. incl.; Premium valve stem seals incl.	
1	Head Set	2000	HS 9293 PT	Exc. Ford Explorer Eddie Bauer, Limited, Postal, Sport; Head bolts not incl.; Head bolt replacement required; PermaDry® molded rubber valve cover gskts. incl.; Premium valve stem seals incl.	
1	Head Set	2000	HS 9293 PT	Ford Explorer Eddie Bauer, Limited, Postal; Head bolts not incl.; Head bolt replacement required; PermaDry® molded rubber valve cover gskts. incl.; Premium valve stem seals incl.	
1	Head Set	2000	HS 9293 PT	Ford Explorer Sport; To 07/23/00; Head bolts not incl.; Head bolt replacement required; PermaDry® molded rubber valve cover gskts. incl.; Premium valve stem seals incl.	
1	Head Set	2000	HS 9293 PT-2	Ford Explorer Sport; From 07/24/00; Head bolts not incl.; Head bolt replacement required; PermaDry® molded rubber valve cover gskts. incl.; Premium valve stem seals incl.	
2	Head Bolt Set	2010-00	ES 72171	Replacement required	
QTY	CONVERSION SET	YEARS	PART NO.	DESCRIPTION	
1	Gasket Conversion Set	2010-05	CS 9293-1	PermaDry® molded rubber oil pan gskt. incl.	
1	Gasket Conversion Set	2004	CS 9293	To 02/28/04; PermaDry® molded rubber oil pan gskt. incl.	
1	Gasket Conversion Set	2004	CS 9293-1	From 03/01/04; PermaDry® molded rubber oil pan gskt. incl.	
1	Gasket Conversion Set	2003-00	CS 9293	PermaDry® molded rubber oil pan gskt. incl.	
QTY	MANIFOLD - INT. & EXH.	YEARS	PART NO.	DESCRIPTION	
1	Int. Manifold Gasket Set	2010-02	MS 96123	Lower set	
1	Int. Manifold Gasket Set	2001	MS 90890	Ford Explorer Eddie Bauer, Limited, Postal; Lower set; Upper set incl.	
1	Int. Manifold Gasket Set	2001	MS 90890	Ford Explorer XL Fleet, XLS, XLT; Lower set; Upper set incl.	
1	Int. Manifold Gasket Set	2001	MS 90890	Mercury Mountaineer Base; Lower set; Upper set incl.	
1	Int. Manifold Gasket Set	2001	MS 90890	Ford Explorer Sport; To 07/23/00; Lower set; Upper set incl.	
1	Int. Manifold Gasket Set	2001	MS 90890	Ford Explorer Sport Trac Base; To 07/23/00; Lower set; Upper set incl.	
1	Int. Manifold Gasket Set	2001	MS 96123	Ford Explorer Sport, Explorer Sport Trac Base; From 07/24/00; Lower set	
1	Int. Manifold Gasket Set	2000	MS 90890	Exc. Ford Explorer Eddie Bauer, Limited, Postal, Sport; Lower set; Upper set incl.	
1	Int. Manifold Gasket Set	2000	MS 90890	Ford Explorer Eddie Bauer, Limited, Postal; Lower set; Upper set incl.	
1	Int. Manifold Gasket Set	2000	MS 90890	Ford Explorer Sport; To 07/23/00; Lower set; Upper set incl.	
1	Int. Manifold Gasket Set	2000	MS 96123	Ford Explorer Sport; From 07/24/00; Lower set	
1	Exh. Manifold Gasket Set	2010-00	MS 90779		
QTY	EXHAUST PIPE FLANGE	YEARS	PART NO.	DESCRIPTION	
1	Exhaust Pipe Gasket	2010-02	60641	Converter	
1	Exhaust Pipe Gasket	2001-00	61061	Converter	
QTY	OIL PAN	YEARS	PART NO.	DESCRIPTION	
1	Oil Pan Gasket Set	2010-00	OS 30687 R	Loc. Lower; PermaDry® molded rubber gskt. incl.	
1	Oil Pan Gasket Set	2010-00	OS 34309 R	Loc. Upper; PermaDry® molded rubber gskt. incl.	
QTY	CRANKSHAFT REAR SEAL	YEARS	PART NO.	DESCRIPTION	
1	Rear Main Seal Set	2010-00	BS 40619	Wear sleeve incl.; Rubber; One-piece	
1	Rear Main Seal Set	2010-00	BS 40647	PTFE Rubber; One-piece	
QTY	VALVE COVER	YEARS	PART NO.	DESCRIPTION	
1	Valve Cover Gasket Set	2010-02	VS 50529 R	w/Grommets; PermaDry® molded rubber gskts. incl.	
1	Valve Cover Gasket Set	2001	VS 50491 R	Ford Explorer Sport, Explorer Sport Trac Base; To 07/23/00; PermaDry® molded rubber gskts. incl.	
1	Valve Cover Gasket Set	2001	VS 50529 R	Ford Explorer Sport; From 07/24/00; w/Grommets; PermaDry® molded rubber gskts. incl.	
1	Valve Cover Gasket Set	2001	VS 50529 R	Ford Explorer Sport Trac Base; From 07/24/00; w/Grommets; PermaDry® molded rubber gskts. incl.	
1	Valve Cover Gasket Set	2001	VS 50529 R	Ford Explorer Eddie Bauer, Limited, Postal; w/Grommets; PermaDry® molded rubber gskts. incl.	
1	Valve Cover Gasket Set	2001	VS 50529 R	Ford Explorer XL Fleet, XLS, XLT; w/Grommets; PermaDry® molded rubber gskts. incl.	

Ford Truck (Incl. Minivans and SUV's) (Cont.)

33 (cont.)		2010 - 2000; 4.0L 244 (4015cc) SOHC V6 (12 Valve) 100.4mm Bore			33 (cont.)
MFI; Flex Fuel; Naturally Aspirated Ford Eng.; VIN Code K					
QTY	VALVE COVER	YEARS	PART NO.	DESCRIPTION	
1	Valve Cover Gasket Set	2001	VS 50529 R	Mercury Mountaineer Base; w/Grommets; PermaDry® molded rubber gsks. incl.	
1	Valve Cover Gasket Set	2000	VS 50491 R	Exc. Ford Explorer Eddie Bauer, Limited, Postal, Sport; PermaDry® molded rubber gsks. incl.	
1	Valve Cover Gasket Set	2000	VS 50491 R	Ford Explorer Eddie Bauer, Limited, Postal; PermaDry® molded rubber gsks. incl.	
1	Valve Cover Gasket Set	2000	VS 50491 R	Ford Explorer Sport; To 07/23/00; PermaDry® molded rubber gsks. incl.	
1	Valve Cover Gasket Set	2000	VS 50529 R	Ford Explorer Sport; From 07/24/00; w/Grommets; PermaDry® molded rubber gsks. incl.	
QTY	VALVE STEM SEAL SET	YEARS	PART NO.	DESCRIPTION	
1	Valve Stem Seal Set	2010-00	SS 70858	Premium valve stem seals incl.	
QTY	THERMOSTAT HOUSING	YEARS	PART NO.	DESCRIPTION	
1	Thermostat Gasket	2010-02	35673	Thermostat Housing; Thermostat housing to manifold	
1	Thermostat Gasket	2001-00	35673	Thermostat Housing; From 07/24/00; Thermostat housing to manifold	
1	O-Ring	2010-00	35617	Thermostat Housing	
QTY	WATER PUMP	YEARS	PART NO.	DESCRIPTION	
1	Water Pump Gasket	2010-00	35474		
QTY	TIMING COVER	YEARS	PART NO.	DESCRIPTION	
1	Timing Cover Set	2010-05	TCS 46061		
1	Timing Cover Set	2004	TCS 45986	To 02/28/04	
1	Timing Cover Set	2004	TCS 46061	From 03/01/04	
1	Timing Cover Set	2003-00	TCS 45986		
QTY	CARB & FUEL INJECTION	YEARS	PART NO.	DESCRIPTION	
3	Fuel Injector O-Ring Set	2010-00	ES 70599	Improved design	
1	Throttle Body Gasket	2010-00	72302	Air bypass valve	
1	Throttle Body Gasket	2010-02	61347	Throttle body to spacer; Gskt.	
1	Throttle Body Gasket	2010-07	61208	Ford Explorer Sport Trac Limited, XLT	
1	Throttle Body Gasket	2005	61208	Ford Explorer Sport Trac Adrenalin, XLS, XLT	
1	Throttle Body Gasket	2004	61208	Ford Explorer Sport Trac XLS, XLT	
1	Throttle Body Gasket	2004	61208	Ford Explorer Eddie Bauer, Limited, NBX, XLS, XLS Sport, XLT, XLT Sport; To 08/03/03	
1	Throttle Body Gasket	2004	61208	Mercury Mountaineer Base, Convenience, Luxury, Premier; To 08/03/03	
1	Throttle Body Gasket	2003	61208	Ford Explorer Sport Trac XLS, XLT	
1	Throttle Body Gasket	2003	61208	Ford Explorer Eddie Bauer, Limited, Postal, Sport, Sport XLS, Sport XLT, XLS, XLT; To 08/03/03	
1	Throttle Body Gasket	2003	61208	Mercury Mountaineer Base, Convenience, Luxury, Premier; To 08/03/03	
1	Throttle Body Gasket	2002	61208		
1	Throttle Body Gasket	2001-00	61056	Spacer to manifold; O-ring	
1	Throttle Body Gasket	2001-00	61057	Throttle body to spacer; Gskt.	
QTY	EXHAUST GAS RECIRCULATION	YEARS	PART NO.	DESCRIPTION	
1	EGR Gasket	2010-00	71202	Tube seal	
1	EGR Gasket	2010-06	71176	Valve	
1	EGR Gasket	2005	70149	Ford Explorer Sport Trac Adrenalin, XLS, XLT; Valve	
1	EGR Gasket	2005	71176	Exc. Ford Explorer Sport Trac Adrenalin, XLS, XLT; Valve	
1	EGR Gasket	2004	70149	Ford Explorer Sport Trac XLS, XLT; Valve	
1	EGR Gasket	2004	71176	Exc. Ford Explorer Sport Trac XLS, XLT; Valve	
1	EGR Gasket	2003-00	70149	Valve	
QTY	OIL COOLER	YEARS	PART NO.	DESCRIPTION	
1	Oil Cooler Gasket	2010-00	72796	Oil cooler O-ring; New Part Number - Check for Availability	
34		2008 - 1997; 4.2L 256 (4196cc) OHV V6 (12 Valve) 96.8mm Bore			34
MFI; Gasoline; Naturally Aspirated Ford Eng.; VIN Code 2					
QTY	CYLINDER HEAD	YEARS	PART NO.	DESCRIPTION	
1	Head Gasket	2008-97	26505 PT	Loc. L.H.; .010" thicker for use when head is refaced; Head bolts not incl.; Head bolt replacement required; PermaTorqueMLS®	
1	Head Gasket	2008-97	26506 PT	Loc. R.H.; .010" thicker for use when head is refaced; Head bolts not incl.; Head bolt replacement required; PermaTorqueMLS®	
1	Head Gasket	2008-97	9250 PT	Loc. L.H.; Head bolts not incl.; Head bolt replacement required; PermaTorqueMLS®	
1	Head Gasket	2008-97	9253 PT	Loc. R.H.; Head bolts not incl.; Head bolt replacement required; PermaTorqueMLS®	
1	Head Set	2008-05	HS 9250 PT-7	Head bolts not incl.; Head bolt replacement required; PermaDry® molded rubber valve cover gsks. incl.; Premium valve stem seals incl.	

Ford Truck (Incl. Minivans and SUV's) (Cont.)

34 (cont.)		2008 - 1997; 4.2L 256 (4196cc) OHV V6 (12 Valve) 96.8mm Bore			34 (cont.)
MFI; Gasoline; Naturally Aspirated Ford Eng.; VIN Code 2					
QTY	CYLINDER HEAD	YEARS	PART NO.	DESCRIPTION	
1	Head Set	2004	HS 9250 PT-5	Exc. Ford Freestar Limited, SEL Mercury Monterey Base, Convenience, Luxury, Premier; Head bolts not incl.; Head bolt replacement required; PermaDry® molded rubber valve cover gskts. incl.; Premium valve stem seals incl.	
1	Head Set	2004	HS 9250 PT-6	Ford Freestar Limited, SEL Mercury Monterey Base, Convenience, Luxury, Premier; Head bolts not incl.; Head bolt replacement required; PermaDry® molded rubber valve cover gskts. incl.; Premium valve stem seals incl.	
1	Head Set	2003-01	HS 9250 PT-5	Head bolts not incl.; Head bolt replacement required; PermaDry® molded rubber valve cover gskts. incl.; Premium valve stem seals incl.	
1	Head Set	2000-99	HS 9250 PT-2	Head bolts not incl.; Head bolt replacement required; PermaDry® molded rubber valve cover gskts. incl.; Premium valve stem seals incl.; PermaDry® molded rubber valve cover gskts. incl.; Premium valve stem seals incl.	
1	Head Set	1998	HS 9250 PT	To 01/14/98; Upper int. manifold gskt. & head bolts not incl.; Head bolt replacement required; PermaDry® molded rubber valve cover gskts. incl.; Premium valve stem seals incl.	
1	Head Set	1998	HS 9250 PT-2	From 01/15/98; Valve stem seals & head bolts not incl.; Head bolt replacement required; PermaDry® molded rubber valve cover gskts. incl.; PermaDry® molded rubber valve cover gskts. incl.; Premium valve stem seals incl.	
1	Head Set	1997	HS 9250 PT	Upper int. manifold gskt. & head bolts not incl.; Head bolt replacement required; PermaDry® molded rubber valve cover gskts. incl.; Premium valve stem seals incl.	
2	Head Bolt Set	2008-97	ES 72160	Replacement required	
QTY	CONVERSION SET	YEARS	PART NO.	DESCRIPTION	
1	Gasket Conversion Set	2008-01	CS 9250-1	RTV sealant incl. for oil pan gskt.; PermaDryPlus® timing cover gskt. incl.	
1	Gasket Conversion Set	2000-97	CS 9250	RTV sealant incl. for oil pan gskt.; PermaDryPlus® timing cover gskt. incl.	
QTY	MANIFOLD - INT. & EXH.	YEARS	PART NO.	DESCRIPTION	
1	Int. Manifold Gasket Set	2008-05	MS 96451	Lower set; Upper set incl.	
1	Int. Manifold Gasket Set	2004-99	MS 95985	Lower set	
1	Int. Manifold Gasket Set	2004	MS 95985-3	Ford Freestar Limited, SEL Mercury Monterey Base, Convenience, Luxury, Premier; Lower set; Upper set incl.; Must be used w/ES 72204	
1	Int. Manifold Gasket Set	2004	MS 98011 T-3	Exc. Ford Freestar Limited, SEL Mercury Monterey Base, Convenience, Luxury, Premier; Lower set; Int. manifold isolators & Upper set incl.; PermaDryPlus® int. manifold gskts. incl.	
1	Int. Manifold Gasket Set	2003-01	MS 98011 T-3	Lower set; Int. manifold isolators & Upper set incl.; PermaDryPlus® int. manifold gskts. incl.	
1	Int. Manifold Gasket Set	2000-99	MS 98011 T-2	Lower set; Upper set incl.; PermaDryPlus® int. manifold gskts. incl.	
1	Int. Manifold Gasket Set	1998-97	MS 98010 T	To 07/30/97; Lower set; Upper set incl.; PermaDryPlus® int. manifold gskts. incl.	
1	Int. Manifold Gasket Set	1998	MS 95932-1	To 01/14/98; Lower set	
1	Int. Manifold Gasket Set	1998	MS 95985	From 01/15/98; Lower set	
1	Int. Manifold Gasket Set	1998	MS 98010 T-1	From 07/31/97 to 01/14/98; Lower set; Upper set incl.; PermaDryPlus® int. manifold gskts. incl.	
1	Int. Manifold Gasket Set	1998	MS 98011 T-2	From 01/15/98; Lower set; Upper set incl.; PermaDryPlus® int. manifold gskts. incl.	
1	Int. Manifold Gasket Set	1997	MS 95932-1	Lower set	
1	Int. Manifold Gasket Set	1997	MS 98010 T-1	From 07/31/97; Lower set; Upper set incl.; PermaDryPlus® int. manifold gskts. incl.	
1	Plenum Gasket Set	2008-05	MS 96239	Upper set	
1	Plenum Gasket Set	2004	MS 94452	Exc. Ford Freestar Limited, SEL Mercury Monterey Base, Convenience, Luxury, Premier; Upper set	
1	Plenum Gasket Set	2004	MS 96239	Ford Freestar Limited, SEL Mercury Monterey Base, Convenience, Luxury, Premier; Upper set	
1	Plenum Gasket Set	2003-01	MS 94452	Upper set	
1	Plenum Gasket Set	2000-99	MS 95981	Upper set	
1	Plenum Gasket Set	1998-97	MS 95981	From 07/31/97; Upper set	
1	Plenum Gasket Set	1998-97	MS 95982	To 07/30/97; Upper set	
1	Intake Manifold Isolator Grommet Set	2004-01	ES 72204	Replacement required	
1	Exh. Manifold Gasket Set	2008-97	MS 95968		
QTY	OIL PAN	YEARS	PART NO.	DESCRIPTION	
1	Oil Pan Gasket Set	2008-01	OS 30702 R	RTV Black silicone w/Rubber end seal	
1	Oil Pan Gasket Set	2000-97	OS 30625 R	RTV Black silicone w/Rubber end seal	
1	Drain Plug Gasket	2008-97	72515		
QTY	CRANKSHAFT REAR SEAL	YEARS	PART NO.	DESCRIPTION	
1	Rear Main Seal Set	2008-97	BS 40620	Rubber; One-piece; Improved design	

Ford Truck (Incl. Minivans and SUV's) (Cont.)

34 (cont.)		2008 - 1997; 4.2L 256 (4196cc) OHV V6 (12 Valve) 96.8mm Bore			34 (cont.)
		MFI; Gasoline; Naturally Aspirated Ford Eng.; VIN Code 2			
QTY	CRANKSHAFT REAR SEAL	YEARS	PART NO.	DESCRIPTION	
1	Rear Main Seal Set	2008-97	BS 40644	PTFE Rubber; One-piece	
1	Repair Sleeve	2008-97	16250	Crankshaft; Use w/installation tool	
1	Repair Sleeve Tool	2008-97	16300	Crankshaft	
QTY	VALVE COVER	YEARS	PART NO.	DESCRIPTION	
1	Valve Cover Gasket Set	2008-97	VS 50441 R	w/Grommets; PermaDry® molded rubber gskts. incl.	
1	Valve Cover Gasket Set	2008-97	VS 50441 R-1	w/o Grommets; PermaDry® molded rubber gskts. incl.	
QTY	VALVE STEM SEAL SET	YEARS	PART NO.	DESCRIPTION	
1	Valve Stem Seal Set	2008-99	SS 70864-1	Premium valve stem seals incl.	
1	Valve Stem Seal Set	1998-97	SS 72875-1	Premium valve stem seals incl.	
QTY	THERMOSTAT HOUSING	YEARS	PART NO.	DESCRIPTION	
1	Water Outlet Gasket	1997	35390	Thermostat Housing; w/o Notch	
1	Water Outlet Gasket	1997	35390 T	Thermostat Housing; w/o Notch; PermaDryPlus®	
1	O-Ring	1997	35708	Thermostat Housing; Seal; w/Notch	
QTY	WATER OUTLET GASKET	YEARS	PART NO.	DESCRIPTION	
1	Water Outlet Gasket	2008-98	35390	Water Outlet	
1	Water Outlet Gasket	2008-98	35390 T	Water Outlet; PermaDryPlus®	
QTY	WATER PUMP	YEARS	PART NO.	DESCRIPTION	
1	Water Pump Gasket	2008-97	35431		
2	O-Ring	2008-97	413	Water Pump; Water pump bypass pipe O-ring	
QTY	TIMING COVER	YEARS	PART NO.	DESCRIPTION	
1	Timing Cover Set	2008-97	TCS 45984	PermaDryPlus® timing cover gskt. incl.	
1	Timing Cover Gasket	2008-97	72754	PermaDryPlus® timing cover gskt. incl.; New Part Number - Check for Availability	
QTY	CARB & FUEL INJECTION	YEARS	PART NO.	DESCRIPTION	
2	Fuel Injector O-Ring Set	2008-97	ES 70599	Improved design	
1	Throttle Body Gasket	2008-97	61046	O-ring	
1	Throttle Body Gasket	2008-97	61052	Gskt.	
1	Throttle Body Gasket	2008-05	72302	Air bypass valve	
1	Throttle Body Gasket	2004-97	71216	Air bypass valve	
QTY	EXHAUST GAS RECIRCULATION	YEARS	PART NO.	DESCRIPTION	
1	EGR Gasket	2008-05	71176		
1	EGR Gasket	2004	70149	Exc. Ford Freestar Limited, SEL Mercury Monterey Base, Convenience, Luxury, Premier	
1	EGR Gasket	2004	71176	Ford Freestar Limited, SEL Mercury Monterey Base, Convenience, Luxury, Premier	
1	EGR Gasket	2003-97	70149		
QTY	OIL COOLER	YEARS	PART NO.	DESCRIPTION	
1	Oil Cooler Gasket	2008-97	72655	Oil cooler seal; New Part Number - Check for Availability	
35		2005; 4.6L 281 (4605cc) DOHC V8 (32 Valve) 90.2mm Bore Intech			35
		MFI; Gasoline; Naturally Aspirated Ford Eng.; VIN Code A			
QTY	CYLINDER HEAD	YEARS	PART NO.	DESCRIPTION	
1	Head Gasket	2005	9790 PT-2	Loc. R.H.; Head bolts not incl.; Head bolt replacement recommended; PermaTorqueMLS®; Improved design	
1	Head Gasket	2005	9792 PT-2	Loc. L.H.; Head bolts not incl.; Head bolt replacement recommended; PermaTorqueMLS®; Improved design	
1	Head Set	2005	HS 9790 PT-20	Head bolts not incl.; Head bolt replacement recommended; PermaDry® molded rubber valve cover gskts. incl.; Premium valve stem seals incl.	
2	Head Bolt Set	2005	ES 71328	Head bolts w/Washers; Replacement recommended; Improved design	
2	Head Bolt Set	2005	ES 72798	Head bolts w/Washers; Replacement recommended; May use ES 71328 instead; Old design	
QTY	CONVERSION SET	YEARS	PART NO.	DESCRIPTION	
1	Gasket Conversion Set	2005	CS 9790-4	PermaDry® molded rubber oil pan gskt. incl.; Consolidated design	
QTY	MANIFOLD - INT. & EXH.	YEARS	PART NO.	DESCRIPTION	
1	Int. Manifold Gasket Set	2005	MS 96139-2	Lower set; Upper set incl.	
1	Exh. Manifold Gasket Set	2005	MS 95949		
QTY	OIL PAN	YEARS	PART NO.	DESCRIPTION	
1	Oil Pan Gasket Set	2005	OS 30725 R	PermaDry® molded rubber gskt. incl.; Improved design	
1	Drain Plug Gasket	2005	72515		
QTY	CRANKSHAFT REAR SEAL	YEARS	PART NO.	DESCRIPTION	
1	Rear Main Seal Set	2005	BS 40620	Rubber; One-piece; Improved design	
1	Rear Main Seal Set	2005	BS 40644	PTFE Rubber; One-piece	

Ford Truck (Incl. Minivans and SUV's) (Cont.)

35 (cont.)		2005; 4.6L 281 (4605cc) DOHC V8 (32 Valve) 90.2mm Bore Intech			35 (cont.)
MFI; Gasoline; Naturally Aspirated Ford Eng.; VIN Code A					
QTY	CRANKSHAFT REAR SEAL	YEARS	PART NO.	DESCRIPTION	
1	Repair Sleeve	2005	16255-1	Crankshaft; 1.105" - 1.135" sleeve length; Use w/installation tool; Improved design	
1	Repair Sleeve Tool	2005	16306	Crankshaft	
QTY	VALVE COVER	YEARS	PART NO.	DESCRIPTION	
1	Valve Cover Gasket Set	2005	VS 50477 R	w/Grommets & Spark plug tube seals; PermaDry® molded rubber gskts. incl.; Improved design	
1	Valve Cover Gasket Set	2005	VS 50477 R-1	w/Grommets & Spark plug tube seals; PermaDry® molded rubber gskts. incl.; Old design	
QTY	VALVE STEM SEAL SET	YEARS	PART NO.	DESCRIPTION	
1	Valve Stem Seal Set	2005	SS 72888	Premium valve stem seals incl.	
QTY	WATER OUTLET GASKET	YEARS	PART NO.	DESCRIPTION	
1	Water Outlet Gasket	2005	35489	Water Outlet	
QTY	WATER PUMP	YEARS	PART NO.	DESCRIPTION	
1	Water Pump Gasket	2005	35478		
2	O-Ring	2005	413	Water Pump; Water pump bypass pipe O-ring	
QTY	TIMING COVER	YEARS	PART NO.	DESCRIPTION	
1	Timing Cover Set	2005	TCS 45980	Repair sleeve not incl.	
1	Crankshaft Front Seal Set	2005	TCS 46114		
1	Repair Sleeve	2005	16207	Timing Cover; Use w/installation tool	
1	Repair Sleeve Tool	2005	16310	Timing Cover	
QTY	CARB & FUEL INJECTION	YEARS	PART NO.	DESCRIPTION	
4	Fuel Injector O-Ring Set	2005	ES 70599	Improved design	
1	Throttle Body Gasket	2005	61050	Housing to spacer	
1	Throttle Body Gasket	2005	71216	Air bypass valve	
QTY	EXHAUST GAS RECIRCULATION	YEARS	PART NO.	DESCRIPTION	
1	EGR Gasket	2005	71176	Valve	
QTY	OIL FILTER MOUNTING	YEARS	PART NO.	DESCRIPTION	
1	Oil Filter Adapter Gasket	2005	70801		
36		2004 - 2003; 4.6L 281 (4605cc) DOHC V8 (32 Valve) 90.2mm Bore Intech			36
MFI; Gasoline; Naturally Aspirated Ford Eng.; VIN Code H					
QTY	CYLINDER HEAD	YEARS	PART NO.	DESCRIPTION	
1	Head Gasket	2004-03	26188 PT	Loc. L.H.; Head bolts not incl.; Head bolt replacement recommended; PermaTorqueMLS® LaserWeld® Technology	
1	Head Gasket	2004-03	26217 PT	Loc. R.H.; Head bolts not incl.; Head bolt replacement recommended; PermaTorqueMLS® LaserWeld® Technology	
1	Head Set	2004-03	HS 26188 PT-1	Head bolts not incl.; Head bolt replacement recommended; PermaDry® molded rubber valve cover gskts. incl.; Premium valve stem seals incl.	
2	Head Bolt Set	2004-03	ES 71328	Head bolts w/Washers; Replacement recommended; Improved design	
2	Head Bolt Set	2004-03	ES 72798	Head bolts w/Washers; Replacement recommended; May use ES 71328 instead; Old design	
QTY	CONVERSION SET	YEARS	PART NO.	DESCRIPTION	
1	Gasket Conversion Set	2004-03	CS 9790-4	PermaDry® molded rubber oil pan gskt. incl.; Consolidated design	
QTY	MANIFOLD - INT. & EXH.	YEARS	PART NO.	DESCRIPTION	
1	Int. Manifold Gasket Set	2004-03	MS 96139-2	Lower set; Upper set incl.	
1	Exh. Manifold Gasket Set	2004-03	MS 95949		
QTY	OIL PAN	YEARS	PART NO.	DESCRIPTION	
1	Oil Pan Gasket Set	2004-03	OS 30725 R	PermaDry® molded rubber gskt. incl.; Improved design	
1	Drain Plug Gasket	2004-03	72515		
QTY	CRANKSHAFT REAR SEAL	YEARS	PART NO.	DESCRIPTION	
1	Rear Main Seal Set	2004-03	BS 40620	Rubber; One-piece; Improved design	
1	Rear Main Seal Set	2004-03	BS 40644	PTFE Rubber; One-piece	
1	Repair Sleeve	2004-03	16255-1	Crankshaft; 1.105" - 1.135" sleeve length; Use w/installation tool; Improved design	
1	Repair Sleeve Tool	2004-03	16306	Crankshaft	
QTY	VALVE COVER	YEARS	PART NO.	DESCRIPTION	
1	Valve Cover Gasket Set	2004-03	VS 50477 R	w/Grommets & Spark plug tube seals; PermaDry® molded rubber gskts. incl.; Improved design	
1	Valve Cover Gasket Set	2004-03	VS 50477 R-1	w/Grommets & Spark plug tube seals; PermaDry® molded rubber gskts. incl.; Old design	
QTY	VALVE STEM SEAL SET	YEARS	PART NO.	DESCRIPTION	
1	Valve Stem Seal Set	2004-03	SS 72888	Premium valve stem seals incl.	
QTY	WATER OUTLET GASKET	YEARS	PART NO.	DESCRIPTION	
1	Water Outlet Gasket	2004-03	35489	Water Outlet	

Ford Truck (Incl. Minivans and SUV's) (Cont.)

36 (cont.)		2004 - 2003; 4.6L 281 (4605cc) DOHC V8 (32 Valve) 90.2mm Bore Intech			36 (cont.)
MFI; Gasoline; Naturally Aspirated Ford Eng.; VIN Code H					
QTY	WATER PUMP	YEARS	PART NO.	DESCRIPTION	
1	Water Pump Gasket	2004-03	35478		
2	O-Ring	2004-03	413	Water Pump; Water pump bypass pipe O-ring	
QTY	TIMING COVER	YEARS	PART NO.	DESCRIPTION	
1	Timing Cover Set	2004-03	TCS 45980	Repair sleeve not incl.	
1	Crankshaft Front Seal Set	2004-03	TCS 46114		
1	Repair Sleeve	2004-03	16207	Timing Cover; Use w/installation tool	
1	Repair Sleeve Tool	2004-03	16310	Timing Cover	
QTY	CARB & FUEL INJECTION	YEARS	PART NO.	DESCRIPTION	
4	Fuel Injector O-Ring Set	2004-03	ES 70599	Improved design	
1	Throttle Body Gasket	2004-03	61050	Housing to spacer	
1	Throttle Body Gasket	2004-03	71216	Air bypass valve	
QTY	EXHAUST GAS RECIRCULATION	YEARS	PART NO.	DESCRIPTION	
1	EGR Gasket	2004-03	71176	Valve	
QTY	OIL FILTER MOUNTING	YEARS	PART NO.	DESCRIPTION	
1	Oil Filter Adapter Gasket	2004-03	70801		
37		2013 - 2006; 4.6L 281 (4605cc) SOHC V8 (16 Valve) 90.2mm Bore Triton			37
MFI; Flex Fuel; Naturally Aspirated Ford Eng.; VIN Code V					
QTY	CYLINDER HEAD	YEARS	PART NO.	DESCRIPTION	
1	Head Gasket	2012-09	26482 PT	Loc. L.H.; Head bolts not incl.; Head bolt replacement recommended; PermaTorqueMLS®	
1	Head Gasket	2012-09	26483 PT	Loc. R.H.; Head bolts not incl.; Head bolt replacement recommended; PermaTorqueMLS®	
1	Head Gasket	2008-06	9790 PT-2	Loc. R.H.; Head bolts not incl.; Head bolt replacement recommended; PermaTorqueMLS®; Improved design	
1	Head Gasket	2008-06	9792 PT-2	Loc. L.H.; Head bolts not incl.; Head bolt replacement recommended; PermaTorqueMLS®; Improved design	
1	Head Set	2008-06	HS 9792 PT-9	Head bolts not incl.; Head bolt replacement recommended; PermaDry® molded rubber valve cover gskts. incl.; Premium valve stem seals incl.	
2	Head Bolt Set	2012-06	ES 71328	Head bolts w/Washers; Replacement recommended; Improved design	
2	Head Bolt Set	2012-06	ES 72798	Head bolts w/Washers; Replacement recommended; May use ES 71328 instead; Old design	
QTY	CONVERSION SET	YEARS	PART NO.	DESCRIPTION	
1	Gasket Conversion Set	2012-06	CS 9790-4	PermaDry® molded rubber oil pan gskt. incl.; Consolidated design	
QTY	MANIFOLD - INT. & EXH.	YEARS	PART NO.	DESCRIPTION	
1	Int. Manifold Gasket Set	2012-06	MS 96281-1	Lower set; Upper set incl.	
1	Plenum Gasket Set	2012-06	MS 92614	Upper set	
1	Exh. Manifold Gasket Set	2012-06	MS 92568	Improved design	
QTY	OIL PAN	YEARS	PART NO.	DESCRIPTION	
1	Oil Pan Gasket Set	2012-06	OS 30725 R	PermaDry® molded rubber gskt. incl.; Improved design	
1	Drain Plug Gasket	2012-06	72515		
QTY	CRANKSHAFT REAR SEAL	YEARS	PART NO.	DESCRIPTION	
1	Rear Main Seal Set	2012-06	BS 40620	Rubber; One-piece; Improved design	
1	Rear Main Seal Set	2012-06	BS 40644	PTFE Rubber; One-piece	
1	Repair Sleeve	2012-06	16270	Crankshaft; Use w/installation tool	
QTY	VALVE COVER	YEARS	PART NO.	DESCRIPTION	
1	Valve Cover Gasket Set	2012-06	VS 50564 R	w/Grommets; PermaDry® molded rubber gskts. incl.	
QTY	VALVE STEM SEAL SET	YEARS	PART NO.	DESCRIPTION	
1	Valve Stem Seal Set	2012-06	SS 72891	Premium valve stem seals incl.; Improved design	
QTY	WATER OUTLET GASKET	YEARS	PART NO.	DESCRIPTION	
1	Water Outlet Gasket	2012-06	35489	Water Outlet	
1	Water Outlet Gasket	2012-06	35957	Water Crossover; Loc. R.H.; New Part Number - Check for Availability	
1	Water Outlet Gasket	2012-06	35958	Water Crossover; Loc. L.H.; New Part Number - Check for Availability	
QTY	WATER PUMP	YEARS	PART NO.	DESCRIPTION	
1	Water Pump Gasket	2012-06	35478		
2	O-Ring	2013-06	413	Water Pump; Water pump bypass pipe O-ring	
QTY	TIMING COVER	YEARS	PART NO.	DESCRIPTION	
1	Timing Cover Set	2012-06	TCS 45869-1	Repair sleeve not incl.	
1	Crankshaft Front Seal Set	2012-06	TCS 46114		
1	Repair Sleeve	2012-06	16207	Timing Cover; Use w/installation tool	
1	Repair Sleeve Tool	2012-06	16310	Timing Cover	
QTY	CARB & FUEL INJECTION	YEARS	PART NO.	DESCRIPTION	
4	Fuel Injector O-Ring Set	2012-06	ES 70599	Improved design	

Ford Truck (Incl. Minivans and SUV's) (Cont.)

37 (cont.)		2013 - 2006; 4.6L 281 (4605cc) SOHC V8 (16 Valve) 90.2mm Bore Triton			37 (cont.)
MFI; Flex Fuel; Naturally Aspirated Ford Eng.; VIN Code V					
QTY	CARB & FUEL INJECTION	YEARS	PART NO.	DESCRIPTION	
1	Throttle Body Gasket	2012-06	61048	Spacer to manifold	
1	Throttle Body Gasket	2012-06	71216	Air bypass valve	
1	Throttle Body Gasket	2012-07	61671	Housing to spacer; New Part Number - Check for Availability	
1	Throttle Body Gasket	2006	61050	Housing to spacer	
QTY	EXHAUST GAS RECIRCULATION	YEARS	PART NO.	DESCRIPTION	
1	EGR Gasket	2012-06	71176		
QTY	OIL FILTER MOUNTING	YEARS	PART NO.	DESCRIPTION	
1	Oil Filter Adapter Gasket	2012-06	70801		
38		2013 - 1997; 4.6L 281 (4605cc) SOHC V8 (16 Valve) 90.2mm Bore Triton Romeo			38
MFI; Gasoline; Naturally Aspirated Ford Eng.; VIN Code W					
QTY	CYLINDER HEAD	YEARS	PART NO.	DESCRIPTION	
1	Head Gasket	2012-09	26482 PT	Loc. L.H.; Head bolts not incl.; Head bolt replacement recommended; PermaTorqueMLS®	
1	Head Gasket	2012-09	26483 PT	Loc. R.H.; Head bolts not incl.; Head bolt replacement recommended; PermaTorqueMLS®	
1	Head Gasket	2008-03	9790 PT-2	Loc. R.H.; Head bolts not incl.; Head bolt replacement recommended; PermaTorqueMLS®; Improved design	
1	Head Gasket	2008-03	9792 PT-2	Loc. L.H.; Head bolts not incl.; Head bolt replacement recommended; PermaTorqueMLS®; Improved design	
1	Head Gasket	2002	26237 PT	Ford Explorer Eddie Bauer, Limited, Postal, XLT Mercury Mountaineer Base; Loc. L.H.; To 02/17/02; Head bolts not incl.; Head bolt replacement recommended; PermaTorqueMLS®	
1	Head Gasket	2002	26238 PT	Ford Explorer Eddie Bauer, Limited, Postal, XLT Mercury Mountaineer Base; Loc. R.H.; To 02/17/02; Head bolts not incl.; Head bolt replacement recommended; PermaTorqueMLS®	
1	Head Gasket	2002	9790 PT-2	Ford Explorer Eddie Bauer, Limited, Postal, XLT; Loc. R.H.; From 02/18/02; Head bolts not incl.; Head bolt replacement recommended; PermaTorqueMLS®; Improved design	
1	Head Gasket	2002	9790 PT-2	Mercury Mountaineer Base; Loc. R.H.; From 02/18/02; Head bolts not incl.; Head bolt replacement recommended; PermaTorqueMLS®; Improved design	
1	Head Gasket	2002	9790 PT-2	Exc. Ford Explorer Eddie Bauer, Limited, Postal, XLT, F-150 Pickup King Ranch, Lariat, XL, XLT Mercury Mountaineer Base; Loc. R.H.; Head bolts not incl.; Head bolt replacement recommended; PermaTorqueMLS®; Improved design	
1	Head Gasket	2002	9790 PT-2	Ford F-150 Pickup King Ranch, Lariat, XL, XLT; Loc. R.H.; Head bolts not incl.; Head bolt replacement recommended; PermaTorqueMLS®; Improved design	
1	Head Gasket	2002	9792 PT-2	Ford Explorer Eddie Bauer, Limited, Postal, XLT; Loc. L.H.; From 02/18/02; Head bolts not incl.; Head bolt replacement recommended; PermaTorqueMLS®; Improved design	
1	Head Gasket	2002	9792 PT-2	Mercury Mountaineer Base; Loc. L.H.; From 02/18/02; Head bolts not incl.; Head bolt replacement recommended; PermaTorqueMLS®; Improved design	
1	Head Gasket	2002	9792 PT-2	Exc. Ford Explorer Eddie Bauer, Limited, Postal, XLT, F-150 Pickup King Ranch, Lariat, XL, XLT Mercury Mountaineer Base; Loc. L.H.; Head bolts not incl.; Head bolt replacement recommended; PermaTorqueMLS®; Improved design	
1	Head Gasket	2002	9792 PT-2	Ford F-150 Pickup King Ranch, Lariat, XL, XLT; Loc. L.H.; Head bolts not incl.; Head bolt replacement recommended; PermaTorqueMLS®; Improved design	
1	Head Gasket	2001-97	9790 PT-2	Loc. R.H.; Head bolts not incl.; Head bolt replacement recommended; PermaTorqueMLS®; Improved design	
1	Head Gasket	2001-97	9792 PT-2	Loc. L.H.; Head bolts not incl.; Head bolt replacement recommended; PermaTorqueMLS®; Improved design	
1	Head Set	2008-06	HS 9792 PT-9	Head bolts not incl.; Head bolt replacement recommended; PermaDry® molded rubber valve cover gskts. incl.; Premium valve stem seals incl.	
1	Head Set	2005-04	HS 9792 PT-8	Ford Explorer Eddie Bauer, Limited, NBX, XLT, XLT Sport Mercury Mountaineer Base, Convenience, Luxury, Premier; Head bolts not incl.; Head bolt replacement recommended; PermaDry® molded rubber valve cover gskts. incl.; Premium valve stem seals incl.	

Ford Truck (Incl. Minivans and SUV's) (Cont.)

38 (cont.)		2013 - 1997; 4.6L 281 (4605cc) SOHC V8 (16 Valve) 90.2mm Bore Triton Romeo			38 (cont.)
MFI; Gasoline; Naturally Aspirated Ford Eng.; VIN Code W					
QTY	CYLINDER HEAD	YEARS	PART NO.	DESCRIPTION	
1	Head Set	2005	HS 9792 PT-9	Exc. Ford Explorer Eddie Bauer, Limited, NBX, XLT, XLT Sport Mercury Mountaineer Base, Convenience, Luxury, Premier; Head bolts not incl.; Head bolt replacement recommended; PermaDry® molded rubber valve cover gskts. incl.; Premium valve stem seals incl.	
1	Head Set	2004	HS 9790 PT-17	Ford Expedition Eddie Bauer, NBX, XLS, XLT, XLT Sport; Head bolts not incl.; Head bolt replacement recommended; PermaDry® molded rubber valve cover gskts. incl.; Premium valve stem seals incl.	
1	Head Set	2004	HS 9792 PT-9	Ford E-150 Econoline Base, E-150 Econoline Club Wagon Chateau, XL, XLT, E-250 Econoline Base, F-150 Heritage XL, XLT, F-150 Pickup Lariat, STX, XL, XLT; Head bolts not incl.; Head bolt replacement recommended; PermaDry® molded rubber valve cover gskts. incl.; Premium valve stem seals incl.	
1	Head Set	2003	HS 9790 PT-17	Exc. Ford Explorer Eddie Bauer, Limited, Postal, Sport, XLT Mercury Mountaineer Base, Convenience, Luxury, Premier; Head bolts not incl.; Head bolt replacement recommended; PermaDry® molded rubber valve cover gskts. incl.; Premium valve stem seals incl.	
1	Head Set	2003	HS 9792 PT-8	Ford Explorer Eddie Bauer, Limited, Postal, Sport, XLT Mercury Mountaineer Base, Convenience, Luxury, Premier; Head bolts not incl.; Head bolt replacement recommended; PermaDry® molded rubber valve cover gskts. incl.; Premium valve stem seals incl.	
1	Head Set	2002	HS 9790 PT-10	Ford Expedition Eddie Bauer, XLT; Head bolts not incl.; Head bolt replacement recommended; PermaDry® molded rubber valve cover gskts. incl.; Premium valve stem seals incl.	
1	Head Set	2002	HS 9790 PT-17	Exc. Ford Expedition Eddie Bauer, XLT, Explorer Eddie Bauer, Limited, Postal, XLT Mercury Mountaineer Base; Head bolts not incl.; Head bolt replacement recommended; PermaDry® molded rubber valve cover gskts. incl.; Premium valve stem seals incl.	
1	Head Set	2002	HS 9792 PT-8	Ford Explorer Eddie Bauer, Limited, Postal, XLT Mercury Mountaineer Base; From 02/18/02 to 03/04/02; Valve cover gskts. & head bolts not incl.; Head bolt replacement recommended; Premium valve stem seals incl.	
1	Head Set	2002	HS 9792 PT-8	Ford Explorer Eddie Bauer, Limited, Postal, XLT Mercury Mountaineer Base; From 03/05/02; Head bolts not incl.; Head bolt replacement recommended; PermaDry® molded rubber valve cover gskts. incl.; Premium valve stem seals incl.	
1	Head Set	2001	HS 9790 PT-10	Head bolts not incl.; Head bolt replacement recommended; PermaDry® molded rubber valve cover gskts. incl.; Premium valve stem seals incl.	
1	Head Set	2000	HS 9790 PT-9	Head bolts not incl.; Head bolt replacement recommended; PermaDry® molded rubber valve cover gskts. incl.; Premium valve stem seals incl.	
1	Head Set	1999-97	HS 9790 PT-8	Int. manifold gskts. w/Pins inside rubber beads; Head bolts not incl.; Head bolt replacement recommended; PermaDry® molded rubber valve cover gskts. incl.; Premium valve stem seals incl.	
2	Head Bolt Set	2012-97	ES 71328	Head bolts w/Washers; Replacement recommended; Improved design	
2	Head Bolt Set	2012-97	ES 72798	Head bolts w/Washers; Replacement recommended; May use ES 71328 instead; Old design	
QTY	CONVERSION SET	YEARS	PART NO.	DESCRIPTION	
1	Gasket Conversion Set	2012-05	CS 9790-4	PermaDry® molded rubber oil pan gskt. incl.; Consolidated design	
1	Gasket Conversion Set	2004	CS 9790-4	Exc. Ford E-150 Econoline Base, E-150 Econoline Club Wagon Chateau, XL, XLT, E-250 Econoline Base; PermaDry® molded rubber oil pan gskt. incl.; Consolidated design	
1	Gasket Conversion Set	2004	CS 9790-5	Ford E-150 Econoline Base, E-150 Econoline Club Wagon Chateau, XL, XLT, E-250 Econoline Base; PermaDry® molded rubber oil pan gskt. incl.; Consolidated design	
1	Gasket Conversion Set	2003	CS 9790-4	Ford Explorer Eddie Bauer, Limited, Postal, Sport, XLT Mercury Mountaineer Base, Convenience, Luxury, Premier; PermaDry® molded rubber oil pan gskt. incl.; Consolidated design	
1	Gasket Conversion Set	2003	CS 9790-5	Exc. Ford Explorer Eddie Bauer, Limited, Postal, Sport, XLT Mercury Mountaineer Base, Convenience, Luxury, Premier; PermaDry® molded rubber oil pan gskt. incl.; Consolidated design	
1	Gasket Conversion Set	2002	CS 9790-4	Ford Explorer Eddie Bauer, Limited, Postal, XLT Mercury Mountaineer Base; PermaDry® molded rubber oil pan gskt. incl.; Consolidated design	
1	Gasket Conversion Set	2002	CS 9790-5	Exc. Ford Explorer Eddie Bauer, Limited, Postal, XLT Mercury Mountaineer Base; PermaDry® molded rubber oil pan gskt. incl.; Consolidated design	
1	Gasket Conversion Set	2001-99	CS 9790-5	PermaDry® molded rubber oil pan gskt. incl.; Consolidated design	
1	Gasket Conversion Set	1998-97	CS 9790-4	PermaDry® molded rubber oil pan gskt. incl.; Consolidated design	
QTY	MANIFOLD - INT. & EXH.	YEARS	PART NO.	DESCRIPTION	
1	Int. Manifold Gasket Set	2012-06	MS 96281-1	Lower set; Upper set incl.	

Ford Truck (Incl. Minivans and SUV's) (Cont.)

38 (cont.)		2013 - 1997; 4.6L 281 (4605cc) SOHC V8 (16 Valve) 90.2mm Bore Triton Romeo			38 (cont.)
MFI; Gasoline; Naturally Aspirated Ford Eng.; VIN Code W					
QTY	MANIFOLD - INT. & EXH.	YEARS	PART NO.	DESCRIPTION	
1	Int. Manifold Gasket Set	2005-04	MS 96281	Ford Explorer Eddie Bauer, Limited, NBX, XLT, XLT Sport Mercury Mountaineer Base, Convenience, Luxury, Premier; Lower set; Upper set incl.	
1	Int. Manifold Gasket Set	2005	MS 96281-1	Exc. Ford Explorer Eddie Bauer, Limited, NBX, XLT, XLT Sport Mercury Mountaineer Base, Convenience, Luxury, Premier; Lower set; Upper set incl.	
1	Int. Manifold Gasket Set	2004	MS 92121-2	Ford Expedition Eddie Bauer, NBX, XLS, XLT, XLT Sport; Lower set; Upper set incl.; Consolidated design	
1	Int. Manifold Gasket Set	2004	MS 96281-1	Ford E-150 Econoline Base, E-150 Econoline Club Wagon Chateau, XL, XLT, E-250 Econoline Base, F-150 Heritage XL, XLT, F-150 Pickup Lariat, STX, XL, XLT; Lower set; Upper set incl.	
1	Int. Manifold Gasket Set	2004	MS 98008 T	Ford Expedition Eddie Bauer, NBX, XLS, XLT, XLT Sport; Lower set; Upper set incl.; PermaDryPlus® int. manifold gskts. incl.	
1	Int. Manifold Gasket Set	2003	MS 92121-2	Exc. Ford Explorer Eddie Bauer, Limited, Postal, Sport, XLT Mercury Mountaineer Base, Convenience, Luxury, Premier; Lower set; Upper set incl.; Consolidated design	
1	Int. Manifold Gasket Set	2003	MS 96281	Ford Explorer Eddie Bauer, Limited, Postal, Sport, XLT Mercury Mountaineer Base, Convenience, Luxury, Premier; Lower set; Upper set incl.	
1	Int. Manifold Gasket Set	2003	MS 98008 T	Exc. Ford Explorer Eddie Bauer, Limited, Postal, Sport, XLT Mercury Mountaineer Base, Convenience, Luxury, Premier; Lower set; Upper set incl.; PermaDryPlus® int. manifold gskts. incl.	
1	Int. Manifold Gasket Set	2002	MS 92121-2	Exc. Ford Explorer Eddie Bauer, Limited, Postal, XLT Mercury Mountaineer Base; Lower set; Upper set incl.; Consolidated design	
1	Int. Manifold Gasket Set	2002	MS 96281	Ford Explorer Eddie Bauer, Limited, Postal, XLT Mercury Mountaineer Base; Lower set; Upper set incl.	
1	Int. Manifold Gasket Set	2002	MS 98008 T	Exc. Ford Explorer Eddie Bauer, Limited, Postal, XLT Mercury Mountaineer Base; Lower set; Upper set incl.; PermaDryPlus® int. manifold gskts. incl.	
1	Int. Manifold Gasket Set	2001	MS 92121-2	Lower set; Upper set incl.; Consolidated design	
1	Int. Manifold Gasket Set	2001	MS 98008 T	Lower set; Upper set incl.; PermaDryPlus® int. manifold gskts. incl.	
1	Int. Manifold Gasket Set	2000	MS 92121-1	Lower set; Upper set incl.	
1	Int. Manifold Gasket Set	2000	MS 98008 T-2	Lower set; Upper set incl.; PermaDryPlus® int. manifold gskts. incl.	
1	Int. Manifold Gasket Set	1999-97	MS 95728-1	w/Pins inside rubber beads; Lower set; Upper set incl.	
1	Int. Manifold Gasket Set	1999-97	MS 98007 T	w/Pins inside rubber beads; Lower set; Upper set incl.; PermaDryPlus® int. manifold gskts. incl.	
1	Int. Manifold Gasket Set	1999-97	MS 98007 T	w/Pins outside rubber beads; Lower set; Upper set incl.; PermaDryPlus® int. manifold gskts. incl.	
1	Int. Manifold Gasket Set	1999-97	MS 92188	w/Pins outside rubber beads; Lower set; Upper set incl.	
1	Plenum Gasket Set	2012-06	MS 92614	Upper set	
1	Plenum Gasket Set	2005-04	MS 92614	Exc. Ford Explorer Eddie Bauer, Limited, NBX, XLT, XLT Sport Mercury Mountaineer Base, Convenience, Luxury, Premier; Upper set	
1	Plenum Gasket Set	2003	MS 92614	Exc. Ford Explorer Eddie Bauer, Limited, Postal, Sport, XLT Mercury Mountaineer Base, Convenience, Luxury, Premier; Upper set	
1	Plenum Gasket Set	2002	MS 92614	Exc. Ford Explorer Eddie Bauer, Limited, Postal, XLT Mercury Mountaineer Base; Upper set	
1	Plenum Gasket Set	2001	MS 92614	Upper set	
1	Plenum Gasket Set	2000	MS 96144	Upper set	
1	Plenum Gasket Set	1999-97	MS 95962	Upper set	
1	Exh. Manifold Gasket Set	2012-97	MS 92568	Improved design	
QTY	OIL PAN	YEARS	PART NO.	DESCRIPTION	
1	Oil Pan Gasket Set	2012-97	OS 30725 R	PermaDry® molded rubber gskt. incl.; Improved design	
1	Drain Plug Gasket	2012-97	72515		
QTY	CRANKSHAFT REAR SEAL	YEARS	PART NO.	DESCRIPTION	
1	Rear Main Seal Set	2012-97	BS 40620	Rubber; One-piece; Improved design	
1	Rear Main Seal Set	2012-97	BS 40644	PTFE Rubber; One-piece	
1	Repair Sleeve	2012-97	16270	Crankshaft; Use w/installation tool	
QTY	VALVE COVER	YEARS	PART NO.	DESCRIPTION	
1	Valve Cover Gasket Set	2012-03	VS 50564 R	w/Grommets; PermaDry® molded rubber gskts. incl.	
1	Valve Cover Gasket Set	2002	VS 50377 R	Ford Explorer Eddie Bauer, Limited, Postal, XLT Mercury Mountaineer Base; To 03/04/02; w/Grommets; PermaDry® molded rubber gskts. incl.	
1	Valve Cover Gasket Set	2002	VS 50377 R	Ford Expedition Eddie Bauer, XLT; w/Grommets; PermaDry® molded rubber gskts. incl.	
1	Valve Cover Gasket Set	2002	VS 50377 R-1	Ford Explorer Eddie Bauer, Limited, Postal, XLT Mercury Mountaineer Base; To 03/04/02; w/o Grommets; PermaDry® molded rubber gskts. incl.	
1	Valve Cover Gasket Set	2002	VS 50377 R-1	Ford Expedition Eddie Bauer, XLT; w/o Grommets; PermaDry® molded rubber gskts. incl.	
1	Valve Cover Gasket Set	2002	VS 50564 R	Ford Explorer Eddie Bauer, Limited, Postal, XLT; From 03/05/02; w/Grommets; PermaDry® molded rubber gskts. incl.	

Ford Truck (Incl. Minivans and SUV's) (Cont.)

38 (cont.)		2013 - 1997; 4.6L 281 (4605cc) SOHC V8 (16 Valve) 90.2mm Bore Triton Romeo			38 (cont.)
MFI; Gasoline; Naturally Aspirated Ford Eng.; VIN Code W					
QTY	VALVE COVER	YEARS	PART NO.	DESCRIPTION	
1	Valve Cover Gasket Set	2002	VS 50564 R	Mercury Mountaineer Base; From 03/05/02; w/Grommets; PermaDry® molded rubber gskts. incl.	
1	Valve Cover Gasket Set	2002	VS 50564 R	Ford E-150 Econoline Base, E-150 Econoline Club Wagon Chateau, XL, XLT, E-250 Econoline Base; w/Grommets; PermaDry® molded rubber gskts. incl.	
1	Valve Cover Gasket Set	2002	VS 50564 R	Ford F-150 Pickup King Ranch, Lariat, XL, XLT; w/Grommets; PermaDry® molded rubber gskts. incl.	
1	Valve Cover Gasket Set	2001-97	VS 50377 R	w/Grommets; PermaDry® molded rubber gskts. incl.	
1	Valve Cover Gasket Set	2001-97	VS 50377 R-1	w/o Grommets; PermaDry® molded rubber gskts. incl.	
QTY	VALVE STEM SEAL SET	YEARS	PART NO.	DESCRIPTION	
1	Valve Stem Seal Set	2012-97	SS 72891	Premium valve stem seals incl.; Improved design	
QTY	WATER OUTLET GASKET	YEARS	PART NO.	DESCRIPTION	
1	Water Outlet Gasket	2012-97	35489	Water Outlet	
1	Water Outlet Gasket	2012-06	35957	Water Crossover; Loc. R.H.; New Part Number - Check for Availability	
1	Water Outlet Gasket	2012-06	35958	Water Crossover; Loc. L.H.; New Part Number - Check for Availability	
QTY	WATER PUMP	YEARS	PART NO.	DESCRIPTION	
1	Water Pump Gasket	2012-97	35478		
2	O-Ring	2013-97	413	Water Pump; Water pump bypass pipe O-ring	
QTY	TIMING COVER	YEARS	PART NO.	DESCRIPTION	
1	Timing Cover Set	2012-06	TCS 45869-1	Repair sleeve not incl.	
1	Timing Cover Set	2005	TCS 45869-1	Exc. Ford Explorer Eddie Bauer, Limited, NBX, XLT, XLT Sport Mercury Mountaineer Base, Convenience, Luxury, Premier; Repair sleeve not incl.	
1	Timing Cover Set	2005	TCS 46065	Ford Explorer Eddie Bauer, Limited, NBX, XLT, XLT Sport Mercury Mountaineer Base, Convenience, Luxury, Premier; Repair sleeve not incl.	
1	Timing Cover Set	2004	TCS 45869-1	Ford Expedition Eddie Bauer, NBX, XLS, XLT, XLT Sport, F-150 Heritage XL, XLT, F-150 Pickup Lariat, STX, XL, XLT; Repair sleeve not incl.	
1	Timing Cover Set	2004	TCS 45869-2	Ford E-150 Econoline Base, E-150 Econoline Club Wagon Chateau, XL, XLT, E-250 Econoline Base; Repair sleeve not incl.	
1	Timing Cover Set	2004	TCS 46064	Ford Explorer Eddie Bauer, Limited, NBX, XLT, XLT Sport Mercury Mountaineer Base, Convenience, Luxury, Premier; To 02/22/04; Repair sleeve not incl.	
1	Timing Cover Set	2004	TCS 46065	Ford Explorer Eddie Bauer, Limited, NBX, XLT, XLT Sport Mercury Mountaineer Base, Convenience, Luxury, Premier; From 02/23/04; Repair sleeve not incl.	
1	Timing Cover Set	2003	TCS 45869-2	Exc. Ford Explorer Eddie Bauer, Limited, Postal, Sport, XLT Mercury Mountaineer Base, Convenience, Luxury, Premier; Repair sleeve not incl.	
1	Timing Cover Set	2003	TCS 46064	Ford Explorer Eddie Bauer, Limited, Postal, Sport, XLT Mercury Mountaineer Base, Convenience, Luxury, Premier; Repair sleeve not incl.	
1	Timing Cover Set	2002	TCS 45869-2	Exc. Ford Explorer Eddie Bauer, Limited, Postal, XLT Mercury Mountaineer Base; Repair sleeve not incl.	
1	Timing Cover Set	2002	TCS 46064	Ford Explorer Eddie Bauer, Limited, Postal, XLT Mercury Mountaineer Base; Repair sleeve not incl.	
1	Timing Cover Set	2001-99	TCS 45869-2	Repair sleeve not incl.	
1	Timing Cover Set	1998-97	TCS 45869-1	Repair sleeve not incl.	
1	Crankshaft Front Seal Set	2012-05	TCS 46114		
1	Crankshaft Front Seal Set	2004	TCS 46114	Exc. Ford E-150 Econoline Base, E-150 Econoline Club Wagon Chateau, XL, XLT, E-250 Econoline Base	
1	Crankshaft Front Seal Set	2004	TCS 46117	Ford E-150 Econoline Base, E-150 Econoline Club Wagon Chateau, XL, XLT, E-250 Econoline Base	
1	Crankshaft Front Seal Set	2003	TCS 46114	Ford Explorer Eddie Bauer, Limited, Postal, Sport, XLT Mercury Mountaineer Base, Convenience, Luxury, Premier	
1	Crankshaft Front Seal Set	2003	TCS 46117	Exc. Ford Explorer Eddie Bauer, Limited, Postal, Sport, XLT Mercury Mountaineer Base, Convenience, Luxury, Premier	
1	Crankshaft Front Seal Set	2002	TCS 46114	Ford Explorer Eddie Bauer, Limited, Postal, XLT Mercury Mountaineer Base	
1	Crankshaft Front Seal Set	2002	TCS 46117	Exc. Ford Explorer Eddie Bauer, Limited, Postal, XLT Mercury Mountaineer Base	
1	Crankshaft Front Seal Set	2001-99	TCS 46117		
1	Crankshaft Front Seal Set	1998-97	TCS 46114		
1	Repair Sleeve	2012-97	16207	Timing Cover; Use w/installation tool	
1	Repair Sleeve Tool	2012-97	16310	Timing Cover	
QTY	CARB & FUEL INJECTION	YEARS	PART NO.	DESCRIPTION	
4	Fuel Injector O-Ring Set	2012-97	ES 70599	Improved design	
1	Throttle Body Gasket	2012-97	71216	Air bypass valve	

Ford Truck (Incl. Minivans and SUV's) (Cont.)

38		2013 - 1997; 4.6L 281 (4605cc) SOHC V8 (16 Valve) 90.2mm Bore Triton Romeo			38
(cont.)		MFI; Gasoline; Naturally Aspirated Ford Eng.; VIN Code W			(cont.)
QTY	CARB & FUEL INJECTION	YEARS	PART NO.	DESCRIPTION	
1	Throttle Body Gasket	2012-06	61048	Spacer to manifold	
1	Throttle Body Gasket	2012-07	61671	Housing to spacer; New Part Number - Check for Availability	
1	Throttle Body Gasket	2006-97	61050	Housing to spacer	
1	Throttle Body Gasket	2005-04	61048	Exc. Ford Explorer Eddie Bauer, Limited, NBX, XLT, XLT Sport Mercury Mountaineer Base, Convenience, Luxury, Premier; Spacer to manifold	
1	Throttle Body Gasket	2005-04	61096	Ford Explorer Eddie Bauer, Limited, NBX, XLT, XLT Sport Mercury Mountaineer Base, Convenience, Luxury, Premier; Spacer to manifold	
1	Throttle Body Gasket	2003	61048	Exc. Ford Explorer Eddie Bauer, Limited, Postal, Sport, XLT Mercury Mountaineer Base, Convenience, Luxury, Premier; Spacer to manifold	
1	Throttle Body Gasket	2003	61096	Ford Explorer Eddie Bauer, Limited, Postal, Sport, XLT Mercury Mountaineer Base, Convenience, Luxury, Premier; Spacer to manifold	
1	Throttle Body Gasket	2002	61048	Exc. Ford Explorer Eddie Bauer, Limited, Postal, XLT Mercury Mountaineer Base; Spacer to manifold	
1	Throttle Body Gasket	2002	61096	Ford Explorer Eddie Bauer, Limited, Postal, XLT Mercury Mountaineer Base; Spacer to manifold	
1	Throttle Body Gasket	2001-97	61048	Spacer to manifold	
QTY	EXHAUST GAS RECIRCULATION	YEARS	PART NO.	DESCRIPTION	
1	EGR Gasket	2012-11	71176		
1	EGR Gasket	2010-06	70149	Ford F-150 Pickup STX, XL, XLT	
1	EGR Gasket	2010-06	71176	Exc. Ford F-150 Pickup STX, XL, XLT	
1	EGR Gasket	2005	70149	Ford F-150 Pickup King Ranch, Lariat, STX, XL, XLT	
1	EGR Gasket	2005	71176	Exc. Ford F-150 Pickup King Ranch, Lariat, STX, XL, XLT	
1	EGR Gasket	2004	70149	Ford E-150 Econoline Base, E-150 Econoline Club Wagon Chateau, XL, XLT, E-250 Econoline Base, Expedition Eddie Bauer, NBX, XLS, XLT, XLT Sport	
1	EGR Gasket	2004	70149	Ford F-150 Heritage XL, XLT, F-150 Pickup Lariat, STX, XL, XLT	
1	EGR Gasket	2004	70149	Ford Explorer Eddie Bauer, Limited, NBX, XLT, XLT Sport; To 08/03/03	
1	EGR Gasket	2004	70149	Mercury Mountaineer Base, Convenience, Luxury, Premier; To 08/03/03	
1	EGR Gasket	2004	71176	Ford Explorer Eddie Bauer, Limited, NBX, XLT, XLT Sport Mercury Mountaineer Base, Convenience, Luxury, Premier; From 08/04/03	
1	EGR Gasket	2003	70149	Ford E-150 Econoline Base, E-150 Econoline Club Wagon Chateau, XL, XLT, E-250 Econoline Base, Expedition Eddie Bauer, XLT	
1	EGR Gasket	2003	70149	Ford F-150 Pickup King Ranch, Lariat, XL, XLT	
1	EGR Gasket	2003	70149	Ford Explorer Eddie Bauer, Limited, Postal, Sport, XLT; To 08/03/03	
1	EGR Gasket	2003	70149	Mercury Mountaineer Base, Convenience, Luxury, Premier; To 08/03/03	
1	EGR Gasket	2003	71176	Ford Explorer Eddie Bauer, Limited, Postal, Sport, XLT Mercury Mountaineer Base, Convenience, Luxury, Premier; From 08/04/03	
1	EGR Gasket	2002-97	70149		
QTY	OIL FILTER MOUNTING	YEARS	PART NO.	DESCRIPTION	
1	Oil Filter Adapter Gasket	2012-97	70801		
39		2003 - 1997; 4.6L 281 (4605cc) SOHC V8 (16 Valve) 90.2mm Bore Triton Windsor			39
		MFI; Gasoline; Naturally Aspirated Ford Eng.; VIN Code 6			
QTY	CYLINDER HEAD	YEARS	PART NO.	DESCRIPTION	
1	Head Gasket	2003-97	9790 PT-2	Loc. R.H.; Head bolts not incl.; Head bolt replacement recommended; PermaTorqueMLS®; Improved design	
1	Head Gasket	2003-97	9792 PT-2	Loc. L.H.; Head bolts not incl.; Head bolt replacement recommended; PermaTorqueMLS®; Improved design	
1	Head Set	2003-01	HS 9792 PT-5	Head bolts not incl.; Head bolt replacement recommended; PermaDry® molded rubber valve cover gskts. incl.; Premium valve stem seals incl.	
1	Head Set	2000	HS 9792 PT-4	Head bolts not incl.; Head bolt replacement recommended; PermaDry® molded rubber valve cover gskts. incl.; Premium valve stem seals incl.	
1	Head Set	1999-97	HS 9792 PT-3	Int. manifold gskts. w/Pins inside rubber beads; Head bolts not incl.; Head bolt replacement recommended; PermaDry® molded rubber valve cover gskts. incl.; Premium valve stem seals incl.	
2	Head Bolt Set	2003-97	ES 71328	Head bolts w/Washers; Replacement recommended; Improved design	
2	Head Bolt Set	2003-97	ES 72798	Head bolts w/Washers; Replacement recommended; May use ES 71328 instead; Old design	
QTY	CONVERSION SET	YEARS	PART NO.	DESCRIPTION	
1	Gasket Conversion Set	2003-99	CS 9790-5	PermaDry® molded rubber oil pan gskt. incl.; Consolidated design	
1	Gasket Conversion Set	1998-97	CS 9790-4	PermaDry® molded rubber oil pan gskt. incl.; Consolidated design	
QTY	MANIFOLD - INT. & EXH.	YEARS	PART NO.	DESCRIPTION	
1	Int. Manifold Gasket Set	2003-01	MS 92121-2	Lower set; Upper set incl.; Consolidated design	
1	Int. Manifold Gasket Set	2003-01	MS 98008 T	Lower set; Upper set incl.; PermaDryPlus® int. manifold gskts. incl.	

Ford Truck (Incl. Minivans and SUV's) (Cont.)

39 (cont.)	2003 - 1997; 4.6L 281 (4605cc) SOHC V8 (16 Valve) 90.2mm Bore Triton Windsor				39 (cont.)
QTY	MANIFOLD - INT. & EXH.	YEARS	PART NO.	DESCRIPTION	
1	Int. Manifold Gasket Set	2000	MS 92121-1	Lower set; Upper set incl.	
1	Int. Manifold Gasket Set	2000	MS 98008 T-2	Lower set; Upper set incl.; PermaDryPlus® int. manifold gskts. incl.	
1	Int. Manifold Gasket Set	1999-97	MS 92188	w/Pins outside rubber beads; Lower set; Upper set incl.	
1	Int. Manifold Gasket Set	1999-97	MS 95728-1	w/Pins inside rubber beads; Lower set; Upper set incl.	
1	Int. Manifold Gasket Set	1999-97	MS 98007 T	w/Pins inside rubber beads; Lower set; Upper set incl.; PermaDryPlus® int. manifold gskts. incl.	
1	Int. Manifold Gasket Set	1999-97	MS 98007 T	w/Pins outside rubber beads; Lower set; Upper set incl.; PermaDryPlus® int. manifold gskts. incl.	
1	Plenum Gasket Set	2003-01	MS 92614	Upper set	
1	Plenum Gasket Set	2000	MS 96144	Upper set	
1	Plenum Gasket Set	1999-97	MS 95962	Upper set	
1	Exh. Manifold Gasket Set	2003-97	MS 92568	Improved design	
QTY	OIL PAN	YEARS	PART NO.	DESCRIPTION	
1	Oil Pan Gasket Set	2003-97	OS 30725 R	PermaDry® molded rubber gskt. incl.; Improved design	
1	Drain Plug Gasket	2003-97	72515		
QTY	CRANKSHAFT REAR SEAL	YEARS	PART NO.	DESCRIPTION	
1	Rear Main Seal Set	2003-97	BS 40620	Rubber; One-piece; Improved design	
1	Rear Main Seal Set	2003-97	BS 40644	PTFE Rubber; One-piece	
1	Repair Sleeve	2003-97	16270	Crankshaft; Use w/installation tool	
QTY	VALVE COVER	YEARS	PART NO.	DESCRIPTION	
1	Valve Cover Gasket Set	2003-97	VS 50481 R	w/o Grommets; PermaDry® molded rubber gskts. incl.	
1	Grommet Set	2003-97	ES 71189	Valve Cover	
QTY	VALVE STEM SEAL SET	YEARS	PART NO.	DESCRIPTION	
1	Valve Stem Seal Set	2003-97	SS 72891	Premium valve stem seals incl.; Improved design	
QTY	WATER OUTLET GASKET	YEARS	PART NO.	DESCRIPTION	
1	Water Outlet Gasket	2003-97	35489	Water Outlet	
QTY	WATER PUMP	YEARS	PART NO.	DESCRIPTION	
1	Water Pump Gasket	2003-97	35478		
2	O-Ring	2003-97	413	Water Pump; Water pump bypass pipe O-ring	
QTY	TIMING COVER	YEARS	PART NO.	DESCRIPTION	
1	Timing Cover Set	2003-99	TCS 45869-2	Repair sleeve not incl.	
1	Timing Cover Set	1998-97	TCS 45869-1	Repair sleeve not incl.	
1	Crankshaft Front Seal Set	2003-99	TCS 46117		
1	Crankshaft Front Seal Set	1998-97	TCS 46114		
1	Repair Sleeve	2003-97	16207	Timing Cover; Use w/installation tool	
1	Repair Sleeve Tool	2003-97	16310	Timing Cover	
QTY	CARB & FUEL INJECTION	YEARS	PART NO.	DESCRIPTION	
4	Fuel Injector O-Ring Set	2003-97	ES 70599	Improved design	
1	Throttle Body Gasket	2003-97	61048	Spacer to manifold	
1	Throttle Body Gasket	2003-97	61050	Housing to spacer	
1	Throttle Body Gasket	2003-97	71216	Air bypass valve	
QTY	EXHAUST GAS RECIRCULATION	YEARS	PART NO.	DESCRIPTION	
1	EGR Gasket	2003-97	70149		
QTY	OIL FILTER MOUNTING	YEARS	PART NO.	DESCRIPTION	
1	Oil Filter Adapter Gasket	2003-97	70801		
40	2010 - 2006; 4.6L 281 (4605cc) SOHC V8 (24 Valve) 90.2mm Bore Triton				40
QTY	CYLINDER HEAD	YEARS	PART NO.	DESCRIPTION	
1	Head Gasket	2010-06	26306 PT	Loc. L.H.; Head bolts not incl.; Head bolt replacement recommended; PermaTorqueMLS® LaserWeld® Technology	
1	Head Gasket	2010-06	26307 PT	Loc. R.H.; Head bolts not incl.; Head bolt replacement recommended; PermaTorqueMLS® LaserWeld® Technology	
1	Head Set	2010-09	HS 26306 PT-4	Head bolts not incl.; Head bolt replacement recommended; PermaDry® molded rubber valve cover gskts. incl.; Premium valve stem seals incl.; New Part Number - Check for Availability	
1	Head Set	2008-07	HS 26306 PT-3	Head bolts not incl.; Head bolt replacement recommended; PermaDry® molded rubber valve cover gskts. incl.; Premium valve stem seals incl.	
1	Head Set	2006	HS 26306 PT-1	Head bolts not incl.; Head bolt replacement recommended; PermaDry® molded rubber valve cover gskts. incl.; Premium valve stem seals incl.	
2	Head Bolt Set	2010-06	ES 71328	Head bolts w/Washers; Replacement recommended; Improved design	
2	Head Bolt Set	2010-06	ES 72798	Head bolts w/Washers; Replacement recommended; May use ES 71328 instead; Old design	

Ford Truck (Incl. Minivans and SUV's) (Cont.)

40 (cont.)		2010 - 2006; 4.6L 281 (4605cc) SOHC V8 (24 Valve) 90.2mm Bore Triton			40 (cont.)
MFI; Gasoline; Naturally Aspirated Ford Eng.; VIN Code 8					
QTY	CONVERSION SET	YEARS	PART NO.	DESCRIPTION	
1	Gasket Conversion Set	2010-06	CS 9790-4	PermaDry® molded rubber oil pan gskt. incl.; Consolidated design	
QTY	MANIFOLD - INT. & EXH.	YEARS	PART NO.	DESCRIPTION	
1	Int. Manifold Gasket Set	2010-09	MS 97181	Lower set; New Part Number - Check for Availability	
1	Int. Manifold Gasket Set	2008-06	MS 96687-1	Lower set	
1	Exh. Manifold Gasket Set	2010-06	MS 96679		
QTY	EXHAUST PIPE FLANGE	YEARS	PART NO.	DESCRIPTION	
1	Exhaust Pipe Gasket	2010-06	61493	Converter	
QTY	OIL PAN	YEARS	PART NO.	DESCRIPTION	
1	Oil Pan Gasket Set	2010-06	OS 30725 R	PermaDry® molded rubber gskt. incl.; Improved design	
1	Drain Plug Gasket	2010-06	72515		
QTY	CRANKSHAFT REAR SEAL	YEARS	PART NO.	DESCRIPTION	
1	Rear Main Seal Set	2010-06	BS 40620	Rubber; One-piece; Improved design	
1	Rear Main Seal Set	2010-06	BS 40644	PTFE Rubber; One-piece	
1	Repair Sleeve	2010-06	16255-1	Crankshaft; 1.105" - 1.135" sleeve length; Use w/installation tool; Improved design	
1	Repair Sleeve Tool	2010-06	16306	Crankshaft	
QTY	VALVE COVER	YEARS	PART NO.	DESCRIPTION	
1	Valve Cover Gasket Set	2010-07	VS 50687 R	w/Grommets; PermaDry® molded rubber gskts. incl.	
1	Valve Cover Gasket Set	2006	VS 50664 R	w/Grommets; PermaDry® molded rubber gskts. incl.	
1	Grommet Set	2010-06	ES 71426	Valve Cover; VCT seals set; New Part Number - Check for Availability	
QTY	VALVE STEM SEAL SET	YEARS	PART NO.	DESCRIPTION	
1	Valve Stem Seal Set	2010-06	SS 72921-1	Premium valve stem seals incl.	
QTY	THERMOSTAT HOUSING	YEARS	PART NO.	DESCRIPTION	
1	Water Outlet Gasket	2010-06	35489	Thermostat Housing; Thermostat seal	
QTY	WATER OUTLET GASKET	YEARS	PART NO.	DESCRIPTION	
1	Water Outlet Gasket	2010-06	35792	Water Crossover; Loc. R.H.	
1	Water Outlet Gasket	2010-06	35835	Water Crossover; Loc. L.H.	
QTY	WATER PUMP	YEARS	PART NO.	DESCRIPTION	
1	Water Pump Gasket	2010-06	35478		
2	O-Ring	2010-06	413	Water Pump; Water pump bypass pipe O-ring	
QTY	TIMING COVER	YEARS	PART NO.	DESCRIPTION	
1	Timing Cover Set	2010-06	TCS 46096	Repair sleeve not incl.	
1	Crankshaft Front Seal Set	2010-06	TCS 46114		
QTY	CARB & FUEL INJECTION	YEARS	PART NO.	DESCRIPTION	
2	Fuel Injector O-Ring Set	2010-06	ES 70599	Lower set; Injectors to cylinder head; Improved design	
1	Throttle Body Gasket	2010-06	61438	Mounting	
QTY	OIL FILTER MOUNTING	YEARS	PART NO.	DESCRIPTION	
1	Oil Filter Adapter Gasket	2010-06	70801		
41		1996 - 1991; 4.9L 300 (4917cc) OHV L6 (12 Valve) 4" Bore			41
MFI; Gasoline; Naturally Aspirated Ford Eng.; VIN Code 9					
QTY	CYLINDER HEAD	YEARS	PART NO.	DESCRIPTION	
1	Head Gasket	1996-91	525 SD	Head bolts not incl.; Head bolt replacement recommended; PermaTorque Severe Duty®	
1	Head Gasket	1996-91	8168 PT	Head bolts not incl.; Head bolt replacement recommended; PermaTorque®	
1	Head Gasket Spacer Shim	1996-91	8168 SP	HeadSaver®	
1	Head Set	1996-93	HS 8168 PT-7	Head bolts not incl.; Head bolt replacement recommended; PermaDry® molded rubber valve cover gskt. incl.; Premium valve stem seals incl.	
1	Head Set	1992	HS 8168 PT-6	Head bolts not incl.; Head bolt replacement recommended; PermaDry® molded rubber valve cover gskt. incl.; Premium valve stem seals incl.	
1	Head Set	1991	HS 8168 PT-5	To 02/02/91; Head bolts not incl.; Head bolt replacement recommended; PermaDry® molded rubber valve cover gskt. incl.; Premium valve stem seals incl.	
1	Head Set	1991	HS 8168 PT-6	From 02/03/91; Head bolts not incl.; Head bolt replacement recommended; PermaDry® molded rubber valve cover gskt. incl.; Premium valve stem seals incl.	
1	Head Installation Set	1996-93	HIS 8168 PT-7	Head bolts not incl.; Head bolt replacement recommended; PermaDry® molded rubber valve cover gskt. incl.	
1	Head Bolt Set	1996-91	ES 72155-1	Flanged hex head; Replacement required; New Part Number - Check for Availability	
QTY	CONVERSION SET	YEARS	PART NO.	DESCRIPTION	
1	Gasket Conversion Set	1996-91	CS 8168-3	PermaDry® molded rubber oil pan gskt. incl.	
QTY	MANIFOLD - INT. & EXH.	YEARS	PART NO.	DESCRIPTION	
1	Int. Manifold Gasket Set	1996-91	MS 95647	Lower set; Upper set incl.	

Ford Truck (Incl. Minivans and SUV's) (Cont.)

41 (cont.)		1996 - 1991; 4.9L 300 (4917cc) OHV L6 (12 Valve) 4" Bore			41 (cont.)
		MFI; Gasoline; Naturally Aspirated Ford Eng.; VIN Code 9			
QTY	MANIFOLD - INT. & EXH.	YEARS	PART NO.	DESCRIPTION	
1	Plenum Gasket Set	1996-91	MS 93838	Upper set	
1	Int. & Exh. Gasket Set	1996-91	MS 93837	Lower set; Upper set incl.	
QTY	OIL PAN	YEARS	PART NO.	DESCRIPTION	
1	Oil Pan Gasket Set	1996-91	OS 34601 R	PermaDry® molded rubber gskt. incl.	
1	Drain Plug Gasket	1996-91	70822		
QTY	CRANKSHAFT REAR SEAL	YEARS	PART NO.	DESCRIPTION	
1	Rear Main Seal Set	1996-91	BS 40592	Rubber; One-piece	
1	Rear Main Seal Set	1996-91	BS 40645	PTFE Rubber; One-piece	
1	Repair Sleeve	1996-91	16251	Crankshaft; Use w/installation tool	
1	Repair Sleeve Tool	1996-91	16301	Crankshaft	
QTY	VALVE COVER	YEARS	PART NO.	DESCRIPTION	
1	Valve Cover Gasket Set	1996-91	VS 50028 R	PermaDry® molded rubber gskt. incl.	
QTY	PUSH ROD COVER	YEARS	PART NO.	DESCRIPTION	
1	Push Rod Cover Gasket Set	1996-91	PS 13809 C	w/Grommets; Cork; Improved design; New Part Number - Check for Availability	
1	Push Rod Cover Gasket Set	1996-91	PS 13809 R	w/Grommets; Rubber; Old design; Superseded - When depleted use PS 13809 C	
6	Grommet Set	1996-91	10740	Push Rod Cover	
QTY	VALVE STEM SEAL SET	YEARS	PART NO.	DESCRIPTION	
1	Valve Stem Seal Set	1996-93	SS 72623	Loc. Int.; Premium valve stem seals incl.	
1	Valve Stem Seal Set	1996-93	SS 72839-1	Loc. Exh.; Premium valve stem seals incl.	
1	Valve Stem Seal Set	1992	SS 72623-1	Loc. Int. & Exh.; Premium valve stem seals incl.	
1	Valve Stem Seal Set	1991	SS 13807	Loc. Int. & Exh.; To 02/02/91; Premium valve stem seals incl.	
1	Valve Stem Seal Set	1991	SS 72623-1	Loc. Int. & Exh.; From 02/03/91; Premium valve stem seals incl.	
QTY	WATER OUTLET GASKET	YEARS	PART NO.	DESCRIPTION	
1	Water Outlet Gasket	1996-91	35355	Water Outlet	
QTY	WATER PUMP	YEARS	PART NO.	DESCRIPTION	
1	Water Pump Gasket	1996-91	13816		
QTY	TIMING COVER	YEARS	PART NO.	DESCRIPTION	
1	Timing Cover Set	1996-91	TCS 45829	w/o Sleeve 'N' Seal®; Must be used w/OS 34601R	
1	Timing Set w/Sleeve & Seal	1996-91	TCS 45830	w/Sleeve 'N' Seal®; Must be used w/OS 34601R	
1	Repair Sleeve	1996-91	16207	Timing Cover; Use w/installation tool	
1	Repair Sleeve Tool	1996-91	16310	Timing Cover	
QTY	CARB & FUEL INJECTION	YEARS	PART NO.	DESCRIPTION	
2	Fuel Injector O-Ring Set	1996-91	ES 70599	Improved design	
1	Throttle Body Gasket	1996-91	60846		
QTY	EXHAUST GAS RECIRCULATION	YEARS	PART NO.	DESCRIPTION	
1	EGR Gasket	1996-91	72649		
QTY	OIL PUMP COVER	YEARS	PART NO.	DESCRIPTION	
1	Oil Pump Gasket	1996-91	70374	To block	
42		1997 - 1991; 4.9L 300 (4917cc) OHV L6 (12 Valve) 4" Bore			42
		MFI; Gasoline; Naturally Aspirated Ford Eng.; VIN Code Y			
QTY	CYLINDER HEAD	YEARS	PART NO.	DESCRIPTION	
1	Head Gasket	1997-91	525 SD	Head bolts not incl.; Head bolt replacement recommended; PermaTorque Severe Duty®	
1	Head Gasket	1997-91	8168 PT	Head bolts not incl.; Head bolt replacement recommended; PermaTorque®	
1	Head Gasket Spacer Shim	1997-91	8168 SP	HeadSaver®	
1	Head Set	1997-93	HS 8168 PT-7	Head bolts not incl.; Head bolt replacement recommended; PermaDry® molded rubber valve cover gskt. incl.; Premium valve stem seals incl.	
1	Head Set	1992	HS 8168 PT-6	Head bolts not incl.; Head bolt replacement recommended; PermaDry® molded rubber valve cover gskt. incl.; Premium valve stem seals incl.	
1	Head Set	1991	HS 8168 PT-5	To 02/02/91; Head bolts not incl.; Head bolt replacement recommended; PermaDry® molded rubber valve cover gskt. incl.; Premium valve stem seals incl.	
1	Head Set	1991	HS 8168 PT-6	From 02/03/91; Head bolts not incl.; Head bolt replacement recommended; PermaDry® molded rubber valve cover gskt. incl.; Premium valve stem seals incl.	
1	Head Installation Set	1997-93	HIS 8168 PT-7	Head bolts not incl.; Head bolt replacement recommended; PermaDry® molded rubber valve cover gskt. incl.	
1	Head Bolt Set	1997-91	ES 72155-1	Flanged hex head; Replacement required; New Part Number - Check for Availability	
QTY	CONVERSION SET	YEARS	PART NO.	DESCRIPTION	
1	Gasket Conversion Set	1997-91	CS 8168-3	PermaDry® molded rubber oil pan gskt. incl.	

Ford Truck (Incl. Minivans and SUV's) (Cont.)

42 (cont.)		1997 - 1991; 4.9L 300 (4917cc) OHV L6 (12 Valve) 4" Bore			42 (cont.)
MFI; Gasoline; Naturally Aspirated Ford Eng.; VIN Code Y					
QTY	MANIFOLD - INT. & EXH.	YEARS	PART NO.	DESCRIPTION	
1	Int. Manifold Gasket Set	1997-91	MS 95647	Lower set; Upper set incl.	
1	Plenum Gasket Set	1997-91	MS 93838	Upper set	
1	Int. & Exh. Gasket Set	1997-91	MS 93837	Lower set; Upper set incl.	
QTY	OIL PAN	YEARS	PART NO.	DESCRIPTION	
1	Oil Pan Gasket Set	1997-91	OS 34601 R	PermaDry® molded rubber gskt. incl.	
1	Drain Plug Gasket	1997-91	70822		
QTY	CRANKSHAFT REAR SEAL	YEARS	PART NO.	DESCRIPTION	
1	Rear Main Seal Set	1997-91	BS 40592	Rubber; One-piece	
1	Rear Main Seal Set	1997-91	BS 40645	PTFE Rubber; One-piece	
1	Repair Sleeve	1997-91	16251	Crankshaft; Use w/installation tool	
1	Repair Sleeve Tool	1997-91	16301	Crankshaft	
QTY	VALVE COVER	YEARS	PART NO.	DESCRIPTION	
1	Valve Cover Gasket Set	1997-91	VS 50028 R	PermaDry® molded rubber gskt. incl.	
QTY	PUSH ROD COVER	YEARS	PART NO.	DESCRIPTION	
1	Push Rod Cover Gasket Set	1997-91	PS 13809 C	w/Grommets; Cork; Improved design; New Part Number - Check for Availability	
1	Push Rod Cover Gasket Set	1997-91	PS 13809 R	w/Grommets; Rubber; Old design; Superseded - When depleted use PS 13809 C	
6	Grommet Set	1997-91	10740	Push Rod Cover	
QTY	VALVE STEM SEAL SET	YEARS	PART NO.	DESCRIPTION	
1	Valve Stem Seal Set	1997-93	SS 72623	Loc. Int.; Premium valve stem seals incl.	
1	Valve Stem Seal Set	1997-93	SS 72839-1	Loc. Exh.; Premium valve stem seals incl.	
1	Valve Stem Seal Set	1992	SS 72623-1	Loc. Int. & Exh.; Premium valve stem seals incl.	
1	Valve Stem Seal Set	1991	SS 13807	Loc. Int. & Exh.; To 02/02/91; Premium valve stem seals incl.	
1	Valve Stem Seal Set	1991	SS 72623-1	Loc. Int. & Exh.; From 02/03/91; Premium valve stem seals incl.	
QTY	WATER OUTLET GASKET	YEARS	PART NO.	DESCRIPTION	
1	Water Outlet Gasket	1997-91	35355	Water Outlet	
QTY	WATER PUMP	YEARS	PART NO.	DESCRIPTION	
1	Water Pump Gasket	1997-91	13816		
QTY	TIMING COVER	YEARS	PART NO.	DESCRIPTION	
1	Timing Cover Set	1997-91	TCS 45829	w/o Sleeve 'N' Seal®; Must be used w/OS 34601R	
1	Timing Set w/Sleeve & Seal	1997-91	TCS 45830	w/Sleeve 'N' Seal®; Must be used w/OS 34601R	
1	Repair Sleeve	1997-91	16207	Timing Cover; Use w/installation tool	
1	Repair Sleeve Tool	1997-91	16310	Timing Cover	
QTY	CARB & FUEL INJECTION	YEARS	PART NO.	DESCRIPTION	
2	Fuel Injector O-Ring Set	1997-91	ES 70599	Improved design	
1	Throttle Body Gasket	1997-91	60846		
QTY	EXHAUST GAS RECIRCULATION	YEARS	PART NO.	DESCRIPTION	
1	EGR Gasket	1997-91	72649		
QTY	OIL PUMP COVER	YEARS	PART NO.	DESCRIPTION	
1	Oil Pump Gasket	1997-91	70374	To block	
43		1997 - 1994; 4.9L 300 (4917cc) OHV L6 (12 Valve) 4" Bore			43
MFI; Bi-Fuel; Naturally Aspirated Ford Eng.; VIN Code Z					
QTY	CYLINDER HEAD	YEARS	PART NO.	DESCRIPTION	
1	Head Gasket	1997-94	525 SD	Head bolts not incl.; Head bolt replacement recommended; PermaTorque Severe Duty®	
1	Head Gasket	1997-94	8168 PT	Head bolts not incl.; Head bolt replacement recommended; PermaTorque®	
1	Head Gasket Spacer Shim	1997-94	8168 SP	HeadSaver®	
1	Head Set	1997-94	HS 8168 PT-7	Head bolts not incl.; Head bolt replacement recommended; PermaDry® molded rubber valve cover gskt. incl.; Premium valve stem seals incl.	
1	Head Installation Set	1997-94	HIS 8168 PT-7	Head bolts not incl.; Head bolt replacement recommended; PermaDry® molded rubber valve cover gskt. incl.	
1	Head Bolt Set	1997-94	ES 72155-1	Flanged hex head; Replacement required; New Part Number - Check for Availability	
QTY	CONVERSION SET	YEARS	PART NO.	DESCRIPTION	
1	Gasket Conversion Set	1997-94	CS 8168-3	PermaDry® molded rubber oil pan gskt. incl.	
QTY	MANIFOLD - INT. & EXH.	YEARS	PART NO.	DESCRIPTION	
1	Int. Manifold Gasket Set	1997-94	MS 95647	Lower set; Upper set incl.	
1	Plenum Gasket Set	1997-94	MS 93838	Upper set	
1	Int. & Exh. Gasket Set	1997-94	MS 93837	Lower set; Upper set incl.	
QTY	OIL PAN	YEARS	PART NO.	DESCRIPTION	
1	Oil Pan Gasket Set	1997-94	OS 34601 R	PermaDry® molded rubber gskt. incl.	
1	Drain Plug Gasket	1997-94	70822		

Ford Truck (Incl. Minivans and SUV's) (Cont.)

43 (cont.)		1997 - 1994; 4.9L 300 (4917cc) OHV L6 (12 Valve) 4" Bore			43 (cont.)
MFI; Bi-Fuel; Naturally Aspirated Ford Eng.; VIN Code Z					
QTY	CRANKSHAFT REAR SEAL	YEARS	PART NO.	DESCRIPTION	
1	Rear Main Seal Set	1997-94	BS 40592	Rubber; One-piece	
1	Rear Main Seal Set	1997-94	BS 40645	PTFE Rubber; One-piece	
1	Repair Sleeve	1997-94	16251	Crankshaft; Use w/installation tool	
1	Repair Sleeve Tool	1997-94	16301	Crankshaft	
QTY	VALVE COVER	YEARS	PART NO.	DESCRIPTION	
1	Valve Cover Gasket Set	1997-94	VS 50028 R	PermaDry® molded rubber gskt. incl.	
QTY	PUSH ROD COVER	YEARS	PART NO.	DESCRIPTION	
1	Push Rod Cover Gasket Set	1997-94	PS 13809 C	w/Grommets; Cork; Improved design; New Part Number - Check for Availability	
1	Push Rod Cover Gasket Set	1997-94	PS 13809 R	w/Grommets; Rubber; Old design; Superseded - When depleted use PS 13809 C	
6	Grommet Set	1997-94	10740	Push Rod Cover	
QTY	VALVE STEM SEAL SET	YEARS	PART NO.	DESCRIPTION	
1	Valve Stem Seal Set	1997-94	SS 72623	Loc. Int.; Premium valve stem seals incl.	
1	Valve Stem Seal Set	1997-94	SS 72839-1	Loc. Exh.; Premium valve stem seals incl.	
QTY	WATER OUTLET GASKET	YEARS	PART NO.	DESCRIPTION	
1	Water Outlet Gasket	1997-94	35355	Water Outlet	
QTY	WATER PUMP	YEARS	PART NO.	DESCRIPTION	
1	Water Pump Gasket	1997-94	13816		
QTY	TIMING COVER	YEARS	PART NO.	DESCRIPTION	
1	Timing Cover Set	1997-94	TCS 45829	w/o Sleeve 'N' Seal®; Must be used w/OS 34601R	
1	Timing Set w/Sleeve & Seal	1997-94	TCS 45830	w/Sleeve 'N' Seal®; Must be used w/OS 34601R	
1	Repair Sleeve	1997-94	16207	Timing Cover; Use w/installation tool	
1	Repair Sleeve Tool	1997-94	16310	Timing Cover	
QTY	CARB & FUEL INJECTION	YEARS	PART NO.	DESCRIPTION	
2	Fuel Injector O-Ring Set	1997-94	ES 70599	Improved design	
1	Throttle Body Gasket	1997-94	60846		
QTY	EXHAUST GAS RECIRCULATION	YEARS	PART NO.	DESCRIPTION	
1	EGR Gasket	1997-94	72649		
QTY	OIL PUMP COVER	YEARS	PART NO.	DESCRIPTION	
1	Oil Pump Gasket	1997-94	70374	To block	
44		1996 - 1991; 5.0L 302 (4950cc) OHV V8 (16 Valve) 4" Bore			44
MFI; Gasoline; Naturally Aspirated Ford Eng.; VIN Code N					
QTY	CYLINDER HEAD	YEARS	PART NO.	DESCRIPTION	
2	Head Gasket	1996-91	8548 PT-2	Head bolts not incl.; Head bolt replacement recommended; PermaTorque®	
2	Head Gasket	1996-91	9333 PT-1	H/D eng.; Head bolts not incl.; Head bolt replacement recommended	
2	Head Gasket Spacer Shim	1996-91	8548 SP-1	HeadSaver®	
1	Head Set	1996-91	HS 8548 PT-13	Head bolts not incl.; Head bolt replacement recommended; Premium valve stem seals incl.	
2	Head Bolt Set	1996-92	ES 72155	Flanged hex head; Replacement required	
1	Dowel Pin	1996-94	ES 70744	Cylinder Head; Cyl. head alignment	
1	Dowel Pin	1993	ES 70744	Cylinder Head; From 05/09/93; Cyl. head alignment	
QTY	CONVERSION SET	YEARS	PART NO.	DESCRIPTION	
1	Gasket Conversion Set	1996-91	CS 8548-9	Water pump to plate gskt. not incl.; PermaDry® molded rubber oil pan gskt. incl.	
1	Gasket Conversion Set	1994-91	CS 8548-2	Water pump to plate gskt. not incl.; Multi-piece oil pan gskt. incl.	
QTY	MANIFOLD - INT. & EXH.	YEARS	PART NO.	DESCRIPTION	
1	Int. Manifold Gasket Set	1996-91	MS 94951	Lower set; Upper set incl.	
1	Plenum Gasket Set	1996-91	MS 93834	Upper set	
1	Exh. Manifold Gasket Set	1996-91	MS 90000		
QTY	EXHAUST PIPE FLANGE	YEARS	PART NO.	DESCRIPTION	
1	Exh. Flange Bolt & Spring Kit	1996-91	ES 72142		
QTY	OIL PAN	YEARS	PART NO.	DESCRIPTION	
1	Oil Pan Gasket Set	1996-91	OS 34508 R	PermaDry® one-piece molded rubber gskt. incl.; Improved design	
1	Oil Pan Gasket Set	1994-91	OS 13260 C	Multi-piece; Cork	
1	Drain Plug Gasket	1996-91	70822		
QTY	CRANKSHAFT REAR SEAL	YEARS	PART NO.	DESCRIPTION	
1	Rear Main Seal Set	1996-91	BS 40620	Rubber; One-piece; Improved design	
1	Rear Main Seal Set	1996-91	BS 40644	PTFE Rubber; One-piece	
1	Repair Sleeve	1996-91	16250	Crankshaft; Use w/installation tool	
1	Repair Sleeve Tool	1996-91	16300	Crankshaft	
QTY	VALVE COVER	YEARS	PART NO.	DESCRIPTION	
1	Valve Cover Gasket Set	1996-91	VS 13264 T	Must be used w/MS 93834; PermaDryPlus®; Improved design	

Ford Truck (Incl. Minivans and SUV's) (Cont.)

44 (cont.)		1996 - 1991; 5.0L 302 (4950cc) OHV V8 (16 Valve) 4" Bore			44 (cont.)
MFI; Gasoline; Naturally Aspirated Ford Eng.; VIN Code N					
QTY	VALVE COVER	YEARS	PART NO.	DESCRIPTION	
1	Valve Cover Gasket Set	1996-91	VS 50029 C	Must be used w/MS 93834; Hi-Temp.; w/Compression stops	
QTY	VALVE STEM SEAL SET	YEARS	PART NO.	DESCRIPTION	
2	Valve Stem Seal Set	1996-91	SS 72683	Loc. Int. & Exh.; Premium valve stem seals incl.	
QTY	WATER OUTLET GASKET	YEARS	PART NO.	DESCRIPTION	
1	Water Outlet Gasket	1996-91	35440	Water Outlet	
QTY	WATER PUMP	YEARS	PART NO.	DESCRIPTION	
1	Water Pump Gasket	1996-91	35380	Pump to plate	
1	Water Pump Gasket	1996-91	35397	Plate to block	
QTY	TIMING COVER	YEARS	PART NO.	DESCRIPTION	
1	Timing Cover Set	1996-91	TCS 45449	w/o Sleeve 'N' Seal®; Eng. w/one-piece oil pan gskt. must be used w/OS 34508R; Water pump to plate gskt. not incl.	
1	Timing Set w/Sleeve & Seal	1996-91	TCS 45450	w/Sleeve 'N' Seal®; Eng. w/one-piece oil pan gskt. must be used w/OS 34508R; Water pump to plate gskt. not incl.	
1	Repair Sleeve	1996-91	16213	Timing Cover; Use w/installation tool	
1	Repair Sleeve Tool	1996-91	16310	Timing Cover	
QTY	CARB & FUEL INJECTION	YEARS	PART NO.	DESCRIPTION	
2	Fuel Injector O-Ring Set	1996-91	ES 70599	Improved design	
1	Throttle Body Gasket	1996-91	60845		
1	Throttle Body Gasket	1996-91	71216	Air bypass valve	
QTY	DISTRIBUTOR MOUNTING	YEARS	PART NO.	DESCRIPTION	
1	O-Ring	1996-91	5511	Distributor Mounting	
QTY	EXHAUST GAS RECIRCULATION	YEARS	PART NO.	DESCRIPTION	
1	EGR Gasket	1996-91	72649		
QTY	OIL PUMP COVER	YEARS	PART NO.	DESCRIPTION	
1	Oil Pump Gasket	1996-91	72516	Inlet tube	
45		2001 - 1996; 5.0L 302 (4950cc) OHV V8 (16 Valve) 4" Bore			45
MFI; Gasoline; Naturally Aspirated Ford Eng.; VIN Code P					
QTY	CYLINDER HEAD	YEARS	PART NO.	DESCRIPTION	
2	Head Gasket	2001-96	8548 PT-2	Head bolts not incl.; Head bolt replacement recommended; PermaTorque®	
2	Head Gasket	2001-96	9333 PT-1	H/D eng.; Head bolts not incl.; Head bolt replacement recommended	
2	Head Gasket Spacer Shim	2001-96	8548 SP-1	HeadSaver®	
1	Head Set	2001-96	HS 8548 PT-14	Head bolts not incl.; Head bolt replacement recommended; Premium valve stem seals incl.	
2	Head Bolt Set	2001-96	ES 72155	Flanged hex head; Replacement required	
1	Dowel Pin	2001-96	ES 70744	Cylinder Head; Cyl. head alignment	
QTY	CONVERSION SET	YEARS	PART NO.	DESCRIPTION	
1	Gasket Conversion Set	2001-96	CS 8548-9	Water pump to plate gskt. not incl.; PermaDry® molded rubber oil pan gskt. incl.	
QTY	MANIFOLD - INT. & EXH.	YEARS	PART NO.	DESCRIPTION	
1	Int. Manifold Gasket Set	2001-96	MS 95952	Lower set; Upper set incl.	
1	Plenum Gasket Set	2001-96	MS 95953	Upper set	
1	Exh. Manifold Gasket Set	2001-96	MS 95954		
QTY	EXHAUST PIPE FLANGE	YEARS	PART NO.	DESCRIPTION	
1	Exh. Flange Bolt & Spring Kit	1999-96	ES 72142		
QTY	OIL PAN	YEARS	PART NO.	DESCRIPTION	
1	Oil Pan Gasket Set	2001-96	OS 34508 R	PermaDry® one-piece molded rubber gskt. incl.; Improved design	
1	Drain Plug Gasket	2001-96	70822		
QTY	CRANKSHAFT REAR SEAL	YEARS	PART NO.	DESCRIPTION	
1	Rear Main Seal Set	2001-96	BS 40620	Rubber; One-piece; Improved design	
1	Rear Main Seal Set	2001-96	BS 40644	PTFE Rubber; One-piece	
1	Repair Sleeve	2001-96	16250	Crankshaft; Use w/installation tool	
1	Repair Sleeve Tool	2001-96	16300	Crankshaft	
QTY	VALVE COVER	YEARS	PART NO.	DESCRIPTION	
1	Valve Cover Gasket Set	2001-96	VS 13264 T	Must be used w/MS 95953; PermaDryPlus®; Improved design	
1	Valve Cover Gasket Set	2001-96	VS 50029 C	Must be used w/MS 95953; Hi-Temp.; w/Compression stops	
QTY	VALVE STEM SEAL SET	YEARS	PART NO.	DESCRIPTION	
2	Valve Stem Seal Set	2001-96	SS 72683	Loc. Int. & Exh.; Premium valve stem seals incl.	
QTY	WATER OUTLET GASKET	YEARS	PART NO.	DESCRIPTION	
1	Water Outlet Gasket	2001-96	35440	Water Outlet	
QTY	WATER PUMP	YEARS	PART NO.	DESCRIPTION	
1	Water Pump Gasket	2001-96	35352	Plate to block	

Ford Truck (Incl. Minivans and SUV's) (Cont.)

45 (cont.)		2001 - 1996; 5.0L 302 (4950cc) OHV V8 (16 Valve) 4" Bore			45 (cont.)
		MFI; Gasoline; Naturally Aspirated Ford Eng.; VIN Code P			
QTY	WATER PUMP	YEARS	PART NO.	DESCRIPTION	
1	Water Pump Gasket	1996	35380	Pump to plate	
QTY	TIMING COVER	YEARS	PART NO.	DESCRIPTION	
1	Timing Cover Set	2001-96	TCS 45449	w/o Sleeve 'N' Seal®; Eng. w/one-piece oil pan gskt. must be used w/OS 34508R; Water pump to plate gskt. not incl.	
1	Timing Set w/Sleeve & Seal	2001-96	TCS 45450	w/Sleeve 'N' Seal®; Eng. w/one-piece oil pan gskt. must be used w/OS 34508R; Water pump to plate gskt. not incl.	
1	Repair Sleeve	2001-96	16213	Timing Cover; Use w/installation tool	
1	Repair Sleeve Tool	2001-96	16310	Timing Cover	
QTY	CARB & FUEL INJECTION	YEARS	PART NO.	DESCRIPTION	
2	Fuel Injector O-Ring Set	2001-96	ES 70599	Improved design	
1	Throttle Body Gasket	2001-96	61081	EGR housing to plenum	
1	Throttle Body Gasket	2001-96	61082	Throttle body to EGR housing	
1	Throttle Body Gasket	2001-96	71216	Air bypass valve	
QTY	DISTRIBUTOR MOUNTING	YEARS	PART NO.	DESCRIPTION	
1	O-Ring	2001-96	5511	Distributor Mounting	
QTY	EXHAUST GAS RECIRCULATION	YEARS	PART NO.	DESCRIPTION	
1	EGR Gasket	2001-97	70149		
1	EGR Gasket	1996	70020		
QTY	OIL PUMP COVER	YEARS	PART NO.	DESCRIPTION	
1	Oil Pump Gasket	2001-96	72516	Inlet tube	
46		1992 - 1991; 5.0L 302 (4950cc) OHV V8 (16 Valve) 4" Bore			46
		MFI; Gasoline; Naturally Aspirated Ford Eng.; VIN Code Y			
QTY	CYLINDER HEAD	YEARS	PART NO.	DESCRIPTION	
2	Head Gasket	1992-91	8548 PT-2	Head bolts not incl.; Head bolt replacement recommended; PermaTorque®	
2	Head Gasket	1992-91	9333 PT-1	H/D eng.; Head bolts not incl.; Head bolt replacement recommended	
2	Head Gasket Spacer Shim	1992-91	8548 SP-1	HeadSaver®	
1	Head Set	1992-91	HS 8548 PT-13	Head bolts not incl.; Head bolt replacement recommended; Premium valve stem seals incl.	
2	Head Bolt Set	1992	ES 72155	Flanged hex head; Replacement required	
QTY	CONVERSION SET	YEARS	PART NO.	DESCRIPTION	
1	Gasket Conversion Set	1992-91	CS 8548-2	Water pump to plate gskt. not incl.; Multi-piece oil pan gskt. incl.	
1	Gasket Conversion Set	1992-91	CS 8548-9	Water pump to plate gskt. not incl.; PermaDry® molded rubber oil pan gskt. incl.	
QTY	MANIFOLD - INT. & EXH.	YEARS	PART NO.	DESCRIPTION	
1	Int. Manifold Gasket Set	1992-91	MS 94951	Lower set; Upper set incl.	
1	Plenum Gasket Set	1992-91	MS 93834	Upper set	
1	Exh. Manifold Gasket Set	1992-91	MS 90000		
QTY	EXHAUST PIPE FLANGE	YEARS	PART NO.	DESCRIPTION	
1	Exh. Flange Bolt & Spring Kit	1992-91	ES 72142		
QTY	OIL PAN	YEARS	PART NO.	DESCRIPTION	
1	Oil Pan Gasket Set	1992-91	OS 13260 C	Multi-piece; Cork	
1	Oil Pan Gasket Set	1992-91	OS 34508 R	PermaDry® one-piece molded rubber gskt. incl.; Improved design	
1	Drain Plug Gasket	1992-91	70822		
QTY	CRANKSHAFT REAR SEAL	YEARS	PART NO.	DESCRIPTION	
1	Rear Main Seal Set	1992-91	BS 40620	Rubber; One-piece; Improved design	
1	Rear Main Seal Set	1992-91	BS 40644	PTFE Rubber; One-piece	
1	Repair Sleeve	1992-91	16250	Crankshaft; Use w/installation tool	
1	Repair Sleeve Tool	1992-91	16300	Crankshaft	
QTY	VALVE COVER	YEARS	PART NO.	DESCRIPTION	
1	Valve Cover Gasket Set	1992-91	VS 13264 T	Must be used w/MS 93834; PermaDryPlus®; Improved design	
1	Valve Cover Gasket Set	1992-91	VS 50029 C	Must be used w/MS 93834; Hi-Temp.; w/Compression stops	
QTY	VALVE STEM SEAL SET	YEARS	PART NO.	DESCRIPTION	
2	Valve Stem Seal Set	1992-91	SS 72683	Loc. Int. & Exh.; Premium valve stem seals incl.	
QTY	WATER OUTLET GASKET	YEARS	PART NO.	DESCRIPTION	
1	Water Outlet Gasket	1992-91	35440	Water Outlet	
QTY	WATER PUMP	YEARS	PART NO.	DESCRIPTION	
1	Water Pump Gasket	1992-91	35380	Pump to plate	
1	Water Pump Gasket	1992-91	35397	Plate to block	
QTY	TIMING COVER	YEARS	PART NO.	DESCRIPTION	
1	Timing Cover Set	1992-91	TCS 45449	w/o Sleeve 'N' Seal®; Eng. w/one-piece oil pan gskt. must be used w/OS 34508R; Water pump to plate gskt. not incl.	

Ford Truck (Incl. Minivans and SUV's) (Cont.)

46 (cont.)		1992 - 1991; 5.0L 302 (4950cc) OHV V8 (16 Valve) 4" Bore			46 (cont.)
MFI; Gasoline; Naturally Aspirated Ford Eng.; VIN Code Y					
QTY	TIMING COVER	YEARS	PART NO.	DESCRIPTION	
1	Timing Set w/Sleeve & Seal	1992-91	TCS 45450	w/Sleeve 'N' Seal®; Eng. w/one-piece oil pan gskt. must be used w/OS 34508R; Water pump to plate gskt. not incl.	
1	Repair Sleeve	1992-91	16213	Timing Cover; Use w/installation tool	
1	Repair Sleeve Tool	1992-91	16310	Timing Cover	
QTY	CARB & FUEL INJECTION	YEARS	PART NO.	DESCRIPTION	
2	Fuel Injector O-Ring Set	1992-91	ES 70599	Improved design	
1	Throttle Body Gasket	1992-91	60845		
1	Throttle Body Gasket	1992-91	71216	Air bypass valve	
QTY	DISTRIBUTOR MOUNTING	YEARS	PART NO.	DESCRIPTION	
1	O-Ring	1992-91	5511	Distributor Mounting	
QTY	EXHAUST GAS RECIRCULATION	YEARS	PART NO.	DESCRIPTION	
1	EGR Gasket	1992-91	72649		
QTY	OIL PUMP COVER	YEARS	PART NO.	DESCRIPTION	
1	Oil Pump Gasket	1992-91	72516	Inlet tube	
47		2013 - 2011; 5.0L 302.1 (4951cc) DOHC V8 (32 Valve) 92.2mm Bore Triton Coyote VVT			47
MFI; Flex Fuel; Naturally Aspirated Ford Eng.; VIN Code F					
QTY	CYLINDER HEAD	YEARS	PART NO.	DESCRIPTION	
1	Head Gasket	2013-11	26550 PT	Loc. L.H.; Head bolts not incl.; Head bolt replacement recommended; PermaTorqueMLS®; New Part Number - Check for Availability	
1	Head Gasket	2013-11	26551 PT	Loc. R.H.; Head bolts not incl.; Head bolt replacement recommended; PermaTorqueMLS®; New Part Number - Check for Availability	
1	Head Set	2013-11	HS 26550 PT	Head bolts not incl.; Head bolt replacement recommended; PermaDry® molded rubber valve cover gskts. incl.; Premium valve stem seals incl.; New Part Number - Check for Availability	
2	Head Bolt Set	2013-11	ES 72479	11mm Head bolts; Head bolts w/Washers; Replacement recommended; New Part Number - Check for Availability	
2	Head Bolt Set	2013-11	ES 72480	12mm Head bolts; Head bolts w/Washers; Replacement recommended; New Part Number - Check for Availability	
QTY	CONVERSION SET	YEARS	PART NO.	DESCRIPTION	
1	Gasket Conversion Set	2013-11	CS 26550	PermaDry® molded rubber oil pan gskt. incl.; New Part Number - Check for Availability	
QTY	MANIFOLD - INT. & EXH.	YEARS	PART NO.	DESCRIPTION	
1	Int. Manifold Gasket Set	2013-11	MS 97215	Lower set; New Part Number - Check for Availability	
1	Exh. Manifold Gasket Set	2013-11	MS 97219	New Part Number - Check for Availability	
QTY	OIL PAN	YEARS	PART NO.	DESCRIPTION	
1	Oil Pan Gasket Set	2013-11	OS 30840 R	PermaDry® molded rubber gskt. incl.; New Part Number - Check for Availability	
QTY	CRANKSHAFT REAR SEAL	YEARS	PART NO.	DESCRIPTION	
1	Rear Main Seal Set	2013-11	BS 40729	Rubber; One-piece	
QTY	VALVE COVER	YEARS	PART NO.	DESCRIPTION	
1	Valve Cover Gasket Set	2013-11	VS 50811 R	w/Grommets & Spark plug tube seals; PermaDry® molded rubber gskts. incl.; New Part Number - Check for Availability	
QTY	VALVE STEM SEAL SET	YEARS	PART NO.	DESCRIPTION	
1	Valve Stem Seal Set	2013-11	SS 72936	Premium valve stem seals incl.; New Part Number - Check for Availability	
QTY	THERMOSTAT HOUSING	YEARS	PART NO.	DESCRIPTION	
1	Thermostat Gasket	2013-11	35984	Thermostat Housing; Thermostat housing O-ring; New Part Number - Check for Availability	
1	Thermostat Gasket	2013-11	35991	Thermostat Housing; Thermostat seal; New Part Number - Check for Availability	
QTY	WATER OUTLET GASKET	YEARS	PART NO.	DESCRIPTION	
1	Water Outlet Gasket	2013-11	35993	Water Outlet; Water outlet connection; New Part Number - Check for Availability	
QTY	WATER PUMP	YEARS	PART NO.	DESCRIPTION	
1	Water Pump Gasket	2013-11	35478		
QTY	TIMING COVER	YEARS	PART NO.	DESCRIPTION	
1	Timing Cover Set	2013-11	TCS 46159	Repair sleeve not incl.; New Part Number - Check for Availability	
1	Crankshaft Front Seal Set	2013-11	TCS 46117		
QTY	CARB & FUEL INJECTION	YEARS	PART NO.	DESCRIPTION	
4	Fuel Injector O-Ring Set	2013-11	ES 70599	Improved design	
1	Throttle Body Gasket	2013-11	61698	Mounting; New Part Number - Check for Availability	

Ford Truck (Incl. Minivans and SUV's) (Cont.)

48		2004 - 1999; 5.4L 330 (5408cc) DOHC V8 (32 Valve) 90.2mm Bore Intech Windsor			48
MFI; Gasoline; Naturally Aspirated Ford Eng.; VIN Code A					
QTY	CYLINDER HEAD	YEARS	PART NO.	DESCRIPTION	
1	Head Gasket	2004-99	9790 PT-2	Loc. R.H.; Head bolts not incl.; Head bolt replacement recommended; PermaTorqueMLS®; Improved design	
1	Head Gasket	2004-99	9792 PT-2	Loc. L.H.; Head bolts not incl.; Head bolt replacement recommended; PermaTorqueMLS®; Improved design	
1	Head Set	2004-99	HS 9790 PT-14	Head bolts not incl.; Head bolt replacement recommended; PermaDry® molded rubber valve cover gskts. incl.; Premium valve stem seals incl.	
2	Head Bolt Set	2004-99	ES 71328	Head bolts w/Washers; Replacement recommended; Improved design	
2	Head Bolt Set	2004-99	ES 72798	Head bolts w/Washers; Replacement recommended; May use ES 71328 instead; Old design	
QTY	CONVERSION SET	YEARS	PART NO.	DESCRIPTION	
1	Gasket Conversion Set	2004-03	CS 9790-4	PermaDry® molded rubber oil pan gskt. incl.; Consolidated design	
1	Gasket Conversion Set	2002-99	CS 9790-5	PermaDry® molded rubber oil pan gskt. incl.; Consolidated design	
QTY	MANIFOLD - INT. & EXH.	YEARS	PART NO.	DESCRIPTION	
1	Int. Manifold Gasket Set	2004-99	MS 92902	Lower set; Upper set incl.	
1	Plenum Gasket Set	2004-99	MS 93168	Upper set	
1	Exh. Manifold Gasket Set	2004-99	MS 95949		
QTY	OIL PAN	YEARS	PART NO.	DESCRIPTION	
1	Oil Pan Gasket Set	2004-99	OS 30725 R	PermaDry® molded rubber gskt. incl.; Improved design	
1	Drain Plug Gasket	2004-99	72515		
QTY	CRANKSHAFT REAR SEAL	YEARS	PART NO.	DESCRIPTION	
1	Rear Main Seal Set	2004-99	BS 40620	Rubber; One-piece; Improved design	
1	Rear Main Seal Set	2004-99	BS 40644	PTFE Rubber; One-piece	
1	Repair Sleeve	2004-99	16270	Crankshaft; Use w/installation tool	
1	Repair Sleeve Tool	2004-99	16300	Crankshaft	
QTY	VALVE COVER	YEARS	PART NO.	DESCRIPTION	
1	Valve Cover Gasket Set	2004-99	VS 50477 R	w/Grommets & Spark plug tube seals; PermaDry® molded rubber gskts. incl.; Improved design	
QTY	VALVE STEM SEAL SET	YEARS	PART NO.	DESCRIPTION	
1	Valve Stem Seal Set	2004-99	SS 72888	Premium valve stem seals incl.	
QTY	WATER OUTLET GASKET	YEARS	PART NO.	DESCRIPTION	
1	Water Outlet Gasket	2004-99	35489	Water Outlet	
QTY	WATER PUMP	YEARS	PART NO.	DESCRIPTION	
1	Water Pump Gasket	2004-99	35478		
2	O-Ring	2004-99	413	Water Pump; Water pump bypass pipe O-ring	
QTY	TIMING COVER	YEARS	PART NO.	DESCRIPTION	
1	Timing Cover Set	2004-03	TCS 46010-1	Repair sleeve not incl.	
1	Timing Cover Set	2002-99	TCS 46010	Repair sleeve not incl.	
1	Crankshaft Front Seal Set	2004-03	TCS 46114		
1	Crankshaft Front Seal Set	2002-99	TCS 46117		
1	Repair Sleeve	2004-99	16207	Timing Cover; Use w/installation tool	
1	Repair Sleeve Tool	2004-99	16310	Timing Cover	
QTY	CARB & FUEL INJECTION	YEARS	PART NO.	DESCRIPTION	
4	Fuel Injector O-Ring Set	2004-99	ES 70599	Improved design	
1	Throttle Body Gasket	2004-99	61042	Mounting	
1	Throttle Body Gasket	2004-99	71216	Air bypass valve	
QTY	EXHAUST GAS RECIRCULATION	YEARS	PART NO.	DESCRIPTION	
1	EGR Gasket	2004-99	70802		
QTY	OIL FILTER MOUNTING	YEARS	PART NO.	DESCRIPTION	
1	Oil Filter Adapter Gasket	2004-99	70801		
49		2005 - 2002; 5.4L 330 (5408cc) DOHC V8 (32 Valve) 90.2mm Bore Intech Windsor			49
MFI; Gasoline; Naturally Aspirated Ford Eng.; VIN Code R					
QTY	CYLINDER HEAD	YEARS	PART NO.	DESCRIPTION	
1	Head Gasket	2005-02	9790 PT-2	Loc. R.H.; Head bolts not incl.; Head bolt replacement recommended; PermaTorqueMLS®; Improved design	
1	Head Gasket	2005-02	9792 PT-2	Loc. L.H.; Head bolts not incl.; Head bolt replacement recommended; PermaTorqueMLS®; Improved design	
1	Head Set	2005-02	HS 9790 PT-14	Head bolts not incl.; Head bolt replacement recommended; PermaDry® molded rubber valve cover gskts. incl.; Premium valve stem seals incl.	
2	Head Bolt Set	2005-02	ES 71328	Head bolts w/Washers; Replacement recommended; Improved design	
2	Head Bolt Set	2005-02	ES 72798	Head bolts w/Washers; Replacement recommended; May use ES 71328 instead; Old design	
QTY	CONVERSION SET	YEARS	PART NO.	DESCRIPTION	
1	Gasket Conversion Set	2005-03	CS 9790-4	PermaDry® molded rubber oil pan gskt. incl.; Consolidated design	

Ford Truck (Incl. Minivans and SUV's) (Cont.)

49		2005 - 2002; 5.4L 330 (5408cc) DOHC V8 (32 Valve) 90.2mm Bore Intech Windsor			49	
(cont.)		MFI; Gasoline; Naturally Aspirated Ford Eng.; VIN Code R			(cont.)	
QTY	CONVERSION SET	YEARS	PART NO.	DESCRIPTION		
1	Gasket Conversion Set	2002	CS 9790-5	PermaDry® molded rubber oil pan gskt. incl.; Consolidated design		
QTY	MANIFOLD - INT. & EXH.	YEARS	PART NO.	DESCRIPTION		
1	Int. Manifold Gasket Set	2005-02	MS 92902	Lower set; Upper set incl.		
1	Plenum Gasket Set	2005-02	MS 93168	Upper set		
1	Exh. Manifold Gasket Set	2005-02	MS 95949			
QTY	OIL PAN	YEARS	PART NO.	DESCRIPTION		
1	Oil Pan Gasket Set	2005-02	OS 30725 R	PermaDry® molded rubber gskt. incl.; Improved design		
1	Drain Plug Gasket	2005-02	72515			
QTY	CRANKSHAFT REAR SEAL	YEARS	PART NO.	DESCRIPTION		
1	Rear Main Seal Set	2005-02	BS 40620	Rubber; One-piece; Improved design		
1	Rear Main Seal Set	2005-02	BS 40644	PTFE Rubber; One-piece		
1	Repair Sleeve	2005-02	16270	Crankshaft; Use w/installation tool		
1	Repair Sleeve Tool	2005-02	16300	Crankshaft		
QTY	VALVE COVER	YEARS	PART NO.	DESCRIPTION		
1	Valve Cover Gasket Set	2005-02	VS 50477 R	w/Grommets & Spark plug tube seals; PermaDry® molded rubber gskts. incl.; Improved design		
QTY	VALVE STEM SEAL SET	YEARS	PART NO.	DESCRIPTION		
1	Valve Stem Seal Set	2005-02	SS 72888	Premium valve stem seals incl.		
QTY	WATER OUTLET GASKET	YEARS	PART NO.	DESCRIPTION		
1	Water Outlet Gasket	2005-02	35489	Water Outlet		
QTY	WATER PUMP	YEARS	PART NO.	DESCRIPTION		
1	Water Pump Gasket	2005-02	35478			
2	O-Ring	2005-02	413	Water Pump; Water pump bypass pipe O-ring		
QTY	TIMING COVER	YEARS	PART NO.	DESCRIPTION		
1	Timing Cover Set	2005-03	TCS 46010-1	Repair sleeve not incl.		
1	Timing Cover Set	2002	TCS 46010	Repair sleeve not incl.		
1	Crankshaft Front Seal Set	2005-03	TCS 46114			
1	Crankshaft Front Seal Set	2002	TCS 46117			
1	Repair Sleeve	2005-02	16207	Timing Cover; Use w/installation tool		
1	Repair Sleeve Tool	2005-02	16310	Timing Cover		
QTY	CARB & FUEL INJECTION	YEARS	PART NO.	DESCRIPTION		
4	Fuel Injector O-Ring Set	2005-02	ES 70599	Improved design		
1	Throttle Body Gasket	2005-02	61042	Mounting		
1	Throttle Body Gasket	2005-02	71216	Air bypass valve		
QTY	EXHAUST GAS RECIRCULATION	YEARS	PART NO.	DESCRIPTION		
1	EGR Gasket	2005-02	70802			
QTY	OIL FILTER MOUNTING	YEARS	PART NO.	DESCRIPTION		
1	Oil Filter Adapter Gasket	2005-02	70801			
50		2004 - 1999; 5.4L 330 (5408cc) SOHC V8 (16 Valve) 90.2mm Bore Triton Windsor			50	
		MFI; Gasoline; Supercharged Ford Eng.; VIN Code 3				
QTY	CYLINDER HEAD	YEARS	PART NO.	DESCRIPTION		
1	Head Gasket	2004-99	9790 PT-2	Loc. R.H.; Head bolts not incl.; Head bolt replacement recommended; PermaTorqueMLS®; Improved design		
1	Head Gasket	2004-99	9792 PT-2	Loc. L.H.; Head bolts not incl.; Head bolt replacement recommended; PermaTorqueMLS®; Improved design		
1	Head Set	2004-02	HS 9790 PT-19	Head bolts not incl.; Head bolt replacement recommended; PermaDry® molded rubber valve cover gskts. incl.; Premium valve stem seals incl.		
1	Head Set	2001	HS 9790 PT-18	To 12/04/00; Upper int. manifold gskt. & head bolts not incl.; Head bolt replacement recommended; PermaDry® molded rubber valve cover gskts. incl.; Premium valve stem seals incl.		
1	Head Set	2001	HS 9790 PT-19	From 12/05/00; Head bolts not incl.; Head bolt replacement recommended; PermaDry® molded rubber valve cover gskts. incl.; Premium valve stem seals incl.		
1	Head Set	2000-99	HS 9790 PT-18	Head bolts not incl.; Head bolt replacement recommended; PermaDry® molded rubber valve cover gskts. incl.; Premium valve stem seals incl.		
QTY	CONVERSION SET	YEARS	PART NO.	DESCRIPTION		
1	Gasket Conversion Set	2004-99	CS 9790-5	PermaDry® molded rubber oil pan gskt. incl.; Consolidated design		
QTY	MANIFOLD - INT. & EXH.	YEARS	PART NO.	DESCRIPTION		
1	Int. Manifold Gasket Set	2004-02	MS 96140	Lower set		
1	Int. Manifold Gasket Set	2004-02	MS 98008 T-3	Lower set; Upper set not incl.; PermaDryPlus® int. manifold gskts. incl.		
1	Int. Manifold Gasket Set	2001	MS 96140	From 12/05/00; Lower set		
1	Int. Manifold Gasket Set	2001	MS 96368	To 12/04/00; Lower set		

Ford Truck (Incl. Minivans and SUV's) (Cont.)

50 (cont.)	2004 - 1999; 5.4L 330 (5408cc) SOHC V8 (16 Valve) 90.2mm Bore Triton Windsor				50 (cont.)
MFI; Gasoline; Supercharged Ford Eng.; VIN Code 3					
QTY	MANIFOLD - INT. & EXH.	YEARS	PART NO.	DESCRIPTION	
1	Int. Manifold Gasket Set	2001	MS 98008 T-3	From 12/05/00; Lower set; Upper set not incl.; PermaDryPlus® int. manifold gskts. incl.	
1	Int. Manifold Gasket Set	2000-99	MS 96368	Lower set	
1	Plenum Gasket Set	2004-01	MS 96375	Upper set	
1	Plenum Gasket Set	2000-99	MS 96374	Upper set	
1	Exh. Manifold Gasket Set	2004-99	MS 92568	Improved design	
QTY	OIL PAN	YEARS	PART NO.	DESCRIPTION	
1	Oil Pan Gasket Set	2004-99	OS 30725 R	PermaDry® molded rubber gskt. incl.; Improved design	
1	Drain Plug Gasket	2004-99	72515		
QTY	CRANKSHAFT REAR SEAL	YEARS	PART NO.	DESCRIPTION	
1	Rear Main Seal Set	2004-99	BS 40620	Rubber; One-piece; Improved design	
1	Rear Main Seal Set	2004-99	BS 40644	PTFE Rubber; One-piece	
1	Repair Sleeve	2004-99	16270	Crankshaft; Use w/installation tool	
QTY	VALVE COVER	YEARS	PART NO.	DESCRIPTION	
1	Valve Cover Gasket Set	2004-99	VS 50481 R	w/o Grommets; PermaDry® molded rubber gskts. incl.	
1	Grommet Set	2004-99	ES 71189	Valve Cover	
QTY	VALVE STEM SEAL SET	YEARS	PART NO.	DESCRIPTION	
1	Valve Stem Seal Set	2004-99	SS 72891	Premium valve stem seals incl.; Improved design	
QTY	WATER OUTLET GASKET	YEARS	PART NO.	DESCRIPTION	
1	Water Outlet Gasket	2004-99	35489	Water Outlet	
1	Water Crossover Mounting Set	2004-99	ES 71213		
QTY	WATER PUMP	YEARS	PART NO.	DESCRIPTION	
1	Water Pump Gasket	2004-99	35478		
2	O-Ring	2004-99	413	Water Pump; Water pump bypass pipe O-ring	
QTY	TIMING COVER	YEARS	PART NO.	DESCRIPTION	
1	Timing Cover Set	2004-99	TCS 45982-1	Repair sleeve not incl.	
1	Crankshaft Front Seal Set	2004-99	TCS 46117		
1	Repair Sleeve	2004-99	16207	Timing Cover; Use w/installation tool	
1	Repair Sleeve Tool	2004-99	16310	Timing Cover	
QTY	CARB & FUEL INJECTION	YEARS	PART NO.	DESCRIPTION	
4	Fuel Injector O-Ring Set	2004-99	ES 70599	Improved design	
1	Throttle Body Gasket	2004-99	61142	Housing to spacer	
1	Throttle Body Gasket	2004-99	61200	Spacer to manifold	
1	Throttle Body Gasket	2004-99	71216	Air bypass valve	
QTY	EXHAUST GAS RECIRCULATION	YEARS	PART NO.	DESCRIPTION	
1	EGR Gasket	2004-99	70802		
QTY	OIL FILTER MOUNTING	YEARS	PART NO.	DESCRIPTION	
1	Oil Filter Adapter Gasket	2004-99	70801		
51	2013 - 1997; 5.4L 330 (5408cc) SOHC V8 (16 Valve) 90.2mm Bore Triton Windsor				51
MFI; Gasoline; Naturally Aspirated Ford Eng.; VIN Code L					
QTY	CYLINDER HEAD	YEARS	PART NO.	DESCRIPTION	
1	Head Gasket	2012-09	26482 PT	Loc. L.H.; Head bolts not incl.; Head bolt replacement recommended; PermaTorqueMLS®	
1	Head Gasket	2012-09	26483 PT	Loc. R.H.; Head bolts not incl.; Head bolt replacement recommended; PermaTorqueMLS®	
1	Head Gasket	2008-97	9790 PT-2	Loc. R.H.; Head bolts not incl.; Head bolt replacement recommended; PermaTorqueMLS®; Improved design	
1	Head Gasket	2008-97	9792 PT-2	Loc. L.H.; Head bolts not incl.; Head bolt replacement recommended; PermaTorqueMLS®; Improved design	
1	Head Set	2012-11	HS 26482 PT-1	Head bolts not incl.; Head bolt replacement recommended; PermaDry® molded rubber valve cover gskts. incl.; Premium valve stem seals incl.; New Part Number - Check for Availability	
1	Head Set	2010	HS 26482 PT-1	From 10/05/09; Head bolts not incl.; Head bolt replacement recommended; PermaDry® molded rubber valve cover gskts. incl.; Premium valve stem seals incl.; New Part Number - Check for Availability	
1	Head Set	2010	HS 26482 PT-1	To 10/04/09; Int. manifold gskts. & head bolts not incl.; Head bolt replacement recommended; PermaDry® molded rubber valve cover gskts. incl.; Premium valve stem seals incl.; New Part Number - Check for Availability	
1	Head Set	2009	HS 26482 PT-1	Int. manifold gskts. & head bolts not incl.; Head bolt replacement recommended; PermaDry® molded rubber valve cover gskts. incl.; Premium valve stem seals incl.; New Part Number - Check for Availability	

Ford Truck (Incl. Minivans and SUV's) (Cont.)

51 (cont.)		2013 - 1997; 5.4L 330 (5408cc) SOHC V8 (16 Valve) 90.2mm Bore Triton Windsor			51 (cont.)
MFI; Gasoline; Naturally Aspirated Ford Eng.; VIN Code L					
QTY	CYLINDER HEAD	YEARS	PART NO.	DESCRIPTION	
1	Head Set	2008	HS 9792 PT-7	Int. manifold gskts. & head bolts not incl.; Head bolt replacement recommended; PermaDry® molded rubber valve cover gskts. incl.; Premium valve stem seals incl.	
1	Head Set	2007-06	HS 9792 PT-7	Head bolts not incl.; Head bolt replacement recommended; PermaDry® molded rubber valve cover gskts. incl.; Premium valve stem seals incl.	
1	Head Set	2005	HS 9790 PT-15	Exc. Ford E-150 Econoline Base, E-150 Econoline Club Wagon Chateau, XL, XLT, E-250 Econoline Base, E-250 Super Duty Base, E-350 Econoline Club Wagon Chateau, XL, XLT, E-350 Super Duty Base, E-450 Econoline Super Duty Base; Valve cover gskts. & head bolts not incl.; Head bolt replacement recommended; PermaDry® molded rubber valve cover gskts. incl.; Premium valve stem seals incl.	
1	Head Set	2005	HS 9792 PT-7	Ford E-150 Econoline Base, E-150 Econoline Club Wagon Chateau, XL, XLT, E-250 Econoline Base, E-250 Super Duty Base, E-350 Econoline Club Wagon Chateau, XL, XLT, E-350 Super Duty Base, E-450 Econoline Super Duty Base; Head bolts not incl.; Head bolt replacement recommended; PermaDry® molded rubber valve cover gskts. incl.; Premium valve stem seals incl.	
1	Head Set	2004	HS 9790 PT-15	Ford F-250 Super Duty Pickup King Ranch, Lariat, XL, XLT, F-350 Super Duty Pickup King Ranch, Lariat, XL, XLT, F-450 Super Duty Pickup Lariat, XL, XLT, F-550 Super Duty Pickup Lariat, XL, XLT; From 04/21/04; Valve cover gskts. & head bolts not incl.; Head bolt replacement recommended; PermaDry® molded rubber valve cover gskts. incl.; Premium valve stem seals incl.	
1	Head Set	2004	HS 9790 PT-15	Ford Expedition Eddie Bauer, NBX, XLS, XLT, XLT Sport; From 05/21/04; Valve cover gskts. & head bolts not incl.; Head bolt replacement recommended; PermaDry® molded rubber valve cover gskts. incl.; Premium valve stem seals incl.	
1	Head Set	2004	HS 9790 PT-15	Ford Excursion Eddie Bauer, Limited, XLS, XLT; Head bolts not incl.; Head bolt replacement recommended; PermaDry® molded rubber valve cover gskts. incl.; Premium valve stem seals incl.	
1	Head Set	2004	HS 9790 PT-15	Ford F-250 Super Duty Pickup King Ranch, Lariat, XL, XLT, F-350 Super Duty Pickup King Ranch, Lariat, XL, XLT, F-450 Super Duty Pickup Lariat, XL, XLT, F-550 Super Duty Pickup Lariat, XL, XLT; To 04/20/04; Head bolts not incl.; Head bolt replacement recommended; PermaDry® molded rubber valve cover gskts. incl.; Premium valve stem seals incl.	
1	Head Set	2004	HS 9790 PT-15	Ford Expedition Eddie Bauer, NBX, XLS, XLT, XLT Sport; To 05/20/04; Head bolts not incl.; Head bolt replacement recommended; PermaDry® molded rubber valve cover gskts. incl.; Premium valve stem seals incl.	
1	Head Set	2004	HS 9792 PT-7	Ford E-150 Econoline Base, E-150 Econoline Club Wagon Chateau, XL, XLT, E-250 Econoline Base, E-250 Super Duty Base, E-350 Econoline Club Wagon Chateau, XL, XLT, E-350 Super Duty Base, E-450 Econoline Super Duty Base; From 04/21/04; Head bolts not incl.; Head bolt replacement recommended; PermaDry® molded rubber valve cover gskts. incl.; Premium valve stem seals incl.	
1	Head Set	2004	HS 9792 PT-7	Ford E-150 Econoline Base, E-150 Econoline Club Wagon Chateau, XL, XLT, E-250 Econoline Base, E-250 Super Duty Base, E-350 Econoline Club Wagon Chateau, XL, XLT, E-350 Super Duty Base, E-450 Econoline Super Duty Base; To 04/20/04; Valve cover gskts. & head bolts not incl.; Head bolt replacement recommended; PermaDry® molded rubber valve cover gskts. incl.; Premium valve stem seals incl.	
1	Head Set	2003-00	HS 9790 PT-15	Head bolts not incl.; Head bolt replacement recommended; PermaDry® molded rubber valve cover gskts. incl.; Premium valve stem seals incl.	
1	Head Set	1999	HS 9790 PT-11	Exc. Ford Expedition Eddie Bauer, XLT, F-150 Pickup Base, Lariat, XL, XLT, F-250 Pickup Base, Lariat, XL, XLT Lincoln Navigator Base; Head bolts not incl.; Head bolt replacement recommended; PermaDry® molded rubber valve cover gskts. incl.; Premium valve stem seals incl.	
1	Head Set	1999	HS 9790 PT-12	Ford Expedition Eddie Bauer, XLT, F-150 Pickup Base, Lariat, XL, XLT, F-250 Pickup Base, Lariat, XL, XLT Lincoln Navigator Base; Head bolts not incl.; Head bolt replacement recommended; PermaDry® molded rubber valve cover gskts. incl.; Premium valve stem seals incl.; Consolidated design	
1	Head Set	1999	HS 9790 PT-13	Lincoln Navigator Base; Head bolts not incl.; Head bolt replacement recommended; PermaDry® molded rubber valve cover gskts. incl.; Premium valve stem seals incl.; May use HS 9790PT-12 instead; Old design; Superseded - When depleted use HS 9790 PT-12	

Ford Truck (Incl. Minivans and SUV's) (Cont.)

51 (cont.)	2013 - 1997; 5.4L 330 (5408cc) SOHC V8 (16 Valve) 90.2mm Bore Triton Windsor MFI; Gasoline; Naturally Aspirated Ford Eng.; VIN Code L				51 (cont.)
QTY	CYLINDER HEAD	YEARS	PART NO.	DESCRIPTION	
1	Head Set	1998-97	HS 9790 PT-11	From 07/21/97; Head bolts not incl.; Head bolt replacement recommended; PermaDry® molded rubber valve cover gskts. incl.; Premium valve stem seals incl.	
1	Head Set	1998-97	HS 9790 PT-4	To 07/20/97; Head bolts not incl.; Head bolt replacement recommended; PermaDry® molded rubber valve cover gskts. incl.; Premium valve stem seals incl.	
2	Head Bolt Set	2012-97	ES 71328	Head bolts w/Washers; Replacement recommended; Improved design	
2	Head Bolt Set	2012-97	ES 72798	Head bolts w/Washers; Replacement recommended; May use ES 71328 instead; Old design	
QTY	CONVERSION SET	YEARS	PART NO.	DESCRIPTION	
1	Gasket Conversion Set	2012-99	CS 9790-5	PermaDry® molded rubber oil pan gskt. incl.; Consolidated design	
1	Gasket Conversion Set	1998-97	CS 9790-1	PermaDry® molded rubber oil pan gskt. incl.	
QTY	MANIFOLD - INT. & EXH.	YEARS	PART NO.	DESCRIPTION	
1	Int. Manifold Gasket Set	2012-11	MS 97200	Lower set; New Part Number - Check for Availability	
1	Int. Manifold Gasket Set	2010	MS 92836-1	To 10/04/09; Lower set; Upper set incl.	
1	Int. Manifold Gasket Set	2010	MS 97200	From 10/05/09; Lower set; New Part Number - Check for Availability	
1	Int. Manifold Gasket Set	2010	MS 98008 T-3	To 10/04/09; Lower set; Upper set incl.; PermaDryPlus® int. manifold gskts. incl.	
1	Int. Manifold Gasket Set	2009-08	MS 92836-1	Lower set; Upper set incl.	
1	Int. Manifold Gasket Set	2009-08	MS 98008 T-3	Lower set; Upper set incl.; PermaDryPlus® int. manifold gskts. incl.	
1	Int. Manifold Gasket Set	2007-06	MS 96281	Lower set; Upper set incl.	
1	Int. Manifold Gasket Set	2005-04	MS 92836-1	Exc. Ford E-150 Econoline Base, E-150 Econoline Club Wagon Chateau, XL, XLT, E-250 Econoline Base, E-250 Super Duty Base, E-350 Econoline Club Wagon Chateau, XL, XLT, E-350 Super Duty Base, E-450 Econoline Super Duty Base; Lower set; Upper set incl.	
1	Int. Manifold Gasket Set	2005-04	MS 96281	Ford E-150 Econoline Base, E-150 Econoline Club Wagon Chateau, XL, XLT, E-250 Econoline Base, E-250 Super Duty Base, E-350 Econoline Club Wagon Chateau, XL, XLT, E-350 Super Duty Base, E-450 Econoline Super Duty Base; Lower set; Upper set incl.	
1	Int. Manifold Gasket Set	2005-04	MS 98008 T-3	Exc. Ford E-150 Econoline Base, E-150 Econoline Club Wagon Chateau, XL, XLT, E-250 Econoline Base, E-250 Super Duty Base, E-350 Econoline Club Wagon Chateau, XL, XLT, E-350 Super Duty Base, E-450 Econoline Super Duty Base; Lower set; Upper set incl.; PermaDryPlus® int. manifold gskts. incl.	
1	Int. Manifold Gasket Set	2003-00	MS 92836-1	Lower set; Upper set incl.	
1	Int. Manifold Gasket Set	2003-00	MS 98008 T-3	Lower set; Upper set incl.; PermaDryPlus® int. manifold gskts. incl.	
1	Int. Manifold Gasket Set	1999	MS 92121-2	Ford Expedition Eddie Bauer, XLT, F-150 Pickup Base, Lariat, XL, XLT, F-250 Pickup Base, Lariat, XL, XLT Lincoln Navigator Base; Lower set; Upper set incl.; Consolidated design	
1	Int. Manifold Gasket Set	1999	MS 92188	Exc. Ford Expedition Eddie Bauer, XLT, F-150 Pickup Base, Lariat, XL, XLT, F-250 Pickup Base, Lariat, XL, XLT Lincoln Navigator Base; Lower set; Upper set incl.	
1	Int. Manifold Gasket Set	1999	MS 92188-1	Ford Expedition Eddie Bauer, XLT, F-150 Pickup Base, Lariat, XL, XLT, F-250 Pickup Base, Lariat, XL, XLT; Lower set; Upper set incl.; May use MS 92121-2 instead; Old design; Superseded - When depleted use MS 92121-2	
1	Int. Manifold Gasket Set	1999	MS 98007 T	Exc. Ford Expedition Eddie Bauer, XLT, F-150 Pickup Base, Lariat, XL, XLT, F-250 Pickup Base, Lariat, XL, XLT Lincoln Navigator Base; Lower set; Upper set incl.; PermaDryPlus® int. manifold gskts. incl.	
1	Int. Manifold Gasket Set	1999	MS 98008 T	Ford Expedition Eddie Bauer, XLT, F-150 Pickup Base, Lariat, XL, XLT, F-250 Pickup Base, Lariat, XL, XLT Lincoln Navigator Base; Lower set; Upper set incl.; PermaDryPlus® int. manifold gskts. incl.	
1	Int. Manifold Gasket Set	1998-97	MS 92188	From 07/21/97; Lower set; Upper set incl.	
1	Int. Manifold Gasket Set	1998-97	MS 95728-1	To 07/20/97; Lower set; Upper set incl.	
1	Int. Manifold Gasket Set	1998-97	MS 98007 T	Lower set; Upper set incl.; PermaDryPlus® int. manifold gskts. incl.	
1	Plenum Gasket Set	1999	MS 92614	Ford Expedition Eddie Bauer, XLT, F-150 Pickup Base, Lariat, XL, XLT, F-250 Pickup Base, Lariat, XL, XLT Lincoln Navigator Base; Upper set	
1	Plenum Gasket Set	1999	MS 95962	Exc. Ford Expedition Eddie Bauer, XLT, F-150 Pickup Base, Lariat, XL, XLT, F-250 Pickup Base, Lariat, XL, XLT Lincoln Navigator Base; Upper set	
1	Plenum Gasket Set	1998-97	MS 95962	Upper set	
1	Exh. Manifold Gasket Set	2012-97	MS 92568	Improved design	
QTY	OIL PAN	YEARS	PART NO.	DESCRIPTION	
1	Oil Pan Gasket Set	2012-97	OS 30725 R	PermaDry® molded rubber gskt. incl.; Improved design	
1	Drain Plug Gasket	2012-97	72515		
QTY	CRANKSHAFT REAR SEAL	YEARS	PART NO.	DESCRIPTION	
1	Rear Main Seal Set	2012-97	BS 40620	Rubber; One-piece; Improved design	

Ford Truck (Incl. Minivans and SUV's) (Cont.)

51		2013 - 1997; 5.4L 330 (5408cc) SOHC V8 (16 Valve) 90.2mm Bore Triton Windsor			51	
(cont.)		MFI; Gasoline; Naturally Aspirated Ford Eng.; VIN Code L			(cont.)	
QTY	CRANKSHAFT REAR SEAL	YEARS	PART NO.	DESCRIPTION		
1	Rear Main Seal Set	2012-97	BS 40644	PTFE Rubber; One-piece		
1	Repair Sleeve	2012-97	16270	Crankshaft; Use w/installation tool		
QTY	VALVE COVER	YEARS	PART NO.	DESCRIPTION		
1	Valve Cover Gasket Set	2012-05	VS 50603 R	w/Grommets; PermaDry® molded rubber gskts. incl.		
1	Valve Cover Gasket Set	2004	VS 50481 R	Ford E-150 Econoline Base, E-150 Econoline Club Wagon Chateau, XL, XLT, E-250 Econoline Base, E-250 Super Duty Base, E-350 Econoline Club Wagon Chateau, XL, XLT, E-350 Super Duty Base, E-450 Econoline Super Duty Base; To 04/20/04; w/o Grommets; PermaDry® molded rubber gskts. incl.		
1	Valve Cover Gasket Set	2004	VS 50481 R	Ford F-250 Super Duty Pickup King Ranch, Lariat, XL, XLT, F-350 Super Duty Pickup King Ranch, Lariat, XL, XLT, F-450 Super Duty Pickup Lariat, XL, XLT, F-550 Super Duty Pickup Lariat, XL, XLT; To 04/20/04; w/o Grommets; PermaDry® molded rubber gskts. incl.		
1	Valve Cover Gasket Set	2004	VS 50481 R	Ford Expedition Eddie Bauer, NBX, XLS, XLT, XLT Sport; To 05/20/04; w/o Grommets; PermaDry® molded rubber gskts. incl.		
1	Valve Cover Gasket Set	2004	VS 50481 R	Ford Excursion Eddie Bauer, Limited, XLS, XLT; w/o Grommets; PermaDry® molded rubber gskts. incl.		
1	Valve Cover Gasket Set	2004	VS 50603 R	Ford E-150 Econoline Base, E-150 Econoline Club Wagon Chateau, XL, XLT, E-250 Econoline Base, E-250 Super Duty Base, E-350 Econoline Club Wagon Chateau, XL, XLT, E-350 Super Duty Base, E-450 Econoline Super Duty Base; From 04/21/04; w/Grommets; PermaDry® molded rubber gskts. incl.		
1	Valve Cover Gasket Set	2004	VS 50603 R	Ford F-250 Super Duty Pickup King Ranch, Lariat, XL, XLT, F-350 Super Duty Pickup King Ranch, Lariat, XL, XLT, F-450 Super Duty Pickup Lariat, XL, XLT, F-550 Super Duty Pickup Lariat, XL, XLT; From 04/21/04; w/Grommets; PermaDry® molded rubber gskts. incl.		
1	Valve Cover Gasket Set	2004	VS 50603 R	Ford Expedition Eddie Bauer, NBX, XLS, XLT, XLT Sport; From 05/21/04; w/Grommets; PermaDry® molded rubber gskts. incl.		
1	Valve Cover Gasket Set	2003-97	VS 50481 R	w/o Grommets; PermaDry® molded rubber gskts. incl.		
1	Grommet Set	2012-97	ES 71189	Valve Cover		
QTY	VALVE STEM SEAL SET	YEARS	PART NO.	DESCRIPTION		
1	Valve Stem Seal Set	2012-97	SS 72891	Premium valve stem seals incl.; Improved design		
QTY	WATER OUTLET GASKET	YEARS	PART NO.	DESCRIPTION		
1	Water Outlet Gasket	2012-97	35489	Water Outlet		
1	Water Crossover Mounting Set	2012-00	ES 71213			
QTY	WATER PUMP	YEARS	PART NO.	DESCRIPTION		
1	Water Pump Gasket	2012-97	35478			
2	O-Ring	2013-97	413	Water Pump; Water pump bypass pipe O-ring		
QTY	TIMING COVER	YEARS	PART NO.	DESCRIPTION		
1	Timing Cover Set	2012-99	TCS 45982-1	Repair sleeve not incl.		
1	Timing Cover Set	1998-97	TCS 45982	Repair sleeve not incl.		
1	Crankshaft Front Seal Set	2012-99	TCS 46117			
1	Crankshaft Front Seal Set	1998-97	TCS 46114			
1	Repair Sleeve	2012-97	16207	Timing Cover; Use w/installation tool		
1	Repair Sleeve Tool	2012-97	16310	Timing Cover		
QTY	CARB & FUEL INJECTION	YEARS	PART NO.	DESCRIPTION		
4	Fuel Injector O-Ring Set	2012-97	ES 70599	Improved design		
1	Throttle Body Gasket	2012-97	71216	Air bypass valve		
1	Throttle Body Gasket	2012-00	61103	Spacer to manifold		
1	Throttle Body Gasket	2012-11	61674	Housing to spacer; New Part Number - Check for Availability		
1	Throttle Body Gasket	2010	61050	To 10/04/09; Housing to spacer		
1	Throttle Body Gasket	2010	61674	From 10/05/09; Housing to spacer; New Part Number - Check for Availability		
1	Throttle Body Gasket	2009-04	61050	Housing to spacer		
1	Throttle Body Gasket	2003-00	61205-1	Housing to spacer		
1	Throttle Body Gasket	1999-97	61048	Spacer to manifold		
1	Throttle Body Gasket	1999-97	61050	Housing to spacer		
QTY	EXHAUST GAS RECIRCULATION	YEARS	PART NO.	DESCRIPTION		
1	EGR Gasket	2012-97	70802			
QTY	OIL FILTER MOUNTING	YEARS	PART NO.	DESCRIPTION		
1	Oil Filter Adapter Gasket	2012-97	70801			

Ford Truck (Incl. Minivans and SUV's) (Cont.)

52		2013 - 1997; 5.4L 330 (5408cc) SOHC V8 (16 Valve) 90.2mm Bore Triton Windsor			52
MFI; Natural Gas; Naturally Aspirated Ford Eng.; VIN Code M					
QTY	CYLINDER HEAD	YEARS	PART NO.	DESCRIPTION	
1	Head Gasket	2012-09	26482 PT	Loc. L.H.; Head bolts not incl.; Head bolt replacement recommended; PermaTorqueMLS®	
1	Head Gasket	2012-09	26483 PT	Loc. R.H.; Head bolts not incl.; Head bolt replacement recommended; PermaTorqueMLS®	
1	Head Gasket	2008-97	9790 PT-2	Loc. R.H.; Head bolts not incl.; Head bolt replacement recommended; PermaTorqueMLS®; Improved design	
1	Head Gasket	2008-97	9792 PT-2	Loc. L.H.; Head bolts not incl.; Head bolt replacement recommended; PermaTorqueMLS®; Improved design	
1	Head Set	2012-11	HS 26482 PT-1	Head bolts not incl.; Head bolt replacement recommended; PermaDry® molded rubber valve cover gskts. incl.; Premium valve stem seals incl.; New Part Number - Check for Availability	
1	Head Set	2010	HS 26482 PT-1	From 10/05/09; Head bolts not incl.; Head bolt replacement recommended; PermaDry® molded rubber valve cover gskts. incl.; Premium valve stem seals incl.; New Part Number - Check for Availability	
1	Head Set	2010	HS 26482 PT-1	To 10/04/09; Int. manifold gskts. & head bolts not incl.; Head bolt replacement recommended; PermaDry® molded rubber valve cover gskts. incl.; Premium valve stem seals incl.; New Part Number - Check for Availability	
1	Head Set	2009	HS 26482 PT-1	Int. manifold gskts. & head bolts not incl.; Head bolt replacement recommended; PermaDry® molded rubber valve cover gskts. incl.; Premium valve stem seals incl.; New Part Number - Check for Availability	
1	Head Set	2008-06	HS 9790 PT-15	Exc. Ford E-250 Econoline Base, E-350 Super Duty Base, Chateau, XL, XLT, E-450 Econoline Super Duty Base; Valve cover gskts. & head bolts not incl.; Head bolt replacement recommended; PermaDry® molded rubber valve cover gskts. incl.; Premium valve stem seals incl.	
1	Head Set	2008	HS 9792 PT-7	Ford E-250 Econoline Base, E-350 Super Duty Base, Chateau, XL, XLT, E-450 Econoline Super Duty Base; Int. manifold gskts. & head bolts not incl.; Head bolt replacement recommended; PermaDry® molded rubber valve cover gskts. incl.; Premium valve stem seals incl.	
1	Head Set	2007-06	HS 9792 PT-7	Ford E-250 Econoline Base, E-350 Super Duty Base, Chateau, XL, XLT, E-450 Econoline Super Duty Base; Head bolts not incl.; Head bolt replacement recommended; PermaDry® molded rubber valve cover gskts. incl.; Premium valve stem seals incl.	
1	Head Set	2005	HS 9790 PT-15	Exc. Ford E-250 Econoline Base, E-250 Super Duty Base, E-350 Econoline Club Wagon Chateau, XL, XLT, E-350 Super Duty Base, E-450 Econoline Super Duty Base; Valve cover gskts. & head bolts not incl.; Head bolt replacement recommended; PermaDry® molded rubber valve cover gskts. incl.; Premium valve stem seals incl.	
1	Head Set	2005	HS 9792 PT-7	Ford E-250 Econoline Base, E-250 Super Duty Base, E-350 Econoline Club Wagon Chateau, XL, XLT, E-350 Super Duty Base, E-450 Econoline Super Duty Base; Head bolts not incl.; Head bolt replacement recommended; PermaDry® molded rubber valve cover gskts. incl.; Premium valve stem seals incl.	
1	Head Set	2004	HS 9790 PT-15	Ford F-250 Super Duty Pickup King Ranch, Lariat, XL, XLT, F-350 Super Duty Pickup King Ranch, Lariat, XL, XLT; From 04/21/04; Valve cover gskts. & head bolts not incl.; Head bolt replacement recommended; PermaDry® molded rubber valve cover gskts. incl.; Premium valve stem seals incl.	
1	Head Set	2004	HS 9790 PT-15	Ford F-150 Pickup FX4, Lariat, STX, XL, XLT; Head bolts not incl.; Head bolt replacement recommended; PermaDry® molded rubber valve cover gskts. incl.; Premium valve stem seals incl.	
1	Head Set	2004	HS 9790 PT-15	Ford F-250 Super Duty Pickup King Ranch, Lariat, XL, XLT, F-350 Super Duty Pickup King Ranch, Lariat, XL, XLT; To 04/20/04; Head bolts not incl.; Head bolt replacement recommended; PermaDry® molded rubber valve cover gskts. incl.; Premium valve stem seals incl.	
1	Head Set	2004	HS 9792 PT-7	Ford E-250 Econoline Base, E-250 Super Duty Base, E-350 Econoline Club Wagon Chateau, XL, XLT, E-350 Super Duty Base, E-450 Econoline Super Duty Base; From 04/21/04; Head bolts not incl.; Head bolt replacement recommended; PermaDry® molded rubber valve cover gskts. incl.; Premium valve stem seals incl.	
1	Head Set	2004	HS 9792 PT-7	Ford E-250 Econoline Base, E-250 Super Duty Base, E-350 Econoline Club Wagon Chateau, XL, XLT, E-350 Super Duty Base, E-450 Econoline Super Duty Base; To 04/20/04; Valve cover gskts. & head bolts not incl.; Head bolt replacement recommended; PermaDry® molded rubber valve cover gskts. incl.; Premium valve stem seals incl.	

Ford Truck (Incl. Minivans and SUV's) (Cont.)

52 (cont.)		2013 - 1997; 5.4L 330 (5408cc) SOHC V8 (16 Valve) 90.2mm Bore Triton Windsor			52 (cont.)
MFI; Natural Gas; Naturally Aspirated Ford Eng.; VIN Code M					
QTY	CYLINDER HEAD	YEARS	PART NO.	DESCRIPTION	
1	Head Set	2003-00	HS 9790 PT-15	Head bolts not incl.; Head bolt replacement recommended; PermaDry® molded rubber valve cover gskts. incl.; Premium valve stem seals incl.	
1	Head Set	1999	HS 9790 PT-11	Exc. Ford F-150 Pickup Base, Lariat, XL, XLT, F-250 Pickup Base, Lariat, XL, XLT; Head bolts not incl.; Head bolt replacement recommended; PermaDry® molded rubber valve cover gskts. incl.; Premium valve stem seals incl.	
1	Head Set	1999	HS 9790 PT-12	Ford F-150 Pickup Base, Lariat, XL, XLT, F-250 Pickup Base, Lariat, XL, XLT; Head bolts not incl.; Head bolt replacement recommended; PermaDry® molded rubber valve cover gskts. incl.; Premium valve stem seals incl.; Consolidated design	
1	Head Set	1998-97	HS 9790 PT-11	From 07/21/97; Head bolts not incl.; Head bolt replacement recommended; PermaDry® molded rubber valve cover gskts. incl.; Premium valve stem seals incl.	
1	Head Set	1998-97	HS 9790 PT-4	To 07/20/97; Head bolts not incl.; Head bolt replacement recommended; PermaDry® molded rubber valve cover gskts. incl.; Premium valve stem seals incl.	
2	Head Bolt Set	2012-97	ES 71328	Head bolts w/Washers; Replacement recommended; Improved design	
2	Head Bolt Set	2012-97	ES 72798	Head bolts w/Washers; Replacement recommended; May use ES 71328 instead; Old design	
QTY	CONVERSION SET	YEARS	PART NO.	DESCRIPTION	
1	Gasket Conversion Set	2012-99	CS 9790-5	PermaDry® molded rubber oil pan gskt. incl.; Consolidated design	
1	Gasket Conversion Set	1998-97	CS 9790-1	PermaDry® molded rubber oil pan gskt. incl.	
QTY	MANIFOLD - INT. & EXH.	YEARS	PART NO.	DESCRIPTION	
1	Int. Manifold Gasket Set	2012-11	MS 97200	Lower set; New Part Number - Check for Availability	
1	Int. Manifold Gasket Set	2010	MS 92836-1	To 10/04/09; Lower set; Upper set incl.	
1	Int. Manifold Gasket Set	2010	MS 97200	From 10/05/09; Lower set; New Part Number - Check for Availability	
1	Int. Manifold Gasket Set	2010	MS 98008 T-3	To 10/04/09; Lower set; Upper set incl.; PermaDryPlus® int. manifold gskts. incl.	
1	Int. Manifold Gasket Set	2009-08	MS 92836-1	Lower set; Upper set incl.	
1	Int. Manifold Gasket Set	2009-08	MS 98008 T-3	Lower set; Upper set incl.; PermaDryPlus® int. manifold gskts. incl.	
1	Int. Manifold Gasket Set	2007-06	MS 92836-1	Exc. Ford E-250 Econoline Base, E-350 Super Duty Base, Chateau, XL, XLT, E-450 Econoline Super Duty Base; Lower set; Upper set incl.	
1	Int. Manifold Gasket Set	2007-06	MS 96281	Ford E-250 Econoline Base, E-350 Super Duty Base, Chateau, XL, XLT, E-450 Econoline Super Duty Base; Lower set; Upper set incl.	
1	Int. Manifold Gasket Set	2007-06	MS 98008 T-3	Exc. Ford E-250 Econoline Base, E-350 Super Duty Base, Chateau, XL, XLT, E-450 Econoline Super Duty Base; Lower set; Upper set incl.; PermaDryPlus® int. manifold gskts. incl.	
1	Int. Manifold Gasket Set	2005-04	MS 96281	Ford E-250 Econoline Base, E-250 Super Duty Base, E-350 Econoline Club Wagon Chateau, XL, XLT, E-350 Super Duty Base, E-450 Econoline Super Duty Base; Lower set; Upper set incl.	
1	Int. Manifold Gasket Set	2005	MS 92836-1	Exc. Ford E-250 Econoline Base, E-250 Super Duty Base, E-350 Econoline Club Wagon Chateau, XL, XLT, E-350 Super Duty Base, E-450 Econoline Super Duty Base; Lower set; Upper set incl.	
1	Int. Manifold Gasket Set	2005	MS 98008 T-3	Exc. Ford E-250 Econoline Base, E-250 Super Duty Base, E-350 Econoline Club Wagon Chateau, XL, XLT, E-350 Super Duty Base, E-450 Econoline Super Duty Base; Lower set; Upper set incl.; PermaDryPlus® int. manifold gskts. incl.	
1	Int. Manifold Gasket Set	2004	MS 92836-1	Ford F-150 Pickup FX4, Lariat, STX, XL, XLT, F-250 Super Duty Pickup King Ranch, Lariat, XL, XLT, F-350 Super Duty Pickup King Ranch, Lariat, XL, XLT; Lower set; Upper set incl.	
1	Int. Manifold Gasket Set	2004	MS 98008 T-3	Ford F-150 Pickup FX4, Lariat, STX, XL, XLT, F-250 Super Duty Pickup King Ranch, Lariat, XL, XLT, F-350 Super Duty Pickup King Ranch, Lariat, XL, XLT; Lower set; Upper set incl.; PermaDryPlus® int. manifold gskts. incl.	
1	Int. Manifold Gasket Set	2003-00	MS 92836-1	Lower set; Upper set incl.	
1	Int. Manifold Gasket Set	2003-00	MS 98008 T-3	Lower set; Upper set incl.; PermaDryPlus® int. manifold gskts. incl.	
1	Int. Manifold Gasket Set	1999	MS 92121-2	Ford F-150 Pickup Base, Lariat, XL, XLT, F-250 Pickup Base, Lariat, XL, XLT; Lower set; Upper set incl.; Consolidated design	
1	Int. Manifold Gasket Set	1999	MS 92188	Exc. Ford F-150 Pickup Base, Lariat, XL, XLT, F-250 Pickup Base, Lariat, XL, XLT; Lower set; Upper set incl.	
1	Int. Manifold Gasket Set	1999	MS 92188-1	Ford F-150 Pickup Base, Lariat, XL, XLT, F-250 Pickup Base, Lariat, XL, XLT; Lower set; Upper set incl.; May use MS 92121-2 instead; Old design; Superseded - When depleted use MS 92121-2	
1	Int. Manifold Gasket Set	1999	MS 98007 T	Exc. Ford F-150 Pickup Base, Lariat, XL, XLT, F-250 Pickup Base, Lariat, XL, XLT; Lower set; Upper set incl.; PermaDryPlus® int. manifold gskts. incl.	

Ford Truck (Incl. Minivans and SUV's) (Cont.)

52 (cont.)	2013 - 1997; 5.4L 330 (5408cc) SOHC V8 (16 Valve) 90.2mm Bore Triton Windsor MFI; Natural Gas; Naturally Aspirated Ford Eng.; VIN Code M				52 (cont.)
QTY	MANIFOLD - INT. & EXH.	YEARS	PART NO.	DESCRIPTION	
1	Int. Manifold Gasket Set	1999	MS 98008 T	Ford F-150 Pickup Base, Lariat, XL, XLT, F-250 Pickup Base, Lariat, XL, XLT; Lower set; Upper set incl.; PermaDryPlus® int. manifold gskts. incl.	
1	Int. Manifold Gasket Set	1998-97	MS 92188	From 07/21/97; Lower set; Upper set incl.	
1	Int. Manifold Gasket Set	1998-97	MS 95728-1	To 07/20/97; Lower set; Upper set incl.	
1	Int. Manifold Gasket Set	1998-97	MS 98007 T	Lower set; Upper set incl.; PermaDryPlus® int. manifold gskts. incl.	
1	Plenum Gasket Set	1999	MS 92614	Ford F-150 Pickup Base, Lariat, XL, XLT, F-250 Pickup Base, Lariat, XL, XLT; Upper set	
1	Plenum Gasket Set	1999	MS 95962	Exc. Ford F-150 Pickup Base, Lariat, XL, XLT, F-250 Pickup Base, Lariat, XL, XLT; Upper set	
1	Plenum Gasket Set	1998-97	MS 95962	Upper set	
1	Exh. Manifold Gasket Set	2012-97	MS 92568	Improved design	
QTY	OIL PAN	YEARS	PART NO.	DESCRIPTION	
1	Oil Pan Gasket Set	2012-97	OS 30725 R	PermaDry® molded rubber gskt. incl.; Improved design	
1	Drain Plug Gasket	2012-97	72515		
QTY	CRANKSHAFT REAR SEAL	YEARS	PART NO.	DESCRIPTION	
1	Rear Main Seal Set	2012-97	BS 40620	Rubber; One-piece; Improved design	
1	Rear Main Seal Set	2012-97	BS 40644	PTFE Rubber; One-piece	
1	Repair Sleeve	2012-97	16270	Crankshaft; Use w/installation tool	
QTY	VALVE COVER	YEARS	PART NO.	DESCRIPTION	
1	Valve Cover Gasket Set	2012-05	VS 50603 R	w/Grommets; PermaDry® molded rubber gskts. incl.	
1	Valve Cover Gasket Set	2004	VS 50481 R	Ford E-250 Econoline Base, E-250 Super Duty Base, E-350 Econoline Club Wagon Chateau, XL, XLT, E-350 Super Duty Base, E-450 Econoline Super Duty Base; To 04/20/04; w/o Grommets; PermaDry® molded rubber gskts. incl.	
1	Valve Cover Gasket Set	2004	VS 50481 R	Ford F-250 Super Duty Pickup King Ranch, Lariat, XL, XLT, F-350 Super Duty Pickup King Ranch, Lariat, XL, XLT; To 04/20/04; w/o Grommets; PermaDry® molded rubber gskts. incl.	
1	Valve Cover Gasket Set	2004	VS 50481 R	Ford F-150 Pickup FX4, Lariat, STX, XL, XLT; w/o Grommets; PermaDry® molded rubber gskts. incl.	
1	Valve Cover Gasket Set	2004	VS 50603 R	Exc. Ford F-150 Pickup FX4, Lariat, STX, XL, XLT; From 04/21/04; w/Grommets; PermaDry® molded rubber gskts. incl.	
1	Valve Cover Gasket Set	2003-97	VS 50481 R	w/o Grommets; PermaDry® molded rubber gskts. incl.	
1	Grommet Set	2012-97	ES 71189	Valve Cover	
QTY	VALVE STEM SEAL SET	YEARS	PART NO.	DESCRIPTION	
1	Valve Stem Seal Set	2012-97	SS 72891	Premium valve stem seals incl.; Improved design	
QTY	WATER OUTLET GASKET	YEARS	PART NO.	DESCRIPTION	
1	Water Outlet Gasket	2012-97	35489	Water Outlet	
1	Water Crossover Mounting Set	2012-00	ES 71213		
QTY	WATER PUMP	YEARS	PART NO.	DESCRIPTION	
1	Water Pump Gasket	2012-97	35478		
2	O-Ring	2013-97	413	Water Pump; Water pump bypass pipe O-ring	
QTY	TIMING COVER	YEARS	PART NO.	DESCRIPTION	
1	Timing Cover Set	2012-99	TCS 45982-1	Repair sleeve not incl.	
1	Timing Cover Set	1998-97	TCS 45982	Repair sleeve not incl.	
1	Crankshaft Front Seal Set	2012-99	TCS 46117		
1	Crankshaft Front Seal Set	1998-97	TCS 46114		
1	Repair Sleeve	2012-97	16207	Timing Cover; Use w/installation tool	
1	Repair Sleeve Tool	2012-97	16310	Timing Cover	
QTY	CARB & FUEL INJECTION	YEARS	PART NO.	DESCRIPTION	
4	Fuel Injector O-Ring Set	2012-97	ES 70599	Improved design	
1	Throttle Body Gasket	2012-97	71216	Air bypass valve	
1	Throttle Body Gasket	2012-00	61103	Spacer to manifold	
1	Throttle Body Gasket	2012-11	61674	Housing to spacer; New Part Number - Check for Availability	
1	Throttle Body Gasket	2010	61050	To 10/04/09; Housing to spacer	
1	Throttle Body Gasket	2010	61674	From 10/05/09; Housing to spacer; New Part Number - Check for Availability	
1	Throttle Body Gasket	2009-04	61050	Housing to spacer	
1	Throttle Body Gasket	2003-00	61205-1	Housing to spacer	
1	Throttle Body Gasket	1999-97	61048	Spacer to manifold	
1	Throttle Body Gasket	1999-97	61050	Housing to spacer	
QTY	EXHAUST GAS RECIRCULATION	YEARS	PART NO.	DESCRIPTION	
1	EGR Gasket	2012-97	70802		
QTY	OIL FILTER MOUNTING	YEARS	PART NO.	DESCRIPTION	
1	Oil Filter Adapter Gasket	2012-97	70801		

Ford Truck (Incl. Minivans and SUV's) (Cont.)

53		2004 - 2001; 5.4L 330 (5408cc) SOHC V8 (16 Valve) 90.2mm Bore Triton Windsor			53
MFI; Gasoline; Naturally Aspirated Ford Eng.; VIN Code W					
QTY	CYLINDER HEAD	YEARS	PART NO.	DESCRIPTION	
1	Head Gasket	2004-01	9790 PT-2	Loc. R.H.; Head bolts not incl.; Head bolt replacement recommended; PermaTorqueMLS®; Improved design	
1	Head Gasket	2004-01	9792 PT-2	Loc. L.H.; Head bolts not incl.; Head bolt replacement recommended; PermaTorqueMLS®; Improved design	
1	Head Set	2004	HS 9790 PT-15	Ford F-250 Super Duty Pickup King Ranch, Lariat, XL, XLT, F-350 Super Duty Pickup King Ranch, Lariat, XL, XLT, F-450 Super Duty Pickup Lariat, XL, XLT, F-550 Super Duty Pickup Lariat, XL, XLT; From 04/21/04; Valve cover gskts. & head bolts not incl.; Head bolt replacement recommended; PermaDry® molded rubber valve cover gskts. incl.; Premium valve stem seals incl.	
1	Head Set	2004	HS 9790 PT-15	Ford Expedition Eddie Bauer, NBX, XLS, XLT, XLT Sport; From 05/21/04; Valve cover gskts. & head bolts not incl.; Head bolt replacement recommended; PermaDry® molded rubber valve cover gskts. incl.; Premium valve stem seals incl.	
1	Head Set	2004	HS 9790 PT-15	Ford Excursion Eddie Bauer, Limited, XLS, XLT; Head bolts not incl.; Head bolt replacement recommended; PermaDry® molded rubber valve cover gskts. incl.; Premium valve stem seals incl.	
1	Head Set	2004	HS 9790 PT-15	Ford F-250 Super Duty Pickup King Ranch, Lariat, XL, XLT, F-350 Super Duty Pickup King Ranch, Lariat, XL, XLT, F-450 Super Duty Pickup Lariat, XL, XLT, F-550 Super Duty Pickup Lariat, XL, XLT; To 04/20/04; Head bolts not incl.; Head bolt replacement recommended; PermaDry® molded rubber valve cover gskts. incl.; Premium valve stem seals incl.	
1	Head Set	2004	HS 9790 PT-15	Ford Expedition Eddie Bauer, NBX, XLS, XLT, XLT Sport; To 05/20/04; Head bolts not incl.; Head bolt replacement recommended; PermaDry® molded rubber valve cover gskts. incl.; Premium valve stem seals incl.	
1	Head Set	2004	HS 9792 PT-7	Ford E-150 Econoline Base, E-150 Econoline Club Wagon Chateau, XL, XLT, E-250 Econoline Base, E-250 Super Duty Base, E-350 Econoline Club Wagon Chateau, XL, XLT, E-350 Super Duty Base, E-450 Econoline Super Duty Base; From 04/21/04; Head bolts not incl.; Head bolt replacement recommended; PermaDry® molded rubber valve cover gskts. incl.; Premium valve stem seals incl.	
1	Head Set	2004	HS 9792 PT-7	Ford E-150 Econoline Base, E-150 Econoline Club Wagon Chateau, XL, XLT, E-250 Econoline Base, E-250 Super Duty Base, E-350 Econoline Club Wagon Chateau, XL, XLT, E-350 Super Duty Base, E-450 Econoline Super Duty Base; To 04/20/04; Valve cover gskts. & head bolts not incl.; Head bolt replacement recommended; PermaDry® molded rubber valve cover gskts. incl.; Premium valve stem seals incl.	
1	Head Set	2003-01	HS 9790 PT-15	Head bolts not incl.; Head bolt replacement recommended; PermaDry® molded rubber valve cover gskts. incl.; Premium valve stem seals incl.	
2	Head Bolt Set	2004-01	ES 71328	Head bolts w/Washers; Replacement recommended; Improved design	
2	Head Bolt Set	2004-01	ES 72798	Head bolts w/Washers; Replacement recommended; May use ES 71328 instead; Old design	
QTY	CONVERSION SET	YEARS	PART NO.	DESCRIPTION	
1	Gasket Conversion Set	2004-01	CS 9790-5	PermaDry® molded rubber oil pan gskt. incl.; Consolidated design	
QTY	MANIFOLD - INT. & EXH.	YEARS	PART NO.	DESCRIPTION	
1	Int. Manifold Gasket Set	2004	MS 92836-1	Exc. Ford E-150 Econoline Base, E-150 Econoline Club Wagon Chateau, XL, XLT, E-250 Econoline Base, E-250 Super Duty Base, E-350 Econoline Club Wagon Chateau, XL, XLT, E-350 Super Duty Base, E-450 Econoline Super Duty Base; Lower set; Upper set incl.	
1	Int. Manifold Gasket Set	2004	MS 96281	Ford E-150 Econoline Base, E-150 Econoline Club Wagon Chateau, XL, XLT, E-250 Econoline Base, E-250 Super Duty Base, E-350 Econoline Club Wagon Chateau, XL, XLT, E-350 Super Duty Base, E-450 Econoline Super Duty Base; Lower set; Upper set incl.	
1	Int. Manifold Gasket Set	2004	MS 98008 T-3	Exc. Ford E-150 Econoline Base, E-150 Econoline Club Wagon Chateau, XL, XLT, E-250 Econoline Base, E-250 Super Duty Base, E-350 Econoline Club Wagon Chateau, XL, XLT, E-350 Super Duty Base, E-450 Econoline Super Duty Base; Lower set; Upper set incl.; PermaDryPlus® int. manifold gskts. incl.	
1	Int. Manifold Gasket Set	2003-01	MS 92836-1	Lower set; Upper set incl.	
1	Int. Manifold Gasket Set	2003-01	MS 98008 T-3	Lower set; Upper set incl.; PermaDryPlus® int. manifold gskts. incl.	
1	Exh. Manifold Gasket Set	2004-01	MS 92568	Improved design	
QTY	OIL PAN	YEARS	PART NO.	DESCRIPTION	
1	Oil Pan Gasket Set	2004-01	OS 30725 R	PermaDry® molded rubber gskt. incl.; Improved design	
1	Drain Plug Gasket	2004-01	72515		
QTY	CRANKSHAFT REAR SEAL	YEARS	PART NO.	DESCRIPTION	
1	Rear Main Seal Set	2004-01	BS 40620	Rubber; One-piece; Improved design	

Ford Truck (Incl. Minivans and SUV's) (Cont.)

53		2004 - 2001; 5.4L 330 (5408cc) SOHC V8 (16 Valve) 90.2mm Bore Triton Windsor			53
(cont.)		MFI; Gasoline; Naturally Aspirated Ford Eng.; VIN Code W			(cont.)
QTY	CRANKSHAFT REAR SEAL	YEARS	PART NO.	DESCRIPTION	
1	Rear Main Seal Set	2004-01	BS 40644	PTFE Rubber; One-piece	
1	Repair Sleeve	2004-01	16270	Crankshaft; Use w/installation tool	
QTY	VALVE COVER	YEARS	PART NO.	DESCRIPTION	
1	Valve Cover Gasket Set	2004	VS 50481 R	Ford E-150 Econoline Base, E-150 Econoline Club Wagon Chateau, XL, XLT, E-250 Econoline Base, E-250 Super Duty Base, E-350 Econoline Club Wagon Chateau, XL, XLT, E-350 Super Duty Base, E-450 Econoline Super Duty Base; To 04/20/04; w/o Grommets; PermaDry® molded rubber gskts. incl.	
1	Valve Cover Gasket Set	2004	VS 50481 R	Ford F-250 Super Duty Pickup King Ranch, Lariat, XL, XLT, F-350 Super Duty Pickup King Ranch, Lariat, XL, XLT, F-450 Super Duty Pickup Lariat, XL, XLT, F-550 Super Duty Pickup Lariat, XL, XLT; To 04/20/04; w/o Grommets; PermaDry® molded rubber gskts. incl.	
1	Valve Cover Gasket Set	2004	VS 50481 R	Ford Expedition Eddie Bauer, NBX, XLS, XLT, XLT Sport; To 05/20/04; w/o Grommets; PermaDry® molded rubber gskts. incl.	
1	Valve Cover Gasket Set	2004	VS 50481 R	Ford Excursion Eddie Bauer, Limited, XLS, XLT; w/o Grommets; PermaDry® molded rubber gskts. incl.	
1	Valve Cover Gasket Set	2004	VS 50603 R	Ford E-150 Econoline Base, E-150 Econoline Club Wagon Chateau, XL, XLT, E-250 Econoline Base, E-250 Super Duty Base, E-350 Econoline Club Wagon Chateau, XL, XLT, E-350 Super Duty Base, E-450 Econoline Super Duty Base; From 04/21/04; w/Grommets; PermaDry® molded rubber gskts. incl.	
1	Valve Cover Gasket Set	2004	VS 50603 R	Ford F-250 Super Duty Pickup King Ranch, Lariat, XL, XLT, F-350 Super Duty Pickup King Ranch, Lariat, XL, XLT, F-450 Super Duty Pickup Lariat, XL, XLT, F-550 Super Duty Pickup Lariat, XL, XLT; From 04/21/04; w/Grommets; PermaDry® molded rubber gskts. incl.	
1	Valve Cover Gasket Set	2004	VS 50603 R	Ford Expedition Eddie Bauer, NBX, XLS, XLT, XLT Sport; From 05/21/04; w/Grommets; PermaDry® molded rubber gskts. incl.	
1	Valve Cover Gasket Set	2003-01	VS 50481 R	w/o Grommets; PermaDry® molded rubber gskts. incl.	
1	Grommet Set	2004-01	ES 71189	Valve Cover	
QTY	VALVE STEM SEAL SET	YEARS	PART NO.	DESCRIPTION	
1	Valve Stem Seal Set	2004-01	SS 72891	Premium valve stem seals incl.; Improved design	
QTY	WATER OUTLET GASKET	YEARS	PART NO.	DESCRIPTION	
1	Water Outlet Gasket	2004-01	35489	Water Outlet	
1	Water Crossover Mounting Set	2004-01	ES 71213		
QTY	WATER PUMP	YEARS	PART NO.	DESCRIPTION	
1	Water Pump Gasket	2004-01	35478		
2	O-Ring	2004-01	413	Water Pump; Water pump bypass pipe O-ring	
QTY	TIMING COVER	YEARS	PART NO.	DESCRIPTION	
1	Timing Cover Set	2004-01	TCS 45982-1	Repair sleeve not incl.	
1	Crankshaft Front Seal Set	2004-01	TCS 46117		
1	Repair Sleeve	2004-01	16207	Timing Cover; Use w/installation tool	
1	Repair Sleeve Tool	2004-01	16310	Timing Cover	
QTY	CARB & FUEL INJECTION	YEARS	PART NO.	DESCRIPTION	
4	Fuel Injector O-Ring Set	2004-01	ES 70599	Improved design	
1	Throttle Body Gasket	2004-01	61103	Spacer to manifold	
1	Throttle Body Gasket	2004-01	71216	Air bypass valve	
1	Throttle Body Gasket	2004	61050	Housing to spacer	
1	Throttle Body Gasket	2003-01	61205-1	Housing to spacer	
QTY	EXHAUST GAS RECIRCULATION	YEARS	PART NO.	DESCRIPTION	
1	EGR Gasket	2004-01	70802		
QTY	OIL FILTER MOUNTING	YEARS	PART NO.	DESCRIPTION	
1	Oil Filter Adapter Gasket	2004-01	70801		
54		2013 - 1997; 5.4L 330 (5408cc) SOHC V8 (16 Valve) 90.2mm Bore Triton Windsor			54
		MFI; Bi-Fuel; Naturally Aspirated Ford Eng.; VIN Code Z			
QTY	CYLINDER HEAD	YEARS	PART NO.	DESCRIPTION	
1	Head Gasket	2012-09	26482 PT	Loc. L.H.; Head bolts not incl.; Head bolt replacement recommended; PermaTorqueMLS®	
1	Head Gasket	2012-09	26483 PT	Loc. R.H.; Head bolts not incl.; Head bolt replacement recommended; PermaTorqueMLS®	
1	Head Gasket	2008-97	9790 PT-2	Loc. R.H.; Head bolts not incl.; Head bolt replacement recommended; PermaTorqueMLS®; Improved design	
1	Head Gasket	2008-97	9792 PT-2	Loc. L.H.; Head bolts not incl.; Head bolt replacement recommended; PermaTorqueMLS®; Improved design	

Ford Truck (Incl. Minivans and SUV's) (Cont.)

54 (cont.)		2013 - 1997; 5.4L 330 (5408cc) SOHC V8 (16 Valve) 90.2mm Bore Triton Windsor			54 (cont.)
MFI; Bi-Fuel; Naturally Aspirated Ford Eng.; VIN Code Z					
QTY	CYLINDER HEAD	YEARS	PART NO.	DESCRIPTION	
1	Head Set	2012-11	HS 26482 PT-1	Head bolts not incl.; Head bolt replacement recommended; PermaDry® molded rubber valve cover gskts. incl.; Premium valve stem seals incl.; New Part Number - Check for Availability	
1	Head Set	2010	HS 26482 PT-1	From 10/05/09; Head bolts not incl.; Head bolt replacement recommended; PermaDry® molded rubber valve cover gskts. incl.; Premium valve stem seals incl.; New Part Number - Check for Availability	
1	Head Set	2010	HS 26482 PT-1	To 10/04/09; Int. manifold gskts. & head bolts not incl.; Head bolt replacement recommended; PermaDry® molded rubber valve cover gskts. incl.; Premium valve stem seals incl.; New Part Number - Check for Availability	
1	Head Set	2009	HS 26482 PT-1	Int. manifold gskts. & head bolts not incl.; Head bolt replacement recommended; PermaDry® molded rubber valve cover gskts. incl.; Premium valve stem seals incl.; New Part Number - Check for Availability	
1	Head Set	2008	HS 9792 PT-7	Int. manifold gskts. & head bolts not incl.; Head bolt replacement recommended; PermaDry® molded rubber valve cover gskts. incl.; Premium valve stem seals incl.	
1	Head Set	2007-05	HS 9792 PT-7	Head bolts not incl.; Head bolt replacement recommended; PermaDry® molded rubber valve cover gskts. incl.; Premium valve stem seals incl.	
1	Head Set	2004	HS 9790 PT-15	Ford F-250 Super Duty Pickup King Ranch, Lariat, XL, XLT, F-350 Super Duty Pickup King Ranch, Lariat, XL, XLT; From 04/21/04; Valve cover gskts. & head bolts not incl.; Head bolt replacement recommended; PermaDry® molded rubber valve cover gskts. incl.; Premium valve stem seals incl.	
1	Head Set	2004	HS 9790 PT-15	Ford F-150 Pickup FX4, Lariat, STX, XL, XLT; Head bolts not incl.; Head bolt replacement recommended; PermaDry® molded rubber valve cover gskts. incl.; Premium valve stem seals incl.	
1	Head Set	2004	HS 9790 PT-15	Ford F-250 Super Duty Pickup King Ranch, Lariat, XL, XLT, F-350 Super Duty Pickup King Ranch, Lariat, XL, XLT; To 04/20/04; Head bolts not incl.; Head bolt replacement recommended; PermaDry® molded rubber valve cover gskts. incl.; Premium valve stem seals incl.	
1	Head Set	2004	HS 9792 PT-7	Ford E-250 Econoline Base, E-250 Super Duty Base, E-350 Econoline Club Wagon Chateau, XL, XLT, E-350 Super Duty Base; From 04/21/04; Head bolts not incl.; Head bolt replacement recommended; PermaDry® molded rubber valve cover gskts. incl.; Premium valve stem seals incl.	
1	Head Set	2004	HS 9792 PT-7	Ford E-250 Econoline Base, E-250 Super Duty Base, E-350 Econoline Club Wagon Chateau, XL, XLT, E-350 Super Duty Base; To 04/20/04; Valve cover gskts. & head bolts not incl.; Head bolt replacement recommended; PermaDry® molded rubber valve cover gskts. incl.; Premium valve stem seals incl.	
1	Head Set	2003-00	HS 9790 PT-15	Head bolts not incl.; Head bolt replacement recommended; PermaDry® molded rubber valve cover gskts. incl.; Premium valve stem seals incl.	
1	Head Set	1999	HS 9790 PT-11	Exc. Ford F-150 Pickup Base, Lariat, XL, XLT, F-250 Pickup Base, Lariat, XL, XLT; Head bolts not incl.; Head bolt replacement recommended; PermaDry® molded rubber valve cover gskts. incl.; Premium valve stem seals incl.	
1	Head Set	1999	HS 9790 PT-12	Ford F-150 Pickup Base, Lariat, XL, XLT, F-250 Pickup Base, Lariat, XL, XLT; Head bolts not incl.; Head bolt replacement recommended; PermaDry® molded rubber valve cover gskts. incl.; Premium valve stem seals incl.; Consolidated design	
1	Head Set	1998-97	HS 9790 PT-11	From 07/21/97; Head bolts not incl.; Head bolt replacement recommended; PermaDry® molded rubber valve cover gskts. incl.; Premium valve stem seals incl.	
1	Head Set	1998-97	HS 9790 PT-4	To 07/20/97; Head bolts not incl.; Head bolt replacement recommended; PermaDry® molded rubber valve cover gskts. incl.; Premium valve stem seals incl.	
2	Head Bolt Set	2012-97	ES 71328	Head bolts w/Washers; Replacement recommended; Improved design	
2	Head Bolt Set	2012-97	ES 72798	Head bolts w/Washers; Replacement recommended; May use ES 71328 instead; Old design	
QTY	CONVERSION SET	YEARS	PART NO.	DESCRIPTION	
1	Gasket Conversion Set	2012-99	CS 9790-5	PermaDry® molded rubber oil pan gskt. incl.; Consolidated design	
1	Gasket Conversion Set	1998-97	CS 9790-1	PermaDry® molded rubber oil pan gskt. incl.	
QTY	MANIFOLD - INT. & EXH.	YEARS	PART NO.	DESCRIPTION	
1	Int. Manifold Gasket Set	2012-11	MS 97200	Lower set; New Part Number - Check for Availability	
1	Int. Manifold Gasket Set	2010	MS 92836-1	To 10/04/09; Lower set; Upper set incl.	
1	Int. Manifold Gasket Set	2010	MS 97200	From 10/05/09; Lower set; New Part Number - Check for Availability	

Ford Truck (Incl. Minivans and SUV's) (Cont.)

54 (cont.)	2013 - 1997; 5.4L 330 (5408cc) SOHC V8 (16 Valve) 90.2mm Bore Triton Windsor MFI; Bi-Fuel; Naturally Aspirated Ford Eng.; VIN Code Z				54 (cont.)
QTY	MANIFOLD - INT. & EXH.	YEARS	PART NO.	DESCRIPTION	
1	Int. Manifold Gasket Set	2010	MS 98008 T-3	To 10/04/09; Lower set; Upper set incl.; PermaDryPlus® int. manifold gskts. incl.	
1	Int. Manifold Gasket Set	2009-08	MS 92836-1	Lower set; Upper set incl.	
1	Int. Manifold Gasket Set	2009-08	MS 98008 T-3	Lower set; Upper set incl.; PermaDryPlus® int. manifold gskts. incl.	
1	Int. Manifold Gasket Set	2007-05	MS 96281	Lower set; Upper set incl.	
1	Int. Manifold Gasket Set	2004	MS 92836-1	Exc. Ford E-250 Econoline Base, E-250 Super Duty Base, E-350 Econoline Club Wagon Chateau, XL, XLT, E-350 Super Duty Base; Lower set; Upper set incl.	
1	Int. Manifold Gasket Set	2004	MS 96281	Ford E-250 Econoline Base, E-250 Super Duty Base, E-350 Econoline Club Wagon Chateau, XL, XLT, E-350 Super Duty Base; Lower set; Upper set incl.	
1	Int. Manifold Gasket Set	2004	MS 98008 T-3	Exc. Ford E-250 Econoline Base, E-250 Super Duty Base, E-350 Econoline Club Wagon Chateau, XL, XLT, E-350 Super Duty Base; Lower set; Upper set incl.; PermaDryPlus® int. manifold gskts. incl.	
1	Int. Manifold Gasket Set	2003-00	MS 92836-1	Lower set; Upper set incl.	
1	Int. Manifold Gasket Set	2003-00	MS 98008 T-3	Lower set; Upper set incl.; PermaDryPlus® int. manifold gskts. incl.	
1	Int. Manifold Gasket Set	1999	MS 92121-2	Ford F-150 Pickup Base, Lariat, XL, XLT, F-250 Pickup Base, Lariat, XL, XLT; Lower set; Upper set incl.; Consolidated design	
1	Int. Manifold Gasket Set	1999	MS 92188	Exc. Ford F-150 Pickup Base, Lariat, XL, XLT, F-250 Pickup Base, Lariat, XL, XLT; Lower set; Upper set incl.	
1	Int. Manifold Gasket Set	1999	MS 92188-1	Ford F-150 Pickup Base, Lariat, XL, XLT, F-250 Pickup Base, Lariat, XL, XLT; Lower set; Upper set incl.; May use MS 92121-2 instead; Old design; Superseded - When depleted use MS 92121-2	
1	Int. Manifold Gasket Set	1999	MS 98007 T	Exc. Ford F-150 Pickup Base, Lariat, XL, XLT, F-250 Pickup Base, Lariat, XL, XLT; Lower set; Upper set incl.; PermaDryPlus® int. manifold gskts. incl.	
1	Int. Manifold Gasket Set	1999	MS 98008 T	Ford F-150 Pickup Base, Lariat, XL, XLT, F-250 Pickup Base, Lariat, XL, XLT; Lower set; Upper set incl.; PermaDryPlus® int. manifold gskts. incl.	
1	Int. Manifold Gasket Set	1998-97	MS 92188	From 07/21/97; Lower set; Upper set incl.	
1	Int. Manifold Gasket Set	1998-97	MS 95728-1	To 07/20/97; Lower set; Upper set incl.	
1	Int. Manifold Gasket Set	1998-97	MS 98007 T	Lower set; Upper set incl.; PermaDryPlus® int. manifold gskts. incl.	
1	Plenum Gasket Set	1999	MS 92614	Ford F-150 Pickup Base, Lariat, XL, XLT, F-250 Pickup Base, Lariat, XL, XLT; Upper set	
1	Plenum Gasket Set	1999	MS 95962	Exc. Ford F-150 Pickup Base, Lariat, XL, XLT, F-250 Pickup Base, Lariat, XL, XLT; Upper set	
1	Plenum Gasket Set	1998-97	MS 95962	Upper set	
1	Exh. Manifold Gasket Set	2012-97	MS 92568	Improved design	
QTY	OIL PAN	YEARS	PART NO.	DESCRIPTION	
1	Oil Pan Gasket Set	2012-97	OS 30725 R	PermaDry® molded rubber gskt. incl.; Improved design	
1	Drain Plug Gasket	2012-97	72515		
QTY	CRANKSHAFT REAR SEAL	YEARS	PART NO.	DESCRIPTION	
1	Rear Main Seal Set	2012-97	BS 40620	Rubber; One-piece; Improved design	
1	Rear Main Seal Set	2012-97	BS 40644	PTFE Rubber; One-piece	
1	Repair Sleeve	2012-97	16270	Crankshaft; Use w/installation tool	
QTY	VALVE COVER	YEARS	PART NO.	DESCRIPTION	
1	Valve Cover Gasket Set	2012-05	VS 50603 R	w/Grommets; PermaDry® molded rubber gskts. incl.	
1	Valve Cover Gasket Set	2004	VS 50481 R	Ford E-250 Econoline Base, E-250 Super Duty Base, E-350 Econoline Club Wagon Chateau, XL, XLT, E-350 Super Duty Base; To 04/20/04; w/o Grommets; PermaDry® molded rubber gskts. incl.	
1	Valve Cover Gasket Set	2004	VS 50481 R	Ford F-250 Super Duty Pickup King Ranch, Lariat, XL, XLT, F-350 Super Duty Pickup King Ranch, Lariat, XL, XLT; To 04/20/04; w/o Grommets; PermaDry® molded rubber gskts. incl.	
1	Valve Cover Gasket Set	2004	VS 50481 R	Ford F-150 Pickup FX4, Lariat, STX, XL, XLT; w/o Grommets; PermaDry® molded rubber gskts. incl.	
1	Valve Cover Gasket Set	2004	VS 50603 R	Exc. Ford F-150 Pickup FX4, Lariat, STX, XL, XLT; From 04/21/04; w/Grommets; PermaDry® molded rubber gskts. incl.	
1	Valve Cover Gasket Set	2003-97	VS 50481 R	w/o Grommets; PermaDry® molded rubber gskts. incl.	
1	Grommet Set	2012-97	ES 71189	Valve Cover	
QTY	VALVE STEM SEAL SET	YEARS	PART NO.	DESCRIPTION	
1	Valve Stem Seal Set	2012-97	SS 72891	Premium valve stem seals incl.; Improved design	
QTY	WATER OUTLET GASKET	YEARS	PART NO.	DESCRIPTION	
1	Water Outlet Gasket	2012-97	35489	Water Outlet	
1	Water Crossover Mounting Set	2012-00	ES 71213		
QTY	WATER PUMP	YEARS	PART NO.	DESCRIPTION	
1	Water Pump Gasket	2012-97	35478		

Ford Truck (Incl. Minivans and SUV's) (Cont.)

54		2013 - 1997; 5.4L 330 (5408cc) SOHC V8 (16 Valve) 90.2mm Bore Triton Windsor			54
(cont.)		MFI; Bi-Fuel; Naturally Aspirated Ford Eng.; VIN Code Z			(cont.)
QTY	WATER PUMP	YEARS	PART NO.	DESCRIPTION	
2	O-Ring	2013-97	413	Water Pump; Water pump bypass pipe O-ring	
QTY	TIMING COVER	YEARS	PART NO.	DESCRIPTION	
1	Timing Cover Set	2012-99	TCS 45982-1	Repair sleeve not incl.	
1	Timing Cover Set	1998-97	TCS 45982	Repair sleeve not incl.	
1	Crankshaft Front Seal Set	2012-99	TCS 46117		
1	Crankshaft Front Seal Set	1998-97	TCS 46114		
1	Repair Sleeve	2012-97	16207	Timing Cover; Use w/installation tool	
1	Repair Sleeve Tool	2012-97	16310	Timing Cover	
QTY	CARB & FUEL INJECTION	YEARS	PART NO.	DESCRIPTION	
4	Fuel Injector O-Ring Set	2012-97	ES 70599	Improved design	
1	Throttle Body Gasket	2012-97	71216	Air bypass valve	
1	Throttle Body Gasket	2012-00	61103	Spacer to manifold	
1	Throttle Body Gasket	2012-11	61674	Housing to spacer; New Part Number - Check for Availability	
1	Throttle Body Gasket	2010	61050	To 10/04/09; Housing to spacer	
1	Throttle Body Gasket	2010	61674	From 10/05/09; Housing to spacer; New Part Number - Check for Availability	
1	Throttle Body Gasket	2009-04	61050	Housing to spacer	
1	Throttle Body Gasket	2003-00	61205-1	Housing to spacer	
1	Throttle Body Gasket	1999-97	61048	Spacer to manifold	
1	Throttle Body Gasket	1999-97	61050	Housing to spacer	
QTY	EXHAUST GAS RECIRCULATION	YEARS	PART NO.	DESCRIPTION	
1	EGR Gasket	2012-97	70802		
QTY	OIL FILTER MOUNTING	YEARS	PART NO.	DESCRIPTION	
1	Oil Filter Adapter Gasket	2012-97	70801		
55		2013 - 2009; 5.4L 330 (5408cc) SOHC V8 (24 Valve) 90.2mm Bore Triton Windsor			55
		MFI; Flex Fuel; Naturally Aspirated Ford Eng.; VIN Code 5			
QTY	CYLINDER HEAD	YEARS	PART NO.	DESCRIPTION	
1	Head Gasket	2012-09	26306 PT	Loc. L.H.; Head bolts not incl.; Head bolt replacement recommended; PermaTorqueMLS® LaserWeld® Technology	
1	Head Gasket	2012-09	26307 PT	Loc. R.H.; Head bolts not incl.; Head bolt replacement recommended; PermaTorqueMLS® LaserWeld® Technology	
1	Head Set	2012-09	HS 26306 PT-2	Head bolts not incl.; Head bolt replacement recommended; PermaDry® molded rubber valve cover gskts. incl.; Premium valve stem seals incl.	
2	Head Bolt Set	2012-09	ES 71328	Head bolts w/Washers; Replacement recommended; Improved design	
2	Head Bolt Set	2012-09	ES 72798	Head bolts w/Washers; Replacement recommended; May use ES 71328 instead; Old design	
QTY	CONVERSION SET	YEARS	PART NO.	DESCRIPTION	
1	Gasket Conversion Set	2012-09	CS 9790-5	PermaDry® molded rubber oil pan gskt. incl.; Consolidated design	
QTY	MANIFOLD - INT. & EXH.	YEARS	PART NO.	DESCRIPTION	
1	Int. Manifold Gasket Set	2012-09	MS 96696	Lower set; Upper set incl.	
1	Exh. Manifold Gasket Set	2012-09	MS 96679		
QTY	OIL PAN	YEARS	PART NO.	DESCRIPTION	
1	Oil Pan Gasket Set	2012-09	OS 30725 R	PermaDry® molded rubber gskt. incl.; Improved design	
1	Drain Plug Gasket	2012-09	72515		
QTY	CRANKSHAFT REAR SEAL	YEARS	PART NO.	DESCRIPTION	
1	Rear Main Seal Set	2012-09	BS 40620	Rubber; One-piece; Improved design	
1	Rear Main Seal Set	2012-09	BS 40644	PTFE Rubber; One-piece	
1	Repair Sleeve	2012-09	16270	Crankshaft; Use w/installation tool	
QTY	VALVE COVER	YEARS	PART NO.	DESCRIPTION	
1	Valve Cover Gasket Set	2012-09	VS 50687 R	w/Grommets; PermaDry® molded rubber gskts. incl.	
1	Grommet Set	2013-09	ES 71426	Valve Cover; VCT seals set; New Part Number - Check for Availability	
QTY	VALVE STEM SEAL SET	YEARS	PART NO.	DESCRIPTION	
1	Valve Stem Seal Set	2012-09	SS 72921-1	Premium valve stem seals incl.	
QTY	THERMOSTAT HOUSING	YEARS	PART NO.	DESCRIPTION	
1	Water Outlet Gasket	2012-09	35489	Thermostat Housing; Thermostat seal	
QTY	WATER OUTLET GASKET	YEARS	PART NO.	DESCRIPTION	
1	Water Outlet Gasket	2012-09	35789	Water Crossover; Loc. L.H.	
1	Water Outlet Gasket	2012-09	35791	Water Crossover; Loc. R.H.	
QTY	WATER PUMP	YEARS	PART NO.	DESCRIPTION	
1	Water Pump Gasket	2012-09	35478		
2	O-Ring	2013-09	413	Water Pump; Water pump bypass pipe O-ring	
QTY	TIMING COVER	YEARS	PART NO.	DESCRIPTION	
1	Timing Cover Set	2012-09	TCS 46078	Repair sleeve not incl.	
1	Crankshaft Front Seal Set	2012-09	TCS 46117		

Ford Truck (Incl. Minivans and SUV's) (Cont.)

55		2013 - 2009; 5.4L 330 (5408cc) SOHC V8 (24 Valve) 90.2mm Bore Triton Windsor			55
(cont.)		MFI; Flex Fuel; Naturally Aspirated Ford Eng.; VIN Code 5			(cont.)
QTY	CARB & FUEL INJECTION	YEARS	PART NO.	DESCRIPTION	
4	Fuel Injector O-Ring Set	2012-09	ES 70599	Improved design	
1	Throttle Body Gasket	2012-09	61438	Mounting	
QTY	OIL FILTER MOUNTING	YEARS	PART NO.	DESCRIPTION	
1	Oil Filter Adapter Gasket	2012-09	70801		
56		2013 - 2004; 5.4L 330 (5408cc) SOHC V8 (24 Valve) 90.2mm Bore Triton Windsor			56
		MFI; Gasoline; Naturally Aspirated Ford Eng.; VIN Code 5			
QTY	CYLINDER HEAD	YEARS	PART NO.	DESCRIPTION	
1	Head Gasket	2012-04	26306 PT	Loc. L.H.; Head bolts not incl.; Head bolt replacement recommended; PermaTorqueMLS® LaserWeld® Technology	
1	Head Gasket	2012-04	26307 PT	Loc. R.H.; Head bolts not incl.; Head bolt replacement recommended; PermaTorqueMLS® LaserWeld® Technology	
1	Head Set	2012-07	HS 26306 PT-2	Head bolts not incl.; Head bolt replacement recommended; PermaDry® molded rubber valve cover gskts. incl.; Premium valve stem seals incl.	
1	Head Set	2006-04	HS 26306 PT	Head bolts not incl.; Head bolt replacement recommended; PermaDry® molded rubber valve cover gskts. incl.; Premium valve stem seals incl.	
2	Head Bolt Set	2012-04	ES 71328	Head bolts w/Washers; Replacement recommended; Improved design	
2	Head Bolt Set	2012-04	ES 72798	Head bolts w/Washers; Replacement recommended; May use ES 71328 instead; Old design	
QTY	CONVERSION SET	YEARS	PART NO.	DESCRIPTION	
1	Gasket Conversion Set	2012-04	CS 9790-5	PermaDry® molded rubber oil pan gskt. incl.; Consolidated design	
QTY	MANIFOLD - INT. & EXH.	YEARS	PART NO.	DESCRIPTION	
1	Int. Manifold Gasket Set	2012-04	MS 96696	Lower set; Upper set incl.	
1	Exh. Manifold Gasket Set	2012-04	MS 96679		
QTY	OIL PAN	YEARS	PART NO.	DESCRIPTION	
1	Oil Pan Gasket Set	2012-04	OS 30725 R	PermaDry® molded rubber gskt. incl.; Improved design	
1	Drain Plug Gasket	2012-04	72515		
QTY	CRANKSHAFT REAR SEAL	YEARS	PART NO.	DESCRIPTION	
1	Rear Main Seal Set	2012-04	BS 40620	Rubber; One-piece; Improved design	
1	Rear Main Seal Set	2012-04	BS 40644	PTFE Rubber; One-piece	
1	Repair Sleeve	2012-04	16270	Crankshaft; Use w/installation tool	
QTY	VALVE COVER	YEARS	PART NO.	DESCRIPTION	
1	Valve Cover Gasket Set	2012-07	VS 50687 R	w/Grommets; PermaDry® molded rubber gskts. incl.	
1	Valve Cover Gasket Set	2006-04	VS 50664 R	w/Grommets; PermaDry® molded rubber gskts. incl.	
1	Grommet Set	2013-04	ES 71426	Valve Cover; VCT seals set; New Part Number - Check for Availability	
QTY	VALVE STEM SEAL SET	YEARS	PART NO.	DESCRIPTION	
1	Valve Stem Seal Set	2012-04	SS 72921-1	Premium valve stem seals incl.	
QTY	THERMOSTAT HOUSING	YEARS	PART NO.	DESCRIPTION	
1	Water Outlet Gasket	2012-04	35489	Thermostat Housing; Thermostat seal	
QTY	WATER OUTLET GASKET	YEARS	PART NO.	DESCRIPTION	
1	Water Outlet Gasket	2012-04	35789	Water Crossover; Loc. L.H.	
1	Water Outlet Gasket	2012-04	35791	Water Crossover; Loc. R.H.	
QTY	WATER PUMP	YEARS	PART NO.	DESCRIPTION	
1	Water Pump Gasket	2012-04	35478		
2	O-Ring	2013-04	413	Water Pump; Water pump bypass pipe O-ring	
QTY	TIMING COVER	YEARS	PART NO.	DESCRIPTION	
1	Timing Cover Set	2012-04	TCS 46078	Repair sleeve not incl.	
1	Crankshaft Front Seal Set	2012-04	TCS 46117		
QTY	CARB & FUEL INJECTION	YEARS	PART NO.	DESCRIPTION	
4	Fuel Injector O-Ring Set	2012-04	ES 70599	Improved design	
1	Throttle Body Gasket	2012-04	61438	Mounting	
QTY	OIL FILTER MOUNTING	YEARS	PART NO.	DESCRIPTION	
1	Oil Filter Adapter Gasket	2012-04	70801		
57		2010 - 2008; 5.4L 330 (5408cc) SOHC V8 (24 Valve) 90.2mm Bore Triton Windsor			57
		MFI; Gasoline; Supercharged Ford Eng.; VIN Code 5			
QTY	WATER PUMP	YEARS	PART NO.	DESCRIPTION	
2	O-Ring	2010-08	413	Water Pump; Water pump bypass pipe O-ring	
QTY	TIMING COVER	YEARS	PART NO.	DESCRIPTION	
1	Crankshaft Front Seal Set	2010-08	TCS 46117		

Ford Truck (Incl. Minivans and SUV's) (Cont.)

58		2010 - 2006; 5.4L 330 (5408cc) SOHC V8 (24 Valve) 90.2mm Bore Triton Windsor			58
MFI; Flex Fuel; Naturally Aspirated Ford Eng.; VIN Code V					
QTY	CYLINDER HEAD	YEARS	PART NO.	DESCRIPTION	
1	Head Gasket	2010-06	26306 PT	Loc. L.H.; Head bolts not incl.; Head bolt replacement recommended; PermaTorqueMLS® LaserWeld® Technology	
1	Head Gasket	2010-06	26307 PT	Loc. R.H.; Head bolts not incl.; Head bolt replacement recommended; PermaTorqueMLS® LaserWeld® Technology	
1	Head Set	2010-07	HS 26306 PT-2	Head bolts not incl.; Head bolt replacement recommended; PermaDry® molded rubber valve cover gskts. incl.; Premium valve stem seals incl.	
1	Head Set	2006	HS 26306 PT	Head bolts not incl.; Head bolt replacement recommended; PermaDry® molded rubber valve cover gskts. incl.; Premium valve stem seals incl.	
2	Head Bolt Set	2010-06	ES 71328	Head bolts w/Washers; Replacement recommended; Improved design	
2	Head Bolt Set	2010-06	ES 72798	Head bolts w/Washers; Replacement recommended; May use ES 71328 instead; Old design	
QTY	CONVERSION SET	YEARS	PART NO.	DESCRIPTION	
1	Gasket Conversion Set	2010-06	CS 9790-5	PermaDry® molded rubber oil pan gskt. incl.; Consolidated design	
QTY	MANIFOLD - INT. & EXH.	YEARS	PART NO.	DESCRIPTION	
1	Int. Manifold Gasket Set	2010-06	MS 96696	Lower set; Upper set incl.	
1	Exh. Manifold Gasket Set	2010-06	MS 96679		
QTY	OIL PAN	YEARS	PART NO.	DESCRIPTION	
1	Oil Pan Gasket Set	2010-06	OS 30725 R	PermaDry® molded rubber gskt. incl.; Improved design	
1	Drain Plug Gasket	2010-06	72515		
QTY	CRANKSHAFT REAR SEAL	YEARS	PART NO.	DESCRIPTION	
1	Rear Main Seal Set	2010-06	BS 40620	Rubber; One-piece; Improved design	
1	Rear Main Seal Set	2010-06	BS 40644	PTFE Rubber; One-piece	
1	Repair Sleeve	2010-06	16270	Crankshaft; Use w/installation tool	
QTY	VALVE COVER	YEARS	PART NO.	DESCRIPTION	
1	Valve Cover Gasket Set	2010-07	VS 50687 R	w/Grommets; PermaDry® molded rubber gskts. incl.	
1	Valve Cover Gasket Set	2006	VS 50664 R	w/Grommets; PermaDry® molded rubber gskts. incl.	
1	Grommet Set	2010-06	ES 71426	Valve Cover; VCT seals set; New Part Number - Check for Availability	
QTY	VALVE STEM SEAL SET	YEARS	PART NO.	DESCRIPTION	
1	Valve Stem Seal Set	2010-06	SS 72921-1	Premium valve stem seals incl.	
QTY	THERMOSTAT HOUSING	YEARS	PART NO.	DESCRIPTION	
1	Water Outlet Gasket	2010-06	35489	Thermostat Housing; Thermostat seal	
QTY	WATER OUTLET GASKET	YEARS	PART NO.	DESCRIPTION	
1	Water Outlet Gasket	2010-06	35789	Water Crossover; Loc. L.H.	
1	Water Outlet Gasket	2010-06	35791	Water Crossover; Loc. R.H.	
QTY	WATER PUMP	YEARS	PART NO.	DESCRIPTION	
1	Water Pump Gasket	2010-06	35478		
2	O-Ring	2010-06	413	Water Pump; Water pump bypass pipe O-ring	
QTY	TIMING COVER	YEARS	PART NO.	DESCRIPTION	
1	Timing Cover Set	2010-06	TCS 46078	Repair sleeve not incl.	
1	Crankshaft Front Seal Set	2010-06	TCS 46117		
QTY	CARB & FUEL INJECTION	YEARS	PART NO.	DESCRIPTION	
4	Fuel Injector O-Ring Set	2010-06	ES 70599	Improved design	
1	Throttle Body Gasket	2010-06	61438	Mounting	
QTY	OIL FILTER MOUNTING	YEARS	PART NO.	DESCRIPTION	
1	Oil Filter Adapter Gasket	2010-06	70801		
59		1998 - 1991; 5.8L 351 (5753cc) OHV V8 (16 Valve) 4" Bore Windsor			59
MFI; Gasoline; Naturally Aspirated Ford Eng.; VIN Code H					
QTY	CYLINDER HEAD	YEARS	PART NO.	DESCRIPTION	
2	Head Gasket	1998-91	8548 PT-2	PermaTorque®	
2	Head Gasket	1998-91	9333 PT-1	H/D eng.	
2	Head Gasket Spacer Shim	1998-91	8548 SP-1	HeadSaver®	
1	Head Set	1998-95	HS 8548 PT-9	Exh. valve stem seals not incl.; Premium valve stem seals incl.	
1	Head Set	1994-91	HS 8548 PT-9	Premium valve stem seals incl.	
QTY	CONVERSION SET	YEARS	PART NO.	DESCRIPTION	
1	Gasket Conversion Set	1998-94	CS 8548-8	PermaDry® molded rubber oil pan gskt. incl.	
1	Gasket Conversion Set	1993-91	CS 8548-7	Water pump to plate gskt. not incl.; Multi-piece oil pan gskt. incl.	
QTY	MANIFOLD - INT. & EXH.	YEARS	PART NO.	DESCRIPTION	
1	Int. Manifold Gasket Set	1998-91	MS 90361	Lower set; Upper set not incl.	
1	Plenum Gasket Set	1998-91	MS 94176	Upper set	
1	Exh. Manifold Gasket Set	1998-91	MS 90000		
QTY	EXHAUST PIPE FLANGE	YEARS	PART NO.	DESCRIPTION	
1	Exhaust Pipe Gasket	1998-97	60712	Inlet pipe to converter	

Ford Truck (Incl. Minivans and SUV's) (Cont.)

59 (cont.)		1998 - 1991; 5.8L 351 (5753cc) OHV V8 (16 Valve) 4" Bore Windsor			59 (cont.)
		MFI; Gasoline; Naturally Aspirated Ford Eng.; VIN Code H			
QTY	EXHAUST PIPE FLANGE	YEARS	PART NO.	DESCRIPTION	
1	Exhaust Pipe Gasket	1996-95	60712	Exc. Ford Bronco Eddie Bauer, XL, XLT, XLT Sport; Inlet pipe to converter	
1	Exhaust Pipe Gasket	1994	60712	Exc. Ford Bronco Eddie Bauer, XL, XLT; Inlet pipe to converter	
1	Exhaust Pipe Gasket	1993	60712	Exc. Ford Bronco Custom, Eddie Bauer, XL, XLT Lariat; Inlet pipe to converter	
1	Exhaust Pipe Gasket	1992	60712	Exc. Ford Bronco Custom, Eddie Bauer, XL, XLT, XLT Nite; Inlet pipe to converter	
1	Exhaust Pipe Gasket	1991	60712	Exc. Ford Bronco Custom, Eddie Bauer, XL, XLT; Inlet pipe to converter	
QTY	OIL PAN	YEARS	PART NO.	DESCRIPTION	
1	Oil Pan Gasket Set	1998-94	OS 34506 R	PermaDry® one-piece molded rubber gskt. incl.	
1	Oil Pan Gasket Set	1993-91	OS 30214 C	Multi-piece; Cork	
1	Oil Pan Gasket Set	1993-91	OS 30616 R	PermaDry® one-piece molded rubber gskt. incl.	
1	Drain Plug Gasket	1998-91	70822		
QTY	CRANKSHAFT REAR SEAL	YEARS	PART NO.	DESCRIPTION	
1	Rear Main Seal Set	1998-91	BS 40592	Rubber; One-piece	
1	Rear Main Seal Set	1998-91	BS 40645	PTFE Rubber; One-piece	
1	Repair Sleeve	1998-91	16251	Crankshaft; Use w/installation tool	
1	Repair Sleeve Tool	1998-91	16301	Crankshaft	
QTY	VALVE COVER	YEARS	PART NO.	DESCRIPTION	
1	Valve Cover Gasket Set	1998-91	VS 13264 T	PermaDryPlus®; Improved design	
1	Valve Cover Gasket Set	1998-91	VS 50029 C	Hi-Temp.; w/Compression stops	
QTY	VALVE STEM SEAL SET	YEARS	PART NO.	DESCRIPTION	
1	Valve Stem Seal Set	1998-91	SS 70070	Loc. Int.; Premium valve stem seals incl.	
1	Valve Stem Seal Set	1998-95	SS 72839	Loc. Exh.; Premium valve stem seals incl.	
1	Valve Stem Seal Set	1994-91	SS 70373	Loc. Exh.; Premium valve stem seals incl.	
QTY	WATER OUTLET GASKET	YEARS	PART NO.	DESCRIPTION	
1	Water Outlet Gasket	1998-91	35440	Water Outlet	
QTY	WATER PUMP	YEARS	PART NO.	DESCRIPTION	
1	Water Pump Gasket	1998-91	35380	Pump to plate	
1	Water Pump Gasket	1998-91	35397	Plate to block	
QTY	TIMING COVER	YEARS	PART NO.	DESCRIPTION	
1	Timing Cover Set	1998-94	TCS 45449	w/o Sleeve 'N' Seal®; Must be used w/OS 34506R; Water pump to plate gskt. not incl.	
1	Timing Cover Set	1993-91	TCS 45449	w/o Sleeve 'N' Seal®; Eng. w/one-piece oil pan gskt. must be used w/OS 30616R; Water pump to plate gskt. not incl.	
1	Timing Set w/Sleeve & Seal	1998-94	TCS 45450	w/Sleeve 'N' Seal®; Must be used w/OS 34506R; Water pump to plate gskt. not incl.	
1	Timing Set w/Sleeve & Seal	1993-91	TCS 45450	w/Sleeve 'N' Seal®; Eng. w/one-piece oil pan gskt. must be used w/OS 30616R; Water pump to plate gskt. not incl.	
1	Repair Sleeve	1998-91	16213	Timing Cover; Use w/installation tool	
1	Repair Sleeve Tool	1998-91	16310	Timing Cover	
QTY	CARB & FUEL INJECTION	YEARS	PART NO.	DESCRIPTION	
2	Fuel Injector O-Ring Set	1998-91	ES 70599	Improved design	
1	Throttle Body Gasket	1998-91	60845	Mounting	
1	Throttle Body Gasket	1998-91	71216	Air bypass valve	
QTY	DISTRIBUTOR MOUNTING	YEARS	PART NO.	DESCRIPTION	
1	O-Ring	1998-91	5511	Distributor Mounting	
QTY	EXHAUST GAS RECIRCULATION	YEARS	PART NO.	DESCRIPTION	
1	EGR Gasket	1998-91	72649		
QTY	OIL PUMP COVER	YEARS	PART NO.	DESCRIPTION	
1	Oil Pump Gasket	1998-91	72607		
1	Oil Pump Gasket	1998-91	72607	Inlet tube	
60		1996 - 1993; 5.8L 351 (5753cc) OHV V8 (16 Valve) 4" Bore Windsor Lightning			60
		MFI; Gasoline; Naturally Aspirated Ford Eng.; VIN Code R			
QTY	CYLINDER HEAD	YEARS	PART NO.	DESCRIPTION	
2	Head Gasket	1996-93	8548 PT-2	PermaTorque®	
2	Head Gasket	1996-93	9333 PT-1	H/D eng.	
2	Head Gasket Spacer Shim	1996-93	8548 SP-1	HeadSaver®	
1	Head Set	1996-95	HS 8548 PT-9	Int. manifold & exh. manifold gskts. not incl.; Exh. valve stem seals not incl.; Premium valve stem seals incl.	
1	Head Set	1994-93	HS 8548 PT-9	Int. manifold & exh. manifold gskts. not incl.; Premium valve stem seals incl.	
QTY	CONVERSION SET	YEARS	PART NO.	DESCRIPTION	
1	Gasket Conversion Set	1996-94	CS 8548-8	PermaDry® molded rubber oil pan gskt. incl.	

Ford Truck (Incl. Minivans and SUV's) (Cont.)

60		1996 - 1993; 5.8L 351 (5753cc) OHV V8 (16 Valve) 4" Bore Windsor Lightning			60	
(cont.)		MFI; Gasoline; Naturally Aspirated Ford Eng.; VIN Code R			(cont.)	
QTY	CONVERSION SET	YEARS	PART NO.	DESCRIPTION		
1	Gasket Conversion Set	1993	CS 8548-7	Water pump to plate gskt. not incl.; Multi-piece oil pan gskt. incl.		
QTY	MANIFOLD - INT. & EXH.	YEARS	PART NO.	DESCRIPTION		
1	Int. Manifold Gasket Set	1996-93	MS 95952-1	Lower set; Upper set incl.		
1	Plenum Gasket Set	1996-93	MS 95953	Upper set		
1	Exh. Manifold Gasket Set	1996-93	MS 95954			
QTY	EXHAUST PIPE FLANGE	YEARS	PART NO.	DESCRIPTION		
1	Exhaust Pipe Gasket	1996-93	60712	Inlet pipe to converter		
QTY	OIL PAN	YEARS	PART NO.	DESCRIPTION		
1	Oil Pan Gasket Set	1996-94	OS 34506 R	PermaDry® one-piece molded rubber gskt. incl.		
1	Oil Pan Gasket Set	1993	OS 30214 C	Multi-piece; Cork		
1	Oil Pan Gasket Set	1993	OS 30616 R	PermaDry® one-piece molded rubber gskt. incl.		
1	Drain Plug Gasket	1996-93	70822			
QTY	CRANKSHAFT REAR SEAL	YEARS	PART NO.	DESCRIPTION		
1	Rear Main Seal Set	1996-93	BS 40592	Rubber; One-piece		
1	Rear Main Seal Set	1996-93	BS 40645	PTFE Rubber; One-piece		
1	Repair Sleeve	1996-93	16251	Crankshaft; Use w/installation tool		
1	Repair Sleeve Tool	1996-93	16301	Crankshaft		
QTY	VALVE COVER	YEARS	PART NO.	DESCRIPTION		
1	Valve Cover Gasket Set	1996-93	VS 13264 T	PermaDryPlus®, Improved design		
1	Valve Cover Gasket Set	1996-93	VS 50029 C	Hi-Temp.; w/Compression stops		
QTY	VALVE STEM SEAL SET	YEARS	PART NO.	DESCRIPTION		
1	Valve Stem Seal Set	1996-93	SS 70070	Loc. Int.; Premium valve stem seals incl.		
1	Valve Stem Seal Set	1996-95	SS 72839	Loc. Exh.; Premium valve stem seals incl.		
1	Valve Stem Seal Set	1994-93	SS 70373	Loc. Exh.; Premium valve stem seals incl.		
QTY	WATER OUTLET GASKET	YEARS	PART NO.	DESCRIPTION		
1	Water Outlet Gasket	1996-93	35440	Water Outlet		
QTY	WATER PUMP	YEARS	PART NO.	DESCRIPTION		
1	Water Pump Gasket	1996-93	35380	Pump to plate		
1	Water Pump Gasket	1996-93	35397	Plate to block		
QTY	TIMING COVER	YEARS	PART NO.	DESCRIPTION		
1	Timing Cover Set	1996-94	TCS 45449	w/o Sleeve 'N' Seal®; Must be used w/OS 34506R; Water pump to plate gskt. not incl.		
1	Timing Cover Set	1993	TCS 45449	w/o Sleeve 'N' Seal®; Eng. w/one-piece oil pan gskt. must be used w/OS 30616R; Water pump to plate gskt. not incl.		
1	Timing Set w/Sleeve & Seal	1996-94	TCS 45450	w/Sleeve 'N' Seal®; Must be used w/OS 34506R; Water pump to plate gskt. not incl.		
1	Timing Set w/Sleeve & Seal	1993	TCS 45450	w/Sleeve 'N' Seal®; Eng. w/one-piece oil pan gskt. must be used w/OS 30616R; Water pump to plate gskt. not incl.		
1	Repair Sleeve	1996-93	16213	Timing Cover; Use w/installation tool		
1	Repair Sleeve Tool	1996-93	16310	Timing Cover		
QTY	CARB & FUEL INJECTION	YEARS	PART NO.	DESCRIPTION		
2	Fuel Injector O-Ring Set	1996-93	ES 70599	Improved design		
1	Throttle Body Gasket	1996-93	60845	Mounting		
1	Throttle Body Gasket	1996-93	71216	Air bypass valve		
QTY	DISTRIBUTOR MOUNTING	YEARS	PART NO.	DESCRIPTION		
1	O-Ring	1996-93	5511	Distributor Mounting		
QTY	EXHAUST GAS RECIRCULATION	YEARS	PART NO.	DESCRIPTION		
1	EGR Gasket	1996-95	70020			
1	EGR Gasket	1994-93	72649			
QTY	OIL PUMP COVER	YEARS	PART NO.	DESCRIPTION		
1	Oil Pump Gasket	1996-93	72607			
1	Oil Pump Gasket	1996-93	72607	Inlet tube		
61		2011 - 2003; 6.0L 365 (5982cc) OHV Turbo - Intercooled V8 (32 Valve) 95mm Bore Power Stroke			61	
		DI; Diesel; Turbo - Intercooled International Eng.; VIN Code P				
QTY	CYLINDER HEAD	YEARS	PART NO.	DESCRIPTION		
2	Head Gasket	2011-03	26374 PT	w/18mm dowel pins; Head bolts not incl.; Head bolt replacement recommended; PermaTorqueMLS®; New Part Number - Check for Availability		
2	Head Gasket	2011-03	26375 PT	w/20mm dowel pins; Head bolts not incl.; Head bolt replacement recommended; PermaTorqueMLS®; New Part Number - Check for Availability		

Ford Truck (Incl. Minivans and SUV's) (Cont.)

61 (cont.)	2011 - 2003; 6.0L 365 (5982cc) OHV Turbo - Intercooled V8 (32 Valve) 95mm Bore Power Stroke DI; Diesel; Turbo - Intercooled International Eng.; VIN Code P				61 (cont.)
QTY	CYLINDER HEAD	YEARS	PART NO.	DESCRIPTION	
1	Head Set w/o Head Gasket	2011-03	HSU 26374	Head gskts. & head bolts not incl.; Head bolt replacement recommended; PermaDry® molded rubber valve cover gskts. incl.; Premium valve stem seals incl.	
2	Head Bolt Set	2011-03	ES 72229	Long bolts only; Must be used w/ES 72242; Replacement recommended	
2	Head Bolt Set	2011-03	ES 72242	Short bolts only; Must be used w/ES 72229; Replacement recommended	
2	Dowel Pin	2011-03	ES 72245	Cylinder Head; w/20mm dowel pins; Cyl. head alignment	
2	Dowel Pin	2011-03	ES 72248	Cylinder Head; w/18mm dowel pins; Cyl. head alignment	
2	Cylinder Base Gasket	2011-05	ES 72260	Crankcase to cylinder head tube	
2	Cylinder Base Gasket	2004-03	ES 72257	Crankcase to cylinder head tube	
QTY	CONVERSION SET	YEARS	PART NO.	DESCRIPTION	
1	Gasket Conversion Set	2011-09	CS 26374-1	PermaDry® molded rubber oil pan gskts. incl.	
1	Gasket Conversion Set	2008-06	CS 26374	Exc. Ford E-250 Econoline Base, E-350 Super Duty Base, Chateau, XL, XLT, E-450 Econoline Super Duty Base; PermaDry® molded rubber oil pan gskts. incl.	
1	Gasket Conversion Set	2008-06	CS 26374-1	Ford E-250 Econoline Base, E-350 Super Duty Base, Chateau, XL, XLT, E-450 Econoline Super Duty Base; PermaDry® molded rubber oil pan gskts. incl.	
1	Gasket Conversion Set	2005	CS 26374	Exc. Ford E-250 Econoline Base, E-250 Super Duty Base, E-350 Econoline Club Wagon Chateau, XL, XLT, E-350 Super Duty Base, E-450 Econoline Super Duty Base; PermaDry® molded rubber oil pan gskts. incl.	
1	Gasket Conversion Set	2005	CS 26374-1	Ford E-250 Econoline Base, E-250 Super Duty Base, E-350 Econoline Club Wagon Chateau, XL, XLT, E-350 Super Duty Base, E-450 Econoline Super Duty Base; PermaDry® molded rubber oil pan gskts. incl.	
1	Gasket Conversion Set	2004	CS 26374	Exc. Ford E-350 Econoline Club Wagon Chateau, XL, XLT, E-350 Super Duty Base, E-450 Econoline Super Duty Base; PermaDry® molded rubber oil pan gskts. incl.	
1	Gasket Conversion Set	2004	CS 26374-1	Ford E-350 Econoline Club Wagon Chateau, XL, XLT, E-350 Super Duty Base, E-450 Econoline Super Duty Base; PermaDry® molded rubber oil pan gskts. incl.	
1	Gasket Conversion Set	2003	CS 26374	PermaDry® molded rubber oil pan gskts. incl.	
QTY	MANIFOLD - INT. & EXH.	YEARS	PART NO.	DESCRIPTION	
1	Int. Manifold Gasket Set	2011-03	MS 96792		
1	Exh. Manifold Gasket Set	2011-03	MS 96833		
QTY	EXHAUST PIPE FLANGE	YEARS	PART NO.	DESCRIPTION	
1	Exhaust Pipe Gasket	2011-03	61474	Turbo outlet	
QTY	OIL PAN	YEARS	PART NO.	DESCRIPTION	
1	Oil Pan Gasket Set	2011-03	OS 30774 R	Loc. Upper No. 1; Upper oil pan to bedplate; PermaDry® molded rubber gskt. incl.	
1	Oil Pan Gasket Set	2011-03	OS 30775 R	Loc. Upper No. 2; Bedplate to block; PermaDry® molded rubber gskts. incl.	
1	Oil Pan Gasket Set	2011-09	OS 30785 R	Loc. Lower; Lower oil pan to bedplate; PermaDry® molded rubber gskt. incl.	
1	Oil Pan Gasket Set	2008-06	OS 30773 R	Exc. Ford E-250 Econoline Base, E-350 Super Duty Base, Chateau, XL, XLT, E-450 Econoline Super Duty Base; Loc. Lower; Lower oil pan to bedplate; PermaDry® molded rubber gskt. incl.	
1	Oil Pan Gasket Set	2008-06	OS 30785 R	Ford E-250 Econoline Base, E-350 Super Duty Base, Chateau, XL, XLT, E-450 Econoline Super Duty Base; Loc. Lower; Lower oil pan to bedplate; PermaDry® molded rubber gskt. incl.	
1	Oil Pan Gasket Set	2005	OS 30773 R	Exc. Ford E-250 Econoline Base, E-250 Super Duty Base, E-350 Econoline Club Wagon Chateau, XL, XLT, E-350 Super Duty Base, E-450 Econoline Super Duty Base; Loc. Lower; Lower oil pan to bedplate; PermaDry® molded rubber gskt. incl.	
1	Oil Pan Gasket Set	2005	OS 30785 R	Ford E-250 Econoline Base, E-250 Super Duty Base, E-350 Econoline Club Wagon Chateau, XL, XLT, E-350 Super Duty Base, E-450 Econoline Super Duty Base; Loc. Lower; Lower oil pan to bedplate; PermaDry® molded rubber gskt. incl.	
1	Oil Pan Gasket Set	2004	OS 30773 R	Exc. Ford E-350 Econoline Club Wagon Chateau, XL, XLT, E-350 Super Duty Base, E-450 Econoline Super Duty Base; Loc. Lower; Lower oil pan to bedplate; PermaDry® molded rubber gskt. incl.	
1	Oil Pan Gasket Set	2004	OS 30785 R	Ford E-350 Econoline Club Wagon Chateau, XL, XLT, E-350 Super Duty Base, E-450 Econoline Super Duty Base; Loc. Lower; Lower oil pan to bedplate; PermaDry® molded rubber gskt. incl.	
1	Oil Pan Gasket Set	2003	OS 30773 R	Loc. Lower; Lower oil pan to bedplate; PermaDry® molded rubber gskt. incl.	
QTY	CRANKSHAFT REAR SEAL	YEARS	PART NO.	DESCRIPTION	
1	Rear Main Seal Set	2011-03	BS 40700	Rubber; One-piece	

Ford Truck (Incl. Minivans and SUV's) (Cont.)

61		2011 - 2003; 6.0L 365 (5982cc) OHV Turbo - Intercooled V8 (32 Valve) 95mm Bore Power Stroke			61
(cont.)		DI; Diesel; Turbo - Intercooled International Eng.; VIN Code P			(cont.)
QTY	VALVE COVER	YEARS	PART NO.	DESCRIPTION	
1	Valve Cover Gasket Set	2011-03	VS 50691 R	Loc. Upper; w/Grommets & Crankcase breather seals; PermaDry® molded rubber gskts. incl.	
1	Valve Cover Gasket Set	2011-03	VS 50695 R	Loc. Lower; PermaDry® molded rubber gskts. incl.	
QTY	VALVE STEM SEAL SET	YEARS	PART NO.	DESCRIPTION	
1	Valve Stem Seal Set	2011-03	SS 71264	Premium valve stem seals incl.	
QTY	THERMOSTAT HOUSING	YEARS	PART NO.	DESCRIPTION	
1	O-Ring	2011-03	35808	Thermostat Housing	
QTY	WATER PUMP	YEARS	PART NO.	DESCRIPTION	
1	Water Pump Gasket	2011-03	35812		
QTY	TIMING COVER	YEARS	PART NO.	DESCRIPTION	
1	Timing Cover Set	2011-03	TCS 46106	Wear sleeve incl.	
1	Crankshaft Front Seal Set	2011-03	TCS 46197	Wear sleeve incl.; New Part Number - Check for Availability	
QTY	CARB & FUEL INJECTION	YEARS	PART NO.	DESCRIPTION	
1	Throttle Body Gasket	2011-03	61478	Mounting	
QTY	EXHAUST GAS RECIRCULATION	YEARS	PART NO.	DESCRIPTION	
1	EGR Gasket	2011-03	71263	EGR cooler; Oval gskt.	
1	EGR Gasket	2011-03	71265	EGR cooler; Round seal	
1	EGR Gasket	2011-03	ES 72961	EGR valve; Mounting set; New Part Number - Check for Availability	
62		2013 - 2011; 6.2L 378.9 (6210cc) SOHC V8 (16 Valve) 102mm Bore Triton Boss VVT			62
		MFI; Flex Fuel; Naturally Aspirated Ford Eng.; VIN Code 6			
QTY	MANIFOLD - INT. & EXH.	YEARS	PART NO.	DESCRIPTION	
1	Int. Manifold Gasket Set	2013-11	MS 97251	Lower set; New Part Number - Check for Availability	
QTY	CRANKSHAFT REAR SEAL	YEARS	PART NO.	DESCRIPTION	
1	Rear Main Seal Set	2013-11	BS 40746	Rubber; One-piece; New Part Number - Check for Availability	
QTY	CARB & FUEL INJECTION	YEARS	PART NO.	DESCRIPTION	
1	Throttle Body Gasket	2013-11	61698	Mounting; New Part Number - Check for Availability	
63		2013 - 2010; 6.2L 378.9 (6210cc) SOHC V8 (16 Valve) 102mm Bore Triton Boss VVT			63
		MFI; Gasoline; Naturally Aspirated Ford Eng.; VIN Code 6			
QTY	MANIFOLD - INT. & EXH.	YEARS	PART NO.	DESCRIPTION	
1	Int. Manifold Gasket Set	2013-10	MS 97251	Lower set; New Part Number - Check for Availability	
QTY	CRANKSHAFT REAR SEAL	YEARS	PART NO.	DESCRIPTION	
1	Rear Main Seal Set	2013-10	BS 40746	Rubber; One-piece; New Part Number - Check for Availability	
QTY	CARB & FUEL INJECTION	YEARS	PART NO.	DESCRIPTION	
1	Throttle Body Gasket	2013-10	61698	Mounting; New Part Number - Check for Availability	
64		2011 - 2008; 6.4L 390 (6391cc) OHV Turbo - Intercooled V8 (32 Valve) 98mm Bore Power Stroke			64
		DI; Diesel; Turbo - Intercooled International Eng.; VIN Code R			
QTY	CYLINDER HEAD	YEARS	PART NO.	DESCRIPTION	
2	Head Gasket	2011-08	26565 PT	Head bolts not incl.; Head bolt replacement recommended; PermaTorqueMLS®; Improved design; New Part Number - Check for Availability	
2	Head Gasket	2011-08	26604 PT	Head bolts not incl.; Head bolt replacement recommended; PermaTorqueMLS®; Old design; Superseded - When depleted use 26565 PT	
2	Head Bolt Set	2011-08	ES 72242	Short bolts only; Must be used w/ES 72581; Replacement recommended	
2	Head Bolt Set	2011-08	ES 72581	Long bolts only; Must be used w/ES 72242; Replacement recommended; New Part Number - Check for Availability	
QTY	VALVE COVER	YEARS	PART NO.	DESCRIPTION	
1	Valve Cover Gasket Set	2011-08	VS 50820 R	Loc. Lower; PermaDry® molded rubber gskts. incl.; New Part Number - Check for Availability	
QTY	WATER PUMP	YEARS	PART NO.	DESCRIPTION	
1	Water Pump Gasket	2011-08	36000	New Part Number - Check for Availability	
QTY	EXHAUST GAS RECIRCULATION	YEARS	PART NO.	DESCRIPTION	
1	EGR Gasket	2011-08	72555	EGR cooler inlet; Lower tube; New Part Number - Check for Availability	
1	EGR Gasket	2011-08	72585	EGR cooler outlet; Upper tube; New Part Number - Check for Availability	
QTY	TURBO MOUNTING SET	YEARS	PART NO.	DESCRIPTION	
2	Turbo Mtg. Gasket Set	2011-08	71472	Turbo inlet pipe; New Part Number - Check for Availability	

Ford Truck (Incl. Minivans and SUV's) (Cont.)

65 2013 - 2011; 6.7L 405.8 (6651cc) OHV Turbo - Intercooled V8 (32 Valve) 99mm Bore Power Stroke 65				
DI; Diesel; Turbo - Intercooled Ford Eng.; VIN Code T				
QTY	MANIFOLD - INT. & EXH.	YEARS	PART NO.	DESCRIPTION
1	Exh. Manifold Gasket Set	2013-11	MS 97247	New Part Number - Check for Availability
QTY	EXHAUST PIPE FLANGE	YEARS	PART NO.	DESCRIPTION
2	Exhaust Pipe Gasket	2013-11	61721	Converter; New Part Number - Check for Availability
2	Exhaust Pipe Gasket	2013-11	61723	Pipe to manifold; New Part Number - Check for Availability
QTY	OIL PAN	YEARS	PART NO.	DESCRIPTION
1	Oil Pan Gasket Set	2013-12	OS 30843	Loc. Lower; New Part Number - Check for Availability
1	Oil Pan Gasket Set	2011	OS 30843	Loc. Lower; From 12/01/11; New Part Number - Check for Availability
QTY	WATER PUMP	YEARS	PART NO.	DESCRIPTION
1	Water Pump Gasket	2013-11	36020	New Part Number - Check for Availability
QTY	EXHAUST GAS RECIRCULATION	YEARS	PART NO.	DESCRIPTION
1	EGR Gasket	2013-11	72743	EGR outlet tube; New Part Number - Check for Availability
1	EGR Gasket	2013-11	72775	EGR control valve; New Part Number - Check for Availability
QTY	OIL FILTER MOUNTING	YEARS	PART NO.	DESCRIPTION
1	Oil Filter Adapter Gasket	2013-11	72744	Oil filter adapter; New Part Number - Check for Availability
66 2013 - 1997; 6.8L 415 (6751cc) SOHC V10 (20 Valve) 90.2mm Bore Triton 66				
MFI; Gasoline; Naturally Aspirated Ford Eng.; VIN Code S				
QTY	CYLINDER HEAD	YEARS	PART NO.	DESCRIPTION
1	Head Gasket	2012-97	26304 PT	Loc. L.H.; Head bolts not incl.; Head bolt replacement recommended; PermaTorqueMLS®; Improved design
1	Head Gasket	2012-97	26305 PT	Loc. R.H.; Head bolts not incl.; Head bolt replacement recommended; PermaTorqueMLS®; Improved design
1	Head Set	2012-03	HS 26304 PT	Head bolts not incl.; Head bolt replacement recommended; PermaDry® molded rubber valve cover gskts. incl.; Premium valve stem seals incl.
1	Head Set	2002-97	HS 26162 PT	Int. manifold upper & lower gskts., valve cover gskts., head bolts not incl.; Head bolt replacement recommended; Premium valve stem seals incl.
2	Head Bolt Set	2012-97	ES 72798-1	Head bolts w/Washers; Replacement recommended
QTY	CONVERSION SET	YEARS	PART NO.	DESCRIPTION
1	Gasket Conversion Set	2012-99	CS 26162-2	PermaDry® molded rubber oil pan gskt. incl.
1	Gasket Conversion Set	1998-97	CS 26162	PermaDry® molded rubber oil pan gskt. incl.
QTY	MANIFOLD - INT. & EXH.	YEARS	PART NO.	DESCRIPTION
1	Int. Manifold Gasket Set	2012-01	MS 94014-1	Lower set; Upper set incl.
1	Int. Manifold Gasket Set	2000	MS 94015	Lower set; Upper set incl.
1	Int. Manifold Gasket Set	1999	MS 94011-1	Exc. Ford E-250 Econoline Base, XL, E-350 Econoline Base, Super, Super Wagon, XL, E-350 Econoline Club Wagon Chateau, Custom, XLT, Econoline Super Duty Custom; From 07/21/98; Lower set; Upper set incl.
1	Int. Manifold Gasket Set	1999	MS 94011-1	Ford E-250 Econoline Base, XL, E-350 Econoline Base, Super, Super Wagon, XL, E-350 Econoline Club Wagon Chateau, Custom, XLT, Econoline Super Duty Custom; Lower set; Upper set incl.
1	Int. Manifold Gasket Set	1999	MS 94012-2	Exc. Ford E-250 Econoline Base, XL, E-350 Econoline Base, Super, Super Wagon, XL, E-350 Econoline Club Wagon Chateau, Custom, XLT, Econoline Super Duty Custom; To 07/20/98; Lower set; Upper set incl.
1	Int. Manifold Gasket Set	1998	MS 94011-1	Ford F-250 Pickup Base, Lariat, XL, XLT, F-350 Pickup Base, Lariat, XL, XLT, F Super Duty Base, XL, F53 Stripped Chassis Base, XL; From 07/21/98; Lower set; Upper set incl.
1	Int. Manifold Gasket Set	1998	MS 94012-1	Exc. Ford F-250 Pickup Base, Lariat, XL, XLT, F-350 Pickup Base, Lariat, XL, XLT, F Super Duty Base, XL, F53 Stripped Chassis Base, XL; Lower set; Upper set incl.
1	Int. Manifold Gasket Set	1998	MS 94012-1	Ford F-250 Pickup Base, Lariat, XL, XLT, F-350 Pickup Base, Lariat, XL, XLT, F Super Duty Base, XL, F53 Stripped Chassis Base, XL; To 10/15/97; Lower set; Upper set incl.
1	Int. Manifold Gasket Set	1998	MS 94012-2	Ford F-250 Pickup Base, Lariat, XL, XLT, F-350 Pickup Base, Lariat, XL, XLT, F Super Duty Base, XL, F53 Stripped Chassis Base, XL; From 10/16/97 to 07/20/98; Lower set; Upper set incl.
1	Int. Manifold Gasket Set	1997	MS 94012-1	Lower set; Upper set incl.
1	Plenum Gasket Set	2012-00	MS 94095-1	Upper set
1	Plenum Gasket Set	1999	MS 94025	Upper set
1	Plenum Gasket Set	1998	MS 94018	Ford F-250 Pickup Base, Lariat, XL, XLT, F-350 Pickup Base, Lariat, XL, XLT, F Super Duty Base, XL, F53 Stripped Chassis Base, XL; To 10/15/97; Upper set
1	Plenum Gasket Set	1998	MS 94018	Exc. Ford F-250 Pickup Base, Lariat, XL, XLT, F-350 Pickup Base, Lariat, XL, XLT, F Super Duty Base, XL, F53 Stripped Chassis Base, XL; Upper set

Ford Truck (Incl. Minivans and SUV's) (Cont.)

66		2013 - 1997; 6.8L 415 (6751cc) SOHC V10 (20 Valve) 90.2mm Bore Triton			66
(cont.)		MFI; Gasoline; Naturally Aspirated Ford Eng.; VIN Code S			(cont.)
QTY	MANIFOLD - INT. & EXH.	YEARS	PART NO.	DESCRIPTION	
1	Plenum Gasket Set	1998	MS 94025	Ford F-250 Pickup Base, Lariat, XL, XLT, F-350 Pickup Base, Lariat, XL, XLT, F Super Duty Base, XL, F53 Stripped Chassis Base, XL; From 10/16/97; Upper set	
1	Plenum Gasket Set	1997	MS 94018	Upper set	
1	Exh. Manifold Gasket Set	2012-97	MS 94108-1		
QTY	EXHAUST PIPE FLANGE	YEARS	PART NO.	DESCRIPTION	
1	Exhaust Pipe Gasket	2012-97	61155	Converter	
QTY	OIL PAN	YEARS	PART NO.	DESCRIPTION	
1	Oil Pan Gasket Set	2012-97	OS 30710 R	PermaDry® molded rubber gskt. incl.	
QTY	CRANKSHAFT REAR SEAL	YEARS	PART NO.	DESCRIPTION	
1	Rear Main Seal Set	2012-97	BS 40620	Rubber; One-piece; Improved design	
1	Rear Main Seal Set	2012-97	BS 40644	PTFE Rubber; One-piece	
1	Repair Sleeve	2012-97	16270	Crankshaft; Use w/installation tool	
QTY	VALVE COVER	YEARS	PART NO.	DESCRIPTION	
1	Valve Cover Gasket Set	2012-97	VS 50547 R	w/Grommets; PermaDry® molded rubber gskts. incl.	
QTY	VALVE STEM SEAL SET	YEARS	PART NO.	DESCRIPTION	
1	Valve Stem Seal Set	2012-97	SS 72891-1	Premium valve stem seals incl.	
QTY	WATER OUTLET GASKET	YEARS	PART NO.	DESCRIPTION	
1	Water Outlet Gasket	2012-97	35489	Water Outlet	
QTY	WATER PUMP	YEARS	PART NO.	DESCRIPTION	
1	Water Pump Gasket	2012-97	35478		
2	O-Ring	2013-97	413	Water Pump; Water pump bypass pipe O-ring	
QTY	TIMING COVER	YEARS	PART NO.	DESCRIPTION	
1	Timing Cover Set	2012-99	TCS 45982-1	Repair sleeve not incl.	
1	Timing Cover Set	1998-97	TCS 45982	Repair sleeve not incl.	
1	Crankshaft Front Seal Set	2012-99	TCS 46117		
1	Crankshaft Front Seal Set	1998-97	TCS 46114		
1	Repair Sleeve	2012-97	16207	Timing Cover; Use w/installation tool	
1	Repair Sleeve Tool	2012-97	16310	Timing Cover	
QTY	CARB & FUEL INJECTION	YEARS	PART NO.	DESCRIPTION	
5	Fuel Injector O-Ring Set	2012-97	ES 70599	Improved design	
1	Throttle Body Gasket	2012-04	61425	Spacer to manifold	
1	Throttle Body Gasket	2012-05	61420	Housing to spacer	
1	Throttle Body Gasket	2004-99	61142	Housing to spacer	
1	Throttle Body Gasket	2003-97	61143	Spacer to manifold	
1	Throttle Body Gasket	1998-97	61141	Housing to spacer	
QTY	EXHAUST GAS RECIRCULATION	YEARS	PART NO.	DESCRIPTION	
1	EGR Gasket	2012-97	70802		
QTY	OIL FILTER MOUNTING	YEARS	PART NO.	DESCRIPTION	
1	Oil Filter Adapter Gasket	2012-97	70801		
67		2013 - 2005; 6.8L 415 (6751cc) SOHC V10 (30 Valve) 90.2mm Bore Triton			67
(cont.)		MFI; Gasoline; Naturally Aspirated Ford Eng.; VIN Code Y			(cont.)
QTY	CYLINDER HEAD	YEARS	PART NO.	DESCRIPTION	
1	Head Gasket	2012-05	26302 PT	Loc. L.H.; Head bolts not incl.; Head bolt replacement recommended; PermaTorqueMLS®	
1	Head Gasket	2012-05	26303 PT	Loc. R.H.; Head bolts not incl.; Head bolt replacement recommended; PermaTorqueMLS®	
1	Head Set	2012-05	HS 26302 PT	Head bolts not incl.; Head bolt replacement recommended; PermaDry® molded rubber valve cover gskts. incl.; Premium valve stem seals incl.	
2	Head Bolt Set	2012-05	ES 72798-1	Head bolts w/Washers; Replacement recommended	
QTY	CONVERSION SET	YEARS	PART NO.	DESCRIPTION	
1	Gasket Conversion Set	2012-05	CS 26162-2	PermaDry® molded rubber oil pan gskt. incl.	
QTY	MANIFOLD - INT. & EXH.	YEARS	PART NO.	DESCRIPTION	
1	Int. Manifold Gasket Set	2012-05	MS 96687	Lower set	
1	Exh. Manifold Gasket Set	2012-05	MS 96679-1		
QTY	EXHAUST PIPE FLANGE	YEARS	PART NO.	DESCRIPTION	
1	Exhaust Pipe Gasket	2012-05	61417	Converter	
QTY	OIL PAN	YEARS	PART NO.	DESCRIPTION	
1	Oil Pan Gasket Set	2012-05	OS 30710 R	PermaDry® molded rubber gskt. incl.	
QTY	CRANKSHAFT REAR SEAL	YEARS	PART NO.	DESCRIPTION	
1	Rear Main Seal Set	2012-05	BS 40620	Rubber; One-piece; Improved design	
1	Rear Main Seal Set	2012-05	BS 40644	PTFE Rubber; One-piece	

Ford Truck (Incl. Minivans and SUV's) (Cont.)

67 (cont.)		2013 - 2005; 6.8L 415 (6751cc) SOHC V10 (30 Valve) 90.2mm Bore Triton			67 (cont.)
		MFI; Gasoline; Naturally Aspirated Ford Eng.; VIN Code Y			
QTY	CRANKSHAFT REAR SEAL	YEARS	PART NO.	DESCRIPTION	
1	Repair Sleeve	2012-05	16270	Crankshaft; Use w/installation tool	
QTY	VALVE COVER	YEARS	PART NO.	DESCRIPTION	
1	Valve Cover Gasket Set	2012-05	VS 50656 R	w/Grommets; PermaDry® molded rubber gskts. incl.	
QTY	VALVE STEM SEAL SET	YEARS	PART NO.	DESCRIPTION	
1	Valve Stem Seal Set	2012-05	SS 72921	Premium valve stem seals incl.	
QTY	WATER OUTLET GASKET	YEARS	PART NO.	DESCRIPTION	
1	Water Outlet Gasket	2012-05	35489	Water Outlet	
1	Water Outlet Gasket	2012-05	35789	Water Crossover; Loc. L.H.	
1	Water Outlet Gasket	2012-05	35791	Water Crossover; Loc. R.H.	
QTY	WATER PUMP	YEARS	PART NO.	DESCRIPTION	
1	Water Pump Gasket	2012-05	35478		
2	O-Ring	2013-05	413	Water Pump; Water pump bypass pipe O-ring	
QTY	TIMING COVER	YEARS	PART NO.	DESCRIPTION	
1	Timing Cover Set	2012-05	TCS 46067	Repair sleeve not incl.	
1	Crankshaft Front Seal Set	2012-05	TCS 46117		
1	Repair Sleeve	2012-05	16207	Timing Cover; Use w/installation tool	
1	Repair Sleeve Tool	2012-05	16310	Timing Cover	
QTY	CARB & FUEL INJECTION	YEARS	PART NO.	DESCRIPTION	
5	Fuel Injector O-Ring Set	2012-05	ES 70599	Improved design	
1	Throttle Body Gasket	2012-05	61418	Spacer to manifold	
1	Throttle Body Gasket	2012-05	61420	Housing to spacer	
QTY	OIL FILTER MOUNTING	YEARS	PART NO.	DESCRIPTION	
1	Oil Filter Adapter Gasket	2012-05	70801		
68		1993 - 1992; 7.3L 444 (7277cc) OHV Turbo V8 (16 Valve) 4.11" Bore			68
		IDI; Diesel; Turbo International Eng.; VIN Code C			
QTY	CYLINDER HEAD	YEARS	PART NO.	DESCRIPTION	
2	Head Gasket	1993-92	9047 PT		
1	Head Set	1993-92	HS 9047 PT	Int. manifold gskt. not incl.; Premium valve stem seals incl.	
QTY	CONVERSION SET	YEARS	PART NO.	DESCRIPTION	
1	Gasket Conversion Set	1993-92	CS 8891		
QTY	MANIFOLD - INT. & EXH.	YEARS	PART NO.	DESCRIPTION	
1	Valley Pan Gasket Set	1993-92	MS 96038		
1	Exh. Manifold Gasket Set	1993-92	MS 91242		
QTY	EXHAUST PIPE FLANGE	YEARS	PART NO.	DESCRIPTION	
1	Exhaust Pipe Gasket	1993-92	60679	Inlet pipe to muffler	
QTY	FUEL PUMP	YEARS	PART NO.	DESCRIPTION	
1	Fuel Pump Mounting Gasket	1993-92	6579	May also be used as a fuel pump block-off plate gasket if desired	
QTY	OIL PAN	YEARS	PART NO.	DESCRIPTION	
1	Oil Pan Gasket Set	1993-92	OS 34200 C		
QTY	CRANKSHAFT REAR SEAL	YEARS	PART NO.	DESCRIPTION	
1	Rear Main Seal Set	1993-92	BS 15868-1	Rubber; One-piece	
1	Rear Main Seal Set	1993-92	BS 40011	PTFE Rubber; One-piece	
1	Rear Main Seal Set	1993-92	BS 40697	Rubber; One-piece; Wear sleeve incl.	
1	Repair Sleeve	1993-92	16256	Crankshaft; Use w/installation tool	
1	Repair Sleeve Tool	1993-92	16301	Crankshaft	
QTY	VALVE COVER	YEARS	PART NO.	DESCRIPTION	
1	Valve Cover Gasket Set	1993-92	VS 50247 R		
QTY	VALVE STEM SEAL SET	YEARS	PART NO.	DESCRIPTION	
1	Valve Stem Seal Set	1993-92	SS 72628-1	Premium valve stem seals incl.	
1	Valve Stem Seal Set	1993-92	SS 72938	Premium valve stem seals incl.; Improved OEM design; New Part Number - Check for Availability	
QTY	WATER OUTLET GASKET	YEARS	PART NO.	DESCRIPTION	
1	Water Outlet Gasket	1993-92	35193	Water Outlet; Loc. L.H.; Lower connector	
1	Water Outlet Gasket	1993-92	35270	Water Outlet; Loc. R.H.; Upper thermostat	
QTY	WATER PUMP	YEARS	PART NO.	DESCRIPTION	
1	Water Pump Gasket	1993-92	35268		
QTY	TIMING COVER	YEARS	PART NO.	DESCRIPTION	
1	Timing Cover Set	1993-92	TCS 45575		
QTY	CYLINDER BLOCK	YEARS	PART NO.	DESCRIPTION	
1	O-Ring	1993-92	70800	Crankcase Vent Cover; Crankcase vent cover & tube gskt.	
QTY	OIL COOLER	YEARS	PART NO.	DESCRIPTION	
1	Oil Cooler Mounting Set	1993-92	ES 70689		

Ford Truck (Incl. Minivans and SUV's) (Cont.)

68		1993 - 1992; 7.3L 444 (7277cc) OHV Turbo V8 (16 Valve) 4.11" Bore			68	
(cont.)		IDI; Diesel; Turbo International Eng.; VIN Code C			(cont.)	
QTY	OIL COOLER	YEARS	PART NO.	DESCRIPTION		
1	Oil Cooler Gasket	1993-92	ES 72519	Oil cooler seals; Mounting set; New Part Number - Check for Availability		
69		1994; 7.3L 444 (7277cc) OHV Turbo V8 (16 Valve) 4.11" Bore			69	
		IDI; Diesel; Turbo International Eng.; VIN Code K				
QTY	CYLINDER HEAD	YEARS	PART NO.	DESCRIPTION		
2	Head Gasket	1994	9047 PT			
1	Head Set	1994	HS 9047 PT	Int. manifold gskt. not incl.; Premium valve stem seals incl.		
QTY	CONVERSION SET	YEARS	PART NO.	DESCRIPTION		
1	Gasket Conversion Set	1994	CS 8891			
QTY	MANIFOLD - INT. & EXH.	YEARS	PART NO.	DESCRIPTION		
1	Valley Pan Gasket Set	1994	MS 96038			
1	Exh. Manifold Gasket Set	1994	MS 91242			
QTY	EXHAUST PIPE FLANGE	YEARS	PART NO.	DESCRIPTION		
1	Exhaust Pipe Gasket	1994	60679	Inlet pipe to muffler		
QTY	FUEL PUMP	YEARS	PART NO.	DESCRIPTION		
1	Fuel Pump Mounting Gasket	1994	6579	May also be used as a fuel pump block-off plate gasket if desired		
QTY	OIL PAN	YEARS	PART NO.	DESCRIPTION		
1	Oil Pan Gasket Set	1994	OS 34200 C			
QTY	CRANKSHAFT REAR SEAL	YEARS	PART NO.	DESCRIPTION		
1	Rear Main Seal Set	1994	BS 15868-1	Rubber; One-piece		
1	Rear Main Seal Set	1994	BS 40011	PTFE Rubber; One-piece		
1	Rear Main Seal Set	1994	BS 40697	Rubber; One-piece; Wear sleeve incl.		
1	Repair Sleeve	1994	16256	Crankshaft; Use w/installation tool		
1	Repair Sleeve Tool	1994	16301	Crankshaft		
QTY	VALVE COVER	YEARS	PART NO.	DESCRIPTION		
1	Valve Cover Gasket Set	1994	VS 50247 R			
QTY	VALVE STEM SEAL SET	YEARS	PART NO.	DESCRIPTION		
1	Valve Stem Seal Set	1994	SS 72628-1	Premium valve stem seals incl.		
1	Valve Stem Seal Set	1994	SS 72938	Premium valve stem seals incl.; Improved OEM design; New Part Number - Check for Availability		
QTY	WATER OUTLET GASKET	YEARS	PART NO.	DESCRIPTION		
1	Water Outlet Gasket	1994	35193	Water Outlet; Loc. L.H.; Lower connector		
1	Water Outlet Gasket	1994	35270	Water Outlet; Loc. R.H.; Upper thermostat		
QTY	WATER PUMP	YEARS	PART NO.	DESCRIPTION		
1	Water Pump Gasket	1994	35268			
QTY	TIMING COVER	YEARS	PART NO.	DESCRIPTION		
1	Timing Cover Set	1994	TCS 45575			
QTY	CYLINDER BLOCK	YEARS	PART NO.	DESCRIPTION		
1	O-Ring	1994	70800	Crankcase Vent Cover; Crankcase vent cover & tube gskt.		
QTY	OIL COOLER	YEARS	PART NO.	DESCRIPTION		
1	Oil Cooler Mounting Set	1994	ES 70689			
1	Oil Cooler Gasket	1994	ES 72519	Oil cooler seals; Mounting set; New Part Number - Check for Availability		
70		2003 - 1994; 7.3L 444 (7277cc) OHV Turbo V8 (16 Valve) 4.11" Bore Power Stroke			70	
		DI; Diesel; Turbo International Eng.; VIN Code F				
QTY	CYLINDER HEAD	YEARS	PART NO.	DESCRIPTION		
2	Head Gasket	2003-94	9239 PT	Head bolts not incl.; Head bolt replacement recommended		
1	Head Set	2003-94	HS 9239 PT	Valve cover gskts. & head bolts not incl.; Head bolt replacement recommended; Premium valve stem seals incl.		
2	Head Bolt Set	2003-94	ES 72161	Replacement recommended		
QTY	CONVERSION SET	YEARS	PART NO.	DESCRIPTION		
1	Gasket Conversion Set	2003-00	CS 9239-1	RTV sealant incl. for oil pan gskt.		
1	Gasket Conversion Set	1999	CS 9239	To 03/31/99; RTV sealant incl. for oil pan gskt.		
1	Gasket Conversion Set	1999	CS 9239-1	From 04/01/99; RTV sealant incl. for oil pan gskt.		
1	Gasket Conversion Set	1998-94	CS 9239	RTV sealant incl. for oil pan gskt.		
QTY	MANIFOLD - INT. & EXH.	YEARS	PART NO.	DESCRIPTION		
1	Exh. Manifold Gasket Set	2003-94	MS 93489	Improved design		
QTY	CRANKSHAFT REAR SEAL	YEARS	PART NO.	DESCRIPTION		
1	Rear Main Seal Set	2003-94	BS 40436	PTFE Rubber; One-piece		
QTY	VALVE COVER	YEARS	PART NO.	DESCRIPTION		
2	Valve Cover Gasket Set	2003-98	VS 50484 R	Services one cover only; PermaDry® molded rubber gskt. incl.		
2	Valve Cover Gasket Set	1997-94	VS 50483 R	Services one cover only; PermaDry® molded rubber gskt. incl.		

Ford Truck (Incl. Minivans and SUV's) (Cont.)

70		2003 - 1994; 7.3L 444 (7277cc) OHV Turbo V8 (16 Valve) 4.11" Bore Power Stroke			70
(cont.)		DI; Diesel; Turbo International Eng.; VIN Code F			(cont.)
QTY	VALVE STEM SEAL SET	YEARS	PART NO.	DESCRIPTION	
1	Valve Stem Seal Set	2003-94	SS 72893	Premium valve stem seals incl.	
QTY	THERMOSTAT HOUSING	YEARS	PART NO.	DESCRIPTION	
1	Thermostat Gasket	2003-94	35610-1	Thermostat Housing; Thermostat seal	
1	Thermostat Gasket	2003-94	35702	Thermostat Housing; Thermostat inlet	
QTY	WATER PUMP	YEARS	PART NO.	DESCRIPTION	
1	Water Pump Gasket	2003-94	35612		
QTY	TIMING COVER	YEARS	PART NO.	DESCRIPTION	
1	Timing Cover Set	2003-00	TCS 45050	Wear sleeve incl.	
1	Timing Cover Set	1999	TCS 45017	To 03/31/99; Wear sleeve incl.	
1	Timing Cover Set	1999	TCS 45050	From 04/01/99; Wear sleeve incl.	
1	Timing Cover Set	1998-96	TCS 45017	Wear sleeve incl.	
1	Timing Cover Set	1995-94	TCS 45016	Wear sleeve incl.	
1	Crankshaft Front Seal Set	2003-94	TCS 46196	Wear sleeve not incl.; New Part Number - Check for Availability	
QTY	OIL PUMP COVER	YEARS	PART NO.	DESCRIPTION	
1	Oil Pump Gasket	2003-96	72795	Oil injection pump; New Part Number - Check for Availability	
QTY	OIL COOLER	YEARS	PART NO.	DESCRIPTION	
1	Oil Cooler Gasket	2003-94	ES 72519	Oil cooler seals; Mounting set; New Part Number - Check for Availability	
QTY	TURBO MOUNTING SET	YEARS	PART NO.	DESCRIPTION	
1	Turbo Mtg. Gasket Set	2003-94	ES 72468		
71		1995 - 1991; 7.3L 444 (7277cc) OHV V8 (16 Valve) 4.11" Bore			71
		IDI; Diesel; Naturally Aspirated International Eng.; VIN Code M			
QTY	CYLINDER HEAD	YEARS	PART NO.	DESCRIPTION	
2	Head Gasket	1995-91	9047 PT		
1	Head Set	1995-91	HS 9047 PT	Int. manifold gskt. not incl.; Premium valve stem seals incl.	
QTY	CONVERSION SET	YEARS	PART NO.	DESCRIPTION	
1	Gasket Conversion Set	1995-91	CS 8891		
QTY	MANIFOLD - INT. & EXH.	YEARS	PART NO.	DESCRIPTION	
1	Valley Pan Gasket Set	1995-91	MS 96038		
1	Exh. Manifold Gasket Set	1995-91	MS 91242		
QTY	EXHAUST PIPE FLANGE	YEARS	PART NO.	DESCRIPTION	
1	Exhaust Pipe Gasket	1995-91	60679	Inlet pipe to muffler	
QTY	FUEL PUMP	YEARS	PART NO.	DESCRIPTION	
1	Fuel Pump Mounting Gasket	1995-91	6579	May also be used as a fuel pump block-off plate gasket if desired	
QTY	OIL PAN	YEARS	PART NO.	DESCRIPTION	
1	Oil Pan Gasket Set	1995-91	OS 34200 C		
QTY	CRANKSHAFT REAR SEAL	YEARS	PART NO.	DESCRIPTION	
1	Rear Main Seal Set	1995-91	BS 15868-1	Rubber; One-piece	
1	Rear Main Seal Set	1995-91	BS 40011	PTFE Rubber; One-piece	
1	Rear Main Seal Set	1995-91	BS 40697	Rubber; One-piece; Wear sleeve incl.	
1	Repair Sleeve	1995-91	16256	Crankshaft; Use w/installation tool	
1	Repair Sleeve Tool	1995-91	16301	Crankshaft	
QTY	VALVE COVER	YEARS	PART NO.	DESCRIPTION	
1	Valve Cover Gasket Set	1995-91	VS 50247 R		
QTY	VALVE STEM SEAL SET	YEARS	PART NO.	DESCRIPTION	
1	Valve Stem Seal Set	1995-91	SS 72628-1	Premium valve stem seals incl.	
1	Valve Stem Seal Set	1995-91	SS 72938	Premium valve stem seals incl.; Improved OEM design; New Part Number - Check for Availability	
QTY	WATER OUTLET GASKET	YEARS	PART NO.	DESCRIPTION	
1	Water Outlet Gasket	1995-91	35193	Water Outlet; Loc. L.H.; Lower connector	
1	Water Outlet Gasket	1995-91	35270	Water Outlet; Loc. R.H.; Upper thermostat	
QTY	WATER PUMP	YEARS	PART NO.	DESCRIPTION	
1	Water Pump Gasket	1995-91	35268		
QTY	TIMING COVER	YEARS	PART NO.	DESCRIPTION	
1	Timing Cover Set	1995-91	TCS 45575		
QTY	CYLINDER BLOCK	YEARS	PART NO.	DESCRIPTION	
1	O-Ring	1995-91	70800	Crankcase Vent Cover; Crankcase vent cover & tube gskt.	
QTY	OIL COOLER	YEARS	PART NO.	DESCRIPTION	
1	Oil Cooler Mounting Set	1995-91	ES 70689		
1	Oil Cooler Gasket	1995-91	ES 72519	Oil cooler seals; Mounting set; New Part Number - Check for Availability	

Ford Truck (Incl. Minivans and SUV's) (Cont.)

72		1998 - 1991; 7.5L 460 (7539cc) OHV V8 (16 Valve) 4.36" Bore			72
MFI; Gasoline; Naturally Aspirated Ford Eng.; VIN Code G					
QTY	CYLINDER HEAD	YEARS	PART NO.	DESCRIPTION	
2	Head Gasket	1998-91	520 SD	PermaTorque Severe Duty®	
2	Head Gasket	1998-91	8558 PT-1	PermaTorque®	
1	Head Set	1998-95	HS 8558 PT-10	Valve cover gskts. over 8500 lbs. GVW not incl.; PermaDry® molded rubber valve cover gskts. incl.; Premium valve stem seals incl.	
1	Head Set	1994-93	HS 8558 PT-10	PermaDry® molded rubber valve cover gskts. incl.; Premium valve stem seals incl.	
1	Head Set	1992	HS 8558 PT-6	From 02/15/92; Valve stem seals not incl.; PermaDry® molded rubber valve cover gskts. incl.	
1	Head Set	1992	HS 8558 PT-6	To 02/14/92; PermaDry® molded rubber valve cover gskts. incl.; Premium valve stem seals incl.	
1	Head Set	1991	HS 8558 PT-6	PermaDry® molded rubber valve cover gskts. incl.; Premium valve stem seals incl.	
QTY	CONVERSION SET	YEARS	PART NO.	DESCRIPTION	
1	Gasket Conversion Set	1998-95	CS 8558-2	Water pump to plate gskt. not incl.; PermaDry® molded rubber oil pan gskt. incl.	
1	Gasket Conversion Set	1994-91	CS 8558-1	Water pump to plate gskt. not incl.; PermaDry® molded rubber oil pan gskt. incl.	
QTY	MANIFOLD - INT. & EXH.	YEARS	PART NO.	DESCRIPTION	
1	Int. Manifold Gasket Set	1998-93	MS 94175	Exc. Ford F53 Stripped Chassis Base, XL; Lower set; Upper set incl.	
1	Int. Manifold Gasket Set	1992-91	MS 94175	Exc. Ford F53 Stripped Chassis Base, Custom; Lower set; Upper set incl.	
1	Valley Pan Gasket Set	1998-93	MS 96018	Ford F53 Stripped Chassis Base, XL	
1	Valley Pan Gasket Set	1992-91	MS 96018	Ford F53 Stripped Chassis Base, Custom	
1	Plenum Gasket Set	1998-91	MS 94177	Upper set	
1	Exh. Manifold Gasket Set	1998-93	MS 94204	Large irregular ports	
1	Exh. Manifold Gasket Set	1992-91	MS 94531	Small irregular ports	
QTY	EXHAUST PIPE FLANGE	YEARS	PART NO.	DESCRIPTION	
1	Exhaust Pipe Gasket	1993-91	60712	Inlet pipe to converter	
QTY	OIL PAN	YEARS	PART NO.	DESCRIPTION	
1	Oil Pan Gasket Set	1998-95	OS 34507 R	PermaDry® molded rubber gskt. incl.	
1	Oil Pan Gasket Set	1994-91	OS 34600 R	PermaDry® molded rubber gskt. incl.	
1	Drain Plug Gasket	1998-91	72515		
QTY	CRANKSHAFT REAR SEAL	YEARS	PART NO.	DESCRIPTION	
1	Rear Main Seal Set	1998-91	BS 40032	Rubber; Two-piece	
1	Rear Main Seal Set	1998-91	BS 40654	Viton®; Two-piece	
QTY	VALVE COVER	YEARS	PART NO.	DESCRIPTION	
1	Valve Cover Gasket Set	1998-95	VS 50067 R	Under 8500 lbs. GVW; PermaDry® molded rubber gskts. incl.	
1	Valve Cover Gasket Set	1998-95	VS 50474 R	Over 8500 lbs. GVW; PermaDry® molded rubber gskts. incl.	
1	Valve Cover Gasket Set	1994-91	VS 50067 R	PermaDry® molded rubber gskts. incl.	
QTY	VALVE STEM SEAL SET	YEARS	PART NO.	DESCRIPTION	
1	Valve Stem Seal Set	1998-93	SS 70070	Loc. Int.; Premium valve stem seals incl.	
1	Valve Stem Seal Set	1998-93	SS 72839	Loc. Exh.; Premium valve stem seals incl.	
1	Valve Stem Seal Set	1992	SS 70070	Loc. Int.; From 02/15/92; Premium valve stem seals incl.	
1	Valve Stem Seal Set	1992	SS 72687	Loc. Int.; To 02/14/92; Premium valve stem seals incl.	
1	Valve Stem Seal Set	1992	SS 72702	Loc. Exh.; To 02/14/92; Premium valve stem seals incl.	
1	Valve Stem Seal Set	1992	SS 72839	Loc. Exh.; From 02/15/92; Premium valve stem seals incl.	
1	Valve Stem Seal Set	1991	SS 72687	Loc. Int.; Premium valve stem seals incl.	
1	Valve Stem Seal Set	1991	SS 72702	Loc. Exh.; Premium valve stem seals incl.	
QTY	WATER OUTLET GASKET	YEARS	PART NO.	DESCRIPTION	
1	Water Outlet Gasket	1998-91	35041	Water Outlet	
1	Water Outlet Gasket	1998-91	35041 T	Water Outlet; PermaDryPlus®	
QTY	WATER PUMP	YEARS	PART NO.	DESCRIPTION	
1	Water Pump Gasket	1998-91	35039	Plate to block	
1	Water Pump Gasket	1998-91	35044	Pump to plate	
QTY	TIMING COVER	YEARS	PART NO.	DESCRIPTION	
1	Timing Cover Set	1998-95	TCS 45129	w/o Sleeve 'N' Seal®; Must be used w/OS 34507R; Water pump to plate gskt. not incl.	
1	Timing Cover Set	1994-91	TCS 45129	w/o Sleeve 'N' Seal®; Must be used w/OS 34600R; Water pump to plate gskt. not incl.	
1	Timing Set w/Sleeve & Seal	1998-95	TCS 45881	w/Sleeve 'N' Seal®; Must be used w/OS 34507R; Water pump to plate gskt. not incl.	
1	Timing Set w/Sleeve & Seal	1994-91	TCS 45881	w/Sleeve 'N' Seal®; Must be used w/OS 34600R; Water pump to plate gskt. not incl.	
1	Repair Sleeve	1998-91	16213	Timing Cover; Use w/installation tool	
1	Repair Sleeve Tool	1998-91	16310	Timing Cover	

Ford Truck (Incl. Minivans and SUV's) (Cont.)

72 (cont.)	1998 - 1991; 7.5L 460 (7539cc) OHV V8 (16 Valve) 4.36" Bore MFI; Gasoline; Naturally Aspirated Ford Eng.; VIN Code G				72 (cont.)
QTY	CARB & FUEL INJECTION	YEARS	PART NO.	DESCRIPTION	
2	Fuel Injector O-Ring Set	1998-91	ES 70599	Improved design	
1	Throttle Body Gasket	1998-91	60845	Mounting	
1	Throttle Body Gasket	1998-91	71216	Air bypass valve	
QTY	CHOKE TUBE	YEARS	PART NO.	DESCRIPTION	
1	Choke Mounting Tube Gasket	1998-91	72580	Exc. California Emission	
QTY	DISTRIBUTOR MOUNTING	YEARS	PART NO.	DESCRIPTION	
1	O-Ring	1998-91	5511	Distributor Mounting	
QTY	EXHAUST GAS RECIRCULATION	YEARS	PART NO.	DESCRIPTION	
2	EGR Gasket	1998-91	72505	Exh. air supply tube	
1	EGR Gasket	1998-91	72649		
QTY	OIL FILTER MOUNTING	YEARS	PART NO.	DESCRIPTION	
1	O-Ring	1998-91	447 RR	Oil Filter Mounting; 5-pack	
1	Oil Filter Adapter Gasket	1998-91	72494	Oil filter adapter O-ring; New Part Number - Check for Availability	
QTY	OIL PUMP COVER	YEARS	PART NO.	DESCRIPTION	
1	Oil Pump Gasket	1998-91	70132		
1	Oil Pump Gasket	1998-91	72516	Inlet tube	

Freightliner Truck

Engine Finding Index				
Engine	Years	Code	Line No.	
2.7L 164 (2686cc) DOHC Turbo - Intercooled L5 (20 Valve) 88mm Bore; MFI; Diesel; Turbo - Intercooled Mercedes-Benz Eng.	2006-02	4	1	
3.0L 182.2 (2987cc) DOHC Turbo - Intercooled V6 (24 Valve) 83mm Bore Bluetec; DI; Diesel; Turbo - Intercooled Mercedes-Benz Eng.	2009-07	4	2	
3.0L 182.2 (2987cc) DOHC Turbo - Intercooled V6 (24 Valve) 83mm Bore Bluetec; DI; Diesel; Turbo - Intercooled Mercedes-Benz Eng.	2009-07	5	3	
3.5L 213.4 (3498cc) DOHC V6 (24 Valve) 92.9mm Bore; MFI; Gasoline; Naturally Aspirated Mercedes-Benz Eng.	2009-07	6	4	

Engine Code Index				
Code	Engine	Line No.		
272.963	3.5L 213.4 (3498cc) DOHC V6 (24 Valve) 92.9mm Bore; MFI; Gasoline; Naturally Aspirated Mercedes-Benz Eng.	4		
602.984	2.7L 164 (2686cc) DOHC Turbo - Intercooled L5 (20 Valve) 88mm Bore; MFI; Diesel; Turbo - Intercooled Mercedes-Benz Eng.	1		
OM642	3.0L 182.2 (2987cc) DOHC Turbo - Intercooled V6 (24 Valve) 83mm Bore Bluetec; DI; Diesel; Turbo - Intercooled Mercedes-Benz Eng.	2		
OM642	3.0L 182.2 (2987cc) DOHC Turbo - Intercooled V6 (24 Valve) 83mm Bore Bluetec; DI; Diesel; Turbo - Intercooled Mercedes-Benz Eng.	3		

Model Index					
Engine (VIN Code / Eng. Code)	Year	Engine (VIN Code / Eng. Code)	Year	Engine (VIN Code / Eng. Code)	Year
Freightliner Truck		Freightliner Truck (cont.)		Freightliner Truck (cont.)	
Sprinter 2500 (Mid-Size Van)		Sprinter 2500 (Mid-Size Van) (cont.)		Sprinter 3500 (Mid-Size Van) (cont.)	
L5 2686cc 2.7L DOHC Turbo-Diesel (602.984)	06-02	V6 3498cc 3.5L DOHC (24 Valve) (272.963)	09-07	V6 2987cc 3.0L DOHC Turbo-Diesel (24 Valve) (642.896)	09-07
V6 2987cc 3.0L DOHC Turbo-Diesel (24 Valve) (642.896)	09-07	L5 2686cc 2.7L DOHC Turbo-Diesel (602.984)	06-02	V6 3498cc 3.5L DOHC (24 Valve) (272.963)	09-07

1	2006 - 2002; 2.7L 164 (2686cc) DOHC Turbo - Intercooled L5 (20 Valve) 88mm Bore MFI; Diesel; Turbo - Intercooled Mercedes-Benz Eng.; VIN Code 4, Eng. Code 602.984				1
QTY	CYLINDER HEAD	YEARS	PART NO.	DESCRIPTION	
1	Head Gasket	2006-02	26319 PT	Head bolts not incl.; Head bolt replacement recommended; PermaTorqueMLS®	
1	Head Set	2006-02	HS 26319 PT	Head bolts not incl.; Head bolt replacement recommended; PermaDry® molded rubber valve cover gskt. incl.; Premium valve stem seals incl.	
1	Head Bolt Set	2006-02	ES 71233	Replacement recommended	
QTY	CONVERSION SET	YEARS	PART NO.	DESCRIPTION	
1	Gasket Conversion Set	2006-02	CS 26319		
QTY	MANIFOLD - INT. & EXH.	YEARS	PART NO.	DESCRIPTION	
1	Int. Manifold Gasket Set	2006-02	MS 96779		
1	Exh. Manifold Gasket Set	2006-02	MS 96785		
QTY	OIL PAN	YEARS	PART NO.	DESCRIPTION	
1	Oil Pan Gasket Set	2006-02	OS 30769		
QTY	CRANKSHAFT REAR SEAL	YEARS	PART NO.	DESCRIPTION	
1	Rear Main Seal Set	2006-02	BS 40699	Rubber; One-piece	
QTY	VALVE COVER	YEARS	PART NO.	DESCRIPTION	
1	Valve Cover Gasket Set	2006-02	VS 50680 R	w/Grommets & Spark plug tube seals; PermaDry® molded rubber gskt. incl.	
QTY	VALVE STEM SEAL SET	YEARS	PART NO.	DESCRIPTION	
1	Valve Stem Seal Set	2006-02	SS 72919-1	Premium valve stem seals incl.	
QTY	THERMOSTAT HOUSING	YEARS	PART NO.	DESCRIPTION	
1	O-Ring	2006-02	35803	Thermostat Housing; Seal	

Freightliner Truck (Cont.)

1 2006 - 2002; 2.7L 164 (2686cc) DOHC Turbo - Intercooled L5 (20 Valve) 88mm Bore 1 (cont.) MFI; Diesel; Turbo - Intercooled Mercedes-Benz Eng.; VIN Code 4, Eng. Code 602.984 (cont.)				
QTY	WATER OUTLET GASKET	YEARS	PART NO.	DESCRIPTION
1	O-Ring	2006-02	35805	Water Outlet; Seal
QTY	WATER PUMP	YEARS	PART NO.	DESCRIPTION
1	Water Pump Gasket	2006-02	35810	Seal
QTY	TIMING COVER	YEARS	PART NO.	DESCRIPTION
1	Crankshaft Front Seal Set	2006-02	TCS 46086	Mounting set
1	Crankshaft Front Seal Set	2006-02	TCS 46188	Seal only; New Part Number - Check for Availability
QTY	EXHAUST GAS RECIRCULATION	YEARS	PART NO.	DESCRIPTION
1	EGR Gasket	2006-02	72219	
2 2009 - 2007; 3.0L 182.2 (2987cc) DOHC Turbo - Intercooled V6 (24 Valve) 83mm Bore Bluetec 2 DI; Diesel; Turbo - Intercooled Mercedes-Benz Eng.; VIN Code 4, Eng. Code OM642				
QTY	TIMING COVER	YEARS	PART NO.	DESCRIPTION
1	Crankshaft Front Seal Set	2009-07	TCS 46188	New Part Number - Check for Availability
3 2009 - 2007; 3.0L 182.2 (2987cc) DOHC Turbo - Intercooled V6 (24 Valve) 83mm Bore Bluetec 3 DI; Diesel; Turbo - Intercooled Mercedes-Benz Eng.; VIN Code 5, Eng. Code OM642				
QTY	TIMING COVER	YEARS	PART NO.	DESCRIPTION
1	Crankshaft Front Seal Set	2009-07	TCS 46188	New Part Number - Check for Availability
4 2009 - 2007; 3.5L 213.4 (3498cc) DOHC V6 (24 Valve) 92.9mm Bore 4 MFI; Gasoline; Naturally Aspirated Mercedes-Benz Eng.; VIN Code 6, Eng. Code 272.963				
QTY	CYLINDER HEAD	YEARS	PART NO.	DESCRIPTION
1	Head Gasket	2009-07	26610 PT	Loc. L.H.; Head bolts not incl.; Head bolt replacement recommended; PermaTorqueMLS®; New Part Number - Check for Availability
1	Head Gasket	2009-07	26623 PT	Loc. R.H.; Head bolts not incl.; Head bolt replacement recommended; PermaTorqueMLS®; New Part Number - Check for Availability
1	Head Set	2009-07	HS 26610 PT	Head bolts not incl.; Head bolt replacement recommended; RTV sealant incl. for valve cover gskts.; Premium valve stem seals incl.; New Part Number - Check for Availability
QTY	CONVERSION SET	YEARS	PART NO.	DESCRIPTION
1	Gasket Conversion Set	2009-07	CS 26610	RTV sealant incl. for oil pan gskt.; New Part Number - Check for Availability
QTY	MANIFOLD - INT. & EXH.	YEARS	PART NO.	DESCRIPTION
1	Int. Manifold Gasket Set	2009-07	MS 97292	Lower set; New Part Number - Check for Availability
1	Exh. Manifold Gasket Set	2009-07	MS 97263	New Part Number - Check for Availability
QTY	OIL COOLER	YEARS	PART NO.	DESCRIPTION
1	Oil Cooler Gasket	2009-07	72979	Oil cooler to housing; New Part Number - Check for Availability

Geo Car - See GM Car

Geo SUV's - See GMC Truck

GM Car (Incl. Buick, Cad., Chev., Geo, Olds., Pontiac, Saturn)

Engine Finding Index

Engine	Years	Code	Line No.
1.0L 61 (993cc) SOHC L3 (6 Valve) 74mm Bore; MFI; Gasoline; Turbo Suzuki Eng.	1991	2	1
1.0L 61 (993cc) SOHC L3 (6 Valve) 74mm Bore; TBI; Gasoline; Naturally Aspirated Suzuki Eng.	2001-91	6	2
1.3L 81 (1324cc) SOHC L4 (16 Valve) 74mm Bore; MFI; Gasoline; Naturally Aspirated Suzuki Eng.	2001-98	2	3
1.3L 81 (1324cc) SOHC L4 (8 Valve) 74mm Bore; TBI; Gasoline; Naturally Aspirated Suzuki Eng.	1997-92	9	4
1.4L 83.2 (1364cc) DOHC L4 (16 Valve) 72.5mm Bore Ecotec VVT; MFI; Hybrid (Gas/Electric); Naturally Aspirated Opel Eng.	2013-11	4	5
1.4L 83.2 (1364cc) DOHC L4 (16 Valve) 72.5mm Bore Ecotec VVT; DI; Gasoline; Turbo - Intercooled Opel Eng.	2013-11	9	6
1.4L 83.2 (1364cc) DOHC L4 (16 Valve) 72.5mm Bore Ecotec VVT; DI; Gasoline; Turbo - Intercooled Opel Eng.	2013-12	B	7
1.4L 83.2 (1364cc) DOHC L4 (16 Valve) 72.5mm Bore Ecotec VVT; DI; Gasoline; Turbo - Intercooled Opel Eng.	2013-12	C	8
1.6L 96.8 (1587cc) DOHC L4 (16 Valve) 81mm Bore; MFI; Gasoline; Naturally Aspirated Toyota Eng.	1992-91	5	9
1.6L 96.8 (1587cc) DOHC L4 (16 Valve) 81mm Bore; MFI; Gasoline; Naturally Aspirated Toyota Eng.	1997-91	6	10
1.6L 96.9 (1588cc) DOHC L4 (16 Valve) 80mm Bore; MFI; Gasoline; Naturally Aspirated Isuzu Eng.	1991	5	11
1.6L 96.9 (1588cc) SOHC L4 (12 Valve) 80mm Bore; MFI; Gasoline; Naturally Aspirated Isuzu Eng.	1993-91	6	12
1.6L 97.5 (1598cc) DOHC L4 (16 Valve) 79mm Bore; MFI; Gasoline; Naturally Aspirated Opel Eng.	2009-06	6	13
1.6L 97.5 (1598cc) DOHC L4 (16 Valve) 79mm Bore; MFI; Gasoline; Naturally Aspirated Opel Eng.	2005-04	D	14
1.6L 97.5 (1598cc) DOHC L4 (16 Valve) 79mm Bore VVT; MFI; Gasoline; Naturally Aspirated Opel Eng.	2011-09	E	15
1.6L 97.5 (1598cc) DOHC L4 (16 Valve) 79mm Bore VVT; MFI; Gasoline; Naturally Aspirated Opel Eng.	2011	G	16
1.6L 97.5 (1598cc) SOHC L4 (8 Valve) 79mm Bore; TBI; Gasoline; Naturally Aspirated Opel Eng.	1993-91	6	17

GM Car (Incl. Buick, Cad., Chev., Geo, Olds., Pontiac, Saturn) (Cont.)

Engine Finding Index (Cont.)			
Engine	Years	Code	Line No.
1.8L 107.5 (1762cc) DOHC L4 (16 Valve) 81mm Bore; MFI; Gasoline; Naturally Aspirated Toyota Eng.	1997-93	8	18
1.8L 109.4 (1794cc) DOHC L4 (16 Valve) 79mm Bore; MFI; Gasoline; Naturally Aspirated Toyota Eng.	1999-98	8	19
1.8L 109.4 (1794cc) DOHC L4 (16 Valve) 79mm Bore VVT-i; MFI; Gasoline; Naturally Aspirated Toyota Eng.	2008-00	8	20
1.8L 109.5 (1796cc) DOHC L4 (16 Valve) 82mm Bore VVT-i; MFI; Gasoline; Naturally Aspirated Toyota Eng.	2006-03	L	21
1.8L 109.6 (1796cc) DOHC L4 (16 Valve) 80.5mm Bore Ecotec VVT; MFI; Gasoline; Naturally Aspirated Opel Eng.	2009-08	1	22
1.8L 109.6 (1796cc) DOHC L4 (16 Valve) 80.5mm Bore Ecotec VVT; MFI; Gasoline; Naturally Aspirated Opel Eng.	2012-11	H	23
1.8L 109.7 (1798cc) DOHC L4 (16 Valve) 80.5mm Bore VVT-i; MFI; Gasoline; Naturally Aspirated Toyota Eng.	2010-09	8	24
1.8L 110.3 (1808cc) DOHC L4 (16 Valve) 80mm Bore; MFI; Gasoline; Naturally Aspirated Isuzu Eng.	1993-92	8	25
1.9L 116 (1901cc) DOHC L4 (16 Valve) 82mm Bore; MFI; Gasoline; Naturally Aspirated GMC Eng.; Saturn	2002-91	7	26
1.9L 116 (1901cc) SOHC L4 (8 Valve) 82mm Bore; MFI; Gasoline; Naturally Aspirated GMC Eng.; Saturn	2002-95	8	27
1.9L 116 (1901cc) SOHC L4 (8 Valve) 82mm Bore; TBI; Gasoline; Naturally Aspirated GMC Eng.; Saturn	1994-91	9	28
2.0L 122 (1998cc) DOHC L4 (16 Valve) 86mm Bore Ecotec; MFI; Gasoline; Supercharged Opel Eng.	2007-04	P	29
2.0L 122 (1998cc) DOHC L4 (16 Valve) 86mm Bore Ecotec; MFI; Gasoline; Turbo - Intercooled Opel Eng.	2010-07	X	30
2.0L 122 (1998cc) DOHC L4 (16 Valve) 86mm Bore Ecotec; MFI; Gasoline; Naturally Aspirated Opel Eng.	2009-04	Z	31
2.0L 122 (1998cc) DOHC L4 (16 Valve) 86mm Bore Ecotec VVT; DI; Gasoline; Turbo - Intercooled Opel Eng.	2013-11	V	32
2.0L 122 (1998cc) SOHC L4 (8 Valve) 86mm Bore; MFI; Gasoline; Naturally Aspirated Opel Eng.	1994-92	H	33
2.0L 122 (1998cc) SOHC L4 (8 Valve) 86mm Bore; TBI; Gasoline; Naturally Aspirated Opel Eng.	1991	K	34
2.2L 134 (2189cc) OHV L4 (8 Valve) 89mm Bore; MFI; Gasoline; Naturally Aspirated GMC Eng.; Chevrolet	2002-92	4	35
2.2L 134 (2189cc) OHV L4 (8 Valve) 89mm Bore; TBI; Gasoline; Naturally Aspirated GMC Eng.; Chevrolet	1991	G	36
2.2L 134.1 (2198cc) DOHC L4 (16 Valve) 86mm Bore Ecotec; MFI; Gasoline; Naturally Aspirated Opel Eng.	2003-02	2	37
2.2L 134.1 (2198cc) DOHC L4 (16 Valve) 86mm Bore Ecotec; MFI; Flex Fuel; Naturally Aspirated Opel Eng.	2005-03	6	38
2.2L 134.1 (2198cc) DOHC L4 (16 Valve) 86mm Bore Ecotec; MFI; Gasoline; Naturally Aspirated Opel Eng.	2008-00	F	39
2.2L 134.1 (2198cc) DOHC L4 (16 Valve) 86mm Bore Ecotec VVT; MFI; Gasoline; Naturally Aspirated Opel Eng.	2010-09	H	40
2.3L 138 (2260cc) DOHC L4 (16 Valve) 92mm Bore Quad 4; MFI; Gasoline; Naturally Aspirated GMC Eng.; Oldsmobile	1995-91	D	41
2.3L 138 (2260cc) DOHC L4 (16 Valve) 92mm Bore Quad 4 H.O.; MFI; Gasoline; Naturally Aspirated GMC Eng.; Oldsmobile	1994-91	A	42
2.3L 138 (2260cc) SOHC L4 (8 Valve) 92mm Bore Quad OHC; MFI; Gasoline; Naturally Aspirated GMC Eng.; Oldsmobile	1994-92	3	43
2.4L 144 (2362cc) DOHC L4 (16 Valve) 88.5mm Bore VVT-i; MFI; Gasoline; Naturally Aspirated Toyota Eng.	2010-09	0	44
2.4L 145.5 (2384cc) DOHC L4 (16 Valve) 88mm Bore Ecotec; MFI; Flex Fuel; Naturally Aspirated Opel Eng.	2012-10	0	45
2.4L 145.5 (2384cc) DOHC L4 (16 Valve) 88mm Bore Ecotec; MFI; Hybrid (Gas/Electric); Naturally Aspirated Opel Eng.	2010-07	5	46
2.4L 145.5 (2384cc) DOHC L4 (16 Valve) 88mm Bore Ecotec; MFI; Gasoline; Naturally Aspirated Opel Eng.	2011-05	B	47
2.4L 145.5 (2384cc) DOHC L4 (16 Valve) 88mm Bore Ecotec VVT; MFI; Gasoline; Naturally Aspirated Opel Eng.	2012-11	1	48
2.4L 145.5 (2384cc) DOHC L4 (16 Valve) 88mm Bore Ecotec VVT; DI; Gasoline; Naturally Aspirated Opel Eng.	2013-10	C	49
2.4L 145.5 (2384cc) DOHC L4 (16 Valve) 88mm Bore Ecotec VVT; MFI; Flex Fuel; Naturally Aspirated Opel Eng.	2012-11	U	50
2.4L 146 (2392cc) DOHC L4 (16 Valve) 90mm Bore Twin Cam; MFI; Gasoline; Naturally Aspirated GMC Eng.; Oldsmobile	2002-96	T	51
2.5L 151 (2475cc) OHV L4 (8 Valve) 4" Bore; TBI; Gasoline; Naturally Aspirated GMC Eng.; Pontiac	1992-91	R	52
2.5L 151 (2475cc) OHV L4 (8 Valve) 4" Bore; TBI; Gasoline; Naturally Aspirated GMC Eng.; Pontiac	1991	U	53
2.6L 158 (2597cc) DOHC V6 (24 Valve) 83.2mm Bore; MFI; Gasoline; Naturally Aspirated Opel Eng.	2004-03	M	54
2.8L 171 (2792cc) DOHC V6 (24 Valve) 89mm Bore; MFI; Gasoline; Naturally Aspirated Opel Eng.	2007-05	T	55
3.0L 181 (2962cc) DOHC V6 (24 Valve) 86mm Bore; MFI; Gasoline; Naturally Aspirated Opel Eng.	2005-97	R	56
3.0L 182.9 (2997cc) DOHC V6 (24 Valve) 89mm Bore VVT; DI; Flex Fuel; Naturally Aspirated Opel Eng.	2012	5	57
3.0L 182.9 (2997cc) DOHC V6 (24 Valve) 89mm Bore VVT; DI; Gasoline; Naturally Aspirated Opel Eng.	2012-10	G	58
3.0L 182.9 (2997cc) DOHC V6 (24 Valve) 89mm Bore VVT; DI; Gasoline; Naturally Aspirated Opel Eng.	2012-11	Y	59
3.1L 189 (3136cc) OHV V6 (12 Valve) 89mm Bore; MFI; Gasoline; Naturally Aspirated GMC Eng.; Chevrolet	2005-99	J	60
3.1L 189 (3136cc) OHV V6 (12 Valve) 89mm Bore; MFI; Gasoline; Naturally Aspirated GMC Eng.; Chevrolet	1999-93	M	61
3.1L 189 (3136cc) OHV V6 (12 Valve) 89mm Bore; MFI; Gasoline; Naturally Aspirated GMC Eng.; Chevrolet	1994-91	T	62
3.1L 189 (3136cc) OHV V6 (12 Valve) 89mm Bore; MFI; Flex Fuel; Naturally Aspirated GMC Eng.; Chevrolet	1993	W	63
3.2L 194 (3175cc) DOHC V6 (24 Valve) 87.5mm Bore; MFI; Gasoline; Naturally Aspirated Opel Eng.	2005-03	N	64
3.3L 204 (3350cc) OHV V6 (12 Valve) 3.7" Bore; MFI; Gasoline; Naturally Aspirated GMC Eng.; Buick	1993-91	N	65
3.4L 207 (3393cc) DOHC V6 (24 Valve) 92mm Bore; MFI; Gasoline; Naturally Aspirated GMC Eng.; Chevrolet	1997-91	X	66
3.4L 207 (3393cc) OHV V6 (12 Valve) 92mm Bore; MFI; Gasoline; Naturally Aspirated GMC Eng.; Chevrolet	2005-99	E	67
3.4L 207 (3393cc) OHV V6 (12 Valve) 92mm Bore; MFI; Gasoline; Naturally Aspirated GMC Eng.; Chevrolet	1995-93	S	68
3.5L 213 (3491cc) OHV V6 (12 Valve) 94mm Bore; MFI; Gasoline; Naturally Aspirated GMC Eng.; Chevrolet	2008-04	8	69
3.5L 214 (3473cc) DOHC V6 (24 Valve) 89.5mm Bore Northstar; MFI; Gasoline; Naturally Aspirated GMC Eng.; Oldsmobile	2002-99	H	70
3.5L 214 (3510cc) OHV V6 (12 Valve) 99mm Bore; MFI; Flex Fuel; Naturally Aspirated GMC Eng.; Chevrolet	2011-06	K	71
3.5L 214 (3510cc) OHV V6 (12 Valve) 99mm Bore; MFI; Gasoline; Naturally Aspirated GMC Eng.; Chevrolet	2011-06	N	72
3.6L 217 (3564cc) DOHC V6 (24 Valve) 94mm Bore; MFI; Gasoline; Naturally Aspirated Opel Eng.	2012-04	7	73
3.6L 217 (3564cc) DOHC V6 (24 Valve) 94mm Bore VVT; DI; Flex Fuel; Naturally Aspirated Opel Eng.	2013-12	3	74
3.6L 217 (3564cc) DOHC V6 (24 Valve) 94mm Bore VVT; DI; Gasoline; Naturally Aspirated Opel Eng.	2013-11	D	75
3.6L 217 (3564cc) DOHC V6 (24 Valve) 94mm Bore VVT; DI; Gasoline; Naturally Aspirated Opel Eng.	2013-08	V	76
3.8L 231 (3791cc) OHV V6 (12 Valve) 3.8" Bore; MFI; Gasoline; Supercharged GMC Eng.; Buick	2005-91	1	77
3.8L 231 (3791cc) OHV V6 (12 Valve) 3.8" Bore; MFI; Gasoline; Naturally Aspirated GMC Eng.; Buick	2009-04	2	78
3.8L 231 (3791cc) OHV V6 (12 Valve) 3.8" Bore; MFI; Gasoline; Supercharged GMC Eng.; Buick	2007-04	4	79
3.8L 231 (3791cc) OHV V6 (12 Valve) 3.8" Bore; MFI; Gasoline; Naturally Aspirated GMC Eng.; Buick	1991	C	80
3.8L 231 (3791cc) OHV V6 (12 Valve) 3.8" Bore; MFI; Gasoline; Naturally Aspirated GMC Eng.; Buick	2005-95	K	81

GM Car (Incl. Buick, Cad., Chev., Geo, Olds., Pontiac, Saturn) (Cont.)

Engine Finding Index (Cont.)

Engine	Years	Code	Line No.
3.8L 231 (3791cc) OHV V6 (12 Valve) 3.8" Bore; MFI; Gasoline; Naturally Aspirated GMC Eng.; Buick	1995-91	L	82
3.9L 242 (3880cc) OHV V6 (12 Valve) 99mm Bore; MFI; Gasoline; Naturally Aspirated GMC Eng.; Chevrolet	2011-06	1	83
3.9L 242 (3880cc) OHV V6 (12 Valve) 99mm Bore; MFI; Flex Fuel; Naturally Aspirated GMC Eng.; Chevrolet	2008-07	3	84
3.9L 242 (3880cc) OHV V6 (12 Valve) 99mm Bore; MFI; Flex Fuel; Naturally Aspirated GMC Eng.; Chevrolet	2011-09	M	85
3.9L 242 (3880cc) OHV V6 (12 Valve) 99mm Bore; MFI; Gasoline; Naturally Aspirated GMC Eng.; Chevrolet	2009-07	R	86
4.0L 244 (3995cc) DOHC V8 (32 Valve) 87mm Bore Northstar; MFI; Gasoline; Naturally Aspirated GMC Eng.; Oldsmobile	2003-95	C	87
4.3L 262 (4294cc) OHV V6 (12 Valve) 4" Bore; TBI; Gasoline; Naturally Aspirated GMC Eng.; Chevrolet	1993-91	Z	88
4.3L 265 (4343cc) OHV V8 (16 Valve) 3.736" Bore LT-1; MFI; Gasoline; Naturally Aspirated GMC Eng.; Chevrolet	1996-94	W	89
4.5L 273 (4474cc) OHV V8 (16 Valve) 92mm Bore; MFI; Gasoline; Naturally Aspirated GMC Eng.; Cadillac	1992-91	8	90
4.6L 281 (4565cc) DOHC V8 (32 Valve) 93mm Bore Northstar; MFI; Gasoline; Naturally Aspirated GMC Eng.; Cadillac	2011	6	91
4.6L 281 (4565cc) DOHC V8 (32 Valve) 93mm Bore Northstar; MFI; Gasoline; Naturally Aspirated GMC Eng.; Cadillac	2011-93	Y	92
4.6L 281 (4565cc) DOHC V8 (32 Valve) 93mm Bore Northstar H.O.; MFI; Gasoline; Naturally Aspirated GMC Eng.; Cadillac	2011-93	9	93
4.6L 281 (4565cc) DOHC V8 (32 Valve) 93mm Bore Northstar H.O.; MFI; Gasoline; Naturally Aspirated GMC Eng.; Cadillac	2010-04	A	94
4.6L 281 (4565cc) DOHC V8 (32 Valve) 93mm Bore Northstar H.O.; MFI; Gasoline; Naturally Aspirated GMC Eng.; Cadillac	2011	S	95
4.9L 298 (4884cc) OHV V8 (16 Valve) 92mm Bore; MFI; Gasoline; Naturally Aspirated GMC Eng.; Cadillac	1995-91	B	96
5.0L 305 (4999cc) OHV V8 (16 Valve) 3.736" Bore; TBI; Gasoline; Naturally Aspirated GMC Eng.; Chevrolet	1993-91	E	97
5.0L 305 (4999cc) OHV V8 (16 Valve) 3.736" Bore; TPI; Gasoline; Naturally Aspirated GMC Eng.; Chevrolet	1992-91	F	98
5.3L 325 (5328cc) OHV V8 (16 Valve) 96mm Bore Vortec LS-4; MFI; Gasoline; Naturally Aspirated GMC Eng.; Chevrolet	2009-05	C	99
5.7L 346 (5665cc) OHV V8 (16 Valve) 99mm Bore LS-1; MFI; Gasoline; Naturally Aspirated GMC Eng.; Chevrolet	2004-97	G	100
5.7L 346 (5665cc) OHV V8 (16 Valve) 99mm Bore LS-6; MFI; Gasoline; Naturally Aspirated GMC Eng.; Chevrolet	2005-01	S	101
5.7L 350 (5736cc) OHV V8 (16 Valve) 4" Bore; TBI; Gasoline; Naturally Aspirated GMC Eng.; Chevrolet	1993-91	7	102
5.7L 350 (5736cc) OHV V8 (16 Valve) 4" Bore; TPI; Gasoline; Naturally Aspirated GMC Eng.; Chevrolet	1992-91	8	103
5.7L 350 (5736cc) OHV V8 (16 Valve) 4" Bore LT-1; MFI; Gasoline; Naturally Aspirated GMC Eng.; Chevrolet	1997-92	P	104
5.7L 350 (5736cc) OHV V8 (16 Valve) 4" Bore LT-4; MFI; Gasoline; Naturally Aspirated GMC Eng.; Chevrolet	1996	5	105
6.0L 364 (5967cc) OHV V8 (16 Valve) 101.6mm Bore Vortec; MFI; Gasoline; Naturally Aspirated GMC Eng.; Chevrolet	2007-05	U	106
6.0L 364 (5967cc) OHV V8 (16 Valve) 101.6mm Bore Vortec; MFI; Gasoline; Naturally Aspirated GMC Eng.; Chevrolet	2009-08	Y	107
6.0L 364 (5967cc) OHV V8 (16 Valve) 101.6mm Bore Vortec LS-2; MFI; Gasoline; Naturally Aspirated GMC Eng.; Chevrolet	2007-05	H	108
6.0L 364 (5967cc) OHV V8 (16 Valve) 101.6mm Bore Vortec VVT L77; MFI; Flex Fuel; Naturally Aspirated GMC Eng.; Chevrolet	2012-11	2	109
6.2L 378 (6195cc) OHV V8 (16 Valve) 103.25mm Bore Vortec L99; MFI; Gasoline; Naturally Aspirated GMC Eng.; Chevrolet	2012-10	J	110
6.2L 378 (6195cc) OHV V8 (16 Valve) 103.25mm Bore Vortec LS-3; MFI; Gasoline; Naturally Aspirated GMC Eng.; Chevrolet	2012-08	W	111
7.0L 427 (6998cc) OHV V8 (16 Valve) 4.125" Bore LS-7; MFI; Gasoline; Naturally Aspirated GMC Eng.; Chevrolet	2012-06	E	112

Engine Code Index

Code	Engine	Line No.
1ZZFE	1.8L 109.4 (1794cc) DOHC L4 (16 Valve) 79mm Bore; MFI; Gasoline; Naturally Aspirated Toyota Eng.	19
1ZZFE	1.8L 109.4 (1794cc) DOHC L4 (16 Valve) 79mm Bore VVT-i; MFI; Gasoline; Naturally Aspirated Toyota Eng.	20
2AZFE	2.4L 144 (2362cc) DOHC L4 (16 Valve) 88.5mm Bore VVT-i; MFI; Gasoline; Naturally Aspirated Toyota Eng.	44
2ZRFE	1.8L 109.7 (1798cc) DOHC L4 (16 Valve) 80.5mm Bore VVT-i; MFI; Gasoline; Naturally Aspirated Toyota Eng.	24
2ZZGE	1.8L 109.5 (1796cc) DOHC L4 (16 Valve) 82mm Bore VVT-i; MFI; Gasoline; Naturally Aspirated Toyota Eng.	21
4AFE	1.6L 96.8 (1587cc) DOHC L4 (16 Valve) 81mm Bore; MFI; Gasoline; Naturally Aspirated Toyota Eng.	10
4AGE	1.6L 96.8 (1587cc) DOHC L4 (16 Valve) 81mm Bore; MFI; Gasoline; Naturally Aspirated Toyota Eng.	9
4XE1V	1.6L 96.9 (1588cc) SOHC L4 (12 Valve) 80mm Bore; MFI; Gasoline; Naturally Aspirated Isuzu Eng.	12
4XE1W	1.6L 96.9 (1588cc) DOHC L4 (16 Valve) 80mm Bore; MFI; Gasoline; Naturally Aspirated Isuzu Eng.	11
4XF1	1.8L 110.3 (1808cc) DOHC L4 (16 Valve) 80mm Bore; MFI; Gasoline; Naturally Aspirated Isuzu Eng.	25
7AFE	1.8L 107.5 (1762cc) DOHC L4 (16 Valve) 81mm Bore; MFI; Gasoline; Naturally Aspirated Toyota Eng.	18
G10	1.0L 61 (993cc) SOHC L3 (6 Valve) 74mm Bore; TBI; Gasoline; Naturally Aspirated Suzuki Eng.	2
G10-T	1.0L 61 (993cc) SOHC L3 (6 Valve) 74mm Bore; MFI; Gasoline; Turbo Suzuki Eng.	1
G13A	1.3L 81 (1324cc) SOHC L4 (8 Valve) 74mm Bore; TBI; Gasoline; Naturally Aspirated Suzuki Eng.	4
SW413	1.3L 81 (1324cc) SOHC L4 (16 Valve) 74mm Bore; MFI; Gasoline; Naturally Aspirated Suzuki Eng.	3

Model Index

Engine (VIN Code / Eng. Code)	Year	Engine (VIN Code / Eng. Code)	Year	Engine (VIN Code / Eng. Code)	Year
Asuna		Buick (cont.)		Buick (cont.)	
GT (Canada)		40 Special (cont.)		50 Super (cont.)	
L4 1598cc 1.6L SOHC (8 Valve) (6)	93-92	V8 364CI 6.0L	58-57	V8 322CI 5.3L	56-53
SE (Canada)		4400 LeSabre		V8 364CI 6.0L	58-57
L4 1598cc 1.6L SOHC (8 Valve) (6)	93-92	V8 364CI 6.0L	61-59	60 Century	
Sunfire (Canada)		V8 401CI 6.6L	62	L8 320.2CI 5.2L (OHV)	42-36
L4 1808cc 1.8L DOHC (16 Valve) (8)	93-92	4600 Invicta		V8 322CI 5.3L	56-54
Buick		V8 401CI 6.6L	62-59	V8 364CI 6.0L	58-57
100 Skylark		4700 Electra		70 Roadmaster	
V8 322CI 5.3L	54	V8 401CI 6.6L	62-59	L8 320.2CI 5.2L (OHV)	52-46
40 Special		4800 Electra		L8 320.2CI 5.2L (OHV)	42-40
L8 248CI 4.1L (OHV)	50-46	V8 401CI 6.6L	62-59	V8 322CI 5.3L	56-53
L8 248CI 4.1L (OHV)	42-34	50 Super		V8 364CI 6.0L	57
L8 263CI 4.3L (OHV)	53-51	L8 248CI 4.1L (OHV)	49-46	700 Limited	
V8 264CI 4.3L	55-54	L8 248CI 4.1L (OHV)	42-40	V8 364CI 6.0L	58
V8 322CI 5.3L	56	L8 263CI 4.3L (OHV)	52-50		

GM Car (Incl. Buick, Cad., Chev., Geo, Olds., Pontiac, Saturn) (Cont.)

Model Index (Cont.)					
Engine (VIN Code / Eng. Code)	Year	Engine (VIN Code / Eng. Code)	Year	Engine (VIN Code / Eng. Code)	Year
Buick (cont.)		Buick (cont.)		Buick (cont.)	
75 Roadmaster		Electra (RWD) (cont.)		LeSabre (FWD) (cont.)	
V8 364CI 6.0L	58-57	V8 305CI 5.0L (H)	85-82	V6 231CI 3.8L (3)	88-86
80		V8 307CI 5.0L (Y)	90-80	V6 231CI 3.8L (B)	86
L8 320.2CI 5.2L (OHV)	36	V8 350CI 5.7L (B)	81	V6 231CI 3.8L (C)	91-88
L8 320.2CI 5.2L (OHV)	39-36	V8 350CI 5.7L (H)	77	V6 231CI 3.8L (K)	05-96
90 Limited		V8 350CI 5.7L (J)	77	V6 231CI 3.8L (L)	95-92
L8 320.2CI 5.2L (OHV)	42-36	V8 350CI 5.7L (R)	80-77	LeSabre (RWD)	
90 Roadmaster		V8 350CI 5.7L (X)	80-78	V6 231CI 3.8L (A)	85-77
L8 320.2CI 5.2L (OHV)	39-36	V8 350CI 5.7L Diesel (N)	85-80	V6 231CI 3.8L (C)	77-76
Allure (Canada)		V8 400CI 6.6L (Z)	79-78	V6 231CI 3.8L Turbo (3)	82-79
V6 231CI 3.8L (2)	08-05	V8 401CI 6.6L	66-59	V6 231CI 3.8L Turbo (G)	78
V6 3564cc 3.6L DOHC (24 Valve) (7)	08-05	V8 403CI 6.6L (K)	79-77	V6 252CI 4.1L (4)	84-80
V8 325CI 5.3L (C)	08	V8 425CI 7.0L	66-64	V8 267CI 4.4L (J)	82-81
Apollo		V8 430CI 7.0L	69-67	V8 300CI 4.9L	65-64
L6 250CI 4.1L (OHV) (D)	75-73	V8 455CI 7.5L	74-70	V8 301CI 4.9L (W)	81-78
V6 231CI 3.8L (C)	75	V8 455CI 7.5L (T)	76-75	V8 301CI 4.9L (Y)	79-77
V8 260CI 4.3L (F)	75	Estate Wagon		V8 305CI 5.0L (H)	85-78
V8 350CI 5.7L (H)	75-73	V6 231CI 3.8L (A)	85-77	V8 305CI 5.0L (U)	78
Centurion		V6 231CI 3.8L (C)	77-75	V8 307CI 5.0L (Y)	90-80
V8 350CI 5.7L	73-72	V6 252CI 4.1L (4)	84-80	V8 340CI 5.6L	67-66
V8 455CI 7.5L	73-71	V8 267CI 4.4L (J)	82-81	V8 350CI 5.7L	74-68
Century (FWD)		V8 300CI 4.9L	64	V8 350CI 5.7L (B)	81
L4 134CI 2.2L OHV (4)	96-93	V8 301CI 4.9L (W)	81-78	V8 350CI 5.7L (H)	77-75
L4 151CI 2.5L (R)	92-82	V8 301CI 4.9L (Y)	79-77	V8 350CI 5.7L (J)	77-75
V6 173CI 2.8L (W)	89-86	V8 305CI 5.0L (E)	92-91	V8 350CI 5.7L (L)	79-77
V6 173CI 2.8L (X)	86-82	V8 305CI 5.0L (H)	85-78	V8 350CI 5.7L (R)	80-77
V6 181CI 3.0L (E)	85-82	V8 307CI 5.0L (Y)	90-80	V8 350CI 5.7L (X)	80-78
V6 189CI 3.1L (J)	05-00	V8 350CI 5.7L	74-70	V8 350CI 5.7L Diesel (N)	85-80
V6 189CI 3.1L (M)	99-94	V8 350CI 5.7L (7)	93-92	V8 364CI 6.0L	61-59
V6 204CI 3.3L (N)	93-89	V8 350CI 5.7L (B)	81	V8 400CI 6.6L (Z)	79-78
V6 231CI 3.8L (3)	88-84	V8 350CI 5.7L (H)	77	V8 401CI 6.6L	64-59
V6 262CI 4.3L Diesel (T)	85-82	V8 350CI 5.7L (J)	77	V8 403CI 6.6L (K)	79-77
Century (RWD)		V8 350CI 5.7L (P)	96-94	V8 425CI 7.0L	64
V6 196CI 3.2L (C)	79-78	V8 350CI 5.7L (R)	80-77	V8 430CI 7.0L	69-68
V6 231CI 3.8L (2)	79-78	V8 350CI 5.7L (X)	80-78	V8 455CI 7.5L	74-70
V6 231CI 3.8L (A)	81-78	V8 350CI 5.7L Diesel (N)	85-80	V8 455CI 7.5L (T)	76-75
V6 231CI 3.8L (C)	77-75	V8 364CI 6.0L	61-59	Lucerne	
V6 231CI 3.8L Turbo (3)	81-79	V8 400CI 6.6L (Z)	79-78	V6 231CI 3.8L (2)	08-06
V6 231CI 3.8L Turbo (G)	78	V8 401CI 6.6L	64-59	V6 242CI 3.9L OHV (12 Valve) (1)	11-09
V8 265CI 4.3L (S)	81-80	V8 403CI 6.6L (K)	79-77	V6 242CI 3.9L OHV (12 Valve) (Flex Fuel) (M)	11-09
V8 267CI 4.4L (J)	81	V8 425CI 7.0L	64	V8 281CI 4.6L DOHC (32 Valve) (9)	11-08
V8 301CI 4.9L (W)	81-78	V8 455CI 7.5L	74-70	V8 281CI 4.6L DOHC (32 Valve) (S)	11
V8 301CI 4.9L (Y)	79-77	V8 455CI 7.5L (T)	76-75	V8 281CI 4.6L DOHC (32 Valve) (Y)	08-06
V8 305CI 5.0L (H)	81-78	Gran Sport		Park Avenue	
V8 305CI 5.0L (U)	78-77	V8 300CI 4.9L	65	V6 231CI 3.8L (C)	90
V8 350CI 5.7L (B)	81	V8 340CI 5.6L	67-66	V6 231CI 3.8L (K)	05-95
V8 350CI 5.7L (H)	77-73	V8 350CI 5.7L	72-68	V6 231CI 3.8L (L)	94-91
V8 350CI 5.7L (J)	77-73	V8 400CI 6.6L	69-65	V6 231CI 3.8L Supercharged (1)	05-91
V8 350CI 5.7L (L)	79-77	V8 401CI 6.6L	66-65	Reatta	
V8 350CI 5.7L (R)	77	V8 425CI 7.0L	66-65	V6 231CI 3.8L (C)	90-88
V8 350CI 5.7L (X)	80-78	V8 455CI 7.5L	72-70	V6 231CI 3.8L (L)	91
V8 403CI 6.6L (K)	77	Invicta		Regal (FWD)	
V8 455CI 7.5L	74-73	V8 401CI 6.6L	63-59	L4 1998cc 2.0L DOHC Turbo (16 Valve) (V)	13-11
V8 455CI 7.5L (T)	76-75	LaCrosse		L4 1998cc 2.0L DOHC Turbo (16 Valve) (Flex Fuel) (V)	13-12
Coachbuilder Wagon		L4 2384cc 2.4L DOHC (16 Valve) (C)	13-10	L4 2384cc 2.4L DOHC (16 Valve) (C)	13-11
V8 305CI 5.0L (E)	92-91	L4 2384cc 2.4L DOHC (16 Valve) (R)	13-12	L4 2384cc 2.4L DOHC (16 Valve) (R)	13-12
V8 307CI 5.0L (Y)	90-80	V6 231CI 3.8L (2)	09-05	L4 2384cc 2.4L DOHC (16 Valve) (Flex Fuel) (K)	13-12
Electra (FWD)		V6 2997cc 3.0L DOHC (24 Valve) (G)	10	V6 173CI 2.8L (W)	89-88
V6 181CI 3.0L (E)	85	V6 3564cc 3.6L DOHC (24 Valve) (7)	08-05	V6 189CI 3.1L (M)	97-94
V6 231CI 3.8L (3)	87-85	V6 3564cc 3.6L DOHC (24 Valve) (D)	13-11	V6 189CI 3.1L (T)	93-89
V6 231CI 3.8L (C)	90-88	V6 3564cc 3.6L DOHC (24 Valve) (V)	13-10	V6 231CI 3.8L (K)	04-96
V6 262CI 4.3L Diesel (T)	85	V6 3564cc 3.6L DOHC (24 Valve) (Flex Fuel) (3)	13-12	V6 231CI 3.8L (L)	95-90
Electra (RWD)		V8 325CI 5.3L (C)	09-08	V6 231CI 3.8L Supercharged (1)	04-97
V6 231CI 3.8L (A)	85-81	LeSabre (FWD)			
V6 252CI 4.1L (4)	84-80	V6 181CI 3.0L (L)	86		
V8 301CI 4.9L (W)	81-80				

GM Car (Incl. Buick, Cad., Chev., Geo, Olds., Pontiac, Saturn) (Cont.)

Model Index (Cont.)					
<i>Engine (VIN Code / Eng. Code)</i>	<i>Year</i>	<i>Engine (VIN Code / Eng. Code)</i>	<i>Year</i>	<i>Engine (VIN Code / Eng. Code)</i>	<i>Year</i>
Buick (cont.)		Buick (cont.)		Buick (cont.)	
Regal (RWD)		Skyhawk (FWD) (cont.)		Verano	
V6 196CI 3.2L (C)	79-78	L4 1796cc 1.8L SOHC Turbo (J)	86-84	L4 1998cc 2.0L DOHC Turbo (16 Valve) (V)	13
V6 231CI 3.8L (2)	79-78	L4 1998cc 2.0L SOHC (K)	88-87	L4 1998cc 2.0L DOHC Turbo (16 Valve) (Flex Fuel) (V)	13
V6 231CI 3.8L (A)	87-77	L4 1998cc 2.0L SOHC Turbo (M)	87	L4 2384cc 2.4L DOHC (16 Valve) (Flex Fuel) (K)	13-12
V6 231CI 3.8L (C)	77-75	Skyhawk (RWD)		L4 2384cc 2.4L DOHC (16 Valve) (Flex Fuel) (R)	13
V6 231CI 3.8L Turbo (3)	82-78	V6 231CI 3.8L (2)	79-78		
V6 231CI 3.8L Turbo (7)	87-86	V6 231CI 3.8L (A)	80-78		
V6 231CI 3.8L Turbo (8)	83	V6 231CI 3.8L (C)	77-75		
V6 231CI 3.8L Turbo (9)	85-84	Skylark (FWD)		Wildcat	
V6 231CI 3.8L Turbo (G)	78	L4 138CI 2.3L DOHC (16 Valve) (A)	94-89	V8 401CI 6.6L	66-62
V6 252CI 4.1L (4)	84-82	L4 138CI 2.3L DOHC (16 Valve) (D)	95-88	V8 425CI 7.0L	66-64
V6 262CI 4.3L (Z)	87-85	L4 138CI 2.3L SOHC (8 Valve) (3)	94-92	V8 430CI 7.0L	69-67
V6 262CI 4.3L Diesel (V)	85-82	L4 146CI 2.4L DOHC (16 Valve) (T)	98-96	V8 455CI 7.5L	70
V8 265CI 4.3L (S)	81-80	L4 151CI 2.5L (5)	83-80	Cadillac	
V8 267CI 4.4L (J)	82-81	L4 151CI 2.5L (R)	85-82	Allante	
V8 301CI 4.9L (W)	81-78	L4 151CI 2.5L (U)	91-86	V8 250CI 4.1L (7)	88-87
V8 301CI 4.9L (Y)	79-77	V6 173CI 2.8L (7)	80	V8 273CI 4.5L (8)	92-89
V8 305CI 5.0L (H)	86-78	V6 173CI 2.8L (W)	85	V8 281CI 4.6L DOHC (32 Valve) (9)	94-93
V8 305CI 5.0L (U)	78-77	V6 173CI 2.8L (X)	85-81	ATS	
V8 307CI 5.0L (Y)	87-86	V6 173CI 2.8L (Z)	84-81	L4 1998cc 2.0L DOHC Turbo (16 Valve) (Flex Fuel) (V)	13-12
V8 350CI 5.7L (H)	77-73	V6 181CI 3.0L (L)	88-86	L4 1998cc 2.0L DOHC Turbo (16 Valve) (Flex Fuel) (X)	13-12
V8 350CI 5.7L (J)	77-73	V6 189CI 3.1L (M)	98-94	L4 2457cc 2.5L DOHC (16 Valve) (A)	13-12
V8 350CI 5.7L (L)	79-77	V6 204CI 3.3L (N)	93-89	V6 3564cc 3.6L DOHC (24 Valve) (Flex Fuel) (3)	13-12
V8 350CI 5.7L (R)	77	Skylark (RWD)		Calais	
V8 350CI 5.7L Diesel (N)	85-81	L6 250CI 4.1L (OHV)	72-68	V8 429CI 7.0L	67-65
V8 403CI 6.6L (K)	77	V6 198CI 3.2L	63-62	V8 472CI 7.7L	74-68
V8 455CI 7.5L	74-73	V6 225CI 3.7L	67-64	V8 500CI 8.2L	74-70
Riviera (FWD)		V6 231CI 3.8L (A)	79-78	V8 500CI 8.2L (S)	76-75
V6 231CI 3.8L (3)	87-86	V6 231CI 3.8L (C)	77-75	Catera	
V6 231CI 3.8L (A)	85-79	V8 215CI 3.5L	63-61	V6 2962cc 3.0L DOHC (24 Valve) (R)	02-97
V6 231CI 3.8L (B)	87-86	V8 260CI 4.3L (F)	76-75	Cimarron	
V6 231CI 3.8L (C)	90-88	V8 300CI 4.9L	67-64	L4 112CI 1.8L OHV (G)	82
V6 231CI 3.8L (K)	97-95	V8 301CI 4.9L (Y)	77	L4 121CI 2.0L OHV (P)	86-83
V6 231CI 3.8L (L)	93-91	V8 305CI 5.0L (G)	79	V6 173CI 2.8L (W)	88-85
V6 231CI 3.8L Supercharged (1)	99-95	V8 305CI 5.0L (U)	78-77	Commercial Chassis	
V6 231CI 3.8L Turbo (3)	82-79	V8 340CI 5.6L	67-66	V8 250CI 4.1L (8)	87-85
V6 231CI 3.8L Turbo (8)	83	V8 350CI 5.7L	74-68	V8 273CI 4.5L (3)	90
V6 231CI 3.8L Turbo (9)	85-84	V8 350CI 5.7L (H)	77-75	V8 273CI 4.5L (5)	89-88
V6 252CI 4.1L (4)	84-81	V8 350CI 5.7L (J)	77-75	V8 298CI 4.9L (B)	95-91
V8 307CI 5.0L (Y)	85-80	V8 350CI 5.7L (L)	79-77	V8 305CI 5.0L (E)	92-91
V8 350CI 5.7L (B)	81	V8 350CI 5.7L (R)	77	V8 307CI 5.0L (Y)	90-86
V8 350CI 5.7L (X)	80-79	V8 350CI 5.7L (X)	79-78	V8 331CI 5.4L	55-49
V8 350CI 5.7L Diesel (N)	85-80	V8 400CI 6.6L	68-65	V8 346CI 5.7L (L-Head)	48-46
Riviera (RWD)		V8 425CI 7.0L	66-65	V8 350CI 5.7L (7)	93-90
V8 301CI 4.9L (Y)	78-77	Somerset		V8 350CI 5.7L (P)	96-94
V8 305CI 5.0L (H)	78	L4 151CI 2.5L (U)	87-85	V8 350CI 5.7L Diesel (N)	85
V8 350CI 5.7L (J)	77	V6 181CI 3.0L (L)	87-85	V8 365CI 6.0L	58-56
V8 350CI 5.7L (R)	78-77	Special		V8 368CI 6.0L (6)	84-80
V8 350CI 5.7L (X)	78	L6 250CI 4.1L (OHV)	69-68	V8 368CI 6.0L (9)	84-81
V8 400CI 6.6L (Z)	78	V6 198CI 3.2L	63-62	V8 390CI 6.4L	63-59
V8 401CI 6.6L	65-63	V6 225CI 3.7L	67-64	V8 425CI 7.0L (S)	79-77
V8 403CI 6.6L (K)	78-77	V6 231CI 3.8L (A)	82-78	V8 425CI 7.0L (T)	79-77
V8 425CI 7.0L	66-63	V6 231CI 3.8L (C)	77-75	V8 429CI 7.0L	67-64
V8 430CI 7.0L	69-67	V8 215CI 3.5L	63-61	V8 472CI 7.7L	74-68
V8 455CI 7.5L	74-70	V8 300CI 4.9L	67-64	V8 500CI 8.2L	74-70
V8 455CI 7.5L (T)	76-75	V8 340CI 5.6L	67-66	V8 500CI 8.2L (S)	76-75
Roadmaster		V8 350CI 5.7L	69-68	Concours	
V8 305CI 5.0L (E)	92-91	Sport Wagon		V8 281CI 4.6L DOHC (32 Valve) (9)	99-96
V8 350CI 5.7L (7)	93-92	V8 300CI 4.9L	65-64	V8 281CI 4.6L DOHC (32 Valve) (Y)	95-94
V8 350CI 5.7L (P)	96-94	V8 340CI 5.6L	67-66	CTS	
Skyhawk (FWD)		V8 350CI 5.7L	72-68	V6 2792cc 2.8L DOHC (24 Valve) (T)	07-05
L4 112CI 1.8L OHV (G)	82	V8 400CI 6.6L	69-68	V6 2997cc 3.0L DOHC (24 Valve) (G)	13-10
L4 121CI 2.0L OHV (1)	89-87	Ultra		V6 2997cc 3.0L DOHC (24 Valve) (Y)	13-11
L4 121CI 2.0L OHV (B)	84-83	V6 231CI 3.8L (C)	90		
L4 121CI 2.0L OHV (P)	86-83	V6 231CI 3.8L (L)	91		
L4 1796cc 1.8L SOHC (0)	86-82	V6 231CI 3.8L Supercharged (1)	05-91		

GM Car (Incl. Buick, Cad., Chev., Geo, Olds., Pontiac, Saturn) (Cont.)

Model Index (Cont.)					
Engine (VIN Code / Eng. Code)	Year	Engine (VIN Code / Eng. Code)	Year	Engine (VIN Code / Eng. Code)	Year
Cadillac (cont.)		Cadillac (cont.)		Cadillac (cont.)	
CTS (cont.)		Fleetwood (FWD) (cont.)		Series 75 Fleetwood (cont.)	
V6 2997cc 3.0L DOHC (24 Valve) (Flex Fuel) (5)	13-12	V8 250CI 4.1L (8)	87-85	V8 500CI 8.2L	74-70
V6 3175cc 3.2L DOHC (24 Valve) (N)	05-03	V8 273CI 4.5L (3)	90	V8 500CI 8.2L (S)	76-75
V6 3564cc 3.6L DOHC (24 Valve) (7)	09-04	V8 273CI 4.5L (5)	89-88	Seville (FWD)	
V6 3564cc 3.6L DOHC (24 Valve) (D)	13-11	V8 298CI 4.9L (B)	92-91	V6 252CI 4.1L (4)	82-81
V6 3564cc 3.6L DOHC (24 Valve) (V)	13-08	Fleetwood (RWD)		V8 250CI 4.1L (8)	87-82
V6 3564cc 3.6L DOHC (24 Valve) (Flex Fuel) (3)	13-12	V6 252CI 4.1L (4)	82-80	V8 273CI 4.5L (3)	90
CTS-V		V8 250CI 4.1L (8)	85-82	V8 273CI 4.5L (5)	89-88
V8 346CI 5.7L (S)	05-04	V8 305CI 5.0L (E)	92-91	V8 281CI 4.6L DOHC (32 Valve) (9)	03-93
V8 364CI 6.0L (U)	07-06	V8 307CI 5.0L (9)	90-86	V8 281CI 4.6L DOHC (32 Valve) (Y)	04-93
V8 378CI 6.2L Supercharged (P)	13-09	V8 307CI 5.0L (Y)	90-86	V8 298CI 4.9L (B)	93-91
DeVille (FWD)		V8 331CI 5.4L	55-49	V8 350CI 5.7L (8)	80
V6 262CI 4.3L Diesel (T)	85	V8 350CI 5.7L (7)	93-90	V8 350CI 5.7L Diesel (N)	85-80
V8 250CI 4.1L (8)	87-85	V8 350CI 5.7L (P)	96-94	V8 368CI 6.0L (9)	81-80
V8 273CI 4.5L (3)	90	V8 350CI 5.7L Diesel (N)	85-78	Seville (RWD)	
V8 273CI 4.5L (5)	89-88	V8 365CI 6.0L	58-56	V8 350CI 5.7L (B)	79-78
V8 281CI 4.6L DOHC (32 Valve) (9)	05-96	V8 368CI 6.0L (6)	82-80	V8 350CI 5.7L (R)	77-75
V8 281CI 4.6L DOHC (32 Valve) (Y)	05-94	V8 368CI 6.0L (9)	84-81	V8 350CI 5.7L Diesel (N)	79-78
V8 298CI 4.9L (B)	95-91	V8 390CI 6.4L	63-59	Sixty Special (FWD)	
DeVille (RWD)		V8 425CI 7.0L (S)	79-77	V8 250CI 4.1L (8)	87-85
V6 252CI 4.1L (4)	83-80	V8 425CI 7.0L (T)	79-77	V8 273CI 4.5L (3)	90
V8 250CI 4.1L (8)	84-82	V8 429CI 7.0L	67-64	V8 273CI 4.5L (5)	89-88
V8 331CI 5.4L	55-49	V8 472CI 7.7L	74-68	V8 298CI 4.9L (B)	93-91
V8 350CI 5.7L Diesel (N)	84-79	V8 500CI 8.2L	74-70	STS	
V8 365CI 6.0L	58-56	V8 500CI 8.2L (S)	76-75	V6 3564cc 3.6L DOHC (24 Valve) (7)	07-05
V8 368CI 6.0L (6)	80	Series 60		V6 3564cc 3.6L DOHC (24 Valve) (V)	11-08
V8 368CI 6.0L (9)	84-81	V8 331CI 5.4L	55-49	V8 281CI 4.6L DOHC (32 Valve) (A)	10-05
V8 390CI 6.4L	63-59	V8 346CI 5.7L (L-Head)	48-46	STS-V	
V8 425CI 7.0L (S)	79-77	V8 346CI 5.7L (L-Head)	42-36	V8 267CI 4.4L DOHC Supercharged (32 Valve) (D)	09-06
V8 425CI 7.0L (T)	79-77	V8 365CI 6.0L	58-56	XLR	
V8 429CI 7.0L	67-64	V8 390CI 6.4L	63-59	V8 281CI 4.6L DOHC (32 Valve) (A)	09-04
V8 472CI 7.7L	74-68	V8 429CI 7.0L	67-64	XLR-V	
V8 500CI 8.2L	74-70	V8 472CI 7.7L	74-68	V8 267CI 4.4L DOHC Supercharged (32 Valve) (D)	09-06
V8 500CI 8.2L (S)	76-75	V8 500CI 8.2L	74-70	XTS	
DTS		V8 500CI 8.2L (S)	76-75	V6 3564cc 3.6L DOHC (24 Valve) (Flex Fuel) (3)	13
V8 281CI 4.6L DOHC (32 Valve) (6)	11	Series 61		Chevrolet	
V8 281CI 4.6L DOHC (32 Valve) (9)	11-06	V8 331CI 5.4L	51-49	150 Series Special	
V8 281CI 4.6L DOHC (32 Valve) (S)	11	V8 346CI 5.7L (L-Head)	48-46	L6 216CI 3.5L	53
V8 281CI 4.6L DOHC (32 Valve) (Y)	11-06	V8 346CI 5.7L (L-Head)	42-41	L6 235CI 3.8L	57-53
Eldorado (FWD)		Series 62		210 Series DeLuxe	
V6 252CI 4.1L (4)	82-81	V8 331CI 5.4L	55-49	L6 216CI 3.5L	53
V8 250CI 4.1L (8)	87-82	V8 346CI 5.7L (L-Head)	48-46	L6 235CI 3.8L	57-53
V8 273CI 4.5L (3)	90	V8 346CI 5.7L (L-Head)	42-40	Aveo	
V8 273CI 4.5L (5)	89-88	V8 365CI 6.0L	58-56	L4 1598cc 1.6L DOHC (16 Valve) (6)	08-06
V8 281CI 4.6L DOHC (32 Valve) (9)	02-93	V8 390CI 6.4L	63-59	L4 1598cc 1.6L DOHC (16 Valve) (D)	05-04
V8 281CI 4.6L DOHC (32 Valve) (Y)	02-93	V8 429CI 7.0L	64	L4 1598cc 1.6L DOHC (16 Valve) (E)	11-09
V8 298CI 4.9L (B)	93-91	Series 63		L4 1598cc 1.6L DOHC (16 Valve) (G)	11
V8 350CI 5.7L (8)	80	V8 346CI 5.7L (L-Head)	42-41	Bel Air	
V8 350CI 5.7L (B)	79	Series 65		L6 230CI 3.8L (OHV)	65-63
V8 350CI 5.7L Diesel (N)	85-79	V8 346CI 5.7L (L-Head)	38-37	L6 235CI 3.8L	62-50
V8 368CI 6.0L (9)	81-80	Series 67		L6 250CI 4.1L (OHV)	73-65
V8 425CI 7.0L (S)	78-77	V8 346CI 5.7L (L-Head)	42-41	V8 265CI 4.3L	57-55
V8 425CI 7.0L (T)	78-77	Series 70 Fleetwood		V8 283CI 4.6L	67-57
V8 429CI 7.0L	67	V8 346CI 5.7L (L-Head)	37-36	V8 307CI 5.0L	68
V8 472CI 7.7L	69-68	Series 72 Fleetwood		V8 327CI 5.3L	69-62
V8 500CI 8.2L	74-70	V8 346CI 5.7L (L-Head)	40	V8 348CI 5.7L	61-58
V8 500CI 8.2L (S)	76-75	Series 75 Fleetwood		V8 350CI 5.7L	71-69
Eldorado (RWD)		V8 331CI 5.4L	55-49	V8 350CI 5.7L (H)	75-72
V8 331CI 5.4L	55-53	V8 346CI 5.7L (L-Head)	48-46	V8 396CI 6.5L	69-65
V8 365CI 6.0L	58-56	V8 346CI 5.7L (L-Head)	42-36	V8 400CI 6.6L	72-70
V8 390CI 6.4L	63-59	V8 365CI 6.0L	58-56	V8 400CI 6.6L (U)	75-73
V8 429CI 7.0L	66-64	V8 390CI 6.4L	63-59	V8 402CI 6.6L	72-70
Fleetwood (FWD)		V8 425CI 7.0L (S)	79-77	V8 409CI 6.7L	65-61
V6 262CI 4.3L Diesel (T)	85	V8 425CI 7.0L (T)	79-77		
		V8 429CI 7.0L	67-64		
		V8 472CI 7.7L	74-68		

GM Car (Incl. Buick, Cad., Chev., Geo, Olds., Pontiac, Saturn) (Cont.)

Model Index (Cont.)					
Engine (VIN Code / Eng. Code)	Year	Engine (VIN Code / Eng. Code)	Year	Engine (VIN Code / Eng. Code)	Year
Chevrolet (cont.)		Chevrolet (cont.)		Chevrolet (cont.)	
Bel Air (cont.)		Camaro (cont.)		Cavalier (cont.)	
V8 427CI 7.0L	69-66	V8 305CI 5.0L (U)	78-77	V6 173CI 2.8L (W)	89-85
V8 454CI 7.4L	72-70	V8 307CI 5.0L	73-68	V6 189CI 3.1L (T)	94-90
V8 454CI 7.4L (Y)	75-73	V8 327CI 5.3L	69-67	Celebrity	
Beretta		V8 346CI 5.7L (G)	02-98	L4 151CI 2.5L (R)	90-82
L4 121CI 2.0L OHV (1)	89-87	V8 350CI 5.7L	71-67	V6 173CI 2.8L (W)	89-85
L4 134CI 2.2L OHV (4)	96-92	V8 350CI 5.7L (8)	92-87	V6 173CI 2.8L (X)	86-82
L4 134CI 2.2L OHV (G)	91-90	V8 350CI 5.7L (L)	81-72	V6 173CI 2.8L (Z)	84
L4 138CI 2.3L DOHC (16 Valve) (A)	94-90	V8 350CI 5.7L (P)	97-93	V6 189CI 3.1L (T)	90
V6 173CI 2.8L (W)	89-87	V8 378CI 6.2L (J)	13-10	V6 262CI 4.3L Diesel (T)	85-82
V6 189CI 3.1L (M)	96-94	V8 378CI 6.2L (W)	13-10	Chevelle	
V6 189CI 3.1L (T)	93-90	V8 378CI 6.2L Supercharged (P)	13-12	L6 194CI 3.2L	66-64
Biscayne		V8 396CI 6.5L	69-67	L6 230CI 3.8L (OHV)	69-64
L6 230CI 3.8L (OHV)	65-63	V8 402CI 6.6L	72-70	L6 250CI 4.1L (OHV)	73-67
L6 235CI 3.8L	62-58	Caprice		V8 283CI 4.6L	67-64
L6 250CI 4.1L (OHV)	72-65	L6 250CI 4.1L (OHV)	71-66	V8 307CI 5.0L	73-68
V8 283CI 4.6L	67-58	L6 250CI 4.1L (OHV) (D)	79-72	V8 327CI 5.3L	68-64
V8 307CI 5.0L	68	V6 200CI 3.3L (M)	79-78	V8 350CI 5.7L	73-68
V8 327CI 5.3L	69-62	V6 229CI 3.8L (9)	84-83	V8 396CI 6.5L	69-65
V8 348CI 5.7L	61-58	V6 229CI 3.8L (K)	82-80	V8 400CI 6.6L	73-70
V8 350CI 5.7L	71-69	V6 231CI 3.8L (A)	87-78	V8 402CI 6.6L	72-70
V8 350CI 5.7L (H)	75-72	V6 262CI 4.3L (Z)	93-85	V8 454CI 7.4L	73-70
V8 396CI 6.5L	69-65	V6 262CI 4.3L Diesel (V)	83-82	Chvette	
V8 400CI 6.6L	72-70	V8 265CI 4.3L (W)	96-94	L4 1817cc 1.8L SOHC Diesel (D)	86-81
V8 400CI 6.6L (U)	75-73	V8 267CI 4.4L (J)	82-79	L4 85CI 1.4L SOHC (I)	77-76
V8 402CI 6.6L	72-70	V8 283CI 4.6L	67-66	L4 98CI 1.6L SOHC (9)	81-80
V8 409CI 6.7L	65-61	V8 305CI 5.0L (E)	93-89	L4 98CI 1.6L SOHC (C)	87-82
V8 427CI 7.0L	69-66	V8 305CI 5.0L (G)	79	L4 98CI 1.6L SOHC (E)	80-76
V8 454CI 7.4L	72-70	V8 305CI 5.0L (H)	88-80	L4 98CI 1.6L SOHC (J)	78
Brookwood Wagon		V8 305CI 5.0L (Q)	76	Chevy II	
L6 250CI 4.1L (OHV)	72-69	V8 305CI 5.0L (U)	78-77	L4 153CI 2.5L	70-62
V8 327CI 5.3L	69	V8 307CI 5.0L	73-68	L6 194CI 3.2L	67-62
V8 350CI 5.7L	72-69	V8 307CI 5.0L (Y)	90-86	L6 230CI 3.8L (OHV)	69-63
V8 396CI 6.5L	69	V8 327CI 5.3L	69-66	L6 250CI 4.1L (OHV)	70-67
V8 400CI 6.6L	72-70	V8 350CI 5.7L	71-69	V8 283CI 4.6L	67-62
V8 402CI 6.6L	72-70	V8 350CI 5.7L (6)	88-85	V8 307CI 5.0L	70-68
V8 427CI 7.0L	69	V8 350CI 5.7L (7)	93-89	V8 327CI 5.3L	68-65
V8 454CI 7.4L	72-70	V8 350CI 5.7L (H)	75-72	V8 350CI 5.7L	70-68
Camaro		V8 350CI 5.7L (L)	84-75	V8 396CI 6.5L	69-68
L4 151CI 2.5L (2)	86-82	V8 350CI 5.7L (P)	96-94	V8 402CI 6.6L	70
L4 151CI 2.5L (F)	83-82	V8 350CI 5.7L (V)	76	Citation	
L6 230CI 3.8L (OHV)	70-67	V8 350CI 5.7L Diesel (N)	85-80	L4 151CI 2.5L (5)	83-80
L6 250CI 4.1L (OHV)	71-67	V8 396CI 6.5L	69-66	L4 151CI 2.5L (R)	85-82
L6 250CI 4.1L (OHV) (D)	79-72	V8 400CI 6.6L	72-70	V6 173CI 2.8L (7)	80
V6 173CI 2.8L (1)	84-82	V8 400CI 6.6L (U)	76-73	V6 173CI 2.8L (W)	85
V6 173CI 2.8L (S)	89-85	V8 402CI 6.6L	72-70	V6 173CI 2.8L (X)	85-81
V6 189CI 3.1L (T)	92-90	V8 427CI 7.0L	69-66	V6 173CI 2.8L (Z)	84-81
V6 207CI 3.4L OHV (12 Valve) (S)	95-93	V8 454CI 7.4L	72-70	Classic	
V6 229CI 3.8L (K)	81-80	V8 454CI 7.4L (S)	76	L4 2198cc 2.2L DOHC (16 Valve) (F)	05-04
V6 231CI 3.8L (A)	81-80	V8 454CI 7.4L (Y)	75-73	Cobalt	
V6 231CI 3.8L (K)	02-95	Caprice PPV		L4 1998cc 2.0L DOHC Supercharged (16 Valve) (P)	07-05
V6 3564cc 3.6L DOHC (24 Valve) (D)	13-11	V6 3564cc 3.6L DOHC (24 Valve) (Flex Fuel) (3)	13-12	L4 1998cc 2.0L DOHC Turbo (16 Valve) (X)	10-08
V6 3564cc 3.6L DOHC (24 Valve) (V)	13-10	V8 364CI 6.0L (Flex Fuel) (2)	13-11	L4 2198cc 2.2L DOHC (16 Valve) (F)	08-05
V6 3564cc 3.6L DOHC (24 Valve) (Flex Fuel) (3)	13-12	Cavalier		L4 2198cc 2.2L DOHC (16 Valve) (H)	10-09
V8 267CI 4.4L (J)	81-80	L4 112CI 1.8L OHV (G)	82	L4 2384cc 2.4L DOHC (16 Valve) (B)	08-06
V8 283CI 4.6L	67	L4 121CI 2.0L OHV (1)	89-87	Corsica	
V8 301CI 4.9L (W)	81-80	L4 121CI 2.0L OHV (B)	84-83	L4 121CI 2.0L OHV (1)	89-87
V8 302CI 4.9L	69-67	L4 121CI 2.0L OHV (P)	86-83	L4 134CI 2.2L OHV (4)	96-92
V8 305CI 5.0L (7)	82	L4 134CI 2.2L OHV (4)	02-92	L4 134CI 2.2L OHV (G)	91-90
V8 305CI 5.0L (E)	92-88	L4 134CI 2.2L OHV (G)	91-90	V6 173CI 2.8L (W)	89-87
V8 305CI 5.0L (F)	92-85	L4 138CI 2.3L DOHC (16 Valve) (D)	95	V6 189CI 3.1L (M)	96-94
V8 305CI 5.0L (G)	86-79	L4 146CI 2.4L DOHC (16 Valve) (T)	02-96	V6 189CI 3.1L (T)	93-90
V8 305CI 5.0L (H)	87-80	L4 2198cc 2.2L DOHC (16 Valve) (F)	05-02	Corvaire	
V8 305CI 5.0L (Q)	76	L4 2198cc 2.2L DOHC (16 Valve) (Flex Fuel) (6)	05-03	H6 140CI 2.3L	61-60
V8 305CI 5.0L (S)	83			H6 145CI 2.4L	63-61

GM Car (Incl. Buick, Cad., Chev., Geo, Olds., Pontiac, Saturn) (Cont.)

Model Index (Cont.)					
Engine (VIN Code / Eng. Code)	Year	Engine (VIN Code / Eng. Code)	Year	Engine (VIN Code / Eng. Code)	Year
Chevrolet (cont.)		Chevrolet (cont.)		Chevrolet (cont.)	
Corvair (cont.)		Impala (FWD) (cont.)		Lumina (cont.)	
H6 145CI 2.4L Turbo	63-62	V6 214CI 3.5L OHV (12 Valve) (N)	11-06	V6 207CI 3.4L DOHC (24 Valve) (X)	97-91
H6 164CI 2.7L	69-64	V6 214CI 3.5L OHV (12 Valve) (Flex Fuel) (K)	11-06	V6 231CI 3.8L (K)	99-98
H6 164CI 2.7L Turbo	66-64	V6 231CI 3.8L (K)	05-00	Malibu (FWD)	
Corvette		V6 231CI 3.8L Supercharged (1)	05-04	L4 146CI 2.4L DOHC (16 Valve) (T)	99-97
L6 235CI 3.8L	55-53	V6 242CI 3.9L OHV (12 Valve) (1)	06	L4 1998cc 2.0L DOHC Turbo (16 Valve) (X)	13
V8 265CI 4.3L	56-55	V6 242CI 3.9L OHV (12 Valve) (R)	09-07	L4 2198cc 2.2L DOHC (16 Valve) (F)	07-04
V8 283CI 4.6L	61-57	V6 242CI 3.9L OHV (12 Valve) (Flex Fuel) (3)	08-07	L4 2384cc 2.4L DOHC (16 Valve) (B)	10-08
V8 305CI 5.0L (H)	82-80	V6 242CI 3.9L OHV (12 Valve) (Flex Fuel) (M)	11-09	L4 2384cc 2.4L DOHC (16 Valve) (R)	13
V8 327CI 5.3L	68-62	V6 3564cc 3.6L DOHC (24 Valve) (Flex Fuel) (3)	13-12	L4 2384cc 2.4L DOHC (16 Valve) (Flex Fuel) (0)	10
V8 346CI 5.7L (G)	04-97	V8 325CI 5.3L (C)	09-06	L4 2384cc 2.4L DOHC (16 Valve) (Flex Fuel) (U)	12-11
V8 346CI 5.7L (S)	04-01	Impala (RWD)		L4 2457cc 2.5L DOHC (16 Valve) (A)	13
V8 350CI 5.7L	72-69	L6 230CI 3.8L (OHV)	65-63	V6 189CI 3.1L (J)	03-99
V8 350CI 5.7L (4)	79	L6 235CI 3.8L	62-58	V6 189CI 3.1L (M)	99-97
V8 350CI 5.7L (5)	96	L6 250CI 4.1L (OHV)	71-65	V6 213CI 3.5L OHV (12 Valve) (8)	07-04
V8 350CI 5.7L (6)	81-80	L6 250CI 4.1L (OHV) (D)	79-72	V6 242CI 3.9L OHV (12 Valve) (1)	07-06
V8 350CI 5.7L (8)	91-82	V6 200CI 3.3L (M)	79-78	V6 3564cc 3.6L DOHC (24 Valve) (7)	12-08
V8 350CI 5.7L (H)	78	V6 229CI 3.8L (9)	84-83	Malibu (RWD)	
V8 350CI 5.7L (L)	79-76	V6 229CI 3.8L (K)	82-80	L6 250CI 4.1L (OHV) (D)	77-74
V8 350CI 5.7L (P)	96-92	V6 231CI 3.8L (A)	86-78	V6 200CI 3.3L (M)	79-78
V8 350CI 5.7L (T)	75-73	V6 262CI 4.3L (Z)	86-85	V6 229CI 3.8L (9)	83
V8 350CI 5.7L (X)	77-76	V6 262CI 4.3L Diesel (V)	83-82	V6 229CI 3.8L (K)	82-80
V8 350CI 5.7L DOHC (32 Valve) (J)	95-90	V8 267CI 4.4L (J)	82-79	V6 231CI 3.8L (A)	83-78
V8 364CI 6.0L (H)	07-05	V8 283CI 4.6L	67-58	V6 262CI 4.3L Diesel (V)	83-82
V8 378CI 6.2L (W)	13-08	V8 305CI 5.0L (G)	79	V8 267CI 4.4L (J)	82-79
V8 378CI 6.2L Supercharged (R)	11-09	V8 305CI 5.0L (H)	86-80	V8 305CI 5.0L (H)	83-79
V8 378CI 6.2L Supercharged (T)	13-11	V8 305CI 5.0L (Q)	76	V8 305CI 5.0L (Q)	76
V8 396CI 6.5L	65	V8 305CI 5.0L (U)	78-77	V8 305CI 5.0L (U)	78-77
V8 427CI 7.0L	69-66	V8 307CI 5.0L	73-68	V8 350CI 5.7L (H)	75-73
V8 427CI 7.0L (E)	13-06	V8 307CI 5.0L (Y)	86	V8 350CI 5.7L (L)	81-76
V8 454CI 7.4L	74-70	V8 327CI 5.3L	69-62	V8 350CI 5.7L (V)	76
Cruze		V8 348CI 5.7L	61-58	V8 350CI 5.7L (V)	83-82
L4 1364cc 1.4L DOHC Turbo (16 Valve) (9)	13-11	V8 350CI 5.7L	71-69	V8 400CI 6.6L (U)	76-74
L4 1364cc 1.4L DOHC Turbo (16 Valve) (C)	13-12	V8 350CI 5.7L (6)	86-85	V8 454CI 7.4L (S)	76
L4 1796cc 1.8L DOHC (16 Valve) (G)	13	V8 350CI 5.7L (H)	75-72	V8 454CI 7.4L (Y)	75-74
L4 1796cc 1.8L DOHC (16 Valve) (H)	13-11	V8 350CI 5.7L (L)	84-72	Malibu Hybrid (FWD)	
Del Ray		V8 350CI 5.7L (P)	96-94	L4 2384cc 2.4L DOHC (16 Valve) (5)	10-08
L6 235CI 3.8L	58	V8 350CI 5.7L (V)	76	Master	
V8 283CI 4.6L	58	V8 350CI 5.7L Diesel (N)	85-80	L6 206.8CI 3.4L	36-35
V8 348CI 5.7L	58	V8 396CI 6.5L	69-65	L6 216CI 3.5L	42-37
Epica (Canada)		V8 400CI 6.6L	72-70	Metro	
L6 2492cc 2.5L DOHC (24 Valve) (L)	06-04	V8 400CI 6.6L (U)	76-73	L3 993cc 1.0L SOHC (6)	01-98
Estate Wagon		V8 402CI 6.6L	72-70	L4 1324cc 1.3L SOHC (16 Valve) (2)	01-98
L6 250CI 4.1L (OHV)	75-69	V8 409CI 6.7L	65-61	Monte Carlo (FWD)	
V8 305CI 5.0L (U)	77	V8 427CI 7.0L	69-66	V6 189CI 3.1L (M)	99-95
V8 307CI 5.0L	73-69	V8 454CI 7.4L	72-70	V6 207CI 3.4L DOHC (24 Valve) (X)	97-95
V8 327CI 5.3L	69	V8 454CI 7.4L (S)	76	V6 207CI 3.4L OHV (12 Valve) (E)	05-00
V8 350CI 5.7L	71-69	V8 454CI 7.4L (Y)	75-73	V6 214CI 3.5L OHV (12 Valve) (N)	07-06
V8 350CI 5.7L (L)	77-72	Kingswood Wagon		V6 214CI 3.5L OHV (12 Valve) (Flex Fuel) (K)	07-06
V8 396CI 6.5L	69	L6 250CI 4.1L (OHV)	72-69	V6 231CI 3.8L (K)	05-98
V8 400CI 6.6L	72-70	V8 307CI 5.0L	72-69	V6 231CI 3.8L Supercharged (1)	05-04
V8 400CI 6.6L (U)	76-73	V8 327CI 5.3L	69	V6 242CI 3.9L OHV (12 Valve) (1)	06
V8 402CI 6.6L	72-70	V8 350CI 5.7L	72-69	V6 242CI 3.9L OHV (12 Valve) (R)	07
V8 427CI 7.0L	69	V8 396CI 6.5L	69	V8 325CI 5.3L (C)	07-06
V8 454CI 7.4L	72-70	V8 400CI 6.6L	72-70	Monte Carlo (RWD)	
V8 454CI 7.4L (S)	76	V8 402CI 6.6L	72-70	V6 200CI 3.3L (M)	79-78
V8 454CI 7.4L (Y)	75-73	V8 427CI 7.0L	69	V6 229CI 3.8L (9)	84-83
Fleetline		V8 454CI 7.4L	72-70	V6 229CI 3.8L (K)	82-80
L6 216CI 3.5L	49-46	Lumina		V6 231CI 3.8L (A)	87-78
L6 216CI 3.5L	42-41	L4 134CI 2.2L OHV (4)	93	V6 231CI 3.8L Turbo (3)	81-80
L6 235CI 3.8L	52-50	L4 151CI 2.5L (R)	92-90	V6 262CI 4.3L (Z)	88-85
Fleetmaster		V6 189CI 3.1L (J)	01-00	V6 262CI 4.3L Diesel (V)	83-82
L6 216CI 3.5L	48-46	V6 189CI 3.1L (M)	99-95	V8 267CI 4.4L (J)	82-79
L6 216CI 3.5L	42-41	V6 189CI 3.1L (T)	94-90	V8 305CI 5.0L (G)	88-84
Impala (FWD)		V6 189CI 3.1L (Flex Fuel) (W)	93		
V6 207CI 3.4L OHV (12 Valve) (E)	05-00				

GM Car (Incl. Buick, Cad., Chev., Geo, Olds., Pontiac, Saturn) (Cont.)

Model Index (Cont.)					
Engine (VIN Code / Eng. Code)	Year	Engine (VIN Code / Eng. Code)	Year	Engine (VIN Code / Eng. Code)	Year
Chevrolet (cont.)		Chevrolet (cont.)		Oldsmobile (cont.)	
Monte Carlo (RWD) (cont.)		Special		70	
V8 305CI 5.0L (H)	88-79	L6 216CI 3.5L	42-40	L6 229.7CI 3.8L (L-Head)	40-39
V8 305CI 5.0L (Q)	76	Spectrum		76	
V8 305CI 5.0L (U)	78-77	L4 1471cc 1.5L SOHC (7)	88-86	L6 238CI 3.9L (L-Head)	48-46
V8 350CI 5.7L	71-70	L4 1471cc 1.5L SOHC (K)	85	L6 238CI 3.9L (L-Head)	42-41
V8 350CI 5.7L (H)	75-72	L4 1471cc 1.5L SOHC Turbo (9)	88-87	L6 257CI 4.2L (L-Head)	50-49
V8 350CI 5.7L (L)	79-75	Sprint		78	
V8 350CI 5.7L (V)	76	L3 993cc 1.0L SOHC (5)	88-86	L8 257.1CI 4.2L (L-Head)	48-46
V8 350CI 5.7L Diesel (N)	84-82	L3 993cc 1.0L SOHC (M)	85	L8 257.1CI 4.2L (L-Head)	42-41
V8 400CI 6.6L	72-70	L3 993cc 1.0L SOHC Turbo (2)	88-87	96	
V8 400CI 6.6L (U)	76-73	Standard		L6 238CI 3.9L (L-Head) 41	
V8 402CI 6.6L	72-70	L6 206.8CI 3.4L	36-35	98	
V8 454CI 7.4L	72-70	Styleline		L8 257.1CI 4.2L (L-Head) 48-46	
V8 454CI 7.4L (S)	76	L6 216CI 3.5L	52-49	L8 257.1CI 4.2L (L-Head) 42-41	
V8 454CI 7.4L (Y)	75-73	L6 235CI 3.8L	52-50	Achieva	
Monza		Stylemaster		L4 138CI 2.3L DOHC (16 Valve) (A) 94-92	
L4 140CI 2.3L SOHC (B)	77-75	L6 216CI 3.5L	48-46	L4 138CI 2.3L DOHC (16 Valve) (D) 95-92	
L4 151CI 2.5L (1)	79-78	Townsmen Wagon		L4 138CI 2.3L SOHC (8 Valve) (3) 94-92	
L4 151CI 2.5L (9)	79	L6 250CI 4.1L (OHV)	72-69	L4 146CI 2.4L DOHC (16 Valve) (T) 98-96	
L4 151CI 2.5L (V)	80-78	V8 307CI 5.0L	72-69	V6 189CI 3.1L (M) 98-94	
V6 196CI 3.2L (C)	79-78	V8 327CI 5.3L	69	V6 204CI 3.3L (N) 93-92	
V6 231CI 3.8L (A)	80-78	V8 350CI 5.7L	72-69	Alero	
V8 262CI 4.3L (G)	76-75	V8 396CI 6.5L	69	L4 146CI 2.4L DOHC (16 Valve) (T) 01-99	
V8 305CI 5.0L (G)	79	V8 400CI 6.6L	72-70	L4 2198cc 2.2L DOHC (16 Valve) (F) 04-02	
V8 305CI 5.0L (Q)	76	V8 402CI 6.6L	72-70	V6 207CI 3.4L OHV (12 Valve) (E) 04-99	
V8 305CI 5.0L (U)	78-77	V8 427CI 7.0L	69	Aurora	
Nomad		V8 454CI 7.4L	72-70	V6 214CI 3.5L DOHC (24 Valve) (H) 02-01	
L6 235CI 3.8L	61-58	Vega		V8 244CI 4.0L DOHC (32 Valve) (C) 99-95	
V8 283CI 4.6L	61-58	L4 122CI 2.0L DOHC (0)	76-75	V8 244CI 4.0L DOHC (32 Valve) (C) 03-01	
V8 348CI 5.7L	61-58	L4 140CI 2.3L SOHC (A)	76-71	Classic 98	
V8 409CI 6.7L	61-58	L4 140CI 2.3L SOHC (B)	77-71	V8 394CI 6.5L 61	
Nova (FWD)		Volt Hybrid		Custom Cruiser	
L4 1587cc 1.6L DOHC (16 Valve) (5)	88	L4 1364cc 1.4L DOHC (16 Valve) (4)	13-11	V6 231CI 3.8L (A) 85-78	
L4 1587cc 1.6L SOHC (8 Valve) (4)	88-85	Yeoman		V6 231CI 3.8L (C) 77-75	
Nova (RWD)		L6 235CI 3.8L	58	V6 252CI 4.1L (4) 85-80	
L4 153CI 2.5L	70-62	V8 283CI 4.6L	58	V6 262CI 4.3L Diesel (V) 83-82	
L6 194CI 3.2L	67-62	V8 348CI 5.7L	58	V8 260CI 4.3L (8) 82	
L6 230CI 3.8L (OHV)	70-63	Geo		V8 260CI 4.3L (F) 81-75	
L6 250CI 4.1L (OHV)	71-67	Metro		V8 267CI 4.4L (J) 82-81	
L6 250CI 4.1L (OHV) (D)	79-72	L3 993cc 1.0L SOHC (6)	97-89	V8 301CI 4.9L (Y) 79-78	
V6 231CI 3.8L (A)	79	L3 993cc 1.0L SOHC Turbo (2)	91-89	V8 305CI 5.0L (E) 92-91	
V8 262CI 4.3L (G)	76-75	L4 1324cc 1.3L SOHC (8 Valve) (9)	97-92	V8 305CI 5.0L (H) 85-78	
V8 283CI 4.6L	67-62	Prizm		V8 307CI 5.0L (Y) 90-80	
V8 305CI 5.0L (G)	79	L4 1587cc 1.6L DOHC (16 Valve) (5)	92-90	V8 350CI 5.7L 71-70	
V8 305CI 5.0L (Q)	76	L4 1587cc 1.6L DOHC (16 Valve) (6)	97-89	V8 350CI 5.7L (7) 92	
V8 305CI 5.0L (U)	78-77	L4 1762cc 1.8L DOHC (16 Valve) (8)	97-93	V8 350CI 5.7L (R) 80-72	
V8 307CI 5.0L	73-68	Spectrum		V8 350CI 5.7L Diesel (N) 85-78	
V8 327CI 5.3L	68-65	L4 1471cc 1.5L SOHC (7)	89	V8 400CI 6.6L (R) 75	
V8 350CI 5.7L	71-68	L4 1471cc 1.5L SOHC Turbo (9)	89	V8 400CI 6.6L (S) 76-75	
V8 350CI 5.7L (H)	75-72	Storm		V8 403CI 6.6L (K) 79-77	
V8 350CI 5.7L (L)	79-75	L4 1588cc 1.6L DOHC (16 Valve) (5)	91-90	V8 455CI 7.5L 74-70	
V8 396CI 6.5L	69-68	L4 1588cc 1.6L SOHC (12 Valve) (6)	93-90	V8 455CI 7.5L (T) 76-75	
V8 402CI 6.6L	72-70	L4 1808cc 1.8L DOHC (16 Valve) (8)	93-92	V8 455CI 7.5L (W) 75	
V8 454CI 7.4L	71-70	Oldsmobile		Cutlass (FWD)	
Optra (Canada)		4-4-2		V6 189CI 3.1L (J) 99	
L4 1598cc 1.6L DOHC (16 Valve) (6)	09-06	V8 307CI 5.0L (9)	87-85	V6 189CI 3.1L (M) 99-97	
L4 1598cc 1.6L DOHC (16 Valve) (D)	05-04	V8 330CI 5.4L	64	Cutlass (RWD)	
L4 1998cc 2.0L DOHC (16 Valve) (Z)	09-04	V8 400CI 6.6L	69-65	L6 250CI 4.1L (OHV) 71-68	
Prizm		V8 455CI 7.5L	71-68	L6 250CI 4.1L (OHV) (D) 76-72	
L4 1794cc 1.8L DOHC (16 Valve) (8)	02-98	60		V6 231CI 3.8L (2) 79	
Sonic		L6 219CI 3.6L (L-Head)	39-37	V6 231CI 3.8L (A) 87-78	
L4 1364cc 1.4L DOHC Turbo (16 Valve) (B)	13-12	L6 229.7CI 3.8L (L-Head)	40-39	V6 231CI 3.8L (C) 77	
L4 1796cc 1.8L DOHC (16 Valve) (G)	13	66		V6 252CI 4.1L (4) 83-82	
L4 1796cc 1.8L DOHC (16 Valve) (H)	13-12	L6 238CI 3.9L (L-Head)	48-46	V6 262CI 4.3L Diesel (V) 85-82	
Spark		L6 238CI 3.9L (L-Head)	42-41	V8 215CI 3.5L 63-62	
L4 1206cc 1.2L DOHC (16 Valve) (9)	13-12	68		V8 215CI 3.5L Turbo 63-62	
		L8 257.1CI 4.2L (L-Head)	48-47		

GM Car (Incl. Buick, Cad., Chev., Geo, Olds., Pontiac, Saturn) (Cont.)

Model Index (Cont.)					
Engine (VIN Code / Eng. Code)	Year	Engine (VIN Code / Eng. Code)	Year	Engine (VIN Code / Eng. Code)	Year
Oldsmobile (cont.)		Oldsmobile (cont.)		Oldsmobile (cont.)	
Cutlass (RWD) (cont.)		Delta 88 (RWD) (cont.)		Intrigue (cont.)	
V8 260CI 4.3L (8)	82	V8 330CI 5.4L	67-65	V6 231CI 3.8L (K)	99-97
V8 260CI 4.3L (F)	81-75	V8 350CI 5.7L	71-68	Jetfire	
V8 260CI 4.3L Diesel (P)	79	V8 350CI 5.7L (R)	80-72	V8 215CI 3.5L Turbo	63-62
V8 267CI 4.4L (J)	82-81	V8 350CI 5.7L Diesel (N)	85-78	Jetstar 88	
V8 305CI 5.0L (G)	79	V8 400CI 6.6L (R)	75	V8 330CI 5.4L	66-64
V8 305CI 5.0L (H)	87-78	V8 400CI 6.6L (S)	76-75	Jetstar I	
V8 305CI 5.0L (U)	78	V8 403CI 6.6L (K)	79-77	V8 394CI 6.5L	64
V8 307CI 5.0L (9)	87-84	V8 425CI 7.0L	67-65	V8 425CI 7.0L	65
V8 307CI 5.0L (Y)	88-80	V8 455CI 7.5L	74-68	L-37	
V8 330CI 5.4L	67-64	V8 455CI 7.5L (T)	76-75	L8 257.1CI 4.2L (L-Head)	37
V8 350CI 5.7L	71-68	V8 455CI 7.5L (W)	75	L-38	
V8 350CI 5.7L (L)	79-77	DeLuxe 88		L8 257.1CI 4.2L (L-Head)	38
V8 350CI 5.7L (R)	80-72	V8 303CI 5.0L	53-52	L-39	
V8 350CI 5.7L Diesel (N)	85-78	V8 324CI 5.3L	56-54	L8 257.1CI 4.2L (L-Head)	39
V8 400CI 6.6L	69-65	Dynamic 88		L-40	
V8 403CI 6.6L (K)	77	V8 371CI 6.1L	60-58	L8 257.1CI 4.2L (L-Head)	40
V8 455CI 7.5L	74-68	V8 394CI 6.5L	64-61	Ninety Eight (FWD)	
V8 455CI 7.5L (T)	76-75	V8 425CI 7.0L	66-65	V6 181CI 3.0L (E)	85
Cutlass Calais (FWD)		Eighty Eight (FWD)		V6 231CI 3.8L (3)	88-85
L4 138CI 2.3L DOHC (16 Valve) (A)	91-89	V6 231CI 3.8L (C)	91-90	V6 231CI 3.8L (C)	90-88
L4 138CI 2.3L DOHC (16 Valve) (D)	91-87	V6 231CI 3.8L (K)	99-95	V6 231CI 3.8L (K)	96-95
L4 151CI 2.5L (U)	91-85	V6 231CI 3.8L (L)	94-92	V6 231CI 3.8L (L)	94-91
V6 181CI 3.0L (L)	88-85	V6 231CI 3.8L Supercharged (1)	99-95	V6 231CI 3.8L Supercharged (1)	95-92
V6 204CI 3.3L (N)	91-89	Eighty Eight (RWD)		V6 262CI 4.3L Diesel (T)	85
V6 231CI 3.8L (3)	88	V8 303CI 5.0L	53-49	Ninety Eight (RWD)	
Cutlass Ciera (FWD)		V8 324CI 5.3L	56-54	V6 252CI 4.1L (4)	83-81
L4 134CI 2.2L OHV (4)	96-93	V8 371CI 6.1L	60-57	V8 303CI 5.0L	53-49
L4 151CI 2.5L (5)	83-82	V8 394CI 6.5L	64-61	V8 305CI 5.0L (H)	85-82
L4 151CI 2.5L (R)	92-82	F-37		V8 307CI 5.0L (Y)	85-80
V6 173CI 2.8L (W)	89-85	L6 219CI 3.6L (L-Head)	37	V8 324CI 5.3L	56-54
V6 173CI 2.8L (X)	86-82	F-38		V8 350CI 5.7L (R)	80-77
V6 181CI 3.0L (E)	85-82	L6 219CI 3.6L (L-Head)	38	V8 350CI 5.7L Diesel (N)	85-78
V6 189CI 3.1L (M)	96-94	F-39		V8 371CI 6.1L	58-57
V6 204CI 3.3L (N)	93-89	L6 219CI 3.6L (L-Head)	39	V8 394CI 6.5L	64-59
V6 231CI 3.8L (3)	88-84	L6 229.7CI 3.8L (L-Head)	39	V8 400CI 6.6L (R)	75
V6 231CI 3.8L (B)	87-86	F-40		V8 400CI 6.6L (S)	76-75
V6 262CI 4.3L Diesel (T)	85-82	L6 229.7CI 3.8L (L-Head)	40	V8 403CI 6.6L (K)	79-77
Cutlass Supreme (FWD)		F-85		V8 425CI 7.0L	67-65
L4 138CI 2.3L DOHC (16 Valve) (A)	91-90	L6 250CI 4.1L (OHV)	72-66	V8 455CI 7.5L	74-68
L4 138CI 2.3L DOHC (16 Valve) (D)	91-90	V6 225CI 3.7L	65-64	V8 455CI 7.5L (T)	76-75
V6 173CI 2.8L (W)	89-88	V8 215CI 3.5L	63-61	V8 455CI 7.5L (W)	75
V6 189CI 3.1L (M)	97-93	V8 215CI 3.5L Turbo	63-62	Omega (FWD)	
V6 189CI 3.1L (T)	93-89	V8 330CI 5.4L	67-64	L4 151CI 2.5L (R)	84-80
V6 207CI 3.4L DOHC (24 Valve) (X)	96-91	V8 350CI 5.7L	72-68	V6 173CI 2.8L (7)	80
Delmont 88		V8 400CI 6.6L	69-65	V6 173CI 2.8L (X)	84-81
V8 330CI 5.4L	67	V8 455CI 7.5L	72-70	V6 173CI 2.8L (Z)	84-81
V8 350CI 5.7L	68	Firenza		Omega (RWD)	
V8 425CI 7.0L	67	L4 112CI 1.8L OHV (G)	82	L6 250CI 4.1L (OHV) (D)	76-73
V8 455CI 7.5L	68	L4 121CI 2.0L OHV (1)	88-87	V6 231CI 3.8L (A)	79-78
Delta 88 (FWD)		L4 121CI 2.0L OHV (B)	84-83	V6 231CI 3.8L (C)	77-75
V6 181CI 3.0L (L)	86	L4 121CI 2.0L OHV (P)	86-83	V8 260CI 4.3L (F)	77-75
V6 231CI 3.8L (3)	88-86	L4 1796cc 1.8L SOHC (0)	86-82	V8 305CI 5.0L (G)	79
V6 231CI 3.8L (B)	86	L4 1998cc 2.0L SOHC (K)	88-87	V8 305CI 5.0L (U)	78-77
V6 231CI 3.8L (C)	89-88	V6 173CI 2.8L (W)	88-85	V8 350CI 5.7L	74-73
Delta 88 (RWD)		Futuramic 98		V8 350CI 5.7L (H)	76-75
V6 231CI 3.8L (A)	85-77	L6 257CI 4.2L (L-Head)	48	V8 350CI 5.7L (J)	76-75
V6 231CI 3.8L (C)	77-75	V8 303CI 5.0L	50-49	V8 350CI 5.7L (L)	79-77
V6 252CI 4.1L (4)	83-82	G-39		Starfire (Compact)	
V6 262CI 4.3L Diesel (V)	83-82	L6 229.7CI 3.8L (L-Head)	39	L4 140CI 2.3L SOHC (B)	77-76
V8 260CI 4.3L (8)	82	G-40		L4 151CI 2.5L (1)	79-78
V8 260CI 4.3L (F)	81-75	L6 229.7CI 3.8L (L-Head)	40	L4 151CI 2.5L (9)	79
V8 267CI 4.4L (J)	82-81	Golden Rocket 88		L4 151CI 2.5L (V)	80-78
V8 301CI 4.9L (Y)	79-78	V8 371CI 6.1L	57	V6 231CI 3.8L (A)	80-77
V8 305CI 5.0L (H)	85-78	Intrigue		V6 231CI 3.8L (C)	77-75
V8 307CI 5.0L (Y)	85-80	V6 214CI 3.5L DOHC (24 Valve) (H)	02-99	V8 305CI 5.0L (G)	79

GM Car (Incl. Buick, Cad., Chev., Geo, Olds., Pontiac, Saturn) (Cont.)

Model Index (Cont.)					
Engine (VIN Code / Eng. Code)	Year	Engine (VIN Code / Eng. Code)	Year	Engine (VIN Code / Eng. Code)	Year
Oldsmobile (cont.)		Pontiac (cont.)		Pontiac (cont.)	
Starfire (Compact) (cont.)		Acadian (Canada) (cont.)		Bonneville (RWD) (Mid-Size)	
V8 305CI 5.0L (U)	78-77	L4 1817cc 1.8L SOHC Diesel (D)	86-81	V6 231CI 3.8L (A)	86-82
Starfire (Full-Size)		L4 85CI 1.4L SOHC (I)	77-76	V6 252CI 4.1L (4)	83-82
V8 394CI 6.5L	64-61	L4 98CI 1.6L SOHC (O)	80-79	V6 262CI 4.3L (Z)	86-85
V8 425CI 7.0L	66-65	L4 98CI 1.6L SOHC (9)	81-80	V6 262CI 4.3L Diesel (V)	83-82
Starfire 98		L4 98CI 1.6L SOHC (C)	87-82	V8 267CI 4.4L (J)	82
V8 371CI 6.1L	57	L4 98CI 1.6L SOHC (E)	80-76	V8 305CI 5.0L (H)	86-82
Super 88		L4 98CI 1.6L SOHC (J)	78	V8 350CI 5.7L Diesel (N)	85-82
V8 303CI 5.0L	53-51	L6 194CI 3.2L	67-62	Catalina	
V8 324CI 5.3L	56-54	L6 230CI 3.8L (OHV)	70-63	L6 239.2CI 3.9L (L-Head)	54-50
V8 371CI 6.1L	58-57	L6 250CI 4.1L (OHV)	71-67	L8 268.2CI 4.4L (L-Head)	54-50
V8 394CI 6.5L	64-59	V8 283CI 4.6L	67-62	V6 231CI 3.8L (A)	81-77
Toronado		V8 307CI 5.0L	71-68	V6 231CI 3.8L (C)	77
V6 231CI 3.8L (3)	87	V8 327CI 5.3L	68-65	V8 265CI 4.3L (S)	81-80
V6 231CI 3.8L (B)	86	V8 350CI 5.7L	71-68	V8 267CI 4.4L (J)	81
V6 231CI 3.8L (C)	90-88	V8 396CI 6.5L	69-68	V8 287.2CI 4.7L	55
V6 231CI 3.8L (L)	92-91	V8 402CI 6.6L	71-70	V8 301CI 4.9L (W)	81-78
V6 252CI 4.1L (4)	85-80	V8 454CI 7.4L	71-70	V8 301CI 4.9L (Y)	79-77
V8 307CI 5.0L (Y)	85-80	Astre		V8 307CI 5.0L (Y)	81
V8 350CI 5.7L (R)	80-77	L4 140CI 2.3L SOHC (A)	76-75	V8 316CI 5.2L	56
V8 350CI 5.7L Diesel (N)	85-78	L4 140CI 2.3L SOHC (B)	77-75	V8 347CI 5.7L	57
V8 403CI 6.6L (K)	78-77	L4 151CI 2.5L (V)	77	V8 350CI 5.7L	71-70
V8 425CI 7.0L	67-66	Beaumont (Canada)		V8 350CI 5.7L (M)	76-72
V8 455CI 7.5L	74-68	L6 194CI 3.2L	66-64	V8 350CI 5.7L (N)	74-72
V8 455CI 7.5L (T)	76-75	L6 230CI 3.8L (OHV)	69-64	V8 350CI 5.7L (P)	77-76
V8 455CI 7.5L (W)	75	L6 250CI 4.1L (OHV)	69-67	V8 350CI 5.7L (R)	80-77
Vista Cruiser		V8 283CI 4.6L	67-64	V8 350CI 5.7L (X)	80-78
L6 250CI 4.1L (OHV)	71-68	V8 307CI 5.0L	69-68	V8 350CI 5.7L Diesel (N)	81-80
L6 250CI 4.1L (OHV) (D)	76-72	V8 327CI 5.3L	68-64	V8 370CI 6.1L	58
V6 231CI 3.8L (A)	83-77	V8 350CI 5.7L	69-68	V8 389CI 6.4L	66-59
V6 252CI 4.1L (4)	83-82	V8 396CI 6.5L	69-65	V8 400CI 6.6L	71-67
V6 260CI 4.3L Diesel (V)	83-82	Bonneville (FWD)		V8 400CI 6.6L (N)	76
V8 260CI 4.3L (8)	82	V6 231CI 3.8L (3)	87	V8 400CI 6.6L (R)	75-72
V8 260CI 4.3L (F)	71-75	V6 231CI 3.8L (C)	91-88	V8 400CI 6.6L (S)	76-72
V8 260CI 4.3L Diesel (P)	79	V6 231CI 3.8L (K)	05-95	V8 400CI 6.6L (Z)	79-76
V8 267CI 4.4L (J)	82-81	V6 231CI 3.8L (L)	94-92	V8 403CI 6.6L (K)	79-77
V8 305CI 5.0L (H)	83-78	V6 231CI 3.8L Supercharged (1)	03-92	V8 421CI 6.9L	66-61
V8 307CI 5.0L (Y)	83-80	V8 281CI 4.6L DOHC (32 Valve) (Y)	05-04	V8 428CI 7.0L	69-67
V8 330CI 5.4L	67-64	Bonneville (RWD) (Full-Size)		V8 455CI 7.5L	71-70
V8 350CI 5.7L	71-68	V6 231CI 3.8L (A)	81-78	V8 455CI 7.5L (W)	76-72
V8 350CI 5.7L (R)	80-72	V8 265CI 4.3L (S)	81-80	Chieftain	
V8 350CI 5.7L Diesel (N)	83-79	V8 267CI 4.4L (J)	81	L6 239.2CI 3.9L (L-Head)	54-49
V8 400CI 6.6L	69-65	V8 301CI 4.9L (W)	81-78	L8 248.9CI 4.1L (L-Head)	49
V8 403CI 6.6L (K)	77	V8 301CI 4.9L (Y)	79-77	L8 268.2CI 4.4L (L-Head)	54-50
V8 455CI 7.5L	74-68	V8 305CI 5.0L (H)	81	V8 287.2CI 4.7L	55
V8 455CI 7.5L (T)	76-75	V8 307CI 5.0L (Y)	81	V8 316CI 5.2L	56
V8 455CI 7.5L (W)	75	V8 347CI 5.7L	57	V8 347CI 5.7L	57
Passport		V8 350CI 5.7L	71-70	V8 370CI 6.1L	58
Optima (Canada)		V8 350CI 5.7L (M)	76-72	Eight	
L4 1598cc 1.6L SOHC (6)	93-88	V8 350CI 5.7L (P)	77-76	L8 223.4 3.6L (L-Head)	35-33
L4 1998cc 2.0L SOHC (K)	91-88	V8 350CI 5.7L (R)	80-77	L8 232.3CI 3.8 (L-Head)	36
Pontiac		V8 350CI 5.7L (X)	80-78	L8 248.9CI 4.1L (L-Head)	40-37
1000		V8 350CI 5.7L Diesel (N)	81-80	Executive	
L4 1817cc 1.8L SOHC Diesel (D)	86-84	V8 370CI 6.1L	58	V8 389CI 6.4L	66
L4 98CI 1.6L SOHC (C)	87-84	V8 389CI 6.4L	66-59	V8 400CI 6.6L	70-67
6000		V8 400CI 6.6L	71-67	V8 421CI 6.9L	66
L4 151CI 2.5L (5)	83-82	V8 400CI 6.6L (N)	76	V8 428CI 7.0L	69-67
L4 151CI 2.5L (R)	91-82	V8 400CI 6.6L (R)	75-72	V8 455CI 7.5L	70
V6 173CI 2.8L (W)	89-85	V8 400CI 6.6L (S)	76-72	Fiero	
V6 173CI 2.8L (X)	86-82	V8 400CI 6.6L (Z)	79-76	L4 151CI 2.5L (R)	88-84
V6 173CI 2.8L (Z)	84-83	V8 403CI 6.6L (K)	79-77	V6 173CI 2.8L (9)	88-85
V6 189CI 3.1L (T)	91-88	V8 421CI 6.9L	66-63	Firebird	
V6 189CI 3.1L Turbo (V)	90-89	V8 428CI 7.0L	69-67	L4 151CI 2.5L (2)	86-82
V6 262CI 4.3L Diesel (T)	85-82	V8 455CI 7.5L	71-70	L4 151CI 2.5L (F)	83-82
Acadian (Canada)		V8 455CI 7.5L (W)	76-72	L6 230CI 3.8L (SOHC)	67
L4 153CI 2.5L	70-62			L6 250CI 4.1L (OHV)	71-70

GM Car (Incl. Buick, Cad., Chev., Geo, Olds., Pontiac, Saturn) (Cont.)

Model Index (Cont.)					
Engine (VIN Code / Eng. Code)	Year	Engine (VIN Code / Eng. Code)	Year	Engine (VIN Code / Eng. Code)	Year
Pontiac (cont.)		Pontiac (cont.)		Pontiac (cont.)	
Firebird (cont.)		Grand Am (FWD) (cont.)		Grand Prix (RWD) (cont.)	
L6 250CI 4.1L (OHV) (D)	76-72	L4 138CI 2.3L SOHC (8 Valve) (3)	94-92	V8 455CI 7.5L	71-70
L6 250CI 4.1L (SOHC)	69-68	L4 146CI 2.4L DOHC (16 Valve) (T)	01-96	V8 455CI 7.5L (W)	76-72
V6 173CI 2.8L (1)	84-82	L4 151CI 2.5L (U)	91-85	Grand Safari Wagon	
V6 173CI 2.8L (S)	89-85	L4 1998cc 2.0L SOHC Turbo (M)	89-87	V8 400CI 6.6L (S)	76-73
V6 189CI 3.1L (T)	92-90	L4 2198cc 2.2L DOHC (16 Valve) (F)	04-02	V8 455CI 7.5L (W)	76-73
V6 207CI 3.4L OHV (12 Valve) (S)	95-93	V6 181CI 3.0L (L)	87-85	Grand Ville	
V6 231CI 3.8L (A)	81-78	V6 189CI 3.1L (M)	98-94	V8 400CI 6.6L	71
V6 231CI 3.8L (C)	77	V6 204CI 3.3L (N)	93-92	V8 400CI 6.6L (S)	75-72
V6 231CI 3.8L (K)	02-95	V6 207CI 3.4L OHV (12 Valve) (E)	05-99	V8 455CI 7.5L	71
V6 231CI 3.8L Turbo (7)	89	Grand Am (RWD)		V8 455CI 7.5L (W)	75-72
V8 265CI 4.3L (S)	81-80	V6 229CI 3.8L (K)	81-80	GTO	
V8 267CI 4.4L (J)	81	V6 231CI 3.8L (2)	79	V8 350CI 5.7L (J)	75-74
V8 301CI 4.9L (W)	81-79	V6 231CI 3.8L (A)	81-78	V8 350CI 5.7L (P)	77-76
V8 301CI 4.9L (Y)	78-77	V8 265CI 4.3L (S)	81-80	V8 389CI 6.4L	66-64
V8 301CI 4.9L Turbo (T)	81-80	V8 301CI 4.9L (W)	81-78	V8 400CI 6.6L	73-67
V8 305CI 5.0L (7)	82	V8 301CI 4.9L (Y)	79-77	V8 421CI 6.9L	66-64
V8 305CI 5.0L (E)	92-88	V8 305CI 5.0L (H)	81-79	V8 455CI 7.5L	73-70
V8 305CI 5.0L (F)	92-85	V8 305CI 5.0L (U)	78	GTO (Import)	
V8 305CI 5.0L (G)	86-79	V8 350CI 5.7L (H)	75	V8 346CI 5.7L OHV (G)	04
V8 305CI 5.0L (H)	87-80	V8 350CI 5.7L (L)	79-78	V8 364CI 6.0L OHV (U)	06-05
V8 305CI 5.0L (S)	83	V8 400CI 6.6L	74-73	J2000	
V8 305CI 5.0L (U)	78-77	V8 400CI 6.6L (R)	75	L4 112CI 1.8L OHV (G)	82
V8 326CI 5.3L	67	V8 400CI 6.6L (S)	75	L4 121CI 2.0L OHV (B)	84-83
V8 346CI 5.7L (G)	02-98	V8 455CI 7.5L (W)	75-73	L4 121CI 2.0L OHV (P)	86-83
V8 350CI 5.7L	71-68	Grand Prix (FWD)		L4 1796cc 1.8L SOHC (0)	86-82
V8 350CI 5.7L (8)	92-87	L4 138CI 2.3L DOHC (16 Valve) (A)	91-90	L4 1796cc 1.8L SOHC Turbo (J)	86-84
V8 350CI 5.7L (E)	75	L4 138CI 2.3L DOHC (16 Valve) (D)	91-90	Laurentian (Canada)	
V8 350CI 5.7L (L)	79-78	V6 173CI 2.8L (W)	89-88	L6 230CI 3.8L (OHV)	67-66
V8 350CI 5.7L (M)	76-72	V6 189CI 3.1L (J)	03-00	L6 250CI 4.1L (OHV)	69-66
V8 350CI 5.7L (P)	97-93	V6 189CI 3.1L (M)	99-94	L6 261CI 4.3L	62-55
V8 350CI 5.7L (P)	77-76	V6 189CI 3.1L (T)	93-89	V6 229CI 3.8L (K)	81-80
V8 350CI 5.7L (R)	77	V6 189CI 3.1L Turbo (V)	90-89	V6 231CI 3.8L (A)	81-77
V8 400CI 6.6L	71-67	V6 207CI 3.4L DOHC (24 Valve) (X)	96-91	V8 265CI 4.3L	57-55
V8 400CI 6.6L (S)	76-72	V6 231CI 3.8L (2)	08-04	V8 267CI 4.4L (J)	81-80
V8 400CI 6.6L (Z)	79-76	V6 231CI 3.8L (K)	03-97	V8 283CI 4.6L	67-57
V8 403CI 6.6L (K)	79-77	V6 231CI 3.8L Supercharged (1)	03-97	V8 305CI 5.0L (H)	81-80
V8 455CI 7.5L	71-70	V6 231CI 3.8L Supercharged (4)	07-04	V8 327CI 5.3L	69-62
V8 455CI 7.5L (W)	76-72	V8 325CI 5.3L (C)	08-05	V8 348CI 5.7L	62-58
Firefly (Canada)		Grand Prix (RWD)		V8 350CI 5.7L	69-68
L3 993cc 1.0L SOHC (5)	88-86	V6 229CI 3.8L (9)	83	V8 350CI 5.7L (L)	81-80
L3 993cc 1.0L SOHC (6)	01-89	V6 229CI 3.8L (K)	82-81	V8 396CI 6.5L	69-65
L3 993cc 1.0L SOHC (M)	85	V6 231CI 3.8L (2)	79	V8 400CI 6.6L	71-67
L3 993cc 1.0L SOHC Turbo (2)	91-87	V6 231CI 3.8L (A)	87-78	V8 400CI 6.6L (N)	76
L4 1324cc 1.3L SOHC (16 Valve) (2)	01-98	V6 252CI 4.1L (4)	83-82	V8 400CI 6.6L (R)	75-72
L4 1324cc 1.3L SOHC (8 Valve) (9)	97-92	V6 262CI 4.3L (Z)	87-85	V8 400CI 6.6L (S)	76-72
G3		V6 262CI 4.3L Diesel (V)	83-82	V8 400CI 6.6L (Z)	79-76
L4 1598cc 1.6L DOHC (16 Valve) (E)	10-09	V8 265CI 4.3L (S)	81-80	V8 402CI 6.6L	72-70
G5		V8 267CI 4.4L (J)	82-81	V8 409CI 6.7L	65-63
L4 2198cc 2.2L DOHC (16 Valve) (F)	08-07	V8 301CI 4.9L (W)	81-78	V8 427CI 7.0L	69-66
L4 2198cc 2.2L DOHC (16 Valve) (H)	10-09	V8 301CI 4.9L (Y)	79-77	V8 454CI 7.4L	80
L4 2384cc 2.4L DOHC (16 Valve) (B)	08-07	V8 305CI 5.0L (H)	87-79	V8 455CI 7.5L	71-70
G6		V8 305CI 5.0L (U)	78	V8 455CI 7.5L (W)	76-72
L4 2384cc 2.4L DOHC (16 Valve) (B)	10-06	V8 350CI 5.7L	71-70	LeMans (FWD)	
V6 213CI 3.5L OHV (12 Valve) (8)	06-05	V8 350CI 5.7L (M)	76-72	L4 1598cc 1.6L SOHC (6)	93-88
V6 214CI 3.5L OHV (12 Valve) (N)	10-07	V8 350CI 5.7L (P)	77-76	L4 1998cc 2.0L SOHC (K)	90-89
V6 214CI 3.5L OHV (12 Valve) (Flex Fuel) (K)	10-09	V8 350CI 5.7L (R)	77	LeMans (RWD)	
V6 242CI 3.9L OHV (12 Valve) (1)	10-06	V8 350CI 5.7L Diesel (N)	85-81	L4 195CI 3.2L	63-61
V6 3564cc 3.6L DOHC (24 Valve) (7)	10-07	V8 389CI 6.4L	66-62	L6 215CI 3.5L	65-64
G8		V8 400CI 6.6L	71-67	L6 230CI 3.8L (SOHC)	67-66
V6 3564cc 3.6L DOHC (24 Valve) (7)	09-08	V8 400CI 6.6L (N)	76	L6 250CI 4.1L (OHV)	71-70
V8 364CI 6.0L OHV (Y)	09-08	V8 400CI 6.6L (S)	76-72	L6 250CI 4.1L (OHV) (D)	76-72
V8 378CI 6.2L OHV (W)	09	V8 400CI 6.6L (Z)	77-76	L6 250CI 4.1L (SOHC)	69-68
Grand Am (FWD)		V8 403CI 6.6L (K)	77	V6 229CI 3.8L (9)	83
L4 138CI 2.3L DOHC (16 Valve) (A)	94-89	V8 421CI 6.9L	66-63	V6 229CI 3.8L (K)	82-80
L4 138CI 2.3L DOHC (16 Valve) (D)	95-88	V8 428CI 7.0L	69-67	V6 231CI 3.8L (2)	79

GM Car (Incl. Buick, Cad., Chev., Geo, Olds., Pontiac, Saturn) (Cont.)

Model Index (Cont.)					
<i>Engine (VIN Code / Eng. Code)</i>	<i>Year</i>	<i>Engine (VIN Code / Eng. Code)</i>	<i>Year</i>	<i>Engine (VIN Code / Eng. Code)</i>	<i>Year</i>
Pontiac (cont.)		Pontiac (cont.)		Pontiac (cont.)	
LeMans (RWD) (cont.)		Pathfinder (Canada)		Solstice	
V6 231CI 3.8L (A)	83-78	L6 261CI 4.3L	58-55	L4 1998cc 2.0L DOHC Turbo (16 Valve) (X)	10-07
V6 231CI 3.8L (C)	77	V8 265CI 4.3L	56-55	L4 2384cc 2.4L DOHC (16 Valve) (B)	10-06
V8 215CI 3.5L	62-61	V8 283CI 4.6L	58-57	Star Chief	
V8 260CI 4.3L (F)	76-75	Phoenix (FWD)		L6 261CI 4.3L	62-55
V8 265CI 4.3L (S)	81-80	L4 151CI 2.5L (R)	84-80	L8 268.2CI 4.4L (L-Head)	54
V8 267CI 4.4L (J)	81	V6 173CI 2.8L (7)	80	V8 287.2CI 4.7L	55
V8 301CI 4.9L (W)	81-78	V6 173CI 2.8L (X)	84-81	V8 316CI 5.2L	56
V8 301CI 4.9L (Y)	79-77	V6 173CI 2.8L (Z)	84-81	V8 347CI 5.7L	57
V8 305CI 5.0L (H)	81-78	Phoenix (RWD)		V8 370CI 6.1L	58
V8 305CI 5.0L (U)	78-77	L4 151CI 2.5L (V)	79-77	V8 389CI 6.4L	66-59
V8 326CI 5.3L	67-63	V6 231CI 3.8L (A)	79-78	V8 421CI 6.9L	66-63
V8 350CI 5.7L	71-68	V6 231CI 3.8L (C)	77	Strato-Chief (Canada)	
V8 350CI 5.7L (E)	75	V8 301CI 4.9L (W)	79-78	L6 230CI 3.8L (OHV)	69-66
V8 350CI 5.7L (H)	75	V8 301CI 4.9L (Y)	79-77	L6 250CI 4.1L (OHV)	70-66
V8 350CI 5.7L (J)	75	V8 305CI 5.0L (G)	79	L6 261CI 4.3L	62-58
V8 350CI 5.7L (L)	79-78	V8 305CI 5.0L (U)	78-77	V8 283CI 4.6L	67-58
V8 350CI 5.7L (M)	76-72	V8 350CI 5.7L (L)	79-77	V8 327CI 5.3L	69-62
V8 350CI 5.7L (P)	77-76	Pursuit (Canada)		V8 348CI 5.7L	65-58
V8 350CI 5.7L (R)	77	L4 1998cc 2.0L DOHC Supercharged (16 Valve) (P)	07-05	V8 350CI 5.7L	70-69
V8 350CI 5.7L Diesel (N)	81-80	L4 2198cc 2.2L DOHC (16 Valve) (F)	08-05	V8 396CI 6.5L	69-65
V8 389CI 6.4L	66-64	L4 2198cc 2.2L DOHC (16 Valve) (H)	10-09	V8 400CI 6.6L	70
V8 400CI 6.6L	71-67	L4 2384cc 2.4L DOHC (16 Valve) (B)	08-06	V8 402CI 6.6L	70
V8 400CI 6.6L (N)	76	Safari Wagon		V8 409CI 6.7L	65-62
V8 400CI 6.6L (S)	76-72	L6 230CI 3.8L (SOHC)	67-66	V8 427CI 7.0L	70-68
V8 400CI 6.6L (Z)	77-76	L6 250CI 4.1L (OHV)	71-70	Streamliner	
V8 403CI 6.6L (K)	77	L6 250CI 4.1L (OHV) (D)	76-72	L6 239.2CI 3.9L (L-Head)	51-46
V8 455CI 7.5L	71-70	L6 250CI 4.1L (SOHC)	69-68	L6 239.2CI 3.9L (L-Head)	42-41
V8 455CI 7.5L (W)	76-72	V6 229CI 3.8L (K)	81-80	L8 248.9CI 4.1L (L-Head)	49-46
Optima (Canada)		V6 231CI 3.8L (A)	81-77	L8 248.9CI 4.1L (L-Head)	42-41
L4 1598cc 1.6L SOHC (6)	93-88	V8 260CI 4.3L (F)	76-75	L8 268.2CI 4.4L (L-Head)	51-50
L4 1998cc 2.0L SOHC (K)	91-89	V8 265CI 4.3L (S)	81-80	Sunbird (FWD)	
Parisienne		V8 287.2CI 4.7L	55	L4 121CI 2.0L OHV (B)	84-83
V6 229CI 3.8L (9)	83	V8 301CI 4.9L (W)	81-78	L4 121CI 2.0L OHV (P)	86-83
V6 231CI 3.8L (A)	86-83	V8 301CI 4.9L (Y)	79-77	L4 1796cc 1.8L SOHC (0)	86-84
V6 262CI 4.3L (Z)	86-85	V8 305CI 5.0L (H)	81-78	L4 1796cc 1.8L SOHC Turbo (J)	86-84
V8 305CI 5.0L (H)	86-83	V8 307CI 5.0L (Y)	89-86	L4 1998cc 2.0L SOHC (H)	94-92
V8 307CI 5.0L (Y)	86	V8 316CI 5.2L	56	L4 1998cc 2.0L SOHC (K)	91-87
V8 350CI 5.7L (6)	86-84	V8 326CI 5.3L	67-66	L4 1998cc 2.0L SOHC Turbo (M)	90-87
V8 350CI 5.7L Diesel (N)	85-83	V8 347CI 5.7L	57	V6 189CI 3.1L (T)	94-91
Parisienne (Canada)		V8 350CI 5.7L	71-68	Sunbird (RWD)	
L6 230CI 3.8L (OHV)	67-66	V8 350CI 5.7L (L)	79-77	L4 140CI 2.3L SOHC (A)	76
L6 250CI 4.1L (OHV)	71-66	V8 350CI 5.7L (M)	76-72	L4 140CI 2.3L SOHC (B)	77-76
L6 250CI 4.1L (OHV) (D)	79-72	V8 350CI 5.7L (P)	77-76	L4 151CI 2.5L (1)	79-78
L6 261CI 4.3L	62-59	V8 350CI 5.7L (R)	77	L4 151CI 2.5L (9)	79-78
V6 229CI 3.8L (K)	82-80	V8 350CI 5.7L Diesel (N)	81-80	L4 151CI 2.5L (V)	80-77
V8 267CI 4.4L (J)	82-80	V8 370CI 6.1L	58	V6 231CI 3.8L (A)	80-77
V8 283CI 4.6L	67-59	V8 389CI 6.4L	66-59	V6 231CI 3.8L (C)	77-76
V8 305CI 5.0L (G)	79	V8 400CI 6.6L	71-67	V8 305CI 5.0L (G)	79
V8 305CI 5.0L (H)	82-80	V8 400CI 6.6L (N)	76	V8 305CI 5.0L (U)	78-77
V8 305CI 5.0L (Q)	76	V8 400CI 6.6L (R)	75-72	Sunburst (Canada)	
V8 305CI 5.0L (U)	78-77	V8 400CI 6.6L (S)	76-72	L4 1471cc 1.5L SOHC (7)	89-86
V8 327CI 5.3L	69-62	V8 400CI 6.6L (Z)	77-76	L4 1471cc 1.5L SOHC (K)	85
V8 348CI 5.7L	65-59	V8 403CI 6.6L (K)	79-77	L4 1471cc 1.5L SOHC Turbo (9)	89-87
V8 350CI 5.7L (P)	77-68	V8 421CI 6.9L	66-63	Sunfire	
V8 350CI 5.7L (X)	80	V8 428CI 7.0L	69-67	L4 134CI 2.2L OHV (4)	02-95
V8 350CI 5.7L Diesel (N)	82-80	V8 455CI 7.5L	71-70	L4 138CI 2.3L DOHC (16 Valve) (D)	95
V8 396CI 6.5L	69-65	V8 455CI 7.5L (W)	76-72	L4 146CI 2.4L DOHC (16 Valve) (T)	02-96
V8 400CI 6.6L	73-70	Silver Streak		L4 2198cc 2.2L DOHC (16 Valve) (F)	05-02
V8 402CI 6.6L	72-70	L6 239.2CI 3.9L (L-Head)	52-48	L4 2198cc 2.2L DOHC (16 Valve) (Flex Fuel) (6)	05-03
V8 409CI 6.7L	65-61	L8 248.9CI 4.1L (L-Head)	49-48	Super Chief	
V8 427CI 7.0L	69-68	L8 268.2CI 4.4L (L-Head)	52-50	V8 347CI 5.7L	57
V8 454CI 7.4L	73-70	Six		V8 370CI 6.1L	58
V8 455CI 7.5L	71-70	L6 208CI 3.4L (L-Head)	36-35	T1000	
V8 455CI 7.5L (W)	76-72	L6 222.7CI 3.6L (L-Head)	40-37	L4 1817cc 1.8L SOHC Diesel (D)	83-82

GM Car (Incl. Buick, Cad., Chev., Geo, Olds., Pontiac, Saturn) (Cont.)

Model Index (Cont.)					
Engine (VIN Code / Eng. Code)	Year	Engine (VIN Code / Eng. Code)	Year	Engine (VIN Code / Eng. Code)	Year
Pontiac (cont.)		Saturn (cont.)			
T1000 (cont.)		Aura			
L4 98CI 1.6L SOHC (9)	81	L4 2384cc 2.4L DOHC (16 Valve) (B)	10-08		
L4 98CI 1.6L SOHC (C)	83-82	V6 3510cc 3.5L OHV (12 Valve) (N)	08-07		
Tempest (FWD) (Canada)		V6 3564cc 3.6L DOHC (24 Valve) (7)		10-07	
L4 121CI 2.0L OHV (1)		Aura Hybrid			
L4 134CI 2.2L OHV (4)	89-87	L4 2384cc 2.4L DOHC (16 Valve) (5)	10-07		
L4 134CI 2.2L OHV (G)	94-92	Ion 1			
V6 173CI 2.8L (W)	91-90	L4 2198cc 2.2L DOHC (16 Valve) (F)	05-03		
V6 189CI 3.1L (T)	89-87	Ion 2			
Tempest (RWD)		L4 2198cc 2.2L DOHC (16 Valve) (F)	07-03		
L4 195CI 3.2L	94-90	Ion 3			
L6 215CI 3.5L	63-61	L4 2198cc 2.2L DOHC (16 Valve) (F)	07-03		
L6 230CI 3.8L (SOHC)	65-64	L4 2384cc 2.4L DOHC (16 Valve) (B)	07-06		
L6 250CI 4.1L (OHV)	67-66	Ion Red Line			
L6 250CI 4.1L (SOHC)	70	L4 1998cc 2.0L DOHC Supercharged (16	07-04		
V8 215CI 3.5L	69-68	Valve) (P)			
V8 326CI 5.3L	62-61	L100			
V8 350CI 5.7L	67-63	L4 2198cc 2.2L DOHC (16 Valve) (F)	02-01		
V8 389CI 6.4L	70-68	L200			
V8 400CI 6.6L	66-64	L4 2198cc 2.2L DOHC (16 Valve) (2)	03-02		
V8 455CI 7.5L	70-67	L4 2198cc 2.2L DOHC (16 Valve) (F)	03-01		
Torpedo		L300			
L6 239.2CI 3.9L (L-Head)	70	L4 2198cc 2.2L DOHC (16 Valve) (F)	04		
L6 239.2CI 3.9L (L-Head)	48-46	V6 2962cc 3.0L DOHC (24 Valve) (R)	05-01		
L8 248.9CI 4.1L (L-Head)	42-41	LS			
L8 248.9CI 4.1L (L-Head)	48-46	L4 2198cc 2.2L DOHC (16 Valve) (F)	00		
Ventura (Full-Size)		LS1			
V8 389CI 6.4L	42-40	L4 2198cc 2.2L DOHC (16 Valve) (F)	00		
V8 400CI 6.6L	66-60	LS2			
V8 421CI 6.9L	70-67	V6 2962cc 3.0L DOHC (24 Valve) (R)	00		
V8 428CI 7.0L	66-61	LW1			
V8 455CI 7.5L	69-67	L4 2198cc 2.2L DOHC (16 Valve) (F)	00		
Ventura II (Compact)		LW2			
L4 151CI 2.5L (V)	70	V6 2962cc 3.0L DOHC (24 Valve) (R)	00		
L6 250CI 4.1L (OHV)	77	LW200			
L6 250CI 4.1L (OHV) (D)	71	L4 2198cc 2.2L DOHC (16 Valve) (2)	03-02		
V6 231CI 3.8L (C)	76-72	L4 2198cc 2.2L DOHC (16 Valve) (F)	03-01		
V8 260CI 4.3L (F)	77	LW300			
V8 301CI 4.9L (Y)	76-75	L4 2198cc 2.2L DOHC (16 Valve) (F)	04		
V8 305CI 5.0L (U)	77	V6 2962cc 3.0L DOHC (24 Valve) (R)	04-01		
V8 307CI 5.0L	72-71	SC			
V8 350CI 5.7L	74-71	L4 116CI 1.9L DOHC (16 Valve) (7)	92-91		
V8 350CI 5.7L (H)	76-75	SC1			
V8 350CI 5.7L (J)	76-75	L4 116CI 1.9L SOHC (8 Valve) (8)	02-95		
V8 350CI 5.7L (L)	77	L4 116CI 1.9L SOHC (8 Valve) (9)	94-93		
V8 350CI 5.7L (P)	77-76	SC2			
V8 350CI 5.7L (R)	77	L4 116CI 1.9L DOHC (16 Valve) (7)	02-93		
Vibe (AWD)		Sky			
L4 1794cc 1.8L DOHC (16 Valve) (8)	06-03	L4 1998cc 2.0L DOHC Turbo (16 Valve) (X)	10-07		
L4 2362cc 2.4L DOHC (16 Valve) (0)	10-09	L4 2384cc 2.4L DOHC (16 Valve) (B)	10-07		
Vibe (FWD)		SL			
L4 1794cc 1.8L DOHC (16 Valve) (8)	08-03	L4 116CI 1.9L SOHC (8 Valve) (8)	02-95		
L4 1796cc 1.8L DOHC (16 Valve) (L)	06-03	L4 116CI 1.9L SOHC (8 Valve) (9)	94-91		
L4 1798cc 1.8L DOHC (16 Valve) (8)	10-09	SL1			
L4 2362cc 2.4L DOHC (16 Valve) (0)	10-09	L4 116CI 1.9L SOHC (8 Valve) (8)	02-95		
Vista		L4 116CI 1.9L SOHC (8 Valve) (9)	94-91		
V8 389CI 6.4L	65-59	SL2			
V8 421CI 6.9L	65-63	L4 116CI 1.9L DOHC (16 Valve) (7)	02-91		
Wave (Canada)		SW1			
L4 1598cc 1.6L DOHC (16 Valve) (6)	08-06	L4 116CI 1.9L SOHC (8 Valve) (8)	99-95		
L4 1598cc 1.6L DOHC (16 Valve) (D)	05	L4 116CI 1.9L SOHC (8 Valve) (9)	94-93		
L4 1598cc 1.6L DOHC (16 Valve) (E)	10-09	SW2			
Saturn		L4 116CI 1.9L DOHC (16 Valve) (7)	01-93		
Astra					
L4 1796cc 1.8L DOHC (16 Valve) (1)	09-08				

GM Car (Incl. Buick, Cad., Chev., Geo, Olds., Pontiac, Saturn) (Cont.)

1		1991; 1.0L 61 (993cc) SOHC L3 (6 Valve) 74mm Bore			1
		MFI; Gasoline; Turbo Suzuki Eng.; VIN Code 2, Eng. Code G10-T			
QTY	CYLINDER HEAD	YEARS	PART NO.	DESCRIPTION	
1	Head Gasket	1991	9651 PT	Head bolts not incl.; Head bolt replacement recommended	
1	Head Set	1991	HS 9651 PT	Turbo mounting gsks., head bolts, exh. pipe packing not incl.; Head bolt replacement recommended; PermaDry® molded rubber valve cover gskt. incl.; Premium valve stem seals incl.	
1	Head Bolt Set	1991	ES 74021	Head bolts w/Washers; Replacement recommended	
QTY	CONVERSION SET	YEARS	PART NO.	DESCRIPTION	
1	Gasket Conversion Set	1991	CS 9435		
QTY	MANIFOLD - INT. & EXH.	YEARS	PART NO.	DESCRIPTION	
1	Int. Manifold Gasket Set	1991	MS 94370		
1	Exh. Manifold Gasket Set	1991	MS 94371		
QTY	EXHAUST PIPE FLANGE	YEARS	PART NO.	DESCRIPTION	
1	Exhaust Pipe Gasket	1991	60566	Converter	
QTY	OIL PAN	YEARS	PART NO.	DESCRIPTION	
1	Oil Pan Gasket Set	1991	OS 30540 C		
QTY	CRANKSHAFT REAR SEAL	YEARS	PART NO.	DESCRIPTION	
1	Rear Main Seal Set	1991	BS 40522	Rubber; One-piece	
QTY	VALVE COVER	YEARS	PART NO.	DESCRIPTION	
1	Valve Cover Gasket Set	1991	VS 50333 R	w/Grommets; PermaDry® molded rubber gskt. incl.	
QTY	VALVE STEM SEAL SET	YEARS	PART NO.	DESCRIPTION	
1	Valve Stem Seal Set	1991	SS 72710	Premium valve stem seals incl.	
QTY	THERMOSTAT HOUSING	YEARS	PART NO.	DESCRIPTION	
1	Thermostat Gasket	1991	35451	Thermostat Housing; Improved design	
QTY	WATER OUTLET GASKET	YEARS	PART NO.	DESCRIPTION	
1	Water Outlet Gasket	1991	35365	Water Outlet	
QTY	WATER PUMP	YEARS	PART NO.	DESCRIPTION	
1	Water Pump Gasket	1991	35366		
QTY	TIMING COVER	YEARS	PART NO.	DESCRIPTION	
1	Timing Cover Dust Seal Set	1991	ES 72778		
1	Crankshaft Front Seal Set	1991	TCS 45461		
1	Camshaft Front Seal Set	1991	TCS 45852		
QTY	CARB & FUEL INJECTION	YEARS	PART NO.	DESCRIPTION	
1	Throttle Body Gasket	1991	61032		
QTY	EXHAUST GAS RECIRCULATION	YEARS	PART NO.	DESCRIPTION	
1	EGR Gasket	1991	71164		
2		2001 - 1991; 1.0L 61 (993cc) SOHC L3 (6 Valve) 74mm Bore			2
		TBI; Gasoline; Naturally Aspirated Suzuki Eng.; VIN Code 6, Eng. Code G10			
QTY	CYLINDER HEAD	YEARS	PART NO.	DESCRIPTION	
1	Head Gasket	2001-91	9651 PT	Head bolts not incl.; Head bolt replacement recommended	
1	Head Set	2001-91	HS 9651 PT	Head bolts & exh. pipe packing not incl.; Head bolt replacement recommended; PermaDry® molded rubber valve cover gskt. incl.; Premium valve stem seals incl.	
1	Head Installation Set	2001-91	HIS 9651 PT	Head bolts & exh. pipe packing not incl.; Head bolt replacement recommended; PermaDry® molded rubber valve cover gskt. incl.	
1	Head Bolt Set	2001-91	ES 74021	Head bolts w/Washers; Replacement recommended	
QTY	CONVERSION SET	YEARS	PART NO.	DESCRIPTION	
1	Gasket Conversion Set	2001-96	CS 9435-1		
1	Gasket Conversion Set	1995-91	CS 9435		
QTY	MANIFOLD - INT. & EXH.	YEARS	PART NO.	DESCRIPTION	
1	Int. Manifold Gasket Set	2001-91	MS 94370		
1	Exh. Manifold Gasket Set	2001-91	MS 94371		
QTY	EXHAUST PIPE FLANGE	YEARS	PART NO.	DESCRIPTION	
1	Exhaust Pipe Gasket	2001-91	60816	Muffler	
1	Exhaust Pipe Gasket	1997-91	60566	Packing	
QTY	OIL PAN	YEARS	PART NO.	DESCRIPTION	
1	Oil Pan Gasket Set	2001-96	OS 30700 C		
1	Oil Pan Gasket Set	1995-91	OS 30540 C		
QTY	CRANKSHAFT REAR SEAL	YEARS	PART NO.	DESCRIPTION	
1	Rear Main Seal Set	2001-91	BS 40522	Rubber; One-piece	
QTY	VALVE COVER	YEARS	PART NO.	DESCRIPTION	
1	Valve Cover Gasket Set	2001-91	VS 50333 R	w/Grommets; PermaDry® molded rubber gskt. incl.	
QTY	VALVE STEM SEAL SET	YEARS	PART NO.	DESCRIPTION	
1	Valve Stem Seal Set	2001-91	SS 72710	Premium valve stem seals incl.	

GM Car (Incl. Buick, Cad., Chev., Geo, Olds., Pontiac, Saturn) (Cont.)

2		2001 - 1991; 1.0L 61 (993cc) SOHC L3 (6 Valve) 74mm Bore			2
(cont.)		TBI; Gasoline; Naturally Aspirated Suzuki Eng.; VIN Code 6, Eng. Code G10			(cont.)
QTY	THERMOSTAT HOUSING	YEARS	PART NO.	DESCRIPTION	
1	Thermostat Gasket	2001-91	35451	Thermostat Housing; Improved design	
QTY	WATER OUTLET GASKET	YEARS	PART NO.	DESCRIPTION	
1	Water Outlet Gasket	2001-91	35365	Water Outlet	
QTY	WATER PUMP	YEARS	PART NO.	DESCRIPTION	
1	Water Pump Gasket	2001-91	35366		
QTY	TIMING COVER	YEARS	PART NO.	DESCRIPTION	
1	Timing Cover Dust Seal Set	2001-91	ES 72778		
1	Crankshaft Front Seal Set	2001-91	TCS 45461		
1	Camshaft Front Seal Set	2001-91	TCS 45852		
QTY	CARB & FUEL INJECTION	YEARS	PART NO.	DESCRIPTION	
1	Throttle Body Gasket	2001-95	61030	Loc. Upper	
1	Throttle Body Gasket	2001-95	61095	Loc. Lower	
1	Throttle Body Gasket	1994	61030	California	
1	Throttle Body Gasket	1994	61031	Exc. California	
1	Throttle Body Gasket	1993	60921	1st Design; To Eng. Block No. G10P-119923	
1	Throttle Body Gasket	1993	61031	2nd Design; From Eng. Block No. G10P-119924	
1	Throttle Body Gasket	1992-91	60921		
QTY	EXHAUST GAS RECIRCULATION	YEARS	PART NO.	DESCRIPTION	
1	EGR Gasket	2001-91	71164		
3		2001 - 1998; 1.3L 81 (1324cc) SOHC L4 (16 Valve) 74mm Bore			3
		MFI; Gasoline; Naturally Aspirated Suzuki Eng.; VIN Code 2, Eng. Code SW413			
QTY	CYLINDER HEAD	YEARS	PART NO.	DESCRIPTION	
1	Head Gasket	2001-98	9623 PT		
1	Head Set	2001-98	HS 9623 PT-2	PermaDry® molded rubber valve cover gskt. incl.; Premium valve stem seals incl.	
QTY	CONVERSION SET	YEARS	PART NO.	DESCRIPTION	
1	Gasket Conversion Set	2001-98	CS 9117-1	RTV sealant incl. for oil pan gskt.	
QTY	MANIFOLD - INT. & EXH.	YEARS	PART NO.	DESCRIPTION	
1	Int. Manifold Gasket Set	2001-98	MS 95402		
1	Exh. Manifold Gasket Set	2001-98	MS 95032		
QTY	EXHAUST PIPE FLANGE	YEARS	PART NO.	DESCRIPTION	
1	Exhaust Pipe Gasket	2001-98	60816	Converter	
QTY	FUEL PUMP	YEARS	PART NO.	DESCRIPTION	
1	Fuel Pump Mounting Gasket	1999-98	70030		
QTY	CRANKSHAFT REAR SEAL	YEARS	PART NO.	DESCRIPTION	
1	Rear Main Seal Set	2001-98	BS 40522	Rubber; One-piece	
QTY	VALVE COVER	YEARS	PART NO.	DESCRIPTION	
1	Valve Cover Gasket Set	2001-98	VS 50473 R	w/Spark plug tube seals; PermaDry® molded rubber gskt. incl.	
QTY	VALVE STEM SEAL SET	YEARS	PART NO.	DESCRIPTION	
1	Valve Stem Seal Set	2001-98	SS 70360	Premium valve stem seals incl.; Improved design	
QTY	THERMOSTAT HOUSING	YEARS	PART NO.	DESCRIPTION	
1	Thermostat Gasket	2001-98	35451	Thermostat Housing; Improved design	
QTY	WATER OUTLET GASKET	YEARS	PART NO.	DESCRIPTION	
1	Water Outlet Gasket	2001-98	35365	Water Outlet	
QTY	WATER PUMP	YEARS	PART NO.	DESCRIPTION	
1	Water Pump Gasket	2001-98	35366		
QTY	TIMING COVER	YEARS	PART NO.	DESCRIPTION	
1	Crankshaft Front Seal Set	2001-98	TCS 45461		
1	Camshaft Front Seal Set	2001-98	TCS 45852		
QTY	CARB & FUEL INJECTION	YEARS	PART NO.	DESCRIPTION	
1	Throttle Body Gasket	2001-98	61094		
QTY	EXHAUST GAS RECIRCULATION	YEARS	PART NO.	DESCRIPTION	
1	EGR Gasket	2001-98	71164		
4		1997 - 1992; 1.3L 81 (1324cc) SOHC L4 (8 Valve) 74mm Bore			4
		TBI; Gasoline; Naturally Aspirated Suzuki Eng.; VIN Code 9, Eng. Code G13A			
QTY	CYLINDER HEAD	YEARS	PART NO.	DESCRIPTION	
1	Head Gasket	1997-92	9623 PT		
1	Head Set	1997-95	HS 9623 PT-1	PermaDry® molded rubber valve cover gskt. incl.; Premium valve stem seals incl.	
1	Head Set	1994-92	HS 9117 PT-1	Premium valve stem seals incl.	

GM Car (Incl. Buick, Cad., Chev., Geo, Olds., Pontiac, Saturn) (Cont.)

4		1997 - 1992; 1.3L 81 (1324cc) SOHC L4 (8 Valve) 74mm Bore			4			
(cont.)		TBI; Gasoline; Naturally Aspirated Suzuki Eng.; VIN Code 9, Eng. Code G13A					(cont.)	
QTY	CONVERSION SET	YEARS	PART NO.	DESCRIPTION				
1	Gasket Conversion Set	1997-96	CS 9117-1	RTV sealant incl. for oil pan gskt.				
1	Gasket Conversion Set	1995-92	CS 9117					
QTY	MANIFOLD - INT. & EXH.	YEARS	PART NO.	DESCRIPTION				
1	Int. Manifold Gasket Set	1997-95	MS 95837					
1	Int. Manifold Gasket Set	1994-92	MS 94326					
1	Exh. Manifold Gasket Set	1997-92	MS 94324					
QTY	EXHAUST PIPE FLANGE	YEARS	PART NO.	DESCRIPTION				
1	Exhaust Pipe Gasket	1997-92	60566	Flange				
1	Exhaust Pipe Gasket	1997-92	60816	Converter				
QTY	FUEL PUMP	YEARS	PART NO.	DESCRIPTION				
1	Fuel Pump Mounting Gasket	1997-92	70030					
QTY	OIL PAN	YEARS	PART NO.	DESCRIPTION				
1	Oil Pan Gasket Set	1997-96	OS 30683 C					
1	Oil Pan Gasket Set	1995-92	OS 30594 C					
QTY	CRANKSHAFT REAR SEAL	YEARS	PART NO.	DESCRIPTION				
1	Rear Main Seal Set	1997-92	BS 40522	Rubber; One-piece				
QTY	VALVE COVER	YEARS	PART NO.	DESCRIPTION				
1	Valve Cover Gasket Set	1997-95	VS 50375 R	w/Grommets; PermaDry® molded rubber gskt. incl.				
1	Valve Cover Gasket Set	1994-92	VS 50323 C	w/Grommets; Cork				
QTY	VALVE STEM SEAL SET	YEARS	PART NO.	DESCRIPTION				
1	Valve Stem Seal Set	1997-92	SS 72675-1	Premium valve stem seals incl.				
QTY	THERMOSTAT HOUSING	YEARS	PART NO.	DESCRIPTION				
1	Thermostat Gasket	1997-92	35451	Thermostat Housing; Improved design				
QTY	WATER OUTLET GASKET	YEARS	PART NO.	DESCRIPTION				
1	Water Outlet Gasket	1997-92	35365	Water Outlet				
QTY	WATER PUMP	YEARS	PART NO.	DESCRIPTION				
1	Water Pump Gasket	1997-92	35366					
QTY	TIMING COVER	YEARS	PART NO.	DESCRIPTION				
1	Crankshaft Front Seal Set	1997-96	TCS 45461	Must be used w/OS 30683C				
1	Crankshaft Front Seal Set	1995-92	TCS 45461	Must be used w/OS 30594C				
1	Camshaft Front Seal Set	1997-92	TCS 45852					
QTY	CARB & FUEL INJECTION	YEARS	PART NO.	DESCRIPTION				
1	Throttle Body Gasket	1997-95	61030	Loc. Upper				
1	Throttle Body Gasket	1997-95	61095	Loc. Lower				
1	Throttle Body Gasket	1994	60921					
1	Throttle Body Gasket	1993	60921	1st Design; To Eng. Block No. G13P-107961				
1	Throttle Body Gasket	1993	61031	2nd Design; From Eng. Block No. G13P-107962				
1	Throttle Body Gasket	1992	60921					
QTY	EXHAUST GAS RECIRCULATION	YEARS	PART NO.	DESCRIPTION				
1	EGR Gasket	1997-92	71164					
5		2013 - 2011; 1.4L 83.2 (1364cc) DOHC L4 (16 Valve) 72.5mm Bore Ecotec VVT					5	
		MFI; Hybrid (Gas/Electric); Naturally Aspirated Opel Eng.; VIN Code 4						
QTY	CYLINDER HEAD	YEARS	PART NO.	DESCRIPTION				
1	Head Gasket	2013-11	26540 PT	Head bolts not incl.; Head bolt replacement recommended; PermaTorqueMLS®; New Part Number - Check for Availability				
1	Head Set	2013-11	HS 26540 PT	Head bolts not incl.; Head bolt replacement recommended; PermaDry® molded rubber valve cover gskt. incl.; Premium valve stem seals incl.; New Part Number - Check for Availability				
1	Head Bolt Set	2013-11	ES 72474	Replacement recommended; New Part Number - Check for Availability				
QTY	CONVERSION SET	YEARS	PART NO.	DESCRIPTION				
1	Gasket Conversion Set	2013-11	CS 26540	RTV sealant incl. for oil pan gskt.; New Part Number - Check for Availability				
QTY	MANIFOLD - INT. & EXH.	YEARS	PART NO.	DESCRIPTION				
1	Int. Manifold Gasket Set	2013-11	MS 97211	New Part Number - Check for Availability				
1	Exh. Manifold Gasket Set	2013-11	MS 97203	New Part Number - Check for Availability				
QTY	EXHAUST PIPE FLANGE	YEARS	PART NO.	DESCRIPTION				
1	Exhaust Pipe Gasket	2013-11	60582	Flange				
1	Exhaust Pipe Gasket	2013-11	61676	Loc. Front; Converter; New Part Number - Check for Availability				
1	Exhaust Pipe Gasket	2013-11	61677	Converter to manifold; New Part Number - Check for Availability				
1	Exhaust Pipe Gasket	2013-11	61681	Loc. Rear; Converter; New Part Number - Check for Availability				
QTY	CRANKSHAFT REAR SEAL	YEARS	PART NO.	DESCRIPTION				
1	Rear Main Seal Set	2013-11	BS 40738	Rubber; One-piece; New Part Number - Check for Availability				

GM Car (Incl. Buick, Cad., Chev., Geo, Olds., Pontiac, Saturn) (Cont.)

5		2013 - 2011; 1.4L 83.2 (1364cc) DOHC L4 (16 Valve) 72.5mm Bore Ecotec VVT			5	
(cont.)		MFI; Hybrid (Gas/Electric); Naturally Aspirated Opel Eng.; VIN Code 4			(cont.)	
QTY	VALVE COVER	YEARS	PART NO.	DESCRIPTION		
1	Valve Cover Gasket Set	2013-11	VS 50807 R	w/Grommets & Spark plug tube seals; PermaDry® molded rubber gskt. incl.; New Part Number - Check for Availability		
QTY	VALVE STEM SEAL SET	YEARS	PART NO.	DESCRIPTION		
1	Valve Stem Seal Set	2013-11	SS 72935	Premium valve stem seals incl.; New Part Number - Check for Availability		
QTY	THERMOSTAT HOUSING	YEARS	PART NO.	DESCRIPTION		
1	Thermostat Gasket	2013-11	35980	Thermostat Housing; Thermostat gskt.; New Part Number - Check for Availability		
QTY	WATER OUTLET GASKET	YEARS	PART NO.	DESCRIPTION		
1	Water Outlet Gasket	2013-11	35979	Water Outlet; Water outlet; New Part Number - Check for Availability		
1	Water Outlet Gasket	2013-11	ES 72471	Water Outlet; Water outlet mounting set; New Part Number - Check for Availability		
QTY	WATER PUMP	YEARS	PART NO.	DESCRIPTION		
1	Water Pump Gasket	2013-11	35986	New Part Number - Check for Availability		
QTY	TIMING COVER	YEARS	PART NO.	DESCRIPTION		
1	Crankshaft Front Seal Set	2013-11	TCS 46155	New Part Number - Check for Availability		
QTY	CARB & FUEL INJECTION	YEARS	PART NO.	DESCRIPTION		
1	Fuel Injector O-Ring Set	2013-11	ES 70599	Upper set; Injectors to fuel rail; Improved design		
1	Throttle Body Gasket	2013-11	61691	New Part Number - Check for Availability		
6		2013 - 2011; 1.4L 83.2 (1364cc) DOHC L4 (16 Valve) 72.5mm Bore Ecotec VVT			6	
		DI; Gasoline; Turbo - Intercooled Opel Eng.; VIN Code 9				
QTY	CYLINDER HEAD	YEARS	PART NO.	DESCRIPTION		
1	Head Gasket	2013-11	26540 PT	Head bolts not incl.; Head bolt replacement recommended; PermaTorqueMLS®; New Part Number - Check for Availability		
1	Head Set	2013-11	HS 26540 PT-1	Head bolts not incl.; Head bolt replacement recommended; PermaDry® molded rubber valve cover gskt. incl.; Premium valve stem seals incl.; New Part Number - Check for Availability		
1	Head Bolt Set	2013-11	ES 72474	Replacement recommended; New Part Number - Check for Availability		
QTY	CONVERSION SET	YEARS	PART NO.	DESCRIPTION		
1	Gasket Conversion Set	2013-11	CS 26540	RTV sealant incl. for oil pan gskt.; New Part Number - Check for Availability		
QTY	MANIFOLD - INT. & EXH.	YEARS	PART NO.	DESCRIPTION		
1	Int. Manifold Gasket Set	2013-11	MS 97211	New Part Number - Check for Availability		
1	Exh. Manifold Gasket Set	2013-11	MS 97202	New Part Number - Check for Availability		
QTY	EXHAUST PIPE FLANGE	YEARS	PART NO.	DESCRIPTION		
1	Exhaust Pipe Gasket	2013-11	61676	Loc. Front; Converter; New Part Number - Check for Availability		
1	Exhaust Pipe Gasket	2013-11	61677	Converter to manifold; New Part Number - Check for Availability		
1	Exhaust Pipe Gasket	2013-11	61681	Loc. Rear; Converter; New Part Number - Check for Availability		
QTY	CRANKSHAFT REAR SEAL	YEARS	PART NO.	DESCRIPTION		
1	Rear Main Seal Set	2013-11	BS 40738	Rubber; One-piece; New Part Number - Check for Availability		
QTY	VALVE COVER	YEARS	PART NO.	DESCRIPTION		
1	Valve Cover Gasket Set	2013-11	VS 50807 R	w/Grommets & Spark plug tube seals; PermaDry® molded rubber gskt. incl.; New Part Number - Check for Availability		
QTY	VALVE STEM SEAL SET	YEARS	PART NO.	DESCRIPTION		
1	Valve Stem Seal Set	2013-11	SS 72935	Premium valve stem seals incl.; New Part Number - Check for Availability		
QTY	THERMOSTAT HOUSING	YEARS	PART NO.	DESCRIPTION		
1	Thermostat Gasket	2013-11	35981	Thermostat Housing; Thermostat gasket; New Part Number - Check for Availability		
QTY	WATER OUTLET GASKET	YEARS	PART NO.	DESCRIPTION		
1	Water Outlet Gasket	2013-11	35979	Water Outlet; Water outlet; New Part Number - Check for Availability		
QTY	WATER PUMP	YEARS	PART NO.	DESCRIPTION		
1	Water Pump Gasket	2013-11	35986	New Part Number - Check for Availability		
QTY	TIMING COVER	YEARS	PART NO.	DESCRIPTION		
1	Crankshaft Front Seal Set	2013-11	TCS 46156	New Part Number - Check for Availability		
QTY	CARB & FUEL INJECTION	YEARS	PART NO.	DESCRIPTION		
1	Fuel Injector O-Ring Set	2013-11	ES 70599	Upper set; Injectors to fuel rail; Improved design		
1	Throttle Body Gasket	2013-11	61691	New Part Number - Check for Availability		
7		2013 - 2012; 1.4L 83.2 (1364cc) DOHC L4 (16 Valve) 72.5mm Bore Ecotec VVT			7	
		DI; Gasoline; Turbo - Intercooled Opel Eng.; VIN Code B				
QTY	CYLINDER HEAD	YEARS	PART NO.	DESCRIPTION		
1	Head Gasket	2013-12	26540 PT	Head bolts not incl.; Head bolt replacement recommended; PermaTorqueMLS®; New Part Number - Check for Availability		

GM Car (Incl. Buick, Cad., Chev., Geo, Olds., Pontiac, Saturn) (Cont.)

7		2013 - 2012; 1.4L 83.2 (1364cc) DOHC L4 (16 Valve) 72.5mm Bore Ecotec VVT			7	
(cont.)		DI; Gasoline; Turbo - Intercooled Opel Eng.; VIN Code B			(cont.)	
QTY	CYLINDER HEAD	YEARS	PART NO.	DESCRIPTION		
1	Head Set	2013-12	HS 26540 PT-1	Head bolts not incl.; Head bolt replacement recommended; PermaDry® molded rubber valve cover gskt. incl.; Premium valve stem seals incl.; New Part Number - Check for Availability		
1	Head Bolt Set	2013-12	ES 72474	Replacement recommended; New Part Number - Check for Availability		
QTY	CONVERSION SET	YEARS	PART NO.	DESCRIPTION		
1	Gasket Conversion Set	2013-12	CS 26540	RTV sealant incl. for oil pan gskt.; New Part Number - Check for Availability		
QTY	MANIFOLD - INT. & EXH.	YEARS	PART NO.	DESCRIPTION		
1	Int. Manifold Gasket Set	2013-12	MS 97211	New Part Number - Check for Availability		
1	Exh. Manifold Gasket Set	2013-12	MS 97202	New Part Number - Check for Availability		
QTY	EXHAUST PIPE FLANGE	YEARS	PART NO.	DESCRIPTION		
1	Exhaust Pipe Gasket	2013-12	61676	Loc. Front; Converter; New Part Number - Check for Availability		
1	Exhaust Pipe Gasket	2013-12	61677	Converter to manifold; New Part Number - Check for Availability		
1	Exhaust Pipe Gasket	2013-12	61681	Loc. Rear; Converter; New Part Number - Check for Availability		
QTY	CRANKSHAFT REAR SEAL	YEARS	PART NO.	DESCRIPTION		
1	Rear Main Seal Set	2013-12	BS 40738	Rubber; One-piece; New Part Number - Check for Availability		
QTY	VALVE COVER	YEARS	PART NO.	DESCRIPTION		
1	Valve Cover Gasket Set	2013-12	VS 50807 R	w/Grommets & Spark plug tube seals; PermaDry® molded rubber gskt. incl.; New Part Number - Check for Availability		
QTY	VALVE STEM SEAL SET	YEARS	PART NO.	DESCRIPTION		
1	Valve Stem Seal Set	2013-12	SS 72935	Premium valve stem seals incl.; New Part Number - Check for Availability		
QTY	THERMOSTAT HOUSING	YEARS	PART NO.	DESCRIPTION		
1	Thermostat Gasket	2013-12	35981	Thermostat Housing; Thermostat gasket; New Part Number - Check for Availability		
QTY	WATER OUTLET GASKET	YEARS	PART NO.	DESCRIPTION		
1	Water Outlet Gasket	2013-12	35979	Water Outlet; Water outlet; New Part Number - Check for Availability		
QTY	WATER PUMP	YEARS	PART NO.	DESCRIPTION		
1	Water Pump Gasket	2013-12	35986	New Part Number - Check for Availability		
QTY	TIMING COVER	YEARS	PART NO.	DESCRIPTION		
1	Crankshaft Front Seal Set	2013-12	TCS 46156	New Part Number - Check for Availability		
QTY	CARB & FUEL INJECTION	YEARS	PART NO.	DESCRIPTION		
1	Fuel Injector O-Ring Set	2013-12	ES 70599	Upper set; Injectors to fuel rail; Improved design		
1	Throttle Body Gasket	2013-12	61691	New Part Number - Check for Availability		
8		2013 - 2012; 1.4L 83.2 (1364cc) DOHC L4 (16 Valve) 72.5mm Bore Ecotec VVT			8	
(cont.)		DI; Gasoline; Turbo - Intercooled Opel Eng.; VIN Code C			(cont.)	
QTY	CYLINDER HEAD	YEARS	PART NO.	DESCRIPTION		
1	Head Gasket	2013-12	26540 PT	Head bolts not incl.; Head bolt replacement recommended; PermaTorqueMLS®; New Part Number - Check for Availability		
1	Head Set	2013-12	HS 26540 PT-1	Head bolts not incl.; Head bolt replacement recommended; PermaDry® molded rubber valve cover gskt. incl.; Premium valve stem seals incl.; New Part Number - Check for Availability		
1	Head Bolt Set	2013-12	ES 72474	Replacement recommended; New Part Number - Check for Availability		
QTY	CONVERSION SET	YEARS	PART NO.	DESCRIPTION		
1	Gasket Conversion Set	2013-12	CS 26540	RTV sealant incl. for oil pan gskt.; New Part Number - Check for Availability		
QTY	MANIFOLD - INT. & EXH.	YEARS	PART NO.	DESCRIPTION		
1	Int. Manifold Gasket Set	2013-12	MS 97211	New Part Number - Check for Availability		
1	Exh. Manifold Gasket Set	2013-12	MS 97202	New Part Number - Check for Availability		
QTY	EXHAUST PIPE FLANGE	YEARS	PART NO.	DESCRIPTION		
1	Exhaust Pipe Gasket	2013-12	61676	Loc. Front; Converter; New Part Number - Check for Availability		
1	Exhaust Pipe Gasket	2013-12	61677	Converter to manifold; New Part Number - Check for Availability		
1	Exhaust Pipe Gasket	2013-12	61681	Loc. Rear; Converter; New Part Number - Check for Availability		
QTY	CRANKSHAFT REAR SEAL	YEARS	PART NO.	DESCRIPTION		
1	Rear Main Seal Set	2013-12	BS 40738	Rubber; One-piece; New Part Number - Check for Availability		
QTY	VALVE COVER	YEARS	PART NO.	DESCRIPTION		
1	Valve Cover Gasket Set	2013-12	VS 50807 R	w/Grommets & Spark plug tube seals; PermaDry® molded rubber gskt. incl.; New Part Number - Check for Availability		
QTY	VALVE STEM SEAL SET	YEARS	PART NO.	DESCRIPTION		
1	Valve Stem Seal Set	2013-12	SS 72935	Premium valve stem seals incl.; New Part Number - Check for Availability		
QTY	THERMOSTAT HOUSING	YEARS	PART NO.	DESCRIPTION		
1	Thermostat Gasket	2013-12	35981	Thermostat Housing; Thermostat gasket; New Part Number - Check for Availability		
QTY	WATER OUTLET GASKET	YEARS	PART NO.	DESCRIPTION		
1	Water Outlet Gasket	2013-12	35979	Water Outlet; Water outlet; New Part Number - Check for Availability		

GM Car (Incl. Buick, Cad., Chev., Geo, Olds., Pontiac, Saturn) (Cont.)

8		2013 - 2012; 1.4L 83.2 (1364cc) DOHC L4 (16 Valve) 72.5mm Bore Ecotec VVT			8
(cont.)		DI; Gasoline; Turbo - Intercooled Opel Eng.; VIN Code C			(cont.)
QTY	WATER PUMP	YEARS	PART NO.	DESCRIPTION	
1	Water Pump Gasket	2013-12	35986	New Part Number - Check for Availability	
QTY	TIMING COVER	YEARS	PART NO.	DESCRIPTION	
1	Crankshaft Front Seal Set	2013-12	TCS 46156	New Part Number - Check for Availability	
QTY	CARB & FUEL INJECTION	YEARS	PART NO.	DESCRIPTION	
1	Fuel Injector O-Ring Set	2013-12	ES 70599	Upper set; Injectors to fuel rail; Improved design	
1	Throttle Body Gasket	2013-12	61691	New Part Number - Check for Availability	
9		1992 - 1991; 1.6L 96.8 (1587cc) DOHC L4 (16 Valve) 81mm Bore			9
		MFI; Gasoline; Naturally Aspirated Toyota Eng.; VIN Code 5, Eng. Code 4AGE			
QTY	CYLINDER HEAD	YEARS	PART NO.	DESCRIPTION	
1	Head Gasket	1992-91	9661 PT	Head bolts not incl.; Head bolt replacement recommended	
QTY	CONVERSION SET	YEARS	PART NO.	DESCRIPTION	
1	Gasket Conversion Set	1992-91	CS 9383		
QTY	MANIFOLD - INT. & EXH.	YEARS	PART NO.	DESCRIPTION	
1	Exh. Manifold Gasket Set	1992-91	MS 92939		
QTY	EXHAUST PIPE FLANGE	YEARS	PART NO.	DESCRIPTION	
1	Exhaust Pipe Gasket	1992-91	23561	Flange; 1 49/64" ID x 2 17/64" OD	
2	Exhaust Pipe Gasket	1992-91	23591	Converter; 1 31/32" ID x 2 35/64" OD	
QTY	OIL PAN	YEARS	PART NO.	DESCRIPTION	
1	Oil Pan Gasket Set	1992-91	OS 30510 A		
1	Drain Plug Gasket	1992-91	70822		
QTY	CRANKSHAFT REAR SEAL	YEARS	PART NO.	DESCRIPTION	
1	Rear Main Seal Set	1992-91	BS 40409	Rubber; One-piece	
1	Repair Sleeve	1992-91	16277	Crankshaft; Use w/installation tool	
QTY	VALVE COVER	YEARS	PART NO.	DESCRIPTION	
1	Valve Cover Gasket Set	1992-91	VS 50268 R	w/o Grommets; PermaDry® molded rubber gskts. incl.	
1	Grommet Set	1992-91	ES 72133	Valve Cover	
QTY	VALVE STEM SEAL SET	YEARS	PART NO.	DESCRIPTION	
1	Valve Stem Seal Set	1992-91	SS 72656	Premium valve stem seals incl.	
QTY	THERMOSTAT HOUSING	YEARS	PART NO.	DESCRIPTION	
1	O-Ring	1992-91	35292	Thermostat Housing; Thermostat inlet	
QTY	WATER OUTLET GASKET	YEARS	PART NO.	DESCRIPTION	
1	Water Outlet Gasket	1992-91	35337	Water Outlet	
QTY	WATER PUMP	YEARS	PART NO.	DESCRIPTION	
1	Water Pump Gasket	1992-91	35235		
1	Water Pump Mounting Set	1992-91	ES 72073		
QTY	TIMING COVER	YEARS	PART NO.	DESCRIPTION	
1	Timing Cover Dust Seal Set	1992-91	ES 72759		
1	Crankshaft Front Seal Set	1992-91	TCS 45624		
1	Camshaft Front Seal Set	1992-91	TCS 45424		
1	Repair Sleeve	1992-91	16225	Timing Cover; Use w/installation tool	
1	Repair Sleeve Tool	1992-91	16325	Timing Cover	
QTY	CARB & FUEL INJECTION	YEARS	PART NO.	DESCRIPTION	
1	Fuel Injector O-Ring Set	1992-91	ES 70600		
1	Throttle Body Gasket	1992-91	60790		
QTY	DISTRIBUTOR MOUNTING	YEARS	PART NO.	DESCRIPTION	
1	Distributor Mounting Gasket	1992-91	72438	O-ring	
QTY	EXHAUST GAS RECIRCULATION	YEARS	PART NO.	DESCRIPTION	
1	EGR Gasket	1992-91	70264		
10		1997 - 1991; 1.6L 96.8 (1587cc) DOHC L4 (16 Valve) 81mm Bore			10
		MFI; Gasoline; Naturally Aspirated Toyota Eng.; VIN Code 6, Eng. Code 4AFE			
QTY	CYLINDER HEAD	YEARS	PART NO.	DESCRIPTION	
1	Head Gasket	1997-93	9604 PT	Head bolts not incl.; Head bolt replacement recommended	
1	Head Gasket	1992-91	8188 PT	Head bolts not incl.; Head bolt replacement recommended	
1	Head Set	1997-93	HS 9604 PT	Head bolts not incl.; Head bolt replacement recommended; PermaDry® molded rubber valve cover gskt. incl.; Premium valve stem seals incl.	
1	Head Set	1992-91	HS 8188 PT	Head bolts not incl.; Head bolt replacement recommended; PermaDry® molded rubber valve cover gskt. incl.; Premium valve stem seals incl.	
1	Head Installation Set	1992-91	HIS 8188 PT	Head bolts & exh. pipe flange not incl.; Head bolt replacement recommended; PermaDry® molded rubber valve cover gskt. incl.	

GM Car (Incl. Buick, Cad., Chev., Geo, Olds., Pontiac, Saturn) (Cont.)

10		1997 - 1991; 1.6L 96.8 (1587cc) DOHC L4 (16 Valve) 81mm Bore			10	
(cont.)		MFI; Gasoline; Naturally Aspirated Toyota Eng.; VIN Code 6, Eng. Code 4AFE			(cont.)	
QTY	CYLINDER HEAD	YEARS	PART NO.	DESCRIPTION		
1	Head Bolt Set	1997-93	ES 72489	Head bolts w/Washers; Replacement recommended; New Part Number - Check for Availability		
QTY	CONVERSION SET	YEARS	PART NO.	DESCRIPTION		
1	Gasket Conversion Set	1997-93	CS 9604			
1	Gasket Conversion Set	1992-91	CS 8188			
QTY	MANIFOLD - INT. & EXH.	YEARS	PART NO.	DESCRIPTION		
1	Int. Manifold Gasket Set	1997-93	MS 95516			
1	Int. Manifold Gasket Set	1992-91	MS 94135			
1	Exh. Manifold Gasket Set	1997-91	MS 94129			
QTY	EXHAUST PIPE FLANGE	YEARS	PART NO.	DESCRIPTION		
1	Exhaust Pipe Gasket	1997-91	23591	Flange; 1 31/32" ID x 2 35/64" OD		
2	Exhaust Pipe Gasket	1997-93	23591	Converter; Exc. California; 1 31/32" ID x 2 35/64" OD		
1	Exhaust Pipe Gasket	1997-93	23591	Loc. Rear; Converter; California; 1 31/32" ID x 2 35/64" OD		
1	Exhaust Pipe Gasket	1997-93	60908	Loc. Front; Converter; California		
2	Exhaust Pipe Gasket	1992-91	23591	Converter; 1 31/32" ID x 2 35/64" OD		
QTY	OIL PAN	YEARS	PART NO.	DESCRIPTION		
1	Oil Pan Gasket Set	1997-93	OS 30639			
1	Oil Pan Gasket Set	1992-91	OS 30510 A			
1	Drain Plug Gasket	1997-91	70822			
QTY	CRANKSHAFT REAR SEAL	YEARS	PART NO.	DESCRIPTION		
1	Rear Main Seal Set	1997-91	BS 40409	Rubber; One-piece		
1	Repair Sleeve	1997-91	16277	Crankshaft; Use w/installation tool		
QTY	VALVE COVER	YEARS	PART NO.	DESCRIPTION		
1	Valve Cover Gasket Set	1997-93	VS 50440 R	w/Grommets & Spark plug tube seals; PermaDry® molded rubber gskt. incl.		
1	Valve Cover Gasket Set	1992-91	VS 50324 R	w/o Grommets & Spark plug tube seals; PermaDry® molded rubber gskt. incl.		
1	Valve Cover Gasket Set	1992-91	VS 50324 R-1	w/o Grommets & w/Spark plug tube seals; PermaDry® molded rubber gskt. incl.		
1	Grommet Set	1992-91	ES 72123	Valve Cover		
1	Spark Plug Tube Seal Set	1997-91	ES 72105	Valve Cover		
QTY	VALVE STEM SEAL SET	YEARS	PART NO.	DESCRIPTION		
1	Valve Stem Seal Set	1997-93	SS 72810	Premium valve stem seals incl.		
1	Valve Stem Seal Set	1992-91	SS 72656	Premium valve stem seals incl.		
QTY	THERMOSTAT HOUSING	YEARS	PART NO.	DESCRIPTION		
1	Thermostat Gasket	1997-93	35592	Thermostat Housing; Thermostat inlet		
QTY	WATER OUTLET GASKET	YEARS	PART NO.	DESCRIPTION		
1	O-Ring	1997-91	35292	Water Outlet		
QTY	WATER PUMP	YEARS	PART NO.	DESCRIPTION		
1	Water Pump Gasket	1997-91	35235			
1	Water Pump Mounting Set	1997-91	ES 72073			
QTY	TIMING COVER	YEARS	PART NO.	DESCRIPTION		
1	Timing Cover Dust Seal Set	1997-91	ES 72747			
1	Crankshaft Front Seal Set	1997-91	TCS 45624			
1	Camshaft Front Seal Set	1997-91	TCS 45592			
1	Repair Sleeve	1997-91	16225	Timing Cover; Use w/installation tool		
1	Repair Sleeve Tool	1997-91	16325	Timing Cover		
QTY	CARB & FUEL INJECTION	YEARS	PART NO.	DESCRIPTION		
1	Fuel Injector O-Ring Set	1997-91	ES 70600			
1	Throttle Body Gasket	1997-93	60977			
1	Throttle Body Gasket	1992-91	60839			
QTY	DISTRIBUTOR MOUNTING	YEARS	PART NO.	DESCRIPTION		
1	Distributor Mounting Gasket	1997-91	72438	O-ring		
QTY	EXHAUST GAS RECIRCULATION	YEARS	PART NO.	DESCRIPTION		
1	EGR Gasket	1997-93	72554			
1	EGR Gasket	1992-91	70264	California		
1	EGR Gasket	1992-91	70368	Exc. California		
11		1991; 1.6L 96.9 (1588cc) DOHC L4 (16 Valve) 80mm Bore			11	
(cont.)		MFI; Gasoline; Naturally Aspirated Isuzu Eng.; VIN Code 5, Eng. Code 4XE1W			(cont.)	
QTY	CYLINDER HEAD	YEARS	PART NO.	DESCRIPTION		
1	Head Gasket	1991	9685 PT-1			
1	Head Set	1991	HS 9685 PT	PermaDry® molded rubber valve cover gskt. incl.; Premium valve stem seals incl.		

GM Car (Incl. Buick, Cad., Chev., Geo, Olds., Pontiac, Saturn) (Cont.)

11 (cont.)		1991; 1.6L 96.9 (1588cc) DOHC L4 (16 Valve) 80mm Bore			11 (cont.)
MFI; Gasoline; Naturally Aspirated Isuzu Eng.; VIN Code 5, Eng. Code 4XE1W					
QTY	CONVERSION SET	YEARS	PART NO.	DESCRIPTION	
1	Gasket Conversion Set	1991	CS 9685	Consolidated design	
QTY	MANIFOLD - INT. & EXH.	YEARS	PART NO.	DESCRIPTION	
1	Int. Manifold Gasket Set	1991	MS 94504	Upper set incl.	
1	Exh. Manifold Gasket Set	1991	MS 94506		
QTY	EXHAUST PIPE FLANGE	YEARS	PART NO.	DESCRIPTION	
2	Exhaust Pipe Gasket	1991	60856	Converter	
1	Exhaust Pipe Gasket	1991	60857	Flange	
QTY	OIL PAN	YEARS	PART NO.	DESCRIPTION	
1	Oil Pan Gasket Set	1991	OS 30539 C		
QTY	CRANKSHAFT REAR SEAL	YEARS	PART NO.	DESCRIPTION	
1	Rear Main Seal Set	1991	BS 40524	Rubber; One-piece; Improved design	
QTY	VALVE COVER	YEARS	PART NO.	DESCRIPTION	
1	Valve Cover Gasket Set	1991	VS 50064 R	PermaDry® molded rubber gskt. incl.	
QTY	THERMOSTAT HOUSING	YEARS	PART NO.	DESCRIPTION	
1	Water Outlet Gasket	1991	35364	Thermostat Housing; Loc. Outer	
1	Thermostat Gasket	1991	35452	Thermostat Housing; Loc. Inner	
QTY	WATER PUMP	YEARS	PART NO.	DESCRIPTION	
1	Water Pump Gasket	1991	35454		
QTY	TIMING COVER	YEARS	PART NO.	DESCRIPTION	
1	Crankshaft Front Seal Set	1991	TCS 45853		
QTY	CARB & FUEL INJECTION	YEARS	PART NO.	DESCRIPTION	
1	Throttle Body Gasket	1991	60842		
QTY	EXHAUST GAS RECIRCULATION	YEARS	PART NO.	DESCRIPTION	
1	EGR Gasket	1991	70372		
12		1993 - 1991; 1.6L 96.9 (1588cc) SOHC L4 (12 Valve) 80mm Bore			12
MFI; Gasoline; Naturally Aspirated Isuzu Eng.; VIN Code 6, Eng. Code 4XE1V					
QTY	CYLINDER HEAD	YEARS	PART NO.	DESCRIPTION	
1	Head Gasket	1993-91	9684 PT		
1	Head Set	1993-91	HS 9684 PT	PermaDry® molded rubber valve cover gskt. incl.; Premium valve stem seals incl.	
1	Head Installation Set	1993-91	HIS 9684 PT	Exh. pipe flange not incl.; PermaDry® molded rubber valve cover gskt. incl.	
QTY	CONVERSION SET	YEARS	PART NO.	DESCRIPTION	
1	Gasket Conversion Set	1993-91	CS 9685	Consolidated design	
QTY	MANIFOLD - INT. & EXH.	YEARS	PART NO.	DESCRIPTION	
1	Int. Manifold Gasket Set	1993-91	MS 94501	Upper set incl.	
1	Exh. Manifold Gasket Set	1993-91	MS 94503		
QTY	EXHAUST PIPE FLANGE	YEARS	PART NO.	DESCRIPTION	
1	Exhaust Pipe Gasket	1993-91	60668	Flange	
2	Exhaust Pipe Gasket	1993-91	60856	Converter	
QTY	OIL PAN	YEARS	PART NO.	DESCRIPTION	
1	Oil Pan Gasket Set	1993-91	OS 30539 C		
QTY	CRANKSHAFT REAR SEAL	YEARS	PART NO.	DESCRIPTION	
1	Rear Main Seal Set	1993-91	BS 40524	Rubber; One-piece; Improved design	
QTY	VALVE COVER	YEARS	PART NO.	DESCRIPTION	
1	Valve Cover Gasket Set	1993-91	VS 50053 R	w/Grommets; PermaDry® molded rubber gskt. incl.	
QTY	VALVE STEM SEAL SET	YEARS	PART NO.	DESCRIPTION	
1	Valve Stem Seal Set	1993-91	SS 72721	Premium valve stem seals incl.	
QTY	THERMOSTAT HOUSING	YEARS	PART NO.	DESCRIPTION	
1	Thermostat Gasket	1993-91	35455	Thermostat Housing; Thermostat housing to head	
QTY	WATER OUTLET GASKET	YEARS	PART NO.	DESCRIPTION	
1	Water Outlet Gasket	1993-91	35364	Water Outlet	
QTY	WATER PUMP	YEARS	PART NO.	DESCRIPTION	
1	Water Pump Gasket	1993-91	35454		
QTY	TIMING COVER	YEARS	PART NO.	DESCRIPTION	
1	Crankshaft Front Seal Set	1993-91	TCS 45853		
1	Camshaft Front Seal Set	1993-91	TCS 45696		
QTY	CARB & FUEL INJECTION	YEARS	PART NO.	DESCRIPTION	
1	Throttle Body Gasket	1993-91	60919		
QTY	EXHAUST GAS RECIRCULATION	YEARS	PART NO.	DESCRIPTION	
1	EGR Gasket	1993-91	70372		

GM Car (Incl. Buick, Cad., Chev., Geo, Olds., Pontiac, Saturn) (Cont.)

13		2009 - 2006; 1.6L 97.5 (1598cc) DOHC L4 (16 Valve) 79mm Bore			13
MFI; Gasoline; Naturally Aspirated Opel Eng.; VIN Code 6					
QTY	CYLINDER HEAD	YEARS	PART NO.	DESCRIPTION	
1	Head Gasket	2009-06	26379 PT	Head bolts not incl.; Head bolt replacement recommended; PermaTorqueMLS®	
1	Head Set	2009-06	HS 26379 PT	Head bolts not incl.; Head bolt replacement recommended; PermaDry® molded rubber valve cover gskt. incl.; Premium valve stem seals incl.	
1	Head Bolt Set	2009-06	ES 72244	Head bolts w/Washers; Replacement recommended	
QTY	CONVERSION SET	YEARS	PART NO.	DESCRIPTION	
1	Gasket Conversion Set	2009-06	CS 26378	RTV sealant incl. for oil pan gskt.	
QTY	MANIFOLD - INT. & EXH.	YEARS	PART NO.	DESCRIPTION	
1	Int. Manifold Gasket Set	2009-06	MS 96995		
1	Exh. Manifold Gasket Set	2009-06	MS 96942		
QTY	EXHAUST PIPE FLANGE	YEARS	PART NO.	DESCRIPTION	
1	Exhaust Pipe Gasket	2009-06	61473	Converter	
1	Exhaust Pipe Gasket	2009-06	61473	Flange	
1	Exhaust Pipe Gasket	2009-06	61527	Loc. Front	
QTY	CRANKSHAFT REAR SEAL	YEARS	PART NO.	DESCRIPTION	
1	Rear Main Seal Set	2009-06	BS 40535	Rubber; One-piece; Improved design	
QTY	VALVE COVER	YEARS	PART NO.	DESCRIPTION	
1	Valve Cover Gasket Set	2009-06	VS 50730 R	w/Grommets; PermaDry® molded rubber gskt. incl.	
QTY	VALVE STEM SEAL SET	YEARS	PART NO.	DESCRIPTION	
1	Valve Stem Seal Set	2009-06	SS 72924	Premium valve stem seals incl.	
QTY	THERMOSTAT HOUSING	YEARS	PART NO.	DESCRIPTION	
1	Thermostat Gasket	2009-06	35862	Thermostat seal	
QTY	WATER PUMP	YEARS	PART NO.	DESCRIPTION	
1	Water Pump Gasket	2009-06	35411		
QTY	TIMING COVER	YEARS	PART NO.	DESCRIPTION	
1	Crankshaft Front Seal Set	2009-06	TCS 46110		
1	Camshaft Front Seal Set	2009-06	TCS 46116		
QTY	CARB & FUEL INJECTION	YEARS	PART NO.	DESCRIPTION	
1	Throttle Body Gasket	2009-06	61526		
QTY	EXHAUST GAS RECIRCULATION	YEARS	PART NO.	DESCRIPTION	
1	EGR Gasket	2009-06	71285	Valve	
1	EGR Gasket	2009-06	71286	Adapter	
1	EGR Gasket	2009-06	71287	Pipe	
1	EGR Gasket	2009-06	71325	Pipe O-ring; New Part Number - Check for Availability	
14		2005 - 2004; 1.6L 97.5 (1598cc) DOHC L4 (16 Valve) 79mm Bore			14
MFI; Gasoline; Naturally Aspirated Opel Eng.; VIN Code D					
QTY	CYLINDER HEAD	YEARS	PART NO.	DESCRIPTION	
1	Head Gasket	2005-04	26378 PT	Head bolts not incl.; Head bolt replacement recommended; PermaTorqueMLS®	
1	Head Set	2005-04	HS 26378 PT	Head bolts not incl.; Head bolt replacement recommended; PermaDry® molded rubber valve cover gskt. incl.; Premium valve stem seals incl.	
1	Head Bolt Set	2005-04	ES 72244	Head bolts w/Washers; Replacement recommended	
QTY	CONVERSION SET	YEARS	PART NO.	DESCRIPTION	
1	Gasket Conversion Set	2005-04	CS 26378	RTV sealant incl. for oil pan gskt.	
QTY	MANIFOLD - INT. & EXH.	YEARS	PART NO.	DESCRIPTION	
1	Int. Manifold Gasket Set	2005-04	MS 96995		
1	Exh. Manifold Gasket Set	2005-04	MS 96942		
QTY	EXHAUST PIPE FLANGE	YEARS	PART NO.	DESCRIPTION	
1	Exhaust Pipe Gasket	2005-04	61473	Converter	
1	Exhaust Pipe Gasket	2005-04	61473	Flange	
1	Exhaust Pipe Gasket	2005-04	61527	Loc. Front	
QTY	CRANKSHAFT REAR SEAL	YEARS	PART NO.	DESCRIPTION	
1	Rear Main Seal Set	2005-04	BS 40535	Rubber; One-piece; Improved design	
QTY	VALVE COVER	YEARS	PART NO.	DESCRIPTION	
1	Valve Cover Gasket Set	2005-04	VS 50730 R	w/Grommets; PermaDry® molded rubber gskt. incl.	
QTY	VALVE STEM SEAL SET	YEARS	PART NO.	DESCRIPTION	
1	Valve Stem Seal Set	2005-04	SS 72924	Premium valve stem seals incl.	
QTY	THERMOSTAT HOUSING	YEARS	PART NO.	DESCRIPTION	
1	Thermostat Gasket	2005-04	35862	Thermostat seal	
QTY	WATER PUMP	YEARS	PART NO.	DESCRIPTION	
1	Water Pump Gasket	2005-04	35411		
QTY	TIMING COVER	YEARS	PART NO.	DESCRIPTION	
1	Crankshaft Front Seal Set	2005-04	TCS 46110		

GM Car (Incl. Buick, Cad., Chev., Geo, Olds., Pontiac, Saturn) (Cont.)

14 (cont.)		2005 - 2004; 1.6L 97.5 (1598cc) DOHC L4 (16 Valve) 79mm Bore			14 (cont.)
		MFI; Gasoline; Naturally Aspirated Opel Eng.; VIN Code D			
QTY	TIMING COVER	YEARS	PART NO.	DESCRIPTION	
1	Camshaft Front Seal Set	2005-04	TCS 46116		
QTY	CARB & FUEL INJECTION	YEARS	PART NO.	DESCRIPTION	
2	Fuel Injector O-Ring Set	2005-04	ES 70599	Improved design	
1	Throttle Body Gasket	2005-04	61526		
QTY	EXHAUST GAS RECIRCULATION	YEARS	PART NO.	DESCRIPTION	
1	EGR Gasket	2005-04	71285	Valve	
1	EGR Gasket	2005-04	71286	Adapter	
1	EGR Gasket	2005-04	71287	Pipe	
1	EGR Gasket	2005-04	71325	Pipe O-ring; New Part Number - Check for Availability	
15		2011 - 2009; 1.6L 97.5 (1598cc) DOHC L4 (16 Valve) 79mm Bore VVT			15
		MFI; Gasoline; Naturally Aspirated Opel Eng.; VIN Code E			
QTY	CYLINDER HEAD	YEARS	PART NO.	DESCRIPTION	
1	Head Gasket	2011-09	26516 PT	Head bolts not incl.; Head bolt replacement recommended; PermaTorqueMLS®	
1	Head Set	2011-09	HS 26516 PT	Head bolts not incl.; Head bolt replacement recommended; PermaDry® molded rubber valve cover gskt. incl.; Premium valve stem seals incl.; New Part Number - Check for Availability	
1	Head Bolt Set	2011-09	ES 72389	Head bolts w/Washers; Replacement recommended; New Part Number - Check for Availability	
QTY	CONVERSION SET	YEARS	PART NO.	DESCRIPTION	
1	Gasket Conversion Set	2011-09	CS 26516	RTV sealant incl. for oil pan gskt.; RTV sealant incl. for water pump gskt.; New Part Number - Check for Availability	
QTY	MANIFOLD - INT. & EXH.	YEARS	PART NO.	DESCRIPTION	
1	Int. Manifold Gasket Set	2011-09	MS 97138	Must be used w/VS 50779R; New Part Number - Check for Availability	
1	Exh. Manifold Gasket Set	2011-09	MS 97154		
QTY	EXHAUST PIPE FLANGE	YEARS	PART NO.	DESCRIPTION	
1	Exhaust Pipe Gasket	2011-09	61473	Flange	
1	Exhaust Pipe Gasket	2011-09	61473	Loc. Front; Converter	
1	Exhaust Pipe Gasket	2011-09	61527	Loc. Rear; Converter	
QTY	CRANKSHAFT REAR SEAL	YEARS	PART NO.	DESCRIPTION	
1	Rear Main Seal Set	2011-09	BS 40731	Rubber; One-piece; New Part Number - Check for Availability	
QTY	VALVE COVER	YEARS	PART NO.	DESCRIPTION	
1	Valve Cover Gasket Set	2011-09	VS 50779 R	PermaDry® molded rubber gskt. incl.; New Part Number - Check for Availability	
QTY	VALVE STEM SEAL SET	YEARS	PART NO.	DESCRIPTION	
1	Valve Stem Seal Set	2011-09	SS 72931	Premium valve stem seals incl.	
QTY	THERMOSTAT HOUSING	YEARS	PART NO.	DESCRIPTION	
1	Thermostat Gasket	2011-09	35937	Thermostat Housing; Water outlet; New Part Number - Check for Availability	
1	Thermostat Gasket	2011-09	35938	Thermostat Housing; Thermostat seal; New Part Number - Check for Availability	
QTY	TIMING COVER	YEARS	PART NO.	DESCRIPTION	
1	Crankshaft Front Seal Set	2011-09	TCS 46142	New Part Number - Check for Availability	
1	Camshaft Front Seal Set	2011-09	TCS 46144	New Part Number - Check for Availability	
QTY	CARB & FUEL INJECTION	YEARS	PART NO.	DESCRIPTION	
1	Throttle Body Gasket	2011-09	61638		
QTY	EXHAUST GAS RECIRCULATION	YEARS	PART NO.	DESCRIPTION	
1	EGR Gasket	2011-09	71325	Pipe O-ring; New Part Number - Check for Availability	
16		2011; 1.6L 97.5 (1598cc) DOHC L4 (16 Valve) 79mm Bore VVT			16
		MFI; Gasoline; Naturally Aspirated Opel Eng.; VIN Code G			
QTY	CYLINDER HEAD	YEARS	PART NO.	DESCRIPTION	
1	Head Gasket	2011	26516 PT	Head bolts not incl.; Head bolt replacement recommended; PermaTorqueMLS®	
1	Head Set	2011	HS 26516 PT	Head bolts not incl.; Head bolt replacement recommended; PermaDry® molded rubber valve cover gskt. incl.; Premium valve stem seals incl.; New Part Number - Check for Availability	
1	Head Bolt Set	2011	ES 72389	Head bolts w/Washers; Replacement recommended; New Part Number - Check for Availability	
QTY	CONVERSION SET	YEARS	PART NO.	DESCRIPTION	
1	Gasket Conversion Set	2011	CS 26516	RTV sealant incl. for oil pan gskt.; RTV sealant incl. for water pump gskt.; New Part Number - Check for Availability	
QTY	MANIFOLD - INT. & EXH.	YEARS	PART NO.	DESCRIPTION	
1	Int. Manifold Gasket Set	2011	MS 97138	Must be used w/VS 50779R; New Part Number - Check for Availability	

GM Car (Incl. Buick, Cad., Chev., Geo, Olds., Pontiac, Saturn) (Cont.)

16 (cont.)		2011; 1.6L 97.5 (1598cc) DOHC L4 (16 Valve) 79mm Bore VVT MFI; Gasoline; Naturally Aspirated Opel Eng.; VIN Code G			16 (cont.)
QTY	MANIFOLD - INT. & EXH.	YEARS	PART NO.	DESCRIPTION	
1	Exh. Manifold Gasket Set	2011	MS 97154		
QTY	EXHAUST PIPE FLANGE	YEARS	PART NO.	DESCRIPTION	
1	Exhaust Pipe Gasket	2011	61473	Flange	
1	Exhaust Pipe Gasket	2011	61473	Loc. Front; Converter	
1	Exhaust Pipe Gasket	2011	61527	Loc. Rear; Converter	
QTY	CRANKSHAFT REAR SEAL	YEARS	PART NO.	DESCRIPTION	
1	Rear Main Seal Set	2011	BS 40731	Rubber; One-piece; New Part Number - Check for Availability	
QTY	VALVE COVER	YEARS	PART NO.	DESCRIPTION	
1	Valve Cover Gasket Set	2011	VS 50779 R	PermaDry® molded rubber gskt. incl.; New Part Number - Check for Availability	
QTY	VALVE STEM SEAL SET	YEARS	PART NO.	DESCRIPTION	
1	Valve Stem Seal Set	2011	SS 72931	Premium valve stem seals incl.	
QTY	THERMOSTAT HOUSING	YEARS	PART NO.	DESCRIPTION	
1	Thermostat Gasket	2011	35937	Thermostat Housing; Water outlet; New Part Number - Check for Availability	
1	Thermostat Gasket	2011	35938	Thermostat Housing; Thermostat seal; New Part Number - Check for Availability	
QTY	TIMING COVER	YEARS	PART NO.	DESCRIPTION	
1	Crankshaft Front Seal Set	2011	TCS 46142	New Part Number - Check for Availability	
1	Camshaft Front Seal Set	2011	TCS 46144	New Part Number - Check for Availability	
QTY	CARB & FUEL INJECTION	YEARS	PART NO.	DESCRIPTION	
1	Throttle Body Gasket	2011	61638		
QTY	EXHAUST GAS RECIRCULATION	YEARS	PART NO.	DESCRIPTION	
1	EGR Gasket	2011	71325	Pipe O-ring; New Part Number - Check for Availability	
17		1993 - 1991; 1.6L 97.5 (1598cc) SOHC L4 (8 Valve) 79mm Bore TBI; Gasoline; Naturally Aspirated Opel Eng.; VIN Code 6			17
QTY	CYLINDER HEAD	YEARS	PART NO.	DESCRIPTION	
1	Head Gasket	1993-91	9553 PT	Head bolts not incl.; Head bolt replacement recommended	
QTY	MANIFOLD - INT. & EXH.	YEARS	PART NO.	DESCRIPTION	
1	Int. Manifold Gasket Set	1993-91	MS 94021		
1	Exh. Manifold Gasket Set	1993-91	MS 94022		
QTY	EXHAUST PIPE FLANGE	YEARS	PART NO.	DESCRIPTION	
1	Exhaust Pipe Gasket	1993-91	60477	Packing	
QTY	OIL PAN	YEARS	PART NO.	DESCRIPTION	
1	Oil Pan Gasket Set	1993-91	OS 30590 C		
1	Drain Plug Gasket	1993-91	70822		
QTY	CRANKSHAFT REAR SEAL	YEARS	PART NO.	DESCRIPTION	
1	Rear Main Seal Set	1993-91	BS 40535	Rubber; One-piece; Improved design	
1	Repair Sleeve	1993-91	16275	Crankshaft; Use w/installation tool	
QTY	VALVE STEM SEAL SET	YEARS	PART NO.	DESCRIPTION	
1	Valve Stem Seal Set	1993-91	SS 72698	Premium valve stem seals incl.	
QTY	WATER OUTLET GASKET	YEARS	PART NO.	DESCRIPTION	
1	O-Ring	1993-91	35410	Water Outlet	
QTY	WATER PUMP	YEARS	PART NO.	DESCRIPTION	
1	Water Pump Gasket	1993-91	35411		
QTY	TIMING COVER	YEARS	PART NO.	DESCRIPTION	
1	Crankshaft Front Seal Set	1993-91	TCS 45831		
1	Camshaft Front Seal Set	1993-91	TCS 45603		
QTY	AIR CLEANER MOUNTING	YEARS	PART NO.	DESCRIPTION	
1	Air Cleaner Gasket	1993-91	60706		
QTY	CARB & FUEL INJECTION	YEARS	PART NO.	DESCRIPTION	
1	Throttle Body Gasket	1993-91	60765		
18		1997 - 1993; 1.8L 107.5 (1762cc) DOHC L4 (16 Valve) 81mm Bore MFI; Gasoline; Naturally Aspirated Toyota Eng.; VIN Code 8, Eng. Code 7AFE			18
QTY	CYLINDER HEAD	YEARS	PART NO.	DESCRIPTION	
1	Head Gasket	1997-93	9955 PT	Head bolts not incl.; Head bolt replacement recommended; PermaTorqueMLS®	
1	Head Set	1997-93	HS 9955 PT	Head bolts not incl.; Head bolt replacement recommended; PermaDry® molded rubber valve cover gskt. incl.; Premium valve stem seals incl.	
1	Head Bolt Set	1997-93	ES 72489	Head bolts w/Washers; Replacement recommended; New Part Number - Check for Availability	

GM Car (Incl. Buick, Cad., Chev., Geo, Olds., Pontiac, Saturn) (Cont.)

18 (cont.)		1997 - 1993; 1.8L 107.5 (1762cc) DOHC L4 (16 Valve) 81mm Bore			18 (cont.)
MFI; Gasoline; Naturally Aspirated Toyota Eng.; VIN Code 8, Eng. Code 7AFE					
QTY	CONVERSION SET	YEARS	PART NO.	DESCRIPTION	
1	Gasket Conversion Set	1997-93	CS 9955	RTV sealant incl. for Upper oil pan gskt.	
QTY	MANIFOLD - INT. & EXH.	YEARS	PART NO.	DESCRIPTION	
1	Int. Manifold Gasket Set	1997-93	MS 95516		
1	Exh. Manifold Gasket Set	1997-93	MS 94129		
QTY	EXHAUST PIPE FLANGE	YEARS	PART NO.	DESCRIPTION	
1	Exhaust Pipe Gasket	1997-93	23591	Flange; 1 31/32" ID x 2 35/64" OD	
2	Exhaust Pipe Gasket	1997-95	23591	Converter; 1 31/32" ID x 2 35/64" OD	
2	Exhaust Pipe Gasket	1994-93	23591	Converter; Exc. California; 1 31/32" ID x 2 35/64" OD	
1	Exhaust Pipe Gasket	1994-93	23591	Loc. Rear; Converter; California; 1 31/32" ID x 2 35/64" OD	
1	Exhaust Pipe Gasket	1994-93	60908	Loc. Front; Converter; California	
QTY	OIL PAN	YEARS	PART NO.	DESCRIPTION	
1	Oil Pan Gasket Set	1997-93	OS 30917 C	Loc. Lower	
1	Drain Plug Gasket	1997-93	70822		
QTY	CRANKSHAFT REAR SEAL	YEARS	PART NO.	DESCRIPTION	
1	Rear Main Seal Set	1997-93	BS 40409	Rubber; One-piece	
1	Repair Sleeve	1997-93	16277	Crankshaft; Use w/installation tool	
QTY	VALVE COVER	YEARS	PART NO.	DESCRIPTION	
1	Valve Cover Gasket Set	1997-93	VS 50440 R	w/Grommets & Spark plug tube seals; PermaDry® molded rubber gskt. incl.	
1	Spark Plug Tube Seal Set	1997-93	ES 72105	Valve Cover	
QTY	VALVE STEM SEAL SET	YEARS	PART NO.	DESCRIPTION	
1	Valve Stem Seal Set	1997-93	SS 72810	Premium valve stem seals incl.	
QTY	THERMOSTAT HOUSING	YEARS	PART NO.	DESCRIPTION	
1	Thermostat Gasket	1997-93	35592	Thermostat Housing; Thermostat inlet	
QTY	WATER OUTLET GASKET	YEARS	PART NO.	DESCRIPTION	
1	O-Ring	1997-93	35292	Water Outlet	
QTY	WATER PUMP	YEARS	PART NO.	DESCRIPTION	
1	Water Pump Gasket	1997-93	35235		
1	Water Pump Mounting Set	1997-93	ES 72073		
QTY	TIMING COVER	YEARS	PART NO.	DESCRIPTION	
1	Timing Cover Dust Seal Set	1997-93	ES 72747		
1	Crankshaft Front Seal Set	1997-93	TCS 45955		
1	Camshaft Front Seal Set	1997-93	TCS 45592		
QTY	CARB & FUEL INJECTION	YEARS	PART NO.	DESCRIPTION	
1	Fuel Injector O-Ring Set	1997-93	ES 70600		
1	Throttle Body Gasket	1997-93	60977		
QTY	DISTRIBUTOR MOUNTING	YEARS	PART NO.	DESCRIPTION	
1	Distributor Mounting Gasket	1997-93	72438	O-ring	
QTY	EXHAUST GAS RECIRCULATION	YEARS	PART NO.	DESCRIPTION	
1	EGR Gasket	1997-96	70264		
1	EGR Gasket	1995	70264	Exc. California	
1	EGR Gasket	1995	72554	California	
1	EGR Gasket	1994-93	72554		
19		1999 - 1998; 1.8L 109.4 (1794cc) DOHC L4 (16 Valve) 79mm Bore			19
MFI; Gasoline; Naturally Aspirated Toyota Eng.; VIN Code 8, Eng. Code 1ZZFE					
QTY	CYLINDER HEAD	YEARS	PART NO.	DESCRIPTION	
1	Head Gasket	1999-98	26158 PT-1	Head bolts not incl.; Head bolt replacement recommended; PermaTorqueMLS®; Improved design	
1	Head Set	1999-98	HS 26158 PT	Head bolts not incl.; Head bolt replacement recommended; PermaDry® molded rubber valve cover gskt. incl.; Premium valve stem seals incl.	
1	Head Bolt Set	1999-98	ES 71066-1	Head bolts w/Washers; Replacement recommended	
QTY	CONVERSION SET	YEARS	PART NO.	DESCRIPTION	
1	Gasket Conversion Set	1999-98	CS 26158		
QTY	MANIFOLD - INT. & EXH.	YEARS	PART NO.	DESCRIPTION	
1	Int. Manifold Gasket Set	1999-98	MS 93856		
1	Exh. Manifold Gasket Set	1999-98	MS 93909		
QTY	EXHAUST PIPE FLANGE	YEARS	PART NO.	DESCRIPTION	
2	Exhaust Pipe Gasket	1999-98	23591	Center pipe to muffler; 1 31/32" ID x 2 35/64" OD	
1	Exhaust Pipe Gasket	1999-98	61116	Converter	
1	Exhaust Pipe Gasket	1999-98	61124	Ring; 1.92" ID	
QTY	OIL PAN	YEARS	PART NO.	DESCRIPTION	
1	Oil Pan Gasket Set	1999-98	OS 30705 C		
1	Drain Plug Gasket	1999-98	70822		

GM Car (Incl. Buick, Cad., Chev., Geo, Olds., Pontiac, Saturn) (Cont.)

19 (cont.)		1999 - 1998; 1.8L 109.4 (1794cc) DOHC L4 (16 Valve) 79mm Bore			19 (cont.)
MFI; Gasoline; Naturally Aspirated Toyota Eng.; VIN Code 8, Eng. Code 1ZZFE					
QTY	CRANKSHAFT REAR SEAL	YEARS	PART NO.	DESCRIPTION	
1	Rear Main Seal Set	1999-98	BS 40661	Rubber; One-piece	
QTY	VALVE COVER	YEARS	PART NO.	DESCRIPTION	
1	Valve Cover Gasket Set	1999-98	VS 50544 R	w/Grommets & Spark plug tube seals; PermaDry® molded rubber gskt. incl.	
QTY	VALVE STEM SEAL SET	YEARS	PART NO.	DESCRIPTION	
1	Valve Stem Seal Set	1999-98	SS 72878-1	Premium valve stem seals incl.	
QTY	THERMOSTAT HOUSING	YEARS	PART NO.	DESCRIPTION	
1	Thermostat Gasket	1999-98	35445	Thermostat Housing; Thermostat inlet	
QTY	WATER PUMP	YEARS	PART NO.	DESCRIPTION	
1	Water Pump Gasket	1999-98	35672	O-ring	
QTY	TIMING COVER	YEARS	PART NO.	DESCRIPTION	
1	Crankshaft Front Seal Set	1999-98	TCS 45054		
QTY	CARB & FUEL INJECTION	YEARS	PART NO.	DESCRIPTION	
1	Throttle Body Gasket	1999-98	61128	Throttle body cover	
1	Throttle Body Gasket	1999-98	61134	Throttle body mounting; Exc. Eng. Ser. No. beginning w/Five - 5XXXXXX	
1	Throttle Body Gasket	1999-98	61134	Throttle body mounting; Exc. Eng. Ser. No. beginning w/Zero - 0XXXXXX	
1	Throttle Body Gasket	1999-98	61433	Throttle body mounting; Eng. Ser. No. beginning w/Five - 5XXXXXX	
1	Throttle Body Gasket	1999-98	61433	Throttle body mounting; Eng. Ser. No. beginning w/Zero - 0XXXXXX	
QTY	OIL PUMP COVER	YEARS	PART NO.	DESCRIPTION	
1	Oil Pump Gasket	1999-98	72749	Oil pump mounting; New Part Number - Check for Availability	
20		2008 - 2000; 1.8L 109.4 (1794cc) DOHC L4 (16 Valve) 79mm Bore VVT-i			20
MFI; Gasoline; Naturally Aspirated Toyota Eng.; VIN Code 8, Eng. Code 1ZZFE					
QTY	CYLINDER HEAD	YEARS	PART NO.	DESCRIPTION	
1	Head Gasket	2008-00	26158 PT-1	Head bolts not incl.; Head bolt replacement recommended; PermaTorqueMLS®; Improved design	
1	Head Set	2008-03	HS 26158 PT-3	Head bolts not incl.; Head bolt replacement recommended; PermaDry® molded rubber valve cover gskt. incl.; Premium valve stem seals incl.	
1	Head Set	2002-00	HS 26158 PT-1	Head bolts not incl.; Head bolt replacement recommended; PermaDry® molded rubber valve cover gskt. incl.; Premium valve stem seals incl.	
1	Head Bolt Set	2008-00	ES 71066-1	Head bolts w/Washers; Replacement recommended	
QTY	CONVERSION SET	YEARS	PART NO.	DESCRIPTION	
1	Gasket Conversion Set	2008-00	CS 26158		
QTY	MANIFOLD - INT. & EXH.	YEARS	PART NO.	DESCRIPTION	
1	Int. Manifold Gasket Set	2008-03	MS 93942		
1	Int. Manifold Gasket Set	2002-00	MS 93856		
1	Exh. Manifold Gasket Set	2008-00	MS 93909		
QTY	EXHAUST PIPE FLANGE	YEARS	PART NO.	DESCRIPTION	
1	Exhaust Pipe Gasket	2008-03	60479	Converter	
1	Exhaust Pipe Gasket	2008-03	61106	Flange; FWD; 2.40" ID	
1	Exhaust Pipe Gasket	2008-06	61016	Exh. connector; FWD; Improved design	
1	Exhaust Pipe Gasket	2006-03	60668	Exh. connector; AWD	
1	Exhaust Pipe Gasket	2006-03	61124	Flange; AWD; 1.92" ID	
1	Exhaust Pipe Gasket	2005	61016	From 04/01/05; Exh. connector; FWD; Improved design	
1	Exhaust Pipe Gasket	2005	61124	To 03/31/05; Exh. connector; FWD; 1.92" ID	
1	Exhaust Pipe Gasket	2004-03	61124	Exh. connector; FWD; 1.92" ID	
2	Exhaust Pipe Gasket	2002-00	23591	Center pipe to muffler; 1 31/32" ID x 2 35/64" OD	
1	Exhaust Pipe Gasket	2002-00	61116	Converter	
1	Exhaust Pipe Gasket	2002-00	61124	Ring; 1.92" ID	
QTY	OIL PAN	YEARS	PART NO.	DESCRIPTION	
1	Oil Pan Gasket Set	2008-00	OS 30705 C		
1	Drain Plug Gasket	2008-00	70822		
QTY	CRANKSHAFT REAR SEAL	YEARS	PART NO.	DESCRIPTION	
1	Rear Main Seal Set	2008-00	BS 40661	Rubber; One-piece	
QTY	VALVE COVER	YEARS	PART NO.	DESCRIPTION	
1	Valve Cover Gasket Set	2008-00	VS 50542 R	w/Grommets & Spark plug tube seals; PermaDry® molded rubber gskt. incl.	
QTY	VALVE STEM SEAL SET	YEARS	PART NO.	DESCRIPTION	
1	Valve Stem Seal Set	2008-03	SS 72878-2	Premium valve stem seals incl.	
1	Valve Stem Seal Set	2002-00	SS 72878-1	Premium valve stem seals incl.	
QTY	THERMOSTAT HOUSING	YEARS	PART NO.	DESCRIPTION	
1	Thermostat Gasket	2008-00	35445	Thermostat Housing; Thermostat inlet	
QTY	WATER PUMP	YEARS	PART NO.	DESCRIPTION	
1	Water Pump Gasket	2008-00	35672	O-ring	
QTY	TIMING COVER	YEARS	PART NO.	DESCRIPTION	
1	Crankshaft Front Seal Set	2008-00	TCS 45054		

GM Car (Incl. Buick, Cad., Chev., Geo, Olds., Pontiac, Saturn) (Cont.)

20 (cont.)	2008 - 2000; 1.8L 109.4 (1794cc) DOHC L4 (16 Valve) 79mm Bore VVT-i				20 (cont.)
QTY	CARB & FUEL INJECTION	YEARS	PART NO.	DESCRIPTION	
1	Throttle Body Gasket	2008-03	61128	Throttle body cover	
1	Throttle Body Gasket	2008-04	61421	Throttle body mounting; FWD	
1	Throttle Body Gasket	2006-04	61134	Throttle body mounting; AWD	
1	Throttle Body Gasket	2003	61134	Throttle body mounting	
1	Throttle Body Gasket	2002-00	61433	Throttle body mounting; Eng. Ser. No. beginning w/Five - 5XXXXXX	
1	Throttle Body Gasket	2002-00	61433	Throttle body mounting; Eng. Ser. No. beginning w/Zero - 0XXXXXX	
1	Throttle Body Gasket	2002-01	61085	Throttle body cover	
1	Throttle Body Gasket	2002-01	61286	Throttle body mounting; Exc. Eng. Ser. No. beginning w/Five - 5XXXXXX	
1	Throttle Body Gasket	2002-01	61286	Throttle body mounting; Exc. Eng. Ser. No. beginning w/Zero - 0XXXXXX	
1	Throttle Body Gasket	2000	61128	Throttle body cover	
1	Throttle Body Gasket	2000	61134	Throttle body mounting; Exc. Eng. Ser. No. beginning w/Five - 5XXXXXX	
1	Throttle Body Gasket	2000	61134	Throttle body mounting; Exc. Eng. Ser. No. beginning w/Zero - 0XXXXXX	
QTY	OIL PUMP COVER	YEARS	PART NO.	DESCRIPTION	
1	Oil Pump Gasket	2008-00	72749	Oil pump mounting; New Part Number - Check for Availability	
21	2006 - 2003; 1.8L 109.5 (1796cc) DOHC L4 (16 Valve) 82mm Bore VVT-i				21
QTY	CYLINDER HEAD	YEARS	PART NO.	DESCRIPTION	
1	Head Gasket	2006-03	26154 PT	Head bolts not incl.; Head bolt replacement recommended; PermaTorqueMLS®	
1	Head Set	2006-04	HS 26154 PT-3	Head bolts not incl.; Head bolt replacement recommended; PermaDry® molded rubber valve cover gskt. incl.; Premium valve stem seals incl.	
1	Head Set	2003	HS 26154 PT-2	To 05/01/03; Head bolts not incl.; Head bolt replacement recommended; PermaDry® molded rubber valve cover gskt. incl.; Premium valve stem seals incl.	
1	Head Set	2003	HS 26154 PT-3	From 05/01/03; Head bolts not incl.; Head bolt replacement recommended; PermaDry® molded rubber valve cover gskt. incl.; Premium valve stem seals incl.	
1	Head Bolt Set	2006-03	ES 71066-1	Head bolts w/Washers; Replacement recommended	
QTY	CONVERSION SET	YEARS	PART NO.	DESCRIPTION	
1	Gasket Conversion Set	2006-03	CS 26154		
QTY	MANIFOLD - INT. & EXH.	YEARS	PART NO.	DESCRIPTION	
1	Int. Manifold Gasket Set	2006-03	MS 93867-1		
1	Exh. Manifold Gasket Set	2006-04	MS 96398		
1	Exh. Manifold Gasket Set	2003	MS 93931	To 05/01/03	
1	Exh. Manifold Gasket Set	2003	MS 96398	From 05/01/03	
QTY	EXHAUST PIPE FLANGE	YEARS	PART NO.	DESCRIPTION	
1	Exhaust Pipe Gasket	2006-03	61106	Converter; 2.40" ID	
1	Exhaust Pipe Gasket	2006-03	61190	Flange	
QTY	OIL PAN	YEARS	PART NO.	DESCRIPTION	
1	Oil Pan Gasket Set	2006-03	OS 30705 C		
1	Drain Plug Gasket	2006-03	70822		
QTY	CRANKSHAFT REAR SEAL	YEARS	PART NO.	DESCRIPTION	
1	Rear Main Seal Set	2006-03	BS 40665	Rubber; One-piece	
QTY	VALVE COVER	YEARS	PART NO.	DESCRIPTION	
1	Valve Cover Gasket Set	2006-03	VS 50546 R	w/Spark plug tube seals; PermaDry® molded rubber gskt. incl.	
1	Spark Plug Tube Seal Set	2006-03	ES 72105	Valve Cover	
QTY	VALVE STEM SEAL SET	YEARS	PART NO.	DESCRIPTION	
1	Valve Stem Seal Set	2006-03	SS 71053	Premium valve stem seals incl.	
QTY	THERMOSTAT HOUSING	YEARS	PART NO.	DESCRIPTION	
1	Thermostat Gasket	2006-03	35445	Thermostat Housing; Thermostat inlet	
1	O-Ring	2006-03	35717	Thermostat Housing	
QTY	WATER PUMP	YEARS	PART NO.	DESCRIPTION	
1	O-Ring	2006-03	35717	Water Pump; Mounting O-ring	
QTY	TIMING COVER	YEARS	PART NO.	DESCRIPTION	
1	Timing Cover Set	2006-03	TCS 45047		
QTY	CARB & FUEL INJECTION	YEARS	PART NO.	DESCRIPTION	
1	Fuel Injector O-Ring Set	2006-03	ES 70600		
1	Throttle Body Gasket	2006-03	61128	Throttle body cover	
1	Throttle Body Gasket	2006-03	61193	Throttle body mounting	

GM Car (Incl. Buick, Cad., Chev., Geo, Olds., Pontiac, Saturn) (Cont.)

22		2009 - 2008; 1.8L 109.6 (1796cc) DOHC L4 (16 Valve) 80.5mm Bore Ecotec VVT			22
MFI; Gasoline; Naturally Aspirated Opel Eng.; VIN Code 1					
QTY	CYLINDER HEAD	YEARS	PART NO.	DESCRIPTION	
1	Head Bolt Set	2009-08	ES 72469	Replacement recommended; New Part Number - Check for Availability	
QTY	CONVERSION SET	YEARS	PART NO.	DESCRIPTION	
1	Gasket Conversion Set	2009-08	CS 26516	RTV sealant incl. for oil pan gskt.; RTV sealant incl. for water pump gskt.; New Part Number - Check for Availability	
QTY	MANIFOLD - INT. & EXH.	YEARS	PART NO.	DESCRIPTION	
1	Exh. Manifold Gasket Set	2009-08	MS 97154		
QTY	EXHAUST PIPE FLANGE	YEARS	PART NO.	DESCRIPTION	
1	Exhaust Pipe Gasket	2009-08	60582	Flange	
1	Exhaust Pipe Gasket	2009-08	61680	Converter; New Part Number - Check for Availability	
QTY	CRANKSHAFT REAR SEAL	YEARS	PART NO.	DESCRIPTION	
1	Rear Main Seal Set	2009-08	BS 40731	Rubber; One-piece; New Part Number - Check for Availability	
QTY	VALVE COVER	YEARS	PART NO.	DESCRIPTION	
1	Valve Cover Gasket Set	2009-08	VS 50779 R	PermaDry® molded rubber gskt. incl.; New Part Number - Check for Availability	
QTY	VALVE STEM SEAL SET	YEARS	PART NO.	DESCRIPTION	
1	Valve Stem Seal Set	2009-08	SS 72931	Premium valve stem seals incl.	
QTY	THERMOSTAT HOUSING	YEARS	PART NO.	DESCRIPTION	
1	Thermostat Gasket	2009-08	35937	Thermostat Housing; Thermostat case; New Part Number - Check for Availability	
1	Thermostat Gasket	2009-08	35938	Thermostat Housing; Thermostat seal; New Part Number - Check for Availability	
QTY	TIMING COVER	YEARS	PART NO.	DESCRIPTION	
1	Crankshaft Front Seal Set	2009-08	TCS 46142	New Part Number - Check for Availability	
1	Camshaft Front Seal Set	2009-08	TCS 46144	New Part Number - Check for Availability	
23		2012 - 2011; 1.8L 109.6 (1796cc) DOHC L4 (16 Valve) 80.5mm Bore Ecotec VVT			23
MFI; Gasoline; Naturally Aspirated Opel Eng.; VIN Code H					
QTY	CYLINDER HEAD	YEARS	PART NO.	DESCRIPTION	
1	Head Gasket	2012-11	26516 PT	Head bolts not incl.; Head bolt replacement recommended; PermaTorqueMLS®	
1	Head Set	2012-11	HS 26516 PT-1	Head bolts not incl.; Head bolt replacement recommended; PermaDry® molded rubber valve cover gskt. incl.; Premium valve stem seals incl.; New Part Number - Check for Availability	
1	Head Bolt Set	2012-11	ES 72469	Replacement recommended; New Part Number - Check for Availability	
QTY	CONVERSION SET	YEARS	PART NO.	DESCRIPTION	
1	Gasket Conversion Set	2012-11	CS 26516	RTV sealant incl. for oil pan gskt.; RTV sealant incl. for water pump gskt.; New Part Number - Check for Availability	
QTY	MANIFOLD - INT. & EXH.	YEARS	PART NO.	DESCRIPTION	
1	Int. Manifold Gasket Set	2012-11	MS 97206	New Part Number - Check for Availability	
1	Exh. Manifold Gasket Set	2012-11	MS 97154		
QTY	EXHAUST PIPE FLANGE	YEARS	PART NO.	DESCRIPTION	
1	Exhaust Pipe Gasket	2012-11	60582	Flange	
1	Exhaust Pipe Gasket	2012-11	61680	Converter; New Part Number - Check for Availability	
QTY	CRANKSHAFT REAR SEAL	YEARS	PART NO.	DESCRIPTION	
1	Rear Main Seal Set	2012-11	BS 40731	Rubber; One-piece; New Part Number - Check for Availability	
QTY	VALVE COVER	YEARS	PART NO.	DESCRIPTION	
1	Valve Cover Gasket Set	2012-11	VS 50779 R	PermaDry® molded rubber gskt. incl.; New Part Number - Check for Availability	
QTY	VALVE STEM SEAL SET	YEARS	PART NO.	DESCRIPTION	
1	Valve Stem Seal Set	2012-11	SS 72931	Premium valve stem seals incl.	
QTY	THERMOSTAT HOUSING	YEARS	PART NO.	DESCRIPTION	
1	Thermostat Gasket	2012-11	35937	Thermostat Housing; Thermostat case; New Part Number - Check for Availability	
1	Thermostat Gasket	2012-11	35938	Thermostat Housing; Thermostat seal; New Part Number - Check for Availability	
QTY	TIMING COVER	YEARS	PART NO.	DESCRIPTION	
1	Crankshaft Front Seal Set	2012-11	TCS 46142	New Part Number - Check for Availability	
1	Camshaft Front Seal Set	2012-11	TCS 46144	New Part Number - Check for Availability	
QTY	CARB & FUEL INJECTION	YEARS	PART NO.	DESCRIPTION	
1	Fuel Injector O-Ring Set	2012-11	ES 70599	Improved design	
1	Throttle Body Gasket	2012-11	61638		

GM Car (Incl. Buick, Cad., Chev., Geo, Olds., Pontiac, Saturn) (Cont.)

24		2010 - 2009; 1.8L 109.7 (1798cc) DOHC L4 (16 Valve) 80.5mm Bore VVT-i			24
		MFI; Gasoline; Naturally Aspirated Toyota Eng.; VIN Code 8, Eng. Code 2ZRFE			
QTY	CYLINDER HEAD	YEARS	PART NO.	DESCRIPTION	
1	Head Gasket	2010	26515 PT	Head bolts not incl.; Head bolt replacement recommended; PermaTorqueMLS®; Improved design	
1	Head Gasket	2009	26513 PT	1st Design; To 04/30/08; Head bolts not incl.; Head bolt replacement recommended; PermaTorqueMLS®; Old design	
1	Head Gasket	2009	26515 PT	1st Design; To 04/30/08; Head bolts not incl.; Head bolt replacement recommended; PermaTorqueMLS®; Improved design	
1	Head Gasket	2009	26515 PT	2nd Design; From 05/01/08; Head bolts not incl.; Head bolt replacement recommended; PermaTorqueMLS®; Improved design	
1	Head Set	2010	HS 26515 PT	Head bolts not incl.; Head bolt replacement recommended; PermaDry® molded rubber valve cover gskt. incl.; Premium valve stem seals incl.; Improved design; New Part Number - Check for Availability	
1	Head Set	2009	HS 26513 PT	1st Design; To 04/30/08; Head bolts not incl.; Head bolt replacement recommended; PermaDry® molded rubber valve cover gskt. incl.; Premium valve stem seals incl.; Old design	
1	Head Set	2009	HS 26515 PT	1st Design; To 04/30/08; Head bolts not incl.; Head bolt replacement recommended; PermaDry® molded rubber valve cover gskt. incl.; Premium valve stem seals incl.; Improved design; New Part Number - Check for Availability	
1	Head Set	2009	HS 26515 PT	2nd Design; From 05/01/08; Head bolts not incl.; Head bolt replacement recommended; PermaDry® molded rubber valve cover gskt. incl.; Premium valve stem seals incl.; Improved design; New Part Number - Check for Availability	
QTY	CONVERSION SET	YEARS	PART NO.	DESCRIPTION	
1	Gasket Conversion Set	2010-09	CS 26515	PermaDry® molded rubber oil pan gskt. incl.; New Part Number - Check for Availability	
QTY	MANIFOLD - INT. & EXH.	YEARS	PART NO.	DESCRIPTION	
1	Int. Manifold Gasket Set	2010-09	MS 97144	New Part Number - Check for Availability	
1	Exh. Manifold Gasket Set	2010-09	MS 97146		
QTY	EXHAUST PIPE FLANGE	YEARS	PART NO.	DESCRIPTION	
1	Exhaust Pipe Gasket	2010-09	61106	Flange; 2.40" ID	
1	Exhaust Pipe Gasket	2010	61598	Converter	
1	Exhaust Pipe Gasket	2009	61016	Converter; Improved design	
QTY	OIL PAN	YEARS	PART NO.	DESCRIPTION	
1	Oil Pan Gasket Set	2010-09	OS 30829	Rubber; Improved design; New Part Number - Check for Availability	
1	Oil Pan Gasket Set	2010-09	OS 30829 R	PermaDry® molded rubber gskt. incl.; Old design; Superseded - When depleted use OS 30829	
1	Drain Plug Gasket	2010-09	70822		
QTY	CRANKSHAFT REAR SEAL	YEARS	PART NO.	DESCRIPTION	
1	Rear Main Seal Set	2010-09	BS 40732	Rubber; One-piece; New Part Number - Check for Availability	
QTY	VALVE COVER	YEARS	PART NO.	DESCRIPTION	
1	Valve Cover Gasket Set	2010-09	VS 50776 R	w/Grommets & Spark plug tube seals; PermaDry® molded rubber gskt. incl.; New Part Number - Check for Availability	
QTY	VALVE STEM SEAL SET	YEARS	PART NO.	DESCRIPTION	
1	Valve Stem Seal Set	2010-09	SS 72878-2	Premium valve stem seals incl.	
QTY	THERMOSTAT HOUSING	YEARS	PART NO.	DESCRIPTION	
1	Thermostat Gasket	2010-09	35445	Thermostat Housing; Thermostat inlet	
1	Thermostat Gasket	2010-09	35949	Thermostat Housing	
QTY	WATER OUTLET GASKET	YEARS	PART NO.	DESCRIPTION	
1	Water Outlet Gasket	2010-09	35866		
QTY	WATER PUMP	YEARS	PART NO.	DESCRIPTION	
1	Water Pump Gasket	2010-09	35873		
QTY	TIMING COVER	YEARS	PART NO.	DESCRIPTION	
1	Crankshaft Front Seal Set	2010-09	TCS 46148	New Part Number - Check for Availability	
QTY	CARB & FUEL INJECTION	YEARS	PART NO.	DESCRIPTION	
1	Throttle Body Gasket	2010-09	61421		
25		1993 - 1992; 1.8L 110.3 (1808cc) DOHC L4 (16 Valve) 80mm Bore			25
		MFI; Gasoline; Naturally Aspirated Isuzu Eng.; VIN Code 8, Eng. Code 4XF1			
QTY	MANIFOLD - INT. & EXH.	YEARS	PART NO.	DESCRIPTION	
1	Int. Manifold Gasket Set	1993-92	MS 94270	Lower set; Upper set incl.	
1	Exh. Manifold Gasket Set	1993-92	MS 94506		
QTY	EXHAUST PIPE FLANGE	YEARS	PART NO.	DESCRIPTION	
2	Exhaust Pipe Gasket	1993-92	60856	Converter	

GM Car (Incl. Buick, Cad., Chev., Geo, Olds., Pontiac, Saturn) (Cont.)

25 (cont.)		1993 - 1992; 1.8L 110.3 (1808cc) DOHC L4 (16 Valve) 80mm Bore			25 (cont.)
MFI; Gasoline; Naturally Aspirated Isuzu Eng.; VIN Code 8, Eng. Code 4XF1					
QTY	EXHAUST PIPE FLANGE	YEARS	PART NO.	DESCRIPTION	
1	Exhaust Pipe Gasket	1993-92	60857	Flange	
QTY	CRANKSHAFT REAR SEAL	YEARS	PART NO.	DESCRIPTION	
1	Rear Main Seal Set	1993-92	BS 40524	Rubber; One-piece; Improved design	
QTY	VALVE COVER	YEARS	PART NO.	DESCRIPTION	
1	Valve Cover Gasket Set	1993-92	VS 50064 R	PermaDry® molded rubber gskt. incl.	
QTY	WATER OUTLET GASKET	YEARS	PART NO.	DESCRIPTION	
1	Water Outlet Gasket	1993-92	35559	Water Outlet	
2	O-Ring	1993-92	35654	Water Outlet; Inlet bypass; Improved design	
QTY	WATER PUMP	YEARS	PART NO.	DESCRIPTION	
1	Water Pump Gasket	1993-92	35454		
QTY	TIMING COVER	YEARS	PART NO.	DESCRIPTION	
1	Crankshaft Front Seal Set	1993-92	TCS 45853		
QTY	CARB & FUEL INJECTION	YEARS	PART NO.	DESCRIPTION	
2	Fuel Injector O-Ring Set	1993-92	ES 70599	Improved design	
1	Throttle Body Gasket	1993-92	60842		
QTY	EXHAUST GAS RECIRCULATION	YEARS	PART NO.	DESCRIPTION	
1	EGR Gasket	1993-92	70372	Valve	
1	EGR Gasket	1993-92	70697	Pipe	
26		2002 - 1991; 1.9L 116 (1901cc) DOHC L4 (16 Valve) 82mm Bore			26
MFI; Gasoline; Naturally Aspirated GMC Eng.; Saturn; VIN Code 7					
QTY	CYLINDER HEAD	YEARS	PART NO.	DESCRIPTION	
1	Head Gasket	2002-91	9968 PT	Head bolts not incl.; Head bolt replacement recommended	
1	Head Set	2002-00	HS 9968 PT-4	Head bolts not incl.; Head bolt replacement recommended; PermaDry® molded rubber valve cover gskt. w/Integral Grommets incl.; Premium valve stem seals incl.	
1	Head Set	1999	HS 9968 PT-3	Head bolts not incl.; Head bolt replacement recommended; PermaDry® molded rubber valve cover gskt. w/Integral Grommets incl.; Premium valve stem seals incl.	
1	Head Set	1998-96	HS 9968 PT-2	Head bolts not incl.; Head bolt replacement recommended; PermaDry® molded rubber valve cover gskt. w/Integral Grommets incl.; Premium valve stem seals incl.	
1	Head Set	1995-94	HS 9968 PT	w/Aluminum valve cover; Valve cover gskt. & head bolts not incl.; Head bolt replacement recommended; Premium valve stem seals incl.	
1	Head Set	1995-94	HS 9968 PT-1	w/Aluminum valve cover; Head bolts not incl.; Head bolt replacement recommended; PermaDry® molded rubber valve cover gskt. w/Integral Grommets incl.; Premium valve stem seals incl.	
1	Head Set	1995-94	HS 9968 PT-2	w/Plastic valve cover; Head bolts not incl.; Head bolt replacement recommended; PermaDry® molded rubber valve cover gskt. w/Integral Grommets incl.; Premium valve stem seals incl.	
1	Head Set	1993-91	HS 9968 PT	Valve cover gskt. & head bolts not incl.; Head bolt replacement recommended; Premium valve stem seals incl.	
1	Head Set	1993-91	HS 9968 PT-1	Head bolts not incl.; Head bolt replacement recommended; PermaDry® molded rubber valve cover gskt. w/Integral Grommets incl.; Premium valve stem seals incl.	
1	Head Bolt Set	2002-91	ES 72903	Head bolts w/Washers; Replacement recommended	
QTY	CONVERSION SET	YEARS	PART NO.	DESCRIPTION	
1	Gasket Conversion Set	2002-91	CS 9971	RTV sealant incl. for oil pan gskt.	
QTY	MANIFOLD - INT. & EXH.	YEARS	PART NO.	DESCRIPTION	
1	Int. Manifold Gasket Set	2002-00	MS 94191		
1	Int. Manifold Gasket Set	1999-91	MS 95630		
1	Exh. Manifold Gasket Set	2002-99	MS 96118		
1	Exh. Manifold Gasket Set	1998-91	MS 95632		
QTY	EXHAUST PIPE FLANGE	YEARS	PART NO.	DESCRIPTION	
1	Exhaust Pipe Gasket	2002-93	61188	Flange	
1	Exhaust Pipe Gasket	1992-91	60993	Flange	
QTY	CRANKSHAFT REAR SEAL	YEARS	PART NO.	DESCRIPTION	
1	Rear Main Seal Set	2002-91	BS 40464	11.0mm thick; Rubber; One-piece; Improved design	
1	Repair Sleeve Tool	2002-91	16304	Crankshaft	
QTY	VALVE COVER	YEARS	PART NO.	DESCRIPTION	
1	Valve Cover Gasket Set	2002-99	VS 50549 R	w/Grommets & Spark plug tube seals; PermaDry® molded rubber gskt. incl.	
1	Valve Cover Gasket Set	1998-96	VS 50454 R	w/Grommets & Spark plug tube seals; PermaDry® molded rubber gskt. incl.	

GM Car (Incl. Buick, Cad., Chev., Geo, Olds., Pontiac, Saturn) (Cont.)

26 (cont.)		2002 - 1991; 1.9L 116 (1901cc) DOHC L4 (16 Valve) 82mm Bore			26 (cont.)
MFI; Gasoline; Naturally Aspirated GMC Eng.; Saturn; VIN Code 7					
QTY	VALVE COVER	YEARS	PART NO.	DESCRIPTION	
1	Valve Cover Gasket Set	1995-94	VS 50451 R	w/Aluminum valve cover; w/Grommets & Spark plug tube seals; PermaDry® molded rubber gskt. incl.	
1	Valve Cover Gasket Set	1995-94	VS 50453 R	w/Aluminum valve cover; RTV Black silicone w/Grommets	
1	Valve Cover Gasket Set	1995-94	VS 50454 R	w/Plastic valve cover; w/Grommets & Spark plug tube seals; PermaDry® molded rubber gskt. incl.	
1	Valve Cover Gasket Set	1993-91	VS 50451 R	w/Grommets & Spark plug tube seals; PermaDry® molded rubber gskt. incl.	
1	Valve Cover Gasket Set	1993-91	VS 50453 R	RTV Black silicone w/Grommets	
QTY	VALVE STEM SEAL SET	YEARS	PART NO.	DESCRIPTION	
1	Valve Stem Seal Set	2002-99	SS 71051	Premium valve stem seals incl.	
2	Valve Stem Seal Set	1998-91	SS 72867	Premium valve stem seals incl.	
QTY	WATER OUTLET GASKET	YEARS	PART NO.	DESCRIPTION	
1	Water Outlet Gasket	2002-91	35087	Water Outlet	
QTY	WATER PUMP	YEARS	PART NO.	DESCRIPTION	
1	Water Pump Gasket	2002-91	35090		
QTY	TIMING COVER	YEARS	PART NO.	DESCRIPTION	
1	Crankshaft Front Seal Set	2002-91	TCS 45958		
QTY	CARB & FUEL INJECTION	YEARS	PART NO.	DESCRIPTION	
1	Throttle Body Gasket	2002-00	61156		
1	Throttle Body Gasket	1999-91	61177		
QTY	EXHAUST GAS RECIRCULATION	YEARS	PART NO.	DESCRIPTION	
1	EGR Gasket	2002-95	70789		
1	EGR Gasket	1994	70789	California	
1	EGR Gasket	1994	70978	Exc. California	
1	EGR Gasket	1993-91	70978		
27		2002 - 1995; 1.9L 116 (1901cc) SOHC L4 (8 Valve) 82mm Bore			27
MFI; Gasoline; Naturally Aspirated GMC Eng.; Saturn; VIN Code 8					
QTY	CYLINDER HEAD	YEARS	PART NO.	DESCRIPTION	
1	Head Gasket	2002-95	9971 PT	Head bolts not incl.; Head bolt replacement recommended	
1	Head Set	2002-00	HS 9971 PT-2	Head bolts not incl.; Head bolt replacement recommended; PermaDry® molded rubber valve cover gskt. incl.; Premium valve stem seals incl.	
1	Head Set	1999-95	HS 9971 PT-1	Head bolts not incl.; Head bolt replacement recommended; PermaDry® molded rubber valve cover gskt. incl.; Premium valve stem seals incl.	
1	Head Bolt Set	2002-95	ES 72902	Replacement recommended	
QTY	CONVERSION SET	YEARS	PART NO.	DESCRIPTION	
1	Gasket Conversion Set	2002-95	CS 9971	RTV sealant incl. for oil pan gskt.	
QTY	MANIFOLD - INT. & EXH.	YEARS	PART NO.	DESCRIPTION	
1	Int. Manifold Gasket Set	2002-95	MS 94286	Improved design	
1	Exh. Manifold Gasket Set	2002-00	MS 96117		
1	Exh. Manifold Gasket Set	1999-95	MS 95631		
QTY	EXHAUST PIPE FLANGE	YEARS	PART NO.	DESCRIPTION	
1	Exhaust Pipe Gasket	2002-95	61188	Flange	
QTY	CRANKSHAFT REAR SEAL	YEARS	PART NO.	DESCRIPTION	
1	Rear Main Seal Set	2002-95	BS 40464	11.0mm thick; Rubber; One-piece; Improved design	
1	Repair Sleeve Tool	2002-95	16304	Crankshaft	
QTY	VALVE COVER	YEARS	PART NO.	DESCRIPTION	
1	Valve Cover Gasket Set	2002-95	VS 50447 R	RTV Black silicone w/Grommets	
1	Valve Cover Gasket Set	2002-95	VS 50701 R	w/Grommets; PermaDry® molded rubber gskt. incl.	
QTY	VALVE STEM SEAL SET	YEARS	PART NO.	DESCRIPTION	
1	Valve Stem Seal Set	2002-95	SS 72867	Premium valve stem seals incl.	
QTY	WATER OUTLET GASKET	YEARS	PART NO.	DESCRIPTION	
1	Water Outlet Gasket	2002-95	35087	Water Outlet	
QTY	WATER PUMP	YEARS	PART NO.	DESCRIPTION	
1	Water Pump Gasket	2002-95	35090		
QTY	TIMING COVER	YEARS	PART NO.	DESCRIPTION	
1	Crankshaft Front Seal Set	2002-95	TCS 45958		
QTY	CARB & FUEL INJECTION	YEARS	PART NO.	DESCRIPTION	
1	Throttle Body Gasket	2002-95	61177		
QTY	EXHAUST GAS RECIRCULATION	YEARS	PART NO.	DESCRIPTION	
1	EGR Gasket	2002-95	70789		

GM Car (Incl. Buick, Cad., Chev., Geo, Olds., Pontiac, Saturn) (Cont.)

28		1994 - 1991; 1.9L 116 (1901cc) SOHC L4 (8 Valve) 82mm Bore			28
TBI; Gasoline; Naturally Aspirated GMC Eng.; Saturn; VIN Code 9					
QTY	CYLINDER HEAD	YEARS	PART NO.	DESCRIPTION	
1	Head Gasket	1994-91	9971 PT	Head bolts not incl.; Head bolt replacement recommended	
1	Head Set	1994-91	HS 9971 PT	Head bolts not incl.; Head bolt replacement recommended; PermaDry® molded rubber valve cover gskt. incl.; Premium valve stem seals incl.	
1	Head Installation Set	1994-91	HIS 9971 PT	Head bolts & exh. pipe flange not incl.; Head bolt replacement recommended; RTV sealant incl. for valve cover gskt.	
1	Head Bolt Set	1994-91	ES 72902	Replacement recommended	
QTY	CONVERSION SET	YEARS	PART NO.	DESCRIPTION	
1	Gasket Conversion Set	1994-91	CS 9971	RTV sealant incl. for oil pan gskt.	
QTY	MANIFOLD - INT. & EXH.	YEARS	PART NO.	DESCRIPTION	
1	Int. Manifold Gasket Set	1994-91	MS 95629		
1	Exh. Manifold Gasket Set	1994-91	MS 95631		
QTY	EXHAUST PIPE FLANGE	YEARS	PART NO.	DESCRIPTION	
1	Exhaust Pipe Gasket	1994-91	61188	Flange	
QTY	CRANKSHAFT REAR SEAL	YEARS	PART NO.	DESCRIPTION	
1	Rear Main Seal Set	1994-91	BS 40464	11.0mm thick; Rubber; One-piece; Improved design	
1	Repair Sleeve Tool	1994-91	16304	Crankshaft	
QTY	VALVE COVER	YEARS	PART NO.	DESCRIPTION	
1	Valve Cover Gasket Set	1994-91	VS 50447 R	RTV Black silicone w/Grommets	
1	Valve Cover Gasket Set	1994-91	VS 50701 R	w/Grommets; PermaDry® molded rubber gskt. incl.	
QTY	VALVE STEM SEAL SET	YEARS	PART NO.	DESCRIPTION	
1	Valve Stem Seal Set	1994-91	SS 72867	Premium valve stem seals incl.	
QTY	WATER OUTLET GASKET	YEARS	PART NO.	DESCRIPTION	
1	Water Outlet Gasket	1994-91	35087	Water Outlet	
QTY	WATER PUMP	YEARS	PART NO.	DESCRIPTION	
1	Water Pump Gasket	1994-91	35090		
QTY	TIMING COVER	YEARS	PART NO.	DESCRIPTION	
1	Crankshaft Front Seal Set	1994-91	TCS 45958		
QTY	CARB & FUEL INJECTION	YEARS	PART NO.	DESCRIPTION	
1	Throttle Body Gasket	1994-91	60998		
QTY	EXHAUST GAS RECIRCULATION	YEARS	PART NO.	DESCRIPTION	
1	EGR Gasket	1994-91	70954		
29		2007 - 2004; 2.0L 122 (1998cc) DOHC L4 (16 Valve) 86mm Bore Ecotec			29
MFI; Gasoline; Supercharged Opel Eng.; VIN Code P					
QTY	CYLINDER HEAD	YEARS	PART NO.	DESCRIPTION	
1	Head Bolt Set	2007-04	ES 72196	Replacement recommended	
QTY	EXHAUST PIPE FLANGE	YEARS	PART NO.	DESCRIPTION	
1	Exhaust Pipe Gasket	2007-04	61362	Loc. Front; Converter	
1	Exhaust Pipe Gasket	2007-04	61440	Loc. Rear; Converter	
QTY	OIL PAN	YEARS	PART NO.	DESCRIPTION	
1	Drain Plug Gasket	2007-04	70820		
QTY	CRANKSHAFT REAR SEAL	YEARS	PART NO.	DESCRIPTION	
1	Rear Main Seal Set	2007-04	BS 40671	Rubber; One-piece; Improved design	
1	Rear Main Seal Set	2007-04	BS 40739	Rubber; One-piece; New Improved design; New Part Number - Check for Availability	
QTY	VALVE COVER	YEARS	PART NO.	DESCRIPTION	
1	Valve Cover Gasket Set	2007-04	VS 50772 R	w/Grommets & Spark plug tube seals; PermaDry® molded rubber gskt. incl.; New Part Number - Check for Availability	
QTY	VALVE STEM SEAL SET	YEARS	PART NO.	DESCRIPTION	
1	Valve Stem Seal Set	2007-04	SS 71198	Premium valve stem seals incl.	
QTY	THERMOSTAT HOUSING	YEARS	PART NO.	DESCRIPTION	
1	Water Outlet Gasket	2007-04	35346	Thermostat Housing; Thermostat seal	
QTY	WATER PUMP	YEARS	PART NO.	DESCRIPTION	
1	Water Pump Gasket	2007-04	35721	Mounting	
1	Water Pump Gasket	2007-04	35724	Cover	
1	Water Pump Mounting Set	2007-04	ES 71282		
QTY	TIMING COVER	YEARS	PART NO.	DESCRIPTION	
1	Timing Cover Set	2007-04	TCS 46079		
1	Crankshaft Front Seal Set	2007-04	TCS 46113		
QTY	CARB & FUEL INJECTION	YEARS	PART NO.	DESCRIPTION	
1	Throttle Body Gasket	2007-04	61337	Improved design	

GM Car (Incl. Buick, Cad., Chev., Geo, Olds., Pontiac, Saturn) (Cont.)

30		2010 - 2007; 2.0L 122 (1998cc) DOHC L4 (16 Valve) 86mm Bore Ecotec MFI; Gasoline; Turbo - Intercooled Opel Eng.; VIN Code X			30
QTY	CYLINDER HEAD	YEARS	PART NO.	DESCRIPTION	
1	Head Bolt Set	2010-07	ES 72196	Replacement recommended	
QTY	MANIFOLD - INT. & EXH.	YEARS	PART NO.	DESCRIPTION	
1	Exh. Manifold Gasket Set	2010-07	MS 97122		
QTY	EXHAUST PIPE FLANGE	YEARS	PART NO.	DESCRIPTION	
1	Exhaust Pipe Gasket	2010-07	61348	Saturn Sky Red Line; Loc. Rear; Converter	
1	Exhaust Pipe Gasket	2010-07	61527	Pontiac Solstice GXP; Loc. Rear; Converter	
QTY	OIL PAN	YEARS	PART NO.	DESCRIPTION	
1	Drain Plug Gasket	2010-07	70820		
QTY	CRANKSHAFT REAR SEAL	YEARS	PART NO.	DESCRIPTION	
1	Rear Main Seal Set	2010-07	BS 40739	Rubber; One-piece; New Improved design; New Part Number - Check for Availability	
1	Rear Main Seal Set	2010-07	BS 40671	Rubber; One-piece; Improved design	
QTY	VALVE COVER	YEARS	PART NO.	DESCRIPTION	
1	Valve Cover Gasket Set	2010-07	VS 50778 R	w/Spark plug tube seals; PermaDry® molded rubber gskt. incl.; New Part Number - Check for Availability	
QTY	VALVE STEM SEAL SET	YEARS	PART NO.	DESCRIPTION	
1	Valve Stem Seal Set	2010-07	SS 71198	Premium valve stem seals incl.	
QTY	THERMOSTAT HOUSING	YEARS	PART NO.	DESCRIPTION	
1	Water Outlet Gasket	2010-07	35346	Thermostat Housing; Thermostat seal	
QTY	WATER PUMP	YEARS	PART NO.	DESCRIPTION	
1	Water Pump Gasket	2010-07	35721	Mounting	
1	Water Pump Gasket	2010-07	35724	Cover	
1	Water Pump Mounting Set	2010-07	ES 71282		
QTY	TIMING COVER	YEARS	PART NO.	DESCRIPTION	
1	Timing Cover Set	2010-07	TCS 46079		
1	Crankshaft Front Seal Set	2010-07	TCS 46113		
31		2009 - 2004; 2.0L 122 (1998cc) DOHC L4 (16 Valve) 86mm Bore Ecotec MFI; Gasoline; Naturally Aspirated Opel Eng.; VIN Code Z			31
QTY	CYLINDER HEAD	YEARS	PART NO.	DESCRIPTION	
1	Head Gasket	2009-04	26317 PT	Head bolts not incl.; Head bolt replacement recommended	
1	Head Set	2009-06	HS 26317 PT	Head bolts not incl.; Head bolt replacement recommended; EGR adapter gskt. NOT INCLUDED; PermaDry® molded rubber valve cover gskt. incl.; Premium valve stem seals incl.	
1	Head Set	2009-06	HS 26317 PT-2	Head bolts not incl.; Head bolt replacement recommended; EGR adapter gskt. INCLUDED; PermaDry® molded rubber valve cover gskt. incl.; Premium valve stem seals incl.; New Part Number - Check for Availability	
1	Head Set	2005-04	HS 26317 PT	Head bolts not incl.; Head bolt replacement recommended; PermaDry® molded rubber valve cover gskt. incl.; Premium valve stem seals incl.	
1	Head Bolt Set	2009-04	ES 72906-1	Head bolts w/Washers; Replacement recommended	
QTY	CONVERSION SET	YEARS	PART NO.	DESCRIPTION	
1	Gasket Conversion Set	2009-04	CS 26317	RTV sealant incl. for oil pan gskt.	
QTY	MANIFOLD - INT. & EXH.	YEARS	PART NO.	DESCRIPTION	
1	Int. Manifold Gasket Set	2009-04	MS 96859		
1	Exh. Manifold Gasket Set	2009-04	MS 96815		
QTY	EXHAUST PIPE FLANGE	YEARS	PART NO.	DESCRIPTION	
1	Exhaust Pipe Gasket	2009-04	61473	Ring	
1	Exhaust Pipe Gasket	2009-04	61475	Exh. connector; 3-bolt	
1	Exhaust Pipe Gasket	2009-04	61488	Exh. connector; 2-bolt	
QTY	CRANKSHAFT REAR SEAL	YEARS	PART NO.	DESCRIPTION	
1	Rear Main Seal Set	2009-04	BS 40555	Rubber; One-piece	
QTY	VALVE COVER	YEARS	PART NO.	DESCRIPTION	
1	Valve Cover Gasket Set	2009-04	VS 50692 R	w/Grommets & Spark plug tube seals; PermaDry® molded rubber gskt. incl.	
QTY	VALVE STEM SEAL SET	YEARS	PART NO.	DESCRIPTION	
1	Valve Stem Seal Set	2009-04	SS 71163-1	Premium valve stem seals incl.	
QTY	THERMOSTAT HOUSING	YEARS	PART NO.	DESCRIPTION	
1	Thermostat Gasket	2009-04	35820	Thermostat Housing; Thermostat seal	
QTY	WATER OUTLET GASKET	YEARS	PART NO.	DESCRIPTION	
1	Water Outlet Gasket	2009-04	35821	Water Outlet	
QTY	WATER PUMP	YEARS	PART NO.	DESCRIPTION	
1	Water Pump Gasket	2009-04	35302	O-ring	
QTY	TIMING COVER	YEARS	PART NO.	DESCRIPTION	
1	Crankshaft Front Seal Set	2009-04	TCS 46097		

GM Car (Incl. Buick, Cad., Chev., Geo, Olds., Pontiac, Saturn) (Cont.)

31		2009 - 2004; 2.0L 122 (1998cc) DOHC L4 (16 Valve) 86mm Bore Ecotec			31	
(cont.)		MFI; Gasoline; Naturally Aspirated Opel Eng.; VIN Code Z			(cont.)	
QTY	TIMING COVER	YEARS	PART NO.	DESCRIPTION		
1	Camshaft Front Seal Set	2009-04	TCS 46094			
QTY	CARB & FUEL INJECTION	YEARS	PART NO.	DESCRIPTION		
1	Fuel Injector O-Ring Set	2009-04	ES 70599	Upper set; Injectors to fuel rail; Improved design		
1	Fuel Injector O-Ring Set	2009-04	ES 71190	Lower set; Injectors to cylinder head		
1	Throttle Body Gasket	2009-04	61384			
QTY	EXHAUST GAS RECIRCULATION	YEARS	PART NO.	DESCRIPTION		
1	EGR Gasket	2009-04	71269	Valve		
1	EGR Gasket	2009-06	71379	Adapter; New Part Number - Check for Availability		
1	EGR Gasket	2005-04	71270	Adapter		
32		2013 - 2011; 2.0L 122 (1998cc) DOHC L4 (16 Valve) 86mm Bore Ecotec VVT			32	
		DI; Gasoline; Turbo - Intercooled Opel Eng.; VIN Code V				
QTY	CYLINDER HEAD	YEARS	PART NO.	DESCRIPTION		
1	Head Bolt Set	2012-11	ES 72196	Replacement recommended		
QTY	MANIFOLD - INT. & EXH.	YEARS	PART NO.	DESCRIPTION		
1	Exh. Manifold Gasket Set	2012-11	MS 97122			
QTY	CRANKSHAFT REAR SEAL	YEARS	PART NO.	DESCRIPTION		
1	Rear Main Seal Set	2013-11	BS 40739	Rubber; One-piece; New Improved design; New Part Number - Check for Availability		
1	Rear Main Seal Set	2012-11	BS 40671	Rubber; One-piece; Improved design		
QTY	VALVE STEM SEAL SET	YEARS	PART NO.	DESCRIPTION		
1	Valve Stem Seal Set	2012-11	SS 71198	Premium valve stem seals incl.		
QTY	THERMOSTAT HOUSING	YEARS	PART NO.	DESCRIPTION		
1	Water Outlet Gasket	2012-11	35346	Thermostat Housing; Thermostat seal		
QTY	WATER PUMP	YEARS	PART NO.	DESCRIPTION		
1	Water Pump Gasket	2012-11	35721	Mounting		
1	Water Pump Gasket	2012-11	35724	Cover		
1	Water Pump Mounting Set	2012-11	ES 71282			
QTY	TIMING COVER	YEARS	PART NO.	DESCRIPTION		
1	Timing Cover Set	2012-11	TCS 46079			
1	Crankshaft Front Seal Set	2012-11	TCS 46113			
33		1994 - 1992; 2.0L 122 (1998cc) SOHC L4 (8 Valve) 86mm Bore			33	
		MFI; Gasoline; Naturally Aspirated Opel Eng.; VIN Code H				
QTY	CYLINDER HEAD	YEARS	PART NO.	DESCRIPTION		
1	Head Gasket	1994-92	9014 PT	Head bolts not incl.; Head bolt replacement required; PermaTorque®		
1	Head Set	1994-92	HS 9188 PT-1	Head bolts & exh. pipe packing not incl.; Head bolt replacement required; Premium valve stem seals incl.		
1	Head Installation Set	1994-92	HIS 9188 PT-1	Head bolts & exh. pipe packing not incl.; Head bolt replacement required		
1	Head Bolt Set	1994-92	ES 72728	Replacement required		
QTY	CONVERSION SET	YEARS	PART NO.	DESCRIPTION		
1	Gasket Conversion Set	1994-92	CS 9472	Oil pan gskt. not incl.		
QTY	MANIFOLD - INT. & EXH.	YEARS	PART NO.	DESCRIPTION		
1	Int. Manifold Gasket Set	1994-92	MS 93625			
1	Exh. Manifold Gasket Set	1994-92	MS 92081			
QTY	EXHAUST PIPE FLANGE	YEARS	PART NO.	DESCRIPTION		
1	Exhaust Pipe Gasket	1994-92	60525	Pipe to manifold; 1 45/64" ID steel sleeve; Improved design		
2	Exhaust Pipe Gasket	1994-92	60850	Converter; 51mm ID		
1	Exh. Flange Bolt & Spring Kit	1994-92	ES 72141			
QTY	CRANKSHAFT REAR SEAL	YEARS	PART NO.	DESCRIPTION		
1	Rear Main Seal Set	1994-92	BS 40555	Rubber; One-piece		
1	Repair Sleeve Tool	1994-92	16300	Crankshaft		
QTY	VALVE COVER	YEARS	PART NO.	DESCRIPTION		
1	Valve Cover Gasket Set	1994-92	VS 50243 C	Cork		
1	Valve Cover Gasket Set	1994-92	VS 50243 T	PermaDryPlus®		
QTY	VALVE STEM SEAL SET	YEARS	PART NO.	DESCRIPTION		
1	Valve Stem Seal Set	1994-92	SS 72698	Premium valve stem seals incl.		
QTY	WATER OUTLET GASKET	YEARS	PART NO.	DESCRIPTION		
1	Thermostat Gasket	1994-92	35435	Water Outlet		
1	O-Ring	1994-92	35261	Water Outlet		
QTY	WATER PUMP	YEARS	PART NO.	DESCRIPTION		
1	Water Pump Gasket	1994-92	35302	O-ring		
QTY	TIMING COVER	YEARS	PART NO.	DESCRIPTION		
1	Crankshaft Front Seal Set	1994-92	TCS 45604			

GM Car (Incl. Buick, Cad., Chev., Geo, Olds., Pontiac, Saturn) (Cont.)

33 (cont.)		1994 - 1992; 2.0L 122 (1998cc) SOHC L4 (8 Valve) 86mm Bore			33 (cont.)
MFI; Gasoline; Naturally Aspirated Opel Eng.; VIN Code H					
QTY	TIMING COVER	YEARS	PART NO.	DESCRIPTION	
1	Camshaft Front Seal Set	1994-92	TCS 45603		
1	Repair Sleeve Tool	1994-92	16303	Timing Cover	
QTY	CARB & FUEL INJECTION	YEARS	PART NO.	DESCRIPTION	
1	Throttle Body Gasket	1994-92	60974		
QTY	EXHAUST GAS RECIRCULATION	YEARS	PART NO.	DESCRIPTION	
1	EGR Gasket	1994-92	70954		
34		1991; 2.0L 122 (1998cc) SOHC L4 (8 Valve) 86mm Bore			34
TBI; Gasoline; Naturally Aspirated Opel Eng.; VIN Code K					
QTY	CYLINDER HEAD	YEARS	PART NO.	DESCRIPTION	
1	Head Gasket	1991	9014 PT	Head bolts not incl.; Head bolt replacement required; PermaTorque®	
1	Head Set	1991	HS 9188 PT-1	Head bolts & exh. pipe packing not incl.; Head bolt replacement required; Premium valve stem seals incl.	
1	Head Installation Set	1991	HIS 9188 PT-1	Head bolts & exh. pipe packing not incl.; Head bolt replacement required	
1	Head Bolt Set	1991	ES 72728	Replacement required	
QTY	CONVERSION SET	YEARS	PART NO.	DESCRIPTION	
1	Gasket Conversion Set	1991	CS 9472	PermaDry® molded rubber oil pan gskt. incl.	
QTY	MANIFOLD - INT. & EXH.	YEARS	PART NO.	DESCRIPTION	
1	Int. Manifold Gasket Set	1991	MS 93625		
1	Exh. Manifold Gasket Set	1991	MS 92081		
QTY	EXHAUST PIPE FLANGE	YEARS	PART NO.	DESCRIPTION	
1	Exhaust Pipe Gasket	1991	60525	Pipe to manifold; 1 45/64" ID steel sleeve; Improved design	
2	Exhaust Pipe Gasket	1991	60850	Converter; 51mm ID	
1	Exh. Flange Bolt & Spring Kit	1991	ES 72141		
QTY	OIL PAN	YEARS	PART NO.	DESCRIPTION	
1	Oil Pan Gasket Set	1991	OS 30574 R	PermaDry® molded rubber gskt. incl.	
QTY	CRANKSHAFT REAR SEAL	YEARS	PART NO.	DESCRIPTION	
1	Rear Main Seal Set	1991	BS 40555	Rubber; One-piece	
1	Repair Sleeve Tool	1991	16300	Crankshaft	
QTY	VALVE COVER	YEARS	PART NO.	DESCRIPTION	
1	Valve Cover Gasket Set	1991	VS 50243 C	Cork	
1	Valve Cover Gasket Set	1991	VS 50243 T	PermaDryPlus®	
QTY	VALVE STEM SEAL SET	YEARS	PART NO.	DESCRIPTION	
1	Valve Stem Seal Set	1991	SS 72698	Premium valve stem seals incl.	
QTY	WATER OUTLET GASKET	YEARS	PART NO.	DESCRIPTION	
1	Thermostat Gasket	1991	35435	Water Outlet	
1	O-Ring	1991	35261	Water Outlet	
QTY	WATER PUMP	YEARS	PART NO.	DESCRIPTION	
1	Water Pump Gasket	1991	35302	O-ring	
QTY	TIMING COVER	YEARS	PART NO.	DESCRIPTION	
1	Crankshaft Front Seal Set	1991	TCS 45604		
1	Camshaft Front Seal Set	1991	TCS 45603		
1	Repair Sleeve Tool	1991	16303	Timing Cover	
QTY	AIR CLEANER MOUNTING	YEARS	PART NO.	DESCRIPTION	
1	Air Cleaner Gasket	1991	60706		
QTY	CARB & FUEL INJECTION	YEARS	PART NO.	DESCRIPTION	
1	Throttle Body Gasket	1991	60863		
QTY	EXHAUST GAS RECIRCULATION	YEARS	PART NO.	DESCRIPTION	
1	EGR Gasket	1991	70954		
35		2002 - 1992; 2.2L 134 (2189cc) OHV L4 (8 Valve) 89mm Bore			35
MFI; Gasoline; Naturally Aspirated GMC Eng.; Chevrolet; VIN Code 4					
QTY	CYLINDER HEAD	YEARS	PART NO.	DESCRIPTION	
1	Head Gasket	2002-98	9170 PT-1	Head bolts not incl.; Head bolt replacement recommended; PermaTorque®; Improved design	
1	Head Gasket	1997-92	9469 PT	Head bolts not incl.; Head bolt replacement recommended; PermaTorque®	
1	Head Gasket Spacer Shim	1997-92	9469 SP	HeadSaver®	
1	Head Set	2002-98	HS 9170 PT-1	Head bolts & exh. pipe packing not incl.; Head bolt replacement recommended; PermaDry® molded rubber valve cover gskt. incl.; Premium valve stem seals incl.	
1	Head Set	1997-94	HS 9469 PT-2	Head bolts & exh. pipe packing not incl.; Head bolt replacement recommended; PermaDry® molded rubber valve cover gskt. incl.; Premium valve stem seals incl.	

GM Car (Incl. Buick, Cad., Chev., Geo, Olds., Pontiac, Saturn) (Cont.)

35 (cont.)		2002 - 1992; 2.2L 134 (2189cc) OHV L4 (8 Valve) 89mm Bore			35 (cont.)	
MFI; Gasoline; Naturally Aspirated GMC Eng.; Chevrolet; VIN Code 4						
QTY	CYLINDER HEAD	YEARS	PART NO.	DESCRIPTION		
1	Head Set	1993	HS 9469 PT-1	w/8mm valve stem diameter; 8th digit of head casting is not followed by an "S"; Head bolts & exh. pipe packing not incl.; Head bolt replacement recommended; PermaDry® molded rubber valve cover gskt. incl.; Premium valve stem seals incl.		
1	Head Set	1993	HS 9469 PT-2	w/7mm valve stem diameter; 8th digit of head casting is followed by an "S"; Head bolts & exh. pipe packing not incl.; Head bolt replacement recommended; PermaDry® molded rubber valve cover gskt. incl.; Premium valve stem seals incl.		
1	Head Set	1992	HS 9469 PT-1	Head bolts & exh. pipe packing not incl.; Head bolt replacement recommended; PermaDry® molded rubber valve cover gskt. incl.; Premium valve stem seals incl.		
1	Head Installation Set	1997-94	HIS 9469 PT-2	Head bolts & exh. pipe packing not incl.; Head bolt replacement recommended; PermaDry® molded rubber valve cover gskt. incl.		
1	Head Installation Set	1993	HIS 9469 PT-1	w/8mm valve stem diameter; 8th digit of head casting is not followed by an "S"; Head bolts & exh. pipe packing not incl.; Head bolt replacement recommended; PermaDry® molded rubber valve cover gskt. incl.		
1	Head Installation Set	1993	HIS 9469 PT-2	w/7mm valve stem diameter; 8th digit of head casting is followed by an "S"; Head bolts & exh. pipe packing not incl.; Head bolt replacement recommended; PermaDry® molded rubber valve cover gskt. incl.		
1	Head Installation Set	1992	HIS 9469 PT-1	Head bolts & exh. pipe packing not incl.; Head bolt replacement recommended; PermaDry® molded rubber valve cover gskt. incl.		
1	Head Bolt Set	2002-98	ES 72170	Replacement recommended		
1	Head Bolt Set	1997-95	ES 72172	Replacement recommended		
1	Head Bolt Set	1994-93	ES 74016	Replacement recommended		
1	Head Bolt Set	1992	ES 72164	Replacement recommended		
QTY	CONVERSION SET	YEARS	PART NO.	DESCRIPTION		
1	Gasket Conversion Set	2002-92	CS 9469			
QTY	MANIFOLD - INT. & EXH.	YEARS	PART NO.	DESCRIPTION		
1	Int. Manifold Gasket Set	2002-98	MS 90543			
1	Int. Manifold Gasket Set	1997-92	MS 95393	Lower set; Upper set incl.		
1	Plenum Gasket Set	1997-92	MS 95397	Upper set		
1	Exh. Manifold Gasket Set	2002-98	MS 90540			
1	Exh. Manifold Gasket Set	1997-92	MS 93812			
QTY	EXHAUST PIPE FLANGE	YEARS	PART NO.	DESCRIPTION		
2	Exhaust Pipe Gasket	2002-92	60850	Converter; 1 or 2 Req'd.; 51mm ID		
1	Exhaust Pipe Gasket	2002-97	60720	Flange		
1	Exhaust Pipe Gasket	1996	60525	Chevrolet Beretta Base, Cavalier Base, LS, Corsica Base Pontiac Sunfire GT, SE; Packing; 1 45/64" ID steel sleeve; Improved design		
1	Exhaust Pipe Gasket	1996	60982	Buick Century Custom, Limited, Special Oldsmobile Ciera SL, Cutlass Ciera Base; Flange		
1	Exhaust Pipe Gasket	1996	61019	Chevrolet Beretta Base, Cavalier Base, LS, Corsica Base Pontiac Sunfire GT, SE; Packing; May use 60525 instead; Old design		
1	Exhaust Pipe Gasket	1995	60525	Chevrolet Beretta Base, Cavalier Base, LS, Corsica Base Pontiac Sunfire GT, SE; Packing; California; w/M/T; 1 45/64" ID steel sleeve; Improved design		
1	Exhaust Pipe Gasket	1995	60525	Chevrolet Beretta Base, Cavalier Base, LS, Corsica Base Pontiac Sunfire GT, SE; Packing; Exc. California; 1 45/64" ID steel sleeve; Improved design		
1	Exhaust Pipe Gasket	1995	60982	Buick Century Custom, Special Oldsmobile Ciera Cruiser SL, SL, Cutlass Ciera Base; Flange		
1	Exhaust Pipe Gasket	1995	60982	Chevrolet Beretta Base, Cavalier Base, LS, Corsica Base Pontiac Sunfire GT, SE; Flange; California; w/A/T		
1	Exhaust Pipe Gasket	1995	61019	Chevrolet Beretta Base, Cavalier Base, LS, Corsica Base Pontiac Sunfire GT, SE; Packing; California; w/M/T; May use 60525 instead; Old design		
1	Exhaust Pipe Gasket	1995	61019	Chevrolet Beretta Base, Cavalier Base, LS, Corsica Base Pontiac Sunfire GT, SE; Packing; Exc. California; May use 60525 instead; Old design		
1	Exhaust Pipe Gasket	1994	60525	Chevrolet Beretta Base, Cavalier RS, VL, Corsica Base Pontiac Tempest Base; Packing; 1 45/64" ID steel sleeve; Improved design		
1	Exhaust Pipe Gasket	1994	60982	Buick Century Custom, Special Oldsmobile Cutlass Ciera Base, Cruiser S, S, SL; Flange		
1	Exhaust Pipe Gasket	1994	61019	Chevrolet Beretta Base, Cavalier RS, VL, Corsica Base Pontiac Tempest Base; Packing; May use 60525 instead; Old design		
1	Exhaust Pipe Gasket	1993	60477	Chevrolet Beretta Base, GT, Cavalier RS, VL, Corsica LT, Lumina Base, Euro Pontiac Tempest Base; Packing; w/o Adapter		
1	Exhaust Pipe Gasket	1993	60538	Chevrolet Beretta Base, GT, Cavalier RS, VL, Corsica LT, Lumina Base, Euro Pontiac Tempest Base; Packing; w/Adapter		

GM Car (Incl. Buick, Cad., Chev., Geo, Olds., Pontiac, Saturn) (Cont.)

35 (cont.)		2002 - 1992; 2.2L 134 (2189cc) OHV L4 (8 Valve) 89mm Bore			35 (cont.)
MFI; Gasoline; Naturally Aspirated GMC Eng.; Chevrolet; VIN Code 4					
QTY	EXHAUST PIPE FLANGE	YEARS	PART NO.	DESCRIPTION	
1	Exhaust Pipe Gasket	1993	60817	Buick Century Custom, Limited, Special Oldsmobile Cutlass Ciera Base, Cruiser S, Cruiser SL, S, SL; Flange	
1	Exhaust Pipe Gasket	1992	60538	Packing	
QTY	OIL PAN	YEARS	PART NO.	DESCRIPTION	
1	Oil Pan Gasket Set	2002-92	OS 34300 C		
1	Drain Plug Gasket	2002-98	70820		
1	Drain Plug Gasket	1997-92	70822		
QTY	CRANKSHAFT REAR SEAL	YEARS	PART NO.	DESCRIPTION	
1	Rear Main Seal Set	2002-92	BS 40464	11.0mm thick; Rubber; One-piece; Improved design	
1	Rear Main Seal Set	2002-92	BS 40625	11.0mm thick; PTFE Rubber; One-piece; Improved design	
1	Repair Sleeve Tool	2002-92	16304	Crankshaft	
QTY	VALVE COVER	YEARS	PART NO.	DESCRIPTION	
1	Valve Cover Gasket Set	2002-98	VS 50485 R	PermaDry® molded rubber gskt. incl.	
1	Valve Cover Gasket Set	1997-92	VS 50313 R	PermaDry® molded rubber gskt. incl.	
QTY	VALVE STEM SEAL SET	YEARS	PART NO.	DESCRIPTION	
1	Valve Stem Seal Set	2002-98	SS 70809	Premium valve stem seals incl.	
1	Valve Stem Seal Set	1997-94	SS 72852	Premium valve stem seals incl.	
1	Valve Stem Seal Set	1993	SS 70816	w/8mm valve stem diameter; 8th digit of head casting is not followed by an "S"; Premium valve stem seals incl.	
1	Valve Stem Seal Set	1993	SS 72852	w/7mm valve stem diameter; 8th digit of head casting is followed by an "S"; Premium valve stem seals incl.	
1	Valve Stem Seal Set	1992	SS 70816	Premium valve stem seals incl.	
QTY	THERMOSTAT HOUSING	YEARS	PART NO.	DESCRIPTION	
1	Thermostat Gasket	2002-93	35614	Thermostat Housing; Thermostat seal; Improved design	
1	Thermostat Gasket	1994-93	35393	Thermostat Housing; Thermostat adapter	
QTY	WATER OUTLET GASKET	YEARS	PART NO.	DESCRIPTION	
1	Water Outlet Gasket	1997-92	35560	Water Outlet	
QTY	WATER PUMP	YEARS	PART NO.	DESCRIPTION	
1	Water Pump Gasket	2002-92	35392	Mounting	
1	Water Pump Gasket	2002-92	36025	Water pump inlet; New Part Number - Check for Availability	
QTY	TIMING COVER	YEARS	PART NO.	DESCRIPTION	
1	Timing Cover Set	2002-92	TCS 45793	w/o Sleeve 'N' Seal®	
1	Timing Cover Gasket	2002-92	72739	New Part Number - Check for Availability	
1	Timing Set w/Sleeve & Seal	2002-92	TCS 45762	w/Sleeve 'N' Seal®	
1	Repair Sleeve	2002-92	16202	Timing Cover; Use w/installation tool	
1	Repair Sleeve Tool	2002-92	16312	Timing Cover	
QTY	CARB & FUEL INJECTION	YEARS	PART NO.	DESCRIPTION	
1	Fuel Injector O-Ring Set	2002-98	ES 70599	Upper set; Injectors to fuel rail; Improved design	
1	Fuel Injector O-Ring Set	2002-98	ES 71190	Lower set; Injectors to cylinder head	
1	Fuel Injector O-Ring Set	2002-00	ES 71192	Upper set; Injectors to fuel rail; Old design	
1	Fuel Injector O-Ring Set	1997-92	ES 71188	Upper set & Lower set; Injectors to fuel rail & Injectors to cylinder head	
1	Throttle Body Gasket	2002-98	61021		
QTY	EXHAUST GAS RECIRCULATION	YEARS	PART NO.	DESCRIPTION	
1	EGR Gasket	2002-96	70789	EGR valve	
1	EGR Gasket	2002-98	70805	EGR adapter cover; New Part Number - Check for Availability	
1	EGR Gasket	2002-98	70808	EGR adapter	
1	EGR Gasket	1997-95	70621	EGR adapter	
1	EGR Gasket	1997-95	70621	Thermostat adapter	
1	EGR Gasket	1995-92	70954	EGR valve	
36		1991; 2.2L 134 (2189cc) OHV L4 (8 Valve) 89mm Bore			36
TBI; Gasoline; Naturally Aspirated GMC Eng.; Chevrolet; VIN Code G					
QTY	CYLINDER HEAD	YEARS	PART NO.	DESCRIPTION	
1	Head Gasket	1991	9469 PT	Head bolts not incl.; Head bolt replacement recommended; PermaTorque®	
1	Head Gasket Spacer Shim	1991	9469 SP	HeadSaver®	
1	Head Set	1991	HS 9469 PT	Head bolts & exh. pipe packing not incl.; Head bolt replacement recommended; PermaDry® molded rubber valve cover gskt. incl.; Premium valve stem seals incl.	
1	Head Installation Set	1991	HIS 9469 PT	Head bolts & exh. pipe packing not incl.; Head bolt replacement recommended; PermaDry® molded rubber valve cover gskt. incl.	
1	Head Bolt Set	1991	ES 72164	Replacement recommended	
QTY	CONVERSION SET	YEARS	PART NO.	DESCRIPTION	
1	Gasket Conversion Set	1991	CS 9469		
QTY	MANIFOLD - INT. & EXH.	YEARS	PART NO.	DESCRIPTION	
1	Int. Manifold Gasket Set	1991	MS 93811		

GM Car (Incl. Buick, Cad., Chev., Geo, Olds., Pontiac, Saturn) (Cont.)

36 (cont.)		1991; 2.2L 134 (2189cc) OHV L4 (8 Valve) 89mm Bore			36 (cont.)
TBI; Gasoline; Naturally Aspirated GMC Eng.; Chevrolet; VIN Code G					
QTY	MANIFOLD - INT. & EXH.	YEARS	PART NO.	DESCRIPTION	
1	Exh. Manifold Gasket Set	1991	MS 93812		
QTY	EXHAUST PIPE FLANGE	YEARS	PART NO.	DESCRIPTION	
1	Exhaust Pipe Gasket	1991	60538	Packing	
2	Exhaust Pipe Gasket	1991	60850	Converter; 1 or 2 Req'd.; 51mm ID	
QTY	OIL PAN	YEARS	PART NO.	DESCRIPTION	
1	Oil Pan Gasket Set	1991	OS 34300 C		
1	Drain Plug Gasket	1991	70822		
QTY	CRANKSHAFT REAR SEAL	YEARS	PART NO.	DESCRIPTION	
1	Rear Main Seal Set	1991	BS 40464	11.0mm thick; Rubber; One-piece; Improved design	
1	Rear Main Seal Set	1991	BS 40625	11.0mm thick; PTFE Rubber; One-piece; Improved design	
1	Repair Sleeve Tool	1991	16304	Crankshaft	
QTY	VALVE COVER	YEARS	PART NO.	DESCRIPTION	
1	Valve Cover Gasket Set	1991	VS 50313 R	PermaDry® molded rubber gskt. incl.	
QTY	VALVE STEM SEAL SET	YEARS	PART NO.	DESCRIPTION	
1	Valve Stem Seal Set	1991	SS 70816	Premium valve stem seals incl.	
QTY	WATER OUTLET GASKET	YEARS	PART NO.	DESCRIPTION	
1	Water Outlet Gasket	1991	35560	Water Outlet	
QTY	WATER PUMP	YEARS	PART NO.	DESCRIPTION	
1	Water Pump Gasket	1991	35392	Mounting	
1	Water Pump Gasket	1991	36025	Water pump inlet; New Part Number - Check for Availability	
QTY	TIMING COVER	YEARS	PART NO.	DESCRIPTION	
1	Timing Cover Set	1991	TCS 45793	w/o Sleeve 'N' Seal®	
1	Timing Cover Gasket	1991	72739	New Part Number - Check for Availability	
1	Timing Set w/Sleeve & Seal	1991	TCS 45762	w/Sleeve 'N' Seal®	
1	Repair Sleeve	1991	16202	Timing Cover; Use w/installation tool	
1	Repair Sleeve Tool	1991	16312	Timing Cover	
QTY	AIR CLEANER MOUNTING	YEARS	PART NO.	DESCRIPTION	
1	Air Cleaner Gasket	1991	60807		
QTY	CARB & FUEL INJECTION	YEARS	PART NO.	DESCRIPTION	
1	Throttle Body Gasket	1991	60785		
QTY	EXHAUST GAS RECIRCULATION	YEARS	PART NO.	DESCRIPTION	
1	EGR Gasket	1991	70954	EGR valve	
37		2003 - 2002; 2.2L 134.1 (2198cc) DOHC L4 (16 Valve) 86mm Bore Ecotec			37
MFI; Gasoline; Naturally Aspirated Opel Eng.; VIN Code 2					
QTY	CYLINDER HEAD	YEARS	PART NO.	DESCRIPTION	
1	Head Gasket	2003-02	26223 PT	Head bolts not incl.; Head bolt replacement recommended; PermaTorqueMLS® LaserWeld® Technology	
1	Head Set	2003-02	HS 26223 PT	w/A/T; Exc. California; Head bolts not incl.; Head bolt replacement recommended; Must be used w/TCS 46041; PermaDry® molded rubber valve cover gskt. incl.; Premium valve stem seals incl.	
1	Head Set	2003-02	HS 26223 PT-4	w/A/T; California; Head bolts not incl.; Head bolt replacement recommended; Must be used w/TCS 46041; PermaDry® molded rubber valve cover gskt. incl.; Premium valve stem seals incl.	
1	Head Set	2003-02	HS 26223 PT-4	w/M/T; Head bolts not incl.; Head bolt replacement recommended; Must be used w/TCS 46041; PermaDry® molded rubber valve cover gskt. incl.; Premium valve stem seals incl.	
1	Head Bolt Set	2003-02	ES 72196	Replacement recommended	
QTY	CONVERSION SET	YEARS	PART NO.	DESCRIPTION	
1	Gasket Conversion Set	2003-02	CS 26223	RTV sealant incl. for oil pan gskt.	
QTY	MANIFOLD - INT. & EXH.	YEARS	PART NO.	DESCRIPTION	
1	Int. Manifold Gasket Set	2003-02	MS 96340		
1	Exh. Manifold Gasket Set	2003-02	MS 96376	w/A/T; California	
1	Exh. Manifold Gasket Set	2003-02	MS 96376	w/M/T	
1	Exh. Manifold Gasket Set	2003-02	MS 96377	w/A/T; Exc. California	
QTY	EXHAUST PIPE FLANGE	YEARS	PART NO.	DESCRIPTION	
1	Exhaust Pipe Gasket	2003-02	60666	Packing	
1	Exhaust Pipe Gasket	2003-02	61187	Converter	
1	Exhaust Pipe Gasket	2003-02	61308	Flange	
QTY	CRANKSHAFT REAR SEAL	YEARS	PART NO.	DESCRIPTION	
1	Rear Main Seal Set	2003-02	BS 40671	Rubber; One-piece; Improved design	
1	Rear Main Seal Set	2003-02	BS 40739	Rubber; One-piece; New Improved design; New Part Number - Check for Availability	

GM Car (Incl. Buick, Cad., Chev., Geo, Olds., Pontiac, Saturn) (Cont.)

37		2003 - 2002; 2.2L 134.1 (2198cc) DOHC L4 (16 Valve) 86mm Bore Ecotec			37
(cont.)		MFI; Gasoline; Naturally Aspirated Opel Eng.; VIN Code 2			(cont.)
QTY	VALVE COVER	YEARS	PART NO.	DESCRIPTION	
1	Valve Cover Gasket Set	2003-02	VS 50596 R	w/Grommets & Spark plug tube seals; PermaDry® molded rubber gskt. incl.	
QTY	VALVE STEM SEAL SET	YEARS	PART NO.	DESCRIPTION	
1	Valve Stem Seal Set	2003-02	SS 71198	Premium valve stem seals incl.	
QTY	WATER OUTLET GASKET	YEARS	PART NO.	DESCRIPTION	
1	Water Outlet Gasket	2003-02	35346	Water Outlet	
QTY	WATER PUMP	YEARS	PART NO.	DESCRIPTION	
1	Water Pump Gasket	2003-02	35721	Mounting	
1	Water Pump Gasket	2003-02	35724	Cover	
1	Water Pump Mounting Set	2003-02	ES 71282		
QTY	TIMING COVER	YEARS	PART NO.	DESCRIPTION	
1	Timing Cover Set	2003-02	TCS 46041		
1	Crankshaft Front Seal Set	2003-02	TCS 46112		
QTY	CARB & FUEL INJECTION	YEARS	PART NO.	DESCRIPTION	
2	Fuel Injector O-Ring Set	2003-02	ES 70599	Improved design	
1	Throttle Body Gasket	2003-02	61021		
QTY	EXHAUST GAS RECIRCULATION	YEARS	PART NO.	DESCRIPTION	
1	EGR Gasket	2003-02	71194		
38		2005 - 2003; 2.2L 134.1 (2198cc) DOHC L4 (16 Valve) 86mm Bore Ecotec			38
		MFI; Flex Fuel; Naturally Aspirated Opel Eng.; VIN Code 6			
QTY	CYLINDER HEAD	YEARS	PART NO.	DESCRIPTION	
1	Head Gasket	2005-03	26223 PT	Head bolts not incl.; Head bolt replacement recommended; PermaTorqueMLS® LaserWeld® Technology	
1	Head Set	2005-03	HS 26223 PT-1	Head bolts not incl.; Head bolt replacement recommended; Must be used w/TCS 46041; PermaDry® molded rubber valve cover gskt. incl.; Premium valve stem seals incl.	
1	Head Bolt Set	2005-03	ES 72196	Replacement recommended	
QTY	CONVERSION SET	YEARS	PART NO.	DESCRIPTION	
1	Gasket Conversion Set	2005-03	CS 26223	RTV sealant incl. for oil pan gskt.	
QTY	MANIFOLD - INT. & EXH.	YEARS	PART NO.	DESCRIPTION	
1	Int. Manifold Gasket Set	2005-03	MS 96351		
1	Exh. Manifold Gasket Set	2005-03	MS 96377		
QTY	EXHAUST PIPE FLANGE	YEARS	PART NO.	DESCRIPTION	
1	Exhaust Pipe Gasket	2005-03	60666	Packing	
1	Exhaust Pipe Gasket	2005-03	60850	Converter; 51mm ID	
QTY	CRANKSHAFT REAR SEAL	YEARS	PART NO.	DESCRIPTION	
1	Rear Main Seal Set	2005-03	BS 40671	Rubber; One-piece; Improved design	
1	Rear Main Seal Set	2005-03	BS 40739	Rubber; One-piece; New Improved design; New Part Number - Check for Availability	
QTY	VALVE COVER	YEARS	PART NO.	DESCRIPTION	
1	Valve Cover Gasket Set	2005-03	VS 50596 R	w/Grommets & Spark plug tube seals; PermaDry® molded rubber gskt. incl.	
QTY	VALVE STEM SEAL SET	YEARS	PART NO.	DESCRIPTION	
1	Valve Stem Seal Set	2005-03	SS 71198	Premium valve stem seals incl.	
QTY	THERMOSTAT HOUSING	YEARS	PART NO.	DESCRIPTION	
1	O-Ring	2003	35725	Thermostat Housing	
QTY	WATER OUTLET GASKET	YEARS	PART NO.	DESCRIPTION	
1	Water Outlet Gasket	2005-04	35346	Water Outlet	
QTY	WATER PUMP	YEARS	PART NO.	DESCRIPTION	
1	Water Pump Gasket	2005-03	35721	Mounting	
1	Water Pump Gasket	2005-03	35724	Cover	
1	Water Pump Mounting Set	2005-03	ES 71282		
QTY	TIMING COVER	YEARS	PART NO.	DESCRIPTION	
1	Timing Cover Set	2005-03	TCS 46041		
1	Crankshaft Front Seal Set	2005-03	TCS 46112		
QTY	CARB & FUEL INJECTION	YEARS	PART NO.	DESCRIPTION	
1	Fuel Injector O-Ring Set	2005-03	ES 70599	Upper set; Injectors to fuel rail; Improved design	
1	Fuel Injector O-Ring Set	2005-03	ES 71190	Lower set; Injectors to cylinder head	
1	Throttle Body Gasket	2005-03	61309		
QTY	EXHAUST GAS RECIRCULATION	YEARS	PART NO.	DESCRIPTION	
1	EGR Gasket	2005-03	71194		

GM Car (Incl. Buick, Cad., Chev., Geo, Olds., Pontiac, Saturn) (Cont.)

39		2008 - 2000; 2.2L 134.1 (2198cc) DOHC L4 (16 Valve) 86mm Bore Ecotec			39
MFI; Gasoline; Naturally Aspirated Opel Eng.; VIN Code F					
QTY	CYLINDER HEAD	YEARS	PART NO.	DESCRIPTION	
1	Head Gasket	2008-00	26223 PT	Head bolts not incl.; Head bolt replacement recommended; PermaTorqueMLS® LaserWeld® Technology	
1	Head Set	2008	HS 26223 PT-5	w/o Secondary Air Injection Pump; Head bolts not incl.; Head bolt replacement recommended; Must be used w/TCS 46079; PermaDry® molded rubber valve cover gskt. incl.; Premium valve stem seals incl.	
1	Head Set	2008	HS 26223 PT-5	w/Secondary Air Injection Pump; Exh. manifold gskt. & head bolts not incl.; Head bolt replacement recommended; Must be used w/TCS 46079; PermaDry® molded rubber valve cover gskt. incl.; Premium valve stem seals incl.	
1	Head Set	2007	HS 26223 PT-5	Saturn Ion 2 Base, Ion 3 Base; California; Exh. manifold gskt. & head bolts not incl.; Head bolt replacement recommended; Must be used w/TCS 46079; PermaDry® molded rubber valve cover gskt. incl.; Premium valve stem seals incl.	
1	Head Set	2007	HS 26223 PT-5	Saturn Ion 2 Base, Ion 3 Base; Exc. California; Head bolts not incl.; Head bolt replacement recommended; Must be used w/TCS 46079; PermaDry® molded rubber valve cover gskt. incl.; Premium valve stem seals incl.	
1	Head Set	2007	HS 26223 PT-5	Exc. Saturn Ion 2 Base, Ion 3 Base; w/o Secondary Air Injection Pump; Head bolts not incl.; Head bolt replacement recommended; Must be used w/TCS 46079; PermaDry® molded rubber valve cover gskt. incl.; Premium valve stem seals incl.	
1	Head Set	2007	HS 26223 PT-5	Exc. Saturn Ion 2 Base, Ion 3 Base; w/Secondary Air Injection Pump; Exh. manifold gskt. & head bolts not incl.; Head bolt replacement recommended; Must be used w/TCS 46079; PermaDry® molded rubber valve cover gskt. incl.; Premium valve stem seals incl.	
1	Head Set	2006	HS 26223 PT-1	Saturn Ion 2 Base, Ion 3 Base; Head bolts not incl.; Head bolt replacement recommended; Must be used w/TCS 46079; PermaDry® molded rubber valve cover gskt. incl.; Premium valve stem seals incl.	
1	Head Set	2006	HS 26223 PT-1	Exc. Saturn Ion 2 Base, Ion 3 Base; w/o Secondary Air Injection Pump; Head bolts not incl.; Head bolt replacement recommended; Must be used w/TCS 46079; PermaDry® molded rubber valve cover gskt. incl.; Premium valve stem seals incl.	
1	Head Set	2006	HS 26223 PT-1	Exc. Saturn Ion 2 Base, Ion 3 Base; w/Secondary Air Injection Pump; Exh. manifold gskt. & head bolts not incl.; Head bolt replacement recommended; Must be used w/TCS 46079; PermaDry® molded rubber valve cover gskt. incl.; Premium valve stem seals incl.	
1	Head Set	2005-04	HS 26223 PT-1	Head bolts not incl.; Head bolt replacement recommended; Must be used w/TCS 46041; PermaDry® molded rubber valve cover gskt. incl.; Premium valve stem seals incl.	
1	Head Set	2003-02	HS 26223 PT	Saturn L100 Base, L200 Base, LW Series Base, LW100 Base, LW200 Base; w/A/T; Exc. California; Head bolts not incl.; Head bolt replacement recommended; Must be used w/TCS 46041; PermaDry® molded rubber valve cover gskt. incl.; Premium valve stem seals incl.	
1	Head Set	2003-02	HS 26223 PT-1	Exc. Saturn L100 Base, L200 Base, LW Series Base, LW100 Base, LW200 Base; Head bolts not incl.; Head bolt replacement recommended; Must be used w/TCS 46041; PermaDry® molded rubber valve cover gskt. incl.; Premium valve stem seals incl.	
1	Head Set	2003-02	HS 26223 PT-4	Saturn L100 Base, L200 Base, LW Series Base, LW100 Base, LW200 Base; w/A/T; California; Head bolts not incl.; Head bolt replacement recommended; Must be used w/TCS 46041; PermaDry® molded rubber valve cover gskt. incl.; Premium valve stem seals incl.	
1	Head Set	2003-02	HS 26223 PT-4	Saturn L100 Base, L200 Base, LW Series Base, LW100 Base, LW200 Base; w/M/T; Head bolts not incl.; Head bolt replacement recommended; Must be used w/TCS 46041; PermaDry® molded rubber valve cover gskt. incl.; Premium valve stem seals incl.	
1	Head Set	2001	HS 26223 PT	w/A/T; Exc. California; Head bolts not incl.; Head bolt replacement recommended; Must be used w/TCS 46041; PermaDry® molded rubber valve cover gskt. incl.; Premium valve stem seals incl.	
1	Head Set	2001	HS 26223 PT-4	w/A/T; California; Head bolts not incl.; Head bolt replacement recommended; Must be used w/TCS 46041; PermaDry® molded rubber valve cover gskt. incl.; Premium valve stem seals incl.	
1	Head Set	2001	HS 26223 PT-4	w/M/T; Head bolts not incl.; Head bolt replacement recommended; Must be used w/TCS 46041; PermaDry® molded rubber valve cover gskt. incl.; Premium valve stem seals incl.	

GM Car (Incl. Buick, Cad., Chev., Geo, Olds., Pontiac, Saturn) (Cont.)

39 (cont.)		2008 - 2000; 2.2L 134.1 (2198cc) DOHC L4 (16 Valve) 86mm Bore Ecotec			39 (cont.)
		MFI; Gasoline; Naturally Aspirated Opel Eng.; VIN Code F			
QTY	CYLINDER HEAD	YEARS	PART NO.	DESCRIPTION	
1	Head Set	2000	HS 26223 PT	Head bolts not incl.; Head bolt replacement recommended; Must be used w/TCS 46041; PermaDry® molded rubber valve cover gskt. incl.; Premium valve stem seals incl.	
1	Head Bolt Set	2008-00	ES 72196	Replacement recommended	
QTY	CONVERSION SET	YEARS	PART NO.	DESCRIPTION	
1	Gasket Conversion Set	2008-06	CS 26223-1	RTV sealant incl. for oil pan gskt.	
1	Gasket Conversion Set	2005-00	CS 26223	RTV sealant incl. for oil pan gskt.	
QTY	MANIFOLD - INT. & EXH.	YEARS	PART NO.	DESCRIPTION	
1	Int. Manifold Gasket Set	2008-04	MS 96351		
1	Int. Manifold Gasket Set	2003-02	MS 96340	Saturn L100 Base, L200 Base, LW Series Base, LW100 Base, LW200 Base	
1	Int. Manifold Gasket Set	2003-02	MS 96351	Exc. Saturn L100 Base, L200 Base, LW Series Base, LW100 Base, LW200 Base	
1	Int. Manifold Gasket Set	2001-00	MS 96340		
1	Exh. Manifold Gasket Set	2008	MS 96376	w/Secondary Air Injection Pump	
1	Exh. Manifold Gasket Set	2008	MS 96377	w/o Secondary Air Injection Pump	
1	Exh. Manifold Gasket Set	2007-06	MS 96376	Exc. Saturn Ion 2 Base, Ion 3 Base; w/Secondary Air Injection Pump	
1	Exh. Manifold Gasket Set	2007-06	MS 96377	Exc. Saturn Ion 2 Base, Ion 3 Base; w/o Secondary Air Injection Pump	
1	Exh. Manifold Gasket Set	2007	MS 96376	Saturn Ion 2 Base, Ion 3 Base; California	
1	Exh. Manifold Gasket Set	2007	MS 96377	Saturn Ion 2 Base, Ion 3 Base; Exc. California	
1	Exh. Manifold Gasket Set	2006	MS 96377	Saturn Ion 2 Base, Ion 3 Base	
1	Exh. Manifold Gasket Set	2005-04	MS 96377		
1	Exh. Manifold Gasket Set	2003-02	MS 96376	Saturn L100 Base, L200 Base, LW Series Base, LW100 Base, LW200 Base; w/A/T; California	
1	Exh. Manifold Gasket Set	2003-02	MS 96376	Saturn L100 Base, L200 Base, LW Series Base, LW100 Base, LW200 Base; w/M/T	
1	Exh. Manifold Gasket Set	2003-02	MS 96377	Exc. Saturn L100 Base, L200 Base, LW Series Base, LW100 Base, LW200 Base	
1	Exh. Manifold Gasket Set	2003-02	MS 96377	Saturn L100 Base, L200 Base, LW Series Base, LW100 Base, LW200 Base; w/A/T; Exc. California	
1	Exh. Manifold Gasket Set	2001	MS 96376	w/A/T; California	
1	Exh. Manifold Gasket Set	2001	MS 96376	w/M/T	
1	Exh. Manifold Gasket Set	2001	MS 96377	w/A/T; Exc. California	
1	Exh. Manifold Gasket Set	2000	MS 96377		
QTY	EXHAUST PIPE FLANGE	YEARS	PART NO.	DESCRIPTION	
1	Exhaust Pipe Gasket	2008	61362	Exc. Chevrolet Classic LS, LT; Flange	
1	Exhaust Pipe Gasket	2008	61440	Exc. Chevrolet Classic LS, LT; Converter	
1	Exhaust Pipe Gasket	2008	61446	Chevrolet Classic LS, LT; Converter	
1	Exhaust Pipe Gasket	2007-06	60666	Exc. Saturn Ion 2 Base, Ion 3 Base; Packing	
1	Exhaust Pipe Gasket	2007-06	60850	Exc. Saturn Ion 2 Base, Ion 3 Base; Converter; 51mm ID	
1	Exhaust Pipe Gasket	2007-06	61361	Saturn Ion 2 Base, Ion 3 Base; Converter	
1	Exhaust Pipe Gasket	2007-06	61362	Exc. Chevrolet Malibu LS, LT; Flange	
1	Exhaust Pipe Gasket	2007-06	61446	Chevrolet Malibu LS, LT; Converter	
1	Exhaust Pipe Gasket	2007	61440	Exc. Chevrolet Malibu LS, LT Saturn Ion 2 Base, Ion 3 Base; Converter	
1	Exhaust Pipe Gasket	2006	61440	Chevrolet Cobalt LS, LT, LTZ Pontiac Pursuit Base, SE; Converter	
1	Exhaust Pipe Gasket	2005-03	60666	Exc. Saturn Ion Base, Ion 1 Base, Ion 2 Base, Ion 3 Base; Packing	
1	Exhaust Pipe Gasket	2005-03	61361	Saturn Ion Base, Ion 1 Base, Ion 2 Base, Ion 3 Base; Converter	
1	Exhaust Pipe Gasket	2005-04	60850	Exc. Saturn Ion Base, Ion 1 Base, Ion 2 Base, Ion 3 Base, L300 1 Base, LW300 1 Base; Converter; 51mm ID	
1	Exhaust Pipe Gasket	2005-04	61187	Saturn L300 1 Base, LW300 1 Base; Converter	
1	Exhaust Pipe Gasket	2005-04	61308	Saturn L300 1 Base, LW300 1 Base; Flange	
1	Exhaust Pipe Gasket	2005-04	61446	Chevrolet Classic Base, LS, Malibu Base, LS; Converter	
1	Exhaust Pipe Gasket	2005	61362	Chevrolet Cobalt Base, LS, LT Pontiac Pursuit Base, SE Saturn Ion Base, Ion 1 Base, Ion 2 Base, Ion 3 Base; Flange	
1	Exhaust Pipe Gasket	2005	61440	Chevrolet Cobalt Base, LS, LT Pontiac Pursuit Base, SE; Converter	
1	Exhaust Pipe Gasket	2004-03	61362	Saturn Ion Base, Ion 1 Base, Ion 2 Base, Ion 3 Base; Flange	
1	Exhaust Pipe Gasket	2003-02	61187	Saturn L100 Base, L200 Base, LW Series Base, LW100 Base, LW200 Base; Converter	
1	Exhaust Pipe Gasket	2003-02	61308	Saturn L100 Base, L200 Base, LW Series Base, LW100 Base, LW200 Base; Flange	
1	Exhaust Pipe Gasket	2003	60850	Exc. Saturn Ion Base, Ion 1 Base, Ion 2 Base, Ion 3 Base, L100 Base, L200 Base, LW Series Base, LW100 Base, LW200 Base; Converter; 51mm ID	
1	Exhaust Pipe Gasket	2002-00	60666	Packing	
1	Exhaust Pipe Gasket	2002	60850	Exc. Saturn L100 Base, L200 Base, LW Series Base, LW100 Base, LW200 Base; Converter; 51mm ID	
1	Exhaust Pipe Gasket	2001-00	61187	Converter	

GM Car (Incl. Buick, Cad., Chev., Geo, Olds., Pontiac, Saturn) (Cont.)

39		2008 - 2000; 2.2L 134.1 (2198cc) DOHC L4 (16 Valve) 86mm Bore Ecotec			39	
(cont.)		MFI; Gasoline; Naturally Aspirated Opel Eng.; VIN Code F			(cont.)	
QTY	EXHAUST PIPE FLANGE	YEARS	PART NO.	DESCRIPTION		
1	Exhaust Pipe Gasket	2001-00	61308	Flange		
QTY	CRANKSHAFT REAR SEAL	YEARS	PART NO.	DESCRIPTION		
1	Rear Main Seal Set	2008-00	BS 40671	Rubber; One-piece; Improved design		
1	Rear Main Seal Set	2008-00	BS 40739	Rubber; One-piece; New Improved design; New Part Number - Check for Availability		
QTY	VALVE COVER	YEARS	PART NO.	DESCRIPTION		
1	Valve Cover Gasket Set	2008-07	VS 50719 R	w/Grommets & Spark plug tube seals; PermaDry® molded rubber gskt. incl.		
1	Valve Cover Gasket Set	2006-00	VS 50596 R	w/Grommets & Spark plug tube seals; PermaDry® molded rubber gskt. incl.		
QTY	VALVE STEM SEAL SET	YEARS	PART NO.	DESCRIPTION		
1	Valve Stem Seal Set	2008-00	SS 71198	Premium valve stem seals incl.		
QTY	THERMOSTAT HOUSING	YEARS	PART NO.	DESCRIPTION		
1	O-Ring	2003	35725	Exc. Saturn Ion Base, Ion 1 Base, Ion 2 Base, Ion 3 Base, L100 Base, L200 Base, LW Series Base, LW100 Base, LW200 Base; Thermostat Housing		
1	O-Ring	2002	35725	Exc. Saturn L100 Base, L200 Base, LW Series Base, LW100 Base, LW200 Base; Thermostat Housing		
QTY	WATER OUTLET GASKET	YEARS	PART NO.	DESCRIPTION		
1	Water Outlet Gasket	2008-04	35346	Water Outlet		
1	Water Outlet Gasket	2003	35346	Saturn Ion Base, Ion 1 Base, Ion 2 Base, Ion 3 Base, L100 Base, L200 Base, LW Series Base, LW100 Base, LW200 Base; Water Outlet		
1	Water Outlet Gasket	2002	35346	Saturn L100 Base, L200 Base, LW Series Base, LW100 Base, LW200 Base; Water Outlet		
1	Water Outlet Gasket	2001-00	35346	Water Outlet		
QTY	WATER PUMP	YEARS	PART NO.	DESCRIPTION		
1	Water Pump Gasket	2008-00	35721	Mounting		
1	Water Pump Gasket	2008-00	35724	Cover		
1	Water Pump Mounting Set	2008-00	ES 71282			
QTY	TIMING COVER	YEARS	PART NO.	DESCRIPTION		
1	Timing Cover Set	2008-06	TCS 46079			
1	Timing Cover Set	2005-00	TCS 46041			
1	Crankshaft Front Seal Set	2008-06	TCS 46113			
1	Crankshaft Front Seal Set	2005-00	TCS 46112			
QTY	CARB & FUEL INJECTION	YEARS	PART NO.	DESCRIPTION		
1	Fuel Injector O-Ring Set	2008-04	ES 70599	Upper set; Injectors to fuel rail; Improved design		
1	Fuel Injector O-Ring Set	2008-04	ES 71190	Lower set; Injectors to cylinder head		
1	Fuel Injector O-Ring Set	2008	ES 72970	Exc. Chevrolet Classic LS, LT; Complete set; Upper & lower injector seals incl.; New Part Number - Check for Availability		
1	Fuel Injector O-Ring Set	2007	ES 72970	Exc. Chevrolet Malibu LS, LT Saturn Ion 2 Base, Ion 3 Base; Complete set; Upper & lower injector seals incl.; New Part Number - Check for Availability		
1	Fuel Injector O-Ring Set	2006	ES 72970	Chevrolet Cobalt LS, LT, LTZ Pontiac Pursuit Base, SE; Complete set; Upper & lower injector seals incl.; New Part Number - Check for Availability		
1	Fuel Injector O-Ring Set	2005	ES 72970	Chevrolet Cobalt Base, LS, LT Pontiac Pursuit Base, SE; Complete set; Upper & lower injector seals incl.; New Part Number - Check for Availability		
2	Fuel Injector O-Ring Set	2003-02	ES 70599	Saturn L100 Base, L200 Base, LW Series Base, LW100 Base, LW200 Base; Improved design		
1	Fuel Injector O-Ring Set	2003-02	ES 70599	Exc. Saturn L100 Base, L200 Base, LW Series Base, LW100 Base, LW200 Base; Upper set; Injectors to fuel rail; Improved design		
1	Fuel Injector O-Ring Set	2003-02	ES 71190	Exc. Saturn L100 Base, L200 Base, LW Series Base, LW100 Base, LW200 Base; Lower set; Injectors to cylinder head		
2	Fuel Injector O-Ring Set	2001-00	ES 70599	Improved design		
1	Throttle Body Gasket	2008-06	61309			
1	Throttle Body Gasket	2005-04	61021	Saturn L300 1 Base, LW300 1 Base		
1	Throttle Body Gasket	2005-04	61309	Exc. Saturn L300 1 Base, LW300 1 Base		
1	Throttle Body Gasket	2003-02	61021	Saturn L100 Base, L200 Base, LW Series Base, LW100 Base, LW200 Base		
1	Throttle Body Gasket	2003-02	61309	Exc. Saturn L100 Base, L200 Base, LW Series Base, LW100 Base, LW200 Base		
1	Throttle Body Gasket	2001-00	61021			
QTY	EXHAUST GAS RECIRCULATION	YEARS	PART NO.	DESCRIPTION		
1	EGR Gasket	2008-00	71194			
40		2010 - 2009; 2.2L 134.1 (2198cc) DOHC L4 (16 Valve) 86mm Bore Ecotec VVT			40	
(cont.)		MFI; Gasoline; Naturally Aspirated Opel Eng.; VIN Code H			(cont.)	
QTY	CYLINDER HEAD	YEARS	PART NO.	DESCRIPTION		
1	Head Gasket	2010-09	26466 PT	Head bolts not incl.; Head bolt replacement recommended; PermaTorqueMLS®		

GM Car (Incl. Buick, Cad., Chev., Geo, Olds., Pontiac, Saturn) (Cont.)

40 (cont.)		2010 - 2009; 2.2L 134.1 (2198cc) DOHC L4 (16 Valve) 86mm Bore Ecotec VVT			40 (cont.)
		MFI; Gasoline; Naturally Aspirated Opel Eng.; VIN Code H			
QTY	CYLINDER HEAD	YEARS	PART NO.	DESCRIPTION	
1	Head Set	2010-09	HS 26466 PT-1	Head bolts & exh. pipe flange not incl.; Head bolt replacement recommended; PermaDry® molded rubber valve cover gskt. incl.; Premium valve stem seals incl.	
1	Head Bolt Set	2010-09	ES 72196	Replacement recommended	
QTY	CONVERSION SET	YEARS	PART NO.	DESCRIPTION	
1	Gasket Conversion Set	2010-09	CS 26223-1	RTV sealant incl. for oil pan gskt.	
QTY	MANIFOLD - INT. & EXH.	YEARS	PART NO.	DESCRIPTION	
1	Int. Manifold Gasket Set	2010-09	MS 96351-1		
1	Exh. Manifold Gasket Set	2010-09	MS 97122		
QTY	EXHAUST PIPE FLANGE	YEARS	PART NO.	DESCRIPTION	
1	Exhaust Pipe Gasket	2010-09	61362	Flange	
1	Exhaust Pipe Gasket	2010-09	61440	Converter	
QTY	OIL PAN	YEARS	PART NO.	DESCRIPTION	
1	Drain Plug Gasket	2010-09	70820		
QTY	CRANKSHAFT REAR SEAL	YEARS	PART NO.	DESCRIPTION	
1	Rear Main Seal Set	2010-09	BS 40671	Rubber; One-piece; Improved design	
1	Rear Main Seal Set	2010-09	BS 40739	Rubber; One-piece; New Improved design; New Part Number - Check for Availability	
QTY	VALVE COVER	YEARS	PART NO.	DESCRIPTION	
1	Valve Cover Gasket Set	2010-09	VS 50769 R	w/Grommets & Spark plug tube seals; PermaDry® molded rubber gskt. incl.	
QTY	VALVE STEM SEAL SET	YEARS	PART NO.	DESCRIPTION	
1	Valve Stem Seal Set	2010-09	SS 71198	Premium valve stem seals incl.	
QTY	WATER OUTLET GASKET	YEARS	PART NO.	DESCRIPTION	
1	Water Outlet Gasket	2010-09	35346	Water Outlet	
QTY	WATER PUMP	YEARS	PART NO.	DESCRIPTION	
1	Water Pump Gasket	2010-09	35721	Mounting	
1	Water Pump Gasket	2010-09	35724	Cover	
1	Water Pump Mounting Set	2010-09	ES 71282		
QTY	TIMING COVER	YEARS	PART NO.	DESCRIPTION	
1	Timing Cover Set	2010-09	TCS 46079		
1	Crankshaft Front Seal Set	2010-09	TCS 46113		
QTY	CARB & FUEL INJECTION	YEARS	PART NO.	DESCRIPTION	
1	Fuel Injector O-Ring Set	2010-09	ES 70599	Upper set; Injectors to fuel rail; Improved design	
1	Fuel Injector O-Ring Set	2010-09	ES 72970	Complete set; Upper & lower injector seals incl.; New Part Number - Check for Availability	
1	Throttle Body Gasket	2010-09	61624		
41		1995 - 1991; 2.3L 138 (2260cc) DOHC L4 (16 Valve) 92mm Bore Quad 4			41
		MFI; Gasoline; Naturally Aspirated GMC Eng.; Oldsmobile; VIN Code D			
QTY	CYLINDER HEAD	YEARS	PART NO.	DESCRIPTION	
1	Head Gasket	1995-91	9515 PT	Head bolts not incl.; Head bolt replacement recommended	
1	Head Set	1995	HS 9515 PT-3	Head bolts, exh. pipe packing, 1st Design timing cover gskts. not incl.; Head bolt replacement recommended; PermaDry® molded rubber valve cover gskts. incl.; Premium valve stem seals incl.	
1	Head Set	1994-92	HS 9515 PT-2	Head bolts, exh. pipe packing, 1st Design timing cover gskts. not incl.; Head bolt replacement recommended; PermaDry® molded rubber valve cover gskts. incl.; Premium valve stem seals incl.	
1	Head Set	1991	HS 9515 PT	Head bolts, exh. pipe packing, 2nd Design timing cover gskts. & valve cover seals not incl.; Head bolt replacement recommended; PermaDry® molded rubber valve cover gskts. incl.; Premium valve stem seals incl.	
1	Head Installation Set	1994-92	HIS 9515 PT-2	Head bolts, exh. pipe packing, 1st Design timing cover gskts. & valve cover seals not incl.; Head bolt replacement recommended; PermaDry® molded rubber valve cover gskts. incl.	
1	Head Installation Set	1991	HIS 9515 PT	Head bolts, exh. pipe packing, 2nd Design timing cover gskts. & valve cover seals not incl.; Head bolt replacement recommended; PermaDry® molded rubber valve cover gskts. incl.	
1	Head Bolt Set	1995-91	ES 72727	Head bolts w/Washers; Replacement recommended	
QTY	CONVERSION SET	YEARS	PART NO.	DESCRIPTION	
1	Gasket Conversion Set	1995	CS 9515-1	PermaDry® molded rubber oil pan gskt. incl.	
1	Gasket Conversion Set	1994-91	CS 9515	PermaDry® molded rubber oil pan gskt. incl.	
QTY	MANIFOLD - INT. & EXH.	YEARS	PART NO.	DESCRIPTION	
1	Int. Manifold Gasket Set	1995-91	MS 90573		
1	Exh. Manifold Gasket Set	1995	MS 91130		
1	Exh. Manifold Gasket Set	1994-91	MS 90559		

GM Car (Incl. Buick, Cad., Chev., Geo, Olds., Pontiac, Saturn) (Cont.)

41 (cont.)		1995 - 1991; 2.3L 138 (2260cc) DOHC L4 (16 Valve) 92mm Bore Quad 4			41 (cont.)
MFI; Gasoline; Naturally Aspirated GMC Eng.; Oldsmobile; VIN Code D					
QTY	EXHAUST PIPE FLANGE	YEARS	PART NO.	DESCRIPTION	
1	Exhaust Pipe Gasket	1995-91	60828	Pipe to manifold; 2 5/8" ID	
2	Exhaust Pipe Gasket	1995-91	60850	Converter; 1 to 2 Req'd.; 51mm ID	
1	Exhaust Pipe Gasket	1995-92	61051	Pipe to manifold; 2 3/32" ID	
2	Exhaust Pipe Gasket	1991	60525	Pipe to manifold; 1 45/64" ID steel sleeve; Improved design	
1	Exh. Flange Bolt & Spring Kit	1995-91	ES 72141		
QTY	OIL PAN	YEARS	PART NO.	DESCRIPTION	
1	Oil Pan Gasket Set	1995	OS 30678 R	PermaDry® molded rubber gskt. incl.	
1	Oil Pan Gasket Set	1994-91	OS 30597 R	PermaDry® molded rubber gskt. incl.	
1	Drain Plug Gasket	1995-91	70822		
QTY	CRANKSHAFT REAR SEAL	YEARS	PART NO.	DESCRIPTION	
1	Rear Main Seal Set	1995-91	BS 40591	Rubber; One-piece	
QTY	VALVE COVER	YEARS	PART NO.	DESCRIPTION	
1	Valve Cover Gasket Set	1995-91	VS 50444 R	Loc. Int.; 2nd Design; Seals fit into grooves in camshaft housing cover; PermaDry® molded rubber gskts. incl.	
1	Valve Cover Gasket Set	1995-91	VS 50445 R	Loc. Exh.; 2nd Design; Seals fit into grooves in camshaft housing cover; PermaDry® molded rubber gskts. incl.	
1	Valve Cover Gasket Set	1994-91	VS 50325 R	Loc. Int. & Exh.; 1st Design; Seals fit into grooves in camshaft housing; PermaDry® molded rubber gskts. incl.	
QTY	VALVE STEM SEAL SET	YEARS	PART NO.	DESCRIPTION	
1	Valve Stem Seal Set	1995-91	SS 70287	Premium valve stem seals incl.	
QTY	THERMOSTAT HOUSING	YEARS	PART NO.	DESCRIPTION	
1	Thermostat Gasket	1995-94	35614	Thermostat Housing; Thermostat seal; Improved design	
QTY	WATER OUTLET GASKET	YEARS	PART NO.	DESCRIPTION	
1	Water Outlet Gasket	1995-94	35597	Water Outlet; Outlet O-ring	
1	Water Outlet Gasket	1993-91	35427	Water Outlet	
QTY	WATER PUMP	YEARS	PART NO.	DESCRIPTION	
1	Water Pump Mounting Set	1995	ES 72102	Must be used w/MS 91130	
1	Water Pump Mounting Set	1994-91	ES 72102	Must be used w/MS 90559	
QTY	TIMING COVER	YEARS	PART NO.	DESCRIPTION	
1	Timing Cover Set	1995-91	TCS 45843	1st Design; w/20 hole gskt.; .70mm thick	
1	Timing Cover Set	1995-91	TCS 45954	2nd Design; w/21 hole gskt.; 3.40mm thick	
QTY	CARB & FUEL INJECTION	YEARS	PART NO.	DESCRIPTION	
2	Fuel Injector O-Ring Set	1995-91	ES 70599	Improved design	
1	Throttle Body Gasket	1995-91	60757		
42		1994 - 1991; 2.3L 138 (2260cc) DOHC L4 (16 Valve) 92mm Bore Quad 4 H.O.			42
MFI; Gasoline; Naturally Aspirated GMC Eng.; Oldsmobile; VIN Code A					
QTY	CYLINDER HEAD	YEARS	PART NO.	DESCRIPTION	
1	Head Gasket	1994-91	9515 PT	Head bolts not incl.; Head bolt replacement recommended	
1	Head Set	1994-92	HS 9515 PT-2	Head bolts, exh. pipe packing, 1st Design timing cover gskts. not incl.; Head bolt replacement recommended; PermaDry® molded rubber valve cover gskts. incl.; Premium valve stem seals incl.	
1	Head Set	1991	HS 9515 PT	Head bolts, exh. pipe packing, 2nd Design timing cover gskts. & valve cover seals not incl.; Head bolt replacement recommended; PermaDry® molded rubber valve cover gskts. incl.; Premium valve stem seals incl.	
1	Head Installation Set	1994-92	HIS 9515 PT-2	Head bolts, exh. pipe packing, 1st Design timing cover gskts. & valve cover seals not incl.; Head bolt replacement recommended; PermaDry® molded rubber valve cover gskts. incl.	
1	Head Installation Set	1991	HIS 9515 PT	Head bolts, exh. pipe packing, 2nd Design timing cover gskts. & valve cover seals not incl.; Head bolt replacement recommended; PermaDry® molded rubber valve cover gskts. incl.	
1	Head Bolt Set	1994-91	ES 72727	Head bolts w/Washers; Replacement recommended	
QTY	CONVERSION SET	YEARS	PART NO.	DESCRIPTION	
1	Gasket Conversion Set	1994-91	CS 9515	PermaDry® molded rubber oil pan gskt. incl.	
QTY	MANIFOLD - INT. & EXH.	YEARS	PART NO.	DESCRIPTION	
1	Int. Manifold Gasket Set	1994-91	MS 90573		
1	Exh. Manifold Gasket Set	1994-91	MS 90559		
QTY	EXHAUST PIPE FLANGE	YEARS	PART NO.	DESCRIPTION	
1	Exhaust Pipe Gasket	1994-91	60828	Pipe to manifold; 2 5/8" ID	
2	Exhaust Pipe Gasket	1994-91	60850	Converter; 1 to 2 Req'd.; 51mm ID	
1	Exhaust Pipe Gasket	1994-92	61051	Pipe to manifold; 2 3/32" ID	
2	Exhaust Pipe Gasket	1991	60525	Pipe to manifold; 1 45/64" ID steel sleeve; Improved design	
1	Exh. Flange Bolt & Spring Kit	1994-91	ES 72141		

GM Car (Incl. Buick, Cad., Chev., Geo, Olds., Pontiac, Saturn) (Cont.)

42 (cont.)		1994 - 1991; 2.3L 138 (2260cc) DOHC L4 (16 Valve) 92mm Bore Quad 4 H.O. MFI; Gasoline; Naturally Aspirated GMC Eng.; Oldsmobile; VIN Code A			42 (cont.)
QTY	OIL PAN	YEARS	PART NO.	DESCRIPTION	
1	Oil Pan Gasket Set	1994-91	OS 30597 R	PermaDry® molded rubber gskt. incl.	
1	Drain Plug Gasket	1994-91	70822		
QTY	CRANKSHAFT REAR SEAL	YEARS	PART NO.	DESCRIPTION	
1	Rear Main Seal Set	1994-91	BS 40591	Rubber; One-piece	
QTY	VALVE COVER	YEARS	PART NO.	DESCRIPTION	
1	Valve Cover Gasket Set	1994-91	VS 50325 R	Loc. Int. & Exh.; 1st Design; Seals fit into grooves in camshaft housing; PermaDry® molded rubber gskts. incl.	
1	Valve Cover Gasket Set	1994-91	VS 50444 R	Loc. Int.; 2nd Design; Seals fit into grooves in camshaft housing cover; PermaDry® molded rubber gskts. incl.	
1	Valve Cover Gasket Set	1994-91	VS 50445 R	Loc. Exh.; 2nd Design; Seals fit into grooves in camshaft housing cover; PermaDry® molded rubber gskts. incl.	
QTY	VALVE STEM SEAL SET	YEARS	PART NO.	DESCRIPTION	
1	Valve Stem Seal Set	1994-91	SS 70287	Premium valve stem seals incl.	
QTY	THERMOSTAT HOUSING	YEARS	PART NO.	DESCRIPTION	
1	Thermostat Gasket	1994	35614	Thermostat Housing; Thermostat seal; Improved design	
QTY	WATER OUTLET GASKET	YEARS	PART NO.	DESCRIPTION	
1	Water Outlet Gasket	1994	35597	Water Outlet; Outlet O-ring	
1	Water Outlet Gasket	1993-91	35427	Water Outlet	
QTY	WATER PUMP	YEARS	PART NO.	DESCRIPTION	
1	Water Pump Mounting Set	1994-91	ES 72102	Must be used w/MS 90559	
QTY	TIMING COVER	YEARS	PART NO.	DESCRIPTION	
1	Timing Cover Set	1994-91	TCS 45843	1st Design; w/20 hole gskt.; .70mm thick	
1	Timing Cover Set	1994-91	TCS 45954	2nd Design; w/21 hole gskt.; 3.40mm thick	
QTY	CARB & FUEL INJECTION	YEARS	PART NO.	DESCRIPTION	
2	Fuel Injector O-Ring Set	1994-91	ES 70599	Improved design	
1	Throttle Body Gasket	1994-91	60757		
43		1994 - 1992; 2.3L 138 (2260cc) SOHC L4 (8 Valve) 92mm Bore Quad OHC MFI; Gasoline; Naturally Aspirated GMC Eng.; Oldsmobile; VIN Code 3			43
QTY	CYLINDER HEAD	YEARS	PART NO.	DESCRIPTION	
1	Head Gasket	1994-92	9515 PT	Head bolts not incl.; Head bolt replacement recommended	
1	Head Set	1994-92	HS 9515 PT-1	Head bolts, exh. pipe packing, 1st Design valve cover seals not incl.; Head bolt replacement recommended; PermaDry® molded rubber valve cover gskts. incl.; Premium valve stem seals incl.	
1	Head Installation Set	1994-92	HIS 9515 PT-1	Head bolts, exh. pipe packing, 2nd Design valve cover seals not incl.; Head bolt replacement recommended; PermaDry® molded rubber valve cover gskts. incl.	
1	Head Bolt Set	1994-92	ES 72727	Head bolts w/Washers; Replacement recommended	
QTY	CONVERSION SET	YEARS	PART NO.	DESCRIPTION	
1	Gasket Conversion Set	1994-92	CS 9515	PermaDry® molded rubber oil pan gskt. incl.	
QTY	MANIFOLD - INT. & EXH.	YEARS	PART NO.	DESCRIPTION	
1	Int. Manifold Gasket Set	1994-92	MS 90573		
1	Exh. Manifold Gasket Set	1994-92	MS 90559		
QTY	EXHAUST PIPE FLANGE	YEARS	PART NO.	DESCRIPTION	
1	Exhaust Pipe Gasket	1994-92	60828	Pipe to manifold; 2 5/8" ID	
1	Exhaust Pipe Gasket	1994-92	61051	Pipe to manifold; 2 3/32" ID	
QTY	OIL PAN	YEARS	PART NO.	DESCRIPTION	
1	Oil Pan Gasket Set	1994-92	OS 30597 R	PermaDry® molded rubber gskt. incl.	
1	Drain Plug Gasket	1994-92	70822		
QTY	CRANKSHAFT REAR SEAL	YEARS	PART NO.	DESCRIPTION	
1	Rear Main Seal Set	1994-92	BS 40591	Rubber; One-piece	
QTY	VALVE COVER	YEARS	PART NO.	DESCRIPTION	
1	Valve Cover Gasket Set	1994-92	VS 50444 R	2nd Design; Seals fit into grooves in camshaft housing cover; PermaDry® molded rubber gskts. incl.	
1	Valve Cover Gasket Set	1994-92	VS 50452 R	1st Design; Seals fit into grooves in camshaft housing; PermaDry® molded rubber gskts. incl.	
QTY	VALVE STEM SEAL SET	YEARS	PART NO.	DESCRIPTION	
1	Valve Stem Seal Set	1994-92	SS 72862	Premium valve stem seals incl.	
QTY	WATER OUTLET GASKET	YEARS	PART NO.	DESCRIPTION	
1	Water Outlet Gasket	1994	35597	Water Outlet	
1	Water Outlet Gasket	1993-92	35427	Water Outlet	
QTY	WATER PUMP	YEARS	PART NO.	DESCRIPTION	
1	Water Pump Mounting Set	1994-92	ES 72102	Must be used w/MS 90559	

GM Car (Incl. Buick, Cad., Chev., Geo, Olds., Pontiac, Saturn) (Cont.)

43 (cont.)	1994 - 1992; 2.3L 138 (2260cc) SOHC L4 (8 Valve) 92mm Bore Quad OHC			43 (cont.)
MFI; Gasoline; Naturally Aspirated GMC Eng.; Oldsmobile; VIN Code 3				
QTY	TIMING COVER	YEARS	PART NO.	DESCRIPTION
1	Timing Cover Set	1994-92	TCS 45960	
QTY	CARB & FUEL INJECTION	YEARS	PART NO.	DESCRIPTION
2	Fuel Injector O-Ring Set	1994-92	ES 70599	Improved design
1	Throttle Body Gasket	1994-92	60757	
44	2010 - 2009; 2.4L 144 (2362cc) DOHC L4 (16 Valve) 88.5mm Bore VVT-i			44
MFI; Gasoline; Naturally Aspirated Toyota Eng.; VIN Code 0, Eng. Code 2AZFE				
QTY	CYLINDER HEAD	YEARS	PART NO.	DESCRIPTION
1	Head Gasket	2010-09	26323 PT	Head bolts not incl.; Head bolt replacement recommended; PermaTorqueMLS® LaserWeld® Technology; Improved design
1	Head Set	2010-09	HS 26323 PT-1	Head bolts not incl.; Head bolt replacement recommended; Must be used w/TCS 46148 & w/OS 30713; PermaDry® molded rubber valve cover gskt. incl.; Premium valve stem seals incl.; New Part Number - Check for Availability
1	Head Bolt Set	2010-09	ES 72249-2	Head bolts w/Washers; Replacement recommended
1	Head Bolt Washer Set	2010-09	ES 72899	Replacement recommended
QTY	CONVERSION SET	YEARS	PART NO.	DESCRIPTION
1	Gasket Conversion Set	2010-09	CS 26232-2	RTV sealant incl. for oil pan gskt.; RTV sealant incl. for water pump gskt.; New Part Number - Check for Availability
QTY	MANIFOLD - INT. & EXH.	YEARS	PART NO.	DESCRIPTION
1	Int. Manifold Gasket Set	2010-09	MS 94295	Consolidated design
1	Exh. Manifold Gasket Set	2010-09	MS 94140-1	
QTY	EXHAUST PIPE FLANGE	YEARS	PART NO.	DESCRIPTION
1	Exhaust Pipe Gasket	2010-09	60906	Loc. Front; Converter
1	Exhaust Pipe Gasket	2010-09	61106	Flange; 2.40" ID
1	Exhaust Pipe Gasket	2010-09	61598	Loc. Rear; Converter
QTY	OIL PAN	YEARS	PART NO.	DESCRIPTION
1	Oil Pan Gasket Set	2010-09	OS 30713	RTV sealant incl. for oil pan gskt.
1	Drain Plug Gasket	2010-09	70822	
QTY	CRANKSHAFT REAR SEAL	YEARS	PART NO.	DESCRIPTION
1	Rear Main Seal Set	2010-09	BS 40629	Rubber; One-piece
QTY	VALVE COVER	YEARS	PART NO.	DESCRIPTION
1	Valve Cover Gasket Set	2010-09	VS 50530 R	PermaDry® molded rubber gskt. incl.
QTY	VALVE STEM SEAL SET	YEARS	PART NO.	DESCRIPTION
1	Valve Stem Seal Set	2010-09	SS 72878-2	Premium valve stem seals incl.
QTY	THERMOSTAT HOUSING	YEARS	PART NO.	DESCRIPTION
1	Thermostat Gasket	2010-09	35445	Thermostat Housing
QTY	WATER OUTLET GASKET	YEARS	PART NO.	DESCRIPTION
1	Water Outlet Gasket	2010-09	35729	Water Outlet; Heater return
QTY	TIMING COVER	YEARS	PART NO.	DESCRIPTION
1	Crankshaft Front Seal Set	2010-09	TCS 46148	New Part Number - Check for Availability
QTY	CARB & FUEL INJECTION	YEARS	PART NO.	DESCRIPTION
1	Throttle Body Gasket	2010-09	61421	
45	2012 - 2010; 2.4L 145.5 (2384cc) DOHC L4 (16 Valve) 88mm Bore Ecotec			45
MFI; Flex Fuel; Naturally Aspirated Opel Eng.; VIN Code 0				
QTY	CYLINDER HEAD	YEARS	PART NO.	DESCRIPTION
1	Head Gasket	2011-10	26466 PT	Head bolts not incl.; Head bolt replacement recommended; PermaTorqueMLS®
1	Head Set	2011-10	HS 26466 PT-1	Head bolts & exh. pipe flange not incl.; Head bolt replacement recommended; PermaDry® molded rubber valve cover gskt. incl.; Premium valve stem seals incl.
1	Head Bolt Set	2011-10	ES 72196	Replacement recommended
QTY	CONVERSION SET	YEARS	PART NO.	DESCRIPTION
1	Gasket Conversion Set	2011-10	CS 26223-1	RTV sealant incl. for oil pan gskt.
QTY	MANIFOLD - INT. & EXH.	YEARS	PART NO.	DESCRIPTION
1	Int. Manifold Gasket Set	2011-10	MS 96351-1	
1	Exh. Manifold Gasket Set	2011-10	MS 97122	
QTY	EXHAUST PIPE FLANGE	YEARS	PART NO.	DESCRIPTION
1	Exhaust Pipe Gasket	2011-10	61054	Pipe to manifold
1	Exhaust Pipe Gasket	2011-10	61442	Loc. Front; Converter
1	Exhaust Pipe Gasket	2011-10	61625	Loc. Rear; Converter

GM Car (Incl. Buick, Cad., Chev., Geo, Olds., Pontiac, Saturn) (Cont.)

45 (cont.)		2012 - 2010; 2.4L 145.5 (2384cc) DOHC L4 (16 Valve) 88mm Bore Ecotec			45 (cont.)
		MFI; Flex Fuel; Naturally Aspirated Opel Eng.; VIN Code 0			
QTY	CRANKSHAFT REAR SEAL	YEARS	PART NO.	DESCRIPTION	
1	Rear Main Seal Set	2012-10	BS 40739	Rubber; One-piece; New Improved design; New Part Number - Check for Availability	
1	Rear Main Seal Set	2011-10	BS 40671	Rubber; One-piece; Improved design	
QTY	VALVE COVER	YEARS	PART NO.	DESCRIPTION	
1	Valve Cover Gasket Set	2011-10	VS 50769 R	w/Grommets & Spark plug tube seals; PermaDry® molded rubber gskt. incl.	
QTY	VALVE STEM SEAL SET	YEARS	PART NO.	DESCRIPTION	
1	Valve Stem Seal Set	2011-10	SS 71198	Premium valve stem seals incl.	
QTY	THERMOSTAT HOUSING	YEARS	PART NO.	DESCRIPTION	
1	Water Outlet Gasket	2011-10	35346	Thermostat Housing; Thermostat seal	
QTY	WATER PUMP	YEARS	PART NO.	DESCRIPTION	
1	Water Pump Gasket	2011-10	35721	Mounting	
1	Water Pump Gasket	2011-10	35724	Cover	
1	Water Pump Mounting Set	2011-10	ES 71282		
QTY	TIMING COVER	YEARS	PART NO.	DESCRIPTION	
1	Timing Cover Set	2011-10	TCS 46079		
1	Crankshaft Front Seal Set	2011-10	TCS 46113		
QTY	CARB & FUEL INJECTION	YEARS	PART NO.	DESCRIPTION	
1	Fuel Injector O-Ring Set	2011-10	ES 70599	Upper set; Injectors to fuel rail; Improved design	
1	Throttle Body Gasket	2011-10	61685	New Part Number - Check for Availability	
46		2010 - 2007; 2.4L 145.5 (2384cc) DOHC L4 (16 Valve) 88mm Bore Ecotec			46
		MFI; Hybrid (Gas/Electric); Naturally Aspirated Opel Eng.; VIN Code 5			
QTY	CYLINDER HEAD	YEARS	PART NO.	DESCRIPTION	
1	Head Gasket	2010-07	26466 PT	Head bolts not incl.; Head bolt replacement recommended; PermaTorqueMLS®	
1	Head Set	2010-09	HS 26466 PT	Saturn Aura Hybrid; Head bolts & exh. pipe flange not incl.; Head bolt replacement recommended; PermaDry® molded rubber valve cover gskt. incl.; Premium valve stem seals incl.	
1	Head Set	2010-09	HS 26466 PT-1	Exc. Saturn Aura Hybrid; Head bolts & exh. pipe flange not incl.; Head bolt replacement recommended; PermaDry® molded rubber valve cover gskt. incl.; Premium valve stem seals incl.	
1	Head Set	2008	HS 26466 PT	Chevrolet Malibu Hybrid; California; Head bolts & exh. pipe flange not incl.; Head bolt replacement recommended; PermaDry® molded rubber valve cover gskt. incl.; Premium valve stem seals incl.	
1	Head Set	2008	HS 26466 PT	Saturn Aura Green Line; Head bolts & exh. pipe flange not incl.; Head bolt replacement recommended; PermaDry® molded rubber valve cover gskt. incl.; Premium valve stem seals incl.	
1	Head Set	2008	HS 26466 PT-1	Chevrolet Malibu Hybrid; Exc. California; Head bolts & exh. pipe flange not incl.; Head bolt replacement recommended; PermaDry® molded rubber valve cover gskt. incl.; Premium valve stem seals incl.	
1	Head Set	2007	HS 26466 PT	Head bolts & exh. pipe flange not incl.; Head bolt replacement recommended; PermaDry® molded rubber valve cover gskt. incl.; Premium valve stem seals incl.	
1	Head Bolt Set	2010-07	ES 72196	Replacement recommended	
QTY	CONVERSION SET	YEARS	PART NO.	DESCRIPTION	
1	Gasket Conversion Set	2010-07	CS 26223-1	RTV sealant incl. for oil pan gskt.	
QTY	MANIFOLD - INT. & EXH.	YEARS	PART NO.	DESCRIPTION	
1	Int. Manifold Gasket Set	2010-07	MS 96351-1		
1	Exh. Manifold Gasket Set	2010-09	MS 96377	Saturn Aura Hybrid	
1	Exh. Manifold Gasket Set	2010-09	MS 97122	Exc. Saturn Aura Hybrid	
1	Exh. Manifold Gasket Set	2008	MS 96377	Saturn Aura Green Line	
1	Exh. Manifold Gasket Set	2008	MS 96377	Chevrolet Malibu Hybrid; California	
1	Exh. Manifold Gasket Set	2008	MS 97122	Chevrolet Malibu Hybrid; Exc. California	
1	Exh. Manifold Gasket Set	2007	MS 96377		
QTY	EXHAUST PIPE FLANGE	YEARS	PART NO.	DESCRIPTION	
1	Exhaust Pipe Gasket	2010-07	61054	Loc. Front; Converter	
1	Exhaust Pipe Gasket	2010-07	61442	Loc. Rear; Converter	
1	Exhaust Pipe Gasket	2010-08	61446	Pipe to manifold	
1	Exhaust Pipe Gasket	2007	61054	Pipe to manifold	
QTY	CRANKSHAFT REAR SEAL	YEARS	PART NO.	DESCRIPTION	
1	Rear Main Seal Set	2010-07	BS 40671	Rubber; One-piece; Improved design	
1	Rear Main Seal Set	2010-07	BS 40739	Rubber; One-piece; New Improved design; New Part Number - Check for Availability	

GM Car (Incl. Buick, Cad., Chev., Geo, Olds., Pontiac, Saturn) (Cont.)

46 (cont.)		2010 - 2007; 2.4L 145.5 (2384cc) DOHC L4 (16 Valve) 88mm Bore Ecotec			46 (cont.)
MFI; Hybrid (Gas/Electric); Naturally Aspirated Opel Eng.; VIN Code 5					
QTY	VALVE COVER	YEARS	PART NO.	DESCRIPTION	
1	Valve Cover Gasket Set	2010-07	VS 50769 R	w/Grommets & Spark plug tube seals; PermaDry® molded rubber gskt. incl.	
QTY	VALVE STEM SEAL SET	YEARS	PART NO.	DESCRIPTION	
1	Valve Stem Seal Set	2010-07	SS 71198	Premium valve stem seals incl.	
QTY	THERMOSTAT HOUSING	YEARS	PART NO.	DESCRIPTION	
1	Water Outlet Gasket	2010-07	35346	Thermostat Housing; Thermostat seal	
QTY	WATER PUMP	YEARS	PART NO.	DESCRIPTION	
1	Water Pump Gasket	2010-07	35721	Mounting	
1	Water Pump Gasket	2010-07	35724	Cover	
1	Water Pump Mounting Set	2010-07	ES 71282		
QTY	TIMING COVER	YEARS	PART NO.	DESCRIPTION	
1	Timing Cover Set	2010-07	TCS 46079		
1	Crankshaft Front Seal Set	2010-07	TCS 46113		
QTY	CARB & FUEL INJECTION	YEARS	PART NO.	DESCRIPTION	
1	Fuel Injector O-Ring Set	2010-07	ES 70599	Upper set; Injectors to fuel rail; Improved design	
1	Throttle Body Gasket	2010-07	61685	New Part Number - Check for Availability	
47		2011 - 2005; 2.4L 145.5 (2384cc) DOHC L4 (16 Valve) 88mm Bore Ecotec			47
MFI; Gasoline; Naturally Aspirated Opel Eng.; VIN Code B					
QTY	CYLINDER HEAD	YEARS	PART NO.	DESCRIPTION	
1	Head Gasket	2011-05	26466 PT	Head bolts not incl.; Head bolt replacement recommended; PermaTorqueMLS®	
1	Head Set	2011-10	HS 26466 PT-1	Head bolts & exh. pipe flange not incl.; Head bolt replacement recommended; PermaDry® molded rubber valve cover gskt. incl.; Premium valve stem seals incl.	
1	Head Set	2009	HS 26466 PT	Pontiac Solstice Base; Head bolts & exh. pipe flange not incl.; Head bolt replacement recommended; PermaDry® molded rubber valve cover gskt. incl.; Premium valve stem seals incl.	
1	Head Set	2009	HS 26466 PT-1	Exc. Pontiac Solstice Base; Head bolts & exh. pipe flange not incl.; Head bolt replacement recommended; PermaDry® molded rubber valve cover gskt. incl.; Premium valve stem seals incl.	
1	Head Set	2008	HS 26466 PT	Chevrolet Malibu LS, LT Pontiac G5 GT, G6 Base Saturn Aura XE; California; Head bolts & exh. pipe flange not incl.; Head bolt replacement recommended; PermaDry® molded rubber valve cover gskt. incl.; Premium valve stem seals incl.	
1	Head Set	2008	HS 26466 PT	Exc. Chevrolet Malibu LS, LT Pontiac G5 GT, G6 Base Saturn Aura XE; Head bolts & exh. pipe flange not incl.; Head bolt replacement recommended; PermaDry® molded rubber valve cover gskt. incl.; Premium valve stem seals incl.	
1	Head Set	2008	HS 26466 PT-1	Chevrolet Malibu LS, LT Pontiac G5 GT, G6 Base Saturn Aura XE; Exc. California; Head bolts & exh. pipe flange not incl.; Head bolt replacement recommended; PermaDry® molded rubber valve cover gskt. incl.; Premium valve stem seals incl.	
1	Head Set	2007-05	HS 26466 PT	Head bolts & exh. pipe flange not incl.; Head bolt replacement recommended; PermaDry® molded rubber valve cover gskt. incl.; Premium valve stem seals incl.	
1	Head Bolt Set	2011-05	ES 72196	Replacement recommended	
QTY	CONVERSION SET	YEARS	PART NO.	DESCRIPTION	
1	Gasket Conversion Set	2011-05	CS 26223-1	RTV sealant incl. for oil pan gskt.	
QTY	MANIFOLD - INT. & EXH.	YEARS	PART NO.	DESCRIPTION	
1	Int. Manifold Gasket Set	2011-05	MS 96351-1		
1	Exh. Manifold Gasket Set	2011-10	MS 97122		
1	Exh. Manifold Gasket Set	2009	MS 96377	Pontiac Solstice Base	
1	Exh. Manifold Gasket Set	2009	MS 97122	Exc. Pontiac Solstice Base	
1	Exh. Manifold Gasket Set	2008	MS 96377	Exc. Chevrolet Malibu LS, LT Pontiac G5 GT, G6 Base Saturn Aura XE	
1	Exh. Manifold Gasket Set	2008	MS 96377	Chevrolet Malibu LS, LT Pontiac G5 GT, G6 Base Saturn Aura XE; California	
1	Exh. Manifold Gasket Set	2008	MS 97122	Chevrolet Malibu LS, LT Pontiac G5 GT, G6 Base Saturn Aura XE; Exc. California	
1	Exh. Manifold Gasket Set	2007-05	MS 96377		
QTY	EXHAUST PIPE FLANGE	YEARS	PART NO.	DESCRIPTION	
1	Exhaust Pipe Gasket	2011	61054	Exc. Chevrolet Malibu LS; Pipe to manifold	
1	Exhaust Pipe Gasket	2011	61442	Exc. Chevrolet Malibu LS; Converter	
1	Exhaust Pipe Gasket	2011	61446	Chevrolet Malibu LS; Pipe to manifold	
1	Exhaust Pipe Gasket	2011	61625	Chevrolet Malibu LS; Converter	

GM Car (Incl. Buick, Cad., Chev., Geo, Olds., Pontiac, Saturn) (Cont.)

47 (cont.)	2011 - 2005; 2.4L 145.5 (2384cc) DOHC L4 (16 Valve) 88mm Bore Ecotec				47 (cont.)
MFI; Gasoline; Naturally Aspirated Opel Eng.; VIN Code B					
QTY	EXHAUST PIPE FLANGE	YEARS	PART NO.	DESCRIPTION	
1	Exhaust Pipe Gasket	2010	61054	Exc. Chevrolet Malibu LS Pontiac G6 Base Saturn Aura XE, XR; Pipe to manifold	
1	Exhaust Pipe Gasket	2010	61348	Pontiac Solstice Base Saturn Sky Base; Converter	
1	Exhaust Pipe Gasket	2010	61442	Chevrolet Malibu LT, LTZ; Converter	
1	Exhaust Pipe Gasket	2010	61442	Pontiac G6 Base; Pipe to manifold	
1	Exhaust Pipe Gasket	2010	61446	Chevrolet Malibu LS Saturn Aura XE, XR; Pipe to manifold	
1	Exhaust Pipe Gasket	2010	61625	Chevrolet Malibu LS Pontiac G6 Base Saturn Aura XE, XR; Converter	
1	Exhaust Pipe Gasket	2009-07	61348	Pontiac Solstice Base Saturn Sky Base; Pipe to manifold	
1	Exhaust Pipe Gasket	2009	61054	Exc. Chevrolet Malibu LTZ Pontiac G6 Base Saturn Aura XE, XR; Converter	
1	Exhaust Pipe Gasket	2009	61054	Chevrolet Malibu LTZ; Loc. Front; Converter	
1	Exhaust Pipe Gasket	2009	61442	Chevrolet Malibu LTZ; Loc. Rear; Converter	
1	Exhaust Pipe Gasket	2009	61446	Chevrolet Malibu LS, LT Pontiac G6 Base Saturn Aura XE, XR; Pipe to manifold	
1	Exhaust Pipe Gasket	2009	61625	Pontiac G6 Base Saturn Aura XE, XR; Converter	
1	Exhaust Pipe Gasket	2009	61625	Chevrolet Malibu LTZ; Pipe to manifold	
1	Exhaust Pipe Gasket	2008-07	61054	Pontiac Solstice Base Saturn Sky Base; Converter	
1	Exhaust Pipe Gasket	2008	61054	Chevrolet Malibu LS, LT; Loc. Front; Converter	
1	Exhaust Pipe Gasket	2008	61362	Chevrolet Cobalt Sport, SS Pontiac G5 GT, Pursuit Base; Pipe to manifold	
1	Exhaust Pipe Gasket	2008	61440	Chevrolet Cobalt Sport, SS Pontiac G5 GT, Pursuit Base; Converter	
1	Exhaust Pipe Gasket	2008	61442	Chevrolet Malibu LS, LT; Loc. Rear; Converter	
1	Exhaust Pipe Gasket	2008	61442	Chevrolet Malibu LS Pontiac G6 Base; Pipe to manifold	
1	Exhaust Pipe Gasket	2008	61446	Chevrolet Malibu LT Saturn Aura XE; Pipe to manifold	
1	Exhaust Pipe Gasket	2008	61625	Pontiac G6 Base Saturn Aura XE; Converter	
1	Exhaust Pipe Gasket	2007-05	61442	Pontiac G6 Base; Converter	
1	Exhaust Pipe Gasket	2007-05	61446	Pontiac G6 Base; Pipe to manifold	
1	Exhaust Pipe Gasket	2007	61362	Exc. Pontiac G6 Base, Solstice Base Saturn Sky Base; Pipe to manifold	
1	Exhaust Pipe Gasket	2007	61440	Exc. Pontiac G6 Base, Solstice Base Saturn Sky Base; Converter	
1	Exhaust Pipe Gasket	2006	61054	Pontiac Solstice Base; Converter	
1	Exhaust Pipe Gasket	2006	61348	Pontiac Solstice Base; Pipe to manifold	
1	Exhaust Pipe Gasket	2006	61362	Exc. Pontiac G6 Base, Solstice Base; Pipe to manifold	
1	Exhaust Pipe Gasket	2006	61440	Exc. Pontiac G6 Base, Solstice Base; Converter	
1	Exhaust Pipe Gasket	2005	61362	Exc. Pontiac G6 Base; Pipe to manifold	
1	Exhaust Pipe Gasket	2005	61440	Exc. Pontiac G6 Base; Converter	
QTY	CRANKSHAFT REAR SEAL	YEARS	PART NO.	DESCRIPTION	
1	Rear Main Seal Set	2011-05	BS 40671	Rubber; One-piece; Improved design	
1	Rear Main Seal Set	2011-05	BS 40739	Rubber; One-piece; New Improved design; New Part Number - Check for Availability	
QTY	VALVE COVER	YEARS	PART NO.	DESCRIPTION	
1	Valve Cover Gasket Set	2011-05	VS 50769 R	w/Grommets & Spark plug tube seals; PermaDry® molded rubber gskt. incl.	
QTY	VALVE STEM SEAL SET	YEARS	PART NO.	DESCRIPTION	
1	Valve Stem Seal Set	2011-05	SS 71198	Premium valve stem seals incl.	
QTY	THERMOSTAT HOUSING	YEARS	PART NO.	DESCRIPTION	
1	Water Outlet Gasket	2011-05	35346	Thermostat Housing; Thermostat seal	
QTY	WATER PUMP	YEARS	PART NO.	DESCRIPTION	
1	Water Pump Gasket	2011-05	35721	Mounting	
1	Water Pump Gasket	2011-05	35724	Cover	
1	Water Pump Mounting Set	2011-05	ES 71282		
QTY	TIMING COVER	YEARS	PART NO.	DESCRIPTION	
1	Timing Cover Set	2011-05	TCS 46079		
1	Crankshaft Front Seal Set	2011-05	TCS 46113		
QTY	CARB & FUEL INJECTION	YEARS	PART NO.	DESCRIPTION	
1	Fuel Injector O-Ring Set	2011-05	ES 70599	Upper set; Injectors to fuel rail; Improved design	
1	Throttle Body Gasket	2011-08	61685	New Part Number - Check for Availability	
1	Throttle Body Gasket	2007	61624	Exc. Pontiac G5 GT, SE, G6 Base	
1	Throttle Body Gasket	2007	61685	Pontiac G5 GT, SE, G6 Base; New Part Number - Check for Availability	
1	Throttle Body Gasket	2006-05	61624	Exc. Pontiac G6 Base	
1	Throttle Body Gasket	2006-05	61685	Pontiac G6 Base; New Part Number - Check for Availability	
48	2012 - 2011; 2.4L 145.5 (2384cc) DOHC L4 (16 Valve) 88mm Bore Ecotec VVT				48
MFI; Gasoline; Naturally Aspirated Opel Eng.; VIN Code 1					
QTY	CYLINDER HEAD	YEARS	PART NO.	DESCRIPTION	
1	Head Gasket	2011	26466 PT	Head bolts not incl.; Head bolt replacement recommended; PermaTorqueMLS®	

GM Car (Incl. Buick, Cad., Chev., Geo, Olds., Pontiac, Saturn) (Cont.)

48 (cont.)		2012 - 2011; 2.4L 145.5 (2384cc) DOHC L4 (16 Valve) 88mm Bore Ecotec VVT			48 (cont.)
MFI; Gasoline; Naturally Aspirated Opel Eng.; VIN Code 1					
QTY	CYLINDER HEAD	YEARS	PART NO.	DESCRIPTION	
1	Head Set	2011	HS 26466 PT-1	Head bolts & exh. pipe flange not incl.; Head bolt replacement recommended; PermaDry® molded rubber valve cover gskt. incl.; Premium valve stem seals incl.	
1	Head Bolt Set	2011	ES 72196	Replacement recommended	
QTY	CONVERSION SET	YEARS	PART NO.	DESCRIPTION	
1	Gasket Conversion Set	2011	CS 26223-1	RTV sealant incl. for oil pan gskt.	
QTY	MANIFOLD - INT. & EXH.	YEARS	PART NO.	DESCRIPTION	
1	Int. Manifold Gasket Set	2011	MS 96351-1		
1	Exh. Manifold Gasket Set	2011	MS 97122		
QTY	EXHAUST PIPE FLANGE	YEARS	PART NO.	DESCRIPTION	
1	Exhaust Pipe Gasket	2011	61054	Pipe to manifold	
1	Exhaust Pipe Gasket	2011	61442	Loc. Front; Converter	
1	Exhaust Pipe Gasket	2011	61625	Loc. Rear; Converter	
QTY	CRANKSHAFT REAR SEAL	YEARS	PART NO.	DESCRIPTION	
1	Rear Main Seal Set	2012-11	BS 40739	Rubber; One-piece; New Improved design; New Part Number - Check for Availability	
1	Rear Main Seal Set	2011	BS 40671	Rubber; One-piece; Improved design	
QTY	VALVE COVER	YEARS	PART NO.	DESCRIPTION	
1	Valve Cover Gasket Set	2011	VS 50769 R	w/Grommets & Spark plug tube seals; PermaDry® molded rubber gskt. incl.	
QTY	VALVE STEM SEAL SET	YEARS	PART NO.	DESCRIPTION	
1	Valve Stem Seal Set	2011	SS 71198	Premium valve stem seals incl.	
QTY	THERMOSTAT HOUSING	YEARS	PART NO.	DESCRIPTION	
1	Water Outlet Gasket	2011	35346	Thermostat Housing; Thermostat seal	
QTY	WATER PUMP	YEARS	PART NO.	DESCRIPTION	
1	Water Pump Gasket	2011	35721	Mounting	
1	Water Pump Gasket	2011	35724	Cover	
1	Water Pump Mounting Set	2011	ES 71282		
QTY	TIMING COVER	YEARS	PART NO.	DESCRIPTION	
1	Timing Cover Set	2011	TCS 46079		
1	Crankshaft Front Seal Set	2011	TCS 46113		
QTY	CARB & FUEL INJECTION	YEARS	PART NO.	DESCRIPTION	
1	Fuel Injector O-Ring Set	2011	ES 70599	Upper set; Injectors to fuel rail; Improved design	
1	Throttle Body Gasket	2011	61685	New Part Number - Check for Availability	
49		2013 - 2010; 2.4L 145.5 (2384cc) DOHC L4 (16 Valve) 88mm Bore Ecotec VVT			49
DI; Gasoline; Naturally Aspirated Opel Eng.; VIN Code C					
QTY	CYLINDER HEAD	YEARS	PART NO.	DESCRIPTION	
1	Head Gasket	2011-10	26517 PT	Head bolts not incl.; Head bolt replacement recommended; PermaTorqueMLS®; New Part Number - Check for Availability	
1	Head Set	2011-10	HS 26517 PT	Head bolts not incl.; Head bolt replacement recommended; PermaDry® molded rubber valve cover gskt. incl.; Premium valve stem seals incl.; New Part Number - Check for Availability	
1	Head Bolt Set	2011-10	ES 72196	Replacement recommended	
QTY	CONVERSION SET	YEARS	PART NO.	DESCRIPTION	
1	Gasket Conversion Set	2011-10	CS 26223-1	RTV sealant incl. for oil pan gskt.	
QTY	MANIFOLD - INT. & EXH.	YEARS	PART NO.	DESCRIPTION	
1	Int. Manifold Gasket Set	2011-10	MS 97208	New Part Number - Check for Availability	
1	Exh. Manifold Gasket Set	2011-10	MS 97122		
QTY	EXHAUST PIPE FLANGE	YEARS	PART NO.	DESCRIPTION	
1	Exhaust Pipe Gasket	2011-10	61054	Pipe to manifold	
1	Exhaust Pipe Gasket	2011-10	61703	Converter; New Part Number - Check for Availability	
QTY	CRANKSHAFT REAR SEAL	YEARS	PART NO.	DESCRIPTION	
1	Rear Main Seal Set	2013-10	BS 40739	Rubber; One-piece; New Improved design; New Part Number - Check for Availability	
1	Rear Main Seal Set	2011-10	BS 40671	Rubber; One-piece; Improved design	
QTY	VALVE COVER	YEARS	PART NO.	DESCRIPTION	
1	Valve Cover Gasket Set	2011-10	VS 50778 R	w/Spark plug tube seals; PermaDry® molded rubber gskt. incl.; New Part Number - Check for Availability	
QTY	VALVE STEM SEAL SET	YEARS	PART NO.	DESCRIPTION	
1	Valve Stem Seal Set	2011-10	SS 71198	Premium valve stem seals incl.	
QTY	THERMOSTAT HOUSING	YEARS	PART NO.	DESCRIPTION	
1	Water Outlet Gasket	2011-10	35346	Thermostat Housing; Thermostat seal	

GM Car (Incl. Buick, Cad., Chev., Geo, Olds., Pontiac, Saturn) (Cont.)

49		2013 - 2010; 2.4L 145.5 (2384cc) DOHC L4 (16 Valve) 88mm Bore Ecotec VVT			49
(cont.)		DI; Gasoline; Naturally Aspirated Opel Eng.; VIN Code C			(cont.)
QTY	WATER PUMP	YEARS	PART NO.	DESCRIPTION	
1	Water Pump Gasket	2011-10	35721	Mounting	
1	Water Pump Gasket	2011-10	35724	Cover	
1	Water Pump Mounting Set	2011-10	ES 71282		
QTY	TIMING COVER	YEARS	PART NO.	DESCRIPTION	
1	Timing Cover Set	2011-10	TCS 46079		
1	Crankshaft Front Seal Set	2011-10	TCS 46113		
QTY	CARB & FUEL INJECTION	YEARS	PART NO.	DESCRIPTION	
1	Fuel Injector O-Ring Set	2011-10	ES 70599	Upper set; Injectors to fuel rail; Improved design	
1	Throttle Body Gasket	2011-10	61690	New Part Number - Check for Availability	
50		2012 - 2011; 2.4L 145.5 (2384cc) DOHC L4 (16 Valve) 88mm Bore Ecotec VVT			50
		MFI; Flex Fuel; Naturally Aspirated Opel Eng.; VIN Code U			
QTY	CYLINDER HEAD	YEARS	PART NO.	DESCRIPTION	
1	Head Gasket	2011	26466 PT	Head bolts not incl.; Head bolt replacement recommended; PermaTorqueMLS®	
1	Head Set	2011	HS 26466 PT-1	Head bolts & exh. pipe flange not incl.; Head bolt replacement recommended; PermaDry® molded rubber valve cover gskt. incl.; Premium valve stem seals incl.	
1	Head Bolt Set	2011	ES 72196	Replacement recommended	
QTY	CONVERSION SET	YEARS	PART NO.	DESCRIPTION	
1	Gasket Conversion Set	2011	CS 26223-1	RTV sealant incl. for oil pan gskt.	
QTY	MANIFOLD - INT. & EXH.	YEARS	PART NO.	DESCRIPTION	
1	Int. Manifold Gasket Set	2011	MS 96351-1		
1	Exh. Manifold Gasket Set	2011	MS 97122		
QTY	EXHAUST PIPE FLANGE	YEARS	PART NO.	DESCRIPTION	
1	Exhaust Pipe Gasket	2011	61443	Loc. Rear; Converter	
1	Exhaust Pipe Gasket	2011	61625	Loc. Front; Converter	
1	Exhaust Pipe Gasket	2011	61625	Pipe to manifold	
QTY	CRANKSHAFT REAR SEAL	YEARS	PART NO.	DESCRIPTION	
1	Rear Main Seal Set	2012-11	BS 40739	Rubber; One-piece; New Improved design; New Part Number - Check for Availability	
1	Rear Main Seal Set	2011	BS 40671	Rubber; One-piece; Improved design	
QTY	VALVE COVER	YEARS	PART NO.	DESCRIPTION	
1	Valve Cover Gasket Set	2011	VS 50769 R	w/Grommets & Spark plug tube seals; PermaDry® molded rubber gskt. incl.	
QTY	VALVE STEM SEAL SET	YEARS	PART NO.	DESCRIPTION	
1	Valve Stem Seal Set	2011	SS 71198	Premium valve stem seals incl.	
QTY	THERMOSTAT HOUSING	YEARS	PART NO.	DESCRIPTION	
1	Water Outlet Gasket	2011	35346	Thermostat Housing; Thermostat seal	
QTY	WATER PUMP	YEARS	PART NO.	DESCRIPTION	
1	Water Pump Gasket	2011	35721	Mounting	
1	Water Pump Gasket	2011	35724	Cover	
1	Water Pump Mounting Set	2011	ES 71282		
QTY	TIMING COVER	YEARS	PART NO.	DESCRIPTION	
1	Timing Cover Set	2011	TCS 46079		
1	Crankshaft Front Seal Set	2011	TCS 46113		
QTY	CARB & FUEL INJECTION	YEARS	PART NO.	DESCRIPTION	
1	Fuel Injector O-Ring Set	2011	ES 70599	Upper set; Injectors to fuel rail; Improved design	
1	Throttle Body Gasket	2011	61685	New Part Number - Check for Availability	
51		2002 - 1996; 2.4L 146 (2392cc) DOHC L4 (16 Valve) 90mm Bore Twin Cam			51
		MFI; Gasoline; Naturally Aspirated GMC Eng.; Oldsmobile; VIN Code T			
QTY	CYLINDER HEAD	YEARS	PART NO.	DESCRIPTION	
1	Head Gasket	2002-00	9059 PT	Head bolts not incl.; Head bolt replacement recommended	
1	Head Gasket	1999	9059 PT	w/o EGR; Head bolts not incl.; Head bolt replacement recommended	
1	Head Gasket	1999	9115 PT	w/EGR; Head bolts not incl.; Head bolt replacement recommended	
1	Head Gasket	1998-96	9115 PT	Head bolts not incl.; Head bolt replacement recommended	
1	Head Set	2002-00	HS 9059 PT	Head bolts not incl.; Head bolt replacement recommended; PermaDry® molded rubber valve cover gskts. incl.; Premium valve stem seals incl.	
1	Head Set	1999	HS 9059 PT	w/o EGR; Head bolts not incl.; Head bolt replacement recommended; PermaDry® molded rubber valve cover gskts. incl.; Premium valve stem seals incl.	
1	Head Set	1999	HS 9115 PT	w/EGR; Head bolts not incl.; Head bolt replacement recommended; PermaDry® molded rubber valve cover gskts. incl.; Premium valve stem seals incl.	

GM Car (Incl. Buick, Cad., Chev., Geo, Olds., Pontiac, Saturn) (Cont.)

51 (cont.)		2002 - 1996; 2.4L 146 (2392cc) DOHC L4 (16 Valve) 90mm Bore Twin Cam			51 (cont.)
MFI; Gasoline; Naturally Aspirated GMC Eng.; Oldsmobile; VIN Code T					
QTY	CYLINDER HEAD	YEARS	PART NO.	DESCRIPTION	
1	Head Set	1998-96	HS 9115 PT	Head bolts not incl.; Head bolt replacement recommended; PermaDry® molded rubber valve cover gskts. incl.; Premium valve stem seals incl.	
1	Head Installation Set	1999	HIS 9115 PT	w/EGR; Head bolts & exh. pipe flange not incl.; Head bolt replacement recommended; PermaDry® molded rubber valve cover gskts. incl.	
1	Head Installation Set	1998-96	HIS 9115 PT	Head bolts & exh. pipe flange not incl.; Head bolt replacement recommended; PermaDry® molded rubber valve cover gskts. incl.	
1	Head Bolt Set	2002-96	ES 72165	Replacement recommended	
QTY	CONVERSION SET	YEARS	PART NO.	DESCRIPTION	
1	Gasket Conversion Set	2002-96	CS 9115	PermaDry® molded rubber oil pan gskt. incl.	
QTY	MANIFOLD - INT. & EXH.	YEARS	PART NO.	DESCRIPTION	
1	Int. Manifold Gasket Set	2002-96	MS 95839		
1	Exh. Manifold Gasket Set	2002-00	MS 90284		
1	Exh. Manifold Gasket Set	1999	MS 90278	w/EGR	
1	Exh. Manifold Gasket Set	1999	MS 90284	w/o EGR	
1	Exh. Manifold Gasket Set	1998-96	MS 90278		
QTY	EXHAUST PIPE FLANGE	YEARS	PART NO.	DESCRIPTION	
1	Exhaust Pipe Gasket	2002-00	60666	Packing	
1	Exhaust Pipe Gasket	1999	60666	Packing; w/o EGR	
1	Exhaust Pipe Gasket	1999	61008	Flange; w/EGR	
1	Exhaust Pipe Gasket	1998-96	61008	Flange	
QTY	OIL PAN	YEARS	PART NO.	DESCRIPTION	
1	Oil Pan Gasket Set	2002-96	OS 30678 R	PermaDry® molded rubber gskt. incl.	
QTY	CRANKSHAFT REAR SEAL	YEARS	PART NO.	DESCRIPTION	
1	Rear Main Seal Set	2002-96	BS 40591	Rubber; One-piece	
QTY	VALVE COVER	YEARS	PART NO.	DESCRIPTION	
1	Valve Cover Gasket Set	2002-96	VS 50445 R	Loc. Exh.; Cam carrier gskts. incl.; PermaDry® molded rubber gskts. incl.	
1	Valve Cover Gasket Set	2002-96	VS 50490 R	Loc. Int.; Cam carrier gskts. incl.; PermaDry® molded rubber gskts. incl.	
QTY	VALVE STEM SEAL SET	YEARS	PART NO.	DESCRIPTION	
1	Valve Stem Seal Set	2002-96	SS 72807-1	Premium valve stem seals incl.	
QTY	THERMOSTAT HOUSING	YEARS	PART NO.	DESCRIPTION	
1	Thermostat Gasket	2002-96	35614	Thermostat Housing; Thermostat seal; Improved design	
QTY	WATER OUTLET GASKET	YEARS	PART NO.	DESCRIPTION	
1	Water Outlet Gasket	2002-96	35597	Water Outlet; Outlet O-ring	
QTY	WATER PUMP	YEARS	PART NO.	DESCRIPTION	
1	Water Pump Mounting Set	2002-96	ES 72103	Must be used w/MS 90278 or w/MS 90284	
QTY	TIMING COVER	YEARS	PART NO.	DESCRIPTION	
1	Timing Cover Set	2002-96	TCS 45972		
QTY	CARB & FUEL INJECTION	YEARS	PART NO.	DESCRIPTION	
1	Fuel Injector O-Ring Set	2002-99	ES 70599	Upper set; Injectors to fuel rail; Improved design	
1	Fuel Injector O-Ring Set	2002-99	ES 71190	Lower set; Injectors to cylinder head	
1	Fuel Injector O-Ring Set	2002-99	ES 71192	Upper set; Injectors to fuel rail; Old design	
2	Fuel Injector O-Ring Set	1998-96	ES 70599	Improved design	
1	Throttle Body Gasket	2002-96	61021		
QTY	EXHAUST GAS RECIRCULATION	YEARS	PART NO.	DESCRIPTION	
1	EGR Gasket	2002-99	70803		
1	EGR Gasket	1998-96	70789	Mounting	
1	EGR Gasket	1998-96	70803	Adapter	
52		1992 - 1991; 2.5L 151 (2475cc) OHV L4 (8 Valve) 4" Bore			52
TBI; Gasoline; Naturally Aspirated GMC Eng.; Pontiac; VIN Code R					
QTY	CYLINDER HEAD	YEARS	PART NO.	DESCRIPTION	
1	Head Gasket	1992-91	515 SD	Head bolts not incl.; Head bolt replacement recommended; PermaTorque Severe Duty®	
1	Head Gasket	1992-91	9405 PT-1	Head bolts not incl.; Head bolt replacement recommended; PermaTorque®	
1	Head Set	1992-91	HS 9405 PT-5	Head bolts & exh. pipe packing not incl.; Head bolt replacement recommended; Premium valve stem seals incl.	
1	Head Bolt Set	1992-91	ES 72733	Replacement recommended	
QTY	CONVERSION SET	YEARS	PART NO.	DESCRIPTION	
1	Gasket Conversion Set	1992-91	CS 9405	RTV sealant incl. for oil pan gskt.	
QTY	MANIFOLD - INT. & EXH.	YEARS	PART NO.	DESCRIPTION	
1	Int. Manifold Gasket Set	1992-91	MS 94278		
1	Exh. Manifold Gasket Set	1992-91	MS 93689		
QTY	EXHAUST PIPE FLANGE	YEARS	PART NO.	DESCRIPTION	
1	Exhaust Pipe Gasket	1992-91	60592	Exc. Chevrolet Lumina Base, Euro; Pipe to manifold	

GM Car (Incl. Buick, Cad., Chev., Geo, Olds., Pontiac, Saturn) (Cont.)

52 (cont.)		1992 - 1991; 2.5L 151 (2475cc) OHV L4 (8 Valve) 4" Bore			52 (cont.)
		TBI; Gasoline; Naturally Aspirated GMC Eng.; Pontiac; VIN Code R			
QTY	EXHAUST PIPE FLANGE	YEARS	PART NO.	DESCRIPTION	
1	Exhaust Pipe Gasket	1992-91	60836	Chevrolet Lumina Base, Euro; Pipe to manifold	
1	Exh. Flange Bolt & Spring Kit	1992-91	ES 72141		
QTY	OIL PAN	YEARS	PART NO.	DESCRIPTION	
1	Drain Plug Gasket	1992-91	72598	Drain plug & filter seal	
QTY	CRANKSHAFT REAR SEAL	YEARS	PART NO.	DESCRIPTION	
1	Rear Main Seal Set	1992-91	BS 40578	Rubber; One-piece; Improved design	
1	Repair Sleeve	1992-91	16259	Crankshaft; Use w/installation tool	
1	Repair Sleeve Tool	1992-91	16304	Crankshaft	
QTY	VALVE COVER	YEARS	PART NO.	DESCRIPTION	
1	Valve Cover Gasket Set	1992-91	VS 50179 T	PermaDryPlus®	
1	Valve Cover Gasket Set	1992-91	VS 50329 C	Cork	
QTY	PUSH ROD COVER	YEARS	PART NO.	DESCRIPTION	
1	Push Rod Cover Gasket Set	1992-91	PS 50276 C	w/Grommets; Cork	
QTY	VALVE STEM SEAL SET	YEARS	PART NO.	DESCRIPTION	
1	Valve Stem Seal Set	1992-91	SS 72684	Premium valve stem seals incl.	
QTY	THERMOSTAT HOUSING	YEARS	PART NO.	DESCRIPTION	
1	Water Outlet Gasket	1992-91	35568	Thermostat Housing	
QTY	WATER OUTLET GASKET	YEARS	PART NO.	DESCRIPTION	
1	O-Ring	1992-91	35533	Water Outlet	
QTY	WATER PUMP	YEARS	PART NO.	DESCRIPTION	
1	Water Pump Gasket	1992-91	35413	Adapter to block	
1	Water Pump Gasket	1992-91	35518	Pump to adapter	
QTY	TIMING COVER	YEARS	PART NO.	DESCRIPTION	
1	Timing Cover Set	1992-91	TCS 13198-2	w/o Sleeve 'N' Seal®	
1	Timing Set w/Sleeve & Seal	1992-91	TCS 45846	w/Sleeve 'N' Seal®	
1	Repair Sleeve	1992-91	16202	Timing Cover; Use w/installation tool	
1	Repair Sleeve Tool	1992-91	16312	Timing Cover	
QTY	AIR CLEANER MOUNTING	YEARS	PART NO.	DESCRIPTION	
1	Air Cleaner Gasket	1992-91	60706		
QTY	CARB & FUEL INJECTION	YEARS	PART NO.	DESCRIPTION	
1	Throttle Body Gasket	1992-91	60764		
QTY	DISTRIBUTOR MOUNTING	YEARS	PART NO.	DESCRIPTION	
1	O-Ring	1992-91	70484-1	Distributor Mounting	
QTY	EXHAUST GAS RECIRCULATION	YEARS	PART NO.	DESCRIPTION	
1	EGR Gasket	1992-91	70978		
53		1991; 2.5L 151 (2475cc) OHV L4 (8 Valve) 4" Bore			53
		TBI; Gasoline; Naturally Aspirated GMC Eng.; Pontiac; VIN Code U			
QTY	CYLINDER HEAD	YEARS	PART NO.	DESCRIPTION	
1	Head Gasket	1991	9406 PT	Head bolts not incl.; Head bolt replacement recommended; PermaTorque®	
1	Head Set	1991	HS 9406 PT-3	Head bolts & exh. pipe packing not incl.; Head bolt replacement recommended; Premium valve stem seals incl.	
1	Head Bolt Set	1991	ES 72858	Replacement recommended	
QTY	CONVERSION SET	YEARS	PART NO.	DESCRIPTION	
1	Gasket Conversion Set	1991	CS 9405	RTV sealant incl. for oil pan gskt.	
QTY	MANIFOLD - INT. & EXH.	YEARS	PART NO.	DESCRIPTION	
1	Int. Manifold Gasket Set	1991	MS 94278		
1	Exh. Manifold Gasket Set	1991	MS 93689		
QTY	EXHAUST PIPE FLANGE	YEARS	PART NO.	DESCRIPTION	
1	Exhaust Pipe Gasket	1991	60592	Pipe to manifold	
1	Exhaust Pipe Gasket	1991	60850	Converter; 51mm ID	
1	Exh. Flange Bolt & Spring Kit	1991	ES 72141		
QTY	OIL PAN	YEARS	PART NO.	DESCRIPTION	
1	Drain Plug Gasket	1991	72598	Drain plug & filter seal	
QTY	CRANKSHAFT REAR SEAL	YEARS	PART NO.	DESCRIPTION	
1	Rear Main Seal Set	1991	BS 40578	Rubber; One-piece; Improved design	
1	Repair Sleeve	1991	16259	Crankshaft; Use w/installation tool	
1	Repair Sleeve Tool	1991	16304	Crankshaft	
QTY	VALVE COVER	YEARS	PART NO.	DESCRIPTION	
1	Valve Cover Gasket Set	1991	VS 50179 T	PermaDryPlus®	
1	Valve Cover Gasket Set	1991	VS 50329 C	Cork	
QTY	PUSH ROD COVER	YEARS	PART NO.	DESCRIPTION	
1	Push Rod Cover Gasket Set	1991	PS 50276 C	w/Grommets; Cork	

GM Car (Incl. Buick, Cad., Chev., Geo, Olds., Pontiac, Saturn) (Cont.)

53		1991; 2.5L 151 (2475cc) OHV L4 (8 Valve) 4" Bore			53	
(cont.)		TBI; Gasoline; Naturally Aspirated GMC Eng.; Pontiac; VIN Code U			(cont.)	
QTY	VALVE STEM SEAL SET	YEARS	PART NO.	DESCRIPTION		
1	Valve Stem Seal Set	1991	SS 72684	Premium valve stem seals incl.		
QTY	WATER OUTLET GASKET	YEARS	PART NO.	DESCRIPTION		
1	Water Outlet Gasket	1991	35568	Water Outlet		
1	O-Ring	1991	35533	Water Outlet		
QTY	WATER PUMP	YEARS	PART NO.	DESCRIPTION		
1	Water Pump Gasket	1991	35215	Adapter to block		
1	Water Pump Gasket	1991	35299	Pump to adapter		
QTY	TIMING COVER	YEARS	PART NO.	DESCRIPTION		
1	Timing Cover Set	1991	TCS 13198-2	w/o Sleeve 'N' Seal®		
1	Timing Set w/Sleeve & Seal	1991	TCS 45846	w/Sleeve 'N' Seal®		
1	Repair Sleeve	1991	16202	Timing Cover; Use w/installation tool		
1	Repair Sleeve Tool	1991	16312	Timing Cover		
QTY	AIR CLEANER MOUNTING	YEARS	PART NO.	DESCRIPTION		
1	Air Cleaner Gasket	1991	60706			
QTY	CARB & FUEL INJECTION	YEARS	PART NO.	DESCRIPTION		
1	Throttle Body Gasket	1991	60764			
QTY	DISTRIBUTOR MOUNTING	YEARS	PART NO.	DESCRIPTION		
1	O-Ring	1991	70484-1	Distributor Mounting		
QTY	EXHAUST GAS RECIRCULATION	YEARS	PART NO.	DESCRIPTION		
1	EGR Gasket	1991	70978			
54		2004 - 2003; 2.6L 158 (2597cc) DOHC V6 (24 Valve) 83.2mm Bore			54	
		MFI; Gasoline; Naturally Aspirated Opel Eng.; VIN Code M				
QTY	CYLINDER HEAD	YEARS	PART NO.	DESCRIPTION		
2	Head Bolt Set	2004-03	ES 72906	Head bolts w/Washers; Replacement recommended		
QTY	CONVERSION SET	YEARS	PART NO.	DESCRIPTION		
1	Gasket Conversion Set	2004-03	CS 26173-4	RTV sealant incl. for oil pan gskt.		
QTY	MANIFOLD - INT. & EXH.	YEARS	PART NO.	DESCRIPTION		
1	Int. Manifold Gasket Set	2004-03	MS 96103	Lower set; Upper set incl.		
1	Plenum Gasket Set	2004-03	MS 96062	Upper set		
1	Exh. Manifold Gasket Set	2004-03	MS 96425			
QTY	EXHAUST PIPE FLANGE	YEARS	PART NO.	DESCRIPTION		
1	Exhaust Pipe Gasket	2004-03	61525	Loc. L.H.; Converter; Improved design		
1	Exhaust Pipe Gasket	2004-03	61626	Loc. R.H.; Converter		
2	Exhaust Pipe Gasket	2004-03	61637	Pipe to manifold		
QTY	CRANKSHAFT REAR SEAL	YEARS	PART NO.	DESCRIPTION		
1	Rear Main Seal Set	2004-03	BS 40671	Rubber; One-piece; Improved design		
1	Rear Main Seal Set	2004-03	BS 40739	Rubber; One-piece; New Improved design; New Part Number - Check for Availability		
QTY	VALVE COVER	YEARS	PART NO.	DESCRIPTION		
1	Valve Cover Gasket Set	2004-03	VS 50628 R	w/Grommets; PermaDry® molded rubber gskts. incl.		
QTY	VALVE STEM SEAL SET	YEARS	PART NO.	DESCRIPTION		
1	Valve Stem Seal Set	2004-03	SS 71163	Premium valve stem seals incl.		
QTY	THERMOSTAT HOUSING	YEARS	PART NO.	DESCRIPTION		
1	O-Ring	2004-03	35749	Thermostat Housing		
QTY	WATER PUMP	YEARS	PART NO.	DESCRIPTION		
1	Water Pump Gasket	2004-03	35665	O-ring		
QTY	TIMING COVER	YEARS	PART NO.	DESCRIPTION		
1	Crankshaft Front Seal Set	2004-03	TCS 46014			
4	Camshaft Front Seal Set	2004-03	TCS 45603			
QTY	CARB & FUEL INJECTION	YEARS	PART NO.	DESCRIPTION		
3	Fuel Injector O-Ring Set	2004-03	ES 70599	Improved design		
2	Throttle Body Gasket	2004-03	61184			
55		2007 - 2005; 2.8L 171 (2792cc) DOHC V6 (24 Valve) 89mm Bore			55	
		MFI; Gasoline; Naturally Aspirated Opel Eng.; VIN Code T				
QTY	CYLINDER HEAD	YEARS	PART NO.	DESCRIPTION		
1	Head Gasket	2007-05	26614 PT	Loc. L.H.; Head bolts not incl.; Head bolt replacement recommended; PermaTorqueMLS®; New Part Number - Check for Availability		
1	Head Gasket	2007-05	26627 PT	Loc. R.H.; Head bolts not incl.; Head bolt replacement recommended; PermaTorqueMLS®; New Part Number - Check for Availability		
2	Head Bolt Set	2007-05	ES 72274	Replacement recommended		

GM Car (Incl. Buick, Cad., Chev., Geo, Olds., Pontiac, Saturn) (Cont.)

55 (cont.)		2007 - 2005; 2.8L 171 (2792cc) DOHC V6 (24 Valve) 89mm Bore			55 (cont.)
		MFI; Gasoline; Naturally Aspirated Opel Eng.; VIN Code T			
QTY	CONVERSION SET	YEARS	PART NO.	DESCRIPTION	
1	Gasket Conversion Set	2007-05	CS 26376-1	RTV sealant incl. for oil pan gskt.; Improved design	
QTY	MANIFOLD - INT. & EXH.	YEARS	PART NO.	DESCRIPTION	
1	Int. Manifold Gasket Set	2007-05	MS 96969	Lower set; Upper set incl.	
1	Plenum Gasket Set	2007-05	MS 96976	Upper set	
1	Exh. Manifold Gasket Set	2007-05	MS 96970		
QTY	EXHAUST PIPE FLANGE	YEARS	PART NO.	DESCRIPTION	
2	Exhaust Pipe Gasket	2007-05	61310	Pipe to manifold; Improved design	
2	Exhaust Pipe Gasket	2007-05	61525	Converter; Improved design	
QTY	CRANKSHAFT REAR SEAL	YEARS	PART NO.	DESCRIPTION	
1	Rear Main Seal Set	2007-05	BS 40711	PTFE Rubber; One-piece; Improved design	
QTY	VALVE COVER	YEARS	PART NO.	DESCRIPTION	
1	Valve Cover Gasket Set	2007-05	VS 50726 R	w/o Spark plug tube seals & w/Grommets; PermaDry® molded rubber gskts. incl.	
1	Spark Plug Tube Seal Set	2007-05	ES 72393	Valve Cover; New Part Number - Check for Availability	
QTY	VALVE STEM SEAL SET	YEARS	PART NO.	DESCRIPTION	
1	Valve Stem Seal Set	2007-05	SS 72923	Premium valve stem seals incl.	
QTY	THERMOSTAT HOUSING	YEARS	PART NO.	DESCRIPTION	
1	Thermostat Gasket	2007-05	35858	Thermostat Housing; Thermostat seal	
1	Thermostat Gasket	2007-05	35871	Thermostat Housing; Thermostat housing to head	
QTY	WATER PUMP	YEARS	PART NO.	DESCRIPTION	
1	Water Pump Gasket	2007-05	35859		
QTY	TIMING COVER	YEARS	PART NO.	DESCRIPTION	
1	Timing Cover Set	2007-05	TCS 46108		
QTY	CARB & FUEL INJECTION	YEARS	PART NO.	DESCRIPTION	
2	Fuel Injector O-Ring Set	2007-05	ES 70599	Upper set; Injectors to fuel rail; Improved design	
2	Fuel Injector O-Ring Set	2007-05	ES 72004	Lower set; Injectors to cylinder head	
1	Throttle Body Gasket	2007-05	61521		
56		2005 - 1997; 3.0L 181 (2962cc) DOHC V6 (24 Valve) 86mm Bore			56
		MFI; Gasoline; Naturally Aspirated Opel Eng.; VIN Code R			
QTY	CYLINDER HEAD	YEARS	PART NO.	DESCRIPTION	
2	Head Gasket	2005-99	26173 PT	Head bolts not incl.; Head bolt replacement recommended; PermaTorqueMLS® LaserWeld® Technology	
2	Head Gasket	1998-97	26189 PT	Head bolts not incl.; Head bolt replacement recommended	
1	Head Set	2005-02	HS 26173 PT-1	Head bolts not incl.; Head bolt replacement recommended; PermaDry® molded rubber valve cover gskts. incl.; Premium valve stem seals incl.	
1	Head Set	2001-00	HS 26173 PT	Cadillac Catera Base, Sport; Head bolts not incl.; Head bolt replacement recommended; PermaDry® molded rubber valve cover gskts. incl.; Premium valve stem seals incl.	
1	Head Set	2001-00	HS 26173 PT-1	Exc. Cadillac Catera Base, Sport; Head bolts not incl.; Head bolt replacement recommended; PermaDry® molded rubber valve cover gskts. incl.; Premium valve stem seals incl.	
1	Head Set	1999	HS 26173 PT	Head bolts not incl.; Head bolt replacement recommended; PermaDry® molded rubber valve cover gskts. incl.; Premium valve stem seals incl.	
1	Head Set	1998-97	HS 26189 PT	Head bolts & exh. pipe packing not incl.; Head bolt replacement recommended; PermaDry® molded rubber valve cover gskts. incl.; Premium valve stem seals incl.	
2	Head Bolt Set	2005-97	ES 72906	Head bolts w/Washers; Replacement recommended	
QTY	CONVERSION SET	YEARS	PART NO.	DESCRIPTION	
1	Gasket Conversion Set	2005-02	CS 26173-4	RTV sealant incl. for oil pan gskt.	
1	Gasket Conversion Set	2001-00	CS 26173	Cadillac Catera Base, Sport; PermaDry® molded rubber oil pan gskt. incl.	
1	Gasket Conversion Set	2001-00	CS 26173-4	Exc. Cadillac Catera Base, Sport; RTV sealant incl. for oil pan gskt.	
1	Gasket Conversion Set	1999-97	CS 26173	PermaDry® molded rubber oil pan gskt. incl.	
QTY	MANIFOLD - INT. & EXH.	YEARS	PART NO.	DESCRIPTION	
1	Int. Manifold Gasket Set	2005-02	MS 96102	Lower set; Upper set incl.	
1	Int. Manifold Gasket Set	2001-00	MS 96102	Exc. Cadillac Catera Base, Sport; Lower set; Upper set incl.	
1	Int. Manifold Gasket Set	2001-00	MS 96103	Cadillac Catera Base, Sport; Lower set; Upper set incl.	
1	Int. Manifold Gasket Set	1999-97	MS 96103	Lower set; Upper set incl.	
1	Plenum Gasket Set	2001-00	MS 96062	Cadillac Catera Base, Sport; Upper set	
1	Plenum Gasket Set	1999-97	MS 96062	Upper set	
1	Exh. Manifold Gasket Set	2005-02	MS 96089		
1	Exh. Manifold Gasket Set	2001-00	MS 96088	Cadillac Catera Base, Sport	
1	Exh. Manifold Gasket Set	2001-00	MS 96089	Exc. Cadillac Catera Base, Sport	
1	Exh. Manifold Gasket Set	1999-97	MS 96088		

GM Car (Incl. Buick, Cad., Chev., Geo, Olds., Pontiac, Saturn) (Cont.)

56 (cont.)		2005 - 1997; 3.0L 181 (2962cc) DOHC V6 (24 Valve) 86mm Bore			56 (cont.)
MFI; Gasoline; Naturally Aspirated Opel Eng.; VIN Code R					
QTY	EXHAUST PIPE FLANGE	YEARS	PART NO.	DESCRIPTION	
1	Exhaust Pipe Gasket	2005-02	61187	Converter	
2	Exhaust Pipe Gasket	2005-02	61187	Pipe to manifold	
1	Exhaust Pipe Gasket	2001-00	61187	Exc. Cadillac Catera Base, Sport; Converter	
2	Exhaust Pipe Gasket	2001-00	61187	Exc. Cadillac Catera Base, Sport; Pipe to manifold	
2	Exhaust Pipe Gasket	2001-00	61206	Cadillac Catera Base, Sport; Pipe to manifold	
2	Exhaust Pipe Gasket	1999-97	61206	Pipe to manifold	
QTY	OIL PAN	YEARS	PART NO.	DESCRIPTION	
1	Oil Pan Gasket Set	2001-00	OS 30716 R	Cadillac Catera Base, Sport; Loc. Upper; PermaDry® molded rubber gskt. incl.	
1	Oil Pan Gasket Set	2001-00	OS 30722 R	Cadillac Catera Base, Sport; Loc. Lower; PermaDry® molded rubber gskt. incl.	
1	Oil Pan Gasket Set	1999-97	OS 30716 R	Loc. Upper; PermaDry® molded rubber gskt. incl.	
1	Oil Pan Gasket Set	1999-97	OS 30722 R	Loc. Lower; PermaDry® molded rubber gskt. incl.	
QTY	CRANKSHAFT REAR SEAL	YEARS	PART NO.	DESCRIPTION	
1	Rear Main Seal Set	2005-97	BS 40671	Rubber; One-piece; Improved design	
1	Rear Main Seal Set	2005-97	BS 40739	Rubber; One-piece; New Improved design; New Part Number - Check for Availability	
QTY	VALVE COVER	YEARS	PART NO.	DESCRIPTION	
1	Valve Cover Gasket Set	2005-02	VS 50567 R	w/Grommets; PermaDry® molded rubber gskts. incl.	
1	Valve Cover Gasket Set	2001-00	VS 50566 R	Cadillac Catera Base, Sport; w/Grommets; PermaDry® molded rubber gskts. incl.	
1	Valve Cover Gasket Set	2001-00	VS 50567 R	Exc. Cadillac Catera Base, Sport; w/Grommets; PermaDry® molded rubber gskts. incl.	
1	Valve Cover Gasket Set	1999-97	VS 50566 R	w/Grommets; PermaDry® molded rubber gskts. incl.	
QTY	VALVE STEM SEAL SET	YEARS	PART NO.	DESCRIPTION	
1	Valve Stem Seal Set	2005-97	SS 71163	Premium valve stem seals incl.	
QTY	THERMOSTAT HOUSING	YEARS	PART NO.	DESCRIPTION	
1	O-Ring	2005-02	35668	Thermostat Housing; Exc. Housing No. 55353492	
1	O-Ring	2005-02	35749	Thermostat Housing; Housing No. 55353492	
1	O-Ring	2001-00	35668	Exc. Cadillac Catera Base, Sport; Thermostat Housing; Exc. Housing No. 55353492	
1	O-Ring	2001-00	35669	Cadillac Catera Base, Sport; Thermostat Housing	
1	O-Ring	2001-00	35749	Exc. Cadillac Catera Base, Sport; Thermostat Housing; Housing No. 55353492	
1	O-Ring	1999-97	35669	Thermostat Housing	
QTY	WATER PUMP	YEARS	PART NO.	DESCRIPTION	
1	Water Pump Gasket	2005-97	35665	O-ring	
QTY	TIMING COVER	YEARS	PART NO.	DESCRIPTION	
1	Crankshaft Front Seal Set	2005-97	TCS 46014		
4	Camshaft Front Seal Set	2005-97	TCS 45603		
QTY	CARB & FUEL INJECTION	YEARS	PART NO.	DESCRIPTION	
1	Throttle Body Gasket	2005-02	61186		
2	Throttle Body Gasket	2001-00	61184	Cadillac Catera Base, Sport	
1	Throttle Body Gasket	2001-00	61186	Exc. Cadillac Catera Base, Sport	
2	Throttle Body Gasket	1999-97	61184		
QTY	EXHAUST GAS RECIRCULATION	YEARS	PART NO.	DESCRIPTION	
1	EGR Gasket	2005-02	70789	Valve	
1	EGR Gasket	2005-02	71103	Adapter	
1	EGR Gasket	2001-00	70789	Exc. Cadillac Catera Base, Sport; Valve	
1	EGR Gasket	2001-00	71103	Exc. Cadillac Catera Base, Sport; Adapter	
QTY	OIL FILTER MOUNTING	YEARS	PART NO.	DESCRIPTION	
1	Oil Filter Adapter Gasket	2005-97	72737	Oil filter adapter; New Part Number - Check for Availability	
57		2012; 3.0L 182.9 (2997cc) DOHC V6 (24 Valve) 89mm Bore VVT			57
DI; Flex Fuel; Naturally Aspirated Opel Eng.; VIN Code 5					
QTY	CYLINDER HEAD	YEARS	PART NO.	DESCRIPTION	
2	Head Bolt Set	2012	ES 72274	Replacement recommended	
QTY	CONVERSION SET	YEARS	PART NO.	DESCRIPTION	
1	Gasket Conversion Set	2012	CS 26376-1	RTV sealant incl. for oil pan gskt.; Improved design	
QTY	EXHAUST PIPE FLANGE	YEARS	PART NO.	DESCRIPTION	
1	Exhaust Pipe Gasket	2012	61465	Loc. Rear; Converter	
1	Exhaust Pipe Gasket	2012	61708	Loc. Front; Converter; New Part Number - Check for Availability	
QTY	OIL PAN	YEARS	PART NO.	DESCRIPTION	
1	Drain Plug Gasket	2012	70820		

GM Car (Incl. Buick, Cad., Chev., Geo, Olds., Pontiac, Saturn) (Cont.)

57		2012; 3.0L 182.9 (2997cc) DOHC V6 (24 Valve) 89mm Bore VVT			57
(cont.)		DI; Flex Fuel; Naturally Aspirated Opel Eng.; VIN Code 5			(cont.)
QTY	CRANKSHAFT REAR SEAL	YEARS	PART NO.	DESCRIPTION	
1	Rear Main Seal Set	2012	BS 40711	PTFE Rubber; One-piece; Improved design	
QTY	VALVE COVER	YEARS	PART NO.	DESCRIPTION	
1	Valve Cover Gasket Set	2012	VS 50808 R	w/Grommets & Spark plug tube seals; PermaDry® molded rubber gskts. incl.; New Part Number - Check for Availability	
1	Spark Plug Tube Seal Set	2012	ES 72393	Valve Cover; New Part Number - Check for Availability	
QTY	THERMOSTAT HOUSING	YEARS	PART NO.	DESCRIPTION	
1	Thermostat Gasket	2012	35858	Thermostat Housing; Thermostat seal	
1	Thermostat Gasket	2012	35871	Thermostat Housing; Thermostat housing to head	
QTY	WATER PUMP	YEARS	PART NO.	DESCRIPTION	
1	Water Pump Gasket	2012	35859		
QTY	TIMING COVER	YEARS	PART NO.	DESCRIPTION	
1	Timing Cover Set	2012	TCS 46108		
QTY	CARB & FUEL INJECTION	YEARS	PART NO.	DESCRIPTION	
2	Fuel Injector O-Ring Set	2012	ES 70599	Upper set; Injectors to fuel rail; Improved design	
2	Fuel Injector O-Ring Set	2012	ES 72004	Lower set; Injectors to cylinder head	
1	Throttle Body Gasket	2012	61699	New Part Number - Check for Availability	
58		2012 - 2010; 3.0L 182.9 (2997cc) DOHC V6 (24 Valve) 89mm Bore VVT			58
		DI; Gasoline; Naturally Aspirated Opel Eng.; VIN Code G			
QTY	CYLINDER HEAD	YEARS	PART NO.	DESCRIPTION	
2	Head Bolt Set	2012-10	ES 72274	Replacement recommended	
QTY	CONVERSION SET	YEARS	PART NO.	DESCRIPTION	
1	Gasket Conversion Set	2012-10	CS 26376-1	RTV sealant incl. for oil pan gskt.; Improved design	
QTY	EXHAUST PIPE FLANGE	YEARS	PART NO.	DESCRIPTION	
1	Exhaust Pipe Gasket	2012-10	61465	Loc. Rear; Converter	
1	Exhaust Pipe Gasket	2012-10	61708	Loc. Front; Converter; New Part Number - Check for Availability	
QTY	OIL PAN	YEARS	PART NO.	DESCRIPTION	
1	Drain Plug Gasket	2012-10	70820		
QTY	CRANKSHAFT REAR SEAL	YEARS	PART NO.	DESCRIPTION	
1	Rear Main Seal Set	2012-10	BS 40711	PTFE Rubber; One-piece; Improved design	
QTY	VALVE COVER	YEARS	PART NO.	DESCRIPTION	
1	Valve Cover Gasket Set	2012-10	VS 50808 R	w/Grommets & Spark plug tube seals; PermaDry® molded rubber gskts. incl.; New Part Number - Check for Availability	
1	Spark Plug Tube Seal Set	2012-10	ES 72393	Valve Cover; New Part Number - Check for Availability	
QTY	THERMOSTAT HOUSING	YEARS	PART NO.	DESCRIPTION	
1	Thermostat Gasket	2012-10	35858	Thermostat Housing; Thermostat seal	
1	Thermostat Gasket	2012-10	35871	Thermostat Housing; Thermostat housing to head	
QTY	WATER PUMP	YEARS	PART NO.	DESCRIPTION	
1	Water Pump Gasket	2012-10	35859		
QTY	TIMING COVER	YEARS	PART NO.	DESCRIPTION	
1	Timing Cover Set	2012-10	TCS 46108		
QTY	CARB & FUEL INJECTION	YEARS	PART NO.	DESCRIPTION	
2	Fuel Injector O-Ring Set	2012-10	ES 70599	Upper set; Injectors to fuel rail; Improved design	
2	Fuel Injector O-Ring Set	2012-10	ES 72004	Lower set; Injectors to cylinder head	
1	Throttle Body Gasket	2012-10	61699	New Part Number - Check for Availability	
59		2012 - 2011; 3.0L 182.9 (2997cc) DOHC V6 (24 Valve) 89mm Bore VVT			59
		DI; Gasoline; Naturally Aspirated Opel Eng.; VIN Code Y			
QTY	CYLINDER HEAD	YEARS	PART NO.	DESCRIPTION	
2	Head Bolt Set	2012-11	ES 72274	Replacement recommended	
QTY	CONVERSION SET	YEARS	PART NO.	DESCRIPTION	
1	Gasket Conversion Set	2012-11	CS 26376-1	RTV sealant incl. for oil pan gskt.; Improved design	
QTY	EXHAUST PIPE FLANGE	YEARS	PART NO.	DESCRIPTION	
1	Exhaust Pipe Gasket	2012-11	61465	Loc. Rear; Converter	
1	Exhaust Pipe Gasket	2012-11	61708	Loc. Front; Converter; New Part Number - Check for Availability	
QTY	OIL PAN	YEARS	PART NO.	DESCRIPTION	
1	Drain Plug Gasket	2012-11	70820		
QTY	CRANKSHAFT REAR SEAL	YEARS	PART NO.	DESCRIPTION	
1	Rear Main Seal Set	2012-11	BS 40711	PTFE Rubber; One-piece; Improved design	
QTY	VALVE COVER	YEARS	PART NO.	DESCRIPTION	
1	Valve Cover Gasket Set	2012-11	VS 50808 R	w/Grommets & Spark plug tube seals; PermaDry® molded rubber gskts. incl.; New Part Number - Check for Availability	

GM Car (Incl. Buick, Cad., Chev., Geo, Olds., Pontiac, Saturn) (Cont.)

59 (cont.)		2012 - 2011; 3.0L 182.9 (2997cc) DOHC V6 (24 Valve) 89mm Bore VVT			59 (cont.)
DI; Gasoline; Naturally Aspirated Opel Eng.; VIN Code Y					
QTY	VALVE COVER	YEARS	PART NO.	DESCRIPTION	
1	Spark Plug Tube Seal Set	2012-11	ES 72393	Valve Cover; New Part Number - Check for Availability	
QTY	THERMOSTAT HOUSING	YEARS	PART NO.	DESCRIPTION	
1	Thermostat Gasket	2012-11	35858	Thermostat Housing; Thermostat seal	
1	Thermostat Gasket	2012-11	35871	Thermostat Housing; Thermostat housing to head	
QTY	WATER PUMP	YEARS	PART NO.	DESCRIPTION	
1	Water Pump Gasket	2012-11	35859		
QTY	TIMING COVER	YEARS	PART NO.	DESCRIPTION	
1	Timing Cover Set	2012-11	TCS 46108		
QTY	CARB & FUEL INJECTION	YEARS	PART NO.	DESCRIPTION	
2	Fuel Injector O-Ring Set	2012-11	ES 70599	Upper set; Injectors to fuel rail; Improved design	
2	Fuel Injector O-Ring Set	2012-11	ES 72004	Lower set; Injectors to cylinder head	
1	Throttle Body Gasket	2012-11	61699	New Part Number - Check for Availability	
60		2005 - 1999; 3.1L 189 (3136cc) OHV V6 (12 Valve) 89mm Bore			60
MFI; Gasoline; Naturally Aspirated GMC Eng.; Chevrolet; VIN Code J					
QTY	CYLINDER HEAD	YEARS	PART NO.	DESCRIPTION	
2	Head Gasket	2005-99	511 SD	Head bolts not incl.; Head bolt replacement recommended; PermaTorque Severe Duty®	
2	Head Gasket	2005-99	9957 PT	Head bolts not incl.; Head bolt replacement recommended; PermaTorque®	
1	Head Set	2005-04	HS 9957 PT-3	Head bolts not incl.; Head bolt replacement recommended; PermaDryPlus® int. manifold gskts. incl.; PermaDry® molded rubber valve cover gskts. incl.; Premium valve stem seals incl.	
1	Head Set	2003-00	HS 9957 PT-1	Head bolts not incl.; Head bolt replacement recommended; PermaDry® molded rubber valve cover gskts. incl.; Premium valve stem seals incl.	
1	Head Set	2003-00	HST 9957 PT-1	Head bolts not incl.; Head bolt replacement recommended; PermaTorque Severe Duty® head gskts. incl.; PermaDryPlus® int. manifold gskts. incl.; PermaDry® molded rubber valve cover gskts. incl.; Premium valve stem seals incl.	
1	Head Set	1999	HS 9957 PT-1	Chevrolet Malibu Base, LS; Head bolts not incl.; Head bolt replacement recommended; PermaDry® molded rubber valve cover gskts. incl.; Premium valve stem seals incl.	
1	Head Set	1999	HS 9957 PT-1	Oldsmobile Cutlass Base, GLS; Valve stem seals & head bolts not incl.; Head bolt replacement recommended; PermaDry® molded rubber valve cover gskts. incl.	
1	Head Set	1999	HST 9957 PT-1	Chevrolet Malibu Base, LS; Head bolts not incl.; Head bolt replacement recommended; PermaTorque Severe Duty® head gskts. incl.; PermaDryPlus® int. manifold gskts. incl.; PermaDry® molded rubber valve cover gskts. incl.; Premium valve stem seals incl.	
1	Head Bolt Set	2005	ES 72892	Exc. Chevrolet Classic Base; Replacement recommended	
1	Head Bolt Set	2004	ES 72892	Buick Century Custom, Limited; Replacement recommended	
1	Head Bolt Set	2003-00	ES 72892	Exc. Chevrolet Malibu Base, LS; Replacement recommended	
1	Head Bolt Set	2003-00	ES 74017	Chevrolet Malibu Base, LS; Replacement recommended	
1	Head Bolt Set	1999	ES 74017	Replacement recommended	
QTY	CONVERSION SET	YEARS	PART NO.	DESCRIPTION	
1	Gasket Conversion Set	2005-99	CS 9957	PermaDry® molded rubber oil pan gskt. incl.	
QTY	MANIFOLD - INT. & EXH.	YEARS	PART NO.	DESCRIPTION	
1	Int. Manifold Gasket Set	2005-99	MS 98003 T	Valve cover gskts. & Upper set incl.; PermaDryPlus® int. manifold gskts. incl.; Manifold bolts not incl.; Manifold bolt replacement recommended	
1	Int. Manifold Gasket Set	2003-99	MS 90565	Valve cover gskts. not incl.; Upper set incl.; Manifold bolts not incl.; Manifold bolt replacement recommended	
1	Plenum Gasket Set	2005-99	MS 90505	Upper set	
1	Int. Manifold Bolt Set	2005-99	ES 72225	Loc. Lower; 13mm corner bolts; Replacement recommended	
1	Int. Manifold Bolt Set	2005-99	ES 72226	Loc. Lower; 10mm corner bolts; Replacement recommended	
1	Exh. Manifold Gasket Set	2005-04	MS 96329		
1	Exh. Manifold Gasket Set	2003-99	MS 95586		
QTY	EXHAUST PIPE FLANGE	YEARS	PART NO.	DESCRIPTION	
1	Exhaust Pipe Gasket	2005-99	61054	Packing	
1	Exhaust Pipe Gasket	2005-99	61314	Converter	
QTY	OIL PAN	YEARS	PART NO.	DESCRIPTION	
1	Oil Pan Gasket Set	2005-99	OS 30668 R	PermaDry® molded rubber gskt. incl.	
1	Drain Plug Gasket	2005-99	70820		
QTY	CRANKSHAFT REAR SEAL	YEARS	PART NO.	DESCRIPTION	
1	Rear Main Seal Set	2005-99	BS 40464	11.0mm thick; Rubber; One-piece; Improved design	
1	Rear Main Seal Set	2005-99	BS 40625	11.0mm thick; PTFE Rubber; One-piece; Improved design	

GM Car (Incl. Buick, Cad., Chev., Geo, Olds., Pontiac, Saturn) (Cont.)

60 (cont.)		2005 - 1999; 3.1L 189 (3136cc) OHV V6 (12 Valve) 89mm Bore			60 (cont.)
		MFI; Gasoline; Naturally Aspirated GMC Eng.; Chevrolet; VIN Code J			
QTY	CRANKSHAFT REAR SEAL	YEARS	PART NO.	DESCRIPTION	
1	Repair Sleeve Tool	2005-99	16304	Crankshaft	
QTY	VALVE COVER	YEARS	PART NO.	DESCRIPTION	
1	Valve Cover Gasket Set	2005-99	VS 50442 R	w/o Grommets; Must be used w/35614; PermaDry® molded rubber gskts. incl.	
1	Grommet Set	2005-99	ES 71044	Valve Cover	
QTY	VALVE STEM SEAL SET	YEARS	PART NO.	DESCRIPTION	
1	Valve Stem Seal Set	2005-00	SS 70829	Premium valve stem seals incl.	
1	Valve Stem Seal Set	1999	SS 70829	Chevrolet Malibu Base, LS; Premium valve stem seals incl.	
1	Valve Stem Seal Set	1999	SS 72851	Oldsmobile Cutlass Base, GLS; Premium valve stem seals incl.	
QTY	THERMOSTAT HOUSING	YEARS	PART NO.	DESCRIPTION	
1	O-Ring	2005-99	70799	Thermostat Housing; Bypass pipe	
QTY	WATER OUTLET GASKET	YEARS	PART NO.	DESCRIPTION	
1	Thermostat Gasket	2005-99	35614	Water Outlet; Improved design	
QTY	WATER PUMP	YEARS	PART NO.	DESCRIPTION	
1	Water Pump Gasket	2005-99	35403		
QTY	TIMING COVER	YEARS	PART NO.	DESCRIPTION	
1	Timing Cover Set	2005-99	TCS 45828	w/o Sleeve 'N' Seal®	
1	Timing Cover Gasket	2005-99	72670	New Part Number - Check for Availability	
1	Timing Set w/Sleeve & Seal	2005-99	TCS 45976	w/Sleeve 'N' Seal®; .565" sleeve length	
1	Repair Sleeve	2005-99	16215	Timing Cover; .565" sleeve length; Use w/installation tool	
1	Repair Sleeve Tool	2005-99	16312	Timing Cover	
QTY	CARB & FUEL INJECTION	YEARS	PART NO.	DESCRIPTION	
2	Fuel Injector O-Ring Set	2005-00	ES 70599	Upper set; Injectors to fuel rail; Improved design	
2	Fuel Injector O-Ring Set	2005-00	ES 71190	Lower set; Injectors to cylinder head	
2	Fuel Injector O-Ring Set	2005-00	ES 71192	Upper set; Injectors to fuel rail; Old design	
3	Fuel Injector O-Ring Set	1999	ES 70599	Improved design	
1	Throttle Body Gasket	2005-00	61053		
1	Throttle Body Gasket	1999	60983		
QTY	DISTRIBUTOR MOUNTING	YEARS	PART NO.	DESCRIPTION	
1	O-Ring	2005-99	72343	Distributor Mounting; O-ring; May also be used as a distributor block-off plate seal or oil pump drive seal if desired	
QTY	EXHAUST GAS RECIRCULATION	YEARS	PART NO.	DESCRIPTION	
1	EGR Gasket	2005-00	70804		
1	EGR Gasket	1999	70766	Pipe	
1	EGR Gasket	1999	70790	Valve	
61		1999 - 1993; 3.1L 189 (3136cc) OHV V6 (12 Valve) 89mm Bore			61
		MFI; Gasoline; Naturally Aspirated GMC Eng.; Chevrolet; VIN Code M			
QTY	CYLINDER HEAD	YEARS	PART NO.	DESCRIPTION	
2	Head Gasket	1999-93	511 SD	Head bolts not incl.; Head bolt replacement recommended; PermaTorque Severe Duty®	
2	Head Gasket	1999-93	9957 PT	Head bolts not incl.; Head bolt replacement recommended; PermaTorque®	
1	Head Set	1999-97	HS 9957 PT-2	Head bolts & exh. pipe packing not incl.; Head bolt replacement recommended; PermaDry® molded rubber valve cover gskts. incl.; Premium valve stem seals incl.	
1	Head Set	1999-97	HST 9957 PT-2	Head bolts & exh. pipe packing not incl.; Head bolt replacement recommended; PermaTorque Severe Duty® head gskts. incl.; PermaDryPlus® int. manifold gskts. incl.; PermaDry® molded rubber valve cover gskts. incl.; Premium valve stem seals incl.	
1	Head Set	1996-95	HS 9957 PT	1st Design; w/Ball & Pivot rocker arms; w/o Push rod guides on int. gskt.; Head bolts & exh. pipe packing not incl.; Head bolt replacement recommended; PermaDry® molded rubber valve cover gskts. incl.; Premium valve stem seals incl.	
1	Head Set	1996-95	HS 9957 PT-2	2nd Design; w/Roller rocker arms; w/Push rod guides on int. gskt.; Head bolts & exh. pipe packing not incl.; Head bolt replacement recommended; PermaDry® molded rubber valve cover gskts. incl.; Premium valve stem seals incl.	
1	Head Set	1996-95	HST 9957 PT-2	1st Design; w/Ball & Pivot rocker arms; w/o Push rod guides on int. gskt.; Head bolts & exh. pipe packing not incl.; Head bolt replacement recommended; PermaTorque Severe Duty® head gskts. incl.; PermaDryPlus® int. manifold gskts. incl.; PermaDry® molded	

GM Car (Incl. Buick, Cad., Chev., Geo, Olds., Pontiac, Saturn) (Cont.)

61 (cont.)		1999 - 1993; 3.1L 189 (3136cc) OHV V6 (12 Valve) 89mm Bore			61 (cont.)
MFI; Gasoline; Naturally Aspirated GMC Eng.; Chevrolet; VIN Code M					
QTY	CYLINDER HEAD	YEARS	PART NO.	DESCRIPTION	
1	Head Set	1996-95	HST 9957 PT-2	2nd Design; w/Roller rocker arms; w/Push rod guides on int. gskt.; Head bolts & exh. pipe packing not incl.; Head bolt replacement recommended; PermaTorque Severe Duty® head gskts. incl.; PermaDryPlus® int. manifold gskts. incl.; PermaDry® molded rubber v	
1	Head Set	1994-93	HS 9957 PT	Head bolts & exh. pipe packing not incl.; Head bolt replacement recommended; PermaDry® molded rubber valve cover gskts. incl.; Premium valve stem seals incl.	
1	Head Set	1994-93	HST 9957 PT-2	Head bolts & exh. pipe packing not incl.; Head bolt replacement recommended; PermaTorque Severe Duty® head gskts. incl.; PermaDryPlus® int. manifold gskts. incl.; PermaDry® molded rubber valve cover gskts. incl.; Premium valve stem seals incl.	
1	Head Installation Set	1999-97	HIS 9957 PT-2	Head bolts & exh. pipe packing not incl.; Head bolt replacement recommended; PermaDry® molded rubber valve cover gskts. incl.	
1	Head Installation Set	1996-95	HIS 9957 PT	1st Design; w/Ball & Pivot rocker arms; w/o Push rod guides on int. gskt.; Head bolts & exh. pipe packing not incl.; Head bolt replacement recommended; PermaDry® molded rubber valve cover gskts. incl.	
1	Head Installation Set	1996-95	HIS 9957 PT-2	2nd Design; w/Roller rocker arms; w/Push rod guides on int. gskt.; Head bolts & exh. pipe packing not incl.; Head bolt replacement recommended; PermaDry® molded rubber valve cover gskts. incl.	
1	Head Installation Set	1994-93	HIS 9957 PT	Head bolts & exh. pipe packing not incl.; Head bolt replacement recommended; PermaDry® molded rubber valve cover gskts. incl.	
1	Head Bolt Set	1999	ES 72892	Exc. Chevrolet Malibu Base, LS; Replacement recommended	
1	Head Bolt Set	1999	ES 74017	Chevrolet Malibu Base, LS; Replacement recommended	
1	Head Bolt Set	1998	ES 72892	Exc. Buick Skylark Custom Chevrolet Malibu Base, LS Oldsmobile Achieva S Pontiac Grand Am GT, SE; Replacement recommended	
1	Head Bolt Set	1998	ES 74017	Buick Skylark Custom Chevrolet Malibu Base, LS Oldsmobile Achieva S Pontiac Grand Am GT, SE; Replacement recommended	
1	Head Bolt Set	1997	ES 72892	Buick Century Custom, Limited, Regal Base, Custom Chevrolet Lumina Base, LS, LTZ, Monte Carlo LS Oldsmobile Cutlass Base, GLS Pontiac Grand Prix SE; Replacement recommended	
1	Head Bolt Set	1997	ES 74017	Buick Skylark Custom, Gran Sport, Limited Chevrolet Malibu Base, LS Oldsmobile Achieva S, SC, SL, Cutlass Supreme Base, SL Pontiac Grand Am GT, SE; Replacement recommended	
1	Head Bolt Set	1996	ES 72892	Buick Century Custom, Limited, Special, Regal Base, Custom, Olympic Gold Edition Chevrolet Lumina Base, LS, Monte Carlo LS Pontiac Grand Prix Base, SE; Replacement recommended	
1	Head Bolt Set	1996	ES 74017	Exc. Buick Century Custom, Limited, Special, Regal Base, Custom, Olympic Gold Edition Chevrolet Lumina Base, LS, Monte Carlo LS Pontiac Grand Prix Base, SE; Replacement recommended	
1	Head Bolt Set	1995-93	ES 74019	Replacement recommended	
QTY	CONVERSION SET	YEARS	PART NO.	DESCRIPTION	
1	Gasket Conversion Set	1999-93	CS 9957	PermaDry® molded rubber oil pan gskt. incl.	
QTY	MANIFOLD - INT. & EXH.	YEARS	PART NO.	DESCRIPTION	
1	Int. Manifold Gasket Set	1999-97	MS 90562	Valve cover gskts. not incl.; Upper set incl.; Manifold bolts not incl.; Manifold bolt replacement recommended	
1	Int. Manifold Gasket Set	1999-97	MS 98004 T	Valve cover gskts. & Upper set incl.; PermaDryPlus® int. manifold gskts. incl.; Manifold bolts not incl.; Manifold bolt replacement recommended	
1	Int. Manifold Gasket Set	1996-95	MS 90562	2nd Design; w/Roller rocker arms; w/Push rod guides on int. gskt.; Valve cover gskts. not incl.; Upper set incl.; Manifold bolts not incl.; Manifold bolt replacement recommended	
1	Int. Manifold Gasket Set	1996-95	MS 95536	1st Design; w/Ball & Pivot rocker arms; w/o Push rod guides on int. gskt.; Valve cover gskts. not incl.; Upper set incl.; Manifold bolts not incl.; Manifold bolt replacement recommended	
1	Int. Manifold Gasket Set	1996-95	MS 98004 T	1st Design; w/Ball & Pivot rocker arms; w/o Push rod guides on int. gskt.; Valve cover gskts. & Upper set incl.; PermaDryPlus® int. manifold gskts. incl.; Manifold bolts not incl.; Manifold bolt replacement recommended	
1	Int. Manifold Gasket Set	1996-95	MS 98004 T	2nd Design; w/Roller rocker arms; w/Push rod guides on int. gskt.; Valve cover gskts. & Upper set incl.; PermaDryPlus® int. manifold gskts. incl.; Manifold bolts not incl.; Manifold bolt replacement recommended	
1	Int. Manifold Gasket Set	1994-93	MS 95536	Valve cover gskts. not incl.; Upper set incl.; Manifold bolts not incl.; Manifold bolt replacement recommended	
1	Int. Manifold Gasket Set	1994-93	MS 98004 T	Valve cover gskts. & Upper set incl.; PermaDryPlus® int. manifold gskts. incl.; Manifold bolts not incl.; Manifold bolt replacement recommended	
1	Plenum Gasket Set	1999-93	MS 91481	Upper set; Improved design	
1	Int. Manifold Bolt Set	1999-93	ES 72225	Loc. Lower; 13mm corner bolts; Replacement recommended	

GM Car (Incl. Buick, Cad., Chev., Geo, Olds., Pontiac, Saturn) (Cont.)

61 (cont.)		1999 - 1993; 3.1L 189 (3136cc) OHV V6 (12 Valve) 89mm Bore			61 (cont.)
		MFI; Gasoline; Naturally Aspirated GMC Eng.; Chevrolet; VIN Code M			
QTY	MANIFOLD - INT. & EXH.	YEARS	PART NO.	DESCRIPTION	
1	Int. Manifold Bolt Set	1999-97	ES 72226	Loc. Lower; 10mm corner bolts; Replacement recommended	
1	Exh. Manifold Gasket Set	1999-93	MS 95586		
QTY	EXHAUST PIPE FLANGE	YEARS	PART NO.	DESCRIPTION	
1	Exhaust Pipe Gasket	1999-97	61054	Packing	
1	Exhaust Pipe Gasket	1996-93	60980	Packing	
QTY	OIL PAN	YEARS	PART NO.	DESCRIPTION	
1	Oil Pan Gasket Set	1999-93	OS 30668 R	PermaDry® molded rubber gskt. incl.	
1	Drain Plug Gasket	1999-93	70820		
QTY	CRANKSHAFT REAR SEAL	YEARS	PART NO.	DESCRIPTION	
1	Rear Main Seal Set	1999-93	BS 40464	11.0mm thick; Rubber; One-piece; Improved design	
1	Rear Main Seal Set	1999-93	BS 40625	11.0mm thick; PTFE Rubber; One-piece; Improved design	
1	Repair Sleeve Tool	1999-93	16304	Crankshaft	
QTY	VALVE COVER	YEARS	PART NO.	DESCRIPTION	
1	Valve Cover Gasket Set	1999-93	VS 50442 R	w/o Grommets; Must be used w/35614; PermaDry® molded rubber gskts. incl.	
1	Grommet Set	1999-93	ES 71044	Valve Cover	
QTY	VALVE STEM SEAL SET	YEARS	PART NO.	DESCRIPTION	
1	Valve Stem Seal Set	1999-93	SS 72851	Premium valve stem seals incl.	
QTY	WATER OUTLET GASKET	YEARS	PART NO.	DESCRIPTION	
1	Thermostat Gasket	1999-93	35614	Water Outlet; Improved design	
QTY	WATER PUMP	YEARS	PART NO.	DESCRIPTION	
1	Water Pump Gasket	1999-93	35403		
QTY	TIMING COVER	YEARS	PART NO.	DESCRIPTION	
1	Timing Cover Set	1999-93	TCS 45828	w/o Sleeve 'N' Seal®	
1	Timing Cover Gasket	1999-93	72670	New Part Number - Check for Availability	
1	Timing Set w/Sleeve & Seal	1999-93	TCS 45976	w/Sleeve 'N' Seal®; .565" sleeve length	
1	Repair Sleeve	1999-93	16215	Timing Cover; .565" sleeve length; Use w/installation tool	
1	Repair Sleeve Tool	1999-93	16312	Timing Cover	
QTY	CARB & FUEL INJECTION	YEARS	PART NO.	DESCRIPTION	
3	Fuel Injector O-Ring Set	1999-93	ES 70599	Improved design	
1	Throttle Body Gasket	1999-97	60983		
1	Throttle Body Gasket	1996	60983	Exc. Buick Century Custom, Limited, Special Oldsmobile Ciera SL, Cutlass Ciera Base	
1	Throttle Body Gasket	1996	61023	Buick Century Custom, Limited, Special Oldsmobile Ciera SL, Cutlass Ciera Base	
1	Throttle Body Gasket	1995	60983	Exc. Buick Century Custom, Special Oldsmobile Ciera Cruiser SL, SL, Cutlass Ciera Base	
1	Throttle Body Gasket	1995	61023	Buick Century Custom, Special Oldsmobile Ciera Cruiser SL, SL, Cutlass Ciera Base	
1	Throttle Body Gasket	1994	60983	Exc. Buick Century Custom, Special Oldsmobile Cutlass Ciera Base, Cruiser S, S, SL, Cutlass Cruiser Base	
1	Throttle Body Gasket	1994	61023	Buick Century Custom, Special Oldsmobile Cutlass Ciera Base, Cruiser S, S, SL, Cutlass Cruiser Base	
1	Throttle Body Gasket	1993	60983		
QTY	DISTRIBUTOR MOUNTING	YEARS	PART NO.	DESCRIPTION	
1	O-Ring	1999-93	70800	Distributor Mounting	
QTY	EXHAUST GAS RECIRCULATION	YEARS	PART NO.	DESCRIPTION	
1	EGR Gasket	1999-96	70766	Pipe	
1	EGR Gasket	1999-96	70790	Valve	
1	EGR Gasket	1995-93	70054	Valve	
1	EGR Gasket	1995-93	70234-1	Pipe	
QTY	OIL FILTER MOUNTING	YEARS	PART NO.	DESCRIPTION	
1	Oil Filter Gasket	1999-93	70672		
62		1994 - 1991; 3.1L 189 (3136cc) OHV V6 (12 Valve) 89mm Bore			62
		MFI; Gasoline; Naturally Aspirated GMC Eng.; Chevrolet; VIN Code T			
QTY	CYLINDER HEAD	YEARS	PART NO.	DESCRIPTION	
2	Head Gasket	1994-93	513 SD	Head bolts not incl.; Head bolt replacement recommended; PermaTorque Severe Duty®	
2	Head Gasket	1994-93	9471 PT	Head bolts not incl.; Head bolt replacement recommended; PermaTorque®	
2	Head Gasket	1992	512 SD	Chevrolet Camaro RS, RS Heritage Edition Pontiac Firebird Base; Head bolts not incl.; Head bolt replacement recommended; PermaTorque Severe Duty®	

GM Car (Incl. Buick, Cad., Chev., Geo, Olds., Pontiac, Saturn) (Cont.)

62 (cont.)		1994 - 1991; 3.1L 189 (3136cc) OHV V6 (12 Valve) 89mm Bore			62 (cont.)
		MFI; Gasoline; Naturally Aspirated GMC Eng.; Chevrolet; VIN Code T			
QTY	CYLINDER HEAD	YEARS	PART NO.	DESCRIPTION	
2	Head Gasket	1992	513 SD	Exc. Chevrolet Camaro RS, RS Heritage Edition Pontiac Firebird Base; Head bolts not incl.; Head bolt replacement recommended; PermaTorque Severe Duty®	
2	Head Gasket	1992	8699 PT-2	Chevrolet Camaro RS, RS Heritage Edition Pontiac Firebird Base; Head bolts not incl.; Head bolt replacement recommended; PermaTorque®	
2	Head Gasket	1992	9471 PT	Exc. Chevrolet Camaro RS, RS Heritage Edition Pontiac Firebird Base; Head bolts not incl.; Head bolt replacement recommended; PermaTorque®	
2	Head Gasket	1991	512 SD	Chevrolet Camaro RS Pontiac Firebird Base; Head bolts not incl.; Head bolt replacement recommended; PermaTorque Severe Duty®	
2	Head Gasket	1991	513 SD	Exc. Chevrolet Camaro RS Pontiac Firebird Base; Head bolts not incl.; Head bolt replacement recommended; PermaTorque Severe Duty®	
2	Head Gasket	1991	8699 PT-2	Chevrolet Camaro RS Pontiac Firebird Base; Head bolts not incl.; Head bolt replacement recommended; PermaTorque®	
2	Head Gasket	1991	9471 PT	Exc. Chevrolet Camaro RS Pontiac Firebird Base; Head bolts not incl.; Head bolt replacement recommended; PermaTorque®	
2	Head Gasket Spacer Shim	1994-91	8699 SP-1	HeadSaver®	
1	Head Set	1994-93	HS 9471 PT-1	Int. manifold gskt., head bolts, exh. pipe packing, valve cover grommets not incl.; Head bolt replacement recommended; PermaDry® molded rubber valve cover gskts. incl.; Premium valve stem seals incl.	
1	Head Set	1992	HS 8699 PT-7	Chevrolet Camaro RS, RS Heritage Edition Pontiac Firebird Base; Head bolts & exh. pipe packing not incl.; Head bolt replacement recommended; Premium valve stem seals incl.	
1	Head Set	1992	HS 9471 PT-1	Exc. Chevrolet Camaro RS, RS Heritage Edition Pontiac Firebird Base; Int. manifold gskt., head bolts, exh. pipe packing, valve cover grommets not incl.; Head bolt replacement recommended; PermaDry® molded rubber valve cover gskts. incl.; Premium valve stem seals incl.	
1	Head Set	1991	HS 8699 PT-7	Chevrolet Camaro RS Pontiac Firebird Base; Head bolts & exh. pipe packing not incl.; Head bolt replacement recommended; Premium valve stem seals incl.	
1	Head Set	1991	HS 9471 PT-1	Exc. Chevrolet Camaro RS Pontiac Firebird Base; Int. manifold gskt., head bolts, exh. pipe packing, valve cover grommets not incl.; Head bolt replacement recommended; PermaDry® molded rubber valve cover gskts. incl.; Premium valve stem seals incl.	
1	Head Installation Set	1994-93	HIS 9471 PT-1	Int. manifold gskt., head bolts, exh. pipe packing, valve cover grommets not incl.; Head bolt replacement recommended; PermaDry® molded rubber valve cover gskts. incl.	
1	Head Installation Set	1992	HIS 9471 PT-1	Exc. Chevrolet Camaro RS, RS Heritage Edition Pontiac Firebird Base; Int. manifold gskt., head bolts, exh. pipe packing, valve cover grommets not incl.; Head bolt replacement recommended; PermaDry® molded rubber valve cover gskts. incl.	
1	Head Installation Set	1991	HIS 9471 PT-1	Exc. Chevrolet Camaro RS Pontiac Firebird Base; Int. manifold gskt., head bolts, exh. pipe packing, valve cover grommets not incl.; Head bolt replacement recommended; PermaDry® molded rubber valve cover gskts. incl.	
1	Head Bolt Set	1994	ES 74017	Exc. Chevrolet Lumina Base, Euro, Euro 3.4 Pontiac Tempest Base; Replacement recommended	
1	Head Bolt Set	1994	ES 74018	Chevrolet Lumina Base, Euro, Euro 3.4 Pontiac Tempest Base; Replacement recommended	
1	Head Bolt Set	1993-92	ES 74017	Chevrolet Cavalier RS, VL, Z24 Pontiac Sunbird GT, LE, LE Value Leader, SE; Replacement recommended	
1	Head Bolt Set	1993	ES 74018	Exc. Chevrolet Cavalier RS, VL, Z24 Pontiac Sunbird GT, LE, LE Value Leader, SE; Replacement recommended	
1	Head Bolt Set	1992	ES 72857	Chevrolet Camaro RS, RS Heritage Edition Pontiac Firebird Base; Replacement recommended	
1	Head Bolt Set	1992	ES 74018	Exc. Chevrolet Camaro RS, RS Heritage Edition, Cavalier RS, VL, Z24 Pontiac Firebird Base, Sunbird GT, LE, LE Value Leader, SE; Replacement recommended	
1	Head Bolt Set	1991	ES 72857	Chevrolet Camaro RS Pontiac Firebird Base; Replacement recommended	
1	Head Bolt Set	1991	ES 74017	Chevrolet Cavalier RS, VL, Z24 Pontiac Sunbird GT, LE, SE, Value Leader; Replacement recommended	
1	Head Bolt Set	1991	ES 74018	Exc. Chevrolet Camaro RS, Cavalier RS, VL, Z24 Pontiac Firebird Base, Sunbird GT, LE, SE, Value Leader; Replacement recommended	
QTY	CONVERSION SET	YEARS	PART NO.	DESCRIPTION	
1	Gasket Conversion Set	1994-91	CS 9471	PermaDry® molded rubber oil pan gskt. incl.	

GM Car (Incl. Buick, Cad., Chev., Geo, Olds., Pontiac, Saturn) (Cont.)

62 (cont.)		1994 - 1991; 3.1L 189 (3136cc) OHV V6 (12 Valve) 89mm Bore			62 (cont.)
MFI; Gasoline; Naturally Aspirated GMC Eng.; Chevrolet; VIN Code T					
QTY	MANIFOLD - INT. & EXH.	YEARS	PART NO.	DESCRIPTION	
1	Int. Manifold Gasket Set	1992	MS 93020	Chevrolet Camaro RS, RS Heritage Edition Pontiac Firebird Base; Lower set; Valve cover gsks. & Upper set incl.	
1	Int. Manifold Gasket Set	1991	MS 93020	Chevrolet Camaro RS Pontiac Firebird Base; Lower set; Valve cover gsks. & Upper set incl.	
1	Valley Pan Gasket Set	1994-93	MS 96046	Valve cover gsks. not incl.; Upper set incl.	
1	Valley Pan Gasket Set	1992	MS 96046	Exc. Chevrolet Camaro RS, RS Heritage Edition Pontiac Firebird Base; Valve cover gsks. not incl.; Upper set incl.	
1	Valley Pan Gasket Set	1991	MS 96041	Buick Regal Base, Custom, Limited; Sequence No. 40001 to 800000; Valve cover gsks. not incl.; Upper set incl.	
1	Valley Pan Gasket Set	1991	MS 96046	Buick Regal Base, Custom, Limited; From Sequence No. 800001; Valve cover gsks. not incl.; Upper set incl.	
1	Valley Pan Gasket Set	1991	MS 96046	Exc. Buick Regal Base, Custom, Limited Chevrolet Camaro RS Pontiac Firebird Base; Valve cover gsks. not incl.; Upper set incl.	
1	Plenum Gasket Set	1994-93	MS 94944	Upper set	
1	Plenum Gasket Set	1992	MS 90453	Chevrolet Camaro RS, RS Heritage Edition Pontiac Firebird Base; Upper set; Center manifold gskt.	
1	Plenum Gasket Set	1992	MS 93020-1	Chevrolet Camaro RS, RS Heritage Edition Pontiac Firebird Base; Upper set; Plenum side gsks.; New Part Number - Check for Availability	
1	Plenum Gasket Set	1992	MS 94944	Exc. Chevrolet Camaro RS, RS Heritage Edition Pontiac Firebird Base; Upper set	
1	Plenum Gasket Set	1991	MS 90453	Chevrolet Camaro RS Pontiac Firebird Base; Upper set; Center manifold gskt.	
1	Plenum Gasket Set	1991	MS 93020-1	Chevrolet Camaro RS Pontiac Firebird Base; Upper set; Plenum side gsks.; New Part Number - Check for Availability	
1	Plenum Gasket Set	1991	MS 93610	Buick Regal Base, Custom, Limited; Sequence No. 40001 to 800000; Upper set	
1	Plenum Gasket Set	1991	MS 94944	Buick Regal Base, Custom, Limited; From Sequence No. 800001; Upper set	
1	Plenum Gasket Set	1991	MS 94944	Exc. Buick Regal Base, Custom, Limited Chevrolet Camaro RS Pontiac Firebird Base; Upper set	
1	Exh. Manifold Gasket Set	1994-93	MS 93692		
1	Exh. Manifold Gasket Set	1992	MS 90864	Chevrolet Camaro RS, RS Heritage Edition Pontiac Firebird Base	
1	Exh. Manifold Gasket Set	1992	MS 93692	Exc. Chevrolet Camaro RS, RS Heritage Edition Pontiac Firebird Base	
1	Exh. Manifold Gasket Set	1991	MS 90864	Chevrolet Camaro RS Pontiac Firebird Base	
1	Exh. Manifold Gasket Set	1991	MS 93692	Exc. Chevrolet Camaro RS Pontiac Firebird Base	
QTY	EXHAUST PIPE FLANGE	YEARS	PART NO.	DESCRIPTION	
1	Exhaust Pipe Gasket	1994-93	60538	Pipe to manifold	
1	Exhaust Pipe Gasket	1992	60538	Chevrolet Camaro RS, RS Heritage Edition Pontiac Firebird Base; Packing	
1	Exhaust Pipe Gasket	1992	60538	Exc. Chevrolet Camaro RS, RS Heritage Edition Pontiac Firebird Base; Pipe to manifold	
1	Exhaust Pipe Gasket	1991	60538	Chevrolet Camaro RS Pontiac Firebird Base; Packing	
1	Exhaust Pipe Gasket	1991	60538	Exc. Chevrolet Camaro RS Pontiac Firebird Base; Pipe to manifold	
QTY	OIL PAN	YEARS	PART NO.	DESCRIPTION	
1	Oil Pan Gasket Set	1994-91	OS 34501 R	PermaDry® molded rubber gskt. incl.	
1	Drain Plug Gasket	1994-91	70822		
QTY	CRANKSHAFT REAR SEAL	YEARS	PART NO.	DESCRIPTION	
1	Rear Main Seal Set	1994-91	BS 40464	11.0mm thick; Rubber; One-piece; Improved design	
1	Rear Main Seal Set	1994-91	BS 40625	11.0mm thick; PTFE Rubber; One-piece; Improved design	
1	Repair Sleeve Tool	1994-91	16304	Crankshaft	
QTY	VALVE COVER	YEARS	PART NO.	DESCRIPTION	
1	Valve Cover Gasket Set	1994-93	VS 50085 R	w/o Grommets; Services both covers; PermaDry® molded rubber gsks. incl.	
2	Valve Cover Gasket Set	1994-93	VS 50314 R	w/o Grommets; Services one cover only; PermaDry® molded rubber gskt. incl.	
1	Valve Cover Gasket Set	1992	VS 50085 R	Exc. Chevrolet Camaro RS, RS Heritage Edition Pontiac Firebird Base; w/o Grommets; Services both covers; PermaDry® molded rubber gsks. incl.	
1	Valve Cover Gasket Set	1992	VS 50272 C	Chevrolet Camaro RS, RS Heritage Edition Pontiac Firebird Base; Cork; Improved design	
1	Valve Cover Gasket Set	1992	VS 50272 R	Chevrolet Camaro RS, RS Heritage Edition Pontiac Firebird Base; Rubber; Old design; Superseded - When depleted use VS 50272 C	
1	Valve Cover Gasket Set	1992	VS 50272 T	Chevrolet Camaro RS, RS Heritage Edition Pontiac Firebird Base; PermaDryPlus®	
2	Valve Cover Gasket Set	1992	VS 50314 R	Exc. Chevrolet Camaro RS, RS Heritage Edition Pontiac Firebird Base; w/o Grommets; Services one cover only; PermaDry® molded rubber gskt. incl.	
1	Valve Cover Gasket Set	1991	VS 50085 R	Exc. Chevrolet Camaro RS Pontiac Firebird Base; w/o Grommets; Services both covers; PermaDry® molded rubber gsks. incl.	

GM Car (Incl. Buick, Cad., Chev., Geo, Olds., Pontiac, Saturn) (Cont.)

62 (cont.)		1994 - 1991; 3.1L 189 (3136cc) OHV V6 (12 Valve) 89mm Bore			62 (cont.)	
MFI; Gasoline; Naturally Aspirated GMC Eng.; Chevrolet; VIN Code T						
QTY	VALVE COVER	YEARS	PART NO.	DESCRIPTION		
1	Valve Cover Gasket Set	1991	VS 50272 C	Chevrolet Camaro RS Pontiac Firebird Base; Cork; Improved design		
1	Valve Cover Gasket Set	1991	VS 50272 R	Chevrolet Camaro RS Pontiac Firebird Base; Rubber; Old design; Superseded - When depleted use VS 50272 C		
1	Valve Cover Gasket Set	1991	VS 50272 T	Chevrolet Camaro RS Pontiac Firebird Base; PermaDryPlus®		
2	Valve Cover Gasket Set	1991	VS 50314 R	Exc. Chevrolet Camaro RS Pontiac Firebird Base; w/o Grommets; Services one cover only; PermaDry® molded rubber gskt. incl.		
1	Grommet Set	1994-93	ES 72125	Valve Cover		
1	Grommet Set	1992	ES 72125	Exc. Chevrolet Camaro RS, RS Heritage Edition Pontiac Firebird Base; Valve Cover		
1	Grommet Set	1991	ES 72125	Exc. Chevrolet Camaro RS Pontiac Firebird Base; Valve Cover		
QTY	VALVE STEM SEAL SET	YEARS	PART NO.	DESCRIPTION		
1	Valve Stem Seal Set	1994-93	SS 72685	Premium valve stem seals incl.		
1	Valve Stem Seal Set	1992	SS 72530	Chevrolet Camaro RS, RS Heritage Edition Pontiac Firebird Base; Premium valve stem seals incl.		
1	Valve Stem Seal Set	1992	SS 72685	Exc. Chevrolet Camaro RS, RS Heritage Edition Pontiac Firebird Base; Premium valve stem seals incl.		
1	Valve Stem Seal Set	1991	SS 72530	Chevrolet Camaro RS Pontiac Firebird Base; Premium valve stem seals incl.		
1	Valve Stem Seal Set	1991	SS 72685	Exc. Chevrolet Camaro RS Pontiac Firebird Base; Premium valve stem seals incl.		
QTY	THERMOSTAT HOUSING	YEARS	PART NO.	DESCRIPTION		
1	Water Outlet Gasket	1992	35258	Chevrolet Camaro RS, RS Heritage Edition Pontiac Firebird Base; Thermostat Housing		
1	Water Outlet Gasket	1991	35258	Chevrolet Camaro RS Pontiac Firebird Base; Thermostat Housing		
1	Thermostat Gasket	1994-91	35571	Thermostat Housing; Bypass pipe		
1	Thermostat Gasket	1994-91	35614	Thermostat Housing; Thermostat seal; Improved design		
QTY	WATER PUMP	YEARS	PART NO.	DESCRIPTION		
1	Water Pump Gasket	1994-93	35403			
1	Water Pump Gasket	1992	35403	Exc. Chevrolet Camaro RS, RS Heritage Edition Pontiac Firebird Base		
1	Water Pump Gasket	1992	35409	Chevrolet Camaro RS, RS Heritage Edition Pontiac Firebird Base		
1	Water Pump Gasket	1991	35403	Exc. Chevrolet Camaro RS Pontiac Firebird Base		
1	Water Pump Gasket	1991	35409	Chevrolet Camaro RS Pontiac Firebird Base		
QTY	TIMING COVER	YEARS	PART NO.	DESCRIPTION		
1	Timing Cover Set	1994-91	TCS 45828	w/o Sleeve 'N' Seal®		
1	Timing Cover Gasket	1994-91	72670	New Part Number - Check for Availability		
1	Timing Cover Gasket	1994-91	72696	Camshaft rear cover plate; New Part Number - Check for Availability		
1	Timing Set w/Sleeve & Seal	1994-91	TCS 45827	w/Sleeve 'N' Seal®; 1.040" sleeve length		
1	Timing Set w/Sleeve & Seal	1994-93	TCS 45976	w/Sleeve 'N' Seal®; .565" sleeve length		
1	Timing Set w/Sleeve & Seal	1992	TCS 45976	Exc. Chevrolet Camaro RS, RS Heritage Edition Pontiac Firebird Base; w/Sleeve 'N' Seal®; .565" sleeve length		
1	Timing Set w/Sleeve & Seal	1991	TCS 45976	Exc. Chevrolet Camaro RS Pontiac Firebird Base; w/Sleeve 'N' Seal®; .565" sleeve length		
1	Repair Sleeve	1994-91	16215	Timing Cover; .565" sleeve length; Use w/installation tool		
1	Repair Sleeve	1994-91	16212	Timing Cover; 1.040" sleeve length; Use w/installation tool		
1	Repair Sleeve Tool	1994-91	16312	Timing Cover		
QTY	CARB & FUEL INJECTION	YEARS	PART NO.	DESCRIPTION		
3	Fuel Injector O-Ring Set	1994-91	ES 70599	Improved design		
1	Throttle Body Gasket	1994-93	60728			
1	Throttle Body Gasket	1992	60728	Exc. Chevrolet Camaro RS, RS Heritage Edition Pontiac Firebird Base		
1	Throttle Body Gasket	1992	60883	Chevrolet Camaro RS, RS Heritage Edition Pontiac Firebird Base		
1	Throttle Body Gasket	1991	60728	Exc. Chevrolet Camaro RS Pontiac Firebird Base		
1	Throttle Body Gasket	1991	60883	Chevrolet Camaro RS Pontiac Firebird Base		
QTY	DISTRIBUTOR MOUNTING	YEARS	PART NO.	DESCRIPTION		
1	O-Ring	1994-91	70800	Distributor Mounting		
QTY	EXHAUST GAS RECIRCULATION	YEARS	PART NO.	DESCRIPTION		
1	EGR Gasket	1994-91	70208	Adapter		
1	EGR Gasket	1994-91	70397	Valve		
QTY	OIL FILTER MOUNTING	YEARS	PART NO.	DESCRIPTION		
1	Oil Filter Gasket	1994-91	70672			

GM Car (Incl. Buick, Cad., Chev., Geo, Olds., Pontiac, Saturn) (Cont.)

63		1993; 3.1L 189 (3136cc) OHV V6 (12 Valve) 89mm Bore			63
		MFI; Flex Fuel; Naturally Aspirated GMC Eng.; Chevrolet; VIN Code W			
QTY	CYLINDER HEAD	YEARS	PART NO.	DESCRIPTION	
2	Head Gasket	1993	513 SD	Head bolts not incl.; Head bolt replacement recommended; PermaTorque Severe Duty®	
2	Head Gasket	1993	9471 PT	Head bolts not incl.; Head bolt replacement recommended; PermaTorque®	
2	Head Gasket Spacer Shim	1993	8699 SP-1	HeadSaver®	
1	Head Set	1993	HS 9471 PT-1	Int. manifold gskt., head bolts, exh. pipe packing, valve cover grommets not incl.; Head bolt replacement recommended; PermaDry® molded rubber valve cover gskts. incl.; Premium valve stem seals incl.	
1	Head Installation Set	1993	HIS 9471 PT-1	Int. manifold gskt., head bolts, exh. pipe packing, valve cover grommets not incl.; Head bolt replacement recommended; PermaDry® molded rubber valve cover gskts. incl.	
1	Head Bolt Set	1993	ES 74018	Replacement recommended	
QTY	CONVERSION SET	YEARS	PART NO.	DESCRIPTION	
1	Gasket Conversion Set	1993	CS 9471	PermaDry® molded rubber oil pan gskt. incl.	
QTY	MANIFOLD - INT. & EXH.	YEARS	PART NO.	DESCRIPTION	
1	Valley Pan Gasket Set	1993	MS 96046	Valve cover gskts. not incl.; Upper set incl.	
1	Plenum Gasket Set	1993	MS 94944	Upper set	
1	Exh. Manifold Gasket Set	1993	MS 93692		
QTY	EXHAUST PIPE FLANGE	YEARS	PART NO.	DESCRIPTION	
1	Exhaust Pipe Gasket	1993	60538	Pipe to manifold	
QTY	OIL PAN	YEARS	PART NO.	DESCRIPTION	
1	Oil Pan Gasket Set	1993	OS 34501 R	PermaDry® molded rubber gskt. incl.	
1	Drain Plug Gasket	1993	70822		
QTY	CRANKSHAFT REAR SEAL	YEARS	PART NO.	DESCRIPTION	
1	Rear Main Seal Set	1993	BS 40464	11.0mm thick; Rubber; One-piece; Improved design	
1	Rear Main Seal Set	1993	BS 40625	11.0mm thick; PTFE Rubber; One-piece; Improved design	
1	Repair Sleeve Tool	1993	16304	Crankshaft	
QTY	VALVE COVER	YEARS	PART NO.	DESCRIPTION	
1	Valve Cover Gasket Set	1993	VS 50085 R	w/o Grommets; Services both covers; PermaDry® molded rubber gskts. incl.	
2	Valve Cover Gasket Set	1993	VS 50314 R	w/o Grommets; Services one cover only; PermaDry® molded rubber gskt. incl.	
1	Grommet Set	1993	ES 72125	Valve Cover	
QTY	VALVE STEM SEAL SET	YEARS	PART NO.	DESCRIPTION	
1	Valve Stem Seal Set	1993	SS 72685	Premium valve stem seals incl.	
QTY	THERMOSTAT HOUSING	YEARS	PART NO.	DESCRIPTION	
1	Thermostat Gasket	1993	35571	Thermostat Housing; Bypass pipe	
1	Thermostat Gasket	1993	35614	Thermostat Housing; Thermostat seal; Improved design	
QTY	WATER PUMP	YEARS	PART NO.	DESCRIPTION	
1	Water Pump Gasket	1993	35403		
QTY	TIMING COVER	YEARS	PART NO.	DESCRIPTION	
1	Timing Cover Set	1993	TCS 45828	w/o Sleeve 'N' Seal®	
1	Timing Cover Gasket	1993	72670	New Part Number - Check for Availability	
1	Timing Cover Gasket	1993	72696	Camshaft rear cover plate; New Part Number - Check for Availability	
1	Timing Set w/Sleeve & Seal	1993	TCS 45827	w/Sleeve 'N' Seal®; 1.040" sleeve length	
1	Timing Set w/Sleeve & Seal	1993	TCS 45976	w/Sleeve 'N' Seal®; .565" sleeve length	
1	Repair Sleeve	1993	16212	Timing Cover; 1.040" sleeve length; Use w/installation tool	
1	Repair Sleeve	1993	16215	Timing Cover; .565" sleeve length; Use w/installation tool	
1	Repair Sleeve Tool	1993	16312	Timing Cover	
QTY	CARB & FUEL INJECTION	YEARS	PART NO.	DESCRIPTION	
3	Fuel Injector O-Ring Set	1993	ES 70599	Improved design	
1	Throttle Body Gasket	1993	60728		
QTY	DISTRIBUTOR MOUNTING	YEARS	PART NO.	DESCRIPTION	
1	O-Ring	1993	70800	Distributor Mounting	
QTY	EXHAUST GAS RECIRCULATION	YEARS	PART NO.	DESCRIPTION	
1	EGR Gasket	1993	70208	Adapter	
1	EGR Gasket	1993	70397	Valve	
QTY	OIL FILTER MOUNTING	YEARS	PART NO.	DESCRIPTION	
1	Oil Filter Gasket	1993	70672		
64		2005 - 2003; 3.2L 194 (3175cc) DOHC V6 (24 Valve) 87.5mm Bore			64
		MFI; Gasoline; Naturally Aspirated Opel Eng.; VIN Code N			
QTY	CYLINDER HEAD	YEARS	PART NO.	DESCRIPTION	
2	Head Gasket	2005-03	26489 PT	Head bolts not incl.; Head bolt replacement recommended; PermaTorqueMLS®	

GM Car (Incl. Buick, Cad., Chev., Geo, Olds., Pontiac, Saturn) (Cont.)

64 (cont.)		2005 - 2003; 3.2L 194 (3175cc) DOHC V6 (24 Valve) 87.5mm Bore			64 (cont.)
MFI; Gasoline; Naturally Aspirated Opel Eng.; VIN Code N					
QTY	CYLINDER HEAD	YEARS	PART NO.	DESCRIPTION	
1	Head Set	2005-03	HS 26489 PT	Head bolts & exh. pipe flange not incl.; Head bolt replacement recommended; PermaDry® molded rubber valve cover gskts. incl.; Premium valve stem seals incl.	
2	Head Bolt Set	2005-03	ES 72906	Head bolts w/Washers; Replacement recommended	
QTY	CONVERSION SET	YEARS	PART NO.	DESCRIPTION	
1	Gasket Conversion Set	2005-03	CS 26173-4	RTV sealant incl. for oil pan gskt.	
QTY	MANIFOLD - INT. & EXH.	YEARS	PART NO.	DESCRIPTION	
1	Int. Manifold Gasket Set	2005-03	MS 96103	Lower set; Upper set incl.	
1	Plenum Gasket Set	2005-03	MS 96062	Upper set	
1	Exh. Manifold Gasket Set	2005-03	MS 96425		
QTY	EXHAUST PIPE FLANGE	YEARS	PART NO.	DESCRIPTION	
1	Exhaust Pipe Gasket	2005-03	61525	Loc. L.H.; Converter; Improved design	
1	Exhaust Pipe Gasket	2005-03	61626	Loc. R.H.; Converter	
2	Exhaust Pipe Gasket	2005-03	61637	Pipe to manifold	
QTY	CRANKSHAFT REAR SEAL	YEARS	PART NO.	DESCRIPTION	
1	Rear Main Seal Set	2005-03	BS 40671	Rubber; One-piece; Improved design	
1	Rear Main Seal Set	2005-03	BS 40739	Rubber; One-piece; New Improved design; New Part Number - Check for Availability	
QTY	VALVE COVER	YEARS	PART NO.	DESCRIPTION	
1	Valve Cover Gasket Set	2005-03	VS 50628 R	w/Grommets; PermaDry® molded rubber gskts. incl.	
QTY	VALVE STEM SEAL SET	YEARS	PART NO.	DESCRIPTION	
1	Valve Stem Seal Set	2005-03	SS 71163	Premium valve stem seals incl.	
QTY	THERMOSTAT HOUSING	YEARS	PART NO.	DESCRIPTION	
1	O-Ring	2005-03	35749	Thermostat Housing	
QTY	WATER PUMP	YEARS	PART NO.	DESCRIPTION	
1	Water Pump Gasket	2005-03	35665	O-ring	
QTY	TIMING COVER	YEARS	PART NO.	DESCRIPTION	
1	Crankshaft Front Seal Set	2005-03	TCS 46014		
4	Camshaft Front Seal Set	2005-03	TCS 45603		
QTY	CARB & FUEL INJECTION	YEARS	PART NO.	DESCRIPTION	
3	Fuel Injector O-Ring Set	2005-03	ES 70599	Improved design	
2	Throttle Body Gasket	2005-03	61184		
65		1993 - 1991; 3.3L 204 (3350cc) OHV V6 (12 Valve) 3.7" Bore			65
MFI; Gasoline; Naturally Aspirated GMC Eng.; Buick; VIN Code N					
QTY	CYLINDER HEAD	YEARS	PART NO.	DESCRIPTION	
2	Head Gasket	1993-91	9644 PT	Head bolts not incl.; Head bolt replacement required	
1	Head Set	1993-92	HS 9644 PT-3	Head bolts & exh. pipe packing not incl.; Head bolt replacement required; PermaDry® molded rubber valve cover gskts. incl.; Premium valve stem seals incl.	
1	Head Set	1991	HS 9644 PT	Head bolts & exh. pipe packing not incl.; Head bolt replacement required; PermaDry® molded rubber valve cover gskts. incl.; Premium valve stem seals incl.	
1	Head Bolt Set	1993-91	ES 74031	Replacement required	
QTY	CONVERSION SET	YEARS	PART NO.	DESCRIPTION	
1	Gasket Conversion Set	1993-91	CS 9644	PermaDry® molded rubber oil pan gskt. incl.; PermaDryPlus® timing cover gskt. incl.	
QTY	MANIFOLD - INT. & EXH.	YEARS	PART NO.	DESCRIPTION	
1	Int. Manifold Gasket Set	1993-92	MS 94066-2		
1	Int. Manifold Gasket Set	1991	MS 94066-1		
1	Exh. Manifold Gasket Set	1993-91	MS 94052		
QTY	EXHAUST PIPE FLANGE	YEARS	PART NO.	DESCRIPTION	
1	Exhaust Pipe Gasket	1993-91	60754	Crossover; 2.270" ID x 3.225" OD	
1	Exhaust Pipe Gasket	1993	60827	Buick Skylark Custom, Gran Sport, Limited Oldsmobile Achieva S, SC, SL, W44 Pontiac Grand Am GT, SE; Adapter	
1	Exhaust Pipe Gasket	1993	60829	Buick Skylark Custom, Gran Sport, Limited Oldsmobile Achieva S, SC, SL, W44 Pontiac Grand Am GT, SE; Pipe to manifold	
1	Exhaust Pipe Gasket	1993	60884	Exc. Buick Skylark Custom, Gran Sport, Limited Oldsmobile Achieva S, SC, SL, W44 Pontiac Grand Am GT, SE; Pipe to manifold; Improved design	
1	Exhaust Pipe Gasket	1992	60827	Buick Skylark Custom, Gran Sport Oldsmobile Achieva S, SC, SL, W44 Pontiac Grand Am GT, SE; Adapter	

GM Car (Incl. Buick, Cad., Chev., Geo, Olds., Pontiac, Saturn) (Cont.)

65 (cont.)		1993 - 1991; 3.3L 204 (3350cc) OHV V6 (12 Valve) 3.7" Bore			65 (cont.)
MFI; Gasoline; Naturally Aspirated GMC Eng.; Buick; VIN Code N					
QTY	EXHAUST PIPE FLANGE	YEARS	PART NO.	DESCRIPTION	
1	Exhaust Pipe Gasket	1992	60829	Buick Skylark Custom, Gran Sport Oldsmobile Achieva S, SC, SL, W44 Pontiac Grand Am GT, SE; Pipe to manifold	
1	Exhaust Pipe Gasket	1992	60884	Exc. Buick Skylark Custom, Gran Sport Oldsmobile Achieva S, SC, SL, W44 Pontiac Grand Am GT, SE; Pipe to manifold; Improved design	
1	Exhaust Pipe Gasket	1991	60827	Buick Skylark Base, Custom, Gran Sport, Luxury Edition Oldsmobile Cutlass Calais Base, GT, International, S, SL; Adapter	
1	Exhaust Pipe Gasket	1991	60829	Buick Skylark Base, Custom, Gran Sport, Luxury Edition Oldsmobile Cutlass Calais Base, GT, International, S, SL; Pipe to manifold	
1	Exhaust Pipe Gasket	1991	60850	Converter; 51mm ID	
1	Exhaust Pipe Gasket	1991	60884	Exc. Buick Skylark Base, Custom, Gran Sport, Luxury Edition Oldsmobile Cutlass Calais Base, GT, International, S, SL; Pipe to manifold; Improved design	
1	Exh. Flange Bolt & Spring Kit	1993-91	ES 72141		
QTY	OIL PAN	YEARS	PART NO.	DESCRIPTION	
1	Oil Pan Gasket Set	1993-91	OS 30522 R	PermaDry® molded rubber gskt. incl.	
1	Oil Pan Gasket Set	1993-91	OS 30522 T	PermaDryPlus®; Oil Pan SnapUps® incl.	
1	Drain Plug Gasket	1993-91	70822		
QTY	CRANKSHAFT REAR SEAL	YEARS	PART NO.	DESCRIPTION	
1	Rear Main Seal Set	1993-91	BS 40621	Rubber; One-piece	
1	Rear Main Seal Set	1993-91	BS 40649	PTFE Rubber; One-piece	
1	Repair Sleeve	1993-91	16276	Crankshaft; Use w/installation tool	
QTY	VALVE COVER	YEARS	PART NO.	DESCRIPTION	
1	Valve Cover Gasket Set	1993-91	VS 50080 R	w/o Grommets; Services both covers; PermaDry® molded rubber gskts. incl.	
2	Valve Cover Gasket Set	1993-91	VS 50320 R	w/o Grommets; Services one cover only; PermaDry® molded rubber gskt. incl.	
1	Grommet Set	1993-91	ES 72833	Valve Cover	
QTY	VALVE STEM SEAL SET	YEARS	PART NO.	DESCRIPTION	
1	Valve Stem Seal Set	1993-91	SS 72700	Premium valve stem seals incl.	
QTY	THERMOSTAT HOUSING	YEARS	PART NO.	DESCRIPTION	
1	Thermostat Gasket	1993-91	35448	Thermostat Housing	
1	Thermostat Gasket	1993-91	35666	Thermostat Housing; Thermostat seal; 1.560" ID; Improved design	
QTY	WATER PUMP	YEARS	PART NO.	DESCRIPTION	
1	Water Pump Gasket	1993-91	35351		
QTY	TIMING COVER	YEARS	PART NO.	DESCRIPTION	
1	Timing Cover Set	1993-91	TCS 45840	w/o Sleeve 'N' Seal®; Must be used w/OS 30522R or w/OS 30522T; PermaDryPlus® timing cover gskt. incl.	
1	Timing Set w/Sleeve & Seal	1993-91	TCS 45974	w/Sleeve 'N' Seal®; Must be used w/OS 30522R or w/OS 30522T; PermaDryPlus® timing cover gskt. incl.	
1	Repair Sleeve	1993-91	16216	Timing Cover; Use w/installation tool	
1	Repair Sleeve Tool	1993-91	16308	Timing Cover	
QTY	CARB & FUEL INJECTION	YEARS	PART NO.	DESCRIPTION	
3	Fuel Injector O-Ring Set	1993-91	ES 70599	Improved design	
1	Throttle Body Gasket	1993-91	60825		
QTY	OIL FILTER MOUNTING	YEARS	PART NO.	DESCRIPTION	
1	Oil Filter Gasket	1993-91	70644		
66		1997 - 1991; 3.4L 207 (3393cc) DOHC V6 (24 Valve) 92mm Bore			66
MFI; Gasoline; Naturally Aspirated GMC Eng.; Chevrolet; VIN Code X					
QTY	CYLINDER HEAD	YEARS	PART NO.	DESCRIPTION	
2	Head Gasket	1997-91	9113 PT	Head bolts not incl.; Head bolt replacement recommended	
1	Head Set	1997-96	HS 9113 PT-2	Head bolts & exh. pipe packing not incl.; Head bolt replacement recommended; PermaDry® molded rubber valve cover gskts. incl.; Premium valve stem seals incl.	
1	Head Set	1995-91	HS 9113 PT-1	Head bolts & exh. pipe packing not incl.; Head bolt replacement recommended; PermaDry® molded rubber valve cover gskts. incl.; Premium valve stem seals incl.	
2	Head Bolt Set	1997-91	ES 72177	Replacement recommended	
QTY	CONVERSION SET	YEARS	PART NO.	DESCRIPTION	
1	Gasket Conversion Set	1997-91	CS 9113	PermaDry® molded rubber oil pan gskt. incl.	
QTY	MANIFOLD - INT. & EXH.	YEARS	PART NO.	DESCRIPTION	
1	Int. Manifold Gasket Set	1997-96	MS 95804	Lower set; Upper set incl.	
1	Int. Manifold Gasket Set	1995-91	MS 95822	Lower set; Upper set incl.	
1	Plenum Gasket Set	1997-96	MS 95745	Upper set	

GM Car (Incl. Buick, Cad., Chev., Geo, Olds., Pontiac, Saturn) (Cont.)

66 (cont.)		1997 - 1991; 3.4L 207 (3393cc) DOHC V6 (24 Valve) 92mm Bore			66 (cont.)
MFI; Gasoline; Naturally Aspirated GMC Eng.; Chevrolet; VIN Code X					
QTY	MANIFOLD - INT. & EXH.	YEARS	PART NO.	DESCRIPTION	
1	Plenum Gasket Set	1995-91	MS 95233	Upper set	
1	Exh. Manifold Gasket Set	1997-96	MS 95803		
1	Exh. Manifold Gasket Set	1995-91	MS 95802		
QTY	EXHAUST PIPE FLANGE	YEARS	PART NO.	DESCRIPTION	
1	Exhaust Pipe Gasket	1997	61054	Pipe to manifold; Packing	
1	Exhaust Pipe Gasket	1996	60640	Pipe to manifold; Packing	
1	Exhaust Pipe Gasket	1995-91	61011	Pipe to manifold; Packing	
QTY	OIL PAN	YEARS	PART NO.	DESCRIPTION	
1	Oil Pan Gasket Set	1997-91	OS 34501 R	PermaDry® molded rubber gskt. incl.	
1	Drain Plug Gasket	1997-91	70822		
QTY	CRANKSHAFT REAR SEAL	YEARS	PART NO.	DESCRIPTION	
1	Rear Main Seal Set	1997-91	BS 40464	11.0mm thick; Rubber; One-piece; Improved design	
1	Rear Main Seal Set	1997-91	BS 40625	11.0mm thick; PTFE Rubber; One-piece; Improved design	
QTY	VALVE COVER	YEARS	PART NO.	DESCRIPTION	
1	Valve Cover Gasket Set	1997-96	VS 50472 R	w/Spark plug tube seals; PermaDry® molded rubber gsks. incl.	
1	Valve Cover Gasket Set	1995-91	VS 50466 R	w/Spark plug tube seals; PermaDry® molded rubber gsks. incl.	
QTY	VALVE STEM SEAL SET	YEARS	PART NO.	DESCRIPTION	
3	Valve Stem Seal Set	1997-91	SS 72862	Premium valve stem seals incl.	
QTY	THERMOSTAT HOUSING	YEARS	PART NO.	DESCRIPTION	
1	Thermostat Gasket	1997-91	35614	Thermostat Housing; Thermostat seal; Improved design	
QTY	WATER OUTLET GASKET	YEARS	PART NO.	DESCRIPTION	
1	Water Outlet Gasket	1997-91	35258	Water Outlet; Inlet	
QTY	WATER PUMP	YEARS	PART NO.	DESCRIPTION	
1	Water Pump Gasket	1997-91	35403		
QTY	TIMING COVER	YEARS	PART NO.	DESCRIPTION	
1	Crankshaft Front Seal Set	1997-91	TCS 45970		
QTY	CARB & FUEL INJECTION	YEARS	PART NO.	DESCRIPTION	
3	Fuel Injector O-Ring Set	1997-91	ES 70599	Improved design	
1	Throttle Body Gasket	1997-96	61028	Adapter to manifold	
1	Throttle Body Gasket	1997-96	61029	Throttle body to adapter	
QTY	EXHAUST GAS RECIRCULATION	YEARS	PART NO.	DESCRIPTION	
1	EGR Gasket	1997-96	70766	Pipe	
1	EGR Gasket	1997-96	70790	Valve	
1	EGR Gasket	1995-91	70791	Adapter	
1	EGR Gasket	1995-91	70793	Mounting	
67		2005 - 1999; 3.4L 207 (3393cc) OHV V6 (12 Valve) 92mm Bore			67
MFI; Gasoline; Naturally Aspirated GMC Eng.; Chevrolet; VIN Code E					
QTY	CYLINDER HEAD	YEARS	PART NO.	DESCRIPTION	
2	Head Gasket	2005-99	541 SD	Head bolts not incl.; Head bolt replacement recommended; PermaTorque Severe Duty®	
2	Head Gasket	2005-99	9071 PT	Head bolts not incl.; Head bolt replacement recommended; PermaTorque®	
1	Head Set	2005-04	HS 9071 PT-2	Head bolts not incl.; Head bolt replacement recommended; PermaDryPlus® int. manifold gsks. incl.; PermaDry® molded rubber valve cover gsks. incl.; Premium valve stem seals incl.	
1	Head Set	2003-00	HS 9071 PT-1	Head bolts not incl.; Head bolt replacement recommended; PermaDry® molded rubber valve cover gsks. incl.; Premium valve stem seals incl.	
1	Head Set	2003-00	HST 9071 PT-1	Head bolts not incl.; Head bolt replacement recommended; PermaTorque Severe Duty® head gsks. incl.; PermaDryPlus® int. manifold gsks. incl.; PermaDry® molded rubber valve cover gsks. incl.; Premium valve stem seals incl.	
1	Head Set	1999	HS 9071 PT	Head bolts not incl.; Head bolt replacement recommended; PermaDry® molded rubber valve cover gsks. incl.; Premium valve stem seals incl.	
1	Head Set	1999	HST 9071 PT	Head bolts not incl.; Head bolt replacement recommended; PermaTorque Severe Duty® head gsks. incl.; PermaDryPlus® int. manifold gsks. incl.; PermaDry® molded rubber valve cover gsks. incl.; Premium valve stem seals incl.	
1	Head Installation Set	1999	HIS 9071 PT	Head bolts & exh. pipe packing not incl.; Head bolt replacement recommended; PermaDry® molded rubber valve cover gsks. incl.	
1	Head Bolt Set	2005	ES 72892	Exc. Pontiac Grand Am GT, GT1, SE; Replacement recommended	
1	Head Bolt Set	2005	ES 74017	Pontiac Grand Am GT, GT1, SE; Replacement recommended	
1	Head Bolt Set	2004	ES 72892	Chevrolet Impala Base, Monte Carlo LS; Replacement recommended	
1	Head Bolt Set	2004	ES 74017	Exc. Chevrolet Impala Base, Monte Carlo LS; Replacement recommended	

GM Car (Incl. Buick, Cad., Chev., Geo, Olds., Pontiac, Saturn) (Cont.)

67 (cont.)		2005 - 1999; 3.4L 207 (3393cc) OHV V6 (12 Valve) 92mm Bore			67 (cont.)
		MFI; Gasoline; Naturally Aspirated GMC Eng.; Chevrolet; VIN Code E			
QTY	CYLINDER HEAD	YEARS	PART NO.	DESCRIPTION	
1	Head Bolt Set	2003	ES 72892	Chevrolet Impala Base, Monte Carlo LS, LS Competition, LS Sport; Replacement recommended	
1	Head Bolt Set	2003	ES 74017	Exc. Chevrolet Impala Base, Monte Carlo LS, LS Competition, LS Sport; Replacement recommended	
1	Head Bolt Set	2002-00	ES 72892	Chevrolet Impala Base, Monte Carlo LS; Replacement recommended	
1	Head Bolt Set	2002-00	ES 74017	Exc. Chevrolet Impala Base, Monte Carlo LS; Replacement recommended	
1	Head Bolt Set	1999	ES 74017	Replacement recommended	
QTY	CONVERSION SET	YEARS	PART NO.	DESCRIPTION	
1	Gasket Conversion Set	2005-99	CS 9957	PermaDry® molded rubber oil pan gskt. incl.	
QTY	MANIFOLD - INT. & EXH.	YEARS	PART NO.	DESCRIPTION	
1	Int. Manifold Gasket Set	2005-99	MS 98003 T	Valve cover gskts. & Upper set incl.; PermaDryPlus® int. manifold gskts. incl.; Manifold bolts not incl.; Manifold bolt replacement recommended	
1	Int. Manifold Gasket Set	2003-99	MS 90565	Valve cover gskts. not incl.; Upper set incl.; Manifold bolts not incl.; Manifold bolt replacement recommended	
1	Plenum Gasket Set	2005-99	MS 90505	Upper set	
1	Int. Manifold Bolt Set	2005-01	ES 72226	Loc. Lower; 10mm corner bolts; Replacement recommended	
1	Int. Manifold Bolt Set	2000	ES 72225	Chevrolet Impala Base, Monte Carlo LS; Loc. Lower; 13mm corner bolts; Replacement recommended	
1	Int. Manifold Bolt Set	2000	ES 72226	Exc. Chevrolet Impala Base, Monte Carlo LS; Loc. Lower; 10mm corner bolts; Replacement recommended	
1	Int. Manifold Bolt Set	1999	ES 72226	Loc. Lower; 10mm corner bolts; Replacement recommended	
1	Exh. Manifold Gasket Set	2005-04	MS 96329		
1	Exh. Manifold Gasket Set	2003-99	MS 95586		
QTY	EXHAUST PIPE FLANGE	YEARS	PART NO.	DESCRIPTION	
1	Exhaust Pipe Gasket	2005-99	61054	Packing	
1	Exhaust Pipe Gasket	2005-99	61314	Converter	
QTY	OIL PAN	YEARS	PART NO.	DESCRIPTION	
1	Oil Pan Gasket Set	2005-99	OS 30668 R	PermaDry® molded rubber gskt. incl.	
1	Drain Plug Gasket	2005-99	70820		
QTY	CRANKSHAFT REAR SEAL	YEARS	PART NO.	DESCRIPTION	
1	Rear Main Seal Set	2005-99	BS 40464	11.0mm thick; Rubber; One-piece; Improved design	
1	Rear Main Seal Set	2005-99	BS 40625	11.0mm thick; PTFE Rubber; One-piece; Improved design	
1	Repair Sleeve Tool	2005-99	16304	Crankshaft	
QTY	VALVE COVER	YEARS	PART NO.	DESCRIPTION	
1	Valve Cover Gasket Set	2005-99	VS 50442 R	w/o Grommets; Must be used w/35614; PermaDry® molded rubber gskts. incl.	
1	Grommet Set	2005-99	ES 71044	Valve Cover	
QTY	VALVE STEM SEAL SET	YEARS	PART NO.	DESCRIPTION	
1	Valve Stem Seal Set	2005-00	SS 70829	Premium valve stem seals incl.	
1	Valve Stem Seal Set	1999	SS 72851	Premium valve stem seals incl.	
QTY	THERMOSTAT HOUSING	YEARS	PART NO.	DESCRIPTION	
1	O-Ring	2005-99	70799	Thermostat Housing; Bypass pipe	
QTY	WATER OUTLET GASKET	YEARS	PART NO.	DESCRIPTION	
1	Thermostat Gasket	2005-99	35614	Water Outlet; Improved design	
QTY	WATER PUMP	YEARS	PART NO.	DESCRIPTION	
1	Water Pump Gasket	2005-99	35403		
QTY	TIMING COVER	YEARS	PART NO.	DESCRIPTION	
1	Timing Cover Set	2005-99	TCS 45828	w/o Sleeve 'N' Seal®	
1	Timing Cover Gasket	2005-99	72670	New Part Number - Check for Availability	
1	Timing Set w/Sleeve & Seal	2005-99	TCS 45976	w/Sleeve 'N' Seal®; .565" sleeve length	
1	Repair Sleeve	2005-99	16215	Timing Cover; .565" sleeve length; Use w/installation tool	
1	Repair Sleeve Tool	2005-99	16312	Timing Cover	
QTY	CARB & FUEL INJECTION	YEARS	PART NO.	DESCRIPTION	
2	Fuel Injector O-Ring Set	2005-00	ES 70599	Upper set; Injectors to fuel rail; Improved design	
2	Fuel Injector O-Ring Set	2005-00	ES 71190	Lower set; Injectors to cylinder head	
2	Fuel Injector O-Ring Set	2005-00	ES 71192	Upper set; Injectors to fuel rail; Old design	
3	Fuel Injector O-Ring Set	1999	ES 70599	Improved design	
1	Throttle Body Gasket	2005-00	61053		
1	Throttle Body Gasket	1999	60983		
QTY	DISTRIBUTOR MOUNTING	YEARS	PART NO.	DESCRIPTION	
1	O-Ring	2005-99	72343	Distributor Mounting; O-ring; May also be used as a distributor block-off plate seal or oil pump drive seal if desired	
QTY	EXHAUST GAS RECIRCULATION	YEARS	PART NO.	DESCRIPTION	
1	EGR Gasket	2005-00	70804		

GM Car (Incl. Buick, Cad., Chev., Geo, Olds., Pontiac, Saturn) (Cont.)

67		2005 - 1999; 3.4L 207 (3393cc) OHV V6 (12 Valve) 92mm Bore			67	
(cont.)		MFI; Gasoline; Naturally Aspirated GMC Eng.; Chevrolet; VIN Code E			(cont.)	
QTY	EXHAUST GAS RECIRCULATION	YEARS	PART NO.	DESCRIPTION		
1	EGR Gasket	1999	70766	Pipe		
1	EGR Gasket	1999	70790	Valve		
68		1995 - 1993; 3.4L 207 (3393cc) OHV V6 (12 Valve) 92mm Bore			68	
		MFI; Gasoline; Naturally Aspirated GMC Eng.; Chevrolet; VIN Code S				
QTY	CYLINDER HEAD	YEARS	PART NO.	DESCRIPTION		
2	Head Gasket	1995-93	9105 PT	Head bolts not incl.; Head bolt replacement recommended		
1	Head Set	1995-93	HS 9105 PT	Head bolts & exh. crossover not incl.; Head bolt replacement recommended; Premium valve stem seals incl.		
1	Head Bolt Set	1995-93	ES 72857	Replacement recommended		
QTY	CONVERSION SET	YEARS	PART NO.	DESCRIPTION		
1	Gasket Conversion Set	1995-93	CS 9471	PermaDry® molded rubber oil pan gskt. incl.		
QTY	MANIFOLD - INT. & EXH.	YEARS	PART NO.	DESCRIPTION		
1	Int. Manifold Gasket Set	1995-93	MS 93020	Lower set; Valve cover gskts. & Upper set incl.		
1	Plenum Gasket Set	1995-93	MS 90453	Upper set; Center manifold gskt.		
1	Plenum Gasket Set	1995-93	MS 93020-1	Upper set; Plenum side gskts.; New Part Number - Check for Availability		
1	Exh. Manifold Gasket Set	1995-93	MS 90864			
QTY	EXHAUST PIPE FLANGE	YEARS	PART NO.	DESCRIPTION		
2	Exhaust Pipe Gasket	1995-93	61010	Crossover		
QTY	OIL PAN	YEARS	PART NO.	DESCRIPTION		
1	Oil Pan Gasket Set	1995-93	OS 34501 R	PermaDry® molded rubber gskt. incl.		
1	Drain Plug Gasket	1995-93	70822			
QTY	CRANKSHAFT REAR SEAL	YEARS	PART NO.	DESCRIPTION		
1	Rear Main Seal Set	1995-93	BS 40464	11.0mm thick; Rubber; One-piece; Improved design		
1	Rear Main Seal Set	1995-93	BS 40625	11.0mm thick; PTFE Rubber; One-piece; Improved design		
1	Repair Sleeve Tool	1995-93	16304	Crankshaft		
QTY	VALVE COVER	YEARS	PART NO.	DESCRIPTION		
1	Valve Cover Gasket Set	1995-93	VS 50272 C	Cork; Improved design		
1	Valve Cover Gasket Set	1995-93	VS 50272 R	Rubber; Old design; Superseded - When depleted use VS 50272 C		
1	Valve Cover Gasket Set	1995-93	VS 50272 T	PermaDryPlus®		
QTY	VALVE STEM SEAL SET	YEARS	PART NO.	DESCRIPTION		
1	Valve Stem Seal Set	1995-93	SS 72530	Premium valve stem seals incl.		
QTY	THERMOSTAT HOUSING	YEARS	PART NO.	DESCRIPTION		
1	Thermostat Gasket	1995-93	35614	Thermostat Housing; Thermostat seal; Improved design		
QTY	WATER PUMP	YEARS	PART NO.	DESCRIPTION		
1	Water Pump Gasket	1995-93	35409			
QTY	TIMING COVER	YEARS	PART NO.	DESCRIPTION		
1	Timing Cover Set	1995-93	TCS 45828	w/o Sleeve 'N' Seal®; Must be used w/OS 34501R		
1	Timing Cover Gasket	1995-93	72670	New Part Number - Check for Availability		
1	Timing Cover Gasket	1995-93	72696	Camshaft rear cover plate; New Part Number - Check for Availability		
1	Timing Set w/Sleeve & Seal	1995-93	TCS 45827	w/Sleeve 'N' Seal®; Must be used w/OS 34501R; 1.040" sleeve length		
1	Repair Sleeve	1995-93	16212	Timing Cover; 1.040" sleeve length; Use w/installation tool		
1	Repair Sleeve Tool	1995-93	16312	Timing Cover		
QTY	CARB & FUEL INJECTION	YEARS	PART NO.	DESCRIPTION		
3	Fuel Injector O-Ring Set	1995-93	ES 70599	Improved design		
1	Throttle Body Gasket	1995-93	60983			
QTY	DISTRIBUTOR MOUNTING	YEARS	PART NO.	DESCRIPTION		
1	O-Ring	1995-93	70800	Distributor Mounting		
QTY	EXHAUST GAS RECIRCULATION	YEARS	PART NO.	DESCRIPTION		
1	EGR Gasket	1995-93	70397	Mounting		
1	EGR Gasket	1995-93	70796	Pipe		
1	EGR Gasket	1995-93	70798	Adapter		
QTY	OIL FILTER MOUNTING	YEARS	PART NO.	DESCRIPTION		
1	Oil Filter Gasket	1995-93	70672			
69		2008 - 2004; 3.5L 213 (3491cc) OHV V6 (12 Valve) 94mm Bore			69	
		MFI; Gasoline; Naturally Aspirated GMC Eng.; Chevrolet; VIN Code 8				
QTY	CYLINDER HEAD	YEARS	PART NO.	DESCRIPTION		
2	Head Gasket	2008-04	26314 PT	Head bolts not incl.; Head bolt replacement recommended		
1	Head Set	2008-04	HS 26314 PT	Head bolts not incl.; Head bolt replacement recommended; PermaDryPlus® int. manifold gskts. incl.; PermaDry® molded rubber valve cover gskts. incl.; Premium valve stem seals incl.		
2	Head Bolt Set	2008-04	ES 72303	Replacement recommended; Improved design		

GM Car (Incl. Buick, Cad., Chev., Geo, Olds., Pontiac, Saturn) (Cont.)

69 (cont.)		2008 - 2004; 3.5L 213 (3491cc) OHV V6 (12 Valve) 94mm Bore			69 (cont.)
MFI; Gasoline; Naturally Aspirated GMC Eng.; Chevrolet; VIN Code 8					
QTY	CONVERSION SET	YEARS	PART NO.	DESCRIPTION	
1	Gasket Conversion Set	2008-04	CS 26314	PermaDry® molded rubber oil pan gskt. incl.	
QTY	MANIFOLD - INT. & EXH.	YEARS	PART NO.	DESCRIPTION	
1	Int. Manifold Gasket Set	2008-04	MS 98013 T	Valve cover gskts. & Upper set incl.; PermaDryPlus® int. manifold gskts. incl.; Manifold bolts not incl.; Manifold bolt replacement recommended	
1	Plenum Gasket Set	2008-04	MS 96730	Upper set	
1	Int. Manifold Bolt Set	2008-04	ES 72226	Loc. Lower; Replacement recommended	
1	Exh. Manifold Gasket Set	2008-04	MS 96727		
QTY	EXHAUST PIPE FLANGE	YEARS	PART NO.	DESCRIPTION	
1	Exhaust Pipe Gasket	2008-04	61054	Loc. Rear; Flange	
1	Exhaust Pipe Gasket	2008-04	61441	Loc. Front; Flange	
1	Exhaust Pipe Gasket	2008-04	61442	Loc. Rear; Converter	
1	Exhaust Pipe Gasket	2008-04	61443	Loc. Front; Converter	
QTY	OIL PAN	YEARS	PART NO.	DESCRIPTION	
1	Oil Pan Gasket Set	2008-04	OS 30766 R	PermaDry® molded rubber gskt. incl.	
QTY	CRANKSHAFT REAR SEAL	YEARS	PART NO.	DESCRIPTION	
1	Rear Main Seal Set	2008-04	BS 40625	11.0mm thick; PTFE Rubber; One-piece; Improved design	
1	Rear Main Seal Set	2008-04	BS 40698	PTFE Rubber; One-piece; May use BS 40625 instead; Old design; Superseded - When depleted use BS 40625	
QTY	VALVE COVER	YEARS	PART NO.	DESCRIPTION	
1	Valve Cover Gasket Set	2008-04	VS 50442 R	w/o Grommets; Must be used w/35614; PermaDry® molded rubber gskts. incl.	
1	Grommet Set	2008-04	ES 71044	Valve Cover	
QTY	VALVE STEM SEAL SET	YEARS	PART NO.	DESCRIPTION	
1	Valve Stem Seal Set	2008-04	SS 70829	Premium valve stem seals incl.	
QTY	WATER OUTLET GASKET	YEARS	PART NO.	DESCRIPTION	
1	Thermostat Gasket	2008-04	35614	Water Outlet; Improved design	
QTY	WATER PUMP	YEARS	PART NO.	DESCRIPTION	
1	Water Pump Gasket	2008-04	35403		
QTY	TIMING COVER	YEARS	PART NO.	DESCRIPTION	
1	Timing Cover Set	2008-04	TCS 46088		
1	Timing Cover Gasket	2008-04	72670	New Part Number - Check for Availability	
QTY	CARB & FUEL INJECTION	YEARS	PART NO.	DESCRIPTION	
2	Fuel Injector O-Ring Set	2008-04	ES 70599	Upper set; Injectors to fuel rail; Improved design	
2	Fuel Injector O-Ring Set	2008-04	ES 71190	Lower set; Injectors to cylinder head	
1	Throttle Body Gasket	2008-04	61456		
QTY	EXHAUST GAS RECIRCULATION	YEARS	PART NO.	DESCRIPTION	
1	EGR Gasket	2008-04	71247	Pipe	
1	EGR Gasket	2008-07	71243	Valve	
1	EGR Gasket	2006	70804	1st Design; Valve; w/Valve No. 12581359	
1	EGR Gasket	2006	71243	2nd Design; Valve; w/Valve No. 12581876	
1	EGR Gasket	2005-04	70804	Valve	
QTY	OIL FILTER MOUNTING	YEARS	PART NO.	DESCRIPTION	
1	Oil Filter Adapter Gasket	2008-04	72423	Improved design	
1	Oil Filter Adapter Gasket	2008-04	72466	Old design	
70		2002 - 1999; 3.5L 214 (3473cc) DOHC V6 (24 Valve) 89.5mm Bore Northstar			70
MFI; Gasoline; Naturally Aspirated GMC Eng.; Oldsmobile; VIN Code H					
QTY	CYLINDER HEAD	YEARS	PART NO.	DESCRIPTION	
1	Head Gasket	2002-99	26230 PT	Loc. L.H.; Head bolts not incl.; Head bolt replacement recommended	
1	Head Gasket	2002-99	26231 PT	Loc. R.H.; Head bolts not incl.; Head bolt replacement recommended	
1	Head Set	2002-00	HS 26230 PT-1	Head bolts not incl.; Head bolt replacement recommended; Must be used w/TCS 46044; PermaDry® molded rubber valve cover gskts. incl.; Premium valve stem seals incl.	
1	Head Set	1999	HS 26230 PT	Head bolts not incl.; Head bolt replacement recommended; Must be used w/TCS 46044; PermaDry® molded rubber valve cover gskts. incl.; Premium valve stem seals incl.	
2	Head Bolt Set	2002-99	ES 72191	Head bolts w/Washers; Replacement recommended	
QTY	CONVERSION SET	YEARS	PART NO.	DESCRIPTION	
1	Gasket Conversion Set	2002-99	CS 26230		
QTY	MANIFOLD - INT. & EXH.	YEARS	PART NO.	DESCRIPTION	
1	Int. Manifold Gasket Set	2002-00	MS 93313-1		
1	Int. Manifold Gasket Set	1999	MS 96359		
1	Exh. Manifold Gasket Set	2002-99	MS 96346		

GM Car (Incl. Buick, Cad., Chev., Geo, Olds., Pontiac, Saturn) (Cont.)

70 (cont.)		2002 - 1999; 3.5L 214 (3473cc) DOHC V6 (24 Valve) 89.5mm Bore Northstar			70 (cont.)
MFI; Gasoline; Naturally Aspirated GMC Eng.; Oldsmobile; VIN Code H					
QTY	EXHAUST PIPE FLANGE	YEARS	PART NO.	DESCRIPTION	
1	Exhaust Pipe Gasket	2002-99	61307	Crossover	
1	Exhaust Pipe Gasket	2002-99	61310	Pipe to manifold; Improved design	
1	Exhaust Pipe Gasket	2002-01	61311	Oldsmobile Aurora Base; Converter	
1	Exhaust Pipe Gasket	2002-01	61314	Exc. Oldsmobile Aurora Base; Converter	
1	Exhaust Pipe Gasket	2000-99	61314	Converter	
QTY	OIL PAN	YEARS	PART NO.	DESCRIPTION	
1	Oil Pan Gasket Set	2002-99	OS 30744		
1	Drain Plug Gasket	2002-99	70820		
QTY	CRANKSHAFT REAR SEAL	YEARS	PART NO.	DESCRIPTION	
1	Rear Main Seal Set	2002-99	BS 40670	12.0mm thick; PTFE Rubber; One-piece	
QTY	VALVE COVER	YEARS	PART NO.	DESCRIPTION	
1	Valve Cover Gasket Set	2002-99	VS 50597 R	w/Grommets & Spark plug tube seals; PermaDry® molded rubber gskts. incl.	
QTY	VALVE STEM SEAL SET	YEARS	PART NO.	DESCRIPTION	
1	Valve Stem Seal Set	2002-99	SS 71043-1	Premium valve stem seals incl.	
QTY	THERMOSTAT HOUSING	YEARS	PART NO.	DESCRIPTION	
1	Thermostat Gasket	2002-99	35723	Thermostat Housing; Thermostat seal	
QTY	WATER OUTLET GASKET	YEARS	PART NO.	DESCRIPTION	
3	Water Outlet Gasket	2002-99	35722	Water Outlet	
QTY	WATER PUMP	YEARS	PART NO.	DESCRIPTION	
1	Water Pump Gasket	2002-99	35726		
QTY	TIMING COVER	YEARS	PART NO.	DESCRIPTION	
1	Crankshaft Front Seal Set	2002-99	TCS 46044		
QTY	CARB & FUEL INJECTION	YEARS	PART NO.	DESCRIPTION	
2	Fuel Injector O-Ring Set	2002-99	ES 71190	Lower set; Injectors to cylinder head	
1	Throttle Body Gasket	2002-99	61304	Throttle body to adapter	
1	Throttle Body Gasket	2002-00	61306	Throttle body to manifold	
1	Throttle Body Gasket	1999	61305	Throttle body to manifold	
QTY	EXHAUST GAS RECIRCULATION	YEARS	PART NO.	DESCRIPTION	
1	EGR Gasket	2002-99	70788	Valve	
71		2011 - 2006; 3.5L 214 (3510cc) OHV V6 (12 Valve) 99mm Bore			71
MFI; Flex Fuel; Naturally Aspirated GMC Eng.; Chevrolet; VIN Code K					
QTY	CYLINDER HEAD	YEARS	PART NO.	DESCRIPTION	
1	Head Gasket	2011-06	26324 PT	Loc. L.H.; Head bolts not incl.; Head bolt replacement recommended; PermaTorqueMLS® LaserWeld® Technology	
1	Head Gasket	2011-06	26325 PT	Loc. R.H.; Head bolts not incl.; Head bolt replacement recommended; PermaTorqueMLS® LaserWeld® Technology	
1	Head Set	2011-06	HS 26324 PT	Head bolts not incl.; Head bolt replacement recommended; PermaDryPlus® int. manifold gskts. incl.; PermaDry® molded rubber valve cover gskts. incl.; Premium valve stem seals incl.	
2	Head Bolt Set	2011-06	ES 72230	Head bolts w/Washers; Replacement recommended; Improved design	
2	Head Bolt Set	2011-09	ES 72230-1	Head bolts w/Washers; Replacement recommended; Old design	
QTY	CONVERSION SET	YEARS	PART NO.	DESCRIPTION	
1	Gasket Conversion Set	2011-06	CS 26324	PermaDry® molded rubber oil pan gskt. incl.	
QTY	MANIFOLD - INT. & EXH.	YEARS	PART NO.	DESCRIPTION	
1	Int. Manifold Gasket Set	2011-06	MS 98015 T	Valve cover gskts. & Upper set incl.; PermaDryPlus® int. manifold gskts. incl.; Manifold bolts not incl.; Manifold bolt replacement recommended	
1	Plenum Gasket Set	2011-06	MS 96824	Upper set	
1	Int. Manifold Bolt Set	2011-06	ES 72226	Loc. Lower; Replacement recommended	
1	Exh. Manifold Gasket Set	2011-06	MS 96818		
QTY	EXHAUST PIPE FLANGE	YEARS	PART NO.	DESCRIPTION	
1	Exhaust Pipe Gasket	2011	61310	Flange; Improved design	
1	Exhaust Pipe Gasket	2011	61465	Converter	
1	Exhaust Pipe Gasket	2010-09	61054	Pontiac G6 Base, GT; Flange	
1	Exhaust Pipe Gasket	2010-09	61310	Chevrolet Impala LS, LT; Flange; Improved design	
1	Exhaust Pipe Gasket	2010-09	61443	Pontiac G6 Base, GT; Loc. Front; Converter	
1	Exhaust Pipe Gasket	2010-09	61465	Chevrolet Impala LS, LT; Converter	
1	Exhaust Pipe Gasket	2010-09	61625	Pontiac G6 Base, GT; Loc. Rear; Converter	
1	Exhaust Pipe Gasket	2008-06	61310	Flange; Improved design	
1	Exhaust Pipe Gasket	2008-06	61465	Converter	
QTY	OIL PAN	YEARS	PART NO.	DESCRIPTION	
1	Oil Pan Gasket Set	2011-06	OS 30776 R	PermaDry® molded rubber gskt. incl.	
QTY	CRANKSHAFT REAR SEAL	YEARS	PART NO.	DESCRIPTION	
1	Rear Main Seal Set	2011-06	BS 40625	11.0mm thick; PTFE Rubber; One-piece; Improved design	

GM Car (Incl. Buick, Cad., Chev., Geo, Olds., Pontiac, Saturn) (Cont.)

71 (cont.)	2011 - 2006; 3.5L 214 (3510cc) OHV V6 (12 Valve) 99mm Bore			71 (cont.)
QTY	CRANKSHAFT REAR SEAL	YEARS	PART NO.	DESCRIPTION
1	Rear Main Seal Set	2011-06	BS 40698	PTFE Rubber; One-piece; May use BS 40625 instead; Old design; Superseded - When depleted use BS 40625
QTY	VALVE COVER	YEARS	PART NO.	DESCRIPTION
1	Valve Cover Gasket Set	2011-06	VS 50442 R	w/o Grommets; Must be used w/35614; PermaDry® molded rubber gskts. incl.
1	Grommet Set	2011-06	ES 71044	Valve Cover
QTY	VALVE STEM SEAL SET	YEARS	PART NO.	DESCRIPTION
1	Valve Stem Seal Set	2011-06	SS 71039-1	Premium valve stem seals incl.
QTY	WATER OUTLET GASKET	YEARS	PART NO.	DESCRIPTION
1	Water Outlet Gasket	2011-06	35815	Water Crossover; Loc. L.H.
1	Water Outlet Gasket	2011-09	35913	Water Crossover; Loc. R.H.
1	Water Outlet Gasket	2008-06	35816	Water Crossover; Loc. R.H.
1	Thermostat Gasket	2011-06	35614	Water Outlet; Improved design
QTY	WATER PUMP	YEARS	PART NO.	DESCRIPTION
1	Water Pump Gasket	2011-06	35814	
QTY	TIMING COVER	YEARS	PART NO.	DESCRIPTION
1	Timing Cover Set	2011-06	TCS 46089	
1	Timing Cover Gasket	2011-06	72966	New Part Number - Check for Availability
QTY	CARB & FUEL INJECTION	YEARS	PART NO.	DESCRIPTION
1	Throttle Body Gasket	2011-06	61466	
QTY	OIL FILTER MOUNTING	YEARS	PART NO.	DESCRIPTION
1	Oil Filter Adapter Gasket	2011-06	72423	Improved design
72	2011 - 2006; 3.5L 214 (3510cc) OHV V6 (12 Valve) 99mm Bore			72
QTY	CYLINDER HEAD	YEARS	PART NO.	DESCRIPTION
1	Head Gasket	2011-06	26324 PT	Loc. L.H.; Head bolts not incl.; Head bolt replacement recommended; PermaTorqueMLS® LaserWeld® Technology
1	Head Gasket	2011-06	26325 PT	Loc. R.H.; Head bolts not incl.; Head bolt replacement recommended; PermaTorqueMLS® LaserWeld® Technology
1	Head Set	2011-06	HS 26324 PT	Head bolts not incl.; Head bolt replacement recommended; PermaDryPlus® int. manifold gskts. incl.; PermaDry® molded rubber valve cover gskts. incl.; Premium valve stem seals incl.
2	Head Bolt Set	2011-06	ES 72230	Head bolts w/Washers; Replacement recommended; Improved design
2	Head Bolt Set	2011-09	ES 72230-1	Head bolts w/Washers; Replacement recommended; Old design
QTY	CONVERSION SET	YEARS	PART NO.	DESCRIPTION
1	Gasket Conversion Set	2011-06	CS 26324	PermaDry® molded rubber oil pan gskt. incl.
QTY	MANIFOLD - INT. & EXH.	YEARS	PART NO.	DESCRIPTION
1	Int. Manifold Gasket Set	2011-06	MS 98015 T	Valve cover gskts. & Upper set incl.; PermaDryPlus® int. manifold gskts. incl.; Manifold bolts not incl.; Manifold bolt replacement recommended
1	Plenum Gasket Set	2011-06	MS 96824	Upper set
1	Int. Manifold Bolt Set	2011-06	ES 72226	Loc. Lower; Replacement recommended
1	Exh. Manifold Gasket Set	2011-06	MS 96818	
QTY	EXHAUST PIPE FLANGE	YEARS	PART NO.	DESCRIPTION
1	Exhaust Pipe Gasket	2011	61310	Flange; Improved design
1	Exhaust Pipe Gasket	2011	61465	Converter
1	Exhaust Pipe Gasket	2010-06	61625	Pontiac G6 Base, GT; Loc. Rear; Converter
1	Exhaust Pipe Gasket	2010-08	61054	Exc. Chevrolet Impala LS, LT; Flange
1	Exhaust Pipe Gasket	2010-08	61310	Chevrolet Impala LS, LT; Flange; Improved design
1	Exhaust Pipe Gasket	2010-08	61443	Exc. Chevrolet Impala LS, LT; Loc. Front; Converter
1	Exhaust Pipe Gasket	2010-08	61465	Chevrolet Impala LS, LT; Converter
1	Exhaust Pipe Gasket	2010-09	61442	Chevrolet Malibu LT, LTZ; Loc. Rear; Converter
1	Exhaust Pipe Gasket	2008	61442	Exc. Chevrolet Impala LS, LT Pontiac G6 Base, GT; Loc. Rear; Converter
1	Exhaust Pipe Gasket	2007-06	61054	Exc. Chevrolet Impala LS, LT, Monte Carlo LS, LT; Flange
1	Exhaust Pipe Gasket	2007-06	61310	Chevrolet Impala LS, LT, Monte Carlo LS, LT; Flange; Improved design
1	Exhaust Pipe Gasket	2007-06	61443	Exc. Chevrolet Impala LS, LT, Monte Carlo LS, LT; Loc. Front; Converter
1	Exhaust Pipe Gasket	2007-06	61465	Chevrolet Impala LS, LT, Monte Carlo LS, LT; Converter
1	Exhaust Pipe Gasket	2007	61442	Chevrolet Malibu LT, LTZ, Maxx LS, Maxx LT, Maxx LTZ Saturn Aura XE; Loc. Rear; Converter
1	Exhaust Pipe Gasket	2006	61442	Chevrolet Malibu LT, LTZ, Maxx LS, Maxx LT, Maxx LTZ; Loc. Rear; Converter
QTY	OIL PAN	YEARS	PART NO.	DESCRIPTION
1	Oil Pan Gasket Set	2011-06	OS 30776 R	PermaDry® molded rubber gskt. incl.

GM Car (Incl. Buick, Cad., Chev., Geo, Olds., Pontiac, Saturn) (Cont.)

72 (cont.)		2011 - 2006; 3.5L 214 (3510cc) OHV V6 (12 Valve) 99mm Bore			72 (cont.)
MFI; Gasoline; Naturally Aspirated GMC Eng.; Chevrolet; VIN Code N					
QTY	CRANKSHAFT REAR SEAL	YEARS	PART NO.	DESCRIPTION	
1	Rear Main Seal Set	2011-06	BS 40625	11.0mm thick; PTFE Rubber; One-piece; Improved design	
1	Rear Main Seal Set	2011-06	BS 40698	PTFE Rubber; One-piece; May use BS 40625 instead; Old design; Superseded - When depleted use BS 40625	
QTY	VALVE COVER	YEARS	PART NO.	DESCRIPTION	
1	Valve Cover Gasket Set	2011-06	VS 50442 R	w/o Grommets; Must be used w/35614; PermaDry® molded rubber gskts. incl.	
1	Grommet Set	2011-06	ES 71044	Valve Cover	
QTY	VALVE STEM SEAL SET	YEARS	PART NO.	DESCRIPTION	
1	Valve Stem Seal Set	2011-06	SS 71039-1	Premium valve stem seals incl.	
QTY	WATER OUTLET GASKET	YEARS	PART NO.	DESCRIPTION	
1	Water Outlet Gasket	2011-06	35815	Water Crossover; Loc. L.H.	
1	Water Outlet Gasket	2011-09	35913	Water Crossover; Loc. R.H.	
1	Water Outlet Gasket	2008-06	35816	Water Crossover; Loc. R.H.	
1	Thermostat Gasket	2011-06	35614	Water Outlet; Improved design	
QTY	WATER PUMP	YEARS	PART NO.	DESCRIPTION	
1	Water Pump Gasket	2011-06	35814		
QTY	TIMING COVER	YEARS	PART NO.	DESCRIPTION	
1	Timing Cover Set	2011-06	TCS 46089		
1	Timing Cover Gasket	2011-06	72966	New Part Number - Check for Availability	
QTY	CARB & FUEL INJECTION	YEARS	PART NO.	DESCRIPTION	
1	Throttle Body Gasket	2011-06	61466		
QTY	OIL FILTER MOUNTING	YEARS	PART NO.	DESCRIPTION	
1	Oil Filter Adapter Gasket	2011-06	72423	Improved design	
73		2012 - 2004; 3.6L 217 (3564cc) DOHC V6 (24 Valve) 94mm Bore			73
MFI; Gasoline; Naturally Aspirated Opel Eng.; VIN Code 7					
QTY	CYLINDER HEAD	YEARS	PART NO.	DESCRIPTION	
1	Head Gasket	2012-04	26376 PT	Loc. L.H.; Head bolts not incl.; Head bolt replacement recommended; PermaTorqueMLS®	
1	Head Gasket	2012-04	26377 PT	Loc. R.H.; Head bolts not incl.; Head bolt replacement recommended; PermaTorqueMLS®	
1	Head Set	2012-10	HS 26376 PT-2	Head bolts not incl.; Head bolt replacement recommended; PermaDry® molded rubber valve cover gskts. incl.; Premium valve stem seals incl.	
1	Head Set	2009-08	HS 26376 PT-3	Pontiac G8 Base; Head bolts not incl.; Head bolt replacement recommended; PermaDry® molded rubber valve cover gskts. incl.; Premium valve stem seals incl.	
1	Head Set	2009	HS 26376 PT	Cadillac CTS Base; Head bolts not incl.; Head bolt replacement recommended; PermaDry® molded rubber valve cover gskts. incl.; Premium valve stem seals incl.	
1	Head Set	2009	HS 26376 PT-2	Exc. Cadillac CTS Base Pontiac G8 Base; Head bolts not incl.; Head bolt replacement recommended; PermaDry® molded rubber valve cover gskts. incl.; Premium valve stem seals incl.	
1	Head Set	2008	HS 26376 PT	Buick Allure CXS, LaCrosse CXS Cadillac CTS Base; Head bolts not incl.; Head bolt replacement recommended; PermaDry® molded rubber valve cover gskts. incl.; Premium valve stem seals incl.	
1	Head Set	2008	HS 26376 PT-2	Chevrolet Malibu LT, LTZ Pontiac G6 GXP Saturn Aura XR; Head bolts not incl.; Head bolt replacement recommended; PermaDry® molded rubber valve cover gskts. incl.; Premium valve stem seals incl.	
1	Head Set	2007	HS 26376 PT	Exc. Pontiac G6 GTP Saturn Aura XR; Head bolts not incl.; Head bolt replacement recommended; PermaDry® molded rubber valve cover gskts. incl.; Premium valve stem seals incl.	
1	Head Set	2007	HS 26376 PT-2	Pontiac G6 GTP Saturn Aura XR; Head bolts not incl.; Head bolt replacement recommended; PermaDry® molded rubber valve cover gskts. incl.; Premium valve stem seals incl.	
1	Head Set	2006-04	HS 26376 PT	Head bolts not incl.; Head bolt replacement recommended; PermaDry® molded rubber valve cover gskts. incl.; Premium valve stem seals incl.	
2	Head Bolt Set	2012-04	ES 72274	Replacement recommended	
QTY	CONVERSION SET	YEARS	PART NO.	DESCRIPTION	
1	Gasket Conversion Set	2012-04	CS 26376-1	RTV sealant incl. for oil pan gskt.; Improved design	
1	Gasket Conversion Set	2007-04	CS 26376	RTV sealant incl. for oil pan gskt.; Old design; New Part Number - Check for Availability	
QTY	MANIFOLD - INT. & EXH.	YEARS	PART NO.	DESCRIPTION	
1	Int. Manifold Gasket Set	2012-04	MS 96969	Lower set; Upper set incl.	
1	Plenum Gasket Set	2012-04	MS 96976	Upper set	
1	Exh. Manifold Gasket Set	2012-10	MS 96973		

GM Car (Incl. Buick, Cad., Chev., Geo, Olds., Pontiac, Saturn) (Cont.)

73 (cont.)	2012 - 2004; 3.6L 217 (3564cc) DOHC V6 (24 Valve) 94mm Bore MFI; Gasoline; Naturally Aspirated Opel Eng.; VIN Code 7				73 (cont.)
QTY	MANIFOLD - INT. & EXH.	YEARS	PART NO.	DESCRIPTION	
1	Exh. Manifold Gasket Set	2009-08	MS 97098	Pontiac G8 Base	
1	Exh. Manifold Gasket Set	2009	MS 96970	Cadillac CTS Base	
1	Exh. Manifold Gasket Set	2009	MS 96973	Exc. Cadillac CTS Base Pontiac G8 Base	
1	Exh. Manifold Gasket Set	2008	MS 96970	Buick Allure CXS, LaCrosse CXS Cadillac CTS Base	
1	Exh. Manifold Gasket Set	2008	MS 96973	Chevrolet Malibu LT, LTZ Pontiac G6 GXP Saturn Aura XR	
1	Exh. Manifold Gasket Set	2007	MS 96970	Exc. Pontiac G6 GTP Saturn Aura XR	
1	Exh. Manifold Gasket Set	2007	MS 96973	Pontiac G6 GTP Saturn Aura XR	
1	Exh. Manifold Gasket Set	2006-04	MS 96970		
QTY	EXHAUST PIPE FLANGE	YEARS	PART NO.	DESCRIPTION	
1	Exhaust Pipe Gasket	2012-10	61054	Loc. L.H.; Pipe to manifold	
1	Exhaust Pipe Gasket	2012-10	61442	Loc. Rear; Converter	
1	Exhaust Pipe Gasket	2012-10	61443	Loc. Front; Converter	
1	Exhaust Pipe Gasket	2012-10	61615	Loc. R.H.; Pipe to manifold	
1	Exhaust Pipe Gasket	2012-10	61625	Exh. connector	
2	Exhaust Pipe Gasket	2009-08	61519	Pontiac G8 Base; Pipe to manifold	
2	Exhaust Pipe Gasket	2009-08	61617	Pontiac G8 Base; Converter	
2	Exhaust Pipe Gasket	2009-08	61627	Cadillac CTS Base; Flange	
2	Exhaust Pipe Gasket	2009-08	61636	Cadillac CTS Base; Converter	
1	Exhaust Pipe Gasket	2009	61054	Exc. Cadillac CTS Base Pontiac G8 Base; Loc. L.H.; Pipe to manifold	
2	Exhaust Pipe Gasket	2009	61310	Cadillac CTS Base; Pipe to manifold; Improved design	
1	Exhaust Pipe Gasket	2009	61442	Exc. Cadillac CTS Base Pontiac G8 Base; Loc. Rear; Converter	
1	Exhaust Pipe Gasket	2009	61443	Exc. Cadillac CTS Base Pontiac G8 Base; Loc. Front; Converter	
1	Exhaust Pipe Gasket	2009	61615	Exc. Cadillac CTS Base Pontiac G8 Base; Loc. R.H.; Pipe to manifold	
1	Exhaust Pipe Gasket	2009	61625	Exc. Cadillac CTS Base Pontiac G8 Base; Exh. connector	
1	Exhaust Pipe Gasket	2008-05	61310	Buick Allure CXS, LaCrosse CXS; Loc. Front; Converter; Improved design	
1	Exhaust Pipe Gasket	2008-05	61314	Buick Allure CXS, LaCrosse CXS; Loc. Rear; Converter	
1	Exhaust Pipe Gasket	2008	61054	Chevrolet Malibu LT, LTZ Pontiac G6 GXP Saturn Aura XR; Loc. L.H.; Pipe to manifold	
2	Exhaust Pipe Gasket	2008	61310	Buick Allure CXS, LaCrosse CXS Cadillac CTS Base; Pipe to manifold; Improved design	
1	Exhaust Pipe Gasket	2008	61442	Chevrolet Malibu LT, LTZ Pontiac G6 GXP Saturn Aura XR; Loc. Rear; Converter	
1	Exhaust Pipe Gasket	2008	61443	Chevrolet Malibu LT, LTZ Pontiac G6 GXP Saturn Aura XR; Loc. Front; Converter	
1	Exhaust Pipe Gasket	2008	61615	Chevrolet Malibu LT, LTZ Pontiac G6 GXP Saturn Aura XR; Loc. R.H.; Pipe to manifold	
1	Exhaust Pipe Gasket	2008	61625	Chevrolet Malibu LT, LTZ Pontiac G6 GXP Saturn Aura XR; Exh. connector	
2	Exhaust Pipe Gasket	2007-05	61525	Cadillac CTS Base, STS Base; Converter; Improved design	
1	Exhaust Pipe Gasket	2007	61054	Pontiac G6 GTP Saturn Aura XR; Loc. L.H.; Pipe to manifold	
2	Exhaust Pipe Gasket	2007	61310	Exc. Pontiac G6 GTP Saturn Aura XR; Pipe to manifold; Improved design	
1	Exhaust Pipe Gasket	2007	61442	Pontiac G6 GTP Saturn Aura XR; Loc. Rear; Converter	
1	Exhaust Pipe Gasket	2007	61443	Pontiac G6 GTP Saturn Aura XR; Loc. Front; Converter	
1	Exhaust Pipe Gasket	2007	61615	Pontiac G6 GTP Saturn Aura XR; Loc. R.H.; Pipe to manifold	
2	Exhaust Pipe Gasket	2006-04	61310	Pipe to manifold; Improved design	
2	Exhaust Pipe Gasket	2004	61525	Converter; Improved design	
QTY	CRANKSHAFT REAR SEAL	YEARS	PART NO.	DESCRIPTION	
1	Rear Main Seal Set	2012-04	BS 40711	PTFE Rubber; One-piece; Improved design	
QTY	VALVE COVER	YEARS	PART NO.	DESCRIPTION	
1	Valve Cover Gasket Set	2012-04	VS 50726 R	w/o Spark plug tube seals & w/Grommets; PermaDry® molded rubber gsks. incl.	
1	Spark Plug Tube Seal Set	2012-04	ES 72393	Valve Cover; New Part Number - Check for Availability	
QTY	VALVE STEM SEAL SET	YEARS	PART NO.	DESCRIPTION	
1	Valve Stem Seal Set	2012-04	SS 72923	Premium valve stem seals incl.	
QTY	THERMOSTAT HOUSING	YEARS	PART NO.	DESCRIPTION	
1	Thermostat Gasket	2012-04	35871	Thermostat Housing; Thermostat housing to head	
1	Thermostat Gasket	2009-08	35858	Cadillac CTS Base; Thermostat Housing; Thermostat seal	
1	Thermostat Gasket	2007-05	35858	Cadillac CTS Base, STS Base; Thermostat Housing; Thermostat seal	
1	Thermostat Gasket	2004	35858	Thermostat Housing; Thermostat seal	
QTY	WATER OUTLET GASKET	YEARS	PART NO.	DESCRIPTION	
1	Water Outlet Gasket	2012-04	35855	Water Outlet; Water outlet O-ring; New Part Number - Check for Availability	
1	Water Outlet Gasket	2012-04	35856	Water Outlet; Water outlet seal; New Part Number - Check for Availability	
QTY	WATER PUMP	YEARS	PART NO.	DESCRIPTION	
1	Water Pump Gasket	2012-04	35859		
QTY	TIMING COVER	YEARS	PART NO.	DESCRIPTION	
1	Timing Cover Set	2012-04	TCS 46108		

GM Car (Incl. Buick, Cad., Chev., Geo, Olds., Pontiac, Saturn) (Cont.)

73		2012 - 2004; 3.6L 217 (3564cc) DOHC V6 (24 Valve) 94mm Bore			73
(cont.)		MFI; Gasoline; Naturally Aspirated Opel Eng.; VIN Code 7			(cont.)
QTY	CARB & FUEL INJECTION	YEARS	PART NO.	DESCRIPTION	
2	Fuel Injector O-Ring Set	2012-04	ES 70599	Upper set; Injectors to fuel rail; Improved design	
2	Fuel Injector O-Ring Set	2012-04	ES 72004	Lower set; Injectors to cylinder head	
1	Fuel Injector O-Ring Set	2012-04	ES 72761	Complete set; Upper & lower injector seals incl.; New Part Number - Check for Availability	
1	Throttle Body Gasket	2012-08	61520		
1	Throttle Body Gasket	2007-05	61521		
1	Throttle Body Gasket	2004	61518		
QTY	OIL FILTER MOUNTING	YEARS	PART NO.	DESCRIPTION	
1	Oil Filter Adapter Gasket	2012-04	72968	Oil filter adapter; New Part Number - Check for Availability	
74		2013 - 2012; 3.6L 217 (3564cc) DOHC V6 (24 Valve) 94mm Bore VVT			74
		DI; Flex Fuel; Naturally Aspirated Opel Eng.; VIN Code 3			
QTY	CYLINDER HEAD	YEARS	PART NO.	DESCRIPTION	
1	Head Gasket	2013-12	26376 PT	Loc. L.H.; Head bolts not incl.; Head bolt replacement recommended; PermaTorqueMLS®	
1	Head Gasket	2013-12	26377 PT	Loc. R.H.; Head bolts not incl.; Head bolt replacement recommended; PermaTorqueMLS®	
2	Head Bolt Set	2013-12	ES 72274	Replacement recommended	
QTY	CONVERSION SET	YEARS	PART NO.	DESCRIPTION	
1	Gasket Conversion Set	2013-12	CS 26376-1	RTV sealant incl. for oil pan gskt.; Improved design	
QTY	CRANKSHAFT REAR SEAL	YEARS	PART NO.	DESCRIPTION	
1	Rear Main Seal Set	2013-12	BS 40711	PTFE Rubber; One-piece; Improved design	
QTY	VALVE COVER	YEARS	PART NO.	DESCRIPTION	
1	Valve Cover Gasket Set	2013-12	VS 50808 R	w/Grommets & Spark plug tube seals; PermaDry® molded rubber gskts. incl.; New Part Number - Check for Availability	
1	Spark Plug Tube Seal Set	2013-12	ES 72393	Valve Cover; New Part Number - Check for Availability	
QTY	THERMOSTAT HOUSING	YEARS	PART NO.	DESCRIPTION	
1	Thermostat Gasket	2013-12	35871	Thermostat Housing; Thermostat housing to head	
QTY	WATER OUTLET GASKET	YEARS	PART NO.	DESCRIPTION	
1	Water Outlet Gasket	2013-12	35855	Water Outlet; Water outlet O-ring; New Part Number - Check for Availability	
1	Water Outlet Gasket	2013-12	35856	Water Outlet; Water outlet seal; New Part Number - Check for Availability	
QTY	WATER PUMP	YEARS	PART NO.	DESCRIPTION	
1	Water Pump Gasket	2013-12	35859		
QTY	TIMING COVER	YEARS	PART NO.	DESCRIPTION	
1	Timing Cover Set	2013-12	TCS 46108		
75		2013 - 2011; 3.6L 217 (3564cc) DOHC V6 (24 Valve) 94mm Bore VVT			75
		DI; Gasoline; Naturally Aspirated Opel Eng.; VIN Code D			
QTY	CYLINDER HEAD	YEARS	PART NO.	DESCRIPTION	
1	Head Gasket	2013-11	26376 PT	Loc. L.H.; Head bolts not incl.; Head bolt replacement recommended; PermaTorqueMLS®	
1	Head Gasket	2013-11	26377 PT	Loc. R.H.; Head bolts not incl.; Head bolt replacement recommended; PermaTorqueMLS®	
2	Head Bolt Set	2013-11	ES 72274	Replacement recommended	
QTY	CONVERSION SET	YEARS	PART NO.	DESCRIPTION	
1	Gasket Conversion Set	2013-11	CS 26376-1	RTV sealant incl. for oil pan gskt.; Improved design	
QTY	MANIFOLD - INT. & EXH.	YEARS	PART NO.	DESCRIPTION	
1	Exh. Manifold Gasket Set	2013-11	MS 96970-1		
QTY	EXHAUST PIPE FLANGE	YEARS	PART NO.	DESCRIPTION	
2	Exhaust Pipe Gasket	2013-12	61054	Buick LaCrosse Convenience, Leather, Premium, Touring; Pipe to manifold	
2	Exhaust Pipe Gasket	2013	61627	Exc. Buick LaCrosse Convenience, Leather, Premium, Touring Chevrolet Camaro LS, LT; Pipe to manifold	
2	Exhaust Pipe Gasket	2013	61636	Exc. Buick LaCrosse Convenience, Leather, Premium, Touring Chevrolet Camaro LS, LT; Converter	
2	Exhaust Pipe Gasket	2012	61627	Cadillac CTS Performance, Premium, Sport Wagon Performance, Sport Wagon Premium; Pipe to manifold	
2	Exhaust Pipe Gasket	2012	61636	Cadillac CTS Performance, Premium, Sport Wagon Performance, Sport Wagon Premium; Converter	
2	Exhaust Pipe Gasket	2011	61054	Buick LaCrosse CXL, CXS; Pipe to manifold	
2	Exhaust Pipe Gasket	2011	61627	Exc. Buick LaCrosse CXL, CXS Chevrolet Camaro LS, LT; Pipe to manifold	
2	Exhaust Pipe Gasket	2011	61636	Exc. Buick LaCrosse CXL, CXS Chevrolet Camaro LS, LT; Converter	
QTY	CRANKSHAFT REAR SEAL	YEARS	PART NO.	DESCRIPTION	
1	Rear Main Seal Set	2013-11	BS 40711	PTFE Rubber; One-piece; Improved design	

GM Car (Incl. Buick, Cad., Chev., Geo, Olds., Pontiac, Saturn) (Cont.)

75 (cont.)	2013 - 2011; 3.6L 217 (3564cc) DOHC V6 (24 Valve) 94mm Bore VVT			75 (cont.)
QTY VALVE COVER	YEARS	PART NO.	DESCRIPTION	
1 Valve Cover Gasket Set	2013-11	VS 50808 R	w/Grommets & Spark plug tube seals; PermaDry® molded rubber gskts. incl.; New Part Number - Check for Availability	
1 Spark Plug Tube Seal Set	2013-11	ES 72393	Valve Cover; New Part Number - Check for Availability	
QTY THERMOSTAT HOUSING	YEARS	PART NO.	DESCRIPTION	
1 Thermostat Gasket	2013-11	35871	Thermostat Housing; Thermostat housing to head	
1 Thermostat Gasket	2013-12	35858	Exc. Buick LaCrosse Convenience, Leather, Premium, Touring; Thermostat Housing; Thermostat seal	
1 Thermostat Gasket	2011	35858	Exc. Buick LaCrosse CXL, CXS; Thermostat Housing; Thermostat seal	
QTY WATER OUTLET GASKET	YEARS	PART NO.	DESCRIPTION	
1 Water Outlet Gasket	2013-11	35855	Water Outlet; Water outlet O-ring; New Part Number - Check for Availability	
1 Water Outlet Gasket	2013-11	35856	Water Outlet; Water outlet seal; New Part Number - Check for Availability	
QTY WATER PUMP	YEARS	PART NO.	DESCRIPTION	
1 Water Pump Gasket	2013-11	35859		
QTY TIMING COVER	YEARS	PART NO.	DESCRIPTION	
1 Timing Cover Set	2013-11	TCS 46108		
QTY CARB & FUEL INJECTION	YEARS	PART NO.	DESCRIPTION	
1 Throttle Body Gasket	2011	61614		
QTY OIL FILTER MOUNTING	YEARS	PART NO.	DESCRIPTION	
1 Oil Filter Adapter Gasket	2013-11	72968	Oil filter adapter; New Part Number - Check for Availability	
76	2013 - 2008; 3.6L 217 (3564cc) DOHC V6 (24 Valve) 94mm Bore VVT			76
QTY CYLINDER HEAD	YEARS	PART NO.	DESCRIPTION	
1 Head Gasket	2013-08	26376 PT	Loc. L.H.; Head bolts not incl.; Head bolt replacement recommended; PermaTorqueMLS®	
1 Head Gasket	2013-08	26377 PT	Loc. R.H.; Head bolts not incl.; Head bolt replacement recommended; PermaTorqueMLS®	
2 Head Bolt Set	2013-08	ES 72274	Replacement recommended	
QTY CONVERSION SET	YEARS	PART NO.	DESCRIPTION	
1 Gasket Conversion Set	2013-08	CS 26376-1	RTV sealant incl. for oil pan gskt.; Improved design	
QTY MANIFOLD - INT. & EXH.	YEARS	PART NO.	DESCRIPTION	
1 Plenum Gasket Set	2013	MS 96976	Exc. Buick LaCrosse Convenience, Leather, Premium, Touring Chevrolet Camaro LS, LT; Upper set	
1 Plenum Gasket Set	2012	MS 96976	Cadillac CTS Performance, Premium, Sport Wagon Performance, Sport Wagon Premium; Upper set	
1 Plenum Gasket Set	2011	MS 96976	Exc. Buick LaCrosse CXL, CXS Chevrolet Camaro LS, LT; Upper set	
1 Plenum Gasket Set	2010	MS 96976	Exc. Buick Allure CXS, LaCrosse CXS Chevrolet Camaro LS, LT; Upper set	
1 Plenum Gasket Set	2009-08	MS 96976	Upper set	
1 Exh. Manifold Gasket Set	2013-12	MS 96970-1	Exc. Buick LaCrosse Convenience, Leather, Premium, Touring	
1 Exh. Manifold Gasket Set	2011	MS 96970-1	Exc. Buick LaCrosse CXL, CXS	
1 Exh. Manifold Gasket Set	2010	MS 96970-1	Exc. Buick Allure CXS, LaCrosse CXS	
1 Exh. Manifold Gasket Set	2009	MS 96970-1		
1 Exh. Manifold Gasket Set	2008	MS 96970		
QTY EXHAUST PIPE FLANGE	YEARS	PART NO.	DESCRIPTION	
2 Exhaust Pipe Gasket	2013-12	61054	Buick LaCrosse Convenience, Leather, Premium, Touring; Pipe to manifold	
2 Exhaust Pipe Gasket	2013	61627	Exc. Buick LaCrosse Convenience, Leather, Premium, Touring Chevrolet Camaro LS, LT; Pipe to manifold	
2 Exhaust Pipe Gasket	2013	61636	Exc. Buick LaCrosse Convenience, Leather, Premium, Touring Chevrolet Camaro LS, LT; Converter	
2 Exhaust Pipe Gasket	2012	61627	Cadillac CTS Performance, Premium, Sport Wagon Performance, Sport Wagon Premium; Pipe to manifold	
2 Exhaust Pipe Gasket	2012	61636	Cadillac CTS Performance, Premium, Sport Wagon Performance, Sport Wagon Premium; Converter	
2 Exhaust Pipe Gasket	2011	61054	Buick LaCrosse CXL, CXS; Pipe to manifold	
2 Exhaust Pipe Gasket	2011	61627	Exc. Buick LaCrosse CXL, CXS Chevrolet Camaro LS, LT; Pipe to manifold	
2 Exhaust Pipe Gasket	2011	61636	Exc. Buick LaCrosse CXL, CXS Chevrolet Camaro LS, LT; Converter	
2 Exhaust Pipe Gasket	2010	61054	Buick Allure CXS, LaCrosse CXS; Pipe to manifold	
2 Exhaust Pipe Gasket	2010	61627	Exc. Buick Allure CXS, LaCrosse CXS Chevrolet Camaro LS, LT; Pipe to manifold	
2 Exhaust Pipe Gasket	2010	61636	Exc. Buick Allure CXS, LaCrosse CXS Chevrolet Camaro LS, LT; Converter	
2 Exhaust Pipe Gasket	2009-08	61627	Pipe to manifold	
2 Exhaust Pipe Gasket	2009-08	61636	Converter	

GM Car (Incl. Buick, Cad., Chev., Geo, Olds., Pontiac, Saturn) (Cont.)

76 (cont.)		2013 - 2008; 3.6L 217 (3564cc) DOHC V6 (24 Valve) 94mm Bore VVT			76 (cont.)
DI; Gasoline; Naturally Aspirated Opel Eng.; VIN Code V					
QTY	CRANKSHAFT REAR SEAL	YEARS	PART NO.	DESCRIPTION	
1	Rear Main Seal Set	2013-08	BS 40711	PTFE Rubber; One-piece; Improved design	
QTY	VALVE COVER	YEARS	PART NO.	DESCRIPTION	
1	Valve Cover Gasket Set	2013-08	VS 50808 R	w/Grommets & Spark plug tube seals; PermaDry® molded rubber gskts. incl.; New Part Number - Check for Availability	
1	Spark Plug Tube Seal Set	2013-08	ES 72393	Valve Cover; New Part Number - Check for Availability	
QTY	THERMOSTAT HOUSING	YEARS	PART NO.	DESCRIPTION	
1	Thermostat Gasket	2013-08	35871	Thermostat Housing; Thermostat housing to head	
1	Thermostat Gasket	2013-12	35858	Exc. Buick LaCrosse Convenience, Leather, Premium, Touring; Thermostat Housing; Thermostat seal	
1	Thermostat Gasket	2011	35858	Exc. Buick LaCrosse CXL, CXS; Thermostat Housing; Thermostat seal	
1	Thermostat Gasket	2010	35858	Exc. Buick Allure CXS, LaCrosse CXS; Thermostat Housing; Thermostat seal	
1	Thermostat Gasket	2009-08	35858	Thermostat Housing; Thermostat seal	
QTY	WATER OUTLET GASKET	YEARS	PART NO.	DESCRIPTION	
1	Water Outlet Gasket	2013-08	35855	Water Outlet; Water outlet O-ring; New Part Number - Check for Availability	
1	Water Outlet Gasket	2013-08	35856	Water Outlet; Water outlet seal; New Part Number - Check for Availability	
QTY	WATER PUMP	YEARS	PART NO.	DESCRIPTION	
1	Water Pump Gasket	2013-08	35859		
QTY	TIMING COVER	YEARS	PART NO.	DESCRIPTION	
1	Timing Cover Set	2013-08	TCS 46108		
QTY	CARB & FUEL INJECTION	YEARS	PART NO.	DESCRIPTION	
1	Throttle Body Gasket	2011-08	61614		
QTY	OIL FILTER MOUNTING	YEARS	PART NO.	DESCRIPTION	
1	Oil Filter Adapter Gasket	2013-08	72968	Oil filter adapter; New Part Number - Check for Availability	
77		2005 - 1991; 3.8L 231 (3791cc) OHV V6 (12 Valve) 3.8" Bore			77
MFI; Gasoline; Supercharged GMC Eng.; Buick; VIN Code 1					
QTY	CYLINDER HEAD	YEARS	PART NO.	DESCRIPTION	
2	Head Gasket	2005-96	9089 PT	Head bolts not incl.; Head bolt replacement required	
2	Head Gasket	1995-91	9088 PT	Head bolts not incl.; Head bolt replacement required	
1	Head Set	2005-98	HS 9089 PT-2	2nd Design; Int. manifold gskts. w/Rubber-plastic end seals w/Locating pins; Head bolts not incl.; Head bolt replacement required; PermaDry® molded rubber valve cover gskts. incl.; Premium valve stem seals incl.	
1	Head Set	1997-96	HS 9089 PT-1	1st Design; Int. manifold gskts. w/Rubber end seals w/o Locating pins; Head bolts & exh. pipe packing not incl.; Head bolt replacement required; PermaDry® molded rubber valve cover gskts. incl.; Premium valve stem seals incl.	
1	Head Set	1997	HS 9089 PT-1	2nd Design; Int. manifold gskts. w/Rubber-plastic end seals w/Locating pins not incl.; Head bolts & exh. pipe packing not incl.; Head bolt replacement required; PermaDry® molded rubber valve cover gskts. incl.; Premium valve stem seals incl.	
1	Head Set	1995-91	HS 9088 PT	Head bolts & exh. pipe packing not incl.; Head bolt replacement required; PermaDry® molded rubber valve cover gskts. incl.; Premium valve stem seals incl.	
1	Head Bolt Set	2005-96	ES 74033	Replacement required	
1	Head Bolt Set	1995-91	ES 72167	Replacement required	
QTY	CONVERSION SET	YEARS	PART NO.	DESCRIPTION	
1	Gasket Conversion Set	2005-04	CS 9917-2	Buick Park Avenue Base, Ultra; RTV not incl. for grooved oil pan; PermaDry® molded rubber oil pan gskt. incl.; PermaDryPlus® timing cover gskt. incl.	
1	Gasket Conversion Set	2005-04	CS 9917-3	Exc. Buick Park Avenue Base, Ultra; PermaDry® molded rubber oil pan gskt. incl.; PermaDryPlus® timing cover gskt. incl.	
1	Gasket Conversion Set	2003-01	CS 9917	Buick Regal GS Pontiac Grand Prix GTP; PermaDry® molded rubber oil pan gskt. incl.; PermaDryPlus® timing cover gskt. incl.	
1	Gasket Conversion Set	2003-01	CS 9917-1	Exc. Buick Regal GS Pontiac Grand Prix GTP; PermaDry® molded rubber oil pan gskt. incl.; PermaDryPlus® timing cover gskt. incl.	
1	Gasket Conversion Set	2000	CS 9917	Buick Regal GS, GSE Pontiac Grand Prix GTP; PermaDry® molded rubber oil pan gskt. incl.; PermaDryPlus® timing cover gskt. incl.	
1	Gasket Conversion Set	2000	CS 9917-1	Exc. Buick Regal GS, GSE Pontiac Grand Prix GTP; PermaDry® molded rubber oil pan gskt. incl.; PermaDryPlus® timing cover gskt. incl.	
1	Gasket Conversion Set	1999-96	CS 9917	PermaDry® molded rubber oil pan gskt. incl.; PermaDryPlus® timing cover gskt. incl.	
1	Gasket Conversion Set	1995	CS 9088-1	Oil pan gskt. not incl.; PermaDryPlus® timing cover gskt. incl.	

GM Car (Incl. Buick, Cad., Chev., Geo, Olds., Pontiac, Saturn) (Cont.)

77 (cont.)	2005 - 1991; 3.8L 231 (3791cc) OHV V6 (12 Valve) 3.8" Bore MFI; Gasoline; Supercharged GMC Eng.; Buick; VIN Code 1			77 (cont.)
QTY	CONVERSION SET	YEARS	PART NO.	DESCRIPTION
1	Gasket Conversion Set	1994-91	CS 9644	PermaDry® molded rubber oil pan gskt. incl.; PermaDryPlus® timing cover gskt. incl.
QTY	MANIFOLD - INT. & EXH.	YEARS	PART NO.	DESCRIPTION
1	Int. Manifold Gasket Set	2005-97	MS 95977-1	2nd Design; w/Rubber-plastic end seals w/Locating pins; Lower set
1	Int. Manifold Gasket Set	2005-97	MS 98014 T	2nd Design; w/Rubber-plastic end seals w/Locating pins; Lower set only; Upper set not incl.; PermaDryPlus® int. manifold gskts. incl.
1	Int. Manifold Gasket Set	1997-96	MS 95977	1st Design; w/Rubber end seals w/o Locating pins; Lower set
1	Int. Manifold Gasket Set	1997-96	MS 98014 T	1st Design; w/Rubber end seals w/o Locating pins; Lower set only; Upper set not incl.; PermaDryPlus® int. manifold gskts. incl.
1	Int. Manifold Gasket Set	1995-91	MS 94918-1	Lower set; Improved design
1	Plenum Gasket Set	2005-96	MS 95744	Upper set
1	Plenum Gasket Set	1995-91	MS 95741	Upper set
1	Exh. Manifold Gasket Set	2005-96	MS 95808	
1	Exh. Manifold Gasket Set	1995-91	MS 94052	
QTY	EXHAUST PIPE FLANGE	YEARS	PART NO.	DESCRIPTION
1	Exhaust Pipe Gasket	2005-96	61009	Crossover
1	Exhaust Pipe Gasket	2005-97	61310	Pipe to manifold; Improved design
1	Exhaust Pipe Gasket	1996	60640	Pipe to manifold
1	Exhaust Pipe Gasket	1995-91	60884	Pipe to manifold; Improved design
1	Exhaust Pipe Gasket	1995-93	61017	Crossover; 2.265" ID x 3.015" OD
1	Exhaust Pipe Gasket	1992-91	60754	1st Design; Crossover; 2.270" ID x 3.225" OD
1	Exhaust Pipe Gasket	1992-91	61017	2nd Design; Crossover; 2.265" ID x 3.015" OD
QTY	OIL PAN	YEARS	PART NO.	DESCRIPTION
1	Oil Pan Gasket Set	2005-04	OS 30699 R	Buick Park Avenue Base, Ultra; RTV not incl. for grooved oil pan; PermaDry® molded rubber gskt. incl.
1	Oil Pan Gasket Set	2005-04	OS 30767 R	Exc. Buick Park Avenue Base, Ultra; PermaDry® molded rubber gskt. incl.; Improved design
1	Oil Pan Gasket Set	2003-01	OS 30699 R	Exc. Buick Regal GS Pontiac Grand Prix GTP; PermaDry® molded rubber gskt. incl.
1	Oil Pan Gasket Set	2003-01	OS 30767 R	Buick Regal GS Pontiac Grand Prix GTP; PermaDry® molded rubber gskt. incl.; Improved design
1	Oil Pan Gasket Set	2000	OS 30699 R	Exc. Buick Regal GS, GSE Pontiac Grand Prix GTP; PermaDry® molded rubber gskt. incl.
1	Oil Pan Gasket Set	2000	OS 30767 R	Buick Regal GS, GSE Pontiac Grand Prix GTP; PermaDry® molded rubber gskt. incl.; Improved design
1	Oil Pan Gasket Set	1999-96	OS 30767 R	PermaDry® molded rubber gskt. incl.; Improved design
1	Oil Pan Gasket Set	1995	OS 30522 R	1st Design; w/o Windage tray; PermaDry® molded rubber gskt. incl.
1	Oil Pan Gasket Set	1995	OS 30522 T	1st Design; w/o Windage tray; PermaDryPlus®; Oil Pan SnapUps® incl.
1	Oil Pan Gasket Set	1995	OS 30767 R	2nd Design; w/Windage tray; PermaDry® molded rubber gskt. incl.; Improved design
1	Oil Pan Gasket Set	1994-91	OS 30522 R	PermaDry® molded rubber gskt. incl.
1	Oil Pan Gasket Set	1994-91	OS 30522 T	PermaDryPlus®; Oil Pan SnapUps® incl.
1	Drain Plug Gasket	2005-95	70820	
1	Drain Plug Gasket	1994-91	70822	
QTY	CRANKSHAFT REAR SEAL	YEARS	PART NO.	DESCRIPTION
1	Rear Main Seal Set	2005-04	BS 40190	Rubber; One-piece
1	Rear Main Seal Set	2003-91	BS 40649	PTFE Rubber; One-piece
1	Rear Main Seal Set	2003-96	BS 40621-1	Rubber; One-piece
1	Rear Main Seal Set	1995-91	BS 40621	Rubber; One-piece
1	Repair Sleeve	2005-91	16276	Crankshaft; Use w/installation tool
QTY	VALVE COVER	YEARS	PART NO.	DESCRIPTION
1	Valve Cover Gasket Set	2005-96	VS 50465 R	w/Grommets; PermaDry® molded rubber gskts. incl.
1	Valve Cover Gasket Set	1995-91	VS 50080 R	w/o Grommets; Services both covers; PermaDry® molded rubber gskts. incl.
2	Valve Cover Gasket Set	1995-91	VS 50320 R	w/o Grommets; Services one cover only; PermaDry® molded rubber gskt. incl.
1	Grommet Set	2005-91	ES 72833	Valve Cover
QTY	VALVE STEM SEAL SET	YEARS	PART NO.	DESCRIPTION
1	Valve Stem Seal Set	2005-98	SS 72144	Premium valve stem seals incl.
1	Valve Stem Seal Set	1997-96	SS 72882	Premium valve stem seals incl.
1	Valve Stem Seal Set	1995-91	SS 72700	Premium valve stem seals incl.
QTY	THERMOSTAT HOUSING	YEARS	PART NO.	DESCRIPTION
1	Thermostat Gasket	2005-91	35666	Thermostat Housing; Thermostat seal; 1.560" ID; Improved design
1	Thermostat Gasket	1998-96	35595	Thermostat Housing
1	Thermostat Gasket	1995-91	35534	Thermostat Housing

GM Car (Incl. Buick, Cad., Chev., Geo, Olds., Pontiac, Saturn) (Cont.)

77 (cont.)		2005 - 1991; 3.8L 231 (3791cc) OHV V6 (12 Valve) 3.8" Bore			77 (cont.)
MFI; Gasoline; Supercharged GMC Eng.; Buick; VIN Code 1					
QTY	WATER OUTLET GASKET	YEARS	PART NO.	DESCRIPTION	
1	Water Outlet Gasket	2005-96	36021	Water Outlet; Water bypass; New Part Number - Check for Availability	
1	Water Outlet Gasket	1995-91	36023	Water Outlet; Water bypass; New Part Number - Check for Availability	
QTY	WATER PUMP	YEARS	PART NO.	DESCRIPTION	
1	Water Pump Gasket	2005-91	35351		
1	Water Pump Gasket	2005-95	35804	Pump stamped "Metal gasket only"	
QTY	TIMING COVER	YEARS	PART NO.	DESCRIPTION	
1	Timing Cover Set	2005-00	TCS 45971	w/o Sleeve 'N' Seal®; Must be used w/OS 30699R or w/OS 30767R or w/OS 34410R; PermaDryPlus® timing cover gskt. incl.	
1	Timing Cover Set	1999-96	TCS 45971	w/o Sleeve 'N' Seal®; Must be used w/OS 30767R or w/OS 34410R; PermaDryPlus® timing cover gskt. incl.	
1	Timing Cover Set	1995	TCS 45840	w/o Sleeve 'N' Seal®; Must be used w/OS 30522R or w/OS 30522T or w/OS 30767R or w/OS 34410R; PermaDryPlus® timing cover gskt. incl.	
1	Timing Cover Set	1994-91	TCS 45840	w/o Sleeve 'N' Seal®; Must be used w/OS 30522R or w/OS 30522T; PermaDryPlus® timing cover gskt. incl.	
1	Timing Set w/Sleeve & Seal	1995	TCS 45974	w/Sleeve 'N' Seal®; Must be used w/OS 30522R or w/OS 30522T or w/OS 30767R or w/OS 34410R; PermaDryPlus® timing cover gskt. incl.	
1	Timing Set w/Sleeve & Seal	1994-91	TCS 45974	w/Sleeve 'N' Seal®; Must be used w/OS 30522R or w/OS 30522T; PermaDryPlus® timing cover gskt. incl.	
1	Repair Sleeve	2005-91	16216	Timing Cover; Use w/installation tool	
1	Repair Sleeve Tool	2005-91	16308	Timing Cover	
QTY	CARB & FUEL INJECTION	YEARS	PART NO.	DESCRIPTION	
3	Fuel Injector O-Ring Set	2005-91	ES 70599	Improved design	
1	Throttle Body Gasket	2005-96	61024		
1	Throttle Body Gasket	1995-94	61025		
1	Throttle Body Gasket	1993-91	61023		
QTY	EXHAUST GAS RECIRCULATION	YEARS	PART NO.	DESCRIPTION	
1	EGR Gasket	2005-96	70783		
1	EGR Gasket	1995-94	70786		
1	EGR Gasket	1993-91	70784		
QTY	OIL FILTER MOUNTING	YEARS	PART NO.	DESCRIPTION	
1	Oil Filter Gasket	2005-91	70644		
78		2009 - 2004; 3.8L 231 (3791cc) OHV V6 (12 Valve) 3.8" Bore			78
MFI; Gasoline; Naturally Aspirated GMC Eng.; Buick; VIN Code 2					
QTY	CYLINDER HEAD	YEARS	PART NO.	DESCRIPTION	
1	Head Gasket	2009-04	9917 PT	Loc. L.H.; Head bolts not incl.; Head bolt replacement required	
1	Head Gasket	2009-04	9918 PT	Loc. R.H.; Head bolts not incl.; Head bolt replacement required	
1	Head Set	2009-06	HS 9917 PT-4	2nd Design; Int. manifold gskts. w/Rubber-plastic end seals w/Locating pins; Head bolts not incl.; Head bolt replacement required; PermaDryPlus® int. manifold gskts. incl.; PermaDry® molded rubber valve cover gskts. incl.; Premium valve stem seals incl.	
1	Head Set	2005-04	HS 9917 PT-3	2nd Design; Int. manifold gskts. w/Rubber-plastic end seals w/Locating pins; Head bolts & exh. pipe packing not incl.; Head bolt replacement required; PermaDry® molded rubber valve cover gskts. incl.; Premium valve stem seals incl.	
1	Head Bolt Set	2009-04	ES 74033	Replacement required	
QTY	CONVERSION SET	YEARS	PART NO.	DESCRIPTION	
1	Gasket Conversion Set	2009-06	CS 9917-4	RTV sealant incl. for oil pan gskt.; PermaDryPlus® timing cover gskt. incl.	
1	Gasket Conversion Set	2005-04	CS 9917-3	PermaDry® molded rubber oil pan gskt. incl.; PermaDryPlus® timing cover gskt. incl.	
QTY	MANIFOLD - INT. & EXH.	YEARS	PART NO.	DESCRIPTION	
1	Int. Manifold Gasket Set	2009-04	MS 98014 T	2nd Design; w/Rubber-plastic end seals w/Locating pins; Lower set only; Upper set not incl.; PermaDryPlus® int. manifold gskts. incl.	
1	Int. Manifold Gasket Set	2005-04	MS 95809-1	2nd Design; w/Rubber-plastic end seals w/Locating pins; Lower set	
1	Plenum Gasket Set	2009-04	MS 96691	Upper set	
1	Exh. Manifold Gasket Set	2009-04	MS 95829		
QTY	EXHAUST PIPE FLANGE	YEARS	PART NO.	DESCRIPTION	
1	Exhaust Pipe Gasket	2009-04	61009	Crossover	
1	Exhaust Pipe Gasket	2009-04	61310	Flange; Improved design	
QTY	OIL PAN	YEARS	PART NO.	DESCRIPTION	
1	Oil Pan Gasket Set	2005-04	OS 30767 R	PermaDry® molded rubber gskt. incl.; Improved design	
1	Drain Plug Gasket	2005-04	70820		
QTY	CRANKSHAFT REAR SEAL	YEARS	PART NO.	DESCRIPTION	
1	Rear Main Seal Set	2009-06	BS 40708	PTFE Rubber; One-piece	

GM Car (Incl. Buick, Cad., Chev., Geo, Olds., Pontiac, Saturn) (Cont.)

78 (cont.)		2009 - 2004; 3.8L 231 (3791cc) OHV V6 (12 Valve) 3.8" Bore			78 (cont.)
		MFI; Gasoline; Naturally Aspirated GMC Eng.; Buick; VIN Code 2			
QTY	CRANKSHAFT REAR SEAL	YEARS	PART NO.	DESCRIPTION	
1	Rear Main Seal Set	2005-04	BS 40190	Rubber; One-piece	
1	Repair Sleeve	2005-04	16276	Crankshaft; Use w/installation tool	
QTY	VALVE COVER	YEARS	PART NO.	DESCRIPTION	
1	Valve Cover Gasket Set	2009-04	VS 50080 R	w/o Grommets; Services both covers; PermaDry® molded rubber gskts. incl.	
2	Valve Cover Gasket Set	2009-04	VS 50320 R	w/o Grommets; Services one cover only; PermaDry® molded rubber gskt. incl.	
1	Grommet Set	2009-04	ES 72833	Valve Cover	
QTY	VALVE STEM SEAL SET	YEARS	PART NO.	DESCRIPTION	
1	Valve Stem Seal Set	2009-04	SS 72144	Premium valve stem seals incl.	
QTY	THERMOSTAT HOUSING	YEARS	PART NO.	DESCRIPTION	
1	Thermostat Gasket	2009-04	35666	Thermostat Housing; Thermostat seal; 1.560" ID; Improved design	
QTY	WATER OUTLET GASKET	YEARS	PART NO.	DESCRIPTION	
1	Water Outlet Gasket	2009-04	36021	Water Outlet; Water bypass; New Part Number - Check for Availability	
QTY	WATER PUMP	YEARS	PART NO.	DESCRIPTION	
1	Water Pump Gasket	2009-04	35804	Pump stamped "Metal gasket only"	
1	Water Pump Gasket	2005-04	35351		
QTY	TIMING COVER	YEARS	PART NO.	DESCRIPTION	
1	Timing Cover Set	2009-06	TCS 46077	PermaDryPlus® timing cover gskt. incl.	
1	Timing Cover Set	2005-04	TCS 45971	w/o Sleeve 'N' Seal®; Must be used w/OS 30767R or w/OS 34410R; PermaDryPlus® timing cover gskt. incl.	
1	Repair Sleeve	2005-04	16216	Timing Cover; Use w/installation tool	
1	Repair Sleeve Tool	2005-04	16308	Timing Cover	
QTY	CARB & FUEL INJECTION	YEARS	PART NO.	DESCRIPTION	
2	Fuel Injector O-Ring Set	2009-04	ES 70599	Upper set; Injectors to fuel rail; Improved design	
2	Fuel Injector O-Ring Set	2009-04	ES 71190	Lower set; Injectors to cylinder head	
2	Fuel Injector O-Ring Set	2009-04	ES 71192	Upper set; Injectors to fuel rail; Old design	
1	Throttle Body Gasket	2009-04	61447		
QTY	EXHAUST GAS RECIRCULATION	YEARS	PART NO.	DESCRIPTION	
1	EGR Gasket	2009-04	70783		
QTY	OIL FILTER MOUNTING	YEARS	PART NO.	DESCRIPTION	
1	Oil Filter Gasket	2009-04	70644		
79		2007 - 2004; 3.8L 231 (3791cc) OHV V6 (12 Valve) 3.8" Bore			79
		MFI; Gasoline; Supercharged GMC Eng.; Buick; VIN Code 4			
QTY	CYLINDER HEAD	YEARS	PART NO.	DESCRIPTION	
2	Head Gasket	2007-04	9089 PT	Head bolts not incl.; Head bolt replacement required	
1	Head Set	2007-06	HS 9089 PT-4	2nd Design; Int. manifold gskts. w/Rubber-plastic end seals w/Locating pins; Head bolts not incl.; Head bolt replacement required; PermaDryPlus® int. manifold gskts. incl.; PermaDry® molded rubber valve cover gskts. incl.; Premium valve stem seals incl.	
1	Head Set	2005-04	HS 9089 PT-3	2nd Design; Int. manifold gskts. w/Rubber-plastic end seals w/Locating pins; Head bolts not incl.; Head bolt replacement required; PermaDryPlus® int. manifold gskts. incl.; PermaDry® molded rubber valve cover gskts. incl.; Premium valve stem seals incl.	
1	Head Bolt Set	2007-04	ES 74033	Replacement required	
QTY	CONVERSION SET	YEARS	PART NO.	DESCRIPTION	
1	Gasket Conversion Set	2007-06	CS 9917-4	RTV sealant incl. for oil pan gskt.; PermaDryPlus® timing cover gskt. incl.	
1	Gasket Conversion Set	2005-04	CS 9917-3	PermaDry® molded rubber oil pan gskt. incl.; PermaDryPlus® timing cover gskt. incl.	
QTY	MANIFOLD - INT. & EXH.	YEARS	PART NO.	DESCRIPTION	
1	Int. Manifold Gasket Set	2007-04	MS 98014 T	2nd Design; w/Rubber-plastic end seals w/Locating pins; Lower set only; Upper set not incl.; PermaDryPlus® int. manifold gskts. incl.	
1	Int. Manifold Gasket Set	2005-04	MS 95977-1	2nd Design; w/Rubber-plastic end seals w/Locating pins; Lower set	
1	Plenum Gasket Set	2007-06	MS 96847	Upper set	
1	Plenum Gasket Set	2005-04	MS 96789	Upper set	
1	Exh. Manifold Gasket Set	2007-04	MS 95829		
QTY	EXHAUST PIPE FLANGE	YEARS	PART NO.	DESCRIPTION	
1	Exhaust Pipe Gasket	2007-04	61009	Crossover	
1	Exhaust Pipe Gasket	2007-04	61310	Pipe to manifold; Improved design	
QTY	OIL PAN	YEARS	PART NO.	DESCRIPTION	
1	Oil Pan Gasket Set	2005-04	OS 30767 R	PermaDry® molded rubber gskt. incl.; Improved design	
1	Drain Plug Gasket	2005-04	70820		
QTY	CRANKSHAFT REAR SEAL	YEARS	PART NO.	DESCRIPTION	
1	Rear Main Seal Set	2007-06	BS 40708	PTFE Rubber; One-piece	

GM Car (Incl. Buick, Cad., Chev., Geo, Olds., Pontiac, Saturn) (Cont.)

79 (cont.)		2007 - 2004; 3.8L 231 (3791cc) OHV V6 (12 Valve) 3.8" Bore			79 (cont.)
MFI; Gasoline; Supercharged GMC Eng.; Buick; VIN Code 4					
QTY	CRANKSHAFT REAR SEAL	YEARS	PART NO.	DESCRIPTION	
1	Rear Main Seal Set	2005-04	BS 40190	Rubber; One-piece	
1	Repair Sleeve	2005-04	16276	Crankshaft; Use w/installation tool	
QTY	VALVE COVER	YEARS	PART NO.	DESCRIPTION	
1	Valve Cover Gasket Set	2007-04	VS 50465 R	w/Grommets; PermaDry® molded rubber gsks. incl.	
1	Grommet Set	2007-04	ES 72833	Valve Cover	
QTY	VALVE STEM SEAL SET	YEARS	PART NO.	DESCRIPTION	
1	Valve Stem Seal Set	2007-04	SS 72144	Premium valve stem seals incl.	
QTY	THERMOSTAT HOUSING	YEARS	PART NO.	DESCRIPTION	
1	Thermostat Gasket	2007-04	35666	Thermostat Housing; Thermostat seal; 1.560" ID; Improved design	
QTY	WATER OUTLET GASKET	YEARS	PART NO.	DESCRIPTION	
1	Water Outlet Gasket	2007-04	36021	Water Outlet; Water bypass; New Part Number - Check for Availability	
QTY	WATER PUMP	YEARS	PART NO.	DESCRIPTION	
1	Water Pump Gasket	2007-04	35804	Pump stamped "Metal gasket only"	
1	Water Pump Gasket	2005-04	35351		
QTY	TIMING COVER	YEARS	PART NO.	DESCRIPTION	
1	Timing Cover Set	2007-06	TCS 46077	PermaDryPlus® timing cover gskt. incl.	
1	Timing Cover Set	2005-04	TCS 45971	w/o Sleeve 'N' Seal®; Must be used w/OS 30767R or w/OS 34410R; PermaDryPlus® timing cover gskt. incl.	
1	Repair Sleeve	2005-04	16216	Timing Cover; Use w/installation tool	
1	Repair Sleeve Tool	2005-04	16308	Timing Cover	
QTY	CARB & FUEL INJECTION	YEARS	PART NO.	DESCRIPTION	
3	Fuel Injector O-Ring Set	2007-04	ES 70599	Improved design	
1	Throttle Body Gasket	2007-04	61447		
QTY	EXHAUST GAS RECIRCULATION	YEARS	PART NO.	DESCRIPTION	
1	EGR Gasket	2005-04	70783		
QTY	OIL FILTER MOUNTING	YEARS	PART NO.	DESCRIPTION	
1	Oil Filter Gasket	2007-04	70644		
80		1991; 3.8L 231 (3791cc) OHV V6 (12 Valve) 3.8" Bore			80
MFI; Gasoline; Naturally Aspirated GMC Eng.; Buick; VIN Code C					
QTY	CYLINDER HEAD	YEARS	PART NO.	DESCRIPTION	
2	Head Gasket	1991	9644 PT	Head bolts not incl.; Head bolt replacement required	
1	Head Set	1991	HS 9644 PT-2	Head bolts & exh. pipe packing not incl.; Head bolt replacement required; PermaDry® molded rubber valve cover gsks. incl.; Premium valve stem seals incl.	
1	Head Bolt Set	1991	ES 74031	Replacement required	
QTY	CONVERSION SET	YEARS	PART NO.	DESCRIPTION	
1	Gasket Conversion Set	1991	CS 9644	PermaDry® molded rubber oil pan gskt. incl.; PermaDryPlus® timing cover gskt. incl.	
QTY	MANIFOLD - INT. & EXH.	YEARS	PART NO.	DESCRIPTION	
1	Int. Manifold Gasket Set	1991	MS 94066		
1	Exh. Manifold Gasket Set	1991	MS 94052		
QTY	EXHAUST PIPE FLANGE	YEARS	PART NO.	DESCRIPTION	
1	Exhaust Pipe Gasket	1991	60754	Crossover; 2.270" ID x 3.225" OD	
1	Exhaust Pipe Gasket	1991	60884	Pipe to manifold; Improved design	
1	Exh. Flange Bolt & Spring Kit	1991	ES 72141		
QTY	OIL PAN	YEARS	PART NO.	DESCRIPTION	
1	Oil Pan Gasket Set	1991	OS 30522 R	PermaDry® molded rubber gskt. incl.	
1	Oil Pan Gasket Set	1991	OS 30522 T	PermaDryPlus®; Oil Pan SnapUps® incl.	
1	Drain Plug Gasket	1991	70822		
QTY	CRANKSHAFT REAR SEAL	YEARS	PART NO.	DESCRIPTION	
1	Rear Main Seal Set	1991	BS 40621	Rubber; One-piece	
1	Rear Main Seal Set	1991	BS 40649	PTFE Rubber; One-piece	
1	Repair Sleeve	1991	16276	Crankshaft; Use w/installation tool	
QTY	VALVE COVER	YEARS	PART NO.	DESCRIPTION	
1	Valve Cover Gasket Set	1991	VS 50080 R	w/o Grommets; Services both covers; PermaDry® molded rubber gsks. incl.	
2	Valve Cover Gasket Set	1991	VS 50320 R	w/o Grommets; Services one cover only; PermaDry® molded rubber gskt. incl.	
1	Grommet Set	1991	ES 72833	Valve Cover	
QTY	VALVE STEM SEAL SET	YEARS	PART NO.	DESCRIPTION	
1	Valve Stem Seal Set	1991	SS 72700	Premium valve stem seals incl.	
QTY	THERMOSTAT HOUSING	YEARS	PART NO.	DESCRIPTION	
1	O-Ring	1991	35126	Thermostat Housing; Thermostat seal	

GM Car (Incl. Buick, Cad., Chev., Geo, Olds., Pontiac, Saturn) (Cont.)

80 (cont.)		1991; 3.8L 231 (3791cc) OHV V6 (12 Valve) 3.8" Bore			80 (cont.)
		MFI; Gasoline; Naturally Aspirated GMC Eng.; Buick; VIN Code C			
QTY	THERMOSTAT HOUSING	YEARS	PART NO.	DESCRIPTION	
1	O-Ring	1991	35608	Thermostat Housing	
QTY	WATER PUMP	YEARS	PART NO.	DESCRIPTION	
1	Water Pump Gasket	1991	35351		
QTY	TIMING COVER	YEARS	PART NO.	DESCRIPTION	
1	Timing Cover Set	1991	TCS 45840	w/o Sleeve 'N' Seal®; Must be used w/OS 30522R or w/OS 30522T; PermaDryPlus® timing cover gskt. incl.	
1	Timing Set w/Sleeve & Seal	1991	TCS 45974	w/Sleeve 'N' Seal®; Must be used w/OS 30522R or w/OS 30522T; PermaDryPlus® timing cover gskt. incl.	
1	Repair Sleeve	1991	16216	Timing Cover; Use w/installation tool	
1	Repair Sleeve Tool	1991	16308	Timing Cover	
QTY	CARB & FUEL INJECTION	YEARS	PART NO.	DESCRIPTION	
3	Fuel Injector O-Ring Set	1991	ES 70599	Improved design	
1	Throttle Body Gasket	1991	60774		
QTY	EXHAUST GAS RECIRCULATION	YEARS	PART NO.	DESCRIPTION	
1	EGR Gasket	1991	70255	EGR valve	
1	EGR Gasket	1991	70256	EGR to adapter	
1	EGR Gasket	1991	70257	Adapter to int. manifold	
QTY	OIL FILTER MOUNTING	YEARS	PART NO.	DESCRIPTION	
1	Oil Filter Gasket	1991	70644		
81		2005 - 1995; 3.8L 231 (3791cc) OHV V6 (12 Valve) 3.8" Bore			81
		MFI; Gasoline; Naturally Aspirated GMC Eng.; Buick; VIN Code K			
QTY	CYLINDER HEAD	YEARS	PART NO.	DESCRIPTION	
1	Head Gasket	2005-95	9917 PT	Loc. L.H.; Head bolts not incl.; Head bolt replacement required	
1	Head Gasket	2005-95	9918 PT	Loc. R.H.; Head bolts not incl.; Head bolt replacement required	
1	Head Set	2005-03	HS 9917 PT-3	2nd Design; Int. manifold gskts. w/Rubber-plastic end seals w/Locating pins; Head bolts & exh. pipe packing not incl.; Head bolt replacement required; PermaDry® molded rubber valve cover gskts. incl.; Premium valve stem seals incl.	
1	Head Set	2002-99	HS 9917 PT-2	Chevrolet Camaro Base Pontiac Firebird Base; 2nd Design; Int. manifold gskts. w/Rubber-plastic end seals w/Locating pins; Head bolts & exh. pipe packing not incl.; Head bolt replacement required; PermaDry® molded rubber valve cover gskts. incl.; Premium valve stem seals incl.	
1	Head Set	2002-99	HS 9917 PT-3	Exc. Chevrolet Camaro Base Pontiac Firebird Base; 2nd Design; Int. manifold gskts. w/Rubber-plastic end seals w/Locating pins; Head bolts & exh. pipe packing not incl.; Head bolt replacement required; PermaDry® molded rubber valve cover gskts. incl.; Premium valve stem seals incl.	
1	Head Set	1998-97	HS 9917 PT-2	Chevrolet Camaro Base, RS Pontiac Firebird Base; 2nd Design; Int. manifold gskts. w/Rubber-plastic end seals w/Locating pins; Head bolts & exh. pipe packing not incl.; Head bolt replacement required; PermaDry® molded rubber valve cover gskts. incl.; Premium valve stem seals incl.	
1	Head Set	1998-97	HS 9917 PT-3	Exc. Chevrolet Camaro Base, RS Pontiac Firebird Base; 2nd Design; Int. manifold gskts. w/Rubber-plastic end seals w/Locating pins; Head bolts & exh. pipe packing not incl.; Head bolt replacement required; PermaDry® molded rubber valve cover gskts. incl.; Premium valve stem seals incl.	
1	Head Set	1997-96	HS 9917 PT	Exc. Chevrolet Camaro Base, RS Pontiac Firebird Base; 1st Design; Int. manifold gskts. w/Rubber end seals w/o Locating pins; Head bolts & exh. pipe packing not incl.; Head bolt replacement required; PermaDry® molded rubber valve cover gskts. incl.; Premium valve stem seals incl.	
1	Head Set	1997-96	HS 9917 PT-1	Chevrolet Camaro Base, RS Pontiac Firebird Base; 1st Design; Int. manifold gskts. w/Rubber end seals w/o Locating pins; Head bolts & exh. pipe packing not incl.; Head bolt replacement required; PermaDry® molded rubber valve cover gskts. incl.; Premium valve stem seals incl.	
1	Head Set	1995	HS 9917 PT	Exc. Chevrolet Camaro Base Pontiac Firebird Base; 1st Design; Int. manifold gskts. w/Rubber end seals w/o Locating pins; Head bolts & exh. pipe packing not incl.; Head bolt replacement required; PermaDry® molded rubber valve cover gskts. incl.; Premium valve stem seals incl.	
1	Head Set	1995	HS 9917 PT-1	Chevrolet Camaro Base Pontiac Firebird Base; 1st Design; Int. manifold gskts. w/Rubber end seals w/o Locating pins; Head bolts & exh. pipe packing not incl.; Head bolt replacement required; PermaDry® molded rubber valve cover gskts. incl.; Premium valve stem seals incl.	
1	Head Bolt Set	2005-95	ES 74033	Replacement required	

GM Car (Incl. Buick, Cad., Chev., Geo, Olds., Pontiac, Saturn) (Cont.)

81 (cont.)		2005 - 1995; 3.8L 231 (3791cc) OHV V6 (12 Valve) 3.8" Bore			81 (cont.)
MFI; Gasoline; Naturally Aspirated GMC Eng.; Buick; VIN Code K					
QTY	CONVERSION SET	YEARS	PART NO.	DESCRIPTION	
1	Gasket Conversion Set	2005	CS 9917-2	Exc. Chevrolet Impala Base, LS, Monte Carlo LT, SS; 1st Design; Eng. block casting No. 24506029; RTV not incl. for grooved oil pan; PermaDry® molded rubber oil pan gskt. incl.; PermaDryPlus® timing cover gskt. incl.	
1	Gasket Conversion Set	2005	CS 9917-3	Chevrolet Impala Base, LS, Monte Carlo LT, SS; PermaDry® molded rubber oil pan gskt. incl.; PermaDryPlus® timing cover gskt. incl.	
1	Gasket Conversion Set	2005	CS 9917-4	Exc. Chevrolet Impala Base, LS, Monte Carlo LT, SS; 2nd Design; Eng. block casting No. 12585793; RTV sealant incl. for oil pan gskt.; PermaDryPlus® timing cover gskt. incl.	
1	Gasket Conversion Set	2004	CS 9917-2	Exc. Buick Regal LS Chevrolet Impala Base, LS, Monte Carlo SS; RTV not incl. for grooved oil pan; PermaDry® molded rubber oil pan gskt. incl.; PermaDryPlus® timing cover gskt. incl.	
1	Gasket Conversion Set	2004	CS 9917-3	Buick Regal LS Chevrolet Impala Base, LS, Monte Carlo SS; PermaDry® molded rubber oil pan gskt. incl.; PermaDryPlus® timing cover gskt. incl.	
1	Gasket Conversion Set	2003-00	CS 9917	Exc. Buick LeSabre Custom, Limited, Park Avenue Base, Ultra Pontiac Bonneville SE, SLE, SSEi; PermaDry® molded rubber oil pan gskt. incl.; PermaDryPlus® timing cover gskt. incl.	
1	Gasket Conversion Set	2003-00	CS 9917-1	Buick LeSabre Custom, Limited, Park Avenue Base, Ultra Pontiac Bonneville SE, SLE, SSEi; PermaDry® molded rubber oil pan gskt. incl.; PermaDryPlus® timing cover gskt. incl.	
1	Gasket Conversion Set	1999-95	CS 9917	PermaDry® molded rubber oil pan gskt. incl.; PermaDryPlus® timing cover gskt. incl.	
QTY	MANIFOLD - INT. & EXH.	YEARS	PART NO.	DESCRIPTION	
1	Int. Manifold Gasket Set	2005-97	MS 95809-1	2nd Design; w/Rubber-plastic end seals w/Locating pins; Lower set	
1	Int. Manifold Gasket Set	2005-97	MS 98014 T	2nd Design; w/Rubber-plastic end seals w/Locating pins; Lower set only; Upper set not incl.; PermaDryPlus® int. manifold gskts. incl.	
1	Int. Manifold Gasket Set	1997-95	MS 95809	1st Design; w/Rubber end seals w/o Locating pins; Lower set	
1	Int. Manifold Gasket Set	1997-95	MS 98014 T	1st Design; w/Rubber end seals w/o Locating pins; Lower set only; Upper set not incl.; PermaDryPlus® int. manifold gskts. incl.	
1	Plenum Gasket Set	2005-03	MS 95812	Upper set	
1	Plenum Gasket Set	2002-99	MS 95746	Chevrolet Camaro Base Pontiac Firebird Base; Throttle body gskt. not incl.; Upper set	
1	Plenum Gasket Set	2002-99	MS 95812	Exc. Chevrolet Camaro Base Pontiac Firebird Base; Upper set	
1	Plenum Gasket Set	1998-96	MS 95746	Chevrolet Camaro Base, RS Pontiac Firebird Base; Upper set	
1	Plenum Gasket Set	1998-96	MS 95812	Exc. Chevrolet Camaro Base, RS Pontiac Firebird Base; Upper set	
1	Plenum Gasket Set	1995	MS 95746	Chevrolet Camaro Base Pontiac Firebird Base; Upper set	
1	Plenum Gasket Set	1995	MS 95812	Exc. Chevrolet Camaro Base Pontiac Firebird Base; Upper set	
1	Exh. Manifold Gasket Set	2005-03	MS 95829		
1	Exh. Manifold Gasket Set	2002-99	MS 95811	Chevrolet Camaro Base Pontiac Firebird Base	
1	Exh. Manifold Gasket Set	2002-99	MS 95829	Exc. Chevrolet Camaro Base Pontiac Firebird Base	
1	Exh. Manifold Gasket Set	1998-96	MS 95811	Chevrolet Camaro Base, RS Pontiac Firebird Base	
1	Exh. Manifold Gasket Set	1998-96	MS 95829	Exc. Chevrolet Camaro Base, RS Pontiac Firebird Base	
1	Exh. Manifold Gasket Set	1995	MS 95811	Chevrolet Camaro Base Pontiac Firebird Base	
1	Exh. Manifold Gasket Set	1995	MS 95829	Exc. Chevrolet Camaro Base Pontiac Firebird Base	
QTY	EXHAUST PIPE FLANGE	YEARS	PART NO.	DESCRIPTION	
1	Exhaust Pipe Gasket	2005-95	61009	Crossover	
1	Exhaust Pipe Gasket	2005-03	61310	Flange; Improved design	
2	Exhaust Pipe Gasket	2002-99	61018	Chevrolet Camaro Base Pontiac Firebird Base; Pipe to manifold	
1	Exhaust Pipe Gasket	2002-99	61310	Exc. Chevrolet Camaro Base Pontiac Firebird Base; Flange; Improved design	
2	Exhaust Pipe Gasket	1998-96	61018	Chevrolet Camaro Base, RS Pontiac Firebird Base; Pipe to manifold	
1	Exhaust Pipe Gasket	1998	61310	Exc. Chevrolet Camaro Base, RS Pontiac Firebird Base; Flange; Improved design	
1	Exhaust Pipe Gasket	1997	60640	Buick LeSabre Custom, Limited; Flange	
1	Exhaust Pipe Gasket	1997	61310	Exc. Buick LeSabre Custom, Limited Chevrolet Camaro Base, RS Pontiac Firebird Base; Flange; Improved design	
1	Exhaust Pipe Gasket	1996	60640	Exc. Chevrolet Camaro Base, RS Pontiac Firebird Base; Flange	
1	Exhaust Pipe Gasket	1995	60640	Exc. Chevrolet Camaro Base Pontiac Firebird Base; Flange	
2	Exhaust Pipe Gasket	1995	61018	Chevrolet Camaro Base Pontiac Firebird Base; Pipe to manifold	
QTY	OIL PAN	YEARS	PART NO.	DESCRIPTION	
1	Oil Pan Gasket Set	2005	OS 30699 R	Exc. Chevrolet Impala Base, LS, Monte Carlo LT, SS; 1st Design; Eng. block casting No. 24506029; RTV not incl. for grooved oil pan; PermaDry® molded rubber gskt. incl.	
1	Oil Pan Gasket Set	2005	OS 30767 R	Chevrolet Impala Base, LS, Monte Carlo LT, SS; PermaDry® molded rubber gskt. incl.; Improved design	

GM Car (Incl. Buick, Cad., Chev., Geo, Olds., Pontiac, Saturn) (Cont.)

81 (cont.)	2005 - 1995; 3.8L 231 (3791cc) OHV V6 (12 Valve) 3.8" Bore				81 (cont.)
QTY	OIL PAN	YEARS	PART NO.	DESCRIPTION	
1	Oil Pan Gasket Set	2004	OS 30699 R	Exc. Buick Regal LS Chevrolet Impala Base, LS, Monte Carlo SS; RTV not incl. for grooved oil pan; PermaDry® molded rubber gskt. incl.	
1	Oil Pan Gasket Set	2004	OS 30767 R	Buick Regal LS Chevrolet Impala Base, LS, Monte Carlo SS; PermaDry® molded rubber gskt. incl.; Improved design	
1	Oil Pan Gasket Set	2003-00	OS 30699 R	Buick LeSabre Custom, Limited, Park Avenue Base, Ultra Pontiac Bonneville SE, SLE, SSEi; PermaDry® molded rubber gskt. incl.	
1	Oil Pan Gasket Set	2003-00	OS 30767 R	Exc. Buick LeSabre Custom, Limited, Park Avenue Base, Ultra Pontiac Bonneville SE, SLE, SSEi; PermaDry® molded rubber gskt. incl.; Improved design	
1	Oil Pan Gasket Set	1999-95	OS 30767 R	PermaDry® molded rubber gskt. incl.; Improved design	
1	Drain Plug Gasket	2005-95	70820		
QTY	CRANKSHAFT REAR SEAL	YEARS	PART NO.	DESCRIPTION	
1	Rear Main Seal Set	2005	BS 40190	Exc. Chevrolet Impala Base, LS, Monte Carlo LT, SS; 1st Design; Eng. block casting No. 24506029; Rubber; One-piece	
1	Rear Main Seal Set	2005	BS 40190	Chevrolet Impala Base, LS, Monte Carlo LT, SS; Rubber; One-piece	
1	Rear Main Seal Set	2005	BS 40708	Exc. Chevrolet Impala Base, LS, Monte Carlo LT, SS; 2nd Design; Eng. block casting No. 12585793; PTFE Rubber; One-piece	
1	Rear Main Seal Set	2004	BS 40190	Rubber; One-piece	
1	Rear Main Seal Set	2003-95	BS 40621-1	Rubber; One-piece	
1	Rear Main Seal Set	2003-95	BS 40649	PTFE Rubber; One-piece	
1	Repair Sleeve	2005-95	16276	Crankshaft; Use w/installation tool	
QTY	VALVE COVER	YEARS	PART NO.	DESCRIPTION	
1	Valve Cover Gasket Set	2005-95	VS 50080 R	w/o Grommets; Services both covers; PermaDry® molded rubber gskts. incl.	
2	Valve Cover Gasket Set	2005-95	VS 50320 R	w/o Grommets; Services one cover only; PermaDry® molded rubber gskt. incl.	
1	Grommet Set	2005-95	ES 72833	Valve Cover	
QTY	VALVE STEM SEAL SET	YEARS	PART NO.	DESCRIPTION	
1	Valve Stem Seal Set	2005-95	SS 72144	Premium valve stem seals incl.	
QTY	THERMOSTAT HOUSING	YEARS	PART NO.	DESCRIPTION	
1	Thermostat Gasket	2005-95	35666	Thermostat Housing; Thermostat seal; 1.560" ID; Improved design	
1	Thermostat Gasket	1998-95	35595	Thermostat Housing	
QTY	WATER OUTLET GASKET	YEARS	PART NO.	DESCRIPTION	
1	Water Outlet Gasket	2005-03	36021	Water Outlet; Water bypass; New Part Number - Check for Availability	
1	Water Outlet Gasket	2002-99	36021	Exc. Chevrolet Camaro Base Pontiac Firebird Base; Water Outlet; Water bypass; New Part Number - Check for Availability	
1	Water Outlet Gasket	1998-96	36021	Exc. Chevrolet Camaro Base, RS Pontiac Firebird Base; Water Outlet; Water bypass; New Part Number - Check for Availability	
1	Water Outlet Gasket	1995	36021	Exc. Chevrolet Camaro Base Pontiac Firebird Base; Water Outlet; Water bypass; New Part Number - Check for Availability	
QTY	WATER PUMP	YEARS	PART NO.	DESCRIPTION	
1	Water Pump Gasket	2005-95	35351		
1	Water Pump Gasket	2005-95	35804	Pump stamped "Metal gasket only"	
QTY	TIMING COVER	YEARS	PART NO.	DESCRIPTION	
1	Timing Cover Set	2005	TCS 45971	Exc. Chevrolet Impala Base, LS, Monte Carlo LT, SS; 1st Design; Eng. block casting No. 24506029; w/o Sleeve 'N' Seal®; Must be used w/OS 30699R; PermaDryPlus® timing cover gskt. incl.	
1	Timing Cover Set	2005	TCS 45971	Chevrolet Impala Base, LS, Monte Carlo LT, SS; w/o Sleeve 'N' Seal®; Must be used w/OS 30767R or w/OS 34410R; PermaDryPlus® timing cover gskt. incl.	
1	Timing Cover Set	2005	TCS 46077	Exc. Chevrolet Impala Base, LS, Monte Carlo LT, SS; 2nd Design; Eng. block casting No. 12585793; PermaDryPlus® timing cover gskt. incl.	
1	Timing Cover Set	2004-00	TCS 45971	w/o Sleeve 'N' Seal®; Must be used w/OS 30699R or w/OS 30767R or w/OS 34410R; PermaDryPlus® timing cover gskt. incl.	
1	Timing Cover Set	1999-95	TCS 45971	w/o Sleeve 'N' Seal®; Must be used w/OS 30767R or w/OS 34410R; PermaDryPlus® timing cover gskt. incl.	
1	Repair Sleeve	2005-95	16216	Timing Cover; Use w/installation tool	
1	Repair Sleeve Tool	2005-95	16308	Timing Cover	
QTY	CARB & FUEL INJECTION	YEARS	PART NO.	DESCRIPTION	
2	Fuel Injector O-Ring Set	2005-00	ES 70599	Upper set; Injectors to fuel rail; Improved design	
2	Fuel Injector O-Ring Set	2005-00	ES 71190	Lower set; Injectors to cylinder head	
2	Fuel Injector O-Ring Set	2005-00	ES 71192	Upper set; Injectors to fuel rail; Old design	
3	Fuel Injector O-Ring Set	1999-95	ES 70599	Improved design	
1	Throttle Body Gasket	2005-03	61093		
1	Throttle Body Gasket	2002-99	60661	Chevrolet Camaro Base Pontiac Firebird Base	

GM Car (Incl. Buick, Cad., Chev., Geo, Olds., Pontiac, Saturn) (Cont.)

81 (cont.)		2005 - 1995; 3.8L 231 (3791cc) OHV V6 (12 Valve) 3.8" Bore			81 (cont.)
MFI; Gasoline; Naturally Aspirated GMC Eng.; Buick; VIN Code K					
QTY	CARB & FUEL INJECTION	YEARS	PART NO.	DESCRIPTION	
1	Throttle Body Gasket	2002-99	61093	Exc. Chevrolet Camaro Base Pontiac Firebird Base	
1	Throttle Body Gasket	1998-96	61027	Chevrolet Camaro Base, RS Pontiac Firebird Base	
1	Throttle Body Gasket	1998-96	61093	Exc. Chevrolet Camaro Base, RS Pontiac Firebird Base	
1	Throttle Body Gasket	1995	61027	Chevrolet Camaro Base Pontiac Firebird Base	
1	Throttle Body Gasket	1995	61093	Exc. Chevrolet Camaro Base Pontiac Firebird Base	
QTY	EXHAUST GAS RECIRCULATION	YEARS	PART NO.	DESCRIPTION	
1	EGR Gasket	2005-95	70783		
QTY	OIL FILTER MOUNTING	YEARS	PART NO.	DESCRIPTION	
1	Oil Filter Gasket	2005-95	70644		
82		1995 - 1991; 3.8L 231 (3791cc) OHV V6 (12 Valve) 3.8" Bore			82
MFI; Gasoline; Naturally Aspirated GMC Eng.; Buick; VIN Code L					
QTY	CYLINDER HEAD	YEARS	PART NO.	DESCRIPTION	
2	Head Gasket	1995-91	9644 PT	Head bolts not incl.; Head bolt replacement required	
1	Head Set	1995-93	HS 9644 PT-1	Upper int. manifold gskt., head bolts, exh. pipe packing not incl.; Head bolt replacement required; PermaDry® molded rubber valve cover gskts. incl.; Premium valve stem seals incl.	
1	Head Set	1992-91	HS 9644 PT-1	Head bolts & exh. pipe packing not incl.; Head bolt replacement required; PermaDry® molded rubber valve cover gskts. incl.; Premium valve stem seals incl.	
1	Head Bolt Set	1995-91	ES 74031	Replacement required	
QTY	CONVERSION SET	YEARS	PART NO.	DESCRIPTION	
1	Gasket Conversion Set	1995	CS 9088-1	Oil pan gskt. not incl.; PermaDryPlus® timing cover gskt. incl.	
1	Gasket Conversion Set	1994-91	CS 9644	PermaDry® molded rubber oil pan gskt. incl.; PermaDryPlus® timing cover gskt. incl.	
QTY	MANIFOLD - INT. & EXH.	YEARS	PART NO.	DESCRIPTION	
1	Int. Manifold Gasket Set	1995-91	MS 94918-1	Lower set; Improved design	
1	Plenum Gasket Set	1995-93	MS 95830	Upper set	
1	Exh. Manifold Gasket Set	1995-91	MS 94052		
QTY	EXHAUST PIPE FLANGE	YEARS	PART NO.	DESCRIPTION	
1	Exhaust Pipe Gasket	1995-91	60884	Pipe to manifold; Improved design	
1	Exhaust Pipe Gasket	1995-93	61017	Crossover; 2.265" ID x 3.015" OD	
1	Exhaust Pipe Gasket	1992-91	60754	Crossover; 2.270" ID x 3.225" OD	
1	Exh. Flange Bolt & Spring Kit	1995-91	ES 72141		
QTY	OIL PAN	YEARS	PART NO.	DESCRIPTION	
1	Oil Pan Gasket Set	1995	OS 30767 R	PermaDry® molded rubber gskt. incl.; Improved design	
1	Oil Pan Gasket Set	1994-91	OS 30522 R	PermaDry® molded rubber gskt. incl.	
1	Oil Pan Gasket Set	1994-91	OS 30522 T	PermaDryPlus®; Oil Pan SnapUps® incl.	
1	Drain Plug Gasket	1995	70820		
1	Drain Plug Gasket	1994-91	70822		
QTY	CRANKSHAFT REAR SEAL	YEARS	PART NO.	DESCRIPTION	
1	Rear Main Seal Set	1995-91	BS 40621	Rubber; One-piece	
1	Rear Main Seal Set	1995-91	BS 40649	PTFE Rubber; One-piece	
1	Repair Sleeve	1995-91	16276	Crankshaft; Use w/installation tool	
QTY	VALVE COVER	YEARS	PART NO.	DESCRIPTION	
1	Valve Cover Gasket Set	1995-91	VS 50080 R	w/o Grommets; Services both covers; PermaDry® molded rubber gskts. incl.	
2	Valve Cover Gasket Set	1995-91	VS 50320 R	w/o Grommets; Services one cover only; PermaDry® molded rubber gskt. incl.	
1	Grommet Set	1995-91	ES 72833	Valve Cover	
QTY	VALVE STEM SEAL SET	YEARS	PART NO.	DESCRIPTION	
1	Valve Stem Seal Set	1995-91	SS 72700	Premium valve stem seals incl.	
QTY	THERMOSTAT HOUSING	YEARS	PART NO.	DESCRIPTION	
1	Thermostat Gasket	1995-91	35534	Thermostat Housing	
1	Thermostat Gasket	1995-91	35666	Thermostat Housing; Thermostat seal; 1.560" ID; Improved design	
QTY	WATER OUTLET GASKET	YEARS	PART NO.	DESCRIPTION	
1	Water Outlet Gasket	1995-91	36023	Water Outlet; Water bypass; New Part Number - Check for Availability	
QTY	WATER PUMP	YEARS	PART NO.	DESCRIPTION	
1	Water Pump Gasket	1995-91	35351		
QTY	TIMING COVER	YEARS	PART NO.	DESCRIPTION	
1	Timing Cover Set	1995	TCS 45840	w/o Sleeve 'N' Seal®; Must be used w/OS 30767R or w/OS 34410R; PermaDryPlus® timing cover gskt. incl.	
1	Timing Cover Set	1994-91	TCS 45840	w/o Sleeve 'N' Seal®; Must be used w/OS 30522R or w/OS 30522T; PermaDryPlus® timing cover gskt. incl.	

GM Car (Incl. Buick, Cad., Chev., Geo, Olds., Pontiac, Saturn) (Cont.)

82 (cont.)		1995 - 1991; 3.8L 231 (3791cc) OHV V6 (12 Valve) 3.8" Bore			82 (cont.)
MFI; Gasoline; Naturally Aspirated GMC Eng.; Buick; VIN Code L					
QTY	TIMING COVER	YEARS	PART NO.	DESCRIPTION	
1	Timing Set w/Sleeve & Seal	1995	TCS 45974	w/Sleeve 'N' Seal®; Must be used w/OS 30767R or w/OS 34410R; PermaDryPlus® timing cover gskt. incl.	
1	Timing Set w/Sleeve & Seal	1994-91	TCS 45974	w/Sleeve 'N' Seal®; Must be used w/OS 30522R or w/OS 30522T; PermaDryPlus® timing cover gskt. incl.	
1	Repair Sleeve	1995-91	16216	Timing Cover; Use w/installation tool	
1	Repair Sleeve Tool	1995-91	16308	Timing Cover	
QTY	CARB & FUEL INJECTION	YEARS	PART NO.	DESCRIPTION	
3	Fuel Injector O-Ring Set	1995-91	ES 70599	Improved design	
1	Throttle Body Gasket	1995-93	61037		
1	Throttle Body Gasket	1992-91	61023		
QTY	EXHAUST GAS RECIRCULATION	YEARS	PART NO.	DESCRIPTION	
1	EGR Gasket	1995-94	70786		
1	EGR Gasket	1993-92	70784		
1	EGR Gasket	1991	72635		
QTY	OIL FILTER MOUNTING	YEARS	PART NO.	DESCRIPTION	
1	Oil Filter Gasket	1995-91	70644		
83		2011 - 2006; 3.9L 242 (3880cc) OHV V6 (12 Valve) 99mm Bore			83
MFI; Gasoline; Naturally Aspirated GMC Eng.; Chevrolet; VIN Code 1					
QTY	CYLINDER HEAD	YEARS	PART NO.	DESCRIPTION	
1	Head Gasket	2011-06	26324 PT	Loc. L.H.; Head bolts not incl.; Head bolt replacement recommended; PermaTorqueMLS® LaserWeld® Technology	
1	Head Gasket	2011-06	26325 PT	Loc. R.H.; Head bolts not incl.; Head bolt replacement recommended; PermaTorqueMLS® LaserWeld® Technology	
1	Head Set	2011-06	HS 26324 PT	Head bolts not incl.; Head bolt replacement recommended; PermaDryPlus® int. manifold gskts. incl.; PermaDry® molded rubber valve cover gskts. incl.; Premium valve stem seals incl.	
2	Head Bolt Set	2011-06	ES 72230	Head bolts w/Washers; Replacement recommended; Improved design	
2	Head Bolt Set	2011-09	ES 72230-1	Head bolts w/Washers; Replacement recommended; Old design	
QTY	CONVERSION SET	YEARS	PART NO.	DESCRIPTION	
1	Gasket Conversion Set	2011-06	CS 26324	PermaDry® molded rubber oil pan gskt. incl.	
QTY	MANIFOLD - INT. & EXH.	YEARS	PART NO.	DESCRIPTION	
1	Int. Manifold Gasket Set	2011-06	MS 98015 T	Valve cover gskts. & Upper set incl.; PermaDryPlus® int. manifold gskts. incl.; Manifold bolts not incl.; Manifold bolt replacement recommended	
1	Plenum Gasket Set	2011-06	MS 96824	Upper set	
1	Int. Manifold Bolt Set	2011-06	ES 72226	Loc. Lower; Replacement recommended	
1	Exh. Manifold Gasket Set	2011-06	MS 96818		
1	Exh. Manifold Gasket Set	2011	MS 97207	OEM style; New Part Number - Check for Availability	
1	Exh. Manifold Gasket Set	2010-09	MS 97207	Exc. Pontiac G6 GT; OEM style; New Part Number - Check for Availability	
QTY	EXHAUST PIPE FLANGE	YEARS	PART NO.	DESCRIPTION	
1	Exhaust Pipe Gasket	2011-06	61310	Flange; Improved design	
1	Exhaust Pipe Gasket	2011	61314	Converter	
1	Exhaust Pipe Gasket	2010-09	61314	Exc. Pontiac G6 GT; Converter	
1	Exhaust Pipe Gasket	2010-09	61443	Pontiac G6 GT; Converter	
1	Exhaust Pipe Gasket	2008	61443	Converter	
1	Exhaust Pipe Gasket	2007-06	61465	Chevrolet Impala LT, LTZ, Monte Carlo LT, LTZ; Converter	
1	Exhaust Pipe Gasket	2007	61443	Chevrolet Malibu Maxx SS, SS Pontiac G6 GT, GTP; Converter	
1	Exhaust Pipe Gasket	2006	61443	Chevrolet Malibu Maxx SS, SS Pontiac G6 GTP; Converter	
QTY	OIL PAN	YEARS	PART NO.	DESCRIPTION	
1	Oil Pan Gasket Set	2011-06	OS 30776 R	PermaDry® molded rubber gskt. incl.	
QTY	CRANKSHAFT REAR SEAL	YEARS	PART NO.	DESCRIPTION	
1	Rear Main Seal Set	2011-06	BS 40625	11.0mm thick; PTFE Rubber; One-piece; Improved design	
1	Rear Main Seal Set	2011-06	BS 40698	PTFE Rubber; One-piece; May use BS 40625 instead; Old design; Superseded - When depleted use BS 40625	
QTY	VALVE COVER	YEARS	PART NO.	DESCRIPTION	
1	Valve Cover Gasket Set	2011-06	VS 50442 R	w/o Grommets; Must be used w/35614; PermaDry® molded rubber gskts. incl.	
1	Grommet Set	2011-06	ES 71044	Valve Cover	
QTY	VALVE STEM SEAL SET	YEARS	PART NO.	DESCRIPTION	
1	Valve Stem Seal Set	2011-06	SS 71039-1	Premium valve stem seals incl.	
QTY	WATER OUTLET GASKET	YEARS	PART NO.	DESCRIPTION	
1	Water Outlet Gasket	2011-06	35815	Water Crossover; Loc. L.H.	
1	Water Outlet Gasket	2011-09	35913	Water Crossover; Loc. R.H.	

GM Car (Incl. Buick, Cad., Chev., Geo, Olds., Pontiac, Saturn) (Cont.)

83		2011 - 2006; 3.9L 242 (3880cc) OHV V6 (12 Valve) 99mm Bore			83	
(cont.)		MFI; Gasoline; Naturally Aspirated GMC Eng.; Chevrolet; VIN Code 1			(cont.)	
QTY	WATER OUTLET GASKET	YEARS	PART NO.	DESCRIPTION		
1	Water Outlet Gasket	2008-06	35816	Water Crossover; Loc. R.H.		
1	Thermostat Gasket	2011-06	35614	Water Outlet; Improved design		
QTY	WATER PUMP	YEARS	PART NO.	DESCRIPTION		
1	Water Pump Gasket	2011-06	35814			
QTY	TIMING COVER	YEARS	PART NO.	DESCRIPTION		
1	Timing Cover Set	2011-06	TCS 46089			
1	Timing Cover Gasket	2011-06	72966	New Part Number - Check for Availability		
QTY	CARB & FUEL INJECTION	YEARS	PART NO.	DESCRIPTION		
1	Throttle Body Gasket	2011-06	61466			
QTY	OIL FILTER MOUNTING	YEARS	PART NO.	DESCRIPTION		
1	Oil Filter Adapter Gasket	2011-06	72423	Improved design		
84		2008 - 2007; 3.9L 242 (3880cc) OHV V6 (12 Valve) 99mm Bore			84	
(cont.)		MFI; Flex Fuel; Naturally Aspirated GMC Eng.; Chevrolet; VIN Code 3			(cont.)	
QTY	CYLINDER HEAD	YEARS	PART NO.	DESCRIPTION		
1	Head Gasket	2008-07	26324 PT	Loc. L.H.; Head bolts not incl.; Head bolt replacement recommended; PermaTorqueMLS® LaserWeld® Technology		
1	Head Gasket	2008-07	26325 PT	Loc. R.H.; Head bolts not incl.; Head bolt replacement recommended; PermaTorqueMLS® LaserWeld® Technology		
1	Head Set	2008-07	HS 26324 PT	Head bolts not incl.; Head bolt replacement recommended; PermaDryPlus® int. manifold gsks. incl.; PermaDry® molded rubber valve cover gsks. incl.; Premium valve stem seals incl.		
2	Head Bolt Set	2008-07	ES 72230	Head bolts w/Washers; Replacement recommended; Improved design		
QTY	CONVERSION SET	YEARS	PART NO.	DESCRIPTION		
1	Gasket Conversion Set	2008-07	CS 26324	PermaDry® molded rubber oil pan gskt. incl.		
QTY	MANIFOLD - INT. & EXH.	YEARS	PART NO.	DESCRIPTION		
1	Int. Manifold Gasket Set	2008-07	MS 98015 T	Valve cover gsks. & Upper set incl.; PermaDryPlus® int. manifold gsks. incl.; Manifold bolts not incl.; Manifold bolt replacement recommended		
1	Plenum Gasket Set	2008-07	MS 96824	Upper set		
1	Int. Manifold Bolt Set	2008-07	ES 72226	Loc. Lower; Replacement recommended		
1	Exh. Manifold Gasket Set	2008-07	MS 96818			
QTY	EXHAUST PIPE FLANGE	YEARS	PART NO.	DESCRIPTION		
1	Exhaust Pipe Gasket	2008-07	61310	Flange; Improved design		
1	Exhaust Pipe Gasket	2008-07	61465	Converter		
QTY	OIL PAN	YEARS	PART NO.	DESCRIPTION		
1	Oil Pan Gasket Set	2008-07	OS 30776 R	PermaDry® molded rubber gskt. incl.		
QTY	CRANKSHAFT REAR SEAL	YEARS	PART NO.	DESCRIPTION		
1	Rear Main Seal Set	2008-07	BS 40625	11.0mm thick; PTFE Rubber; One-piece; Improved design		
1	Rear Main Seal Set	2008-07	BS 40698	PTFE Rubber; One-piece; May use BS 40625 instead; Old design; Superseded - When depleted use BS 40625		
QTY	VALVE COVER	YEARS	PART NO.	DESCRIPTION		
1	Valve Cover Gasket Set	2008-07	VS 50442 R	w/o Grommets; Must be used w/35614; PermaDry® molded rubber gsks. incl.		
1	Grommet Set	2008-07	ES 71044	Valve Cover		
QTY	VALVE STEM SEAL SET	YEARS	PART NO.	DESCRIPTION		
1	Valve Stem Seal Set	2008-07	SS 71039-1	Premium valve stem seals incl.		
QTY	WATER OUTLET GASKET	YEARS	PART NO.	DESCRIPTION		
1	Water Outlet Gasket	2008-07	35815	Water Crossover; Loc. L.H.		
1	Water Outlet Gasket	2008-07	35816	Water Crossover; Loc. R.H.		
1	Thermostat Gasket	2008-07	35614	Water Outlet; Improved design		
QTY	WATER PUMP	YEARS	PART NO.	DESCRIPTION		
1	Water Pump Gasket	2008-07	35814			
QTY	TIMING COVER	YEARS	PART NO.	DESCRIPTION		
1	Timing Cover Set	2008-07	TCS 46089			
1	Timing Cover Gasket	2008-07	72966	New Part Number - Check for Availability		
QTY	CARB & FUEL INJECTION	YEARS	PART NO.	DESCRIPTION		
1	Throttle Body Gasket	2008-07	61466			
QTY	OIL FILTER MOUNTING	YEARS	PART NO.	DESCRIPTION		
1	Oil Filter Adapter Gasket	2008-07	72423	Improved design		

GM Car (Incl. Buick, Cad., Chev., Geo, Olds., Pontiac, Saturn) (Cont.)

85		2011 - 2009; 3.9L 242 (3880cc) OHV V6 (12 Valve) 99mm Bore			85
MFI; Flex Fuel; Naturally Aspirated GMC Eng.; Chevrolet; VIN Code M					
QTY	CYLINDER HEAD	YEARS	PART NO.	DESCRIPTION	
1	Head Gasket	2011-09	26324 PT	Loc. L.H.; Head bolts not incl.; Head bolt replacement recommended; PermaTorqueMLS® LaserWeld® Technology	
1	Head Gasket	2011-09	26325 PT	Loc. R.H.; Head bolts not incl.; Head bolt replacement recommended; PermaTorqueMLS® LaserWeld® Technology	
1	Head Set	2011-09	HS 26324 PT	Head bolts not incl.; Head bolt replacement recommended; PermaDryPlus® int. manifold gskts. incl.; PermaDry® molded rubber valve cover gskts. incl.; Premium valve stem seals incl.	
2	Head Bolt Set	2011-09	ES 72230	Head bolts w/Washers; Replacement recommended; Improved design	
2	Head Bolt Set	2011-09	ES 72230-1	Head bolts w/Washers; Replacement recommended; Old design	
QTY	CONVERSION SET	YEARS	PART NO.	DESCRIPTION	
1	Gasket Conversion Set	2011-09	CS 26324	PermaDry® molded rubber oil pan gskt. incl.	
QTY	MANIFOLD - INT. & EXH.	YEARS	PART NO.	DESCRIPTION	
1	Int. Manifold Gasket Set	2011-09	MS 98015 T	Valve cover gskts. & Upper set incl.; PermaDryPlus® int. manifold gskts. incl.; Manifold bolts not incl.; Manifold bolt replacement recommended	
1	Plenum Gasket Set	2011-09	MS 96824	Upper set	
1	Int. Manifold Bolt Set	2011-09	ES 72226	Loc. Lower; Replacement recommended	
1	Exh. Manifold Gasket Set	2011-09	MS 96818		
1	Exh. Manifold Gasket Set	2011	MS 97207	Exc. Chevrolet Impala LT, LTZ, PPV; OEM style; New Part Number - Check for Availability	
1	Exh. Manifold Gasket Set	2010	MS 97207	Exc. Chevrolet Impala LT, LTZ; OEM style; New Part Number - Check for Availability	
1	Exh. Manifold Gasket Set	2009	MS 97207	Buick Lucerne CX, CXL; OEM style; New Part Number - Check for Availability	
QTY	EXHAUST PIPE FLANGE	YEARS	PART NO.	DESCRIPTION	
1	Exhaust Pipe Gasket	2011-09	61310	Flange; Improved design	
1	Exhaust Pipe Gasket	2011	61314	Exc. Chevrolet Impala LT, LTZ, PPV; Converter	
1	Exhaust Pipe Gasket	2011	61465	Chevrolet Impala LT, LTZ, PPV; Converter	
1	Exhaust Pipe Gasket	2010-09	61465	Chevrolet Impala LT, LTZ; Converter	
1	Exhaust Pipe Gasket	2010	61314	Exc. Chevrolet Impala LT, LTZ; Converter	
1	Exhaust Pipe Gasket	2009	61314	Buick Lucerne CX, CXL; Converter	
QTY	OIL PAN	YEARS	PART NO.	DESCRIPTION	
1	Oil Pan Gasket Set	2011-09	OS 30776 R	PermaDry® molded rubber gskt. incl.	
QTY	CRANKSHAFT REAR SEAL	YEARS	PART NO.	DESCRIPTION	
1	Rear Main Seal Set	2011-09	BS 40625	11.0mm thick; PTFE Rubber; One-piece; Improved design	
1	Rear Main Seal Set	2011-09	BS 40698	PTFE Rubber; One-piece; May use BS 40625 instead; Old design; Superseded - When depleted use BS 40625	
QTY	VALVE COVER	YEARS	PART NO.	DESCRIPTION	
1	Valve Cover Gasket Set	2011-09	VS 50442 R	w/o Grommets; Must be used w/35614; PermaDry® molded rubber gskts. incl.	
1	Grommet Set	2011-09	ES 71044	Valve Cover	
QTY	VALVE STEM SEAL SET	YEARS	PART NO.	DESCRIPTION	
1	Valve Stem Seal Set	2011-09	SS 71039-1	Premium valve stem seals incl.	
QTY	WATER OUTLET GASKET	YEARS	PART NO.	DESCRIPTION	
1	Water Outlet Gasket	2011-09	35815	Water Crossover; Loc. L.H.	
1	Water Outlet Gasket	2011-09	35913	Water Crossover; Loc. R.H.	
1	Thermostat Gasket	2011-09	35614	Water Outlet; Improved design	
QTY	WATER PUMP	YEARS	PART NO.	DESCRIPTION	
1	Water Pump Gasket	2011-09	35814		
QTY	TIMING COVER	YEARS	PART NO.	DESCRIPTION	
1	Timing Cover Set	2011-09	TCS 46089		
1	Timing Cover Gasket	2011-09	72966	New Part Number - Check for Availability	
QTY	CARB & FUEL INJECTION	YEARS	PART NO.	DESCRIPTION	
1	Throttle Body Gasket	2011-09	61466		
QTY	OIL FILTER MOUNTING	YEARS	PART NO.	DESCRIPTION	
1	Oil Filter Adapter Gasket	2011-09	72423	Improved design	
86		2009 - 2007; 3.9L 242 (3880cc) OHV V6 (12 Valve) 99mm Bore			86
MFI; Gasoline; Naturally Aspirated GMC Eng.; Chevrolet; VIN Code R					
QTY	CYLINDER HEAD	YEARS	PART NO.	DESCRIPTION	
1	Head Gasket	2009-07	26324 PT	Loc. L.H.; Head bolts not incl.; Head bolt replacement recommended; PermaTorqueMLS® LaserWeld® Technology	
1	Head Gasket	2009-07	26325 PT	Loc. R.H.; Head bolts not incl.; Head bolt replacement recommended; PermaTorqueMLS® LaserWeld® Technology	

GM Car (Incl. Buick, Cad., Chev., Geo, Olds., Pontiac, Saturn) (Cont.)

86 (cont.)		2009 - 2007; 3.9L 242 (3880cc) OHV V6 (12 Valve) 99mm Bore			86 (cont.)
MFI; Gasoline; Naturally Aspirated GMC Eng.; Chevrolet; VIN Code R					
QTY	CYLINDER HEAD	YEARS	PART NO.	DESCRIPTION	
1	Head Set	2009-07	HS 26324 PT	Head bolts not incl.; Head bolt replacement recommended; PermaDryPlus® int. manifold gskts. incl.; PermaDry® molded rubber valve cover gskts. incl.; Premium valve stem seals incl.	
2	Head Bolt Set	2009-07	ES 72230	Head bolts w/Washers; Replacement recommended; Improved design	
QTY	CONVERSION SET	YEARS	PART NO.	DESCRIPTION	
1	Gasket Conversion Set	2009-07	CS 26324	PermaDry® molded rubber oil pan gskt. incl.	
QTY	MANIFOLD - INT. & EXH.	YEARS	PART NO.	DESCRIPTION	
1	Int. Manifold Gasket Set	2009-07	MS 98015 T	Valve cover gskts. & Upper set incl.; PermaDryPlus® int. manifold gskts. incl.; Manifold bolts not incl.; Manifold bolt replacement recommended	
1	Plenum Gasket Set	2009-07	MS 96824	Upper set	
1	Int. Manifold Bolt Set	2009-07	ES 72226	Loc. Lower; Replacement recommended	
1	Exh. Manifold Gasket Set	2009-07	MS 96818		
QTY	EXHAUST PIPE FLANGE	YEARS	PART NO.	DESCRIPTION	
1	Exhaust Pipe Gasket	2009-07	61310	Flange; Improved design	
1	Exhaust Pipe Gasket	2009-07	61465	Converter	
QTY	OIL PAN	YEARS	PART NO.	DESCRIPTION	
1	Oil Pan Gasket Set	2009-07	OS 30776 R	PermaDry® molded rubber gskt. incl.	
QTY	CRANKSHAFT REAR SEAL	YEARS	PART NO.	DESCRIPTION	
1	Rear Main Seal Set	2009-07	BS 40625	11.0mm thick; PTFE Rubber; One-piece; Improved design	
1	Rear Main Seal Set	2009-07	BS 40698	PTFE Rubber; One-piece; May use BS 40625 instead; Old design; Superseded - When depleted use BS 40625	
QTY	VALVE COVER	YEARS	PART NO.	DESCRIPTION	
1	Valve Cover Gasket Set	2009-07	VS 50442 R	w/o Grommets; Must be used w/35614; PermaDry® molded rubber gskts. incl.	
1	Grommet Set	2009-07	ES 71044	Valve Cover	
QTY	VALVE STEM SEAL SET	YEARS	PART NO.	DESCRIPTION	
1	Valve Stem Seal Set	2009-07	SS 71039-1	Premium valve stem seals incl.	
QTY	WATER OUTLET GASKET	YEARS	PART NO.	DESCRIPTION	
1	Water Outlet Gasket	2009-07	35815	Water Crossover; Loc. L.H.	
1	Water Outlet Gasket	2009	35913	Water Crossover; Loc. R.H.	
1	Water Outlet Gasket	2008-07	35816	Water Crossover; Loc. R.H.	
1	Thermostat Gasket	2009-07	35614	Water Outlet; Improved design	
QTY	WATER PUMP	YEARS	PART NO.	DESCRIPTION	
1	Water Pump Gasket	2009-07	35814		
QTY	TIMING COVER	YEARS	PART NO.	DESCRIPTION	
1	Timing Cover Set	2009-07	TCS 46089		
1	Timing Cover Gasket	2009-07	72966	New Part Number - Check for Availability	
QTY	CARB & FUEL INJECTION	YEARS	PART NO.	DESCRIPTION	
1	Throttle Body Gasket	2009-07	61466		
QTY	OIL FILTER MOUNTING	YEARS	PART NO.	DESCRIPTION	
1	Oil Filter Adapter Gasket	2009-07	72423	Improved design	
87		2003 - 1995; 4.0L 244 (3995cc) DOHC V8 (32 Valve) 87mm Bore Northstar			87
MFI; Gasoline; Naturally Aspirated GMC Eng.; Oldsmobile; VIN Code C					
QTY	CYLINDER HEAD	YEARS	PART NO.	DESCRIPTION	
1	Head Gasket	2003-01	26152 PT	Loc. L.H.; Head bolts not incl.; Head bolt replacement recommended	
1	Head Gasket	2003-01	26153 PT	Loc. R.H.; Head bolts not incl.; Head bolt replacement recommended	
1	Head Gasket	1999-95	26152 PT	Loc. L.H.; Head bolts not incl.; Head bolt replacement recommended	
1	Head Gasket	1999-95	26153 PT	Loc. R.H.; Head bolts not incl.; Head bolt replacement recommended	
1	Head Set	2003-02	HS 26152 PT-2	Head bolts & exh. pipe packing not incl.; Head bolt replacement recommended; Must be used w/TCS 46013; PermaDry® molded rubber valve cover gskts. incl.; Premium valve stem seals incl.	
1	Head Set	2001	HS 26152 PT-1	Head bolts & exh. pipe packing not incl.; Head bolt replacement recommended; Must be used w/TCS 46013; PermaDry® molded rubber valve cover gskts. incl.; Premium valve stem seals incl.	
1	Head Set	1999-95	HS 26152 PT	Head bolts & exh. pipe packing not incl.; Head bolt replacement recommended; Must be used w/TCS 46012 or w/TCS 46018; PermaDry® molded rubber valve cover gskts. incl.; Premium valve stem seals incl.	
2	Head Bolt Set	2003-01	ES 72187	Head bolts w/Washers; Replacement recommended	
2	Head Bolt Set	1999-95	ES 72186	Head bolts w/Washers; Replacement recommended	
QTY	CONVERSION SET	YEARS	PART NO.	DESCRIPTION	
1	Gasket Conversion Set	2003-01	CS 26150-3	PermaDry® molded rubber oil pan gskt. incl.	
1	Gasket Conversion Set	1999	CS 26150-2	PermaDry® molded rubber oil pan gskt. incl.	

GM Car (Incl. Buick, Cad., Chev., Geo, Olds., Pontiac, Saturn) (Cont.)

87 (cont.)	2003 - 1995; 4.0L 244 (3995cc) DOHC V8 (32 Valve) 87mm Bore Northstar MFI; Gasoline; Naturally Aspirated GMC Eng.; Oldsmobile; VIN Code C				87 (cont.)
QTY	CONVERSION SET	YEARS	PART NO.	DESCRIPTION	
1	Gasket Conversion Set	1998	CS 26150-1	1st Design; w/o Part number stamp on timing cover; PermaDry® molded rubber oil pan gskt. incl.	
1	Gasket Conversion Set	1998	CS 26150-2	2nd Design; w/Part number stamp on timing cover; PermaDry® molded rubber oil pan gskt. incl.	
1	Gasket Conversion Set	1997-96	CS 26150-1	2nd Design; 12.0mm thick rear main brg. seal; PermaDry® molded rubber oil pan gskt. incl.	
1	Gasket Conversion Set	1996-95	CS 26150	1st Design; 9.0mm thick rear main brg. seal; PermaDry® molded rubber oil pan gskt. incl.	
QTY	MANIFOLD - INT. & EXH.	YEARS	PART NO.	DESCRIPTION	
1	Int. Manifold Gasket Set	2003-01	MS 93313		
1	Int. Manifold Gasket Set	1999-95	MS 93222		
1	Exh. Manifold Gasket Set	2003-01	MS 93371		
1	Exh. Manifold Gasket Set	1999-95	MS 93455		
QTY	EXHAUST PIPE FLANGE	YEARS	PART NO.	DESCRIPTION	
1	Exhaust Pipe Gasket	2003-01	61009	Loc. L.H.; Pipe to manifold	
1	Exhaust Pipe Gasket	2003-01	61009	Loc. Rear	
1	Exhaust Pipe Gasket	2003-01	61129	Loc. R.H.; Pipe to manifold; Old design; Superseded - When depleted use 61431	
1	Exhaust Pipe Gasket	2003-01	61431	Loc. R.H.; Pipe to manifold; Improved design	
1	Exhaust Pipe Gasket	1999-95	61009	Pipe to manifold	
1	Exhaust Pipe Gasket	1999-96	61009	Loc. Rear	
1	Exhaust Pipe Gasket	1995	61017	Loc. Rear; 2.265" ID x 3.015" OD	
QTY	OIL PAN	YEARS	PART NO.	DESCRIPTION	
1	Oil Pan Gasket Set	2003-01	OS 30704 R	PermaDry® molded rubber gskt. incl.	
1	Oil Pan Gasket Set	1999-95	OS 30704 R	PermaDry® molded rubber gskt. incl.	
QTY	CRANKSHAFT REAR SEAL	YEARS	PART NO.	DESCRIPTION	
1	Rear Main Seal Set	2003-01	BS 40670	2nd Design; 12.0mm thick; PTFE Rubber; One-piece	
1	Rear Main Seal Set	1999-96	BS 40670	2nd Design; 12.0mm thick; PTFE Rubber; One-piece	
1	Rear Main Seal Set	1996-95	BS 40669	1st Design; 9.0mm thick; Rubber; One-piece	
QTY	VALVE COVER	YEARS	PART NO.	DESCRIPTION	
1	Valve Cover Gasket Set	2003-01	VS 50526 R	w/Grommets & Spark plug tube seals; PermaDry® molded rubber gskts. incl.	
1	Valve Cover Gasket Set	1999-95	VS 50524 R	w/Grommets & Spark plug tube seals; PermaDry® molded rubber gskts. incl.	
QTY	VALVE STEM SEAL SET	YEARS	PART NO.	DESCRIPTION	
2	Valve Stem Seal Set	2003-02	SS 71043	Premium valve stem seals incl.	
2	Valve Stem Seal Set	2001	SS 71042	Premium valve stem seals incl.	
2	Valve Stem Seal Set	1999-95	SS 71146	Premium valve stem seals incl.	
QTY	WATER OUTLET GASKET	YEARS	PART NO.	DESCRIPTION	
1	Water Outlet Gasket	2003-01	35346	Water Outlet	
1	Water Outlet Gasket	1999-95	35346	Water Outlet	
QTY	WATER PUMP	YEARS	PART NO.	DESCRIPTION	
2	Water Pump Gasket	2003-01	35656	Loc. Lower; To block	
2	Water Pump Gasket	2003-01	35659	Loc. Upper; To block	
1	Water Pump Gasket	2003-01	35794	Body cover; Improved design	
2	Water Pump Gasket	1999-95	35656	Loc. Lower; To block	
2	Water Pump Gasket	1999-95	35658	Loc. Upper; To block	
1	Water Pump Gasket	1999-95	35794	Body cover; Improved design	
QTY	TIMING COVER	YEARS	PART NO.	DESCRIPTION	
1	Timing Cover Gasket	2003-01	72673	New Part Number - Check for Availability	
1	Timing Cover Gasket	1999	72673	New Part Number - Check for Availability	
1	Timing Cover Gasket	1998	72673	2nd Design; w/Part number stamp on timing cover; New Part Number - Check for Availability	
1	Crankshaft Front Seal Set	2003-01	TCS 46013		
1	Crankshaft Front Seal Set	1999	TCS 46018		
1	Crankshaft Front Seal Set	1998	TCS 46012	1st Design; w/o Part number stamp on timing cover	
1	Crankshaft Front Seal Set	1998	TCS 46018	2nd Design; w/Part number stamp on timing cover	
1	Crankshaft Front Seal Set	1997-95	TCS 46012		
1	Camshaft Rear Seal Set	2003-01	TCS 46011		
1	Camshaft Rear Seal Set	1999-95	TCS 46011		
QTY	CARB & FUEL INJECTION	YEARS	PART NO.	DESCRIPTION	
4	Fuel Injector O-Ring Set	2003-01	ES 70599	Improved design	
1	Throttle Body Gasket	2003-01	61125		
1	Throttle Body Gasket	1999-95	61113	Spacer to manifold	
1	Throttle Body Gasket	1999-96	61111	Throttle body to spacer	
1	Throttle Body Gasket	1995	61318	Throttle body to spacer	

GM Car (Incl. Buick, Cad., Chev., Geo, Olds., Pontiac, Saturn) (Cont.)

87		2003 - 1995; 4.0L 244 (3995cc) DOHC V8 (32 Valve) 87mm Bore Northstar			87	
(cont.)		MFI; Gasoline; Naturally Aspirated GMC Eng.; Oldsmobile; VIN Code C			(cont.)	
QTY	EXHAUST GAS RECIRCULATION	YEARS	PART NO.	DESCRIPTION		
1	EGR Gasket	2003-01	70914	Valve		
1	EGR Gasket	1999-95	70788	Valve		
88		1993 - 1991; 4.3L 262 (4294cc) OHV V6 (12 Valve) 4" Bore			88	
		TBI; Gasoline; Naturally Aspirated GMC Eng.; Chevrolet; VIN Code Z				
QTY	CYLINDER HEAD	YEARS	PART NO.	DESCRIPTION		
2	Head Gasket	1993-91	510 SD	Head bolts not incl.; Head bolt replacement recommended; PermaTorque Severe Duty®		
2	Head Gasket	1993-91	522 SD	Head bolts not incl.; Head bolt replacement recommended; PermaTorque Severe Duty® MLS		
2	Head Gasket	1993-91	9354 PT-1	Head bolts not incl.; Head bolt replacement recommended; PermaTorque®		
1	Head Set	1993	HS 9354 PT-2	Head bolts & exh. pipe packing not incl.; Head bolt replacement recommended; PermaDry® molded rubber valve cover gskts. incl.; Premium valve stem seals incl.		
1	Head Set	1992	HS 9354 PT-1	Head bolts & exh. pipe packing not incl.; Head bolt replacement recommended; PermaDry® molded rubber valve cover gskts. incl.; Premium valve stem seals incl.		
1	Head Set	1991	HS 9354 PT	Head bolts not incl.; Head bolt replacement recommended; PermaDry® molded rubber valve cover gskts. incl.; Premium valve stem seals incl.		
2	Head Bolt Set	1993-91	ES 74034	Replacement recommended		
QTY	CONVERSION SET	YEARS	PART NO.	DESCRIPTION		
1	Gasket Conversion Set	1993-91	CS 9354-1	PermaDry® molded rubber oil pan gskt. incl.		
QTY	MANIFOLD - INT. & EXH.	YEARS	PART NO.	DESCRIPTION		
1	Int. Manifold Gasket Set	1993	MS 93346-1			
1	Int. Manifold Gasket Set	1992	MS 93346			
1	Int. Manifold Gasket Set	1991	MS 93040			
1	Exh. Manifold Gasket Set	1993-91	MS 90746			
QTY	EXHAUST PIPE FLANGE	YEARS	PART NO.	DESCRIPTION		
2	Exhaust Pipe Gasket	1993-92	60718	Packing; 2 3/32" ID Steel sleeve		
2	Exhaust Pipe Gasket	1991	60771	Flange		
QTY	FUEL PUMP	YEARS	PART NO.	DESCRIPTION		
1	Fuel Pump Mounting Gasket	1993-91	71097	Plate		
QTY	OIL PAN	YEARS	PART NO.	DESCRIPTION		
1	Oil Pan Gasket Set	1993-91	OS 34502 R	PermaDry® molded rubber gskt. incl.		
1	Drain Plug Gasket	1993-91	70822			
QTY	CRANKSHAFT REAR SEAL	YEARS	PART NO.	DESCRIPTION		
1	Rear Main Seal Set	1993-91	BS 40520	Rubber; One-piece		
1	Rear Main Seal Set	1993-91	BS 40626	PTFE Rubber; One-piece		
1	Repair Sleeve	1993-91	16258	Crankshaft; Use w/installation tool		
1	Repair Sleeve Tool	1993-91	16301	Crankshaft		
QTY	VALVE COVER	YEARS	PART NO.	DESCRIPTION		
1	Valve Cover Gasket Set	1993-91	VS 50086 R	Services both covers; PermaDry® molded rubber gskts. incl.		
2	Valve Cover Gasket Set	1993-91	VS 50277 R	Services one cover only; PermaDry® molded rubber gskt. incl.		
QTY	VALVE STEM SEAL SET	YEARS	PART NO.	DESCRIPTION		
1	Valve Stem Seal Set	1993-91	SS 72530	Loc. Int.; Premium valve stem seals incl.		
1	Valve Stem Seal Set	1993-91	SS 72876	Loc. Exh.; Opt. Hi-Temp. premium valve stem seals incl.		
QTY	THERMOSTAT HOUSING	YEARS	PART NO.	DESCRIPTION		
1	O-Ring	1993-92	35710	Thermostat Housing; 1.954" ID; Improved design		
QTY	WATER OUTLET GASKET	YEARS	PART NO.	DESCRIPTION		
1	Water Outlet Gasket	1993-91	35062	Water Outlet; 1 13/16" ID		
1	Water Outlet Gasket	1993-91	35562 T	Water Outlet; 1 13/16" ID; PermaDryPlus®		
QTY	WATER PUMP	YEARS	PART NO.	DESCRIPTION		
1	Water Pump Gasket	1993-91	13032	To plate		
2	Water Pump Gasket	1993-91	5152	To block		
QTY	TIMING COVER	YEARS	PART NO.	DESCRIPTION		
1	Timing Cover Set	1993-91	TCS 45121	w/o Sleeve 'N' Seal®; Must be used w/OS 34502R		
1	Timing Set w/Sleeve & Seal	1993-91	TCS 45265	w/Sleeve 'N' Seal®; Must be used w/OS 34502R		
1	Repair Sleeve	1993-91	16202	Timing Cover; Use w/installation tool		
1	Repair Sleeve Tool	1993-91	16312	Timing Cover		
QTY	AIR CLEANER MOUNTING	YEARS	PART NO.	DESCRIPTION		
1	Air Cleaner Gasket	1993-91	60038	5 1/32" ID		
QTY	CARB & FUEL INJECTION	YEARS	PART NO.	DESCRIPTION		
1	Throttle Body Gasket	1993-91	60903			
QTY	DISTRIBUTOR MOUNTING	YEARS	PART NO.	DESCRIPTION		
1	Distributor Mounting Gasket	1993-91	70056			

GM Car (Incl. Buick, Cad., Chev., Geo, Olds., Pontiac, Saturn) (Cont.)

88		1993 - 1991; 4.3L 262 (4294cc) OHV V6 (12 Valve) 4" Bore			88
(cont.)		TBI; Gasoline; Naturally Aspirated GMC Eng.; Chevrolet; VIN Code Z			(cont.)
QTY	EXHAUST GAS RECIRCULATION	YEARS	PART NO.	DESCRIPTION	
1	EGR Gasket	1993-91	70978		
QTY	OIL PUMP RETAINER	YEARS	PART NO.	DESCRIPTION	
1	Oil Pump Shaft Guide	1993-91	72665	Distributor to oil pump shaft retainer	
89		1996 - 1994; 4.3L 265 (4343cc) OHV V8 (16 Valve) 3.736" Bore LT-1			89
(cont.)		MFI; Gasoline; Naturally Aspirated GMC Eng.; Chevrolet; VIN Code W			(cont.)
QTY	CYLINDER HEAD	YEARS	PART NO.	DESCRIPTION	
2	Head Gasket	1996-94	9085 PT	Head bolts not incl.; Head bolt replacement recommended	
1	Head Set	1996-94	HS 9085 PT	Head bolts not incl.; Head bolt replacement recommended; PermaDry® molded rubber valve cover gskts. incl.; Premium valve stem seals incl.	
2	Head Bolt Set	1996-94	ES 72856	Replacement recommended	
QTY	CONVERSION SET	YEARS	PART NO.	DESCRIPTION	
1	Gasket Conversion Set	1996-94	CS 9966	PermaDry® molded rubber oil pan gskt. incl.	
QTY	MANIFOLD - INT. & EXH.	YEARS	PART NO.	DESCRIPTION	
1	Int. Manifold Gasket Set	1996-94	MS 95580		
1	Exh. Manifold Gasket Set	1996-94	MS 95585		
QTY	EXHAUST PIPE FLANGE	YEARS	PART NO.	DESCRIPTION	
2	Exhaust Pipe Gasket	1996-94	60988	Flange	
QTY	OIL PAN	YEARS	PART NO.	DESCRIPTION	
1	Oil Pan Gasket Set	1996-94	OS 34500 R	PermaDry® molded rubber gskt. incl.	
1	Drain Plug Gasket	1996-94	70822		
QTY	CRANKSHAFT REAR SEAL	YEARS	PART NO.	DESCRIPTION	
1	Rear Main Seal Set	1996-94	BS 40520	Rubber; One-piece	
1	Rear Main Seal Set	1996-94	BS 40626	PTFE Rubber; One-piece	
1	Repair Sleeve	1996-94	16258	Crankshaft; Use w/installation tool	
1	Repair Sleeve Tool	1996-94	16301	Crankshaft	
QTY	VALVE COVER	YEARS	PART NO.	DESCRIPTION	
1	Valve Cover Gasket Set	1996-94	VS 50088 R	Services both covers; PermaDry® molded rubber gskts. incl.	
2	Valve Cover Gasket Set	1996-94	VS 50293 R	Services one cover only; PermaDry® molded rubber gskt. incl.	
QTY	VALVE STEM SEAL SET	YEARS	PART NO.	DESCRIPTION	
1	Valve Stem Seal Set	1996-94	SS 72861	Premium valve stem seals incl.; Improved design	
QTY	WATER OUTLET GASKET	YEARS	PART NO.	DESCRIPTION	
1	O-Ring	1996-94	35710	Water Outlet; 1.954" ID; Improved design	
QTY	WATER PUMP	YEARS	PART NO.	DESCRIPTION	
2	Water Pump Gasket	1996-94	35072		
QTY	TIMING COVER	YEARS	PART NO.	DESCRIPTION	
1	Timing Cover Set	1996-94	TCS 45956	Must be used w/OS 34500R	
1	Repair Sleeve	1996-94	16202	Timing Cover; Use w/installation tool	
1	Repair Sleeve Tool	1996-94	16312	Timing Cover	
QTY	CARB & FUEL INJECTION	YEARS	PART NO.	DESCRIPTION	
4	Fuel Injector O-Ring Set	1996-94	ES 70599	Improved design	
1	Throttle Body Gasket	1996-94	60655		
QTY	EXHAUST GAS RECIRCULATION	YEARS	PART NO.	DESCRIPTION	
1	EGR Gasket	1996-94	70978		
QTY	OIL PUMP RETAINER	YEARS	PART NO.	DESCRIPTION	
1	Oil Pump Shaft Guide	1996-94	72665	Distributor to oil pump shaft retainer	
QTY	OIL COOLER	YEARS	PART NO.	DESCRIPTION	
1	Oil Cooler Mounting Set	1996-94	ES 70687		
90		1992 - 1991; 4.5L 273 (4474cc) OHV V8 (16 Valve) 92mm Bore			90
(cont.)		MFI; Gasoline; Naturally Aspirated GMC Eng.; Cadillac; VIN Code 8			(cont.)
QTY	CYLINDER HEAD	YEARS	PART NO.	DESCRIPTION	
2	Head Gasket	1992-91	8753 PT-1		
1	Head Set	1992-91	HS 8753 PT-4	Exh. pipe packing & valve cover grommets not incl.; PermaDry® molded rubber valve cover gskts. incl.; Premium valve stem seals incl.	
QTY	CONVERSION SET	YEARS	PART NO.	DESCRIPTION	
1	Gasket Conversion Set	1992-91	CS 8753-2		
QTY	MANIFOLD - INT. & EXH.	YEARS	PART NO.	DESCRIPTION	
1	Int. Manifold Gasket Set	1992-91	MS 94548	Upper set incl.; Must be used w/VS 50074R	
1	Plenum Gasket Set	1992-91	MS 94613	Upper set	
1	Exh. Manifold Gasket Set	1992-91	MS 94250		
QTY	EXHAUST PIPE FLANGE	YEARS	PART NO.	DESCRIPTION	
1	Exhaust Pipe Gasket	1992-91	60854	Pipe to manifold	

GM Car (Incl. Buick, Cad., Chev., Geo, Olds., Pontiac, Saturn) (Cont.)

90 (cont.)		1992 - 1991; 4.5L 273 (4474cc) OHV V8 (16 Valve) 92mm Bore			90 (cont.)
MFI; Gasoline; Naturally Aspirated GMC Eng.; Cadillac; VIN Code 8					
QTY	EXHAUST PIPE FLANGE	YEARS	PART NO.	DESCRIPTION	
1	Exhaust Pipe Gasket	1992-91	61013	Converter	
1	Exh. Flange Bolt & Spring Kit	1992-91	ES 72141		
QTY	OIL PAN	YEARS	PART NO.	DESCRIPTION	
1	Oil Pan Gasket Set	1992-91	OS 30525 C	Cork	
1	Oil Pan Gasket Set	1992-91	OS 30525 T	PermaDryPlus®; Oil Pan SnapUps® incl.	
1	Drain Plug Gasket	1992-91	70822		
QTY	CRANKSHAFT REAR SEAL	YEARS	PART NO.	DESCRIPTION	
1	Rear Main Seal Set	1992-91	BS 40396	Rubber; One-piece	
QTY	VALVE COVER	YEARS	PART NO.	DESCRIPTION	
1	Valve Cover Gasket Set	1992-91	VS 50074 R	w/o Grommets; Services both covers; When servicing Rear valve cover use w/Int. manifold upper set MS 94613; PermaDry® molded rubber gskts. incl.	
2	Valve Cover Gasket Set	1992-91	VS 50315 R	w/o Grommets; Services one cover only; When servicing Rear valve cover use w/Int. manifold upper set MS 94613; PermaDry® molded rubber gskt. incl.	
1	Grommet Set	1992-91	ES 72833	Valve Cover	
QTY	VALVE STEM SEAL SET	YEARS	PART NO.	DESCRIPTION	
1	Valve Stem Seal Set	1992-91	SS 72564	Premium valve stem seals incl.	
QTY	WATER OUTLET GASKET	YEARS	PART NO.	DESCRIPTION	
1	Water Outlet Gasket	1992-91	35346	Water Outlet	
QTY	WATER PUMP	YEARS	PART NO.	DESCRIPTION	
1	Water Pump Gasket	1992-91	35345	Inlet	
1	Water Pump Gasket	1992-91	35388	Housing	
QTY	TIMING COVER	YEARS	PART NO.	DESCRIPTION	
1	Timing Cover Set	1992-91	TCS 45522-2		
QTY	AIR CLEANER MOUNTING	YEARS	PART NO.	DESCRIPTION	
1	Air Cleaner Gasket	1992-91	60038	5 1/32" ID	
QTY	CARB & FUEL INJECTION	YEARS	PART NO.	DESCRIPTION	
4	Fuel Injector O-Ring Set	1992-91	ES 70599	Improved design	
QTY	DISTRIBUTOR MOUNTING	YEARS	PART NO.	DESCRIPTION	
1	O-Ring	1992-91	425 RR	Distributor Mounting	
QTY	EXHAUST GAS RECIRCULATION	YEARS	PART NO.	DESCRIPTION	
1	EGR Gasket	1992-91	70954		
91		2011; 4.6L 281 (4565cc) DOHC V8 (32 Valve) 93mm Bore Northstar			91
MFI; Gasoline; Naturally Aspirated GMC Eng.; Cadillac; VIN Code 6					
QTY	CYLINDER HEAD	YEARS	PART NO.	DESCRIPTION	
1	Head Gasket	2011	26150 PT	Loc. L.H.; Head bolts not incl.; Head bolt replacement recommended	
1	Head Gasket	2011	26151 PT	Loc. R.H.; Head bolts not incl.; Head bolt replacement recommended	
1	Head Set	2011	HS 26150 PT-4	Head bolts not incl.; Head bolt replacement recommended; Must be used w/TCS 46076; PermaDry® molded rubber valve cover gskts. incl.; Premium valve stem seals incl.	
2	Head Bolt Set	2011	ES 72217	Head bolts w/Washers; Replacement recommended	
QTY	CONVERSION SET	YEARS	PART NO.	DESCRIPTION	
1	Gasket Conversion Set	2011	CS 26150-4	PermaDry® molded rubber oil pan gskt. incl.	
QTY	MANIFOLD - INT. & EXH.	YEARS	PART NO.	DESCRIPTION	
1	Int. Manifold Gasket Set	2011	MS 96716		
1	Exh. Manifold Gasket Set	2011	MS 93371		
QTY	EXHAUST PIPE FLANGE	YEARS	PART NO.	DESCRIPTION	
2	Exhaust Pipe Gasket	2011	61009	Crossover	
1	Exhaust Pipe Gasket	2011	61311	Converter	
1	Exhaust Pipe Gasket	2011	61431	Pipe to manifold; Improved design	
QTY	OIL PAN	YEARS	PART NO.	DESCRIPTION	
1	Oil Pan Gasket Set	2011	OS 30704 R	PermaDry® molded rubber gskt. incl.	
QTY	CRANKSHAFT REAR SEAL	YEARS	PART NO.	DESCRIPTION	
1	Rear Main Seal Set	2011	BS 40670	12.0mm thick; PTFE Rubber; One-piece	
QTY	VALVE COVER	YEARS	PART NO.	DESCRIPTION	
1	Valve Cover Gasket Set	2011	VS 50526 R	w/Grommets & Spark plug tube seals; PermaDry® molded rubber gskts. incl.	
QTY	VALVE STEM SEAL SET	YEARS	PART NO.	DESCRIPTION	
2	Valve Stem Seal Set	2011	SS 71043	Premium valve stem seals incl.	
QTY	THERMOSTAT HOUSING	YEARS	PART NO.	DESCRIPTION	
1	O-Ring	2011	35725	Thermostat Housing	
QTY	WATER PUMP	YEARS	PART NO.	DESCRIPTION	
1	Water Pump Gasket	2011	35499	O-ring; Improved design	

GM Car (Incl. Buick, Cad., Chev., Geo, Olds., Pontiac, Saturn) (Cont.)

91 (cont.)		2011; 4.6L 281 (4565cc) DOHC V8 (32 Valve) 93mm Bore Northstar			91 (cont.)
		MFI; Gasoline; Naturally Aspirated GMC Eng.; Cadillac; VIN Code 6			
QTY	WATER PUMP	YEARS	PART NO.	DESCRIPTION	
2	Water Pump Gasket	2011	35656	Loc. Lower; To block	
2	Water Pump Gasket	2011	35659	Loc. Upper; To block	
1	Water Pump Gasket	2011	35794	Body cover; Improved design	
1	Water Pump Mounting Set	2011	ES 72758	Water pump mounting gsks., water pump cover gskt., throttle body gsks. incl.; New Part Number - Check for Availability	
QTY	TIMING COVER	YEARS	PART NO.	DESCRIPTION	
1	Timing Cover Gasket	2011	72673	New Part Number - Check for Availability	
1	Crankshaft Front Seal Set	2011	TCS 46076		
1	Camshaft Rear Seal Set	2011	TCS 46011		
QTY	CARB & FUEL INJECTION	YEARS	PART NO.	DESCRIPTION	
2	Fuel Injector O-Ring Set	2011	ES 70599	Lower set; Injectors to cylinder head; Improved design	
2	Fuel Injector O-Ring Set	2011	ES 72004	Upper set; Injectors to fuel rail	
1	Throttle Body Gasket	2011	61436		
QTY	EXHAUST GAS RECIRCULATION	YEARS	PART NO.	DESCRIPTION	
1	EGR Gasket	2011	70914	Valve	
92		2011 - 1993; 4.6L 281 (4565cc) DOHC V8 (32 Valve) 93mm Bore Northstar			92
		MFI; Gasoline; Naturally Aspirated GMC Eng.; Cadillac; VIN Code Y			
QTY	CYLINDER HEAD	YEARS	PART NO.	DESCRIPTION	
1	Head Gasket	2011-93	26150 PT	Loc. L.H.; Head bolts not incl.; Head bolt replacement recommended	
1	Head Gasket	2011-93	26151 PT	Loc. R.H.; Head bolts not incl.; Head bolt replacement recommended	
1	Head Set	2011-06	HS 26150 PT-4	Head bolts not incl.; Head bolt replacement recommended; Must be used w/TCS 46076; PermaDry® molded rubber valve cover gsks. incl.; Premium valve stem seals incl.	
1	Head Set	2005-02	HS 26150 PT-3	Head bolts & exh. pipe packing not incl.; Head bolt replacement recommended; Must be used w/TCS 46013; PermaDry® molded rubber valve cover gsks. incl.; Premium valve stem seals incl.	
1	Head Set	2001-00	HS 26150 PT-2	Head bolts & exh. pipe packing not incl.; Head bolt replacement recommended; Must be used w/TCS 46013; PermaDry® molded rubber valve cover gsks. incl.; Premium valve stem seals incl.	
1	Head Set	1999-95	HS 26150 PT-1	Head bolts & exh. pipe packing not incl.; Head bolt replacement recommended; Must be used w/TCS 46012 or w/TCS 46018; PermaDry® molded rubber valve cover gsks. incl.; Premium valve stem seals incl.	
1	Head Set	1994-93	HS 26150 PT	Head bolts & exh. pipe packing not incl.; Head bolt replacement recommended; Must be used w/TCS 46012; PermaDry® molded rubber valve cover gsks. incl.; Premium valve stem seals incl.	
2	Head Bolt Set	2011-04	ES 72217	Head bolts w/Washers; Replacement recommended	
2	Head Bolt Set	2003-00	ES 72187	Head bolts w/Washers; Replacement recommended	
2	Head Bolt Set	1999-93	ES 72186	Head bolts w/Washers; Replacement recommended	
QTY	CONVERSION SET	YEARS	PART NO.	DESCRIPTION	
1	Gasket Conversion Set	2011-06	CS 26150-4	PermaDry® molded rubber oil pan gskt. incl.	
1	Gasket Conversion Set	2005-00	CS 26150-3	PermaDry® molded rubber oil pan gskt. incl.	
1	Gasket Conversion Set	1999	CS 26150-2	PermaDry® molded rubber oil pan gskt. incl.	
1	Gasket Conversion Set	1998	CS 26150-1	1st Design; w/o Part number stamp on timing cover; PermaDry® molded rubber oil pan gskt. incl.	
1	Gasket Conversion Set	1998	CS 26150-2	2nd Design; w/Part number stamp on timing cover; PermaDry® molded rubber oil pan gskt. incl.	
1	Gasket Conversion Set	1997-96	CS 26150-1	2nd Design; 12.0mm thick rear main brg. seal; PermaDry® molded rubber oil pan gskt. incl.	
1	Gasket Conversion Set	1996-93	CS 26150	1st Design; 9.0mm thick rear main brg. seal; PermaDry® molded rubber oil pan gskt. incl.	
QTY	MANIFOLD - INT. & EXH.	YEARS	PART NO.	DESCRIPTION	
1	Int. Manifold Gasket Set	2011-06	MS 96716		
1	Int. Manifold Gasket Set	2005-00	MS 93313		
1	Int. Manifold Gasket Set	1999-95	MS 93222		
1	Int. Manifold Gasket Set	1994-93	MS 93225		
1	Exh. Manifold Gasket Set	2011-00	MS 93371		
1	Exh. Manifold Gasket Set	1999-93	MS 93455		
QTY	EXHAUST PIPE FLANGE	YEARS	PART NO.	DESCRIPTION	
1	Exhaust Pipe Gasket	2011-96	61311	Converter	
2	Exhaust Pipe Gasket	2011-06	61009	Crossover	
1	Exhaust Pipe Gasket	2011-06	61431	Pipe to manifold; Improved design	
1	Exhaust Pipe Gasket	2005-04	61009	Cadillac DeVille Base, DHS; Pipe to manifold	
1	Exhaust Pipe Gasket	2005	61009	Cadillac DeVille Base, DHS; Loc. Rear	

GM Car (Incl. Buick, Cad., Chev., Geo, Olds., Pontiac, Saturn) (Cont.)

92		2011 - 1993; 4.6L 281 (4565cc) DOHC V8 (32 Valve) 93mm Bore Northstar			92	
(cont.)		MFI; Gasoline; Naturally Aspirated GMC Eng.; Cadillac; VIN Code Y			(cont.)	
QTY	EXHAUST PIPE FLANGE	YEARS	PART NO.	DESCRIPTION		
1	Exhaust Pipe Gasket	2004-01	61009	Cadillac Seville SLS; Loc. L.H.; Pipe to manifold		
1	Exhaust Pipe Gasket	2004-01	61129	Cadillac Seville SLS; Loc. R.H.; Pipe to manifold; Old design; Superseded - When depleted use 61431		
1	Exhaust Pipe Gasket	2004-01	61431	Cadillac Seville SLS; Loc. R.H.; Pipe to manifold; Improved design		
1	Exhaust Pipe Gasket	2004	61009	Exc. Pontiac Bonneville GXP; Loc. Rear		
1	Exhaust Pipe Gasket	2003-96	61009	Loc. Rear		
1	Exhaust Pipe Gasket	2003-01	61009	Exc. Cadillac Seville SLS; Pipe to manifold		
1	Exhaust Pipe Gasket	2000-98	61009	Cadillac Seville Base, SLS; Loc. L.H.; Pipe to manifold		
1	Exhaust Pipe Gasket	2000-98	61009	Exc. Cadillac Seville Base, SLS; Pipe to manifold		
1	Exhaust Pipe Gasket	2000-98	61129	Cadillac Seville Base, SLS; Loc. R.H.; Pipe to manifold; Old design; Superseded - When depleted use 61431		
1	Exhaust Pipe Gasket	2000-98	61431	Cadillac Seville Base, SLS; Loc. R.H.; Pipe to manifold; Improved design		
1	Exhaust Pipe Gasket	1997-93	61009	Pipe to manifold		
1	Exhaust Pipe Gasket	1995-93	61017	Loc. Rear; 2.265" ID x 3.015" OD		
QTY	OIL PAN	YEARS	PART NO.	DESCRIPTION		
1	Oil Pan Gasket Set	2011-93	OS 30704 R	PermaDry® molded rubber gskt. incl.		
QTY	CRANKSHAFT REAR SEAL	YEARS	PART NO.	DESCRIPTION		
1	Rear Main Seal Set	2011-96	BS 40670	2nd Design; 12.0mm thick; PTFE Rubber; One-piece		
1	Rear Main Seal Set	1996-93	BS 40669	1st Design; 9.0mm thick; Rubber; One-piece		
QTY	VALVE COVER	YEARS	PART NO.	DESCRIPTION		
1	Valve Cover Gasket Set	2011-00	VS 50526 R	w/Grommets & Spark plug tube seals; PermaDry® molded rubber gskts. incl.		
1	Valve Cover Gasket Set	1999-93	VS 50524 R	w/Grommets & Spark plug tube seals; PermaDry® molded rubber gskts. incl.		
QTY	VALVE STEM SEAL SET	YEARS	PART NO.	DESCRIPTION		
2	Valve Stem Seal Set	2011-02	SS 71043	Premium valve stem seals incl.		
2	Valve Stem Seal Set	2001-00	SS 71042	Premium valve stem seals incl.		
2	Valve Stem Seal Set	1999-93	SS 71146	Premium valve stem seals incl.		
QTY	THERMOSTAT HOUSING	YEARS	PART NO.	DESCRIPTION		
1	O-Ring	2011-06	35725	Thermostat Housing		
QTY	WATER OUTLET GASKET	YEARS	PART NO.	DESCRIPTION		
1	Water Outlet Gasket	2005-93	35346	Water Outlet		
QTY	WATER PUMP	YEARS	PART NO.	DESCRIPTION		
2	Water Pump Gasket	2011-93	35656	Loc. Lower; To block		
1	Water Pump Gasket	2011-93	35794	Body cover; Improved design		
2	Water Pump Gasket	2011-00	35659	Loc. Upper; To block		
1	Water Pump Gasket	2011-06	35499	O-ring; Improved design		
1	Water Pump Gasket	2005-93	35987	O-ring; New Part Number - Check for Availability		
2	Water Pump Gasket	1999-93	35658	Loc. Upper; To block		
1	Water Pump Mounting Set	2011-93	ES 72758	Water pump mounting gskts., water pump cover gskt., throttle body gskts. incl.; New Part Number - Check for Availability		
QTY	TIMING COVER	YEARS	PART NO.	DESCRIPTION		
1	Timing Cover Gasket	2011-99	72673	New Part Number - Check for Availability		
1	Timing Cover Gasket	1998	72673	2nd Design; w/Part number stamp on timing cover; New Part Number - Check for Availability		
1	Crankshaft Front Seal Set	2011-06	TCS 46076			
1	Crankshaft Front Seal Set	2005-00	TCS 46013			
1	Crankshaft Front Seal Set	1999	TCS 46018			
1	Crankshaft Front Seal Set	1998	TCS 46012	1st Design; w/o Part number stamp on timing cover		
1	Crankshaft Front Seal Set	1998	TCS 46018	2nd Design; w/Part number stamp on timing cover		
1	Crankshaft Front Seal Set	1997-93	TCS 46012			
1	Camshaft Rear Seal Set	2011-93	TCS 46011			
QTY	CARB & FUEL INJECTION	YEARS	PART NO.	DESCRIPTION		
2	Fuel Injector O-Ring Set	2011-06	ES 70599	Lower set; Injectors to cylinder head; Improved design		
2	Fuel Injector O-Ring Set	2011-06	ES 72004	Upper set; Injectors to fuel rail		
4	Fuel Injector O-Ring Set	2005-00	ES 70599	Improved design		
1	Throttle Body Gasket	2011-06	61436			
1	Throttle Body Gasket	2005-00	61125			
1	Throttle Body Gasket	1999-95	61113	Spacer to manifold		
1	Throttle Body Gasket	1999-96	61111	Throttle body to spacer		
1	Throttle Body Gasket	1995	61318	Throttle body to spacer		
1	Throttle Body Gasket	1994-93	61318			
QTY	EXHAUST GAS RECIRCULATION	YEARS	PART NO.	DESCRIPTION		
1	EGR Gasket	2011-00	70914	Valve		
1	EGR Gasket	1999-93	70788	Valve		

GM Car (Incl. Buick, Cad., Chev., Geo, Olds., Pontiac, Saturn) (Cont.)

93		2011 - 1993; 4.6L 281 (4565cc) DOHC V8 (32 Valve) 93mm Bore Northstar H.O.			93
		MFI; Gasoline; Naturally Aspirated GMC Eng.; Cadillac; VIN Code 9			
QTY	CYLINDER HEAD	YEARS	PART NO.	DESCRIPTION	
1	Head Gasket	2011-93	26150 PT	Loc. L.H.; Head bolts not incl.; Head bolt replacement recommended	
1	Head Gasket	2011-93	26151 PT	Loc. R.H.; Head bolts not incl.; Head bolt replacement recommended	
1	Head Set	2011-06	HS 26150 PT-4	Head bolts not incl.; Head bolt replacement recommended; Must be used w/TCS 46076; PermaDry® molded rubber valve cover gsks. incl.; Premium valve stem seals incl.	
1	Head Set	2005-02	HS 26150 PT-3	Head bolts & exh. pipe packing not incl.; Head bolt replacement recommended; Must be used w/TCS 46013; PermaDry® molded rubber valve cover gsks. incl.; Premium valve stem seals incl.	
1	Head Set	2001-00	HS 26150 PT-2	Head bolts & exh. pipe packing not incl.; Head bolt replacement recommended; Must be used w/TCS 46013; PermaDry® molded rubber valve cover gsks. incl.; Premium valve stem seals incl.	
1	Head Set	1999-95	HS 26150 PT-1	Head bolts & exh. pipe packing not incl.; Head bolt replacement recommended; Must be used w/TCS 46012 or w/TCS 46018; PermaDry® molded rubber valve cover gsks. incl.; Premium valve stem seals incl.	
1	Head Set	1994-93	HS 26150 PT	Head bolts & exh. pipe packing not incl.; Head bolt replacement recommended; Must be used w/TCS 46012; PermaDry® molded rubber valve cover gsks. incl.; Premium valve stem seals incl.	
2	Head Bolt Set	2011-04	ES 72217	Head bolts w/Washers; Replacement recommended	
2	Head Bolt Set	2003-00	ES 72187	Head bolts w/Washers; Replacement recommended	
2	Head Bolt Set	1999-93	ES 72186	Head bolts w/Washers; Replacement recommended	
QTY	CONVERSION SET	YEARS	PART NO.	DESCRIPTION	
1	Gasket Conversion Set	2011-06	CS 26150-4	PermaDry® molded rubber oil pan gskt. incl.	
1	Gasket Conversion Set	2005-00	CS 26150-3	PermaDry® molded rubber oil pan gskt. incl.	
1	Gasket Conversion Set	1999	CS 26150-2	PermaDry® molded rubber oil pan gskt. incl.	
1	Gasket Conversion Set	1998	CS 26150-1	1st Design; w/o Part number stamp on timing cover; PermaDry® molded rubber oil pan gskt. incl.	
1	Gasket Conversion Set	1998	CS 26150-2	2nd Design; w/Part number stamp on timing cover; PermaDry® molded rubber oil pan gskt. incl.	
1	Gasket Conversion Set	1997-96	CS 26150-1	2nd Design; 12.0mm thick rear main brg. seal; PermaDry® molded rubber oil pan gskt. incl.	
1	Gasket Conversion Set	1996-93	CS 26150	1st Design; 9.0mm thick rear main brg. seal; PermaDry® molded rubber oil pan gskt. incl.	
QTY	MANIFOLD - INT. & EXH.	YEARS	PART NO.	DESCRIPTION	
1	Int. Manifold Gasket Set	2011-06	MS 96716		
1	Int. Manifold Gasket Set	2005-00	MS 93313		
1	Int. Manifold Gasket Set	1999-95	MS 93222		
1	Int. Manifold Gasket Set	1994-93	MS 93225		
1	Exh. Manifold Gasket Set	2011-00	MS 93371		
1	Exh. Manifold Gasket Set	1999-93	MS 93455		
QTY	EXHAUST PIPE FLANGE	YEARS	PART NO.	DESCRIPTION	
1	Exhaust Pipe Gasket	2011-96	61311	Converter	
2	Exhaust Pipe Gasket	2011-06	61009	Crossover	
1	Exhaust Pipe Gasket	2011-06	61431	Pipe to manifold; Improved design	
1	Exhaust Pipe Gasket	2005-96	61009	Loc. Rear	
1	Exhaust Pipe Gasket	2005-04	61009	Pipe to manifold	
1	Exhaust Pipe Gasket	2003-98	61009	Cadillac Seville STS; Loc. L.H.; Pipe to manifold	
1	Exhaust Pipe Gasket	2003-98	61129	Cadillac Seville STS; Loc. R.H.; Pipe to manifold; Old design; Superseded - When depleted use 61431	
1	Exhaust Pipe Gasket	2003-98	61431	Cadillac Seville STS; Loc. R.H.; Pipe to manifold; Improved design	
1	Exhaust Pipe Gasket	2003	61009	Cadillac DeVille DTS; Pipe to manifold	
1	Exhaust Pipe Gasket	2002-98	61009	Exc. Cadillac Seville STS; Pipe to manifold	
1	Exhaust Pipe Gasket	1997-94	61009	Pipe to manifold	
1	Exhaust Pipe Gasket	1995-94	61017	Loc. Rear; 2.265" ID x 3.015" OD	
1	Exhaust Pipe Gasket	1993	61009	Cadillac Eldorado Touring, Seville STS; Pipe to manifold	
1	Exhaust Pipe Gasket	1993	61017	Cadillac Eldorado Touring, Seville STS; Loc. Rear; 2.265" ID x 3.015" OD	
QTY	OIL PAN	YEARS	PART NO.	DESCRIPTION	
1	Oil Pan Gasket Set	2011-93	OS 30704 R	PermaDry® molded rubber gskt. incl.	
QTY	CRANKSHAFT REAR SEAL	YEARS	PART NO.	DESCRIPTION	
1	Rear Main Seal Set	2011-96	BS 40670	2nd Design; 12.0mm thick; PTFE Rubber; One-piece	
1	Rear Main Seal Set	1996-93	BS 40669	1st Design; 9.0mm thick; Rubber; One-piece	
QTY	VALVE COVER	YEARS	PART NO.	DESCRIPTION	
1	Valve Cover Gasket Set	2011-00	VS 50526 R	w/Grommets & Spark plug tube seals; PermaDry® molded rubber gsks. incl.	
1	Valve Cover Gasket Set	1999-93	VS 50524 R	w/Grommets & Spark plug tube seals; PermaDry® molded rubber gsks. incl.	
QTY	VALVE STEM SEAL SET	YEARS	PART NO.	DESCRIPTION	
2	Valve Stem Seal Set	2011-02	SS 71043	Premium valve stem seals incl.	

GM Car (Incl. Buick, Cad., Chev., Geo, Olds., Pontiac, Saturn) (Cont.)

93		2011 - 1993; 4.6L 281 (4565cc) DOHC V8 (32 Valve) 93mm Bore Northstar H.O.			93	
(cont.)		MFI; Gasoline; Naturally Aspirated GMC Eng.; Cadillac; VIN Code 9			(cont.)	
QTY	VALVE STEM SEAL SET	YEARS	PART NO.	DESCRIPTION		
2	Valve Stem Seal Set	2001-00	SS 71042	Premium valve stem seals incl.		
2	Valve Stem Seal Set	1999-93	SS 71146	Premium valve stem seals incl.		
QTY	THERMOSTAT HOUSING	YEARS	PART NO.	DESCRIPTION		
1	O-Ring	2011-06	35725	Thermostat Housing		
QTY	WATER OUTLET GASKET	YEARS	PART NO.	DESCRIPTION		
1	Water Outlet Gasket	2005-93	35346	Water Outlet		
QTY	WATER PUMP	YEARS	PART NO.	DESCRIPTION		
2	Water Pump Gasket	2011-93	35656	Loc. Lower; To block		
1	Water Pump Gasket	2011-93	35794	Body cover; Improved design		
2	Water Pump Gasket	2011-00	35659	Loc. Upper; To block		
1	Water Pump Gasket	2011-06	35499	O-ring; Improved design		
1	Water Pump Gasket	2005-93	35987	O-ring; New Part Number - Check for Availability		
2	Water Pump Gasket	1999-93	35658	Loc. Upper; To block		
1	Water Pump Mounting Set	2011-93	ES 72758	Water pump mounting gskts., water pump cover gskt., throttle body gskts. incl.; New Part Number - Check for Availability		
QTY	TIMING COVER	YEARS	PART NO.	DESCRIPTION		
1	Timing Cover Gasket	2011-99	72673	New Part Number - Check for Availability		
1	Timing Cover Gasket	1998	72673	2nd Design; w/Part number stamp on timing cover; New Part Number - Check for Availability		
1	Crankshaft Front Seal Set	2011-06	TCS 46076			
1	Crankshaft Front Seal Set	2005-00	TCS 46013			
1	Crankshaft Front Seal Set	1999	TCS 46018			
1	Crankshaft Front Seal Set	1998	TCS 46012	1st Design; w/o Part number stamp on timing cover		
1	Crankshaft Front Seal Set	1998	TCS 46018	2nd Design; w/Part number stamp on timing cover		
1	Crankshaft Front Seal Set	1997-93	TCS 46012			
1	Camshaft Rear Seal Set	2011-93	TCS 46011			
QTY	CARB & FUEL INJECTION	YEARS	PART NO.	DESCRIPTION		
2	Fuel Injector O-Ring Set	2011-06	ES 70599	Lower set; Injectors to cylinder head; Improved design		
2	Fuel Injector O-Ring Set	2011-06	ES 72004	Upper set; Injectors to fuel rail		
4	Fuel Injector O-Ring Set	2005-00	ES 70599	Improved design		
1	Throttle Body Gasket	2011-06	61436			
1	Throttle Body Gasket	2005-00	61125			
1	Throttle Body Gasket	1999-95	61113	Spacer to manifold		
1	Throttle Body Gasket	1999-96	61111	Throttle body to spacer		
1	Throttle Body Gasket	1995	61318	Throttle body to spacer		
1	Throttle Body Gasket	1994-93	61318			
QTY	EXHAUST GAS RECIRCULATION	YEARS	PART NO.	DESCRIPTION		
1	EGR Gasket	2011-00	70914	Valve		
1	EGR Gasket	1999-93	70788	Valve		
94		2010 - 2004; 4.6L 281 (4565cc) DOHC V8 (32 Valve) 93mm Bore Northstar H.O.			94	
		MFI; Gasoline; Naturally Aspirated GMC Eng.; Cadillac; VIN Code A				
QTY	CYLINDER HEAD	YEARS	PART NO.	DESCRIPTION		
1	Head Gasket	2010-04	26380 PT	Loc. L.H.; Head bolts not incl.; Head bolt replacement recommended		
1	Head Gasket	2010-04	26381 PT	Loc. R.H.; Head bolts not incl.; Head bolt replacement recommended		
1	Head Set	2010-06	HS 26380 PT-1	Head bolts not incl.; Head bolt replacement recommended; Must be used w/TCS 46076-1; PermaDry® molded rubber valve cover gskts. incl.; Premium valve stem seals incl.		
1	Head Set	2005-04	HS 26380 PT	Head bolts not incl.; Head bolt replacement recommended; Must be used w/TCS 46076-1; PermaDry® molded rubber valve cover gskts. incl.; Premium valve stem seals incl.		
2	Head Bolt Set	2010-04	ES 72217	Head bolts w/Washers; Replacement recommended		
QTY	CONVERSION SET	YEARS	PART NO.	DESCRIPTION		
1	Gasket Conversion Set	2010-04	CS 26380	PermaDry® molded rubber oil pan gskt. incl.		
QTY	MANIFOLD - INT. & EXH.	YEARS	PART NO.	DESCRIPTION		
1	Int. Manifold Gasket Set	2010-06	MS 96716			
1	Int. Manifold Gasket Set	2005-04	MS 93313			
1	Exh. Manifold Gasket Set	2010-04	MS 96999			
QTY	EXHAUST PIPE FLANGE	YEARS	PART NO.	DESCRIPTION		
1	Exhaust Pipe Gasket	2010-04	61311	Converter		
2	Exhaust Pipe Gasket	2010-06	61009	Crossover		
2	Exhaust Pipe Gasket	2010	61525	Pipe to manifold; Improved design		
2	Exhaust Pipe Gasket	2009-05	61525	Cadillac STS Base; Pipe to manifold; Improved design		
2	Exhaust Pipe Gasket	2009	61012	Exc. Cadillac STS Base; Pipe to manifold		

GM Car (Incl. Buick, Cad., Chev., Geo, Olds., Pontiac, Saturn) (Cont.)

94		2010 - 2004; 4.6L 281 (4565cc) DOHC V8 (32 Valve) 93mm Bore Northstar H.O.			94
(cont.)		MFI; Gasoline; Naturally Aspirated GMC Eng.; Cadillac; VIN Code A			(cont.)
QTY	EXHAUST PIPE FLANGE	YEARS	PART NO.	DESCRIPTION	
2	Exhaust Pipe Gasket	2008-05	61012	Cadillac XLR Base; Pipe to manifold	
2	Exhaust Pipe Gasket	2004	61012	Pipe to manifold	
QTY	OIL PAN	YEARS	PART NO.	DESCRIPTION	
1	Oil Pan Gasket Set	2010-04	OS 30796 R	PermaDry® molded rubber gskt. incl.	
QTY	CRANKSHAFT REAR SEAL	YEARS	PART NO.	DESCRIPTION	
1	Rear Main Seal Set	2010-04	BS 40670	2nd Design; 12.0mm thick; PTFE Rubber; One-piece	
QTY	VALVE COVER	YEARS	PART NO.	DESCRIPTION	
1	Valve Cover Gasket Set	2010-04	VS 50728 R	w/Grommets & Spark plug tube seals; PermaDry® molded rubber gskts. incl.	
QTY	VALVE STEM SEAL SET	YEARS	PART NO.	DESCRIPTION	
2	Valve Stem Seal Set	2010-04	SS 71043	Premium valve stem seals incl.	
QTY	THERMOSTAT HOUSING	YEARS	PART NO.	DESCRIPTION	
1	Thermostat Gasket	2010-04	35660	Thermostat Housing; Thermostat seal	
QTY	WATER OUTLET GASKET	YEARS	PART NO.	DESCRIPTION	
1	Water Outlet Gasket	2010-04	35863	Water Outlet	
QTY	WATER PUMP	YEARS	PART NO.	DESCRIPTION	
1	Water Pump Gasket	2010-04	35860	O-ring	
QTY	TIMING COVER	YEARS	PART NO.	DESCRIPTION	
1	Crankshaft Front Seal Set	2010-04	TCS 46076-1		
1	Camshaft Rear Seal Set	2010-04	TCS 46011		
QTY	CARB & FUEL INJECTION	YEARS	PART NO.	DESCRIPTION	
2	Fuel Injector O-Ring Set	2010-07	ES 70599	Lower set; Injectors to cylinder head; Improved design	
2	Fuel Injector O-Ring Set	2010-07	ES 72004	Upper set; Injectors to fuel rail	
4	Fuel Injector O-Ring Set	2006-04	ES 70599	Improved design	
1	Throttle Body Gasket	2010-06	61436		
1	Throttle Body Gasket	2005-04	61528		
QTY	EXHAUST GAS RECIRCULATION	YEARS	PART NO.	DESCRIPTION	
1	EGR Gasket	2010-04	70914	Valve	
QTY	OIL FILTER MOUNTING	YEARS	PART NO.	DESCRIPTION	
1	Oil Filter Adapter Gasket	2010-04	71288	Oil filter adapter; New Part Number - Check for Availability	
95		2011; 4.6L 281 (4565cc) DOHC V8 (32 Valve) 93mm Bore Northstar H.O.			95
		MFI; Gasoline; Naturally Aspirated GMC Eng.; Cadillac; VIN Code S			
QTY	CYLINDER HEAD	YEARS	PART NO.	DESCRIPTION	
1	Head Gasket	2011	26150 PT	Loc. L.H.; Head bolts not incl.; Head bolt replacement recommended	
1	Head Gasket	2011	26151 PT	Loc. R.H.; Head bolts not incl.; Head bolt replacement recommended	
1	Head Set	2011	HS 26150 PT-4	Head bolts not incl.; Head bolt replacement recommended; Must be used w/TCS 46076; PermaDry® molded rubber valve cover gskts. incl.; Premium valve stem seals incl.	
2	Head Bolt Set	2011	ES 72217	Head bolts w/Washers; Replacement recommended	
QTY	CONVERSION SET	YEARS	PART NO.	DESCRIPTION	
1	Gasket Conversion Set	2011	CS 26150-4	PermaDry® molded rubber oil pan gskt. incl.	
QTY	MANIFOLD - INT. & EXH.	YEARS	PART NO.	DESCRIPTION	
1	Int. Manifold Gasket Set	2011	MS 96716		
1	Exh. Manifold Gasket Set	2011	MS 93371		
QTY	EXHAUST PIPE FLANGE	YEARS	PART NO.	DESCRIPTION	
2	Exhaust Pipe Gasket	2011	61009	Crossover	
1	Exhaust Pipe Gasket	2011	61311	Converter	
1	Exhaust Pipe Gasket	2011	61431	Pipe to manifold; Improved design	
QTY	OIL PAN	YEARS	PART NO.	DESCRIPTION	
1	Oil Pan Gasket Set	2011	OS 30704 R	PermaDry® molded rubber gskt. incl.	
QTY	CRANKSHAFT REAR SEAL	YEARS	PART NO.	DESCRIPTION	
1	Rear Main Seal Set	2011	BS 40670	12.0mm thick; PTFE Rubber; One-piece	
QTY	VALVE COVER	YEARS	PART NO.	DESCRIPTION	
1	Valve Cover Gasket Set	2011	VS 50526 R	w/Grommets & Spark plug tube seals; PermaDry® molded rubber gskts. incl.	
QTY	VALVE STEM SEAL SET	YEARS	PART NO.	DESCRIPTION	
2	Valve Stem Seal Set	2011	SS 71043	Premium valve stem seals incl.	
QTY	THERMOSTAT HOUSING	YEARS	PART NO.	DESCRIPTION	
1	O-Ring	2011	35725	Thermostat Housing	
QTY	WATER PUMP	YEARS	PART NO.	DESCRIPTION	
1	Water Pump Gasket	2011	35499	O-ring; Improved design	
2	Water Pump Gasket	2011	35656	Loc. Lower; To block	
2	Water Pump Gasket	2011	35659	Loc. Upper; To block	

GM Car (Incl. Buick, Cad., Chev., Geo, Olds., Pontiac, Saturn) (Cont.)

95 (cont.)		2011; 4.6L 281 (4565cc) DOHC V8 (32 Valve) 93mm Bore Northstar H.O.			95 (cont.)
MFI; Gasoline; Naturally Aspirated GMC Eng.; Cadillac; VIN Code S					
QTY	WATER PUMP	YEARS	PART NO.	DESCRIPTION	
1	Water Pump Gasket	2011	35794	Body cover; Improved design	
1	Water Pump Mounting Set	2011	ES 72758	Water pump mounting gskts., water pump cover gskt., throttle body gskts. incl.; New Part Number - Check for Availability	
QTY	TIMING COVER	YEARS	PART NO.	DESCRIPTION	
1	Timing Cover Gasket	2011	72673	New Part Number - Check for Availability	
1	Crankshaft Front Seal Set	2011	TCS 46076		
1	Camshaft Rear Seal Set	2011	TCS 46011		
QTY	CARB & FUEL INJECTION	YEARS	PART NO.	DESCRIPTION	
2	Fuel Injector O-Ring Set	2011	ES 70599	Lower set; Injectors to cylinder head; Improved design	
2	Fuel Injector O-Ring Set	2011	ES 72004	Upper set; Injectors to fuel rail	
1	Throttle Body Gasket	2011	61436		
QTY	EXHAUST GAS RECIRCULATION	YEARS	PART NO.	DESCRIPTION	
1	EGR Gasket	2011	70914	Valve	
96		1995 - 1991; 4.9L 298 (4884cc) OHV V8 (16 Valve) 92mm Bore			96
MFI; Gasoline; Naturally Aspirated GMC Eng.; Cadillac; VIN Code B					
QTY	CYLINDER HEAD	YEARS	PART NO.	DESCRIPTION	
2	Head Gasket	1995-91	8753 PT-1		
1	Head Set	1995-91	HS 8753 PT-4	Exh. pipe packing & valve cover grommets not incl.; PermaDry® molded rubber valve cover gskts. incl.; Premium valve stem seals incl.	
QTY	CONVERSION SET	YEARS	PART NO.	DESCRIPTION	
1	Gasket Conversion Set	1995-91	CS 8753-2		
QTY	MANIFOLD - INT. & EXH.	YEARS	PART NO.	DESCRIPTION	
1	Int. Manifold Gasket Set	1995-91	MS 94548-1	Must be used w/VS 50074R	
1	Exh. Manifold Gasket Set	1995-91	MS 94250		
QTY	EXHAUST PIPE FLANGE	YEARS	PART NO.	DESCRIPTION	
1	Exhaust Pipe Gasket	1995-91	61013	Converter	
1	Exhaust Pipe Gasket	1993-92	60854	Cadillac DeVille Base, Touring; Pipe to manifold	
1	Exhaust Pipe Gasket	1991	60854	Cadillac DeVille Base, Spring Edition, Touring; Pipe to manifold	
1	Exh. Flange Bolt & Spring Kit	1993-91	ES 72141		
QTY	OIL PAN	YEARS	PART NO.	DESCRIPTION	
1	Oil Pan Gasket Set	1995-91	OS 30525 C	Cork	
1	Oil Pan Gasket Set	1995-91	OS 30525 T	PermaDryPlus®; Oil Pan SnapUps® incl.	
1	Drain Plug Gasket	1995-91	70822		
QTY	CRANKSHAFT REAR SEAL	YEARS	PART NO.	DESCRIPTION	
1	Rear Main Seal Set	1995-91	BS 40396	Rubber; One-piece	
QTY	VALVE COVER	YEARS	PART NO.	DESCRIPTION	
1	Valve Cover Gasket Set	1995-91	VS 50074 R	w/o Grommets; Services both covers; PermaDry® molded rubber gskts. incl.	
2	Valve Cover Gasket Set	1995-91	VS 50315 R	w/o Grommets; Services one cover only; PermaDry® molded rubber gskt. incl.	
1	Grommet Set	1995-91	ES 72833	Valve Cover	
QTY	VALVE STEM SEAL SET	YEARS	PART NO.	DESCRIPTION	
1	Valve Stem Seal Set	1995-91	SS 72564	Premium valve stem seals incl.	
QTY	WATER OUTLET GASKET	YEARS	PART NO.	DESCRIPTION	
1	Water Outlet Gasket	1995-91	35346	Water Outlet	
QTY	WATER PUMP	YEARS	PART NO.	DESCRIPTION	
1	Water Pump Gasket	1995-91	35345	Inlet	
1	Water Pump Gasket	1995-91	35388	Housing	
QTY	TIMING COVER	YEARS	PART NO.	DESCRIPTION	
1	Timing Cover Set	1995-91	TCS 45522-2		
QTY	CARB & FUEL INJECTION	YEARS	PART NO.	DESCRIPTION	
4	Fuel Injector O-Ring Set	1995-91	ES 70599	Improved design	
1	Throttle Body Gasket	1995-91	60841		
QTY	DISTRIBUTOR MOUNTING	YEARS	PART NO.	DESCRIPTION	
1	O-Ring	1995-91	425 RR	Distributor Mounting	
QTY	EXHAUST GAS RECIRCULATION	YEARS	PART NO.	DESCRIPTION	
1	EGR Gasket	1995-91	70954		
97		1993 - 1991; 5.0L 305 (4999cc) OHV V8 (16 Valve) 3.736" Bore			97
TBI; Gasoline; Naturally Aspirated GMC Eng.; Chevrolet; VIN Code E					
QTY	CYLINDER HEAD	YEARS	PART NO.	DESCRIPTION	
2	Head Gasket	1993-91	505 SD	Head bolts not incl.; Head bolt replacement recommended; PermaTorque Severe Duty®	

GM Car (Incl. Buick, Cad., Chev., Geo, Olds., Pontiac, Saturn) (Cont.)

97 (cont.)		1993 - 1991; 5.0L 305 (4999cc) OHV V8 (16 Valve) 3.736" Bore			97 (cont.)
		TBI; Gasoline; Naturally Aspirated GMC Eng.; Chevrolet; VIN Code E			
QTY	CYLINDER HEAD	YEARS	PART NO.	DESCRIPTION	
2	Head Gasket	1993-91	8510 PT	Head bolts not incl.; Head bolt replacement recommended; PermaTorque®	
1	Head Set	1993-91	HS 8510 PT-4	Head bolts not incl.; Head bolt replacement recommended; PermaDry® molded rubber valve cover gskts. incl.; Premium valve stem seals incl.	
2	Head Bolt Set	1993-91	ES 72856	Replacement recommended	
QTY	CONVERSION SET	YEARS	PART NO.	DESCRIPTION	
1	Gasket Conversion Set	1993-91	CS 8510	PermaDry® molded rubber oil pan gskt. incl.	
QTY	MANIFOLD - INT. & EXH.	YEARS	PART NO.	DESCRIPTION	
1	Int. Manifold Gasket Set	1993-91	MS 93317		
1	Exh. Manifold Gasket Set	1993-91	MS 9275 B		
QTY	FUEL PUMP	YEARS	PART NO.	DESCRIPTION	
1	Fuel Pump Mounting Gasket	1993-91	5182	Plate	
1	Fuel Pump Mounting Gasket	1993-91	6579	May also be used as a fuel pump block-off plate gasket if desired	
QTY	OIL PAN	YEARS	PART NO.	DESCRIPTION	
1	Oil Pan Gasket Set	1993-91	OS 34500 R	PermaDry® molded rubber gskt. incl.	
1	Drain Plug Gasket	1993-91	70822		
QTY	CRANKSHAFT REAR SEAL	YEARS	PART NO.	DESCRIPTION	
1	Rear Main Seal Set	1993-91	BS 40520	Rubber; One-piece	
1	Rear Main Seal Set	1993-91	BS 40626	PTFE Rubber; One-piece	
1	Repair Sleeve	1993-91	16258	Crankshaft; Use w/installation tool	
1	Repair Sleeve Tool	1993-91	16301	Crankshaft	
QTY	VALVE COVER	YEARS	PART NO.	DESCRIPTION	
1	Valve Cover Gasket Set	1993-91	VS 50088 R	Services both covers; PermaDry® molded rubber gskts. incl.	
2	Valve Cover Gasket Set	1993-91	VS 50293 R	Services one cover only; PermaDry® molded rubber gskt. incl.	
QTY	VALVE STEM SEAL SET	YEARS	PART NO.	DESCRIPTION	
1	Valve Stem Seal Set	1993-91	SS 72526	Loc. Exh.; Premium valve stem seals incl.	
1	Valve Stem Seal Set	1993-91	SS 72527	Loc. Int.; Premium valve stem seals incl.	
1	Valve Stem Seal Set	1993-91	SS 72877	Loc. Exh.; Opt. Hi-Temp. premium valve stem seals incl.	
QTY	WATER OUTLET GASKET	YEARS	PART NO.	DESCRIPTION	
1	Water Outlet Gasket	1993-91	35062	Water Outlet; 1 13/16" ID	
1	Water Outlet Gasket	1993-91	35562 T	Water Outlet; 1 13/16" ID; PermaDryPlus®	
QTY	WATER PUMP	YEARS	PART NO.	DESCRIPTION	
1	Water Pump Gasket	1993-91	13032	To plate	
2	Water Pump Gasket	1993-91	5152	To block	
QTY	TIMING COVER	YEARS	PART NO.	DESCRIPTION	
1	Timing Cover Set	1993-91	TCS 45121	w/o Sleeve 'N' Seal®; Must be used w/OS 34500R	
1	Timing Set w/Sleeve & Seal	1993-91	TCS 45265	w/Sleeve 'N' Seal®; Must be used w/OS 34500R	
1	Repair Sleeve	1993-91	16202	Timing Cover; Use w/installation tool	
1	Repair Sleeve Tool	1993-91	16312	Timing Cover	
QTY	AIR CLEANER MOUNTING	YEARS	PART NO.	DESCRIPTION	
1	Air Cleaner Gasket	1993-91	60038	5 1/32" ID	
QTY	CARB & FUEL INJECTION	YEARS	PART NO.	DESCRIPTION	
1	Throttle Body Gasket	1993-91	60903		
QTY	DISTRIBUTOR MOUNTING	YEARS	PART NO.	DESCRIPTION	
1	Distributor Mounting Gasket	1993-91	70056		
QTY	EXHAUST GAS RECIRCULATION	YEARS	PART NO.	DESCRIPTION	
1	EGR Gasket	1993-91	70978		
QTY	OIL PUMP RETAINER	YEARS	PART NO.	DESCRIPTION	
1	Oil Pump Shaft Guide	1993-91	72665	Distributor to oil pump shaft retainer	
98		1992 - 1991; 5.0L 305 (4999cc) OHV V8 (16 Valve) 3.736" Bore			98
		TPI; Gasoline; Naturally Aspirated GMC Eng.; Chevrolet; VIN Code F			
QTY	CYLINDER HEAD	YEARS	PART NO.	DESCRIPTION	
2	Head Gasket	1992-91	505 SD	Head bolts not incl.; Head bolt replacement recommended; PermaTorque Severe Duty®	
2	Head Gasket	1992-91	8510 PT	Head bolts not incl.; Head bolt replacement recommended; PermaTorque®	
1	Head Set	1992-91	HS 8510 PT-5	Head bolts not incl.; Head bolt replacement recommended; PermaDry® molded rubber valve cover gskts. incl.; Premium valve stem seals incl.	
2	Head Bolt Set	1992-91	ES 72856	Replacement recommended	
QTY	CONVERSION SET	YEARS	PART NO.	DESCRIPTION	
1	Gasket Conversion Set	1992-91	CS 8510	PermaDry® molded rubber oil pan gskt. incl.	
QTY	MANIFOLD - INT. & EXH.	YEARS	PART NO.	DESCRIPTION	
1	Int. Manifold Gasket Set	1992-91	MS 93035-1	Upper set incl.	

GM Car (Incl. Buick, Cad., Chev., Geo, Olds., Pontiac, Saturn) (Cont.)

98 (cont.)		1992 - 1991; 5.0L 305 (4999cc) OHV V8 (16 Valve) 3.736" Bore			98 (cont.)
TPI; Gasoline; Naturally Aspirated GMC Eng.; Chevrolet; VIN Code F					
QTY	MANIFOLD - INT. & EXH.	YEARS	PART NO.	DESCRIPTION	
1	Plenum Gasket Set	1992-91	MS 93160	Upper set	
1	Exh. Manifold Gasket Set	1992-91	MS 9275 B		
QTY	FUEL PUMP	YEARS	PART NO.	DESCRIPTION	
1	Fuel Pump Mounting Gasket	1992-91	5182	Plate	
1	Fuel Pump Mounting Gasket	1992-91	6579	May also be used as a fuel pump block-off plate gasket if desired	
QTY	OIL PAN	YEARS	PART NO.	DESCRIPTION	
1	Oil Pan Gasket Set	1992-91	OS 34500 R	PermaDry® molded rubber gskt. incl.	
1	Drain Plug Gasket	1992-91	70822		
QTY	CRANKSHAFT REAR SEAL	YEARS	PART NO.	DESCRIPTION	
1	Rear Main Seal Set	1992-91	BS 40520	Rubber; One-piece	
1	Rear Main Seal Set	1992-91	BS 40626	PTFE Rubber; One-piece	
1	Repair Sleeve	1992-91	16258	Crankshaft; Use w/installation tool	
1	Repair Sleeve Tool	1992-91	16301	Crankshaft	
QTY	VALVE COVER	YEARS	PART NO.	DESCRIPTION	
1	Valve Cover Gasket Set	1992-91	VS 50088 R	Services both covers; PermaDry® molded rubber gskts. incl.	
2	Valve Cover Gasket Set	1992-91	VS 50293 R	Services one cover only; PermaDry® molded rubber gskt. incl.	
QTY	VALVE STEM SEAL SET	YEARS	PART NO.	DESCRIPTION	
1	Valve Stem Seal Set	1992-91	SS 72526	Loc. Exh.; Premium valve stem seals incl.	
1	Valve Stem Seal Set	1992-91	SS 72527	Loc. Int.; Premium valve stem seals incl.	
1	Valve Stem Seal Set	1992-91	SS 72877	Loc. Exh.; Opt. Hi-Temp. premium valve stem seals incl.	
QTY	WATER OUTLET GASKET	YEARS	PART NO.	DESCRIPTION	
1	Water Outlet Gasket	1992-91	35062	Water Outlet; 1 13/16" ID	
1	Water Outlet Gasket	1992-91	35562 T	Water Outlet; 1 13/16" ID; PermaDryPlus®	
QTY	WATER PUMP	YEARS	PART NO.	DESCRIPTION	
1	Water Pump Gasket	1992-91	13032	To plate	
2	Water Pump Gasket	1992-91	5152	To block	
QTY	TIMING COVER	YEARS	PART NO.	DESCRIPTION	
1	Timing Cover Set	1992-91	TCS 45121	w/o Sleeve 'N' Seal®; Must be used w/OS 34500R	
1	Timing Set w/Sleeve & Seal	1992-91	TCS 45265	w/Sleeve 'N' Seal®; Must be used w/OS 34500R	
1	Repair Sleeve	1992-91	16202	Timing Cover; Use w/installation tool	
1	Repair Sleeve Tool	1992-91	16312	Timing Cover	
QTY	CARB & FUEL INJECTION	YEARS	PART NO.	DESCRIPTION	
4	Fuel Injector O-Ring Set	1992-91	ES 70599	Improved design	
1	Throttle Body Gasket	1992-91	60826		
QTY	DISTRIBUTOR MOUNTING	YEARS	PART NO.	DESCRIPTION	
1	Distributor Mounting Gasket	1992-91	70194		
QTY	EXHAUST GAS RECIRCULATION	YEARS	PART NO.	DESCRIPTION	
1	EGR Gasket	1992-91	70954		
QTY	OIL PUMP RETAINER	YEARS	PART NO.	DESCRIPTION	
1	Oil Pump Shaft Guide	1992-91	72665	Distributor to oil pump shaft retainer	
99		2009 - 2005; 5.3L 325 (5328cc) OHV V8 (16 Valve) 96mm Bore Vortec LS-4			99
MFI; Gasoline; Naturally Aspirated GMC Eng.; Chevrolet; VIN Code C					
QTY	CYLINDER HEAD	YEARS	PART NO.	DESCRIPTION	
2	Head Gasket	2009-05	26190 PT	Head bolts not incl.; Head bolt replacement recommended; PermaTorqueMLS® LaserWeld® Technology	
1	Head Set	2009-05	HS 26190 PT-3	Head bolts not incl.; Head bolt replacement recommended; When servicing Displacement-On-Demand solenoids use w/Lifter valley cover set MS 96871; PermaDry® molded rubber valve cover gskts. incl.; Premium valve stem seals incl.	
2	Head Bolt Set	2009-05	ES 72220	Replacement recommended	
QTY	CONVERSION SET	YEARS	PART NO.	DESCRIPTION	
1	Gasket Conversion Set	2009-05	CS 9284	PermaDry® molded rubber oil pan gskt. incl.	
QTY	MANIFOLD - INT. & EXH.	YEARS	PART NO.	DESCRIPTION	
1	Int. Manifold Gasket Set	2009-05	MS 96857	Lifter valley cover set; Perimeter seal only	
1	Int. Manifold Gasket Set	2009-05	MS 96871	Lifter valley cover set; For use when servicing Displacement-On-Demand solenoids	
1	Int. Manifold Gasket Set	2009-05	MS 96941		
1	Exh. Manifold Gasket Set	2009-05	MS 92467		
QTY	EXHAUST PIPE FLANGE	YEARS	PART NO.	DESCRIPTION	
2	Exhaust Pipe Gasket	2009-05	61310	Pipe to manifold; Improved design	
1	Exhaust Pipe Gasket	2009-05	61465	Converter	
QTY	OIL PAN	YEARS	PART NO.	DESCRIPTION	
1	Oil Pan Gasket Set	2009-05	OS 30693 R	PermaDry® molded rubber gskt. incl.	

GM Car (Incl. Buick, Cad., Chev., Geo, Olds., Pontiac, Saturn) (Cont.)

99		2009 - 2005; 5.3L 325 (5328cc) OHV V8 (16 Valve) 96mm Bore Vortec LS-4			99
(cont.)		MFI; Gasoline; Naturally Aspirated GMC Eng.; Chevrolet; VIN Code C			(cont.)
QTY	CRANKSHAFT REAR SEAL	YEARS	PART NO.	DESCRIPTION	
1	Rear Main Seal Set	2009-05	BS 40640	PTFE Rubber; One-piece	
1	Repair Sleeve	2009-05	16228	Crankshaft; Narrow lip; .780" sleeve length; Requires crankshaft machining due to clearance issues; Use w/installation tool	
1	Repair Sleeve	2009-05	16229	Crankshaft; Wide lip; 1.156" sleeve length; Requires crankshaft machining due to clearance issues; Use w/installation tool	
1	Repair Sleeve Tool	2009-05	16329	Crankshaft	
QTY	VALVE COVER	YEARS	PART NO.	DESCRIPTION	
1	Valve Cover Gasket Set	2009-05	VS 50504 R	w/o Grommets; PermaDry® molded rubber gskts. incl.	
1	Valve Cover Gasket Set	2009-05	VS 50504 R-1	w/Grommets; PermaDry® molded rubber gskts. incl.; New Part Number - Check for Availability	
1	Grommet Set	2009-05	ES 72233	Valve Cover	
QTY	VALVE STEM SEAL SET	YEARS	PART NO.	DESCRIPTION	
1	Valve Stem Seal Set	2009-05	SS 71039	Premium valve stem seals incl.	
QTY	THERMOSTAT HOUSING	YEARS	PART NO.	DESCRIPTION	
1	O-Ring	2009-05	35720	Thermostat Housing	
QTY	WATER PUMP	YEARS	PART NO.	DESCRIPTION	
2	Water Pump Gasket	2009-05	35852		
1	O-Ring	2009-05	35633	Water Pump	
QTY	TIMING COVER	YEARS	PART NO.	DESCRIPTION	
1	Timing Cover Set	2009-05	TCS 45993	Must be used w/OS 30693R	
QTY	CARB & FUEL INJECTION	YEARS	PART NO.	DESCRIPTION	
2	Fuel Injector O-Ring Set	2009-05	ES 70599	Upper set; Injectors to fuel rail; Improved design	
1	Throttle Body Gasket	2009-05	61337	Improved design	
QTY	OIL FILTER MOUNTING	YEARS	PART NO.	DESCRIPTION	
1	Oil Cooler Gasket	2009-05	72462	Oil Filter; Center tube; Dual round port	
QTY	OIL PUMP COVER	YEARS	PART NO.	DESCRIPTION	
1	O-Ring	2009-05	72401	Oil Pump; Inlet tube	
QTY	OIL COOLER	YEARS	PART NO.	DESCRIPTION	
1	Oil Cooler Gasket	2009-05	72435	Oval port	
1	Oil Cooler Gasket	2009-05	72462	Dual round port	
100		2004 - 1997; 5.7L 346 (5665cc) OHV V8 (16 Valve) 99mm Bore LS-1			100
		MFI; Gasoline; Naturally Aspirated GMC Eng.; Chevrolet; VIN Code G			
QTY	CYLINDER HEAD	YEARS	PART NO.	DESCRIPTION	
2	Head Gasket	2004-02	26190 PT	Head bolts not incl.; Head bolt replacement recommended; PermaTorqueMLS® LaserWeld® Technology	
2	Head Gasket	2001-97	9284 PT	Head bolts not incl.; Head bolt replacement recommended	
1	Head Set	2004	HS 26190 PT	Exc. Pontiac GTO Base; Head bolts not incl.; Head bolt replacement recommended; PermaDry® molded rubber valve cover gskts. incl.; Premium valve stem seals incl.	
1	Head Set	2004	HS 26190 PT-1	Pontiac GTO Base; Head bolts not incl.; Head bolt replacement recommended; PermaDry® molded rubber valve cover gskts. incl.; Premium valve stem seals incl.	
1	Head Set	2003	HS 26190 PT	Head bolts not incl.; Head bolt replacement recommended; PermaDry® molded rubber valve cover gskts. incl.; Premium valve stem seals incl.	
1	Head Set	2002	HS 26190 PT	Chevrolet Corvette Base; Head bolts not incl.; Head bolt replacement recommended; PermaDry® molded rubber valve cover gskts. incl.; Premium valve stem seals incl.	
1	Head Set	2002	HS 26190 PT-1	Exc. Chevrolet Corvette Base; Head bolts not incl.; Head bolt replacement recommended; PermaDry® molded rubber valve cover gskts. incl.; Premium valve stem seals incl.	
1	Head Set	2001	HS 9284 PT-1	Exc. Chevrolet Corvette Base; Head bolts not incl.; Head bolt replacement recommended; PermaDry® molded rubber valve cover gskts. incl.; Premium valve stem seals incl.	
1	Head Set	2001	HS 9284 PT-2	Chevrolet Corvette Base; Head bolts not incl.; Head bolt replacement recommended; PermaDry® molded rubber valve cover gskts. incl.; Premium valve stem seals incl.	
1	Head Set	2000-99	HS 9284 PT-1	Head bolts not incl.; Head bolt replacement recommended; PermaDry® molded rubber valve cover gskts. incl.; Premium valve stem seals incl.	
1	Head Set	1998-97	HS 9284 PT	Head bolts not incl.; Head bolt replacement recommended; PermaDry® molded rubber valve cover gskts. incl.; Premium valve stem seals incl.	
2	Head Bolt Set	2004-97	ES 72173	1st Design; Replacement recommended	
2	Head Bolt Set	2004	ES 72220	2nd Design; Replacement recommended	

GM Car (Incl. Buick, Cad., Chev., Geo, Olds., Pontiac, Saturn) (Cont.)

100 (cont.)		2004 - 1997; 5.7L 346 (5665cc) OHV V8 (16 Valve) 99mm Bore LS-1			100 (cont.)	
MFI; Gasoline; Naturally Aspirated GMC Eng.; Chevrolet; VIN Code G						
QTY	CONVERSION SET	YEARS	PART NO.	DESCRIPTION		
1	Gasket Conversion Set	2004	CS 9284	Exc. Pontiac GTO Base; Lower oil pan gskt. not incl.; PermaDry® molded rubber oil pan gskt. incl.		
1	Gasket Conversion Set	2004	CS 9284	Pontiac GTO Base; PermaDry® molded rubber oil pan gskt. incl.		
1	Gasket Conversion Set	2003	CS 9284	Lower oil pan gskt. not incl.; PermaDry® molded rubber oil pan gskt. incl.		
1	Gasket Conversion Set	2002-01	CS 9284	Chevrolet Corvette Base; Lower oil pan gskt. not incl.; PermaDry® molded rubber oil pan gskt. incl.		
1	Gasket Conversion Set	2002-01	CS 9284	Exc. Chevrolet Corvette Base; PermaDry® molded rubber oil pan gskt. incl.		
1	Gasket Conversion Set	2000-97	CS 9284	PermaDry® molded rubber oil pan gskt. incl.		
QTY	MANIFOLD - INT. & EXH.	YEARS	PART NO.	DESCRIPTION		
1	Int. Manifold Gasket Set	2004-97	MS 92438			
1	Int. Manifold Gasket Set	2004-97	MS 92465	Lifter valley cover set		
1	Exh. Manifold Gasket Set	2004	MS 92467	Pontiac GTO Base		
1	Exh. Manifold Gasket Set	2004	MS 92904	Exc. Pontiac GTO Base		
1	Exh. Manifold Gasket Set	2003	MS 92904			
1	Exh. Manifold Gasket Set	2002-01	MS 92467	Exc. Chevrolet Corvette Base		
1	Exh. Manifold Gasket Set	2002-01	MS 92904	Chevrolet Corvette Base		
1	Exh. Manifold Gasket Set	2000-97	MS 92467			
QTY	EXHAUST PIPE FLANGE	YEARS	PART NO.	DESCRIPTION		
1	Exhaust Pipe Gasket	2002-99	60988	Exc. Chevrolet Corvette Base; Loc. R.H.; Pipe to manifold		
1	Exhaust Pipe Gasket	2002-99	61077	Exc. Chevrolet Corvette Base; Loc. L.H.; Pipe to manifold		
1	Exhaust Pipe Gasket	1998	60988	Exc. Chevrolet Corvette Base, Indianapolis 500 Pace Car; Loc. R.H.; Pipe to manifold		
1	Exhaust Pipe Gasket	1998	61077	Exc. Chevrolet Corvette Base, Indianapolis 500 Pace Car; Loc. L.H.; Pipe to manifold		
QTY	OIL PAN	YEARS	PART NO.	DESCRIPTION		
1	Oil Pan Gasket Set	2004	OS 30693 R	Exc. Pontiac GTO Base; Loc. Upper; PermaDry® molded rubber gskt. incl.		
1	Oil Pan Gasket Set	2004	OS 30693 R	Pontiac GTO Base; PermaDry® molded rubber gskt. incl.		
1	Oil Pan Gasket Set	2004	OS 30703 R	Exc. Pontiac GTO Base; Loc. Lower; PermaDry® molded rubber gskt. incl.		
1	Oil Pan Gasket Set	2003	OS 30693 R	Loc. Upper; PermaDry® molded rubber gskt. incl.		
1	Oil Pan Gasket Set	2003	OS 30703 R	Loc. Lower; PermaDry® molded rubber gskt. incl.		
1	Oil Pan Gasket Set	2002-01	OS 30693 R	Chevrolet Corvette Base; Loc. Upper; PermaDry® molded rubber gskt. incl.		
1	Oil Pan Gasket Set	2002-01	OS 30693 R	Exc. Chevrolet Corvette Base; PermaDry® molded rubber gskt. incl.		
1	Oil Pan Gasket Set	2002-01	OS 30703 R	Chevrolet Corvette Base; Loc. Lower; PermaDry® molded rubber gskt. incl.		
1	Oil Pan Gasket Set	2000-97	OS 30693 R	PermaDry® molded rubber gskt. incl.		
QTY	CRANKSHAFT REAR SEAL	YEARS	PART NO.	DESCRIPTION		
1	Rear Main Seal Set	2004-97	BS 40640	PTFE Rubber; One-piece		
1	Repair Sleeve	2004-97	16228	Crankshaft; Narrow lip; .780" sleeve length; Requires crankshaft machining due to clearance issues; Use w/installation tool		
1	Repair Sleeve	2004-97	16229	Crankshaft; Wide lip; 1.156" sleeve length; Requires crankshaft machining due to clearance issues; Use w/installation tool		
1	Repair Sleeve Tool	2004-97	16329	Crankshaft		
QTY	VALVE COVER	YEARS	PART NO.	DESCRIPTION		
1	Valve Cover Gasket Set	2004-99	VS 50504 R	w/o Grommets; PermaDry® molded rubber gskts. incl.		
1	Valve Cover Gasket Set	2004-99	VS 50504 R-1	w/Grommets; PermaDry® molded rubber gskts. incl.; New Part Number - Check for Availability		
1	Valve Cover Gasket Set	1998-97	VS 50503 R	w/o Grommets; PermaDry® molded rubber gskts. incl.		
1	Grommet Set	2004-97	ES 72233	Valve Cover		
QTY	VALVE STEM SEAL SET	YEARS	PART NO.	DESCRIPTION		
1	Valve Stem Seal Set	2004-02	SS 71039	Premium valve stem seals incl.		
1	Valve Stem Seal Set	2001-97	SS 70945	Premium valve stem seals incl.		
QTY	THERMOSTAT HOUSING	YEARS	PART NO.	DESCRIPTION		
1	Thermostat Gasket	2003-97	35632	Thermostat Housing; Thermostat O-ring		
1	O-Ring	2004	35720	Thermostat Housing		
QTY	WATER PUMP	YEARS	PART NO.	DESCRIPTION		
2	Water Pump Gasket	2004-99	35635			
2	Water Pump Gasket	1998-97	35636			
1	O-Ring	2004-97	35633	Water Pump		
1	Water Pump Mounting Set	2004-99	ES 73010	Mounting gasket set; New Part Number - Check for Availability		
QTY	TIMING COVER	YEARS	PART NO.	DESCRIPTION		
1	Timing Cover Set	2004-97	TCS 45993	Must be used w/OS 30693R or w/OS 30703R		
QTY	CARB & FUEL INJECTION	YEARS	PART NO.	DESCRIPTION		
1	Throttle Body Gasket	2004-97	61069			
QTY	EXHAUST GAS RECIRCULATION	YEARS	PART NO.	DESCRIPTION		
1	EGR Gasket	2004-97	70895	Pipe; O-ring		

GM Car (Incl. Buick, Cad., Chev., Geo, Olds., Pontiac, Saturn) (Cont.)

100 (cont.)		2004 - 1997; 5.7L 346 (5665cc) OHV V8 (16 Valve) 99mm Bore LS-1			100 (cont.)
MFI; Gasoline; Naturally Aspirated GMC Eng.; Chevrolet; VIN Code G					
QTY	EXHAUST GAS RECIRCULATION	YEARS	PART NO.	DESCRIPTION	
1	EGR Gasket	2004-97	70914	Valve	
1	EGR Gasket	2004-97	70947	Pipe	
QTY	OIL FILTER MOUNTING	YEARS	PART NO.	DESCRIPTION	
1	Oil Cooler Gasket	2004-97	72462	Oil Filter; Center tube; Dual round port	
QTY	OIL PUMP COVER	YEARS	PART NO.	DESCRIPTION	
1	O-Ring	2004-97	72401	Oil Pump; Inlet tube	
QTY	OIL COOLER	YEARS	PART NO.	DESCRIPTION	
1	Oil Cooler Gasket	2004-97	72435	Oval port	
1	Oil Cooler Gasket	2004-97	72462	Dual round port	
101		2005 - 2001; 5.7L 346 (5665cc) OHV V8 (16 Valve) 99mm Bore LS-6			101
MFI; Gasoline; Naturally Aspirated GMC Eng.; Chevrolet; VIN Code S					
QTY	CYLINDER HEAD	YEARS	PART NO.	DESCRIPTION	
2	Head Gasket	2005-02	26190 PT	Head bolts not incl.; Head bolt replacement recommended; PermaTorqueMLS® LaserWeld® Technology	
2	Head Gasket	2001	9284 PT	Head bolts not incl.; Head bolt replacement recommended	
1	Head Set	2005	HS 26190 PT-1	Head bolts not incl.; Head bolt replacement recommended; PermaDry® molded rubber valve cover gsks. incl.; Premium valve stem seals incl.	
1	Head Set	2004	HS 26190 PT	Exc. Cadillac CTS V; Head bolts not incl.; Head bolt replacement recommended; PermaDry® molded rubber valve cover gsks. incl.; Premium valve stem seals incl.	
1	Head Set	2004	HS 26190 PT-1	Cadillac CTS V; Head bolts not incl.; Head bolt replacement recommended; PermaDry® molded rubber valve cover gsks. incl.; Premium valve stem seals incl.	
1	Head Set	2003-02	HS 26190 PT	Head bolts not incl.; Head bolt replacement recommended; PermaDry® molded rubber valve cover gsks. incl.; Premium valve stem seals incl.	
1	Head Set	2001	HS 9284 PT-2	Head bolts not incl.; Head bolt replacement recommended; PermaDry® molded rubber valve cover gsks. incl.; Premium valve stem seals incl.	
2	Head Bolt Set	2005-04	ES 72220	2nd Design; Replacement recommended	
2	Head Bolt Set	2004-01	ES 72173	1st Design; Replacement recommended	
QTY	CONVERSION SET	YEARS	PART NO.	DESCRIPTION	
1	Gasket Conversion Set	2005	CS 9284	PermaDry® molded rubber oil pan gskt. incl.	
1	Gasket Conversion Set	2004	CS 9284	Exc. Cadillac CTS V; Lower oil pan gskt. not incl.; PermaDry® molded rubber oil pan gskt. incl.	
1	Gasket Conversion Set	2004	CS 9284	Cadillac CTS V; PermaDry® molded rubber oil pan gskt. incl.	
1	Gasket Conversion Set	2003-01	CS 9284	Lower oil pan gskt. not incl.; PermaDry® molded rubber oil pan gskt. incl.	
QTY	MANIFOLD - INT. & EXH.	YEARS	PART NO.	DESCRIPTION	
1	Int. Manifold Gasket Set	2005-01	MS 92438		
1	Int. Manifold Gasket Set	2005-01	MS 92465	Lifter valley cover set	
1	Exh. Manifold Gasket Set	2005	MS 92467		
1	Exh. Manifold Gasket Set	2004	MS 92467	Cadillac CTS V	
1	Exh. Manifold Gasket Set	2004	MS 92904	Exc. Cadillac CTS V	
1	Exh. Manifold Gasket Set	2003-01	MS 92904		
QTY	EXHAUST PIPE FLANGE	YEARS	PART NO.	DESCRIPTION	
2	Exhaust Pipe Gasket	2005	61054	Pipe to manifold; Packing	
2	Exhaust Pipe Gasket	2004	61054	Cadillac CTS V; Pipe to manifold; Packing	
QTY	OIL PAN	YEARS	PART NO.	DESCRIPTION	
1	Oil Pan Gasket Set	2005	OS 30693 R	PermaDry® molded rubber gskt. incl.	
1	Oil Pan Gasket Set	2004	OS 30693 R	Exc. Cadillac CTS V; Loc. Upper; PermaDry® molded rubber gskt. incl.	
1	Oil Pan Gasket Set	2004	OS 30693 R	Cadillac CTS V; PermaDry® molded rubber gskt. incl.	
1	Oil Pan Gasket Set	2004	OS 30703 R	Exc. Cadillac CTS V; Loc. Lower; PermaDry® molded rubber gskt. incl.	
1	Oil Pan Gasket Set	2003-01	OS 30693 R	Loc. Upper; PermaDry® molded rubber gskt. incl.	
1	Oil Pan Gasket Set	2003-01	OS 30703 R	Loc. Lower; PermaDry® molded rubber gskt. incl.	
QTY	CRANKSHAFT REAR SEAL	YEARS	PART NO.	DESCRIPTION	
1	Rear Main Seal Set	2005-01	BS 40640	PTFE Rubber; One-piece	
1	Repair Sleeve	2005-01	16228	Crankshaft; Narrow lip; .780" sleeve length; Requires crankshaft machining due to clearance issues; Use w/installation tool	
1	Repair Sleeve	2005-01	16229	Crankshaft; Wide lip; 1.156" sleeve length; Requires crankshaft machining due to clearance issues; Use w/installation tool	
1	Repair Sleeve Tool	2005-01	16329	Crankshaft	
QTY	VALVE COVER	YEARS	PART NO.	DESCRIPTION	
1	Valve Cover Gasket Set	2005-01	VS 50504 R	w/o Grommets; PermaDry® molded rubber gsks. incl.	
1	Valve Cover Gasket Set	2005-01	VS 50504 R-1	w/Grommets; PermaDry® molded rubber gsks. incl.; New Part Number - Check for Availability	

GM Car (Incl. Buick, Cad., Chev., Geo, Olds., Pontiac, Saturn) (Cont.)

101 (cont.)		2005 - 2001; 5.7L 346 (5665cc) OHV V8 (16 Valve) 99mm Bore LS-6 MFI; Gasoline; Naturally Aspirated GMC Eng.; Chevrolet; VIN Code S			101 (cont.)
QTY	VALVE COVER	YEARS	PART NO.	DESCRIPTION	
1	Grommet Set	2005-01	ES 72233	Valve Cover	
QTY	VALVE STEM SEAL SET	YEARS	PART NO.	DESCRIPTION	
1	Valve Stem Seal Set	2005-02	SS 71039	Premium valve stem seals incl.	
1	Valve Stem Seal Set	2001	SS 70945	Premium valve stem seals incl.	
QTY	THERMOSTAT HOUSING	YEARS	PART NO.	DESCRIPTION	
1	Thermostat Gasket	2003-01	35632	Thermostat Housing; Thermostat O-ring	
1	O-Ring	2005-04	35720	Thermostat Housing	
QTY	WATER PUMP	YEARS	PART NO.	DESCRIPTION	
2	Water Pump Gasket	2005-01	35635		
1	O-Ring	2005-01	35633	Water Pump	
1	Water Pump Mounting Set	2005-01	ES 73010	Mounting gasket set; New Part Number - Check for Availability	
QTY	TIMING COVER	YEARS	PART NO.	DESCRIPTION	
1	Timing Cover Set	2005-01	TCS 45993	Must be used w/OS 30693R or w/OS 30703R	
QTY	CARB & FUEL INJECTION	YEARS	PART NO.	DESCRIPTION	
1	Throttle Body Gasket	2005-01	61069		
QTY	EXHAUST GAS RECIRCULATION	YEARS	PART NO.	DESCRIPTION	
1	EGR Gasket	2005-01	70895	Pipe; O-ring	
1	EGR Gasket	2005-01	70914	Valve	
1	EGR Gasket	2005-01	70947	Pipe	
QTY	OIL FILTER MOUNTING	YEARS	PART NO.	DESCRIPTION	
1	Oil Cooler Gasket	2005-01	72462	Oil Filter; Center tube; Dual round port	
QTY	OIL PUMP COVER	YEARS	PART NO.	DESCRIPTION	
1	O-Ring	2005-01	72401	Oil Pump; Inlet tube	
QTY	OIL COOLER	YEARS	PART NO.	DESCRIPTION	
1	Oil Cooler Gasket	2005-01	72435	Oval port	
1	Oil Cooler Gasket	2005-01	72462	Dual round port	
102		1993 - 1991; 5.7L 350 (5736cc) OHV V8 (16 Valve) 4" Bore TBI; Gasoline; Naturally Aspirated GMC Eng.; Chevrolet; VIN Code 7			102
QTY	CYLINDER HEAD	YEARS	PART NO.	DESCRIPTION	
2	Head Gasket	1993-91	501 SD	Head bolts not incl.; Head bolt replacement recommended; PermaTorque Severe Duty®	
2	Head Gasket	1993-91	7733 PT-2	Head bolts not incl.; Head bolt replacement recommended; PermaTorque®	
2	Head Gasket Spacer Shim	1993-91	7733 SP	HeadSaver®	
1	Head Set	1993-91	HS 7733 PT-15	Head bolts not incl.; Head bolt replacement recommended; PermaDry® molded rubber valve cover gskts. incl.; Premium valve stem seals incl.	
2	Head Bolt Set	1993-91	ES 72856	Replacement recommended	
QTY	CONVERSION SET	YEARS	PART NO.	DESCRIPTION	
1	Gasket Conversion Set	1993-91	CS 8510	PermaDry® molded rubber oil pan gskt. incl.	
QTY	MANIFOLD - INT. & EXH.	YEARS	PART NO.	DESCRIPTION	
1	Int. Manifold Gasket Set	1993-91	MS 93317		
1	Exh. Manifold Gasket Set	1993-91	MS 9275 B		
QTY	FUEL PUMP	YEARS	PART NO.	DESCRIPTION	
1	Fuel Pump Mounting Gasket	1993-91	5182	Plate	
1	Fuel Pump Mounting Gasket	1993-91	6579	May also be used as a fuel pump block-off plate gasket if desired	
QTY	OIL PAN	YEARS	PART NO.	DESCRIPTION	
1	Oil Pan Gasket Set	1993-91	OS 34500 R	PermaDry® molded rubber gskt. incl.	
1	Drain Plug Gasket	1993-91	70822		
QTY	CRANKSHAFT REAR SEAL	YEARS	PART NO.	DESCRIPTION	
1	Rear Main Seal Set	1993-91	BS 40520	Rubber; One-piece	
1	Rear Main Seal Set	1993-91	BS 40626	PTFE Rubber; One-piece	
1	Repair Sleeve	1993-91	16258	Crankshaft; Use w/installation tool	
1	Repair Sleeve Tool	1993-91	16301	Crankshaft	
QTY	VALVE COVER	YEARS	PART NO.	DESCRIPTION	
1	Valve Cover Gasket Set	1993-91	VS 50088 R	Services both covers; PermaDry® molded rubber gskts. incl.	
2	Valve Cover Gasket Set	1993-91	VS 50293 R	Services one cover only; PermaDry® molded rubber gskt. incl.	
QTY	VALVE STEM SEAL SET	YEARS	PART NO.	DESCRIPTION	
1	Valve Stem Seal Set	1993-91	SS 72526	Loc. Exh.; Premium valve stem seals incl.	
1	Valve Stem Seal Set	1993-91	SS 72527	Loc. Int.; Premium valve stem seals incl.	
1	Valve Stem Seal Set	1993-91	SS 72877	Loc. Exh.; Opt. Hi-Temp. premium valve stem seals incl.	
QTY	WATER OUTLET GASKET	YEARS	PART NO.	DESCRIPTION	
1	Water Outlet Gasket	1993-91	35062	Water Outlet; 1 13/16" ID	

GM Car (Incl. Buick, Cad., Chev., Geo, Olds., Pontiac, Saturn) (Cont.)

102		1993 - 1991; 5.7L 350 (5736cc) OHV V8 (16 Valve) 4" Bore			102
(cont.)		TBI; Gasoline; Naturally Aspirated GMC Eng.; Chevrolet; VIN Code 7			(cont.)
QTY	WATER OUTLET GASKET	YEARS	PART NO.	DESCRIPTION	
1	Water Outlet Gasket	1993-91	35562 T	Water Outlet; 1 13/16" ID; PermaDryPlus®	
QTY	WATER PUMP	YEARS	PART NO.	DESCRIPTION	
1	Water Pump Gasket	1993-91	13032	To plate	
2	Water Pump Gasket	1993-91	5152	To block	
QTY	TIMING COVER	YEARS	PART NO.	DESCRIPTION	
1	Timing Cover Set	1993-91	TCS 45121	w/o Sleeve 'N' Seal®; Must be used w/OS 34500R	
1	Timing Set w/Sleeve & Seal	1993-91	TCS 45265	w/Sleeve 'N' Seal®; Must be used w/OS 34500R	
1	Repair Sleeve	1993-91	16202	Timing Cover; Use w/installation tool	
1	Repair Sleeve Tool	1993-91	16312	Timing Cover	
QTY	AIR CLEANER MOUNTING	YEARS	PART NO.	DESCRIPTION	
1	Air Cleaner Gasket	1993-91	60038	5 1/32" ID	
QTY	CARB & FUEL INJECTION	YEARS	PART NO.	DESCRIPTION	
1	Throttle Body Gasket	1993-91	60903		
QTY	DISTRIBUTOR MOUNTING	YEARS	PART NO.	DESCRIPTION	
1	Distributor Mounting Gasket	1993-91	70056		
QTY	EXHAUST GAS RECIRCULATION	YEARS	PART NO.	DESCRIPTION	
1	EGR Gasket	1993-91	70978		
QTY	OIL PUMP RETAINER	YEARS	PART NO.	DESCRIPTION	
1	Oil Pump Shaft Guide	1993-91	72665	Distributor to oil pump shaft retainer	
103		1992 - 1991; 5.7L 350 (5736cc) OHV V8 (16 Valve) 4" Bore			103
(cont.)		TPI; Gasoline; Naturally Aspirated GMC Eng.; Chevrolet; VIN Code 8			(cont.)
QTY	CYLINDER HEAD	YEARS	PART NO.	DESCRIPTION	
2	Head Gasket	1992-91	501 SD	Head bolts not incl.; Head bolt replacement recommended; PermaTorque Severe Duty®	
2	Head Gasket	1992-91	7733 PT-2	Head bolts not incl.; Head bolt replacement recommended; PermaTorque®	
2	Head Gasket Spacer Shim	1992-91	7733 SP	HeadSaver®	
1	Head Set	1992	HS 7733 PT-15	Int. manifold gskts. not incl.; Head bolts not incl.; Head bolt replacement recommended; PermaDry® molded rubber valve cover gskts. incl.; Premium valve stem seals incl.	
1	Head Set	1991	HS 7733 PT-15	Exc. Chevrolet Corvette Base; Int. manifold gskts. not incl.; Head bolts not incl.; Head bolt replacement recommended; PermaDry® molded rubber valve cover gskts. incl.; Premium valve stem seals incl.	
1	Head Set	1991	HS 7733 PT-9	Chevrolet Corvette Base; Head bolts not incl.; Head bolt replacement recommended; PermaDry® molded rubber valve cover gskts. incl.; Premium valve stem seals incl.	
2	Head Bolt Set	1992-91	ES 72856	Replacement recommended	
QTY	CONVERSION SET	YEARS	PART NO.	DESCRIPTION	
1	Gasket Conversion Set	1992-91	CS 8510	PermaDry® molded rubber oil pan gskt. incl.	
QTY	MANIFOLD - INT. & EXH.	YEARS	PART NO.	DESCRIPTION	
1	Int. Manifold Gasket Set	1992	MS 93035-1	Upper set incl.	
1	Int. Manifold Gasket Set	1991	MS 93035-1	Exc. Chevrolet Corvette Base; Upper set incl.	
1	Int. Manifold Gasket Set	1991	MS 93318	Chevrolet Corvette Base; Upper set incl.	
1	Plenum Gasket Set	1992-91	MS 93160	Upper set	
1	Exh. Manifold Gasket Set	1992	MS 9275 B		
1	Exh. Manifold Gasket Set	1991	MS 9275 B	Exc. Chevrolet Corvette Base	
1	Exh. Manifold Gasket Set	1991	MS 94054	Chevrolet Corvette Base	
QTY	FUEL PUMP	YEARS	PART NO.	DESCRIPTION	
1	Fuel Pump Mounting Gasket	1992-91	5182	Plate	
1	Fuel Pump Mounting Gasket	1992-91	6579	May also be used as a fuel pump block-off plate gasket if desired	
QTY	OIL PAN	YEARS	PART NO.	DESCRIPTION	
1	Oil Pan Gasket Set	1992-91	OS 34500 R	PermaDry® molded rubber gskt. incl.	
1	Drain Plug Gasket	1992-91	70822		
QTY	CRANKSHAFT REAR SEAL	YEARS	PART NO.	DESCRIPTION	
1	Rear Main Seal Set	1992-91	BS 40520	Rubber; One-piece	
1	Rear Main Seal Set	1992-91	BS 40626	PTFE Rubber; One-piece	
1	Repair Sleeve	1992-91	16258	Crankshaft; Use w/installation tool	
1	Repair Sleeve Tool	1992-91	16301	Crankshaft	
QTY	VALVE COVER	YEARS	PART NO.	DESCRIPTION	
1	Valve Cover Gasket Set	1992-91	VS 50088 R	Services both covers; PermaDry® molded rubber gskts. incl.	
2	Valve Cover Gasket Set	1992-91	VS 50293 R	Services one cover only; PermaDry® molded rubber gskt. incl.	
QTY	VALVE STEM SEAL SET	YEARS	PART NO.	DESCRIPTION	
1	Valve Stem Seal Set	1992-91	SS 72526	Loc. Exh.; Premium valve stem seals incl.	

GM Car (Incl. Buick, Cad., Chev., Geo, Olds., Pontiac, Saturn) (Cont.)

103		1992 - 1991; 5.7L 350 (5736cc) OHV V8 (16 Valve) 4" Bore			103	
(cont.)		TPI; Gasoline; Naturally Aspirated GMC Eng.; Chevrolet; VIN Code 8			(cont.)	
QTY	VALVE STEM SEAL SET	YEARS	PART NO.	DESCRIPTION		
1	Valve Stem Seal Set	1992-91	SS 72527	Loc. Int.; Premium valve stem seals incl.		
1	Valve Stem Seal Set	1992-91	SS 72877	Loc. Exh.; Opt. Hi-Temp. premium valve stem seals incl.		
QTY	WATER OUTLET GASKET	YEARS	PART NO.	DESCRIPTION		
1	Water Outlet Gasket	1992-91	35062	Water Outlet; 1 13/16" ID		
1	Water Outlet Gasket	1992-91	35562 T	Water Outlet; 1 13/16" ID; PermaDryPlus®		
QTY	WATER PUMP	YEARS	PART NO.	DESCRIPTION		
1	Water Pump Gasket	1992-91	13032	To plate		
2	Water Pump Gasket	1992-91	5152	To block		
QTY	TIMING COVER	YEARS	PART NO.	DESCRIPTION		
1	Timing Cover Set	1992-91	TCS 45121	w/o Sleeve 'N' Seal®; Must be used w/OS 34500R		
1	Timing Set w/Sleeve & Seal	1992-91	TCS 45265	w/Sleeve 'N' Seal®; Must be used w/OS 34500R		
1	Repair Sleeve	1992-91	16202	Timing Cover; Use w/installation tool		
1	Repair Sleeve Tool	1992-91	16312	Timing Cover		
QTY	CARB & FUEL INJECTION	YEARS	PART NO.	DESCRIPTION		
4	Fuel Injector O-Ring Set	1992-91	ES 70599	Improved design		
1	Throttle Body Gasket	1992-91	60826			
QTY	DISTRIBUTOR MOUNTING	YEARS	PART NO.	DESCRIPTION		
1	Distributor Mounting Gasket	1992-91	70194			
QTY	EXHAUST GAS RECIRCULATION	YEARS	PART NO.	DESCRIPTION		
1	EGR Gasket	1992-91	70954			
QTY	OIL PUMP RETAINER	YEARS	PART NO.	DESCRIPTION		
1	Oil Pump Shaft Guide	1992-91	72665	Distributor to oil pump shaft retainer		
104		1997 - 1992; 5.7L 350 (5736cc) OHV V8 (16 Valve) 4" Bore LT-1			104	
(cont.)		MFI; Gasoline; Naturally Aspirated GMC Eng.; Chevrolet; VIN Code P			(cont.)	
QTY	CYLINDER HEAD	YEARS	PART NO.	DESCRIPTION		
2	Head Gasket	1997-92	9966 PT	Head bolts not incl.; Head bolt replacement recommended		
1	Head Set	1997	HS 9966 PT	Head bolts not incl.; Head bolt replacement recommended; PermaDry® molded rubber valve cover gskts. incl.; Premium valve stem seals incl.		
1	Head Set	1996	HS 9966 PT	Exc. Chevrolet Corvette Base, Collector's Edition, Grand Sport; Head bolts not incl.; Head bolt replacement recommended; PermaDry® molded rubber valve cover gskts. incl.; Premium valve stem seals incl.		
1	Head Set	1996	HS 9966 PT-2	Chevrolet Corvette Base, Collector's Edition, Grand Sport; Head bolts & exh. pipe packing not incl.; Head bolt replacement recommended; PermaDry® molded rubber valve cover gskts. incl.; Premium valve stem seals incl.; Consolidated design		
1	Head Set	1995	HS 9966 PT	Exc. Chevrolet Corvette Base, Indianapolis 500 Pace Car; Head bolts not incl.; Head bolt replacement recommended; PermaDry® molded rubber valve cover gskts. incl.; Premium valve stem seals incl.		
1	Head Set	1995	HS 9966 PT-2	Chevrolet Corvette Base, Indianapolis 500 Pace Car; Head bolts & exh. pipe packing not incl.; Head bolt replacement recommended; PermaDry® molded rubber valve cover gskts. incl.; Premium valve stem seals incl.; Consolidated design		
1	Head Set	1994	HS 9966 PT	Exc. Chevrolet Corvette Base; Head bolts not incl.; Head bolt replacement recommended; PermaDry® molded rubber valve cover gskts. incl.; Premium valve stem seals incl.		
1	Head Set	1994	HS 9966 PT-2	Chevrolet Corvette Base; Head bolts & exh. pipe packing not incl.; Head bolt replacement recommended; PermaDry® molded rubber valve cover gskts. incl.; Premium valve stem seals incl.; Consolidated design		
1	Head Set	1993	HS 9966 PT	Exc. Chevrolet Corvette 40th Anniversary Edition, Base; Head bolts not incl.; Head bolt replacement recommended; PermaDry® molded rubber valve cover gskts. incl.; Premium valve stem seals incl.		
1	Head Set	1993	HS 9966 PT-2	Chevrolet Corvette 40th Anniversary Edition, Base; Head bolts & exh. pipe packing not incl.; Head bolt replacement recommended; PermaDry® molded rubber valve cover gskts. incl.; Premium valve stem seals incl.; Consolidated design		
1	Head Set	1992	HS 9966 PT-2	Head bolts & exh. pipe packing not incl.; Head bolt replacement recommended; PermaDry® molded rubber valve cover gskts. incl.; Premium valve stem seals incl.; Consolidated design		
2	Head Bolt Set	1997-92	ES 72856	Replacement recommended		
QTY	CONVERSION SET	YEARS	PART NO.	DESCRIPTION		
1	Gasket Conversion Set	1997	CS 9966	Rear main brg. seal not incl.; PermaDry® molded rubber oil pan gskt. incl.		
1	Gasket Conversion Set	1996-92	CS 9966	PermaDry® molded rubber oil pan gskt. incl.		
QTY	MANIFOLD - INT. & EXH.	YEARS	PART NO.	DESCRIPTION		
1	Int. Manifold Gasket Set	1997-92	MS 95580			

GM Car (Incl. Buick, Cad., Chev., Geo, Olds., Pontiac, Saturn) (Cont.)

104 (cont.)		1997 - 1992; 5.7L 350 (5736cc) OHV V8 (16 Valve) 4" Bore LT-1			104 (cont.)
MFI; Gasoline; Naturally Aspirated GMC Eng.; Chevrolet; VIN Code P					
QTY	MANIFOLD - INT. & EXH.	YEARS	PART NO.	DESCRIPTION	
1	Exh. Manifold Gasket Set	1997	MS 95585		
1	Exh. Manifold Gasket Set	1996	MS 95573-1	Chevrolet Corvette Base, Collector's Edition, Grand Sport; Improved design	
1	Exh. Manifold Gasket Set	1996	MS 95585	Exc. Chevrolet Corvette Base, Collector's Edition, Grand Sport	
1	Exh. Manifold Gasket Set	1995	MS 95573-1	Chevrolet Corvette Base, Indianapolis 500 Pace Car; Improved design	
1	Exh. Manifold Gasket Set	1995	MS 95585	Exc. Chevrolet Corvette Base, Indianapolis 500 Pace Car	
1	Exh. Manifold Gasket Set	1994	MS 95573-1	Chevrolet Corvette Base; Improved design	
1	Exh. Manifold Gasket Set	1994	MS 95585	Exc. Chevrolet Corvette Base	
1	Exh. Manifold Gasket Set	1993	MS 95573-1	Chevrolet Corvette 40th Anniversary Edition, Base; Improved design	
1	Exh. Manifold Gasket Set	1993	MS 95585	Exc. Chevrolet Corvette 40th Anniversary Edition, Base	
1	Exh. Manifold Gasket Set	1992	MS 95573-1	Improved design	
QTY	EXHAUST PIPE FLANGE	YEARS	PART NO.	DESCRIPTION	
1	Exhaust Pipe Gasket	1997	60988	Loc. R.H.	
1	Exhaust Pipe Gasket	1997	60996	Loc. L.H.	
1	Exhaust Pipe Gasket	1996-95	60988	Chevrolet Camaro Z28 Pontiac Firebird Formula, Trans Am; Loc. R.H.	
1	Exhaust Pipe Gasket	1996-95	60996	Chevrolet Camaro Z28 Pontiac Firebird Formula, Trans Am; Loc. L.H.	
2	Exhaust Pipe Gasket	1996	60988	Exc. Chevrolet Camaro Z28, Corvette Base, Collector's Edition, Grand Sport Pontiac Firebird Formula, Trans Am	
2	Exhaust Pipe Gasket	1996	61258	Chevrolet Corvette Base, Collector's Edition, Grand Sport	
2	Exhaust Pipe Gasket	1995	60988	Exc. Chevrolet Camaro Z28, Corvette Base, Indianapolis 500 Pace Car Pontiac Firebird Formula, Trans Am	
2	Exhaust Pipe Gasket	1995	61258	Chevrolet Corvette Base, Indianapolis 500 Pace Car	
2	Exhaust Pipe Gasket	1994	60988	Exc. Chevrolet Camaro Z28, Corvette Base Pontiac Firebird Formula, Trans Am, Trans Am GT	
2	Exhaust Pipe Gasket	1994	61258	Chevrolet Corvette Base	
2	Exhaust Pipe Gasket	1993	61258	Chevrolet Corvette 40th Anniversary Edition, Base	
2	Exhaust Pipe Gasket	1992	61258		
QTY	OIL PAN	YEARS	PART NO.	DESCRIPTION	
1	Oil Pan Gasket Set	1997-92	OS 34500 R	PermaDry® molded rubber gskt. incl.	
1	Drain Plug Gasket	1997-92	70822		
QTY	CRANKSHAFT REAR SEAL	YEARS	PART NO.	DESCRIPTION	
1	Rear Main Seal Set	1997	BS 40656	PTFE Rubber; One-piece; Improved design	
1	Rear Main Seal Set	1996-92	BS 40520	Rubber; One-piece	
1	Rear Main Seal Set	1996-92	BS 40626	PTFE Rubber; One-piece	
1	Repair Sleeve	1997-92	16258	Crankshaft; Use w/installation tool	
1	Repair Sleeve Tool	1997-92	16301	Crankshaft	
QTY	VALVE COVER	YEARS	PART NO.	DESCRIPTION	
1	Valve Cover Gasket Set	1997	VS 50088 R	Services both covers; PermaDry® molded rubber gskts. incl.	
2	Valve Cover Gasket Set	1997	VS 50293 R	Services one cover only; PermaDry® molded rubber gskt. incl.	
1	Valve Cover Gasket Set	1996	VS 50088 R	Exc. Chevrolet Corvette Base, Collector's Edition, Grand Sport; Services both covers; PermaDry® molded rubber gskts. incl.	
2	Valve Cover Gasket Set	1996	VS 50293 R	Exc. Chevrolet Corvette Base, Collector's Edition, Grand Sport; Services one cover only; PermaDry® molded rubber gskt. incl.	
1	Valve Cover Gasket Set	1996	VS 50443 R	Chevrolet Corvette Base, Collector's Edition, Grand Sport; w/Grommets; PermaDry® molded rubber gskts. incl.	
1	Valve Cover Gasket Set	1995	VS 50088 R	Exc. Chevrolet Corvette Base, Indianapolis 500 Pace Car; Services both covers; PermaDry® molded rubber gskts. incl.	
2	Valve Cover Gasket Set	1995	VS 50293 R	Exc. Chevrolet Corvette Base, Indianapolis 500 Pace Car; Services one cover only; PermaDry® molded rubber gskt. incl.	
1	Valve Cover Gasket Set	1995	VS 50443 R	Chevrolet Corvette Base, Indianapolis 500 Pace Car; w/Grommets; PermaDry® molded rubber gskts. incl.	
1	Valve Cover Gasket Set	1994	VS 50088 R	Exc. Chevrolet Corvette Base; Services both covers; PermaDry® molded rubber gskts. incl.	
2	Valve Cover Gasket Set	1994	VS 50293 R	Exc. Chevrolet Corvette Base; Services one cover only; PermaDry® molded rubber gskt. incl.	
1	Valve Cover Gasket Set	1994	VS 50443 R	Chevrolet Corvette Base; w/Grommets; PermaDry® molded rubber gskts. incl.	
1	Valve Cover Gasket Set	1993	VS 50088 R	Exc. Chevrolet Corvette 40th Anniversary Edition, Base; Services both covers; PermaDry® molded rubber gskts. incl.	
2	Valve Cover Gasket Set	1993	VS 50293 R	Exc. Chevrolet Corvette 40th Anniversary Edition, Base; Services one cover only; PermaDry® molded rubber gskt. incl.	
1	Valve Cover Gasket Set	1993	VS 50443 R	Chevrolet Corvette 40th Anniversary Edition, Base; w/Grommets; PermaDry® molded rubber gskts. incl.	
1	Valve Cover Gasket Set	1992	VS 50443 R	w/Grommets; PermaDry® molded rubber gskts. incl.	
QTY	VALVE STEM SEAL SET	YEARS	PART NO.	DESCRIPTION	
1	Valve Stem Seal Set	1997-92	SS 72861	Premium valve stem seals incl.; Improved design	

GM Car (Incl. Buick, Cad., Chev., Geo, Olds., Pontiac, Saturn) (Cont.)

104 (cont.)		1997 - 1992; 5.7L 350 (5736cc) OHV V8 (16 Valve) 4" Bore LT-1			104 (cont.)
MFI; Gasoline; Naturally Aspirated GMC Eng.; Chevrolet; VIN Code P					
QTY	WATER OUTLET GASKET	YEARS	PART NO.	DESCRIPTION	
1	O-Ring	1997-92	35710	Water Outlet; 1.954" ID; Improved design	
QTY	WATER PUMP	YEARS	PART NO.	DESCRIPTION	
2	Water Pump Gasket	1997-92	35072		
QTY	TIMING COVER	YEARS	PART NO.	DESCRIPTION	
1	Timing Cover Set	1997-95	TCS 45956	Must be used w/OS 34500R	
1	Timing Cover Set	1994	TCS 45953	Chevrolet Camaro Z28, Corvette Base Pontiac Firebird Formula, Trans Am, Trans Am GT; Must be used w/OS 34500R	
1	Timing Cover Set	1994	TCS 45956	Exc. Chevrolet Camaro Z28, Corvette Base Pontiac Firebird Formula, Trans Am, Trans Am GT; Must be used w/OS 34500R	
1	Timing Cover Set	1993-92	TCS 45953	Must be used w/OS 34500R	
1	Repair Sleeve	1997-92	16202	Timing Cover; Use w/installation tool	
1	Repair Sleeve Tool	1997-92	16312	Timing Cover	
QTY	CARB & FUEL INJECTION	YEARS	PART NO.	DESCRIPTION	
4	Fuel Injector O-Ring Set	1997-92	ES 70599	Improved design	
1	Throttle Body Gasket	1997-92	60655		
QTY	EXHAUST GAS RECIRCULATION	YEARS	PART NO.	DESCRIPTION	
1	EGR Gasket	1997-92	70978		
QTY	OIL PUMP RETAINER	YEARS	PART NO.	DESCRIPTION	
1	Oil Pump Shaft Guide	1997-92	72665	Distributor to oil pump shaft retainer	
QTY	OIL COOLER	YEARS	PART NO.	DESCRIPTION	
1	Oil Cooler Mounting Set	1997-92	ES 70687		
105		1996; 5.7L 350 (5736cc) OHV V8 (16 Valve) 4" Bore LT-4			105
MFI; Gasoline; Naturally Aspirated GMC Eng.; Chevrolet; VIN Code 5					
QTY	CYLINDER HEAD	YEARS	PART NO.	DESCRIPTION	
2	Head Gasket	1996	9966 PT	Head bolts not incl.; Head bolt replacement recommended	
1	Head Set	1996	HS 9966 PT-2	Int. manifold gskts., head bolts, exh. pipe packing not incl.; Head bolt replacement recommended; PermaDry® molded rubber valve cover gskts. incl.; Premium valve stem seals incl.; Consolidated design	
2	Head Bolt Set	1996	ES 72856	Replacement recommended	
QTY	CONVERSION SET	YEARS	PART NO.	DESCRIPTION	
1	Gasket Conversion Set	1996	CS 9966	PermaDry® molded rubber oil pan gskt. incl.	
QTY	MANIFOLD - INT. & EXH.	YEARS	PART NO.	DESCRIPTION	
1	Int. Manifold Gasket Set	1996	MS 96386		
1	Exh. Manifold Gasket Set	1996	MS 95573-1	Improved design	
QTY	EXHAUST PIPE FLANGE	YEARS	PART NO.	DESCRIPTION	
2	Exhaust Pipe Gasket	1996	61258		
QTY	OIL PAN	YEARS	PART NO.	DESCRIPTION	
1	Oil Pan Gasket Set	1996	OS 34500 R	PermaDry® molded rubber gskt. incl.	
1	Drain Plug Gasket	1996	70822		
QTY	CRANKSHAFT REAR SEAL	YEARS	PART NO.	DESCRIPTION	
1	Rear Main Seal Set	1996	BS 40520	Rubber; One-piece	
1	Rear Main Seal Set	1996	BS 40626	PTFE Rubber; One-piece	
1	Repair Sleeve	1996	16258	Crankshaft; Use w/installation tool	
1	Repair Sleeve Tool	1996	16301	Crankshaft	
QTY	VALVE COVER	YEARS	PART NO.	DESCRIPTION	
1	Valve Cover Gasket Set	1996	VS 50443 R	w/Grommets; PermaDry® molded rubber gskts. incl.	
QTY	VALVE STEM SEAL SET	YEARS	PART NO.	DESCRIPTION	
1	Valve Stem Seal Set	1996	SS 72861	Premium valve stem seals incl.; Improved design	
QTY	WATER OUTLET GASKET	YEARS	PART NO.	DESCRIPTION	
1	O-Ring	1996	35710	Water Outlet; 1.954" ID; Improved design	
QTY	WATER PUMP	YEARS	PART NO.	DESCRIPTION	
2	Water Pump Gasket	1996	35072		
QTY	TIMING COVER	YEARS	PART NO.	DESCRIPTION	
1	Timing Cover Set	1996	TCS 45956	Must be used w/OS 34500R	
1	Repair Sleeve	1996	16202	Timing Cover; Use w/installation tool	
1	Repair Sleeve Tool	1996	16312	Timing Cover	
QTY	CARB & FUEL INJECTION	YEARS	PART NO.	DESCRIPTION	
4	Fuel Injector O-Ring Set	1996	ES 70599	Improved design	
1	Throttle Body Gasket	1996	60655		
QTY	EXHAUST GAS RECIRCULATION	YEARS	PART NO.	DESCRIPTION	
1	EGR Gasket	1996	70978		

GM Car (Incl. Buick, Cad., Chev., Geo, Olds., Pontiac, Saturn) (Cont.)

105		1996; 5.7L 350 (5736cc) OHV V8 (16 Valve) 4" Bore LT-4			105
(cont.)		MFI; Gasoline; Naturally Aspirated GMC Eng.; Chevrolet; VIN Code 5			(cont.)
QTY	OIL PUMP RETAINER	YEARS	PART NO.	DESCRIPTION	
1	Oil Pump Shaft Guide	1996	72665	Distributor to oil pump shaft retainer	
QTY	OIL COOLER	YEARS	PART NO.	DESCRIPTION	
1	Oil Cooler Mounting Set	1996	ES 70687		
106		2007 - 2005; 6.0L 364 (5967cc) OHV V8 (16 Valve) 101.6mm Bore Vortec			106
(cont.)		MFI; Gasoline; Naturally Aspirated GMC Eng.; Chevrolet; VIN Code U			(cont.)
QTY	CYLINDER HEAD	YEARS	PART NO.	DESCRIPTION	
2	Head Gasket	2007-05	26192 PT	Head bolts not incl.; Head bolt replacement recommended; PermaTorqueMLS® LaserWeld® Technology	
1	Head Set	2007-05	HS 26192 PT-3	Head bolts not incl.; Head bolt replacement recommended; PermaDry® molded rubber valve cover gskts. incl.; Premium valve stem seals incl.	
2	Head Bolt Set	2007-05	ES 72220	Replacement recommended	
QTY	CONVERSION SET	YEARS	PART NO.	DESCRIPTION	
1	Gasket Conversion Set	2007-05	CS 9284	PermaDry® molded rubber oil pan gskt. incl.	
QTY	MANIFOLD - INT. & EXH.	YEARS	PART NO.	DESCRIPTION	
1	Int. Manifold Gasket Set	2007-05	MS 96169	Lifter valley cover set	
1	Int. Manifold Gasket Set	2007-05	MS 96718		
1	Exh. Manifold Gasket Set	2007-05	MS 92467		
QTY	EXHAUST PIPE FLANGE	YEARS	PART NO.	DESCRIPTION	
2	Exhaust Pipe Gasket	2007	61054	Pipe to manifold	
2	Exhaust Pipe Gasket	2006	61054	Cadillac CTS V; Pipe to manifold	
QTY	OIL PAN	YEARS	PART NO.	DESCRIPTION	
1	Oil Pan Gasket Set	2007-05	OS 30693 R	PermaDry® molded rubber gskt. incl.	
QTY	CRANKSHAFT REAR SEAL	YEARS	PART NO.	DESCRIPTION	
1	Rear Main Seal Set	2007-05	BS 40640	PTFE Rubber; One-piece	
1	Repair Sleeve	2007-05	16228	Crankshaft; Narrow lip; .780" sleeve length; Requires crankshaft machining due to clearance issues; Use w/installation tool	
1	Repair Sleeve	2007-05	16229	Crankshaft; Wide lip; 1.156" sleeve length; Requires crankshaft machining due to clearance issues; Use w/installation tool	
1	Repair Sleeve Tool	2007-05	16329	Crankshaft	
QTY	VALVE COVER	YEARS	PART NO.	DESCRIPTION	
1	Valve Cover Gasket Set	2007-05	VS 50504 R	w/o Grommets; PermaDry® molded rubber gskts. incl.	
1	Valve Cover Gasket Set	2007-05	VS 50504 R-1	w/Grommets; PermaDry® molded rubber gskts. incl.; New Part Number - Check for Availability	
1	Grommet Set	2007-05	ES 72233	Valve Cover	
QTY	VALVE STEM SEAL SET	YEARS	PART NO.	DESCRIPTION	
1	Valve Stem Seal Set	2007-05	SS 71039	Premium valve stem seals incl.	
QTY	THERMOSTAT HOUSING	YEARS	PART NO.	DESCRIPTION	
1	O-Ring	2007-05	35720	Thermostat Housing	
QTY	WATER PUMP	YEARS	PART NO.	DESCRIPTION	
2	Water Pump Gasket	2007-05	35635		
1	O-Ring	2007-05	35633	Water Pump	
1	Water Pump Mounting Set	2007-05	ES 73010	Mounting gasket set; New Part Number - Check for Availability	
QTY	TIMING COVER	YEARS	PART NO.	DESCRIPTION	
1	Timing Cover Set	2007-05	TCS 45993	Must be used w/OS 30693R	
QTY	CARB & FUEL INJECTION	YEARS	PART NO.	DESCRIPTION	
2	Fuel Injector O-Ring Set	2007-05	ES 70599	Upper set; Injectors to fuel rail; Improved design	
2	Fuel Injector O-Ring Set	2007-05	ES 71190	Lower set; Injectors to cylinder head	
2	Fuel Injector O-Ring Set	2007-05	ES 71192	Upper set; Injectors to fuel rail; Old design	
1	Throttle Body Gasket	2007-05	61436		
QTY	EXHAUST GAS RECIRCULATION	YEARS	PART NO.	DESCRIPTION	
1	EGR Gasket	2007-05	70895	Pipe; O-ring	
1	EGR Gasket	2007-05	70914	Valve	
1	EGR Gasket	2007-05	70947	Pipe	
QTY	OIL FILTER MOUNTING	YEARS	PART NO.	DESCRIPTION	
1	Oil Cooler Gasket	2007-05	72462	Oil Filter; Center tube; Dual round port	
QTY	OIL PUMP COVER	YEARS	PART NO.	DESCRIPTION	
1	O-Ring	2007-05	72401	Oil Pump; Inlet tube	
QTY	OIL COOLER	YEARS	PART NO.	DESCRIPTION	
1	Oil Cooler Gasket	2007-05	72435	Oval port	
1	Oil Cooler Gasket	2007-05	72462	Dual round port	

GM Car (Incl. Buick, Cad., Chev., Geo, Olds., Pontiac, Saturn) (Cont.)

107		2009 - 2008; 6.0L 364 (5967cc) OHV V8 (16 Valve) 101.6mm Bore Vortec MFI; Gasoline; Naturally Aspirated GMC Eng.; Chevrolet; VIN Code Y			107
QTY	CYLINDER HEAD	YEARS	PART NO.	DESCRIPTION	
2	Head Gasket	2009-08	26192 PT	Head bolts not incl.; Head bolt replacement recommended; PermaTorqueMLS® LaserWeld® Technology	
1	Head Set	2009-08	HS 26192 PT-7	Head bolts not incl.; Head bolt replacement recommended; PermaDry® molded rubber valve cover gskts. incl.; Premium valve stem seals incl.; New Part Number - Check for Availability	
2	Head Bolt Set	2009-08	ES 72390	Replacement recommended; New Part Number - Check for Availability	
QTY	CONVERSION SET	YEARS	PART NO.	DESCRIPTION	
1	Gasket Conversion Set	2009-08	CS 9284	PermaDry® molded rubber oil pan gskt. incl.	
QTY	MANIFOLD - INT. & EXH.	YEARS	PART NO.	DESCRIPTION	
1	Int. Manifold Gasket Set	2009-08	MS 96857	Lifter valley cover set; Perimeter seal only	
1	Int. Manifold Gasket Set	2009-08	MS 97151	New Part Number - Check for Availability	
1	Exh. Manifold Gasket Set	2009-08	MS 92467		
QTY	EXHAUST PIPE FLANGE	YEARS	PART NO.	DESCRIPTION	
2	Exhaust Pipe Gasket	2009-08	61519	Pipe to manifold	
2	Exhaust Pipe Gasket	2009-08	61617	Converter	
QTY	OIL PAN	YEARS	PART NO.	DESCRIPTION	
1	Oil Pan Gasket Set	2009-08	OS 30693 R	PermaDry® molded rubber gskt. incl.	
QTY	CRANKSHAFT REAR SEAL	YEARS	PART NO.	DESCRIPTION	
1	Rear Main Seal Set	2009-08	BS 40640	PTFE Rubber; One-piece	
1	Repair Sleeve	2009-08	16228	Crankshaft; Narrow lip; .780" sleeve length; Requires crankshaft machining due to clearance issues; Use w/installation tool	
1	Repair Sleeve	2009-08	16229	Crankshaft; Wide lip; 1.156" sleeve length; Requires crankshaft machining due to clearance issues; Use w/installation tool	
1	Repair Sleeve Tool	2009-08	16329	Crankshaft	
QTY	VALVE COVER	YEARS	PART NO.	DESCRIPTION	
1	Valve Cover Gasket Set	2009-08	VS 50504 R	w/o Grommets; PermaDry® molded rubber gskts. incl.	
1	Valve Cover Gasket Set	2009-08	VS 50504 R-1	w/Grommets; PermaDry® molded rubber gskts. incl.; New Part Number - Check for Availability	
1	Grommet Set	2009-08	ES 72233	Valve Cover	
QTY	VALVE STEM SEAL SET	YEARS	PART NO.	DESCRIPTION	
1	Valve Stem Seal Set	2009-08	SS 71039	Premium valve stem seals incl.	
QTY	THERMOSTAT HOUSING	YEARS	PART NO.	DESCRIPTION	
1	O-Ring	2009-08	35720	Thermostat Housing	
QTY	WATER PUMP	YEARS	PART NO.	DESCRIPTION	
2	Water Pump Gasket	2009-08	35635		
1	O-Ring	2009-08	35633	Water Pump	
1	Water Pump Mounting Set	2009-08	ES 73010	Mounting gasket set; New Part Number - Check for Availability	
QTY	TIMING COVER	YEARS	PART NO.	DESCRIPTION	
1	Timing Cover Set	2009-08	TCS 45993	Must be used w/OS 30693R	
1	Camshaft Sensor Seal	2009-08	72760	Variable camshaft sensor seal; New Part Number - Check for Availability	
QTY	CARB & FUEL INJECTION	YEARS	PART NO.	DESCRIPTION	
2	Fuel Injector O-Ring Set	2009-08	ES 70599	Upper set; Injectors to fuel rail; Improved design	
2	Fuel Injector O-Ring Set	2009-08	ES 71190	Lower set; Injectors to cylinder head	
2	Fuel Injector O-Ring Set	2009-08	ES 71192	Upper set; Injectors to fuel rail; Old design	
1	Throttle Body Gasket	2009-08	61436		
QTY	OIL FILTER MOUNTING	YEARS	PART NO.	DESCRIPTION	
1	Oil Cooler Gasket	2009-08	72462	Oil Filter; Center tube; Dual round port	
QTY	OIL PUMP COVER	YEARS	PART NO.	DESCRIPTION	
1	O-Ring	2009-08	72401	Oil Pump; Inlet tube	
QTY	OIL COOLER	YEARS	PART NO.	DESCRIPTION	
1	Oil Cooler Gasket	2009-08	72435	Oval port	
1	Oil Cooler Gasket	2009-08	72462	Dual round port	
108		2007 - 2005; 6.0L 364 (5967cc) OHV V8 (16 Valve) 101.6mm Bore Vortec LS-2 MFI; Gasoline; Naturally Aspirated GMC Eng.; Chevrolet; VIN Code H			108
QTY	CYLINDER HEAD	YEARS	PART NO.	DESCRIPTION	
2	Head Gasket	2007-05	26192 PT	Head bolts not incl.; Head bolt replacement recommended; PermaTorqueMLS® LaserWeld® Technology	
1	Head Set	2007-05	HS 26192 PT-3	Head bolts not incl.; Head bolt replacement recommended; PermaDry® molded rubber valve cover gskts. incl.; Premium valve stem seals incl.	
2	Head Bolt Set	2007-05	ES 72220	Replacement recommended	
QTY	CONVERSION SET	YEARS	PART NO.	DESCRIPTION	
1	Gasket Conversion Set	2007-05	CS 9284	PermaDry® molded rubber oil pan gskt. incl.	

GM Car (Incl. Buick, Cad., Chev., Geo, Olds., Pontiac, Saturn) (Cont.)

108		2007 - 2005; 6.0L 364 (5967cc) OHV V8 (16 Valve) 101.6mm Bore Vortec LS-2			108
(cont.)		MFI; Gasoline; Naturally Aspirated GMC Eng.; Chevrolet; VIN Code H			(cont.)
QTY	MANIFOLD - INT. & EXH.	YEARS	PART NO.	DESCRIPTION	
1	Int. Manifold Gasket Set	2007-05	MS 96169	Lifter valley cover set	
1	Int. Manifold Gasket Set	2007-05	MS 96718		
1	Exh. Manifold Gasket Set	2007-05	MS 92467		
QTY	EXHAUST PIPE FLANGE	YEARS	PART NO.	DESCRIPTION	
1	Exhaust Pipe Gasket	2007-05	61012	Converter	
2	Exhaust Pipe Gasket	2007-05	61431	Pipe to manifold; Improved design	
QTY	OIL PAN	YEARS	PART NO.	DESCRIPTION	
1	Oil Pan Gasket Set	2007-05	OS 30693 R	PermaDry® molded rubber gskt. incl.	
QTY	CRANKSHAFT REAR SEAL	YEARS	PART NO.	DESCRIPTION	
1	Rear Main Seal Set	2007-05	BS 40640	PTFE Rubber; One-piece	
1	Repair Sleeve	2007-05	16228	Crankshaft; Narrow lip; .780" sleeve length; Requires crankshaft machining due to clearance issues; Use w/installation tool	
1	Repair Sleeve	2007-05	16229	Crankshaft; Wide lip; 1.156" sleeve length; Requires crankshaft machining due to clearance issues; Use w/installation tool	
1	Repair Sleeve Tool	2007-05	16329	Crankshaft	
QTY	VALVE COVER	YEARS	PART NO.	DESCRIPTION	
1	Valve Cover Gasket Set	2007-05	VS 50504 R	w/o Grommets; PermaDry® molded rubber gskts. incl.	
1	Valve Cover Gasket Set	2007-05	VS 50504 R-1	w/Grommets; PermaDry® molded rubber gskts. incl.; New Part Number - Check for Availability	
1	Grommet Set	2007-05	ES 72233	Valve Cover	
QTY	VALVE STEM SEAL SET	YEARS	PART NO.	DESCRIPTION	
1	Valve Stem Seal Set	2007-05	SS 71039	Premium valve stem seals incl.	
QTY	THERMOSTAT HOUSING	YEARS	PART NO.	DESCRIPTION	
1	O-Ring	2007-05	35720	Thermostat Housing	
QTY	WATER PUMP	YEARS	PART NO.	DESCRIPTION	
2	Water Pump Gasket	2007-05	35635		
1	O-Ring	2007-05	35633	Water Pump	
1	Water Pump Mounting Set	2007-05	ES 73010	Mounting gasket set; New Part Number - Check for Availability	
QTY	TIMING COVER	YEARS	PART NO.	DESCRIPTION	
1	Timing Cover Set	2007-05	TCS 45993	Must be used w/OS 30693R	
QTY	CARB & FUEL INJECTION	YEARS	PART NO.	DESCRIPTION	
2	Fuel Injector O-Ring Set	2007-05	ES 70599	Upper set; Injectors to fuel rail; Improved design	
2	Fuel Injector O-Ring Set	2007-05	ES 71190	Lower set; Injectors to cylinder head	
2	Fuel Injector O-Ring Set	2007-05	ES 71192	Upper set; Injectors to fuel rail; Old design	
1	Throttle Body Gasket	2007-05	61436		
QTY	EXHAUST GAS RECIRCULATION	YEARS	PART NO.	DESCRIPTION	
1	EGR Gasket	2007-05	70895	Pipe; O-ring	
1	EGR Gasket	2007-05	70914	Valve	
1	EGR Gasket	2007-05	70947	Pipe	
QTY	OIL FILTER MOUNTING	YEARS	PART NO.	DESCRIPTION	
1	Oil Cooler Gasket	2007-05	72462	Oil Filter; Center tube; Dual round port	
QTY	OIL PUMP COVER	YEARS	PART NO.	DESCRIPTION	
1	O-Ring	2007-05	72401	Oil Pump; Inlet tube	
QTY	OIL COOLER	YEARS	PART NO.	DESCRIPTION	
1	Oil Cooler Gasket	2007-05	72435	Oval port	
1	Oil Cooler Gasket	2007-05	72462	Dual round port	
109		2012 - 2011; 6.0L 364 (5967cc) OHV V8 (16 Valve) 101.6mm Bore Vortec VVT L77			109
(cont.)		MFI; Flex Fuel; Naturally Aspirated GMC Eng.; Chevrolet; VIN Code 2			(cont.)
QTY	CYLINDER HEAD	YEARS	PART NO.	DESCRIPTION	
2	Head Gasket	2011	26192 PT	Head bolts not incl.; Head bolt replacement recommended; PermaTorqueMLS® LaserWeld® Technology	
1	Head Set	2011	HS 26192 PT-7	Head bolts not incl.; Head bolt replacement recommended; PermaDry® molded rubber valve cover gskts. incl.; Premium valve stem seals incl.; New Part Number - Check for Availability	
2	Head Bolt Set	2012-11	ES 72390	Replacement recommended; New Part Number - Check for Availability	
QTY	CONVERSION SET	YEARS	PART NO.	DESCRIPTION	
1	Gasket Conversion Set	2011	CS 9284	PermaDry® molded rubber oil pan gskt. incl.	
QTY	MANIFOLD - INT. & EXH.	YEARS	PART NO.	DESCRIPTION	
1	Int. Manifold Gasket Set	2012-11	MS 97151	New Part Number - Check for Availability	
1	Int. Manifold Gasket Set	2011	MS 96857	Lifter valley cover set; Perimeter seal only	
1	Exh. Manifold Gasket Set	2011	MS 92467		
QTY	EXHAUST PIPE FLANGE	YEARS	PART NO.	DESCRIPTION	
2	Exhaust Pipe Gasket	2011	61519	Pipe to manifold	

GM Car (Incl. Buick, Cad., Chev., Geo, Olds., Pontiac, Saturn) (Cont.)

109		2012 - 2011; 6.0L 364 (5967cc) OHV V8 (16 Valve) 101.6mm Bore Vortec VVT L77			109	
(cont.)		MFI; Flex Fuel; Naturally Aspirated GMC Eng.; Chevrolet; VIN Code 2			(cont.)	
QTY	EXHAUST PIPE FLANGE	YEARS	PART NO.	DESCRIPTION		
2	Exhaust Pipe Gasket	2011	61617	Converter		
QTY	OIL PAN	YEARS	PART NO.	DESCRIPTION		
1	Oil Pan Gasket Set	2011	OS 30693 R	PermaDry® molded rubber gskt. incl.		
QTY	CRANKSHAFT REAR SEAL	YEARS	PART NO.	DESCRIPTION		
1	Rear Main Seal Set	2011	BS 40640	PTFE Rubber; One-piece		
1	Repair Sleeve	2011	16228	Crankshaft; Narrow lip; .780" sleeve length; Requires crankshaft machining due to clearance issues; Use w/installation tool		
1	Repair Sleeve	2011	16229	Crankshaft; Wide lip; 1.156" sleeve length; Requires crankshaft machining due to clearance issues; Use w/installation tool		
1	Repair Sleeve Tool	2011	16329	Crankshaft		
QTY	VALVE COVER	YEARS	PART NO.	DESCRIPTION		
1	Valve Cover Gasket Set	2011	VS 50504 R	w/o Grommets; PermaDry® molded rubber gskts. incl.		
1	Valve Cover Gasket Set	2011	VS 50504 R-1	w/Grommets; PermaDry® molded rubber gskts. incl.; New Part Number - Check for Availability		
1	Grommet Set	2011	ES 72233	Valve Cover		
QTY	VALVE STEM SEAL SET	YEARS	PART NO.	DESCRIPTION		
1	Valve Stem Seal Set	2011	SS 71039	Premium valve stem seals incl.		
QTY	THERMOSTAT HOUSING	YEARS	PART NO.	DESCRIPTION		
1	O-Ring	2011	35720	Thermostat Housing		
QTY	WATER PUMP	YEARS	PART NO.	DESCRIPTION		
2	Water Pump Gasket	2011	35635			
1	O-Ring	2011	35633	Water Pump		
1	Water Pump Mounting Set	2011	ES 73010	Mounting gasket set; New Part Number - Check for Availability		
QTY	TIMING COVER	YEARS	PART NO.	DESCRIPTION		
1	Timing Cover Set	2011	TCS 45993	Must be used w/OS 30693R		
1	Camshaft Sensor Seal	2011	72760	Variable camshaft sensor seal; New Part Number - Check for Availability		
QTY	CARB & FUEL INJECTION	YEARS	PART NO.	DESCRIPTION		
2	Fuel Injector O-Ring Set	2011	ES 70599	Upper set; Injectors to fuel rail; Improved design		
2	Fuel Injector O-Ring Set	2011	ES 71190	Lower set; Injectors to cylinder head		
2	Fuel Injector O-Ring Set	2011	ES 71192	Upper set; Injectors to fuel rail; Old design		
1	Throttle Body Gasket	2011	61436			
QTY	OIL FILTER MOUNTING	YEARS	PART NO.	DESCRIPTION		
1	Oil Cooler Gasket	2011	72462	Oil Filter; Center tube; Dual round port		
QTY	OIL PUMP COVER	YEARS	PART NO.	DESCRIPTION		
1	O-Ring	2011	72401	Oil Pump; Inlet tube		
QTY	OIL COOLER	YEARS	PART NO.	DESCRIPTION		
1	Oil Cooler Gasket	2011	72435	Oval port		
1	Oil Cooler Gasket	2011	72462	Dual round port		
110		2012 - 2010; 6.2L 378 (6195cc) OHV V8 (16 Valve) 103.25mm Bore Vortec L99			110	
(cont.)		MFI; Gasoline; Naturally Aspirated GMC Eng.; Chevrolet; VIN Code J			(cont.)	
QTY	CYLINDER HEAD	YEARS	PART NO.	DESCRIPTION		
2	Head Gasket	2011-10	26192 PT	Head bolts not incl.; Head bolt replacement recommended; PermaTorqueMLS® LaserWeld® Technology		
1	Head Set	2011-10	HS 26192 PT-9	Head bolts not incl.; Head bolt replacement recommended; PermaDry® molded rubber valve cover gskts. incl.; Premium valve stem seals incl.; New Part Number - Check for Availability		
2	Head Bolt Set	2012-10	ES 72390	Replacement recommended; New Part Number - Check for Availability		
QTY	CONVERSION SET	YEARS	PART NO.	DESCRIPTION		
1	Gasket Conversion Set	2011-10	CS 9284	PermaDry® molded rubber oil pan gskt. incl.		
QTY	MANIFOLD - INT. & EXH.	YEARS	PART NO.	DESCRIPTION		
1	Int. Manifold Gasket Set	2012-10	MS 97151	New Part Number - Check for Availability		
1	Int. Manifold Gasket Set	2011-10	MS 96169	Lifter valley cover set		
1	Exh. Manifold Gasket Set	2011-10	MS 92467			
QTY	EXHAUST PIPE FLANGE	YEARS	PART NO.	DESCRIPTION		
2	Exhaust Pipe Gasket	2011-10	61012	Converter		
QTY	OIL PAN	YEARS	PART NO.	DESCRIPTION		
1	Oil Pan Gasket Set	2011-10	OS 30693 R	PermaDry® molded rubber gskt. incl.		
QTY	CRANKSHAFT REAR SEAL	YEARS	PART NO.	DESCRIPTION		
1	Rear Main Seal Set	2011-10	BS 40640	PTFE Rubber; One-piece		
1	Repair Sleeve	2011-10	16228	Crankshaft; Narrow lip; .780" sleeve length; Requires crankshaft machining due to clearance issues; Use w/installation tool		

GM Car (Incl. Buick, Cad., Chev., Geo, Olds., Pontiac, Saturn) (Cont.)

110 (cont.)		2012 - 2010; 6.2L 378 (6195cc) OHV V8 (16 Valve) 103.25mm Bore Vortec L99			110 (cont.)
MFI; Gasoline; Naturally Aspirated GMC Eng.; Chevrolet; VIN Code J					
QTY	CRANKSHAFT REAR SEAL	YEARS	PART NO.	DESCRIPTION	
1	Repair Sleeve	2011-10	16229	Crankshaft; Wide lip; 1.156" sleeve length; Requires crankshaft machining due to clearance issues; Use w/installation tool	
1	Repair Sleeve Tool	2011-10	16329	Crankshaft	
QTY	VALVE COVER	YEARS	PART NO.	DESCRIPTION	
1	Valve Cover Gasket Set	2011-10	VS 50504 R	w/o Grommets; PermaDry® molded rubber gskts. incl.	
1	Valve Cover Gasket Set	2011-10	VS 50504 R-1	w/Grommets; PermaDry® molded rubber gskts. incl.; New Part Number - Check for Availability	
1	Grommet Set	2011-10	ES 72233	Valve Cover	
QTY	VALVE STEM SEAL SET	YEARS	PART NO.	DESCRIPTION	
1	Valve Stem Seal Set	2011-10	SS 71039	Premium valve stem seals incl.	
QTY	THERMOSTAT HOUSING	YEARS	PART NO.	DESCRIPTION	
1	O-Ring	2011-10	35720	Thermostat Housing	
QTY	WATER PUMP	YEARS	PART NO.	DESCRIPTION	
2	Water Pump Gasket	2011-10	35635		
1	O-Ring	2011-10	35633	Water Pump	
1	Water Pump Mounting Set	2011-10	ES 73010	Mounting gasket set; New Part Number - Check for Availability	
QTY	TIMING COVER	YEARS	PART NO.	DESCRIPTION	
1	Timing Cover Set	2011-10	TCS 45993	Must be used w/OS 30693R	
QTY	CARB & FUEL INJECTION	YEARS	PART NO.	DESCRIPTION	
2	Fuel Injector O-Ring Set	2011-10	ES 70599	Upper set; Injectors to fuel rail; Improved design	
2	Fuel Injector O-Ring Set	2011-10	ES 71190	Lower set; Injectors to cylinder head	
2	Fuel Injector O-Ring Set	2011-10	ES 71192	Upper set; Injectors to fuel rail; Old design	
1	Throttle Body Gasket	2011-10	61436		
QTY	OIL FILTER MOUNTING	YEARS	PART NO.	DESCRIPTION	
1	Oil Cooler Gasket	2011-10	72462	Oil Filter; Center tube; Dual round port	
QTY	OIL PUMP COVER	YEARS	PART NO.	DESCRIPTION	
1	O-Ring	2011-10	72401	Oil Pump; Inlet tube	
QTY	OIL COOLER	YEARS	PART NO.	DESCRIPTION	
1	Oil Cooler Gasket	2011-10	72435	Oval port	
1	Oil Cooler Gasket	2011-10	72462	Dual round port	
111		2012 - 2008; 6.2L 378 (6195cc) OHV V8 (16 Valve) 103.25mm Bore Vortec LS-3			111
MFI; Gasoline; Naturally Aspirated GMC Eng.; Chevrolet; VIN Code W					
QTY	CYLINDER HEAD	YEARS	PART NO.	DESCRIPTION	
2	Head Gasket	2011-08	26192 PT	Head bolts not incl.; Head bolt replacement recommended; PermaTorqueMLS® LaserWeld® Technology	
1	Head Set	2011-08	HS 26192 PT-9	Head bolts not incl.; Head bolt replacement recommended; PermaDry® molded rubber valve cover gskts. incl.; Premium valve stem seals incl.; New Part Number - Check for Availability	
2	Head Bolt Set	2012-08	ES 72390	Replacement recommended; New Part Number - Check for Availability	
QTY	CONVERSION SET	YEARS	PART NO.	DESCRIPTION	
1	Gasket Conversion Set	2011-08	CS 9284	PermaDry® molded rubber oil pan gskt. incl.	
QTY	MANIFOLD - INT. & EXH.	YEARS	PART NO.	DESCRIPTION	
1	Int. Manifold Gasket Set	2012-08	MS 97151	New Part Number - Check for Availability	
1	Int. Manifold Gasket Set	2011-08	MS 96169	Lifter valley cover set	
1	Exh. Manifold Gasket Set	2011-08	MS 92467		
QTY	EXHAUST PIPE FLANGE	YEARS	PART NO.	DESCRIPTION	
2	Exhaust Pipe Gasket	2011-10	61012	Converter	
2	Exhaust Pipe Gasket	2011-10	61431	Exc. Chevrolet Camaro SS; Pipe to manifold; Improved design	
2	Exhaust Pipe Gasket	2009	61012	Exc. Pontiac G8 GXP; Converter	
2	Exhaust Pipe Gasket	2009	61431	Exc. Pontiac G8 GXP; Pipe to manifold; Improved design	
2	Exhaust Pipe Gasket	2009	61519	Pontiac G8 GXP; Pipe to manifold	
2	Exhaust Pipe Gasket	2009	61617	Pontiac G8 GXP; Converter	
2	Exhaust Pipe Gasket	2008	61012	Converter	
2	Exhaust Pipe Gasket	2008	61431	Pipe to manifold; Improved design	
QTY	OIL PAN	YEARS	PART NO.	DESCRIPTION	
1	Oil Pan Gasket Set	2011-08	OS 30693 R	PermaDry® molded rubber gskt. incl.	
QTY	CRANKSHAFT REAR SEAL	YEARS	PART NO.	DESCRIPTION	
1	Rear Main Seal Set	2011-08	BS 40640	PTFE Rubber; One-piece	
1	Repair Sleeve	2011-08	16228	Crankshaft; Narrow lip; .780" sleeve length; Requires crankshaft machining due to clearance issues; Use w/installation tool	
1	Repair Sleeve	2011-08	16229	Crankshaft; Wide lip; 1.156" sleeve length; Requires crankshaft machining due to clearance issues; Use w/installation tool	

GM Car (Incl. Buick, Cad., Chev., Geo, Olds., Pontiac, Saturn) (Cont.)

111		2012 - 2008; 6.2L 378 (6195cc) OHV V8 (16 Valve) 103.25mm Bore Vortec LS-3			111	
(cont.)		MFI; Gasoline; Naturally Aspirated GMC Eng.; Chevrolet; VIN Code W			(cont.)	
QTY	CRANKSHAFT REAR SEAL	YEARS	PART NO.	DESCRIPTION		
1	Repair Sleeve Tool	2011-08	16329	Crankshaft		
QTY	VALVE COVER	YEARS	PART NO.	DESCRIPTION		
1	Valve Cover Gasket Set	2011-08	VS 50504 R	w/o Grommets; PermaDry® molded rubber gskts. incl.		
1	Valve Cover Gasket Set	2011-08	VS 50504 R-1	w/Grommets; PermaDry® molded rubber gskts. incl.; New Part Number - Check for Availability		
1	Grommet Set	2011-08	ES 72233	Valve Cover		
QTY	VALVE STEM SEAL SET	YEARS	PART NO.	DESCRIPTION		
1	Valve Stem Seal Set	2011-08	SS 71039	Premium valve stem seals incl.		
QTY	THERMOSTAT HOUSING	YEARS	PART NO.	DESCRIPTION		
1	O-Ring	2011-08	35720	Thermostat Housing		
QTY	WATER PUMP	YEARS	PART NO.	DESCRIPTION		
2	Water Pump Gasket	2011-08	35635			
1	O-Ring	2011-08	35633	Water Pump		
1	Water Pump Mounting Set	2011-08	ES 73010	Mounting gasket set; New Part Number - Check for Availability		
QTY	TIMING COVER	YEARS	PART NO.	DESCRIPTION		
1	Timing Cover Set	2011-08	TCS 45993	Must be used w/OS 30693R		
QTY	CARB & FUEL INJECTION	YEARS	PART NO.	DESCRIPTION		
2	Fuel Injector O-Ring Set	2011-08	ES 70599	Upper set; Injectors to fuel rail; Improved design		
2	Fuel Injector O-Ring Set	2011-08	ES 71190	Lower set; Injectors to cylinder head		
2	Fuel Injector O-Ring Set	2011-08	ES 71192	Upper set; Injectors to fuel rail; Old design		
1	Throttle Body Gasket	2011-08	61436			
QTY	OIL FILTER MOUNTING	YEARS	PART NO.	DESCRIPTION		
1	Oil Cooler Gasket	2011-08	72462	Oil Filter; Center tube; Dual round port		
QTY	OIL PUMP COVER	YEARS	PART NO.	DESCRIPTION		
1	O-Ring	2011-08	72401	Oil Pump; Inlet tube		
QTY	OIL COOLER	YEARS	PART NO.	DESCRIPTION		
1	Oil Cooler Gasket	2011-08	72435	Oval port		
1	Oil Cooler Gasket	2011-08	72462	Dual round port		
112		2012 - 2006; 7.0L 427 (6998cc) OHV V8 (16 Valve) 4.125" Bore LS-7			112	
(cont.)		MFI; Gasoline; Naturally Aspirated GMC Eng.; Chevrolet; VIN Code E			(cont.)	
QTY	CYLINDER HEAD	YEARS	PART NO.	DESCRIPTION		
2	Head Bolt Set	2012-06	ES 72390	Replacement recommended; New Part Number - Check for Availability		

GMC Minivans - See GMC Truck

GMC SUV's - See GMC Truck

GMC Truck (Incl. Minivans and SUV's)

Engine Finding Index			
Engine	Years	Code	Line No.
1.4L 83.2 (1364cc) DOHC L4 (16 Valve) 72.5mm Bore Ecotec VVT; DI; Gasoline; Turbo - Intercooled Opel Eng.	2013	B	1
1.6L 97 (1590cc) SOHC L4 (16 Valve) 75mm Bore; MFI; Gasoline; Naturally Aspirated Suzuki Eng.	2002-94	6	2
1.6L 97 (1590cc) SOHC L4 (8 Valve) 75mm Bore; TBI; Gasoline; Naturally Aspirated Suzuki Eng.	1995-91	U	3
2.0L 121.7 (1995cc) DOHC L4 (16 Valve) 84mm Bore; MFI; Gasoline; Naturally Aspirated Suzuki Eng.	2004-99	C	4
2.0L 122 (1998cc) DOHC L4 (16 Valve) 86mm Bore Ecotec; MFI; Gasoline; Turbo - Intercooled Opel Eng.	2010	M	5
2.0L 122 (1998cc) DOHC L4 (16 Valve) 86mm Bore Ecotec; MFI; Gasoline; Turbo - Intercooled Opel Eng.	2010-08	X	6
2.2L 134 (2189cc) OHV L4 (8 Valve) 89mm Bore; MFI; Gasoline; Naturally Aspirated GMC Eng.; Chevrolet	2003-94	4	7
2.2L 134 (2189cc) OHV L4 (8 Valve) 89mm Bore; MFI; Flex Fuel; Naturally Aspirated GMC Eng.; Chevrolet	2002-00	5	8
2.2L 134.1 (2198cc) DOHC L4 (16 Valve) 86mm Bore Ecotec; MFI; Flex Fuel; Naturally Aspirated Opel Eng.	2011-09	B	9
2.2L 134.1 (2198cc) DOHC L4 (16 Valve) 86mm Bore Ecotec; MFI; Gasoline; Naturally Aspirated Opel Eng.	2008-02	D	10
2.2L 134.1 (2198cc) DOHC L4 (16 Valve) 86mm Bore Ecotec; MFI; Flex Fuel; Naturally Aspirated Opel Eng.	2011	W	11
2.3L 138 (2260cc) DOHC L4 (16 Valve) 92mm Bore Quad 4; MFI; Gasoline; Naturally Aspirated GMC Eng.; Oldsmobile	1995-93	G	12
2.4L 145.5 (2384cc) DOHC L4 (16 Valve) 88mm Bore Ecotec; MFI; Gasoline; Naturally Aspirated Opel Eng.	2010-06	P	13
2.4L 145.5 (2384cc) DOHC L4 (16 Valve) 88mm Bore Ecotec; MFI; Flex Fuel; Naturally Aspirated Opel Eng.	2011	U	14
2.4L 145.5 (2384cc) DOHC L4 (16 Valve) 88mm Bore Ecotec; MFI; Flex Fuel; Naturally Aspirated Opel Eng.	2011-09	V	15
2.4L 145.5 (2384cc) DOHC L4 (16 Valve) 88mm Bore Ecotec; MFI; Hybrid (Gas/Electric); Naturally Aspirated Opel Eng.	2010-07	Z	16
2.4L 145.5 (2384cc) DOHC L4 (16 Valve) 88mm Bore Ecotec VVT; DI; Gasoline; Naturally Aspirated Opel Eng.	2011	C	17
2.4L 145.5 (2384cc) DOHC L4 (16 Valve) 88mm Bore Ecotec VVT; DI; Gasoline; Naturally Aspirated Opel Eng.	2013-10	W	18
2.5L 151 (2475cc) OHV L4 (8 Valve) 4" Bore; TBI; Gasoline; Naturally Aspirated GMC Eng.; Pontiac	1993-91	A	19

GMC Truck (Incl. Minivans and SUV's) (Cont.)

Engine Finding Index (Cont.)		Years	Code	Line No.
Engine				
2.5L 151 (2475cc) OHV L4 (8 Valve) 4" Bore; TBI; Gasoline; Naturally Aspirated GMC Eng.; Pontiac		1991	E	20
2.5L 152 (2492cc) DOHC V6 (24 Valve) 84mm Bore; MFI; Gasoline; Naturally Aspirated Suzuki Eng.		2004-01	4	21
2.8L 169 (2770cc) DOHC L4 (16 Valve) 93mm Bore Vortec; MFI; Gasoline; Naturally Aspirated GMC Eng.; Chevrolet		2006-04	8	22
2.8L 171 (2792cc) DOHC V6 (24 Valve) 89mm Bore; DI; Gasoline; Turbo - Intercooled Opel Eng.		2011-10	4	23
2.8L 171 (2792cc) DOHC V6 (24 Valve) 89mm Bore; DI; Gasoline; Turbo - Intercooled Opel Eng.		2011	6	24
2.8L 173 (2835cc) OHV V6 (12 Valve) 89mm Bore; TBI; Gasoline; Naturally Aspirated GMC Eng.; Chevrolet		1993-91	R	25
2.9L 178.2 (2921cc) DOHC L4 (16 Valve) 95.5mm Bore Vortec; MFI; Gasoline; Naturally Aspirated GMC Eng.; Chevrolet		2012-07	9	26
3.0L 181 (2962cc) DOHC V6 (24 Valve) 86mm Bore; MFI; Gasoline; Naturally Aspirated Opel Eng.		2003-02	B	27
3.0L 182.9 (2997cc) DOHC V6 (24 Valve) 89mm Bore VVT; DI; Flex Fuel; Naturally Aspirated Opel Eng.		2012-11	5	28
3.0L 182.9 (2997cc) DOHC V6 (24 Valve) 89mm Bore VVT; DI; Gasoline; Naturally Aspirated Opel Eng.		2012-10	Y	29
3.1L 189 (3136cc) OHV V6 (12 Valve) 89mm Bore; TBI; Gasoline; Naturally Aspirated GMC Eng.; Chevrolet		1995-91	D	30
3.4L 207 (3393cc) OHV V6 (12 Valve) 92mm Bore; MFI; Gasoline; Naturally Aspirated GMC Eng.; Chevrolet		2009-04	9	31
3.4L 207 (3393cc) OHV V6 (12 Valve) 92mm Bore; MFI; Gasoline; Naturally Aspirated GMC Eng.; Chevrolet		2005-96	E	32
3.4L 207 (3393cc) OHV V6 (12 Valve) 92mm Bore; MFI; Gasoline; Naturally Aspirated GMC Eng.; Chevrolet		2009-04	F	33
3.5L 211 (3460cc) DOHC L5 (20 Valve) 93mm Bore Vortec; MFI; Gasoline; Naturally Aspirated GMC Eng.; Chevrolet		2006-04	6	34
3.5L 212 (3471cc) SOHC V6 (24 Valve) 89mm Bore VTEC; MFI; Gasoline; Naturally Aspirated Honda Eng.		2007-04	4	35
3.5L 213 (3491cc) OHV V6 (12 Valve) 94mm Bore; MFI; Gasoline; Naturally Aspirated GMC Eng.; Chevrolet		2007-06	8	36
3.5L 213 (3491cc) OHV V6 (12 Valve) 94mm Bore; MFI; Gasoline; Naturally Aspirated GMC Eng.; Chevrolet		2006-05	L	37
3.5L 214 (3510cc) OHV V6 (12 Valve) 99mm Bore; MFI; Gasoline; Naturally Aspirated GMC Eng.; Chevrolet		2010-08	N	38
3.6L 217 (3564cc) DOHC V6 (24 Valve) 94mm Bore; MFI; Gasoline; Naturally Aspirated Opel Eng.		2010-04	7	39
3.6L 217 (3564cc) DOHC V6 (24 Valve) 94mm Bore; MFI; Hybrid (Gas/Electric); Naturally Aspirated Opel Eng.		2010-09	B	40
3.6L 217 (3564cc) DOHC V6 (24 Valve) 94mm Bore VVT; DI; Flex Fuel; Naturally Aspirated Opel Eng.		2013-12	3	41
3.6L 217 (3564cc) DOHC V6 (24 Valve) 94mm Bore VVT; DI; Gasoline; Naturally Aspirated Opel Eng.		2013-09	D	42
3.6L 217 (3564cc) DOHC V6 (24 Valve) 94mm Bore VVT; DI; Gasoline; Naturally Aspirated Opel Eng.		2013-12	V	43
3.7L 223 (3654cc) DOHC L5 (20 Valve) 95.5mm Bore Vortec; MFI; Gasoline; Naturally Aspirated GMC Eng.; Chevrolet		2012-07	E	44
3.8L 231 (3791cc) OHV V6 (12 Valve) 3.8" Bore; MFI; Gasoline; Naturally Aspirated GMC Eng.; Buick		1995-92	L	45
3.9L 235.2 (3856cc) OHV Turbo L4 (8 Valve) 102mm Bore; DI; Diesel; Turbo Isuzu Eng.		1994-91	4BD1-T	46
3.9L 242 (3880cc) OHV V6 (12 Valve) 99mm Bore; MFI; Gasoline; Naturally Aspirated GMC Eng.; Chevrolet		2009-06	1	47
3.9L 242 (3880cc) OHV V6 (12 Valve) 99mm Bore; MFI; Flex Fuel; Naturally Aspirated GMC Eng.; Chevrolet		2009-07	W	48
4.2L 254 (4160cc) DOHC L6 (24 Valve) 93mm Bore Vortec; MFI; Gasoline; Naturally Aspirated GMC Eng.; Chevrolet		2009-02	S	49
4.3L 262 (4294cc) OHV V6 (12 Valve) 4" Bore; MFI; Gasoline; Turbo - Intercooled GMC Eng.; Chevrolet		1993-91	Z	50
4.3L 262 (4294cc) OHV V6 (12 Valve) 4" Bore; TBI; Gasoline; Naturally Aspirated GMC Eng.; Chevrolet		1996-91	Z	51
4.3L 262 (4294cc) OHV V6 (12 Valve) 4" Bore H.O.; TBI; Gasoline; Naturally Aspirated GMC Eng.; Chevrolet		1991	B	52
4.3L 262 (4294cc) OHV V6 (12 Valve) 4" Bore Vortec; CPI; Gasoline; Naturally Aspirated GMC Eng.; Chevrolet		2013-96	X	53
4.3L 262 (4294cc) OHV V6 (12 Valve) 4" Bore Vortec H.O.; CPI; Gasoline; Naturally Aspirated GMC Eng.; Chevrolet		2003-92	W	54
4.6L 281 (4565cc) DOHC V8 (32 Valve) 93mm Bore Northstar H.O.; MFI; Gasoline; Naturally Aspirated GMC Eng.; Cadillac		2009-04	A	55
4.8L 293 (4807cc) OHV V8 (16 Valve) 96mm Bore Vortec; MFI; Gasoline; Naturally Aspirated GMC Eng.; Chevrolet		2010-07	C	56
4.8L 293 (4807cc) OHV V8 (16 Valve) 96mm Bore Vortec; MFI; Gasoline; Naturally Aspirated GMC Eng.; Chevrolet		2008-99	V	57
4.8L 293 (4807cc) OHV V8 (16 Valve) 96mm Bore Vortec VVT; MFI; Flex Fuel; Naturally Aspirated GMC Eng.; Chevrolet		2013-10	A	58
5.0L 305 (4999cc) OHV V8 (16 Valve) 3.736" Bore; TBI; Gasoline; Naturally Aspirated GMC Eng.; Chevrolet		1996-91	H	59
5.0L 305 (4999cc) OHV V8 (16 Valve) 3.736" Bore Vortec; CPI; Gasoline; Naturally Aspirated GMC Eng.; Chevrolet		2002-96	M	60
5.3L 325 (5328cc) OHV V8 (16 Valve) 96mm Bore Vortec; MFI; Flex Fuel; Naturally Aspirated GMC Eng.; Chevrolet		2013-07	0	61
5.3L 325 (5328cc) OHV V8 (16 Valve) 96mm Bore Vortec; MFI; Flex Fuel; Naturally Aspirated GMC Eng.; Chevrolet		2013-07	3	62
5.3L 325 (5328cc) OHV V8 (16 Valve) 96mm Bore Vortec; MFI; Gasoline; Naturally Aspirated GMC Eng.; Chevrolet		2007-05	B	63
5.3L 325 (5328cc) OHV V8 (16 Valve) 96mm Bore Vortec; MFI; Gasoline; Naturally Aspirated GMC Eng.; Chevrolet		2010-07	J	64
5.3L 325 (5328cc) OHV V8 (16 Valve) 96mm Bore Vortec; MFI; Gasoline; Naturally Aspirated GMC Eng.; Chevrolet		2009-08	L	65
5.3L 325 (5328cc) OHV V8 (16 Valve) 96mm Bore Vortec; MFI; Gasoline; Naturally Aspirated GMC Eng.; Chevrolet		2010-05	M	66
5.3L 325 (5328cc) OHV V8 (16 Valve) 96mm Bore Vortec; MFI; Gasoline; Naturally Aspirated GMC Eng.; Chevrolet		2005-03	P	67
5.3L 325 (5328cc) OHV V8 (16 Valve) 96mm Bore Vortec; MFI; Gasoline; Naturally Aspirated GMC Eng.; Chevrolet		2008-99	T	68
5.3L 325 (5328cc) OHV V8 (16 Valve) 96mm Bore Vortec; MFI; Flex Fuel; Naturally Aspirated GMC Eng.; Chevrolet		2008-02	Z	69
5.3L 325 (5328cc) OHV V8 (16 Valve) 96mm Bore Vortec VVT; MFI; Flex Fuel; Naturally Aspirated GMC Eng.; Chevrolet		2013-09	4	70
5.3L 325 (5328cc) OHV V8 (16 Valve) 96mm Bore Vortec VVT; MFI; Flex Fuel; Naturally Aspirated GMC Eng.; Chevrolet		2010	P	71
5.3L 325 (5328cc) OHV V8 (16 Valve) 96mm Bore Vortec VVT; MFI; Gasoline; Naturally Aspirated GMC Eng.; Chevrolet		2012-10	P	72
5.7L 350 (5736cc) OHV V8 (16 Valve) 4" Bore; TBI; Gasoline; Naturally Aspirated GMC Eng.; Chevrolet		1996-91	K	73
5.7L 350 (5736cc) OHV V8 (16 Valve) 4" Bore Vortec; CPI; Gasoline; Naturally Aspirated GMC Eng.; Chevrolet		2002-96	R	74
6.0L 364 (5967cc) OHV V8 (16 Valve) 101.6mm Bore Vortec; MFI; Hybrid (Gas/Electric); Naturally Aspirated GMC Eng.; Chevrolet		2013-08	5	75
6.0L 364 (5967cc) OHV V8 (16 Valve) 101.6mm Bore Vortec; MFI; Flex Fuel Hybrid (Gas/Electric); Naturally Aspirated GMC Eng.; Chevrolet		2013-10	J	76
6.0L 364 (5967cc) OHV V8 (16 Valve) 101.6mm Bore Vortec; MFI; Gasoline; Naturally Aspirated GMC Eng.; Chevrolet		2010-07	K	77
6.0L 364 (5967cc) OHV V8 (16 Valve) 101.6mm Bore Vortec; MFI; Gasoline; Naturally Aspirated GMC Eng.; Chevrolet		2008-99	U	78
6.0L 364 (5967cc) OHV V8 (16 Valve) 101.6mm Bore Vortec; MFI; Gasoline; Naturally Aspirated GMC Eng.; Chevrolet		2010-07	Y	79
6.0L 364 (5967cc) OHV V8 (16 Valve) 101.6mm Bore Vortec H.O.; MFI; Gasoline; Naturally Aspirated GMC Eng.; Chevrolet		2007-02	N	80
6.0L 364 (5967cc) OHV V8 (16 Valve) 101.6mm Bore Vortec LS-2; MFI; Gasoline; Naturally Aspirated GMC Eng.; Chevrolet		2009-05	H	81
6.0L 364 (5967cc) OHV V8 (16 Valve) 101.6mm Bore Vortec VVT; MFI; Flex Fuel; Naturally Aspirated GMC Eng.; Chevrolet		2013-10	G	82

GMC Truck (Incl. Minivans and SUV's) (Cont.)

Engine Finding Index (Cont.)

Engine	Years	Code	Line No.
6.2L 378 (6195cc) OHV V8 (16 Valve) 103.25mm Bore Vortec; MFI; Flex Fuel; Naturally Aspirated GMC Eng.; Chevrolet	2013-09	2	83
6.2L 378 (6195cc) OHV V8 (16 Valve) 103.25mm Bore Vortec; MFI; Gasoline; Naturally Aspirated GMC Eng.; Chevrolet	2009-07	8	84
6.2L 378 (6195cc) OHV V8 (16 Valve) 103.25mm Bore Vortec; MFI; Flex Fuel; Naturally Aspirated GMC Eng.; Chevrolet	2013-10	F	85
6.2L 379 (6211cc) OHV V8 (16 Valve) 101mm Bore H/D; MFI; Diesel; Naturally Aspirated GMC Eng.; Chevrolet	1993-91	J	86
6.2L 379 (6211cc) OHV V8 (16 Valve) 101mm Bore L/D; MFI; Diesel; Naturally Aspirated GMC Eng.; Chevrolet	1993-91	C	87
6.5L 395 (6468cc) OHV Turbo V8 (16 Valve) 103mm Bore; MFI; Diesel; Turbo GMC Eng.; Chevrolet	2002-92	F	88
6.5L 395 (6468cc) OHV Turbo V8 (16 Valve) 103mm Bore; MFI; Diesel; Turbo GMC Eng.; Chevrolet	2005-02	Z	89
6.5L 395 (6468cc) OHV Turbo V8 (16 Valve) 103mm Bore H.O.; MFI; Diesel; Turbo GMC Eng.; Chevrolet	2002-94	S	90
6.5L 395 (6468cc) OHV V8 (16 Valve) 103mm Bore; MFI; Diesel; Naturally Aspirated GMC Eng.; Chevrolet	1995-94	P	91
6.5L 395 (6468cc) OHV V8 (16 Valve) 103mm Bore H.O.; MFI; Diesel; Naturally Aspirated GMC Eng.; Chevrolet	1999-94	Y	92
6.6L 402 (6599cc) OHV Turbo - Intercooled V8 (32 Valve) 103mm Bore Duramax; MFI; Diesel; Turbo - Intercooled GMC Eng.	2005-01	1	93
6.6L 402 (6599cc) OHV Turbo - Intercooled V8 (32 Valve) 103mm Bore Duramax; MFI; Diesel; Turbo - Intercooled GMC Eng.	2007-04	2	94
6.6L 402 (6599cc) OHV Turbo - Intercooled V8 (32 Valve) 103mm Bore Duramax; MFI; Diesel; Turbo - Intercooled GMC Eng.	2006	3	95
6.6L 402 (6599cc) OHV Turbo - Intercooled V8 (32 Valve) 103mm Bore Duramax; MFI; Diesel; Turbo - Intercooled GMC Eng.	2013-07	6	96
6.6L 402 (6599cc) OHV Turbo - Intercooled V8 (32 Valve) 103mm Bore Duramax; MFI; Diesel; Turbo - Intercooled GMC Eng.	2013-11	8	97
6.6L 402 (6599cc) OHV Turbo - Intercooled V8 (32 Valve) 103mm Bore Duramax; MFI; Diesel; Turbo - Intercooled GMC Eng.	2013-11	L	98
6.6L 402 (6599cc) OHV Turbo - Intercooled V8 (32 Valve) 103mm Bore Duramax H.O.; MFI; Diesel; Turbo - Intercooled GMC Eng.	2007-06	D	99
7.4L 454 (7441cc) OHV V8 (16 Valve) 4.25" Bore; TBI; Gasoline; Naturally Aspirated GMC Eng.; Chevrolet	1997-91	N	100
7.4L 454 (7441cc) OHV V8 (16 Valve) 4.25" Bore Vortec; CPI; Gasoline; Naturally Aspirated GMC Eng.; Chevrolet	1999-98	B	101
7.4L 454 (7441cc) OHV V8 (16 Valve) 4.25" Bore Vortec; CPI; Gasoline; Naturally Aspirated GMC Eng.; Chevrolet	2000-96	J	102
8.1L 496 (8129cc) OHV V8 (16 Valve) 4.25" Bore Vortec; MFI; Gasoline; Naturally Aspirated GMC Eng.; Chevrolet	2007-01	G	103

Engine Code Index

Code	Engine	Line No.
4BD1-T	3.9L 235.2 (3856cc) OHV Turbo L4 (8 Valve) 102mm Bore; DI; Diesel; Turbo Isuzu Eng.	46
G16KC	1.6L 97 (1590cc) SOHC L4 (8 Valve) 75mm Bore; TBI; Gasoline; Naturally Aspirated Suzuki Eng.	3
G16KV	1.6L 97 (1590cc) SOHC L4 (16 Valve) 75mm Bore; MFI; Gasoline; Naturally Aspirated Suzuki Eng.	2
H25A	2.5L 152 (2492cc) DOHC V6 (24 Valve) 84mm Bore; MFI; Gasoline; Naturally Aspirated Suzuki Eng.	21
J20A	2.0L 121.7 (1995cc) DOHC L4 (16 Valve) 84mm Bore; MFI; Gasoline; Naturally Aspirated Suzuki Eng.	4
J35A4	3.5L 212 (3471cc) SOHC V6 (24 Valve) 89mm Bore VTEC; MFI; Gasoline; Naturally Aspirated Honda Eng.	35

Model Index

Engine (VIN Code / Eng. Code)	Year	Engine (VIN Code / Eng. Code)	Year	Engine (VIN Code / Eng. Code)	Year
Asuna Truck		Buick Truck (cont.)		Cadillac Truck (cont.)	
SunRunner (2WD Compact SUV) (Canada)		Terraza (AWD Minivan) (cont.)		Escalade EXT (AWD Full-Size Pickup) (cont.)	
L4 1590cc 1.6L SOHC (16 Valve) (6)	97-94	V6 242CI 3.9L OHV (12 Valve) (1)	07-06	V8 378CI 6.2L (8)	08-07
L4 1590cc 1.6L SOHC (8 Valve) (U)	95-89	V6 242CI 3.9L OHV (12 Valve) (Flex Fuel)	07	V8 378CI 6.2L (Flex Fuel) (2)	13-09
SunRunner (4WD Compact SUV) (Canada)		(W)		V8 378CI 6.2L (Flex Fuel) (F)	13-10
L4 1590cc 1.6L SOHC (16 Valve) (6)	97-94	Terraza (FWD Minivan)		Escalade Hybrid (2WD Full-Size SUV)	
L4 1590cc 1.6L SOHC (8 Valve) (U)	95-89	V6 213CI 3.5L OHV (12 Valve) (L)	06-05	V8 364CI 6.0L (5)	11-09
Buick Truck		V6 242CI 3.9L OHV (12 Valve) (1)	07-06	V8 364CI 6.0L (Flex Fuel) (J)	13-10
Enclave (AWD Mid-Size SUV)		V6 242CI 3.9L OHV (12 Valve) (Flex Fuel)	07	Escalade Hybrid (AWD Full-Size SUV)	
V6 3564cc 3.6L DOHC (24 Valve) (7)	08	(W)		V8 364CI 6.0L (5)	11-09
V6 3564cc 3.6L DOHC (24 Valve) (D)	13-09	Cadillac Truck		V8 364CI 6.0L (Flex Fuel) (J)	13-10
Enclave (FWD Mid-Size SUV)		Escalade (2WD Full-Size SUV)		SRX (2WD Mid-Size SUV)	
V6 3564cc 3.6L DOHC (24 Valve) (7)	08	V8 325CI 5.3L (T)	05-02	V6 3564cc 3.6L DOHC (24 Valve) (7)	09-04
V6 3564cc 3.6L DOHC (24 Valve) (D)	13-09	V8 350CI 5.7L (R)	00-99	V8 281CI 4.6L DOHC (32 Valve) (A)	09-04
Encore (AWD Compact SUV)		V8 364CI 6.0L (N)	06-05	SRX (AWD Mid-Size SUV)	
L4 1364cc 1.4L DOHC Turbo (16 Valve) (B)	13	V8 378CI 6.2L (8)	08-07	V6 2792cc 2.8L DOHC Turbo (24 Valve) (4)	11-10
Encore (FWD Compact SUV)		V8 378CI 6.2L (Flex Fuel) (2)	13-09	V6 2792cc 2.8L DOHC Turbo (24 Valve) (6)	11
L4 1364cc 1.4L DOHC Turbo (16 Valve) (B)	13	V8 378CI 6.2L (Flex Fuel) (F)	13-10	V6 2997cc 3.0L DOHC (24 Valve) (Y)	11-10
Rainier (2WD Mid-Size SUV)		Escalade (AWD Full-Size SUV)		V6 3564cc 3.6L DOHC (24 Valve) (7)	09-04
L6 254CI 4.2L DOHC (24 Valve) (S)	07-04	V8 350CI 5.7L (R)	00-99	V6 3564cc 3.6L DOHC (24 Valve) (V)	13-12
V8 325CI 5.3L (M)	07-05	V8 364CI 6.0L (N)	06-02	V6 3564cc 3.6L DOHC (24 Valve) (Flex Fuel)	13-12
V8 325CI 5.3L (P)	05-04	V8 364CI 6.0L (U)	01	(3)	
Rainier (4WD Mid-Size SUV)		V8 378CI 6.2L (8)	08-07	V8 281CI 4.6L DOHC (32 Valve) (A)	09-04
L6 254CI 4.2L DOHC (24 Valve) (S)	07-04	V8 378CI 6.2L (Flex Fuel) (2)	13-09	SRX (FWD Mid-Size SUV)	
V8 325CI 5.3L (M)	07-05	V8 378CI 6.2L (Flex Fuel) (F)	13-10	V6 2792cc 2.8L DOHC Turbo (24 Valve) (4)	11-10
V8 325CI 5.3L (P)	05-04	Escalade ESV (2WD Full-Size SUV)		V6 2792cc 2.8L DOHC Turbo (24 Valve) (6)	11
Rendezvous (AWD Mid-Size SUV)		V8 378CI 6.2L (8)	08	V6 2997cc 3.0L DOHC (24 Valve) (Y)	11-10
V6 207CI 3.4L OHV (12 Valve) (E)	05-01	V8 378CI 6.2L (Flex Fuel) (2)	13-09	V6 3564cc 3.6L DOHC (24 Valve) (V)	13-12
V6 213CI 3.5L OHV (12 Valve) (8)	07-06	V8 378CI 6.2L (Flex Fuel) (F)	13-10	V6 3564cc 3.6L DOHC (24 Valve) (Flex Fuel)	13-12
V6 3564cc 3.6L DOHC (24 Valve) (7)	06-04	Escalade ESV (AWD Full-Size SUV)		(3)	
Rendezvous (FWD Mid-Size SUV)		V8 364CI 6.0L (N)	06-03	Chevrolet Truck	
V6 207CI 3.4L OHV (12 Valve) (E)	05-01	V8 378CI 6.2L (8)	08-07	1100 Series	
V6 213CI 3.5L OHV (12 Valve) (8)	07-06	V8 378CI 6.2L (Flex Fuel) (2)	13-09	L6 235CI 3.8L	59-58
V6 3564cc 3.6L DOHC (24 Valve) (7)	06-04	V8 378CI 6.2L (Flex Fuel) (F)	13-10	V8 283CI 4.6L	59-58
Terraza (AWD Minivan)		Escalade EXT (AWD Full-Size Pickup)			
V6 213CI 3.5L OHV (12 Valve) (L)	06-05	V8 364CI 6.0L (N)	06-02		

GMC Truck (Incl. Minivans and SUV's) (Cont.)

Model Index (Cont.)					
Engine (VIN Code / Eng. Code)	Year	Engine (VIN Code / Eng. Code)	Year	Engine (VIN Code / Eng. Code)	Year
Chevrolet Truck (cont.)		Chevrolet Truck (cont.)		Chevrolet Truck (cont.)	
1500 Series		AM Series		Blazer (4WD Full-Size SUV) (cont.)	
L6 216CI 3.5L	53-47	L6 216CI 3.5L	41	L6 292CI 4.8L (T)	80-70
L6 235CI 3.8L	59-50	AN Series		V8 305CI 5.0L (F)	86-81
L6 261CI 4.3L	59-54	L6 216CI 3.5L	41	V8 305CI 5.0L (G)	81-80
V8 265CI 4.3L	57-55	Astro (2WD Minivan)		V8 305CI 5.0L (H)	94-81
V8 283CI 4.6L	59-57	L4 151CI 2.5L (E)	90-85	V8 305CI 5.0L (U)	79-76
V8 322CI 5.3L	59-56	V6 262CI 4.3L (B)	91-90	V8 307CI 5.0L	73-69
V8 324CI 5.3L	56-55	V6 262CI 4.3L (N)	85	V8 350CI 5.7L	72-69
V8 348CI 5.7L	59-58	V6 262CI 4.3L (W)	03-92	V8 350CI 5.7L (K)	94-87
3100 Series		V6 262CI 4.3L (X)	99-96	V8 350CI 5.7L (L)	86-76
L6 235CI 3.8L	59-58	V6 262CI 4.3L (X)	05-02	V8 350CI 5.7L (V)	76-75
V8 283CI 4.6L	59-58	V6 262CI 4.3L (Z)	94-86	V8 350CI 5.7L (Y)	75-73
3200 Series		Astro (AWD Minivan)		V8 379CI 6.2L Diesel (C)	93-82
L6 235CI 3.8L	59-58	V6 262CI 4.3L (W)	03-92	V8 395CI 6.5L Turbo-Diesel (S)	94
V8 283CI 4.6L	59-58	V6 262CI 4.3L (X)	99-96	V8 400CI 6.6L (M)	75
3400 Series		V6 262CI 4.3L (X)	05-02	V8 400CI 6.6L (R)	79-77
L6 235CI 3.8L	59-58	V6 262CI 4.3L (Z)	94-90	V8 400CI 6.6L (U)	76
V8 283CI 4.6L	59-58	Avalanche 1500 (2WD Full-Size Pickup)		V8 400CI 6.6L (X)	80
3500 Series		V8 325CI 5.3L (J)	10-07	BM Series	
L6 235CI 3.8L	59-58	V8 325CI 5.3L (T)	06-02	L6 216CI 3.5L	42
V8 283CI 4.6L	59-58	V8 325CI 5.3L (Flex Fuel) (0)	13-07	BN Series	
3600 Series		V8 325CI 5.3L (Flex Fuel) (3)	13-07	L6 216CI 3.5L	42
L6 235CI 3.8L	59-58	V8 325CI 5.3L (Flex Fuel) (7)	13-12	C10 (Full-Size Pickup)	
V8 283CI 4.6L	59-58	V8 325CI 5.3L (Flex Fuel) (Z)	06-02	L6 230CI 3.8L	69-63
3700 Series		V8 364CI 6.0L (K)	10-07	L6 235CI 3.8L	62-60
L6 235CI 3.8L	59-58	V8 364CI 6.0L (Y)	10-07	L6 250CI 4.1L	72-66
V8 283CI 4.6L	59-58	Avalanche 1500 (4WD Full-Size Pickup)		L6 250CI 4.1L (D)	84-76
3800 Series		V8 325CI 5.3L (J)	10-07	L6 250CI 4.1L (Q)	75-73
L6 235CI 3.8L	59-58	V8 325CI 5.3L (T)	06-02	L6 261CI 4.3L	62-61
V8 283CI 4.6L	59-58	V8 325CI 5.3L (Flex Fuel) (0)	13-07	L6 292CI 4.8L	72-63
3A (3100 Series)		V8 325CI 5.3L (Flex Fuel) (3)	13-07	L6 292CI 4.8L (T)	86-73
L6 235CI 3.8L	58-56	V8 325CI 5.3L (Flex Fuel) (7)	13-12	V6 262CI 4.3L (N)	86-85
V8 265CI 4.3L	57-56	V8 325CI 5.3L (Flex Fuel) (Z)	06-02	V8 283CI 4.6L	67-60
V8 283CI 4.6L	58	V8 364CI 6.0L (K)	10-07	V8 305CI 5.0L (F)	86-81
3B (3200 Series)		V8 364CI 6.0L (Y)	10-07	V8 305CI 5.0L (G)	81-80
L6 235CI 3.8L	58-56	Avalanche 2500 (2WD Full-Size Pickup)		V8 305CI 5.0L (Q)	76
V8 265CI 4.3L	57-56	V8 496CI 8.1L (G)	06-02	V8 305CI 5.0L (U)	79-77
V8 283CI 4.6L	58	Avalanche 2500 (4WD Full-Size Pickup)		V8 307CI 5.0L	73-68
3C (3400 Series)		V8 496CI 8.1L (G)	06-02	V8 327CI 5.3L	69-66
L6 235CI 3.8L	58-56	BG Series		V8 350CI 5.7L	72-69
V8 265CI 4.3L	57-56	L6 216CI 3.5L	42	V8 350CI 5.7L (L)	86-76
V8 283CI 4.6L	58	BJ Series		V8 350CI 5.7L (V)	76-74
3D (3500 Series)		L6 216CI 3.5L	42	V8 350CI 5.7L (Y)	75-73
L6 235CI 3.8L	58-56	BK Series		V8 350CI 5.7L Diesel (Z)	81-78
V8 265CI 4.3L	57-56	L6 216CI 3.5L	44-42	V8 379CI 6.2L Diesel (C)	86-82
V8 283CI 4.6L	58	BL Series		V8 396CI 6.5L	69-68
3E (3600 Series)		L6 216CI 3.5L	42	V8 402CI 6.6L	72-70
L6 235CI 3.8L	58-56	Blazer (2WD Full-Size SUV)		V8 454CI 7.4L (S)	79-76
V8 265CI 4.3L	57-56	L6 250CI 4.1L	72-69	V8 454CI 7.4L (W)	80
V8 283CI 4.6L	58	L6 250CI 4.1L (D)	82-76	V8 454CI 7.4L (Z)	75-73
3F (3700 Series)		L6 250CI 4.1L (Q)	75-73	C10 Suburban (Full-Size SUV)	
L6 235CI 3.8L	58-56	L6 292CI 4.8L (T)	80-70	L6 230CI 3.8L	65-63
V8 265CI 4.3L	57-56	V8 305CI 5.0L (F)	86-81	L6 235CI 3.8L	60
V8 283CI 4.6L	58	V8 305CI 5.0L (G)	81-80	L6 250CI 4.1L	72-66
3G (3800 Series)		V8 305CI 5.0L (H)	94-81	L6 250CI 4.1L (D)	80-76
L6 235CI 3.8L	58-56	V8 305CI 5.0L (U)	79-76	L6 250CI 4.1L (Q)	75-73
V8 265CI 4.3L	57-56	V8 307CI 5.0L	73-69	L6 261CI 4.3L	62-61
V8 283CI 4.6L	58	V8 350CI 5.7L	72-69	L6 292CI 4.8L	72-63
AG Series		V8 350CI 5.7L (K)	94-87	L6 292CI 4.8L (T)	75-73
L6 216CI 3.5L	41	V8 350CI 5.7L (L)	86-76	V8 283CI 4.6L	67-60
AJ Series		V8 350CI 5.7L (V)	76-75	V8 305CI 5.0L (G)	81-80
L6 216CI 3.5L	41	V8 350CI 5.7L (Y)	75-73	V8 305CI 5.0L (H)	86-81
AK Series		Blazer (4WD Full-Size SUV)		V8 305CI 5.0L (U)	79-77
L6 216CI 3.5L	41	L6 250CI 4.1L	72-69	V8 307CI 5.0L	73-68
AL Series		L6 250CI 4.1L (D)	78-76	V8 327CI 5.3L	69-66
L6 216CI 3.5L	41	L6 250CI 4.1L (Q)	75-73	V8 350CI 5.7L	72-70

GMC Truck (Incl. Minivans and SUV's) (Cont.)

Model Index (Cont.)					
<i>Engine (VIN Code / Eng. Code)</i>	<i>Year</i>	<i>Engine (VIN Code / Eng. Code)</i>	<i>Year</i>	<i>Engine (VIN Code / Eng. Code)</i>	<i>Year</i>
Chevrolet Truck (cont.)		Chevrolet Truck (cont.)		Chevrolet Truck (cont.)	
C10 Suburban (Full-Size SUV) (cont.)		C20 Suburban (Full-Size SUV)		C30 (Full-Size Pickup) (cont.)	
V8 350CI 5.7L (L)	86-76	L6 230CI 3.8L	65-63	V8 379CI 6.2L Diesel (J)	86-82
V8 350CI 5.7L (V)	76-74	L6 235CI 3.8L	60	V8 396CI 6.5L	69-68
V8 350CI 5.7L (Y)	75-73	L6 250CI 4.1L	72-66	V8 402CI 6.6L	72-70
V8 379CI 6.2L Diesel (C)	86-82	L6 250CI 4.1L (Q)	74-73	V8 454CI 7.4L (L)	75-73
V8 402CI 6.6L	72	L6 261CI 4.3L	62-61	V8 454CI 7.4L (S)	79-76
V8 454CI 7.4L (S)	79-76	L6 292CI 4.8L	71-63	V8 454CI 7.4L (W)	86-80
V8 454CI 7.4L (W)	80	V8 283CI 4.6L	67-60	V8 454CI 7.4L (Y)	78-76
V8 454CI 7.4L (Z)	75-73	V8 305CI 5.0L (U)	78-77	V8 454CI 7.4L (Z)	75-73
C1500 (Full-Size Pickup)		C2500 (Full-Size Pickup)		C3500 (Full-Size Pickup)	
V6 262CI 4.3L (W)	98-96	V8 350CI 5.7L (L)	86-76	V8 350CI 5.7L (K)	95-88
V6 262CI 4.3L (Z)	95-88	V8 350CI 5.7L (M)	86-80	V8 350CI 5.7L (R)	00-96
V8 305CI 5.0L (H)	95-88	V8 350CI 5.7L (V)	76-74	V8 379CI 6.2L Diesel (C)	93-88
V8 305CI 5.0L (M)	00-96	V8 350CI 5.7L (Y)	75-73	V8 379CI 6.2L Diesel (J)	93-88
V8 350CI 5.7L (K)	95-88	V8 379CI 6.2L Diesel (C)	86-82	V8 395CI 6.5L Diesel (P)	95-94
V8 350CI 5.7L (R)	00-96	V8 402CI 6.6L	72	V8 395CI 6.5L Turbo-Diesel (F)	00-92
V8 379CI 6.2L Diesel (C)	93-88	V8 454CI 7.4L (L)	75-73	V8 395CI 6.5L Turbo-Diesel (S)	00-94
V8 379CI 6.2L Diesel (J)	93-88	V8 454CI 7.4L (S)	79-76	V8 454CI 7.4L (J)	00-96
V8 395CI 6.5L Diesel (P)	95-94	V8 454CI 7.4L (W)	86-80	V8 454CI 7.4L (N)	95-88
V8 395CI 6.5L Turbo-Diesel (F)	00-92	V8 454CI 7.4L (Y)	76	V8 496CI 8.1L (G)	02-01
V8 395CI 6.5L Turbo-Diesel (S)	00-94	V8 454CI 7.4L (Z)	75-73	Captiva Sport (AWD Compact SUV)	
C1500 Suburban (Full-Size SUV)		C2500 (Full-Size Pickup)		Captiva Sport (FWD Compact SUV)	
V8 325CI 5.3L (J)	10-07	V6 262CI 4.3L (W)	97-96	L4 2384cc 2.4L DOHC (16 Valve) (W)	13-12
V8 325CI 5.3L (T)	06-00	V6 262CI 4.3L (Z)	95-88	L4 2384cc 2.4L DOHC (16 Valve) (Fles Fuel) (K)	13-12
V8 325CI 5.3L (Flex Fuel) (0)	13-07	V8 305CI 5.0L (H)	95-88	V6 2997cc 3.0L DOHC (24 Valve) (Flex Fuel) (5)	13-12
V8 325CI 5.3L (Flex Fuel) (3)	13-07	V8 305CI 5.0L (M)	00-96	Captiva Sport (FWD Compact SUV)	
V8 325CI 5.3L (Flex Fuel) (7)	13-12	V8 350CI 5.7L (K)	95-88	L4 2384cc 2.4L DOHC (16 Valve) (W)	13-12
V8 325CI 5.3L (Flex Fuel) (Z)	06-02	V8 350CI 5.7L (R)	00-96	L4 2384cc 2.4L DOHC (16 Valve) (Fles Fuel) (K)	13-12
V8 350CI 5.7L (K)	95-92	V8 379CI 6.2L Diesel (C)	93-88	V6 2997cc 3.0L DOHC (24 Valve) (Flex Fuel) (5)	13-12
V8 350CI 5.7L (R)	99-96	V8 379CI 6.2L Diesel (J)	93-88	CK Series	
V8 364CI 6.0L (K)	10-07	V8 395CI 6.5L Diesel (P)	95-94	L6 216CI 3.5L	
V8 364CI 6.0L (U)	06	V8 395CI 6.5L Turbo-Diesel (F)	00-92	46-45	
V8 364CI 6.0L (Y)	10-07	V8 395CI 6.5L Turbo-Diesel (S)	00-94	Colorado (2WD Compact Pickup)	
V8 364CI 6.0L (Flex Fuel) (G)	13-10	V8 454CI 7.4L (J)	00-96	L4 169CI 2.8L DOHC (16 Valve) (8)	06-04
V8 395CI 6.5L Turbo-Diesel (F)	99-94	V8 454CI 7.4L (N)	95-88	L4 178CI 2.9L DOHC (16 Valve) (9)	12-07
V8 395CI 6.5L Turbo-Diesel (S)	99-94	C2500 Suburban (Full-Size SUV)		L5 211CI 3.5L DOHC (20 Valve) (6)	06-04
C20 (Full-Size Pickup)		V8 325CI 5.3L (T)	06-00	L5 223CI 3.7L DOHC (20 Valve) (E)	12-07
L6 230CI 3.8L	65-63	V8 325CI 5.3L (Flex Fuel) (Z)	06-02	V8 325CI 5.3L (L)	09
L6 235CI 3.8L	62-60	V8 350CI 5.7L (K)	95-92	V8 325CI 5.3L (P)	12-10
L6 250CI 4.1L	71-66	V8 350CI 5.7L (R)	99-96	Colorado (4WD Compact Pickup)	
L6 250CI 4.1L (Q)	74-72	V8 364CI 6.0L (K)	10-07	L4 169CI 2.8L DOHC (16 Valve) (8)	06-04
L6 261CI 4.3L	62-61	V8 364CI 6.0L (U)	06-00	L4 178CI 2.9L DOHC (16 Valve) (9)	12-07
L6 292CI 4.8L	72-63	V8 364CI 6.0L (Y)	10-07	L5 211CI 3.5L DOHC (20 Valve) (6)	06-04
L6 292CI 4.8L (T)	86-73	V8 364CI 6.0L (Flex Fuel) (G)	13-10	L5 223CI 3.7L DOHC (20 Valve) (E)	12-07
V6 262CI 4.3L (N)	86-85	V8 395CI 6.5L Turbo-Diesel (F)	99-94	V8 325CI 5.3L (L)	09
V8 283CI 4.6L	67-60	V8 395CI 6.5L Turbo-Diesel (S)	99-94	V8 325CI 5.3L (P)	12-10
V8 305CI 5.0L (F)	86-81	V8 454CI 7.4L (J)	99-96	Corvair (Pickup)	
V8 305CI 5.0L (G)	81-80	V8 454CI 7.4L (N)	95-92	H6 145CI 2.4L	63-61
V8 305CI 5.0L (H)	86-81	V8 496CI 8.1L (G)	06-01	H6 164CI 2.7L	65-64
V8 305CI 5.0L (U)	79-76	C30 (Full-Size Pickup)		Corvan (Van)	
V8 307CI 5.0L	73-68	L6 230CI 3.8L	65-63	H6 145CI 2.4L	63-61
V8 327CI 5.3L	69-66	L6 235CI 3.8L	62-60	H6 164CI 2.7L	65-64
V8 350CI 5.7L	72-69	L6 250CI 4.1L	71-66	D1500 Series	
V8 350CI 5.7L (L)	86-76	L6 250CI 4.1L (Q)	74-72	L6 235CI 3.8L	
V8 350CI 5.7L (M)	86-80	L6 261CI 4.3L	62-61	53	
V8 350CI 5.7L (Y)	75-73	L6 292CI 4.8L	72-63	D2551 Series	
V8 379CI 6.2L Diesel (C)	86-82	L6 292CI 4.8L (T)	86-73	L6 235CI 3.8L	
V8 379CI 6.2L Diesel (J)	86-82	V8 283CI 4.6L	67-60	55	
V8 396CI 6.5L	69-68	V8 307CI 5.0L	73-68	D5415 Series	
V8 402CI 6.6L	72-70	V8 327CI 5.3L	69-66	L6 235CI 3.8L	
V8 454CI 7.4L (L)	75-73	V8 350CI 5.7L	72-69	54	
V8 454CI 7.4L (S)	79-76	V8 350CI 5.7L (E)	84	D5615 Series	
V8 454CI 7.4L (W)	86-80	V8 350CI 5.7L (L)	79-76	L6 235CI 3.8L	
V8 454CI 7.4L (Y)	76	V8 350CI 5.7L (M)	86-80	56	
V8 454CI 7.4L (Z)	75-73	V8 350CI 5.7L (P)	83-80	D5715 Series	
		V8 350CI 5.7L (Y)	75-73	V8 265CI 4.3L	
				57	
				V8 283CI 4.6L	
				57	

GMC Truck (Incl. Minivans and SUV's) (Cont.)

Model Index (Cont.)					
Engine (VIN Code / Eng. Code)	Year	Engine (VIN Code / Eng. Code)	Year	Engine (VIN Code / Eng. Code)	Year
Chevrolet Truck (cont.)		Chevrolet Truck (cont.)		Chevrolet Truck (cont.)	
D5815 Series		Equinox (FWD Mid-Size SUV) (cont.)		G20 (Full-Size Van) (cont.)	
L6 235CI 3.8L	58	V6 207CI 3.4L OHV (12 Valve) (9)	09-04	L6 250CI 4.1L (Q)	75-73
V8 283CI 4.6L	58	V6 2997cc 3.0L DOHC (24 Valve) (Y)	13-10	L6 292CI 4.8L (T)	78-75
DJ Series		V6 2997cc 3.0L DOHC (24 Valve) (Flex Fuel)	13-11	V6 262CI 4.3L (N)	86-85
L6 216CI 3.5L	46-45	(5)		V6 262CI 4.3L (Z)	95-87
DP Series		V6 3564cc 3.6L DOHC (24 Valve) (7)	09-08	V8 283CI 4.6L	67
L6 216CI 3.5L	46	V6 3564cc 3.6L DOHC (24 Valve) (Flex Fuel)	13	V8 305CI 5.0L (F)	86-81
DR Series		(3)		V8 305CI 5.0L (H)	95-85
L6 216CI 3.5L	46	ER3600 Series		V8 307CI 5.0L	73-68
DS Series		L6 216CI 3.5L	47	V8 350CI 5.7L (K)	95-87
L6 216CI 3.5L	46	ES3800 Series		V8 350CI 5.7L (L)	86-76
EB Series		L6 216CI 3.5L	47	V8 350CI 5.7L (M)	88-85
L6 206.8CI 3.4L	35	F2553 Series		V8 350CI 5.7L (R)	97-96
EC Series		L6 235CI 3.8L	55	V8 350CI 5.7L (V)	76-75
L6 206.8CI 3.4L	35	FB Series		V8 350CI 5.7L (Y)	75-73
EJ1500 Series		L6 206.8CI 3.4L	36	V8 379CI 6.2L Diesel (C)	93-89
L6 216CI 3.5L	47	FC Series		V8 379CI 6.2L Diesel (J)	93-83
El Camino (Pickup)		L6 206.8CI 3.4L	36	V8 395CI 6.5L Diesel (P)	95-94
L6 194CI 3.2L	66-64	FJ1500 Series		V8 395CI 6.5L Diesel (Y)	95-94
L6 230CI 3.8L	69-63	L6 216CI 3.5L	48	V8 395CI 6.5L Turbo-Diesel (F)	02-96
L6 235CI 3.8L	62-59	FP3100 Series		V8 395CI 6.5L Turbo-Diesel (S)	02-96
L6 250CI 4.1L	71-67	L6 216CI 3.5L	48	V8 400CI 6.6L (M)	75
L6 250CI 4.1L (D)	77-72	FR3600 Series		V8 400CI 6.6L (R)	79-77
V6 200CI 3.3L (M)	79-78	L6 216CI 3.5L	48	V8 400CI 6.6L (U)	76
V6 229CI 3.8L (9)	84-83	FS3800 Series		V8 400CI 6.6L (X)	80
V6 229CI 3.8L (K)	82-80	L6 216CI 3.5L	48	G2500 (Full-Size Van)	
V6 231CI 3.8L (A)	84-78	FT3700 Series		V6 262CI 4.3L (W)	03-96
V6 262CI 4.3L (Z)	87-85	L6 216CI 3.5L	48	V6 262CI 4.3L (X)	08-03
V8 267CI 4.4L (J)	82-79	FU3900 Series		V8 293CI 4.8L (C)	10-08
V8 283CI 4.6L	67-59	L6 216CI 3.5L	48	V8 293CI 4.8L (V)	08-03
V8 305CI 5.0L (G)	87-84	G10 (Full-Size Van)		V8 293CI 4.8L (Flex Fuel) (A)	13-10
V8 305CI 5.0L (H)	87-79	L4 153CI 2.5L	65-63	V8 305CI 5.0L (M)	02-96
V8 305CI 5.0L (Q)	76	L6 194CI 3.2L	66-63	V8 325CI 5.3L (T)	08-03
V8 305CI 5.0L (U)	78-77	L6 230CI 3.8L	69-65	V8 325CI 5.3L (Flex Fuel) (4)	13-09
V8 307CI 5.0L	73-68	L6 250CI 4.1L	72-66	V8 325CI 5.3L (Flex Fuel) (Z)	08-03
V8 327CI 5.3L	69-62	L6 250CI 4.1L (D)	84-76	V8 350CI 5.7L (R)	02-96
V8 348CI 5.7L	60-59	L6 250CI 4.1L (Q)	75-73	V8 364CI 6.0L (K)	10-08
V8 350CI 5.7L	71-68	V6 262CI 4.3L (N)	86-85	V8 364CI 6.0L (U)	08-03
V8 350CI 5.7L (L)	81-72	V6 262CI 4.3L (Z)	95-87	V8 364CI 6.0L (Flex Fuel) (G)	13-10
V8 350CI 5.7L (V)	76	V8 283CI 4.6L	67	V8 364CI 6.0L (Natural Gas) (B)	13-12
V8 350CI 5.7L Diesel (N)	84-83	V8 305CI 5.0L (F)	86-81	V8 395CI 6.5L Turbo-Diesel (F)	02-96
V8 396CI 6.5L	69-66	V8 305CI 5.0L (G)	81-80	V8 395CI 6.5L Turbo-Diesel (S)	02-96
V8 400CI 6.6L	72-70	V8 305CI 5.0L (H)	95-85	V8 402CI 6.6L Turbo-Diesel (2)	07-06
V8 400CI 6.6L (U)	76-73	V8 305CI 5.0L (U)	79-77	V8 402CI 6.6L Turbo-Diesel (6)	13-08
V8 402CI 6.6L	72-70	V8 307CI 5.0L	73-68	V8 402CI 6.6L Turbo-Diesel (L)	13-11
V8 454CI 7.4L	72-70	V8 350CI 5.7L (K)	95-87	G2553 Series	
V8 454CI 7.4L (Y)	76-73	V8 350CI 5.7L (L)	86-76	L6 235CI 3.8L	55
EP3100 Series		V8 350CI 5.7L (V)	76-75	G30 (Full-Size Van)	
L6 216CI 3.5L	47	V8 350CI 5.7L (Y)	75-73	L6 250CI 4.1L	72-70
Equinox (AWD Mid-Size SUV)		V8 400CI 6.6L (R)	79-77	L6 250CI 4.1L (D)	84-76
L4 2384cc 2.4L DOHC (16 Valve) (C)	11	V8 400CI 6.6L (U)	76	L6 250CI 4.1L (Q)	75-73
L4 2384cc 2.4L DOHC (16 Valve) (W)	13-10	G1500 (Full-Size Van)		L6 292CI 4.8L (T)	78-75
L4 2384cc 2.4L DOHC (16 Valve) (Flex Fuel)	13-12	V6 262CI 4.3L (W)	03-96	V6 262CI 4.3L (N)	86-85
(K)		V6 262CI 4.3L (X)	13-03	V6 262CI 4.3L (Z)	95-87
V6 207CI 3.4L OHV (12 Valve) (9)	09-04	V8 293CI 4.8L (C)	10-08	V8 350CI 5.7L (K)	95-87
V6 2997cc 3.0L DOHC (24 Valve) (Y)	13-10	V8 293CI 4.8L (V)	08-03	V8 350CI 5.7L (L)	86-76
V6 2997cc 3.0L DOHC (24 Valve) (Flex Fuel)	13-11	V8 293CI 4.8L (Flex Fuel) (A)	13-10	V8 350CI 5.7L (M)	88-80
(5)		V8 305CI 5.0L (M)	02-96	V8 350CI 5.7L (R)	97-96
V6 3564cc 3.6L DOHC (24 Valve) (7)	09-08	V8 325CI 5.3L (T)	08-03	V8 350CI 5.7L (V)	76-75
V6 3564cc 3.6L DOHC (24 Valve) (Flex Fuel)	13	V8 325CI 5.3L (Flex Fuel) (4)	13-09	V8 350CI 5.7L (Y)	75-73
(3)		V8 325CI 5.3L (Flex Fuel) (Z)	08-03	V8 379CI 6.2L Diesel (J)	93-83
Equinox (FWD Mid-Size SUV)		V8 350CI 5.7L (R)	02-96	V8 395CI 6.5L Diesel (P)	95-94
L4 2384cc 2.4L DOHC (16 Valve) (C)	11	G20 (Full-Size Van)		V8 395CI 6.5L Diesel (Y)	95-94
L4 2384cc 2.4L DOHC (16 Valve) (W)	13-10	L6 230CI 3.8L	69-65	V8 395CI 6.5L Turbo-Diesel (F)	02-96
L4 2384cc 2.4L DOHC (16 Valve) (Flex Fuel)	13-12	L6 250CI 4.1L	72-66	V8 395CI 6.5L Turbo-Diesel (S)	02-96
(K)		L6 250CI 4.1L (D)	84-76	V8 400CI 6.6L (M)	75

GMC Truck (Incl. Minivans and SUV's) (Cont.)

Model Index (Cont.)					
Engine (VIN Code / Eng. Code)	Year	Engine (VIN Code / Eng. Code)	Year	Engine (VIN Code / Eng. Code)	Year
Chevrolet Truck (cont.)		Chevrolet Truck (cont.)		Chevrolet Truck (cont.)	
G30 (Full-Size Van) (cont.)		HHR (FWD Compact SUV) (cont.)		K10 (Full-Size Pickup) (cont.)	
V8 400CI 6.6L (R)	79-77	L4 2198cc 2.2L DOHC (16 Valve) (Flex Fuel) (B)	11-09	V8 350CI 5.7L (L)	86-75
V8 400CI 6.6L (U)	76			V8 350CI 5.7L (V)	76-75
V8 400CI 6.6L (X)	80	L4 2198cc 2.2L DOHC (16 Valve) (Flex Fuel) (W)	11	V8 350CI 5.7L (Y)	75-73
V8 454CI 7.4L (N)	97-88			V8 379CI 6.2L Diesel (C)	86-82
G3500 (Full-Size Van)		L4 2384cc 2.4L DOHC (16 Valve) (P)	08-06	V8 400CI 6.6L (M)	75
V6 262CI 4.3L (W)	98-96	L4 2384cc 2.4L DOHC (16 Valve) (Flex Fuel) (U)	11	V8 400CI 6.6L (R)	79-77
V8 293CI 4.8L (C)	10-08			V8 400CI 6.6L (U)	76
V8 293CI 4.8L (V)	08-03	L4 2384cc 2.4L DOHC (16 Valve) (Flex Fuel) (V)	11-09	V8 402CI 6.6L	72
V8 293CI 4.8L (Flex Fuel) (A)	13-10	HJ1500 Series		K10 Suburban (Full-Size SUV)	
V8 325CI 5.3L (T)	08-03	L6 216CI 3.5L	50	L6 230CI 3.8L	65-63
V8 325CI 5.3L (Flex Fuel) (4)	13-09	HP3100 Series		L6 235CI 3.8L	60
V8 325CI 5.3L (Flex Fuel) (Z)	08-03	L6 216CI 3.5L	50	L6 250CI 4.1L	72-66
V8 350CI 5.7L (R)	02-96	HR3600 Series		L6 250CI 4.1L (Q)	73
V8 364CI 6.0L (K)	10-08	L6 216CI 3.5L	50	L6 261CI 4.3L	62-61
V8 364CI 6.0L (U)	08-03	HS3800 Series		L6 292CI 4.8L	67-63
V8 364CI 6.0L (Flex Fuel) (G)	13-10	L6 216CI 3.5L	50	V8 283CI 4.6L	67-60
V8 364CI 6.0L (Natural Gas) (B)	13-12	HT3700 Series		V8 305CI 5.0L (U)	78-77
V8 395CI 6.5L Turbo-Diesel (F)	02-96	L6 235CI 3.8L	50	V8 350CI 5.7L	72-70
V8 395CI 6.5L Turbo-Diesel (S)	02-96	HU3900 Series		V8 350CI 5.7L (L)	86-76
V8 402CI 6.6L Turbo-Diesel (2)	07-06	L6 235CI 3.8L	50	V8 350CI 5.7L (V)	76-74
V8 402CI 6.6L Turbo-Diesel (6)	13-08	J2553 Series		V8 350CI 5.7L (Y)	75-73
V8 402CI 6.6L Turbo-Diesel (L)	13-11	L6 235CI 3.8L	55	V8 379CI 6.2L Diesel (C)	86-82
V8 454CI 7.4L (J)	00-96	V8 265CI 4.3L	55	V8 400CI 6.6L (M)	75
V8 454CI 7.4L (N)	95-88	J3600 Series		V8 400CI 6.6L (R)	79-77
V8 496CI 8.1L (G)	07-01	L6 235CI 3.8L	53	V8 400CI 6.6L (U)	76
GB Series		J5436 Series		V8 402CI 6.6L	72
L6 216CI 3.5L	37	L6 235CI 3.8L	54	K1500 (Full-Size Pickup)	
GC Series		JB Series		V6 262CI 4.3L (W)	98-96
L6 216CI 3.5L	37	L6 216CI 3.5L	39	V6 262CI 4.3L (Z)	95-88
GD Series		JC Series		V8 305CI 5.0L (H)	95-88
L6 216CI 3.5L	37	L6 216CI 3.5L	39	V8 305CI 5.0L (M)	98-96
GE Series		JD Series		V8 350CI 5.7L (K)	95-88
L6 216CI 3.5L	37	L6 216CI 3.5L	39	V8 350CI 5.7L (R)	00-96
GJ1508 Series		JJ1500 Series		V8 379CI 6.2L Diesel (C)	93-88
L6 216CI 3.5L	49	L6 216CI 3.5L	51	V8 379CI 6.2L Diesel (J)	93-88
GP3100 Series		JP3100 Series		V8 395CI 6.5L Diesel (P)	95-94
L6 216CI 3.5L	49	L6 216CI 3.5L	51	V8 395CI 6.5L Turbo-Diesel (F)	00-92
GR3600 Series		JP3600 Series		V8 395CI 6.5L Turbo-Diesel (S)	00-94
L6 216CI 3.5L	49	L6 216CI 3.5L	51	K1500 Suburban (Full-Size SUV)	
GS3800 Series		JR3600 Series		V8 325CI 5.3L (J)	10-07
L6 216CI 3.5L	49	L6 216CI 3.5L	51	V8 325CI 5.3L (T)	06-00
GT3700 Series		JS3800 Series		V8 325CI 5.3L (Flex Fuel) (0)	13-07
L6 216CI 3.5L	49	L6 216CI 3.5L	51	V8 325CI 5.3L (Flex Fuel) (3)	13-07
GU3900 Series		JT3700 Series		V8 325CI 5.3L (Flex Fuel) (7)	13-12
L6 216CI 3.5L	49	L6 216CI 3.5L	51	V8 325CI 5.3L (Flex Fuel) (Z)	06-02
H2553 Series		JU3900 Series		V8 350CI 5.7L (K)	95-92
L6 235CI 3.8L	55	L6 216CI 3.5L	51	V8 350CI 5.7L (R)	99-96
V8 265CI 4.3L	55	K10 (Full-Size Pickup)		V8 364CI 6.0L (K)	10-07
H3100 Series		L6 230CI 3.8L	65-63	V8 364CI 6.0L (U)	06
L6 235CI 3.8L	53	L6 235CI 3.8L	62-60	V8 364CI 6.0L (Y)	10-07
H5431 Series		L6 250CI 4.1L	72-66	V8 364CI 6.0L (Flex Fuel) (G)	13-10
L6 235CI 3.8L	54	L6 250CI 4.1L (D)	78-76	V8 395CI 6.5L Turbo-Diesel (F)	99-94
HB Series		L6 250CI 4.1L (Q)	75-73	V8 395CI 6.5L Turbo-Diesel (S)	99-94
L6 216CI 3.5L	38	L6 261CI 4.3L	62-61	K20 (Full-Size Pickup)	
HC Series		L6 292CI 4.8L	67-63	L6 230CI 3.8L	65-63
L6 216CI 3.5L	38	V6 262CI 4.3L (N)	86-85	L6 235CI 3.8L	63-60
HD Series		V8 283CI 4.6L	67-60	L6 250CI 4.1L	72-66
L6 216CI 3.5L	38	V8 305CI 5.0L (F)	86-81	L6 250CI 4.1L (D)	74-73
HE Series		V8 305CI 5.0L (G)	81-80	L6 261CI 4.3L	62-61
L6 216CI 3.5L	38	V8 305CI 5.0L (H)	86-81	L6 292CI 4.8L	72-63
HHR (FWD Compact SUV)		V8 305CI 5.0L (U)	79-76	L6 292CI 4.8L (T)	86-73
L4 1998cc 2.0L DOHC Turbo (16 Valve) (M)	10	V8 307CI 5.0L	73-68	V6 262CI 4.3L (N)	86-85
L4 1998cc 2.0L DOHC Turbo (16 Valve) (X)	10-08	V8 327CI 5.3L	69-67	V8 283CI 4.6L	67-60
L4 2198cc 2.2L DOHC (16 Valve) (D)	08-06	V8 350CI 5.7L	72-69	V8 305CI 5.0L (F)	86-81
				V8 305CI 5.0L (G)	81-80

GMC Truck (Incl. Minivans and SUV's) (Cont.)

Model Index (Cont.)					
Engine (VIN Code / Eng. Code)	Year	Engine (VIN Code / Eng. Code)	Year	Engine (VIN Code / Eng. Code)	Year
Chevrolet Truck (cont.)		Chevrolet Truck (cont.)		Chevrolet Truck (cont.)	
K20 (Full-Size Pickup) (cont.)		K30 (Full-Size Pickup) (cont.)		LUV (4WD Mini-Pickup)	
V8 305CI 5.0L (H)	86-81	V8 350CI 5.7L (E)	84	L4 1817cc 1.8L SOHC (N)	82-79
V8 305CI 5.0L (U)	79-76	V8 350CI 5.7L (L)	79-77	L4 2238cc 2.2L OHV Diesel (S)	82-81
V8 307CI 5.0L	73-68	V8 350CI 5.7L (M)	86-80	M2553 Series	
V8 327CI 5.3L	69-67	V8 350CI 5.7L (P)	83-80	L6 235CI 3.8L	55
V8 350CI 5.7L	72-69	V8 379CI 6.2L Diesel (J)	86-82	V8 265CI 4.3L	55
V8 350CI 5.7L (L)	86-76	V8 400CI 6.6L (R)	79-77	M3900 Series	
V8 350CI 5.7L (M)	86-80	V8 400CI 6.6L (X)	80	L6 235CI 3.8L	53
V8 350CI 5.7L (Y)	75-73	V8 454CI 7.4L (W)	86-81	M5439 Series	
V8 379CI 6.2L Diesel (C)	86-82	K3500 (Full-Size Pickup)		L6 235CI 3.8L	54
V8 379CI 6.2L Diesel (J)	86-82	V8 350CI 5.7L (K)	95-88	Orlando (AWD Compact SUV)	
V8 400CI 6.6L (M)	75	V8 350CI 5.7L (R)	00-96	L4 2384cc 2.4L DOHC (16 Valve) (M)	13-12
V8 400CI 6.6L (R)	79-77	V8 379CI 6.2L Diesel (C)	93-88	L4 2384cc 2.4L DOHC (16 Valve) (T)	13
V8 400CI 6.6L (U)	76	V8 379CI 6.2L Diesel (J)	93-88	Orlando (FWD Compact SUV)	
V8 400CI 6.6L (X)	80	V8 395CI 6.5L Diesel (P)	95-94	L4 2384cc 2.4L DOHC (16 Valve) (M)	13-12
V8 402CI 6.6L	72	V8 395CI 6.5L Turbo-Diesel (F)	00-92	L4 2384cc 2.4L DOHC (16 Valve) (T)	13
K20 Suburban (Full-Size SUV)		V8 395CI 6.5L Turbo-Diesel (S)	00-94	P10 (Parcel Delivery)	
L6 230CI 3.8L	65-63	V8 454CI 7.4L (J)	00-96	L4 153CI 2.5L	65-63
L6 250CI 4.1L	72-66	V8 454CI 7.4L (N)	95-88	L6 194CI 3.2L	66
L6 250CI 4.1L (D)	73	K3700 Series		L6 230CI 3.8L	69-63
L6 292CI 4.8L	71-63	L6 235CI 3.8L	53	L6 235CI 3.8L	62-60
V8 283CI 4.6L	67-60	K5437 Series		L6 250CI 4.1L	72-66
V8 305CI 5.0L (U)	78-77	L6 235CI 3.8L	54	L6 250CI 4.1L (Q)	74-73
V8 350CI 5.7L	72-70	KB Series		L6 261CI 4.3L	62-61
V8 350CI 5.7L (L)	86-76	L6 216CI 3.5L	40	L6 292CI 4.8L (T)	81-75
V8 350CI 5.7L (M)	86-80	KC Series		V8 283CI 4.6L	62-61
V8 350CI 5.7L (Y)	75-73	L6 216CI 3.5L	40	P20 (Parcel Delivery)	
V8 379CI 6.2L Diesel (C)	86-82	KD Series		L6 230CI 3.8L	65-63
V8 379CI 6.2L Diesel (J)	86-82	L6 216CI 3.5L	40	L6 235CI 3.8L	62-60
V8 400CI 6.6L (M)	75	KF Series		L6 250CI 4.1L	72-66
V8 400CI 6.6L (R)	79-77	L6 216CI 3.5L	40	L6 250CI 4.1L (D)	74-73
V8 400CI 6.6L (U)	76	KH Series		L6 261CI 4.3L	62-61
V8 400CI 6.6L (X)	80	L6 216CI 3.5L	40	L6 292CI 4.8L	72-63
V8 402CI 6.6L	72	KJ1500 Series		L6 292CI 4.8L (T)	89-73
K2500 (Full-Size Pickup)		L6 216CI 3.5L	52	V8 283CI 4.6L	62-61
V6 262CI 4.3L (W)	97-96	L6 235CI 3.8L	52	V8 307CI 5.0L	73-68
V6 262CI 4.3L (Z)	95-88	KP Series		V8 327CI 5.3L	69-68
V8 305CI 5.0L (H)	95-88	L6 216CI 3.5L	40	V8 350CI 5.7L	72-69
V8 305CI 5.0L (M)	98-96	KP3100 Series		V8 350CI 5.7L (K)	90-87
V8 350CI 5.7L (K)	95-88	L6 216CI 3.5L	52	V8 350CI 5.7L (L)	79-76
V8 350CI 5.7L (R)	00-96	KR3600 Series		V8 350CI 5.7L (M)	88-80
V8 379CI 6.2L Diesel (C)	93-88	L6 216CI 3.5L	52	V8 350CI 5.7L (V)	76-75
V8 379CI 6.2L Diesel (J)	93-88	KS3800 Series		V8 350CI 5.7L (Y)	75-73
V8 395CI 6.5L Diesel (P)	95-94	L6 216CI 3.5L	52	V8 379CI 6.2L Diesel (J)	89-82
V8 395CI 6.5L Turbo-Diesel (F)	00-92	KT3700 Series		P30 (Motor Home Chassis)	
V8 395CI 6.5L Turbo-Diesel (S)	00-94	L6 216CI 3.5L	52	V8 395CI 6.5L Diesel (Y)	99-94
V8 454CI 7.4L (J)	00-96	L6 235CI 3.8L	52	V8 454CI 7.4L (B)	99-98
V8 454CI 7.4L (N)	95-88	KU3900 Series		V8 454CI 7.4L (N)	97-90
K2500 Suburban (Full-Size SUV)		L6 216CI 3.5L	52	V8 454CI 7.4L (S)	79-77
V8 325CI 5.3L (T)	06-00	L6 235CI 3.8L	52	V8 454CI 7.4L (W)	89-80
V8 325CI 5.3L (Flex Fuel) (Z)	06-02	L2553 Series		V8 454CI 7.4L (Y)	78-76
V8 350CI 5.7L (K)	95-92	L6 235CI 3.8L	55	V8 454CI 7.4L (Z)	75-74
V8 350CI 5.7L (R)	99-96	V8 265CI 4.3L	55	P30 (Parcel Delivery)	
V8 364CI 6.0L (K)	10-07	L3800 Series		L3 159CI 2.6L Diesel	70-67
V8 364CI 6.0L (U)	06-00	L6 235CI 3.8L	53	L6 230CI 3.8L	65-63
V8 364CI 6.0L (Y)	10-07	L5438 Series		L6 235CI 3.8L	62-60
V8 364CI 6.0L (Flex Fuel) (G)	13-10	L6 235CI 3.8L	54	L6 250CI 4.1L	72-66
V8 395CI 6.5L Turbo-Diesel (F)	99-94	Lumina APV (FWD Minivan)		L6 250CI 4.1L (D)	74-73
V8 395CI 6.5L Turbo-Diesel (S)	99-94	V6 189CI 3.1L (D)	95-90	L6 261CI 4.3L	62-61
V8 454CI 7.4L (J)	99-96	V6 207CI 3.4L OHV (12 Valve) (E)	96	L6 292CI 4.8L	72-63
V8 454CI 7.4L (N)	95-92	V6 231CI 3.8L (L)	95-92	L6 292CI 4.8L (T)	89-73
V8 496CI 8.1L (G)	06-01	LUV (2WD Mini-Pickup)		V6 262CI 4.3L (W)	99-96
K2553 Series		L4 1817cc 1.8L SOHC	72	V6 262CI 4.3L (Z)	95-90
L6 235CI 3.8L	55	L4 1817cc 1.8L SOHC (N)	82-73	V8 283CI 4.6L	62-61
K30 (Full-Size Pickup)		L4 2238cc 2.2L OHV Diesel (S)	82-81	V8 307CI 5.0L	73-68
L6 292CI 4.8L (T)	86-77			V8 327CI 5.3L	69-68

GMC Truck (Incl. Minivans and SUV's) (Cont.)

Model Index (Cont.)					
Engine (VIN Code / Eng. Code)	Year	Engine (VIN Code / Eng. Code)	Year	Engine (VIN Code / Eng. Code)	Year
Chevrolet Truck (cont.)		Chevrolet Truck (cont.)		Chevrolet Truck (cont.)	
P30 (Parcel Delivery) (cont.)		R3500 (Full-Size Pickup)		Silverado 1500 (2WD Full-Size Pickup) (cont.)	
V8 350CI 5.7L	72-69	V8 350CI 5.7L (K)	91-90	V8 325CI 5.3L (Flex Fuel) (3)	13-07
V8 350CI 5.7L (K)	95-87	V8 379CI 6.2L Diesel (C)	91-90	V8 325CI 5.3L (Flex Fuel) (7)	13-12
V8 350CI 5.7L (L)	79-76	V8 379CI 6.2L Diesel (J)	91-90	V8 325CI 5.3L (Flex Fuel) (Z)	07-02
V8 350CI 5.7L (M)	88-80	V8 454CI 7.4L (N)	91-90	V8 364CI 6.0L (N)	07-03
V8 350CI 5.7L (R)	99-96	S10 (2WD Compact Pickup)		V8 364CI 6.0L (U)	07-02
V8 350CI 5.7L (V)	76-75	L4 121CI 2.0L OHV (Y)	84-83	V8 364CI 6.0L (Y)	10-07
V8 350CI 5.7L (Y)	75-73	L4 134CI 2.2L OHV (4)	03-94	V8 378CI 6.2L (Flex Fuel) (2)	13-09
V8 379CI 6.2L Diesel (J)	93-82	L4 134CI 2.2L OHV (Flex Fuel) (5)	02-00	Silverado 1500 (4WD Full-Size Pickup)	
V8 395CI 6.5L Diesel (Y)	99-94	L4 151CI 2.5L (A)	93-91	V6 262CI 4.3L (W)	03-99
V8 454CI 7.4L (B)	99-98	L4 151CI 2.5L (E)	91-85	V6 262CI 4.3L (X)	13-02
V8 454CI 7.4L (N)	97-90	L4 1949cc 1.9L SOHC (A)	85-82	V8 293CI 4.8L (C)	09-07
V8 454CI 7.4L (S)	79-77	L4 2238cc 2.2L OHV Diesel (S)	85-83	V8 293CI 4.8L (V)	07-99
V8 454CI 7.4L (W)	89-80	V6 173CI 2.8L (B)	85-82	V8 293CI 4.8L (Flex Fuel) (A)	13-10
V8 454CI 7.4L (Y)	78-76	V6 173CI 2.8L (R)	93-86	V8 325CI 5.3L (B)	07-05
V8 454CI 7.4L (Z)	75-74	V6 262CI 4.3L (W)	03-92	V8 325CI 5.3L (J)	10-07
R10 (Full-Size Pickup)		V6 262CI 4.3L (X)	99-96	V8 325CI 5.3L (M)	10-07
V6 262CI 4.3L (Z)	87	V6 262CI 4.3L (X)	04-03	V8 325CI 5.3L (T)	07-99
V8 305CI 5.0L (H)	87	V6 262CI 4.3L (Z)	95-88	V8 325CI 5.3L (Flex Fuel) (0)	13-07
V8 350CI 5.7L (K)	89-87	S10 (4WD Compact Pickup)		V8 325CI 5.3L (Flex Fuel) (3)	13-07
V8 350CI 5.7L (M)	88-87	L4 121CI 2.0L OHV (Y)	84-83	V8 325CI 5.3L (Flex Fuel) (7)	13-12
V8 379CI 6.2L Diesel (C)	89-87	L4 134CI 2.2L OHV (4)	03-94	V8 325CI 5.3L (Flex Fuel) (Z)	07-02
V8 379CI 6.2L Diesel (J)	89-87	L4 134CI 2.2L OHV (Flex Fuel) (5)	02-00	V8 364CI 6.0L (N)	07-03
R10 Suburban (Full-Size SUV)		L4 151CI 2.5L (A)	93-91	V8 364CI 6.0L (U)	07-02
V8 305CI 5.0L (H)	87	L4 151CI 2.5L (E)	91-85	V8 364CI 6.0L (Y)	10-07
V8 350CI 5.7L (K)	88-87	L4 1949cc 1.9L SOHC (A)	85-82	V8 378CI 6.2L (Flex Fuel) (2)	13-09
V8 379CI 6.2L Diesel (J)	88-87	L4 2238cc 2.2L OHV Diesel (S)	85-83	Silverado 2500 (2WD Full-Size Pickup)	
R1500 (Full-Size Pickup)		V6 173CI 2.8L (B)	85-82	V8 293CI 4.8L (V)	07-99
V8 350CI 5.7L (K)	91-90	V6 173CI 2.8L (R)	93-86	V8 325CI 5.3L (B)	07-05
V8 379CI 6.2L Diesel (C)	91-90	V6 262CI 4.3L (W)	03-92	V8 325CI 5.3L (T)	07-99
V8 379CI 6.2L Diesel (J)	91-90	V6 262CI 4.3L (X)	99-96	V8 325CI 5.3L (Flex Fuel) (Z)	07-02
V8 454CI 7.4L (N)	91-90	V6 262CI 4.3L (X)	04-03	V8 364CI 6.0L (K)	10-07
R1500 Suburban (Full-Size SUV)		V6 262CI 4.3L (Z)	95-88	V8 364CI 6.0L (U)	07-99
V8 350CI 5.7L (K)	91-89	S10 Blazer (2WD Mid-Size SUV)		V8 364CI 6.0L (Y)	10-07
V8 379CI 6.2L Diesel (J)	91-89	L4 121CI 2.0L OHV (Y)	84-83	V8 364CI 6.0L (Flex Fuel) (G)	13-10
R20 (Full-Size Pickup)		L4 151CI 2.5L (A)	93-91	V8 364CI 6.0L (Natural Gas) (B)	13
L6 292CI 4.8L (T)	89-87	L4 151CI 2.5L (E)	91-85	Silverado 2500 (4WD Full-Size Pickup)	
V6 262CI 4.3L (Z)	87	L4 1949cc 1.9L SOHC (A)	84-83	V8 293CI 4.8L (V)	07-99
V8 305CI 5.0L (H)	87	V6 173CI 2.8L (B)	85-83	V8 325CI 5.3L (B)	07-05
V8 350CI 5.7L (K)	89-87	V6 173CI 2.8L (R)	93-86	V8 325CI 5.3L (T)	07-99
V8 350CI 5.7L (M)	88-87	V6 262CI 4.3L (W)	03-92	V8 325CI 5.3L (Flex Fuel) (Z)	07-02
V8 379CI 6.2L Diesel (C)	89-87	V6 262CI 4.3L (X)	99-96	V8 364CI 6.0L (K)	10-07
V8 379CI 6.2L Diesel (J)	89-87	V6 262CI 4.3L (X)	05-03	V8 364CI 6.0L (U)	07-99
V8 454CI 7.4L (N)	89-87	V6 262CI 4.3L (Z)	95-88	V8 364CI 6.0L (Y)	10-07
R20 Suburban (Full-Size SUV)		S10 Blazer (4WD Mid-Size SUV)		V8 364CI 6.0L (Flex Fuel) (G)	13-10
V8 350CI 5.7L (K)	88-87	L4 121CI 2.0L OHV (Y)	84-83	V8 364CI 6.0L (Natural Gas) (B)	13
V8 379CI 6.2L Diesel (J)	88-87	L4 151CI 2.5L (A)	93-91	Silverado 2500HD (2WD Full-Size Pickup)	
V8 454CI 7.4L (W)	88-87	L4 151CI 2.5L (E)	91-85	V8 364CI 6.0L (K)	10-07
R2500 (Full-Size Pickup)		L4 1949cc 1.9L SOHC (A)	84-83	V8 364CI 6.0L (U)	07-01
V8 350CI 5.7L (K)	91-90	V6 173CI 2.8L (B)	85-83	V8 364CI 6.0L (Y)	10-07
V8 379CI 6.2L Diesel (C)	91-90	V6 173CI 2.8L (R)	93-86	V8 364CI 6.0L (Flex Fuel) (G)	13-10
V8 379CI 6.2L Diesel (J)	91-90	V6 262CI 4.3L (W)	03-92	V8 364CI 6.0L (Natural Gas) (B)	13
V8 454CI 7.4L (N)	91-90	V6 262CI 4.3L (X)	99-96	V8 402CI 6.6L Turbo-Diesel (1)	05-01
R2500 Suburban (Full-Size SUV)		V6 262CI 4.3L (X)	05-03	V8 402CI 6.6L Turbo-Diesel (2)	07-04
V8 350CI 5.7L (K)	91-89	V6 262CI 4.3L (Z)	95-88	V8 402CI 6.6L Turbo-Diesel (6)	10-07
V8 379CI 6.2L Diesel (J)	91-89	Silverado 1500 (2WD Full-Size Pickup)		V8 402CI 6.6L Turbo-Diesel (8)	13-11
V8 454CI 7.4L (N)	91-90	V6 262CI 4.3L (W)	03-99	V8 402CI 6.6L Turbo-Diesel (D)	07-06
V8 454CI 7.4L (W)	89	V6 262CI 4.3L (X)	13-02	V8 402CI 6.6L Turbo-Diesel (L)	13-11
R30 (Full-Size Pickup)		V8 293CI 4.8L (C)	09-07	V8 496CI 8.1L (G)	07-01
L6 292CI 4.8L (T)	89-87	V8 293CI 4.8L (V)	07-99	Silverado 2500HD (4WD Full-Size Pickup)	
V8 350CI 5.7L (K)	89-87	V8 293CI 4.8L (Flex Fuel) (A)	13-10	V8 364CI 6.0L (K)	10-07
V8 350CI 5.7L (M)	88-87	V8 325CI 5.3L (B)	07-05	V8 364CI 6.0L (U)	07-01
V8 379CI 6.2L Diesel (C)	89-87	V8 325CI 5.3L (J)	10-07	V8 364CI 6.0L (Y)	10-07
V8 379CI 6.2L Diesel (J)	89-87	V8 325CI 5.3L (M)	10-07	V8 364CI 6.0L (Flex Fuel) (G)	13-10
V8 454CI 7.4L (N)	89-87	V8 325CI 5.3L (T)	07-99	V8 364CI 6.0L (Natural Gas) (B)	13
V8 454CI 7.4L (W)	89-88	V8 325CI 5.3L (Flex Fuel) (0)	13-07	V8 402CI 6.6L Turbo-Diesel (1)	05-01

GMC Truck (Incl. Minivans and SUV's) (Cont.)

Model Index (Cont.)					
Engine (VIN Code / Eng. Code)	Year	Engine (VIN Code / Eng. Code)	Year	Engine (VIN Code / Eng. Code)	Year
Chevrolet Truck (cont.)		Chevrolet Truck (cont.)		Chevrolet Truck (cont.)	
Silverado 2500HD (4WD Full-Size Pickup) (cont.)		Tahoe (4WD Full-Size SUV) (cont.)		V1500 (Full-Size Pickup)	
V8 402CI 6.6L Turbo-Diesel (2)	07-04	V8 350CI 5.7L (R)	00-96	V8 350CI 5.7L (K)	91-90
V8 402CI 6.6L Turbo-Diesel (6)	10-07	V8 378CI 6.2L (Flex Fuel) (2)	10-09	V8 379CI 6.2L Diesel (C)	91-90
V8 402CI 6.6L Turbo-Diesel (8)	13-11	V8 395CI 6.5L Turbo-Diesel (F)	99-95	V8 379CI 6.2L Diesel (J)	91-90
V8 402CI 6.6L Turbo-Diesel (D)	07-06	V8 395CI 6.5L Turbo-Diesel (S)	99-95	V8 454CI 7.4L (N)	91-90
V8 402CI 6.6L Turbo-Diesel (L)	13-11	Tahoe Hybrid (2WD Full-Size SUV)		V1500 Suburban (Full-Size SUV)	
V8 496CI 8.1L (G)	07-01	V8 364CI 6.0L (5)	13-08	V8 350CI 5.7L (K)	91-89
Silverado 3500 (2WD Full-Size Pickup)		V8 364CI 6.0L (Flex Fuel) (J)	13-10	V8 379CI 6.2L Diesel (J)	91-89
V8 364CI 6.0L (K)	10-07	Tahoe Hybrid (4WD Full-Size SUV)		V20 (Full-Size Pickup)	
V8 364CI 6.0L (U)	07-99	V8 364CI 6.0L (5)	13-08	L6 292CI 4.8L (T)	89-87
V8 364CI 6.0L (Y)	10-07	V8 364CI 6.0L (Flex Fuel) (J)	13-10	V6 262CI 4.3L (Z)	87
V8 364CI 6.0L (Flex Fuel) (G)	13-10	Tracker (2WD Compact SUV)		V8 350CI 5.7L (K)	89-87
V8 364CI 6.0L (Natural Gas) (B)	13	L4 1590cc 1.6L SOHC (16 Valve) (6)	02-98	V8 350CI 5.7L (M)	88-87
V8 402CI 6.6L Turbo-Diesel (1)	05-01	L4 1995cc 2.0L DOHC (16 Valve) (C)	03-99	V8 379CI 6.2L Diesel (C)	89-87
V8 402CI 6.6L Turbo-Diesel (2)	07-04	V6 2492cc 2.5L DOHC (24 Valve) (4)	04-01	V8 379CI 6.2L Diesel (J)	89-87
V8 402CI 6.6L Turbo-Diesel (6)	10-07	Tracker (4WD Compact SUV)		V8 454CI 7.4L (N)	89-87
V8 402CI 6.6L Turbo-Diesel (8)	13-11	L4 1590cc 1.6L SOHC (16 Valve) (6)	02-98	V8 454CI 7.4L (W)	89-88
V8 402CI 6.6L Turbo-Diesel (D)	07-06	L4 1995cc 2.0L DOHC (16 Valve) (C)	03-99	V20 Suburban (Full-Size SUV)	
V8 402CI 6.6L Turbo-Diesel (L)	13-11	V6 2492cc 2.5L DOHC (24 Valve) (4)	04-01	V8 350CI 5.7L (K)	88-87
V8 496CI 8.1L (G)	07-01	TrailBlazer (2WD Mid-Size SUV)		V8 379CI 6.2L Diesel (J)	88-87
Silverado 3500 (4WD Full-Size Pickup)		L6 254CI 4.2L DOHC (24 Valve) (S)	09-02	V2500 (Full-Size Pickup)	
V8 364CI 6.0L (K)	10-07	V8 325CI 5.3L (M)	08-06	V8 350CI 5.7L (K)	91-90
V8 364CI 6.0L (U)	07-99	TrailBlazer (4WD Mid-Size SUV)		V8 379CI 6.2L Diesel (C)	91-90
V8 364CI 6.0L (Y)	10-07	L6 254CI 4.2L DOHC (24 Valve) (S)	09-02	V8 379CI 6.2L Diesel (J)	91-90
V8 364CI 6.0L (Flex Fuel) (G)	13-10	V8 325CI 5.3L (M)	08-06	V8 454CI 7.4L (N)	91-90
V8 364CI 6.0L (Natural Gas) (B)	13	TrailBlazer EXT (2WD Mid-Size SUV)		V2500 Suburban (Full-Size SUV)	
V8 402CI 6.6L Turbo-Diesel (1)	05-01	L6 254CI 4.2L DOHC (24 Valve) (S)	06-02	V8 350CI 5.7L (K)	91-89
V8 402CI 6.6L Turbo-Diesel (2)	07-04	V8 325CI 5.3L (M)	06-05	V8 379CI 6.2L Diesel (J)	91-89
V8 402CI 6.6L Turbo-Diesel (6)	10-07	V8 325CI 5.3L (P)	05-03	V30 (Full-Size Pickup)	
V8 402CI 6.6L Turbo-Diesel (8)	13-11	TrailBlazer EXT (4WD Mid-Size SUV)		L6 292CI 4.8L (T)	89-87
V8 402CI 6.6L Turbo-Diesel (D)	07-06	L6 254CI 4.2L DOHC (24 Valve) (S)	06-02	V8 350CI 5.7L (K)	89-87
V8 402CI 6.6L Turbo-Diesel (L)	13-11	V8 325CI 5.3L (M)	06-05	V8 350CI 5.7L (M)	88-87
V8 496CI 8.1L (G)	07-01	V8 325CI 5.3L (P)	05-03	V8 379CI 6.2L Diesel (C)	89-87
Silverado Hybrid (2WD Full-Size Pickup)		TrailBlazer SS (2WD Mid-Size SUV)		V8 379CI 6.2L Diesel (J)	89-87
V8 325CI 5.3L (T)	07-05	V8 364CI 6.0L (H)	09-06	V8 454CI 7.4L (N)	89-87
V8 364CI 6.0L (5)	13-09	TrailBlazer SS (4WD Mid-Size SUV)		V8 454CI 7.4L (W)	89-88
V8 364CI 6.0L (Flex Fuel) (J)	13-10	V8 364CI 6.0L (H)	09-06	V3500 (Full-Size Pickup)	
Silverado Hybrid (4WD Full-Size Pickup)		Traverse (AWD Mid-Size SUV)		V8 350CI 5.7L (K)	91-90
V8 325CI 5.3L (T)	07-05	V6 3564cc 3.6L DOHC (24 Valve) (D)	13-09	V8 379CI 6.2L Diesel (C)	91-90
V8 364CI 6.0L (5)	13-09	Traverse (FWD Mid-Size SUV)		V8 379CI 6.2L Diesel (J)	91-90
V8 364CI 6.0L (Flex Fuel) (J)	13-10	V6 3564cc 3.6L DOHC (24 Valve) (D)	13-09	V8 454CI 7.4L (N)	91-90
SSR (Compact Pickup)		Trax (AWD Compact SUV)		VA Series	
V8 325CI 5.3L (P)	04-03	L4 1364cc 1.4L DOHC Turbo (16 Valve) (B)	13	L6 216CI 3.5L	39
V8 364CI 6.0L (H)	06-05	Trax (FWD Compact SUV)		Vega (Panel Delivery)	
Tahoe (2WD Full-Size SUV)		L4 1364cc 1.4L DOHC Turbo (16 Valve) (B)	13	L4 140CI 2.3L SOHC (B)	75-71
V8 293CI 4.8L (C)	10-07	Uplander (AWD Minivan)		Venture (AWD Minivan)	
V8 293CI 4.8L (V)	06-00	V6 213CI 3.5L OHV (12 Valve) (L)	06-05	V6 207CI 3.4L OHV (12 Valve) (E)	05-97
V8 325CI 5.3L (J)	10-07	V6 242CI 3.9L OHV (12 Valve) (1)	08-06	Venture (FWD Minivan)	
V8 325CI 5.3L (T)	06-00	V6 242CI 3.9L OHV (12 Valve) (Flex Fuel) (W)	08-07	V6 207CI 3.4L OHV (12 Valve) (E)	05-97
V8 325CI 5.3L (Flex Fuel) (0)	13-07	Uplander (FWD Minivan)		W4S042 (Forward Control Chassis)	
V8 325CI 5.3L (Flex Fuel) (3)	13-07	V6 213CI 3.5L OHV (12 Valve) (L)	06-05	L4 3856cc 3.9L OHV Diesel (4BD1-N)	88-87
V8 325CI 5.3L (Flex Fuel) (7)	13-12	V6 242CI 3.9L OHV (12 Valve) (1)	08-06	L4 3856cc 3.9L OHV Turbo-Diesel (4BD1-T)	94-87
V8 325CI 5.3L (Flex Fuel) (Z)	06-02	V6 242CI 3.9L OHV (12 Valve) (Flex Fuel) (W)	08-07	L4 3856cc 3.9L OHV Turbo-Diesel (4BD2-TC)	98-95
V8 350CI 5.7L (K)	95	V10 (Full-Size Pickup)		V8 350CI 5.7L (K)	95-93
V8 350CI 5.7L (R)	00-96	V6 262CI 4.3L (Z)	87	V8 350CI 5.7L (R)	00-96
V8 378CI 6.2L (Flex Fuel) (2)	10-09	V8 305CI 5.0L (H)	87	WA Series	
Tahoe (4WD Full-Size SUV)		V8 350CI 5.7L (K)	89-87	L6 216CI 3.5L	40
V8 293CI 4.8L (C)	10-07	V8 350CI 5.7L (M)	88-87	YR Series	
V8 293CI 4.8L (V)	06-00	V8 379CI 6.2L Diesel (C)	89-87	L6 216CI 3.5L	41
V8 325CI 5.3L (J)	10-07	V8 379CI 6.2L Diesel (J)	89-87	Geo Truck	
V8 325CI 5.3L (T)	06-00	V10 Suburban (Full-Size SUV)		Tracker (2WD Compact SUV)	
V8 325CI 5.3L (Flex Fuel) (0)	13-07	V8 305CI 5.0L (H)	87	L4 1590cc 1.6L SOHC (16 Valve) (6)	97-94
V8 325CI 5.3L (Flex Fuel) (3)	13-07	V8 350CI 5.7L (K)	88-87	L4 1590cc 1.6L SOHC (8 Valve) (U)	95-89
V8 325CI 5.3L (Flex Fuel) (7)	13-12	V8 379CI 6.2L Diesel (J)	89-87	Tracker (4WD Compact SUV)	
V8 325CI 5.3L (Flex Fuel) (Z)	06-02	V8 305CI 5.0L (H)	87	L4 1590cc 1.6L SOHC (16 Valve) (6)	97-94
V8 350CI 5.7L (K)	95	V8 350CI 5.7L (K)	88-87		
		V8 379CI 6.2L Diesel (J)	88-87		

GMC Truck (Incl. Minivans and SUV's) (Cont.)

Model Index (Cont.)					
Engine (VIN Code / Eng. Code)	Year	Engine (VIN Code / Eng. Code)	Year	Engine (VIN Code / Eng. Code)	Year
Geo Truck (cont.)		GMC Truck (cont.)		GMC Truck (cont.)	
Tracker (4WD Compact SUV) (cont.)		Acadia (AWD Mid-Size SUV)		C1500 Suburban (Full-Size SUV) (cont.)	
L4 1590cc 1.6L SOHC (8 Valve) (U)	95-89	V6 3564cc 3.6L DOHC (24 Valve) (7)	08-07	V8 395CI 6.5L Turbo-Diesel (F)	99-94
GMC Truck		V6 3564cc 3.6L DOHC (24 Valve) (D)	13-09	V8 395CI 6.5L Turbo-Diesel (S)	99-94
100 Series		Acadia (FWD Mid-Size SUV)		V8 402CI 6.6L	72
L6 248CI 4.1L	55	V6 3564cc 3.6L DOHC (24 Valve) (7)	08-07	V8 454CI 7.4L (S)	79-76
L6 270CI 4.4L	59-56	V6 3564cc 3.6L DOHC (24 Valve) (D)	13-09	V8 454CI 7.4L (W)	80
V8 288CI 4.7L	55	B3500 Series		V8 454CI 7.4L (Z)	75-73
V8 316CI 5.2L	56-55	V6 305CI 5.0L	65-64	C2500 (Full-Size Pickup)	
V8 322CI 5.3L	59-56	C1500 (Full-Size Pickup)		L6 230CI 3.8L	65-63
V8 324CI 5.3L	56-55	L6 230CI 3.8L	69-63	L6 250CI 4.1L	71-66
V8 336.9CI 5.5L	59-58	L6 250CI 4.1L	71-66	L6 250CI 4.1L (Q)	74-72
V8 347CI 5.7L	57	L6 250CI 4.1L (D)	84-76	L6 292CI 4.8L	72-63
V8 370CI 6.1L	59-57	L6 250CI 4.1L (Q)	75-72	L6 292CI 4.8L (T)	86-73
100-22 Series		L6 292CI 4.8L	72-63	V6 262CI 4.3L (N)	86-85
L6 228CI 3.7L	53-51	L6 292CI 4.8L (T)	86-73	V6 262CI 4.3L (W)	97-96
100-24 Series		V6 262CI 4.3L (N)	86-85	V6 262CI 4.3L (Z)	95-88
L6 248CI 4.1L	54	V6 262CI 4.3L (W)	98-96	V6 305CI 5.0L	69-67
1000 Series		V6 262CI 4.3L (Z)	95-88	V6 351CI 5.7L	68-67
V6 305CI 5.0L	66-60	V6 305CI 5.0L	69-67	V8 305CI 5.0L (F)	86-81
V6 351CI 5.7L	66-65	V6 351CI 5.7L	68-67	V8 305CI 5.0L (G)	81-80
102-22		V8 305CI 5.0L (F)	86-81	V8 305CI 5.0L (H)	95-81
L6 228CI 3.7L	52	V8 305CI 5.0L (G)	81-80	V8 305CI 5.0L (M)	00-96
150 Series		V8 305CI 5.0L (H)	95-81	V8 305CI 5.0L (U)	79-77
L6 248CI 4.1L	55	V8 305CI 5.0L (M)	00-96	V8 307CI 5.0L	73-68
L6 270CI 4.4L	59-56	V8 305CI 5.0L (U)	79-76	V8 327CI 5.3L	68-67
V8 288CI 4.7L	55	V8 307CI 5.0L	73-68	V8 350CI 5.7L	72-69
V8 316CI 5.2L	56-55	V8 327CI 5.3L	68-67	V8 350CI 5.7L (K)	95-88
V8 324CI 5.3L	56-55	V8 350CI 5.7L	72-69	V8 350CI 5.7L (L)	86-76
V8 336.9CI 5.5L	59-58	V8 350CI 5.7L (K)	95-88	V8 350CI 5.7L (M)	86-80
V8 347CI 5.7L	57	V8 350CI 5.7L (L)	86-76	V8 350CI 5.7L (R)	00-96
V8 370CI 6.1L	59-57	V8 350CI 5.7L (R)	00-96	V8 350CI 5.7L (Y)	75-73
150-22 Series		V8 350CI 5.7L (V)	76-75	V8 350CI 5.7L (LPG) (W)	76-73
L6 228CI 3.7L	53-51	V8 350CI 5.7L (Y)	75-73	V8 379CI 6.2L Diesel (C)	93-88
150-24 Series		V8 350CI 5.7L (LPG) (W)	76-73	V8 379CI 6.2L Diesel (J)	93-82
L6 248CI 4.1L	54	V8 350CI 5.7L Diesel (Z)	81-78	V8 395CI 6.5L Diesel (P)	95-94
1500 Series		V8 379CI 6.2L Diesel (C)	93-82	V8 395CI 6.5L Turbo-Diesel (F)	00-92
V6 305CI 5.0L	66-60	V8 379CI 6.2L Diesel (J)	93-88	V8 395CI 6.5L Turbo-Diesel (S)	00-94
V6 351CI 5.7L	66-65	V8 395CI 6.5L Diesel (P)	95-94	V8 396CI 6.5L	69-68
250 Series		V8 395CI 6.5L Turbo-Diesel (F)	00-92	V8 402CI 6.6L	72-70
L6 248CI 4.1L	55	V8 395CI 6.5L Turbo-Diesel (S)	00-94	V8 454CI 7.4L (J)	00-96
L6 270CI 4.4L	59-56	V8 396CI 6.5L	69-68	V8 454CI 7.4L (L)	75-73
V8 288CI 4.7L	55	V8 402CI 6.6L	72-70	V8 454CI 7.4L (N)	95-88
V8 316CI 5.2L	56-55	V8 454CI 7.4L (S)	79-76	V8 454CI 7.4L (S)	79-76
V8 324CI 5.3L	56-55	V8 454CI 7.4L (W)	80	V8 454CI 7.4L (W)	86-80
V8 336.9CI 5.5L	59-58	V8 454CI 7.4L (Z)	75-73	V8 454CI 7.4L (Z)	75-73
V8 347CI 5.7L	57	C1500 Suburban (Full-Size SUV)		C2500 Suburban (Full-Size SUV)	
V8 370CI 6.1L	59-57	L6 230CI 3.8L	65-63	L6 250CI 4.1L	71-66
250-22 Series		L6 235CI 3.8L	62-60	L6 250CI 4.1L (Q)	74-72
L6 228CI 3.7L	53-51	L6 250CI 4.1L	72-66	L6 292CI 4.8L	71-67
250-24 Series		L6 250CI 4.1L (D)	80-76	V8 283CI 4.6L	67
L6 248CI 4.1L	54	L6 250CI 4.1L (Q)	75-73	V8 305CI 5.0L (U)	78-77
2500 Series		L6 261CI 4.3L	62-61	V8 350CI 5.7L	72-70
V6 305CI 5.0L	66-60	L6 292CI 4.8L	72-63	V8 350CI 5.7L (K)	95-92
V6 351CI 5.7L	66-65	L6 292CI 4.8L (T)	75-73	V8 350CI 5.7L (L)	86-76
253-22		V8 283CI 4.6L	67-60	V8 350CI 5.7L (R)	99-96
L6 228CI 3.7L	53-52	V8 305CI 5.0L (G)	81-80	V8 350CI 5.7L (V)	76-75
AC100 Series		V8 305CI 5.0L (H)	86-81	V8 350CI 5.7L (Y)	75-73
L6 228CI 3.7L	40-39	V8 305CI 5.0L (U)	79-77	V8 379CI 6.2L Diesel (J)	86-82
AC150 Series		V8 350CI 5.7L	72-70	V8 395CI 6.5L Turbo-Diesel (F)	99-94
L6 228CI 3.7L	40-39	V8 350CI 5.7L (K)	95-92	V8 395CI 6.5L Turbo-Diesel (S)	99-94
AC250 Series		V8 350CI 5.7L (L)	86-76	V8 402CI 6.6L	72
L6 228CI 3.7L	40-39	V8 350CI 5.7L (R)	99-96	V8 454CI 7.4L (J)	99-96
AC300 Series		V8 350CI 5.7L (V)	76-75	V8 454CI 7.4L (L)	75-73
L6 228CI 3.7L	40	V8 350CI 5.7L (Y)	75-73	V8 454CI 7.4L (N)	95-92
		V8 379CI 6.2L Diesel (C)	86-82	V8 454CI 7.4L (S)	79-76

GMC Truck (Incl. Minivans and SUV's) (Cont.)

Model Index (Cont.)					
Engine (VIN Code / Eng. Code)	Year	Engine (VIN Code / Eng. Code)	Year	Engine (VIN Code / Eng. Code)	Year
GMC Truck (cont.)		GMC Truck (cont.)		GMC Truck (cont.)	
C2500 Suburban (Full-Size SUV) (cont.)		CC102 Series		FC102 Series	
V8 454CI 7.4L (W)	86-80	L6 228CI 3.7L	47-45	L6 228CI 3.7L	50-47
V8 454CI 7.4L (Z)	75-73	CC150 Series		FC150 Series	
C3500 (Full-Size Pickup)		L6 228CI 3.7L	42-41	L6 228CI 3.7L	50-47
L6 230CI 3.8L	65-63	CC250 Series		FC152 Series	
L6 250CI 4.1L	71-66	L6 228CI 3.7L	42-41	L6 228CI 3.7L	50-47
L6 250CI 4.1L (Q)	74-72	CC260 Series		FC250 Series	
L6 292CI 4.8L	72-63	L6 228CI 3.7L	42-41	L6 228CI 3.7L	50-47
L6 292CI 4.8L (T)	86-73	CC300 Series		FC251 Series	
V6 305CI 5.0L	69-67	L6 228CI 3.7L	42-41	L6 228CI 3.7L	50-47
V6 351CI 5.7L	68-67	EC100 Series		FC252 Series	
V8 307CI 5.0L	73-68	L6 228CI 3.7L	47	L6 228CI 3.7L	50-47
V8 327CI 5.3L	68-67	EC101 Series		FC253 Series	
V8 350CI 5.7L	72-69	L6 228CI 3.7L	47	L6 228CI 3.7L	50-47
V8 350CI 5.7L (E)	84	EC102 Series		FC280 Series	
V8 350CI 5.7L (K)	95-88	L6 228CI 3.7L	47	L6 228CI 3.7L	50-47
V8 350CI 5.7L (L)	79-76	EC150 Series		FC281 Series	
V8 350CI 5.7L (M)	86-80	L6 228CI 3.7L	47	L6 228CI 3.7L	50-47
V8 350CI 5.7L (P)	83-80	EC152 Series		FC283 Series	
V8 350CI 5.7L (R)	00-96	L6 228CI 3.7L	47	L6 228CI 3.7L	47
V8 350CI 5.7L (Y)	75-73	EC250 Series		FP152 Series	
V8 350CI 5.7L (LPG) (W)	76-73	L6 228CI 3.7L	47	L6 228CI 3.7L	50-49
V8 379CI 6.2L Diesel (C)	93-88	EC251 Series		G1000 (Full-Size Van)	
V8 379CI 6.2L Diesel (J)	93-82	L6 228CI 3.7L	47	L4 153CI 2.5L	67-63
V8 395CI 6.5L Diesel (P)	95-94	EC252 Series		L6 194CI 3.2L	66-63
V8 395CI 6.5L Turbo-Diesel (F)	00-92	L6 228CI 3.7L	47	L6 230CI 3.8L	66-65
V8 395CI 6.5L Turbo-Diesel (S)	00-94	EC280 Series		G1500 (Full-Size Van)	
V8 396CI 6.5L	69-68	L6 228CI 3.7L	47	L4 153CI 2.5L	65-64
V8 402CI 6.6L	72-70	EC282 Series		L6 194CI 3.2L	66-64
V8 454CI 7.4L (J)	00-96	L6 228CI 3.7L	47	L6 230CI 3.8L	69-65
V8 454CI 7.4L (L)	75-73	EC283 Series		L6 250CI 4.1L	72-66
V8 454CI 7.4L (N)	95-88	L6 228CI 3.7L	47	L6 250CI 4.1L (D)	84-76
V8 454CI 7.4L (S)	79-76	EF241 Series		L6 250CI 4.1L (Q)	75-73
V8 454CI 7.4L (W)	86-80	L6 228CI 3.7L	49-47	V6 262CI 4.3L (N)	86-85
V8 454CI 7.4L (Z)	75-73	EF242 Series		V6 262CI 4.3L (W)	03-96
Caballero (Pickup)		L6 228CI 3.7L	49-48	V6 262CI 4.3L (X)	13-03
V6 200CI 3.3L (M)	79-78	Envoy (2WD Mid-Size SUV)		V6 262CI 4.3L (Z)	95-87
V6 229CI 3.8L (9)	84-83	L6 254CI 4.2L DOHC (24 Valve) (S)	09-02	V8 293CI 4.8L (C)	10-08
V6 229CI 3.8L (K)	82-80	V8 325CI 5.3L (M)	09-05	V8 293CI 4.8L (V)	08-03
V6 231CI 3.8L (A)	84-78	Envoy (4WD Mid-Size SUV)		V8 293CI 4.8L (Flex Fuel) (A)	13-10
V6 262CI 4.3L (Z)	87-85	L6 254CI 4.2L DOHC (24 Valve) (S)	09-02	V8 305CI 5.0L (F)	86-81
V8 267CI 4.4L (J)	82-79	V8 325CI 5.3L (M)	09-05	V8 305CI 5.0L (G)	81-80
V8 305CI 5.0L (G)	87-84	Envoy XL (2WD Mid-Size SUV)		V8 305CI 5.0L (H)	95-81
V8 305CI 5.0L (H)	87-79	L6 254CI 4.2L DOHC (24 Valve) (S)	06-02	V8 305CI 5.0L (M)	02-96
V8 305CI 5.0L (U)	78	V8 325CI 5.3L (M)	06-05	V8 305CI 5.0L (U)	79-77
V8 350CI 5.7L (L)	81-78	V8 325CI 5.3L (P)	05-03	V8 307CI 5.0L	73-68
V8 350CI 5.7L Diesel (N)	84-83	Envoy XL (4WD Mid-Size SUV)		V8 325CI 5.3L (T)	08-03
Canyon (2WD Compact Pickup)		L6 254CI 4.2L DOHC (24 Valve) (S)	06-02	V8 325CI 5.3L (Flex Fuel) (4)	13-09
L4 169CI 2.8L DOHC (16 Valve) (8)	06-04	V8 325CI 5.3L (M)	06-05	V8 325CI 5.3L (Flex Fuel) (Z)	08-03
L4 178CI 2.9L DOHC (16 Valve) (9)	12-07	V8 325CI 5.3L (P)	05-03	V8 350CI 5.7L (K)	95-87
L5 211CI 3.5L DOHC (20 Valve) (6)	06-04	Envoy XUV (2WD Mid-Size SUV)		V8 350CI 5.7L (L)	86-76
L5 223CI 3.7L DOHC (20 Valve) (E)	12-07	L6 254CI 4.2L DOHC (24 Valve) (S)	05-04	V8 350CI 5.7L (R)	02-96
V8 325CI 5.3L (L)	09	V8 325CI 5.3L (M)	05	V8 350CI 5.7L (V)	76-75
V8 325CI 5.3L (P)	12-10	V8 325CI 5.3L (P)	05-04	V8 350CI 5.7L (Y)	75-73
Canyon (4WD Compact Pickup)		Envoy XUV (4WD Mid-Size SUV)		V8 400CI 6.6L (R)	79-77
L4 169CI 2.8L DOHC (16 Valve) (8)	06-04	L6 254CI 4.2L DOHC (24 Valve) (S)	05-04	V8 400CI 6.6L (U)	76
L4 178CI 2.9L DOHC (16 Valve) (9)	12-07	V8 325CI 5.3L (M)	05	G2500 (Full-Size Van)	
L5 211CI 3.5L DOHC (20 Valve) (6)	06-04	V8 325CI 5.3L (P)	05-04	L6 230CI 3.8L	69-67
L5 223CI 3.7L DOHC (20 Valve) (E)	12-07	FC100 Series		L6 250CI 4.1L	72-66
V8 325CI 5.3L (L)	09	L6 228CI 3.7L	50-47	L6 250CI 4.1L (D)	84-76
V8 325CI 5.3L (P)	12-10	FC100-22 Series		L6 250CI 4.1L (Q)	75-73
CC100 Series		L6 228CI 3.7L	52	L6 292CI 4.8L (T)	78-75
L6 228CI 3.7L	42-41	FC101 Series		V6 262CI 4.3L (N)	86-85
CC101 Series		L6 228CI 3.7L	50-47	V6 262CI 4.3L (W)	03-96
L6 228CI 3.7L	47-45			V6 262CI 4.3L (X)	08-03

GMC Truck (Incl. Minivans and SUV's) (Cont.)

Model Index (Cont.)					
Engine (VIN Code / Eng. Code)	Year	Engine (VIN Code / Eng. Code)	Year	Engine (VIN Code / Eng. Code)	Year
GMC Truck (cont.)		GMC Truck (cont.)		GMC Truck (cont.)	
G2500 (Full-Size Van) (cont.)		G3500 (Full-Size Van) (cont.)		K1500 (Full-Size Pickup) (cont.)	
V6 262CI 4.3L (Z)	95-87	V8 395CI 6.5L Turbo-Diesel (F)	02-96	L6 250CI 4.1L (D)	78-76
V8 293CI 4.8L (C)	10-08	V8 395CI 6.5L Turbo-Diesel (S)	02-96	L6 250CI 4.1L (Q)	75-73
V8 293CI 4.8L (V)	08-03	V8 400CI 6.6L (M)	75	V6 262CI 4.3L (N)	86-85
V8 293CI 4.8L (Flex Fuel) (A)	13-10	V8 400CI 6.6L (R)	79-77	V6 262CI 4.3L (W)	98-96
V8 305CI 5.0L (F)	86-81	V8 400CI 6.6L (U)	76	V6 262CI 4.3L (Z)	95-88
V8 305CI 5.0L (G)	81	V8 400CI 6.6L (X)	80	V6 305CI 5.0L	66-60
V8 305CI 5.0L (H)	95-81	V8 402CI 6.6L Turbo-Diesel (2)	07-06	V8 305CI 5.0L (F)	86-81
V8 305CI 5.0L (M)	02-96	V8 402CI 6.6L Turbo-Diesel (6)	13-08	V8 305CI 5.0L (G)	81-80
V8 307CI 5.0L	73-68	V8 402CI 6.6L Turbo-Diesel (L)	13-11	V8 305CI 5.0L (H)	95-81
V8 325CI 5.3L (T)	08-03	V8 454CI 7.4L (J)	00-96	V8 305CI 5.0L (M)	98-96
V8 325CI 5.3L (Flex Fuel) (4)	13-09	V8 454CI 7.4L (N)	95-88	V8 305CI 5.0L (U)	79-76
V8 325CI 5.3L (Flex Fuel) (Z)	08-03	V8 496CI 8.1L (G)	07-01	V8 307CI 5.0L	73-68
V8 350CI 5.7L (K)	95-88	I1000 Series		V8 327CI 5.3L	68-67
V8 350CI 5.7L (L)	86-76	L6 230CI 3.8L	65-64	V8 350CI 5.7L	72-69
V8 350CI 5.7L (M)	88-80	L6 250CI 4.1L	66	V8 350CI 5.7L (K)	95-88
V8 350CI 5.7L (R)	02-96	I1500 Series		V8 350CI 5.7L (L)	86-76
V8 350CI 5.7L (Y)	75-73	L6 230CI 3.8L	65	V8 350CI 5.7L (R)	00-96
V8 364CI 6.0L (K)	10-08	L6 250CI 4.1L	66	V8 350CI 5.7L (V)	76-75
V8 364CI 6.0L (U)	08-03	I2500 Series		V8 350CI 5.7L (Y)	75-73
V8 364CI 6.0L (Flex Fuel) (G)	13-10	L6 230CI 3.8L	65	V8 379CI 6.2L Diesel (C)	93-82
V8 364CI 6.0L (Natural Gas) (B)	13-12	L6 250CI 4.1L	66	V8 379CI 6.2L Diesel (J)	93-82
V8 379CI 6.2L Diesel (C)	93-83	I3500 Series		V8 395CI 6.5L Diesel (P)	95-94
V8 379CI 6.2L Diesel (J)	93-83	L6 250CI 4.1L	66	V8 395CI 6.5L Turbo-Diesel (F)	00-92
V8 395CI 6.5L Diesel (P)	95-94	Jimmy (2WD Full-Size SUV)		V8 395CI 6.5L Turbo-Diesel (S)	00-94
V8 395CI 6.5L Diesel (Y)	95-94	L6 250CI 4.1L	72-70	V8 400CI 6.6L (R)	79-77
V8 395CI 6.5L Turbo-Diesel (F)	02-96	L6 250CI 4.1L (D)	82-76	V8 400CI 6.6L (U)	76
V8 395CI 6.5L Turbo-Diesel (S)	02-96	L6 250CI 4.1L (Q)	75-73	V8 402CI 6.6L	72
V8 400CI 6.6L (M)	75	L6 292CI 4.8L (T)	80-70	K1500 Suburban (Full-Size SUV)	
V8 400CI 6.6L (R)	79-77	V8 305CI 5.0L (F)	86-81	L6 230CI 3.8L	65-63
V8 400CI 6.6L (U)	76	V8 305CI 5.0L (G)	81-80	L6 250CI 4.1L	72-66
V8 400CI 6.6L (X)	80	V8 305CI 5.0L (H)	94-81	L6 250CI 4.1L (Q)	73
V8 402CI 6.6L Turbo-Diesel (2)	07-06	V8 305CI 5.0L (U)	79-76	L6 261CI 4.3L	62-61
V8 402CI 6.6L Turbo-Diesel (6)	13-08	V8 307CI 5.0L	73-70	L6 292CI 4.8L	67-63
V8 402CI 6.6L Turbo-Diesel (L)	13-11	V8 350CI 5.7L	72-70	V8 283CI 4.6L	67-60
G3500 (Full-Size Van)		V8 350CI 5.7L (K)	94-87	V8 305CI 5.0L (U)	78-77
L6 250CI 4.1L	72-67	V8 350CI 5.7L (L)	86-76	V8 350CI 5.7L	72-70
L6 250CI 4.1L (D)	84-78	V8 350CI 5.7L (V)	76-75	V8 350CI 5.7L (K)	95-92
L6 250CI 4.1L (Q)	74-73	V8 350CI 5.7L (Y)	75-73	V8 350CI 5.7L (L)	86-76
L6 292CI 4.8L (T)	78-75	Jimmy (4WD Full-Size SUV)		V8 350CI 5.7L (R)	99-96
V6 262CI 4.3L (N)	86-85	L6 250CI 4.1L	72-70	V8 350CI 5.7L (V)	76-75
V6 262CI 4.3L (W)	98-96	L6 250CI 4.1L (D)	78-76	V8 350CI 5.7L (Y)	75-73
V6 262CI 4.3L (Z)	95-87	L6 250CI 4.1L (Q)	75-73	V8 379CI 6.2L Diesel (C)	86-82
V8 283CI 4.6L	67	L6 292CI 4.8L (T)	80-70	V8 379CI 6.2L Diesel (J)	86-82
V8 293CI 4.8L (C)	10-08	V8 305CI 5.0L (F)	86-81	V8 395CI 6.5L Turbo-Diesel (F)	99-94
V8 293CI 4.8L (V)	08-03	V8 305CI 5.0L (G)	81-80	V8 395CI 6.5L Turbo-Diesel (S)	99-94
V8 293CI 4.8L (Flex Fuel) (A)	13-10	V8 305CI 5.0L (H)	94-81	V8 400CI 6.6L (R)	79-77
V8 307CI 5.0L	73-68	V8 305CI 5.0L (U)	79-76	V8 400CI 6.6L (U)	76-75
V8 325CI 5.3L (T)	08-03	V8 307CI 5.0L	73-70	V8 402CI 6.6L	72
V8 325CI 5.3L (Flex Fuel) (4)	13-09	V8 350CI 5.7L	72-70	K2500 (Full-Size Pickup)	
V8 325CI 5.3L (Flex Fuel) (Z)	08-03	V8 350CI 5.7L (K)	94-87	L6 230CI 3.8L	65-63
V8 327CI 5.3L	69-67	V8 350CI 5.7L (L)	86-76	L6 250CI 4.1L	72-66
V8 350CI 5.7L (K)	95-87	V8 350CI 5.7L (V)	76-75	L6 250CI 4.1L (Q)	74-73
V8 350CI 5.7L (L)	86-76	V8 350CI 5.7L (Y)	75-73	V6 262CI 4.3L (N)	86-85
V8 350CI 5.7L (M)	88-80	V8 379CI 6.2L Diesel (C)	93-82	V6 262CI 4.3L (W)	97-96
V8 350CI 5.7L (R)	02-96	V8 395CI 6.5L Turbo-Diesel (S)	94	V6 262CI 4.3L (Z)	95-88
V8 350CI 5.7L (Y)	75-73	V8 400CI 6.6L (M)	75	V6 305CI 5.0L	69-67
V8 364CI 6.0L (K)	10-08	V8 400CI 6.6L (R)	79-77	V8 305CI 5.0L (F)	86-81
V8 364CI 6.0L (U)	08-03	V8 400CI 6.6L (U)	76	V8 305CI 5.0L (G)	81-80
V8 364CI 6.0L (Flex Fuel) (G)	13-10	V8 400CI 6.6L (X)	80	V8 305CI 5.0L (H)	95-81
V8 364CI 6.0L (Natural Gas) (B)	13-12	K1000 (Full-Size Pickup)		V8 305CI 5.0L (M)	98-96
V8 379CI 6.2L Diesel (C)	93-83	V6 305CI 5.0L	66-60	V8 305CI 5.0L (U)	79-76
V8 379CI 6.2L Diesel (J)	93-83	K1500 (Full-Size Pickup)		V8 307CI 5.0L	73-68
V8 395CI 6.5L Diesel (P)	95-94	L6 230CI 3.8L	65-63	V8 327CI 5.3L	68-67
V8 395CI 6.5L Diesel (Y)	95-94	L6 250CI 4.1L	72-66	V8 350CI 5.7L	72-69

GMC Truck (Incl. Minivans and SUV's) (Cont.)

Model Index (Cont.)					
Engine (VIN Code / Eng. Code)	Year	Engine (VIN Code / Eng. Code)	Year	Engine (VIN Code / Eng. Code)	Year
GMC Truck (cont.)		GMC Truck (cont.)		GMC Truck (cont.)	
K2500 (Full-Size Pickup) (cont.)		P1000 (Parcel Delivery) (cont.)		PB1000 (Utility Van) (cont.)	
V8 350CI 5.7L (K)	95-88	L6 235CI 3.8L	62-61	L6 194CI 3.2L	66
V8 350CI 5.7L (L)	86-76	P150-22 Series (Parcel Delivery)		L6 230CI 3.8L	66-63
V8 350CI 5.7L (M)	86-80	L6 228CI 3.7L	51	L6 235CI 3.8L	62-61
V8 350CI 5.7L (R)	00-96	P1500 (Parcel Delivery)		PB1500 (Utility Van)	
V8 350CI 5.7L (Y)	75-73	L4 153CI 2.5L	65-63	L6 230CI 3.8L	65-63
V8 379CI 6.2L Diesel (C)	93-82	L6 194CI 3.2L	64	L6 250CI 4.1L	66
V8 379CI 6.2L Diesel (J)	93-82	L6 230CI 3.8L	69-63	L6 292CI 4.8L	66-65
V8 395CI 6.5L Diesel (P)	95-94	L6 250CI 4.1L	72-66	PB2500 (Utility Van)	
V8 395CI 6.5L Turbo-Diesel (F)	00-92	L6 250CI 4.1L (Q)	74-73	L6 230CI 3.8L	65
V8 395CI 6.5L Turbo-Diesel (S)	00-94	L6 270CI 4.4L	62-60	L6 250CI 4.1L	66
V8 400CI 6.6L (M)	75	L6 292CI 4.8L (T)	81-75	L6 292CI 4.8L	66-65
V8 400CI 6.6L (R)	79-77	P2500 (Parcel Delivery)		PM150 Series	
V8 400CI 6.6L (U)	76	L3 159CI 2.6L Diesel	68-67	L6 248CI 4.1L	55
V8 400CI 6.6L (X)	80	L6 230CI 3.8L	65-63	L6 270CI 4.4L	59-56
V8 402CI 6.6L	72	L6 250CI 4.1L	72-66	PM150-22 Series (Parcel Delivery)	
V8 454CI 7.4L (J)	00-96	L6 250CI 4.1L (Q)	74-73	L6 228CI 3.7L	53-52
V8 454CI 7.4L (N)	95-88	L6 270CI 4.4L	62-60	PM150-24 Series (Parcel Delivery)	
K2500 Suburban (Full-Size SUV)		L6 292CI 4.8L	71-65	L6 248CI 4.1L	54
L6 250CI 4.1L	72-66	L6 292CI 4.8L (T)	89-72	PM250 Series	
L6 250CI 4.1L (Q)	73	V8 307CI 5.0L	73-68	L6 248CI 4.1L	55
V8 283CI 4.6L	67	V8 327CI 5.3L	69-68	L6 270CI 4.4L	59-56
V8 305CI 5.0L (U)	78-77	V8 350CI 5.7L	72-69	R1500 (Full-Size Pickup)	
V8 350CI 5.7L	72-70	V8 350CI 5.7L (K)	90-87	V6 262CI 4.3L (Z)	87
V8 350CI 5.7L (K)	95-92	V8 350CI 5.7L (L)	86-76	V8 305CI 5.0L (H)	87
V8 350CI 5.7L (L)	86-76	V8 350CI 5.7L (M)	88-80	V8 350CI 5.7L (K)	91-87
V8 350CI 5.7L (R)	99-96	V8 350CI 5.7L (Y)	75-73	V8 350CI 5.7L (M)	88-87
V8 350CI 5.7L (V)	76-75	V8 379CI 6.2L Diesel (J)	89-83	V8 379CI 6.2L Diesel (C)	91-87
V8 350CI 5.7L (Y)	75-73	P3500 (Motor Home Chassis)		V8 379CI 6.2L Diesel (J)	91-87
V8 379CI 6.2L Diesel (J)	86-82	V8 395CI 6.5L Diesel (Y)	99-94	R1500 Suburban (Full-Size SUV)	
V8 395CI 6.5L Turbo-Diesel (F)	99-94	V8 454CI 7.4L (B)	99-98	V8 305CI 5.0L (H)	87
V8 395CI 6.5L Turbo-Diesel (S)	99-94	V8 454CI 7.4L (L)	75-74	V8 350CI 5.7L (K)	91-87
V8 400CI 6.6L (M)	75	V8 454CI 7.4L (N)	97-87	V8 379CI 6.2L Diesel (C)	91-87
V8 400CI 6.6L (R)	79-77	V8 454CI 7.4L (S)	79-77	V8 379CI 6.2L Diesel (J)	91-87
V8 400CI 6.6L (U)	76	V8 454CI 7.4L (W)	89-80	R2500 (Full-Size Pickup)	
V8 400CI 6.6L (X)	80	V8 454CI 7.4L (Y)	78-76	L6 292CI 4.8L (T)	89-87
V8 402CI 6.6L	72	V8 454CI 7.4L (Z)	75-74	V6 262CI 4.3L (Z)	87
V8 454CI 7.4L (J)	99-96	P3500 (Parcel Delivery)		V8 305CI 5.0L (H)	87
V8 454CI 7.4L (N)	95-92	L3 159CI 2.6L Diesel	68-67	V8 350CI 5.7L (K)	91-87
K3500 (Full-Size Pickup)		L6 230CI 3.8L	65-63	V8 350CI 5.7L (M)	88-87
L6 292CI 4.8L (T)	86-77	L6 250CI 4.1L (Q)	74-73	V8 379CI 6.2L Diesel (C)	91-87
V8 350CI 5.7L (E)	84	L6 292CI 4.8L	72-65	V8 379CI 6.2L Diesel (J)	91-87
V8 350CI 5.7L (K)	95-88	L6 292CI 4.8L (T)	89-73	V8 454CI 7.4L (N)	91-87
V8 350CI 5.7L (L)	79-77	V6 262CI 4.3L (W)	99-96	R2500 Suburban (Full-Size SUV)	
V8 350CI 5.7L (M)	86-80	V6 262CI 4.3L (Z)	95-90	V8 350CI 5.7L (K)	91-87
V8 350CI 5.7L (P)	83-80	V8 307CI 5.0L	73-68	V8 350CI 5.7L (M)	88-87
V8 350CI 5.7L (R)	00-96	V8 327CI 5.3L	69-68	V8 379CI 6.2L Diesel (C)	91-87
V8 379CI 6.2L Diesel (C)	93-82	V8 350CI 5.7L	72-69	V8 379CI 6.2L Diesel (J)	91-87
V8 379CI 6.2L Diesel (J)	93-82	V8 350CI 5.7L (K)	95-87	V8 454CI 7.4L (N)	91-87
V8 395CI 6.5L Diesel (P)	95-94	V8 350CI 5.7L (L)	79-76	R3500 (Full-Size Pickup)	
V8 395CI 6.5L Turbo-Diesel (F)	00-92	V8 350CI 5.7L (M)	88-80	L6 292CI 4.8L (T)	89-87
V8 395CI 6.5L Turbo-Diesel (S)	00-94	V8 350CI 5.7L (R)	99-96	V8 350CI 5.7L (K)	91-87
V8 400CI 6.6L (R)	79-77	V8 350CI 5.7L (V)	75	V8 350CI 5.7L (M)	88-87
V8 400CI 6.6L (X)	80	V8 350CI 5.7L (Y)	75-73	V8 379CI 6.2L Diesel (C)	91-87
V8 454CI 7.4L (J)	00-96	V8 379CI 6.2L Diesel (J)	93-82	V8 379CI 6.2L Diesel (J)	91-87
V8 454CI 7.4L (N)	95-88	V8 395CI 6.5L Diesel (Y)	99-94	V8 454CI 7.4L (N)	91-87
V8 454CI 7.4L (W)	86-81	V8 454CI 7.4L (B)	99-98	S15 (2WD Compact Pickup)	
L3500 Series		V8 454CI 7.4L (L)	75-74	L4 121CI 2.0L OHV (Y)	84-83
V6 305CI 5.0L	67-65	V8 454CI 7.4L (N)	97-87	L4 151CI 2.5L (E)	90-85
LI3500 Series		V8 454CI 7.4L (S)	79-77	L4 1949cc 1.9L SOHC (A)	85-82
L6 250CI 4.1L	67-66	V8 454CI 7.4L (W)	89-80	L4 2238cc 2.2L OHV Diesel (S)	85-83
P1000 (Parcel Delivery)		V8 454CI 7.4L (Y)	78-76	V6 173CI 2.8L (B)	85-82
L4 153CI 2.5L	66-63	V8 454CI 7.4L (Z)	75-74	V6 173CI 2.8L (R)	90-86
L6 194CI 3.2L	66	PB1000 (Utility Van)		V6 262CI 4.3L (Z)	90-88
L6 230CI 3.8L	66-63	L4 153CI 2.5L	66-63		

GMC Truck (Incl. Minivans and SUV's) (Cont.)

Model Index (Cont.)					
Engine (VIN Code / Eng. Code)	Year	Engine (VIN Code / Eng. Code)	Year	Engine (VIN Code / Eng. Code)	Year
GMC Truck (cont.)		GMC Truck (cont.)		GMC Truck (cont.)	
S15 (4WD Compact Pickup)		Sierra 1500 (4WD Full-Size Pickup) (cont.)		Sierra 3500 (2WD Full-Size Pickup) (cont.)	
L4 121CI 2.0L OHV (Y)	84-83	V8 293CI 4.8L (C)	09-07	V8 364CI 6.0L (U)	07-99
L4 151CI 2.5L (E)	90-85	V8 293CI 4.8L (V)	07-99	V8 364CI 6.0L (Y)	10-07
L4 1949cc 1.9L SOHC (A)	85-82	V8 293CI 4.8L (Flex Fuel) (A)	13-10	V8 364CI 6.0L (Flex Fuel) (G)	13-10
L4 2238cc 2.2L OHV Diesel (S)	85-83	V8 325CI 5.3L (B)	07-05	V8 364CI 6.0L (Natural Gas) (B)	13
V6 173CI 2.8L (B)	85-82	V8 325CI 5.3L (J)	10-07	V8 402CI 6.6L Turbo-Diesel (1)	05-01
V6 173CI 2.8L (R)	90-86	V8 325CI 5.3L (M)	10-07	V8 402CI 6.6L Turbo-Diesel (2)	07-04
V6 262CI 4.3L (Z)	90-88	V8 325CI 5.3L (T)	07-99	V8 402CI 6.6L Turbo-Diesel (6)	10-07
S15 Jimmy (2WD Mid-Size SUV)		V8 325CI 5.3L (Flex Fuel) (0)	13-07	V8 402CI 6.6L Turbo-Diesel (8)	13-11
L4 121CI 2.0L OHV (Y)	84-83	V8 325CI 5.3L (Flex Fuel) (3)	13-07	V8 402CI 6.6L Turbo-Diesel (D)	07-06
L4 151CI 2.5L (A)	93-91	V8 325CI 5.3L (Flex Fuel) (7)	13-12	V8 402CI 6.6L Turbo-Diesel (L)	13-11
L4 151CI 2.5L (E)	91-85	V8 325CI 5.3L (Flex Fuel) (Z)	07-02	V8 496CI 8.1L (G)	07-01
L4 1949cc 1.9L SOHC (A)	84-83	V8 364CI 6.0L (N)	07-05	Sierra 3500 (4WD Full-Size Pickup)	
V6 173CI 2.8L (B)	85-83	V8 364CI 6.0L (U)	07-01	V8 364CI 6.0L (K)	10-07
V6 173CI 2.8L (R)	93-86	V8 364CI 6.0L (Y)	10-07	V8 364CI 6.0L (U)	07-99
V6 262CI 4.3L (W)	03-92	V8 378CI 6.2L (8)	08-07	V8 364CI 6.0L (Y)	10-07
V6 262CI 4.3L (X)	99-96	V8 378CI 6.2L (Flex Fuel) (2)	13-09	V8 364CI 6.0L (Flex Fuel) (G)	13-10
V6 262CI 4.3L (X)	05-03	Sierra 2500 (2WD Full-Size Pickup)		V8 364CI 6.0L (Natural Gas) (B)	13
V6 262CI 4.3L (Z)	95-88	V8 293CI 4.8L (V)	07-99	V8 402CI 6.6L Turbo-Diesel (1)	05-01
S15 Jimmy (4WD Mid-Size SUV)		V8 325CI 5.3L (B)	07-05	V8 402CI 6.6L Turbo-Diesel (2)	07-04
L4 121CI 2.0L OHV (Y)	84-83	V8 325CI 5.3L (T)	07-99	V8 402CI 6.6L Turbo-Diesel (6)	10-07
L4 151CI 2.5L (A)	93-91	V8 325CI 5.3L (Flex Fuel) (Z)	07-02	V8 402CI 6.6L Turbo-Diesel (8)	13-11
L4 151CI 2.5L (E)	91-85	V8 364CI 6.0L (K)	10-07	V8 402CI 6.6L Turbo-Diesel (D)	07-06
L4 1949cc 1.9L SOHC (A)	84-83	V8 364CI 6.0L (U)	07-99	V8 402CI 6.6L Turbo-Diesel (L)	13-11
V6 173CI 2.8L (B)	85-83	V8 364CI 6.0L (Y)	10-07	V8 496CI 8.1L (G)	07-01
V6 173CI 2.8L (R)	93-86	V8 364CI 6.0L (Flex Fuel) (G)	13-10	Sierra Hybrid (2WD Full-Size Pickup)	
V6 262CI 4.3L (W)	03-92	V8 364CI 6.0L (Natural Gas) (B)	13	V8 325CI 5.3L (T)	07-05
V6 262CI 4.3L (X)	99-96	Sierra 2500 (4WD Full-Size Pickup)		V8 364CI 6.0L (5)	13-09
V6 262CI 4.3L (X)	05-03	V8 293CI 4.8L (V)	07-99	V8 364CI 6.0L (Flex Fuel) (J)	13-10
V6 262CI 4.3L (Z)	95-88	V8 325CI 5.3L (B)	07-05	Sierra Hybrid (4WD Full-Size Pickup)	
Safari (2WD Minivan)		V8 325CI 5.3L (T)	07-99	V8 325CI 5.3L (T)	07-05
L4 151CI 2.5L (E)	90-85	V8 325CI 5.3L (Flex Fuel) (Z)	07-02	V8 364CI 6.0L (5)	13-09
V6 262CI 4.3L (B)	91-90	V8 364CI 6.0L (K)	10-07	V8 364CI 6.0L (Flex Fuel) (J)	13-10
V6 262CI 4.3L (N)	85	V8 364CI 6.0L (U)	07-99	Sonoma (2WD Compact Pickup)	
V6 262CI 4.3L (W)	03-92	V8 364CI 6.0L (Y)	10-07	L4 134CI 2.2L OHV (4)	03-94
V6 262CI 4.3L (X)	99-96	V8 364CI 6.0L (Flex Fuel) (G)	13-10	L4 134CI 2.2L OHV (Flex Fuel) (5)	02-00
V6 262CI 4.3L (X)	05-02	V8 364CI 6.0L (Natural Gas) (B)	13	L4 151CI 2.5L (A)	93-91
V6 262CI 4.3L (Z)	94-86	Sierra 2500HD (2WD Full-Size Pickup)		L4 151CI 2.5L (E)	91
Safari (AWD Minivan)		V8 364CI 6.0L (K)	10-07	V6 173CI 2.8L (R)	93-91
V6 262CI 4.3L (W)	03-92	V8 364CI 6.0L (U)	07-99	V6 262CI 4.3L (W)	03-92
V6 262CI 4.3L (X)	99-96	V8 364CI 6.0L (Y)	10-07	V6 262CI 4.3L (X)	99-96
V6 262CI 4.3L (X)	05-02	V8 364CI 6.0L (Flex Fuel) (G)	13-10	V6 262CI 4.3L (X)	04-03
V6 262CI 4.3L (Z)	94-90	V8 364CI 6.0L (Natural Gas) (B)	13	V6 262CI 4.3L (Z)	95-91
Sierra 1500 (2WD Full-Size Pickup)		V8 402CI 6.6L Turbo-Diesel (1)	05-01	Sonoma (4WD Compact Pickup)	
V6 262CI 4.3L (W)	03-99	V8 402CI 6.6L Turbo-Diesel (2)	07-04	L4 134CI 2.2L OHV (4)	03-94
V6 262CI 4.3L (X)	13-02	V8 402CI 6.6L Turbo-Diesel (6)	10-07	L4 134CI 2.2L OHV (Flex Fuel) (5)	02-00
V8 293CI 4.8L (C)	09-07	V8 402CI 6.6L Turbo-Diesel (8)	13-11	L4 151CI 2.5L (A)	93-91
V8 293CI 4.8L (V)	07-99	V8 402CI 6.6L Turbo-Diesel (D)	07-06	L4 151CI 2.5L (E)	91
V8 293CI 4.8L (Flex Fuel) (A)	13-10	V8 402CI 6.6L Turbo-Diesel (L)	13-11	V6 173CI 2.8L (R)	93-91
V8 325CI 5.3L (B)	07-05	V8 496CI 8.1L (G)	07-01	V6 262CI 4.3L (W)	03-92
V8 325CI 5.3L (J)	10-07	Sierra 2500HD (4WD Full-Size Pickup)		V6 262CI 4.3L (X)	99-96
V8 325CI 5.3L (M)	10-07	V8 364CI 6.0L (K)	10-07	V6 262CI 4.3L (X)	04-03
V8 325CI 5.3L (T)	07-99	V8 364CI 6.0L (U)	07-99	V6 262CI 4.3L (Z)	95-91
V8 325CI 5.3L (Flex Fuel) (0)	13-07	V8 364CI 6.0L (Y)	10-07	Sprint (Pickup)	
V8 325CI 5.3L (Flex Fuel) (3)	13-07	V8 364CI 6.0L (Flex Fuel) (G)	13-10	L6 250CI 4.1L (D)	77-71
V8 325CI 5.3L (Flex Fuel) (7)	13-12	V8 364CI 6.0L (Natural Gas) (B)	13	V8 305CI 5.0L (Q)	76
V8 325CI 5.3L (Flex Fuel) (Z)	07-02	V8 402CI 6.6L Turbo-Diesel (1)	05-01	V8 305CI 5.0L (U)	77
V8 364CI 6.0L (N)	07-05	V8 402CI 6.6L Turbo-Diesel (2)	07-04	V8 307CI 5.0L	73-71
V8 364CI 6.0L (U)	07-01	V8 402CI 6.6L Turbo-Diesel (6)	10-07	V8 350CI 5.7L (H)	75-71
V8 364CI 6.0L (Y)	10-07	V8 402CI 6.6L Turbo-Diesel (8)	13-11	V8 350CI 5.7L (L)	77-75
V8 378CI 6.2L (8)	08-07	V8 402CI 6.6L Turbo-Diesel (D)	07-06	V8 350CI 5.7L (V)	76
V8 378CI 6.2L (Flex Fuel) (2)	13-09	V8 402CI 6.6L Turbo-Diesel (L)	13-11	V8 400CI 6.6L (U)	76-75
Sierra 1500 (4WD Full-Size Pickup)		V8 496CI 8.1L (G)	07-01	V8 402CI 6.6L	72-71
V6 262CI 4.3L (W)	03-99	Sierra 3500 (2WD Full-Size Pickup)		V8 454CI 7.4L	72-71
V6 262CI 4.3L (X)	13-02	V8 364CI 6.0L (K)	10-07	V8 454CI 7.4L (Y)	76-73

GMC Truck (Incl. Minivans and SUV's) (Cont.)

Model Index (Cont.)					
Engine (VIN Code / Eng. Code)	Year	Engine (VIN Code / Eng. Code)	Year	Engine (VIN Code / Eng. Code)	Year
GMC Truck (cont.)		GMC Truck (cont.)		Hummer Truck (cont.)	
Syclone (Compact Pickup)		V3500 (Full-Size Pickup) (cont.)		H2 (AWD Full-Size SUV)	
V6 262CI 4.3L Turbo (Z)	92-91	V8 350CI 5.7L (M)	88-87	V8 364CI 6.0L (N)	03
T145 Series		V8 379CI 6.2L Diesel (C)	91-87	V8 364CI 6.0L (U)	07-03
L6 229.7CI 3.8L (L-Head)	38	V8 379CI 6.2L Diesel (J)	91-87	V8 378CI 6.2L (8)	08
T14A Series		V8 454CI 7.4L (N)	91-87	V8 378CI 6.2L (Flex Fuel) (2)	10-09
L6 229.7CI 3.8L (L-Head)	38-37	W4S042 (Forward Control Chassis)		H3 (AWD Mid-Size SUV)	
T14B Series		L4 3856cc 3.9L OHV Diesel (4BD1-N)	88-87	L5 211CI 3.5L DOHC (20 Valve) (6)	06
L6 229.7CI 3.8L (L-Head)	38-37	L4 3856cc 3.9L OHV Turbo-Diesel (4BD1-T)	94-87	L5 223CI 3.7L DOHC (20 Valve) (E)	10-07
T15 Series		L4 3856cc 3.9L OHV Turbo-Diesel (4BD2-TC)	98-95	V8 325CI 5.3L (L)	09-08
L6 229.7CI 3.8L (L-Head)	38	V8 350CI 5.7L (K)	95-93	V8 325CI 5.3L (Flex Fuel) (P)	10
T155 Series		V8 350CI 5.7L (R)	00-96	Oldsmobile Truck	
L6 229.7CI 3.8L (L-Head)	38	Yukon (2WD Full-Size SUV)		Bravada (2WD Mid-Size SUV)	
T16L Suburban		V8 293CI 4.8L (C)	10-07	L6 254CI 4.2L DOHC (24 Valve) (S)	04-02
L6 229.7CI 3.8L (L-Head)	37	V8 293CI 4.8L (V)	06-00	Bravada (AWD Mid-Size SUV)	
Terrain (AWD Mid-Size SUV)		V8 325CI 5.3L (J)	10-07	L6 254CI 4.2L DOHC (24 Valve) (S)	04-02
L4 2384cc 2.4L DOHC (16 Valve) (C)	11	V8 325CI 5.3L (T)	06-00	V6 262CI 4.3L (W)	01-92
L4 2384cc 2.4L DOHC (16 Valve) (W)	13-10	V8 325CI 5.3L (Flex Fuel) (0)	13-07	V6 262CI 4.3L (Z)	92-91
L4 2384cc 2.4L DOHC (16 Valve) (Flex Fuel) (K)	13-12	V8 325CI 5.3L (Flex Fuel) (3)	13-07	Silhouette (AWD Minivan)	
V6 2997cc 3.0L DOHC (24 Valve) (Y)	13-10	V8 325CI 5.3L (Flex Fuel) (7)	13-12	V6 207CI 3.4L OHV (12 Valve) (E)	04-96
V6 2997cc 3.0L DOHC (24 Valve) (Flex Fuel) (5)	13-11	V8 325CI 5.3L (Flex Fuel) (Z)	06-02	Silhouette (FWD Minivan)	
V6 3564cc 3.6L DOHC (24 Valve) (Flex Fuel) (3)	13	V8 350CI 5.7L (K)	95-92	L4 138CI 2.3L DOHC (16 Valve) (G)	96-93
Terrain (FWD Mid-Size SUV)		V8 350CI 5.7L (R)	00-96	V6 189CI 3.1L (D)	95-90
L4 2384cc 2.4L DOHC (16 Valve) (C)	11	V8 364CI 6.0L (K)	10-07	V6 207CI 3.4L OHV (12 Valve) (E)	04-96
L4 2384cc 2.4L DOHC (16 Valve) (W)	13-10	V8 364CI 6.0L (N)	06-05	V6 231CI 3.8L (L)	95-92
L4 2384cc 2.4L DOHC (16 Valve) (Flex Fuel) (K)	13-12	V8 364CI 6.0L (U)	06-00	Pontiac Truck	
V6 2997cc 3.0L DOHC (24 Valve) (Y)	13-10	V8 364CI 6.0L (Y)	10-07	Aztek (AWD Mid-Size SUV)	
V6 2997cc 3.0L DOHC (24 Valve) (Flex Fuel) (5)	13-11	V8 364CI 6.0L (Flex Fuel) (G)	13-10	V6 207CI 3.4L OHV (12 Valve) (E)	05-01
V6 3564cc 3.6L DOHC (24 Valve) (Flex Fuel) (3)	13	V8 378CI 6.2L (8)	08-07	Aztek (FWD Mid-Size SUV)	
Transmode Motor Home (FWD)		V8 378CI 6.2L (Flex Fuel) (2)	13-09	V6 207CI 3.4L OHV (12 Valve) (E)	05-01
V8 403CI 6.6L (K)	78-77	V8 378CI 6.2L (Flex Fuel) (F)	13-10	Chieftain (Sedan Delivery)	
V8 455CI 7.5L (S)	76	V8 496CI 8.1L (G)	06-01	L6 239.2CI 3.9L (L-Head)	53-52
V8 455CI 7.5L (W)	75-73	Yukon (4WD Full-Size SUV)		L8 268.2CI 4.4L (L-Head)	53-52
Typhoon (Compact SUV)		V8 293CI 4.8L (C)	10-07	Montana (AWD Minivan)	
V6 262CI 4.3L Turbo (Z)	93-91	V8 293CI 4.8L (V)	06-00	V6 207CI 3.4L OHV (12 Valve) (E)	05-99
V1500 (Full-Size Pickup)		V8 325CI 5.3L (J)	10-07	Montana (FWD Minivan)	
V6 262CI 4.3L (Z)	87	V8 325CI 5.3L (T)	06-00	V6 207CI 3.4L OHV (12 Valve) (E)	05-99
V8 305CI 5.0L (H)	87	V8 325CI 5.3L (Flex Fuel) (0)	13-07	Montana SV6 (AWD Minivan)	
V8 350CI 5.7L (K)	91-87	V8 325CI 5.3L (Flex Fuel) (3)	13-07	V6 213CI 3.5L OHV (12 Valve) (L)	06-05
V8 350CI 5.7L (M)	88-87	V8 325CI 5.3L (Flex Fuel) (7)	13-12	V6 242CI 3.9L OHV (12 Valve) (1)	08-06
V8 379CI 6.2L Diesel (C)	91-87	V8 325CI 5.3L (Flex Fuel) (Z)	06-02	V6 242CI 3.9L OHV (12 Valve) (Flex Fuel) (W)	08-07
V8 379CI 6.2L Diesel (J)	91-87	V8 350CI 5.7L (K)	95-92	Montana SV6 (FWD Minivan)	
V1500 Suburban (Full-Size SUV)		V8 350CI 5.7L (R)	00-96	V6 213CI 3.5L OHV (12 Valve) (L)	06-05
V8 305CI 5.0L (H)	87	V8 364CI 6.0L (K)	10-07	V6 242CI 3.9L OHV (12 Valve) (1)	08-06
V8 350CI 5.7L (K)	91-87	V8 364CI 6.0L (N)	06-05	V6 242CI 3.9L OHV (12 Valve) (Flex Fuel) (W)	08-07
V8 379CI 6.2L Diesel (J)	91-87	V8 364CI 6.0L (U)	06-00	Streamliner (Sedan Delivery)	
V2500 (Full-Size Pickup)		V8 364CI 6.0L (Y)	10-07	L6 239.2CI 3.9L (L-Head)	51-49
L6 292CI 4.8L (T)	89-87	V8 364CI 6.0L (Flex Fuel) (G)	13-10	L8 248.9CI 4.1L (L-Head)	49
V6 262CI 4.3L (Z)	87	V8 378CI 6.2L (8)	08-07	L8 268.2CI 4.4L (L-Head)	51-50
V8 350CI 5.7L (K)	91-87	V8 378CI 6.2L (Flex Fuel) (2)	13-09	SunRunner (2WD Compact SUV)	
V8 350CI 5.7L (M)	88-87	V8 378CI 6.2L (Flex Fuel) (F)	13-10	L4 1590cc 1.6L SOHC (16 Valve) (6)	97-94
V8 379CI 6.2L Diesel (C)	91-87	V8 395CI 6.5L Turbo-Diesel (F)	99-94	L4 1590cc 1.6L SOHC (8 Valve) (U)	95-89
V8 379CI 6.2L Diesel (J)	91-87	V8 395CI 6.5L Turbo-Diesel (S)	99-94	SunRunner (4WD Compact SUV)	
V8 454CI 7.4L (N)	91-87	V8 496CI 8.1L (G)	06-01	L4 1590cc 1.6L SOHC (16 Valve) (6)	97-94
V2500 Suburban (Full-Size SUV)		Yukon Hybrid (2WD Full-Size SUV)		L4 1590cc 1.6L SOHC (8 Valve) (U)	95-89
V8 350CI 5.7L (K)	91-87	V8 364CI 6.0L (5)	13-08	SV6 (AWD Minivan)	
V8 379CI 6.2L Diesel (J)	91-87	V8 364CI 6.0L (Flex Fuel) (J)	13-10	V6 213CI 3.5L OHV (12 Valve) (L)	06-05
V3500 (Full-Size Pickup)		Yukon Hybrid (4WD Full-Size SUV)		V6 242CI 3.9L OHV (12 Valve) (1)	08-06
L6 292CI 4.8L (T)	89-87	V8 364CI 6.0L (5)	13-08	V6 242CI 3.9L OHV (12 Valve) (Flex Fuel) (W)	08-07
V8 350CI 5.7L (K)	91-87	V8 364CI 6.0L (Flex Fuel) (J)	13-10	SV6 (FWD Minivan)	
V3500 (Full-Size Pickup)		Hummer Truck		V6 213CI 3.5L OHV (12 Valve) (L)	06-05
V8 350CI 5.7L (K)	91-87	H1 (4WD Full-Size SUV)		V6 242CI 3.9L OHV (12 Valve) (1)	08-06
V8 379CI 6.2L Diesel (J)	91-87	V8 395CI 6.5L Turbo-Diesel (Z)	05-02	V6 242CI 3.9L OHV (12 Valve) (Flex Fuel) (W)	08-07
V3500 (Full-Size Pickup)		V8 402CI 6.6L Turbo-Diesel (3)	06	SV6 (FWD Minivan)	
L6 292CI 4.8L (T)	89-87	V8 496CI 8.1L (G)	03-02	V6 213CI 3.5L OHV (12 Valve) (L)	06-05
V8 350CI 5.7L (K)	91-87			V6 242CI 3.9L OHV (12 Valve) (1)	08-06

GMC Truck (Incl. Minivans and SUV's) (Cont.)

Model Index (Cont.)

<i>Engine (VIN Code / Eng. Code)</i>	<i>Year</i>	<i>Engine (VIN Code / Eng. Code)</i>	<i>Year</i>	<i>Engine (VIN Code / Eng. Code)</i>	<i>Year</i>
Pontiac Truck (cont.)					
Torrent (AWD Mid-Size SUV)					
V6 207CI 3.4L OHV (12 Valve) (9)	09-06				
V6 3564cc 3.6L DOHC (24 Valve) (7)	09-08				
Torrent (FWD Mid-Size SUV)					
V6 207CI 3.4L OHV (12 Valve) (9)	09-06				
V6 3564cc 3.6L DOHC (24 Valve) (7)	09-08				
Trans Sport (FWD Minivan)					
V6 189CI 3.1L (D)	95-90				
V6 207CI 3.4L OHV (12 Valve) (E)	98-96				
V6 231CI 3.8L (L)	95-92				
Saturn Truck					
Outlook (AWD Mid-Size SUV)					
V6 3564cc 3.6L DOHC (24 Valve) (7)	08-07				
V6 3564cc 3.6L DOHC (24 Valve) (D)	10-09				
Outlook (FWD Mid-Size SUV)					
V6 3564cc 3.6L DOHC (24 Valve) (7)	08-07				
V6 3564cc 3.6L DOHC (24 Valve) (D)	10-09				
Relay (AWD Minivan)					
V6 3491cc 3.5L OHV (12 Valve) (L)	06-05				
V6 3880cc 3.9L OHV (12 Valve) (1)	07-06				
V6 3880cc 3.9L OHV (12 Valve) (Flex Fuel) (W)	07				
Relay (FWD Minivan)					
V6 3491cc 3.5L OHV (12 Valve) (L)	06-05				
V6 3880cc 3.9L OHV (12 Valve) (1)	07-06				
V6 3880cc 3.9L OHV (12 Valve) (Flex Fuel) (W)	07				
Vue (AWD Compact SUV)					
L4 2198cc 2.2L DOHC (16 Valve) (D)	07-02				
L4 2384cc 2.4L DOHC (16 Valve) (P)	10-08				
V6 2962cc 3.0L DOHC (24 Valve) (B)	03-02				
V6 3471cc 3.5L SOHC (24 Valve) (4)	07-04				
V6 3510cc 3.5L OHV (12 Valve) (N)	10-08				
V6 3564cc 3.6L DOHC (24 Valve) (7)	10-08				
Vue (FWD Compact SUV)					
L4 2198cc 2.2L DOHC (16 Valve) (D)	07-02				
L4 2384cc 2.4L DOHC (16 Valve) (P)	10-08				
V6 2962cc 3.0L DOHC (24 Valve) (B)	03-02				
V6 3471cc 3.5L SOHC (24 Valve) (4)	07-04				
V6 3510cc 3.5L OHV (12 Valve) (N)	10-08				
V6 3564cc 3.6L DOHC (24 Valve) (7)	10-08				
Vue Hybrid (AWD Compact SUV)					
L4 2384cc 2.4L DOHC (16 Valve) (Z)	10-07				
V6 3564cc 3.6L DOHC (24 Valve) (B)	10-09				
Vue Hybrid (FWD Compact SUV)					
L4 2384cc 2.4L DOHC (16 Valve) (Z)	10-07				
V6 3564cc 3.6L DOHC (24 Valve) (B)	10-09				

GMC Truck (Incl. Minivans and SUV's) (Cont.)

1				
2013; 1.4L 83.2 (1364cc) DOHC L4 (16 Valve) 72.5mm Bore Ecotec VVT				
DI; Gasoline; Turbo - Intercooled Opel Eng.; VIN Code B				
1				
QTY	CYLINDER HEAD	YEARS	PART NO.	DESCRIPTION
1	Head Gasket	2013	26540 PT	Head bolts not incl.; Head bolt replacement recommended; PermaTorqueMLS®; New Part Number - Check for Availability
1	Head Set	2013	HS 26540 PT-1	Head bolts not incl.; Head bolt replacement recommended; PermaDry® molded rubber valve cover gskt. incl.; Premium valve stem seals incl.; New Part Number - Check for Availability
1	Head Bolt Set	2013	ES 72474	Replacement recommended; New Part Number - Check for Availability
QTY	CONVERSION SET	YEARS	PART NO.	DESCRIPTION
1	Gasket Conversion Set	2013	CS 26540	RTV sealant incl. for oil pan gskt.; New Part Number - Check for Availability
QTY	MANIFOLD - INT. & EXH.	YEARS	PART NO.	DESCRIPTION
1	Int. Manifold Gasket Set	2013	MS 97211	New Part Number - Check for Availability
1	Exh. Manifold Gasket Set	2013	MS 97202	New Part Number - Check for Availability
QTY	EXHAUST PIPE FLANGE	YEARS	PART NO.	DESCRIPTION
1	Exhaust Pipe Gasket	2013	61676	Loc. Front; Converter; New Part Number - Check for Availability
1	Exhaust Pipe Gasket	2013	61677	Converter to manifold; New Part Number - Check for Availability
1	Exhaust Pipe Gasket	2013	61681	Loc. Rear; Converter; New Part Number - Check for Availability
QTY	CRANKSHAFT REAR SEAL	YEARS	PART NO.	DESCRIPTION
1	Rear Main Seal Set	2013	BS 40738	Rubber; One-piece; New Part Number - Check for Availability
QTY	VALVE COVER	YEARS	PART NO.	DESCRIPTION
1	Valve Cover Gasket Set	2013	VS 50807 R	w/Grommets & Spark plug tube seals; PermaDry® molded rubber gskt. incl.; New Part Number - Check for Availability
QTY	VALVE STEM SEAL SET	YEARS	PART NO.	DESCRIPTION
1	Valve Stem Seal Set	2013	SS 72935	Premium valve stem seals incl.; New Part Number - Check for Availability
QTY	THERMOSTAT HOUSING	YEARS	PART NO.	DESCRIPTION
1	Thermostat Gasket	2013	35981	Thermostat Housing; Thermostat gasket; New Part Number - Check for Availability
QTY	WATER OUTLET GASKET	YEARS	PART NO.	DESCRIPTION
1	Water Outlet Gasket	2013	35979	Water Outlet; Water outlet; New Part Number - Check for Availability
QTY	WATER PUMP	YEARS	PART NO.	DESCRIPTION
1	Water Pump Gasket	2013	35986	New Part Number - Check for Availability
QTY	TIMING COVER	YEARS	PART NO.	DESCRIPTION
1	Crankshaft Front Seal Set	2013	TCS 46156	New Part Number - Check for Availability
QTY	CARB & FUEL INJECTION	YEARS	PART NO.	DESCRIPTION
1	Fuel Injector O-Ring Set	2013	ES 70599	Upper set; Injectors to fuel rail; Improved design
1	Throttle Body Gasket	2013	61691	New Part Number - Check for Availability
2				
2002 - 1994; 1.6L 97 (1590cc) SOHC L4 (16 Valve) 75mm Bore				
MFI; Gasoline; Naturally Aspirated Suzuki Eng.; VIN Code 6, Eng. Code G16KV				
2				
QTY	CYLINDER HEAD	YEARS	PART NO.	DESCRIPTION
1	Head Gasket	2002-94	9683 PT-1	
1	Head Set	2002-94	HS 9683 PT-1	Exh. pipe packing not incl.; PermaDry® molded rubber valve cover gskt. incl.; Premium valve stem seals incl.
QTY	CONVERSION SET	YEARS	PART NO.	DESCRIPTION
1	Gasket Conversion Set	2002-96	CS 9683-1	RTV sealant incl. for oil pan gskt.
1	Gasket Conversion Set	1995-94	CS 9683	
QTY	MANIFOLD - INT. & EXH.	YEARS	PART NO.	DESCRIPTION
1	Int. Manifold Gasket Set	2002-94	MS 95402	
1	Exh. Manifold Gasket Set	2002-94	MS 95032	
QTY	EXHAUST PIPE FLANGE	YEARS	PART NO.	DESCRIPTION
1	Exhaust Pipe Gasket	2002-94	61015	Loc. Rear; Converter
1	Exhaust Pipe Gasket	2002-94	61016	Flange; Improved design
1	Exhaust Pipe Gasket	2002-94	61016	Loc. Front; Converter; Improved design
QTY	OIL PAN	YEARS	PART NO.	DESCRIPTION
1	Oil Pan Gasket Set	1997-96	OS 30698 C	
1	Oil Pan Gasket Set	1995-94	OS 30594 C	
QTY	CRANKSHAFT REAR SEAL	YEARS	PART NO.	DESCRIPTION
1	Rear Main Seal Set	2002-94	BS 40603	Rubber; One-piece
QTY	VALVE COVER	YEARS	PART NO.	DESCRIPTION
1	Valve Cover Gasket Set	2002-94	VS 50473 R	w/Spark plug tube seals; PermaDry® molded rubber gskt. incl.
QTY	VALVE STEM SEAL SET	YEARS	PART NO.	DESCRIPTION
1	Valve Stem Seal Set	2002-94	SS 70360	Premium valve stem seals incl.; Improved design
QTY	THERMOSTAT HOUSING	YEARS	PART NO.	DESCRIPTION
1	Thermostat Gasket	2002-94	35432	Thermostat Housing; Thermostat seal

GMC Truck (Incl. Minivans and SUV's) (Cont.)

2		2002 - 1994; 1.6L 97 (1590cc) SOHC L4 (16 Valve) 75mm Bore			2
(cont.)		MFI; Gasoline; Naturally Aspirated Suzuki Eng.; VIN Code 6, Eng. Code G16KV			(cont.)
QTY	WATER OUTLET GASKET	YEARS	PART NO.	DESCRIPTION	
1	Thermostat Gasket	2002-94	35451	Water Outlet; Improved design	
QTY	WATER PUMP	YEARS	PART NO.	DESCRIPTION	
1	Water Pump Gasket	2002-94	35366		
QTY	TIMING COVER	YEARS	PART NO.	DESCRIPTION	
1	Crankshaft Front Seal Set	2002-94	TCS 45895		
1	Camshaft Front Seal Set	2002-94	TCS 45852		
QTY	CARB & FUEL INJECTION	YEARS	PART NO.	DESCRIPTION	
1	Throttle Body Gasket	2002-99	61090		
1	Throttle Body Gasket	1998-94	61033		
QTY	EXHAUST GAS RECIRCULATION	YEARS	PART NO.	DESCRIPTION	
1	EGR Gasket	2002-95	71026	Pipe	
1	EGR Gasket	2002-99	70984	Valve	
1	EGR Gasket	1998-95	71164	Valve	
1	EGR Gasket	1994	71164		
3		1995 - 1991; 1.6L 97 (1590cc) SOHC L4 (8 Valve) 75mm Bore			3
		TBI; Gasoline; Naturally Aspirated Suzuki Eng.; VIN Code U, Eng. Code G16KC			
QTY	CYLINDER HEAD	YEARS	PART NO.	DESCRIPTION	
1	Head Gasket	1995-91	9683 PT-1		
1	Head Set	1995-91	HS 9683 PT	Premium valve stem seals incl.	
QTY	CONVERSION SET	YEARS	PART NO.	DESCRIPTION	
1	Gasket Conversion Set	1995-91	CS 9683		
QTY	MANIFOLD - INT. & EXH.	YEARS	PART NO.	DESCRIPTION	
1	Int. Manifold Gasket Set	1995-91	MS 94477		
1	Exh. Manifold Gasket Set	1995-91	MS 94478	Improved design	
QTY	EXHAUST PIPE FLANGE	YEARS	PART NO.	DESCRIPTION	
1	Exhaust Pipe Gasket	1995-91	60566	Converter	
1	Exhaust Pipe Gasket	1995-94	23566	Packing	
1	Exhaust Pipe Gasket	1993	23566	Packing; Exc. California	
1	Exhaust Pipe Gasket	1992-91	23566	Packing	
QTY	OIL PAN	YEARS	PART NO.	DESCRIPTION	
1	Oil Pan Gasket Set	1995-91	OS 30594 C		
QTY	CRANKSHAFT REAR SEAL	YEARS	PART NO.	DESCRIPTION	
1	Rear Main Seal Set	1995-91	BS 40603	Rubber; One-piece	
QTY	VALVE COVER	YEARS	PART NO.	DESCRIPTION	
1	Valve Cover Gasket Set	1995-91	VS 50323 C	w/Grommets; Cork	
QTY	VALVE STEM SEAL SET	YEARS	PART NO.	DESCRIPTION	
1	Valve Stem Seal Set	1995-91	SS 72675-1	Premium valve stem seals incl.	
QTY	THERMOSTAT HOUSING	YEARS	PART NO.	DESCRIPTION	
1	Thermostat Gasket	1995-91	35416	Thermostat Housing	
QTY	WATER PUMP	YEARS	PART NO.	DESCRIPTION	
1	Water Pump Gasket	1995-91	35366		
QTY	TIMING COVER	YEARS	PART NO.	DESCRIPTION	
1	Timing Cover Dust Seal Set	1995-91	ES 72778		
1	Crankshaft Front Seal Set	1995-91	TCS 45895		
1	Camshaft Front Seal Set	1995-91	TCS 45852		
QTY	CARB & FUEL INJECTION	YEARS	PART NO.	DESCRIPTION	
1	Throttle Body Gasket	1995-91	60840		
QTY	EXHAUST GAS RECIRCULATION	YEARS	PART NO.	DESCRIPTION	
1	EGR Gasket	1995	71026	Pipe	
1	EGR Gasket	1995	71164	Valve	
1	EGR Gasket	1994-91	71164		
4		2004 - 1999; 2.0L 121.7 (1995cc) DOHC L4 (16 Valve) 84mm Bore			4
		MFI; Gasoline; Naturally Aspirated Suzuki Eng.; VIN Code C, Eng. Code J20A			
QTY	CYLINDER HEAD	YEARS	PART NO.	DESCRIPTION	
1	Head Gasket	2004-99	26278 PT	Head bolts not incl.; Head bolt replacement recommended; PermaTorqueMLS®	
1	Head Set	2004-99	HS 26278 PT	Head bolts not incl.; Head bolt replacement recommended; PermaDry® molded rubber valve cover gskt. incl.; Premium valve stem seals incl.	
1	Head Bolt Set	2004-99	ES 72206	Head bolts w/Washers; Replacement recommended	
QTY	CONVERSION SET	YEARS	PART NO.	DESCRIPTION	
1	Gasket Conversion Set	2004-99	CS 26278		

GMC Truck (Incl. Minivans and SUV's) (Cont.)

4		2004 - 1999; 2.0L 121.7 (1995cc) DOHC L4 (16 Valve) 84mm Bore			4
(cont.)		MFI; Gasoline; Naturally Aspirated Suzuki Eng.; VIN Code C, Eng. Code J20A			(cont.)
QTY	MANIFOLD - INT. & EXH.	YEARS	PART NO.	DESCRIPTION	
1	Int. Manifold Gasket Set	2004-99	MS 96603		
1	Exh. Manifold Gasket Set	2004-99	MS 96602		
QTY	EXHAUST PIPE FLANGE	YEARS	PART NO.	DESCRIPTION	
1	Exhaust Pipe Gasket	2004-99	61015	Loc. Rear; Exh. connector	
1	Exhaust Pipe Gasket	2004-99	61016	Loc. Front; Exh. connector; Improved design	
1	Exhaust Pipe Gasket	2004-99	61386	Ring	
1	Exhaust Pipe Gasket	2004-99	61387	Converter	
QTY	OIL PAN	YEARS	PART NO.	DESCRIPTION	
1	Oil Pan Gasket Set	2004-99	OS 30765		
QTY	CRANKSHAFT REAR SEAL	YEARS	PART NO.	DESCRIPTION	
1	Rear Main Seal Set	2004-99	BS 40687	Rubber; One-piece	
QTY	VALVE COVER	YEARS	PART NO.	DESCRIPTION	
1	Valve Cover Gasket Set	2004-99	VS 50633 R	w/Semi-circular plug & Grommets & Spark plug tube seals; PermaDry® molded rubber gskt. incl.	
QTY	VALVE STEM SEAL SET	YEARS	PART NO.	DESCRIPTION	
1	Valve Stem Seal Set	2004-99	SS 70283-1	Premium valve stem seals incl.	
QTY	THERMOSTAT HOUSING	YEARS	PART NO.	DESCRIPTION	
1	Thermostat Gasket	2004-99	35769	Thermostat Housing; Thermostat seal	
QTY	WATER OUTLET GASKET	YEARS	PART NO.	DESCRIPTION	
1	Water Outlet Gasket	2004-99	35766	Water Outlet	
QTY	WATER PUMP	YEARS	PART NO.	DESCRIPTION	
1	O-Ring	2004-99	35768	Water Pump	
QTY	TIMING COVER	YEARS	PART NO.	DESCRIPTION	
1	Crankshaft Front Seal Set	2004-99	TCS 46056		
QTY	CARB & FUEL INJECTION	YEARS	PART NO.	DESCRIPTION	
1	Fuel Injector O-Ring Set	2004-99	ES 70599	Upper set; Injectors to fuel rail; Improved design	
1	Fuel Injector O-Ring Set	2004-99	ES 71190	Lower set; Injectors to cylinder head	
1	Throttle Body Gasket	2004-99	61090		
QTY	EXHAUST GAS RECIRCULATION	YEARS	PART NO.	DESCRIPTION	
1	EGR Gasket	2004-99	71026	Pipe	
1	EGR Gasket	2004-99	71218	Valve	
5		2010; 2.0L 122 (1998cc) DOHC L4 (16 Valve) 86mm Bore Ecotec			5
(cont.)		MFI; Gasoline; Turbo - Intercooled Opel Eng.; VIN Code M			(cont.)
QTY	CYLINDER HEAD	YEARS	PART NO.	DESCRIPTION	
1	Head Bolt Set	2010	ES 72196	Replacement recommended	
QTY	MANIFOLD - INT. & EXH.	YEARS	PART NO.	DESCRIPTION	
1	Exh. Manifold Gasket Set	2010	MS 97122		
QTY	CRANKSHAFT REAR SEAL	YEARS	PART NO.	DESCRIPTION	
1	Rear Main Seal Set	2010	BS 40671	Rubber; One-piece; Improved design	
1	Rear Main Seal Set	2010	BS 40739	Rubber; One-piece; New Improved design; New Part Number - Check for Availability	
QTY	VALVE COVER	YEARS	PART NO.	DESCRIPTION	
1	Valve Cover Gasket Set	2010	VS 50778 R	w/Spark plug tube seals; PermaDry® molded rubber gskt. incl.; New Part Number - Check for Availability	
QTY	VALVE STEM SEAL SET	YEARS	PART NO.	DESCRIPTION	
1	Valve Stem Seal Set	2010	SS 71198	Premium valve stem seals incl.	
QTY	THERMOSTAT HOUSING	YEARS	PART NO.	DESCRIPTION	
1	Water Outlet Gasket	2010	35346	Thermostat Housing; Thermostat seal	
QTY	WATER PUMP	YEARS	PART NO.	DESCRIPTION	
1	Water Pump Gasket	2010	35721	Mounting	
1	Water Pump Gasket	2010	35724	Cover	
1	Water Pump Mounting Set	2010	ES 71282		
QTY	TIMING COVER	YEARS	PART NO.	DESCRIPTION	
1	Timing Cover Set	2010	TCS 46079		
1	Crankshaft Front Seal Set	2010	TCS 46113		
6		2010 - 2008; 2.0L 122 (1998cc) DOHC L4 (16 Valve) 86mm Bore Ecotec			6
(cont.)		MFI; Gasoline; Turbo - Intercooled Opel Eng.; VIN Code X			(cont.)
QTY	CYLINDER HEAD	YEARS	PART NO.	DESCRIPTION	
1	Head Bolt Set	2010-08	ES 72196	Replacement recommended	
QTY	MANIFOLD - INT. & EXH.	YEARS	PART NO.	DESCRIPTION	
1	Exh. Manifold Gasket Set	2010-08	MS 97122		

GMC Truck (Incl. Minivans and SUV's) (Cont.)

6		2010 - 2008; 2.0L 122 (1998cc) DOHC L4 (16 Valve) 86mm Bore Ecotec			6	
(cont.)		MFI; Gasoline; Turbo - Intercooled Opel Eng.; VIN Code X			(cont.)	
QTY	OIL PAN	YEARS	PART NO.	DESCRIPTION		
1	Drain Plug Gasket	2010-08	70820			
QTY	CRANKSHAFT REAR SEAL	YEARS	PART NO.	DESCRIPTION		
1	Rear Main Seal Set	2010-08	BS 40671	Rubber; One-piece; Improved design		
1	Rear Main Seal Set	2010-08	BS 40739	Rubber; One-piece; New Improved design; New Part Number - Check for Availability		
QTY	VALVE COVER	YEARS	PART NO.	DESCRIPTION		
1	Valve Cover Gasket Set	2010-08	VS 50778 R	w/Spark plug tube seals; PermaDry® molded rubber gskt. incl.; New Part Number - Check for Availability		
QTY	VALVE STEM SEAL SET	YEARS	PART NO.	DESCRIPTION		
1	Valve Stem Seal Set	2010-08	SS 71198	Premium valve stem seals incl.		
QTY	THERMOSTAT HOUSING	YEARS	PART NO.	DESCRIPTION		
1	Water Outlet Gasket	2010-08	35346	Thermostat Housing; Thermostat seal		
QTY	WATER PUMP	YEARS	PART NO.	DESCRIPTION		
1	Water Pump Gasket	2010-08	35721	Mounting		
1	Water Pump Gasket	2010-08	35724	Cover		
1	Water Pump Mounting Set	2010-08	ES 71282			
QTY	TIMING COVER	YEARS	PART NO.	DESCRIPTION		
1	Timing Cover Set	2010-08	TCS 46079			
1	Crankshaft Front Seal Set	2010-08	TCS 46113			
7		2003 - 1994; 2.2L 134 (2189cc) OHV L4 (8 Valve) 89mm Bore			7	
(cont.)		MFI; Gasoline; Naturally Aspirated GMC Eng.; Chevrolet; VIN Code 4			(cont.)	
QTY	CYLINDER HEAD	YEARS	PART NO.	DESCRIPTION		
1	Head Gasket	2003-94	9170 PT-1	Head bolts not incl.; Head bolt replacement recommended; PermaTorque®; Improved design		
1	Head Set	2003	HS 9170 PT-2	Head bolts & exh. pipe packing not incl.; Head bolt replacement recommended; PermaDry® molded rubber valve cover gskt. incl.; Premium valve stem seals incl.		
1	Head Set	2002-98	HS 9170 PT-1	Head bolts & exh. pipe packing not incl.; Head bolt replacement recommended; PermaDry® molded rubber valve cover gskt. incl.; Premium valve stem seals incl.		
1	Head Set	1997-94	HS 9170 PT	Head bolts & exh. pipe packing not incl.; Head bolt replacement recommended; PermaDry® molded rubber valve cover gskt. incl.; Premium valve stem seals incl.		
1	Head Installation Set	1997-94	HIS 9170 PT	Head bolts & exh. pipe packing not incl.; Head bolt replacement recommended; PermaDry® molded rubber valve cover gskt. incl.		
1	Head Bolt Set	2003-98	ES 72170	Replacement recommended		
1	Head Bolt Set	1997-95	ES 72172	Replacement recommended		
1	Head Bolt Set	1994	ES 74016	Replacement recommended		
QTY	CONVERSION SET	YEARS	PART NO.	DESCRIPTION		
1	Gasket Conversion Set	2003-94	CS 9469			
QTY	MANIFOLD - INT. & EXH.	YEARS	PART NO.	DESCRIPTION		
1	Int. Manifold Gasket Set	2003-98	MS 90543			
1	Int. Manifold Gasket Set	1997-94	MS 95393	Lower set; Upper set incl.		
1	Plenum Gasket Set	1997-94	MS 95397	Upper set		
1	Exh. Manifold Gasket Set	2003	MS 92794			
1	Exh. Manifold Gasket Set	2002-98	MS 90540			
1	Exh. Manifold Gasket Set	1997-94	MS 93812			
QTY	EXHAUST PIPE FLANGE	YEARS	PART NO.	DESCRIPTION		
1	Exhaust Pipe Gasket	2003-97	60729	Packing		
1	Exhaust Pipe Gasket	1996	60982	Packing		
1	Exhaust Pipe Gasket	1995-94	60538	Packing		
QTY	OIL PAN	YEARS	PART NO.	DESCRIPTION		
1	Oil Pan Gasket Set	2003-94	OS 34300 C			
1	Drain Plug Gasket	2003-98	70820			
1	Drain Plug Gasket	1997-94	70822			
QTY	CRANKSHAFT REAR SEAL	YEARS	PART NO.	DESCRIPTION		
1	Rear Main Seal Set	2003-94	BS 40464	11.0mm thick; Rubber; One-piece; Improved design		
1	Rear Main Seal Set	2003-94	BS 40625	11.0mm thick; PTFE Rubber; One-piece; Improved design		
1	Repair Sleeve Tool	2003-94	16304	Crankshaft		
QTY	VALVE COVER	YEARS	PART NO.	DESCRIPTION		
1	Valve Cover Gasket Set	2003-98	VS 50485 R	PermaDry® molded rubber gskt. incl.		
1	Valve Cover Gasket Set	1997-94	VS 50313 R	PermaDry® molded rubber gskt. incl.		

GMC Truck (Incl. Minivans and SUV's) (Cont.)

7 (cont.)	2003 - 1994; 2.2L 134 (2189cc) OHV L4 (8 Valve) 89mm Bore			7 (cont.)
MFI; Gasoline; Naturally Aspirated GMC Eng.; Chevrolet; VIN Code 4				
QTY	VALVE STEM SEAL SET	YEARS	PART NO.	DESCRIPTION
1	Valve Stem Seal Set	2003-98	SS 70809	Premium valve stem seals incl.
1	Valve Stem Seal Set	1997-94	SS 72852	Premium valve stem seals incl.
QTY	THERMOSTAT HOUSING	YEARS	PART NO.	DESCRIPTION
1	Thermostat Gasket	2003-94	35614	Thermostat Housing; Thermostat seal; Improved design
1	Thermostat Gasket	1997-94	35393	Thermostat Housing; Adapter cover
1	Thermostat Gasket	1997-94	35598	Thermostat Housing; Thermostat adapter
1	Thermostat Gasket	1995-94	35393	Thermostat Housing; EGR adapter
QTY	WATER OUTLET GASKET	YEARS	PART NO.	DESCRIPTION
1	Water Outlet Gasket	2003-98	35613	Water Outlet; Outlet adapter
1	Water Outlet Gasket	1997-94	35560	Water Outlet
QTY	WATER PUMP	YEARS	PART NO.	DESCRIPTION
1	Water Pump Gasket	2003-94	35392	Mounting
1	Water Pump Gasket	2003-94	36025	Water pump inlet; New Part Number - Check for Availability
QTY	TIMING COVER	YEARS	PART NO.	DESCRIPTION
1	Timing Cover Set	2003-94	TCS 45793	w/o Sleeve 'N' Seal®
1	Timing Cover Gasket	2003-94	72739	New Part Number - Check for Availability
1	Timing Set w/Sleeve & Seal	2003-94	TCS 45762	w/Sleeve 'N' Seal®
1	Repair Sleeve	2003-94	16202	Timing Cover; Use w/installation tool
1	Repair Sleeve Tool	2003-94	16312	Timing Cover
QTY	CARB & FUEL INJECTION	YEARS	PART NO.	DESCRIPTION
1	Fuel Injector O-Ring Set	2003-98	ES 70599	Upper set; Injectors to fuel rail; Improved design
1	Fuel Injector O-Ring Set	2003-98	ES 71190	Lower set; Injectors to cylinder head
1	Fuel Injector O-Ring Set	1997-94	ES 71188	Upper set & Lower set; Injectors to fuel rail & Injectors to cylinder head
1	Throttle Body Gasket	2003-98	61021	
QTY	EXHAUST GAS RECIRCULATION	YEARS	PART NO.	DESCRIPTION
1	EGR Gasket	2003-96	70789	EGR valve
1	EGR Gasket	2003-98	70805	EGR adapter cover; New Part Number - Check for Availability
1	EGR Gasket	2003-98	70808	EGR adapter
1	EGR Gasket	1997-96	70621	EGR adapter
1	EGR Gasket	1995-94	70954	EGR valve
8	2002 - 2000; 2.2L 134 (2189cc) OHV L4 (8 Valve) 89mm Bore			8
MFI; Flex Fuel; Naturally Aspirated GMC Eng.; Chevrolet; VIN Code 5				
QTY	CYLINDER HEAD	YEARS	PART NO.	DESCRIPTION
1	Head Gasket	2002-00	9170 PT-1	Head bolts not incl.; Head bolt replacement recommended; PermaTorque®; Improved design
1	Head Set	2002-00	HS 9170 PT-2	Head bolts & exh. pipe packing not incl.; Head bolt replacement recommended; PermaDry® molded rubber valve cover gskt. incl.; Premium valve stem seals incl.
1	Head Bolt Set	2002-00	ES 72170	Replacement recommended
QTY	CONVERSION SET	YEARS	PART NO.	DESCRIPTION
1	Gasket Conversion Set	2002-00	CS 9469	
QTY	MANIFOLD - INT. & EXH.	YEARS	PART NO.	DESCRIPTION
1	Int. Manifold Gasket Set	2002-00	MS 90543	
1	Exh. Manifold Gasket Set	2002-00	MS 92794	
QTY	EXHAUST PIPE FLANGE	YEARS	PART NO.	DESCRIPTION
1	Exhaust Pipe Gasket	2002-00	60729	Packing
QTY	OIL PAN	YEARS	PART NO.	DESCRIPTION
1	Oil Pan Gasket Set	2002-00	OS 34300 C	
1	Drain Plug Gasket	2002-00	70820	
QTY	CRANKSHAFT REAR SEAL	YEARS	PART NO.	DESCRIPTION
1	Rear Main Seal Set	2002-00	BS 40464	11.0mm thick; Rubber; One-piece; Improved design
1	Rear Main Seal Set	2002-00	BS 40625	11.0mm thick; PTFE Rubber; One-piece; Improved design
1	Repair Sleeve Tool	2002-00	16304	Crankshaft
QTY	VALVE COVER	YEARS	PART NO.	DESCRIPTION
1	Valve Cover Gasket Set	2002-00	VS 50485 R	PermaDry® molded rubber gskt. incl.
QTY	VALVE STEM SEAL SET	YEARS	PART NO.	DESCRIPTION
1	Valve Stem Seal Set	2002-00	SS 70809	Premium valve stem seals incl.
QTY	THERMOSTAT HOUSING	YEARS	PART NO.	DESCRIPTION
1	Thermostat Gasket	2002-00	35614	Thermostat Housing; Thermostat seal; Improved design
QTY	WATER OUTLET GASKET	YEARS	PART NO.	DESCRIPTION
1	Water Outlet Gasket	2002-00	35613	Water Outlet; Outlet adapter
QTY	WATER PUMP	YEARS	PART NO.	DESCRIPTION
1	Water Pump Gasket	2002-00	35392	Mounting

GMC Truck (Incl. Minivans and SUV's) (Cont.)

8		2002 - 2000; 2.2L 134 (2189cc) OHV L4 (8 Valve) 89mm Bore			8	
(cont.)		MFI; Flex Fuel; Naturally Aspirated GMC Eng.; Chevrolet; VIN Code 5			(cont.)	
QTY	WATER PUMP	YEARS	PART NO.	DESCRIPTION		
1	Water Pump Gasket	2002-00	36025	Water pump inlet; New Part Number - Check for Availability		
QTY	TIMING COVER	YEARS	PART NO.	DESCRIPTION		
1	Timing Cover Set	2002-00	TCS 45793	w/o Sleeve 'N' Seal®		
1	Timing Cover Gasket	2002-00	72739	New Part Number - Check for Availability		
1	Timing Set w/Sleeve & Seal	2002-00	TCS 45762	w/Sleeve 'N' Seal®		
1	Repair Sleeve	2002-00	16202	Timing Cover; Use w/installation tool		
1	Repair Sleeve Tool	2002-00	16312	Timing Cover		
QTY	CARB & FUEL INJECTION	YEARS	PART NO.	DESCRIPTION		
1	Fuel Injector O-Ring Set	2002-00	ES 70599	Upper set; Injectors to fuel rail; Improved design		
1	Fuel Injector O-Ring Set	2002-00	ES 71190	Lower set; Injectors to cylinder head		
1	Throttle Body Gasket	2002-00	61021			
QTY	EXHAUST GAS RECIRCULATION	YEARS	PART NO.	DESCRIPTION		
1	EGR Gasket	2002-00	70789	EGR valve		
1	EGR Gasket	2002-00	70805	EGR adapter cover; New Part Number - Check for Availability		
1	EGR Gasket	2002-00	70808	EGR adapter		
9		2011 - 2009; 2.2L 134.1 (2198cc) DOHC L4 (16 Valve) 86mm Bore Ecotec			9	
		MFI; Flex Fuel; Naturally Aspirated Opel Eng.; VIN Code B				
QTY	CYLINDER HEAD	YEARS	PART NO.	DESCRIPTION		
1	Head Gasket	2011-09	26466 PT	Head bolts not incl.; Head bolt replacement recommended; PermaTorqueMLS®		
1	Head Set	2011-09	HS 26466 PT-1	Head bolts & exh. pipe flange not incl.; Head bolt replacement recommended; PermaDry® molded rubber valve cover gskt. incl.; Premium valve stem seals incl.		
1	Head Bolt Set	2011-09	ES 72196	Replacement recommended		
QTY	CONVERSION SET	YEARS	PART NO.	DESCRIPTION		
1	Gasket Conversion Set	2011-09	CS 26223-1	RTV sealant incl. for oil pan gskt.		
QTY	MANIFOLD - INT. & EXH.	YEARS	PART NO.	DESCRIPTION		
1	Int. Manifold Gasket Set	2011-09	MS 96351-1			
1	Exh. Manifold Gasket Set	2011-09	MS 97122			
QTY	EXHAUST PIPE FLANGE	YEARS	PART NO.	DESCRIPTION		
1	Exhaust Pipe Gasket	2011-09	61362	Flange		
1	Exhaust Pipe Gasket	2011-09	61440	Converter		
QTY	OIL PAN	YEARS	PART NO.	DESCRIPTION		
1	Drain Plug Gasket	2011-09	70820			
QTY	CRANKSHAFT REAR SEAL	YEARS	PART NO.	DESCRIPTION		
1	Rear Main Seal Set	2011-09	BS 40671	Rubber; One-piece; Improved design		
1	Rear Main Seal Set	2011-09	BS 40739	Rubber; One-piece; New Improved design; New Part Number - Check for Availability		
QTY	VALVE COVER	YEARS	PART NO.	DESCRIPTION		
1	Valve Cover Gasket Set	2011-09	VS 50769 R	w/Grommets & Spark plug tube seals; PermaDry® molded rubber gskt. incl.		
QTY	VALVE STEM SEAL SET	YEARS	PART NO.	DESCRIPTION		
1	Valve Stem Seal Set	2011-09	SS 71198	Premium valve stem seals incl.		
QTY	WATER OUTLET GASKET	YEARS	PART NO.	DESCRIPTION		
1	Water Outlet Gasket	2011-09	35346	Water Outlet		
QTY	WATER PUMP	YEARS	PART NO.	DESCRIPTION		
1	Water Pump Gasket	2011-09	35721	Mounting		
1	Water Pump Gasket	2011-09	35724	Cover		
1	Water Pump Mounting Set	2011-09	ES 71282			
QTY	TIMING COVER	YEARS	PART NO.	DESCRIPTION		
1	Timing Cover Set	2011-09	TCS 46079			
1	Crankshaft Front Seal Set	2011-09	TCS 46113			
QTY	CARB & FUEL INJECTION	YEARS	PART NO.	DESCRIPTION		
1	Fuel Injector O-Ring Set	2011-09	ES 70599	Upper set; Injectors to fuel rail; Improved design		
1	Throttle Body Gasket	2011-09	61624			
10		2008 - 2002; 2.2L 134.1 (2198cc) DOHC L4 (16 Valve) 86mm Bore Ecotec			10	
		MFI; Gasoline; Naturally Aspirated Opel Eng.; VIN Code D				
QTY	CYLINDER HEAD	YEARS	PART NO.	DESCRIPTION		
1	Head Gasket	2008-02	26223 PT	Head bolts not incl.; Head bolt replacement recommended; PermaTorqueMLS® LaserWeld® Technology		

GMC Truck (Incl. Minivans and SUV's) (Cont.)

10 (cont.)	2008 - 2002; 2.2L 134.1 (2198cc) DOHC L4 (16 Valve) 86mm Bore Ecotec MFI; Gasoline; Naturally Aspirated Opel Eng.; VIN Code D			10 (cont.)
QTY	CYLINDER HEAD	YEARS	PART NO.	DESCRIPTION
1	Head Set	2008	HS 26223 PT-5	California; Head bolts not incl.; Head bolt replacement recommended; Must be used w/TCS 46079; PermaDry® molded rubber valve cover gskt. incl.; Premium valve stem seals incl.
1	Head Set	2008	HS 26223 PT-5	Exc. California; Exh. manifold gskt. & head bolts not incl.; Head bolt replacement recommended; Must be used w/TCS 46079; PermaDry® molded rubber valve cover gskt. incl.; Premium valve stem seals incl.
1	Head Set	2007	HS 26223 PT-1	Saturn Vue Base; Head bolts not incl.; Head bolt replacement recommended; Must be used w/TCS 46079; PermaDry® molded rubber valve cover gskt. incl.; Premium valve stem seals incl.
1	Head Set	2007	HS 26223 PT-5	Exc. Saturn Vue Base; Head bolts not incl.; Head bolt replacement recommended; Must be used w/TCS 46079; PermaDry® molded rubber valve cover gskt. incl.; Premium valve stem seals incl.
1	Head Set	2006	HS 26223 PT-1	Head bolts not incl.; Head bolt replacement recommended; Must be used w/TCS 46079; PermaDry® molded rubber valve cover gskt. incl.; Premium valve stem seals incl.
1	Head Set	2005-02	HS 26223 PT-1	Head bolts not incl.; Head bolt replacement recommended; Must be used w/TCS 46041; PermaDry® molded rubber valve cover gskt. incl.; Premium valve stem seals incl.
1	Head Bolt Set	2008-02	ES 72196	Replacement recommended
QTY	CONVERSION SET	YEARS	PART NO.	DESCRIPTION
1	Gasket Conversion Set	2008-06	CS 26223-1	RTV sealant incl. for oil pan gskt.
1	Gasket Conversion Set	2005-02	CS 26223	RTV sealant incl. for oil pan gskt.
QTY	MANIFOLD - INT. & EXH.	YEARS	PART NO.	DESCRIPTION
1	Int. Manifold Gasket Set	2008-02	MS 96351	
1	Exh. Manifold Gasket Set	2008	MS 96377	California
1	Exh. Manifold Gasket Set	2008	MS 97122	Exc. California
1	Exh. Manifold Gasket Set	2007-02	MS 96377	
QTY	EXHAUST PIPE FLANGE	YEARS	PART NO.	DESCRIPTION
1	Exhaust Pipe Gasket	2008-06	61440	Converter
1	Exhaust Pipe Gasket	2008	61362	Flange
1	Exhaust Pipe Gasket	2007-06	60666	Saturn Vue Base; Packing
1	Exhaust Pipe Gasket	2007-06	61362	Exc. Saturn Vue Base; Flange
1	Exhaust Pipe Gasket	2005-02	60666	Packing
1	Exhaust Pipe Gasket	2005-02	61361	Converter
QTY	CRANKSHAFT REAR SEAL	YEARS	PART NO.	DESCRIPTION
1	Rear Main Seal Set	2008-02	BS 40671	Rubber; One-piece; Improved design
1	Rear Main Seal Set	2008-02	BS 40739	Rubber; One-piece; New Improved design; New Part Number - Check for Availability
QTY	VALVE COVER	YEARS	PART NO.	DESCRIPTION
1	Valve Cover Gasket Set	2008	VS 50719 R	w/Grommets & Spark plug tube seals; PermaDry® molded rubber gskt. incl.
1	Valve Cover Gasket Set	2007	VS 50596 R	Saturn Vue Base; w/Grommets & Spark plug tube seals; PermaDry® molded rubber gskt. incl.
1	Valve Cover Gasket Set	2007	VS 50719 R	Exc. Saturn Vue Base; w/Grommets & Spark plug tube seals; PermaDry® molded rubber gskt. incl.
1	Valve Cover Gasket Set	2006-02	VS 50596 R	w/Grommets & Spark plug tube seals; PermaDry® molded rubber gskt. incl.
QTY	VALVE STEM SEAL SET	YEARS	PART NO.	DESCRIPTION
1	Valve Stem Seal Set	2008-02	SS 71198	Premium valve stem seals incl.
QTY	WATER OUTLET GASKET	YEARS	PART NO.	DESCRIPTION
1	Water Outlet Gasket	2008-02	35346	Water Outlet
QTY	WATER PUMP	YEARS	PART NO.	DESCRIPTION
1	Water Pump Gasket	2008-02	35721	Mounting
1	Water Pump Gasket	2008-02	35724	Cover
1	Water Pump Mounting Set	2008-02	ES 71282	
QTY	TIMING COVER	YEARS	PART NO.	DESCRIPTION
1	Timing Cover Set	2008-06	TCS 46079	
1	Timing Cover Set	2005-02	TCS 46041	
1	Crankshaft Front Seal Set	2008-06	TCS 46113	
1	Crankshaft Front Seal Set	2005-02	TCS 46112	
QTY	CARB & FUEL INJECTION	YEARS	PART NO.	DESCRIPTION
1	Fuel Injector O-Ring Set	2008-02	ES 70599	Upper set; Injectors to fuel rail; Improved design
1	Fuel Injector O-Ring Set	2008-02	ES 71190	Lower set; Injectors to cylinder head
1	Throttle Body Gasket	2008-02	61309	
QTY	EXHAUST GAS RECIRCULATION	YEARS	PART NO.	DESCRIPTION
1	EGR Gasket	2008-02	71194	

GMC Truck (Incl. Minivans and SUV's) (Cont.)

11		2011; 2.2L 134.1 (2198cc) DOHC L4 (16 Valve) 86mm Bore Ecotec			11
MFI; Flex Fuel; Naturally Aspirated Opel Eng.; VIN Code W					
QTY	CYLINDER HEAD	YEARS	PART NO.	DESCRIPTION	
1	Head Gasket	2011	26466 PT	Head bolts not incl.; Head bolt replacement recommended; PermaTorqueMLS®	
1	Head Set	2011	HS 26466 PT-1	Head bolts & exh. pipe flange not incl.; Head bolt replacement recommended; PermaDry® molded rubber valve cover gskt. incl.; Premium valve stem seals incl.	
1	Head Bolt Set	2011	ES 72196	Replacement recommended	
QTY	CONVERSION SET	YEARS	PART NO.	DESCRIPTION	
1	Gasket Conversion Set	2011	CS 26223-1	RTV sealant incl. for oil pan gskt.	
QTY	MANIFOLD - INT. & EXH.	YEARS	PART NO.	DESCRIPTION	
1	Int. Manifold Gasket Set	2011	MS 96351-1		
1	Exh. Manifold Gasket Set	2011	MS 97122		
QTY	EXHAUST PIPE FLANGE	YEARS	PART NO.	DESCRIPTION	
1	Exhaust Pipe Gasket	2011	61362	Flange	
1	Exhaust Pipe Gasket	2011	61440	Converter	
QTY	OIL PAN	YEARS	PART NO.	DESCRIPTION	
1	Drain Plug Gasket	2011	70820		
QTY	CRANKSHAFT REAR SEAL	YEARS	PART NO.	DESCRIPTION	
1	Rear Main Seal Set	2011	BS 40671	Rubber; One-piece; Improved design	
1	Rear Main Seal Set	2011	BS 40739	Rubber; One-piece; New Improved design; New Part Number - Check for Availability	
QTY	VALVE COVER	YEARS	PART NO.	DESCRIPTION	
1	Valve Cover Gasket Set	2011	VS 50769 R	w/Grommets & Spark plug tube seals; PermaDry® molded rubber gskt. incl.	
QTY	VALVE STEM SEAL SET	YEARS	PART NO.	DESCRIPTION	
1	Valve Stem Seal Set	2011	SS 71198	Premium valve stem seals incl.	
QTY	WATER OUTLET GASKET	YEARS	PART NO.	DESCRIPTION	
1	Water Outlet Gasket	2011	35346	Water Outlet	
QTY	WATER PUMP	YEARS	PART NO.	DESCRIPTION	
1	Water Pump Gasket	2011	35721	Mounting	
1	Water Pump Gasket	2011	35724	Cover	
1	Water Pump Mounting Set	2011	ES 71282		
QTY	TIMING COVER	YEARS	PART NO.	DESCRIPTION	
1	Timing Cover Set	2011	TCS 46079		
1	Crankshaft Front Seal Set	2011	TCS 46113		
QTY	CARB & FUEL INJECTION	YEARS	PART NO.	DESCRIPTION	
1	Fuel Injector O-Ring Set	2011	ES 70599	Upper set; Injectors to fuel rail; Improved design	
1	Throttle Body Gasket	2011	61624		
12		1995 - 1993; 2.3L 138 (2260cc) DOHC L4 (16 Valve) 92mm Bore Quad 4			12
MFI; Gasoline; Naturally Aspirated GMC Eng.; Oldsmobile; VIN Code G					
QTY	CYLINDER HEAD	YEARS	PART NO.	DESCRIPTION	
1	Head Gasket	1995-93	9515 PT	Head bolts not incl.; Head bolt replacement recommended	
1	Head Set	1995	HS 9515 PT-3	Head bolts, exh. pipe packing, 1st Design timing cover gskts. not incl.; Head bolt replacement recommended; PermaDry® molded rubber valve cover gskts. incl.; Premium valve stem seals incl.	
1	Head Set	1994-93	HS 9515 PT-2	Head bolts, exh. pipe packing, 1st Design timing cover gskts. not incl.; Head bolt replacement recommended; PermaDry® molded rubber valve cover gskts. incl.; Premium valve stem seals incl.	
1	Head Installation Set	1994-93	HIS 9515 PT-2	Head bolts, exh. pipe packing, 1st Design timing cover gskts. & valve cover seals not incl.; Head bolt replacement recommended; PermaDry® molded rubber valve cover gskts. incl.	
1	Head Bolt Set	1995-93	ES 72727	Head bolts w/Washers; Replacement recommended	
QTY	CONVERSION SET	YEARS	PART NO.	DESCRIPTION	
1	Gasket Conversion Set	1995	CS 9515-1	PermaDry® molded rubber oil pan gskt. incl.	
1	Gasket Conversion Set	1994-93	CS 9515	PermaDry® molded rubber oil pan gskt. incl.	
QTY	MANIFOLD - INT. & EXH.	YEARS	PART NO.	DESCRIPTION	
1	Int. Manifold Gasket Set	1995-93	MS 90573		
1	Exh. Manifold Gasket Set	1995	MS 91130		
1	Exh. Manifold Gasket Set	1994-93	MS 90559		
QTY	EXHAUST PIPE FLANGE	YEARS	PART NO.	DESCRIPTION	
1	Exhaust Pipe Gasket	1995-93	60828	Pipe to manifold; 2 5/8" ID	
2	Exhaust Pipe Gasket	1995-93	60850	Converter; 1 to 2 Req'd.; 51mm ID	
1	Exhaust Pipe Gasket	1995-93	61051	Pipe to manifold; 2 3/32" ID	
1	Exh. Flange Bolt & Spring Kit	1995-93	ES 72141		

GMC Truck (Incl. Minivans and SUV's) (Cont.)

12		1995 - 1993; 2.3L 138 (2260cc) DOHC L4 (16 Valve) 92mm Bore Quad 4			12	
(cont.)		MFI; Gasoline; Naturally Aspirated GMC Eng.; Oldsmobile; VIN Code G			(cont.)	
QTY	OIL PAN	YEARS	PART NO.	DESCRIPTION		
1	Oil Pan Gasket Set	1995	OS 30678 R	PermaDry® molded rubber gskt. incl.		
1	Oil Pan Gasket Set	1994-93	OS 30597 R	PermaDry® molded rubber gskt. incl.		
1	Drain Plug Gasket	1995-93	70822			
QTY	CRANKSHAFT REAR SEAL	YEARS	PART NO.	DESCRIPTION		
1	Rear Main Seal Set	1995-93	BS 40591	Rubber; One-piece		
QTY	VALVE COVER	YEARS	PART NO.	DESCRIPTION		
1	Valve Cover Gasket Set	1995-93	VS 50444 R	Loc. Int.; 2nd Design; Seals fit into grooves in camshaft housing cover; PermaDry® molded rubber gskts. incl.		
1	Valve Cover Gasket Set	1995-93	VS 50445 R	Loc. Exh.; 2nd Design; Seals fit into grooves in camshaft housing cover; PermaDry® molded rubber gskts. incl.		
1	Valve Cover Gasket Set	1994-93	VS 50325 R	Loc. Int. & Exh.; 1st Design; Seals fit into grooves in camshaft housing; PermaDry® molded rubber gskts. incl.		
QTY	VALVE STEM SEAL SET	YEARS	PART NO.	DESCRIPTION		
1	Valve Stem Seal Set	1995-93	SS 70287	Premium valve stem seals incl.		
QTY	THERMOSTAT HOUSING	YEARS	PART NO.	DESCRIPTION		
1	Thermostat Gasket	1995-94	35614	Thermostat Housing; Thermostat seal; Improved design		
QTY	WATER OUTLET GASKET	YEARS	PART NO.	DESCRIPTION		
1	Water Outlet Gasket	1995-94	35597	Water Outlet; Outlet O-ring		
1	Water Outlet Gasket	1993	35427	Water Outlet		
QTY	WATER PUMP	YEARS	PART NO.	DESCRIPTION		
1	Water Pump Mounting Set	1995	ES 72102	Must be used w/MS 91130		
1	Water Pump Mounting Set	1994-93	ES 72102	Must be used w/MS 90559		
QTY	TIMING COVER	YEARS	PART NO.	DESCRIPTION		
1	Timing Cover Set	1995-93	TCS 45843	1st Design; w/20 hole gskt.; .70mm thick		
1	Timing Cover Set	1995-93	TCS 45954	2nd Design; w/21 hole gskt.; 3.40mm thick		
QTY	CARB & FUEL INJECTION	YEARS	PART NO.	DESCRIPTION		
2	Fuel Injector O-Ring Set	1995-93	ES 70599	Improved design		
1	Throttle Body Gasket	1995-93	60757			
13		2010 - 2006; 2.4L 145.5 (2384cc) DOHC L4 (16 Valve) 88mm Bore Ecotec			13	
		MFI; Gasoline; Naturally Aspirated Opel Eng.; VIN Code P				
QTY	CYLINDER HEAD	YEARS	PART NO.	DESCRIPTION		
1	Head Gasket	2010-06	26466 PT	Head bolts not incl.; Head bolt replacement recommended; PermaTorqueMLS®		
1	Head Set	2010-09	HS 26466 PT-1	Head bolts & exh. pipe flange not incl.; Head bolt replacement recommended; PermaDry® molded rubber valve cover gskt. incl.; Premium valve stem seals incl.		
1	Head Set	2008	HS 26466 PT	California; Head bolts & exh. pipe flange not incl.; Head bolt replacement recommended; PermaDry® molded rubber valve cover gskt. incl.; Premium valve stem seals incl.		
1	Head Set	2008	HS 26466 PT-1	Exc. California; Head bolts & exh. pipe flange not incl.; Head bolt replacement recommended; PermaDry® molded rubber valve cover gskt. incl.; Premium valve stem seals incl.		
1	Head Set	2007-06	HS 26466 PT	Head bolts & exh. pipe flange not incl.; Head bolt replacement recommended; PermaDry® molded rubber valve cover gskt. incl.; Premium valve stem seals incl.		
1	Head Bolt Set	2010-06	ES 72196	Replacement recommended		
QTY	CONVERSION SET	YEARS	PART NO.	DESCRIPTION		
1	Gasket Conversion Set	2010-06	CS 26223-1	RTV sealant incl. for oil pan gskt.		
QTY	MANIFOLD - INT. & EXH.	YEARS	PART NO.	DESCRIPTION		
1	Int. Manifold Gasket Set	2010-06	MS 96351-1			
1	Exh. Manifold Gasket Set	2010-09	MS 97122			
1	Exh. Manifold Gasket Set	2008	MS 96377	California		
1	Exh. Manifold Gasket Set	2008	MS 97122	Exc. California		
1	Exh. Manifold Gasket Set	2007-06	MS 96377			
QTY	EXHAUST PIPE FLANGE	YEARS	PART NO.	DESCRIPTION		
1	Exhaust Pipe Gasket	2010-09	61704	Converter; New Part Number - Check for Availability		
1	Exhaust Pipe Gasket	2008	61362	Exc. Saturn Vue XE; Pipe to manifold		
1	Exhaust Pipe Gasket	2008	61440	Exc. Saturn Vue XE; Converter		
1	Exhaust Pipe Gasket	2008	61704	Saturn Vue XE; Converter; New Part Number - Check for Availability		
1	Exhaust Pipe Gasket	2007-06	61362	Pipe to manifold		
1	Exhaust Pipe Gasket	2007-06	61440	Converter		
QTY	CRANKSHAFT REAR SEAL	YEARS	PART NO.	DESCRIPTION		
1	Rear Main Seal Set	2010-06	BS 40671	Rubber; One-piece; Improved design		

GMC Truck (Incl. Minivans and SUV's) (Cont.)

13		2010 - 2006; 2.4L 145.5 (2384cc) DOHC L4 (16 Valve) 88mm Bore Ecotec			13
(cont.)		MFI; Gasoline; Naturally Aspirated Opel Eng.; VIN Code P			(cont.)
QTY	CRANKSHAFT REAR SEAL	YEARS	PART NO.	DESCRIPTION	
1	Rear Main Seal Set	2010-06	BS 40739	Rubber; One-piece; New Improved design; New Part Number - Check for Availability	
QTY	VALVE COVER	YEARS	PART NO.	DESCRIPTION	
1	Valve Cover Gasket Set	2010-06	VS 50769 R	w/Grommets & Spark plug tube seals; PermaDry® molded rubber gskt. incl.	
QTY	VALVE STEM SEAL SET	YEARS	PART NO.	DESCRIPTION	
1	Valve Stem Seal Set	2010-06	SS 71198	Premium valve stem seals incl.	
QTY	THERMOSTAT HOUSING	YEARS	PART NO.	DESCRIPTION	
1	Water Outlet Gasket	2010-06	35346	Thermostat Housing; Thermostat seal	
QTY	WATER PUMP	YEARS	PART NO.	DESCRIPTION	
1	Water Pump Gasket	2010-06	35721	Mounting	
1	Water Pump Gasket	2010-06	35724	Cover	
1	Water Pump Mounting Set	2010-06	ES 71282		
QTY	TIMING COVER	YEARS	PART NO.	DESCRIPTION	
1	Timing Cover Set	2010-06	TCS 46079		
1	Crankshaft Front Seal Set	2010-06	TCS 46113		
QTY	CARB & FUEL INJECTION	YEARS	PART NO.	DESCRIPTION	
1	Fuel Injector O-Ring Set	2010-06	ES 70599	Upper set; Injectors to fuel rail; Improved design	
1	Throttle Body Gasket	2010-08	61685	New Part Number - Check for Availability	
1	Throttle Body Gasket	2007-06	61624		
14		2011; 2.4L 145.5 (2384cc) DOHC L4 (16 Valve) 88mm Bore Ecotec			14
		MFI; Flex Fuel; Naturally Aspirated Opel Eng.; VIN Code U			
QTY	CYLINDER HEAD	YEARS	PART NO.	DESCRIPTION	
1	Head Gasket	2011	26466 PT	Head bolts not incl.; Head bolt replacement recommended; PermaTorqueMLS®	
1	Head Set	2011	HS 26466 PT-1	Head bolts & exh. pipe flange not incl.; Head bolt replacement recommended; PermaDry® molded rubber valve cover gskt. incl.; Premium valve stem seals incl.	
1	Head Bolt Set	2011	ES 72196	Replacement recommended	
QTY	CONVERSION SET	YEARS	PART NO.	DESCRIPTION	
1	Gasket Conversion Set	2011	CS 26223-1	RTV sealant incl. for oil pan gskt.	
QTY	MANIFOLD - INT. & EXH.	YEARS	PART NO.	DESCRIPTION	
1	Int. Manifold Gasket Set	2011	MS 96351-1		
1	Exh. Manifold Gasket Set	2011	MS 97122		
QTY	EXHAUST PIPE FLANGE	YEARS	PART NO.	DESCRIPTION	
1	Exhaust Pipe Gasket	2011	61362	Pipe to manifold	
1	Exhaust Pipe Gasket	2011	61440	Converter	
QTY	CRANKSHAFT REAR SEAL	YEARS	PART NO.	DESCRIPTION	
1	Rear Main Seal Set	2011	BS 40671	Rubber; One-piece; Improved design	
1	Rear Main Seal Set	2011	BS 40739	Rubber; One-piece; New Improved design; New Part Number - Check for Availability	
QTY	VALVE COVER	YEARS	PART NO.	DESCRIPTION	
1	Valve Cover Gasket Set	2011	VS 50769 R	w/Grommets & Spark plug tube seals; PermaDry® molded rubber gskt. incl.	
QTY	VALVE STEM SEAL SET	YEARS	PART NO.	DESCRIPTION	
1	Valve Stem Seal Set	2011	SS 71198	Premium valve stem seals incl.	
QTY	THERMOSTAT HOUSING	YEARS	PART NO.	DESCRIPTION	
1	Water Outlet Gasket	2011	35346	Thermostat Housing; Thermostat seal	
QTY	WATER PUMP	YEARS	PART NO.	DESCRIPTION	
1	Water Pump Gasket	2011	35721	Mounting	
1	Water Pump Gasket	2011	35724	Cover	
1	Water Pump Mounting Set	2011	ES 71282		
QTY	TIMING COVER	YEARS	PART NO.	DESCRIPTION	
1	Timing Cover Set	2011	TCS 46079		
1	Crankshaft Front Seal Set	2011	TCS 46113		
QTY	CARB & FUEL INJECTION	YEARS	PART NO.	DESCRIPTION	
1	Fuel Injector O-Ring Set	2011	ES 70599	Upper set; Injectors to fuel rail; Improved design	
1	Throttle Body Gasket	2011	61685	New Part Number - Check for Availability	
15		2011 - 2009; 2.4L 145.5 (2384cc) DOHC L4 (16 Valve) 88mm Bore Ecotec			15
		MFI; Flex Fuel; Naturally Aspirated Opel Eng.; VIN Code V			
QTY	CYLINDER HEAD	YEARS	PART NO.	DESCRIPTION	
1	Head Gasket	2011-09	26466 PT	Head bolts not incl.; Head bolt replacement recommended; PermaTorqueMLS®	

GMC Truck (Incl. Minivans and SUV's) (Cont.)

15 (cont.)	2011 - 2009; 2.4L 145.5 (2384cc) DOHC L4 (16 Valve) 88mm Bore Ecotec MFI; Flex Fuel; Naturally Aspirated Opel Eng.; VIN Code V				15 (cont.)
QTY	CYLINDER HEAD	YEARS	PART NO.	DESCRIPTION	
1	Head Set	2011-09	HS 26466 PT-1	Head bolts & exh. pipe flange not incl.; Head bolt replacement recommended; PermaDry® molded rubber valve cover gskt. incl.; Premium valve stem seals incl.	
1	Head Bolt Set	2011-09	ES 72196	Replacement recommended	
QTY	CONVERSION SET	YEARS	PART NO.	DESCRIPTION	
1	Gasket Conversion Set	2011-09	CS 26223-1	RTV sealant incl. for oil pan gskt.	
QTY	MANIFOLD - INT. & EXH.	YEARS	PART NO.	DESCRIPTION	
1	Int. Manifold Gasket Set	2011-09	MS 96351-1		
1	Exh. Manifold Gasket Set	2011-09	MS 97122		
QTY	EXHAUST PIPE FLANGE	YEARS	PART NO.	DESCRIPTION	
1	Exhaust Pipe Gasket	2011-09	61362	Pipe to manifold	
1	Exhaust Pipe Gasket	2011-09	61440	Converter	
QTY	CRANKSHAFT REAR SEAL	YEARS	PART NO.	DESCRIPTION	
1	Rear Main Seal Set	2011-09	BS 40671	Rubber; One-piece; Improved design	
1	Rear Main Seal Set	2011-09	BS 40739	Rubber; One-piece; New Improved design; New Part Number - Check for Availability	
QTY	VALVE COVER	YEARS	PART NO.	DESCRIPTION	
1	Valve Cover Gasket Set	2011-09	VS 50769 R	w/Grommets & Spark plug tube seals; PermaDry® molded rubber gskt. incl.	
QTY	VALVE STEM SEAL SET	YEARS	PART NO.	DESCRIPTION	
1	Valve Stem Seal Set	2011-09	SS 71198	Premium valve stem seals incl.	
QTY	THERMOSTAT HOUSING	YEARS	PART NO.	DESCRIPTION	
1	Water Outlet Gasket	2011-09	35346	Thermostat Housing; Thermostat seal	
QTY	WATER PUMP	YEARS	PART NO.	DESCRIPTION	
1	Water Pump Gasket	2011-09	35721	Mounting	
1	Water Pump Gasket	2011-09	35724	Cover	
1	Water Pump Mounting Set	2011-09	ES 71282		
QTY	TIMING COVER	YEARS	PART NO.	DESCRIPTION	
1	Timing Cover Set	2011-09	TCS 46079		
1	Crankshaft Front Seal Set	2011-09	TCS 46113		
QTY	CARB & FUEL INJECTION	YEARS	PART NO.	DESCRIPTION	
1	Fuel Injector O-Ring Set	2011-09	ES 70599	Upper set; Injectors to fuel rail; Improved design	
1	Throttle Body Gasket	2011-09	61685	New Part Number - Check for Availability	
16	2010 - 2007; 2.4L 145.5 (2384cc) DOHC L4 (16 Valve) 88mm Bore Ecotec MFI; Hybrid (Gas/Electric); Naturally Aspirated Opel Eng.; VIN Code Z				16
QTY	CYLINDER HEAD	YEARS	PART NO.	DESCRIPTION	
1	Head Gasket	2010-07	26466 PT	Head bolts not incl.; Head bolt replacement recommended; PermaTorqueMLS®	
1	Head Set	2010	HS 26466 PT-1	Head bolts & exh. pipe flange not incl.; Head bolt replacement recommended; PermaDry® molded rubber valve cover gskt. incl.; Premium valve stem seals incl.	
1	Head Set	2009-08	HS 26466 PT	California; Head bolts & exh. pipe flange not incl.; Head bolt replacement recommended; PermaDry® molded rubber valve cover gskt. incl.; Premium valve stem seals incl.	
1	Head Set	2009-08	HS 26466 PT-1	Exc. California; Head bolts & exh. pipe flange not incl.; Head bolt replacement recommended; PermaDry® molded rubber valve cover gskt. incl.; Premium valve stem seals incl.	
1	Head Set	2007	HS 26466 PT	Head bolts & exh. pipe flange not incl.; Head bolt replacement recommended; PermaDry® molded rubber valve cover gskt. incl.; Premium valve stem seals incl.	
1	Head Bolt Set	2010-07	ES 72196	Replacement recommended	
QTY	CONVERSION SET	YEARS	PART NO.	DESCRIPTION	
1	Gasket Conversion Set	2010-07	CS 26223-1	RTV sealant incl. for oil pan gskt.	
QTY	MANIFOLD - INT. & EXH.	YEARS	PART NO.	DESCRIPTION	
1	Int. Manifold Gasket Set	2010-07	MS 96351-1		
1	Exh. Manifold Gasket Set	2010	MS 97122		
1	Exh. Manifold Gasket Set	2009-08	MS 96377	California	
1	Exh. Manifold Gasket Set	2009-08	MS 97122	Exc. California	
1	Exh. Manifold Gasket Set	2007	MS 96377		
QTY	CRANKSHAFT REAR SEAL	YEARS	PART NO.	DESCRIPTION	
1	Rear Main Seal Set	2010-07	BS 40671	Rubber; One-piece; Improved design	
1	Rear Main Seal Set	2010-07	BS 40739	Rubber; One-piece; New Improved design; New Part Number - Check for Availability	

GMC Truck (Incl. Minivans and SUV's) (Cont.)

16 (cont.)		2010 - 2007; 2.4L 145.5 (2384cc) DOHC L4 (16 Valve) 88mm Bore Ecotec MFI; Hybrid (Gas/Electric); Naturally Aspirated Opel Eng.; VIN Code Z			16 (cont.)
QTY	VALVE COVER	YEARS	PART NO.	DESCRIPTION	
1	Valve Cover Gasket Set	2010-07	VS 50769 R	w/Grommets & Spark plug tube seals; PermaDry® molded rubber gskt. incl.	
QTY	VALVE STEM SEAL SET	YEARS	PART NO.	DESCRIPTION	
1	Valve Stem Seal Set	2010-07	SS 71198	Premium valve stem seals incl.	
QTY	THERMOSTAT HOUSING	YEARS	PART NO.	DESCRIPTION	
1	Water Outlet Gasket	2010-07	35346	Thermostat Housing; Thermostat seal	
QTY	WATER PUMP	YEARS	PART NO.	DESCRIPTION	
1	Water Pump Gasket	2010-07	35721	Mounting	
1	Water Pump Gasket	2010-07	35724	Cover	
1	Water Pump Mounting Set	2010-07	ES 71282		
QTY	TIMING COVER	YEARS	PART NO.	DESCRIPTION	
1	Timing Cover Set	2010-07	TCS 46079		
1	Crankshaft Front Seal Set	2010-07	TCS 46113		
QTY	CARB & FUEL INJECTION	YEARS	PART NO.	DESCRIPTION	
1	Fuel Injector O-Ring Set	2010-07	ES 70599	Upper set; Injectors to fuel rail; Improved design	
1	Throttle Body Gasket	2010-07	61685	New Part Number - Check for Availability	
17		2011; 2.4L 145.5 (2384cc) DOHC L4 (16 Valve) 88mm Bore Ecotec VVT DI; Gasoline; Naturally Aspirated Opel Eng.; VIN Code C			17
QTY	CYLINDER HEAD	YEARS	PART NO.	DESCRIPTION	
1	Head Gasket	2011	26517 PT	Head bolts not incl.; Head bolt replacement recommended; PermaTorqueMLS®; New Part Number - Check for Availability	
1	Head Set	2011	HS 26517 PT	Head bolts not incl.; Head bolt replacement recommended; PermaDry® molded rubber valve cover gskt. incl.; Premium valve stem seals incl.; New Part Number - Check for Availability	
1	Head Bolt Set	2011	ES 72196	Replacement recommended	
QTY	CONVERSION SET	YEARS	PART NO.	DESCRIPTION	
1	Gasket Conversion Set	2011	CS 26223-1	RTV sealant incl. for oil pan gskt.	
QTY	MANIFOLD - INT. & EXH.	YEARS	PART NO.	DESCRIPTION	
1	Int. Manifold Gasket Set	2011	MS 97208	New Part Number - Check for Availability	
1	Exh. Manifold Gasket Set	2011	MS 97122		
QTY	EXHAUST PIPE FLANGE	YEARS	PART NO.	DESCRIPTION	
1	Exhaust Pipe Gasket	2011	61054	Pipe to manifold	
1	Exhaust Pipe Gasket	2011	61709	Converter; New Part Number - Check for Availability	
QTY	CRANKSHAFT REAR SEAL	YEARS	PART NO.	DESCRIPTION	
1	Rear Main Seal Set	2011	BS 40671	Rubber; One-piece; Improved design	
1	Rear Main Seal Set	2011	BS 40739	Rubber; One-piece; New Improved design; New Part Number - Check for Availability	
QTY	VALVE COVER	YEARS	PART NO.	DESCRIPTION	
1	Valve Cover Gasket Set	2011	VS 50778 R	w/Spark plug tube seals; PermaDry® molded rubber gskt. incl.; New Part Number - Check for Availability	
QTY	VALVE STEM SEAL SET	YEARS	PART NO.	DESCRIPTION	
1	Valve Stem Seal Set	2011	SS 71198	Premium valve stem seals incl.	
QTY	THERMOSTAT HOUSING	YEARS	PART NO.	DESCRIPTION	
1	Water Outlet Gasket	2011	35346	Thermostat Housing; Thermostat seal	
QTY	WATER PUMP	YEARS	PART NO.	DESCRIPTION	
1	Water Pump Gasket	2011	35721	Mounting	
1	Water Pump Gasket	2011	35724	Cover	
1	Water Pump Mounting Set	2011	ES 71282		
QTY	TIMING COVER	YEARS	PART NO.	DESCRIPTION	
1	Timing Cover Set	2011	TCS 46079		
1	Crankshaft Front Seal Set	2011	TCS 46113		
QTY	CARB & FUEL INJECTION	YEARS	PART NO.	DESCRIPTION	
1	Fuel Injector O-Ring Set	2011	ES 70599	Upper set; Injectors to fuel rail; Improved design	
1	Throttle Body Gasket	2011	61690	New Part Number - Check for Availability	
18		2013 - 2010; 2.4L 145.5 (2384cc) DOHC L4 (16 Valve) 88mm Bore Ecotec VVT DI; Gasoline; Naturally Aspirated Opel Eng.; VIN Code W			18
QTY	CYLINDER HEAD	YEARS	PART NO.	DESCRIPTION	
1	Head Gasket	2011-10	26517 PT	Head bolts not incl.; Head bolt replacement recommended; PermaTorqueMLS®; New Part Number - Check for Availability	
1	Head Set	2011-10	HS 26517 PT	Head bolts not incl.; Head bolt replacement recommended; PermaDry® molded rubber valve cover gskt. incl.; Premium valve stem seals incl.; New Part Number - Check for Availability	

GMC Truck (Incl. Minivans and SUV's) (Cont.)

18 (cont.)		2013 - 2010; 2.4L 145.5 (2384cc) DOHC L4 (16 Valve) 88mm Bore Ecotec VVT			18 (cont.)
		DI; Gasoline; Naturally Aspirated Opel Eng.; VIN Code W			
QTY	CYLINDER HEAD	YEARS	PART NO.	DESCRIPTION	
1	Head Bolt Set	2011-10	ES 72196	Replacement recommended	
QTY	CONVERSION SET	YEARS	PART NO.	DESCRIPTION	
1	Gasket Conversion Set	2011-10	CS 26223-1	RTV sealant incl. for oil pan gskt.	
QTY	MANIFOLD - INT. & EXH.	YEARS	PART NO.	DESCRIPTION	
1	Int. Manifold Gasket Set	2011-10	MS 97208	New Part Number - Check for Availability	
1	Exh. Manifold Gasket Set	2011-10	MS 97122		
QTY	EXHAUST PIPE FLANGE	YEARS	PART NO.	DESCRIPTION	
1	Exhaust Pipe Gasket	2011-10	61054	Pipe to manifold	
1	Exhaust Pipe Gasket	2011-10	61709	Converter; New Part Number - Check for Availability	
QTY	CRANKSHAFT REAR SEAL	YEARS	PART NO.	DESCRIPTION	
1	Rear Main Seal Set	2013-10	BS 40739	Rubber; One-piece; New Improved design; New Part Number - Check for Availability	
1	Rear Main Seal Set	2011-10	BS 40671	Rubber; One-piece; Improved design	
QTY	VALVE COVER	YEARS	PART NO.	DESCRIPTION	
1	Valve Cover Gasket Set	2011-10	VS 50778 R	w/Spark plug tube seals; PermaDry® molded rubber gskt. incl.; New Part Number - Check for Availability	
QTY	VALVE STEM SEAL SET	YEARS	PART NO.	DESCRIPTION	
1	Valve Stem Seal Set	2011-10	SS 71198	Premium valve stem seals incl.	
QTY	THERMOSTAT HOUSING	YEARS	PART NO.	DESCRIPTION	
1	Water Outlet Gasket	2011-10	35346	Thermostat Housing; Thermostat seal	
QTY	WATER PUMP	YEARS	PART NO.	DESCRIPTION	
1	Water Pump Gasket	2011-10	35721	Mounting	
1	Water Pump Gasket	2011-10	35724	Cover	
1	Water Pump Mounting Set	2011-10	ES 71282		
QTY	TIMING COVER	YEARS	PART NO.	DESCRIPTION	
1	Timing Cover Set	2011-10	TCS 46079		
1	Crankshaft Front Seal Set	2011-10	TCS 46113		
QTY	CARB & FUEL INJECTION	YEARS	PART NO.	DESCRIPTION	
1	Fuel Injector O-Ring Set	2011-10	ES 70599	Upper set; Injectors to fuel rail; Improved design	
1	Throttle Body Gasket	2011-10	61690	New Part Number - Check for Availability	
19		1993 - 1991; 2.5L 151 (2475cc) OHV L4 (8 Valve) 4" Bore			19
		TBI; Gasoline; Naturally Aspirated GMC Eng.; Pontiac; VIN Code A			
QTY	CYLINDER HEAD	YEARS	PART NO.	DESCRIPTION	
1	Head Gasket	1993-91	515 SD	Head bolts not incl.; Head bolt replacement recommended; PermaTorque Severe Duty®	
1	Head Gasket	1993-91	9405 PT-1	Head bolts not incl.; Head bolt replacement recommended; PermaTorque®	
1	Head Set	1993-91	HS 9405 PT-5	Head bolts & exh. pipe packing not incl.; Head bolt replacement recommended; Premium valve stem seals incl.	
1	Head Bolt Set	1993-91	ES 72733	Replacement recommended	
QTY	CONVERSION SET	YEARS	PART NO.	DESCRIPTION	
1	Gasket Conversion Set	1993-91	CS 8686		
QTY	MANIFOLD - INT. & EXH.	YEARS	PART NO.	DESCRIPTION	
1	Int. Manifold Gasket Set	1993-91	MS 94278		
1	Exh. Manifold Gasket Set	1993-91	MS 93689		
QTY	EXHAUST PIPE FLANGE	YEARS	PART NO.	DESCRIPTION	
1	Exhaust Pipe Gasket	1993-91	60592	Packing	
QTY	OIL PAN	YEARS	PART NO.	DESCRIPTION	
1	Oil Pan Gasket Set	1993-91	OS 30409 C		
1	Drain Plug Gasket	1993-91	70822		
1	Drain Plug Gasket	1993-91	72598	Drain plug & filter seal	
QTY	CRANKSHAFT REAR SEAL	YEARS	PART NO.	DESCRIPTION	
1	Rear Main Seal Set	1993-91	BS 40578	Rubber; One-piece; Improved design	
1	Repair Sleeve	1993-91	16259	Crankshaft; Use w/installation tool	
1	Repair Sleeve Tool	1993-91	16304	Crankshaft	
QTY	VALVE COVER	YEARS	PART NO.	DESCRIPTION	
1	Valve Cover Gasket Set	1993-91	VS 50179 T	PermaDryPlus®	
1	Valve Cover Gasket Set	1993-91	VS 50329 C	Cork	
QTY	PUSH ROD COVER	YEARS	PART NO.	DESCRIPTION	
1	Push Rod Cover Gasket Set	1993-91	PS 50276 C	w/Grommets; Cork	
QTY	VALVE STEM SEAL SET	YEARS	PART NO.	DESCRIPTION	
1	Valve Stem Seal Set	1993-91	SS 72684	Premium valve stem seals incl.	

GMC Truck (Incl. Minivans and SUV's) (Cont.)

19 (cont.)		1993 - 1991; 2.5L 151 (2475cc) OHV L4 (8 Valve) 4" Bore			19 (cont.)
TBI; Gasoline; Naturally Aspirated GMC Eng.; Pontiac; VIN Code A					
QTY	THERMOSTAT HOUSING	YEARS	PART NO.	DESCRIPTION	
1	Thermostat Gasket	1993-91	35543	Thermostat Housing; Housing to head	
QTY	WATER OUTLET GASKET	YEARS	PART NO.	DESCRIPTION	
1	Water Outlet Gasket	1993-91	35568	Water Outlet	
QTY	WATER PUMP	YEARS	PART NO.	DESCRIPTION	
1	Water Pump Gasket	1993-91	35490		
QTY	TIMING COVER	YEARS	PART NO.	DESCRIPTION	
1	Timing Cover Set	1993-91	TCS 13198-2	w/o Sleeve 'N' Seal®	
1	Timing Set w/Sleeve & Seal	1993-91	TCS 45264	w/Sleeve 'N' Seal®	
1	Repair Sleeve	1993-91	16202	Timing Cover; Use w/installation tool	
1	Repair Sleeve Tool	1993-91	16312	Timing Cover	
QTY	AIR CLEANER MOUNTING	YEARS	PART NO.	DESCRIPTION	
1	Air Cleaner Gasket	1993-91	11528	4" ID	
QTY	CARB & FUEL INJECTION	YEARS	PART NO.	DESCRIPTION	
1	Throttle Body Gasket	1993-91	60764		
QTY	DISTRIBUTOR MOUNTING	YEARS	PART NO.	DESCRIPTION	
1	O-Ring	1993-91	70484-1	Distributor Mounting	
QTY	EXHAUST GAS RECIRCULATION	YEARS	PART NO.	DESCRIPTION	
1	EGR Gasket	1993-91	70978		
20		1991; 2.5L 151 (2475cc) OHV L4 (8 Valve) 4" Bore			20
TBI; Gasoline; Naturally Aspirated GMC Eng.; Pontiac; VIN Code E					
QTY	CYLINDER HEAD	YEARS	PART NO.	DESCRIPTION	
1	Head Gasket	1991	515 SD	Head bolts not incl.; Head bolt replacement recommended; PermaTorque Severe Duty®	
1	Head Gasket	1991	9405 PT-1	Head bolts not incl.; Head bolt replacement recommended; PermaTorque®	
1	Head Set	1991	HS 9405 PT-4	Head bolts & exh. pipe packing not incl.; Head bolt replacement recommended; Premium valve stem seals incl.	
1	Head Bolt Set	1991	ES 72733	Replacement recommended	
QTY	CONVERSION SET	YEARS	PART NO.	DESCRIPTION	
1	Gasket Conversion Set	1991	CS 8686		
QTY	MANIFOLD - INT. & EXH.	YEARS	PART NO.	DESCRIPTION	
1	Int. Manifold Gasket Set	1991	MS 93688		
1	Exh. Manifold Gasket Set	1991	MS 93689		
QTY	EXHAUST PIPE FLANGE	YEARS	PART NO.	DESCRIPTION	
1	Exhaust Pipe Gasket	1991	60592	Packing	
QTY	OIL PAN	YEARS	PART NO.	DESCRIPTION	
1	Oil Pan Gasket Set	1991	OS 30409 C		
1	Drain Plug Gasket	1991	70822		
1	Drain Plug Gasket	1991	72598	Drain plug & filter seal	
QTY	CRANKSHAFT REAR SEAL	YEARS	PART NO.	DESCRIPTION	
1	Rear Main Seal Set	1991	BS 40578	Rubber; One-piece; Improved design	
1	Repair Sleeve	1991	16259	Crankshaft; Use w/installation tool	
1	Repair Sleeve Tool	1991	16304	Crankshaft	
QTY	VALVE COVER	YEARS	PART NO.	DESCRIPTION	
1	Valve Cover Gasket Set	1991	VS 50179 T	PermaDryPlus®	
1	Valve Cover Gasket Set	1991	VS 50329 C	Cork	
QTY	PUSH ROD COVER	YEARS	PART NO.	DESCRIPTION	
1	Push Rod Cover Gasket Set	1991	PS 50276 C	w/Grommets; Cork	
QTY	VALVE STEM SEAL SET	YEARS	PART NO.	DESCRIPTION	
1	Valve Stem Seal Set	1991	SS 72684	Premium valve stem seals incl.	
QTY	THERMOSTAT HOUSING	YEARS	PART NO.	DESCRIPTION	
1	Thermostat Gasket	1991	35543	Thermostat Housing; Housing to head	
QTY	WATER OUTLET GASKET	YEARS	PART NO.	DESCRIPTION	
1	Water Outlet Gasket	1991	35568	Water Outlet	
QTY	WATER PUMP	YEARS	PART NO.	DESCRIPTION	
1	Water Pump Gasket	1991	35490		
QTY	TIMING COVER	YEARS	PART NO.	DESCRIPTION	
1	Timing Cover Set	1991	TCS 13198-2	w/o Sleeve 'N' Seal®	
1	Timing Set w/Sleeve & Seal	1991	TCS 45264	w/Sleeve 'N' Seal®	
1	Repair Sleeve	1991	16202	Timing Cover; Use w/installation tool	
1	Repair Sleeve Tool	1991	16312	Timing Cover	
QTY	AIR CLEANER MOUNTING	YEARS	PART NO.	DESCRIPTION	
1	Air Cleaner Gasket	1991	11528	4" ID	

GMC Truck (Incl. Minivans and SUV's) (Cont.)

20 (cont.)		1991; 2.5L 151 (2475cc) OHV L4 (8 Valve) 4" Bore			20 (cont.)
		TBI; Gasoline; Naturally Aspirated GMC Eng.; Pontiac; VIN Code E			
QTY	CARB & FUEL INJECTION	YEARS	PART NO.	DESCRIPTION	
1	Throttle Body Gasket	1991	60764		
QTY	DISTRIBUTOR MOUNTING	YEARS	PART NO.	DESCRIPTION	
1	O-Ring	1991	70484-1	Distributor Mounting	
QTY	EXHAUST GAS RECIRCULATION	YEARS	PART NO.	DESCRIPTION	
1	EGR Gasket	1991	70978		
21		2004 - 2001; 2.5L 152 (2492cc) DOHC V6 (24 Valve) 84mm Bore			21
		MFI; Gasoline; Naturally Aspirated Suzuki Eng.; VIN Code 4, Eng. Code H25A			
QTY	CYLINDER HEAD	YEARS	PART NO.	DESCRIPTION	
1	Head Gasket	2004-01	26386 PT	Loc. L.H.; Head bolts not incl.; Head bolt replacement recommended	
1	Head Gasket	2004-01	26387 PT	Loc. R.H.; Head bolts not incl.; Head bolt replacement recommended	
1	Head Set	2004-01	HS 26386 PT	Head bolts not incl.; Head bolt replacement recommended; PermaDry® molded rubber valve cover gskts. incl.; Premium valve stem seals incl.	
2	Head Bolt Set	2004-01	ES 72206	Head bolts w/Washers; Replacement recommended	
QTY	CONVERSION SET	YEARS	PART NO.	DESCRIPTION	
1	Gasket Conversion Set	2004-01	CS 26386	RTV sealant incl. for Upper oil pan gskt.	
QTY	MANIFOLD - INT. & EXH.	YEARS	PART NO.	DESCRIPTION	
1	Int. Manifold Gasket Set	2004-01	MS 97028	Lower set; Upper set incl.	
1	Exh. Manifold Gasket Set	2004-01	MS 97043		
QTY	EXHAUST PIPE FLANGE	YEARS	PART NO.	DESCRIPTION	
2	Exhaust Pipe Gasket	2004-01	61016	Converter; Improved design	
2	Exhaust Pipe Gasket	2004-01	61387	Pipe to manifold	
QTY	OIL PAN	YEARS	PART NO.	DESCRIPTION	
1	Oil Pan Gasket Set	2004-01	OS 30802	Loc. Lower	
QTY	CRANKSHAFT REAR SEAL	YEARS	PART NO.	DESCRIPTION	
1	Rear Main Seal Set	2004-01	BS 40687	Rubber; One-piece	
QTY	VALVE COVER	YEARS	PART NO.	DESCRIPTION	
1	Valve Cover Gasket Set	2004-01	VS 50736 R	w/Grommets & Spark plug tube seals; PermaDry® molded rubber gskts. incl.	
1	Semi-Circular Plug	2004-01	CP 75024	Valve Cover; New Part Number - Check for Availability	
QTY	VALVE STEM SEAL SET	YEARS	PART NO.	DESCRIPTION	
2	Valve Stem Seal Set	2004-01	SS 70283-2	Premium valve stem seals incl.	
QTY	THERMOSTAT HOUSING	YEARS	PART NO.	DESCRIPTION	
1	O-Ring	2004-01	35768	Thermostat Housing; Thermostat seal	
QTY	WATER OUTLET GASKET	YEARS	PART NO.	DESCRIPTION	
1	Water Outlet Gasket	2004-01	35878	Water Outlet; Loc. Front	
QTY	WATER PUMP	YEARS	PART NO.	DESCRIPTION	
1	Water Pump Gasket	2004-01	35875	O-ring	
QTY	TIMING COVER	YEARS	PART NO.	DESCRIPTION	
1	Crankshaft Front Seal Set	2004-01	TCS 46136		
QTY	CARB & FUEL INJECTION	YEARS	PART NO.	DESCRIPTION	
1	Throttle Body Gasket	2004-01	61534		
QTY	EXHAUST GAS RECIRCULATION	YEARS	PART NO.	DESCRIPTION	
1	EGR Gasket	2004-01	71026	Pipe	
1	EGR Gasket	2004-01	71218	Valve	
22		2006 - 2004; 2.8L 169 (2770cc) DOHC L4 (16 Valve) 93mm Bore Vortec			22
		MFI; Gasoline; Naturally Aspirated GMC Eng.; Chevrolet; VIN Code 8			
QTY	CYLINDER HEAD	YEARS	PART NO.	DESCRIPTION	
1	Head Gasket	2006-04	26335 PT	Head bolts not incl.; Head bolt replacement recommended; PermaTorqueMLS®	
1	Head Set	2006-04	HS 26335 PT	Head bolts not incl.; Head bolt replacement recommended; PermaDry® molded rubber valve cover gskt. incl.; Premium valve stem seals incl.	
1	Head Bolt Set	2006-04	ES 71334	Head bolts w/Washers; Replacement recommended; Improved design	
1	Head Bolt Set	2006-04	ES 72195	Head bolts w/Washers; Replacement recommended; Old design	
QTY	CONVERSION SET	YEARS	PART NO.	DESCRIPTION	
1	Gasket Conversion Set	2006-04	CS 26335	RTV sealant incl. for oil pan gskt.	
QTY	MANIFOLD - INT. & EXH.	YEARS	PART NO.	DESCRIPTION	
1	Int. Manifold Gasket Set	2006-04	MS 96440-1		
1	Exh. Manifold Gasket Set	2006-04	MS 96888		
QTY	EXHAUST PIPE FLANGE	YEARS	PART NO.	DESCRIPTION	
1	Exhaust Pipe Gasket	2006-04	61348	Pipe to manifold	
QTY	CRANKSHAFT REAR SEAL	YEARS	PART NO.	DESCRIPTION	
1	Rear Main Seal Set	2006-04	BS 40705	PTFE Rubber; One-piece	

GMC Truck (Incl. Minivans and SUV's) (Cont.)

22 (cont.)		2006 - 2004; 2.8L 169 (2770cc) DOHC L4 (16 Valve) 93mm Bore Vortec MFI; Gasoline; Naturally Aspirated GMC Eng.; Chevrolet; VIN Code 8			22 (cont.)
QTY	VALVE COVER	YEARS	PART NO.	DESCRIPTION	
1	Valve Cover Gasket Set	2006-04	VS 50704 R	w/Grommets & Spark plug tube seals; Must be used w/MS 96440-1; PermaDry® molded rubber gskt. incl.	
QTY	VALVE STEM SEAL SET	YEARS	PART NO.	DESCRIPTION	
1	Valve Stem Seal Set	2006-04	SS 71043	Premium valve stem seals incl.	
QTY	THERMOSTAT HOUSING	YEARS	PART NO.	DESCRIPTION	
1	Thermostat Gasket	2006-04	35632	Thermostat Housing; Thermostat O-ring	
QTY	WATER OUTLET GASKET	YEARS	PART NO.	DESCRIPTION	
1	Water Outlet Gasket	2006-04	36009	Water Outlet; Coolant outlet seal; New Part Number - Check for Availability	
QTY	WATER PUMP	YEARS	PART NO.	DESCRIPTION	
1	Water Pump Gasket	2006-04	35704		
QTY	TIMING COVER	YEARS	PART NO.	DESCRIPTION	
1	Timing Cover Set	2006-04	TCS 45052		
QTY	CARB & FUEL INJECTION	YEARS	PART NO.	DESCRIPTION	
1	Fuel Injector O-Ring Set	2006-04	ES 70599	Upper set; Injectors to fuel rail; Improved design	
1	Fuel Injector O-Ring Set	2006-04	ES 71190	Lower set; Injectors to cylinder head	
1	Fuel Injector O-Ring Set	2006-04	ES 71192	Upper set; Injectors to fuel rail; Old design	
1	Throttle Body Gasket	2006-04	61337	Improved design	
QTY	EXHAUST GAS RECIRCULATION	YEARS	PART NO.	DESCRIPTION	
1	EGR Gasket	2006-04	72755	EGR tube; New Part Number - Check for Availability	
23		2011 - 2010; 2.8L 171 (2792cc) DOHC V6 (24 Valve) 89mm Bore DI; Gasoline; Turbo - Intercooled Opel Eng.; VIN Code 4			23
QTY	CYLINDER HEAD	YEARS	PART NO.	DESCRIPTION	
2	Head Bolt Set	2011-10	ES 72274	Replacement recommended	
QTY	CONVERSION SET	YEARS	PART NO.	DESCRIPTION	
1	Gasket Conversion Set	2011-10	CS 26376-1	RTV sealant incl. for oil pan gskt.; Improved design	
QTY	MANIFOLD - INT. & EXH.	YEARS	PART NO.	DESCRIPTION	
1	Int. Manifold Gasket Set	2011-10	MS 96969	Lower set; Upper set incl.	
1	Plenum Gasket Set	2011-10	MS 96976	Upper set	
1	Exh. Manifold Gasket Set	2011-10	MS 96970		
QTY	EXHAUST PIPE FLANGE	YEARS	PART NO.	DESCRIPTION	
2	Exhaust Pipe Gasket	2011-10	61615	Pipe to manifold	
2	Exhaust Pipe Gasket	2011-10	61636	Converter	
QTY	CRANKSHAFT REAR SEAL	YEARS	PART NO.	DESCRIPTION	
1	Rear Main Seal Set	2011-10	BS 40711	PTFE Rubber; One-piece; Improved design	
QTY	VALVE COVER	YEARS	PART NO.	DESCRIPTION	
1	Valve Cover Gasket Set	2011-10	VS 50726 R	w/o Spark plug tube seals & w/Grommets; PermaDry® molded rubber gskts. incl.	
1	Spark Plug Tube Seal Set	2011-10	ES 72393	Valve Cover; New Part Number - Check for Availability	
QTY	VALVE STEM SEAL SET	YEARS	PART NO.	DESCRIPTION	
1	Valve Stem Seal Set	2011-10	SS 72923	Premium valve stem seals incl.	
QTY	THERMOSTAT HOUSING	YEARS	PART NO.	DESCRIPTION	
1	Thermostat Gasket	2011-10	35858	Thermostat Housing; Thermostat seal	
1	Thermostat Gasket	2011-10	35871	Thermostat Housing; Thermostat housing to head	
QTY	WATER PUMP	YEARS	PART NO.	DESCRIPTION	
1	Water Pump Gasket	2011-10	35859		
QTY	TIMING COVER	YEARS	PART NO.	DESCRIPTION	
1	Timing Cover Set	2011-10	TCS 46108		
QTY	CARB & FUEL INJECTION	YEARS	PART NO.	DESCRIPTION	
2	Fuel Injector O-Ring Set	2011-10	ES 70599	Upper set; Injectors to fuel rail; Improved design	
2	Fuel Injector O-Ring Set	2011-10	ES 72004	Lower set; Injectors to cylinder head	
1	Throttle Body Gasket	2011-10	61520		
24		2011; 2.8L 171 (2792cc) DOHC V6 (24 Valve) 89mm Bore DI; Gasoline; Turbo - Intercooled Opel Eng.; VIN Code 6			24
QTY	CYLINDER HEAD	YEARS	PART NO.	DESCRIPTION	
2	Head Bolt Set	2011	ES 72274	Replacement recommended	
QTY	CONVERSION SET	YEARS	PART NO.	DESCRIPTION	
1	Gasket Conversion Set	2011	CS 26376-1	RTV sealant incl. for oil pan gskt.; Improved design	
QTY	MANIFOLD - INT. & EXH.	YEARS	PART NO.	DESCRIPTION	
1	Int. Manifold Gasket Set	2011	MS 96969	Lower set; Upper set incl.	
1	Plenum Gasket Set	2011	MS 96976	Upper set	
1	Exh. Manifold Gasket Set	2011	MS 96970		

GMC Truck (Incl. Minivans and SUV's) (Cont.)

24 (cont.)		2011; 2.8L 171 (2792cc) DOHC V6 (24 Valve) 89mm Bore			24 (cont.)
		DI; Gasoline; Turbo - Intercooled Opel Eng.; VIN Code 6			
QTY	EXHAUST PIPE FLANGE	YEARS	PART NO.	DESCRIPTION	
2	Exhaust Pipe Gasket	2011	61615	Pipe to manifold	
2	Exhaust Pipe Gasket	2011	61636	Converter	
QTY	CRANKSHAFT REAR SEAL	YEARS	PART NO.	DESCRIPTION	
1	Rear Main Seal Set	2011	BS 40711	PTFE Rubber; One-piece; Improved design	
QTY	VALVE COVER	YEARS	PART NO.	DESCRIPTION	
1	Valve Cover Gasket Set	2011	VS 50726 R	w/o Spark plug tube seals & w/Grommets; PermaDry® molded rubber gskts. incl.	
1	Spark Plug Tube Seal Set	2011	ES 72393	Valve Cover; New Part Number - Check for Availability	
QTY	VALVE STEM SEAL SET	YEARS	PART NO.	DESCRIPTION	
1	Valve Stem Seal Set	2011	SS 72923	Premium valve stem seals incl.	
QTY	THERMOSTAT HOUSING	YEARS	PART NO.	DESCRIPTION	
1	Thermostat Gasket	2011	35858	Thermostat Housing; Thermostat seal	
1	Thermostat Gasket	2011	35871	Thermostat Housing; Thermostat housing to head	
QTY	WATER PUMP	YEARS	PART NO.	DESCRIPTION	
1	Water Pump Gasket	2011	35859		
QTY	TIMING COVER	YEARS	PART NO.	DESCRIPTION	
1	Timing Cover Set	2011	TCS 46108		
QTY	CARB & FUEL INJECTION	YEARS	PART NO.	DESCRIPTION	
2	Fuel Injector O-Ring Set	2011	ES 72004	Lower set; Injectors to cylinder head	
2	Fuel Injector O-Ring Set	2011	ES 70599	Upper set; Injectors to fuel rail; Improved design	
1	Throttle Body Gasket	2011	61520		
25		1993 - 1991; 2.8L 173 (2835cc) OHV V6 (12 Valve) 89mm Bore			25
		TBI; Gasoline; Naturally Aspirated GMC Eng.; Chevrolet; VIN Code R			
QTY	CYLINDER HEAD	YEARS	PART NO.	DESCRIPTION	
2	Head Gasket	1993-91	512 SD	Head bolts not incl.; Head bolt replacement recommended; PermaTorque Severe Duty®	
2	Head Gasket	1993-91	8699 PT-2	Head bolts not incl.; Head bolt replacement recommended; PermaTorque®	
2	Head Gasket Spacer Shim	1993-91	8699 SP-1	HeadSaver®	
1	Head Set	1993-91	HS 8699 PT-6	Head bolts & exh. pipe packing not incl.; Head bolt replacement recommended; Premium valve stem seals incl.	
1	Head Installation Set	1993-91	HIS 8699 PT-6	Head bolts & exh. pipe packing not incl.; Head bolt replacement recommended	
1	Head Bolt Set	1993-91	ES 72857	Replacement recommended	
QTY	CONVERSION SET	YEARS	PART NO.	DESCRIPTION	
1	Gasket Conversion Set	1993-91	CS 9471	PermaDry® molded rubber oil pan gskt. incl.	
QTY	MANIFOLD - INT. & EXH.	YEARS	PART NO.	DESCRIPTION	
1	Int. Manifold Gasket Set	1993-91	MS 91022		
1	Exh. Manifold Gasket Set	1993-91	MS 90864		
QTY	EXHAUST PIPE FLANGE	YEARS	PART NO.	DESCRIPTION	
2	Exhaust Pipe Gasket	1993-91	60538	Packing	
QTY	FUEL PUMP	YEARS	PART NO.	DESCRIPTION	
1	Fuel Pump Mounting Gasket	1993-91	70015		
QTY	OIL PAN	YEARS	PART NO.	DESCRIPTION	
1	Oil Pan Gasket Set	1993-91	OS 34501 R	PermaDry® molded rubber gskt. incl.	
1	Drain Plug Gasket	1993-91	70822		
QTY	CRANKSHAFT REAR SEAL	YEARS	PART NO.	DESCRIPTION	
1	Rear Main Seal Set	1993-91	BS 40464	11.0mm thick; Rubber; One-piece; Improved design	
1	Rear Main Seal Set	1993-91	BS 40625	11.0mm thick; PTFE Rubber; One-piece; Improved design	
1	Repair Sleeve Tool	1993-91	16304	Crankshaft	
QTY	VALVE COVER	YEARS	PART NO.	DESCRIPTION	
1	Valve Cover Gasket Set	1993-91	VS 50272 C	Cork; Improved design	
1	Valve Cover Gasket Set	1993-91	VS 50272 R	Rubber; Old design; Superseded - When depleted use VS 50272 C	
1	Valve Cover Gasket Set	1993-91	VS 50272 T	PermaDryPlus®	
QTY	VALVE STEM SEAL SET	YEARS	PART NO.	DESCRIPTION	
1	Valve Stem Seal Set	1993-91	SS 72530	Premium valve stem seals incl.	
QTY	WATER OUTLET GASKET	YEARS	PART NO.	DESCRIPTION	
1	Water Outlet Gasket	1993-91	35258	Water Outlet	
QTY	WATER PUMP	YEARS	PART NO.	DESCRIPTION	
1	Water Pump Gasket	1993-91	35409		
QTY	TIMING COVER	YEARS	PART NO.	DESCRIPTION	
1	Timing Cover Set	1993-91	TCS 45828	w/o Sleeve 'N' Seal®; Must be used w/OS 34501R	

GMC Truck (Incl. Minivans and SUV's) (Cont.)

25 (cont.)		1993 - 1991; 2.8L 173 (2835cc) OHV V6 (12 Valve) 89mm Bore			25 (cont.)	
TBI; Gasoline; Naturally Aspirated GMC Eng.; Chevrolet; VIN Code R						
QTY	TIMING COVER	YEARS	PART NO.	DESCRIPTION		
1	Timing Cover Gasket	1993-91	72670	New Part Number - Check for Availability		
1	Timing Cover Gasket	1993-91	72696	Camshaft rear cover plate; New Part Number - Check for Availability		
1	Timing Set w/Sleeve & Seal	1993-91	TCS 45827	w/Sleeve 'N' Seal®; Must be used w/OS 34501R; 1.040" sleeve length		
1	Repair Sleeve	1993-91	16212	Timing Cover; 1.040" sleeve length; Use w/installation tool		
1	Repair Sleeve Tool	1993-91	16312	Timing Cover		
QTY	AIR CLEANER MOUNTING	YEARS	PART NO.	DESCRIPTION		
1	Air Cleaner Gasket	1993-91	60038	5 1/32" ID		
QTY	CARB & FUEL INJECTION	YEARS	PART NO.	DESCRIPTION		
1	Throttle Body Gasket	1993-91	60770			
QTY	DISTRIBUTOR MOUNTING	YEARS	PART NO.	DESCRIPTION		
1	O-Ring	1993-91	70800	Distributor Mounting		
QTY	EXHAUST GAS RECIRCULATION	YEARS	PART NO.	DESCRIPTION		
1	EGR Gasket	1993-91	70954			
QTY	OIL FILTER MOUNTING	YEARS	PART NO.	DESCRIPTION		
1	Oil Filter Gasket	1993-91	70672			
26		2012 - 2007; 2.9L 178.2 (2921cc) DOHC L4 (16 Valve) 95.5mm Bore Vortec				26
MFI; Gasoline; Naturally Aspirated GMC Eng.; Chevrolet; VIN Code 9						
QTY	CYLINDER HEAD	YEARS	PART NO.	DESCRIPTION		
1	Head Gasket	2012-07	26389 PT	Head bolts not incl.; Head bolt replacement recommended; PermaTorqueMLS®		
1	Head Set	2012-07	HS 26389 PT	Head bolts not incl.; Head bolt replacement recommended; PermaDry® molded rubber valve cover gskt. incl.; Premium valve stem seals incl.		
1	Head Bolt Set	2012-07	ES 71334	Head bolts w/Washers; Replacement recommended; Improved design		
1	Head Bolt Set	2012-07	ES 72195	Head bolts w/Washers; Replacement recommended; Old design		
QTY	CONVERSION SET	YEARS	PART NO.	DESCRIPTION		
1	Gasket Conversion Set	2012-07	CS 26335	RTV sealant incl. for oil pan gskt.		
QTY	MANIFOLD - INT. & EXH.	YEARS	PART NO.	DESCRIPTION		
1	Int. Manifold Gasket Set	2012-07	MS 96440-1			
1	Exh. Manifold Gasket Set	2012-07	MS 97008			
QTY	EXHAUST PIPE FLANGE	YEARS	PART NO.	DESCRIPTION		
1	Exhaust Pipe Gasket	2012-07	61348	Pipe to manifold		
QTY	CRANKSHAFT REAR SEAL	YEARS	PART NO.	DESCRIPTION		
1	Rear Main Seal Set	2012-07	BS 40705	PTFE Rubber; One-piece		
QTY	VALVE COVER	YEARS	PART NO.	DESCRIPTION		
1	Valve Cover Gasket Set	2012-07	VS 50738 R	w/Grommets & Spark plug tube seals; Must be used w/MS 96440-1; PermaDry® molded rubber gskt. incl.		
QTY	VALVE STEM SEAL SET	YEARS	PART NO.	DESCRIPTION		
1	Valve Stem Seal Set	2012-07	SS 71237-1	Premium valve stem seals incl.		
QTY	THERMOSTAT HOUSING	YEARS	PART NO.	DESCRIPTION		
1	Thermostat Gasket	2012-07	35632	Thermostat O-ring		
QTY	WATER OUTLET GASKET	YEARS	PART NO.	DESCRIPTION		
1	Water Outlet Gasket	2012-07	36017	Water Outlet; Coolant outlet seal; New Part Number - Check for Availability		
QTY	WATER PUMP	YEARS	PART NO.	DESCRIPTION		
1	Water Pump Gasket	2012-07	35704			
QTY	TIMING COVER	YEARS	PART NO.	DESCRIPTION		
1	Timing Cover Set	2012-07	TCS 45052			
QTY	CARB & FUEL INJECTION	YEARS	PART NO.	DESCRIPTION		
1	Fuel Injector O-Ring Set	2012-07	ES 70599	Upper set; Injectors to fuel rail; Improved design		
1	Fuel Injector O-Ring Set	2012-07	ES 71190	Lower set; Injectors to cylinder head		
1	Fuel Injector O-Ring Set	2012-07	ES 71192	Upper set; Injectors to fuel rail; Old design		
1	Throttle Body Gasket	2012-07	61337	Improved design		
QTY	EXHAUST GAS RECIRCULATION	YEARS	PART NO.	DESCRIPTION		
1	EGR Gasket	2012-07	72755	EGR tube; New Part Number - Check for Availability		
27		2003 - 2002; 3.0L 181 (2962cc) DOHC V6 (24 Valve) 86mm Bore				27
MFI; Gasoline; Naturally Aspirated Opel Eng.; VIN Code B						
QTY	CYLINDER HEAD	YEARS	PART NO.	DESCRIPTION		
2	Head Gasket	2003-02	26173 PT	Head bolts not incl.; Head bolt replacement recommended; PermaTorqueMLS® LaserWeld® Technology		

GMC Truck (Incl. Minivans and SUV's) (Cont.)

27 (cont.)	2003 - 2002; 3.0L 181 (2962cc) DOHC V6 (24 Valve) 86mm Bore				27 (cont.)
MFI; Gasoline; Naturally Aspirated Opel Eng.; VIN Code B					
QTY	CYLINDER HEAD	YEARS	PART NO.	DESCRIPTION	
1	Head Set	2003	HS 26173 PT-3	1st Design; To Eng. Ser. No. 779874; Head bolts not incl.; Head bolt replacement recommended; PermaDry® molded rubber valve cover gskts. incl.; Premium valve stem seals incl.	
1	Head Set	2003	HS 26173 PT-4	2nd Design; From Eng. Ser. No. 779875; Head bolts not incl.; Head bolt replacement recommended; PermaDry® molded rubber valve cover gskts. incl.; Premium valve stem seals incl.	
1	Head Set	2002	HS 26173 PT-3	Head bolts not incl.; Head bolt replacement recommended; PermaDry® molded rubber valve cover gskts. incl.; Premium valve stem seals incl.	
2	Head Bolt Set	2003-02	ES 72906	Head bolts w/Washers; Replacement recommended	
QTY	CONVERSION SET	YEARS	PART NO.	DESCRIPTION	
1	Gasket Conversion Set	2003-02	CS 26173-4	RTV sealant incl. for oil pan gskt.	
QTY	MANIFOLD - INT. & EXH.	YEARS	PART NO.	DESCRIPTION	
1	Int. Manifold Gasket Set	2003-02	MS 96538	Lower set; Upper set incl.	
1	Exh. Manifold Gasket Set	2003-02	MS 96425		
QTY	EXHAUST PIPE FLANGE	YEARS	PART NO.	DESCRIPTION	
1	Exhaust Pipe Gasket	2003-02	61187	Converter	
2	Exhaust Pipe Gasket	2003-02	61187	Pipe to manifold	
QTY	CRANKSHAFT REAR SEAL	YEARS	PART NO.	DESCRIPTION	
1	Rear Main Seal Set	2003-02	BS 40671	Rubber; One-piece; Improved design	
1	Rear Main Seal Set	2003-02	BS 40739	Rubber; One-piece; New Improved design; New Part Number - Check for Availability	
QTY	VALVE COVER	YEARS	PART NO.	DESCRIPTION	
1	Valve Cover Gasket Set	2003	VS 50566 R	1st Design; To Eng. Ser. No. 779874; w/Grommets; PermaDry® molded rubber gskts. incl.	
1	Valve Cover Gasket Set	2003	VS 50628 R	2nd Design; From Eng. Ser. No. 779875; w/Grommets; PermaDry® molded rubber gskts. incl.	
1	Valve Cover Gasket Set	2002	VS 50566 R	w/Grommets; PermaDry® molded rubber gskts. incl.	
QTY	VALVE STEM SEAL SET	YEARS	PART NO.	DESCRIPTION	
1	Valve Stem Seal Set	2003-02	SS 71163	Premium valve stem seals incl.	
QTY	THERMOSTAT HOUSING	YEARS	PART NO.	DESCRIPTION	
1	O-Ring	2003-02	35668	Thermostat Housing; Exc. Housing No. 55353492	
1	O-Ring	2003-02	35749	Thermostat Housing; Housing No. 55353492	
QTY	WATER PUMP	YEARS	PART NO.	DESCRIPTION	
1	Water Pump Gasket	2003-02	35665	O-ring	
QTY	TIMING COVER	YEARS	PART NO.	DESCRIPTION	
1	Crankshaft Front Seal Set	2003-02	TCS 46014		
4	Camshaft Front Seal Set	2003-02	TCS 45603		
QTY	CARB & FUEL INJECTION	YEARS	PART NO.	DESCRIPTION	
3	Fuel Injector O-Ring Set	2003-02	ES 70599	Improved design	
1	Throttle Body Gasket	2003-02	61335		
QTY	EXHAUST GAS RECIRCULATION	YEARS	PART NO.	DESCRIPTION	
1	EGR Gasket	2003-02	70789	Valve	
1	EGR Gasket	2003-02	71103	Adapter	
QTY	OIL FILTER MOUNTING	YEARS	PART NO.	DESCRIPTION	
1	Oil Filter Adapter Gasket	2003-02	72737	Oil filter adapter; New Part Number - Check for Availability	
28	2012 - 2011; 3.0L 182.9 (2997cc) DOHC V6 (24 Valve) 89mm Bore VVT				28
DI; Flex Fuel; Naturally Aspirated Opel Eng.; VIN Code 5					
QTY	CYLINDER HEAD	YEARS	PART NO.	DESCRIPTION	
2	Head Bolt Set	2012-11	ES 72274	Replacement recommended	
QTY	CONVERSION SET	YEARS	PART NO.	DESCRIPTION	
1	Gasket Conversion Set	2012-11	CS 26376-1	RTV sealant incl. for oil pan gskt.; Improved design	
QTY	EXHAUST PIPE FLANGE	YEARS	PART NO.	DESCRIPTION	
1	Exhaust Pipe Gasket	2012-11	61465	Loc. Rear; Converter	
1	Exhaust Pipe Gasket	2012-11	61708	Loc. Front; Converter; New Part Number - Check for Availability	
QTY	OIL PAN	YEARS	PART NO.	DESCRIPTION	
1	Drain Plug Gasket	2012-11	70820		
QTY	CRANKSHAFT REAR SEAL	YEARS	PART NO.	DESCRIPTION	
1	Rear Main Seal Set	2012-11	BS 40711	PTFE Rubber; One-piece; Improved design	
QTY	VALVE COVER	YEARS	PART NO.	DESCRIPTION	
1	Valve Cover Gasket Set	2012-11	VS 50808 R	w/Grommets & Spark plug tube seals; PermaDry® molded rubber gskts. incl.; New Part Number - Check for Availability	

GMC Truck (Incl. Minivans and SUV's) (Cont.)

28		2012 - 2011; 3.0L 182.9 (2997cc) DOHC V6 (24 Valve) 89mm Bore VVT			28
(cont.)		DI; Flex Fuel; Naturally Aspirated Opel Eng.; VIN Code 5			(cont.)
QTY	VALVE COVER	YEARS	PART NO.	DESCRIPTION	
1	Spark Plug Tube Seal Set	2012-11	ES 72393	Valve Cover; New Part Number - Check for Availability	
QTY	THERMOSTAT HOUSING	YEARS	PART NO.	DESCRIPTION	
1	Thermostat Gasket	2012-11	35858	Thermostat Housing; Thermostat seal	
1	Thermostat Gasket	2012-11	35871	Thermostat Housing; Thermostat housing to head	
QTY	WATER PUMP	YEARS	PART NO.	DESCRIPTION	
1	Water Pump Gasket	2012-11	35859		
QTY	TIMING COVER	YEARS	PART NO.	DESCRIPTION	
1	Timing Cover Set	2012-11	TCS 46108		
QTY	CARB & FUEL INJECTION	YEARS	PART NO.	DESCRIPTION	
2	Fuel Injector O-Ring Set	2012-11	ES 70599	Upper set; Injectors to fuel rail; Improved design	
2	Fuel Injector O-Ring Set	2012-11	ES 72004	Lower set; Injectors to cylinder head	
1	Throttle Body Gasket	2012-11	61699	New Part Number - Check for Availability	
29		2012 - 2010; 3.0L 182.9 (2997cc) DOHC V6 (24 Valve) 89mm Bore VVT			29
		DI; Gasoline; Naturally Aspirated Opel Eng.; VIN Code Y			
QTY	CYLINDER HEAD	YEARS	PART NO.	DESCRIPTION	
2	Head Bolt Set	2012-10	ES 72274	Replacement recommended	
QTY	CONVERSION SET	YEARS	PART NO.	DESCRIPTION	
1	Gasket Conversion Set	2012-10	CS 26376-1	RTV sealant incl. for oil pan gskt.; Improved design	
QTY	EXHAUST PIPE FLANGE	YEARS	PART NO.	DESCRIPTION	
1	Exhaust Pipe Gasket	2012-10	61465	Loc. Rear; Converter	
1	Exhaust Pipe Gasket	2012-10	61708	Loc. Front; Converter; New Part Number - Check for Availability	
QTY	OIL PAN	YEARS	PART NO.	DESCRIPTION	
1	Drain Plug Gasket	2012-10	70820		
QTY	CRANKSHAFT REAR SEAL	YEARS	PART NO.	DESCRIPTION	
1	Rear Main Seal Set	2012-10	BS 40711	PTFE Rubber; One-piece; Improved design	
QTY	VALVE COVER	YEARS	PART NO.	DESCRIPTION	
1	Valve Cover Gasket Set	2012-10	VS 50808 R	w/Grommets & Spark plug tube seals; PermaDry® molded rubber gskts. incl.; New Part Number - Check for Availability	
1	Spark Plug Tube Seal Set	2012-10	ES 72393	Valve Cover; New Part Number - Check for Availability	
QTY	THERMOSTAT HOUSING	YEARS	PART NO.	DESCRIPTION	
1	Thermostat Gasket	2012-10	35858	Thermostat Housing; Thermostat seal	
1	Thermostat Gasket	2012-10	35871	Thermostat Housing; Thermostat housing to head	
QTY	WATER PUMP	YEARS	PART NO.	DESCRIPTION	
1	Water Pump Gasket	2012-10	35859		
QTY	TIMING COVER	YEARS	PART NO.	DESCRIPTION	
1	Timing Cover Set	2012-10	TCS 46108		
QTY	CARB & FUEL INJECTION	YEARS	PART NO.	DESCRIPTION	
2	Fuel Injector O-Ring Set	2012-10	ES 70599	Upper set; Injectors to fuel rail; Improved design	
2	Fuel Injector O-Ring Set	2012-10	ES 72004	Lower set; Injectors to cylinder head	
1	Throttle Body Gasket	2012-10	61699	New Part Number - Check for Availability	
30		1995 - 1991; 3.1L 189 (3136cc) OHV V6 (12 Valve) 89mm Bore			30
		TBI; Gasoline; Naturally Aspirated GMC Eng.; Chevrolet; VIN Code D			
QTY	CYLINDER HEAD	YEARS	PART NO.	DESCRIPTION	
2	Head Gasket	1995-91	512 SD	Head bolts not incl.; Head bolt replacement recommended; PermaTorque Severe Duty®	
2	Head Gasket	1995-91	8699 PT-2	Head bolts not incl.; Head bolt replacement recommended; PermaTorque®	
2	Head Gasket Spacer Shim	1995-91	8699 SP-1	HeadSaver®	
1	Head Set	1995-91	HS 8699 PT-7	Head bolts & exh. pipe packing not incl.; Head bolt replacement recommended; Premium valve stem seals incl.	
1	Head Installation Set	1995-91	HIS 8699 PT-7	Head bolts & exh. pipe packing not incl.; Head bolt replacement recommended	
1	Head Bolt Set	1995-91	ES 72901	Replacement recommended	
QTY	CONVERSION SET	YEARS	PART NO.	DESCRIPTION	
1	Gasket Conversion Set	1995-91	CS 9471	PermaDry® molded rubber oil pan gskt. incl.	
QTY	MANIFOLD - INT. & EXH.	YEARS	PART NO.	DESCRIPTION	
1	Int. Manifold Gasket Set	1995-91	MS 91022		
1	Exh. Manifold Gasket Set	1995-91	MS 90864		
QTY	EXHAUST PIPE FLANGE	YEARS	PART NO.	DESCRIPTION	
1	Exhaust Pipe Gasket	1995-94	60997	Packing	
1	Exhaust Pipe Gasket	1993-91	60538	Packing	

GMC Truck (Incl. Minivans and SUV's) (Cont.)

30 (cont.)		1995 - 1991; 3.1L 189 (3136cc) OHV V6 (12 Valve) 89mm Bore			30 (cont.)
TBI; Gasoline; Naturally Aspirated GMC Eng.; Chevrolet; VIN Code D					
QTY	OIL PAN	YEARS	PART NO.	DESCRIPTION	
1	Oil Pan Gasket Set	1995-91	OS 34501 R	PermaDry® molded rubber gskt. incl.	
1	Drain Plug Gasket	1995-91	70822		
QTY	CRANKSHAFT REAR SEAL	YEARS	PART NO.	DESCRIPTION	
1	Rear Main Seal Set	1995-91	BS 40464	11.0mm thick; Rubber; One-piece; Improved design	
1	Rear Main Seal Set	1995-91	BS 40625	11.0mm thick; PTFE Rubber; One-piece; Improved design	
1	Repair Sleeve Tool	1995-91	16304	Crankshaft	
QTY	VALVE COVER	YEARS	PART NO.	DESCRIPTION	
1	Valve Cover Gasket Set	1995-91	VS 50272 C	Cork; Improved design	
1	Valve Cover Gasket Set	1995-91	VS 50272 R	Rubber; Old design; Superseded - When depleted use VS 50272 C	
1	Valve Cover Gasket Set	1995-91	VS 50272 T	PermaDryPlus®	
QTY	VALVE STEM SEAL SET	YEARS	PART NO.	DESCRIPTION	
1	Valve Stem Seal Set	1995-91	SS 72530	Premium valve stem seals incl.	
QTY	THERMOSTAT HOUSING	YEARS	PART NO.	DESCRIPTION	
1	Water Outlet Gasket	1995-91	35258	Thermostat Housing	
1	Thermostat Gasket	1995-91	35571	Thermostat Housing; Bypass pipe	
1	Thermostat Gasket	1995-91	35614	Thermostat Housing; Thermostat seal; Improved design	
QTY	WATER PUMP	YEARS	PART NO.	DESCRIPTION	
1	Water Pump Gasket	1995-91	35403		
QTY	TIMING COVER	YEARS	PART NO.	DESCRIPTION	
1	Timing Cover Set	1995-91	TCS 45828	w/o Sleeve 'N' Seal®; Must be used w/OS 34501R	
1	Timing Cover Gasket	1995-91	72670	New Part Number - Check for Availability	
1	Timing Cover Gasket	1995-91	72696	Camshaft rear cover plate; New Part Number - Check for Availability	
1	Timing Set w/Sleeve & Seal	1995-91	TCS 45827	w/Sleeve 'N' Seal®; Must be used w/OS 34501R; 1.040" sleeve length	
1	Repair Sleeve	1995-91	16212	Timing Cover; 1.040" sleeve length; Use w/installation tool	
1	Repair Sleeve Tool	1995-91	16312	Timing Cover	
QTY	CARB & FUEL INJECTION	YEARS	PART NO.	DESCRIPTION	
3	Fuel Injector O-Ring Set	1995-91	ES 70599	Improved design	
1	Throttle Body Gasket	1995-91	60770		
QTY	DISTRIBUTOR MOUNTING	YEARS	PART NO.	DESCRIPTION	
1	O-Ring	1995-91	70800	Distributor Mounting	
QTY	EXHAUST GAS RECIRCULATION	YEARS	PART NO.	DESCRIPTION	
1	EGR Gasket	1995-91	70978		
QTY	OIL FILTER MOUNTING	YEARS	PART NO.	DESCRIPTION	
1	Oil Filter Gasket	1995-91	70672		
31		2009 - 2004; 3.4L 207 (3393cc) OHV V6 (12 Valve) 92mm Bore			31
MFI; Gasoline; Naturally Aspirated GMC Eng.; Chevrolet; VIN Code 9					
QTY	CYLINDER HEAD	YEARS	PART NO.	DESCRIPTION	
2	Head Gasket	2009-04	541 SD	Head bolts not incl.; Head bolt replacement recommended; PermaTorque Severe Duty®	
2	Head Gasket	2009-04	9071 PT	Head bolts not incl.; Head bolt replacement recommended; PermaTorque®	
1	Head Set	2009-04	HS 9071 PT-3	Head bolts not incl.; Head bolt replacement recommended; PermaDryPlus® int. manifold gskts. incl.; PermaDry® molded rubber valve cover gskts. incl.; Premium valve stem seals incl.	
1	Head Bolt Set	2009-04	ES 72892	Replacement recommended	
QTY	CONVERSION SET	YEARS	PART NO.	DESCRIPTION	
1	Gasket Conversion Set	2009-04	CS 9071	PermaDry® molded rubber oil pan gskt. incl.	
QTY	MANIFOLD - INT. & EXH.	YEARS	PART NO.	DESCRIPTION	
1	Int. Manifold Gasket Set	2009-04	MS 98003 T-1	Valve cover gskts. & Upper set incl.; PermaDryPlus® int. manifold gskts. incl.; Manifold bolts not incl.; Manifold bolt replacement recommended	
1	Plenum Gasket Set	2009-04	MS 96730-1	Upper set	
1	Int. Manifold Bolt Set	2009-04	ES 72226	Loc. Lower; Replacement recommended	
1	Exh. Manifold Gasket Set	2009-04	MS 95586		
QTY	EXHAUST PIPE FLANGE	YEARS	PART NO.	DESCRIPTION	
1	Exhaust Pipe Gasket	2009-04	61054	Packing	
1	Exhaust Pipe Gasket	2009-04	61314	Converter	
QTY	OIL PAN	YEARS	PART NO.	DESCRIPTION	
1	Oil Pan Gasket Set	2009-04	OS 30772 R	PermaDry® molded rubber gskt. incl.	
QTY	CRANKSHAFT REAR SEAL	YEARS	PART NO.	DESCRIPTION	
1	Rear Main Seal Set	2009-04	BS 40625	11.0mm thick; PTFE Rubber; One-piece; Improved design	
1	Rear Main Seal Set	2009-04	BS 40698	PTFE Rubber; One-piece; May use BS 40625 instead; Old design; Superseded - When depleted use BS 40625	

GMC Truck (Incl. Minivans and SUV's) (Cont.)

31 (cont.)		2009 - 2004; 3.4L 207 (3393cc) OHV V6 (12 Valve) 92mm Bore			31 (cont.)
MFI; Gasoline; Naturally Aspirated GMC Eng.; Chevrolet; VIN Code 9					
QTY	VALVE COVER	YEARS	PART NO.	DESCRIPTION	
1	Valve Cover Gasket Set	2009-04	VS 50442 R	w/o Grommets; Must be used w/35614; PermaDry® molded rubber gsks. incl.	
1	Grommet Set	2009-04	ES 71044	Valve Cover	
QTY	VALVE STEM SEAL SET	YEARS	PART NO.	DESCRIPTION	
1	Valve Stem Seal Set	2009-04	SS 70829	Premium valve stem seals incl.	
QTY	WATER OUTLET GASKET	YEARS	PART NO.	DESCRIPTION	
1	Thermostat Gasket	2009-04	35614	Water Outlet; Improved design	
QTY	WATER PUMP	YEARS	PART NO.	DESCRIPTION	
1	Water Pump Gasket	2009-04	35403		
QTY	TIMING COVER	YEARS	PART NO.	DESCRIPTION	
1	Timing Cover Set	2009-04	TCS 45828	w/o Sleeve 'N' Seal®	
1	Timing Cover Gasket	2009-04	72670	New Part Number - Check for Availability	
1	Timing Set w/Sleeve & Seal	2009-04	TCS 45976	w/Sleeve 'N' Seal®; .565" sleeve length	
1	Repair Sleeve	2009-04	16215	Timing Cover; .565" sleeve length; Use w/installation tool	
1	Repair Sleeve Tool	2009-04	16312	Timing Cover	
QTY	CARB & FUEL INJECTION	YEARS	PART NO.	DESCRIPTION	
3	Fuel Injector O-Ring Set	2009-04	ES 70599	Improved design	
1	Throttle Body Gasket	2009-07	61466		
1	Throttle Body Gasket	2006-04	61456		
QTY	DISTRIBUTOR MOUNTING	YEARS	PART NO.	DESCRIPTION	
1	O-Ring	2009-04	72343	Distributor Mounting; O-ring; May also be used as a distributor block-off plate seal or oil pump drive seal if desired	
QTY	EXHAUST GAS RECIRCULATION	YEARS	PART NO.	DESCRIPTION	
1	EGR Gasket	2009-04	70804	Valve	
32		2005 - 1996; 3.4L 207 (3393cc) OHV V6 (12 Valve) 92mm Bore			32
MFI; Gasoline; Naturally Aspirated GMC Eng.; Chevrolet; VIN Code E					
QTY	CYLINDER HEAD	YEARS	PART NO.	DESCRIPTION	
2	Head Gasket	2005-96	541 SD	Head bolts not incl.; Head bolt replacement recommended; PermaTorque Severe Duty®	
2	Head Gasket	2005-96	9071 PT	Head bolts not incl.; Head bolt replacement recommended; PermaTorque®	
1	Head Set	2005-04	HS 9071 PT-2	Head bolts not incl.; Head bolt replacement recommended; PermaDryPlus® int. manifold gsks. incl.; PermaDry® molded rubber valve cover gsks. incl.; Premium valve stem seals incl.	
1	Head Set	2003-00	HS 9071 PT-1	Head bolts not incl.; Head bolt replacement recommended; PermaDry® molded rubber valve cover gsks. incl.; Premium valve stem seals incl.	
1	Head Set	2003-00	HST 9071 PT-1	Head bolts not incl.; Head bolt replacement recommended; PermaTorque Severe Duty® head gsks. incl.; PermaDryPlus® int. manifold gsks. incl.; PermaDry® molded rubber valve cover gsks. incl.; Premium valve stem seals incl.	
1	Head Set	1999-96	HST 9071 PT	Head bolts not incl.; Head bolt replacement recommended; PermaTorque Severe Duty® head gsks. incl.; PermaDryPlus® int. manifold gsks. incl.; PermaDry® molded rubber valve cover gsks. incl.; Premium valve stem seals incl.	
1	Head Set	1999-96	HS 9071 PT	Head bolts not incl.; Head bolt replacement recommended; PermaDry® molded rubber valve cover gsks. incl.; Premium valve stem seals incl.	
1	Head Installation Set	1999-96	HIS 9071 PT	Head bolts & exh. pipe packing not incl.; Head bolt replacement recommended; PermaDry® molded rubber valve cover gsks. incl.	
1	Head Bolt Set	2005-96	ES 72892	Replacement recommended	
QTY	CONVERSION SET	YEARS	PART NO.	DESCRIPTION	
1	Gasket Conversion Set	2005-96	CS 9957	PermaDry® molded rubber oil pan gskt. incl.	
QTY	MANIFOLD - INT. & EXH.	YEARS	PART NO.	DESCRIPTION	
1	Int. Manifold Gasket Set	2005-96	MS 98003 T	Valve cover gsks. & Upper set incl.; PermaDryPlus® int. manifold gsks. incl.; Manifold bolts not incl.; Manifold bolt replacement recommended	
1	Int. Manifold Gasket Set	2003-96	MS 90565	Valve cover gsks. not incl.; Upper set incl.; Manifold bolts not incl.; Manifold bolt replacement recommended	
1	Plenum Gasket Set	2005-96	MS 90505	Upper set	
1	Int. Manifold Bolt Set	2005-01	ES 72226	Loc. Lower; 10mm corner bolts; Replacement recommended	
1	Int. Manifold Bolt Set	2002-96	ES 72225	Loc. Lower; 13mm corner bolts; Replacement recommended	
1	Exh. Manifold Gasket Set	2005-04	MS 96329		
1	Exh. Manifold Gasket Set	2003-96	MS 95586		
QTY	EXHAUST PIPE FLANGE	YEARS	PART NO.	DESCRIPTION	
1	Exhaust Pipe Gasket	2005-96	61054	Packing	

GMC Truck (Incl. Minivans and SUV's) (Cont.)

32 (cont.)		2005 - 1996; 3.4L 207 (3393cc) OHV V6 (12 Valve) 92mm Bore			32 (cont.)
MFI; Gasoline; Naturally Aspirated GMC Eng.; Chevrolet; VIN Code E					
QTY	EXHAUST PIPE FLANGE	YEARS	PART NO.	DESCRIPTION	
1	Exhaust Pipe Gasket	2005-96	61314	Converter	
QTY	OIL PAN	YEARS	PART NO.	DESCRIPTION	
1	Oil Pan Gasket Set	2005-96	OS 30668 R	PermaDry® molded rubber gskt. incl.	
1	Drain Plug Gasket	2005-96	70820		
QTY	CRANKSHAFT REAR SEAL	YEARS	PART NO.	DESCRIPTION	
1	Rear Main Seal Set	2005-96	BS 40464	11.0mm thick; Rubber; One-piece; Improved design	
1	Rear Main Seal Set	2005-96	BS 40625	11.0mm thick; PTFE Rubber; One-piece; Improved design	
1	Repair Sleeve Tool	2005-96	16304	Crankshaft	
QTY	VALVE COVER	YEARS	PART NO.	DESCRIPTION	
1	Valve Cover Gasket Set	2005-96	VS 50442 R	w/o Grommets; Must be used w/35614; PermaDry® molded rubber gskts. incl.	
1	Grommet Set	2005-96	ES 71044	Valve Cover	
QTY	VALVE STEM SEAL SET	YEARS	PART NO.	DESCRIPTION	
1	Valve Stem Seal Set	2005-00	SS 70829	Premium valve stem seals incl.	
1	Valve Stem Seal Set	1999-96	SS 72851	Premium valve stem seals incl.	
QTY	THERMOSTAT HOUSING	YEARS	PART NO.	DESCRIPTION	
1	O-Ring	2005-96	70799	Thermostat Housing; Bypass pipe	
QTY	WATER OUTLET GASKET	YEARS	PART NO.	DESCRIPTION	
1	Thermostat Gasket	2005-96	35614	Water Outlet; Improved design	
QTY	WATER PUMP	YEARS	PART NO.	DESCRIPTION	
1	Water Pump Gasket	2005-96	35403		
QTY	TIMING COVER	YEARS	PART NO.	DESCRIPTION	
1	Timing Cover Set	2005-96	TCS 45828	w/o Sleeve 'N' Seal®	
1	Timing Cover Gasket	2005-96	72670	New Part Number - Check for Availability	
1	Timing Set w/Sleeve & Seal	2005-96	TCS 45976	w/Sleeve 'N' Seal®; .565" sleeve length	
1	Repair Sleeve	2005-96	16215	Timing Cover; .565" sleeve length; Use w/installation tool	
1	Repair Sleeve Tool	2005-96	16312	Timing Cover	
QTY	CARB & FUEL INJECTION	YEARS	PART NO.	DESCRIPTION	
2	Fuel Injector O-Ring Set	2005-00	ES 70599	Upper set; Injectors to fuel rail; Improved design	
2	Fuel Injector O-Ring Set	2005-00	ES 71190	Lower set; Injectors to cylinder head	
2	Fuel Injector O-Ring Set	2005-00	ES 71192	Upper set; Injectors to fuel rail; Old design	
3	Fuel Injector O-Ring Set	1999-96	ES 70599	Improved design	
1	Throttle Body Gasket	2005-00	61053		
1	Throttle Body Gasket	1999-96	60983		
QTY	DISTRIBUTOR MOUNTING	YEARS	PART NO.	DESCRIPTION	
1	O-Ring	2005-96	72343	Distributor Mounting; O-ring; May also be used as a distributor block-off plate seal or oil pump drive seal if desired	
QTY	EXHAUST GAS RECIRCULATION	YEARS	PART NO.	DESCRIPTION	
1	EGR Gasket	2005-00	70804		
1	EGR Gasket	1999-96	70766	Pipe	
1	EGR Gasket	1999-96	70790	Valve	
33		2009 - 2004; 3.4L 207 (3393cc) OHV V6 (12 Valve) 92mm Bore			33
MFI; Gasoline; Naturally Aspirated GMC Eng.; Chevrolet; VIN Code F					
QTY	CYLINDER HEAD	YEARS	PART NO.	DESCRIPTION	
2	Head Gasket	2009-04	541 SD	Head bolts not incl.; Head bolt replacement recommended; PermaTorque Severe Duty®	
2	Head Gasket	2009-04	9071 PT	Head bolts not incl.; Head bolt replacement recommended; PermaTorque®	
1	Head Set	2009-04	HS 9071 PT-3	Head bolts not incl.; Head bolt replacement recommended; PermaDryPlus® int. manifold gskts. incl.; PermaDry® molded rubber valve cover gskts. incl.; Premium valve stem seals incl.	
1	Head Bolt Set	2009-04	ES 72892	Replacement recommended	
QTY	CONVERSION SET	YEARS	PART NO.	DESCRIPTION	
1	Gasket Conversion Set	2009-04	CS 9071	PermaDry® molded rubber oil pan gskt. incl.	
QTY	MANIFOLD - INT. & EXH.	YEARS	PART NO.	DESCRIPTION	
1	Int. Manifold Gasket Set	2009-04	MS 98003 T-1	Valve cover gskts. & Upper set incl.; PermaDryPlus® int. manifold gskts. incl.; Manifold bolts not incl.; Manifold bolt replacement recommended	
1	Plenum Gasket Set	2009-04	MS 96730-1	Upper set	
1	Int. Manifold Bolt Set	2009-04	ES 72226	Loc. Lower; Replacement recommended	
1	Exh. Manifold Gasket Set	2009-04	MS 95586		
QTY	EXHAUST PIPE FLANGE	YEARS	PART NO.	DESCRIPTION	
1	Exhaust Pipe Gasket	2009-04	61054	Packing	
1	Exhaust Pipe Gasket	2009-04	61314	Converter	

GMC Truck (Incl. Minivans and SUV's) (Cont.)

33 (cont.)		2009 - 2004; 3.4L 207 (3393cc) OHV V6 (12 Valve) 92mm Bore			33 (cont.)
MFI; Gasoline; Naturally Aspirated GMC Eng.; Chevrolet; VIN Code F					
QTY	OIL PAN	YEARS	PART NO.	DESCRIPTION	
1	Oil Pan Gasket Set	2009-04	OS 30772 R	PermaDry® molded rubber gskt. incl.	
QTY	CRANKSHAFT REAR SEAL	YEARS	PART NO.	DESCRIPTION	
1	Rear Main Seal Set	2009-04	BS 40625	11.0mm thick; PTFE Rubber; One-piece; Improved design	
1	Rear Main Seal Set	2009-04	BS 40698	PTFE Rubber; One-piece; May use BS 40625 instead; Old design; Superseded - When depleted use BS 40625	
QTY	VALVE COVER	YEARS	PART NO.	DESCRIPTION	
1	Valve Cover Gasket Set	2009-04	VS 50442 R	w/o Grommets; Must be used w/35614; PermaDry® molded rubber gskts. incl.	
1	Grommet Set	2009-04	ES 71044	Valve Cover	
QTY	VALVE STEM SEAL SET	YEARS	PART NO.	DESCRIPTION	
1	Valve Stem Seal Set	2009-04	SS 70829	Premium valve stem seals incl.	
QTY	WATER OUTLET GASKET	YEARS	PART NO.	DESCRIPTION	
1	Thermostat Gasket	2009-04	35614	Water Outlet; Improved design	
QTY	WATER PUMP	YEARS	PART NO.	DESCRIPTION	
1	Water Pump Gasket	2009-04	35403		
QTY	TIMING COVER	YEARS	PART NO.	DESCRIPTION	
1	Timing Cover Set	2009-04	TCS 45828	w/o Sleeve 'N' Seal®	
1	Timing Cover Gasket	2009-04	72670	New Part Number - Check for Availability	
1	Timing Set w/Sleeve & Seal	2009-04	TCS 45976	w/Sleeve 'N' Seal®; .565" sleeve length	
1	Repair Sleeve	2009-04	16215	Timing Cover; .565" sleeve length; Use w/installation tool	
1	Repair Sleeve Tool	2009-04	16312	Timing Cover	
QTY	CARB & FUEL INJECTION	YEARS	PART NO.	DESCRIPTION	
3	Fuel Injector O-Ring Set	2009-04	ES 70599	Improved design	
1	Throttle Body Gasket	2009-07	61466		
1	Throttle Body Gasket	2006-04	61456		
QTY	DISTRIBUTOR MOUNTING	YEARS	PART NO.	DESCRIPTION	
1	O-Ring	2009-04	72343	Distributor Mounting; O-ring; May also be used as a distributor block-off plate seal or oil pump drive seal if desired	
QTY	EXHAUST GAS RECIRCULATION	YEARS	PART NO.	DESCRIPTION	
1	EGR Gasket	2009-04	70804	Valve	
34		2006 - 2004; 3.5L 211 (3460cc) DOHC L5 (20 Valve) 93mm Bore Vortec			34
MFI; Gasoline; Naturally Aspirated GMC Eng.; Chevrolet; VIN Code 6					
QTY	CYLINDER HEAD	YEARS	PART NO.	DESCRIPTION	
1	Head Gasket	2006-04	26336 PT	Head bolts not incl.; Head bolt replacement recommended; PermaTorqueMLS®	
1	Head Set	2006-04	HS 26336 PT	Head bolts not incl.; Head bolt replacement recommended; PermaDry® molded rubber valve cover gskt. incl.; Premium valve stem seals incl.	
1	Head Bolt Set	2006-04	ES 71334	Head bolts w/Washers; Replacement recommended; Improved design	
1	Head Bolt Set	2006-04	ES 72195	Head bolts w/Washers; Replacement recommended; Old design	
QTY	CONVERSION SET	YEARS	PART NO.	DESCRIPTION	
1	Gasket Conversion Set	2006-04	CS 26335	RTV sealant incl. for oil pan gskt.	
QTY	MANIFOLD - INT. & EXH.	YEARS	PART NO.	DESCRIPTION	
1	Int. Manifold Gasket Set	2006-04	MS 96440-2		
1	Exh. Manifold Gasket Set	2006-04	MS 96889		
QTY	EXHAUST PIPE FLANGE	YEARS	PART NO.	DESCRIPTION	
1	Exhaust Pipe Gasket	2006-04	61348	Pipe to manifold	
QTY	CRANKSHAFT REAR SEAL	YEARS	PART NO.	DESCRIPTION	
1	Rear Main Seal Set	2006-04	BS 40705	PTFE Rubber; One-piece	
QTY	VALVE COVER	YEARS	PART NO.	DESCRIPTION	
1	Valve Cover Gasket Set	2006-04	VS 50703 R	w/Grommets & Spark plug tube seals; Must be used w/MS 96440-2; PermaDry® molded rubber gskt. incl.	
QTY	VALVE STEM SEAL SET	YEARS	PART NO.	DESCRIPTION	
1	Valve Stem Seal Set	2006-04	SS 71043-2	Premium valve stem seals incl.	
QTY	THERMOSTAT HOUSING	YEARS	PART NO.	DESCRIPTION	
1	Thermostat Gasket	2006-04	35632	Thermostat Housing; Thermostat O-ring	
QTY	WATER OUTLET GASKET	YEARS	PART NO.	DESCRIPTION	
1	Water Outlet Gasket	2006-04	36009	Water Outlet; Coolant outlet seal; New Part Number - Check for Availability	
QTY	WATER PUMP	YEARS	PART NO.	DESCRIPTION	
1	Water Pump Gasket	2006-04	35704		
QTY	TIMING COVER	YEARS	PART NO.	DESCRIPTION	
1	Timing Cover Set	2006-04	TCS 45052		

GMC Truck (Incl. Minivans and SUV's) (Cont.)

34 (cont.)		2006 - 2004; 3.5L 211 (3460cc) DOHC L5 (20 Valve) 93mm Bore Vortec			34 (cont.)
		MFI; Gasoline; Naturally Aspirated GMC Eng.; Chevrolet; VIN Code 6			
QTY	CARB & FUEL INJECTION	YEARS	PART NO.	DESCRIPTION	
2	Fuel Injector O-Ring Set	2006-04	ES 70599	Upper set; Injectors to fuel rail; Improved design	
2	Fuel Injector O-Ring Set	2006-04	ES 71190	Lower set; Injectors to cylinder head	
2	Fuel Injector O-Ring Set	2006-04	ES 71192	Upper set; Injectors to fuel rail; Old design	
1	Throttle Body Gasket	2006-04	61337	Improved design	
QTY	EXHAUST GAS RECIRCULATION	YEARS	PART NO.	DESCRIPTION	
1	EGR Gasket	2006-04	72755	EGR tube; New Part Number - Check for Availability	
35		2007 - 2004; 3.5L 212 (3471cc) SOHC V6 (24 Valve) 89mm Bore VTEC			35
		MFI; Gasoline; Naturally Aspirated Honda Eng.; VIN Code 4, Eng. Code J35A4			
QTY	CYLINDER HEAD	YEARS	PART NO.	DESCRIPTION	
2	Head Gasket	2007-04	26265 PT	Head bolts not incl.; Head bolt replacement recommended; PermaTorqueMLS®	
1	Head Set	2007-04	HS 26265 PT-3	Head bolts not incl.; Head bolt replacement recommended; PermaDry® molded rubber valve cover gskts. incl.; Premium valve stem seals incl.	
2	Head Bolt Set	2007-04	ES 72221	Head bolts w/Washers; Replacement recommended	
QTY	CONVERSION SET	YEARS	PART NO.	DESCRIPTION	
1	Gasket Conversion Set	2007-04	CS 26265	RTV sealant incl. for oil pan gskt.	
QTY	MANIFOLD - INT. & EXH.	YEARS	PART NO.	DESCRIPTION	
1	Int. Manifold Gasket Set	2007-04	MS 96405	Lower set	
1	Plenum Gasket Set	2007-04	MS 96409-1	Upper set	
1	Exh. Manifold Gasket Set	2007-04	MS 96411		
QTY	EXHAUST PIPE FLANGE	YEARS	PART NO.	DESCRIPTION	
2	Exhaust Pipe Gasket	2007-04	61394	Converter	
2	Exhaust Pipe Gasket	2007-04	61439	Pipe to manifold	
QTY	CRANKSHAFT REAR SEAL	YEARS	PART NO.	DESCRIPTION	
1	Rear Main Seal Set	2007-04	BS 40685	Rubber; One-piece	
QTY	VALVE COVER	YEARS	PART NO.	DESCRIPTION	
1	Valve Cover Gasket Set	2007-04	VS 50607 R	w/Grommets & Spark plug tube seals; PermaDry® molded rubber gskts. incl.	
QTY	VALVE STEM SEAL SET	YEARS	PART NO.	DESCRIPTION	
2	Valve Stem Seal Set	2007-04	SS 70283-2	Premium valve stem seals incl.	
QTY	THERMOSTAT HOUSING	YEARS	PART NO.	DESCRIPTION	
1	O-Ring	2007-04	35162	Thermostat Housing	
QTY	WATER OUTLET GASKET	YEARS	PART NO.	DESCRIPTION	
1	Water Crossover Mounting Set	2007-04	ES 72998	Water Outlet; Water bypass set; OEM style; New Part Number - Check for Availability	
QTY	WATER PUMP	YEARS	PART NO.	DESCRIPTION	
1	Water Pump Gasket	2007-04	35677		
QTY	TIMING COVER	YEARS	PART NO.	DESCRIPTION	
1	Crankshaft Front Seal Set	2007-04	TCS 46026		
1	Camshaft Front Seal Set	2007-04	TCS 46025		
QTY	CARB & FUEL INJECTION	YEARS	PART NO.	DESCRIPTION	
3	Fuel Injector O-Ring Set	2007-04	ES 70599	Improved design	
1	Throttle Body Gasket	2007-04	61331		
QTY	EXHAUST GAS RECIRCULATION	YEARS	PART NO.	DESCRIPTION	
1	EGR Gasket	2007-04	70978		
QTY	OIL FILTER MOUNTING	YEARS	PART NO.	DESCRIPTION	
1	Oil Filter Adapter Gasket	2007-04	72951	Oil filter adapter; New Part Number - Check for Availability	
36		2007 - 2006; 3.5L 213 (3491cc) OHV V6 (12 Valve) 94mm Bore			36
		MFI; Gasoline; Naturally Aspirated GMC Eng.; Chevrolet; VIN Code 8			
QTY	CYLINDER HEAD	YEARS	PART NO.	DESCRIPTION	
2	Head Gasket	2007-06	26314 PT	Head bolts not incl.; Head bolt replacement recommended	
1	Head Set	2007-06	HS 26314 PT	Head bolts not incl.; Head bolt replacement recommended; PermaDryPlus® int. manifold gskts. incl.; PermaDry® molded rubber valve cover gskts. incl.; Premium valve stem seals incl.	
1	Head Bolt Set	2007-06	ES 72892	Replacement recommended	
QTY	CONVERSION SET	YEARS	PART NO.	DESCRIPTION	
1	Gasket Conversion Set	2007-06	CS 26314	PermaDry® molded rubber oil pan gskt. incl.	
QTY	MANIFOLD - INT. & EXH.	YEARS	PART NO.	DESCRIPTION	
1	Int. Manifold Gasket Set	2007-06	MS 98013 T	Valve cover gskts. & Upper set incl.; PermaDryPlus® int. manifold gskts. incl.; Manifold bolts not incl.; Manifold bolt replacement recommended	
1	Plenum Gasket Set	2007-06	MS 96730	Upper set	

GMC Truck (Incl. Minivans and SUV's) (Cont.)

36 (cont.)		2007 - 2006; 3.5L 213 (3491cc) OHV V6 (12 Valve) 94mm Bore			36 (cont.)
MFI; Gasoline; Naturally Aspirated GMC Eng.; Chevrolet; VIN Code 8					
QTY	MANIFOLD - INT. & EXH.	YEARS	PART NO.	DESCRIPTION	
1	Int. Manifold Bolt Set	2007-06	ES 72226	Loc. Lower; Replacement recommended	
1	Exh. Manifold Gasket Set	2007-06	MS 96727		
QTY	EXHAUST PIPE FLANGE	YEARS	PART NO.	DESCRIPTION	
1	Exhaust Pipe Gasket	2007-06	61054	Flange	
1	Exhaust Pipe Gasket	2007-06	61314	Converter	
QTY	OIL PAN	YEARS	PART NO.	DESCRIPTION	
1	Oil Pan Gasket Set	2007-06	OS 30766 R	PermaDry® molded rubber gskt. incl.	
QTY	CRANKSHAFT REAR SEAL	YEARS	PART NO.	DESCRIPTION	
1	Rear Main Seal Set	2007-06	BS 40625	11.0mm thick; PTFE Rubber; One-piece; Improved design	
1	Rear Main Seal Set	2007-06	BS 40698	PTFE Rubber; One-piece; May use BS 40625 instead; Old design; Superseded - When depleted use BS 40625	
QTY	VALVE COVER	YEARS	PART NO.	DESCRIPTION	
1	Valve Cover Gasket Set	2007-06	VS 50442 R	w/o Grommets; Must be used w/35614; PermaDry® molded rubber gskts. incl.	
1	Grommet Set	2007-06	ES 71044	Valve Cover	
QTY	VALVE STEM SEAL SET	YEARS	PART NO.	DESCRIPTION	
1	Valve Stem Seal Set	2007-06	SS 70829	Premium valve stem seals incl.	
QTY	WATER OUTLET GASKET	YEARS	PART NO.	DESCRIPTION	
1	Thermostat Gasket	2007-06	35614	Water Outlet; Improved design	
QTY	WATER PUMP	YEARS	PART NO.	DESCRIPTION	
1	Water Pump Gasket	2007-06	35403		
QTY	TIMING COVER	YEARS	PART NO.	DESCRIPTION	
1	Timing Cover Set	2007-06	TCS 46088		
1	Timing Cover Gasket	2007-06	72670	New Part Number - Check for Availability	
QTY	CARB & FUEL INJECTION	YEARS	PART NO.	DESCRIPTION	
2	Fuel Injector O-Ring Set	2007-06	ES 70599	Upper set; Injectors to fuel rail; Improved design	
2	Fuel Injector O-Ring Set	2007-06	ES 71190	Lower set; Injectors to cylinder head	
1	Throttle Body Gasket	2007-06	61456		
QTY	EXHAUST GAS RECIRCULATION	YEARS	PART NO.	DESCRIPTION	
1	EGR Gasket	2007-06	70804	Valve	
1	EGR Gasket	2007-06	71247	Pipe	
QTY	OIL FILTER MOUNTING	YEARS	PART NO.	DESCRIPTION	
1	Oil Filter Adapter Gasket	2007-06	72423	Improved design	
1	Oil Filter Adapter Gasket	2007-06	72466	Old design	
37		2006 - 2005; 3.5L 213 (3491cc) OHV V6 (12 Valve) 94mm Bore			37
MFI; Gasoline; Naturally Aspirated GMC Eng.; Chevrolet; VIN Code L					
QTY	CYLINDER HEAD	YEARS	PART NO.	DESCRIPTION	
2	Head Gasket	2006-05	26314 PT	Head bolts not incl.; Head bolt replacement recommended	
1	Head Set	2006	HS 26314 PT-1	Head bolts not incl.; Head bolt replacement recommended; PermaDryPlus® int. manifold gskts. incl.; PermaDry® molded rubber valve cover gskts. incl.; Premium valve stem seals incl.	
1	Head Set	2005	HS 26314 PT-1	1st Design; Manifold No. 10182321 or 24506309; Exh. manifold gskts. & head bolts not incl.; Head bolt replacement recommended; PermaDryPlus® int. manifold gskts. incl.; PermaDry® molded rubber valve cover gskts. incl.; Premium valve stem seals incl.	
1	Head Set	2005	HS 26314 PT-1	2nd Design; Manifold No. 12568405 or 12578348; Head bolts not incl.; Head bolt replacement recommended; PermaDryPlus® int. manifold gskts. incl.; PermaDry® molded rubber valve cover gskts. incl.; Premium valve stem seals incl.	
1	Head Bolt Set	2006-05	ES 72892	Replacement recommended	
QTY	CONVERSION SET	YEARS	PART NO.	DESCRIPTION	
1	Gasket Conversion Set	2006-05	CS 26314	Exc. Saturn Relay 2 Base, Relay 3 Base; PermaDry® molded rubber oil pan gskt. incl.	
1	Gasket Conversion Set	2006-05	CS 26314-1	Saturn Relay 2 Base, Relay 3 Base; PermaDry® molded rubber oil pan gskt. incl.	
QTY	MANIFOLD - INT. & EXH.	YEARS	PART NO.	DESCRIPTION	
1	Int. Manifold Gasket Set	2006-05	MS 98013 T	Valve cover gskts. & Upper set incl.; PermaDryPlus® int. manifold gskts. incl.; Manifold bolts not incl.; Manifold bolt replacement recommended	
1	Plenum Gasket Set	2006-05	MS 96730	Upper set	
1	Int. Manifold Bolt Set	2006-05	ES 72226	Loc. Lower; Replacement recommended	
1	Exh. Manifold Gasket Set	2006	MS 96329		
1	Exh. Manifold Gasket Set	2005	MS 95586	1st Design; Manifold No. 10182321 or 24506309	

GMC Truck (Incl. Minivans and SUV's) (Cont.)

37		2006 - 2005; 3.5L 213 (3491cc) OHV V6 (12 Valve) 94mm Bore			37
(cont.)		MFI; Gasoline; Naturally Aspirated GMC Eng.; Chevrolet; VIN Code L			(cont.)
QTY	MANIFOLD - INT. & EXH.	YEARS	PART NO.	DESCRIPTION	
1	Exh. Manifold Gasket Set	2005	MS 96329	2nd Design; Manifold No. 12568405 or 12578348	
QTY	EXHAUST PIPE FLANGE	YEARS	PART NO.	DESCRIPTION	
1	Exhaust Pipe Gasket	2006-05	61054	Flange	
1	Exhaust Pipe Gasket	2006-05	61314	Converter	
QTY	OIL PAN	YEARS	PART NO.	DESCRIPTION	
1	Oil Pan Gasket Set	2006-05	OS 30766 R	PermaDry® molded rubber gskt. incl.	
QTY	CRANKSHAFT REAR SEAL	YEARS	PART NO.	DESCRIPTION	
1	Rear Main Seal Set	2006-05	BS 40625	11.0mm thick; PTFE Rubber; One-piece; Improved design	
1	Rear Main Seal Set	2006-05	BS 40698	PTFE Rubber; One-piece; May use BS 40625 instead; Old design; Superseded - When depleted use BS 40625	
QTY	VALVE COVER	YEARS	PART NO.	DESCRIPTION	
1	Valve Cover Gasket Set	2006-05	VS 50442 R	w/o Grommets; Must be used w/35614; PermaDry® molded rubber gskts. incl.	
1	Grommet Set	2006-05	ES 71044	Valve Cover	
QTY	VALVE STEM SEAL SET	YEARS	PART NO.	DESCRIPTION	
1	Valve Stem Seal Set	2006-05	SS 70829	Premium valve stem seals incl.	
QTY	WATER OUTLET GASKET	YEARS	PART NO.	DESCRIPTION	
1	Thermostat Gasket	2006-05	35614	Water Outlet; Improved design	
QTY	WATER PUMP	YEARS	PART NO.	DESCRIPTION	
1	Water Pump Gasket	2006-05	35403		
QTY	TIMING COVER	YEARS	PART NO.	DESCRIPTION	
1	Timing Cover Set	2006-05	TCS 46088	Exc. Saturn Relay 2 Base, Relay 3 Base	
1	Timing Cover Set	2006-05	TCS 46099	Saturn Relay 2 Base, Relay 3 Base	
1	Timing Cover Gasket	2006-05	72670	New Part Number - Check for Availability	
QTY	CARB & FUEL INJECTION	YEARS	PART NO.	DESCRIPTION	
2	Fuel Injector O-Ring Set	2006-05	ES 70599	Upper set; Injectors to fuel rail; Improved design	
2	Fuel Injector O-Ring Set	2006-05	ES 71190	Lower set; Injectors to cylinder head	
1	Throttle Body Gasket	2006-05	61456		
QTY	EXHAUST GAS RECIRCULATION	YEARS	PART NO.	DESCRIPTION	
1	EGR Gasket	2006-05	70804	Valve	
1	EGR Gasket	2006-05	71247	Pipe	
QTY	OIL FILTER MOUNTING	YEARS	PART NO.	DESCRIPTION	
1	Oil Filter Adapter Gasket	2006-05	72423	Improved design	
1	Oil Filter Adapter Gasket	2006-05	72466	Old design	
38		2010 - 2008; 3.5L 214 (3510cc) OHV V6 (12 Valve) 99mm Bore			38
(cont.)		MFI; Gasoline; Naturally Aspirated GMC Eng.; Chevrolet; VIN Code N			
QTY	CYLINDER HEAD	YEARS	PART NO.	DESCRIPTION	
1	Head Gasket	2010-08	26324 PT	Loc. L.H.; Head bolts not incl.; Head bolt replacement recommended; PermaTorqueMLS® LaserWeld® Technology	
1	Head Gasket	2010-08	26325 PT	Loc. R.H.; Head bolts not incl.; Head bolt replacement recommended; PermaTorqueMLS® LaserWeld® Technology	
1	Head Set	2010-08	HS 26324 PT	Head bolts not incl.; Head bolt replacement recommended; PermaDryPlus® int. manifold gskts. incl.; PermaDry® molded rubber valve cover gskts. incl.; Premium valve stem seals incl.	
2	Head Bolt Set	2010-08	ES 72230	Head bolts w/Washers; Replacement recommended; Improved design	
2	Head Bolt Set	2010-09	ES 72230-1	Head bolts w/Washers; Replacement recommended; Old design	
QTY	CONVERSION SET	YEARS	PART NO.	DESCRIPTION	
1	Gasket Conversion Set	2010-08	CS 26324	PermaDry® molded rubber oil pan gskt. incl.	
QTY	MANIFOLD - INT. & EXH.	YEARS	PART NO.	DESCRIPTION	
1	Int. Manifold Gasket Set	2010-08	MS 98015 T	Valve cover gskts. & Upper set incl.; PermaDryPlus® int. manifold gskts. incl.; Manifold bolts not incl.; Manifold bolt replacement recommended	
1	Plenum Gasket Set	2010-08	MS 96824	Upper set	
1	Int. Manifold Bolt Set	2010-08	ES 72226	Loc. Lower; Replacement recommended	
1	Exh. Manifold Gasket Set	2010-08	MS 96818		
QTY	EXHAUST PIPE FLANGE	YEARS	PART NO.	DESCRIPTION	
1	Exhaust Pipe Gasket	2010-08	61310	Flange; Improved design	
1	Exhaust Pipe Gasket	2010-08	61465	Converter	
QTY	OIL PAN	YEARS	PART NO.	DESCRIPTION	
1	Oil Pan Gasket Set	2010-08	OS 30776 R	PermaDry® molded rubber gskt. incl.	
QTY	CRANKSHAFT REAR SEAL	YEARS	PART NO.	DESCRIPTION	
1	Rear Main Seal Set	2010-08	BS 40625	11.0mm thick; PTFE Rubber; One-piece; Improved design	

GMC Truck (Incl. Minivans and SUV's) (Cont.)

38 (cont.)		2010 - 2008; 3.5L 214 (3510cc) OHV V6 (12 Valve) 99mm Bore			38 (cont.)
MFI; Gasoline; Naturally Aspirated GMC Eng.; Chevrolet; VIN Code N					
QTY	CRANKSHAFT REAR SEAL	YEARS	PART NO.	DESCRIPTION	
1	Rear Main Seal Set	2010-08	BS 40698	PTFE Rubber; One-piece; May use BS 40625 instead; Old design; Superseded - When depleted use BS 40625	
QTY	VALVE COVER	YEARS	PART NO.	DESCRIPTION	
1	Valve Cover Gasket Set	2010-08	VS 50442 R	w/o Grommets; Must be used w/35614; PermaDry® molded rubber gskts. incl.	
1	Grommet Set	2010-08	ES 71044	Valve Cover	
QTY	VALVE STEM SEAL SET	YEARS	PART NO.	DESCRIPTION	
1	Valve Stem Seal Set	2010-08	SS 71039-1	Premium valve stem seals incl.	
QTY	WATER OUTLET GASKET	YEARS	PART NO.	DESCRIPTION	
1	Water Outlet Gasket	2010-08	35815	Water Crossover; Loc. L.H.	
1	Water Outlet Gasket	2010-09	35913	Water Crossover; Loc. R.H.	
1	Water Outlet Gasket	2008	35816	Water Crossover; Loc. R.H.	
1	Thermostat Gasket	2010-08	35614	Water Outlet; Improved design	
QTY	WATER PUMP	YEARS	PART NO.	DESCRIPTION	
1	Water Pump Gasket	2010-08	35814		
QTY	TIMING COVER	YEARS	PART NO.	DESCRIPTION	
1	Timing Cover Set	2010-08	TCS 46089		
1	Timing Cover Gasket	2010-08	72966	New Part Number - Check for Availability	
QTY	CARB & FUEL INJECTION	YEARS	PART NO.	DESCRIPTION	
1	Throttle Body Gasket	2010-08	61466		
QTY	OIL FILTER MOUNTING	YEARS	PART NO.	DESCRIPTION	
1	Oil Filter Adapter Gasket	2010-08	72423	Improved design	
39		2010 - 2004; 3.6L 217 (3564cc) DOHC V6 (24 Valve) 94mm Bore			39
MFI; Gasoline; Naturally Aspirated Opel Eng.; VIN Code 7					
QTY	CYLINDER HEAD	YEARS	PART NO.	DESCRIPTION	
1	Head Gasket	2010-04	26376 PT	Loc. L.H.; Head bolts not incl.; Head bolt replacement recommended; PermaTorqueMLS®	
1	Head Gasket	2010-04	26377 PT	Loc. R.H.; Head bolts not incl.; Head bolt replacement recommended; PermaTorqueMLS®	
1	Head Set	2010	HS 26376 PT-2	Head bolts not incl.; Head bolt replacement recommended; PermaDry® molded rubber valve cover gskts. incl.; Premium valve stem seals incl.	
1	Head Set	2009-08	HS 26376 PT-1	Buick Enclave CX, CXL GMC Acadia Base, SLE, SLT Saturn Outlook XE, XR; Head bolts not incl.; Head bolt replacement recommended; PermaDry® molded rubber valve cover gskts. incl.; Premium valve stem seals incl.	
1	Head Set	2009-08	HS 26376 PT-2	Chevrolet Equinox Sport Pontiac Torrent GXP Saturn Vue Red Line, XR; Head bolts not incl.; Head bolt replacement recommended; PermaDry® molded rubber valve cover gskts. incl.; Premium valve stem seals incl.	
1	Head Set	2009	HS 26376 PT-4	Cadillac SRX Base; Head bolts not incl.; Head bolt replacement recommended; PermaDry® molded rubber valve cover gskts. incl.; Premium valve stem seals incl.	
1	Head Set	2008-07	HS 26376 PT	Cadillac SRX Base; Head bolts not incl.; Head bolt replacement recommended; PermaDry® molded rubber valve cover gskts. incl.; Premium valve stem seals incl.	
1	Head Set	2007	HS 26376 PT-1	Exc. Cadillac SRX Base; Head bolts not incl.; Head bolt replacement recommended; PermaDry® molded rubber valve cover gskts. incl.; Premium valve stem seals incl.	
1	Head Set	2006-04	HS 26376 PT	Head bolts not incl.; Head bolt replacement recommended; PermaDry® molded rubber valve cover gskts. incl.; Premium valve stem seals incl.	
2	Head Bolt Set	2010-04	ES 72274	Replacement recommended	
QTY	CONVERSION SET	YEARS	PART NO.	DESCRIPTION	
1	Gasket Conversion Set	2010-04	CS 26376-1	RTV sealant incl. for oil pan gskt.; Improved design	
1	Gasket Conversion Set	2007-04	CS 26376	RTV sealant incl. for oil pan gskt.; Old design; New Part Number - Check for Availability	
QTY	MANIFOLD - INT. & EXH.	YEARS	PART NO.	DESCRIPTION	
1	Int. Manifold Gasket Set	2010	MS 96969	Lower set; Upper set incl.	
1	Int. Manifold Gasket Set	2009-08	MS 96969	Exc. Buick Enclave CX, CXL GMC Acadia Base, SLE, SLT Saturn Outlook XE, XR; Lower set; Upper set incl.	
1	Int. Manifold Gasket Set	2009-08	MS 96974	Buick Enclave CX, CXL GMC Acadia Base, SLE, SLT Saturn Outlook XE, XR; Lower set; Upper set incl.	
1	Int. Manifold Gasket Set	2007	MS 96969	Cadillac SRX Base; Lower set; Upper set incl.	
1	Int. Manifold Gasket Set	2007	MS 96974	Exc. Cadillac SRX Base; Lower set; Upper set incl.	
1	Int. Manifold Gasket Set	2006-04	MS 96969	Lower set; Upper set incl.	
1	Plenum Gasket Set	2010	MS 96976	Upper set	

GMC Truck (Incl. Minivans and SUV's) (Cont.)

39 (cont.)	2010 - 2004; 3.6L 217 (3564cc) DOHC V6 (24 Valve) 94mm Bore MFI; Gasoline; Naturally Aspirated Opel Eng.; VIN Code 7				39 (cont.)
QTY	MANIFOLD - INT. & EXH.	YEARS	PART NO.	DESCRIPTION	
1	Plenum Gasket Set	2009-08	MS 96976	Exc. Buick Enclave CX, CXL GMC Acadia Base, SLE, SLT Saturn Outlook XE, XR; Upper set	
1	Plenum Gasket Set	2009-08	MS 96977	Buick Enclave CX, CXL GMC Acadia Base, SLE, SLT Saturn Outlook XE, XR; Upper set	
1	Plenum Gasket Set	2007	MS 96976	Cadillac SRX Base; Upper set	
1	Plenum Gasket Set	2007	MS 96977	Exc. Cadillac SRX Base; Upper set	
1	Plenum Gasket Set	2006-04	MS 96976	Upper set	
1	Exh. Manifold Gasket Set	2010	MS 96973		
1	Exh. Manifold Gasket Set	2009-07	MS 96973	Exc. Cadillac SRX Base	
1	Exh. Manifold Gasket Set	2009	MS 96970-1	Cadillac SRX Base	
1	Exh. Manifold Gasket Set	2008-07	MS 96970	Cadillac SRX Base	
1	Exh. Manifold Gasket Set	2006-04	MS 96970		
QTY	EXHAUST PIPE FLANGE	YEARS	PART NO.	DESCRIPTION	
2	Exhaust Pipe Gasket	2010	61054	Pipe to manifold	
2	Exhaust Pipe Gasket	2010	61618	Converter	
2	Exhaust Pipe Gasket	2009-07	61615	Cadillac SRX Base; Pipe to manifold	
2	Exhaust Pipe Gasket	2009-08	61054	Chevrolet Equinox Sport Pontiac Torrent GXP Saturn Vue Red Line, XR; Pipe to manifold	
2	Exhaust Pipe Gasket	2009-08	61519	Buick Enclave CX, CXL GMC Acadia Base, SLE, SLT Saturn Outlook XE, XR; Pipe to manifold	
2	Exhaust Pipe Gasket	2009-08	61536	Buick Enclave CX, CXL GMC Acadia Base, SLE, SLT Saturn Outlook XE, XR; Converter	
2	Exhaust Pipe Gasket	2009-08	61618	Chevrolet Equinox Sport Pontiac Torrent GXP Saturn Vue Red Line, XR; Converter	
2	Exhaust Pipe Gasket	2009-08	61636	Cadillac SRX Base; Converter	
2	Exhaust Pipe Gasket	2007-04	61525	Cadillac SRX Base; Converter; Improved design	
2	Exhaust Pipe Gasket	2007	61519	Exc. Cadillac SRX Base; Pipe to manifold	
2	Exhaust Pipe Gasket	2007	61536	Exc. Cadillac SRX Base; Converter	
2	Exhaust Pipe Gasket	2006-04	61443	Exc. Cadillac SRX Base; Converter	
2	Exhaust Pipe Gasket	2006-04	61539	Exc. Cadillac SRX Base; Crossover	
2	Exhaust Pipe Gasket	2006-04	61615	Pipe to manifold	
QTY	CRANKSHAFT REAR SEAL	YEARS	PART NO.	DESCRIPTION	
1	Rear Main Seal Set	2010-04	BS 40711	PTFE Rubber; One-piece; Improved design	
QTY	VALVE COVER	YEARS	PART NO.	DESCRIPTION	
1	Valve Cover Gasket Set	2010-04	VS 50726 R	w/o Spark plug tube seals & w/Grommets; PermaDry® molded rubber gskts. incl.	
1	Spark Plug Tube Seal Set	2010-04	ES 72393	Valve Cover; New Part Number - Check for Availability	
QTY	VALVE STEM SEAL SET	YEARS	PART NO.	DESCRIPTION	
1	Valve Stem Seal Set	2010-04	SS 72923	Premium valve stem seals incl.	
QTY	THERMOSTAT HOUSING	YEARS	PART NO.	DESCRIPTION	
1	Thermostat Gasket	2010-04	35871	Thermostat Housing; Thermostat housing to head	
1	Thermostat Gasket	2009-04	35858	Cadillac SRX Base; Thermostat Housing; Thermostat seal	
QTY	WATER OUTLET GASKET	YEARS	PART NO.	DESCRIPTION	
1	Water Outlet Gasket	2010-04	35855	Water Outlet; Water outlet O-ring; New Part Number - Check for Availability	
1	Water Outlet Gasket	2010-04	35856	Water Outlet; Water outlet seal; New Part Number - Check for Availability	
QTY	WATER PUMP	YEARS	PART NO.	DESCRIPTION	
1	Water Pump Gasket	2010-04	35859		
QTY	TIMING COVER	YEARS	PART NO.	DESCRIPTION	
1	Timing Cover Set	2010-04	TCS 46108		
QTY	CARB & FUEL INJECTION	YEARS	PART NO.	DESCRIPTION	
2	Fuel Injector O-Ring Set	2010-04	ES 70599	Upper set; Injectors to fuel rail; Improved design	
2	Fuel Injector O-Ring Set	2010-04	ES 72004	Lower set; Injectors to cylinder head	
1	Fuel Injector O-Ring Set	2010-04	ES 72761	Complete set; Upper & lower injector seals incl.; New Part Number - Check for Availability	
1	Throttle Body Gasket	2010	61614		
1	Throttle Body Gasket	2009-08	61520	Exc. Chevrolet Equinox Sport Pontiac Torrent GXP Saturn Vue Red Line, XR	
1	Throttle Body Gasket	2009-08	61614	Chevrolet Equinox Sport Pontiac Torrent GXP Saturn Vue Red Line, XR	
1	Throttle Body Gasket	2007	61520	Exc. Cadillac SRX Base	
1	Throttle Body Gasket	2007	61521	Cadillac SRX Base	
1	Throttle Body Gasket	2006-05	61521		
1	Throttle Body Gasket	2004	61518		
QTY	OIL FILTER MOUNTING	YEARS	PART NO.	DESCRIPTION	
1	Oil Filter Adapter Gasket	2010-04	72968	Oil filter adapter; New Part Number - Check for Availability	

GMC Truck (Incl. Minivans and SUV's) (Cont.)

40		2010 - 2009; 3.6L 217 (3564cc) DOHC V6 (24 Valve) 94mm Bore			40
MFI; Hybrid (Gas/Electric); Naturally Aspirated Opel Eng.; VIN Code B					
QTY	CYLINDER HEAD	YEARS	PART NO.	DESCRIPTION	
1	Head Gasket	2010-09	26376 PT	Loc. L.H.; Head bolts not incl.; Head bolt replacement recommended; PermaTorqueMLS®	
1	Head Gasket	2010-09	26377 PT	Loc. R.H.; Head bolts not incl.; Head bolt replacement recommended; PermaTorqueMLS®	
1	Head Set	2010-09	HS 26376 PT-2	Head bolts not incl.; Head bolt replacement recommended; PermaDry® molded rubber valve cover gskts. incl.; Premium valve stem seals incl.	
2	Head Bolt Set	2010-09	ES 72274	Replacement recommended	
QTY	CONVERSION SET	YEARS	PART NO.	DESCRIPTION	
1	Gasket Conversion Set	2010-09	CS 26376-1	RTV sealant incl. for oil pan gskt.; Improved design	
QTY	MANIFOLD - INT. & EXH.	YEARS	PART NO.	DESCRIPTION	
1	Int. Manifold Gasket Set	2010-09	MS 96969	Lower set; Upper set incl.	
1	Plenum Gasket Set	2010-09	MS 96976	Upper set	
1	Exh. Manifold Gasket Set	2010-09	MS 96973		
QTY	EXHAUST PIPE FLANGE	YEARS	PART NO.	DESCRIPTION	
2	Exhaust Pipe Gasket	2010-09	61054	Pipe to manifold	
2	Exhaust Pipe Gasket	2010-09	61618	Converter	
QTY	CRANKSHAFT REAR SEAL	YEARS	PART NO.	DESCRIPTION	
1	Rear Main Seal Set	2010-09	BS 40711	PTFE Rubber; One-piece; Improved design	
QTY	VALVE COVER	YEARS	PART NO.	DESCRIPTION	
1	Valve Cover Gasket Set	2010-09	VS 50726 R	w/o Spark plug tube seals & w/Grommets; PermaDry® molded rubber gskts. incl.	
1	Spark Plug Tube Seal Set	2010-09	ES 72393	Valve Cover; New Part Number - Check for Availability	
QTY	VALVE STEM SEAL SET	YEARS	PART NO.	DESCRIPTION	
1	Valve Stem Seal Set	2010-09	SS 72923	Premium valve stem seals incl.	
QTY	THERMOSTAT HOUSING	YEARS	PART NO.	DESCRIPTION	
1	Thermostat Gasket	2010-09	35871	Thermostat Housing; Thermostat housing to head	
QTY	WATER OUTLET GASKET	YEARS	PART NO.	DESCRIPTION	
1	Water Outlet Gasket	2010-09	35855	Water Outlet; Water outlet O-ring; New Part Number - Check for Availability	
1	Water Outlet Gasket	2010-09	35856	Water Outlet; Water outlet seal; New Part Number - Check for Availability	
QTY	WATER PUMP	YEARS	PART NO.	DESCRIPTION	
1	Water Pump Gasket	2010-09	35859		
QTY	TIMING COVER	YEARS	PART NO.	DESCRIPTION	
1	Timing Cover Set	2010-09	TCS 46108		
QTY	CARB & FUEL INJECTION	YEARS	PART NO.	DESCRIPTION	
2	Fuel Injector O-Ring Set	2010-09	ES 70599	Upper set; Injectors to fuel rail; Improved design	
2	Fuel Injector O-Ring Set	2010-09	ES 72004	Lower set; Injectors to cylinder head	
1	Fuel Injector O-Ring Set	2010-09	ES 72761	Complete set; Upper & lower injector seals incl.; New Part Number - Check for Availability	
1	Throttle Body Gasket	2010-09	61614		
QTY	OIL FILTER MOUNTING	YEARS	PART NO.	DESCRIPTION	
1	Oil Filter Adapter Gasket	2010-09	72968	Oil filter adapter; New Part Number - Check for Availability	
41		2013 - 2012; 3.6L 217 (3564cc) DOHC V6 (24 Valve) 94mm Bore VVT			41
DI; Flex Fuel; Naturally Aspirated Opel Eng.; VIN Code 3					
QTY	CYLINDER HEAD	YEARS	PART NO.	DESCRIPTION	
1	Head Gasket	2013-12	26376 PT	Loc. L.H.; Head bolts not incl.; Head bolt replacement recommended; PermaTorqueMLS®	
1	Head Gasket	2013-12	26377 PT	Loc. R.H.; Head bolts not incl.; Head bolt replacement recommended; PermaTorqueMLS®	
2	Head Bolt Set	2013-12	ES 72274	Replacement recommended	
QTY	CONVERSION SET	YEARS	PART NO.	DESCRIPTION	
1	Gasket Conversion Set	2013-12	CS 26376-1	RTV sealant incl. for oil pan gskt.; Improved design	
QTY	MANIFOLD - INT. & EXH.	YEARS	PART NO.	DESCRIPTION	
1	Plenum Gasket Set	2013-12	MS 97241	Upper set; New Part Number - Check for Availability	
QTY	CRANKSHAFT REAR SEAL	YEARS	PART NO.	DESCRIPTION	
1	Rear Main Seal Set	2013-12	BS 40711	PTFE Rubber; One-piece; Improved design	
QTY	VALVE COVER	YEARS	PART NO.	DESCRIPTION	
1	Valve Cover Gasket Set	2013-12	VS 50808 R	w/Grommets & Spark plug tube seals; PermaDry® molded rubber gskts. incl.; New Part Number - Check for Availability	
1	Spark Plug Tube Seal Set	2013-12	ES 72393	Valve Cover; New Part Number - Check for Availability	
QTY	THERMOSTAT HOUSING	YEARS	PART NO.	DESCRIPTION	
1	Thermostat Gasket	2013-12	35871	Thermostat Housing; Thermostat housing to head	

GMC Truck (Incl. Minivans and SUV's) (Cont.)

41		2013 - 2012; 3.6L 217 (3564cc) DOHC V6 (24 Valve) 94mm Bore VVT			41
(cont.)		DI; Flex Fuel; Naturally Aspirated Opel Eng.; VIN Code 3			(cont.)
QTY	WATER OUTLET GASKET	YEARS	PART NO.	DESCRIPTION	
1	Water Outlet Gasket	2013-12	35855	Water Outlet; Water outlet O-ring; New Part Number - Check for Availability	
1	Water Outlet Gasket	2013-12	35856	Water Outlet; Water outlet seal; New Part Number - Check for Availability	
QTY	WATER PUMP	YEARS	PART NO.	DESCRIPTION	
1	Water Pump Gasket	2013-12	35859		
QTY	TIMING COVER	YEARS	PART NO.	DESCRIPTION	
1	Timing Cover Set	2013-12	TCS 46108		
42		2013 - 2009; 3.6L 217 (3564cc) DOHC V6 (24 Valve) 94mm Bore VVT			42
(cont.)		DI; Gasoline; Naturally Aspirated Opel Eng.; VIN Code D			(cont.)
QTY	CYLINDER HEAD	YEARS	PART NO.	DESCRIPTION	
1	Head Gasket	2013-09	26376 PT	Loc. L.H.; Head bolts not incl.; Head bolt replacement recommended; PermaTorqueMLS®	
1	Head Gasket	2013-09	26377 PT	Loc. R.H.; Head bolts not incl.; Head bolt replacement recommended; PermaTorqueMLS®	
2	Head Bolt Set	2013-09	ES 72274	Replacement recommended	
QTY	CONVERSION SET	YEARS	PART NO.	DESCRIPTION	
1	Gasket Conversion Set	2013-09	CS 26376-1	RTV sealant incl. for oil pan gskt.; Improved design	
QTY	MANIFOLD - INT. & EXH.	YEARS	PART NO.	DESCRIPTION	
1	Plenum Gasket Set	2013-12	MS 97241	Upper set; New Part Number - Check for Availability	
1	Exh. Manifold Gasket Set	2013-09	MS 96973		
QTY	EXHAUST PIPE FLANGE	YEARS	PART NO.	DESCRIPTION	
2	Exhaust Pipe Gasket	2013-09	61519	Pipe to manifold	
2	Exhaust Pipe Gasket	2013-09	61536	Converter	
QTY	CRANKSHAFT REAR SEAL	YEARS	PART NO.	DESCRIPTION	
1	Rear Main Seal Set	2013-09	BS 40711	PTFE Rubber; One-piece; Improved design	
QTY	VALVE COVER	YEARS	PART NO.	DESCRIPTION	
1	Valve Cover Gasket Set	2013-09	VS 50808 R	w/Grommets & Spark plug tube seals; PermaDry® molded rubber gskts. incl.; New Part Number - Check for Availability	
1	Spark Plug Tube Seal Set	2013-09	ES 72393	Valve Cover; New Part Number - Check for Availability	
QTY	THERMOSTAT HOUSING	YEARS	PART NO.	DESCRIPTION	
1	Thermostat Gasket	2013-09	35871	Thermostat Housing; Thermostat housing to head	
QTY	WATER OUTLET GASKET	YEARS	PART NO.	DESCRIPTION	
1	Water Outlet Gasket	2013-09	35855	Water Outlet; Water outlet O-ring; New Part Number - Check for Availability	
1	Water Outlet Gasket	2013-09	35856	Water Outlet; Water outlet seal; New Part Number - Check for Availability	
QTY	WATER PUMP	YEARS	PART NO.	DESCRIPTION	
1	Water Pump Gasket	2013-09	35859		
QTY	TIMING COVER	YEARS	PART NO.	DESCRIPTION	
1	Timing Cover Set	2013-09	TCS 46108		
QTY	CARB & FUEL INJECTION	YEARS	PART NO.	DESCRIPTION	
1	Throttle Body Gasket	2011-09	61614		
QTY	OIL FILTER MOUNTING	YEARS	PART NO.	DESCRIPTION	
1	Oil Filter Adapter Gasket	2013-09	72968	Oil filter adapter; New Part Number - Check for Availability	
43		2013 - 2012; 3.6L 217 (3564cc) DOHC V6 (24 Valve) 94mm Bore VVT			43
(cont.)		DI; Gasoline; Naturally Aspirated Opel Eng.; VIN Code V			(cont.)
QTY	CYLINDER HEAD	YEARS	PART NO.	DESCRIPTION	
1	Head Gasket	2013-12	26376 PT	Loc. L.H.; Head bolts not incl.; Head bolt replacement recommended; PermaTorqueMLS®	
1	Head Gasket	2013-12	26377 PT	Loc. R.H.; Head bolts not incl.; Head bolt replacement recommended; PermaTorqueMLS®	
2	Head Bolt Set	2013-12	ES 72274	Replacement recommended	
QTY	CONVERSION SET	YEARS	PART NO.	DESCRIPTION	
1	Gasket Conversion Set	2013-12	CS 26376-1	RTV sealant incl. for oil pan gskt.; Improved design	
QTY	CRANKSHAFT REAR SEAL	YEARS	PART NO.	DESCRIPTION	
1	Rear Main Seal Set	2013-12	BS 40711	PTFE Rubber; One-piece; Improved design	
QTY	VALVE COVER	YEARS	PART NO.	DESCRIPTION	
1	Valve Cover Gasket Set	2013-12	VS 50808 R	w/Grommets & Spark plug tube seals; PermaDry® molded rubber gskts. incl.; New Part Number - Check for Availability	
1	Spark Plug Tube Seal Set	2013-12	ES 72393	Valve Cover; New Part Number - Check for Availability	
QTY	THERMOSTAT HOUSING	YEARS	PART NO.	DESCRIPTION	
1	Thermostat Gasket	2013-12	35871	Thermostat Housing; Thermostat housing to head	
QTY	WATER OUTLET GASKET	YEARS	PART NO.	DESCRIPTION	
1	Water Outlet Gasket	2013-12	35855	Water Outlet; Water outlet O-ring; New Part Number - Check for Availability	

GMC Truck (Incl. Minivans and SUV's) (Cont.)

43		2013 - 2012; 3.6L 217 (3564cc) DOHC V6 (24 Valve) 94mm Bore VVT			43	
(cont.)		DI; Gasoline; Naturally Aspirated Opel Eng.; VIN Code V			(cont.)	
QTY	WATER OUTLET GASKET	YEARS	PART NO.	DESCRIPTION		
1	Water Outlet Gasket	2013-12	35856	Water Outlet; Water outlet seal; New Part Number - Check for Availability		
QTY	WATER PUMP	YEARS	PART NO.	DESCRIPTION		
1	Water Pump Gasket	2013-12	35859			
QTY	TIMING COVER	YEARS	PART NO.	DESCRIPTION		
1	Timing Cover Set	2013-12	TCS 46108			
QTY	OIL FILTER MOUNTING	YEARS	PART NO.	DESCRIPTION		
1	Oil Filter Adapter Gasket	2013-12	72968	Oil filter adapter; New Part Number - Check for Availability		
44		2012 - 2007; 3.7L 223 (3654cc) DOHC L5 (20 Valve) 95.5mm Bore Vortec			44	
		MFI; Gasoline; Naturally Aspirated GMC Eng.; Chevrolet; VIN Code E				
QTY	CYLINDER HEAD	YEARS	PART NO.	DESCRIPTION		
1	Head Gasket	2012-07	26390 PT	Head bolts not incl.; Head bolt replacement recommended; PermaTorqueMLS®		
1	Head Set	2012-07	HS 26390 PT	Head bolts not incl.; Head bolt replacement recommended; PermaDry® molded rubber valve cover gskt. incl.; Premium valve stem seals incl.		
1	Head Bolt Set	2012-07	ES 71334	Head bolts w/Washers; Replacement recommended; Improved design		
1	Head Bolt Set	2012-07	ES 72195	Head bolts w/Washers; Replacement recommended; Old design		
QTY	CONVERSION SET	YEARS	PART NO.	DESCRIPTION		
1	Gasket Conversion Set	2012-07	CS 26335	RTV sealant incl. for oil pan gskt.		
QTY	MANIFOLD - INT. & EXH.	YEARS	PART NO.	DESCRIPTION		
1	Int. Manifold Gasket Set	2012-07	MS 96440-2			
1	Exh. Manifold Gasket Set	2012-07	MS 97009			
QTY	EXHAUST PIPE FLANGE	YEARS	PART NO.	DESCRIPTION		
1	Exhaust Pipe Gasket	2012-07	61348	Pipe to manifold		
QTY	CRANKSHAFT REAR SEAL	YEARS	PART NO.	DESCRIPTION		
1	Rear Main Seal Set	2012-07	BS 40705	PTFE Rubber; One-piece		
QTY	VALVE COVER	YEARS	PART NO.	DESCRIPTION		
1	Valve Cover Gasket Set	2012-07	VS 50739 R	w/Grommets & Spark plug tube seals; Must be used w/MS 96440-2; PermaDry® molded rubber gskt. incl.		
QTY	VALVE STEM SEAL SET	YEARS	PART NO.	DESCRIPTION		
1	Valve Stem Seal Set	2012-07	SS 71237-2	Premium valve stem seals incl.		
QTY	THERMOSTAT HOUSING	YEARS	PART NO.	DESCRIPTION		
1	Thermostat Gasket	2012-07	35632	Thermostat O-ring		
QTY	WATER OUTLET GASKET	YEARS	PART NO.	DESCRIPTION		
1	Water Outlet Gasket	2012-07	36017	Water Outlet; Coolant outlet seal; New Part Number - Check for Availability		
QTY	WATER PUMP	YEARS	PART NO.	DESCRIPTION		
1	Water Pump Gasket	2012-07	35704			
QTY	TIMING COVER	YEARS	PART NO.	DESCRIPTION		
1	Timing Cover Set	2012-07	TCS 45052			
QTY	CARB & FUEL INJECTION	YEARS	PART NO.	DESCRIPTION		
2	Fuel Injector O-Ring Set	2012-07	ES 70599	Upper set; Injectors to fuel rail; Improved design		
2	Fuel Injector O-Ring Set	2012-07	ES 71190	Lower set; Injectors to cylinder head		
2	Fuel Injector O-Ring Set	2012-07	ES 71192	Upper set; Injectors to fuel rail; Old design		
1	Throttle Body Gasket	2012-07	61337	Improved design		
QTY	EXHAUST GAS RECIRCULATION	YEARS	PART NO.	DESCRIPTION		
1	EGR Gasket	2012-07	72755	EGR tube; New Part Number - Check for Availability		
45		1995 - 1992; 3.8L 231 (3791cc) OHV V6 (12 Valve) 3.8" Bore			45	
		MFI; Gasoline; Naturally Aspirated GMC Eng.; Buick; VIN Code L				
QTY	CYLINDER HEAD	YEARS	PART NO.	DESCRIPTION		
2	Head Gasket	1995-92	9644 PT	Head bolts not incl.; Head bolt replacement required		
1	Head Set	1995-93	HS 9644 PT-1	Upper int. manifold gskt., head bolts, exh. pipe packing not incl.; Head bolt replacement required; PermaDry® molded rubber valve cover gskts. incl.; Premium valve stem seals incl.		
1	Head Set	1992	HS 9644 PT-1	Head bolts & exh. pipe packing not incl.; Head bolt replacement required; PermaDry® molded rubber valve cover gskts. incl.; Premium valve stem seals incl.		
1	Head Bolt Set	1995-92	ES 74031	Replacement required		
QTY	CONVERSION SET	YEARS	PART NO.	DESCRIPTION		
1	Gasket Conversion Set	1995	CS 9088-1	Oil pan gskt. not incl.; PermaDryPlus® timing cover gskt. incl.		
1	Gasket Conversion Set	1994-92	CS 9644	PermaDry® molded rubber oil pan gskt. incl.; PermaDryPlus® timing cover gskt. incl.		

GMC Truck (Incl. Minivans and SUV's) (Cont.)

45 (cont.)		1995 - 1992; 3.8L 231 (3791cc) OHV V6 (12 Valve) 3.8" Bore			45 (cont.)
MFI; Gasoline; Naturally Aspirated GMC Eng.; Buick; VIN Code L					
QTY	MANIFOLD - INT. & EXH.	YEARS	PART NO.	DESCRIPTION	
1	Int. Manifold Gasket Set	1995-92	MS 94918-1	Lower set; Improved design	
1	Plenum Gasket Set	1995-93	MS 95830	Upper set	
1	Exh. Manifold Gasket Set	1995-92	MS 94052		
QTY	EXHAUST PIPE FLANGE	YEARS	PART NO.	DESCRIPTION	
1	Exhaust Pipe Gasket	1995-92	60884	Pipe to manifold; Improved design	
1	Exhaust Pipe Gasket	1995-93	61017	Crossover; 2.265" ID x 3.015" OD	
1	Exhaust Pipe Gasket	1992	60754	Crossover; 2.270" ID x 3.225" OD	
1	Exh. Flange Bolt & Spring Kit	1995-92	ES 72141		
QTY	OIL PAN	YEARS	PART NO.	DESCRIPTION	
1	Oil Pan Gasket Set	1995	OS 30767 R	PermaDry® molded rubber gskt. incl.; Improved design	
1	Oil Pan Gasket Set	1994-92	OS 30522 R	PermaDry® molded rubber gskt. incl.	
1	Oil Pan Gasket Set	1994-92	OS 30522 T	PermaDryPlus®; Oil Pan SnapUps® incl.	
1	Drain Plug Gasket	1995	70820		
1	Drain Plug Gasket	1994-92	70822		
QTY	CRANKSHAFT REAR SEAL	YEARS	PART NO.	DESCRIPTION	
1	Rear Main Seal Set	1995-92	BS 40621	Rubber; One-piece	
1	Rear Main Seal Set	1995-92	BS 40649	PTFE Rubber; One-piece	
1	Repair Sleeve	1995-92	16276	Crankshaft; Use w/installation tool	
QTY	VALVE COVER	YEARS	PART NO.	DESCRIPTION	
1	Valve Cover Gasket Set	1995-92	VS 50080 R	w/o Grommets; Services both covers; PermaDry® molded rubber gskts. incl.	
2	Valve Cover Gasket Set	1995-92	VS 50320 R	w/o Grommets; Services one cover only; PermaDry® molded rubber gskt. incl.	
1	Grommet Set	1995-92	ES 72833	Valve Cover	
QTY	VALVE STEM SEAL SET	YEARS	PART NO.	DESCRIPTION	
1	Valve Stem Seal Set	1995-92	SS 72700	Premium valve stem seals incl.	
QTY	THERMOSTAT HOUSING	YEARS	PART NO.	DESCRIPTION	
1	Thermostat Gasket	1995-92	35534	Thermostat Housing	
1	Thermostat Gasket	1995-92	35666	Thermostat Housing; Thermostat seal; 1.560" ID; Improved design	
QTY	WATER OUTLET GASKET	YEARS	PART NO.	DESCRIPTION	
1	Water Outlet Gasket	1995-92	36023	Water Outlet; Water bypass; New Part Number - Check for Availability	
QTY	WATER PUMP	YEARS	PART NO.	DESCRIPTION	
1	Water Pump Gasket	1995-92	35351		
QTY	TIMING COVER	YEARS	PART NO.	DESCRIPTION	
1	Timing Cover Set	1995	TCS 45840	w/o Sleeve 'N' Seal®; Must be used w/OS 30767R or w/OS 34410R; PermaDryPlus® timing cover gskt. incl.	
1	Timing Cover Set	1994-92	TCS 45840	w/o Sleeve 'N' Seal®; Must be used w/OS 30522R or w/OS 30522T; PermaDryPlus® timing cover gskt. incl.	
1	Timing Set w/Sleeve & Seal	1995	TCS 45974	w/Sleeve 'N' Seal®; Must be used w/OS 30767R or w/OS 34410R; PermaDryPlus® timing cover gskt. incl.	
1	Timing Set w/Sleeve & Seal	1994-92	TCS 45974	w/Sleeve 'N' Seal®; Must be used w/OS 30522R or w/OS 30522T; PermaDryPlus® timing cover gskt. incl.	
1	Repair Sleeve	1995-92	16216	Timing Cover; Use w/installation tool	
1	Repair Sleeve Tool	1995-92	16308	Timing Cover	
QTY	CARB & FUEL INJECTION	YEARS	PART NO.	DESCRIPTION	
3	Fuel Injector O-Ring Set	1995-92	ES 70599	Improved design	
1	Throttle Body Gasket	1995-93	61037		
1	Throttle Body Gasket	1992	61023		
QTY	EXHAUST GAS RECIRCULATION	YEARS	PART NO.	DESCRIPTION	
1	EGR Gasket	1995-94	70786		
1	EGR Gasket	1993-92	70784		
QTY	OIL FILTER MOUNTING	YEARS	PART NO.	DESCRIPTION	
1	Oil Filter Gasket	1995-92	70644		
46		1994 - 1991; 3.9L 235.2 (3856cc) OHV Turbo L4 (8 Valve) 102mm Bore			46
DI; Diesel; Turbo Isuzu Eng.; Eng. Code 4BD1-T					
QTY	FULL GASKET SET	YEARS	PART NO.	DESCRIPTION	
1	Full Gasket Set	1994-91	FS 9015 B		
47		2009 - 2006; 3.9L 242 (3880cc) OHV V6 (12 Valve) 99mm Bore			47
MFI; Gasoline; Naturally Aspirated GMC Eng.; Chevrolet; VIN Code 1					
QTY	CYLINDER HEAD	YEARS	PART NO.	DESCRIPTION	
1	Head Gasket	2009-06	26324 PT	Loc. L.H.; Head bolts not incl.; Head bolt replacement recommended; PermaTorqueMLS® LaserWeld® Technology	

GMC Truck (Incl. Minivans and SUV's) (Cont.)

47 (cont.)		2009 - 2006; 3.9L 242 (3880cc) OHV V6 (12 Valve) 99mm Bore			47 (cont.)
MFI; Gasoline; Naturally Aspirated GMC Eng.; Chevrolet; VIN Code 1					
QTY	CYLINDER HEAD	YEARS	PART NO.	DESCRIPTION	
1	Head Gasket	2009-06	26325 PT	Loc. R.H.; Head bolts not incl.; Head bolt replacement recommended; PermaTorqueMLS® LaserWeld® Technology	
1	Head Set	2009-06	HS 26324 PT	Head bolts not incl.; Head bolt replacement recommended; PermaDryPlus® int. manifold gsks. incl.; PermaDry® molded rubber valve cover gsks. incl.; Premium valve stem seals incl.	
2	Head Bolt Set	2009-06	ES 72230	Head bolts w/Washers; Replacement recommended; Improved design	
QTY	CONVERSION SET	YEARS	PART NO.	DESCRIPTION	
1	Gasket Conversion Set	2009-06	CS 26324	PermaDry® molded rubber oil pan gskt. incl.	
QTY	MANIFOLD - INT. & EXH.	YEARS	PART NO.	DESCRIPTION	
1	Int. Manifold Gasket Set	2009-06	MS 98015 T	Valve cover gsks. & Upper set incl.; PermaDryPlus® int. manifold gsks. incl.; Manifold bolts not incl.; Manifold bolt replacement recommended	
1	Plenum Gasket Set	2009-06	MS 96824	Upper set	
1	Int. Manifold Bolt Set	2009-06	ES 72226	Loc. Lower; Replacement recommended	
1	Exh. Manifold Gasket Set	2009-06	MS 96818		
QTY	EXHAUST PIPE FLANGE	YEARS	PART NO.	DESCRIPTION	
1	Exhaust Pipe Gasket	2009-06	61310	Flange; Improved design	
1	Exhaust Pipe Gasket	2009-06	61314	Converter	
QTY	OIL PAN	YEARS	PART NO.	DESCRIPTION	
1	Oil Pan Gasket Set	2009-06	OS 30776 R	PermaDry® molded rubber gskt. incl.	
QTY	CRANKSHAFT REAR SEAL	YEARS	PART NO.	DESCRIPTION	
1	Rear Main Seal Set	2009-06	BS 40625	11.0mm thick; PTFE Rubber; One-piece; Improved design	
1	Rear Main Seal Set	2009-06	BS 40698	PTFE Rubber; One-piece; May use BS 40625 instead; Old design; Superseded - When depleted use BS 40625	
QTY	VALVE COVER	YEARS	PART NO.	DESCRIPTION	
1	Valve Cover Gasket Set	2009-06	VS 50442 R	w/o Grommets; Must be used w/35614; PermaDry® molded rubber gsks. incl.	
1	Grommet Set	2009-06	ES 71044	Valve Cover	
QTY	VALVE STEM SEAL SET	YEARS	PART NO.	DESCRIPTION	
1	Valve Stem Seal Set	2009-06	SS 71039-1	Premium valve stem seals incl.	
QTY	WATER OUTLET GASKET	YEARS	PART NO.	DESCRIPTION	
1	Water Outlet Gasket	2009-06	35815	Water Crossover; Loc. L.H.	
1	Water Outlet Gasket	2009	35913	Water Crossover; Loc. R.H.	
1	Water Outlet Gasket	2008-06	35816	Water Crossover; Loc. R.H.	
1	Thermostat Gasket	2009-06	35614	Water Outlet; Improved design	
QTY	WATER PUMP	YEARS	PART NO.	DESCRIPTION	
1	Water Pump Gasket	2009-06	35814		
QTY	TIMING COVER	YEARS	PART NO.	DESCRIPTION	
1	Timing Cover Set	2009-06	TCS 46089		
1	Timing Cover Gasket	2009-06	72966	New Part Number - Check for Availability	
QTY	CARB & FUEL INJECTION	YEARS	PART NO.	DESCRIPTION	
1	Throttle Body Gasket	2009-06	61466		
QTY	OIL FILTER MOUNTING	YEARS	PART NO.	DESCRIPTION	
1	Oil Filter Adapter Gasket	2009-06	72423	Improved design	

48		2009 - 2007; 3.9L 242 (3880cc) OHV V6 (12 Valve) 99mm Bore			48
MFI; Flex Fuel; Naturally Aspirated GMC Eng.; Chevrolet; VIN Code W					
QTY	CYLINDER HEAD	YEARS	PART NO.	DESCRIPTION	
1	Head Gasket	2009-07	26324 PT	Loc. L.H.; Head bolts not incl.; Head bolt replacement recommended; PermaTorqueMLS® LaserWeld® Technology	
1	Head Gasket	2009-07	26325 PT	Loc. R.H.; Head bolts not incl.; Head bolt replacement recommended; PermaTorqueMLS® LaserWeld® Technology	
1	Head Set	2009-07	HS 26324 PT	Head bolts not incl.; Head bolt replacement recommended; PermaDryPlus® int. manifold gsks. incl.; PermaDry® molded rubber valve cover gsks. incl.; Premium valve stem seals incl.	
2	Head Bolt Set	2009-07	ES 72230	Head bolts w/Washers; Replacement recommended; Improved design	
QTY	CONVERSION SET	YEARS	PART NO.	DESCRIPTION	
1	Gasket Conversion Set	2009-07	CS 26324	PermaDry® molded rubber oil pan gskt. incl.	
QTY	MANIFOLD - INT. & EXH.	YEARS	PART NO.	DESCRIPTION	
1	Int. Manifold Gasket Set	2009-07	MS 98015 T	Valve cover gsks. & Upper set incl.; PermaDryPlus® int. manifold gsks. incl.; Manifold bolts not incl.; Manifold bolt replacement recommended	
1	Plenum Gasket Set	2009-07	MS 96824	Upper set	
1	Int. Manifold Bolt Set	2009-07	ES 72226	Loc. Lower; Replacement recommended	
1	Exh. Manifold Gasket Set	2009-07	MS 96818		

GMC Truck (Incl. Minivans and SUV's) (Cont.)

48		2009 - 2007; 3.9L 242 (3880cc) OHV V6 (12 Valve) 99mm Bore			48
(cont.)		MFI; Flex Fuel; Naturally Aspirated GMC Eng.; Chevrolet; VIN Code W			(cont.)
QTY	EXHAUST PIPE FLANGE	YEARS	PART NO.	DESCRIPTION	
1	Exhaust Pipe Gasket	2009-07	61310	Flange; Improved design	
1	Exhaust Pipe Gasket	2009-07	61314	Converter	
QTY	OIL PAN	YEARS	PART NO.	DESCRIPTION	
1	Oil Pan Gasket Set	2009-07	OS 30776 R	PermaDry® molded rubber gskt. incl.	
QTY	CRANKSHAFT REAR SEAL	YEARS	PART NO.	DESCRIPTION	
1	Rear Main Seal Set	2009-07	BS 40625	11.0mm thick; PTFE Rubber; One-piece; Improved design	
1	Rear Main Seal Set	2009-07	BS 40698	PTFE Rubber; One-piece; May use BS 40625 instead; Old design; Superseded - When depleted use BS 40625	
QTY	VALVE COVER	YEARS	PART NO.	DESCRIPTION	
1	Valve Cover Gasket Set	2009-07	VS 50442 R	w/o Grommets; Must be used w/35614; PermaDry® molded rubber gskts. incl.	
1	Grommet Set	2009-07	ES 71044	Valve Cover	
QTY	VALVE STEM SEAL SET	YEARS	PART NO.	DESCRIPTION	
1	Valve Stem Seal Set	2009-07	SS 71039-1	Premium valve stem seals incl.	
QTY	WATER OUTLET GASKET	YEARS	PART NO.	DESCRIPTION	
1	Water Outlet Gasket	2009-07	35815	Water Crossover; Loc. L.H.	
1	Water Outlet Gasket	2009	35913	Water Crossover; Loc. R.H.	
1	Water Outlet Gasket	2008-07	35816	Water Crossover; Loc. R.H.	
1	Thermostat Gasket	2009-07	35614	Water Outlet; Improved design	
QTY	WATER PUMP	YEARS	PART NO.	DESCRIPTION	
1	Water Pump Gasket	2009-07	35814		
QTY	TIMING COVER	YEARS	PART NO.	DESCRIPTION	
1	Timing Cover Set	2009-07	TCS 46089		
1	Timing Cover Gasket	2009-07	72966	New Part Number - Check for Availability	
QTY	CARB & FUEL INJECTION	YEARS	PART NO.	DESCRIPTION	
1	Throttle Body Gasket	2009-07	61466		
QTY	OIL FILTER MOUNTING	YEARS	PART NO.	DESCRIPTION	
1	Oil Filter Adapter Gasket	2009-07	72423	Improved design	
49		2009 - 2002; 4.2L 254 (4160cc) DOHC L6 (24 Valve) 93mm Bore Vortec			49
(cont.)		MFI; Gasoline; Naturally Aspirated GMC Eng.; Chevrolet; VIN Code S			(cont.)
QTY	CYLINDER HEAD	YEARS	PART NO.	DESCRIPTION	
1	Head Gasket	2009-02	26214 PT	Head bolts not incl.; Head bolt replacement recommended; PermaTorqueMLS®; Improved design	
1	Head Gasket	2003-02	26213 PT	Head bolts not incl.; Head bolt replacement recommended; PermaTorqueMLS®; May use 26214PT instead; Old design; Superseded - When depleted use 26214 PT	
1	Head Set	2009-06	HS 26214 PT-2	Head bolts not incl.; Head bolt replacement recommended; PermaDry® molded rubber valve cover gskt. incl.; Premium valve stem seals incl.	
1	Head Set	2005	HS 26214 PT-1	Head bolts not incl.; Head bolt replacement recommended; PermaDry® molded rubber valve cover gskt. incl.; Premium valve stem seals incl.	
1	Head Set	2004-02	HS 26214 PT	Head bolts not incl.; Head bolt replacement recommended; PermaDry® molded rubber valve cover gskt. incl.; Premium valve stem seals incl.; Improved design	
1	Head Set	2003-02	HS 26213 PT	Head bolts not incl.; Head bolt replacement recommended; PermaDry® molded rubber valve cover gskt. incl.; Premium valve stem seals incl.; May use HS 26214PT instead; Old design; Superseded - When depleted use HS 26214 PT	
1	Head Bolt Set	2009-02	ES 71334	Head bolts w/Washers; Replacement recommended; Improved design	
1	Head Bolt Set	2009-02	ES 72195	Head bolts w/Washers; Replacement recommended; Old design	
QTY	CONVERSION SET	YEARS	PART NO.	DESCRIPTION	
1	Gasket Conversion Set	2009-04	CS 26213-1	2nd Design; Balancer w/step on hub; RTV sealant incl. for oil pan gskt.	
1	Gasket Conversion Set	2005-04	CS 26213	1st Design; Balancer w/o step on hub; RTV sealant incl. for oil pan gskt.	
1	Gasket Conversion Set	2003-02	CS 26213	RTV sealant incl. for oil pan gskt.	
QTY	MANIFOLD - INT. & EXH.	YEARS	PART NO.	DESCRIPTION	
1	Int. Manifold Gasket Set	2009-05	MS 96440		
1	Int. Manifold Gasket Set	2004-02	MS 96294		
1	Exh. Manifold Gasket Set	2009-06	MS 96707		
1	Exh. Manifold Gasket Set	2005-02	MS 96302		
QTY	EXHAUST PIPE FLANGE	YEARS	PART NO.	DESCRIPTION	
1	Exhaust Pipe Gasket	2009-02	61255	Flange	
QTY	CRANKSHAFT REAR SEAL	YEARS	PART NO.	DESCRIPTION	
1	Rear Main Seal Set	2009-02	BS 40678	PTFE Rubber; One-piece	

GMC Truck (Incl. Minivans and SUV's) (Cont.)

49 (cont.)		2009 - 2002; 4.2L 254 (4160cc) DOHC L6 (24 Valve) 93mm Bore Vortec MFI; Gasoline; Naturally Aspirated GMC Eng.; Chevrolet; VIN Code S			49 (cont.)
QTY	VALVE COVER	YEARS	PART NO.	DESCRIPTION	
1	Valve Cover Gasket Set	2009-06	VS 50667 R	w/Grommets & Spark plug tube seals; Must be used w/MS 96440; PermaDry® molded rubber gskt. incl.	
1	Valve Cover Gasket Set	2005	VS 50584 R	w/Grommets & Spark plug tube seals; Must be used w/MS 96440; PermaDry® molded rubber gskt. incl.	
1	Valve Cover Gasket Set	2004-02	VS 50584 R	w/Grommets & Spark plug tube seals; Must be used w/MS 96294; PermaDry® molded rubber gskt. incl.	
QTY	VALVE STEM SEAL SET	YEARS	PART NO.	DESCRIPTION	
1	Valve Stem Seal Set	2009-06	SS 71237	Premium valve stem seals incl.	
1	Valve Stem Seal Set	2005-02	SS 71043-1	Premium valve stem seals incl.	
QTY	THERMOSTAT HOUSING	YEARS	PART NO.	DESCRIPTION	
1	Thermostat Gasket	2009-02	35632	Thermostat Housing; Thermostat O-ring	
QTY	WATER OUTLET GASKET	YEARS	PART NO.	DESCRIPTION	
1	Water Outlet Gasket	2009-06	36017	Water Outlet; Coolant outlet seal; New Part Number - Check for Availability	
1	Water Outlet Gasket	2005-02	36009	Water Outlet; Coolant outlet seal; New Part Number - Check for Availability	
QTY	WATER PUMP	YEARS	PART NO.	DESCRIPTION	
1	Water Pump Gasket	2009-02	35704		
QTY	TIMING COVER	YEARS	PART NO.	DESCRIPTION	
1	Timing Cover Set	2009-04	TCS 45052	2nd Design; Balancer w/step on hub	
1	Timing Cover Set	2005-04	TCS 45051	1st Design; Balancer w/o step on hub	
1	Timing Cover Set	2003-02	TCS 45051		
QTY	CARB & FUEL INJECTION	YEARS	PART NO.	DESCRIPTION	
2	Fuel Injector O-Ring Set	2009-02	ES 70599	Upper set; Injectors to fuel rail; Improved design	
2	Fuel Injector O-Ring Set	2009-02	ES 71190	Lower set; Injectors to cylinder head	
2	Fuel Injector O-Ring Set	2009-02	ES 71192	Upper set; Injectors to fuel rail; Old design	
1	Throttle Body Gasket	2009-02	61337	Improved design	
QTY	EXHAUST GAS RECIRCULATION	YEARS	PART NO.	DESCRIPTION	
1	EGR Gasket	2009-02	72755	EGR tube; New Part Number - Check for Availability	
50		1993 - 1991; 4.3L 262 (4294cc) OHV V6 (12 Valve) 4" Bore MFI; Gasoline; Turbo - Intercooled GMC Eng.; Chevrolet; VIN Code Z			50
QTY	CONVERSION SET	YEARS	PART NO.	DESCRIPTION	
1	Gasket Conversion Set	1993-91	CS 9354-1	PermaDry® molded rubber oil pan gskt. incl.	
QTY	MANIFOLD - INT. & EXH.	YEARS	PART NO.	DESCRIPTION	
1	Exh. Manifold Gasket Set	1993-91	MS 95842		
QTY	EXHAUST PIPE FLANGE	YEARS	PART NO.	DESCRIPTION	
2	Exhaust Pipe Gasket	1993-91	60718	Packing; 2 3/32" ID Steel sleeve	
QTY	FUEL PUMP	YEARS	PART NO.	DESCRIPTION	
1	Fuel Pump Mounting Gasket	1993-91	71097	Plate	
QTY	OIL PAN	YEARS	PART NO.	DESCRIPTION	
1	Oil Pan Gasket Set	1993-91	OS 34502 R	PermaDry® molded rubber gskt. incl.	
1	Drain Plug Gasket	1993-91	70822		
QTY	CRANKSHAFT REAR SEAL	YEARS	PART NO.	DESCRIPTION	
1	Rear Main Seal Set	1993-91	BS 40520	Rubber; One-piece	
1	Rear Main Seal Set	1993-91	BS 40626	PTFE Rubber; One-piece	
1	Repair Sleeve	1993-91	16258	Crankshaft; Use w/installation tool	
1	Repair Sleeve Tool	1993-91	16301	Crankshaft	
QTY	VALVE COVER	YEARS	PART NO.	DESCRIPTION	
1	Valve Cover Gasket Set	1993-91	VS 50086 R	Services both covers; PermaDry® molded rubber gskts. incl.	
2	Valve Cover Gasket Set	1993-91	VS 50277 R	Services one cover only; PermaDry® molded rubber gskt. incl.	
QTY	VALVE STEM SEAL SET	YEARS	PART NO.	DESCRIPTION	
1	Valve Stem Seal Set	1993-91	SS 72530	Loc. Int.; Premium valve stem seals incl.	
1	Valve Stem Seal Set	1993-91	SS 72876	Loc. Exh.; Opt. Hi-Temp. premium valve stem seals incl.	
QTY	THERMOSTAT HOUSING	YEARS	PART NO.	DESCRIPTION	
1	O-Ring	1993-92	35710	Thermostat Housing; 1.954" ID; Improved design	
QTY	WATER OUTLET GASKET	YEARS	PART NO.	DESCRIPTION	
1	Water Outlet Gasket	1993-91	35062	Water Outlet; 1 13/16" ID	
1	Water Outlet Gasket	1993-91	35562 T	Water Outlet; 1 13/16" ID; PermaDryPlus®	
QTY	WATER PUMP	YEARS	PART NO.	DESCRIPTION	
1	Water Pump Gasket	1993-91	13032	To plate	
2	Water Pump Gasket	1993-91	5152	To block	
QTY	TIMING COVER	YEARS	PART NO.	DESCRIPTION	
1	Timing Cover Set	1993-91	TCS 45121	w/o Sleeve 'N' Seal®; Must be used w/OS 34502R	

GMC Truck (Incl. Minivans and SUV's) (Cont.)

50 (cont.)		1993 - 1991; 4.3L 262 (4294cc) OHV V6 (12 Valve) 4" Bore			50 (cont.)
		MFI; Gasoline; Turbo - Intercooled GMC Eng.; Chevrolet; VIN Code Z			
QTY	TIMING COVER	YEARS	PART NO.	DESCRIPTION	
1	Timing Set w/Sleeve & Seal	1993-91	TCS 45265	w/Sleeve 'N' Seal®; Must be used w/OS 34502R	
1	Repair Sleeve	1993-91	16202	Timing Cover; Use w/installation tool	
1	Repair Sleeve Tool	1993-91	16312	Timing Cover	
QTY	DISTRIBUTOR MOUNTING	YEARS	PART NO.	DESCRIPTION	
1	Distributor Mounting Gasket	1993-91	70194		
QTY	OIL PUMP RETAINER	YEARS	PART NO.	DESCRIPTION	
1	Oil Pump Shaft Guide	1993-91	72665	Distributor to oil pump shaft retainer	
QTY	OIL COOLER	YEARS	PART NO.	DESCRIPTION	
1	Oil Cooler Mounting Set	1993-91	ES 70016		
51		1996 - 1991; 4.3L 262 (4294cc) OHV V6 (12 Valve) 4" Bore			51
		TBI; Gasoline; Naturally Aspirated GMC Eng.; Chevrolet; VIN Code Z			
QTY	CYLINDER HEAD	YEARS	PART NO.	DESCRIPTION	
2	Head Gasket	1996-91	510 SD	Head bolts not incl.; Head bolt replacement recommended; PermaTorque Severe Duty®	
2	Head Gasket	1996-91	522 SD	Head bolts not incl.; Head bolt replacement recommended; PermaTorque Severe Duty® MLS	
2	Head Gasket	1996-91	9354 PT-1	Head bolts not incl.; Head bolt replacement recommended; PermaTorque®	
1	Head Set	1996-94	HS 9354 PT-5	Head bolts & exh. pipe packing not incl.; Head bolt replacement recommended; PermaDry® molded rubber valve cover gskts. incl.; Premium valve stem seals incl.	
1	Head Set	1993	HS 9354 PT-2	Head bolts & exh. pipe packing not incl.; Head bolt replacement recommended; PermaDry® molded rubber valve cover gskts. incl.; Premium valve stem seals incl.	
1	Head Set	1992-91	HS 9354 PT-1	Head bolts & exh. pipe packing not incl.; Head bolt replacement recommended; PermaDry® molded rubber valve cover gskts. incl.; Premium valve stem seals incl.	
2	Head Bolt Set	1996-91	ES 74034	Replacement recommended	
QTY	CONVERSION SET	YEARS	PART NO.	DESCRIPTION	
1	Gasket Conversion Set	1996	CS 9354-3	Plastic timing cover not incl.; PermaDry® molded rubber oil pan gskt. incl.; Consolidated design	
1	Gasket Conversion Set	1995-91	CS 9354-1	PermaDry® molded rubber oil pan gskt. incl.	
QTY	MANIFOLD - INT. & EXH.	YEARS	PART NO.	DESCRIPTION	
1	Int. Manifold Gasket Set	1996-93	MS 93346-1		
1	Int. Manifold Gasket Set	1992-91	MS 93346		
1	Exh. Manifold Gasket Set	1996-91	MS 90746		
QTY	EXHAUST PIPE FLANGE	YEARS	PART NO.	DESCRIPTION	
2	Exhaust Pipe Gasket	1996	61014	Pipe to manifold	
2	Exhaust Pipe Gasket	1995-91	60718	Packing; 2 3/32" ID Steel sleeve	
QTY	FUEL PUMP	YEARS	PART NO.	DESCRIPTION	
1	Fuel Pump Mounting Gasket	1996-91	71097	Plate	
QTY	OIL PAN	YEARS	PART NO.	DESCRIPTION	
1	Oil Pan Gasket Set	1996	OS 30680 R	PermaDry® molded rubber gskt. incl.	
1	Oil Pan Gasket Set	1995-91	OS 34502 R	PermaDry® molded rubber gskt. incl.	
1	Drain Plug Gasket	1996	70820		
1	Drain Plug Gasket	1995-91	70822		
QTY	CRANKSHAFT REAR SEAL	YEARS	PART NO.	DESCRIPTION	
1	Rear Main Seal Set	1996	BS 40656	PTFE Rubber; One-piece; Improved design	
1	Rear Main Seal Set	1995-91	BS 40520	Rubber; One-piece	
1	Rear Main Seal Set	1995-91	BS 40626	PTFE Rubber; One-piece	
1	Repair Sleeve	1995-91	16258	Crankshaft; Use w/installation tool	
1	Repair Sleeve Tool	1995-91	16301	Crankshaft	
QTY	VALVE COVER	YEARS	PART NO.	DESCRIPTION	
1	Valve Cover Gasket Set	1996-94	VS 50464 R	w/Grommets; PermaDry® molded rubber gskts. incl.	
1	Valve Cover Gasket Set	1993-91	VS 50086 R	Services both covers; PermaDry® molded rubber gskts. incl.	
2	Valve Cover Gasket Set	1993-91	VS 50277 R	Services one cover only; PermaDry® molded rubber gskt. incl.	
QTY	VALVE STEM SEAL SET	YEARS	PART NO.	DESCRIPTION	
1	Valve Stem Seal Set	1996	SS 72861-1	Loc. Int. & Exh.; Premium valve stem seals incl.	
1	Valve Stem Seal Set	1995-91	SS 72530	Loc. Int.; Premium valve stem seals incl.	
1	Valve Stem Seal Set	1995-91	SS 72876	Loc. Exh.; Opt. Hi-Temp. premium valve stem seals incl.	
QTY	THERMOSTAT HOUSING	YEARS	PART NO.	DESCRIPTION	
1	O-Ring	1996-92	35710	Thermostat Housing; 1.954" ID; Improved design	
QTY	WATER OUTLET GASKET	YEARS	PART NO.	DESCRIPTION	
1	Water Outlet Gasket	1992-91	35062	Water Outlet; 1 13/16" ID	

GMC Truck (Incl. Minivans and SUV's) (Cont.)

51		1996 - 1991; 4.3L 262 (4294cc) OHV V6 (12 Valve) 4" Bore			51
(cont.)		TBI; Gasoline; Naturally Aspirated GMC Eng.; Chevrolet; VIN Code Z			(cont.)
QTY	WATER OUTLET GASKET	YEARS	PART NO.	DESCRIPTION	
1	Water Outlet Gasket	1992-91	35562 T	Water Outlet; 1 13/16" ID; PermaDryPlus®	
QTY	WATER PUMP	YEARS	PART NO.	DESCRIPTION	
1	Water Pump Gasket	1996-91	13032	To plate	
2	Water Pump Gasket	1996-91	5152	To block	
QTY	TIMING COVER	YEARS	PART NO.	DESCRIPTION	
1	Timing Cover Set	1996	TCS 46091	Eng. w/2.42" OD timing cover seal; Must be used w/OS 30680R	
1	Timing Cover Set	1995-91	TCS 45121	w/o Sleeve 'N' Seal®; Must be used w/OS 34502R	
1	Timing Set w/Sleeve & Seal	1995-91	TCS 45265	w/Sleeve 'N' Seal®; Must be used w/OS 34502R	
1	Repair Sleeve	1995-91	16202	Timing Cover; Use w/installation tool	
1	Repair Sleeve Tool	1995-91	16312	Timing Cover	
QTY	AIR CLEANER MOUNTING	YEARS	PART NO.	DESCRIPTION	
1	Air Cleaner Gasket	1996-91	60038	5 1/32" ID	
QTY	CARB & FUEL INJECTION	YEARS	PART NO.	DESCRIPTION	
1	Throttle Body Gasket	1996-91	60903		
QTY	DISTRIBUTOR MOUNTING	YEARS	PART NO.	DESCRIPTION	
1	Distributor Mounting Gasket	1996-91	70194		
QTY	EXHAUST GAS RECIRCULATION	YEARS	PART NO.	DESCRIPTION	
1	EGR Gasket	1996	70789		
1	EGR Gasket	1995	70789	Chevrolet G10 Van Beauville, Chevy Van, Sportvan, G20 Van Beauville, Chevy Van, Sportvan, G30 Van Beauville, Chevy Van, Hi-Cube, Sportvan GMC G1500 Van Rally, Rally STX, Vandura, G2500 Van Rally, Rally STX, Vandura, G3500 Van Magnavan, Rally, Rally Camp	
1	EGR Gasket	1995	70789	Chevrolet S10 Pickup Base, LS, SS, ZR2 GMC Sonoma SL, SLE, SLS; w/A/T	
1	EGR Gasket	1995	70978	Exc. Chevrolet G10 Van Beauville, Chevy Van, Sportvan, G20 Van Beauville, Chevy Van, Sportvan, G30 Van Beauville, Chevy Van, Hi-Cube, Sportvan, S10 Pickup Base, LS, SS, ZR2 GMC G1500 Van Rally, Rally STX, Vandura, G2500 Van Rally, Rally STX, Vandura, G3	
1	EGR Gasket	1995	70978	Chevrolet S10 Pickup Base, LS, SS, ZR2 GMC Sonoma SL, SLE, SLS; w/M/T	
1	EGR Gasket	1994	70789	Chevrolet Astro Base, CL, CS, LT GMC Safari Base, SLE, SLT, SLX, XT; w/H/D cooling	
1	EGR Gasket	1994	70978	Exc. Chevrolet Astro Base, CL, CS, LT GMC Safari Base, SLE, SLT, SLX, XT	
1	EGR Gasket	1994	70978	Chevrolet Astro Base, CL, CS, LT GMC Safari Base, SLE, SLT, SLX, XT; w/o H/D cooling	
1	EGR Gasket	1993	70789	Chevrolet Astro Base, CL, CS, LT GMC Safari Base, GT, SLE, SLT, XT; w/H/D cooling	
1	EGR Gasket	1993	70978	Exc. Chevrolet Astro Base, CL, CS, LT GMC Safari Base, GT, SLE, SLT, XT	
1	EGR Gasket	1993	70978	Chevrolet Astro Base, CL, CS, LT GMC Safari Base, GT, SLE, SLT, XT; w/o H/D cooling	
1	EGR Gasket	1992	70789	Chevrolet Astro Base, CL, CS, LT GMC Safari Base, SLE, SLT, XT; w/H/D cooling	
1	EGR Gasket	1992	70978	Exc. Chevrolet Astro Base, CL, CS, LT GMC Safari Base, SLE, SLT, XT	
1	EGR Gasket	1992	70978	Chevrolet Astro Base, CL, CS, LT GMC Safari Base, SLE, SLT, XT; w/o H/D cooling	
1	EGR Gasket	1991	70978		
QTY	OIL PUMP RETAINER	YEARS	PART NO.	DESCRIPTION	
1	Oil Pump Shaft Guide	1996-91	72665	Distributor to oil pump shaft retainer	
QTY	OIL COOLER	YEARS	PART NO.	DESCRIPTION	
1	Oil Cooler Mounting Set	1996-91	ES 70016		
52		1991; 4.3L 262 (4294cc) OHV V6 (12 Valve) 4" Bore H.O.			52
		TBI; Gasoline; Naturally Aspirated GMC Eng.; Chevrolet; VIN Code B			
QTY	CYLINDER HEAD	YEARS	PART NO.	DESCRIPTION	
2	Head Gasket	1991	510 SD	Head bolts not incl.; Head bolt replacement recommended; PermaTorque Severe Duty®	
2	Head Gasket	1991	522 SD	Head bolts not incl.; Head bolt replacement recommended; PermaTorque Severe Duty® MLS	
2	Head Gasket	1991	9354 PT-1	Head bolts not incl.; Head bolt replacement recommended; PermaTorque®	
1	Head Set	1991	HS 9354 PT-1	Head bolts & exh. pipe packing not incl.; Head bolt replacement recommended; PermaDry® molded rubber valve cover gskts. incl.; Premium valve stem seals incl.	

GMC Truck (Incl. Minivans and SUV's) (Cont.)

52 (cont.)		1991; 4.3L 262 (4294cc) OHV V6 (12 Valve) 4" Bore H.O.			52 (cont.)
		TBI; Gasoline; Naturally Aspirated GMC Eng.; Chevrolet; VIN Code B			
QTY	CYLINDER HEAD	YEARS	PART NO.	DESCRIPTION	
2	Head Bolt Set	1991	ES 74034	Replacement recommended	
QTY	CONVERSION SET	YEARS	PART NO.	DESCRIPTION	
1	Gasket Conversion Set	1991	CS 9354-1	PermaDry® molded rubber oil pan gskt. incl.	
QTY	MANIFOLD - INT. & EXH.	YEARS	PART NO.	DESCRIPTION	
1	Int. Manifold Gasket Set	1991	MS 93346		
1	Exh. Manifold Gasket Set	1991	MS 90746		
QTY	EXHAUST PIPE FLANGE	YEARS	PART NO.	DESCRIPTION	
2	Exhaust Pipe Gasket	1991	60718	Packing; 2 3/32" ID Steel sleeve	
QTY	FUEL PUMP	YEARS	PART NO.	DESCRIPTION	
1	Fuel Pump Mounting Gasket	1991	71097	Plate	
QTY	OIL PAN	YEARS	PART NO.	DESCRIPTION	
1	Oil Pan Gasket Set	1991	OS 34502 R	PermaDry® molded rubber gskt. incl.	
1	Drain Plug Gasket	1991	70822		
QTY	CRANKSHAFT REAR SEAL	YEARS	PART NO.	DESCRIPTION	
1	Rear Main Seal Set	1991	BS 40520	Rubber; One-piece	
1	Rear Main Seal Set	1991	BS 40626	PTFE Rubber; One-piece	
1	Repair Sleeve	1991	16258	Crankshaft; Use w/installation tool	
1	Repair Sleeve Tool	1991	16301	Crankshaft	
QTY	VALVE COVER	YEARS	PART NO.	DESCRIPTION	
1	Valve Cover Gasket Set	1991	VS 50086 R	Services both covers; PermaDry® molded rubber gskts. incl.	
2	Valve Cover Gasket Set	1991	VS 50277 R	Services one cover only; PermaDry® molded rubber gskt. incl.	
QTY	VALVE STEM SEAL SET	YEARS	PART NO.	DESCRIPTION	
1	Valve Stem Seal Set	1991	SS 72530	Loc. Int.; Premium valve stem seals incl.	
1	Valve Stem Seal Set	1991	SS 72876	Loc. Exh.; Opt. Hi-Temp. premium valve stem seals incl.	
QTY	WATER OUTLET GASKET	YEARS	PART NO.	DESCRIPTION	
1	Water Outlet Gasket	1991	35062	Water Outlet; 1 13/16" ID	
1	Water Outlet Gasket	1991	35562 T	Water Outlet; 1 13/16" ID; PermaDryPlus®	
QTY	WATER PUMP	YEARS	PART NO.	DESCRIPTION	
1	Water Pump Gasket	1991	13032	To plate	
2	Water Pump Gasket	1991	5152	To block	
QTY	TIMING COVER	YEARS	PART NO.	DESCRIPTION	
1	Timing Cover Set	1991	TCS 45121	w/o Sleeve 'N' Seal®; Must be used w/OS 34502R	
1	Timing Set w/Sleeve & Seal	1991	TCS 45265	w/Sleeve 'N' Seal®; Must be used w/OS 34502R	
1	Repair Sleeve	1991	16202	Timing Cover; Use w/installation tool	
1	Repair Sleeve Tool	1991	16312	Timing Cover	
QTY	AIR CLEANER MOUNTING	YEARS	PART NO.	DESCRIPTION	
1	Air Cleaner Gasket	1991	60038	5 1/32" ID	
QTY	CARB & FUEL INJECTION	YEARS	PART NO.	DESCRIPTION	
1	Throttle Body Gasket	1991	60903		
QTY	DISTRIBUTOR MOUNTING	YEARS	PART NO.	DESCRIPTION	
1	Distributor Mounting Gasket	1991	70194		
QTY	EXHAUST GAS RECIRCULATION	YEARS	PART NO.	DESCRIPTION	
1	EGR Gasket	1991	70978		
QTY	OIL PUMP RETAINER	YEARS	PART NO.	DESCRIPTION	
1	Oil Pump Shaft Guide	1991	72665	Distributor to oil pump shaft retainer	
QTY	OIL COOLER	YEARS	PART NO.	DESCRIPTION	
1	Oil Cooler Mounting Set	1991	ES 70016		
53		2013 - 1996; 4.3L 262 (4294cc) OHV V6 (12 Valve) 4" Bore Vortec			53
		CPI; Gasoline; Naturally Aspirated GMC Eng.; Chevrolet; VIN Code X			
QTY	CYLINDER HEAD	YEARS	PART NO.	DESCRIPTION	
2	Head Gasket	2011-02	510 SD	Head bolts not incl.; Head bolt replacement recommended; PermaTorque Severe Duty®	
2	Head Gasket	2011-02	522 SD	Head bolts not incl.; Head bolt replacement recommended; PermaTorque Severe Duty® MLS	
2	Head Gasket	2011-02	9354 PT-1	Head bolts not incl.; Head bolt replacement recommended; PermaTorque®	
2	Head Gasket	1999-96	510 SD	Head bolts not incl.; Head bolt replacement recommended; PermaTorque Severe Duty®	
2	Head Gasket	1999-96	522 SD	Head bolts not incl.; Head bolt replacement recommended; PermaTorque Severe Duty® MLS	
2	Head Gasket	1999-96	9354 PT-1	Head bolts not incl.; Head bolt replacement recommended; PermaTorque®	

GMC Truck (Incl. Minivans and SUV's) (Cont.)

53 (cont.)		2013 - 1996; 4.3L 262 (4294cc) OHV V6 (12 Valve) 4" Bore Vortec CPI; Gasoline; Naturally Aspirated GMC Eng.; Chevrolet; VIN Code X			53 (cont.)
QTY	CYLINDER HEAD	YEARS	PART NO.	DESCRIPTION	
1	Head Set	2011-07	HS 9354 PT-7	Head bolts & exh. pipe packing not incl.; Head bolt replacement recommended; PermaDryPlus® int. manifold gskts. incl.; PermaDry® molded rubber valve cover gskts. incl.; Premium valve stem seals incl.	
1	Head Set	2006-02	HS 9354 PT-6	Head bolts & exh. pipe packing not incl.; Head bolt replacement recommended; PermaDry® molded rubber valve cover gskts. incl.; Premium valve stem seals incl.	
1	Head Set	2006-02	HST 9354 PT-6	Head bolts & exh. pipe packing not incl.; Head bolt replacement recommended; PermaTorque Severe Duty® head gskts. incl.; PermaDryPlus® int. manifold gskts. incl.; PermaDry® molded rubber valve cover gskts. incl.; Premium valve stem seals incl.	
1	Head Set	1999-96	HS 9354 PT-6	Head bolts & exh. pipe packing not incl.; Head bolt replacement recommended; PermaDry® molded rubber valve cover gskts. incl.; Premium valve stem seals incl.	
1	Head Set	1999-96	HST 9354 PT-6	Head bolts & exh. pipe packing not incl.; Head bolt replacement recommended; PermaTorque Severe Duty® head gskts. incl.; PermaDryPlus® int. manifold gskts. incl.; PermaDry® molded rubber valve cover gskts. incl.; Premium valve stem seals incl.	
2	Head Bolt Set	2011-02	ES 74034	Replacement recommended	
2	Head Bolt Set	1999-96	ES 74034	Replacement recommended	
QTY	CONVERSION SET	YEARS	PART NO.	DESCRIPTION	
1	Gasket Conversion Set	2011-07	CS 9354-4	Plastic timing cover not incl.; Timing cover gskt. incl.; PermaDry® molded rubber oil pan gskt. incl.	
1	Gasket Conversion Set	2006-02	CS 9354-3	Plastic timing cover not incl.; PermaDry® molded rubber oil pan gskt. incl.; Consolidated design	
1	Gasket Conversion Set	1999-96	CS 9354-3	Plastic timing cover not incl.; PermaDry® molded rubber oil pan gskt. incl.; Consolidated design	
QTY	MANIFOLD - INT. & EXH.	YEARS	PART NO.	DESCRIPTION	
1	Int. Manifold Gasket Set	2011-07	MS 98002 T-1	Valve cover gskts. & valve cover grommets incl.; Upper set incl.; PermaDryPlus® int. manifold gskts. incl.; Manifold bolts not incl.; Manifold bolt replacement recommended	
1	Int. Manifold Gasket Set	2006-02	MS 95817	Lower set; Upper set incl.; Manifold bolts not incl.; Manifold bolt replacement recommended	
1	Int. Manifold Gasket Set	2006-02	MS 95817-1	Lower set only; Upper set not incl.; Manifold bolts not incl.; Manifold bolt replacement recommended	
1	Int. Manifold Gasket Set	2006-02	MS 98002 T	Valve cover gskts. & valve cover grommets incl.; Upper set incl.; PermaDryPlus® int. manifold gskts. incl.; Manifold bolts not incl.; Manifold bolt replacement recommended	
1	Int. Manifold Gasket Set	1999-96	MS 95817	Lower set; Upper set incl.; Manifold bolts not incl.; Manifold bolt replacement recommended	
1	Int. Manifold Gasket Set	1999-96	MS 95817-1	Lower set only; Upper set not incl.; Manifold bolts not incl.; Manifold bolt replacement recommended	
1	Int. Manifold Gasket Set	1999-96	MS 98002 T	Valve cover gskts. & valve cover grommets incl.; Upper set incl.; PermaDryPlus® int. manifold gskts. incl.; Manifold bolts not incl.; Manifold bolt replacement recommended	
1	Plenum Gasket Set	2011-07	MS 96932	Upper set	
1	Plenum Gasket Set	2006-02	MS 95816	Upper set	
1	Plenum Gasket Set	1999-96	MS 95816	Upper set	
1	Int. Manifold Bolt Set	2011-02	ES 72224	Loc. Lower; Replacement recommended	
1	Int. Manifold Bolt Set	1999-96	ES 72224	Loc. Lower; Replacement recommended	
1	Exh. Manifold Gasket Set	2011-02	MS 95842		
1	Exh. Manifold Gasket Set	1999-96	MS 95842		
QTY	EXHAUST PIPE FLANGE	YEARS	PART NO.	DESCRIPTION	
1	Exhaust Pipe Gasket	2013-06	61089	Loc. R.H.; Pipe to manifold	
1	Exhaust Pipe Gasket	2013-06	61323	Loc. L.H.; Pipe to manifold	
1	Exhaust Pipe Gasket	2013-10	61561	Exc. Chevrolet Silverado 1500 LS, WT, XFE GMC Sierra 1500 SL, WT, XFE; Converter; 2-bolt	
1	Exhaust Pipe Gasket	2009	61561	Chevrolet Express 1500 Van Base, LS, LT GMC Savana 1500 Base, LS, LT; Converter; 2-bolt	
1	Exhaust Pipe Gasket	2008	61561	Exc. Chevrolet Silverado 1500 LS, WT GMC Sierra 1500 SL, WT; Converter; 2-bolt	
1	Exhaust Pipe Gasket	2007	61561	Chevrolet Express 1500 Van Base, LS, LT GMC Savana 1500 Base, LS, LT; Converter; 2-bolt	
1	Exhaust Pipe Gasket	2006	61561	Exc. Chevrolet Silverado 1500 LS, WT GMC Sierra 1500 SL, WT; Converter; 2-bolt	

GMC Truck (Incl. Minivans and SUV's) (Cont.)

53 (cont.)	2013 - 1996; 4.3L 262 (4294cc) OHV V6 (12 Valve) 4" Bore Vortec CPI; Gasoline; Naturally Aspirated GMC Eng.; Chevrolet; VIN Code X				53 (cont.)
QTY	EXHAUST PIPE FLANGE	YEARS	PART NO.	DESCRIPTION	
2	Exhaust Pipe Gasket	2005	61014	Chevrolet Astro Base, LS, LT, Blazer Base, ZR2 GMC Jimmy Base, SLE, SLS, SLT, Safari Base, SLE, SLT; Pipe to manifold	
1	Exhaust Pipe Gasket	2005	61089	Exc. Chevrolet Astro Base, LS, LT, Blazer Base, ZR2 GMC Jimmy Base, SLE, SLS, SLT, Safari Base, SLE, SLT; Loc. R.H.; Pipe to manifold	
1	Exhaust Pipe Gasket	2005	61323	Exc. Chevrolet Astro Base, LS, LT, Blazer Base, ZR2 GMC Jimmy Base, SLE, SLS, SLT, Safari Base, SLE, SLT; Loc. L.H.; Pipe to manifold	
1	Exhaust Pipe Gasket	2005	61561	Chevrolet Express 1500 Van Base, LS, Express 2500 Van Base, LS GMC Savana 1500 Base, SLE, Savana 2500 Base, SLE; Converter; 2-bolt	
2	Exhaust Pipe Gasket	2004	61014	Chevrolet Astro Base, LS, LT, Blazer Extreme, LS, ZR2, S10 Pickup LS, ZR5 GMC Jimmy SLE, SLS, SLT, Safari Base, SLE, SLT, Sonoma SL, SLS; Pipe to manifold	
1	Exhaust Pipe Gasket	2004	61089	Exc. Chevrolet Astro Base, LS, LT, Blazer Extreme, LS, ZR2, S10 Pickup LS, ZR5 GMC Jimmy SLE, SLS, SLT, Safari Base, SLE, SLT, Sonoma SL, SLS; Loc. R.H.; Pipe to manifold	
1	Exhaust Pipe Gasket	2004	61323	Exc. Chevrolet Astro Base, LS, LT, Blazer Extreme, LS, ZR2, S10 Pickup LS, ZR5 GMC Jimmy SLE, SLS, SLT, Safari Base, SLE, SLT, Sonoma SL, SLS; Loc. L.H.; Pipe to manifold	
2	Exhaust Pipe Gasket	2003	61014	Chevrolet Astro Base, LS, LT, Blazer Extreme, LS, ZR2, S10 Pickup Base, Extreme, LS, ZR2, ZR5 GMC Jimmy SLE, SLS, SLT, Safari Base, SLE, SLT, Sonoma SL, SLS; Pipe to manifold	
1	Exhaust Pipe Gasket	2003	61089	Exc. Chevrolet Astro Base, LS, LT, Blazer Extreme, LS, ZR2, S10 Pickup Base, Extreme, LS, ZR2, ZR5 GMC Jimmy SLE, SLS, SLT, Safari Base, SLE, SLT, Sonoma SL, SLS; Loc. R.H.; Pipe to manifold	
1	Exhaust Pipe Gasket	2003	61323	Exc. Chevrolet Astro Base, LS, LT, Blazer Extreme, LS, ZR2, S10 Pickup Base, Extreme, LS, ZR2, ZR5 GMC Jimmy SLE, SLS, SLT, Safari Base, SLE, SLT, Sonoma SL, SLS; Loc. L.H.; Pipe to manifold	
2	Exhaust Pipe Gasket	2002	61014	Chevrolet Astro Base, LS, LT GMC Safari SL, SLE, SLT; Pipe to manifold	
1	Exhaust Pipe Gasket	2002	61089	Exc. Chevrolet Astro Base, LS, LT GMC Safari SL, SLE, SLT; Loc. R.H.; Pipe to manifold	
1	Exhaust Pipe Gasket	2002	61323	Exc. Chevrolet Astro Base, LS, LT GMC Safari SL, SLE, SLT; Loc. L.H.; Pipe to manifold	
2	Exhaust Pipe Gasket	1999-96	61014	Pipe to manifold	
QTY	OIL PAN	YEARS	PART NO.	DESCRIPTION	
1	Oil Pan Gasket Set	2011-07	OS 30786 R	PermaDry® molded rubber gskt. incl.	
1	Oil Pan Gasket Set	2006-02	OS 30680 R	PermaDry® molded rubber gskt. incl.	
1	Oil Pan Gasket Set	1999-96	OS 30680 R	PermaDry® molded rubber gskt. incl.	
1	Drain Plug Gasket	2011-02	70820		
1	Drain Plug Gasket	1999-96	70820		
QTY	CRANKSHAFT REAR SEAL	YEARS	PART NO.	DESCRIPTION	
1	Rear Main Seal Set	2011-07	BS 40707	PTFE Rubber; One-piece	
1	Rear Main Seal Set	2006-02	BS 40656	PTFE Rubber; One-piece; Improved design	
1	Rear Main Seal Set	1999-96	BS 40656	PTFE Rubber; One-piece; Improved design	
QTY	VALVE COVER	YEARS	PART NO.	DESCRIPTION	
1	Valve Cover Gasket Set	2011-02	VS 50464 R	w/Grommets; PermaDry® molded rubber gskts. incl.	
1	Valve Cover Gasket Set	1999-96	VS 50464 R	w/Grommets; PermaDry® molded rubber gskts. incl.	
QTY	VALVE STEM SEAL SET	YEARS	PART NO.	DESCRIPTION	
1	Valve Stem Seal Set	2011-02	SS 72861-1	Loc. Int. & Exh.; Premium valve stem seals incl.	
1	Valve Stem Seal Set	1999-96	SS 72861-1	Loc. Int. & Exh.; Premium valve stem seals incl.	
QTY	THERMOSTAT HOUSING	YEARS	PART NO.	DESCRIPTION	
1	O-Ring	2011-02	35710	Thermostat Housing; 1.954" ID; Improved design	
1	O-Ring	1999-96	35710	Thermostat Housing; 1.954" ID; Improved design	
QTY	WATER OUTLET GASKET	YEARS	PART NO.	DESCRIPTION	
1	Water Outlet Gasket	2011-10	35346	Water Outlet	
QTY	WATER PUMP	YEARS	PART NO.	DESCRIPTION	
1	Water Pump Gasket	2011-02	13032	To plate	
2	Water Pump Gasket	2011-07	35841	To block	
2	Water Pump Gasket	2006-02	5152	To block	
1	Water Pump Gasket	1999-96	13032	To plate	
2	Water Pump Gasket	1999-96	5152	To block	
QTY	TIMING COVER	YEARS	PART NO.	DESCRIPTION	
1	Timing Cover Set	2011-07	TCS 46100	Must be used w/OS 30786R	
1	Timing Cover Set	2006-02	TCS 46091	Eng. w/2.42" OD timing cover seal; Must be used w/OS 30680R	
1	Timing Cover Set	1999-96	TCS 46091	Eng. w/2.42" OD timing cover seal; Must be used w/OS 30680R	
QTY	CARB & FUEL INJECTION	YEARS	PART NO.	DESCRIPTION	
1	Throttle Body Gasket	2011-07	61507		

GMC Truck (Incl. Minivans and SUV's) (Cont.)

53 (cont.)		2013 - 1996; 4.3L 262 (4294cc) OHV V6 (12 Valve) 4" Bore Vortec CPI; Gasoline; Naturally Aspirated GMC Eng.; Chevrolet; VIN Code X			53 (cont.)
QTY	CARB & FUEL INJECTION	YEARS	PART NO.	DESCRIPTION	
1	Throttle Body Gasket	2006-02	61036		
1	Throttle Body Gasket	1999-96	61036		
QTY	DISTRIBUTOR MOUNTING	YEARS	PART NO.	DESCRIPTION	
1	Distributor Mounting Gasket	2011-02	70194		
1	Distributor Mounting Gasket	1999-96	70194		
QTY	EXHAUST GAS RECIRCULATION	YEARS	PART NO.	DESCRIPTION	
1	EGR Gasket	2011-02	70789		
1	EGR Gasket	1999-96	70789		
QTY	OIL PUMP RETAINER	YEARS	PART NO.	DESCRIPTION	
1	Oil Pump Shaft Guide	2011-02	72665	Distributor to oil pump shaft retainer	
1	Oil Pump Shaft Guide	1999-96	72665	Distributor to oil pump shaft retainer	
QTY	OIL COOLER	YEARS	PART NO.	DESCRIPTION	
1	Oil Cooler Mounting Set	2011-02	ES 70016		
1	Oil Cooler Mounting Set	1999-96	ES 70016		
54		2003 - 1992; 4.3L 262 (4294cc) OHV V6 (12 Valve) 4" Bore Vortec H.O. CPI; Gasoline; Naturally Aspirated GMC Eng.; Chevrolet; VIN Code W			54
QTY	CYLINDER HEAD	YEARS	PART NO.	DESCRIPTION	
2	Head Gasket	2003-92	510 SD	Head bolts not incl.; Head bolt replacement recommended; PermaTorque Severe Duty®	
2	Head Gasket	2003-92	522 SD	Head bolts not incl.; Head bolt replacement recommended; PermaTorque Severe Duty® MLS	
2	Head Gasket	2003-92	9354 PT-1	Head bolts not incl.; Head bolt replacement recommended; PermaTorque®	
1	Head Set	2003-96	HS 9354 PT-6	Head bolts & exh. pipe packing not incl.; Head bolt replacement recommended; PermaDry® molded rubber valve cover gskts. incl.; Premium valve stem seals incl.	
1	Head Set	2003-96	HST 9354 PT-6	Head bolts & exh. pipe packing not incl.; Head bolt replacement recommended; PermaTorque Severe Duty® head gskts. incl.; PermaDryPlus® int. manifold gskts. incl.; PermaDry® molded rubber valve cover gskts. incl.; Premium valve stem seals incl.	
1	Head Set	1995-94	HS 9354 PT-4	Head bolts & exh. pipe packing not incl.; Head bolt replacement recommended; PermaDry® molded rubber valve cover gskts. incl.; Premium valve stem seals incl.	
1	Head Set	1993-92	HS 9354 PT-3	Head bolts & exh. pipe packing not incl.; Head bolt replacement recommended; PermaDry® molded rubber valve cover gskts. incl.; Premium valve stem seals incl.	
2	Head Bolt Set	2003-92	ES 74034	Replacement recommended	
QTY	CONVERSION SET	YEARS	PART NO.	DESCRIPTION	
1	Gasket Conversion Set	2003-96	CS 9354-3	Plastic timing cover not incl.; PermaDry® molded rubber oil pan gskt. incl.; Consolidated design	
1	Gasket Conversion Set	1995	CS 9354-1	Eng. w/o plastic timing cover; PermaDry® molded rubber oil pan gskt. incl.	
1	Gasket Conversion Set	1995	CS 9354-1	Eng. w/plastic timing cover; Plastic timing cover not incl.; PermaDry® molded rubber oil pan gskt. incl.	
1	Gasket Conversion Set	1994-92	CS 9354-1	PermaDry® molded rubber oil pan gskt. incl.	
QTY	MANIFOLD - INT. & EXH.	YEARS	PART NO.	DESCRIPTION	
1	Int. Manifold Gasket Set	2003-96	MS 95817	Lower set; Upper set incl.; Manifold bolts not incl.; Manifold bolt replacement recommended	
1	Int. Manifold Gasket Set	2003-96	MS 95817-1	Lower set only; Upper set not incl.; Manifold bolts not incl.; Manifold bolt replacement recommended	
1	Int. Manifold Gasket Set	2003-96	MS 98002 T	Valve cover gskts. & valve cover grommets incl.; Upper set incl.; PermaDryPlus® int. manifold gskts. incl.; Manifold bolts not incl.; Manifold bolt replacement recommended	
1	Int. Manifold Gasket Set	1995-92	MS 95832	Lower set	
1	Plenum Gasket Set	2003-96	MS 95816	Upper set	
1	Plenum Gasket Set	1995-92	MS 95818	Upper set	
1	Int. Manifold Bolt Set	2003-96	ES 72224	Loc. Lower; Replacement recommended	
1	Exh. Manifold Gasket Set	2003-92	MS 95842		
QTY	EXHAUST PIPE FLANGE	YEARS	PART NO.	DESCRIPTION	
2	Exhaust Pipe Gasket	2003	61014	Chevrolet Astro Base, LS, LT, Blazer Extreme, LS, ZR2, S10 Pickup Base, Extreme, LS, ZR2, ZR5 GMC Jimmy SLE, SLS, SLT, Safari Base, SLE, SLT, Sonoma SL, SLS; Pipe to manifold	
1	Exhaust Pipe Gasket	2003	61089	Exc. Chevrolet Astro Base, LS, LT, Blazer Extreme, LS, ZR2, S10 Pickup Base, Extreme, LS, ZR2, ZR5 GMC Jimmy SLE, SLS, SLT, Safari Base, SLE, SLT, Sonoma SL, SLS; Loc. R.H.; Pipe to manifold	

GMC Truck (Incl. Minivans and SUV's) (Cont.)

54 (cont.)	2003 - 1992; 4.3L 262 (4294cc) OHV V6 (12 Valve) 4" Bore Vortec H.O. CPI; Gasoline; Naturally Aspirated GMC Eng.; Chevrolet; VIN Code W				54 (cont.)
QTY	EXHAUST PIPE FLANGE	YEARS	PART NO.	DESCRIPTION	
1	Exhaust Pipe Gasket	2003	61323	Exc. Chevrolet Astro Base, LS, LT, Blazer Extreme, LS, ZR2, S10 Pickup Base, Extreme, LS, ZR2, ZR5 GMC Jimmy SLE, SLS, SLT, Safari Base, SLE, SLT, Sonoma SL, SLS; Loc. L.H.; Pipe to manifold	
2	Exhaust Pipe Gasket	2002	61014	Chevrolet Astro Base, LS, LT, Blazer Extreme, LS, S10 Pickup Base, Extreme, LS, ZR2, ZR5 GMC Jimmy SLE, SLS, SLT, Safari SL, SLE, SLT, Sonoma SL, SLS; Pipe to manifold	
1	Exhaust Pipe Gasket	2002	61089	Exc. Chevrolet Astro Base, LS, LT, Blazer Extreme, LS, S10 Pickup Base, Extreme, LS, ZR2, ZR5 GMC Jimmy SLE, SLS, SLT, Safari SL, SLE, SLT, Sonoma SL, SLS; Loc. R.H.; Pipe to manifold	
1	Exhaust Pipe Gasket	2002	61323	Exc. Chevrolet Astro Base, LS, LT, Blazer Extreme, LS, S10 Pickup Base, Extreme, LS, ZR2, ZR5 GMC Jimmy SLE, SLS, SLT, Safari SL, SLE, SLT, Sonoma SL, SLS; Loc. L.H.; Pipe to manifold	
2	Exhaust Pipe Gasket	2001	61014	Exc. Chevrolet Express 1500 Van Base, LS, Express 2500 Van Base, LS, Silverado 1500 Base, LS, LT GMC Savana 1500 Base, SLT, Savana 2500 Base, SLT, Sierra 1500 Crew Cab, SL, SLE, SLT; Pipe to manifold	
1	Exhaust Pipe Gasket	2001	61074	Chevrolet Express 1500 Van Base, LS, Express 2500 Van Base, LS, Silverado 1500 Base, LS, LT GMC Savana 1500 Base, SLT, Savana 2500 Base, SLT, Sierra 1500 Crew Cab, SL, SLE, SLT; Loc. L.H.; Pipe to manifold	
1	Exhaust Pipe Gasket	2001	61089	Chevrolet Express 1500 Van Base, LS, Express 2500 Van Base, LS, Silverado 1500 Base, LS, LT GMC Savana 1500 Base, SLT, Savana 2500 Base, SLT, Sierra 1500 Crew Cab, SL, SLE, SLT; Loc. R.H.; Pipe to manifold	
2	Exhaust Pipe Gasket	2000-99	61014	Exc. Chevrolet Express 1500 Van Base, LS, Express 2500 Van Base, LS, Silverado 1500 Base, LS, LT GMC Savana 1500 Base, SLE, Savana 2500 Base, SLE, Sierra 1500 SL, SLE, SLT; Pipe to manifold	
1	Exhaust Pipe Gasket	2000-99	61074	Chevrolet Express 1500 Van Base, LS, Express 2500 Van Base, LS, Silverado 1500 Base, LS, LT GMC Savana 1500 Base, SLE, Savana 2500 Base, SLE, Sierra 1500 SL, SLE, SLT; Loc. L.H.; Pipe to manifold	
1	Exhaust Pipe Gasket	2000-99	61089	Chevrolet Express 1500 Van Base, LS, Express 2500 Van Base, LS, Silverado 1500 Base, LS, LT GMC Savana 1500 Base, SLE, Savana 2500 Base, SLE, Sierra 1500 SL, SLE, SLT; Loc. R.H.; Pipe to manifold	
2	Exhaust Pipe Gasket	1998-96	61014	Pipe to manifold	
2	Exhaust Pipe Gasket	1995-92	60718	Packing; 2 3/32" ID Steel sleeve	
QTY	OIL PAN	YEARS	PART NO.	DESCRIPTION	
1	Oil Pan Gasket Set	2003-96	OS 30680 R	PermaDry® molded rubber gskt. incl.	
1	Oil Pan Gasket Set	1995-92	OS 34502 R	PermaDry® molded rubber gskt. incl.	
1	Drain Plug Gasket	2003-96	70820		
1	Drain Plug Gasket	1995-92	70822		
QTY	CRANKSHAFT REAR SEAL	YEARS	PART NO.	DESCRIPTION	
1	Rear Main Seal Set	2003-96	BS 40656	PTFE Rubber; One-piece; Improved design	
1	Rear Main Seal Set	1995-92	BS 40520	Rubber; One-piece	
1	Rear Main Seal Set	1995-92	BS 40626	PTFE Rubber; One-piece	
1	Repair Sleeve	1995-92	16258	Crankshaft; Use w/installation tool	
1	Repair Sleeve Tool	1995-92	16301	Crankshaft	
QTY	VALVE COVER	YEARS	PART NO.	DESCRIPTION	
1	Valve Cover Gasket Set	2003-94	VS 50464 R	w/Grommets; PermaDry® molded rubber gskts. incl.	
1	Valve Cover Gasket Set	1993-92	VS 50086 R	Services both covers; PermaDry® molded rubber gskts. incl.	
2	Valve Cover Gasket Set	1993-92	VS 50277 R	Services one cover only; PermaDry® molded rubber gskt. incl.	
QTY	VALVE STEM SEAL SET	YEARS	PART NO.	DESCRIPTION	
1	Valve Stem Seal Set	2003-96	SS 72861-1	Loc. Int. & Exh.; Premium valve stem seals incl.	
1	Valve Stem Seal Set	1995-92	SS 72530	Loc. Int.; Premium valve stem seals incl.	
1	Valve Stem Seal Set	1995-92	SS 72876	Loc. Exh.; Opt. Hi-Temp. premium valve stem seals incl.	
QTY	THERMOSTAT HOUSING	YEARS	PART NO.	DESCRIPTION	
1	Thermostat Gasket	1995-92	35595	Thermostat Housing	
1	Thermostat Gasket	1995-92	35666	Thermostat Housing; Thermostat seal; 1.560" ID; Improved design	
1	O-Ring	2003-92	35710	Thermostat Housing; 1.954" ID; Improved design	
QTY	WATER PUMP	YEARS	PART NO.	DESCRIPTION	
1	Water Pump Gasket	2003-92	13032	To plate	
2	Water Pump Gasket	2003-92	5152	To block	
QTY	TIMING COVER	YEARS	PART NO.	DESCRIPTION	
1	Timing Cover Set	2003-96	TCS 46091	Eng. w/2.42" OD timing cover seal; Must be used w/OS 30680R	
1	Timing Cover Set	1995	TCS 45947	Eng. w/o plastic timing cover; Must be used w/OS 34502R	

GMC Truck (Incl. Minivans and SUV's) (Cont.)

54 (cont.)		2003 - 1992; 4.3L 262 (4294cc) OHV V6 (12 Valve) 4" Bore Vortec H.O. CPI; Gasoline; Naturally Aspirated GMC Eng.; Chevrolet; VIN Code W			54 (cont.)
QTY	TIMING COVER	YEARS	PART NO.	DESCRIPTION	
1	Timing Cover Set	1995	TCS 46091	Eng. w/plastic timing cover; Eng. w/2.42" OD timing cover seal; Must be used w/OS 34502R	
1	Timing Cover Set	1994-92	TCS 45947	Must be used w/OS 34502R	
QTY	AIR CLEANER MOUNTING	YEARS	PART NO.	DESCRIPTION	
1	Air Cleaner Gasket	1995-92	60038	5 1/32" ID	
QTY	CARB & FUEL INJECTION	YEARS	PART NO.	DESCRIPTION	
1	Throttle Body Gasket	2003-96	61036		
QTY	DISTRIBUTOR MOUNTING	YEARS	PART NO.	DESCRIPTION	
1	Distributor Mounting Gasket	2003-92	70194		
QTY	EXHAUST GAS RECIRCULATION	YEARS	PART NO.	DESCRIPTION	
1	EGR Gasket	2003-95	70789		
1	EGR Gasket	1994	70788	Exc. Chevrolet Astro Base, CL, CS, LT GMC Safari Base, SLE, SLT, SLX, XT	
1	EGR Gasket	1994	70789	Chevrolet Astro Base, CL, CS, LT GMC Safari Base, SLE, SLT, SLX, XT	
1	EGR Gasket	1993	70789	Chevrolet Astro Base, CL, CS, LT GMC Safari Base, GT, SLE, SLT, XT	
1	EGR Gasket	1992	70789	Chevrolet Astro Base, CL, CS, LT GMC Safari Base, SLE, SLT, XT	
QTY	OIL PUMP RETAINER	YEARS	PART NO.	DESCRIPTION	
1	Oil Pump Shaft Guide	2003-92	72665	Distributor to oil pump shaft retainer	
QTY	OIL COOLER	YEARS	PART NO.	DESCRIPTION	
1	Oil Cooler Mounting Set	2003-92	ES 70016		
55		2009 - 2004; 4.6L 281 (4565cc) DOHC V8 (32 Valve) 93mm Bore Northstar H.O. MFI; Gasoline; Naturally Aspirated GMC Eng.; Cadillac; VIN Code A			55
QTY	CYLINDER HEAD	YEARS	PART NO.	DESCRIPTION	
1	Head Gasket	2009-04	26380 PT	Loc. L.H.; Head bolts not incl.; Head bolt replacement recommended	
1	Head Gasket	2009-04	26381 PT	Loc. R.H.; Head bolts not incl.; Head bolt replacement recommended	
1	Head Set	2009-06	HS 26380 PT-1	Head bolts not incl.; Head bolt replacement recommended; Must be used w/TCS 46076-1; PermaDry® molded rubber valve cover gskts. incl.; Premium valve stem seals incl.	
1	Head Set	2005-04	HS 26380 PT	Head bolts not incl.; Head bolt replacement recommended; Must be used w/TCS 46076-1; PermaDry® molded rubber valve cover gskts. incl.; Premium valve stem seals incl.	
2	Head Bolt Set	2009-04	ES 72217	Head bolts w/Washers; Replacement recommended	
QTY	CONVERSION SET	YEARS	PART NO.	DESCRIPTION	
1	Gasket Conversion Set	2009-04	CS 26380	PermaDry® molded rubber oil pan gskt. incl.	
QTY	MANIFOLD - INT. & EXH.	YEARS	PART NO.	DESCRIPTION	
1	Int. Manifold Gasket Set	2009-06	MS 96716		
1	Int. Manifold Gasket Set	2005-04	MS 93313		
1	Exh. Manifold Gasket Set	2009-04	MS 96999		
QTY	EXHAUST PIPE FLANGE	YEARS	PART NO.	DESCRIPTION	
1	Exhaust Pipe Gasket	2009-04	61311	Converter	
2	Exhaust Pipe Gasket	2009-04	61525	Pipe to manifold; Improved design	
2	Exhaust Pipe Gasket	2009-06	61009	Crossover	
QTY	OIL PAN	YEARS	PART NO.	DESCRIPTION	
1	Oil Pan Gasket Set	2009-04	OS 30796 R	PermaDry® molded rubber gskt. incl.	
QTY	CRANKSHAFT REAR SEAL	YEARS	PART NO.	DESCRIPTION	
1	Rear Main Seal Set	2009-04	BS 40670	12.0mm thick; PTFE Rubber; One-piece	
QTY	VALVE COVER	YEARS	PART NO.	DESCRIPTION	
1	Valve Cover Gasket Set	2009-04	VS 50728 R	w/Grommets & Spark plug tube seals; PermaDry® molded rubber gskts. incl.	
QTY	VALVE STEM SEAL SET	YEARS	PART NO.	DESCRIPTION	
2	Valve Stem Seal Set	2009-04	SS 71043	Premium valve stem seals incl.	
QTY	THERMOSTAT HOUSING	YEARS	PART NO.	DESCRIPTION	
1	Thermostat Gasket	2009-04	35660	Thermostat Housing; Thermostat seal	
QTY	WATER OUTLET GASKET	YEARS	PART NO.	DESCRIPTION	
1	Water Outlet Gasket	2009-04	35863	Water Outlet	
QTY	WATER PUMP	YEARS	PART NO.	DESCRIPTION	
1	Water Pump Gasket	2009-04	35860	O-ring	
QTY	TIMING COVER	YEARS	PART NO.	DESCRIPTION	
1	Crankshaft Front Seal Set	2009-04	TCS 46076-1		
1	Camshaft Rear Seal Set	2009-04	TCS 46011		
QTY	CARB & FUEL INJECTION	YEARS	PART NO.	DESCRIPTION	
2	Fuel Injector O-Ring Set	2009-07	ES 70599	Lower set; Injectors to cylinder head; Improved design	

GMC Truck (Incl. Minivans and SUV's) (Cont.)

55		2009 - 2004; 4.6L 281 (4565cc) DOHC V8 (32 Valve) 93mm Bore Northstar H.O.			55
(cont.)		MFI; Gasoline; Naturally Aspirated GMC Eng.; Cadillac; VIN Code A			(cont.)
QTY	CARB & FUEL INJECTION	YEARS	PART NO.	DESCRIPTION	
2	Fuel Injector O-Ring Set	2009-07	ES 72004	Upper set; Injectors to fuel rail	
4	Fuel Injector O-Ring Set	2006-04	ES 70599	Improved design	
1	Throttle Body Gasket	2009-06	61436		
1	Throttle Body Gasket	2005-04	61528		
QTY	EXHAUST GAS RECIRCULATION	YEARS	PART NO.	DESCRIPTION	
1	EGR Gasket	2009-04	70914	Valve	
QTY	OIL FILTER MOUNTING	YEARS	PART NO.	DESCRIPTION	
1	Oil Filter Adapter Gasket	2009-04	71288	Oil filter adapter; New Part Number - Check for Availability	
56		2010 - 2007; 4.8L 293 (4807cc) OHV V8 (16 Valve) 96mm Bore Vortec			56
		MFI; Gasoline; Naturally Aspirated GMC Eng.; Chevrolet; VIN Code C			
QTY	CYLINDER HEAD	YEARS	PART NO.	DESCRIPTION	
2	Head Gasket	2010-07	26190 PT	Head bolts not incl.; Head bolt replacement recommended; PermaTorqueMLS® LaserWeld® Technology	
1	Head Set	2010-08	HS 26190 PT-4	Head bolts not incl.; Head bolt replacement recommended; PermaDryPlus® int. manifold gskts. incl.; PermaDry® molded rubber valve cover gskts. incl.; Premium valve stem seals incl.	
1	Head Set	2007	HS 26190 PT-2	Head bolts not incl.; Head bolt replacement recommended; PermaDryPlus® int. manifold gskts. incl.; PermaDry® molded rubber valve cover gskts. incl.; Premium valve stem seals incl.	
2	Head Bolt Set	2010-07	ES 72220	Replacement recommended	
QTY	CONVERSION SET	YEARS	PART NO.	DESCRIPTION	
1	Gasket Conversion Set	2010-07	CS 9284	PermaDry® molded rubber oil pan gskt. incl.	
QTY	MANIFOLD - INT. & EXH.	YEARS	PART NO.	DESCRIPTION	
1	Int. Manifold Gasket Set	2010-07	MS 96587		
1	Int. Manifold Gasket Set	2010-07	MS 98016 T	PermaDryPlus® int. manifold gskts. incl.	
1	Int. Manifold Gasket Set	2010-08	MS 96169	Lifter valley cover set	
1	Int. Manifold Gasket Set	2007	MS 92465	Lifter valley cover set	
1	Exh. Manifold Gasket Set	2010-07	MS 92467		
QTY	EXHAUST PIPE FLANGE	YEARS	PART NO.	DESCRIPTION	
1	Exhaust Pipe Gasket	2010-07	61089	Loc. R.H.; Pipe to manifold	
1	Exhaust Pipe Gasket	2010-07	61323	Loc. L.H.; Pipe to manifold	
1	Exhaust Pipe Gasket	2010-07	61559	Converter; 3-bolt	
1	Exhaust Pipe Gasket	2009	61561	Exc. Chevrolet Silverado 1500 LS, LT, WT, XFE, Tahoe LS, LT, LTZ, XFE GMC Sierra 1500 SL, SLE, WT, XFE, Yukon SLE, SLT, XFE; Converter; 2-bolt	
1	Exhaust Pipe Gasket	2008	61561	Exc. Chevrolet Silverado 1500 LS, LT, WT, Tahoe LS, LT, LTZ GMC Sierra 1500 SL, SLE, WT, Yukon SLE, SLT; Converter; 2-bolt	
QTY	OIL PAN	YEARS	PART NO.	DESCRIPTION	
1	Oil Pan Gasket Set	2010-07	OS 30693 R	PermaDry® molded rubber gskt. incl.	
QTY	CRANKSHAFT REAR SEAL	YEARS	PART NO.	DESCRIPTION	
1	Rear Main Seal Set	2010-07	BS 40640	PTFE Rubber; One-piece	
1	Repair Sleeve	2010-07	16228	Crankshaft; Narrow lip; .780" sleeve length; Requires crankshaft machining due to clearance issues; Use w/installation tool	
1	Repair Sleeve	2010-07	16229	Crankshaft; Wide lip; 1.156" sleeve length; Requires crankshaft machining due to clearance issues; Use w/installation tool	
1	Repair Sleeve Tool	2010-07	16329	Crankshaft	
QTY	VALVE COVER	YEARS	PART NO.	DESCRIPTION	
1	Valve Cover Gasket Set	2010-07	VS 50504 R	w/o Grommets; PermaDry® molded rubber gskts. incl.	
1	Valve Cover Gasket Set	2010-07	VS 50504 R-1	w/Grommets; PermaDry® molded rubber gskts. incl.; New Part Number - Check for Availability	
1	Grommet Set	2010-07	ES 72233	Valve Cover	
QTY	VALVE STEM SEAL SET	YEARS	PART NO.	DESCRIPTION	
1	Valve Stem Seal Set	2010-07	SS 71039	Premium valve stem seals incl.	
QTY	THERMOSTAT HOUSING	YEARS	PART NO.	DESCRIPTION	
1	O-Ring	2010-07	35720	Thermostat Housing	
QTY	WATER PUMP	YEARS	PART NO.	DESCRIPTION	
2	Water Pump Gasket	2010-07	35635		
1	O-Ring	2010-07	35633	Water Pump	
1	Water Pump Mounting Set	2010-07	ES 73010	Mounting gasket set; New Part Number - Check for Availability	
QTY	TIMING COVER	YEARS	PART NO.	DESCRIPTION	
1	Timing Cover Set	2010-07	TCS 45993	Must be used w/OS 30693R	
QTY	CARB & FUEL INJECTION	YEARS	PART NO.	DESCRIPTION	
2	Fuel Injector O-Ring Set	2010-07	ES 70599	Upper set; Injectors to fuel rail; Improved design	

GMC Truck (Incl. Minivans and SUV's) (Cont.)

56 (cont.)		2010 - 2007; 4.8L 293 (4807cc) OHV V8 (16 Valve) 96mm Bore Vortec MFI; Gasoline; Naturally Aspirated GMC Eng.; Chevrolet; VIN Code C			56 (cont.)
QTY	CARB & FUEL INJECTION	YEARS	PART NO.	DESCRIPTION	
2	Fuel Injector O-Ring Set	2010-07	ES 71190	Lower set; Injectors to cylinder head	
2	Fuel Injector O-Ring Set	2010-07	ES 71192	Upper set; Injectors to fuel rail; Old design	
1	Throttle Body Gasket	2010-07	61469		
QTY	EXHAUST GAS RECIRCULATION	YEARS	PART NO.	DESCRIPTION	
1	EGR Gasket	2010-07	70895	Pipe; O-ring	
1	EGR Gasket	2010-07	70914	Valve	
1	EGR Gasket	2010-07	70947	Pipe	
QTY	OIL FILTER MOUNTING	YEARS	PART NO.	DESCRIPTION	
1	Oil Cooler Gasket	2010-07	72462	Oil Filter; Center tube; Dual round port	
QTY	OIL PUMP COVER	YEARS	PART NO.	DESCRIPTION	
1	O-Ring	2010-07	72401	Oil Pump; Inlet tube	
QTY	OIL COOLER	YEARS	PART NO.	DESCRIPTION	
1	Oil Cooler Gasket	2010-07	72435	Oval port	
1	Oil Cooler Gasket	2010-07	72462	Dual round port	
57		2008 - 1999; 4.8L 293 (4807cc) OHV V8 (16 Valve) 96mm Bore Vortec MFI; Gasoline; Naturally Aspirated GMC Eng.; Chevrolet; VIN Code V			57
QTY	CYLINDER HEAD	YEARS	PART NO.	DESCRIPTION	
2	Head Gasket	2008-02	26191 PT	Head bolts not incl.; Head bolt replacement recommended; PermaTorqueMLS® LaserWeld® Technology	
2	Head Gasket	2001-99	9292 PT	Head bolts not incl.; Head bolt replacement recommended	
1	Head Set	2008-04	HS 26191 PT-1	Head bolts not incl.; Head bolt replacement recommended; PermaDryPlus® int. manifold gsks. incl.; PermaDry® molded rubber valve cover gsks. incl.; Premium valve stem seals incl.	
1	Head Set	2003-02	HS 26191 PT	Head bolts not incl.; Head bolt replacement recommended; PermaDryPlus® int. manifold gsks. incl.; PermaDry® molded rubber valve cover gsks. incl.; Premium valve stem seals incl.	
1	Head Set	2001	HS 9292 PT	1st Design; Positive type valve stem seals; Head bolts not incl.; Head bolt replacement recommended; PermaDryPlus® int. manifold gsks. incl.; PermaDry® molded rubber valve cover gsks. incl.; Premium valve stem seals incl.	
1	Head Set	2001	HS 9292 PT-1	2nd Design; Top-Hat Design valve stem seals; Head bolts not incl.; Head bolt replacement recommended; PermaDryPlus® int. manifold gsks. incl.; PermaDry® molded rubber valve cover gsks. incl.; Premium valve stem seals incl.	
1	Head Set	2000-99	HS 9292 PT	Head bolts not incl.; Head bolt replacement recommended; PermaDryPlus® int. manifold gsks. incl.; PermaDry® molded rubber valve cover gsks. incl.; Premium valve stem seals incl.	
2	Head Bolt Set	2008-04	ES 72220	2nd Design; Replacement recommended	
2	Head Bolt Set	2004-99	ES 72173	1st Design; Replacement recommended	
QTY	CONVERSION SET	YEARS	PART NO.	DESCRIPTION	
1	Gasket Conversion Set	2008-99	CS 9284	PermaDry® molded rubber oil pan gskt. incl.	
QTY	MANIFOLD - INT. & EXH.	YEARS	PART NO.	DESCRIPTION	
1	Int. Manifold Gasket Set	2008-99	MS 92465	Lifter valley cover set	
1	Int. Manifold Gasket Set	2008-99	MS 98016 T	PermaDryPlus® int. manifold gsks. incl.	
1	Int. Manifold Gasket Set	2008-04	MS 96587		
1	Int. Manifold Gasket Set	2003-99	MS 92211		
1	Exh. Manifold Gasket Set	2008-99	MS 92467		
QTY	EXHAUST PIPE FLANGE	YEARS	PART NO.	DESCRIPTION	
1	Exhaust Pipe Gasket	2008-99	61089	Loc. R.H.; Pipe to manifold	
1	Exhaust Pipe Gasket	2008-04	61323	Loc. L.H.; Pipe to manifold	
1	Exhaust Pipe Gasket	2008	61561	Converter; 2-bolt	
1	Exhaust Pipe Gasket	2007	61561	Exc. Chevrolet Silverado 1500 LS, LT, WT, Silverado 1500 Classic LS, LT, WT GMC Sierra 1500 SL, SLE, WT, Sierra 1500 Classic SL, SLE, WT; Converter; 2-bolt	
1	Exhaust Pipe Gasket	2006	61561	Exc. Chevrolet Silverado 1500 LS, LT, WT, Tahoe Base, LS, Z71 GMC Sierra 1500 SL, SLE, WT, Yukon SL, SLE; Converter; 2-bolt	
1	Exhaust Pipe Gasket	2005	61561	Exc. Chevrolet Silverado 1500 Base, LS, LT, Silverado 2500 Base, Tahoe LS, LT, Z71 GMC Sierra 1500 Base, SLE, SLT, WT, Sierra 2500 SLE, SLT, Yukon SLE, SLT; Converter; 2-bolt	
1	Exhaust Pipe Gasket	2003-99	61074	Loc. L.H.; Pipe to manifold	
QTY	OIL PAN	YEARS	PART NO.	DESCRIPTION	
1	Oil Pan Gasket Set	2008-99	OS 30693 R	PermaDry® molded rubber gskt. incl.	
QTY	CRANKSHAFT REAR SEAL	YEARS	PART NO.	DESCRIPTION	
1	Rear Main Seal Set	2008-99	BS 40640	PTFE Rubber; One-piece	

GMC Truck (Incl. Minivans and SUV's) (Cont.)

57 (cont.)		2008 - 1999; 4.8L 293 (4807cc) OHV V8 (16 Valve) 96mm Bore Vortec			57 (cont.)
		MFI; Gasoline; Naturally Aspirated GMC Eng.; Chevrolet; VIN Code V			
QTY	CRANKSHAFT REAR SEAL	YEARS	PART NO.	DESCRIPTION	
1	Repair Sleeve	2008-99	16228	Crankshaft; Narrow lip; .780" sleeve length; Requires crankshaft machining due to clearance issues; Use w/installation tool	
1	Repair Sleeve	2008-99	16229	Crankshaft; Wide lip; 1.156" sleeve length; Requires crankshaft machining due to clearance issues; Use w/installation tool	
1	Repair Sleeve Tool	2008-99	16329	Crankshaft	
QTY	VALVE COVER	YEARS	PART NO.	DESCRIPTION	
1	Valve Cover Gasket Set	2008-99	VS 50504 R	w/o Grommets; PermaDry® molded rubber gskts. incl.	
1	Valve Cover Gasket Set	2008-99	VS 50504 R-1	w/Grommets; PermaDry® molded rubber gskts. incl.; New Part Number - Check for Availability	
1	Grommet Set	2008-99	ES 72233	Valve Cover	
QTY	VALVE STEM SEAL SET	YEARS	PART NO.	DESCRIPTION	
1	Valve Stem Seal Set	2008-01	SS 71039	2nd Design; Top-Hat Design seal; Premium valve stem seals incl.	
1	Valve Stem Seal Set	2001-99	SS 70945	1st Design; Positive type seal; Premium valve stem seals incl.	
QTY	THERMOSTAT HOUSING	YEARS	PART NO.	DESCRIPTION	
1	Thermostat Gasket	2003-99	35632	Thermostat Housing; Thermostat O-ring	
1	O-Ring	2008-04	35720	Thermostat Housing	
QTY	WATER PUMP	YEARS	PART NO.	DESCRIPTION	
2	Water Pump Gasket	2008-99	35635		
1	O-Ring	2008-99	35633	Water Pump	
1	Water Pump Mounting Set	2008-99	ES 73010	Mounting gasket set; New Part Number - Check for Availability	
QTY	TIMING COVER	YEARS	PART NO.	DESCRIPTION	
1	Timing Cover Set	2008-99	TCS 45993	Must be used w/OS 30693R	
QTY	CARB & FUEL INJECTION	YEARS	PART NO.	DESCRIPTION	
2	Fuel Injector O-Ring Set	2008-99	ES 70599	Upper set; Injectors to fuel rail; Improved design	
2	Fuel Injector O-Ring Set	2008-99	ES 71190	Lower set; Injectors to cylinder head	
2	Fuel Injector O-Ring Set	2008-01	ES 71192	Upper set; Injectors to fuel rail; Old design	
1	Throttle Body Gasket	2008-99	61070		
QTY	EXHAUST GAS RECIRCULATION	YEARS	PART NO.	DESCRIPTION	
1	EGR Gasket	2008-99	70895	Pipe; O-ring	
1	EGR Gasket	2008-99	70914	Valve	
1	EGR Gasket	2008-99	70947	Pipe	
QTY	OIL FILTER MOUNTING	YEARS	PART NO.	DESCRIPTION	
1	Oil Cooler Gasket	2008-99	72462	Oil Filter; Center tube; Dual round port	
QTY	OIL PUMP COVER	YEARS	PART NO.	DESCRIPTION	
1	O-Ring	2008-99	72401	Oil Pump; Inlet tube	
QTY	OIL COOLER	YEARS	PART NO.	DESCRIPTION	
1	Oil Cooler Gasket	2008-99	72435	Oval port	
1	Oil Cooler Gasket	2008-99	72462	Dual round port	
58		2013 - 2010; 4.8L 293 (4807cc) OHV V8 (16 Valve) 96mm Bore Vortec VVT			58
		MFI; Flex Fuel; Naturally Aspirated GMC Eng.; Chevrolet; VIN Code A			
QTY	CYLINDER HEAD	YEARS	PART NO.	DESCRIPTION	
2	Head Gasket	2013-10	26190 PT	Head bolts not incl.; Head bolt replacement recommended; PermaTorqueMLS® LaserWeld® Technology	
1	Head Set	2013-10	HS 26190 PT-4	Head bolts not incl.; Head bolt replacement recommended; PermaDryPlus® int. manifold gskts. incl.; PermaDry® molded rubber valve cover gskts. incl.; Premium valve stem seals incl.	
2	Head Bolt Set	2013-10	ES 72390	Replacement recommended; New Part Number - Check for Availability	
QTY	CONVERSION SET	YEARS	PART NO.	DESCRIPTION	
1	Gasket Conversion Set	2013-10	CS 9284	PermaDry® molded rubber oil pan gskt. incl.	
QTY	MANIFOLD - INT. & EXH.	YEARS	PART NO.	DESCRIPTION	
1	Int. Manifold Gasket Set	2013-10	MS 96169	Lifter valley cover set	
1	Int. Manifold Gasket Set	2013-10	MS 96587		
1	Int. Manifold Gasket Set	2013-10	MS 98016 T	PermaDryPlus® int. manifold gskts. incl.	
1	Exh. Manifold Gasket Set	2013-10	MS 92467		
QTY	EXHAUST PIPE FLANGE	YEARS	PART NO.	DESCRIPTION	
1	Exhaust Pipe Gasket	2013-10	61089	Loc. R.H.; Pipe to manifold	
1	Exhaust Pipe Gasket	2013-10	61323	Loc. L.H.; Pipe to manifold	
1	Exhaust Pipe Gasket	2013-10	61559	Converter; 3-bolt	
1	Exhaust Pipe Gasket	2013-10	61561	Exc. Chevrolet Silverado 1500 LS, LT, WT, XFE GMC Sierra 1500 SL, SLE, WT, XFE; Converter; 2-bolt	
QTY	OIL PAN	YEARS	PART NO.	DESCRIPTION	
1	Oil Pan Gasket Set	2013-10	OS 30693 R	PermaDry® molded rubber gskt. incl.	

GMC Truck (Incl. Minivans and SUV's) (Cont.)

58 (cont.)		2013 - 2010; 4.8L 293 (4807cc) OHV V8 (16 Valve) 96mm Bore Vortec VVT			58 (cont.)
MFI; Flex Fuel; Naturally Aspirated GMC Eng.; Chevrolet; VIN Code A					
QTY	CRANKSHAFT REAR SEAL	YEARS	PART NO.	DESCRIPTION	
1	Rear Main Seal Set	2013-10	BS 40640	PTFE Rubber; One-piece	
1	Repair Sleeve	2013-10	16228	Crankshaft; Narrow lip; .780" sleeve length; Requires crankshaft machining due to clearance issues; Use w/installation tool	
1	Repair Sleeve	2013-10	16229	Crankshaft; Wide lip; 1.156" sleeve length; Requires crankshaft machining due to clearance issues; Use w/installation tool	
1	Repair Sleeve Tool	2013-10	16329	Crankshaft	
QTY	VALVE COVER	YEARS	PART NO.	DESCRIPTION	
1	Valve Cover Gasket Set	2013-10	VS 50504 R	w/o Grommets; PermaDry® molded rubber gskts. incl.	
1	Valve Cover Gasket Set	2013-10	VS 50504 R-1	w/Grommets; PermaDry® molded rubber gskts. incl.; New Part Number - Check for Availability	
1	Grommet Set	2013-10	ES 72233	Valve Cover	
QTY	VALVE STEM SEAL SET	YEARS	PART NO.	DESCRIPTION	
1	Valve Stem Seal Set	2013-10	SS 71039	Premium valve stem seals incl.	
QTY	THERMOSTAT HOUSING	YEARS	PART NO.	DESCRIPTION	
1	O-Ring	2013-10	35720	Thermostat Housing	
QTY	WATER PUMP	YEARS	PART NO.	DESCRIPTION	
2	Water Pump Gasket	2013-10	35635		
1	O-Ring	2013-10	35633	Water Pump	
1	Water Pump Mounting Set	2013-10	ES 73010	Mounting gasket set; New Part Number - Check for Availability	
QTY	TIMING COVER	YEARS	PART NO.	DESCRIPTION	
1	Timing Cover Set	2013-10	TCS 45993	Must be used w/OS 30693R	
QTY	CARB & FUEL INJECTION	YEARS	PART NO.	DESCRIPTION	
2	Fuel Injector O-Ring Set	2013-10	ES 70599	Upper set; Injectors to fuel rail; Improved design	
2	Fuel Injector O-Ring Set	2013-10	ES 71190	Lower set; Injectors to cylinder head	
2	Fuel Injector O-Ring Set	2013-10	ES 71192	Upper set; Injectors to fuel rail; Old design	
1	Throttle Body Gasket	2013-10	61469		
QTY	EXHAUST GAS RECIRCULATION	YEARS	PART NO.	DESCRIPTION	
1	EGR Gasket	2013-10	70895	Pipe; O-ring	
1	EGR Gasket	2013-10	70914	Valve	
1	EGR Gasket	2013-10	70947	Pipe	
QTY	OIL FILTER MOUNTING	YEARS	PART NO.	DESCRIPTION	
1	Oil Cooler Gasket	2013-10	72462	Oil Filter; Center tube; Dual round port	
QTY	OIL PUMP COVER	YEARS	PART NO.	DESCRIPTION	
1	O-Ring	2013-10	72401	Oil Pump; Inlet tube	
QTY	OIL COOLER	YEARS	PART NO.	DESCRIPTION	
1	Oil Cooler Gasket	2013-10	72435	Oval port	
1	Oil Cooler Gasket	2013-10	72462	Dual round port	
59		1996 - 1991; 5.0L 305 (4999cc) OHV V8 (16 Valve) 3.736" Bore			59
TBI; Gasoline; Naturally Aspirated GMC Eng.; Chevrolet; VIN Code H					
QTY	CYLINDER HEAD	YEARS	PART NO.	DESCRIPTION	
2	Head Gasket	1996-91	505 SD	Head bolts not incl.; Head bolt replacement recommended; PermaTorque Severe Duty®	
2	Head Gasket	1996-91	8510 PT	Head bolts not incl.; Head bolt replacement recommended; PermaTorque®	
1	Head Set	1996	HS 8510 PT-4	Head bolts & exh. pipe packing not incl.; Head bolt replacement recommended; PermaDry® molded rubber valve cover gskts. incl.; Premium valve stem seals incl.	
1	Head Set	1995-94	HS 8510 PT-4	Chevrolet C2500 Pickup Base, Cheyenne, Silverado, WT, G20 Van Beauville, Chevy Van, Sportvan, K2500 Pickup Base, Cheyenne, Silverado, WT GMC C2500 Pickup Sierra SL, Sierra SLE, Sierra SLT, G2500 Van Rally, Rally STX, Vandura, K2500 Pickup Sierra SL, Sie; Exh. valve stem seals not incl.; Head bolts & exh. pipe packing not incl.; Head bolt replacement recommended; PermaDry® molded rubber valve cover gskts. incl.; Premium valve stem seals incl.	
1	Head Set	1995-94	HS 8510 PT-4	Exc. Chevrolet C2500 Pickup Base, Cheyenne, Silverado, WT, G20 Van Beauville, Chevy Van, Sportvan, K2500 Pickup Base, Cheyenne, Silverado, WT GMC C2500 Pickup Sierra SL, Sierra SLE, Sierra SLT, G2500 Van Rally, Rally STX, Vandura, K2500 Pickup Sierra SL; Head bolts & exh. pipe packing not incl.; Head bolt replacement recommended; PermaDry® molded rubber valve cover gskts. incl.; Premium valve stem seals incl.	

GMC Truck (Incl. Minivans and SUV's) (Cont.)

59 (cont.)	1996 - 1991; 5.0L 305 (4999cc) OHV V8 (16 Valve) 3.736" Bore TBI; Gasoline; Naturally Aspirated GMC Eng.; Chevrolet; VIN Code H			59 (cont.)
QTY	CYLINDER HEAD	YEARS	PART NO.	DESCRIPTION
1	Head Set	1993-91	HS 8510 PT-4	Exc. Chevrolet C2500 Pickup Cheyenne, Silverado, G20 Van Beauville, Chevy Van, Sportvan, K2500 Pickup Cheyenne, Silverado GMC C2500 Pickup Sierra, Sierra SLE, Sierra SLX, G2500 Van Rally, Rally STX, Vandura, K2500 Pickup Sierra, Sierra SLE, Sierra SLX; Head bolts & exh. pipe packing not incl.; Head bolt replacement recommended; PermaDry® molded rubber valve cover gskts. incl.; Premium valve stem seals incl.
1	Head Set	1993-91	HS 8510 PT-4	Chevrolet C2500 Pickup Cheyenne, Silverado, G20 Van Beauville, Chevy Van, Sportvan, K2500 Pickup Cheyenne, Silverado GMC C2500 Pickup Sierra, Sierra SLE, Sierra SLX, G2500 Van Rally, Rally STX, Vandura, K2500 Pickup Sierra, Sierra SLE, Sierra SLX; Exh. valve stem seals not incl.; Head bolts & exh. pipe packing not incl.; Head bolt replacement recommended; PermaDry® molded rubber valve cover gskts. incl.; Premium valve stem seals incl.
2	Head Bolt Set	1996-91	ES 72856	Replacement recommended
QTY	CONVERSION SET	YEARS	PART NO.	DESCRIPTION
1	Gasket Conversion Set	1996	CS 8510-1	Plastic timing cover not incl.; PermaDry® molded rubber oil pan gskt. incl.
1	Gasket Conversion Set	1995-91	CS 8510	PermaDry® molded rubber oil pan gskt. incl.
QTY	MANIFOLD - INT. & EXH.	YEARS	PART NO.	DESCRIPTION
1	Int. Manifold Gasket Set	1996-91	MS 93317	
1	Exh. Manifold Gasket Set	1996-91	MS 9275 B	
QTY	EXHAUST PIPE FLANGE	YEARS	PART NO.	DESCRIPTION
2	Exhaust Pipe Gasket	1996-91	60718	Packing; 2 3/32" ID Steel sleeve
QTY	FUEL PUMP	YEARS	PART NO.	DESCRIPTION
1	Fuel Pump Mounting Gasket	1996-91	5182	Plate
1	Fuel Pump Mounting Gasket	1995-91	6579	May also be used as a fuel pump block-off plate gasket if desired
QTY	OIL PAN	YEARS	PART NO.	DESCRIPTION
1	Oil Pan Gasket Set	1996-91	OS 34500 R	PermaDry® molded rubber gskt. incl.
1	Drain Plug Gasket	1996	70820	
1	Drain Plug Gasket	1995-91	70822	
QTY	CRANKSHAFT REAR SEAL	YEARS	PART NO.	DESCRIPTION
1	Rear Main Seal Set	1996	BS 40656	PTFE Rubber; One-piece; Improved design
1	Rear Main Seal Set	1995-91	BS 40520	Rubber; One-piece
1	Rear Main Seal Set	1995-91	BS 40626	PTFE Rubber; One-piece
1	Repair Sleeve	1995-91	16258	Crankshaft; One-piece rear main brg. seal; Use w/installation tool
1	Repair Sleeve Tool	1995-91	16301	Crankshaft; One-piece rear main brg. seal
QTY	VALVE COVER	YEARS	PART NO.	DESCRIPTION
1	Valve Cover Gasket Set	1996-91	VS 50088 R	Services both covers; PermaDry® molded rubber gskts. incl.
2	Valve Cover Gasket Set	1996-91	VS 50293 R	Services one cover only; PermaDry® molded rubber gskt. incl.
QTY	VALVE STEM SEAL SET	YEARS	PART NO.	DESCRIPTION
1	Valve Stem Seal Set	1996-91	SS 72527	Loc. Int.; Premium valve stem seals incl.
1	Valve Stem Seal Set	1996	SS 72526	Loc. Exh.; Premium valve stem seals incl.
1	Valve Stem Seal Set	1996	SS 72877	Loc. Exh.; Opt. Hi-Temp. premium valve stem seals incl.
1	Valve Stem Seal Set	1995-94	SS 72525	Chevrolet C2500 Pickup Base, Cheyenne, Silverado, WT, G20 Van Beauville, Chevy Van, Sportvan, K2500 Pickup Base, Cheyenne, Silverado, WT GMC C2500 Pickup Sierra SL, Sierra SLE, Sierra SLT, G2500 Van Rally, Rally STX, Vandura, K2500 Pickup Sierra SL, Sie; Loc. Exh.; Premium valve stem seals incl.
1	Valve Stem Seal Set	1995-94	SS 72526	Exc. Chevrolet C2500 Pickup Base, Cheyenne, Silverado, WT, G20 Van Beauville, Chevy Van, Sportvan, K2500 Pickup Base, Cheyenne, Silverado, WT GMC C2500 Pickup Sierra SL, Sierra SLE, Sierra SLT, G2500 Van Rally, Rally STX, Vandura, K2500 Pickup Sierra SL; Loc. Exh.; Premium valve stem seals incl.
1	Valve Stem Seal Set	1995-94	SS 72877	Exc. Chevrolet C2500 Pickup Base, Cheyenne, Silverado, WT, G20 Van Beauville, Chevy Van, Sportvan, K2500 Pickup Base, Cheyenne, Silverado, WT GMC C2500 Pickup Sierra SL, Sierra SLE, Sierra SLT, G2500 Van Rally, Rally STX, Vandura, K2500 Pickup Sierra SL; Loc. Exh.; Opt. Hi-Temp. premium valve stem seals incl.
1	Valve Stem Seal Set	1995-94	SS 72883	Chevrolet C2500 Pickup Base, Cheyenne, Silverado, WT, G20 Van Beauville, Chevy Van, Sportvan, K2500 Pickup Base, Cheyenne, Silverado, WT GMC C2500 Pickup Sierra SL, Sierra SLE, Sierra SLT, G2500 Van Rally, Rally STX, Vandura, K2500 Pickup Sierra SL, Sie; Loc. Exh.; Opt. Hi-Temp. premium valve stem seals incl.

GMC Truck (Incl. Minivans and SUV's) (Cont.)

59		1996 - 1991; 5.0L 305 (4999cc) OHV V8 (16 Valve) 3.736" Bore			59	
(cont.)		TBI; Gasoline; Naturally Aspirated GMC Eng.; Chevrolet; VIN Code H			(cont.)	
QTY	VALVE STEM SEAL SET	YEARS	PART NO.	DESCRIPTION		
1	Valve Stem Seal Set	1993-91	SS 72525	Chevrolet C2500 Pickup Cheyenne, Silverado, G20 Van Beauville, Chevy Van, Sportvan, K2500 Pickup Cheyenne, Silverado GMC C2500 Pickup Sierra, Sierra SLE, Sierra SLX, G2500 Van Rally, Rally STX, Vandura, K2500 Pickup Sierra, Sierra SLE, Sierra SLX; Loc. Exh.; Premium valve stem seals incl.		
1	Valve Stem Seal Set	1993-91	SS 72526	Exc. Chevrolet C2500 Pickup Cheyenne, Silverado, G20 Van Beauville, Chevy Van, Sportvan, K2500 Pickup Cheyenne, Silverado GMC C2500 Pickup Sierra, Sierra SLE, Sierra SLX, G2500 Van Rally, Rally STX, Vandura, K2500 Pickup Sierra, Sierra SLE, Sierra SLX; Loc. Exh.; Premium valve stem seals incl.		
1	Valve Stem Seal Set	1993-91	SS 72877	Exc. Chevrolet C2500 Pickup Cheyenne, Silverado, G20 Van Beauville, Chevy Van, Sportvan, K2500 Pickup Cheyenne, Silverado GMC C2500 Pickup Sierra, Sierra SLE, Sierra SLX, G2500 Van Rally, Rally STX, Vandura, K2500 Pickup Sierra, Sierra SLE, Sierra SLX; Loc. Exh.; Opt. Hi-Temp. premium valve stem seals incl.		
1	Valve Stem Seal Set	1993-91	SS 72883	Chevrolet C2500 Pickup Cheyenne, Silverado, G20 Van Beauville, Chevy Van, Sportvan, K2500 Pickup Cheyenne, Silverado GMC C2500 Pickup Sierra, Sierra SLE, Sierra SLX, G2500 Van Rally, Rally STX, Vandura, K2500 Pickup Sierra, Sierra SLE, Sierra SLX; Loc. Exh.; Opt. Hi-Temp. premium valve stem seals incl.		
QTY	THERMOSTAT HOUSING	YEARS	PART NO.	DESCRIPTION		
1	O-Ring	1996-91	35710	Thermostat Housing; 1.954" ID; Improved design		
QTY	WATER OUTLET GASKET	YEARS	PART NO.	DESCRIPTION		
1	Water Outlet Gasket	1995-91	35062	Water Outlet; 1 13/16" ID		
1	Water Outlet Gasket	1995-91	35562 T	Water Outlet; 1 13/16" ID; PermaDryPlus®		
QTY	WATER PUMP	YEARS	PART NO.	DESCRIPTION		
1	Water Pump Gasket	1996-91	13032	To plate		
2	Water Pump Gasket	1996-91	5152	To block		
QTY	TIMING COVER	YEARS	PART NO.	DESCRIPTION		
1	Timing Cover Set	1996	TCS 46093	Eng. w/2.42" OD timing cover seal; Must be used w/OS 34500R		
1	Timing Cover Set	1995-91	TCS 45121	w/o Sleeve 'N' Seal®; Must be used w/OS 34500R		
1	Timing Set w/Sleeve & Seal	1995-91	TCS 45265	w/Sleeve 'N' Seal®; Must be used w/OS 34500R		
1	Repair Sleeve	1995-91	16202	Timing Cover; Use w/installation tool		
1	Repair Sleeve Tool	1995-91	16312	Timing Cover		
QTY	AIR CLEANER MOUNTING	YEARS	PART NO.	DESCRIPTION		
1	Air Cleaner Gasket	1996-91	60038	5 1/32" ID		
QTY	CARB & FUEL INJECTION	YEARS	PART NO.	DESCRIPTION		
1	Throttle Body Gasket	1996-91	60903			
QTY	DISTRIBUTOR MOUNTING	YEARS	PART NO.	DESCRIPTION		
1	Distributor Mounting Gasket	1996-91	70194			
QTY	EXHAUST GAS RECIRCULATION	YEARS	PART NO.	DESCRIPTION		
1	EGR Gasket	1996-91	70978			
QTY	OIL PUMP RETAINER	YEARS	PART NO.	DESCRIPTION		
1	Oil Pump Shaft Guide	1996-91	72665	Distributor to oil pump shaft retainer		
QTY	OIL COOLER	YEARS	PART NO.	DESCRIPTION		
1	Oil Cooler Mounting Set	1996-91	ES 72671			
60		2002 - 1996; 5.0L 305 (4999cc) OHV V8 (16 Valve) 3.736" Bore Vortec			60	
(cont.)		CPI; Gasoline; Naturally Aspirated GMC Eng.; Chevrolet; VIN Code M			(cont.)	
QTY	CYLINDER HEAD	YEARS	PART NO.	DESCRIPTION		
2	Head Gasket	2002-96	505 SD	Head bolts not incl.; Head bolt replacement recommended; PermaTorque Severe Duty®		
2	Head Gasket	2002-96	8510 PT	Head bolts not incl.; Head bolt replacement recommended; PermaTorque®		
1	Head Set	2002-96	HS 8510 PT-6	Head bolts & exh. pipe packing not incl.; Head bolt replacement recommended; PermaDry® molded rubber valve cover gskts. incl.; Premium valve stem seals incl.		
1	Head Set	2002-96	HST 8510 PT-6	Head bolts & exh. pipe packing not incl.; Head bolt replacement recommended; PermaTorque Severe Duty® head gskts. incl.; PermaDryPlus® int. manifold gskts. incl.; PermaDry® molded rubber valve cover gskts. incl.; Premium valve stem seals incl.		
2	Head Bolt Set	2002-96	ES 72856	Replacement recommended		
QTY	CONVERSION SET	YEARS	PART NO.	DESCRIPTION		
1	Gasket Conversion Set	2002-96	CS 8510-1	Plastic timing cover not incl.; PermaDry® molded rubber oil pan gskt. incl.		

GMC Truck (Incl. Minivans and SUV's) (Cont.)

60 (cont.)		2002 - 1996; 5.0L 305 (4999cc) OHV V8 (16 Valve) 3.736" Bore Vortec CPI; Gasoline; Naturally Aspirated GMC Eng.; Chevrolet; VIN Code M			60 (cont.)
QTY	MANIFOLD - INT. & EXH.	YEARS	PART NO.	DESCRIPTION	
1	Int. Manifold Gasket Set	2002-96	MS 90131	Lower set; Upper set incl.; Manifold bolts not incl.; Manifold bolt replacement recommended	
1	Int. Manifold Gasket Set	2002-96	MS 90131-2	Lower set only; Upper set not incl.; Manifold bolts not incl.; Manifold bolt replacement recommended	
1	Int. Manifold Gasket Set	2002-96	MS 98000 T	Single valve cover gskt. incl.; Upper set incl.; PermaDryPlus® int. manifold gskts. incl.; When servicing second valve cover use VS 50293R if required; Manifold bolts not incl.; Manifold bolt replacement recommended	
1	Plenum Gasket Set	2002-96	MS 90269	Upper set	
1	Int. Manifold Bolt Set	2002-96	ES 72224	Loc. Lower; Replacement recommended	
1	Exh. Manifold Gasket Set	2002-96	MS 94054		
QTY	EXHAUST PIPE FLANGE	YEARS	PART NO.	DESCRIPTION	
2	Exhaust Pipe Gasket	2002-96	61014	Pipe to manifold	
1	Exhaust Pipe Gasket	2002-96	61559	Converter; 3-bolt	
1	Exhaust Pipe Gasket	2002-96	61561	Converter; 2-bolt	
1	Exhaust Pipe Gasket	2002-96	61683	Exh. connector; New Part Number - Check for Availability	
QTY	FUEL PUMP	YEARS	PART NO.	DESCRIPTION	
1	Fuel Pump Mounting Gasket	2002-96	5182	Plate	
QTY	OIL PAN	YEARS	PART NO.	DESCRIPTION	
1	Oil Pan Gasket Set	2002-96	OS 34500 R	PermaDry® molded rubber gskt. incl.	
1	Drain Plug Gasket	2002-96	70820		
QTY	CRANKSHAFT REAR SEAL	YEARS	PART NO.	DESCRIPTION	
1	Rear Main Seal Set	2002-96	BS 40656	PTFE Rubber; One-piece; Improved design	
QTY	VALVE COVER	YEARS	PART NO.	DESCRIPTION	
1	Valve Cover Gasket Set	2002-96	VS 50088 R	Services both covers; PermaDry® molded rubber gskts. incl.	
2	Valve Cover Gasket Set	2002-96	VS 50293 R	Services one cover only; PermaDry® molded rubber gskt. incl.	
QTY	VALVE STEM SEAL SET	YEARS	PART NO.	DESCRIPTION	
1	Valve Stem Seal Set	2002-96	SS 72861	Loc. Int. & Exh.; Premium valve stem seals incl.; Improved design	
QTY	THERMOSTAT HOUSING	YEARS	PART NO.	DESCRIPTION	
1	O-Ring	2002-96	35710	Thermostat Housing; 1.954" ID; Improved design	
QTY	WATER PUMP	YEARS	PART NO.	DESCRIPTION	
1	Water Pump Gasket	2002-96	13032	To plate	
2	Water Pump Gasket	2002-96	5152	To block	
QTY	TIMING COVER	YEARS	PART NO.	DESCRIPTION	
1	Timing Cover Set	2002-96	TCS 46093	Eng. w/2.42" OD timing cover seal; Must be used w/OS 34500R	
QTY	CARB & FUEL INJECTION	YEARS	PART NO.	DESCRIPTION	
1	Throttle Body Gasket	2002-96	61036		
QTY	DISTRIBUTOR MOUNTING	YEARS	PART NO.	DESCRIPTION	
1	Distributor Mounting Gasket	2002-96	70194		
QTY	EXHAUST GAS RECIRCULATION	YEARS	PART NO.	DESCRIPTION	
1	EGR Gasket	2002-96	70789		
QTY	OIL PUMP RETAINER	YEARS	PART NO.	DESCRIPTION	
1	Oil Pump Shaft Guide	2002-96	72665	Distributor to oil pump shaft retainer	
QTY	OIL COOLER	YEARS	PART NO.	DESCRIPTION	
1	Oil Cooler Mounting Set	2002-96	ES 72671		
61		2013 - 2007; 5.3L 325 (5328cc) OHV V8 (16 Valve) 96mm Bore Vortec MFI; Flex Fuel; Naturally Aspirated GMC Eng.; Chevrolet; VIN Code 0			61
QTY	CYLINDER HEAD	YEARS	PART NO.	DESCRIPTION	
2	Head Gasket	2011-07	26190 PT	Head bolts not incl.; Head bolt replacement recommended; PermaTorqueMLS® LaserWeld® Technology	
1	Head Set	2011-07	HS 26190 PT-2	Head bolts not incl.; Head bolt replacement recommended; When servicing Displacement-On-Demand solenoids use w/Lifter valley cover set MS 96871; PermaDryPlus® int. manifold gskts. incl.; PermaDry® molded rubber valve cover gskts. incl.; Premium valve stem	
2	Head Bolt Set	2012-07	ES 72390	Replacement recommended; New Part Number - Check for Availability	
QTY	CONVERSION SET	YEARS	PART NO.	DESCRIPTION	
1	Gasket Conversion Set	2011-07	CS 9284	PermaDry® molded rubber oil pan gskt. incl.	
QTY	MANIFOLD - INT. & EXH.	YEARS	PART NO.	DESCRIPTION	
1	Int. Manifold Gasket Set	2011-07	MS 96587		
1	Int. Manifold Gasket Set	2011-07	MS 96857	Lifter valley cover set; Perimeter seal only	
1	Int. Manifold Gasket Set	2011-07	MS 96871	Lifter valley cover set; For use when servicing Displacement-On-Demand solenoids	
1	Int. Manifold Gasket Set	2011-07	MS 98016 T	PermaDryPlus® int. manifold gskts. incl.	
1	Exh. Manifold Gasket Set	2011-07	MS 92467		

GMC Truck (Incl. Minivans and SUV's) (Cont.)

61 (cont.)		2013 - 2007; 5.3L 325 (5328cc) OHV V8 (16 Valve) 96mm Bore Vortec			61 (cont.)
		MFI; Flex Fuel; Naturally Aspirated GMC Eng.; Chevrolet; VIN Code 0			
QTY	EXHAUST PIPE FLANGE	YEARS	PART NO.	DESCRIPTION	
1	Exhaust Pipe Gasket	2013-07	61089	Loc. R.H.; Pipe to manifold	
1	Exhaust Pipe Gasket	2013-07	61323	Loc. L.H.; Pipe to manifold	
QTY	OIL PAN	YEARS	PART NO.	DESCRIPTION	
1	Oil Pan Gasket Set	2011-07	OS 30693 R	PermaDry® molded rubber gskt. incl.	
QTY	CRANKSHAFT REAR SEAL	YEARS	PART NO.	DESCRIPTION	
1	Rear Main Seal Set	2011-07	BS 40640	PTFE Rubber; One-piece	
1	Repair Sleeve	2011-07	16228	Crankshaft; Narrow lip; .780" sleeve length; Requires crankshaft machining due to clearance issues; Use w/installation tool	
1	Repair Sleeve	2011-07	16229	Crankshaft; Wide lip; 1.156" sleeve length; Requires crankshaft machining due to clearance issues; Use w/installation tool	
1	Repair Sleeve Tool	2011-07	16329	Crankshaft	
QTY	VALVE COVER	YEARS	PART NO.	DESCRIPTION	
1	Valve Cover Gasket Set	2011-07	VS 50504 R	w/o Grommets; PermaDry® molded rubber gsks. incl.	
1	Valve Cover Gasket Set	2011-07	VS 50504 R-1	w/Grommets; PermaDry® molded rubber gsks. incl.; New Part Number - Check for Availability	
1	Grommet Set	2011-07	ES 72233	Valve Cover	
QTY	VALVE STEM SEAL SET	YEARS	PART NO.	DESCRIPTION	
1	Valve Stem Seal Set	2011-07	SS 71039	Premium valve stem seals incl.	
QTY	THERMOSTAT HOUSING	YEARS	PART NO.	DESCRIPTION	
1	O-Ring	2011-07	35720	Thermostat Housing	
QTY	WATER PUMP	YEARS	PART NO.	DESCRIPTION	
2	Water Pump Gasket	2011-07	35635		
1	O-Ring	2011-07	35633	Water Pump	
1	Water Pump Mounting Set	2011-07	ES 73010	Mounting gasket set; New Part Number - Check for Availability	
QTY	TIMING COVER	YEARS	PART NO.	DESCRIPTION	
1	Timing Cover Set	2011-07	TCS 45993	Must be used w/OS 30693R	
QTY	CARB & FUEL INJECTION	YEARS	PART NO.	DESCRIPTION	
2	Fuel Injector O-Ring Set	2011-07	ES 70599	Upper set; Injectors to fuel rail; Improved design	
2	Fuel Injector O-Ring Set	2011-07	ES 71190	Lower set; Injectors to cylinder head	
2	Fuel Injector O-Ring Set	2011-07	ES 71192	Upper set; Injectors to fuel rail; Old design	
1	Throttle Body Gasket	2011-07	61469		
QTY	EXHAUST GAS RECIRCULATION	YEARS	PART NO.	DESCRIPTION	
1	EGR Gasket	2011-07	70895	Pipe; O-ring	
1	EGR Gasket	2011-07	70914	Valve	
1	EGR Gasket	2011-07	70947	Pipe	
QTY	OIL FILTER MOUNTING	YEARS	PART NO.	DESCRIPTION	
1	Oil Cooler Gasket	2011-07	72462	Oil Filter; Center tube; Dual round port	
QTY	OIL PUMP COVER	YEARS	PART NO.	DESCRIPTION	
1	O-Ring	2011-07	72401	Oil Pump; Inlet tube	
QTY	OIL COOLER	YEARS	PART NO.	DESCRIPTION	
1	Oil Cooler Gasket	2011-07	72435	Oval port	
1	Oil Cooler Gasket	2011-07	72462	Dual round port	
62		2013 - 2007; 5.3L 325 (5328cc) OHV V8 (16 Valve) 96mm Bore Vortec			62
		MFI; Flex Fuel; Naturally Aspirated GMC Eng.; Chevrolet; VIN Code 3			
QTY	CYLINDER HEAD	YEARS	PART NO.	DESCRIPTION	
2	Head Gasket	2011-07	26190 PT	Head bolts not incl.; Head bolt replacement recommended; PermaTorqueMLS® LaserWeld® Technology	
1	Head Set	2011-07	HS 26190 PT-2	Head bolts not incl.; Head bolt replacement recommended; When servicing Displacement-On-Demand solenoids use w/Lifter valley cover set MS 96871; PermaDryPlus® int. manifold gsks. incl.; PermaDry® molded rubber valve cover gsks. incl.; Premium valve stem	
2	Head Bolt Set	2012-07	ES 72390	Replacement recommended; New Part Number - Check for Availability	
QTY	CONVERSION SET	YEARS	PART NO.	DESCRIPTION	
1	Gasket Conversion Set	2011-07	CS 9284	PermaDry® molded rubber oil pan gskt. incl.	
QTY	MANIFOLD - INT. & EXH.	YEARS	PART NO.	DESCRIPTION	
1	Int. Manifold Gasket Set	2011-07	MS 96587		
1	Int. Manifold Gasket Set	2011-07	MS 96857	Lifter valley cover set; Perimeter seal only	
1	Int. Manifold Gasket Set	2011-07	MS 96871	Lifter valley cover set; For use when servicing Displacement-On-Demand solenoids	
1	Int. Manifold Gasket Set	2011-07	MS 98016 T	PermaDryPlus® int. manifold gsks. incl.	
1	Exh. Manifold Gasket Set	2011-07	MS 92467		
QTY	EXHAUST PIPE FLANGE	YEARS	PART NO.	DESCRIPTION	
1	Exhaust Pipe Gasket	2013-07	61089	Loc. R.H.; Pipe to manifold	

GMC Truck (Incl. Minivans and SUV's) (Cont.)

62 (cont.)		2013 - 2007; 5.3L 325 (5328cc) OHV V8 (16 Valve) 96mm Bore Vortec MFI; Flex Fuel; Naturally Aspirated GMC Eng.; Chevrolet; VIN Code 3			62 (cont.)
QTY	EXHAUST PIPE FLANGE	YEARS	PART NO.	DESCRIPTION	
1	Exhaust Pipe Gasket	2013-07	61323	Loc. L.H.; Pipe to manifold	
QTY	OIL PAN	YEARS	PART NO.	DESCRIPTION	
1	Oil Pan Gasket Set	2011-07	OS 30693 R	PermaDry® molded rubber gskt. incl.	
QTY	CRANKSHAFT REAR SEAL	YEARS	PART NO.	DESCRIPTION	
1	Rear Main Seal Set	2011-07	BS 40640	PTFE Rubber; One-piece	
1	Repair Sleeve	2011-07	16228	Crankshaft; Narrow lip; .780" sleeve length; Requires crankshaft machining due to clearance issues; Use w/installation tool	
1	Repair Sleeve	2011-07	16229	Crankshaft; Wide lip; 1.156" sleeve length; Requires crankshaft machining due to clearance issues; Use w/installation tool	
1	Repair Sleeve Tool	2011-07	16329	Crankshaft	
QTY	VALVE COVER	YEARS	PART NO.	DESCRIPTION	
1	Valve Cover Gasket Set	2011-07	VS 50504 R	w/o Grommets; PermaDry® molded rubber gskts. incl.	
1	Valve Cover Gasket Set	2011-07	VS 50504 R-1	w/Grommets; PermaDry® molded rubber gskts. incl.; New Part Number - Check for Availability	
1	Grommet Set	2011-07	ES 72233	Valve Cover	
QTY	VALVE STEM SEAL SET	YEARS	PART NO.	DESCRIPTION	
1	Valve Stem Seal Set	2011-07	SS 71039	Premium valve stem seals incl.	
QTY	THERMOSTAT HOUSING	YEARS	PART NO.	DESCRIPTION	
1	O-Ring	2011-07	35720	Thermostat Housing	
QTY	WATER PUMP	YEARS	PART NO.	DESCRIPTION	
2	Water Pump Gasket	2011-07	35635		
1	O-Ring	2011-07	35633	Water Pump	
1	Water Pump Mounting Set	2011-07	ES 73010	Mounting gasket set; New Part Number - Check for Availability	
QTY	TIMING COVER	YEARS	PART NO.	DESCRIPTION	
1	Timing Cover Set	2011-07	TCS 45993	Must be used w/OS 30693R	
QTY	CARB & FUEL INJECTION	YEARS	PART NO.	DESCRIPTION	
2	Fuel Injector O-Ring Set	2011-07	ES 70599	Upper set; Injectors to fuel rail; Improved design	
2	Fuel Injector O-Ring Set	2011-07	ES 71190	Lower set; Injectors to cylinder head	
2	Fuel Injector O-Ring Set	2011-07	ES 71192	Upper set; Injectors to fuel rail; Old design	
1	Throttle Body Gasket	2011-07	61469		
QTY	EXHAUST GAS RECIRCULATION	YEARS	PART NO.	DESCRIPTION	
1	EGR Gasket	2011-07	70895	Pipe; O-ring	
1	EGR Gasket	2011-07	70914	Valve	
1	EGR Gasket	2011-07	70947	Pipe	
QTY	OIL FILTER MOUNTING	YEARS	PART NO.	DESCRIPTION	
1	Oil Cooler Gasket	2011-07	72462	Oil Filter; Center tube; Dual round port	
QTY	OIL PUMP COVER	YEARS	PART NO.	DESCRIPTION	
1	O-Ring	2011-07	72401	Oil Pump; Inlet tube	
QTY	OIL COOLER	YEARS	PART NO.	DESCRIPTION	
1	Oil Cooler Gasket	2011-07	72435	Oval port	
1	Oil Cooler Gasket	2011-07	72462	Dual round port	
63		2007 - 2005; 5.3L 325 (5328cc) OHV V8 (16 Valve) 96mm Bore Vortec MFI; Gasoline; Naturally Aspirated GMC Eng.; Chevrolet; VIN Code B			63
QTY	CYLINDER HEAD	YEARS	PART NO.	DESCRIPTION	
2	Head Gasket	2007-05	26190 PT	Head bolts not incl.; Head bolt replacement recommended; PermaTorqueMLS® LaserWeld® Technology	
1	Head Set	2007-05	HS 26190 PT-2	Head bolts not incl.; Head bolt replacement recommended; PermaDryPlus® int. manifold gskts. incl.; PermaDry® molded rubber valve cover gskts. incl.; Premium valve stem seals incl.	
2	Head Bolt Set	2007-05	ES 72220	2nd Design; Replacement recommended	
QTY	CONVERSION SET	YEARS	PART NO.	DESCRIPTION	
1	Gasket Conversion Set	2007-05	CS 9284	PermaDry® molded rubber oil pan gskt. incl.	
QTY	MANIFOLD - INT. & EXH.	YEARS	PART NO.	DESCRIPTION	
1	Int. Manifold Gasket Set	2007-05	MS 92465	Lifter valley cover set	
1	Int. Manifold Gasket Set	2007-05	MS 96587		
1	Int. Manifold Gasket Set	2007-05	MS 98016 T	PermaDryPlus® int. manifold gskts. incl.	
1	Exh. Manifold Gasket Set	2007-05	MS 92467		
QTY	EXHAUST PIPE FLANGE	YEARS	PART NO.	DESCRIPTION	
1	Exhaust Pipe Gasket	2007-05	61074	Loc. L.H.; Pipe to manifold	
1	Exhaust Pipe Gasket	2007-05	61089	Loc. R.H.; Pipe to manifold	
QTY	OIL PAN	YEARS	PART NO.	DESCRIPTION	
1	Oil Pan Gasket Set	2007-05	OS 30693 R	PermaDry® molded rubber gskt. incl.	

GMC Truck (Incl. Minivans and SUV's) (Cont.)

63 (cont.)		2007 - 2005; 5.3L 325 (5328cc) OHV V8 (16 Valve) 96mm Bore Vortec MFI; Gasoline; Naturally Aspirated GMC Eng.; Chevrolet; VIN Code B			63 (cont.)
QTY	CRANKSHAFT REAR SEAL	YEARS	PART NO.	DESCRIPTION	
1	Rear Main Seal Set	2007-05	BS 40640	PTFE Rubber; One-piece	
1	Repair Sleeve	2007-05	16228	Crankshaft; Narrow lip; .780" sleeve length; Requires crankshaft machining due to clearance issues; Use w/installation tool	
1	Repair Sleeve	2007-05	16229	Crankshaft; Wide lip; 1.156" sleeve length; Requires crankshaft machining due to clearance issues; Use w/installation tool	
1	Repair Sleeve Tool	2007-05	16329	Crankshaft	
QTY	VALVE COVER	YEARS	PART NO.	DESCRIPTION	
1	Valve Cover Gasket Set	2007-05	VS 50504 R	w/o Grommets; PermaDry® molded rubber gskts. incl.	
1	Valve Cover Gasket Set	2007-05	VS 50504 R-1	w/Grommets; PermaDry® molded rubber gskts. incl.; New Part Number - Check for Availability	
1	Grommet Set	2007-05	ES 72233	Valve Cover	
QTY	VALVE STEM SEAL SET	YEARS	PART NO.	DESCRIPTION	
1	Valve Stem Seal Set	2007-05	SS 71039	2nd Design; Top-Hat Design seal; Premium valve stem seals incl.	
QTY	THERMOSTAT HOUSING	YEARS	PART NO.	DESCRIPTION	
1	O-Ring	2007-05	35720	Thermostat Housing	
QTY	WATER PUMP	YEARS	PART NO.	DESCRIPTION	
2	Water Pump Gasket	2007-05	35635		
1	O-Ring	2007-05	35633	Water Pump	
1	Water Pump Mounting Set	2007-05	ES 73010	Mounting gasket set; New Part Number - Check for Availability	
QTY	TIMING COVER	YEARS	PART NO.	DESCRIPTION	
1	Timing Cover Set	2007-05	TCS 45993	Must be used w/OS 30693R	
QTY	CARB & FUEL INJECTION	YEARS	PART NO.	DESCRIPTION	
2	Fuel Injector O-Ring Set	2007-05	ES 70599	Upper set; Injectors to fuel rail; Improved design	
2	Fuel Injector O-Ring Set	2007-05	ES 71190	Lower set; Injectors to cylinder head	
2	Fuel Injector O-Ring Set	2007-05	ES 71192	Upper set; Injectors to fuel rail; Old design	
1	Throttle Body Gasket	2007-05	61070		
QTY	EXHAUST GAS RECIRCULATION	YEARS	PART NO.	DESCRIPTION	
1	EGR Gasket	2007-05	70895	Pipe; O-ring	
1	EGR Gasket	2007-05	70914	Valve	
1	EGR Gasket	2007-05	70947	Pipe	
QTY	OIL FILTER MOUNTING	YEARS	PART NO.	DESCRIPTION	
1	Oil Cooler Gasket	2007-05	72462	Oil Filter; Center tube; Dual round port	
QTY	OIL PUMP COVER	YEARS	PART NO.	DESCRIPTION	
1	O-Ring	2007-05	72401	Oil Pump; Inlet tube	
QTY	OIL COOLER	YEARS	PART NO.	DESCRIPTION	
1	Oil Cooler Gasket	2007-05	72435	Oval port	
1	Oil Cooler Gasket	2007-05	72462	Dual round port	
64		2010 - 2007; 5.3L 325 (5328cc) OHV V8 (16 Valve) 96mm Bore Vortec MFI; Gasoline; Naturally Aspirated GMC Eng.; Chevrolet; VIN Code J			64
QTY	CYLINDER HEAD	YEARS	PART NO.	DESCRIPTION	
2	Head Gasket	2010-07	26190 PT	Head bolts not incl.; Head bolt replacement recommended; PermaTorqueMLS® LaserWeld® Technology	
1	Head Set	2010-07	HS 26190 PT-2	Head bolts not incl.; Head bolt replacement recommended; When servicing Displacement-On-Demand solenoids use w/Lifter valley cover set MS 96871; PermaDryPlus® int. manifold gskts. incl.; PermaDry® molded rubber valve cover gskts. incl.; Premium valve stem	
2	Head Bolt Set	2010-07	ES 72390	Replacement recommended; New Part Number - Check for Availability	
QTY	CONVERSION SET	YEARS	PART NO.	DESCRIPTION	
1	Gasket Conversion Set	2010-07	CS 9284	PermaDry® molded rubber oil pan gskt. incl.	
QTY	MANIFOLD - INT. & EXH.	YEARS	PART NO.	DESCRIPTION	
1	Int. Manifold Gasket Set	2010-07	MS 96587		
1	Int. Manifold Gasket Set	2010-07	MS 96857	Lifter valley cover set; Perimeter seal only	
1	Int. Manifold Gasket Set	2010-07	MS 96871	Lifter valley cover set; For use when servicing Displacement-On-Demand solenoids	
1	Int. Manifold Gasket Set	2010-07	MS 98016 T	PermaDryPlus® int. manifold gskts. incl.	
1	Exh. Manifold Gasket Set	2010-07	MS 92467		
QTY	EXHAUST PIPE FLANGE	YEARS	PART NO.	DESCRIPTION	
1	Exhaust Pipe Gasket	2010-07	61089	Loc. R.H.; Pipe to manifold	
1	Exhaust Pipe Gasket	2010-07	61323	Loc. L.H.; Pipe to manifold	
QTY	OIL PAN	YEARS	PART NO.	DESCRIPTION	
1	Oil Pan Gasket Set	2010-07	OS 30693 R	PermaDry® molded rubber gskt. incl.	
QTY	CRANKSHAFT REAR SEAL	YEARS	PART NO.	DESCRIPTION	
1	Rear Main Seal Set	2010-07	BS 40640	PTFE Rubber; One-piece	

GMC Truck (Incl. Minivans and SUV's) (Cont.)

64		2010 - 2007; 5.3L 325 (5328cc) OHV V8 (16 Valve) 96mm Bore Vortec			64
(cont.)		MFI; Gasoline; Naturally Aspirated GMC Eng.; Chevrolet; VIN Code J			(cont.)
QTY	CRANKSHAFT REAR SEAL	YEARS	PART NO.	DESCRIPTION	
1	Repair Sleeve	2010-07	16228	Crankshaft; Narrow lip; .780" sleeve length; Requires crankshaft machining due to clearance issues; Use w/installation tool	
1	Repair Sleeve	2010-07	16229	Crankshaft; Wide lip; 1.156" sleeve length; Requires crankshaft machining due to clearance issues; Use w/installation tool	
1	Repair Sleeve Tool	2010-07	16329	Crankshaft	
QTY	VALVE COVER	YEARS	PART NO.	DESCRIPTION	
1	Valve Cover Gasket Set	2010-07	VS 50504 R	w/o Grommets; PermaDry® molded rubber gskts. incl.	
1	Valve Cover Gasket Set	2010-07	VS 50504 R-1	w/Grommets; PermaDry® molded rubber gskts. incl.; New Part Number - Check for Availability	
1	Grommet Set	2010-07	ES 72233	Valve Cover	
QTY	VALVE STEM SEAL SET	YEARS	PART NO.	DESCRIPTION	
1	Valve Stem Seal Set	2010-07	SS 71039	Premium valve stem seals incl.	
QTY	THERMOSTAT HOUSING	YEARS	PART NO.	DESCRIPTION	
1	O-Ring	2010-07	35720	Thermostat Housing	
QTY	WATER PUMP	YEARS	PART NO.	DESCRIPTION	
2	Water Pump Gasket	2010-07	35635		
1	O-Ring	2010-07	35633	Water Pump	
1	Water Pump Mounting Set	2010-07	ES 73010	Mounting gasket set; New Part Number - Check for Availability	
QTY	TIMING COVER	YEARS	PART NO.	DESCRIPTION	
1	Timing Cover Set	2010-07	TCS 45993	Must be used w/OS 30693R	
QTY	CARB & FUEL INJECTION	YEARS	PART NO.	DESCRIPTION	
2	Fuel Injector O-Ring Set	2010-07	ES 70599	Upper set; Injectors to fuel rail; Improved design	
2	Fuel Injector O-Ring Set	2010-07	ES 71190	Lower set; Injectors to cylinder head	
2	Fuel Injector O-Ring Set	2010-07	ES 71192	Upper set; Injectors to fuel rail; Old design	
1	Throttle Body Gasket	2010-07	61469		
QTY	EXHAUST GAS RECIRCULATION	YEARS	PART NO.	DESCRIPTION	
1	EGR Gasket	2010-07	70895	Pipe; O-ring	
1	EGR Gasket	2010-07	70914	Valve	
1	EGR Gasket	2010-07	70947	Pipe	
QTY	OIL FILTER MOUNTING	YEARS	PART NO.	DESCRIPTION	
1	Oil Cooler Gasket	2010-07	72462	Oil Filter; Center tube; Dual round port	
QTY	OIL PUMP COVER	YEARS	PART NO.	DESCRIPTION	
1	O-Ring	2010-07	72401	Oil Pump; Inlet tube	
QTY	OIL COOLER	YEARS	PART NO.	DESCRIPTION	
1	Oil Cooler Gasket	2010-07	72435	Oval port	
1	Oil Cooler Gasket	2010-07	72462	Dual round port	
65		2009 - 2008; 5.3L 325 (5328cc) OHV V8 (16 Valve) 96mm Bore Vortec			65
(cont.)		MFI; Gasoline; Naturally Aspirated GMC Eng.; Chevrolet; VIN Code L			(cont.)
QTY	CYLINDER HEAD	YEARS	PART NO.	DESCRIPTION	
2	Head Gasket	2009-08	26190 PT	Head bolts not incl.; Head bolt replacement recommended; PermaTorqueMLS® LaserWeld® Technology	
1	Head Set	2009-08	HS 26190 PT-2	Head bolts not incl.; Head bolt replacement recommended; PermaDryPlus® int. manifold gskts. incl.; PermaDry® molded rubber valve cover gskts. incl.; Premium valve stem seals incl.	
2	Head Bolt Set	2009-08	ES 72220	2nd Design; Replacement recommended	
QTY	CONVERSION SET	YEARS	PART NO.	DESCRIPTION	
1	Gasket Conversion Set	2009-08	CS 9284	PermaDry® molded rubber oil pan gskt. incl.	
QTY	MANIFOLD - INT. & EXH.	YEARS	PART NO.	DESCRIPTION	
1	Int. Manifold Gasket Set	2009-08	MS 92465	Lifter valley cover set	
1	Int. Manifold Gasket Set	2009-08	MS 96587		
1	Int. Manifold Gasket Set	2009-08	MS 98016 T	PermaDryPlus® int. manifold gskts. incl.	
1	Exh. Manifold Gasket Set	2009-08	MS 92467		
QTY	EXHAUST PIPE FLANGE	YEARS	PART NO.	DESCRIPTION	
1	Exhaust Pipe Gasket	2009-08	61074	Loc. L.H.; Pipe to manifold	
1	Exhaust Pipe Gasket	2009-08	61089	Loc. R.H.; Pipe to manifold	
QTY	OIL PAN	YEARS	PART NO.	DESCRIPTION	
1	Oil Pan Gasket Set	2009-08	OS 30693 R	PermaDry® molded rubber gskt. incl.	
QTY	CRANKSHAFT REAR SEAL	YEARS	PART NO.	DESCRIPTION	
1	Rear Main Seal Set	2009-08	BS 40640	PTFE Rubber; One-piece	
1	Repair Sleeve	2009-08	16228	Crankshaft; Narrow lip; .780" sleeve length; Requires crankshaft machining due to clearance issues; Use w/installation tool	

GMC Truck (Incl. Minivans and SUV's) (Cont.)

65 (cont.)		2009 - 2008; 5.3L 325 (5328cc) OHV V8 (16 Valve) 96mm Bore Vortec			65 (cont.)
		MFI; Gasoline; Naturally Aspirated GMC Eng.; Chevrolet; VIN Code L			
QTY	CRANKSHAFT REAR SEAL	YEARS	PART NO.	DESCRIPTION	
1	Repair Sleeve	2009-08	16229	Crankshaft; Wide lip; 1.156" sleeve length; Requires crankshaft machining due to clearance issues; Use w/installation tool	
1	Repair Sleeve Tool	2009-08	16329	Crankshaft	
QTY	VALVE COVER	YEARS	PART NO.	DESCRIPTION	
1	Valve Cover Gasket Set	2009-08	VS 50504 R	w/o Grommets; PermaDry® molded rubber gskts. incl.	
1	Valve Cover Gasket Set	2009-08	VS 50504 R-1	w/Grommets; PermaDry® molded rubber gskts. incl.; New Part Number - Check for Availability	
1	Grommet Set	2009-08	ES 72233	Valve Cover	
QTY	VALVE STEM SEAL SET	YEARS	PART NO.	DESCRIPTION	
1	Valve Stem Seal Set	2009-08	SS 71039	2nd Design; Top-Hat Design seal; Premium valve stem seals incl.	
QTY	THERMOSTAT HOUSING	YEARS	PART NO.	DESCRIPTION	
1	O-Ring	2009-08	35720	Thermostat Housing	
QTY	WATER PUMP	YEARS	PART NO.	DESCRIPTION	
2	Water Pump Gasket	2009-08	35635		
1	O-Ring	2009-08	35633	Water Pump	
1	Water Pump Mounting Set	2009-08	ES 73010	Mounting gasket set; New Part Number - Check for Availability	
QTY	TIMING COVER	YEARS	PART NO.	DESCRIPTION	
1	Timing Cover Set	2009-08	TCS 45993	Must be used w/OS 30693R	
QTY	CARB & FUEL INJECTION	YEARS	PART NO.	DESCRIPTION	
2	Fuel Injector O-Ring Set	2009-08	ES 70599	Upper set; Injectors to fuel rail; Improved design	
2	Fuel Injector O-Ring Set	2009-08	ES 71190	Lower set; Injectors to cylinder head	
2	Fuel Injector O-Ring Set	2009-08	ES 71192	Upper set; Injectors to fuel rail; Old design	
1	Throttle Body Gasket	2009-08	61469		
QTY	EXHAUST GAS RECIRCULATION	YEARS	PART NO.	DESCRIPTION	
1	EGR Gasket	2009-08	70895	Pipe; O-ring	
1	EGR Gasket	2009-08	70914	Valve	
1	EGR Gasket	2009-08	70947	Pipe	
QTY	OIL FILTER MOUNTING	YEARS	PART NO.	DESCRIPTION	
1	Oil Cooler Gasket	2009-08	72462	Oil Filter; Center tube; Dual round port	
QTY	OIL PUMP COVER	YEARS	PART NO.	DESCRIPTION	
1	O-Ring	2009-08	72401	Oil Pump; Inlet tube	
QTY	OIL COOLER	YEARS	PART NO.	DESCRIPTION	
1	Oil Cooler Gasket	2009-08	72435	Oval port	
1	Oil Cooler Gasket	2009-08	72462	Dual round port	
66		2010 - 2005; 5.3L 325 (5328cc) OHV V8 (16 Valve) 96mm Bore Vortec			66
		MFI; Gasoline; Naturally Aspirated GMC Eng.; Chevrolet; VIN Code M			
QTY	CYLINDER HEAD	YEARS	PART NO.	DESCRIPTION	
2	Head Gasket	2010-05	26190 PT	Head bolts not incl.; Head bolt replacement recommended; PermaTorqueMLS® LaserWeld® Technology	
1	Head Set	2010-05	HS 26190 PT-2	Head bolts not incl.; Head bolt replacement recommended; When servicing Displacement-On-Demand solenoids use w/Lifter valley cover set MS 96871; PermaDryPlus® int. manifold gskts. incl.; PermaDry® molded rubber valve cover gskts. incl.; Premium valve stem	
2	Head Bolt Set	2010-05	ES 72220	2nd Design; Replacement recommended	
QTY	CONVERSION SET	YEARS	PART NO.	DESCRIPTION	
1	Gasket Conversion Set	2010-05	CS 9284	PermaDry® molded rubber oil pan gskt. incl.	
QTY	MANIFOLD - INT. & EXH.	YEARS	PART NO.	DESCRIPTION	
1	Int. Manifold Gasket Set	2010-05	MS 96587		
1	Int. Manifold Gasket Set	2010-05	MS 96857	Lifter valley cover set; Perimeter seal only	
1	Int. Manifold Gasket Set	2010-05	MS 96871	Lifter valley cover set; For use when servicing Displacement-On-Demand solenoids	
1	Int. Manifold Gasket Set	2010-05	MS 98016 T	PermaDryPlus® int. manifold gskts. incl.	
1	Exh. Manifold Gasket Set	2010-05	MS 92467		
QTY	EXHAUST PIPE FLANGE	YEARS	PART NO.	DESCRIPTION	
1	Exhaust Pipe Gasket	2010-05	61074	Loc. L.H.; Pipe to manifold	
1	Exhaust Pipe Gasket	2010-05	61089	Loc. R.H.; Pipe to manifold	
QTY	OIL PAN	YEARS	PART NO.	DESCRIPTION	
1	Oil Pan Gasket Set	2010-05	OS 30693 R	PermaDry® molded rubber gskt. incl.	
QTY	CRANKSHAFT REAR SEAL	YEARS	PART NO.	DESCRIPTION	
1	Rear Main Seal Set	2010-05	BS 40640	PTFE Rubber; One-piece	
1	Repair Sleeve	2010-05	16228	Crankshaft; Narrow lip; .780" sleeve length; Requires crankshaft machining due to clearance issues; Use w/installation tool	

GMC Truck (Incl. Minivans and SUV's) (Cont.)

66 (cont.)		2010 - 2005; 5.3L 325 (5328cc) OHV V8 (16 Valve) 96mm Bore Vortec MFI; Gasoline; Naturally Aspirated GMC Eng.; Chevrolet; VIN Code M			66 (cont.)
QTY	CRANKSHAFT REAR SEAL	YEARS	PART NO.	DESCRIPTION	
1	Repair Sleeve	2010-05	16229	Crankshaft; Wide lip; 1.156" sleeve length; Requires crankshaft machining due to clearance issues; Use w/installation tool	
1	Repair Sleeve Tool	2010-05	16329	Crankshaft	
QTY	VALVE COVER	YEARS	PART NO.	DESCRIPTION	
1	Valve Cover Gasket Set	2010-05	VS 50504 R	w/o Grommets; PermaDry® molded rubber gskts. incl.	
1	Valve Cover Gasket Set	2010-05	VS 50504 R-1	w/Grommets; PermaDry® molded rubber gskts. incl.; New Part Number - Check for Availability	
1	Grommet Set	2010-05	ES 72233	Valve Cover	
QTY	VALVE STEM SEAL SET	YEARS	PART NO.	DESCRIPTION	
1	Valve Stem Seal Set	2010-05	SS 71039	2nd Design; Top-Hat Design seal; Premium valve stem seals incl.	
QTY	THERMOSTAT HOUSING	YEARS	PART NO.	DESCRIPTION	
1	O-Ring	2010-05	35720	Thermostat Housing	
QTY	WATER PUMP	YEARS	PART NO.	DESCRIPTION	
2	Water Pump Gasket	2010-05	35635		
1	O-Ring	2010-05	35633	Water Pump	
1	Water Pump Mounting Set	2010-05	ES 73010	Mounting gasket set; New Part Number - Check for Availability	
QTY	TIMING COVER	YEARS	PART NO.	DESCRIPTION	
1	Timing Cover Set	2010-05	TCS 45993	Must be used w/OS 30693R	
QTY	CARB & FUEL INJECTION	YEARS	PART NO.	DESCRIPTION	
2	Fuel Injector O-Ring Set	2010-05	ES 70599	Upper set; Injectors to fuel rail; Improved design	
2	Fuel Injector O-Ring Set	2010-05	ES 71190	Lower set; Injectors to cylinder head	
2	Fuel Injector O-Ring Set	2010-05	ES 71192	Upper set; Injectors to fuel rail; Old design	
1	Throttle Body Gasket	2010-06	61469		
1	Throttle Body Gasket	2005	61454		
QTY	EXHAUST GAS RECIRCULATION	YEARS	PART NO.	DESCRIPTION	
1	EGR Gasket	2010-05	70895	Pipe; O-ring	
1	EGR Gasket	2010-05	70914	Valve	
1	EGR Gasket	2010-05	70947	Pipe	
QTY	OIL FILTER MOUNTING	YEARS	PART NO.	DESCRIPTION	
1	Oil Cooler Gasket	2010-05	72462	Oil Filter; Center tube; Dual round port	
QTY	OIL PUMP COVER	YEARS	PART NO.	DESCRIPTION	
1	O-Ring	2010-05	72401	Oil Pump; Inlet tube	
QTY	OIL COOLER	YEARS	PART NO.	DESCRIPTION	
1	Oil Cooler Gasket	2010-05	72435	Oval port	
1	Oil Cooler Gasket	2010-05	72462	Dual round port	
67		2005 - 2003; 5.3L 325 (5328cc) OHV V8 (16 Valve) 96mm Bore Vortec MFI; Gasoline; Naturally Aspirated GMC Eng.; Chevrolet; VIN Code P			67
QTY	CYLINDER HEAD	YEARS	PART NO.	DESCRIPTION	
2	Head Gasket	2005-03	26191 PT	Head bolts not incl.; Head bolt replacement recommended; PermaTorqueMLS® LaserWeld® Technology	
1	Head Set	2005-04	HS 26191 PT-1	Head bolts not incl.; Head bolt replacement recommended; PermaDryPlus® int. manifold gskts. incl.; PermaDry® molded rubber valve cover gskts. incl.; Premium valve stem seals incl.	
1	Head Set	2003	HS 26191 PT	Head bolts not incl.; Head bolt replacement recommended; PermaDryPlus® int. manifold gskts. incl.; PermaDry® molded rubber valve cover gskts. incl.; Premium valve stem seals incl.	
2	Head Bolt Set	2005-04	ES 72220	2nd Design; Replacement recommended	
2	Head Bolt Set	2004-03	ES 72173	1st Design; Replacement recommended	
QTY	CONVERSION SET	YEARS	PART NO.	DESCRIPTION	
1	Gasket Conversion Set	2005-03	CS 9284	PermaDry® molded rubber oil pan gskt. incl.	
QTY	MANIFOLD - INT. & EXH.	YEARS	PART NO.	DESCRIPTION	
1	Int. Manifold Gasket Set	2005-03	MS 92465	Lifter valley cover set	
1	Int. Manifold Gasket Set	2005-03	MS 98016 T	PermaDryPlus® int. manifold gskts. incl.	
1	Int. Manifold Gasket Set	2005-04	MS 96587		
1	Int. Manifold Gasket Set	2003	MS 92211		
1	Exh. Manifold Gasket Set	2005-03	MS 92467		
QTY	EXHAUST PIPE FLANGE	YEARS	PART NO.	DESCRIPTION	
1	Exhaust Pipe Gasket	2005-03	61089	Loc. R.H.; Pipe to manifold	
1	Exhaust Pipe Gasket	2005-04	61323	Loc. L.H.; Pipe to manifold	
1	Exhaust Pipe Gasket	2003	61074	Loc. L.H.; Pipe to manifold	
QTY	OIL PAN	YEARS	PART NO.	DESCRIPTION	
1	Oil Pan Gasket Set	2005-03	OS 30693 R	PermaDry® molded rubber gskt. incl.	

GMC Truck (Incl. Minivans and SUV's) (Cont.)

67 (cont.)		2005 - 2003; 5.3L 325 (5328cc) OHV V8 (16 Valve) 96mm Bore Vortec MFI; Gasoline; Naturally Aspirated GMC Eng.; Chevrolet; VIN Code P			67 (cont.)
QTY	CRANKSHAFT REAR SEAL	YEARS	PART NO.	DESCRIPTION	
1	Rear Main Seal Set	2005-03	BS 40640	PTFE Rubber; One-piece	
1	Repair Sleeve	2005-03	16228	Crankshaft; Narrow lip; .780" sleeve length; Requires crankshaft machining due to clearance issues; Use w/installation tool	
1	Repair Sleeve	2005-03	16229	Crankshaft; Wide lip; 1.156" sleeve length; Requires crankshaft machining due to clearance issues; Use w/installation tool	
1	Repair Sleeve Tool	2005-03	16329	Crankshaft	
QTY	VALVE COVER	YEARS	PART NO.	DESCRIPTION	
1	Valve Cover Gasket Set	2005-03	VS 50504 R	w/o Grommets; PermaDry® molded rubber gskts. incl.	
1	Valve Cover Gasket Set	2005-03	VS 50504 R-1	w/Grommets; PermaDry® molded rubber gskts. incl.; New Part Number - Check for Availability	
1	Grommet Set	2005-03	ES 72233	Valve Cover	
QTY	VALVE STEM SEAL SET	YEARS	PART NO.	DESCRIPTION	
1	Valve Stem Seal Set	2005-03	SS 71039	2nd Design; Top-Hat Design seal; Premium valve stem seals incl.	
QTY	THERMOSTAT HOUSING	YEARS	PART NO.	DESCRIPTION	
1	Thermostat Gasket	2003	35632	Thermostat Housing; Thermostat O-ring	
1	O-Ring	2005-04	35720	Thermostat Housing	
QTY	WATER PUMP	YEARS	PART NO.	DESCRIPTION	
2	Water Pump Gasket	2005-03	35635		
1	O-Ring	2005-03	35633	Water Pump	
1	Water Pump Mounting Set	2005-03	ES 73010	Mounting gasket set; New Part Number - Check for Availability	
QTY	TIMING COVER	YEARS	PART NO.	DESCRIPTION	
1	Timing Cover Set	2005-03	TCS 45993	Must be used w/OS 30693R	
QTY	CARB & FUEL INJECTION	YEARS	PART NO.	DESCRIPTION	
2	Fuel Injector O-Ring Set	2005-03	ES 70599	Upper set; Injectors to fuel rail; Improved design	
2	Fuel Injector O-Ring Set	2005-03	ES 71190	Lower set; Injectors to cylinder head	
2	Fuel Injector O-Ring Set	2005-03	ES 71192	Upper set; Injectors to fuel rail; Old design	
1	Throttle Body Gasket	2005-03	61070		
QTY	EXHAUST GAS RECIRCULATION	YEARS	PART NO.	DESCRIPTION	
1	EGR Gasket	2005-03	70895	Pipe; O-ring	
1	EGR Gasket	2005-03	70914	Valve	
1	EGR Gasket	2005-03	70947	Pipe	
QTY	OIL FILTER MOUNTING	YEARS	PART NO.	DESCRIPTION	
1	Oil Cooler Gasket	2005-03	72462	Oil Filter; Center tube; Dual round port	
QTY	OIL PUMP COVER	YEARS	PART NO.	DESCRIPTION	
1	O-Ring	2005-03	72401	Oil Pump; Inlet tube	
QTY	OIL COOLER	YEARS	PART NO.	DESCRIPTION	
1	Oil Cooler Gasket	2005-03	72435	Oval port	
1	Oil Cooler Gasket	2005-03	72462	Dual round port	
68		2008 - 1999; 5.3L 325 (5328cc) OHV V8 (16 Valve) 96mm Bore Vortec MFI; Gasoline; Naturally Aspirated GMC Eng.; Chevrolet; VIN Code T			68
QTY	CYLINDER HEAD	YEARS	PART NO.	DESCRIPTION	
2	Head Gasket	2008-02	26191 PT	Head bolts not incl.; Head bolt replacement recommended; PermaTorqueMLS® LaserWeld® Technology	
2	Head Gasket	2001-99	9292 PT	Head bolts not incl.; Head bolt replacement recommended	
1	Head Set	2008-04	HS 26191 PT-1	Head bolts not incl.; Head bolt replacement recommended; PermaDryPlus® int. manifold gskts. incl.; PermaDry® molded rubber valve cover gskts. incl.; Premium valve stem seals incl.	
1	Head Set	2003-02	HS 26191 PT	Head bolts not incl.; Head bolt replacement recommended; PermaDryPlus® int. manifold gskts. incl.; PermaDry® molded rubber valve cover gskts. incl.; Premium valve stem seals incl.	
1	Head Set	2001	HS 9292 PT	1st Design; Positive type valve stem seals; Head bolts not incl.; Head bolt replacement recommended; PermaDryPlus® int. manifold gskts. incl.; PermaDry® molded rubber valve cover gskts. incl.; Premium valve stem seals incl.	
1	Head Set	2001	HS 9292 PT-1	2nd Design; Top-Hat Design valve stem seals; Head bolts not incl.; Head bolt replacement recommended; PermaDryPlus® int. manifold gskts. incl.; PermaDry® molded rubber valve cover gskts. incl.; Premium valve stem seals incl.	
1	Head Set	2000-99	HS 9292 PT	Head bolts not incl.; Head bolt replacement recommended; PermaDryPlus® int. manifold gskts. incl.; PermaDry® molded rubber valve cover gskts. incl.; Premium valve stem seals incl.	
2	Head Bolt Set	2008-04	ES 72220	2nd Design; Replacement recommended	

GMC Truck (Incl. Minivans and SUV's) (Cont.)

68 (cont.)	2008 - 1999; 5.3L 325 (5328cc) OHV V8 (16 Valve) 96mm Bore Vortec			68 (cont.)
QTY	CYLINDER HEAD	YEARS	PART NO.	DESCRIPTION
2	Head Bolt Set	2004-99	ES 72173	1st Design; Replacement recommended
QTY	CONVERSION SET	YEARS	PART NO.	DESCRIPTION
1	Gasket Conversion Set	2008-99	CS 9284	PermaDry® molded rubber oil pan gskt. incl.
QTY	MANIFOLD - INT. & EXH.	YEARS	PART NO.	DESCRIPTION
1	Int. Manifold Gasket Set	2008-99	MS 92465	Lifter valley cover set
1	Int. Manifold Gasket Set	2008-99	MS 98016 T	PermaDryPlus® int. manifold gskts. incl.
1	Int. Manifold Gasket Set	2008-04	MS 96587	
1	Int. Manifold Gasket Set	2003-99	MS 92211	
1	Exh. Manifold Gasket Set	2008-99	MS 92467	
QTY	EXHAUST PIPE FLANGE	YEARS	PART NO.	DESCRIPTION
1	Exhaust Pipe Gasket	2008-99	61089	Loc. R.H.; Pipe to manifold
1	Exhaust Pipe Gasket	2008-04	61323	Loc. L.H.; Pipe to manifold
1	Exhaust Pipe Gasket	2008	61561	Converter; 2-bolt
1	Exhaust Pipe Gasket	2007-06	61561	Chevrolet Express 1500 Van Base, LS, LT, Express 2500 Van Base, LS, LT, Express 3500 Van Base, LS, LT GMC Savana 1500 Base, LS, LT, Savana 2500 Base, LS, LT, Savana 3500 Base; Converter; 2-bolt
1	Exhaust Pipe Gasket	2005	61561	Chevrolet Express 1500 Van Base, LS, Express 2500 Van Base, LS, Express 3500 Van Base, LS GMC Savana 1500 Base, SLE, Savana 2500 Base, SLE, Savana 3500 Base, SLE; Converter; 2-bolt
1	Exhaust Pipe Gasket	2003-99	61074	Loc. L.H.; Pipe to manifold
QTY	OIL PAN	YEARS	PART NO.	DESCRIPTION
1	Oil Pan Gasket Set	2008-99	OS 30693 R	PermaDry® molded rubber gskt. incl.
QTY	CRANKSHAFT REAR SEAL	YEARS	PART NO.	DESCRIPTION
1	Rear Main Seal Set	2008-99	BS 40640	PTFE Rubber; One-piece
1	Repair Sleeve	2008-99	16228	Crankshaft; Narrow lip; .780" sleeve length; Requires crankshaft machining due to clearance issues; Use w/installation tool
1	Repair Sleeve	2008-99	16229	Crankshaft; Wide lip; 1.156" sleeve length; Requires crankshaft machining due to clearance issues; Use w/installation tool
1	Repair Sleeve Tool	2008-99	16329	Crankshaft
QTY	VALVE COVER	YEARS	PART NO.	DESCRIPTION
1	Valve Cover Gasket Set	2008-99	VS 50504 R	w/o Grommets; PermaDry® molded rubber gskts. incl.
1	Valve Cover Gasket Set	2008-99	VS 50504 R-1	w/Grommets; PermaDry® molded rubber gskts. incl.; New Part Number - Check for Availability
1	Grommet Set	2008-99	ES 72233	Valve Cover
QTY	VALVE STEM SEAL SET	YEARS	PART NO.	DESCRIPTION
1	Valve Stem Seal Set	2008-01	SS 71039	2nd Design; Top-Hat Design seal; Premium valve stem seals incl.
1	Valve Stem Seal Set	2001-99	SS 70945	1st Design; Positive type seal; Premium valve stem seals incl.
QTY	THERMOSTAT HOUSING	YEARS	PART NO.	DESCRIPTION
1	Thermostat Gasket	2003-99	35632	Thermostat Housing; Thermostat O-ring
1	O-Ring	2008-04	35720	Thermostat Housing
QTY	WATER PUMP	YEARS	PART NO.	DESCRIPTION
2	Water Pump Gasket	2008-99	35635	
1	O-Ring	2008-99	35633	Water Pump
1	Water Pump Mounting Set	2008-99	ES 73010	Mounting gasket set; New Part Number - Check for Availability
QTY	TIMING COVER	YEARS	PART NO.	DESCRIPTION
1	Timing Cover Set	2008-99	TCS 45993	Must be used w/OS 30693R
QTY	CARB & FUEL INJECTION	YEARS	PART NO.	DESCRIPTION
2	Fuel Injector O-Ring Set	2008-99	ES 70599	Upper set; Injectors to fuel rail; Improved design
2	Fuel Injector O-Ring Set	2008-99	ES 71190	Lower set; Injectors to cylinder head
2	Fuel Injector O-Ring Set	2008-01	ES 71192	Upper set; Injectors to fuel rail; Old design
1	Throttle Body Gasket	2008-99	61070	
QTY	EXHAUST GAS RECIRCULATION	YEARS	PART NO.	DESCRIPTION
1	EGR Gasket	2008-99	70895	Pipe; O-ring
1	EGR Gasket	2008-99	70914	Valve
1	EGR Gasket	2008-99	70947	Pipe
QTY	OIL FILTER MOUNTING	YEARS	PART NO.	DESCRIPTION
1	Oil Cooler Gasket	2008-99	72462	Oil Filter; Center tube; Dual round port
QTY	OIL PUMP COVER	YEARS	PART NO.	DESCRIPTION
1	O-Ring	2008-99	72401	Oil Pump; Inlet tube
QTY	OIL COOLER	YEARS	PART NO.	DESCRIPTION
1	Oil Cooler Gasket	2008-99	72435	Oval port
1	Oil Cooler Gasket	2008-99	72462	Dual round port

GMC Truck (Incl. Minivans and SUV's) (Cont.)

69		2008 - 2002; 5.3L 325 (5328cc) OHV V8 (16 Valve) 96mm Bore Vortec MFI; Flex Fuel; Naturally Aspirated GMC Eng.; Chevrolet; VIN Code Z			69
QTY	CYLINDER HEAD	YEARS	PART NO.	DESCRIPTION	
2	Head Gasket	2008-02	26191 PT	Head bolts not incl.; Head bolt replacement recommended; PermaTorqueMLS® LaserWeld® Technology	
1	Head Set	2008-02	HS 26191 PT-1	Head bolts not incl.; Head bolt replacement recommended; PermaDryPlus® int. manifold gsks. incl.; PermaDry® molded rubber valve cover gsks. incl.; Premium valve stem seals incl.	
2	Head Bolt Set	2008-04	ES 72220	2nd Design; Replacement recommended	
2	Head Bolt Set	2004-02	ES 72173	1st Design; Replacement recommended	
QTY	CONVERSION SET	YEARS	PART NO.	DESCRIPTION	
1	Gasket Conversion Set	2008-02	CS 9284	PermaDry® molded rubber oil pan gskt. incl.	
QTY	MANIFOLD - INT. & EXH.	YEARS	PART NO.	DESCRIPTION	
1	Int. Manifold Gasket Set	2008-02	MS 92465	Lifter valley cover set	
1	Int. Manifold Gasket Set	2008-02	MS 96587		
1	Int. Manifold Gasket Set	2008-02	MS 98016 T	PermaDryPlus® int. manifold gsks. incl.	
1	Exh. Manifold Gasket Set	2008-02	MS 92467		
QTY	EXHAUST PIPE FLANGE	YEARS	PART NO.	DESCRIPTION	
1	Exhaust Pipe Gasket	2008-02	61089	Loc. R.H.; Pipe to manifold	
1	Exhaust Pipe Gasket	2008-04	61323	Loc. L.H.; Pipe to manifold	
1	Exhaust Pipe Gasket	2008	61561	Converter; 2-bolt	
1	Exhaust Pipe Gasket	2007-06	61561	Chevrolet Express 1500 Van Base, LS, LT, Express 2500 Van Base, LS, LT GMC Savana 1500 Base, LS, LT, Savana 2500 Base, LS, LT; Converter; 2-bolt	
1	Exhaust Pipe Gasket	2005	61561	Chevrolet Express 1500 Van Base, LS, Express 2500 Van Base, LS GMC Savana 1500 Base, SLE, Savana 2500 Base, SLE; Converter; 2-bolt	
1	Exhaust Pipe Gasket	2003-02	61074	Loc. L.H.; Pipe to manifold	
QTY	OIL PAN	YEARS	PART NO.	DESCRIPTION	
1	Oil Pan Gasket Set	2008-02	OS 30693 R	PermaDry® molded rubber gskt. incl.	
QTY	CRANKSHAFT REAR SEAL	YEARS	PART NO.	DESCRIPTION	
1	Rear Main Seal Set	2008-02	BS 40640	PTFE Rubber; One-piece	
1	Repair Sleeve	2008-02	16228	Crankshaft; Narrow lip; .780" sleeve length; Requires crankshaft machining due to clearance issues; Use w/installation tool	
1	Repair Sleeve	2008-02	16229	Crankshaft; Wide lip; 1.156" sleeve length; Requires crankshaft machining due to clearance issues; Use w/installation tool	
1	Repair Sleeve Tool	2008-02	16329	Crankshaft	
QTY	VALVE COVER	YEARS	PART NO.	DESCRIPTION	
1	Valve Cover Gasket Set	2008-02	VS 50504 R	w/o Grommets; PermaDry® molded rubber gsks. incl.	
1	Valve Cover Gasket Set	2008-02	VS 50504 R-1	w/Grommets; PermaDry® molded rubber gsks. incl.; New Part Number - Check for Availability	
1	Grommet Set	2008-02	ES 72233	Valve Cover	
QTY	VALVE STEM SEAL SET	YEARS	PART NO.	DESCRIPTION	
1	Valve Stem Seal Set	2008-02	SS 71039	2nd Design; Top-Hat Design seal; Premium valve stem seals incl.	
QTY	THERMOSTAT HOUSING	YEARS	PART NO.	DESCRIPTION	
1	Thermostat Gasket	2003-02	35632	Thermostat Housing; Thermostat O-ring	
1	O-Ring	2008-04	35720	Thermostat Housing	
QTY	WATER PUMP	YEARS	PART NO.	DESCRIPTION	
2	Water Pump Gasket	2008-02	35635		
1	O-Ring	2008-02	35633	Water Pump	
1	Water Pump Mounting Set	2008-02	ES 73010	Mounting gasket set; New Part Number - Check for Availability	
QTY	TIMING COVER	YEARS	PART NO.	DESCRIPTION	
1	Timing Cover Set	2008-02	TCS 45993	Must be used w/OS 30693R	
QTY	CARB & FUEL INJECTION	YEARS	PART NO.	DESCRIPTION	
2	Fuel Injector O-Ring Set	2008-02	ES 70599	Upper set; Injectors to fuel rail; Improved design	
2	Fuel Injector O-Ring Set	2008-02	ES 71190	Lower set; Injectors to cylinder head	
2	Fuel Injector O-Ring Set	2008-02	ES 71192	Upper set; Injectors to fuel rail; Old design	
1	Throttle Body Gasket	2008-02	61070		
QTY	EXHAUST GAS RECIRCULATION	YEARS	PART NO.	DESCRIPTION	
1	EGR Gasket	2008-02	70895	Pipe; O-ring	
1	EGR Gasket	2008-02	70914	Valve	
1	EGR Gasket	2008-02	70947	Pipe	
QTY	OIL FILTER MOUNTING	YEARS	PART NO.	DESCRIPTION	
1	Oil Cooler Gasket	2008-02	72462	Oil Filter; Center tube; Dual round port	
QTY	OIL PUMP COVER	YEARS	PART NO.	DESCRIPTION	
1	O-Ring	2008-02	72401	Oil Pump; Inlet tube	
QTY	OIL COOLER	YEARS	PART NO.	DESCRIPTION	
1	Oil Cooler Gasket	2008-02	72435	Oval port	

GMC Truck (Incl. Minivans and SUV's) (Cont.)

69 (cont.)		2008 - 2002; 5.3L 325 (5328cc) OHV V8 (16 Valve) 96mm Bore Vortec MFI; Flex Fuel; Naturally Aspirated GMC Eng.; Chevrolet; VIN Code Z			69 (cont.)
QTY	OIL COOLER	YEARS	PART NO.	DESCRIPTION	
1	Oil Cooler Gasket	2008-02	72462	Dual round port	
70		2013 - 2009; 5.3L 325 (5328cc) OHV V8 (16 Valve) 96mm Bore Vortec VVT MFI; Flex Fuel; Naturally Aspirated GMC Eng.; Chevrolet; VIN Code 4			70
QTY	CYLINDER HEAD	YEARS	PART NO.	DESCRIPTION	
2	Head Gasket	2013-09	26190 PT	Head bolts not incl.; Head bolt replacement recommended; PermaTorqueMLS® LaserWeld® Technology	
1	Head Set	2013-09	HS 26190 PT-4	Head bolts not incl.; Head bolt replacement recommended; PermaDryPlus® int. manifold gskts. incl.; PermaDry® molded rubber valve cover gskts. incl.; Premium valve stem seals incl.	
2	Head Bolt Set	2013-09	ES 72390	Replacement recommended; New Part Number - Check for Availability	
QTY	CONVERSION SET	YEARS	PART NO.	DESCRIPTION	
1	Gasket Conversion Set	2013-09	CS 9284	PermaDry® molded rubber oil pan gskt. incl.	
QTY	MANIFOLD - INT. & EXH.	YEARS	PART NO.	DESCRIPTION	
1	Int. Manifold Gasket Set	2013-09	MS 96169	Lifter valley cover set	
1	Int. Manifold Gasket Set	2013-09	MS 96587		
1	Int. Manifold Gasket Set	2013-09	MS 98016 T	PermaDryPlus® int. manifold gskts. incl.	
1	Exh. Manifold Gasket Set	2013-09	MS 92467		
QTY	EXHAUST PIPE FLANGE	YEARS	PART NO.	DESCRIPTION	
1	Exhaust Pipe Gasket	2013-09	61089	Loc. R.H.; Pipe to manifold	
1	Exhaust Pipe Gasket	2013-09	61323	Loc. L.H.; Pipe to manifold	
1	Exhaust Pipe Gasket	2013-09	61559	Converter; 3-bolt	
1	Exhaust Pipe Gasket	2013-09	61561	Converter; 2-bolt	
QTY	OIL PAN	YEARS	PART NO.	DESCRIPTION	
1	Oil Pan Gasket Set	2013-09	OS 30693 R	PermaDry® molded rubber gskt. incl.	
QTY	CRANKSHAFT REAR SEAL	YEARS	PART NO.	DESCRIPTION	
1	Rear Main Seal Set	2013-09	BS 40640	PTFE Rubber; One-piece	
1	Repair Sleeve	2013-09	16228	Crankshaft; Narrow lip; .780" sleeve length; Requires crankshaft machining due to clearance issues; Use w/installation tool	
1	Repair Sleeve	2013-09	16229	Crankshaft; Wide lip; 1.156" sleeve length; Requires crankshaft machining due to clearance issues; Use w/installation tool	
1	Repair Sleeve Tool	2013-09	16329	Crankshaft	
QTY	VALVE COVER	YEARS	PART NO.	DESCRIPTION	
1	Valve Cover Gasket Set	2013-09	VS 50504 R	w/o Grommets; PermaDry® molded rubber gskts. incl.	
1	Valve Cover Gasket Set	2013-09	VS 50504 R-1	w/Grommets; PermaDry® molded rubber gskts. incl.; New Part Number - Check for Availability	
1	Grommet Set	2013-09	ES 72233	Valve Cover	
QTY	VALVE STEM SEAL SET	YEARS	PART NO.	DESCRIPTION	
1	Valve Stem Seal Set	2013-09	SS 71039	Premium valve stem seals incl.	
QTY	THERMOSTAT HOUSING	YEARS	PART NO.	DESCRIPTION	
1	O-Ring	2013-09	35720	Thermostat Housing	
QTY	WATER PUMP	YEARS	PART NO.	DESCRIPTION	
2	Water Pump Gasket	2013-09	35635		
1	O-Ring	2013-09	35633	Water Pump	
1	Water Pump Mounting Set	2013-09	ES 73010	Mounting gasket set; New Part Number - Check for Availability	
QTY	TIMING COVER	YEARS	PART NO.	DESCRIPTION	
1	Timing Cover Set	2013-09	TCS 45993	Must be used w/OS 30693R	
QTY	CARB & FUEL INJECTION	YEARS	PART NO.	DESCRIPTION	
2	Fuel Injector O-Ring Set	2013-09	ES 70599	Upper set; Injectors to fuel rail; Improved design	
2	Fuel Injector O-Ring Set	2013-09	ES 71190	Lower set; Injectors to cylinder head	
2	Fuel Injector O-Ring Set	2013-09	ES 71192	Upper set; Injectors to fuel rail; Old design	
1	Throttle Body Gasket	2013-09	61469		
QTY	EXHAUST GAS RECIRCULATION	YEARS	PART NO.	DESCRIPTION	
1	EGR Gasket	2013-09	70895	Pipe; O-ring	
1	EGR Gasket	2013-09	70914	Valve	
1	EGR Gasket	2013-09	70947	Pipe	
QTY	OIL FILTER MOUNTING	YEARS	PART NO.	DESCRIPTION	
1	Oil Cooler Gasket	2013-09	72462	Oil Filter; Center tube; Dual round port	
QTY	OIL PUMP COVER	YEARS	PART NO.	DESCRIPTION	
1	O-Ring	2013-09	72401	Oil Pump; Inlet tube	
QTY	OIL COOLER	YEARS	PART NO.	DESCRIPTION	
1	Oil Cooler Gasket	2013-09	72435	Oval port	
1	Oil Cooler Gasket	2013-09	72462	Dual round port	

GMC Truck (Incl. Minivans and SUV's) (Cont.)

71		2010; 5.3L 325 (5328cc) OHV V8 (16 Valve) 96mm Bore Vortec VVT			71
MFI; Flex Fuel; Naturally Aspirated GMC Eng.; Chevrolet; VIN Code P					
QTY	CYLINDER HEAD	YEARS	PART NO.	DESCRIPTION	
2	Head Gasket	2010	26190 PT	Head bolts not incl.; Head bolt replacement recommended; PermaTorqueMLS® LaserWeld® Technology	
1	Head Set	2010	HS 26190 PT-4	Head bolts not incl.; Head bolt replacement recommended; PermaDryPlus® int. manifold gskts. incl.; PermaDry® molded rubber valve cover gskts. incl.; Premium valve stem seals incl.	
2	Head Bolt Set	2010	ES 72390	Replacement recommended; New Part Number - Check for Availability	
QTY	CONVERSION SET	YEARS	PART NO.	DESCRIPTION	
1	Gasket Conversion Set	2010	CS 9284	PermaDry® molded rubber oil pan gskt. incl.	
QTY	MANIFOLD - INT. & EXH.	YEARS	PART NO.	DESCRIPTION	
1	Int. Manifold Gasket Set	2010	MS 96169	Lifter valley cover set	
1	Int. Manifold Gasket Set	2010	MS 96587		
1	Int. Manifold Gasket Set	2010	MS 98016 T	PermaDryPlus® int. manifold gskts. incl.	
1	Exh. Manifold Gasket Set	2010	MS 92467		
QTY	EXHAUST PIPE FLANGE	YEARS	PART NO.	DESCRIPTION	
1	Exhaust Pipe Gasket	2010	61089	Loc. R.H.; Pipe to manifold	
1	Exhaust Pipe Gasket	2010	61323	Loc. L.H.; Pipe to manifold	
1	Exhaust Pipe Gasket	2010	61559	Converter; 3-bolt	
QTY	OIL PAN	YEARS	PART NO.	DESCRIPTION	
1	Oil Pan Gasket Set	2010	OS 30693 R	PermaDry® molded rubber gskt. incl.	
QTY	CRANKSHAFT REAR SEAL	YEARS	PART NO.	DESCRIPTION	
1	Rear Main Seal Set	2010	BS 40640	PTFE Rubber; One-piece	
1	Repair Sleeve	2010	16228	Crankshaft; Narrow lip; .780" sleeve length; Requires crankshaft machining due to clearance issues; Use w/installation tool	
1	Repair Sleeve	2010	16229	Crankshaft; Wide lip; 1.156" sleeve length; Requires crankshaft machining due to clearance issues; Use w/installation tool	
1	Repair Sleeve Tool	2010	16329	Crankshaft	
QTY	VALVE COVER	YEARS	PART NO.	DESCRIPTION	
1	Valve Cover Gasket Set	2010	VS 50504 R	w/o Grommets; PermaDry® molded rubber gskts. incl.	
1	Valve Cover Gasket Set	2010	VS 50504 R-1	w/Grommets; PermaDry® molded rubber gskts. incl.; New Part Number - Check for Availability	
1	Grommet Set	2010	ES 72233	Valve Cover	
QTY	VALVE STEM SEAL SET	YEARS	PART NO.	DESCRIPTION	
1	Valve Stem Seal Set	2010	SS 71039	Premium valve stem seals incl.	
QTY	THERMOSTAT HOUSING	YEARS	PART NO.	DESCRIPTION	
1	O-Ring	2010	35720	Thermostat Housing	
QTY	WATER PUMP	YEARS	PART NO.	DESCRIPTION	
2	Water Pump Gasket	2010	35635		
1	O-Ring	2010	35633	Water Pump	
1	Water Pump Mounting Set	2010	ES 73010	Mounting gasket set; New Part Number - Check for Availability	
QTY	TIMING COVER	YEARS	PART NO.	DESCRIPTION	
1	Timing Cover Set	2010	TCS 45993	Must be used w/OS 30693R	
QTY	CARB & FUEL INJECTION	YEARS	PART NO.	DESCRIPTION	
2	Fuel Injector O-Ring Set	2010	ES 70599	Upper set; Injectors to fuel rail; Improved design	
2	Fuel Injector O-Ring Set	2010	ES 71190	Lower set; Injectors to cylinder head	
2	Fuel Injector O-Ring Set	2010	ES 71192	Upper set; Injectors to fuel rail; Old design	
1	Throttle Body Gasket	2010	61469		
QTY	EXHAUST GAS RECIRCULATION	YEARS	PART NO.	DESCRIPTION	
1	EGR Gasket	2010	70895	Pipe; O-ring	
1	EGR Gasket	2010	70914	Valve	
1	EGR Gasket	2010	70947	Pipe	
QTY	OIL FILTER MOUNTING	YEARS	PART NO.	DESCRIPTION	
1	Oil Cooler Gasket	2010	72462	Oil Filter; Center tube; Dual round port	
QTY	OIL PUMP COVER	YEARS	PART NO.	DESCRIPTION	
1	O-Ring	2010	72401	Oil Pump; Inlet tube	
QTY	OIL COOLER	YEARS	PART NO.	DESCRIPTION	
1	Oil Cooler Gasket	2010	72435	Oval port	
1	Oil Cooler Gasket	2010	72462	Dual round port	
72		2012 - 2010; 5.3L 325 (5328cc) OHV V8 (16 Valve) 96mm Bore Vortec VVT			72
MFI; Gasoline; Naturally Aspirated GMC Eng.; Chevrolet; VIN Code P					
QTY	CYLINDER HEAD	YEARS	PART NO.	DESCRIPTION	
2	Head Gasket	2011-10	26190 PT	Head bolts not incl.; Head bolt replacement recommended; PermaTorqueMLS® LaserWeld® Technology	

GMC Truck (Incl. Minivans and SUV's) (Cont.)

72 (cont.)		2012 - 2010; 5.3L 325 (5328cc) OHV V8 (16 Valve) 96mm Bore Vortec VVT			72 (cont.)
		MFI; Gasoline; Naturally Aspirated GMC Eng.; Chevrolet; VIN Code P			
QTY	CYLINDER HEAD	YEARS	PART NO.	DESCRIPTION	
1	Head Set	2011-10	HS 26190 PT-4	Head bolts not incl.; Head bolt replacement recommended; PermaDryPlus® int. manifold gsks. incl.; PermaDry® molded rubber valve cover gsks. incl.; Premium valve stem seals incl.	
2	Head Bolt Set	2012-10	ES 72390	Replacement recommended; New Part Number - Check for Availability	
QTY	CONVERSION SET	YEARS	PART NO.	DESCRIPTION	
1	Gasket Conversion Set	2011-10	CS 9284	PermaDry® molded rubber oil pan gskt. incl.	
QTY	MANIFOLD - INT. & EXH.	YEARS	PART NO.	DESCRIPTION	
1	Int. Manifold Gasket Set	2011-10	MS 96169	Lifter valley cover set	
1	Int. Manifold Gasket Set	2011-10	MS 96587		
1	Int. Manifold Gasket Set	2011-10	MS 98016 T	PermaDryPlus® int. manifold gsks. incl.	
1	Exh. Manifold Gasket Set	2011-10	MS 92467		
QTY	EXHAUST PIPE FLANGE	YEARS	PART NO.	DESCRIPTION	
1	Exhaust Pipe Gasket	2012-10	61089	Loc. R.H.; Pipe to manifold	
1	Exhaust Pipe Gasket	2012-10	61323	Loc. L.H.; Pipe to manifold	
1	Exhaust Pipe Gasket	2012-10	61559	Converter; 3-bolt	
QTY	OIL PAN	YEARS	PART NO.	DESCRIPTION	
1	Oil Pan Gasket Set	2011-10	OS 30693 R	PermaDry® molded rubber gskt. incl.	
QTY	CRANKSHAFT REAR SEAL	YEARS	PART NO.	DESCRIPTION	
1	Rear Main Seal Set	2011-10	BS 40640	PTFE Rubber; One-piece	
1	Repair Sleeve	2011-10	16228	Crankshaft; Narrow lip; .780" sleeve length; Requires crankshaft machining due to clearance issues; Use w/installation tool	
1	Repair Sleeve	2011-10	16229	Crankshaft; Wide lip; 1.156" sleeve length; Requires crankshaft machining due to clearance issues; Use w/installation tool	
1	Repair Sleeve Tool	2011-10	16329	Crankshaft	
QTY	VALVE COVER	YEARS	PART NO.	DESCRIPTION	
1	Valve Cover Gasket Set	2011-10	VS 50504 R	w/o Grommets; PermaDry® molded rubber gsks. incl.	
1	Valve Cover Gasket Set	2011-10	VS 50504 R-1	w/Grommets; PermaDry® molded rubber gsks. incl.; New Part Number - Check for Availability	
1	Grommet Set	2011-10	ES 72233	Valve Cover	
QTY	VALVE STEM SEAL SET	YEARS	PART NO.	DESCRIPTION	
1	Valve Stem Seal Set	2011-10	SS 71039	Premium valve stem seals incl.	
QTY	THERMOSTAT HOUSING	YEARS	PART NO.	DESCRIPTION	
1	O-Ring	2011-10	35720	Thermostat Housing	
QTY	WATER PUMP	YEARS	PART NO.	DESCRIPTION	
2	Water Pump Gasket	2011-10	35635		
1	O-Ring	2011-10	35633	Water Pump	
1	Water Pump Mounting Set	2011-10	ES 73010	Mounting gasket set; New Part Number - Check for Availability	
QTY	TIMING COVER	YEARS	PART NO.	DESCRIPTION	
1	Timing Cover Set	2011-10	TCS 45993	Must be used w/OS 30693R	
QTY	CARB & FUEL INJECTION	YEARS	PART NO.	DESCRIPTION	
2	Fuel Injector O-Ring Set	2011-10	ES 70599	Upper set; Injectors to fuel rail; Improved design	
2	Fuel Injector O-Ring Set	2011-10	ES 71190	Lower set; Injectors to cylinder head	
2	Fuel Injector O-Ring Set	2011-10	ES 71192	Upper set; Injectors to fuel rail; Old design	
1	Throttle Body Gasket	2011-10	61469		
QTY	EXHAUST GAS RECIRCULATION	YEARS	PART NO.	DESCRIPTION	
1	EGR Gasket	2011-10	70895	Pipe; O-ring	
1	EGR Gasket	2011-10	70914	Valve	
1	EGR Gasket	2011-10	70947	Pipe	
QTY	OIL FILTER MOUNTING	YEARS	PART NO.	DESCRIPTION	
1	Oil Cooler Gasket	2011-10	72462	Oil Filter; Center tube; Dual round port	
QTY	OIL PUMP COVER	YEARS	PART NO.	DESCRIPTION	
1	O-Ring	2011-10	72401	Oil Pump; Inlet tube	
QTY	OIL COOLER	YEARS	PART NO.	DESCRIPTION	
1	Oil Cooler Gasket	2011-10	72435	Oval port	
1	Oil Cooler Gasket	2011-10	72462	Dual round port	

73		1996 - 1991; 5.7L 350 (5736cc) OHV V8 (16 Valve) 4" Bore			73
		TBI; Gasoline; Naturally Aspirated GMC Eng.; Chevrolet; VIN Code K			
QTY	CYLINDER HEAD	YEARS	PART NO.	DESCRIPTION	
2	Head Gasket	1996-91	501 SD	Head bolts not incl.; Head bolt replacement recommended; PermaTorque Severe Duty®	
2	Head Gasket	1996-91	7733 PT-2	Head bolts not incl.; Head bolt replacement recommended; PermaTorque®	
2	Head Gasket Spacer Shim	1996-91	7733 SP	HeadSaver®	

GMC Truck (Incl. Minivans and SUV's) (Cont.)

73 (cont.)		1996 - 1991; 5.7L 350 (5736cc) OHV V8 (16 Valve) 4" Bore			73 (cont.)
TBI; Gasoline; Naturally Aspirated GMC Eng.; Chevrolet; VIN Code K					
QTY	CYLINDER HEAD	YEARS	PART NO.	DESCRIPTION	
1	Head Set	1996	HS 7733 PT-15	Exc. Chevrolet Express 3500 Van Base, LS GMC Savana 3500 Base, SLE; Exh. valve stem seals not incl.; Head bolts & exh. pipe packing not incl.; Head bolt replacement recommended; PermaDry® molded rubber valve cover gskts. incl.; Premium valve stem seals incl.	
1	Head Set	1996	HS 7733 PT-15	Chevrolet Express 3500 Van Base, LS GMC Savana 3500 Base, SLE; Head bolts & exh. pipe packing not incl.; Head bolt replacement recommended; PermaDry® molded rubber valve cover gskts. incl.; Premium valve stem seals incl.	
1	Head Set	1995	HS 7733 PT-15	Exc. Chevrolet C1500 Pickup Base, Cheyenne, Silverado, WT, C1500 Suburban Base, LS, LT, G10 Van Beauville, Chevy Van, Sportvan, K1500 Pickup Base, Cheyenne, Silverado, WT, K1500 Suburban Base, LS, LT, P30 Series Base, Tahoe Base, LS, LT, W4S042 Base GMC; Exh. valve stem seals not incl.; Head bolts & exh. pipe packing not incl.; Head bolt replacement recommended; PermaDry® molded rubber valve cover gskts. incl.; Premium valve stem seals incl.	
1	Head Set	1995	HS 7733 PT-15	Chevrolet C1500 Pickup Base, Cheyenne, Silverado, WT, C1500 Suburban Base, LS, LT, G10 Van Beauville, Chevy Van, Sportvan, K1500 Pickup Base, Cheyenne, Silverado, WT, K1500 Suburban Base, LS, LT, P30 Series Base, Tahoe Base, LS, LT, W4S042 Base GMC C150; Head bolts & exh. pipe packing not incl.; Head bolt replacement recommended; PermaDry® molded rubber valve cover gskts. incl.; Premium valve stem seals incl.	
1	Head Set	1994	HS 7733 PT-15	Exc. Chevrolet Blazer Base, Silverado, Silverado Sport, C1500 Pickup Base, Cheyenne, Silverado, WT, C1500 Suburban Base, Silverado, G10 Van Beauville, Chevy Van, Sportvan, K1500 Pickup Base, Cheyenne, Silverado, WT, K1500 Suburban Base, Silverado, P30 Ser; Exh. valve stem seals not incl.; Head bolts & exh. pipe packing not incl.; Head bolt replacement recommended; PermaDry® molded rubber valve cover gskts. incl.; Premium valve stem seals incl.	
1	Head Set	1994	HS 7733 PT-15	Chevrolet Blazer Base, Silverado, Silverado Sport, C1500 Pickup Base, Cheyenne, Silverado, WT, C1500 Suburban Base, Silverado, G10 Van Beauville, Chevy Van, Sportvan, K1500 Pickup Base, Cheyenne, Silverado, WT, K1500 Suburban Base, Silverado, P30 Series B; Head bolts & exh. pipe packing not incl.; Head bolt replacement recommended; PermaDry® molded rubber valve cover gskts. incl.; Premium valve stem seals incl.	
1	Head Set	1993	HS 7733 PT-15	Exc. Chevrolet Blazer Cheyenne, Silverado, C1500 Pickup Cheyenne, Silverado, WT, C1500 Suburban Base, Silverado, G10 Van Beauville, Chevy Van, Sportvan, K1500 Pickup Cheyenne, Silverado, WT, K1500 Suburban Base, Silverado, P30 Series Base, W4S042 Base G; Exh. valve stem seals not incl.; Head bolts & exh. pipe packing not incl.; Head bolt replacement recommended; PermaDry® molded rubber valve cover gskts. incl.; Premium valve stem seals incl.	
1	Head Set	1993	HS 7733 PT-15	Chevrolet Blazer Cheyenne, Silverado, C1500 Pickup Cheyenne, Silverado, WT, C1500 Suburban Base, Silverado, G10 Van Beauville, Chevy Van, Sportvan, K1500 Pickup Cheyenne, Silverado, WT, K1500 Suburban Base, Silverado, P30 Series Base, W4S042 Base GMC C1; Head bolts & exh. pipe packing not incl.; Head bolt replacement recommended; PermaDry® molded rubber valve cover gskts. incl.; Premium valve stem seals incl.	
1	Head Set	1992	HS 7733 PT-15	Exc. Chevrolet Blazer Cheyenne, Silverado, C1500 Pickup Cheyenne, Silverado, WT, C1500 Suburban Base, Silverado, G10 Van Beauville, Chevy Van, Sportvan, K1500 Pickup Cheyenne, Silverado, WT, K1500 Suburban Base, Silverado, P30 Series Base GMC C1500 Pick; Exh. valve stem seals not incl.; Head bolts & exh. pipe packing not incl.; Head bolt replacement recommended; PermaDry® molded rubber valve cover gskts. incl.; Premium valve stem seals incl.	
1	Head Set	1992	HS 7733 PT-15	Chevrolet Blazer Cheyenne, Silverado, C1500 Pickup Cheyenne, Silverado, WT, C1500 Suburban Base, Silverado, G10 Van Beauville, Chevy Van, Sportvan, K1500 Pickup Cheyenne, Silverado, WT, K1500 Suburban Base, Silverado, P30 Series Base GMC C1500 Pickup Si; Head bolts & exh. pipe packing not incl.; Head bolt replacement recommended; PermaDry® molded rubber valve cover gskts. incl.; Premium valve stem seals incl.	

GMC Truck (Incl. Minivans and SUV's) (Cont.)

73 (cont.)		1996 - 1991; 5.7L 350 (5736cc) OHV V8 (16 Valve) 4" Bore			73 (cont.)
TBI; Gasoline; Naturally Aspirated GMC Eng.; Chevrolet; VIN Code K					
QTY	CYLINDER HEAD	YEARS	PART NO.	DESCRIPTION	
1	Head Set	1991	HS 7733 PT-15	Chevrolet C2500 Pickup Cheyenne, Silverado, C3500 Pickup Cheyenne, Silverado, G20 Van Beauville, Chevy Van, Sportvan, G30 Van Beauville, Chevy Van, Hi-Cube, Sportvan, K2500 Pickup Cheyenne, Silverado, K3500 Pickup Cheyenne, Silverado GMC C2500 Pickup Si; Exh. valve stem seals not incl.; Head bolts & exh. pipe packing not incl.; Head bolt replacement recommended; PermaDry® molded rubber valve cover gskts. incl.; Premium valve stem seals incl.	
1	Head Set	1991	HS 7733 PT-15	Exc. Chevrolet C2500 Pickup Cheyenne, Silverado, C3500 Pickup Cheyenne, Silverado, G20 Van Beauville, Chevy Van, Sportvan, G30 Van Beauville, Chevy Van, Hi-Cube, Sportvan, K2500 Pickup Cheyenne, Silverado, K3500 Pickup Cheyenne, Silverado GMC C2500 Pick; Head bolts & exh. pipe packing not incl.; Head bolt replacement recommended; PermaDry® molded rubber valve cover gskts. incl.; Premium valve stem seals incl.	
2	Head Bolt Set	1996-91	ES 72856	Replacement recommended	
QTY	CONVERSION SET	YEARS	PART NO.	DESCRIPTION	
1	Gasket Conversion Set	1996	CS 8510-1	Plastic timing cover not incl.; PermaDry® molded rubber oil pan gskt. incl.	
1	Gasket Conversion Set	1995-91	CS 8510	PermaDry® molded rubber oil pan gskt. incl.	
QTY	MANIFOLD - INT. & EXH.	YEARS	PART NO.	DESCRIPTION	
1	Int. Manifold Gasket Set	1996-91	MS 93317		
1	Exh. Manifold Gasket Set	1996-91	MS 9275 B		
QTY	EXHAUST PIPE FLANGE	YEARS	PART NO.	DESCRIPTION	
2	Exhaust Pipe Gasket	1996-91	60718	2 3/32" ID Steel sleeve	
2	Exhaust Pipe Gasket	1996-91	60584	Packing; 2 1/2" ID Steel sleeve to manifold; 2 1/4" ID Gasket to pipe	
QTY	FUEL PUMP	YEARS	PART NO.	DESCRIPTION	
1	Fuel Pump Mounting Gasket	1996-91	5182	Plate	
1	Fuel Pump Mounting Gasket	1995-91	6579	May also be used as a fuel pump block-off plate gasket if desired	
QTY	OIL PAN	YEARS	PART NO.	DESCRIPTION	
1	Oil Pan Gasket Set	1996-91	OS 34500 R	PermaDry® molded rubber gskt. incl.	
1	Drain Plug Gasket	1996	70820		
1	Drain Plug Gasket	1995-91	70822		
QTY	CRANKSHAFT REAR SEAL	YEARS	PART NO.	DESCRIPTION	
1	Rear Main Seal Set	1996	BS 40656	PTFE Rubber; One-piece; Improved design	
1	Rear Main Seal Set	1995-91	BS 40520	Rubber; One-piece	
1	Rear Main Seal Set	1995-91	BS 40626	PTFE Rubber; One-piece	
1	Repair Sleeve	1995-91	16258	Crankshaft; Use w/installation tool	
1	Repair Sleeve Tool	1995-91	16301	Crankshaft	
QTY	VALVE COVER	YEARS	PART NO.	DESCRIPTION	
1	Valve Cover Gasket Set	1996-91	VS 50088 R	Services both covers; PermaDry® molded rubber gskts. incl.	
2	Valve Cover Gasket Set	1996-91	VS 50293 R	Services one cover only; PermaDry® molded rubber gskt. incl.	
QTY	VALVE STEM SEAL SET	YEARS	PART NO.	DESCRIPTION	
1	Valve Stem Seal Set	1996-91	SS 72527	Loc. Int.; Premium valve stem seals incl.	
1	Valve Stem Seal Set	1996	SS 72525	Exc. Chevrolet Express 3500 Van Base, LS GMC Savana 3500 Base, SLE; Loc. Exh.; Premium valve stem seals incl.	
1	Valve Stem Seal Set	1996	SS 72526	Chevrolet Express 3500 Van Base, LS GMC Savana 3500 Base, SLE; Loc. Exh.; Premium valve stem seals incl.	
1	Valve Stem Seal Set	1996	SS 72877	Chevrolet Express 3500 Van Base, LS GMC Savana 3500 Base, SLE; Loc. Exh.; Opt. Hi-Temp. premium valve stem seals incl.	
1	Valve Stem Seal Set	1996	SS 72883	Exc. Chevrolet Express 3500 Van Base, LS GMC Savana 3500 Base, SLE; Loc. Exh.; Opt. Hi-Temp. premium valve stem seals incl.	
1	Valve Stem Seal Set	1995	SS 72525	Exc. Chevrolet C1500 Pickup Base, Cheyenne, Silverado, WT, C1500 Suburban Base, LS, LT, G10 Van Beauville, Chevy Van, Sportvan, K1500 Pickup Base, Cheyenne, Silverado, WT, K1500 Suburban Base, LS, LT, P30 Series Base, Tahoe Base, LS, LT, W4S042 Base GMC; Loc. Exh.; Premium valve stem seals incl.	
1	Valve Stem Seal Set	1995	SS 72526	Chevrolet C1500 Pickup Base, Cheyenne, Silverado, WT, C1500 Suburban Base, LS, LT, G10 Van Beauville, Chevy Van, Sportvan, K1500 Pickup Base, Cheyenne, Silverado, WT, K1500 Suburban Base, LS, LT, P30 Series Base, Tahoe Base, LS, LT, W4S042 Base GMC C150; Loc. Exh.; Premium valve stem seals incl.	

GMC Truck (Incl. Minivans and SUV's) (Cont.)

73 (cont.)		1996 - 1991; 5.7L 350 (5736cc) OHV V8 (16 Valve) 4" Bore			73 (cont.)
TBI; Gasoline; Naturally Aspirated GMC Eng.; Chevrolet; VIN Code K					
QTY	VALVE STEM SEAL SET	YEARS	PART NO.	DESCRIPTION	
1	Valve Stem Seal Set	1995	SS 72877	Chevrolet C1500 Pickup Base, Cheyenne, Silverado, WT, C1500 Suburban Base, LS, LT, G10 Van Beauville, Chevy Van, Sportvan, K1500 Pickup Base, Cheyenne, Silverado, WT, K1500 Suburban Base, LS, LT, P30 Series Base, Tahoe Base, LS, LT, W4S042 Base GMC C150; Loc. Exh.; Opt. Hi-Temp. premium valve stem seals incl.	
1	Valve Stem Seal Set	1995	SS 72883	Exc. Chevrolet C1500 Pickup Base, Cheyenne, Silverado, WT, C1500 Suburban Base, LS, LT, G10 Van Beauville, Chevy Van, Sportvan, K1500 Pickup Base, Cheyenne, Silverado, WT, K1500 Suburban Base, LS, LT, P30 Series Base, Tahoe Base, LS, LT, W4S042 Base GMC; Loc. Exh.; Opt. Hi-Temp. premium valve stem seals incl.	
1	Valve Stem Seal Set	1994	SS 72525	Exc. Chevrolet Blazer Base, Silverado, Silverado Sport, C1500 Pickup Base, Cheyenne, Silverado, WT, C1500 Suburban Base, Silverado, G10 Van Beauville, Chevy Van, Sportvan, K1500 Pickup Base, Cheyenne, Silverado, WT, K1500 Suburban Base, Silverado, P30 Ser; Loc. Exh.; Premium valve stem seals incl.	
1	Valve Stem Seal Set	1994	SS 72526	Chevrolet Blazer Base, Silverado, Silverado Sport, C1500 Pickup Base, Cheyenne, Silverado, WT, C1500 Suburban Base, Silverado, G10 Van Beauville, Chevy Van, Sportvan, K1500 Pickup Base, Cheyenne, Silverado, WT, K1500 Suburban Base, Silverado, P30 Series B; Loc. Exh.; Premium valve stem seals incl.	
1	Valve Stem Seal Set	1994	SS 72877	Chevrolet Blazer Base, Silverado, Silverado Sport, C1500 Pickup Base, Cheyenne, Silverado, WT, C1500 Suburban Base, Silverado, G10 Van Beauville, Chevy Van, Sportvan, K1500 Pickup Base, Cheyenne, Silverado, WT, K1500 Suburban Base, Silverado, P30 Series B; Loc. Exh.; Opt. Hi-Temp. premium valve stem seals incl.	
1	Valve Stem Seal Set	1994	SS 72883	Exc. Chevrolet Blazer Base, Silverado, Silverado Sport, C1500 Pickup Base, Cheyenne, Silverado, WT, C1500 Suburban Base, Silverado, G10 Van Beauville, Chevy Van, Sportvan, K1500 Pickup Base, Cheyenne, Silverado, WT, K1500 Suburban Base, Silverado, P30 Ser; Loc. Exh.; Opt. Hi-Temp. premium valve stem seals incl.	
1	Valve Stem Seal Set	1993	SS 72525	Exc. Chevrolet Blazer Cheyenne, Silverado, C1500 Pickup Cheyenne, Silverado, WT, C1500 Suburban Base, Silverado, G10 Van Beauville, Chevy Van, Sportvan, K1500 Pickup Cheyenne, Silverado, WT, K1500 Suburban Base, Silverado, P30 Series Base, W4S042 Base G; Loc. Exh.; Premium valve stem seals incl.	
1	Valve Stem Seal Set	1993	SS 72526	Chevrolet Blazer Cheyenne, Silverado, C1500 Pickup Cheyenne, Silverado, WT, C1500 Suburban Base, Silverado, G10 Van Beauville, Chevy Van, Sportvan, K1500 Pickup Cheyenne, Silverado, WT, K1500 Suburban Base, Silverado, P30 Series Base, W4S042 Base GMC C1; Loc. Exh.; Premium valve stem seals incl.	
1	Valve Stem Seal Set	1993	SS 72877	Chevrolet Blazer Cheyenne, Silverado, C1500 Pickup Cheyenne, Silverado, WT, C1500 Suburban Base, Silverado, G10 Van Beauville, Chevy Van, Sportvan, K1500 Pickup Cheyenne, Silverado, WT, K1500 Suburban Base, Silverado, P30 Series Base, W4S042 Base GMC C1; Loc. Exh.; Opt. Hi-Temp. premium valve stem seals incl.	
1	Valve Stem Seal Set	1993	SS 72883	Exc. Chevrolet Blazer Cheyenne, Silverado, C1500 Pickup Cheyenne, Silverado, WT, C1500 Suburban Base, Silverado, G10 Van Beauville, Chevy Van, Sportvan, K1500 Pickup Cheyenne, Silverado, WT, K1500 Suburban Base, Silverado, P30 Series Base, W4S042 Base G; Loc. Exh.; Opt. Hi-Temp. premium valve stem seals incl.	
1	Valve Stem Seal Set	1992	SS 72525	Exc. Chevrolet Blazer Cheyenne, Silverado, C1500 Pickup Cheyenne, Silverado, WT, C1500 Suburban Base, Silverado, G10 Van Beauville, Chevy Van, Sportvan, K1500 Pickup Cheyenne, Silverado, WT, K1500 Suburban Base, Silverado, P30 Series Base GMC C1500 Pick; Loc. Exh.; Premium valve stem seals incl.	
1	Valve Stem Seal Set	1992	SS 72526	Chevrolet Blazer Cheyenne, Silverado, C1500 Pickup Cheyenne, Silverado, WT, C1500 Suburban Base, Silverado, G10 Van Beauville, Chevy Van, Sportvan, K1500 Pickup Cheyenne, Silverado, WT, K1500 Suburban Base, Silverado, P30 Series Base GMC C1500 Pickup Si; Loc. Exh.; Premium valve stem seals incl.	
1	Valve Stem Seal Set	1992	SS 72877	Chevrolet Blazer Cheyenne, Silverado, C1500 Pickup Cheyenne, Silverado, WT, C1500 Suburban Base, Silverado, G10 Van Beauville, Chevy Van, Sportvan, K1500 Pickup Cheyenne, Silverado, WT, K1500 Suburban Base, Silverado, P30 Series Base GMC C1500 Pickup Si; Loc. Exh.; Opt. Hi-Temp. premium valve stem seals incl.	

GMC Truck (Incl. Minivans and SUV's) (Cont.)

73		1996 - 1991; 5.7L 350 (5736cc) OHV V8 (16 Valve) 4" Bore			73
(cont.)		TBI; Gasoline; Naturally Aspirated GMC Eng.; Chevrolet; VIN Code K			(cont.)
QTY	VALVE STEM SEAL SET	YEARS	PART NO.	DESCRIPTION	
1	Valve Stem Seal Set	1992	SS 72883	Exc. Chevrolet Blazer Cheyenne, Silverado, C1500 Pickup Cheyenne, Silverado, WT, C1500 Suburban Base, Silverado, G10 Van Beauville, Chevy Van, Sportvan, K1500 Pickup Cheyenne, Silverado, WT, K1500 Suburban Base, Silverado, P30 Series Base GMC C1500 Pick; Loc. Exh.; Opt. Hi-Temp. premium valve stem seals incl.	
1	Valve Stem Seal Set	1991	SS 72525	Chevrolet C2500 Pickup Cheyenne, Silverado, C3500 Pickup Cheyenne, Silverado, G20 Van Beauville, Chevy Van, Sportvan, G30 Van Beauville, Chevy Van, Hi-Cube, Sportvan, K2500 Pickup Cheyenne, Silverado, K3500 Pickup Cheyenne, Silverado GMC C2500 Pickup Si; Loc. Exh.; Premium valve stem seals incl.	
1	Valve Stem Seal Set	1991	SS 72526	Exc. Chevrolet C2500 Pickup Cheyenne, Silverado, C3500 Pickup Cheyenne, Silverado, G20 Van Beauville, Chevy Van, Sportvan, G30 Van Beauville, Chevy Van, Hi-Cube, Sportvan, K2500 Pickup Cheyenne, Silverado, K3500 Pickup Cheyenne, Silverado GMC C2500 Pick; Loc. Exh.; Premium valve stem seals incl.	
1	Valve Stem Seal Set	1991	SS 72877	Exc. Chevrolet C2500 Pickup Cheyenne, Silverado, C3500 Pickup Cheyenne, Silverado, G20 Van Beauville, Chevy Van, Sportvan, G30 Van Beauville, Chevy Van, Hi-Cube, Sportvan, K2500 Pickup Cheyenne, Silverado, K3500 Pickup Cheyenne, Silverado GMC C2500 Pick; Loc. Exh.; Opt. Hi-Temp. premium valve stem seals incl.	
1	Valve Stem Seal Set	1991	SS 72883	Chevrolet C2500 Pickup Cheyenne, Silverado, C3500 Pickup Cheyenne, Silverado, G20 Van Beauville, Chevy Van, Sportvan, G30 Van Beauville, Chevy Van, Hi-Cube, Sportvan, K2500 Pickup Cheyenne, Silverado, K3500 Pickup Cheyenne, Silverado GMC C2500 Pickup Si; Loc. Exh.; Opt. Hi-Temp. premium valve stem seals incl.	
QTY	THERMOSTAT HOUSING	YEARS	PART NO.	DESCRIPTION	
1	O-Ring	1996-91	35710	Thermostat Housing; 1.954" ID; Improved design	
QTY	WATER OUTLET GASKET	YEARS	PART NO.	DESCRIPTION	
1	Water Outlet Gasket	1995-91	35062	Water Outlet; 1 13/16" ID	
1	Water Outlet Gasket	1995-91	35562 T	Water Outlet; 1 13/16" ID; PermaDryPlus®	
QTY	WATER PUMP	YEARS	PART NO.	DESCRIPTION	
1	Water Pump Gasket	1996-91	13032	To plate	
2	Water Pump Gasket	1996-91	5152	To block	
QTY	TIMING COVER	YEARS	PART NO.	DESCRIPTION	
1	Timing Cover Set	1996	TCS 46093	Eng. w/2.42" OD timing cover seal; Must be used w/OS 34500R	
1	Timing Cover Set	1995-91	TCS 45121	w/o Sleeve 'N' Seal®; Must be used w/OS 34500R	
1	Timing Set w/Sleeve & Seal	1995-91	TCS 45265	w/Sleeve 'N' Seal®; Must be used w/OS 34500R	
1	Repair Sleeve	1995-91	16202	Timing Cover; Use w/installation tool	
1	Repair Sleeve Tool	1995-91	16312	Timing Cover	
QTY	AIR CLEANER MOUNTING	YEARS	PART NO.	DESCRIPTION	
1	Air Cleaner Gasket	1996-91	60038	5 1/32" ID	
QTY	CARB & FUEL INJECTION	YEARS	PART NO.	DESCRIPTION	
1	Throttle Body Gasket	1996-91	60903		
QTY	DISTRIBUTOR MOUNTING	YEARS	PART NO.	DESCRIPTION	
1	Distributor Mounting Gasket	1996-91	70194		
QTY	EXHAUST GAS RECIRCULATION	YEARS	PART NO.	DESCRIPTION	
1	EGR Gasket	1996-91	70978		
QTY	OIL PUMP RETAINER	YEARS	PART NO.	DESCRIPTION	
1	Oil Pump Shaft Guide	1996-91	72665	Distributor to oil pump shaft retainer	
QTY	OIL COOLER	YEARS	PART NO.	DESCRIPTION	
1	Oil Cooler Mounting Set	1996-91	ES 72671		
74		2002 - 1996; 5.7L 350 (5736cc) OHV V8 (16 Valve) 4" Bore Vortec			74
(cont.)		CPI; Gasoline; Naturally Aspirated GMC Eng.; Chevrolet; VIN Code R			(cont.)
QTY	CYLINDER HEAD	YEARS	PART NO.	DESCRIPTION	
2	Head Gasket	2002-96	501 SD	Head bolts not incl.; Head bolt replacement recommended; PermaTorque Severe Duty®	
2	Head Gasket	2002-96	7733 PT-2	Head bolts not incl.; Head bolt replacement recommended; PermaTorque®	
2	Head Gasket Spacer Shim	2002-96	7733 SP	HeadSaver®	
1	Head Set	2002-96	HS 7733 PT-16	Head bolts & exh. pipe packing not incl.; Head bolt replacement recommended; PermaDry® molded rubber valve cover gskts. incl.; Premium valve stem seals incl.	

GMC Truck (Incl. Minivans and SUV's) (Cont.)

74 (cont.)		2002 - 1996; 5.7L 350 (5736cc) OHV V8 (16 Valve) 4" Bore Vortec CPI; Gasoline; Naturally Aspirated GMC Eng.; Chevrolet; VIN Code R			74 (cont.)
QTY	CYLINDER HEAD	YEARS	PART NO.	DESCRIPTION	
1	Head Set	2002-96	HST 7733 PT-16	Head bolts & exh. pipe packing not incl.; Head bolt replacement recommended; PermaTorque Severe Duty® head gskts. incl.; PermaDryPlus® int. manifold gskts. incl.; PermaDry® molded rubber valve cover gskts. incl.; Premium valve stem seals incl.	
2	Head Bolt Set	2002-96	ES 72856	Replacement recommended	
QTY	CONVERSION SET	YEARS	PART NO.	DESCRIPTION	
1	Gasket Conversion Set	2002-96	CS 8510-1	Plastic timing cover not incl.; PermaDry® molded rubber oil pan gskt. incl.	
QTY	MANIFOLD - INT. & EXH.	YEARS	PART NO.	DESCRIPTION	
1	Int. Manifold Gasket Set	2002-96	MS 90131	Lower set; Upper set incl.; Manifold bolts not incl.; Manifold bolt replacement recommended	
1	Int. Manifold Gasket Set	2002-96	MS 90131-2	Lower set only; Upper set not incl.; Manifold bolts not incl.; Manifold bolt replacement recommended	
1	Int. Manifold Gasket Set	2002-96	MS 98000 T	Single valve cover gskt. incl.; Upper set incl.; PermaDryPlus® int. manifold gskts. incl.; When servicing second valve cover use VS 50293R if required; Manifold bolts not incl.; Manifold bolt replacement recommended	
1	Plenum Gasket Set	2002-96	MS 90269	Upper set	
1	Int. Manifold Bolt Set	2002-96	ES 72224	Loc. Lower; Replacement recommended	
1	Exh. Manifold Gasket Set	2002-96	MS 94054		
QTY	EXHAUST PIPE FLANGE	YEARS	PART NO.	DESCRIPTION	
2	Exhaust Pipe Gasket	2002-96	61014	Pipe to manifold	
1	Exhaust Pipe Gasket	2002-96	61559	Converter; 3-bolt	
1	Exhaust Pipe Gasket	2002-96	61561	Converter; 2-bolt	
1	Exhaust Pipe Gasket	2002-96	61683	Exh. connector; New Part Number - Check for Availability	
QTY	FUEL PUMP	YEARS	PART NO.	DESCRIPTION	
1	Fuel Pump Mounting Gasket	2002-96	5182	Plate	
QTY	OIL PAN	YEARS	PART NO.	DESCRIPTION	
1	Oil Pan Gasket Set	2002-96	OS 34500 R	PermaDry® molded rubber gskt. incl.	
1	Drain Plug Gasket	2002-96	70820		
QTY	CRANKSHAFT REAR SEAL	YEARS	PART NO.	DESCRIPTION	
1	Rear Main Seal Set	2002-96	BS 40656	PTFE Rubber; One-piece; Improved design	
QTY	VALVE COVER	YEARS	PART NO.	DESCRIPTION	
1	Valve Cover Gasket Set	2002-96	VS 50088 R	Services both covers; PermaDry® molded rubber gskts. incl.	
2	Valve Cover Gasket Set	2002-96	VS 50293 R	Services one cover only; PermaDry® molded rubber gskt. incl.	
QTY	VALVE STEM SEAL SET	YEARS	PART NO.	DESCRIPTION	
1	Valve Stem Seal Set	2002-96	SS 72861	Loc. Int. & Exh.; Premium valve stem seals incl.; Improved design	
QTY	THERMOSTAT HOUSING	YEARS	PART NO.	DESCRIPTION	
1	O-Ring	2002-96	35710	Thermostat Housing; 1.954" ID; Improved design	
QTY	WATER PUMP	YEARS	PART NO.	DESCRIPTION	
1	Water Pump Gasket	2002-96	13032	To plate	
2	Water Pump Gasket	2002-96	5152	To block	
QTY	TIMING COVER	YEARS	PART NO.	DESCRIPTION	
1	Timing Cover Set	2002-96	TCS 46093	Eng. w/2.42" OD timing cover seal; Must be used w/OS 34500R	
QTY	CARB & FUEL INJECTION	YEARS	PART NO.	DESCRIPTION	
1	Throttle Body Gasket	2002-96	61036		
QTY	DISTRIBUTOR MOUNTING	YEARS	PART NO.	DESCRIPTION	
1	Distributor Mounting Gasket	2002-96	70194		
QTY	EXHAUST GAS RECIRCULATION	YEARS	PART NO.	DESCRIPTION	
1	EGR Gasket	2002-96	70789		
QTY	OIL PUMP RETAINER	YEARS	PART NO.	DESCRIPTION	
1	Oil Pump Shaft Guide	2002-96	72665	Distributor to oil pump shaft retainer	
QTY	OIL COOLER	YEARS	PART NO.	DESCRIPTION	
1	Oil Cooler Mounting Set	2002-96	ES 72671		
75		2013 - 2008; 6.0L 364 (5967cc) OHV V8 (16 Valve) 101.6mm Bore Vortec MFI; Hybrid (Gas/Electric); Naturally Aspirated GMC Eng.; Chevrolet; VIN Code 5			75
QTY	CYLINDER HEAD	YEARS	PART NO.	DESCRIPTION	
2	Head Gasket	2011-08	26192 PT	Head bolts not incl.; Head bolt replacement recommended; PermaTorqueMLS® LaserWeld® Technology	
1	Head Set	2011-10	HS 26192 PT-8	Head bolts not incl.; Head bolt replacement recommended; PermaDryPlus® int. manifold gskts. incl.; PermaDry® molded rubber valve cover gskts. incl.; Premium valve stem seals incl.; New Part Number - Check for Availability	

GMC Truck (Incl. Minivans and SUV's) (Cont.)

75 (cont.)	2013 - 2008; 6.0L 364 (5967cc) OHV V8 (16 Valve) 101.6mm Bore Vortec MFI; Hybrid (Gas/Electric); Naturally Aspirated GMC Eng.; Chevrolet; VIN Code 5				75 (cont.)
QTY	CYLINDER HEAD	YEARS	PART NO.	DESCRIPTION	
1	Head Set	2009-08	HS 26192 PT-4	Head bolts not incl.; Head bolt replacement recommended; PermaDryPlus® int. manifold gskts. incl.; PermaDry® molded rubber valve cover gskts. incl.; Premium valve stem seals incl.	
2	Head Bolt Set	2012-10	ES 72390	Replacement recommended; New Part Number - Check for Availability	
2	Head Bolt Set	2009-08	ES 72220	2nd Design; Replacement recommended	
QTY	CONVERSION SET	YEARS	PART NO.	DESCRIPTION	
1	Gasket Conversion Set	2011-08	CS 9284	PermaDry® molded rubber oil pan gskt. incl.	
QTY	MANIFOLD - INT. & EXH.	YEARS	PART NO.	DESCRIPTION	
1	Int. Manifold Gasket Set	2013-08	MS 96587		
1	Int. Manifold Gasket Set	2013-08	MS 98016 T	PermaDryPlus® int. manifold gskts. incl.	
1	Int. Manifold Gasket Set	2013-10	MS 96857	Lifter valley cover set; Perimeter seal only	
1	Int. Manifold Gasket Set	2009-08	MS 96169	Lifter valley cover set	
1	Exh. Manifold Gasket Set	2013-08	MS 92467		
QTY	EXHAUST PIPE FLANGE	YEARS	PART NO.	DESCRIPTION	
1	Exhaust Pipe Gasket	2013-08	61089	Loc. R.H.; Pipe to manifold	
1	Exhaust Pipe Gasket	2013-08	61287	Converter	
1	Exhaust Pipe Gasket	2013-08	61323	Loc. L.H.; Pipe to manifold	
QTY	OIL PAN	YEARS	PART NO.	DESCRIPTION	
1	Oil Pan Gasket Set	2011-08	OS 30693 R	PermaDry® molded rubber gskt. incl.	
QTY	CRANKSHAFT REAR SEAL	YEARS	PART NO.	DESCRIPTION	
1	Rear Main Seal Set	2011-08	BS 40640	PTFE Rubber; One-piece	
1	Repair Sleeve	2011-08	16228	Crankshaft; Narrow lip; .780" sleeve length; Requires crankshaft machining due to clearance issues; Use w/installation tool	
1	Repair Sleeve	2011-08	16229	Crankshaft; Wide lip; 1.156" sleeve length; Requires crankshaft machining due to clearance issues; Use w/installation tool	
1	Repair Sleeve Tool	2011-08	16329	Crankshaft	
QTY	VALVE COVER	YEARS	PART NO.	DESCRIPTION	
1	Valve Cover Gasket Set	2011-08	VS 50504 R	w/o Grommets; PermaDry® molded rubber gskts. incl.	
1	Valve Cover Gasket Set	2011-08	VS 50504 R-1	w/Grommets; PermaDry® molded rubber gskts. incl.; New Part Number - Check for Availability	
1	Grommet Set	2011-08	ES 72233	Valve Cover	
QTY	VALVE STEM SEAL SET	YEARS	PART NO.	DESCRIPTION	
1	Valve Stem Seal Set	2011-08	SS 71039	2nd Design; Top-Hat Design seal; Premium valve stem seals incl.	
QTY	THERMOSTAT HOUSING	YEARS	PART NO.	DESCRIPTION	
1	O-Ring	2011-08	35720	Thermostat Housing	
QTY	WATER PUMP	YEARS	PART NO.	DESCRIPTION	
2	Water Pump Gasket	2011-08	35635		
1	O-Ring	2011-08	35633	Water Pump	
1	Water Pump Mounting Set	2011-08	ES 73010	Mounting gasket set; New Part Number - Check for Availability	
QTY	TIMING COVER	YEARS	PART NO.	DESCRIPTION	
1	Timing Cover Set	2011-08	TCS 45993	Must be used w/OS 30693R	
1	Camshaft Sensor Seal	2011-08	72760	Variable camshaft sensor seal; New Part Number - Check for Availability	
QTY	CARB & FUEL INJECTION	YEARS	PART NO.	DESCRIPTION	
2	Fuel Injector O-Ring Set	2011-08	ES 70599	Upper set; Injectors to fuel rail; Improved design	
2	Fuel Injector O-Ring Set	2011-08	ES 71190	Lower set; Injectors to cylinder head	
2	Fuel Injector O-Ring Set	2011-08	ES 71192	Upper set; Injectors to fuel rail; Old design	
1	Throttle Body Gasket	2011-08	61469		
QTY	EXHAUST GAS RECIRCULATION	YEARS	PART NO.	DESCRIPTION	
1	EGR Gasket	2011-08	70895	Pipe; O-ring	
1	EGR Gasket	2011-08	70914	Valve	
1	EGR Gasket	2011-08	70947	Pipe	
QTY	OIL FILTER MOUNTING	YEARS	PART NO.	DESCRIPTION	
1	Oil Cooler Gasket	2011-08	72462	Oil Filter; Center tube; Dual round port	
QTY	OIL PUMP COVER	YEARS	PART NO.	DESCRIPTION	
1	O-Ring	2011-08	72401	Oil Pump; Inlet tube	
QTY	OIL COOLER	YEARS	PART NO.	DESCRIPTION	
1	Oil Cooler Gasket	2011-08	72435	Oval port	
1	Oil Cooler Gasket	2011-08	72462	Dual round port	

GMC Truck (Incl. Minivans and SUV's) (Cont.)

76		2013 - 2010; 6.0L 364 (5967cc) OHV V8 (16 Valve) 101.6mm Bore Vortec			76
MFI; Flex Fuel Hybrid (Gas/Electric); Naturally Aspirated GMC Eng.; Chevrolet; VIN Code J					
QTY	CYLINDER HEAD	YEARS	PART NO.	DESCRIPTION	
2	Head Gasket	2011-10	26192 PT	Head bolts not incl.; Head bolt replacement recommended; PermaTorqueMLS® LaserWeld® Technology	
1	Head Set	2011-10	HS 26192 PT-8	Head bolts not incl.; Head bolt replacement recommended; PermaDryPlus® int. manifold gskts. incl.; PermaDry® molded rubber valve cover gskts. incl.; Premium valve stem seals incl.; New Part Number - Check for Availability	
2	Head Bolt Set	2012-10	ES 72390	Replacement recommended; New Part Number - Check for Availability	
QTY	CONVERSION SET	YEARS	PART NO.	DESCRIPTION	
1	Gasket Conversion Set	2011-10	CS 9284	PermaDry® molded rubber oil pan gskt. incl.	
QTY	MANIFOLD - INT. & EXH.	YEARS	PART NO.	DESCRIPTION	
1	Int. Manifold Gasket Set	2013-10	MS 96587		
1	Int. Manifold Gasket Set	2013-10	MS 96857	Lifter valley cover set; Perimeter seal only	
1	Int. Manifold Gasket Set	2013-10	MS 98016 T	PermaDryPlus® int. manifold gskts. incl.	
1	Exh. Manifold Gasket Set	2013-10	MS 92467		
QTY	EXHAUST PIPE FLANGE	YEARS	PART NO.	DESCRIPTION	
1	Exhaust Pipe Gasket	2013-10	61089	Loc. R.H.; Pipe to manifold	
1	Exhaust Pipe Gasket	2013-10	61287	Converter	
1	Exhaust Pipe Gasket	2013-10	61323	Loc. L.H.; Pipe to manifold	
QTY	OIL PAN	YEARS	PART NO.	DESCRIPTION	
1	Oil Pan Gasket Set	2011-10	OS 30693 R	PermaDry® molded rubber gskt. incl.	
QTY	CRANKSHAFT REAR SEAL	YEARS	PART NO.	DESCRIPTION	
1	Rear Main Seal Set	2011-10	BS 40640	PTFE Rubber; One-piece	
1	Repair Sleeve	2011-10	16228	Crankshaft; Narrow lip; .780" sleeve length; Requires crankshaft machining due to clearance issues; Use w/installation tool	
1	Repair Sleeve	2011-10	16229	Crankshaft; Wide lip; 1.156" sleeve length; Requires crankshaft machining due to clearance issues; Use w/installation tool	
1	Repair Sleeve Tool	2011-10	16329	Crankshaft	
QTY	VALVE COVER	YEARS	PART NO.	DESCRIPTION	
1	Valve Cover Gasket Set	2011-10	VS 50504 R	w/o Grommets; PermaDry® molded rubber gskts. incl.	
1	Valve Cover Gasket Set	2011-10	VS 50504 R-1	w/Grommets; PermaDry® molded rubber gskts. incl.; New Part Number - Check for Availability	
1	Grommet Set	2011-10	ES 72233	Valve Cover	
QTY	VALVE STEM SEAL SET	YEARS	PART NO.	DESCRIPTION	
1	Valve Stem Seal Set	2011-10	SS 71039	Premium valve stem seals incl.	
QTY	THERMOSTAT HOUSING	YEARS	PART NO.	DESCRIPTION	
1	O-Ring	2011-10	35720	Thermostat Housing	
QTY	WATER PUMP	YEARS	PART NO.	DESCRIPTION	
2	Water Pump Gasket	2011-10	35635		
1	O-Ring	2011-10	35633	Water Pump	
1	Water Pump Mounting Set	2011-10	ES 73010	Mounting gasket set; New Part Number - Check for Availability	
QTY	TIMING COVER	YEARS	PART NO.	DESCRIPTION	
1	Timing Cover Set	2011-10	TCS 45993	Must be used w/OS 30693R	
1	Camshaft Sensor Seal	2011-10	72760	Variable camshaft sensor seal; New Part Number - Check for Availability	
QTY	CARB & FUEL INJECTION	YEARS	PART NO.	DESCRIPTION	
2	Fuel Injector O-Ring Set	2011-10	ES 70599	Upper set; Injectors to fuel rail; Improved design	
2	Fuel Injector O-Ring Set	2011-10	ES 71190	Lower set; Injectors to cylinder head	
2	Fuel Injector O-Ring Set	2011-10	ES 71192	Upper set; Injectors to fuel rail; Old design	
1	Throttle Body Gasket	2011-10	61469		
QTY	OIL FILTER MOUNTING	YEARS	PART NO.	DESCRIPTION	
1	Oil Cooler Gasket	2011-10	72462	Oil Filter; Center tube; Dual round port	
QTY	OIL PUMP COVER	YEARS	PART NO.	DESCRIPTION	
1	O-Ring	2011-10	72401	Oil Pump; Inlet tube	
QTY	OIL COOLER	YEARS	PART NO.	DESCRIPTION	
1	Oil Cooler Gasket	2011-10	72435	Oval port	
1	Oil Cooler Gasket	2011-10	72462	Dual round port	
77		2010 - 2007; 6.0L 364 (5967cc) OHV V8 (16 Valve) 101.6mm Bore Vortec			77
MFI; Gasoline; Naturally Aspirated GMC Eng.; Chevrolet; VIN Code K					
QTY	CYLINDER HEAD	YEARS	PART NO.	DESCRIPTION	
2	Head Gasket	2010-07	26192 PT	Head bolts not incl.; Head bolt replacement recommended; PermaTorqueMLS® LaserWeld® Technology	
1	Head Set	2010-07	HS 26192 PT-5	Head bolts not incl.; Head bolt replacement recommended; PermaDry® molded rubber valve cover gskts. incl.; Premium valve stem seals incl.; New Part Number - Check for Availability	

GMC Truck (Incl. Minivans and SUV's) (Cont.)

77 (cont.)	2010 - 2007; 6.0L 364 (5967cc) OHV V8 (16 Valve) 101.6mm Bore Vortec MFI; Gasoline; Naturally Aspirated GMC Eng.; Chevrolet; VIN Code K				77 (cont.)
QTY	CYLINDER HEAD	YEARS	PART NO.	DESCRIPTION	
2	Head Bolt Set	2010-09	ES 72390	Replacement recommended; New Part Number - Check for Availability	
2	Head Bolt Set	2008-07	ES 72220	Replacement recommended	
QTY	CONVERSION SET	YEARS	PART NO.	DESCRIPTION	
1	Gasket Conversion Set	2010-07	CS 9284	PermaDry® molded rubber oil pan gskt. incl.	
QTY	MANIFOLD - INT. & EXH.	YEARS	PART NO.	DESCRIPTION	
1	Int. Manifold Gasket Set	2010-07	MS 96169	Lifter valley cover set	
1	Int. Manifold Gasket Set	2010-07	MS 97126	New Part Number - Check for Availability	
1	Exh. Manifold Gasket Set	2010-07	MS 92467		
QTY	EXHAUST PIPE FLANGE	YEARS	PART NO.	DESCRIPTION	
1	Exhaust Pipe Gasket	2010-07	61323	Loc. L.H.; Pipe to manifold	
1	Exhaust Pipe Gasket	2010-08	61089	Exc. Chevrolet Silverado 2500 HD LS, LT, LTZ, WT, Silverado 3500 LS, LT, LTZ, WT GMC Sierra 2500 HD SL, SLE, SLT, WT, Sierra 3500 SL, SLE, SLT, WT; Loc. R.H.; Pipe to manifold	
1	Exhaust Pipe Gasket	2010-08	61694	Chevrolet Silverado 2500 HD LS, LT, LTZ, WT, Silverado 3500 LS, LT, LTZ, WT GMC Sierra 2500 HD SL, SLE, SLT, WT, Sierra 3500 SL, SLE, SLT, WT; Loc. R.H.; Pipe to manifold; New Part Number - Check for Availability	
1	Exhaust Pipe Gasket	2010	61287	Exc. Chevrolet Express 2500 Van Base, LS, LT, Express 3500 Van Base, LS, LT GMC Savana 2500 Base, LS, LT, SL, SLE, Savana 3500 Base, LS, LT, SL, SLE; Converter	
1	Exhaust Pipe Gasket	2010	61559	Chevrolet Express 2500 Van Base, LS, LT, Express 3500 Van Base, LS, LT GMC Savana 2500 Base, LS, LT, SL, SLE, Savana 3500 Base, LS, LT, SL, SLE; Converter; 3-bolt	
1	Exhaust Pipe Gasket	2009-08	61287	Exc. Chevrolet Express 2500 Van Base, LS, LT, Express 3500 Van Base, LS, LT GMC Savana 2500 Base, LS, LT, Savana 3500 Base, LS, LT; Converter	
1	Exhaust Pipe Gasket	2009-08	61559	Chevrolet Express 2500 Van Base, LS, LT, Express 3500 Van Base, LS, LT GMC Savana 2500 Base, LS, LT, Savana 3500 Base, LS, LT; Converter; 3-bolt	
1	Exhaust Pipe Gasket	2007	61089	Exc. Chevrolet Silverado 2500 HD LT, LTZ, WT, Silverado 3500 LS, LT, LTZ, WT GMC Sierra 2500 HD SLE, SLT, WT, Sierra 3500 SL, SLE, SLT, WT; Loc. R.H.; Pipe to manifold	
1	Exhaust Pipe Gasket	2007	61287	Converter	
1	Exhaust Pipe Gasket	2007	61694	Chevrolet Silverado 2500 HD LT, LTZ, WT, Silverado 3500 LS, LT, LTZ, WT GMC Sierra 2500 HD SLE, SLT, WT, Sierra 3500 SL, SLE, SLT, WT; Loc. R.H.; Pipe to manifold; New Part Number - Check for Availability	
QTY	OIL PAN	YEARS	PART NO.	DESCRIPTION	
1	Oil Pan Gasket Set	2010-07	OS 30693 R	PermaDry® molded rubber gskt. incl.	
QTY	CRANKSHAFT REAR SEAL	YEARS	PART NO.	DESCRIPTION	
1	Rear Main Seal Set	2010-07	BS 40640	PTFE Rubber; One-piece	
1	Repair Sleeve	2010-07	16228	Crankshaft; Narrow lip; .780" sleeve length; Requires crankshaft machining due to clearance issues; Use w/installation tool	
1	Repair Sleeve	2010-07	16229	Crankshaft; Wide lip; 1.156" sleeve length; Requires crankshaft machining due to clearance issues; Use w/installation tool	
1	Repair Sleeve Tool	2010-07	16329	Crankshaft	
QTY	VALVE COVER	YEARS	PART NO.	DESCRIPTION	
1	Valve Cover Gasket Set	2010-07	VS 50504 R	w/o Grommets; PermaDry® molded rubber gskts. incl.	
1	Valve Cover Gasket Set	2010-07	VS 50504 R-1	w/Grommets; PermaDry® molded rubber gskts. incl.; New Part Number - Check for Availability	
1	Grommet Set	2010-07	ES 72233	Valve Cover	
QTY	VALVE STEM SEAL SET	YEARS	PART NO.	DESCRIPTION	
1	Valve Stem Seal Set	2010-07	SS 71039	Premium valve stem seals incl.	
QTY	THERMOSTAT HOUSING	YEARS	PART NO.	DESCRIPTION	
1	O-Ring	2010-07	35720	Thermostat Housing	
QTY	WATER PUMP	YEARS	PART NO.	DESCRIPTION	
2	Water Pump Gasket	2010-07	35635		
1	O-Ring	2010-07	35633	Water Pump	
1	Water Pump Mounting Set	2010-07	ES 73010	Mounting gasket set; New Part Number - Check for Availability	
QTY	TIMING COVER	YEARS	PART NO.	DESCRIPTION	
1	Timing Cover Set	2010-07	TCS 45993	Must be used w/OS 30693R	
1	Camshaft Sensor Seal	2010-07	72760	Variable camshaft sensor seal; New Part Number - Check for Availability	
QTY	CARB & FUEL INJECTION	YEARS	PART NO.	DESCRIPTION	
2	Fuel Injector O-Ring Set	2010-07	ES 70599	Upper set; Injectors to fuel rail; Improved design	
2	Fuel Injector O-Ring Set	2010-07	ES 71190	Lower set; Injectors to cylinder head	

GMC Truck (Incl. Minivans and SUV's) (Cont.)

77		2010 - 2007; 6.0L 364 (5967cc) OHV V8 (16 Valve) 101.6mm Bore Vortec			77
(cont.)		MFI; Gasoline; Naturally Aspirated GMC Eng.; Chevrolet; VIN Code K			(cont.)
QTY	CARB & FUEL INJECTION	YEARS	PART NO.	DESCRIPTION	
2	Fuel Injector O-Ring Set	2010-07	ES 71192	Upper set; Injectors to fuel rail; Old design	
1	Throttle Body Gasket	2010-07	61469		
QTY	OIL FILTER MOUNTING	YEARS	PART NO.	DESCRIPTION	
1	Oil Cooler Gasket	2010-07	72462	Oil Filter; Center tube; Dual round port	
QTY	OIL PUMP COVER	YEARS	PART NO.	DESCRIPTION	
1	O-Ring	2010-07	72401	Oil Pump; Inlet tube	
QTY	OIL COOLER	YEARS	PART NO.	DESCRIPTION	
1	Oil Cooler Gasket	2010-07	72435	Oval port	
1	Oil Cooler Gasket	2010-07	72462	Dual round port	
78		2008 - 1999; 6.0L 364 (5967cc) OHV V8 (16 Valve) 101.6mm Bore Vortec			78
		MFI; Gasoline; Naturally Aspirated GMC Eng.; Chevrolet; VIN Code U			
QTY	CYLINDER HEAD	YEARS	PART NO.	DESCRIPTION	
2	Head Gasket	2008-01	26192 PT	Head bolts not incl.; Head bolt replacement recommended; PermaTorqueMLS® LaserWeld® Technology	
2	Head Gasket	2000-99	9199 PT	Head bolts not incl.; Head bolt replacement recommended	
1	Head Set	2008-04	HS 26192 PT-2	Head bolts not incl.; Head bolt replacement recommended; PermaDryPlus® int. manifold gsks. incl.; PermaDry® molded rubber valve cover gsks. incl.; Premium valve stem seals incl.	
1	Head Set	2003-02	HS 26192 PT	Head bolts not incl.; Head bolt replacement recommended; PermaDryPlus® int. manifold gsks. incl.; PermaDry® molded rubber valve cover gsks. incl.; Premium valve stem seals incl.	
1	Head Set	2001	HS 26192 PT	2nd Design; Top-Hat Design valve stem seals; Head bolts not incl.; Head bolt replacement recommended; PermaDryPlus® int. manifold gsks. incl.; PermaDry® molded rubber valve cover gsks. incl.; Premium valve stem seals incl.	
1	Head Set	2001	HS 26192 PT-1	1st Design; Positive type valve stem seals; Head bolts not incl.; Head bolt replacement recommended; PermaDryPlus® int. manifold gsks. incl.; PermaDry® molded rubber valve cover gsks. incl.; Premium valve stem seals incl.	
1	Head Set	2000-99	HS 9199 PT	Head bolts not incl.; Head bolt replacement recommended; PermaDryPlus® int. manifold gsks. incl.; PermaDry® molded rubber valve cover gsks. incl.; Premium valve stem seals incl.	
2	Head Bolt Set	2008-04	ES 72220	2nd Design; Replacement recommended	
2	Head Bolt Set	2004-99	ES 72173	1st Design; Replacement recommended	
QTY	CONVERSION SET	YEARS	PART NO.	DESCRIPTION	
1	Gasket Conversion Set	2008-99	CS 9284	PermaDry® molded rubber oil pan gskt. incl.	
QTY	MANIFOLD - INT. & EXH.	YEARS	PART NO.	DESCRIPTION	
1	Int. Manifold Gasket Set	2008-99	MS 92465	Lifter valley cover set	
1	Int. Manifold Gasket Set	2008-99	MS 98016 T	PermaDryPlus® int. manifold gsks. incl.	
1	Int. Manifold Gasket Set	2008-04	MS 96587		
1	Int. Manifold Gasket Set	2003-99	MS 92211		
1	Exh. Manifold Gasket Set	2008-99	MS 92467		
QTY	EXHAUST PIPE FLANGE	YEARS	PART NO.	DESCRIPTION	
1	Exhaust Pipe Gasket	2008-99	61287	Converter	
2	Exhaust Pipe Gasket	2008-01	61323	Pipe to manifold	
2	Exhaust Pipe Gasket	2000-99	61074	Pipe to manifold	
QTY	OIL PAN	YEARS	PART NO.	DESCRIPTION	
1	Oil Pan Gasket Set	2008-99	OS 30693 R	PermaDry® molded rubber gskt. incl.	
QTY	CRANKSHAFT REAR SEAL	YEARS	PART NO.	DESCRIPTION	
1	Rear Main Seal Set	2008-99	BS 40640	PTFE Rubber; One-piece	
1	Repair Sleeve	2008-99	16228	Crankshaft; Narrow lip; .780" sleeve length; Requires crankshaft machining due to clearance issues; Use w/installation tool	
1	Repair Sleeve	2008-99	16229	Crankshaft; Wide lip; 1.156" sleeve length; Requires crankshaft machining due to clearance issues; Use w/installation tool	
1	Repair Sleeve Tool	2008-99	16329	Crankshaft	
QTY	VALVE COVER	YEARS	PART NO.	DESCRIPTION	
1	Valve Cover Gasket Set	2008-99	VS 50504 R	w/o Grommets; PermaDry® molded rubber gsks. incl.	
1	Valve Cover Gasket Set	2008-99	VS 50504 R-1	w/Grommets; PermaDry® molded rubber gsks. incl.; New Part Number - Check for Availability	
1	Grommet Set	2008-99	ES 72233	Valve Cover	
QTY	VALVE STEM SEAL SET	YEARS	PART NO.	DESCRIPTION	
1	Valve Stem Seal Set	2008-01	SS 71039	2nd Design; Top-Hat Design seal; Premium valve stem seals incl.	

GMC Truck (Incl. Minivans and SUV's) (Cont.)

78 (cont.)		2008 - 1999; 6.0L 364 (5967cc) OHV V8 (16 Valve) 101.6mm Bore Vortec			78 (cont.)
		MFI; Gasoline; Naturally Aspirated GMC Eng.; Chevrolet; VIN Code U			
QTY	VALVE STEM SEAL SET	YEARS	PART NO.	DESCRIPTION	
1	Valve Stem Seal Set	2001-99	SS 70945	1st Design; Positive type seal; Premium valve stem seals incl.	
QTY	THERMOSTAT HOUSING	YEARS	PART NO.	DESCRIPTION	
1	Thermostat Gasket	2003-99	35632	Thermostat Housing; Thermostat O-ring	
1	O-Ring	2008-04	35720	Thermostat Housing	
QTY	WATER PUMP	YEARS	PART NO.	DESCRIPTION	
2	Water Pump Gasket	2008-99	35635		
1	O-Ring	2008-99	35633	Water Pump	
1	Water Pump Mounting Set	2008-99	ES 73010	Mounting gasket set; New Part Number - Check for Availability	
QTY	TIMING COVER	YEARS	PART NO.	DESCRIPTION	
1	Timing Cover Set	2008-99	TCS 45993	Must be used w/OS 30693R	
QTY	CARB & FUEL INJECTION	YEARS	PART NO.	DESCRIPTION	
2	Fuel Injector O-Ring Set	2008-99	ES 70599	Upper set; Injectors to fuel rail; Improved design	
2	Fuel Injector O-Ring Set	2008-99	ES 71190	Lower set; Injectors to cylinder head	
2	Fuel Injector O-Ring Set	2008-01	ES 71192	Upper set; Injectors to fuel rail; Old design	
1	Throttle Body Gasket	2008-99	61070		
QTY	EXHAUST GAS RECIRCULATION	YEARS	PART NO.	DESCRIPTION	
1	EGR Gasket	2008-99	70895	Pipe; O-ring	
1	EGR Gasket	2008-99	70914	Valve	
1	EGR Gasket	2008-99	70947	Pipe	
QTY	OIL FILTER MOUNTING	YEARS	PART NO.	DESCRIPTION	
1	Oil Cooler Gasket	2008-99	72462	Oil Filter; Center tube; Dual round port	
QTY	OIL PUMP COVER	YEARS	PART NO.	DESCRIPTION	
1	O-Ring	2008-99	72401	Oil Pump; Inlet tube	
QTY	OIL COOLER	YEARS	PART NO.	DESCRIPTION	
1	Oil Cooler Gasket	2008-99	72435	Oval port	
1	Oil Cooler Gasket	2008-99	72462	Dual round port	
79		2010 - 2007; 6.0L 364 (5967cc) OHV V8 (16 Valve) 101.6mm Bore Vortec			79
		MFI; Gasoline; Naturally Aspirated GMC Eng.; Chevrolet; VIN Code Y			
QTY	CYLINDER HEAD	YEARS	PART NO.	DESCRIPTION	
2	Head Gasket	2010-07	26192 PT	Head bolts not incl.; Head bolt replacement recommended; PermaTorqueMLS® LaserWeld® Technology	
1	Head Set	2010-07	HS 26192 PT-6	Head bolts not incl.; Head bolt replacement recommended; PermaDry® molded rubber valve cover gskts. incl.; Premium valve stem seals incl.; New Part Number - Check for Availability	
2	Head Bolt Set	2010-08	ES 72390	Replacement recommended; New Part Number - Check for Availability	
2	Head Bolt Set	2007	ES 72220	Replacement recommended	
QTY	CONVERSION SET	YEARS	PART NO.	DESCRIPTION	
1	Gasket Conversion Set	2010-07	CS 9284	PermaDry® molded rubber oil pan gskt. incl.	
QTY	MANIFOLD - INT. & EXH.	YEARS	PART NO.	DESCRIPTION	
1	Int. Manifold Gasket Set	2010-07	MS 96857	Lifter valley cover set; Perimeter seal only	
1	Int. Manifold Gasket Set	2010-07	MS 97126	New Part Number - Check for Availability	
1	Exh. Manifold Gasket Set	2010-07	MS 92467		
QTY	EXHAUST PIPE FLANGE	YEARS	PART NO.	DESCRIPTION	
1	Exhaust Pipe Gasket	2010-07	61089	Loc. R.H.; Pipe to manifold	
1	Exhaust Pipe Gasket	2010-07	61287	Converter	
1	Exhaust Pipe Gasket	2010-07	61323	Loc. L.H.; Pipe to manifold	
QTY	OIL PAN	YEARS	PART NO.	DESCRIPTION	
1	Oil Pan Gasket Set	2010-07	OS 30693 R	PermaDry® molded rubber gskt. incl.	
QTY	CRANKSHAFT REAR SEAL	YEARS	PART NO.	DESCRIPTION	
1	Rear Main Seal Set	2010-07	BS 40640	PTFE Rubber; One-piece	
1	Repair Sleeve	2010-07	16228	Crankshaft; Narrow lip; .780" sleeve length; Requires crankshaft machining due to clearance issues; Use w/installation tool	
1	Repair Sleeve	2010-07	16229	Crankshaft; Wide lip; 1.156" sleeve length; Requires crankshaft machining due to clearance issues; Use w/installation tool	
1	Repair Sleeve Tool	2010-07	16329	Crankshaft	
QTY	VALVE COVER	YEARS	PART NO.	DESCRIPTION	
1	Valve Cover Gasket Set	2010-07	VS 50504 R	w/o Grommets; PermaDry® molded rubber gskts. incl.	
1	Valve Cover Gasket Set	2010-07	VS 50504 R-1	w/Grommets; PermaDry® molded rubber gskts. incl.; New Part Number - Check for Availability	
1	Grommet Set	2010-07	ES 72233	Valve Cover	
QTY	VALVE STEM SEAL SET	YEARS	PART NO.	DESCRIPTION	
1	Valve Stem Seal Set	2010-07	SS 71039	Premium valve stem seals incl.	

GMC Truck (Incl. Minivans and SUV's) (Cont.)

79		2010 - 2007; 6.0L 364 (5967cc) OHV V8 (16 Valve) 101.6mm Bore Vortec			79
(cont.)		MFI; Gasoline; Naturally Aspirated GMC Eng.; Chevrolet; VIN Code Y			(cont.)
QTY	THERMOSTAT HOUSING	YEARS	PART NO.	DESCRIPTION	
1	O-Ring	2010-07	35720	Thermostat Housing	
QTY	WATER PUMP	YEARS	PART NO.	DESCRIPTION	
2	Water Pump Gasket	2010-07	35635		
1	O-Ring	2010-07	35633	Water Pump	
1	Water Pump Mounting Set	2010-07	ES 73010	Mounting gasket set; New Part Number - Check for Availability	
QTY	TIMING COVER	YEARS	PART NO.	DESCRIPTION	
1	Timing Cover Set	2010-07	TCS 45993	Must be used w/OS 30693R	
1	Camshaft Sensor Seal	2010-07	72760	Variable camshaft sensor seal; New Part Number - Check for Availability	
QTY	CARB & FUEL INJECTION	YEARS	PART NO.	DESCRIPTION	
2	Fuel Injector O-Ring Set	2010-07	ES 70599	Upper set; Injectors to fuel rail; Improved design	
2	Fuel Injector O-Ring Set	2010-07	ES 71190	Lower set; Injectors to cylinder head	
2	Fuel Injector O-Ring Set	2010-07	ES 71192	Upper set; Injectors to fuel rail; Old design	
1	Throttle Body Gasket	2010-07	61469		
QTY	OIL FILTER MOUNTING	YEARS	PART NO.	DESCRIPTION	
1	Oil Cooler Gasket	2010-07	72462	Oil Filter; Center tube; Dual round port	
QTY	OIL PUMP COVER	YEARS	PART NO.	DESCRIPTION	
1	O-Ring	2010-07	72401	Oil Pump; Inlet tube	
QTY	OIL COOLER	YEARS	PART NO.	DESCRIPTION	
1	Oil Cooler Gasket	2010-07	72435	Oval port	
1	Oil Cooler Gasket	2010-07	72462	Dual round port	
80		2007 - 2002; 6.0L 364 (5967cc) OHV V8 (16 Valve) 101.6mm Bore Vortec H.O.			80
(cont.)		MFI; Gasoline; Naturally Aspirated GMC Eng.; Chevrolet; VIN Code N			(cont.)
QTY	CYLINDER HEAD	YEARS	PART NO.	DESCRIPTION	
2	Head Gasket	2007-02	26192 PT	Head bolts not incl.; Head bolt replacement recommended; PermaTorqueMLS® LaserWeld® Technology	
1	Head Set	2007-04	HS 26192 PT-2	Head bolts not incl.; Head bolt replacement recommended; PermaDryPlus® int. manifold gsks. incl.; PermaDry® molded rubber valve cover gsks. incl.; Premium valve stem seals incl.	
1	Head Set	2003-02	HS 26192 PT	Head bolts not incl.; Head bolt replacement recommended; PermaDryPlus® int. manifold gsks. incl.; PermaDry® molded rubber valve cover gsks. incl.; Premium valve stem seals incl.	
2	Head Bolt Set	2007-04	ES 72220	2nd Design; Replacement recommended	
2	Head Bolt Set	2004-02	ES 72173	1st Design; Replacement recommended	
QTY	CONVERSION SET	YEARS	PART NO.	DESCRIPTION	
1	Gasket Conversion Set	2007-02	CS 9284	PermaDry® molded rubber oil pan gskt. incl.	
QTY	MANIFOLD - INT. & EXH.	YEARS	PART NO.	DESCRIPTION	
1	Int. Manifold Gasket Set	2007-02	MS 92465	Lifter valley cover set	
1	Int. Manifold Gasket Set	2007-02	MS 98016 T	PermaDryPlus® int. manifold gsks. incl.	
1	Int. Manifold Gasket Set	2007-04	MS 96587		
1	Int. Manifold Gasket Set	2003-02	MS 92211		
1	Exh. Manifold Gasket Set	2007-02	MS 92467		
QTY	EXHAUST PIPE FLANGE	YEARS	PART NO.	DESCRIPTION	
1	Exhaust Pipe Gasket	2007-02	61287	Converter	
2	Exhaust Pipe Gasket	2007-02	61323	Pipe to manifold	
QTY	OIL PAN	YEARS	PART NO.	DESCRIPTION	
1	Oil Pan Gasket Set	2007-02	OS 30693 R	PermaDry® molded rubber gskt. incl.	
QTY	CRANKSHAFT REAR SEAL	YEARS	PART NO.	DESCRIPTION	
1	Rear Main Seal Set	2007-02	BS 40640	PTFE Rubber; One-piece	
1	Repair Sleeve	2007-02	16228	Crankshaft; Narrow lip; .780" sleeve length; Requires crankshaft machining due to clearance issues; Use w/installation tool	
1	Repair Sleeve	2007-02	16229	Crankshaft; Wide lip; 1.156" sleeve length; Requires crankshaft machining due to clearance issues; Use w/installation tool	
1	Repair Sleeve Tool	2007-02	16329	Crankshaft	
QTY	VALVE COVER	YEARS	PART NO.	DESCRIPTION	
1	Valve Cover Gasket Set	2007-02	VS 50504 R	w/o Grommets; PermaDry® molded rubber gsks. incl.	
1	Valve Cover Gasket Set	2007-02	VS 50504 R-1	w/Grommets; PermaDry® molded rubber gsks. incl.; New Part Number - Check for Availability	
1	Grommet Set	2007-02	ES 72233	Valve Cover	
QTY	VALVE STEM SEAL SET	YEARS	PART NO.	DESCRIPTION	
1	Valve Stem Seal Set	2007-02	SS 71039	2nd Design; Top-Hat Design seal; Premium valve stem seals incl.	
QTY	THERMOSTAT HOUSING	YEARS	PART NO.	DESCRIPTION	
1	Thermostat Gasket	2003-02	35632	Thermostat Housing; Thermostat O-ring	

GMC Truck (Incl. Minivans and SUV's) (Cont.)

80 (cont.)	2007 - 2002; 6.0L 364 (5967cc) OHV V8 (16 Valve) 101.6mm Bore Vortec H.O.			80 (cont.)
MFI; Gasoline; Naturally Aspirated GMC Eng.; Chevrolet; VIN Code N				
QTY	THERMOSTAT HOUSING	YEARS	PART NO.	DESCRIPTION
1	O-Ring	2007-04	35720	Thermostat Housing
QTY	WATER PUMP	YEARS	PART NO.	DESCRIPTION
2	Water Pump Gasket	2007-02	35635	
1	O-Ring	2007-02	35633	Water Pump
1	Water Pump Mounting Set	2007-02	ES 73010	Mounting gasket set; New Part Number - Check for Availability
QTY	TIMING COVER	YEARS	PART NO.	DESCRIPTION
1	Timing Cover Set	2007-02	TCS 45993	Must be used w/OS 30693R
QTY	CARB & FUEL INJECTION	YEARS	PART NO.	DESCRIPTION
2	Fuel Injector O-Ring Set	2007-02	ES 70599	Upper set; Injectors to fuel rail; Improved design
2	Fuel Injector O-Ring Set	2007-02	ES 71190	Lower set; Injectors to cylinder head
2	Fuel Injector O-Ring Set	2007-02	ES 71192	Upper set; Injectors to fuel rail; Old design
1	Throttle Body Gasket	2007-02	61070	
QTY	EXHAUST GAS RECIRCULATION	YEARS	PART NO.	DESCRIPTION
1	EGR Gasket	2007-02	70895	Pipe; O-ring
1	EGR Gasket	2007-02	70914	Valve
1	EGR Gasket	2007-02	70947	Pipe
QTY	OIL FILTER MOUNTING	YEARS	PART NO.	DESCRIPTION
1	Oil Cooler Gasket	2007-02	72462	Oil Filter; Center tube; Dual round port
QTY	OIL PUMP COVER	YEARS	PART NO.	DESCRIPTION
1	O-Ring	2007-02	72401	Oil Pump; Inlet tube
QTY	OIL COOLER	YEARS	PART NO.	DESCRIPTION
1	Oil Cooler Gasket	2007-02	72435	Oval port
1	Oil Cooler Gasket	2007-02	72462	Dual round port
81	2009 - 2005; 6.0L 364 (5967cc) OHV V8 (16 Valve) 101.6mm Bore Vortec LS-2			81
MFI; Gasoline; Naturally Aspirated GMC Eng.; Chevrolet; VIN Code H				
QTY	CYLINDER HEAD	YEARS	PART NO.	DESCRIPTION
2	Head Gasket	2009-05	26192 PT	Head bolts not incl.; Head bolt replacement recommended; PermaTorqueMLS® LaserWeld® Technology
1	Head Set	2009-05	HS 26192 PT-4	Head bolts not incl.; Head bolt replacement recommended; PermaDryPlus® int. manifold gsks. incl.; PermaDry® molded rubber valve cover gsks. incl.; Premium valve stem seals incl.
2	Head Bolt Set	2009-05	ES 72220	2nd Design; Replacement recommended
QTY	CONVERSION SET	YEARS	PART NO.	DESCRIPTION
1	Gasket Conversion Set	2009-05	CS 9284	PermaDry® molded rubber oil pan gskt. incl.
QTY	MANIFOLD - INT. & EXH.	YEARS	PART NO.	DESCRIPTION
1	Int. Manifold Gasket Set	2009-05	MS 96169	Lifter valley cover set
1	Int. Manifold Gasket Set	2009-05	MS 96587	
1	Int. Manifold Gasket Set	2009-05	MS 98016 T	PermaDryPlus® int. manifold gsks. incl.
1	Exh. Manifold Gasket Set	2009-05	MS 92467	
QTY	EXHAUST PIPE FLANGE	YEARS	PART NO.	DESCRIPTION
1	Exhaust Pipe Gasket	2009-05	61089	Loc. R.H.; Pipe to manifold
1	Exhaust Pipe Gasket	2009-05	61287	Converter
1	Exhaust Pipe Gasket	2009-05	61323	Loc. L.H.; Pipe to manifold
QTY	OIL PAN	YEARS	PART NO.	DESCRIPTION
1	Oil Pan Gasket Set	2009-05	OS 30693 R	PermaDry® molded rubber gskt. incl.
QTY	CRANKSHAFT REAR SEAL	YEARS	PART NO.	DESCRIPTION
1	Rear Main Seal Set	2009-05	BS 40640	PTFE Rubber; One-piece
1	Repair Sleeve	2009-05	16228	Crankshaft; Narrow lip; .780" sleeve length; Requires crankshaft machining due to clearance issues; Use w/installation tool
1	Repair Sleeve	2009-05	16229	Crankshaft; Wide lip; 1.156" sleeve length; Requires crankshaft machining due to clearance issues; Use w/installation tool
1	Repair Sleeve Tool	2009-05	16329	Crankshaft
QTY	VALVE COVER	YEARS	PART NO.	DESCRIPTION
1	Valve Cover Gasket Set	2009-05	VS 50504 R	w/o Grommets; PermaDry® molded rubber gsks. incl.
1	Valve Cover Gasket Set	2009-05	VS 50504 R-1	w/Grommets; PermaDry® molded rubber gsks. incl.; New Part Number - Check for Availability
1	Grommet Set	2009-05	ES 72233	Valve Cover
QTY	VALVE STEM SEAL SET	YEARS	PART NO.	DESCRIPTION
1	Valve Stem Seal Set	2009-05	SS 71039	2nd Design; Top-Hat Design seal; Premium valve stem seals incl.
QTY	THERMOSTAT HOUSING	YEARS	PART NO.	DESCRIPTION
1	O-Ring	2009-05	35720	Thermostat Housing
QTY	WATER PUMP	YEARS	PART NO.	DESCRIPTION
2	Water Pump Gasket	2009-05	35635	

GMC Truck (Incl. Minivans and SUV's) (Cont.)

81		2009 - 2005; 6.0L 364 (5967cc) OHV V8 (16 Valve) 101.6mm Bore Vortec LS-2			81	
(cont.)		MFI; Gasoline; Naturally Aspirated GMC Eng.; Chevrolet; VIN Code H			(cont.)	
QTY	WATER PUMP	YEARS	PART NO.	DESCRIPTION		
1	O-Ring	2009-05	35633	Water Pump		
1	Water Pump Mounting Set	2009-05	ES 73010	Mounting gasket set; New Part Number - Check for Availability		
QTY	TIMING COVER	YEARS	PART NO.	DESCRIPTION		
1	Timing Cover Set	2009-05	TCS 45993	Must be used w/OS 30693R		
QTY	CARB & FUEL INJECTION	YEARS	PART NO.	DESCRIPTION		
2	Fuel Injector O-Ring Set	2009-05	ES 70599	Upper set; Injectors to fuel rail; Improved design		
2	Fuel Injector O-Ring Set	2009-05	ES 71190	Lower set; Injectors to cylinder head		
2	Fuel Injector O-Ring Set	2009-05	ES 71192	Upper set; Injectors to fuel rail; Old design		
1	Throttle Body Gasket	2009-06	61469			
1	Throttle Body Gasket	2005	61454			
QTY	EXHAUST GAS RECIRCULATION	YEARS	PART NO.	DESCRIPTION		
1	EGR Gasket	2009-05	70895	Pipe; O-ring		
1	EGR Gasket	2009-05	70914	Valve		
1	EGR Gasket	2009-05	70947	Pipe		
QTY	OIL FILTER MOUNTING	YEARS	PART NO.	DESCRIPTION		
1	Oil Cooler Gasket	2009-05	72462	Oil Filter; Center tube; Dual round port		
QTY	OIL PUMP COVER	YEARS	PART NO.	DESCRIPTION		
1	O-Ring	2009-05	72401	Oil Pump; Inlet tube		
QTY	OIL COOLER	YEARS	PART NO.	DESCRIPTION		
1	Oil Cooler Gasket	2009-05	72435	Oval port		
1	Oil Cooler Gasket	2009-05	72462	Dual round port		
82		2013 - 2010; 6.0L 364 (5967cc) OHV V8 (16 Valve) 101.6mm Bore Vortec VVT			82	
(cont.)		MFI; Flex Fuel; Naturally Aspirated GMC Eng.; Chevrolet; VIN Code G			(cont.)	
QTY	CYLINDER HEAD	YEARS	PART NO.	DESCRIPTION		
2	Head Gasket	2011-10	26192 PT	Head bolts not incl.; Head bolt replacement recommended; PermaTorqueMLS® LaserWeld® Technology		
1	Head Set	2011-10	HS 26192 PT-5	Head bolts not incl.; Head bolt replacement recommended; PermaDry® molded rubber valve cover gskts. incl.; Premium valve stem seals incl.; New Part Number - Check for Availability		
2	Head Bolt Set	2012-10	ES 72390	Replacement recommended; New Part Number - Check for Availability		
QTY	CONVERSION SET	YEARS	PART NO.	DESCRIPTION		
1	Gasket Conversion Set	2011-10	CS 9284	PermaDry® molded rubber oil pan gskt. incl.		
QTY	MANIFOLD - INT. & EXH.	YEARS	PART NO.	DESCRIPTION		
1	Int. Manifold Gasket Set	2011-10	MS 96169	Lifter valley cover set		
1	Int. Manifold Gasket Set	2011-10	MS 97126	New Part Number - Check for Availability		
1	Exh. Manifold Gasket Set	2011-10	MS 92467			
QTY	EXHAUST PIPE FLANGE	YEARS	PART NO.	DESCRIPTION		
1	Exhaust Pipe Gasket	2013-10	61287	Exc. Chevrolet Express 2500 Van Base, LS, LT, Express 3500 Van Base, LS, LT, Express 4500 Van Base GMC Savana 2500 Base, LS, LT, SL, SLE, Savana 3500 Base, LS, LT, SL, SLE, Savana 4500 Base; Converter		
1	Exhaust Pipe Gasket	2013-10	61323	Loc. L.H.; Pipe to manifold		
1	Exhaust Pipe Gasket	2013-10	61559	Chevrolet Express 2500 Van Base, LS, LT, Express 3500 Van Base, LS, LT, Express 4500 Van Base GMC Savana 2500 Base, LS, LT, SL, SLE, Savana 3500 Base, LS, LT, SL, SLE, Savana 4500 Base; Converter; 3-bolt		
1	Exhaust Pipe Gasket	2013-10	61561	Chevrolet Express 2500 Van Base, LS, LT, Express 3500 Van Base, LS, LT, Express 4500 Van Base GMC Savana 2500 Base, LS, LT, SL, SLE, Savana 3500 Base, LS, LT, SL, SLE, Savana 4500 Base; Converter; 2-bolt		
1	Exhaust Pipe Gasket	2013-11	61089	Exc. Chevrolet Silverado 2500 HD LS, LT, LTZ, WT, Silverado 3500 HD LS, LT, LTZ, WT GMC Sierra 2500 HD Denali, SL, SLE, SLT, WT, Sierra 3500 HD Denali, SL, SLE, SLT, WT; Loc. R.H.; Pipe to manifold		
1	Exhaust Pipe Gasket	2013-11	61694	Chevrolet Silverado 2500 HD LS, LT, LTZ, WT, Silverado 3500 HD LS, LT, LTZ, WT GMC Sierra 2500 HD Denali, SL, SLE, SLT, WT, Sierra 3500 HD Denali, SL, SLE, SLT, WT; Loc. R.H.; Pipe to manifold; New Part Number - Check for Availability		
1	Exhaust Pipe Gasket	2010	61089	Exc. Chevrolet Silverado 2500 HD LS, LT, LTZ, WT, Silverado 3500 LS, LT, LTZ, WT GMC Sierra 2500 HD SL, SLE, SLT, WT, Sierra 3500 SL, SLE, SLT, WT; Loc. R.H.; Pipe to manifold		
1	Exhaust Pipe Gasket	2010	61694	Chevrolet Silverado 2500 HD LS, LT, LTZ, WT, Silverado 3500 LS, LT, LTZ, WT GMC Sierra 2500 HD SL, SLE, SLT, WT, Sierra 3500 SL, SLE, SLT, WT; Loc. R.H.; Pipe to manifold; New Part Number - Check for Availability		
QTY	OIL PAN	YEARS	PART NO.	DESCRIPTION		
1	Oil Pan Gasket Set	2011-10	OS 30693 R	PermaDry® molded rubber gskt. incl.		

GMC Truck (Incl. Minivans and SUV's) (Cont.)

82 (cont.)		2013 - 2010; 6.0L 364 (5967cc) OHV V8 (16 Valve) 101.6mm Bore Vortec VVT			82 (cont.)
		MFI; Flex Fuel; Naturally Aspirated GMC Eng.; Chevrolet; VIN Code G			
QTY	CRANKSHAFT REAR SEAL	YEARS	PART NO.	DESCRIPTION	
1	Rear Main Seal Set	2011-10	BS 40640	PTFE Rubber; One-piece	
1	Repair Sleeve	2011-10	16228	Crankshaft; Narrow lip; .780" sleeve length; Requires crankshaft machining due to clearance issues; Use w/installation tool	
1	Repair Sleeve	2011-10	16229	Crankshaft; Wide lip; 1.156" sleeve length; Requires crankshaft machining due to clearance issues; Use w/installation tool	
1	Repair Sleeve Tool	2011-10	16329	Crankshaft	
QTY	VALVE COVER	YEARS	PART NO.	DESCRIPTION	
1	Valve Cover Gasket Set	2011-10	VS 50504 R	w/o Grommets; PermaDry® molded rubber gsks. incl.	
1	Valve Cover Gasket Set	2011-10	VS 50504 R-1	w/Grommets; PermaDry® molded rubber gsks. incl.; New Part Number - Check for Availability	
1	Grommet Set	2011-10	ES 72233	Valve Cover	
QTY	VALVE STEM SEAL SET	YEARS	PART NO.	DESCRIPTION	
1	Valve Stem Seal Set	2011-10	SS 71039	Premium valve stem seals incl.	
QTY	THERMOSTAT HOUSING	YEARS	PART NO.	DESCRIPTION	
1	O-Ring	2011-10	35720	Thermostat Housing	
QTY	WATER PUMP	YEARS	PART NO.	DESCRIPTION	
2	Water Pump Gasket	2011-10	35635		
1	O-Ring	2011-10	35633	Water Pump	
1	Water Pump Mounting Set	2011-10	ES 73010	Mounting gasket set; New Part Number - Check for Availability	
QTY	TIMING COVER	YEARS	PART NO.	DESCRIPTION	
1	Timing Cover Set	2011-10	TCS 45993	Must be used w/OS 30693R	
1	Camshaft Sensor Seal	2011-10	72760	Variable camshaft sensor seal; New Part Number - Check for Availability	
QTY	CARB & FUEL INJECTION	YEARS	PART NO.	DESCRIPTION	
2	Fuel Injector O-Ring Set	2011-10	ES 70599	Upper set; Injectors to fuel rail; Improved design	
2	Fuel Injector O-Ring Set	2011-10	ES 71190	Lower set; Injectors to cylinder head	
2	Fuel Injector O-Ring Set	2011-10	ES 71192	Upper set; Injectors to fuel rail; Old design	
1	Throttle Body Gasket	2011-10	61469		
QTY	OIL FILTER MOUNTING	YEARS	PART NO.	DESCRIPTION	
1	Oil Cooler Gasket	2011-10	72462	Oil Filter; Center tube; Dual round port	
QTY	OIL PUMP COVER	YEARS	PART NO.	DESCRIPTION	
1	O-Ring	2011-10	72401	Oil Pump; Inlet tube	
QTY	OIL COOLER	YEARS	PART NO.	DESCRIPTION	
1	Oil Cooler Gasket	2011-10	72435	Oval port	
1	Oil Cooler Gasket	2011-10	72462	Dual round port	
83		2013 - 2009; 6.2L 378 (6195cc) OHV V8 (16 Valve) 103.25mm Bore Vortec			83
		MFI; Flex Fuel; Naturally Aspirated GMC Eng.; Chevrolet; VIN Code 2			
QTY	CYLINDER HEAD	YEARS	PART NO.	DESCRIPTION	
2	Head Gasket	2011-09	26192 PT	Head bolts not incl.; Head bolt replacement recommended; PermaTorqueMLS® LaserWeld® Technology	
1	Head Set	2011-10	HS 26192 PT-4	Chevrolet Silverado 1500 LS, LT, LTZ, Silverado 1500 HD LT GMC Sierra 1500 SL, SLE, SLT, Sierra 1500 HD SLE, SLT, Sierra Denali Base; Head bolts not incl.; Head bolt replacement recommended; PermaDryPlus® int. manifold gsks. incl.; PermaDry® molded rubber valve cover gsks. incl.; Premium valve stem seals incl.	
1	Head Set	2011-10	HS 26192 PT-5	Exc. Chevrolet Silverado 1500 LS, LT, LTZ, Silverado 1500 HD LT GMC Sierra 1500 SL, SLE, SLT, Sierra 1500 HD SLE, SLT, Sierra Denali Base; Head bolts not incl.; Head bolt replacement recommended; PermaDry® molded rubber valve cover gsks. incl.; Premium valve stem seals incl.; New Part Number - Check for Availability	
1	Head Set	2009	HS 26192 PT-4	Exc. Cadillac Escalade Base, ESV, EXT Chevrolet Tahoe LTZ GMC Yukon Denali Base, Yukon Denali XL Base Hummer H2 Base, SUT, SUV; Head bolts not incl.; Head bolt replacement recommended; PermaDryPlus® int. manifold gsks. incl.; PermaDry® molded rubber valve cover gsks. incl.; Premium valve stem seals incl.	
1	Head Set	2009	HS 26192 PT-5	Cadillac Escalade Base, ESV, EXT Chevrolet Tahoe LTZ GMC Yukon Denali Base, Yukon Denali XL Base Hummer H2 Base, SUT, SUV; Head bolts not incl.; Head bolt replacement recommended; PermaDry® molded rubber valve cover gsks. incl.; Premium valve stem seals incl.; New Part Number - Check for Availability	
2	Head Bolt Set	2012-09	ES 72390	Replacement recommended; New Part Number - Check for Availability	
QTY	CONVERSION SET	YEARS	PART NO.	DESCRIPTION	
1	Gasket Conversion Set	2011-09	CS 9284	PermaDry® molded rubber oil pan gskt. incl.	

GMC Truck (Incl. Minivans and SUV's) (Cont.)

83 (cont.)		2013 - 2009; 6.2L 378 (6195cc) OHV V8 (16 Valve) 103.25mm Bore Vortec			83 (cont.)
MFI; Flex Fuel; Naturally Aspirated GMC Eng.; Chevrolet; VIN Code 2					
QTY	MANIFOLD - INT. & EXH.	YEARS	PART NO.	DESCRIPTION	
1	Int. Manifold Gasket Set	2011-09	MS 96169	Lifter valley cover set	
1	Int. Manifold Gasket Set	2011-10	MS 96587	Chevrolet Silverado 1500 LS, LT, LTZ, Silverado 1500 HD LT GMC Sierra 1500 SL, SLE, SLT, Sierra 1500 HD SLE, SLT, Sierra Denali Base	
1	Int. Manifold Gasket Set	2011-10	MS 97126	Exc. Chevrolet Silverado 1500 LS, LT, LTZ, Silverado 1500 HD LT GMC Sierra 1500 SL, SLE, SLT, Sierra 1500 HD SLE, SLT, Sierra Denali Base; New Part Number - Check for Availability	
1	Int. Manifold Gasket Set	2011-10	MS 98016 T	Chevrolet Silverado 1500 LS, LT, LTZ, Silverado 1500 HD LT GMC Sierra 1500 SL, SLE, SLT, Sierra 1500 HD SLE, SLT, Sierra Denali Base; PermaDryPlus® int. manifold gskts. incl.	
1	Int. Manifold Gasket Set	2009	MS 96587	Exc. Cadillac Escalade Base, ESV, EXT Chevrolet Tahoe LTZ GMC Yukon Denali Base, Yukon Denali XL Base Hummer H2 Base, SUT, SUV	
1	Int. Manifold Gasket Set	2009	MS 97126	Cadillac Escalade Base, ESV, EXT Chevrolet Tahoe LTZ GMC Yukon Denali Base, Yukon Denali XL Base Hummer H2 Base, SUT, SUV; New Part Number - Check for Availability	
1	Int. Manifold Gasket Set	2009	MS 98016 T	Exc. Cadillac Escalade Base, ESV, EXT Chevrolet Tahoe LTZ GMC Yukon Denali Base, Yukon Denali XL Base Hummer H2 Base, SUT, SUV; PermaDryPlus® int. manifold gskts. incl.	
1	Exh. Manifold Gasket Set	2011-09	MS 92467		
QTY	EXHAUST PIPE FLANGE	YEARS	PART NO.	DESCRIPTION	
1	Exhaust Pipe Gasket	2013-09	61089	Loc. R.H.; Pipe to manifold	
1	Exhaust Pipe Gasket	2013-09	61287	Converter	
1	Exhaust Pipe Gasket	2013-09	61323	Loc. L.H.; Pipe to manifold	
QTY	OIL PAN	YEARS	PART NO.	DESCRIPTION	
1	Oil Pan Gasket Set	2011-09	OS 30693 R	PermaDry® molded rubber gskt. incl.	
QTY	CRANKSHAFT REAR SEAL	YEARS	PART NO.	DESCRIPTION	
1	Rear Main Seal Set	2011-09	BS 40640	PTFE Rubber; One-piece	
1	Repair Sleeve	2011-09	16228	Crankshaft; Narrow lip; .780" sleeve length; Requires crankshaft machining due to clearance issues; Use w/installation tool	
1	Repair Sleeve	2011-09	16229	Crankshaft; Wide lip; 1.156" sleeve length; Requires crankshaft machining due to clearance issues; Use w/installation tool	
1	Repair Sleeve Tool	2011-09	16329	Crankshaft	
QTY	VALVE COVER	YEARS	PART NO.	DESCRIPTION	
1	Valve Cover Gasket Set	2011-09	VS 50504 R	w/o Grommets; PermaDry® molded rubber gskts. incl.	
1	Valve Cover Gasket Set	2011-09	VS 50504 R-1	w/Grommets; PermaDry® molded rubber gskts. incl.; New Part Number - Check for Availability	
1	Grommet Set	2011-09	ES 72233	Valve Cover	
QTY	VALVE STEM SEAL SET	YEARS	PART NO.	DESCRIPTION	
1	Valve Stem Seal Set	2011-09	SS 71039	Premium valve stem seals incl.	
QTY	THERMOSTAT HOUSING	YEARS	PART NO.	DESCRIPTION	
1	O-Ring	2011-09	35720	Thermostat Housing	
QTY	WATER PUMP	YEARS	PART NO.	DESCRIPTION	
2	Water Pump Gasket	2011-09	35635		
1	O-Ring	2011-09	35633	Water Pump	
1	Water Pump Mounting Set	2011-09	ES 73010	Mounting gasket set; New Part Number - Check for Availability	
QTY	TIMING COVER	YEARS	PART NO.	DESCRIPTION	
1	Timing Cover Set	2011-09	TCS 45993	Must be used w/OS 30693R	
1	Camshaft Sensor Seal	2011-09	72760	Variable camshaft sensor seal; New Part Number - Check for Availability	
QTY	CARB & FUEL INJECTION	YEARS	PART NO.	DESCRIPTION	
2	Fuel Injector O-Ring Set	2011-09	ES 70599	Upper set; Injectors to fuel rail; Improved design	
2	Fuel Injector O-Ring Set	2011-09	ES 71190	Lower set; Injectors to cylinder head	
2	Fuel Injector O-Ring Set	2011-09	ES 71192	Upper set; Injectors to fuel rail; Old design	
1	Throttle Body Gasket	2011-09	61469		
QTY	OIL FILTER MOUNTING	YEARS	PART NO.	DESCRIPTION	
1	Oil Cooler Gasket	2011-09	72462	Oil Filter; Center tube; Dual round port	
QTY	OIL PUMP COVER	YEARS	PART NO.	DESCRIPTION	
1	O-Ring	2011-09	72401	Oil Pump; Inlet tube	
QTY	OIL COOLER	YEARS	PART NO.	DESCRIPTION	
1	Oil Cooler Gasket	2011-09	72435	Oval port	
1	Oil Cooler Gasket	2011-09	72462	Dual round port	

GMC Truck (Incl. Minivans and SUV's) (Cont.)

84		2009 - 2007; 6.2L 378 (6195cc) OHV V8 (16 Valve) 103.25mm Bore Vortec			84
		MFI; Gasoline; Naturally Aspirated GMC Eng.; Chevrolet; VIN Code 8			
QTY	CYLINDER HEAD	YEARS	PART NO.	DESCRIPTION	
2	Head Gasket	2009-07	26192 PT	Head bolts not incl.; Head bolt replacement recommended; PermaTorqueMLS® LaserWeld® Technology	
1	Head Set	2009	HS 26192 PT-6	Head bolts not incl.; Head bolt replacement recommended; PermaDry® molded rubber valve cover gskts. incl.; Premium valve stem seals incl.; New Part Number - Check for Availability	
1	Head Set	2008	HS 26192 PT-5	Hummer H2 Base, SUT, SUV; Head bolts not incl.; Head bolt replacement recommended; PermaDry® molded rubber valve cover gskts. incl.; Premium valve stem seals incl.; New Part Number - Check for Availability	
1	Head Set	2008	HS 26192 PT-6	Exc. Hummer H2 Base, SUT, SUV; Head bolts not incl.; Head bolt replacement recommended; PermaDry® molded rubber valve cover gskts. incl.; Premium valve stem seals incl.; New Part Number - Check for Availability	
1	Head Set	2007	HS 26192 PT-6	Head bolts not incl.; Head bolt replacement recommended; PermaDry® molded rubber valve cover gskts. incl.; Premium valve stem seals incl.; New Part Number - Check for Availability	
2	Head Bolt Set	2009-07	ES 72220	Replacement recommended	
QTY	CONVERSION SET	YEARS	PART NO.	DESCRIPTION	
1	Gasket Conversion Set	2009-07	CS 9284	PermaDry® molded rubber oil pan gskt. incl.	
QTY	MANIFOLD - INT. & EXH.	YEARS	PART NO.	DESCRIPTION	
1	Int. Manifold Gasket Set	2009-07	MS 97126	New Part Number - Check for Availability	
1	Int. Manifold Gasket Set	2009	MS 96857	Lifter valley cover set; Perimeter seal only	
1	Int. Manifold Gasket Set	2008	MS 96169	Hummer H2 Base, SUT, SUV; Lifter valley cover set	
1	Int. Manifold Gasket Set	2008	MS 96857	Exc. Hummer H2 Base, SUT, SUV; Lifter valley cover set; Perimeter seal only	
1	Int. Manifold Gasket Set	2007	MS 96857	Lifter valley cover set; Perimeter seal only	
1	Exh. Manifold Gasket Set	2009-07	MS 92467		
QTY	EXHAUST PIPE FLANGE	YEARS	PART NO.	DESCRIPTION	
1	Exhaust Pipe Gasket	2009-07	61089	Loc. R.H.; Pipe to manifold	
1	Exhaust Pipe Gasket	2009-07	61287	Converter	
1	Exhaust Pipe Gasket	2009-07	61323	Loc. L.H.; Pipe to manifold	
QTY	OIL PAN	YEARS	PART NO.	DESCRIPTION	
1	Oil Pan Gasket Set	2009-07	OS 30693 R	PermaDry® molded rubber gskt. incl.	
QTY	CRANKSHAFT REAR SEAL	YEARS	PART NO.	DESCRIPTION	
1	Rear Main Seal Set	2009-07	BS 40640	PTFE Rubber; One-piece	
1	Repair Sleeve	2009-07	16228	Crankshaft; Narrow lip; .780" sleeve length; Requires crankshaft machining due to clearance issues; Use w/installation tool	
1	Repair Sleeve	2009-07	16229	Crankshaft; Wide lip; 1.156" sleeve length; Requires crankshaft machining due to clearance issues; Use w/installation tool	
1	Repair Sleeve Tool	2009-07	16329	Crankshaft	
QTY	VALVE COVER	YEARS	PART NO.	DESCRIPTION	
1	Valve Cover Gasket Set	2009-07	VS 50504 R	w/o Grommets; PermaDry® molded rubber gskts. incl.	
1	Valve Cover Gasket Set	2009-07	VS 50504 R-1	w/Grommets; PermaDry® molded rubber gskts. incl.; New Part Number - Check for Availability	
1	Grommet Set	2009-07	ES 72233	Valve Cover	
QTY	VALVE STEM SEAL SET	YEARS	PART NO.	DESCRIPTION	
1	Valve Stem Seal Set	2009-07	SS 71039	Premium valve stem seals incl.	
QTY	THERMOSTAT HOUSING	YEARS	PART NO.	DESCRIPTION	
1	O-Ring	2009-07	35720	Thermostat Housing	
QTY	WATER PUMP	YEARS	PART NO.	DESCRIPTION	
2	Water Pump Gasket	2009-07	35635		
1	O-Ring	2009-07	35633	Water Pump	
1	Water Pump Mounting Set	2009-07	ES 73010	Mounting gasket set; New Part Number - Check for Availability	
QTY	TIMING COVER	YEARS	PART NO.	DESCRIPTION	
1	Timing Cover Set	2009-07	TCS 45993	Must be used w/OS 30693R	
1	Camshaft Sensor Seal	2009-07	72760	Variable camshaft sensor seal; New Part Number - Check for Availability	
QTY	CARB & FUEL INJECTION	YEARS	PART NO.	DESCRIPTION	
2	Fuel Injector O-Ring Set	2009-07	ES 70599	Upper set; Injectors to fuel rail; Improved design	
2	Fuel Injector O-Ring Set	2009-07	ES 71190	Lower set; Injectors to cylinder head	
2	Fuel Injector O-Ring Set	2009-07	ES 71192	Upper set; Injectors to fuel rail; Old design	
1	Throttle Body Gasket	2009-07	61469		
QTY	EXHAUST GAS RECIRCULATION	YEARS	PART NO.	DESCRIPTION	
1	EGR Gasket	2009-07	70895	Pipe; O-ring	
1	EGR Gasket	2009-07	70914	Valve	

GMC Truck (Incl. Minivans and SUV's) (Cont.)

84		2009 - 2007; 6.2L 378 (6195cc) OHV V8 (16 Valve) 103.25mm Bore Vortec			84	
(cont.)		MFI; Gasoline; Naturally Aspirated GMC Eng.; Chevrolet; VIN Code 8			(cont.)	
QTY	EXHAUST GAS RECIRCULATION	YEARS	PART NO.	DESCRIPTION		
1	EGR Gasket	2009-07	70947	Pipe		
QTY	OIL FILTER MOUNTING	YEARS	PART NO.	DESCRIPTION		
1	Oil Cooler Gasket	2009-07	72462	Oil Filter; Center tube; Dual round port		
QTY	OIL PUMP COVER	YEARS	PART NO.	DESCRIPTION		
1	O-Ring	2009-07	72401	Oil Pump; Inlet tube		
QTY	OIL COOLER	YEARS	PART NO.	DESCRIPTION		
1	Oil Cooler Gasket	2009-07	72435	Oval port		
1	Oil Cooler Gasket	2009-07	72462	Dual round port		
85		2013 - 2010; 6.2L 378 (6195cc) OHV V8 (16 Valve) 103.25mm Bore Vortec			85	
		MFI; Flex Fuel; Naturally Aspirated GMC Eng.; Chevrolet; VIN Code F				
QTY	CYLINDER HEAD	YEARS	PART NO.	DESCRIPTION		
2	Head Gasket	2011-10	26192 PT	Head bolts not incl.; Head bolt replacement recommended; PermaTorqueMLS® LaserWeld® Technology		
1	Head Set	2011-10	HS 26192 PT-6	Head bolts not incl.; Head bolt replacement recommended; PermaDry® molded rubber valve cover gskts. incl.; Premium valve stem seals incl.; New Part Number - Check for Availability		
2	Head Bolt Set	2012-10	ES 72390	Replacement recommended; New Part Number - Check for Availability		
QTY	CONVERSION SET	YEARS	PART NO.	DESCRIPTION		
1	Gasket Conversion Set	2011-10	CS 9284	PermaDry® molded rubber oil pan gskt. incl.		
QTY	MANIFOLD - INT. & EXH.	YEARS	PART NO.	DESCRIPTION		
1	Int. Manifold Gasket Set	2011-10	MS 96857	Lifter valley cover set; Perimeter seal only		
1	Int. Manifold Gasket Set	2011-10	MS 97126	New Part Number - Check for Availability		
1	Exh. Manifold Gasket Set	2011-10	MS 92467			
QTY	EXHAUST PIPE FLANGE	YEARS	PART NO.	DESCRIPTION		
1	Exhaust Pipe Gasket	2013-10	61089	Loc. R.H.; Pipe to manifold		
1	Exhaust Pipe Gasket	2013-10	61287	Converter		
1	Exhaust Pipe Gasket	2013-10	61323	Loc. L.H.; Pipe to manifold		
QTY	OIL PAN	YEARS	PART NO.	DESCRIPTION		
1	Oil Pan Gasket Set	2011-10	OS 30693 R	PermaDry® molded rubber gskt. incl.		
QTY	CRANKSHAFT REAR SEAL	YEARS	PART NO.	DESCRIPTION		
1	Rear Main Seal Set	2011-10	BS 40640	PTFE Rubber; One-piece		
1	Repair Sleeve	2011-10	16228	Crankshaft; Narrow lip; .780" sleeve length; Requires crankshaft machining due to clearance issues; Use w/installation tool		
1	Repair Sleeve	2011-10	16229	Crankshaft; Wide lip; 1.156" sleeve length; Requires crankshaft machining due to clearance issues; Use w/installation tool		
1	Repair Sleeve Tool	2011-10	16329	Crankshaft		
QTY	VALVE COVER	YEARS	PART NO.	DESCRIPTION		
1	Valve Cover Gasket Set	2011-10	VS 50504 R	w/o Grommets; PermaDry® molded rubber gskts. incl.		
1	Valve Cover Gasket Set	2011-10	VS 50504 R-1	w/Grommets; PermaDry® molded rubber gskts. incl.; New Part Number - Check for Availability		
1	Grommet Set	2011-10	ES 72233	Valve Cover		
QTY	VALVE STEM SEAL SET	YEARS	PART NO.	DESCRIPTION		
1	Valve Stem Seal Set	2011-10	SS 71039	Premium valve stem seals incl.		
QTY	THERMOSTAT HOUSING	YEARS	PART NO.	DESCRIPTION		
1	O-Ring	2011-10	35720	Thermostat Housing		
QTY	WATER PUMP	YEARS	PART NO.	DESCRIPTION		
2	Water Pump Gasket	2011-10	35635			
1	O-Ring	2011-10	35633	Water Pump		
1	Water Pump Mounting Set	2011-10	ES 73010	Mounting gasket set; New Part Number - Check for Availability		
QTY	TIMING COVER	YEARS	PART NO.	DESCRIPTION		
1	Timing Cover Set	2011-10	TCS 45993	Must be used w/OS 30693R		
1	Camshaft Sensor Seal	2011-10	72760	Variable camshaft sensor seal; New Part Number - Check for Availability		
QTY	CARB & FUEL INJECTION	YEARS	PART NO.	DESCRIPTION		
2	Fuel Injector O-Ring Set	2011-10	ES 70599	Upper set; Injectors to fuel rail; Improved design		
2	Fuel Injector O-Ring Set	2011-10	ES 71190	Lower set; Injectors to cylinder head		
2	Fuel Injector O-Ring Set	2011-10	ES 71192	Upper set; Injectors to fuel rail; Old design		
1	Throttle Body Gasket	2011-10	61469			
QTY	OIL FILTER MOUNTING	YEARS	PART NO.	DESCRIPTION		
1	Oil Cooler Gasket	2011-10	72462	Oil Filter; Center tube; Dual round port		
QTY	OIL PUMP COVER	YEARS	PART NO.	DESCRIPTION		
1	O-Ring	2011-10	72401	Oil Pump; Inlet tube		
QTY	OIL COOLER	YEARS	PART NO.	DESCRIPTION		
1	Oil Cooler Gasket	2011-10	72435	Oval port		

GMC Truck (Incl. Minivans and SUV's) (Cont.)

85 (cont.)	2013 - 2010; 6.2L 378 (6195cc) OHV V8 (16 Valve) 103.25mm Bore Vortec				85 (cont.)
86	1993 - 1991; 6.2L 379 (6211cc) OHV V8 (16 Valve) 101mm Bore H/D				86
QTY	OIL COOLER	YEARS	PART NO.	DESCRIPTION	
1	Oil Cooler Gasket	2011-10	72462	Dual round port	
QTY	CYLINDER HEAD	YEARS	PART NO.	DESCRIPTION	
2	Head Gasket	1993-91	8726 PT	Standard thickness; Head bolts not incl.; Head bolt replacement recommended	
2	Head Gasket	1993-91	9128 PT	.010" thicker for use when block is refaced; Head bolts not incl.; Head bolt replacement recommended	
1	Head Set w/o Head Gasket	1993-91	HSU 8726-1	H/D eng.; Head gsks., head bolts, exh. pipe packing, positive control exh. valve stem seals not incl.; Head bolt replacement recommended	
2	Head Bolt Set	1993-91	ES 72724	Replacement recommended	
QTY	CONVERSION SET	YEARS	PART NO.	DESCRIPTION	
1	Gasket Conversion Set	1993-92	CS 8726-2		
1	Gasket Conversion Set	1991	CS 8726-1		
QTY	MANIFOLD - INT. & EXH.	YEARS	PART NO.	DESCRIPTION	
1	Int. Manifold Gasket Set	1993-91	MS 91586	H/D eng.	
1	Exh. Manifold Gasket Set	1993-91	MS 91587		
QTY	EXHAUST PIPE FLANGE	YEARS	PART NO.	DESCRIPTION	
2	Exhaust Pipe Gasket	1993	60718	Packing; 2 3/32" ID Steel sleeve	
2	Exhaust Pipe Gasket	1992-91	60556	Packing; 1 3/4" ID	
QTY	FUEL PUMP	YEARS	PART NO.	DESCRIPTION	
1	Fuel Pump Mounting Gasket	1993-91	5182	Plate	
1	Fuel Pump Mounting Gasket	1993-91	6579	May also be used as a fuel pump block-off plate gasket if desired	
1	Fuel Pump Mounting Gasket	1993-91	70150	Injection pump mounting	
QTY	OIL PAN	YEARS	PART NO.	DESCRIPTION	
1	Oil Pan Gasket Set	1993-92	OS 34406		
1	Oil Pan Gasket Set	1991	OS 34400		
1	Drain Plug Gasket	1993-91	70822		
QTY	CRANKSHAFT REAR SEAL	YEARS	PART NO.	DESCRIPTION	
1	Rear Main Seal Set	1993-92	BS 40604	Rubber; One-piece	
1	Rear Main Seal Set	1991	BS 40529	Rubber; Two-piece	
QTY	VALVE COVER	YEARS	PART NO.	DESCRIPTION	
1	Valve Cover Gasket Set	1993-91	VS 50228 C		
QTY	VALVE STEM SEAL SET	YEARS	PART NO.	DESCRIPTION	
1	Valve Stem Seal Set	1993-91	SS 5112	Loc. Int. & Exh.; O-ring	
1	Valve Stem Seal Set	1993-91	SS 72711	Loc. Exh.; Positive control; Premium valve stem seals incl.	
QTY	WATER OUTLET GASKET	YEARS	PART NO.	DESCRIPTION	
2	Water Outlet Gasket	1993-91	35357	Water Crossover	
1	Thermostat Gasket	1993-91	35271	Exc. Chevrolet G20 Van Beauville, Chevy Van, Sportvan, G30 Van Beauville, Chevy Van, Hi-Cube, Sportvan GMC G2500 Van Rally, Rally STX, Vandura, G3500 Van Magnavan, Rally, Rally Camper Special, Rally STX, Vandura, Vandura Special; Water Outlet; Exc. Forward control chassis	
1	Thermostat Gasket	1993-91	35289	Chevrolet G20 Van Beauville, Chevy Van, Sportvan, G30 Van Beauville, Chevy Van, Hi-Cube, Sportvan GMC G2500 Van Rally, Rally STX, Vandura, G3500 Van Magnavan, Rally, Rally Camper Special, Rally STX, Vandura, Vandura Special; Water Outlet	
1	Thermostat Gasket	1993-91	35289	Exc. Chevrolet G20 Van Beauville, Chevy Van, Sportvan, G30 Van Beauville, Chevy Van, Hi-Cube, Sportvan GMC G2500 Van Rally, Rally STX, Vandura, G3500 Van Magnavan, Rally, Rally Camper Special, Rally STX, Vandura, Vandura Special; Water Outlet; Forward control chassis	
QTY	WATER PUMP	YEARS	PART NO.	DESCRIPTION	
1	Water Pump Mounting Set	1993-91	ES 72674		
QTY	TIMING COVER	YEARS	PART NO.	DESCRIPTION	
1	Timing Cover Set	1993-91	TCS 45554	w/o Sleeve 'N' Seal®	
1	Timing Set w/Sleeve & Seal	1993-91	TCS 45686	w/Sleeve 'N' Seal®	
1	Repair Sleeve	1993-91	16209	Timing Cover; Use w/installation tool	
1	Repair Sleeve Tool	1993-91	16311	Timing Cover	
QTY	AIR CLEANER MOUNTING	YEARS	PART NO.	DESCRIPTION	
1	Air Cleaner Gasket	1993-91	60555		

GMC Truck (Incl. Minivans and SUV's) (Cont.)

87		1993 - 1991; 6.2L 379 (6211cc) OHV V8 (16 Valve) 101mm Bore L/D			87
		MFI; Diesel; Naturally Aspirated GMC Eng.; Chevrolet; VIN Code C			
QTY	CYLINDER HEAD	YEARS	PART NO.	DESCRIPTION	
2	Head Gasket	1993-91	8726 PT	Standard thickness; Head bolts not incl.; Head bolt replacement recommended	
2	Head Gasket	1993-91	9128 PT	.010" thicker for use when block is refaced; Head bolts not incl.; Head bolt replacement recommended	
1	Head Set w/o Head Gasket	1993-91	HSU 8726	L/D eng.; Head gskts., head bolts, exh. pipe packing, positive control exh. valve stem seals not incl.; Head bolt replacement recommended	
2	Head Bolt Set	1993-91	ES 72724	Replacement recommended	
QTY	CONVERSION SET	YEARS	PART NO.	DESCRIPTION	
1	Gasket Conversion Set	1993-92	CS 8726-2		
1	Gasket Conversion Set	1991	CS 8726-1		
QTY	MANIFOLD - INT. & EXH.	YEARS	PART NO.	DESCRIPTION	
1	Int. Manifold Gasket Set	1993-91	MS 91585	L/D eng.	
1	Exh. Manifold Gasket Set	1993-91	MS 91587		
QTY	EXHAUST PIPE FLANGE	YEARS	PART NO.	DESCRIPTION	
2	Exhaust Pipe Gasket	1993	60718	Packing; 2 3/32" ID Steel sleeve	
2	Exhaust Pipe Gasket	1992-91	60556	Packing; 1 3/4" ID	
QTY	FUEL PUMP	YEARS	PART NO.	DESCRIPTION	
1	Fuel Pump Mounting Gasket	1993-91	5182	Plate	
1	Fuel Pump Mounting Gasket	1993-91	6579	May also be used as a fuel pump block-off plate gasket if desired	
1	Fuel Pump Mounting Gasket	1993-91	70150	Injection pump mounting	
QTY	OIL PAN	YEARS	PART NO.	DESCRIPTION	
1	Oil Pan Gasket Set	1993-92	OS 34406		
1	Oil Pan Gasket Set	1991	OS 34400		
1	Drain Plug Gasket	1993-91	70822		
QTY	CRANKSHAFT REAR SEAL	YEARS	PART NO.	DESCRIPTION	
1	Rear Main Seal Set	1993-92	BS 40604	Rubber; One-piece	
1	Rear Main Seal Set	1991	BS 40529	Rubber; Two-piece	
QTY	VALVE COVER	YEARS	PART NO.	DESCRIPTION	
1	Valve Cover Gasket Set	1993-91	VS 50228 C		
QTY	VALVE STEM SEAL SET	YEARS	PART NO.	DESCRIPTION	
1	Valve Stem Seal Set	1993-91	SS 5112	Loc. Int. & Exh.; O-ring	
1	Valve Stem Seal Set	1993-91	SS 72711	Loc. Exh.; Positive control; Premium valve stem seals incl.	
QTY	WATER OUTLET GASKET	YEARS	PART NO.	DESCRIPTION	
2	Water Outlet Gasket	1993-91	35357	Water Crossover	
1	Thermostat Gasket	1993-91	35271	Exc. Chevrolet G20 Van Beauville, Chevy Van, Sportvan, G30 Van Beauville, Chevy Van, Hi-Cube, Sportvan GMC G2500 Van Rally, Rally STX, Vandura, G3500 Van Magnavan, Rally, Rally Camper Special, Rally STX, Vandura, Vandura Special; Water Outlet; Exc. Forward control chassis	
1	Thermostat Gasket	1993-91	35289	Chevrolet G20 Van Beauville, Chevy Van, Sportvan, G30 Van Beauville, Chevy Van, Hi-Cube, Sportvan GMC G2500 Van Rally, Rally STX, Vandura, G3500 Van Magnavan, Rally, Rally Camper Special, Rally STX, Vandura, Vandura Special; Water Outlet	
1	Thermostat Gasket	1993-91	35289	Exc. Chevrolet G20 Van Beauville, Chevy Van, Sportvan, G30 Van Beauville, Chevy Van, Hi-Cube, Sportvan GMC G2500 Van Rally, Rally STX, Vandura, G3500 Van Magnavan, Rally, Rally Camper Special, Rally STX, Vandura, Vandura Special; Water Outlet; Forward control chassis	
QTY	WATER PUMP	YEARS	PART NO.	DESCRIPTION	
1	Water Pump Mounting Set	1993-91	ES 72674		
QTY	TIMING COVER	YEARS	PART NO.	DESCRIPTION	
1	Timing Cover Set	1993-91	TCS 45554	w/o Sleeve 'N' Seal®	
1	Timing Set w/Sleeve & Seal	1993-91	TCS 45686	w/Sleeve 'N' Seal®	
1	Repair Sleeve	1993-91	16209	Timing Cover; Use w/installation tool	
1	Repair Sleeve Tool	1993-91	16311	Timing Cover	
QTY	AIR CLEANER MOUNTING	YEARS	PART NO.	DESCRIPTION	
1	Air Cleaner Gasket	1993-91	60555		
88		2002 - 1992; 6.5L 395 (6468cc) OHV Turbo V8 (16 Valve) 103mm Bore			88
		MFI; Diesel; Turbo GMC Eng.; Chevrolet; VIN Code F			
QTY	CYLINDER HEAD	YEARS	PART NO.	DESCRIPTION	
2	Head Gasket	2002-92	9521 PT	.010" thicker for use when block is refaced; Head bolts not incl.; Head bolt replacement recommended	
2	Head Gasket	2002-92	9701 PT	Standard thickness; Head bolts not incl.; Head bolt replacement recommended	

GMC Truck (Incl. Minivans and SUV's) (Cont.)

88 (cont.)		2002 - 1992; 6.5L 395 (6468cc) OHV Turbo V8 (16 Valve) 103mm Bore			88 (cont.)
		MFI; Diesel; Turbo GMC Eng.; Chevrolet; VIN Code F			
QTY	CYLINDER HEAD	YEARS	PART NO.	DESCRIPTION	
1	Head Set w/o Head Gasket	2002-92	HSU 8726	Head gskts., head bolts, exh. pipe packing, positive control exh. valve stem seals not incl.; Upper int. manifold gskt. not incl.; Head bolt replacement recommended	
2	Head Bolt Set	2002-92	ES 72724	Replacement recommended	
QTY	CONVERSION SET	YEARS	PART NO.	DESCRIPTION	
1	Gasket Conversion Set	2002-92	CS 8726-2		
QTY	MANIFOLD - INT. & EXH.	YEARS	PART NO.	DESCRIPTION	
1	Int. Manifold Gasket Set	2002-92	MS 91585	Lower set	
1	Plenum Gasket Set	2002-01	MS 90176-1	Chevrolet C3500 Pickup HD GMC C3500 Pickup HD; Upper set	
1	Plenum Gasket Set	2002-01	MS 97032	Exc. Chevrolet C3500 Pickup HD GMC C3500 Pickup HD; Upper set	
1	Plenum Gasket Set	2000-98	MS 90176-1	Exc. Chevrolet Express 2500 Van Base, LS, Express 3500 Van Base, LS GMC Savana 2500 Base, SLE, Savana 3500 Base, SLE; Upper set	
1	Plenum Gasket Set	2000-98	MS 97032	Chevrolet Express 2500 Van Base, LS, Express 3500 Van Base, LS GMC Savana 2500 Base, SLE, Savana 3500 Base, SLE; Upper set	
1	Plenum Gasket Set	1997-96	MS 90176-1	Exc. Chevrolet Express 2500 Van Base, LS, Express 3500 Van Base, LS, G20 Van Beauville, Chevy Van, Sportvan, G30 Van Beauville, Chevy Van, Hi-Cube, Sportvan GMC G2500 Van Rally, Rally STX, Vandura, G3500 Van Magnavan, Rally, Rally Camper Special, Rally; Upper set	
1	Plenum Gasket Set	1997-96	MS 97032	Chevrolet Express 2500 Van Base, LS, Express 3500 Van Base, LS, G20 Van Beauville, Chevy Van, Sportvan, G30 Van Beauville, Chevy Van, Hi-Cube, Sportvan GMC G2500 Van Rally, Rally STX, Vandura, G3500 Van Magnavan, Rally, Rally Camper Special, Rally STX.; Upper set	
1	Plenum Gasket Set	1995-92	MS 90176-1	Upper set	
1	Exh. Manifold Gasket Set	2002-92	MS 91587		
QTY	EXHAUST PIPE FLANGE	YEARS	PART NO.	DESCRIPTION	
2	Exhaust Pipe Gasket	2002-92	60556	Pipe to manifold; 1 3/4" ID	
2	Exhaust Pipe Gasket	2002-92	60718	Crossover; 2 3/32" ID Steel sleeve	
QTY	FUEL PUMP	YEARS	PART NO.	DESCRIPTION	
1	Fuel Pump Mounting Gasket	2002-92	5182	Plate	
1	Fuel Pump Mounting Gasket	2002-92	6579	May also be used as a fuel pump block-off plate gasket if desired	
1	Fuel Pump Mounting Gasket	2002-92	70150	Injection pump mounting	
QTY	OIL PAN	YEARS	PART NO.	DESCRIPTION	
1	Oil Pan Gasket Set	2002-92	OS 34406		
1	Drain Plug Gasket	2002-92	70822		
QTY	CRANKSHAFT REAR SEAL	YEARS	PART NO.	DESCRIPTION	
1	Rear Main Seal Set	2002-92	BS 40604	Rubber; One-piece	
QTY	VALVE COVER	YEARS	PART NO.	DESCRIPTION	
1	Valve Cover Gasket Set	2002-92	VS 50228 C		
QTY	VALVE STEM SEAL SET	YEARS	PART NO.	DESCRIPTION	
1	Valve Stem Seal Set	2002-92	SS 5112	Loc. Int. & Exh.; O-ring	
1	Valve Stem Seal Set	2002-92	SS 72711	Loc. Exh.; Positive control; Premium valve stem seals incl.	
QTY	THERMOSTAT HOUSING	YEARS	PART NO.	DESCRIPTION	
1	Thermostat Gasket	1996	35271	Exc. Chevrolet G20 Van Beauville, Chevy Van, Sportvan, G30 Van Beauville, Chevy Van, Hi-Cube, Sportvan GMC G2500 Van Rally, Rally STX, Vandura, G3500 Van Magnavan, Rally, Rally Camper Special, Rally STX, Vandura, Vandura Special; Thermostat Housing; Exc. Forward control chassis	
1	Thermostat Gasket	1996	35289	Chevrolet G20 Van Beauville, Chevy Van, Sportvan, G30 Van Beauville, Chevy Van, Hi-Cube, Sportvan GMC G2500 Van Rally, Rally STX, Vandura, G3500 Van Magnavan, Rally, Rally Camper Special, Rally STX, Vandura, Vandura Special; Thermostat Housing	
1	Thermostat Gasket	1996	35289	Exc. Chevrolet G20 Van Beauville, Chevy Van, Sportvan, G30 Van Beauville, Chevy Van, Hi-Cube, Sportvan GMC G2500 Van Rally, Rally STX, Vandura, G3500 Van Magnavan, Rally, Rally Camper Special, Rally STX, Vandura, Vandura Special; Thermostat Housing; Forward control chassis	
1	Thermostat Gasket	1995-92	35271	Thermostat Housing; Exc. Forward control chassis	
1	Thermostat Gasket	1995-92	35289	Thermostat Housing; Forward control chassis	
2	O-Ring	2002-97	35710	Thermostat Housing; 1.954" ID; Improved design	
QTY	WATER OUTLET GASKET	YEARS	PART NO.	DESCRIPTION	
2	Water Outlet Gasket	2002-92	35357	Water Crossover	
QTY	WATER PUMP	YEARS	PART NO.	DESCRIPTION	
1	Water Pump Mounting Set	2002-92	ES 72674		

GMC Truck (Incl. Minivans and SUV's) (Cont.)

88		2002 - 1992; 6.5L 395 (6468cc) OHV Turbo V8 (16 Valve) 103mm Bore			88
(cont.)		MFI; Diesel; Turbo GMC Eng.; Chevrolet; VIN Code F			(cont.)
QTY	TIMING COVER	YEARS	PART NO.	DESCRIPTION	
1	Timing Cover Set	2002-92	TCS 45554	w/o Sleeve 'N' Seal®	
1	Timing Set w/Sleeve & Seal	2001-92	TCS 45686	w/Sleeve 'N' Seal®	
1	Repair Sleeve	2001-92	16209	Timing Cover; Use w/installation tool	
1	Repair Sleeve Tool	2001-92	16311	Timing Cover	
QTY	EXHAUST GAS RECIRCULATION	YEARS	PART NO.	DESCRIPTION	
1	EGR Gasket	2002-92	70781		
89		2005 - 2002; 6.5L 395 (6468cc) OHV Turbo V8 (16 Valve) 103mm Bore			89
		MFI; Diesel; Turbo GMC Eng.; Chevrolet; VIN Code Z			
QTY	CYLINDER HEAD	YEARS	PART NO.	DESCRIPTION	
2	Head Gasket	2005-02	9521 PT	.010" thicker for use when block is refaced; Head bolts not incl.; Head bolt replacement recommended	
2	Head Gasket	2005-02	9701 PT	Standard thickness; Head bolts not incl.; Head bolt replacement recommended	
1	Head Set w/o Head Gasket	2005-02	HSU 8726	Head gskts., head bolts, exh. pipe packing, positive control exh. valve stem seals not incl.; Upper int. manifold gskt. not incl.; Head bolt replacement recommended	
2	Head Bolt Set	2005-02	ES 72724	Replacement recommended	
QTY	CONVERSION SET	YEARS	PART NO.	DESCRIPTION	
1	Gasket Conversion Set	2005-02	CS 8726-2		
QTY	MANIFOLD - INT. & EXH.	YEARS	PART NO.	DESCRIPTION	
1	Int. Manifold Gasket Set	2005-02	MS 91585	Lower set	
1	Plenum Gasket Set	2005-02	MS 90176-1	Upper set	
1	Exh. Manifold Gasket Set	2005-02	MS 91587		
QTY	EXHAUST PIPE FLANGE	YEARS	PART NO.	DESCRIPTION	
2	Exhaust Pipe Gasket	2005-02	60556	Pipe to manifold; 1 3/4" ID	
2	Exhaust Pipe Gasket	2005-02	60718	Crossover; 2 3/32" ID Steel sleeve	
QTY	FUEL PUMP	YEARS	PART NO.	DESCRIPTION	
1	Fuel Pump Mounting Gasket	2005-02	5182	Plate	
1	Fuel Pump Mounting Gasket	2005-02	6579	May also be used as a fuel pump block-off plate gasket if desired	
1	Fuel Pump Mounting Gasket	2005-02	70150	Injection pump mounting	
QTY	OIL PAN	YEARS	PART NO.	DESCRIPTION	
1	Oil Pan Gasket Set	2005-02	OS 34406		
1	Drain Plug Gasket	2005-02	70822		
QTY	CRANKSHAFT REAR SEAL	YEARS	PART NO.	DESCRIPTION	
1	Rear Main Seal Set	2005-02	BS 40604	Rubber; One-piece	
QTY	VALVE COVER	YEARS	PART NO.	DESCRIPTION	
1	Valve Cover Gasket Set	2005-02	VS 50228 C		
QTY	VALVE STEM SEAL SET	YEARS	PART NO.	DESCRIPTION	
1	Valve Stem Seal Set	2005-02	SS 5112	Loc. Int. & Exh.; O-ring	
1	Valve Stem Seal Set	2005-02	SS 72711	Loc. Exh.; Positive control; Premium valve stem seals incl.	
QTY	THERMOSTAT HOUSING	YEARS	PART NO.	DESCRIPTION	
2	O-Ring	2005-02	35710	Thermostat Housing; 1.954" ID; Improved design	
QTY	WATER OUTLET GASKET	YEARS	PART NO.	DESCRIPTION	
2	Water Outlet Gasket	2005-02	35357	Water Crossover	
QTY	WATER PUMP	YEARS	PART NO.	DESCRIPTION	
1	Water Pump Mounting Set	2005-02	ES 72674		
QTY	TIMING COVER	YEARS	PART NO.	DESCRIPTION	
1	Timing Cover Set	2005-02	TCS 45554	w/o Sleeve 'N' Seal®	
QTY	EXHAUST GAS RECIRCULATION	YEARS	PART NO.	DESCRIPTION	
1	EGR Gasket	2005-02	70781		
90		2002 - 1994; 6.5L 395 (6468cc) OHV Turbo V8 (16 Valve) 103mm Bore H.O.			90
		MFI; Diesel; Turbo GMC Eng.; Chevrolet; VIN Code S			
QTY	CYLINDER HEAD	YEARS	PART NO.	DESCRIPTION	
2	Head Gasket	2002-94	9521 PT	.010" thicker for use when block is refaced; Head bolts not incl.; Head bolt replacement recommended	
2	Head Gasket	2002-94	9701 PT	Standard thickness; Head bolts not incl.; Head bolt replacement recommended	
1	Head Set w/o Head Gasket	2002-94	HSU 8726	Head gskts., head bolts, exh. pipe packing, positive control exh. valve stem seals not incl.; Upper int. manifold gskt. not incl.; Head bolt replacement recommended	
2	Head Bolt Set	2002-94	ES 72724	Replacement recommended	
QTY	CONVERSION SET	YEARS	PART NO.	DESCRIPTION	
1	Gasket Conversion Set	2002-94	CS 8726-2		

GMC Truck (Incl. Minivans and SUV's) (Cont.)

90 (cont.)	2002 - 1994; 6.5L 395 (6468cc) OHV Turbo V8 (16 Valve) 103mm Bore H.O. MFI; Diesel; Turbo GMC Eng.; Chevrolet; VIN Code S				90 (cont.)
QTY	MANIFOLD - INT. & EXH.	YEARS	PART NO.	DESCRIPTION	
1	Int. Manifold Gasket Set	2002-94	MS 91585	Lower set	
1	Plenum Gasket Set	2002-01	MS 90176-1	Chevrolet C3500 Pickup HD GMC C3500 Pickup HD; Upper set	
1	Plenum Gasket Set	2002-01	MS 97032	Exc. Chevrolet C3500 Pickup HD GMC C3500 Pickup HD; Upper set	
1	Plenum Gasket Set	2000-98	MS 90176-1	Exc. Chevrolet Express 2500 Van Base, LS, Express 3500 Van Base, LS GMC Savana 2500 Base, SLE, Savana 3500 Base, SLE; Upper set	
1	Plenum Gasket Set	2000-98	MS 97032	Chevrolet Express 2500 Van Base, LS, Express 3500 Van Base, LS GMC Savana 2500 Base, SLE, Savana 3500 Base, SLE; Upper set	
1	Plenum Gasket Set	1997	MS 90176-1	Exc. Chevrolet Express 2500 Van Base, LS, Express 3500 Van Base, LS, G20 Van Beauville, Chevy Van, Sportvan, G30 Van Beauville, Chevy Van, Hi-Cube, Sportvan GMC G2500 Van Rally, Rally STX, Vandura, G3500 Van Magnavan, Rally, Rally Camper Special, Rally; Upper set	
1	Plenum Gasket Set	1997	MS 97032	Chevrolet Express 2500 Van Base, LS, Express 3500 Van Base, LS, G20 Van Beauville, Chevy Van, Sportvan, G30 Van Beauville, Chevy Van, Hi-Cube, Sportvan GMC G2500 Van Rally, Rally STX, Vandura, G3500 Van Magnavan, Rally, Rally Camper Special, Rally STX;; Upper set	
1	Plenum Gasket Set	1996	MS 90176-1	Exc. Chevrolet Express 2500 Van Base, LS, Express 3500 Van Base, LS, G20 Van Beauville, Chevy Van, Sportvan, G30 Van Beauville, Chevy Van, Hi-Cube, Sportvan GMC G2500 Van Rally, Rally STX, Vandura, G3500 Van Magnavan, Rally, Rally Camper Special, Rally; Upper set	
1	Plenum Gasket Set	1996	MS 97032	Chevrolet Express 2500 Van Base, LS, Express 3500 Van Base, LS, G20 Van Beauville, Chevy Van, Sportvan, G30 Van Beauville, Chevy Van, Hi-Cube, Sportvan GMC G2500 Van Rally, Rally STX, Vandura, G3500 Van Magnavan, Rally, Rally Camper Special, Rally STX;; Upper set	
1	Plenum Gasket Set	1995-94	MS 90176-1	Upper set	
1	Exh. Manifold Gasket Set	2002-94	MS 91587		
QTY	EXHAUST PIPE FLANGE	YEARS	PART NO.	DESCRIPTION	
2	Exhaust Pipe Gasket	2002-94	60556	Pipe to manifold; 1 3/4" ID	
2	Exhaust Pipe Gasket	2002-94	60718	Crossover; 2 3/32" ID Steel sleeve	
QTY	FUEL PUMP	YEARS	PART NO.	DESCRIPTION	
1	Fuel Pump Mounting Gasket	2002-94	5182	Plate	
1	Fuel Pump Mounting Gasket	2002-94	6579	May also be used as a fuel pump block-off plate gasket if desired	
1	Fuel Pump Mounting Gasket	2002-94	70150	Injection pump mounting	
QTY	OIL PAN	YEARS	PART NO.	DESCRIPTION	
1	Oil Pan Gasket Set	2002-94	OS 34406		
1	Drain Plug Gasket	2002-94	70822		
QTY	CRANKSHAFT REAR SEAL	YEARS	PART NO.	DESCRIPTION	
1	Rear Main Seal Set	2002-94	BS 40604	Rubber; One-piece	
QTY	VALVE COVER	YEARS	PART NO.	DESCRIPTION	
1	Valve Cover Gasket Set	2002-94	VS 50228 C		
QTY	VALVE STEM SEAL SET	YEARS	PART NO.	DESCRIPTION	
1	Valve Stem Seal Set	2002-94	SS 5112	Loc. Int. & Exh.; O-ring	
1	Valve Stem Seal Set	2002-94	SS 72711	Loc. Exh.; Positive control; Premium valve stem seals incl.	
QTY	THERMOSTAT HOUSING	YEARS	PART NO.	DESCRIPTION	
1	Thermostat Gasket	1996	35271	Exc. Chevrolet G20 Van Beauville, Chevy Van, Sportvan, G30 Van Beauville, Chevy Van, Hi-Cube, Sportvan GMC G2500 Van Rally, Rally STX, Vandura, G3500 Van Magnavan, Rally, Rally Camper Special, Rally STX, Vandura, Vandura Special; Thermostat Housing; Exc. Forward control chassis	
1	Thermostat Gasket	1996	35289	Chevrolet G20 Van Beauville, Chevy Van, Sportvan, G30 Van Beauville, Chevy Van, Hi-Cube, Sportvan GMC G2500 Van Rally, Rally STX, Vandura, G3500 Van Magnavan, Rally, Rally Camper Special, Rally STX, Vandura, Vandura Special; Thermostat Housing	
1	Thermostat Gasket	1996	35289	Exc. Chevrolet G20 Van Beauville, Chevy Van, Sportvan, G30 Van Beauville, Chevy Van, Hi-Cube, Sportvan GMC G2500 Van Rally, Rally STX, Vandura, G3500 Van Magnavan, Rally, Rally Camper Special, Rally STX, Vandura, Vandura Special; Thermostat Housing; Forward control chassis	
1	Thermostat Gasket	1995-94	35271	Thermostat Housing; Exc. Forward control chassis	
1	Thermostat Gasket	1995-94	35289	Thermostat Housing; Forward control chassis	
2	O-Ring	2002-97	35710	Thermostat Housing; 1.954" ID; Improved design	
QTY	WATER OUTLET GASKET	YEARS	PART NO.	DESCRIPTION	
2	Water Outlet Gasket	2002-94	35357	Water Crossover	
QTY	WATER PUMP	YEARS	PART NO.	DESCRIPTION	
1	Water Pump Mounting Set	2002-94	ES 72674		

GMC Truck (Incl. Minivans and SUV's) (Cont.)

90		2002 - 1994; 6.5L 395 (6468cc) OHV Turbo V8 (16 Valve) 103mm Bore H.O.			90	
(cont.)		MFI; Diesel; Turbo GMC Eng.; Chevrolet; VIN Code S			(cont.)	
QTY	TIMING COVER	YEARS	PART NO.	DESCRIPTION		
1	Timing Cover Set	2002-94	TCS 45554	w/o Sleeve 'N' Seal®		
1	Timing Set w/Sleeve & Seal	2001-94	TCS 45686	w/Sleeve 'N' Seal®		
1	Repair Sleeve	2001-94	16209	Timing Cover; Use w/installation tool		
1	Repair Sleeve Tool	2001-94	16311	Timing Cover		
QTY	EXHAUST GAS RECIRCULATION	YEARS	PART NO.	DESCRIPTION		
1	EGR Gasket	2002-94	70781			
91		1995 - 1994; 6.5L 395 (6468cc) OHV V8 (16 Valve) 103mm Bore			91	
		MFI; Diesel; Naturally Aspirated GMC Eng.; Chevrolet; VIN Code P				
QTY	CYLINDER HEAD	YEARS	PART NO.	DESCRIPTION		
2	Head Gasket	1995-94	9521 PT	.010" thicker for use when block is refaced; Head bolts not incl.; Head bolt replacement recommended		
2	Head Gasket	1995-94	9701 PT	Standard thickness; Head bolts not incl.; Head bolt replacement recommended		
1	Head Set w/o Head Gasket	1995-94	HSU 8726	Head gskts., head bolts, exh. pipe packing, positive control exh. valve stem seals not incl.; Head bolt replacement recommended		
2	Head Bolt Set	1995-94	ES 72724	Replacement recommended		
QTY	CONVERSION SET	YEARS	PART NO.	DESCRIPTION		
1	Gasket Conversion Set	1995-94	CS 8726-2			
QTY	MANIFOLD - INT. & EXH.	YEARS	PART NO.	DESCRIPTION		
1	Int. Manifold Gasket Set	1995-94	MS 91585	Lower set		
1	Exh. Manifold Gasket Set	1995-94	MS 91587			
QTY	EXHAUST PIPE FLANGE	YEARS	PART NO.	DESCRIPTION		
2	Exhaust Pipe Gasket	1995-94	60556	Pipe to manifold; 1 3/4" ID		
2	Exhaust Pipe Gasket	1995-94	60718	Crossover; 2 3/32" ID Steel sleeve		
QTY	FUEL PUMP	YEARS	PART NO.	DESCRIPTION		
1	Fuel Pump Mounting Gasket	1995-94	5182	Plate		
1	Fuel Pump Mounting Gasket	1995-94	6579	May also be used as a fuel pump block-off plate gasket if desired		
1	Fuel Pump Mounting Gasket	1995-94	70150	Injection pump mounting		
QTY	OIL PAN	YEARS	PART NO.	DESCRIPTION		
1	Oil Pan Gasket Set	1995-94	OS 34406			
1	Drain Plug Gasket	1995-94	70822			
QTY	CRANKSHAFT REAR SEAL	YEARS	PART NO.	DESCRIPTION		
1	Rear Main Seal Set	1995-94	BS 40604	Rubber; One-piece		
QTY	VALVE COVER	YEARS	PART NO.	DESCRIPTION		
1	Valve Cover Gasket Set	1995-94	VS 50228 C			
QTY	VALVE STEM SEAL SET	YEARS	PART NO.	DESCRIPTION		
1	Valve Stem Seal Set	1995-94	SS 5112	Loc. Int. & Exh.; O-ring		
1	Valve Stem Seal Set	1995-94	SS 72711	Loc. Exh.; Positive control; Premium valve stem seals incl.		
QTY	THERMOSTAT HOUSING	YEARS	PART NO.	DESCRIPTION		
1	Thermostat Gasket	1995-94	35271	Exc. Chevrolet G20 Van Beauville, Chevy Van, Sportvan, G30 Van Beauville, Chevy Van, Hi-Cube, Sportvan GMC G2500 Van Rally, Rally STX, Vandura, G3500 Van Magnavan, Rally, Rally Camper Special, Rally STX, Vandura, Vandura Special; Thermostat Housing; Exc. Forward control chassis		
1	Thermostat Gasket	1995-94	35289	Chevrolet G20 Van Beauville, Chevy Van, Sportvan, G30 Van Beauville, Chevy Van, Hi-Cube, Sportvan GMC G2500 Van Rally, Rally STX, Vandura, G3500 Van Magnavan, Rally, Rally Camper Special, Rally STX, Vandura, Vandura Special; Thermostat Housing		
1	Thermostat Gasket	1995-94	35289	Exc. Chevrolet G20 Van Beauville, Chevy Van, Sportvan, G30 Van Beauville, Chevy Van, Hi-Cube, Sportvan GMC G2500 Van Rally, Rally STX, Vandura, G3500 Van Magnavan, Rally, Rally Camper Special, Rally STX, Vandura, Vandura Special; Thermostat Housing; Forward control chassis		
QTY	WATER OUTLET GASKET	YEARS	PART NO.	DESCRIPTION		
2	Water Outlet Gasket	1995-94	35357	Water Crossover		
QTY	WATER PUMP	YEARS	PART NO.	DESCRIPTION		
1	Water Pump Mounting Set	1995-94	ES 72674			
QTY	TIMING COVER	YEARS	PART NO.	DESCRIPTION		
1	Timing Cover Set	1995-94	TCS 45554	w/o Sleeve 'N' Seal®		
1	Timing Set w/Sleeve & Seal	1995-94	TCS 45686	w/Sleeve 'N' Seal®		
1	Repair Sleeve	1995-94	16209	Timing Cover; Use w/installation tool		
1	Repair Sleeve Tool	1995-94	16311	Timing Cover		
QTY	AIR CLEANER MOUNTING	YEARS	PART NO.	DESCRIPTION		
1	Air Cleaner Gasket	1995-94	60555			

GMC Truck (Incl. Minivans and SUV's) (Cont.)

92		1999 - 1994; 6.5L 395 (6468cc) OHV V8 (16 Valve) 103mm Bore H.O. MFI; Diesel; Naturally Aspirated GMC Eng.; Chevrolet; VIN Code Y			92
QTY	CYLINDER HEAD	YEARS	PART NO.	DESCRIPTION	
2	Head Gasket	1999-94	9521 PT	.010" thicker for use when block is refaced; Head bolts not incl.; Head bolt replacement recommended	
2	Head Gasket	1999-94	9701 PT	Standard thickness; Head bolts not incl.; Head bolt replacement recommended	
1	Head Set w/o Head Gasket	1999-94	HSU 8726	Head gskts., head bolts, exh. pipe packing, positive control exh. valve stem seals not incl.; Head bolt replacement recommended	
2	Head Bolt Set	1999-94	ES 72724	Replacement recommended	
QTY	CONVERSION SET	YEARS	PART NO.	DESCRIPTION	
1	Gasket Conversion Set	1999-94	CS 8726-2		
QTY	MANIFOLD - INT. & EXH.	YEARS	PART NO.	DESCRIPTION	
1	Int. Manifold Gasket Set	1999-94	MS 91585	Lower set	
1	Exh. Manifold Gasket Set	1999-94	MS 91587		
QTY	EXHAUST PIPE FLANGE	YEARS	PART NO.	DESCRIPTION	
2	Exhaust Pipe Gasket	1999-94	60556	Pipe to manifold; 1 3/4" ID	
2	Exhaust Pipe Gasket	1999-94	60718	Crossover; 2 3/32" ID Steel sleeve	
QTY	FUEL PUMP	YEARS	PART NO.	DESCRIPTION	
1	Fuel Pump Mounting Gasket	1999-94	5182	Plate	
1	Fuel Pump Mounting Gasket	1999-94	6579	May also be used as a fuel pump block-off plate gasket if desired	
1	Fuel Pump Mounting Gasket	1999-94	70150	Injection pump mounting	
QTY	OIL PAN	YEARS	PART NO.	DESCRIPTION	
1	Oil Pan Gasket Set	1999-94	OS 34406		
1	Drain Plug Gasket	1999-94	70822		
QTY	CRANKSHAFT REAR SEAL	YEARS	PART NO.	DESCRIPTION	
1	Rear Main Seal Set	1999-94	BS 40604	Rubber; One-piece	
QTY	VALVE COVER	YEARS	PART NO.	DESCRIPTION	
1	Valve Cover Gasket Set	1999-94	VS 50228 C		
QTY	VALVE STEM SEAL SET	YEARS	PART NO.	DESCRIPTION	
1	Valve Stem Seal Set	1999-94	SS 5112	Loc. Int. & Exh.; O-ring	
1	Valve Stem Seal Set	1999-94	SS 72711	Loc. Exh.; Positive control; Premium valve stem seals incl.	
QTY	THERMOSTAT HOUSING	YEARS	PART NO.	DESCRIPTION	
1	Thermostat Gasket	1996	35289	Chevrolet Express 2500 Van Base, LS, Express 3500 Van Base, LS, P30 Series Base GMC P3500 Van Base, Savana 2500 Base, SLE, Savana 3500 Base, SLE; Thermostat Housing; Forward control chassis	
1	Thermostat Gasket	1996	35271	Chevrolet Express 2500 Van Base, LS, Express 3500 Van Base, LS, P30 Series Base GMC P3500 Van Base, Savana 2500 Base, SLE, Savana 3500 Base, SLE; Thermostat Housing; Exc. Forward control chassis	
1	Thermostat Gasket	1996	35289	Exc. Chevrolet Express 2500 Van Base, LS, Express 3500 Van Base, LS, P30 Series Base GMC P3500 Van Base, Savana 2500 Base, SLE, Savana 3500 Base, SLE; Thermostat Housing	
1	Thermostat Gasket	1995-94	35271	Chevrolet P30 Series Base GMC P3500 Van Base; Thermostat Housing; Exc. Forward control chassis	
1	Thermostat Gasket	1995-94	35289	Exc. Chevrolet P30 Series Base GMC P3500 Van Base; Thermostat Housing	
1	Thermostat Gasket	1995-94	35289	Chevrolet P30 Series Base GMC P3500 Van Base; Thermostat Housing; Forward control chassis	
2	O-Ring	1999-97	35710	Thermostat Housing; 1.954" ID; Improved design	
QTY	WATER OUTLET GASKET	YEARS	PART NO.	DESCRIPTION	
2	Water Outlet Gasket	1999-94	35357	Water Crossover	
QTY	WATER PUMP	YEARS	PART NO.	DESCRIPTION	
1	Water Pump Mounting Set	1999-94	ES 72674		
QTY	TIMING COVER	YEARS	PART NO.	DESCRIPTION	
1	Timing Cover Set	1999-94	TCS 45554	w/o Sleeve 'N' Seal®	
1	Timing Set w/Sleeve & Seal	1999-94	TCS 45686	w/Sleeve 'N' Seal®	
1	Repair Sleeve	1999-94	16209	Timing Cover; Use w/installation tool	
1	Repair Sleeve Tool	1999-94	16311	Timing Cover	
QTY	AIR CLEANER MOUNTING	YEARS	PART NO.	DESCRIPTION	
1	Air Cleaner Gasket	1999-94	60555		
93		2005 - 2001; 6.6L 402 (6599cc) OHV Turbo - Intercooled V8 (32 Valve) 103mm Bore Duramax MFI; Diesel; Turbo - Intercooled GMC Eng.; VIN Code 1			93
QTY	CYLINDER HEAD	YEARS	PART NO.	DESCRIPTION	
1	Head Gasket	2005-01	26269 PT-1	Loc. L.H.; No hole; .0354" - .0394" thick; Head bolts not incl.; Head bolt replacement recommended; PermaTorqueMLS®; May use 26401PT instead; Improved design; Superseded - When depleted use 26401 PT	

GMC Truck (Incl. Minivans and SUV's) (Cont.)

93 (cont.)		2005 - 2001; 6.6L 402 (6599cc) OHV Turbo - Intercooled V8 (32 Valve) 103mm Bore Duramax MFI; Diesel; Turbo - Intercooled GMC Eng.; VIN Code 1			93 (cont.)
QTY	CYLINDER HEAD	YEARS	PART NO.	DESCRIPTION	
1	Head Gasket	2005-01	26270 PT-1	Loc. R.H.; No hole; .0354" - .0394" thick; Head bolts not incl.; Head bolt replacement recommended; PermaTorqueMLS®; May use 26402PT instead; Improved design; Superseded - When depleted use 26402 PT	
1	Head Gasket	2005-01	26271 PT-1	Loc. L.H.; 1 hole; .0372" - .0413" thick; Head bolts not incl.; Head bolt replacement recommended; PermaTorqueMLS®; May use 26401PT instead; Improved design; Superseded - When depleted use 26401 PT	
1	Head Gasket	2005-01	26272 PT-1	Loc. R.H.; 1 hole; .0372" - .0413" thick; Head bolts not incl.; Head bolt replacement recommended; PermaTorqueMLS®; May use 26402PT instead; Improved design; Superseded - When depleted use 26402 PT	
1	Head Gasket	2005-01	26273 PT-1	Loc. L.H.; 2 holes; .0394" - .0433" thick; Head bolts not incl.; Head bolt replacement recommended; PermaTorqueMLS®; May use 26401PT instead; Improved design; Superseded - When depleted use 26401 PT	
1	Head Gasket	2005-01	26274 PT-1	Loc. R.H.; 2 holes; .0394" - .0433" thick; Head bolts not incl.; Head bolt replacement recommended; PermaTorqueMLS®; May use 26402PT instead; Improved design; Superseded - When depleted use 26402 PT	
1	Head Gasket	2005-01	26401 PT	Loc. L.H.; .037" thick; Head bolts not incl.; Head bolt replacement recommended; PermaTorqueMLS® LaserWeld® Technology; Consolidated Improved design	
1	Head Gasket	2005-01	26402 PT	Loc. R.H.; .037" thick; Head bolts not incl.; Head bolt replacement recommended; PermaTorqueMLS® LaserWeld® Technology; Consolidated Improved design	
1	Head Gasket	2005-01	26405 PT	Loc. L.H.; .047" thick; .010" thicker for use when block is refaced; Head bolts not incl.; Head bolt replacement recommended; PermaTorqueMLS® LaserWeld® Technology	
1	Head Gasket	2005-01	26406 PT	Loc. R.H.; .047" thick; .010" thicker for use when block is refaced; Head bolts not incl.; Head bolt replacement recommended; PermaTorqueMLS® LaserWeld® Technology	
1	Head Set w/o Head Gasket	2005-01	HSU 26269	Head gskts. & head bolts not incl.; Head bolt replacement recommended; RTV sealant incl. for intake manifold gskts.; PermaDry® molded rubber valve cover gskts. incl.; Premium valve stem seals incl.	
2	Head Bolt Set	2005-01	ES 72199	Head bolts w/Washers; Replacement recommended; Old design	
2	Head Bolt Set	2005-01	ES 72344	Head bolts w/Washers; Replacement recommended; Improved design; New Part Number - Check for Availability	
QTY	CONVERSION SET	YEARS	PART NO.	DESCRIPTION	
1	Gasket Conversion Set	2005-01	CS 26269	RTV sealant incl. for Upper oil pan gskt.	
QTY	MANIFOLD - INT. & EXH.	YEARS	PART NO.	DESCRIPTION	
1	Int. Manifold Gasket Set	2005-01	MS 96541	Lower set; RTV sealant incl. for intake manifold gskts.; New Part Number - Check for Availability	
1	Plenum Gasket Set	2005-01	72762	Intake plenum tube; New Part Number - Check for Availability	
1	Exh. Manifold Gasket Set	2005-01	MS 96543		
QTY	EXHAUST PIPE FLANGE	YEARS	PART NO.	DESCRIPTION	
2	Exhaust Pipe Gasket	2005-01	61379	Flange	
1	Exhaust Pipe Gasket	2005-04	61457	Converter	
QTY	OIL PAN	YEARS	PART NO.	DESCRIPTION	
1	Oil Pan Gasket Set	2005-01	OS 30748	Loc. Lower	
QTY	CRANKSHAFT REAR SEAL	YEARS	PART NO.	DESCRIPTION	
1	Rear Main Seal Set	2005-01	BS 40683	Rubber; One-piece	
QTY	VALVE COVER	YEARS	PART NO.	DESCRIPTION	
1	Valve Cover Gasket Set	2005-01	VS 50622 R	w/Grommets; Fuel injector to Valve cover seals incl.; PermaDry® molded rubber gskts. incl.	
1	Valve Cover Gasket Set	2005-01	VS 50822 R	Complete set; w/Grommets & Fuel injector seals incl.; PermaDry® molded rubber gskts. incl.; New Part Number - Check for Availability	
QTY	VALVE STEM SEAL SET	YEARS	PART NO.	DESCRIPTION	
1	Valve Stem Seal Set	2005-01	SS 72916	Premium valve stem seals incl.	
QTY	THERMOSTAT HOUSING	YEARS	PART NO.	DESCRIPTION	
2	Thermostat Gasket	2005-01	35762	Thermostat Housing; Thermostat seal	
QTY	WATER OUTLET GASKET	YEARS	PART NO.	DESCRIPTION	
2	Water Outlet Gasket	2005-01	35757	Water Crossover; Crossover pipe	
1	O-Ring	2005-01	35759	Water Outlet	
QTY	WATER PUMP	YEARS	PART NO.	DESCRIPTION	
1	Water Pump Gasket	2005-01	35756	Mounting O-ring	
1	Water Pump Gasket	2005-01	35758	Pump to pipe	
1	Water Pump Mounting Set	2005-01	ES 71347		
QTY	TIMING COVER	YEARS	PART NO.	DESCRIPTION	
1	Timing Cover Set	2005-01	TCS 45055		

GMC Truck (Incl. Minivans and SUV's) (Cont.)

93		2005 - 2001; 6.6L 402 (6599cc) OHV Turbo - Intercooled V8 (32 Valve) 103mm Bore Duramax			93
(cont.)		MFI; Diesel; Turbo - Intercooled GMC Eng.; VIN Code 1			(cont.)
QTY	TIMING COVER	YEARS	PART NO.	DESCRIPTION	
1	Crankshaft Front Seal Set	2005-01	TCS 46193	New Part Number - Check for Availability	
QTY	EXHAUST GAS RECIRCULATION	YEARS	PART NO.	DESCRIPTION	
1	EGR Gasket	2005-01	71219	Tube	
1	EGR Gasket	2005-01	71220	Valve	
QTY	TURBO MOUNTING SET	YEARS	PART NO.	DESCRIPTION	
1	Turbo Mtg. Gasket Set	2005-01	61720	Turbo air inlet pipe; New Part Number - Check for Availability	
94		2007 - 2004; 6.6L 402 (6599cc) OHV Turbo - Intercooled V8 (32 Valve) 103mm Bore Duramax			94
		MFI; Diesel; Turbo - Intercooled GMC Eng.; VIN Code 2			
QTY	CYLINDER HEAD	YEARS	PART NO.	DESCRIPTION	
1	Head Gasket	2007-04	26269 PT-1	Loc. L.H.; No hole; .0354" - .0394" thick; Head bolts not incl.; Head bolt replacement recommended; PermaTorqueMLS®; May use 26401PT instead; Improved design; Superseded - When depleted use 26401 PT	
1	Head Gasket	2007-04	26270 PT-1	Loc. R.H.; No hole; .0354" - .0394" thick; Head bolts not incl.; Head bolt replacement recommended; PermaTorqueMLS®; May use 26402PT instead; Improved design; Superseded - When depleted use 26402 PT	
1	Head Gasket	2007-04	26271 PT-1	Loc. L.H.; 1 hole; .0372" - .0413" thick; Head bolts not incl.; Head bolt replacement recommended; PermaTorqueMLS®; May use 26401PT instead; Improved design; Superseded - When depleted use 26401 PT	
1	Head Gasket	2007-04	26272 PT-1	Loc. R.H.; 1 hole; .0372" - .0413" thick; Head bolts not incl.; Head bolt replacement recommended; PermaTorqueMLS®; May use 26402PT instead; Improved design; Superseded - When depleted use 26402 PT	
1	Head Gasket	2007-04	26273 PT-1	Loc. L.H.; 2 holes; .0394" - .0433" thick; Head bolts not incl.; Head bolt replacement recommended; PermaTorqueMLS®; May use 26401PT instead; Improved design; Superseded - When depleted use 26401 PT	
1	Head Gasket	2007-04	26274 PT-1	Loc. R.H.; 2 holes; .0394" - .0433" thick; Head bolts not incl.; Head bolt replacement recommended; PermaTorqueMLS®; May use 26402PT instead; Improved design; Superseded - When depleted use 26402 PT	
1	Head Gasket	2007-04	26401 PT	Loc. L.H.; .037" thick; Head bolts not incl.; Head bolt replacement recommended; PermaTorqueMLS® LaserWeld® Technology; Consolidated Improved design	
1	Head Gasket	2007-04	26402 PT	Loc. R.H.; .037" thick; Head bolts not incl.; Head bolt replacement recommended; PermaTorqueMLS® LaserWeld® Technology; Consolidated Improved design	
1	Head Gasket	2007-04	26405 PT	Loc. L.H.; .047" thick; .010" thicker for use when block is refaced; Head bolts not incl.; Head bolt replacement recommended; PermaTorqueMLS® LaserWeld® Technology	
1	Head Gasket	2007-04	26406 PT	Loc. R.H.; .047" thick; .010" thicker for use when block is refaced; Head bolts not incl.; Head bolt replacement recommended; PermaTorqueMLS® LaserWeld® Technology	
1	Head Set w/o Head Gasket	2007-04	HSU 26269-1	Head gskts. & head bolts not incl.; Head bolt replacement recommended; RTV sealant incl. for intake manifold gskts.; PermaDry® molded rubber valve cover gskts. incl.; Premium valve stem seals incl.	
2	Head Bolt Set	2007-04	ES 72199	Head bolts w/Washers; Replacement recommended; Old design	
2	Head Bolt Set	2007-04	ES 72344	Head bolts w/Washers; Replacement recommended; Improved design; New Part Number - Check for Availability	
QTY	CONVERSION SET	YEARS	PART NO.	DESCRIPTION	
1	Gasket Conversion Set	2007-04	CS 26269	RTV sealant incl. for Upper oil pan gskt.	
QTY	MANIFOLD - INT. & EXH.	YEARS	PART NO.	DESCRIPTION	
1	Int. Manifold Gasket Set	2007-06	MS 97291	Lower set; RTV sealant incl. for intake manifold gskts.; New Part Number - Check for Availability	
1	Int. Manifold Gasket Set	2005-04	MS 96541	Lower set; RTV sealant incl. for intake manifold gskts.; New Part Number - Check for Availability	
2	Plenum Gasket Set	2007-04	72946	Intake plenum tube O-ring; New Part Number - Check for Availability	
1	Plenum Gasket Set	2007-06	72764	Exc. Chevrolet Express 2500 Van Base, LS, LT, Express 3500 Van Base, LS, LT GMC Savana 2500 Base, LS, LT, Savana 3500 Base, LS, LT; Intake plenum tube; New Part Number - Check for Availability	
1	Plenum Gasket Set	2007-06	72767	Chevrolet Express 2500 Van Base, LS, LT, Express 3500 Van Base, LS, LT GMC Savana 2500 Base, LS, LT, Savana 3500 Base, LS, LT; Intake plenum tube; New Part Number - Check for Availability	
1	Plenum Gasket Set	2005-04	72763	Intake plenum tube; New Part Number - Check for Availability	
1	Exh. Manifold Gasket Set	2007-04	MS 96788		
QTY	EXHAUST PIPE FLANGE	YEARS	PART NO.	DESCRIPTION	
2	Exhaust Pipe Gasket	2007-04	61379	Flange	

GMC Truck (Incl. Minivans and SUV's) (Cont.)

94		2007 - 2004; 6.6L 402 (6599cc) OHV Turbo - Intercooled V8 (32 Valve) 103mm Bore Duramax			94	
(cont.)		MFI; Diesel; Turbo - Intercooled GMC Eng.; VIN Code 2			(cont.)	
QTY	EXHAUST PIPE FLANGE	YEARS	PART NO.	DESCRIPTION		
1	Exhaust Pipe Gasket	2007-04	61457	Converter		
QTY	OIL PAN	YEARS	PART NO.	DESCRIPTION		
1	Oil Pan Gasket Set	2007-04	OS 30748	Loc. Lower		
QTY	CRANKSHAFT REAR SEAL	YEARS	PART NO.	DESCRIPTION		
1	Rear Main Seal Set	2007-04	BS 40683	Rubber; One-piece		
QTY	VALVE COVER	YEARS	PART NO.	DESCRIPTION		
1	Valve Cover Gasket Set	2007-04	VS 50681	Loc. Lower		
1	Valve Cover Gasket Set	2007-04	VS 50684 R	Loc. Upper; w/Grommets; PermaDry® molded rubber gskts. incl.		
1	Valve Cover Gasket Set	2007-04	VS 50821 R	Complete set; Upper & Lower valve cover gskts incl.; w/Grommets & Fuel injector seals incl.; PermaDry® molded rubber gskts. incl.; New Part Number - Check for Availability		
QTY	VALVE STEM SEAL SET	YEARS	PART NO.	DESCRIPTION		
1	Valve Stem Seal Set	2007-04	SS 72916	Premium valve stem seals incl.		
QTY	THERMOSTAT HOUSING	YEARS	PART NO.	DESCRIPTION		
2	Thermostat Gasket	2007-04	35762	Thermostat Housing; Thermostat seal		
QTY	WATER OUTLET GASKET	YEARS	PART NO.	DESCRIPTION		
2	Water Outlet Gasket	2007-04	35757	Water Crossover; Crossover pipe		
1	O-Ring	2007-04	35759	Water Outlet		
QTY	WATER PUMP	YEARS	PART NO.	DESCRIPTION		
1	Water Pump Gasket	2007-04	35756	Mounting O-ring		
1	Water Pump Gasket	2007-04	35758	Pump to pipe		
1	Water Pump Mounting Set	2007-04	ES 71347			
QTY	TIMING COVER	YEARS	PART NO.	DESCRIPTION		
1	Timing Cover Set	2007-04	TCS 45055			
1	Crankshaft Front Seal Set	2007-04	TCS 46193	New Part Number - Check for Availability		
QTY	CARB & FUEL INJECTION	YEARS	PART NO.	DESCRIPTION		
1	Throttle Body Gasket	2007-06	61746	Heater to plenum; New Part Number - Check for Availability		
QTY	EXHAUST GAS RECIRCULATION	YEARS	PART NO.	DESCRIPTION		
1	EGR Gasket	2007-04	71248	Valve		
1	EGR Gasket	2007-06	71249	Loc. R.H.; Pipe		
1	EGR Gasket	2007-06	71251	Loc. L.H.; Pipe		
1	EGR Gasket	2007	61693	EGR cooler; Turbo inlet flange; New Part Number - Check for Availability		
1	EGR Gasket	2005-04	71250	Pipe		
95		2006; 6.6L 402 (6599cc) OHV Turbo - Intercooled V8 (32 Valve) 103mm Bore Duramax			95	
		MFI; Diesel; Turbo - Intercooled GMC Eng.; VIN Code 3				
QTY	CYLINDER HEAD	YEARS	PART NO.	DESCRIPTION		
1	Head Gasket	2006	26269 PT-1	Loc. L.H.; No hole; .0354" - .0394" thick; Head bolts not incl.; Head bolt replacement recommended; PermaTorqueMLS®; May use 26401PT instead; Improved design; Superseded - When depleted use 26401 PT		
1	Head Gasket	2006	26270 PT-1	Loc. R.H.; No hole; .0354" - .0394" thick; Head bolts not incl.; Head bolt replacement recommended; PermaTorqueMLS®; May use 26402PT instead; Improved design; Superseded - When depleted use 26402 PT		
1	Head Gasket	2006	26271 PT-1	Loc. L.H.; 1 hole; .0372" - .0413" thick; Head bolts not incl.; Head bolt replacement recommended; PermaTorqueMLS®; May use 26401PT instead; Improved design; Superseded - When depleted use 26401 PT		
1	Head Gasket	2006	26272 PT-1	Loc. R.H.; 1 hole; .0372" - .0413" thick; Head bolts not incl.; Head bolt replacement recommended; PermaTorqueMLS®; May use 26402PT instead; Improved design; Superseded - When depleted use 26402 PT		
1	Head Gasket	2006	26273 PT-1	Loc. L.H.; 2 holes; .0394" - .0433" thick; Head bolts not incl.; Head bolt replacement recommended; PermaTorqueMLS®; May use 26401PT instead; Improved design; Superseded - When depleted use 26401 PT		
1	Head Gasket	2006	26274 PT-1	Loc. R.H.; 2 holes; .0394" - .0433" thick; Head bolts not incl.; Head bolt replacement recommended; PermaTorqueMLS®; May use 26402PT instead; Improved design; Superseded - When depleted use 26402 PT		
1	Head Gasket	2006	26401 PT	Loc. L.H.; .037" thick; Head bolts not incl.; Head bolt replacement recommended; PermaTorqueMLS® LaserWeld® Technology; Consolidated Improved design		
1	Head Gasket	2006	26402 PT	Loc. R.H.; .037" thick; Head bolts not incl.; Head bolt replacement recommended; PermaTorqueMLS® LaserWeld® Technology; Consolidated Improved design		

GMC Truck (Incl. Minivans and SUV's) (Cont.)

95 (cont.)		2006; 6.6L 402 (6599cc) OHV Turbo - Intercooled V8 (32 Valve) 103mm Bore Duramax			95 (cont.)
		MFI; Diesel; Turbo - Intercooled GMC Eng.; VIN Code 3			
QTY	CYLINDER HEAD	YEARS	PART NO.	DESCRIPTION	
1	Head Gasket	2006	26405 PT	Loc. L.H.; .047" thick; .010" thicker for use when block is refaced; Head bolts not incl.; Head bolt replacement recommended; PermaTorqueMLS® LaserWeld® Technology	
1	Head Gasket	2006	26406 PT	Loc. R.H.; .047" thick; .010" thicker for use when block is refaced; Head bolts not incl.; Head bolt replacement recommended; PermaTorqueMLS® LaserWeld® Technology	
1	Head Set w/o Head Gasket	2006	HSU 26269-1	Head gskts. & head bolts not incl.; Head bolt replacement recommended; RTV sealant incl. for intake manifold gskts.; PermaDry® molded rubber valve cover gskts. incl.; Premium valve stem seals incl.	
2	Head Bolt Set	2006	ES 72199	Head bolts w/Washers; Replacement recommended; Old design	
2	Head Bolt Set	2006	ES 72344	Head bolts w/Washers; Replacement recommended; Improved design; New Part Number - Check for Availability	
QTY	CONVERSION SET	YEARS	PART NO.	DESCRIPTION	
1	Gasket Conversion Set	2006	CS 26269	RTV sealant incl. for Upper oil pan gskt.	
QTY	MANIFOLD - INT. & EXH.	YEARS	PART NO.	DESCRIPTION	
1	Int. Manifold Gasket Set	2006	MS 97291	Lower set; RTV sealant incl. for intake manifold gskts.; New Part Number - Check for Availability	
1	Plenum Gasket Set	2006	72764	Intake plenum tube; New Part Number - Check for Availability	
2	Plenum Gasket Set	2006	72946	Intake plenum tube O-ring; New Part Number - Check for Availability	
1	Exh. Manifold Gasket Set	2006	MS 96788		
QTY	EXHAUST PIPE FLANGE	YEARS	PART NO.	DESCRIPTION	
2	Exhaust Pipe Gasket	2006	61379	Flange	
1	Exhaust Pipe Gasket	2006	61457	Converter	
QTY	OIL PAN	YEARS	PART NO.	DESCRIPTION	
1	Oil Pan Gasket Set	2006	OS 30748	Loc. Lower	
QTY	CRANKSHAFT REAR SEAL	YEARS	PART NO.	DESCRIPTION	
1	Rear Main Seal Set	2006	BS 40683	Rubber; One-piece	
QTY	VALVE COVER	YEARS	PART NO.	DESCRIPTION	
1	Valve Cover Gasket Set	2006	VS 50681	Loc. Lower	
1	Valve Cover Gasket Set	2006	VS 50684 R	Loc. Upper; w/Grommets; PermaDry® molded rubber gskts. incl.	
1	Valve Cover Gasket Set	2006	VS 50821 R	Complete set; Upper & Lower valve cover gskts incl.; w/Grommets & Fuel injector seals incl.; PermaDry® molded rubber gskts. incl.; New Part Number - Check for Availability	
QTY	VALVE STEM SEAL SET	YEARS	PART NO.	DESCRIPTION	
1	Valve Stem Seal Set	2006	SS 72916	Premium valve stem seals incl.	
QTY	THERMOSTAT HOUSING	YEARS	PART NO.	DESCRIPTION	
2	Thermostat Gasket	2006	35762	Thermostat Housing; Thermostat seal	
QTY	WATER OUTLET GASKET	YEARS	PART NO.	DESCRIPTION	
2	Water Outlet Gasket	2006	35757	Water Crossover; Crossover pipe	
1	O-Ring	2006	35759	Water Outlet	
QTY	WATER PUMP	YEARS	PART NO.	DESCRIPTION	
1	Water Pump Gasket	2006	35756	Mounting O-ring	
1	Water Pump Gasket	2006	35758	Pump to pipe	
1	Water Pump Mounting Set	2006	ES 71347		
QTY	TIMING COVER	YEARS	PART NO.	DESCRIPTION	
1	Timing Cover Set	2006	TCS 45055		
1	Crankshaft Front Seal Set	2006	TCS 46193	New Part Number - Check for Availability	
QTY	CARB & FUEL INJECTION	YEARS	PART NO.	DESCRIPTION	
1	Throttle Body Gasket	2006	61746	Heater to plenum; New Part Number - Check for Availability	
QTY	EXHAUST GAS RECIRCULATION	YEARS	PART NO.	DESCRIPTION	
1	EGR Gasket	2006	71248	Valve	
1	EGR Gasket	2006	71249	Loc. R.H.; Pipe	
1	EGR Gasket	2006	71251	Loc. L.H.; Pipe	
96		2013 - 2007; 6.6L 402 (6599cc) OHV Turbo - Intercooled V8 (32 Valve) 103mm Bore Duramax			96
		MFI; Diesel; Turbo - Intercooled GMC Eng.; VIN Code 6			
QTY	CYLINDER HEAD	YEARS	PART NO.	DESCRIPTION	
1	Head Gasket	2011-07	26401 PT	Loc. L.H.; .037" thick; Head bolts not incl.; Head bolt replacement recommended; PermaTorqueMLS® LaserWeld® Technology; Consolidated Improved design	
1	Head Gasket	2011-07	26402 PT	Loc. R.H.; .037" thick; Head bolts not incl.; Head bolt replacement recommended; PermaTorqueMLS® LaserWeld® Technology; Consolidated Improved design	

GMC Truck (Incl. Minivans and SUV's) (Cont.)

96		2013 - 2007; 6.6L 402 (6599cc) OHV Turbo - Intercooled V8 (32 Valve) 103mm Bore Duramax			96
(cont.)		MFI; Diesel; Turbo - Intercooled GMC Eng.; VIN Code 6			(cont.)
QTY	CYLINDER HEAD	YEARS	PART NO.	DESCRIPTION	
1	Head Gasket	2011-07	26405 PT	Loc. L.H.; .047" thick; .010" thicker for use when block is refaced; Head bolts not incl.; Head bolt replacement recommended; PermaTorqueMLS® LaserWeld® Technology	
1	Head Gasket	2011-07	26406 PT	Loc. R.H.; .047" thick; .010" thicker for use when block is refaced; Head bolts not incl.; Head bolt replacement recommended; PermaTorqueMLS® LaserWeld® Technology	
1	Head Gasket	2007	26269 PT-1	Loc. L.H.; No hole; .0354" - .0394" thick; Head bolts not incl.; Head bolt replacement recommended; PermaTorqueMLS®; May use 26401PT instead; Improved design; Superseded - When depleted use 26401 PT	
1	Head Gasket	2007	26270 PT-1	Loc. R.H.; No hole; .0354" - .0394" thick; Head bolts not incl.; Head bolt replacement recommended; PermaTorqueMLS®; May use 26402PT instead; Improved design; Superseded - When depleted use 26402 PT	
1	Head Gasket	2007	26271 PT-1	Loc. L.H.; 1 hole; .0372" - .0413" thick; Head bolts not incl.; Head bolt replacement recommended; PermaTorqueMLS®; May use 26401PT instead; Improved design; Superseded - When depleted use 26401 PT	
1	Head Gasket	2007	26272 PT-1	Loc. R.H.; 1 hole; .0372" - .0413" thick; Head bolts not incl.; Head bolt replacement recommended; PermaTorqueMLS®; May use 26402PT instead; Improved design; Superseded - When depleted use 26402 PT	
1	Head Gasket	2007	26273 PT-1	Loc. L.H.; 2 holes; .0394" - .0433" thick; Head bolts not incl.; Head bolt replacement recommended; PermaTorqueMLS®; May use 26401PT instead; Improved design; Superseded - When depleted use 26401 PT	
1	Head Gasket	2007	26274 PT-1	Loc. R.H.; 2 holes; .0394" - .0433" thick; Head bolts not incl.; Head bolt replacement recommended; PermaTorqueMLS®; May use 26402PT instead; Improved design; Superseded - When depleted use 26402 PT	
1	Head Set w/o Head Gasket	2013-11	HSU 26269-3	Head gskts. & head bolts not incl.; Head bolt replacement recommended; RTV sealant incl. for intake manifold gskts.; PermaDry® molded rubber valve cover gskts. incl.; Premium valve stem seals incl.; New Part Number - Check for Availability	
1	Head Set w/o Head Gasket	2010	HSU 26269-1	Exc. Chevrolet Express 4500 Van Base GMC Savana 4500 Base; Head gskts. & head bolts not incl.; Head bolt replacement recommended; RTV sealant incl. for intake manifold gskts.; PermaDry® molded rubber valve cover gskts. incl.; Premium valve stem seals incl.	
1	Head Set w/o Head Gasket	2010	HSU 26269-2	Chevrolet Express 4500 Van Base GMC Savana 4500 Base; Head gskts. & head bolts not incl.; Head bolt replacement recommended; RTV sealant incl. for intake manifold gskts.; PermaDry® molded rubber valve cover gskts. incl.; Premium valve stem seals incl.; New Part Number - Check for Availability	
1	Head Set w/o Head Gasket	2009-07	HSU 26269-1	Head gskts. & head bolts not incl.; Head bolt replacement recommended; RTV sealant incl. for intake manifold gskts.; PermaDry® molded rubber valve cover gskts. incl.; Premium valve stem seals incl.	
2	Head Bolt Set	2011-07	ES 72199	Head bolts w/Washers; Replacement recommended; Old design	
2	Head Bolt Set	2011-07	ES 72344	Head bolts w/Washers; Replacement recommended; Improved design; New Part Number - Check for Availability	
QTY	CONVERSION SET	YEARS	PART NO.	DESCRIPTION	
1	Gasket Conversion Set	2013-11	CS 26269-2	RTV sealant incl. for Upper oil pan gskt.; New Part Number - Check for Availability	
1	Gasket Conversion Set	2010-07	CS 26269	RTV sealant incl. for Upper oil pan gskt.	
QTY	MANIFOLD - INT. & EXH.	YEARS	PART NO.	DESCRIPTION	
1	Int. Manifold Gasket Set	2010-07	MS 97318	Lower set; RTV sealant incl. for intake manifold gskts.; New Part Number - Check for Availability	
1	Plenum Gasket Set	2013-11	72767	Exc. Chevrolet Silverado 2500 HD LS, LT, LTZ, WT GMC Sierra 2500 HD SL, SLE, SLT, WT; Intake plenum tube; New Part Number - Check for Availability	
1	Plenum Gasket Set	2013-11	73009	Chevrolet Silverado 2500 HD LS, LT, LTZ, WT GMC Sierra 2500 HD SL, SLE, SLT, WT; Intake plenum tube; New Part Number - Check for Availability	
2	Plenum Gasket Set	2010-07	72946	Intake plenum tube O-ring; New Part Number - Check for Availability	
1	Plenum Gasket Set	2010	72764	Chevrolet Silverado 2500 HD LS, LT, LTZ, WT, Silverado 3500 LS, LT, LTZ, WT GMC Sierra 2500 HD SL, SLE, SLT, WT, Sierra 3500 SL, SLE, SLT, WT; Intake plenum tube; New Part Number - Check for Availability	
1	Plenum Gasket Set	2010	72767	Exc. Chevrolet Silverado 2500 HD LS, LT, LTZ, WT, Silverado 3500 LS, LT, LTZ, WT GMC Sierra 2500 HD SL, SLE, SLT, WT, Sierra 3500 SL, SLE, SLT, WT; Intake plenum tube; New Part Number - Check for Availability	

GMC Truck (Incl. Minivans and SUV's) (Cont.)

96 (cont.)	2013 - 2007; 6.6L 402 (6599cc) OHV Turbo - Intercooled V8 (32 Valve) 103mm Bore Duramax MFI; Diesel; Turbo - Intercooled GMC Eng.; VIN Code 6				96 (cont.)
QTY	MANIFOLD - INT. & EXH.	YEARS	PART NO.	DESCRIPTION	
1	Plenum Gasket Set	2009-08	72764	Exc. Chevrolet Express 2500 Van Base, LS, LT, Express 3500 Van Base, LS, LT GMC Savana 2500 Base, LS, LT, Savana 3500 Base, LS, LT; Intake plenum tube; New Part Number - Check for Availability	
1	Plenum Gasket Set	2009-08	72767	Chevrolet Express 2500 Van Base, LS, LT, Express 3500 Van Base, LS, LT GMC Savana 2500 Base, LS, LT, Savana 3500 Base, LS, LT; Intake plenum tube; New Part Number - Check for Availability	
1	Plenum Gasket Set	2007	72764	Intake plenum tube; New Part Number - Check for Availability	
1	Exh. Manifold Gasket Set	2013-07	MS 96788		
QTY	EXHAUST PIPE FLANGE	YEARS	PART NO.	DESCRIPTION	
2	Exhaust Pipe Gasket	2013-07	61379	Flange	
1	Exhaust Pipe Gasket	2013-07	61457	Converter	
QTY	OIL PAN	YEARS	PART NO.	DESCRIPTION	
1	Oil Pan Gasket Set	2013-11	OS 30838	Loc. Lower; New Part Number - Check for Availability	
1	Oil Pan Gasket Set	2010-07	OS 30748	Loc. Lower	
QTY	CRANKSHAFT REAR SEAL	YEARS	PART NO.	DESCRIPTION	
1	Rear Main Seal Set	2013-07	BS 40683	Rubber; One-piece	
QTY	VALVE COVER	YEARS	PART NO.	DESCRIPTION	
1	Valve Cover Gasket Set	2013-07	VS 50681	Loc. Lower	
1	Valve Cover Gasket Set	2013-11	VS 50813 R	Loc. Upper; w/Grommets & PCV seals; PermaDry® molded rubber gskts. incl.; New Part Number - Check for Availability	
1	Valve Cover Gasket Set	2010	VS 50684 R	Exc. Chevrolet Express 4500 Van Base GMC Savana 4500 Base; Loc. Upper; w/Grommets; PermaDry® molded rubber gskts. incl.	
1	Valve Cover Gasket Set	2010	VS 50813 R	Chevrolet Express 4500 Van Base GMC Savana 4500 Base; Loc. Upper; w/Grommets & PCV seals; PermaDry® molded rubber gskts. incl.; New Part Number - Check for Availability	
1	Valve Cover Gasket Set	2010	VS 50821 R	Exc. Chevrolet Express 4500 Van Base GMC Savana 4500 Base; Complete set; Upper & Lower valve cover gskts incl.; w/Grommets & Fuel injector seals incl.; PermaDry® molded rubber gskts. incl.; New Part Number - Check for Availability	
1	Valve Cover Gasket Set	2009-07	VS 50684 R	Loc. Upper; w/Grommets; PermaDry® molded rubber gskts. incl.	
1	Valve Cover Gasket Set	2009-07	VS 50821 R	Complete set; Upper & Lower valve cover gskts incl.; w/Grommets & Fuel injector seals incl.; PermaDry® molded rubber gskts. incl.; New Part Number - Check for Availability	
QTY	VALVE STEM SEAL SET	YEARS	PART NO.	DESCRIPTION	
1	Valve Stem Seal Set	2013-11	SS 72551	Premium valve stem seals incl.; New Part Number - Check for Availability	
1	Valve Stem Seal Set	2010-07	SS 72916	Premium valve stem seals incl.	
QTY	THERMOSTAT HOUSING	YEARS	PART NO.	DESCRIPTION	
2	Thermostat Gasket	2013-07	35762	Thermostat Housing; Thermostat seal	
QTY	WATER OUTLET GASKET	YEARS	PART NO.	DESCRIPTION	
2	Water Outlet Gasket	2013-07	35757	Water Crossover; Crossover pipe	
1	O-Ring	2013-07	35759	Water Outlet	
QTY	WATER PUMP	YEARS	PART NO.	DESCRIPTION	
1	Water Pump Gasket	2013-07	35756	Mounting O-ring	
1	Water Pump Gasket	2013-07	35758	Pump to pipe	
1	Water Pump Mounting Set	2013-07	ES 71347		
QTY	TIMING COVER	YEARS	PART NO.	DESCRIPTION	
1	Timing Cover Set	2013-07	TCS 45055		
1	Crankshaft Front Seal Set	2013-07	TCS 46193	New Part Number - Check for Availability	
QTY	CARB & FUEL INJECTION	YEARS	PART NO.	DESCRIPTION	
1	Throttle Body Gasket	2013-07	61746	Heater to plenum; New Part Number - Check for Availability	
1	Throttle Body Gasket	2013-11	61696	Heater to intake tube; New Part Number - Check for Availability	
1	Throttle Body Gasket	2013-11	61697	Heater to throttle body; New Part Number - Check for Availability	
1	Throttle Body Gasket	2010	61747	Chevrolet Silverado 2500 HD LS, LT, LTZ, WT, Silverado 3500 LS, LT, LTZ, WT GMC Sierra 2500 HD SL, SLE, SLT, WT, Sierra 3500 SL, SLE, SLT, WT; Throttle body mounting; New Part Number - Check for Availability	
1	Throttle Body Gasket	2009-08	61747	Exc. Chevrolet Express 2500 Van Base, LS, LT, Express 3500 Van Base, LS, LT GMC Savana 2500 Base, LS, LT, Savana 3500 Base, LS, LT; Throttle body mounting; New Part Number - Check for Availability	
1	Throttle Body Gasket	2007	61747	Throttle body mounting; New Part Number - Check for Availability	
QTY	EXHAUST GAS RECIRCULATION	YEARS	PART NO.	DESCRIPTION	
1	EGR Gasket	2013-11	61692	Exc. Chevrolet Silverado 2500 HD LS, LT, LTZ, WT GMC Sierra 2500 HD SL, SLE, SLT, WT; EGR cooler; Turbo inlet flange; New Part Number - Check for Availability	

GMC Truck (Incl. Minivans and SUV's) (Cont.)

96		2013 - 2007; 6.6L 402 (6599cc) OHV Turbo - Intercooled V8 (32 Valve) 103mm Bore Duramax			96	
(cont.)		MFI; Diesel; Turbo - Intercooled GMC Eng.; VIN Code 6			(cont.)	
QTY	EXHAUST GAS RECIRCULATION	YEARS	PART NO.	DESCRIPTION		
2	EGR Gasket	2013-11	71442	EGR valve to int. manifold; New Part Number - Check for Availability		
1	EGR Gasket	2013-11	71443	EGR valve to cooler; New Part Number - Check for Availability		
1	EGR Gasket	2010-07	61693	EGR cooler; Turbo inlet flange; New Part Number - Check for Availability		
1	EGR Gasket	2010-07	71248	Valve		
1	EGR Gasket	2010-07	71249	Loc. R.H.; Pipe		
1	EGR Gasket	2010-07	71251	Loc. L.H.; Pipe		
97		2013 - 2011; 6.6L 402 (6599cc) OHV Turbo - Intercooled V8 (32 Valve) 103mm Bore Duramax			97	
		MFI; Diesel; Turbo - Intercooled GMC Eng.; VIN Code 8				
QTY	CYLINDER HEAD	YEARS	PART NO.	DESCRIPTION		
1	Head Gasket	2011	26401 PT	Loc. L.H.; .037" thick; Head bolts not incl.; Head bolt replacement recommended; PermaTorqueMLS® LaserWeld® Technology; Consolidated Improved design		
1	Head Gasket	2011	26402 PT	Loc. R.H.; .037" thick; Head bolts not incl.; Head bolt replacement recommended; PermaTorqueMLS® LaserWeld® Technology; Consolidated Improved design		
1	Head Gasket	2011	26405 PT	Loc. L.H.; .047" thick; .010" thicker for use when block is refaced; Head bolts not incl.; Head bolt replacement recommended; PermaTorqueMLS® LaserWeld® Technology		
1	Head Gasket	2011	26406 PT	Loc. R.H.; .047" thick; .010" thicker for use when block is refaced; Head bolts not incl.; Head bolt replacement recommended; PermaTorqueMLS® LaserWeld® Technology		
1	Head Set w/o Head Gasket	2013-11	HSU 26269-3	Head gskts. & head bolts not incl.; Head bolt replacement recommended; RTV sealant incl. for intake manifold gskts.; PermaDry® molded rubber valve cover gskts. incl.; Premium valve stem seals incl.; New Part Number - Check for Availability		
2	Head Bolt Set	2011	ES 72344	Head bolts w/Washers; Replacement recommended; Improved design; New Part Number - Check for Availability		
QTY	CONVERSION SET	YEARS	PART NO.	DESCRIPTION		
1	Gasket Conversion Set	2013-11	CS 26269-2	RTV sealant incl. for Upper oil pan gskt.; New Part Number - Check for Availability		
QTY	MANIFOLD - INT. & EXH.	YEARS	PART NO.	DESCRIPTION		
1	Plenum Gasket Set	2013-11	73009	Intake plenum tube; New Part Number - Check for Availability		
1	Exh. Manifold Gasket Set	2013-11	MS 96788			
QTY	EXHAUST PIPE FLANGE	YEARS	PART NO.	DESCRIPTION		
2	Exhaust Pipe Gasket	2013-11	61379	Pipe to manifold		
2	Exhaust Pipe Gasket	2013-11	61457	Converter		
QTY	OIL PAN	YEARS	PART NO.	DESCRIPTION		
1	Oil Pan Gasket Set	2013-11	OS 30838	Loc. Lower; New Part Number - Check for Availability		
QTY	CRANKSHAFT REAR SEAL	YEARS	PART NO.	DESCRIPTION		
1	Rear Main Seal Set	2013-11	BS 40683	Rubber; One-piece		
QTY	VALVE COVER	YEARS	PART NO.	DESCRIPTION		
1	Valve Cover Gasket Set	2013-11	VS 50681	Loc. Lower		
1	Valve Cover Gasket Set	2013-11	VS 50813 R	Loc. Upper; w/Grommets & PCV seals; PermaDry® molded rubber gskts. incl.; New Part Number - Check for Availability		
QTY	VALVE STEM SEAL SET	YEARS	PART NO.	DESCRIPTION		
1	Valve Stem Seal Set	2013-11	SS 72551	Premium valve stem seals incl.; New Part Number - Check for Availability		
QTY	THERMOSTAT HOUSING	YEARS	PART NO.	DESCRIPTION		
2	Thermostat Gasket	2013-11	35762	Thermostat Housing; Thermostat seal		
QTY	WATER OUTLET GASKET	YEARS	PART NO.	DESCRIPTION		
2	Water Outlet Gasket	2013-11	35757	Water Crossover; Crossover pipe		
1	O-Ring	2013-11	35759	Water Outlet		
QTY	WATER PUMP	YEARS	PART NO.	DESCRIPTION		
1	Water Pump Gasket	2013-11	35756	Mounting O-ring		
1	Water Pump Gasket	2013-11	35758	Pump to pipe		
1	Water Pump Mounting Set	2013-11	ES 71347			
QTY	TIMING COVER	YEARS	PART NO.	DESCRIPTION		
1	Timing Cover Set	2013-11	TCS 45055			
1	Crankshaft Front Seal Set	2013-11	TCS 46193	New Part Number - Check for Availability		
QTY	CARB & FUEL INJECTION	YEARS	PART NO.	DESCRIPTION		
1	Throttle Body Gasket	2013-11	61696	Heater to intake tube; New Part Number - Check for Availability		
1	Throttle Body Gasket	2013-11	61697	Heater to throttle body; New Part Number - Check for Availability		
1	Throttle Body Gasket	2013-11	61746	Heater to plenum; New Part Number - Check for Availability		

GMC Truck (Incl. Minivans and SUV's) (Cont.)

97		2013 - 2011; 6.6L 402 (6599cc) OHV Turbo - Intercooled V8 (32 Valve) 103mm Bore Duramax			97
(cont.)		MFI; Diesel; Turbo - Intercooled GMC Eng.; VIN Code 8			(cont.)
QTY	EXHAUST GAS RECIRCULATION	YEARS	PART NO.	DESCRIPTION	
2	EGR Gasket	2013-11	71442	EGR valve to int. manifold; New Part Number - Check for Availability	
1	EGR Gasket	2013-11	71443	EGR valve to cooler; New Part Number - Check for Availability	
98		2013 - 2011; 6.6L 402 (6599cc) OHV Turbo - Intercooled V8 (32 Valve) 103mm Bore Duramax			98
		MFI; Diesel; Turbo - Intercooled GMC Eng.; VIN Code L			
QTY	CYLINDER HEAD	YEARS	PART NO.	DESCRIPTION	
1	Head Gasket	2011	26401 PT	Loc. L.H.; .037" thick; Head bolts not incl.; Head bolt replacement recommended; PermaTorqueMLS® LaserWeld® Technology; Consolidated Improved design	
1	Head Gasket	2011	26402 PT	Loc. R.H.; .037" thick; Head bolts not incl.; Head bolt replacement recommended; PermaTorqueMLS® LaserWeld® Technology; Consolidated Improved design	
1	Head Gasket	2011	26405 PT	Loc. L.H.; .047" thick; .010" thicker for use when block is refaced; Head bolts not incl.; Head bolt replacement recommended; PermaTorqueMLS® LaserWeld® Technology	
1	Head Gasket	2011	26406 PT	Loc. R.H.; .047" thick; .010" thicker for use when block is refaced; Head bolts not incl.; Head bolt replacement recommended; PermaTorqueMLS® LaserWeld® Technology	
1	Head Set w/o Head Gasket	2013-11	HSU 26269-3	Head gskts. & head bolts not incl.; Head bolt replacement recommended; RTV sealant incl. for intake manifold gskts.; PermaDry® molded rubber valve cover gskts. incl.; Premium valve stem seals incl.; New Part Number - Check for Availability	
2	Head Bolt Set	2011	ES 72344	Head bolts w/Washers; Replacement recommended; Improved design; New Part Number - Check for Availability	
QTY	CONVERSION SET	YEARS	PART NO.	DESCRIPTION	
1	Gasket Conversion Set	2013-11	CS 26269-2	RTV sealant incl. for Upper oil pan gskt.; New Part Number - Check for Availability	
QTY	MANIFOLD - INT. & EXH.	YEARS	PART NO.	DESCRIPTION	
1	Plenum Gasket Set	2013-12	72767	Exc. Chevrolet Silverado 2500 HD LS, LT, LTZ, WT, Silverado 3500 HD LS, LT, LTZ, WT GMC Sierra 2500 HD Denali, SL, SLE, SLT, WT, Sierra 3500 HD Denali, SL, SLE, SLT, WT; Intake plenum tube; New Part Number - Check for Availability	
1	Plenum Gasket Set	2013-12	73009	Chevrolet Silverado 2500 HD LS, LT, LTZ, WT, Silverado 3500 HD LS, LT, LTZ, WT GMC Sierra 2500 HD Denali, SL, SLE, SLT, WT, Sierra 3500 HD Denali, SL, SLE, SLT, WT; Intake plenum tube; New Part Number - Check for Availability	
1	Plenum Gasket Set	2011	72767	GMC Savana 2500 Base, LS, LT, SL, SLE, Savana 3500 Base, LS, LT, SL, SLE; Intake plenum tube; New Part Number - Check for Availability	
1	Plenum Gasket Set	2011	73009	Exc. GMC Savana 2500 Base, LS, LT, SL, SLE, Savana 3500 Base, LS, LT, SL, SLE; Intake plenum tube; New Part Number - Check for Availability	
1	Exh. Manifold Gasket Set	2013-11	MS 96788		
QTY	EXHAUST PIPE FLANGE	YEARS	PART NO.	DESCRIPTION	
2	Exhaust Pipe Gasket	2013-11	61379	Pipe to manifold	
2	Exhaust Pipe Gasket	2013-11	61457	Converter	
QTY	OIL PAN	YEARS	PART NO.	DESCRIPTION	
1	Oil Pan Gasket Set	2013-11	OS 30838	Loc. Lower; New Part Number - Check for Availability	
QTY	CRANKSHAFT REAR SEAL	YEARS	PART NO.	DESCRIPTION	
1	Rear Main Seal Set	2013-11	BS 40683	Rubber; One-piece	
QTY	VALVE COVER	YEARS	PART NO.	DESCRIPTION	
1	Valve Cover Gasket Set	2013-11	VS 50681	Loc. Lower	
1	Valve Cover Gasket Set	2013-11	VS 50813 R	Loc. Upper; w/Grommets & PCV seals; PermaDry® molded rubber gskts. incl.; New Part Number - Check for Availability	
QTY	VALVE STEM SEAL SET	YEARS	PART NO.	DESCRIPTION	
1	Valve Stem Seal Set	2013-11	SS 72551	Premium valve stem seals incl.; New Part Number - Check for Availability	
QTY	THERMOSTAT HOUSING	YEARS	PART NO.	DESCRIPTION	
2	Thermostat Gasket	2013-11	35762	Thermostat Housing; Thermostat seal	
QTY	WATER OUTLET GASKET	YEARS	PART NO.	DESCRIPTION	
2	Water Outlet Gasket	2013-11	35757	Water Crossover; Crossover pipe	
1	O-Ring	2013-11	35759	Water Outlet	
QTY	WATER PUMP	YEARS	PART NO.	DESCRIPTION	
1	Water Pump Gasket	2013-11	35756	Mounting O-ring	
1	Water Pump Gasket	2013-11	35758	Pump to pipe	
1	Water Pump Mounting Set	2013-11	ES 71347		
QTY	TIMING COVER	YEARS	PART NO.	DESCRIPTION	
1	Timing Cover Set	2013-11	TCS 45055		

GMC Truck (Incl. Minivans and SUV's) (Cont.)

98		2013 - 2011; 6.6L 402 (6599cc) OHV Turbo - Intercooled V8 (32 Valve) 103mm Bore Duramax			98
(cont.)		MFI; Diesel; Turbo - Intercooled GMC Eng.; VIN Code L			(cont.)
QTY	TIMING COVER	YEARS	PART NO.	DESCRIPTION	
1	Crankshaft Front Seal Set	2013-11	TCS 46193	New Part Number - Check for Availability	
QTY	CARB & FUEL INJECTION	YEARS	PART NO.	DESCRIPTION	
1	Throttle Body Gasket	2013-11	61696	Heater to intake tube; New Part Number - Check for Availability	
1	Throttle Body Gasket	2013-11	61697	Heater to throttle body; New Part Number - Check for Availability	
1	Throttle Body Gasket	2013-11	61746	Heater to plenum; New Part Number - Check for Availability	
QTY	EXHAUST GAS RECIRCULATION	YEARS	PART NO.	DESCRIPTION	
2	EGR Gasket	2013-11	71442	EGR valve to int. manifold; New Part Number - Check for Availability	
1	EGR Gasket	2013-11	71443	EGR valve to cooler; New Part Number - Check for Availability	
1	EGR Gasket	2013-12	61692	Exc. Chevrolet Silverado 2500 HD LS, LT, LTZ, WT, Silverado 3500 HD LS, LT, LTZ, WT GMC Sierra 2500 HD Denali, SL, SLE, SLT, WT, Sierra 3500 HD Denali, SL, SLE, SLT, WT; EGR cooler; Turbo inlet flange; New Part Number - Check for Availability	
1	EGR Gasket	2011	61692	GMC Savana 2500 Base, LS, LT, SL, SLE, Savana 3500 Base, LS, LT, SL, SLE; EGR cooler; Turbo inlet flange; New Part Number - Check for Availability	
99		2007 - 2006; 6.6L 402 (6599cc) OHV Turbo - Intercooled V8 (32 Valve) 103mm Bore Duramax H.O.			99
		MFI; Diesel; Turbo - Intercooled GMC Eng.; VIN Code D			
QTY	CYLINDER HEAD	YEARS	PART NO.	DESCRIPTION	
1	Head Gasket	2007-06	26269 PT-1	Loc. L.H.; No hole; .0354" - .0394" thick; Head bolts not incl.; Head bolt replacement recommended; PermaTorqueMLS®; May use 26401PT instead; Improved design; Superseded - When depleted use 26401 PT	
1	Head Gasket	2007-06	26270 PT-1	Loc. R.H.; No hole; .0354" - .0394" thick; Head bolts not incl.; Head bolt replacement recommended; PermaTorqueMLS®; May use 26402PT instead; Improved design; Superseded - When depleted use 26402 PT	
1	Head Gasket	2007-06	26271 PT-1	Loc. L.H.; 1 hole; .0372" - .0413" thick; Head bolts not incl.; Head bolt replacement recommended; PermaTorqueMLS®; May use 26401PT instead; Improved design; Superseded - When depleted use 26401 PT	
1	Head Gasket	2007-06	26272 PT-1	Loc. R.H.; 1 hole; .0372" - .0413" thick; Head bolts not incl.; Head bolt replacement recommended; PermaTorqueMLS®; May use 26402PT instead; Improved design; Superseded - When depleted use 26402 PT	
1	Head Gasket	2007-06	26273 PT-1	Loc. L.H.; 2 holes; .0394" - .0433" thick; Head bolts not incl.; Head bolt replacement recommended; PermaTorqueMLS®; May use 26401PT instead; Improved design; Superseded - When depleted use 26401 PT	
1	Head Gasket	2007-06	26274 PT-1	Loc. R.H.; 2 holes; .0394" - .0433" thick; Head bolts not incl.; Head bolt replacement recommended; PermaTorqueMLS®; May use 26402PT instead; Improved design; Superseded - When depleted use 26402 PT	
1	Head Gasket	2007-06	26401 PT	Loc. L.H.; .037" thick; Head bolts not incl.; Head bolt replacement recommended; PermaTorqueMLS® LaserWeld® Technology; Consolidated Improved design	
1	Head Gasket	2007-06	26402 PT	Loc. R.H.; .037" thick; Head bolts not incl.; Head bolt replacement recommended; PermaTorqueMLS® LaserWeld® Technology; Consolidated Improved design	
1	Head Gasket	2007-06	26405 PT	Loc. L.H.; .047" thick; .010" thicker for use when block is refaced; Head bolts not incl.; Head bolt replacement recommended; PermaTorqueMLS® LaserWeld® Technology	
1	Head Gasket	2007-06	26406 PT	Loc. R.H.; .047" thick; .010" thicker for use when block is refaced; Head bolts not incl.; Head bolt replacement recommended; PermaTorqueMLS® LaserWeld® Technology	
1	Head Set w/o Head Gasket	2007-06	HSU 26269-1	Head gskts. & head bolts not incl.; Head bolt replacement recommended; RTV sealant incl. for intake manifold gskts.; PermaDry® molded rubber valve cover gskts. incl.; Premium valve stem seals incl.	
2	Head Bolt Set	2007-06	ES 72199	Head bolts w/Washers; Replacement recommended; Old design	
2	Head Bolt Set	2007-06	ES 72344	Head bolts w/Washers; Replacement recommended; Improved design; New Part Number - Check for Availability	
QTY	CONVERSION SET	YEARS	PART NO.	DESCRIPTION	
1	Gasket Conversion Set	2007-06	CS 26269	RTV sealant incl. for Upper oil pan gskt.	
QTY	MANIFOLD - INT. & EXH.	YEARS	PART NO.	DESCRIPTION	
1	Int. Manifold Gasket Set	2007-06	MS 97291	Lower set; RTV sealant incl. for intake manifold gskts.; New Part Number - Check for Availability	
1	Plenum Gasket Set	2007-06	72764	Intake plenum tube; New Part Number - Check for Availability	
2	Plenum Gasket Set	2007-06	72946	Intake plenum tube O-ring; New Part Number - Check for Availability	
1	Exh. Manifold Gasket Set	2007-06	MS 96788		
QTY	EXHAUST PIPE FLANGE	YEARS	PART NO.	DESCRIPTION	
2	Exhaust Pipe Gasket	2007-06	61379	Flange	

GMC Truck (Incl. Minivans and SUV's) (Cont.)

99		2007 - 2006; 6.6L 402 (6599cc) OHV Turbo - Intercooled V8 (32 Valve) 103mm Bore Duramax H.O.			99
(cont.)		MFI; Diesel; Turbo - Intercooled GMC Eng.; VIN Code D			(cont.)
QTY	EXHAUST PIPE FLANGE	YEARS	PART NO.	DESCRIPTION	
1	Exhaust Pipe Gasket	2007-06	61457	Converter	
QTY	OIL PAN	YEARS	PART NO.	DESCRIPTION	
1	Oil Pan Gasket Set	2007-06	OS 30748	Loc. Lower	
QTY	CRANKSHAFT REAR SEAL	YEARS	PART NO.	DESCRIPTION	
1	Rear Main Seal Set	2007-06	BS 40683	Rubber; One-piece	
QTY	VALVE COVER	YEARS	PART NO.	DESCRIPTION	
1	Valve Cover Gasket Set	2007-06	VS 50681	Loc. Lower	
1	Valve Cover Gasket Set	2007-06	VS 50684 R	Loc. Upper; w/Grommets; PermaDry® molded rubber gsks. incl.	
1	Valve Cover Gasket Set	2007-06	VS 50821 R	Complete set; Upper & Lower valve cover gsks incl.; w/Grommets & Fuel injector seals incl.; PermaDry® molded rubber gsks. incl.; New Part Number - Check for Availability	
QTY	VALVE STEM SEAL SET	YEARS	PART NO.	DESCRIPTION	
1	Valve Stem Seal Set	2007-06	SS 72916	Premium valve stem seals incl.	
QTY	THERMOSTAT HOUSING	YEARS	PART NO.	DESCRIPTION	
2	Thermostat Gasket	2007-06	35762	Thermostat Housing; Thermostat seal	
QTY	WATER OUTLET GASKET	YEARS	PART NO.	DESCRIPTION	
2	Water Outlet Gasket	2007-06	35757	Water Crossover; Crossover pipe	
1	O-Ring	2007-06	35759	Water Outlet	
QTY	WATER PUMP	YEARS	PART NO.	DESCRIPTION	
1	Water Pump Gasket	2007-06	35756	Mounting O-ring	
1	Water Pump Gasket	2007-06	35758	Pump to pipe	
1	Water Pump Mounting Set	2007-06	ES 71347		
QTY	TIMING COVER	YEARS	PART NO.	DESCRIPTION	
1	Timing Cover Set	2007-06	TCS 45055		
1	Crankshaft Front Seal Set	2007-06	TCS 46193	New Part Number - Check for Availability	
QTY	CARB & FUEL INJECTION	YEARS	PART NO.	DESCRIPTION	
1	Throttle Body Gasket	2007-06	61748	Heater to plenum; New Part Number - Check for Availability	
QTY	EXHAUST GAS RECIRCULATION	YEARS	PART NO.	DESCRIPTION	
1	EGR Gasket	2007-06	71248	Valve	
1	EGR Gasket	2007-06	71249	Loc. R.H.; Pipe	
1	EGR Gasket	2007-06	71251	Loc. L.H.; Pipe	
1	EGR Gasket	2007	61693	EGR cooler; Turbo inlet flange; New Part Number - Check for Availability	
100		1997 - 1991; 7.4L 454 (7441cc) OHV V8 (16 Valve) 4.25" Bore			100
		TBI; Gasoline; Naturally Aspirated GMC Eng.; Chevrolet; VIN Code N			
QTY	CYLINDER HEAD	YEARS	PART NO.	DESCRIPTION	
2	Head Gasket	1997-96	9502 PT	PermaTorque®	
2	Head Gasket	1995-91	508 SD	PermaTorque Severe Duty®	
2	Head Gasket	1995-91	8523 PT-1	PermaTorque®	
2	Head Gasket Spacer Shim	1995-91	8180 SP-1	HeadSaver®	
1	Head Set	1997-96	HS 9502 PT	Int. manifold gsks. & exh. pipe packing not incl.; PermaDry® molded rubber valve cover gsks. incl.; Premium valve stem seals incl.	
1	Head Set	1995-91	HS 8523 PT-2	Exh. pipe packing not incl.; PermaDry® molded rubber valve cover gsks. incl.; Premium valve stem seals incl.	
2	Head Bolt Set	1997-91	ES 72264	Replacement recommended	
QTY	CONVERSION SET	YEARS	PART NO.	DESCRIPTION	
1	Gasket Conversion Set	1997-96	CS 8523	PermaDry® molded rubber oil pan gskt. incl.	
1	Gasket Conversion Set	1995-91	CS 8180-2	PermaDry® molded rubber oil pan gskt. incl.	
QTY	MANIFOLD - INT. & EXH.	YEARS	PART NO.	DESCRIPTION	
1	Int. Manifold Gasket Set	1997-91	MS 95255		
1	Exh. Manifold Gasket Set	1997-96	MS 95840		
1	Exh. Manifold Gasket Set	1995-91	MS 90206	OEM style	
1	Exh. Manifold Gasket Set	1995-91	MS 90502	Opt. H/D	
QTY	EXHAUST PIPE FLANGE	YEARS	PART NO.	DESCRIPTION	
2	Exhaust Pipe Gasket	1997-96	61012	Packing	
2	Exhaust Pipe Gasket	1995-91	60584	Packing; 2 1/2" ID Steel sleeve to manifold; 2 1/4" ID Gasket to pipe	
QTY	OIL PAN	YEARS	PART NO.	DESCRIPTION	
1	Oil Pan Gasket Set	1997-91	OS 34407 R	PermaDry® molded rubber gskt. incl.	
1	Drain Plug Gasket	1997-91	70820		
QTY	CRANKSHAFT REAR SEAL	YEARS	PART NO.	DESCRIPTION	
1	Rear Main Seal Set	1997-91	BS 40622	Viton®; One-piece	
1	Repair Sleeve	1997-91	16269-1	Crankshaft; 1.280" - 1.310" sleeve length; Use w/installation tool; Improved design	

GMC Truck (Incl. Minivans and SUV's) (Cont.)

100 (cont.)		1997 - 1991; 7.4L 454 (7441cc) OHV V8 (16 Valve) 4.25" Bore			100 (cont.)
TBI; Gasoline; Naturally Aspirated GMC Eng.; Chevrolet; VIN Code N					
QTY	CRANKSHAFT REAR SEAL	YEARS	PART NO.	DESCRIPTION	
1	Repair Sleeve Tool	1997-91	16316	Crankshaft	
QTY	VALVE COVER	YEARS	PART NO.	DESCRIPTION	
1	Valve Cover Gasket Set	1997-91	VS 50388 R	PermaDry® molded rubber gskts. incl.	
QTY	VALVE STEM SEAL SET	YEARS	PART NO.	DESCRIPTION	
1	Valve Stem Seal Set	1997-91	SS 72823	Premium valve stem seals incl.	
QTY	THERMOSTAT HOUSING	YEARS	PART NO.	DESCRIPTION	
1	Thermostat Gasket	1997-91	35614	Thermostat Housing; Thermostat seal; Improved design	
QTY	WATER OUTLET GASKET	YEARS	PART NO.	DESCRIPTION	
1	Water Outlet Gasket	1995-91	35062	Water Outlet; 1 13/16" ID	
1	Water Outlet Gasket	1995-91	35562 T	Water Outlet; 1 13/16" ID; PermaDryPlus®	
QTY	WATER PUMP	YEARS	PART NO.	DESCRIPTION	
1	Water Pump Gasket	1997-91	11725	To plate	
2	Water Pump Gasket	1997-91	30060	To block	
QTY	TIMING COVER	YEARS	PART NO.	DESCRIPTION	
1	Timing Cover Set	1997-96	TCS 45969	w/o Sleeve 'N' Seal®; Must be used w/OS 34407R	
1	Timing Cover Set	1995-91	TCS 45060	w/o Sleeve 'N' Seal®; Must be used w/OS 34407R	
1	Timing Set w/Sleeve & Seal	1997-96	TCS 45053	w/Sleeve 'N' Seal®; Must be used w/OS 34407R	
1	Timing Set w/Sleeve & Seal	1995-91	TCS 45272	w/Sleeve 'N' Seal®; Must be used w/OS 34407R	
1	Repair Sleeve	1995-91	16205	Timing Cover; Use w/installation tool	
1	Repair Sleeve Tool	1995-91	16311	Timing Cover	
QTY	CARB & FUEL INJECTION	YEARS	PART NO.	DESCRIPTION	
4	Fuel Injector O-Ring Set	1997-96	ES 70599	Improved design	
1	Throttle Body Gasket	1997-91	60954		
QTY	DISTRIBUTOR MOUNTING	YEARS	PART NO.	DESCRIPTION	
1	Distributor Mounting Gasket	1997-91	70194		
QTY	EXHAUST GAS RECIRCULATION	YEARS	PART NO.	DESCRIPTION	
1	EGR Gasket	1997-96	70788		
1	EGR Gasket	1995-91	70978		
QTY	OIL PUMP COVER	YEARS	PART NO.	DESCRIPTION	
1	Oil Pump Gasket	1997-91	71012	Oil pump mounting; New Part Number - Check for Availability	
QTY	OIL PUMP RETAINER	YEARS	PART NO.	DESCRIPTION	
1	Oil Pump Shaft Guide	1997-91	72665	Distributor to oil pump shaft retainer	
QTY	OIL COOLER	YEARS	PART NO.	DESCRIPTION	
1	Oil Cooler Mounting Set	1997-91	ES 72671		
101		1999 - 1998; 7.4L 454 (7441cc) OHV V8 (16 Valve) 4.25" Bore Vortec			101
CPI; Gasoline; Naturally Aspirated GMC Eng.; Chevrolet; VIN Code B					
QTY	CYLINDER HEAD	YEARS	PART NO.	DESCRIPTION	
2	Head Gasket	1999-98	9502 PT	PermaTorque®	
1	Head Set	1999-98	HS 9502 PT	Exh. pipe packing not incl.; PermaDry® molded rubber valve cover gskts. incl.; Premium valve stem seals incl.	
2	Head Bolt Set	1999-98	ES 72264	Replacement recommended	
QTY	CONVERSION SET	YEARS	PART NO.	DESCRIPTION	
1	Gasket Conversion Set	1999-98	CS 8523	PermaDry® molded rubber oil pan gskt. incl.	
QTY	MANIFOLD - INT. & EXH.	YEARS	PART NO.	DESCRIPTION	
1	Int. Manifold Gasket Set	1999-98	MS 95826	Lower set	
1	Plenum Gasket Set	1999-98	MS 95787	Upper set	
1	Exh. Manifold Gasket Set	1999-98	MS 95840		
QTY	EXHAUST PIPE FLANGE	YEARS	PART NO.	DESCRIPTION	
2	Exhaust Pipe Gasket	1999-98	61012	Packing	
QTY	OIL PAN	YEARS	PART NO.	DESCRIPTION	
1	Oil Pan Gasket Set	1999-98	OS 34407 R	PermaDry® molded rubber gskt. incl.	
1	Drain Plug Gasket	1999-98	70820		
QTY	CRANKSHAFT REAR SEAL	YEARS	PART NO.	DESCRIPTION	
1	Rear Main Seal Set	1999-98	BS 40622	Viton®; One-piece	
1	Repair Sleeve	1999-98	16269-1	Crankshaft; 1.280" - 1.310" sleeve length; Use w/installation tool; Improved design	
1	Repair Sleeve Tool	1999-98	16316	Crankshaft	
QTY	VALVE COVER	YEARS	PART NO.	DESCRIPTION	
1	Valve Cover Gasket Set	1999-98	VS 50388 R	PermaDry® molded rubber gskts. incl.	
QTY	VALVE STEM SEAL SET	YEARS	PART NO.	DESCRIPTION	
1	Valve Stem Seal Set	1999-98	SS 72823	Premium valve stem seals incl.	

GMC Truck (Incl. Minivans and SUV's) (Cont.)

101		1999 - 1998; 7.4L 454 (7441cc) OHV V8 (16 Valve) 4.25" Bore Vortec			101
(cont.)		CPI; Gasoline; Naturally Aspirated GMC Eng.; Chevrolet; VIN Code B			(cont.)
QTY	THERMOSTAT HOUSING	YEARS	PART NO.	DESCRIPTION	
1	Thermostat Gasket	1999-98	35614	Thermostat Housing; Thermostat seal; Improved design	
QTY	WATER PUMP	YEARS	PART NO.	DESCRIPTION	
1	Water Pump Gasket	1999-98	11725	To plate	
2	Water Pump Gasket	1999-98	30060	To block	
QTY	TIMING COVER	YEARS	PART NO.	DESCRIPTION	
1	Timing Cover Set	1999-98	TCS 45969	w/o Sleeve 'N' Seal®; Must be used w/OS 34407R	
1	Timing Set w/Sleeve & Seal	1999-98	TCS 45053	w/Sleeve 'N' Seal®; Must be used w/OS 34407R	
QTY	CARB & FUEL INJECTION	YEARS	PART NO.	DESCRIPTION	
4	Fuel Injector O-Ring Set	1999-98	ES 70599	Improved design	
1	Throttle Body Gasket	1999-98	61178	Improved design	
QTY	DISTRIBUTOR MOUNTING	YEARS	PART NO.	DESCRIPTION	
1	Distributor Mounting Gasket	1999-98	70194		
QTY	EXHAUST GAS RECIRCULATION	YEARS	PART NO.	DESCRIPTION	
1	EGR Gasket	1999-98	70788		
QTY	OIL PUMP COVER	YEARS	PART NO.	DESCRIPTION	
1	Oil Pump Gasket	1999-98	71012	Oil pump mounting; New Part Number - Check for Availability	
QTY	OIL PUMP RETAINER	YEARS	PART NO.	DESCRIPTION	
1	Oil Pump Shaft Guide	1999-98	72665	Distributor to oil pump shaft retainer	
QTY	OIL COOLER	YEARS	PART NO.	DESCRIPTION	
1	Oil Cooler Mounting Set	1999-98	ES 72671		
102		2000 - 1996; 7.4L 454 (7441cc) OHV V8 (16 Valve) 4.25" Bore Vortec			102
(cont.)		CPI; Gasoline; Naturally Aspirated GMC Eng.; Chevrolet; VIN Code J			(cont.)
QTY	CYLINDER HEAD	YEARS	PART NO.	DESCRIPTION	
2	Head Gasket	2000-96	9502 PT	PermaTorque®	
1	Head Set	2000-96	HS 9502 PT	Exh. pipe packing not incl.; PermaDry® molded rubber valve cover gsks. incl.; Premium valve stem seals incl.	
2	Head Bolt Set	2000-96	ES 72264	Replacement recommended	
QTY	CONVERSION SET	YEARS	PART NO.	DESCRIPTION	
1	Gasket Conversion Set	2000-96	CS 8523	PermaDry® molded rubber oil pan gskt. incl.	
QTY	MANIFOLD - INT. & EXH.	YEARS	PART NO.	DESCRIPTION	
1	Int. Manifold Gasket Set	2000-96	MS 95826	Lower set	
1	Plenum Gasket Set	2000-96	MS 95787	Upper set	
1	Exh. Manifold Gasket Set	2000-96	MS 95840		
QTY	EXHAUST PIPE FLANGE	YEARS	PART NO.	DESCRIPTION	
2	Exhaust Pipe Gasket	2000-96	61012	Packing	
QTY	OIL PAN	YEARS	PART NO.	DESCRIPTION	
1	Oil Pan Gasket Set	2000-96	OS 34407 R	PermaDry® molded rubber gskt. incl.	
1	Drain Plug Gasket	2000-96	70820		
QTY	CRANKSHAFT REAR SEAL	YEARS	PART NO.	DESCRIPTION	
1	Rear Main Seal Set	2000-96	BS 40622	Viton®; One-piece	
1	Repair Sleeve	2000-96	16269-1	Crankshaft; 1.280" - 1.310" sleeve length; Use w/installation tool; Improved design	
1	Repair Sleeve Tool	2000-96	16316	Crankshaft	
QTY	VALVE COVER	YEARS	PART NO.	DESCRIPTION	
1	Valve Cover Gasket Set	2000-96	VS 50388 R	PermaDry® molded rubber gsks. incl.	
QTY	VALVE STEM SEAL SET	YEARS	PART NO.	DESCRIPTION	
1	Valve Stem Seal Set	2000-96	SS 72823	Premium valve stem seals incl.	
QTY	THERMOSTAT HOUSING	YEARS	PART NO.	DESCRIPTION	
1	Thermostat Gasket	2000-96	35614	Thermostat Housing; Thermostat seal; Improved design	
QTY	WATER PUMP	YEARS	PART NO.	DESCRIPTION	
1	Water Pump Gasket	2000-96	11725	To plate	
2	Water Pump Gasket	2000-96	30060	To block	
QTY	TIMING COVER	YEARS	PART NO.	DESCRIPTION	
1	Timing Cover Set	2000-96	TCS 45969	w/o Sleeve 'N' Seal®; Must be used w/OS 34407R	
1	Timing Set w/Sleeve & Seal	2000-96	TCS 45053	w/Sleeve 'N' Seal®; Must be used w/OS 34407R	
QTY	CARB & FUEL INJECTION	YEARS	PART NO.	DESCRIPTION	
4	Fuel Injector O-Ring Set	2000-96	ES 70599	Improved design	
1	Throttle Body Gasket	2000-96	61178	Improved design	
QTY	DISTRIBUTOR MOUNTING	YEARS	PART NO.	DESCRIPTION	
1	Distributor Mounting Gasket	2000-96	70194		
QTY	EXHAUST GAS RECIRCULATION	YEARS	PART NO.	DESCRIPTION	
1	EGR Gasket	2000-96	70788		

GMC Truck (Incl. Minivans and SUV's) (Cont.)

102 (cont.)		2000 - 1996; 7.4L 454 (7441cc) OHV V8 (16 Valve) 4.25" Bore Vortec CPI; Gasoline; Naturally Aspirated GMC Eng.; Chevrolet; VIN Code J			102 (cont.)
QTY	OIL PUMP COVER	YEARS	PART NO.	DESCRIPTION	
1	Oil Pump Gasket	2000-96	71012	Oil pump mounting; New Part Number - Check for Availability	
QTY	OIL PUMP RETAINER	YEARS	PART NO.	DESCRIPTION	
1	Oil Pump Shaft Guide	2000-96	72665	Distributor to oil pump shaft retainer	
QTY	OIL COOLER	YEARS	PART NO.	DESCRIPTION	
1	Oil Cooler Mounting Set	2000-96	ES 72671		
103		2007 - 2001; 8.1L 496 (8129cc) OHV V8 (16 Valve) 4.25" Bore Vortec MFI; Gasoline; Naturally Aspirated GMC Eng.; Chevrolet; VIN Code G			103
QTY	CYLINDER HEAD	YEARS	PART NO.	DESCRIPTION	
1	Head Gasket	2007-01	26168 PT	Loc. L.H.; Head bolts not incl.; Head bolt replacement recommended	
1	Head Gasket	2007-01	26169 PT	Loc. R.H.; Head bolts not incl.; Head bolt replacement recommended	
1	Head Set	2007-01	HS 26168 PT	Head bolts & exh. pipe packing not incl.; Head bolt replacement recommended; PermaDry® molded rubber valve cover gsks. incl.; Premium valve stem seals incl.	
2	Head Bolt Set	2007-01	ES 72188	Replacement recommended	
QTY	CONVERSION SET	YEARS	PART NO.	DESCRIPTION	
1	Gasket Conversion Set	2007-01	CS 26168	PermaDry® molded rubber oil pan gskt. incl.	
QTY	MANIFOLD - INT. & EXH.	YEARS	PART NO.	DESCRIPTION	
1	Int. Manifold Gasket Set	2007-01	MS 96057		
1	Exh. Manifold Gasket Set	2007-01	MS 95840		
QTY	EXHAUST PIPE FLANGE	YEARS	PART NO.	DESCRIPTION	
1	Exhaust Pipe Gasket	2007-01	61287	Converter	
2	Exhaust Pipe Gasket	2007-03	61323	Pipe to manifold	
2	Exhaust Pipe Gasket	2002-01	61258	Chevrolet C3500 Pickup HD GMC C3500 Pickup HD; Cab & Chassis model; Pipe to manifold	
2	Exhaust Pipe Gasket	2002-01	61323	Chevrolet C3500 Pickup HD GMC C3500 Pickup HD; Exc. Cab & Chassis model; Pipe to manifold	
2	Exhaust Pipe Gasket	2002-01	61323	Exc. Chevrolet C3500 Pickup HD GMC C3500 Pickup HD; Pipe to manifold	
QTY	OIL PAN	YEARS	PART NO.	DESCRIPTION	
1	Oil Pan Gasket Set	2007-01	OS 30714 R	PermaDry® molded rubber gskt. incl.	
1	Drain Plug Gasket	2007-01	70820		
QTY	CRANKSHAFT REAR SEAL	YEARS	PART NO.	DESCRIPTION	
1	Rear Main Seal Set	2007-01	BS 40673	Wear sleeve incl.; PTFE Rubber; One-piece	
QTY	VALVE COVER	YEARS	PART NO.	DESCRIPTION	
1	Valve Cover Gasket Set	2007-01	VS 50554 R	w/Grommets; PermaDry® molded rubber gsks. incl.	
QTY	VALVE STEM SEAL SET	YEARS	PART NO.	DESCRIPTION	
1	Valve Stem Seal Set	2007-01	SS 70579-1	Premium valve stem seals incl.	
QTY	THERMOSTAT HOUSING	YEARS	PART NO.	DESCRIPTION	
1	Thermostat Gasket	2007-01	35614	Thermostat Housing; Thermostat seal; Improved design	
QTY	WATER PUMP	YEARS	PART NO.	DESCRIPTION	
2	Water Pump Gasket	2007-01	35664		
QTY	TIMING COVER	YEARS	PART NO.	DESCRIPTION	
1	Timing Cover Set	2007-01	TCS 46007		
QTY	CARB & FUEL INJECTION	YEARS	PART NO.	DESCRIPTION	
2	Fuel Injector O-Ring Set	2007-01	ES 70599	Upper set; Injectors to fuel rail; Improved design	
2	Fuel Injector O-Ring Set	2007-01	ES 71190	Lower set; Injectors to cylinder head	
2	Fuel Injector O-Ring Set	2007-01	ES 71192	Upper set; Injectors to fuel rail; Old design	
1	Throttle Body Gasket	2007-01	61178	Improved design	
QTY	EXHAUST GAS RECIRCULATION	YEARS	PART NO.	DESCRIPTION	
1	EGR Gasket	2007-01	70783	Valve	
1	EGR Gasket	2007-01	71081	Pipe; Large hole	
1	EGR Gasket	2007-01	71093	Pipe; Small hole	

Grumman Truck

Engine Finding Index

Engine	Years	Code	Line No.
2.2L 134 (2189cc) OHV L4 (8 Valve) 89mm Bore; MFI; Gasoline; Naturally Aspirated GMC Eng.; Chevrolet	1995-94	4	1
2.5L 151 (2475cc) OHV L4 (8 Valve) 4" Bore; TBI; Gasoline; Naturally Aspirated GMC Eng.; Pontiac	1993-91	A	2
2.5L 151 (2475cc) OHV L4 (8 Valve) 4" Bore; TBI; Gasoline; Naturally Aspirated GMC Eng.; Pontiac	1991	E	3

Model Index						
Engine (VIN Code / Eng. Code)		Year	Engine (VIN Code / Eng. Code)		Year	
Grumann Truck			Grumann Truck (cont.)			
LLV			LLV (cont.)			
L4 134CI 2.2L OHV (4)		95-94	L4 151CI 2.5L OHV (A)		93-91	
L4 151CI 2.5L OHV (E)					91-87	
1		1995 - 1994; 2.2L 134 (2189cc) OHV L4 (8 Valve) 89mm Bore				1
MFI; Gasoline; Naturally Aspirated GMC Eng.; Chevrolet; VIN Code 4						
QTY	CYLINDER HEAD	YEARS	PART NO.	DESCRIPTION		
1	Head Gasket	1995-94	9170 PT-1	Head bolts not incl.; Head bolt replacement recommended; PermaTorque®; Improved design		
1	Head Set	1995-94	HS 9170 PT	Head bolts & exh. pipe packing not incl.; Head bolt replacement recommended; PermaDry® molded rubber valve cover gskt. incl.; Premium valve stem seals incl.		
1	Head Installation Set	1995-94	HIS 9170 PT	Head bolts & exh. pipe packing not incl.; Head bolt replacement recommended; PermaDry® molded rubber valve cover gskt. incl.		
1	Head Bolt Set	1995	ES 72172	Replacement recommended		
1	Head Bolt Set	1994	ES 74016	Replacement recommended		
QTY	CONVERSION SET	YEARS	PART NO.	DESCRIPTION		
1	Gasket Conversion Set	1995-94	CS 9469			
QTY	MANIFOLD - INT. & EXH.	YEARS	PART NO.	DESCRIPTION		
1	Int. Manifold Gasket Set	1995-94	MS 95393	Lower set; Upper set incl.		
1	Plenum Gasket Set	1995-94	MS 95397	Upper set		
1	Exh. Manifold Gasket Set	1995-94	MS 93812			
QTY	EXHAUST PIPE FLANGE	YEARS	PART NO.	DESCRIPTION		
1	Exhaust Pipe Gasket	1995-94	60538	Packing		
QTY	OIL PAN	YEARS	PART NO.	DESCRIPTION		
1	Oil Pan Gasket Set	1995-94	OS 34300 C			
1	Drain Plug Gasket	1995-94	70822			
QTY	CRANKSHAFT REAR SEAL	YEARS	PART NO.	DESCRIPTION		
1	Rear Main Seal Set	1995-94	BS 40464	11.0mm thick; Rubber; One-piece; Improved design		
1	Rear Main Seal Set	1995-94	BS 40625	11.0mm thick; PTFE Rubber; One-piece; Improved design		
1	Repair Sleeve Tool	1995-94	16304	Crankshaft		
QTY	VALVE COVER	YEARS	PART NO.	DESCRIPTION		
1	Valve Cover Gasket Set	1995-94	VS 50313 R	PermaDry® molded rubber gskt. incl.		
QTY	VALVE STEM SEAL SET	YEARS	PART NO.	DESCRIPTION		
1	Valve Stem Seal Set	1995-94	SS 72852	Premium valve stem seals incl.		
QTY	THERMOSTAT HOUSING	YEARS	PART NO.	DESCRIPTION		
1	Thermostat Gasket	1995-94	35393	Thermostat Housing; Adapter cover		
1	Thermostat Gasket	1995-94	35393	Thermostat Housing; EGR adapter		
1	Thermostat Gasket	1995-94	35598	Thermostat Housing; Thermostat adapter		
1	Thermostat Gasket	1995-94	35614	Thermostat Housing; Thermostat seal; Improved design		
QTY	WATER OUTLET GASKET	YEARS	PART NO.	DESCRIPTION		
1	Water Outlet Gasket	1995-94	35560	Water Outlet		
QTY	WATER PUMP	YEARS	PART NO.	DESCRIPTION		
1	Water Pump Gasket	1995-94	35392	Mounting		
1	Water Pump Gasket	1995-94	36025	Water pump inlet; New Part Number - Check for Availability		
QTY	TIMING COVER	YEARS	PART NO.	DESCRIPTION		
1	Timing Cover Set	1995-94	TCS 45793	w/o Sleeve 'N' Seal®		
1	Timing Cover Gasket	1995-94	72739	New Part Number - Check for Availability		
1	Timing Set w/Sleeve & Seal	1995-94	TCS 45762	w/Sleeve 'N' Seal®		
1	Repair Sleeve	1995-94	16202	Timing Cover; Use w/installation tool		
1	Repair Sleeve Tool	1995-94	16312	Timing Cover		
QTY	CARB & FUEL INJECTION	YEARS	PART NO.	DESCRIPTION		
1	Fuel Injector O-Ring Set	1995-94	ES 71188	Upper set & Lower set; Injectors to fuel rail & Injectors to cylinder head		
QTY	EXHAUST GAS RECIRCULATION	YEARS	PART NO.	DESCRIPTION		
1	EGR Gasket	1995-94	70954	EGR valve		
2		1993 - 1991; 2.5L 151 (2475cc) OHV L4 (8 Valve) 4" Bore				2
TBI; Gasoline; Naturally Aspirated GMC Eng.; Pontiac; VIN Code A						
QTY	CYLINDER HEAD	YEARS	PART NO.	DESCRIPTION		
1	Head Gasket	1993-91	515 SD	Head bolts not incl.; Head bolt replacement recommended; PermaTorque Severe Duty®		
1	Head Gasket	1993-91	9405 PT-1	Head bolts not incl.; Head bolt replacement recommended; PermaTorque®		
1	Head Set	1993-91	HS 9405 PT-5	Head bolts & exh. pipe packing not incl.; Head bolt replacement recommended; Premium valve stem seals incl.		

Grumman Truck (Cont.)

2		1993 - 1991; 2.5L 151 (2475cc) OHV L4 (8 Valve) 4" Bore			2	
(cont.)		TBI; Gasoline; Naturally Aspirated GMC Eng.; Pontiac; VIN Code A			(cont.)	
QTY	CYLINDER HEAD	YEARS	PART NO.	DESCRIPTION		
1	Head Bolt Set	1993-91	ES 72733	Replacement recommended		
QTY	CONVERSION SET	YEARS	PART NO.	DESCRIPTION		
1	Gasket Conversion Set	1993-91	CS 8686			
QTY	MANIFOLD - INT. & EXH.	YEARS	PART NO.	DESCRIPTION		
1	Int. Manifold Gasket Set	1993-91	MS 94278			
1	Exh. Manifold Gasket Set	1993-91	MS 93689			
QTY	EXHAUST PIPE FLANGE	YEARS	PART NO.	DESCRIPTION		
1	Exhaust Pipe Gasket	1993-91	60592	Packing		
QTY	OIL PAN	YEARS	PART NO.	DESCRIPTION		
1	Oil Pan Gasket Set	1993-91	OS 30409 C			
1	Drain Plug Gasket	1993-91	70822			
1	Drain Plug Gasket	1993-91	72598	Drain plug & filter seal		
QTY	CRANKSHAFT REAR SEAL	YEARS	PART NO.	DESCRIPTION		
1	Rear Main Seal Set	1993-91	BS 40578	Rubber; One-piece; Improved design		
1	Repair Sleeve	1993-91	16259	Crankshaft; Use w/installation tool		
1	Repair Sleeve Tool	1993-91	16304	Crankshaft		
QTY	VALVE COVER	YEARS	PART NO.	DESCRIPTION		
1	Valve Cover Gasket Set	1993-91	VS 50179 T	PermaDryPlus®		
1	Valve Cover Gasket Set	1993-91	VS 50329 C	Cork		
QTY	PUSH ROD COVER	YEARS	PART NO.	DESCRIPTION		
1	Push Rod Cover Gasket Set	1993-91	PS 50276 C	w/Grommets; Cork		
QTY	VALVE STEM SEAL SET	YEARS	PART NO.	DESCRIPTION		
1	Valve Stem Seal Set	1993-91	SS 72684	Premium valve stem seals incl.		
QTY	THERMOSTAT HOUSING	YEARS	PART NO.	DESCRIPTION		
1	Thermostat Gasket	1993-91	35543	Thermostat Housing; Housing to head		
QTY	WATER OUTLET GASKET	YEARS	PART NO.	DESCRIPTION		
1	Water Outlet Gasket	1993-91	35568	Water Outlet		
QTY	WATER PUMP	YEARS	PART NO.	DESCRIPTION		
1	Water Pump Gasket	1993-91	35490			
QTY	TIMING COVER	YEARS	PART NO.	DESCRIPTION		
1	Timing Cover Set	1993-91	TCS 13198-2	w/o Sleeve 'N' Seal®		
1	Timing Set w/Sleeve & Seal	1993-91	TCS 45264	w/Sleeve 'N' Seal®		
1	Repair Sleeve	1993-91	16202	Timing Cover; Use w/installation tool		
1	Repair Sleeve Tool	1993-91	16312	Timing Cover		
QTY	AIR CLEANER MOUNTING	YEARS	PART NO.	DESCRIPTION		
1	Air Cleaner Gasket	1993-91	11528	4" ID		
QTY	CARB & FUEL INJECTION	YEARS	PART NO.	DESCRIPTION		
1	Throttle Body Gasket	1993-91	60764			
QTY	DISTRIBUTOR MOUNTING	YEARS	PART NO.	DESCRIPTION		
1	O-Ring	1993-91	70484-1	Distributor Mounting		
QTY	EXHAUST GAS RECIRCULATION	YEARS	PART NO.	DESCRIPTION		
1	EGR Gasket	1993-91	70978			
3		1991; 2.5L 151 (2475cc) OHV L4 (8 Valve) 4" Bore			3	
(cont.)		TBI; Gasoline; Naturally Aspirated GMC Eng.; Pontiac; VIN Code E			(cont.)	
QTY	CYLINDER HEAD	YEARS	PART NO.	DESCRIPTION		
1	Head Gasket	1991	515 SD	Head bolts not incl.; Head bolt replacement recommended; PermaTorque Severe Duty®		
1	Head Gasket	1991	9405 PT-1	Head bolts not incl.; Head bolt replacement recommended; PermaTorque®		
1	Head Set	1991	HS 9405 PT-4	Head bolts & exh. pipe packing not incl.; Head bolt replacement recommended; Premium valve stem seals incl.		
1	Head Bolt Set	1991	ES 72733	Replacement recommended		
QTY	CONVERSION SET	YEARS	PART NO.	DESCRIPTION		
1	Gasket Conversion Set	1991	CS 8686			
QTY	MANIFOLD - INT. & EXH.	YEARS	PART NO.	DESCRIPTION		
1	Int. Manifold Gasket Set	1991	MS 93688			
1	Exh. Manifold Gasket Set	1991	MS 93689			
QTY	EXHAUST PIPE FLANGE	YEARS	PART NO.	DESCRIPTION		
1	Exhaust Pipe Gasket	1991	60592	Packing		
QTY	OIL PAN	YEARS	PART NO.	DESCRIPTION		
1	Oil Pan Gasket Set	1991	OS 30409 C			
1	Drain Plug Gasket	1991	70822			

3 (cont.)		1991; 2.5L 151 (2475cc) OHV L4 (8 Valve) 4" Bore			3 (cont.)	
TBI; Gasoline; Naturally Aspirated GMC Eng.; Pontiac; VIN Code E						
QTY	OIL PAN	YEARS	PART NO.	DESCRIPTION		
1	Drain Plug Gasket	1991	72598	Drain plug & filter seal		
QTY	CRANKSHAFT REAR SEAL	YEARS	PART NO.	DESCRIPTION		
1	Rear Main Seal Set	1991	BS 40578	Rubber; One-piece; Improved design		
1	Repair Sleeve	1991	16259	Crankshaft; Use w/installation tool		
1	Repair Sleeve Tool	1991	16304	Crankshaft		
QTY	VALVE COVER	YEARS	PART NO.	DESCRIPTION		
1	Valve Cover Gasket Set	1991	VS 50179 T	PermaDryPlus®		
1	Valve Cover Gasket Set	1991	VS 50329 C	Cork		
QTY	PUSH ROD COVER	YEARS	PART NO.	DESCRIPTION		
1	Push Rod Cover Gasket Set	1991	PS 50276 C	w/Grommets; Cork		
QTY	VALVE STEM SEAL SET	YEARS	PART NO.	DESCRIPTION		
1	Valve Stem Seal Set	1991	SS 72684	Premium valve stem seals incl.		
QTY	THERMOSTAT HOUSING	YEARS	PART NO.	DESCRIPTION		
1	Thermostat Gasket	1991	35543	Thermostat Housing; Housing to head		
QTY	WATER OUTLET GASKET	YEARS	PART NO.	DESCRIPTION		
1	Water Outlet Gasket	1991	35568	Water Outlet		
QTY	WATER PUMP	YEARS	PART NO.	DESCRIPTION		
1	Water Pump Gasket	1991	35490			
QTY	TIMING COVER	YEARS	PART NO.	DESCRIPTION		
1	Timing Cover Set	1991	TCS 13198-2	w/o Sleeve 'N' Seal®		
1	Timing Set w/Sleeve & Seal	1991	TCS 45264	w/Sleeve 'N' Seal®		
1	Repair Sleeve	1991	16202	Timing Cover; Use w/installation tool		
1	Repair Sleeve Tool	1991	16312	Timing Cover		
QTY	AIR CLEANER MOUNTING	YEARS	PART NO.	DESCRIPTION		
1	Air Cleaner Gasket	1991	11528	4" ID		
QTY	CARB & FUEL INJECTION	YEARS	PART NO.	DESCRIPTION		
1	Throttle Body Gasket	1991	60764			
QTY	DISTRIBUTOR MOUNTING	YEARS	PART NO.	DESCRIPTION		
1	O-Ring	1991	70484-1	Distributor Mounting		
QTY	EXHAUST GAS RECIRCULATION	YEARS	PART NO.	DESCRIPTION		
1	EGR Gasket	1991	70978			

Honda Car (Incl. Acura, Honda)

Engine Finding Index				
Engine	Years	Code	Line No.	
1.0L 61 (995cc) SOHC L3 (12 Valve) 72mm Bore VTEC; MFI; Hybrid (Gas/Electric); Naturally Aspirated Honda Eng.	2006-00	ECA1	1	
1.3L 81 (1339cc) SOHC L4 (8 Valve) 73mm Bore VTEC; MFI; Hybrid (Gas/Electric); Naturally Aspirated Honda Eng.	2005-03	LDA1	2	
1.3L 81 (1339cc) SOHC L4 (8 Valve) 73mm Bore i-VTEC; MFI; Hybrid (Gas/Electric); Naturally Aspirated Honda Eng.	2011-06	LDA2	3	
1.3L 81 (1339cc) SOHC L4 (8 Valve) 73mm Bore i-VTEC; MFI; Hybrid (Gas/Electric); Naturally Aspirated Honda Eng.	2013-10	LDA3	4	
1.5L 91 (1493cc) SOHC L4 (16 Valve) 75mm Bore; TBI; Gasoline; Naturally Aspirated Honda Eng.	1991	D15B1	5	
1.5L 91 (1493cc) SOHC L4 (16 Valve) 75mm Bore; TBI; Gasoline; Naturally Aspirated Honda Eng.	1991	D15B2	6	
1.5L 91 (1493cc) SOHC L4 (16 Valve) 75mm Bore; MFI; Gasoline; Naturally Aspirated Honda Eng.	1995-92	D15B7	7	
1.5L 91 (1493cc) SOHC L4 (16 Valve) 75mm Bore VTEC-E; MFI; Gasoline; Naturally Aspirated Honda Eng.	1995-92	D15Z1	8	
1.5L 91 (1493cc) SOHC L4 (8 Valve) 75mm Bore; MFI; Gasoline; Naturally Aspirated Honda Eng.	1991	D15B6	9	
1.5L 91 (1493cc) SOHC L4 (8 Valve) 75mm Bore; MFI; Gasoline; Naturally Aspirated Honda Eng.	1995-92	D15B8	10	
1.5L 91.3 (1496cc) SOHC L4 (16 Valve) 73mm Bore VTEC; MFI; Gasoline; Naturally Aspirated Honda Eng.	2008-07	L15A1	11	
1.5L 91.3 (1496cc) SOHC L4 (16 Valve) 73mm Bore i-VTEC; MFI; Gasoline; Naturally Aspirated Honda Eng.	2013-09	L15A7	12	
1.5L 91.3 (1496cc) SOHC L4 (16 Valve) 73mm Bore i-VTEC; MFI; Hybrid (Gas/Electric); Naturally Aspirated Honda Eng.	2013-11	LEA1	13	
1.5L 91.3 (1496cc) SOHC L4 (8 Valve) 73mm Bore i-VTEC; MFI; Hybrid (Gas/Electric); Naturally Aspirated Honda Eng.	2013-12	LEA2	14	
1.6L 97 (1590cc) SOHC L4 (16 Valve) 75mm Bore; MFI; Gasoline; Naturally Aspirated Honda Eng.	1991	D16A6	15	
1.6L 97 (1590cc) SOHC L4 (16 Valve) 75mm Bore; MFI; Natural Gas; Naturally Aspirated Honda Eng.	2000-98	D16B5	16	
1.6L 97 (1590cc) SOHC L4 (16 Valve) 75mm Bore; MFI; Gasoline; Naturally Aspirated Honda Eng.	2000-96	D16Y7	17	
1.6L 97 (1590cc) SOHC L4 (16 Valve) 75mm Bore VTEC; MFI; Gasoline; Naturally Aspirated Honda Eng.	2000-96	D16Y5	18	
1.6L 97 (1590cc) SOHC L4 (16 Valve) 75mm Bore VTEC; MFI; Gasoline; Naturally Aspirated Honda Eng.	2000-96	D16Y8	19	
1.6L 97 (1590cc) SOHC L4 (16 Valve) 75mm Bore VTEC; MFI; Gasoline; Naturally Aspirated Honda Eng.	1995-92	D16Z6	20	
1.6L 97.3 (1595cc) DOHC L4 (16 Valve) 81mm Bore VTEC; MFI; Gasoline; Naturally Aspirated Honda Eng.	2000-96	B16A2	21	
1.6L 97.3 (1595cc) DOHC L4 (16 Valve) 81mm Bore VTEC; MFI; Gasoline; Naturally Aspirated Honda Eng.	1995-94	B16A3	22	
1.7L 101 (1668cc) SOHC L4 (16 Valve) 75mm Bore; MFI; Gasoline; Naturally Aspirated Honda Eng.	2005-01	D17A1	23	
1.7L 101 (1668cc) SOHC L4 (16 Valve) 75mm Bore; MFI; Natural Gas; Naturally Aspirated Honda Eng.	2005-01	D17A7	24	
1.7L 101 (1668cc) SOHC L4 (16 Valve) 75mm Bore VTEC; MFI; Gasoline; Naturally Aspirated Honda Eng.	2005-01	D17A2	25	

Honda Car (Incl. Acura, Honda) (Cont.)

Engine Finding Index (Cont.)

Engine	Years	Code	Line No.
1.7L 101 (1668cc) SOHC L4 (16 Valve) 75mm Bore VTEC; MFI; Gasoline; Naturally Aspirated Honda Eng.	2005-01	D17A6	26
1.7L 102.4 (1678cc) DOHC L4 (16 Valve) 81mm Bore VTEC; MFI; Gasoline; Naturally Aspirated Honda Eng.	1993-92	B17A1	27
1.8L 109.6 (1797cc) DOHC L4 (16 Valve) 81mm Bore VTEC; MFI; Gasoline; Naturally Aspirated Honda Eng.	2001-94	B18C1	28
1.8L 109.6 (1797cc) DOHC L4 (16 Valve) 81mm Bore VTEC; MFI; Gasoline; Naturally Aspirated Honda Eng.	2001-97	B18C5	29
1.8L 109.8 (1799cc) SOHC L4 (16 Valve) 81mm Bore i-VTEC; MFI; Gasoline; Naturally Aspirated Honda Eng.	2011-06	R18A1	30
1.8L 109.8 (1799cc) SOHC L4 (16 Valve) 81mm Bore i-VTEC; MFI; Natural Gas; Naturally Aspirated Honda Eng.	2011-06	R18A4	31
1.8L 109.8 (1799cc) SOHC L4 (16 Valve) 81mm Bore i-VTEC; MFI; Natural Gas; Naturally Aspirated Honda Eng.	2013-12	R18A9	32
1.8L 109.8 (1799cc) SOHC L4 (16 Valve) 81mm Bore i-VTEC; MFI; Gasoline; Naturally Aspirated Honda Eng.	2013-12	R18Z1	33
1.8L 111.8 (1834cc) DOHC L4 (16 Valve) 81mm Bore; MFI; Gasoline; Naturally Aspirated Honda Eng.	1993-91	B18A1	34
1.8L 111.8 (1834cc) DOHC L4 (16 Valve) 81mm Bore; MFI; Gasoline; Naturally Aspirated Honda Eng.	2001-94	B18B1	35
2.0L 119.5 (1958cc) DOHC L4 (16 Valve) 81mm Bore; MFI; Gasoline; Naturally Aspirated Honda Eng.	1991	B20A5	36
2.0L 121.9 (1997cc) DOHC L4 (16 Valve) 87mm Bore VTEC; MFI; Gasoline; Naturally Aspirated Honda Eng.	2003-00	F20C1	37
2.0L 122 (1998cc) DOHC L4 (16 Valve) 86mm Bore i-VTEC; MFI; Gasoline; Naturally Aspirated Honda Eng.	2004-02	K20A2	38
2.0L 122 (1998cc) DOHC L4 (16 Valve) 86mm Bore i-VTEC; MFI; Gasoline; Naturally Aspirated Honda Eng.	2006-02	K20A3	39
2.0L 122 (1998cc) DOHC L4 (16 Valve) 86mm Bore i-VTEC; MFI; Gasoline; Naturally Aspirated Honda Eng.	2006-05	K20Z1	40
2.0L 122 (1998cc) DOHC L4 (16 Valve) 86mm Bore i-VTEC; MFI; Gasoline; Naturally Aspirated Honda Eng.	2011-06	K20Z3	41
2.1L 125 (2056cc) DOHC L4 (16 Valve) 83mm Bore; MFI; Gasoline; Naturally Aspirated Honda Eng.	1991	B21A1	42
2.2L 131.6 (2156cc) SOHC L4 (16 Valve) 85mm Bore; MFI; Gasoline; Naturally Aspirated Honda Eng.	1996-91	F22A1	43
2.2L 131.6 (2156cc) SOHC L4 (16 Valve) 85mm Bore; MFI; Gasoline; Naturally Aspirated Honda Eng.	1991	F22A4	44
2.2L 131.6 (2156cc) SOHC L4 (16 Valve) 85mm Bore; MFI; Gasoline; Naturally Aspirated Honda Eng.	1993-91	F22A6	45
2.2L 131.6 (2156cc) SOHC L4 (16 Valve) 85mm Bore; MFI; Gasoline; Naturally Aspirated Honda Eng.	1997-94	F22B2	46
2.2L 131.6 (2156cc) SOHC L4 (16 Valve) 85mm Bore VTEC; MFI; Gasoline; Naturally Aspirated Honda Eng.	1997-94	F22B1	47
2.2L 132 (2157cc) DOHC L4 (16 Valve) 87mm Bore VTEC; MFI; Gasoline; Naturally Aspirated Honda Eng.	1996-93	H22A1	48
2.2L 132 (2157cc) DOHC L4 (16 Valve) 87mm Bore VTEC; MFI; Gasoline; Naturally Aspirated Honda Eng.	2001-97	H22A4	49
2.2L 132.8 (2178cc) DOHC L4 (16 Valve) 87mm Bore VTEC; MFI; Gasoline; Naturally Aspirated Honda Eng.	2009-04	F22C1	50
2.3L 137.5 (2254cc) SOHC L4 (16 Valve) 86mm Bore; MFI; Gasoline; Naturally Aspirated Honda Eng.	2002-98	F23A5	51
2.3L 137.5 (2254cc) SOHC L4 (16 Valve) 86mm Bore VTEC; MFI; Gasoline; Naturally Aspirated Honda Eng.	2002-98	F23A1	52
2.3L 137.5 (2254cc) SOHC L4 (16 Valve) 86mm Bore VTEC; MFI; Gasoline; Naturally Aspirated Honda Eng.	2002-98	F23A4	53
2.3L 138 (2259cc) DOHC L4 (16 Valve) 87mm Bore; MFI; Gasoline; Naturally Aspirated Honda Eng.	1996-92	H23A1	54
2.4L 144 (2354cc) DOHC L4 (16 Valve) 87mm Bore i-VTEC; MFI; Gasoline; Naturally Aspirated Honda Eng.	2008-04	K24A2	55
2.4L 144 (2354cc) DOHC L4 (16 Valve) 87mm Bore i-VTEC; MFI; Gasoline; Naturally Aspirated Honda Eng.	2005-03	K24A4	56
2.4L 144 (2354cc) DOHC L4 (16 Valve) 87mm Bore i-VTEC; MFI; Gasoline; Naturally Aspirated Honda Eng.	2007-06	K24A8	57
2.4L 144 (2354cc) DOHC L4 (16 Valve) 87mm Bore i-VTEC; MFI; Gasoline; Naturally Aspirated Honda Eng.	2012-08	K24Z2	58
2.4L 144 (2354cc) DOHC L4 (16 Valve) 87mm Bore i-VTEC; MFI; Gasoline; Naturally Aspirated Honda Eng.	2013-08	K24Z3	59
2.4L 144 (2354cc) DOHC L4 (16 Valve) 87mm Bore i-VTEC; MFI; Gasoline; Naturally Aspirated Honda Eng.	2013-12	K24Z7	60
2.5L 149.8 (2451cc) SOHC L5 (20 Valve) 85mm Bore; MFI; Gasoline; Naturally Aspirated Honda Eng.	1994-92	G25A1	61
2.5L 149.8 (2451cc) SOHC L5 (20 Valve) 85mm Bore; MFI; Gasoline; Naturally Aspirated Honda Eng.	1998-95	G25A4	62
2.7L 163.2 (2675cc) SOHC V6 (24 Valve) 87mm Bore; MFI; Gasoline; Naturally Aspirated Honda Eng.	1997-95	C27A4	63
3.0L 181.6 (2977cc) DOHC V6 (24 Valve) 90mm Bore VTEC; MFI; Gasoline; Naturally Aspirated Honda Eng.	2005-91	C30A1	64
3.0L 182.9 (2997cc) SOHC V6 (24 Valve) 86mm Bore VTEC; MFI; Gasoline; Naturally Aspirated Honda Eng.	2002-97	J30A1	65
3.0L 182.9 (2997cc) SOHC V6 (24 Valve) 86mm Bore VTEC; MFI; Gasoline; Naturally Aspirated Honda Eng.	2005-03	J30A4	66
3.0L 182.9 (2997cc) SOHC V6 (24 Valve) 86mm Bore VTEC; MFI; Gasoline; Naturally Aspirated Honda Eng.	2007-06	J30A5	67
3.0L 182.9 (2997cc) SOHC V6 (24 Valve) 86mm Bore VTEC; MFI; Hybrid (Gas/Electric); Naturally Aspirated Honda Eng.	2007-05	JNA1	68
3.2L 195.6 (3206cc) SOHC V6 (24 Valve) 90mm Bore; MFI; Gasoline; Naturally Aspirated Honda Eng.	1995-91	C32A1	69
3.2L 195.6 (3206cc) SOHC V6 (24 Valve) 90mm Bore; MFI; Gasoline; Naturally Aspirated Honda Eng.	1998-96	C32A6	70
3.2L 196 (3210cc) SOHC V6 (24 Valve) 89mm Bore VTEC; MFI; Gasoline; Naturally Aspirated Honda Eng.	2003-99	J32A1	71
3.2L 196 (3210cc) SOHC V6 (24 Valve) 89mm Bore VTEC; MFI; Gasoline; Naturally Aspirated Honda Eng.	2003-01	J32A2	72
3.2L 196 (3210cc) SOHC V6 (24 Valve) 89mm Bore VTEC; MFI; Gasoline; Naturally Aspirated Honda Eng.	2008-04	J32A3	73
3.5L 212 (3471cc) SOHC V6 (24 Valve) 89mm Bore VTEC; MFI; Gasoline; Naturally Aspirated Honda Eng.	2008-05	J35A8	74
3.5L 212 (3471cc) SOHC V6 (24 Valve) 89mm Bore VTEC; MFI; Gasoline; Naturally Aspirated Honda Eng.	2012-08	J35Z2	75
3.5L 212 (3471cc) SOHC V6 (24 Valve) 89mm Bore VTEC; MFI; Gasoline; Naturally Aspirated Honda Eng.	2012-08	J35Z3	76
3.5L 212 (3471cc) SOHC V6 (24 Valve) 89mm Bore VTEC; MFI; Gasoline; Naturally Aspirated Honda Eng.	2013-09	J35Z6	77
3.5L 212 (3471cc) SOHC V6 (24 Valve) 89mm Bore i-VTEC; MFI; Gasoline; Naturally Aspirated Honda Eng.	2013	J35Y1	78
3.5L 212 (3474cc) SOHC V6 (24 Valve) 90mm Bore; MFI; Gasoline; Naturally Aspirated Honda Eng.	2004-96	C35A1	79
3.7L 223.6 (3664cc) SOHC V6 (24 Valve) 90mm Bore VTEC; MFI; Gasoline; Naturally Aspirated Honda Eng.	2013-09	J37A2	80
3.7L 223.6 (3664cc) SOHC V6 (24 Valve) 90mm Bore VTEC; MFI; Gasoline; Naturally Aspirated Honda Eng.	2013-09	J37A4	81

Engine Code Index

Code	Engine	Line No.
B16A2	1.6L 97.3 (1595cc) DOHC L4 (16 Valve) 81mm Bore VTEC; MFI; Gasoline; Naturally Aspirated Honda Eng.	21
B16A3	1.6L 97.3 (1595cc) DOHC L4 (16 Valve) 81mm Bore VTEC; MFI; Gasoline; Naturally Aspirated Honda Eng.	22
B17A1	1.7L 102.4 (1678cc) DOHC L4 (16 Valve) 81mm Bore VTEC; MFI; Gasoline; Naturally Aspirated Honda Eng.	27
B18A1	1.8L 111.8 (1834cc) DOHC L4 (16 Valve) 81mm Bore; MFI; Gasoline; Naturally Aspirated Honda Eng.	34
B18B1	1.8L 111.8 (1834cc) DOHC L4 (16 Valve) 81mm Bore; MFI; Gasoline; Naturally Aspirated Honda Eng.	35

Honda Car (Incl. Acura, Honda) (Cont.)

Engine Code Index (Cont.)		
Code	Engine	Line No.
B18C1	1.8L 109.6 (1797cc) DOHC L4 (16 Valve) 81mm Bore VTEC; MFI; Gasoline; Naturally Aspirated Honda Eng.	28
B18C5	1.8L 109.6 (1797cc) DOHC L4 (16 Valve) 81mm Bore VTEC; MFI; Gasoline; Naturally Aspirated Honda Eng.	29
B20A5	2.0L 119.5 (1958cc) DOHC L4 (16 Valve) 81mm Bore; MFI; Gasoline; Naturally Aspirated Honda Eng.	36
B21A1	2.1L 125 (2056cc) DOHC L4 (16 Valve) 83mm Bore; MFI; Gasoline; Naturally Aspirated Honda Eng.	42
C27A4	2.7L 163.2 (2675cc) SOHC V6 (24 Valve) 87mm Bore; MFI; Gasoline; Naturally Aspirated Honda Eng.	63
C30A1	3.0L 181.6 (2977cc) DOHC V6 (24 Valve) 90mm Bore VTEC; MFI; Gasoline; Naturally Aspirated Honda Eng.	64
C32A1	3.2L 195.6 (3206cc) SOHC V6 (24 Valve) 90mm Bore; MFI; Gasoline; Naturally Aspirated Honda Eng.	69
C32A6	3.2L 195.6 (3206cc) SOHC V6 (24 Valve) 90mm Bore; MFI; Gasoline; Naturally Aspirated Honda Eng.	70
C35A1	3.5L 212 (3474cc) SOHC V6 (24 Valve) 90mm Bore; MFI; Gasoline; Naturally Aspirated Honda Eng.	79
D15B1	1.5L 91 (1493cc) SOHC L4 (16 Valve) 75mm Bore; TBI; Gasoline; Naturally Aspirated Honda Eng.	5
D15B2	1.5L 91 (1493cc) SOHC L4 (16 Valve) 75mm Bore; TBI; Gasoline; Naturally Aspirated Honda Eng.	6
D15B6	1.5L 91 (1493cc) SOHC L4 (8 Valve) 75mm Bore; MFI; Gasoline; Naturally Aspirated Honda Eng.	9
D15B7	1.5L 91 (1493cc) SOHC L4 (16 Valve) 75mm Bore; MFI; Gasoline; Naturally Aspirated Honda Eng.	7
D15B8	1.5L 91 (1493cc) SOHC L4 (8 Valve) 75mm Bore; MFI; Gasoline; Naturally Aspirated Honda Eng.	10
D15Z1	1.5L 91 (1493cc) SOHC L4 (16 Valve) 75mm Bore VTEC-E; MFI; Gasoline; Naturally Aspirated Honda Eng.	8
D16A6	1.6L 97 (1590cc) SOHC L4 (16 Valve) 75mm Bore; MFI; Gasoline; Naturally Aspirated Honda Eng.	15
D16B5	1.6L 97 (1590cc) SOHC L4 (16 Valve) 75mm Bore; MFI; Natural Gas; Naturally Aspirated Honda Eng.	16
D16Y5	1.6L 97 (1590cc) SOHC L4 (16 Valve) 75mm Bore VTEC; MFI; Gasoline; Naturally Aspirated Honda Eng.	18
D16Y7	1.6L 97 (1590cc) SOHC L4 (16 Valve) 75mm Bore; MFI; Gasoline; Naturally Aspirated Honda Eng.	17
D16Y8	1.6L 97 (1590cc) SOHC L4 (16 Valve) 75mm Bore VTEC; MFI; Gasoline; Naturally Aspirated Honda Eng.	19
D16Z6	1.6L 97 (1590cc) SOHC L4 (16 Valve) 75mm Bore VTEC; MFI; Gasoline; Naturally Aspirated Honda Eng.	20
D17A1	1.7L 101 (1668cc) SOHC L4 (16 Valve) 75mm Bore; MFI; Gasoline; Naturally Aspirated Honda Eng.	23
D17A2	1.7L 101 (1668cc) SOHC L4 (16 Valve) 75mm Bore VTEC; MFI; Gasoline; Naturally Aspirated Honda Eng.	25
D17A6	1.7L 101 (1668cc) SOHC L4 (16 Valve) 75mm Bore VTEC; MFI; Gasoline; Naturally Aspirated Honda Eng.	26
D17A7	1.7L 101 (1668cc) SOHC L4 (16 Valve) 75mm Bore; MFI; Natural Gas; Naturally Aspirated Honda Eng.	24
ECA1	1.0L 61 (995cc) SOHC L3 (12 Valve) 72mm Bore VTEC; MFI; Hybrid (Gas/Electric); Naturally Aspirated Honda Eng.	1
F20C1	2.0L 121.9 (1997cc) DOHC L4 (16 Valve) 87mm Bore VTEC; MFI; Gasoline; Naturally Aspirated Honda Eng.	37
F22A1	2.2L 131.6 (2156cc) SOHC L4 (16 Valve) 85mm Bore; MFI; Gasoline; Naturally Aspirated Honda Eng.	43
F22A4	2.2L 131.6 (2156cc) SOHC L4 (16 Valve) 85mm Bore; MFI; Gasoline; Naturally Aspirated Honda Eng.	44
F22A6	2.2L 131.6 (2156cc) SOHC L4 (16 Valve) 85mm Bore; MFI; Gasoline; Naturally Aspirated Honda Eng.	45
F22B1	2.2L 131.6 (2156cc) SOHC L4 (16 Valve) 85mm Bore VTEC; MFI; Gasoline; Naturally Aspirated Honda Eng.	47
F22B2	2.2L 131.6 (2156cc) SOHC L4 (16 Valve) 85mm Bore; MFI; Gasoline; Naturally Aspirated Honda Eng.	46
F22C1	2.2L 132.8 (2178cc) DOHC L4 (16 Valve) 87mm Bore VTEC; MFI; Gasoline; Naturally Aspirated Honda Eng.	50
F23A1	2.3L 137.5 (2254cc) SOHC L4 (16 Valve) 86mm Bore VTEC; MFI; Gasoline; Naturally Aspirated Honda Eng.	52
F23A4	2.3L 137.5 (2254cc) SOHC L4 (16 Valve) 86mm Bore VTEC; MFI; Gasoline; Naturally Aspirated Honda Eng.	53
F23A5	2.3L 137.5 (2254cc) SOHC L4 (16 Valve) 86mm Bore; MFI; Gasoline; Naturally Aspirated Honda Eng.	51
G25A1	2.5L 149.8 (2451cc) SOHC L5 (20 Valve) 85mm Bore; MFI; Gasoline; Naturally Aspirated Honda Eng.	61
G25A4	2.5L 149.8 (2451cc) SOHC L5 (20 Valve) 85mm Bore; MFI; Gasoline; Naturally Aspirated Honda Eng.	62
H22A1	2.2L 132 (2157cc) DOHC L4 (16 Valve) 87mm Bore VTEC; MFI; Gasoline; Naturally Aspirated Honda Eng.	48
H22A4	2.2L 132 (2157cc) DOHC L4 (16 Valve) 87mm Bore VTEC; MFI; Gasoline; Naturally Aspirated Honda Eng.	49
H23A1	2.3L 138 (2259cc) DOHC L4 (16 Valve) 87mm Bore; MFI; Gasoline; Naturally Aspirated Honda Eng.	54
J30A1	3.0L 182.9 (2997cc) SOHC V6 (24 Valve) 86mm Bore VTEC; MFI; Gasoline; Naturally Aspirated Honda Eng.	65
J30A4	3.0L 182.9 (2997cc) SOHC V6 (24 Valve) 86mm Bore VTEC; MFI; Gasoline; Naturally Aspirated Honda Eng.	66
J30A5	3.0L 182.9 (2997cc) SOHC V6 (24 Valve) 86mm Bore VTEC; MFI; Gasoline; Naturally Aspirated Honda Eng.	67
J32A1	3.2L 196 (3210cc) SOHC V6 (24 Valve) 89mm Bore VTEC; MFI; Gasoline; Naturally Aspirated Honda Eng.	71
J32A2	3.2L 196 (3210cc) SOHC V6 (24 Valve) 89mm Bore VTEC; MFI; Gasoline; Naturally Aspirated Honda Eng.	72
J32A3	3.2L 196 (3210cc) SOHC V6 (24 Valve) 89mm Bore VTEC; MFI; Gasoline; Naturally Aspirated Honda Eng.	73
J35A8	3.5L 212 (3471cc) SOHC V6 (24 Valve) 89mm Bore VTEC; MFI; Gasoline; Naturally Aspirated Honda Eng.	74
J35Y1	3.5L 212 (3471cc) SOHC V6 (24 Valve) 89mm Bore i-VTEC; MFI; Gasoline; Naturally Aspirated Honda Eng.	78
J35Z2	3.5L 212 (3471cc) SOHC V6 (24 Valve) 89mm Bore VTEC; MFI; Gasoline; Naturally Aspirated Honda Eng.	75
J35Z3	3.5L 212 (3471cc) SOHC V6 (24 Valve) 89mm Bore VTEC; MFI; Gasoline; Naturally Aspirated Honda Eng.	76
J35Z6	3.5L 212 (3471cc) SOHC V6 (24 Valve) 89mm Bore VTEC; MFI; Gasoline; Naturally Aspirated Honda Eng.	77
J37A2	3.7L 223.6 (3664cc) SOHC V6 (24 Valve) 90mm Bore VTEC; MFI; Gasoline; Naturally Aspirated Honda Eng.	80
J37A4	3.7L 223.6 (3664cc) SOHC V6 (24 Valve) 90mm Bore VTEC; MFI; Gasoline; Naturally Aspirated Honda Eng.	81
JNA1	3.0L 182.9 (2997cc) SOHC V6 (24 Valve) 86mm Bore VTEC; MFI; Hybrid (Gas/Electric); Naturally Aspirated Honda Eng.	68
K20A2	2.0L 122 (1998cc) DOHC L4 (16 Valve) 86mm Bore i-VTEC; MFI; Gasoline; Naturally Aspirated Honda Eng.	38
K20A3	2.0L 122 (1998cc) DOHC L4 (16 Valve) 86mm Bore i-VTEC; MFI; Gasoline; Naturally Aspirated Honda Eng.	39
K20Z1	2.0L 122 (1998cc) DOHC L4 (16 Valve) 86mm Bore i-VTEC; MFI; Gasoline; Naturally Aspirated Honda Eng.	40
K20Z3	2.0L 122 (1998cc) DOHC L4 (16 Valve) 86mm Bore i-VTEC; MFI; Gasoline; Naturally Aspirated Honda Eng.	41
K24A2	2.4L 144 (2354cc) DOHC L4 (16 Valve) 87mm Bore i-VTEC; MFI; Gasoline; Naturally Aspirated Honda Eng.	55
K24A4	2.4L 144 (2354cc) DOHC L4 (16 Valve) 87mm Bore i-VTEC; MFI; Gasoline; Naturally Aspirated Honda Eng.	56
K24A8	2.4L 144 (2354cc) DOHC L4 (16 Valve) 87mm Bore i-VTEC; MFI; Gasoline; Naturally Aspirated Honda Eng.	57
K24Z2	2.4L 144 (2354cc) DOHC L4 (16 Valve) 87mm Bore i-VTEC; MFI; Gasoline; Naturally Aspirated Honda Eng.	58
K24Z3	2.4L 144 (2354cc) DOHC L4 (16 Valve) 87mm Bore i-VTEC; MFI; Gasoline; Naturally Aspirated Honda Eng.	59

Honda Car (Incl. Acura, Honda) (Cont.)

Engine Code Index (Cont.)

Code	Engine	Line No.
K24Z7	2.4L 144 (2354cc) DOHC L4 (16 Valve) 87mm Bore i-VTEC; MFI; Gasoline; Naturally Aspirated Honda Eng.	60
L15A1	1.5L 91.3 (1496cc) SOHC L4 (16 Valve) 73mm Bore VTEC; MFI; Gasoline; Naturally Aspirated Honda Eng.	11
L15A7	1.5L 91.3 (1496cc) SOHC L4 (16 Valve) 73mm Bore i-VTEC; MFI; Gasoline; Naturally Aspirated Honda Eng.	12
LDA1	1.3L 81 (1339cc) SOHC L4 (8 Valve) 73mm Bore VTEC; MFI; Hybrid (Gas/Electric); Naturally Aspirated Honda Eng.	2
LDA2	1.3L 81 (1339cc) SOHC L4 (8 Valve) 73mm Bore i-VTEC; MFI; Hybrid (Gas/Electric); Naturally Aspirated Honda Eng.	3
LDA3	1.3L 81 (1339cc) SOHC L4 (8 Valve) 73mm Bore i-VTEC; MFI; Hybrid (Gas/Electric); Naturally Aspirated Honda Eng.	4
LEA1	1.5L 91.3 (1496cc) SOHC L4 (16 Valve) 73mm Bore i-VTEC; MFI; Hybrid (Gas/Electric); Naturally Aspirated Honda Eng.	13
LEA2	1.5L 91.3 (1496cc) SOHC L4 (8 Valve) 73mm Bore i-VTEC; MFI; Hybrid (Gas/Electric); Naturally Aspirated Honda Eng.	14
R18A1	1.8L 109.8 (1799cc) SOHC L4 (16 Valve) 81mm Bore i-VTEC; MFI; Gasoline; Naturally Aspirated Honda Eng.	30
R18A4	1.8L 109.8 (1799cc) SOHC L4 (16 Valve) 81mm Bore i-VTEC; MFI; Natural Gas; Naturally Aspirated Honda Eng.	31
R18A9	1.8L 109.8 (1799cc) SOHC L4 (16 Valve) 81mm Bore i-VTEC; MFI; Natural Gas; Naturally Aspirated Honda Eng.	32
R18Z1	1.8L 109.8 (1799cc) SOHC L4 (16 Valve) 81mm Bore i-VTEC; MFI; Gasoline; Naturally Aspirated Honda Eng.	33

Model Index

Engine (VIN Code / Eng. Code)	Year	Engine (VIN Code / Eng. Code)	Year	Engine (VIN Code / Eng. Code)	Year
Acura		Acura (cont.)		Honda (cont.)	
1.6EL (Canada)		Integra (cont.)		Accord (cont.)	
L4 1590cc 1.6L SOHC (16 Valve) (D16Y7)	00-97	L4 1834cc 1.8L DOHC (16 Valve) (B18A1)	93-90	L4 1829cc 1.8L SOHC (12 Valve) (ET1)	85-84
L4 1590cc 1.6L SOHC VTEC (16 Valve) (D16Y5)	00-97	L4 1834cc 1.8L DOHC (16 Valve) (B18B1)	01-94	L4 1955cc 2.0L SOHC (12 Valve) (A20A1)	89-87
L4 1590cc 1.6L SOHC VTEC (16 Valve) (D16Y8)	00-97	Legend		L4 1955cc 2.0L SOHC (12 Valve) (A20A2)	87
1.7EL (Canada)		V6 2494cc 2.5L SOHC (24 Valve) (C25A1)	87-86	L4 1955cc 2.0L SOHC (12 Valve) (A20A3)	89-87
L4 1668cc 1.7L SOHC (16 Valve) (D17A1)	05-01	V6 2675cc 2.7L SOHC (24 Valve) (C27A1)	90-87	L4 1955cc 2.0L SOHC (12 Valve) (A20A4)	87
L4 1668cc 1.7L SOHC VTEC (16 Valve) (D17A2)	05-01	V6 3206cc 3.2L SOHC (24 Valve) (C32A1)	95-91	L4 1955cc 2.0L SOHC (12 Valve) (BS1)	86
2.2CL		NSX		L4 1955cc 2.0L SOHC (12 Valve) (BS2)	86
L4 2156cc 2.2L SOHC VTEC (16 Valve) (F22B1)	97	V6 2977cc 3.0L DOHC VTEC (24 Valve) (C30A1)	05-91	L4 1955cc 2.0L SOHC (12 Valve) (BT2)	86
2.3CL		V6 3179cc 3.2L DOHC VTEC (24 Valve) (C32B1)	05-97	L4 2156cc 2.2L SOHC (16 Valve) (F22A1)	91-90
L4 2254cc 2.3L SOHC VTEC (16 Valve) (F23A4)	00-98	RL		L4 2156cc 2.2L SOHC (16 Valve) (F22A6)	93-91
2.5TL		V6 3471cc 3.5L SOHC VTEC (24 Valve) (J35A8)	08-05	L4 2156cc 2.2L SOHC (16 Valve) (F22B2)	97-94
L5 2451cc 2.5L SOHC (20 Valve) (G25A4)	98-95	V6 3664cc 3.7L SOHC VTEC (24 Valve) (J37A2)	13-09	L4 2156cc 2.2L SOHC VTEC (16 Valve) (F22B1)	97-94
3.0CL		RSX		L4 2254cc 2.3L SOHC (16 Valve) (F23A5)	02-98
V6 2997cc 3.0L SOHC VTEC (24 Valve) (J30A1)	00-97	L4 1998cc 2.0L DOHC i-VTEC (16 Valve) (K20A2)	04-02	L4 2254cc 2.3L SOHC VTEC (16 Valve) (F23A4)	02-98
3.2CL		L4 1998cc 2.0L DOHC i-VTEC (16 Valve) (K20A3)	06-02	L4 2354cc 2.4L DOHC i-VTEC (16 Valve) (K24A4)	05-03
V6 3210cc 3.2L SOHC VTEC (24 Valve) (J32A1)	03-01	L4 1998cc 2.0L DOHC i-VTEC (16 Valve) (K20Z1)	06-05	L4 2354cc 2.4L DOHC i-VTEC (16 Valve) (K24A8)	07-06
V6 3210cc 3.2L SOHC VTEC (24 Valve) (J32A2)	03-01	TL		L4 2354cc 2.4L DOHC i-VTEC (16 Valve) (K24W1)	13
3.2TL		V6 3210cc 3.2L SOHC VTEC (24 Valve) (J32A3)	08-04	L4 2354cc 2.4L DOHC i-VTEC (16 Valve) (K24Z2)	12-08
V6 3206cc 3.2L SOHC (24 Valve) (C32A6)	98-96	V6 3471cc 3.5L SOHC VTEC (24 Valve) (J35A8)	08-07	L4 2354cc 2.4L DOHC i-VTEC (16 Valve) (K24Z3)	12-08
V6 3210cc 3.2L SOHC VTEC (24 Valve) (J32A1)	03-99	V6 3471cc 3.5L SOHC VTEC (24 Valve) (J35Z6)	13-09	V6 2675cc 2.7L SOHC (24 Valve) (C27A4)	97-95
V6 3210cc 3.2L SOHC VTEC (24 Valve) (J32A2)	03-02	V6 3664cc 3.7L SOHC VTEC (24 Valve) (J37A4)	13-09	V6 2997cc 3.0L SOHC VTEC (24 Valve) (J30A1)	02-98
3.5RL		TSX		V6 2997cc 3.0L SOHC VTEC (24 Valve) (J30A4)	05-03
V6 3474cc 3.5L SOHC (24 Valve) (C35A1)	04-96	L4 2354cc 2.4L DOHC i-VTEC (16 Valve) (K24A2)	08-04	V6 2997cc 3.0L SOHC VTEC (24 Valve) (J30A5)	07-06
ILX		L4 2354cc 2.4L DOHC i-VTEC (16 Valve) (K24Z3)	13-09	V6 3471cc 3.5L SOHC i-VTEC (24 Valve) (J35Y1)	13
L4 1997cc 2.0L SOHC i-VTEC (16 Valve) (R20A1)	13-12	V6 3471cc 3.5L SOHC VTEC (24 Valve) (J35Z6)	13-10	V6 3471cc 3.5L SOHC VTEC (24 Valve) (J35Z2)	12-08
L4 1997cc 2.0L SOHC i-VTEC (16 Valve) (R20A5)	13-12	Vigor		V6 3471cc 3.5L SOHC VTEC (24 Valve) (J35Z3)	12-08
L4 2354cc 2.4L DOHC i-VTEC (16 Valve) (K24Z7)	13-12	L5 2451cc 2.5L SOHC (20 Valve) (G25A1)	94-92	Accord Hybrid	
ILX Hybrid		Honda		Accord	
L4 1496cc 1.5L SOHC i-VTEC (8 Valve) (LEA2)	13-12	Accord		Accord Hybrid	
Integra		L4 1599cc 1.6L SOHC (EF1)	78-76	V6 2997cc 3.0L SOHC VTEC (24 Valve) (JNA1)	07-05
L4 1590cc 1.6L DOHC (16 Valve) (D16A1)	89-86	L4 1599cc 1.6L SOHC (EF2)	78-76	Civic	
L4 1678cc 1.7L DOHC VTEC (16 Valve) (B17A1)	93-92	L4 1599cc 1.6L SOHC (EG)	79-78	L4 1169cc 1.2L SOHC (EB1)	73
L4 1797cc 1.8L DOHC VTEC (16 Valve) (B18C1)	01-94	L4 1601cc 1.6L SOHC (EL)	83-79	L4 1238cc 1.2L SOHC (EB2)	77-74
L4 1797cc 1.8L DOHC VTEC (16 Valve) (B18C5)	01-97	L4 1601cc 1.6L SOHC (EZ1)	85-84	L4 1238cc 1.2L SOHC (EB3)	79-78
		L4 1751cc 1.8L SOHC (12 Valve) (EK1)	83-79	L4 1335cc 1.3L SOHC (EJ1)	83-80
		L4 1829cc 1.8L SOHC (12 Valve) (ES2)	85-84	L4 1335cc 1.3L SOHC (EN1)	83-80
		L4 1829cc 1.8L SOHC (12 Valve) (ES3)	85		

Honda Car (Incl. Acura, Honda) (Cont.)

Model Index (Cont.)					
Engine (VIN Code / Eng. Code)	Year	Engine (VIN Code / Eng. Code)	Year	Engine (VIN Code / Eng. Code)	Year
Honda (cont.)		Honda (cont.)		Honda (cont.)	
Civic (cont.)		Civic (cont.)		Prelude (cont.)	
L4 1342cc 1.3L SOHC (8 Valve) (D13A1)	87	L4 2354cc 2.4L DOHC i-VTEC (16 Valve) (K24Z7)	13-12	L4 1829cc 1.8L SOHC (12 Valve) (ES1)	83
L4 1342cc 1.3L SOHC (8 Valve) (D13A2)	87	Civic Hybrid		L4 1829cc 1.8L SOHC (12 Valve) (ET2)	86-84
L4 1342cc 1.3L SOHC (8 Valve) (EV1)	86-84	L4 1339cc 1.3L SOHC i-VTEC (8 Valve) (LDA2)	11-06	L4 1955cc 2.0L SOHC (12 Valve) (A20A3)	87
L4 1342cc 1.3L SOHC (8 Valve) (EV2)	86-84	L4 1339cc 1.3L SOHC VTEC (8 Valve) (LDA1)	05-03	L4 1955cc 2.0L SOHC (12 Valve) (A20A4)	87
L4 1488cc 1.5L SOHC (12 Valve) (D15A1)	87	L4 1496cc 1.5L SOHC i-VTEC (8 Valve) (LEA2)	13-12	L4 1955cc 2.0L SOHC (12 Valve) (BT1)	85
L4 1488cc 1.5L SOHC (12 Valve) (D15A2)	87	Civic Wagon 4WD		L4 1955cc 2.0L SOHC (12 Valve) (BT2)	86
L4 1488cc 1.5L SOHC (12 Valve) (D15A3)	87	L4 1488cc 1.5L SOHC (12 Valve) (EW1)	86-84	L4 1958cc 2.0L DOHC (16 Valve) (B20A5)	91-88
L4 1488cc 1.5L SOHC (12 Valve) (EW1)	86-84	L4 1493cc 1.5L SOHC (16 Valve) (D15A2)	87	L4 1958cc 2.0L SOHC (12 Valve) (B20A3)	90-88
L4 1488cc 1.5L SOHC (12 Valve) (EW2)	86-84	L4 1590cc 1.6L SOHC (16 Valve) (D16A6)	91-88	L4 2056cc 2.1L DOHC (16 Valve) (B21A1)	91-90
L4 1488cc 1.5L SOHC (12 Valve) (EW4)	86	CR-Z Hybrid		L4 2156cc 2.2L SOHC (16 Valve) (F22A1)	96-92
L4 1488cc 1.5L SOHC (8 Valve) (EC)	79-75	L4 1496cc 1.5L SOHC i-VTEC (16 Valve) (LEA1)	13-11	L4 2157cc 2.2L DOHC VTEC (16 Valve) (H22A1)	96-93
L4 1488cc 1.5L SOHC (8 Valve) (ED1)	75	CRX		L4 2157cc 2.2L DOHC VTEC (16 Valve) (H22A4)	01-97
L4 1488cc 1.5L SOHC (8 Valve) (ED2)	75	L4 1342cc 1.3L SOHC (8 Valve) (EV1)	84	L4 2259cc 2.3L DOHC (16 Valve) (H23A1)	96-92
L4 1488cc 1.5L SOHC (8 Valve) (ED3)	79-76	L4 1488cc 1.5L SOHC (12 Valve) (D15A2)	87	S2000	
L4 1488cc 1.5L SOHC (8 Valve) (ED4)	79-78	L4 1488cc 1.5L SOHC (12 Valve) (D15A3)	87	L4 1997cc 2.0L DOHC VTEC (16 Valve) (F20C1)	03-00
L4 1488cc 1.5L SOHC (8 Valve) (EM1)	83-80	L4 1488cc 1.5L SOHC (12 Valve) (EW1)	86-84	L4 2178cc 2.2L DOHC VTEC (16 Valve) (F22C1)	09-04
L4 1493cc 1.5L SOHC (16 Valve) (D15B1)	91-88	L4 1488cc 1.5L SOHC (12 Valve) (EW3)	85		
L4 1493cc 1.5L SOHC (16 Valve) (D15B2)	91-88	L4 1488cc 1.5L SOHC (12 Valve) (EW4)	86		
L4 1493cc 1.5L SOHC (16 Valve) (D15B7)	95-92	L4 1488cc 1.5L SOHC (8 Valve) (D15A2)	87		
L4 1493cc 1.5L SOHC (8 Valve) (D15B8)	95-92	L4 1488cc 1.5L SOHC (8 Valve) (EW1)	86-85		
L4 1493cc 1.5L SOHC VTEC-E (16 Valve) (D15Z1)	95-92	L4 1493cc 1.5L SOHC (16 Valve) (D15B2)	91-88		
L4 1590cc 1.6L SOHC (16 Valve) (D16A6)	91-88	L4 1493cc 1.5L SOHC (8 Valve) (D15B6)	91-88		
L4 1590cc 1.6L SOHC (16 Valve) (D16Y7)	00-96	L4 1590cc 1.6L SOHC (16 Valve) (D16A6)	91-88		
L4 1590cc 1.6L SOHC (Natural Gas) (D16B5)	00-98	Del Sol			
L4 1590cc 1.6L SOHC VTEC (16 Valve) (D16Y5)	00-96	L4 1493cc 1.5L SOHC (16 Valve) (D15B7)	95-93		
L4 1590cc 1.6L SOHC VTEC (16 Valve) (D16Y8)	00-96	L4 1590cc 1.6L SOHC (16 Valve) (D16Y7)	97-96		
L4 1590cc 1.6L SOHC VTEC (16 Valve) (D16Z6)	95-92	L4 1590cc 1.6L SOHC VTEC (16 Valve) (D16Y8)	97-96		
L4 1595cc 1.6L DOHC VTEC (16 Valve) (B16A2)	00-99	L4 1590cc 1.6L SOHC VTEC (16 Valve) (D16Z6)	95-93		
L4 1668cc 1.7L SOHC (16 Valve) (D17A1)	05-01	L4 1595cc 1.6L DOHC VTEC (16 Valve) (B16A2)	97-96		
L4 1668cc 1.7L SOHC (Natural Gas) (D17A7)	05-01	L4 1595cc 1.6L DOHC VTEC (16 Valve) (B16A3)	95-94		
L4 1668cc 1.7L SOHC VTEC (16 Valve) (D17A2)	05-01	Fit			
L4 1668cc 1.7L SOHC VTEC (16 Valve) (D17A6)	05-01	L4 1496cc 1.5L SOHC i-VTEC (16 Valve) (L15A7)	13-09		
L4 1799cc 1.8L SOHC i-VTEC (16 Valve) (R18A1)	11-06	L4 1496cc 1.5L SOHC VTEC (16 Valve) (L15A1)	08-07		
L4 1799cc 1.8L SOHC i-VTEC (16 Valve) (R18Z1)	13-12	Insight Hybrid			
L4 1799cc 1.8L SOHC i-VTEC (Natural Gas) (R18A4)	11-06	L3 995cc 1.0L SOHC VTEC (12 Valve) (ECA1)	06-00		
L4 1799cc 1.8L SOHC i-VTEC (Natural Gas) (R18A9)	13-12	L4 1339cc 1.3L SOHC i-VTEC (8 Valve) (LDA3)	13-10		
L4 1998cc 2.0L DOHC i-VTEC (16 Valve) (K20A3)	05-02	Prelude			
L4 1998cc 2.0L DOHC i-VTEC (16 Valve) (K20Z3)	11-06	L4 1751cc 1.8L SOHC (12 Valve) (EK1)	82-79		
		L4 1829cc 1.8L SOHC (12 Valve) (A18A1)	87		
		L4 1829cc 1.8L SOHC (12 Valve) (A18A2)	87		

1

**2006 - 2000; 1.0L 61 (995cc) SOHC L3 (12 Valve) 72mm Bore VTEC
MFI; Hybrid (Gas/Electric); Naturally Aspirated Honda Eng.; Eng. Code ECA1**

1

QTY	CYLINDER HEAD	YEARS	PART NO.	DESCRIPTION
1	Head Gasket	2006-00	26638 PT	Head bolts not incl.; Head bolt replacement recommended; PermaTorqueMLS®; New Part Number - Check for Availability
QTY	VALVE STEM SEAL SET	YEARS	PART NO.	DESCRIPTION
1	Valve Stem Seal Set	2006-00	SS 70283-2	Premium valve stem seals incl.

Honda Car (Incl. Acura, Honda) (Cont.)

2		2005 - 2003; 1.3L 81 (1339cc) SOHC L4 (8 Valve) 73mm Bore VTEC			2
MFI; Hybrid (Gas/Electric); Naturally Aspirated Honda Eng.; Eng. Code LDA1					
QTY	CYLINDER HEAD	YEARS	PART NO.	DESCRIPTION	
1	Head Gasket	2005-03	26528 PT	Head bolts not incl.; Head bolt replacement recommended; PermaTorqueMLS®	
1	Head Set	2005-03	HS 26528 PT	Head bolts not incl.; Head bolt replacement recommended; PermaDry® molded rubber valve cover gskt. incl.; Premium valve stem seals incl.; New Part Number - Check for Availability	
1	Head Bolt Set	2005-03	ES 72449-1	Head bolts w/Washers; Replacement recommended; New Part Number - Check for Availability	
QTY	CONVERSION SET	YEARS	PART NO.	DESCRIPTION	
1	Gasket Conversion Set	2005-03	CS 26529	RTV sealant incl. for oil pan gskt.; New Part Number - Check for Availability	
QTY	MANIFOLD - INT. & EXH.	YEARS	PART NO.	DESCRIPTION	
1	Int. Manifold Gasket Set	2005-03	MS 97168	Lower set; Upper set incl.; New Part Number - Check for Availability	
1	Exh. Manifold Gasket Set	2005-03	MS 97170		
QTY	EXHAUST PIPE FLANGE	YEARS	PART NO.	DESCRIPTION	
1	Exhaust Pipe Gasket	2005-03	60690	Pipe to manifold	
QTY	OIL PAN	YEARS	PART NO.	DESCRIPTION	
1	Oil Pan Gasket Set	2005-03	OS 30837 R	RTV sealant incl. for oil pan gskt.; New Part Number - Check for Availability	
QTY	CRANKSHAFT REAR SEAL	YEARS	PART NO.	DESCRIPTION	
1	Rear Main Seal Set	2005-03	BS 40535	Rubber; One-piece; Improved design	
QTY	VALVE COVER	YEARS	PART NO.	DESCRIPTION	
1	Valve Cover Gasket Set	2005-03	VS 50784 R	w/Grommets; PermaDry® molded rubber gskt. incl.; New Part Number - Check for Availability	
QTY	VALVE STEM SEAL SET	YEARS	PART NO.	DESCRIPTION	
1	Valve Stem Seal Set	2005-03	SS 70283	Premium valve stem seals incl.	
QTY	THERMOSTAT HOUSING	YEARS	PART NO.	DESCRIPTION	
1	Thermostat Gasket	2005-03	35480	Thermostat Housing; Thermostat O-ring	
QTY	WATER PUMP	YEARS	PART NO.	DESCRIPTION	
1	Water Pump Gasket	2005-03	35960	New Part Number - Check for Availability	
QTY	CARB & FUEL INJECTION	YEARS	PART NO.	DESCRIPTION	
2	Fuel Injector O-Ring Set	2005-03	ES 70599	Improved design	
1	Throttle Body Gasket	2005-03	61663	New Part Number - Check for Availability	
QTY	EXHAUST GAS RECIRCULATION	YEARS	PART NO.	DESCRIPTION	
1	EGR Gasket	2005-03	70978	Valve	
3		2011 - 2006; 1.3L 81 (1339cc) SOHC L4 (8 Valve) 73mm Bore i-VTEC			3
MFI; Hybrid (Gas/Electric); Naturally Aspirated Honda Eng.; Eng. Code LDA2					
QTY	CYLINDER HEAD	YEARS	PART NO.	DESCRIPTION	
1	Head Gasket	2011-06	26527 PT	Head bolts not incl.; Head bolt replacement recommended; PermaTorqueMLS®	
1	Head Set	2011-06	HS 26527 PT	Head bolts not incl.; Head bolt replacement recommended; PermaDry® molded rubber valve cover gskt. incl.; Premium valve stem seals incl.; New Part Number - Check for Availability	
1	Head Bolt Set	2011-06	ES 72449-1	Head bolts w/Washers; Replacement recommended; New Part Number - Check for Availability	
QTY	CONVERSION SET	YEARS	PART NO.	DESCRIPTION	
1	Gasket Conversion Set	2011-06	CS 26529	RTV sealant incl. for oil pan gskt.; New Part Number - Check for Availability	
QTY	MANIFOLD - INT. & EXH.	YEARS	PART NO.	DESCRIPTION	
1	Int. Manifold Gasket Set	2011-06	MS 97169	Lower set; Upper set incl.; New Part Number - Check for Availability	
1	Plenum Gasket Set	2011-06	MS 97175	Upper set; New Part Number - Check for Availability	
1	Exh. Manifold Gasket Set	2011-06	MS 97171		
QTY	EXHAUST PIPE FLANGE	YEARS	PART NO.	DESCRIPTION	
1	Exhaust Pipe Gasket	2011-06	60690	Pipe to manifold	
QTY	OIL PAN	YEARS	PART NO.	DESCRIPTION	
1	Oil Pan Gasket Set	2011-06	OS 30837 R	RTV sealant incl. for oil pan gskt.; New Part Number - Check for Availability	
QTY	CRANKSHAFT REAR SEAL	YEARS	PART NO.	DESCRIPTION	
1	Rear Main Seal Set	2011-06	BS 40535	Rubber; One-piece; Improved design	
QTY	VALVE COVER	YEARS	PART NO.	DESCRIPTION	
1	Valve Cover Gasket Set	2011-06	VS 50786 R	w/Grommets & Spark plug tube seals; PermaDry® molded rubber gskt. incl.; New Part Number - Check for Availability	
QTY	VALVE STEM SEAL SET	YEARS	PART NO.	DESCRIPTION	
1	Valve Stem Seal Set	2011-06	SS 70283	Premium valve stem seals incl.	
QTY	THERMOSTAT HOUSING	YEARS	PART NO.	DESCRIPTION	
1	Thermostat Gasket	2011-06	35734	Thermostat Housing; Thermostat seal	

Honda Car (Incl. Acura, Honda) (Cont.)

3		2011 - 2006; 1.3L 81 (1339cc) SOHC L4 (8 Valve) 73mm Bore i-VTEC			3
(cont.)		MFI; Hybrid (Gas/Electric); Naturally Aspirated Honda Eng.; Eng. Code LDA2			(cont.)
QTY	WATER PUMP	YEARS	PART NO.	DESCRIPTION	
1	Water Pump Gasket	2011-06	35960	New Part Number - Check for Availability	
QTY	CARB & FUEL INJECTION	YEARS	PART NO.	DESCRIPTION	
2	Fuel Injector O-Ring Set	2011-06	ES 70599	Improved design	
1	Throttle Body Gasket	2011-06	61542		
QTY	EXHAUST GAS RECIRCULATION	YEARS	PART NO.	DESCRIPTION	
1	EGR Gasket	2011-06	70978	Valve	
4		2013 - 2010; 1.3L 81 (1339cc) SOHC L4 (8 Valve) 73mm Bore i-VTEC			4
		MFI; Hybrid (Gas/Electric); Naturally Aspirated Honda Eng.; Eng. Code LDA3			
QTY	CYLINDER HEAD	YEARS	PART NO.	DESCRIPTION	
1	Head Gasket	2012-10	26529 PT	Head bolts not incl.; Head bolt replacement recommended; PermaTorqueMLS®; New Part Number - Check for Availability	
1	Head Set	2012-11	HS 26529 PT-3	Head bolts not incl.; Head bolt replacement recommended; PermaDry® molded rubber valve cover gskt. incl.; Premium valve stem seals incl.; New Part Number - Check for Availability	
1	Head Set	2010	HS 26529 PT	Head bolts not incl.; Head bolt replacement recommended; PermaDry® molded rubber valve cover gskt. incl.; Premium valve stem seals incl.; New Part Number - Check for Availability	
1	Head Bolt Set	2012-10	ES 72449-1	Head bolts w/Washers; Replacement recommended; New Part Number - Check for Availability	
QTY	CONVERSION SET	YEARS	PART NO.	DESCRIPTION	
1	Gasket Conversion Set	2013-10	CS 26529	RTV sealant incl. for oil pan gskt.; New Part Number - Check for Availability	
QTY	MANIFOLD - INT. & EXH.	YEARS	PART NO.	DESCRIPTION	
1	Int. Manifold Gasket Set	2012-10	MS 97177	Lower set; New Part Number - Check for Availability	
1	Exh. Manifold Gasket Set	2012-10	MS 97172		
QTY	EXHAUST PIPE FLANGE	YEARS	PART NO.	DESCRIPTION	
1	Exhaust Pipe Gasket	2012-10	60478	Pipe to manifold	
QTY	OIL PAN	YEARS	PART NO.	DESCRIPTION	
1	Oil Pan Gasket Set	2013-10	OS 30837 R	RTV sealant incl. for oil pan gskt.; New Part Number - Check for Availability	
QTY	CRANKSHAFT REAR SEAL	YEARS	PART NO.	DESCRIPTION	
1	Rear Main Seal Set	2013-10	BS 40535	Rubber; One-piece; Improved design	
QTY	VALVE COVER	YEARS	PART NO.	DESCRIPTION	
1	Valve Cover Gasket Set	2012-11	VS 50783 R	w/Grommets & Spark plug tube seals; PermaDry® molded rubber gskt. incl.; New Part Number - Check for Availability	
1	Valve Cover Gasket Set	2010	VS 50786 R	w/Grommets & Spark plug tube seals; PermaDry® molded rubber gskt. incl.; New Part Number - Check for Availability	
1	Circular Plug	2012-10	ES 72476	Valve Cover; New Part Number - Check for Availability	
QTY	VALVE STEM SEAL SET	YEARS	PART NO.	DESCRIPTION	
1	Valve Stem Seal Set	2012-10	SS 70283	Premium valve stem seals incl.	
QTY	THERMOSTAT HOUSING	YEARS	PART NO.	DESCRIPTION	
1	Thermostat Gasket	2012-10	35480	Thermostat Housing; Thermostat O-ring	
QTY	WATER PUMP	YEARS	PART NO.	DESCRIPTION	
1	Water Pump Gasket	2013-10	35961	New Part Number - Check for Availability	
QTY	CARB & FUEL INJECTION	YEARS	PART NO.	DESCRIPTION	
2	Fuel Injector O-Ring Set	2012-10	ES 70599	Improved design	
1	Throttle Body Gasket	2012-10	61664	New Part Number - Check for Availability	
QTY	EXHAUST GAS RECIRCULATION	YEARS	PART NO.	DESCRIPTION	
1	EGR Gasket	2012-10	70978	Valve	
1	EGR Gasket	2012-10	72370	Loc. Upper; Pipe	
1	EGR Gasket	2012-10	72371	Loc. Lower; Pipe	
5		1991; 1.5L 91 (1493cc) SOHC L4 (16 Valve) 75mm Bore			5
		TBI; Gasoline; Naturally Aspirated Honda Eng.; Eng. Code D15B1			
QTY	CYLINDER HEAD	YEARS	PART NO.	DESCRIPTION	
1	Head Gasket	1991	26320 PT	Head bolts not incl.; Head bolt replacement recommended; PermaTorqueMLS®	
1	Head Gasket	1991	9123 PT		
1	Head Set	1991	HS 9123 PT	Exh. pipe to muffler gskt. & flexible joint ring not incl.; PermaDry® molded rubber valve cover gskt. incl.; Premium valve stem seals incl.	
1	Head Installation Set	1991	HIS 9123 PT	Exh. pipe to manifold gskt., exh. pipe to muffler gskt., flexible joint ring not incl.; PermaDry® molded rubber valve cover gskt. incl.	
QTY	CONVERSION SET	YEARS	PART NO.	DESCRIPTION	
1	Gasket Conversion Set	1991	CS 9123	PermaDry® molded rubber oil pan gskt. incl.	

Honda Car (Incl. Acura, Honda) (Cont.)

5		1991; 1.5L 91 (1493cc) SOHC L4 (16 Valve) 75mm Bore			5	
(cont.)		TBI; Gasoline; Naturally Aspirated Honda Eng.; Eng. Code D15B1			(cont.)	
QTY	MANIFOLD - INT. & EXH.	YEARS	PART NO.	DESCRIPTION		
1	Int. Manifold Gasket Set	1991	MS 94119-2	Improved design		
1	Exh. Manifold Gasket Set	1991	MS 94118-1			
QTY	EXHAUST PIPE FLANGE	YEARS	PART NO.	DESCRIPTION		
1	Exhaust Pipe Gasket	1991	23624	Pipe to manifold		
1	Exhaust Pipe Gasket	1991	60517	After converter		
1	Exhaust Pipe Gasket	1991	60568	Pipe to muffler		
1	Exhaust Pipe Gasket	1991	60669	To converter		
QTY	OIL PAN	YEARS	PART NO.	DESCRIPTION		
1	Oil Pan Gasket Set	1991	OS 30542 R	PermaDry® molded rubber gskt. incl.		
QTY	CRANKSHAFT REAR SEAL	YEARS	PART NO.	DESCRIPTION		
1	Rear Main Seal Set	1991	BS 40430	Rubber; One-piece		
1	Repair Sleeve	1991	16275	Crankshaft; Use w/installation tool		
QTY	VALVE COVER	YEARS	PART NO.	DESCRIPTION		
1	Valve Cover Gasket Set	1991	VS 50326 R	w/o Grommets & Spark plug tube seals; PermaDry® molded rubber gskt. incl.		
1	Valve Cover Gasket Set	1991	VS 50326 R-1	w/Grommets & Spark plug tube seals; PermaDry® molded rubber gskt. incl.		
1	Grommet Set	1991	ES 70362	Valve Cover		
1	Spark Plug Tube Seal Set	1991	ES 70280	Valve Cover		
QTY	VALVE STEM SEAL SET	YEARS	PART NO.	DESCRIPTION		
1	Valve Stem Seal Set	1991	SS 70283-1	Premium valve stem seals incl.		
QTY	THERMOSTAT HOUSING	YEARS	PART NO.	DESCRIPTION		
1	Thermostat Gasket	1991	35424	Thermostat Housing		
QTY	WATER OUTLET GASKET	YEARS	PART NO.	DESCRIPTION		
1	Water Outlet Gasket	1991	35498	Water Outlet		
QTY	WATER PUMP	YEARS	PART NO.	DESCRIPTION		
1	Water Pump Gasket	1991	35371			
QTY	TIMING COVER	YEARS	PART NO.	DESCRIPTION		
1	Crankshaft Front Seal Set	1991	TCS 45845	w/Dust seals; Must be used w/OS 30542R		
1	Crankshaft Front Seal Set	1991	TCS 45879	w/o Dust seals; Must be used w/OS 30542R		
1	Camshaft Front Seal Set	1991	TCS 45620	w/o Dust seals		
1	Camshaft Front Seal Set	1991	TCS 45844	w/Dust seals		
QTY	CARB & FUEL INJECTION	YEARS	PART NO.	DESCRIPTION		
1	Throttle Body Gasket	1991	60782	Gskt.		
1	Throttle Body Gasket	1991	60792	O-ring		
QTY	DISTRIBUTOR MOUNTING	YEARS	PART NO.	DESCRIPTION		
1	Distributor Mounting Gasket	1991	72454	Distributor Mounting; O-ring; 26.5mm ID		
QTY	EXHAUST GAS RECIRCULATION	YEARS	PART NO.	DESCRIPTION		
1	EGR Gasket	1991	70978			
6		1991; 1.5L 91 (1493cc) SOHC L4 (16 Valve) 75mm Bore			6	
(cont.)		TBI; Gasoline; Naturally Aspirated Honda Eng.; Eng. Code D15B2			(cont.)	
QTY	CYLINDER HEAD	YEARS	PART NO.	DESCRIPTION		
1	Head Gasket	1991	26320 PT	Head bolts not incl.; Head bolt replacement recommended; PermaTorqueMLS®		
1	Head Gasket	1991	9123 PT			
1	Head Set	1991	HS 9123 PT	Exh. pipe to muffler gskt. & flexible joint ring not incl.; PermaDry® molded rubber valve cover gskt. incl.; Premium valve stem seals incl.		
1	Head Installation Set	1991	HIS 9123 PT	Exh. pipe to manifold gskt., exh. pipe to muffler gskt., flexible joint ring not incl.; PermaDry® molded rubber valve cover gskt. incl.		
QTY	CONVERSION SET	YEARS	PART NO.	DESCRIPTION		
1	Gasket Conversion Set	1991	CS 9123	PermaDry® molded rubber oil pan gskt. incl.		
QTY	MANIFOLD - INT. & EXH.	YEARS	PART NO.	DESCRIPTION		
1	Int. Manifold Gasket Set	1991	MS 94119-2	Improved design		
1	Exh. Manifold Gasket Set	1991	MS 94118-1			
QTY	EXHAUST PIPE FLANGE	YEARS	PART NO.	DESCRIPTION		
1	Exhaust Pipe Gasket	1991	23624	Pipe to manifold		
1	Exhaust Pipe Gasket	1991	60517	After converter		
1	Exhaust Pipe Gasket	1991	60568	Pipe to muffler		
1	Exhaust Pipe Gasket	1991	60669	To converter		
QTY	OIL PAN	YEARS	PART NO.	DESCRIPTION		
1	Oil Pan Gasket Set	1991	OS 30542 R	PermaDry® molded rubber gskt. incl.		
QTY	CRANKSHAFT REAR SEAL	YEARS	PART NO.	DESCRIPTION		
1	Rear Main Seal Set	1991	BS 40430	Rubber; One-piece		

Honda Car (Incl. Acura, Honda) (Cont.)

6 (cont.)		1991; 1.5L 91 (1493cc) SOHC L4 (16 Valve) 75mm Bore			6 (cont.)
		TBI; Gasoline; Naturally Aspirated Honda Eng.; Eng. Code D15B2			
QTY	CRANKSHAFT REAR SEAL	YEARS	PART NO.	DESCRIPTION	
1	Repair Sleeve	1991	16275	Crankshaft; Use w/installation tool	
QTY	VALVE COVER	YEARS	PART NO.	DESCRIPTION	
1	Valve Cover Gasket Set	1991	VS 50326 R	w/o Grommets & Spark plug tube seals; PermaDry® molded rubber gskt. incl.	
1	Valve Cover Gasket Set	1991	VS 50326 R-1	w/Grommets & Spark plug tube seals; PermaDry® molded rubber gskt. incl.	
1	Grommet Set	1991	ES 70362	Valve Cover	
1	Spark Plug Tube Seal Set	1991	ES 70280	Valve Cover	
QTY	VALVE STEM SEAL SET	YEARS	PART NO.	DESCRIPTION	
1	Valve Stem Seal Set	1991	SS 70283-1	Premium valve stem seals incl.	
QTY	THERMOSTAT HOUSING	YEARS	PART NO.	DESCRIPTION	
1	Thermostat Gasket	1991	35424	Thermostat Housing	
QTY	WATER OUTLET GASKET	YEARS	PART NO.	DESCRIPTION	
1	Water Outlet Gasket	1991	35498	Water Outlet	
QTY	WATER PUMP	YEARS	PART NO.	DESCRIPTION	
1	Water Pump Gasket	1991	35371		
QTY	TIMING COVER	YEARS	PART NO.	DESCRIPTION	
1	Crankshaft Front Seal Set	1991	TCS 45845	w/Dust seals; Must be used w/OS 30542R	
1	Crankshaft Front Seal Set	1991	TCS 45879	w/o Dust seals; Must be used w/OS 30542R	
1	Camshaft Front Seal Set	1991	TCS 45620	w/o Dust seals	
1	Camshaft Front Seal Set	1991	TCS 45844	w/Dust seals	
QTY	CARB & FUEL INJECTION	YEARS	PART NO.	DESCRIPTION	
1	Throttle Body Gasket	1991	60782	Gskt.	
1	Throttle Body Gasket	1991	60792	O-ring	
QTY	DISTRIBUTOR MOUNTING	YEARS	PART NO.	DESCRIPTION	
1	Distributor Mounting Gasket	1991	72454	Distributor Mounting; O-ring; 26.5mm ID	
QTY	EXHAUST GAS RECIRCULATION	YEARS	PART NO.	DESCRIPTION	
1	EGR Gasket	1991	70978		
7		1995 - 1992; 1.5L 91 (1493cc) SOHC L4 (16 Valve) 75mm Bore			7
		MFI; Gasoline; Naturally Aspirated Honda Eng.; Eng. Code D15B7			
QTY	CYLINDER HEAD	YEARS	PART NO.	DESCRIPTION	
1	Head Gasket	1995-92	26320 PT	Head bolts not incl.; Head bolt replacement recommended; PermaTorqueMLS®	
1	Head Gasket	1995-92	9123 PT		
1	Head Set	1995-92	HS 9123 PT-2	PermaDry® molded rubber valve cover gskt. incl.; Premium valve stem seals incl.	
QTY	CONVERSION SET	YEARS	PART NO.	DESCRIPTION	
1	Gasket Conversion Set	1995-92	CS 9123	PermaDry® molded rubber oil pan gskt. incl.	
QTY	MANIFOLD - INT. & EXH.	YEARS	PART NO.	DESCRIPTION	
1	Int. Manifold Gasket Set	1995-92	MS 94119-2	Improved design	
1	Exh. Manifold Gasket Set	1995-92	MS 94118-1		
QTY	EXHAUST PIPE FLANGE	YEARS	PART NO.	DESCRIPTION	
1	Exhaust Pipe Gasket	1995-92	23624	Pipe to manifold	
1	Exhaust Pipe Gasket	1995-92	60517	After converter	
1	Exhaust Pipe Gasket	1995-92	60669	To converter	
1	Exhaust Pipe Gasket	1995-92	60789	Front pipe	
QTY	OIL PAN	YEARS	PART NO.	DESCRIPTION	
1	Oil Pan Gasket Set	1995-92	OS 30542 R	PermaDry® molded rubber gskt. incl.	
QTY	CRANKSHAFT REAR SEAL	YEARS	PART NO.	DESCRIPTION	
1	Rear Main Seal Set	1995-92	BS 40430	Rubber; One-piece	
1	Repair Sleeve	1995-92	16275	Crankshaft; Use w/installation tool	
QTY	VALVE COVER	YEARS	PART NO.	DESCRIPTION	
1	Valve Cover Gasket Set	1995-92	VS 50326 R	w/o Grommets & Spark plug tube seals; PermaDry® molded rubber gskt. incl.	
1	Valve Cover Gasket Set	1995-92	VS 50326 R-1	w/Grommets & Spark plug tube seals; PermaDry® molded rubber gskt. incl.	
1	Grommet Set	1995-92	ES 70362	Valve Cover	
1	Spark Plug Tube Seal Set	1995-92	ES 70280	Valve Cover	
QTY	VALVE STEM SEAL SET	YEARS	PART NO.	DESCRIPTION	
1	Valve Stem Seal Set	1995-92	SS 70283-1	Premium valve stem seals incl.	
QTY	THERMOSTAT HOUSING	YEARS	PART NO.	DESCRIPTION	
1	Thermostat Gasket	1995-92	35009	Thermostat Housing	
1	Thermostat Gasket	1995-92	35480	Thermostat Housing; Thermostat O-ring	

Honda Car (Incl. Acura, Honda) (Cont.)

7		1995 - 1992; 1.5L 91 (1493cc) SOHC L4 (16 Valve) 75mm Bore			7	
(cont.)		MFI; Gasoline; Naturally Aspirated Honda Eng.; Eng. Code D15B7			(cont.)	
QTY	WATER OUTLET GASKET	YEARS	PART NO.	DESCRIPTION		
1	Water Outlet Gasket	1995-92	35498	Water Outlet		
QTY	WATER PUMP	YEARS	PART NO.	DESCRIPTION		
1	Water Pump Gasket	1995-92	35371			
QTY	TIMING COVER	YEARS	PART NO.	DESCRIPTION		
1	Crankshaft Front Seal Set	1995-92	TCS 45845	w/Dust seals; Must be used w/OS 30542R		
1	Crankshaft Front Seal Set	1995-92	TCS 45879	w/o Dust seals; Must be used w/OS 30542R		
1	Camshaft Front Seal Set	1995-92	TCS 45620	w/o Dust seals		
1	Camshaft Front Seal Set	1995-92	TCS 45844	w/Dust seals		
QTY	CARB & FUEL INJECTION	YEARS	PART NO.	DESCRIPTION		
1	Throttle Body Gasket	1995-92	60979			
QTY	DISTRIBUTOR MOUNTING	YEARS	PART NO.	DESCRIPTION		
1	Distributor Mounting Gasket	1995-92	72454	Distributor Mounting; O-ring; 26.5mm ID		
QTY	EXHAUST GAS RECIRCULATION	YEARS	PART NO.	DESCRIPTION		
1	EGR Gasket	1995-92	70978			
8		1995 - 1992; 1.5L 91 (1493cc) SOHC L4 (16 Valve) 75mm Bore VTEC-E			8	
		MFI; Gasoline; Naturally Aspirated Honda Eng.; Eng. Code D15Z1				
QTY	CYLINDER HEAD	YEARS	PART NO.	DESCRIPTION		
1	Head Gasket	1995-92	9915 PT	Head bolts not incl.; Head bolt replacement recommended; PermaTorqueMLS®		
QTY	CONVERSION SET	YEARS	PART NO.	DESCRIPTION		
1	Gasket Conversion Set	1995-92	CS 9915	PermaDry® molded rubber oil pan gskt. incl.		
QTY	MANIFOLD - INT. & EXH.	YEARS	PART NO.	DESCRIPTION		
1	Exh. Manifold Gasket Set	1995-92	MS 94118-1			
QTY	EXHAUST PIPE FLANGE	YEARS	PART NO.	DESCRIPTION		
1	Exhaust Pipe Gasket	1995-92	60787	Pipe to manifold		
1	Exhaust Pipe Gasket	1995-92	60789	Converter; Exc. California		
1	Exhaust Pipe Gasket	1995-92	61344	Converter; California		
QTY	OIL PAN	YEARS	PART NO.	DESCRIPTION		
1	Oil Pan Gasket Set	1995-92	OS 30542 R	PermaDry® molded rubber gskt. incl.		
QTY	CRANKSHAFT REAR SEAL	YEARS	PART NO.	DESCRIPTION		
1	Rear Main Seal Set	1995-92	BS 40430	Rubber; One-piece		
1	Repair Sleeve	1995-92	16275	Crankshaft; Use w/installation tool		
QTY	VALVE COVER	YEARS	PART NO.	DESCRIPTION		
1	Valve Cover Gasket Set	1995-92	VS 50499 R	w/Grommets & Spark plug tube seals; PermaDry® molded rubber gskt. incl.		
QTY	VALVE STEM SEAL SET	YEARS	PART NO.	DESCRIPTION		
1	Valve Stem Seal Set	1995-92	SS 70283-1	Premium valve stem seals incl.		
QTY	THERMOSTAT HOUSING	YEARS	PART NO.	DESCRIPTION		
1	Thermostat Gasket	1995-92	35480	Thermostat Housing; Thermostat O-ring		
QTY	WATER PUMP	YEARS	PART NO.	DESCRIPTION		
1	Water Pump Gasket	1995-92	35627			
QTY	TIMING COVER	YEARS	PART NO.	DESCRIPTION		
1	Crankshaft Front Seal Set	1995-92	TCS 45989	Must be used w/OS 30542R		
1	Camshaft Front Seal Set	1995-92	TCS 45620	w/o Dust seals		
QTY	CARB & FUEL INJECTION	YEARS	PART NO.	DESCRIPTION		
1	Throttle Body Gasket	1995-92	60972			
QTY	DISTRIBUTOR MOUNTING	YEARS	PART NO.	DESCRIPTION		
1	Distributor Mounting Gasket	1995-92	72454	Distributor Mounting; O-ring; 26.5mm ID		
9		1991; 1.5L 91 (1493cc) SOHC L4 (8 Valve) 75mm Bore			9	
		MFI; Gasoline; Naturally Aspirated Honda Eng.; Eng. Code D15B6				
QTY	CYLINDER HEAD	YEARS	PART NO.	DESCRIPTION		
1	Head Gasket	1991	26320 PT	Head bolts not incl.; Head bolt replacement recommended; PermaTorqueMLS®		
1	Head Gasket	1991	9123 PT			
1	Head Set	1991	HS 9123 PT-1	Exh. pipe to muffler gskt. & flexible joint ring not incl.; PermaDry® molded rubber valve cover gskt. incl.; Premium valve stem seals incl.		
QTY	CONVERSION SET	YEARS	PART NO.	DESCRIPTION		
1	Gasket Conversion Set	1991	CS 9123	PermaDry® molded rubber oil pan gskt. incl.		
QTY	MANIFOLD - INT. & EXH.	YEARS	PART NO.	DESCRIPTION		
1	Int. Manifold Gasket Set	1991	MS 94179			
1	Exh. Manifold Gasket Set	1991	MS 94118-1			

Honda Car (Incl. Acura, Honda) (Cont.)

9 (cont.)		1991; 1.5L 91 (1493cc) SOHC L4 (8 Valve) 75mm Bore			9 (cont.)
		MFI; Gasoline; Naturally Aspirated Honda Eng.; Eng. Code D15B6			
QTY	EXHAUST PIPE FLANGE	YEARS	PART NO.	DESCRIPTION	
1	Exhaust Pipe Gasket	1991	60568	Pipe to muffler	
1	Exhaust Pipe Gasket	1991	60787	Pipe to manifold	
1	Exhaust Pipe Gasket	1991	60789	Converter to manifold	
QTY	OIL PAN	YEARS	PART NO.	DESCRIPTION	
1	Oil Pan Gasket Set	1991	OS 30542 R	PermaDry® molded rubber gskt. incl.	
QTY	CRANKSHAFT REAR SEAL	YEARS	PART NO.	DESCRIPTION	
1	Rear Main Seal Set	1991	BS 40430	Rubber; One-piece	
1	Repair Sleeve	1991	16275	Crankshaft; Use w/installation tool	
QTY	VALVE COVER	YEARS	PART NO.	DESCRIPTION	
1	Valve Cover Gasket Set	1991	VS 50326 R	w/o Grommets & Spark plug tube seals; PermaDry® molded rubber gskt. incl.	
1	Valve Cover Gasket Set	1991	VS 50326 R-1	w/Grommets & Spark plug tube seals; PermaDry® molded rubber gskt. incl.	
1	Grommet Set	1991	ES 70362	Valve Cover	
1	Spark Plug Tube Seal Set	1991	ES 70280	Valve Cover	
QTY	VALVE STEM SEAL SET	YEARS	PART NO.	DESCRIPTION	
1	Valve Stem Seal Set	1991	SS 70283	Premium valve stem seals incl.	
QTY	THERMOSTAT HOUSING	YEARS	PART NO.	DESCRIPTION	
1	Thermostat Gasket	1991	35424	Thermostat Housing	
QTY	WATER OUTLET GASKET	YEARS	PART NO.	DESCRIPTION	
1	Water Outlet Gasket	1991	35498	Water Outlet	
QTY	WATER PUMP	YEARS	PART NO.	DESCRIPTION	
1	Water Pump Gasket	1991	35371		
QTY	TIMING COVER	YEARS	PART NO.	DESCRIPTION	
1	Crankshaft Front Seal Set	1991	TCS 45845	w/Dust seals; Must be used w/OS 30542R	
1	Crankshaft Front Seal Set	1991	TCS 45879	w/o Dust seals; Must be used w/OS 30542R	
1	Camshaft Front Seal Set	1991	TCS 45620	w/o Dust seals	
1	Camshaft Front Seal Set	1991	TCS 45844	w/Dust seals	
QTY	CARB & FUEL INJECTION	YEARS	PART NO.	DESCRIPTION	
1	Throttle Body Gasket	1991	60788		
QTY	DISTRIBUTOR MOUNTING	YEARS	PART NO.	DESCRIPTION	
1	Distributor Mounting Gasket	1991	72454	Distributor Mounting; O-ring; 26.5mm ID	
QTY	EXHAUST GAS RECIRCULATION	YEARS	PART NO.	DESCRIPTION	
1	EGR Gasket	1991	70978		
10		1995 - 1992; 1.5L 91 (1493cc) SOHC L4 (8 Valve) 75mm Bore			10
		MFI; Gasoline; Naturally Aspirated Honda Eng.; Eng. Code D15B8			
QTY	CYLINDER HEAD	YEARS	PART NO.	DESCRIPTION	
1	Head Gasket	1995-92	26320 PT	Head bolts not incl.; Head bolt replacement recommended; PermaTorqueMLS®	
1	Head Gasket	1995-92	9123 PT		
1	Head Set	1995-92	HS 9123 PT-3	PermaDry® molded rubber valve cover gskt. incl.; Premium valve stem seals incl.	
QTY	CONVERSION SET	YEARS	PART NO.	DESCRIPTION	
1	Gasket Conversion Set	1995-92	CS 9123	PermaDry® molded rubber oil pan gskt. incl.	
QTY	MANIFOLD - INT. & EXH.	YEARS	PART NO.	DESCRIPTION	
1	Int. Manifold Gasket Set	1995-92	MS 94179		
1	Exh. Manifold Gasket Set	1995-92	MS 94118-1		
QTY	EXHAUST PIPE FLANGE	YEARS	PART NO.	DESCRIPTION	
1	Exhaust Pipe Gasket	1995-92	60566	Converter	
1	Exhaust Pipe Gasket	1995-92	60787	Pipe to manifold	
QTY	OIL PAN	YEARS	PART NO.	DESCRIPTION	
1	Oil Pan Gasket Set	1995-92	OS 30542 R	PermaDry® molded rubber gskt. incl.	
QTY	CRANKSHAFT REAR SEAL	YEARS	PART NO.	DESCRIPTION	
1	Rear Main Seal Set	1995-92	BS 40430	Rubber; One-piece	
1	Repair Sleeve	1995-92	16275	Crankshaft; Use w/installation tool	
QTY	VALVE COVER	YEARS	PART NO.	DESCRIPTION	
1	Valve Cover Gasket Set	1995-92	VS 50326 R	w/o Grommets & Spark plug tube seals; PermaDry® molded rubber gskt. incl.	
1	Valve Cover Gasket Set	1995-92	VS 50326 R-1	w/Grommets & Spark plug tube seals; PermaDry® molded rubber gskt. incl.	
1	Grommet Set	1995-92	ES 70362	Valve Cover	
1	Spark Plug Tube Seal Set	1995-92	ES 70280	Valve Cover	
QTY	VALVE STEM SEAL SET	YEARS	PART NO.	DESCRIPTION	
1	Valve Stem Seal Set	1995-92	SS 70283	Premium valve stem seals incl.	

Honda Car (Incl. Acura, Honda) (Cont.)

10		1995 - 1992; 1.5L 91 (1493cc) SOHC L4 (8 Valve) 75mm Bore			10	
(cont.)		MFI; Gasoline; Naturally Aspirated Honda Eng.; Eng. Code D15B8			(cont.)	
QTY	THERMOSTAT HOUSING	YEARS	PART NO.	DESCRIPTION		
1	Thermostat Gasket	1995-92	35009	Thermostat Housing		
1	Thermostat Gasket	1995-92	35480	Thermostat Housing; Thermostat O-ring		
QTY	WATER OUTLET GASKET	YEARS	PART NO.	DESCRIPTION		
1	Water Outlet Gasket	1995-92	35498	Water Outlet		
QTY	WATER PUMP	YEARS	PART NO.	DESCRIPTION		
1	Water Pump Gasket	1995-92	35371			
QTY	TIMING COVER	YEARS	PART NO.	DESCRIPTION		
1	Crankshaft Front Seal Set	1995-92	TCS 45845	w/Dust seals; Must be used w/OS 30542R		
1	Crankshaft Front Seal Set	1995-92	TCS 45879	w/o Dust seals; Must be used w/OS 30542R		
1	Camshaft Front Seal Set	1995-92	TCS 45620	w/o Dust seals		
1	Camshaft Front Seal Set	1995-92	TCS 45844	w/Dust seals		
QTY	CARB & FUEL INJECTION	YEARS	PART NO.	DESCRIPTION		
1	Throttle Body Gasket	1995-92	60972			
QTY	DISTRIBUTOR MOUNTING	YEARS	PART NO.	DESCRIPTION		
1	Distributor Mounting Gasket	1995-92	72454	Distributor Mounting; O-ring; 26.5mm ID		
QTY	EXHAUST GAS RECIRCULATION	YEARS	PART NO.	DESCRIPTION		
1	EGR Gasket	1995-92	70978			
11		2008 - 2007; 1.5L 91.3 (1496cc) SOHC L4 (16 Valve) 73mm Bore VTEC			11	
		MFI; Gasoline; Naturally Aspirated Honda Eng.; Eng. Code L15A1				
QTY	CYLINDER HEAD	YEARS	PART NO.	DESCRIPTION		
1	Head Gasket	2008-07	26530 PT	Head bolts not incl.; Head bolt replacement recommended; PermaTorqueMLS®; New Part Number - Check for Availability		
1	Head Set	2008-07	HS 26530 PT	Head bolts not incl.; Head bolt replacement recommended; PermaDry® molded rubber valve cover gskt. incl.; Premium valve stem seals incl.; New Part Number - Check for Availability		
1	Head Bolt Set	2008-07	ES 72449	Head bolts w/Washers; Replacement recommended; New Part Number - Check for Availability		
QTY	CONVERSION SET	YEARS	PART NO.	DESCRIPTION		
1	Gasket Conversion Set	2008-07	CS 26529-1	RTV sealant incl. for oil pan gskt.; New Part Number - Check for Availability		
QTY	MANIFOLD - INT. & EXH.	YEARS	PART NO.	DESCRIPTION		
1	Int. Manifold Gasket Set	2008-07	MS 97173	Lower set; Upper set incl.; New Part Number - Check for Availability		
1	Plenum Gasket Set	2008-07	MS 97182	Upper set; New Part Number - Check for Availability		
1	Exh. Manifold Gasket Set	2008-07	MS 97170			
QTY	EXHAUST PIPE FLANGE	YEARS	PART NO.	DESCRIPTION		
1	Exhaust Pipe Gasket	2008-07	60477	Pipe to manifold		
QTY	OIL PAN	YEARS	PART NO.	DESCRIPTION		
1	Oil Pan Gasket Set	2008-07	OS 30837 R	RTV sealant incl. for oil pan gskt.; New Part Number - Check for Availability		
QTY	CRANKSHAFT REAR SEAL	YEARS	PART NO.	DESCRIPTION		
1	Rear Main Seal Set	2008-07	BS 40535	Rubber; One-piece; Improved design		
QTY	VALVE COVER	YEARS	PART NO.	DESCRIPTION		
1	Valve Cover Gasket Set	2008-07	VS 50782 R	w/Grommets; PermaDry® molded rubber gskt. incl.; New Part Number - Check for Availability		
QTY	VALVE STEM SEAL SET	YEARS	PART NO.	DESCRIPTION		
1	Valve Stem Seal Set	2008-07	SS 70283-1	Premium valve stem seals incl.		
QTY	THERMOSTAT HOUSING	YEARS	PART NO.	DESCRIPTION		
1	Thermostat Gasket	2008-07	35734	Thermostat Housing; Thermostat seal		
QTY	WATER PUMP	YEARS	PART NO.	DESCRIPTION		
1	Water Pump Gasket	2008-07	35962	New Part Number - Check for Availability		
QTY	CARB & FUEL INJECTION	YEARS	PART NO.	DESCRIPTION		
2	Fuel Injector O-Ring Set	2008-07	ES 70599	Improved design		
1	Throttle Body Gasket	2008-07	61542			
QTY	EXHAUST GAS RECIRCULATION	YEARS	PART NO.	DESCRIPTION		
1	EGR Gasket	2008-07	70978	EGR valve		
1	EGR Gasket	2008-07	71369	EGR passage; New Part Number - Check for Availability		
12		2013 - 2009; 1.5L 91.3 (1496cc) SOHC L4 (16 Valve) 73mm Bore i-VTEC			12	
		MFI; Gasoline; Naturally Aspirated Honda Eng.; Eng. Code L15A7				
QTY	CYLINDER HEAD	YEARS	PART NO.	DESCRIPTION		
1	Head Gasket	2012-09	26529 PT	Head bolts not incl.; Head bolt replacement recommended; PermaTorqueMLS®; New Part Number - Check for Availability		

Honda Car (Incl. Acura, Honda) (Cont.)

12 (cont.)		2013 - 2009; 1.5L 91.3 (1496cc) SOHC L4 (16 Valve) 73mm Bore i-VTEC MFI; Gasoline; Naturally Aspirated Honda Eng.; Eng. Code L15A7			12 (cont.)
QTY	CYLINDER HEAD	YEARS	PART NO.	DESCRIPTION	
1	Head Set	2012-09	HS 26529 PT-2	Head bolts not incl.; Head bolt replacement recommended; PermaDry® molded rubber valve cover gskt. incl.; Premium valve stem seals incl.; New Part Number - Check for Availability	
1	Head Bolt Set	2012-09	ES 72449	Head bolts w/Washers; Replacement recommended; New Part Number - Check for Availability	
QTY	CONVERSION SET	YEARS	PART NO.	DESCRIPTION	
1	Gasket Conversion Set	2013-09	CS 26529	RTV sealant incl. for oil pan gskt.; New Part Number - Check for Availability	
QTY	MANIFOLD - INT. & EXH.	YEARS	PART NO.	DESCRIPTION	
1	Int. Manifold Gasket Set	2012-09	MS 97174	Lower set; Upper set incl.; New Part Number - Check for Availability	
1	Plenum Gasket Set	2012-09	MS 97178	Upper set; New Part Number - Check for Availability	
1	Exh. Manifold Gasket Set	2012-09	MS 97172		
QTY	EXHAUST PIPE FLANGE	YEARS	PART NO.	DESCRIPTION	
1	Exhaust Pipe Gasket	2012-09	60478	Pipe to manifold	
QTY	OIL PAN	YEARS	PART NO.	DESCRIPTION	
1	Oil Pan Gasket Set	2013-09	OS 30837 R	RTV sealant incl. for oil pan gskt.; New Part Number - Check for Availability	
QTY	CRANKSHAFT REAR SEAL	YEARS	PART NO.	DESCRIPTION	
1	Rear Main Seal Set	2013-09	BS 40535	Rubber; One-piece; Improved design	
QTY	VALVE COVER	YEARS	PART NO.	DESCRIPTION	
1	Valve Cover Gasket Set	2012-09	VS 50785 R	PermaDry® molded rubber gskt. incl.; New Part Number - Check for Availability	
1	Circular Plug	2012-09	ES 72476	Valve Cover; New Part Number - Check for Availability	
QTY	VALVE STEM SEAL SET	YEARS	PART NO.	DESCRIPTION	
1	Valve Stem Seal Set	2012-09	SS 70283-1	Premium valve stem seals incl.	
QTY	THERMOSTAT HOUSING	YEARS	PART NO.	DESCRIPTION	
1	Thermostat Gasket	2012-09	35480	Thermostat Housing; Thermostat O-ring	
QTY	WATER PUMP	YEARS	PART NO.	DESCRIPTION	
1	Water Pump Gasket	2013-09	35961	New Part Number - Check for Availability	
QTY	CARB & FUEL INJECTION	YEARS	PART NO.	DESCRIPTION	
2	Fuel Injector O-Ring Set	2012-09	ES 70599	Improved design	
1	Throttle Body Gasket	2012-09	61664	New Part Number - Check for Availability	
QTY	EXHAUST GAS RECIRCULATION	YEARS	PART NO.	DESCRIPTION	
1	EGR Gasket	2012-09	70978	Valve	
1	EGR Gasket	2012-09	72370	Loc. Upper; Pipe	
1	EGR Gasket	2012-09	72371	Loc. Lower; Pipe	
13		2013 - 2011; 1.5L 91.3 (1496cc) SOHC L4 (16 Valve) 73mm Bore i-VTEC MFI; Hybrid (Gas/Electric); Naturally Aspirated Honda Eng.; Eng. Code LEA1			13
QTY	CYLINDER HEAD	YEARS	PART NO.	DESCRIPTION	
1	Head Gasket	2012-11	26529 PT	Head bolts not incl.; Head bolt replacement recommended; PermaTorqueMLS®; New Part Number - Check for Availability	
1	Head Set	2012-11	HS 26529 PT-2	Head bolts not incl.; Head bolt replacement recommended; PermaDry® molded rubber valve cover gskt. incl.; Premium valve stem seals incl.; New Part Number - Check for Availability	
1	Head Bolt Set	2012-11	ES 72449	Head bolts w/Washers; Replacement recommended; New Part Number - Check for Availability	
QTY	CONVERSION SET	YEARS	PART NO.	DESCRIPTION	
1	Gasket Conversion Set	2013-11	CS 26529	RTV sealant incl. for oil pan gskt.; New Part Number - Check for Availability	
QTY	MANIFOLD - INT. & EXH.	YEARS	PART NO.	DESCRIPTION	
1	Int. Manifold Gasket Set	2012-11	MS 97174	Lower set; Upper set incl.; New Part Number - Check for Availability	
1	Plenum Gasket Set	2012-11	MS 97178	Upper set; New Part Number - Check for Availability	
1	Exh. Manifold Gasket Set	2012-11	MS 97172		
QTY	EXHAUST PIPE FLANGE	YEARS	PART NO.	DESCRIPTION	
1	Exhaust Pipe Gasket	2012-11	60478	Pipe to manifold	
QTY	OIL PAN	YEARS	PART NO.	DESCRIPTION	
1	Oil Pan Gasket Set	2013-11	OS 30837 R	RTV sealant incl. for oil pan gskt.; New Part Number - Check for Availability	
QTY	CRANKSHAFT REAR SEAL	YEARS	PART NO.	DESCRIPTION	
1	Rear Main Seal Set	2013-11	BS 40535	Rubber; One-piece; Improved design	
QTY	VALVE COVER	YEARS	PART NO.	DESCRIPTION	
1	Valve Cover Gasket Set	2012-11	VS 50785 R	PermaDry® molded rubber gskt. incl.; New Part Number - Check for Availability	
1	Circular Plug	2012-11	ES 72476	Valve Cover; New Part Number - Check for Availability	
QTY	VALVE STEM SEAL SET	YEARS	PART NO.	DESCRIPTION	
1	Valve Stem Seal Set	2012-11	SS 70283-1	Premium valve stem seals incl.	

Honda Car (Incl. Acura, Honda) (Cont.)

13		2013 - 2011; 1.5L 91.3 (1496cc) SOHC L4 (16 Valve) 73mm Bore i-VTEC			13	
(cont.)		MFI; Hybrid (Gas/Electric); Naturally Aspirated Honda Eng.; Eng. Code LEA1			(cont.)	
QTY	THERMOSTAT HOUSING	YEARS	PART NO.	DESCRIPTION		
1	Thermostat Gasket	2012-11	35480	Thermostat Housing; Thermostat O-ring		
QTY	WATER PUMP	YEARS	PART NO.	DESCRIPTION		
1	Water Pump Gasket	2013-11	35961	New Part Number - Check for Availability		
QTY	CARB & FUEL INJECTION	YEARS	PART NO.	DESCRIPTION		
2	Fuel Injector O-Ring Set	2012-11	ES 70599	Improved design		
1	Throttle Body Gasket	2012-11	61664	New Part Number - Check for Availability		
QTY	EXHAUST GAS RECIRCULATION	YEARS	PART NO.	DESCRIPTION		
1	EGR Gasket	2012-11	70978	Valve		
1	EGR Gasket	2012-11	72370	Loc. Upper; Pipe		
1	EGR Gasket	2012-11	72371	Loc. Lower; Pipe		
14		2013 - 2012; 1.5L 91.3 (1496cc) SOHC L4 (8 Valve) 73mm Bore i-VTEC			14	
		MFI; Hybrid (Gas/Electric); Naturally Aspirated Honda Eng.; Eng. Code LEA2				
QTY	CYLINDER HEAD	YEARS	PART NO.	DESCRIPTION		
1	Head Gasket	2012	26529 PT	Head bolts not incl.; Head bolt replacement recommended; PermaTorqueMLS®; New Part Number - Check for Availability		
1	Head Set	2012	HS 26529 PT-1	Head bolts not incl.; Head bolt replacement recommended; PermaDry® molded rubber valve cover gskt. incl.; Premium valve stem seals incl.; New Part Number - Check for Availability		
1	Head Bolt Set	2012	ES 72449-1	Head bolts w/Washers; Replacement recommended; New Part Number - Check for Availability		
QTY	CONVERSION SET	YEARS	PART NO.	DESCRIPTION		
1	Gasket Conversion Set	2013-12	CS 26529-1	RTV sealant incl. for oil pan gskt.; New Part Number - Check for Availability		
QTY	MANIFOLD - INT. & EXH.	YEARS	PART NO.	DESCRIPTION		
1	Int. Manifold Gasket Set	2012	MS 97180	Lower set; Upper set incl.; New Part Number - Check for Availability		
1	Plenum Gasket Set	2012	MS 97184	Upper set; New Part Number - Check for Availability		
1	Exh. Manifold Gasket Set	2012	MS 97172			
QTY	EXHAUST PIPE FLANGE	YEARS	PART NO.	DESCRIPTION		
1	Exhaust Pipe Gasket	2012	60478	Pipe to manifold		
QTY	OIL PAN	YEARS	PART NO.	DESCRIPTION		
1	Oil Pan Gasket Set	2013-12	OS 30837 R	RTV sealant incl. for oil pan gskt.; New Part Number - Check for Availability		
QTY	CRANKSHAFT REAR SEAL	YEARS	PART NO.	DESCRIPTION		
1	Rear Main Seal Set	2013-12	BS 40535	Rubber; One-piece; Improved design		
QTY	VALVE COVER	YEARS	PART NO.	DESCRIPTION		
1	Valve Cover Gasket Set	2012	VS 50783 R	w/Grommets & Spark plug tube seals; PermaDry® molded rubber gskt. incl.; New Part Number - Check for Availability		
2	Circular Plug	2012	ES 72476	Valve Cover; New Part Number - Check for Availability		
QTY	VALVE STEM SEAL SET	YEARS	PART NO.	DESCRIPTION		
1	Valve Stem Seal Set	2012	SS 70283	Premium valve stem seals incl.		
QTY	THERMOSTAT HOUSING	YEARS	PART NO.	DESCRIPTION		
1	Thermostat Gasket	2012	35480	Thermostat Housing; Thermostat O-ring		
QTY	WATER PUMP	YEARS	PART NO.	DESCRIPTION		
1	Water Pump Gasket	2013-12	35967	New Part Number - Check for Availability		
QTY	CARB & FUEL INJECTION	YEARS	PART NO.	DESCRIPTION		
2	Fuel Injector O-Ring Set	2012	ES 70599	Improved design		
1	Throttle Body Gasket	2012	61682	New Part Number - Check for Availability		
QTY	EXHAUST GAS RECIRCULATION	YEARS	PART NO.	DESCRIPTION		
1	EGR Gasket	2012	70978	Valve		
1	EGR Gasket	2012	72370	Loc. Upper; Pipe		
1	EGR Gasket	2012	72371	Loc. Lower; Pipe		
15		1991; 1.6L 97 (1590cc) SOHC L4 (16 Valve) 75mm Bore			15	
		MFI; Gasoline; Naturally Aspirated Honda Eng.; Eng. Code D16A6				
QTY	CYLINDER HEAD	YEARS	PART NO.	DESCRIPTION		
1	Head Gasket	1991	26320 PT	Head bolts not incl.; Head bolt replacement recommended; PermaTorqueMLS®		
1	Head Gasket	1991	9123 PT			
1	Head Set	1991	HS 9123 PT	Exh. pipe to muffler gskt. & flexible joint ring not incl.; PermaDry® molded rubber valve cover gskt. incl.; Premium valve stem seals incl.		
1	Head Installation Set	1991	HIS 9123 PT	Exh. pipe to manifold gskt., exh. pipe to muffler gskt., flexible joint ring not incl.; PermaDry® molded rubber valve cover gskt. incl.		
QTY	CONVERSION SET	YEARS	PART NO.	DESCRIPTION		
1	Gasket Conversion Set	1991	CS 9123	PermaDry® molded rubber oil pan gskt. incl.		

15 (cont.)		1991; 1.6L 97 (1590cc) SOHC L4 (16 Valve) 75mm Bore			15 (cont.)	
MFI; Gasoline; Naturally Aspirated Honda Eng.; Eng. Code D16A6						
QTY	MANIFOLD - INT. & EXH.	YEARS	PART NO.	DESCRIPTION		
1	Int. Manifold Gasket Set	1991	MS 94119-2	Improved design		
1	Exh. Manifold Gasket Set	1991	MS 94118-1			
QTY	EXHAUST PIPE FLANGE	YEARS	PART NO.	DESCRIPTION		
1	Exhaust Pipe Gasket	1991	23624	Pipe to manifold		
1	Exhaust Pipe Gasket	1991	60517	Converter Pre-Chamber		
1	Exhaust Pipe Gasket	1991	60566	Pipe to muffler		
QTY	OIL PAN	YEARS	PART NO.	DESCRIPTION		
1	Oil Pan Gasket Set	1991	OS 30542 R	PermaDry® molded rubber gskt. incl.		
QTY	CRANKSHAFT REAR SEAL	YEARS	PART NO.	DESCRIPTION		
1	Rear Main Seal Set	1991	BS 40430	Rubber; One-piece		
1	Repair Sleeve	1991	16275	Crankshaft; Use w/installation tool		
QTY	VALVE COVER	YEARS	PART NO.	DESCRIPTION		
1	Valve Cover Gasket Set	1991	VS 50326 R	w/o Grommets & Spark plug tube seals; PermaDry® molded rubber gskt. incl.		
1	Valve Cover Gasket Set	1991	VS 50326 R-1	w/Grommets & Spark plug tube seals; PermaDry® molded rubber gskt. incl.		
1	Grommet Set	1991	ES 70362	Valve Cover		
1	Spark Plug Tube Seal Set	1991	ES 70280	Valve Cover		
QTY	VALVE STEM SEAL SET	YEARS	PART NO.	DESCRIPTION		
1	Valve Stem Seal Set	1991	SS 70283-1	Premium valve stem seals incl.		
QTY	THERMOSTAT HOUSING	YEARS	PART NO.	DESCRIPTION		
1	Thermostat Gasket	1991	35424	Thermostat Housing		
QTY	WATER OUTLET GASKET	YEARS	PART NO.	DESCRIPTION		
1	Water Outlet Gasket	1991	35498	Water Outlet		
QTY	WATER PUMP	YEARS	PART NO.	DESCRIPTION		
1	Water Pump Gasket	1991	35371			
QTY	TIMING COVER	YEARS	PART NO.	DESCRIPTION		
1	Crankshaft Front Seal Set	1991	TCS 45845	w/Dust seals; Must be used w/OS 30542R		
1	Crankshaft Front Seal Set	1991	TCS 45879	w/o Dust seals; Must be used w/OS 30542R		
1	Camshaft Front Seal Set	1991	TCS 45620	w/o Dust seals		
1	Camshaft Front Seal Set	1991	TCS 45844	w/Dust seals		
QTY	CARB & FUEL INJECTION	YEARS	PART NO.	DESCRIPTION		
1	Throttle Body Gasket	1991	60737			
QTY	DISTRIBUTOR MOUNTING	YEARS	PART NO.	DESCRIPTION		
1	Distributor Mounting Gasket	1991	72454	Distributor Mounting; O-ring; 26.5mm ID		
QTY	EXHAUST GAS RECIRCULATION	YEARS	PART NO.	DESCRIPTION		
1	EGR Gasket	1991	70978			
16		2000 - 1998; 1.6L 97 (1590cc) SOHC L4 (16 Valve) 75mm Bore			16	
MFI; Natural Gas; Naturally Aspirated Honda Eng.; Eng. Code D16B5						
QTY	CARB & FUEL INJECTION	YEARS	PART NO.	DESCRIPTION		
1	Throttle Body Gasket	2000-98	61065	w/A/T		
1	Throttle Body Gasket	2000-98	61066	w/M/T		
QTY	DISTRIBUTOR MOUNTING	YEARS	PART NO.	DESCRIPTION		
1	Distributor Mounting Gasket	2000-98	72454	Distributor Mounting; O-ring; 26.5mm ID		
17		2000 - 1996; 1.6L 97 (1590cc) SOHC L4 (16 Valve) 75mm Bore			17	
MFI; Gasoline; Naturally Aspirated Honda Eng.; Eng. Code D16Y7						
QTY	CYLINDER HEAD	YEARS	PART NO.	DESCRIPTION		
1	Head Gasket	2000-96	9915 PT	Head bolts not incl.; Head bolt replacement recommended; PermaTorqueMLS®		
1	Head Set	2000-96	HS 9915 PT-1	Head bolts not incl.; Head bolt replacement recommended; PermaDry® molded rubber valve cover gskt. incl.; Premium valve stem seals incl.		
QTY	CONVERSION SET	YEARS	PART NO.	DESCRIPTION		
1	Gasket Conversion Set	2000-96	CS 9915-1	PermaDry® molded rubber oil pan gskt. incl.		
QTY	MANIFOLD - INT. & EXH.	YEARS	PART NO.	DESCRIPTION		
1	Int. Manifold Gasket Set	2000-96	MS 91485			
1	Exh. Manifold Gasket Set	2000-96	MS 94118-1			
QTY	EXHAUST PIPE FLANGE	YEARS	PART NO.	DESCRIPTION		
2	Exhaust Pipe Gasket	2000-96	60787	Pipe to manifold		
QTY	OIL PAN	YEARS	PART NO.	DESCRIPTION		
1	Oil Pan Gasket Set	2000-96	OS 30690 R	PermaDry® molded rubber gskt. incl.		
QTY	CRANKSHAFT REAR SEAL	YEARS	PART NO.	DESCRIPTION		
1	Rear Main Seal Set	2000-96	BS 40430	Rubber; One-piece		

Honda Car (Incl. Acura, Honda) (Cont.)

17		2000 - 1996; 1.6L 97 (1590cc) SOHC L4 (16 Valve) 75mm Bore			17
(cont.)		MFI; Gasoline; Naturally Aspirated Honda Eng.; Eng. Code D16Y7			(cont.)
QTY	CRANKSHAFT REAR SEAL	YEARS	PART NO.	DESCRIPTION	
1	Repair Sleeve	2000-96	16275	Crankshaft; Use w/installation tool	
QTY	VALVE COVER	YEARS	PART NO.	DESCRIPTION	
1	Valve Cover Gasket Set	2000-96	VS 50500 R	w/Grommets & Spark plug tube seals; PermaDry® molded rubber gskt. incl.	
QTY	VALVE STEM SEAL SET	YEARS	PART NO.	DESCRIPTION	
1	Valve Stem Seal Set	2000-96	SS 70283-1	Premium valve stem seals incl.	
QTY	THERMOSTAT HOUSING	YEARS	PART NO.	DESCRIPTION	
1	Thermostat Gasket	2000-96	35480	Thermostat Housing; Thermostat O-ring	
QTY	WATER PUMP	YEARS	PART NO.	DESCRIPTION	
1	Water Pump Gasket	2000-96	35627		
QTY	TIMING COVER	YEARS	PART NO.	DESCRIPTION	
1	Crankshaft Front Seal Set	2000-96	TCS 45989	Must be used w/OS 30690R	
1	Camshaft Front Seal Set	2000-96	TCS 45620	w/o Dust seals	
QTY	CARB & FUEL INJECTION	YEARS	PART NO.	DESCRIPTION	
1	Throttle Body Gasket	2000-96	61065	w/A/T	
1	Throttle Body Gasket	2000-96	61066	w/M/T	
QTY	DISTRIBUTOR MOUNTING	YEARS	PART NO.	DESCRIPTION	
1	Distributor Mounting Gasket	2000-96	72454	Distributor Mounting; O-ring; 26.5mm ID	
18		2000 - 1996; 1.6L 97 (1590cc) SOHC L4 (16 Valve) 75mm Bore VTEC			18
		MFI; Gasoline; Naturally Aspirated Honda Eng.; Eng. Code D16Y5			
QTY	CYLINDER HEAD	YEARS	PART NO.	DESCRIPTION	
1	Head Gasket	2000-96	9915 PT	Head bolts not incl.; Head bolt replacement recommended; PermaTorqueMLS®	
1	Head Set	2000-96	HS 9915 PT-1	Head bolts not incl.; Head bolt replacement recommended; PermaDry® molded rubber valve cover gskt. incl.; Premium valve stem seals incl.	
QTY	CONVERSION SET	YEARS	PART NO.	DESCRIPTION	
1	Gasket Conversion Set	2000-96	CS 9915-2	PermaDry® molded rubber oil pan gskt. incl.	
QTY	MANIFOLD - INT. & EXH.	YEARS	PART NO.	DESCRIPTION	
1	Int. Manifold Gasket Set	2000-96	MS 91485		
1	Exh. Manifold Gasket Set	2000-96	MS 94118-1		
QTY	EXHAUST PIPE FLANGE	YEARS	PART NO.	DESCRIPTION	
2	Exhaust Pipe Gasket	2000-96	60787	Pipe to manifold	
QTY	OIL PAN	YEARS	PART NO.	DESCRIPTION	
1	Oil Pan Gasket Set	2000-96	OS 30691 R	PermaDry® molded rubber gskt. incl.	
QTY	CRANKSHAFT REAR SEAL	YEARS	PART NO.	DESCRIPTION	
1	Rear Main Seal Set	2000-96	BS 40430	Rubber; One-piece	
1	Repair Sleeve	2000-96	16275	Crankshaft; Use w/installation tool	
QTY	VALVE COVER	YEARS	PART NO.	DESCRIPTION	
1	Valve Cover Gasket Set	2000-96	VS 50500 R	w/Grommets & Spark plug tube seals; PermaDry® molded rubber gskt. incl.	
QTY	VALVE STEM SEAL SET	YEARS	PART NO.	DESCRIPTION	
1	Valve Stem Seal Set	2000-96	SS 70283-1	Premium valve stem seals incl.	
QTY	THERMOSTAT HOUSING	YEARS	PART NO.	DESCRIPTION	
1	Thermostat Gasket	2000-96	35480	Thermostat Housing; Thermostat O-ring	
QTY	WATER PUMP	YEARS	PART NO.	DESCRIPTION	
1	Water Pump Gasket	2000-96	35627		
QTY	TIMING COVER	YEARS	PART NO.	DESCRIPTION	
1	Crankshaft Front Seal Set	2000-96	TCS 45989	Must be used w/OS 30691R	
1	Camshaft Front Seal Set	2000-96	TCS 45620	w/o Dust seals	
QTY	CARB & FUEL INJECTION	YEARS	PART NO.	DESCRIPTION	
1	Throttle Body Gasket	2000-96	61065	w/CVT	
1	Throttle Body Gasket	2000-96	61066	w/M/T	
QTY	DISTRIBUTOR MOUNTING	YEARS	PART NO.	DESCRIPTION	
1	Distributor Mounting Gasket	2000-96	72454	Distributor Mounting; O-ring; 26.5mm ID	
19		2000 - 1996; 1.6L 97 (1590cc) SOHC L4 (16 Valve) 75mm Bore VTEC			19
		MFI; Gasoline; Naturally Aspirated Honda Eng.; Eng. Code D16Y8			
QTY	CYLINDER HEAD	YEARS	PART NO.	DESCRIPTION	
1	Head Gasket	2000-96	9915 PT	Head bolts not incl.; Head bolt replacement recommended; PermaTorqueMLS®	
1	Head Set	2000-99	HS 9915 PT-2	Head bolts not incl.; Head bolt replacement recommended; PermaDry® molded rubber valve cover gskt. incl.; Premium valve stem seals incl.	

Honda Car (Incl. Acura, Honda) (Cont.)

19 (cont.)		2000 - 1996; 1.6L 97 (1590cc) SOHC L4 (16 Valve) 75mm Bore VTEC			19 (cont.)
		MFI; Gasoline; Naturally Aspirated Honda Eng.; Eng. Code D16Y8			
QTY	CYLINDER HEAD	YEARS	PART NO.	DESCRIPTION	
1	Head Set	1998-96	HS 9915 PT-1	Head bolts not incl.; Head bolt replacement recommended; PermaDry® molded rubber valve cover gskt. incl.; Premium valve stem seals incl.	
QTY	CONVERSION SET	YEARS	PART NO.	DESCRIPTION	
1	Gasket Conversion Set	2000-98	CS 9915-2	PermaDry® molded rubber oil pan gskt. incl.	
1	Gasket Conversion Set	1997	CS 9915-1	Honda Civic Del Sol Si; PermaDry® molded rubber oil pan gskt. incl.	
1	Gasket Conversion Set	1997	CS 9915-2	Exc. Honda Civic Del Sol Si; PermaDry® molded rubber oil pan gskt. incl.	
1	Gasket Conversion Set	1996	CS 9915-1	Exc. Honda Civic EX; PermaDry® molded rubber oil pan gskt. incl.	
1	Gasket Conversion Set	1996	CS 9915-2	Honda Civic EX; PermaDry® molded rubber oil pan gskt. incl.	
QTY	MANIFOLD - INT. & EXH.	YEARS	PART NO.	DESCRIPTION	
1	Int. Manifold Gasket Set	2000-99	MS 91553		
1	Int. Manifold Gasket Set	1998-96	MS 91485		
1	Exh. Manifold Gasket Set	2000-96	MS 94118-1		
QTY	EXHAUST PIPE FLANGE	YEARS	PART NO.	DESCRIPTION	
2	Exhaust Pipe Gasket	2000-96	60776	Pipe to manifold	
QTY	OIL PAN	YEARS	PART NO.	DESCRIPTION	
1	Oil Pan Gasket Set	2000-98	OS 30691 R	PermaDry® molded rubber gskt. incl.	
1	Oil Pan Gasket Set	1997	OS 30690 R	Honda Civic Del Sol Si; PermaDry® molded rubber gskt. incl.	
1	Oil Pan Gasket Set	1997	OS 30691 R	Exc. Honda Civic Del Sol Si; PermaDry® molded rubber gskt. incl.	
1	Oil Pan Gasket Set	1996	OS 30690 R	Exc. Honda Civic EX; PermaDry® molded rubber gskt. incl.	
1	Oil Pan Gasket Set	1996	OS 30691 R	Honda Civic EX; PermaDry® molded rubber gskt. incl.	
QTY	CRANKSHAFT REAR SEAL	YEARS	PART NO.	DESCRIPTION	
1	Rear Main Seal Set	2000-96	BS 40430	Rubber; One-piece	
1	Repair Sleeve	2000-96	16275	Crankshaft; Use w/installation tool	
QTY	VALVE COVER	YEARS	PART NO.	DESCRIPTION	
1	Valve Cover Gasket Set	2000-96	VS 50500 R	w/Grommets & Spark plug tube seals; PermaDry® molded rubber gskt. incl.	
QTY	VALVE STEM SEAL SET	YEARS	PART NO.	DESCRIPTION	
1	Valve Stem Seal Set	2000-96	SS 70283-1	Premium valve stem seals incl.	
QTY	THERMOSTAT HOUSING	YEARS	PART NO.	DESCRIPTION	
1	Thermostat Gasket	2000-96	35480	Thermostat Housing; Thermostat O-ring	
QTY	WATER PUMP	YEARS	PART NO.	DESCRIPTION	
1	Water Pump Gasket	2000-96	35627		
QTY	TIMING COVER	YEARS	PART NO.	DESCRIPTION	
1	Crankshaft Front Seal Set	2000-96	TCS 45989	Must be used w/OS 30690R or w/OS 30691R	
1	Camshaft Front Seal Set	2000-96	TCS 45620	w/o Dust seals	
QTY	CARB & FUEL INJECTION	YEARS	PART NO.	DESCRIPTION	
1	Throttle Body Gasket	2000-96	61065	w/A/T	
1	Throttle Body Gasket	2000-96	61066	w/M/T	
QTY	DISTRIBUTOR MOUNTING	YEARS	PART NO.	DESCRIPTION	
1	Distributor Mounting Gasket	2000-96	72454	Distributor Mounting; O-ring; 26.5mm ID	
20		1995 - 1992; 1.6L 97 (1590cc) SOHC L4 (16 Valve) 75mm Bore VTEC			20
		MFI; Gasoline; Naturally Aspirated Honda Eng.; Eng. Code D16Z6			
QTY	CYLINDER HEAD	YEARS	PART NO.	DESCRIPTION	
1	Head Gasket	1995-92	9915 PT	Head bolts not incl.; Head bolt replacement recommended; PermaTorqueMLS®	
1	Head Set	1995-92	HS 9915 PT	Head bolts not incl.; Head bolt replacement recommended; PermaDry® molded rubber valve cover gskt. incl.; Premium valve stem seals incl.	
QTY	CONVERSION SET	YEARS	PART NO.	DESCRIPTION	
1	Gasket Conversion Set	1995-92	CS 9915	PermaDry® molded rubber oil pan gskt. incl.	
QTY	MANIFOLD - INT. & EXH.	YEARS	PART NO.	DESCRIPTION	
1	Int. Manifold Gasket Set	1995-92	MS 94119-2	Improved design	
1	Exh. Manifold Gasket Set	1995-92	MS 94118-1		
QTY	EXHAUST PIPE FLANGE	YEARS	PART NO.	DESCRIPTION	
2	Exhaust Pipe Gasket	1995-92	60776	Pipe to manifold	
QTY	OIL PAN	YEARS	PART NO.	DESCRIPTION	
1	Oil Pan Gasket Set	1995-92	OS 30542 R	PermaDry® molded rubber gskt. incl.	
QTY	CRANKSHAFT REAR SEAL	YEARS	PART NO.	DESCRIPTION	
1	Rear Main Seal Set	1995-92	BS 40430	Rubber; One-piece	
1	Repair Sleeve	1995-92	16275	Crankshaft; Use w/installation tool	
QTY	VALVE COVER	YEARS	PART NO.	DESCRIPTION	
1	Valve Cover Gasket Set	1995-92	VS 50499 R	w/Grommets & Spark plug tube seals; PermaDry® molded rubber gskt. incl.	
QTY	VALVE STEM SEAL SET	YEARS	PART NO.	DESCRIPTION	
1	Valve Stem Seal Set	1995-92	SS 70283-1	Premium valve stem seals incl.	

Honda Car (Incl. Acura, Honda) (Cont.)

20 (cont.)		1995 - 1992; 1.6L 97 (1590cc) SOHC L4 (16 Valve) 75mm Bore VTEC			20 (cont.)
		MFI; Gasoline; Naturally Aspirated Honda Eng.; Eng. Code D16Z6			
QTY	THERMOSTAT HOUSING	YEARS	PART NO.	DESCRIPTION	
1	Thermostat Gasket	1995-92	35480	Thermostat Housing; Thermostat O-ring	
QTY	WATER PUMP	YEARS	PART NO.	DESCRIPTION	
1	Water Pump Gasket	1995-92	35627		
QTY	TIMING COVER	YEARS	PART NO.	DESCRIPTION	
1	Crankshaft Front Seal Set	1995-92	TCS 45989	Must be used w/OS 30542R	
1	Camshaft Front Seal Set	1995-92	TCS 45620	w/o Dust seals	
QTY	CARB & FUEL INJECTION	YEARS	PART NO.	DESCRIPTION	
1	Throttle Body Gasket	1995-92	60979		
QTY	DISTRIBUTOR MOUNTING	YEARS	PART NO.	DESCRIPTION	
1	Distributor Mounting Gasket	1995-92	72454	Distributor Mounting; O-ring; 26.5mm ID	
21		2000 - 1996; 1.6L 97.3 (1595cc) DOHC L4 (16 Valve) 81mm Bore VTEC			21
		MFI; Gasoline; Naturally Aspirated Honda Eng.; Eng. Code B16A2			
QTY	CYLINDER HEAD	YEARS	PART NO.	DESCRIPTION	
1	Head Gasket	2000-99	9274 PT	Head bolts not incl.; Head bolt replacement recommended; PermaTorqueMLS® LaserWeld® Technology	
1	Head Gasket	1997-96	9274 PT	Head bolts not incl.; Head bolt replacement recommended; PermaTorqueMLS® LaserWeld® Technology	
1	Head Set	2000-99	HS 9274 PT	Head bolts not incl.; Head bolt replacement recommended; PermaDry® molded rubber valve cover gskt. incl.; Premium valve stem seals incl.; Consolidated design	
1	Head Set	1997-96	HS 9274 PT	Head bolts not incl.; Head bolt replacement recommended; PermaDry® molded rubber valve cover gskt. incl.; Premium valve stem seals incl.; Consolidated design	
QTY	CONVERSION SET	YEARS	PART NO.	DESCRIPTION	
1	Gasket Conversion Set	2000-99	CS 9274	PermaDry® molded rubber oil pan gskt. incl.	
1	Gasket Conversion Set	1997-96	CS 9274	PermaDry® molded rubber oil pan gskt. incl.	
QTY	MANIFOLD - INT. & EXH.	YEARS	PART NO.	DESCRIPTION	
1	Int. Manifold Gasket Set	2000-99	MS 91484		
1	Int. Manifold Gasket Set	1997-96	MS 91484		
1	Exh. Manifold Gasket Set	2000-99	MS 94602		
1	Exh. Manifold Gasket Set	1997-96	MS 94602		
QTY	EXHAUST PIPE FLANGE	YEARS	PART NO.	DESCRIPTION	
2	Exhaust Pipe Gasket	2000-99	60578	Pipe to manifold	
2	Exhaust Pipe Gasket	1997-96	60578	Pipe to manifold	
QTY	OIL PAN	YEARS	PART NO.	DESCRIPTION	
1	Oil Pan Gasket Set	2000-99	OS 30630 R	PermaDry® molded rubber gskt. incl.	
1	Oil Pan Gasket Set	1997-96	OS 30630 R	PermaDry® molded rubber gskt. incl.	
QTY	CRANKSHAFT REAR SEAL	YEARS	PART NO.	DESCRIPTION	
1	Rear Main Seal Set	2000-99	BS 40430	Rubber; One-piece	
1	Rear Main Seal Set	1997-96	BS 40430	Rubber; One-piece	
1	Repair Sleeve	2000-99	16275	Crankshaft; Use w/installation tool	
1	Repair Sleeve	1997-96	16275	Crankshaft; Use w/installation tool	
QTY	VALVE COVER	YEARS	PART NO.	DESCRIPTION	
1	Valve Cover Gasket Set	2000-99	VS 50498 R	w/Grommets & Spark plug tube seals; PermaDry® molded rubber gskt. incl.	
1	Valve Cover Gasket Set	1997-96	VS 50498 R	w/Grommets & Spark plug tube seals; PermaDry® molded rubber gskt. incl.	
1	Grommet Set	2000-99	ES 72132-1	Valve Cover	
1	Grommet Set	1997-96	ES 72132-1	Valve Cover	
1	Spark Plug Tube Seal Set	2000-99	ES 72179	Valve Cover	
1	Spark Plug Tube Seal Set	1997-96	ES 72179	Valve Cover	
QTY	VALVE STEM SEAL SET	YEARS	PART NO.	DESCRIPTION	
1	Valve Stem Seal Set	2000-99	SS 70283-1	Premium valve stem seals incl.	
1	Valve Stem Seal Set	1997-96	SS 70283-1	Premium valve stem seals incl.	
QTY	THERMOSTAT HOUSING	YEARS	PART NO.	DESCRIPTION	
1	Thermostat Gasket	2000-99	35480	Thermostat Housing; Thermostat O-ring	
1	Thermostat Gasket	1997-96	35480	Thermostat Housing; Thermostat O-ring	
QTY	WATER PUMP	YEARS	PART NO.	DESCRIPTION	
1	Water Pump Gasket	2000-99	35499	Improved design	
1	Water Pump Gasket	1997-96	35499	Improved design	
QTY	TIMING COVER	YEARS	PART NO.	DESCRIPTION	
1	Crankshaft Front Seal Set	2000-99	TCS 45988		
1	Crankshaft Front Seal Set	1997-96	TCS 45988		
1	Camshaft Front Seal Set	2000-99	TCS 45987		
1	Camshaft Front Seal Set	1997-96	TCS 45987		

21		2000 - 1996; 1.6L 97.3 (1595cc) DOHC L4 (16 Valve) 81mm Bore VTEC			21	
(cont.)		MFI; Gasoline; Naturally Aspirated Honda Eng.; Eng. Code B16A2			(cont.)	
QTY	CARB & FUEL INJECTION	YEARS	PART NO.	DESCRIPTION		
1	Throttle Body Gasket	2000-99	61067	Improved design		
1	Throttle Body Gasket	1997-96	61067	Improved design		
QTY	DISTRIBUTOR MOUNTING	YEARS	PART NO.	DESCRIPTION		
1	Distributor Mounting Gasket	2000-99	72454	Distributor Mounting; O-ring; 26.5mm ID		
1	Distributor Mounting Gasket	1997-96	72454	Distributor Mounting; O-ring; 26.5mm ID		
22		1995 - 1994; 1.6L 97.3 (1595cc) DOHC L4 (16 Valve) 81mm Bore VTEC			22	
(cont.)		MFI; Gasoline; Naturally Aspirated Honda Eng.; Eng. Code B16A3			(cont.)	
QTY	CYLINDER HEAD	YEARS	PART NO.	DESCRIPTION		
1	Head Gasket	1995-94	9274 PT	Head bolts not incl.; Head bolt replacement recommended; PermaTorqueMLS® LaserWeld® Technology		
1	Head Set	1995-94	HS 9274 PT	Head bolts not incl.; Head bolt replacement recommended; PermaDry® molded rubber valve cover gskt. incl.; Premium valve stem seals incl.; Consolidated design		
QTY	CONVERSION SET	YEARS	PART NO.	DESCRIPTION		
1	Gasket Conversion Set	1995-94	CS 9274	PermaDry® molded rubber oil pan gskt. incl.		
QTY	MANIFOLD - INT. & EXH.	YEARS	PART NO.	DESCRIPTION		
1	Int. Manifold Gasket Set	1995-94	MS 91484			
1	Exh. Manifold Gasket Set	1995-94	MS 94602			
QTY	EXHAUST PIPE FLANGE	YEARS	PART NO.	DESCRIPTION		
2	Exhaust Pipe Gasket	1995-94	60578	Pipe to manifold		
QTY	OIL PAN	YEARS	PART NO.	DESCRIPTION		
1	Oil Pan Gasket Set	1995-94	OS 30630 R	PermaDry® molded rubber gskt. incl.		
QTY	CRANKSHAFT REAR SEAL	YEARS	PART NO.	DESCRIPTION		
1	Rear Main Seal Set	1995-94	BS 40430	Rubber; One-piece		
1	Repair Sleeve	1995-94	16275	Crankshaft; Use w/installation tool		
QTY	VALVE COVER	YEARS	PART NO.	DESCRIPTION		
1	Valve Cover Gasket Set	1995-94	VS 50498 R	w/Grommets & Spark plug tube seals; PermaDry® molded rubber gskt. incl.		
1	Grommet Set	1995-94	ES 72132-1	Valve Cover		
1	Spark Plug Tube Seal Set	1995-94	ES 72179	Valve Cover		
QTY	VALVE STEM SEAL SET	YEARS	PART NO.	DESCRIPTION		
1	Valve Stem Seal Set	1995-94	SS 70283-1	Premium valve stem seals incl.		
QTY	THERMOSTAT HOUSING	YEARS	PART NO.	DESCRIPTION		
1	Thermostat Gasket	1995-94	35480	Thermostat Housing; Thermostat O-ring		
QTY	WATER PUMP	YEARS	PART NO.	DESCRIPTION		
1	Water Pump Gasket	1995-94	35626-1			
QTY	TIMING COVER	YEARS	PART NO.	DESCRIPTION		
1	Crankshaft Front Seal Set	1995-94	TCS 45988			
1	Camshaft Front Seal Set	1995-94	TCS 45987			
QTY	CARB & FUEL INJECTION	YEARS	PART NO.	DESCRIPTION		
1	Throttle Body Gasket	1995-94	60973			
QTY	DISTRIBUTOR MOUNTING	YEARS	PART NO.	DESCRIPTION		
1	Distributor Mounting Gasket	1995-94	72454	Distributor Mounting; O-ring; 26.5mm ID		
23		2005 - 2001; 1.7L 101 (1668cc) SOHC L4 (16 Valve) 75mm Bore			23	
(cont.)		MFI; Gasoline; Naturally Aspirated Honda Eng.; Eng. Code D17A1			(cont.)	
QTY	CYLINDER HEAD	YEARS	PART NO.	DESCRIPTION		
1	Head Gasket	2005-01	26236 PT	Head bolts not incl.; Head bolt replacement recommended; PermaTorqueMLS® LaserWeld® Technology		
1	Head Set	2005-04	HS 26236 PT-2	Head bolts not incl.; Head bolt replacement recommended; PermaDry® molded rubber valve cover gskt. incl.; Premium valve stem seals incl.		
1	Head Set	2003-01	HS 26236 PT	Head bolts not incl.; Head bolt replacement recommended; PermaDry® molded rubber valve cover gskt. incl.; Premium valve stem seals incl.		
QTY	CONVERSION SET	YEARS	PART NO.	DESCRIPTION		
1	Gasket Conversion Set	2005-01	CS 26236	PermaDry® molded rubber oil pan gskt. incl.		
QTY	MANIFOLD - INT. & EXH.	YEARS	PART NO.	DESCRIPTION		
1	Int. Manifold Gasket Set	2005-04	MS 96390-1	Lower set; Upper set incl.		
1	Int. Manifold Gasket Set	2005	MS 96390-1	Honda Civic Value Package; Lower set		
1	Int. Manifold Gasket Set	2003-01	MS 96390	Lower set; Upper set incl.		
1	Plenum Gasket Set	2005-01	MS 97333	Upper set; New Part Number - Check for Availability		
1	Exh. Manifold Gasket Set	2005-01	MS 96447			
QTY	EXHAUST PIPE FLANGE	YEARS	PART NO.	DESCRIPTION		
1	Exhaust Pipe Gasket	2005-01	60517	Converter		

Honda Car (Incl. Acura, Honda) (Cont.)

23 (cont.)		2005 - 2001; 1.7L 101 (1668cc) SOHC L4 (16 Valve) 75mm Bore			23 (cont.)
MFI; Gasoline; Naturally Aspirated Honda Eng.; Eng. Code D17A1					
QTY	EXHAUST PIPE FLANGE	YEARS	PART NO.	DESCRIPTION	
1	Exhaust Pipe Gasket	2005-01	60690	Pipe to manifold	
QTY	OIL PAN	YEARS	PART NO.	DESCRIPTION	
1	Oil Pan Gasket Set	2005-01	OS 30690 R	PermaDry® molded rubber gskt. incl.	
QTY	CRANKSHAFT REAR SEAL	YEARS	PART NO.	DESCRIPTION	
1	Rear Main Seal Set	2005-01	BS 40430	Rubber; One-piece	
1	Repair Sleeve	2005-01	16275	Crankshaft; Use w/installation tool	
QTY	VALVE COVER	YEARS	PART NO.	DESCRIPTION	
1	Valve Cover Gasket Set	2005-01	VS 50606 R	w/Grommets & Spark plug tube seals; PermaDry® molded rubber gskt. incl.	
1	Valve Cover Gasket Set	2005-01	VS 50606 R-1	w/o Grommets & Spark plug tube seals; PermaDry® molded rubber gskt. incl.	
1	Circular Plug	2005-01	ES 72476	Valve Cover; New Part Number - Check for Availability	
1	Spark Plug Tube Seal Set	2005-01	ES 72967	Valve Cover; New Part Number - Check for Availability	
QTY	VALVE STEM SEAL SET	YEARS	PART NO.	DESCRIPTION	
1	Valve Stem Seal Set	2005-01	SS 70283-1	Premium valve stem seals incl.	
QTY	THERMOSTAT HOUSING	YEARS	PART NO.	DESCRIPTION	
1	Thermostat Gasket	2005-01	35734	Thermostat Housing; Thermostat seal	
QTY	WATER OUTLET GASKET	YEARS	PART NO.	DESCRIPTION	
1	Water Outlet Gasket	2005-01	35948	Water Outlet; Water passage	
QTY	WATER PUMP	YEARS	PART NO.	DESCRIPTION	
1	Water Pump Gasket	2005-01	35627		
QTY	TIMING COVER	YEARS	PART NO.	DESCRIPTION	
1	Crankshaft Front Seal Set	2005-01	TCS 45904		
1	Camshaft Front Seal Set	2005-01	TCS 45620	w/o Dust seals	
QTY	CARB & FUEL INJECTION	YEARS	PART NO.	DESCRIPTION	
1	Fuel Injector O-Ring Set	2005-01	ES 70599	Improved design	
1	Throttle Body Gasket	2005-01	61322		
QTY	EXHAUST GAS RECIRCULATION	YEARS	PART NO.	DESCRIPTION	
1	EGR Gasket	2005-01	70978		
24		2005 - 2001; 1.7L 101 (1668cc) SOHC L4 (16 Valve) 75mm Bore			24
MFI; Natural Gas; Naturally Aspirated Honda Eng.; Eng. Code D17A7					
QTY	CYLINDER HEAD	YEARS	PART NO.	DESCRIPTION	
1	Head Gasket	2005-01	26236 PT	Head bolts not incl.; Head bolt replacement recommended; PermaTorqueMLS® LaserWeld® Technology	
1	Head Set	2005-01	HS 26236 PT-1	Head bolts not incl.; Head bolt replacement recommended; PermaDry® molded rubber valve cover gskt. incl.; Premium valve stem seals incl.	
QTY	CONVERSION SET	YEARS	PART NO.	DESCRIPTION	
1	Gasket Conversion Set	2005-01	CS 26236-1	RTV sealant incl. for oil pan gskt.	
QTY	MANIFOLD - INT. & EXH.	YEARS	PART NO.	DESCRIPTION	
1	Int. Manifold Gasket Set	2005-01	MS 96415		
1	Exh. Manifold Gasket Set	2005-01	MS 96447		
QTY	EXHAUST PIPE FLANGE	YEARS	PART NO.	DESCRIPTION	
1	Exhaust Pipe Gasket	2005-01	60517	Converter	
1	Exhaust Pipe Gasket	2005-01	60690	Pipe to manifold	
QTY	CRANKSHAFT REAR SEAL	YEARS	PART NO.	DESCRIPTION	
1	Rear Main Seal Set	2005-01	BS 40430	Rubber; One-piece	
1	Repair Sleeve	2005-01	16275	Crankshaft; Use w/installation tool	
QTY	VALVE COVER	YEARS	PART NO.	DESCRIPTION	
1	Valve Cover Gasket Set	2005-01	VS 50606 R	w/Grommets & Spark plug tube seals; PermaDry® molded rubber gskt. incl.	
1	Valve Cover Gasket Set	2005-01	VS 50606 R-1	w/o Grommets & Spark plug tube seals; PermaDry® molded rubber gskt. incl.	
1	Circular Plug	2005-01	ES 72476	Valve Cover; New Part Number - Check for Availability	
1	Spark Plug Tube Seal Set	2005-01	ES 72967	Valve Cover; New Part Number - Check for Availability	
QTY	VALVE STEM SEAL SET	YEARS	PART NO.	DESCRIPTION	
1	Valve Stem Seal Set	2005-01	SS 70283-1	Premium valve stem seals incl.	
QTY	THERMOSTAT HOUSING	YEARS	PART NO.	DESCRIPTION	
1	Thermostat Gasket	2005-01	35734	Thermostat Housing; Thermostat seal	
QTY	WATER OUTLET GASKET	YEARS	PART NO.	DESCRIPTION	
1	Water Outlet Gasket	2005-01	35948	Water Outlet; Water passage	
QTY	WATER PUMP	YEARS	PART NO.	DESCRIPTION	
1	Water Pump Gasket	2005-01	35627		
QTY	TIMING COVER	YEARS	PART NO.	DESCRIPTION	
1	Crankshaft Front Seal Set	2005-01	TCS 45904		

24		2005 - 2001; 1.7L 101 (1668cc) SOHC L4 (16 Valve) 75mm Bore			24	
(cont.)		MFI; Natural Gas; Naturally Aspirated Honda Eng.; Eng. Code D17A7			(cont.)	
QTY	TIMING COVER	YEARS	PART NO.	DESCRIPTION		
1	Camshaft Front Seal Set	2005-01	TCS 45620	w/o Dust seals		
QTY	CARB & FUEL INJECTION	YEARS	PART NO.	DESCRIPTION		
1	Throttle Body Gasket	2005-01	61321			
QTY	EXHAUST GAS RECIRCULATION	YEARS	PART NO.	DESCRIPTION		
1	EGR Gasket	2005-01	70978			
25		2005 - 2001; 1.7L 101 (1668cc) SOHC L4 (16 Valve) 75mm Bore VTEC			25	
		MFI; Gasoline; Naturally Aspirated Honda Eng.; Eng. Code D17A2				
QTY	CYLINDER HEAD	YEARS	PART NO.	DESCRIPTION		
1	Head Gasket	2005-01	26236 PT	Head bolts not incl.; Head bolt replacement recommended; PermaTorqueMLS® LaserWeld® Technology		
1	Head Set	2005-01	HS 26236 PT-2	Head bolts not incl.; Head bolt replacement recommended; PermaDry® molded rubber valve cover gskt. incl.; Premium valve stem seals incl.		
QTY	CONVERSION SET	YEARS	PART NO.	DESCRIPTION		
1	Gasket Conversion Set	2005-01	CS 26236-1	RTV sealant incl. for oil pan gskt.		
QTY	MANIFOLD - INT. & EXH.	YEARS	PART NO.	DESCRIPTION		
1	Int. Manifold Gasket Set	2005-01	MS 96390-1	Lower set; Upper set incl.		
1	Plenum Gasket Set	2005-01	MS 97333	Upper set; New Part Number - Check for Availability		
1	Exh. Manifold Gasket Set	2005-01	MS 96447			
QTY	EXHAUST PIPE FLANGE	YEARS	PART NO.	DESCRIPTION		
1	Exhaust Pipe Gasket	2005-01	60517	Converter		
1	Exhaust Pipe Gasket	2005-01	60884	Pipe to manifold; Improved design		
QTY	CRANKSHAFT REAR SEAL	YEARS	PART NO.	DESCRIPTION		
1	Rear Main Seal Set	2005-01	BS 40430	Rubber; One-piece		
1	Repair Sleeve	2005-01	16275	Crankshaft; Use w/installation tool		
QTY	VALVE COVER	YEARS	PART NO.	DESCRIPTION		
1	Valve Cover Gasket Set	2005-01	VS 50606 R	w/Grommets & Spark plug tube seals; PermaDry® molded rubber gskt. incl.		
1	Valve Cover Gasket Set	2005-01	VS 50606 R-1	w/o Grommets & Spark plug tube seals; PermaDry® molded rubber gskt. incl.		
1	Circular Plug	2005-01	ES 72476	Valve Cover; New Part Number - Check for Availability		
1	Spark Plug Tube Seal Set	2005-01	ES 72967	Valve Cover; New Part Number - Check for Availability		
QTY	VALVE STEM SEAL SET	YEARS	PART NO.	DESCRIPTION		
1	Valve Stem Seal Set	2005-01	SS 70283-1	Premium valve stem seals incl.		
QTY	THERMOSTAT HOUSING	YEARS	PART NO.	DESCRIPTION		
1	Thermostat Gasket	2005-01	35734	Thermostat Housing; Thermostat seal		
QTY	WATER OUTLET GASKET	YEARS	PART NO.	DESCRIPTION		
1	Water Outlet Gasket	2005-01	35948	Water Outlet; Water passage		
QTY	WATER PUMP	YEARS	PART NO.	DESCRIPTION		
1	Water Pump Gasket	2005-01	35627			
QTY	TIMING COVER	YEARS	PART NO.	DESCRIPTION		
1	Crankshaft Front Seal Set	2005-01	TCS 45904			
1	Camshaft Front Seal Set	2005-01	TCS 45620	w/o Dust seals		
QTY	CARB & FUEL INJECTION	YEARS	PART NO.	DESCRIPTION		
1	Fuel Injector O-Ring Set	2005-01	ES 70599	Improved design		
1	Throttle Body Gasket	2005-01	61322			
QTY	EXHAUST GAS RECIRCULATION	YEARS	PART NO.	DESCRIPTION		
1	EGR Gasket	2005-01	70978			
26		2005 - 2001; 1.7L 101 (1668cc) SOHC L4 (16 Valve) 75mm Bore VTEC			26	
		MFI; Gasoline; Naturally Aspirated Honda Eng.; Eng. Code D17A6				
QTY	CYLINDER HEAD	YEARS	PART NO.	DESCRIPTION		
1	Head Gasket	2005-01	26236 PT	Head bolts not incl.; Head bolt replacement recommended; PermaTorqueMLS® LaserWeld® Technology		
1	Head Set	2005-01	HS 26236 PT-2	Head bolts not incl.; Head bolt replacement recommended; PermaDry® molded rubber valve cover gskt. incl.; Premium valve stem seals incl.		
QTY	CONVERSION SET	YEARS	PART NO.	DESCRIPTION		
1	Gasket Conversion Set	2005-01	CS 26236-1	RTV sealant incl. for oil pan gskt.		
QTY	MANIFOLD - INT. & EXH.	YEARS	PART NO.	DESCRIPTION		
1	Int. Manifold Gasket Set	2005-01	MS 96390-1	Lower set; Upper set incl.		
1	Plenum Gasket Set	2005-01	MS 97333	Upper set; New Part Number - Check for Availability		
1	Exh. Manifold Gasket Set	2005-01	MS 96447			
QTY	EXHAUST PIPE FLANGE	YEARS	PART NO.	DESCRIPTION		
1	Exhaust Pipe Gasket	2005-01	60517	Converter		

Honda Car (Incl. Acura, Honda) (Cont.)

26 (cont.)		2005 - 2001; 1.7L 101 (1668cc) SOHC L4 (16 Valve) 75mm Bore VTEC			26 (cont.)
MFI; Gasoline; Naturally Aspirated Honda Eng.; Eng. Code D17A6					
QTY	EXHAUST PIPE FLANGE	YEARS	PART NO.	DESCRIPTION	
1	Exhaust Pipe Gasket	2005-01	60690	Pipe to manifold	
QTY	CRANKSHAFT REAR SEAL	YEARS	PART NO.	DESCRIPTION	
1	Rear Main Seal Set	2005-01	BS 40430	Rubber; One-piece	
1	Repair Sleeve	2005-01	16275	Crankshaft; Use w/installation tool	
QTY	VALVE COVER	YEARS	PART NO.	DESCRIPTION	
1	Valve Cover Gasket Set	2005-01	VS 50606 R	w/Grommets & Spark plug tube seals; PermaDry® molded rubber gskt. incl.	
1	Valve Cover Gasket Set	2005-01	VS 50606 R-1	w/o Grommets & Spark plug tube seals; PermaDry® molded rubber gskt. incl.	
1	Circular Plug	2005-01	ES 72476	Valve Cover; New Part Number - Check for Availability	
1	Spark Plug Tube Seal Set	2005-01	ES 72967	Valve Cover; New Part Number - Check for Availability	
QTY	VALVE STEM SEAL SET	YEARS	PART NO.	DESCRIPTION	
1	Valve Stem Seal Set	2005-01	SS 70283-1	Premium valve stem seals incl.	
QTY	THERMOSTAT HOUSING	YEARS	PART NO.	DESCRIPTION	
1	Thermostat Gasket	2005-01	35734	Thermostat Housing; Thermostat seal	
QTY	WATER OUTLET GASKET	YEARS	PART NO.	DESCRIPTION	
1	Water Outlet Gasket	2005-01	35948	Water Outlet; Water passage	
QTY	WATER PUMP	YEARS	PART NO.	DESCRIPTION	
1	Water Pump Gasket	2005-01	35627		
QTY	TIMING COVER	YEARS	PART NO.	DESCRIPTION	
1	Crankshaft Front Seal Set	2005-01	TCS 45904		
1	Camshaft Front Seal Set	2005-01	TCS 45620	w/o Dust seals	
QTY	CARB & FUEL INJECTION	YEARS	PART NO.	DESCRIPTION	
1	Fuel Injector O-Ring Set	2005-01	ES 70599	Improved design	
1	Throttle Body Gasket	2005-01	61322		
QTY	EXHAUST GAS RECIRCULATION	YEARS	PART NO.	DESCRIPTION	
1	EGR Gasket	2005-01	70978		
27		1993 - 1992; 1.7L 102.4 (1678cc) DOHC L4 (16 Valve) 81mm Bore VTEC			27
MFI; Gasoline; Naturally Aspirated Honda Eng.; Eng. Code B17A1					
QTY	CYLINDER HEAD	YEARS	PART NO.	DESCRIPTION	
1	Head Gasket	1993-92	9274 PT	Head bolts not incl.; Head bolt replacement recommended; PermaTorqueMLS® LaserWeld® Technology	
1	Head Set	1993-92	HS 9274 PT-3	Head bolts not incl.; Head bolt replacement recommended; PermaDry® molded rubber valve cover gskt. incl.; Premium valve stem seals incl.	
QTY	CONVERSION SET	YEARS	PART NO.	DESCRIPTION	
1	Gasket Conversion Set	1993-92	CS 9274	PermaDry® molded rubber oil pan gskt. incl.	
QTY	MANIFOLD - INT. & EXH.	YEARS	PART NO.	DESCRIPTION	
1	Int. Manifold Gasket Set	1993-92	MS 92505		
1	Exh. Manifold Gasket Set	1993-92	MS 94602		
QTY	EXHAUST PIPE FLANGE	YEARS	PART NO.	DESCRIPTION	
1	Exhaust Pipe Gasket	1993-92	60517	Loc. Rear; Converter	
1	Exhaust Pipe Gasket	1993-92	60669	Loc. Front; Converter	
1	Exhaust Pipe Gasket	1993-92	60776	Flange	
QTY	OIL PAN	YEARS	PART NO.	DESCRIPTION	
1	Oil Pan Gasket Set	1993-92	OS 30630 R	PermaDry® molded rubber gskt. incl.	
QTY	CRANKSHAFT REAR SEAL	YEARS	PART NO.	DESCRIPTION	
1	Rear Main Seal Set	1993-92	BS 40430	Rubber; One-piece	
1	Repair Sleeve	1993-92	16275	Crankshaft; Use w/installation tool	
QTY	VALVE COVER	YEARS	PART NO.	DESCRIPTION	
1	Valve Cover Gasket Set	1993-92	VS 50498 R	w/Grommets & Spark plug tube seals; PermaDry® molded rubber gskt. incl.	
1	Grommet Set	1993-92	ES 72132-1	Valve Cover	
1	Spark Plug Tube Seal Set	1993-92	ES 72179	Valve Cover	
QTY	VALVE STEM SEAL SET	YEARS	PART NO.	DESCRIPTION	
1	Valve Stem Seal Set	1993-92	SS 70283-1	Premium valve stem seals incl.	
QTY	THERMOSTAT HOUSING	YEARS	PART NO.	DESCRIPTION	
1	Thermostat Gasket	1993-92	35480	Thermostat Housing; Thermostat O-ring	
QTY	WATER PUMP	YEARS	PART NO.	DESCRIPTION	
1	Water Pump Gasket	1993-92	35626-1		
QTY	TIMING COVER	YEARS	PART NO.	DESCRIPTION	
1	Crankshaft Front Seal Set	1993-92	TCS 45988		
1	Camshaft Front Seal Set	1993-92	TCS 45987		
QTY	CARB & FUEL INJECTION	YEARS	PART NO.	DESCRIPTION	
1	Throttle Body Gasket	1993-92	60971	Improved design	

28		2001 - 1994; 1.8L 109.6 (1797cc) DOHC L4 (16 Valve) 81mm Bore VTEC MFI; Gasoline; Naturally Aspirated Honda Eng.; Eng. Code B18C1			28
QTY	CYLINDER HEAD	YEARS	PART NO.	DESCRIPTION	
1	Head Gasket	2001-94	9274 PT	Head bolts not incl.; Head bolt replacement recommended; PermaTorqueMLS® LaserWeld® Technology	
1	Head Set	2001-94	HS 9274 PT-2	Head bolts not incl.; Head bolt replacement recommended; PermaDry® molded rubber valve cover gskt. incl.; Premium valve stem seals incl.	
QTY	CONVERSION SET	YEARS	PART NO.	DESCRIPTION	
1	Gasket Conversion Set	2001-94	CS 9274	PermaDry® molded rubber oil pan gskt. incl.	
QTY	MANIFOLD - INT. & EXH.	YEARS	PART NO.	DESCRIPTION	
1	Int. Manifold Gasket Set	2001-94	MS 92504		
1	Exh. Manifold Gasket Set	2001-94	MS 94602		
QTY	EXHAUST PIPE FLANGE	YEARS	PART NO.	DESCRIPTION	
1	Exhaust Pipe Gasket	2001-94	60517	Loc. Rear; Converter	
1	Exhaust Pipe Gasket	2001-94	60669	Loc. Front; Converter	
2	Exhaust Pipe Gasket	2001-94	60776	Flange	
QTY	OIL PAN	YEARS	PART NO.	DESCRIPTION	
1	Oil Pan Gasket Set	2001-94	OS 30630 R	PermaDry® molded rubber gskt. incl.	
QTY	CRANKSHAFT REAR SEAL	YEARS	PART NO.	DESCRIPTION	
1	Rear Main Seal Set	2001-94	BS 40430	Rubber; One-piece	
1	Repair Sleeve	2001-94	16275	Crankshaft; Use w/installation tool	
QTY	VALVE COVER	YEARS	PART NO.	DESCRIPTION	
1	Valve Cover Gasket Set	2001-94	VS 50498 R	w/Grommets & Spark plug tube seals; PermaDry® molded rubber gskt. incl.	
1	Grommet Set	2001-94	ES 72132-1	Valve Cover	
1	Circular Plug	2001-94	ES 72476	Valve Cover; New Part Number - Check for Availability	
1	Spark Plug Tube Seal Set	2001-94	ES 72179	Valve Cover	
QTY	VALVE STEM SEAL SET	YEARS	PART NO.	DESCRIPTION	
1	Valve Stem Seal Set	2001-94	SS 70283-1	Premium valve stem seals incl.	
QTY	THERMOSTAT HOUSING	YEARS	PART NO.	DESCRIPTION	
1	Thermostat Gasket	2001-94	35480	Thermostat Housing; Thermostat O-ring	
QTY	WATER PUMP	YEARS	PART NO.	DESCRIPTION	
1	Water Pump Gasket	2001-94	35499	Improved design	
QTY	TIMING COVER	YEARS	PART NO.	DESCRIPTION	
1	Crankshaft Front Seal Set	2001-94	TCS 45988		
1	Camshaft Front Seal Set	2001-94	TCS 45987		
QTY	CARB & FUEL INJECTION	YEARS	PART NO.	DESCRIPTION	
1	Throttle Body Gasket	2001-96	61067	Improved design	
1	Throttle Body Gasket	1995-94	60973		
QTY	DISTRIBUTOR MOUNTING	YEARS	PART NO.	DESCRIPTION	
1	Distributor Mounting Gasket	2001-94	72454	Distributor Mounting; O-ring; 26.5mm ID	
29		2001 - 1997; 1.8L 109.6 (1797cc) DOHC L4 (16 Valve) 81mm Bore VTEC MFI; Gasoline; Naturally Aspirated Honda Eng.; Eng. Code B18C5			29
QTY	CYLINDER HEAD	YEARS	PART NO.	DESCRIPTION	
1	Head Gasket	2001-97	9274 PT	Head bolts not incl.; Head bolt replacement recommended; PermaTorqueMLS® LaserWeld® Technology	
1	Head Set	2001-97	HS 9274 PT-3	Head bolts not incl.; Head bolt replacement recommended; PermaDry® molded rubber valve cover gskt. incl.; Premium valve stem seals incl.	
QTY	CONVERSION SET	YEARS	PART NO.	DESCRIPTION	
1	Gasket Conversion Set	2001-97	CS 9274	PermaDry® molded rubber oil pan gskt. incl.	
QTY	MANIFOLD - INT. & EXH.	YEARS	PART NO.	DESCRIPTION	
1	Int. Manifold Gasket Set	2001-97	MS 92505		
1	Exh. Manifold Gasket Set	2001-97	MS 94602		
QTY	EXHAUST PIPE FLANGE	YEARS	PART NO.	DESCRIPTION	
2	Exhaust Pipe Gasket	2001-97	60776	Flange	
QTY	OIL PAN	YEARS	PART NO.	DESCRIPTION	
1	Oil Pan Gasket Set	2001-97	OS 30630 R	PermaDry® molded rubber gskt. incl.	
QTY	CRANKSHAFT REAR SEAL	YEARS	PART NO.	DESCRIPTION	
1	Rear Main Seal Set	2001-97	BS 40430	Rubber; One-piece	
1	Repair Sleeve	2001-97	16275	Crankshaft; Use w/installation tool	
QTY	VALVE COVER	YEARS	PART NO.	DESCRIPTION	
1	Valve Cover Gasket Set	2001-97	VS 50498 R-1	w/Grommets & Spark plug tube seals; PermaDry® molded rubber gskt. incl.	
1	Grommet Set	2001-97	ES 72178	Valve Cover	
1	Circular Plug	2001-97	ES 72476	Valve Cover; New Part Number - Check for Availability	
1	Spark Plug Tube Seal Set	2001-97	ES 72179	Valve Cover	

Honda Car (Incl. Acura, Honda) (Cont.)

29		2001 - 1997; 1.8L 109.6 (1797cc) DOHC L4 (16 Valve) 81mm Bore VTEC			29	
(cont.)		MFI; Gasoline; Naturally Aspirated Honda Eng.; Eng. Code B18C5			(cont.)	
QTY	VALVE STEM SEAL SET	YEARS	PART NO.	DESCRIPTION		
1	Valve Stem Seal Set	2001-97	SS 70283-1	Premium valve stem seals incl.		
QTY	THERMOSTAT HOUSING	YEARS	PART NO.	DESCRIPTION		
1	Thermostat Gasket	2001-97	35480	Thermostat Housing; Thermostat O-ring		
QTY	WATER PUMP	YEARS	PART NO.	DESCRIPTION		
1	Water Pump Gasket	2001-97	35499	Improved design		
QTY	TIMING COVER	YEARS	PART NO.	DESCRIPTION		
1	Crankshaft Front Seal Set	2001-97	TCS 45988			
1	Camshaft Front Seal Set	2001-97	TCS 45987			
QTY	CARB & FUEL INJECTION	YEARS	PART NO.	DESCRIPTION		
1	Throttle Body Gasket	2001-97	61067	Improved design		
1	Throttle Body Gasket	2001-97	61071	Old design		
QTY	DISTRIBUTOR MOUNTING	YEARS	PART NO.	DESCRIPTION		
1	Distributor Mounting Gasket	2001-97	72454	Distributor Mounting; O-ring; 26.5mm ID		
30		2011 - 2006; 1.8L 109.8 (1799cc) SOHC L4 (16 Valve) 81mm Bore i-VTEC			30	
		MFI; Gasoline; Naturally Aspirated Honda Eng.; Eng. Code R18A1				
QTY	CYLINDER HEAD	YEARS	PART NO.	DESCRIPTION		
1	Head Gasket	2011-06	26397 PT	Head bolts not incl.; Head bolt replacement recommended; PermaTorqueMLS®		
1	Head Set	2011-06	HS 26397 PT	Head bolts not incl.; Head bolt replacement recommended; PermaDry® molded rubber valve cover gskt. incl.; Premium valve stem seals incl.		
1	Head Bolt Set	2011-06	ES 72284	Head bolts w/Washers; Replacement recommended		
QTY	CONVERSION SET	YEARS	PART NO.	DESCRIPTION		
1	Gasket Conversion Set	2011-06	CS 26397	RTV sealant incl. for oil pan gskt.		
QTY	MANIFOLD - INT. & EXH.	YEARS	PART NO.	DESCRIPTION		
1	Int. Manifold Gasket Set	2011-06	MS 97035			
1	Exh. Manifold Gasket Set	2011-06	MS 97023			
QTY	EXHAUST PIPE FLANGE	YEARS	PART NO.	DESCRIPTION		
1	Exhaust Pipe Gasket	2011-06	60477	Flexible joint ring		
1	Exhaust Pipe Gasket	2011-06	60884	Pipe to manifold; Improved design		
1	Exhaust Pipe Gasket	2011-06	61015	Exh. connector		
QTY	CRANKSHAFT REAR SEAL	YEARS	PART NO.	DESCRIPTION		
1	Rear Main Seal Set	2011-06	BS 40535	Rubber; One-piece; Improved design		
QTY	VALVE COVER	YEARS	PART NO.	DESCRIPTION		
1	Valve Cover Gasket Set	2011-06	VS 50741 R	w/Spark plug tube seals; PermaDry® molded rubber gskt. incl.		
QTY	VALVE STEM SEAL SET	YEARS	PART NO.	DESCRIPTION		
1	Valve Stem Seal Set	2011-06	SS 70283-1	Premium valve stem seals incl.		
QTY	THERMOSTAT HOUSING	YEARS	PART NO.	DESCRIPTION		
1	Thermostat Gasket	2011-06	35734	Thermostat Housing; Thermostat seal		
QTY	WATER PUMP	YEARS	PART NO.	DESCRIPTION		
1	Water Pump Gasket	2011-06	35884			
QTY	TIMING COVER	YEARS	PART NO.	DESCRIPTION		
1	Crankshaft Front Seal Set	2011-06	TCS 46118			
QTY	CARB & FUEL INJECTION	YEARS	PART NO.	DESCRIPTION		
2	Fuel Injector O-Ring Set	2011-06	ES 70599	Upper set & Lower set; Injectors to fuel rail & Injectors to cylinder head; Improved design		
1	Throttle Body Gasket	2011-06	61542			
QTY	EXHAUST GAS RECIRCULATION	YEARS	PART NO.	DESCRIPTION		
1	EGR Gasket	2011-06	70978	Valve		
1	EGR Gasket	2011-06	72370	Loc. Upper; Pipe		
1	EGR Gasket	2011-06	72371	Loc. Lower; Pipe		
31		2011 - 2006; 1.8L 109.8 (1799cc) SOHC L4 (16 Valve) 81mm Bore i-VTEC			31	
		MFI; Natural Gas; Naturally Aspirated Honda Eng.; Eng. Code R18A4				
QTY	CYLINDER HEAD	YEARS	PART NO.	DESCRIPTION		
1	Head Gasket	2011-06	26397 PT	Head bolts not incl.; Head bolt replacement recommended; PermaTorqueMLS®		
1	Head Set	2011-06	HS 26397 PT	Head bolts not incl.; Head bolt replacement recommended; PermaDry® molded rubber valve cover gskt. incl.; Premium valve stem seals incl.		
1	Head Bolt Set	2011-06	ES 72284	Head bolts w/Washers; Replacement recommended		
QTY	CONVERSION SET	YEARS	PART NO.	DESCRIPTION		
1	Gasket Conversion Set	2011-06	CS 26397	RTV sealant incl. for oil pan gskt.		
QTY	MANIFOLD - INT. & EXH.	YEARS	PART NO.	DESCRIPTION		
1	Int. Manifold Gasket Set	2011-06	MS 97035			

31 (cont.)		2011 - 2006; 1.8L 109.8 (1799cc) SOHC L4 (16 Valve) 81mm Bore i-VTEC			31 (cont.)
MFI; Natural Gas; Naturally Aspirated Honda Eng.; Eng. Code R18A4					
QTY	MANIFOLD - INT. & EXH.	YEARS	PART NO.	DESCRIPTION	
1	Exh. Manifold Gasket Set	2011-06	MS 97023		
QTY	EXHAUST PIPE FLANGE	YEARS	PART NO.	DESCRIPTION	
1	Exhaust Pipe Gasket	2011-06	60477	Flexible joint ring	
1	Exhaust Pipe Gasket	2011-06	60884	Pipe to manifold; Improved design	
1	Exhaust Pipe Gasket	2011-06	61015	Exh. connector	
QTY	CRANKSHAFT REAR SEAL	YEARS	PART NO.	DESCRIPTION	
1	Rear Main Seal Set	2011-06	BS 40535	Rubber; One-piece; Improved design	
QTY	VALVE COVER	YEARS	PART NO.	DESCRIPTION	
1	Valve Cover Gasket Set	2011-06	VS 50741 R	w/Spark plug tube seals; PermaDry® molded rubber gskt. incl.	
QTY	VALVE STEM SEAL SET	YEARS	PART NO.	DESCRIPTION	
1	Valve Stem Seal Set	2011-06	SS 70283-1	Premium valve stem seals incl.	
QTY	THERMOSTAT HOUSING	YEARS	PART NO.	DESCRIPTION	
1	Thermostat Gasket	2011-06	35734	Thermostat Housing; Thermostat seal	
QTY	WATER PUMP	YEARS	PART NO.	DESCRIPTION	
1	Water Pump Gasket	2011-06	35884		
QTY	TIMING COVER	YEARS	PART NO.	DESCRIPTION	
1	Crankshaft Front Seal Set	2011-06	TCS 46118		
QTY	CARB & FUEL INJECTION	YEARS	PART NO.	DESCRIPTION	
1	Fuel Injector O-Ring Set	2011-06	ES 70599	Upper set; Injectors to fuel rail; Improved design	
1	Fuel Injector O-Ring Set	2011-06	ES 72291	Lower set; Injectors to cylinder head	
1	Throttle Body Gasket	2011-06	61542		
QTY	EXHAUST GAS RECIRCULATION	YEARS	PART NO.	DESCRIPTION	
1	EGR Gasket	2011-06	70978	Valve	
1	EGR Gasket	2011-06	72370	Loc. Upper; Pipe	
1	EGR Gasket	2011-06	72371	Loc. Lower; Pipe	
32		2013 - 2012; 1.8L 109.8 (1799cc) SOHC L4 (16 Valve) 81mm Bore i-VTEC			32
MFI; Natural Gas; Naturally Aspirated Honda Eng.; Eng. Code R18A9					
QTY	CYLINDER HEAD	YEARS	PART NO.	DESCRIPTION	
1	Head Gasket	2013-12	26397 PT	Head bolts not incl.; Head bolt replacement recommended; PermaTorqueMLS®	
1	Head Set	2013-12	HS 26397 PT	Head bolts not incl.; Head bolt replacement recommended; PermaDry® molded rubber valve cover gskt. incl.; Premium valve stem seals incl.	
1	Head Bolt Set	2013-12	ES 72284	Head bolts w/Washers; Replacement recommended	
QTY	CONVERSION SET	YEARS	PART NO.	DESCRIPTION	
1	Gasket Conversion Set	2013-12	CS 26397	RTV sealant incl. for oil pan gskt.	
QTY	MANIFOLD - INT. & EXH.	YEARS	PART NO.	DESCRIPTION	
1	Int. Manifold Gasket Set	2013-12	MS 97035		
1	Exh. Manifold Gasket Set	2013-12	MS 97023		
QTY	EXHAUST PIPE FLANGE	YEARS	PART NO.	DESCRIPTION	
1	Exhaust Pipe Gasket	2013-12	60477	Exh. connector	
1	Exhaust Pipe Gasket	2013-12	60776	Converter	
1	Exhaust Pipe Gasket	2013-12	60884	Pipe to manifold; Improved design	
QTY	CRANKSHAFT REAR SEAL	YEARS	PART NO.	DESCRIPTION	
1	Rear Main Seal Set	2013-12	BS 40535	Rubber; One-piece; Improved design	
QTY	VALVE COVER	YEARS	PART NO.	DESCRIPTION	
1	Valve Cover Gasket Set	2013-12	VS 50741 R	w/Spark plug tube seals; PermaDry® molded rubber gskt. incl.	
QTY	VALVE STEM SEAL SET	YEARS	PART NO.	DESCRIPTION	
1	Valve Stem Seal Set	2013-12	SS 70283-1	Premium valve stem seals incl.	
QTY	THERMOSTAT HOUSING	YEARS	PART NO.	DESCRIPTION	
1	Thermostat Gasket	2013-12	35734	Thermostat Housing; Thermostat seal	
QTY	WATER PUMP	YEARS	PART NO.	DESCRIPTION	
1	Water Pump Gasket	2013-12	35884		
QTY	TIMING COVER	YEARS	PART NO.	DESCRIPTION	
1	Crankshaft Front Seal Set	2013-12	TCS 46118		
QTY	CARB & FUEL INJECTION	YEARS	PART NO.	DESCRIPTION	
1	Fuel Injector O-Ring Set	2013-12	ES 70599	Upper set; Injectors to fuel rail; Improved design	
1	Fuel Injector O-Ring Set	2013-12	ES 72291	Lower set; Injectors to cylinder head	
1	Throttle Body Gasket	2013-12	61542		
QTY	EXHAUST GAS RECIRCULATION	YEARS	PART NO.	DESCRIPTION	
1	EGR Gasket	2013-12	70978	Valve	
1	EGR Gasket	2013-12	72370	Loc. Upper; Pipe	

Honda Car (Incl. Acura, Honda) (Cont.)

32		2013 - 2012; 1.8L 109.8 (1799cc) SOHC L4 (16 Valve) 81mm Bore i-VTEC			32	
(cont.)		MFI; Natural Gas; Naturally Aspirated Honda Eng.; Eng. Code R18A9			(cont.)	
QTY	EXHAUST GAS RECIRCULATION	YEARS	PART NO.	DESCRIPTION		
1	EGR Gasket	2013-12	72371	Loc. Lower; Pipe		
33		2013 - 2012; 1.8L 109.8 (1799cc) SOHC L4 (16 Valve) 81mm Bore i-VTEC			33	
		MFI; Gasoline; Naturally Aspirated Honda Eng.; Eng. Code R18Z1				
QTY	CYLINDER HEAD	YEARS	PART NO.	DESCRIPTION		
1	Head Gasket	2013-12	26397 PT	Head bolts not incl.; Head bolt replacement recommended; PermaTorqueMLS®		
1	Head Set	2013-12	HS 26397 PT	Head bolts not incl.; Head bolt replacement recommended; PermaDry® molded rubber valve cover gskt. incl.; Premium valve stem seals incl.		
1	Head Bolt Set	2013-12	ES 72284	Head bolts w/Washers; Replacement recommended		
QTY	CONVERSION SET	YEARS	PART NO.	DESCRIPTION		
1	Gasket Conversion Set	2013-12	CS 26397	RTV sealant incl. for oil pan gskt.		
QTY	MANIFOLD - INT. & EXH.	YEARS	PART NO.	DESCRIPTION		
1	Int. Manifold Gasket Set	2013-12	MS 97035			
1	Exh. Manifold Gasket Set	2013-12	MS 97023			
QTY	EXHAUST PIPE FLANGE	YEARS	PART NO.	DESCRIPTION		
1	Exhaust Pipe Gasket	2013-12	60477	Exh. connector		
1	Exhaust Pipe Gasket	2013-12	60776	Converter		
1	Exhaust Pipe Gasket	2013-12	60884	Pipe to manifold; Improved design		
QTY	CRANKSHAFT REAR SEAL	YEARS	PART NO.	DESCRIPTION		
1	Rear Main Seal Set	2013-12	BS 40535	Rubber; One-piece; Improved design		
QTY	VALVE COVER	YEARS	PART NO.	DESCRIPTION		
1	Valve Cover Gasket Set	2013-12	VS 50741 R	w/Spark plug tube seals; PermaDry® molded rubber gskt. incl.		
QTY	VALVE STEM SEAL SET	YEARS	PART NO.	DESCRIPTION		
1	Valve Stem Seal Set	2013-12	SS 70283-1	Premium valve stem seals incl.		
QTY	THERMOSTAT HOUSING	YEARS	PART NO.	DESCRIPTION		
1	Thermostat Gasket	2013-12	35734	Thermostat Housing; Thermostat seal		
QTY	WATER PUMP	YEARS	PART NO.	DESCRIPTION		
1	Water Pump Gasket	2013-12	35884			
QTY	TIMING COVER	YEARS	PART NO.	DESCRIPTION		
1	Crankshaft Front Seal Set	2013-12	TCS 46118			
QTY	CARB & FUEL INJECTION	YEARS	PART NO.	DESCRIPTION		
2	Fuel Injector O-Ring Set	2013-12	ES 70599	Upper set & Lower set; Injectors to fuel rail & Injectors to cylinder head; Improved design		
1	Throttle Body Gasket	2013-12	61542			
QTY	EXHAUST GAS RECIRCULATION	YEARS	PART NO.	DESCRIPTION		
1	EGR Gasket	2013-12	70978	Valve		
1	EGR Gasket	2013-12	72370	Loc. Upper; Pipe		
1	EGR Gasket	2013-12	72371	Loc. Lower; Pipe		
34		1993 - 1991; 1.8L 111.8 (1834cc) DOHC L4 (16 Valve) 81mm Bore			34	
		MFI; Gasoline; Naturally Aspirated Honda Eng.; Eng. Code B18A1				
QTY	CYLINDER HEAD	YEARS	PART NO.	DESCRIPTION		
1	Head Gasket	1993-91	9698 PT	Head bolts not incl.; Head bolt replacement recommended; PermaTorqueMLS® LaserWeld® Technology		
1	Head Set	1993-91	HS 9698 PT-1	Head bolts & exh. pipe flange not incl.; Head bolt replacement recommended; PermaDry® molded rubber valve cover gskt. incl.; Premium valve stem seals incl.; Consolidated design		
QTY	CONVERSION SET	YEARS	PART NO.	DESCRIPTION		
1	Gasket Conversion Set	1993-91	CS 9698	PermaDry® molded rubber oil pan gskt. incl.		
QTY	MANIFOLD - INT. & EXH.	YEARS	PART NO.	DESCRIPTION		
1	Int. Manifold Gasket Set	1993-91	MS 92506	Improved design		
1	Exh. Manifold Gasket Set	1993-91	MS 94602			
QTY	EXHAUST PIPE FLANGE	YEARS	PART NO.	DESCRIPTION		
1	Exhaust Pipe Gasket	1993-91	60517	Loc. Rear; Converter		
1	Exhaust Pipe Gasket	1993-91	60669	Loc. Front; Converter		
2	Exhaust Pipe Gasket	1993-92	60776	Flange		
1	Exhaust Pipe Gasket	1991	23624	Flange		
1	Exhaust Pipe Gasket	1991	60777	Pipe to muffler		
QTY	OIL PAN	YEARS	PART NO.	DESCRIPTION		
1	Oil Pan Gasket Set	1993-91	OS 30630 R	PermaDry® molded rubber gskt. incl.		
QTY	CRANKSHAFT REAR SEAL	YEARS	PART NO.	DESCRIPTION		
1	Rear Main Seal Set	1993-91	BS 40430	Rubber; One-piece		

Honda Car (Incl. Acura, Honda) (Cont.)

34 (cont.)		1993 - 1991; 1.8L 111.8 (1834cc) DOHC L4 (16 Valve) 81mm Bore			34 (cont.)
MFI; Gasoline; Naturally Aspirated Honda Eng.; Eng. Code B18A1					
QTY	CRANKSHAFT REAR SEAL	YEARS	PART NO.	DESCRIPTION	
1	Repair Sleeve	1993-91	16275	Crankshaft; Use w/installation tool	
QTY	VALVE COVER	YEARS	PART NO.	DESCRIPTION	
1	Valve Cover Gasket Set	1993-91	VS 50362 R	w/o Grommets & w/Spark plug tube seals; PermaDry® molded rubber gskt. incl.	
1	Grommet Set	1993-91	ES 72132	Valve Cover	
1	Circular Plug	1993-91	ES 72476	Valve Cover; New Part Number - Check for Availability	
1	Spark Plug Tube Seal Set	1993-91	ES 72179	Valve Cover	
QTY	VALVE STEM SEAL SET	YEARS	PART NO.	DESCRIPTION	
1	Valve Stem Seal Set	1993-91	SS 72632-1	Premium valve stem seals incl.	
QTY	THERMOSTAT HOUSING	YEARS	PART NO.	DESCRIPTION	
1	Thermostat Gasket	1993-91	35480	Thermostat Housing; Thermostat O-ring	
QTY	WATER OUTLET GASKET	YEARS	PART NO.	DESCRIPTION	
1	Water Outlet Gasket	1993-91	35535	Water Outlet	
QTY	WATER PUMP	YEARS	PART NO.	DESCRIPTION	
1	Water Pump Gasket	1993-91	35499	Improved design	
QTY	TIMING COVER	YEARS	PART NO.	DESCRIPTION	
1	Crankshaft Front Seal Set	1993-91	TCS 45904		
1	Camshaft Front Seal Set	1993-91	TCS 45718		
QTY	CARB & FUEL INJECTION	YEARS	PART NO.	DESCRIPTION	
1	Throttle Body Gasket	1993-91	60971	Improved design	
1	Throttle Body Gasket	1991	60875	Old design	
QTY	DISTRIBUTOR MOUNTING	YEARS	PART NO.	DESCRIPTION	
1	Distributor Mounting Gasket	1993-91	72454	Distributor Mounting; O-ring; 26.5mm ID	
QTY	EXHAUST GAS RECIRCULATION	YEARS	PART NO.	DESCRIPTION	
1	EGR Gasket	1993-91	70978		
35		2001 - 1994; 1.8L 111.8 (1834cc) DOHC L4 (16 Valve) 81mm Bore			35
MFI; Gasoline; Naturally Aspirated Honda Eng.; Eng. Code B18B1					
QTY	CYLINDER HEAD	YEARS	PART NO.	DESCRIPTION	
1	Head Gasket	2001-94	9698 PT	Head bolts not incl.; Head bolt replacement recommended; PermaTorqueMLS® LaserWeld® Technology	
1	Head Set	2001-94	HS 9698 PT-1	Head bolts & exh. pipe flange not incl.; Head bolt replacement recommended; PermaDry® molded rubber valve cover gskt. incl.; Premium valve stem seals incl.; Consolidated design	
QTY	CONVERSION SET	YEARS	PART NO.	DESCRIPTION	
1	Gasket Conversion Set	2001-94	CS 9698	PermaDry® molded rubber oil pan gskt. incl.	
QTY	MANIFOLD - INT. & EXH.	YEARS	PART NO.	DESCRIPTION	
1	Int. Manifold Gasket Set	2001-94	MS 92506	Improved design	
1	Exh. Manifold Gasket Set	2001-94	MS 94602		
QTY	EXHAUST PIPE FLANGE	YEARS	PART NO.	DESCRIPTION	
1	Exhaust Pipe Gasket	2001-94	60517	Loc. Rear; Converter	
1	Exhaust Pipe Gasket	2001-94	60669	Loc. Front; Converter	
2	Exhaust Pipe Gasket	2001-94	60776	Flange	
QTY	OIL PAN	YEARS	PART NO.	DESCRIPTION	
1	Oil Pan Gasket Set	2001-94	OS 30630 R	PermaDry® molded rubber gskt. incl.	
QTY	CRANKSHAFT REAR SEAL	YEARS	PART NO.	DESCRIPTION	
1	Rear Main Seal Set	2001-94	BS 40430	Rubber; One-piece	
1	Repair Sleeve	2001-94	16275	Crankshaft; Use w/installation tool	
QTY	VALVE COVER	YEARS	PART NO.	DESCRIPTION	
1	Valve Cover Gasket Set	2001-94	VS 50362 R	w/o Grommets & w/Spark plug tube seals; PermaDry® molded rubber gskt. incl.	
1	Grommet Set	2001-94	ES 72132	Valve Cover	
1	Circular Plug	2001-94	ES 72476	Valve Cover; New Part Number - Check for Availability	
1	Spark Plug Tube Seal Set	2001-94	ES 72179	Valve Cover	
QTY	VALVE STEM SEAL SET	YEARS	PART NO.	DESCRIPTION	
1	Valve Stem Seal Set	2001-94	SS 72632-1	Premium valve stem seals incl.	
QTY	THERMOSTAT HOUSING	YEARS	PART NO.	DESCRIPTION	
1	Thermostat Gasket	2001-94	35480	Thermostat Housing; Thermostat O-ring	
QTY	WATER OUTLET GASKET	YEARS	PART NO.	DESCRIPTION	
1	Water Outlet Gasket	1995-94	35535	Water Outlet	
QTY	WATER PUMP	YEARS	PART NO.	DESCRIPTION	
1	Water Pump Gasket	2001-94	35499	Improved design	
QTY	TIMING COVER	YEARS	PART NO.	DESCRIPTION	
1	Crankshaft Front Seal Set	2001-94	TCS 45904		

Honda Car (Incl. Acura, Honda) (Cont.)

35 (cont.)		2001 - 1994; 1.8L 111.8 (1834cc) DOHC L4 (16 Valve) 81mm Bore			35 (cont.)
		MFI; Gasoline; Naturally Aspirated Honda Eng.; Eng. Code B18B1			
QTY	TIMING COVER	YEARS	PART NO.	DESCRIPTION	
1	Camshaft Front Seal Set	2001-94	TCS 45718		
QTY	CARB & FUEL INJECTION	YEARS	PART NO.	DESCRIPTION	
1	Throttle Body Gasket	2001-96	60973	w/A/T	
1	Throttle Body Gasket	2001-96	61067	w/M/T; Improved design	
1	Throttle Body Gasket	1995-94	60973		
QTY	DISTRIBUTOR MOUNTING	YEARS	PART NO.	DESCRIPTION	
1	Distributor Mounting Gasket	2001-94	72454	Distributor Mounting; O-ring; 26.5mm ID	
36		1991; 2.0L 119.5 (1958cc) DOHC L4 (16 Valve) 81mm Bore			36
		MFI; Gasoline; Naturally Aspirated Honda Eng.; Eng. Code B20A5			
QTY	CYLINDER HEAD	YEARS	PART NO.	DESCRIPTION	
1	Head Gasket	1991	9124 PT-1		
1	Head Set	1991	HS 9124 PT-4	Exh. pipe to muffler gskt. not incl.; PermaDry® molded rubber valve cover gskt. incl.; Premium valve stem seals incl.	
QTY	CONVERSION SET	YEARS	PART NO.	DESCRIPTION	
1	Gasket Conversion Set	1991	CS 9124-1	PermaDry® molded rubber oil pan gskt. incl.	
QTY	MANIFOLD - INT. & EXH.	YEARS	PART NO.	DESCRIPTION	
1	Int. Manifold Gasket Set	1991	MS 94121		
1	Exh. Manifold Gasket Set	1991	MS 94128		
QTY	EXHAUST PIPE FLANGE	YEARS	PART NO.	DESCRIPTION	
2	Exhaust Pipe Gasket	1991	60517	Converter	
2	Exhaust Pipe Gasket	1991	60776	Loc. Front	
1	Exhaust Pipe Gasket	1991	60777	Pipe to muffler	
QTY	OIL PAN	YEARS	PART NO.	DESCRIPTION	
1	Oil Pan Gasket Set	1991	OS 30598 R	PermaDry® molded rubber gskt. incl.	
QTY	CRANKSHAFT REAR SEAL	YEARS	PART NO.	DESCRIPTION	
1	Rear Main Seal Set	1991	BS 40430	Rubber; One-piece	
1	Repair Sleeve	1991	16275	Crankshaft; Use w/installation tool	
QTY	VALVE COVER	YEARS	PART NO.	DESCRIPTION	
1	Valve Cover Gasket Set	1991	VS 50327 R	w/o Grommets & Spark plug tube seals; PermaDry® molded rubber gskt. incl.	
1	Valve Cover Gasket Set	1991	VS 50391 R	w/Grommets & Spark plug tube seals; PermaDry® molded rubber gskt. incl.	
1	Spark Plug Tube Seal Set	1991	ES 72179	Valve Cover	
QTY	VALVE STEM SEAL SET	YEARS	PART NO.	DESCRIPTION	
1	Valve Stem Seal Set	1991	SS 72546-1	Premium valve stem seals incl.	
QTY	THERMOSTAT HOUSING	YEARS	PART NO.	DESCRIPTION	
1	O-Ring	1991	35315	Thermostat Housing	
1	O-Ring	1991	35508	Thermostat Housing; Case to head	
QTY	WATER PUMP	YEARS	PART NO.	DESCRIPTION	
1	Water Pump Gasket	1991	35423		
QTY	TIMING COVER	YEARS	PART NO.	DESCRIPTION	
1	Crankshaft Front Seal Set	1991	TCS 45873-1	w/o Dust seals	
1	Crankshaft Front Seal Set	1991	TCS 45875	w/Dust seals	
1	Camshaft Front Seal Set	1991	TCS 45718	w/o Dust seals	
QTY	CARB & FUEL INJECTION	YEARS	PART NO.	DESCRIPTION	
1	Throttle Body Gasket	1991	60778		
QTY	DISTRIBUTOR MOUNTING	YEARS	PART NO.	DESCRIPTION	
1	Distributor Mounting Gasket	1991	72454	Distributor Mounting; O-ring; 26.5mm ID	
QTY	EXHAUST GAS RECIRCULATION	YEARS	PART NO.	DESCRIPTION	
1	EGR Gasket	1991	70978		
37		2003 - 2000; 2.0L 121.9 (1997cc) DOHC L4 (16 Valve) 87mm Bore VTEC			37
		MFI; Gasoline; Naturally Aspirated Honda Eng.; Eng. Code F20C1			
QTY	CYLINDER HEAD	YEARS	PART NO.	DESCRIPTION	
1	Head Gasket	2003-00	26601 PT	Head bolts not incl.; Head bolt replacement recommended; PermaTorqueMLS®; New Part Number - Check for Availability	
38		2004 - 2002; 2.0L 122 (1998cc) DOHC L4 (16 Valve) 86mm Bore i-VTEC			38
		MFI; Gasoline; Naturally Aspirated Honda Eng.; Eng. Code K20A2			
QTY	CYLINDER HEAD	YEARS	PART NO.	DESCRIPTION	
1	Head Gasket	2004-02	26399 PT	Head bolts not incl.; Head bolt replacement recommended; PermaTorqueMLS®	

Honda Car (Incl. Acura, Honda) (Cont.)

38 (cont.)		2004 - 2002; 2.0L 122 (1998cc) DOHC L4 (16 Valve) 86mm Bore i-VTEC			38 (cont.)
MFI; Gasoline; Naturally Aspirated Honda Eng.; Eng. Code K20A2					
QTY	CYLINDER HEAD	YEARS	PART NO.	DESCRIPTION	
1	Head Set	2004-02	HS 26399 PT	Head bolts not incl.; Head bolt replacement recommended; PermaDry® molded rubber valve cover gskt. incl.; Premium valve stem seals incl.	
1	Head Bolt Set	2004-02	ES 71333	Head bolts w/Washers; Replacement recommended	
QTY	CONVERSION SET	YEARS	PART NO.	DESCRIPTION	
1	Gasket Conversion Set	2004-02	CS 26399	RTV sealant incl. for oil pan gskt.; Improved design	
QTY	MANIFOLD - INT. & EXH.	YEARS	PART NO.	DESCRIPTION	
1	Int. Manifold Gasket Set	2004-02	MS 96477		
1	Exh. Manifold Gasket Set	2004-02	MS 96474		
QTY	EXHAUST PIPE FLANGE	YEARS	PART NO.	DESCRIPTION	
1	Exhaust Pipe Gasket	2004-02	61550	Packing	
1	Exhaust Pipe Gasket	2004-02	61555	Converter	
QTY	OIL PAN	YEARS	PART NO.	DESCRIPTION	
1	Oil Pan Gasket Set	2004-02	OS 30746		
QTY	CRANKSHAFT REAR SEAL	YEARS	PART NO.	DESCRIPTION	
1	Rear Main Seal Set	2004-02	BS 40535	Rubber; One-piece; Improved design	
QTY	VALVE COVER	YEARS	PART NO.	DESCRIPTION	
1	Valve Cover Gasket Set	2004-02	VS 50614 R	w/Grommets & Spark plug tube seals; PermaDry® molded rubber gskt. incl.; Improved design	
1	Spark Plug Tube Seal Set	2004-02	ES 72967	Valve Cover; New Part Number - Check for Availability	
QTY	VALVE STEM SEAL SET	YEARS	PART NO.	DESCRIPTION	
1	Valve Stem Seal Set	2004-02	SS 70283-1	Premium valve stem seals incl.	
QTY	THERMOSTAT HOUSING	YEARS	PART NO.	DESCRIPTION	
1	Thermostat Gasket	2004-02	35739	Thermostat Housing; Thermostat case	
1	Thermostat Gasket	2004-02	35741	Thermostat Housing; Thermostat seal	
QTY	WATER OUTLET GASKET	YEARS	PART NO.	DESCRIPTION	
1	Water Outlet Gasket	2004-02	35740	Water Outlet; Water outlet	
1	Water Outlet Gasket	2004-02	36022	Water Outlet; Water pipe O-ring; New Part Number - Check for Availability	
QTY	WATER PUMP	YEARS	PART NO.	DESCRIPTION	
1	Water Pump Gasket	2004-02	35888		
QTY	TIMING COVER	YEARS	PART NO.	DESCRIPTION	
1	Crankshaft Front Seal Set	2004-02	TCS 46051	Must be used w/OS 30746	
QTY	CARB & FUEL INJECTION	YEARS	PART NO.	DESCRIPTION	
2	Fuel Injector O-Ring Set	2004-02	ES 70599	Improved design	
1	Throttle Body Gasket	2004-02	61547		
39		2006 - 2002; 2.0L 122 (1998cc) DOHC L4 (16 Valve) 86mm Bore i-VTEC			39
MFI; Gasoline; Naturally Aspirated Honda Eng.; Eng. Code K20A3					
QTY	CYLINDER HEAD	YEARS	PART NO.	DESCRIPTION	
1	Head Gasket	2006-02	26403 PT	Head bolts not incl.; Head bolt replacement recommended; PermaTorqueMLS®	
1	Head Set	2006-02	HS 26403 PT	Head bolts not incl.; Head bolt replacement recommended; PermaDry® molded rubber valve cover gskt. incl.; Premium valve stem seals incl.	
1	Head Bolt Set	2006-02	ES 71333	Head bolts w/Washers; Replacement recommended	
QTY	CONVERSION SET	YEARS	PART NO.	DESCRIPTION	
1	Gasket Conversion Set	2006-02	CS 26399	RTV sealant incl. for oil pan gskt.; Improved design	
QTY	MANIFOLD - INT. & EXH.	YEARS	PART NO.	DESCRIPTION	
1	Int. Manifold Gasket Set	2006	MS 96491	Upper set incl.	
1	Int. Manifold Gasket Set	2005-02	MS 96477	Honda Civic Si	
1	Int. Manifold Gasket Set	2005-02	MS 96491	Acura RSX Base, L; Upper set incl.	
1	Exh. Manifold Gasket Set	2006	MS 97033		
1	Exh. Manifold Gasket Set	2005	MS 96474	Honda Civic Si	
1	Exh. Manifold Gasket Set	2005	MS 97033	Acura RSX Base, L	
1	Exh. Manifold Gasket Set	2004-02	MS 97033		
QTY	EXHAUST PIPE FLANGE	YEARS	PART NO.	DESCRIPTION	
1	Exhaust Pipe Gasket	2006-02	60517	Converter	
1	Exhaust Pipe Gasket	2006-02	61348	Packing	
QTY	OIL PAN	YEARS	PART NO.	DESCRIPTION	
1	Oil Pan Gasket Set	2006-02	OS 30746		
QTY	CRANKSHAFT REAR SEAL	YEARS	PART NO.	DESCRIPTION	
1	Rear Main Seal Set	2006-02	BS 40535	Rubber; One-piece; Improved design	
QTY	VALVE COVER	YEARS	PART NO.	DESCRIPTION	
1	Valve Cover Gasket Set	2006-02	VS 50614 R	w/Grommets & Spark plug tube seals; PermaDry® molded rubber gskt. incl.; Improved design	

Honda Car (Incl. Acura, Honda) (Cont.)

39		2006 - 2002; 2.0L 122 (1998cc) DOHC L4 (16 Valve) 86mm Bore i-VTEC			39	
(cont.)		MFI; Gasoline; Naturally Aspirated Honda Eng.; Eng. Code K20A3			(cont.)	
QTY	VALVE COVER	YEARS	PART NO.	DESCRIPTION		
1	Spark Plug Tube Seal Set	2006-02	ES 72967	Valve Cover; New Part Number - Check for Availability		
QTY	VALVE STEM SEAL SET	YEARS	PART NO.	DESCRIPTION		
1	Valve Stem Seal Set	2006-02	SS 70283-1	Premium valve stem seals incl.		
QTY	THERMOSTAT HOUSING	YEARS	PART NO.	DESCRIPTION		
1	Thermostat Gasket	2006-02	35739	Thermostat Housing; Thermostat case		
1	Thermostat Gasket	2006-02	35741	Thermostat Housing; Thermostat seal		
QTY	WATER OUTLET GASKET	YEARS	PART NO.	DESCRIPTION		
1	Water Outlet Gasket	2006-02	35740	Water Outlet; Water outlet		
1	Water Outlet Gasket	2006-02	36022	Water Outlet; Water pipe O-ring; New Part Number - Check for Availability		
QTY	WATER PUMP	YEARS	PART NO.	DESCRIPTION		
1	Water Pump Gasket	2006-02	35738			
QTY	TIMING COVER	YEARS	PART NO.	DESCRIPTION		
1	Crankshaft Front Seal Set	2006-02	TCS 46051	Must be used w/OS 30746		
QTY	CARB & FUEL INJECTION	YEARS	PART NO.	DESCRIPTION		
2	Fuel Injector O-Ring Set	2006-02	ES 70599	Improved design		
1	Throttle Body Gasket	2006	61350			
1	Throttle Body Gasket	2005-02	61350	Acura RSX Base, L		
1	Throttle Body Gasket	2005-02	61547	Honda Civic Si		
40		2006 - 2005; 2.0L 122 (1998cc) DOHC L4 (16 Valve) 86mm Bore i-VTEC			40	
		MFI; Gasoline; Naturally Aspirated Honda Eng.; Eng. Code K20Z1				
QTY	CYLINDER HEAD	YEARS	PART NO.	DESCRIPTION		
1	Head Gasket	2006-05	26399 PT	Head bolts not incl.; Head bolt replacement recommended; PermaTorqueMLS®		
1	Head Set	2006-05	HS 26399 PT	Head bolts not incl.; Head bolt replacement recommended; PermaDry® molded rubber valve cover gskt. incl.; Premium valve stem seals incl.		
1	Head Bolt Set	2006-05	ES 71333	Head bolts w/Washers; Replacement recommended		
QTY	CONVERSION SET	YEARS	PART NO.	DESCRIPTION		
1	Gasket Conversion Set	2006-05	CS 26399	RTV sealant incl. for oil pan gskt.; Improved design		
QTY	MANIFOLD - INT. & EXH.	YEARS	PART NO.	DESCRIPTION		
1	Int. Manifold Gasket Set	2006-05	MS 96477			
1	Exh. Manifold Gasket Set	2006-05	MS 96474			
QTY	EXHAUST PIPE FLANGE	YEARS	PART NO.	DESCRIPTION		
1	Exhaust Pipe Gasket	2006-05	61550	Packing		
1	Exhaust Pipe Gasket	2006-05	61555	Converter		
QTY	OIL PAN	YEARS	PART NO.	DESCRIPTION		
1	Oil Pan Gasket Set	2006-05	OS 30746			
QTY	CRANKSHAFT REAR SEAL	YEARS	PART NO.	DESCRIPTION		
1	Rear Main Seal Set	2006-05	BS 40535	Rubber; One-piece; Improved design		
QTY	VALVE COVER	YEARS	PART NO.	DESCRIPTION		
1	Valve Cover Gasket Set	2006-05	VS 50614 R	w/Grommets & Spark plug tube seals; PermaDry® molded rubber gskt. incl.; Improved design		
1	Spark Plug Tube Seal Set	2006-05	ES 72967	Valve Cover; New Part Number - Check for Availability		
QTY	VALVE STEM SEAL SET	YEARS	PART NO.	DESCRIPTION		
1	Valve Stem Seal Set	2006-05	SS 70283-1	Premium valve stem seals incl.		
QTY	THERMOSTAT HOUSING	YEARS	PART NO.	DESCRIPTION		
1	Thermostat Gasket	2006-05	35739	Thermostat Housing; Thermostat case		
1	Thermostat Gasket	2006-05	35741	Thermostat Housing; Thermostat seal		
QTY	WATER OUTLET GASKET	YEARS	PART NO.	DESCRIPTION		
1	Water Outlet Gasket	2006-05	35740	Water Outlet; Water outlet		
1	Water Outlet Gasket	2006-05	36022	Water Outlet; Water pipe O-ring; New Part Number - Check for Availability		
QTY	WATER PUMP	YEARS	PART NO.	DESCRIPTION		
1	Water Pump Gasket	2006-05	35888			
QTY	TIMING COVER	YEARS	PART NO.	DESCRIPTION		
1	Crankshaft Front Seal Set	2006-05	TCS 46051	Must be used w/OS 30746		
QTY	CARB & FUEL INJECTION	YEARS	PART NO.	DESCRIPTION		
2	Fuel Injector O-Ring Set	2006-05	ES 70599	Improved design		
1	Throttle Body Gasket	2006-05	61548			

41		2011 - 2006; 2.0L 122 (1998cc) DOHC L4 (16 Valve) 86mm Bore i-VTEC MFI; Gasoline; Naturally Aspirated Honda Eng.; Eng. Code K20Z3			41
QTY	CYLINDER HEAD	YEARS	PART NO.	DESCRIPTION	
1	Head Gasket	2011-06	26404 PT	Head bolts not incl.; Head bolt replacement recommended; PermaTorqueMLS®	
1	Head Set	2011-06	HS 26404 PT	Head bolts not incl.; Head bolt replacement recommended; PermaDry® molded rubber valve cover gskt. incl.; Premium valve stem seals incl.	
1	Head Bolt Set	2011-06	ES 71333	Head bolts w/Washers; Replacement recommended	
QTY	CONVERSION SET	YEARS	PART NO.	DESCRIPTION	
1	Gasket Conversion Set	2011-06	CS 26399	RTV sealant incl. for oil pan gskt.; Improved design	
QTY	MANIFOLD - INT. & EXH.	YEARS	PART NO.	DESCRIPTION	
1	Int. Manifold Gasket Set	2011-06	MS 96476		
1	Exh. Manifold Gasket Set	2011-06	MS 96474		
QTY	EXHAUST PIPE FLANGE	YEARS	PART NO.	DESCRIPTION	
1	Exhaust Pipe Gasket	2011-06	61550	Packing	
1	Exhaust Pipe Gasket	2011-06	61555	Converter	
QTY	OIL PAN	YEARS	PART NO.	DESCRIPTION	
1	Oil Pan Gasket Set	2011-06	OS 30746		
QTY	CRANKSHAFT REAR SEAL	YEARS	PART NO.	DESCRIPTION	
1	Rear Main Seal Set	2011-06	BS 40535	Rubber; One-piece; Improved design	
QTY	VALVE COVER	YEARS	PART NO.	DESCRIPTION	
1	Valve Cover Gasket Set	2011-06	VS 50614 R	w/Grommets & Spark plug tube seals; PermaDry® molded rubber gskt. incl.; Improved design	
1	Spark Plug Tube Seal Set	2011-06	ES 72967	Valve Cover; New Part Number - Check for Availability	
QTY	VALVE STEM SEAL SET	YEARS	PART NO.	DESCRIPTION	
1	Valve Stem Seal Set	2011-06	SS 70283-1	Premium valve stem seals incl.	
QTY	THERMOSTAT HOUSING	YEARS	PART NO.	DESCRIPTION	
1	Thermostat Gasket	2011-06	35739	Thermostat Housing; Thermostat case	
1	Thermostat Gasket	2011-06	35741	Thermostat Housing; Thermostat seal	
QTY	WATER OUTLET GASKET	YEARS	PART NO.	DESCRIPTION	
1	Water Outlet Gasket	2011-06	36022	Water Outlet; Water pipe O-ring; New Part Number - Check for Availability	
QTY	WATER PUMP	YEARS	PART NO.	DESCRIPTION	
1	Water Pump Gasket	2011-06	35888		
QTY	TIMING COVER	YEARS	PART NO.	DESCRIPTION	
1	Crankshaft Front Seal Set	2011-06	TCS 46051	Must be used w/OS 30746	
QTY	CARB & FUEL INJECTION	YEARS	PART NO.	DESCRIPTION	
2	Fuel Injector O-Ring Set	2011-06	ES 70599	Improved design	
1	Throttle Body Gasket	2011-06	61549		
QTY	EXHAUST GAS RECIRCULATION	YEARS	PART NO.	DESCRIPTION	
1	EGR Gasket	2011-06	70978	Valve	
1	EGR Gasket	2011-06	71217	Passage	
42		1991; 2.1L 125 (2056cc) DOHC L4 (16 Valve) 83mm Bore MFI; Gasoline; Naturally Aspirated Honda Eng.; Eng. Code B21A1			42
QTY	CYLINDER HEAD	YEARS	PART NO.	DESCRIPTION	
1	Head Gasket	1991	9124 PT-2		
1	Head Set	1991	HS 9124 PT-3	PermaDry® molded rubber valve cover gskt. incl.; Premium valve stem seals incl.	
QTY	CONVERSION SET	YEARS	PART NO.	DESCRIPTION	
1	Gasket Conversion Set	1991	CS 9124-1	PermaDry® molded rubber oil pan gskt. incl.	
QTY	MANIFOLD - INT. & EXH.	YEARS	PART NO.	DESCRIPTION	
1	Int. Manifold Gasket Set	1991	MS 94836	Upper set incl.	
1	Exh. Manifold Gasket Set	1991	MS 94128		
QTY	EXHAUST PIPE FLANGE	YEARS	PART NO.	DESCRIPTION	
1	Exhaust Pipe Gasket	1991	23624	Flange	
2	Exhaust Pipe Gasket	1991	60517	Converter	
QTY	OIL PAN	YEARS	PART NO.	DESCRIPTION	
1	Oil Pan Gasket Set	1991	OS 30598 R	PermaDry® molded rubber gskt. incl.	
QTY	CRANKSHAFT REAR SEAL	YEARS	PART NO.	DESCRIPTION	
1	Rear Main Seal Set	1991	BS 40430	Rubber; One-piece	
1	Repair Sleeve	1991	16275	Crankshaft; Use w/installation tool	
QTY	VALVE COVER	YEARS	PART NO.	DESCRIPTION	
1	Valve Cover Gasket Set	1991	VS 50327 R	w/o Grommets & Spark plug tube seals; PermaDry® molded rubber gskt. incl.	
1	Valve Cover Gasket Set	1991	VS 50391 R	w/Grommets & Spark plug tube seals; PermaDry® molded rubber gskt. incl.	

Honda Car (Incl. Acura, Honda) (Cont.)

42 (cont.)		1991; 2.1L 125 (2056cc) DOHC L4 (16 Valve) 83mm Bore			42 (cont.)
		MFI; Gasoline; Naturally Aspirated Honda Eng.; Eng. Code B21A1			
QTY	VALVE COVER	YEARS	PART NO.	DESCRIPTION	
1	Spark Plug Tube Seal Set	1991	ES 72179	Valve Cover	
QTY	VALVE STEM SEAL SET	YEARS	PART NO.	DESCRIPTION	
1	Valve Stem Seal Set	1991	SS 72632-1	Premium valve stem seals incl.	
QTY	THERMOSTAT HOUSING	YEARS	PART NO.	DESCRIPTION	
1	O-Ring	1991	35315	Thermostat Housing	
1	O-Ring	1991	35508	Thermostat Housing; Case to head	
QTY	WATER PUMP	YEARS	PART NO.	DESCRIPTION	
1	Water Pump Gasket	1991	35423		
QTY	TIMING COVER	YEARS	PART NO.	DESCRIPTION	
1	Crankshaft Front Seal Set	1991	TCS 45873-1	w/o Dust seals	
1	Crankshaft Front Seal Set	1991	TCS 45875	w/Dust seals	
1	Camshaft Front Seal Set	1991	TCS 45718	w/o Dust seals	
QTY	CARB & FUEL INJECTION	YEARS	PART NO.	DESCRIPTION	
1	Throttle Body Gasket	1991	60778		
QTY	DISTRIBUTOR MOUNTING	YEARS	PART NO.	DESCRIPTION	
1	Distributor Mounting Gasket	1991	72454	Distributor Mounting; O-ring; 26.5mm ID	
QTY	EXHAUST GAS RECIRCULATION	YEARS	PART NO.	DESCRIPTION	
1	EGR Gasket	1991	70978		
43		1996 - 1991; 2.2L 131.6 (2156cc) SOHC L4 (16 Valve) 85mm Bore			43
		MFI; Gasoline; Naturally Aspirated Honda Eng.; Eng. Code F22A1			
QTY	CYLINDER HEAD	YEARS	PART NO.	DESCRIPTION	
1	Head Gasket	1996-91	9851 PT	Head bolts not incl.; Head bolt replacement recommended; PermaTorqueMLS®	
1	Head Set	1996-91	HS 9851 PT	Head bolts not incl.; Head bolt replacement recommended; Exh. pipe to muffler gskt. not incl.; PermaDry® molded rubber valve cover gskt. incl.; Premium valve stem seals incl.	
1	Head Installation Set	1996-91	HIS 9851 PT	Head bolts not incl.; Head bolt replacement recommended; Exh. pipe to manifold gskt. & exh. pipe to muffler gskt. not incl.; PermaDry® molded rubber valve cover gskt. incl.	
QTY	CONVERSION SET	YEARS	PART NO.	DESCRIPTION	
1	Gasket Conversion Set	1996-91	CS 9851	PermaDry® molded rubber oil pan gskt. incl.	
QTY	MANIFOLD - INT. & EXH.	YEARS	PART NO.	DESCRIPTION	
1	Int. Manifold Gasket Set	1996-91	MS 94664	Upper set incl.	
1	Exh. Manifold Gasket Set	1996-91	MS 94625		
QTY	EXHAUST PIPE FLANGE	YEARS	PART NO.	DESCRIPTION	
2	Exhaust Pipe Gasket	1996-91	60517	Converter	
1	Exhaust Pipe Gasket	1996-91	60877	Loc. Front	
1	Exhaust Pipe Gasket	1996-91	60878	Pipe to muffler	
QTY	OIL PAN	YEARS	PART NO.	DESCRIPTION	
1	Oil Pan Gasket Set	1996-91	OS 30632 R	PermaDry® molded rubber gskt. incl.	
QTY	CRANKSHAFT REAR SEAL	YEARS	PART NO.	DESCRIPTION	
1	Rear Main Seal Set	1996-91	BS 40430	Rubber; One-piece	
1	Repair Sleeve	1996-91	16275	Crankshaft; Use w/installation tool	
QTY	VALVE COVER	YEARS	PART NO.	DESCRIPTION	
1	Valve Cover Gasket Set	1996-91	VS 50365 R	w/Grommets & Spark plug tube seals; PermaDry® molded rubber gskt. incl.	
1	Valve Cover Gasket Set	1996-91	VS 50365 R-1	w/o Grommets & Spark plug tube seals; PermaDry® molded rubber gskt. incl.	
QTY	VALVE STEM SEAL SET	YEARS	PART NO.	DESCRIPTION	
1	Valve Stem Seal Set	1996-91	SS 70283-1	Premium valve stem seals incl.	
QTY	THERMOSTAT HOUSING	YEARS	PART NO.	DESCRIPTION	
1	Thermostat Gasket	1996-91	35480	Thermostat Housing; Thermostat O-ring	
QTY	WATER OUTLET GASKET	YEARS	PART NO.	DESCRIPTION	
1	Water Outlet Gasket	1996-91	35469	Water Outlet	
QTY	WATER PUMP	YEARS	PART NO.	DESCRIPTION	
1	Water Pump Mounting Set	1996-91	ES 72804		
QTY	TIMING COVER	YEARS	PART NO.	DESCRIPTION	
1	Crankshaft Front Seal Set	1996-91	TCS 45899	Must be used w/OS 30632R	
1	Camshaft Front Seal Set	1996-91	TCS 45898		
1	Repair Sleeve	1996-91	16222	Timing Cover; Use w/installation tool	
1	Repair Sleeve Tool	1996-91	16323	Timing Cover	
QTY	CARB & FUEL INJECTION	YEARS	PART NO.	DESCRIPTION	
1	Throttle Body Gasket	1996-91	60778		

Honda Car (Incl. Acura, Honda) (Cont.)

43		1996 - 1991; 2.2L 131.6 (2156cc) SOHC L4 (16 Valve) 85mm Bore			43
(cont.)		MFI; Gasoline; Naturally Aspirated Honda Eng.; Eng. Code F22A1			(cont.)
QTY	DISTRIBUTOR MOUNTING	YEARS	PART NO.	DESCRIPTION	
1	Distributor Mounting Gasket	1996-91	72454	Distributor Mounting; O-ring; 26.5mm ID	
QTY	EXHAUST GAS RECIRCULATION	YEARS	PART NO.	DESCRIPTION	
1	EGR Gasket	1996-91	70978		
44		1991; 2.2L 131.6 (2156cc) SOHC L4 (16 Valve) 85mm Bore			44
		MFI; Gasoline; Naturally Aspirated Honda Eng.; Eng. Code F22A4			
QTY	CYLINDER HEAD	YEARS	PART NO.	DESCRIPTION	
1	Head Gasket	1991	9851 PT	Head bolts not incl.; Head bolt replacement recommended; PermaTorqueMLS®	
1	Head Set	1991	HS 9851 PT-1	Head bolts not incl.; Head bolt replacement recommended; Exh. pipe to muffler gskt. not incl.; PermaDry® molded rubber valve cover gskt. incl.; Premium valve stem seals incl.	
QTY	CONVERSION SET	YEARS	PART NO.	DESCRIPTION	
1	Gasket Conversion Set	1991	CS 9851	PermaDry® molded rubber oil pan gskt. incl.	
QTY	MANIFOLD - INT. & EXH.	YEARS	PART NO.	DESCRIPTION	
1	Int. Manifold Gasket Set	1991	MS 94781	Lower set; Upper set incl.	
1	Plenum Gasket Set	1991	MS 94781-1	Upper set	
1	Exh. Manifold Gasket Set	1991	MS 94959		
QTY	EXHAUST PIPE FLANGE	YEARS	PART NO.	DESCRIPTION	
2	Exhaust Pipe Gasket	1991	60517	Converter	
1	Exhaust Pipe Gasket	1991	60568	Pipe to muffler	
2	Exhaust Pipe Gasket	1991	60776	Loc. Front	
QTY	OIL PAN	YEARS	PART NO.	DESCRIPTION	
1	Oil Pan Gasket Set	1991	OS 30632 R	PermaDry® molded rubber gskt. incl.	
QTY	CRANKSHAFT REAR SEAL	YEARS	PART NO.	DESCRIPTION	
1	Rear Main Seal Set	1991	BS 40430	Rubber; One-piece	
1	Repair Sleeve	1991	16275	Crankshaft; Use w/installation tool	
QTY	VALVE COVER	YEARS	PART NO.	DESCRIPTION	
1	Valve Cover Gasket Set	1991	VS 50365 R	w/Grommets & Spark plug tube seals; PermaDry® molded rubber gskt. incl.	
1	Valve Cover Gasket Set	1991	VS 50365 R-1	w/o Grommets & Spark plug tube seals; PermaDry® molded rubber gskt. incl.	
QTY	VALVE STEM SEAL SET	YEARS	PART NO.	DESCRIPTION	
1	Valve Stem Seal Set	1991	SS 70283-1	Premium valve stem seals incl.	
QTY	THERMOSTAT HOUSING	YEARS	PART NO.	DESCRIPTION	
1	Thermostat Gasket	1991	35480	Thermostat Housing; Thermostat O-ring	
QTY	WATER OUTLET GASKET	YEARS	PART NO.	DESCRIPTION	
1	Water Outlet Gasket	1991	35469	Water Outlet	
QTY	WATER PUMP	YEARS	PART NO.	DESCRIPTION	
1	Water Pump Mounting Set	1991	ES 72804		
QTY	TIMING COVER	YEARS	PART NO.	DESCRIPTION	
1	Crankshaft Front Seal Set	1991	TCS 45899	Must be used w/OS 30632R	
1	Camshaft Front Seal Set	1991	TCS 45898		
1	Repair Sleeve	1991	16222	Timing Cover; Use w/installation tool	
1	Repair Sleeve Tool	1991	16323	Timing Cover	
QTY	CARB & FUEL INJECTION	YEARS	PART NO.	DESCRIPTION	
1	Throttle Body Gasket	1991	60778		
QTY	DISTRIBUTOR MOUNTING	YEARS	PART NO.	DESCRIPTION	
1	Distributor Mounting Gasket	1991	72454	Distributor Mounting; O-ring; 26.5mm ID	
QTY	EXHAUST GAS RECIRCULATION	YEARS	PART NO.	DESCRIPTION	
1	EGR Gasket	1991	70978		
45		1993 - 1991; 2.2L 131.6 (2156cc) SOHC L4 (16 Valve) 85mm Bore			45
		MFI; Gasoline; Naturally Aspirated Honda Eng.; Eng. Code F22A6			
QTY	CYLINDER HEAD	YEARS	PART NO.	DESCRIPTION	
1	Head Gasket	1993-91	9851 PT	Head bolts not incl.; Head bolt replacement recommended; PermaTorqueMLS®	
1	Head Set	1993-91	HS 9851 PT	Head bolts not incl.; Head bolt replacement recommended; Exh. pipe to muffler gskt. not incl.; PermaDry® molded rubber valve cover gskt. incl.; Premium valve stem seals incl.	
1	Head Installation Set	1993-91	HIS 9851 PT	Head bolts not incl.; Head bolt replacement recommended; Exh. pipe to manifold gskt. & exh. pipe to muffler gskt. not incl.; PermaDry® molded rubber valve cover gskt. incl.	
QTY	CONVERSION SET	YEARS	PART NO.	DESCRIPTION	
1	Gasket Conversion Set	1993-91	CS 9851	PermaDry® molded rubber oil pan gskt. incl.	

Honda Car (Incl. Acura, Honda) (Cont.)

45 (cont.)		1993 - 1991; 2.2L 131.6 (2156cc) SOHC L4 (16 Valve) 85mm Bore			45 (cont.)
MFI; Gasoline; Naturally Aspirated Honda Eng.; Eng. Code F22A6					
QTY	MANIFOLD - INT. & EXH.	YEARS	PART NO.	DESCRIPTION	
1	Int. Manifold Gasket Set	1993-91	MS 94664	Upper set incl.	
1	Exh. Manifold Gasket Set	1993-91	MS 94625		
QTY	EXHAUST PIPE FLANGE	YEARS	PART NO.	DESCRIPTION	
2	Exhaust Pipe Gasket	1993-91	60517	Converter	
1	Exhaust Pipe Gasket	1993-91	60877	Loc. Front	
1	Exhaust Pipe Gasket	1993-91	60878	Pipe to muffler	
QTY	OIL PAN	YEARS	PART NO.	DESCRIPTION	
1	Oil Pan Gasket Set	1993-91	OS 30632 R	PermaDry® molded rubber gskt. incl.	
QTY	CRANKSHAFT REAR SEAL	YEARS	PART NO.	DESCRIPTION	
1	Rear Main Seal Set	1993-91	BS 40430	Rubber; One-piece	
1	Repair Sleeve	1993-91	16275	Crankshaft; Use w/installation tool	
QTY	VALVE COVER	YEARS	PART NO.	DESCRIPTION	
1	Valve Cover Gasket Set	1993-91	VS 50365 R	w/Grommets & Spark plug tube seals; PermaDry® molded rubber gskt. incl.	
1	Valve Cover Gasket Set	1993-91	VS 50365 R-1	w/o Grommets & Spark plug tube seals; PermaDry® molded rubber gskt. incl.	
QTY	VALVE STEM SEAL SET	YEARS	PART NO.	DESCRIPTION	
1	Valve Stem Seal Set	1993-91	SS 70283-1	Premium valve stem seals incl.	
QTY	THERMOSTAT HOUSING	YEARS	PART NO.	DESCRIPTION	
1	Thermostat Gasket	1993-91	35480	Thermostat Housing; Thermostat O-ring	
QTY	WATER OUTLET GASKET	YEARS	PART NO.	DESCRIPTION	
1	Water Outlet Gasket	1993-91	35469	Water Outlet	
QTY	WATER PUMP	YEARS	PART NO.	DESCRIPTION	
1	Water Pump Mounting Set	1993-91	ES 72804		
QTY	TIMING COVER	YEARS	PART NO.	DESCRIPTION	
1	Crankshaft Front Seal Set	1993-91	TCS 45899	Must be used w/OS 30632R	
1	Camshaft Front Seal Set	1993-91	TCS 45898		
1	Repair Sleeve	1993-91	16222	Timing Cover; Use w/installation tool	
1	Repair Sleeve Tool	1993-91	16323	Timing Cover	
QTY	CARB & FUEL INJECTION	YEARS	PART NO.	DESCRIPTION	
1	Throttle Body Gasket	1993-91	60778		
QTY	DISTRIBUTOR MOUNTING	YEARS	PART NO.	DESCRIPTION	
1	Distributor Mounting Gasket	1993-91	72454	Distributor Mounting; O-ring; 26.5mm ID	
QTY	EXHAUST GAS RECIRCULATION	YEARS	PART NO.	DESCRIPTION	
1	EGR Gasket	1993-91	70978		
46		1997 - 1994; 2.2L 131.6 (2156cc) SOHC L4 (16 Valve) 85mm Bore			46
MFI; Gasoline; Naturally Aspirated Honda Eng.; Eng. Code F22B2					
QTY	CYLINDER HEAD	YEARS	PART NO.	DESCRIPTION	
1	Head Gasket	1997-94	9958 PT-1	Head bolts not incl.; Head bolt replacement recommended; PermaTorqueMLS®; Improved design	
1	Head Set	1997-94	HS 9958 PT	Head bolts not incl.; Head bolt replacement recommended; PermaDry® molded rubber valve cover gskt. incl.; Premium valve stem seals incl.	
QTY	CONVERSION SET	YEARS	PART NO.	DESCRIPTION	
1	Gasket Conversion Set	1997-94	CS 9851	PermaDry® molded rubber oil pan gskt. incl.	
QTY	MANIFOLD - INT. & EXH.	YEARS	PART NO.	DESCRIPTION	
1	Int. Manifold Gasket Set	1997-94	MS 95612	Upper set incl.	
1	Exh. Manifold Gasket Set	1997-94	MS 94184	Improved design	
QTY	EXHAUST PIPE FLANGE	YEARS	PART NO.	DESCRIPTION	
1	Exhaust Pipe Gasket	1997-94	60517	Loc. Rear; Converter	
1	Exhaust Pipe Gasket	1997-94	60669	Loc. Front; Converter	
1	Exhaust Pipe Gasket	1997-94	60877	Flange	
QTY	OIL PAN	YEARS	PART NO.	DESCRIPTION	
1	Oil Pan Gasket Set	1997-94	OS 30632 R	PermaDry® molded rubber gskt. incl.	
QTY	CRANKSHAFT REAR SEAL	YEARS	PART NO.	DESCRIPTION	
1	Rear Main Seal Set	1997-94	BS 40430	Rubber; One-piece	
1	Repair Sleeve	1997-94	16275	Crankshaft; Use w/installation tool	
QTY	VALVE COVER	YEARS	PART NO.	DESCRIPTION	
1	Valve Cover Gasket Set	1997-94	VS 50365 R	w/Grommets & Spark plug tube seals; PermaDry® molded rubber gskt. incl.	
1	Valve Cover Gasket Set	1997-94	VS 50365 R-1	w/o Grommets & Spark plug tube seals; PermaDry® molded rubber gskt. incl.	
QTY	VALVE STEM SEAL SET	YEARS	PART NO.	DESCRIPTION	
1	Valve Stem Seal Set	1997-94	SS 70283-1	Premium valve stem seals incl.	

Honda Car (Incl. Acura, Honda) (Cont.)

46 (cont.)		1997 - 1994; 2.2L 131.6 (2156cc) SOHC L4 (16 Valve) 85mm Bore			46 (cont.)
		MFI; Gasoline; Naturally Aspirated Honda Eng.; Eng. Code F22B2			
QTY	THERMOSTAT HOUSING	YEARS	PART NO.	DESCRIPTION	
1	Thermostat Gasket	1997-94	35480	Thermostat Housing; Thermostat O-ring	
QTY	WATER OUTLET GASKET	YEARS	PART NO.	DESCRIPTION	
1	Water Outlet Gasket	1997-94	35469	Water Outlet	
QTY	WATER PUMP	YEARS	PART NO.	DESCRIPTION	
1	Water Pump Mounting Set	1997-94	ES 72804		
QTY	TIMING COVER	YEARS	PART NO.	DESCRIPTION	
1	Crankshaft Front Seal Set	1997-94	TCS 45899	Must be used w/OS 30632R	
1	Camshaft Front Seal Set	1997-94	TCS 45898		
1	Repair Sleeve	1997-94	16222	Timing Cover; Use w/installation tool	
1	Repair Sleeve Tool	1997-94	16323	Timing Cover	
QTY	CARB & FUEL INJECTION	YEARS	PART NO.	DESCRIPTION	
1	Throttle Body Gasket	1997-94	60979		
QTY	DISTRIBUTOR MOUNTING	YEARS	PART NO.	DESCRIPTION	
1	Distributor Mounting Gasket	1997-94	72454	Distributor Mounting; O-ring; 26.5mm ID	
1	O-Ring	1997-94	72416	Distributor Mounting; 25mm ID	
QTY	EXHAUST GAS RECIRCULATION	YEARS	PART NO.	DESCRIPTION	
1	EGR Gasket	1997-94	70978		
47		1997 - 1994; 2.2L 131.6 (2156cc) SOHC L4 (16 Valve) 85mm Bore VTEC			47
		MFI; Gasoline; Naturally Aspirated Honda Eng.; Eng. Code F22B1			
QTY	CYLINDER HEAD	YEARS	PART NO.	DESCRIPTION	
1	Head Gasket	1997-94	9958 PT-1	Head bolts not incl.; Head bolt replacement recommended; PermaTorqueMLS®; Improved design	
1	Head Set	1997	HS 9958 PT-1	Honda Accord EX, EX-R; Coupe; Head bolts not incl.; Head bolt replacement recommended; PermaDry® molded rubber valve cover gskt. incl.; Premium valve stem seals incl.	
1	Head Set	1997	HS 9958 PT-1	Acura CL Base, Premium; Head bolts not incl.; Head bolt replacement recommended; PermaDry® molded rubber valve cover gskt. incl.; Premium valve stem seals incl.	
1	Head Set	1997	HS 9958 PT-2	Honda Accord EX, EX-R; Sedan; Head bolts not incl.; Head bolt replacement recommended; PermaDry® molded rubber valve cover gskt. incl.; Premium valve stem seals incl.	
1	Head Set	1997	HS 9958 PT-2	Honda Accord EX, EX-R; Wagon; Head bolts not incl.; Head bolt replacement recommended; PermaDry® molded rubber valve cover gskt. incl.; Premium valve stem seals incl.	
1	Head Set	1996	HS 9958 PT-1	Coupe; Head bolts not incl.; Head bolt replacement recommended; PermaDry® molded rubber valve cover gskt. incl.; Premium valve stem seals incl.	
1	Head Set	1996	HS 9958 PT-2	Sedan; Head bolts not incl.; Head bolt replacement recommended; PermaDry® molded rubber valve cover gskt. incl.; Premium valve stem seals incl.	
1	Head Set	1996	HS 9958 PT-2	Wagon; Head bolts not incl.; Head bolt replacement recommended; PermaDry® molded rubber valve cover gskt. incl.; Premium valve stem seals incl.	
1	Head Set	1995-94	HS 9958 PT-2	Head bolts not incl.; Head bolt replacement recommended; PermaDry® molded rubber valve cover gskt. incl.; Premium valve stem seals incl.	
QTY	CONVERSION SET	YEARS	PART NO.	DESCRIPTION	
1	Gasket Conversion Set	1997-94	CS 9851	PermaDry® molded rubber oil pan gskt. incl.	
QTY	MANIFOLD - INT. & EXH.	YEARS	PART NO.	DESCRIPTION	
1	Int. Manifold Gasket Set	1997	MS 95533	Honda Accord EX, EX-R; Sedan; Upper set incl.	
1	Int. Manifold Gasket Set	1997	MS 95533	Honda Accord EX, EX-R; Wagon; Upper set incl.	
1	Int. Manifold Gasket Set	1997	MS 95612	Honda Accord EX, EX-R; Coupe; Upper set incl.	
1	Int. Manifold Gasket Set	1997	MS 95612	Acura CL Base, Premium; Upper set incl.	
1	Int. Manifold Gasket Set	1996	MS 95533	Sedan; Upper set incl.	
1	Int. Manifold Gasket Set	1996	MS 95533	Wagon; Upper set incl.	
1	Int. Manifold Gasket Set	1996	MS 95612	Coupe; Upper set incl.	
1	Int. Manifold Gasket Set	1995-94	MS 95533	Upper set incl.	
1	Exh. Manifold Gasket Set	1997-94	MS 94184	Improved design	
QTY	EXHAUST PIPE FLANGE	YEARS	PART NO.	DESCRIPTION	
1	Exhaust Pipe Gasket	1997-94	60517	Loc. Rear; Converter	
1	Exhaust Pipe Gasket	1997-94	60669	Loc. Front; Converter	
2	Exhaust Pipe Gasket	1997-94	60776	Flange	
QTY	OIL PAN	YEARS	PART NO.	DESCRIPTION	
1	Oil Pan Gasket Set	1997-94	OS 30632 R	PermaDry® molded rubber gskt. incl.	

Honda Car (Incl. Acura, Honda) (Cont.)

47 (cont.)		1997 - 1994; 2.2L 131.6 (2156cc) SOHC L4 (16 Valve) 85mm Bore VTEC			47 (cont.)
MFI; Gasoline; Naturally Aspirated Honda Eng.; Eng. Code F22B1					
QTY	CRANKSHAFT REAR SEAL	YEARS	PART NO.	DESCRIPTION	
1	Rear Main Seal Set	1997-94	BS 40430	Rubber; One-piece	
1	Repair Sleeve	1997-94	16275	Crankshaft; Use w/installation tool	
QTY	VALVE COVER	YEARS	PART NO.	DESCRIPTION	
1	Valve Cover Gasket Set	1997-94	VS 50493 R	w/Grommets & Spark plug tube seals; PermaDry® molded rubber gskt. incl.	
QTY	VALVE STEM SEAL SET	YEARS	PART NO.	DESCRIPTION	
1	Valve Stem Seal Set	1997-94	SS 70283-1	Premium valve stem seals incl.	
QTY	THERMOSTAT HOUSING	YEARS	PART NO.	DESCRIPTION	
1	Thermostat Gasket	1997-94	35480	Thermostat Housing; Thermostat O-ring	
QTY	WATER OUTLET GASKET	YEARS	PART NO.	DESCRIPTION	
1	Water Outlet Gasket	1997-94	35469	Water Outlet	
QTY	WATER PUMP	YEARS	PART NO.	DESCRIPTION	
1	Water Pump Mounting Set	1997-94	ES 72804		
QTY	TIMING COVER	YEARS	PART NO.	DESCRIPTION	
1	Crankshaft Front Seal Set	1997-94	TCS 45899	Must be used w/OS 30632R	
1	Camshaft Front Seal Set	1997-94	TCS 45898		
1	Repair Sleeve	1997-94	16222	Timing Cover; Use w/installation tool	
1	Repair Sleeve Tool	1997-94	16323	Timing Cover	
QTY	CARB & FUEL INJECTION	YEARS	PART NO.	DESCRIPTION	
1	Throttle Body Gasket	1997-94	60979		
QTY	DISTRIBUTOR MOUNTING	YEARS	PART NO.	DESCRIPTION	
1	Distributor Mounting Gasket	1997-94	72454	Distributor Mounting; O-ring; 26.5mm ID	
1	O-Ring	1997-94	72416	Distributor Mounting; 25mm ID	
QTY	EXHAUST GAS RECIRCULATION	YEARS	PART NO.	DESCRIPTION	
1	EGR Gasket	1997-94	70978		
48		1996 - 1993; 2.2L 132 (2157cc) DOHC L4 (16 Valve) 87mm Bore VTEC			48
MFI; Gasoline; Naturally Aspirated Honda Eng.; Eng. Code H22A1					
QTY	CYLINDER HEAD	YEARS	PART NO.	DESCRIPTION	
1	Head Gasket	1996-93	26408 PT	Head bolts not incl.; Head bolt replacement recommended; PermaTorqueMLS®	
1	Head Set	1996-93	HS 26408 PT	Head bolts not incl.; Head bolt replacement recommended; PermaDry® molded rubber valve cover gskt. incl.; Premium valve stem seals incl.	
QTY	CONVERSION SET	YEARS	PART NO.	DESCRIPTION	
1	Gasket Conversion Set	1996-93	CS 9851-1	PermaDry® molded rubber oil pan gskt. incl.	
QTY	MANIFOLD - INT. & EXH.	YEARS	PART NO.	DESCRIPTION	
1	Int. Manifold Gasket Set	1996-93	MS 97045	Lower set; Upper set incl.	
1	Plenum Gasket Set	1996-93	MS 94781-1	Upper set	
1	Exh. Manifold Gasket Set	1996-93	MS 97046		
QTY	EXHAUST PIPE FLANGE	YEARS	PART NO.	DESCRIPTION	
2	Exhaust Pipe Gasket	1996-93	60776	Flange	
1	Exhaust Pipe Gasket	1996-93	61555	Loc. Front; Converter	
1	Exhaust Pipe Gasket	1996-93	61555	Loc. Rear; Converter	
QTY	OIL PAN	YEARS	PART NO.	DESCRIPTION	
1	Oil Pan Gasket Set	1996-93	OS 30632 R	PermaDry® molded rubber gskt. incl.	
QTY	CRANKSHAFT REAR SEAL	YEARS	PART NO.	DESCRIPTION	
1	Rear Main Seal Set	1996-93	BS 40430	Rubber; One-piece	
1	Repair Sleeve	1996-93	16275	Crankshaft; Use w/installation tool	
QTY	VALVE COVER	YEARS	PART NO.	DESCRIPTION	
1	Valve Cover Gasket Set	1996-93	VS 50747 R	w/Grommets & Spark plug tube seals; PermaDry® molded rubber gskt. incl.	
1	Circular Plug	1996-93	ES 72476	Valve Cover; New Part Number - Check for Availability	
QTY	VALVE STEM SEAL SET	YEARS	PART NO.	DESCRIPTION	
1	Valve Stem Seal Set	1996-93	SS 70283-1	Premium valve stem seals incl.	
QTY	THERMOSTAT HOUSING	YEARS	PART NO.	DESCRIPTION	
1	Thermostat Gasket	1996-93	35731	Thermostat Housing; Thermostat seal	
QTY	WATER OUTLET GASKET	YEARS	PART NO.	DESCRIPTION	
1	Water Outlet Gasket	1996-93	35469	Water Outlet	
QTY	WATER PUMP	YEARS	PART NO.	DESCRIPTION	
1	Water Pump Gasket	1996-93	35005		
QTY	TIMING COVER	YEARS	PART NO.	DESCRIPTION	
1	Crankshaft Front Seal Set	1996-93	TCS 45945	Must be used w/OS 30632R	
1	Camshaft Front Seal Set	1996-93	TCS 45987		
QTY	CARB & FUEL INJECTION	YEARS	PART NO.	DESCRIPTION	
1	Throttle Body Gasket	1996-93	60973		

48		1996 - 1993; 2.2L 132 (2157cc) DOHC L4 (16 Valve) 87mm Bore VTEC			48	
(cont.)		MFI; Gasoline; Naturally Aspirated Honda Eng.; Eng. Code H22A1			(cont.)	
QTY	DISTRIBUTOR MOUNTING	YEARS	PART NO.	DESCRIPTION		
1	Distributor Mounting Gasket	1996-93	72454	Distributor Mounting; O-ring; 26.5mm ID		
QTY	EXHAUST GAS RECIRCULATION	YEARS	PART NO.	DESCRIPTION		
1	EGR Gasket	1996-93	70978			
49		2001 - 1997; 2.2L 132 (2157cc) DOHC L4 (16 Valve) 87mm Bore VTEC			49	
		MFI; Gasoline; Naturally Aspirated Honda Eng.; Eng. Code H22A4				
QTY	CYLINDER HEAD	YEARS	PART NO.	DESCRIPTION		
1	Head Gasket	2001-97	26411 PT	Head bolts not incl.; Head bolt replacement recommended; PermaTorqueMLS®		
1	Head Set	2001-97	HS 26411 PT	Head bolts not incl.; Head bolt replacement recommended; PermaDry® molded rubber valve cover gskt. incl.; Premium valve stem seals incl.		
QTY	CONVERSION SET	YEARS	PART NO.	DESCRIPTION		
1	Gasket Conversion Set	2001-97	CS 9851-1	PermaDry® molded rubber oil pan gskt. incl.		
QTY	MANIFOLD - INT. & EXH.	YEARS	PART NO.	DESCRIPTION		
1	Int. Manifold Gasket Set	2001-97	MS 97045	Lower set; Upper set incl.		
1	Plenum Gasket Set	2001-97	MS 94781-1	Upper set		
1	Exh. Manifold Gasket Set	2001-97	MS 97047			
QTY	EXHAUST PIPE FLANGE	YEARS	PART NO.	DESCRIPTION		
1	Exhaust Pipe Gasket	2001-97	60517	Loc. Rear; Converter		
2	Exhaust Pipe Gasket	2001-97	60776	Flange		
1	Exhaust Pipe Gasket	2001-97	61555	Loc. Front; Converter		
QTY	OIL PAN	YEARS	PART NO.	DESCRIPTION		
1	Oil Pan Gasket Set	2001-97	OS 30632 R	PermaDry® molded rubber gskt. incl.		
QTY	CRANKSHAFT REAR SEAL	YEARS	PART NO.	DESCRIPTION		
1	Rear Main Seal Set	2001-97	BS 40430	Rubber; One-piece		
1	Repair Sleeve	2001-97	16275	Crankshaft; Use w/installation tool		
QTY	VALVE COVER	YEARS	PART NO.	DESCRIPTION		
1	Valve Cover Gasket Set	2001-97	VS 50747 R	w/Grommets & Spark plug tube seals; PermaDry® molded rubber gskt. incl.		
1	Circular Plug	2001-97	ES 72476	Valve Cover; New Part Number - Check for Availability		
QTY	VALVE STEM SEAL SET	YEARS	PART NO.	DESCRIPTION		
1	Valve Stem Seal Set	2001-97	SS 70283-1	Premium valve stem seals incl.		
QTY	THERMOSTAT HOUSING	YEARS	PART NO.	DESCRIPTION		
1	Thermostat Gasket	2001-99	35731	Thermostat Housing; Thermostat seal		
1	O-Ring	1998-97	35162	Thermostat Housing; Thermostat seal		
QTY	WATER OUTLET GASKET	YEARS	PART NO.	DESCRIPTION		
1	Water Outlet Gasket	2001-97	35469	Water Outlet		
QTY	WATER PUMP	YEARS	PART NO.	DESCRIPTION		
1	Water Pump Gasket	2001-97	35005			
QTY	TIMING COVER	YEARS	PART NO.	DESCRIPTION		
1	Crankshaft Front Seal Set	2001-97	TCS 45945	Must be used w/OS 30632R		
1	Camshaft Front Seal Set	2001-97	TCS 45987			
QTY	CARB & FUEL INJECTION	YEARS	PART NO.	DESCRIPTION		
1	Throttle Body Gasket	2001-97	60973			
QTY	DISTRIBUTOR MOUNTING	YEARS	PART NO.	DESCRIPTION		
1	Distributor Mounting Gasket	2001-97	72454	Distributor Mounting; O-ring; 26.5mm ID		
QTY	EXHAUST GAS RECIRCULATION	YEARS	PART NO.	DESCRIPTION		
1	EGR Gasket	2001-97	70978			
50		2009 - 2004; 2.2L 132.8 (2178cc) DOHC L4 (16 Valve) 87mm Bore VTEC			50	
		MFI; Gasoline; Naturally Aspirated Honda Eng.; Eng. Code F22C1				
QTY	CYLINDER HEAD	YEARS	PART NO.	DESCRIPTION		
1	Head Gasket	2009-04	26601 PT	Head bolts not incl.; Head bolt replacement recommended; PermaTorqueMLS®; New Part Number - Check for Availability		
51		2002 - 1998; 2.3L 137.5 (2254cc) SOHC L4 (16 Valve) 86mm Bore			51	
		MFI; Gasoline; Naturally Aspirated Honda Eng.; Eng. Code F23A5				
QTY	CYLINDER HEAD	YEARS	PART NO.	DESCRIPTION		
1	Head Gasket	2002-98	9958 PT-1	Head bolts not incl.; Head bolt replacement recommended; PermaTorqueMLS®; Improved design		
1	Head Set	2002-98	HS 26155 PT	Head bolts not incl.; Head bolt replacement recommended; PermaDry® molded rubber valve cover gskt. incl.; Premium valve stem seals incl.		
1	Head Bolt Set	2002-98	ES 71329	Head bolts w/Washers; Replacement recommended		

Honda Car (Incl. Acura, Honda) (Cont.)

51 (cont.)		2002 - 1998; 2.3L 137.5 (2254cc) SOHC L4 (16 Valve) 86mm Bore			51 (cont.)
MFI; Gasoline; Naturally Aspirated Honda Eng.; Eng. Code F23A5					
QTY	CONVERSION SET	YEARS	PART NO.	DESCRIPTION	
1	Gasket Conversion Set	2002-98	CS 26155	PermaDry® molded rubber oil pan gskt. incl.	
QTY	MANIFOLD - INT. & EXH.	YEARS	PART NO.	DESCRIPTION	
1	Int. Manifold Gasket Set	2002-98	MS 95612-1	Upper set incl.	
1	Exh. Manifold Gasket Set	2002-98	MS 94184	California; Improved design	
1	Exh. Manifold Gasket Set	2002-98	MS 94184	Exc. California; Improved design	
QTY	EXHAUST PIPE FLANGE	YEARS	PART NO.	DESCRIPTION	
1	Exhaust Pipe Gasket	2002-98	60877	Flange	
QTY	OIL PAN	YEARS	PART NO.	DESCRIPTION	
1	Oil Pan Gasket Set	2002-98	OS 30632 R	PermaDry® molded rubber gskt. incl.	
QTY	CRANKSHAFT REAR SEAL	YEARS	PART NO.	DESCRIPTION	
1	Rear Main Seal Set	2002-98	BS 40430	Rubber; One-piece	
1	Repair Sleeve	2002-98	16275	Crankshaft; Use w/installation tool	
QTY	VALVE COVER	YEARS	PART NO.	DESCRIPTION	
1	Valve Cover Gasket Set	2002-98	VS 50493 R	w/Grommets & Spark plug tube seals; PermaDry® molded rubber gskt. incl.	
QTY	VALVE STEM SEAL SET	YEARS	PART NO.	DESCRIPTION	
1	Valve Stem Seal Set	2002-98	SS 70283-1	Premium valve stem seals incl.	
QTY	THERMOSTAT HOUSING	YEARS	PART NO.	DESCRIPTION	
1	Thermostat Gasket	2002-98	35480	Thermostat Housing; Thermostat O-ring	
QTY	WATER OUTLET GASKET	YEARS	PART NO.	DESCRIPTION	
1	Water Outlet Gasket	2002-98	35469	Water Outlet	
QTY	WATER PUMP	YEARS	PART NO.	DESCRIPTION	
1	Water Pump Gasket	2002-98	35482		
QTY	TIMING COVER	YEARS	PART NO.	DESCRIPTION	
1	Crankshaft Front Seal Set	2002-98	TCS 45899	Must be used w/OS 30632R	
1	Camshaft Front Seal Set	2002-98	TCS 45898		
1	Repair Sleeve	2002-98	16222	Timing Cover; Use w/installation tool	
1	Repair Sleeve Tool	2002-98	16323	Timing Cover	
QTY	CARB & FUEL INJECTION	YEARS	PART NO.	DESCRIPTION	
1	Throttle Body Gasket	2002	61126		
1	Throttle Body Gasket	2001-98	61115		
QTY	DISTRIBUTOR MOUNTING	YEARS	PART NO.	DESCRIPTION	
1	Distributor Mounting Gasket	2002-98	72454	Distributor Mounting; O-ring; 26.5mm ID	
1	O-Ring	2002-98	72416	Distributor Mounting; 25mm ID	
QTY	EXHAUST GAS RECIRCULATION	YEARS	PART NO.	DESCRIPTION	
1	EGR Gasket	2002-98	70978		
52		2002 - 1998; 2.3L 137.5 (2254cc) SOHC L4 (16 Valve) 86mm Bore VTEC			52
MFI; Gasoline; Naturally Aspirated Honda Eng.; Eng. Code F23A1					
QTY	CYLINDER HEAD	YEARS	PART NO.	DESCRIPTION	
1	Head Gasket	2002-98	9958 PT-1	Head bolts not incl.; Head bolt replacement recommended; PermaTorqueMLS®; Improved design	
1	Head Set	2002-98	HS 26155 PT	Head bolts not incl.; Head bolt replacement recommended; PermaDry® molded rubber valve cover gskt. incl.; Premium valve stem seals incl.	
1	Head Bolt Set	2002-98	ES 71329	Head bolts w/Washers; Replacement recommended	
QTY	CONVERSION SET	YEARS	PART NO.	DESCRIPTION	
1	Gasket Conversion Set	2002-98	CS 26155	PermaDry® molded rubber oil pan gskt. incl.	
QTY	MANIFOLD - INT. & EXH.	YEARS	PART NO.	DESCRIPTION	
1	Int. Manifold Gasket Set	2002-98	MS 94125-1	Upper set incl.	
1	Exh. Manifold Gasket Set	2002-98	MS 94184	California; Improved design	
1	Exh. Manifold Gasket Set	2002-98	MS 94184	Exc. California; Improved design	
QTY	EXHAUST PIPE FLANGE	YEARS	PART NO.	DESCRIPTION	
1	Exhaust Pipe Gasket	2002-98	60877	Flange	
QTY	OIL PAN	YEARS	PART NO.	DESCRIPTION	
1	Oil Pan Gasket Set	2002-98	OS 30632 R	PermaDry® molded rubber gskt. incl.	
QTY	CRANKSHAFT REAR SEAL	YEARS	PART NO.	DESCRIPTION	
1	Rear Main Seal Set	2002-98	BS 40430	Rubber; One-piece	
1	Repair Sleeve	2002-98	16275	Crankshaft; Use w/installation tool	
QTY	VALVE COVER	YEARS	PART NO.	DESCRIPTION	
1	Valve Cover Gasket Set	2002-98	VS 50493 R	w/Grommets & Spark plug tube seals; PermaDry® molded rubber gskt. incl.	
QTY	VALVE STEM SEAL SET	YEARS	PART NO.	DESCRIPTION	
1	Valve Stem Seal Set	2002-98	SS 70283-1	Premium valve stem seals incl.	
QTY	THERMOSTAT HOUSING	YEARS	PART NO.	DESCRIPTION	
1	Thermostat Gasket	2002-98	35480	Thermostat Housing; Thermostat O-ring	

Honda Car (Incl. Acura, Honda) (Cont.)

52 (cont.)		2002 - 1998; 2.3L 137.5 (2254cc) SOHC L4 (16 Valve) 86mm Bore VTEC MFI; Gasoline; Naturally Aspirated Honda Eng.; Eng. Code F23A1			52 (cont.)
QTY	WATER OUTLET GASKET	YEARS	PART NO.	DESCRIPTION	
1	Water Outlet Gasket	2002-98	35469	Water Outlet	
QTY	WATER PUMP	YEARS	PART NO.	DESCRIPTION	
1	Water Pump Gasket	2002-98	35482		
QTY	TIMING COVER	YEARS	PART NO.	DESCRIPTION	
1	Crankshaft Front Seal Set	2002-98	TCS 45899	Must be used w/OS 30632R	
1	Camshaft Front Seal Set	2002-98	TCS 45898		
1	Repair Sleeve	2002-98	16222	Timing Cover; Use w/installation tool	
1	Repair Sleeve Tool	2002-98	16323	Timing Cover	
QTY	CARB & FUEL INJECTION	YEARS	PART NO.	DESCRIPTION	
1	Throttle Body Gasket	2002	61126		
1	Throttle Body Gasket	2001-98	61115		
QTY	DISTRIBUTOR MOUNTING	YEARS	PART NO.	DESCRIPTION	
1	Distributor Mounting Gasket	2002-98	72454	Distributor Mounting; O-ring; 26.5mm ID	
1	O-Ring	2002-98	72416	Distributor Mounting; 25mm ID	
QTY	EXHAUST GAS RECIRCULATION	YEARS	PART NO.	DESCRIPTION	
1	EGR Gasket	2002-98	70978		
53		2002 - 1998; 2.3L 137.5 (2254cc) SOHC L4 (16 Valve) 86mm Bore VTEC MFI; Gasoline; Naturally Aspirated Honda Eng.; Eng. Code F23A4			53
QTY	CYLINDER HEAD	YEARS	PART NO.	DESCRIPTION	
1	Head Gasket	2002-98	9958 PT-1	Head bolts not incl.; Head bolt replacement recommended; PermaTorqueMLS®; Improved design	
1	Head Set	2002-98	HS 26155 PT	Head bolts not incl.; Head bolt replacement recommended; PermaDry® molded rubber valve cover gskt. incl.; Premium valve stem seals incl.	
1	Head Bolt Set	2002-98	ES 71329	Head bolts w/Washers; Replacement recommended	
QTY	CONVERSION SET	YEARS	PART NO.	DESCRIPTION	
1	Gasket Conversion Set	2002-98	CS 26155	PermaDry® molded rubber oil pan gskt. incl.	
QTY	MANIFOLD - INT. & EXH.	YEARS	PART NO.	DESCRIPTION	
1	Int. Manifold Gasket Set	2002-98	MS 94125-1	Upper set incl.	
1	Exh. Manifold Gasket Set	2002-98	MS 94184	California; Improved design	
1	Exh. Manifold Gasket Set	2002-98	MS 94184	Exc. California; Improved design	
QTY	EXHAUST PIPE FLANGE	YEARS	PART NO.	DESCRIPTION	
1	Exhaust Pipe Gasket	2002-98	60877	Flange	
QTY	OIL PAN	YEARS	PART NO.	DESCRIPTION	
1	Oil Pan Gasket Set	2002-98	OS 30632 R	PermaDry® molded rubber gskt. incl.	
QTY	CRANKSHAFT REAR SEAL	YEARS	PART NO.	DESCRIPTION	
1	Rear Main Seal Set	2002-98	BS 40430	Rubber; One-piece	
1	Repair Sleeve	2002-98	16275	Crankshaft; Use w/installation tool	
QTY	VALVE COVER	YEARS	PART NO.	DESCRIPTION	
1	Valve Cover Gasket Set	2002-98	VS 50493 R	w/Grommets & Spark plug tube seals; PermaDry® molded rubber gskt. incl.	
QTY	VALVE STEM SEAL SET	YEARS	PART NO.	DESCRIPTION	
1	Valve Stem Seal Set	2002-98	SS 70283-1	Premium valve stem seals incl.	
QTY	THERMOSTAT HOUSING	YEARS	PART NO.	DESCRIPTION	
1	Thermostat Gasket	2002-98	35480	Thermostat Housing; Thermostat O-ring	
QTY	WATER OUTLET GASKET	YEARS	PART NO.	DESCRIPTION	
1	Water Outlet Gasket	2002-98	35469	Water Outlet	
QTY	WATER PUMP	YEARS	PART NO.	DESCRIPTION	
1	Water Pump Gasket	2002-98	35482		
QTY	TIMING COVER	YEARS	PART NO.	DESCRIPTION	
1	Crankshaft Front Seal Set	2002-98	TCS 45899	Must be used w/OS 30632R	
1	Camshaft Front Seal Set	2002-98	TCS 45898		
1	Repair Sleeve	2002-98	16222	Timing Cover; Use w/installation tool	
1	Repair Sleeve Tool	2002-98	16323	Timing Cover	
QTY	CARB & FUEL INJECTION	YEARS	PART NO.	DESCRIPTION	
1	Throttle Body Gasket	2002	61126		
1	Throttle Body Gasket	2001-98	61115		
QTY	DISTRIBUTOR MOUNTING	YEARS	PART NO.	DESCRIPTION	
1	Distributor Mounting Gasket	2002-98	72454	Distributor Mounting; O-ring; 26.5mm ID	
1	O-Ring	2002-98	72416	Distributor Mounting; 25mm ID	
QTY	EXHAUST GAS RECIRCULATION	YEARS	PART NO.	DESCRIPTION	
1	EGR Gasket	2002-98	70978		

Honda Car (Incl. Acura, Honda) (Cont.)

54		1996 - 1992; 2.3L 138 (2259cc) DOHC L4 (16 Valve) 87mm Bore MFI; Gasoline; Naturally Aspirated Honda Eng.; Eng. Code H23A1			54
QTY	CYLINDER HEAD	YEARS	PART NO.	DESCRIPTION	
1	Head Gasket	1996-92	9919 PT	Head bolts not incl.; Head bolt replacement recommended; PermaTorqueMLS®	
1	Head Set	1996-92	HS 9919 PT	Head bolts & exh. pipe flange not incl.; Head bolt replacement recommended; PermaDry® molded rubber valve cover gskt. incl.; Premium valve stem seals incl.	
QTY	CONVERSION SET	YEARS	PART NO.	DESCRIPTION	
1	Gasket Conversion Set	1996-92	CS 9851-1	PermaDry® molded rubber oil pan gskt. incl.	
QTY	MANIFOLD - INT. & EXH.	YEARS	PART NO.	DESCRIPTION	
1	Int. Manifold Gasket Set	1996-92	MS 94781	Lower set; Upper set incl.	
1	Plenum Gasket Set	1996-92	MS 94781-1	Upper set	
1	Exh. Manifold Gasket Set	1996-92	MS 94625		
QTY	EXHAUST PIPE FLANGE	YEARS	PART NO.	DESCRIPTION	
2	Exhaust Pipe Gasket	1996-92	60517	Converter	
2	Exhaust Pipe Gasket	1996-92	60776	Flange	
QTY	OIL PAN	YEARS	PART NO.	DESCRIPTION	
1	Oil Pan Gasket Set	1996-92	OS 30632 R	PermaDry® molded rubber gskt. incl.	
QTY	CRANKSHAFT REAR SEAL	YEARS	PART NO.	DESCRIPTION	
1	Rear Main Seal Set	1996-92	BS 40430	Rubber; One-piece	
1	Repair Sleeve	1996-92	16275	Crankshaft; Use w/installation tool	
QTY	VALVE COVER	YEARS	PART NO.	DESCRIPTION	
1	Valve Cover Gasket Set	1996-92	VS 50437 R	w/Grommets & Spark plug tube seals; PermaDry® molded rubber gskt. incl.	
1	Circular Plug	1996-92	ES 72476	Valve Cover; New Part Number - Check for Availability	
QTY	VALVE STEM SEAL SET	YEARS	PART NO.	DESCRIPTION	
1	Valve Stem Seal Set	1996-92	SS 72632-1	Premium valve stem seals incl.	
QTY	THERMOSTAT HOUSING	YEARS	PART NO.	DESCRIPTION	
1	Thermostat Gasket	1996-92	35480	Thermostat Housing; Thermostat O-ring	
QTY	WATER OUTLET GASKET	YEARS	PART NO.	DESCRIPTION	
1	Water Outlet Gasket	1996-92	35469	Water Outlet	
QTY	WATER PUMP	YEARS	PART NO.	DESCRIPTION	
1	Water Pump Gasket	1996-92	35005		
QTY	TIMING COVER	YEARS	PART NO.	DESCRIPTION	
1	Crankshaft Front Seal Set	1996-92	TCS 45945	Must be used w/OS 30632R	
2	Camshaft Front Seal Set	1996-92	TCS 45898		
QTY	CARB & FUEL INJECTION	YEARS	PART NO.	DESCRIPTION	
1	Throttle Body Gasket	1996-92	60973		
QTY	DISTRIBUTOR MOUNTING	YEARS	PART NO.	DESCRIPTION	
1	Distributor Mounting Gasket	1996-92	72454	Distributor Mounting; O-ring; 26.5mm ID	
QTY	EXHAUST GAS RECIRCULATION	YEARS	PART NO.	DESCRIPTION	
1	EGR Gasket	1996-92	70978		
55		2008 - 2004; 2.4L 144 (2354cc) DOHC L4 (16 Valve) 87mm Bore i-VTEC MFI; Gasoline; Naturally Aspirated Honda Eng.; Eng. Code K24A2			55
QTY	CYLINDER HEAD	YEARS	PART NO.	DESCRIPTION	
1	Head Gasket	2008-04	26337 PT	Head bolts not incl.; Head bolt replacement recommended; PermaTorqueMLS®	
1	Head Set	2008-04	HS 26337 PT	Head bolts not incl.; Head bolt replacement recommended; PermaDry® molded rubber valve cover gskt. incl.; Premium valve stem seals incl.	
1	Head Bolt Set	2008-04	ES 71333	Head bolts w/Washers; Replacement recommended	
QTY	CONVERSION SET	YEARS	PART NO.	DESCRIPTION	
1	Gasket Conversion Set	2008-04	CS 26243		
QTY	MANIFOLD - INT. & EXH.	YEARS	PART NO.	DESCRIPTION	
1	Int. Manifold Gasket Set	2008-04	MS 96473	Upper set incl.	
1	Exh. Manifold Gasket Set	2008-04	MS 96474		
QTY	EXHAUST PIPE FLANGE	YEARS	PART NO.	DESCRIPTION	
1	Exhaust Pipe Gasket	2008-04	61550	Packing	
QTY	OIL PAN	YEARS	PART NO.	DESCRIPTION	
1	Oil Pan Gasket Set	2008-04	OS 30746		
QTY	CRANKSHAFT REAR SEAL	YEARS	PART NO.	DESCRIPTION	
1	Rear Main Seal Set	2008-04	BS 40535	Rubber; One-piece; Improved design	
QTY	VALVE COVER	YEARS	PART NO.	DESCRIPTION	
1	Valve Cover Gasket Set	2008-04	VS 50614 R	w/Grommets & Spark plug tube seals; PermaDry® molded rubber gskt. incl.; Improved design	

Honda Car (Incl. Acura, Honda) (Cont.)

55 (cont.)		2008 - 2004; 2.4L 144 (2354cc) DOHC L4 (16 Valve) 87mm Bore i-VTEC			55 (cont.)
		MFI; Gasoline; Naturally Aspirated Honda Eng.; Eng. Code K24A2			
QTY	VALVE COVER	YEARS	PART NO.	DESCRIPTION	
1	Spark Plug Tube Seal Set	2008-04	ES 72967	Valve Cover; New Part Number - Check for Availability	
QTY	VALVE STEM SEAL SET	YEARS	PART NO.	DESCRIPTION	
1	Valve Stem Seal Set	2008-04	SS 70283-1	Premium valve stem seals incl.	
QTY	THERMOSTAT HOUSING	YEARS	PART NO.	DESCRIPTION	
1	Thermostat Gasket	2008-04	35739	Thermostat Housing; Thermostat case	
1	Thermostat Gasket	2008-04	35741	Thermostat Housing; Thermostat seal	
QTY	WATER OUTLET GASKET	YEARS	PART NO.	DESCRIPTION	
1	Water Outlet Gasket	2008-04	36022	Water Outlet; Water pipe O-ring; New Part Number - Check for Availability	
QTY	WATER PUMP	YEARS	PART NO.	DESCRIPTION	
1	Water Pump Gasket	2008-04	35738		
QTY	TIMING COVER	YEARS	PART NO.	DESCRIPTION	
1	Crankshaft Front Seal Set	2008-04	TCS 46051	Must be used w/OS 30746	
QTY	CARB & FUEL INJECTION	YEARS	PART NO.	DESCRIPTION	
1	Fuel Injector O-Ring Set	2008-04	ES 70599	Improved design	
1	Throttle Body Gasket	2008-06	61551		
1	Throttle Body Gasket	2005-04	61349		
QTY	EXHAUST GAS RECIRCULATION	YEARS	PART NO.	DESCRIPTION	
1	EGR Gasket	2008-04	70978	Valve	
1	EGR Gasket	2008-04	71217	Passage	
QTY	OIL FILTER MOUNTING	YEARS	PART NO.	DESCRIPTION	
1	Oil Filter Gasket	2008-04	ES 72748	Oil filter adapter mounting set; New Part Number - Check for Availability	
56		2005 - 2003; 2.4L 144 (2354cc) DOHC L4 (16 Valve) 87mm Bore i-VTEC			56
		MFI; Gasoline; Naturally Aspirated Honda Eng.; Eng. Code K24A4			
QTY	CYLINDER HEAD	YEARS	PART NO.	DESCRIPTION	
1	Head Gasket	2005-03	26243 PT	Head bolts not incl.; Head bolt replacement recommended; PermaTorqueMLS®	
1	Head Set	2005-03	HS 26243 PT	Head bolts not incl.; Head bolt replacement recommended; PermaDry® molded rubber valve cover gskt. incl.; Premium valve stem seals incl.	
1	Head Bolt Set	2005-03	ES 71333	Head bolts w/Washers; Replacement recommended	
QTY	CONVERSION SET	YEARS	PART NO.	DESCRIPTION	
1	Gasket Conversion Set	2005-03	CS 26243		
QTY	MANIFOLD - INT. & EXH.	YEARS	PART NO.	DESCRIPTION	
1	Int. Manifold Gasket Set	2005-03	MS 96473	Upper set incl.	
1	Exh. Manifold Gasket Set	2005-03	MS 96474		
QTY	EXHAUST PIPE FLANGE	YEARS	PART NO.	DESCRIPTION	
1	Exhaust Pipe Gasket	2005-03	61348	Packing	
QTY	OIL PAN	YEARS	PART NO.	DESCRIPTION	
1	Oil Pan Gasket Set	2005-03	OS 30746		
QTY	CRANKSHAFT REAR SEAL	YEARS	PART NO.	DESCRIPTION	
1	Rear Main Seal Set	2005-03	BS 40535	Rubber; One-piece; Improved design	
QTY	VALVE COVER	YEARS	PART NO.	DESCRIPTION	
1	Valve Cover Gasket Set	2005-03	VS 50614 R	w/Grommets & Spark plug tube seals; PermaDry® molded rubber gskt. incl.; Improved design	
1	Valve Cover Gasket Set	2005-03	VS 50627 R	w/Grommets & Spark plug tube seals; PermaDry® molded rubber gskt. incl.; Old design	
1	Spark Plug Tube Seal Set	2005-03	ES 72967	Valve Cover; New Part Number - Check for Availability	
QTY	VALVE STEM SEAL SET	YEARS	PART NO.	DESCRIPTION	
1	Valve Stem Seal Set	2005-03	SS 70283-1	Premium valve stem seals incl.	
QTY	THERMOSTAT HOUSING	YEARS	PART NO.	DESCRIPTION	
1	Thermostat Gasket	2005-03	35739	Thermostat Housing; Thermostat case	
1	Thermostat Gasket	2005-03	35741	Thermostat Housing; Thermostat seal	
QTY	WATER OUTLET GASKET	YEARS	PART NO.	DESCRIPTION	
1	Water Outlet Gasket	2005-03	36022	Water Outlet; Water pipe O-ring; New Part Number - Check for Availability	
QTY	WATER PUMP	YEARS	PART NO.	DESCRIPTION	
1	Water Pump Gasket	2005-03	35738		
QTY	TIMING COVER	YEARS	PART NO.	DESCRIPTION	
1	Crankshaft Front Seal Set	2005-03	TCS 46051	Must be used w/OS 30746	
QTY	CARB & FUEL INJECTION	YEARS	PART NO.	DESCRIPTION	
1	Fuel Injector O-Ring Set	2005-03	ES 70599	Improved design	
1	Throttle Body Gasket	2005-03	61349		
QTY	EXHAUST GAS RECIRCULATION	YEARS	PART NO.	DESCRIPTION	
1	EGR Gasket	2005-03	70978	Valve	

Honda Car (Incl. Acura, Honda) (Cont.)

56		2005 - 2003; 2.4L 144 (2354cc) DOHC L4 (16 Valve) 87mm Bore i-VTEC			56
(cont.)		MFI; Gasoline; Naturally Aspirated Honda Eng.; Eng. Code K24A4			(cont.)
QTY	EXHAUST GAS RECIRCULATION	YEARS	PART NO.	DESCRIPTION	
1	EGR Gasket	2005-03	71217	Passage	
QTY	OIL FILTER MOUNTING	YEARS	PART NO.	DESCRIPTION	
1	Oil Filter Gasket	2005-03	ES 72748	Oil filter adapter mounting set; New Part Number - Check for Availability	
57		2007 - 2006; 2.4L 144 (2354cc) DOHC L4 (16 Valve) 87mm Bore i-VTEC			57
(cont.)		MFI; Gasoline; Naturally Aspirated Honda Eng.; Eng. Code K24A8			(cont.)
QTY	CYLINDER HEAD	YEARS	PART NO.	DESCRIPTION	
1	Head Gasket	2007-06	26337 PT	Head bolts not incl.; Head bolt replacement recommended; PermaTorqueMLS®	
1	Head Set	2007-06	HS 26337 PT	Head bolts not incl.; Head bolt replacement recommended; PermaDry® molded rubber valve cover gskt. incl.; Premium valve stem seals incl.	
1	Head Bolt Set	2007-06	ES 71333	Head bolts w/Washers; Replacement recommended	
QTY	CONVERSION SET	YEARS	PART NO.	DESCRIPTION	
1	Gasket Conversion Set	2007-06	CS 26243		
QTY	MANIFOLD - INT. & EXH.	YEARS	PART NO.	DESCRIPTION	
1	Int. Manifold Gasket Set	2007-06	MS 96473	Upper set incl.	
1	Exh. Manifold Gasket Set	2007-06	MS 96474		
QTY	EXHAUST PIPE FLANGE	YEARS	PART NO.	DESCRIPTION	
1	Exhaust Pipe Gasket	2007-06	61348	Packing	
QTY	OIL PAN	YEARS	PART NO.	DESCRIPTION	
1	Oil Pan Gasket Set	2007-06	OS 30746		
QTY	CRANKSHAFT REAR SEAL	YEARS	PART NO.	DESCRIPTION	
1	Rear Main Seal Set	2007-06	BS 40535	Rubber; One-piece; Improved design	
QTY	VALVE COVER	YEARS	PART NO.	DESCRIPTION	
1	Valve Cover Gasket Set	2007-06	VS 50614 R	w/Grommets & Spark plug tube seals; PermaDry® molded rubber gskt. incl.; Improved design	
1	Spark Plug Tube Seal Set	2007-06	ES 72967	Valve Cover; New Part Number - Check for Availability	
QTY	VALVE STEM SEAL SET	YEARS	PART NO.	DESCRIPTION	
1	Valve Stem Seal Set	2007-06	SS 70283-1	Premium valve stem seals incl.	
QTY	THERMOSTAT HOUSING	YEARS	PART NO.	DESCRIPTION	
1	Thermostat Gasket	2007-06	35739	Thermostat Housing; Thermostat case	
1	Thermostat Gasket	2007-06	35741	Thermostat Housing; Thermostat seal	
QTY	WATER OUTLET GASKET	YEARS	PART NO.	DESCRIPTION	
1	Water Outlet Gasket	2007-06	36022	Water Outlet; Water pipe O-ring; New Part Number - Check for Availability	
QTY	WATER PUMP	YEARS	PART NO.	DESCRIPTION	
1	Water Pump Gasket	2007-06	35738		
QTY	TIMING COVER	YEARS	PART NO.	DESCRIPTION	
1	Crankshaft Front Seal Set	2007-06	TCS 46051	Must be used w/OS 30746	
QTY	CARB & FUEL INJECTION	YEARS	PART NO.	DESCRIPTION	
1	Fuel Injector O-Ring Set	2007-06	ES 70599	Improved design	
1	Throttle Body Gasket	2007-06	61557		
QTY	EXHAUST GAS RECIRCULATION	YEARS	PART NO.	DESCRIPTION	
1	EGR Gasket	2007-06	70978	Valve	
1	EGR Gasket	2007-06	71217	Passage	
QTY	OIL FILTER MOUNTING	YEARS	PART NO.	DESCRIPTION	
1	Oil Filter Gasket	2007-06	ES 72748	Oil filter adapter mounting set; New Part Number - Check for Availability	
58		2012 - 2008; 2.4L 144 (2354cc) DOHC L4 (16 Valve) 87mm Bore i-VTEC			58
(cont.)		MFI; Gasoline; Naturally Aspirated Honda Eng.; Eng. Code K24Z2			(cont.)
QTY	CYLINDER HEAD	YEARS	PART NO.	DESCRIPTION	
1	Head Gasket	2012-08	26435 PT	Head bolts not incl.; Head bolt replacement recommended; PermaTorqueMLS®	
1	Head Set	2012-08	HS 26435 PT	Head bolts not incl.; Head bolt replacement recommended; PermaDry® molded rubber valve cover gskt. incl.; Premium valve stem seals incl.	
1	Head Bolt Set	2012-08	ES 72284	Head bolts w/Washers; Replacement recommended	
QTY	CONVERSION SET	YEARS	PART NO.	DESCRIPTION	
1	Gasket Conversion Set	2012-08	CS 26399	RTV sealant incl. for oil pan gskt.; Improved design	
1	Gasket Conversion Set	2012-08	CS 26435	RTV sealant incl. for oil pan gskt.; Old design	
QTY	MANIFOLD - INT. & EXH.	YEARS	PART NO.	DESCRIPTION	
1	Int. Manifold Gasket Set	2012-08	MS 97093	Upper set incl.	
1	Exh. Manifold Gasket Set	2012-08	MS 97036		
QTY	EXHAUST PIPE FLANGE	YEARS	PART NO.	DESCRIPTION	
2	Exhaust Pipe Gasket	2012-08	61344	Converter	

Honda Car (Incl. Acura, Honda) (Cont.)

58		2012 - 2008; 2.4L 144 (2354cc) DOHC L4 (16 Valve) 87mm Bore i-VTEC			58	
(cont.)		MFI; Gasoline; Naturally Aspirated Honda Eng.; Eng. Code K24Z2			(cont.)	
QTY	EXHAUST PIPE FLANGE	YEARS	PART NO.	DESCRIPTION		
1	Exhaust Pipe Gasket	2012-08	61550	Packing		
QTY	OIL PAN	YEARS	PART NO.	DESCRIPTION		
1	Oil Pan Gasket Set	2012-08	OS 30746			
QTY	CRANKSHAFT REAR SEAL	YEARS	PART NO.	DESCRIPTION		
1	Rear Main Seal Set	2012-08	BS 40535	Rubber; One-piece; Improved design		
QTY	VALVE COVER	YEARS	PART NO.	DESCRIPTION		
1	Valve Cover Gasket Set	2012-08	VS 50614 R	w/Grommets & Spark plug tube seals; PermaDry® molded rubber gskt. incl.; Improved design		
1	Spark Plug Tube Seal Set	2012-08	ES 72967	Valve Cover; New Part Number - Check for Availability		
QTY	VALVE STEM SEAL SET	YEARS	PART NO.	DESCRIPTION		
1	Valve Stem Seal Set	2012-08	SS 70283-1	Premium valve stem seals incl.		
QTY	THERMOSTAT HOUSING	YEARS	PART NO.	DESCRIPTION		
1	Thermostat Gasket	2012-08	35739	Thermostat Housing; Thermostat case		
1	Thermostat Gasket	2012-08	35741	Thermostat Housing; Thermostat seal		
1	Thermostat Gasket	2012-08	35890	Thermostat Housing; Thermostat housing to block		
QTY	WATER OUTLET GASKET	YEARS	PART NO.	DESCRIPTION		
1	Water Outlet Gasket	2012-08	36022	Water Outlet; Water pipe O-ring; New Part Number - Check for Availability		
QTY	WATER PUMP	YEARS	PART NO.	DESCRIPTION		
1	Water Pump Gasket	2012-08	35738			
QTY	TIMING COVER	YEARS	PART NO.	DESCRIPTION		
1	Crankshaft Front Seal Set	2012-08	TCS 46051	Must be used w/OS 30746		
QTY	CARB & FUEL INJECTION	YEARS	PART NO.	DESCRIPTION		
1	Fuel Injector O-Ring Set	2012-08	ES 70599	Improved design		
1	Throttle Body Gasket	2012-08	61557			
QTY	EXHAUST GAS RECIRCULATION	YEARS	PART NO.	DESCRIPTION		
1	EGR Gasket	2012-08	70978	Valve		
QTY	OIL FILTER MOUNTING	YEARS	PART NO.	DESCRIPTION		
1	Oil Filter Gasket	2012-08	ES 73006	Oil filter mounting seal set; New Part Number - Check for Availability		
59		2013 - 2008; 2.4L 144 (2354cc) DOHC L4 (16 Valve) 87mm Bore i-VTEC			59	
		MFI; Gasoline; Naturally Aspirated Honda Eng.; Eng. Code K24Z3				
QTY	CYLINDER HEAD	YEARS	PART NO.	DESCRIPTION		
1	Head Gasket	2013-08	26435 PT	Head bolts not incl.; Head bolt replacement recommended; PermaTorqueMLS®		
1	Head Set	2013-08	HS 26435 PT	Head bolts not incl.; Head bolt replacement recommended; PermaDry® molded rubber valve cover gskt. incl.; Premium valve stem seals incl.		
1	Head Bolt Set	2013-08	ES 72284	Head bolts w/Washers; Replacement recommended		
QTY	CONVERSION SET	YEARS	PART NO.	DESCRIPTION		
1	Gasket Conversion Set	2013-08	CS 26399	RTV sealant incl. for oil pan gskt.; Improved design		
1	Gasket Conversion Set	2013-08	CS 26435	RTV sealant incl. for oil pan gskt.; Old design		
QTY	MANIFOLD - INT. & EXH.	YEARS	PART NO.	DESCRIPTION		
1	Int. Manifold Gasket Set	2013-08	MS 97093	Upper set incl.		
1	Exh. Manifold Gasket Set	2013-08	MS 97036			
QTY	EXHAUST PIPE FLANGE	YEARS	PART NO.	DESCRIPTION		
2	Exhaust Pipe Gasket	2013-08	61344	Converter		
1	Exhaust Pipe Gasket	2013-08	61550	Packing		
QTY	OIL PAN	YEARS	PART NO.	DESCRIPTION		
1	Oil Pan Gasket Set	2013-08	OS 30746			
QTY	CRANKSHAFT REAR SEAL	YEARS	PART NO.	DESCRIPTION		
1	Rear Main Seal Set	2013-08	BS 40535	Rubber; One-piece; Improved design		
QTY	VALVE COVER	YEARS	PART NO.	DESCRIPTION		
1	Valve Cover Gasket Set	2013-08	VS 50614 R	w/Grommets & Spark plug tube seals; PermaDry® molded rubber gskt. incl.; Improved design		
1	Spark Plug Tube Seal Set	2013-08	ES 72967	Valve Cover; New Part Number - Check for Availability		
QTY	VALVE STEM SEAL SET	YEARS	PART NO.	DESCRIPTION		
1	Valve Stem Seal Set	2013-08	SS 70283-1	Premium valve stem seals incl.		
QTY	THERMOSTAT HOUSING	YEARS	PART NO.	DESCRIPTION		
1	Thermostat Gasket	2013-08	35739	Thermostat Housing; Thermostat case		
1	Thermostat Gasket	2013-08	35741	Thermostat Housing; Thermostat seal		
1	Thermostat Gasket	2013-08	35890	Thermostat Housing; Thermostat housing to block		
QTY	WATER OUTLET GASKET	YEARS	PART NO.	DESCRIPTION		
1	Water Outlet Gasket	2013-08	36022	Water Outlet; Water pipe O-ring; New Part Number - Check for Availability		
QTY	WATER PUMP	YEARS	PART NO.	DESCRIPTION		
1	Water Pump Gasket	2013-08	35738			

Honda Car (Incl. Acura, Honda) (Cont.)

59		2013 - 2008; 2.4L 144 (2354cc) DOHC L4 (16 Valve) 87mm Bore i-VTEC			59	
(cont.)		MFI; Gasoline; Naturally Aspirated Honda Eng.; Eng. Code K24Z3			(cont.)	
QTY	TIMING COVER	YEARS	PART NO.	DESCRIPTION		
1	Crankshaft Front Seal Set	2013-08	TCS 46051	Must be used w/OS 30746		
QTY	CARB & FUEL INJECTION	YEARS	PART NO.	DESCRIPTION		
1	Fuel Injector O-Ring Set	2013-08	ES 70599	Improved design		
1	Throttle Body Gasket	2013-08	61557			
QTY	EXHAUST GAS RECIRCULATION	YEARS	PART NO.	DESCRIPTION		
1	EGR Gasket	2013-08	70978	Valve		
QTY	OIL FILTER MOUNTING	YEARS	PART NO.	DESCRIPTION		
1	Oil Filter Gasket	2013-08	ES 73006	Oil filter mounting seal set; New Part Number - Check for Availability		
60		2013 - 2012; 2.4L 144 (2354cc) DOHC L4 (16 Valve) 87mm Bore i-VTEC			60	
		MFI; Gasoline; Naturally Aspirated Honda Eng.; Eng. Code K24Z7				
QTY	CYLINDER HEAD	YEARS	PART NO.	DESCRIPTION		
1	Head Gasket	2013-12	26435 PT	Head bolts not incl.; Head bolt replacement recommended; PermaTorqueMLS®		
1	Head Set	2013-12	HS 26435 PT	Head bolts not incl.; Head bolt replacement recommended; PermaDry® molded rubber valve cover gskt. incl.; Premium valve stem seals incl.		
1	Head Bolt Set	2013-12	ES 72284	Head bolts w/Washers; Replacement recommended		
QTY	CONVERSION SET	YEARS	PART NO.	DESCRIPTION		
1	Gasket Conversion Set	2013-12	CS 26399	RTV sealant incl. for oil pan gskt.; Improved design		
1	Gasket Conversion Set	2013-12	CS 26435	RTV sealant incl. for oil pan gskt.; Old design		
QTY	MANIFOLD - INT. & EXH.	YEARS	PART NO.	DESCRIPTION		
1	Int. Manifold Gasket Set	2013-12	MS 97093	Upper set incl.		
1	Exh. Manifold Gasket Set	2013-12	MS 97036			
QTY	EXHAUST PIPE FLANGE	YEARS	PART NO.	DESCRIPTION		
1	Exhaust Pipe Gasket	2013-12	60884	Exh. connector; Improved design		
1	Exhaust Pipe Gasket	2013-12	61344	Converter		
1	Exhaust Pipe Gasket	2013-12	61550	Pipe to manifold		
QTY	OIL PAN	YEARS	PART NO.	DESCRIPTION		
1	Oil Pan Gasket Set	2013-12	OS 30746			
QTY	CRANKSHAFT REAR SEAL	YEARS	PART NO.	DESCRIPTION		
1	Rear Main Seal Set	2013-12	BS 40535	Rubber; One-piece; Improved design		
QTY	VALVE COVER	YEARS	PART NO.	DESCRIPTION		
1	Valve Cover Gasket Set	2013-12	VS 50614 R	w/Grommets & Spark plug tube seals; PermaDry® molded rubber gskt. incl.; Improved design		
1	Spark Plug Tube Seal Set	2013-12	ES 72967	Valve Cover; New Part Number - Check for Availability		
QTY	VALVE STEM SEAL SET	YEARS	PART NO.	DESCRIPTION		
1	Valve Stem Seal Set	2013-12	SS 70283-1	Premium valve stem seals incl.		
QTY	THERMOSTAT HOUSING	YEARS	PART NO.	DESCRIPTION		
1	Thermostat Gasket	2013-12	35739	Thermostat Housing; Thermostat case		
1	Thermostat Gasket	2013-12	35741	Thermostat Housing; Thermostat seal		
1	Thermostat Gasket	2013-12	35890	Thermostat Housing; Thermostat housing to block		
QTY	WATER OUTLET GASKET	YEARS	PART NO.	DESCRIPTION		
1	Water Outlet Gasket	2013-12	36022	Water Outlet; Water pipe O-ring; New Part Number - Check for Availability		
QTY	WATER PUMP	YEARS	PART NO.	DESCRIPTION		
1	Water Pump Gasket	2013-12	35738			
QTY	TIMING COVER	YEARS	PART NO.	DESCRIPTION		
1	Crankshaft Front Seal Set	2013-12	TCS 46051	Must be used w/OS 30746		
QTY	CARB & FUEL INJECTION	YEARS	PART NO.	DESCRIPTION		
1	Fuel Injector O-Ring Set	2013-12	ES 70599	Improved design		
1	Throttle Body Gasket	2013-12	61557			
QTY	EXHAUST GAS RECIRCULATION	YEARS	PART NO.	DESCRIPTION		
1	EGR Gasket	2013-12	70978	Valve		
QTY	OIL FILTER MOUNTING	YEARS	PART NO.	DESCRIPTION		
1	Oil Filter Gasket	2013-12	ES 73006	Oil filter mounting seal set; New Part Number - Check for Availability		
61		1994 - 1992; 2.5L 149.8 (2451cc) SOHC L5 (20 Valve) 85mm Bore			61	
		MFI; Gasoline; Naturally Aspirated Honda Eng.; Eng. Code G25A1				
QTY	CYLINDER HEAD	YEARS	PART NO.	DESCRIPTION		
1	Head Gasket	1994-92	26413 PT	Head bolts not incl.; Head bolt replacement recommended; PermaTorqueMLS®		
1	Head Set	1994-92	HS 26413 PT	Head bolts not incl.; Head bolt replacement recommended; PermaDry® molded rubber valve cover gskt. incl.; Premium valve stem seals incl.		

Honda Car (Incl. Acura, Honda) (Cont.)

61 (cont.)		1994 - 1992; 2.5L 149.8 (2451cc) SOHC L5 (20 Valve) 85mm Bore			61 (cont.)
MFI; Gasoline; Naturally Aspirated Honda Eng.; Eng. Code G25A1					
QTY	CONVERSION SET	YEARS	PART NO.	DESCRIPTION	
1	Gasket Conversion Set	1994-92	CS 26412	RTV sealant incl. for oil pan gskt.	
QTY	MANIFOLD - INT. & EXH.	YEARS	PART NO.	DESCRIPTION	
1	Int. Manifold Gasket Set	1994-92	MS 97050	Upper set incl.	
1	Exh. Manifold Gasket Set	1994-92	MS 97049		
QTY	EXHAUST PIPE FLANGE	YEARS	PART NO.	DESCRIPTION	
1	Exhaust Pipe Gasket	1994-92	23624	Flange	
1	Exhaust Pipe Gasket	1994-92	23624	Loc. Front; Converter	
1	Exhaust Pipe Gasket	1994-92	60517	Loc. Rear; Converter	
QTY	OIL PAN	YEARS	PART NO.	DESCRIPTION	
1	Oil Pan Gasket Set	1994-92	OS 30812	RTV Black silicone w/Rubber end seals	
QTY	CRANKSHAFT REAR SEAL	YEARS	PART NO.	DESCRIPTION	
1	Rear Main Seal Set	1994-92	BS 40723	Rubber; One-piece	
QTY	VALVE COVER	YEARS	PART NO.	DESCRIPTION	
1	Valve Cover Gasket Set	1994-92	VS 50753 R	w/Grommets & Spark plug tube seals; PermaDry® molded rubber gskt. incl.	
QTY	VALVE STEM SEAL SET	YEARS	PART NO.	DESCRIPTION	
1	Valve Stem Seal Set	1994-92	SS 70283-3	Premium valve stem seals incl.	
QTY	THERMOSTAT HOUSING	YEARS	PART NO.	DESCRIPTION	
1	Thermostat Gasket	1994-92	35902	Thermostat Housing; Thermostat seal	
QTY	WATER PUMP	YEARS	PART NO.	DESCRIPTION	
1	Water Pump Gasket	1994-92	35900		
QTY	TIMING COVER	YEARS	PART NO.	DESCRIPTION	
1	Crankshaft Front Seal Set	1994-92	TCS 46128	Must be used w/OS 30812	
1	Camshaft Front Seal Set	1994-92	TCS 46139		
QTY	CARB & FUEL INJECTION	YEARS	PART NO.	DESCRIPTION	
1	Throttle Body Gasket	1994-92	61545		
QTY	EXHAUST GAS RECIRCULATION	YEARS	PART NO.	DESCRIPTION	
1	EGR Gasket	1994-92	70978	Valve	
1	EGR Gasket	1994-92	72316	Loc. Rear; Pipe	
62		1998 - 1995; 2.5L 149.8 (2451cc) SOHC L5 (20 Valve) 85mm Bore			62
MFI; Gasoline; Naturally Aspirated Honda Eng.; Eng. Code G25A4					
QTY	CYLINDER HEAD	YEARS	PART NO.	DESCRIPTION	
1	Head Gasket	1998-95	26412 PT	Head bolts not incl.; Head bolt replacement recommended; PermaTorqueMLS®	
1	Head Set	1998-95	HS 26412 PT	Head bolts not incl.; Head bolt replacement recommended; PermaDry® molded rubber valve cover gskt. incl.; Premium valve stem seals incl.	
QTY	CONVERSION SET	YEARS	PART NO.	DESCRIPTION	
1	Gasket Conversion Set	1998-95	CS 26412	RTV sealant incl. for oil pan gskt.	
QTY	MANIFOLD - INT. & EXH.	YEARS	PART NO.	DESCRIPTION	
1	Int. Manifold Gasket Set	1998-95	MS 97050	Upper set incl.	
1	Exh. Manifold Gasket Set	1998-95	MS 97049		
QTY	EXHAUST PIPE FLANGE	YEARS	PART NO.	DESCRIPTION	
1	Exhaust Pipe Gasket	1998-95	23624	Flange	
1	Exhaust Pipe Gasket	1998-95	23624	Loc. Front; Converter	
1	Exhaust Pipe Gasket	1998-95	60517	Loc. Rear; Converter	
QTY	OIL PAN	YEARS	PART NO.	DESCRIPTION	
1	Oil Pan Gasket Set	1998-95	OS 30812	RTV Black silicone w/Rubber end seals	
QTY	CRANKSHAFT REAR SEAL	YEARS	PART NO.	DESCRIPTION	
1	Rear Main Seal Set	1998-95	BS 40723	Rubber; One-piece	
QTY	VALVE COVER	YEARS	PART NO.	DESCRIPTION	
1	Valve Cover Gasket Set	1998-95	VS 50753 R	w/Grommets & Spark plug tube seals; PermaDry® molded rubber gskt. incl.	
QTY	VALVE STEM SEAL SET	YEARS	PART NO.	DESCRIPTION	
1	Valve Stem Seal Set	1998-95	SS 70283-3	Premium valve stem seals incl.	
QTY	THERMOSTAT HOUSING	YEARS	PART NO.	DESCRIPTION	
1	Thermostat Gasket	1998-95	35902	Thermostat Housing; Thermostat seal	
QTY	WATER PUMP	YEARS	PART NO.	DESCRIPTION	
1	Water Pump Gasket	1998-95	35900		
QTY	TIMING COVER	YEARS	PART NO.	DESCRIPTION	
1	Crankshaft Front Seal Set	1998-95	TCS 46128	Must be used w/OS 30812	
1	Camshaft Front Seal Set	1998-95	TCS 46139		
QTY	CARB & FUEL INJECTION	YEARS	PART NO.	DESCRIPTION	
1	Throttle Body Gasket	1998-95	61544		

Honda Car (Incl. Acura, Honda) (Cont.)

62 (cont.)	1998 - 1995; 2.5L 149.8 (2451cc) SOHC L5 (20 Valve) 85mm Bore			62 (cont.)
MFI; Gasoline; Naturally Aspirated Honda Eng.; Eng. Code G25A4				
QTY	EXHAUST GAS RECIRCULATION	YEARS	PART NO.	DESCRIPTION
1	EGR Gasket	1998-95	70978	Valve
63	1997 - 1995; 2.7L 163.2 (2675cc) SOHC V6 (24 Valve) 87mm Bore			63
MFI; Gasoline; Naturally Aspirated Honda Eng.; Eng. Code C27A4				
QTY	CYLINDER HEAD	YEARS	PART NO.	DESCRIPTION
2	Head Gasket	1997-95	9531 PT	
1	Head Set	1997-95	HS 9531 PT-1	PermaDry® molded rubber valve cover gsks. incl.; Premium valve stem seals incl.
QTY	CONVERSION SET	YEARS	PART NO.	DESCRIPTION
1	Gasket Conversion Set	1997-95	CS 9450	PermaDry® molded rubber oil pan gskt. incl.
QTY	MANIFOLD - INT. & EXH.	YEARS	PART NO.	DESCRIPTION
1	Int. Manifold Gasket Set	1997-95	MS 93770-1	Upper set incl.
1	Exh. Manifold Gasket Set	1997-95	MS 93361	
QTY	EXHAUST PIPE FLANGE	YEARS	PART NO.	DESCRIPTION
1	Exhaust Pipe Gasket	1997-95	23624	Loc. Front
2	Exhaust Pipe Gasket	1997-95	60517	Converter
1	Exhaust Pipe Gasket	1997-95	60578	Loc. Rear
QTY	OIL PAN	YEARS	PART NO.	DESCRIPTION
1	Oil Pan Gasket Set	1997-95	OS 30544 R	PermaDry® molded rubber gskt. incl.
QTY	CRANKSHAFT REAR SEAL	YEARS	PART NO.	DESCRIPTION
1	Rear Main Seal Set	1997-95	BS 40535	Rubber; One-piece; Improved design
1	Repair Sleeve	1997-95	16275	Crankshaft; Use w/installation tool
QTY	VALVE COVER	YEARS	PART NO.	DESCRIPTION
1	Valve Cover Gasket Set	1997-95	VS 50299 R-2	w/o Circular plugs & w/Grommets; PermaDry® molded rubber gsks. incl.
2	Circular Plug	1997-95	CP 75015	Valve Cover
QTY	VALVE STEM SEAL SET	YEARS	PART NO.	DESCRIPTION
1	Valve Stem Seal Set	1997-95	SS 72632-2	Premium valve stem seals incl.
QTY	THERMOSTAT HOUSING	YEARS	PART NO.	DESCRIPTION
1	Thermostat Gasket	1997-95	35731	Thermostat Housing; Thermostat seal
QTY	WATER PUMP	YEARS	PART NO.	DESCRIPTION
1	Water Pump Gasket	1997-95	35372	
QTY	TIMING COVER	YEARS	PART NO.	DESCRIPTION
1	Crankshaft Front Seal Set	1997-95	TCS 46060	
1	Camshaft Front Seal Set	1997-95	TCS 45704	
QTY	EXHAUST GAS RECIRCULATION	YEARS	PART NO.	DESCRIPTION
1	EGR Gasket	1997-95	70978	
64	2005 - 1991; 3.0L 181.6 (2977cc) DOHC V6 (24 Valve) 90mm Bore VTEC			64
MFI; Gasoline; Naturally Aspirated Honda Eng.; Eng. Code C30A1				
QTY	CYLINDER HEAD	YEARS	PART NO.	DESCRIPTION
2	Head Gasket	2005-91	26635 PT	Head bolts not incl.; Head bolt replacement recommended; New Part Number - Check for Availability
QTY	MANIFOLD - INT. & EXH.	YEARS	PART NO.	DESCRIPTION
1	Int. Manifold Gasket Set	2005-91	MS 97288	Lower set; Upper set incl.; New Part Number - Check for Availability
1	Exh. Manifold Gasket Set	2005-91	MS 97257	New Part Number - Check for Availability
QTY	VALVE COVER	YEARS	PART NO.	DESCRIPTION
1	Valve Cover Gasket Set	2005-91	VS 50840 R	w/Grommets & Spark plug tube seals; PermaDry® molded rubber gsks. incl.; New Part Number - Check for Availability
65	2002 - 1997; 3.0L 182.9 (2997cc) SOHC V6 (24 Valve) 86mm Bore VTEC			65
MFI; Gasoline; Naturally Aspirated Honda Eng.; Eng. Code J30A1				
QTY	CYLINDER HEAD	YEARS	PART NO.	DESCRIPTION
2	Head Gasket	2002-97	26196 PT	Head bolts not incl.; Head bolt replacement recommended; PermaTorqueMLS®; Old design
2	Head Gasket	2002-97	26260 PT	Head bolts not incl.; Head bolt replacement recommended; PermaTorqueMLS®; Improved design
1	Head Set	2002-97	HS 26196 PT	Head bolts not incl.; Head bolt replacement recommended; PermaDry® molded rubber valve cover gsks. incl.; Premium valve stem seals incl.
2	Head Bolt Set	2002-97	ES 71331	6-point Head bolts; Head bolts w/Washers; Replacement recommended
QTY	CONVERSION SET	YEARS	PART NO.	DESCRIPTION
1	Gasket Conversion Set	2002-97	CS 26196	RTV sealant incl. for oil pan gskt.
QTY	MANIFOLD - INT. & EXH.	YEARS	PART NO.	DESCRIPTION
1	Int. Manifold Gasket Set	2002-97	MS 96168	Lower set

Honda Car (Incl. Acura, Honda) (Cont.)

65		2002 - 1997; 3.0L 182.9 (2997cc) SOHC V6 (24 Valve) 86mm Bore VTEC			65
(cont.)		MFI; Gasoline; Naturally Aspirated Honda Eng.; Eng. Code J30A1			(cont.)
QTY	MANIFOLD - INT. & EXH.	YEARS	PART NO.	DESCRIPTION	
1	Plenum Gasket Set	2002-97	MS 96167	Upper set	
1	Plenum Gasket Set	2002-97	MS 96167-2	Upper set; Plenum gskt. only; New Part Number - Check for Availability	
1	Exh. Manifold Gasket Set	2002-97	MS 96166		
QTY	EXHAUST PIPE FLANGE	YEARS	PART NO.	DESCRIPTION	
2	Exhaust Pipe Gasket	2002-97	60578	Pipe to manifold	
QTY	CRANKSHAFT REAR SEAL	YEARS	PART NO.	DESCRIPTION	
1	Rear Main Seal Set	2002-97	BS 40675	Rubber; One-piece	
QTY	VALVE COVER	YEARS	PART NO.	DESCRIPTION	
1	Valve Cover Gasket Set	2002-97	VS 50576 R	w/Grommets & Spark plug tube seals; PermaDry® molded rubber gskts. incl.	
QTY	VALVE STEM SEAL SET	YEARS	PART NO.	DESCRIPTION	
2	Valve Stem Seal Set	2002-97	SS 70283-2	Premium valve stem seals incl.	
QTY	THERMOSTAT HOUSING	YEARS	PART NO.	DESCRIPTION	
1	O-Ring	2002-97	35162	Thermostat Housing	
QTY	WATER OUTLET GASKET	YEARS	PART NO.	DESCRIPTION	
1	Water Crossover Mounting Set	2002-97	ES 72998	Water Outlet; Water bypass set; OEM style; New Part Number - Check for Availability	
QTY	WATER PUMP	YEARS	PART NO.	DESCRIPTION	
1	Water Pump Gasket	2002-97	35677		
QTY	TIMING COVER	YEARS	PART NO.	DESCRIPTION	
1	Crankshaft Front Seal Set	2002-97	TCS 46026		
1	Camshaft Front Seal Set	2002-97	TCS 46025		
QTY	CARB & FUEL INJECTION	YEARS	PART NO.	DESCRIPTION	
1	Throttle Body Gasket	2002-97	61209	Spacer to manifold	
1	Throttle Body Gasket	2002-97	61210	Throttle body to spacer	
QTY	DISTRIBUTOR MOUNTING	YEARS	PART NO.	DESCRIPTION	
1	Distributor Mounting Gasket	2002-97	72454	Distributor Mounting; O-ring; 26.5mm ID	
1	O-Ring	2002-97	72416	Distributor Mounting; 25mm ID	
QTY	EXHAUST GAS RECIRCULATION	YEARS	PART NO.	DESCRIPTION	
1	EGR Gasket	2002-97	70978		
66		2005 - 2003; 3.0L 182.9 (2997cc) SOHC V6 (24 Valve) 86mm Bore VTEC			66
		MFI; Gasoline; Naturally Aspirated Honda Eng.; Eng. Code J30A4			
QTY	CYLINDER HEAD	YEARS	PART NO.	DESCRIPTION	
2	Head Gasket	2005-03	26334 PT	Head bolts not incl.; Head bolt replacement recommended; PermaTorqueMLS®	
1	Head Set	2005-03	HS 26334 PT	Head bolts not incl.; Head bolt replacement recommended; PermaDry® molded rubber valve cover gskts. incl.; Premium valve stem seals incl.	
2	Head Bolt Set	2005-03	ES 71331	6-point Head bolts; Head bolts w/Washers; Replacement recommended	
2	Head Bolt Set	2005-04	ES 71329-1	12-point Head bolts; Head bolts w/Washers; Replacement recommended	
QTY	CONVERSION SET	YEARS	PART NO.	DESCRIPTION	
1	Gasket Conversion Set	2005-03	CS 26265	RTV sealant incl. for oil pan gskt.	
QTY	MANIFOLD - INT. & EXH.	YEARS	PART NO.	DESCRIPTION	
1	Int. Manifold Gasket Set	2005-03	MS 96405	Lower set	
1	Plenum Gasket Set	2005-03	MS 96410	Upper set	
1	Exh. Manifold Gasket Set	2005-03	MS 96411		
QTY	EXHAUST PIPE FLANGE	YEARS	PART NO.	DESCRIPTION	
2	Exhaust Pipe Gasket	2005-03	60578	Pipe to manifold	
QTY	CRANKSHAFT REAR SEAL	YEARS	PART NO.	DESCRIPTION	
1	Rear Main Seal Set	2005-03	BS 40685	Rubber; One-piece	
QTY	VALVE COVER	YEARS	PART NO.	DESCRIPTION	
1	Valve Cover Gasket Set	2005-03	VS 50607 R	w/Grommets & Spark plug tube seals; PermaDry® molded rubber gskts. incl.	
QTY	VALVE STEM SEAL SET	YEARS	PART NO.	DESCRIPTION	
2	Valve Stem Seal Set	2005-03	SS 70283-2	Premium valve stem seals incl.	
QTY	THERMOSTAT HOUSING	YEARS	PART NO.	DESCRIPTION	
1	O-Ring	2005-03	35162	Thermostat Housing	
QTY	WATER OUTLET GASKET	YEARS	PART NO.	DESCRIPTION	
1	Water Crossover Mounting Set	2005-03	ES 72998	Water Outlet; Water bypass set; OEM style; New Part Number - Check for Availability	
QTY	WATER PUMP	YEARS	PART NO.	DESCRIPTION	
1	Water Pump Gasket	2005-03	35677		
QTY	TIMING COVER	YEARS	PART NO.	DESCRIPTION	
1	Crankshaft Front Seal Set	2005-03	TCS 46026		
1	Camshaft Front Seal Set	2005-03	TCS 46025		

Honda Car (Incl. Acura, Honda) (Cont.)

66		2005 - 2003; 3.0L 182.9 (2997cc) SOHC V6 (24 Valve) 86mm Bore VTEC			66	
(cont.)		MFI; Gasoline; Naturally Aspirated Honda Eng.; Eng. Code J30A4			(cont.)	
QTY	CARB & FUEL INJECTION	YEARS	PART NO.	DESCRIPTION		
1	Throttle Body Gasket	2005-03	61320	Throttle body mounting		
QTY	EXHAUST GAS RECIRCULATION	YEARS	PART NO.	DESCRIPTION		
1	EGR Gasket	2005-03	70978			
QTY	OIL FILTER MOUNTING	YEARS	PART NO.	DESCRIPTION		
1	Oil Filter Adapter Gasket	2005-03	72951	Oil filter adapter; New Part Number - Check for Availability		
67		2007 - 2006; 3.0L 182.9 (2997cc) SOHC V6 (24 Valve) 86mm Bore VTEC			67	
		MFI; Gasoline; Naturally Aspirated Honda Eng.; Eng. Code J30A5				
QTY	CYLINDER HEAD	YEARS	PART NO.	DESCRIPTION		
2	Head Gasket	2007-06	26334 PT	Head bolts not incl.; Head bolt replacement recommended; PermaTorqueMLS®		
1	Head Set	2007-06	HS 26334 PT	Head bolts not incl.; Head bolt replacement recommended; PermaDry® molded rubber valve cover gskts. incl.; Premium valve stem seals incl.		
2	Head Bolt Set	2007-06	ES 71329-1	12-point Head bolts; Head bolts w/Washers; Replacement recommended		
2	Head Bolt Set	2007-06	ES 71331	6-point Head bolts; Head bolts w/Washers; Replacement recommended		
QTY	CONVERSION SET	YEARS	PART NO.	DESCRIPTION		
1	Gasket Conversion Set	2007-06	CS 26265	RTV sealant incl. for oil pan gskt.		
QTY	MANIFOLD - INT. & EXH.	YEARS	PART NO.	DESCRIPTION		
1	Int. Manifold Gasket Set	2007-06	MS 96405	Lower set		
1	Plenum Gasket Set	2007-06	MS 96410	Upper set		
1	Exh. Manifold Gasket Set	2007-06	MS 96411			
QTY	EXHAUST PIPE FLANGE	YEARS	PART NO.	DESCRIPTION		
2	Exhaust Pipe Gasket	2007-06	60578	Pipe to manifold		
QTY	CRANKSHAFT REAR SEAL	YEARS	PART NO.	DESCRIPTION		
1	Rear Main Seal Set	2007-06	BS 40685	Rubber; One-piece		
QTY	VALVE COVER	YEARS	PART NO.	DESCRIPTION		
1	Valve Cover Gasket Set	2007-06	VS 50607 R	w/Grommets & Spark plug tube seals; PermaDry® molded rubber gskts. incl.		
QTY	VALVE STEM SEAL SET	YEARS	PART NO.	DESCRIPTION		
2	Valve Stem Seal Set	2007-06	SS 70283-2	Premium valve stem seals incl.		
QTY	THERMOSTAT HOUSING	YEARS	PART NO.	DESCRIPTION		
1	O-Ring	2007-06	35162	Thermostat Housing		
QTY	WATER OUTLET GASKET	YEARS	PART NO.	DESCRIPTION		
1	Water Crossover Mounting Set	2007-06	ES 72998	Water Outlet; Water bypass set; OEM style; New Part Number - Check for Availability		
QTY	WATER PUMP	YEARS	PART NO.	DESCRIPTION		
1	Water Pump Gasket	2007-06	35677			
QTY	TIMING COVER	YEARS	PART NO.	DESCRIPTION		
1	Crankshaft Front Seal Set	2007-06	TCS 46026			
1	Camshaft Front Seal Set	2007-06	TCS 46025			
QTY	CARB & FUEL INJECTION	YEARS	PART NO.	DESCRIPTION		
1	Throttle Body Gasket	2007-06	61331	Throttle body mounting		
QTY	EXHAUST GAS RECIRCULATION	YEARS	PART NO.	DESCRIPTION		
1	EGR Gasket	2007-06	70978			
QTY	OIL FILTER MOUNTING	YEARS	PART NO.	DESCRIPTION		
1	Oil Filter Adapter Gasket	2007-06	72951	Oil filter adapter; New Part Number - Check for Availability		
68		2007 - 2005; 3.0L 182.9 (2997cc) SOHC V6 (24 Valve) 86mm Bore VTEC			68	
		MFI; Hybrid (Gas/Electric); Naturally Aspirated Honda Eng.; Eng. Code JNA1				
QTY	CYLINDER HEAD	YEARS	PART NO.	DESCRIPTION		
2	Head Gasket	2007-05	26334 PT	Head bolts not incl.; Head bolt replacement recommended; PermaTorqueMLS®		
1	Head Set	2007-05	HS 26334 PT-1	Head bolts not incl.; Head bolt replacement recommended; PermaDry® molded rubber valve cover gskts. incl.; Premium valve stem seals incl.		
2	Head Bolt Set	2007-05	ES 71329-1	12-point Head bolts; Head bolts w/Washers; Replacement recommended		
2	Head Bolt Set	2007-05	ES 71331	6-point Head bolts; Head bolts w/Washers; Replacement recommended		
QTY	CONVERSION SET	YEARS	PART NO.	DESCRIPTION		
1	Gasket Conversion Set	2007-05	CS 26265	RTV sealant incl. for oil pan gskt.		
QTY	MANIFOLD - INT. & EXH.	YEARS	PART NO.	DESCRIPTION		
1	Int. Manifold Gasket Set	2007-05	MS 96405	Lower set		
1	Plenum Gasket Set	2007-05	MS 96409	Upper set; Old design; Superseded - When depleted use MS 96409-3		
1	Plenum Gasket Set	2007-05	MS 96409-3	Upper set; Improved design; New Part Number - Check for Availability		
1	Exh. Manifold Gasket Set	2007-05	MS 96411			

Honda Car (Incl. Acura, Honda) (Cont.)

68		2007 - 2005; 3.0L 182.9 (2997cc) SOHC V6 (24 Valve) 86mm Bore VTEC			68
(cont.)		MFI; Hybrid (Gas/Electric); Naturally Aspirated Honda Eng.; Eng. Code JNA1			(cont.)
QTY	EXHAUST PIPE FLANGE	YEARS	PART NO.	DESCRIPTION	
2	Exhaust Pipe Gasket	2007-05	60578	Pipe to manifold	
QTY	CRANKSHAFT REAR SEAL	YEARS	PART NO.	DESCRIPTION	
1	Rear Main Seal Set	2007-05	BS 40685	Rubber; One-piece	
QTY	VALVE COVER	YEARS	PART NO.	DESCRIPTION	
1	Valve Cover Gasket Set	2007-05	VS 50699 R	w/Grommets & Spark plug tube seals; PermaDry® molded rubber gskts. incl.	
QTY	VALVE STEM SEAL SET	YEARS	PART NO.	DESCRIPTION	
2	Valve Stem Seal Set	2007-05	SS 70283-2	Premium valve stem seals incl.	
QTY	THERMOSTAT HOUSING	YEARS	PART NO.	DESCRIPTION	
1	O-Ring	2007-05	35162	Thermostat Housing	
QTY	WATER OUTLET GASKET	YEARS	PART NO.	DESCRIPTION	
1	Water Crossover Mounting Set	2007-05	ES 72998	Water Outlet; Water bypass set; OEM style; New Part Number - Check for Availability	
QTY	WATER PUMP	YEARS	PART NO.	DESCRIPTION	
1	Water Pump Gasket	2007-05	35677		
QTY	TIMING COVER	YEARS	PART NO.	DESCRIPTION	
1	Crankshaft Front Seal Set	2007-05	TCS 46026		
1	Camshaft Front Seal Set	2007-05	TCS 46025		
QTY	CARB & FUEL INJECTION	YEARS	PART NO.	DESCRIPTION	
1	Throttle Body Gasket	2007-05	61320	Throttle body mounting	
QTY	EXHAUST GAS RECIRCULATION	YEARS	PART NO.	DESCRIPTION	
1	EGR Gasket	2007-05	70978		
QTY	OIL FILTER MOUNTING	YEARS	PART NO.	DESCRIPTION	
1	Oil Filter Adapter Gasket	2007-05	72951	Oil filter adapter; New Part Number - Check for Availability	
69		1995 - 1991; 3.2L 195.6 (3206cc) SOHC V6 (24 Valve) 90mm Bore			69
(cont.)		MFI; Gasoline; Naturally Aspirated Honda Eng.; Eng. Code C32A1			(cont.)
QTY	CYLINDER HEAD	YEARS	PART NO.	DESCRIPTION	
1	Head Gasket	1995-91	9031 PT	Loc. L.H.	
1	Head Gasket	1995-91	9032 PT	Loc. R.H.	
1	Head Set	1995-91	HS 9031 PT	PermaDry® molded rubber valve cover gskts. incl.; Premium valve stem seals incl.	
QTY	CONVERSION SET	YEARS	PART NO.	DESCRIPTION	
1	Gasket Conversion Set	1995-91	CS 9031	RTV sealant incl. for oil pan gskt.	
QTY	MANIFOLD - INT. & EXH.	YEARS	PART NO.	DESCRIPTION	
1	Int. Manifold Gasket Set	1995-91	MS 95683	Upper set incl.	
1	Exh. Manifold Gasket Set	1995-91	MS 95682		
QTY	EXHAUST PIPE FLANGE	YEARS	PART NO.	DESCRIPTION	
2	Exhaust Pipe Gasket	1995-91	23624	Flange	
QTY	CRANKSHAFT REAR SEAL	YEARS	PART NO.	DESCRIPTION	
1	Rear Main Seal Set	1995-91	BS 40535-1	Rubber; One-piece	
QTY	VALVE COVER	YEARS	PART NO.	DESCRIPTION	
1	Valve Cover Gasket Set	1995-91	VS 50448 R	w/Circular plugs & Grommets & Spark plug tube seals; PermaDry® molded rubber gskts. incl.	
QTY	VALVE STEM SEAL SET	YEARS	PART NO.	DESCRIPTION	
2	Valve Stem Seal Set	1995-91	SS 70283-2	Premium valve stem seals incl.	
QTY	THERMOSTAT HOUSING	YEARS	PART NO.	DESCRIPTION	
1	Thermostat Gasket	1995-91	35217	Thermostat Housing; Thermostat case	
1	O-Ring	1995-91	35162	Thermostat Housing	
QTY	WATER PUMP	YEARS	PART NO.	DESCRIPTION	
1	Water Pump Gasket	1995-91	35167		
QTY	TIMING COVER	YEARS	PART NO.	DESCRIPTION	
1	Crankshaft Front Seal Set	1995-91	TCS 45959		
1	Camshaft Front Seal Set	1995-91	TCS 45704		
QTY	CARB & FUEL INJECTION	YEARS	PART NO.	DESCRIPTION	
1	Throttle Body Gasket	1995-91	60890	Old design; Superseded - When depleted use 61483	
1	Throttle Body Gasket	1995-91	61483	Improved design	
QTY	EXHAUST GAS RECIRCULATION	YEARS	PART NO.	DESCRIPTION	
1	EGR Gasket	1995-91	70978		

Honda Car (Incl. Acura, Honda) (Cont.)

70		1998 - 1996; 3.2L 195.6 (3206cc) SOHC V6 (24 Valve) 90mm Bore MFI; Gasoline; Naturally Aspirated Honda Eng.; Eng. Code C32A6			70
QTY	CYLINDER HEAD	YEARS	PART NO.	DESCRIPTION	
1	Head Gasket	1998-96	9031 PT	Loc. L.H.	
1	Head Gasket	1998-96	9032 PT	Loc. R.H.	
QTY	CONVERSION SET	YEARS	PART NO.	DESCRIPTION	
1	Gasket Conversion Set	1998-96	CS 9031	Water pump gskt. not incl.; RTV sealant incl. for oil pan gskt.	
QTY	MANIFOLD - INT. & EXH.	YEARS	PART NO.	DESCRIPTION	
1	Exh. Manifold Gasket Set	1998-96	MS 95682		
QTY	EXHAUST PIPE FLANGE	YEARS	PART NO.	DESCRIPTION	
2	Exhaust Pipe Gasket	1998-96	23624	Flange	
QTY	CRANKSHAFT REAR SEAL	YEARS	PART NO.	DESCRIPTION	
1	Rear Main Seal Set	1998-96	BS 40535-1	Rubber; One-piece	
QTY	VALVE COVER	YEARS	PART NO.	DESCRIPTION	
1	Valve Cover Gasket Set	1998-96	VS 50448 R	w/Circular plugs & Grommets & Spark plug tube seals; PermaDry® molded rubber gskts. incl.	
QTY	VALVE STEM SEAL SET	YEARS	PART NO.	DESCRIPTION	
2	Valve Stem Seal Set	1998-96	SS 70283-2	Premium valve stem seals incl.	
QTY	THERMOSTAT HOUSING	YEARS	PART NO.	DESCRIPTION	
1	Thermostat Gasket	1998-96	35217	Thermostat Housing; Thermostat case	
1	O-Ring	1998-96	35162	Thermostat Housing	
QTY	TIMING COVER	YEARS	PART NO.	DESCRIPTION	
1	Crankshaft Front Seal Set	1998-96	TCS 45959		
1	Camshaft Front Seal Set	1998-96	TCS 45704		
QTY	CARB & FUEL INJECTION	YEARS	PART NO.	DESCRIPTION	
1	Throttle Body Gasket	1996	60890	To Eng. Ser. No. 1310377; Old design; Superseded - When depleted use 61483	
1	Throttle Body Gasket	1996	61483	To Eng. Ser. No. 1310377; Improved design	
QTY	EXHAUST GAS RECIRCULATION	YEARS	PART NO.	DESCRIPTION	
1	EGR Gasket	1998-96	70978		
71		2003 - 1999; 3.2L 196 (3210cc) SOHC V6 (24 Valve) 89mm Bore VTEC MFI; Gasoline; Naturally Aspirated Honda Eng.; Eng. Code J32A1			71
QTY	CYLINDER HEAD	YEARS	PART NO.	DESCRIPTION	
2	Head Gasket	2003-99	26260 PT	Head bolts not incl.; Head bolt replacement recommended; PermaTorqueMLS®; Improved design	
1	Head Set	2003-00	HS 26260 PT-1	Head bolts not incl.; Head bolt replacement recommended; PermaDry® molded rubber valve cover gskts. incl.; Premium valve stem seals incl.	
1	Head Set	1999	HS 26260 PT	Head bolts not incl.; Head bolt replacement recommended; PermaDry® molded rubber valve cover gskts. incl.; Premium valve stem seals incl.	
2	Head Bolt Set	2003-99	ES 71331	6-point Head bolts; Head bolts w/Washers; Replacement recommended	
QTY	CONVERSION SET	YEARS	PART NO.	DESCRIPTION	
1	Gasket Conversion Set	2003-99	CS 26196	RTV sealant incl. for oil pan gskt.	
QTY	MANIFOLD - INT. & EXH.	YEARS	PART NO.	DESCRIPTION	
1	Int. Manifold Gasket Set	2003-00	MS 96427	Lower set	
1	Int. Manifold Gasket Set	1999	MS 96168	Lower set	
1	Plenum Gasket Set	2003-00	MS 96384-1	Upper set	
1	Plenum Gasket Set	2003-00	MS 96384-3	Upper set; Plenum gskts. only; New Part Number - Check for Availability	
1	Plenum Gasket Set	1999	MS 96167-1	Upper set	
1	Plenum Gasket Set	1999	MS 96167-2	Upper set; Plenum gskt. only; New Part Number - Check for Availability	
1	Exh. Manifold Gasket Set	2003-99	MS 96166		
QTY	EXHAUST PIPE FLANGE	YEARS	PART NO.	DESCRIPTION	
2	Exhaust Pipe Gasket	2003-99	60578	Pipe to manifold	
QTY	CRANKSHAFT REAR SEAL	YEARS	PART NO.	DESCRIPTION	
1	Rear Main Seal Set	2003-99	BS 40675	Rubber; One-piece	
QTY	VALVE COVER	YEARS	PART NO.	DESCRIPTION	
1	Valve Cover Gasket Set	2003-99	VS 50576 R	w/Grommets & Spark plug tube seals; PermaDry® molded rubber gskts. incl.	
QTY	VALVE STEM SEAL SET	YEARS	PART NO.	DESCRIPTION	
2	Valve Stem Seal Set	2003-99	SS 70283-2	Premium valve stem seals incl.	
QTY	THERMOSTAT HOUSING	YEARS	PART NO.	DESCRIPTION	
1	O-Ring	2003-99	35162	Thermostat Housing	
QTY	WATER OUTLET GASKET	YEARS	PART NO.	DESCRIPTION	
1	Water Crossover Mounting Set	2003-99	ES 72998	Water Outlet; Water bypass set; OEM style; New Part Number - Check for Availability	
QTY	WATER PUMP	YEARS	PART NO.	DESCRIPTION	
1	Water Pump Gasket	2003-99	35677		

71		2003 - 1999; 3.2L 196 (3210cc) SOHC V6 (24 Valve) 89mm Bore VTEC			71	
(cont.)		MFI; Gasoline; Naturally Aspirated Honda Eng.; Eng. Code J32A1			(cont.)	
QTY	TIMING COVER	YEARS	PART NO.	DESCRIPTION		
1	Crankshaft Front Seal Set	2003-99	TCS 46026			
1	Camshaft Front Seal Set	2003-99	TCS 46025			
QTY	CARB & FUEL INJECTION	YEARS	PART NO.	DESCRIPTION		
1	Throttle Body Gasket	2003-99	61316	Throttle body to spacer		
1	Throttle Body Gasket	2003-99	61317	Spacer to manifold		
QTY	EXHAUST GAS RECIRCULATION	YEARS	PART NO.	DESCRIPTION		
1	EGR Gasket	2003-99	70978			
72		2003 - 2001; 3.2L 196 (3210cc) SOHC V6 (24 Valve) 89mm Bore VTEC			72	
(cont.)		MFI; Gasoline; Naturally Aspirated Honda Eng.; Eng. Code J32A2			(cont.)	
QTY	CYLINDER HEAD	YEARS	PART NO.	DESCRIPTION		
2	Head Gasket	2003-01	26260 PT	Head bolts not incl.; Head bolt replacement recommended; PermaTorqueMLS®; Improved design		
1	Head Set	2003-01	HS 26260 PT-1	Head bolts not incl.; Head bolt replacement recommended; PermaDry® molded rubber valve cover gskts. incl.; Premium valve stem seals incl.		
2	Head Bolt Set	2003-01	ES 71331	6-point Head bolts; Head bolts w/Washers; Replacement recommended		
QTY	CONVERSION SET	YEARS	PART NO.	DESCRIPTION		
1	Gasket Conversion Set	2003-01	CS 26196	RTV sealant incl. for oil pan gskt.		
QTY	MANIFOLD - INT. & EXH.	YEARS	PART NO.	DESCRIPTION		
1	Int. Manifold Gasket Set	2003-01	MS 96427	Lower set		
1	Plenum Gasket Set	2003-01	MS 96384-2	Upper set; New Part Number - Check for Availability		
1	Plenum Gasket Set	2003-01	MS 96384-3	Upper set; Plenum gskts. only; New Part Number - Check for Availability		
1	Exh. Manifold Gasket Set	2003-01	MS 96166			
QTY	EXHAUST PIPE FLANGE	YEARS	PART NO.	DESCRIPTION		
2	Exhaust Pipe Gasket	2003-01	60578	Pipe to manifold		
QTY	CRANKSHAFT REAR SEAL	YEARS	PART NO.	DESCRIPTION		
1	Rear Main Seal Set	2003-01	BS 40675	Rubber; One-piece		
QTY	VALVE COVER	YEARS	PART NO.	DESCRIPTION		
1	Valve Cover Gasket Set	2003-01	VS 50576 R	w/Grommets & Spark plug tube seals; PermaDry® molded rubber gskts. incl.		
QTY	VALVE STEM SEAL SET	YEARS	PART NO.	DESCRIPTION		
2	Valve Stem Seal Set	2003-01	SS 70283-2	Premium valve stem seals incl.		
QTY	THERMOSTAT HOUSING	YEARS	PART NO.	DESCRIPTION		
1	O-Ring	2003-01	35162	Thermostat Housing		
QTY	WATER OUTLET GASKET	YEARS	PART NO.	DESCRIPTION		
1	Water Crossover Mounting Set	2003-01	ES 72998	Water Outlet; Water bypass set; OEM style; New Part Number - Check for Availability		
QTY	WATER PUMP	YEARS	PART NO.	DESCRIPTION		
1	Water Pump Gasket	2003-01	35677			
QTY	TIMING COVER	YEARS	PART NO.	DESCRIPTION		
1	Crankshaft Front Seal Set	2003-01	TCS 46026			
1	Camshaft Front Seal Set	2003-01	TCS 46025			
QTY	CARB & FUEL INJECTION	YEARS	PART NO.	DESCRIPTION		
1	Throttle Body Gasket	2003-01	61319			
QTY	EXHAUST GAS RECIRCULATION	YEARS	PART NO.	DESCRIPTION		
1	EGR Gasket	2003-01	70978			
73		2008 - 2004; 3.2L 196 (3210cc) SOHC V6 (24 Valve) 89mm Bore VTEC			73	
(cont.)		MFI; Gasoline; Naturally Aspirated Honda Eng.; Eng. Code J32A3			(cont.)	
QTY	CYLINDER HEAD	YEARS	PART NO.	DESCRIPTION		
2	Head Gasket	2008-04	26265 PT	Head bolts not incl.; Head bolt replacement recommended; PermaTorqueMLS®		
1	Head Set	2008-07	HS 26265 PT-6	Head bolts not incl.; Head bolt replacement recommended; PermaDry® molded rubber valve cover gskts. incl.; Premium valve stem seals incl.; Improved design; New Part Number - Check for Availability		
1	Head Set	2006-04	HS 26265 PT-1	Head bolts not incl.; Head bolt replacement recommended; PermaDry® molded rubber valve cover gskts. incl.; Premium valve stem seals incl.		
2	Head Bolt Set	2008-04	ES 71329-1	12-point Head bolts; Head bolts w/Washers; Replacement recommended		
2	Head Bolt Set	2008-04	ES 71331	6-point Head bolts; Head bolts w/Washers; Replacement recommended		
QTY	CONVERSION SET	YEARS	PART NO.	DESCRIPTION		
1	Gasket Conversion Set	2008-04	CS 26265	RTV sealant incl. for oil pan gskt.		
QTY	MANIFOLD - INT. & EXH.	YEARS	PART NO.	DESCRIPTION		
1	Int. Manifold Gasket Set	2008-04	MS 96405	Lower set		

Honda Car (Incl. Acura, Honda) (Cont.)

73 (cont.)		2008 - 2004; 3.2L 196 (3210cc) SOHC V6 (24 Valve) 89mm Bore VTEC			73 (cont.)
MFI; Gasoline; Naturally Aspirated Honda Eng.; Eng. Code J32A3					
QTY	MANIFOLD - INT. & EXH.	YEARS	PART NO.	DESCRIPTION	
1	Plenum Gasket Set	2008-07	MS 96409-3	Upper set; Improved design; New Part Number - Check for Availability	
1	Plenum Gasket Set	2006-04	MS 96410	Upper set	
1	Exh. Manifold Gasket Set	2008-04	MS 96411		
QTY	EXHAUST PIPE FLANGE	YEARS	PART NO.	DESCRIPTION	
2	Exhaust Pipe Gasket	2008-04	60578	Pipe to manifold	
QTY	CRANKSHAFT REAR SEAL	YEARS	PART NO.	DESCRIPTION	
1	Rear Main Seal Set	2008-04	BS 40685	Rubber; One-piece	
QTY	VALVE COVER	YEARS	PART NO.	DESCRIPTION	
1	Valve Cover Gasket Set	2008-04	VS 50607 R	w/Grommets & Spark plug tube seals; PermaDry® molded rubber gsks. incl.	
QTY	VALVE STEM SEAL SET	YEARS	PART NO.	DESCRIPTION	
2	Valve Stem Seal Set	2008-04	SS 70283-2	Premium valve stem seals incl.	
QTY	THERMOSTAT HOUSING	YEARS	PART NO.	DESCRIPTION	
1	O-Ring	2008-04	35162	Thermostat Housing	
QTY	WATER OUTLET GASKET	YEARS	PART NO.	DESCRIPTION	
1	Water Crossover Mounting Set	2008-04	ES 72998	Water Outlet; Water bypass set; OEM style; New Part Number - Check for Availability	
QTY	WATER PUMP	YEARS	PART NO.	DESCRIPTION	
1	Water Pump Gasket	2008-04	35677		
QTY	TIMING COVER	YEARS	PART NO.	DESCRIPTION	
1	Crankshaft Front Seal Set	2008-04	TCS 46026		
1	Camshaft Front Seal Set	2008-04	TCS 46025		
QTY	CARB & FUEL INJECTION	YEARS	PART NO.	DESCRIPTION	
3	Fuel Injector O-Ring Set	2008-04	ES 70599	Improved design	
1	Throttle Body Gasket	2008-04	61331		
QTY	EXHAUST GAS RECIRCULATION	YEARS	PART NO.	DESCRIPTION	
1	EGR Gasket	2008-04	70978		
QTY	OIL FILTER MOUNTING	YEARS	PART NO.	DESCRIPTION	
1	Oil Filter Adapter Gasket	2008-04	72951	Oil filter adapter; New Part Number - Check for Availability	
74		2008 - 2005; 3.5L 212 (3471cc) SOHC V6 (24 Valve) 89mm Bore VTEC			74
MFI; Gasoline; Naturally Aspirated Honda Eng.; Eng. Code J35A8					
QTY	CYLINDER HEAD	YEARS	PART NO.	DESCRIPTION	
2	Head Gasket	2008-05	26329 PT	Head bolts not incl.; Head bolt replacement recommended; PermaTorqueMLS®	
1	Head Set	2008-05	HS 26329 PT	Head bolts not incl.; Head bolt replacement recommended; PermaDry® molded rubber valve cover gsks. incl.; Premium valve stem seals incl.	
2	Head Bolt Set	2008-05	ES 71329-1	12-point Head bolts; Head bolts w/Washers; Replacement recommended	
2	Head Bolt Set	2008-05	ES 71331	6-point Head bolts; Head bolts w/Washers; Replacement recommended	
QTY	CONVERSION SET	YEARS	PART NO.	DESCRIPTION	
1	Gasket Conversion Set	2008-05	CS 26265	RTV sealant incl. for oil pan gskt.	
QTY	MANIFOLD - INT. & EXH.	YEARS	PART NO.	DESCRIPTION	
1	Int. Manifold Gasket Set	2008-05	MS 96405	Lower set	
1	Plenum Gasket Set	2008-05	MS 96409-3	Upper set; Improved design; New Part Number - Check for Availability	
1	Exh. Manifold Gasket Set	2008-05	MS 96411		
QTY	EXHAUST PIPE FLANGE	YEARS	PART NO.	DESCRIPTION	
2	Exhaust Pipe Gasket	2008-05	60578	Pipe to manifold	
QTY	CRANKSHAFT REAR SEAL	YEARS	PART NO.	DESCRIPTION	
1	Rear Main Seal Set	2008-05	BS 40685	Rubber; One-piece	
QTY	VALVE COVER	YEARS	PART NO.	DESCRIPTION	
1	Valve Cover Gasket Set	2008-05	VS 50607 R	w/Grommets & Spark plug tube seals; PermaDry® molded rubber gsks. incl.	
QTY	VALVE STEM SEAL SET	YEARS	PART NO.	DESCRIPTION	
2	Valve Stem Seal Set	2008-05	SS 70283-2	Premium valve stem seals incl.	
QTY	THERMOSTAT HOUSING	YEARS	PART NO.	DESCRIPTION	
1	O-Ring	2008-05	35162	Thermostat Housing	
QTY	WATER OUTLET GASKET	YEARS	PART NO.	DESCRIPTION	
1	Water Crossover Mounting Set	2008-05	ES 72998	Water Outlet; Water bypass set; OEM style; New Part Number - Check for Availability	
QTY	WATER PUMP	YEARS	PART NO.	DESCRIPTION	
1	Water Pump Gasket	2008-05	35677		
QTY	TIMING COVER	YEARS	PART NO.	DESCRIPTION	
1	Crankshaft Front Seal Set	2008-05	TCS 46026		
1	Camshaft Front Seal Set	2008-05	TCS 46025		

Honda Car (Incl. Acura, Honda) (Cont.)

74		2008 - 2005; 3.5L 212 (3471cc) SOHC V6 (24 Valve) 89mm Bore VTEC			74
(cont.)		MFI; Gasoline; Naturally Aspirated Honda Eng.; Eng. Code J35A8			(cont.)
QTY	CARB & FUEL INJECTION	YEARS	PART NO.	DESCRIPTION	
3	Fuel Injector O-Ring Set	2008-05	ES 70599	Improved design	
1	Throttle Body Gasket	2008-05	61331		
QTY	EXHAUST GAS RECIRCULATION	YEARS	PART NO.	DESCRIPTION	
1	EGR Gasket	2008-05	70978		
QTY	OIL FILTER MOUNTING	YEARS	PART NO.	DESCRIPTION	
1	Oil Filter Adapter Gasket	2008-05	72951	Oil filter adapter; New Part Number - Check for Availability	
75		2012 - 2008; 3.5L 212 (3471cc) SOHC V6 (24 Valve) 89mm Bore VTEC			75
(cont.)		MFI; Gasoline; Naturally Aspirated Honda Eng.; Eng. Code J35Z2			(cont.)
QTY	CYLINDER HEAD	YEARS	PART NO.	DESCRIPTION	
1	Head Gasket	2012-08	26509 PT	Loc. L.H.; Head bolts not incl.; Head bolt replacement recommended; PermaTorqueMLS®; New Part Number - Check for Availability	
1	Head Gasket	2012-08	26510 PT	Loc. R.H.; Head bolts not incl.; Head bolt replacement recommended; PermaTorqueMLS®; New Part Number - Check for Availability	
1	Head Set	2012-08	HS 26509 PT	Head bolts not incl.; Head bolt replacement recommended; PermaDry® molded rubber valve cover gskts. incl.; Premium valve stem seals incl.; New Part Number - Check for Availability	
2	Head Bolt Set	2012-08	ES 71329-1	12-point Head bolts; Head bolts w/Washers; Replacement recommended	
QTY	CONVERSION SET	YEARS	PART NO.	DESCRIPTION	
1	Gasket Conversion Set	2012-08	CS 26265	RTV sealant incl. for oil pan gskt.	
QTY	MANIFOLD - INT. & EXH.	YEARS	PART NO.	DESCRIPTION	
1	Int. Manifold Gasket Set	2012-08	MS 97136	Lower set	
1	Plenum Gasket Set	2012-08	MS 96409-3	Upper set; Improved design; New Part Number - Check for Availability	
1	Exh. Manifold Gasket Set	2012-08	MS 97133		
QTY	EXHAUST PIPE FLANGE	YEARS	PART NO.	DESCRIPTION	
2	Exhaust Pipe Gasket	2012-08	60578	Pipe to manifold	
1	Exhaust Pipe Gasket	2012-08	61015	Exh. connector	
1	Exhaust Pipe Gasket	2012-08	61338	Converter	
QTY	CRANKSHAFT REAR SEAL	YEARS	PART NO.	DESCRIPTION	
1	Rear Main Seal Set	2012-08	BS 40685	Rubber; One-piece	
QTY	VALVE COVER	YEARS	PART NO.	DESCRIPTION	
1	Valve Cover Gasket Set	2012-08	VS 50773 R	w/Grommets & Spark plug tube seals; PermaDry® molded rubber gskts. incl.; New Part Number - Check for Availability	
QTY	VALVE STEM SEAL SET	YEARS	PART NO.	DESCRIPTION	
2	Valve Stem Seal Set	2012-08	SS 70283-2	Premium valve stem seals incl.	
QTY	THERMOSTAT HOUSING	YEARS	PART NO.	DESCRIPTION	
1	O-Ring	2012-08	35162	Thermostat Housing; Thermostat seal	
QTY	WATER OUTLET GASKET	YEARS	PART NO.	DESCRIPTION	
1	Water Crossover Mounting Set	2012-08	ES 72998	Water Outlet; Water bypass set; OEM style; New Part Number - Check for Availability	
QTY	WATER PUMP	YEARS	PART NO.	DESCRIPTION	
1	Water Pump Gasket	2012-08	35677		
QTY	TIMING COVER	YEARS	PART NO.	DESCRIPTION	
1	Crankshaft Front Seal Set	2012-08	TCS 46026		
1	Camshaft Front Seal Set	2012-08	TCS 46025		
QTY	CARB & FUEL INJECTION	YEARS	PART NO.	DESCRIPTION	
3	Fuel Injector O-Ring Set	2012-08	ES 70599	Improved design	
1	Throttle Body Gasket	2012-08	61331		
QTY	EXHAUST GAS RECIRCULATION	YEARS	PART NO.	DESCRIPTION	
1	EGR Gasket	2012-08	70978	Valve	
1	EGR Gasket	2012-08	72371	Loc. Lower; Pipe	
1	EGR Gasket	2012-08	72420	Loc. Upper; Pipe	
QTY	OIL FILTER MOUNTING	YEARS	PART NO.	DESCRIPTION	
1	Oil Filter Adapter Gasket	2012-08	72951	Oil filter adapter; New Part Number - Check for Availability	
76		2012 - 2008; 3.5L 212 (3471cc) SOHC V6 (24 Valve) 89mm Bore VTEC			76
(cont.)		MFI; Gasoline; Naturally Aspirated Honda Eng.; Eng. Code J35Z3			(cont.)
QTY	CYLINDER HEAD	YEARS	PART NO.	DESCRIPTION	
1	Head Gasket	2012-08	26509 PT	Loc. L.H.; Head bolts not incl.; Head bolt replacement recommended; PermaTorqueMLS®; New Part Number - Check for Availability	
1	Head Gasket	2012-08	26510 PT	Loc. R.H.; Head bolts not incl.; Head bolt replacement recommended; PermaTorqueMLS®; New Part Number - Check for Availability	

Honda Car (Incl. Acura, Honda) (Cont.)

76 (cont.)		2012 - 2008; 3.5L 212 (3471cc) SOHC V6 (24 Valve) 89mm Bore VTEC			76 (cont.)
MFI; Gasoline; Naturally Aspirated Honda Eng.; Eng. Code J35Z3					
QTY	CYLINDER HEAD	YEARS	PART NO.	DESCRIPTION	
1	Head Set	2012-08	HS 26509 PT	Head bolts not incl.; Head bolt replacement recommended; PermaDry® molded rubber valve cover gskts. incl.; Premium valve stem seals incl.; New Part Number - Check for Availability	
2	Head Bolt Set	2012-08	ES 71329-1	12-point Head bolts; Head bolts w/Washers; Replacement recommended	
QTY	CONVERSION SET	YEARS	PART NO.	DESCRIPTION	
1	Gasket Conversion Set	2012-08	CS 26265	RTV sealant incl. for oil pan gskt.	
QTY	MANIFOLD - INT. & EXH.	YEARS	PART NO.	DESCRIPTION	
1	Int. Manifold Gasket Set	2012-08	MS 97136	Lower set	
1	Plenum Gasket Set	2012-08	MS 96409-3	Upper set; Improved design; New Part Number - Check for Availability	
1	Exh. Manifold Gasket Set	2012-08	MS 97133		
QTY	EXHAUST PIPE FLANGE	YEARS	PART NO.	DESCRIPTION	
2	Exhaust Pipe Gasket	2012-08	60578	Pipe to manifold	
1	Exhaust Pipe Gasket	2012-08	61015	Exh. connector	
1	Exhaust Pipe Gasket	2012-08	61338	Converter	
QTY	CRANKSHAFT REAR SEAL	YEARS	PART NO.	DESCRIPTION	
1	Rear Main Seal Set	2012-08	BS 40685	Rubber; One-piece	
QTY	VALVE COVER	YEARS	PART NO.	DESCRIPTION	
1	Valve Cover Gasket Set	2012-08	VS 50773 R	w/Grommets & Spark plug tube seals; PermaDry® molded rubber gskts. incl.; New Part Number - Check for Availability	
QTY	VALVE STEM SEAL SET	YEARS	PART NO.	DESCRIPTION	
2	Valve Stem Seal Set	2012-08	SS 70283-2	Premium valve stem seals incl.	
QTY	THERMOSTAT HOUSING	YEARS	PART NO.	DESCRIPTION	
1	O-Ring	2012-08	35162	Thermostat Housing; Thermostat seal	
QTY	WATER OUTLET GASKET	YEARS	PART NO.	DESCRIPTION	
1	Water Crossover Mounting Set	2012-08	ES 72998	Water Outlet; Water bypass set; OEM style; New Part Number - Check for Availability	
QTY	WATER PUMP	YEARS	PART NO.	DESCRIPTION	
1	Water Pump Gasket	2012-08	35677		
QTY	TIMING COVER	YEARS	PART NO.	DESCRIPTION	
1	Crankshaft Front Seal Set	2012-08	TCS 46026		
1	Camshaft Front Seal Set	2012-08	TCS 46025		
QTY	CARB & FUEL INJECTION	YEARS	PART NO.	DESCRIPTION	
3	Fuel Injector O-Ring Set	2012-08	ES 70599	Improved design	
1	Throttle Body Gasket	2012-08	61331		
QTY	EXHAUST GAS RECIRCULATION	YEARS	PART NO.	DESCRIPTION	
1	EGR Gasket	2012-08	70978	Valve	
1	EGR Gasket	2012-08	72371	Loc. Lower; Pipe	
1	EGR Gasket	2012-08	72420	Loc. Upper; Pipe	
QTY	OIL FILTER MOUNTING	YEARS	PART NO.	DESCRIPTION	
1	Oil Filter Adapter Gasket	2012-08	72951	Oil filter adapter; New Part Number - Check for Availability	
77		2013 - 2009; 3.5L 212 (3471cc) SOHC V6 (24 Valve) 89mm Bore VTEC			77
MFI; Gasoline; Naturally Aspirated Honda Eng.; Eng. Code J35Z6					
QTY	CYLINDER HEAD	YEARS	PART NO.	DESCRIPTION	
1	Head Gasket	2013-09	26509 PT	Loc. L.H.; Head bolts not incl.; Head bolt replacement recommended; PermaTorqueMLS®; New Part Number - Check for Availability	
1	Head Gasket	2013-09	26510 PT	Loc. R.H.; Head bolts not incl.; Head bolt replacement recommended; PermaTorqueMLS®; New Part Number - Check for Availability	
1	Head Set	2013-09	HS 26509 PT	Head bolts not incl.; Head bolt replacement recommended; PermaDry® molded rubber valve cover gskts. incl.; Premium valve stem seals incl.; New Part Number - Check for Availability	
2	Head Bolt Set	2013-09	ES 71329-1	12-point Head bolts; Head bolts w/Washers; Replacement recommended	
QTY	CONVERSION SET	YEARS	PART NO.	DESCRIPTION	
1	Gasket Conversion Set	2013-09	CS 26265	RTV sealant incl. for oil pan gskt.	
QTY	MANIFOLD - INT. & EXH.	YEARS	PART NO.	DESCRIPTION	
1	Int. Manifold Gasket Set	2013-09	MS 97136	Lower set	
1	Plenum Gasket Set	2013-09	MS 96409-3	Upper set; Improved design; New Part Number - Check for Availability	
1	Exh. Manifold Gasket Set	2013-09	MS 97133		
QTY	EXHAUST PIPE FLANGE	YEARS	PART NO.	DESCRIPTION	
2	Exhaust Pipe Gasket	2013-09	60578	Pipe to manifold	
1	Exhaust Pipe Gasket	2013-09	61015	Exh. connector	
1	Exhaust Pipe Gasket	2013-09	61338	Converter	
QTY	CRANKSHAFT REAR SEAL	YEARS	PART NO.	DESCRIPTION	
1	Rear Main Seal Set	2013-09	BS 40685	Rubber; One-piece	

Honda Car (Incl. Acura, Honda) (Cont.)

77 (cont.)		2013 - 2009; 3.5L 212 (3471cc) SOHC V6 (24 Valve) 89mm Bore VTEC			77 (cont.)
		MFI; Gasoline; Naturally Aspirated Honda Eng.; Eng. Code J35Z6			
QTY	VALVE COVER	YEARS	PART NO.	DESCRIPTION	
1	Valve Cover Gasket Set	2013-09	VS 50773 R	w/Grommets & Spark plug tube seals; PermaDry® molded rubber gsks. incl.; New Part Number - Check for Availability	
QTY	VALVE STEM SEAL SET	YEARS	PART NO.	DESCRIPTION	
2	Valve Stem Seal Set	2013-09	SS 70283-2	Premium valve stem seals incl.	
QTY	THERMOSTAT HOUSING	YEARS	PART NO.	DESCRIPTION	
1	O-Ring	2013-09	35162	Thermostat Housing; Thermostat seal	
QTY	WATER OUTLET GASKET	YEARS	PART NO.	DESCRIPTION	
1	Water Crossover Mounting Set	2013-09	ES 72998	Water Outlet; Water bypass set; OEM style; New Part Number - Check for Availability	
QTY	WATER PUMP	YEARS	PART NO.	DESCRIPTION	
1	Water Pump Gasket	2013-09	35677		
QTY	TIMING COVER	YEARS	PART NO.	DESCRIPTION	
1	Crankshaft Front Seal Set	2013-09	TCS 46026		
1	Camshaft Front Seal Set	2013-09	TCS 46025		
QTY	CARB & FUEL INJECTION	YEARS	PART NO.	DESCRIPTION	
3	Fuel Injector O-Ring Set	2013-09	ES 70599	Improved design	
1	Throttle Body Gasket	2013-10	61331	Acura TSX Technology Package, V6	
1	Throttle Body Gasket	2013-12	61635	Exc. Acura TSX Technology Package, V6	
1	Throttle Body Gasket	2011-10	61635	Acura TL Base, Technology Package	
1	Throttle Body Gasket	2009	61635		
QTY	EXHAUST GAS RECIRCULATION	YEARS	PART NO.	DESCRIPTION	
1	EGR Gasket	2013-09	70978	Valve	
1	EGR Gasket	2013-09	72371	Loc. Lower; Pipe	
1	EGR Gasket	2013-09	72420	Loc. Upper; Pipe	
QTY	OIL FILTER MOUNTING	YEARS	PART NO.	DESCRIPTION	
1	Oil Filter Adapter Gasket	2013-09	72951	Oil filter adapter; New Part Number - Check for Availability	
78		2013; 3.5L 212 (3471cc) SOHC V6 (24 Valve) 89mm Bore i-VTEC			78
		MFI; Gasoline; Naturally Aspirated Honda Eng.; Eng. Code J35Y1			
QTY	CYLINDER HEAD	YEARS	PART NO.	DESCRIPTION	
1	Head Gasket	2013	26509 PT	Loc. L.H.; Head bolts not incl.; Head bolt replacement recommended; PermaTorqueMLS®; New Part Number - Check for Availability	
1	Head Gasket	2013	26510 PT	Loc. R.H.; Head bolts not incl.; Head bolt replacement recommended; PermaTorqueMLS®; New Part Number - Check for Availability	
1	Head Set	2013	HS 26509 PT	Head bolts not incl.; Head bolt replacement recommended; PermaDry® molded rubber valve cover gsks. incl.; Premium valve stem seals incl.; New Part Number - Check for Availability	
2	Head Bolt Set	2013	ES 71329-1	12-point Head bolts; Replacement recommended	
QTY	CONVERSION SET	YEARS	PART NO.	DESCRIPTION	
1	Gasket Conversion Set	2013	CS 26265	RTV sealant incl. for oil pan gskt.	
QTY	MANIFOLD - INT. & EXH.	YEARS	PART NO.	DESCRIPTION	
1	Int. Manifold Gasket Set	2013	MS 97136	Lower set	
1	Plenum Gasket Set	2013	MS 96409-3	Upper set; Improved design; New Part Number - Check for Availability	
1	Exh. Manifold Gasket Set	2013	MS 97133		
QTY	EXHAUST PIPE FLANGE	YEARS	PART NO.	DESCRIPTION	
2	Exhaust Pipe Gasket	2013	60578	Pipe to manifold	
1	Exhaust Pipe Gasket	2013	61015	Exh. connector	
2	Exhaust Pipe Gasket	2013	61338	Converter	
QTY	CRANKSHAFT REAR SEAL	YEARS	PART NO.	DESCRIPTION	
1	Rear Main Seal Set	2013	BS 40685	Rubber; One-piece	
QTY	VALVE COVER	YEARS	PART NO.	DESCRIPTION	
1	Valve Cover Gasket Set	2013	VS 50773 R	w/Grommets & Spark plug tube seals; PermaDry® molded rubber gsks. incl.; New Part Number - Check for Availability	
QTY	VALVE STEM SEAL SET	YEARS	PART NO.	DESCRIPTION	
2	Valve Stem Seal Set	2013	SS 70283-2	Premium valve stem seals incl.	
QTY	THERMOSTAT HOUSING	YEARS	PART NO.	DESCRIPTION	
1	Thermostat Gasket	2013	35741	Thermostat Housing; Thermostat O-ring	
1	O-Ring	2013	35162	Thermostat Housing; Thermostat seal	
QTY	WATER OUTLET GASKET	YEARS	PART NO.	DESCRIPTION	
1	Water Crossover Mounting Set	2013	ES 72998	Water Outlet; Water bypass set; OEM style; New Part Number - Check for Availability	
QTY	WATER PUMP	YEARS	PART NO.	DESCRIPTION	
1	Water Pump Gasket	2013	35677		

Honda Car (Incl. Acura, Honda) (Cont.)

78		2013; 3.5L 212 (3471cc) SOHC V6 (24 Valve) 89mm Bore i-VTEC			78
(cont.)		MFI; Gasoline; Naturally Aspirated Honda Eng.; Eng. Code J35Y1			(cont.)
QTY	TIMING COVER	YEARS	PART NO.	DESCRIPTION	
1	Crankshaft Front Seal Set	2013	TCS 46026		
1	Camshaft Front Seal Set	2013	TCS 46025		
QTY	CARB & FUEL INJECTION	YEARS	PART NO.	DESCRIPTION	
3	Fuel Injector O-Ring Set	2013	ES 70599	Improved design	
1	Throttle Body Gasket	2013	61331		
QTY	EXHAUST GAS RECIRCULATION	YEARS	PART NO.	DESCRIPTION	
1	EGR Gasket	2013	70978	Valve	
1	EGR Gasket	2013	72371	Loc. Lower; Pipe	
1	EGR Gasket	2013	72420	Loc. Upper; Pipe	
QTY	OIL FILTER MOUNTING	YEARS	PART NO.	DESCRIPTION	
1	Oil Filter Adapter Gasket	2013	72951	Oil filter adapter; New Part Number - Check for Availability	
79		2004 - 1996; 3.5L 212 (3474cc) SOHC V6 (24 Valve) 90mm Bore			79
(cont.)		MFI; Gasoline; Naturally Aspirated Honda Eng.; Eng. Code C35A1			(cont.)
QTY	CYLINDER HEAD	YEARS	PART NO.	DESCRIPTION	
1	Head Gasket	2004-96	9031 PT	Loc. L.H.; Head bolts not incl.; Head bolt replacement recommended	
1	Head Gasket	2004-96	9032 PT	Loc. R.H.; Head bolts not incl.; Head bolt replacement recommended	
1	Head Set	2004-96	HS 9031 PT-1	Head bolts not incl.; Head bolt replacement recommended; PermaDry® molded rubber valve cover gskts. incl.; Premium valve stem seals incl.	
QTY	CONVERSION SET	YEARS	PART NO.	DESCRIPTION	
1	Gasket Conversion Set	2004-96	CS 9031-1	RTV sealant incl. for oil pan gskt.	
QTY	MANIFOLD - INT. & EXH.	YEARS	PART NO.	DESCRIPTION	
1	Int. Manifold Gasket Set	2004-96	MS 96919	Upper set incl.	
1	Exh. Manifold Gasket Set	2004-96	MS 95682		
QTY	EXHAUST PIPE FLANGE	YEARS	PART NO.	DESCRIPTION	
2	Exhaust Pipe Gasket	2004-96	23624	Flange	
1	Exhaust Pipe Gasket	2004-96	60486	Loc. Front; Converter; Old design	
1	Exhaust Pipe Gasket	2004-96	60884	Loc. Front; Converter; Improved design	
1	Exhaust Pipe Gasket	2004-96	61344	Loc. Rear; Converter	
QTY	CRANKSHAFT REAR SEAL	YEARS	PART NO.	DESCRIPTION	
1	Rear Main Seal Set	2004-96	BS 40535-1	Rubber; One-piece	
QTY	VALVE COVER	YEARS	PART NO.	DESCRIPTION	
1	Valve Cover Gasket Set	2004-96	VS 50448 R	w/Circular plugs & Grommets & Spark plug tube seals; PermaDry® molded rubber gskts. incl.	
QTY	VALVE STEM SEAL SET	YEARS	PART NO.	DESCRIPTION	
2	Valve Stem Seal Set	2004-96	SS 70283-2	Premium valve stem seals incl.	
QTY	THERMOSTAT HOUSING	YEARS	PART NO.	DESCRIPTION	
1	Thermostat Gasket	2004-96	35828	Thermostat Housing; Thermostat case	
1	O-Ring	2004-96	35162	Thermostat Housing	
QTY	WATER PUMP	YEARS	PART NO.	DESCRIPTION	
1	Water Pump Gasket	2004-96	35832		
QTY	TIMING COVER	YEARS	PART NO.	DESCRIPTION	
1	Crankshaft Front Seal Set	2004-96	TCS 45959		
1	Camshaft Front Seal Set	2004-96	TCS 46095		
QTY	CARB & FUEL INJECTION	YEARS	PART NO.	DESCRIPTION	
1	Throttle Body Gasket	2004-96	61483	Throttle body to case; Improved design	
80		2013 - 2009; 3.7L 223.6 (3664cc) SOHC V6 (24 Valve) 90mm Bore VTEC			80
(cont.)		MFI; Gasoline; Naturally Aspirated Honda Eng.; Eng. Code J37A2			(cont.)
QTY	CYLINDER HEAD	YEARS	PART NO.	DESCRIPTION	
2	Head Bolt Set	2013-09	ES 71329-1	12-point Head bolts; Head bolts w/Washers; Replacement recommended	
QTY	CONVERSION SET	YEARS	PART NO.	DESCRIPTION	
1	Gasket Conversion Set	2013-09	CS 26265	RTV sealant incl. for oil pan gskt.	
QTY	MANIFOLD - INT. & EXH.	YEARS	PART NO.	DESCRIPTION	
1	Int. Manifold Gasket Set	2013-09	MS 97136	Lower set	
1	Plenum Gasket Set	2013-09	MS 96409-3	Upper set; Improved design; New Part Number - Check for Availability	
1	Exh. Manifold Gasket Set	2013-09	MS 97133		
QTY	EXHAUST PIPE FLANGE	YEARS	PART NO.	DESCRIPTION	
2	Exhaust Pipe Gasket	2013-09	60578	Pipe to manifold	
1	Exhaust Pipe Gasket	2013-09	61015	Exh. connector	
1	Exhaust Pipe Gasket	2013-09	61338	Converter	
QTY	CRANKSHAFT REAR SEAL	YEARS	PART NO.	DESCRIPTION	
1	Rear Main Seal Set	2013-09	BS 40685	Rubber; One-piece	

80 (cont.)		2013 - 2009; 3.7L 223.6 (3664cc) SOHC V6 (24 Valve) 90mm Bore VTEC			80 (cont.)	
MFI; Gasoline; Naturally Aspirated Honda Eng.; Eng. Code J37A2						
QTY	VALVE COVER	YEARS	PART NO.	DESCRIPTION		
1	Valve Cover Gasket Set	2013-09	VS 50773 R	w/Grommets & Spark plug tube seals; PermaDry® molded rubber gskts. incl.; New Part Number - Check for Availability		
QTY	VALVE STEM SEAL SET	YEARS	PART NO.	DESCRIPTION		
2	Valve Stem Seal Set	2013-09	SS 70283-2	Premium valve stem seals incl.		
QTY	THERMOSTAT HOUSING	YEARS	PART NO.	DESCRIPTION		
1	O-Ring	2013-09	35162	Thermostat Housing; Thermostat seal		
QTY	WATER OUTLET GASKET	YEARS	PART NO.	DESCRIPTION		
1	Water Crossover Mounting Set	2013-09	ES 72998	Water Outlet; Water bypass set; OEM style; New Part Number - Check for Availability		
QTY	WATER PUMP	YEARS	PART NO.	DESCRIPTION		
1	Water Pump Gasket	2013-09	35677			
QTY	TIMING COVER	YEARS	PART NO.	DESCRIPTION		
1	Crankshaft Front Seal Set	2013-09	TCS 46026			
1	Camshaft Front Seal Set	2013-09	TCS 46025			
QTY	CARB & FUEL INJECTION	YEARS	PART NO.	DESCRIPTION		
1	Throttle Body Gasket	2013-09	61724	New Part Number - Check for Availability		
QTY	EXHAUST GAS RECIRCULATION	YEARS	PART NO.	DESCRIPTION		
1	EGR Gasket	2013-09	70978	Valve		
1	EGR Gasket	2013-09	72371	Loc. Lower; Pipe		
1	EGR Gasket	2013-09	72420	Loc. Upper; Pipe		
QTY	OIL FILTER MOUNTING	YEARS	PART NO.	DESCRIPTION		
1	Oil Filter Adapter Gasket	2013-09	72951	Oil filter adapter; New Part Number - Check for Availability		
81		2013 - 2009; 3.7L 223.6 (3664cc) SOHC V6 (24 Valve) 90mm Bore VTEC			81	
MFI; Gasoline; Naturally Aspirated Honda Eng.; Eng. Code J37A4						
QTY	CYLINDER HEAD	YEARS	PART NO.	DESCRIPTION		
2	Head Bolt Set	2013-09	ES 71329-1	12-point Head bolts; Head bolts w/Washers; Replacement recommended		
QTY	CONVERSION SET	YEARS	PART NO.	DESCRIPTION		
1	Gasket Conversion Set	2013-09	CS 26265	RTV sealant incl. for oil pan gskt.		
QTY	MANIFOLD - INT. & EXH.	YEARS	PART NO.	DESCRIPTION		
1	Int. Manifold Gasket Set	2013-09	MS 97136	Lower set		
1	Plenum Gasket Set	2013-09	MS 96409-3	Upper set; Improved design; New Part Number - Check for Availability		
1	Exh. Manifold Gasket Set	2013-09	MS 97133			
QTY	EXHAUST PIPE FLANGE	YEARS	PART NO.	DESCRIPTION		
2	Exhaust Pipe Gasket	2013-09	60578	Pipe to manifold		
1	Exhaust Pipe Gasket	2013-09	61015	Exh. connector		
1	Exhaust Pipe Gasket	2013-09	61338	Converter		
QTY	CRANKSHAFT REAR SEAL	YEARS	PART NO.	DESCRIPTION		
1	Rear Main Seal Set	2013-09	BS 40685	Rubber; One-piece		
QTY	VALVE COVER	YEARS	PART NO.	DESCRIPTION		
1	Valve Cover Gasket Set	2013-09	VS 50773 R	w/Grommets & Spark plug tube seals; PermaDry® molded rubber gskts. incl.; New Part Number - Check for Availability		
QTY	VALVE STEM SEAL SET	YEARS	PART NO.	DESCRIPTION		
2	Valve Stem Seal Set	2013-09	SS 70283-2	Premium valve stem seals incl.		
QTY	THERMOSTAT HOUSING	YEARS	PART NO.	DESCRIPTION		
1	O-Ring	2013-09	35162	Thermostat Housing; Thermostat seal		
QTY	WATER OUTLET GASKET	YEARS	PART NO.	DESCRIPTION		
1	Water Crossover Mounting Set	2013-09	ES 72998	Water Outlet; Water bypass set; OEM style; New Part Number - Check for Availability		
QTY	WATER PUMP	YEARS	PART NO.	DESCRIPTION		
1	Water Pump Gasket	2013-09	35677			
QTY	TIMING COVER	YEARS	PART NO.	DESCRIPTION		
1	Crankshaft Front Seal Set	2013-09	TCS 46026			
1	Camshaft Front Seal Set	2013-09	TCS 46025			
QTY	CARB & FUEL INJECTION	YEARS	PART NO.	DESCRIPTION		
1	Throttle Body Gasket	2013-09	61724	New Part Number - Check for Availability		
QTY	EXHAUST GAS RECIRCULATION	YEARS	PART NO.	DESCRIPTION		
1	EGR Gasket	2013-09	70978	Valve		
1	EGR Gasket	2013-09	72371	Loc. Lower; Pipe		
1	EGR Gasket	2013-09	72420	Loc. Upper; Pipe		
QTY	OIL FILTER MOUNTING	YEARS	PART NO.	DESCRIPTION		
1	Oil Filter Adapter Gasket	2013-09	72951	Oil filter adapter; New Part Number - Check for Availability		

Honda Minivans - See Honda Truck

Honda SUV's - See Honda Truck

Honda Truck (Incl. Minivans and SUV's)

Engine Finding Index			
Engine	Years	Code	Line No.
2.0L 120.3 (1972cc) DOHC L4 (16 Valve) 84mm Bore; MFI; Gasoline; Naturally Aspirated Honda Eng.	1998-97	B20B4	1
2.0L 120.3 (1972cc) DOHC L4 (16 Valve) 84mm Bore; MFI; Gasoline; Naturally Aspirated Honda Eng.	2001-99	B20Z2	2
2.2L 131.6 (2156cc) SOHC L4 (16 Valve) 85mm Bore; MFI; Gasoline; Naturally Aspirated Honda Eng.	1997-95	F22B6	3
2.3L 137.5 (2254cc) SOHC L4 (16 Valve) 86mm Bore VTEC; MFI; Gasoline; Naturally Aspirated Honda Eng.	1998	F23A7	4
2.4L 144 (2354cc) DOHC L4 (16 Valve) 87mm Bore i-VTEC; MFI; Gasoline; Naturally Aspirated Honda Eng.	2006-02	K24A1	5
2.4L 144 (2354cc) DOHC L4 (16 Valve) 87mm Bore i-VTEC; MFI; Gasoline; Naturally Aspirated Honda Eng.	2006-03	K24A4	6
2.4L 144 (2354cc) DOHC L4 (16 Valve) 87mm Bore i-VTEC; MFI; Gasoline; Naturally Aspirated Honda Eng.	2011-07	K24A8	7
2.4L 144 (2354cc) DOHC L4 (16 Valve) 87mm Bore i-VTEC; MFI; Gasoline; Naturally Aspirated Honda Eng.	2013-12	K24Y2	8
2.4L 144 (2354cc) DOHC L4 (16 Valve) 87mm Bore i-VTEC; MFI; Gasoline; Naturally Aspirated Honda Eng.	2009-07	K24Z1	9
2.4L 144 (2354cc) DOHC L4 (16 Valve) 87mm Bore i-VTEC; MFI; Gasoline; Naturally Aspirated Honda Eng.	2011-10	K24Z6	10
2.4L 144 (2354cc) DOHC L4 (16 Valve) 87mm Bore i-VTEC; MFI; Gasoline; Naturally Aspirated Honda Eng.	2013-12	K24Z7	11
2.6L 156.2 (2559cc) SOHC L4 (8 Valve) 92.6mm Bore; MFI; Gasoline; Naturally Aspirated Isuzu Eng.	1997-94	4ZE1	12
3.2L 193 (3165cc) DOHC V6 (24 Valve) 93.4mm Bore; MFI; Gasoline; Naturally Aspirated Isuzu Eng.	2002-98	6VD2	13
3.2L 193 (3165cc) SOHC V6 (24 Valve) 93.4mm Bore; MFI; Gasoline; Naturally Aspirated Isuzu Eng.	1997-94	6VD1	14
3.5L 212 (3471cc) SOHC V6 (24 Valve) 89mm Bore VTEC; MFI; Gasoline; Naturally Aspirated Honda Eng.	2001-99	J35A1	15
3.5L 212 (3471cc) SOHC V6 (24 Valve) 89mm Bore VTEC; MFI; Gasoline; Naturally Aspirated Honda Eng.	2002-01	J35A3	16
3.5L 212 (3471cc) SOHC V6 (24 Valve) 89mm Bore VTEC; MFI; Gasoline; Naturally Aspirated Honda Eng.	2004-02	J35A4	17
3.5L 212 (3471cc) SOHC V6 (24 Valve) 89mm Bore VTEC; MFI; Gasoline; Naturally Aspirated Honda Eng.	2006-03	J35A5	18
3.5L 212 (3471cc) SOHC V6 (24 Valve) 89mm Bore VTEC; MFI; Gasoline; Naturally Aspirated Honda Eng.	2010-05	J35A6	19
3.5L 212 (3471cc) SOHC V6 (24 Valve) 89mm Bore VTEC; MFI; Gasoline; Naturally Aspirated Honda Eng.	2013-11	J35A8	20
3.5L 212 (3471cc) SOHC V6 (24 Valve) 89mm Bore VTEC; MFI; Gasoline; Naturally Aspirated Honda Eng.	2008-06	J35A9	21
3.5L 212 (3471cc) SOHC V6 (24 Valve) 89mm Bore VTEC; MFI; Gasoline; Naturally Aspirated Honda Eng.	2008-06	J35Z1	22
3.5L 212 (3471cc) SOHC V6 (24 Valve) 89mm Bore VTEC; MFI; Gasoline; Naturally Aspirated Honda Eng.	2013-10	J35Z2	23
3.5L 212 (3471cc) SOHC V6 (24 Valve) 89mm Bore VTEC; MFI; Gasoline; Naturally Aspirated Honda Eng.	2013-09	J35Z5	24
3.5L 212 (3471cc) SOHC V6 (24 Valve) 89mm Bore i-VTEC; MFI; Gasoline; Naturally Aspirated Honda Eng.	2010-05	J35A7	25
3.5L 212 (3471cc) SOHC V6 (24 Valve) 89mm Bore i-VTEC; MFI; Gasoline; Naturally Aspirated Honda Eng.	2013	J35Y1	26
3.5L 212 (3471cc) SOHC V6 (24 Valve) 89mm Bore i-VTEC; MFI; Gasoline; Naturally Aspirated Honda Eng.	2013-09	J35Z4	27
3.5L 214 (3494cc) DOHC V6 (24 Valve) 93.4mm Bore; MFI; Gasoline; Naturally Aspirated Isuzu Eng.	2000-98	6VE1	28
3.7L 223.6 (3664cc) SOHC V6 (24 Valve) 90mm Bore VTEC; MFI; Gasoline; Naturally Aspirated Honda Eng.	2013-07	J37A1	29
3.7L 223.6 (3664cc) SOHC V6 (24 Valve) 90mm Bore VTEC; MFI; Gasoline; Naturally Aspirated Honda Eng.	2013-10	J37A5	30

Engine Code Index		
Code	Engine	Line No.
4ZE1	2.6L 156.2 (2559cc) SOHC L4 (8 Valve) 92.6mm Bore; MFI; Gasoline; Naturally Aspirated Isuzu Eng.	12
6VD1	3.2L 193 (3165cc) SOHC V6 (24 Valve) 93.4mm Bore; MFI; Gasoline; Naturally Aspirated Isuzu Eng.	14
6VD2	3.2L 193 (3165cc) DOHC V6 (24 Valve) 93.4mm Bore; MFI; Gasoline; Naturally Aspirated Isuzu Eng.	13
6VE1	3.5L 214 (3494cc) DOHC V6 (24 Valve) 93.4mm Bore; MFI; Gasoline; Naturally Aspirated Isuzu Eng.	28
B20B4	2.0L 120.3 (1972cc) DOHC L4 (16 Valve) 84mm Bore; MFI; Gasoline; Naturally Aspirated Honda Eng.	1
B20Z2	2.0L 120.3 (1972cc) DOHC L4 (16 Valve) 84mm Bore; MFI; Gasoline; Naturally Aspirated Honda Eng.	2
F22B6	2.2L 131.6 (2156cc) SOHC L4 (16 Valve) 85mm Bore; MFI; Gasoline; Naturally Aspirated Honda Eng.	3
F23A7	2.3L 137.5 (2254cc) SOHC L4 (16 Valve) 86mm Bore VTEC; MFI; Gasoline; Naturally Aspirated Honda Eng.	4
J35A1	3.5L 212 (3471cc) SOHC V6 (24 Valve) 89mm Bore VTEC; MFI; Gasoline; Naturally Aspirated Honda Eng.	15
J35A3	3.5L 212 (3471cc) SOHC V6 (24 Valve) 89mm Bore VTEC; MFI; Gasoline; Naturally Aspirated Honda Eng.	16
J35A4	3.5L 212 (3471cc) SOHC V6 (24 Valve) 89mm Bore VTEC; MFI; Gasoline; Naturally Aspirated Honda Eng.	17
J35A5	3.5L 212 (3471cc) SOHC V6 (24 Valve) 89mm Bore VTEC; MFI; Gasoline; Naturally Aspirated Honda Eng.	18
J35A6	3.5L 212 (3471cc) SOHC V6 (24 Valve) 89mm Bore VTEC; MFI; Gasoline; Naturally Aspirated Honda Eng.	19
J35A7	3.5L 212 (3471cc) SOHC V6 (24 Valve) 89mm Bore i-VTEC; MFI; Gasoline; Naturally Aspirated Honda Eng.	25
J35A8	3.5L 212 (3471cc) SOHC V6 (24 Valve) 89mm Bore VTEC; MFI; Gasoline; Naturally Aspirated Honda Eng.	20
J35A9	3.5L 212 (3471cc) SOHC V6 (24 Valve) 89mm Bore VTEC; MFI; Gasoline; Naturally Aspirated Honda Eng.	21
J35Y1	3.5L 212 (3471cc) SOHC V6 (24 Valve) 89mm Bore i-VTEC; MFI; Gasoline; Naturally Aspirated Honda Eng.	26
J35Z1	3.5L 212 (3471cc) SOHC V6 (24 Valve) 89mm Bore VTEC; MFI; Gasoline; Naturally Aspirated Honda Eng.	22
J35Z2	3.5L 212 (3471cc) SOHC V6 (24 Valve) 89mm Bore VTEC; MFI; Gasoline; Naturally Aspirated Honda Eng.	23
J35Z4	3.5L 212 (3471cc) SOHC V6 (24 Valve) 89mm Bore i-VTEC; MFI; Gasoline; Naturally Aspirated Honda Eng.	27
J35Z5	3.5L 212 (3471cc) SOHC V6 (24 Valve) 89mm Bore VTEC; MFI; Gasoline; Naturally Aspirated Honda Eng.	24
J37A1	3.7L 223.6 (3664cc) SOHC V6 (24 Valve) 90mm Bore VTEC; MFI; Gasoline; Naturally Aspirated Honda Eng.	29
J37A5	3.7L 223.6 (3664cc) SOHC V6 (24 Valve) 90mm Bore VTEC; MFI; Gasoline; Naturally Aspirated Honda Eng.	30
K24A1	2.4L 144 (2354cc) DOHC L4 (16 Valve) 87mm Bore i-VTEC; MFI; Gasoline; Naturally Aspirated Honda Eng.	5
K24A4	2.4L 144 (2354cc) DOHC L4 (16 Valve) 87mm Bore i-VTEC; MFI; Gasoline; Naturally Aspirated Honda Eng.	6
K24A8	2.4L 144 (2354cc) DOHC L4 (16 Valve) 87mm Bore i-VTEC; MFI; Gasoline; Naturally Aspirated Honda Eng.	7
K24Y2	2.4L 144 (2354cc) DOHC L4 (16 Valve) 87mm Bore i-VTEC; MFI; Gasoline; Naturally Aspirated Honda Eng.	8
K24Z1	2.4L 144 (2354cc) DOHC L4 (16 Valve) 87mm Bore i-VTEC; MFI; Gasoline; Naturally Aspirated Honda Eng.	9

Honda Truck (Incl. Minivans and SUV's) (Cont.)

Engine Code Index (Cont.)

Code	Engine	Line No.
K24Z6	2.4L 144 (2354cc) DOHC L4 (16 Valve) 87mm Bore i-VTEC; MFI; Gasoline; Naturally Aspirated Honda Eng.	10
K24Z7	2.4L 144 (2354cc) DOHC L4 (16 Valve) 87mm Bore i-VTEC; MFI; Gasoline; Naturally Aspirated Honda Eng.	11

Model Index

Engine (VIN Code / Eng. Code)	Year	Engine (VIN Code / Eng. Code)	Year	Engine (VIN Code / Eng. Code)	Year
Acura Truck		Honda Truck (cont.)		Honda Truck (cont.)	
MDX (AWD Mid-Size SUV)		CR-V (FWD Compact SUV)		Odyssey (FWD Minivan) (cont.)	
V6 3471cc 3.5L SOHC VTEC (24 Valve) (J35A3)	02-01	L4 1972cc 2.0L DOHC (16 Valve) (B20B4)	98-97	V6 3471cc 3.5L SOHC i-VTEC (24 Valve) (J35A8)	13-11
V6 3471cc 3.5L SOHC VTEC (24 Valve) (J35A5)	06-03	L4 1972cc 2.0L DOHC (16 Valve) (B20Z2)	01-99	V6 3471cc 3.5L SOHC VTEC (24 Valve) (J35A1)	01-99
V6 3664cc 3.7L SOHC VTEC (24 Valve) (J37A1)	13-07	L4 2354cc 2.4L DOHC i-VTEC (16 Valve) (K24A1)	06-02	V6 3471cc 3.5L SOHC VTEC (24 Valve) (J35A4)	04-02
RDX (AWD Compact SUV)		L4 2354cc 2.4L DOHC i-VTEC (16 Valve) (K24Z1)	09-07	V6 3471cc 3.5L SOHC VTEC (24 Valve) (J35A6)	10-05
L4 2301cc 2.3L DOHC i-VTEC Turbo (16 Valve) (K23A1)	12-07	L4 2354cc 2.4L DOHC i-VTEC (16 Valve) (K24Z6)	11-10	Passport (2WD Mid-Size SUV)	
V6 3471cc 3.5L SOHC VTEC (24 Valve) (J35Z2)	13	L4 2354cc 2.4L DOHC i-VTEC (16 Valve) (K24Z7)	13-12	L4 2559cc 2.6L SOHC (4ZE1)	97-94
RDX (FWD Compact SUV)		Crosstour (AWD Mid-Size SUV)		V6 3165cc 3.2L DOHC (24 Valve) (6VD2)	02-98
V6 3471cc 3.5L SOHC VTEC (24 Valve) (J35Z2)	13	V6 3471cc 3.5L SOHC i-VTEC (24 Valve) (J35Y1)	13	V6 3165cc 3.2L SOHC (24 Valve) (6VD1)	97-94
SLX (AWD Full-Size SUV)		V6 3471cc 3.5L SOHC VTEC (24 Valve) (J35Z2)	13-12	Passport (4WD Mid-Size SUV)	
V6 3165cc 3.2L SOHC (24 Valve) (6VD1)	97-96	Crosstour (FWD Mid-Size SUV)		V6 3165cc 3.2L DOHC (24 Valve) (6VD2)	02-98
V6 3494cc 3.5L DOHC (24 Valve) (6VE1)	00-98	L4 2354cc 2.4L DOHC i-VTEC (16 Valve) (K24Y2)	13-12	V6 3165cc 3.2L SOHC (24 Valve) (6VD1)	97-94
ZDX (AWD Mid-Size SUV)		V6 3471cc 3.5L SOHC i-VTEC (24 Valve) (J35Y1)	13	Pilot (AWD Mid-Size SUV)	
V6 3664cc 3.7L SOHC VTEC (24 Valve) (J37A5)	13-10	V6 3471cc 3.5L SOHC VTEC (24 Valve) (J35Z2)	13-12	V6 3471cc 3.5L SOHC i-VTEC (24 Valve) (J35Z4)	13-09
Honda Truck		Element (AWD Compact SUV)		V6 3471cc 3.5L SOHC VTEC (24 Valve) (J35A4)	04-03
Accord Crosstour (AWD Mid-Size SUV)		V6 3471cc 3.5L SOHC VTEC (24 Valve) (J35Z2)	13-12	V6 3471cc 3.5L SOHC VTEC (24 Valve) (J35A6)	05
V6 3471cc 3.5L SOHC VTEC (24 Valve) (J35Z2)	11-10	Element (FWD Compact SUV)		V6 3471cc 3.5L SOHC VTEC (24 Valve) (J35A9)	08-06
Accord Crosstour (FWD Mid-Size SUV)		L4 2354cc 2.4L DOHC i-VTEC (16 Valve) (K24A4)	06-03	Pilot (FWD Mid-Size SUV)	
V6 3471cc 3.5L SOHC VTEC (24 Valve) (J35Z2)	11-10	L4 2354cc 2.4L DOHC i-VTEC (16 Valve) (K24A8)	11-07	V6 3471cc 3.5L SOHC i-VTEC (24 Valve) (J35Z4)	13-09
CR-V (AWD Compact SUV)		Element (FWD Compact SUV)		V6 3471cc 3.5L SOHC VTEC (24 Valve) (J35Z1)	08-06
L4 1972cc 2.0L DOHC (16 Valve) (B20B4)	98-97	L4 2354cc 2.4L DOHC i-VTEC (16 Valve) (K24A4)	06-03	Ridgeline (AWD Compact Pickup)	
L4 1972cc 2.0L DOHC (16 Valve) (B20Z2)	01-99	L4 2354cc 2.4L DOHC i-VTEC (16 Valve) (K24A8)	11-07	V6 3471cc 3.5L SOHC VTEC (24 Valve) (J35A9)	08-06
L4 2354cc 2.4L DOHC i-VTEC (16 Valve) (K24A1)	06-02	Odyssey (FWD Minivan)		V6 3471cc 3.5L SOHC VTEC (24 Valve) (J35Z5)	13-09
L4 2354cc 2.4L DOHC i-VTEC (16 Valve) (K24Z1)	09-07	L4 2156cc 2.2L SOHC (16 Valve) (F22B6)	97-95		
L4 2354cc 2.4L DOHC i-VTEC (16 Valve) (K24Z6)	11-10	L4 2254cc 2.3L SOHC VTEC (16 Valve) (F23A7)	98		
L4 2354cc 2.4L DOHC i-VTEC (16 Valve) (K24Z7)	13-12	V6 3471cc 3.5L SOHC i-VTEC (24 Valve) (J35A7)	10-05		

1

**1998 - 1997; 2.0L 120.3 (1972cc) DOHC L4 (16 Valve) 84mm Bore
MFI; Gasoline; Naturally Aspirated Honda Eng.; Eng. Code B20B4**

1

QTY	CYLINDER HEAD	YEARS	PART NO.	DESCRIPTION
1	Head Gasket	1998-97	26159 PT	Head bolts not incl.; Head bolt replacement recommended; PermaTorqueMLS® LaserWeld® Technology
1	Head Set	1998-97	HS 26159 PT	Head bolts & exh. pipe flange not incl.; Head bolt replacement recommended; PermaDry® molded rubber valve cover gskt. incl.; Premium valve stem seals incl.
QTY	CONVERSION SET	YEARS	PART NO.	DESCRIPTION
1	Gasket Conversion Set	1998-97	CS 9698	PermaDry® molded rubber oil pan gskt. incl.
QTY	MANIFOLD - INT. & EXH.	YEARS	PART NO.	DESCRIPTION
1	Int. Manifold Gasket Set	1998-97	MS 92506	Improved design
1	Exh. Manifold Gasket Set	1998-97	MS 94602	
QTY	EXHAUST PIPE FLANGE	YEARS	PART NO.	DESCRIPTION
1	Exhaust Pipe Gasket	1998-97	23624	Flange; California
2	Exhaust Pipe Gasket	1998-97	60776	Flange; Exc. California
QTY	OIL PAN	YEARS	PART NO.	DESCRIPTION
1	Oil Pan Gasket Set	1998-97	OS 30630 R	PermaDry® molded rubber gskt. incl.
QTY	CRANKSHAFT REAR SEAL	YEARS	PART NO.	DESCRIPTION
1	Rear Main Seal Set	1998-97	BS 40430	Rubber; One-piece

Honda Truck (Incl. Minivans and SUV's) (Cont.)

1		1998 - 1997; 2.0L 120.3 (1972cc) DOHC L4 (16 Valve) 84mm Bore			1	
(cont.)		MFI; Gasoline; Naturally Aspirated Honda Eng.; Eng. Code B20B4			(cont.)	
QTY	CRANKSHAFT REAR SEAL	YEARS	PART NO.	DESCRIPTION		
1	Repair Sleeve	1998-97	16275	Crankshaft; Use w/installation tool		
QTY	VALVE COVER	YEARS	PART NO.	DESCRIPTION		
1	Valve Cover Gasket Set	1998-97	VS 50362 R	w/o Grommets & w/Spark plug tube seals; PermaDry® molded rubber gskt. incl.		
1	Grommet Set	1998-97	ES 72132	Valve Cover		
1	Circular Plug	1998-97	ES 72476	Valve Cover; New Part Number - Check for Availability		
1	Spark Plug Tube Seal Set	1998-97	ES 72179	Valve Cover		
QTY	VALVE STEM SEAL SET	YEARS	PART NO.	DESCRIPTION		
1	Valve Stem Seal Set	1998-97	SS 72632-1	Premium valve stem seals incl.		
QTY	THERMOSTAT HOUSING	YEARS	PART NO.	DESCRIPTION		
1	Thermostat Gasket	1998-97	35480	Thermostat Housing; Thermostat O-ring		
QTY	WATER PUMP	YEARS	PART NO.	DESCRIPTION		
1	Water Pump Gasket	1998-97	35499	Improved design		
QTY	TIMING COVER	YEARS	PART NO.	DESCRIPTION		
1	Crankshaft Front Seal Set	1998-97	TCS 45904			
1	Camshaft Front Seal Set	1998-97	TCS 45718			
QTY	CARB & FUEL INJECTION	YEARS	PART NO.	DESCRIPTION		
1	Throttle Body Gasket	1998-97	60979	w/A/T		
1	Throttle Body Gasket	1998-97	61066	w/M/T		
QTY	DISTRIBUTOR MOUNTING	YEARS	PART NO.	DESCRIPTION		
1	Distributor Mounting Gasket	1998-97	72454	Distributor Mounting; O-ring; 26.5mm ID		
2		2001 - 1999; 2.0L 120.3 (1972cc) DOHC L4 (16 Valve) 84mm Bore			2	
(cont.)		MFI; Gasoline; Naturally Aspirated Honda Eng.; Eng. Code B20Z2			(cont.)	
QTY	CYLINDER HEAD	YEARS	PART NO.	DESCRIPTION		
1	Head Gasket	2001-99	26159 PT	Head bolts not incl.; Head bolt replacement recommended; PermaTorqueMLS® LaserWeld® Technology		
1	Head Set	2001-99	HS 26159 PT	Head bolts & exh. pipe flange not incl.; Head bolt replacement recommended; PermaDry® molded rubber valve cover gskt. incl.; Premium valve stem seals incl.		
QTY	CONVERSION SET	YEARS	PART NO.	DESCRIPTION		
1	Gasket Conversion Set	2001-99	CS 9698	PermaDry® molded rubber oil pan gskt. incl.		
QTY	MANIFOLD - INT. & EXH.	YEARS	PART NO.	DESCRIPTION		
1	Int. Manifold Gasket Set	2001-99	MS 92506	Improved design		
1	Exh. Manifold Gasket Set	2001-99	MS 94602			
QTY	EXHAUST PIPE FLANGE	YEARS	PART NO.	DESCRIPTION		
2	Exhaust Pipe Gasket	2001-99	60776	Flange		
QTY	OIL PAN	YEARS	PART NO.	DESCRIPTION		
1	Oil Pan Gasket Set	2001-99	OS 30630 R	PermaDry® molded rubber gskt. incl.		
QTY	CRANKSHAFT REAR SEAL	YEARS	PART NO.	DESCRIPTION		
1	Rear Main Seal Set	2001-99	BS 40430	Rubber; One-piece		
1	Repair Sleeve	2001-99	16275	Crankshaft; Use w/installation tool		
QTY	VALVE COVER	YEARS	PART NO.	DESCRIPTION		
1	Valve Cover Gasket Set	2001-99	VS 50362 R	w/o Grommets & w/Spark plug tube seals; PermaDry® molded rubber gskt. incl.		
1	Grommet Set	2001-99	ES 72132	Valve Cover		
1	Circular Plug	2001-99	ES 72476	Valve Cover; New Part Number - Check for Availability		
1	Spark Plug Tube Seal Set	2001-99	ES 72179	Valve Cover		
QTY	VALVE STEM SEAL SET	YEARS	PART NO.	DESCRIPTION		
1	Valve Stem Seal Set	2001-99	SS 72632-1	Premium valve stem seals incl.		
QTY	THERMOSTAT HOUSING	YEARS	PART NO.	DESCRIPTION		
1	Thermostat Gasket	2001-99	35480	Thermostat Housing; Thermostat O-ring		
QTY	WATER PUMP	YEARS	PART NO.	DESCRIPTION		
1	Water Pump Gasket	2001-99	35499	Improved design		
QTY	TIMING COVER	YEARS	PART NO.	DESCRIPTION		
1	Crankshaft Front Seal Set	2001-99	TCS 45904			
1	Camshaft Front Seal Set	2001-99	TCS 45718			
QTY	CARB & FUEL INJECTION	YEARS	PART NO.	DESCRIPTION		
1	Throttle Body Gasket	2001-99	60973	w/A/T		
1	Throttle Body Gasket	2001-99	61067	w/M/T; Improved design		
QTY	DISTRIBUTOR MOUNTING	YEARS	PART NO.	DESCRIPTION		
1	Distributor Mounting Gasket	2001-99	72454	Distributor Mounting; O-ring; 26.5mm ID		

Honda Truck (Incl. Minivans and SUV's) (Cont.)

3	1997 - 1995; 2.2L 131.6 (2156cc) SOHC L4 (16 Valve) 85mm Bore MFI; Gasoline; Naturally Aspirated Honda Eng.; Eng. Code F22B6				3
QTY	CYLINDER HEAD	YEARS	PART NO.	DESCRIPTION	
1	Head Gasket	1997-95	9958 PT-1	Head bolts not incl.; Head bolt replacement recommended; PermaTorqueMLS®; Improved design	
1	Head Set	1997-95	HS 9958 PT	Head bolts & exh. pipe flange not incl.; Head bolt replacement recommended; PermaDry® molded rubber valve cover gskt. incl.; Premium valve stem seals incl.	
QTY	CONVERSION SET	YEARS	PART NO.	DESCRIPTION	
1	Gasket Conversion Set	1997-95	CS 9851	PermaDry® molded rubber oil pan gskt. incl.	
QTY	MANIFOLD - INT. & EXH.	YEARS	PART NO.	DESCRIPTION	
1	Int. Manifold Gasket Set	1997-95	MS 95612	Upper set incl.	
1	Exh. Manifold Gasket Set	1997-95	MS 94184	Improved design	
QTY	EXHAUST PIPE FLANGE	YEARS	PART NO.	DESCRIPTION	
1	Exhaust Pipe Gasket	1997-95	60517	Loc. Rear; Converter	
1	Exhaust Pipe Gasket	1997-95	60669	Loc. Front; Converter	
2	Exhaust Pipe Gasket	1997-95	60776	Flange	
QTY	OIL PAN	YEARS	PART NO.	DESCRIPTION	
1	Oil Pan Gasket Set	1997-95	OS 30632 R	PermaDry® molded rubber gskt. incl.	
QTY	CRANKSHAFT REAR SEAL	YEARS	PART NO.	DESCRIPTION	
1	Rear Main Seal Set	1997-95	BS 40430	Rubber; One-piece	
1	Repair Sleeve	1997-95	16275	Crankshaft; Use w/installation tool	
QTY	VALVE COVER	YEARS	PART NO.	DESCRIPTION	
1	Valve Cover Gasket Set	1997-95	VS 50365 R	w/Grommets & Spark plug tube seals; PermaDry® molded rubber gskt. incl.	
1	Valve Cover Gasket Set	1997-95	VS 50365 R-1	w/o Grommets & Spark plug tube seals; PermaDry® molded rubber gskt. incl.	
QTY	VALVE STEM SEAL SET	YEARS	PART NO.	DESCRIPTION	
1	Valve Stem Seal Set	1997-95	SS 70283-1	Premium valve stem seals incl.	
QTY	THERMOSTAT HOUSING	YEARS	PART NO.	DESCRIPTION	
1	Thermostat Gasket	1997-95	35480	Thermostat Housing; Thermostat O-ring	
QTY	WATER OUTLET GASKET	YEARS	PART NO.	DESCRIPTION	
1	Water Outlet Gasket	1997-95	35469	Water Outlet	
QTY	WATER PUMP	YEARS	PART NO.	DESCRIPTION	
1	Water Pump Mounting Set	1997-95	ES 72804		
QTY	TIMING COVER	YEARS	PART NO.	DESCRIPTION	
1	Crankshaft Front Seal Set	1997-95	TCS 45899	Must be used w/OS 30632R	
1	Camshaft Front Seal Set	1997-95	TCS 45898		
1	Repair Sleeve	1997-95	16222	Timing Cover; Use w/installation tool	
1	Repair Sleeve Tool	1997-95	16323	Timing Cover	
QTY	CARB & FUEL INJECTION	YEARS	PART NO.	DESCRIPTION	
1	Throttle Body Gasket	1997-95	60979		
QTY	DISTRIBUTOR MOUNTING	YEARS	PART NO.	DESCRIPTION	
1	Distributor Mounting Gasket	1997-95	72454	Distributor Mounting; O-ring; 26.5mm ID	
1	O-Ring	1997-95	72416	Distributor Mounting; 25mm ID	
QTY	EXHAUST GAS RECIRCULATION	YEARS	PART NO.	DESCRIPTION	
1	EGR Gasket	1997-95	70978		
4	1998; 2.3L 137.5 (2254cc) SOHC L4 (16 Valve) 86mm Bore VTEC MFI; Gasoline; Naturally Aspirated Honda Eng.; Eng. Code F23A7				4
QTY	CYLINDER HEAD	YEARS	PART NO.	DESCRIPTION	
1	Head Gasket	1998	9958 PT-1	Head bolts not incl.; Head bolt replacement recommended; PermaTorqueMLS®; Improved design	
1	Head Set	1998	HS 26155 PT	Head bolts not incl.; Head bolt replacement recommended; PermaDry® molded rubber valve cover gskt. incl.; Premium valve stem seals incl.	
1	Head Bolt Set	1998	ES 71329	Head bolts w/Washers; Replacement recommended	
QTY	CONVERSION SET	YEARS	PART NO.	DESCRIPTION	
1	Gasket Conversion Set	1998	CS 26155	PermaDry® molded rubber oil pan gskt. incl.	
QTY	MANIFOLD - INT. & EXH.	YEARS	PART NO.	DESCRIPTION	
1	Int. Manifold Gasket Set	1998	MS 94125-1	Upper set incl.	
1	Exh. Manifold Gasket Set	1998	MS 94184	Improved design	
QTY	EXHAUST PIPE FLANGE	YEARS	PART NO.	DESCRIPTION	
1	Exhaust Pipe Gasket	1998	60877	Flange	
QTY	OIL PAN	YEARS	PART NO.	DESCRIPTION	
1	Oil Pan Gasket Set	1998	OS 30632 R	PermaDry® molded rubber gskt. incl.	
QTY	CRANKSHAFT REAR SEAL	YEARS	PART NO.	DESCRIPTION	
1	Rear Main Seal Set	1998	BS 40430	Rubber; One-piece	

Honda Truck (Incl. Minivans and SUV's) (Cont.)

4		1998; 2.3L 137.5 (2254cc) SOHC L4 (16 Valve) 86mm Bore VTEC			4	
(cont.)		MFI; Gasoline; Naturally Aspirated Honda Eng.; Eng. Code F23A7			(cont.)	
QTY	CRANKSHAFT REAR SEAL	YEARS	PART NO.	DESCRIPTION		
1	Repair Sleeve	1998	16275	Crankshaft; Use w/installation tool		
QTY	VALVE COVER	YEARS	PART NO.	DESCRIPTION		
1	Valve Cover Gasket Set	1998	VS 50493 R	w/Grommets & Spark plug tube seals; PermaDry® molded rubber gskt. incl.		
QTY	VALVE STEM SEAL SET	YEARS	PART NO.	DESCRIPTION		
1	Valve Stem Seal Set	1998	SS 70283-1	Premium valve stem seals incl.		
QTY	THERMOSTAT HOUSING	YEARS	PART NO.	DESCRIPTION		
1	Thermostat Gasket	1998	35480	Thermostat Housing; Thermostat O-ring		
QTY	WATER OUTLET GASKET	YEARS	PART NO.	DESCRIPTION		
1	Water Outlet Gasket	1998	35469	Water Outlet		
QTY	WATER PUMP	YEARS	PART NO.	DESCRIPTION		
1	Water Pump Gasket	1998	35482			
QTY	TIMING COVER	YEARS	PART NO.	DESCRIPTION		
1	Crankshaft Front Seal Set	1998	TCS 45899	Must be used w/OS 30632R		
1	Camshaft Front Seal Set	1998	TCS 45898			
1	Repair Sleeve	1998	16222	Timing Cover; Use w/installation tool		
1	Repair Sleeve Tool	1998	16323	Timing Cover		
QTY	CARB & FUEL INJECTION	YEARS	PART NO.	DESCRIPTION		
1	Throttle Body Gasket	1998	61115			
QTY	DISTRIBUTOR MOUNTING	YEARS	PART NO.	DESCRIPTION		
1	Distributor Mounting Gasket	1998	72454	Distributor Mounting; O-ring; 26.5mm ID		
1	O-Ring	1998	72416	Distributor Mounting; 25mm ID		
QTY	EXHAUST GAS RECIRCULATION	YEARS	PART NO.	DESCRIPTION		
1	EGR Gasket	1998	70978			
5		2006 - 2002; 2.4L 144 (2354cc) DOHC L4 (16 Valve) 87mm Bore i-VTEC			5	
(cont.)		MFI; Gasoline; Naturally Aspirated Honda Eng.; Eng. Code K24A1			(cont.)	
QTY	CYLINDER HEAD	YEARS	PART NO.	DESCRIPTION		
1	Head Gasket	2006-02	26244 PT	Head bolts not incl.; Head bolt replacement recommended; PermaTorqueMLS®		
1	Head Set	2006-02	HS 26244 PT	Head bolts not incl.; Head bolt replacement recommended; PermaDry® molded rubber valve cover gskt. incl.; Premium valve stem seals incl.		
1	Head Bolt Set	2006-02	ES 71333	Head bolts w/Washers; Replacement recommended		
QTY	CONVERSION SET	YEARS	PART NO.	DESCRIPTION		
1	Gasket Conversion Set	2006-02	CS 26243			
QTY	MANIFOLD - INT. & EXH.	YEARS	PART NO.	DESCRIPTION		
1	Int. Manifold Gasket Set	2006-02	MS 96491	Upper set incl.		
1	Exh. Manifold Gasket Set	2006-02	MS 96474			
QTY	EXHAUST PIPE FLANGE	YEARS	PART NO.	DESCRIPTION		
1	Exhaust Pipe Gasket	2006-02	61348	Packing		
QTY	OIL PAN	YEARS	PART NO.	DESCRIPTION		
1	Oil Pan Gasket Set	2006-02	OS 30746			
QTY	CRANKSHAFT REAR SEAL	YEARS	PART NO.	DESCRIPTION		
1	Rear Main Seal Set	2006-02	BS 40535	Rubber; One-piece; Improved design		
QTY	VALVE COVER	YEARS	PART NO.	DESCRIPTION		
1	Valve Cover Gasket Set	2006-02	VS 50614 R	w/Grommets & Spark plug tube seals; PermaDry® molded rubber gskt. incl.; Improved design		
1	Spark Plug Tube Seal Set	2006-02	ES 72967	Valve Cover; New Part Number - Check for Availability		
QTY	VALVE STEM SEAL SET	YEARS	PART NO.	DESCRIPTION		
1	Valve Stem Seal Set	2006-02	SS 70283-1	Premium valve stem seals incl.		
QTY	THERMOSTAT HOUSING	YEARS	PART NO.	DESCRIPTION		
1	Thermostat Gasket	2006-02	35741	Thermostat Housing; Thermostat seal		
QTY	WATER OUTLET GASKET	YEARS	PART NO.	DESCRIPTION		
1	Water Outlet Gasket	2006-02	35740	Water Outlet; Water outlet		
1	Water Outlet Gasket	2006-02	36022	Water Outlet; Water pipe O-ring; New Part Number - Check for Availability		
QTY	WATER PUMP	YEARS	PART NO.	DESCRIPTION		
1	Water Pump Gasket	2006-02	35738			
QTY	TIMING COVER	YEARS	PART NO.	DESCRIPTION		
1	Crankshaft Front Seal Set	2006-02	TCS 46051	Must be used w/OS 30746		
QTY	CARB & FUEL INJECTION	YEARS	PART NO.	DESCRIPTION		
1	Fuel Injector O-Ring Set	2006-02	ES 70599	Improved design		
1	Throttle Body Gasket	2006-05	61408	Throttle body to spacer		
1	Throttle Body Gasket	2006-05	61422	Spacer to manifold		
1	Throttle Body Gasket	2004-02	61350			

Honda Truck (Incl. Minivans and SUV's) (Cont.)

5 (cont.)	2006 - 2002; 2.4L 144 (2354cc) DOHC L4 (16 Valve) 87mm Bore i-VTEC MFI; Gasoline; Naturally Aspirated Honda Eng.; Eng. Code K24A1				5 (cont.)
QTY	EXHAUST GAS RECIRCULATION	YEARS	PART NO.	DESCRIPTION	
1	EGR Gasket	2006-02	70978	Valve	
1	EGR Gasket	2006-02	71217	Passage	
QTY	OIL FILTER MOUNTING	YEARS	PART NO.	DESCRIPTION	
1	Oil Filter Gasket	2006-02	ES 72748	Oil filter adapter mounting set; New Part Number - Check for Availability	
6	2006 - 2003; 2.4L 144 (2354cc) DOHC L4 (16 Valve) 87mm Bore i-VTEC MFI; Gasoline; Naturally Aspirated Honda Eng.; Eng. Code K24A4				6
QTY	CYLINDER HEAD	YEARS	PART NO.	DESCRIPTION	
1	Head Gasket	2006-03	26243 PT	Head bolts not incl.; Head bolt replacement recommended; PermaTorqueMLS®	
1	Head Set	2006-03	HS 26243 PT	Head bolts not incl.; Head bolt replacement recommended; PermaDry® molded rubber valve cover gskt. incl.; Premium valve stem seals incl.	
1	Head Bolt Set	2006-03	ES 71333	Head bolts w/Washers; Replacement recommended	
QTY	CONVERSION SET	YEARS	PART NO.	DESCRIPTION	
1	Gasket Conversion Set	2006-03	CS 26243		
QTY	MANIFOLD - INT. & EXH.	YEARS	PART NO.	DESCRIPTION	
1	Int. Manifold Gasket Set	2006-03	MS 96473	Upper set incl.	
1	Exh. Manifold Gasket Set	2006-03	MS 96474		
QTY	EXHAUST PIPE FLANGE	YEARS	PART NO.	DESCRIPTION	
1	Exhaust Pipe Gasket	2006-03	61348	Packing	
QTY	OIL PAN	YEARS	PART NO.	DESCRIPTION	
1	Oil Pan Gasket Set	2006-03	OS 30746		
QTY	CRANKSHAFT REAR SEAL	YEARS	PART NO.	DESCRIPTION	
1	Rear Main Seal Set	2006-03	BS 40535	Rubber; One-piece; Improved design	
QTY	VALVE COVER	YEARS	PART NO.	DESCRIPTION	
1	Valve Cover Gasket Set	2006-03	VS 50614 R	w/Grommets & Spark plug tube seals; PermaDry® molded rubber gskt. incl.; Improved design	
1	Valve Cover Gasket Set	2006-03	VS 50627 R	w/Grommets & Spark plug tube seals; PermaDry® molded rubber gskt. incl.; Old design	
1	Spark Plug Tube Seal Set	2006-03	ES 72967	Valve Cover; New Part Number - Check for Availability	
QTY	VALVE STEM SEAL SET	YEARS	PART NO.	DESCRIPTION	
1	Valve Stem Seal Set	2006-03	SS 70283-1	Premium valve stem seals incl.	
QTY	THERMOSTAT HOUSING	YEARS	PART NO.	DESCRIPTION	
1	Thermostat Gasket	2006-03	35739	Thermostat Housing; Thermostat case	
1	Thermostat Gasket	2006-03	35741	Thermostat Housing; Thermostat seal	
QTY	WATER OUTLET GASKET	YEARS	PART NO.	DESCRIPTION	
1	Water Outlet Gasket	2006-03	36022	Water Outlet; Water pipe O-ring; New Part Number - Check for Availability	
QTY	WATER PUMP	YEARS	PART NO.	DESCRIPTION	
1	Water Pump Gasket	2006-03	35738		
QTY	TIMING COVER	YEARS	PART NO.	DESCRIPTION	
1	Crankshaft Front Seal Set	2006-03	TCS 46051	Must be used w/OS 30746	
QTY	CARB & FUEL INJECTION	YEARS	PART NO.	DESCRIPTION	
1	Fuel Injector O-Ring Set	2006-03	ES 70599	Improved design	
1	Throttle Body Gasket	2006-03	61349		
QTY	EXHAUST GAS RECIRCULATION	YEARS	PART NO.	DESCRIPTION	
1	EGR Gasket	2006-03	70978	Valve	
1	EGR Gasket	2006-03	71217	Passage	
QTY	OIL FILTER MOUNTING	YEARS	PART NO.	DESCRIPTION	
1	Oil Filter Gasket	2006-03	ES 72748	Oil filter adapter mounting set; New Part Number - Check for Availability	
7	2011 - 2007; 2.4L 144 (2354cc) DOHC L4 (16 Valve) 87mm Bore i-VTEC MFI; Gasoline; Naturally Aspirated Honda Eng.; Eng. Code K24A8				7
QTY	CYLINDER HEAD	YEARS	PART NO.	DESCRIPTION	
1	Head Gasket	2011-07	26337 PT	Head bolts not incl.; Head bolt replacement recommended; PermaTorqueMLS®	
1	Head Set	2011-07	HS 26337 PT	Head bolts not incl.; Head bolt replacement recommended; PermaDry® molded rubber valve cover gskt. incl.; Premium valve stem seals incl.	
1	Head Bolt Set	2011-07	ES 71333	Head bolts w/Washers; Replacement recommended	
QTY	CONVERSION SET	YEARS	PART NO.	DESCRIPTION	
1	Gasket Conversion Set	2011-07	CS 26243		
QTY	MANIFOLD - INT. & EXH.	YEARS	PART NO.	DESCRIPTION	
1	Int. Manifold Gasket Set	2011-07	MS 96473	Upper set incl.	
1	Exh. Manifold Gasket Set	2011-07	MS 96474		

Honda Truck (Incl. Minivans and SUV's) (Cont.)

7		2011 - 2007; 2.4L 144 (2354cc) DOHC L4 (16 Valve) 87mm Bore i-VTEC			7
(cont.)		MFI; Gasoline; Naturally Aspirated Honda Eng.; Eng. Code K24A8			(cont.)
QTY	EXHAUST PIPE FLANGE	YEARS	PART NO.	DESCRIPTION	
1	Exhaust Pipe Gasket	2011-07	61348	Packing	
QTY	OIL PAN	YEARS	PART NO.	DESCRIPTION	
1	Oil Pan Gasket Set	2011-07	OS 30746		
QTY	CRANKSHAFT REAR SEAL	YEARS	PART NO.	DESCRIPTION	
1	Rear Main Seal Set	2011-07	BS 40535	Rubber; One-piece; Improved design	
QTY	VALVE COVER	YEARS	PART NO.	DESCRIPTION	
1	Valve Cover Gasket Set	2011-07	VS 50614 R	w/Grommets & Spark plug tube seals; PermaDry® molded rubber gskt. incl.; Improved design	
1	Spark Plug Tube Seal Set	2011-07	ES 72967	Valve Cover; New Part Number - Check for Availability	
QTY	VALVE STEM SEAL SET	YEARS	PART NO.	DESCRIPTION	
1	Valve Stem Seal Set	2011-07	SS 70283-1	Premium valve stem seals incl.	
QTY	THERMOSTAT HOUSING	YEARS	PART NO.	DESCRIPTION	
1	Thermostat Gasket	2011-07	35739	Thermostat Housing; Thermostat case	
1	Thermostat Gasket	2011-07	35741	Thermostat Housing; Thermostat seal	
QTY	WATER OUTLET GASKET	YEARS	PART NO.	DESCRIPTION	
1	Water Outlet Gasket	2011-07	36022	Water Outlet; Water pipe O-ring; New Part Number - Check for Availability	
QTY	WATER PUMP	YEARS	PART NO.	DESCRIPTION	
1	Water Pump Gasket	2011-07	35738		
QTY	TIMING COVER	YEARS	PART NO.	DESCRIPTION	
1	Crankshaft Front Seal Set	2011-07	TCS 46051	Must be used w/OS 30746	
QTY	CARB & FUEL INJECTION	YEARS	PART NO.	DESCRIPTION	
1	Fuel Injector O-Ring Set	2011-07	ES 70599	Improved design	
1	Throttle Body Gasket	2011-07	61551		
QTY	EXHAUST GAS RECIRCULATION	YEARS	PART NO.	DESCRIPTION	
1	EGR Gasket	2011-07	70978	Valve	
1	EGR Gasket	2011-07	71217	Passage	
QTY	OIL FILTER MOUNTING	YEARS	PART NO.	DESCRIPTION	
1	Oil Filter Gasket	2011-07	ES 72748	Oil filter adapter mounting set; New Part Number - Check for Availability	
8		2013 - 2012; 2.4L 144 (2354cc) DOHC L4 (16 Valve) 87mm Bore i-VTEC			8
(cont.)		MFI; Gasoline; Naturally Aspirated Honda Eng.; Eng. Code K24Y2			(cont.)
QTY	CYLINDER HEAD	YEARS	PART NO.	DESCRIPTION	
1	Head Gasket	2013-12	26435 PT	Head bolts not incl.; Head bolt replacement recommended; PermaTorqueMLS®	
1	Head Set	2013-12	HS 26435 PT	Head bolts not incl.; Head bolt replacement recommended; PermaDry® molded rubber valve cover gskt. incl.; Premium valve stem seals incl.	
1	Head Bolt Set	2013-12	ES 72284	Head bolts w/Washers; Replacement recommended	
QTY	CONVERSION SET	YEARS	PART NO.	DESCRIPTION	
1	Gasket Conversion Set	2013-12	CS 26399	RTV sealant incl. for oil pan gskt.; Improved design	
1	Gasket Conversion Set	2013-12	CS 26435	RTV sealant incl. for oil pan gskt.; Old design	
QTY	MANIFOLD - INT. & EXH.	YEARS	PART NO.	DESCRIPTION	
1	Int. Manifold Gasket Set	2013-12	MS 97093	Upper set incl.	
1	Exh. Manifold Gasket Set	2013-12	MS 97036		
QTY	EXHAUST PIPE FLANGE	YEARS	PART NO.	DESCRIPTION	
1	Exhaust Pipe Gasket	2013-12	61015	Exh. connector	
2	Exhaust Pipe Gasket	2013-12	61344	Converter	
1	Exhaust Pipe Gasket	2013-12	61550	Pipe to manifold	
QTY	OIL PAN	YEARS	PART NO.	DESCRIPTION	
1	Oil Pan Gasket Set	2013-12	OS 30746		
QTY	CRANKSHAFT REAR SEAL	YEARS	PART NO.	DESCRIPTION	
1	Rear Main Seal Set	2013-12	BS 40535	Rubber; One-piece; Improved design	
QTY	VALVE COVER	YEARS	PART NO.	DESCRIPTION	
1	Valve Cover Gasket Set	2013-12	VS 50614 R	w/Grommets & Spark plug tube seals; PermaDry® molded rubber gskt. incl.; Improved design	
1	Spark Plug Tube Seal Set	2013-12	ES 72967	Valve Cover; New Part Number - Check for Availability	
QTY	VALVE STEM SEAL SET	YEARS	PART NO.	DESCRIPTION	
1	Valve Stem Seal Set	2013-12	SS 70283-1	Premium valve stem seals incl.	
QTY	THERMOSTAT HOUSING	YEARS	PART NO.	DESCRIPTION	
1	Thermostat Gasket	2013-12	35739	Thermostat Housing; Thermostat case	
1	Thermostat Gasket	2013-12	35741	Thermostat Housing; Thermostat seal	
1	Thermostat Gasket	2013-12	35890	Thermostat Housing; Thermostat housing to block	
QTY	WATER OUTLET GASKET	YEARS	PART NO.	DESCRIPTION	
1	Water Outlet Gasket	2013-12	36022	Water Outlet; Water pipe O-ring; New Part Number - Check for Availability	

Honda Truck (Incl. Minivans and SUV's) (Cont.)

8 (cont.)	2013 - 2012; 2.4L 144 (2354cc) DOHC L4 (16 Valve) 87mm Bore i-VTEC				8 (cont.)
MFI; Gasoline; Naturally Aspirated Honda Eng.; Eng. Code K24Y2					
QTY	WATER PUMP	YEARS	PART NO.	DESCRIPTION	
1	Water Pump Gasket	2013-12	35738		
QTY	TIMING COVER	YEARS	PART NO.	DESCRIPTION	
1	Crankshaft Front Seal Set	2013-12	TCS 46051	Must be used w/OS 30746	
QTY	CARB & FUEL INJECTION	YEARS	PART NO.	DESCRIPTION	
1	Fuel Injector O-Ring Set	2013-12	ES 70599	Improved design	
1	Throttle Body Gasket	2013-12	61557		
QTY	EXHAUST GAS RECIRCULATION	YEARS	PART NO.	DESCRIPTION	
1	EGR Gasket	2013-12	70978	Valve	
QTY	OIL FILTER MOUNTING	YEARS	PART NO.	DESCRIPTION	
1	Oil Filter Gasket	2013-12	ES 73006	Oil filter mounting seal set; New Part Number - Check for Availability	
9	2009 - 2007; 2.4L 144 (2354cc) DOHC L4 (16 Valve) 87mm Bore i-VTEC				9
MFI; Gasoline; Naturally Aspirated Honda Eng.; Eng. Code K24Z1					
QTY	CYLINDER HEAD	YEARS	PART NO.	DESCRIPTION	
1	Head Gasket	2009-07	26337 PT	Head bolts not incl.; Head bolt replacement recommended; PermaTorqueMLS®	
1	Head Set	2009-07	HS 26337 PT	Head bolts not incl.; Head bolt replacement recommended; PermaDry® molded rubber valve cover gskt. incl.; Premium valve stem seals incl.	
1	Head Bolt Set	2009-07	ES 71333	Head bolts w/Washers; Replacement recommended	
QTY	CONVERSION SET	YEARS	PART NO.	DESCRIPTION	
1	Gasket Conversion Set	2009-07	CS 26243		
QTY	MANIFOLD - INT. & EXH.	YEARS	PART NO.	DESCRIPTION	
1	Int. Manifold Gasket Set	2009-07	MS 96473	Upper set incl.	
1	Exh. Manifold Gasket Set	2009-07	MS 96474		
QTY	EXHAUST PIPE FLANGE	YEARS	PART NO.	DESCRIPTION	
1	Exhaust Pipe Gasket	2009-07	61550	Packing	
QTY	OIL PAN	YEARS	PART NO.	DESCRIPTION	
1	Oil Pan Gasket Set	2009-07	OS 30746		
QTY	CRANKSHAFT REAR SEAL	YEARS	PART NO.	DESCRIPTION	
1	Rear Main Seal Set	2009-07	BS 40535	Rubber; One-piece; Improved design	
QTY	VALVE COVER	YEARS	PART NO.	DESCRIPTION	
1	Valve Cover Gasket Set	2009-07	VS 50614 R	w/Grommets & Spark plug tube seals; PermaDry® molded rubber gskt. incl.; Improved design	
1	Spark Plug Tube Seal Set	2009-07	ES 72967	Valve Cover; New Part Number - Check for Availability	
QTY	VALVE STEM SEAL SET	YEARS	PART NO.	DESCRIPTION	
1	Valve Stem Seal Set	2009-07	SS 70283-1	Premium valve stem seals incl.	
QTY	THERMOSTAT HOUSING	YEARS	PART NO.	DESCRIPTION	
1	Thermostat Gasket	2009-07	35739	Thermostat Housing; Thermostat case	
1	Thermostat Gasket	2009-07	35741	Thermostat Housing; Thermostat seal	
QTY	WATER OUTLET GASKET	YEARS	PART NO.	DESCRIPTION	
1	Water Outlet Gasket	2009-07	36022	Water Outlet; Water pipe O-ring; New Part Number - Check for Availability	
QTY	WATER PUMP	YEARS	PART NO.	DESCRIPTION	
1	Water Pump Gasket	2009-07	35738		
QTY	TIMING COVER	YEARS	PART NO.	DESCRIPTION	
1	Crankshaft Front Seal Set	2009-07	TCS 46051	Must be used w/OS 30746	
QTY	CARB & FUEL INJECTION	YEARS	PART NO.	DESCRIPTION	
1	Fuel Injector O-Ring Set	2009-07	ES 70599	Improved design	
1	Throttle Body Gasket	2009-07	61551		
QTY	EXHAUST GAS RECIRCULATION	YEARS	PART NO.	DESCRIPTION	
1	EGR Gasket	2009-07	70978	Valve	
1	EGR Gasket	2009-07	71217	Passage	
QTY	OIL FILTER MOUNTING	YEARS	PART NO.	DESCRIPTION	
1	Oil Filter Gasket	2009-07	ES 72748	Oil filter adapter mounting set; New Part Number - Check for Availability	
1	Oil Filter Gasket	2009-07	ES 73006	Oil filter mounting seal set; New Part Number - Check for Availability	
10	2011 - 2010; 2.4L 144 (2354cc) DOHC L4 (16 Valve) 87mm Bore i-VTEC				10
MFI; Gasoline; Naturally Aspirated Honda Eng.; Eng. Code K24Z6					
QTY	CYLINDER HEAD	YEARS	PART NO.	DESCRIPTION	
1	Head Gasket	2011-10	26435 PT	Head bolts not incl.; Head bolt replacement recommended; PermaTorqueMLS®	
1	Head Set	2011-10	HS 26435 PT	Head bolts not incl.; Head bolt replacement recommended; PermaDry® molded rubber valve cover gskt. incl.; Premium valve stem seals incl.	

Honda Truck (Incl. Minivans and SUV's) (Cont.)

10 (cont.)		2011 - 2010; 2.4L 144 (2354cc) DOHC L4 (16 Valve) 87mm Bore i-VTEC			10 (cont.)
MFI; Gasoline; Naturally Aspirated Honda Eng.; Eng. Code K24Z6					
QTY	CYLINDER HEAD	YEARS	PART NO.	DESCRIPTION	
1	Head Bolt Set	2011-10	ES 72284	Head bolts w/Washers; Replacement recommended	
QTY	CONVERSION SET	YEARS	PART NO.	DESCRIPTION	
1	Gasket Conversion Set	2011-10	CS 26399	RTV sealant incl. for oil pan gskt.; Improved design	
1	Gasket Conversion Set	2011-10	CS 26435	RTV sealant incl. for oil pan gskt.; Old design	
QTY	MANIFOLD - INT. & EXH.	YEARS	PART NO.	DESCRIPTION	
1	Int. Manifold Gasket Set	2011-10	MS 97093	Upper set incl.	
1	Exh. Manifold Gasket Set	2011-10	MS 97036		
QTY	EXHAUST PIPE FLANGE	YEARS	PART NO.	DESCRIPTION	
1	Exhaust Pipe Gasket	2011-10	60478	Exh. connector	
1	Exhaust Pipe Gasket	2011-10	61344	Converter	
1	Exhaust Pipe Gasket	2011-10	61550	Pipe to manifold	
QTY	OIL PAN	YEARS	PART NO.	DESCRIPTION	
1	Oil Pan Gasket Set	2011-10	OS 30746		
QTY	CRANKSHAFT REAR SEAL	YEARS	PART NO.	DESCRIPTION	
1	Rear Main Seal Set	2011-10	BS 40535	Rubber; One-piece; Improved design	
QTY	VALVE COVER	YEARS	PART NO.	DESCRIPTION	
1	Valve Cover Gasket Set	2011-10	VS 50614 R	w/Grommets & Spark plug tube seals; PermaDry® molded rubber gskt. incl.; Improved design	
1	Spark Plug Tube Seal Set	2011-10	ES 72967	Valve Cover; New Part Number - Check for Availability	
QTY	VALVE STEM SEAL SET	YEARS	PART NO.	DESCRIPTION	
1	Valve Stem Seal Set	2011-10	SS 70283-1	Premium valve stem seals incl.	
QTY	THERMOSTAT HOUSING	YEARS	PART NO.	DESCRIPTION	
1	Thermostat Gasket	2011-10	35739	Thermostat Housing; Thermostat case	
1	Thermostat Gasket	2011-10	35741	Thermostat Housing; Thermostat seal	
1	Thermostat Gasket	2011-10	35890	Thermostat Housing; Thermostat housing to block	
QTY	WATER OUTLET GASKET	YEARS	PART NO.	DESCRIPTION	
1	Water Outlet Gasket	2011-10	36022	Water Outlet; Water pipe O-ring; New Part Number - Check for Availability	
QTY	WATER PUMP	YEARS	PART NO.	DESCRIPTION	
1	Water Pump Gasket	2011-10	35738		
QTY	TIMING COVER	YEARS	PART NO.	DESCRIPTION	
1	Crankshaft Front Seal Set	2011-10	TCS 46051	Must be used w/OS 30746	
QTY	CARB & FUEL INJECTION	YEARS	PART NO.	DESCRIPTION	
1	Fuel Injector O-Ring Set	2011-10	ES 70599	Improved design	
1	Throttle Body Gasket	2011-10	61557		
QTY	EXHAUST GAS RECIRCULATION	YEARS	PART NO.	DESCRIPTION	
1	EGR Gasket	2011-10	70978	Valve	
QTY	OIL FILTER MOUNTING	YEARS	PART NO.	DESCRIPTION	
1	Oil Filter Gasket	2011-10	ES 73006	Oil filter mounting seal set; New Part Number - Check for Availability	
11		2013 - 2012; 2.4L 144 (2354cc) DOHC L4 (16 Valve) 87mm Bore i-VTEC			11
MFI; Gasoline; Naturally Aspirated Honda Eng.; Eng. Code K24Z7					
QTY	CYLINDER HEAD	YEARS	PART NO.	DESCRIPTION	
1	Head Gasket	2013-12	26435 PT	Head bolts not incl.; Head bolt replacement recommended; PermaTorqueMLS®	
1	Head Set	2013-12	HS 26435 PT	Head bolts not incl.; Head bolt replacement recommended; PermaDry® molded rubber valve cover gskt. incl.; Premium valve stem seals incl.	
1	Head Bolt Set	2013-12	ES 72284	Head bolts w/Washers; Replacement recommended	
QTY	CONVERSION SET	YEARS	PART NO.	DESCRIPTION	
1	Gasket Conversion Set	2013-12	CS 26399	RTV sealant incl. for oil pan gskt.; Improved design	
1	Gasket Conversion Set	2013-12	CS 26435	RTV sealant incl. for oil pan gskt.; Old design	
QTY	MANIFOLD - INT. & EXH.	YEARS	PART NO.	DESCRIPTION	
1	Int. Manifold Gasket Set	2013-12	MS 97093	Upper set incl.	
1	Exh. Manifold Gasket Set	2013-12	MS 97036		
QTY	EXHAUST PIPE FLANGE	YEARS	PART NO.	DESCRIPTION	
1	Exhaust Pipe Gasket	2013-12	60478	Exh. connector	
1	Exhaust Pipe Gasket	2013-12	61344	Converter	
1	Exhaust Pipe Gasket	2013-12	61550	Pipe to manifold	
QTY	OIL PAN	YEARS	PART NO.	DESCRIPTION	
1	Oil Pan Gasket Set	2013-12	OS 30746		
QTY	CRANKSHAFT REAR SEAL	YEARS	PART NO.	DESCRIPTION	
1	Rear Main Seal Set	2013-12	BS 40535	Rubber; One-piece; Improved design	

Honda Truck (Incl. Minivans and SUV's) (Cont.)

11 (cont.)		2013 - 2012; 2.4L 144 (2354cc) DOHC L4 (16 Valve) 87mm Bore i-VTEC			11 (cont.)
		MFI; Gasoline; Naturally Aspirated Honda Eng.; Eng. Code K24Z7			
QTY	VALVE COVER	YEARS	PART NO.	DESCRIPTION	
1	Valve Cover Gasket Set	2013-12	VS 50614 R	w/Grommets & Spark plug tube seals; PermaDry® molded rubber gskt. incl.; Improved design	
1	Spark Plug Tube Seal Set	2013-12	ES 72967	Valve Cover; New Part Number - Check for Availability	
QTY	VALVE STEM SEAL SET	YEARS	PART NO.	DESCRIPTION	
1	Valve Stem Seal Set	2013-12	SS 70283-1	Premium valve stem seals incl.	
QTY	THERMOSTAT HOUSING	YEARS	PART NO.	DESCRIPTION	
1	Thermostat Gasket	2013-12	35739	Thermostat Housing; Thermostat case	
1	Thermostat Gasket	2013-12	35741	Thermostat Housing; Thermostat seal	
1	Thermostat Gasket	2013-12	35890	Thermostat Housing; Thermostat housing to block	
QTY	WATER OUTLET GASKET	YEARS	PART NO.	DESCRIPTION	
1	Water Outlet Gasket	2013-12	36022	Water Outlet; Water pipe O-ring; New Part Number - Check for Availability	
QTY	WATER PUMP	YEARS	PART NO.	DESCRIPTION	
1	Water Pump Gasket	2013-12	35738		
QTY	TIMING COVER	YEARS	PART NO.	DESCRIPTION	
1	Crankshaft Front Seal Set	2013-12	TCS 46051	Must be used w/OS 30746	
QTY	CARB & FUEL INJECTION	YEARS	PART NO.	DESCRIPTION	
1	Fuel Injector O-Ring Set	2013-12	ES 70599	Improved design	
1	Throttle Body Gasket	2013-12	61557		
QTY	EXHAUST GAS RECIRCULATION	YEARS	PART NO.	DESCRIPTION	
1	EGR Gasket	2013-12	70978	Valve	
QTY	OIL FILTER MOUNTING	YEARS	PART NO.	DESCRIPTION	
1	Oil Filter Gasket	2013-12	ES 73006	Oil filter mounting seal set; New Part Number - Check for Availability	
12		1997 - 1994; 2.6L 156.2 (2559cc) SOHC L4 (8 Valve) 92.6mm Bore			12
		MFI; Gasoline; Naturally Aspirated Isuzu Eng.; Eng. Code 4ZE1			
QTY	CYLINDER HEAD	YEARS	PART NO.	DESCRIPTION	
1	Head Gasket	1997-94	8215 PT		
1	Head Set	1997-94	HS 8215 PT-2	Exh. pipe flange not incl.; PermaDry® molded rubber valve cover gskt. incl.; Premium valve stem seals incl.	
QTY	CONVERSION SET	YEARS	PART NO.	DESCRIPTION	
1	Gasket Conversion Set	1997-94	CS 9496-1	PermaDry® molded rubber oil pan gskt. incl.; RTV sealant incl. for oil pan gskt.	
QTY	MANIFOLD - INT. & EXH.	YEARS	PART NO.	DESCRIPTION	
1	Int. Manifold Gasket Set	1997-94	MS 93657-1	Upper set incl.	
1	Exh. Manifold Gasket Set	1997-94	MS 94244		
QTY	EXHAUST PIPE FLANGE	YEARS	PART NO.	DESCRIPTION	
1	Exhaust Pipe Gasket	1997-94	60554	Flange	
2	Exhaust Pipe Gasket	1997-94	60856	Converter	
QTY	OIL PAN	YEARS	PART NO.	DESCRIPTION	
1	Oil Pan Gasket Set	1997-94	OS 30556 A	RTV sealant incl. for oil pan gskt.	
QTY	CRANKSHAFT REAR SEAL	YEARS	PART NO.	DESCRIPTION	
1	Rear Main Seal Set	1997-94	BS 40449-1	Rubber; One-piece	
QTY	VALVE COVER	YEARS	PART NO.	DESCRIPTION	
1	Valve Cover Gasket Set	1997-94	VS 50311 R	w/o Semi-circular plugs & Grommets; PermaDry® molded rubber gskt. incl.	
1	Valve Cover Gasket Set	1997-94	VS 50344 R	w/Semi-circular plugs & Grommets; PermaDry® molded rubber gskt. incl.	
1	Semi-Circular Plug	1997-94	CP 75003	Valve Cover	
QTY	VALVE STEM SEAL SET	YEARS	PART NO.	DESCRIPTION	
1	Valve Stem Seal Set	1997-94	SS 72829	Premium valve stem seals incl.	
QTY	WATER OUTLET GASKET	YEARS	PART NO.	DESCRIPTION	
1	Water Outlet Gasket	1997-94	35364	Water Outlet	
QTY	WATER PUMP	YEARS	PART NO.	DESCRIPTION	
1	Water Pump Gasket	1997-94	35387		
QTY	TIMING COVER	YEARS	PART NO.	DESCRIPTION	
1	Crankshaft Front Seal Set	1997-94	TCS 45783		
1	Camshaft Front Seal Set	1997-94	TCS 45782		
1	Repair Sleeve	1997-94	16220	Timing Cover; Use w/installation tool; Improved design	
1	Repair Sleeve	1997-94	16223	Timing Cover; Use w/installation tool; May use 16220 instead; Old design; Superseded - When depleted use 16220	
1	Repair Sleeve Tool	1997-94	16323	Timing Cover	
QTY	CARB & FUEL INJECTION	YEARS	PART NO.	DESCRIPTION	
1	Throttle Body Gasket	1997-96	61034		
1	Throttle Body Gasket	1995-94	60991		

Honda Truck (Incl. Minivans and SUV's) (Cont.)

13		2002 - 1998; 3.2L 193 (3165cc) DOHC V6 (24 Valve) 93.4mm Bore MFI; Gasoline; Naturally Aspirated Isuzu Eng.; Eng. Code 6VD2			13
QTY	CYLINDER HEAD	YEARS	PART NO.	DESCRIPTION	
1	Head Gasket	2002-98	9254 PT	Loc. R.H.; Head bolts not incl.; Head bolt replacement recommended; PermaTorqueMLS® LaserWeld® Technology	
1	Head Gasket	2002-98	9256 PT	Loc. L.H.; Head bolts not incl.; Head bolt replacement recommended; PermaTorqueMLS® LaserWeld® Technology	
1	Head Set	2002-98	HS 9254 PT	Head bolts not incl.; Head bolt replacement recommended; PermaDry® molded rubber valve cover gskts. incl.; Premium valve stem seals incl.	
QTY	CONVERSION SET	YEARS	PART NO.	DESCRIPTION	
1	Gasket Conversion Set	2002-98	CS 9254		
QTY	MANIFOLD - INT. & EXH.	YEARS	PART NO.	DESCRIPTION	
1	Int. Manifold Gasket Set	2002-98	MS 90610	Lower set; Upper set incl.	
1	Exh. Manifold Gasket Set	2002-98	MS 90725		
QTY	EXHAUST PIPE FLANGE	YEARS	PART NO.	DESCRIPTION	
2	Exhaust Pipe Gasket	2002-98	60554	Flange	
QTY	OIL PAN	YEARS	PART NO.	DESCRIPTION	
1	Oil Pan Gasket Set	2002-98	OS 30685	Loc. Upper	
1	Oil Pan Gasket Set	2002-98	OS 34511	Loc. Lower	
QTY	CRANKSHAFT REAR SEAL	YEARS	PART NO.	DESCRIPTION	
1	Rear Main Seal Set	2002-98	BS 40624	Rubber; One-piece	
QTY	VALVE COVER	YEARS	PART NO.	DESCRIPTION	
1	Valve Cover Gasket Set	2002-98	VS 50486 R	w/Grommets & Spark plug tube seals; PermaDry® molded rubber gskts. incl.	
QTY	VALVE STEM SEAL SET	YEARS	PART NO.	DESCRIPTION	
2	Valve Stem Seal Set	2002-98	SS 72721	Premium valve stem seals incl.	
QTY	THERMOSTAT HOUSING	YEARS	PART NO.	DESCRIPTION	
1	Thermostat Gasket	2002-98	35615	Thermostat Housing; Thermostat seal	
QTY	WATER PUMP	YEARS	PART NO.	DESCRIPTION	
1	Water Pump Gasket	2002-98	35593		
QTY	TIMING COVER	YEARS	PART NO.	DESCRIPTION	
1	Crankshaft Front Seal Set	2002-98	TCS 45866	Oil pump mounting seals incl.	
1	Crankshaft Front Seal Set	2002-98	TCS 45983	Oil cooler mounting seals incl.	
1	Camshaft Front Seal Set	2002-98	TCS 45859		
4	Camshaft Rear Seal Plug Set	2002-98	TCS 45868	Use for both front & rear camshaft plugs	
QTY	CARB & FUEL INJECTION	YEARS	PART NO.	DESCRIPTION	
1	Throttle Body Gasket	2002-01	61517		
1	Throttle Body Gasket	2000-99	61034	To 07/31/99	
1	Throttle Body Gasket	2000-99	61517	From 08/01/99	
1	Throttle Body Gasket	1998	61034		
QTY	EXHAUST GAS RECIRCULATION	YEARS	PART NO.	DESCRIPTION	
1	EGR Gasket	2002-98	70789	Valve	
1	EGR Gasket	2002-98	70794	Tube	
14		1997 - 1994; 3.2L 193 (3165cc) SOHC V6 (24 Valve) 93.4mm Bore MFI; Gasoline; Naturally Aspirated Isuzu Eng.; Eng. Code 6VD1			14
QTY	CYLINDER HEAD	YEARS	PART NO.	DESCRIPTION	
2	Head Gasket	1997-94	9174 PT		
1	Head Set	1997-96	HS 9174 PT-2	PermaDry® molded rubber valve cover gskts. incl.; Premium valve stem seals incl.	
1	Head Set	1995-94	HS 9174 PT-1	PermaDry® molded rubber valve cover gskts. incl.; Premium valve stem seals incl.	
QTY	CONVERSION SET	YEARS	PART NO.	DESCRIPTION	
1	Gasket Conversion Set	1997-94	CS 9174		
QTY	MANIFOLD - INT. & EXH.	YEARS	PART NO.	DESCRIPTION	
1	Int. Manifold Gasket Set	1997-94	MS 95751	Lower set; Upper set incl.	
1	Plenum Gasket Set	1997-94	MS 95751-1	Upper set	
1	Exh. Manifold Gasket Set	1997-96	MS 90725		
1	Exh. Manifold Gasket Set	1995-94	MS 95813		
QTY	EXHAUST PIPE FLANGE	YEARS	PART NO.	DESCRIPTION	
2	Exhaust Pipe Gasket	1997-94	60554	Flange	
2	Exhaust Pipe Gasket	1997-94	60856	Converter	
QTY	OIL PAN	YEARS	PART NO.	DESCRIPTION	
1	Oil Pan Gasket Set	1997-94	OS 30679 C		
QTY	CRANKSHAFT REAR SEAL	YEARS	PART NO.	DESCRIPTION	
1	Rear Main Seal Set	1997-94	BS 40624	Rubber; One-piece	

Honda Truck (Incl. Minivans and SUV's) (Cont.)

14 (cont.)	1997 - 1994; 3.2L 193 (3165cc) SOHC V6 (24 Valve) 93.4mm Bore MFI; Gasoline; Naturally Aspirated Isuzu Eng.; Eng. Code 6VD1			14 (cont.)
QTY	VALVE COVER	YEARS	PART NO.	DESCRIPTION
1	Valve Cover Gasket Set	1997-94	VS 50469 R	w/o Spark plug tube seals; PermaDry® molded rubber gsks. incl.
1	Spark Plug Tube Seal Set	1997-94	ES 70691	Valve Cover
QTY	VALVE STEM SEAL SET	YEARS	PART NO.	DESCRIPTION
2	Valve Stem Seal Set	1997-94	SS 72721	Premium valve stem seals incl.
QTY	THERMOSTAT HOUSING	YEARS	PART NO.	DESCRIPTION
1	Thermostat Gasket	1997-94	35599	Thermostat Housing; Thermostat seal
QTY	WATER OUTLET GASKET	YEARS	PART NO.	DESCRIPTION
2	Water Outlet Gasket	1997-94	35590	Water Outlet; Water manifold
1	Water Outlet Gasket	1997-94	35591	Water Outlet; Coolant housing
QTY	WATER PUMP	YEARS	PART NO.	DESCRIPTION
1	Water Pump Gasket	1997-94	35593	
QTY	TIMING COVER	YEARS	PART NO.	DESCRIPTION
1	Crankshaft Front Seal Set	1997-94	TCS 45866	Oil pump mounting seals incl.
1	Crankshaft Front Seal Set	1997-94	TCS 45983	Oil cooler mounting seals incl.
1	Camshaft Front Seal Set	1997-94	TCS 45859	
1	Camshaft Rear Seal Plug Set	1997-94	TCS 45868	
QTY	CARB & FUEL INJECTION	YEARS	PART NO.	DESCRIPTION
3	Fuel Injector O-Ring Set	1995-94	ES 70599	Improved design
1	Throttle Body Gasket	1997-94	61034	
QTY	EXHAUST GAS RECIRCULATION	YEARS	PART NO.	DESCRIPTION
1	EGR Gasket	1997-94	70794	Tube
1	EGR Gasket	1997-96	70789	Valve
1	EGR Gasket	1997-96	70832	Adapter
1	EGR Gasket	1995-94	70372	Valve
15	2001 - 1999; 3.5L 212 (3471cc) SOHC V6 (24 Valve) 89mm Bore VTEC MFI; Gasoline; Naturally Aspirated Honda Eng.; Eng. Code J35A1			15
QTY	CYLINDER HEAD	YEARS	PART NO.	DESCRIPTION
2	Head Gasket	2001-99	26260 PT	Head bolts not incl.; Head bolt replacement recommended; PermaTorqueMLS®; Improved design
1	Head Set	2001-99	HS 26260 PT	Head bolts not incl.; Head bolt replacement recommended; PermaDry® molded rubber valve cover gsks. incl.; Premium valve stem seals incl.
2	Head Bolt Set	2001-99	ES 71331	6-point Head bolts; Head bolts w/Washers; Replacement recommended
QTY	CONVERSION SET	YEARS	PART NO.	DESCRIPTION
1	Gasket Conversion Set	2001-99	CS 26196	RTV sealant incl. for oil pan gskt.
QTY	MANIFOLD - INT. & EXH.	YEARS	PART NO.	DESCRIPTION
1	Int. Manifold Gasket Set	2001-99	MS 96168	Lower set
1	Plenum Gasket Set	2001-99	MS 96167-1	Upper set
1	Plenum Gasket Set	2001-99	MS 96167-2	Upper set; Plenum gskt. only; New Part Number - Check for Availability
1	Exh. Manifold Gasket Set	2001-99	MS 96166	
QTY	EXHAUST PIPE FLANGE	YEARS	PART NO.	DESCRIPTION
2	Exhaust Pipe Gasket	2001-99	60578	Pipe to manifold
QTY	CRANKSHAFT REAR SEAL	YEARS	PART NO.	DESCRIPTION
1	Rear Main Seal Set	2001-99	BS 40675	Rubber; One-piece
QTY	VALVE COVER	YEARS	PART NO.	DESCRIPTION
1	Valve Cover Gasket Set	2001-99	VS 50576 R	w/Grommets & Spark plug tube seals; PermaDry® molded rubber gsks. incl.
QTY	VALVE STEM SEAL SET	YEARS	PART NO.	DESCRIPTION
2	Valve Stem Seal Set	2001-99	SS 70283-2	Premium valve stem seals incl.
QTY	THERMOSTAT HOUSING	YEARS	PART NO.	DESCRIPTION
1	O-Ring	2001-99	35162	Thermostat Housing
QTY	WATER OUTLET GASKET	YEARS	PART NO.	DESCRIPTION
1	Water Crossover Mounting Set	2001-99	ES 72998	Water Outlet; Water bypass set; OEM style; New Part Number - Check for Availability
QTY	WATER PUMP	YEARS	PART NO.	DESCRIPTION
1	Water Pump Gasket	2001-99	35677	
QTY	TIMING COVER	YEARS	PART NO.	DESCRIPTION
1	Crankshaft Front Seal Set	2001-99	TCS 46026	
1	Camshaft Front Seal Set	2001-99	TCS 46025	
QTY	CARB & FUEL INJECTION	YEARS	PART NO.	DESCRIPTION
1	Throttle Body Gasket	2001-99	61316	Throttle body to spacer
1	Throttle Body Gasket	2001-99	61317	Spacer to manifold
QTY	EXHAUST GAS RECIRCULATION	YEARS	PART NO.	DESCRIPTION
1	EGR Gasket	2001-99	70978	

Honda Truck (Incl. Minivans and SUV's) (Cont.)

16		2002 - 2001; 3.5L 212 (3471cc) SOHC V6 (24 Valve) 89mm Bore VTEC MFI; Gasoline; Naturally Aspirated Honda Eng.; Eng. Code J35A3			16
QTY	CYLINDER HEAD	YEARS	PART NO.	DESCRIPTION	
2	Head Gasket	2002-01	26260 PT	Head bolts not incl.; Head bolt replacement recommended; PermaTorqueMLS®; Improved design	
1	Head Set	2002-01	HS 26260 PT-2	Head bolts not incl.; Head bolt replacement recommended; PermaDry® molded rubber valve cover gskts. incl.; Premium valve stem seals incl.	
2	Head Bolt Set	2002-01	ES 71331	6-point Head bolts; Head bolts w/Washers; Replacement recommended	
QTY	CONVERSION SET	YEARS	PART NO.	DESCRIPTION	
1	Gasket Conversion Set	2002-01	CS 26196	RTV sealant incl. for oil pan gskt.	
QTY	MANIFOLD - INT. & EXH.	YEARS	PART NO.	DESCRIPTION	
1	Int. Manifold Gasket Set	2002-01	MS 96427	Lower set	
1	Plenum Gasket Set	2002-01	MS 96384	Upper set	
1	Plenum Gasket Set	2002-01	MS 96384-3	Upper set; Plenum gskts. only; New Part Number - Check for Availability	
1	Exh. Manifold Gasket Set	2002-01	MS 96166		
QTY	EXHAUST PIPE FLANGE	YEARS	PART NO.	DESCRIPTION	
2	Exhaust Pipe Gasket	2002-01	60578	Pipe to manifold	
QTY	CRANKSHAFT REAR SEAL	YEARS	PART NO.	DESCRIPTION	
1	Rear Main Seal Set	2002-01	BS 40675	Rubber; One-piece	
QTY	VALVE COVER	YEARS	PART NO.	DESCRIPTION	
1	Valve Cover Gasket Set	2002-01	VS 50576 R	w/Grommets & Spark plug tube seals; PermaDry® molded rubber gskts. incl.	
QTY	VALVE STEM SEAL SET	YEARS	PART NO.	DESCRIPTION	
2	Valve Stem Seal Set	2002-01	SS 70283-2	Premium valve stem seals incl.	
QTY	THERMOSTAT HOUSING	YEARS	PART NO.	DESCRIPTION	
1	O-Ring	2002-01	35162	Thermostat Housing	
QTY	WATER OUTLET GASKET	YEARS	PART NO.	DESCRIPTION	
1	Water Crossover Mounting Set	2002-01	ES 72998	Water Outlet; Water bypass set; OEM style; New Part Number - Check for Availability	
QTY	WATER PUMP	YEARS	PART NO.	DESCRIPTION	
1	Water Pump Gasket	2002-01	35677		
QTY	TIMING COVER	YEARS	PART NO.	DESCRIPTION	
1	Crankshaft Front Seal Set	2002-01	TCS 46026		
1	Camshaft Front Seal Set	2002-01	TCS 46025		
QTY	CARB & FUEL INJECTION	YEARS	PART NO.	DESCRIPTION	
1	Throttle Body Gasket	2002-01	61319		
QTY	EXHAUST GAS RECIRCULATION	YEARS	PART NO.	DESCRIPTION	
1	EGR Gasket	2002-01	70978		
17		2004 - 2002; 3.5L 212 (3471cc) SOHC V6 (24 Valve) 89mm Bore VTEC MFI; Gasoline; Naturally Aspirated Honda Eng.; Eng. Code J35A4			17
QTY	CYLINDER HEAD	YEARS	PART NO.	DESCRIPTION	
2	Head Gasket	2004-02	26260 PT	Head bolts not incl.; Head bolt replacement recommended; PermaTorqueMLS®; Improved design	
1	Head Set	2004-02	HS 26260 PT-2	Head bolts not incl.; Head bolt replacement recommended; PermaDry® molded rubber valve cover gskts. incl.; Premium valve stem seals incl.	
2	Head Bolt Set	2004-02	ES 71331	6-point Head bolts; Head bolts w/Washers; Replacement recommended	
QTY	CONVERSION SET	YEARS	PART NO.	DESCRIPTION	
1	Gasket Conversion Set	2004-02	CS 26196	RTV sealant incl. for oil pan gskt.	
QTY	MANIFOLD - INT. & EXH.	YEARS	PART NO.	DESCRIPTION	
1	Int. Manifold Gasket Set	2004-02	MS 96427	Lower set	
1	Plenum Gasket Set	2004-02	MS 96384	Upper set	
1	Plenum Gasket Set	2004-02	MS 96384-3	Upper set; Plenum gskts. only; New Part Number - Check for Availability	
1	Exh. Manifold Gasket Set	2004-02	MS 96166		
QTY	EXHAUST PIPE FLANGE	YEARS	PART NO.	DESCRIPTION	
2	Exhaust Pipe Gasket	2004-02	60578	Pipe to manifold	
QTY	CRANKSHAFT REAR SEAL	YEARS	PART NO.	DESCRIPTION	
1	Rear Main Seal Set	2004-02	BS 40675	Rubber; One-piece	
QTY	VALVE COVER	YEARS	PART NO.	DESCRIPTION	
1	Valve Cover Gasket Set	2004-02	VS 50576 R	w/Grommets & Spark plug tube seals; PermaDry® molded rubber gskts. incl.	
QTY	VALVE STEM SEAL SET	YEARS	PART NO.	DESCRIPTION	
2	Valve Stem Seal Set	2004-02	SS 70283-2	Premium valve stem seals incl.	
QTY	THERMOSTAT HOUSING	YEARS	PART NO.	DESCRIPTION	
1	O-Ring	2004-02	35162	Thermostat Housing	
QTY	WATER OUTLET GASKET	YEARS	PART NO.	DESCRIPTION	
1	Water Crossover Mounting Set	2004-02	ES 72998	Water Outlet; Water bypass set; OEM style; New Part Number - Check for Availability	

Honda Truck (Incl. Minivans and SUV's) (Cont.)

17 (cont.)	2004 - 2002; 3.5L 212 (3471cc) SOHC V6 (24 Valve) 89mm Bore VTEC MFI; Gasoline; Naturally Aspirated Honda Eng.; Eng. Code J35A4				17 (cont.)
QTY	WATER PUMP	YEARS	PART NO.	DESCRIPTION	
1	Water Pump Gasket	2004-02	35677		
QTY	TIMING COVER	YEARS	PART NO.	DESCRIPTION	
1	Crankshaft Front Seal Set	2004-02	TCS 46026		
1	Camshaft Front Seal Set	2004-02	TCS 46025		
QTY	CARB & FUEL INJECTION	YEARS	PART NO.	DESCRIPTION	
1	Throttle Body Gasket	2004-02	61319		
QTY	EXHAUST GAS RECIRCULATION	YEARS	PART NO.	DESCRIPTION	
1	EGR Gasket	2004-02	70978		
18	2006 - 2003; 3.5L 212 (3471cc) SOHC V6 (24 Valve) 89mm Bore VTEC MFI; Gasoline; Naturally Aspirated Honda Eng.; Eng. Code J35A5				18
QTY	CYLINDER HEAD	YEARS	PART NO.	DESCRIPTION	
2	Head Gasket	2006-03	26265 PT	Head bolts not incl.; Head bolt replacement recommended; PermaTorqueMLS®	
1	Head Set	2006-03	HS 26265 PT-5	Head bolts not incl.; Head bolt replacement recommended; PermaDry® molded rubber valve cover gskts. incl.; Premium valve stem seals incl.; Improved design	
2	Head Bolt Set	2006-03	ES 71331	6-point Head bolts; Head bolts w/Washers; Replacement recommended	
2	Head Bolt Set	2006-04	ES 71329-1	12-point Head bolts; Head bolts w/Washers; Replacement recommended	
QTY	CONVERSION SET	YEARS	PART NO.	DESCRIPTION	
1	Gasket Conversion Set	2006-03	CS 26265	RTV sealant incl. for oil pan gskt.	
QTY	MANIFOLD - INT. & EXH.	YEARS	PART NO.	DESCRIPTION	
1	Int. Manifold Gasket Set	2006-03	MS 96405	Lower set	
1	Plenum Gasket Set	2006-03	MS 96410-1	Upper set	
1	Exh. Manifold Gasket Set	2006-03	MS 96411		
QTY	EXHAUST PIPE FLANGE	YEARS	PART NO.	DESCRIPTION	
2	Exhaust Pipe Gasket	2006-03	60578	Pipe to manifold	
1	Exhaust Pipe Gasket	2006-03	61344	Converter	
QTY	CRANKSHAFT REAR SEAL	YEARS	PART NO.	DESCRIPTION	
1	Rear Main Seal Set	2006-03	BS 40685	Rubber; One-piece	
QTY	VALVE COVER	YEARS	PART NO.	DESCRIPTION	
1	Valve Cover Gasket Set	2006-03	VS 50607 R	w/Grommets & Spark plug tube seals; PermaDry® molded rubber gskts. incl.	
QTY	VALVE STEM SEAL SET	YEARS	PART NO.	DESCRIPTION	
2	Valve Stem Seal Set	2006-03	SS 70283-2	Premium valve stem seals incl.	
QTY	THERMOSTAT HOUSING	YEARS	PART NO.	DESCRIPTION	
1	O-Ring	2006-03	35162	Thermostat Housing	
QTY	WATER OUTLET GASKET	YEARS	PART NO.	DESCRIPTION	
1	Water Crossover Mounting Set	2006-03	ES 72998	Water Outlet; Water bypass set; OEM style; New Part Number - Check for Availability	
QTY	WATER PUMP	YEARS	PART NO.	DESCRIPTION	
1	Water Pump Gasket	2006-03	35677		
QTY	TIMING COVER	YEARS	PART NO.	DESCRIPTION	
1	Crankshaft Front Seal Set	2006-03	TCS 46026		
1	Camshaft Front Seal Set	2006-03	TCS 46025		
QTY	CARB & FUEL INJECTION	YEARS	PART NO.	DESCRIPTION	
3	Fuel Injector O-Ring Set	2006-03	ES 70599	Improved design	
1	Throttle Body Gasket	2006-05	61331		
1	Throttle Body Gasket	2004-03	61320		
QTY	EXHAUST GAS RECIRCULATION	YEARS	PART NO.	DESCRIPTION	
1	EGR Gasket	2006-03	70978		
QTY	OIL FILTER MOUNTING	YEARS	PART NO.	DESCRIPTION	
1	Oil Filter Adapter Gasket	2006-03	72951	Oil filter adapter; New Part Number - Check for Availability	
19	2010 - 2005; 3.5L 212 (3471cc) SOHC V6 (24 Valve) 89mm Bore VTEC MFI; Gasoline; Naturally Aspirated Honda Eng.; Eng. Code J35A6				19
QTY	CYLINDER HEAD	YEARS	PART NO.	DESCRIPTION	
2	Head Gasket	2010-05	26265 PT	Head bolts not incl.; Head bolt replacement recommended; PermaTorqueMLS®	
1	Head Set	2010-05	HS 26265 PT	Head bolts not incl.; Head bolt replacement recommended; PermaDry® molded rubber valve cover gskts. incl.; Premium valve stem seals incl.; Old design; Superseded - When depleted use HS 26265 PT-5	

Honda Truck (Incl. Minivans and SUV's) (Cont.)

19 (cont.)		2010 - 2005; 3.5L 212 (3471cc) SOHC V6 (24 Valve) 89mm Bore VTEC			19 (cont.)
MFI; Gasoline; Naturally Aspirated Honda Eng.; Eng. Code J35A6					
QTY	CYLINDER HEAD	YEARS	PART NO.	DESCRIPTION	
1	Head Set	2010-05	HS 26265 PT-5	Head bolts not incl.; Head bolt replacement recommended; PermaDry® molded rubber valve cover gskts. incl.; Premium valve stem seals incl.; Improved design	
2	Head Bolt Set	2010-05	ES 71329-1	12-point Head bolts; Head bolts w/Washers; Replacement recommended	
2	Head Bolt Set	2010-05	ES 71331	6-point Head bolts; Head bolts w/Washers; Replacement recommended	
QTY	CONVERSION SET	YEARS	PART NO.	DESCRIPTION	
1	Gasket Conversion Set	2010-05	CS 26265	RTV sealant incl. for oil pan gskt.	
QTY	MANIFOLD - INT. & EXH.	YEARS	PART NO.	DESCRIPTION	
1	Int. Manifold Gasket Set	2010-05	MS 96405	Lower set	
1	Plenum Gasket Set	2010-06	MS 96410	Upper set	
1	Plenum Gasket Set	2005	MS 96410	Honda Odyssey EX, LX; Upper set	
1	Plenum Gasket Set	2005	MS 96410-1	Honda Pilot EX, EX-L, LX; Upper set	
1	Exh. Manifold Gasket Set	2010-05	MS 96411		
QTY	EXHAUST PIPE FLANGE	YEARS	PART NO.	DESCRIPTION	
2	Exhaust Pipe Gasket	2010-05	60578	Pipe to manifold	
1	Exhaust Pipe Gasket	2010-05	61338	Loc. Rear; Converter	
1	Exhaust Pipe Gasket	2010-05	61344	Loc. Front; Converter	
QTY	CRANKSHAFT REAR SEAL	YEARS	PART NO.	DESCRIPTION	
1	Rear Main Seal Set	2010-05	BS 40685	Rubber; One-piece	
QTY	VALVE COVER	YEARS	PART NO.	DESCRIPTION	
1	Valve Cover Gasket Set	2010-05	VS 50607 R	w/Grommets & Spark plug tube seals; PermaDry® molded rubber gskts. incl.	
QTY	VALVE STEM SEAL SET	YEARS	PART NO.	DESCRIPTION	
2	Valve Stem Seal Set	2010-05	SS 70283-2	Premium valve stem seals incl.	
QTY	THERMOSTAT HOUSING	YEARS	PART NO.	DESCRIPTION	
1	O-Ring	2010-05	35162	Thermostat Housing	
QTY	WATER OUTLET GASKET	YEARS	PART NO.	DESCRIPTION	
1	Water Crossover Mounting Set	2010-05	ES 72998	Water Outlet; Water bypass set; OEM style; New Part Number - Check for Availability	
QTY	WATER PUMP	YEARS	PART NO.	DESCRIPTION	
1	Water Pump Gasket	2010-05	35677		
QTY	TIMING COVER	YEARS	PART NO.	DESCRIPTION	
1	Crankshaft Front Seal Set	2010-05	TCS 46026		
1	Camshaft Front Seal Set	2010-05	TCS 46025		
QTY	CARB & FUEL INJECTION	YEARS	PART NO.	DESCRIPTION	
3	Fuel Injector O-Ring Set	2010-05	ES 70599	Improved design	
1	Throttle Body Gasket	2010-06	61331		
1	Throttle Body Gasket	2005	61320		
QTY	EXHAUST GAS RECIRCULATION	YEARS	PART NO.	DESCRIPTION	
1	EGR Gasket	2010-05	70978		
QTY	OIL FILTER MOUNTING	YEARS	PART NO.	DESCRIPTION	
1	Oil Filter Adapter Gasket	2010-05	72951	Oil filter adapter; New Part Number - Check for Availability	
20		2013 - 2011; 3.5L 212 (3471cc) SOHC V6 (24 Valve) 89mm Bore VTEC			20
MFI; Gasoline; Naturally Aspirated Honda Eng.; Eng. Code J35A8					
QTY	CYLINDER HEAD	YEARS	PART NO.	DESCRIPTION	
1	Head Gasket	2013-11	26509 PT	Loc. L.H.; Head bolts not incl.; Head bolt replacement recommended; PermaTorqueMLS®; New Part Number - Check for Availability	
1	Head Gasket	2013-11	26510 PT	Loc. R.H.; Head bolts not incl.; Head bolt replacement recommended; PermaTorqueMLS®; New Part Number - Check for Availability	
1	Head Set	2013-11	HS 26509 PT	Head bolts not incl.; Head bolt replacement recommended; PermaDry® molded rubber valve cover gskts. incl.; Premium valve stem seals incl.; New Part Number - Check for Availability	
2	Head Bolt Set	2013-11	ES 71329-1	12-point Head bolts; Head bolts w/Washers; Replacement recommended	
QTY	CONVERSION SET	YEARS	PART NO.	DESCRIPTION	
1	Gasket Conversion Set	2013-11	CS 26265	RTV sealant incl. for oil pan gskt.	
QTY	MANIFOLD - INT. & EXH.	YEARS	PART NO.	DESCRIPTION	
1	Int. Manifold Gasket Set	2013-11	MS 97136	Lower set	
1	Plenum Gasket Set	2013-11	MS 96409-3	Upper set; Improved design; New Part Number - Check for Availability	
1	Exh. Manifold Gasket Set	2013-11	MS 97133		
QTY	EXHAUST PIPE FLANGE	YEARS	PART NO.	DESCRIPTION	
2	Exhaust Pipe Gasket	2013-11	60578	Pipe to manifold	
1	Exhaust Pipe Gasket	2013-11	61015	Exh. connector	
1	Exhaust Pipe Gasket	2013-11	61338	Converter	

Honda Truck (Incl. Minivans and SUV's) (Cont.)

20 (cont.)	2013 - 2011; 3.5L 212 (3471cc) SOHC V6 (24 Valve) 89mm Bore VTEC				20 (cont.)
MFI; Gasoline; Naturally Aspirated Honda Eng.; Eng. Code J35A8					
QTY	CRANKSHAFT REAR SEAL	YEARS	PART NO.	DESCRIPTION	
1	Rear Main Seal Set	2013-11	BS 40685	Rubber; One-piece	
QTY	VALVE COVER	YEARS	PART NO.	DESCRIPTION	
1	Valve Cover Gasket Set	2013-11	VS 50773 R	w/Grommets & Spark plug tube seals; PermaDry® molded rubber gsks. incl.; New Part Number - Check for Availability	
QTY	VALVE STEM SEAL SET	YEARS	PART NO.	DESCRIPTION	
2	Valve Stem Seal Set	2013-11	SS 70283-2	Premium valve stem seals incl.	
QTY	THERMOSTAT HOUSING	YEARS	PART NO.	DESCRIPTION	
1	O-Ring	2013-11	35162	Thermostat Housing; Thermostat seal	
QTY	WATER OUTLET GASKET	YEARS	PART NO.	DESCRIPTION	
1	Water Crossover Mounting Set	2013-11	ES 72998	Water Outlet; Water bypass set; OEM style; New Part Number - Check for Availability	
QTY	WATER PUMP	YEARS	PART NO.	DESCRIPTION	
1	Water Pump Gasket	2013-11	35677		
QTY	TIMING COVER	YEARS	PART NO.	DESCRIPTION	
1	Crankshaft Front Seal Set	2013-11	TCS 46026		
1	Camshaft Front Seal Set	2013-11	TCS 46025		
QTY	CARB & FUEL INJECTION	YEARS	PART NO.	DESCRIPTION	
3	Fuel Injector O-Ring Set	2013-11	ES 70599	Improved design	
1	Throttle Body Gasket	2013-11	61331		
QTY	EXHAUST GAS RECIRCULATION	YEARS	PART NO.	DESCRIPTION	
1	EGR Gasket	2013-11	70978	Valve	
1	EGR Gasket	2013-11	72371	Loc. Lower; Pipe	
1	EGR Gasket	2013-11	72420	Loc. Upper; Pipe	
QTY	OIL FILTER MOUNTING	YEARS	PART NO.	DESCRIPTION	
1	Oil Filter Adapter Gasket	2013-11	72951	Oil filter adapter; New Part Number - Check for Availability	
21	2008 - 2006; 3.5L 212 (3471cc) SOHC V6 (24 Valve) 89mm Bore VTEC				21
MFI; Gasoline; Naturally Aspirated Honda Eng.; Eng. Code J35A9					
QTY	CYLINDER HEAD	YEARS	PART NO.	DESCRIPTION	
2	Head Gasket	2008-06	26265 PT	Head bolts not incl.; Head bolt replacement recommended; PermaTorqueMLS®	
1	Head Set	2008	HS 26265 PT-4	Exc. Honda Pilot EX, EX-L, SE, VP; Head bolts not incl.; Head bolt replacement recommended; PermaDry® molded rubber valve cover gsks. incl.; Premium valve stem seals incl.	
1	Head Set	2008	HS 26265 PT-5	Honda Pilot EX, EX-L, SE, VP; Head bolts not incl.; Head bolt replacement recommended; PermaDry® molded rubber valve cover gsks. incl.; Premium valve stem seals incl.; Improved design	
1	Head Set	2007-06	HS 26265 PT-4	Exc. Honda Pilot EX, EX-L, LX; Head bolts not incl.; Head bolt replacement recommended; PermaDry® molded rubber valve cover gsks. incl.; Premium valve stem seals incl.	
1	Head Set	2007-06	HS 26265 PT-5	Honda Pilot EX, EX-L, LX; Head bolts not incl.; Head bolt replacement recommended; PermaDry® molded rubber valve cover gsks. incl.; Premium valve stem seals incl.; Improved design	
2	Head Bolt Set	2008-06	ES 71329-1	12-point Head bolts; Head bolts w/Washers; Replacement recommended	
2	Head Bolt Set	2008-06	ES 71331	6-point Head bolts; Head bolts w/Washers; Replacement recommended	
QTY	CONVERSION SET	YEARS	PART NO.	DESCRIPTION	
1	Gasket Conversion Set	2008-06	CS 26265	RTV sealant incl. for oil pan gskt.	
QTY	MANIFOLD - INT. & EXH.	YEARS	PART NO.	DESCRIPTION	
1	Int. Manifold Gasket Set	2008-06	MS 96405	Lower set	
1	Plenum Gasket Set	2008	MS 96409-2	Exc. Honda Pilot EX, EX-L, SE, VP; Upper set	
1	Plenum Gasket Set	2008	MS 96410-1	Honda Pilot EX, EX-L, SE, VP; Upper set	
1	Plenum Gasket Set	2007-06	MS 96409-2	Exc. Honda Pilot EX, EX-L, LX; Upper set	
1	Plenum Gasket Set	2007-06	MS 96410-1	Honda Pilot EX, EX-L, LX; Upper set	
1	Exh. Manifold Gasket Set	2008-06	MS 96411		
QTY	EXHAUST PIPE FLANGE	YEARS	PART NO.	DESCRIPTION	
2	Exhaust Pipe Gasket	2008-06	60578	Pipe to manifold	
1	Exhaust Pipe Gasket	2008-06	61338	Loc. Rear; Converter	
1	Exhaust Pipe Gasket	2008-06	61344	Loc. Front; Converter	
QTY	CRANKSHAFT REAR SEAL	YEARS	PART NO.	DESCRIPTION	
1	Rear Main Seal Set	2008-06	BS 40685	Rubber; One-piece	
QTY	VALVE COVER	YEARS	PART NO.	DESCRIPTION	
1	Valve Cover Gasket Set	2008-06	VS 50607 R	w/Grommets & Spark plug tube seals; PermaDry® molded rubber gsks. incl.	
QTY	VALVE STEM SEAL SET	YEARS	PART NO.	DESCRIPTION	
2	Valve Stem Seal Set	2008-06	SS 70283-2	Premium valve stem seals incl.	

Honda Truck (Incl. Minivans and SUV's) (Cont.)

21 (cont.)		2008 - 2006; 3.5L 212 (3471cc) SOHC V6 (24 Valve) 89mm Bore VTEC			21 (cont.)
MFI; Gasoline; Naturally Aspirated Honda Eng.; Eng. Code J35A9					
QTY	THERMOSTAT HOUSING	YEARS	PART NO.	DESCRIPTION	
1	O-Ring	2008-06	35162	Thermostat Housing	
QTY	WATER OUTLET GASKET	YEARS	PART NO.	DESCRIPTION	
1	Water Crossover Mounting Set	2008-06	ES 72998	Water Outlet; Water bypass set; OEM style; New Part Number - Check for Availability	
QTY	WATER PUMP	YEARS	PART NO.	DESCRIPTION	
1	Water Pump Gasket	2008-06	35677		
QTY	TIMING COVER	YEARS	PART NO.	DESCRIPTION	
1	Crankshaft Front Seal Set	2008-06	TCS 46026		
1	Camshaft Front Seal Set	2008-06	TCS 46025		
QTY	CARB & FUEL INJECTION	YEARS	PART NO.	DESCRIPTION	
3	Fuel Injector O-Ring Set	2008-06	ES 70599	Improved design	
1	Throttle Body Gasket	2008-06	61331		
QTY	EXHAUST GAS RECIRCULATION	YEARS	PART NO.	DESCRIPTION	
1	EGR Gasket	2008-06	70978		
QTY	OIL FILTER MOUNTING	YEARS	PART NO.	DESCRIPTION	
1	Oil Filter Adapter Gasket	2008-06	72951	Oil filter adapter; New Part Number - Check for Availability	
22		2008 - 2006; 3.5L 212 (3471cc) SOHC V6 (24 Valve) 89mm Bore VTEC			22
MFI; Gasoline; Naturally Aspirated Honda Eng.; Eng. Code J35Z1					
QTY	CYLINDER HEAD	YEARS	PART NO.	DESCRIPTION	
2	Head Gasket	2008-06	26265 PT	Head bolts not incl.; Head bolt replacement recommended; PermaTorqueMLS®	
1	Head Set	2008-06	HS 26265 PT-7	Head bolts not incl.; Head bolt replacement recommended; PermaDry® molded rubber valve cover gskts. incl.; Premium valve stem seals incl.; New Part Number - Check for Availability	
2	Head Bolt Set	2008-06	ES 71329-1	12-point Head bolts; Head bolts w/Washers; Replacement recommended	
2	Head Bolt Set	2008-06	ES 71331	6-point Head bolts; Head bolts w/Washers; Replacement recommended	
QTY	CONVERSION SET	YEARS	PART NO.	DESCRIPTION	
1	Gasket Conversion Set	2008-06	CS 26265	RTV sealant incl. for oil pan gskt.	
QTY	MANIFOLD - INT. & EXH.	YEARS	PART NO.	DESCRIPTION	
1	Int. Manifold Gasket Set	2008-06	MS 96405	Lower set	
1	Plenum Gasket Set	2008-06	MS 96410-1	Upper set	
1	Exh. Manifold Gasket Set	2008-06	MS 96411		
QTY	EXHAUST PIPE FLANGE	YEARS	PART NO.	DESCRIPTION	
2	Exhaust Pipe Gasket	2008-06	60578	Pipe to manifold	
1	Exhaust Pipe Gasket	2008-06	61338	Loc. Rear; Converter	
1	Exhaust Pipe Gasket	2008-06	61344	Loc. Front; Converter	
QTY	CRANKSHAFT REAR SEAL	YEARS	PART NO.	DESCRIPTION	
1	Rear Main Seal Set	2008-06	BS 40685	Rubber; One-piece	
QTY	VALVE COVER	YEARS	PART NO.	DESCRIPTION	
1	Valve Cover Gasket Set	2008-06	VS 50607 R-1	w/Grommets & Spark plug tube seals; PermaDry® molded rubber gskts. incl.	
QTY	VALVE STEM SEAL SET	YEARS	PART NO.	DESCRIPTION	
2	Valve Stem Seal Set	2008-06	SS 70283-2	Premium valve stem seals incl.	
QTY	THERMOSTAT HOUSING	YEARS	PART NO.	DESCRIPTION	
1	O-Ring	2008-06	35162	Thermostat Housing	
QTY	WATER OUTLET GASKET	YEARS	PART NO.	DESCRIPTION	
1	Water Crossover Mounting Set	2008-06	ES 72998	Water Outlet; Water bypass set; OEM style; New Part Number - Check for Availability	
QTY	WATER PUMP	YEARS	PART NO.	DESCRIPTION	
1	Water Pump Gasket	2008-06	35677		
QTY	TIMING COVER	YEARS	PART NO.	DESCRIPTION	
1	Crankshaft Front Seal Set	2008-06	TCS 46026		
1	Camshaft Front Seal Set	2008-06	TCS 46025		
QTY	CARB & FUEL INJECTION	YEARS	PART NO.	DESCRIPTION	
3	Fuel Injector O-Ring Set	2008-06	ES 70599	Improved design	
1	Throttle Body Gasket	2008-06	61331		
QTY	EXHAUST GAS RECIRCULATION	YEARS	PART NO.	DESCRIPTION	
1	EGR Gasket	2008-06	70978		
QTY	OIL FILTER MOUNTING	YEARS	PART NO.	DESCRIPTION	
1	Oil Filter Adapter Gasket	2008-06	72951	Oil filter adapter; New Part Number - Check for Availability	

Honda Truck (Incl. Minivans and SUV's) (Cont.)

23	2013 - 2010; 3.5L 212 (3471cc) SOHC V6 (24 Valve) 89mm Bore VTEC				23
MFI; Gasoline; Naturally Aspirated Honda Eng.; Eng. Code J35Z2					
QTY	CYLINDER HEAD	YEARS	PART NO.	DESCRIPTION	
1	Head Gasket	2013-10	26509 PT	Loc. L.H.; Head bolts not incl.; Head bolt replacement recommended; PermaTorqueMLS®; New Part Number - Check for Availability	
1	Head Gasket	2013-10	26510 PT	Loc. R.H.; Head bolts not incl.; Head bolt replacement recommended; PermaTorqueMLS®; New Part Number - Check for Availability	
1	Head Set	2013-10	HS 26509 PT	Head bolts not incl.; Head bolt replacement recommended; PermaDry® molded rubber valve cover gskts. incl.; Premium valve stem seals incl.; New Part Number - Check for Availability	
2	Head Bolt Set	2013-10	ES 71329-1	12-point Head bolts; Head bolts w/Washers; Replacement recommended	
QTY	CONVERSION SET	YEARS	PART NO.	DESCRIPTION	
1	Gasket Conversion Set	2013-10	CS 26265	RTV sealant incl. for oil pan gskt.	
QTY	MANIFOLD - INT. & EXH.	YEARS	PART NO.	DESCRIPTION	
1	Int. Manifold Gasket Set	2013-10	MS 97136	Lower set	
1	Plenum Gasket Set	2013-10	MS 96409-3	Upper set; Improved design; New Part Number - Check for Availability	
1	Exh. Manifold Gasket Set	2013-10	MS 97133		
QTY	EXHAUST PIPE FLANGE	YEARS	PART NO.	DESCRIPTION	
2	Exhaust Pipe Gasket	2013-10	60578	Pipe to manifold	
1	Exhaust Pipe Gasket	2013-10	61015	Exh. connector	
1	Exhaust Pipe Gasket	2013-10	61338	Converter	
QTY	CRANKSHAFT REAR SEAL	YEARS	PART NO.	DESCRIPTION	
1	Rear Main Seal Set	2013-10	BS 40685	Rubber; One-piece	
QTY	VALVE COVER	YEARS	PART NO.	DESCRIPTION	
1	Valve Cover Gasket Set	2013-10	VS 50773 R	w/Grommets & Spark plug tube seals; PermaDry® molded rubber gskts. incl.; New Part Number - Check for Availability	
QTY	VALVE STEM SEAL SET	YEARS	PART NO.	DESCRIPTION	
2	Valve Stem Seal Set	2013-10	SS 70283-2	Premium valve stem seals incl.	
QTY	THERMOSTAT HOUSING	YEARS	PART NO.	DESCRIPTION	
1	O-Ring	2013-10	35162	Thermostat Housing; Thermostat seal	
QTY	WATER OUTLET GASKET	YEARS	PART NO.	DESCRIPTION	
1	Water Crossover Mounting Set	2013-10	ES 72998	Water Outlet; Water bypass set; OEM style; New Part Number - Check for Availability	
QTY	WATER PUMP	YEARS	PART NO.	DESCRIPTION	
1	Water Pump Gasket	2013-10	35677		
QTY	TIMING COVER	YEARS	PART NO.	DESCRIPTION	
1	Crankshaft Front Seal Set	2013-10	TCS 46026		
1	Camshaft Front Seal Set	2013-10	TCS 46025		
QTY	CARB & FUEL INJECTION	YEARS	PART NO.	DESCRIPTION	
3	Fuel Injector O-Ring Set	2013-10	ES 70599	Improved design	
1	Throttle Body Gasket	2013-10	61331		
QTY	EXHAUST GAS RECIRCULATION	YEARS	PART NO.	DESCRIPTION	
1	EGR Gasket	2013-10	70978	Valve	
1	EGR Gasket	2013-10	72371	Loc. Lower; Pipe	
1	EGR Gasket	2013-10	72420	Loc. Upper; Pipe	
QTY	OIL FILTER MOUNTING	YEARS	PART NO.	DESCRIPTION	
1	Oil Filter Adapter Gasket	2013-10	72951	Oil filter adapter; New Part Number - Check for Availability	
24	2013 - 2009; 3.5L 212 (3471cc) SOHC V6 (24 Valve) 89mm Bore VTEC				24
MFI; Gasoline; Naturally Aspirated Honda Eng.; Eng. Code J35Z5					
QTY	CYLINDER HEAD	YEARS	PART NO.	DESCRIPTION	
1	Head Gasket	2013-09	26509 PT	Loc. L.H.; Head bolts not incl.; Head bolt replacement recommended; PermaTorqueMLS®; New Part Number - Check for Availability	
1	Head Gasket	2013-09	26510 PT	Loc. R.H.; Head bolts not incl.; Head bolt replacement recommended; PermaTorqueMLS®; New Part Number - Check for Availability	
1	Head Set	2013-09	HS 26509 PT	Head bolts not incl.; Head bolt replacement recommended; PermaDry® molded rubber valve cover gskts. incl.; Premium valve stem seals incl.; New Part Number - Check for Availability	
2	Head Bolt Set	2013-09	ES 71329-1	12-point Head bolts; Head bolts w/Washers; Replacement recommended	
QTY	CONVERSION SET	YEARS	PART NO.	DESCRIPTION	
1	Gasket Conversion Set	2013-09	CS 26265	RTV sealant incl. for oil pan gskt.	
QTY	MANIFOLD - INT. & EXH.	YEARS	PART NO.	DESCRIPTION	
1	Int. Manifold Gasket Set	2013-09	MS 97136	Lower set	
1	Plenum Gasket Set	2013-09	MS 96409-3	Upper set; Improved design; New Part Number - Check for Availability	
1	Exh. Manifold Gasket Set	2013-09	MS 97133		
QTY	EXHAUST PIPE FLANGE	YEARS	PART NO.	DESCRIPTION	
2	Exhaust Pipe Gasket	2013-09	60578	Pipe to manifold	

Honda Truck (Incl. Minivans and SUV's) (Cont.)

24 (cont.)		2013 - 2009; 3.5L 212 (3471cc) SOHC V6 (24 Valve) 89mm Bore VTEC			24 (cont.)
MFI; Gasoline; Naturally Aspirated Honda Eng.; Eng. Code J35Z5					
QTY	EXHAUST PIPE FLANGE	YEARS	PART NO.	DESCRIPTION	
1	Exhaust Pipe Gasket	2013-09	61015	Exh. connector	
1	Exhaust Pipe Gasket	2013-09	61338	Converter	
QTY	CRANKSHAFT REAR SEAL	YEARS	PART NO.	DESCRIPTION	
1	Rear Main Seal Set	2013-09	BS 40685	Rubber; One-piece	
QTY	VALVE COVER	YEARS	PART NO.	DESCRIPTION	
1	Valve Cover Gasket Set	2013-09	VS 50773 R	w/Grommets & Spark plug tube seals; PermaDry® molded rubber gskts. incl.; New Part Number - Check for Availability	
QTY	VALVE STEM SEAL SET	YEARS	PART NO.	DESCRIPTION	
2	Valve Stem Seal Set	2013-09	SS 70283-2	Premium valve stem seals incl.	
QTY	THERMOSTAT HOUSING	YEARS	PART NO.	DESCRIPTION	
1	O-Ring	2013-09	35162	Thermostat Housing; Thermostat seal	
QTY	WATER OUTLET GASKET	YEARS	PART NO.	DESCRIPTION	
1	Water Crossover Mounting Set	2013-09	ES 72998	Water Outlet; Water bypass set; OEM style; New Part Number - Check for Availability	
QTY	WATER PUMP	YEARS	PART NO.	DESCRIPTION	
1	Water Pump Gasket	2013-09	35677		
QTY	TIMING COVER	YEARS	PART NO.	DESCRIPTION	
1	Crankshaft Front Seal Set	2013-09	TCS 46026		
1	Camshaft Front Seal Set	2013-09	TCS 46025		
QTY	CARB & FUEL INJECTION	YEARS	PART NO.	DESCRIPTION	
3	Fuel Injector O-Ring Set	2013-09	ES 70599	Improved design	
1	Throttle Body Gasket	2013-09	61331		
QTY	EXHAUST GAS RECIRCULATION	YEARS	PART NO.	DESCRIPTION	
1	EGR Gasket	2013-09	70978	Valve	
1	EGR Gasket	2013-09	72371	Loc. Lower; Pipe	
1	EGR Gasket	2013-09	72420	Loc. Upper; Pipe	
QTY	OIL FILTER MOUNTING	YEARS	PART NO.	DESCRIPTION	
1	Oil Filter Adapter Gasket	2013-09	72951	Oil filter adapter; New Part Number - Check for Availability	
25		2010 - 2005; 3.5L 212 (3471cc) SOHC V6 (24 Valve) 89mm Bore i-VTEC			25
MFI; Gasoline; Naturally Aspirated Honda Eng.; Eng. Code J35A7					
QTY	CYLINDER HEAD	YEARS	PART NO.	DESCRIPTION	
1	Head Gasket	2010-08	26509 PT	Loc. L.H.; Head bolts not incl.; Head bolt replacement recommended; PermaTorqueMLS®; New Part Number - Check for Availability	
1	Head Gasket	2010-08	26510 PT	Loc. R.H.; Head bolts not incl.; Head bolt replacement recommended; PermaTorqueMLS®; New Part Number - Check for Availability	
2	Head Gasket	2007-05	26265 PT	Head bolts not incl.; Head bolt replacement recommended; PermaTorqueMLS®	
1	Head Set	2010-08	HS 26509 PT	Head bolts not incl.; Head bolt replacement recommended; PermaDry® molded rubber valve cover gskts. incl.; Premium valve stem seals incl.; New Part Number - Check for Availability	
1	Head Set	2007-05	HS 26265 PT-2	Head bolts not incl.; Head bolt replacement recommended; PermaDry® molded rubber valve cover gskts. incl.; Premium valve stem seals incl.	
2	Head Bolt Set	2010-05	ES 71329-1	12-point Head bolts; Head bolts w/Washers; Replacement recommended	
2	Head Bolt Set	2010-05	ES 71331	6-point Head bolts; Head bolts w/Washers; Replacement recommended	
QTY	CONVERSION SET	YEARS	PART NO.	DESCRIPTION	
1	Gasket Conversion Set	2010-05	CS 26265	RTV sealant incl. for oil pan gskt.	
QTY	MANIFOLD - INT. & EXH.	YEARS	PART NO.	DESCRIPTION	
1	Int. Manifold Gasket Set	2010-08	MS 97136	Lower set	
1	Int. Manifold Gasket Set	2007-05	MS 96405	Lower set	
1	Plenum Gasket Set	2010-05	MS 96409-3	Upper set; Improved design; New Part Number - Check for Availability	
1	Exh. Manifold Gasket Set	2010-08	MS 97133		
1	Exh. Manifold Gasket Set	2007-05	MS 96411		
QTY	EXHAUST PIPE FLANGE	YEARS	PART NO.	DESCRIPTION	
2	Exhaust Pipe Gasket	2010-05	60578	Pipe to manifold	
1	Exhaust Pipe Gasket	2010-05	61338	Loc. Rear; Converter	
1	Exhaust Pipe Gasket	2010-05	61344	Loc. Front; Converter	
QTY	CRANKSHAFT REAR SEAL	YEARS	PART NO.	DESCRIPTION	
1	Rear Main Seal Set	2010-05	BS 40685	Rubber; One-piece	
QTY	VALVE COVER	YEARS	PART NO.	DESCRIPTION	
1	Valve Cover Gasket Set	2010-08	VS 50773 R	w/Grommets & Spark plug tube seals; PermaDry® molded rubber gskts. incl.; New Part Number - Check for Availability	
1	Valve Cover Gasket Set	2007-05	VS 50607 R-1	w/Grommets & Spark plug tube seals; PermaDry® molded rubber gskts. incl.	

Honda Truck (Incl. Minivans and SUV's) (Cont.)

25 (cont.)	2010 - 2005; 3.5L 212 (3471cc) SOHC V6 (24 Valve) 89mm Bore i-VTEC			25 (cont.)
MFI; Gasoline; Naturally Aspirated Honda Eng.; Eng. Code J35A7				
QTY	VALVE STEM SEAL SET	YEARS	PART NO.	DESCRIPTION
2	Valve Stem Seal Set	2010-05	SS 70283-2	Premium valve stem seals incl.
QTY	THERMOSTAT HOUSING	YEARS	PART NO.	DESCRIPTION
1	O-Ring	2010-05	35162	Thermostat Housing
QTY	WATER OUTLET GASKET	YEARS	PART NO.	DESCRIPTION
1	Water Crossover Mounting Set	2010-05	ES 72998	Water Outlet; Water bypass set; OEM style; New Part Number - Check for Availability
QTY	WATER PUMP	YEARS	PART NO.	DESCRIPTION
1	Water Pump Gasket	2010-05	35677	
QTY	TIMING COVER	YEARS	PART NO.	DESCRIPTION
1	Crankshaft Front Seal Set	2010-05	TCS 46026	
1	Camshaft Front Seal Set	2010-05	TCS 46025	
QTY	CARB & FUEL INJECTION	YEARS	PART NO.	DESCRIPTION
3	Fuel Injector O-Ring Set	2010-05	ES 70599	Improved design
1	Throttle Body Gasket	2010-06	61331	
1	Throttle Body Gasket	2005	61320	
QTY	EXHAUST GAS RECIRCULATION	YEARS	PART NO.	DESCRIPTION
1	EGR Gasket	2010-05	70978	Valve
1	EGR Gasket	2010-08	72371	Loc. Lower; Pipe
1	EGR Gasket	2010-08	72420	Loc. Upper; Pipe
QTY	OIL FILTER MOUNTING	YEARS	PART NO.	DESCRIPTION
1	Oil Filter Adapter Gasket	2010-05	72951	Oil filter adapter; New Part Number - Check for Availability
26	2013; 3.5L 212 (3471cc) SOHC V6 (24 Valve) 89mm Bore i-VTEC			26
MFI; Gasoline; Naturally Aspirated Honda Eng.; Eng. Code J35Y1				
QTY	CYLINDER HEAD	YEARS	PART NO.	DESCRIPTION
1	Head Gasket	2013	26509 PT	Loc. L.H.; Head bolts not incl.; Head bolt replacement recommended; PermaTorqueMLS®; New Part Number - Check for Availability
1	Head Gasket	2013	26510 PT	Loc. R.H.; Head bolts not incl.; Head bolt replacement recommended; PermaTorqueMLS®; New Part Number - Check for Availability
1	Head Set	2013	HS 26509 PT	Head bolts not incl.; Head bolt replacement recommended; PermaDry® molded rubber valve cover gskts. incl.; Premium valve stem seals incl.; New Part Number - Check for Availability
2	Head Bolt Set	2013	ES 71329-1	12-point Head bolts; Replacement recommended
QTY	CONVERSION SET	YEARS	PART NO.	DESCRIPTION
1	Gasket Conversion Set	2013	CS 26265	RTV sealant incl. for oil pan gskt.
QTY	MANIFOLD - INT. & EXH.	YEARS	PART NO.	DESCRIPTION
1	Int. Manifold Gasket Set	2013	MS 97136	Lower set
1	Plenum Gasket Set	2013	MS 96409-3	Upper set; Improved design; New Part Number - Check for Availability
1	Exh. Manifold Gasket Set	2013	MS 97133	
QTY	EXHAUST PIPE FLANGE	YEARS	PART NO.	DESCRIPTION
2	Exhaust Pipe Gasket	2013	60578	Pipe to manifold
1	Exhaust Pipe Gasket	2013	61015	Exh. connector
2	Exhaust Pipe Gasket	2013	61338	Converter
QTY	CRANKSHAFT REAR SEAL	YEARS	PART NO.	DESCRIPTION
1	Rear Main Seal Set	2013	BS 40685	Rubber; One-piece
QTY	VALVE COVER	YEARS	PART NO.	DESCRIPTION
1	Valve Cover Gasket Set	2013	VS 50773 R	w/Grommets & Spark plug tube seals; PermaDry® molded rubber gskts. incl.; New Part Number - Check for Availability
QTY	VALVE STEM SEAL SET	YEARS	PART NO.	DESCRIPTION
2	Valve Stem Seal Set	2013	SS 70283-2	Premium valve stem seals incl.
QTY	THERMOSTAT HOUSING	YEARS	PART NO.	DESCRIPTION
1	Thermostat Gasket	2013	35741	Thermostat Housing; Thermostat O-ring
1	O-Ring	2013	35162	Thermostat Housing; Thermostat seal
QTY	WATER OUTLET GASKET	YEARS	PART NO.	DESCRIPTION
1	Water Crossover Mounting Set	2013	ES 72998	Water Outlet; Water bypass set; OEM style; New Part Number - Check for Availability
QTY	WATER PUMP	YEARS	PART NO.	DESCRIPTION
1	Water Pump Gasket	2013	35677	
QTY	TIMING COVER	YEARS	PART NO.	DESCRIPTION
1	Crankshaft Front Seal Set	2013	TCS 46026	
1	Camshaft Front Seal Set	2013	TCS 46025	
QTY	CARB & FUEL INJECTION	YEARS	PART NO.	DESCRIPTION
3	Fuel Injector O-Ring Set	2013	ES 70599	Improved design

Honda Truck (Incl. Minivans and SUV's) (Cont.)

26 (cont.)		2013; 3.5L 212 (3471cc) SOHC V6 (24 Valve) 89mm Bore i-VTEC			26 (cont.)
		MFI; Gasoline; Naturally Aspirated Honda Eng.; Eng. Code J35Y1			
QTY	CARB & FUEL INJECTION	YEARS	PART NO.	DESCRIPTION	
1	Throttle Body Gasket	2013	61331		
QTY	EXHAUST GAS RECIRCULATION	YEARS	PART NO.	DESCRIPTION	
1	EGR Gasket	2013	70978	Valve	
1	EGR Gasket	2013	72371	Loc. Lower; Pipe	
1	EGR Gasket	2013	72420	Loc. Upper; Pipe	
QTY	OIL FILTER MOUNTING	YEARS	PART NO.	DESCRIPTION	
1	Oil Filter Adapter Gasket	2013	72951	Oil filter adapter; New Part Number - Check for Availability	
27		2013 - 2009; 3.5L 212 (3471cc) SOHC V6 (24 Valve) 89mm Bore i-VTEC			27
		MFI; Gasoline; Naturally Aspirated Honda Eng.; Eng. Code J35Z4			
QTY	CYLINDER HEAD	YEARS	PART NO.	DESCRIPTION	
1	Head Gasket	2013-09	26509 PT	Loc. L.H.; Head bolts not incl.; Head bolt replacement recommended; PermaTorqueMLS®; New Part Number - Check for Availability	
1	Head Gasket	2013-09	26510 PT	Loc. R.H.; Head bolts not incl.; Head bolt replacement recommended; PermaTorqueMLS®; New Part Number - Check for Availability	
1	Head Set	2013-09	HS 26509 PT	Head bolts not incl.; Head bolt replacement recommended; PermaDry® molded rubber valve cover gskts. incl.; Premium valve stem seals incl.; New Part Number - Check for Availability	
2	Head Bolt Set	2013-09	ES 71329-1	12-point Head bolts; Head bolts w/Washers; Replacement recommended	
QTY	CONVERSION SET	YEARS	PART NO.	DESCRIPTION	
1	Gasket Conversion Set	2013-09	CS 26265	RTV sealant incl. for oil pan gskt.	
QTY	MANIFOLD - INT. & EXH.	YEARS	PART NO.	DESCRIPTION	
1	Int. Manifold Gasket Set	2013-09	MS 97136	Lower set	
1	Plenum Gasket Set	2013-09	MS 96409-3	Upper set; Improved design; New Part Number - Check for Availability	
1	Exh. Manifold Gasket Set	2013-09	MS 97133		
QTY	EXHAUST PIPE FLANGE	YEARS	PART NO.	DESCRIPTION	
2	Exhaust Pipe Gasket	2013-09	60578	Pipe to manifold	
1	Exhaust Pipe Gasket	2013-09	61015	Exh. connector	
1	Exhaust Pipe Gasket	2013-09	61338	Converter	
QTY	CRANKSHAFT REAR SEAL	YEARS	PART NO.	DESCRIPTION	
1	Rear Main Seal Set	2013-09	BS 40685	Rubber; One-piece	
QTY	VALVE COVER	YEARS	PART NO.	DESCRIPTION	
1	Valve Cover Gasket Set	2013-09	VS 50773 R	w/Grommets & Spark plug tube seals; PermaDry® molded rubber gskts. incl.; New Part Number - Check for Availability	
QTY	VALVE STEM SEAL SET	YEARS	PART NO.	DESCRIPTION	
2	Valve Stem Seal Set	2013-09	SS 70283-2	Premium valve stem seals incl.	
QTY	THERMOSTAT HOUSING	YEARS	PART NO.	DESCRIPTION	
1	O-Ring	2013-09	35162	Thermostat Housing; Thermostat seal	
QTY	WATER OUTLET GASKET	YEARS	PART NO.	DESCRIPTION	
1	Water Crossover Mounting Set	2013-09	ES 72998	Water Outlet; Water bypass set; OEM style; New Part Number - Check for Availability	
QTY	WATER PUMP	YEARS	PART NO.	DESCRIPTION	
1	Water Pump Gasket	2013-09	35677		
QTY	TIMING COVER	YEARS	PART NO.	DESCRIPTION	
1	Crankshaft Front Seal Set	2013-09	TCS 46026		
1	Camshaft Front Seal Set	2013-09	TCS 46025		
QTY	CARB & FUEL INJECTION	YEARS	PART NO.	DESCRIPTION	
3	Fuel Injector O-Ring Set	2013-09	ES 70599	Improved design	
1	Throttle Body Gasket	2013-09	61331		
QTY	EXHAUST GAS RECIRCULATION	YEARS	PART NO.	DESCRIPTION	
1	EGR Gasket	2013-09	70978	Valve	
1	EGR Gasket	2013-09	72371	Loc. Lower; Pipe	
1	EGR Gasket	2013-09	72420	Loc. Upper; Pipe	
QTY	OIL FILTER MOUNTING	YEARS	PART NO.	DESCRIPTION	
1	Oil Filter Adapter Gasket	2013-09	72951	Oil filter adapter; New Part Number - Check for Availability	
28		2000 - 1998; 3.5L 214 (3494cc) DOHC V6 (24 Valve) 93.4mm Bore			28
		MFI; Gasoline; Naturally Aspirated Isuzu Eng.; Eng. Code 6VE1			
QTY	CYLINDER HEAD	YEARS	PART NO.	DESCRIPTION	
1	Head Gasket	2000-98	9254 PT	Loc. R.H.; Head bolts not incl.; Head bolt replacement recommended; PermaTorqueMLS® LaserWeld® Technology	
1	Head Gasket	2000-98	9256 PT	Loc. L.H.; Head bolts not incl.; Head bolt replacement recommended; PermaTorqueMLS® LaserWeld® Technology	

Honda Truck (Incl. Minivans and SUV's) (Cont.)

28 (cont.)	2000 - 1998; 3.5L 214 (3494cc) DOHC V6 (24 Valve) 93.4mm Bore MFI; Gasoline; Naturally Aspirated Isuzu Eng.; Eng. Code 6VE1			28 (cont.)
QTY	CYLINDER HEAD	YEARS	PART NO.	DESCRIPTION
1	Head Set	2000-98	HS 9254 PT	Head bolts not incl.; Head bolt replacement recommended; PermaDry® molded rubber valve cover gskts. incl.; Premium valve stem seals incl.
QTY	CONVERSION SET	YEARS	PART NO.	DESCRIPTION
1	Gasket Conversion Set	2000-98	CS 9254	
QTY	MANIFOLD - INT. & EXH.	YEARS	PART NO.	DESCRIPTION
1	Int. Manifold Gasket Set	2000-98	MS 90610	Lower set; Upper set incl.
1	Exh. Manifold Gasket Set	2000-98	MS 90725	
QTY	EXHAUST PIPE FLANGE	YEARS	PART NO.	DESCRIPTION
2	Exhaust Pipe Gasket	2000-98	60554	Flange
QTY	OIL PAN	YEARS	PART NO.	DESCRIPTION
1	Oil Pan Gasket Set	2000-98	OS 30685	Loc. Upper
1	Oil Pan Gasket Set	2000-98	OS 34511	Loc. Lower
QTY	CRANKSHAFT REAR SEAL	YEARS	PART NO.	DESCRIPTION
1	Rear Main Seal Set	2000-98	BS 40624	Rubber; One-piece
QTY	VALVE COVER	YEARS	PART NO.	DESCRIPTION
1	Valve Cover Gasket Set	2000-98	VS 50486 R	w/Grommets & Spark plug tube seals; PermaDry® molded rubber gskts. incl.
QTY	VALVE STEM SEAL SET	YEARS	PART NO.	DESCRIPTION
2	Valve Stem Seal Set	2000-98	SS 72721	Premium valve stem seals incl.
QTY	THERMOSTAT HOUSING	YEARS	PART NO.	DESCRIPTION
1	Thermostat Gasket	2000-98	35615	Thermostat Housing; Thermostat seal
QTY	WATER PUMP	YEARS	PART NO.	DESCRIPTION
1	Water Pump Gasket	2000-98	35593	
QTY	TIMING COVER	YEARS	PART NO.	DESCRIPTION
1	Crankshaft Front Seal Set	2000-98	TCS 45866	Oil pump mounting seals incl.
1	Crankshaft Front Seal Set	2000-98	TCS 45983	Oil cooler mounting seals incl.
1	Camshaft Front Seal Set	2000-98	TCS 45859	
4	Camshaft Rear Seal Plug Set	2000-98	TCS 45868	Use for both front & rear camshaft plugs
QTY	CARB & FUEL INJECTION	YEARS	PART NO.	DESCRIPTION
1	Throttle Body Gasket	2000-99	61034	To 07/31/99
1	Throttle Body Gasket	2000-99	61517	From 08/01/99
1	Throttle Body Gasket	1998	61034	
QTY	EXHAUST GAS RECIRCULATION	YEARS	PART NO.	DESCRIPTION
1	EGR Gasket	2000-98	70789	Valve
1	EGR Gasket	2000-98	70794	Inlet
29	2013 - 2007; 3.7L 223.6 (3664cc) SOHC V6 (24 Valve) 90mm Bore VTEC MFI; Gasoline; Naturally Aspirated Honda Eng.; Eng. Code J37A1			29
QTY	CYLINDER HEAD	YEARS	PART NO.	DESCRIPTION
2	Head Bolt Set	2013-07	ES 71329-1	12-point Head bolts; Head bolts w/Washers; Replacement recommended
QTY	CONVERSION SET	YEARS	PART NO.	DESCRIPTION
1	Gasket Conversion Set	2013-07	CS 26265	RTV sealant incl. for oil pan gskt.
QTY	MANIFOLD - INT. & EXH.	YEARS	PART NO.	DESCRIPTION
1	Int. Manifold Gasket Set	2013-07	MS 97136	Lower set
1	Plenum Gasket Set	2013-07	MS 96409-3	Upper set; Improved design; New Part Number - Check for Availability
1	Exh. Manifold Gasket Set	2013-10	MS 97133	
1	Exh. Manifold Gasket Set	2009-07	MS 96411	
QTY	EXHAUST PIPE FLANGE	YEARS	PART NO.	DESCRIPTION
2	Exhaust Pipe Gasket	2013-07	60578	Pipe to manifold
1	Exhaust Pipe Gasket	2013-07	61015	Exh. connector
1	Exhaust Pipe Gasket	2013-07	61338	Converter
QTY	CRANKSHAFT REAR SEAL	YEARS	PART NO.	DESCRIPTION
1	Rear Main Seal Set	2013-07	BS 40685	Rubber; One-piece
QTY	VALVE COVER	YEARS	PART NO.	DESCRIPTION
1	Valve Cover Gasket Set	2013-10	VS 50773 R	w/Grommets & Spark plug tube seals; PermaDry® molded rubber gskts. incl.; New Part Number - Check for Availability
1	Valve Cover Gasket Set	2009-07	VS 50607 R	w/Grommets & Spark plug tube seals; PermaDry® molded rubber gskts. incl.
QTY	VALVE STEM SEAL SET	YEARS	PART NO.	DESCRIPTION
2	Valve Stem Seal Set	2013-07	SS 70283-2	Premium valve stem seals incl.
QTY	THERMOSTAT HOUSING	YEARS	PART NO.	DESCRIPTION
1	O-Ring	2013-07	35162	Thermostat Housing; Thermostat seal
QTY	WATER OUTLET GASKET	YEARS	PART NO.	DESCRIPTION
1	Water Crossover Mounting Set	2013-07	ES 72998	Water Outlet; Water bypass set; OEM style; New Part Number - Check for Availability

Honda Truck (Incl. Minivans and SUV's) (Cont.)

29 (cont.)		2013 - 2007; 3.7L 223.6 (3664cc) SOHC V6 (24 Valve) 90mm Bore VTEC			29 (cont.)
MFI; Gasoline; Naturally Aspirated Honda Eng.; Eng. Code J37A1					
QTY	WATER PUMP	YEARS	PART NO.	DESCRIPTION	
1	Water Pump Gasket	2013-07	35677		
QTY	TIMING COVER	YEARS	PART NO.	DESCRIPTION	
1	Crankshaft Front Seal Set	2013-07	TCS 46026		
1	Camshaft Front Seal Set	2013-07	TCS 46025		
QTY	CARB & FUEL INJECTION	YEARS	PART NO.	DESCRIPTION	
1	Throttle Body Gasket	2013-10	61724	New Part Number - Check for Availability	
1	Throttle Body Gasket	2009-07	61331		
QTY	EXHAUST GAS RECIRCULATION	YEARS	PART NO.	DESCRIPTION	
1	EGR Gasket	2013-07	70978	Valve	
1	EGR Gasket	2013-07	72371	Loc. Lower; Pipe	
1	EGR Gasket	2013-07	72420	Loc. Upper; Pipe	
QTY	OIL FILTER MOUNTING	YEARS	PART NO.	DESCRIPTION	
1	Oil Filter Adapter Gasket	2013-07	72951	Oil filter adapter; New Part Number - Check for Availability	
30		2013 - 2010; 3.7L 223.6 (3664cc) SOHC V6 (24 Valve) 90mm Bore VTEC			30
MFI; Gasoline; Naturally Aspirated Honda Eng.; Eng. Code J37A5					
QTY	CYLINDER HEAD	YEARS	PART NO.	DESCRIPTION	
2	Head Bolt Set	2013-10	ES 71329-1	12-point Head bolts; Head bolts w/Washers; Replacement recommended	
QTY	CONVERSION SET	YEARS	PART NO.	DESCRIPTION	
1	Gasket Conversion Set	2013-10	CS 26265	RTV sealant incl. for oil pan gskt.	
QTY	MANIFOLD - INT. & EXH.	YEARS	PART NO.	DESCRIPTION	
1	Int. Manifold Gasket Set	2013-10	MS 97136	Lower set	
1	Plenum Gasket Set	2013-10	MS 96409-3	Upper set; Improved design; New Part Number - Check for Availability	
1	Exh. Manifold Gasket Set	2013-10	MS 97133		
QTY	EXHAUST PIPE FLANGE	YEARS	PART NO.	DESCRIPTION	
2	Exhaust Pipe Gasket	2013-10	60578	Pipe to manifold	
1	Exhaust Pipe Gasket	2013-10	61015	Exh. connector	
1	Exhaust Pipe Gasket	2013-10	61338	Converter	
QTY	CRANKSHAFT REAR SEAL	YEARS	PART NO.	DESCRIPTION	
1	Rear Main Seal Set	2013-10	BS 40685	Rubber; One-piece	
QTY	VALVE COVER	YEARS	PART NO.	DESCRIPTION	
1	Valve Cover Gasket Set	2013-10	VS 50773 R	w/Grommets & Spark plug tube seals; PermaDry® molded rubber gskts. incl.; New Part Number - Check for Availability	
QTY	VALVE STEM SEAL SET	YEARS	PART NO.	DESCRIPTION	
2	Valve Stem Seal Set	2013-10	SS 70283-2	Premium valve stem seals incl.	
QTY	THERMOSTAT HOUSING	YEARS	PART NO.	DESCRIPTION	
1	O-Ring	2013-10	35162	Thermostat Housing; Thermostat seal	
QTY	WATER OUTLET GASKET	YEARS	PART NO.	DESCRIPTION	
1	Water Crossover Mounting Set	2013-10	ES 72998	Water Outlet; Water bypass set; OEM style; New Part Number - Check for Availability	
QTY	WATER PUMP	YEARS	PART NO.	DESCRIPTION	
1	Water Pump Gasket	2013-10	35677		
QTY	TIMING COVER	YEARS	PART NO.	DESCRIPTION	
1	Crankshaft Front Seal Set	2013-10	TCS 46026		
1	Camshaft Front Seal Set	2013-10	TCS 46025		
QTY	CARB & FUEL INJECTION	YEARS	PART NO.	DESCRIPTION	
1	Throttle Body Gasket	2013-10	61724	New Part Number - Check for Availability	
QTY	EXHAUST GAS RECIRCULATION	YEARS	PART NO.	DESCRIPTION	
1	EGR Gasket	2013-10	70978	Valve	
1	EGR Gasket	2013-10	72371	Loc. Lower; Pipe	
1	EGR Gasket	2013-10	72420	Loc. Upper; Pipe	
QTY	OIL FILTER MOUNTING	YEARS	PART NO.	DESCRIPTION	
1	Oil Filter Adapter Gasket	2013-10	72951	Oil filter adapter; New Part Number - Check for Availability	

Hummer SUV's (1992-2001) - See AM General Truck

Engine Finding Index			
Engine	Years	Code	Line No.
1.5L 89.6 (1468cc) SOHC L4 (8 Valve) 75.5mm Bore; MFI; Gasoline; Naturally Aspirated Mitsubishi Eng.	1994-91	G4G15	1
1.5L 89.6 (1468cc) SOHC L4 (8 Valve) 75.5mm Bore; MFI; Gasoline; Naturally Aspirated Mitsubishi Eng.	1994-91	G4DJ	2
1.5L 91.2 (1494cc) DOHC L4 (16 Valve) 75.5mm Bore; MFI; Gasoline; Naturally Aspirated Hyundai Eng.	1998-96	G4FK	3
1.5L 91.2 (1494cc) SOHC L4 (12 Valve) 75.5mm Bore; MFI; Gasoline; Naturally Aspirated Hyundai Eng.	2002-93	G4EK	4
1.5L 91.2 (1494cc) SOHC L4 (12 Valve) 75.5mm Bore; MFI; Gasoline; Turbo Hyundai Eng.	1995-93	G4EK-T	5
1.6L 97.1 (1591cc) DOHC L4 (16 Valve) 77mm Bore Gamma GDi VVT; DI; Gasoline; Naturally Aspirated Hyundai Eng.	2013-12	G4FD	6
1.6L 97.1 (1591cc) DOHC L4 (16 Valve) 77mm Bore Gamma GDi VVT; DI; Gasoline; Turbo - Intercooled Hyundai Eng.	2013	G4FD-T	7
1.6L 97.3 (1595cc) DOHC L4 (16 Valve) 82.3mm Bore; MFI; Gasoline; Naturally Aspirated Mitsubishi Eng.	1995-92	G4CR	8
1.6L 98 (1599cc) DOHC L4 (16 Valve) 76.5mm Bore; MFI; Gasoline; Naturally Aspirated Hyundai Eng.	2008-01	G4CR	9
1.6L 98 (1599cc) DOHC L4 (16 Valve) 76.5mm Bore; MFI; Gasoline; Naturally Aspirated Hyundai Eng.	2005-01	G4EC	10
1.6L 98 (1599cc) DOHC L4 (16 Valve) 76.5mm Bore VVT; MFI; Gasoline; Naturally Aspirated Hyundai Eng.	2011-06	G4ED	11
1.8L 109.5 (1796cc) DOHC L4 (16 Valve) 82mm Bore; MFI; Gasoline; Naturally Aspirated Hyundai Eng.	1998-96	G4GM	12
1.8L 109.7 (1797cc) DOHC L4 (16 Valve) 81mm Bore Nu VVT; MFI; Gasoline; Naturally Aspirated Hyundai Eng.	2013-11		13
1.8L 112 (1836cc) DOHC L4 (16 Valve) 80.6mm Bore; MFI; Gasoline; Naturally Aspirated Hyundai Eng.	1995-93	G4CN	14
2.0L 120.5 (1975cc) DOHC L4 (16 Valve) 82mm Bore; MFI; Gasoline; Naturally Aspirated Hyundai Eng.	2012-97	G4GF	15
2.0L 121.9 (1998cc) DOHC L4 (16 Valve) 86mm Bore Theta GDi VVT; DI; Gasoline; Turbo - Intercooled Hyundai Eng.	2013-11		16
2.0L 121.9 (1998cc) DOHC L4 (16 Valve) 86mm Bore Theta VVT; MFI; Gasoline; Turbo - Intercooled Hyundai Eng.	2012-10		17
2.0L 122 (1997cc) DOHC L4 (16 Valve) 85mm Bore; MFI; Gasoline; Naturally Aspirated Mitsubishi Eng.	1998-92	G4CP	18
2.4L 143.4 (2351cc) DOHC L4 (16 Valve) 86.5mm Bore; MFI; Gasoline; Naturally Aspirated Mitsubishi Eng.	2005-99	G4JS	19
2.4L 143.4 (2351cc) SOHC L4 (8 Valve) 86.5mm Bore; MFI; Gasoline; Naturally Aspirated Mitsubishi Eng.	1991	G4CS	20
2.4L 144 (2359cc) DOHC L4 (16 Valve) 88mm Bore; MFI; Gasoline; Naturally Aspirated Hyundai Eng.	2008-06	G4KC	21
2.4L 144 (2359cc) DOHC L4 (16 Valve) 88mm Bore Theta GDi VVT; DI; Gasoline; Naturally Aspirated Hyundai Eng.	2013-11		22
2.4L 144 (2359cc) DOHC L4 (16 Valve) 88mm Bore Theta GDi VVT; DI; Hybrid (Gas/Electric); Naturally Aspirated Hyundai Eng.	2013-11		23
2.4L 144 (2359cc) DOHC L4 (16 Valve) 88mm Bore VVT; MFI; Gasoline; Naturally Aspirated Hyundai Eng.	2010-09	G4KC	24
2.5L 152 (2493cc) DOHC V6 (24 Valve) 84mm Bore; MFI; Gasoline; Naturally Aspirated Hyundai Eng.	2001-99	G6BV	25
2.7L 162 (2656cc) DOHC V6 (24 Valve) 86.7mm Bore; MFI; Gasoline; Naturally Aspirated Hyundai Eng.	2009-02	G6BA	26
3.0L 181.1 (2972cc) DOHC V6 (24 Valve) 91.1mm Bore; MFI; Gasoline; Naturally Aspirated Mitsubishi Eng.	2001	G6CT	27
3.0L 181.1 (2972cc) SOHC V6 (12 Valve) 91.1mm Bore; MFI; Gasoline; Naturally Aspirated Mitsubishi Eng.	1998-91	G6AT	28
3.3L 204 (3342cc) DOHC V6 (24 Valve) 92mm Bore Lambda; MFI; Gasoline; Naturally Aspirated Hyundai Eng.	2010-06	G6DB	29
3.3L 204 (3342cc) DOHC V6 (24 Valve) 92mm Bore Lambda VVT; MFI; Gasoline; Naturally Aspirated Hyundai Eng.	2011	G6DB	30
3.5L 213.3 (3497cc) DOHC V6 (24 Valve) 93mm Bore; MFI; Gasoline; Naturally Aspirated Mitsubishi Eng.	2005-02	G6CU	31
3.8L 230 (3778cc) DOHC V6 (24 Valve) 96mm Bore Lambda; MFI; Gasoline; Naturally Aspirated Hyundai Eng.	2010-06	G6DA	32
3.8L 230 (3778cc) DOHC V6 (24 Valve) 96mm Bore Lambda VVT; MFI; Gasoline; Naturally Aspirated Hyundai Eng.	2012-09	G6DA	33
4.6L 282.4 (4627cc) DOHC V8 (32 Valve) 92mm Bore Tau VVT; MFI; Gasoline; Naturally Aspirated Hyundai Eng.	2012-09	G8BA	34
5.0L 307.3 (5038cc) DOHC V8 (32 Valve) 96mm Bore Tau GDi VVT; DI; Gasoline; Naturally Aspirated Hyundai Eng.	2013-12	G8BE	35

Engine Code Index

Code	Engine	Line No.
G4G15	1.5L 89.6 (1468cc) SOHC L4 (8 Valve) 75.5mm Bore; MFI; Gasoline; Naturally Aspirated Mitsubishi Eng.	1
G4CN	1.8L 112 (1836cc) DOHC L4 (16 Valve) 80.6mm Bore; MFI; Gasoline; Naturally Aspirated Hyundai Eng.	14
G4CP	2.0L 122 (1997cc) DOHC L4 (16 Valve) 85mm Bore; MFI; Gasoline; Naturally Aspirated Mitsubishi Eng.	18
G4CR	1.6L 97.3 (1595cc) DOHC L4 (16 Valve) 82.3mm Bore; MFI; Gasoline; Naturally Aspirated Mitsubishi Eng.	8
G4CR	1.6L 98 (1599cc) DOHC L4 (16 Valve) 76.5mm Bore; MFI; Gasoline; Naturally Aspirated Hyundai Eng.	9
G4CS	2.4L 143.4 (2351cc) SOHC L4 (8 Valve) 86.5mm Bore; MFI; Gasoline; Naturally Aspirated Mitsubishi Eng.	20
G4DJ	1.5L 89.6 (1468cc) SOHC L4 (8 Valve) 75.5mm Bore; MFI; Gasoline; Naturally Aspirated Mitsubishi Eng.	2
G4EC	1.6L 98 (1599cc) DOHC L4 (16 Valve) 76.5mm Bore; MFI; Gasoline; Naturally Aspirated Hyundai Eng.	10
G4ED	1.6L 98 (1599cc) DOHC L4 (16 Valve) 76.5mm Bore VVT; MFI; Gasoline; Naturally Aspirated Hyundai Eng.	11
G4EK	1.5L 91.2 (1494cc) SOHC L4 (12 Valve) 75.5mm Bore; MFI; Gasoline; Naturally Aspirated Hyundai Eng.	4
G4EK-T	1.5L 91.2 (1494cc) SOHC L4 (12 Valve) 75.5mm Bore; MFI; Gasoline; Turbo Hyundai Eng.	5
G4FD	1.6L 97.1 (1591cc) DOHC L4 (16 Valve) 77mm Bore Gamma GDi VVT; DI; Gasoline; Naturally Aspirated Hyundai Eng.	6
G4FD-T	1.6L 97.1 (1591cc) DOHC L4 (16 Valve) 77mm Bore Gamma GDi VVT; DI; Gasoline; Turbo - Intercooled Hyundai Eng.	7
G4FK	1.5L 91.2 (1494cc) DOHC L4 (16 Valve) 75.5mm Bore; MFI; Gasoline; Naturally Aspirated Hyundai Eng.	3
G4GF	2.0L 120.5 (1975cc) DOHC L4 (16 Valve) 82mm Bore; MFI; Gasoline; Naturally Aspirated Hyundai Eng.	15
G4GM	1.8L 109.5 (1796cc) DOHC L4 (16 Valve) 82mm Bore; MFI; Gasoline; Naturally Aspirated Hyundai Eng.	12
G4JS	2.4L 143.4 (2351cc) DOHC L4 (16 Valve) 86.5mm Bore; MFI; Gasoline; Naturally Aspirated Mitsubishi Eng.	19
G4KC	2.4L 144 (2359cc) DOHC L4 (16 Valve) 88mm Bore; MFI; Gasoline; Naturally Aspirated Hyundai Eng.	21
G4KC	2.4L 144 (2359cc) DOHC L4 (16 Valve) 88mm Bore VVT; MFI; Gasoline; Naturally Aspirated Hyundai Eng.	24
G6AT	3.0L 181.1 (2972cc) SOHC V6 (12 Valve) 91.1mm Bore; MFI; Gasoline; Naturally Aspirated Mitsubishi Eng.	28
G6BA	2.7L 162 (2656cc) DOHC V6 (24 Valve) 86.7mm Bore; MFI; Gasoline; Naturally Aspirated Hyundai Eng.	26
G6BV	2.5L 152 (2493cc) DOHC V6 (24 Valve) 84mm Bore; MFI; Gasoline; Naturally Aspirated Hyundai Eng.	25
G6CT	3.0L 181.1 (2972cc) DOHC V6 (24 Valve) 91.1mm Bore; MFI; Gasoline; Naturally Aspirated Mitsubishi Eng.	27
G6CU	3.5L 213.3 (3497cc) DOHC V6 (24 Valve) 93mm Bore; MFI; Gasoline; Naturally Aspirated Mitsubishi Eng.	31

Hyundai Car (Cont.)

Engine Code Index (Cont.)

Code	Engine	Line No.
G6DA	3.8L 230 (3778cc) DOHC V6 (24 Valve) 96mm Bore Lambda; MFI; Gasoline; Naturally Aspirated Hyundai Eng.	32
G6DA	3.8L 230 (3778cc) DOHC V6 (24 Valve) 96mm Bore Lambda VVT; MFI; Gasoline; Naturally Aspirated Hyundai Eng.	33
G6DB	3.3L 204 (3342cc) DOHC V6 (24 Valve) 92mm Bore Lambda; MFI; Gasoline; Naturally Aspirated Hyundai Eng.	29
G6DB	3.3L 204 (3342cc) DOHC V6 (24 Valve) 92mm Bore Lambda VVT; MFI; Gasoline; Naturally Aspirated Hyundai Eng.	30
G8BA	4.6L 282.4 (4627cc) DOHC V8 (32 Valve) 92mm Bore Tau VVT; MFI; Gasoline; Naturally Aspirated Hyundai Eng.	34
G8BE	5.0L 307.3 (5038cc) DOHC V8 (32 Valve) 96mm Bore Tau GDi VVT; DI; Gasoline; Naturally Aspirated Hyundai Eng.	35

Model Index

Engine (VIN Code / Eng. Code)	Year	Engine (VIN Code / Eng. Code)	Year	Engine (VIN Code / Eng. Code)	Year
Hyundai		Hyundai (cont.)		Hyundai (cont.)	
Accent		Genesis Coupe (cont.)		Sonata (cont.)	
L4 1494cc 1.5L DOHC (16 Valve) (G4FK)	98-96	V6 3778cc 3.8L DOHC (24 Valve) (G6DA)	12-10	V6 2493cc 2.5L DOHC (24 Valve) (G6BV)	01-99
L4 1494cc 1.5L SOHC (12 Valve) (G4EK)	02-95	V6 3778cc 3.8L DOHC (24 Valve) (G6DJ)	13	V6 2656cc 2.7L DOHC (24 Valve) (G6BA)	05-02
L4 1591cc 1.6L DOHC (16 Valve) (G4FD)	13-12	Genesis Sedan		V6 2972cc 3.0L SOHC (12 Valve) (G6AT)	98-90
L4 1599cc 1.6L DOHC (16 Valve) (G4EC)	05-01	V6 3778cc 3.8L DOHC (24 Valve) (G6DA)	11-09	V6 3342cc 3.3L DOHC (24 Valve) (G6DB)	10-06
L4 1599cc 1.6L DOHC (16 Valve) (G4ED)	11-06	V6 3778cc 3.8L DOHC (24 Valve) (G6DJ)	13-12	Sonata Hybrid	
Azera		V8 4627cc 4.6L DOHC (32 Valve) (G8BA)	12-09	L4 2359cc 2.4L DOHC (16 Valve) (Theta)	13-11
V6 3342cc 3.3L DOHC (24 Valve) (G6DB)	11-07	V8 5038cc 5.0L DOHC (32 Valve) (G8BE)	13-12	Stellar (Canada)	
V6 3342cc 3.3L DOHC (24 Valve) (G6DH)	13-12	Pony (Canada)		L4 1597cc 1.6L SOHC (8 Valve) (G32B)	90-85
V6 3778cc 3.8L DOHC (24 Valve) (G6DA)	11-06	L4 1439cc 1.4L SOHC (4G33)	87-83	L4 1997cc 2.0L SOHC (8 Valve) (G63B)	90-85
Elantra		L4 1597cc 1.6L SOHC (8 Valve) (4G32)	90-85	Tiburon	
L4 1595cc 1.6L DOHC (16 Valve) (G4CR)	95-92	Scoupe		L4 1796cc 1.8L DOHC (16 Valve) (G4GM)	97
L4 1796cc 1.8L DOHC (16 Valve) (G4GM)	98-96	L4 1468cc 1.5L SOHC (8 Valve) (G4DJ)	92-91	L4 1975cc 2.0L DOHC (16 Valve) (G4GF)	09-97
L4 1797cc 1.8L DOHC (16 Valve) (Nu)	13-11	L4 1494cc 1.5L SOHC (12 Valve) (G4EK)	95-93	V6 2656cc 2.7L DOHC (24 Valve) (G6BA)	09-03
L4 1836cc 1.8L DOHC (16 Valve) (G4CN)	95-93	L4 1494cc 1.5L SOHC Turbo (12 Valve) (G4EK-T)	95-93	Veloster	
L4 1975cc 2.0L DOHC (16 Valve) (G4GF)	12-99	Sonata		L4 1591cc 1.6L DOHC (16 Valve) (G4FD)	13-12
Equus		L4 1997cc 2.0L DOHC (16 Valve) (G4CP)	98-92	L4 1591cc 1.6L DOHC Turbo (16 Valve) (G4FD-T)	13
V8 5038cc 5.0L DOHC (32 Valve) (G8BE)	13-12	L4 1998cc 2.0L DOHC Turbo (16 Valve) (Theta)	13-11	XG300	
Excel		L4 2351cc 2.4L DOHC (16 Valve) (G4JS)	05-99	V6 2972cc 3.0L DOHC (24 Valve) (G6CT)	01
L4 1468cc 1.5L SOHC (8 Valve) (G4AJ)	89-86	L4 2351cc 2.4L SOHC (8 Valve) (G4CS)	91-89	XG350	
L4 1468cc 1.5L SOHC (8 Valve) (G4DJ)	94-90	L4 2359cc 2.4L DOHC (16 Valve) (G4KC)	10-06	V6 3497cc 3.5L DOHC (24 Valve) (G6CU)	05-02
Genesis Coupe		L4 2359cc 2.4L DOHC (16 Valve) (Theta)	13-11		
L4 1998cc 2.0L DOHC Turbo (16 Valve) (Theta)	13-10				

1 1994 - 1991; 1.5L 89.6 (1468cc) SOHC L4 (8 Valve) 75.5mm Bore MFI; Gasoline; Naturally Aspirated Mitsubishi Eng.; Eng. Code 4G15 1

QTY	CYLINDER HEAD	YEARS	PART NO.	DESCRIPTION
1	Head Gasket	1994-91	9352 PT	PermaTorque®
1	Head Set	1994-91	HS 9352 PT-2	PermaDry® molded rubber valve cover gskt. incl.; Premium valve stem seals incl.
QTY	CONVERSION SET	YEARS	PART NO.	DESCRIPTION
1	Gasket Conversion Set	1994-91	CS 8767-1	
QTY	MANIFOLD - INT. & EXH.	YEARS	PART NO.	DESCRIPTION
1	Int. Manifold Gasket Set	1994-91	MS 94825	Upper set incl.
1	Exh. Manifold Gasket Set	1994-91	MS 94763	
QTY	EXHAUST PIPE FLANGE	YEARS	PART NO.	DESCRIPTION
1	Exhaust Pipe Gasket	1994-91	60680	Flange
QTY	OIL PAN	YEARS	PART NO.	DESCRIPTION
1	Oil Pan Gasket Set	1994-91	OS 30414 C	
QTY	CRANKSHAFT REAR SEAL	YEARS	PART NO.	DESCRIPTION
1	Rear Main Seal Set	1994-91	BS 40097-1	Rubber; One-piece
1	Repair Sleeve	1994-91	16275	Crankshaft; Use w/installation tool
QTY	VALVE COVER	YEARS	PART NO.	DESCRIPTION
1	Valve Cover Gasket Set	1994-91	VS 50195 R	PermaDry® molded rubber gskt. incl.
QTY	VALVE STEM SEAL SET	YEARS	PART NO.	DESCRIPTION
1	Valve Stem Seal Set	1994-91	SS 72524	Loc. Int. & Exh.; Premium valve stem seals incl.
1	Valve Stem Seal Set	1994-91	SS 72681	Loc. Aux.; Premium valve stem seals incl.
QTY	WATER OUTLET GASKET	YEARS	PART NO.	DESCRIPTION
1	Water Outlet Gasket	1994-91	35336	Water Outlet
QTY	WATER PUMP	YEARS	PART NO.	DESCRIPTION
1	Water Pump Gasket	1994-91	35225	
1	Water Pump Gasket	1994-91	ES 72872	O-ring
QTY	TIMING COVER	YEARS	PART NO.	DESCRIPTION
1	Crankshaft Front Seal Set	1994-91	TCS 45482-1	
1	Camshaft Front Seal Set	1994-91	TCS 45483	

1 1994 - 1991; 1.5L 89.6 (1468cc) SOHC L4 (8 Valve) 75.5mm Bore 1				
(cont.) MFI; Gasoline; Naturally Aspirated Mitsubishi Eng.; Eng. Code 4G15 (cont.)				
QTY	AIR CLEANER MOUNTING	YEARS	PART NO.	DESCRIPTION
1	Air Cleaner Gasket	1994-91	60756	
QTY	CARB & FUEL INJECTION	YEARS	PART NO.	DESCRIPTION
1	Fuel Injector O-Ring Set	1994-91	ES 70600	
1	Throttle Body Gasket	1994-92	60855	
1	Throttle Body Gasket	1991	60855	From 07/01/90
QTY	EXHAUST GAS RECIRCULATION	YEARS	PART NO.	DESCRIPTION
1	EGR Gasket	1994-91	70152	
2 1994 - 1991; 1.5L 89.6 (1468cc) SOHC L4 (8 Valve) 75.5mm Bore 2				
MFI; Gasoline; Naturally Aspirated Mitsubishi Eng.; Eng. Code G4DJ				
QTY	CYLINDER HEAD	YEARS	PART NO.	DESCRIPTION
1	Head Gasket	1994-91	9352 PT	PermaTorque®
1	Head Set	1994-91	HS 9352 PT-2	PermaDry® molded rubber valve cover gskt. incl.; Premium valve stem seals incl.
QTY	CONVERSION SET	YEARS	PART NO.	DESCRIPTION
1	Gasket Conversion Set	1994-91	CS 8767-1	
QTY	MANIFOLD - INT. & EXH.	YEARS	PART NO.	DESCRIPTION
1	Int. Manifold Gasket Set	1994-91	MS 94825	Upper set incl.
1	Exh. Manifold Gasket Set	1994-91	MS 94763	
QTY	EXHAUST PIPE FLANGE	YEARS	PART NO.	DESCRIPTION
1	Exhaust Pipe Gasket	1994-91	60680	Flange
QTY	OIL PAN	YEARS	PART NO.	DESCRIPTION
1	Oil Pan Gasket Set	1994-91	OS 30414 C	
QTY	CRANKSHAFT REAR SEAL	YEARS	PART NO.	DESCRIPTION
1	Rear Main Seal Set	1994-91	BS 40097-1	Rubber; One-piece
1	Repair Sleeve	1994-91	16275	Crankshaft; Use w/installation tool
QTY	VALVE COVER	YEARS	PART NO.	DESCRIPTION
1	Valve Cover Gasket Set	1994-91	VS 50195 R	PermaDry® molded rubber gskt. incl.
QTY	VALVE STEM SEAL SET	YEARS	PART NO.	DESCRIPTION
1	Valve Stem Seal Set	1994-91	SS 72524	Loc. Int. & Exh.; Premium valve stem seals incl.
1	Valve Stem Seal Set	1994-91	SS 72681	Loc. Aux.; Premium valve stem seals incl.
QTY	WATER OUTLET GASKET	YEARS	PART NO.	DESCRIPTION
1	Water Outlet Gasket	1994-91	35336	Water Outlet
QTY	WATER PUMP	YEARS	PART NO.	DESCRIPTION
1	Water Pump Gasket	1994-91	35225	
1	Water Pump Gasket	1994-91	ES 72872	O-ring
QTY	TIMING COVER	YEARS	PART NO.	DESCRIPTION
1	Crankshaft Front Seal Set	1994-91	TCS 45482-1	
1	Camshaft Front Seal Set	1994-91	TCS 45483	
QTY	AIR CLEANER MOUNTING	YEARS	PART NO.	DESCRIPTION
1	Air Cleaner Gasket	1994-91	60756	
QTY	CARB & FUEL INJECTION	YEARS	PART NO.	DESCRIPTION
1	Fuel Injector O-Ring Set	1994-91	ES 70600	
1	Throttle Body Gasket	1994-92	60855	
1	Throttle Body Gasket	1991	60855	From 07/01/90
QTY	EXHAUST GAS RECIRCULATION	YEARS	PART NO.	DESCRIPTION
1	EGR Gasket	1994-91	70152	
3 1998 - 1996; 1.5L 91.2 (1494cc) DOHC L4 (16 Valve) 75.5mm Bore 3				
MFI; Gasoline; Naturally Aspirated Hyundai Eng.; Eng. Code G4FK				
QTY	CYLINDER HEAD	YEARS	PART NO.	DESCRIPTION
1	Head Set	1998-96	HS 26225 PT	Head bolts not incl.; Head bolt replacement recommended; PermaDry® molded rubber valve cover gskt. incl.; Premium valve stem seals incl.
1	Head Bolt Set	1998-96	ES 71204	Head bolts w/Washers; Replacement recommended
QTY	CONVERSION SET	YEARS	PART NO.	DESCRIPTION
1	Gasket Conversion Set	1998-96	CS 26224	
QTY	MANIFOLD - INT. & EXH.	YEARS	PART NO.	DESCRIPTION
1	Int. Manifold Gasket Set	1998-96	MS 96331	
1	Exh. Manifold Gasket Set	1998-96	MS 96332	
QTY	EXHAUST PIPE FLANGE	YEARS	PART NO.	DESCRIPTION
1	Exhaust Pipe Gasket	1998	61302	Flange
1	Exhaust Pipe Gasket	1997-96	61294	Flange; Small ports

Hyundai Car (Cont.)

3		1998 - 1996; 1.5L 91.2 (1494cc) DOHC L4 (16 Valve) 75.5mm Bore			3
(cont.)		MFI; Gasoline; Naturally Aspirated Hyundai Eng.; Eng. Code G4FK			(cont.)
QTY	EXHAUST PIPE FLANGE	YEARS	PART NO.	DESCRIPTION	
1	Exhaust Pipe Gasket	1997-96	61295	Flange; Large ports	
QTY	OIL PAN	YEARS	PART NO.	DESCRIPTION	
1	Oil Pan Gasket Set	1998-96	OS 30726		
QTY	CRANKSHAFT REAR SEAL	YEARS	PART NO.	DESCRIPTION	
1	Rear Main Seal Set	1998-96	BS 40672	Rubber; One-piece	
QTY	VALVE COVER	YEARS	PART NO.	DESCRIPTION	
1	Valve Cover Gasket Set	1998-96	VS 50593 R	w/Spark plug tube seals; PermaDry® molded rubber gskt. incl.	
1	Circular Plug	1998-96	CP 75023	Valve Cover	
1	Spark Plug Tube Seal Set	1998-96	ES 72974	Valve Cover; New Part Number - Check for Availability	
QTY	VALVE STEM SEAL SET	YEARS	PART NO.	DESCRIPTION	
1	Valve Stem Seal Set	1998-96	SS 70795-1	Premium valve stem seals incl.	
QTY	THERMOSTAT HOUSING	YEARS	PART NO.	DESCRIPTION	
1	Thermostat Gasket	1998-96	35719	Thermostat Housing	
QTY	WATER PUMP	YEARS	PART NO.	DESCRIPTION	
1	Water Pump Gasket	1998-96	35699		
QTY	TIMING COVER	YEARS	PART NO.	DESCRIPTION	
1	Crankshaft Front Seal Set	1998-96	TCS 46019-1		
1	Camshaft Front Seal Set	1998-96	TCS 45704-1		
QTY	CARB & FUEL INJECTION	YEARS	PART NO.	DESCRIPTION	
2	Fuel Injector O-Ring Set	1998-96	ES 70599	Improved design	
1	Throttle Body Gasket	1998-96	61244		
4		2002 - 1993; 1.5L 91.2 (1494cc) SOHC L4 (12 Valve) 75.5mm Bore			4
(cont.)		MFI; Gasoline; Naturally Aspirated Hyundai Eng.; Eng. Code G4EK			(cont.)
QTY	CYLINDER HEAD	YEARS	PART NO.	DESCRIPTION	
1	Head Gasket	2002-00	26197 PT	Head bolts not incl.; Head bolt replacement recommended; PermaTorqueMLS®	
1	Head Gasket	1999-93	26195 PT	Head bolts not incl.; Head bolt replacement recommended; PermaTorqueMLS®	
1	Head Set	2002-00	HS 26197 PT	Head bolts not incl.; Head bolt replacement recommended; PermaDry® molded rubber valve cover gskt. incl.; Premium valve stem seals incl.	
1	Head Set	1999-93	HS 26195 PT	Head bolts not incl.; Head bolt replacement recommended; PermaDry® molded rubber valve cover gskt. incl.; Premium valve stem seals incl.	
1	Head Bolt Set	2002-93	ES 71201	Head bolts w/Washers; Replacement recommended	
QTY	CONVERSION SET	YEARS	PART NO.	DESCRIPTION	
1	Gasket Conversion Set	2002-93	CS 26195		
QTY	MANIFOLD - INT. & EXH.	YEARS	PART NO.	DESCRIPTION	
1	Int. Manifold Gasket Set	2002-93	MS 96148	Upper set incl.	
1	Exh. Manifold Gasket Set	2002-93	MS 96162		
QTY	EXHAUST PIPE FLANGE	YEARS	PART NO.	DESCRIPTION	
2	Exhaust Pipe Gasket	2002-96	60620	Exh. connector	
1	Exhaust Pipe Gasket	2002-98	61302	Flange	
1	Exhaust Pipe Gasket	1997-96	60752	Flange; California	
1	Exhaust Pipe Gasket	1997-96	61295	Flange; Exc. California	
2	Exhaust Pipe Gasket	1995	60620	Hyundai Accent Base, GL, L; Exh. connector	
1	Exhaust Pipe Gasket	1995	61295	Hyundai Scoupe Base, LS; Flange	
1	Exhaust Pipe Gasket	1995	61295	Hyundai Accent Base, GL, L; Flange; Dual port	
1	Exhaust Pipe Gasket	1995	61296	Hyundai Accent Base, GL, L; Flange; Single port	
1	Exhaust Pipe Gasket	1994-93	61295	Flange	
QTY	OIL PAN	YEARS	PART NO.	DESCRIPTION	
1	Oil Pan Gasket Set	2002-93	OS 30726		
1	Drain Plug Gasket	2002-93	72515		
QTY	CRANKSHAFT REAR SEAL	YEARS	PART NO.	DESCRIPTION	
1	Rear Main Seal Set	2002-93	BS 40672	Rubber; One-piece	
QTY	VALVE COVER	YEARS	PART NO.	DESCRIPTION	
1	Valve Cover Gasket Set	2002-93	VS 50575 R	PermaDry® molded rubber gskt. incl.	
1	Circular Plug	2002-93	CP 75023	Valve Cover	
QTY	VALVE STEM SEAL SET	YEARS	PART NO.	DESCRIPTION	
1	Valve Stem Seal Set	2002-93	SS 70795-2	Premium valve stem seals incl.	
QTY	THERMOSTAT HOUSING	YEARS	PART NO.	DESCRIPTION	
1	Thermostat Gasket	2002-93	35674	Thermostat Housing	
QTY	WATER OUTLET GASKET	YEARS	PART NO.	DESCRIPTION	
1	Thermostat Gasket	2002-96	35697	Water Outlet	

4		2002 - 1993; 1.5L 91.2 (1494cc) SOHC L4 (12 Valve) 75.5mm Bore			4	
(cont.)		MFI; Gasoline; Naturally Aspirated Hyundai Eng.; Eng. Code G4EK			(cont.)	
QTY	WATER OUTLET GASKET	YEARS	PART NO.	DESCRIPTION		
1	Thermostat Gasket	1995	35697	Hyundai Accent Base, GL, L; Water Outlet		
QTY	WATER PUMP	YEARS	PART NO.	DESCRIPTION		
1	Water Pump Gasket	2002-93	35699			
QTY	TIMING COVER	YEARS	PART NO.	DESCRIPTION		
1	Crankshaft Front Seal Set	2002-93	TCS 46019	Camshaft front seal incl.		
1	Camshaft Front Seal Set	2002-93	TCS 45704-1			
QTY	CARB & FUEL INJECTION	YEARS	PART NO.	DESCRIPTION		
2	Fuel Injector O-Ring Set	2002-93	ES 70599	Improved design		
1	Throttle Body Gasket	2002-93	61244			
5		1995 - 1993; 1.5L 91.2 (1494cc) SOHC L4 (12 Valve) 75.5mm Bore			5	
		MFI; Gasoline; Turbo Hyundai Eng.; Eng. Code G4EK-T				
QTY	CYLINDER HEAD	YEARS	PART NO.	DESCRIPTION		
1	Head Gasket	1995-93	26195 PT	Head bolts not incl.; Head bolt replacement recommended; PermaTorqueMLS®		
1	Head Set	1995-93	HS 26195 PT-1	Head bolts not incl.; Head bolt replacement recommended; PermaDry® molded rubber valve cover gskt. incl.; Premium valve stem seals incl.		
1	Head Bolt Set	1995-93	ES 71201	Head bolts w/Washers; Replacement recommended		
QTY	CONVERSION SET	YEARS	PART NO.	DESCRIPTION		
1	Gasket Conversion Set	1995-93	CS 26195			
QTY	MANIFOLD - INT. & EXH.	YEARS	PART NO.	DESCRIPTION		
1	Int. Manifold Gasket Set	1995-93	MS 96148	Upper set incl.		
1	Exh. Manifold Gasket Set	1995-93	MS 96162			
QTY	EXHAUST PIPE FLANGE	YEARS	PART NO.	DESCRIPTION		
1	Exhaust Pipe Gasket	1995-93	61295	Flange		
QTY	OIL PAN	YEARS	PART NO.	DESCRIPTION		
1	Oil Pan Gasket Set	1995-93	OS 30726			
1	Drain Plug Gasket	1995-93	72515			
QTY	CRANKSHAFT REAR SEAL	YEARS	PART NO.	DESCRIPTION		
1	Rear Main Seal Set	1995-93	BS 40672	Rubber; One-piece		
QTY	VALVE COVER	YEARS	PART NO.	DESCRIPTION		
1	Valve Cover Gasket Set	1995-93	VS 50590 R	PermaDry® molded rubber gskt. incl.		
1	Circular Plug	1995-93	CP 75023	Valve Cover		
QTY	VALVE STEM SEAL SET	YEARS	PART NO.	DESCRIPTION		
1	Valve Stem Seal Set	1995-93	SS 70795-2	Premium valve stem seals incl.		
QTY	THERMOSTAT HOUSING	YEARS	PART NO.	DESCRIPTION		
1	Thermostat Gasket	1995-93	35674	Thermostat Housing		
QTY	WATER PUMP	YEARS	PART NO.	DESCRIPTION		
1	Water Pump Gasket	1995-93	35699			
QTY	TIMING COVER	YEARS	PART NO.	DESCRIPTION		
1	Crankshaft Front Seal Set	1995-93	TCS 46019	Camshaft front seal incl.		
1	Camshaft Front Seal Set	1995-93	TCS 45704-1			
QTY	CARB & FUEL INJECTION	YEARS	PART NO.	DESCRIPTION		
2	Fuel Injector O-Ring Set	1995-93	ES 70599	Improved design		
1	Throttle Body Gasket	1995-93	61244			
6		2013 - 2012; 1.6L 97.1 (1591cc) DOHC L4 (16 Valve) 77mm Bore Gamma GDi VVT			6	
		DI; Gasoline; Naturally Aspirated Hyundai Eng.; Eng. Code G4FD				
QTY	CYLINDER HEAD	YEARS	PART NO.	DESCRIPTION		
1	Head Gasket	2013-12	26554 PT	Head bolts not incl.; Head bolt replacement recommended; PermaTorqueMLS®; New Part Number - Check for Availability		
QTY	CONVERSION SET	YEARS	PART NO.	DESCRIPTION		
1	Gasket Conversion Set	2013-12	CS 26554	RTV sealant incl. for oil pan gskt.; New Part Number - Check for Availability		
QTY	MANIFOLD - INT. & EXH.	YEARS	PART NO.	DESCRIPTION		
1	Int. Manifold Gasket Set	2013-12	MS 97228	New Part Number - Check for Availability		
1	Exh. Manifold Gasket Set	2013-12	MS 97231	New Part Number - Check for Availability		
QTY	EXHAUST PIPE FLANGE	YEARS	PART NO.	DESCRIPTION		
1	Exhaust Pipe Gasket	2013-12	61707	Converter; New Part Number - Check for Availability		
QTY	CRANKSHAFT REAR SEAL	YEARS	PART NO.	DESCRIPTION		
1	Rear Main Seal Set	2013-12	BS 40740	Rubber; One-piece; New Part Number - Check for Availability		
QTY	VALVE COVER	YEARS	PART NO.	DESCRIPTION		
1	Valve Cover Gasket Set	2013-12	VS 50818 R	w/Spark plug tube seals; PermaDry® molded rubber gskt. incl.; New Part Number - Check for Availability		

Hyundai Car (Cont.)

6		2013 - 2012; 1.6L 97.1 (1591cc) DOHC L4 (16 Valve) 77mm Bore Gamma GDi VVT			6	
(cont.)		DI; Gasoline; Naturally Aspirated Hyundai Eng.; Eng. Code G4FD			(cont.)	
QTY	VALVE STEM SEAL SET	YEARS	PART NO.	DESCRIPTION		
1	Valve Stem Seal Set	2013-12	SS 72939	Premium valve stem seals incl.; New Part Number - Check for Availability		
QTY	WATER PUMP	YEARS	PART NO.	DESCRIPTION		
1	Water Pump Gasket	2013-12	36003	New Part Number - Check for Availability		
QTY	TIMING COVER	YEARS	PART NO.	DESCRIPTION		
1	Crankshaft Front Seal Set	2013-12	TCS 46166	New Part Number - Check for Availability		
QTY	CARB & FUEL INJECTION	YEARS	PART NO.	DESCRIPTION		
1	Throttle Body Gasket	2013-12	61712	New Part Number - Check for Availability		
7		2013; 1.6L 97.1 (1591cc) DOHC L4 (16 Valve) 77mm Bore Gamma GDi VVT			7	
		DI; Gasoline; Turbo - Intercooled Hyundai Eng.; Eng. Code G4FD-T				
QTY	CONVERSION SET	YEARS	PART NO.	DESCRIPTION		
1	Gasket Conversion Set	2013	CS 26554	RTV sealant incl. for oil pan gskt.; New Part Number - Check for Availability		
QTY	MANIFOLD - INT. & EXH.	YEARS	PART NO.	DESCRIPTION		
1	Int. Manifold Gasket Set	2013	MS 97228	New Part Number - Check for Availability		
QTY	CRANKSHAFT REAR SEAL	YEARS	PART NO.	DESCRIPTION		
1	Rear Main Seal Set	2013	BS 40740	Rubber; One-piece; New Part Number - Check for Availability		
QTY	VALVE COVER	YEARS	PART NO.	DESCRIPTION		
1	Valve Cover Gasket Set	2013	VS 50818 R	w/Spark plug tube seals; PermaDry® molded rubber gskt. incl.; New Part Number - Check for Availability		
QTY	VALVE STEM SEAL SET	YEARS	PART NO.	DESCRIPTION		
1	Valve Stem Seal Set	2013	SS 72939	Premium valve stem seals incl.; New Part Number - Check for Availability		
QTY	WATER PUMP	YEARS	PART NO.	DESCRIPTION		
1	Water Pump Gasket	2013	36003	New Part Number - Check for Availability		
QTY	TIMING COVER	YEARS	PART NO.	DESCRIPTION		
1	Crankshaft Front Seal Set	2013	TCS 46166	New Part Number - Check for Availability		
QTY	CARB & FUEL INJECTION	YEARS	PART NO.	DESCRIPTION		
1	Throttle Body Gasket	2013	61712	New Part Number - Check for Availability		
8		1995 - 1992; 1.6L 97.3 (1595cc) DOHC L4 (16 Valve) 82.3mm Bore			8	
		MFI; Gasoline; Naturally Aspirated Mitsubishi Eng.; Eng. Code G4CR				
QTY	CYLINDER HEAD	YEARS	PART NO.	DESCRIPTION		
1	Head Gasket	1995-92	9627 PT			
1	Head Set	1995	HS 9627 PT-2	Exh. pipe flange not incl.; PermaDry® molded rubber valve cover gskt. incl.; Premium valve stem seals incl.		
1	Head Set	1994-92	HS 9627 PT	Exh. pipe flange not incl.; PermaDry® molded rubber valve cover gskt. incl.; Premium valve stem seals incl.		
QTY	CONVERSION SET	YEARS	PART NO.	DESCRIPTION		
1	Gasket Conversion Set	1995-92	CS 9627			
QTY	MANIFOLD - INT. & EXH.	YEARS	PART NO.	DESCRIPTION		
1	Int. Manifold Gasket Set	1995-92	MS 94328			
1	Exh. Manifold Gasket Set	1995-92	MS 95470			
QTY	EXHAUST PIPE FLANGE	YEARS	PART NO.	DESCRIPTION		
1	Exhaust Pipe Gasket	1995-93	60680	Flange; Exc. California		
1	Exhaust Pipe Gasket	1995-93	61410	Flange; California		
2	Exhaust Pipe Gasket	1994-92	60620	Converter		
1	Exhaust Pipe Gasket	1992	60680	Flange		
QTY	OIL PAN	YEARS	PART NO.	DESCRIPTION		
1	Oil Pan Gasket Set	1995-92	OS 30460 A			
QTY	CRANKSHAFT REAR SEAL	YEARS	PART NO.	DESCRIPTION		
1	Rear Main Seal Set	1995-92	BS 40444	Rubber; One-piece		
QTY	VALVE COVER	YEARS	PART NO.	DESCRIPTION		
1	Valve Cover Gasket Set	1995	VS 50266 R	w/Semi-circular plug & Spark plug tube seals; PermaDry® molded rubber gskt. incl.; Old design		
1	Valve Cover Gasket Set	1995	VS 50534 R	w/Semi-circular plug & Spark plug tube seals; PermaDry® molded rubber gskt. incl.; Improved design		
1	Valve Cover Gasket Set	1994-92	VS 50041 R	w/Semi-circular plug & Spark plug tube seals; PermaDry® molded rubber gskt. incl.		
1	Semi-Circular Plug	1995-92	CP 75013	Valve Cover		
QTY	VALVE STEM SEAL SET	YEARS	PART NO.	DESCRIPTION		
1	Valve Stem Seal Set	1995-92	SS 70359	Premium valve stem seals incl.		
QTY	WATER OUTLET GASKET	YEARS	PART NO.	DESCRIPTION		
1	Water Outlet Gasket	1995-92	35336	Water Outlet		

8		1995 - 1992; 1.6L 97.3 (1595cc) DOHC L4 (16 Valve) 82.3mm Bore			8	
(cont.)		MFI; Gasoline; Naturally Aspirated Mitsubishi Eng.; Eng. Code G4CR			(cont.)	
QTY	WATER PUMP	YEARS	PART NO.	DESCRIPTION		
1	Water Pump Gasket	1995-92	ES 72872	O-ring		
QTY	TIMING COVER	YEARS	PART NO.	DESCRIPTION		
1	Crankshaft Front Seal Set	1995-92	TCS 45938			
2	Camshaft Front Seal Set	1995-92	TCS 45483			
QTY	AIR CLEANER MOUNTING	YEARS	PART NO.	DESCRIPTION		
1	Air Cleaner Gasket	1995-92	60756			
QTY	CARB & FUEL INJECTION	YEARS	PART NO.	DESCRIPTION		
1	Fuel Injector O-Ring Set	1995-92	ES 70600			
1	Throttle Body Gasket	1995-92	60963			
QTY	EXHAUST GAS RECIRCULATION	YEARS	PART NO.	DESCRIPTION		
1	EGR Gasket	1995-92	70152			
9		2008 - 2001; 1.6L 98 (1599cc) DOHC L4 (16 Valve) 76.5mm Bore			9	
(cont.)		MFI; Gasoline; Naturally Aspirated Hyundai Eng.; Eng. Code G4CR			(cont.)	
QTY	CYLINDER HEAD	YEARS	PART NO.	DESCRIPTION		
1	Head Gasket	2008-01	26224 PT	Head bolts not incl.; Head bolt replacement recommended; PermaTorqueMLS®		
1	Head Set	2008-06	HS 26224 PT-2	Head bolts not incl.; Head bolt replacement recommended; PermaDry® molded rubber valve cover gskt. incl.; Premium valve stem seals incl.		
1	Head Set	2005	HS 26224 PT-1	Head bolts not incl.; Head bolt replacement recommended; PermaDry® molded rubber valve cover gskt. incl.; Premium valve stem seals incl.		
1	Head Set	2004-01	HS 26224 PT	Head bolts not incl.; Head bolt replacement recommended; PermaDry® molded rubber valve cover gskt. incl.; Premium valve stem seals incl.		
1	Head Bolt Set	2008-01	ES 71203	Head bolts w/Washers; Replacement recommended		
QTY	CONVERSION SET	YEARS	PART NO.	DESCRIPTION		
1	Gasket Conversion Set	2008-05	CS 26224-1	w/Aluminum oil pan; RTV sealant incl. for oil pan gskt.		
1	Gasket Conversion Set	2005-01	CS 26224	w/Stamped steel oil pan		
QTY	MANIFOLD - INT. & EXH.	YEARS	PART NO.	DESCRIPTION		
1	Int. Manifold Gasket Set	2008-01	MS 96331			
1	Exh. Manifold Gasket Set	2008-01	MS 96332			
QTY	EXHAUST PIPE FLANGE	YEARS	PART NO.	DESCRIPTION		
1	Exhaust Pipe Gasket	2008-01	60620	Exh. connector		
1	Exhaust Pipe Gasket	2008-01	61302	Flange		
QTY	OIL PAN	YEARS	PART NO.	DESCRIPTION		
1	Oil Pan Gasket Set	2008-05	OS 30780	w/Aluminum oil pan; RTV sealant incl. for oil pan gskt.		
1	Oil Pan Gasket Set	2005-01	OS 30726	w/Stamped steel oil pan		
QTY	CRANKSHAFT REAR SEAL	YEARS	PART NO.	DESCRIPTION		
1	Rear Main Seal Set	2008-01	BS 40672	Rubber; One-piece		
QTY	VALVE COVER	YEARS	PART NO.	DESCRIPTION		
1	Valve Cover Gasket Set	2008-06	VS 50705 R	w/Spark plug tube seals; PermaDry® molded rubber gskt. incl.		
1	Valve Cover Gasket Set	2005	VS 50700 R	w/Spark plug tube seals; PermaDry® molded rubber gskt. incl.		
1	Valve Cover Gasket Set	2004-01	VS 50593 R	w/Spark plug tube seals; PermaDry® molded rubber gskt. incl.		
1	Circular Plug	2008-01	CP 75023	Valve Cover		
1	Spark Plug Tube Seal Set	2008-01	ES 72974	Valve Cover; New Part Number - Check for Availability		
QTY	VALVE STEM SEAL SET	YEARS	PART NO.	DESCRIPTION		
1	Valve Stem Seal Set	2008-01	SS 70795-1	Premium valve stem seals incl.		
QTY	THERMOSTAT HOUSING	YEARS	PART NO.	DESCRIPTION		
1	Thermostat Gasket	2008-06	35827	Thermostat Housing; Thermostat housing		
1	Thermostat Gasket	2005-01	35719	Thermostat Housing		
1	O-Ring	2008-06	35830	Thermostat Housing; Thermostat seal		
QTY	WATER OUTLET GASKET	YEARS	PART NO.	DESCRIPTION		
1	Water Outlet Gasket	2008-01	35730	Water Outlet		
1	Water Outlet Gasket	2008-01	36049	Water Outlet; Water inlet pipe seal; New Part Number - Check for Availability		
QTY	WATER PUMP	YEARS	PART NO.	DESCRIPTION		
1	Water Pump Gasket	2008-01	35727			
QTY	TIMING COVER	YEARS	PART NO.	DESCRIPTION		
1	Crankshaft Front Seal Set	2008-01	TCS 46019-1			
1	Camshaft Front Seal Set	2008-01	TCS 45704-1			
QTY	CARB & FUEL INJECTION	YEARS	PART NO.	DESCRIPTION		
2	Fuel Injector O-Ring Set	2008-01	ES 70599	Improved design		
1	Throttle Body Gasket	2008-04	60914	Idle air control		
1	Throttle Body Gasket	2008-06	61485	Throttle body		
1	Throttle Body Gasket	2005-01	61244	Throttle body		

Hyundai Car (Cont.)

9		2008 - 2001; 1.6L 98 (1599cc) DOHC L4 (16 Valve) 76.5mm Bore			9	
(cont.)		MFI; Gasoline; Naturally Aspirated Hyundai Eng.; Eng. Code G4CR			(cont.)	
QTY	CARB & FUEL INJECTION	YEARS	PART NO.	DESCRIPTION		
1	Throttle Body Gasket	2003-01	61245	Idle air control		
10		2005 - 2001; 1.6L 98 (1599cc) DOHC L4 (16 Valve) 76.5mm Bore			10	
		MFI; Gasoline; Naturally Aspirated Hyundai Eng.; Eng. Code G4EC				
QTY	CYLINDER HEAD	YEARS	PART NO.	DESCRIPTION		
1	Head Gasket	2005-01	26224 PT	Head bolts not incl.; Head bolt replacement recommended; PermaTorqueMLS®		
1	Head Set	2005	HS 26224 PT-1	Head bolts not incl.; Head bolt replacement recommended; PermaDry® molded rubber valve cover gskt. incl.; Premium valve stem seals incl.		
1	Head Set	2004-01	HS 26224 PT	Head bolts not incl.; Head bolt replacement recommended; PermaDry® molded rubber valve cover gskt. incl.; Premium valve stem seals incl.		
1	Head Bolt Set	2005-01	ES 71203	Head bolts w/Washers; Replacement recommended		
QTY	CONVERSION SET	YEARS	PART NO.	DESCRIPTION		
1	Gasket Conversion Set	2005-01	CS 26224	w/Stamped steel oil pan		
1	Gasket Conversion Set	2005	CS 26224-1	w/Aluminum oil pan; RTV sealant incl. for oil pan gskt.		
QTY	MANIFOLD - INT. & EXH.	YEARS	PART NO.	DESCRIPTION		
1	Int. Manifold Gasket Set	2005-01	MS 96331			
1	Exh. Manifold Gasket Set	2005-01	MS 96332			
QTY	EXHAUST PIPE FLANGE	YEARS	PART NO.	DESCRIPTION		
1	Exhaust Pipe Gasket	2005-01	60620	Exh. connector		
1	Exhaust Pipe Gasket	2005-01	61302	Flange		
QTY	OIL PAN	YEARS	PART NO.	DESCRIPTION		
1	Oil Pan Gasket Set	2005-01	OS 30726	w/Stamped steel oil pan		
1	Oil Pan Gasket Set	2005	OS 30780	w/Aluminum oil pan; RTV sealant incl. for oil pan gskt.		
QTY	CRANKSHAFT REAR SEAL	YEARS	PART NO.	DESCRIPTION		
1	Rear Main Seal Set	2005-01	BS 40672	Rubber; One-piece		
QTY	VALVE COVER	YEARS	PART NO.	DESCRIPTION		
1	Valve Cover Gasket Set	2005	VS 50700 R	w/Spark plug tube seals; PermaDry® molded rubber gskt. incl.		
1	Valve Cover Gasket Set	2004-01	VS 50593 R	w/Spark plug tube seals; PermaDry® molded rubber gskt. incl.		
1	Circular Plug	2005-01	CP 75023	Valve Cover		
1	Spark Plug Tube Seal Set	2005-01	ES 72974	Valve Cover; New Part Number - Check for Availability		
QTY	VALVE STEM SEAL SET	YEARS	PART NO.	DESCRIPTION		
1	Valve Stem Seal Set	2005-01	SS 70795-1	Premium valve stem seals incl.		
QTY	THERMOSTAT HOUSING	YEARS	PART NO.	DESCRIPTION		
1	Thermostat Gasket	2005-01	35719	Thermostat Housing		
QTY	WATER OUTLET GASKET	YEARS	PART NO.	DESCRIPTION		
1	Water Outlet Gasket	2005-01	35730	Water Outlet		
1	Water Outlet Gasket	2005-01	36049	Water Outlet; Water inlet pipe seal; New Part Number - Check for Availability		
QTY	WATER PUMP	YEARS	PART NO.	DESCRIPTION		
1	Water Pump Gasket	2005-01	35727			
QTY	TIMING COVER	YEARS	PART NO.	DESCRIPTION		
1	Crankshaft Front Seal Set	2005-01	TCS 46019-1			
1	Camshaft Front Seal Set	2005-01	TCS 45704-1			
QTY	CARB & FUEL INJECTION	YEARS	PART NO.	DESCRIPTION		
2	Fuel Injector O-Ring Set	2005-01	ES 70599	Improved design		
1	Throttle Body Gasket	2005-01	61244	Throttle body		
1	Throttle Body Gasket	2005-04	60914	Idle air control		
1	Throttle Body Gasket	2003-01	61245	Idle air control		
11		2011 - 2006; 1.6L 98 (1599cc) DOHC L4 (16 Valve) 76.5mm Bore VVT			11	
		MFI; Gasoline; Naturally Aspirated Hyundai Eng.; Eng. Code G4ED				
QTY	CYLINDER HEAD	YEARS	PART NO.	DESCRIPTION		
1	Head Gasket	2011-06	26224 PT	Head bolts not incl.; Head bolt replacement recommended; PermaTorqueMLS®		
1	Head Set	2011-06	HS 26224 PT-2	Head bolts not incl.; Head bolt replacement recommended; PermaDry® molded rubber valve cover gskt. incl.; Premium valve stem seals incl.		
1	Head Bolt Set	2011-06	ES 71203	Head bolts w/Washers; Replacement recommended		
QTY	CONVERSION SET	YEARS	PART NO.	DESCRIPTION		
1	Gasket Conversion Set	2011-06	CS 26224-1	RTV sealant incl. for oil pan gskt.		
QTY	MANIFOLD - INT. & EXH.	YEARS	PART NO.	DESCRIPTION		
1	Int. Manifold Gasket Set	2011-06	MS 96331			
1	Exh. Manifold Gasket Set	2011-06	MS 96332			
QTY	EXHAUST PIPE FLANGE	YEARS	PART NO.	DESCRIPTION		
2	Exhaust Pipe Gasket	2011-06	60620	Converter		

11		2011 - 2006; 1.6L 98 (1599cc) DOHC L4 (16 Valve) 76.5mm Bore VVT			11	
(cont.)		MFI; Gasoline; Naturally Aspirated Hyundai Eng.; Eng. Code G4ED			(cont.)	
QTY	EXHAUST PIPE FLANGE	YEARS	PART NO.	DESCRIPTION		
1	Exhaust Pipe Gasket	2011-06	60620	Exh. connector		
1	Exhaust Pipe Gasket	2011-06	61302	Flange		
QTY	OIL PAN	YEARS	PART NO.	DESCRIPTION		
1	Oil Pan Gasket Set	2011-06	OS 30780	RTV sealant incl. for oil pan gskt.		
QTY	CRANKSHAFT REAR SEAL	YEARS	PART NO.	DESCRIPTION		
1	Rear Main Seal Set	2011-06	BS 40672	Rubber; One-piece		
QTY	VALVE COVER	YEARS	PART NO.	DESCRIPTION		
1	Valve Cover Gasket Set	2011-06	VS 50705 R	w/Spark plug tube seals; PermaDry® molded rubber gskt. incl.		
1	Circular Plug	2011-06	CP 75023	Valve Cover		
1	Spark Plug Tube Seal Set	2011-06	ES 72974	Valve Cover; New Part Number - Check for Availability		
QTY	VALVE STEM SEAL SET	YEARS	PART NO.	DESCRIPTION		
1	Valve Stem Seal Set	2011-06	SS 70795-1	Premium valve stem seals incl.		
QTY	THERMOSTAT HOUSING	YEARS	PART NO.	DESCRIPTION		
1	Thermostat Gasket	2011-06	35827	Thermostat Housing; Thermostat housing		
1	Thermostat Gasket	2011-09	35915	Thermostat Housing; Thermostat case		
1	O-Ring	2011-06	35830	Thermostat Housing; Thermostat seal		
QTY	WATER OUTLET GASKET	YEARS	PART NO.	DESCRIPTION		
1	Water Outlet Gasket	2011-06	35730	Water Outlet		
1	Water Outlet Gasket	2011-06	36049	Water Outlet; Water inlet pipe seal; New Part Number - Check for Availability		
QTY	WATER PUMP	YEARS	PART NO.	DESCRIPTION		
1	Water Pump Gasket	2011-06	35727			
QTY	TIMING COVER	YEARS	PART NO.	DESCRIPTION		
1	Crankshaft Front Seal Set	2011-06	TCS 46019-1			
1	Camshaft Front Seal Set	2011-06	TCS 45704-1			
QTY	CARB & FUEL INJECTION	YEARS	PART NO.	DESCRIPTION		
2	Fuel Injector O-Ring Set	2011-06	ES 70599	Improved design		
1	Throttle Body Gasket	2011-06	60914	Idle air control		
1	Throttle Body Gasket	2011-06	61485	Throttle body		
12		1998 - 1996; 1.8L 109.5 (1796cc) DOHC L4 (16 Valve) 82mm Bore			12	
		MFI; Gasoline; Naturally Aspirated Hyundai Eng.; Eng. Code G4GM				
QTY	CYLINDER HEAD	YEARS	PART NO.	DESCRIPTION		
1	Head Gasket	1998-96	26180 PT	Head bolts not incl.; Head bolt replacement recommended; PermaTorqueMLS® LaserWeld® Technology		
1	Head Set	1998-96	HS 26180 PT	Head bolts & exh. pipe flange not incl.; Head bolt replacement recommended; PermaDry® molded rubber valve cover gskt. incl.; Premium valve stem seals incl.		
1	Head Bolt Set	1998-96	ES 71313	Head bolts w/Washers; Replacement recommended		
QTY	CONVERSION SET	YEARS	PART NO.	DESCRIPTION		
1	Gasket Conversion Set	1998-96	CS 26180			
QTY	MANIFOLD - INT. & EXH.	YEARS	PART NO.	DESCRIPTION		
1	Int. Manifold Gasket Set	1998-96	MS 96141			
1	Exh. Manifold Gasket Set	1998-96	MS 96128			
QTY	EXHAUST PIPE FLANGE	YEARS	PART NO.	DESCRIPTION		
1	Exhaust Pipe Gasket	1998	60899	Flange		
1	Exhaust Pipe Gasket	1997-96	61404	Flange		
QTY	OIL PAN	YEARS	PART NO.	DESCRIPTION		
1	Oil Pan Gasket Set	1998-96	OS 30718			
QTY	CRANKSHAFT REAR SEAL	YEARS	PART NO.	DESCRIPTION		
1	Rear Main Seal Set	1998-96	BS 40444	Rubber; One-piece		
QTY	VALVE COVER	YEARS	PART NO.	DESCRIPTION		
1	Valve Cover Gasket Set	1998-96	VS 50572 R	w/Semi-circular plugs & Spark plug tube seals; PermaDry® molded rubber gskt. incl.		
1	Semi-Circular Plug	1998-96	CP 75013	Valve Cover		
QTY	VALVE STEM SEAL SET	YEARS	PART NO.	DESCRIPTION		
1	Valve Stem Seal Set	1998-96	SS 70795-1	Premium valve stem seals incl.		
QTY	THERMOSTAT HOUSING	YEARS	PART NO.	DESCRIPTION		
1	Water Outlet Gasket	1998-96	25538	Thermostat Housing; Loc. Upper		
1	Thermostat Gasket	1998-96	35671	Thermostat Housing; Loc. Lower		
QTY	WATER PUMP	YEARS	PART NO.	DESCRIPTION		
1	Water Pump Gasket	1998-96	35628			
QTY	TIMING COVER	YEARS	PART NO.	DESCRIPTION		
1	Crankshaft Front Seal Set	1998-96	TCS 46017			

Hyundai Car (Cont.)

12		1998 - 1996; 1.8L 109.5 (1796cc) DOHC L4 (16 Valve) 82mm Bore			12	
(cont.)		MFI; Gasoline; Naturally Aspirated Hyundai Eng.; Eng. Code G4GM			(cont.)	
QTY	TIMING COVER	YEARS	PART NO.	DESCRIPTION		
1	Camshaft Front Seal Set	1998-96	TCS 45704-1			
QTY	CARB & FUEL INJECTION	YEARS	PART NO.	DESCRIPTION		
2	Fuel Injector O-Ring Set	1998-96	ES 70599	Improved design		
1	Throttle Body Gasket	1998-96	61195			
13		2013 - 2011; 1.8L 109.7 (1797cc) DOHC L4 (16 Valve) 81mm Bore Nu VVT			13	
		MFI; Gasoline; Naturally Aspirated Hyundai Eng.				
QTY	CYLINDER HEAD	YEARS	PART NO.	DESCRIPTION		
1	Head Bolt Set	2013-11	ES 72486	Head bolts w/Washers; Replacement recommended; New Part Number - Check for Availability		
QTY	MANIFOLD - INT. & EXH.	YEARS	PART NO.	DESCRIPTION		
1	Exh. Manifold Gasket Set	2013-11	MS 97239	New Part Number - Check for Availability		
QTY	EXHAUST PIPE FLANGE	YEARS	PART NO.	DESCRIPTION		
2	Exhaust Pipe Gasket	2013-11	61707	Loc. Front; Converter; New Part Number - Check for Availability		
2	Exhaust Pipe Gasket	2013-11	61707	Loc. Rear; Converter; New Part Number - Check for Availability		
QTY	VALVE STEM SEAL SET	YEARS	PART NO.	DESCRIPTION		
1	Valve Stem Seal Set	2013-11	SS 71268	Premium valve stem seals incl.		
QTY	WATER PUMP	YEARS	PART NO.	DESCRIPTION		
1	Water Pump Gasket	2013-11	36015	New Part Number - Check for Availability		
QTY	CARB & FUEL INJECTION	YEARS	PART NO.	DESCRIPTION		
1	Throttle Body Gasket	2013-11	61713	New Part Number - Check for Availability		
14		1995 - 1993; 1.8L 112 (1836cc) DOHC L4 (16 Valve) 80.6mm Bore			14	
		MFI; Gasoline; Naturally Aspirated Hyundai Eng.; Eng. Code G4CN				
QTY	CYLINDER HEAD	YEARS	PART NO.	DESCRIPTION		
1	Head Gasket	1995-93	9627 PT			
1	Head Set	1995	HS 9627 PT-2	Exh. pipe flange not incl.; PermaDry® molded rubber valve cover gskt. incl.; Premium valve stem seals incl.		
1	Head Set	1994-93	HS 9627 PT	Exh. pipe flange not incl.; PermaDry® molded rubber valve cover gskt. incl.; Premium valve stem seals incl.		
QTY	CONVERSION SET	YEARS	PART NO.	DESCRIPTION		
1	Gasket Conversion Set	1995-93	CS 9627			
QTY	MANIFOLD - INT. & EXH.	YEARS	PART NO.	DESCRIPTION		
1	Int. Manifold Gasket Set	1995-93	MS 94328			
1	Exh. Manifold Gasket Set	1995-93	MS 95470			
QTY	EXHAUST PIPE FLANGE	YEARS	PART NO.	DESCRIPTION		
1	Exhaust Pipe Gasket	1995-93	60680	Flange; Exc. California		
1	Exhaust Pipe Gasket	1995-93	61410	Flange; California		
2	Exhaust Pipe Gasket	1994-93	60620	Converter		
QTY	OIL PAN	YEARS	PART NO.	DESCRIPTION		
1	Oil Pan Gasket Set	1995-93	OS 30460 A			
QTY	CRANKSHAFT REAR SEAL	YEARS	PART NO.	DESCRIPTION		
1	Rear Main Seal Set	1995-93	BS 40444	Rubber; One-piece		
QTY	VALVE COVER	YEARS	PART NO.	DESCRIPTION		
1	Valve Cover Gasket Set	1995	VS 50266 R	w/Semi-circular plug & Spark plug tube seals; PermaDry® molded rubber gskt. incl.; Old design		
1	Valve Cover Gasket Set	1995	VS 50534 R	w/Semi-circular plug & Spark plug tube seals; PermaDry® molded rubber gskt. incl.; Improved design		
1	Valve Cover Gasket Set	1994-93	VS 50041 R	w/Semi-circular plug & Spark plug tube seals; PermaDry® molded rubber gskt. incl.		
1	Semi-Circular Plug	1995-93	CP 75013	Valve Cover		
QTY	VALVE STEM SEAL SET	YEARS	PART NO.	DESCRIPTION		
1	Valve Stem Seal Set	1995-93	SS 70359	Premium valve stem seals incl.		
QTY	WATER OUTLET GASKET	YEARS	PART NO.	DESCRIPTION		
1	Water Outlet Gasket	1995-93	35084	Water Outlet		
QTY	WATER PUMP	YEARS	PART NO.	DESCRIPTION		
1	Water Pump Gasket	1995-93	35273			
1	Water Pump Gasket	1995-93	ES 72872	O-ring		
QTY	TIMING COVER	YEARS	PART NO.	DESCRIPTION		
1	Crankshaft Front Seal Set	1995-93	TCS 45938			
2	Camshaft Front Seal Set	1995-93	TCS 45483			
QTY	AIR CLEANER MOUNTING	YEARS	PART NO.	DESCRIPTION		
1	Air Cleaner Gasket	1995-93	60756			

14 (cont.)		1995 - 1993; 1.8L 112 (1836cc) DOHC L4 (16 Valve) 80.6mm Bore			14 (cont.)
		MFI; Gasoline; Naturally Aspirated Hyundai Eng.; Eng. Code G4CN			
QTY	CARB & FUEL INJECTION	YEARS	PART NO.	DESCRIPTION	
1	Fuel Injector O-Ring Set	1995-93	ES 70600		
1	Throttle Body Gasket	1995-93	60813		
QTY	EXHAUST GAS RECIRCULATION	YEARS	PART NO.	DESCRIPTION	
1	EGR Gasket	1995-93	70152		
15		2012 - 1997; 2.0L 120.5 (1975cc) DOHC L4 (16 Valve) 82mm Bore			15
		MFI; Gasoline; Naturally Aspirated Hyundai Eng.; Eng. Code G4GF			
QTY	CYLINDER HEAD	YEARS	PART NO.	DESCRIPTION	
1	Head Gasket	2012-02	26181 PT	Head bolts not incl.; Head bolt replacement recommended; PermaTorqueMLS® LaserWeld® Technology	
1	Head Gasket	2001-97	26180 PT	Head bolts not incl.; Head bolt replacement recommended; PermaTorqueMLS® LaserWeld® Technology	
1	Head Set	2012-08	HS 26181 PT-3	Head bolts & exh. pipe flange not incl.; Head bolt replacement recommended; PermaDry® molded rubber valve cover gskt. incl.; Premium valve stem seals incl.	
1	Head Set	2007-04	HS 26181 PT-1	Head bolts & exh. pipe flange not incl.; Head bolt replacement recommended; PermaDry® molded rubber valve cover gskt. incl.; Premium valve stem seals incl.	
1	Head Set	2003	HS 26181 PT	To 10/31/02; w/13-bolt valve cover; Head bolts & exh. pipe flange not incl.; Head bolt replacement recommended; PermaDry® molded rubber valve cover gskt. incl.; Premium valve stem seals incl.	
1	Head Set	2003	HS 26181 PT-1	From 11/01/02; w/12-bolt valve cover; Head bolts & exh. pipe flange not incl.; Head bolt replacement recommended; PermaDry® molded rubber valve cover gskt. incl.; Premium valve stem seals incl.	
1	Head Set	2002	HS 26181 PT	Head bolts & exh. pipe flange not incl.; Head bolt replacement recommended; PermaDry® molded rubber valve cover gskt. incl.; Premium valve stem seals incl.	
1	Head Set	2001-97	HS 26180 PT	Head bolts & exh. pipe flange not incl.; Head bolt replacement recommended; PermaDry® molded rubber valve cover gskt. incl.; Premium valve stem seals incl.	
1	Head Bolt Set	2012-97	ES 71313	Head bolts w/Washers; Replacement recommended	
QTY	CONVERSION SET	YEARS	PART NO.	DESCRIPTION	
1	Gasket Conversion Set	2012-09	CS 26180	California; RTV sealant incl. for oil pan gskt.	
1	Gasket Conversion Set	2012-09	CS 26180-1	Exc. California	
1	Gasket Conversion Set	2008-02	CS 26180	RTV sealant incl. for oil pan gskt.	
1	Gasket Conversion Set	2001-97	CS 26180		
QTY	MANIFOLD - INT. & EXH.	YEARS	PART NO.	DESCRIPTION	
1	Int. Manifold Gasket Set	2012-03	MS 96275		
1	Int. Manifold Gasket Set	2002	MS 96130		
1	Int. Manifold Gasket Set	2001-97	MS 96141		
1	Exh. Manifold Gasket Set	2012-08	MS 97102		
1	Exh. Manifold Gasket Set	2007-97	MS 96128		
QTY	EXHAUST PIPE FLANGE	YEARS	PART NO.	DESCRIPTION	
1	Exhaust Pipe Gasket	2012	61707	Loc. Front; Converter; New Part Number - Check for Availability	
1	Exhaust Pipe Gasket	2012	61707	Loc. Rear; Converter; New Part Number - Check for Availability	
1	Exhaust Pipe Gasket	2011	61499	Hyundai Elantra Blue, GLS, SE; Loc. Front; Converter	
1	Exhaust Pipe Gasket	2011	61503	Hyundai Elantra Blue, GLS, SE; Loc. Rear; Converter	
1	Exhaust Pipe Gasket	2011	61612	Hyundai Elantra Blue, GLS, SE; Exh. connector	
1	Exhaust Pipe Gasket	2011	61707	Exc. Hyundai Elantra Blue, GLS, SE; Loc. Front; Converter; New Part Number - Check for Availability	
1	Exhaust Pipe Gasket	2011	61707	Exc. Hyundai Elantra Blue, GLS, SE; Loc. Rear; Converter; New Part Number - Check for Availability	
1	Exhaust Pipe Gasket	2010	61499	Hyundai Elantra Blue, GL, GLS, L, SE; Loc. Front; Converter	
1	Exhaust Pipe Gasket	2010	61503	Hyundai Elantra Blue, GL, GLS, L, SE; Loc. Rear; Converter	
1	Exhaust Pipe Gasket	2010	61612	Hyundai Elantra Blue, GL, GLS, L, SE; Exh. connector	
1	Exhaust Pipe Gasket	2010	61707	Exc. Hyundai Elantra Blue, GL, GLS, L, SE; Loc. Front; Converter; New Part Number - Check for Availability	
1	Exhaust Pipe Gasket	2010	61707	Exc. Hyundai Elantra Blue, GL, GLS, L, SE; Loc. Rear; Converter; New Part Number - Check for Availability	
1	Exhaust Pipe Gasket	2009-07	60899	Hyundai Tiburon GS; Exh. connector	
1	Exhaust Pipe Gasket	2009	61499	Hyundai Elantra GLS, SE; Loc. Front; Converter	
1	Exhaust Pipe Gasket	2009	61503	Hyundai Elantra GLS, SE; Loc. Rear; Converter	
1	Exhaust Pipe Gasket	2009	61612	Hyundai Elantra GLS, SE; Exh. connector	

Hyundai Car (Cont.)

15 (cont.)		2012 - 1997; 2.0L 120.5 (1975cc) DOHC L4 (16 Valve) 82mm Bore MFI; Gasoline; Naturally Aspirated Hyundai Eng.; Eng. Code G4GF			15 (cont.)	
QTY	EXHAUST PIPE FLANGE	YEARS	PART NO.	DESCRIPTION		
1	Exhaust Pipe Gasket	2009	61707	Hyundai Elantra Touring; Loc. Front; Converter; New Part Number - Check for Availability		
1	Exhaust Pipe Gasket	2009	61707	Hyundai Elantra Touring; Loc. Rear; Converter; New Part Number - Check for Availability		
1	Exhaust Pipe Gasket	2008-07	61499	Exc. Hyundai Tiburon GS; Loc. Front; Converter		
1	Exhaust Pipe Gasket	2008-07	61503	Exc. Hyundai Tiburon GS; Loc. Rear; Converter		
1	Exhaust Pipe Gasket	2008-07	61612	Exc. Hyundai Tiburon GS; Exh. connector		
QTY	OIL PAN	YEARS	PART NO.	DESCRIPTION		
1	Oil Pan Gasket Set	2012-09	OS 30825	Exc. California		
1	Oil Pan Gasket Set	2001-97	OS 30718			
1	Drain Plug Gasket	2012-97	72515			
QTY	CRANKSHAFT REAR SEAL	YEARS	PART NO.	DESCRIPTION		
1	Rear Main Seal Set	2012-97	BS 40444	Rubber; One-piece		
QTY	VALVE COVER	YEARS	PART NO.	DESCRIPTION		
1	Valve Cover Gasket Set	2012-04	VS 50583 R	w/Spark plug tube seals; PermaDry® molded rubber gskt. incl.		
1	Valve Cover Gasket Set	2003	VS 50572 R	To 10/31/02; w/13-bolt valve cover; w/Semi-circular plugs & Spark plug tube seals; PermaDry® molded rubber gskt. incl.		
1	Valve Cover Gasket Set	2003	VS 50583 R	From 11/01/02; w/12-bolt valve cover; w/Spark plug tube seals; PermaDry® molded rubber gskt. incl.		
1	Valve Cover Gasket Set	2002-97	VS 50572 R	w/Semi-circular plugs & Spark plug tube seals; PermaDry® molded rubber gskt. incl.		
1	Spark Plug Tube Seal Set	2012-97	ES 72974	Valve Cover; New Part Number - Check for Availability		
QTY	VALVE STEM SEAL SET	YEARS	PART NO.	DESCRIPTION		
1	Valve Stem Seal Set	2012-97	SS 70795-1	Premium valve stem seals incl.		
QTY	THERMOSTAT HOUSING	YEARS	PART NO.	DESCRIPTION		
1	Water Outlet Gasket	2012-97	25538	Thermostat Housing; Loc. Upper		
1	Thermostat Gasket	2012-97	35671	Thermostat Housing; Loc. Lower		
QTY	WATER OUTLET GASKET	YEARS	PART NO.	DESCRIPTION		
1	Water Outlet Gasket	2012-97	36049	Water Outlet; Water inlet pipe seal; New Part Number - Check for Availability		
1	Water Outlet Gasket	2012-09	35925	Water Outlet		
QTY	WATER PUMP	YEARS	PART NO.	DESCRIPTION		
1	Water Pump Gasket	2012-09	35923			
1	Water Pump Gasket	2008-97	35628			
QTY	TIMING COVER	YEARS	PART NO.	DESCRIPTION		
1	Crankshaft Front Seal Set	2012-97	TCS 46017			
1	Camshaft Front Seal Set	2012-97	TCS 45704-1			
QTY	CARB & FUEL INJECTION	YEARS	PART NO.	DESCRIPTION		
2	Fuel Injector O-Ring Set	2012-08	ES 70599	Improved design		
2	Fuel Injector O-Ring Set	2007-04	ES 70599	Exc. California; Improved design		
2	Fuel Injector O-Ring Set	2007-04	ES 70600	California		
2	Fuel Injector O-Ring Set	2003-97	ES 70599	Improved design		
1	Throttle Body Gasket	2012-04	60914	Idle air control		
1	Throttle Body Gasket	2012-06	61476	Throttle body		
1	Throttle Body Gasket	2005-01	61217	Throttle body		
1	Throttle Body Gasket	2003-01	61245	Idle air control		
1	Throttle Body Gasket	2000-97	61195	Throttle body		
QTY	OIL PUMP COVER	YEARS	PART NO.	DESCRIPTION		
1	Oil Pump Gasket	2012-97	72983	Oil pump mounting gskt.; New Part Number - Check for Availability		
16		2013 - 2011; 2.0L 121.9 (1998cc) DOHC L4 (16 Valve) 86mm Bore Theta GDi VVT DI; Gasoline; Turbo - Intercooled Hyundai Eng.			16	
QTY	CYLINDER HEAD	YEARS	PART NO.	DESCRIPTION		
1	Head Bolt Set	2013-11	ES 72465-1	Head bolts w/Washers; Replacement recommended; New Part Number - Check for Availability		
QTY	CRANKSHAFT REAR SEAL	YEARS	PART NO.	DESCRIPTION		
1	Rear Main Seal Set	2013-11	BS 40702	Rubber; One-piece		
QTY	VALVE STEM SEAL SET	YEARS	PART NO.	DESCRIPTION		
1	Valve Stem Seal Set	2013-11	SS 71268	Premium valve stem seals incl.		
QTY	THERMOSTAT HOUSING	YEARS	PART NO.	DESCRIPTION		
1	Thermostat Gasket	2013-11	35918	Thermostat Housing; Thermostat case		
1	Thermostat Gasket	2013-11	35921	Thermostat Housing; Thermostat O-ring		
QTY	WATER PUMP	YEARS	PART NO.	DESCRIPTION		
1	Water Pump Gasket	2013-11	35802	To cover		

16		2013 - 2011; 2.0L 121.9 (1998cc) DOHC L4 (16 Valve) 86mm Bore Theta GDi VVT			16	
(cont.)		DI; Gasoline; Turbo - Intercooled Hyundai Eng.			(cont.)	
QTY	WATER PUMP	YEARS	PART NO.	DESCRIPTION		
1	Water Pump Gasket	2013-11	35813	To block; Improved design		
1	Water Pump Gasket	2013-11	35822	To block; Old design		
1	Water Pump Gasket	2013-11	ES 72872	O-ring		
QTY	TIMING COVER	YEARS	PART NO.	DESCRIPTION		
1	Crankshaft Front Seal Set	2013-11	TCS 46133			
QTY	CARB & FUEL INJECTION	YEARS	PART NO.	DESCRIPTION		
1	Throttle Body Gasket	2013-11	61504	Throttle body		
17		2012 - 2010; 2.0L 121.9 (1998cc) DOHC L4 (16 Valve) 86mm Bore Theta VVT			17	
		MFI; Gasoline; Turbo - Intercooled Hyundai Eng.				
QTY	CYLINDER HEAD	YEARS	PART NO.	DESCRIPTION		
1	Head Bolt Set	2012-10	ES 72465-1	Head bolts w/Washers; Replacement recommended; New Part Number - Check for Availability		
QTY	CRANKSHAFT REAR SEAL	YEARS	PART NO.	DESCRIPTION		
1	Rear Main Seal Set	2012-10	BS 40702	Rubber; One-piece		
QTY	VALVE STEM SEAL SET	YEARS	PART NO.	DESCRIPTION		
1	Valve Stem Seal Set	2012-10	SS 71268	Premium valve stem seals incl.		
QTY	WATER OUTLET GASKET	YEARS	PART NO.	DESCRIPTION		
1	Thermostat Gasket	2012-10	35368	Water Outlet; Inlet to water pump		
QTY	TIMING COVER	YEARS	PART NO.	DESCRIPTION		
1	Crankshaft Front Seal Set	2012-10	TCS 46133			
18		1998 - 1992; 2.0L 122 (1997cc) DOHC L4 (16 Valve) 85mm Bore			18	
		MFI; Gasoline; Naturally Aspirated Mitsubishi Eng.; Eng. Code G4CP				
QTY	CYLINDER HEAD	YEARS	PART NO.	DESCRIPTION		
1	Head Gasket	1998-92	9627 PT	Head bolts not incl.; Head bolt replacement recommended		
1	Head Set	1998	HS 9627 PT-4	Head bolts & exh. pipe flange not incl.; Head bolt replacement recommended; PermaDry® molded rubber valve cover gskt. incl.; Premium valve stem seals incl.		
1	Head Set	1997-96	HS 9627 PT-2	To 08/27/96; Head bolts & exh. pipe flange not incl.; Head bolt replacement recommended; PermaDry® molded rubber valve cover gskt. incl.; Premium valve stem seals incl.		
1	Head Set	1997-96	HS 9627 PT-4	From 08/28/96; Head bolts & exh. pipe flange not incl.; Head bolt replacement recommended; PermaDry® molded rubber valve cover gskt. incl.; Premium valve stem seals incl.		
1	Head Set	1995-94	HS 9627 PT	To 07/06/94; Head bolts & exh. pipe flange not incl.; Head bolt replacement recommended; PermaDry® molded rubber valve cover gskt. incl.; Premium valve stem seals incl.		
1	Head Set	1995-94	HS 9627 PT-2	From 07/07/94; Head bolts & exh. pipe flange not incl.; Head bolt replacement recommended; PermaDry® molded rubber valve cover gskt. incl.; Premium valve stem seals incl.		
1	Head Set	1993-92	HS 9627 PT	Head bolts & exh. pipe flange not incl.; Head bolt replacement recommended; PermaDry® molded rubber valve cover gskt. incl.; Premium valve stem seals incl.		
1	Head Bolt Set	1998-92	ES 71175	Replacement recommended		
QTY	CONVERSION SET	YEARS	PART NO.	DESCRIPTION		
1	Gasket Conversion Set	1998-97	CS 9627-1			
1	Gasket Conversion Set	1996	CS 9627	To 09/01/95		
1	Gasket Conversion Set	1996	CS 9627-1	From 09/02/95		
1	Gasket Conversion Set	1995-92	CS 9627			
QTY	MANIFOLD - INT. & EXH.	YEARS	PART NO.	DESCRIPTION		
1	Int. Manifold Gasket Set	1998-92	MS 94328			
1	Exh. Manifold Gasket Set	1998-92	MS 95470			
QTY	EXHAUST PIPE FLANGE	YEARS	PART NO.	DESCRIPTION		
1	Exhaust Pipe Gasket	1998	60899	Flange		
1	Exhaust Pipe Gasket	1997-96	61404	Flange		
1	Exhaust Pipe Gasket	1995-93	60680	Flange; Exc. California		
1	Exhaust Pipe Gasket	1995-93	61410	Flange; California		
2	Exhaust Pipe Gasket	1994-92	60620	Converter		
1	Exhaust Pipe Gasket	1992	60680	Flange		
QTY	OIL PAN	YEARS	PART NO.	DESCRIPTION		
1	Oil Pan Gasket Set	1998-97	OS 30724			
1	Oil Pan Gasket Set	1996	OS 30460 A	To 09/01/95		

Hyundai Car (Cont.)

18 (cont.)		1998 - 1992; 2.0L 122 (1997cc) DOHC L4 (16 Valve) 85mm Bore			18 (cont.)
		MFI; Gasoline; Naturally Aspirated Mitsubishi Eng.; Eng. Code G4CP			
QTY	OIL PAN	YEARS	PART NO.	DESCRIPTION	
1	Oil Pan Gasket Set	1996	OS 30724	From 09/02/95	
1	Oil Pan Gasket Set	1995-92	OS 30460 A		
QTY	CRANKSHAFT REAR SEAL	YEARS	PART NO.	DESCRIPTION	
1	Rear Main Seal Set	1998-92	BS 40444	Rubber; One-piece	
QTY	VALVE COVER	YEARS	PART NO.	DESCRIPTION	
1	Valve Cover Gasket Set	1998	VS 50534 R	w/Semi-circular plug & Spark plug tube seals; PermaDry® molded rubber gskt. incl.; Improved design	
1	Valve Cover Gasket Set	1997-96	VS 50266 R	To 08/27/96; w/Semi-circular plug & Spark plug tube seals; PermaDry® molded rubber gskt. incl.; Old design	
1	Valve Cover Gasket Set	1997	VS 50534 R	Hyundai Sonata Base; From 08/28/96; w/Semi-circular plug & Spark plug tube seals; PermaDry® molded rubber gskt. incl.; Improved design	
1	Valve Cover Gasket Set	1997	VS 50534 R	Hyundai Sonata GL; From 08/28/96; w/Semi-circular plug & Spark plug tube seals; PermaDry® molded rubber gskt. incl.; Improved design	
1	Valve Cover Gasket Set	1997	VS 50534 R	To 08/27/96; w/Semi-circular plug & Spark plug tube seals; PermaDry® molded rubber gskt. incl.; Improved design	
1	Valve Cover Gasket Set	1996	VS 50534 R	Hyundai Sonata Base; From 08/28/96; w/Semi-circular plug & Spark plug tube seals; PermaDry® molded rubber gskt. incl.; Improved design	
1	Valve Cover Gasket Set	1996	VS 50534 R	Hyundai Sonata GL; From 08/28/96; w/Semi-circular plug & Spark plug tube seals; PermaDry® molded rubber gskt. incl.; Improved design	
1	Valve Cover Gasket Set	1996	VS 50534 R	To 08/27/96; w/Semi-circular plug & Spark plug tube seals; PermaDry® molded rubber gskt. incl.; Improved design	
1	Valve Cover Gasket Set	1995-94	VS 50041 R	To 07/06/94; w/Semi-circular plug & Spark plug tube seals; PermaDry® molded rubber gskt. incl.	
1	Valve Cover Gasket Set	1995-94	VS 50266 R	From 07/07/94; w/Semi-circular plug & Spark plug tube seals; PermaDry® molded rubber gskt. incl.; Old design	
1	Valve Cover Gasket Set	1995-94	VS 50534 R	From 07/07/94; w/Semi-circular plug & Spark plug tube seals; PermaDry® molded rubber gskt. incl.; Improved design	
1	Valve Cover Gasket Set	1993-92	VS 50041 R	w/Semi-circular plug & Spark plug tube seals; PermaDry® molded rubber gskt. incl.	
1	Semi-Circular Plug	1998-92	CP 75013	Valve Cover	
QTY	VALVE STEM SEAL SET	YEARS	PART NO.	DESCRIPTION	
1	Valve Stem Seal Set	1998	SS 71179-1	Premium valve stem seals incl.	
1	Valve Stem Seal Set	1997-96	SS 70359	To 08/27/96; Premium valve stem seals incl.	
1	Valve Stem Seal Set	1997-96	SS 71179-1	From 08/28/96; Premium valve stem seals incl.	
1	Valve Stem Seal Set	1995-92	SS 70359	Premium valve stem seals incl.	
QTY	WATER OUTLET GASKET	YEARS	PART NO.	DESCRIPTION	
1	Water Outlet Gasket	1998-92	35084	Water Outlet	
QTY	WATER PUMP	YEARS	PART NO.	DESCRIPTION	
1	Water Pump Gasket	1998-92	35273		
1	Water Pump Gasket	1998-92	ES 72872	O-ring	
QTY	TIMING COVER	YEARS	PART NO.	DESCRIPTION	
1	Crankshaft Front Seal Set	1998-92	TCS 45938		
1	Camshaft Front Seal Set	1998	TCS 45704		
2	Camshaft Front Seal Set	1997-96	TCS 45483	To 08/27/96	
1	Camshaft Front Seal Set	1997-96	TCS 45704	From 08/28/96	
2	Camshaft Front Seal Set	1995-92	TCS 45483		
QTY	AIR CLEANER MOUNTING	YEARS	PART NO.	DESCRIPTION	
1	Air Cleaner Gasket	1998-92	60756		
QTY	CARB & FUEL INJECTION	YEARS	PART NO.	DESCRIPTION	
1	Fuel Injector O-Ring Set	1998-92	ES 70600		
1	Throttle Body Gasket	1998-92	60813		
QTY	EXHAUST GAS RECIRCULATION	YEARS	PART NO.	DESCRIPTION	
1	EGR Gasket	1998-92	70152		
19		2005 - 1999; 2.4L 143.4 (2351cc) DOHC L4 (16 Valve) 86.5mm Bore			19
		MFI; Gasoline; Naturally Aspirated Mitsubishi Eng.; Eng. Code G4JS			
QTY	CYLINDER HEAD	YEARS	PART NO.	DESCRIPTION	
1	Head Gasket	2005-99	26282 PT	Head bolts not incl.; Head bolt replacement recommended; PermaTorqueMLS® LaserWeld® Technology	
1	Head Set	2005-99	HS 26282 PT	Head bolts not incl.; Head bolt replacement recommended; PermaDry® molded rubber valve cover gskt. incl.; Premium valve stem seals incl.	
1	Head Bolt Set	2005-99	ES 72211	Head bolts w/Washers; Replacement recommended	
QTY	CONVERSION SET	YEARS	PART NO.	DESCRIPTION	
1	Gasket Conversion Set	2005-02	CS 26282-1	RTV sealant incl. for Upper oil pan gskt.	

19 (cont.)		2005 - 1999; 2.4L 143.4 (2351cc) DOHC L4 (16 Valve) 86.5mm Bore			19 (cont.)
		MFI; Gasoline; Naturally Aspirated Mitsubishi Eng.; Eng. Code G4JS			
QTY	CONVERSION SET	YEARS	PART NO.	DESCRIPTION	
1	Gasket Conversion Set	2001-99	CS 26282	RTV sealant incl. for Upper oil pan gskt.	
QTY	MANIFOLD - INT. & EXH.	YEARS	PART NO.	DESCRIPTION	
1	Int. Manifold Gasket Set	2005-99	MS 96633		
1	Exh. Manifold Gasket Set	2005-99	MS 95470		
QTY	EXHAUST PIPE FLANGE	YEARS	PART NO.	DESCRIPTION	
1	Exhaust Pipe Gasket	2005-99	60899	Exh. connector	
1	Exhaust Pipe Gasket	2005-99	61399	Converter	
1	Exhaust Pipe Gasket	2005-02	61400	Flange	
1	Exhaust Pipe Gasket	2001-99	61294	Flange; Small ports	
1	Exhaust Pipe Gasket	2001-99	61400	Flange; Large ports	
QTY	OIL PAN	YEARS	PART NO.	DESCRIPTION	
1	Oil Pan Gasket Set	2005-02	OS 30759	Loc. Lower; RTV sealant incl. for Upper oil pan gskt.	
1	Oil Pan Gasket Set	2001-99	OS 30758	Loc. Lower; RTV sealant incl. for Upper oil pan gskt.	
QTY	CRANKSHAFT REAR SEAL	YEARS	PART NO.	DESCRIPTION	
1	Rear Main Seal Set	2005-99	BS 40663	Rubber; One-piece	
QTY	VALVE COVER	YEARS	PART NO.	DESCRIPTION	
1	Valve Cover Gasket Set	2005-99	VS 50651 R	w/Semi-circular plug & Grommets & Spark plug tube seals; PermaDry® molded rubber gskt. incl.	
1	Semi-Circular Plug	2005-99	CP 75013	Valve Cover	
QTY	VALVE STEM SEAL SET	YEARS	PART NO.	DESCRIPTION	
1	Valve Stem Seal Set	2005-99	SS 71179-2	Premium valve stem seals incl.	
QTY	THERMOSTAT HOUSING	YEARS	PART NO.	DESCRIPTION	
1	Thermostat Gasket	2005-02	35778	Thermostat Housing	
1	Thermostat Gasket	2001-99	35764	Thermostat Housing	
QTY	WATER PUMP	YEARS	PART NO.	DESCRIPTION	
1	Water Pump Gasket	2005-99	35777		
QTY	TIMING COVER	YEARS	PART NO.	DESCRIPTION	
1	Crankshaft Front Seal Set	2005-99	TCS 46062		
1	Camshaft Front Seal Set	2005-99	TCS 45704		
QTY	CARB & FUEL INJECTION	YEARS	PART NO.	DESCRIPTION	
2	Fuel Injector O-Ring Set	2005-99	ES 70599	Improved design	
1	Throttle Body Gasket	2005-99	61390		
QTY	EXHAUST GAS RECIRCULATION	YEARS	PART NO.	DESCRIPTION	
1	EGR Gasket	2005-99	70152		
20		1991; 2.4L 143.4 (2351cc) SOHC L4 (8 Valve) 86.5mm Bore			20
		MFI; Gasoline; Naturally Aspirated Mitsubishi Eng.; Eng. Code G4CS			
QTY	CYLINDER HEAD	YEARS	PART NO.	DESCRIPTION	
1	Head Gasket	1991	9388 PT		
1	Head Set	1991	HS 9388 PT-1	PermaDry® molded rubber valve cover gskt. incl.; Premium valve stem seals incl.	
QTY	CONVERSION SET	YEARS	PART NO.	DESCRIPTION	
1	Gasket Conversion Set	1991	CS 9388-1		
QTY	MANIFOLD - INT. & EXH.	YEARS	PART NO.	DESCRIPTION	
1	Int. Manifold Gasket Set	1991	MS 92964-1	Lower set; Upper set incl.	
1	Exh. Manifold Gasket Set	1991	MS 94841		
QTY	EXHAUST PIPE FLANGE	YEARS	PART NO.	DESCRIPTION	
1	Exhaust Pipe Gasket	1991	60680	Flange	
QTY	OIL PAN	YEARS	PART NO.	DESCRIPTION	
1	Oil Pan Gasket Set	1991	OS 30460 A		
QTY	CRANKSHAFT REAR SEAL	YEARS	PART NO.	DESCRIPTION	
1	Rear Main Seal Set	1991	BS 40408-1	Rubber; One-piece	
1	Repair Sleeve	1991	16275	Crankshaft; Use w/installation tool	
QTY	VALVE COVER	YEARS	PART NO.	DESCRIPTION	
1	Valve Cover Gasket Set	1991	VS 50132 R	w/Semi-circular plug & Grommets; PermaDry® molded rubber gskt. incl.	
1	Valve Cover Gasket Set	1991	VS 50234 R	w/o Semi-circular plug & Grommets; PermaDry® molded rubber gskt. incl.	
1	Grommet Set	1991	ES 70342	Valve Cover	
1	Semi-Circular Plug	1991	CP 75001	Valve Cover	
QTY	VALVE STEM SEAL SET	YEARS	PART NO.	DESCRIPTION	
1	Valve Stem Seal Set	1991	SS 70598	Loc. Int. & Exh.; Premium valve stem seals incl.; Improved design	
1	Valve Stem Seal Set	1991	SS 72681	Loc. Aux.; Premium valve stem seals incl.	
QTY	WATER OUTLET GASKET	YEARS	PART NO.	DESCRIPTION	
1	Water Outlet Gasket	1991	35084	Water Outlet	

Hyundai Car (Cont.)

20 (cont.)		1991; 2.4L 143.4 (2351cc) SOHC L4 (8 Valve) 86.5mm Bore			20 (cont.)
		MFI; Gasoline; Naturally Aspirated Mitsubishi Eng.; Eng. Code G4CS			
QTY	WATER PUMP	YEARS	PART NO.	DESCRIPTION	
1	Water Pump Gasket	1991	35273		
QTY	TIMING COVER	YEARS	PART NO.	DESCRIPTION	
1	Camshaft Front Seal Set	1991	TCS 45483		
QTY	AIR CLEANER MOUNTING	YEARS	PART NO.	DESCRIPTION	
1	Air Cleaner Gasket	1991	60756		
QTY	CARB & FUEL INJECTION	YEARS	PART NO.	DESCRIPTION	
1	Fuel Injector O-Ring Set	1991	ES 70600		
1	Throttle Body Gasket	1991	60855	From 07/01/90	
QTY	EXHAUST GAS RECIRCULATION	YEARS	PART NO.	DESCRIPTION	
1	EGR Gasket	1991	70152		
21		2008 - 2006; 2.4L 144 (2359cc) DOHC L4 (16 Valve) 88mm Bore			21
		MFI; Gasoline; Naturally Aspirated Hyundai Eng.; Eng. Code G4KC			
QTY	CYLINDER HEAD	YEARS	PART NO.	DESCRIPTION	
1	Head Gasket	2008-06	26333 PT	Head bolts not incl.; Head bolt replacement recommended; PermaTorqueMLS®	
1	Head Set	2008-06	HS 26333 PT	Head bolts not incl.; Head bolt replacement recommended; PermaDry® molded rubber valve cover gskt. incl.; Premium valve stem seals incl.	
1	Head Bolt Set	2008-06	ES 72465-1	Head bolts w/Washers; Replacement recommended; New Part Number - Check for Availability	
QTY	CONVERSION SET	YEARS	PART NO.	DESCRIPTION	
1	Gasket Conversion Set	2008	CS 26333-1	RTV sealant incl. for oil pan gskt.	
1	Gasket Conversion Set	2007-06	CS 26333	RTV sealant incl. for oil pan gskt.	
QTY	MANIFOLD - INT. & EXH.	YEARS	PART NO.	DESCRIPTION	
1	Int. Manifold Gasket Set	2008-06	MS 97116		
1	Exh. Manifold Gasket Set	2008-06	MS 96874		
QTY	EXHAUST PIPE FLANGE	YEARS	PART NO.	DESCRIPTION	
1	Exhaust Pipe Gasket	2008-06	60899	Exh. connector	
1	Exhaust Pipe Gasket	2008-06	61479	Converter	
QTY	OIL PAN	YEARS	PART NO.	DESCRIPTION	
1	Oil Pan Gasket Set	2008-06	OS 30778	RTV sealant incl. for oil pan gskt.; Old design	
1	Oil Pan Gasket Set	2008-06	OS 30782	RTV sealant incl. for oil pan gskt.; Improved design	
QTY	CRANKSHAFT REAR SEAL	YEARS	PART NO.	DESCRIPTION	
1	Rear Main Seal Set	2008-06	BS 40702	Rubber; One-piece	
QTY	VALVE COVER	YEARS	PART NO.	DESCRIPTION	
1	Valve Cover Gasket Set	2008-06	VS 50697 R	w/Spark plug tube seals; PermaDry® molded rubber gskt. incl.	
QTY	VALVE STEM SEAL SET	YEARS	PART NO.	DESCRIPTION	
1	Valve Stem Seal Set	2008-06	SS 71268	Premium valve stem seals incl.	
QTY	THERMOSTAT HOUSING	YEARS	PART NO.	DESCRIPTION	
1	Thermostat Gasket	2008-06	35927	Thermostat Housing; Thermostat housing	
QTY	WATER OUTLET GASKET	YEARS	PART NO.	DESCRIPTION	
1	Thermostat Gasket	2008-06	35368	Water Outlet	
QTY	WATER PUMP	YEARS	PART NO.	DESCRIPTION	
1	Water Pump Gasket	2008-06	35802	To cover	
1	Water Pump Gasket	2008-06	35813	To block; Improved design	
1	Water Pump Gasket	2008-06	35822	To block; Old design	
1	Water Pump Gasket	2008-06	ES 72872	O-ring	
QTY	TIMING COVER	YEARS	PART NO.	DESCRIPTION	
1	Crankshaft Front Seal Set	2008	TCS 46133		
1	Crankshaft Front Seal Set	2007-06	TCS 46087		
QTY	CARB & FUEL INJECTION	YEARS	PART NO.	DESCRIPTION	
2	Fuel Injector O-Ring Set	2008-06	ES 70599	Improved design	
1	Throttle Body Gasket	2008-06	61504	Throttle body	
QTY	EXHAUST GAS RECIRCULATION	YEARS	PART NO.	DESCRIPTION	
1	EGR Gasket	2008-06	70152		
QTY	OIL FILTER MOUNTING	YEARS	PART NO.	DESCRIPTION	
1	Oil Filter Adapter Gasket	2008-06	72997	Oil filter adapter gskt.; New Part Number - Check for Availability	
22		2013 - 2011; 2.4L 144 (2359cc) DOHC L4 (16 Valve) 88mm Bore Theta GDi VVT			22
		DI; Gasoline; Naturally Aspirated Hyundai Eng.			
QTY	CYLINDER HEAD	YEARS	PART NO.	DESCRIPTION	
1	Head Bolt Set	2013-11	ES 72465-1	Head bolts w/Washers; Replacement recommended; New Part Number - Check for Availability	

22		2013 - 2011; 2.4L 144 (2359cc) DOHC L4 (16 Valve) 88mm Bore Theta GDi VVT			22	
(cont.)		DI; Gasoline; Naturally Aspirated Hyundai Eng.			(cont.)	
QTY	MANIFOLD - INT. & EXH.	YEARS	PART NO.	DESCRIPTION		
1	Int. Manifold Gasket Set	2012-11	MS 97319	Lower set; New Part Number - Check for Availability		
1	Exh. Manifold Gasket Set	2013-11	MS 96874			
QTY	EXHAUST PIPE FLANGE	YEARS	PART NO.	DESCRIPTION		
1	Exhaust Pipe Gasket	2013-11	60899	Loc. Rear; Secondary converter		
1	Exhaust Pipe Gasket	2013-11	61451	Loc. Front; Secondary converter		
1	Exhaust Pipe Gasket	2013-11	61499	Exh. connector		
1	Exhaust Pipe Gasket	2013-11	61499	Loc. Front; Converter		
1	Exhaust Pipe Gasket	2013-11	61503	Loc. Rear; Converter		
QTY	FUEL PUMP	YEARS	PART NO.	DESCRIPTION		
1	Fuel Pump Mounting Gasket	2012-11	61751	New Part Number - Check for Availability		
QTY	CRANKSHAFT REAR SEAL	YEARS	PART NO.	DESCRIPTION		
1	Rear Main Seal Set	2013-11	BS 40702	Rubber; One-piece		
QTY	VALVE COVER	YEARS	PART NO.	DESCRIPTION		
1	Valve Cover Gasket Set	2012-11	VS 50869 R	w/Spark plug tube seals; PermaDry® molded rubber gskt. incl.; New Part Number - Check for Availability		
QTY	VALVE STEM SEAL SET	YEARS	PART NO.	DESCRIPTION		
1	Valve Stem Seal Set	2013-11	SS 71268	Premium valve stem seals incl.		
QTY	THERMOSTAT HOUSING	YEARS	PART NO.	DESCRIPTION		
1	Thermostat Gasket	2013-11	35918	Thermostat Housing; Thermostat case		
1	Thermostat Gasket	2013-11	35921	Thermostat Housing; Thermostat O-ring		
QTY	WATER OUTLET GASKET	YEARS	PART NO.	DESCRIPTION		
1	Thermostat Gasket	2013-11	35368	Water Outlet; Inlet to water pump		
QTY	WATER PUMP	YEARS	PART NO.	DESCRIPTION		
1	Water Pump Gasket	2013-11	35802	To cover		
1	Water Pump Gasket	2013-11	35813	To block; Improved design		
1	Water Pump Gasket	2013-11	35822	To block; Old design		
1	Water Pump Gasket	2013-11	ES 72872	O-ring		
QTY	TIMING COVER	YEARS	PART NO.	DESCRIPTION		
1	Crankshaft Front Seal Set	2013-11	TCS 46133			
QTY	CARB & FUEL INJECTION	YEARS	PART NO.	DESCRIPTION		
2	Fuel Injector O-Ring Set	2013-11	ES 70599	Improved design		
23		2013 - 2011; 2.4L 144 (2359cc) DOHC L4 (16 Valve) 88mm Bore Theta GDi VVT			23	
		DI; Hybrid (Gas/Electric); Naturally Aspirated Hyundai Eng.				
QTY	CYLINDER HEAD	YEARS	PART NO.	DESCRIPTION		
1	Head Bolt Set	2013-11	ES 72465-1	Head bolts w/Washers; Replacement recommended; New Part Number - Check for Availability		
QTY	MANIFOLD - INT. & EXH.	YEARS	PART NO.	DESCRIPTION		
1	Exh. Manifold Gasket Set	2013-11	MS 96874			
QTY	EXHAUST PIPE FLANGE	YEARS	PART NO.	DESCRIPTION		
1	Exhaust Pipe Gasket	2013-11	60899	Loc. Rear; Secondary converter		
1	Exhaust Pipe Gasket	2013-11	61451	Loc. Front; Secondary converter		
1	Exhaust Pipe Gasket	2013-11	61499	Exh. connector		
1	Exhaust Pipe Gasket	2013-11	61499	Loc. Front; Converter		
1	Exhaust Pipe Gasket	2013-11	61503	Loc. Rear; Converter		
QTY	CRANKSHAFT REAR SEAL	YEARS	PART NO.	DESCRIPTION		
1	Rear Main Seal Set	2013-11	BS 40702	Rubber; One-piece		
QTY	VALVE STEM SEAL SET	YEARS	PART NO.	DESCRIPTION		
1	Valve Stem Seal Set	2013-11	SS 71268	Premium valve stem seals incl.		
QTY	THERMOSTAT HOUSING	YEARS	PART NO.	DESCRIPTION		
1	Thermostat Gasket	2013-11	35918	Thermostat Housing; Thermostat case		
1	Thermostat Gasket	2013-11	35921	Thermostat Housing; Thermostat O-ring		
QTY	WATER OUTLET GASKET	YEARS	PART NO.	DESCRIPTION		
1	Thermostat Gasket	2013-11	35368	Water Outlet; Inlet to water pump		
QTY	WATER PUMP	YEARS	PART NO.	DESCRIPTION		
1	Water Pump Gasket	2013-11	35802	To cover		
1	Water Pump Gasket	2013-11	35813	To block; Improved design		
1	Water Pump Gasket	2013-11	35822	To block; Old design		
1	Water Pump Gasket	2013-11	ES 72872	O-ring		
QTY	TIMING COVER	YEARS	PART NO.	DESCRIPTION		
1	Crankshaft Front Seal Set	2013-11	TCS 46133			
QTY	CARB & FUEL INJECTION	YEARS	PART NO.	DESCRIPTION		
2	Fuel Injector O-Ring Set	2013-11	ES 70599	Improved design		

Hyundai Car (Cont.)

24		2010 - 2009; 2.4L 144 (2359cc) DOHC L4 (16 Valve) 88mm Bore VVT MFI; Gasoline; Naturally Aspirated Hyundai Eng.; Eng. Code G4KC			24
QTY	CYLINDER HEAD	YEARS	PART NO.	DESCRIPTION	
1	Head Gasket	2010-09	26333 PT	Head bolts not incl.; Head bolt replacement recommended; PermaTorqueMLS®	
1	Head Set	2009	HS 26333 PT-1	Exc. California; Head bolts not incl.; Head bolt replacement recommended; PermaDry® molded rubber valve cover gskt. incl.; Premium valve stem seals incl.	
1	Head Bolt Set	2010-09	ES 72465-1	Head bolts w/Washers; Replacement recommended; New Part Number - Check for Availability	
QTY	CONVERSION SET	YEARS	PART NO.	DESCRIPTION	
1	Gasket Conversion Set	2010-09	CS 26333-1	RTV sealant incl. for oil pan gskt.	
QTY	MANIFOLD - INT. & EXH.	YEARS	PART NO.	DESCRIPTION	
1	Int. Manifold Gasket Set	2010-09	MS 97100	Exc. California	
1	Int. Manifold Gasket Set	2010-09	MS 97106	California; New Part Number - Check for Availability	
1	Exh. Manifold Gasket Set	2010-09	MS 96874		
QTY	EXHAUST PIPE FLANGE	YEARS	PART NO.	DESCRIPTION	
1	Exhaust Pipe Gasket	2010-09	60899	Exh. connector	
1	Exhaust Pipe Gasket	2010-09	61479	Converter	
QTY	OIL PAN	YEARS	PART NO.	DESCRIPTION	
1	Oil Pan Gasket Set	2010-09	OS 30778	RTV sealant incl. for oil pan gskt.; Old design	
1	Oil Pan Gasket Set	2010-09	OS 30782	RTV sealant incl. for oil pan gskt.; Improved design	
QTY	CRANKSHAFT REAR SEAL	YEARS	PART NO.	DESCRIPTION	
1	Rear Main Seal Set	2010-09	BS 40702	Rubber; One-piece	
QTY	VALVE COVER	YEARS	PART NO.	DESCRIPTION	
1	Valve Cover Gasket Set	2009	VS 50697 R	w/Spark plug tube seals; PermaDry® molded rubber gskt. incl.	
QTY	VALVE STEM SEAL SET	YEARS	PART NO.	DESCRIPTION	
1	Valve Stem Seal Set	2010-09	SS 71268	Premium valve stem seals incl.	
QTY	THERMOSTAT HOUSING	YEARS	PART NO.	DESCRIPTION	
1	Thermostat Gasket	2010-09	35918	Thermostat Housing; Thermostat case	
1	Thermostat Gasket	2010-09	35921	Thermostat Housing; Thermostat O-ring	
QTY	WATER PUMP	YEARS	PART NO.	DESCRIPTION	
1	Water Pump Gasket	2010-09	35802	To cover	
1	Water Pump Gasket	2010-09	35813	To block; Improved design	
1	Water Pump Gasket	2010-09	35822	To block; Old design	
1	Water Pump Gasket	2010-09	ES 72872	O-ring	
QTY	TIMING COVER	YEARS	PART NO.	DESCRIPTION	
1	Crankshaft Front Seal Set	2010-09	TCS 46133		
QTY	CARB & FUEL INJECTION	YEARS	PART NO.	DESCRIPTION	
2	Fuel Injector O-Ring Set	2010-09	ES 70599	Improved design	
1	Throttle Body Gasket	2010-09	61504	Throttle body	
QTY	EXHAUST GAS RECIRCULATION	YEARS	PART NO.	DESCRIPTION	
1	EGR Gasket	2010-09	70152		
QTY	OIL FILTER MOUNTING	YEARS	PART NO.	DESCRIPTION	
1	Oil Filter Adapter Gasket	2010-09	72997	Oil filter adapter gskt.; New Part Number - Check for Availability	
25		2001 - 1999; 2.5L 152 (2493cc) DOHC V6 (24 Valve) 84mm Bore MFI; Gasoline; Naturally Aspirated Hyundai Eng.; Eng. Code G6BV			25
QTY	CYLINDER HEAD	YEARS	PART NO.	DESCRIPTION	
2	Head Bolt Set	2001-99	ES 72205	Head bolts w/Washers; Replacement recommended	
QTY	CONVERSION SET	YEARS	PART NO.	DESCRIPTION	
1	Gasket Conversion Set	2001-99	CS 26276	RTV sealant incl. for Upper oil pan gskt.	
QTY	MANIFOLD - INT. & EXH.	YEARS	PART NO.	DESCRIPTION	
1	Int. Manifold Gasket Set	2001-99	MS 96597	Upper set incl.	
1	Plenum Gasket Set	2001-99	MS 96591	Upper set	
1	Exh. Manifold Gasket Set	2001-99	MS 96598		
QTY	EXHAUST PIPE FLANGE	YEARS	PART NO.	DESCRIPTION	
1	Exhaust Pipe Gasket	2001-99	60899	Converter	
2	Exhaust Pipe Gasket	2001-99	60899	Exh. connector; 1 or 2 Req'd.	
1	Exhaust Pipe Gasket	2001-99	61381	Loc. Rear; Flange	
1	Exhaust Pipe Gasket	2001-99	61382	Loc. Front; Flange	
QTY	OIL PAN	YEARS	PART NO.	DESCRIPTION	
1	Oil Pan Gasket Set	2001-99	OS 30753	Loc. Lower; RTV sealant incl. for Upper oil pan gskt.	
1	Drain Plug Gasket	2001-99	72515		
QTY	CRANKSHAFT REAR SEAL	YEARS	PART NO.	DESCRIPTION	
1	Rear Main Seal Set	2001-99	BS 40562	Rubber; One-piece	

25 (cont.)		2001 - 1999; 2.5L 152 (2493cc) DOHC V6 (24 Valve) 84mm Bore			25 (cont.)
		MFI; Gasoline; Naturally Aspirated Hyundai Eng.; Eng. Code G6BV			
QTY	VALVE COVER	YEARS	PART NO.	DESCRIPTION	
1	Valve Cover Gasket Set	2001-99	VS 50640 R	w/Spark plug tube seals; PermaDry® molded rubber gskts. incl.	
1	Circular Plug	2001-99	CP 75023	Valve Cover	
QTY	VALVE STEM SEAL SET	YEARS	PART NO.	DESCRIPTION	
1	Valve Stem Seal Set	2001-99	SS 72819	Premium valve stem seals incl.	
QTY	THERMOSTAT HOUSING	YEARS	PART NO.	DESCRIPTION	
2	Thermostat Gasket	2001-99	35764	Thermostat Housing	
2	Thermostat Gasket	2001-99	35764	Thermostat Housing; Thermostat case to head	
QTY	WATER PUMP	YEARS	PART NO.	DESCRIPTION	
1	Water Pump Gasket	2001-99	35765		
QTY	TIMING COVER	YEARS	PART NO.	DESCRIPTION	
1	Crankshaft Front Seal Set	2001-99	TCS 45911		
1	Camshaft Front Seal Set	2001-99	TCS 46053		
1	Camshaft Rear Seal Set	2001-99	TCS 46052		
QTY	CARB & FUEL INJECTION	YEARS	PART NO.	DESCRIPTION	
3	Fuel Injector O-Ring Set	2001-99	ES 70599	Improved design	
1	Throttle Body Gasket	2001-99	61245	Idle air control	
1	Throttle Body Gasket	2001-99	61380	Throttle body	
QTY	EXHAUST GAS RECIRCULATION	YEARS	PART NO.	DESCRIPTION	
1	EGR Gasket	2001-99	70152		
26		2009 - 2002; 2.7L 162 (2656cc) DOHC V6 (24 Valve) 86.7mm Bore			26
		MFI; Gasoline; Naturally Aspirated Hyundai Eng.; Eng. Code G6BA			
QTY	CYLINDER HEAD	YEARS	PART NO.	DESCRIPTION	
1	Head Gasket	2009-02	26276 PT	Loc. L.H.; Head bolts not incl.; Head bolt replacement recommended; PermaTorqueMLS®	
1	Head Gasket	2009-02	26277 PT	Loc. R.H.; Head bolts not incl.; Head bolt replacement recommended; PermaTorqueMLS®	
1	Head Set	2009-05	HS 26276 PT-1	Head bolts not incl.; Head bolt replacement recommended; PermaDry® molded rubber valve cover gskts. incl.; Premium valve stem seals incl.	
1	Head Set	2004	HS 26276 PT	To 09/09/03; Head bolts not incl.; Head bolt replacement recommended; PermaDry® molded rubber valve cover gskts. incl.; Premium valve stem seals incl.	
1	Head Set	2004	HS 26276 PT-1	From 09/10/03; Head bolts not incl.; Head bolt replacement recommended; PermaDry® molded rubber valve cover gskts. incl.; Premium valve stem seals incl.	
1	Head Set	2003-02	HS 26276 PT	Head bolts not incl.; Head bolt replacement recommended; PermaDry® molded rubber valve cover gskts. incl.; Premium valve stem seals incl.	
2	Head Bolt Set	2009-02	ES 72205	Head bolts w/Washers; Replacement recommended	
QTY	CONVERSION SET	YEARS	PART NO.	DESCRIPTION	
1	Gasket Conversion Set	2009-02	CS 26276	RTV sealant incl. for Upper oil pan gskt.	
QTY	MANIFOLD - INT. & EXH.	YEARS	PART NO.	DESCRIPTION	
1	Int. Manifold Gasket Set	2009-02	MS 96597	Upper set incl.	
1	Plenum Gasket Set	2009-02	MS 96591	Upper set	
1	Exh. Manifold Gasket Set	2009-02	MS 96598		
QTY	EXHAUST PIPE FLANGE	YEARS	PART NO.	DESCRIPTION	
1	Exhaust Pipe Gasket	2009-02	60899	Converter	
2	Exhaust Pipe Gasket	2009-02	60899	Exh. connector; 1 or 2 Req'd.	
2	Exhaust Pipe Gasket	2009-06	61381	Flange	
2	Exhaust Pipe Gasket	2005	61381	Hyundai Tiburon GT, SE; Flange	
1	Exhaust Pipe Gasket	2005	61381	Hyundai Sonata GL, GLS, LX; Loc. Rear; Flange	
1	Exhaust Pipe Gasket	2005	61382	Hyundai Sonata GL, GLS, LX; Loc. Front; Flange	
2	Exhaust Pipe Gasket	2004-03	61381	Hyundai Tiburon GT; Flange	
1	Exhaust Pipe Gasket	2004-03	61381	Exc. Hyundai Tiburon GT; Loc. Rear; Flange	
1	Exhaust Pipe Gasket	2004-03	61382	Exc. Hyundai Tiburon GT; Loc. Front; Flange	
1	Exhaust Pipe Gasket	2002	61381	Loc. Rear; Flange	
1	Exhaust Pipe Gasket	2002	61382	Loc. Front; Flange	
QTY	OIL PAN	YEARS	PART NO.	DESCRIPTION	
1	Oil Pan Gasket Set	2009-02	OS 30753	Loc. Lower; RTV sealant incl. for Upper oil pan gskt.	
1	Drain Plug Gasket	2009-02	72515		
QTY	CRANKSHAFT REAR SEAL	YEARS	PART NO.	DESCRIPTION	
1	Rear Main Seal Set	2009-02	BS 40562	Rubber; One-piece	
QTY	VALVE COVER	YEARS	PART NO.	DESCRIPTION	
1	Valve Cover Gasket Set	2009-05	VS 50641 R	w/Spark plug tube seals; PermaDry® molded rubber gskts. incl.	

Hyundai Car (Cont.)

26 (cont.)		2009 - 2002; 2.7L 162 (2656cc) DOHC V6 (24 Valve) 86.7mm Bore			26 (cont.)
MFI; Gasoline; Naturally Aspirated Hyundai Eng.; Eng. Code G6BA					
QTY	VALVE COVER	YEARS	PART NO.	DESCRIPTION	
1	Valve Cover Gasket Set	2004	VS 50640 R	To 09/09/03; w/Spark plug tube seals; PermaDry® molded rubber gskts. incl.	
1	Valve Cover Gasket Set	2004	VS 50641 R	From 09/10/03; w/Spark plug tube seals; PermaDry® molded rubber gskts. incl.	
1	Valve Cover Gasket Set	2003-02	VS 50640 R	w/Spark plug tube seals; PermaDry® molded rubber gskts. incl.	
1	Circular Plug	2009-02	CP 75023	Valve Cover	
QTY	VALVE STEM SEAL SET	YEARS	PART NO.	DESCRIPTION	
1	Valve Stem Seal Set	2009-02	SS 72819	Premium valve stem seals incl.	
QTY	THERMOSTAT HOUSING	YEARS	PART NO.	DESCRIPTION	
2	Thermostat Gasket	2009-02	35764	Thermostat Housing	
2	Thermostat Gasket	2009-02	35764	Thermostat Housing; Thermostat case to head	
1	O-Ring	2009-02	35555	Thermostat Housing; Thermostat seal	
QTY	WATER PUMP	YEARS	PART NO.	DESCRIPTION	
1	Water Pump Gasket	2009-02	35765		
QTY	TIMING COVER	YEARS	PART NO.	DESCRIPTION	
1	Crankshaft Front Seal Set	2009-02	TCS 45911		
1	Camshaft Front Seal Set	2009-02	TCS 46053		
1	Camshaft Rear Seal Set	2009-02	TCS 46052		
QTY	CARB & FUEL INJECTION	YEARS	PART NO.	DESCRIPTION	
3	Fuel Injector O-Ring Set	2009-02	ES 70599	Improved design	
1	Throttle Body Gasket	2009-02	61380	Throttle body	
1	Throttle Body Gasket	2009-06	60914	w/A/T; Idle air control	
1	Throttle Body Gasket	2009-06	61245	w/M/T; Idle air control	
1	Throttle Body Gasket	2005	60914	Hyundai Tiburon GT, SE; w/A/T; Idle air control	
1	Throttle Body Gasket	2005	61245	Hyundai Sonata GL, GLS, LX; Idle air control	
1	Throttle Body Gasket	2005	61245	Hyundai Tiburon GT, SE; w/M/T; Idle air control	
1	Throttle Body Gasket	2004-03	60914	Hyundai Tiburon GT; w/A/T; Idle air control	
1	Throttle Body Gasket	2004-03	61245	Exc. Hyundai Tiburon GT; Idle air control	
1	Throttle Body Gasket	2004-03	61245	Hyundai Tiburon GT; w/M/T; Idle air control	
1	Throttle Body Gasket	2002	61245	Idle air control	
QTY	EXHAUST GAS RECIRCULATION	YEARS	PART NO.	DESCRIPTION	
1	EGR Gasket	2009-02	70152		
27		2001; 3.0L 181.1 (2972cc) DOHC V6 (24 Valve) 91.1mm Bore			27
MFI; Gasoline; Naturally Aspirated Mitsubishi Eng.; Eng. Code G6CT					
QTY	CYLINDER HEAD	YEARS	PART NO.	DESCRIPTION	
1	Head Bolt Set	2001	ES 72859	Head bolts w/Washers; Replacement recommended	
QTY	MANIFOLD - INT. & EXH.	YEARS	PART NO.	DESCRIPTION	
1	Int. Manifold Gasket Set	2001	MS 96460	Lower set; Upper set incl.	
1	Plenum Gasket Set	2001	MS 95008	Upper set	
1	Exh. Manifold Gasket Set	2001	MS 95082		
QTY	EXHAUST PIPE FLANGE	YEARS	PART NO.	DESCRIPTION	
1	Exhaust Pipe Gasket	2001	60899	Loc. Front; Exh. connector	
1	Exhaust Pipe Gasket	2001	60899	Loc. Rear; Exh. connector	
1	Exhaust Pipe Gasket	2001	61383	Loc. Rear; Converter	
1	Exhaust Pipe Gasket	2001	61429	Loc. Front; Converter	
QTY	CRANKSHAFT REAR SEAL	YEARS	PART NO.	DESCRIPTION	
1	Rear Main Seal Set	2001	BS 40562	Rubber; One-piece	
QTY	VALVE COVER	YEARS	PART NO.	DESCRIPTION	
1	Valve Cover Gasket Set	2001	VS 50658 R	w/Spark plug tube seals; PermaDry® molded rubber gskts. incl.	
4	Circular Plug	2001	CP 75023	Valve Cover	
QTY	VALVE STEM SEAL SET	YEARS	PART NO.	DESCRIPTION	
1	Valve Stem Seal Set	2001	SS 71179	Premium valve stem seals incl.	
QTY	THERMOSTAT HOUSING	YEARS	PART NO.	DESCRIPTION	
2	Thermostat Gasket	2001	35764	Thermostat Housing; Thermostat case to head	
2	Thermostat Gasket	2001	35764	Thermostat Housing; Thermostat housing	
1	Thermostat Gasket	2001	35917	Thermostat Housing; Water outlet	
QTY	WATER OUTLET GASKET	YEARS	PART NO.	DESCRIPTION	
2	Water Outlet Gasket	2001	35959	Water Outlet; Water pipe; O-ring	
QTY	WATER PUMP	YEARS	PART NO.	DESCRIPTION	
1	Water Pump Gasket	2001	35787	Mounting	
QTY	TIMING COVER	YEARS	PART NO.	DESCRIPTION	
2	Camshaft Front Seal Set	2001	TCS 46053		
QTY	CARB & FUEL INJECTION	YEARS	PART NO.	DESCRIPTION	
1	Throttle Body Gasket	2001	61416		

27 (cont.)		2001; 3.0L 181.1 (2972cc) DOHC V6 (24 Valve) 91.1mm Bore			27 (cont.)
MFI; Gasoline; Naturally Aspirated Mitsubishi Eng.; Eng. Code G6CT					
QTY	EXHAUST GAS RECIRCULATION	YEARS	PART NO.	DESCRIPTION	
1	EGR Gasket	2001	70568	Tube	
28		1998 - 1991; 3.0L 181.1 (2972cc) SOHC V6 (12 Valve) 91.1mm Bore			28
MFI; Gasoline; Naturally Aspirated Mitsubishi Eng.; Eng. Code G6AT					
QTY	CYLINDER HEAD	YEARS	PART NO.	DESCRIPTION	
2	Head Gasket	1998-91	9112 PT	Head bolts not incl.; Head bolt replacement recommended	
1	Head Set	1998-91	HS 9112 PT-2	Head bolts & exh. pipe flange not incl.; Head bolt replacement recommended; PermaDry® molded rubber valve cover gskts. incl.; Premium valve stem seals incl.	
1	Head Bolt Set	1998-91	ES 72859	Head bolts w/Washers; Replacement recommended	
QTY	CONVERSION SET	YEARS	PART NO.	DESCRIPTION	
1	Gasket Conversion Set	1996	CS 9112	To 11/01/95	
1	Gasket Conversion Set	1995-91	CS 9112		
QTY	MANIFOLD - INT. & EXH.	YEARS	PART NO.	DESCRIPTION	
1	Int. Manifold Gasket Set	1998-91	MS 94599	Upper set incl.	
1	Exh. Manifold Gasket Set	1998-91	MS 93797		
QTY	EXHAUST PIPE FLANGE	YEARS	PART NO.	DESCRIPTION	
1	Exhaust Pipe Gasket	1998-91	60496-1	Flange	
QTY	OIL PAN	YEARS	PART NO.	DESCRIPTION	
1	Oil Pan Gasket Set	1996	OS 30570 C	To 11/01/95; Cork	
1	Oil Pan Gasket Set	1996	OS 30570 T	To 11/01/95; PermaDryPlus®; Oil Pan SnapUps® incl.	
1	Oil Pan Gasket Set	1995-91	OS 30570 C	Cork	
1	Oil Pan Gasket Set	1995-91	OS 30570 T	PermaDryPlus®; Oil Pan SnapUps® incl.	
QTY	CRANKSHAFT REAR SEAL	YEARS	PART NO.	DESCRIPTION	
1	Rear Main Seal Set	1998-91	BS 40562	Rubber; One-piece	
1	Rear Main Seal Set	1998-91	BS 40627	PTFE Rubber; One-piece	
1	Repair Sleeve Tool	1998-91	16300	Crankshaft	
QTY	VALVE COVER	YEARS	PART NO.	DESCRIPTION	
1	Valve Cover Gasket Set	1998-91	VS 50026 R-1	w/o Circular plugs & Grommets; PermaDry® molded rubber gskts. incl.	
1	Valve Cover Gasket Set	1998-91	VS 50173 R	w/Circular plugs & Grommets; PermaDry® molded rubber gskts. incl.	
2	Grommet Set	1998-91	ES 70342	Valve Cover	
2	Circular Plug	1998-91	CP 75018	Valve Cover	
QTY	VALVE STEM SEAL SET	YEARS	PART NO.	DESCRIPTION	
1	Valve Stem Seal Set	1998-91	SS 70710	Premium valve stem seals incl.; Improved design	
QTY	WATER OUTLET GASKET	YEARS	PART NO.	DESCRIPTION	
1	Water Outlet Gasket	1998-91	35336	Water Outlet	
QTY	WATER PUMP	YEARS	PART NO.	DESCRIPTION	
1	Water Pump Gasket	1998-91	35399	To block	
1	Water Pump Gasket	1998-91	35468	Inlet	
1	Water Pump Gasket	1998-91	35603	To cover	
1	Water Pump Gasket	1998-91	ES 72872	O-ring	
QTY	TIMING COVER	YEARS	PART NO.	DESCRIPTION	
1	Crankshaft Front Seal Set	1998-91	TCS 45750		
2	Camshaft Front Seal Set	1998-91	TCS 45483	Must be used w/VS 50173R or w/VS 50026R-1	
QTY	AIR CLEANER MOUNTING	YEARS	PART NO.	DESCRIPTION	
1	Air Cleaner Gasket	1998-91	60756		
QTY	CARB & FUEL INJECTION	YEARS	PART NO.	DESCRIPTION	
2	Fuel Injector O-Ring Set	1998-91	ES 70600		
1	Throttle Body Gasket	1998-95	60963		
QTY	EXHAUST GAS RECIRCULATION	YEARS	PART NO.	DESCRIPTION	
1	EGR Gasket	1998-91	70152		
29		2010 - 2006; 3.3L 204 (3342cc) DOHC V6 (24 Valve) 92mm Bore Lambda			29
MFI; Gasoline; Naturally Aspirated Hyundai Eng.; Eng. Code G6DB					
QTY	CYLINDER HEAD	YEARS	PART NO.	DESCRIPTION	
1	Head Gasket	2010-08	26427 PT	Loc. L.H.; Head bolts not incl.; Head bolt replacement recommended; PermaTorqueMLS®	
1	Head Gasket	2010-08	26429 PT	Loc. R.H.; Head bolts not incl.; Head bolt replacement recommended; PermaTorqueMLS®	
1	Head Gasket	2007	26422 PT	Loc. R.H.; To 04/20/07; Head bolts not incl.; Head bolt replacement recommended; PermaTorqueMLS®	
1	Head Gasket	2007	26424 PT	Loc. L.H.; To 04/20/07; Head bolts not incl.; Head bolt replacement recommended; PermaTorqueMLS®	

Hyundai Car (Cont.)

29 (cont.)		2010 - 2006; 3.3L 204 (3342cc) DOHC V6 (24 Valve) 92mm Bore Lambda MFI; Gasoline; Naturally Aspirated Hyundai Eng.; Eng. Code G6DB			29 (cont.)
QTY	CYLINDER HEAD	YEARS	PART NO.	DESCRIPTION	
1	Head Gasket	2007	26427 PT	Loc. L.H.; From 04/21/07; Head bolts not incl.; Head bolt replacement recommended; PermaTorqueMLS®	
1	Head Gasket	2007	26429 PT	Loc. R.H.; From 04/21/07; Head bolts not incl.; Head bolt replacement recommended; PermaTorqueMLS®	
1	Head Gasket	2006	26422 PT	Loc. R.H.; Head bolts not incl.; Head bolt replacement recommended; PermaTorqueMLS®	
1	Head Gasket	2006	26424 PT	Loc. L.H.; Head bolts not incl.; Head bolt replacement recommended; PermaTorqueMLS®	
1	Head Set	2009-08	HS 26427 PT	Head bolts not incl.; Head bolt replacement recommended; PermaDry® molded rubber valve cover gskts. incl.; Premium valve stem seals incl.	
1	Head Set	2007	HS 26422 PT	To 04/20/07; Head bolts not incl.; Head bolt replacement recommended; PermaDry® molded rubber valve cover gskts. incl.; Premium valve stem seals incl.	
1	Head Set	2007	HS 26427 PT	From 04/21/07; Head bolts not incl.; Head bolt replacement recommended; PermaDry® molded rubber valve cover gskts. incl.; Premium valve stem seals incl.	
1	Head Set	2006	HS 26422 PT	Head bolts not incl.; Head bolt replacement recommended; PermaDry® molded rubber valve cover gskts. incl.; Premium valve stem seals incl.	
1	Head Bolt Set	2010-06	ES 72366	Replacement recommended	
QTY	CONVERSION SET	YEARS	PART NO.	DESCRIPTION	
1	Gasket Conversion Set	2010-06	CS 26414	RTV sealant incl. for Upper oil pan gskt.; New Part Number - Check for Availability	
QTY	MANIFOLD - INT. & EXH.	YEARS	PART NO.	DESCRIPTION	
1	Int. Manifold Gasket Set	2010-06	MS 97086	Lower set; Upper set incl.	
1	Plenum Gasket Set	2010-06	MS 97227	Upper set; New Part Number - Check for Availability	
1	Exh. Manifold Gasket Set	2010	MS 97115		
1	Exh. Manifold Gasket Set	2009-06	MS 97074		
QTY	EXHAUST PIPE FLANGE	YEARS	PART NO.	DESCRIPTION	
2	Exhaust Pipe Gasket	2010-06	61383	Loc. Front; Pipe to manifold	
1	Exhaust Pipe Gasket	2010-06	61451	Exh. connector	
1	Exhaust Pipe Gasket	2010-06	61479	Loc. Front; Converter	
2	Exhaust Pipe Gasket	2010-06	61499	Loc. Rear; Pipe to manifold	
1	Exhaust Pipe Gasket	2010-06	60899	Loc. Rear; Converter	
QTY	OIL PAN	YEARS	PART NO.	DESCRIPTION	
1	Oil Pan Gasket Set	2010-06	OS 30822	Loc. Lower	
QTY	CRANKSHAFT REAR SEAL	YEARS	PART NO.	DESCRIPTION	
1	Rear Main Seal Set	2010-06	BS 40710	Rubber; One-piece	
QTY	VALVE COVER	YEARS	PART NO.	DESCRIPTION	
1	Valve Cover Gasket Set	2010-06	VS 50750 R	w/Spark plug tube seals; PermaDry® molded rubber gskts. incl.	
QTY	VALVE STEM SEAL SET	YEARS	PART NO.	DESCRIPTION	
1	Valve Stem Seal Set	2010-06	SS 72298	Premium valve stem seals incl.	
QTY	THERMOSTAT HOUSING	YEARS	PART NO.	DESCRIPTION	
1	Thermostat Gasket	2010-08	35933	Thermostat Housing	
QTY	WATER OUTLET GASKET	YEARS	PART NO.	DESCRIPTION	
1	Water Outlet Gasket	2010-06	35868	Water Outlet; Loc. L.H.	
1	Water Outlet Gasket	2010-06	35870	Water Outlet; Loc. R.H.	
1	Water Outlet Gasket	2010-06	35894	Water Outlet; O-ring; New Part Number - Check for Availability	
2	Water Outlet Gasket	2010-06	35959	Water Outlet; Water pipe; O-ring	
1	Water Crossover Mounting Set	2010-06	ES 72971	Water Outlet; New Part Number - Check for Availability	
QTY	WATER PUMP	YEARS	PART NO.	DESCRIPTION	
1	Water Pump Gasket	2010-06	35896	Loc. R.H.	
1	Water Pump Gasket	2010-06	35903	Loc. L.H.; New Part Number - Check for Availability	
QTY	TIMING COVER	YEARS	PART NO.	DESCRIPTION	
1	Crankshaft Front Seal Set	2010-06	TCS 46111		
QTY	CARB & FUEL INJECTION	YEARS	PART NO.	DESCRIPTION	
1	Throttle Body Gasket	2010-09	61566	Hyundai Azera GLS	
1	Throttle Body Gasket	2010-09	61613	Exc. Hyundai Azera GLS	
1	Throttle Body Gasket	2008-06	61566		
30		2011; 3.3L 204 (3342cc) DOHC V6 (24 Valve) 92mm Bore Lambda VVT MFI; Gasoline; Naturally Aspirated Hyundai Eng.; Eng. Code G6DB			30
QTY	CYLINDER HEAD	YEARS	PART NO.	DESCRIPTION	
1	Head Gasket	2011	26427 PT	Loc. L.H.; Head bolts not incl.; Head bolt replacement recommended; PermaTorqueMLS®	

30 (cont.)		2011; 3.3L 204 (3342cc) DOHC V6 (24 Valve) 92mm Bore Lambda VVT			30 (cont.)
MFI; Gasoline; Naturally Aspirated Hyundai Eng.; Eng. Code G6DB					
QTY	CYLINDER HEAD	YEARS	PART NO.	DESCRIPTION	
1	Head Gasket	2011	26429 PT	Loc. R.H.; Head bolts not incl.; Head bolt replacement recommended; PermaTorqueMLS®	
1	Head Bolt Set	2011	ES 72366	Replacement recommended	
QTY	CONVERSION SET	YEARS	PART NO.	DESCRIPTION	
1	Gasket Conversion Set	2011	CS 26414	RTV sealant incl. for Upper oil pan gskt.; New Part Number - Check for Availability	
QTY	MANIFOLD - INT. & EXH.	YEARS	PART NO.	DESCRIPTION	
1	Int. Manifold Gasket Set	2011	MS 97086	Lower set; Upper set incl.	
1	Plenum Gasket Set	2011	MS 97227	Upper set; New Part Number - Check for Availability	
1	Exh. Manifold Gasket Set	2011	MS 97115		
QTY	EXHAUST PIPE FLANGE	YEARS	PART NO.	DESCRIPTION	
1	Exhaust Pipe Gasket	2011	60899	Loc. Rear; Converter	
2	Exhaust Pipe Gasket	2011	61383	Loc. Front; Pipe to manifold	
1	Exhaust Pipe Gasket	2011	61451	Exh. connector	
1	Exhaust Pipe Gasket	2011	61479	Loc. Front; Converter	
2	Exhaust Pipe Gasket	2011	61499	Loc. Rear; Pipe to manifold	
QTY	OIL PAN	YEARS	PART NO.	DESCRIPTION	
1	Oil Pan Gasket Set	2011	OS 30822	Loc. Lower	
QTY	CRANKSHAFT REAR SEAL	YEARS	PART NO.	DESCRIPTION	
1	Rear Main Seal Set	2011	BS 40710	Rubber; One-piece	
QTY	VALVE COVER	YEARS	PART NO.	DESCRIPTION	
1	Valve Cover Gasket Set	2011	VS 50750 R	w/Spark plug tube seals; PermaDry® molded rubber gskts. incl.	
QTY	VALVE STEM SEAL SET	YEARS	PART NO.	DESCRIPTION	
1	Valve Stem Seal Set	2011	SS 72298	Premium valve stem seals incl.	
QTY	THERMOSTAT HOUSING	YEARS	PART NO.	DESCRIPTION	
1	Thermostat Gasket	2011	35933	Thermostat Housing	
QTY	WATER OUTLET GASKET	YEARS	PART NO.	DESCRIPTION	
1	Water Outlet Gasket	2011	35868	Water Outlet; Loc. L.H.	
1	Water Outlet Gasket	2011	35870	Water Outlet; Loc. R.H.	
1	Water Outlet Gasket	2011	35894	Water Outlet; O-ring; New Part Number - Check for Availability	
2	Water Outlet Gasket	2011	35959	Water Outlet; Water pipe; O-ring	
1	Water Crossover Mounting Set	2011	ES 72971	Water Outlet; New Part Number - Check for Availability	
QTY	WATER PUMP	YEARS	PART NO.	DESCRIPTION	
1	Water Pump Gasket	2011	35896	Loc. R.H.	
1	Water Pump Gasket	2011	35903	Loc. L.H.; New Part Number - Check for Availability	
QTY	TIMING COVER	YEARS	PART NO.	DESCRIPTION	
1	Crankshaft Front Seal Set	2011	TCS 46111		
QTY	CARB & FUEL INJECTION	YEARS	PART NO.	DESCRIPTION	
1	Throttle Body Gasket	2011	61566		
31		2005 - 2002; 3.5L 213.3 (3497cc) DOHC V6 (24 Valve) 93mm Bore			31
MFI; Gasoline; Naturally Aspirated Mitsubishi Eng.; Eng. Code G6CU					
QTY	CYLINDER HEAD	YEARS	PART NO.	DESCRIPTION	
1	Head Gasket	2005-02	26293 PT	Loc. R.H.; Head bolts not incl.; Head bolt replacement recommended; PermaTorqueMLS®	
1	Head Gasket	2005-02	26294 PT	Loc. L.H.; Head bolts not incl.; Head bolt replacement recommended; PermaTorqueMLS®	
1	Head Set	2005-02	HS 26293 PT	Head bolts not incl.; Head bolt replacement recommended; PermaDry® molded rubber valve cover gskts. incl.; Premium valve stem seals incl.	
1	Head Bolt Set	2005-02	ES 72859	Head bolts w/Washers; Replacement recommended	
QTY	CONVERSION SET	YEARS	PART NO.	DESCRIPTION	
1	Gasket Conversion Set	2005-02	CS 26293	RTV sealant incl. for Upper oil pan gskt.; Old design	
1	Gasket Conversion Set	2005-02	CS 26293-2	RTV sealant incl. for Upper oil pan gskt.; Improved design	
QTY	MANIFOLD - INT. & EXH.	YEARS	PART NO.	DESCRIPTION	
1	Int. Manifold Gasket Set	2005-02	MS 96460	Lower set; Upper set incl.	
1	Plenum Gasket Set	2005-02	MS 95008	Upper set	
1	Exh. Manifold Gasket Set	2005-02	MS 95082		
QTY	EXHAUST PIPE FLANGE	YEARS	PART NO.	DESCRIPTION	
1	Exhaust Pipe Gasket	2005-02	60899	Loc. Rear; Exh. connector	
1	Exhaust Pipe Gasket	2005-02	61383	Loc. Center; Exh. connector	
1	Exhaust Pipe Gasket	2005-02	61383	Loc. Front; Flange	
1	Exhaust Pipe Gasket	2005-02	61423	Loc. R.H.; Converter	
1	Exhaust Pipe Gasket	2005-02	61429	Loc. L.H.; Converter	

Hyundai Car (Cont.)

31 (cont.)		2005 - 2002; 3.5L 213.3 (3497cc) DOHC V6 (24 Valve) 93mm Bore			31 (cont.)
		MFI; Gasoline; Naturally Aspirated Mitsubishi Eng.; Eng. Code G6CU			
QTY	EXHAUST PIPE FLANGE	YEARS	PART NO.	DESCRIPTION	
2	Exhaust Pipe Gasket	2005-02	61477	Loc. Front; Converter	
1	Exhaust Pipe Gasket	2005-04	61419	Loc. Rear; Flange	
QTY	OIL PAN	YEARS	PART NO.	DESCRIPTION	
1	Oil Pan Gasket Set	2005-02	OS 30762	Loc. Lower; RTV sealant incl. for Upper oil pan gskt.	
1	Drain Plug Gasket	2005-02	72515		
QTY	CRANKSHAFT REAR SEAL	YEARS	PART NO.	DESCRIPTION	
1	Rear Main Seal Set	2005-02	BS 40562	Rubber; One-piece	
QTY	VALVE COVER	YEARS	PART NO.	DESCRIPTION	
1	Valve Cover Gasket Set	2005-02	VS 50658 R-1	w/Spark plug tube seals; PermaDry® molded rubber gskts. incl.	
4	Circular Plug	2005-02	CP 75023	Valve Cover	
QTY	VALVE STEM SEAL SET	YEARS	PART NO.	DESCRIPTION	
1	Valve Stem Seal Set	2005-02	SS 71179	Premium valve stem seals incl.	
QTY	THERMOSTAT HOUSING	YEARS	PART NO.	DESCRIPTION	
2	Thermostat Gasket	2005-02	35764	Thermostat Housing	
2	Thermostat Gasket	2005-02	35764	Thermostat Housing; Thermostat case to head	
1	O-Ring	2005-02	35555	Thermostat Housing; Thermostat seal	
QTY	WATER PUMP	YEARS	PART NO.	DESCRIPTION	
1	Water Pump Gasket	2005-02	35787		
QTY	TIMING COVER	YEARS	PART NO.	DESCRIPTION	
1	Crankshaft Front Seal Set	2005-02	TCS 46074	Old design	
1	Crankshaft Front Seal Set	2005-02	TCS 46085	Improved design	
2	Camshaft Front Seal Set	2005-02	TCS 46053		
QTY	CARB & FUEL INJECTION	YEARS	PART NO.	DESCRIPTION	
1	Throttle Body Gasket	2005-02	61416		
QTY	EXHAUST GAS RECIRCULATION	YEARS	PART NO.	DESCRIPTION	
1	EGR Gasket	2005-02	70568	Tube	
QTY	OIL PUMP COVER	YEARS	PART NO.	DESCRIPTION	
1	Oil Pump Gasket	2005-02	71262	Oil pump mounting; New Part Number - Check for Availability	
32		2010 - 2006; 3.8L 230 (3778cc) DOHC V6 (24 Valve) 96mm Bore Lambda			32
		MFI; Gasoline; Naturally Aspirated Hyundai Eng.; Eng. Code G6DA			
QTY	CYLINDER HEAD	YEARS	PART NO.	DESCRIPTION	
1	Head Gasket	2010-06	26416 PT	Loc. R.H.; Head bolts not incl.; Head bolt replacement recommended; PermaTorqueMLS®	
1	Head Gasket	2010-08	26420 PT	Loc. L.H.; Head bolts not incl.; Head bolt replacement recommended; PermaTorqueMLS®	
1	Head Gasket	2007	26414 PT	Loc. L.H.; To 04/20/07; Head bolts not incl.; Head bolt replacement recommended; PermaTorqueMLS®	
1	Head Gasket	2007	26420 PT	Loc. L.H.; From 04/21/07; Head bolts not incl.; Head bolt replacement recommended; PermaTorqueMLS®	
1	Head Gasket	2006	26414 PT	Loc. L.H.; Head bolts not incl.; Head bolt replacement recommended; PermaTorqueMLS®	
1	Head Set	2009-08	HS 26420 PT	Head bolts not incl.; Head bolt replacement recommended; PermaDry® molded rubber valve cover gskts. incl.; Premium valve stem seals incl.	
1	Head Set	2007	HS 26414 PT	To 04/20/07; Head bolts not incl.; Head bolt replacement recommended; PermaDry® molded rubber valve cover gskts. incl.; Premium valve stem seals incl.	
1	Head Set	2007	HS 26420 PT	From 04/21/07; Head bolts not incl.; Head bolt replacement recommended; PermaDry® molded rubber valve cover gskts. incl.; Premium valve stem seals incl.	
1	Head Set	2006	HS 26414 PT	Head bolts not incl.; Head bolt replacement recommended; PermaDry® molded rubber valve cover gskts. incl.; Premium valve stem seals incl.	
1	Head Bolt Set	2010-06	ES 72366	Replacement recommended	
QTY	CONVERSION SET	YEARS	PART NO.	DESCRIPTION	
1	Gasket Conversion Set	2010-06	CS 26414	RTV sealant incl. for Upper oil pan gskt.; New Part Number - Check for Availability	
QTY	MANIFOLD - INT. & EXH.	YEARS	PART NO.	DESCRIPTION	
1	Int. Manifold Gasket Set	2010-06	MS 97086	Lower set; Upper set incl.	
1	Plenum Gasket Set	2010-06	MS 97227	Upper set; New Part Number - Check for Availability	
1	Exh. Manifold Gasket Set	2010	MS 97115		
1	Exh. Manifold Gasket Set	2009-06	MS 97074		
QTY	EXHAUST PIPE FLANGE	YEARS	PART NO.	DESCRIPTION	
1	Exhaust Pipe Gasket	2010-06	60899	Loc. Rear; Converter	

32 (cont.)		2010 - 2006; 3.8L 230 (3778cc) DOHC V6 (24 Valve) 96mm Bore Lambda MFI; Gasoline; Naturally Aspirated Hyundai Eng.; Eng. Code G6DA			32 (cont.)
QTY	EXHAUST PIPE FLANGE	YEARS	PART NO.	DESCRIPTION	
2	Exhaust Pipe Gasket	2010-06	61383	Loc. Front; Pipe to manifold	
1	Exhaust Pipe Gasket	2010-06	61451	Exh. connector	
1	Exhaust Pipe Gasket	2010-06	61479	Loc. Front; Converter	
2	Exhaust Pipe Gasket	2010-06	61499	Loc. Rear; Pipe to manifold	
QTY	OIL PAN	YEARS	PART NO.	DESCRIPTION	
1	Oil Pan Gasket Set	2010-06	OS 30822	Loc. Lower	
QTY	CRANKSHAFT REAR SEAL	YEARS	PART NO.	DESCRIPTION	
1	Rear Main Seal Set	2010-06	BS 40710	Rubber; One-piece	
QTY	VALVE COVER	YEARS	PART NO.	DESCRIPTION	
1	Valve Cover Gasket Set	2010-06	VS 50750 R	w/Spark plug tube seals; PermaDry® molded rubber gsks. incl.	
QTY	VALVE STEM SEAL SET	YEARS	PART NO.	DESCRIPTION	
1	Valve Stem Seal Set	2010-06	SS 72298	Premium valve stem seals incl.	
QTY	THERMOSTAT HOUSING	YEARS	PART NO.	DESCRIPTION	
1	Thermostat Gasket	2010-08	35933	Thermostat Housing	
QTY	WATER OUTLET GASKET	YEARS	PART NO.	DESCRIPTION	
1	Water Outlet Gasket	2010-06	35868	Water Outlet; Loc. L.H.	
1	Water Outlet Gasket	2010-06	35870	Water Outlet; Loc. R.H.	
1	Water Outlet Gasket	2010-06	35894	Water Outlet; O-ring; New Part Number - Check for Availability	
2	Water Outlet Gasket	2010-06	35959	Water Outlet; Water pipe; O-ring	
1	Water Crossover Mounting Set	2010-06	ES 72971	Water Outlet; New Part Number - Check for Availability	
QTY	WATER PUMP	YEARS	PART NO.	DESCRIPTION	
1	Water Pump Gasket	2010-06	35896	Loc. R.H.	
1	Water Pump Gasket	2010	35935	Loc. L.H.	
1	Water Pump Gasket	2009-06	35903	Loc. L.H.; New Part Number - Check for Availability	
QTY	TIMING COVER	YEARS	PART NO.	DESCRIPTION	
1	Crankshaft Front Seal Set	2010-06	TCS 46111		
QTY	CARB & FUEL INJECTION	YEARS	PART NO.	DESCRIPTION	
1	Throttle Body Gasket	2010-06	61560		
33		2012 - 2009; 3.8L 230 (3778cc) DOHC V6 (24 Valve) 96mm Bore Lambda VVT MFI; Gasoline; Naturally Aspirated Hyundai Eng.; Eng. Code G6DA			33
QTY	CYLINDER HEAD	YEARS	PART NO.	DESCRIPTION	
1	Head Gasket	2011-09	26416 PT	Loc. R.H.; Head bolts not incl.; Head bolt replacement recommended; PermaTorqueMLS®	
1	Head Gasket	2011-09	26420 PT	Loc. L.H.; Head bolts not incl.; Head bolt replacement recommended; PermaTorqueMLS®	
1	Head Set	2011	HS 26420 PT-3	Exc. Hyundai Azera Limited; Head bolts not incl.; Head bolt replacement recommended; PermaDry® molded rubber valve cover gsks. incl.; Premium valve stem seals incl.; New Part Number - Check for Availability	
1	Head Set	2010-09	HS 26420 PT-3	Head bolts not incl.; Head bolt replacement recommended; PermaDry® molded rubber valve cover gsks. incl.; Premium valve stem seals incl.; New Part Number - Check for Availability	
1	Head Bolt Set	2011-09	ES 72366	Replacement recommended	
QTY	CONVERSION SET	YEARS	PART NO.	DESCRIPTION	
1	Gasket Conversion Set	2012	CS 26420-1	RTV sealant incl. for Upper oil pan gskt.; New Part Number - Check for Availability	
1	Gasket Conversion Set	2011	CS 26414	Hyundai Azera Limited; RTV sealant incl. for Upper oil pan gskt.; New Part Number - Check for Availability	
1	Gasket Conversion Set	2011	CS 26420-1	Exc. Hyundai Azera Limited; RTV sealant incl. for Upper oil pan gskt.; New Part Number - Check for Availability	
1	Gasket Conversion Set	2010-09	CS 26420-1	RTV sealant incl. for Upper oil pan gskt.; New Part Number - Check for Availability	
QTY	MANIFOLD - INT. & EXH.	YEARS	PART NO.	DESCRIPTION	
1	Int. Manifold Gasket Set	2011-09	MS 97086	Lower set; Upper set incl.	
1	Plenum Gasket Set	2011-09	MS 97227	Upper set; New Part Number - Check for Availability	
1	Exh. Manifold Gasket Set	2011-09	MS 97115		
QTY	EXHAUST PIPE FLANGE	YEARS	PART NO.	DESCRIPTION	
1	Exhaust Pipe Gasket	2011-09	60899	Loc. Rear; Converter	
2	Exhaust Pipe Gasket	2011-09	61383	Loc. Front; Pipe to manifold	
1	Exhaust Pipe Gasket	2011-09	61479	Loc. Front; Converter	
2	Exhaust Pipe Gasket	2011-09	61499	Loc. Rear; Pipe to manifold	
1	Exhaust Pipe Gasket	2011	61451	Hyundai Azera Limited; Exh. connector	
1	Exhaust Pipe Gasket	2011	61612	Exc. Hyundai Azera Limited; Exh. connector	

Hyundai Car (Cont.)

33		2012 - 2009; 3.8L 230 (3778cc) DOHC V6 (24 Valve) 96mm Bore Lambda VVT			33
(cont.)		MFI; Gasoline; Naturally Aspirated Hyundai Eng.; Eng. Code G6DA			(cont.)
QTY	EXHAUST PIPE FLANGE	YEARS	PART NO.	DESCRIPTION	
1	Exhaust Pipe Gasket	2010-09	61612	Exh. connector	
QTY	OIL PAN	YEARS	PART NO.	DESCRIPTION	
1	Oil Pan Gasket Set	2012	OS 30823	Loc. Lower	
1	Oil Pan Gasket Set	2011	OS 30822	Hyundai Azera Limited; Loc. Lower	
1	Oil Pan Gasket Set	2011	OS 30823	Exc. Hyundai Azera Limited; Loc. Lower	
1	Oil Pan Gasket Set	2010-09	OS 30823	Loc. Lower	
QTY	CRANKSHAFT REAR SEAL	YEARS	PART NO.	DESCRIPTION	
1	Rear Main Seal Set	2012-09	BS 40710	Rubber; One-piece	
QTY	VALVE COVER	YEARS	PART NO.	DESCRIPTION	
1	Valve Cover Gasket Set	2011	VS 50750 R	Hyundai Azera Limited; w/Spark plug tube seals; PermaDry® molded rubber gskts. incl.	
1	Valve Cover Gasket Set	2011	VS 50764 R	Exc. Hyundai Azera Limited; w/Spark plug tube seals; PermaDry® molded rubber gskts. incl.; New Part Number - Check for Availability	
1	Valve Cover Gasket Set	2010-09	VS 50764 R	w/Spark plug tube seals; PermaDry® molded rubber gskts. incl.; New Part Number - Check for Availability	
QTY	VALVE STEM SEAL SET	YEARS	PART NO.	DESCRIPTION	
1	Valve Stem Seal Set	2011-09	SS 72298	Premium valve stem seals incl.	
QTY	THERMOSTAT HOUSING	YEARS	PART NO.	DESCRIPTION	
1	Thermostat Gasket	2011-09	35916	Thermostat Housing; Loc. L.H.; Thermostat case	
1	Thermostat Gasket	2011-09	35931	Thermostat Housing; Loc. R.H.; Thermostat case	
1	Thermostat Gasket	2011	35933	Hyundai Azera Limited; Thermostat Housing	
QTY	WATER OUTLET GASKET	YEARS	PART NO.	DESCRIPTION	
1	Water Outlet Gasket	2011-09	35868	Water Outlet; Loc. L.H.	
1	Water Outlet Gasket	2011-09	35870	Water Outlet; Loc. R.H.	
1	Water Outlet Gasket	2011-09	35894	Water Outlet; O-ring; New Part Number - Check for Availability	
2	Water Outlet Gasket	2011-09	35959	Water Outlet; Water pipe; O-ring	
1	Water Crossover Mounting Set	2011-09	ES 72971	Water Outlet; New Part Number - Check for Availability	
QTY	WATER PUMP	YEARS	PART NO.	DESCRIPTION	
1	Water Pump Gasket	2012-09	35896	Loc. R.H.	
1	Water Pump Gasket	2012-10	35935	Loc. L.H.	
1	Water Pump Gasket	2009	35903	Loc. L.H.; New Part Number - Check for Availability	
QTY	TIMING COVER	YEARS	PART NO.	DESCRIPTION	
1	Crankshaft Front Seal Set	2012-09	TCS 46111		
QTY	CARB & FUEL INJECTION	YEARS	PART NO.	DESCRIPTION	
1	Throttle Body Gasket	2011	61560	Hyundai Azera Limited	
1	Throttle Body Gasket	2011	61566	Exc. Hyundai Azera Limited	
1	Throttle Body Gasket	2010-09	61566		
34		2012 - 2009; 4.6L 282.4 (4627cc) DOHC V8 (32 Valve) 92mm Bore Tau VVT			34
		MFI; Gasoline; Naturally Aspirated Hyundai Eng.; Eng. Code G8BA			
QTY	EXHAUST PIPE FLANGE	YEARS	PART NO.	DESCRIPTION	
2	Exhaust Pipe Gasket	2012-09	61503	Loc. Front; Secondary converter	
2	Exhaust Pipe Gasket	2012-09	61503	Loc. Rear; Secondary converter	
2	Exhaust Pipe Gasket	2012-09	61503	Muffler	
QTY	CRANKSHAFT REAR SEAL	YEARS	PART NO.	DESCRIPTION	
1	Rear Main Seal Set	2012-09	BS 40727	Rubber; One-piece	
35		2013 - 2012; 5.0L 307.3 (5038cc) DOHC V8 (32 Valve) 96mm Bore Tau GDi VVT			35
		DI; Gasoline; Naturally Aspirated Hyundai Eng.; Eng. Code G8BE			
QTY	EXHAUST PIPE FLANGE	YEARS	PART NO.	DESCRIPTION	
2	Exhaust Pipe Gasket	2013-12	61503	Loc. Front; Secondary converter	
2	Exhaust Pipe Gasket	2013-12	61503	Loc. Rear; Secondary converter	
2	Exhaust Pipe Gasket	2013-12	61503	Silencer	

Hyundai Minivans - See Hyundai Truck

Hyundai SUV's - See Hyundai Truck

Hyundai Truck (Incl. Minivans and SUV's)

Engine Finding Index

Engine	Years	Code	Line No.
2.0L 120.5 (1975cc) DOHC L4 (16 Valve) 82mm Bore; MFI; Gasoline; Naturally Aspirated Hyundai Eng.	2009-05	G4GF	1
2.0L 121.9 (1998cc) DOHC L4 (16 Valve) 86mm Bore Theta GDV VVT; DI; Gasoline; Turbo - Intercooled Hyundai Eng.	2013		2
2.0L 121.9 (1998cc) DOHC L4 (16 Valve) 86mm Bore Theta VVT; MFI; Gasoline; Naturally Aspirated Hyundai Eng.	2013-11		3
2.4L 143.4 (2351cc) DOHC L4 (16 Valve) 86.5mm Bore; MFI; Gasoline; Naturally Aspirated Mitsubishi Eng.	2006-01	G4JS	4
2.4L 144 (2359cc) DOHC L4 (16 Valve) 88mm Bore Theta GDV VVT; DI; Gasoline; Naturally Aspirated Hyundai Eng.	2013		5
2.4L 144 (2359cc) DOHC L4 (16 Valve) 88mm Bore VVT; MFI; Gasoline; Naturally Aspirated Hyundai Eng.	2012-10	G4KC	6
2.7L 162 (2656cc) DOHC V6 (24 Valve) 86.7mm Bore; MFI; Gasoline; Naturally Aspirated Hyundai Eng.	2009-01	G6BA	7
3.3L 204 (3342cc) DOHC V6 (24 Valve) 92mm Bore Lambda; MFI; Gasoline; Naturally Aspirated Hyundai Eng.	2009-07	G6DB	8
3.5L 211.7 (3470cc) DOHC V6 (24 Valve) 92mm Bore Lambda VVT; MFI; Gasoline; Naturally Aspirated Hyundai Eng.	2012-10	G6DC	9
3.5L 213.3 (3497cc) DOHC V6 (24 Valve) 93mm Bore; MFI; Gasoline; Naturally Aspirated Mitsubishi Eng.	2006-03	G6CU	10
3.8L 230 (3778cc) DOHC V6 (24 Valve) 96mm Bore Lambda; MFI; Gasoline; Naturally Aspirated Hyundai Eng.	2012-07	G6DA	11

Engine Code Index

Code	Engine	Line No.
G4GF	2.0L 120.5 (1975cc) DOHC L4 (16 Valve) 82mm Bore; MFI; Gasoline; Naturally Aspirated Hyundai Eng.	1
G4JS	2.4L 143.4 (2351cc) DOHC L4 (16 Valve) 86.5mm Bore; MFI; Gasoline; Naturally Aspirated Mitsubishi Eng.	4
G4KC	2.4L 144 (2359cc) DOHC L4 (16 Valve) 88mm Bore VVT; MFI; Gasoline; Naturally Aspirated Hyundai Eng.	6
G6BA	2.7L 162 (2656cc) DOHC V6 (24 Valve) 86.7mm Bore; MFI; Gasoline; Naturally Aspirated Hyundai Eng.	7
G6CU	3.5L 213.3 (3497cc) DOHC V6 (24 Valve) 93mm Bore; MFI; Gasoline; Naturally Aspirated Mitsubishi Eng.	10
G6DA	3.8L 230 (3778cc) DOHC V6 (24 Valve) 96mm Bore Lambda; MFI; Gasoline; Naturally Aspirated Hyundai Eng.	11
G6DB	3.3L 204 (3342cc) DOHC V6 (24 Valve) 92mm Bore Lambda; MFI; Gasoline; Naturally Aspirated Hyundai Eng.	8
G6DC	3.5L 211.7 (3470cc) DOHC V6 (24 Valve) 92mm Bore Lambda VVT; MFI; Gasoline; Naturally Aspirated Hyundai Eng.	9

Model Index

Engine (VIN Code / Eng. Code)	Year	Engine (VIN Code / Eng. Code)	Year	Engine (VIN Code / Eng. Code)	Year
Hyundai Truck		Hyundai Truck (cont.)		Hyundai Truck (cont.)	
Entourage (FWD Minivan)		Santa Fe (FWD Compact SUV) (cont.)		Tucson (AWD Compact SUV)	
V6 3778cc 3.8L DOHC (24 Valve) (G6DA)	09-07	V6 3342cc 3.3L DOHC (24 Valve) (G6DB)	09-07	L4 1975cc 2.0L DOHC (16 Valve) (G4GF)	09-05
Santa Fe (AWD Compact SUV)		V6 3470cc 3.5L DOHC (24 Valve) (G6DC)	12-10	L4 1998cc 2.0L DOHC (16 Valve) (Theta)	13-11
L4 2351cc 2.4L DOHC (16 Valve) (G4JS)	06-01	V6 3497cc 3.5L DOHC (24 Valve) (G6CU)	06-04	L4 2359cc 2.4L DOHC (16 Valve) (G4KC)	13-10
L4 2359cc 2.4L DOHC (16 Valve) (G4KC)	12-10	Santa Fe (FWD Mid-Size SUV)		V6 2656cc 2.7L DOHC (24 Valve) (G6BA)	09-05
V6 2656cc 2.7L DOHC (24 Valve) (G6BA)	09-01	V6 3342cc 3.3L DOHC (24 Valve) (G6DH)	13	Tucson (FWD Compact SUV)	
V6 3342cc 3.3L DOHC (24 Valve) (G6DB)	09-07	Santa Fe Sport (AWD Compact SUV)		L4 1975cc 2.0L DOHC (16 Valve) (G4GF)	09-05
V6 3470cc 3.5L DOHC (24 Valve) (G6DC)	12-10	L4 1998cc 2.0L DOHC Turbo (16 Valve) (Theta)	13	L4 1998cc 2.0L DOHC (16 Valve) (Theta)	13-11
V6 3497cc 3.5L DOHC (24 Valve) (G6CU)	06-04	L4 2359cc 2.4L DOHC (16 Valve) (Theta)	13	L4 2359cc 2.4L DOHC (16 Valve) (G4KC)	13-10
Santa Fe (AWD Mid-Size SUV)		L4 2359cc 2.4L DOHC (16 Valve) (Theta)	13	V6 2656cc 2.7L DOHC (24 Valve) (G6BA)	09-05
V6 3342cc 3.3L DOHC (24 Valve) (G6DH)	13	Santa Fe Sport (FWD Compact SUV)		Veracruz (AWD Mid-Size SUV)	
Santa Fe (FWD Compact SUV)		L4 1998cc 2.0L DOHC Turbo (16 Valve) (Theta)	13	V6 3778cc 3.8L DOHC (24 Valve) (G6DA)	12-07
L4 2351cc 2.4L DOHC (16 Valve) (G4JS)	06-01	L4 2359cc 2.4L DOHC (16 Valve) (Theta)	13	Veracruz (FWD Mid-Size SUV)	
L4 2359cc 2.4L DOHC (16 Valve) (G4KC)	12-10			V6 3778cc 3.8L DOHC (24 Valve) (G6DA)	12-07
V6 2656cc 2.7L DOHC (24 Valve) (G6BA)	09-01				

1

**2009 - 2005; 2.0L 120.5 (1975cc) DOHC L4 (16 Valve) 82mm Bore
MFI; Gasoline; Naturally Aspirated Hyundai Eng.; Eng. Code G4GF**

1

QTY	CYLINDER HEAD	YEARS	PART NO.	DESCRIPTION
1	Head Gasket	2009-05	26181 PT	Head bolts not incl.; Head bolt replacement recommended; PermaTorqueMLS® LaserWeld® Technology
1	Head Set	2009-08	HS 26181 PT-3	Head bolts & exh. pipe flange not incl.; Head bolt replacement recommended; PermaDry® molded rubber valve cover gskt. incl.; Premium valve stem seals incl.
1	Head Set	2007-05	HS 26181 PT-1	Head bolts & exh. pipe flange not incl.; Head bolt replacement recommended; PermaDry® molded rubber valve cover gskt. incl.; Premium valve stem seals incl.
1	Head Bolt Set	2009-05	ES 71313	Head bolts w/Washers; Replacement recommended
QTY	CONVERSION SET	YEARS	PART NO.	DESCRIPTION
1	Gasket Conversion Set	2009-05	CS 26180	RTV sealant incl. for oil pan gskt.
QTY	MANIFOLD - INT. & EXH.	YEARS	PART NO.	DESCRIPTION
1	Int. Manifold Gasket Set	2009-05	MS 96275	
1	Exh. Manifold Gasket Set	2009-08	MS 97102	
1	Exh. Manifold Gasket Set	2007-05	MS 96128	
QTY	EXHAUST PIPE FLANGE	YEARS	PART NO.	DESCRIPTION
2	Exhaust Pipe Gasket	2009-05	60899	Loc. Rear; Converter
1	Exhaust Pipe Gasket	2009-05	60899	Muffler
1	Exhaust Pipe Gasket	2009-05	61499	Loc. Front; Converter
QTY	OIL PAN	YEARS	PART NO.	DESCRIPTION
1	Drain Plug Gasket	2009-05	72515	
QTY	CRANKSHAFT REAR SEAL	YEARS	PART NO.	DESCRIPTION
1	Rear Main Seal Set	2009-05	BS 40444	Rubber; One-piece

Hyundai Truck (Incl. Minivans and SUV's) (Cont.)

1		2009 - 2005; 2.0L 120.5 (1975cc) DOHC L4 (16 Valve) 82mm Bore			1	
(cont.)		MFI; Gasoline; Naturally Aspirated Hyundai Eng.; Eng. Code G4GF			(cont.)	
QTY	VALVE COVER	YEARS	PART NO.	DESCRIPTION		
1	Valve Cover Gasket Set	2009-05	VS 50583 R	w/Spark plug tube seals; PermaDry® molded rubber gskt. incl.		
1	Spark Plug Tube Seal Set	2009-05	ES 72974	Valve Cover; New Part Number - Check for Availability		
QTY	VALVE STEM SEAL SET	YEARS	PART NO.	DESCRIPTION		
1	Valve Stem Seal Set	2009-05	SS 70795-1	Premium valve stem seals incl.		
QTY	THERMOSTAT HOUSING	YEARS	PART NO.	DESCRIPTION		
1	Water Outlet Gasket	2009-05	25538	Thermostat Housing; Loc. Upper		
1	Thermostat Gasket	2009-05	35671	Thermostat Housing; Loc. Lower		
QTY	WATER OUTLET GASKET	YEARS	PART NO.	DESCRIPTION		
1	Water Outlet Gasket	2009-05	36049	Water Outlet; Water inlet pipe seal; New Part Number - Check for Availability		
1	Water Outlet Gasket	2009	35925	Water Outlet		
QTY	WATER PUMP	YEARS	PART NO.	DESCRIPTION		
1	Water Pump Gasket	2009	35923			
1	Water Pump Gasket	2008-05	35628			
QTY	TIMING COVER	YEARS	PART NO.	DESCRIPTION		
1	Crankshaft Front Seal Set	2009-05	TCS 46017			
1	Camshaft Front Seal Set	2009-05	TCS 45704-1			
QTY	CARB & FUEL INJECTION	YEARS	PART NO.	DESCRIPTION		
2	Fuel Injector O-Ring Set	2009-08	ES 70599	Improved design		
2	Fuel Injector O-Ring Set	2007-05	ES 70599	Exc. California; Improved design		
2	Fuel Injector O-Ring Set	2007-05	ES 70600	California		
1	Throttle Body Gasket	2009-05	60914	Idle air control		
1	Throttle Body Gasket	2009-06	61476	Throttle body		
1	Throttle Body Gasket	2005	61217	Throttle body		
QTY	OIL PUMP COVER	YEARS	PART NO.	DESCRIPTION		
1	Oil Pump Gasket	2009-05	72983	Oil pump mounting gskt.; New Part Number - Check for Availability		
2		2013; 2.0L 121.9 (1998cc) DOHC L4 (16 Valve) 86mm Bore Theta GD i VVT			2	
		DI; Gasoline; Turbo - Intercooled Hyundai Eng.				
QTY	CYLINDER HEAD	YEARS	PART NO.	DESCRIPTION		
1	Head Bolt Set	2013	ES 72465-1	Head bolts w/Washers; Replacement recommended; New Part Number - Check for Availability		
QTY	CRANKSHAFT REAR SEAL	YEARS	PART NO.	DESCRIPTION		
1	Rear Main Seal Set	2013	BS 40702	Rubber; One-piece		
QTY	VALVE STEM SEAL SET	YEARS	PART NO.	DESCRIPTION		
1	Valve Stem Seal Set	2013	SS 71268	Premium valve stem seals incl.		
QTY	THERMOSTAT HOUSING	YEARS	PART NO.	DESCRIPTION		
1	Thermostat Gasket	2013	35918	Thermostat Housing; Thermostat case		
1	Thermostat Gasket	2013	35921	Thermostat Housing; Thermostat O-ring		
QTY	WATER PUMP	YEARS	PART NO.	DESCRIPTION		
1	Water Pump Gasket	2013	35802	To cover		
1	Water Pump Gasket	2013	35813	To block; Improved design		
1	Water Pump Gasket	2013	35822	To block; Old design		
1	Water Pump Gasket	2013	ES 72872	O-ring		
QTY	TIMING COVER	YEARS	PART NO.	DESCRIPTION		
1	Crankshaft Front Seal Set	2013	TCS 46133			
QTY	CARB & FUEL INJECTION	YEARS	PART NO.	DESCRIPTION		
1	Throttle Body Gasket	2013	61504	Throttle body		
3		2013 - 2011; 2.0L 121.9 (1998cc) DOHC L4 (16 Valve) 86mm Bore Theta VVT			3	
		MFI; Gasoline; Naturally Aspirated Hyundai Eng.				
QTY	CYLINDER HEAD	YEARS	PART NO.	DESCRIPTION		
1	Head Bolt Set	2013-11	ES 72465-1	Head bolts w/Washers; Replacement recommended; New Part Number - Check for Availability		
QTY	MANIFOLD - INT. & EXH.	YEARS	PART NO.	DESCRIPTION		
1	Int. Manifold Gasket Set	2013-11	MS 97100			
1	Exh. Manifold Gasket Set	2013-11	MS 96874			
QTY	EXHAUST PIPE FLANGE	YEARS	PART NO.	DESCRIPTION		
1	Exhaust Pipe Gasket	2013-11	61499	Exh. connector		
1	Exhaust Pipe Gasket	2013-11	61499	Loc. Rear; Converter		
1	Exhaust Pipe Gasket	2013-11	61503	Loc. Front; Converter		
QTY	CRANKSHAFT REAR SEAL	YEARS	PART NO.	DESCRIPTION		
1	Rear Main Seal Set	2013-11	BS 40702	Rubber; One-piece		

Hyundai Truck (Incl. Minivans and SUV's) (Cont.)

3		2013 - 2011; 2.0L 121.9 (1998cc) DOHC L4 (16 Valve) 86mm Bore Theta VVT			3
(cont.)		MFI; Gasoline; Naturally Aspirated Hyundai Eng.			(cont.)
QTY	VALVE STEM SEAL SET	YEARS	PART NO.	DESCRIPTION	
1	Valve Stem Seal Set	2013-11	SS 71268	Premium valve stem seals incl.	
QTY	THERMOSTAT HOUSING	YEARS	PART NO.	DESCRIPTION	
1	Thermostat Gasket	2013-11	35918	Thermostat Housing; Thermostat case	
1	Thermostat Gasket	2013-11	35921	Thermostat Housing; Thermostat O-ring	
QTY	WATER OUTLET GASKET	YEARS	PART NO.	DESCRIPTION	
1	Thermostat Gasket	2013-11	35368	Water Outlet; Inlet to water pump	
QTY	WATER PUMP	YEARS	PART NO.	DESCRIPTION	
1	Water Pump Gasket	2013-11	35802	To cover	
1	Water Pump Gasket	2013-11	35813	To block; Improved design	
1	Water Pump Gasket	2013-11	35822	To block; Old design	
1	Water Pump Gasket	2013-11	ES 72872	O-ring	
QTY	TIMING COVER	YEARS	PART NO.	DESCRIPTION	
1	Crankshaft Front Seal Set	2013-11	TCS 46133		
QTY	CARB & FUEL INJECTION	YEARS	PART NO.	DESCRIPTION	
2	Fuel Injector O-Ring Set	2013-11	ES 70599	Improved design	
1	Throttle Body Gasket	2013-11	61504	Throttle body	
4		2006 - 2001; 2.4L 143.4 (2351cc) DOHC L4 (16 Valve) 86.5mm Bore			4
		MFI; Gasoline; Naturally Aspirated Mitsubishi Eng.; Eng. Code G4JS			
QTY	CYLINDER HEAD	YEARS	PART NO.	DESCRIPTION	
1	Head Gasket	2006-01	26282 PT	Head bolts not incl.; Head bolt replacement recommended; PermaTorqueMLS® LaserWeld® Technology	
1	Head Set	2006-01	HS 26282 PT	Head bolts not incl.; Head bolt replacement recommended; PermaDry® molded rubber valve cover gskt. incl.; Premium valve stem seals incl.	
1	Head Bolt Set	2006-01	ES 72211	Head bolts w/Washers; Replacement recommended	
QTY	CONVERSION SET	YEARS	PART NO.	DESCRIPTION	
1	Gasket Conversion Set	2006-02	CS 26282-1	RTV sealant incl. for Upper oil pan gskt.	
1	Gasket Conversion Set	2001	CS 26282	To 07/02/00; RTV sealant incl. for Upper oil pan gskt.	
1	Gasket Conversion Set	2001	CS 26282-1	From 07/03/00; RTV sealant incl. for Upper oil pan gskt.	
QTY	MANIFOLD - INT. & EXH.	YEARS	PART NO.	DESCRIPTION	
1	Int. Manifold Gasket Set	2006-01	MS 96633		
1	Exh. Manifold Gasket Set	2006-01	MS 95470		
QTY	EXHAUST PIPE FLANGE	YEARS	PART NO.	DESCRIPTION	
1	Exhaust Pipe Gasket	2006-01	60899	Exh. connector	
1	Exhaust Pipe Gasket	2006-01	61399	Converter	
1	Exhaust Pipe Gasket	2006-01	61400	Flange	
QTY	OIL PAN	YEARS	PART NO.	DESCRIPTION	
1	Oil Pan Gasket Set	2006-02	OS 30759	Loc. Lower; RTV sealant incl. for Upper oil pan gskt.	
1	Oil Pan Gasket Set	2001	OS 30758	Loc. Lower; To 07/02/00; RTV sealant incl. for Upper oil pan gskt.	
1	Oil Pan Gasket Set	2001	OS 30759	Loc. Lower; From 07/03/00; RTV sealant incl. for Upper oil pan gskt.	
QTY	CRANKSHAFT REAR SEAL	YEARS	PART NO.	DESCRIPTION	
1	Rear Main Seal Set	2006-01	BS 40663	Rubber; One-piece	
QTY	VALVE COVER	YEARS	PART NO.	DESCRIPTION	
1	Valve Cover Gasket Set	2006-01	VS 50651 R	w/Semi-circular plug & Grommets & Spark plug tube seals; PermaDry® molded rubber gskt. incl.	
1	Semi-Circular Plug	2006-01	CP 75013	Valve Cover	
QTY	VALVE STEM SEAL SET	YEARS	PART NO.	DESCRIPTION	
1	Valve Stem Seal Set	2006-01	SS 71179-2	Premium valve stem seals incl.	
QTY	THERMOSTAT HOUSING	YEARS	PART NO.	DESCRIPTION	
1	Thermostat Gasket	2006-01	35778	Thermostat Housing	
QTY	WATER PUMP	YEARS	PART NO.	DESCRIPTION	
1	Water Pump Gasket	2006-01	35777		
QTY	TIMING COVER	YEARS	PART NO.	DESCRIPTION	
1	Crankshaft Front Seal Set	2006-01	TCS 46062		
1	Camshaft Front Seal Set	2006-01	TCS 45704		
QTY	CARB & FUEL INJECTION	YEARS	PART NO.	DESCRIPTION	
2	Fuel Injector O-Ring Set	2006-01	ES 70599	Improved design	
1	Throttle Body Gasket	2006-01	61245	Idle air control	
1	Throttle Body Gasket	2006-01	61390	Throttle body	
QTY	EXHAUST GAS RECIRCULATION	YEARS	PART NO.	DESCRIPTION	
1	EGR Gasket	2006-01	70152		

Hyundai Truck (Incl. Minivans and SUV's) (Cont.)

5		2013; 2.4L 144 (2359cc) DOHC L4 (16 Valve) 88mm Bore Theta GDi VVT			5
Dl; Gasoline; Naturally Aspirated Hyundai Eng.					
QTY	CYLINDER HEAD	YEARS	PART NO.	DESCRIPTION	
1	Head Bolt Set	2013	ES 72465-1	Head bolts w/Washers; Replacement recommended; New Part Number - Check for Availability	
QTY	MANIFOLD - INT. & EXH.	YEARS	PART NO.	DESCRIPTION	
1	Exh. Manifold Gasket Set	2013	MS 96874		
QTY	CRANKSHAFT REAR SEAL	YEARS	PART NO.	DESCRIPTION	
1	Rear Main Seal Set	2013	BS 40702	Rubber; One-piece	
QTY	VALVE STEM SEAL SET	YEARS	PART NO.	DESCRIPTION	
1	Valve Stem Seal Set	2013	SS 71268	Premium valve stem seals incl.	
QTY	THERMOSTAT HOUSING	YEARS	PART NO.	DESCRIPTION	
1	Thermostat Gasket	2013	35918	Thermostat Housing; Thermostat case	
1	Thermostat Gasket	2013	35921	Thermostat Housing; Thermostat O-ring	
QTY	WATER OUTLET GASKET	YEARS	PART NO.	DESCRIPTION	
1	Thermostat Gasket	2013	35368	Water Outlet; Inlet to water pump	
QTY	WATER PUMP	YEARS	PART NO.	DESCRIPTION	
1	Water Pump Gasket	2013	35802	To cover	
1	Water Pump Gasket	2013	35813	To block; Improved design	
1	Water Pump Gasket	2013	35822	To block; Old design	
1	Water Pump Gasket	2013	ES 72872	O-ring	
QTY	TIMING COVER	YEARS	PART NO.	DESCRIPTION	
1	Crankshaft Front Seal Set	2013	TCS 46133		
QTY	CARB & FUEL INJECTION	YEARS	PART NO.	DESCRIPTION	
2	Fuel Injector O-Ring Set	2013	ES 70599	Improved design	
6		2012 - 2010; 2.4L 144 (2359cc) DOHC L4 (16 Valve) 88mm Bore VVT			6
MFI; Gasoline; Naturally Aspirated Hyundai Eng.; Eng. Code G4KC					
QTY	CYLINDER HEAD	YEARS	PART NO.	DESCRIPTION	
1	Head Gasket	2012-10	26333 PT	Head bolts not incl.; Head bolt replacement recommended; PermaTorqueMLS®	
1	Head Bolt Set	2012-10	ES 72465-1	Head bolts w/Washers; Replacement recommended; New Part Number - Check for Availability	
QTY	CONVERSION SET	YEARS	PART NO.	DESCRIPTION	
1	Gasket Conversion Set	2012-10	CS 26333-1	RTV sealant incl. for oil pan gskt.	
QTY	MANIFOLD - INT. & EXH.	YEARS	PART NO.	DESCRIPTION	
1	Int. Manifold Gasket Set	2012-10	MS 97100		
1	Exh. Manifold Gasket Set	2012-10	MS 96874		
QTY	EXHAUST PIPE FLANGE	YEARS	PART NO.	DESCRIPTION	
1	Exhaust Pipe Gasket	2012-10	61499	Exh. connector	
1	Exhaust Pipe Gasket	2012-10	61499	Loc. Rear; Converter	
1	Exhaust Pipe Gasket	2012-10	61503	Loc. Front; Converter	
1	Exhaust Pipe Gasket	2012-10	61503	Pipe to manifold	
QTY	OIL PAN	YEARS	PART NO.	DESCRIPTION	
1	Oil Pan Gasket Set	2012-10	OS 30778	RTV sealant incl. for oil pan gskt.; Old design	
1	Oil Pan Gasket Set	2012-10	OS 30782	RTV sealant incl. for oil pan gskt.; Improved design	
QTY	CRANKSHAFT REAR SEAL	YEARS	PART NO.	DESCRIPTION	
1	Rear Main Seal Set	2012-10	BS 40702	Rubber; One-piece	
QTY	VALVE STEM SEAL SET	YEARS	PART NO.	DESCRIPTION	
1	Valve Stem Seal Set	2012-10	SS 71268	Premium valve stem seals incl.	
QTY	THERMOSTAT HOUSING	YEARS	PART NO.	DESCRIPTION	
1	Thermostat Gasket	2012-10	35918	Thermostat Housing; Thermostat case	
1	Thermostat Gasket	2012-10	35921	Thermostat Housing; Thermostat O-ring	
QTY	WATER PUMP	YEARS	PART NO.	DESCRIPTION	
1	Water Pump Gasket	2012-10	35802	To cover	
1	Water Pump Gasket	2012-10	35813	To block; Improved design	
1	Water Pump Gasket	2012-10	35822	To block; Old design	
1	Water Pump Gasket	2012-10	ES 72872	O-ring	
QTY	TIMING COVER	YEARS	PART NO.	DESCRIPTION	
1	Crankshaft Front Seal Set	2012-10	TCS 46133		
QTY	CARB & FUEL INJECTION	YEARS	PART NO.	DESCRIPTION	
2	Fuel Injector O-Ring Set	2012-10	ES 70599	Improved design	
1	Throttle Body Gasket	2012-10	61504	Throttle body	
QTY	EXHAUST GAS RECIRCULATION	YEARS	PART NO.	DESCRIPTION	
1	EGR Gasket	2012-10	70152		

Hyundai Truck (Incl. Minivans and SUV's) (Cont.)

6 (cont.)	2012 - 2010; 2.4L 144 (2359cc) DOHC L4 (16 Valve) 88mm Bore VVT MFI; Gasoline; Naturally Aspirated Hyundai Eng.; Eng. Code G4KC				6 (cont.)
QTY	OIL FILTER MOUNTING	YEARS	PART NO.	DESCRIPTION	
1	Oil Filter Adapter Gasket	2012-10	72997	Oil filter adapter gskt.; New Part Number - Check for Availability	
7	2009 - 2001; 2.7L 162 (2656cc) DOHC V6 (24 Valve) 86.7mm Bore MFI; Gasoline; Naturally Aspirated Hyundai Eng.; Eng. Code G6BA				7
QTY	CYLINDER HEAD	YEARS	PART NO.	DESCRIPTION	
1	Head Gasket	2009-07	26276 PT	Exc. Hyundai Santa Fe GLS; Loc. L.H.; Head bolts not incl.; Head bolt replacement recommended; PermaTorqueMLS®	
1	Head Gasket	2009-07	26277 PT	Exc. Hyundai Santa Fe GLS; Loc. R.H.; Head bolts not incl.; Head bolt replacement recommended; PermaTorqueMLS®	
1	Head Gasket	2009	26437 PT	Hyundai Santa Fe GLS; Loc. L.H.; Head bolts not incl.; Head bolt replacement recommended; PermaTorqueMLS®	
1	Head Gasket	2009	26439 PT	Hyundai Santa Fe GLS; Loc. R.H.; Head bolts not incl.; Head bolt replacement recommended; PermaTorqueMLS®	
1	Head Gasket	2008	26340 PT	Hyundai Santa Fe GLS; Loc. R.H.; To 11/24/07; Head bolts not incl.; Head bolt replacement recommended; PermaTorqueMLS®	
1	Head Gasket	2008	26341 PT	Hyundai Santa Fe GLS; Loc. L.H.; To 11/24/07; Head bolts not incl.; Head bolt replacement recommended; PermaTorqueMLS®	
1	Head Gasket	2008	26437 PT	Hyundai Santa Fe GLS; Loc. L.H.; From 11/25/07; Head bolts not incl.; Head bolt replacement recommended; PermaTorqueMLS®	
1	Head Gasket	2008	26439 PT	Hyundai Santa Fe GLS; Loc. R.H.; From 11/25/07; Head bolts not incl.; Head bolt replacement recommended; PermaTorqueMLS®	
1	Head Gasket	2007	26340 PT	Hyundai Santa Fe GLS; Loc. R.H.; Head bolts not incl.; Head bolt replacement recommended; PermaTorqueMLS®	
1	Head Gasket	2007	26341 PT	Hyundai Santa Fe GLS; Loc. L.H.; Head bolts not incl.; Head bolt replacement recommended; PermaTorqueMLS®	
1	Head Gasket	2006-01	26276 PT	Loc. L.H.; Head bolts not incl.; Head bolt replacement recommended; PermaTorqueMLS®	
1	Head Gasket	2006-01	26277 PT	Loc. R.H.; Head bolts not incl.; Head bolt replacement recommended; PermaTorqueMLS®	
1	Head Set	2009	HS 26276 PT-1	Exc. Hyundai Santa Fe GLS; To 02/17/09; Head bolts not incl.; Head bolt replacement recommended; PermaDry® molded rubber valve cover gskts. incl.; Premium valve stem seals incl.	
1	Head Set	2009	HS 26276 PT-2	Exc. Hyundai Santa Fe GLS; From 02/18/09; Head bolts not incl.; Head bolt replacement recommended; PermaDry® molded rubber valve cover gskts. incl.; Premium valve stem seals incl.	
1	Head Set	2009	HS 26437 PT	Hyundai Santa Fe GLS; Head bolts not incl.; Head bolt replacement recommended; PermaDry® molded rubber valve cover gskts. incl.; Premium valve stem seals incl.	
1	Head Set	2008-07	HS 26276 PT-1	Exc. Hyundai Santa Fe GLS; Head bolts not incl.; Head bolt replacement recommended; PermaDry® molded rubber valve cover gskts. incl.; Premium valve stem seals incl.	
1	Head Set	2008	HS 26340 PT	Hyundai Santa Fe GLS; To 11/24/07; Head bolts not incl.; Head bolt replacement recommended; PermaDry® molded rubber valve cover gskts. incl.; Premium valve stem seals incl.	
1	Head Set	2008	HS 26437 PT	Hyundai Santa Fe GLS; From 11/25/07; Head bolts not incl.; Head bolt replacement recommended; PermaDry® molded rubber valve cover gskts. incl.; Premium valve stem seals incl.	
1	Head Set	2007	HS 26340 PT	Hyundai Santa Fe GLS; Head bolts not incl.; Head bolt replacement recommended; PermaDry® molded rubber valve cover gskts. incl.; Premium valve stem seals incl.	
1	Head Set	2006-05	HS 26276 PT-1	Head bolts not incl.; Head bolt replacement recommended; PermaDry® molded rubber valve cover gskts. incl.; Premium valve stem seals incl.	
1	Head Set	2004	HS 26276 PT	To 08/31/03; Head bolts not incl.; Head bolt replacement recommended; PermaDry® molded rubber valve cover gskts. incl.; Premium valve stem seals incl.	
1	Head Set	2004	HS 26276 PT-1	From 09/01/03; Head bolts not incl.; Head bolt replacement recommended; PermaDry® molded rubber valve cover gskts. incl.; Premium valve stem seals incl.	
1	Head Set	2003-01	HS 26276 PT	Head bolts not incl.; Head bolt replacement recommended; PermaDry® molded rubber valve cover gskts. incl.; Premium valve stem seals incl.	
2	Head Bolt Set	2009-01	ES 72205	Head bolts w/Washers; Replacement recommended	
QTY	CONVERSION SET	YEARS	PART NO.	DESCRIPTION	
1	Gasket Conversion Set	2009-07	CS 26276	Exc. Hyundai Santa Fe GLS; RTV sealant incl. for Upper oil pan gskt.	
1	Gasket Conversion Set	2009-07	CS 26340	Hyundai Santa Fe GLS; RTV sealant incl. for Upper oil pan gskt.	
1	Gasket Conversion Set	2006-01	CS 26276	RTV sealant incl. for Upper oil pan gskt.	

Hyundai Truck (Incl. Minivans and SUV's) (Cont.)

7 (cont.)		2009 - 2001; 2.7L 162 (2656cc) DOHC V6 (24 Valve) 86.7mm Bore MFI; Gasoline; Naturally Aspirated Hyundai Eng.; Eng. Code G6BA			7 (cont.)
QTY	MANIFOLD - INT. & EXH.	YEARS	PART NO.	DESCRIPTION	
1	Int. Manifold Gasket Set	2009-07	MS 96597-1	Hyundai Santa Fe GLS; Upper set incl.	
1	Int. Manifold Gasket Set	2009	MS 96597	Exc. Hyundai Santa Fe GLS; To 02/17/09; Upper set incl.	
1	Int. Manifold Gasket Set	2009	MS 97104	Exc. Hyundai Santa Fe GLS; From 02/18/09; Upper set incl.	
1	Int. Manifold Gasket Set	2008-07	MS 96597	Exc. Hyundai Santa Fe GLS; Upper set incl.	
1	Int. Manifold Gasket Set	2006-01	MS 96597	Upper set incl.	
1	Plenum Gasket Set	2009-07	MS 96591	Exc. Hyundai Santa Fe GLS; Upper set	
1	Plenum Gasket Set	2006-01	MS 96591	Upper set	
1	Exh. Manifold Gasket Set	2009-01	MS 96598		
QTY	EXHAUST PIPE FLANGE	YEARS	PART NO.	DESCRIPTION	
2	Exhaust Pipe Gasket	2009-01	60899	Exh. connector; 1 or 2 Req'd.	
1	Exhaust Pipe Gasket	2009-01	60899	Loc. L.H.; Flange	
1	Exhaust Pipe Gasket	2009-01	61381	Loc. R.H.; Flange	
1	Exhaust Pipe Gasket	2009-06	61503	Exc. Hyundai Santa Fe GLS; Loc. Rear; Exh. connector	
1	Exhaust Pipe Gasket	2009-06	61505	Exc. Hyundai Santa Fe GLS; Loc. Front; Exh. connector	
1	Exhaust Pipe Gasket	2009-07	60899	Exc. Hyundai Santa Fe GLS; Converter	
1	Exhaust Pipe Gasket	2009-07	61499	Hyundai Santa Fe GLS; Loc. Rear; Converter	
1	Exhaust Pipe Gasket	2009-07	61503	Hyundai Santa Fe GLS; Loc. Front; Converter	
2	Exhaust Pipe Gasket	2009-07	61505	Hyundai Santa Fe GLS; Pipe to manifold	
1	Exhaust Pipe Gasket	2006-01	60899	Converter	
1	Exhaust Pipe Gasket	2005	61503	Hyundai Tucson GLS, LX; Loc. Rear; Exh. connector	
1	Exhaust Pipe Gasket	2005	61505	Hyundai Tucson GLS, LX; Loc. Front; Exh. connector	
QTY	OIL PAN	YEARS	PART NO.	DESCRIPTION	
1	Oil Pan Gasket Set	2009-07	OS 30753	Exc. Hyundai Santa Fe GLS; Loc. Lower; RTV sealant incl. for Upper oil pan gskt.	
1	Oil Pan Gasket Set	2009-07	OS 30789	Hyundai Santa Fe GLS; Loc. Lower; RTV sealant incl. for Upper oil pan gskt.	
1	Oil Pan Gasket Set	2006-01	OS 30753	Loc. Lower; RTV sealant incl. for Upper oil pan gskt.	
1	Drain Plug Gasket	2009-01	72515		
QTY	CRANKSHAFT REAR SEAL	YEARS	PART NO.	DESCRIPTION	
1	Rear Main Seal Set	2009-01	BS 40562	Rubber; One-piece	
QTY	VALVE COVER	YEARS	PART NO.	DESCRIPTION	
1	Valve Cover Gasket Set	2009-07	VS 50641 R	Exc. Hyundai Santa Fe GLS; w/Spark plug tube seals; PermaDry® molded rubber gskts. incl.	
1	Valve Cover Gasket Set	2009-07	VS 50693 R	Hyundai Santa Fe GLS; w/Spark plug tube seals; PermaDry® molded rubber gskts. incl.	
1	Valve Cover Gasket Set	2006-05	VS 50641 R	w/Spark plug tube seals; PermaDry® molded rubber gskts. incl.	
1	Valve Cover Gasket Set	2004	VS 50640 R	To 08/31/03; w/Spark plug tube seals; PermaDry® molded rubber gskts. incl.	
1	Valve Cover Gasket Set	2004	VS 50641 R	From 09/01/03; w/Spark plug tube seals; PermaDry® molded rubber gskts. incl.	
1	Valve Cover Gasket Set	2003-01	VS 50640 R	w/Spark plug tube seals; PermaDry® molded rubber gskts. incl.	
1	Circular Plug	2009-01	CP 75023	Valve Cover	
QTY	VALVE STEM SEAL SET	YEARS	PART NO.	DESCRIPTION	
1	Valve Stem Seal Set	2009-01	SS 72819	Premium valve stem seals incl.	
QTY	THERMOSTAT HOUSING	YEARS	PART NO.	DESCRIPTION	
2	Thermostat Gasket	2009-08	35764	Thermostat Housing; To 07/14/08	
2	Thermostat Gasket	2009-08	35764	Thermostat Housing; To 07/14/08; Thermostat case to head	
1	Thermostat Gasket	2009-08	35917	Thermostat Housing; From 07/15/08	
2	Thermostat Gasket	2009-08	35920	Thermostat Housing; From 07/15/08; Thermostat case to head	
2	Thermostat Gasket	2007-01	35764	Thermostat Housing	
2	Thermostat Gasket	2007-01	35764	Thermostat Housing; Thermostat case to head	
1	O-Ring	2009-01	35555	Thermostat Housing; Thermostat seal	
QTY	WATER PUMP	YEARS	PART NO.	DESCRIPTION	
1	Water Pump Gasket	2009-07	35819	Hyundai Santa Fe GLS	
1	Water Pump Gasket	2009	35765	Exc. Hyundai Santa Fe GLS; To 09/30/08	
1	Water Pump Gasket	2009	35919	Exc. Hyundai Santa Fe GLS; From 10/01/08	
1	Water Pump Gasket	2008-07	35765	Exc. Hyundai Santa Fe GLS	
1	Water Pump Gasket	2006-01	35765		
QTY	TIMING COVER	YEARS	PART NO.	DESCRIPTION	
1	Crankshaft Front Seal Set	2009-01	TCS 45911		
1	Camshaft Front Seal Set	2009-01	TCS 46053		
1	Camshaft Rear Seal Set	2009-01	TCS 46052		
QTY	CARB & FUEL INJECTION	YEARS	PART NO.	DESCRIPTION	
3	Fuel Injector O-Ring Set	2009-01	ES 70599	Improved design	
1	Throttle Body Gasket	2009-01	61245	Idle air control	
1	Throttle Body Gasket	2009-07	61380	Exc. Hyundai Santa Fe GLS; Throttle body	

Hyundai Truck (Incl. Minivans and SUV's) (Cont.)

7 (cont.)		2009 - 2001; 2.7L 162 (2656cc) DOHC V6 (24 Valve) 86.7mm Bore			7 (cont.)
		MFI; Gasoline; Naturally Aspirated Hyundai Eng.; Eng. Code G6BA			
QTY	CARB & FUEL INJECTION	YEARS	PART NO.	DESCRIPTION	
1	Throttle Body Gasket	2009-07	61496	Hyundai Santa Fe GLS; Throttle body; Improved design; New Part Number - Check for Availability	
1	Throttle Body Gasket	2006-01	61380	Throttle body	
QTY	EXHAUST GAS RECIRCULATION	YEARS	PART NO.	DESCRIPTION	
1	EGR Gasket	2009-01	70152		
8		2009 - 2007; 3.3L 204 (3342cc) DOHC V6 (24 Valve) 92mm Bore Lambda			8
		MFI; Gasoline; Naturally Aspirated Hyundai Eng.; Eng. Code G6DB			
QTY	CYLINDER HEAD	YEARS	PART NO.	DESCRIPTION	
1	Head Gasket	2009-08	26427 PT	Loc. L.H.; Head bolts not incl.; Head bolt replacement recommended; PermaTorqueMLS®	
1	Head Gasket	2009-08	26429 PT	Loc. R.H.; Head bolts not incl.; Head bolt replacement recommended; PermaTorqueMLS®	
1	Head Gasket	2007	26422 PT	Loc. R.H.; To 04/20/07; Head bolts not incl.; Head bolt replacement recommended; PermaTorqueMLS®	
1	Head Gasket	2007	26424 PT	Loc. L.H.; To 04/20/07; Head bolts not incl.; Head bolt replacement recommended; PermaTorqueMLS®	
1	Head Gasket	2007	26427 PT	Loc. L.H.; From 04/21/07; Head bolts not incl.; Head bolt replacement recommended; PermaTorqueMLS®	
1	Head Gasket	2007	26429 PT	Loc. R.H.; From 04/21/07; Head bolts not incl.; Head bolt replacement recommended; PermaTorqueMLS®	
1	Head Set	2009-08	HS 26427 PT	Head bolts not incl.; Head bolt replacement recommended; PermaDry® molded rubber valve cover gskts. incl.; Premium valve stem seals incl.	
1	Head Set	2007	HS 26422 PT	To 04/20/07; Head bolts not incl.; Head bolt replacement recommended; PermaDry® molded rubber valve cover gskts. incl.; Premium valve stem seals incl.	
1	Head Set	2007	HS 26427 PT	From 04/21/07; Head bolts not incl.; Head bolt replacement recommended; PermaDry® molded rubber valve cover gskts. incl.; Premium valve stem seals incl.	
1	Head Bolt Set	2009-07	ES 72366	Replacement recommended	
QTY	CONVERSION SET	YEARS	PART NO.	DESCRIPTION	
1	Gasket Conversion Set	2009-07	CS 26414	RTV sealant incl. for Upper oil pan gskt.; New Part Number - Check for Availability	
QTY	MANIFOLD - INT. & EXH.	YEARS	PART NO.	DESCRIPTION	
1	Int. Manifold Gasket Set	2009-07	MS 97086	Lower set; Upper set incl.	
1	Plenum Gasket Set	2009-07	MS 97227	Upper set; New Part Number - Check for Availability	
1	Exh. Manifold Gasket Set	2009-07	MS 97074		
QTY	EXHAUST PIPE FLANGE	YEARS	PART NO.	DESCRIPTION	
1	Exhaust Pipe Gasket	2009-07	60899	Loc. Rear; Converter	
1	Exhaust Pipe Gasket	2009-07	61451	Exh. connector	
1	Exhaust Pipe Gasket	2009-07	61479	Loc. Front; Converter	
2	Exhaust Pipe Gasket	2009-07	61503	Loc. Rear; Pipe to manifold	
2	Exhaust Pipe Gasket	2009-07	61570	Loc. Front; Pipe to manifold	
QTY	OIL PAN	YEARS	PART NO.	DESCRIPTION	
1	Oil Pan Gasket Set	2009-07	OS 30822	Loc. Lower	
QTY	CRANKSHAFT REAR SEAL	YEARS	PART NO.	DESCRIPTION	
1	Rear Main Seal Set	2009-07	BS 40710	Rubber; One-piece	
QTY	VALVE COVER	YEARS	PART NO.	DESCRIPTION	
1	Valve Cover Gasket Set	2009-07	VS 50750 R	w/Spark plug tube seals; PermaDry® molded rubber gskts. incl.	
QTY	VALVE STEM SEAL SET	YEARS	PART NO.	DESCRIPTION	
1	Valve Stem Seal Set	2009-07	SS 72298	Premium valve stem seals incl.	
QTY	THERMOSTAT HOUSING	YEARS	PART NO.	DESCRIPTION	
1	Thermostat Gasket	2009-08	35933	Thermostat Housing	
QTY	WATER OUTLET GASKET	YEARS	PART NO.	DESCRIPTION	
1	Water Outlet Gasket	2009-07	35868	Water Outlet; Loc. L.H.	
1	Water Outlet Gasket	2009-07	35870	Water Outlet; Loc. R.H.	
1	Water Outlet Gasket	2009-07	35894	Water Outlet; O-ring; New Part Number - Check for Availability	
2	Water Outlet Gasket	2009-07	35959	Water Outlet; Water pipe; O-ring	
1	Water Crossover Mounting Set	2009-07	ES 72971	Water Outlet; New Part Number - Check for Availability	
QTY	WATER PUMP	YEARS	PART NO.	DESCRIPTION	
1	Water Pump Gasket	2009-07	35896	Loc. R.H.	
1	Water Pump Gasket	2009-07	35903	Loc. L.H.; New Part Number - Check for Availability	
QTY	TIMING COVER	YEARS	PART NO.	DESCRIPTION	
1	Crankshaft Front Seal Set	2009-07	TCS 46111		

Hyundai Truck (Incl. Minivans and SUV's) (Cont.)

8		2009 - 2007; 3.3L 204 (3342cc) DOHC V6 (24 Valve) 92mm Bore Lambda			8	
(cont.)		MFI; Gasoline; Naturally Aspirated Hyundai Eng.; Eng. Code G6DB			(cont.)	
QTY	CARB & FUEL INJECTION	YEARS	PART NO.	DESCRIPTION		
1	Throttle Body Gasket	2009-07	61566			
1	Throttle Body Gasket	2009	61560	To 04/06/09		
1	Throttle Body Gasket	2008-07	61560			
9		2012 - 2010; 3.5L 211.7 (3470cc) DOHC V6 (24 Valve) 92mm Bore Lambda VVT			9	
		MFI; Gasoline; Naturally Aspirated Hyundai Eng.; Eng. Code G6DC				
QTY	CYLINDER HEAD	YEARS	PART NO.	DESCRIPTION		
1	Head Gasket	2011-10	26427 PT	Loc. L.H.; Head bolts not incl.; Head bolt replacement recommended; PermaTorqueMLS®		
1	Head Gasket	2011-10	26429 PT	Loc. R.H.; Head bolts not incl.; Head bolt replacement recommended; PermaTorqueMLS®		
1	Head Bolt Set	2011-10	ES 72366	Replacement recommended		
QTY	MANIFOLD - INT. & EXH.	YEARS	PART NO.	DESCRIPTION		
1	Int. Manifold Gasket Set	2011-10	MS 97322	Lower set; Upper set incl.; OEM style; New Part Number - Check for Availability		
1	Exh. Manifold Gasket Set	2012-10	MS 97115			
QTY	EXHAUST PIPE FLANGE	YEARS	PART NO.	DESCRIPTION		
2	Exhaust Pipe Gasket	2012-10	61503	Exh. connector		
2	Exhaust Pipe Gasket	2012-10	61503	Loc. Rear; Converter		
2	Exhaust Pipe Gasket	2012-10	61604	Loc. Front; Converter		
QTY	CRANKSHAFT REAR SEAL	YEARS	PART NO.	DESCRIPTION		
1	Rear Main Seal Set	2012-10	BS 40562	Rubber; One-piece		
QTY	VALVE COVER	YEARS	PART NO.	DESCRIPTION		
1	Valve Cover Gasket Set	2012-10	VS 50764 R	w/Spark plug tube seals; PermaDry® molded rubber gskts. incl.; New Part Number - Check for Availability		
QTY	VALVE STEM SEAL SET	YEARS	PART NO.	DESCRIPTION		
1	Valve Stem Seal Set	2012-10	SS 72298	Premium valve stem seals incl.		
QTY	WATER OUTLET GASKET	YEARS	PART NO.	DESCRIPTION		
1	Water Crossover Mounting Set	2012-10	ES 73007	Water Outlet; New Part Number - Check for Availability		
QTY	WATER PUMP	YEARS	PART NO.	DESCRIPTION		
1	Water Pump Gasket	2012-10	35896	Loc. R.H.		
1	Water Pump Gasket	2012-10	35935	Loc. L.H.		
QTY	TIMING COVER	YEARS	PART NO.	DESCRIPTION		
1	Crankshaft Front Seal Set	2012-10	TCS 46111			
QTY	CARB & FUEL INJECTION	YEARS	PART NO.	DESCRIPTION		
3	Fuel Injector O-Ring Set	2012-10	ES 70599	Improved design		
1	Throttle Body Gasket	2012-10	61566			
10		2006 - 2003; 3.5L 213.3 (3497cc) DOHC V6 (24 Valve) 93mm Bore			10	
		MFI; Gasoline; Naturally Aspirated Mitsubishi Eng.; Eng. Code G6CU				
QTY	CYLINDER HEAD	YEARS	PART NO.	DESCRIPTION		
1	Head Gasket	2006-03	26293 PT	Loc. R.H.; Head bolts not incl.; Head bolt replacement recommended; PermaTorqueMLS®		
1	Head Gasket	2006-03	26294 PT	Loc. L.H.; Head bolts not incl.; Head bolt replacement recommended; PermaTorqueMLS®		
1	Head Set	2006-03	HS 26293 PT	Head bolts not incl.; Head bolt replacement recommended; PermaDry® molded rubber valve cover gskts. incl.; Premium valve stem seals incl.		
1	Head Bolt Set	2006-03	ES 72859	Head bolts w/Washers; Replacement recommended		
QTY	CONVERSION SET	YEARS	PART NO.	DESCRIPTION		
1	Gasket Conversion Set	2006-03	CS 26293	RTV sealant incl. for Upper oil pan gskt.; Old design		
1	Gasket Conversion Set	2006-03	CS 26293-2	RTV sealant incl. for Upper oil pan gskt.; Improved design		
QTY	MANIFOLD - INT. & EXH.	YEARS	PART NO.	DESCRIPTION		
1	Int. Manifold Gasket Set	2006-03	MS 96460	Lower set; Upper set incl.		
1	Plenum Gasket Set	2006-03	MS 95008	Upper set		
1	Exh. Manifold Gasket Set	2006-03	MS 95082			
QTY	EXHAUST PIPE FLANGE	YEARS	PART NO.	DESCRIPTION		
1	Exhaust Pipe Gasket	2006-03	60899	Loc. Front; Exh. connector		
1	Exhaust Pipe Gasket	2006-03	61383	Loc. Front; Flange		
1	Exhaust Pipe Gasket	2006-03	61383	Loc. Rear; Exh. connector		
1	Exhaust Pipe Gasket	2006-03	61419	Loc. Rear; Flange		
1	Exhaust Pipe Gasket	2006-03	61423	Loc. R.H.; Converter		
1	Exhaust Pipe Gasket	2006-03	61429	Loc. L.H.; Converter		
2	Exhaust Pipe Gasket	2006-03	61451	Loc. Front; Converter		

Hyundai Truck (Incl. Minivans and SUV's) (Cont.)

10 (cont.)	2006 - 2003; 3.5L 213.3 (3497cc) DOHC V6 (24 Valve) 93mm Bore MFI; Gasoline; Naturally Aspirated Mitsubishi Eng.; Eng. Code G6CU				10 (cont.)
QTY	OIL PAN	YEARS	PART NO.	DESCRIPTION	
1	Oil Pan Gasket Set	2006-03	OS 30762	Loc. Lower; RTV sealant incl. for Upper oil pan gskt.	
1	Drain Plug Gasket	2006-03	72515		
QTY	CRANKSHAFT REAR SEAL	YEARS	PART NO.	DESCRIPTION	
1	Rear Main Seal Set	2006-03	BS 40562	Rubber; One-piece	
QTY	VALVE COVER	YEARS	PART NO.	DESCRIPTION	
1	Valve Cover Gasket Set	2006-03	VS 50658 R	w/Spark plug tube seals; PermaDry® molded rubber gskts. incl.	
4	Circular Plug	2006-03	CP 75023	Valve Cover	
QTY	VALVE STEM SEAL SET	YEARS	PART NO.	DESCRIPTION	
1	Valve Stem Seal Set	2006-03	SS 71179	Premium valve stem seals incl.	
QTY	THERMOSTAT HOUSING	YEARS	PART NO.	DESCRIPTION	
2	Thermostat Gasket	2006-03	35764	Thermostat Housing	
2	Thermostat Gasket	2006-03	35764	Thermostat Housing; Thermostat case to head	
1	O-Ring	2006-03	35555	Thermostat Housing; Thermostat seal	
QTY	WATER PUMP	YEARS	PART NO.	DESCRIPTION	
1	Water Pump Gasket	2006-03	35787		
QTY	TIMING COVER	YEARS	PART NO.	DESCRIPTION	
1	Crankshaft Front Seal Set	2006-03	TCS 46074	Old design	
1	Crankshaft Front Seal Set	2006-03	TCS 46085	Improved design	
2	Camshaft Front Seal Set	2006-03	TCS 46053		
QTY	CARB & FUEL INJECTION	YEARS	PART NO.	DESCRIPTION	
1	Throttle Body Gasket	2006-03	61416		
QTY	EXHAUST GAS RECIRCULATION	YEARS	PART NO.	DESCRIPTION	
1	EGR Gasket	2006-03	70568	Tube	
QTY	OIL PUMP COVER	YEARS	PART NO.	DESCRIPTION	
1	Oil Pump Gasket	2006-03	71262	Oil pump mounting; New Part Number - Check for Availability	
11	2012 - 2007; 3.8L 230 (3778cc) DOHC V6 (24 Valve) 96mm Bore Lambda MFI; Gasoline; Naturally Aspirated Hyundai Eng.; Eng. Code G6DA				11
QTY	CYLINDER HEAD	YEARS	PART NO.	DESCRIPTION	
1	Head Gasket	2011-07	26416 PT	Loc. R.H.; Head bolts not incl.; Head bolt replacement recommended; PermaTorqueMLS®	
1	Head Gasket	2011-08	26420 PT	Loc. L.H.; Head bolts not incl.; Head bolt replacement recommended; PermaTorqueMLS®	
1	Head Gasket	2007	26414 PT	Loc. L.H.; To 04/20/07; Head bolts not incl.; Head bolt replacement recommended; PermaTorqueMLS®	
1	Head Gasket	2007	26420 PT	Loc. L.H.; From 04/21/07; Head bolts not incl.; Head bolt replacement recommended; PermaTorqueMLS®	
1	Head Set	2011-09	HS 26420 PT-2	Head bolts not incl.; Head bolt replacement recommended; PermaDry® molded rubber valve cover gskts. incl.; Premium valve stem seals incl.	
1	Head Set	2008	HS 26420 PT	To 12/25/08; Head bolts not incl.; Head bolt replacement recommended; PermaDry® molded rubber valve cover gskts. incl.; Premium valve stem seals incl.	
1	Head Set	2008	HS 26420 PT-2	From 12/26/08; Head bolts not incl.; Head bolt replacement recommended; PermaDry® molded rubber valve cover gskts. incl.; Premium valve stem seals incl.	
1	Head Set	2007	HS 26414 PT	To 04/20/07; Head bolts not incl.; Head bolt replacement recommended; PermaDry® molded rubber valve cover gskts. incl.; Premium valve stem seals incl.	
1	Head Set	2007	HS 26420 PT	From 04/21/07; Head bolts not incl.; Head bolt replacement recommended; PermaDry® molded rubber valve cover gskts. incl.; Premium valve stem seals incl.	
1	Head Bolt Set	2011-07	ES 72366	Replacement recommended	
QTY	CONVERSION SET	YEARS	PART NO.	DESCRIPTION	
1	Gasket Conversion Set	2012-07	CS 26414	RTV sealant incl. for Upper oil pan gskt.; New Part Number - Check for Availability	
QTY	MANIFOLD - INT. & EXH.	YEARS	PART NO.	DESCRIPTION	
1	Int. Manifold Gasket Set	2011-07	MS 97086	Lower set; Upper set incl.	
1	Int. Manifold Gasket Set	2011-09	MS 97320	Lower set; Upper set incl.; OEM style; New Part Number - Check for Availability	
1	Plenum Gasket Set	2012-07	MS 97227	Upper set; New Part Number - Check for Availability	
1	Exh. Manifold Gasket Set	2011-09	MS 97115		
1	Exh. Manifold Gasket Set	2008	MS 97074	To 12/25/08	
1	Exh. Manifold Gasket Set	2008	MS 97115	From 12/26/08	
1	Exh. Manifold Gasket Set	2007	MS 97074		

Hyundai Truck (Incl. Minivans and SUV's) (Cont.)

11 (cont.)		2012 - 2007; 3.8L 230 (3778cc) DOHC V6 (24 Valve) 96mm Bore Lambda MFI; Gasoline; Naturally Aspirated Hyundai Eng.; Eng. Code G6DA			11 (cont.)	
QTY	EXHAUST PIPE FLANGE	YEARS	PART NO.	DESCRIPTION		
1	Exhaust Pipe Gasket	2010-08	61567	Hyundai Entourage GLS, Limited; Converter		
2	Exhaust Pipe Gasket	2010-08	61568	Hyundai Entourage GLS, Limited; Pipe to manifold		
1	Exhaust Pipe Gasket	2010	61503	Hyundai Veracruz GL, GLS, Limited; Converter		
2	Exhaust Pipe Gasket	2010	61570	Hyundai Veracruz GL, GLS, Limited; Pipe to manifold		
1	Exhaust Pipe Gasket	2009-07	61503	Hyundai Veracruz GLS, Limited, SE; Converter		
2	Exhaust Pipe Gasket	2009-07	61570	Hyundai Veracruz GLS, Limited, SE; Pipe to manifold		
1	Exhaust Pipe Gasket	2007	61567	Hyundai Entourage GLS, Limited, SE; Converter		
2	Exhaust Pipe Gasket	2007	61568	Hyundai Entourage GLS, Limited, SE; Pipe to manifold		
QTY	OIL PAN	YEARS	PART NO.	DESCRIPTION		
1	Oil Pan Gasket Set	2012-07	OS 30822	Loc. Lower		
QTY	CRANKSHAFT REAR SEAL	YEARS	PART NO.	DESCRIPTION		
1	Rear Main Seal Set	2012-07	BS 40710	Rubber; One-piece		
QTY	VALVE COVER	YEARS	PART NO.	DESCRIPTION		
1	Valve Cover Gasket Set	2011-07	VS 50750 R	w/Spark plug tube seals; PermaDry® molded rubber gskts. incl.		
QTY	VALVE STEM SEAL SET	YEARS	PART NO.	DESCRIPTION		
1	Valve Stem Seal Set	2011-07	SS 72298	Premium valve stem seals incl.		
QTY	THERMOSTAT HOUSING	YEARS	PART NO.	DESCRIPTION		
1	Thermostat Gasket	2011-08	35933	Thermostat Housing		
QTY	WATER OUTLET GASKET	YEARS	PART NO.	DESCRIPTION		
1	Water Outlet Gasket	2011-07	35868	Water Outlet; Loc. L.H.		
1	Water Outlet Gasket	2011-07	35870	Water Outlet; Loc. R.H.		
1	Water Outlet Gasket	2011-07	35894	Water Outlet; O-ring; New Part Number - Check for Availability		
2	Water Outlet Gasket	2011-07	35959	Water Outlet; Water pipe; O-ring		
1	Water Crossover Mounting Set	2011-07	ES 72971	Water Outlet; New Part Number - Check for Availability		
QTY	WATER PUMP	YEARS	PART NO.	DESCRIPTION		
1	Water Pump Gasket	2012-07	35896	Loc. R.H.		
1	Water Pump Gasket	2012-10	35935	Loc. L.H.		
1	Water Pump Gasket	2009-07	35903	Loc. L.H.; New Part Number - Check for Availability		
QTY	TIMING COVER	YEARS	PART NO.	DESCRIPTION		
1	Crankshaft Front Seal Set	2012-07	TCS 46111			
QTY	CARB & FUEL INJECTION	YEARS	PART NO.	DESCRIPTION		
1	Throttle Body Gasket	2011-10	61613			
1	Throttle Body Gasket	2009	61560	To 04/06/09		
1	Throttle Body Gasket	2009	61613	From 04/07/09		
1	Throttle Body Gasket	2008-07	61560			

Infiniti Car - See Nissan Car

Infiniti SUV's - See Nissan Truck

Isuzu Car

Engine Finding Index					
Engine	Years	Code	Line No.		
1.6L 96.9 (1588cc) DOHC L4 (16 Valve) 80mm Bore; MFI; Gasoline; Naturally Aspirated Isuzu Eng.	1992-91	4XE1W	1		
1.6L 96.9 (1588cc) DOHC L4 (16 Valve) 80mm Bore; MFI; Gasoline; Turbo - Intercooled Isuzu Eng.	1992-91	4XE1W-T	2		
1.6L 96.9 (1588cc) SOHC L4 (12 Valve) 80mm Bore; MFI; Gasoline; Naturally Aspirated Isuzu Eng.	1993-91	4XE1V	3		
1.8L 110.3 (1808cc) DOHC L4 (16 Valve) 80mm Bore; MFI; Gasoline; Naturally Aspirated Isuzu Eng.	1993-92	4XF1	4		
Engine Code Index					
Code	Engine	Line No.			
4XE1V	1.6L 96.9 (1588cc) SOHC L4 (12 Valve) 80mm Bore; MFI; Gasoline; Naturally Aspirated Isuzu Eng.	3			
4XE1W	1.6L 96.9 (1588cc) DOHC L4 (16 Valve) 80mm Bore; MFI; Gasoline; Naturally Aspirated Isuzu Eng.	1			
4XE1W-T	1.6L 96.9 (1588cc) DOHC L4 (16 Valve) 80mm Bore; MFI; Gasoline; Turbo - Intercooled Isuzu Eng.	2			
4XF1	1.8L 110.3 (1808cc) DOHC L4 (16 Valve) 80mm Bore; MFI; Gasoline; Naturally Aspirated Isuzu Eng.	4			
Model Index					
Engine (VIN Code / Eng. Code)	Year	Engine (VIN Code / Eng. Code)	Year	Engine (VIN Code / Eng. Code)	Year
Isuzu		Isuzu (cont.)		Isuzu (cont.)	
I-Mark (FWD)		Impulse (AWD)		Impulse (RWD) (cont.)	
L4 1471cc 1.5L SOHC (4XC1)	89-85	L4 1588cc 1.6L DOHC Turbo (16 Valve)	92-90	L4 1994cc 2.0L SOHC Turbo (4ZC1-T)	89-85
L4 1471cc 1.5L SOHC Turbo (4XC1-T)	89-87	(4XE1W-T)		L4 2254cc 2.3L SOHC (4ZD1)	89-88
L4 1588cc 1.6L DOHC (16 Valve) (4XE1W)	89	Impulse (FWD)		Stylus	
I-Mark (RWD)		L4 1588cc 1.6L DOHC (16 Valve) (4XE1W)	91-90	L4 1588cc 1.6L DOHC (16 Valve) (4XE1W)	91-90
L4 1817cc 1.8L SOHC (G180Z)	85-81	L4 1808cc 1.8L DOHC (16 Valve) (4XF1)	93-92	L4 1588cc 1.6L SOHC (12 Valve) (4XE1V)	93-90
L4 1817cc 1.8L SOHC Diesel (4FB1)	85-81	Impulse (RWD)		L4 1808cc 1.8L DOHC (16 Valve) (4XF1)	93-92
		L4 1949cc 1.9L SOHC (G200Z)	87-83		

1				
1992 - 1991; 1.6L 96.9 (1588cc) DOHC L4 (16 Valve) 80mm Bore				
MFI; Gasoline; Naturally Aspirated Isuzu Eng.; Eng. Code 4XE1W				
QTY	CYLINDER HEAD	YEARS	PART NO.	DESCRIPTION
1	Head Gasket	1992-91	9685 PT-1	
1	Head Set	1992-91	HS 9685 PT	PermaDry® molded rubber valve cover gskt. incl.; Premium valve stem seals incl.
QTY	CONVERSION SET	YEARS	PART NO.	DESCRIPTION
1	Gasket Conversion Set	1992-91	CS 9685	Consolidated design
QTY	MANIFOLD - INT. & EXH.	YEARS	PART NO.	DESCRIPTION
1	Int. Manifold Gasket Set	1992-91	MS 94504	Upper set incl.
1	Exh. Manifold Gasket Set	1992-91	MS 94506	
QTY	EXHAUST PIPE FLANGE	YEARS	PART NO.	DESCRIPTION
2	Exhaust Pipe Gasket	1992-91	60856	Converter
1	Exhaust Pipe Gasket	1992-91	60857	Flange
QTY	OIL PAN	YEARS	PART NO.	DESCRIPTION
1	Oil Pan Gasket Set	1992-91	OS 30539 C	
QTY	CRANKSHAFT REAR SEAL	YEARS	PART NO.	DESCRIPTION
1	Rear Main Seal Set	1992-91	BS 40524	Rubber; One-piece; Improved design
QTY	VALVE COVER	YEARS	PART NO.	DESCRIPTION
1	Valve Cover Gasket Set	1992-91	VS 50064 R	PermaDry® molded rubber gskt. incl.
QTY	THERMOSTAT HOUSING	YEARS	PART NO.	DESCRIPTION
1	Water Outlet Gasket	1992-91	35364	Thermostat Housing; Loc. Outer
1	Thermostat Gasket	1992-91	35452	Thermostat Housing; Loc. Inner
QTY	WATER PUMP	YEARS	PART NO.	DESCRIPTION
1	Water Pump Gasket	1992-91	35454	
QTY	TIMING COVER	YEARS	PART NO.	DESCRIPTION
1	Crankshaft Front Seal Set	1992-91	TCS 45853	
QTY	CARB & FUEL INJECTION	YEARS	PART NO.	DESCRIPTION
1	Throttle Body Gasket	1992-91	60842	
QTY	EXHAUST GAS RECIRCULATION	YEARS	PART NO.	DESCRIPTION
1	EGR Gasket	1992-91	70372	
2				
1992 - 1991; 1.6L 96.9 (1588cc) DOHC L4 (16 Valve) 80mm Bore				
MFI; Gasoline; Turbo - Intercooled Isuzu Eng.; Eng. Code 4XE1W-T				
QTY	CYLINDER HEAD	YEARS	PART NO.	DESCRIPTION
1	Head Gasket	1992-91	9685 PT-1	
1	Head Set	1992-91	HS 9685 PT	PermaDry® molded rubber valve cover gskt. incl.; Premium valve stem seals incl.
QTY	CONVERSION SET	YEARS	PART NO.	DESCRIPTION
1	Gasket Conversion Set	1992-91	CS 9685	Consolidated design
QTY	MANIFOLD - INT. & EXH.	YEARS	PART NO.	DESCRIPTION
1	Int. Manifold Gasket Set	1992-91	MS 94504	Upper set incl.
1	Exh. Manifold Gasket Set	1992-91	MS 94506	
QTY	EXHAUST PIPE FLANGE	YEARS	PART NO.	DESCRIPTION
2	Exhaust Pipe Gasket	1992-91	60856	Converter
1	Exhaust Pipe Gasket	1992-91	60857	Flange
QTY	OIL PAN	YEARS	PART NO.	DESCRIPTION
1	Oil Pan Gasket Set	1992-91	OS 30539 C	
QTY	CRANKSHAFT REAR SEAL	YEARS	PART NO.	DESCRIPTION
1	Rear Main Seal Set	1992-91	BS 40524	Rubber; One-piece; Improved design
QTY	VALVE COVER	YEARS	PART NO.	DESCRIPTION
1	Valve Cover Gasket Set	1992-91	VS 50064 R	PermaDry® molded rubber gskt. incl.
QTY	THERMOSTAT HOUSING	YEARS	PART NO.	DESCRIPTION
1	Water Outlet Gasket	1992-91	35364	Thermostat Housing; Loc. Outer
1	Thermostat Gasket	1992-91	35452	Thermostat Housing; Loc. Inner
QTY	WATER PUMP	YEARS	PART NO.	DESCRIPTION
1	Water Pump Gasket	1992-91	35454	
QTY	TIMING COVER	YEARS	PART NO.	DESCRIPTION
1	Crankshaft Front Seal Set	1992-91	TCS 45853	
QTY	CARB & FUEL INJECTION	YEARS	PART NO.	DESCRIPTION
1	Throttle Body Gasket	1992-91	60842	
QTY	EXHAUST GAS RECIRCULATION	YEARS	PART NO.	DESCRIPTION
1	EGR Gasket	1992-91	70372	

Isuzu Car (Cont.)

3		1993 - 1991; 1.6L 96.9 (1588cc) SOHC L4 (12 Valve) 80mm Bore			3
		MFI; Gasoline; Naturally Aspirated Isuzu Eng.; Eng. Code 4XE1V			
QTY	CYLINDER HEAD	YEARS	PART NO.	DESCRIPTION	
1	Head Gasket	1993-91	9684 PT		
1	Head Set	1993-91	HS 9684 PT	PermaDry® molded rubber valve cover gskt. incl.; Premium valve stem seals incl.	
1	Head Installation Set	1993-91	HIS 9684 PT	Exh. pipe flange not incl.; PermaDry® molded rubber valve cover gskt. incl.	
QTY	CONVERSION SET	YEARS	PART NO.	DESCRIPTION	
1	Gasket Conversion Set	1993-91	CS 9685	Consolidated design	
QTY	MANIFOLD - INT. & EXH.	YEARS	PART NO.	DESCRIPTION	
1	Int. Manifold Gasket Set	1993-91	MS 94501	Upper set incl.	
1	Exh. Manifold Gasket Set	1993-91	MS 94503		
QTY	EXHAUST PIPE FLANGE	YEARS	PART NO.	DESCRIPTION	
1	Exhaust Pipe Gasket	1993-91	60668	Flange	
2	Exhaust Pipe Gasket	1993-91	60856	Converter	
QTY	OIL PAN	YEARS	PART NO.	DESCRIPTION	
1	Oil Pan Gasket Set	1993-91	OS 30539 C		
QTY	CRANKSHAFT REAR SEAL	YEARS	PART NO.	DESCRIPTION	
1	Rear Main Seal Set	1993-91	BS 40524	Rubber; One-piece; Improved design	
QTY	VALVE COVER	YEARS	PART NO.	DESCRIPTION	
1	Valve Cover Gasket Set	1993-91	VS 50053 R	w/Grommets; PermaDry® molded rubber gskt. incl.	
QTY	VALVE STEM SEAL SET	YEARS	PART NO.	DESCRIPTION	
1	Valve Stem Seal Set	1993-91	SS 72721	Premium valve stem seals incl.	
QTY	THERMOSTAT HOUSING	YEARS	PART NO.	DESCRIPTION	
1	Thermostat Gasket	1993-91	35455	Thermostat Housing; Thermostat housing to head	
QTY	WATER OUTLET GASKET	YEARS	PART NO.	DESCRIPTION	
1	Water Outlet Gasket	1993-91	35364	Water Outlet	
QTY	WATER PUMP	YEARS	PART NO.	DESCRIPTION	
1	Water Pump Gasket	1993-91	35454		
QTY	TIMING COVER	YEARS	PART NO.	DESCRIPTION	
1	Crankshaft Front Seal Set	1993-91	TCS 45853		
1	Camshaft Front Seal Set	1993-91	TCS 45696		
QTY	CARB & FUEL INJECTION	YEARS	PART NO.	DESCRIPTION	
1	Throttle Body Gasket	1993-91	60919		
QTY	EXHAUST GAS RECIRCULATION	YEARS	PART NO.	DESCRIPTION	
1	EGR Gasket	1993-91	70372		
4		1993 - 1992; 1.8L 110.3 (1808cc) DOHC L4 (16 Valve) 80mm Bore			4
		MFI; Gasoline; Naturally Aspirated Isuzu Eng.; Eng. Code 4XF1			
QTY	MANIFOLD - INT. & EXH.	YEARS	PART NO.	DESCRIPTION	
1	Int. Manifold Gasket Set	1993-92	MS 94270	Lower set; Upper set incl.	
1	Exh. Manifold Gasket Set	1993-92	MS 94506		
QTY	EXHAUST PIPE FLANGE	YEARS	PART NO.	DESCRIPTION	
2	Exhaust Pipe Gasket	1993-92	60856	Converter	
1	Exhaust Pipe Gasket	1993-92	60857	Flange	
QTY	CRANKSHAFT REAR SEAL	YEARS	PART NO.	DESCRIPTION	
1	Rear Main Seal Set	1993-92	BS 40524	Rubber; One-piece; Improved design	
QTY	VALVE COVER	YEARS	PART NO.	DESCRIPTION	
1	Valve Cover Gasket Set	1993-92	VS 50064 R	PermaDry® molded rubber gskt. incl.	
QTY	WATER OUTLET GASKET	YEARS	PART NO.	DESCRIPTION	
1	Water Outlet Gasket	1993-92	35559	Water Outlet	
2	O-Ring	1993-92	35654	Water Outlet; Inlet bypass; Improved design	
QTY	WATER PUMP	YEARS	PART NO.	DESCRIPTION	
1	Water Pump Gasket	1993-92	35454		
QTY	TIMING COVER	YEARS	PART NO.	DESCRIPTION	
1	Crankshaft Front Seal Set	1993-92	TCS 45853		
QTY	CARB & FUEL INJECTION	YEARS	PART NO.	DESCRIPTION	
2	Fuel Injector O-Ring Set	1993-92	ES 70599	Improved design	
1	Throttle Body Gasket	1993-92	60842		
QTY	EXHAUST GAS RECIRCULATION	YEARS	PART NO.	DESCRIPTION	
1	EGR Gasket	1993-92	70372	Valve	
1	EGR Gasket	1993-92	70697	Pipe	

Isuzu Minivans - See Isuzu Truck
Isuzu SUV's - See Isuzu Truck
Isuzu Truck (Incl. Minivans and SUV's)

Engine Finding Index			
<i>Engine</i>	<i>Years</i>	<i>Code</i>	<i>Line No.</i>
2.2L 131.6 (2156cc) SOHC L4 (16 Valve) 85mm Bore; MFI; Gasoline; Naturally Aspirated Honda Eng.	1997-96	F22B6	1
2.2L 134 (2189cc) OHV L4 (8 Valve) 89mm Bore; MFI; Gasoline; Naturally Aspirated GMC Eng.; Chevrolet	2001-96	4	2
2.2L 134 (2189cc) OHV L4 (8 Valve) 89mm Bore; MFI; Flex Fuel; Naturally Aspirated GMC Eng.; Chevrolet	2001-00	5	3
2.2L 134.1 (2198cc) DOHC L4 (16 Valve) 86mm Bore Ecotec; MFI; Gasoline; Naturally Aspirated Isuzu Eng.	2003-98	X22SE	4
2.3L 137.5 (2254cc) SOHC L4 (16 Valve) 86mm Bore VTEC; MFI; Gasoline; Naturally Aspirated Honda Eng.	1999-98	F23A7	5
2.3L 137.5 (2254cc) SOHC L4 (8 Valve) 89.3mm Bore; 2 Bbl.; Gasoline; Naturally Aspirated Isuzu Eng.	1995-91	4ZD1	6
2.3L 137.5 (2254cc) SOHC L4 (8 Valve) 89.3mm Bore; MFI; Gasoline; Naturally Aspirated Isuzu Eng.	1995-94	4ZD1	7
2.6L 156.2 (2559cc) SOHC L4 (8 Valve) 92.6mm Bore; MFI; Gasoline; Naturally Aspirated Isuzu Eng.	1997-91	4ZE1	8
2.8L 169 (2770cc) DOHC L4 (16 Valve) 93mm Bore Vortec; MFI; Gasoline; Naturally Aspirated GMC Eng.; Chevrolet	2006	8	9
2.8L 173 (2835cc) OHV V6 (12 Valve) 89mm Bore; TBI; Gasoline; Naturally Aspirated GMC Eng.; Chevrolet	1991	LL2	10
2.9L 178.2 (2921cc) DOHC L4 (16 Valve) 95.5mm Bore Vortec; MFI; Gasoline; Naturally Aspirated GMC Eng.; Chevrolet	2008-07	9	11
3.1L 189 (3136cc) OHV V6 (12 Valve) 89mm Bore; TBI; Gasoline; Naturally Aspirated GMC Eng.; Chevrolet	1994-91	LG6	12
3.2L 193 (3165cc) DOHC V6 (24 Valve) 93.4mm Bore; MFI; Gasoline; Naturally Aspirated Isuzu Eng.	2004-92	6VD2	13
3.2L 193 (3165cc) SOHC V6 (24 Valve) 93.4mm Bore; MFI; Gasoline; Naturally Aspirated Isuzu Eng.	1997-92	6VD1	14
3.5L 211 (3460cc) DOHC L5 (20 Valve) 93mm Bore Vortec; MFI; Gasoline; Naturally Aspirated GMC Eng.; Chevrolet	2006	6	15
3.5L 214 (3494cc) DOHC V6 (24 Valve) 93.4mm Bore; MFI; Gasoline; Naturally Aspirated Isuzu Eng.	2004-98	6VE1	16
3.7L 223 (3654cc) DOHC L5 (20 Valve) 95.5mm Bore Vortec; MFI; Gasoline; Naturally Aspirated GMC Eng.; Chevrolet	2008-07	E	17
3.9L 235.2 (3856cc) OHV Turbo L4 (8 Valve) 102mm Bore; DI; Diesel; Turbo Isuzu Eng.	1994-91	4BD1-T	18
4.2L 254 (4160cc) DOHC L6 (24 Valve) 93mm Bore Vortec; MFI; Gasoline; Naturally Aspirated GMC Eng.; Chevrolet	2009-03	S	19
4.3L 262 (4294cc) OHV V6 (12 Valve) 4" Bore Vortec; CPI; Gasoline; Naturally Aspirated GMC Eng.; Chevrolet	2001-97	X	20
4.3L 262 (4294cc) OHV V6 (12 Valve) 4" Bore Vortec H.O.; CPI; Gasoline; Naturally Aspirated GMC Eng.; Chevrolet	2001-97	W	21
5.3L 325 (5328cc) OHV V8 (16 Valve) 96mm Bore Vortec; MFI; Gasoline; Naturally Aspirated GMC Eng.; Chevrolet	2007-05	M	22
5.3L 325 (5328cc) OHV V8 (16 Valve) 96mm Bore Vortec; MFI; Gasoline; Naturally Aspirated GMC Eng.; Chevrolet	2005-03	P	23
5.7L 350 (5736cc) OHV V8 (16 Valve) 4" Bore; CPI; Gasoline; Naturally Aspirated GMC Eng.; Chevrolet	2000-96	CPC	24
5.7L 350 (5736cc) OHV V8 (16 Valve) 4" Bore; TBI; Gasoline; Naturally Aspirated GMC Eng.; Chevrolet	1995-93	CPC	25

Engine Code Index			
<i>Code</i>	<i>Engine</i>	<i>Line No.</i>	
4BD1-T	3.9L 235.2 (3856cc) OHV Turbo L4 (8 Valve) 102mm Bore; DI; Diesel; Turbo Isuzu Eng.	18	
4ZD1	2.3L 137.5 (2254cc) SOHC L4 (8 Valve) 89.3mm Bore; 2 Bbl.; Gasoline; Naturally Aspirated Isuzu Eng.	6	
4ZD1	2.3L 137.5 (2254cc) SOHC L4 (8 Valve) 89.3mm Bore; MFI; Gasoline; Naturally Aspirated Isuzu Eng.	7	
4ZE1	2.6L 156.2 (2559cc) SOHC L4 (8 Valve) 92.6mm Bore; MFI; Gasoline; Naturally Aspirated Isuzu Eng.	8	
6VD1	3.2L 193 (3165cc) SOHC V6 (24 Valve) 93.4mm Bore; MFI; Gasoline; Naturally Aspirated Isuzu Eng.	14	
6VD2	3.2L 193 (3165cc) DOHC V6 (24 Valve) 93.4mm Bore; MFI; Gasoline; Naturally Aspirated Isuzu Eng.	13	
6VE1	3.5L 214 (3494cc) DOHC V6 (24 Valve) 93.4mm Bore; MFI; Gasoline; Naturally Aspirated Isuzu Eng.	16	
CPC	5.7L 350 (5736cc) OHV V8 (16 Valve) 4" Bore; CPI; Gasoline; Naturally Aspirated GMC Eng.; Chevrolet	24	
CPC	5.7L 350 (5736cc) OHV V8 (16 Valve) 4" Bore; TBI; Gasoline; Naturally Aspirated GMC Eng.; Chevrolet	25	
F22B6	2.2L 131.6 (2156cc) SOHC L4 (16 Valve) 85mm Bore; MFI; Gasoline; Naturally Aspirated Honda Eng.	1	
F23A7	2.3L 137.5 (2254cc) SOHC L4 (16 Valve) 86mm Bore VTEC; MFI; Gasoline; Naturally Aspirated Honda Eng.	5	
LB4	4.3L 262 (4294cc) OHV V6 (12 Valve) 4" Bore Vortec; CPI; Gasoline; Naturally Aspirated GMC Eng.; Chevrolet	20	
LF6	4.3L 262 (4294cc) OHV V6 (12 Valve) 4" Bore Vortec H.O.; CPI; Gasoline; Naturally Aspirated GMC Eng.; Chevrolet	21	
LG6	3.1L 189 (3136cc) OHV V6 (12 Valve) 89mm Bore; TBI; Gasoline; Naturally Aspirated GMC Eng.; Chevrolet	12	
LL2	2.8L 173 (2835cc) OHV V6 (12 Valve) 89mm Bore; TBI; Gasoline; Naturally Aspirated GMC Eng.; Chevrolet	10	
LN2	2.2L 134 (2189cc) OHV L4 (8 Valve) 89mm Bore; MFI; Gasoline; Naturally Aspirated GMC Eng.; Chevrolet	2	
LN2	2.2L 134 (2189cc) OHV L4 (8 Valve) 89mm Bore; MFI; Flex Fuel; Naturally Aspirated GMC Eng.; Chevrolet	3	
X22SE	2.2L 134.1 (2198cc) DOHC L4 (16 Valve) 86mm Bore Ecotec; MFI; Gasoline; Naturally Aspirated Isuzu Eng.	4	

Model Index					
<i>Engine (VIN Code / Eng. Code)</i>	<i>Year</i>	<i>Engine (VIN Code / Eng. Code)</i>	<i>Year</i>	<i>Engine (VIN Code / Eng. Code)</i>	<i>Year</i>
Isuzu Truck		Isuzu Truck (cont.)		Isuzu Truck (cont.)	
Amigo (2WD Compact SUV)		Ascender (4WD Mid-Size SUV) (cont.)		i-290 (2WD Compact Pickup)	
L4 2198cc 2.2L DOHC (16 Valve) (X22SE)	00-98	V8 5328cc 5.3L OHV (P)	05-03	L4 2921cc 2.9L DOHC (16 Valve) (9)	08-07
L4 2254cc 2.3L SOHC (4ZD1)	94-89	Axiom (2WD Mid-Size SUV)		i-350 (4WD Compact Pickup)	
L4 2559cc 2.6L SOHC (4ZE1)	95-89	V6 3494cc 3.5L DOHC (24 Valve) (6VE1)	04-02	L5 3460cc 3.5L DOHC (20 Valve) (6)	06
V6 3165cc 3.2L DOHC (24 Valve) (6VD2)	00-98	Axiom (4WD Mid-Size SUV)		i-370 (2WD Compact Pickup)	
Amigo (4WD Compact SUV)		V6 3494cc 3.5L DOHC (24 Valve) (6VE1)	04-02	L5 3654cc 3.7L DOHC (20 Valve) (E)	08-07
L4 2559cc 2.6L SOHC (4ZE1)	95-89	Hombre (2WD Compact Pickup)		i-370 (4WD Compact Pickup)	
V6 3165cc 3.2L DOHC (24 Valve) (6VD2)	00-98	L4 2189cc 2.2L OHV (LN2)	01-96	L5 3654cc 3.7L DOHC (20 Valve) (E)	08-07
Ascender (2WD Mid-Size SUV)		V6 4293cc 4.3L OHV (LB4)	99-96	NPR (Forward Control Chassis)	
L6 4160cc 4.2L DOHC (24 Valve) (S)	08-03	V6 4293cc 4.3L OHV (LF6)	01-00	L4 3856cc 3.9L OHV Diesel (4BD1-N)	88-85
V8 5328cc 5.3L OHV (M)	06-05	Hombre (4WD Compact Pickup)		L4 3856cc 3.9L OHV Turbo-Diesel (4BD1-T)	94-85
V8 5328cc 5.3L OHV (P)	05-03	V6 4293cc 4.3L OHV (LF6)	01-98	L4 3856cc 3.9L OHV Turbo-Diesel (4BD2-TC)	98-95
Ascender (4WD Mid-Size SUV)		i-280 (2WD Compact Pickup)		V8 5736cc 5.7L OHV (CPC)	00-93
L6 4160cc 4.2L DOHC (24 Valve) (S)	08-03	L4 2770cc 2.8L DOHC (16 Valve) (8)	06	Oasis (FWD Minivan)	
V8 5328cc 5.3L OHV (M)	06-05			L4 2156cc 2.2L SOHC (16 Valve) (F22B6)	97-96

Isuzu Truck (Incl. Minivans and SUV's) (Cont.)

Model Index (Cont.)

Engine (VIN Code / Eng. Code)	Year	Engine (VIN Code / Eng. Code)	Year	Engine (VIN Code / Eng. Code)	Year
Isuzu Truck (cont.)		Isuzu Truck (cont.)		Isuzu Truck (cont.)	
Oasis (FWD Minivan) (cont.)		Pickup (4WD Compact Pickup) (cont.)		Trooper (2WD Full-Size SUV)	
L4 2254cc 2.3L SOHC VTEC (16 Valve) (F23A7)	99-98	V6 3136cc 3.1L OHV (LG6)	94-91	V6 3494cc 3.5L DOHC (24 Valve) (6VE1)	02-00
P'up (2WD Mini-Pickup)		Rodeo (2WD Mid-Size SUV)		Trooper (4WD Full-Size SUV)	
L4 1817cc 1.8L SOHC (G180Z)	82-81	L4 2198cc 2.2L DOHC (16 Valve) (X22SE)	03-98	V6 3165cc 3.2L DOHC (24 Valve) (6VD2)	95-92
L4 1949cc 1.9L SOHC (G200Z)	87-83	L4 2559cc 2.6L SOHC (4ZE1)	97-91	V6 3165cc 3.2L SOHC (24 Valve) (6VD1)	97-92
L4 2238cc 2.2L OHV Diesel (C223)	87-81	V6 3136cc 3.1L OHV (LG6)	92-91	V6 3494cc 3.5L DOHC (24 Valve) (6VE1)	02-98
L4 2238cc 2.2L OHV Turbo-Diesel (C223-T)	87-86	V6 3165cc 3.2L DOHC (24 Valve) (6VD2)	04-98	Trooper II (4WD Compact SUV)	
L4 2254cc 2.3L SOHC (4ZD1)	87-86	V6 3165cc 3.2L SOHC (24 Valve) (6VD1)	97-93	L4 1949cc 1.9L SOHC (G200Z)	85-83
P'up (4WD Mini-Pickup)		Rodeo (4WD Mid-Size SUV)		L4 2238cc 2.2L OHV Diesel (C223)	87-86
L4 1817cc 1.8L SOHC (G180Z)	82-81	V6 3136cc 3.1L OHV (LG6)	92-91	L4 2238cc 2.2L OHV Turbo-Diesel (C223-T)	87-86
L4 1949cc 1.9L SOHC (G200Z)	87-83	V6 3165cc 3.2L DOHC (24 Valve) (6VD2)	04-98	L4 2254cc 2.3L SOHC (4ZD1)	89-86
L4 2238cc 2.2L OHV Turbo-Diesel (C223-T)	87-86	V6 3165cc 3.2L SOHC (24 Valve) (6VD1)	97-93	L4 2559cc 2.6L SOHC (4ZE1)	91-88
L4 2254cc 2.3L SOHC (4ZD1)	87-86	V6 3494cc 3.5L DOHC (24 Valve) (6VE1)	04	V6 2835cc 2.8L OHV (LL2)	91-89
Pickup (2WD Compact Pickup)		Rodeo Sport (2WD Compact SUV)		VehiCROSS (4WD Compact SUV)	
L4 2254cc 2.3L SOHC (4ZD1)	95-88	L4 2198cc 2.2L DOHC (16 Valve) (X22SE)	03-01	V6 3494cc 3.5L DOHC (24 Valve) (6VE1)	02-99
L4 2559cc 2.6L SOHC (4ZE1)	95-88	V6 3165cc 3.2L DOHC (24 Valve) (6VD2)	03-01	VX-4 (4WD Compact SUV)	
Pickup (4WD Compact Pickup)		Rodeo Sport (4WD Compact SUV)		V6 3494cc 3.5L DOHC (24 Valve) (6VE1)	01
L4 2559cc 2.6L SOHC (4ZE1)	95-88	V6 3165cc 3.2L DOHC (24 Valve) (6VD2)	03-01		

1 1997 - 1996; 2.2L 131.6 (2156cc) SOHC L4 (16 Valve) 85mm Bore MFI; Gasoline; Naturally Aspirated Honda Eng.; Eng. Code F22B6 1

QTY	CYLINDER HEAD	YEARS	PART NO.	DESCRIPTION
1	Head Gasket	1997-96	9958 PT-1	Head bolts not incl.; Head bolt replacement recommended; PermaTorqueMLS®; Improved design
1	Head Set	1997-96	HS 9958 PT	Head bolts & exh. pipe flange not incl.; Head bolt replacement recommended; PermaDry® molded rubber valve cover gsckt. incl.; Premium valve stem seals incl.
QTY	CONVERSION SET	YEARS	PART NO.	DESCRIPTION
1	Gasket Conversion Set	1997-96	CS 9851	PermaDry® molded rubber oil pan gsckt. incl.
QTY	MANIFOLD - INT. & EXH.	YEARS	PART NO.	DESCRIPTION
1	Int. Manifold Gasket Set	1997-96	MS 95612	Upper set incl.
1	Exh. Manifold Gasket Set	1997-96	MS 94184	Improved design
QTY	EXHAUST PIPE FLANGE	YEARS	PART NO.	DESCRIPTION
1	Exhaust Pipe Gasket	1997-96	60517	Loc. Rear; Converter
1	Exhaust Pipe Gasket	1997-96	60669	Loc. Front; Converter
2	Exhaust Pipe Gasket	1997-96	60776	Flange
QTY	OIL PAN	YEARS	PART NO.	DESCRIPTION
1	Oil Pan Gasket Set	1997-96	OS 30632 R	PermaDry® molded rubber gsckt. incl.
QTY	CRANKSHAFT REAR SEAL	YEARS	PART NO.	DESCRIPTION
1	Rear Main Seal Set	1997-96	BS 40430	Rubber; One-piece
1	Repair Sleeve	1997-96	16275	Crankshaft; Use w/installation tool
QTY	VALVE COVER	YEARS	PART NO.	DESCRIPTION
1	Valve Cover Gasket Set	1997-96	VS 50365 R	w/Grommets & Spark plug tube seals; PermaDry® molded rubber gsckt. incl.
1	Valve Cover Gasket Set	1997-96	VS 50365 R-1	w/o Grommets & Spark plug tube seals; PermaDry® molded rubber gsckt. incl.
QTY	VALVE STEM SEAL SET	YEARS	PART NO.	DESCRIPTION
1	Valve Stem Seal Set	1997-96	SS 70283-1	Premium valve stem seals incl.
QTY	THERMOSTAT HOUSING	YEARS	PART NO.	DESCRIPTION
1	Thermostat Gasket	1997-96	35480	Thermostat Housing; Thermostat O-ring
QTY	WATER OUTLET GASKET	YEARS	PART NO.	DESCRIPTION
1	Water Outlet Gasket	1997-96	35469	Water Outlet
QTY	WATER PUMP	YEARS	PART NO.	DESCRIPTION
1	Water Pump Mounting Set	1997-96	ES 72804	
QTY	TIMING COVER	YEARS	PART NO.	DESCRIPTION
1	Crankshaft Front Seal Set	1997-96	TCS 45899	Must be used w/OS 30632R
1	Camshaft Front Seal Set	1997-96	TCS 45898	
1	Repair Sleeve	1997-96	16222	Timing Cover; Use w/installation tool
1	Repair Sleeve Tool	1997-96	16323	Timing Cover
QTY	CARB & FUEL INJECTION	YEARS	PART NO.	DESCRIPTION
1	Throttle Body Gasket	1997-96	60979	
QTY	DISTRIBUTOR MOUNTING	YEARS	PART NO.	DESCRIPTION
1	Distributor Mounting Gasket	1997-96	72454	Distributor Mounting; O-ring; 26.5mm ID
1	O-Ring	1997-96	72416	Distributor Mounting; 25mm ID
QTY	EXHAUST GAS RECIRCULATION	YEARS	PART NO.	DESCRIPTION
1	EGR Gasket	1997-96	70978	

Isuzu Truck (Incl. Minivans and SUV's) (Cont.)

2		2001 - 1996; 2.2L 134 (2189cc) OHV L4 (8 Valve) 89mm Bore			2
MFI; Gasoline; Naturally Aspirated GMC Eng.; Chevrolet; VIN Code 4, Eng. Code LN2					
QTY	CYLINDER HEAD	YEARS	PART NO.	DESCRIPTION	
1	Head Gasket	2001-96	9170 PT-1	Head bolts not incl.; Head bolt replacement recommended; PermaTorque®; Improved design	
1	Head Set	2001-98	HS 9170 PT-1	Head bolts & exh. pipe packing not incl.; Head bolt replacement recommended; PermaDry® molded rubber valve cover gskt. incl.; Premium valve stem seals incl.	
1	Head Set	1997-96	HS 9170 PT	Head bolts & exh. pipe packing not incl.; Head bolt replacement recommended; PermaDry® molded rubber valve cover gskt. incl.; Premium valve stem seals incl.	
1	Head Installation Set	1997-96	HIS 9170 PT	Head bolts & exh. pipe packing not incl.; Head bolt replacement recommended; PermaDry® molded rubber valve cover gskt. incl.	
1	Head Bolt Set	2001-98	ES 72170	Replacement recommended	
1	Head Bolt Set	1997-96	ES 72172	Replacement recommended	
QTY	CONVERSION SET	YEARS	PART NO.	DESCRIPTION	
1	Gasket Conversion Set	2001-96	CS 9469		
QTY	MANIFOLD - INT. & EXH.	YEARS	PART NO.	DESCRIPTION	
1	Int. Manifold Gasket Set	2001-98	MS 90543		
1	Int. Manifold Gasket Set	1997-96	MS 95393	Lower set; Upper set incl.	
1	Plenum Gasket Set	1997-96	MS 95397	Upper set	
1	Exh. Manifold Gasket Set	2001-98	MS 90540		
1	Exh. Manifold Gasket Set	1997-96	MS 93812		
QTY	EXHAUST PIPE FLANGE	YEARS	PART NO.	DESCRIPTION	
1	Exhaust Pipe Gasket	2001-97	60729	Packing	
1	Exhaust Pipe Gasket	1996	60982	Packing	
QTY	OIL PAN	YEARS	PART NO.	DESCRIPTION	
1	Oil Pan Gasket Set	2001-96	OS 34300 C		
1	Drain Plug Gasket	2001-98	70820		
1	Drain Plug Gasket	1997-96	70822		
QTY	CRANKSHAFT REAR SEAL	YEARS	PART NO.	DESCRIPTION	
1	Rear Main Seal Set	2001-96	BS 40464	11.0mm thick; Rubber; One-piece; Improved design	
1	Rear Main Seal Set	2001-96	BS 40625	11.0mm thick; PTFE Rubber; One-piece; Improved design	
1	Repair Sleeve Tool	2001-96	16304	Crankshaft	
QTY	VALVE COVER	YEARS	PART NO.	DESCRIPTION	
1	Valve Cover Gasket Set	2001-98	VS 50485 R	PermaDry® molded rubber gskt. incl.	
1	Valve Cover Gasket Set	1997-96	VS 50313 R	PermaDry® molded rubber gskt. incl.	
QTY	VALVE STEM SEAL SET	YEARS	PART NO.	DESCRIPTION	
1	Valve Stem Seal Set	2001-98	SS 70809	Premium valve stem seals incl.	
1	Valve Stem Seal Set	1997-96	SS 72852	Premium valve stem seals incl.	
QTY	THERMOSTAT HOUSING	YEARS	PART NO.	DESCRIPTION	
1	Thermostat Gasket	2001-96	35614	Thermostat Housing; Thermostat seal; Improved design	
1	Thermostat Gasket	1997-96	35393	Thermostat Housing; Adapter cover	
1	Thermostat Gasket	1997-96	35598	Thermostat Housing; Thermostat adapter	
QTY	WATER OUTLET GASKET	YEARS	PART NO.	DESCRIPTION	
1	Water Outlet Gasket	2001-98	35613	Water Outlet; Outlet adapter	
1	Water Outlet Gasket	1997-96	35560	Water Outlet	
QTY	WATER PUMP	YEARS	PART NO.	DESCRIPTION	
1	Water Pump Gasket	2001-96	35392	Mounting	
1	Water Pump Gasket	2001-96	36025	Water pump inlet; New Part Number - Check for Availability	
QTY	TIMING COVER	YEARS	PART NO.	DESCRIPTION	
1	Timing Cover Set	2001-96	TCS 45793	w/o Sleeve 'N' Seal®	
1	Timing Cover Gasket	2001-96	72739	New Part Number - Check for Availability	
1	Timing Set w/Sleeve & Seal	2001-96	TCS 45762	w/Sleeve 'N' Seal®	
1	Repair Sleeve	2001-96	16202	Timing Cover; Use w/installation tool	
1	Repair Sleeve Tool	2001-96	16312	Timing Cover	
QTY	CARB & FUEL INJECTION	YEARS	PART NO.	DESCRIPTION	
1	Fuel Injector O-Ring Set	2001-98	ES 70599	Upper set; Injectors to fuel rail; Improved design	
1	Fuel Injector O-Ring Set	2001-98	ES 71190	Lower set; Injectors to cylinder head	
1	Fuel Injector O-Ring Set	1997-96	ES 71188	Upper set & Lower set; Injectors to fuel rail & Injectors to cylinder head	
1	Throttle Body Gasket	2001-98	61021		
QTY	EXHAUST GAS RECIRCULATION	YEARS	PART NO.	DESCRIPTION	
1	EGR Gasket	2001-96	70789	EGR valve	
1	EGR Gasket	2001-98	70805	EGR adapter cover; New Part Number - Check for Availability	
1	EGR Gasket	2001-98	70808	EGR adapter	
1	EGR Gasket	1997-96	70621	EGR adapter	

Isuzu Truck (Incl. Minivans and SUV's) (Cont.)

3		2001 - 2000; 2.2L 134 (2189cc) OHV L4 (8 Valve) 89mm Bore			3
MFI; Flex Fuel; Naturally Aspirated GMC Eng.; Chevrolet; VIN Code 5, Eng. Code LN2					
QTY	CYLINDER HEAD	YEARS	PART NO.	DESCRIPTION	
1	Head Gasket	2001-00	9170 PT-1	Head bolts not incl.; Head bolt replacement recommended; PermaTorque®; Improved design	
1	Head Set	2001-00	HS 9170 PT-2	Head bolts & exh. pipe packing not incl.; Head bolt replacement recommended; PermaDry® molded rubber valve cover gskt. incl.; Premium valve stem seals incl.	
1	Head Bolt Set	2001-00	ES 72170	Replacement recommended	
QTY	CONVERSION SET	YEARS	PART NO.	DESCRIPTION	
1	Gasket Conversion Set	2001-00	CS 9469		
QTY	MANIFOLD - INT. & EXH.	YEARS	PART NO.	DESCRIPTION	
1	Int. Manifold Gasket Set	2001-00	MS 90543		
1	Exh. Manifold Gasket Set	2001-00	MS 92794		
QTY	EXHAUST PIPE FLANGE	YEARS	PART NO.	DESCRIPTION	
1	Exhaust Pipe Gasket	2001-00	60729	Packing	
QTY	OIL PAN	YEARS	PART NO.	DESCRIPTION	
1	Oil Pan Gasket Set	2001-00	OS 34300 C		
1	Drain Plug Gasket	2001-00	70820		
QTY	CRANKSHAFT REAR SEAL	YEARS	PART NO.	DESCRIPTION	
1	Rear Main Seal Set	2001-00	BS 40464	11.0mm thick; Rubber; One-piece; Improved design	
1	Rear Main Seal Set	2001-00	BS 40625	11.0mm thick; PTFE Rubber; One-piece; Improved design	
1	Repair Sleeve Tool	2001-00	16304	Crankshaft	
QTY	VALVE COVER	YEARS	PART NO.	DESCRIPTION	
1	Valve Cover Gasket Set	2001-00	VS 50485 R	PermaDry® molded rubber gskt. incl.	
QTY	VALVE STEM SEAL SET	YEARS	PART NO.	DESCRIPTION	
1	Valve Stem Seal Set	2001-00	SS 70809	Premium valve stem seals incl.	
QTY	THERMOSTAT HOUSING	YEARS	PART NO.	DESCRIPTION	
1	Thermostat Gasket	2001-00	35614	Thermostat Housing; Thermostat seal; Improved design	
QTY	WATER OUTLET GASKET	YEARS	PART NO.	DESCRIPTION	
1	Water Outlet Gasket	2001-00	35613	Water Outlet; Outlet adapter	
QTY	WATER PUMP	YEARS	PART NO.	DESCRIPTION	
1	Water Pump Gasket	2001-00	35392	Mounting	
1	Water Pump Gasket	2001-00	36025	Water pump inlet; New Part Number - Check for Availability	
QTY	TIMING COVER	YEARS	PART NO.	DESCRIPTION	
1	Timing Cover Set	2001-00	TCS 45793	w/o Sleeve 'N' Seal®	
1	Timing Cover Gasket	2001-00	72739	New Part Number - Check for Availability	
1	Timing Set w/Sleeve & Seal	2001-00	TCS 45762	w/Sleeve 'N' Seal®	
1	Repair Sleeve	2001-00	16202	Timing Cover; Use w/installation tool	
1	Repair Sleeve Tool	2001-00	16312	Timing Cover	
QTY	CARB & FUEL INJECTION	YEARS	PART NO.	DESCRIPTION	
1	Fuel Injector O-Ring Set	2001-00	ES 70599	Upper set; Injectors to fuel rail; Improved design	
1	Fuel Injector O-Ring Set	2001-00	ES 71190	Lower set; Injectors to cylinder head	
1	Throttle Body Gasket	2001-00	61021		
QTY	EXHAUST GAS RECIRCULATION	YEARS	PART NO.	DESCRIPTION	
1	EGR Gasket	2001-00	70789	EGR valve	
1	EGR Gasket	2001-00	70805	EGR adapter cover; New Part Number - Check for Availability	
1	EGR Gasket	2001-00	70808	EGR adapter	
4		2003 - 1998; 2.2L 134.1 (2198cc) DOHC L4 (16 Valve) 86mm Bore Ecotec			4
MFI; Gasoline; Naturally Aspirated Isuzu Eng.; Eng. Code X22SE					
QTY	CYLINDER HEAD	YEARS	PART NO.	DESCRIPTION	
1	Head Gasket	2003-98	26317 PT	Head bolts not incl.; Head bolt replacement recommended	
1	Head Set	2003-98	HS 26317 PT-1	Head bolts not incl.; Head bolt replacement recommended; PermaDry® molded rubber valve cover gskt. incl.; Premium valve stem seals incl.	
1	Head Bolt Set	2003-98	ES 72906-1	Head bolts w/Washers; Replacement recommended	
QTY	CONVERSION SET	YEARS	PART NO.	DESCRIPTION	
1	Gasket Conversion Set	2003-98	CS 26317-1	PermaDry® molded rubber oil pan gskt. incl.	
QTY	MANIFOLD - INT. & EXH.	YEARS	PART NO.	DESCRIPTION	
1	Int. Manifold Gasket Set	2003-98	MS 96859		
1	Exh. Manifold Gasket Set	2003-98	MS 96968		
QTY	EXHAUST PIPE FLANGE	YEARS	PART NO.	DESCRIPTION	
1	Exhaust Pipe Gasket	2003-98	60309	Converter; 2 1/2" ID	
1	Exhaust Pipe Gasket	2003-02	61523	Flange	
1	Exhaust Pipe Gasket	2001-00	61522	To 07/31/00; Flange	
1	Exhaust Pipe Gasket	2001-00	61523	From 08/01/00; Flange	

Isuzu Truck (Incl. Minivans and SUV's) (Cont.)

4 (cont.)		2003 - 1998; 2.2L 134.1 (2198cc) DOHC L4 (16 Valve) 86mm Bore Ecotec MFI; Gasoline; Naturally Aspirated Isuzu Eng.; Eng. Code X22SE			4 (cont.)
QTY	EXHAUST PIPE FLANGE	YEARS	PART NO.	DESCRIPTION	
1	Exhaust Pipe Gasket	1999-98	61522	Flange	
QTY	OIL PAN	YEARS	PART NO.	DESCRIPTION	
1	Oil Pan Gasket Set	2003-98	OS 30792 R	Loc. Lower; PermaDry® molded rubber gskt. incl.	
1	Oil Pan Gasket Set	2003-98	OS 30794 R	Loc. Upper; PermaDry® molded rubber gskt. incl.	
QTY	CRANKSHAFT REAR SEAL	YEARS	PART NO.	DESCRIPTION	
1	Rear Main Seal Set	2003-98	BS 40671	Rubber; One-piece; Improved design	
1	Rear Main Seal Set	2003-98	BS 40739	Rubber; One-piece; New Improved design; New Part Number - Check for Availability	
QTY	VALVE COVER	YEARS	PART NO.	DESCRIPTION	
1	Valve Cover Gasket Set	2003-98	VS 50722 R	w/Grommets; PermaDry® molded rubber gskt. incl.	
QTY	VALVE STEM SEAL SET	YEARS	PART NO.	DESCRIPTION	
1	Valve Stem Seal Set	2003-98	SS 71163-1	Premium valve stem seals incl.	
QTY	THERMOSTAT HOUSING	YEARS	PART NO.	DESCRIPTION	
1	Thermostat Gasket	2003-98	35820	Thermostat seal	
QTY	WATER OUTLET GASKET	YEARS	PART NO.	DESCRIPTION	
1	Water Outlet Gasket	2003-98	35821	Outlet	
QTY	WATER PUMP	YEARS	PART NO.	DESCRIPTION	
1	Water Pump Gasket	2003-98	35302	O-ring	
QTY	TIMING COVER	YEARS	PART NO.	DESCRIPTION	
1	Crankshaft Front Seal Set	2003-98	TCS 45128		
1	Camshaft Front Seal Set	2003-98	TCS 46094		
QTY	CARB & FUEL INJECTION	YEARS	PART NO.	DESCRIPTION	
1	Fuel Injector O-Ring Set	2003-98	ES 70599	Upper set; Injectors to fuel rail; Improved design	
1	Fuel Injector O-Ring Set	2003-98	ES 71190	Lower set; Injectors to cylinder head	
1	Fuel Injector O-Ring Set	2003-98	ES 71192	Upper set; Injectors to fuel rail; Old design	
1	Throttle Body Gasket	2003-98	61384		
QTY	EXHAUST GAS RECIRCULATION	YEARS	PART NO.	DESCRIPTION	
1	EGR Gasket	2003-98	70789	Valve	
1	EGR Gasket	2003-98	72268	Adapter	
5		1999 - 1998; 2.3L 137.5 (2254cc) SOHC L4 (16 Valve) 86mm Bore VTEC MFI; Gasoline; Naturally Aspirated Honda Eng.; Eng. Code F23A7			5
QTY	CYLINDER HEAD	YEARS	PART NO.	DESCRIPTION	
1	Head Gasket	1999-98	9958 PT-1	Head bolts not incl.; Head bolt replacement recommended; PermaTorqueMLS®; Improved design	
1	Head Set	1999-98	HS 26155 PT	Head bolts not incl.; Head bolt replacement recommended; PermaDry® molded rubber valve cover gskt. incl.; Premium valve stem seals incl.	
1	Head Bolt Set	1999-98	ES 71329	Head bolts w/Washers; Replacement recommended	
QTY	CONVERSION SET	YEARS	PART NO.	DESCRIPTION	
1	Gasket Conversion Set	1999-98	CS 26155	PermaDry® molded rubber oil pan gskt. incl.	
QTY	MANIFOLD - INT. & EXH.	YEARS	PART NO.	DESCRIPTION	
1	Int. Manifold Gasket Set	1999-98	MS 94125-1	Upper set incl.	
1	Exh. Manifold Gasket Set	1999-98	MS 94184	Improved design	
QTY	EXHAUST PIPE FLANGE	YEARS	PART NO.	DESCRIPTION	
1	Exhaust Pipe Gasket	1999-98	60877	Flange	
QTY	OIL PAN	YEARS	PART NO.	DESCRIPTION	
1	Oil Pan Gasket Set	1999-98	OS 30632 R	PermaDry® molded rubber gskt. incl.	
QTY	CRANKSHAFT REAR SEAL	YEARS	PART NO.	DESCRIPTION	
1	Rear Main Seal Set	1999-98	BS 40430	Rubber; One-piece	
1	Repair Sleeve	1999-98	16275	Crankshaft; Use w/installation tool	
QTY	VALVE COVER	YEARS	PART NO.	DESCRIPTION	
1	Valve Cover Gasket Set	1999-98	VS 50493 R	w/Grommets & Spark plug tube seals; PermaDry® molded rubber gskt. incl.	
QTY	VALVE STEM SEAL SET	YEARS	PART NO.	DESCRIPTION	
1	Valve Stem Seal Set	1999-98	SS 70283-1	Premium valve stem seals incl.	
QTY	THERMOSTAT HOUSING	YEARS	PART NO.	DESCRIPTION	
1	Thermostat Gasket	1999-98	35480	Thermostat Housing; Thermostat O-ring	
QTY	WATER OUTLET GASKET	YEARS	PART NO.	DESCRIPTION	
1	Water Outlet Gasket	1999-98	35469	Water Outlet	
QTY	WATER PUMP	YEARS	PART NO.	DESCRIPTION	
1	Water Pump Gasket	1999-98	35482		
QTY	TIMING COVER	YEARS	PART NO.	DESCRIPTION	
1	Crankshaft Front Seal Set	1999-98	TCS 45899	Must be used w/OS 30632R	
1	Camshaft Front Seal Set	1999-98	TCS 45898		

Isuzu Truck (Incl. Minivans and SUV's) (Cont.)

5		1999 - 1998; 2.3L 137.5 (2254cc) SOHC L4 (16 Valve) 86mm Bore VTEC			5	
(cont.)		MFI; Gasoline; Naturally Aspirated Honda Eng.; Eng. Code F23A7			(cont.)	
QTY	TIMING COVER	YEARS	PART NO.	DESCRIPTION		
1	Repair Sleeve	1999-98	16222	Timing Cover; Use w/installation tool		
1	Repair Sleeve Tool	1999-98	16323	Timing Cover		
QTY	CARB & FUEL INJECTION	YEARS	PART NO.	DESCRIPTION		
1	Throttle Body Gasket	1999-98	61115			
QTY	DISTRIBUTOR MOUNTING	YEARS	PART NO.	DESCRIPTION		
1	Distributor Mounting Gasket	1999-98	72454	Distributor Mounting; O-ring; 26.5mm ID		
1	O-Ring	1999-98	72416	Distributor Mounting; 25mm ID		
QTY	EXHAUST GAS RECIRCULATION	YEARS	PART NO.	DESCRIPTION		
1	EGR Gasket	1999-98	70978			
6		1995 - 1991; 2.3L 137.5 (2254cc) SOHC L4 (8 Valve) 89.3mm Bore			6	
		2 Bbl.; Gasoline; Naturally Aspirated Isuzu Eng.; Eng. Code 4ZD1				
QTY	CYLINDER HEAD	YEARS	PART NO.	DESCRIPTION		
1	Head Gasket	1995-91	9496 PT			
1	Head Set	1995-91	HS 9496 PT-3	PermaDry® molded rubber valve cover gskt. incl.; Premium valve stem seals incl.		
QTY	CONVERSION SET	YEARS	PART NO.	DESCRIPTION		
1	Gasket Conversion Set	1995-91	CS 9496-1	PermaDry® molded rubber oil pan gskt. incl.; RTV sealant incl. for oil pan gskt.		
QTY	MANIFOLD - INT. & EXH.	YEARS	PART NO.	DESCRIPTION		
1	Int. Manifold Gasket Set	1995-91	MS 93657			
1	Exh. Manifold Gasket Set	1995-91	MS 94244			
QTY	EXHAUST PIPE FLANGE	YEARS	PART NO.	DESCRIPTION		
1	Exhaust Pipe Gasket	1995-91	60554	Flange		
2	Exhaust Pipe Gasket	1995-91	60856	Converter		
QTY	FUEL PUMP	YEARS	PART NO.	DESCRIPTION		
2	Fuel Pump Mounting Gasket	1995-91	70159			
QTY	OIL PAN	YEARS	PART NO.	DESCRIPTION		
1	Oil Pan Gasket Set	1995-91	OS 30481 R	PermaDry® molded rubber gskt. incl.		
QTY	CRANKSHAFT REAR SEAL	YEARS	PART NO.	DESCRIPTION		
1	Rear Main Seal Set	1995-91	BS 40449-1	Rubber; One-piece		
QTY	VALVE COVER	YEARS	PART NO.	DESCRIPTION		
1	Valve Cover Gasket Set	1995-91	VS 50311 R	w/o Semi-circular plugs & Grommets; PermaDry® molded rubber gskt. incl.		
1	Valve Cover Gasket Set	1995-91	VS 50344 R	w/Semi-circular plugs & Grommets; PermaDry® molded rubber gskt. incl.		
1	Semi-Circular Plug	1995-91	CP 75003	Valve Cover		
QTY	VALVE STEM SEAL SET	YEARS	PART NO.	DESCRIPTION		
1	Valve Stem Seal Set	1995-91	SS 72829	Premium valve stem seals incl.		
QTY	WATER OUTLET GASKET	YEARS	PART NO.	DESCRIPTION		
1	Water Outlet Gasket	1995-92	35364	Water Outlet		
1	Water Outlet Gasket	1991	25581	Water Outlet		
QTY	WATER PUMP	YEARS	PART NO.	DESCRIPTION		
1	Water Pump Gasket	1995-91	35387			
QTY	TIMING COVER	YEARS	PART NO.	DESCRIPTION		
1	Crankshaft Front Seal Set	1995-91	TCS 45783			
1	Camshaft Front Seal Set	1995-91	TCS 45782			
1	Repair Sleeve	1995-91	16220	Timing Cover; Use w/installation tool; Improved design		
1	Repair Sleeve	1995-91	16223	Timing Cover; Use w/installation tool; May use 16220 instead; Old design; Superseded - When depleted use 16220		
1	Repair Sleeve Tool	1995-91	16323	Timing Cover		
QTY	CARB & FUEL INJECTION	YEARS	PART NO.	DESCRIPTION		
2	Carb. Mounting Gasket	1995-91	60703			
QTY	EXHAUST GAS RECIRCULATION	YEARS	PART NO.	DESCRIPTION		
1	EGR Gasket	1995-91	70692	Adapter		
7		1995 - 1994; 2.3L 137.5 (2254cc) SOHC L4 (8 Valve) 89.3mm Bore			7	
		MFI; Gasoline; Naturally Aspirated Isuzu Eng.; Eng. Code 4ZD1				
QTY	CYLINDER HEAD	YEARS	PART NO.	DESCRIPTION		
1	Head Gasket	1995-94	9496 PT			
1	Head Set	1995-94	HS 9496 PT-3	PermaDry® molded rubber valve cover gskt. incl.; Premium valve stem seals incl.		
QTY	CONVERSION SET	YEARS	PART NO.	DESCRIPTION		
1	Gasket Conversion Set	1995-94	CS 9496-1	PermaDry® molded rubber oil pan gskt. incl.; RTV sealant incl. for oil pan gskt.		

Isuzu Truck (Incl. Minivans and SUV's) (Cont.)

7 (cont.)	1995 - 1994; 2.3L 137.5 (2254cc) SOHC L4 (8 Valve) 89.3mm Bore MFI; Gasoline; Naturally Aspirated Isuzu Eng.; Eng. Code 4ZD1				7 (cont.)
QTY	MANIFOLD - INT. & EXH.	YEARS	PART NO.	DESCRIPTION	
1	Int. Manifold Gasket Set	1995-94	MS 93657-1	Upper set incl.	
1	Exh. Manifold Gasket Set	1995-94	MS 94244		
QTY	EXHAUST PIPE FLANGE	YEARS	PART NO.	DESCRIPTION	
1	Exhaust Pipe Gasket	1995-94	60554	Flange	
2	Exhaust Pipe Gasket	1995-94	60856	Converter	
QTY	FUEL PUMP	YEARS	PART NO.	DESCRIPTION	
2	Fuel Pump Mounting Gasket	1995-94	70159		
QTY	OIL PAN	YEARS	PART NO.	DESCRIPTION	
1	Oil Pan Gasket Set	1995-94	OS 30481 R	PermaDry® molded rubber gskt. incl.	
QTY	CRANKSHAFT REAR SEAL	YEARS	PART NO.	DESCRIPTION	
1	Rear Main Seal Set	1995-94	BS 40449-1	Rubber; One-piece	
QTY	VALVE COVER	YEARS	PART NO.	DESCRIPTION	
1	Valve Cover Gasket Set	1995-94	VS 50311 R	w/o Semi-circular plugs & Grommets; PermaDry® molded rubber gskt. incl.	
1	Valve Cover Gasket Set	1995-94	VS 50344 R	w/Semi-circular plugs & Grommets; PermaDry® molded rubber gskt. incl.	
1	Semi-Circular Plug	1995-94	CP 75003	Valve Cover	
QTY	VALVE STEM SEAL SET	YEARS	PART NO.	DESCRIPTION	
1	Valve Stem Seal Set	1995-94	SS 72829	Premium valve stem seals incl.	
QTY	WATER OUTLET GASKET	YEARS	PART NO.	DESCRIPTION	
1	Water Outlet Gasket	1995-94	35364	Water Outlet	
QTY	WATER PUMP	YEARS	PART NO.	DESCRIPTION	
1	Water Pump Gasket	1995-94	35387		
QTY	TIMING COVER	YEARS	PART NO.	DESCRIPTION	
1	Crankshaft Front Seal Set	1995-94	TCS 45783		
1	Camshaft Front Seal Set	1995-94	TCS 45782		
1	Repair Sleeve	1995-94	16220	Timing Cover; Use w/installation tool; Improved design	
1	Repair Sleeve	1995-94	16223	Timing Cover; Use w/installation tool; May use 16220 instead; Old design; Superseded - When depleted use 16220	
1	Repair Sleeve Tool	1995-94	16323	Timing Cover	
QTY	CARB & FUEL INJECTION	YEARS	PART NO.	DESCRIPTION	
1	Throttle Body Gasket	1995-94	60991		
8	1997 - 1991; 2.6L 156.2 (2559cc) SOHC L4 (8 Valve) 92.6mm Bore MFI; Gasoline; Naturally Aspirated Isuzu Eng.; Eng. Code 4ZE1				8
QTY	CYLINDER HEAD	YEARS	PART NO.	DESCRIPTION	
1	Head Gasket	1997-91	8215 PT		
1	Head Set	1997-91	HS 8215 PT-2	Exh. pipe flange not incl.; PermaDry® molded rubber valve cover gskt. incl.; Premium valve stem seals incl.	
QTY	CONVERSION SET	YEARS	PART NO.	DESCRIPTION	
1	Gasket Conversion Set	1997-91	CS 9496-1	PermaDry® molded rubber oil pan gskt. incl.; RTV sealant incl. for oil pan gskt.	
QTY	MANIFOLD - INT. & EXH.	YEARS	PART NO.	DESCRIPTION	
1	Int. Manifold Gasket Set	1997-91	MS 93657-1	Upper set incl.	
1	Exh. Manifold Gasket Set	1997-91	MS 94244		
QTY	EXHAUST PIPE FLANGE	YEARS	PART NO.	DESCRIPTION	
2	Exhaust Pipe Gasket	1997-91	60856	Converter	
1	Exhaust Pipe Gasket	1997-94	60554	Flange	
1	Exhaust Pipe Gasket	1993-91	60554	Flange; California	
1	Exhaust Pipe Gasket	1993-92	60857	Flange; Exc. California	
1	Exhaust Pipe Gasket	1991	60642	To 11/01/90; Flange; Exc. California	
1	Exhaust Pipe Gasket	1991	60857	From 11/02/90; Flange; Exc. California	
QTY	OIL PAN	YEARS	PART NO.	DESCRIPTION	
1	Oil Pan Gasket Set	1997-91	OS 30556 A	RTV sealant incl. for oil pan gskt.	
QTY	CRANKSHAFT REAR SEAL	YEARS	PART NO.	DESCRIPTION	
1	Rear Main Seal Set	1997-91	BS 40449-1	Rubber; One-piece	
QTY	VALVE COVER	YEARS	PART NO.	DESCRIPTION	
1	Valve Cover Gasket Set	1997-91	VS 50311 R	w/o Semi-circular plugs & Grommets; PermaDry® molded rubber gskt. incl.	
1	Valve Cover Gasket Set	1997-91	VS 50344 R	w/Semi-circular plugs & Grommets; PermaDry® molded rubber gskt. incl.	
1	Semi-Circular Plug	1997-91	CP 75003	Valve Cover	
QTY	VALVE STEM SEAL SET	YEARS	PART NO.	DESCRIPTION	
1	Valve Stem Seal Set	1997-91	SS 72829	Premium valve stem seals incl.	
QTY	WATER OUTLET GASKET	YEARS	PART NO.	DESCRIPTION	
1	Water Outlet Gasket	1997-92	35364	Water Outlet	

Isuzu Truck (Incl. Minivans and SUV's) (Cont.)

8		1997 - 1991; 2.6L 156.2 (2559cc) SOHC L4 (8 Valve) 92.6mm Bore			8	
(cont.)		MFI; Gasoline; Naturally Aspirated Isuzu Eng.; Eng. Code 4ZE1			(cont.)	
QTY	WATER OUTLET GASKET	YEARS	PART NO.	DESCRIPTION		
1	Water Outlet Gasket	1991	25581	Water Outlet		
QTY	WATER PUMP	YEARS	PART NO.	DESCRIPTION		
1	Water Pump Gasket	1997-91	35387			
QTY	TIMING COVER	YEARS	PART NO.	DESCRIPTION		
1	Crankshaft Front Seal Set	1997-91	TCS 45783			
1	Camshaft Front Seal Set	1997-91	TCS 45782			
1	Repair Sleeve	1997-91	16220	Timing Cover; Use w/installation tool; Improved design		
1	Repair Sleeve	1997-91	16223	Timing Cover; Use w/installation tool; May use 16220 instead; Old design; Superseded - When depleted use 16220		
1	Repair Sleeve Tool	1997-91	16323	Timing Cover		
QTY	CARB & FUEL INJECTION	YEARS	PART NO.	DESCRIPTION		
1	Throttle Body Gasket	1997-96	61034			
1	Throttle Body Gasket	1995-93	60991			
1	Throttle Body Gasket	1992-91	60721			
9		2006; 2.8L 169 (2770cc) DOHC L4 (16 Valve) 93mm Bore Vortec			9	
		MFI; Gasoline; Naturally Aspirated GMC Eng.; Chevrolet; VIN Code 8				
QTY	CYLINDER HEAD	YEARS	PART NO.	DESCRIPTION		
1	Head Gasket	2006	26335 PT	Head bolts not incl.; Head bolt replacement recommended; PermaTorqueMLS®		
1	Head Set	2006	HS 26335 PT	Head bolts not incl.; Head bolt replacement recommended; PermaDry® molded rubber valve cover gskt. incl.; Premium valve stem seals incl.		
1	Head Bolt Set	2006	ES 71334	Head bolts w/Washers; Replacement recommended; Improved design		
1	Head Bolt Set	2006	ES 72195	Head bolts w/Washers; Replacement recommended; Old design		
QTY	CONVERSION SET	YEARS	PART NO.	DESCRIPTION		
1	Gasket Conversion Set	2006	CS 26335	RTV sealant incl. for oil pan gskt.		
QTY	MANIFOLD - INT. & EXH.	YEARS	PART NO.	DESCRIPTION		
1	Int. Manifold Gasket Set	2006	MS 96440-1			
1	Exh. Manifold Gasket Set	2006	MS 96888			
QTY	EXHAUST PIPE FLANGE	YEARS	PART NO.	DESCRIPTION		
1	Exhaust Pipe Gasket	2006	61348	Pipe to manifold		
QTY	CRANKSHAFT REAR SEAL	YEARS	PART NO.	DESCRIPTION		
1	Rear Main Seal Set	2006	BS 40705	PTFE Rubber; One-piece		
QTY	VALVE COVER	YEARS	PART NO.	DESCRIPTION		
1	Valve Cover Gasket Set	2006	VS 50704 R	w/Grommets & Spark plug tube seals; Must be used w/MS 96440-1; PermaDry® molded rubber gskt. incl.		
QTY	VALVE STEM SEAL SET	YEARS	PART NO.	DESCRIPTION		
1	Valve Stem Seal Set	2006	SS 71043	Premium valve stem seals incl.		
QTY	THERMOSTAT HOUSING	YEARS	PART NO.	DESCRIPTION		
1	Thermostat Gasket	2006	35632	Thermostat Housing; Thermostat O-ring		
QTY	WATER OUTLET GASKET	YEARS	PART NO.	DESCRIPTION		
1	Water Outlet Gasket	2006	36009	Water Outlet; Coolant outlet seal; New Part Number - Check for Availability		
QTY	WATER PUMP	YEARS	PART NO.	DESCRIPTION		
1	Water Pump Gasket	2006	35704			
QTY	TIMING COVER	YEARS	PART NO.	DESCRIPTION		
1	Timing Cover Set	2006	TCS 45052			
QTY	CARB & FUEL INJECTION	YEARS	PART NO.	DESCRIPTION		
1	Fuel Injector O-Ring Set	2006	ES 70599	Upper set; Injectors to fuel rail; Improved design		
1	Fuel Injector O-Ring Set	2006	ES 71190	Lower set; Injectors to cylinder head		
1	Fuel Injector O-Ring Set	2006	ES 71192	Upper set; Injectors to fuel rail; Old design		
1	Throttle Body Gasket	2006	61337	Improved design		
QTY	EXHAUST GAS RECIRCULATION	YEARS	PART NO.	DESCRIPTION		
1	EGR Gasket	2006	72755	EGR tube; New Part Number - Check for Availability		
10		1991; 2.8L 173 (2835cc) OHV V6 (12 Valve) 89mm Bore			10	
		TBI; Gasoline; Naturally Aspirated GMC Eng.; Chevrolet; Eng. Code LL2				
QTY	CYLINDER HEAD	YEARS	PART NO.	DESCRIPTION		
2	Head Gasket	1991	512 SD	Head bolts not incl.; Head bolt replacement recommended; PermaTorque Severe Duty®		
2	Head Gasket	1991	8699 PT-2	Head bolts not incl.; Head bolt replacement recommended; PermaTorque®		
2	Head Gasket Spacer Shim	1991	8699 SP-1	HeadSaver®		
1	Head Set	1991	HS 8699 PT-6	Head bolts & exh. pipe packing not incl.; Head bolt replacement recommended; Premium valve stem seals incl.		

Isuzu Truck (Incl. Minivans and SUV's) (Cont.)

10 (cont.)		1991; 2.8L 173 (2835cc) OHV V6 (12 Valve) 89mm Bore			10 (cont.)
		TBI; Gasoline; Naturally Aspirated GMC Eng.; Chevrolet; Eng. Code LL2			
QTY	CYLINDER HEAD	YEARS	PART NO.	DESCRIPTION	
1	Head Installation Set	1991	HIS 8699 PT-6	Head bolts & exh. pipe packing not incl.; Head bolt replacement recommended	
1	Head Bolt Set	1991	ES 72857	Replacement recommended	
QTY	CONVERSION SET	YEARS	PART NO.	DESCRIPTION	
1	Gasket Conversion Set	1991	CS 9471	PermaDry® molded rubber oil pan gskt. incl.	
QTY	MANIFOLD - INT. & EXH.	YEARS	PART NO.	DESCRIPTION	
1	Int. Manifold Gasket Set	1991	MS 91022		
1	Exh. Manifold Gasket Set	1991	MS 90864		
QTY	EXHAUST PIPE FLANGE	YEARS	PART NO.	DESCRIPTION	
2	Exhaust Pipe Gasket	1991	60538	Packing	
QTY	FUEL PUMP	YEARS	PART NO.	DESCRIPTION	
1	Fuel Pump Mounting Gasket	1991	70015		
QTY	OIL PAN	YEARS	PART NO.	DESCRIPTION	
1	Oil Pan Gasket Set	1991	OS 34501 R	PermaDry® molded rubber gskt. incl.	
1	Drain Plug Gasket	1991	70822		
QTY	CRANKSHAFT REAR SEAL	YEARS	PART NO.	DESCRIPTION	
1	Rear Main Seal Set	1991	BS 40464	11.0mm thick; Rubber; One-piece; Improved design	
1	Rear Main Seal Set	1991	BS 40625	11.0mm thick; PTFE Rubber; One-piece; Improved design	
1	Repair Sleeve Tool	1991	16304	Crankshaft	
QTY	VALVE COVER	YEARS	PART NO.	DESCRIPTION	
1	Valve Cover Gasket Set	1991	VS 50272 C	Cork; Improved design	
1	Valve Cover Gasket Set	1991	VS 50272 R	Rubber; Old design; Superseded - When depleted use VS 50272 C	
1	Valve Cover Gasket Set	1991	VS 50272 T	PermaDryPlus®	
QTY	VALVE STEM SEAL SET	YEARS	PART NO.	DESCRIPTION	
1	Valve Stem Seal Set	1991	SS 72530	Premium valve stem seals incl.	
QTY	WATER OUTLET GASKET	YEARS	PART NO.	DESCRIPTION	
1	Water Outlet Gasket	1991	35258	Water Outlet	
QTY	WATER PUMP	YEARS	PART NO.	DESCRIPTION	
1	Water Pump Gasket	1991	35409		
QTY	TIMING COVER	YEARS	PART NO.	DESCRIPTION	
1	Timing Cover Set	1991	TCS 45828	w/o Sleeve 'N' Seal®; Must be used w/OS 34501R	
1	Timing Cover Gasket	1991	72670	New Part Number - Check for Availability	
1	Timing Cover Gasket	1991	72696	Camshaft rear cover plate; New Part Number - Check for Availability	
1	Timing Set w/Sleeve & Seal	1991	TCS 45827	w/Sleeve 'N' Seal®; Must be used w/OS 34501R; 1.040" sleeve length	
1	Repair Sleeve	1991	16212	Timing Cover; 1.040" sleeve length; Use w/installation tool	
1	Repair Sleeve Tool	1991	16312	Timing Cover	
QTY	AIR CLEANER MOUNTING	YEARS	PART NO.	DESCRIPTION	
1	Air Cleaner Gasket	1991	60038	5 1/32" ID	
QTY	CARB & FUEL INJECTION	YEARS	PART NO.	DESCRIPTION	
1	Throttle Body Gasket	1991	60770		
QTY	DISTRIBUTOR MOUNTING	YEARS	PART NO.	DESCRIPTION	
1	O-Ring	1991	70800	Distributor Mounting	
QTY	EXHAUST GAS RECIRCULATION	YEARS	PART NO.	DESCRIPTION	
1	EGR Gasket	1991	70954		
QTY	OIL FILTER MOUNTING	YEARS	PART NO.	DESCRIPTION	
1	Oil Filter Gasket	1991	70672		
11		2008 - 2007; 2.9L 178.2 (2921cc) DOHC L4 (16 Valve) 95.5mm Bore Vortec			11
		MFI; Gasoline; Naturally Aspirated GMC Eng.; Chevrolet; VIN Code 9			
QTY	CYLINDER HEAD	YEARS	PART NO.	DESCRIPTION	
1	Head Gasket	2008-07	26389 PT	Head bolts not incl.; Head bolt replacement recommended; PermaTorqueMLS®	
1	Head Set	2008-07	HS 26389 PT	Head bolts not incl.; Head bolt replacement recommended; PermaDry® molded rubber valve cover gskt. incl.; Premium valve stem seals incl.	
1	Head Bolt Set	2008-07	ES 71334	Head bolts w/Washers; Replacement recommended; Improved design	
1	Head Bolt Set	2008-07	ES 72195	Head bolts w/Washers; Replacement recommended; Old design	
QTY	CONVERSION SET	YEARS	PART NO.	DESCRIPTION	
1	Gasket Conversion Set	2008-07	CS 26335	RTV sealant incl. for oil pan gskt.	
QTY	MANIFOLD - INT. & EXH.	YEARS	PART NO.	DESCRIPTION	
1	Int. Manifold Gasket Set	2008-07	MS 96440-1		
1	Exh. Manifold Gasket Set	2008-07	MS 97008		
QTY	EXHAUST PIPE FLANGE	YEARS	PART NO.	DESCRIPTION	
1	Exhaust Pipe Gasket	2008-07	61348	Pipe to manifold	

Isuzu Truck (Incl. Minivans and SUV's) (Cont.)

11 (cont.)		2008 - 2007; 2.9L 178.2 (2921cc) DOHC L4 (16 Valve) 95.5mm Bore Vortec			11 (cont.)
		MFI; Gasoline; Naturally Aspirated GMC Eng.; Chevrolet; VIN Code 9			
QTY	CRANKSHAFT REAR SEAL	YEARS	PART NO.	DESCRIPTION	
1	Rear Main Seal Set	2008-07	BS 40705	PTFE Rubber; One-piece	
QTY	VALVE COVER	YEARS	PART NO.	DESCRIPTION	
1	Valve Cover Gasket Set	2008-07	VS 50738 R	w/Grommets & Spark plug tube seals; Must be used w/MS 96440-1; PermaDry® molded rubber gskt. incl.	
QTY	VALVE STEM SEAL SET	YEARS	PART NO.	DESCRIPTION	
1	Valve Stem Seal Set	2008-07	SS 71237-1	Premium valve stem seals incl.	
QTY	THERMOSTAT HOUSING	YEARS	PART NO.	DESCRIPTION	
1	Thermostat Gasket	2008-07	35632	Thermostat O-ring	
QTY	WATER OUTLET GASKET	YEARS	PART NO.	DESCRIPTION	
1	Water Outlet Gasket	2008-07	36017	Water Outlet; Coolant outlet seal; New Part Number - Check for Availability	
QTY	WATER PUMP	YEARS	PART NO.	DESCRIPTION	
1	Water Pump Gasket	2008-07	35704		
QTY	TIMING COVER	YEARS	PART NO.	DESCRIPTION	
1	Timing Cover Set	2008-07	TCS 45052		
QTY	CARB & FUEL INJECTION	YEARS	PART NO.	DESCRIPTION	
1	Fuel Injector O-Ring Set	2008-07	ES 70599	Upper set; Injectors to fuel rail; Improved design	
1	Fuel Injector O-Ring Set	2008-07	ES 71190	Lower set; Injectors to cylinder head	
1	Fuel Injector O-Ring Set	2008-07	ES 71192	Upper set; Injectors to fuel rail; Old design	
1	Throttle Body Gasket	2008-07	61337	Improved design	
QTY	EXHAUST GAS RECIRCULATION	YEARS	PART NO.	DESCRIPTION	
1	EGR Gasket	2008-07	72755	EGR tube; New Part Number - Check for Availability	
12		1994 - 1991; 3.1L 189 (3136cc) OHV V6 (12 Valve) 89mm Bore			12
		TBI; Gasoline; Naturally Aspirated GMC Eng.; Chevrolet; Eng. Code LG6			
QTY	CYLINDER HEAD	YEARS	PART NO.	DESCRIPTION	
2	Head Gasket	1994-91	512 SD	Head bolts not incl.; Head bolt replacement recommended; PermaTorque Severe Duty®	
2	Head Gasket	1994-91	8699 PT-2	Head bolts not incl.; Head bolt replacement recommended; PermaTorque®	
2	Head Gasket Spacer Shim	1994-91	8699 SP-1	HeadSaver®	
1	Head Set	1994-91	HS 8699 PT-7	Head bolts & exh. pipe packing not incl.; Head bolt replacement recommended; Premium valve stem seals incl.	
1	Head Installation Set	1994-91	HIS 8699 PT-7	Head bolts & exh. pipe packing not incl.; Head bolt replacement recommended	
1	Head Bolt Set	1994-91	ES 72901	Replacement recommended	
QTY	CONVERSION SET	YEARS	PART NO.	DESCRIPTION	
1	Gasket Conversion Set	1994-91	CS 9471	PermaDry® molded rubber oil pan gskt. incl.	
QTY	MANIFOLD - INT. & EXH.	YEARS	PART NO.	DESCRIPTION	
1	Int. Manifold Gasket Set	1994-91	MS 91022		
1	Exh. Manifold Gasket Set	1994-91	MS 90864		
QTY	EXHAUST PIPE FLANGE	YEARS	PART NO.	DESCRIPTION	
1	Exhaust Pipe Gasket	1994-93	60554	Packing	
1	Exhaust Pipe Gasket	1992-91	60538	Packing	
QTY	OIL PAN	YEARS	PART NO.	DESCRIPTION	
1	Oil Pan Gasket Set	1994-91	OS 34501 R	PermaDry® molded rubber gskt. incl.	
1	Drain Plug Gasket	1994-91	70822		
QTY	CRANKSHAFT REAR SEAL	YEARS	PART NO.	DESCRIPTION	
1	Rear Main Seal Set	1994-91	BS 40464	11.0mm thick; Rubber; One-piece; Improved design	
1	Rear Main Seal Set	1994-91	BS 40625	11.0mm thick; PTFE Rubber; One-piece; Improved design	
1	Repair Sleeve Tool	1994-91	16304	Crankshaft	
QTY	VALVE COVER	YEARS	PART NO.	DESCRIPTION	
1	Valve Cover Gasket Set	1994-91	VS 50272 C	Cork; Improved design	
1	Valve Cover Gasket Set	1994-91	VS 50272 R	Rubber; Old design; Superseded - When depleted use VS 50272 C	
1	Valve Cover Gasket Set	1994-91	VS 50272 T	PermaDryPlus®	
QTY	VALVE STEM SEAL SET	YEARS	PART NO.	DESCRIPTION	
1	Valve Stem Seal Set	1994-91	SS 72530	Premium valve stem seals incl.	
QTY	THERMOSTAT HOUSING	YEARS	PART NO.	DESCRIPTION	
1	Water Outlet Gasket	1994-91	35258	Thermostat Housing	
1	Thermostat Gasket	1994-91	35571	Thermostat Housing; Bypass pipe	
1	Thermostat Gasket	1994-91	35614	Thermostat Housing; Thermostat seal; Improved design	
QTY	WATER PUMP	YEARS	PART NO.	DESCRIPTION	
1	Water Pump Gasket	1994-91	35409		
QTY	TIMING COVER	YEARS	PART NO.	DESCRIPTION	
1	Timing Cover Set	1994-91	TCS 45828	w/o Sleeve 'N' Seal®; Must be used w/OS 34501R	

Isuzu Truck (Incl. Minivans and SUV's) (Cont.)

12 (cont.)		1994 - 1991; 3.1L 189 (3136cc) OHV V6 (12 Valve) 89mm Bore			12 (cont.)
		TBI; Gasoline; Naturally Aspirated GMC Eng.; Chevrolet; Eng. Code LG6			
QTY	TIMING COVER	YEARS	PART NO.	DESCRIPTION	
1	Timing Cover Gasket	1994-91	72670	New Part Number - Check for Availability	
1	Timing Cover Gasket	1994-91	72696	Camshaft rear cover plate; New Part Number - Check for Availability	
1	Timing Set w/Sleeve & Seal	1994-91	TCS 45827	w/Sleeve 'N' Seal®; Must be used w/OS 34501R; 1.040" sleeve length	
1	Repair Sleeve	1994-91	16212	Timing Cover; 1.040" sleeve length; Use w/installation tool	
1	Repair Sleeve Tool	1994-91	16312	Timing Cover	
QTY	AIR CLEANER MOUNTING	YEARS	PART NO.	DESCRIPTION	
1	Air Cleaner Gasket	1994-91	60038	5 1/32" ID	
QTY	CARB & FUEL INJECTION	YEARS	PART NO.	DESCRIPTION	
1	Throttle Body Gasket	1994-91	60770		
QTY	DISTRIBUTOR MOUNTING	YEARS	PART NO.	DESCRIPTION	
1	O-Ring	1994-91	70800	Distributor Mounting	
QTY	EXHAUST GAS RECIRCULATION	YEARS	PART NO.	DESCRIPTION	
1	EGR Gasket	1994-91	70954		
QTY	OIL FILTER MOUNTING	YEARS	PART NO.	DESCRIPTION	
1	Oil Filter Gasket	1994-91	70672		
13		2004 - 1992; 3.2L 193 (3165cc) DOHC V6 (24 Valve) 93.4mm Bore			13
		MFI; Gasoline; Naturally Aspirated Isuzu Eng.; Eng. Code 6VD2			
QTY	CYLINDER HEAD	YEARS	PART NO.	DESCRIPTION	
1	Head Gasket	2004-98	9254 PT	Loc. R.H.; Head bolts not incl.; Head bolt replacement recommended; PermaTorqueMLS® LaserWeld® Technology	
1	Head Gasket	2004-98	9256 PT	Loc. L.H.; Head bolts not incl.; Head bolt replacement recommended; PermaTorqueMLS® LaserWeld® Technology	
2	Head Gasket	1995-92	9174 PT		
1	Head Set	2004-98	HS 9254 PT	Head bolts not incl.; Head bolt replacement recommended; PermaDry® molded rubber valve cover gskts. incl.; Premium valve stem seals incl.	
1	Head Set	1995-92	HS 9174 PT	PermaDry® molded rubber valve cover gskts. incl.; Premium valve stem seals incl.	
QTY	CONVERSION SET	YEARS	PART NO.	DESCRIPTION	
1	Gasket Conversion Set	2004-98	CS 9254		
1	Gasket Conversion Set	1995-92	CS 9174		
QTY	MANIFOLD - INT. & EXH.	YEARS	PART NO.	DESCRIPTION	
1	Int. Manifold Gasket Set	2004-98	MS 90610	Lower set; Upper set incl.	
1	Int. Manifold Gasket Set	1995-92	MS 95752	Lower set; Upper set incl.	
1	Plenum Gasket Set	1995-92	MS 95753	Upper set; New Part Number - Check for Availability	
1	Exh. Manifold Gasket Set	2004-98	MS 90725		
1	Exh. Manifold Gasket Set	1995-92	MS 95813		
QTY	EXHAUST PIPE FLANGE	YEARS	PART NO.	DESCRIPTION	
2	Exhaust Pipe Gasket	2004-98	60554	Flange	
2	Exhaust Pipe Gasket	1995-92	60554	Flange	
2	Exhaust Pipe Gasket	1995-92	60856	Converter	
QTY	OIL PAN	YEARS	PART NO.	DESCRIPTION	
1	Oil Pan Gasket Set	2004-98	OS 30685	Loc. Upper	
1	Oil Pan Gasket Set	2004-98	OS 34511	Loc. Lower	
1	Oil Pan Gasket Set	1995-92	OS 30679 C		
QTY	CRANKSHAFT REAR SEAL	YEARS	PART NO.	DESCRIPTION	
1	Rear Main Seal Set	2004-98	BS 40624	Rubber; One-piece	
1	Rear Main Seal Set	1995-92	BS 40624	Rubber; One-piece	
QTY	VALVE COVER	YEARS	PART NO.	DESCRIPTION	
1	Valve Cover Gasket Set	2004-98	VS 50486 R	w/Grommets & Spark plug tube seals; PermaDry® molded rubber gskts. incl.	
1	Valve Cover Gasket Set	1995-92	VS 50468 R	w/o Spark plug tube seals; PermaDry® molded rubber gskts. incl.	
1	Spark Plug Tube Seal Set	1995-92	ES 70691	Valve Cover	
QTY	VALVE STEM SEAL SET	YEARS	PART NO.	DESCRIPTION	
2	Valve Stem Seal Set	2004-98	SS 72721	Premium valve stem seals incl.	
2	Valve Stem Seal Set	1995-92	SS 72721	Premium valve stem seals incl.	
QTY	THERMOSTAT HOUSING	YEARS	PART NO.	DESCRIPTION	
1	Thermostat Gasket	2004-98	35615	Thermostat Housing; Thermostat seal	
1	Thermostat Gasket	1995-92	35599	Thermostat Housing; Thermostat seal	
QTY	WATER OUTLET GASKET	YEARS	PART NO.	DESCRIPTION	
2	Water Outlet Gasket	1995-92	35590	Water Outlet; Water manifold	
1	Water Outlet Gasket	1995-92	35591	Water Outlet; Coolant housing	
QTY	WATER PUMP	YEARS	PART NO.	DESCRIPTION	
1	Water Pump Gasket	2004-98	35593		
1	Water Pump Gasket	1995-92	35593		

Isuzu Truck (Incl. Minivans and SUV's) (Cont.)

13 (cont.)		2004 - 1992; 3.2L 193 (3165cc) DOHC V6 (24 Valve) 93.4mm Bore MFI; Gasoline; Naturally Aspirated Isuzu Eng.; Eng. Code 6VD2			13 (cont.)
QTY	TIMING COVER	YEARS	PART NO.	DESCRIPTION	
1	Crankshaft Front Seal Set	2004-98	TCS 45866	Oil pump mounting seals incl.	
1	Crankshaft Front Seal Set	2004-98	TCS 45983	Oil cooler mounting seals incl.	
1	Crankshaft Front Seal Set	1995-92	TCS 45866	Oil pump mounting seals incl.	
1	Crankshaft Front Seal Set	1995-92	TCS 45983	Oil cooler mounting seals incl.	
1	Camshaft Front Seal Set	2004-98	TCS 45859		
1	Camshaft Front Seal Set	1995-92	TCS 45859		
4	Camshaft Rear Seal Plug Set	2004-98	TCS 45868	Use for both front & rear camshaft plugs	
3	Camshaft Rear Seal Plug Set	1995-92	TCS 45868	Use for both front & rear camshaft plugs	
QTY	CARB & FUEL INJECTION	YEARS	PART NO.	DESCRIPTION	
3	Fuel Injector O-Ring Set	1995-92	ES 70599	Improved design	
1	Throttle Body Gasket	2004-01	61517		
1	Throttle Body Gasket	2000-99	61034	To 07/31/99	
1	Throttle Body Gasket	2000-99	61517	From 08/01/99	
1	Throttle Body Gasket	1998	61034		
1	Throttle Body Gasket	1995-92	61034		
QTY	EXHAUST GAS RECIRCULATION	YEARS	PART NO.	DESCRIPTION	
1	EGR Gasket	2004-98	70789	Valve	
1	EGR Gasket	2004-98	70794	Inlet	
1	EGR Gasket	1995-92	70372	Valve	
1	EGR Gasket	1995-92	70794	Inlet	
14		1997 - 1992; 3.2L 193 (3165cc) SOHC V6 (24 Valve) 93.4mm Bore MFI; Gasoline; Naturally Aspirated Isuzu Eng.; Eng. Code 6VD1			14
QTY	CYLINDER HEAD	YEARS	PART NO.	DESCRIPTION	
2	Head Gasket	1997-92	9174 PT		
1	Head Set	1997-96	HS 9174 PT-2	PermaDry® molded rubber valve cover gskts. incl.; Premium valve stem seals incl.	
1	Head Set	1995-92	HS 9174 PT-1	PermaDry® molded rubber valve cover gskts. incl.; Premium valve stem seals incl.	
QTY	CONVERSION SET	YEARS	PART NO.	DESCRIPTION	
1	Gasket Conversion Set	1997-92	CS 9174		
QTY	MANIFOLD - INT. & EXH.	YEARS	PART NO.	DESCRIPTION	
1	Int. Manifold Gasket Set	1997-92	MS 95751	Lower set; Upper set incl.	
1	Plenum Gasket Set	1997-92	MS 95751-1	Upper set	
1	Exh. Manifold Gasket Set	1997-96	MS 90725		
1	Exh. Manifold Gasket Set	1995-92	MS 95813		
QTY	EXHAUST PIPE FLANGE	YEARS	PART NO.	DESCRIPTION	
2	Exhaust Pipe Gasket	1997-92	60554	Flange	
2	Exhaust Pipe Gasket	1997-92	60856	Converter	
QTY	OIL PAN	YEARS	PART NO.	DESCRIPTION	
1	Oil Pan Gasket Set	1997-92	OS 30679 C		
QTY	CRANKSHAFT REAR SEAL	YEARS	PART NO.	DESCRIPTION	
1	Rear Main Seal Set	1997-92	BS 40624	Rubber; One-piece	
QTY	VALVE COVER	YEARS	PART NO.	DESCRIPTION	
1	Valve Cover Gasket Set	1997-92	VS 50469 R	w/o Spark plug tube seals; PermaDry® molded rubber gskts. incl.	
1	Spark Plug Tube Seal Set	1997-92	ES 70691	Valve Cover	
QTY	VALVE STEM SEAL SET	YEARS	PART NO.	DESCRIPTION	
2	Valve Stem Seal Set	1997-92	SS 72721	Premium valve stem seals incl.	
QTY	THERMOSTAT HOUSING	YEARS	PART NO.	DESCRIPTION	
1	Thermostat Gasket	1997-92	35599	Thermostat Housing; Thermostat seal	
QTY	WATER OUTLET GASKET	YEARS	PART NO.	DESCRIPTION	
2	Water Outlet Gasket	1997-92	35590	Water Outlet; Water manifold	
1	Water Outlet Gasket	1997-92	35591	Water Outlet; Coolant housing	
QTY	WATER PUMP	YEARS	PART NO.	DESCRIPTION	
1	Water Pump Gasket	1997-92	35593		
QTY	TIMING COVER	YEARS	PART NO.	DESCRIPTION	
1	Crankshaft Front Seal Set	1997-92	TCS 45866	Oil pump mounting seals incl.	
1	Crankshaft Front Seal Set	1997-92	TCS 45983	Oil cooler mounting seals incl.	
1	Camshaft Front Seal Set	1997-92	TCS 45859		
1	Camshaft Rear Seal Plug Set	1997-92	TCS 45868		
QTY	CARB & FUEL INJECTION	YEARS	PART NO.	DESCRIPTION	
3	Fuel Injector O-Ring Set	1995-92	ES 70599	Improved design	
1	Throttle Body Gasket	1997-92	61034		

Isuzu Truck (Incl. Minivans and SUV's) (Cont.)

14		1997 - 1992; 3.2L 193 (3165cc) SOHC V6 (24 Valve) 93.4mm Bore			14
(cont.)		MFI; Gasoline; Naturally Aspirated Isuzu Eng.; Eng. Code 6VD1			(cont.)
QTY	EXHAUST GAS RECIRCULATION	YEARS	PART NO.	DESCRIPTION	
1	EGR Gasket	1997-92	70794	Inlet	
1	EGR Gasket	1997-96	70789	Valve	
1	EGR Gasket	1997-96	70832	Adapter	
1	EGR Gasket	1995-92	70372	Valve	
15		2006; 3.5L 211 (3460cc) DOHC L5 (20 Valve) 93mm Bore Vortec			15
(cont.)		MFI; Gasoline; Naturally Aspirated GMC Eng.; Chevrolet; VIN Code 6			(cont.)
QTY	CYLINDER HEAD	YEARS	PART NO.	DESCRIPTION	
1	Head Gasket	2006	26336 PT	Head bolts not incl.; Head bolt replacement recommended; PermaTorqueMLS®	
1	Head Set	2006	HS 26336 PT	Head bolts not incl.; Head bolt replacement recommended; PermaDry® molded rubber valve cover gskt. incl.; Premium valve stem seals incl.	
1	Head Bolt Set	2006	ES 71334	Head bolts w/Washers; Replacement recommended; Improved design	
1	Head Bolt Set	2006	ES 72195	Head bolts w/Washers; Replacement recommended; Old design	
QTY	CONVERSION SET	YEARS	PART NO.	DESCRIPTION	
1	Gasket Conversion Set	2006	CS 26335	RTV sealant incl. for oil pan gskt.	
QTY	MANIFOLD - INT. & EXH.	YEARS	PART NO.	DESCRIPTION	
1	Int. Manifold Gasket Set	2006	MS 96440-2		
1	Exh. Manifold Gasket Set	2006	MS 96889		
QTY	EXHAUST PIPE FLANGE	YEARS	PART NO.	DESCRIPTION	
1	Exhaust Pipe Gasket	2006	61348	Pipe to manifold	
QTY	CRANKSHAFT REAR SEAL	YEARS	PART NO.	DESCRIPTION	
1	Rear Main Seal Set	2006	BS 40705	PTFE Rubber; One-piece	
QTY	VALVE COVER	YEARS	PART NO.	DESCRIPTION	
1	Valve Cover Gasket Set	2006	VS 50703 R	w/Grommets & Spark plug tube seals; Must be used w/MS 96440-2; PermaDry® molded rubber gskt. incl.	
QTY	VALVE STEM SEAL SET	YEARS	PART NO.	DESCRIPTION	
1	Valve Stem Seal Set	2006	SS 71043-2	Premium valve stem seals incl.	
QTY	THERMOSTAT HOUSING	YEARS	PART NO.	DESCRIPTION	
1	Thermostat Gasket	2006	35632	Thermostat Housing; Thermostat O-ring	
QTY	WATER OUTLET GASKET	YEARS	PART NO.	DESCRIPTION	
1	Water Outlet Gasket	2006	36009	Water Outlet; Coolant outlet seal; New Part Number - Check for Availability	
QTY	WATER PUMP	YEARS	PART NO.	DESCRIPTION	
1	Water Pump Gasket	2006	35704		
QTY	TIMING COVER	YEARS	PART NO.	DESCRIPTION	
1	Timing Cover Set	2006	TCS 45052		
QTY	CARB & FUEL INJECTION	YEARS	PART NO.	DESCRIPTION	
2	Fuel Injector O-Ring Set	2006	ES 70599	Upper set; Injectors to fuel rail; Improved design	
2	Fuel Injector O-Ring Set	2006	ES 71190	Lower set; Injectors to cylinder head	
2	Fuel Injector O-Ring Set	2006	ES 71192	Upper set; Injectors to fuel rail; Old design	
1	Throttle Body Gasket	2006	61337	Improved design	
QTY	EXHAUST GAS RECIRCULATION	YEARS	PART NO.	DESCRIPTION	
1	EGR Gasket	2006	72755	EGR tube; New Part Number - Check for Availability	
16		2004 - 1998; 3.5L 214 (3494cc) DOHC V6 (24 Valve) 93.4mm Bore			16
(cont.)		MFI; Gasoline; Naturally Aspirated Isuzu Eng.; Eng. Code 6VE1			(cont.)
QTY	CYLINDER HEAD	YEARS	PART NO.	DESCRIPTION	
1	Head Gasket	2004	26417 PT	Loc. L.H.; Head bolts not incl.; Head bolt replacement recommended; PermaTorqueMLS®	
1	Head Gasket	2004	26418 PT	Loc. R.H.; Head bolts not incl.; Head bolt replacement recommended; PermaTorqueMLS®	
1	Head Gasket	2003-98	9254 PT	Loc. R.H.; Head bolts not incl.; Head bolt replacement recommended; PermaTorqueMLS® LaserWeld® Technology	
1	Head Gasket	2003-98	9256 PT	Loc. L.H.; Head bolts not incl.; Head bolt replacement recommended; PermaTorqueMLS® LaserWeld® Technology	
1	Head Set	2004	HS 26417 PT	Head bolts not incl.; Head bolt replacement recommended; PermaDry® molded rubber valve cover gskts. incl.; Premium valve stem seals incl.	
1	Head Set	2003-98	HS 9254 PT	Head bolts not incl.; Head bolt replacement recommended; PermaDry® molded rubber valve cover gskts. incl.; Premium valve stem seals incl.	
QTY	CONVERSION SET	YEARS	PART NO.	DESCRIPTION	
1	Gasket Conversion Set	2004-98	CS 9254		
QTY	MANIFOLD - INT. & EXH.	YEARS	PART NO.	DESCRIPTION	
1	Int. Manifold Gasket Set	2004	MS 97053	Lower set; Upper set incl.	

Isuzu Truck (Incl. Minivans and SUV's) (Cont.)

16 (cont.)		2004 - 1998; 3.5L 214 (3494cc) DOHC V6 (24 Valve) 93.4mm Bore			16 (cont.)
		MFI; Gasoline; Naturally Aspirated Isuzu Eng.; Eng. Code 6VE1			
QTY	MANIFOLD - INT. & EXH.	YEARS	PART NO.	DESCRIPTION	
1	Int. Manifold Gasket Set	2003-98	MS 90610	Lower set; Upper set incl.	
1	Exh. Manifold Gasket Set	2004-98	MS 90725		
QTY	EXHAUST PIPE FLANGE	YEARS	PART NO.	DESCRIPTION	
2	Exhaust Pipe Gasket	2004-98	60554	Flange	
QTY	OIL PAN	YEARS	PART NO.	DESCRIPTION	
1	Oil Pan Gasket Set	2004-98	OS 30685	Loc. Upper	
1	Oil Pan Gasket Set	2004-98	OS 34511	Loc. Lower	
QTY	CRANKSHAFT REAR SEAL	YEARS	PART NO.	DESCRIPTION	
1	Rear Main Seal Set	2004-98	BS 40624	Rubber; One-piece	
QTY	VALVE COVER	YEARS	PART NO.	DESCRIPTION	
1	Valve Cover Gasket Set	2004	VS 50754 R	w/Grommets & Spark plug tube seals; PermaDry® molded rubber gskts. incl.	
1	Valve Cover Gasket Set	2003-98	VS 50486 R	w/Grommets & Spark plug tube seals; PermaDry® molded rubber gskts. incl.	
QTY	VALVE STEM SEAL SET	YEARS	PART NO.	DESCRIPTION	
2	Valve Stem Seal Set	2004-98	SS 72721	Premium valve stem seals incl.	
QTY	THERMOSTAT HOUSING	YEARS	PART NO.	DESCRIPTION	
1	Thermostat Gasket	2004-98	35615	Thermostat seal	
QTY	WATER PUMP	YEARS	PART NO.	DESCRIPTION	
1	Water Pump Gasket	2004-98	35593		
QTY	TIMING COVER	YEARS	PART NO.	DESCRIPTION	
1	Crankshaft Front Seal Set	2004-98	TCS 45866	Oil pump mounting seals incl.	
1	Crankshaft Front Seal Set	2004-98	TCS 45983	Oil cooler mounting seals incl.	
2	Camshaft Front Seal Set	2004	TCS 45483		
1	Camshaft Front Seal Set	2003-98	TCS 45859		
4	Camshaft Rear Seal Plug Set	2004-98	TCS 45868	Use for both front & rear camshaft plugs	
QTY	CARB & FUEL INJECTION	YEARS	PART NO.	DESCRIPTION	
1	Throttle Body Gasket	2004	61577		
1	Throttle Body Gasket	2003-01	61517		
1	Throttle Body Gasket	2000-99	61034	To 07/31/99	
1	Throttle Body Gasket	2000-99	61517	From 08/01/99	
1	Throttle Body Gasket	1998	61034		
QTY	EXHAUST GAS RECIRCULATION	YEARS	PART NO.	DESCRIPTION	
1	EGR Gasket	2004-98	70789	Valve	
1	EGR Gasket	2004-98	70794	Inlet	
17		2008 - 2007; 3.7L 223 (3654cc) DOHC L5 (20 Valve) 95.5mm Bore Vortec			17
		MFI; Gasoline; Naturally Aspirated GMC Eng.; Chevrolet; VIN Code E			
QTY	CYLINDER HEAD	YEARS	PART NO.	DESCRIPTION	
1	Head Gasket	2008-07	26390 PT	Head bolts not incl.; Head bolt replacement recommended; PermaTorqueMLS®	
1	Head Set	2008-07	HS 26390 PT	Head bolts not incl.; Head bolt replacement recommended; PermaDry® molded rubber valve cover gskt. incl.; Premium valve stem seals incl.	
1	Head Bolt Set	2008-07	ES 71334	Head bolts w/Washers; Replacement recommended; Improved design	
1	Head Bolt Set	2008-07	ES 72195	Head bolts w/Washers; Replacement recommended; Old design	
QTY	CONVERSION SET	YEARS	PART NO.	DESCRIPTION	
1	Gasket Conversion Set	2008-07	CS 26335	RTV sealant incl. for oil pan gskt.	
QTY	MANIFOLD - INT. & EXH.	YEARS	PART NO.	DESCRIPTION	
1	Int. Manifold Gasket Set	2008-07	MS 96440-2		
1	Exh. Manifold Gasket Set	2008-07	MS 97009		
QTY	EXHAUST PIPE FLANGE	YEARS	PART NO.	DESCRIPTION	
1	Exhaust Pipe Gasket	2008-07	61348	Pipe to manifold	
QTY	CRANKSHAFT REAR SEAL	YEARS	PART NO.	DESCRIPTION	
1	Rear Main Seal Set	2008-07	BS 40705	PTFE Rubber; One-piece	
QTY	VALVE COVER	YEARS	PART NO.	DESCRIPTION	
1	Valve Cover Gasket Set	2008-07	VS 50739 R	w/Grommets & Spark plug tube seals; Must be used w/MS 96440-2; PermaDry® molded rubber gskt. incl.	
QTY	VALVE STEM SEAL SET	YEARS	PART NO.	DESCRIPTION	
1	Valve Stem Seal Set	2008-07	SS 71237-2	Premium valve stem seals incl.	
QTY	THERMOSTAT HOUSING	YEARS	PART NO.	DESCRIPTION	
1	Thermostat Gasket	2008-07	35632	Thermostat O-ring	
QTY	WATER OUTLET GASKET	YEARS	PART NO.	DESCRIPTION	
1	Water Outlet Gasket	2008-07	36017	Water Outlet; Coolant outlet seal; New Part Number - Check for Availability	
QTY	WATER PUMP	YEARS	PART NO.	DESCRIPTION	
1	Water Pump Gasket	2008-07	35704		

Isuzu Truck (Incl. Minivans and SUV's) (Cont.)

17 (cont.)	2008 - 2007; 3.7L 223 (3654cc) DOHC L5 (20 Valve) 95.5mm Bore Vortec				17 (cont.)
QTY	TIMING COVER	YEARS	PART NO.	DESCRIPTION	
1	Timing Cover Set	2008-07	TCS 45052		
QTY	CARB & FUEL INJECTION	YEARS	PART NO.	DESCRIPTION	
2	Fuel Injector O-Ring Set	2008-07	ES 70599	Upper set; Injectors to fuel rail; Improved design	
2	Fuel Injector O-Ring Set	2008-07	ES 71190	Lower set; Injectors to cylinder head	
2	Fuel Injector O-Ring Set	2008-07	ES 71192	Upper set; Injectors to fuel rail; Old design	
1	Throttle Body Gasket	2008-07	61337	Improved design	
QTY	EXHAUST GAS RECIRCULATION	YEARS	PART NO.	DESCRIPTION	
1	EGR Gasket	2008-07	72755	EGR tube; New Part Number - Check for Availability	
18	1994 - 1991; 3.9L 235.2 (3856cc) OHV Turbo L4 (8 Valve) 102mm Bore				18
DI; Diesel; Turbo Isuzu Eng.; Eng. Code 4BD1-T					
QTY	FULL GASKET SET	YEARS	PART NO.	DESCRIPTION	
1	Full Gasket Set	1994-91	FS 9015 B		
19	2009 - 2003; 4.2L 254 (4160cc) DOHC L6 (24 Valve) 93mm Bore Vortec				19
MFI; Gasoline; Naturally Aspirated GMC Eng.; Chevrolet; VIN Code S					
QTY	CYLINDER HEAD	YEARS	PART NO.	DESCRIPTION	
1	Head Gasket	2009-03	26214 PT	Head bolts not incl.; Head bolt replacement recommended; PermaTorqueMLS®; Improved design	
1	Head Gasket	2003	26213 PT	Head bolts not incl.; Head bolt replacement recommended; PermaTorqueMLS®; May use 26214PT instead; Old design; Superseded - When depleted use 26214 PT	
1	Head Set	2009-06	HS 26214 PT-2	Head bolts not incl.; Head bolt replacement recommended; PermaDry® molded rubber valve cover gskt. incl.; Premium valve stem seals incl.	
1	Head Set	2005	HS 26214 PT-1	Head bolts not incl.; Head bolt replacement recommended; PermaDry® molded rubber valve cover gskt. incl.; Premium valve stem seals incl.	
1	Head Set	2004-03	HS 26214 PT	Head bolts not incl.; Head bolt replacement recommended; PermaDry® molded rubber valve cover gskt. incl.; Premium valve stem seals incl.; Improved design	
1	Head Set	2003	HS 26213 PT	Head bolts not incl.; Head bolt replacement recommended; PermaDry® molded rubber valve cover gskt. incl.; Premium valve stem seals incl.; May use HS 26214PT instead; Old design; Superseded - When depleted use HS 26214 PT	
1	Head Bolt Set	2009-03	ES 71334	Head bolts w/Washers; Replacement recommended; Improved design	
1	Head Bolt Set	2009-03	ES 72195	Head bolts w/Washers; Replacement recommended; Old design	
QTY	CONVERSION SET	YEARS	PART NO.	DESCRIPTION	
1	Gasket Conversion Set	2009-04	CS 26213-1	2nd Design; Balancer w/step on hub; RTV sealant incl. for oil pan gskt.	
1	Gasket Conversion Set	2005-04	CS 26213	1st Design; Balancer w/o step on hub; RTV sealant incl. for oil pan gskt.	
1	Gasket Conversion Set	2003	CS 26213	RTV sealant incl. for oil pan gskt.	
QTY	MANIFOLD - INT. & EXH.	YEARS	PART NO.	DESCRIPTION	
1	Int. Manifold Gasket Set	2009-05	MS 96440		
1	Int. Manifold Gasket Set	2004-03	MS 96294		
1	Exh. Manifold Gasket Set	2009-06	MS 96707		
1	Exh. Manifold Gasket Set	2005-03	MS 96302		
QTY	EXHAUST PIPE FLANGE	YEARS	PART NO.	DESCRIPTION	
1	Exhaust Pipe Gasket	2009-03	61255	Flange	
QTY	CRANKSHAFT REAR SEAL	YEARS	PART NO.	DESCRIPTION	
1	Rear Main Seal Set	2009-03	BS 40678	PTFE Rubber; One-piece	
QTY	VALVE COVER	YEARS	PART NO.	DESCRIPTION	
1	Valve Cover Gasket Set	2009-06	VS 50667 R	w/Grommets & Spark plug tube seals; Must be used w/MS 96440; PermaDry® molded rubber gskt. incl.	
1	Valve Cover Gasket Set	2005	VS 50584 R	w/Grommets & Spark plug tube seals; Must be used w/MS 96440; PermaDry® molded rubber gskt. incl.	
1	Valve Cover Gasket Set	2004-03	VS 50584 R	w/Grommets & Spark plug tube seals; Must be used w/MS 96294; PermaDry® molded rubber gskt. incl.	
QTY	VALVE STEM SEAL SET	YEARS	PART NO.	DESCRIPTION	
1	Valve Stem Seal Set	2009-06	SS 71237	Premium valve stem seals incl.	
1	Valve Stem Seal Set	2005-03	SS 71043-1	Premium valve stem seals incl.	
QTY	THERMOSTAT HOUSING	YEARS	PART NO.	DESCRIPTION	
1	Thermostat Gasket	2009-03	35632	Thermostat Housing; Thermostat O-ring	
QTY	WATER OUTLET GASKET	YEARS	PART NO.	DESCRIPTION	
1	Water Outlet Gasket	2009-06	36017	Water Outlet; Coolant outlet seal; New Part Number - Check for Availability	
1	Water Outlet Gasket	2005-03	36009	Water Outlet; Coolant outlet seal; New Part Number - Check for Availability	
QTY	WATER PUMP	YEARS	PART NO.	DESCRIPTION	
1	Water Pump Gasket	2009-03	35704		

Isuzu Truck (Incl. Minivans and SUV's) (Cont.)

19 (cont.)		2009 - 2003; 4.2L 254 (4160cc) DOHC L6 (24 Valve) 93mm Bore Vortec MFI; Gasoline; Naturally Aspirated GMC Eng.; Chevrolet; VIN Code S			19 (cont.)
QTY	TIMING COVER	YEARS	PART NO.	DESCRIPTION	
1	Timing Cover Set	2009-04	TCS 45052	2nd Design; Balancer w/step on hub	
1	Timing Cover Set	2005-04	TCS 45051	1st Design; Balancer w/o step on hub	
1	Timing Cover Set	2003	TCS 45051		
QTY	CARB & FUEL INJECTION	YEARS	PART NO.	DESCRIPTION	
2	Fuel Injector O-Ring Set	2009-03	ES 70599	Upper set; Injectors to fuel rail; Improved design	
2	Fuel Injector O-Ring Set	2009-03	ES 71190	Lower set; Injectors to cylinder head	
2	Fuel Injector O-Ring Set	2009-03	ES 71192	Upper set; Injectors to fuel rail; Old design	
1	Throttle Body Gasket	2009-03	61337	Improved design	
QTY	EXHAUST GAS RECIRCULATION	YEARS	PART NO.	DESCRIPTION	
1	EGR Gasket	2009-03	72755	EGR tube; New Part Number - Check for Availability	
20		2001 - 1997; 4.3L 262 (4294cc) OHV V6 (12 Valve) 4" Bore Vortec CPI; Gasoline; Naturally Aspirated GMC Eng.; Chevrolet; VIN Code X, Eng. Code LB4			20
QTY	CYLINDER HEAD	YEARS	PART NO.	DESCRIPTION	
2	Head Gasket	2001-97	510 SD	Head bolts not incl.; Head bolt replacement recommended; PermaTorque Severe Duty®	
2	Head Gasket	2001-97	522 SD	Head bolts not incl.; Head bolt replacement recommended; PermaTorque Severe Duty® MLS	
2	Head Gasket	2001-97	9354 PT-1	Head bolts not incl.; Head bolt replacement recommended; PermaTorque®	
1	Head Set	2001-97	HS 9354 PT-6	Head bolts & exh. pipe packing not incl.; Head bolt replacement recommended; PermaDry® molded rubber valve cover gskts. incl.; Premium valve stem seals incl.	
1	Head Set	2001-97	HST 9354 PT-6	Head bolts & exh. pipe packing not incl.; Head bolt replacement recommended; PermaTorque Severe Duty® head gskts. incl.; PermaDryPlus® int. manifold gskts. incl.; PermaDry® molded rubber valve cover gskts. incl.; Premium valve stem seals incl.	
2	Head Bolt Set	2001-97	ES 74034	Replacement recommended	
QTY	CONVERSION SET	YEARS	PART NO.	DESCRIPTION	
1	Gasket Conversion Set	2001-97	CS 9354-3	Plastic timing cover not incl.; PermaDry® molded rubber oil pan gskt. incl.; Consolidated design	
QTY	MANIFOLD - INT. & EXH.	YEARS	PART NO.	DESCRIPTION	
1	Int. Manifold Gasket Set	2001-97	MS 95817	Lower set; Upper set incl.; Manifold bolts not incl.; Manifold bolt replacement recommended	
1	Int. Manifold Gasket Set	2001-97	MS 95817-1	Lower set only; Upper set not incl.; Manifold bolts not incl.; Manifold bolt replacement recommended	
1	Int. Manifold Gasket Set	2001-97	MS 98002 T	Valve cover gskts. & valve cover grommets incl.; Upper set incl.; PermaDryPlus® int. manifold gskts. incl.; Manifold bolts not incl.; Manifold bolt replacement recommended	
1	Plenum Gasket Set	2001-97	MS 95816	Upper set	
1	Int. Manifold Bolt Set	2001-97	ES 72224	Loc. Lower; Replacement recommended	
1	Exh. Manifold Gasket Set	2001-97	MS 95842		
QTY	EXHAUST PIPE FLANGE	YEARS	PART NO.	DESCRIPTION	
2	Exhaust Pipe Gasket	2001-97	61014	Pipe to manifold	
QTY	OIL PAN	YEARS	PART NO.	DESCRIPTION	
1	Oil Pan Gasket Set	2001-97	OS 30680 R	PermaDry® molded rubber gskt. incl.	
1	Drain Plug Gasket	2001-97	70820		
QTY	CRANKSHAFT REAR SEAL	YEARS	PART NO.	DESCRIPTION	
1	Rear Main Seal Set	2001-97	BS 40656	PTFE Rubber; One-piece; Improved design	
QTY	VALVE COVER	YEARS	PART NO.	DESCRIPTION	
1	Valve Cover Gasket Set	2001-97	VS 50464 R	w/Grommets; PermaDry® molded rubber gskts. incl.	
QTY	VALVE STEM SEAL SET	YEARS	PART NO.	DESCRIPTION	
1	Valve Stem Seal Set	2001-97	SS 72861-1	Loc. Int. & Exh.; Premium valve stem seals incl.	
QTY	THERMOSTAT HOUSING	YEARS	PART NO.	DESCRIPTION	
1	O-Ring	2001-97	35710	Thermostat Housing; 1.954" ID; Improved design	
QTY	WATER PUMP	YEARS	PART NO.	DESCRIPTION	
1	Water Pump Gasket	2001-97	13032	To plate	
2	Water Pump Gasket	2001-97	5152	To block	
QTY	TIMING COVER	YEARS	PART NO.	DESCRIPTION	
1	Timing Cover Set	2001-97	TCS 46091	Eng. w/2.42" OD timing cover seal; Must be used w/OS 30680R	
QTY	CARB & FUEL INJECTION	YEARS	PART NO.	DESCRIPTION	
1	Throttle Body Gasket	2001-97	61036		
QTY	DISTRIBUTOR MOUNTING	YEARS	PART NO.	DESCRIPTION	
1	Distributor Mounting Gasket	2001-97	70194		
QTY	EXHAUST GAS RECIRCULATION	YEARS	PART NO.	DESCRIPTION	
1	EGR Gasket	2001-97	70789		

Isuzu Truck (Incl. Minivans and SUV's) (Cont.)

20		2001 - 1997; 4.3L 262 (4294cc) OHV V6 (12 Valve) 4" Bore Vortec			20
(cont.)		CPI; Gasoline; Naturally Aspirated GMC Eng.; Chevrolet; VIN Code X, Eng. Code LB4			(cont.)
QTY	OIL PUMP RETAINER	YEARS	PART NO.	DESCRIPTION	
1	Oil Pump Shaft Guide	2001-97	72665	Distributor to oil pump shaft retainer	
QTY	OIL COOLER	YEARS	PART NO.	DESCRIPTION	
1	Oil Cooler Mounting Set	2001-97	ES 70016		
21		2001 - 1997; 4.3L 262 (4294cc) OHV V6 (12 Valve) 4" Bore Vortec H.O.			21
(cont.)		CPI; Gasoline; Naturally Aspirated GMC Eng.; Chevrolet; VIN Code W, Eng. Code LF6			(cont.)
QTY	CYLINDER HEAD	YEARS	PART NO.	DESCRIPTION	
2	Head Gasket	2001-97	510 SD	Head bolts not incl.; Head bolt replacement recommended; PermaTorque Severe Duty®	
2	Head Gasket	2001-97	522 SD	Head bolts not incl.; Head bolt replacement recommended; PermaTorque Severe Duty® MLS	
2	Head Gasket	2001-97	9354 PT-1	Head bolts not incl.; Head bolt replacement recommended; PermaTorque®	
1	Head Set	2001-97	HS 9354 PT-6	Head bolts & exh. pipe packing not incl.; Head bolt replacement recommended; PermaDry® molded rubber valve cover gskts. incl.; Premium valve stem seals incl.	
1	Head Set	2001-97	HST 9354 PT-6	Head bolts & exh. pipe packing not incl.; Head bolt replacement recommended; PermaTorque Severe Duty® head gskts. incl.; PermaDryPlus® int. manifold gskts. incl.; PermaDry® molded rubber valve cover gskts. incl.; Premium valve stem seals incl.	
2	Head Bolt Set	2001-97	ES 74034	Replacement recommended	
QTY	CONVERSION SET	YEARS	PART NO.	DESCRIPTION	
1	Gasket Conversion Set	2001-97	CS 9354-3	Plastic timing cover not incl.; PermaDry® molded rubber oil pan gskt. incl.; Consolidated design	
QTY	MANIFOLD - INT. & EXH.	YEARS	PART NO.	DESCRIPTION	
1	Int. Manifold Gasket Set	2001-97	MS 95817	Lower set; Upper set incl.; Manifold bolts not incl.; Manifold bolt replacement recommended	
1	Int. Manifold Gasket Set	2001-97	MS 95817-1	Lower set only; Upper set not incl.; Manifold bolts not incl.; Manifold bolt replacement recommended	
1	Int. Manifold Gasket Set	2001-97	MS 98002 T	Valve cover gskts. & valve cover grommets incl.; Upper set incl.; PermaDryPlus® int. manifold gskts. incl.; Manifold bolts not incl.; Manifold bolt replacement recommended	
1	Plenum Gasket Set	2001-97	MS 95816	Upper set	
1	Int. Manifold Bolt Set	2001-97	ES 72224	Loc. Lower; Replacement recommended	
1	Exh. Manifold Gasket Set	2001-97	MS 95842		
QTY	EXHAUST PIPE FLANGE	YEARS	PART NO.	DESCRIPTION	
2	Exhaust Pipe Gasket	2001-97	61014	Pipe to manifold	
QTY	OIL PAN	YEARS	PART NO.	DESCRIPTION	
1	Oil Pan Gasket Set	2001-97	OS 30680 R	PermaDry® molded rubber gskt. incl.	
1	Drain Plug Gasket	2001-97	70820		
QTY	CRANKSHAFT REAR SEAL	YEARS	PART NO.	DESCRIPTION	
1	Rear Main Seal Set	2001-97	BS 40656	PTFE Rubber; One-piece; Improved design	
QTY	VALVE COVER	YEARS	PART NO.	DESCRIPTION	
1	Valve Cover Gasket Set	2001-97	VS 50464 R	w/Grommets; PermaDry® molded rubber gskts. incl.	
QTY	VALVE STEM SEAL SET	YEARS	PART NO.	DESCRIPTION	
1	Valve Stem Seal Set	2001-97	SS 72861-1	Loc. Int. & Exh.; Premium valve stem seals incl.	
QTY	THERMOSTAT HOUSING	YEARS	PART NO.	DESCRIPTION	
1	O-Ring	2001-97	35710	Thermostat Housing; 1.954" ID; Improved design	
QTY	WATER PUMP	YEARS	PART NO.	DESCRIPTION	
1	Water Pump Gasket	2001-97	13032	To plate	
2	Water Pump Gasket	2001-97	5152	To block	
QTY	TIMING COVER	YEARS	PART NO.	DESCRIPTION	
1	Timing Cover Set	2001-97	TCS 46091	Eng. w/2.42" OD timing cover seal; Must be used w/OS 30680R	
QTY	CARB & FUEL INJECTION	YEARS	PART NO.	DESCRIPTION	
1	Throttle Body Gasket	2001-97	61036		
QTY	DISTRIBUTOR MOUNTING	YEARS	PART NO.	DESCRIPTION	
1	Distributor Mounting Gasket	2001-97	70194		
QTY	EXHAUST GAS RECIRCULATION	YEARS	PART NO.	DESCRIPTION	
1	EGR Gasket	2001-97	70789		
QTY	OIL PUMP RETAINER	YEARS	PART NO.	DESCRIPTION	
1	Oil Pump Shaft Guide	2001-97	72665	Distributor to oil pump shaft retainer	
QTY	OIL COOLER	YEARS	PART NO.	DESCRIPTION	
1	Oil Cooler Mounting Set	2001-97	ES 70016		

Isuzu Truck (Incl. Minivans and SUV's) (Cont.)

22		2007 - 2005; 5.3L 325 (5328cc) OHV V8 (16 Valve) 96mm Bore Vortec MFI; Gasoline; Naturally Aspirated GMC Eng.; Chevrolet; VIN Code M			22
QTY	CYLINDER HEAD	YEARS	PART NO.	DESCRIPTION	
2	Head Gasket	2007-05	26190 PT	Head bolts not incl.; Head bolt replacement recommended; PermaTorqueMLS® LaserWeld® Technology	
1	Head Set	2007-05	HS 26190 PT-2	Head bolts not incl.; Head bolt replacement recommended; When servicing Displacement-On-Demand solenoids use w/Lifter valley cover set MS 96871; PermaDryPlus® int. manifold gskts. incl.; PermaDry® molded rubber valve cover gskts. incl.; Premium valve stem	
2	Head Bolt Set	2007-05	ES 72220	2nd Design; Replacement recommended	
QTY	CONVERSION SET	YEARS	PART NO.	DESCRIPTION	
1	Gasket Conversion Set	2007-05	CS 9284	PermaDry® molded rubber oil pan gskt. incl.	
QTY	MANIFOLD - INT. & EXH.	YEARS	PART NO.	DESCRIPTION	
1	Int. Manifold Gasket Set	2007-05	MS 96587		
1	Int. Manifold Gasket Set	2007-05	MS 96857	Lifter valley cover set; Perimeter seal only	
1	Int. Manifold Gasket Set	2007-05	MS 96871	Lifter valley cover set; For use when servicing Displacement-On-Demand solenoids	
1	Int. Manifold Gasket Set	2007-05	MS 98016 T	PermaDryPlus® int. manifold gskts. incl.	
1	Exh. Manifold Gasket Set	2007-05	MS 92467		
QTY	EXHAUST PIPE FLANGE	YEARS	PART NO.	DESCRIPTION	
1	Exhaust Pipe Gasket	2007-05	61074	Loc. L.H.; Pipe to manifold	
1	Exhaust Pipe Gasket	2007-05	61089	Loc. R.H.; Pipe to manifold	
QTY	OIL PAN	YEARS	PART NO.	DESCRIPTION	
1	Oil Pan Gasket Set	2007-05	OS 30693 R	PermaDry® molded rubber gskt. incl.	
QTY	CRANKSHAFT REAR SEAL	YEARS	PART NO.	DESCRIPTION	
1	Rear Main Seal Set	2007-05	BS 40640	PTFE Rubber; One-piece	
1	Repair Sleeve	2007-05	16228	Crankshaft; Narrow lip; .780" sleeve length; Requires crankshaft machining due to clearance issues; Use w/installation tool	
1	Repair Sleeve	2007-05	16229	Crankshaft; Wide lip; 1.156" sleeve length; Requires crankshaft machining due to clearance issues; Use w/installation tool	
1	Repair Sleeve Tool	2007-05	16329	Crankshaft	
QTY	VALVE COVER	YEARS	PART NO.	DESCRIPTION	
1	Valve Cover Gasket Set	2007-05	VS 50504 R	w/o Grommets; PermaDry® molded rubber gskts. incl.	
1	Valve Cover Gasket Set	2007-05	VS 50504 R-1	w/Grommets; PermaDry® molded rubber gskts. incl.; New Part Number - Check for Availability	
1	Grommet Set	2007-05	ES 72233	Valve Cover	
QTY	VALVE STEM SEAL SET	YEARS	PART NO.	DESCRIPTION	
1	Valve Stem Seal Set	2007-05	SS 71039	Premium valve stem seals incl.	
QTY	THERMOSTAT HOUSING	YEARS	PART NO.	DESCRIPTION	
1	O-Ring	2007-05	35720	Thermostat Housing; Thermostat O-ring	
QTY	WATER PUMP	YEARS	PART NO.	DESCRIPTION	
2	Water Pump Gasket	2007-05	35635		
1	O-Ring	2007-05	35633	Water Pump	
1	Water Pump Mounting Set	2007-05	ES 73010	Mounting gasket set; New Part Number - Check for Availability	
QTY	TIMING COVER	YEARS	PART NO.	DESCRIPTION	
1	Timing Cover Set	2007-05	TCS 45993	Must be used w/OS 30693R	
QTY	CARB & FUEL INJECTION	YEARS	PART NO.	DESCRIPTION	
2	Fuel Injector O-Ring Set	2007-05	ES 70599	Upper set; Injectors to fuel rail; Improved design	
2	Fuel Injector O-Ring Set	2007-05	ES 71190	Lower set; Injectors to cylinder head	
2	Fuel Injector O-Ring Set	2007-05	ES 71192	Upper set; Injectors to fuel rail; Old design	
1	Throttle Body Gasket	2007-06	61469		
1	Throttle Body Gasket	2005	61454		
QTY	EXHAUST GAS RECIRCULATION	YEARS	PART NO.	DESCRIPTION	
1	EGR Gasket	2007-05	70895	Pipe; O-ring	
1	EGR Gasket	2007-05	70914	Valve	
1	EGR Gasket	2007-05	70947	Pipe	
QTY	OIL FILTER MOUNTING	YEARS	PART NO.	DESCRIPTION	
1	Oil Cooler Gasket	2007-05	72462	Oil Filter; Center tube; Dual round port	
QTY	OIL PUMP COVER	YEARS	PART NO.	DESCRIPTION	
1	O-Ring	2007-05	72401	Oil Pump; Inlet tube	
QTY	OIL COOLER	YEARS	PART NO.	DESCRIPTION	
1	Oil Cooler Gasket	2007-05	72435	Oval port	
1	Oil Cooler Gasket	2007-05	72462	Dual round port	

Isuzu Truck (Incl. Minivans and SUV's) (Cont.)

23		2005 - 2003; 5.3L 325 (5328cc) OHV V8 (16 Valve) 96mm Bore Vortec			23
		MFI; Gasoline; Naturally Aspirated GMC Eng.; Chevrolet; VIN Code P			
QTY	CYLINDER HEAD	YEARS	PART NO.	DESCRIPTION	
2	Head Gasket	2005-03	26191 PT	Head bolts not incl.; Head bolt replacement recommended; PermaTorqueMLS® LaserWeld® Technology	
1	Head Set	2005-04	HS 26191 PT-1	Head bolts not incl.; Head bolt replacement recommended; PermaDryPlus® int. manifold gskts. incl.; PermaDry® molded rubber valve cover gskts. incl.; Premium valve stem seals incl.	
1	Head Set	2003	HS 26191 PT	Head bolts not incl.; Head bolt replacement recommended; PermaDryPlus® int. manifold gskts. incl.; PermaDry® molded rubber valve cover gskts. incl.; Premium valve stem seals incl.	
2	Head Bolt Set	2005-04	ES 72220	2nd Design; Replacement recommended	
2	Head Bolt Set	2004-03	ES 72173	1st Design; Replacement recommended	
QTY	CONVERSION SET	YEARS	PART NO.	DESCRIPTION	
1	Gasket Conversion Set	2005-03	CS 9284	PermaDry® molded rubber oil pan gskt. incl.	
QTY	MANIFOLD - INT. & EXH.	YEARS	PART NO.	DESCRIPTION	
1	Int. Manifold Gasket Set	2005-03	MS 92465	Lifter valley cover set	
1	Int. Manifold Gasket Set	2005-03	MS 98016 T	PermaDryPlus® int. manifold gskts. incl.	
1	Int. Manifold Gasket Set	2005-04	MS 96587		
1	Int. Manifold Gasket Set	2003	MS 92211		
1	Exh. Manifold Gasket Set	2005-03	MS 92467		
QTY	EXHAUST PIPE FLANGE	YEARS	PART NO.	DESCRIPTION	
1	Exhaust Pipe Gasket	2005-03	61089	Loc. R.H.; Pipe to manifold	
1	Exhaust Pipe Gasket	2005-04	61323	Loc. L.H.; Pipe to manifold	
1	Exhaust Pipe Gasket	2003	61074	Loc. L.H.; Pipe to manifold	
QTY	OIL PAN	YEARS	PART NO.	DESCRIPTION	
1	Oil Pan Gasket Set	2005-03	OS 30693 R	PermaDry® molded rubber gskt. incl.	
QTY	CRANKSHAFT REAR SEAL	YEARS	PART NO.	DESCRIPTION	
1	Rear Main Seal Set	2005-03	BS 40640	PTFE Rubber; One-piece	
1	Repair Sleeve	2005-03	16228	Crankshaft; Narrow lip; .780" sleeve length; Requires crankshaft machining due to clearance issues; Use w/installation tool	
1	Repair Sleeve	2005-03	16229	Crankshaft; Wide lip; 1.156" sleeve length; Requires crankshaft machining due to clearance issues; Use w/installation tool	
1	Repair Sleeve Tool	2005-03	16329	Crankshaft	
QTY	VALVE COVER	YEARS	PART NO.	DESCRIPTION	
1	Valve Cover Gasket Set	2005-03	VS 50504 R	w/o Grommets; PermaDry® molded rubber gskts. incl.	
1	Valve Cover Gasket Set	2005-03	VS 50504 R-1	w/Grommets; PermaDry® molded rubber gskts. incl.; New Part Number - Check for Availability	
1	Grommet Set	2005-03	ES 72233	Valve Cover	
QTY	VALVE STEM SEAL SET	YEARS	PART NO.	DESCRIPTION	
1	Valve Stem Seal Set	2005-03	SS 71039	Premium valve stem seals incl.	
QTY	THERMOSTAT HOUSING	YEARS	PART NO.	DESCRIPTION	
1	Thermostat Gasket	2003	35632	Thermostat Housing; Thermostat O-ring	
1	O-Ring	2005-04	35720	Thermostat Housing; Thermostat O-ring	
QTY	WATER PUMP	YEARS	PART NO.	DESCRIPTION	
2	Water Pump Gasket	2005-03	35635		
1	O-Ring	2005-03	35633	Water Pump	
1	Water Pump Mounting Set	2005-03	ES 73010	Mounting gasket set; New Part Number - Check for Availability	
QTY	TIMING COVER	YEARS	PART NO.	DESCRIPTION	
1	Timing Cover Set	2005-03	TCS 45993	Must be used w/OS 30693R	
QTY	CARB & FUEL INJECTION	YEARS	PART NO.	DESCRIPTION	
2	Fuel Injector O-Ring Set	2005-03	ES 70599	Upper set; Injectors to fuel rail; Improved design	
2	Fuel Injector O-Ring Set	2005-03	ES 71190	Lower set; Injectors to cylinder head	
2	Fuel Injector O-Ring Set	2005-03	ES 71192	Upper set; Injectors to fuel rail; Old design	
1	Throttle Body Gasket	2005-03	61070		
QTY	EXHAUST GAS RECIRCULATION	YEARS	PART NO.	DESCRIPTION	
1	EGR Gasket	2005-03	70895	Pipe; O-ring	
1	EGR Gasket	2005-03	70914	Valve	
1	EGR Gasket	2005-03	70947	Pipe	
QTY	OIL FILTER MOUNTING	YEARS	PART NO.	DESCRIPTION	
1	Oil Cooler Gasket	2005-03	72462	Oil Filter; Center tube; Dual round port	
QTY	OIL PUMP COVER	YEARS	PART NO.	DESCRIPTION	
1	O-Ring	2005-03	72401	Oil Pump; Inlet tube	
QTY	OIL COOLER	YEARS	PART NO.	DESCRIPTION	
1	Oil Cooler Gasket	2005-03	72435	Oval port	
1	Oil Cooler Gasket	2005-03	72462	Dual round port	

Isuzu Truck (Incl. Minivans and SUV's) (Cont.)

24		2000 - 1996; 5.7L 350 (5736cc) OHV V8 (16 Valve) 4" Bore			24
CPI; Gasoline; Naturally Aspirated GMC Eng.; Chevrolet; Eng. Code CPC					
QTY	CYLINDER HEAD	YEARS	PART NO.	DESCRIPTION	
2	Head Gasket	2000-96	501 SD	Head bolts not incl.; Head bolt replacement recommended; PermaTorque Severe Duty®	
2	Head Gasket	2000-96	7733 PT-2	Head bolts not incl.; Head bolt replacement recommended; PermaTorque®	
2	Head Gasket Spacer Shim	2000-96	7733 SP	HeadSaver®	
1	Head Set	2000-96	HS 7733 PT-16	Head bolts & exh. pipe packing not incl.; Head bolt replacement recommended; PermaDry® molded rubber valve cover gskts. incl.; Premium valve stem seals incl.	
1	Head Set	2000-96	HST 7733 PT-16	Head bolts & exh. pipe packing not incl.; Head bolt replacement recommended; PermaTorque Severe Duty® head gskts. incl.; PermaDryPlus® int. manifold gskts. incl.; PermaDry® molded rubber valve cover gskts. incl.; Premium valve stem seals incl.	
2	Head Bolt Set	2000-96	ES 72856	Replacement recommended	
QTY	CONVERSION SET	YEARS	PART NO.	DESCRIPTION	
1	Gasket Conversion Set	2000-96	CS 8510-1	Plastic timing cover not incl.; PermaDry® molded rubber oil pan gskt. incl.	
QTY	MANIFOLD - INT. & EXH.	YEARS	PART NO.	DESCRIPTION	
1	Int. Manifold Gasket Set	2000-96	MS 90131	Lower set; Upper set incl.; Manifold bolts not incl.; Manifold bolt replacement recommended	
1	Int. Manifold Gasket Set	2000-96	MS 90131-2	Lower set only; Upper set not incl.; Manifold bolts not incl.; Manifold bolt replacement recommended	
1	Int. Manifold Gasket Set	2000-96	MS 98000 T	Single valve cover gskt. incl.; Upper set incl.; PermaDryPlus® int. manifold gskts. incl.; When servicing second valve cover use VS 50293R if required; Manifold bolts not incl.; Manifold bolt replacement recommended	
1	Plenum Gasket Set	2000-96	MS 90269	Upper set	
1	Int. Manifold Bolt Set	2000-96	ES 72224	Loc. Lower; Replacement recommended	
1	Exh. Manifold Gasket Set	2000-96	MS 94054		
QTY	EXHAUST PIPE FLANGE	YEARS	PART NO.	DESCRIPTION	
2	Exhaust Pipe Gasket	2000-96	61014	Pipe to manifold	
1	Exhaust Pipe Gasket	2000-96	61559	Converter; 3-bolt	
1	Exhaust Pipe Gasket	2000-96	61561	Converter; 2-bolt	
1	Exhaust Pipe Gasket	2000-96	61683	Exh. connector; New Part Number - Check for Availability	
QTY	FUEL PUMP	YEARS	PART NO.	DESCRIPTION	
1	Fuel Pump Mounting Gasket	2000-96	5182	Plate	
QTY	OIL PAN	YEARS	PART NO.	DESCRIPTION	
1	Oil Pan Gasket Set	2000-96	OS 34500 R	PermaDry® molded rubber gskt. incl.	
1	Drain Plug Gasket	2000-96	70820		
QTY	CRANKSHAFT REAR SEAL	YEARS	PART NO.	DESCRIPTION	
1	Rear Main Seal Set	2000-96	BS 40656	PTFE Rubber; One-piece; Improved design	
QTY	VALVE COVER	YEARS	PART NO.	DESCRIPTION	
1	Valve Cover Gasket Set	2000-96	VS 50088 R	Services both covers; PermaDry® molded rubber gskts. incl.	
2	Valve Cover Gasket Set	2000-96	VS 50293 R	Services one cover only; PermaDry® molded rubber gskt. incl.	
QTY	VALVE STEM SEAL SET	YEARS	PART NO.	DESCRIPTION	
1	Valve Stem Seal Set	2000-96	SS 72861	Loc. Int. & Exh.; Premium valve stem seals incl.; Improved design	
QTY	THERMOSTAT HOUSING	YEARS	PART NO.	DESCRIPTION	
1	O-Ring	2000-96	35710	Thermostat Housing; 1.954" ID; Improved design	
QTY	WATER PUMP	YEARS	PART NO.	DESCRIPTION	
1	Water Pump Gasket	2000-96	13032	To plate	
2	Water Pump Gasket	2000-96	5152	To block	
QTY	TIMING COVER	YEARS	PART NO.	DESCRIPTION	
1	Timing Cover Set	2000-96	TCS 46093	Eng. w/2.42" OD timing cover seal; Must be used w/OS 34500R	
QTY	CARB & FUEL INJECTION	YEARS	PART NO.	DESCRIPTION	
1	Throttle Body Gasket	2000-96	61036		
QTY	DISTRIBUTOR MOUNTING	YEARS	PART NO.	DESCRIPTION	
1	Distributor Mounting Gasket	2000-96	70194		
QTY	EXHAUST GAS RECIRCULATION	YEARS	PART NO.	DESCRIPTION	
1	EGR Gasket	2000-96	70789		
QTY	OIL PUMP RETAINER	YEARS	PART NO.	DESCRIPTION	
1	Oil Pump Shaft Guide	2000-96	72665	Distributor to oil pump shaft retainer	
QTY	OIL COOLER	YEARS	PART NO.	DESCRIPTION	
1	Oil Cooler Mounting Set	2000-96	ES 72671		

Isuzu Truck (Incl. Minivans and SUV's) (Cont.)

25		1995 - 1993; 5.7L 350 (5736cc) OHV V8 (16 Valve) 4" Bore			25
		TBI; Gasoline; Naturally Aspirated GMC Eng.; Chevrolet; Eng. Code CPC			
QTY	CYLINDER HEAD	YEARS	PART NO.	DESCRIPTION	
2	Head Gasket	1995-93	501 SD	Head bolts not incl.; Head bolt replacement recommended; PermaTorque Severe Duty®	
2	Head Gasket	1995-93	7733 PT-2	Head bolts not incl.; Head bolt replacement recommended; PermaTorque®	
2	Head Gasket Spacer Shim	1995-93	7733 SP	HeadSaver®	
1	Head Set	1995-93	HS 7733 PT-15	Head bolts & exh. pipe packing not incl.; Head bolt replacement recommended; PermaDry® molded rubber valve cover gskts. incl.; Premium valve stem seals incl.	
2	Head Bolt Set	1995-93	ES 72856	Replacement recommended	
QTY	CONVERSION SET	YEARS	PART NO.	DESCRIPTION	
1	Gasket Conversion Set	1995-93	CS 8510	PermaDry® molded rubber oil pan gskt. incl.	
QTY	MANIFOLD - INT. & EXH.	YEARS	PART NO.	DESCRIPTION	
1	Int. Manifold Gasket Set	1995-93	MS 93317		
1	Exh. Manifold Gasket Set	1995-93	MS 9275 B		
QTY	EXHAUST PIPE FLANGE	YEARS	PART NO.	DESCRIPTION	
2	Exhaust Pipe Gasket	1995-93	60584	Packing; 2 1/2" ID Steel sleeve to manifold; 2 1/4" ID Gasket to pipe	
2	Exhaust Pipe Gasket	1995-93	60718	Packing; 2 3/32" ID Steel sleeve	
QTY	FUEL PUMP	YEARS	PART NO.	DESCRIPTION	
1	Fuel Pump Mounting Gasket	1995-93	5182	Plate	
1	Fuel Pump Mounting Gasket	1995-93	6579	May also be used as a fuel pump block-off plate gasket if desired	
QTY	OIL PAN	YEARS	PART NO.	DESCRIPTION	
1	Oil Pan Gasket Set	1995-93	OS 34500 R	PermaDry® molded rubber gskt. incl.	
1	Drain Plug Gasket	1995-93	70822		
QTY	CRANKSHAFT REAR SEAL	YEARS	PART NO.	DESCRIPTION	
1	Rear Main Seal Set	1995-93	BS 40520	Rubber; One-piece	
1	Rear Main Seal Set	1995-93	BS 40626	PTFE Rubber; One-piece	
1	Repair Sleeve	1995-93	16258	Crankshaft; Use w/installation tool	
1	Repair Sleeve Tool	1995-93	16301	Crankshaft	
QTY	VALVE COVER	YEARS	PART NO.	DESCRIPTION	
1	Valve Cover Gasket Set	1995-93	VS 50088 R	Services both covers; PermaDry® molded rubber gskts. incl.	
2	Valve Cover Gasket Set	1995-93	VS 50293 R	Services one cover only; PermaDry® molded rubber gskt. incl.	
QTY	VALVE STEM SEAL SET	YEARS	PART NO.	DESCRIPTION	
1	Valve Stem Seal Set	1995-93	SS 72526	Loc. Exh.; Premium valve stem seals incl.	
1	Valve Stem Seal Set	1995-93	SS 72527	Loc. Int.; Premium valve stem seals incl.	
1	Valve Stem Seal Set	1995-93	SS 72877	Loc. Exh.; Opt. Hi-Temp. premium valve stem seals incl.	
QTY	THERMOSTAT HOUSING	YEARS	PART NO.	DESCRIPTION	
1	O-Ring	1995-93	35710	Thermostat Housing; 1.954" ID; Improved design	
QTY	WATER OUTLET GASKET	YEARS	PART NO.	DESCRIPTION	
1	Water Outlet Gasket	1995-93	35062	Water Outlet; 1 13/16" ID	
1	Water Outlet Gasket	1995-93	35562 T	Water Outlet; 1 13/16" ID; PermaDryPlus®	
QTY	WATER PUMP	YEARS	PART NO.	DESCRIPTION	
1	Water Pump Gasket	1995-93	13032	To plate	
2	Water Pump Gasket	1995-93	5152	To block	
QTY	TIMING COVER	YEARS	PART NO.	DESCRIPTION	
1	Timing Cover Set	1995-93	TCS 45121	w/o Sleeve 'N' Seal®; Must be used w/OS 34500R	
1	Timing Set w/Sleeve & Seal	1995-93	TCS 45265	w/Sleeve 'N' Seal®; Must be used w/OS 34500R	
1	Repair Sleeve	1995-93	16202	Timing Cover; Use w/installation tool	
1	Repair Sleeve Tool	1995-93	16312	Timing Cover	
QTY	AIR CLEANER MOUNTING	YEARS	PART NO.	DESCRIPTION	
1	Air Cleaner Gasket	1995-93	60038	5 1/32" ID	
QTY	CARB & FUEL INJECTION	YEARS	PART NO.	DESCRIPTION	
1	Throttle Body Gasket	1995-93	60903		
QTY	DISTRIBUTOR MOUNTING	YEARS	PART NO.	DESCRIPTION	
1	Distributor Mounting Gasket	1995-93	70194		
QTY	EXHAUST GAS RECIRCULATION	YEARS	PART NO.	DESCRIPTION	
1	EGR Gasket	1995-93	70978		
QTY	OIL PUMP RETAINER	YEARS	PART NO.	DESCRIPTION	
1	Oil Pump Shaft Guide	1995-93	72665	Distributor to oil pump shaft retainer	
QTY	OIL COOLER	YEARS	PART NO.	DESCRIPTION	
1	Oil Cooler Mounting Set	1995-93	ES 72671		

Engine Finding Index

Engine	Years	Code	Line No.
2.5L 152 (2495cc) DOHC V6 (24 Valve) 81.6mm Bore Duratec; MFI; Gasoline; Naturally Aspirated Ford Eng.	2005-02	D	1
3.0L 181 (2967cc) DOHC V6 (24 Valve) 89mm Bore Duratec; MFI; Gasoline; Naturally Aspirated Ford Eng.	2008-00	F	2
4.0L 242.8 (3980cc) DOHC L6 (24 Valve) 91mm Bore; MFI; Gasoline; Naturally Aspirated Jaguar Eng.	1994-91	AJ6 4.0	3
4.0L 244 (3996cc) DOHC V8 (32 Valve) 86mm Bore; MFI; Gasoline; Supercharged Jaguar Eng.	2003-98	AJ27 4.0SC	4

Engine Code Index

Code	Engine	Line No.
AJ27 4.0SC	4.0L 244 (3996cc) DOHC V8 (32 Valve) 86mm Bore; MFI; Gasoline; Supercharged Jaguar Eng.	4
AJ6 4.0	4.0L 242.8 (3980cc) DOHC L6 (24 Valve) 91mm Bore; MFI; Gasoline; Naturally Aspirated Jaguar Eng.	3

Model Index

Engine (VIN Code / Eng. Code)	Year	Engine (VIN Code / Eng. Code)	Year	Engine (VIN Code / Eng. Code)	Year
Jaguar		Jaguar (cont.)		Jaguar (cont.)	
F-Type		XF (cont.)		XJ6	
V6 2995cc 3.0L DOHC Supercharged (24 Valve) (Si6)	13	V8 4196cc 4.2L DOHC Supercharged (32 Valve) (AJ34 4.2SC)	09	L6 4235cc 4.2L DOHC	87-68
V8 4997cc 5.0L DOHC Supercharged (32 Valve) (AJ133 5.0SC)	13	V8 4997cc 5.0L DOHC (32 Valve) (AJ133 5.0)	12-10	V8 4196cc 4.2L DOHC (32 Valve) (AJ34 4.2)	09-04
		V8 4997cc 5.0L DOHC Supercharged (32 Valve) (AJ133 5.0SC)	13-10	XJ8-L	
				V8 4196cc 4.2L DOHC (32 Valve) (AJ34 4.2)	09-05
S-Type		XFR		XJR	
V6 2967cc 3.0L DOHC (24 Valve) (F)	08-00	V8 4997cc 5.0L DOHC Supercharged (32 Valve) (AJ133 5.0SC)	13-10	V8 4196cc 4.2L DOHC Supercharged (32 Valve) (AJ34 4.2SC)	09-04
V8 3996cc 4.0L DOHC (32 Valve) (AJ27 4.0)	02-00			XK	
V8 4196cc 4.2L DOHC (32 Valve) (AJ34 4.2)	08-03	XFR-S		V8 4997cc 5.0L DOHC (32 Valve) (AJ133 5.0)	13-10
V8 4196cc 4.2L DOHC Supercharged (32 Valve) (AJ34 4.2SC)	08-03	V8 4997cc 5.0L DOHC Supercharged (32 Valve) (AJ133 5.0SC)	13	XK8	
Super V8		XJ		V8 4196cc 4.2L DOHC (32 Valve) (AJ34 4.2)	09-04
V8 4196cc 4.2L DOHC Supercharged (32 Valve) (AJ34 4.2SC)	09-05	L6 4235cc 4.2L DOHC	72-69	XKE	
Vanden Plas		V6 2995cc 3.0L DOHC Supercharged (24 Valve) (Si6)	13	L6 4235cc 4.2L DOHC	71-65
V8 4196cc 4.2L DOHC (32 Valve) (AJ34 4.2)	09-04	V8 4997cc 5.0L DOHC (32 Valve) (AJ133 5.0)	12-10	XKR	
X-Type		V8 4997cc 5.0L DOHC Supercharged (32 Valve) (AJ133 5.0SC)	13-10	V8 4196cc 4.2L DOHC Supercharged (32 Valve) (AJ34 4.2SC)	09-04
V6 2495cc 2.5L DOHC (24 Valve) (D)	05-02			V8 4997cc 5.0L DOHC Supercharged (32 Valve) (AJ133 5.0SC)	13-10
V6 2967cc 3.0L DOHC (24 Valve) (F)	08-02	XJ-L		XKR-S	
XF		V6 2995cc 3.0L DOHC Supercharged (24 Valve) (Si6)	13	V8 4997cc 5.0L DOHC Supercharged (32 Valve) (AJ133 5.0SC)	13-12
L4 1999cc 2.0L DOHC Turbo (16 Valve) (Si4)	13	V8 4997cc 5.0L DOHC (32 Valve) (AJ133 5.0)	13-10		
V6 2995cc 3.0L DOHC Supercharged (24 Valve) (Si6)	13	V8 4997cc 5.0L DOHC Supercharged (32 Valve) (AJ133 5.0SC)	13-10		
V8 4196cc 4.2L DOHC (32 Valve) (AJ34 4.2)	11-09				

1 2005 - 2002; 2.5L 152 (2495cc) DOHC V6 (24 Valve) 81.6mm Bore Duratec MFI; Gasoline; Naturally Aspirated Ford Eng.; VIN Code D 1

QTY	CYLINDER HEAD	YEARS	PART NO.	DESCRIPTION
1	Head Gasket	2005-02	26538 PT	Loc. L.H.; Head bolts not incl.; Head bolt replacement recommended; PermaTorqueMLS®; New Part Number - Check for Availability
1	Head Gasket	2005-02	26539 PT	Loc. R.H.; Head bolts not incl.; Head bolt replacement recommended; PermaTorqueMLS®; New Part Number - Check for Availability
1	Head Set	2005-02	HS 26538 PT	Head bolts not incl.; Head bolt replacement recommended; PermaDry® molded rubber valve cover gskts. incl.; Premium valve stem seals incl.; New Part Number - Check for Availability
2	Head Bolt Set	2005-02	ES 72208	Head bolts w/Washers; Replacement recommended
QTY	CONVERSION SET	YEARS	PART NO.	DESCRIPTION
1	Gasket Conversion Set	2005-02	CS 26248-1	PermaDry® molded rubber oil pan gskt. incl.
QTY	MANIFOLD - INT. & EXH.	YEARS	PART NO.	DESCRIPTION
1	Int. Manifold Gasket Set	2005-02	MS 96485	Lower set
1	Plenum Gasket Set	2005-02	MS 96494	Upper set
1	Exh. Manifold Gasket Set	2005-02	MS 95715	
QTY	EXHAUST PIPE FLANGE	YEARS	PART NO.	DESCRIPTION
2	Exhaust Pipe Gasket	2005-02	61388	Ring
1	Exhaust Pipe Gasket	2005-02	61678	Exh. connector; New Part Number - Check for Availability
QTY	OIL PAN	YEARS	PART NO.	DESCRIPTION
1	Oil Pan Gasket Set	2005-02	OS 30697 R	Loc. Lower; PermaDry® molded rubber gskt. incl.; Improved design
QTY	CRANKSHAFT REAR SEAL	YEARS	PART NO.	DESCRIPTION
1	Rear Main Seal Set	2005-02	BS 40620	Rubber; One-piece; Improved design
1	Rear Main Seal Set	2005-02	BS 40644	PTFE Rubber; One-piece
QTY	VALVE COVER	YEARS	PART NO.	DESCRIPTION
1	Valve Cover Gasket Set	2005-02	VS 50615 R	w/Grommets & Spark plug tube seals; PermaDry® molded rubber gskts. incl.

1		2005 - 2002; 2.5L 152 (2495cc) DOHC V6 (24 Valve) 81.6mm Bore Duratec			1	
(cont.)		MFI; Gasoline; Naturally Aspirated Ford Eng.; VIN Code D			(cont.)	
QTY	VALVE STEM SEAL SET	YEARS	PART NO.	DESCRIPTION		
1	Valve Stem Seal Set	2005-02	SS 72911	Premium valve stem seals incl.		
QTY	THERMOSTAT HOUSING	YEARS	PART NO.	DESCRIPTION		
1	Water Outlet Gasket	2005-02	35983	Thermostat Housing; Thermostat case; New Part Number - Check for Availability		
1	Thermostat Gasket	2005-02	35742	Thermostat Housing; Thermostat housing		
1	Thermostat Gasket	2005-02	35984	Thermostat Housing; Thermostat O-ring; New Part Number - Check for Availability		
QTY	WATER PUMP	YEARS	PART NO.	DESCRIPTION		
1	Water Pump Gasket	2005-02	35663	8-bolt gskt.; Improved design		
1	Water Pump Gasket	2005-02	35751	7-bolt gskt.		
QTY	TIMING COVER	YEARS	PART NO.	DESCRIPTION		
1	Crankshaft Front Seal Set	2005-02	TCS 46055	Must be used w/OS 30697R		
QTY	CARB & FUEL INJECTION	YEARS	PART NO.	DESCRIPTION		
1	Throttle Body Gasket	2005-02	61689	Mounting; New Part Number - Check for Availability		
QTY	EXHAUST GAS RECIRCULATION	YEARS	PART NO.	DESCRIPTION		
1	EGR Gasket	2005-02	70149			
2		2008 - 2000; 3.0L 181 (2967cc) DOHC V6 (24 Valve) 89mm Bore Duratec			2	
		MFI; Gasoline; Naturally Aspirated Ford Eng.; VIN Code F				
QTY	CYLINDER HEAD	YEARS	PART NO.	DESCRIPTION		
1	Head Gasket	2007-00	26248 PT	Loc. L.H.; Head bolts not incl.; Head bolt replacement recommended; PermaTorqueMLS®		
1	Head Gasket	2007-00	26249 PT	Loc. R.H.; Head bolts not incl.; Head bolt replacement recommended; PermaTorqueMLS®		
1	Head Set	2007-05	HS 26248 PT-1	Exc. Jaguar S-Type Base, Sport; Head bolts not incl.; Head bolt replacement recommended; PermaDry® molded rubber valve cover gskts. incl.; Premium valve stem seals incl.		
1	Head Set	2007-05	HS 26248 PT-2	Jaguar S-Type Base, Sport; Head bolts not incl.; Head bolt replacement recommended; PermaDry® molded rubber valve cover gskts. incl.; Premium valve stem seals incl.		
1	Head Set	2004-02	HS 26248 PT-1	Jaguar X-Type Base; Head bolts not incl.; Head bolt replacement recommended; PermaDry® molded rubber valve cover gskts. incl.; Premium valve stem seals incl.		
1	Head Set	2004-03	HS 26248 PT	Jaguar S-Type Base; To Chassis No. N13088; Int. manifold upper & lower gskts. not incl.; Head bolts not incl.; Head bolt replacement recommended; PermaDry® molded rubber valve cover gskts. incl.; Premium valve stem seals incl.		
1	Head Set	2004-03	HS 26248 PT-2	Jaguar S-Type Base; From Chassis No. N13089; Head bolts not incl.; Head bolt replacement recommended; PermaDry® molded rubber valve cover gskts. incl.; Premium valve stem seals incl.		
1	Head Set	2002	HS 26248 PT	Jaguar S-Type Base; Int. manifold upper & lower gskts. not incl.; Head bolts not incl.; Head bolt replacement recommended; PermaDry® molded rubber valve cover gskts. incl.; Premium valve stem seals incl.		
1	Head Set	2001-00	HS 26248 PT	Int. manifold upper & lower gskts. not incl.; Head bolts not incl.; Head bolt replacement recommended; PermaDry® molded rubber valve cover gskts. incl.; Premium valve stem seals incl.		
2	Head Bolt Set	2007-00	ES 72208	Head bolts w/Washers; Replacement recommended		
QTY	CONVERSION SET	YEARS	PART NO.	DESCRIPTION		
1	Gasket Conversion Set	2007-00	CS 26248-1	PermaDry® molded rubber oil pan gskt. incl.		
QTY	MANIFOLD - INT. & EXH.	YEARS	PART NO.	DESCRIPTION		
1	Int. Manifold Gasket Set	2008-01	MS 96485	Lower set		
1	Int. Manifold Gasket Set	2000	MS 96475	Lower set		
1	Plenum Gasket Set	2008-02	MS 96494	Upper set		
1	Plenum Gasket Set	2001	MS 96484	To Chassis No. L86901; Upper set		
1	Plenum Gasket Set	2001	MS 96494	From Chassis No. L86902; Upper set		
1	Plenum Gasket Set	2000	MS 96484	Upper set		
1	Exh. Manifold Gasket Set	2007-00	MS 95715			
QTY	EXHAUST PIPE FLANGE	YEARS	PART NO.	DESCRIPTION		
2	Exhaust Pipe Gasket	2007-05	61388	Exc. Jaguar S-Type Base, Sport; Ring		
2	Exhaust Pipe Gasket	2004-02	61388	Jaguar X-Type Base; Ring		
QTY	OIL PAN	YEARS	PART NO.	DESCRIPTION		
1	Oil Pan Gasket Set	2007-00	OS 30697 R	Loc. Lower; PermaDry® molded rubber gskt. incl.; Improved design		
QTY	CRANKSHAFT REAR SEAL	YEARS	PART NO.	DESCRIPTION		
1	Rear Main Seal Set	2007-00	BS 40620	Rubber; One-piece; Improved design		

Jaguar (Cont.)

2		2008 - 2000; 3.0L 181 (2967cc) DOHC V6 (24 Valve) 89mm Bore Duratec			2	
(cont.)		MFI; Gasoline; Naturally Aspirated Ford Eng.; VIN Code F			(cont.)	
QTY	CRANKSHAFT REAR SEAL	YEARS	PART NO.	DESCRIPTION		
1	Rear Main Seal Set	2007-00	BS 40644	PTFE Rubber; One-piece		
QTY	VALVE COVER	YEARS	PART NO.	DESCRIPTION		
1	Valve Cover Gasket Set	2007-05	VS 50612 R	Jaguar S-Type Base, Sport; w/Grommets & Spark plug tube seals; PermaDry® molded rubber gskts. incl.		
1	Valve Cover Gasket Set	2007-05	VS 50615 R	Exc. Jaguar S-Type Base, Sport; w/Grommets & Spark plug tube seals; PermaDry® molded rubber gskts. incl.		
1	Valve Cover Gasket Set	2004-02	VS 50615 R	Jaguar X-Type Base; w/Grommets & Spark plug tube seals; PermaDry® molded rubber gskts. incl.		
1	Valve Cover Gasket Set	2004-03	VS 50610 R	Jaguar S-Type Base; To Chassis No. N13088; w/Grommets & Spark plug tube seals; PermaDry® molded rubber gskts. incl.		
1	Valve Cover Gasket Set	2004-03	VS 50612 R	Jaguar S-Type Base; From Chassis No. N13089; w/Grommets & Spark plug tube seals; PermaDry® molded rubber gskts. incl.		
1	Valve Cover Gasket Set	2002	VS 50610 R	Jaguar S-Type Base; w/Grommets & Spark plug tube seals; PermaDry® molded rubber gskts. incl.		
1	Valve Cover Gasket Set	2001-00	VS 50610 R	w/Grommets & Spark plug tube seals; PermaDry® molded rubber gskts. incl.		
QTY	VALVE STEM SEAL SET	YEARS	PART NO.	DESCRIPTION		
1	Valve Stem Seal Set	2008-00	SS 72911	Premium valve stem seals incl.		
QTY	THERMOSTAT HOUSING	YEARS	PART NO.	DESCRIPTION		
1	Water Outlet Gasket	2007-00	35489	Thermostat Housing; Thermostat seal		
1	Thermostat Gasket	2007-00	35742	Thermostat Housing		
QTY	WATER PUMP	YEARS	PART NO.	DESCRIPTION		
1	Water Pump Gasket	2007-00	35663	8-bolt gskt.; Improved design		
1	Water Pump Gasket	2007-00	35751	7-bolt gskt.		
QTY	TIMING COVER	YEARS	PART NO.	DESCRIPTION		
1	Crankshaft Front Seal Set	2007-00	TCS 46055	Must be used w/OS 30697R		
QTY	CARB & FUEL INJECTION	YEARS	PART NO.	DESCRIPTION		
2	Fuel Injector O-Ring Set	2007-00	ES 70599	Improved design		
1	Throttle Body Gasket	2008-00	72302	Air bypass valve		
1	Throttle Body Gasket	2007-04	61376	Mounting		
1	Throttle Body Gasket	2003-00	61351	Mounting		
QTY	EXHAUST GAS RECIRCULATION	YEARS	PART NO.	DESCRIPTION		
1	EGR Gasket	2007-00	70149			
3		1994 - 1991; 4.0L 242.8 (3980cc) DOHC L6 (24 Valve) 91mm Bore			3	
(cont.)		MFI; Gasoline; Naturally Aspirated Jaguar Eng.; Eng. Code AJ6 4.0			(cont.)	
QTY	VALVE COVER	YEARS	PART NO.	DESCRIPTION		
1	Valve Cover Gasket Set	1994-91	VS 50839 R	w/Semi-circular plugs & Spark plug tube seals; PermaDry® molded rubber gskt. incl.; New Part Number - Check for Availability		
4		2003 - 1998; 4.0L 244 (3996cc) DOHC V8 (32 Valve) 86mm Bore			4	
(cont.)		MFI; Gasoline; Supercharged Jaguar Eng.; Eng. Code AJ27 4.0SC			(cont.)	
QTY	MANIFOLD - INT. & EXH.	YEARS	PART NO.	DESCRIPTION		
1	Int. Manifold Gasket Set	2003-98	MS 97311	Lower set; New Part Number - Check for Availability		

Jeep Truck (Incl. Jeep, Willys)

Engine Finding Index				
Engine	Years	Code	Line No.	
2.0L 122 (1998cc) DOHC L4 (16 Valve) 86mm Bore; MFI; Gasoline; Naturally Aspirated Chrysler Eng.	2013-07	0	1	
2.0L 122 (1998cc) DOHC L4 (16 Valve) 86mm Bore; MFI; Gasoline; Naturally Aspirated Chrysler Eng.	2013-09	A	2	
2.4L 144 (2360cc) DOHC L4 (16 Valve) 88mm Bore; MFI; Gasoline; Naturally Aspirated Chrysler Eng.	2013-09	B	3	
2.4L 144 (2360cc) DOHC L4 (16 Valve) 88mm Bore; MFI; Gasoline; Naturally Aspirated Chrysler Eng.	2013-07	W	4	
2.4L 148 (2429cc) DOHC L4 (16 Valve) 87.5mm Bore; MFI; Gasoline; Naturally Aspirated Chrysler Eng.	2006-02	1	5	
2.5L 150 (2464cc) OHV L4 (8 Valve) 3.875" Bore; MFI; Gasoline; Naturally Aspirated AMC Eng.	2002-97	H	6	
2.5L 150 (2464cc) OHV L4 (8 Valve) 3.875" Bore; MFI; Gasoline; Naturally Aspirated AMC Eng.	2002-91	P	7	
3.6L 219.9 (3604cc) DOHC V6 (24 Valve) 96mm Bore Pentastar VVT; MFI; Flex Fuel; Naturally Aspirated Chrysler Eng.	2013-11	G	8	
3.7L 226 (3704cc) SOHC V6 (12 Valve) 93mm Bore; MFI; Gasoline; Naturally Aspirated Chrysler Eng.	2012-02	K	9	
3.8L 231 (3785cc) OHV V6 (12 Valve) 96mm Bore; MFI; Gasoline; Naturally Aspirated Chrysler Eng.	2011-07	1	10	
4.0L 242 (3964cc) OHV L6 (12 Valve) 3.875" Bore; MFI; Gasoline; Naturally Aspirated AMC Eng.; Jeep	2006-91	S	11	
4.0L 242 (3964cc) OHV L6 (12 Valve) 3.875" Bore; MFI; Gasoline; Naturally Aspirated AMC Eng.; Jeep	2005-97	V	12	
4.7L 287 (4703cc) SOHC V8 (16 Valve) 93mm Bore; MFI; Gasoline; Naturally Aspirated Chrysler Eng.	2009-99	N	13	

Engine Finding Index (Cont.)

Engine	Years	Code	Line No.
4.7L 287 (4703cc) SOHC V8 (16 Valve) 93mm Bore; MFI; Flex Fuel; Naturally Aspirated Chrysler Eng.	2009-07	P	14
4.7L 287 (4703cc) SOHC V8 (16 Valve) 93mm Bore H.O.; MFI; Gasoline; Naturally Aspirated Chrysler Eng.	2004-02	J	15
5.2L 318 (5212cc) OHV V8 (16 Valve) 3.9063" Bore; MFI; Gasoline; Naturally Aspirated Chrysler Eng.	1998-93	Y	16
5.7L 345 (5654cc) OHV V8 (16 Valve) 99.5mm Bore Hemi; MFI; Gasoline; Naturally Aspirated Chrysler Eng.	2008-05	2	17
5.7L 345 (5654cc) OHV V8 (16 Valve) 99.5mm Bore Hemi; MFI; Gasoline; Naturally Aspirated Chrysler Eng.	2013-09	T	18
5.9L 360 (5899cc) OHV V8 (16 Valve) 4.08" Bore; 2 Bbl.; Gasoline; Naturally Aspirated AMC Eng.	1993-91	7	19
5.9L 360 (5900cc) OHV V8 (16 Valve) 4" Bore L/D; MFI; Gasoline; Naturally Aspirated Chrysler Eng.	1998	Z	20
6.1L 370 (6059cc) OHV V8 (16 Valve) 103mm Bore Hemi; MFI; Gasoline; Naturally Aspirated Chrysler Eng.	2010-06	3	21
6.1L 370 (6059cc) OHV V8 (16 Valve) 103mm Bore Hemi; MFI; Gasoline; Naturally Aspirated Chrysler Eng.	2010	W	22

Model Index

Engine (VIN Code / Eng. Code)	Year	Engine (VIN Code / Eng. Code)	Year	Engine (VIN Code / Eng. Code)	Year
Jeep					
Briarwood (4WD) (J-100)		Jeep (cont.)		Jeep (cont.)	
L4 150CI 2.46L OHV (P)	92-91	L4 150CI 2.46L OHV (U)	86-83	L4 192CI 3.1L OHV Diesel	66-63
L6 242CI 4.0L (S)	92-91	L4 151CI 2.5L OHV (B)	83-80	DJ-5	
Cherokee (2WD Mid-Size SUV)		L6 232CI 3.8L (E)	79-76	L4 134CI 2.2L (F-Head)	71-65
L4 150CI 2.46L OHV (E)	90-89	L6 258CI 4.2L (A)	78-76	L4 192CI 3.1L OHV Diesel	66-65
L4 150CI 2.46L OHV (H)	88-86	L6 258CI 4.2L (C)	86-79	L6 232CI 3.8L (E)	73-72
L4 150CI 2.46L OHV (P)	00-91	V8 304CI 5.0L (H)	81-76	L6 258CI 4.2L (A)	74-73
L4 150CI 2.46L OHV (U)	85-84	CJ-8		V6 225CI 3.7L	71-66
L4 2068cc 2.1L SOHC Turbo-Diesel (B)	90-85	L4 150CI 2.46L OHV (U)	85-83	V8 304CI 5.0L (H)	74-73
L6 242CI 4.0L (L)	90-89	L4 151CI 2.5L OHV (B)	83-80	DJ-6	
L6 242CI 4.0L (M)	88-87	L6 258CI 4.2L (C)	85-80	L4 134CI 2.2L (F-Head)	68-65
L6 242CI 4.0L (S)	01-91	V8 304CI 5.0L (H)	81	L4 192CI 3.1L OHV Diesel	66-65
V6 173CI 2.8L (W)	86-84	Comanche (2WD Compact Pickup)		V6 225CI 3.7L	68-66
Cherokee (4WD Mid-Size SUV)		L4 150CI 2.46L OHV (E)	90-89	FC-150 (Forward Control)	
L4 150CI 2.46L OHV (E)	90-89	L4 150CI 2.46L OHV (H)	88-86	L4 134CI 2.2L (F-Head)	66-63
L4 150CI 2.46L OHV (H)	88-86	L4 150CI 2.46L OHV (P)	93-91	L4 134CI 2.2L (L-Head)	63-57
L4 150CI 2.46L OHV (P)	00-91	L4 2068cc 2.1L SOHC Turbo-Diesel (B)	90-86	FC-170 (Forward Control)	
L4 150CI 2.46L OHV (U)	85-84	L6 242CI 4.0L (L)	90-89	L6 226CI 3.7L (L-Head)	66-57
L4 2068cc 2.1L SOHC Turbo-Diesel (B)	90-85	L6 242CI 4.0L (M)	88-87	FC-170HD (Forward Control)	
L6 242CI 4.0L (L)	90-89	L6 242CI 4.0L (S)	93-91	L6 226CI 3.7L (L-Head)	66-57
L6 242CI 4.0L (M)	88-87	V6 173CI 2.8L (W)	86	FJ	
L6 242CI 4.0L (S)	01-91	Comanche (4WD Compact Pickup)		L4 134CI 2.2L (L-Head)	51
L6 258CI 4.2L (A)	78-74	L4 150CI 2.46L OHV (E)	90-89	FJ-3	
L6 258CI 4.2L (C)	83-77	L4 150CI 2.46L OHV (H)	88-86	L4 134CI 2.2L (F-Head)	64
V6 173CI 2.8L (W)	86-84	L4 150CI 2.46L OHV (P)	93-91	FJ-3A	
V8 360CI 5.9L (N)	83-74	L4 2068cc 2.1L SOHC Turbo-Diesel (B)	90-86	L4 134CI 2.2L (F-Head)	64-61
V8 360CI 5.9L (P)	78-74	L6 242CI 4.0L (L)	90-89	Gladiator (Pickup)	
V8 401CI 6.6L (Z)	78-74	L6 242CI 4.0L (M)	88-87	L6 230CI 3.8L (SOHC)	65-63
CJ-2A		L6 242CI 4.0L (S)	93-91	L6 232CI 3.8L	69-66
L4 134CI 2.2L (L-Head)	49-43	V6 173CI 2.8L (W)	86	V8 327CI 5.3L	69-65
CJ-3A		Commander (2WD Mid-Size SUV)		Grand Cherokee (2WD Mid-Size SUV)	
L4 134CI 2.2L (L-Head)	53-49	V6 226CI 3.7L SOHC (12 Valve) (K)	10-06	L6 242CI 4.0L (S)	04-92
CJ-3B		V8 287CI 4.7L SOHC (N)	09-06	V6 220CI 3.6L DOHC (24 Valve) (Flex Fuel) (G)	13-11
L4 134CI 2.2L (F-Head)	66-53	V8 287CI 4.7L SOHC (Flex Fuel) (P)	09-07	V6 226CI 3.7L SOHC (12 Valve) (K)	10-05
CJ-5		V8 345CI 5.7L (Hemi) (2)	08-06	V6 2987cc 3.0L DOHC Turbo-Diesel (24 Valve) (M)	09-07
L4 134CI 2.2L (F-Head)	73-55	V8 345CI 5.7L (Hemi) (T)	10-09	V8 287CI 4.7L SOHC (J)	04-02
L4 150CI 2.46L OHV (U)	83	Commander (4WD Mid-Size SUV)		V8 287CI 4.7L SOHC (N)	09-99
L4 151CI 2.5L OHV (B)	83-80	V6 226CI 3.7L SOHC (12 Valve) (K)	10-06	V8 287CI 4.7L SOHC (Flex Fuel) (P)	09-07
L6 232CI 3.8L (E)	78-72	V8 287CI 4.7L SOHC (N)	09-06	V8 318CI 5.2L (Y)	98-93
L6 258CI 4.2L (A)	78-72	V8 287CI 4.7L SOHC (Flex Fuel) (P)	09-07	V8 345CI 5.7L (Hemi) (2)	08-05
L6 258CI 4.2L (C)	83-79	V8 345CI 5.7L (Hemi) (2)	08-06	V8 345CI 5.7L (Hemi) (T)	13-09
V6 225CI 3.7L	71-66	V8 345CI 5.7L (Hemi) (T)	10-09	Grand Cherokee (4WD Mid-Size SUV)	
V8 304CI 5.0L (H)	81-72	Commando		L6 242CI 4.0L (S)	04-92
CJ-5A		L6 232CI 3.8L (E)	73-72	V6 220CI 3.6L DOHC (24 Valve) (Flex Fuel) (G)	13-11
L4 134CI 2.2L (F-Head)	68-64	L6 258CI 4.2L (A)	73-72	V6 226CI 3.7L SOHC (12 Valve) (K)	10-05
V6 225CI 3.7L	68-66	V8 304CI 5.0L (H)	73-72	V6 2987cc 3.0L DOHC Turbo-Diesel (24 Valve) (M)	09-07
CJ-6		Compass (AWD Compact SUV)		V8 287CI 4.7L SOHC (J)	04-02
L4 134CI 2.2L (F-Head)	71-56	L4 2360cc 2.4L DOHC (16 Valve) (B)	13-09	V8 287CI 4.7L SOHC (N)	09-99
L6 232CI 3.8L (E)	76-72	L4 2360cc 2.4L DOHC (16 Valve) (W)	13-07	V8 287CI 4.7L SOHC (Flex Fuel) (P)	09-07
L6 258CI 4.2L (A)	76-72	Compass (FWD Compact SUV)		V8 318CI 5.2L (Y)	98-93
V6 225CI 3.7L	71-66	L4 1998cc 2.0L DOHC (16 Valve) (0)	13-07	V8 345CI 5.7L (Hemi) (2)	08-05
V8 304CI 5.0L (H)	76-72	L4 1998cc 2.0L DOHC (16 Valve) (A)	13-09	V8 345CI 5.7L (Hemi) (T)	13-09
CJ-6A		L4 2360cc 2.4L DOHC (16 Valve) (B)	13-09	Grand Cherokee (4WD Mid-Size SUV)	
L4 134CI 2.2L (F-Head)	68-64	L4 2360cc 2.4L DOHC (16 Valve) (W)	13-07	L6 242CI 4.0L (S)	04-92
V6 225CI 3.7L	68-66	DJ-3A		V6 220CI 3.6L DOHC (24 Valve) (Flex Fuel) (G)	13-11
		L4 134CI 2.2L (L-Head)	66-56	V6 226CI 3.7L SOHC (12 Valve) (K)	10-05
				V6 2987cc 3.0L DOHC Turbo-Diesel (24 Valve) (M)	09-07
				V8 287CI 4.7L SOHC (J)	04-02
				V8 287CI 4.7L SOHC (N)	09-99
				V8 287CI 4.7L SOHC (Flex Fuel) (P)	09-07
				V8 318CI 5.2L (Y)	98-93
				V8 345CI 5.7L (Hemi) (2)	08-05
				V8 345CI 5.7L (Hemi) (T)	13-09

Jeep Truck (Incl. Jeep, Willys) (Cont.)

Model Index (Cont.)					
Engine (VIN Code / Eng. Code)	Year	Engine (VIN Code / Eng. Code)	Year	Engine (VIN Code / Eng. Code)	Year
Jeep (cont.)		Jeep (cont.)		Jeep (cont.)	
Grand Cherokee (4WD Mid-Size SUV) (cont.)		J-2600 (2WD Gladiator Pickup) (cont.)		J-3600 (4WD Gladiator Pickup)	
V8 345CI 5.7L (Hemi) (T)	13-09	L6 232CI 3.8L	70-66	L6 230CI 3.8L (SOHC)	65
V8 360CI 5.9L (Z)	98	L6 258CI 4.2L (A)	73-71	L6 232CI 3.8L	70-66
V8 370CI 6.1L (Hemi) (3)	10-06	V8 304CI 5.0L (H)	73-71	V8 327CI 5.3L	70-65
V8 370CI 6.1L (Hemi) (W)	10	V8 327CI 5.3L	70-65	J-3700 (2WD Gladiator Pickup)	
V8 392CI 6.4L (Hemi) (J)	13-12	V8 360CI 5.9L (N)	73-71	L6 230CI 3.8L (SOHC)	65
Grand Wagoneer (Full-Size SUV)		J-2600 (4WD Gladiator Pickup)		L6 232CI 3.8L	70-66
L6 258CI 4.2L (C)	86-84	L6 230CI 3.8L (SOHC)	65	V8 327CI 5.3L	70-65
V8 360CI 5.9L (7)	93-89	L6 232CI 3.8L	70-66	J-3700 (4WD Gladiator Pickup)	
V8 360CI 5.9L (N)	88-84	L6 258CI 4.2L (A)	73-71	L6 230CI 3.8L (SOHC)	65
J-10 (Pickup)		V8 304CI 5.0L (H)	73-71	L6 232CI 3.8L	70-66
L6 258CI 4.2L (A)	76-74	V8 327CI 5.3L	70-65	V8 327CI 5.3L	70-65
L6 258CI 4.2L (C)	88-77	V8 360CI 5.9L (N)	73-71	J-3800 (4WD Gladiator Pickup)	
V8 360CI 5.9L (N)	88-74	J-2700 (2WD Gladiator Pickup)		L6 230CI 3.8L (SOHC)	65
V8 401CI 6.6L (Z)	78-74	L6 230CI 3.8L (SOHC)	65	L6 232CI 3.8L	70-66
J-100 (2WD Wagoneer)		L6 232CI 3.8L	70-66	L6 258CI 4.2L (A)	71
L6 230CI 3.8L (SOHC)	65-63	V8 327CI 5.3L	70-65	V8 327CI 5.3L	70-65
L6 232CI 3.8L	69-66	J-2700 (4WD Gladiator Pickup)		V8 360CI 5.9L (N)	71
V8 327CI 5.3L	69-65	L6 230CI 3.8L (SOHC)	65	J-4500 (4WD Gladiator Pickup)	
J-100 (4WD Wagoneer)		L6 232CI 3.8L	70-66	L6 232CI 3.8L	70
L6 230CI 3.8L (SOHC)	65-63	V8 327CI 5.3L	70-65	L6 258CI 4.2L (A)	73-71
L6 232CI 3.8L	69-66	J-2800 (2WD Gladiator Pickup)		V8 304CI 5.0L (H)	73-71
V8 327CI 5.3L	69-65	L6 230CI 3.8L (SOHC)	65	V8 327CI 5.3L	70
J-20 (Pickup)		L6 232CI 3.8L	68-66	V8 360CI 5.9L (N)	73-71
V8 360CI 5.9L (N)	88-74	V8 327CI 5.3L	68-65	J-4600 (4WD Gladiator Pickup)	
V8 401CI 6.6L (Z)	78-74	J-2800 (4WD Gladiator Pickup)		L6 232CI 3.8L	70
J-200 (2WD Gladiator Pickup)		L6 230CI 3.8L (SOHC)	65	L6 258CI 4.2L (A)	73-71
L6 230CI 3.8L (SOHC)	65-63	L6 232CI 3.8L	68-66	V8 304CI 5.0L (H)	73-71
V8 327CI 5.3L	65	V8 327CI 5.3L	68-65	V8 327CI 5.3L	70
J-200 (4WD Gladiator Pickup)		J-300 (2WD Gladiator Pickup)		V8 360CI 5.9L (N)	73-71
L6 230CI 3.8L (SOHC)	65-63	L6 230CI 3.8L (SOHC)	65-63	J-4700 (4WD Gladiator Pickup)	
V8 327CI 5.3L	65	V8 327CI 5.3L	65	L6 258CI 4.2L (A)	73-71
J-210 (2WD Gladiator Pickup)		J-300 (4WD Gladiator Pickup)		V8 304CI 5.0L (H)	73-71
L6 230CI 3.8L (SOHC)	65-63	L6 230CI 3.8L (SOHC)	65-63	V8 360CI 5.9L (N)	73-71
V8 327CI 5.3L	65	V8 327CI 5.3L	65	J-4800 (4WD Gladiator Pickup)	
J-210 (4WD Gladiator Pickup)		J-310 (2WD Gladiator Pickup)		L6 258CI 4.2L (A)	73-71
L6 230CI 3.8L (SOHC)	65-63	L6 230CI 3.8L (SOHC)	65-63	V8 304CI 5.0L (H)	73-71
V8 327CI 5.3L	65	V8 327CI 5.3L	65	V8 360CI 5.9L (N)	73-71
J-220 (2WD Gladiator Pickup)		J-310 (4WD Gladiator Pickup)		Jeepster Commando	
L6 230CI 3.8L (SOHC)	65-63	L6 230CI 3.8L (SOHC)	65-63	L4 134CI 2.2L (F-Head)	71-67
V8 327CI 5.3L	65	V8 327CI 5.3L	65	L6 232CI 3.8L (E)	73-72
J-220 (4WD Gladiator Pickup)		J-320 (2WD Gladiator Pickup)		L6 258CI 4.2L (A)	73-72
L6 230CI 3.8L (SOHC)	65-63	L6 230CI 3.8L (SOHC)	65-63	V6 225CI 3.7L	70-67
V8 327CI 5.3L	65	V8 327CI 5.3L	65	V8 304CI 5.0L (H)	73-72
J-230 (2WD Gladiator Pickup)		J-320 (4WD Gladiator Pickup)		Lark	
L6 230CI 3.8L (SOHC)	65-63	L6 230CI 3.8L (SOHC)	65-63	L6 161CI 2.6L (L-Head)	55-51
V8 327CI 5.3L	65	V8 327CI 5.3L	65	Liberty (2WD Compact SUV)	
J-230 (4WD Gladiator Pickup)		J-330 (2WD Gladiator Pickup)		L4 148CI 2.4L DOHC (16 Valve) (1)	05-02
L6 230CI 3.8L (SOHC)	65-63	L6 230CI 3.8L (SOHC)	65-63	L4 2768cc 2.8L DOHC Turbo-Diesel (5)	06-05
V8 327CI 5.3L	65	V8 327CI 5.3L	65	V6 226CI 3.7L SOHC (12 Valve) (K)	12-02
J-2500 (2WD Gladiator Pickup)		J-330 (4WD Gladiator Pickup)		Liberty (4WD Compact SUV)	
L6 230CI 3.8L (SOHC)	65	L6 230CI 3.8L (SOHC)	65-63	L4 148CI 2.4L DOHC (16 Valve) (1)	05-02
L6 232CI 3.8L	70-66	V8 327CI 5.3L	65	L4 2768cc 2.8L DOHC Turbo-Diesel (5)	06-05
L6 258CI 4.2L (A)	73-71	J-3500 (2WD Gladiator Pickup)		V6 226CI 3.7L SOHC (12 Valve) (K)	12-02
V8 304CI 5.0L (H)	73-71	L6 230CI 3.8L (SOHC)	65	MA (Utility)	
V8 327CI 5.3L	70-65	L6 232CI 3.8L	70-66	L4 134CI 2.2L (L-Head)	43-39
V8 360CI 5.9L (N)	73-71	V8 327CI 5.3L	70-65	MB (Utility)	
J-2500 (4WD Gladiator Pickup)		J-3500 (4WD Gladiator Pickup)		L4 134CI 2.2L (L-Head)	43-39
L6 230CI 3.8L (SOHC)	65	L6 230CI 3.8L (SOHC)	65	Patriot (AWD Compact SUV)	
L6 232CI 3.8L	70-66	L6 232CI 3.8L	70-66	L4 2360cc 2.4L DOHC (16 Valve) (B)	13-09
L6 258CI 4.2L (A)	73-71	V8 327CI 5.3L	70-65	L4 2360cc 2.4L DOHC (16 Valve) (W)	13-07
V8 304CI 5.0L (H)	73-71	J-3600 (2WD Gladiator Pickup)		Patriot (FWD Compact SUV)	
V8 327CI 5.3L	70-65	L6 230CI 3.8L (SOHC)	65	L4 1998cc 2.0L DOHC (16 Valve) (0)	13-07
V8 360CI 5.9L (N)	73-71	L6 232CI 3.8L	70-66	L4 1998cc 2.0L DOHC (16 Valve) (A)	13-09
J-2600 (2WD Gladiator Pickup)		V8 327CI 5.3L	70-65	L4 2360cc 2.4L DOHC (16 Valve) (B)	13-09
L6 230CI 3.8L (SOHC)	65			L4 2360cc 2.4L DOHC (16 Valve) (W)	13-07

Jeep Truck (Incl. Jeep, Willys) (Cont.)

Model Index (Cont.)					
Engine (VIN Code / Eng. Code)		Year	Engine (VIN Code / Eng. Code)		Year
Jeep (cont.)			Jeep (cont.)		
Scrambler			YJ Series (Canada) (cont.)		
Truck			Willys Truck		
Utility Wagon (2WD)			38 (Truck)		
Utility Wagon (4WD)			440P (Truck)		
Wagoneer (2WD) (J-100)			441 (Utility)		
Wagoneer (4WD) (J-100)			442 (Truck)		
Wrangler (4WD Compact SUV)			475SD (Truck)		
Wrangler Unlimited (2WD Compact SUV)			CJ-2A		
Wrangler Unlimited (4WD Compact SUV)			CJ-3B		
YJ Series (Canada)			CJ-5A		
			CJ-6		
			CJ-6A		
			DJ-3A		
			DJ-5		
			DJ-6		
			F-134 (Truck)		
			F4-134 (Truck)		
			FA-134 (Truck)		
			FC-150 (Forward Control)		
			FC-170 (Forward Control)		
			FC-170HD (Forward Control)		
			FJ		
			FJ-3		
			FJ-3A		
			Gladiator (Pickup)		
			J-100 (2WD Wagoneer)		
			J-100 (4WD Wagoneer)		
			J-200 (2WD Gladiator Pickup)		
			J-200 (4WD Gladiator Pickup)		
			J-210 (2WD Gladiator Pickup)		
			J-210 (4WD Gladiator Pickup)		
			J-220 (2WD Gladiator Pickup)		
			J-220 (4WD Gladiator Pickup)		
L4 150CI 2.46L OHV (U)	85-83	L4 150CI 2.46L OHV (P)	95-91	L4 134CI 2.2L (F-Head)	69-56
L4 151CI 2.5L OHV (B)	83-81	L6 242CI 4.0L (L)	90	V6 225CI 3.7L	69-66
L6 258CI 4.2L (C)	85-81	L6 242CI 4.0L (S)	95-91		
		L6 258CI 4.2L (C)	88-87	L4 134CI 2.2L (F-Head)	68-64
		L6 258CI 4.2L (M)	89	V6 225CI 3.7L	68-66
		L6 258CI 4.2L (T)	90		
				L4 134CI 2.2L (L-Head)	66-56
				L4 192CI 3.1L OHV Diesel	66-63
				L4 134CI 2.2L (F-Head)	69-65
				L4 192CI 3.1L OHV Diesel	66-65
				V6 225CI 3.7L	69-66
				L4 134CI 2.2L (F-Head)	68-65
				L4 192CI 3.1L OHV Diesel	66-65
				V6 225CI 3.7L	68-66
				L4 134CI 2.2L (F-Head)	65-63
				L4 134CI 2.2L (F-Head)	62-57
				L4 134CI 2.2L (F-Head)	60-58
				L4 134CI 2.2L (F-Head)	66-63
				L4 134CI 2.2L (L-Head)	63-57
				L6 226CI 3.7L (L-Head)	66-57
				L6 226CI 3.7L (L-Head)	66-57
				L4 134CI 2.2L (L-Head)	51
				L4 134CI 2.2L (F-Head)	64
				L4 134CI 2.2L (F-Head)	64-61
				L6 230CI 3.8L (SOHC)	65-63
				L6 232CI 3.8L	69-66
				V8 327CI 5.3L	69-65
				L6 230CI 3.8L (SOHC)	65-63
				L6 232CI 3.8L	69-66
				V8 327CI 5.3L	69-65
				L6 230CI 3.8L (SOHC)	65-63
				L6 232CI 3.8L	69-66
				V8 327CI 5.3L	69-65
				L6 230CI 3.8L (SOHC)	65-63
				L6 232CI 3.8L	69-66
				V8 327CI 5.3L	69-65
				L6 230CI 3.8L (SOHC)	65-63
				L6 232CI 3.8L	69-66
				V8 327CI 5.3L	69-65
				L6 230CI 3.8L (SOHC)	65-63
				L6 232CI 3.8L	69-66
				V8 327CI 5.3L	69-65
				L6 230CI 3.8L (SOHC)	65-63
				L6 232CI 3.8L	69-66
				V8 327CI 5.3L	69-65
				L6 230CI 3.8L (SOHC)	65-63
				L6 232CI 3.8L	69-66
				V8 327CI 5.3L	69-65
				L6 230CI 3.8L (SOHC)	65-63
				L6 232CI 3.8L	69-66
				V8 327CI 5.3L	69-65
				L6 230CI 3.8L (SOHC)	65-63
				L6 232CI 3.8L	69-66
				V8 327CI 5.3L	69-65
				L6 230CI 3.8L (SOHC)	65-63
				L6 232CI 3.8L	69-66
				V8 327CI 5.3L	69-65
				L6 230CI 3.8L (SOHC)	65-63
				L6 232CI 3.8L	69-66
				V8 327CI 5.3L	69-65
				L6 230CI 3.8L (SOHC)	65-63
				L6 232CI 3.8L	69-66
				V8 327CI 5.3L	69-65
				L6 230CI 3.8L (SOHC)	65-63
				L6 232CI 3.8L	69-66
				V8 327CI 5.3L	69-65
				L6 230CI 3.8L (SOHC)	65-63
				L6 232CI 3.8L	69-66
				V8 327CI 5.3L	69-65

Jeep Truck (Incl. Jeep, Willys) (Cont.)

Model Index (Cont.)

Engine (VIN Code / Eng. Code)	Year	Engine (VIN Code / Eng. Code)	Year	Engine (VIN Code / Eng. Code)	Year
Willys Truck (cont.)		Willys Truck (cont.)			
J-230 (2WD Gladiator Pickup)		J-3500 (4WD Gladiator Pickup)			
L6 230CI 3.8L (SOHC)	65-63	L6 230CI 3.8L (SOHC)	65		
V8 327CI 5.3L	65	L6 232CI 3.8L	69-66		
J-230 (4WD Gladiator Pickup)		V8 327CI 5.3L			
L6 230CI 3.8L (SOHC)	65-63	J-3600 (2WD Gladiator Pickup)			
V8 327CI 5.3L	65	L6 230CI 3.8L (SOHC)			
J-2500 (2WD Gladiator Pickup)		L6 232CI 3.8L			
L6 230CI 3.8L (SOHC)	65	V8 327CI 5.3L			
L6 232CI 3.8L	69-66	J-3600 (4WD Gladiator Pickup)			
V8 327CI 5.3L	69-65	L6 230CI 3.8L (SOHC)			
J-2500 (4WD Gladiator Pickup)		L6 232CI 3.8L			
L6 230CI 3.8L (SOHC)	65	V8 327CI 5.3L			
L6 232CI 3.8L	69-66	J-3700 (2WD Gladiator Pickup)			
V8 327CI 5.3L	69-65	L6 230CI 3.8L (SOHC)			
J-2600 (2WD Gladiator Pickup)		L6 232CI 3.8L			
L6 230CI 3.8L (SOHC)	65	V8 327CI 5.3L			
L6 232CI 3.8L	69-66	J-3700 (4WD Gladiator Pickup)			
V8 327CI 5.3L	69-65	L6 230CI 3.8L (SOHC)			
J-2600 (4WD Gladiator Pickup)		L6 232CI 3.8L			
L6 230CI 3.8L (SOHC)	65	V8 327CI 5.3L			
L6 232CI 3.8L	69-66	J-3800 (4WD Gladiator Pickup)			
V8 327CI 5.3L	69-65	L6 230CI 3.8L (SOHC)			
J-2700 (2WD Gladiator Pickup)		L6 232CI 3.8L			
L6 230CI 3.8L (SOHC)	65	V8 327CI 5.3L			
L6 232CI 3.8L	69-66	Jeepster Commando			
V8 327CI 5.3L	69-65	L4 134CI 2.2L (F-Head)			
J-2700 (4WD Gladiator Pickup)		V6 225CI 3.7L			
L6 230CI 3.8L (SOHC)	65	L6-226 (Truck)			
L6 232CI 3.8L	69-66	L6 226CI 3.7L (L-Head)			
V8 327CI 5.3L	69-65	Truck			
J-2800 (2WD Gladiator Pickup)		L4 134CI 2.2L (L-Head)			
L6 230CI 3.8L (SOHC)	65	Wagoneer (2WD Full-Size SUV)			
L6 232CI 3.8L	68-66	L6 230CI 3.8L (SOHC)			
V8 327CI 5.3L	68-65	L6 232CI 3.8L			
J-2800 (4WD Gladiator Pickup)		V8 327CI 5.3L			
L6 230CI 3.8L (SOHC)	65	Wagoneer (4WD Full-Size SUV)			
L6 232CI 3.8L	68-66	L6 230CI 3.8L (SOHC)			
V8 327CI 5.3L	68-65	L6 232CI 3.8L			
J-300 (2WD Gladiator Pickup)		V8 327CI 5.3L			
L6 230CI 3.8L (SOHC)	65-63				
V8 327CI 5.3L	65				
J-300 (4WD Gladiator Pickup)					
L6 230CI 3.8L (SOHC)	65-63				
V8 327CI 5.3L	65				
J-310 (2WD Gladiator Pickup)					
L6 230CI 3.8L (SOHC)	65-63				
V8 327CI 5.3L	65				
J-310 (4WD Gladiator Pickup)					
L6 230CI 3.8L (SOHC)	65-63				
V8 327CI 5.3L	65				
J-320 (2WD Gladiator Pickup)					
L6 230CI 3.8L (SOHC)	65-63				
V8 327CI 5.3L	65				
J-320 (4WD Gladiator Pickup)					
L6 230CI 3.8L (SOHC)	65-63				
V8 327CI 5.3L	65				
J-330 (2WD Gladiator Pickup)					
L6 230CI 3.8L (SOHC)	65-63				
V8 327CI 5.3L	65				
J-330 (4WD Gladiator Pickup)					
L6 230CI 3.8L (SOHC)	65-63				
V8 327CI 5.3L	65				
J-3500 (2WD Gladiator Pickup)					
L6 230CI 3.8L (SOHC)	65				
L6 232CI 3.8L	69-66				
V8 327CI 5.3L	69-65				

Jeep Truck (Incl. Jeep, Willys) (Cont.)

1		2013 - 2007; 2.0L 122 (1998cc) DOHC L4 (16 Valve) 86mm Bore MFI; Gasoline; Naturally Aspirated Chrysler Eng.; VIN Code 0			1
QTY	CYLINDER HEAD	YEARS	PART NO.	DESCRIPTION	
1	Head Gasket	2013-07	26360 PT	Head bolts not incl.; Head bolt replacement recommended; PermaTorqueMLS®; Old design	
1	Head Gasket	2013-07	26557 PT	Head bolts not incl.; Head bolt replacement recommended; PermaTorqueMLS®; Improved design; New Part Number - Check for Availability	
1	Head Set	2013-07	HS 26360 PT	Head bolts not incl.; Head bolt replacement recommended; PermaDry® molded rubber valve cover gskt. incl.; Premium valve stem seals incl.	
1	Head Bolt Set	2013-07	ES 72256	Head bolts w/Washers; Replacement recommended; Old design; Superseded - When depleted use ES 72267	
1	Head Bolt Set	2013-07	ES 72267	Head bolts w/Washers; Replacement recommended; Improved design	
QTY	CONVERSION SET	YEARS	PART NO.	DESCRIPTION	
1	Gasket Conversion Set	2013-07	CS 26332-1	RTV sealant incl. for oil pan gskt.	
QTY	MANIFOLD - INT. & EXH.	YEARS	PART NO.	DESCRIPTION	
1	Int. Manifold Gasket Set	2013-07	MS 96840		
1	Exh. Manifold Gasket Set	2013-07	MS 96902		
QTY	EXHAUST PIPE FLANGE	YEARS	PART NO.	DESCRIPTION	
1	Exhaust Pipe Gasket	2013-07	61002	Pipe to manifold	
1	Exhaust Pipe Gasket	2013-07	61506	Converter; 2.975" ID	
1	Exhaust Pipe Gasket	2013-07	61524	Converter; 2.757" ID	
QTY	OIL PAN	YEARS	PART NO.	DESCRIPTION	
1	Oil Pan Gasket Set	2013-07	OS 30782	RTV sealant incl. for oil pan gskt.; Improved design	
QTY	CRANKSHAFT REAR SEAL	YEARS	PART NO.	DESCRIPTION	
1	Rear Main Seal Set	2013-07	BS 40663	Rubber; One-piece	
QTY	VALVE COVER	YEARS	PART NO.	DESCRIPTION	
1	Valve Cover Gasket Set	2013-07	VS 50698 R	w/o Grommets & w/Spark plug tube seals; PermaDry® molded rubber gskt. incl.	
1	Grommet Set	2013-07	ES 72252-1	Valve Cover	
QTY	VALVE STEM SEAL SET	YEARS	PART NO.	DESCRIPTION	
1	Valve Stem Seal Set	2013-07	SS 71268	Premium valve stem seals incl.	
QTY	THERMOSTAT HOUSING	YEARS	PART NO.	DESCRIPTION	
1	Thermostat Gasket	2013-07	35826	Thermostat seal	
QTY	WATER OUTLET GASKET	YEARS	PART NO.	DESCRIPTION	
1	Water Outlet Gasket	2013-07	35837	Outlet	
QTY	WATER PUMP	YEARS	PART NO.	DESCRIPTION	
1	Water Pump Gasket	2013-07	36005	Cover; New Part Number - Check for Availability	
1	Water Pump Gasket	2013-07	35813	Inlet; Improved design	
1	Water Pump Gasket	2013-07	35813	Mounting; Improved design	
1	Water Pump Gasket	2013-07	35822	Mounting; Old design	
QTY	TIMING COVER	YEARS	PART NO.	DESCRIPTION	
1	Crankshaft Front Seal Set	2013-07	TCS 46098		
2	Camshaft Front Seal Set	2013-07	TCS 45961		
1	Camshaft Sensor Seal	2013-07	70725		
QTY	CARB & FUEL INJECTION	YEARS	PART NO.	DESCRIPTION	
2	Fuel Injector O-Ring Set	2013-07	ES 70599	Improved design	
1	Throttle Body Gasket	2013-07	61480	Mounting	
QTY	EXHAUST GAS RECIRCULATION	YEARS	PART NO.	DESCRIPTION	
1	EGR Gasket	2013-07	70720	Valve	
2		2013 - 2009; 2.0L 122 (1998cc) DOHC L4 (16 Valve) 86mm Bore MFI; Gasoline; Naturally Aspirated Chrysler Eng.; VIN Code A			2
QTY	CYLINDER HEAD	YEARS	PART NO.	DESCRIPTION	
1	Head Gasket	2013-09	26360 PT	Head bolts not incl.; Head bolt replacement recommended; PermaTorqueMLS®; Old design	
1	Head Gasket	2013-09	26557 PT	Head bolts not incl.; Head bolt replacement recommended; PermaTorqueMLS®; Improved design; New Part Number - Check for Availability	
1	Head Set	2013-09	HS 26360 PT	Head bolts not incl.; Head bolt replacement recommended; PermaDry® molded rubber valve cover gskt. incl.; Premium valve stem seals incl.	
1	Head Bolt Set	2013-09	ES 72256	Head bolts w/Washers; Replacement recommended; Old design; Superseded - When depleted use ES 72267	
1	Head Bolt Set	2013-09	ES 72267	Head bolts w/Washers; Replacement recommended; Improved design	
QTY	CONVERSION SET	YEARS	PART NO.	DESCRIPTION	
1	Gasket Conversion Set	2013-09	CS 26332-1	RTV sealant incl. for oil pan gskt.	
QTY	MANIFOLD - INT. & EXH.	YEARS	PART NO.	DESCRIPTION	
1	Int. Manifold Gasket Set	2013-09	MS 96840		

Jeep Truck (Incl. Jeep, Willys) (Cont.)

2 (cont.)		2013 - 2009; 2.0L 122 (1998cc) DOHC L4 (16 Valve) 86mm Bore			2 (cont.)
MFI; Gasoline; Naturally Aspirated Chrysler Eng.; VIN Code A					
QTY	MANIFOLD - INT. & EXH.	YEARS	PART NO.	DESCRIPTION	
1	Exh. Manifold Gasket Set	2013-09	MS 96902		
QTY	EXHAUST PIPE FLANGE	YEARS	PART NO.	DESCRIPTION	
1	Exhaust Pipe Gasket	2013-09	61002	Pipe to manifold	
1	Exhaust Pipe Gasket	2013-09	61506	Converter; 2.975" ID	
1	Exhaust Pipe Gasket	2013-09	61524	Converter; 2.757" ID	
QTY	OIL PAN	YEARS	PART NO.	DESCRIPTION	
1	Oil Pan Gasket Set	2013-09	OS 30782	RTV sealant incl. for oil pan gskt.; Improved design	
QTY	CRANKSHAFT REAR SEAL	YEARS	PART NO.	DESCRIPTION	
1	Rear Main Seal Set	2013-09	BS 40663	Rubber; One-piece	
QTY	VALVE COVER	YEARS	PART NO.	DESCRIPTION	
1	Valve Cover Gasket Set	2013-09	VS 50698 R	w/o Grommets & w/Spark plug tube seals; PermaDry® molded rubber gskt. incl.	
1	Grommet Set	2013-09	ES 72252-1	Valve Cover	
QTY	VALVE STEM SEAL SET	YEARS	PART NO.	DESCRIPTION	
1	Valve Stem Seal Set	2013-09	SS 71268	Premium valve stem seals incl.	
QTY	THERMOSTAT HOUSING	YEARS	PART NO.	DESCRIPTION	
1	Thermostat Gasket	2013-09	35826	Thermostat seal	
QTY	WATER OUTLET GASKET	YEARS	PART NO.	DESCRIPTION	
1	Water Outlet Gasket	2013-09	35837	Outlet	
QTY	WATER PUMP	YEARS	PART NO.	DESCRIPTION	
1	Water Pump Gasket	2013-09	35813	Inlet; Improved design	
1	Water Pump Gasket	2013-09	35813	Mounting; Improved design	
1	Water Pump Gasket	2013-09	35822	Mounting; Old design	
1	Water Pump Gasket	2013-09	36005	Cover; New Part Number - Check for Availability	
QTY	TIMING COVER	YEARS	PART NO.	DESCRIPTION	
1	Crankshaft Front Seal Set	2013-09	TCS 46098		
2	Camshaft Front Seal Set	2013-09	TCS 45961		
1	Camshaft Sensor Seal	2013-09	70725		
QTY	CARB & FUEL INJECTION	YEARS	PART NO.	DESCRIPTION	
2	Fuel Injector O-Ring Set	2013-09	ES 70599	Improved design	
1	Throttle Body Gasket	2013-09	61480	Mounting	
QTY	EXHAUST GAS RECIRCULATION	YEARS	PART NO.	DESCRIPTION	
1	EGR Gasket	2013-09	70720	Valve	
3		2013 - 2009; 2.4L 144 (2360cc) DOHC L4 (16 Valve) 88mm Bore			3
MFI; Gasoline; Naturally Aspirated Chrysler Eng.; VIN Code B					
QTY	CYLINDER HEAD	YEARS	PART NO.	DESCRIPTION	
1	Head Gasket	2013-09	26332 PT	Head bolts not incl.; Head bolt replacement recommended; PermaTorqueMLS®; Old design	
1	Head Gasket	2013-09	26557 PT	Head bolts not incl.; Head bolt replacement recommended; PermaTorqueMLS®; Improved design; New Part Number - Check for Availability	
1	Head Set	2013-09	HS 26332 PT	Head bolts not incl.; Head bolt replacement recommended; PermaDry® molded rubber valve cover gskt. incl.; Premium valve stem seals incl.	
1	Head Bolt Set	2013-09	ES 72267	Head bolts w/Washers; Replacement recommended; Improved design	
QTY	CONVERSION SET	YEARS	PART NO.	DESCRIPTION	
1	Gasket Conversion Set	2013-09	CS 26332	RTV sealant incl. for oil pan gskt.	
QTY	MANIFOLD - INT. & EXH.	YEARS	PART NO.	DESCRIPTION	
1	Int. Manifold Gasket Set	2013-09	MS 96840		
1	Exh. Manifold Gasket Set	2013-09	MS 96902		
QTY	EXHAUST PIPE FLANGE	YEARS	PART NO.	DESCRIPTION	
1	Exhaust Pipe Gasket	2013-09	61002	Pipe to manifold	
1	Exhaust Pipe Gasket	2013-09	61506	Converter; 2.975" ID	
1	Exhaust Pipe Gasket	2013-09	61524	Converter; 2.757" ID	
QTY	OIL PAN	YEARS	PART NO.	DESCRIPTION	
1	Oil Pan Gasket Set	2013-09	OS 30782	RTV sealant incl. for oil pan gskt.; Improved design	
QTY	CRANKSHAFT REAR SEAL	YEARS	PART NO.	DESCRIPTION	
1	Rear Main Seal Set	2013-09	BS 40684	Retainer w/Seal; PTFE Rubber; One-piece; Improved design	
1	Rear Main Seal Set	2013-09	BS 40703	Rubber; One-piece; Old design; Superseded - When depleted use BS 40684	
QTY	VALVE COVER	YEARS	PART NO.	DESCRIPTION	
1	Valve Cover Gasket Set	2013-09	VS 50698 R	w/o Grommets & w/Spark plug tube seals; PermaDry® molded rubber gskt. incl.	

Jeep Truck (Incl. Jeep, Willys) (Cont.)

3 (cont.)		2013 - 2009; 2.4L 144 (2360cc) DOHC L4 (16 Valve) 88mm Bore MFI; Gasoline; Naturally Aspirated Chrysler Eng.; VIN Code B			3 (cont.)
QTY	VALVE COVER	YEARS	PART NO.	DESCRIPTION	
1	Grommet Set	2013-09	ES 72252-1	Valve Cover	
QTY	VALVE STEM SEAL SET	YEARS	PART NO.	DESCRIPTION	
1	Valve Stem Seal Set	2013-09	SS 71268	Premium valve stem seals incl.	
QTY	THERMOSTAT HOUSING	YEARS	PART NO.	DESCRIPTION	
1	Thermostat Gasket	2013-09	35826	Thermostat Housing; Thermostat seal	
QTY	WATER OUTLET GASKET	YEARS	PART NO.	DESCRIPTION	
1	Water Outlet Gasket	2013-09	35837	Water Outlet	
QTY	WATER PUMP	YEARS	PART NO.	DESCRIPTION	
1	Water Pump Gasket	2013-09	35813	Inlet; Improved design	
1	Water Pump Gasket	2013-09	35813	Mounting; Improved design	
1	Water Pump Gasket	2013-09	35822	Mounting; Old design	
1	Water Pump Gasket	2013-09	36005	Cover; New Part Number - Check for Availability	
QTY	TIMING COVER	YEARS	PART NO.	DESCRIPTION	
1	Crankshaft Front Seal Set	2013-09	TCS 46098		
2	Camshaft Front Seal Set	2013-09	TCS 45961		
1	Camshaft Sensor Seal	2013-09	70725		
QTY	CARB & FUEL INJECTION	YEARS	PART NO.	DESCRIPTION	
2	Fuel Injector O-Ring Set	2013-09	ES 70599	Improved design	
1	Throttle Body Gasket	2013-09	61480	Mounting	
QTY	EXHAUST GAS RECIRCULATION	YEARS	PART NO.	DESCRIPTION	
1	EGR Gasket	2013-09	70720	Valve	
4		2013 - 2007; 2.4L 144 (2360cc) DOHC L4 (16 Valve) 88mm Bore MFI; Gasoline; Naturally Aspirated Chrysler Eng.; VIN Code W			4
QTY	CYLINDER HEAD	YEARS	PART NO.	DESCRIPTION	
1	Head Gasket	2013-07	26332 PT	Head bolts not incl.; Head bolt replacement recommended; PermaTorqueMLS®; Old design	
1	Head Gasket	2013-07	26557 PT	Head bolts not incl.; Head bolt replacement recommended; PermaTorqueMLS®; Improved design; New Part Number - Check for Availability	
1	Head Set	2013-07	HS 26332 PT	Head bolts not incl.; Head bolt replacement recommended; PermaDry® molded rubber valve cover gskt. incl.; Premium valve stem seals incl.	
1	Head Bolt Set	2013-07	ES 72267	Head bolts w/Washers; Replacement recommended; Improved design	
QTY	CONVERSION SET	YEARS	PART NO.	DESCRIPTION	
1	Gasket Conversion Set	2013-07	CS 26332	RTV sealant incl. for oil pan gskt.	
QTY	MANIFOLD - INT. & EXH.	YEARS	PART NO.	DESCRIPTION	
1	Int. Manifold Gasket Set	2013-07	MS 96840		
1	Exh. Manifold Gasket Set	2013-07	MS 96902		
QTY	EXHAUST PIPE FLANGE	YEARS	PART NO.	DESCRIPTION	
1	Exhaust Pipe Gasket	2013-07	61002	Pipe to manifold	
1	Exhaust Pipe Gasket	2013-07	61506	Converter; 2.975" ID	
1	Exhaust Pipe Gasket	2013-07	61524	Converter; 2.757" ID	
QTY	OIL PAN	YEARS	PART NO.	DESCRIPTION	
1	Oil Pan Gasket Set	2013-07	OS 30782	RTV sealant incl. for oil pan gskt.; Improved design	
QTY	CRANKSHAFT REAR SEAL	YEARS	PART NO.	DESCRIPTION	
1	Rear Main Seal Set	2013-07	BS 40684	Retainer w/Seal; PTFE Rubber; One-piece; Improved design	
1	Rear Main Seal Set	2013-07	BS 40703	Rubber; One-piece; Old design; Superseded - When depleted use BS 40684	
QTY	VALVE COVER	YEARS	PART NO.	DESCRIPTION	
1	Valve Cover Gasket Set	2013-07	VS 50698 R	w/o Grommets & w/Spark plug tube seals; PermaDry® molded rubber gskt. incl.	
1	Grommet Set	2013-07	ES 72252-1	Valve Cover	
QTY	VALVE STEM SEAL SET	YEARS	PART NO.	DESCRIPTION	
1	Valve Stem Seal Set	2013-07	SS 71268	Premium valve stem seals incl.	
QTY	THERMOSTAT HOUSING	YEARS	PART NO.	DESCRIPTION	
1	Thermostat Gasket	2013-07	35826	Thermostat Housing; Thermostat seal	
QTY	WATER OUTLET GASKET	YEARS	PART NO.	DESCRIPTION	
1	Water Outlet Gasket	2013-07	35837	Water Outlet	
QTY	WATER PUMP	YEARS	PART NO.	DESCRIPTION	
1	Water Pump Gasket	2013-07	35813	Inlet; Improved design	
1	Water Pump Gasket	2013-07	35813	Mounting; Improved design	
1	Water Pump Gasket	2013-07	35822	Mounting; Old design	
1	Water Pump Gasket	2013-07	36005	Cover; New Part Number - Check for Availability	
QTY	TIMING COVER	YEARS	PART NO.	DESCRIPTION	
1	Crankshaft Front Seal Set	2013-07	TCS 46098		

Jeep Truck (Incl. Jeep, Willys) (Cont.)

4 (cont.)		2013 - 2007; 2.4L 144 (2360cc) DOHC L4 (16 Valve) 88mm Bore			4 (cont.)
		MFI; Gasoline; Naturally Aspirated Chrysler Eng.; VIN Code W			
QTY	TIMING COVER	YEARS	PART NO.	DESCRIPTION	
2	Camshaft Front Seal Set	2013-07	TCS 45961		
1	Camshaft Sensor Seal	2013-07	70725		
QTY	CARB & FUEL INJECTION	YEARS	PART NO.	DESCRIPTION	
2	Fuel Injector O-Ring Set	2013-07	ES 70599	Improved design	
1	Throttle Body Gasket	2013-07	61480	Mounting	
QTY	EXHAUST GAS RECIRCULATION	YEARS	PART NO.	DESCRIPTION	
1	EGR Gasket	2013-07	70720	Valve	
5		2006 - 2002; 2.4L 148 (2429cc) DOHC L4 (16 Valve) 87.5mm Bore			5
		MFI; Gasoline; Naturally Aspirated Chrysler Eng.; VIN Code 1			
QTY	CYLINDER HEAD	YEARS	PART NO.	DESCRIPTION	
1	Head Gasket	2006-02	26202 PT	Head bolts not incl.; Head bolt replacement recommended; PermaTorqueMLS® LaserWeld® Technology; Improved design	
1	Head Gasket	2004-02	26206 PT	Head bolts not incl.; Head bolt replacement recommended; PermaTorqueMLS®; Old design	
1	Head Set	2006-05	HS 26202 PT-3	Head bolts not incl.; Head bolt replacement recommended; PermaDry® molded rubber valve cover gskt. incl.; Premium valve stem seals incl.	
1	Head Set	2004-02	HS 26206 PT-1	Head bolts not incl.; Head bolt replacement recommended; PermaDry® molded rubber valve cover gskt. incl.; Premium valve stem seals incl.	
1	Head Bolt Set	2006-02	ES 71028	Head bolts w/Washers; Replacement recommended	
QTY	CONVERSION SET	YEARS	PART NO.	DESCRIPTION	
1	Gasket Conversion Set	2006-02	CS 9924	PermaDry® molded rubber oil pan gskt. incl.	
QTY	MANIFOLD - INT. & EXH.	YEARS	PART NO.	DESCRIPTION	
1	Int. Manifold Gasket Set	2006-02	MS 93219	Lower set; Upper set incl.	
1	Plenum Gasket Set	2006-02	MS 93220	Upper set	
1	Exh. Manifold Gasket Set	2006-02	MS 92846		
QTY	EXHAUST PIPE FLANGE	YEARS	PART NO.	DESCRIPTION	
1	Exhaust Pipe Gasket	2006-02	61002	Pipe to manifold	
QTY	OIL PAN	YEARS	PART NO.	DESCRIPTION	
1	Oil Pan Gasket Set	2006-02	OS 30676 R	PermaDry® molded rubber gskt. incl.	
QTY	CRANKSHAFT REAR SEAL	YEARS	PART NO.	DESCRIPTION	
1	Rear Main Seal Set	2006-02	BS 40182	Rubber; One-piece	
1	Rear Main Seal Set	2006-02	BS 40627	PTFE Rubber; One-piece	
QTY	VALVE COVER	YEARS	PART NO.	DESCRIPTION	
1	Valve Cover Gasket Set	2006-02	VS 50518 R	w/Spark plug tube seals; PermaDry® molded rubber gskt. incl.	
1	Semi-Circular Plug	2006-02	ES 72357	Valve Cover	
QTY	VALVE STEM SEAL SET	YEARS	PART NO.	DESCRIPTION	
1	Valve Stem Seal Set	2006-02	SS 72871	Premium valve stem seals incl.	
QTY	THERMOSTAT HOUSING	YEARS	PART NO.	DESCRIPTION	
1	Thermostat Gasket	2006-02	35678	Thermostat Housing; Thermostat gskt.	
1	Thermostat Gasket	2006	35796	Thermostat housing	
1	Thermostat Gasket	2006	35796	Thermostat Housing; Thermostat housing	
QTY	WATER PUMP	YEARS	PART NO.	DESCRIPTION	
1	Water Pump Gasket	2006-02	35586	O-ring	
1	Water Pump Gasket	2006-02	35587	Seal	
QTY	TIMING COVER	YEARS	PART NO.	DESCRIPTION	
1	Crankshaft Front Seal Set	2006-02	TCS 45962		
2	Camshaft Front Seal Set	2006-02	TCS 45961		
1	Camshaft Sensor Seal	2006-02	70725		
1	Repair Sleeve	2006-02	16224	Timing Cover; Use w/installation tool	
1	Repair Sleeve Tool	2006-02	16325	Timing Cover	
QTY	CARB & FUEL INJECTION	YEARS	PART NO.	DESCRIPTION	
2	Fuel Injector O-Ring Set	2006-02	ES 70599	Improved design	
1	Throttle Body Gasket	2006-03	61324	Idle air control; 21mm ID	
1	Throttle Body Gasket	2006-03	61326	Idle air control; 30mm ID	
1	Throttle Body Gasket	2006	60948	Mounting	
1	Throttle Body Gasket	2005-03	60948	Exc. Jeep Liberty Sport; Mounting	
1	Throttle Body Gasket	2005-03	61214	Jeep Liberty Sport; Mounting	
1	Throttle Body Gasket	2002	61214	Mounting	
QTY	EXHAUST GAS RECIRCULATION	YEARS	PART NO.	DESCRIPTION	
1	EGR Gasket	2006-02	70720	Valve	
1	EGR Gasket	2006-02	70721	Tube flange	

Jeep Truck (Incl. Jeep, Willys) (Cont.)

6		2002 - 1997; 2.5L 150 (2464cc) OHV L4 (8 Valve) 3.875" Bore			6
		MFI; Gasoline; Naturally Aspirated AMC Eng.; VIN Code H			
QTY	CYLINDER HEAD	YEARS	PART NO.	DESCRIPTION	
1	Head Gasket	2002-97	9196 PT	Head bolts not incl.; Head bolt replacement recommended	
1	Head Set	2002-97	HS 9196 PT-5	Head bolts not incl.; Head bolt replacement recommended; PermaDry® molded rubber valve cover gskt. incl.; Premium valve stem seals incl.	
1	Head Bolt Set	2002-97	ES 72896	Replacement recommended	
QTY	CONVERSION SET	YEARS	PART NO.	DESCRIPTION	
1	Gasket Conversion Set	2002-97	CS 9196-2	PermaDry® molded rubber oil pan gskt. incl.	
QTY	MANIFOLD - INT. & EXH.	YEARS	PART NO.	DESCRIPTION	
1	Int. & Exh. Gasket Set	2002-97	MS 92100		
QTY	EXHAUST PIPE FLANGE	YEARS	PART NO.	DESCRIPTION	
1	Exhaust Pipe Gasket	2002-97	60292	Converter	
1	Exhaust Pipe Gasket	2002-97	60836	Packing	
QTY	FUEL PUMP	YEARS	PART NO.	DESCRIPTION	
1	Fuel Pump Mounting Gasket	2002-97	6579	May also be used as a fuel pump block-off plate gasket if desired	
QTY	OIL PAN	YEARS	PART NO.	DESCRIPTION	
1	Oil Pan Gasket Set	2002-97	OS 34007 R	PermaDry® molded rubber gskt. incl.	
QTY	CRANKSHAFT REAR SEAL	YEARS	PART NO.	DESCRIPTION	
1	Rear Main Seal Set	2002-97	BS 40578	Rubber; One-piece; Improved design	
1	Repair Sleeve Tool	2002-97	16304	Crankshaft	
QTY	VALVE COVER	YEARS	PART NO.	DESCRIPTION	
1	Valve Cover Gasket Set	2002-97	VS 50502 R	PermaDry® molded rubber gskt. incl.	
QTY	VALVE STEM SEAL SET	YEARS	PART NO.	DESCRIPTION	
1	Valve Stem Seal Set	2002-97	SS 72854	Premium valve stem seals incl.	
QTY	THERMOSTAT HOUSING	YEARS	PART NO.	DESCRIPTION	
1	Thermostat Gasket	2002-99	35630	Thermostat Housing	
QTY	WATER OUTLET GASKET	YEARS	PART NO.	DESCRIPTION	
1	Water Outlet Gasket	1998-97	35024	Water Outlet	
QTY	WATER PUMP	YEARS	PART NO.	DESCRIPTION	
1	Water Pump Gasket	2002-99	35629		
1	Water Pump Gasket	1998-97	35582		
QTY	TIMING COVER	YEARS	PART NO.	DESCRIPTION	
1	Timing Cover Set	2002-97	TCS 45117	w/o Sleeve 'N' Seal®; Must be used w/OS 34007R	
1	Timing Set w/Sleeve & Seal	2002-97	TCS 45458	w/Sleeve 'N' Seal®; Must be used w/OS 34007R	
1	Repair Sleeve	2002-97	16210	Timing Cover; Use w/installation tool	
1	Repair Sleeve Tool	2002-97	16312	Timing Cover	
QTY	CARB & FUEL INJECTION	YEARS	PART NO.	DESCRIPTION	
2	Fuel Injector O-Ring Set	2002-97	ES 70599	Improved design	
1	Throttle Body Gasket	2002-97	60948		
QTY	DISTRIBUTOR MOUNTING	YEARS	PART NO.	DESCRIPTION	
1	Distributor Mounting Gasket	2002-97	70051	1 11/32" OD	
7		2002 - 1991; 2.5L 150 (2464cc) OHV L4 (8 Valve) 3.875" Bore			7
		MFI; Gasoline; Naturally Aspirated AMC Eng.; VIN Code P			
QTY	CYLINDER HEAD	YEARS	PART NO.	DESCRIPTION	
1	Head Gasket	2002-91	9196 PT	Head bolts not incl.; Head bolt replacement recommended	
1	Head Set	2002-97	HS 9196 PT-5	Head bolts not incl.; Head bolt replacement recommended; PermaDry® molded rubber valve cover gskt. incl.; Premium valve stem seals incl.	
1	Head Set	1996-94	HS 9196 PT-3	Premium valve stem seals incl.	
1	Head Set	1993-91	HS 9196 PT-2	w/Plastic valve cover; Premium valve stem seals incl.	
1	Head Set	1993-91	HS 9196 PT-4	w/Aluminum valve cover; Premium valve stem seals incl.	
1	Head Bolt Set	2002-97	ES 72896	Replacement recommended	
QTY	CONVERSION SET	YEARS	PART NO.	DESCRIPTION	
1	Gasket Conversion Set	2002-92	CS 9196-2	PermaDry® molded rubber oil pan gskt. incl.	
1	Gasket Conversion Set	1991	CS 9196		
QTY	MANIFOLD - INT. & EXH.	YEARS	PART NO.	DESCRIPTION	
1	Int. & Exh. Gasket Set	2002-91	MS 92100		
QTY	EXHAUST PIPE FLANGE	YEARS	PART NO.	DESCRIPTION	
1	Exhaust Pipe Gasket	2002-91	60836	Packing	
1	Exhaust Pipe Gasket	2002-93	60292	Converter	
QTY	FUEL PUMP	YEARS	PART NO.	DESCRIPTION	
1	Fuel Pump Mounting Gasket	2002-91	6579	May also be used as a fuel pump block-off plate gasket if desired	
QTY	OIL PAN	YEARS	PART NO.	DESCRIPTION	
1	Oil Pan Gasket Set	2002-92	OS 34007 R	PermaDry® molded rubber gskt. incl.	

Jeep Truck (Incl. Jeep, Willys) (Cont.)

7		2002 - 1991; 2.5L 150 (2464cc) OHV L4 (8 Valve) 3.875" Bore			7	
(cont.)		MFI; Gasoline; Naturally Aspirated AMC Eng.; VIN Code P			(cont.)	
QTY	OIL PAN	YEARS	PART NO.	DESCRIPTION		
1	Oil Pan Gasket Set	1991	OS 30476 C	Cork		
QTY	CRANKSHAFT REAR SEAL	YEARS	PART NO.	DESCRIPTION		
1	Rear Main Seal Set	2002-91	BS 40578	Rubber; One-piece; Improved design		
1	Repair Sleeve Tool	2002-91	16304	Crankshaft		
QTY	VALVE COVER	YEARS	PART NO.	DESCRIPTION		
1	Valve Cover Gasket Set	2002-97	VS 50502 R	PermaDry® molded rubber gskt. incl.		
1	Valve Cover Gasket Set	1996-94	VS 50430 C	Cork		
1	Valve Cover Gasket Set	1993-91	VS 50421 C	w/Aluminum valve cover; Cork		
1	Valve Cover Gasket Set	1993-91	VS 50430 C	w/Plastic valve cover; Cork		
QTY	VALVE STEM SEAL SET	YEARS	PART NO.	DESCRIPTION		
1	Valve Stem Seal Set	2002-94	SS 72854	Premium valve stem seals incl.		
1	Valve Stem Seal Set	1993-91	SS 70816	Premium valve stem seals incl.		
QTY	THERMOSTAT HOUSING	YEARS	PART NO.	DESCRIPTION		
1	Thermostat Gasket	2002-99	35630	Thermostat Housing		
QTY	WATER OUTLET GASKET	YEARS	PART NO.	DESCRIPTION		
1	Water Outlet Gasket	1998-91	35024	Water Outlet		
QTY	WATER PUMP	YEARS	PART NO.	DESCRIPTION		
1	Water Pump Gasket	2002-99	35629			
1	Water Pump Gasket	1998-94	35582			
1	Water Pump Gasket	1993-91	13877			
QTY	TIMING COVER	YEARS	PART NO.	DESCRIPTION		
1	Timing Cover Set	2002-92	TCS 45117	w/o Sleeve 'N' Seal®; Must be used w/OS 34007R		
1	Timing Cover Set	1991	TCS 45117	w/o Sleeve 'N' Seal®		
1	Timing Set w/Sleeve & Seal	2002-92	TCS 45458	w/Sleeve 'N' Seal®; Must be used w/OS 34007R		
1	Timing Set w/Sleeve & Seal	1991	TCS 45458	w/Sleeve 'N' Seal®		
1	Repair Sleeve	2002-91	16210	Timing Cover; Use w/installation tool		
1	Repair Sleeve Tool	2002-91	16312	Timing Cover		
QTY	CARB & FUEL INJECTION	YEARS	PART NO.	DESCRIPTION		
2	Fuel Injector O-Ring Set	2002-91	ES 70599	Improved design		
1	Throttle Body Gasket	2002-91	60948			
QTY	DISTRIBUTOR MOUNTING	YEARS	PART NO.	DESCRIPTION		
1	Distributor Mounting Gasket	2002-91	70051	1 11/32" OD		
8		2013 - 2011; 3.6L 219.9 (3604cc) DOHC V6 (24 Valve) 96mm Bore Pentastar VVT			8	
		MFI; Flex Fuel; Naturally Aspirated Chrysler Eng.; VIN Code G				
QTY	CYLINDER HEAD	YEARS	PART NO.	DESCRIPTION		
1	Head Gasket	2013-11	26541 PT	Loc. R.H.; Head bolts not incl.; Head bolt replacement recommended; PermaTorqueMLS®; New Part Number - Check for Availability		
1	Head Gasket	2013-11	26542 PT	Loc. L.H.; Head bolts not incl.; Head bolt replacement recommended; PermaTorqueMLS®; New Part Number - Check for Availability		
1	Head Set	2013-11	HS 26541 PT	Head bolts not incl.; Head bolt replacement recommended; PermaDry® molded rubber valve cover gskts. incl.; Premium valve stem seals incl.; New Part Number - Check for Availability		
2	Head Bolt Set	2013-11	ES 72467	Replacement recommended; New Part Number - Check for Availability		
QTY	MANIFOLD - INT. & EXH.	YEARS	PART NO.	DESCRIPTION		
1	Int. Manifold Gasket Set	2013-11	MS 97204	Lower set; Upper set incl.; New Part Number - Check for Availability		
1	Plenum Gasket Set	2013-11	MS 97205	Upper set; New Part Number - Check for Availability		
1	Exh. Manifold Gasket Set	2013-11	MS 97197	New Part Number - Check for Availability		
QTY	EXHAUST PIPE FLANGE	YEARS	PART NO.	DESCRIPTION		
2	Exhaust Pipe Gasket	2013-11	61494	Crossover		
QTY	OIL PAN	YEARS	PART NO.	DESCRIPTION		
1	Oil Pan Gasket Set	2013	OS 30834	Jeep Grand Cherokee Laredo, Laredo Altitude, Laredo E, Laredo Trailhawk, Laredo X, Limited, Overland, Overland Summit; Loc. Lower; New Part Number - Check for Availability		
1	Oil Pan Gasket Set	2013	OS 30835	Exc. Jeep Grand Cherokee Laredo, Laredo Altitude, Laredo E, Laredo Trailhawk, Laredo X, Limited, Overland, Overland Summit; Loc. Lower; New Part Number - Check for Availability		
1	Oil Pan Gasket Set	2012	OS 30834	Jeep Grand Cherokee Laredo, Laredo Altitude, Laredo E, Laredo X, Limited, Overland, Overland Summit; Loc. Lower; New Part Number - Check for Availability		
1	Oil Pan Gasket Set	2012	OS 30835	Exc. Jeep Grand Cherokee Laredo, Laredo Altitude, Laredo E, Laredo X, Limited, Overland, Overland Summit; Loc. Lower; New Part Number - Check for Availability		

Jeep Truck (Incl. Jeep, Willys) (Cont.)

8 (cont.)	2013 - 2011; 3.6L 219.9 (3604cc) DOHC V6 (24 Valve) 96mm Bore Pentastar VVT				8 (cont.)
MFI; Flex Fuel; Naturally Aspirated Chrysler Eng.; VIN Code G					
QTY	OIL PAN	YEARS	PART NO.	DESCRIPTION	
1	Oil Pan Gasket Set	2011	OS 30834	Loc. Lower; New Part Number - Check for Availability	
QTY	CRANKSHAFT REAR SEAL	YEARS	PART NO.	DESCRIPTION	
1	Rear Main Seal Set	2013-11	BS 40737	Rubber; One-piece; New Part Number - Check for Availability	
QTY	VALVE COVER	YEARS	PART NO.	DESCRIPTION	
1	Valve Cover Gasket Set	2013-11	VS 50805 R	w/Spark plug tube seals; PermaDry® molded rubber gskts. incl.; New Part Number - Check for Availability	
QTY	VALVE STEM SEAL SET	YEARS	PART NO.	DESCRIPTION	
1	Valve Stem Seal Set	2013-11	SS 71074-3	Premium valve stem seals incl.; New Part Number - Check for Availability	
QTY	THERMOSTAT HOUSING	YEARS	PART NO.	DESCRIPTION	
1	Thermostat Gasket	2013-11	35974	Thermostat Housing; Thermostat gskt.; New Part Number - Check for Availability	
QTY	WATER OUTLET GASKET	YEARS	PART NO.	DESCRIPTION	
1	Water Outlet Gasket	2013-11	35975	Water Outlet; Water outlet crossover; New Part Number - Check for Availability	
QTY	WATER PUMP	YEARS	PART NO.	DESCRIPTION	
1	Water Pump Gasket	2013-11	35982	New Part Number - Check for Availability	
QTY	TIMING COVER	YEARS	PART NO.	DESCRIPTION	
1	Timing Cover Set	2013-11	TCS 46162	New Part Number - Check for Availability	
QTY	CARB & FUEL INJECTION	YEARS	PART NO.	DESCRIPTION	
1	Throttle Body Gasket	2013-11	61679	New Part Number - Check for Availability	
9	2012 - 2002; 3.7L 226 (3704cc) SOHC V6 (12 Valve) 93mm Bore				9
MFI; Gasoline; Naturally Aspirated Chrysler Eng.; VIN Code K					
QTY	CYLINDER HEAD	YEARS	PART NO.	DESCRIPTION	
2	Head Gasket	2012-02	26229 PT	Head bolts not incl.; Head bolt replacement recommended; PermaTorqueMLS®	
1	Head Set	2012-05	HS 26229 PT-1	w/Plastic valve covers; Head bolts not incl.; Head bolt replacement recommended; Must be used w/TCS 46022; PermaDry® molded rubber valve cover gskts. incl.; Premium valve stem seals incl.	
1	Head Set	2005	HS 26229 PT	w/Stamped steel valve covers; Head bolts not incl.; Head bolt replacement recommended; Must be used w/TCS 46022; PermaDry® molded rubber valve cover gskts. incl.; Premium valve stem seals incl.	
1	Head Set	2004-02	HS 26229 PT	Head bolts not incl.; Head bolt replacement recommended; Must be used w/TCS 46022; PermaDry® molded rubber valve cover gskts. incl.; Premium valve stem seals incl.	
2	Head Bolt Set	2012-02	ES 71129-1	Head bolts w/Washers; Replacement recommended	
QTY	CONVERSION SET	YEARS	PART NO.	DESCRIPTION	
1	Gasket Conversion Set	2012-02	CS 26229	PermaDry® molded rubber oil pan gskt. incl.	
QTY	MANIFOLD - INT. & EXH.	YEARS	PART NO.	DESCRIPTION	
1	Int. Manifold Gasket Set	2012-02	MS 93205-1		
1	Exh. Manifold Gasket Set	2012-02	MS 96344-1	Improved design	
1	Exh. Manifold Gasket Set	2006-02	MS 96344	Old design	
QTY	EXHAUST PIPE FLANGE	YEARS	PART NO.	DESCRIPTION	
1	Exhaust Pipe Gasket	2012-02	61240	Flange	
1	Exhaust Pipe Gasket	2012-02	61289	Ring	
QTY	OIL PAN	YEARS	PART NO.	DESCRIPTION	
1	Oil Pan Gasket Set	2012-02	OS 30743 R	PermaDry® molded rubber gskt. incl.	
QTY	CRANKSHAFT REAR SEAL	YEARS	PART NO.	DESCRIPTION	
1	Rear Main Seal Set	2012-02	BS 40186	Rubber; One-piece	
1	Repair Sleeve	2012-02	16230	Crankshaft; Use w/installation tool	
1	Repair Sleeve Tool	2012-02	16328	Crankshaft	
QTY	VALVE COVER	YEARS	PART NO.	DESCRIPTION	
1	Valve Cover Gasket Set	2012-05	VS 50652 R	w/Plastic valve covers; w/Grommets; PermaDry® molded rubber gskts. incl.	
1	Valve Cover Gasket Set	2005	VS 50594 R	w/Stamped steel valve covers; w/Grommets; PermaDry® molded rubber gskts. incl.	
1	Valve Cover Gasket Set	2004-02	VS 50594 R	w/Grommets; PermaDry® molded rubber gskts. incl.	
QTY	VALVE STEM SEAL SET	YEARS	PART NO.	DESCRIPTION	
1	Valve Stem Seal Set	2012-02	SS 71041-1	Premium valve stem seals incl.	
QTY	THERMOSTAT HOUSING	YEARS	PART NO.	DESCRIPTION	
1	Thermostat Gasket	2012-02	35692	Thermostat Housing; Thermostat seal	
QTY	WATER PUMP	YEARS	PART NO.	DESCRIPTION	
1	Water Pump Gasket	2012-02	35655		
QTY	TIMING COVER	YEARS	PART NO.	DESCRIPTION	
1	Timing Cover Set	2012-02	TCS 46022		

Jeep Truck (Incl. Jeep, Willys) (Cont.)

9		2012 - 2002; 3.7L 226 (3704cc) SOHC V6 (12 Valve) 93mm Bore			9	
(cont.)		MFI; Gasoline; Naturally Aspirated Chrysler Eng.; VIN Code K			(cont.)	
QTY	CARB & FUEL INJECTION	YEARS	PART NO.	DESCRIPTION		
2	Fuel Injector O-Ring Set	2012-02	ES 70599	Improved design		
1	Throttle Body Gasket	2012-02	61324	Idle air control; 21mm ID		
1	Throttle Body Gasket	2012-02	61326	Idle air control; 30mm ID		
1	Throttle Body Gasket	2012-09	61702	Mounting; New Part Number - Check for Availability		
1	Throttle Body Gasket	2008-07	61467	Mounting		
1	Throttle Body Gasket	2006-02	61225	Mounting		
QTY	EXHAUST GAS RECIRCULATION	YEARS	PART NO.	DESCRIPTION		
2	EGR Gasket	2012-05	70721	Tube flange		
1	EGR Gasket	2012-05	72251	Valve		
10		2011 - 2007; 3.8L 231 (3785cc) OHV V6 (12 Valve) 96mm Bore			10	
		MFI; Gasoline; Naturally Aspirated Chrysler Eng.; VIN Code 1				
QTY	CYLINDER HEAD	YEARS	PART NO.	DESCRIPTION		
1	Head Gasket	2011-07	26326 PT	Loc. R.H.; Head bolts not incl.; Head bolt replacement recommended; PermaTorqueMLS® LaserWeld® Technology		
1	Head Gasket	2011-07	26327 PT	Loc. L.H.; Head bolts not incl.; Head bolt replacement recommended; PermaTorqueMLS® LaserWeld® Technology		
1	Head Set	2011-07	HS 26326 PT	Int. manifold gskt., head bolts, exh. pipe to manifold gskt. not incl.; Head bolt replacement recommended; RTV sealant incl. for thermostat gskt.; PermaDry® molded rubber valve cover gskts. incl.; Premium valve stem seals incl.		
2	Head Bolt Set	2011-07	ES 72163	Head bolts w/Washers; Replacement recommended		
QTY	CONVERSION SET	YEARS	PART NO.	DESCRIPTION		
1	Gasket Conversion Set	2011-09	CS 26326-1	RTV sealant incl. for Lower oil pan gskt.; PermaDry® molded rubber oil pan gskt. incl.		
1	Gasket Conversion Set	2008-07	CS 26326	RTV sealant incl. for Lower oil pan gskt.; PermaDry® molded rubber oil pan gskt. incl.		
QTY	MANIFOLD - INT. & EXH.	YEARS	PART NO.	DESCRIPTION		
1	Int. Manifold Gasket Set	2011-07	MS 92808-1	Upper set incl.		
1	Plenum Gasket Set	2011-07	MS 96176	Upper set		
1	Exh. Manifold Gasket Set	2011-07	MS 96908			
QTY	OIL PAN	YEARS	PART NO.	DESCRIPTION		
1	Oil Pan Gasket Set	2011-07	OS 30622 R	Loc. Upper; RTV sealant not incl. for Lower oil pan gskt.; PermaDry® molded rubber gskt. incl.		
QTY	CRANKSHAFT REAR SEAL	YEARS	PART NO.	DESCRIPTION		
1	Rear Main Seal Set	2011-07	BS 40713	Rubber; One-piece		
QTY	VALVE COVER	YEARS	PART NO.	DESCRIPTION		
1	Valve Cover Gasket Set	2011-07	VS 50599 R	w/Plastic valve covers; w/Grommets; PermaDry® molded rubber gskts. incl.		
2	Grommet Set	2011-07	ES 72252	Valve Cover		
QTY	VALVE STEM SEAL SET	YEARS	PART NO.	DESCRIPTION		
1	Valve Stem Seal Set	2011-07	SS 71035	Premium valve stem seals incl.		
QTY	THERMOSTAT HOUSING	YEARS	PART NO.	DESCRIPTION		
1	Thermostat Gasket	2011-07	35651	Thermostat Housing; Thermostat gskt.		
1	O-Ring	2011-07	35861	Thermostat Housing; Thermostat seal		
QTY	WATER PUMP	YEARS	PART NO.	DESCRIPTION		
1	Water Pump Gasket	2011-07	35844	Old design		
1	Water Pump Gasket	2011-07	35998	Improved design; New Part Number - Check for Availability		
QTY	TIMING COVER	YEARS	PART NO.	DESCRIPTION		
1	Timing Cover Set	2011-09	TCS 46023-1	Must be used w/OS 30622R		
1	Timing Cover Set	2008-07	TCS 46134	Must be used w/OS 30622R		
1	Timing Cover Gasket	2011-07	72706	New Part Number - Check for Availability		
1	Crankshaft Front Seal Set	2008-07	TCS 46194	New Part Number - Check for Availability		
1	Repair Sleeve Tool	2008-07	16326	Timing Cover		
QTY	CARB & FUEL INJECTION	YEARS	PART NO.	DESCRIPTION		
3	Fuel Injector O-Ring Set	2011-07	ES 70599	Improved design		
1	Throttle Body Gasket	2011-07	61324	Idle air control; 21mm ID		
1	Throttle Body Gasket	2011-07	61326	Idle air control; 30mm ID		
1	Throttle Body Gasket	2011-07	61467	Mounting; Flush mount		
1	Throttle Body Gasket	2011-07	61700	Mounting; Recessed lip; New Part Number - Check for Availability		
QTY	EXHAUST GAS RECIRCULATION	YEARS	PART NO.	DESCRIPTION		
2	EGR Gasket	2011-07	70696	Tube seal		
2	EGR Gasket	2011-07	70721	Tube flange		
1	EGR Gasket	2011-07	71185	Valve		

Jeep Truck (Incl. Jeep, Willys) (Cont.)

11		2006 - 1991; 4.0L 242 (3964cc) OHV L6 (12 Valve) 3.875" Bore			11
		MFI; Gasoline; Naturally Aspirated AMC Eng.; Jeep; VIN Code S			
QTY	CYLINDER HEAD	YEARS	PART NO.	DESCRIPTION	
1	Head Gasket	2006-91	26211 PT	Head bolts not incl.; Head bolt replacement recommended; PermaTorqueMLS®	
1	Head Gasket	2003-91	530 SD	Head bolts not incl.; Head bolt replacement recommended; PermaTorque Severe Duty®	
1	Head Gasket	2003-91	9076 PT-1	Head bolts not incl.; Head bolt replacement recommended; PermaTorque®; Improved design	
1	Head Set	2006-00	HS 26211 PT	Head bolts & exh. pipe packing not incl.; Head bolt replacement recommended; PermaTorqueMLS® head gskt. incl.; PermaDry® molded rubber valve cover gskt. incl.; Premium valve stem seals incl.	
1	Head Set	2003-00	HS 9076 PT-4	Head bolts & exh. pipe packing not incl.; Head bolt replacement recommended; PermaDry® molded rubber valve cover gskt. incl.; Premium valve stem seals incl.	
1	Head Set	1999	HS 26211 PT	Exc. Jeep TJ Base, Wrangler Sahara, SE, Sport; Head bolts & exh. pipe packing not incl.; Head bolt replacement recommended; PermaTorqueMLS® head gskt. incl.; PermaDry® molded rubber valve cover gskt. incl.; Premium valve stem seals incl.	
1	Head Set	1999	HS 9076 PT-3	Jeep TJ Base, Wrangler Sahara, SE, Sport; Head bolts & exh. pipe packing not incl.; Head bolt replacement recommended; PermaDry® molded rubber valve cover gskt. incl.; Premium valve stem seals incl.	
1	Head Set	1999	HS 9076 PT-4	Exc. Jeep TJ Base, Wrangler Sahara, SE, Sport; Head bolts & exh. pipe packing not incl.; Head bolt replacement recommended; PermaDry® molded rubber valve cover gskt. incl.; Premium valve stem seals incl.	
1	Head Set	1998-96	HS 9076 PT-3	Head bolts & exh. pipe packing not incl.; Head bolt replacement recommended; PermaDry® molded rubber valve cover gskt. incl.; Premium valve stem seals incl.	
1	Head Set	1995-94	HS 9076 PT-2	Exh. pipe packing not incl.; Premium valve stem seals incl.	
1	Head Set	1993-91	HS 9076 PT-1	Exh. pipe packing not incl.; Premium valve stem seals incl.	
1	Head Bolt Set	2006-96	ES 71102	Replacement recommended	
QTY	CONVERSION SET	YEARS	PART NO.	DESCRIPTION	
1	Gasket Conversion Set	2006-00	CS 8169-4	PermaDry® one-piece molded rubber oil pan gskt. incl.	
1	Gasket Conversion Set	1999-92	CS 8169-3	PermaDry® one-piece molded rubber oil pan gskt. incl.	
1	Gasket Conversion Set	1991	CS 8169-2	Multi-piece oil pan gskt. incl.	
QTY	MANIFOLD - INT. & EXH.	YEARS	PART NO.	DESCRIPTION	
1	Int. & Exh. Gasket Set	2006-00	MS 93094		
1	Int. & Exh. Gasket Set	1999	MS 93094	Exc. Jeep TJ Base, Wrangler Sahara, SE, Sport	
1	Int. & Exh. Gasket Set	1999	MS 94790	Jeep TJ Base, Wrangler Sahara, SE, Sport	
1	Int. & Exh. Gasket Set	1998-91	MS 94790		
QTY	EXHAUST PIPE FLANGE	YEARS	PART NO.	DESCRIPTION	
1	Exhaust Pipe Gasket	2006-91	60292	Converter	
1	Exhaust Pipe Gasket	2006-91	60836	Packing	
1	Exhaust Pipe Gasket	2006-02	61241	Flange	
QTY	FUEL PUMP	YEARS	PART NO.	DESCRIPTION	
1	Fuel Pump Mounting Gasket	2006-91	6579	May also be used as a fuel pump block-off plate gasket if desired	
QTY	OIL PAN	YEARS	PART NO.	DESCRIPTION	
1	Oil Pan Gasket Set	2006-91	OS 34308 R	PermaDry® one-piece molded rubber gskt. incl.	
1	Oil Pan Gasket Set	1991	OS 13881 C-1	Multi-piece; Cork	
QTY	CRANKSHAFT REAR SEAL	YEARS	PART NO.	DESCRIPTION	
1	Rear Main Seal Set	2006-00	BS 40183	Rubber; Two-piece	
1	Rear Main Seal Set	1999-91	BS 40612	Rubber; Two-piece; Double lip; Improved design	
QTY	VALVE COVER	YEARS	PART NO.	DESCRIPTION	
1	Valve Cover Gasket Set	2006-96	VS 50458 R	w/Grommets; PermaDry® molded rubber gskt. incl.	
1	Valve Cover Gasket Set	1995-91	VS 50022 C-1	Cork	
1	Valve Cover Gasket Set	1995-91	VS 50522 T	PermaDryPlus®	
QTY	VALVE STEM SEAL SET	YEARS	PART NO.	DESCRIPTION	
1	Valve Stem Seal Set	2006-94	SS 72835	Premium valve stem seals incl.	
1	Valve Stem Seal Set	1993-91	SS 70819	Premium valve stem seals incl.; Improved design	
QTY	THERMOSTAT HOUSING	YEARS	PART NO.	DESCRIPTION	
1	Thermostat Gasket	2006-99	35630	Thermostat Housing	
QTY	WATER OUTLET GASKET	YEARS	PART NO.	DESCRIPTION	
1	Water Outlet Gasket	1998-91	35024	Water Outlet	
QTY	WATER PUMP	YEARS	PART NO.	DESCRIPTION	
1	Water Pump Gasket	2006-99	35629		
1	Water Pump Gasket	1998-94	35582		
1	Water Pump Gasket	1993-91	13877		

Jeep Truck (Incl. Jeep, Willys) (Cont.)

11 (cont.)		2006 - 1991; 4.0L 242 (3964cc) OHV L6 (12 Valve) 3.875" Bore			11 (cont.)
		MFI; Gasoline; Naturally Aspirated AMC Eng.; Jeep; VIN Code S			
QTY	TIMING COVER	YEARS	PART NO.	DESCRIPTION	
1	Timing Cover Set	2006-92	TCS 45117	w/o Sleeve 'N' Seal®; Must be used w/OS 34308R	
1	Timing Cover Set	1991	TCS 45117	w/o Sleeve 'N' Seal®	
1	Timing Set w/Sleeve & Seal	2006-92	TCS 45458	w/Sleeve 'N' Seal®; Must be used w/OS 34308R	
1	Timing Set w/Sleeve & Seal	1991	TCS 45458	w/Sleeve 'N' Seal®	
1	Repair Sleeve	2006-91	16210	Timing Cover; Use w/installation tool	
1	Repair Sleeve Tool	2006-91	16312	Timing Cover	
QTY	CARB & FUEL INJECTION	YEARS	PART NO.	DESCRIPTION	
3	Fuel Injector O-Ring Set	2006-91	ES 70599	Improved design	
1	Throttle Body Gasket	2006-91	60948		
QTY	DISTRIBUTOR MOUNTING	YEARS	PART NO.	DESCRIPTION	
1	Distributor Mounting Gasket	2003-91	70051	1 11/32" OD	
QTY	EXHAUST GAS RECIRCULATION	YEARS	PART NO.	DESCRIPTION	
1	EGR Gasket	1999	70561	Jeep TJ Base, Wrangler Sahara, SE, Sport	
1	EGR Gasket	1998-91	70561		
QTY	OIL FILTER MOUNTING	YEARS	PART NO.	DESCRIPTION	
1	Oil Filter Gasket	2006-91	ES 72962	Oil filter adapter; Mounting set; New Part Number - Check for Availability	
1	Oil Filter Adapter Gasket	2006-91	70301		
12		2005 - 1997; 4.0L 242 (3964cc) OHV L6 (12 Valve) 3.875" Bore			12
		MFI; Gasoline; Naturally Aspirated AMC Eng.; Jeep; VIN Code V			
QTY	CYLINDER HEAD	YEARS	PART NO.	DESCRIPTION	
1	Head Gasket	2005-97	26211 PT	Head bolts not incl.; Head bolt replacement recommended; PermaTorqueMLS®	
1	Head Gasket	2003-97	530 SD	Head bolts not incl.; Head bolt replacement recommended; PermaTorque Severe Duty®	
1	Head Gasket	2003-97	9076 PT-1	Head bolts not incl.; Head bolt replacement recommended; PermaTorque®; Improved design	
1	Head Set	2005-00	HS 26211 PT	Head bolts & exh. pipe packing not incl.; Head bolt replacement recommended; PermaTorqueMLS® head gskt. incl.; PermaDry® molded rubber valve cover gskt. incl.; Premium valve stem seals incl.	
1	Head Set	2003-00	HS 9076 PT-4	Head bolts & exh. pipe packing not incl.; Head bolt replacement recommended; PermaDry® molded rubber valve cover gskt. incl.; Premium valve stem seals incl.	
1	Head Set	1999-97	HS 9076 PT-3	Head bolts & exh. pipe packing not incl.; Head bolt replacement recommended; PermaDry® molded rubber valve cover gskt. incl.; Premium valve stem seals incl.	
1	Head Bolt Set	2005-97	ES 71102	Replacement recommended	
QTY	CONVERSION SET	YEARS	PART NO.	DESCRIPTION	
1	Gasket Conversion Set	2005-00	CS 8169-4	PermaDry® one-piece molded rubber oil pan gskt. incl.	
1	Gasket Conversion Set	1999-97	CS 8169-3	PermaDry® one-piece molded rubber oil pan gskt. incl.	
QTY	MANIFOLD - INT. & EXH.	YEARS	PART NO.	DESCRIPTION	
1	Int. & Exh. Gasket Set	2005-00	MS 93094		
1	Int. & Exh. Gasket Set	1999-97	MS 94790		
QTY	EXHAUST PIPE FLANGE	YEARS	PART NO.	DESCRIPTION	
1	Exhaust Pipe Gasket	2005-97	60292	Converter	
1	Exhaust Pipe Gasket	2005-97	60836	Packing	
1	Exhaust Pipe Gasket	2005-02	61241	Flange	
QTY	FUEL PUMP	YEARS	PART NO.	DESCRIPTION	
1	Fuel Pump Mounting Gasket	2005-97	6579	May also be used as a fuel pump block-off plate gasket if desired	
QTY	OIL PAN	YEARS	PART NO.	DESCRIPTION	
1	Oil Pan Gasket Set	2005-97	OS 34308 R	PermaDry® one-piece molded rubber gskt. incl.	
QTY	CRANKSHAFT REAR SEAL	YEARS	PART NO.	DESCRIPTION	
1	Rear Main Seal Set	2005-00	BS 40183	Rubber; Two-piece	
1	Rear Main Seal Set	1999-97	BS 40612	Rubber; Two-piece; Double lip; Improved design	
QTY	VALVE COVER	YEARS	PART NO.	DESCRIPTION	
1	Valve Cover Gasket Set	2005-97	VS 50458 R	w/Grommets; PermaDry® molded rubber gskt. incl.	
QTY	VALVE STEM SEAL SET	YEARS	PART NO.	DESCRIPTION	
1	Valve Stem Seal Set	2005-97	SS 72835	Premium valve stem seals incl.	
QTY	THERMOSTAT HOUSING	YEARS	PART NO.	DESCRIPTION	
1	Thermostat Gasket	2005-99	35630	Thermostat Housing	
QTY	WATER OUTLET GASKET	YEARS	PART NO.	DESCRIPTION	
1	Water Outlet Gasket	1998-97	35024	Water Outlet	
QTY	WATER PUMP	YEARS	PART NO.	DESCRIPTION	
1	Water Pump Gasket	2005-99	35629		

Jeep Truck (Incl. Jeep, Willys) (Cont.)

12		2005 - 1997; 4.0L 242 (3964cc) OHV L6 (12 Valve) 3.875" Bore			12
(cont.)		MFI; Gasoline; Naturally Aspirated AMC Eng.; Jeep; VIN Code V			(cont.)
QTY	WATER PUMP	YEARS	PART NO.	DESCRIPTION	
1	Water Pump Gasket	1998-97	35582		
QTY	TIMING COVER	YEARS	PART NO.	DESCRIPTION	
1	Timing Cover Set	2005-97	TCS 45117	w/o Sleeve 'N' Seal®; Must be used w/OS 34308R	
1	Timing Set w/Sleeve & Seal	2005-97	TCS 45458	w/Sleeve 'N' Seal®; Must be used w/OS 34308R	
1	Repair Sleeve	2005-97	16210	Timing Cover; Use w/installation tool	
1	Repair Sleeve Tool	2005-97	16312	Timing Cover	
QTY	CARB & FUEL INJECTION	YEARS	PART NO.	DESCRIPTION	
3	Fuel Injector O-Ring Set	2005-97	ES 70599	Improved design	
1	Throttle Body Gasket	2005-97	60948		
QTY	DISTRIBUTOR MOUNTING	YEARS	PART NO.	DESCRIPTION	
1	Distributor Mounting Gasket	2003-97	70051	1 11/32" OD	
QTY	EXHAUST GAS RECIRCULATION	YEARS	PART NO.	DESCRIPTION	
1	EGR Gasket	1999-97	70561		
QTY	OIL FILTER MOUNTING	YEARS	PART NO.	DESCRIPTION	
1	Oil Filter Gasket	2005-97	ES 72962	Oil filter adapter; Mounting set; New Part Number - Check for Availability	
1	Oil Filter Adapter Gasket	2005-97	70301		
13		2009 - 1999; 4.7L 287 (4703cc) SOHC V8 (16 Valve) 93mm Bore			13
(cont.)		MFI; Gasoline; Naturally Aspirated Chrysler Eng.; VIN Code N			(cont.)
QTY	CYLINDER HEAD	YEARS	PART NO.	DESCRIPTION	
2	Head Gasket	2009-99	26157 PT	Head bolts not incl.; Head bolt replacement recommended; PermaTorqueMLS®	
1	Head Set	2009-08	HS 26157 PT-2	Unified valve spring/seal not incl.; Head bolts not incl.; Head bolt replacement recommended; Must be used w/TCS 46022; PermaDry® molded rubber valve cover gskts. incl.; Premium valve stem seals incl.	
1	Head Set	2007-04	HS 26157 PT-1	Head bolts not incl.; Head bolt replacement recommended; Must be used w/TCS 46022; PermaDry® molded rubber valve cover gskts. incl.; Premium valve stem seals incl.	
1	Head Set	2003-02	HS 26157 PT	Head bolts not incl.; Head bolt replacement recommended; Must be used w/TCS 46000 or TCS 46022; PermaDry® molded rubber valve cover gskts. incl.; Premium valve stem seals incl.	
1	Head Set	2001-99	HS 26157 PT	Head bolts not incl.; Head bolt replacement recommended; Must be used w/TCS 46000; PermaDry® molded rubber valve cover gskts. incl.; Premium valve stem seals incl.	
2	Head Bolt Set	2009-99	ES 71129	Head bolts w/Washers; Replacement recommended	
QTY	CONVERSION SET	YEARS	PART NO.	DESCRIPTION	
1	Gasket Conversion Set	2009-04	CS 26157	RTV sealant incl. for timing cover gskt.; PermaDry® molded rubber oil pan gskt. incl.	
1	Gasket Conversion Set	2003-02	CS 26157	1st Design; w/Timing cover gskt.; PermaDry® molded rubber oil pan gskt. incl.	
1	Gasket Conversion Set	2003-02	CS 26157	2nd Design; w/o Timing cover gskt.; RTV sealant incl. for timing cover gskt.; PermaDry® molded rubber oil pan gskt. incl.	
1	Gasket Conversion Set	2001-99	CS 26157	PermaDry® molded rubber oil pan gskt. incl.	
QTY	MANIFOLD - INT. & EXH.	YEARS	PART NO.	DESCRIPTION	
1	Int. Manifold Gasket Set	2009-08	MS 96998		
1	Int. Manifold Gasket Set	2007-99	MS 93205		
1	Exh. Manifold Gasket Set	2009-08	MS 96994		
1	Exh. Manifold Gasket Set	2007-99	MS 93217		
QTY	OIL PAN	YEARS	PART NO.	DESCRIPTION	
1	Oil Pan Gasket Set	2009-99	OS 30709 R	w/Windage tray; PermaDry® molded rubber gskt. incl.	
QTY	CRANKSHAFT REAR SEAL	YEARS	PART NO.	DESCRIPTION	
1	Rear Main Seal Set	2009-99	BS 40186	Rubber; One-piece	
1	Repair Sleeve	2009-99	16230	Crankshaft; Use w/installation tool	
1	Repair Sleeve Tool	2009-99	16328	Crankshaft	
QTY	VALVE COVER	YEARS	PART NO.	DESCRIPTION	
1	Valve Cover Gasket Set	2009-08	VS 50733 R	w/Grommets; PermaDry® molded rubber gskts. incl.	
1	Valve Cover Gasket Set	2007-04	VS 50577 R	w/Grommets; PermaDry® molded rubber gskts. incl.	
1	Valve Cover Gasket Set	2003-99	VS 50521 R	w/Grommets; PermaDry® molded rubber gskts. incl.	
QTY	VALVE STEM SEAL SET	YEARS	PART NO.	DESCRIPTION	
1	Valve Stem Seal Set	2009-08	SS 71041	Replaces unified valve spring/seal; Premium valve stem seals incl.	
1	Valve Stem Seal Set	2009-08	SS 72446	Unified valve spring/seal; Premium valve stem seals incl.; New Part Number - Check for Availability	
1	Valve Stem Seal Set	2007-99	SS 71041	Premium valve stem seals incl.	

Jeep Truck (Incl. Jeep, Willys) (Cont.)

13 (cont.)		2009 - 1999; 4.7L 287 (4703cc) SOHC V8 (16 Valve) 93mm Bore			13 (cont.)
MFI; Gasoline; Naturally Aspirated Chrysler Eng.; VIN Code N					
QTY	THERMOSTAT HOUSING	YEARS	PART NO.	DESCRIPTION	
1	Thermostat Gasket	2009-99	35692	Thermostat Housing; Thermostat seal	
QTY	WATER PUMP	YEARS	PART NO.	DESCRIPTION	
1	Water Pump Gasket	2009-99	35655		
QTY	TIMING COVER	YEARS	PART NO.	DESCRIPTION	
1	Timing Cover Set	2009-04	TCS 46022	RTV sealant incl. for timing cover gskt.	
1	Timing Cover Set	2003-02	TCS 46000	1st Design; w/Timing cover gskt.	
1	Timing Cover Set	2003-02	TCS 46022	2nd Design; w/o Timing cover gskt.; RTV sealant incl. for timing cover gskt.	
1	Timing Cover Set	2001-99	TCS 46000		
QTY	AIR CLEANER MOUNTING	YEARS	PART NO.	DESCRIPTION	
1	Air Cleaner Gasket	2009-99	61216		
QTY	CARB & FUEL INJECTION	YEARS	PART NO.	DESCRIPTION	
2	Fuel Injector O-Ring Set	2009-99	ES 70599	Lower set; Injectors to cylinder head; Improved design	
2	Fuel Injector O-Ring Set	2009-99	ES 70599	Upper set; Injectors to fuel rail; Improved design	
1	Throttle Body Gasket	2009-03	61324	Idle air control; 21mm ID	
1	Throttle Body Gasket	2009-03	61326	Idle air control; 30mm ID	
1	Throttle Body Gasket	2009-08	61438	Mounting	
1	Throttle Body Gasket	2007-99	61182	Mounting	
QTY	EXHAUST GAS RECIRCULATION	YEARS	PART NO.	DESCRIPTION	
2	EGR Gasket	2009-04	70721	Tube flange	
2	EGR Gasket	2009-04	72928	Tube seal	
1	EGR Gasket	2009-08	71221	Valve	
1	EGR Gasket	2009-08	72251	Flange	
1	EGR Gasket	2007-04	71238	Valve	
1	EGR Gasket	2007-04	71240	Flange	
14		2009 - 2007; 4.7L 287 (4703cc) SOHC V8 (16 Valve) 93mm Bore			14
MFI; Flex Fuel; Naturally Aspirated Chrysler Eng.; VIN Code P					
QTY	CYLINDER HEAD	YEARS	PART NO.	DESCRIPTION	
2	Head Gasket	2009-07	26157 PT	Head bolts not incl.; Head bolt replacement recommended; PermaTorqueMLS®	
1	Head Set	2009-08	HS 26157 PT-2	Unified valve spring/seal not incl.; Head bolts not incl.; Head bolt replacement recommended; Must be used w/TCS 46022; PermaDry® molded rubber valve cover gskts. incl.; Premium valve stem seals incl.	
1	Head Set	2007	HS 26157 PT-1	Head bolts not incl.; Head bolt replacement recommended; Must be used w/TCS 46022; PermaDry® molded rubber valve cover gskts. incl.; Premium valve stem seals incl.	
2	Head Bolt Set	2009-07	ES 71129	Head bolts w/Washers; Replacement recommended	
QTY	CONVERSION SET	YEARS	PART NO.	DESCRIPTION	
1	Gasket Conversion Set	2009-07	CS 26157	RTV sealant incl. for timing cover gskt.; PermaDry® molded rubber oil pan gskt. incl.	
QTY	MANIFOLD - INT. & EXH.	YEARS	PART NO.	DESCRIPTION	
1	Int. Manifold Gasket Set	2009-08	MS 96998		
1	Int. Manifold Gasket Set	2007	MS 93205		
1	Exh. Manifold Gasket Set	2009-08	MS 96994		
1	Exh. Manifold Gasket Set	2007	MS 93217		
QTY	OIL PAN	YEARS	PART NO.	DESCRIPTION	
1	Oil Pan Gasket Set	2009-07	OS 30709 R	w/Windage tray; PermaDry® molded rubber gskt. incl.	
QTY	CRANKSHAFT REAR SEAL	YEARS	PART NO.	DESCRIPTION	
1	Rear Main Seal Set	2009-07	BS 40186	Rubber; One-piece	
1	Repair Sleeve	2009-07	16230	Crankshaft; Use w/installation tool	
1	Repair Sleeve Tool	2009-07	16328	Crankshaft	
QTY	VALVE COVER	YEARS	PART NO.	DESCRIPTION	
1	Valve Cover Gasket Set	2009-08	VS 50733 R	w/Grommets; PermaDry® molded rubber gskts. incl.	
1	Valve Cover Gasket Set	2007	VS 50577 R	w/Grommets; PermaDry® molded rubber gskts. incl.	
QTY	VALVE STEM SEAL SET	YEARS	PART NO.	DESCRIPTION	
1	Valve Stem Seal Set	2009-08	SS 71041	Replaces unified valve spring/seal; Premium valve stem seals incl.	
1	Valve Stem Seal Set	2009-08	SS 72446	Unified valve spring/seal; Premium valve stem seals incl.; New Part Number - Check for Availability	
1	Valve Stem Seal Set	2007	SS 71041	Premium valve stem seals incl.	
QTY	THERMOSTAT HOUSING	YEARS	PART NO.	DESCRIPTION	
1	Thermostat Gasket	2009-07	35692	Thermostat Housing; Thermostat seal	
QTY	WATER PUMP	YEARS	PART NO.	DESCRIPTION	
1	Water Pump Gasket	2009-07	35655		

Jeep Truck (Incl. Jeep, Willys) (Cont.)

14 (cont.)		2009 - 2007; 4.7L 287 (4703cc) SOHC V8 (16 Valve) 93mm Bore			14 (cont.)
		MFI; Flex Fuel; Naturally Aspirated Chrysler Eng.; VIN Code P			
QTY	TIMING COVER	YEARS	PART NO.	DESCRIPTION	
1	Timing Cover Set	2009-07	TCS 46022	RTV sealant incl. for timing cover gskt.	
QTY	AIR CLEANER MOUNTING	YEARS	PART NO.	DESCRIPTION	
1	Air Cleaner Gasket	2009-07	61216		
QTY	CARB & FUEL INJECTION	YEARS	PART NO.	DESCRIPTION	
2	Fuel Injector O-Ring Set	2009-07	ES 70599	Lower set; Injectors to cylinder head; Improved design	
2	Fuel Injector O-Ring Set	2009-07	ES 70599	Upper set; Injectors to fuel rail; Improved design	
1	Throttle Body Gasket	2009-07	61324	Idle air control; 21mm ID	
1	Throttle Body Gasket	2009-07	61326	Idle air control; 30mm ID	
1	Throttle Body Gasket	2009-08	61438	Mounting	
1	Throttle Body Gasket	2007	61182	Mounting	
QTY	EXHAUST GAS RECIRCULATION	YEARS	PART NO.	DESCRIPTION	
2	EGR Gasket	2009-07	70721	Tube flange	
2	EGR Gasket	2009-07	72928	Tube seal	
1	EGR Gasket	2009-08	71221	Valve	
1	EGR Gasket	2009-08	72251	Flange	
1	EGR Gasket	2007	71238	Valve	
1	EGR Gasket	2007	71240	Flange	
15		2004 - 2002; 4.7L 287 (4703cc) SOHC V8 (16 Valve) 93mm Bore H.O.			15
		MFI; Gasoline; Naturally Aspirated Chrysler Eng.; VIN Code J			
QTY	CYLINDER HEAD	YEARS	PART NO.	DESCRIPTION	
2	Head Gasket	2004-02	26157 PT	Head bolts not incl.; Head bolt replacement recommended; PermaTorqueMLS®	
1	Head Set	2004	HS 26157 PT-1	Head bolts not incl.; Head bolt replacement recommended; Must be used w/TCS 46022; PermaDry® molded rubber valve cover gskts. incl.; Premium valve stem seals incl.	
1	Head Set	2003-02	HS 26157 PT	Head bolts not incl.; Head bolt replacement recommended; Must be used w/TCS 46000 or TCS 46022; PermaDry® molded rubber valve cover gskts. incl.; Premium valve stem seals incl.	
2	Head Bolt Set	2004-02	ES 71129	Head bolts w/Washers; Replacement recommended	
QTY	CONVERSION SET	YEARS	PART NO.	DESCRIPTION	
1	Gasket Conversion Set	2004	CS 26157	RTV sealant incl. for timing cover gskt.; PermaDry® molded rubber oil pan gskt. incl.	
1	Gasket Conversion Set	2003-02	CS 26157	1st Design; w/Timing cover gskt.; PermaDry® molded rubber oil pan gskt. incl.	
1	Gasket Conversion Set	2003-02	CS 26157	2nd Design; w/o Timing cover gskt.; RTV sealant incl. for timing cover gskt.; PermaDry® molded rubber oil pan gskt. incl.	
QTY	MANIFOLD - INT. & EXH.	YEARS	PART NO.	DESCRIPTION	
1	Int. Manifold Gasket Set	2004-02	MS 93205		
1	Exh. Manifold Gasket Set	2004-02	MS 93217		
QTY	OIL PAN	YEARS	PART NO.	DESCRIPTION	
1	Oil Pan Gasket Set	2004-02	OS 30709 R	w/Windage tray; PermaDry® molded rubber gskt. incl.	
QTY	CRANKSHAFT REAR SEAL	YEARS	PART NO.	DESCRIPTION	
1	Rear Main Seal Set	2004-02	BS 40186	Rubber; One-piece	
1	Repair Sleeve	2004-02	16230	Crankshaft; Use w/installation tool	
1	Repair Sleeve Tool	2004-02	16328	Crankshaft	
QTY	VALVE COVER	YEARS	PART NO.	DESCRIPTION	
1	Valve Cover Gasket Set	2004	VS 50577 R	w/Grommets; PermaDry® molded rubber gskts. incl.	
1	Valve Cover Gasket Set	2003-02	VS 50521 R	w/Grommets; PermaDry® molded rubber gskts. incl.	
QTY	VALVE STEM SEAL SET	YEARS	PART NO.	DESCRIPTION	
1	Valve Stem Seal Set	2004-02	SS 71041	Premium valve stem seals incl.	
QTY	THERMOSTAT HOUSING	YEARS	PART NO.	DESCRIPTION	
1	Thermostat Gasket	2004-02	35692	Thermostat Housing; Thermostat seal	
QTY	WATER PUMP	YEARS	PART NO.	DESCRIPTION	
1	Water Pump Gasket	2004-02	35655		
QTY	TIMING COVER	YEARS	PART NO.	DESCRIPTION	
1	Timing Cover Set	2004	TCS 46022	RTV sealant incl. for timing cover gskt.	
1	Timing Cover Set	2003-02	TCS 46000	1st Design; w/Timing cover gskt.	
1	Timing Cover Set	2003-02	TCS 46022	2nd Design; w/o Timing cover gskt.; RTV sealant incl. for timing cover gskt.	
QTY	AIR CLEANER MOUNTING	YEARS	PART NO.	DESCRIPTION	
1	Air Cleaner Gasket	2004-02	61216		
QTY	CARB & FUEL INJECTION	YEARS	PART NO.	DESCRIPTION	
2	Fuel Injector O-Ring Set	2004-02	ES 70599	Lower set; Injectors to cylinder head; Improved design	

Jeep Truck (Incl. Jeep, Willys) (Cont.)

15 (cont.)		2004 - 2002; 4.7L 287 (4703cc) SOHC V8 (16 Valve) 93mm Bore H.O.			15 (cont.)
MFI; Gasoline; Naturally Aspirated Chrysler Eng.; VIN Code J					
QTY	CARB & FUEL INJECTION	YEARS	PART NO.	DESCRIPTION	
2	Fuel Injector O-Ring Set	2004-02	ES 70599	Upper set; Injectors to fuel rail; Improved design	
1	Throttle Body Gasket	2004-02	61182	Mounting	
1	Throttle Body Gasket	2004-03	61324	Idle air control; 21mm ID	
1	Throttle Body Gasket	2004-03	61326	Idle air control; 30mm ID	
QTY	EXHAUST GAS RECIRCULATION	YEARS	PART NO.	DESCRIPTION	
2	EGR Gasket	2004	70721	Tube flange	
1	EGR Gasket	2004	71238	Valve	
1	EGR Gasket	2004	71240	Flange	
2	EGR Gasket	2004	72928	Tube seal	
16		1998 - 1993; 5.2L 318 (5212cc) OHV V8 (16 Valve) 3.9063" Bore			16
MFI; Gasoline; Naturally Aspirated Chrysler Eng.; VIN Code Y					
QTY	CYLINDER HEAD	YEARS	PART NO.	DESCRIPTION	
2	Head Gasket	1998-93	26179 PT	Head bolts not incl.; Head bolt replacement recommended; PermaTorque®	
2	Head Gasket	1998-93	540 SD	Head bolts not incl.; Head bolt replacement recommended; PermaTorque Severe Duty®	
1	Head Set	1998	HS 26179 PT-2	Head bolts not incl.; Head bolt replacement recommended; PermaDry® molded rubber valve cover gskts. incl.; Premium valve stem seals incl.	
1	Head Set	1997-93	HS 26179 PT-1	Head bolts not incl.; Head bolt replacement recommended; PermaDry® molded rubber valve cover gskts. incl.; Premium valve stem seals incl.	
1	Head Bolt Set	1998-94	ES 71038-1	Replacement recommended	
QTY	CONVERSION SET	YEARS	PART NO.	DESCRIPTION	
1	Gasket Conversion Set	1998-97	CS 9898-3	PermaDry® molded rubber oil pan gskt. incl.; PermaDryPlus® timing cover gskt. incl.	
1	Gasket Conversion Set	1996-93	CS 9898	PermaDry® molded rubber oil pan gskt. incl.	
QTY	MANIFOLD - INT. & EXH.	YEARS	PART NO.	DESCRIPTION	
1	Int. Manifold Gasket Set	1998	MS 95392-1	Lower set; Upper set incl.; Manifold bolts not incl.; Manifold bolt replacement recommended	
1	Int. Manifold Gasket Set	1997-93	MS 95392	Lower set; Upper set incl.; Manifold bolts not incl.; Manifold bolt replacement recommended	
1	Plenum Gasket Set	1998-93	MS 95462	Upper set	
1	Int. Manifold Bolt Set	1998-93	ES 72169	Int. manifold bolts w/Washers; Replacement recommended	
1	Exh. Manifold Gasket Set	1998-93	MS 95480		
QTY	OIL PAN	YEARS	PART NO.	DESCRIPTION	
1	Oil Pan Gasket Set	1998-93	OS 34408 R	PermaDry® molded rubber gskt. incl.	
1	Drain Plug Gasket	1998-93	70822		
QTY	CRANKSHAFT REAR SEAL	YEARS	PART NO.	DESCRIPTION	
1	Rear Main Seal Set	1998-93	BS 40181	Rubber; Two-piece	
QTY	VALVE COVER	YEARS	PART NO.	DESCRIPTION	
1	Valve Cover Gasket Set	1998-93	VS 50419 R	PermaDry® molded rubber gskts. incl.	
QTY	VALVE STEM SEAL SET	YEARS	PART NO.	DESCRIPTION	
1	Valve Stem Seal Set	1998-93	SS 72844	Premium valve stem seals incl.	
QTY	WATER OUTLET GASKET	YEARS	PART NO.	DESCRIPTION	
1	Water Outlet Gasket	1998-93	35064	Water Outlet	
QTY	WATER PUMP	YEARS	PART NO.	DESCRIPTION	
1	Water Pump Gasket	1998-93	35540		
QTY	TIMING COVER	YEARS	PART NO.	DESCRIPTION	
1	Timing Cover Set	1998-97	TCS 45996	w/o Sleeve 'N' Seal®; Must be used w/OS 34408R; PermaDryPlus® timing cover gskt. incl.	
1	Timing Cover Set	1996-93	TCS 45952	w/o Sleeve 'N' Seal®; Must be used w/OS 34408R	
1	Timing Set w/Sleeve & Seal	1998-97	TCS 45999	w/Sleeve 'N' Seal®; Must be used w/OS 34408R; PermaDryPlus® timing cover gskt. incl.	
1	Timing Set w/Sleeve & Seal	1996-93	TCS 45949	w/Sleeve 'N' Seal®; Must be used w/OS 34408R	
1	Crankshaft Front Seal Set	1998-93	TCS 46198	New Part Number - Check for Availability	
1	Repair Sleeve	1998-93	16201	Timing Cover; Use w/installation tool	
QTY	AIR CLEANER MOUNTING	YEARS	PART NO.	DESCRIPTION	
1	Air Cleaner Gasket	1998-93	60038	5 1/32" ID	
QTY	CARB & FUEL INJECTION	YEARS	PART NO.	DESCRIPTION	
4	Fuel Injector O-Ring Set	1998-93	ES 70599	Improved design	
1	Throttle Body Gasket	1998-93	60958-1		
QTY	EXHAUST GAS RECIRCULATION	YEARS	PART NO.	DESCRIPTION	
1	EGR Gasket	1998-93	70561		
QTY	OIL FILTER MOUNTING	YEARS	PART NO.	DESCRIPTION	
1	Oil Filter Adapter Gasket	1998-93	70522		

Jeep Truck (Incl. Jeep, Willys) (Cont.)

17		2008 - 2005; 5.7L 345 (5654cc) OHV V8 (16 Valve) 99.5mm Bore Hemi			17
MFI; Gasoline; Naturally Aspirated Chrysler Eng.; VIN Code 2					
QTY	CYLINDER HEAD	YEARS	PART NO.	DESCRIPTION	
1	Head Gasket	2008-05	26284 PT	Loc. L.H.; Head bolts not incl.; Head bolt replacement recommended; PermaTorqueMLS®	
1	Head Gasket	2008-05	26286 PT	Loc. R.H.; Head bolts not incl.; Head bolt replacement recommended; PermaTorqueMLS®	
1	Head Set	2008-05	HS 26284 PT-1	Head bolts not incl.; Head bolt replacement recommended; RTV sealant incl. for thermostat gskt.; PermaDry® molded rubber valve cover gskts. incl.; Premium valve stem seals incl.; Improved design	
1	Head Set	2006-05	HS 26284 PT	Head bolts not incl.; Head bolt replacement recommended; RTV sealant incl. for thermostat gskt.; PermaDry® molded rubber valve cover gskts. incl.; Premium valve stem seals incl.; Old design	
2	Head Bolt Set	2008-05	ES 72200	Head bolts w/Washers; Replacement recommended	
QTY	CONVERSION SET	YEARS	PART NO.	DESCRIPTION	
1	Gasket Conversion Set	2008-05	CS 26284-1	PermaDry® molded rubber oil pan gskt. incl.	
QTY	MANIFOLD - INT. & EXH.	YEARS	PART NO.	DESCRIPTION	
1	Int. Manifold Gasket Set	2008-05	MS 96574		
1	Exh. Manifold Gasket Set	2008-05	MS 96905	Consolidated design	
1	Exh. Manifold Gasket Set	2006-05	MS 96532	May use MS 96905 instead; Old design	
QTY	EXHAUST PIPE FLANGE	YEARS	PART NO.	DESCRIPTION	
1	Exhaust Pipe Gasket	2008-05	61240	Flange	
QTY	OIL PAN	YEARS	PART NO.	DESCRIPTION	
1	Oil Pan Gasket Set	2008-05	OS 30761 R	PermaDry® molded rubber gskt. incl.	
QTY	CRANKSHAFT REAR SEAL	YEARS	PART NO.	DESCRIPTION	
1	Rear Main Seal Set	2008-05	BS 40684	Retainer w/Seal; PTFE Rubber; One-piece; Improved design	
1	Rear Main Seal Set	2008-05	BS 40735	Rubber; One-piece; New Part Number - Check for Availability	
1	Repair Sleeve	2008-05	16230	Crankshaft; Use w/installation tool	
1	Repair Sleeve Tool	2008-05	16328	Crankshaft	
QTY	VALVE COVER	YEARS	PART NO.	DESCRIPTION	
1	Valve Cover Gasket Set	2008-05	VS 50625 R	w/Spark plug tube seals; PermaDry® molded rubber gskts. incl.	
QTY	VALVE STEM SEAL SET	YEARS	PART NO.	DESCRIPTION	
1	Valve Stem Seal Set	2008-05	SS 72914	Premium valve stem seals incl.	
QTY	THERMOSTAT HOUSING	YEARS	PART NO.	DESCRIPTION	
1	Thermostat Gasket	2008-05	35840	Thermostat Housing; Thermostat housing	
QTY	WATER PUMP	YEARS	PART NO.	DESCRIPTION	
1	Water Pump Gasket	2008-05	35783		
QTY	TIMING COVER	YEARS	PART NO.	DESCRIPTION	
1	Timing Cover Set	2008-05	TCS 46049	Old design	
1	Timing Cover Set	2008-05	TCS 46169	Improved design; New Part Number - Check for Availability	
QTY	CARB & FUEL INJECTION	YEARS	PART NO.	DESCRIPTION	
2	Fuel Injector O-Ring Set	2008-05	ES 70599	Improved design	
1	Throttle Body Gasket	2008-05	61372	Loc. Lower	
1	Throttle Body Gasket	2008-05	61415	Loc. Upper	
QTY	EXHAUST GAS RECIRCULATION	YEARS	PART NO.	DESCRIPTION	
2	EGR Gasket	2008-05	70721	Tube flange	
1	EGR Gasket	2008-05	71221	Valve	
2	EGR Gasket	2008-05	72928	Tube seal	
18		2013 - 2009; 5.7L 345 (5654cc) OHV V8 (16 Valve) 99.5mm Bore Hemi			18
MFI; Gasoline; Naturally Aspirated Chrysler Eng.; VIN Code T					
QTY	CYLINDER HEAD	YEARS	PART NO.	DESCRIPTION	
1	Head Gasket	2012-09	26423 PT	Loc. L.H.; Head bolts not incl.; Head bolt replacement recommended; PermaTorqueMLS®	
1	Head Gasket	2012-09	26426 PT	Loc. R.H.; Head bolts not incl.; Head bolt replacement recommended; PermaTorqueMLS®	
1	Head Set	2012-09	HS 26423 PT	Head bolts not incl.; Head bolt replacement recommended; PermaDry® molded rubber valve cover gskts. incl.; Premium valve stem seals incl.	
2	Head Bolt Set	2012-09	ES 72200	Head bolts w/Washers; Replacement recommended	
QTY	CONVERSION SET	YEARS	PART NO.	DESCRIPTION	
1	Gasket Conversion Set	2012-11	CS 26284-2	PermaDry® molded rubber oil pan gskt. incl.; Improved design; New Part Number - Check for Availability	
1	Gasket Conversion Set	2010-09	CS 26284-1	PermaDry® molded rubber oil pan gskt. incl.	
QTY	MANIFOLD - INT. & EXH.	YEARS	PART NO.	DESCRIPTION	
1	Int. Manifold Gasket Set	2012-09	MS 97089		
1	Exh. Manifold Gasket Set	2012-09	MS 97083		

Jeep Truck (Incl. Jeep, Willys) (Cont.)

18		2013 - 2009; 5.7L 345 (5654cc) OHV V8 (16 Valve) 99.5mm Bore Hemi			18	
(cont.)		MFI; Gasoline; Naturally Aspirated Chrysler Eng.; VIN Code T			(cont.)	
QTY	EXHAUST PIPE FLANGE	YEARS	PART NO.	DESCRIPTION		
1	Exhaust Pipe Gasket	2012-09	61240	Flange		
2	Exhaust Pipe Gasket	2012-09	61710	Pipe to manifold; New Part Number - Check for Availability		
QTY	OIL PAN	YEARS	PART NO.	DESCRIPTION		
1	Oil Pan Gasket Set	2012-11	OS 30841 R	PermaDry® molded rubber gskt. incl.; Improved design; New Part Number - Check for Availability		
1	Oil Pan Gasket Set	2010-09	OS 30761 R	PermaDry® molded rubber gskt. incl.		
QTY	CRANKSHAFT REAR SEAL	YEARS	PART NO.	DESCRIPTION		
1	Rear Main Seal Set	2012-09	BS 40684	Retainer w/Seal; PTFE Rubber; One-piece; Improved design		
1	Rear Main Seal Set	2012-09	BS 40735	Rubber; One-piece; New Part Number - Check for Availability		
1	Repair Sleeve	2012-09	16230	Crankshaft; Use w/installation tool		
1	Repair Sleeve Tool	2012-09	16328	Crankshaft		
QTY	VALVE COVER	YEARS	PART NO.	DESCRIPTION		
1	Valve Cover Gasket Set	2012-09	VS 50625 R	w/Spark plug tube seals; PermaDry® molded rubber gskts. incl.		
QTY	VALVE STEM SEAL SET	YEARS	PART NO.	DESCRIPTION		
1	Valve Stem Seal Set	2012-09	SS 72929	Premium valve stem seals incl.		
QTY	THERMOSTAT HOUSING	YEARS	PART NO.	DESCRIPTION		
1	Thermostat Gasket	2012-09	35840	Thermostat Housing; Thermostat housing		
QTY	WATER PUMP	YEARS	PART NO.	DESCRIPTION		
1	Water Pump Gasket	2012-09	35783			
QTY	TIMING COVER	YEARS	PART NO.	DESCRIPTION		
1	Timing Cover Set	2013-09	TCS 46169	Improved design; New Part Number - Check for Availability		
1	Timing Cover Set	2012-09	TCS 46049	Old design		
QTY	CARB & FUEL INJECTION	YEARS	PART NO.	DESCRIPTION		
2	Fuel Injector O-Ring Set	2012-09	ES 70599	Improved design		
1	Throttle Body Gasket	2012-09	61372	Loc. Lower		
1	Throttle Body Gasket	2012-09	61586	Loc. Upper		
QTY	EXHAUST GAS RECIRCULATION	YEARS	PART NO.	DESCRIPTION		
2	EGR Gasket	2012-09	70721	Tube flange		
1	EGR Gasket	2012-09	71221	Valve		
2	EGR Gasket	2012-09	72535	Tube gskt.; New Part Number - Check for Availability		
2	EGR Gasket	2012-09	72928	Tube seal		
19		1993 - 1991; 5.9L 360 (5899cc) OHV V8 (16 Valve) 4.08" Bore			19	
		2 Bbl.; Gasoline; Naturally Aspirated AMC Eng.; VIN Code 7				
QTY	CYLINDER HEAD	YEARS	PART NO.	DESCRIPTION		
2	Head Gasket	1993-91	8266 PT-1			
1	Head Set	1993-91	HS 8266 PT-4	Int. manifold gskt. & exh. pipe flange not incl.; Premium valve stem seals incl.		
QTY	FULL GASKET SET	YEARS	PART NO.	DESCRIPTION		
1	Full Gasket Set	1993-91	FS 8266 PT-4	Int. manifold gskt. & exh. pipe flange not incl.; Premium valve stem seals incl.		
QTY	MANIFOLD - INT. & EXH.	YEARS	PART NO.	DESCRIPTION		
1	Valley Pan Gasket Set	1993-91	MS 96011			
1	Exh. Manifold Gasket Set	1993-91	MS 90166			
QTY	EXHAUST PIPE FLANGE	YEARS	PART NO.	DESCRIPTION		
1	Exhaust Pipe Gasket	1993-91	60103-1	Packing; 2 1/8" ID		
1	Exhaust Pipe Gasket	1993-91	60133	Flange		
QTY	FUEL PUMP	YEARS	PART NO.	DESCRIPTION		
1	Fuel Pump Mounting Gasket	1993-91	6579	May also be used as a fuel pump block-off plate gasket if desired		
QTY	OIL PAN	YEARS	PART NO.	DESCRIPTION		
1	Oil Pan Gasket Set	1993-91	OS 30187 C			
QTY	CRANKSHAFT REAR SEAL	YEARS	PART NO.	DESCRIPTION		
1	Rear Main Seal Set	1993-91	BS 40003	Rubber; Two-piece		
QTY	VALVE COVER	YEARS	PART NO.	DESCRIPTION		
1	Valve Cover Gasket Set	1993-91	VS 50001 C	Cork; Improved design; New Part Number - Check for Availability		
1	Valve Cover Gasket Set	1993-91	VS 50001 R	Rubber; Old design; Superseded - When depleted use VS 50001 C		
QTY	VALVE STEM SEAL SET	YEARS	PART NO.	DESCRIPTION		
1	Valve Stem Seal Set	1993-91	SS 70529	Premium valve stem seals incl.		
QTY	WATER OUTLET GASKET	YEARS	PART NO.	DESCRIPTION		
1	Water Outlet Gasket	1993-91	35130	Water Outlet		
QTY	WATER PUMP	YEARS	PART NO.	DESCRIPTION		
1	Water Pump Gasket	1993-91	35014			

Jeep Truck (Incl. Jeep, Willys) (Cont.)

19 (cont.)		1993 - 1991; 5.9L 360 (5899cc) OHV V8 (16 Valve) 4.08" Bore 2 Bbl.; Gasoline; Naturally Aspirated AMC Eng.; VIN Code 7			19 (cont.)
QTY	TIMING COVER	YEARS	PART NO.	DESCRIPTION	
1	Timing Cover Set	1993-91	TCS 45003	w/o Sleeve 'N' Seal®	
1	Timing Set w/Sleeve & Seal	1993-91	TCS 45271	w/Sleeve 'N' Seal®	
1	Repair Sleeve	1993-91	16204	Timing Cover; Use w/installation tool	
1	Repair Sleeve Tool	1993-91	16308	Timing Cover	
QTY	AIR CLEANER MOUNTING	YEARS	PART NO.	DESCRIPTION	
1	Air Cleaner Gasket	1993-91	60038	5 1/32" ID	
QTY	CARB & FUEL INJECTION	YEARS	PART NO.	DESCRIPTION	
1	Carb. Mounting Gasket	1993-91	60102	Insulator to manifold	
1	Carb. Mounting Gasket	1993-91	60320	Carb. to insulator	
QTY	CHOKE TUBE	YEARS	PART NO.	DESCRIPTION	
1	Choke Mounting Tube Gasket	1993-91	72590		
QTY	DISTRIBUTOR MOUNTING	YEARS	PART NO.	DESCRIPTION	
1	Distributor Mounting Gasket	1993-91	70051	1 11/32" OD	
QTY	EXHAUST GAS RECIRCULATION	YEARS	PART NO.	DESCRIPTION	
1	EGR Gasket	1993-91	70253		
20		1998; 5.9L 360 (5900cc) OHV V8 (16 Valve) 4" Bore L/D MFI; Gasoline; Naturally Aspirated Chrysler Eng.; VIN Code Z			20
QTY	CYLINDER HEAD	YEARS	PART NO.	DESCRIPTION	
2	Head Gasket	1998	519 SD	Head bolts not incl.; Head bolt replacement recommended; PermaTorque Severe Duty®	
2	Head Gasket	1998	9898 PT	Head bolts not incl.; Head bolt replacement recommended; PermaTorque®; Improved design	
1	Head Set	1998	HS 9898 PT-2	Head bolts not incl.; Head bolt replacement recommended; PermaDry® molded rubber valve cover gskts. incl.; Premium valve stem seals incl.; Consolidated design	
1	Head Set	1998	HS 9920 PT	Head bolts not incl.; Head bolt replacement recommended; PermaDry® molded rubber valve cover gskts. incl.; Premium valve stem seals incl.; May use HS 9898PT-2 instead; Old design; Superseded - When depleted use HS 9898 PT-2	
1	Head Bolt Set	1998	ES 71038-1	Replacement recommended	
QTY	CONVERSION SET	YEARS	PART NO.	DESCRIPTION	
1	Gasket Conversion Set	1998	CS 9898-2	PermaDry® molded rubber oil pan gskt. incl.; PermaDryPlus® timing cover gskt. incl.	
QTY	MANIFOLD - INT. & EXH.	YEARS	PART NO.	DESCRIPTION	
1	Int. Manifold Gasket Set	1998	MS 95392-1	Lower set; Upper set incl.; Manifold bolts not incl.; Manifold bolt replacement recommended	
1	Plenum Gasket Set	1998	MS 95462	Upper set	
1	Int. Manifold Bolt Set	1998	ES 72169	Int. manifold bolts w/Washers; Replacement recommended	
1	Exh. Manifold Gasket Set	1998	MS 95480		
QTY	OIL PAN	YEARS	PART NO.	DESCRIPTION	
1	Oil Pan Gasket Set	1998	OS 34409 R	PermaDry® molded rubber gskt. incl.	
QTY	CRANKSHAFT REAR SEAL	YEARS	PART NO.	DESCRIPTION	
1	Rear Main Seal Set	1998	BS 40651	Viton®; Two-piece	
QTY	VALVE COVER	YEARS	PART NO.	DESCRIPTION	
1	Valve Cover Gasket Set	1998	VS 50419 R	PermaDry® molded rubber gskts. incl.	
QTY	VALVE STEM SEAL SET	YEARS	PART NO.	DESCRIPTION	
1	Valve Stem Seal Set	1998	SS 72844	Premium valve stem seals incl.	
QTY	WATER OUTLET GASKET	YEARS	PART NO.	DESCRIPTION	
1	Water Outlet Gasket	1998	35064	Water Outlet	
QTY	WATER PUMP	YEARS	PART NO.	DESCRIPTION	
1	Water Pump Gasket	1998	35540		
QTY	TIMING COVER	YEARS	PART NO.	DESCRIPTION	
1	Timing Cover Set	1998	TCS 45996	w/o Sleeve 'N' Seal®; Must be used w/OS 34409R; PermaDryPlus® timing cover gskt. incl.	
1	Timing Set w/Sleeve & Seal	1998	TCS 45999	w/Sleeve 'N' Seal®; Must be used w/OS 34409R; PermaDryPlus® timing cover gskt. incl.	
1	Crankshaft Front Seal Set	1998	TCS 46198	New Part Number - Check for Availability	
1	Repair Sleeve	1998	16201	Timing Cover; Use w/installation tool	
QTY	AIR CLEANER MOUNTING	YEARS	PART NO.	DESCRIPTION	
1	Air Cleaner Gasket	1998	60038	5 1/32" ID	
QTY	CARB & FUEL INJECTION	YEARS	PART NO.	DESCRIPTION	
4	Fuel Injector O-Ring Set	1998	ES 70599	Improved design	
1	Throttle Body Gasket	1998	60958-1		

Jeep Truck (Incl. Jeep, Willys) (Cont.)

20 (cont.)		1998; 5.9L 360 (5900cc) OHV V8 (16 Valve) 4" Bore L/D			20 (cont.)
MFI; Gasoline; Naturally Aspirated Chrysler Eng.; VIN Code Z					
QTY	EXHAUST GAS RECIRCULATION	YEARS	PART NO.	DESCRIPTION	
1	EGR Gasket	1998	70561		
QTY	OIL FILTER MOUNTING	YEARS	PART NO.	DESCRIPTION	
1	Oil Filter Adapter Gasket	1998	70522		
21		2010 - 2006; 6.1L 370 (6059cc) OHV V8 (16 Valve) 103mm Bore Hemi			21
MFI; Gasoline; Naturally Aspirated Chrysler Eng.; VIN Code 3					
QTY	CYLINDER HEAD	YEARS	PART NO.	DESCRIPTION	
2	Head Gasket	2010-06	26366 PT	Head bolts not incl.; Head bolt replacement recommended; PermaTorqueMLS®	
1	Head Set	2010-06	HS 26366 PT	Head bolts not incl.; Head bolt replacement recommended; PermaDry® molded rubber valve cover gskts. incl.; Premium valve stem seals incl.	
2	Head Bolt Set	2010-06	ES 72200	Head bolts w/Washers; Replacement recommended	
QTY	CONVERSION SET	YEARS	PART NO.	DESCRIPTION	
1	Gasket Conversion Set	2010-06	CS 26366-1	PermaDry® molded rubber oil pan gskt. incl.	
QTY	MANIFOLD - INT. & EXH.	YEARS	PART NO.	DESCRIPTION	
1	Int. Manifold Gasket Set	2010-06	MS 96916	Lower set; Upper set incl.	
1	Exh. Manifold Gasket Set	2010-06	MS 96964		
QTY	OIL PAN	YEARS	PART NO.	DESCRIPTION	
1	Oil Pan Gasket Set	2010-06	OS 30793 R	PermaDry® molded rubber gskt. incl.	
QTY	CRANKSHAFT REAR SEAL	YEARS	PART NO.	DESCRIPTION	
1	Rear Main Seal Set	2010-06	BS 40684	Retainer w/Seal; PTFE Rubber; One-piece; Improved design	
1	Rear Main Seal Set	2010-06	BS 40735	Rubber; One-piece; New Part Number - Check for Availability	
1	Repair Sleeve	2010-06	16230	Crankshaft; Use w/installation tool	
1	Repair Sleeve Tool	2010-06	16328	Crankshaft	
QTY	VALVE COVER	YEARS	PART NO.	DESCRIPTION	
1	Valve Cover Gasket Set	2010-06	VS 50625 R	w/Spark plug tube seals; PermaDry® molded rubber gskts. incl.	
QTY	VALVE STEM SEAL SET	YEARS	PART NO.	DESCRIPTION	
1	Valve Stem Seal Set	2010-06	SS 72914-1	Premium valve stem seals incl.	
QTY	THERMOSTAT HOUSING	YEARS	PART NO.	DESCRIPTION	
1	O-Ring	2010-06	35857	Thermostat Housing; Thermostat seal	
QTY	WATER PUMP	YEARS	PART NO.	DESCRIPTION	
1	Water Pump Gasket	2010-06	35783		
QTY	TIMING COVER	YEARS	PART NO.	DESCRIPTION	
1	Timing Cover Set	2010-06	TCS 46049	Old design	
1	Timing Cover Set	2010-06	TCS 46169	Improved design; New Part Number - Check for Availability	
QTY	CARB & FUEL INJECTION	YEARS	PART NO.	DESCRIPTION	
2	Fuel Injector O-Ring Set	2010-06	ES 70599	Improved design	
1	Throttle Body Gasket	2010-06	61324	Idle air control; 21mm ID	
1	Throttle Body Gasket	2010-06	61372	Mounting	
22		2010; 6.1L 370 (6059cc) OHV V8 (16 Valve) 103mm Bore Hemi			22
MFI; Gasoline; Naturally Aspirated Chrysler Eng.; VIN Code W					
QTY	CYLINDER HEAD	YEARS	PART NO.	DESCRIPTION	
2	Head Gasket	2010	26366 PT	Head bolts not incl.; Head bolt replacement recommended; PermaTorqueMLS®	
1	Head Set	2010	HS 26366 PT	Head bolts not incl.; Head bolt replacement recommended; PermaDry® molded rubber valve cover gskts. incl.; Premium valve stem seals incl.	
2	Head Bolt Set	2010	ES 72200	Head bolts w/Washers; Replacement recommended	
QTY	CONVERSION SET	YEARS	PART NO.	DESCRIPTION	
1	Gasket Conversion Set	2010	CS 26366-1	PermaDry® molded rubber oil pan gskt. incl.	
QTY	MANIFOLD - INT. & EXH.	YEARS	PART NO.	DESCRIPTION	
1	Int. Manifold Gasket Set	2010	MS 96916	Lower set; Upper set incl.	
1	Exh. Manifold Gasket Set	2010	MS 96964		
QTY	OIL PAN	YEARS	PART NO.	DESCRIPTION	
1	Oil Pan Gasket Set	2010	OS 30793 R	PermaDry® molded rubber gskt. incl.	
QTY	CRANKSHAFT REAR SEAL	YEARS	PART NO.	DESCRIPTION	
1	Rear Main Seal Set	2010	BS 40684	Retainer w/Seal; PTFE Rubber; One-piece; Improved design	
1	Rear Main Seal Set	2010	BS 40735	Rubber; One-piece; New Part Number - Check for Availability	
1	Repair Sleeve	2010	16230	Crankshaft; Use w/installation tool	
1	Repair Sleeve Tool	2010	16328	Crankshaft	
QTY	VALVE COVER	YEARS	PART NO.	DESCRIPTION	
1	Valve Cover Gasket Set	2010	VS 50625 R	w/Spark plug tube seals; PermaDry® molded rubber gskts. incl.	

Jeep Truck (Incl. Jeep, Willys) (Cont.)

22 (cont.)	2010; 6.1L 370 (6059cc) OHV V8 (16 Valve) 103mm Bore Hemi			22 (cont.)
QTY VALVE STEM SEAL SET	YEARS	PART NO.	DESCRIPTION	
1 Valve Stem Seal Set	2010	SS 72914-1	Premium valve stem seals incl.	
QTY THERMOSTAT HOUSING	YEARS	PART NO.	DESCRIPTION	
1 O-Ring	2010	35857	Thermostat Housing; Thermostat seal	
QTY WATER PUMP	YEARS	PART NO.	DESCRIPTION	
1 Water Pump Gasket	2010	35783		
QTY TIMING COVER	YEARS	PART NO.	DESCRIPTION	
1 Timing Cover Set	2010	TCS 46049	Old design	
1 Timing Cover Set	2010	TCS 46169	Improved design; New Part Number - Check for Availability	
QTY CARB & FUEL INJECTION	YEARS	PART NO.	DESCRIPTION	
2 Fuel Injector O-Ring Set	2010	ES 70599	Improved design	
1 Throttle Body Gasket	2010	61324	Idle air control; 21mm ID	
1 Throttle Body Gasket	2010	61372	Mounting	

Kia Car

Engine Finding Index					
<i>Engine</i>	<i>Years</i>	<i>Code</i>	<i>Line No.</i>		
1.5L 91.2 (1493cc) DOHC L4 (16 Valve) 75.5mm Bore; MFI; Gasoline; Naturally Aspirated Kia Eng.	2002-01	B5	1		
1.6L 97.1 (1591cc) DOHC L4 (16 Valve) 77mm Bore Gamma GDi VVT; DI; Gasoline; Naturally Aspirated Hyundai Eng.	2013-12	G4FD	2		
1.6L 97.1 (1591cc) DOHC L4 (16 Valve) 77mm Bore Gamma VVT; MFI; Gasoline; Naturally Aspirated Hyundai Eng.	2011-10	G4FC	3		
1.6L 97.3 (1594cc) DOHC L4 (16 Valve) 78mm Bore; MFI; Gasoline; Naturally Aspirated Kia Eng.	2005-03	B6	4		
1.6L 97.5 (1597cc) DOHC L4 (16 Valve) 78mm Bore; MFI; Gasoline; Naturally Aspirated Mazda Eng.	1997-95	B6-ZE	5		
1.6L 97.5 (1597cc) SOHC L4 (16 Valve) 78mm Bore; MFI; Gasoline; Naturally Aspirated Mazda Eng.	1995	B6	6		
1.6L 97.5 (1597cc) SOHC L4 (8 Valve) 78mm Bore; MFI; Gasoline; Naturally Aspirated Mazda Eng.	1995-93	B6	7		
1.6L 98 (1599cc) DOHC L4 (16 Valve) 76.5mm Bore; MFI; Gasoline; Naturally Aspirated Hyundai Eng.	2008-06	G4CR	8		
1.6L 98 (1599cc) DOHC L4 (16 Valve) 76.5mm Bore VVT; MFI; Gasoline; Naturally Aspirated Hyundai Eng.	2011-06	G4ED	9		
1.8L 109.4 (1793cc) DOHC L4 (16 Valve) 81mm Bore; MFI; Gasoline; Naturally Aspirated Kia Eng.	2004-98	T8	10		
1.8L 112.2 (1839cc) DOHC L4 (16 Valve) 83mm Bore; MFI; Gasoline; Naturally Aspirated Mazda Eng.	1997-95	BP-ZE	11		
2.0L 120.5 (1975cc) DOHC L4 (16 Valve) 82mm Bore; MFI; Gasoline; Naturally Aspirated Hyundai Eng.	2011-04	G4GF	12		
2.0L 121.9 (1998cc) DOHC L4 (16 Valve) 86mm Bore Theta GDi VVT; DI; Gasoline; Turbo - Intercooled Hyundai Eng.	2013-11		13		
2.0L 121.9 (1998cc) DOHC L4 (16 Valve) 86mm Bore Theta VVT; MFI; Gasoline; Naturally Aspirated Hyundai Eng.	2013-10		14		
2.0L 121.9 (1999cc) DOHC L4 (16 Valve) 81mm Bore Nu VVT; MFI; Gasoline; Naturally Aspirated Hyundai Eng.	2013-12		15		
2.4L 143.4 (2351cc) DOHC L4 (16 Valve) 86.5mm Bore; MFI; Gasoline; Naturally Aspirated Mitsubishi Eng.	2006-01	G4JS	16		
2.4L 144 (2359cc) DOHC L4 (16 Valve) 88mm Bore; MFI; Gasoline; Naturally Aspirated Hyundai Eng.	2008-06	G4KC	17		
2.4L 144 (2359cc) DOHC L4 (16 Valve) 88mm Bore Theta GDi VVT; DI; Gasoline; Naturally Aspirated Hyundai Eng.	2013-11		18		
2.4L 144 (2359cc) DOHC L4 (16 Valve) 88mm Bore Theta GDi VVT; DI; Hybrid (Gas/Electric); Naturally Aspirated Hyundai Eng.	2013-11		19		
2.4L 144 (2359cc) DOHC L4 (16 Valve) 88mm Bore VVT; MFI; Gasoline; Naturally Aspirated Hyundai Eng.	2013-09	G4KC	20		
2.5L 152 (2493cc) DOHC V6 (24 Valve) 84mm Bore; MFI; Gasoline; Naturally Aspirated Hyundai Eng.	2001	G6BV	21		
2.7L 162 (2656cc) DOHC V6 (24 Valve) 86.7mm Bore; MFI; Gasoline; Naturally Aspirated Hyundai Eng.	2010-02	G6BA	22		
3.5L 213.3 (3497cc) DOHC V6 (24 Valve) 93mm Bore; MFI; Gasoline; Naturally Aspirated Mitsubishi Eng.	2006-04	G6CU	23		
3.8L 230 (3778cc) DOHC V6 (24 Valve) 96mm Bore Lambda; MFI; Gasoline; Naturally Aspirated Hyundai Eng.	2009-07	G6DA	24		
Engine Code Index					
<i>Code</i>	<i>Engine</i>				<i>Line No.</i>
B5	1.5L 91.2 (1493cc) DOHC L4 (16 Valve) 75.5mm Bore; MFI; Gasoline; Naturally Aspirated Kia Eng.				1
B6	1.6L 97.3 (1594cc) DOHC L4 (16 Valve) 78mm Bore; MFI; Gasoline; Naturally Aspirated Kia Eng.				4
B6	1.6L 97.5 (1597cc) SOHC L4 (16 Valve) 78mm Bore; MFI; Gasoline; Naturally Aspirated Mazda Eng.				6
B6	1.6L 97.5 (1597cc) SOHC L4 (8 Valve) 78mm Bore; MFI; Gasoline; Naturally Aspirated Mazda Eng.				7
B6-ZE	1.6L 97.5 (1597cc) DOHC L4 (16 Valve) 78mm Bore; MFI; Gasoline; Naturally Aspirated Mazda Eng.				5
BP-ZE	1.8L 112.2 (1839cc) DOHC L4 (16 Valve) 83mm Bore; MFI; Gasoline; Naturally Aspirated Mazda Eng.				11
G4CR	1.6L 98 (1599cc) DOHC L4 (16 Valve) 76.5mm Bore; MFI; Gasoline; Naturally Aspirated Hyundai Eng.				8
G4ED	1.6L 98 (1599cc) DOHC L4 (16 Valve) 76.5mm Bore VVT; MFI; Gasoline; Naturally Aspirated Hyundai Eng.				9
G4FC	1.6L 97.1 (1591cc) DOHC L4 (16 Valve) 77mm Bore Gamma VVT; MFI; Gasoline; Naturally Aspirated Hyundai Eng.				3
G4FD	1.6L 97.1 (1591cc) DOHC L4 (16 Valve) 77mm Bore Gamma GDi VVT; DI; Gasoline; Naturally Aspirated Hyundai Eng.				2
G4GF	2.0L 120.5 (1975cc) DOHC L4 (16 Valve) 82mm Bore; MFI; Gasoline; Naturally Aspirated Hyundai Eng.				12
G4JS	2.4L 143.4 (2351cc) DOHC L4 (16 Valve) 86.5mm Bore; MFI; Gasoline; Naturally Aspirated Mitsubishi Eng.				16
G4KC	2.4L 144 (2359cc) DOHC L4 (16 Valve) 88mm Bore; MFI; Gasoline; Naturally Aspirated Hyundai Eng.				17
G4KC	2.4L 144 (2359cc) DOHC L4 (16 Valve) 88mm Bore VVT; MFI; Gasoline; Naturally Aspirated Hyundai Eng.				20
G6BA	2.7L 162 (2656cc) DOHC V6 (24 Valve) 86.7mm Bore; MFI; Gasoline; Naturally Aspirated Hyundai Eng.				22
G6BV	2.5L 152 (2493cc) DOHC V6 (24 Valve) 84mm Bore; MFI; Gasoline; Naturally Aspirated Hyundai Eng.				21
G6CU	3.5L 213.3 (3497cc) DOHC V6 (24 Valve) 93mm Bore; MFI; Gasoline; Naturally Aspirated Mitsubishi Eng.				23
G6DA	3.8L 230 (3778cc) DOHC V6 (24 Valve) 96mm Bore Lambda; MFI; Gasoline; Naturally Aspirated Hyundai Eng.				24

Kia Car (Cont.)

Engine Code Index (Cont.)

Code	Engine	Line No.			
T8	1.8L 109.4 (1793cc) DOHC L4 (16 Valve) 81mm Bore; MFI; Gasoline; Naturally Aspirated Kia Eng.	10			
Model Index					
Engine (VIN Code / Eng. Code)	Year	Engine (VIN Code / Eng. Code)	Year	Engine (VIN Code / Eng. Code)	Year
Kia		Kia (cont.)		Kia (cont.)	
Amanti		Optima (cont.)		Sephia	
V6 3497cc 3.5L DOHC (24 Valve) (G6CU)	06-04	L4 2359cc 2.4L DOHC (16 Valve) (Theta)	13-11	L4 1597cc 1.6L DOHC (16 Valve) (B6-ZE)	97-95
V6 3778cc 3.8L DOHC (24 Valve) (G6DA)	09-07	V6 2493cc 2.5L DOHC (24 Valve) (G6BV)	01	L4 1597cc 1.6L SOHC (16 Valve) (B6)	95
Cinco		Optima Hybrid		L4 1597cc 1.6L SOHC (8 Valve) (B6)	95-93
L4 1493cc 1.5L DOHC (16 Valve) (B5)	02-01	L4 2359cc 2.4L DOHC (16 Valve) (Theta)	13-11	L4 1793cc 1.8L DOHC (16 Valve) (T8)	01-98
L4 1594cc 1.6L DOHC (16 Valve) (B6)	05-03			L4 1839cc 1.8L DOHC (16 Valve) (BP-ZE)	97-95
Forte		Rio		Soul	
L4 1998cc 2.0L DOHC (16 Valve) (Theta)	13-10	L4 1493cc 1.5L DOHC (16 Valve) (B5)	02-01	L4 1591cc 1.6L DOHC (16 Valve) (G4FC)	11-10
L4 2359cc 2.4L DOHC (16 Valve) (G4KC)	13-10	L4 1591cc 1.6L DOHC (16 Valve) (G4FD)	13-12	L4 1591cc 1.6L DOHC (16 Valve) (G4FD)	13-12
Optima		L4 1594cc 1.6L DOHC (16 Valve) (B6)	05-03	L4 1975cc 2.0L DOHC (16 Valve) (G4GF)	11-10
L4 1998cc 2.0L DOHC Turbo (16 Valve) (Theta)	13-11	L4 1599cc 1.6L DOHC (16 Valve) (G4ED)	11-06	L4 1999cc 2.0L DOHC (16 Valve) (Nu)	13-12
L4 2351cc 2.4L DOHC (16 Valve) (G4JS)	06-01	Rondo		Spectra	
L4 2359cc 2.4L DOHC (16 Valve) (G4KC)	10-06	L4 2359cc 2.4L DOHC (16 Valve) (G4KC)	13-07	L4 1793cc 1.8L DOHC (16 Valve) (T8)	04-00
		V6 2656cc 2.7L DOHC (24 Valve) (G6BA)	13-07	L4 1975cc 2.0L DOHC (16 Valve) (G4GF)	09-04
1	2002 - 2001; 1.5L 91.2 (1493cc) DOHC L4 (16 Valve) 75.5mm Bore MFI; Gasoline; Naturally Aspirated Kia Eng.; Eng. Code B5				1
QTY	CYLINDER HEAD	YEARS	PART NO.	DESCRIPTION	
1	Head Gasket	2002-01	26315 PT	Head bolts not incl.; Head bolt replacement recommended; PermaTorqueMLS®	
1	Head Set	2002-01	HS 26315 PT	Head bolts not incl.; Head bolt replacement recommended; PermaDry® molded rubber valve cover gskt. incl.; Premium valve stem seals incl.	
1	Head Bolt Set	2002-01	ES 72227	Head bolts w/Washers; Replacement recommended	
QTY	CONVERSION SET	YEARS	PART NO.	DESCRIPTION	
1	Gasket Conversion Set	2002-01	CS 26315	RTV sealant incl. for oil pan gskt.	
QTY	MANIFOLD - INT. & EXH.	YEARS	PART NO.	DESCRIPTION	
1	Int. Manifold Gasket Set	2002-01	MS 96734		
1	Exh. Manifold Gasket Set	2002-01	MS 96733		
QTY	EXHAUST PIPE FLANGE	YEARS	PART NO.	DESCRIPTION	
1	Exhaust Pipe Gasket	2002-01	61044	Flange	
1	Exhaust Pipe Gasket	2002-01	61272	Loc. Front; Converter	
1	Exhaust Pipe Gasket	2002-01	61449	Loc. Rear; Converter	
QTY	OIL PAN	YEARS	PART NO.	DESCRIPTION	
1	Oil Pan Gasket Set	2002-01	OS 30768	RTV Black silicone w/Rubber end seals	
QTY	CRANKSHAFT REAR SEAL	YEARS	PART NO.	DESCRIPTION	
1	Rear Main Seal Set	2002-01	BS 40634	Rubber; One-piece	
QTY	VALVE COVER	YEARS	PART NO.	DESCRIPTION	
1	Valve Cover Gasket Set	2002-01	VS 50670 R	w/Spark plug tube seals; PermaDry® molded rubber gskt. incl.	
QTY	VALVE STEM SEAL SET	YEARS	PART NO.	DESCRIPTION	
1	Valve Stem Seal Set	2002-01	SS 71245	Premium valve stem seals incl.	
QTY	THERMOSTAT HOUSING	YEARS	PART NO.	DESCRIPTION	
1	Water Outlet Gasket	2002-01	35251	Thermostat Housing; Thermostat	
QTY	WATER OUTLET GASKET	YEARS	PART NO.	DESCRIPTION	
1	Water Outlet Gasket	2002-01	35797	Water inlet	
QTY	WATER PUMP	YEARS	PART NO.	DESCRIPTION	
1	Water Pump Gasket	2002-01	35798		
QTY	TIMING COVER	YEARS	PART NO.	DESCRIPTION	
1	Crankshaft Front Seal Set	2002-01	TCS 46028		
1	Camshaft Front Seal Set	2002-01	TCS 46075		
QTY	CARB & FUEL INJECTION	YEARS	PART NO.	DESCRIPTION	
1	Throttle Body Gasket	2002-01	61245	Idle air control	
1	Throttle Body Gasket	2002-01	61448	Throttle body	
2	2013 - 2012; 1.6L 97.1 (1591cc) DOHC L4 (16 Valve) 77mm Bore Gamma GDi VVT Di; Gasoline; Naturally Aspirated Hyundai Eng.; Eng. Code G4FD				2
QTY	CYLINDER HEAD	YEARS	PART NO.	DESCRIPTION	
1	Head Gasket	2013-12	26554 PT	Head bolts not incl.; Head bolt replacement recommended; PermaTorqueMLS®; New Part Number - Check for Availability	
QTY	CONVERSION SET	YEARS	PART NO.	DESCRIPTION	
1	Gasket Conversion Set	2013-12	CS 26554	RTV sealant incl. for oil pan gskt.; New Part Number - Check for Availability	

2		2013 - 2012; 1.6L 97.1 (1591cc) DOHC L4 (16 Valve) 77mm Bore Gamma GDI VVT			2	
(cont.)		DI; Gasoline; Naturally Aspirated Hyundai Eng.; Eng. Code G4FD			(cont.)	
QTY	MANIFOLD - INT. & EXH.	YEARS	PART NO.	DESCRIPTION		
1	Int. Manifold Gasket Set	2013-12	MS 97228	New Part Number - Check for Availability		
1	Exh. Manifold Gasket Set	2013-12	MS 97231	New Part Number - Check for Availability		
QTY	EXHAUST PIPE FLANGE	YEARS	PART NO.	DESCRIPTION		
1	Exhaust Pipe Gasket	2013-12	61706	Kia Soul Base; Converter; New Part Number - Check for Availability		
1	Exhaust Pipe Gasket	2013-12	61707	Exc. Kia Soul Base; Converter; New Part Number - Check for Availability		
QTY	CRANKSHAFT REAR SEAL	YEARS	PART NO.	DESCRIPTION		
1	Rear Main Seal Set	2013-12	BS 40740	Rubber; One-piece; New Part Number - Check for Availability		
QTY	VALVE COVER	YEARS	PART NO.	DESCRIPTION		
1	Valve Cover Gasket Set	2013-12	VS 50818 R	w/Spark plug tube seals; PermaDry® molded rubber gskt. incl.; New Part Number - Check for Availability		
QTY	VALVE STEM SEAL SET	YEARS	PART NO.	DESCRIPTION		
1	Valve Stem Seal Set	2013-12	SS 72939	Premium valve stem seals incl.; New Part Number - Check for Availability		
QTY	WATER PUMP	YEARS	PART NO.	DESCRIPTION		
1	Water Pump Gasket	2013-12	36003	New Part Number - Check for Availability		
QTY	TIMING COVER	YEARS	PART NO.	DESCRIPTION		
1	Crankshaft Front Seal Set	2013-12	TCS 46166	New Part Number - Check for Availability		
QTY	CARB & FUEL INJECTION	YEARS	PART NO.	DESCRIPTION		
1	Throttle Body Gasket	2013-12	61712	New Part Number - Check for Availability		
3		2011 - 2010; 1.6L 97.1 (1591cc) DOHC L4 (16 Valve) 77mm Bore Gamma VVT			3	
		MFI; Gasoline; Naturally Aspirated Hyundai Eng.; Eng. Code G4FC				
QTY	CYLINDER HEAD	YEARS	PART NO.	DESCRIPTION		
1	Head Gasket	2011-10	26554 PT	Head bolts not incl.; Head bolt replacement recommended; PermaTorqueMLS®; New Part Number - Check for Availability		
QTY	CONVERSION SET	YEARS	PART NO.	DESCRIPTION		
1	Gasket Conversion Set	2011-10	CS 26554	RTV sealant incl. for oil pan gskt.; New Part Number - Check for Availability		
QTY	MANIFOLD - INT. & EXH.	YEARS	PART NO.	DESCRIPTION		
1	Exh. Manifold Gasket Set	2011-10	MS 97231	New Part Number - Check for Availability		
QTY	EXHAUST PIPE FLANGE	YEARS	PART NO.	DESCRIPTION		
1	Exhaust Pipe Gasket	2011-10	61706	Converter; New Part Number - Check for Availability		
QTY	CRANKSHAFT REAR SEAL	YEARS	PART NO.	DESCRIPTION		
1	Rear Main Seal Set	2011-10	BS 40740	Rubber; One-piece; New Part Number - Check for Availability		
QTY	VALVE COVER	YEARS	PART NO.	DESCRIPTION		
1	Valve Cover Gasket Set	2011-10	VS 50817 R	w/Spark plug tube seals; PermaDry® molded rubber gskt. incl.; New Part Number - Check for Availability		
QTY	VALVE STEM SEAL SET	YEARS	PART NO.	DESCRIPTION		
1	Valve Stem Seal Set	2011-10	SS 72939	Premium valve stem seals incl.; New Part Number - Check for Availability		
QTY	WATER PUMP	YEARS	PART NO.	DESCRIPTION		
1	Water Pump Gasket	2011-10	36003	New Part Number - Check for Availability		
QTY	TIMING COVER	YEARS	PART NO.	DESCRIPTION		
1	Crankshaft Front Seal Set	2011-10	TCS 46166	New Part Number - Check for Availability		
QTY	CARB & FUEL INJECTION	YEARS	PART NO.	DESCRIPTION		
1	Throttle Body Gasket	2011-10	61718	New Part Number - Check for Availability		
4		2005 - 2003; 1.6L 97.3 (1594cc) DOHC L4 (16 Valve) 78mm Bore			4	
		MFI; Gasoline; Naturally Aspirated Kia Eng.; Eng. Code B6				
QTY	CYLINDER HEAD	YEARS	PART NO.	DESCRIPTION		
1	Head Gasket	2005-03	26315 PT	Head bolts not incl.; Head bolt replacement recommended; PermaTorqueMLS®		
1	Head Set	2005-04	HS 26315 PT-1	Head bolts not incl.; Head bolt replacement recommended; PermaDry® molded rubber valve cover gskt. incl.; Premium valve stem seals incl.		
1	Head Set	2003	HS 26315 PT-1	From 02/11/03; Head bolts not incl.; Head bolt replacement recommended; PermaDry® molded rubber valve cover gskt. incl.; Premium valve stem seals incl.		
1	Head Set	2003	HS 26315 PT-2	To 02/10/03; Head bolts not incl.; Head bolt replacement recommended; PermaDry® molded rubber valve cover gskt. incl.; Premium valve stem seals incl.		
1	Head Bolt Set	2005-03	ES 72227	Head bolts w/Washers; Replacement recommended		
QTY	CONVERSION SET	YEARS	PART NO.	DESCRIPTION		
1	Gasket Conversion Set	2005-03	CS 26315	RTV sealant incl. for oil pan gskt.		
QTY	MANIFOLD - INT. & EXH.	YEARS	PART NO.	DESCRIPTION		
1	Int. Manifold Gasket Set	2005-03	MS 96753			
1	Exh. Manifold Gasket Set	2005-03	MS 96733			

Kia Car (Cont.)

4 (cont.)		2005 - 2003; 1.6L 97.3 (1594cc) DOHC L4 (16 Valve) 78mm Bore MFI; Gasoline; Naturally Aspirated Kia Eng.; Eng. Code B6			4 (cont.)
QTY	EXHAUST PIPE FLANGE	YEARS	PART NO.	DESCRIPTION	
1	Exhaust Pipe Gasket	2005-03	60620	Flange	
1	Exhaust Pipe Gasket	2005-03	61449	Converter	
QTY	OIL PAN	YEARS	PART NO.	DESCRIPTION	
1	Oil Pan Gasket Set	2005-03	OS 30768	RTV Black silicone w/Rubber end seals	
QTY	CRANKSHAFT REAR SEAL	YEARS	PART NO.	DESCRIPTION	
1	Rear Main Seal Set	2005-03	BS 40634	Rubber; One-piece	
QTY	VALVE COVER	YEARS	PART NO.	DESCRIPTION	
1	Valve Cover Gasket Set	2005-04	VS 50671 R	w/Spark plug tube seals; PermaDry® molded rubber gskt. incl.	
1	Valve Cover Gasket Set	2003	VS 50670 R	To 02/10/03; w/Spark plug tube seals; PermaDry® molded rubber gskt. incl.	
1	Valve Cover Gasket Set	2003	VS 50671 R	From 02/11/03; w/Spark plug tube seals; PermaDry® molded rubber gskt. incl.	
QTY	VALVE STEM SEAL SET	YEARS	PART NO.	DESCRIPTION	
1	Valve Stem Seal Set	2005-03	SS 71245	Premium valve stem seals incl.	
QTY	THERMOSTAT HOUSING	YEARS	PART NO.	DESCRIPTION	
1	Water Outlet Gasket	2005-03	35251	Thermostat Housing; Thermostat	
QTY	WATER OUTLET GASKET	YEARS	PART NO.	DESCRIPTION	
1	Water Outlet Gasket	2005-03	35797	Water inlet	
QTY	WATER PUMP	YEARS	PART NO.	DESCRIPTION	
1	Water Pump Gasket	2005-03	35798		
QTY	TIMING COVER	YEARS	PART NO.	DESCRIPTION	
1	Crankshaft Front Seal Set	2005-03	TCS 46028		
1	Camshaft Front Seal Set	2005-03	TCS 46075		
QTY	CARB & FUEL INJECTION	YEARS	PART NO.	DESCRIPTION	
1	Throttle Body Gasket	2005-03	61245	Idle air control	
1	Throttle Body Gasket	2005-03	61448	Throttle body	
5		1997 - 1995; 1.6L 97.5 (1597cc) DOHC L4 (16 Valve) 78mm Bore MFI; Gasoline; Naturally Aspirated Mazda Eng.; Eng. Code B6-ZE			5
QTY	CYLINDER HEAD	YEARS	PART NO.	DESCRIPTION	
1	Head Gasket	1997-95	26438 PT	Head bolts not incl.; Head bolt replacement recommended; PermaTorqueMLS®	
1	Head Set	1997-95	HS 26438 PT	Head bolts not incl.; Head bolt replacement recommended; PermaDry® molded rubber valve cover gskt. incl.; Premium valve stem seals incl.	
QTY	CONVERSION SET	YEARS	PART NO.	DESCRIPTION	
1	Gasket Conversion Set	1997-95	CS 26315	RTV sealant incl. for oil pan gskt.	
QTY	MANIFOLD - INT. & EXH.	YEARS	PART NO.	DESCRIPTION	
1	Int. Manifold Gasket Set	1997-95	MS 97062	Lower set; Upper set incl.	
1	Plenum Gasket Set	1997-95	MS 97065	Upper set	
1	Exh. Manifold Gasket Set	1997-95	MS 97063		
QTY	EXHAUST PIPE FLANGE	YEARS	PART NO.	DESCRIPTION	
1	Exhaust Pipe Gasket	1997-95	61016	Loc. Front; Converter; Improved design	
1	Exhaust Pipe Gasket	1997-95	61044	Loc. Front; Exh. connector	
1	Exhaust Pipe Gasket	1997-95	61499	Loc. Rear; Exh. connector	
1	Exhaust Pipe Gasket	1997-95	61599	Flange	
1	Exhaust Pipe Gasket	1997-95	61600	Loc. Rear; Converter	
QTY	OIL PAN	YEARS	PART NO.	DESCRIPTION	
1	Oil Pan Gasket Set	1997-95	OS 30768	RTV Black silicone w/Rubber end seals	
QTY	CRANKSHAFT REAR SEAL	YEARS	PART NO.	DESCRIPTION	
1	Rear Main Seal Set	1997-95	BS 40634	Rubber; One-piece	
QTY	VALVE COVER	YEARS	PART NO.	DESCRIPTION	
1	Valve Cover Gasket Set	1997-95	VS 50718 R	w/Spark plug tube seals; PermaDry® molded rubber gskt. incl.	
QTY	VALVE STEM SEAL SET	YEARS	PART NO.	DESCRIPTION	
1	Valve Stem Seal Set	1997-95	SS 72802	Premium valve stem seals incl.	
QTY	THERMOSTAT HOUSING	YEARS	PART NO.	DESCRIPTION	
1	Water Outlet Gasket	1997-95	35251	Thermostat Housing; Thermostat	
QTY	WATER OUTLET GASKET	YEARS	PART NO.	DESCRIPTION	
1	Water Outlet Gasket	1997-95	35797	Water inlet	
QTY	WATER PUMP	YEARS	PART NO.	DESCRIPTION	
1	Water Pump Gasket	1997-95	35456	Mounting	
1	Water Pump Gasket	1997-95	35457	Inlet	
QTY	TIMING COVER	YEARS	PART NO.	DESCRIPTION	
1	Crankshaft Front Seal Set	1997-95	TCS 46028		
2	Camshaft Front Seal Set	1997-95	TCS 46029		

5		1997 - 1995; 1.6L 97.5 (1597cc) DOHC L4 (16 Valve) 78mm Bore			5
(cont.)		MFI; Gasoline; Naturally Aspirated Mazda Eng.; Eng. Code B6-ZE			(cont.)
QTY	CARB & FUEL INJECTION	YEARS	PART NO.	DESCRIPTION	
1	Throttle Body Gasket	1997-95	60984		
QTY	EXHAUST GAS RECIRCULATION	YEARS	PART NO.	DESCRIPTION	
1	EGR Gasket	1997-95	70431		
6		1995; 1.6L 97.5 (1597cc) SOHC L4 (16 Valve) 78mm Bore			6
		MFI; Gasoline; Naturally Aspirated Mazda Eng.; Eng. Code B6			
QTY	CYLINDER HEAD	YEARS	PART NO.	DESCRIPTION	
1	Head Gasket	1995	9930 PT		
1	Head Set	1995	HS 9930 PT	PermaDry® molded rubber valve cover gskt. incl.; Premium valve stem seals incl.	
QTY	CONVERSION SET	YEARS	PART NO.	DESCRIPTION	
1	Gasket Conversion Set	1995	CS 9696-1	RTV sealant incl. for oil pan gskt.	
QTY	MANIFOLD - INT. & EXH.	YEARS	PART NO.	DESCRIPTION	
1	Int. Manifold Gasket Set	1995	MS 95467	Upper set incl.	
1	Exh. Manifold Gasket Set	1995	MS 95469		
QTY	EXHAUST PIPE FLANGE	YEARS	PART NO.	DESCRIPTION	
1	Exhaust Pipe Gasket	1995	60620	Loc. Rear; Converter	
1	Exhaust Pipe Gasket	1995	60798	Flange	
1	Exhaust Pipe Gasket	1995	60867	Loc. Front; Converter	
QTY	OIL PAN	YEARS	PART NO.	DESCRIPTION	
1	Oil Pan Gasket Set	1995	OS 30631 R	RTV Black silicone w/Rubber end seals	
QTY	CRANKSHAFT REAR SEAL	YEARS	PART NO.	DESCRIPTION	
1	Rear Main Seal Set	1995	BS 40634	Rubber; One-piece	
QTY	VALVE COVER	YEARS	PART NO.	DESCRIPTION	
1	Valve Cover Gasket Set	1995	VS 50359 R	PermaDry® molded rubber gskt. incl.	
QTY	VALVE STEM SEAL SET	YEARS	PART NO.	DESCRIPTION	
1	Valve Stem Seal Set	1995	SS 72782	Premium valve stem seals incl.	
QTY	WATER OUTLET GASKET	YEARS	PART NO.	DESCRIPTION	
1	Water Outlet Gasket	1995	35251	Water Outlet	
QTY	WATER PUMP	YEARS	PART NO.	DESCRIPTION	
1	Water Pump Gasket	1995	35456	Mounting	
1	Water Pump Gasket	1995	35457	Inlet	
QTY	TIMING COVER	YEARS	PART NO.	DESCRIPTION	
1	Crankshaft Front Seal Set	1995	TCS 45921	Must be used w/OS 30631R	
1	Camshaft Front Seal Set	1995	TCS 45724		
QTY	CARB & FUEL INJECTION	YEARS	PART NO.	DESCRIPTION	
1	Fuel Injector O-Ring Set	1995	ES 70600		
1	Throttle Body Gasket	1995	60874		
QTY	DISTRIBUTOR MOUNTING	YEARS	PART NO.	DESCRIPTION	
1	O-Ring	1995	35608	Distributor Mounting	
7		1995 - 1993; 1.6L 97.5 (1597cc) SOHC L4 (8 Valve) 78mm Bore			7
		MFI; Gasoline; Naturally Aspirated Mazda Eng.; Eng. Code B6			
QTY	CYLINDER HEAD	YEARS	PART NO.	DESCRIPTION	
1	Head Gasket	1995-93	9696 B		
1	Head Set	1995-93	HS 9696 B	PermaDry® molded rubber valve cover gskt. incl.; Premium valve stem seals incl.	
1	Head Bolt Set	1995-93	ES 72846	Replacement recommended; New Part Number - Check for Availability	
QTY	CONVERSION SET	YEARS	PART NO.	DESCRIPTION	
1	Gasket Conversion Set	1995-93	CS 9696-1	RTV sealant incl. for oil pan gskt.	
QTY	MANIFOLD - INT. & EXH.	YEARS	PART NO.	DESCRIPTION	
1	Int. Manifold Gasket Set	1995-93	MS 94569	Upper set incl.	
1	Exh. Manifold Gasket Set	1995-93	MS 94570		
QTY	EXHAUST PIPE FLANGE	YEARS	PART NO.	DESCRIPTION	
1	Exhaust Pipe Gasket	1995-93	60620	Loc. Rear; Converter	
1	Exhaust Pipe Gasket	1995-93	60798	Flange	
1	Exhaust Pipe Gasket	1995-93	60867	Loc. Front; Converter	
QTY	OIL PAN	YEARS	PART NO.	DESCRIPTION	
1	Oil Pan Gasket Set	1995-93	OS 30631 R	RTV Black silicone w/Rubber end seals	
QTY	CRANKSHAFT REAR SEAL	YEARS	PART NO.	DESCRIPTION	
1	Rear Main Seal Set	1995-93	BS 40634	Rubber; One-piece	
QTY	VALVE COVER	YEARS	PART NO.	DESCRIPTION	
1	Valve Cover Gasket Set	1995-93	VS 50359 R	PermaDry® molded rubber gskt. incl.	

Kia Car (Cont.)

7		1995 - 1993; 1.6L 97.5 (1597cc) SOHC L4 (8 Valve) 78mm Bore			7
(cont.)		MFI; Gasoline; Naturally Aspirated Mazda Eng.; Eng. Code B6			(cont.)
QTY	VALVE STEM SEAL SET	YEARS	PART NO.	DESCRIPTION	
1	Valve Stem Seal Set	1995-93	SS 72680	Premium valve stem seals incl.	
QTY	WATER OUTLET GASKET	YEARS	PART NO.	DESCRIPTION	
1	Water Outlet Gasket	1995-93	35251	Water Outlet	
QTY	WATER PUMP	YEARS	PART NO.	DESCRIPTION	
1	Water Pump Gasket	1995-93	35456	Mounting	
1	Water Pump Gasket	1995-93	35457	Inlet	
QTY	TIMING COVER	YEARS	PART NO.	DESCRIPTION	
1	Timing Cover Dust Seal Set	1995-93	ES 72765		
1	Crankshaft Front Seal Set	1995-93	TCS 45921	Must be used w/OS 30631R	
1	Camshaft Front Seal Set	1995-93	TCS 45724		
QTY	CARB & FUEL INJECTION	YEARS	PART NO.	DESCRIPTION	
1	Fuel Injector O-Ring Set	1995-93	ES 70600		
1	Throttle Body Gasket	1995-93	60865		
QTY	DISTRIBUTOR MOUNTING	YEARS	PART NO.	DESCRIPTION	
1	O-Ring	1995-93	35608	Distributor Mounting	
8		2008 - 2006; 1.6L 98 (1599cc) DOHC L4 (16 Valve) 76.5mm Bore			8
		MFI; Gasoline; Naturally Aspirated Hyundai Eng.; Eng. Code G4CR			
QTY	CYLINDER HEAD	YEARS	PART NO.	DESCRIPTION	
1	Head Gasket	2008-06	26224 PT	Head bolts not incl.; Head bolt replacement recommended; PermaTorqueMLS®	
1	Head Set	2008-06	HS 26224 PT-2	Head bolts not incl.; Head bolt replacement recommended; PermaDry® molded rubber valve cover gskt. incl.; Premium valve stem seals incl.	
1	Head Bolt Set	2008-06	ES 71203	Head bolts w/Washers; Replacement recommended	
QTY	CONVERSION SET	YEARS	PART NO.	DESCRIPTION	
1	Gasket Conversion Set	2008-06	CS 26224-1	RTV sealant incl. for oil pan gskt.	
QTY	MANIFOLD - INT. & EXH.	YEARS	PART NO.	DESCRIPTION	
1	Int. Manifold Gasket Set	2008-06	MS 96331		
1	Exh. Manifold Gasket Set	2008-06	MS 96332		
QTY	EXHAUST PIPE FLANGE	YEARS	PART NO.	DESCRIPTION	
1	Exhaust Pipe Gasket	2008-06	60620	Exh. connector	
1	Exhaust Pipe Gasket	2008-06	61302	Flange	
QTY	OIL PAN	YEARS	PART NO.	DESCRIPTION	
1	Oil Pan Gasket Set	2008-06	OS 30780	RTV sealant incl. for oil pan gskt.	
QTY	CRANKSHAFT REAR SEAL	YEARS	PART NO.	DESCRIPTION	
1	Rear Main Seal Set	2008-06	BS 40672	Rubber; One-piece	
QTY	VALVE COVER	YEARS	PART NO.	DESCRIPTION	
1	Valve Cover Gasket Set	2008-06	VS 50705 R	w/Spark plug tube seals; PermaDry® molded rubber gskt. incl.	
1	Circular Plug	2008-06	CP 75023	Valve Cover	
1	Spark Plug Tube Seal Set	2008-06	ES 72974	Valve Cover; New Part Number - Check for Availability	
QTY	VALVE STEM SEAL SET	YEARS	PART NO.	DESCRIPTION	
1	Valve Stem Seal Set	2008-06	SS 70795-1	Premium valve stem seals incl.	
QTY	THERMOSTAT HOUSING	YEARS	PART NO.	DESCRIPTION	
1	Thermostat Gasket	2008-06	35827	Thermostat Housing; Thermostat housing	
1	O-Ring	2008-06	35830	Thermostat Housing; Thermostat seal	
QTY	WATER OUTLET GASKET	YEARS	PART NO.	DESCRIPTION	
1	Water Outlet Gasket	2008-06	35730	Water Outlet	
1	Water Outlet Gasket	2008-06	36049	Water Outlet; Water inlet pipe seal; New Part Number - Check for Availability	
QTY	WATER PUMP	YEARS	PART NO.	DESCRIPTION	
1	Water Pump Gasket	2008-06	35727		
QTY	TIMING COVER	YEARS	PART NO.	DESCRIPTION	
1	Crankshaft Front Seal Set	2008-06	TCS 46019-1		
1	Camshaft Front Seal Set	2008-06	TCS 45704-1		
QTY	CARB & FUEL INJECTION	YEARS	PART NO.	DESCRIPTION	
2	Fuel Injector O-Ring Set	2008-06	ES 70599	Improved design	
1	Throttle Body Gasket	2008-06	60914	Idle air control	
1	Throttle Body Gasket	2008-06	61485	Throttle body	
9		2011 - 2006; 1.6L 98 (1599cc) DOHC L4 (16 Valve) 76.5mm Bore VVT			9
		MFI; Gasoline; Naturally Aspirated Hyundai Eng.; Eng. Code G4ED			
QTY	CYLINDER HEAD	YEARS	PART NO.	DESCRIPTION	
1	Head Gasket	2011-06	26224 PT	Head bolts not incl.; Head bolt replacement recommended; PermaTorqueMLS®	

9 (cont.)		2011 - 2006; 1.6L 98 (1599cc) DOHC L4 (16 Valve) 76.5mm Bore VVT MFI; Gasoline; Naturally Aspirated Hyundai Eng.; Eng. Code G4ED			9 (cont.)
QTY	CYLINDER HEAD	YEARS	PART NO.	DESCRIPTION	
1	Head Set	2011-06	HS 26224 PT-2	Head bolts not incl.; Head bolt replacement recommended; PermaDry® molded rubber valve cover gskt. incl.; Premium valve stem seals incl.	
1	Head Bolt Set	2011-06	ES 71203	Head bolts w/Washers; Replacement recommended	
QTY	CONVERSION SET	YEARS	PART NO.	DESCRIPTION	
1	Gasket Conversion Set	2011-06	CS 26224-1	RTV sealant incl. for oil pan gskt.	
QTY	MANIFOLD - INT. & EXH.	YEARS	PART NO.	DESCRIPTION	
1	Int. Manifold Gasket Set	2011-06	MS 96331		
1	Exh. Manifold Gasket Set	2011-06	MS 96332		
QTY	EXHAUST PIPE FLANGE	YEARS	PART NO.	DESCRIPTION	
2	Exhaust Pipe Gasket	2011-06	60620	Converter	
1	Exhaust Pipe Gasket	2011-06	60620	Exh. connector	
1	Exhaust Pipe Gasket	2011-06	61302	Flange	
QTY	OIL PAN	YEARS	PART NO.	DESCRIPTION	
1	Oil Pan Gasket Set	2011-06	OS 30780	RTV sealant incl. for oil pan gskt.	
QTY	CRANKSHAFT REAR SEAL	YEARS	PART NO.	DESCRIPTION	
1	Rear Main Seal Set	2011-06	BS 40672	Rubber; One-piece	
QTY	VALVE COVER	YEARS	PART NO.	DESCRIPTION	
1	Valve Cover Gasket Set	2011-06	VS 50705 R	w/Spark plug tube seals; PermaDry® molded rubber gskt. incl.	
1	Circular Plug	2011-06	CP 75023	Valve Cover	
1	Spark Plug Tube Seal Set	2011-06	ES 72974	Valve Cover; New Part Number - Check for Availability	
QTY	VALVE STEM SEAL SET	YEARS	PART NO.	DESCRIPTION	
1	Valve Stem Seal Set	2011-06	SS 70795-1	Premium valve stem seals incl.	
QTY	THERMOSTAT HOUSING	YEARS	PART NO.	DESCRIPTION	
1	Thermostat Gasket	2011-06	35827	Thermostat Housing; Thermostat housing	
1	Thermostat Gasket	2011-09	35915	Thermostat Housing; Thermostat case	
1	O-Ring	2011-06	35830	Thermostat Housing; Thermostat seal	
QTY	WATER OUTLET GASKET	YEARS	PART NO.	DESCRIPTION	
1	Water Outlet Gasket	2011-06	35730	Water Outlet	
1	Water Outlet Gasket	2011-06	36049	Water Outlet; Water inlet pipe seal; New Part Number - Check for Availability	
QTY	WATER PUMP	YEARS	PART NO.	DESCRIPTION	
1	Water Pump Gasket	2011-06	35727		
QTY	TIMING COVER	YEARS	PART NO.	DESCRIPTION	
1	Crankshaft Front Seal Set	2011-06	TCS 46019-1		
1	Camshaft Front Seal Set	2011-06	TCS 45704-1		
QTY	CARB & FUEL INJECTION	YEARS	PART NO.	DESCRIPTION	
2	Fuel Injector O-Ring Set	2011-06	ES 70599	Improved design	
1	Throttle Body Gasket	2011-06	60914	Idle air control	
1	Throttle Body Gasket	2011-06	61485	Throttle body	
10		2004 - 1998; 1.8L 109.4 (1793cc) DOHC L4 (16 Valve) 81mm Bore MFI; Gasoline; Naturally Aspirated Kia Eng.; Eng. Code T8			10
QTY	CYLINDER HEAD	YEARS	PART NO.	DESCRIPTION	
1	Head Gasket	2004-02	26432 PT	Head bolts not incl.; Head bolt replacement recommended; PermaTorqueMLS®	
1	Head Gasket	2001	26221 PT	Exc. Kia Sephia Base, LS; To 05/22/01; Head bolts not incl.; Head bolt replacement recommended; PermaTorqueMLS® LaserWeld® Technology	
1	Head Gasket	2001	26432 PT	Exc. Kia Sephia Base, LS; From 05/23/01; Head bolts not incl.; Head bolt replacement recommended; PermaTorqueMLS®	
1	Head Gasket	2001	26221 PT	Kia Sephia Base, LS; Head bolts not incl.; Head bolt replacement recommended; PermaTorqueMLS® LaserWeld® Technology	
1	Head Gasket	2000-98	26221 PT	Head bolts not incl.; Head bolt replacement recommended; PermaTorqueMLS® LaserWeld® Technology	
1	Head Set	2004-02	HS 26432 PT	Head bolts not incl.; Head bolt replacement recommended; PermaDry® molded rubber valve cover gskt. incl.; Premium valve stem seals incl.; Improved design	
1	Head Set	2003-02	HS 26221 PT-1	Head bolts not incl.; Head bolt replacement recommended; PermaDry® molded rubber valve cover gskt. incl.; Premium valve stem seals incl.; Old design	
1	Head Set	2001	HS 26221 PT	Kia Sephia Base, LS; Head bolts not incl.; Head bolt replacement recommended; PermaDry® molded rubber valve cover gskt. incl.; Premium valve stem seals incl.	

Kia Car (Cont.)

10 (cont.)		2004 - 1998; 1.8L 109.4 (1793cc) DOHC L4 (16 Valve) 81mm Bore			10 (cont.)
MFI; Gasoline; Naturally Aspirated Kia Eng.; Eng. Code T8					
QTY	CYLINDER HEAD	YEARS	PART NO.	DESCRIPTION	
1	Head Set	2001	HS 26221 PT	Exc. Kia Sephia Base, LS; To 05/22/01; Head bolts not incl.; Head bolt replacement recommended; PermaDry® molded rubber valve cover gskt. incl.; Premium valve stem seals incl.	
1	Head Set	2001	HS 26221 PT-1	Exc. Kia Sephia Base, LS; From 05/23/01; PermaDry® molded rubber valve cover gskt. incl.; Premium valve stem seals incl.; Old design	
1	Head Set	2001	HS 26432 PT	Exc. Kia Sephia Base, LS; From 05/23/01; Head bolts not incl.; Head bolt replacement recommended; PermaDry® molded rubber valve cover gskt. incl.; Premium valve stem seals incl.; Improved design	
1	Head Set	2000-98	HS 26221 PT	Head bolts not incl.; Head bolt replacement recommended; PermaDry® molded rubber valve cover gskt. incl.; Premium valve stem seals incl.	
1	Head Bolt Set	2004-98	ES 72909	Head bolts w/Washers; Replacement recommended	
QTY	CONVERSION SET	YEARS	PART NO.	DESCRIPTION	
1	Gasket Conversion Set	2004-98	CS 26221-1	RTV sealant incl. for oil pan gskt.	
QTY	MANIFOLD - INT. & EXH.	YEARS	PART NO.	DESCRIPTION	
1	Int. Manifold Gasket Set	2004-02	MS 96311		
1	Int. Manifold Gasket Set	2001	MS 96311	Exc. Kia Sephia Base, LS; From 05/23/01	
1	Int. Manifold Gasket Set	2001	MS 96312	Exc. Kia Sephia Base, LS; To 05/22/01; Upper set incl.	
1	Int. Manifold Gasket Set	2001	MS 96312	Kia Sephia Base, LS; Upper set incl.	
1	Int. Manifold Gasket Set	2000-98	MS 96312	Upper set incl.	
1	Exh. Manifold Gasket Set	2004-98	MS 96310		
QTY	EXHAUST PIPE FLANGE	YEARS	PART NO.	DESCRIPTION	
2	Exhaust Pipe Gasket	2004-98	61272	Converter	
1	Exhaust Pipe Gasket	2004-02	61044	Flange	
1	Exhaust Pipe Gasket	2001	61044	Exc. Kia Sephia Base, LS; From 05/23/01; Flange	
1	Exhaust Pipe Gasket	2001	61596	Kia Sephia Base, LS; Flange	
1	Exhaust Pipe Gasket	2001	61596	Exc. Kia Sephia Base, LS; To 05/22/01; Flange	
1	Exhaust Pipe Gasket	2000-98	61596	Flange	
QTY	CRANKSHAFT REAR SEAL	YEARS	PART NO.	DESCRIPTION	
1	Rear Main Seal Set	2004-98	BS 40189	Rubber; One-piece	
QTY	VALVE COVER	YEARS	PART NO.	DESCRIPTION	
1	Valve Cover Gasket Set	2004-98	VS 50586 R	w/Spark plug tube seals; PermaDry® molded rubber gskt. incl.	
QTY	VALVE STEM SEAL SET	YEARS	PART NO.	DESCRIPTION	
1	Valve Stem Seal Set	2004-98	SS 72802	Premium valve stem seals incl.	
QTY	THERMOSTAT HOUSING	YEARS	PART NO.	DESCRIPTION	
1	Water Outlet Gasket	2004-98	35251	Thermostat Housing	
QTY	WATER PUMP	YEARS	PART NO.	DESCRIPTION	
1	Water Pump Gasket	2004-98	35714		
1	Water Pump Gasket	2004-02	35713	Inlet	
1	Water Pump Gasket	2001	35457	Kia Sephia Base, LS; Inlet	
1	Water Pump Gasket	2001	35713	Exc. Kia Sephia Base, LS; Inlet	
1	Water Pump Gasket	2000-98	35457	Inlet	
QTY	TIMING COVER	YEARS	PART NO.	DESCRIPTION	
1	Crankshaft Front Seal Set	2004-98	TCS 46028		
2	Camshaft Front Seal Set	2004-98	TCS 46029		
QTY	CARB & FUEL INJECTION	YEARS	PART NO.	DESCRIPTION	
2	Fuel Injector O-Ring Set	2004-98	ES 70599	Improved design	
1	Throttle Body Gasket	2004-02	61245	Idle air control	
1	Throttle Body Gasket	2004-02	61271	Throttle body	
1	Throttle Body Gasket	2001	61245	Exc. Kia Sephia Base, LS; From 05/23/01; Idle air control	
1	Throttle Body Gasket	2001	61271	Exc. Kia Sephia Base, LS; From 05/23/01; Throttle body	
1	Throttle Body Gasket	2001	61273	Kia Sephia Base, LS; Throttle body	
1	Throttle Body Gasket	2001	61273	Exc. Kia Sephia Base, LS; To 05/22/01; Throttle body	
1	Throttle Body Gasket	2000-98	61273	Throttle body	
QTY	EXHAUST GAS RECIRCULATION	YEARS	PART NO.	DESCRIPTION	
1	EGR Gasket	2004-98	70431		
11		1997 - 1995; 1.8L 112.2 (1839cc) DOHC L4 (16 Valve) 83mm Bore			11
MFI; Gasoline; Naturally Aspirated Mazda Eng.; Eng. Code BP-ZE					
QTY	CYLINDER HEAD	YEARS	PART NO.	DESCRIPTION	
1	Head Gasket	1997-95	9717 PT	Head bolts not incl.; Head bolt replacement recommended; PermaTorqueMLS®	
1	Head Set	1997-95	HS 9717 PT-2	Head bolts not incl.; Head bolt replacement recommended; PermaDry® molded rubber valve cover gskt. incl.; Premium valve stem seals incl.	

11 (cont.)		1997 - 1995; 1.8L 112.2 (1839cc) DOHC L4 (16 Valve) 83mm Bore			11 (cont.)
		MFI; Gasoline; Naturally Aspirated Mazda Eng.; Eng. Code BP-ZE			
QTY	CYLINDER HEAD	YEARS	PART NO.	DESCRIPTION	
1	Head Bolt Set	1997-95	ES 72909	Head bolts w/Washers; Replacement recommended	
QTY	CONVERSION SET	YEARS	PART NO.	DESCRIPTION	
1	Gasket Conversion Set	1997-95	CS 26221	RTV sealant incl. for oil pan gskt.	
QTY	MANIFOLD - INT. & EXH.	YEARS	PART NO.	DESCRIPTION	
1	Int. Manifold Gasket Set	1997-95	MS 94612-2	Lower set; Upper set incl.	
1	Plenum Gasket Set	1997-95	MS 96525	Upper set	
1	Exh. Manifold Gasket Set	1997-95	MS 94570		
QTY	EXHAUST PIPE FLANGE	YEARS	PART NO.	DESCRIPTION	
1	Exhaust Pipe Gasket	1997-95	60620	Loc. Rear; Converter	
1	Exhaust Pipe Gasket	1997-95	60867	Loc. Front; Converter	
1	Exhaust Pipe Gasket	1997-95	61044	Flange	
QTY	OIL PAN	YEARS	PART NO.	DESCRIPTION	
1	Oil Pan Gasket Set	1997-95	OS 30631 R	RTV Black silicone w/Rubber end seals	
QTY	CRANKSHAFT REAR SEAL	YEARS	PART NO.	DESCRIPTION	
1	Rear Main Seal Set	1997-95	BS 40634	Rubber; One-piece	
QTY	VALVE COVER	YEARS	PART NO.	DESCRIPTION	
1	Valve Cover Gasket Set	1997-95	VS 50569 R	w/Spark plug tube seals; PermaDry® molded rubber gskt. incl.; Improved design	
QTY	VALVE STEM SEAL SET	YEARS	PART NO.	DESCRIPTION	
1	Valve Stem Seal Set	1997-95	SS 72802	Premium valve stem seals incl.	
QTY	THERMOSTAT HOUSING	YEARS	PART NO.	DESCRIPTION	
1	Water Outlet Gasket	1997-95	35251	Thermostat Housing	
QTY	WATER PUMP	YEARS	PART NO.	DESCRIPTION	
1	Water Pump Gasket	1997-95	35456	Mounting	
1	Water Pump Gasket	1997-95	35457	Inlet	
QTY	TIMING COVER	YEARS	PART NO.	DESCRIPTION	
1	Crankshaft Front Seal Set	1997-95	TCS 46028	Must be used w/OS 30631R	
2	Camshaft Front Seal Set	1997-95	TCS 46029		
QTY	CARB & FUEL INJECTION	YEARS	PART NO.	DESCRIPTION	
1	Fuel Injector O-Ring Set	1997-95	ES 70600		
1	Throttle Body Gasket	1997-95	60984		
QTY	DISTRIBUTOR MOUNTING	YEARS	PART NO.	DESCRIPTION	
1	O-Ring	1997-95	35608	Distributor Mounting	
QTY	EXHAUST GAS RECIRCULATION	YEARS	PART NO.	DESCRIPTION	
1	EGR Gasket	1997-95	70431		
12		2011 - 2004; 2.0L 120.5 (1975cc) DOHC L4 (16 Valve) 82mm Bore			12
		MFI; Gasoline; Naturally Aspirated Hyundai Eng.; Eng. Code G4GF			
QTY	CYLINDER HEAD	YEARS	PART NO.	DESCRIPTION	
1	Head Gasket	2011-04	26181 PT	Head bolts not incl.; Head bolt replacement recommended; PermaTorqueMLS® LaserWeld® Technology	
1	Head Set	2011-08	HS 26181 PT-3	Head bolts & exh. pipe flange not incl.; Head bolt replacement recommended; PermaDry® molded rubber valve cover gskt. incl.; Premium valve stem seals incl.	
1	Head Set	2007-04	HS 26181 PT-1	Head bolts & exh. pipe flange not incl.; Head bolt replacement recommended; PermaDry® molded rubber valve cover gskt. incl.; Premium valve stem seals incl.	
1	Head Bolt Set	2011-04	ES 71313	Head bolts w/Washers; Replacement recommended	
QTY	CONVERSION SET	YEARS	PART NO.	DESCRIPTION	
1	Gasket Conversion Set	2011-09	CS 26180	California; RTV sealant incl. for oil pan gskt.	
1	Gasket Conversion Set	2011-09	CS 26180-1	Exc. California	
1	Gasket Conversion Set	2008-04	CS 26180	RTV sealant incl. for oil pan gskt.	
QTY	MANIFOLD - INT. & EXH.	YEARS	PART NO.	DESCRIPTION	
1	Int. Manifold Gasket Set	2011-04	MS 96275		
1	Exh. Manifold Gasket Set	2011-08	MS 97102		
1	Exh. Manifold Gasket Set	2007-04	MS 96128		
QTY	EXHAUST PIPE FLANGE	YEARS	PART NO.	DESCRIPTION	
1	Exhaust Pipe Gasket	2011-07	61499	Loc. Front; Converter	
1	Exhaust Pipe Gasket	2011-07	61503	Loc. Rear; Converter	
1	Exhaust Pipe Gasket	2011-07	61612	Exh. connector	
1	Exhaust Pipe Gasket	2011-10	61383	Muffler	
1	Exhaust Pipe Gasket	2011-10	61499	Secondary converter	
QTY	OIL PAN	YEARS	PART NO.	DESCRIPTION	
1	Oil Pan Gasket Set	2011-09	OS 30825	Exc. California	

Kia Car (Cont.)

12		2011 - 2004; 2.0L 120.5 (1975cc) DOHC L4 (16 Valve) 82mm Bore			12	
(cont.)		MFI; Gasoline; Naturally Aspirated Hyundai Eng.; Eng. Code G4GF			(cont.)	
QTY	OIL PAN	YEARS	PART NO.	DESCRIPTION		
1	Drain Plug Gasket	2011-04	72515			
QTY	CRANKSHAFT REAR SEAL	YEARS	PART NO.	DESCRIPTION		
1	Rear Main Seal Set	2011-04	BS 40444	Rubber; One-piece		
QTY	VALVE COVER	YEARS	PART NO.	DESCRIPTION		
1	Valve Cover Gasket Set	2011-04	VS 50583 R	w/Spark plug tube seals; PermaDry® molded rubber gskt. incl.		
1	Spark Plug Tube Seal Set	2011-04	ES 72974	Valve Cover; New Part Number - Check for Availability		
QTY	VALVE STEM SEAL SET	YEARS	PART NO.	DESCRIPTION		
1	Valve Stem Seal Set	2011-04	SS 70795-1	Premium valve stem seals incl.		
QTY	THERMOSTAT HOUSING	YEARS	PART NO.	DESCRIPTION		
1	Water Outlet Gasket	2011-04	25538	Thermostat Housing; Loc. Upper		
1	Thermostat Gasket	2011-04	35671	Thermostat Housing; Loc. Lower		
QTY	WATER OUTLET GASKET	YEARS	PART NO.	DESCRIPTION		
1	Water Outlet Gasket	2011-04	36049	Water Outlet; Water inlet pipe seal; New Part Number - Check for Availability		
1	Water Outlet Gasket	2011-09	35925	Water Outlet		
QTY	WATER PUMP	YEARS	PART NO.	DESCRIPTION		
1	Water Pump Gasket	2011-09	35923			
1	Water Pump Gasket	2008-04	35628			
QTY	TIMING COVER	YEARS	PART NO.	DESCRIPTION		
1	Crankshaft Front Seal Set	2011-04	TCS 46017			
1	Camshaft Front Seal Set	2011-04	TCS 45704-1			
QTY	CARB & FUEL INJECTION	YEARS	PART NO.	DESCRIPTION		
2	Fuel Injector O-Ring Set	2011-08	ES 70599	Improved design		
2	Fuel Injector O-Ring Set	2007-04	ES 70599	Exc. California; Improved design		
2	Fuel Injector O-Ring Set	2007-04	ES 70600	California		
1	Throttle Body Gasket	2011-04	60914	Idle air control		
1	Throttle Body Gasket	2011-06	61476	Throttle body		
1	Throttle Body Gasket	2005-04	61217	Throttle body		
QTY	OIL PUMP COVER	YEARS	PART NO.	DESCRIPTION		
1	Oil Pump Gasket	2011-04	72983	Oil pump mounting gskt.; New Part Number - Check for Availability		
13		2013 - 2011; 2.0L 121.9 (1998cc) DOHC L4 (16 Valve) 86mm Bore Theta GDi VVT			13	
		DI; Gasoline; Turbo - Intercooled Hyundai Eng.				
QTY	CYLINDER HEAD	YEARS	PART NO.	DESCRIPTION		
1	Head Bolt Set	2013-11	ES 72465-1	Head bolts w/Washers; Replacement recommended; New Part Number - Check for Availability		
QTY	CRANKSHAFT REAR SEAL	YEARS	PART NO.	DESCRIPTION		
1	Rear Main Seal Set	2013-11	BS 40702	Rubber; One-piece		
QTY	VALVE STEM SEAL SET	YEARS	PART NO.	DESCRIPTION		
1	Valve Stem Seal Set	2013-11	SS 71268	Premium valve stem seals incl.		
QTY	THERMOSTAT HOUSING	YEARS	PART NO.	DESCRIPTION		
1	Thermostat Gasket	2013-11	35918	Thermostat Housing; Thermostat case		
1	Thermostat Gasket	2013-11	35921	Thermostat Housing; Thermostat O-ring		
QTY	WATER PUMP	YEARS	PART NO.	DESCRIPTION		
1	Water Pump Gasket	2013-11	35802	To cover		
1	Water Pump Gasket	2013-11	35813	To block; Improved design		
1	Water Pump Gasket	2013-11	35822	To block; Old design		
1	Water Pump Gasket	2013-11	ES 72872	O-ring		
QTY	TIMING COVER	YEARS	PART NO.	DESCRIPTION		
1	Crankshaft Front Seal Set	2013-11	TCS 46133			
QTY	CARB & FUEL INJECTION	YEARS	PART NO.	DESCRIPTION		
1	Throttle Body Gasket	2013-11	61504	Throttle body		
14		2013 - 2010; 2.0L 121.9 (1998cc) DOHC L4 (16 Valve) 86mm Bore Theta VVT			14	
		MFI; Gasoline; Naturally Aspirated Hyundai Eng.				
QTY	CYLINDER HEAD	YEARS	PART NO.	DESCRIPTION		
1	Head Bolt Set	2013-10	ES 72465-1	Head bolts w/Washers; Replacement recommended; New Part Number - Check for Availability		
QTY	MANIFOLD - INT. & EXH.	YEARS	PART NO.	DESCRIPTION		
1	Int. Manifold Gasket Set	2013-10	MS 97100	Exc. California		
1	Int. Manifold Gasket Set	2013-10	MS 97106	California; New Part Number - Check for Availability		
1	Exh. Manifold Gasket Set	2013-10	MS 96874			
QTY	EXHAUST PIPE FLANGE	YEARS	PART NO.	DESCRIPTION		
1	Exhaust Pipe Gasket	2013-10	60899	Loc. Rear; Secondary converter		

14		2013 - 2010; 2.0L 121.9 (1998cc) DOHC L4 (16 Valve) 86mm Bore Theta VVT			14	
(cont.)		MFI; Gasoline; Naturally Aspirated Hyundai Eng.			(cont.)	
QTY	EXHAUST PIPE FLANGE	YEARS	PART NO.	DESCRIPTION		
1	Exhaust Pipe Gasket	2013-10	61451	Loc. Front; Secondary converter		
1	Exhaust Pipe Gasket	2013-10	61499	Exh. connector		
1	Exhaust Pipe Gasket	2013-10	61499	Loc. Front; Converter		
1	Exhaust Pipe Gasket	2013-10	61503	Loc. Rear; Converter		
QTY	CRANKSHAFT REAR SEAL	YEARS	PART NO.	DESCRIPTION		
1	Rear Main Seal Set	2013-10	BS 40702	Rubber; One-piece		
QTY	VALVE STEM SEAL SET	YEARS	PART NO.	DESCRIPTION		
1	Valve Stem Seal Set	2013-10	SS 71268	Premium valve stem seals incl.		
QTY	THERMOSTAT HOUSING	YEARS	PART NO.	DESCRIPTION		
1	Thermostat Gasket	2013-10	35918	Thermostat Housing; Thermostat case		
1	Thermostat Gasket	2013-10	35921	Thermostat Housing; Thermostat O-ring		
QTY	WATER OUTLET GASKET	YEARS	PART NO.	DESCRIPTION		
1	Thermostat Gasket	2013-10	35368	Water Outlet; Inlet to water pump		
QTY	WATER PUMP	YEARS	PART NO.	DESCRIPTION		
1	Water Pump Gasket	2013-10	35802	To cover		
1	Water Pump Gasket	2013-10	35813	To block; Improved design		
1	Water Pump Gasket	2013-10	35822	To block; Old design		
1	Water Pump Gasket	2013-10	ES 72872	O-ring		
QTY	TIMING COVER	YEARS	PART NO.	DESCRIPTION		
1	Crankshaft Front Seal Set	2013-10	TCS 46133			
QTY	CARB & FUEL INJECTION	YEARS	PART NO.	DESCRIPTION		
2	Fuel Injector O-Ring Set	2013-10	ES 70599	Improved design		
1	Throttle Body Gasket	2013-10	61504	Throttle body		
15		2013 - 2012; 2.0L 121.9 (1999cc) DOHC L4 (16 Valve) 81mm Bore Nu VVT			15	
		MFI; Gasoline; Naturally Aspirated Hyundai Eng.				
QTY	CYLINDER HEAD	YEARS	PART NO.	DESCRIPTION		
1	Head Bolt Set	2013-12	ES 72486	Head bolts w/Washers; Replacement recommended; New Part Number - Check for Availability		
QTY	MANIFOLD - INT. & EXH.	YEARS	PART NO.	DESCRIPTION		
1	Exh. Manifold Gasket Set	2013-12	MS 97239	New Part Number - Check for Availability		
QTY	EXHAUST PIPE FLANGE	YEARS	PART NO.	DESCRIPTION		
1	Exhaust Pipe Gasket	2013-12	61503	Loc. Front; Converter		
1	Exhaust Pipe Gasket	2013-12	61503	Loc. Rear; Converter		
1	Exhaust Pipe Gasket	2013-12	61567	Silencer		
QTY	VALVE STEM SEAL SET	YEARS	PART NO.	DESCRIPTION		
1	Valve Stem Seal Set	2013-12	SS 71268	Premium valve stem seals incl.		
QTY	WATER PUMP	YEARS	PART NO.	DESCRIPTION		
1	Water Pump Gasket	2013-12	36015	New Part Number - Check for Availability		
QTY	CARB & FUEL INJECTION	YEARS	PART NO.	DESCRIPTION		
1	Throttle Body Gasket	2013-12	61713	New Part Number - Check for Availability		
16		2006 - 2001; 2.4L 143.4 (2351cc) DOHC L4 (16 Valve) 86.5mm Bore			16	
		MFI; Gasoline; Naturally Aspirated Mitsubishi Eng.; Eng. Code G4JS				
QTY	CYLINDER HEAD	YEARS	PART NO.	DESCRIPTION		
1	Head Gasket	2006-01	26282 PT	Head bolts not incl.; Head bolt replacement recommended; PermaTorqueMLS® LaserWeld® Technology		
1	Head Set	2006-01	HS 26282 PT	Head bolts not incl.; Head bolt replacement recommended; PermaDry® molded rubber valve cover gskt. incl.; Premium valve stem seals incl.		
1	Head Bolt Set	2006-01	ES 72211	Head bolts w/Washers; Replacement recommended		
QTY	CONVERSION SET	YEARS	PART NO.	DESCRIPTION		
1	Gasket Conversion Set	2006-01	CS 26282-1	RTV sealant incl. for Upper oil pan gskt.		
QTY	MANIFOLD - INT. & EXH.	YEARS	PART NO.	DESCRIPTION		
1	Int. Manifold Gasket Set	2006-01	MS 96633			
1	Exh. Manifold Gasket Set	2006-01	MS 95470			
QTY	EXHAUST PIPE FLANGE	YEARS	PART NO.	DESCRIPTION		
1	Exhaust Pipe Gasket	2006-01	60899	Exh. connector		
1	Exhaust Pipe Gasket	2006-01	61294	Flange; Small ports		
2	Exhaust Pipe Gasket	2006-01	61383	Converter		
1	Exhaust Pipe Gasket	2006-01	61400	Flange; Large ports		
QTY	OIL PAN	YEARS	PART NO.	DESCRIPTION		
1	Oil Pan Gasket Set	2006-01	OS 30759	Loc. Lower; RTV sealant incl. for Upper oil pan gskt.		

Kia Car (Cont.)

16 (cont.)		2006 - 2001; 2.4L 143.4 (2351cc) DOHC L4 (16 Valve) 86.5mm Bore			16 (cont.)
MFI; Gasoline; Naturally Aspirated Mitsubishi Eng.; Eng. Code G4JS					
QTY	CRANKSHAFT REAR SEAL	YEARS	PART NO.	DESCRIPTION	
1	Rear Main Seal Set	2006-01	BS 40663	Rubber; One-piece	
QTY	VALVE COVER	YEARS	PART NO.	DESCRIPTION	
1	Valve Cover Gasket Set	2006-01	VS 50651 R	w/Semi-circular plug & Grommets & Spark plug tube seals; PermaDry® molded rubber gskt. incl.	
1	Semi-Circular Plug	2006-01	CP 75013	Valve Cover	
QTY	VALVE STEM SEAL SET	YEARS	PART NO.	DESCRIPTION	
1	Valve Stem Seal Set	2006-01	SS 71179-2	Premium valve stem seals incl.	
QTY	THERMOSTAT HOUSING	YEARS	PART NO.	DESCRIPTION	
1	Thermostat Gasket	2006-01	35764	Thermostat Housing	
1	Thermostat Gasket	2006-01	35806	Thermostat Housing; Thermostat seal	
QTY	WATER PUMP	YEARS	PART NO.	DESCRIPTION	
1	Water Pump Gasket	2006-01	35777		
QTY	TIMING COVER	YEARS	PART NO.	DESCRIPTION	
1	Crankshaft Front Seal Set	2006-01	TCS 46062		
1	Camshaft Front Seal Set	2006-01	TCS 45704		
QTY	CARB & FUEL INJECTION	YEARS	PART NO.	DESCRIPTION	
2	Fuel Injector O-Ring Set	2006-01	ES 70599	Improved design	
1	Throttle Body Gasket	2006-01	61390		
QTY	EXHAUST GAS RECIRCULATION	YEARS	PART NO.	DESCRIPTION	
1	EGR Gasket	2006-01	70152		
17		2008 - 2006; 2.4L 144 (2359cc) DOHC L4 (16 Valve) 88mm Bore			17
MFI; Gasoline; Naturally Aspirated Hyundai Eng.; Eng. Code G4KC					
QTY	CYLINDER HEAD	YEARS	PART NO.	DESCRIPTION	
1	Head Gasket	2008-06	26333 PT	Head bolts not incl.; Head bolt replacement recommended; PermaTorqueMLS®	
1	Head Set	2008-06	HS 26333 PT	Head bolts not incl.; Head bolt replacement recommended; PermaDry® molded rubber valve cover gskt. incl.; Premium valve stem seals incl.	
1	Head Bolt Set	2008-06	ES 72465-1	Head bolts w/Washers; Replacement recommended; New Part Number - Check for Availability	
QTY	CONVERSION SET	YEARS	PART NO.	DESCRIPTION	
1	Gasket Conversion Set	2008	CS 26333-1	RTV sealant incl. for oil pan gskt.	
1	Gasket Conversion Set	2007-06	CS 26333	RTV sealant incl. for oil pan gskt.	
QTY	MANIFOLD - INT. & EXH.	YEARS	PART NO.	DESCRIPTION	
1	Int. Manifold Gasket Set	2008-06	MS 97116		
1	Exh. Manifold Gasket Set	2008-06	MS 96874		
QTY	EXHAUST PIPE FLANGE	YEARS	PART NO.	DESCRIPTION	
1	Exhaust Pipe Gasket	2008-06	60899	Exh. connector	
1	Exhaust Pipe Gasket	2008-06	61479	Converter	
QTY	OIL PAN	YEARS	PART NO.	DESCRIPTION	
1	Oil Pan Gasket Set	2008-06	OS 30778	RTV sealant incl. for oil pan gskt.; Old design	
1	Oil Pan Gasket Set	2008-06	OS 30782	RTV sealant incl. for oil pan gskt.; Improved design	
QTY	CRANKSHAFT REAR SEAL	YEARS	PART NO.	DESCRIPTION	
1	Rear Main Seal Set	2008-06	BS 40702	Rubber; One-piece	
QTY	VALVE COVER	YEARS	PART NO.	DESCRIPTION	
1	Valve Cover Gasket Set	2008-06	VS 50697 R	w/Spark plug tube seals; PermaDry® molded rubber gskt. incl.	
QTY	VALVE STEM SEAL SET	YEARS	PART NO.	DESCRIPTION	
1	Valve Stem Seal Set	2008-06	SS 71268	Premium valve stem seals incl.	
QTY	THERMOSTAT HOUSING	YEARS	PART NO.	DESCRIPTION	
1	Thermostat Gasket	2008-06	35927	Thermostat Housing; Thermostat housing	
QTY	WATER OUTLET GASKET	YEARS	PART NO.	DESCRIPTION	
1	Thermostat Gasket	2008-06	35368	Water Outlet	
QTY	WATER PUMP	YEARS	PART NO.	DESCRIPTION	
1	Water Pump Gasket	2008-06	35802	To cover	
1	Water Pump Gasket	2008-06	35813	To block; Improved design	
1	Water Pump Gasket	2008-06	35822	To block; Old design	
1	Water Pump Gasket	2008-06	ES 72872	O-ring	
QTY	TIMING COVER	YEARS	PART NO.	DESCRIPTION	
1	Crankshaft Front Seal Set	2008	TCS 46133		
1	Crankshaft Front Seal Set	2007-06	TCS 46087		
QTY	CARB & FUEL INJECTION	YEARS	PART NO.	DESCRIPTION	
2	Fuel Injector O-Ring Set	2008-06	ES 70599	Improved design	

17		2008 - 2006; 2.4L 144 (2359cc) DOHC L4 (16 Valve) 88mm Bore			17	
(cont.)		MFI; Gasoline; Naturally Aspirated Hyundai Eng.; Eng. Code G4KC			(cont.)	
QTY	CARB & FUEL INJECTION	YEARS	PART NO.	DESCRIPTION		
1	Throttle Body Gasket	2008-06	61504	Throttle body		
QTY	EXHAUST GAS RECIRCULATION	YEARS	PART NO.	DESCRIPTION		
1	EGR Gasket	2008-06	70152			
QTY	OIL FILTER MOUNTING	YEARS	PART NO.	DESCRIPTION		
1	Oil Filter Adapter Gasket	2008-06	72997	Oil filter adapter gskt.; New Part Number - Check for Availability		
18		2013 - 2011; 2.4L 144 (2359cc) DOHC L4 (16 Valve) 88mm Bore Theta GDi VVT			18	
		DI; Gasoline; Naturally Aspirated Hyundai Eng.				
QTY	CYLINDER HEAD	YEARS	PART NO.	DESCRIPTION		
1	Head Bolt Set	2013-11	ES 72465-1	Head bolts w/Washers; Replacement recommended; New Part Number - Check for Availability		
QTY	MANIFOLD - INT. & EXH.	YEARS	PART NO.	DESCRIPTION		
1	Int. Manifold Gasket Set	2012-11	MS 97319	Lower set; New Part Number - Check for Availability		
1	Exh. Manifold Gasket Set	2013-11	MS 96874			
QTY	EXHAUST PIPE FLANGE	YEARS	PART NO.	DESCRIPTION		
1	Exhaust Pipe Gasket	2013-11	60899	Loc. Rear; Secondary converter		
1	Exhaust Pipe Gasket	2013-11	61451	Loc. Front; Secondary converter		
1	Exhaust Pipe Gasket	2013-11	61499	Exh. connector		
1	Exhaust Pipe Gasket	2013-11	61499	Loc. Front; Converter		
1	Exhaust Pipe Gasket	2013-11	61503	Loc. Rear; Converter		
QTY	FUEL PUMP	YEARS	PART NO.	DESCRIPTION		
1	Fuel Pump Mounting Gasket	2012-11	61751	New Part Number - Check for Availability		
QTY	CRANKSHAFT REAR SEAL	YEARS	PART NO.	DESCRIPTION		
1	Rear Main Seal Set	2013-11	BS 40702	Rubber; One-piece		
QTY	VALVE COVER	YEARS	PART NO.	DESCRIPTION		
1	Valve Cover Gasket Set	2012-11	VS 50869 R	w/Spark plug tube seals; PermaDry® molded rubber gskt. incl.; New Part Number - Check for Availability		
QTY	VALVE STEM SEAL SET	YEARS	PART NO.	DESCRIPTION		
1	Valve Stem Seal Set	2013-11	SS 71268	Premium valve stem seals incl.		
QTY	THERMOSTAT HOUSING	YEARS	PART NO.	DESCRIPTION		
1	Thermostat Gasket	2013-11	35918	Thermostat Housing; Thermostat case		
1	Thermostat Gasket	2013-11	35921	Thermostat Housing; Thermostat O-ring		
QTY	WATER OUTLET GASKET	YEARS	PART NO.	DESCRIPTION		
1	Thermostat Gasket	2013-11	35368	Water Outlet; Inlet to water pump		
QTY	WATER PUMP	YEARS	PART NO.	DESCRIPTION		
1	Water Pump Gasket	2013-11	35802	To cover		
1	Water Pump Gasket	2013-11	35813	To block; Improved design		
1	Water Pump Gasket	2013-11	35822	To block; Old design		
1	Water Pump Gasket	2013-11	ES 72872	O-ring		
QTY	TIMING COVER	YEARS	PART NO.	DESCRIPTION		
1	Crankshaft Front Seal Set	2013-11	TCS 46133			
QTY	CARB & FUEL INJECTION	YEARS	PART NO.	DESCRIPTION		
2	Fuel Injector O-Ring Set	2013-11	ES 70599	Improved design		
19		2013 - 2011; 2.4L 144 (2359cc) DOHC L4 (16 Valve) 88mm Bore Theta GDi VVT			19	
		DI; Hybrid (Gas/Electric); Naturally Aspirated Hyundai Eng.				
QTY	CYLINDER HEAD	YEARS	PART NO.	DESCRIPTION		
1	Head Bolt Set	2013-11	ES 72465-1	Head bolts w/Washers; Replacement recommended; New Part Number - Check for Availability		
QTY	MANIFOLD - INT. & EXH.	YEARS	PART NO.	DESCRIPTION		
1	Exh. Manifold Gasket Set	2013-11	MS 96874			
QTY	EXHAUST PIPE FLANGE	YEARS	PART NO.	DESCRIPTION		
1	Exhaust Pipe Gasket	2013-11	60899	Loc. Rear; Secondary converter		
1	Exhaust Pipe Gasket	2013-11	61451	Loc. Front; Secondary converter		
1	Exhaust Pipe Gasket	2013-11	61499	Exh. connector		
1	Exhaust Pipe Gasket	2013-11	61499	Loc. Front; Converter		
1	Exhaust Pipe Gasket	2013-11	61503	Loc. Rear; Converter		
QTY	CRANKSHAFT REAR SEAL	YEARS	PART NO.	DESCRIPTION		
1	Rear Main Seal Set	2013-11	BS 40702	Rubber; One-piece		
QTY	VALVE STEM SEAL SET	YEARS	PART NO.	DESCRIPTION		
1	Valve Stem Seal Set	2013-11	SS 71268	Premium valve stem seals incl.		
QTY	THERMOSTAT HOUSING	YEARS	PART NO.	DESCRIPTION		
1	Thermostat Gasket	2013-11	35921	Thermostat Housing; Thermostat O-ring		

Kia Car (Cont.)

19		2013 - 2011; 2.4L 144 (2359cc) DOHC L4 (16 Valve) 88mm Bore Theta GDi VVT			19	
(cont.)		DI; Hybrid (Gas/Electric); Naturally Aspirated Hyundai Eng.			(cont.)	
QTY	THERMOSTAT HOUSING	YEARS	PART NO.	DESCRIPTION		
1	Thermostat Gasket	2013-11	35918	Thermostat Housing; Thermostat case		
QTY	WATER OUTLET GASKET	YEARS	PART NO.	DESCRIPTION		
1	Thermostat Gasket	2013-11	35368	Water Outlet; Inlet to water pump		
QTY	WATER PUMP	YEARS	PART NO.	DESCRIPTION		
1	Water Pump Gasket	2013-11	35802	To cover		
1	Water Pump Gasket	2013-11	35813	To block; Improved design		
1	Water Pump Gasket	2013-11	35822	To block; Old design		
1	Water Pump Gasket	2013-11	ES 72872	O-ring		
QTY	TIMING COVER	YEARS	PART NO.	DESCRIPTION		
1	Crankshaft Front Seal Set	2013-11	TCS 46133			
QTY	CARB & FUEL INJECTION	YEARS	PART NO.	DESCRIPTION		
2	Fuel Injector O-Ring Set	2013-11	ES 70599	Improved design		
20		2013 - 2009; 2.4L 144 (2359cc) DOHC L4 (16 Valve) 88mm Bore VVT			20	
		MFI; Gasoline; Naturally Aspirated Hyundai Eng.; Eng. Code G4KC				
QTY	CYLINDER HEAD	YEARS	PART NO.	DESCRIPTION		
1	Head Gasket	2010-09	26333 PT	Head bolts not incl.; Head bolt replacement recommended; PermaTorqueMLS®		
1	Head Set	2009	HS 26333 PT-1	Exc. California; Head bolts not incl.; Head bolt replacement recommended; PermaDry® molded rubber valve cover gskt. incl.; Premium valve stem seals incl.		
1	Head Bolt Set	2011-09	ES 72465-1	Head bolts w/Washers; Replacement recommended; New Part Number - Check for Availability		
QTY	CONVERSION SET	YEARS	PART NO.	DESCRIPTION		
1	Gasket Conversion Set	2010-09	CS 26333-1	RTV sealant incl. for oil pan gskt.		
QTY	MANIFOLD - INT. & EXH.	YEARS	PART NO.	DESCRIPTION		
1	Int. Manifold Gasket Set	2013-09	MS 97106	California; New Part Number - Check for Availability		
1	Int. Manifold Gasket Set	2010-09	MS 97100	Exc. California		
1	Exh. Manifold Gasket Set	2010-09	MS 96874			
QTY	EXHAUST PIPE FLANGE	YEARS	PART NO.	DESCRIPTION		
1	Exhaust Pipe Gasket	2010-09	60899	Exh. connector		
2	Exhaust Pipe Gasket	2010-09	61383	Kia Rondo EX, LX; Loc. Center; Exh. connector		
1	Exhaust Pipe Gasket	2010-09	61479	Converter		
1	Exhaust Pipe Gasket	2010-09	61503	Kia Rondo EX, LX; Loc. Front; Front converter		
1	Exhaust Pipe Gasket	2010-09	61503	Kia Rondo EX, LX; Loc. Front; Rear converter		
1	Exhaust Pipe Gasket	2010-09	61568	Kia Rondo EX, LX; Loc. Rear; Front converter		
1	Exhaust Pipe Gasket	2010-09	61568	Kia Rondo EX, LX; Loc. Rear; Rear converter		
1	Exhaust Pipe Gasket	2010	61503	Kia Optima EX, LX, SX; Loc. Front; Converter		
1	Exhaust Pipe Gasket	2010	61503	Kia Optima EX, LX, SX; Loc. Rear; Converter		
1	Exhaust Pipe Gasket	2009	61503	Kia Optima EX, LX; Loc. Front; Converter		
1	Exhaust Pipe Gasket	2009	61503	Kia Optima EX, LX; Loc. Rear; Converter		
QTY	OIL PAN	YEARS	PART NO.	DESCRIPTION		
1	Oil Pan Gasket Set	2010-09	OS 30778	RTV sealant incl. for oil pan gskt.; Old design		
1	Oil Pan Gasket Set	2010-09	OS 30782	RTV sealant incl. for oil pan gskt.; Improved design		
QTY	CRANKSHAFT REAR SEAL	YEARS	PART NO.	DESCRIPTION		
1	Rear Main Seal Set	2010-09	BS 40702	Rubber; One-piece		
QTY	VALVE COVER	YEARS	PART NO.	DESCRIPTION		
1	Valve Cover Gasket Set	2009	VS 50697 R	w/Spark plug tube seals; PermaDry® molded rubber gskt. incl.		
QTY	VALVE STEM SEAL SET	YEARS	PART NO.	DESCRIPTION		
1	Valve Stem Seal Set	2010-09	SS 71268	Premium valve stem seals incl.		
QTY	THERMOSTAT HOUSING	YEARS	PART NO.	DESCRIPTION		
1	Thermostat Gasket	2010-09	35918	Thermostat Housing; Thermostat case		
1	Thermostat Gasket	2010-09	35921	Thermostat Housing; Thermostat O-ring		
QTY	WATER PUMP	YEARS	PART NO.	DESCRIPTION		
1	Water Pump Gasket	2010-09	35802	To cover		
1	Water Pump Gasket	2010-09	35813	To block; Improved design		
1	Water Pump Gasket	2010-09	35822	To block; Old design		
1	Water Pump Gasket	2010-09	ES 72872	O-ring		
QTY	TIMING COVER	YEARS	PART NO.	DESCRIPTION		
1	Crankshaft Front Seal Set	2010-09	TCS 46133			
QTY	CARB & FUEL INJECTION	YEARS	PART NO.	DESCRIPTION		
2	Fuel Injector O-Ring Set	2010-09	ES 70599	Improved design		
1	Throttle Body Gasket	2010-09	61504	Throttle body		
QTY	EXHAUST GAS RECIRCULATION	YEARS	PART NO.	DESCRIPTION		
1	EGR Gasket	2010-09	70152			

20 (cont.)		2013 - 2009; 2.4L 144 (2359cc) DOHC L4 (16 Valve) 88mm Bore VVT MFI; Gasoline; Naturally Aspirated Hyundai Eng.; Eng. Code G4KC			20 (cont.)
QTY	OIL FILTER MOUNTING	YEARS	PART NO.	DESCRIPTION	
1	Oil Filter Adapter Gasket	2012-09	72997	Oil filter adapter gskt.; New Part Number - Check for Availability	
21		2001; 2.5L 152 (2493cc) DOHC V6 (24 Valve) 84mm Bore MFI; Gasoline; Naturally Aspirated Hyundai Eng.; Eng. Code G6BV			21
QTY	CYLINDER HEAD	YEARS	PART NO.	DESCRIPTION	
2	Head Bolt Set	2001	ES 72205	Head bolts w/Washers; Replacement recommended	
QTY	CONVERSION SET	YEARS	PART NO.	DESCRIPTION	
1	Gasket Conversion Set	2001	CS 26276	RTV sealant incl. for Upper oil pan gskt.	
QTY	MANIFOLD - INT. & EXH.	YEARS	PART NO.	DESCRIPTION	
1	Int. Manifold Gasket Set	2001	MS 96597	Upper set incl.	
1	Plenum Gasket Set	2001	MS 96591	Upper set	
1	Exh. Manifold Gasket Set	2001	MS 96598		
QTY	EXHAUST PIPE FLANGE	YEARS	PART NO.	DESCRIPTION	
1	Exhaust Pipe Gasket	2001	60899	Converter	
2	Exhaust Pipe Gasket	2001	60899	Exh. connector; 1 or 2 Req'd.	
1	Exhaust Pipe Gasket	2001	61381	Loc. Rear; Flange	
1	Exhaust Pipe Gasket	2001	61382	Loc. Front; Flange	
QTY	OIL PAN	YEARS	PART NO.	DESCRIPTION	
1	Oil Pan Gasket Set	2001	OS 30753	Loc. Lower; RTV sealant incl. for Upper oil pan gskt.	
1	Drain Plug Gasket	2001	72515		
QTY	CRANKSHAFT REAR SEAL	YEARS	PART NO.	DESCRIPTION	
1	Rear Main Seal Set	2001	BS 40562	Rubber; One-piece	
QTY	VALVE COVER	YEARS	PART NO.	DESCRIPTION	
1	Valve Cover Gasket Set	2001	VS 50640 R	w/Spark plug tube seals; PermaDry® molded rubber gskts. incl.	
1	Circular Plug	2001	CP 75023	Valve Cover	
QTY	VALVE STEM SEAL SET	YEARS	PART NO.	DESCRIPTION	
1	Valve Stem Seal Set	2001	SS 72819	Premium valve stem seals incl.	
QTY	THERMOSTAT HOUSING	YEARS	PART NO.	DESCRIPTION	
2	Thermostat Gasket	2001	35764	Thermostat Housing	
2	Thermostat Gasket	2001	35764	Thermostat Housing; Thermostat case to head	
QTY	WATER PUMP	YEARS	PART NO.	DESCRIPTION	
1	Water Pump Gasket	2001	35765		
QTY	TIMING COVER	YEARS	PART NO.	DESCRIPTION	
1	Crankshaft Front Seal Set	2001	TCS 45911		
1	Camshaft Front Seal Set	2001	TCS 46053		
1	Camshaft Rear Seal Set	2001	TCS 46052		
QTY	CARB & FUEL INJECTION	YEARS	PART NO.	DESCRIPTION	
3	Fuel Injector O-Ring Set	2001	ES 70599	Improved design	
1	Throttle Body Gasket	2001	61245	Idle air control	
1	Throttle Body Gasket	2001	61380	Throttle body	
QTY	EXHAUST GAS RECIRCULATION	YEARS	PART NO.	DESCRIPTION	
1	EGR Gasket	2001	70152		
22		2010 - 2002; 2.7L 162 (2656cc) DOHC V6 (24 Valve) 86.7mm Bore MFI; Gasoline; Naturally Aspirated Hyundai Eng.; Eng. Code G6BA			22
QTY	CYLINDER HEAD	YEARS	PART NO.	DESCRIPTION	
1	Head Gasket	2010-07	26437 PT	Loc. L.H.; Head bolts not incl.; Head bolt replacement recommended; PermaTorqueMLS®	
1	Head Gasket	2010-07	26439 PT	Loc. R.H.; Head bolts not incl.; Head bolt replacement recommended; PermaTorqueMLS®	
1	Head Gasket	2006	26276 PT	Loc. L.H.; Eng. I.D. Code "8"; Head bolts not incl.; Head bolt replacement recommended; PermaTorqueMLS®	
1	Head Gasket	2006	26277 PT	Loc. R.H.; Eng. I.D. Code "8"; Head bolts not incl.; Head bolt replacement recommended; PermaTorqueMLS®	
1	Head Gasket	2006	26437 PT	Loc. L.H.; Eng. I.D. Code "4"; Head bolts not incl.; Head bolt replacement recommended; PermaTorqueMLS®	
1	Head Gasket	2006	26439 PT	Loc. R.H.; Eng. I.D. Code "4"; Head bolts not incl.; Head bolt replacement recommended; PermaTorqueMLS®	
1	Head Gasket	2005-02	26276 PT	Loc. L.H.; Head bolts not incl.; Head bolt replacement recommended; PermaTorqueMLS®	
1	Head Gasket	2005-02	26277 PT	Loc. R.H.; Head bolts not incl.; Head bolt replacement recommended; PermaTorqueMLS®	

Kia Car (Cont.)

22 (cont.)		2010 - 2002; 2.7L 162 (2656cc) DOHC V6 (24 Valve) 86.7mm Bore			22 (cont.)
MFI; Gasoline; Naturally Aspirated Hyundai Eng.; Eng. Code G6BA					
QTY	CYLINDER HEAD	YEARS	PART NO.	DESCRIPTION	
1	Head Set	2010-07	HS 26437 PT	Head bolts not incl.; Head bolt replacement recommended; PermaDry® molded rubber valve cover gskts. incl.; Premium valve stem seals incl.	
1	Head Set	2006	HS 26276 PT-1	Eng. I.D. Code "8"; Head bolts not incl.; Head bolt replacement recommended; PermaDry® molded rubber valve cover gskts. incl.; Premium valve stem seals incl.	
1	Head Set	2006	HS 26437 PT	Eng. I.D. Code "4"; Head bolts not incl.; Head bolt replacement recommended; PermaDry® molded rubber valve cover gskts. incl.; Premium valve stem seals incl.	
1	Head Set	2005	HS 26276 PT-1	Head bolts not incl.; Head bolt replacement recommended; PermaDry® molded rubber valve cover gskts. incl.; Premium valve stem seals incl.	
1	Head Set	2004	HS 26276 PT	To 09/25/03; Head bolts not incl.; Head bolt replacement recommended; PermaDry® molded rubber valve cover gskts. incl.; Premium valve stem seals incl.	
1	Head Set	2004	HS 26276 PT-1	From 09/26/03; Head bolts not incl.; Head bolt replacement recommended; PermaDry® molded rubber valve cover gskts. incl.; Premium valve stem seals incl.	
1	Head Set	2003-02	HS 26276 PT	Head bolts not incl.; Head bolt replacement recommended; PermaDry® molded rubber valve cover gskts. incl.; Premium valve stem seals incl.	
2	Head Bolt Set	2010-02	ES 72205	Head bolts w/Washers; Replacement recommended	
QTY	CONVERSION SET	YEARS	PART NO.	DESCRIPTION	
1	Gasket Conversion Set	2010-07	CS 26340	RTV sealant incl. for Upper oil pan gskt.	
1	Gasket Conversion Set	2006	CS 26276	Eng. I.D. Code "8"; RTV sealant incl. for Upper oil pan gskt.	
1	Gasket Conversion Set	2006	CS 26340	Eng. I.D. Code "4"; RTV sealant incl. for Upper oil pan gskt.	
1	Gasket Conversion Set	2005-02	CS 26276	RTV sealant incl. for Upper oil pan gskt.	
QTY	MANIFOLD - INT. & EXH.	YEARS	PART NO.	DESCRIPTION	
1	Int. Manifold Gasket Set	2010-07	MS 96597-1	Upper set incl.	
1	Int. Manifold Gasket Set	2006	MS 96597	Eng. I.D. Code "8"; Upper set incl.	
1	Int. Manifold Gasket Set	2006	MS 96597-1	Eng. I.D. Code "4"; Upper set incl.	
1	Int. Manifold Gasket Set	2005-02	MS 96597	Upper set incl.	
1	Plenum Gasket Set	2006	MS 96591	Eng. I.D. Code "8"; Upper set	
1	Plenum Gasket Set	2005-02	MS 96591	Upper set	
1	Exh. Manifold Gasket Set	2010-02	MS 96598		
QTY	EXHAUST PIPE FLANGE	YEARS	PART NO.	DESCRIPTION	
2	Exhaust Pipe Gasket	2010-02	60899	Exh. connector; 1 or 2 Req'd.	
1	Exhaust Pipe Gasket	2010-02	61381	Flange	
2	Exhaust Pipe Gasket	2010-02	61383	Converter	
QTY	OIL PAN	YEARS	PART NO.	DESCRIPTION	
1	Oil Pan Gasket Set	2010-07	OS 30789	Loc. Lower; RTV sealant incl. for Upper oil pan gskt.	
1	Oil Pan Gasket Set	2006	OS 30753	Loc. Lower; Eng. I.D. Code "8"; RTV sealant incl. for Upper oil pan gskt.	
1	Oil Pan Gasket Set	2006	OS 30789	Loc. Lower; Eng. I.D. Code "4"; RTV sealant incl. for Upper oil pan gskt.	
1	Oil Pan Gasket Set	2005-02	OS 30753	Loc. Lower; RTV sealant incl. for Upper oil pan gskt.	
1	Drain Plug Gasket	2010-02	72515		
QTY	CRANKSHAFT REAR SEAL	YEARS	PART NO.	DESCRIPTION	
1	Rear Main Seal Set	2010-02	BS 40562	Rubber; One-piece	
QTY	VALVE COVER	YEARS	PART NO.	DESCRIPTION	
1	Valve Cover Gasket Set	2010-07	VS 50693 R	w/Spark plug tube seals; PermaDry® molded rubber gskts. incl.	
1	Valve Cover Gasket Set	2006	VS 50641 R	Eng. I.D. Code "8"; w/Spark plug tube seals; PermaDry® molded rubber gskts. incl.	
1	Valve Cover Gasket Set	2006	VS 50693 R	Eng. I.D. Code "4"; w/Spark plug tube seals; PermaDry® molded rubber gskts. incl.	
1	Valve Cover Gasket Set	2005	VS 50641 R	w/Spark plug tube seals; PermaDry® molded rubber gskts. incl.	
1	Valve Cover Gasket Set	2004	VS 50640 R	To 09/25/03; w/Spark plug tube seals; PermaDry® molded rubber gskts. incl.	
1	Valve Cover Gasket Set	2004	VS 50641 R	From 09/26/03; w/Spark plug tube seals; PermaDry® molded rubber gskts. incl.	
1	Valve Cover Gasket Set	2003-02	VS 50640 R	w/Spark plug tube seals; PermaDry® molded rubber gskts. incl.	
1	Circular Plug	2010-02	CP 75023	Valve Cover	
QTY	VALVE STEM SEAL SET	YEARS	PART NO.	DESCRIPTION	
1	Valve Stem Seal Set	2010-02	SS 72819	Premium valve stem seals incl.	
QTY	THERMOSTAT HOUSING	YEARS	PART NO.	DESCRIPTION	
1	Thermostat Gasket	2010	35917	Thermostat Housing	
2	Thermostat Gasket	2010	35920	Thermostat Housing; Thermostat case to head	
2	Thermostat Gasket	2009-08	35764	Thermostat Housing; To 07/14/08	
2	Thermostat Gasket	2009-08	35764	Thermostat Housing; To 07/14/08; Thermostat case to head	
1	Thermostat Gasket	2009-08	35917	Thermostat Housing; From 07/15/08	

22 (cont.)		2010 - 2002; 2.7L 162 (2656cc) DOHC V6 (24 Valve) 86.7mm Bore			22 (cont.)
MFI; Gasoline; Naturally Aspirated Hyundai Eng.; Eng. Code G6BA					
QTY	THERMOSTAT HOUSING	YEARS	PART NO.	DESCRIPTION	
2	Thermostat Gasket	2009-08	35920	Thermostat Housing; From 07/15/08; Thermostat case to head	
2	Thermostat Gasket	2007-02	35764	Thermostat Housing	
2	Thermostat Gasket	2007-02	35764	Thermostat Housing; Thermostat case to head	
1	O-Ring	2010-02	35555	Thermostat Housing; Thermostat seal	
QTY	WATER PUMP	YEARS	PART NO.	DESCRIPTION	
1	Water Pump Gasket	2010-07	35819		
1	Water Pump Gasket	2006	35765	Eng. I.D. Code "8"	
1	Water Pump Gasket	2006	35819	Eng. I.D. Code "4"	
1	Water Pump Gasket	2005-02	35765		
QTY	TIMING COVER	YEARS	PART NO.	DESCRIPTION	
1	Crankshaft Front Seal Set	2010-02	TCS 45911		
1	Camshaft Front Seal Set	2010-02	TCS 46053		
1	Camshaft Rear Seal Set	2010-02	TCS 46052		
QTY	CARB & FUEL INJECTION	YEARS	PART NO.	DESCRIPTION	
3	Fuel Injector O-Ring Set	2010-02	ES 70599	Improved design	
1	Throttle Body Gasket	2010-02	61245	Idle air control	
1	Throttle Body Gasket	2010-07	61496	Throttle body; Improved design; New Part Number - Check for Availability	
1	Throttle Body Gasket	2006	61380	Eng. I.D. Code "8"; Throttle body	
1	Throttle Body Gasket	2006	61496	Eng. I.D. Code "4"; Throttle body; Improved design; New Part Number - Check for Availability	
1	Throttle Body Gasket	2005-02	61380	Throttle body	
QTY	EXHAUST GAS RECIRCULATION	YEARS	PART NO.	DESCRIPTION	
1	EGR Gasket	2010-02	70152		
23		2006 - 2004; 3.5L 213.3 (3497cc) DOHC V6 (24 Valve) 93mm Bore			23
MFI; Gasoline; Naturally Aspirated Mitsubishi Eng.; Eng. Code G6CU					
QTY	CYLINDER HEAD	YEARS	PART NO.	DESCRIPTION	
1	Head Gasket	2006-04	26293 PT	Loc. R.H.; Head bolts not incl.; Head bolt replacement recommended; PermaTorqueMLS®	
1	Head Gasket	2006-04	26294 PT	Loc. L.H.; Head bolts not incl.; Head bolt replacement recommended; PermaTorqueMLS®	
1	Head Set	2006-04	HS 26293 PT	Head bolts not incl.; Head bolt replacement recommended; PermaDry® molded rubber valve cover gsks. incl.; Premium valve stem seals incl.	
1	Head Bolt Set	2006-04	ES 72859	Head bolts w/Washers; Replacement recommended	
QTY	CONVERSION SET	YEARS	PART NO.	DESCRIPTION	
1	Gasket Conversion Set	2006-04	CS 26293	RTV sealant incl. for Upper oil pan gskt.; Old design	
1	Gasket Conversion Set	2006-04	CS 26293-2	RTV sealant incl. for Upper oil pan gskt.; Improved design	
QTY	MANIFOLD - INT. & EXH.	YEARS	PART NO.	DESCRIPTION	
1	Int. Manifold Gasket Set	2006-04	MS 96460	Lower set; Upper set incl.	
1	Plenum Gasket Set	2006-04	MS 95008	Upper set	
1	Exh. Manifold Gasket Set	2006-04	MS 95082		
QTY	EXHAUST PIPE FLANGE	YEARS	PART NO.	DESCRIPTION	
2	Exhaust Pipe Gasket	2006-04	60899	Flange	
1	Exhaust Pipe Gasket	2006-04	60899	Loc. Front; Converter	
1	Exhaust Pipe Gasket	2006-04	61268	Loc. Rear; Converter	
1	Exhaust Pipe Gasket	2006-04	61383	Loc. Center; Exh. connector	
2	Exhaust Pipe Gasket	2006-04	61429	Converter case	
QTY	OIL PAN	YEARS	PART NO.	DESCRIPTION	
1	Oil Pan Gasket Set	2006-04	OS 30762	Loc. Lower; RTV sealant incl. for Upper oil pan gskt.	
1	Drain Plug Gasket	2006-04	72515		
QTY	CRANKSHAFT REAR SEAL	YEARS	PART NO.	DESCRIPTION	
1	Rear Main Seal Set	2006-04	BS 40562	Rubber; One-piece	
QTY	VALVE COVER	YEARS	PART NO.	DESCRIPTION	
1	Valve Cover Gasket Set	2006-04	VS 50658 R-1	w/Spark plug tube seals; PermaDry® molded rubber gsks. incl.	
4	Circular Plug	2006-04	CP 75023	Valve Cover	
QTY	VALVE STEM SEAL SET	YEARS	PART NO.	DESCRIPTION	
1	Valve Stem Seal Set	2006-04	SS 71179	Premium valve stem seals incl.	
QTY	THERMOSTAT HOUSING	YEARS	PART NO.	DESCRIPTION	
2	Thermostat Gasket	2006-04	35764	Thermostat Housing	
2	Thermostat Gasket	2006-04	35764	Thermostat Housing; Thermostat case to head	
1	O-Ring	2006-04	35555	Thermostat Housing; Thermostat seal	
QTY	WATER PUMP	YEARS	PART NO.	DESCRIPTION	
1	Water Pump Gasket	2006-04	35787		

Kia Car (Cont.)

23 (cont.)		2006 - 2004; 3.5L 213.3 (3497cc) DOHC V6 (24 Valve) 93mm Bore MFI; Gasoline; Naturally Aspirated Mitsubishi Eng.; Eng. Code G6CU			23 (cont.)
QTY	TIMING COVER	YEARS	PART NO.	DESCRIPTION	
1	Crankshaft Front Seal Set	2006-04	TCS 46074	Old design	
1	Crankshaft Front Seal Set	2006-04	TCS 46085	Improved design	
2	Camshaft Front Seal Set	2006-04	TCS 46053		
QTY	CARB & FUEL INJECTION	YEARS	PART NO.	DESCRIPTION	
1	Throttle Body Gasket	2006-04	61416		
QTY	EXHAUST GAS RECIRCULATION	YEARS	PART NO.	DESCRIPTION	
1	EGR Gasket	2006-04	70568	Tube	
QTY	OIL PUMP COVER	YEARS	PART NO.	DESCRIPTION	
1	Oil Pump Gasket	2006-04	71262	Oil pump mounting; New Part Number - Check for Availability	
24		2009 - 2007; 3.8L 230 (3778cc) DOHC V6 (24 Valve) 96mm Bore Lambda MFI; Gasoline; Naturally Aspirated Hyundai Eng.; Eng. Code G6DA			24
QTY	CYLINDER HEAD	YEARS	PART NO.	DESCRIPTION	
1	Head Gasket	2009-07	26416 PT	Loc. R.H.; Head bolts not incl.; Head bolt replacement recommended; PermaTorqueMLS®	
1	Head Gasket	2009-08	26420 PT	Loc. L.H.; Head bolts not incl.; Head bolt replacement recommended; PermaTorqueMLS®	
1	Head Gasket	2007	26414 PT	Loc. L.H.; To 04/20/07; Head bolts not incl.; Head bolt replacement recommended; PermaTorqueMLS®	
1	Head Gasket	2007	26420 PT	Loc. L.H.; From 04/21/07; Head bolts not incl.; Head bolt replacement recommended; PermaTorqueMLS®	
1	Head Set	2009-08	HS 26420 PT	Head bolts not incl.; Head bolt replacement recommended; PermaDry® molded rubber valve cover gskts. incl.; Premium valve stem seals incl.	
1	Head Set	2007	HS 26414 PT	To 04/20/07; Head bolts not incl.; Head bolt replacement recommended; PermaDry® molded rubber valve cover gskts. incl.; Premium valve stem seals incl.	
1	Head Set	2007	HS 26420 PT	From 04/21/07; Head bolts not incl.; Head bolt replacement recommended; PermaDry® molded rubber valve cover gskts. incl.; Premium valve stem seals incl.	
1	Head Bolt Set	2009-07	ES 72366	Replacement recommended	
QTY	CONVERSION SET	YEARS	PART NO.	DESCRIPTION	
1	Gasket Conversion Set	2009-07	CS 26414	RTV sealant incl. for Upper oil pan gskt.; New Part Number - Check for Availability	
QTY	MANIFOLD - INT. & EXH.	YEARS	PART NO.	DESCRIPTION	
1	Int. Manifold Gasket Set	2009-07	MS 97086	Lower set; Upper set incl.	
1	Plenum Gasket Set	2009-07	MS 97227	Upper set; New Part Number - Check for Availability	
1	Exh. Manifold Gasket Set	2009-07	MS 97074		
QTY	EXHAUST PIPE FLANGE	YEARS	PART NO.	DESCRIPTION	
1	Exhaust Pipe Gasket	2009-07	60899	Loc. Rear; Converter	
2	Exhaust Pipe Gasket	2009-07	61383	Loc. Front; Pipe to manifold	
1	Exhaust Pipe Gasket	2009-07	61451	Exh. connector	
1	Exhaust Pipe Gasket	2009-07	61479	Loc. Front; Converter	
2	Exhaust Pipe Gasket	2009-07	61499	Loc. Rear; Pipe to manifold	
QTY	OIL PAN	YEARS	PART NO.	DESCRIPTION	
1	Oil Pan Gasket Set	2009-07	OS 30822	Loc. Lower	
QTY	CRANKSHAFT REAR SEAL	YEARS	PART NO.	DESCRIPTION	
1	Rear Main Seal Set	2009-07	BS 40710	Rubber; One-piece	
QTY	VALVE COVER	YEARS	PART NO.	DESCRIPTION	
1	Valve Cover Gasket Set	2009-07	VS 50750 R	w/Spark plug tube seals; PermaDry® molded rubber gskts. incl.	
QTY	VALVE STEM SEAL SET	YEARS	PART NO.	DESCRIPTION	
1	Valve Stem Seal Set	2009-07	SS 72298	Premium valve stem seals incl.	
QTY	THERMOSTAT HOUSING	YEARS	PART NO.	DESCRIPTION	
1	Thermostat Gasket	2009-08	35933	Thermostat Housing	
QTY	WATER OUTLET GASKET	YEARS	PART NO.	DESCRIPTION	
1	Water Outlet Gasket	2009-07	35868	Water Outlet; Loc. L.H.	
1	Water Outlet Gasket	2009-07	35870	Water Outlet; Loc. R.H.	
1	Water Outlet Gasket	2009-07	35894	Water Outlet; O-ring; New Part Number - Check for Availability	
2	Water Outlet Gasket	2009-07	35959	Water Outlet; Water pipe; O-ring	
1	Water Crossover Mounting Set	2009-07	ES 72971	Water Outlet; New Part Number - Check for Availability	
QTY	WATER PUMP	YEARS	PART NO.	DESCRIPTION	
1	Water Pump Gasket	2009-07	35896	Loc. R.H.	
1	Water Pump Gasket	2009-07	35903	Loc. L.H.; New Part Number - Check for Availability	
QTY	TIMING COVER	YEARS	PART NO.	DESCRIPTION	
1	Crankshaft Front Seal Set	2009-07	TCS 46111		

24 (cont.)	2009 - 2007; 3.8L 230 (3778cc) DOHC V6 (24 Valve) 96mm Bore Lambda			24 (cont.)
MFI; Gasoline; Naturally Aspirated Hyundai Eng.; Eng. Code G6DA				
QTY	CARB & FUEL INJECTION	YEARS	PART NO.	DESCRIPTION
1	Throttle Body Gasket	2009-07	61560	

Kia Minivans - See Kia Truck

Kia SUV's - See Kia Truck

Kia Truck (Incl. Minivans and SUV's)

Engine Finding Index					
Engine	Years	Code	Line No.		
2.0L 120.5 (1975cc) DOHC L4 (16 Valve) 82mm Bore; MFI; Gasoline; Naturally Aspirated Hyundai Eng.	2010-05	G4GF	1		
2.0L 121.9 (1998cc) DOHC L4 (16 Valve) 86mm Bore; MFI; Gasoline; Naturally Aspirated Mazda Eng.	2002-95	FED	2		
2.0L 121.9 (1998cc) DOHC L4 (16 Valve) 86mm Bore Theta GDi VVT; DI; Gasoline; Turbo - Intercooled Hyundai Eng.	2013-11		3		
2.0L 121.9 (1998cc) SOHC L4 (8 Valve) 86mm Bore; MFI; Gasoline; Naturally Aspirated Mazda Eng.	1995	FE	4		
2.4L 144 (2359cc) DOHC L4 (16 Valve) 88mm Bore Theta GDi VVT; DI; Gasoline; Naturally Aspirated Hyundai Eng.	2013-12		5		
2.4L 144 (2359cc) DOHC L4 (16 Valve) 88mm Bore VVT; MFI; Gasoline; Naturally Aspirated Hyundai Eng.	2012-11	G4KC	6		
2.7L 162 (2656cc) DOHC V6 (24 Valve) 86.7mm Bore; MFI; Gasoline; Naturally Aspirated Hyundai Eng.	2010-05	G6BA	7		
3.3L 204 (3342cc) DOHC V6 (24 Valve) 92mm Bore Lambda; MFI; Gasoline; Naturally Aspirated Hyundai Eng.	2010-08	G6DB	8		
3.5L 211.7 (3470cc) DOHC V6 (24 Valve) 92mm Bore Lambda VVT; MFI; Gasoline; Naturally Aspirated Hyundai Eng.	2013-11	G6DC	9		
3.5L 213.3 (3497cc) DOHC V6 (24 Valve) 93mm Bore; MFI; Gasoline; Naturally Aspirated Mitsubishi Eng.	2006-02	G6CU	10		
3.8L 230 (3778cc) DOHC V6 (24 Valve) 96mm Bore Lambda; MFI; Gasoline; Naturally Aspirated Hyundai Eng.	2011-06	G6DA	11		
4.6L 282.4 (4627cc) DOHC V8 (32 Valve) 92mm Bore Tau VVT; MFI; Gasoline; Naturally Aspirated Hyundai Eng.	2011-09	G8BA	12		
Engine Code Index					
Code	Engine	Line No.			
FE	2.0L 121.9 (1998cc) SOHC L4 (8 Valve) 86mm Bore; MFI; Gasoline; Naturally Aspirated Mazda Eng.	4			
FED	2.0L 121.9 (1998cc) DOHC L4 (16 Valve) 86mm Bore; MFI; Gasoline; Naturally Aspirated Mazda Eng.	2			
G4GF	2.0L 120.5 (1975cc) DOHC L4 (16 Valve) 82mm Bore; MFI; Gasoline; Naturally Aspirated Hyundai Eng.	1			
G4KC	2.4L 144 (2359cc) DOHC L4 (16 Valve) 88mm Bore VVT; MFI; Gasoline; Naturally Aspirated Hyundai Eng.	6			
G6BA	2.7L 162 (2656cc) DOHC V6 (24 Valve) 86.7mm Bore; MFI; Gasoline; Naturally Aspirated Hyundai Eng.	7			
G6CU	3.5L 213.3 (3497cc) DOHC V6 (24 Valve) 93mm Bore; MFI; Gasoline; Naturally Aspirated Mitsubishi Eng.	10			
G6DA	3.8L 230 (3778cc) DOHC V6 (24 Valve) 96mm Bore Lambda; MFI; Gasoline; Naturally Aspirated Hyundai Eng.	11			
G6DB	3.3L 204 (3342cc) DOHC V6 (24 Valve) 92mm Bore Lambda; MFI; Gasoline; Naturally Aspirated Hyundai Eng.	8			
G6DC	3.5L 211.7 (3470cc) DOHC V6 (24 Valve) 92mm Bore Lambda VVT; MFI; Gasoline; Naturally Aspirated Hyundai Eng.	9			
G8BA	4.6L 282.4 (4627cc) DOHC V8 (32 Valve) 92mm Bore Tau VVT; MFI; Gasoline; Naturally Aspirated Hyundai Eng.	12			
Model Index					
Engine (VIN Code / Eng. Code)	Year	Engine (VIN Code / Eng. Code)	Year	Engine (VIN Code / Eng. Code)	Year
Kia Truck		Kia Truck (cont.)		Kia Truck (cont.)	
Borrego (2WD Mid-Size SUV)		Sorento (2WD Mid-Size SUV) (cont.)		Sportage (4WD Compact SUV) (cont.)	
V6 3778cc 3.8L DOHC (24 Valve) (G6DA)	11-09	V6 3497cc 3.5L DOHC (24 Valve) (G6CU)	06-03	L4 1998cc 2.0L SOHC (8 Valve) (FE)	95
V8 4627cc 4.6L DOHC (32 Valve) (G8BA)	11-09	V6 3778cc 3.8L DOHC (24 Valve) (G6DA)	10-07	Sportage (AWD Compact SUV)	
Borrego (4WD Mid-Size SUV)		Sorento (4WD Mid-Size SUV)		L4 1975cc 2.0L DOHC (16 Valve) (G4GF)	10-05
V6 3778cc 3.8L DOHC (24 Valve) (G6DA)	11-09	L4 2359cc 2.4L DOHC (16 Valve) (G4KC)	13-11	L4 1998cc 2.0L DOHC Turbo (16 Valve)	13-11
V8 4627cc 4.6L DOHC (32 Valve) (G8BA)	11-09	L4 2359cc 2.4L DOHC (16 Valve) (Theta)	13-12	(Theta)	
Sedona (FWD Minivan)		V6 3342cc 3.3L DOHC (24 Valve) (G6DB)	10-08	L4 2359cc 2.4L DOHC (16 Valve) (G4KC)	13-11
V6 3470cc 3.5L DOHC (24 Valve) (G6DC)	12-11	V6 3470cc 3.5L DOHC (24 Valve) (G6DC)	13-11	V6 2656cc 2.7L DOHC (24 Valve) (G6BA)	10-05
V6 3497cc 3.5L DOHC (24 Valve) (G6CU)	05-02	V6 3497cc 3.5L DOHC (24 Valve) (G6CU)	06-03	Sportage (FWD Compact SUV)	
V6 3778cc 3.8L DOHC (24 Valve) (G6DA)	10-06	V6 3778cc 3.8L DOHC (24 Valve) (G6DA)	10-07	L4 1975cc 2.0L DOHC (16 Valve) (G4GF)	10-05
Sorento (2WD Mid-Size SUV)		Sportage (2WD Compact SUV)		L4 1998cc 2.0L DOHC Turbo (16 Valve)	13-11
L4 2359cc 2.4L DOHC (16 Valve) (G4KC)	13-11	L4 1998cc 2.0L DOHC (16 Valve) (FED)	02-95	(Theta)	
L4 2359cc 2.4L DOHC (16 Valve) (Theta)	13-12	L4 1998cc 2.0L SOHC (8 Valve) (FE)	95	L4 2359cc 2.4L DOHC (16 Valve) (G4KC)	13-11
V6 3342cc 3.3L DOHC (24 Valve) (G6DB)	10-08	Sportage (4WD Compact SUV)		V6 2656cc 2.7L DOHC (24 Valve) (G6BA)	10-05
V6 3470cc 3.5L DOHC (24 Valve) (G6DC)	13-11	L4 1998cc 2.0L DOHC (16 Valve) (FED)	02-95		
1	2010 - 2005; 2.0L 120.5 (1975cc) DOHC L4 (16 Valve) 82mm Bore				1
MFI; Gasoline; Naturally Aspirated Hyundai Eng.; Eng. Code G4GF					
QTY	CYLINDER HEAD	YEARS	PART NO.	DESCRIPTION	
1	Head Gasket	2010-05	26181 PT	Head bolts not incl.; Head bolt replacement recommended; PermaTorqueMLS® LaserWeld® Technology	
1	Head Set	2010-08	HS 26181 PT-3	Head bolts & exh. pipe flange not incl.; Head bolt replacement recommended; PermaDry® molded rubber valve cover gskt. incl.; Premium valve stem seals incl.	
1	Head Set	2007-05	HS 26181 PT-1	Head bolts & exh. pipe flange not incl.; Head bolt replacement recommended; PermaDry® molded rubber valve cover gskt. incl.; Premium valve stem seals incl.	

Kia Truck (Incl. Minivans and SUV's) (Cont.)

1		2010 - 2005; 2.0L 120.5 (1975cc) DOHC L4 (16 Valve) 82mm Bore			1
(cont.)		MFI; Gasoline; Naturally Aspirated Hyundai Eng.; Eng. Code G4GF			(cont.)
QTY	CYLINDER HEAD	YEARS	PART NO.	DESCRIPTION	
1	Head Bolt Set	2010-05	ES 71313	Head bolts w/Washers; Replacement recommended	
QTY	CONVERSION SET	YEARS	PART NO.	DESCRIPTION	
1	Gasket Conversion Set	2010-05	CS 26180	RTV sealant incl. for oil pan gskt.	
QTY	MANIFOLD - INT. & EXH.	YEARS	PART NO.	DESCRIPTION	
1	Int. Manifold Gasket Set	2010-05	MS 96275		
1	Exh. Manifold Gasket Set	2010-08	MS 97102		
1	Exh. Manifold Gasket Set	2007-05	MS 96128		
QTY	EXHAUST PIPE FLANGE	YEARS	PART NO.	DESCRIPTION	
2	Exhaust Pipe Gasket	2010-05	60899	Loc. Rear; Converter	
1	Exhaust Pipe Gasket	2010-05	60899	Muffler	
1	Exhaust Pipe Gasket	2010-05	61499	Loc. Front; Converter	
QTY	OIL PAN	YEARS	PART NO.	DESCRIPTION	
1	Drain Plug Gasket	2010-05	72515		
QTY	CRANKSHAFT REAR SEAL	YEARS	PART NO.	DESCRIPTION	
1	Rear Main Seal Set	2010-05	BS 40444	Rubber; One-piece	
QTY	VALVE COVER	YEARS	PART NO.	DESCRIPTION	
1	Valve Cover Gasket Set	2010-05	VS 50583 R	w/Spark plug tube seals; PermaDry® molded rubber gskt. incl.	
1	Spark Plug Tube Seal Set	2010-05	ES 72974	Valve Cover; New Part Number - Check for Availability	
QTY	VALVE STEM SEAL SET	YEARS	PART NO.	DESCRIPTION	
1	Valve Stem Seal Set	2010-05	SS 70795-1	Premium valve stem seals incl.	
QTY	THERMOSTAT HOUSING	YEARS	PART NO.	DESCRIPTION	
1	Water Outlet Gasket	2010-05	25538	Thermostat Housing; Loc. Upper	
1	Thermostat Gasket	2010-05	35671	Thermostat Housing; Loc. Lower	
QTY	WATER OUTLET GASKET	YEARS	PART NO.	DESCRIPTION	
1	Water Outlet Gasket	2010-05	36049	Water Outlet; Water inlet pipe seal; New Part Number - Check for Availability	
1	Water Outlet Gasket	2010-09	35925	Water Outlet	
QTY	WATER PUMP	YEARS	PART NO.	DESCRIPTION	
1	Water Pump Gasket	2010-09	35923		
1	Water Pump Gasket	2008-05	35628		
QTY	TIMING COVER	YEARS	PART NO.	DESCRIPTION	
1	Crankshaft Front Seal Set	2010-05	TCS 46017		
1	Camshaft Front Seal Set	2010-05	TCS 45704-1		
QTY	CARB & FUEL INJECTION	YEARS	PART NO.	DESCRIPTION	
2	Fuel Injector O-Ring Set	2010-08	ES 70599	Improved design	
2	Fuel Injector O-Ring Set	2007-05	ES 70599	Exc. California; Improved design	
2	Fuel Injector O-Ring Set	2007-05	ES 70600	California	
1	Throttle Body Gasket	2010-05	60914	Idle air control	
1	Throttle Body Gasket	2010-06	61476	Throttle body	
1	Throttle Body Gasket	2005	61217	Throttle body	
QTY	OIL PUMP COVER	YEARS	PART NO.	DESCRIPTION	
1	Oil Pump Gasket	2010-05	72983	Oil pump mounting gskt.; New Part Number - Check for Availability	
2		2002 - 1995; 2.0L 121.9 (1998cc) DOHC L4 (16 Valve) 86mm Bore			2
(cont.)		MFI; Gasoline; Naturally Aspirated Mazda Eng.; Eng. Code FED			(cont.)
QTY	CYLINDER HEAD	YEARS	PART NO.	DESCRIPTION	
1	Head Gasket	2002-95	26220 PT		
1	Head Set	2002-95	HS 26220 PT	PermaDry® molded rubber valve cover gskt. incl.; Premium valve stem seals incl.	
QTY	CONVERSION SET	YEARS	PART NO.	DESCRIPTION	
1	Gasket Conversion Set	2002-95	CS 26220		
QTY	MANIFOLD - INT. & EXH.	YEARS	PART NO.	DESCRIPTION	
1	Int. Manifold Gasket Set	2002-95	MS 96289	Lower set; Upper set incl.	
1	Plenum Gasket Set	2002-95	MS 96293	Upper set; New Part Number - Check for Availability	
1	Exh. Manifold Gasket Set	2002-95	MS 96290		
QTY	EXHAUST PIPE FLANGE	YEARS	PART NO.	DESCRIPTION	
1	Exhaust Pipe Gasket	2002-95	61044	Flange	
1	Exhaust Pipe Gasket	2002-95	61268	Loc. Rear; Converter	
1	Exhaust Pipe Gasket	2002-95	61270	Loc. Front; Converter	
1	Exhaust Pipe Gasket	2002-95	61599	Converter Pre-Chamber	
QTY	OIL PAN	YEARS	PART NO.	DESCRIPTION	
2	Oil Pan Gasket Set	2002-95	OS 30734		
QTY	CRANKSHAFT REAR SEAL	YEARS	PART NO.	DESCRIPTION	
1	Rear Main Seal Set	2002-95	BS 40188	Rubber; One-piece	

Kia Truck (Incl. Minivans and SUV's) (Cont.)

2		2002 - 1995; 2.0L 121.9 (1998cc) DOHC L4 (16 Valve) 86mm Bore			2
(cont.)		MFI; Gasoline; Naturally Aspirated Mazda Eng.; Eng. Code FED			(cont.)
QTY	VALVE COVER	YEARS	PART NO.	DESCRIPTION	
1	Valve Cover Gasket Set	2002-95	VS 50585 R	PermaDry® molded rubber gskt. incl.	
QTY	VALVE STEM SEAL SET	YEARS	PART NO.	DESCRIPTION	
1	Valve Stem Seal Set	2002-95	SS 72802	Premium valve stem seals incl.	
QTY	THERMOSTAT HOUSING	YEARS	PART NO.	DESCRIPTION	
1	Thermostat Gasket	2002-95	35711	Thermostat Housing	
QTY	WATER OUTLET GASKET	YEARS	PART NO.	DESCRIPTION	
1	Water Outlet Gasket	2002-95	35709	Water Outlet	
1	Water Outlet Gasket	2002-95	35712	Water Outlet; Inlet	
QTY	WATER PUMP	YEARS	PART NO.	DESCRIPTION	
1	Water Pump Gasket	2002-95	35458		
QTY	TIMING COVER	YEARS	PART NO.	DESCRIPTION	
1	Crankshaft Front Seal Set	2002-95	TCS 46030	Must be used w/OS 30734	
2	Camshaft Front Seal Set	2002-95	TCS 46029		
QTY	CARB & FUEL INJECTION	YEARS	PART NO.	DESCRIPTION	
1	Fuel Injector O-Ring Set	2002-95	ES 70599	Improved design	
1	Throttle Body Gasket	2002-98	61259		
1	Throttle Body Gasket	1997-95	61260		
QTY	EXHAUST GAS RECIRCULATION	YEARS	PART NO.	DESCRIPTION	
1	EGR Gasket	2002-95	70431		
3		2013 - 2011; 2.0L 121.9 (1998cc) DOHC L4 (16 Valve) 86mm Bore Theta GDi VVT			3
		DI; Gasoline; Turbo - Intercooled Hyundai Eng.			
QTY	CYLINDER HEAD	YEARS	PART NO.	DESCRIPTION	
1	Head Bolt Set	2013-11	ES 72465-1	Head bolts w/Washers; Replacement recommended; New Part Number - Check for Availability	
QTY	EXHAUST PIPE FLANGE	YEARS	PART NO.	DESCRIPTION	
1	Exhaust Pipe Gasket	2013-11	61499	Exh. connector	
1	Exhaust Pipe Gasket	2013-11	61499	Loc. Front; Converter	
1	Exhaust Pipe Gasket	2013-11	61499	Loc. Rear; Converter	
QTY	CRANKSHAFT REAR SEAL	YEARS	PART NO.	DESCRIPTION	
1	Rear Main Seal Set	2013-11	BS 40702	Rubber; One-piece	
QTY	VALVE STEM SEAL SET	YEARS	PART NO.	DESCRIPTION	
1	Valve Stem Seal Set	2013-11	SS 71268	Premium valve stem seals incl.	
QTY	THERMOSTAT HOUSING	YEARS	PART NO.	DESCRIPTION	
1	Thermostat Gasket	2013-11	35918	Thermostat Housing; Thermostat case	
1	Thermostat Gasket	2013-11	35921	Thermostat Housing; Thermostat O-ring	
QTY	WATER PUMP	YEARS	PART NO.	DESCRIPTION	
1	Water Pump Gasket	2013-11	35802	To cover	
1	Water Pump Gasket	2013-11	35813	To block; Improved design	
1	Water Pump Gasket	2013-11	35822	To block; Old design	
1	Water Pump Gasket	2013-11	ES 72872	O-ring	
QTY	TIMING COVER	YEARS	PART NO.	DESCRIPTION	
1	Crankshaft Front Seal Set	2013-11	TCS 46133		
QTY	CARB & FUEL INJECTION	YEARS	PART NO.	DESCRIPTION	
1	Throttle Body Gasket	2013-11	61504	Throttle body	
4		1995; 2.0L 121.9 (1998cc) SOHC L4 (8 Valve) 86mm Bore			4
		MFI; Gasoline; Naturally Aspirated Mazda Eng.; Eng. Code FE			
QTY	CYLINDER HEAD	YEARS	PART NO.	DESCRIPTION	
1	Head Gasket	1995	9422 PT		
1	Head Set	1995	HS 9422 PT-2	Exh. manifold gskt. & exh. pipe flange not incl.; PermaDry® molded rubber valve cover gskt. incl.; Premium valve stem seals incl.	
QTY	CONVERSION SET	YEARS	PART NO.	DESCRIPTION	
1	Gasket Conversion Set	1995	CS 9139		
QTY	MANIFOLD - INT. & EXH.	YEARS	PART NO.	DESCRIPTION	
1	Int. Manifold Gasket Set	1995	MS 93248	Upper set incl.	
1	Exh. Manifold Gasket Set	1995	MS 94697		
QTY	EXHAUST PIPE FLANGE	YEARS	PART NO.	DESCRIPTION	
1	Exhaust Pipe Gasket	1995	60817	Flange	
2	Exhaust Pipe Gasket	1995	60831	Converter	
QTY	FUEL PUMP	YEARS	PART NO.	DESCRIPTION	
2	Fuel Pump Mounting Gasket	1995	72611		
QTY	OIL PAN	YEARS	PART NO.	DESCRIPTION	
1	Oil Pan Gasket Set	1995	OS 30467 C		

Kia Truck (Incl. Minivans and SUV's) (Cont.)

4		1995; 2.0L 121.9 (1998cc) SOHC L4 (8 Valve) 86mm Bore			4
(cont.)		MFI; Gasoline; Naturally Aspirated Mazda Eng.; Eng. Code FE			(cont.)
QTY	CRANKSHAFT REAR SEAL	YEARS	PART NO.	DESCRIPTION	
1	Rear Main Seal Set	1995	BS 40421	Rubber; One-piece	
QTY	VALVE COVER	YEARS	PART NO.	DESCRIPTION	
1	Valve Cover Gasket Set	1995	VS 50238 R	w/o Grommets; Circular plug not incl.; PermaDry® molded rubber gskt. incl.	
1	Valve Cover Gasket Set	1995	VS 50424 R	w/Grommets; Circular plug not incl.; PermaDry® molded rubber gskt. incl.	
1	Grommet Set	1995	ES 70341	Valve Cover	
1	Circular Plug	1995	CP 75019	Valve Cover	
QTY	VALVE STEM SEAL SET	YEARS	PART NO.	DESCRIPTION	
1	Valve Stem Seal Set	1995	SS 72512	Premium valve stem seals incl.	
QTY	WATER OUTLET GASKET	YEARS	PART NO.	DESCRIPTION	
1	Water Outlet Gasket	1995	35251	Water Outlet	
QTY	WATER PUMP	YEARS	PART NO.	DESCRIPTION	
1	Water Pump Gasket	1995	35291	Outlet	
1	Water Pump Gasket	1995	35457	Inlet	
QTY	TIMING COVER	YEARS	PART NO.	DESCRIPTION	
1	Timing Cover Set	1995	TCS 45723	Camshaft; Front seal set	
1	Timing Cover Set	1995	TCS 45723	Crankshaft; Front seal set	
1	Timing Cover Dust Seal Set	1995	ES 72750		
1	Repair Sleeve	1995	16272	Timing Cover; Use w/installation tool	
QTY	CARB & FUEL INJECTION	YEARS	PART NO.	DESCRIPTION	
1	Fuel Injector O-Ring Set	1995	ES 70600		
1	Throttle Body Gasket	1995	60907		
QTY	EXHAUST GAS RECIRCULATION	YEARS	PART NO.	DESCRIPTION	
1	EGR Gasket	1995	70122		
5		2013 - 2012; 2.4L 144 (2359cc) DOHC L4 (16 Valve) 88mm Bore Theta GDi VVT			5
		DI; Gasoline; Naturally Aspirated Hyundai Eng.			
QTY	CYLINDER HEAD	YEARS	PART NO.	DESCRIPTION	
1	Head Bolt Set	2013-12	ES 72465-1	Head bolts w/Washers; Replacement recommended; New Part Number - Check for Availability	
QTY	MANIFOLD - INT. & EXH.	YEARS	PART NO.	DESCRIPTION	
1	Exh. Manifold Gasket Set	2013-12	MS 96874		
QTY	CRANKSHAFT REAR SEAL	YEARS	PART NO.	DESCRIPTION	
1	Rear Main Seal Set	2013-12	BS 40702	Rubber; One-piece	
QTY	VALVE STEM SEAL SET	YEARS	PART NO.	DESCRIPTION	
1	Valve Stem Seal Set	2013-12	SS 71268	Premium valve stem seals incl.	
QTY	THERMOSTAT HOUSING	YEARS	PART NO.	DESCRIPTION	
1	Thermostat Gasket	2013-12	35918	Thermostat Housing; Thermostat case	
1	Thermostat Gasket	2013-12	35921	Thermostat Housing; Thermostat O-ring	
QTY	WATER OUTLET GASKET	YEARS	PART NO.	DESCRIPTION	
1	Thermostat Gasket	2013-12	35368	Water Outlet; Inlet to water pump	
QTY	WATER PUMP	YEARS	PART NO.	DESCRIPTION	
1	Water Pump Gasket	2013-12	35802	To cover	
1	Water Pump Gasket	2013-12	35813	To block; Improved design	
1	Water Pump Gasket	2013-12	35822	To block; Old design	
1	Water Pump Gasket	2013-12	ES 72872	O-ring	
QTY	TIMING COVER	YEARS	PART NO.	DESCRIPTION	
1	Crankshaft Front Seal Set	2013-12	TCS 46133		
QTY	CARB & FUEL INJECTION	YEARS	PART NO.	DESCRIPTION	
2	Fuel Injector O-Ring Set	2013-12	ES 70599	Improved design	
6		2012 - 2011; 2.4L 144 (2359cc) DOHC L4 (16 Valve) 88mm Bore VVT			6
		MFI; Gasoline; Naturally Aspirated Hyundai Eng.; Eng. Code G4KC			
QTY	CYLINDER HEAD	YEARS	PART NO.	DESCRIPTION	
1	Head Gasket	2012-11	26333 PT	Head bolts not incl.; Head bolt replacement recommended; PermaTorqueMLS®	
1	Head Bolt Set	2012-11	ES 72465-1	Head bolts w/Washers; Replacement recommended; New Part Number - Check for Availability	
QTY	CONVERSION SET	YEARS	PART NO.	DESCRIPTION	
1	Gasket Conversion Set	2012-11	CS 26333-1	RTV sealant incl. for oil pan gskt.	
QTY	MANIFOLD - INT. & EXH.	YEARS	PART NO.	DESCRIPTION	
1	Int. Manifold Gasket Set	2012-11	MS 97100		
1	Exh. Manifold Gasket Set	2012-11	MS 96874		

Kia Truck (Incl. Minivans and SUV's) (Cont.)

6 (cont.)	2012 - 2011; 2.4L 144 (2359cc) DOHC L4 (16 Valve) 88mm Bore VVT MFI; Gasoline; Naturally Aspirated Hyundai Eng.; Eng. Code G4KC				6 (cont.)
QTY	EXHAUST PIPE FLANGE	YEARS	PART NO.	DESCRIPTION	
1	Exhaust Pipe Gasket	2012-11	61499	Exh. connector	
1	Exhaust Pipe Gasket	2012-11	61499	Loc. Rear; Converter	
1	Exhaust Pipe Gasket	2012-11	61503	Loc. Front; Converter	
1	Exhaust Pipe Gasket	2012-11	61503	Pipe to manifold	
QTY	OIL PAN	YEARS	PART NO.	DESCRIPTION	
1	Oil Pan Gasket Set	2012-11	OS 30778	RTV sealant incl. for oil pan gskt.; Old design	
1	Oil Pan Gasket Set	2012-11	OS 30782	RTV sealant incl. for oil pan gskt.; Improved design	
QTY	CRANKSHAFT REAR SEAL	YEARS	PART NO.	DESCRIPTION	
1	Rear Main Seal Set	2012-11	BS 40702	Rubber; One-piece	
QTY	VALVE STEM SEAL SET	YEARS	PART NO.	DESCRIPTION	
1	Valve Stem Seal Set	2012-11	SS 71268	Premium valve stem seals incl.	
QTY	THERMOSTAT HOUSING	YEARS	PART NO.	DESCRIPTION	
1	Thermostat Gasket	2012-11	35918	Thermostat Housing; Thermostat case	
1	Thermostat Gasket	2012-11	35921	Thermostat Housing; Thermostat O-ring	
QTY	WATER PUMP	YEARS	PART NO.	DESCRIPTION	
1	Water Pump Gasket	2012-11	35802	To cover	
1	Water Pump Gasket	2012-11	35813	To block; Improved design	
1	Water Pump Gasket	2012-11	35822	To block; Old design	
1	Water Pump Gasket	2012-11	ES 72872	O-ring	
QTY	TIMING COVER	YEARS	PART NO.	DESCRIPTION	
1	Crankshaft Front Seal Set	2012-11	TCS 46133		
QTY	CARB & FUEL INJECTION	YEARS	PART NO.	DESCRIPTION	
2	Fuel Injector O-Ring Set	2012-11	ES 70599	Improved design	
1	Throttle Body Gasket	2012-11	61504	Throttle body	
QTY	EXHAUST GAS RECIRCULATION	YEARS	PART NO.	DESCRIPTION	
1	EGR Gasket	2012-11	70152		
QTY	OIL FILTER MOUNTING	YEARS	PART NO.	DESCRIPTION	
1	Oil Filter Adapter Gasket	2012-11	72997	Oil filter adapter gskt.; New Part Number - Check for Availability	
7	2010 - 2005; 2.7L 162 (2656cc) DOHC V6 (24 Valve) 86.7mm Bore MFI; Gasoline; Naturally Aspirated Hyundai Eng.; Eng. Code G6BA				7
QTY	CYLINDER HEAD	YEARS	PART NO.	DESCRIPTION	
1	Head Gasket	2010-05	26276 PT	Loc. L.H.; Head bolts not incl.; Head bolt replacement recommended; PermaTorqueMLS®	
1	Head Gasket	2010-05	26277 PT	Loc. R.H.; Head bolts not incl.; Head bolt replacement recommended; PermaTorqueMLS®	
1	Head Set	2010	HS 26276 PT-2	Head bolts not incl.; Head bolt replacement recommended; PermaDry® molded rubber valve cover gskts. incl.; Premium valve stem seals incl.	
1	Head Set	2009	HS 26276 PT-1	To 02/17/09; Head bolts not incl.; Head bolt replacement recommended; PermaDry® molded rubber valve cover gskts. incl.; Premium valve stem seals incl.	
1	Head Set	2009	HS 26276 PT-2	From 02/18/09; Head bolts not incl.; Head bolt replacement recommended; PermaDry® molded rubber valve cover gskts. incl.; Premium valve stem seals incl.	
1	Head Set	2008-05	HS 26276 PT-1	Head bolts not incl.; Head bolt replacement recommended; PermaDry® molded rubber valve cover gskts. incl.; Premium valve stem seals incl.	
2	Head Bolt Set	2010-05	ES 72205	Head bolts w/Washers; Replacement recommended	
QTY	CONVERSION SET	YEARS	PART NO.	DESCRIPTION	
1	Gasket Conversion Set	2010-05	CS 26276	RTV sealant incl. for Upper oil pan gskt.	
QTY	MANIFOLD - INT. & EXH.	YEARS	PART NO.	DESCRIPTION	
1	Int. Manifold Gasket Set	2010	MS 97104	Upper set incl.	
1	Int. Manifold Gasket Set	2009	MS 96597	To 02/17/09; Upper set incl.	
1	Int. Manifold Gasket Set	2009	MS 97104	From 02/18/09; Upper set incl.	
1	Int. Manifold Gasket Set	2008-05	MS 96597	Upper set incl.	
1	Plenum Gasket Set	2010-05	MS 96591	Upper set	
1	Exh. Manifold Gasket Set	2010-05	MS 96598		
QTY	EXHAUST PIPE FLANGE	YEARS	PART NO.	DESCRIPTION	
1	Exhaust Pipe Gasket	2010-05	60899	Converter	
2	Exhaust Pipe Gasket	2010-05	60899	Exh. connector; 1 or 2 Req'd.	
1	Exhaust Pipe Gasket	2010-05	60899	Loc. L.H.; Flange	
1	Exhaust Pipe Gasket	2010-05	61381	Loc. R.H.; Flange	
QTY	OIL PAN	YEARS	PART NO.	DESCRIPTION	
1	Oil Pan Gasket Set	2010-05	OS 30753	Loc. Lower; RTV sealant incl. for Upper oil pan gskt.	
1	Drain Plug Gasket	2010-05	72515		

Kia Truck (Incl. Minivans and SUV's) (Cont.)

7		2010 - 2005; 2.7L 162 (2656cc) DOHC V6 (24 Valve) 86.7mm Bore			7
(cont.)		MFI; Gasoline; Naturally Aspirated Hyundai Eng.; Eng. Code G6BA			(cont.)
QTY	CRANKSHAFT REAR SEAL	YEARS	PART NO.	DESCRIPTION	
1	Rear Main Seal Set	2010-05	BS 40562	Rubber; One-piece	
QTY	VALVE COVER	YEARS	PART NO.	DESCRIPTION	
1	Valve Cover Gasket Set	2010-05	VS 50641 R	w/Spark plug tube seals; PermaDry® molded rubber gskts. incl.	
1	Circular Plug	2010-05	CP 75023	Valve Cover	
QTY	VALVE STEM SEAL SET	YEARS	PART NO.	DESCRIPTION	
1	Valve Stem Seal Set	2010-05	SS 72819	Premium valve stem seals incl.	
QTY	THERMOSTAT HOUSING	YEARS	PART NO.	DESCRIPTION	
1	Thermostat Gasket	2010	35917	Thermostat Housing	
2	Thermostat Gasket	2010	35920	Thermostat Housing; Thermostat case to head	
2	Thermostat Gasket	2009-08	35764	Thermostat Housing; To 07/14/08	
2	Thermostat Gasket	2009-08	35764	Thermostat Housing; To 07/14/08; Thermostat case to head	
1	Thermostat Gasket	2009-08	35917	Thermostat Housing; From 07/15/08	
2	Thermostat Gasket	2009-08	35920	Thermostat Housing; From 07/15/08; Thermostat case to head	
2	Thermostat Gasket	2007-05	35764	Thermostat Housing	
2	Thermostat Gasket	2007-05	35764	Thermostat Housing; Thermostat case to head	
1	O-Ring	2010-05	35555	Thermostat Housing; Thermostat seal	
QTY	WATER PUMP	YEARS	PART NO.	DESCRIPTION	
1	Water Pump Gasket	2010	35919		
1	Water Pump Gasket	2009	35765	To 09/30/08	
1	Water Pump Gasket	2009	35919	From 10/01/08	
1	Water Pump Gasket	2008-05	35765		
QTY	TIMING COVER	YEARS	PART NO.	DESCRIPTION	
1	Crankshaft Front Seal Set	2010-05	TCS 45911		
1	Camshaft Front Seal Set	2010-05	TCS 46053		
1	Camshaft Rear Seal Set	2010-05	TCS 46052		
QTY	CARB & FUEL INJECTION	YEARS	PART NO.	DESCRIPTION	
3	Fuel Injector O-Ring Set	2010-05	ES 70599	Improved design	
1	Throttle Body Gasket	2010-05	61245	Idle air control	
1	Throttle Body Gasket	2010-05	61380	Throttle body	
QTY	EXHAUST GAS RECIRCULATION	YEARS	PART NO.	DESCRIPTION	
1	EGR Gasket	2010-05	70152		
8		2010 - 2008; 3.3L 204 (3342cc) DOHC V6 (24 Valve) 92mm Bore Lambda			8
(cont.)		MFI; Gasoline; Naturally Aspirated Hyundai Eng.; Eng. Code G6DB			(cont.)
QTY	CYLINDER HEAD	YEARS	PART NO.	DESCRIPTION	
1	Head Gasket	2010-08	26427 PT	Loc. L.H.; Head bolts not incl.; Head bolt replacement recommended; PermaTorqueMLS®	
1	Head Gasket	2010-08	26429 PT	Loc. R.H.; Head bolts not incl.; Head bolt replacement recommended; PermaTorqueMLS®	
1	Head Set	2010-08	HS 26427 PT	Head bolts not incl.; Head bolt replacement recommended; PermaDry® molded rubber valve cover gskts. incl.; Premium valve stem seals incl.	
1	Head Bolt Set	2010-08	ES 72366	Replacement recommended	
QTY	CONVERSION SET	YEARS	PART NO.	DESCRIPTION	
1	Gasket Conversion Set	2010-08	CS 26414	RTV sealant incl. for Upper oil pan gskt.; New Part Number - Check for Availability	
QTY	MANIFOLD - INT. & EXH.	YEARS	PART NO.	DESCRIPTION	
1	Int. Manifold Gasket Set	2010-08	MS 97086	Lower set; Upper set incl.	
1	Plenum Gasket Set	2010-08	MS 97227	Upper set; New Part Number - Check for Availability	
1	Exh. Manifold Gasket Set	2010-08	MS 97074		
QTY	EXHAUST PIPE FLANGE	YEARS	PART NO.	DESCRIPTION	
1	Exhaust Pipe Gasket	2010-08	60899	Loc. Rear; Converter	
1	Exhaust Pipe Gasket	2010-08	61451	Exh. connector	
1	Exhaust Pipe Gasket	2010-08	61479	Loc. Front; Converter	
2	Exhaust Pipe Gasket	2010-08	61503	Loc. Rear; Pipe to manifold	
2	Exhaust Pipe Gasket	2010-08	61570	Loc. Front; Pipe to manifold	
QTY	OIL PAN	YEARS	PART NO.	DESCRIPTION	
1	Oil Pan Gasket Set	2010-08	OS 30822	Loc. Lower	
QTY	CRANKSHAFT REAR SEAL	YEARS	PART NO.	DESCRIPTION	
1	Rear Main Seal Set	2010-08	BS 40710	Rubber; One-piece	
QTY	VALVE COVER	YEARS	PART NO.	DESCRIPTION	
1	Valve Cover Gasket Set	2010-08	VS 50750 R	w/Spark plug tube seals; PermaDry® molded rubber gskts. incl.	
QTY	VALVE STEM SEAL SET	YEARS	PART NO.	DESCRIPTION	
1	Valve Stem Seal Set	2010-08	SS 72298	Premium valve stem seals incl.	

Kia Truck (Incl. Minivans and SUV's) (Cont.)

8		2010 - 2008; 3.3L 204 (3342cc) DOHC V6 (24 Valve) 92mm Bore Lambda			8
(cont.)		MFI; Gasoline; Naturally Aspirated Hyundai Eng.; Eng. Code G6DB			(cont.)
QTY	THERMOSTAT HOUSING	YEARS	PART NO.	DESCRIPTION	
1	Thermostat Gasket	2010-08	35933	Thermostat Housing	
QTY	WATER OUTLET GASKET	YEARS	PART NO.	DESCRIPTION	
1	Water Outlet Gasket	2010-08	35868	Water Outlet; Loc. L.H.	
1	Water Outlet Gasket	2010-08	35870	Water Outlet; Loc. R.H.	
1	Water Outlet Gasket	2010-08	35894	Water Outlet; O-ring; New Part Number - Check for Availability	
2	Water Outlet Gasket	2010-08	35959	Water Outlet; Water pipe; O-ring	
1	Water Crossover Mounting Set	2010-08	ES 72971	Water Outlet; New Part Number - Check for Availability	
QTY	WATER PUMP	YEARS	PART NO.	DESCRIPTION	
1	Water Pump Gasket	2010-08	35896	Loc. R.H.	
1	Water Pump Gasket	2010-08	35903	Loc. L.H.; New Part Number - Check for Availability	
QTY	TIMING COVER	YEARS	PART NO.	DESCRIPTION	
1	Crankshaft Front Seal Set	2010-08	TCS 46111		
QTY	CARB & FUEL INJECTION	YEARS	PART NO.	DESCRIPTION	
1	Throttle Body Gasket	2010-08	61562		
9		2013 - 2011; 3.5L 211.7 (3470cc) DOHC V6 (24 Valve) 92mm Bore Lambda VVT			9
(cont.)		MFI; Gasoline; Naturally Aspirated Hyundai Eng.; Eng. Code G6DC			(cont.)
QTY	CYLINDER HEAD	YEARS	PART NO.	DESCRIPTION	
1	Head Gasket	2011	26427 PT	Loc. L.H.; Head bolts not incl.; Head bolt replacement recommended; PermaTorqueMLS®	
1	Head Gasket	2011	26429 PT	Loc. R.H.; Head bolts not incl.; Head bolt replacement recommended; PermaTorqueMLS®	
1	Head Set	2011	HS 26427 PT-1	Kia Sedona EX, LX; Head bolts not incl.; Head bolt replacement recommended; PermaDry® molded rubber valve cover gskts. incl.; Premium valve stem seals incl.; OEM style; New Part Number - Check for Availability	
1	Head Bolt Set	2011	ES 72366	Replacement recommended	
QTY	MANIFOLD - INT. & EXH.	YEARS	PART NO.	DESCRIPTION	
1	Int. Manifold Gasket Set	2011	MS 97322	Exc. Kia Sedona EX, LX; Lower set; Upper set incl.; OEM style; New Part Number - Check for Availability	
1	Exh. Manifold Gasket Set	2013-11	MS 97115		
QTY	EXHAUST PIPE FLANGE	YEARS	PART NO.	DESCRIPTION	
2	Exhaust Pipe Gasket	2013-11	61503	Loc. Rear; Converter	
2	Exhaust Pipe Gasket	2013	61604	Exh. connector	
2	Exhaust Pipe Gasket	2013	61604	Loc. Front; Converter	
2	Exhaust Pipe Gasket	2013	61730	Flange; New Part Number - Check for Availability	
2	Exhaust Pipe Gasket	2012-11	61499	Kia Sedona EX, LX; Loc. Front; Converter	
2	Exhaust Pipe Gasket	2012-11	61503	Kia Sedona EX, LX; Exh. connector	
2	Exhaust Pipe Gasket	2012-11	61604	Exc. Kia Sedona EX, LX; Exh. connector	
2	Exhaust Pipe Gasket	2012-11	61604	Exc. Kia Sedona EX, LX; Loc. Front; Converter	
2	Exhaust Pipe Gasket	2012-11	61730	Exc. Kia Sedona EX, LX; Flange; New Part Number - Check for Availability	
QTY	CRANKSHAFT REAR SEAL	YEARS	PART NO.	DESCRIPTION	
1	Rear Main Seal Set	2013-11	BS 40562	Rubber; One-piece	
QTY	VALVE COVER	YEARS	PART NO.	DESCRIPTION	
1	Valve Cover Gasket Set	2013-11	VS 50764 R	w/Spark plug tube seals; PermaDry® molded rubber gskts. incl.; New Part Number - Check for Availability	
QTY	VALVE STEM SEAL SET	YEARS	PART NO.	DESCRIPTION	
1	Valve Stem Seal Set	2013-11	SS 72298	Premium valve stem seals incl.	
QTY	WATER OUTLET GASKET	YEARS	PART NO.	DESCRIPTION	
1	Water Crossover Mounting Set	2013-11	ES 73007	Water Outlet; New Part Number - Check for Availability	
QTY	WATER PUMP	YEARS	PART NO.	DESCRIPTION	
1	Water Pump Gasket	2013-11	35896	Loc. R.H.	
1	Water Pump Gasket	2013-11	35935	Loc. L.H.	
QTY	TIMING COVER	YEARS	PART NO.	DESCRIPTION	
1	Crankshaft Front Seal Set	2013-11	TCS 46111		
QTY	CARB & FUEL INJECTION	YEARS	PART NO.	DESCRIPTION	
3	Fuel Injector O-Ring Set	2013-11	ES 70599	Improved design	
1	Throttle Body Gasket	2013	61566		
1	Throttle Body Gasket	2012-11	61560	Kia Sedona EX, LX	
1	Throttle Body Gasket	2012-11	61566	Exc. Kia Sedona EX, LX	

Kia Truck (Incl. Minivans and SUV's) (Cont.)

10		2006 - 2002; 3.5L 213.3 (3497cc) DOHC V6 (24 Valve) 93mm Bore			10
MFI; Gasoline; Naturally Aspirated Mitsubishi Eng.; Eng. Code G6CU					
QTY	CYLINDER HEAD	YEARS	PART NO.	DESCRIPTION	
1	Head Gasket	2006-02	26293 PT	Loc. R.H.; Head bolts not incl.; Head bolt replacement recommended; PermaTorqueMLS®	
1	Head Gasket	2006-02	26294 PT	Loc. L.H.; Head bolts not incl.; Head bolt replacement recommended; PermaTorqueMLS®	
1	Head Set	2006	HS 26293 PT-2	Head bolts not incl.; Head bolt replacement recommended; PermaDry® molded rubber valve cover gskts. incl.; Premium valve stem seals incl.	
1	Head Set	2005-03	HS 26293 PT-1	Kia Sedona EX, LX; Head bolts not incl.; Head bolt replacement recommended; PermaDry® molded rubber valve cover gskts. incl.; Premium valve stem seals incl.	
1	Head Set	2005-04	HS 26293 PT-2	Exc. Kia Sedona EX, LX; Head bolts not incl.; Head bolt replacement recommended; PermaDry® molded rubber valve cover gskts. incl.; Premium valve stem seals incl.	
1	Head Set	2003	HS 26293 PT-2	Kia Sorento EX, LX; Head bolts not incl.; Head bolt replacement recommended; PermaDry® molded rubber valve cover gskts. incl.; Premium valve stem seals incl.	
1	Head Set	2002	HS 26293 PT-1	Head bolts not incl.; Head bolt replacement recommended; PermaDry® molded rubber valve cover gskts. incl.; Premium valve stem seals incl.	
1	Head Bolt Set	2006-02	ES 72859	Head bolts w/Washers; Replacement recommended	
QTY	CONVERSION SET	YEARS	PART NO.	DESCRIPTION	
1	Gasket Conversion Set	2006	CS 26293-1	RTV sealant incl. for Upper oil pan gskt.	
1	Gasket Conversion Set	2005-03	CS 26293-2	Kia Sedona EX, LX; RTV sealant incl. for Upper oil pan gskt.; Improved design	
1	Gasket Conversion Set	2005-04	CS 26293-1	Exc. Kia Sedona EX, LX; RTV sealant incl. for Upper oil pan gskt.	
1	Gasket Conversion Set	2003	CS 26293-1	Kia Sorento EX, LX; RTV sealant incl. for Upper oil pan gskt.	
1	Gasket Conversion Set	2002	CS 26293-2	RTV sealant incl. for Upper oil pan gskt.; Improved design	
QTY	MANIFOLD - INT. & EXH.	YEARS	PART NO.	DESCRIPTION	
1	Int. Manifold Gasket Set	2006	MS 96460-1	Lower set; Upper set incl.	
1	Int. Manifold Gasket Set	2005-03	MS 96460	Kia Sedona EX, LX; Lower set; Upper set incl.	
1	Int. Manifold Gasket Set	2005-04	MS 96460-1	Exc. Kia Sedona EX, LX; Lower set; Upper set incl.	
1	Int. Manifold Gasket Set	2003	MS 96460-1	Kia Sorento EX, LX; Lower set; Upper set incl.	
1	Int. Manifold Gasket Set	2002	MS 96460	Lower set; Upper set incl.	
1	Plenum Gasket Set	2006	MS 96741	Upper set; Old design; Superseded - When depleted use MS 97135	
1	Plenum Gasket Set	2006	MS 97135	Upper set; Improved design	
1	Plenum Gasket Set	2005-03	MS 95008	Kia Sedona EX, LX; Upper set	
1	Plenum Gasket Set	2005-04	MS 96741	Exc. Kia Sedona EX, LX; Upper set; Old design; Superseded - When depleted use MS 97135	
1	Plenum Gasket Set	2005-04	MS 97135	Exc. Kia Sedona EX, LX; Upper set; Improved design	
1	Plenum Gasket Set	2003	MS 96741	Kia Sorento EX, LX; Upper set; Old design; Superseded - When depleted use MS 97135	
1	Plenum Gasket Set	2003	MS 97135	Kia Sorento EX, LX; Upper set; Improved design	
1	Plenum Gasket Set	2002	MS 95008	Upper set	
1	Exh. Manifold Gasket Set	2006-02	MS 95082		
QTY	EXHAUST PIPE FLANGE	YEARS	PART NO.	DESCRIPTION	
2	Exhaust Pipe Gasket	2006-02	60899	Flange	
1	Exhaust Pipe Gasket	2006-02	60899	Loc. Front; Exh. connector	
1	Exhaust Pipe Gasket	2006-02	61383	Loc. Rear; Exh. connector	
1	Exhaust Pipe Gasket	2006	61479	Loc. Front; Converter	
1	Exhaust Pipe Gasket	2005-03	60899	Kia Sedona EX, LX; Loc. Front; Converter	
1	Exhaust Pipe Gasket	2005-03	61268	Kia Sedona EX, LX; Loc. Rear; Converter	
2	Exhaust Pipe Gasket	2005-03	61429	Kia Sedona EX, LX; Converter case; Flange	
1	Exhaust Pipe Gasket	2005-04	61479	Exc. Kia Sedona EX, LX; Loc. Front; Converter	
1	Exhaust Pipe Gasket	2003	61479	Kia Sorento EX, LX; Loc. Front; Converter	
1	Exhaust Pipe Gasket	2002	60899	Loc. Front; Converter	
1	Exhaust Pipe Gasket	2002	61268	Loc. Rear; Converter	
2	Exhaust Pipe Gasket	2002	61429	Converter case; Flange	
QTY	OIL PAN	YEARS	PART NO.	DESCRIPTION	
1	Oil Pan Gasket Set	2006	OS 30771	Loc. Lower; RTV sealant incl. for Upper oil pan gskt.	
1	Oil Pan Gasket Set	2005-03	OS 30762	Kia Sedona EX, LX; Loc. Lower; RTV sealant incl. for Upper oil pan gskt.	
1	Oil Pan Gasket Set	2005-04	OS 30771	Exc. Kia Sedona EX, LX; Loc. Lower; RTV sealant incl. for Upper oil pan gskt.	
1	Oil Pan Gasket Set	2003	OS 30771	Kia Sorento EX, LX; Loc. Lower; RTV sealant incl. for Upper oil pan gskt.	
1	Oil Pan Gasket Set	2002	OS 30762	Loc. Lower; RTV sealant incl. for Upper oil pan gskt.	
1	Drain Plug Gasket	2006-02	72515		
QTY	CRANKSHAFT REAR SEAL	YEARS	PART NO.	DESCRIPTION	
1	Rear Main Seal Set	2006-02	BS 40562	Rubber; One-piece	

Kia Truck (Incl. Minivans and SUV's) (Cont.)

10 (cont.)	2006 - 2002; 3.5L 213.3 (3497cc) DOHC V6 (24 Valve) 93mm Bore			10 (cont.)
QTY VALVE COVER	YEARS	PART NO.	DESCRIPTION	
1 Valve Cover Gasket Set	2006-02	VS 50658 R-2	w/Grommets & Spark plug tube seals; PermaDry® molded rubber gskts. incl.	
4 Circular Plug	2006-02	CP 75023	Valve Cover	
QTY VALVE STEM SEAL SET	YEARS	PART NO.	DESCRIPTION	
1 Valve Stem Seal Set	2006-02	SS 71179	Premium valve stem seals incl.	
QTY THERMOSTAT HOUSING	YEARS	PART NO.	DESCRIPTION	
2 Thermostat Gasket	2006-02	35764	Thermostat Housing	
2 Thermostat Gasket	2006-02	35764	Thermostat Housing; Thermostat case to head	
2 Thermostat Gasket	2006	35825	Thermostat Housing; Thermostat case	
2 Thermostat Gasket	2005-04	35825	Exc. Kia Sedona EX, LX; Thermostat Housing; Thermostat case	
2 Thermostat Gasket	2003	35825	Kia Sorento EX, LX; Thermostat Housing; Thermostat case	
1 O-Ring	2006-02	35555	Thermostat Housing; Thermostat seal	
QTY WATER OUTLET GASKET	YEARS	PART NO.	DESCRIPTION	
2 Water Outlet Gasket	2006-02	35959	Water Outlet; Water pipe; O-ring	
QTY WATER PUMP	YEARS	PART NO.	DESCRIPTION	
1 Water Pump Gasket	2006-02	35787		
QTY TIMING COVER	YEARS	PART NO.	DESCRIPTION	
1 Crankshaft Front Seal Set	2006-02	TCS 46085	Improved design	
2 Camshaft Front Seal Set	2006-02	TCS 46053		
QTY CARB & FUEL INJECTION	YEARS	PART NO.	DESCRIPTION	
3 Fuel Injector O-Ring Set	2006-02	ES 70599	Improved design	
1 Throttle Body Gasket	2006-02	61416		
QTY EXHAUST GAS RECIRCULATION	YEARS	PART NO.	DESCRIPTION	
1 EGR Gasket	2006-02	70568	Tube	
QTY OIL PUMP COVER	YEARS	PART NO.	DESCRIPTION	
1 Oil Pump Gasket	2006-02	71262	Oil pump mounting; New Part Number - Check for Availability	
11	2011 - 2006; 3.8L 230 (3778cc) DOHC V6 (24 Valve) 96mm Bore Lambda			11
QTY CYLINDER HEAD	YEARS	PART NO.	DESCRIPTION	
1 Head Gasket	2011-06	26416 PT	Loc. R.H.; Head bolts not incl.; Head bolt replacement recommended; PermaTorqueMLS®	
1 Head Gasket	2011-08	26420 PT	Loc. L.H.; Head bolts not incl.; Head bolt replacement recommended; PermaTorqueMLS®	
1 Head Gasket	2007	26414 PT	Loc. L.H.; To 04/20/07; Head bolts not incl.; Head bolt replacement recommended; PermaTorqueMLS®	
1 Head Gasket	2007	26420 PT	Loc. L.H.; From 04/21/07; Head bolts not incl.; Head bolt replacement recommended; PermaTorqueMLS®	
1 Head Gasket	2006	26414 PT	Loc. L.H.; Head bolts not incl.; Head bolt replacement recommended; PermaTorqueMLS®	
1 Head Set	2011	HS 26420 PT-1	Head bolts not incl.; Head bolt replacement recommended; PermaDry® molded rubber valve cover gskts. incl.; Premium valve stem seals incl.; New Part Number - Check for Availability	
1 Head Set	2010	HS 26420 PT	Exc. Kia Borrego EX, LX; Head bolts not incl.; Head bolt replacement recommended; PermaDry® molded rubber valve cover gskts. incl.; Premium valve stem seals incl.	
1 Head Set	2010	HS 26420 PT-1	Kia Borrego EX, LX; Head bolts not incl.; Head bolt replacement recommended; PermaDry® molded rubber valve cover gskts. incl.; Premium valve stem seals incl.; New Part Number - Check for Availability	
1 Head Set	2009	HS 26420 PT	Exc. Kia Borrego EX, Limited, LX; Head bolts not incl.; Head bolt replacement recommended; PermaDry® molded rubber valve cover gskts. incl.; Premium valve stem seals incl.	
1 Head Set	2009	HS 26420 PT-1	Kia Borrego EX, Limited, LX; Head bolts not incl.; Head bolt replacement recommended; PermaDry® molded rubber valve cover gskts. incl.; Premium valve stem seals incl.; New Part Number - Check for Availability	
1 Head Set	2008	HS 26420 PT	Head bolts not incl.; Head bolt replacement recommended; PermaDry® molded rubber valve cover gskts. incl.; Premium valve stem seals incl.	
1 Head Set	2007	HS 26414 PT	To 04/20/07; Head bolts not incl.; Head bolt replacement recommended; PermaDry® molded rubber valve cover gskts. incl.; Premium valve stem seals incl.	
1 Head Set	2007	HS 26420 PT	From 04/21/07; Head bolts not incl.; Head bolt replacement recommended; PermaDry® molded rubber valve cover gskts. incl.; Premium valve stem seals incl.	
1 Head Set	2006	HS 26414 PT	Head bolts not incl.; Head bolt replacement recommended; PermaDry® molded rubber valve cover gskts. incl.; Premium valve stem seals incl.	

Kia Truck (Incl. Minivans and SUV's) (Cont.)

11		2011 - 2006; 3.8L 230 (3778cc) DOHC V6 (24 Valve) 96mm Bore Lambda			11	
(cont.)		MFI; Gasoline; Naturally Aspirated Hyundai Eng.; Eng. Code G6DA			(cont.)	
QTY	CYLINDER HEAD	YEARS	PART NO.	DESCRIPTION		
1	Head Bolt Set	2011-06	ES 72366	Replacement recommended		
QTY	CONVERSION SET	YEARS	PART NO.	DESCRIPTION		
1	Gasket Conversion Set	2011	CS 26420-2	RTV sealant incl. for Upper oil pan gskt.; New Part Number - Check for Availability		
1	Gasket Conversion Set	2010	CS 26414	Exc. Kia Borrego EX, LX; RTV sealant incl. for Upper oil pan gskt.; New Part Number - Check for Availability		
1	Gasket Conversion Set	2010	CS 26420-2	Kia Borrego EX, LX; RTV sealant incl. for Upper oil pan gskt.; New Part Number - Check for Availability		
1	Gasket Conversion Set	2009	CS 26414	Exc. Kia Borrego EX, Limited, LX; RTV sealant incl. for Upper oil pan gskt.; New Part Number - Check for Availability		
1	Gasket Conversion Set	2009	CS 26420-2	Kia Borrego EX, Limited, LX; RTV sealant incl. for Upper oil pan gskt.; New Part Number - Check for Availability		
1	Gasket Conversion Set	2008-06	CS 26414	RTV sealant incl. for Upper oil pan gskt.; New Part Number - Check for Availability		
QTY	MANIFOLD - INT. & EXH.	YEARS	PART NO.	DESCRIPTION		
1	Int. Manifold Gasket Set	2011	MS 97086-1	Lower set; Upper set incl.; New Part Number - Check for Availability		
1	Int. Manifold Gasket Set	2011	MS 97321	Lower set; Upper set incl.; OEM style; New Part Number - Check for Availability		
1	Int. Manifold Gasket Set	2010	MS 97086	Exc. Kia Borrego EX, LX; Lower set; Upper set incl.		
1	Int. Manifold Gasket Set	2010	MS 97086-1	Kia Borrego EX, LX; Lower set; Upper set incl.; New Part Number - Check for Availability		
1	Int. Manifold Gasket Set	2010	MS 97320	Exc. Kia Borrego EX, LX; Lower set; Upper set incl.; OEM style; New Part Number - Check for Availability		
1	Int. Manifold Gasket Set	2010	MS 97321	Kia Borrego EX, LX; Lower set; Upper set incl.; OEM style; New Part Number - Check for Availability		
1	Int. Manifold Gasket Set	2009	MS 97086	Exc. Kia Borrego EX, Limited, LX; Lower set; Upper set incl.		
1	Int. Manifold Gasket Set	2009	MS 97086-1	Kia Borrego EX, Limited, LX; Lower set; Upper set incl.; New Part Number - Check for Availability		
1	Int. Manifold Gasket Set	2009	MS 97320	Exc. Kia Borrego EX, Limited, LX; Lower set; Upper set incl.; OEM style; New Part Number - Check for Availability		
1	Int. Manifold Gasket Set	2009	MS 97321	Kia Borrego EX, Limited, LX; Lower set; Upper set incl.; OEM style; New Part Number - Check for Availability		
1	Int. Manifold Gasket Set	2008-06	MS 97086	Lower set; Upper set incl.		
1	Plenum Gasket Set	2011	MS 97099	Upper set; New Part Number - Check for Availability		
1	Plenum Gasket Set	2010	MS 97099	Kia Borrego EX, LX; Upper set; New Part Number - Check for Availability		
1	Plenum Gasket Set	2010	MS 97227	Exc. Kia Borrego EX, LX; Upper set; New Part Number - Check for Availability		
1	Plenum Gasket Set	2009	MS 97099	Kia Borrego EX, Limited, LX; Upper set; New Part Number - Check for Availability		
1	Plenum Gasket Set	2009	MS 97227	Exc. Kia Borrego EX, Limited, LX; Upper set; New Part Number - Check for Availability		
1	Plenum Gasket Set	2008-06	MS 97227	Upper set; New Part Number - Check for Availability		
1	Exh. Manifold Gasket Set	2011	MS 97115			
1	Exh. Manifold Gasket Set	2010	MS 97074	Exc. Kia Borrego EX, LX		
1	Exh. Manifold Gasket Set	2010	MS 97115	Kia Borrego EX, LX		
1	Exh. Manifold Gasket Set	2009	MS 97074	Exc. Kia Borrego EX, Limited, LX		
1	Exh. Manifold Gasket Set	2009	MS 97115	Kia Borrego EX, Limited, LX		
1	Exh. Manifold Gasket Set	2008-06	MS 97074			
QTY	EXHAUST PIPE FLANGE	YEARS	PART NO.	DESCRIPTION		
2	Exhaust Pipe Gasket	2011-09	61568	Pipe to manifold		
1	Exhaust Pipe Gasket	2011	61499	Converter		
1	Exhaust Pipe Gasket	2011	61604	Exh. connector		
1	Exhaust Pipe Gasket	2010-08	61479	Kia Sorento EX; Exh. connector		
1	Exhaust Pipe Gasket	2010-08	61567	Kia Sorento EX; Converter		
1	Exhaust Pipe Gasket	2010-09	61383	Kia Sedona Base, EX, LX; Exh. connector		
1	Exhaust Pipe Gasket	2010-09	61568	Kia Sedona Base, EX, LX; Converter		
1	Exhaust Pipe Gasket	2010	61499	Kia Borrego EX, LX; Converter		
1	Exhaust Pipe Gasket	2010	61604	Kia Borrego EX, LX; Exh. connector		
1	Exhaust Pipe Gasket	2009	61499	Kia Borrego EX, Limited, LX; Converter		
1	Exhaust Pipe Gasket	2009	61604	Kia Borrego EX, Limited, LX; Exh. connector		
1	Exhaust Pipe Gasket	2008	61383	Exc. Kia Sorento EX; Exh. connector		
1	Exhaust Pipe Gasket	2008	61568	Exc. Kia Sorento EX; Converter		
2	Exhaust Pipe Gasket	2008	61568	Kia Sorento EX; Pipe to manifold		
1	Exhaust Pipe Gasket	2007	61383	Kia Sedona Base, EX, LX; Exh. connector		
1	Exhaust Pipe Gasket	2007	61479	Kia Sorento Base, EX, LX; Exh. connector		

Kia Truck (Incl. Minivans and SUV's) (Cont.)

11		2011 - 2006; 3.8L 230 (3778cc) DOHC V6 (24 Valve) 96mm Bore Lambda			11
(cont.)		MFI; Gasoline; Naturally Aspirated Hyundai Eng.; Eng. Code G6DA			(cont.)
QTY	EXHAUST PIPE FLANGE	YEARS	PART NO.	DESCRIPTION	
1	Exhaust Pipe Gasket	2007	61567	Kia Sorento Base, EX, LX; Converter	
1	Exhaust Pipe Gasket	2007	61568	Kia Sedona Base, EX, LX; Converter	
2	Exhaust Pipe Gasket	2007	61568	Kia Sorento Base, EX, LX; Pipe to manifold	
1	Exhaust Pipe Gasket	2006	61383	Exh. connector	
1	Exhaust Pipe Gasket	2006	61568	Converter	
QTY	OIL PAN	YEARS	PART NO.	DESCRIPTION	
1	Oil Pan Gasket Set	2011	OS 30823	Loc. Lower	
1	Oil Pan Gasket Set	2010	OS 30822	Exc. Kia Borrego EX, LX; Loc. Lower	
1	Oil Pan Gasket Set	2010	OS 30823	Kia Borrego EX, LX; Loc. Lower	
1	Oil Pan Gasket Set	2009	OS 30822	Exc. Kia Borrego EX, Limited, LX; Loc. Lower	
1	Oil Pan Gasket Set	2009	OS 30823	Kia Borrego EX, Limited, LX; Loc. Lower	
1	Oil Pan Gasket Set	2008-06	OS 30822	Loc. Lower	
QTY	CRANKSHAFT REAR SEAL	YEARS	PART NO.	DESCRIPTION	
1	Rear Main Seal Set	2011	BS 40727	Rubber; One-piece	
1	Rear Main Seal Set	2010	BS 40710	Exc. Kia Borrego EX, LX; Rubber; One-piece	
1	Rear Main Seal Set	2010	BS 40727	Kia Borrego EX, LX; Rubber; One-piece	
1	Rear Main Seal Set	2009	BS 40710	Exc. Kia Borrego EX, Limited, LX; Rubber; One-piece	
1	Rear Main Seal Set	2009	BS 40727	Kia Borrego EX, Limited, LX; Rubber; One-piece	
1	Rear Main Seal Set	2008-06	BS 40710	Rubber; One-piece	
QTY	VALVE COVER	YEARS	PART NO.	DESCRIPTION	
1	Valve Cover Gasket Set	2011	VS 50764 R	w/Spark plug tube seals; PermaDry® molded rubber gskts. incl.; New Part Number - Check for Availability	
1	Valve Cover Gasket Set	2010	VS 50750 R	Exc. Kia Borrego EX, LX; w/Spark plug tube seals; PermaDry® molded rubber gskts. incl.	
1	Valve Cover Gasket Set	2010	VS 50764 R	Kia Borrego EX, LX; w/Spark plug tube seals; PermaDry® molded rubber gskts. incl.; New Part Number - Check for Availability	
1	Valve Cover Gasket Set	2009	VS 50750 R	Exc. Kia Borrego EX, Limited, LX; w/Spark plug tube seals; PermaDry® molded rubber gskts. incl.	
1	Valve Cover Gasket Set	2009	VS 50764 R	Kia Borrego EX, Limited, LX; w/Spark plug tube seals; PermaDry® molded rubber gskts. incl.; New Part Number - Check for Availability	
1	Valve Cover Gasket Set	2008-06	VS 50750 R	w/Spark plug tube seals; PermaDry® molded rubber gskts. incl.	
QTY	VALVE STEM SEAL SET	YEARS	PART NO.	DESCRIPTION	
1	Valve Stem Seal Set	2011-06	SS 72298	Premium valve stem seals incl.	
QTY	THERMOSTAT HOUSING	YEARS	PART NO.	DESCRIPTION	
1	Thermostat Gasket	2011-08	35933	Thermostat Housing	
QTY	WATER OUTLET GASKET	YEARS	PART NO.	DESCRIPTION	
1	Water Outlet Gasket	2011-06	35870	Water Outlet; Loc. R.H.	
1	Water Outlet Gasket	2011-06	35894	Water Outlet; O-ring; New Part Number - Check for Availability	
2	Water Outlet Gasket	2011-06	35959	Water Outlet; Water pipe; O-ring	
1	Water Outlet Gasket	2011-06	35868	Water Outlet; Loc. L.H.	
1	Water Crossover Mounting Set	2011-06	ES 72971	Water Outlet; New Part Number - Check for Availability	
QTY	WATER PUMP	YEARS	PART NO.	DESCRIPTION	
1	Water Pump Gasket	2011-06	35896	Loc. R.H.	
1	Water Pump Gasket	2011-10	35935	Loc. L.H.	
1	Water Pump Gasket	2009-06	35903	Loc. L.H.; New Part Number - Check for Availability	
QTY	TIMING COVER	YEARS	PART NO.	DESCRIPTION	
1	Crankshaft Front Seal Set	2011-06	TCS 46111		
QTY	CARB & FUEL INJECTION	YEARS	PART NO.	DESCRIPTION	
1	Throttle Body Gasket	2011	61613		
1	Throttle Body Gasket	2010-08	61562	Kia Sorento EX	
1	Throttle Body Gasket	2010	61613	Exc. Kia Sorento EX	
1	Throttle Body Gasket	2009	61560	Kia Sedona Base, EX, LX; To 01/06/09	
1	Throttle Body Gasket	2009	61613	Kia Borrego EX, Limited, LX	
1	Throttle Body Gasket	2009	61613	Kia Sedona Base, EX, LX; From 01/07/09	
1	Throttle Body Gasket	2008	61560	Exc. Kia Sorento EX	
1	Throttle Body Gasket	2007	61560	Kia Sedona Base, EX, LX	
1	Throttle Body Gasket	2007	61562	Kia Sorento Base, EX, LX	
1	Throttle Body Gasket	2006	61560		
12		2011 - 2009; 4.6L 282.4 (4627cc) DOHC V8 (32 Valve) 92mm Bore Tau VVT			12
(cont.)		MFI; Gasoline; Naturally Aspirated Hyundai Eng.; Eng. Code G8BA			(cont.)
QTY	EXHAUST PIPE FLANGE	YEARS	PART NO.	DESCRIPTION	
2	Exhaust Pipe Gasket	2011-09	61499	Loc. Front; Secondary converter	
2	Exhaust Pipe Gasket	2011-09	61499	Loc. Rear; Converter	

Kia Truck (Incl. Minivans and SUV's) (Cont.)

12 (cont.)		2011 - 2009; 4.6L 282.4 (4627cc) DOHC V8 (32 Valve) 92mm Bore Tau VVT MFI; Gasoline; Naturally Aspirated Hyundai Eng.; Eng. Code G8BA			12 (cont.)	
QTY	EXHAUST PIPE FLANGE	YEARS	PART NO.	DESCRIPTION		
2	Exhaust Pipe Gasket	2011-09	61499	Loc. Rear; Secondary converter		
QTY	CRANKSHAFT REAR SEAL	YEARS	PART NO.	DESCRIPTION		
1	Rear Main Seal Set	2011-09	BS 40727	Rubber; One-piece		

LaForza SUV's - See LaForza Truck

LaForza Truck (Incl. SUV's)

Engine Finding Index						
Engine	Years	Code	Line No.			
5.0L 302 (4950cc) OHV V8 (16 Valve) 4" Bore; MFI; Gasoline; Naturally Aspirated Ford Eng.	2001-91		1			
5.0L 302 (4950cc) OHV V8 (16 Valve) 4" Bore; MFI; Gasoline; Supercharged Ford Eng.	2001-98		2			
Model Index						
Engine (VIN Code / Eng. Code)	Year	Engine (VIN Code / Eng. Code)	Year	Engine (VIN Code / Eng. Code)	Year	
LaForza Truck		LaForza Truck (cont.)		LaForza Truck (cont.)		
		LaForza		LaForza (cont.)		
		V8 302CI 5.0L OHV	01-89	V8 302CI 5.0L OHV Supercharged	01-98	

1		2001 - 1991; 5.0L 302 (4950cc) OHV V8 (16 Valve) 4" Bore MFI; Gasoline; Naturally Aspirated Ford Eng.			1	
QTY	CYLINDER HEAD	YEARS	PART NO.	DESCRIPTION		
2	Head Gasket	2001-91	8548 PT-2	Head bolts not incl.; Head bolt replacement recommended; PermaTorque®		
2	Head Gasket	2001-91	9333 PT-1	H/D eng.; Head bolts not incl.; Head bolt replacement recommended		
2	Head Gasket Spacer Shim	2001-91	8548 SP-1	HeadSaver®		
1	Head Set	2001-97	HS 8548 PT-14	Head bolts not incl.; Head bolt replacement recommended; Premium valve stem seals incl.		
1	Head Set	1996-91	HS 8548 PT-13	Head bolts not incl.; Head bolt replacement recommended; Premium valve stem seals incl.		
2	Head Bolt Set	2001-92	ES 72155	Flanged hex head; Replacement required		
1	Dowel Pin	2001-94	ES 70744	Cylinder Head; Cyl. head alignment		
1	Dowel Pin	1993	ES 70744	Cylinder Head; From 05/09/93; Cyl. head alignment		
QTY	CONVERSION SET	YEARS	PART NO.	DESCRIPTION		
1	Gasket Conversion Set	2001-91	CS 8548-9	Water pump to plate gskt. not incl.; PermaDry® molded rubber oil pan gskt. incl.		
1	Gasket Conversion Set	1994-91	CS 8548-2	Water pump to plate gskt. not incl.; Multi-piece oil pan gskt. incl.		
QTY	MANIFOLD - INT. & EXH.	YEARS	PART NO.	DESCRIPTION		
1	Int. Manifold Gasket Set	2001-97	MS 95952	Lower set; Upper set incl.		
1	Int. Manifold Gasket Set	1996-91	MS 94951	Lower set; Upper set incl.		
1	Plenum Gasket Set	2001-97	MS 95953	Upper set		
1	Plenum Gasket Set	1996-91	MS 93834	Upper set		
1	Exh. Manifold Gasket Set	2001-97	MS 95954			
1	Exh. Manifold Gasket Set	1996-91	MS 90000			
QTY	EXHAUST PIPE FLANGE	YEARS	PART NO.	DESCRIPTION		
1	Exh. Flange Bolt & Spring Kit	1999-91	ES 72142			
QTY	OIL PAN	YEARS	PART NO.	DESCRIPTION		
1	Oil Pan Gasket Set	2001-91	OS 34508 R	PermaDry® one-piece molded rubber gskt. incl.; Improved design		
1	Oil Pan Gasket Set	1994-91	OS 13260 C	Multi-piece; Cork		
1	Drain Plug Gasket	2001-91	70822			
QTY	CRANKSHAFT REAR SEAL	YEARS	PART NO.	DESCRIPTION		
1	Rear Main Seal Set	2001-91	BS 40620	Rubber; One-piece; Improved design		
1	Rear Main Seal Set	2001-91	BS 40644	PTFE Rubber; One-piece		
1	Repair Sleeve	2001-91	16250	Crankshaft; Use w/installation tool		
1	Repair Sleeve Tool	2001-91	16300	Crankshaft		
QTY	VALVE COVER	YEARS	PART NO.	DESCRIPTION		
1	Valve Cover Gasket Set	2001-91	VS 13264 T	Must be used w/MS 93834 or w/MS 95953; PermaDryPlus®; Improved design		
1	Valve Cover Gasket Set	2001-91	VS 50029 C	Must be used w/MS 93834 or w/MS 95953; Hi-Temp.; w/Compression stops		
QTY	VALVE STEM SEAL SET	YEARS	PART NO.	DESCRIPTION		
2	Valve Stem Seal Set	2001-91	SS 72683	Loc. Int. & Exh.; Premium valve stem seals incl.		
QTY	WATER OUTLET GASKET	YEARS	PART NO.	DESCRIPTION		
1	Water Outlet Gasket	2001-91	35440	Water Outlet		
QTY	WATER PUMP	YEARS	PART NO.	DESCRIPTION		
1	Water Pump Gasket	2001-97	35352	Plate to block		

1		2001 - 1991; 5.0L 302 (4950cc) OHV V8 (16 Valve) 4" Bore			1
(cont.)		MFI; Gasoline; Naturally Aspirated Ford Eng.			(cont.)
QTY	WATER PUMP	YEARS	PART NO.	DESCRIPTION	
1	Water Pump Gasket	1996-91	35380	Pump to plate	
1	Water Pump Gasket	1996-91	35397	Plate to block	
QTY	TIMING COVER	YEARS	PART NO.	DESCRIPTION	
1	Timing Cover Set	2001-91	TCS 45449	w/o Sleeve 'N' Seal®; Eng. w/one-piece oil pan gskt. must be used w/OS 34508R; Water pump to plate gskt. not incl.	
1	Timing Set w/Sleeve & Seal	2001-91	TCS 45450	w/Sleeve 'N' Seal®; Eng. w/one-piece oil pan gskt. must be used w/OS 34508R; Water pump to plate gskt. not incl.	
1	Repair Sleeve	2001-91	16213	Timing Cover; Use w/installation tool	
1	Repair Sleeve Tool	2001-91	16310	Timing Cover	
QTY	CARB & FUEL INJECTION	YEARS	PART NO.	DESCRIPTION	
2	Fuel Injector O-Ring Set	2001-91	ES 70599	Improved design	
1	Throttle Body Gasket	2001-91	71216	Air bypass valve	
1	Throttle Body Gasket	2001-97	61081	EGR housing to plenum	
1	Throttle Body Gasket	2001-97	61082	Throttle body to EGR housing	
1	Throttle Body Gasket	1996-91	60845	Throttle body mounting	
QTY	DISTRIBUTOR MOUNTING	YEARS	PART NO.	DESCRIPTION	
1	O-Ring	2001-91	5511	Distributor Mounting	
QTY	EXHAUST GAS RECIRCULATION	YEARS	PART NO.	DESCRIPTION	
1	EGR Gasket	2001-97	70149		
1	EGR Gasket	1996-91	72649		
QTY	OIL PUMP COVER	YEARS	PART NO.	DESCRIPTION	
1	Oil Pump Gasket	2001-91	72516	Inlet tube	
2		2001 - 1998; 5.0L 302 (4950cc) OHV V8 (16 Valve) 4" Bore			2
(cont.)		MFI; Gasoline; Supercharged Ford Eng.			(cont.)
QTY	CYLINDER HEAD	YEARS	PART NO.	DESCRIPTION	
2	Head Gasket	2001-98	8548 PT-2	Head bolts not incl.; Head bolt replacement recommended; PermaTorque®	
2	Head Gasket	2001-98	9333 PT-1	H/D eng.; Head bolts not incl.; Head bolt replacement recommended	
2	Head Gasket Spacer Shim	2001-98	8548 SP-1	HeadSaver®	
1	Head Set	2001-98	HS 8548 PT-14	Head bolts not incl.; Head bolt replacement recommended; Premium valve stem seals incl.	
2	Head Bolt Set	2001-98	ES 72155	Flanged hex head; Replacement required	
1	Dowel Pin	2001-98	ES 70744	Cylinder Head; Cyl. head alignment	
QTY	CONVERSION SET	YEARS	PART NO.	DESCRIPTION	
1	Gasket Conversion Set	2001-98	CS 8548-9	Water pump to plate gskt. not incl.; PermaDry® molded rubber oil pan gskt. incl.	
QTY	MANIFOLD - INT. & EXH.	YEARS	PART NO.	DESCRIPTION	
1	Int. Manifold Gasket Set	2001-98	MS 95952	Lower set; Upper set incl.	
1	Plenum Gasket Set	2001-98	MS 95953	Upper set	
1	Exh. Manifold Gasket Set	2001-98	MS 95954		
QTY	EXHAUST PIPE FLANGE	YEARS	PART NO.	DESCRIPTION	
1	Exh. Flange Bolt & Spring Kit	1999-98	ES 72142		
QTY	OIL PAN	YEARS	PART NO.	DESCRIPTION	
1	Oil Pan Gasket Set	2001-98	OS 34508 R	PermaDry® one-piece molded rubber gskt. incl.; Improved design	
1	Drain Plug Gasket	2001-98	70822		
QTY	CRANKSHAFT REAR SEAL	YEARS	PART NO.	DESCRIPTION	
1	Rear Main Seal Set	2001-98	BS 40620	Rubber; One-piece; Improved design	
1	Rear Main Seal Set	2001-98	BS 40644	PTFE Rubber; One-piece	
1	Repair Sleeve	2001-98	16250	Crankshaft; Use w/installation tool	
1	Repair Sleeve Tool	2001-98	16300	Crankshaft	
QTY	VALVE COVER	YEARS	PART NO.	DESCRIPTION	
1	Valve Cover Gasket Set	2001-98	VS 13264 T	Must be used w/MS 95953; PermaDryPlus®; Improved design	
1	Valve Cover Gasket Set	2001-98	VS 50029 C	Must be used w/MS 95953; Hi-Temp.; w/Compression stops	
QTY	VALVE STEM SEAL SET	YEARS	PART NO.	DESCRIPTION	
2	Valve Stem Seal Set	2001-98	SS 72683	Loc. Int. & Exh.; Premium valve stem seals incl.	
QTY	WATER OUTLET GASKET	YEARS	PART NO.	DESCRIPTION	
1	Water Outlet Gasket	2001-98	35440	Water Outlet	
QTY	WATER PUMP	YEARS	PART NO.	DESCRIPTION	
1	Water Pump Gasket	2001-98	35352	Plate to block	
QTY	TIMING COVER	YEARS	PART NO.	DESCRIPTION	
1	Timing Cover Set	2001-98	TCS 45449	w/o Sleeve 'N' Seal®; Eng. w/one-piece oil pan gskt. must be used w/OS 34508R; Water pump to plate gskt. not incl.	

LaForza Truck (Incl. SUV's) (Cont.)

2 (cont.)		2001 - 1998; 5.0L 302 (4950cc) OHV V8 (16 Valve) 4" Bore			2 (cont.)
MFI; Gasoline; Supercharged Ford Eng.					
QTY	TIMING COVER	YEARS	PART NO.	DESCRIPTION	
1	Timing Set w/Sleeve & Seal	2001-98	TCS 45450	w/Sleeve 'N' Seal®; Eng. w/one-piece oil pan gskt. must be used w/OS 34508R; Water pump to plate gskt. not incl.	
1	Repair Sleeve	2001-98	16213	Timing Cover; Use w/installation tool	
1	Repair Sleeve Tool	2001-98	16310	Timing Cover	
QTY	CARB & FUEL INJECTION	YEARS	PART NO.	DESCRIPTION	
2	Fuel Injector O-Ring Set	2001-98	ES 70599	Improved design	
1	Throttle Body Gasket	2001-98	61081	EGR housing to plenum	
1	Throttle Body Gasket	2001-98	61082	Throttle body to EGR housing	
1	Throttle Body Gasket	2001-98	71216	Air bypass valve	
QTY	DISTRIBUTOR MOUNTING	YEARS	PART NO.	DESCRIPTION	
1	O-Ring	2001-98	5511	Distributor Mounting	
QTY	EXHAUST GAS RECIRCULATION	YEARS	PART NO.	DESCRIPTION	
1	EGR Gasket	2001-98	70149		
QTY	OIL PUMP COVER	YEARS	PART NO.	DESCRIPTION	
1	Oil Pump Gasket	2001-98	72516	Inlet tube	

Land Rover SUV's - See Land Rover Truck

Land Rover Truck (Incl. SUV's)

Engine Finding Index			
Engine	Years	Code	Line No.
2.5L 152.4 (2497cc) DOHC V6 (24 Valve) 80mm Bore; MFI; Gasoline; Naturally Aspirated Rover Eng.	2005-02	KV6	1
3.2L 194.8 (3192cc) DOHC L6 (24 Valve) 84mm Bore; MFI; Gasoline; Naturally Aspirated Volvo Eng.	2012-08	B6324S	2
3.9L 241 (3948cc) OHV V8 (16 Valve) 94mm Bore; MFI; Gasoline; Naturally Aspirated Rover Eng.; Buick	1995-93	29G	3
3.9L 241 (3948cc) OHV V8 (16 Valve) 94mm Bore; MFI; Gasoline; Naturally Aspirated Rover Eng.; Buick	1995-94	35D	4
3.9L 241 (3948cc) OHV V8 (16 Valve) 94mm Bore; MFI; Gasoline; Naturally Aspirated Rover Eng.; Buick	1995-93	36D	5
3.9L 241 (3948cc) OHV V8 (16 Valve) 94mm Bore; MFI; Gasoline; Naturally Aspirated Rover Eng.; Buick	1992-91	38D	6
3.9L 241 (3948cc) OHV V8 (16 Valve) 94mm Bore; MFI; Gasoline; Naturally Aspirated Rover Eng.; Buick	2000-96	42D	7
3.9L 241 (3948cc) OHV V8 (16 Valve) 94mm Bore; MFI; Gasoline; Naturally Aspirated Rover Eng.; Buick	1999-96	50D	8
3.9L 241 (3948cc) OHV V8 (16 Valve) 94mm Bore; MFI; Gasoline; Naturally Aspirated Rover Eng.; Buick	2002-00	56D	9
4.0L 244 (4015cc) SOHC V6 (12 Valve) 100.4mm Bore; MFI; Gasoline; Naturally Aspirated Ford Eng.	2009-05	F40	10
4.3L 261 (4275cc) OHV V8 (16 Valve) 94mm Bore; MFI; Gasoline; Naturally Aspirated Rover Eng.; Buick	1995-93	40D	11
4.3L 261 (4275cc) OHV V8 (16 Valve) 94mm Bore; MFI; Gasoline; Naturally Aspirated Rover Eng.; Buick	1995	42D	12
4.4L 268.4 (4398cc) DOHC V8 (32 Valve) 92mm Bore; MFI; Gasoline; Naturally Aspirated BMW Eng.	2005-03	M62B44	13
4.6L 278 (4554cc) OHV V8 (16 Valve) 94mm Bore; MFI; Gasoline; Naturally Aspirated Rover Eng.; Buick	2004-96	46D	14

Engine Code Index			
Code	Engine	Line No.	
29G	3.9L 241 (3948cc) OHV V8 (16 Valve) 94mm Bore; MFI; Gasoline; Naturally Aspirated Rover Eng.; Buick	3	
35D	3.9L 241 (3948cc) OHV V8 (16 Valve) 94mm Bore; MFI; Gasoline; Naturally Aspirated Rover Eng.; Buick	4	
36D	3.9L 241 (3948cc) OHV V8 (16 Valve) 94mm Bore; MFI; Gasoline; Naturally Aspirated Rover Eng.; Buick	5	
38D	3.9L 241 (3948cc) OHV V8 (16 Valve) 94mm Bore; MFI; Gasoline; Naturally Aspirated Rover Eng.; Buick	6	
40D	4.3L 261 (4275cc) OHV V8 (16 Valve) 94mm Bore; MFI; Gasoline; Naturally Aspirated Rover Eng.; Buick	11	
42D	3.9L 241 (3948cc) OHV V8 (16 Valve) 94mm Bore; MFI; Gasoline; Naturally Aspirated Rover Eng.; Buick	7	
42D	4.3L 261 (4275cc) OHV V8 (16 Valve) 94mm Bore; MFI; Gasoline; Naturally Aspirated Rover Eng.; Buick	12	
46D	4.6L 278 (4554cc) OHV V8 (16 Valve) 94mm Bore; MFI; Gasoline; Naturally Aspirated Rover Eng.; Buick	14	
50D	3.9L 241 (3948cc) OHV V8 (16 Valve) 94mm Bore; MFI; Gasoline; Naturally Aspirated Rover Eng.; Buick	8	
56D	3.9L 241 (3948cc) OHV V8 (16 Valve) 94mm Bore; MFI; Gasoline; Naturally Aspirated Rover Eng.; Buick	9	
B6324S	3.2L 194.8 (3192cc) DOHC L6 (24 Valve) 84mm Bore; MFI; Gasoline; Naturally Aspirated Volvo Eng.	2	
F40	4.0L 244 (4015cc) SOHC V6 (12 Valve) 100.4mm Bore; MFI; Gasoline; Naturally Aspirated Ford Eng.	10	
KV6	2.5L 152.4 (2497cc) DOHC V6 (24 Valve) 80mm Bore; MFI; Gasoline; Naturally Aspirated Rover Eng.	1	
M62B44	4.4L 268.4 (4398cc) DOHC V8 (32 Valve) 92mm Bore; MFI; Gasoline; Naturally Aspirated BMW Eng.	13	

Model Index					
Engine (VIN Code / Eng. Code)	Year	Engine (VIN Code / Eng. Code)	Year	Engine (VIN Code / Eng. Code)	Year
Land Rover Truck		Land Rover Truck (cont.)		Land Rover Truck (cont.)	
Defender (AWD Mid-Size SUV)		Freelander (AWD Compact SUV)		Range Rover (AWD Full-Size SUV)	
V8 3948cc 3.9L OHV (16 Valve) (29G)	95-93	V6 2497cc 2.5L DOHC (24 Valve) (KV6)	05-02	V8 3948cc 3.9L OHV (16 Valve) (36D)	95-93
V8 3948cc 3.9L OHV (16 Valve) (50D)	97	LR2 (AWD Compact SUV)		V8 3948cc 3.9L OHV (16 Valve) (38D)	92-89
Discovery (AWD Mid-Size SUV)		L4 1999cc 2.0L DOHC Turbo (16 Valve) (Si4)	13	V8 3948cc 3.9L OHV (16 Valve) (42D)	00-96
V8 3948cc 3.9L OHV (16 Valve) (35D)	95-94	L6 3192cc 3.2L DOHC (24 Valve) (B6324S)	12-08	V8 4196cc 4.2L DOHC Supercharged (32 Valve) (AJ34 4.2SC)	09-06
V8 3948cc 3.9L OHV (16 Valve) (36D)	95-94	LR3 (AWD Mid-Size SUV)		V8 4275cc 4.3L OHV (16 Valve) (40D)	95-93
V8 3948cc 3.9L OHV (16 Valve) (50D)	99-96	V6 4015cc 4.0L SOHC (12 Valve) (F40)	08-05	V8 4275cc 4.3L OHV (16 Valve) (42D)	95
V8 3948cc 3.9L OHV (16 Valve) (56D)	02-00	V8 4394cc 4.4L DOHC (32 Valve) (AJ34 4.4)	09-05	V8 4394cc 4.4L DOHC (32 Valve) (AJ34 4.4)	09-06
V8 4554cc 4.6L OHV (16 Valve) (46D)	04-03	LR4 (AWD Mid-Size SUV)			
		V8 4997cc 5.0L DOHC (32 Valve) (AJ133 5.0)	13-10		

Land Rover Truck (Incl. SUV's) (Cont.)

Model Index (Cont.)					
Engine (VIN Code / Eng. Code)	Year	Engine (VIN Code / Eng. Code)	Year	Engine (VIN Code / Eng. Code)	Year
Land Rover Truck (cont.)		Land Rover Truck (cont.)			
Range Rover (AWD Full-Size SUV) (cont.)		Range Rover Sport (AWD Mid-Size SUV)			
V8 4398cc 4.4L DOHC (32 Valve) (M62B44)	05-03	V8 4196cc 4.2L DOHC Supercharged (32 Valve) (AJ34 4.2SC)	09-06		
V8 4554cc 4.6L OHV (16 Valve) (46D)	02-96	V8 4394cc 4.4L DOHC (32 Valve) (AJ34 4.4)	09-06		
V8 4997cc 5.0L DOHC (32 Valve) (AJ133 5.0)	13-10	V8 4997cc 5.0L DOHC (32 Valve) (AJ133 5.0)	13-10		
V8 4997cc 5.0L DOHC Supercharged (32 Valve) (AJ133 5.0SC)	13-10	V8 4997cc 5.0L DOHC Supercharged (32 Valve) (AJ133 5.0SC)	13-10		
Range Rover Evoque (AWD Compact SUV)					
L4 1999cc 2.0L DOHC Turbo (16 Valve) (Si4)	13-12				
1	2005 - 2002; 2.5L 152.4 (2497cc) DOHC V6 (24 Valve) 80mm Bore MFI; Gasoline; Naturally Aspirated Rover Eng.; Eng. Code KV6				1
QTY	CYLINDER HEAD	YEARS	PART NO.	DESCRIPTION	
2	Head Gasket	2005-02	26652 PT	Head bolts not incl.; Head bolt replacement recommended; PermaTorqueMLS®; New Part Number - Check for Availability	
QTY	MANIFOLD - INT. & EXH.	YEARS	PART NO.	DESCRIPTION	
1	Int. Manifold Gasket Set	2005-02	MS 97309	Lower set; New Part Number - Check for Availability	
1	Exh. Manifold Gasket Set	2005-02	MS 97278	New Part Number - Check for Availability	
QTY	VALVE COVER	YEARS	PART NO.	DESCRIPTION	
2	Valve Cover Gasket Set	2005-02	VS 50853	New Part Number - Check for Availability	
QTY	TIMING COVER	YEARS	PART NO.	DESCRIPTION	
4	Camshaft Rear Seal Set	2005-02	TCS 46191	New Part Number - Check for Availability	
2	2012 - 2008; 3.2L 194.8 (3192cc) DOHC L6 (24 Valve) 84mm Bore MFI; Gasoline; Naturally Aspirated Volvo Eng.; Eng. Code B6324S				2
QTY	CYLINDER HEAD	YEARS	PART NO.	DESCRIPTION	
1	Head Gasket	2012-08	26602 PT	Head bolts not incl.; Head bolt replacement recommended; PermaTorqueMLS®; New Part Number - Check for Availability	
QTY	CONVERSION SET	YEARS	PART NO.	DESCRIPTION	
1	Gasket Conversion Set	2012-08	CS 26602	Rear main brg. seal not incl.; RTV sealant incl. for oil pan gskt.; New Part Number - Check for Availability	
QTY	MANIFOLD - INT. & EXH.	YEARS	PART NO.	DESCRIPTION	
1	Exh. Manifold Gasket Set	2012-08	MS 97279	New Part Number - Check for Availability	
QTY	VALVE COVER	YEARS	PART NO.	DESCRIPTION	
1	Valve Cover Gasket Set	2012-08	VS 50856 R	w/Grommets & Spark plug tube seals; RTV sealant incl. for valve cover gskt.; PermaDry® molded rubber gskt. incl.; New Part Number - Check for Availability	
3	1995 - 1993; 3.9L 241 (3948cc) OHV V8 (16 Valve) 94mm Bore MFI; Gasoline; Naturally Aspirated Rover Eng.; Buick; Eng. Code 29G				3
QTY	CYLINDER HEAD	YEARS	PART NO.	DESCRIPTION	
2	Head Gasket	1995	26532 PT	Head bolts not incl.; Head bolt replacement recommended; New Part Number - Check for Availability	
2	Head Gasket	1994	26532 PT	From 02/01/94; Head bolts not incl.; Head bolt replacement recommended; New Part Number - Check for Availability	
2	Head Gasket	1994	26651 PT	To 01/31/94; Head bolts not incl.; Head bolt replacement recommended; New Part Number - Check for Availability	
2	Head Gasket	1993	26651 PT	Head bolts not incl.; Head bolt replacement recommended; New Part Number - Check for Availability	
1	Head Set	1995	HS 26436 PT	Head bolts not incl.; Head bolt replacement recommended; PermaDry® molded rubber valve cover gskts. incl.; Premium valve stem seals incl.	
1	Head Set	1994	HS 26436 PT	From 02/01/94; Head bolts not incl.; Head bolt replacement recommended; PermaDry® molded rubber valve cover gskts. incl.; Premium valve stem seals incl.	
QTY	CONVERSION SET	YEARS	PART NO.	DESCRIPTION	
1	Gasket Conversion Set	1995	CS 26436		
1	Gasket Conversion Set	1994	CS 26436	From 02/01/94	
QTY	MANIFOLD - INT. & EXH.	YEARS	PART NO.	DESCRIPTION	
1	Valley Pan Gasket Set	1995-93	MS 97186	Lower set; New Part Number - Check for Availability	
1	Exh. Manifold Gasket Set	1995-93	MS 97185		
QTY	CRANKSHAFT REAR SEAL	YEARS	PART NO.	DESCRIPTION	
1	Rear Main Seal Set	1995-93	BS 40750	Rubber; One-piece; New Part Number - Check for Availability	
QTY	VALVE COVER	YEARS	PART NO.	DESCRIPTION	
1	Valve Cover Gasket Set	1995-93	VS 50789 R	PermaDry® molded rubber gskts. incl.	
QTY	WATER PUMP	YEARS	PART NO.	DESCRIPTION	
1	Water Pump Gasket	1995-93	35911	New Part Number - Check for Availability	

Land Rover Truck (Incl. SUV's) (Cont.)

3		1995 - 1993; 3.9L 241 (3948cc) OHV V8 (16 Valve) 94mm Bore			3	
(cont.)		MFI; Gasoline; Naturally Aspirated Rover Eng.; Buick; Eng. Code 29G			(cont.)	
QTY	TIMING COVER	YEARS	PART NO.	DESCRIPTION		
1	Crankshaft Front Seal Set	1995-93	TCS 46190	New Part Number - Check for Availability		
4		1995 - 1994; 3.9L 241 (3948cc) OHV V8 (16 Valve) 94mm Bore			4	
(cont.)		MFI; Gasoline; Naturally Aspirated Rover Eng.; Buick; Eng. Code 35D			(cont.)	
QTY	CYLINDER HEAD	YEARS	PART NO.	DESCRIPTION		
2	Head Gasket	1995	26532 PT	Head bolts not incl.; Head bolt replacement recommended; New Part Number - Check for Availability		
2	Head Gasket	1994	26532 PT	From 02/01/94; Head bolts not incl.; Head bolt replacement recommended; New Part Number - Check for Availability		
2	Head Gasket	1994	26651 PT	To 01/31/94; Head bolts not incl.; Head bolt replacement recommended; New Part Number - Check for Availability		
1	Head Set	1995	HS 26436 PT	Head bolts not incl.; Head bolt replacement recommended; PermaDry® molded rubber valve cover gskts. incl.; Premium valve stem seals incl.		
1	Head Set	1994	HS 26436 PT	From 02/01/94; Head bolts not incl.; Head bolt replacement recommended; PermaDry® molded rubber valve cover gskts. incl.; Premium valve stem seals incl.		
QTY	CONVERSION SET	YEARS	PART NO.	DESCRIPTION		
1	Gasket Conversion Set	1995	CS 26436			
1	Gasket Conversion Set	1994	CS 26436	From 02/01/94		
QTY	MANIFOLD - INT. & EXH.	YEARS	PART NO.	DESCRIPTION		
1	Valley Pan Gasket Set	1995-94	MS 97186	Lower set; New Part Number - Check for Availability		
1	Exh. Manifold Gasket Set	1995-94	MS 97185			
QTY	CRANKSHAFT REAR SEAL	YEARS	PART NO.	DESCRIPTION		
1	Rear Main Seal Set	1995-94	BS 40750	Rubber; One-piece; New Part Number - Check for Availability		
QTY	VALVE COVER	YEARS	PART NO.	DESCRIPTION		
1	Valve Cover Gasket Set	1995-94	VS 50789 R	PermaDry® molded rubber gskts. incl.		
QTY	WATER PUMP	YEARS	PART NO.	DESCRIPTION		
1	Water Pump Gasket	1995-94	35911	New Part Number - Check for Availability		
QTY	TIMING COVER	YEARS	PART NO.	DESCRIPTION		
1	Crankshaft Front Seal Set	1995-94	TCS 46190	New Part Number - Check for Availability		
5		1995 - 1993; 3.9L 241 (3948cc) OHV V8 (16 Valve) 94mm Bore			5	
(cont.)		MFI; Gasoline; Naturally Aspirated Rover Eng.; Buick; Eng. Code 36D			(cont.)	
QTY	CYLINDER HEAD	YEARS	PART NO.	DESCRIPTION		
2	Head Gasket	1995	26532 PT	Head bolts not incl.; Head bolt replacement recommended; New Part Number - Check for Availability		
2	Head Gasket	1994	26532 PT	From 02/01/94; Head bolts not incl.; Head bolt replacement recommended; New Part Number - Check for Availability		
2	Head Gasket	1994	26651 PT	To 01/31/94; Head bolts not incl.; Head bolt replacement recommended; New Part Number - Check for Availability		
2	Head Gasket	1993	26651 PT	Head bolts not incl.; Head bolt replacement recommended; New Part Number - Check for Availability		
1	Head Set	1995	HS 26436 PT	Head bolts not incl.; Head bolt replacement recommended; PermaDry® molded rubber valve cover gskts. incl.; Premium valve stem seals incl.		
1	Head Set	1994	HS 26436 PT	From 02/01/94; Head bolts not incl.; Head bolt replacement recommended; PermaDry® molded rubber valve cover gskts. incl.; Premium valve stem seals incl.		
QTY	CONVERSION SET	YEARS	PART NO.	DESCRIPTION		
1	Gasket Conversion Set	1995	CS 26436			
1	Gasket Conversion Set	1994	CS 26436	From 02/01/94		
QTY	MANIFOLD - INT. & EXH.	YEARS	PART NO.	DESCRIPTION		
1	Valley Pan Gasket Set	1995-93	MS 97186	Lower set; New Part Number - Check for Availability		
1	Exh. Manifold Gasket Set	1995-94	MS 97185			
QTY	CRANKSHAFT REAR SEAL	YEARS	PART NO.	DESCRIPTION		
1	Rear Main Seal Set	1995-93	BS 40750	Rubber; One-piece; New Part Number - Check for Availability		
QTY	VALVE COVER	YEARS	PART NO.	DESCRIPTION		
1	Valve Cover Gasket Set	1995-93	VS 50789 R	PermaDry® molded rubber gskts. incl.		
QTY	WATER PUMP	YEARS	PART NO.	DESCRIPTION		
1	Water Pump Gasket	1995-93	35911	New Part Number - Check for Availability		
QTY	TIMING COVER	YEARS	PART NO.	DESCRIPTION		
1	Crankshaft Front Seal Set	1995-93	TCS 46190	New Part Number - Check for Availability		

Land Rover Truck (Incl. SUV's) (Cont.)

6		1992 - 1991; 3.9L 241 (3948cc) OHV V8 (16 Valve) 94mm Bore			6
		MFI; Gasoline; Naturally Aspirated Rover Eng.; Buick; Eng. Code 38D			
QTY	CYLINDER HEAD	YEARS	PART NO.	DESCRIPTION	
2	Head Gasket	1992-91	26651 PT	Head bolts not incl.; Head bolt replacement recommended; New Part Number - Check for Availability	
QTY	MANIFOLD - INT. & EXH.	YEARS	PART NO.	DESCRIPTION	
1	Valley Pan Gasket Set	1992-91	MS 97186	Lower set; New Part Number - Check for Availability	
QTY	CRANKSHAFT REAR SEAL	YEARS	PART NO.	DESCRIPTION	
1	Rear Main Seal Set	1992-91	BS 40750	Rubber; One-piece; New Part Number - Check for Availability	
QTY	VALVE COVER	YEARS	PART NO.	DESCRIPTION	
1	Valve Cover Gasket Set	1992-91	VS 50789 R	PermaDry® molded rubber gskts. incl.	
QTY	WATER PUMP	YEARS	PART NO.	DESCRIPTION	
1	Water Pump Gasket	1992-91	35911	New Part Number - Check for Availability	
QTY	TIMING COVER	YEARS	PART NO.	DESCRIPTION	
1	Crankshaft Front Seal Set	1992-91	TCS 46190	New Part Number - Check for Availability	
7		2000 - 1996; 3.9L 241 (3948cc) OHV V8 (16 Valve) 94mm Bore			7
		MFI; Gasoline; Naturally Aspirated Rover Eng.; Buick; Eng. Code 42D			
QTY	CYLINDER HEAD	YEARS	PART NO.	DESCRIPTION	
2	Head Gasket	2000-96	26532 PT	Head bolts not incl.; Head bolt replacement recommended; New Part Number - Check for Availability	
1	Head Set	2000-96	HS 26436 PT	Head bolts not incl.; Head bolt replacement recommended; PermaDry® molded rubber valve cover gskts. incl.; Premium valve stem seals incl.	
QTY	CONVERSION SET	YEARS	PART NO.	DESCRIPTION	
1	Gasket Conversion Set	2000-96	CS 26436	Oil pan gskt. for Bosch Injected eng. not incl.	
QTY	MANIFOLD - INT. & EXH.	YEARS	PART NO.	DESCRIPTION	
1	Valley Pan Gasket Set	2000-96	MS 97186	Lower set; New Part Number - Check for Availability	
1	Plenum Gasket Set	2000-96	MS 97221	Upper set; New Part Number - Check for Availability	
1	Exh. Manifold Gasket Set	2000-96	MS 97185		
QTY	OIL PAN	YEARS	PART NO.	DESCRIPTION	
1	Oil Pan Gasket Set	2000-96	OS 30861 R	Oil pan gskt. for Bosch Injected eng.; PermaDry® molded rubber gskt. incl.; New Part Number - Check for Availability	
QTY	CRANKSHAFT REAR SEAL	YEARS	PART NO.	DESCRIPTION	
1	Rear Main Seal Set	2000-96	BS 40750	Rubber; One-piece; New Part Number - Check for Availability	
QTY	VALVE COVER	YEARS	PART NO.	DESCRIPTION	
1	Valve Cover Gasket Set	2000-96	VS 50789 R	PermaDry® molded rubber gskts. incl.	
QTY	WATER PUMP	YEARS	PART NO.	DESCRIPTION	
1	Water Pump Gasket	2000-96	35911	New Part Number - Check for Availability	
QTY	TIMING COVER	YEARS	PART NO.	DESCRIPTION	
1	Crankshaft Front Seal Set	2000-96	TCS 46190	New Part Number - Check for Availability	
8		1999 - 1996; 3.9L 241 (3948cc) OHV V8 (16 Valve) 94mm Bore			8
		MFI; Gasoline; Naturally Aspirated Rover Eng.; Buick; Eng. Code 50D			
QTY	CYLINDER HEAD	YEARS	PART NO.	DESCRIPTION	
2	Head Gasket	1999-96	26532 PT	Head bolts not incl.; Head bolt replacement recommended; New Part Number - Check for Availability	
1	Head Set	1999-96	HS 26436 PT	Head bolts not incl.; Head bolt replacement recommended; PermaDry® molded rubber valve cover gskts. incl.; Premium valve stem seals incl.	
QTY	CONVERSION SET	YEARS	PART NO.	DESCRIPTION	
1	Gasket Conversion Set	1999-96	CS 26436	Oil pan gskt. for Bosch Injected eng. not incl.	
QTY	MANIFOLD - INT. & EXH.	YEARS	PART NO.	DESCRIPTION	
1	Valley Pan Gasket Set	1999-96	MS 97186	Lower set; New Part Number - Check for Availability	
1	Plenum Gasket Set	1999-96	MS 97221	Upper set; New Part Number - Check for Availability	
1	Exh. Manifold Gasket Set	1999-96	MS 97185		
QTY	OIL PAN	YEARS	PART NO.	DESCRIPTION	
1	Oil Pan Gasket Set	1999-96	OS 30861 R	Oil pan gskt. for Bosch Injected eng.; PermaDry® molded rubber gskt. incl.; New Part Number - Check for Availability	
QTY	CRANKSHAFT REAR SEAL	YEARS	PART NO.	DESCRIPTION	
1	Rear Main Seal Set	1999-96	BS 40750	Rubber; One-piece; New Part Number - Check for Availability	
QTY	VALVE COVER	YEARS	PART NO.	DESCRIPTION	
1	Valve Cover Gasket Set	1999-96	VS 50789 R	PermaDry® molded rubber gskts. incl.	
QTY	WATER PUMP	YEARS	PART NO.	DESCRIPTION	
1	Water Pump Gasket	1999-96	35911	New Part Number - Check for Availability	
QTY	TIMING COVER	YEARS	PART NO.	DESCRIPTION	
1	Crankshaft Front Seal Set	1999-96	TCS 46190	New Part Number - Check for Availability	

Land Rover Truck (Incl. SUV's) (Cont.)

9		2002 - 2000; 3.9L 241 (3948cc) OHV V8 (16 Valve) 94mm Bore			9
MFI; Gasoline; Naturally Aspirated Rover Eng.; Buick; Eng. Code 56D					
QTY	CYLINDER HEAD	YEARS	PART NO.	DESCRIPTION	
2	Head Gasket	2002-00	26532 PT	Head bolts not incl.; Head bolt replacement recommended; New Part Number - Check for Availability	
1	Head Set	2002-00	HS 26436 PT	Head bolts not incl.; Head bolt replacement recommended; PermaDry® molded rubber valve cover gskts. incl.; Premium valve stem seals incl.	
QTY	CONVERSION SET	YEARS	PART NO.	DESCRIPTION	
1	Gasket Conversion Set	2002-00	CS 26436	Oil pan gskt. for Bosch Injected eng. not incl.	
QTY	MANIFOLD - INT. & EXH.	YEARS	PART NO.	DESCRIPTION	
1	Valley Pan Gasket Set	2002-00	MS 97186	Lower set; New Part Number - Check for Availability	
1	Plenum Gasket Set	2002-00	MS 97221	Upper set; New Part Number - Check for Availability	
1	Exh. Manifold Gasket Set	2002-00	MS 97185		
QTY	OIL PAN	YEARS	PART NO.	DESCRIPTION	
1	Oil Pan Gasket Set	2002-00	OS 30861 R	Oil pan gskt. for Bosch Injected eng.; PermaDry® molded rubber gskt. incl.; New Part Number - Check for Availability	
QTY	CRANKSHAFT REAR SEAL	YEARS	PART NO.	DESCRIPTION	
1	Rear Main Seal Set	2002-00	BS 40750	Rubber; One-piece; New Part Number - Check for Availability	
QTY	VALVE COVER	YEARS	PART NO.	DESCRIPTION	
1	Valve Cover Gasket Set	2002-00	VS 50789 R	PermaDry® molded rubber gskts. incl.	
QTY	WATER PUMP	YEARS	PART NO.	DESCRIPTION	
1	Water Pump Gasket	2002-00	35911	New Part Number - Check for Availability	
QTY	TIMING COVER	YEARS	PART NO.	DESCRIPTION	
1	Crankshaft Front Seal Set	2002-00	TCS 46190	New Part Number - Check for Availability	
10		2009 - 2005; 4.0L 244 (4015cc) SOHC V6 (12 Valve) 100.4mm Bore			10
MFI; Gasoline; Naturally Aspirated Ford Eng.; Eng. Code F40					
QTY	CYLINDER HEAD	YEARS	PART NO.	DESCRIPTION	
1	Head Gasket	2009-05	26300 PT	Loc. L.H.; Head bolts not incl.; Head bolt replacement required; PermaTorqueMLS® LaserWeld® Technology; Improved design	
1	Head Gasket	2009-05	26301 PT	Loc. R.H.; Head bolts not incl.; Head bolt replacement required; PermaTorqueMLS® LaserWeld® Technology; Improved design	
1	Head Set	2009-05	HS 26300 PT	Head bolts not incl.; Head bolt replacement required; PermaDry® molded rubber valve cover gskts. incl.; Premium valve stem seals incl.	
2	Head Bolt Set	2009-05	ES 72171	Replacement required	
QTY	CONVERSION SET	YEARS	PART NO.	DESCRIPTION	
1	Gasket Conversion Set	2009-05	CS 9293-1	PermaDry® molded rubber oil pan gskt. incl.	
QTY	MANIFOLD - INT. & EXH.	YEARS	PART NO.	DESCRIPTION	
1	Int. Manifold Gasket Set	2009-05	MS 96123	Lower set	
1	Exh. Manifold Gasket Set	2009-05	MS 90779		
QTY	OIL PAN	YEARS	PART NO.	DESCRIPTION	
1	Oil Pan Gasket Set	2009-05	OS 30687 R	Loc. Lower; PermaDry® molded rubber gskt. incl.	
1	Oil Pan Gasket Set	2009-05	OS 34309 R	Loc. Upper; PermaDry® molded rubber gskt. incl.	
QTY	CRANKSHAFT REAR SEAL	YEARS	PART NO.	DESCRIPTION	
1	Rear Main Seal Set	2009-05	BS 40619	Wear sleeve incl.; Rubber; One-piece	
1	Rear Main Seal Set	2009-05	BS 40647	PTFE Rubber; One-piece	
QTY	VALVE COVER	YEARS	PART NO.	DESCRIPTION	
1	Valve Cover Gasket Set	2009-05	VS 50529 R	w/Grommets; PermaDry® molded rubber gskts. incl.	
QTY	VALVE STEM SEAL SET	YEARS	PART NO.	DESCRIPTION	
1	Valve Stem Seal Set	2009-05	SS 70858	Premium valve stem seals incl.	
QTY	THERMOSTAT HOUSING	YEARS	PART NO.	DESCRIPTION	
1	Thermostat Gasket	2009-05	35673	Thermostat Housing; Thermostat housing to manifold	
1	O-Ring	2009-05	35617	Thermostat Housing	
QTY	WATER PUMP	YEARS	PART NO.	DESCRIPTION	
1	Water Pump Gasket	2009-05	35474		
QTY	TIMING COVER	YEARS	PART NO.	DESCRIPTION	
1	Timing Cover Set	2009-05	TCS 46061		
QTY	CARB & FUEL INJECTION	YEARS	PART NO.	DESCRIPTION	
3	Fuel Injector O-Ring Set	2009-05	ES 70599	Improved design	
1	Throttle Body Gasket	2009-05	61208		
1	Throttle Body Gasket	2009-05	61347	Throttle body to spacer; Gskt.	
1	Throttle Body Gasket	2009-05	72302	Air bypass valve	
QTY	EXHAUST GAS RECIRCULATION	YEARS	PART NO.	DESCRIPTION	
1	EGR Gasket	2009-05	70149	Valve	
1	EGR Gasket	2009-05	71202	Tube seal	

Land Rover Truck (Incl. SUV's) (Cont.)

10 (cont.)	2009 - 2005; 4.0L 244 (4015cc) SOHC V6 (12 Valve) 100.4mm Bore			10 (cont.)
MFI; Gasoline; Naturally Aspirated Ford Eng.; Eng. Code F40				
QTY	OIL COOLER	YEARS	PART NO.	DESCRIPTION
1	Oil Cooler Gasket	2009-05	72796	Oil cooler O-ring; New Part Number - Check for Availability
11	1995 - 1993; 4.3L 261 (4275cc) OHV V8 (16 Valve) 94mm Bore			11
MFI; Gasoline; Naturally Aspirated Rover Eng.; Buick; Eng. Code 40D				
QTY	CYLINDER HEAD	YEARS	PART NO.	DESCRIPTION
2	Head Gasket	1995	26532 PT	Head bolts not incl.; Head bolt replacement recommended; New Part Number - Check for Availability
2	Head Gasket	1994	26532 PT	From 02/01/94; Head bolts not incl.; Head bolt replacement recommended; New Part Number - Check for Availability
2	Head Gasket	1994	26651 PT	To 01/31/94; Head bolts not incl.; Head bolt replacement recommended; New Part Number - Check for Availability
2	Head Gasket	1993	26651 PT	Head bolts not incl.; Head bolt replacement recommended; New Part Number - Check for Availability
1	Head Set	1995	HS 26436 PT	Head bolts not incl.; Head bolt replacement recommended; PermaDry® molded rubber valve cover gskts. incl.; Premium valve stem seals incl.
1	Head Set	1994	HS 26436 PT	From 02/01/94; Head bolts not incl.; Head bolt replacement recommended; PermaDry® molded rubber valve cover gskts. incl.; Premium valve stem seals incl.
QTY	CONVERSION SET	YEARS	PART NO.	DESCRIPTION
1	Gasket Conversion Set	1995	CS 26436	
1	Gasket Conversion Set	1994	CS 26436	From 02/01/94
QTY	MANIFOLD - INT. & EXH.	YEARS	PART NO.	DESCRIPTION
1	Valley Pan Gasket Set	1995-93	MS 97186	Lower set; New Part Number - Check for Availability
1	Exh. Manifold Gasket Set	1995-94	MS 97185	
QTY	CRANKSHAFT REAR SEAL	YEARS	PART NO.	DESCRIPTION
1	Rear Main Seal Set	1995-93	BS 40750	Rubber; One-piece; New Part Number - Check for Availability
QTY	VALVE COVER	YEARS	PART NO.	DESCRIPTION
1	Valve Cover Gasket Set	1995-93	VS 50789 R	PermaDry® molded rubber gskts. incl.
QTY	WATER PUMP	YEARS	PART NO.	DESCRIPTION
1	Water Pump Gasket	1995-93	35911	New Part Number - Check for Availability
QTY	TIMING COVER	YEARS	PART NO.	DESCRIPTION
1	Crankshaft Front Seal Set	1995-93	TCS 46190	New Part Number - Check for Availability
12	1995; 4.3L 261 (4275cc) OHV V8 (16 Valve) 94mm Bore			12
MFI; Gasoline; Naturally Aspirated Rover Eng.; Buick; Eng. Code 42D				
QTY	CYLINDER HEAD	YEARS	PART NO.	DESCRIPTION
2	Head Gasket	1995	26532 PT	Head bolts not incl.; Head bolt replacement recommended; New Part Number - Check for Availability
1	Head Set	1995	HS 26436 PT	Head bolts not incl.; Head bolt replacement recommended; PermaDry® molded rubber valve cover gskts. incl.; Premium valve stem seals incl.
QTY	CONVERSION SET	YEARS	PART NO.	DESCRIPTION
1	Gasket Conversion Set	1995	CS 26436	
QTY	MANIFOLD - INT. & EXH.	YEARS	PART NO.	DESCRIPTION
1	Valley Pan Gasket Set	1995	MS 97186	Lower set; New Part Number - Check for Availability
1	Exh. Manifold Gasket Set	1995	MS 97185	
QTY	CRANKSHAFT REAR SEAL	YEARS	PART NO.	DESCRIPTION
1	Rear Main Seal Set	1995	BS 40750	Rubber; One-piece; New Part Number - Check for Availability
QTY	VALVE COVER	YEARS	PART NO.	DESCRIPTION
1	Valve Cover Gasket Set	1995	VS 50789 R	PermaDry® molded rubber gskts. incl.
QTY	WATER PUMP	YEARS	PART NO.	DESCRIPTION
1	Water Pump Gasket	1995	35911	New Part Number - Check for Availability
QTY	TIMING COVER	YEARS	PART NO.	DESCRIPTION
1	Crankshaft Front Seal Set	1995	TCS 46190	New Part Number - Check for Availability
13	2005 - 2003; 4.4L 268.4 (4398cc) DOHC V8 (32 Valve) 92mm Bore			13
MFI; Gasoline; Naturally Aspirated BMW Eng.; Eng. Code M62B44				
QTY	CYLINDER HEAD	YEARS	PART NO.	DESCRIPTION
1	Head Gasket	2005-03	26345 PT	Loc. R.H.; Head bolts not incl.; Head bolt replacement recommended; 1.74mm thick; PermaTorqueMLS®
1	Head Gasket	2005-03	26346 PT	Loc. L.H.; Head bolts not incl.; Head bolt replacement recommended; 1.74mm thick; PermaTorqueMLS®

Land Rover Truck (Incl. SUV's) (Cont.)

13 (cont.)		2005 - 2003; 4.4L 268.4 (4398cc) DOHC V8 (32 Valve) 92mm Bore			13 (cont.)
		MFI; Gasoline; Naturally Aspirated BMW Eng.; Eng. Code M62B44			
QTY	CYLINDER HEAD	YEARS	PART NO.	DESCRIPTION	
1	Head Set w/o Head Gasket	2005-03	HSU 26345	Head gskts. & head bolts not incl.; Head bolt replacement recommended; PermaDry® molded rubber valve cover gskts. incl.; Premium valve stem seals incl.	
2	Head Bolt Set	2005-03	ES 72439	Head bolts w/Washers; Replacement recommended; New Part Number - Check for Availability	
QTY	CONVERSION SET	YEARS	PART NO.	DESCRIPTION	
1	Gasket Conversion Set	2005-03	CS 26339	PermaDry® molded rubber oil pan gskt. incl.	
QTY	MANIFOLD - INT. & EXH.	YEARS	PART NO.	DESCRIPTION	
1	Int. Manifold Gasket Set	2005-03	MS 97187	Lower set	
1	Exh. Manifold Gasket Set	2005-03	MS 97274	New Part Number - Check for Availability	
QTY	OIL PAN	YEARS	PART NO.	DESCRIPTION	
1	Oil Pan Gasket Set	2005-03	OS 30866 R	Loc. Lower; PermaDry® molded rubber gskt. incl.; New Part Number - Check for Availability	
QTY	VALVE COVER	YEARS	PART NO.	DESCRIPTION	
1	Valve Cover Gasket Set	2005-03	VS 50790 R	Loc. R.H.; w/Spark plug tube seals; PermaDry® molded rubber gskt. incl.	
1	Valve Cover Gasket Set	2005-03	VS 50791 R	Loc. L.H.; w/Spark plug tube seals; PermaDry® molded rubber gskt. incl.	
QTY	WATER OUTLET GASKET	YEARS	PART NO.	DESCRIPTION	
2	Water Outlet Gasket	2005-03	36053	Water Outlet; Water crossover pipe; New Part Number - Check for Availability	
2	Water Outlet Gasket	2005-03	36054	Water Outlet; Water inlet pipe seal; 34.2mm ID; New Part Number - Check for Availability	
2	Water Outlet Gasket	2005-03	36055	Water Outlet; Water inlet pipe seal; 19.5mm ID; New Part Number - Check for Availability	
QTY	EXHAUST GAS RECIRCULATION	YEARS	PART NO.	DESCRIPTION	
1	EGR Gasket	2005-03	72996	Air pump check valve; New Part Number - Check for Availability	
14		2004 - 1996; 4.6L 278 (4554cc) OHV V8 (16 Valve) 94mm Bore			14
		MFI; Gasoline; Naturally Aspirated Rover Eng.; Buick; Eng. Code 46D			
QTY	CYLINDER HEAD	YEARS	PART NO.	DESCRIPTION	
2	Head Gasket	2004-96	26532 PT	Head bolts not incl.; Head bolt replacement recommended; New Part Number - Check for Availability	
1	Head Set	2004-96	HS 26436 PT	Head bolts not incl.; Head bolt replacement recommended; PermaDry® molded rubber valve cover gskts. incl.; Premium valve stem seals incl.	
QTY	CONVERSION SET	YEARS	PART NO.	DESCRIPTION	
1	Gasket Conversion Set	2004-96	CS 26436	Oil pan gskt. for Bosch Injected eng. not incl.	
QTY	MANIFOLD - INT. & EXH.	YEARS	PART NO.	DESCRIPTION	
1	Valley Pan Gasket Set	2004-96	MS 97186	Lower set; New Part Number - Check for Availability	
1	Plenum Gasket Set	2004-96	MS 97221	Upper set; New Part Number - Check for Availability	
1	Exh. Manifold Gasket Set	2004-96	MS 97185		
QTY	OIL PAN	YEARS	PART NO.	DESCRIPTION	
1	Oil Pan Gasket Set	2004-96	OS 30861 R	Oil pan gskt. for Bosch Injected eng.; PermaDry® molded rubber gskt. incl.; New Part Number - Check for Availability	
QTY	CRANKSHAFT REAR SEAL	YEARS	PART NO.	DESCRIPTION	
1	Rear Main Seal Set	2004-96	BS 40750	Rubber; One-piece; New Part Number - Check for Availability	
QTY	VALVE COVER	YEARS	PART NO.	DESCRIPTION	
1	Valve Cover Gasket Set	2004-96	VS 50789 R	PermaDry® molded rubber gskts. incl.	
QTY	WATER PUMP	YEARS	PART NO.	DESCRIPTION	
1	Water Pump Gasket	2004-96	35911	New Part Number - Check for Availability	
QTY	TIMING COVER	YEARS	PART NO.	DESCRIPTION	
1	Crankshaft Front Seal Set	2004-96	TCS 46190	New Part Number - Check for Availability	

Lexus Car - See Toyota Car

Lexus SUV's - See Toyota Truck

Lincoln Car - See Ford Car

Engine Finding Index						
<i>Engine</i>	<i>Years</i>	<i>Code</i>	<i>Line No.</i>			
1.6L 96.9 (1588cc) DOHC L4 (16 Valve) 80mm Bore; MFI; Gasoline; Turbo - Intercooled Isuzu Eng.	1993-91	4XE1W-T	1			
1.8L 109.5 (1796cc) DOHC L4 (16 Valve) 82mm Bore VVT-i; MFI; Gasoline; Naturally Aspirated Toyota Eng.	2011-04	2ZZGE	2			
1.8L 109.5 (1796cc) DOHC L4 (16 Valve) 82mm Bore VVT-i; MFI; Gasoline; Supercharged Toyota Eng.	2011-06	2ZZGE	3			
1.8L 109.5 (1796cc) DOHC L4 (16 Valve) 82mm Bore VVT-i; MFI; Gasoline; Supercharged - Intercooled Toyota Eng.	2011-06	2ZZGE	4			
3.5L 211 (3456cc) DOHC V6 (24 Valve) 94mm Bore VVT-i; MFI; Gasoline; Naturally Aspirated Toyota Eng.	2013-10	2GRFE	5			
3.5L 211 (3456cc) DOHC V6 (24 Valve) 94mm Bore VVT-i; MFI; Gasoline; Supercharged Toyota Eng.	2013-11	2GRFE	6			
Engine Code Index						
<i>Code</i>	<i>Engine</i>	<i>Line No.</i>				
2GRFE	3.5L 211 (3456cc) DOHC V6 (24 Valve) 94mm Bore VVT-i; MFI; Gasoline; Naturally Aspirated Toyota Eng.	5				
2GRFE	3.5L 211 (3456cc) DOHC V6 (24 Valve) 94mm Bore VVT-i; MFI; Gasoline; Supercharged Toyota Eng.	6				
2ZZGE	1.8L 109.5 (1796cc) DOHC L4 (16 Valve) 82mm Bore VVT-i; MFI; Gasoline; Naturally Aspirated Toyota Eng.	2				
2ZZGE	1.8L 109.5 (1796cc) DOHC L4 (16 Valve) 82mm Bore VVT-i; MFI; Gasoline; Supercharged Toyota Eng.	3				
2ZZGE	1.8L 109.5 (1796cc) DOHC L4 (16 Valve) 82mm Bore VVT-i; MFI; Gasoline; Supercharged - Intercooled Toyota Eng.	4				
4XE1W-T	1.6L 96.9 (1588cc) DOHC L4 (16 Valve) 80mm Bore; MFI; Gasoline; Turbo - Intercooled Isuzu Eng.	1				
Model Index						
<i>Engine (VIN Code / Eng. Code)</i>	<i>Year</i>	<i>Engine (VIN Code / Eng. Code)</i>	<i>Year</i>	<i>Engine (VIN Code / Eng. Code)</i>	<i>Year</i>	
Lotus		Lotus (cont.)		Lotus (cont.)		
Elan		Evora		Exige (cont.)		
L4 1588cc 1.6L DOHC Turbo (16 Valve) (4XE1W-T)	93-90	V6 3456cc 3.5L DOHC (24 Valve) (2GRFE) V6 3456cc 3.5L DOHC Supercharged (24 Valve) (2GRFE)	13-10 13-11	L4 1796cc 1.8L DOHC Supercharged (16 Valve) (2ZZGE)	11-06	
Elise		Exige		Seven		
L4 1796cc 1.8L DOHC (16 Valve) (2ZZGE)	11-04	L4 1796cc 1.8L DOHC (16 Valve) (2ZZGE)	11-06	L4 948cc 0.9L OHV	61-58	
L4 1796cc 1.8L DOHC Supercharged (16 Valve) (2ZZGE)	11-06					
1		1993 - 1991; 1.6L 96.9 (1588cc) DOHC L4 (16 Valve) 80mm Bore MFI; Gasoline; Turbo - Intercooled Isuzu Eng.; Eng. Code 4XE1W-T				1
QTY	CYLINDER HEAD	YEARS	PART NO.	DESCRIPTION		
1	Head Gasket	1993-91	9685 PT-1			
1	Head Set	1993-91	HS 9685 PT	PermaDry® molded rubber valve cover gskt. incl.; Premium valve stem seals incl.		
QTY	CONVERSION SET	YEARS	PART NO.	DESCRIPTION		
1	Gasket Conversion Set	1993-91	CS 9685	Consolidated design		
QTY	MANIFOLD - INT. & EXH.	YEARS	PART NO.	DESCRIPTION		
1	Int. Manifold Gasket Set	1993-91	MS 94504	Upper set incl.		
1	Exh. Manifold Gasket Set	1993-91	MS 94506			
QTY	EXHAUST PIPE FLANGE	YEARS	PART NO.	DESCRIPTION		
2	Exhaust Pipe Gasket	1993-91	60856	Converter		
1	Exhaust Pipe Gasket	1993-91	60857	Flange		
QTY	OIL PAN	YEARS	PART NO.	DESCRIPTION		
1	Oil Pan Gasket Set	1993-91	OS 30539 C			
QTY	CRANKSHAFT REAR SEAL	YEARS	PART NO.	DESCRIPTION		
1	Rear Main Seal Set	1993-91	BS 40524	Rubber; One-piece; Improved design		
QTY	VALVE COVER	YEARS	PART NO.	DESCRIPTION		
1	Valve Cover Gasket Set	1993-91	VS 50064 R	PermaDry® molded rubber gskt. incl.		
QTY	THERMOSTAT HOUSING	YEARS	PART NO.	DESCRIPTION		
1	Water Outlet Gasket	1993-91	35364	Thermostat Housing; Loc. Outer		
1	Thermostat Gasket	1993-91	35452	Thermostat Housing; Loc. Inner		
QTY	WATER PUMP	YEARS	PART NO.	DESCRIPTION		
1	Water Pump Gasket	1993-91	35454			
QTY	TIMING COVER	YEARS	PART NO.	DESCRIPTION		
1	Crankshaft Front Seal Set	1993-91	TCS 45853			
QTY	CARB & FUEL INJECTION	YEARS	PART NO.	DESCRIPTION		
1	Throttle Body Gasket	1993-91	60842			
QTY	EXHAUST GAS RECIRCULATION	YEARS	PART NO.	DESCRIPTION		
1	EGR Gasket	1993-91	70372			

Lotus (Cont.)

2		2011 - 2004; 1.8L 109.5 (1796cc) DOHC L4 (16 Valve) 82mm Bore VVT-i			2
MFI; Gasoline; Naturally Aspirated Toyota Eng.; Eng. Code 2ZZGE					
QTY	CYLINDER HEAD	YEARS	PART NO.	DESCRIPTION	
1	Head Gasket	2011-04	26154 PT	Head bolts not incl.; Head bolt replacement recommended; PermaTorqueMLS®	
1	Head Set	2011-04	HS 26154 PT-1	Head bolts not incl.; Head bolt replacement recommended; PermaDry® molded rubber valve cover gskt. incl.; Premium valve stem seals incl.	
1	Head Bolt Set	2011-04	ES 71066	Head bolts w/Washers; Replacement recommended	
QTY	CONVERSION SET	YEARS	PART NO.	DESCRIPTION	
1	Gasket Conversion Set	2011-04	CS 26154		
QTY	MANIFOLD - INT. & EXH.	YEARS	PART NO.	DESCRIPTION	
1	Int. Manifold Gasket Set	2011-04	MS 93867		
1	Exh. Manifold Gasket Set	2011-04	MS 96398		
QTY	EXHAUST PIPE FLANGE	YEARS	PART NO.	DESCRIPTION	
1	Exhaust Pipe Gasket	2011-04	61106	Converter; 2.40" ID	
1	Exhaust Pipe Gasket	2011-04	61190	Flange	
QTY	OIL PAN	YEARS	PART NO.	DESCRIPTION	
1	Oil Pan Gasket Set	2011-04	OS 30705 C		
1	Drain Plug Gasket	2011-04	70822		
QTY	CRANKSHAFT REAR SEAL	YEARS	PART NO.	DESCRIPTION	
1	Rear Main Seal Set	2011-04	BS 40665	Rubber; One-piece	
QTY	VALVE COVER	YEARS	PART NO.	DESCRIPTION	
1	Valve Cover Gasket Set	2011-04	VS 50546 R	w/Spark plug tube seals; PermaDry® molded rubber gskt. incl.	
1	Spark Plug Tube Seal Set	2011-04	ES 72105	Valve Cover	
QTY	VALVE STEM SEAL SET	YEARS	PART NO.	DESCRIPTION	
1	Valve Stem Seal Set	2011-04	SS 71053	Premium valve stem seals incl.	
QTY	THERMOSTAT HOUSING	YEARS	PART NO.	DESCRIPTION	
1	Thermostat Gasket	2011-04	35445	Thermostat Housing; Thermostat inlet	
1	O-Ring	2011-04	35717	Thermostat Housing; Thermostat seal	
QTY	WATER PUMP	YEARS	PART NO.	DESCRIPTION	
1	O-Ring	2011-04	35717	Water Pump; Mounting O-ring	
QTY	TIMING COVER	YEARS	PART NO.	DESCRIPTION	
1	Timing Cover Set	2011-04	TCS 45047		
QTY	CARB & FUEL INJECTION	YEARS	PART NO.	DESCRIPTION	
1	Fuel Injector O-Ring Set	2011-04	ES 70600		
1	Throttle Body Gasket	2011-04	61128	Throttle body cover	
1	Throttle Body Gasket	2011-04	61312	Throttle body mounting	
3		2011 - 2006; 1.8L 109.5 (1796cc) DOHC L4 (16 Valve) 82mm Bore VVT-i			3
MFI; Gasoline; Supercharged Toyota Eng.; Eng. Code 2ZZGE					
QTY	CYLINDER HEAD	YEARS	PART NO.	DESCRIPTION	
1	Head Gasket	2011-06	26154 PT	Head bolts not incl.; Head bolt replacement recommended; PermaTorqueMLS®	
1	Head Set	2011-06	HS 26154 PT-1	Head bolts not incl.; Head bolt replacement recommended; PermaDry® molded rubber valve cover gskt. incl.; Premium valve stem seals incl.	
1	Head Bolt Set	2011-06	ES 71066	Head bolts w/Washers; Replacement recommended	
QTY	CONVERSION SET	YEARS	PART NO.	DESCRIPTION	
1	Gasket Conversion Set	2011-06	CS 26154		
QTY	MANIFOLD - INT. & EXH.	YEARS	PART NO.	DESCRIPTION	
1	Int. Manifold Gasket Set	2011-06	MS 93867		
1	Exh. Manifold Gasket Set	2011-06	MS 96398		
QTY	EXHAUST PIPE FLANGE	YEARS	PART NO.	DESCRIPTION	
1	Exhaust Pipe Gasket	2011-06	61106	Converter; 2.40" ID	
1	Exhaust Pipe Gasket	2011-06	61190	Flange	
QTY	OIL PAN	YEARS	PART NO.	DESCRIPTION	
1	Oil Pan Gasket Set	2011-06	OS 30705 C		
1	Drain Plug Gasket	2011-06	70822		
QTY	CRANKSHAFT REAR SEAL	YEARS	PART NO.	DESCRIPTION	
1	Rear Main Seal Set	2011-06	BS 40665	Rubber; One-piece	
QTY	VALVE COVER	YEARS	PART NO.	DESCRIPTION	
1	Valve Cover Gasket Set	2011-06	VS 50546 R	w/Spark plug tube seals; PermaDry® molded rubber gskt. incl.	
1	Spark Plug Tube Seal Set	2011-06	ES 72105	Valve Cover	
QTY	VALVE STEM SEAL SET	YEARS	PART NO.	DESCRIPTION	
1	Valve Stem Seal Set	2011-06	SS 71053	Premium valve stem seals incl.	
QTY	THERMOSTAT HOUSING	YEARS	PART NO.	DESCRIPTION	
1	Thermostat Gasket	2011-06	35445	Thermostat Housing; Thermostat inlet	

3		2011 - 2006; 1.8L 109.5 (1796cc) DOHC L4 (16 Valve) 82mm Bore VVT-i			3	
(cont.)		MFI; Gasoline; Supercharged Toyota Eng.; Eng. Code 2ZZGE			(cont.)	
QTY	THERMOSTAT HOUSING	YEARS	PART NO.	DESCRIPTION		
1	O-Ring	2011-06	35717	Thermostat Housing; Thermostat seal		
QTY	WATER PUMP	YEARS	PART NO.	DESCRIPTION		
1	O-Ring	2011-06	35717	Water Pump; Mounting O-ring		
QTY	TIMING COVER	YEARS	PART NO.	DESCRIPTION		
1	Timing Cover Set	2011-06	TCS 45047			
QTY	CARB & FUEL INJECTION	YEARS	PART NO.	DESCRIPTION		
1	Fuel Injector O-Ring Set	2011-06	ES 70600			
1	Throttle Body Gasket	2011-06	61128	Throttle body cover		
1	Throttle Body Gasket	2011-06	61312	Throttle body mounting		
4		2011 - 2006; 1.8L 109.5 (1796cc) DOHC L4 (16 Valve) 82mm Bore VVT-i			4	
		MFI; Gasoline; Supercharged - Intercooled Toyota Eng.; Eng. Code 2ZZGE				
QTY	CYLINDER HEAD	YEARS	PART NO.	DESCRIPTION		
1	Head Gasket	2011-06	26154 PT	Head bolts not incl.; Head bolt replacement recommended; PermaTorqueMLS®		
1	Head Set	2011-06	HS 26154 PT-1	Head bolts not incl.; Head bolt replacement recommended; PermaDry® molded rubber valve cover gskt. incl.; Premium valve stem seals incl.		
1	Head Bolt Set	2011-06	ES 71066	Head bolts w/Washers; Replacement recommended		
QTY	CONVERSION SET	YEARS	PART NO.	DESCRIPTION		
1	Gasket Conversion Set	2011-06	CS 26154			
QTY	MANIFOLD - INT. & EXH.	YEARS	PART NO.	DESCRIPTION		
1	Int. Manifold Gasket Set	2011-06	MS 93867			
1	Exh. Manifold Gasket Set	2011-06	MS 96398			
QTY	EXHAUST PIPE FLANGE	YEARS	PART NO.	DESCRIPTION		
1	Exhaust Pipe Gasket	2011-06	61106	Converter; 2.40" ID		
1	Exhaust Pipe Gasket	2011-06	61190	Flange		
QTY	OIL PAN	YEARS	PART NO.	DESCRIPTION		
1	Oil Pan Gasket Set	2011-06	OS 30705 C			
1	Drain Plug Gasket	2011-06	70822			
QTY	CRANKSHAFT REAR SEAL	YEARS	PART NO.	DESCRIPTION		
1	Rear Main Seal Set	2011-06	BS 40665	Rubber; One-piece		
QTY	VALVE COVER	YEARS	PART NO.	DESCRIPTION		
1	Valve Cover Gasket Set	2011-06	VS 50546 R	w/Spark plug tube seals; PermaDry® molded rubber gskt. incl.		
1	Spark Plug Tube Seal Set	2011-06	ES 72105	Valve Cover		
QTY	VALVE STEM SEAL SET	YEARS	PART NO.	DESCRIPTION		
1	Valve Stem Seal Set	2011-06	SS 71053	Premium valve stem seals incl.		
QTY	THERMOSTAT HOUSING	YEARS	PART NO.	DESCRIPTION		
1	Thermostat Gasket	2011-06	35445	Thermostat Housing; Thermostat inlet		
1	O-Ring	2011-06	35717	Thermostat Housing; Thermostat seal		
QTY	WATER PUMP	YEARS	PART NO.	DESCRIPTION		
1	O-Ring	2011-06	35717	Water Pump; Mounting O-ring		
QTY	TIMING COVER	YEARS	PART NO.	DESCRIPTION		
1	Timing Cover Set	2011-06	TCS 45047			
QTY	CARB & FUEL INJECTION	YEARS	PART NO.	DESCRIPTION		
1	Fuel Injector O-Ring Set	2011-06	ES 70600			
1	Throttle Body Gasket	2011-06	61128	Throttle body cover		
1	Throttle Body Gasket	2011-06	61312	Throttle body mounting		
5		2013 - 2010; 3.5L 211 (3456cc) DOHC V6 (24 Valve) 94mm Bore VVT-i			5	
		MFI; Gasoline; Naturally Aspirated Toyota Eng.; Eng. Code 2GRFE				
QTY	CYLINDER HEAD	YEARS	PART NO.	DESCRIPTION		
1	Head Gasket	2013-10	26321 PT	Loc. L.H.; Head bolts not incl.; Head bolt replacement recommended; PermaTorqueMLS®		
1	Head Gasket	2013-10	26322 PT	Loc. R.H.; Head bolts not incl.; Head bolt replacement recommended; PermaTorqueMLS®		
1	Head Set	2013-10	HS 26321 PT	Head bolts not incl.; Head bolt replacement recommended; PermaDry® molded rubber valve cover gskts. incl.; Premium valve stem seals incl.		
1	Head Bolt Set	2013-10	ES 72249	Head bolts w/Washers; Replacement recommended		
QTY	CONVERSION SET	YEARS	PART NO.	DESCRIPTION		
1	Gasket Conversion Set	2013-12	CS 26321-1	RTV sealant incl. for oil pan gskt.		
1	Gasket Conversion Set	2011-10	CS 26321	RTV sealant incl. for oil pan gskt.		
QTY	MANIFOLD - INT. & EXH.	YEARS	PART NO.	DESCRIPTION		
1	Int. Manifold Gasket Set	2013-10	MS 96790	Lower set; Upper set incl.		

Lotus (Cont.)

5		2013 - 2010; 3.5L 211 (3456cc) DOHC V6 (24 Valve) 94mm Bore VVT-i			5
(cont.)		MFI; Gasoline; Naturally Aspirated Toyota Eng.; Eng. Code 2GRFE			(cont.)
QTY	MANIFOLD - INT. & EXH.	YEARS	PART NO.	DESCRIPTION	
1	Plenum Gasket Set	2013-10	MS 96786	Upper set; New Part Number - Check for Availability	
1	Exh. Manifold Gasket Set	2013-10	MS 96795	Improved design	
QTY	EXHAUST PIPE FLANGE	YEARS	PART NO.	DESCRIPTION	
1	Exhaust Pipe Gasket	2013-10	23591	Exh. connector; 1 31/32" ID x 2 35/64" OD	
1	Exhaust Pipe Gasket	2013-10	61039	Converter	
1	Exhaust Pipe Gasket	2013-10	61040	Exh. connector; 1.98" ID	
QTY	OIL PAN	YEARS	PART NO.	DESCRIPTION	
1	Oil Pan Gasket Set	2013-10	OS 30770	RTV sealant incl. for oil pan gskt.; Improved design	
1	Drain Plug Gasket	2013-10	70822		
QTY	CRANKSHAFT REAR SEAL	YEARS	PART NO.	DESCRIPTION	
1	Rear Main Seal Set	2013-12	BS 40643	Rubber; One-piece	
1	Rear Main Seal Set	2011-10	BS 40701	Rubber; One-piece	
QTY	VALVE COVER	YEARS	PART NO.	DESCRIPTION	
1	Valve Cover Gasket Set	2013-10	VS 50682 R	w/Spark plug tube seals; PermaDry® molded rubber gskts. incl.	
1	Spark Plug Tube Seal Set	2013-10	ES 72701	Valve Cover; New Part Number - Check for Availability	
QTY	VALVE STEM SEAL SET	YEARS	PART NO.	DESCRIPTION	
1	Valve Stem Seal Set	2013-10	SS 72878	Premium valve stem seals incl.	
QTY	THERMOSTAT HOUSING	YEARS	PART NO.	DESCRIPTION	
1	Thermostat Gasket	2013-10	35445	Thermostat Housing; Thermostat	
QTY	WATER OUTLET GASKET	YEARS	PART NO.	DESCRIPTION	
2	Water Outlet Gasket	2013-10	35767	Water Outlet; Outlet; Improved design	
1	Water Outlet Gasket	2013-10	35809	Water Outlet; Water inlet O-ring; New Part Number - Check for Availability	
1	Thermostat Gasket	2013-10	35801	Water Outlet; Inlet	
QTY	WATER PUMP	YEARS	PART NO.	DESCRIPTION	
1	Water Pump Gasket	2013-10	35807		
QTY	TIMING COVER	YEARS	PART NO.	DESCRIPTION	
1	Crankshaft Front Seal Set	2013-10	TCS 46080		
QTY	CARB & FUEL INJECTION	YEARS	PART NO.	DESCRIPTION	
1	Throttle Body Gasket	2013-10	61445		
6		2013 - 2011; 3.5L 211 (3456cc) DOHC V6 (24 Valve) 94mm Bore VVT-i			6
(cont.)		MFI; Gasoline; Supercharged Toyota Eng.; Eng. Code 2GRFE			(cont.)
QTY	CYLINDER HEAD	YEARS	PART NO.	DESCRIPTION	
1	Head Gasket	2013-11	26321 PT	Loc. L.H.; Head bolts not incl.; Head bolt replacement recommended; PermaTorqueMLS®	
1	Head Gasket	2013-11	26322 PT	Loc. R.H.; Head bolts not incl.; Head bolt replacement recommended; PermaTorqueMLS®	
1	Head Set	2013-11	HS 26321 PT	Head bolts not incl.; Head bolt replacement recommended; PermaDry® molded rubber valve cover gskts. incl.; Premium valve stem seals incl.	
1	Head Bolt Set	2013-11	ES 72249	Head bolts w/Washers; Replacement recommended	
QTY	CONVERSION SET	YEARS	PART NO.	DESCRIPTION	
1	Gasket Conversion Set	2013-12	CS 26321-1	RTV sealant incl. for oil pan gskt.	
1	Gasket Conversion Set	2011	CS 26321	RTV sealant incl. for oil pan gskt.	
QTY	MANIFOLD - INT. & EXH.	YEARS	PART NO.	DESCRIPTION	
1	Int. Manifold Gasket Set	2013-11	MS 96790	Lower set; Upper set incl.	
1	Plenum Gasket Set	2013-11	MS 96786	Upper set; New Part Number - Check for Availability	
1	Exh. Manifold Gasket Set	2013-11	MS 96795	Improved design	
QTY	EXHAUST PIPE FLANGE	YEARS	PART NO.	DESCRIPTION	
1	Exhaust Pipe Gasket	2013-11	23591	Exh. connector; 1 31/32" ID x 2 35/64" OD	
1	Exhaust Pipe Gasket	2013-11	61039	Converter	
1	Exhaust Pipe Gasket	2013-11	61040	Exh. connector; 1.98" ID	
QTY	OIL PAN	YEARS	PART NO.	DESCRIPTION	
1	Oil Pan Gasket Set	2013-11	OS 30770	RTV sealant incl. for oil pan gskt.; Improved design	
1	Drain Plug Gasket	2013-11	70822		
QTY	CRANKSHAFT REAR SEAL	YEARS	PART NO.	DESCRIPTION	
1	Rear Main Seal Set	2013-12	BS 40643	Rubber; One-piece	
1	Rear Main Seal Set	2011	BS 40701	Rubber; One-piece	
QTY	VALVE COVER	YEARS	PART NO.	DESCRIPTION	
1	Valve Cover Gasket Set	2013-11	VS 50682 R	w/Spark plug tube seals; PermaDry® molded rubber gskts. incl.	
1	Spark Plug Tube Seal Set	2013-11	ES 72701	Valve Cover; New Part Number - Check for Availability	
QTY	VALVE STEM SEAL SET	YEARS	PART NO.	DESCRIPTION	
1	Valve Stem Seal Set	2013-11	SS 72878	Premium valve stem seals incl.	

6 (cont.)		2013 - 2011; 3.5L 211 (3456cc) DOHC V6 (24 Valve) 94mm Bore VVT-i MFI; Gasoline; Supercharged Toyota Eng.; Eng. Code 2GRFE			6 (cont.)
QTY	THERMOSTAT HOUSING	YEARS	PART NO.	DESCRIPTION	
1	Thermostat Gasket	2013-11	35445	Thermostat Housing; Thermostat	
QTY	WATER OUTLET GASKET	YEARS	PART NO.	DESCRIPTION	
2	Water Outlet Gasket	2013-11	35767	Water Outlet; Outlet; Improved design	
1	Water Outlet Gasket	2013-11	35809	Water Outlet; Water inlet O-ring; New Part Number - Check for Availability	
1	Thermostat Gasket	2013-11	35801	Water Outlet; Inlet	
QTY	WATER PUMP	YEARS	PART NO.	DESCRIPTION	
1	Water Pump Gasket	2013-11	35807		
QTY	TIMING COVER	YEARS	PART NO.	DESCRIPTION	
1	Crankshaft Front Seal Set	2013-11	TCS 46080		
QTY	CARB & FUEL INJECTION	YEARS	PART NO.	DESCRIPTION	
1	Throttle Body Gasket	2013-11	61445		

**Maybach - See Mercedes-Benz Car
Mazda Car**

Engine Finding Index				
Engine	Years	Code	Line No.	
1.3L 80 (1308cc) ROTARY R2 (Valve) Bore (Mazda Eng.); MFI; Gasoline; Naturally Aspirated Ford Eng.	2011-03	13B	1	
1.5L 90.8 (1489cc) DOHC L4 (16 Valve) 75.3mm Bore; MFI; Gasoline; Naturally Aspirated Mazda Eng.	1998-95	Z5-DE	2	
1.5L 91.4 (1498cc) DOHC L4 (16 Valve) 78mm Bore Duratec VVT; MFI; Gasoline; Naturally Aspirated Mazda Eng.	2013-11	ZY-VE	3	
1.6L 97.5 (1597cc) DOHC L4 (16 Valve) 78mm Bore; MFI; Gasoline; Naturally Aspirated Mazda Eng.	1996-91	B6-ZE	4	
1.6L 97.5 (1597cc) DOHC L4 (16 Valve) 78mm Bore; MFI; Gasoline; Naturally Aspirated Mazda Eng.	2003-99	ZM-DE	5	
1.6L 97.5 (1597cc) SOHC L4 (16 Valve) 78mm Bore; MFI; Gasoline; Naturally Aspirated Mazda Eng.	1993-92	B6	6	
1.6L 97.5 (1597cc) SOHC L4 (8 Valve) 78mm Bore; MFI; Gasoline; Naturally Aspirated Mazda Eng.	1995-91	B6	7	
1.8L 112.2 (1839cc) DOHC L4 (16 Valve) 83mm Bore; MFI; Gasoline; Naturally Aspirated Mazda Eng.	2000-99	BP-4W	8	
1.8L 112.2 (1839cc) DOHC L4 (16 Valve) 83mm Bore; MFI; Gasoline; Naturally Aspirated Mazda Eng.	2005-01	BP-Z3	9	
1.8L 112.2 (1839cc) DOHC L4 (16 Valve) 83mm Bore; MFI; Gasoline; Turbo - Intercooled Mazda Eng.	2005-04	BP-Z3T	10	
1.8L 112.2 (1839cc) DOHC L4 (16 Valve) 83mm Bore; MFI; Gasoline; Naturally Aspirated Mazda Eng.	1998-91	BP-ZE	11	
1.8L 112.2 (1839cc) DOHC L4 (16 Valve) 83mm Bore; MFI; Gasoline; Naturally Aspirated Mazda Eng.	2001-99	FP-ZE	12	
1.8L 112.2 (1839cc) SOHC L4 (16 Valve) 83mm Bore; MFI; Gasoline; Naturally Aspirated Mazda Eng.	1996-91	BP-ZD	13	
2.0L 121.5 (1991cc) DOHC L4 (16 Valve) 83mm Bore; MFI; Gasoline; Naturally Aspirated Mazda Eng.	2003-93	FS-DE	14	
2.0L 121.5 (1991cc) DOHC L4 (16 Valve) 83mm Bore; MFI; Gasoline; Turbo - Intercooled Mazda Eng.	2003	FS-DET	15	
2.0L 121.9 (1998cc) DOHC L4 (16 Valve) 83.5mm Bore SkyActiv-G VVT; DI; Gasoline; Naturally Aspirated Mazda Eng.	2013-12	PE-VPS	16	
2.0L 122 (1999cc) DOHC L4 (16 Valve) 87.5mm Bore Duratec; MFI; Gasoline; Naturally Aspirated Ford Eng.	2013-04	LFD	17	
2.2L 133 (2184cc) SOHC L4 (12 Valve) 86mm Bore; MFI; Gasoline; Naturally Aspirated Mazda Eng.	1992-91	F2	18	
2.2L 133 (2184cc) SOHC L4 (12 Valve) 86mm Bore; MFI; Gasoline; Turbo - Intercooled Mazda Eng.	1992-91	F2-T	19	
2.3L 137.5 (2254cc) DOHC V6 (24 Valve) 80.3mm Bore; MFI; Gasoline; Supercharged Mazda Eng.	2002-95	EJ	20	
2.3L 138 (2261cc) DOHC L4 (16 Valve) 87.5mm Bore Duratec; MFI; Gasoline; Naturally Aspirated Ford Eng.	2011-03	MZR	21	
2.3L 138 (2261cc) DOHC L4 (16 Valve) 87.5mm Bore Duratec; MFI; Gasoline; Turbo - Intercooled Ford Eng.	2013-06	MZR-T	22	
2.5L 151.8 (2488cc) DOHC L4 (16 Valve) 89mm Bore Duratec; MFI; Gasoline; Naturally Aspirated Ford Eng.	2013-09	MZR	23	
2.5L 152 (2497cc) DOHC V6 (24 Valve) 84.5mm Bore; MFI; Gasoline; Naturally Aspirated Mazda Eng.	2002-93	KL-ZE	24	
3.0L 180.3 (2954cc) DOHC V6 (24 Valve) 90mm Bore; MFI; Gasoline; Naturally Aspirated Mazda Eng.	1991	JE-27	25	
3.0L 180.3 (2954cc) DOHC V6 (24 Valve) 90mm Bore; MFI; Gasoline; Naturally Aspirated Mazda Eng.	1995-92	JE-48	26	
3.0L 180.3 (2954cc) DOHC V6 (24 Valve) 90mm Bore; MFI; Gasoline; Naturally Aspirated Mazda Eng.	1995-91	JE-ZE	27	
3.0L 180.3 (2954cc) SOHC V6 (18 Valve) 90mm Bore; MFI; Gasoline; Naturally Aspirated Mazda Eng.	1991	JE	28	
3.0L 180.3 (2954cc) SOHC V6 (18 Valve) 90mm Bore; MFI; Gasoline; Naturally Aspirated Mazda Eng.	1991	JE-39	29	
3.0L 181 (2967cc) DOHC V6 (24 Valve) 89mm Bore Duratec; MFI; Gasoline; Naturally Aspirated Ford Eng.	2008-03	MZI	30	
3.7L 227 (3721cc) DOHC V6 (24 Valve) 95.5mm Bore Duratec Cyclone; MFI; Gasoline; Naturally Aspirated Ford Eng.	2013-09	MZI	31	
Engine Code Index				
Code	Engine		Line No.	
13B	1.3L 80 (1308cc) ROTARY R2 (Valve) Bore (Mazda Eng.); MFI; Gasoline; Naturally Aspirated Ford Eng.		1	
B6	1.6L 97.5 (1597cc) SOHC L4 (16 Valve) 78mm Bore; MFI; Gasoline; Naturally Aspirated Mazda Eng.		6	
B6	1.6L 97.5 (1597cc) SOHC L4 (8 Valve) 78mm Bore; MFI; Gasoline; Naturally Aspirated Mazda Eng.		7	
B6-ZE	1.6L 97.5 (1597cc) DOHC L4 (16 Valve) 78mm Bore; MFI; Gasoline; Naturally Aspirated Mazda Eng.		4	
BP-4W	1.8L 112.2 (1839cc) DOHC L4 (16 Valve) 83mm Bore; MFI; Gasoline; Naturally Aspirated Mazda Eng.		8	
BP-Z3	1.8L 112.2 (1839cc) DOHC L4 (16 Valve) 83mm Bore; MFI; Gasoline; Naturally Aspirated Mazda Eng.		9	
BP-Z3T	1.8L 112.2 (1839cc) DOHC L4 (16 Valve) 83mm Bore; MFI; Gasoline; Turbo - Intercooled Mazda Eng.		10	
BP-ZD	1.8L 112.2 (1839cc) SOHC L4 (16 Valve) 83mm Bore; MFI; Gasoline; Naturally Aspirated Mazda Eng.		13	
BP-ZE	1.8L 112.2 (1839cc) DOHC L4 (16 Valve) 83mm Bore; MFI; Gasoline; Naturally Aspirated Mazda Eng.		11	
EJ	2.3L 137.5 (2254cc) DOHC V6 (24 Valve) 80.3mm Bore; MFI; Gasoline; Supercharged Mazda Eng.		20	

Mazda Car (Cont.)

Engine Code Index (Cont.)

Code	Engine	Line No.
F2	2.2L 133 (2184cc) SOHC L4 (12 Valve) 86mm Bore; MFI; Gasoline; Naturally Aspirated Mazda Eng.	18
F2-T	2.2L 133 (2184cc) SOHC L4 (12 Valve) 86mm Bore; MFI; Gasoline; Turbo - Intercooled Mazda Eng.	19
FP-ZE	1.8L 112.2 (1839cc) DOHC L4 (16 Valve) 83mm Bore; MFI; Gasoline; Naturally Aspirated Mazda Eng.	12
FS-DE	2.0L 121.5 (1991cc) DOHC L4 (16 Valve) 83mm Bore; MFI; Gasoline; Naturally Aspirated Mazda Eng.	14
FS-DET	2.0L 121.5 (1991cc) DOHC L4 (16 Valve) 83mm Bore; MFI; Gasoline; Turbo - Intercooled Mazda Eng.	15
JE	3.0L 180.3 (2954cc) SOHC V6 (18 Valve) 90mm Bore; MFI; Gasoline; Naturally Aspirated Mazda Eng.	28
JE-27	3.0L 180.3 (2954cc) DOHC V6 (24 Valve) 90mm Bore; MFI; Gasoline; Naturally Aspirated Mazda Eng.	25
JE-39	3.0L 180.3 (2954cc) SOHC V6 (18 Valve) 90mm Bore; MFI; Gasoline; Naturally Aspirated Mazda Eng.	29
JE-48	3.0L 180.3 (2954cc) DOHC V6 (24 Valve) 90mm Bore; MFI; Gasoline; Naturally Aspirated Mazda Eng.	26
JE-ZE	3.0L 180.3 (2954cc) DOHC V6 (24 Valve) 90mm Bore; MFI; Gasoline; Naturally Aspirated Mazda Eng.	27
KL-ZE	2.5L 152 (2497cc) DOHC V6 (24 Valve) 84.5mm Bore; MFI; Gasoline; Naturally Aspirated Mazda Eng.	24
LFD	2.0L 122 (1999cc) DOHC L4 (16 Valve) 87.5mm Bore Duratec; MFI; Gasoline; Naturally Aspirated Ford Eng.	17
MZI	3.0L 181 (2967cc) DOHC V6 (24 Valve) 89mm Bore Duratec; MFI; Gasoline; Naturally Aspirated Ford Eng.	30
MZI	3.7L 227 (3721cc) DOHC V6 (24 Valve) 95.5mm Bore Duratec Cyclone; MFI; Gasoline; Naturally Aspirated Ford Eng.	31
MZR	2.3L 138 (2261cc) DOHC L4 (16 Valve) 87.5mm Bore Duratec; MFI; Gasoline; Naturally Aspirated Ford Eng.	21
MZR	2.5L 151.8 (2488cc) DOHC L4 (16 Valve) 89mm Bore Duratec; MFI; Gasoline; Naturally Aspirated Ford Eng.	23
MZR-T	2.3L 138 (2261cc) DOHC L4 (16 Valve) 87.5mm Bore Duratec; MFI; Gasoline; Turbo - Intercooled Ford Eng.	22
PE-VPS	2.0L 121.9 (1998cc) DOHC L4 (16 Valve) 83.5mm Bore SkyActiv-G VVT; DI; Gasoline; Naturally Aspirated Mazda Eng.	16
Z5-DE	1.5L 90.8 (1489cc) DOHC L4 (16 Valve) 75.3mm Bore; MFI; Gasoline; Naturally Aspirated Mazda Eng.	2
ZM-DE	1.6L 97.5 (1597cc) DOHC L4 (16 Valve) 78mm Bore; MFI; Gasoline; Naturally Aspirated Mazda Eng.	5
ZY-VE	1.5L 91.4 (1498cc) DOHC L4 (16 Valve) 78mm Bore Duratec VVT; MFI; Gasoline; Naturally Aspirated Mazda Eng.	3

Model Index

Engine (VIN Code / Eng. Code)	Year	Engine (VIN Code / Eng. Code)	Year	Engine (VIN Code / Eng. Code)	Year
Mazda		Mazda (cont.)		Mazda (cont.)	
2		6s		MX-5 Miata	
L4 1498cc 1.5L DOHC (16 Valve) (ZY-VE)	13-11	V6 2967cc 3.0L DOHC (24 Valve) (MZI)	08-03	L4 1597cc 1.6L DOHC (16 Valve) (B6-ZE)	93-90
323		V6 3721cc 3.7L DOHC (24 Valve) (MZI)	13-09	L4 1839cc 1.8L DOHC (16 Valve) (BP-4W)	00-99
L4 1597cc 1.6L DOHC Turbo (16 Valve) (B6-T)	89-88	808		L4 1839cc 1.8L DOHC (16 Valve) (BP-Z3)	05-01
L4 1597cc 1.6L SOHC (8 Valve) (B6)	94-86	L4 1272cc 1.3L SOHC (TC)	77-76	L4 1839cc 1.8L DOHC (16 Valve) (BP-ZE)	98-94
L4 1597cc 1.6L DOHC Turbo (16 Valve) (B6-T)	89-88	L4 1586cc 1.6L SOHC (NA)	77-72	L4 1839cc 1.8L DOHC Turbo (16 Valve) (BP-Z3T)	05-04
3i		929		L4 1999cc 2.0L DOHC (16 Valve) (LFD)	13-06
L4 1998cc 2.0L DOHC (16 Valve) (PE-VPS)	13-12	V6 2954cc 3.0L DOHC (24 Valve) (JE-27)	91-90	MX-6	
L4 1999cc 2.0L DOHC (16 Valve) (LFD)	13-04	V6 2954cc 3.0L DOHC (24 Valve) (JE-48)	95-92	L4 1991cc 2.0L DOHC (16 Valve) (FS-DE)	97-93
3s		V6 2954cc 3.0L DOHC (24 Valve) (JE-ZE)	95-90	L4 2184cc 2.2L SOHC (12 Valve) (F2)	92-88
L4 2261cc 2.3L DOHC (16 Valve) (MZR)	09-04	V6 2954cc 3.0L SOHC (18 Valve) (JE)	91-88	L4 2184cc 2.2L SOHC Turbo (12 Valve) (F2-T)	92-88
L4 2488cc 2.5L DOHC (16 Valve) (MZR)	13-10	V6 2954cc 3.0L SOHC (18 Valve) (JE-06)	89-88	V6 2497cc 2.5L DOHC (24 Valve) (KL-ZE)	97-93
5		V6 2954cc 3.0L SOHC (18 Valve) (JE-07)	89-88	Protege	
L4 2261cc 2.3L DOHC (16 Valve) (MZR)	11-06	V6 2954cc 3.0L SOHC (18 Valve) (JE-39)	91-90	L4 1489cc 1.5L DOHC (16 Valve) (Z5-DE)	98-95
L4 2488cc 2.5L DOHC (16 Valve) (MZR)	13-11	GLC (FWD)		L4 1597cc 1.6L DOHC (16 Valve) (ZM-DE)	03-99
616		L4 1490cc 1.5L SOHC (E5)	85-81	L4 1839cc 1.8L DOHC (16 Valve) (BP-ZE)	98-90
L4 1586cc 1.6L SOHC (NA)	72-70	GLC (RWD)		L4 1839cc 1.8L DOHC (16 Valve) (FP-ZE)	01-99
618		L4 1272cc 1.3L SOHC (TC)	78-77	L4 1839cc 1.8L SOHC (16 Valve) (BP-ZD)	96-90
L4 1796cc 1.8L SOHC (VB)	73-72	L4 1415cc 1.4L SOHC (UC)	80-79	L4 1991cc 2.0L DOHC (16 Valve) (FS-DE)	03-01
626 (FWD)		L4 1490cc 1.5L SOHC (D5)	85-81	L4 1991cc 2.0L DOHC Turbo (16 Valve) (FS-DET)	03
L4 1991cc 2.0L DOHC (16 Valve) (FS-DE)	02-93	MazdaSpeed 3		Protege AWD	
L4 1998cc 2.0L SOHC (8 Valve) (FE)	87-83	L4 2261cc 2.3L DOHC Turbo (16 Valve) (MZR-T)	13-07	L4 1839cc 1.8L DOHC (16 Valve) (BP-ZE)	91-90
L4 1998cc 2.0L SOHC (8 Valve) (FEH1)	87-83	MazdaSpeed 6		L4 1839cc 1.8L SOHC (16 Valve) (BP-ZD)	91-90
L4 1998cc 2.0L SOHC Diesel (RF)	85-84	L4 2261cc 2.3L DOHC Turbo (16 Valve) (MZR-T)	08-06	RX-2	
L4 1998cc 2.0L SOHC Turbo (8 Valve) (FE-T)	87-86	Millenia		R2 1146cc 1.1L Rotary (12A)	74-71
L4 1998cc 2.0L SOHC Turbo (8 Valve) (FEH5)	87-86	V6 2254cc 2.3L DOHC Supercharged (24 Valve) (EJ)	02-95	RX-3	
L4 2184cc 2.2L SOHC (12 Valve) (F2)	92-88	V6 2497cc 2.5L DOHC (24 Valve) (KL-ZE)	02-95	R2 1146cc 1.1L Rotary (12A)	78-72
L4 2184cc 2.2L SOHC Turbo (12 Valve) (F2-T)	92-88	Mizer		RX-4	
V6 2497cc 2.5L DOHC (24 Valve) (KL-ZE)	02-93	L4 1272cc 1.3L SOHC (TC)	77-76	R2 1308cc 1.3L Rotary (13B)	78-74
626 (RWD)		MX-3		RX-7	
L4 1970cc 2.0L SOHC (MA)	82-79	L4 1597cc 1.6L DOHC (16 Valve) (B6-ZE)	96-94	R2 1146cc 1.1L Rotary (12A)	85-79
6i		L4 1597cc 1.6L SOHC (16 Valve) (B6)	93-92	R2 1308cc 1.3L Rotary (13B)	91-84
L4 2261cc 2.3L DOHC (16 Valve) (MZR)	08-03	V6 1844cc 1.8L DOHC (24 Valve) (K8-ZE)	96-92	R2 1308cc 1.3L Rotary Turbo (13B-T)	95-86
L4 2488cc 2.5L DOHC (16 Valve) (MZR)	13-09	MX-6		RX-8	
1 2011 - 2003; 1.3L 80 (1308cc) ROTARY R2 (Valve) Bore (Mazda Eng.) MFI; Gasoline; Naturally Aspirated Ford Eng.; Eng. Code 13B 1					
QTY	EXHAUST PIPE FLANGE	YEARS	PART NO.	DESCRIPTION	
1	Exhaust Pipe Gasket	2011-03	61348	Loc. Rear; Converter	

1		2011 - 2003; 1.3L 80 (1308cc) ROTARY R2 (Valve) Bore (Mazda Eng.)			1
(cont.)		MFI; Gasoline; Naturally Aspirated Ford Eng.; Eng. Code 13B			(cont.)
QTY	EXHAUST PIPE FLANGE	YEARS	PART NO.	DESCRIPTION	
1	Exhaust Pipe Gasket	2011-03	61573	Loc. Front; Converter	
QTY	CARB & FUEL INJECTION	YEARS	PART NO.	DESCRIPTION	
2	Fuel Injector O-Ring Set	2011-03	ES 70600		
2		1998 - 1995; 1.5L 90.8 (1489cc) DOHC L4 (16 Valve) 75.3mm Bore			2
		MFI; Gasoline; Naturally Aspirated Mazda Eng.; Eng. Code Z5-DE			
QTY	CYLINDER HEAD	YEARS	PART NO.	DESCRIPTION	
1	Head Gasket	1998-95	9213 PT	Head bolts not incl.; Head bolt replacement recommended; PermaTorqueMLS®	
1	Head Set	1998-95	HS 9213 PT	Head bolts not incl.; Head bolt replacement recommended; PermaDry® molded rubber valve cover gskt. incl.; Premium valve stem seals incl.	
QTY	CONVERSION SET	YEARS	PART NO.	DESCRIPTION	
1	Gasket Conversion Set	1998-95	CS 9213	RTV sealant incl. for Upper oil pan gskt.	
QTY	MANIFOLD - INT. & EXH.	YEARS	PART NO.	DESCRIPTION	
1	Int. Manifold Gasket Set	1998-95	MS 95922		
1	Exh. Manifold Gasket Set	1998-95	MS 95923		
QTY	EXHAUST PIPE FLANGE	YEARS	PART NO.	DESCRIPTION	
1	Exhaust Pipe Gasket	1998-95	61016	Converter; Improved design	
1	Exhaust Pipe Gasket	1998-95	61044	Loc. Front; Exh. connector	
1	Exhaust Pipe Gasket	1998-95	61537	Flange	
QTY	OIL PAN	YEARS	PART NO.	DESCRIPTION	
1	Oil Pan Gasket Set	1998-95	OS 30633 R	Loc. Upper; RTV Black silicone w/Rubber end seals	
1	Oil Pan Gasket Set	1998-95	OS 30684 C	Loc. Lower; Cork	
QTY	CRANKSHAFT REAR SEAL	YEARS	PART NO.	DESCRIPTION	
1	Rear Main Seal Set	1998-95	BS 40634	Rubber; One-piece	
QTY	VALVE COVER	YEARS	PART NO.	DESCRIPTION	
1	Valve Cover Gasket Set	1998-95	VS 50475 R	w/Spark plug tube seals; PermaDry® molded rubber gskt. incl.	
QTY	VALVE STEM SEAL SET	YEARS	PART NO.	DESCRIPTION	
1	Valve Stem Seal Set	1998-95	SS 72885	Premium valve stem seals incl.	
QTY	WATER OUTLET GASKET	YEARS	PART NO.	DESCRIPTION	
1	Water Outlet Gasket	1998-95	35251	Water Outlet	
QTY	WATER PUMP	YEARS	PART NO.	DESCRIPTION	
1	Water Pump Gasket	1998-95	35456	Mounting	
1	Water Pump Gasket	1998-95	35457	Inlet	
QTY	TIMING COVER	YEARS	PART NO.	DESCRIPTION	
1	Crankshaft Front Seal Set	1998-95	TCS 45981		
1	Camshaft Front Seal Set	1998-95	TCS 45860		
QTY	CARB & FUEL INJECTION	YEARS	PART NO.	DESCRIPTION	
1	Fuel Injector O-Ring Set	1998-95	ES 70600	Upper set	
1	Throttle Body Gasket	1998-95	60984		
QTY	DISTRIBUTOR MOUNTING	YEARS	PART NO.	DESCRIPTION	
1	O-Ring	1998-95	35608	Distributor Mounting	
QTY	EXHAUST GAS RECIRCULATION	YEARS	PART NO.	DESCRIPTION	
1	EGR Gasket	1998-95	70431		
3		2013 - 2011; 1.5L 91.4 (1498cc) DOHC L4 (16 Valve) 78mm Bore Duratec VVT			3
		MFI; Gasoline; Naturally Aspirated Mazda Eng.; Eng. Code ZY-VE			
QTY	VALVE STEM SEAL SET	YEARS	PART NO.	DESCRIPTION	
1	Valve Stem Seal Set	2013-11	SS 72917	Premium valve stem seals incl.	
QTY	TIMING COVER	YEARS	PART NO.	DESCRIPTION	
1	Crankshaft Front Seal Set	2013-11	TCS 46165	Crankshaft front seal only; New Part Number - Check for Availability	
QTY	CARB & FUEL INJECTION	YEARS	PART NO.	DESCRIPTION	
1	Fuel Injector O-Ring Set	2013-11	ES 70600		
4		1996 - 1991; 1.6L 97.5 (1597cc) DOHC L4 (16 Valve) 78mm Bore			4
		MFI; Gasoline; Naturally Aspirated Mazda Eng.; Eng. Code B6-ZE			
QTY	CYLINDER HEAD	YEARS	PART NO.	DESCRIPTION	
1	Head Gasket	1993-91	9691 PT		
1	Head Set	1993-91	HS 9691 PT	PermaDry® molded rubber valve cover gskt. incl.; Premium valve stem seals incl.	
QTY	CONVERSION SET	YEARS	PART NO.	DESCRIPTION	
1	Gasket Conversion Set	1996-92	CS 9691-3	RTV sealant incl. for oil pan gskt.	

Mazda Car (Cont.)

4 (cont.)		1996 - 1991; 1.6L 97.5 (1597cc) DOHC L4 (16 Valve) 78mm Bore			4 (cont.)
MFI; Gasoline; Naturally Aspirated Mazda Eng.; Eng. Code B6-ZE					
QTY	CONVERSION SET	YEARS	PART NO.	DESCRIPTION	
1	Gasket Conversion Set	1991	CS 9691	To Ser. No. 209446; RTV sealant incl. for oil pan gskt.	
1	Gasket Conversion Set	1991	CS 9691-3	From Ser. No. 209447; RTV sealant incl. for oil pan gskt.	
QTY	MANIFOLD - INT. & EXH.	YEARS	PART NO.	DESCRIPTION	
1	Int. Manifold Gasket Set	1993-91	MS 94750		
1	Exh. Manifold Gasket Set	1993-91	MS 94532		
QTY	EXHAUST PIPE FLANGE	YEARS	PART NO.	DESCRIPTION	
1	Exhaust Pipe Gasket	1996-94	23561	Loc. Rear; Exh. connector; 1 49/64" ID x 2 17/64" OD	
1	Exhaust Pipe Gasket	1996-94	61016	Loc. Front; Exh. connector; Improved design	
1	Exhaust Pipe Gasket	1996-94	61016	Muffler; Improved design	
1	Exhaust Pipe Gasket	1996-94	61044	Converter	
1	Exhaust Pipe Gasket	1993-91	60620	Loc. Front; Converter	
1	Exhaust Pipe Gasket	1993-91	60831	Loc. Rear; Converter	
1	Exhaust Pipe Gasket	1993-91	60866	Flange	
QTY	FUEL PUMP	YEARS	PART NO.	DESCRIPTION	
1	Fuel Pump Mounting Gasket	1993-91	70030		
QTY	OIL PAN	YEARS	PART NO.	DESCRIPTION	
1	Oil Pan Gasket Set	1996-91	OS 30633 R	RTV Black silicone w/Rubber end seals	
QTY	CRANKSHAFT REAR SEAL	YEARS	PART NO.	DESCRIPTION	
1	Rear Main Seal Set	1996-91	BS 40634	Rubber; One-piece	
QTY	VALVE COVER	YEARS	PART NO.	DESCRIPTION	
1	Valve Cover Gasket Set	1996-94	VS 50718 R	w/Spark plug tube seals; PermaDry® molded rubber gskt. incl.	
1	Valve Cover Gasket Set	1993-91	VS 50094 R	w/Spark plug tube seals; PermaDry® molded rubber gskt. incl.	
QTY	VALVE STEM SEAL SET	YEARS	PART NO.	DESCRIPTION	
1	Valve Stem Seal Set	1996-94	SS 72802	Premium valve stem seals incl.	
1	Valve Stem Seal Set	1993-91	SS 72782	Premium valve stem seals incl.	
QTY	WATER OUTLET GASKET	YEARS	PART NO.	DESCRIPTION	
1	Water Outlet Gasket	1996-91	35251	Water Outlet	
QTY	WATER PUMP	YEARS	PART NO.	DESCRIPTION	
1	Water Pump Gasket	1996-91	35456	Mounting	
1	Water Pump Gasket	1996-91	35457	Inlet	
QTY	TIMING COVER	YEARS	PART NO.	DESCRIPTION	
1	Crankshaft Front Seal Set	1996-92	TCS 45921	Must be used w/OS 30633R	
1	Crankshaft Front Seal Set	1991	TCS 45722	To Ser. No. 209446; Must be used w/OS 30633R	
1	Crankshaft Front Seal Set	1991	TCS 45921	From Ser. No. 209447; Must be used w/OS 30633R	
1	Camshaft Front Seal Set	1996-91	TCS 45860		
QTY	CARB & FUEL INJECTION	YEARS	PART NO.	DESCRIPTION	
2	Fuel Injector O-Ring Set	1996-94	ES 70600		
1	Fuel Injector O-Ring Set	1993-91	ES 70600		
1	Throttle Body Gasket	1996-94	60984		
1	Throttle Body Gasket	1993-91	60874		
QTY	DISTRIBUTOR MOUNTING	YEARS	PART NO.	DESCRIPTION	
1	O-Ring	1993-91	35608	Distributor Mounting; Camshaft Angle Sensor seal	
QTY	EXHAUST GAS RECIRCULATION	YEARS	PART NO.	DESCRIPTION	
1	EGR Gasket	1996-94	70431		
5		2003 - 1999; 1.6L 97.5 (1597cc) DOHC L4 (16 Valve) 78mm Bore			5
MFI; Gasoline; Naturally Aspirated Mazda Eng.; Eng. Code ZM-DE					
QTY	CYLINDER HEAD	YEARS	PART NO.	DESCRIPTION	
1	Head Gasket	2003-02	26392 PT	Head bolts not incl.; Head bolt replacement recommended; PermaTorqueMLS®	
1	Head Gasket	2001	26391 PT	To Ser. No. 549027; Head bolts not incl.; Head bolt replacement recommended; PermaTorqueMLS®	
1	Head Gasket	2001	26392 PT	From Ser. No. 549028; Head bolts not incl.; Head bolt replacement recommended; PermaTorqueMLS®	
1	Head Gasket	2000-99	26391 PT	Head bolts not incl.; Head bolt replacement recommended; PermaTorqueMLS®	
1	Head Set	2003-02	HS 26392 PT	Head bolts not incl.; Head bolt replacement recommended; PermaDry® molded rubber valve cover gskt. incl.; Premium valve stem seals incl.	
1	Head Set	2001	HS 26391 PT	To Ser. No. 549027; Head bolts not incl.; Head bolt replacement recommended; PermaDry® molded rubber valve cover gskt. incl.; Premium valve stem seals incl.	

5 (cont.)		2003 - 1999; 1.6L 97.5 (1597cc) DOHC L4 (16 Valve) 78mm Bore			5 (cont.)
		MFI; Gasoline; Naturally Aspirated Mazda Eng.; Eng. Code ZM-DE			
QTY	CYLINDER HEAD	YEARS	PART NO.	DESCRIPTION	
1	Head Set	2001	HS 26392 PT	From Ser. No. 549028; Head bolts not incl.; Head bolt replacement recommended; PermaDry® molded rubber valve cover gskt. incl.; Premium valve stem seals incl.	
1	Head Set	2000-99	HS 26391 PT	Head bolts not incl.; Head bolt replacement recommended; PermaDry® molded rubber valve cover gskt. incl.; Premium valve stem seals incl.	
QTY	CONVERSION SET	YEARS	PART NO.	DESCRIPTION	
1	Gasket Conversion Set	2003-99	CS 9696-1	RTV sealant incl. for oil pan gskt.	
QTY	MANIFOLD - INT. & EXH.	YEARS	PART NO.	DESCRIPTION	
1	Int. Manifold Gasket Set	2003-99	MS 97024	Lower set	
1	Plenum Gasket Set	2003-99	MS 96417	Upper set	
1	Exh. Manifold Gasket Set	2003-99	MS 97025		
QTY	EXHAUST PIPE FLANGE	YEARS	PART NO.	DESCRIPTION	
1	Exhaust Pipe Gasket	2003-99	23591	Loc. Rear; Converter; 1 31/32" ID x 2 35/64" OD	
1	Exhaust Pipe Gasket	2003-99	61016	Loc. Front; Converter; Improved design	
1	Exhaust Pipe Gasket	2003-99	61044	Flange	
1	Exhaust Pipe Gasket	2003-99	61537	Converter Pre-Chamber	
QTY	OIL PAN	YEARS	PART NO.	DESCRIPTION	
1	Oil Pan Gasket Set	2003-99	OS 30631 R	RTV Black silicone w/Rubber end seals	
QTY	CRANKSHAFT REAR SEAL	YEARS	PART NO.	DESCRIPTION	
1	Rear Main Seal Set	2003-99	BS 40634	Rubber; One-piece	
QTY	VALVE COVER	YEARS	PART NO.	DESCRIPTION	
1	Valve Cover Gasket Set	2003-99	VS 50740 R	w/Spark plug tube seals; PermaDry® molded rubber gskt. incl.	
QTY	VALVE STEM SEAL SET	YEARS	PART NO.	DESCRIPTION	
1	Valve Stem Seal Set	2003-99	SS 72802	Premium valve stem seals incl.	
QTY	WATER OUTLET GASKET	YEARS	PART NO.	DESCRIPTION	
1	Water Outlet Gasket	2003-99	35251		
QTY	WATER PUMP	YEARS	PART NO.	DESCRIPTION	
1	Water Pump Gasket	2003-99	35456	Mounting	
1	Water Pump Gasket	2003-99	35457	Inlet	
QTY	TIMING COVER	YEARS	PART NO.	DESCRIPTION	
1	Crankshaft Front Seal Set	2003-99	TCS 45921	Must be used w/OS 30631R	
1	Camshaft Front Seal Set	2003-99	TCS 45860		
QTY	CARB & FUEL INJECTION	YEARS	PART NO.	DESCRIPTION	
1	Fuel Injector O-Ring Set	2003-99	ES 70600		
1	Throttle Body Gasket	2003-99	60984		
QTY	EXHAUST GAS RECIRCULATION	YEARS	PART NO.	DESCRIPTION	
1	EGR Gasket	2003-99	70431		
6		1993 - 1992; 1.6L 97.5 (1597cc) SOHC L4 (16 Valve) 78mm Bore			6
		MFI; Gasoline; Naturally Aspirated Mazda Eng.; Eng. Code B6			
QTY	CYLINDER HEAD	YEARS	PART NO.	DESCRIPTION	
1	Head Gasket	1993-92	9930 PT		
1	Head Set	1993-92	HS 9930 PT	PermaDry® molded rubber valve cover gskt. incl.; Premium valve stem seals incl.	
QTY	CONVERSION SET	YEARS	PART NO.	DESCRIPTION	
1	Gasket Conversion Set	1993-92	CS 9696-1	RTV sealant incl. for oil pan gskt.	
QTY	MANIFOLD - INT. & EXH.	YEARS	PART NO.	DESCRIPTION	
1	Int. Manifold Gasket Set	1993-92	MS 95467	Upper set incl.	
1	Exh. Manifold Gasket Set	1993-92	MS 95469		
QTY	EXHAUST PIPE FLANGE	YEARS	PART NO.	DESCRIPTION	
1	Exhaust Pipe Gasket	1993-92	60620	Loc. Rear; Converter	
1	Exhaust Pipe Gasket	1993-92	60798	Flange	
1	Exhaust Pipe Gasket	1993-92	60867	Loc. Front; Converter	
QTY	OIL PAN	YEARS	PART NO.	DESCRIPTION	
1	Oil Pan Gasket Set	1993-92	OS 30631 R	RTV Black silicone w/Rubber end seals	
QTY	CRANKSHAFT REAR SEAL	YEARS	PART NO.	DESCRIPTION	
1	Rear Main Seal Set	1993-92	BS 40634	Rubber; One-piece	
QTY	VALVE COVER	YEARS	PART NO.	DESCRIPTION	
1	Valve Cover Gasket Set	1993-92	VS 50359 R	PermaDry® molded rubber gskt. incl.	
QTY	VALVE STEM SEAL SET	YEARS	PART NO.	DESCRIPTION	
1	Valve Stem Seal Set	1993-92	SS 72782	Premium valve stem seals incl.	
QTY	WATER OUTLET GASKET	YEARS	PART NO.	DESCRIPTION	
1	Water Outlet Gasket	1993-92	35251	Water Outlet	

Mazda Car (Cont.)

6		1993 - 1992; 1.6L 97.5 (1597cc) SOHC L4 (16 Valve) 78mm Bore			6	
(cont.)		MFI; Gasoline; Naturally Aspirated Mazda Eng.; Eng. Code B6			(cont.)	
QTY	WATER PUMP	YEARS	PART NO.	DESCRIPTION		
1	Water Pump Gasket	1993-92	35456	Mounting		
1	Water Pump Gasket	1993-92	35457	Inlet		
QTY	TIMING COVER	YEARS	PART NO.	DESCRIPTION		
1	Crankshaft Front Seal Set	1993-92	TCS 45921	Must be used w/OS 30631R		
1	Camshaft Front Seal Set	1993-92	TCS 45724			
QTY	CARB & FUEL INJECTION	YEARS	PART NO.	DESCRIPTION		
1	Fuel Injector O-Ring Set	1993-92	ES 70600			
1	Throttle Body Gasket	1993-92	60874			
QTY	DISTRIBUTOR MOUNTING	YEARS	PART NO.	DESCRIPTION		
1	O-Ring	1993-92	35608	Distributor Mounting		
7		1995 - 1991; 1.6L 97.5 (1597cc) SOHC L4 (8 Valve) 78mm Bore			7	
(cont.)		MFI; Gasoline; Naturally Aspirated Mazda Eng.; Eng. Code B6			(cont.)	
QTY	CYLINDER HEAD	YEARS	PART NO.	DESCRIPTION		
1	Head Gasket	1995-91	9696 B			
1	Head Set	1995-91	HS 9696 B	PermaDry® molded rubber valve cover gskt. incl.; Premium valve stem seals incl.		
1	Head Bolt Set	1995-91	ES 72846	Replacement recommended; New Part Number - Check for Availability		
QTY	CONVERSION SET	YEARS	PART NO.	DESCRIPTION		
1	Gasket Conversion Set	1995-92	CS 9696-1	RTV sealant incl. for oil pan gskt.		
1	Gasket Conversion Set	1991	CS 9696-1	From Ser. No. 221257; RTV sealant incl. for oil pan gskt.		
QTY	MANIFOLD - INT. & EXH.	YEARS	PART NO.	DESCRIPTION		
1	Int. Manifold Gasket Set	1995-91	MS 94569	Upper set incl.		
1	Exh. Manifold Gasket Set	1995-91	MS 94570			
QTY	EXHAUST PIPE FLANGE	YEARS	PART NO.	DESCRIPTION		
1	Exhaust Pipe Gasket	1995-91	60620	Loc. Rear; Converter		
1	Exhaust Pipe Gasket	1995-91	60798	Flange		
1	Exhaust Pipe Gasket	1995-91	60867	Loc. Front; Converter		
QTY	OIL PAN	YEARS	PART NO.	DESCRIPTION		
1	Oil Pan Gasket Set	1995-91	OS 30631 R	RTV Black silicone w/Rubber end seals		
QTY	CRANKSHAFT REAR SEAL	YEARS	PART NO.	DESCRIPTION		
1	Rear Main Seal Set	1995-91	BS 40634	Rubber; One-piece		
QTY	VALVE COVER	YEARS	PART NO.	DESCRIPTION		
1	Valve Cover Gasket Set	1995-91	VS 50359 R	PermaDry® molded rubber gskt. incl.		
QTY	VALVE STEM SEAL SET	YEARS	PART NO.	DESCRIPTION		
1	Valve Stem Seal Set	1995-91	SS 72680	Premium valve stem seals incl.		
QTY	WATER OUTLET GASKET	YEARS	PART NO.	DESCRIPTION		
1	Water Outlet Gasket	1995-91	35251	Water Outlet		
QTY	WATER PUMP	YEARS	PART NO.	DESCRIPTION		
1	Water Pump Gasket	1995-91	35456	Mounting		
1	Water Pump Gasket	1995-91	35457	Inlet		
QTY	TIMING COVER	YEARS	PART NO.	DESCRIPTION		
1	Timing Cover Dust Seal Set	1995-91	ES 72765			
1	Crankshaft Front Seal Set	1995-92	TCS 45921	Must be used w/OS 30631R		
1	Crankshaft Front Seal Set	1991	TCS 45722	To Ser. No. 221256; Must be used w/OS 30631R		
1	Crankshaft Front Seal Set	1991	TCS 45921	From Ser. No. 221257; Must be used w/OS 30631R		
1	Camshaft Front Seal Set	1995-91	TCS 45724			
QTY	CARB & FUEL INJECTION	YEARS	PART NO.	DESCRIPTION		
1	Fuel Injector O-Ring Set	1995-91	ES 70600			
1	Throttle Body Gasket	1995-91	60865			
QTY	DISTRIBUTOR MOUNTING	YEARS	PART NO.	DESCRIPTION		
1	O-Ring	1995-91	35608	Distributor Mounting		
8		2000 - 1999; 1.8L 112.2 (1839cc) DOHC L4 (16 Valve) 83mm Bore			8	
(cont.)		MFI; Gasoline; Naturally Aspirated Mazda Eng.; Eng. Code BP-4W			(cont.)	
QTY	CYLINDER HEAD	YEARS	PART NO.	DESCRIPTION		
1	Head Gasket	2000-99	9717 PT	Head bolts not incl.; Head bolt replacement recommended; PermaTorqueMLS®		
1	Head Set	2000-99	HS 9717 PT-3	Head bolts not incl.; Head bolt replacement recommended; PermaDry® molded rubber valve cover gskt. incl.; Premium valve stem seals incl.		
1	Head Bolt Set	2000-99	ES 72846	Replacement recommended; New Part Number - Check for Availability		
QTY	CONVERSION SET	YEARS	PART NO.	DESCRIPTION		
1	Gasket Conversion Set	2000-99	CS 9691-3	RTV sealant incl. for oil pan gskt.		

8		2000 - 1999; 1.8L 112.2 (1839cc) DOHC L4 (16 Valve) 83mm Bore			8	
(cont.)		MFI; Gasoline; Naturally Aspirated Mazda Eng.; Eng. Code BP-4W			(cont.)	
QTY	MANIFOLD - INT. & EXH.	YEARS	PART NO.	DESCRIPTION		
1	Int. Manifold Gasket Set	2000-99	MS 96404	Lower set		
1	Plenum Gasket Set	2000-99	MS 96418	Upper set		
1	Exh. Manifold Gasket Set	2000-99	MS 94611			
QTY	EXHAUST PIPE FLANGE	YEARS	PART NO.	DESCRIPTION		
2	Exhaust Pipe Gasket	2000-99	60831	Converter		
1	Exhaust Pipe Gasket	2000-99	60866	Flange		
QTY	OIL PAN	YEARS	PART NO.	DESCRIPTION		
1	Oil Pan Gasket Set	2000-99	OS 30633 R	RTV Black silicone w/Rubber end seals		
QTY	CRANKSHAFT REAR SEAL	YEARS	PART NO.	DESCRIPTION		
1	Rear Main Seal Set	2000-99	BS 40634	Rubber; One-piece		
QTY	VALVE COVER	YEARS	PART NO.	DESCRIPTION		
1	Valve Cover Gasket Set	2000-99	VS 50569 R	w/Spark plug tube seals; PermaDry® molded rubber gskt. incl.; Improved design		
QTY	VALVE STEM SEAL SET	YEARS	PART NO.	DESCRIPTION		
1	Valve Stem Seal Set	2000-99	SS 72802	Premium valve stem seals incl.		
QTY	THERMOSTAT HOUSING	YEARS	PART NO.	DESCRIPTION		
1	Water Outlet Gasket	2000-99	35251	Thermostat Housing; Thermostat gskt.		
QTY	WATER OUTLET GASKET	YEARS	PART NO.	DESCRIPTION		
1	Water Outlet Gasket	2000-99	35251	Water Outlet; Water outlet gskt.		
QTY	WATER PUMP	YEARS	PART NO.	DESCRIPTION		
1	Water Pump Gasket	2000-99	35456	Mounting		
1	Water Pump Gasket	2000-99	35457	Inlet		
QTY	TIMING COVER	YEARS	PART NO.	DESCRIPTION		
1	Crankshaft Front Seal Set	2000-99	TCS 45921	Must be used w/OS 30633R		
1	Camshaft Front Seal Set	2000-99	TCS 45860			
QTY	CARB & FUEL INJECTION	YEARS	PART NO.	DESCRIPTION		
1	Fuel Injector O-Ring Set	2000-99	ES 70600			
1	Throttle Body Gasket	2000-99	60984			
QTY	DISTRIBUTOR MOUNTING	YEARS	PART NO.	DESCRIPTION		
1	O-Ring	2000-99	35608	Distributor Mounting; Camshaft Angle Sensor seal		
QTY	EXHAUST GAS RECIRCULATION	YEARS	PART NO.	DESCRIPTION		
1	EGR Gasket	2000-99	70431			
9		2005 - 2001; 1.8L 112.2 (1839cc) DOHC L4 (16 Valve) 83mm Bore			9	
(cont.)		MFI; Gasoline; Naturally Aspirated Mazda Eng.; Eng. Code BP-Z3			(cont.)	
QTY	CYLINDER HEAD	YEARS	PART NO.	DESCRIPTION		
1	Head Gasket	2005-01	26234 PT	Head bolts not incl.; Head bolt replacement recommended; PermaTorqueMLS®		
1	Head Set	2005-01	HS 26234 PT-1	Head bolts not incl.; Head bolt replacement recommended; PermaDry® molded rubber valve cover gskt. incl.; Premium valve stem seals incl.; Improved design		
1	Head Set	2001	HS 26234 PT	Head bolts not incl.; Head bolt replacement recommended; PermaDry® molded rubber valve cover gskt. incl.; Premium valve stem seals incl.; Old design; Superseded - When depleted use HS 26234 PT-1		
1	Head Bolt Set	2005-01	ES 72846	Replacement recommended; New Part Number - Check for Availability		
QTY	CONVERSION SET	YEARS	PART NO.	DESCRIPTION		
1	Gasket Conversion Set	2005-01	CS 9696-1	RTV sealant incl. for oil pan gskt.		
QTY	MANIFOLD - INT. & EXH.	YEARS	PART NO.	DESCRIPTION		
1	Int. Manifold Gasket Set	2005-01	MS 96404	Lower set		
1	Plenum Gasket Set	2005-01	MS 96419	Upper set		
1	Exh. Manifold Gasket Set	2005-01	MS 94611			
QTY	EXHAUST PIPE FLANGE	YEARS	PART NO.	DESCRIPTION		
1	Exhaust Pipe Gasket	2005-01	61327	Flange		
QTY	OIL PAN	YEARS	PART NO.	DESCRIPTION		
1	Oil Pan Gasket Set	2005-01	OS 30631 R	RTV Black silicone w/Rubber end seals		
QTY	CRANKSHAFT REAR SEAL	YEARS	PART NO.	DESCRIPTION		
1	Rear Main Seal Set	2005-01	BS 40634	Rubber; One-piece		
QTY	VALVE COVER	YEARS	PART NO.	DESCRIPTION		
1	Valve Cover Gasket Set	2005-01	VS 50602 R	w/Spark plug tube seals; PermaDry® molded rubber gskt. incl.		
QTY	VALVE STEM SEAL SET	YEARS	PART NO.	DESCRIPTION		
1	Valve Stem Seal Set	2005-01	SS 72802	Premium valve stem seals incl.		
QTY	THERMOSTAT HOUSING	YEARS	PART NO.	DESCRIPTION		
1	Water Outlet Gasket	2005-01	35251	Thermostat Housing; Thermostat gskt.		

Mazda Car (Cont.)

9		2005 - 2001; 1.8L 112.2 (1839cc) DOHC L4 (16 Valve) 83mm Bore			9	
(cont.)		MFI; Gasoline; Naturally Aspirated Mazda Eng.; Eng. Code BP-Z3			(cont.)	
QTY	WATER OUTLET GASKET	YEARS	PART NO.	DESCRIPTION		
1	Water Outlet Gasket	2005-01	35251	Water Outlet; Water outlet gskt.		
QTY	WATER PUMP	YEARS	PART NO.	DESCRIPTION		
1	Water Pump Gasket	2005-01	35456	Mounting		
1	Water Pump Gasket	2005-01	35457	Inlet		
QTY	TIMING COVER	YEARS	PART NO.	DESCRIPTION		
1	Crankshaft Front Seal Set	2005-01	TCS 45921	Must be used w/OS 30631R		
1	Camshaft Front Seal Set	2005-01	TCS 46066			
QTY	CARB & FUEL INJECTION	YEARS	PART NO.	DESCRIPTION		
1	Fuel Injector O-Ring Set	2005-01	ES 70600			
1	Throttle Body Gasket	2005-01	60984			
QTY	DISTRIBUTOR MOUNTING	YEARS	PART NO.	DESCRIPTION		
1	O-Ring	2005-01	35608	Distributor Mounting; Crankshaft Position Sensor seal		
QTY	EXHAUST GAS RECIRCULATION	YEARS	PART NO.	DESCRIPTION		
1	EGR Gasket	2005-01	70431			
10		2005 - 2004; 1.8L 112.2 (1839cc) DOHC L4 (16 Valve) 83mm Bore			10	
		MFI; Gasoline; Turbo - Intercooled Mazda Eng.; Eng. Code BP-Z3T				
QTY	CYLINDER HEAD	YEARS	PART NO.	DESCRIPTION		
1	Head Gasket	2005-04	26234 PT	Head bolts not incl.; Head bolt replacement recommended; PermaTorqueMLS®		
1	Head Set	2005-04	HS 26234 PT-2	Head bolts not incl.; Head bolt replacement recommended; PermaDry® molded rubber valve cover gskt. incl.; Premium valve stem seals incl.; Improved design; New Part Number - Check for Availability		
1	Head Bolt Set	2005-04	ES 72846	Replacement recommended; New Part Number - Check for Availability		
QTY	CONVERSION SET	YEARS	PART NO.	DESCRIPTION		
1	Gasket Conversion Set	2005-04	CS 9696-1	RTV sealant incl. for oil pan gskt.		
QTY	MANIFOLD - INT. & EXH.	YEARS	PART NO.	DESCRIPTION		
1	Int. Manifold Gasket Set	2005-04	MS 96404	Lower set		
1	Plenum Gasket Set	2005-04	MS 96419	Upper set		
1	Exh. Manifold Gasket Set	2005-04	MS 94611			
QTY	EXHAUST PIPE FLANGE	YEARS	PART NO.	DESCRIPTION		
1	Exhaust Pipe Gasket	2005-04	61327	Flange		
QTY	OIL PAN	YEARS	PART NO.	DESCRIPTION		
1	Oil Pan Gasket Set	2005-04	OS 30631 R	RTV Black silicone w/Rubber end seals		
QTY	CRANKSHAFT REAR SEAL	YEARS	PART NO.	DESCRIPTION		
1	Rear Main Seal Set	2005-04	BS 40634	Rubber; One-piece		
QTY	VALVE COVER	YEARS	PART NO.	DESCRIPTION		
1	Valve Cover Gasket Set	2005-04	VS 50569 R	w/Spark plug tube seals; PermaDry® molded rubber gskt. incl.; Improved design		
QTY	VALVE STEM SEAL SET	YEARS	PART NO.	DESCRIPTION		
1	Valve Stem Seal Set	2005-04	SS 72802	Premium valve stem seals incl.		
QTY	THERMOSTAT HOUSING	YEARS	PART NO.	DESCRIPTION		
1	Water Outlet Gasket	2005-04	35251	Thermostat Housing; Thermostat gskt.		
QTY	WATER OUTLET GASKET	YEARS	PART NO.	DESCRIPTION		
1	Water Outlet Gasket	2005-04	35251	Water Outlet; Water outlet gskt.		
QTY	WATER PUMP	YEARS	PART NO.	DESCRIPTION		
1	Water Pump Gasket	2005-04	35456	Mounting		
1	Water Pump Gasket	2005-04	35457	Inlet		
QTY	TIMING COVER	YEARS	PART NO.	DESCRIPTION		
1	Crankshaft Front Seal Set	2005-04	TCS 45921	Must be used w/OS 30631R		
1	Camshaft Front Seal Set	2005-04	TCS 45860			
QTY	CARB & FUEL INJECTION	YEARS	PART NO.	DESCRIPTION		
1	Fuel Injector O-Ring Set	2005-04	ES 70600			
1	Throttle Body Gasket	2005-04	60984			
QTY	DISTRIBUTOR MOUNTING	YEARS	PART NO.	DESCRIPTION		
1	O-Ring	2005-04	35608	Distributor Mounting; Crankshaft Position Sensor seal		
QTY	EXHAUST GAS RECIRCULATION	YEARS	PART NO.	DESCRIPTION		
1	EGR Gasket	2005-04	70431			

11		1998 - 1991; 1.8L 112.2 (1839cc) DOHC L4 (16 Valve) 83mm Bore			11
		MFI; Gasoline; Naturally Aspirated Mazda Eng.; Eng. Code BP-ZE			
QTY	CYLINDER HEAD	YEARS	PART NO.	DESCRIPTION	
1	Head Gasket	1998-91	9717 PT	Head bolts not incl.; Head bolt replacement recommended; PermaTorqueMLS®	
1	Head Set	1998	HS 9717 PT-1	Exc. Mazda Protege ES; Head bolts & exh. pipe flange not incl.; Head bolt replacement recommended; PermaDry® molded rubber valve cover gskt. incl.; Premium valve stem seals incl.	
1	Head Set	1998	HS 9717 PT-1	Mazda Protege ES; Upper int. manifold gskt., head bolts, exh. pipe flange not incl.; Head bolt replacement recommended; PermaDry® molded rubber valve cover gskt. incl.; Premium valve stem seals incl.	
1	Head Set	1997-96	HS 9717 PT-1	Exc. Mazda Protege ES, SE; Head bolts & exh. pipe flange not incl.; Head bolt replacement recommended; PermaDry® molded rubber valve cover gskt. incl.; Premium valve stem seals incl.	
1	Head Set	1997-96	HS 9717 PT-1	Mazda Protege ES, SE; Upper int. manifold gskt., head bolts, exh. pipe flange not incl.; Head bolt replacement recommended; PermaDry® molded rubber valve cover gskt. incl.; Premium valve stem seals incl.	
1	Head Set	1995	HS 9717 PT-1	Exc. Mazda Protege ES, S; Head bolts & exh. pipe flange not incl.; Head bolt replacement recommended; PermaDry® molded rubber valve cover gskt. incl.; Premium valve stem seals incl.	
1	Head Set	1995	HS 9717 PT-1	Mazda Protege ES, S; Upper int. manifold gskt., head bolts, exh. pipe flange not incl.; Head bolt replacement recommended; PermaDry® molded rubber valve cover gskt. incl.; Premium valve stem seals incl.	
1	Head Set	1994	HS 9717 PT	Mazda Protege LX; Head bolts & exh. pipe flange not incl.; Head bolt replacement recommended; PermaDry® molded rubber valve cover gskt. incl.; Premium valve stem seals incl.	
1	Head Set	1994	HS 9717 PT-1	Exc. Mazda Protege LX; Head bolts & exh. pipe flange not incl.; Head bolt replacement recommended; PermaDry® molded rubber valve cover gskt. incl.; Premium valve stem seals incl.	
1	Head Set	1993-91	HS 9717 PT	Head bolts not incl.; Head bolt replacement recommended; PermaDry® molded rubber valve cover gskt. incl.; Premium valve stem seals incl.	
1	Head Bolt Set	1998-91	ES 72846	Replacement recommended; New Part Number - Check for Availability	
QTY	CONVERSION SET	YEARS	PART NO.	DESCRIPTION	
1	Gasket Conversion Set	1998	CS 9691-3	Exc. Mazda Protege ES; RTV sealant incl. for oil pan gskt.	
1	Gasket Conversion Set	1998	CS 9696-1	Mazda Protege ES; RTV sealant incl. for oil pan gskt.	
1	Gasket Conversion Set	1997-96	CS 9691-3	Exc. Mazda Protege ES, SE; RTV sealant incl. for oil pan gskt.	
1	Gasket Conversion Set	1997-96	CS 9696-1	Mazda Protege ES, SE; RTV sealant incl. for oil pan gskt.	
1	Gasket Conversion Set	1995	CS 9691-3	Exc. Mazda Protege ES, S; RTV sealant incl. for oil pan gskt.	
1	Gasket Conversion Set	1995	CS 9696-1	Mazda Protege ES, S; RTV sealant incl. for oil pan gskt.	
1	Gasket Conversion Set	1994	CS 9691-3	Exc. Mazda Protege LX; RTV sealant incl. for oil pan gskt.	
1	Gasket Conversion Set	1994	CS 9696-1	Mazda Protege LX; RTV sealant incl. for oil pan gskt.	
1	Gasket Conversion Set	1993-92	CS 9696-1	RTV sealant incl. for oil pan gskt.	
1	Gasket Conversion Set	1991	CS 9696-1	From Ser. No. 237237; RTV sealant incl. for oil pan gskt.	
QTY	MANIFOLD - INT. & EXH.	YEARS	PART NO.	DESCRIPTION	
1	Int. Manifold Gasket Set	1998-95	MS 94612-1	Lower set	
1	Int. Manifold Gasket Set	1994	MS 94612	Mazda Protege LX; Lower set; Upper set incl.	
1	Int. Manifold Gasket Set	1994	MS 94612-1	Exc. Mazda Protege LX; Lower set	
1	Int. Manifold Gasket Set	1993-91	MS 94612	Lower set; Upper set incl.	
1	Plenum Gasket Set	1998	MS 96525	Mazda Protege ES; Upper set	
1	Plenum Gasket Set	1997-96	MS 96525	Mazda Protege ES, SE; Upper set	
1	Plenum Gasket Set	1995	MS 96525	Mazda Protege ES, S; Upper set	
1	Exh. Manifold Gasket Set	1998-91	MS 94611		
QTY	EXHAUST PIPE FLANGE	YEARS	PART NO.	DESCRIPTION	
1	Exhaust Pipe Gasket	1998	60620	Mazda Protege ES; Loc. Rear; Converter	
2	Exhaust Pipe Gasket	1998	60831	Exc. Mazda Protege ES; Converter	
1	Exhaust Pipe Gasket	1998	60866	Exc. Mazda Protege ES; Flange	
1	Exhaust Pipe Gasket	1998	60867	Mazda Protege ES; Loc. Front; Converter	
1	Exhaust Pipe Gasket	1998	60967	Mazda Protege ES; Flange	
1	Exhaust Pipe Gasket	1997-96	60620	Mazda Protege ES, SE; Loc. Rear; Converter	
2	Exhaust Pipe Gasket	1997-96	60831	Exc. Mazda Protege ES, SE; Converter	
1	Exhaust Pipe Gasket	1997-96	60866	Exc. Mazda Protege ES, SE; Flange	
1	Exhaust Pipe Gasket	1997-96	60867	Mazda Protege ES, SE; Loc. Front; Converter	
1	Exhaust Pipe Gasket	1997-96	60967	Mazda Protege ES, SE; Flange	
1	Exhaust Pipe Gasket	1995	60620	Mazda Protege ES, S; Loc. Rear; Converter	
2	Exhaust Pipe Gasket	1995	60831	Exc. Mazda Protege ES, S; Converter	
1	Exhaust Pipe Gasket	1995	60866	Exc. Mazda Protege ES, S; Flange	
1	Exhaust Pipe Gasket	1995	60867	Mazda Protege ES, S; Loc. Front; Converter	
1	Exhaust Pipe Gasket	1995	60967	Mazda Protege ES, S; Flange	

Mazda Car (Cont.)

11 (cont.)		1998 - 1991; 1.8L 112.2 (1839cc) DOHC L4 (16 Valve) 83mm Bore MFI; Gasoline; Naturally Aspirated Mazda Eng.; Eng. Code BP-ZE			11 (cont.)
QTY	EXHAUST PIPE FLANGE	YEARS	PART NO.	DESCRIPTION	
1	Exhaust Pipe Gasket	1994	60620	Mazda Protege LX; Loc. Rear; Converter	
2	Exhaust Pipe Gasket	1994	60831	Exc. Mazda Protege LX; Converter	
1	Exhaust Pipe Gasket	1994	60866	Exc. Mazda Protege LX; Flange	
1	Exhaust Pipe Gasket	1994	60867	Mazda Protege LX; Loc. Front; Converter	
1	Exhaust Pipe Gasket	1994	60967	Mazda Protege LX; Flange	
1	Exhaust Pipe Gasket	1993-91	60620	Loc. Rear; Converter	
1	Exhaust Pipe Gasket	1993-91	60798	Flange	
1	Exhaust Pipe Gasket	1993-91	60867	Loc. Front; Converter	
QTY	OIL PAN	YEARS	PART NO.	DESCRIPTION	
1	Oil Pan Gasket Set	1998	OS 30631 R	Mazda Protege ES; RTV Black silicone w/Rubber end seals	
1	Oil Pan Gasket Set	1998	OS 30633 R	Exc. Mazda Protege ES; RTV Black silicone w/Rubber end seals	
1	Oil Pan Gasket Set	1997-96	OS 30631 R	Mazda Protege ES, SE; RTV Black silicone w/Rubber end seals	
1	Oil Pan Gasket Set	1997-96	OS 30633 R	Exc. Mazda Protege ES, SE; RTV Black silicone w/Rubber end seals	
1	Oil Pan Gasket Set	1995	OS 30631 R	Mazda Protege ES, S; RTV Black silicone w/Rubber end seals	
1	Oil Pan Gasket Set	1995	OS 30633 R	Exc. Mazda Protege ES, S; RTV Black silicone w/Rubber end seals	
1	Oil Pan Gasket Set	1994	OS 30631 R	Mazda Protege LX; RTV Black silicone w/Rubber end seals	
1	Oil Pan Gasket Set	1994	OS 30633 R	Exc. Mazda Protege LX; RTV Black silicone w/Rubber end seals	
1	Oil Pan Gasket Set	1993-91	OS 30631 R	RTV Black silicone w/Rubber end seals	
QTY	CRANKSHAFT REAR SEAL	YEARS	PART NO.	DESCRIPTION	
1	Rear Main Seal Set	1998-91	BS 40634	Rubber; One-piece	
QTY	VALVE COVER	YEARS	PART NO.	DESCRIPTION	
1	Valve Cover Gasket Set	1998-91	VS 50569 R	w/Spark plug tube seals; PermaDry® molded rubber gskt. incl.; Improved design	
QTY	VALVE STEM SEAL SET	YEARS	PART NO.	DESCRIPTION	
1	Valve Stem Seal Set	1998-95	SS 72802	Premium valve stem seals incl.	
1	Valve Stem Seal Set	1994	SS 72782	Mazda Protege LX; Premium valve stem seals incl.	
1	Valve Stem Seal Set	1994	SS 72802	Exc. Mazda Protege LX; Premium valve stem seals incl.	
1	Valve Stem Seal Set	1993-91	SS 72782	Premium valve stem seals incl.	
QTY	THERMOSTAT HOUSING	YEARS	PART NO.	DESCRIPTION	
1	Water Outlet Gasket	1998	35251	Exc. Mazda Protege ES; Thermostat Housing; Thermostat gskt.	
1	Water Outlet Gasket	1997-96	35251	Exc. Mazda Protege ES, SE; Thermostat Housing; Thermostat gskt.	
1	Water Outlet Gasket	1995	35251	Exc. Mazda Protege ES, S; Thermostat Housing; Thermostat gskt.	
1	Water Outlet Gasket	1994	35251	Exc. Mazda Protege LX; Thermostat Housing; Thermostat gskt.	
QTY	WATER OUTLET GASKET	YEARS	PART NO.	DESCRIPTION	
1	Water Outlet Gasket	1998	35251	Mazda Protege ES; Water Outlet	
1	Water Outlet Gasket	1998	35251	Exc. Mazda Protege ES; Water Outlet; Water outlet gskt.	
1	Water Outlet Gasket	1997-96	35251	Mazda Protege ES, SE; Water Outlet	
1	Water Outlet Gasket	1997-96	35251	Exc. Mazda Protege ES, SE; Water Outlet; Water outlet gskt.	
1	Water Outlet Gasket	1995	35251	Mazda Protege ES, S; Water Outlet	
1	Water Outlet Gasket	1995	35251	Exc. Mazda Protege ES, S; Water Outlet; Water outlet gskt.	
1	Water Outlet Gasket	1994	35251	Mazda Protege LX; Water Outlet	
1	Water Outlet Gasket	1994	35251	Exc. Mazda Protege LX; Water Outlet; Water outlet gskt.	
1	Water Outlet Gasket	1993-91	35251	Water Outlet	
QTY	WATER PUMP	YEARS	PART NO.	DESCRIPTION	
1	Water Pump Gasket	1998-91	35456	Mounting	
1	Water Pump Gasket	1998-91	35457	Inlet	
QTY	TIMING COVER	YEARS	PART NO.	DESCRIPTION	
1	Crankshaft Front Seal Set	1998	TCS 45921	Mazda Protege ES; Must be used w/OS 30631R	
1	Crankshaft Front Seal Set	1998	TCS 45921	Exc. Mazda Protege ES; Must be used w/OS 30633R	
1	Crankshaft Front Seal Set	1997-96	TCS 45921	Mazda Protege ES, SE; Must be used w/OS 30631R	
1	Crankshaft Front Seal Set	1997-96	TCS 45921	Exc. Mazda Protege ES, SE; Must be used w/OS 30633R	
1	Crankshaft Front Seal Set	1995	TCS 45921	Mazda Protege ES, S; Must be used w/OS 30631R	
1	Crankshaft Front Seal Set	1995	TCS 45921	Exc. Mazda Protege ES, S; Must be used w/OS 30633R	
1	Crankshaft Front Seal Set	1994	TCS 45921	Mazda Protege LX; Must be used w/OS 30631R	
1	Crankshaft Front Seal Set	1994	TCS 45921	Exc. Mazda Protege LX; Must be used w/OS 30633R	
1	Crankshaft Front Seal Set	1993-92	TCS 45921	Must be used w/OS 30631R	
1	Crankshaft Front Seal Set	1991	TCS 45722	To Ser. No. 237236; Must be used w/OS 30631R	
1	Crankshaft Front Seal Set	1991	TCS 45921	From Ser. No. 237237; Must be used w/OS 30631R	
1	Camshaft Front Seal Set	1998-91	TCS 45860		
QTY	CARB & FUEL INJECTION	YEARS	PART NO.	DESCRIPTION	
1	Fuel Injector O-Ring Set	1998-91	ES 70600		
1	Throttle Body Gasket	1998-95	60984		
1	Throttle Body Gasket	1994	60874	Mazda Protege LX	
1	Throttle Body Gasket	1994	60984	Exc. Mazda Protege LX	
1	Throttle Body Gasket	1993-91	60874		

11 (cont.)		1998 - 1991; 1.8L 112.2 (1839cc) DOHC L4 (16 Valve) 83mm Bore			11 (cont.)	
MFI; Gasoline; Naturally Aspirated Mazda Eng.; Eng. Code BP-ZE						
QTY	DISTRIBUTOR MOUNTING	YEARS	PART NO.	DESCRIPTION		
1	O-Ring	1998-91	35608	Distributor Mounting; Camshaft Angle Sensor seal		
QTY	EXHAUST GAS RECIRCULATION	YEARS	PART NO.	DESCRIPTION		
1	EGR Gasket	1998-91	70431			
12		2001 - 1999; 1.8L 112.2 (1839cc) DOHC L4 (16 Valve) 83mm Bore			12	
MFI; Gasoline; Naturally Aspirated Mazda Eng.; Eng. Code FP-ZE						
QTY	CYLINDER HEAD	YEARS	PART NO.	DESCRIPTION		
1	Head Gasket	2001-99	9711 PT	Head bolts not incl.; Head bolt replacement required; PermaTorqueMLS®		
1	Head Set	2001-99	HS 9711 PT-1	Upper int. manifold gskt. & head bolts not incl.; Head bolt replacement required; PermaDry® molded rubber valve cover gskt. incl.; Premium valve stem seals incl.		
QTY	CONVERSION SET	YEARS	PART NO.	DESCRIPTION		
1	Gasket Conversion Set	2001-99	CS 9711	RTV sealant incl. for Upper oil pan gskt.		
QTY	MANIFOLD - INT. & EXH.	YEARS	PART NO.	DESCRIPTION		
1	Int. Manifold Gasket Set	2001-99	MS 96149	Lower set; Improved design		
1	Plenum Gasket Set	2001-99	MS 96417	Upper set		
1	Exh. Manifold Gasket Set	2001-99	MS 95425			
QTY	EXHAUST PIPE FLANGE	YEARS	PART NO.	DESCRIPTION		
1	Exhaust Pipe Gasket	2001-99	61044	Flange		
QTY	OIL PAN	YEARS	PART NO.	DESCRIPTION		
1	Oil Pan Gasket Set	2001-99	OS 30908 C	Loc. Lower		
1	Drain Plug Gasket	2001-99	72515			
QTY	CRANKSHAFT REAR SEAL	YEARS	PART NO.	DESCRIPTION		
1	Rear Main Seal Set	2001-99	BS 40667	Rubber; One-piece		
QTY	VALVE COVER	YEARS	PART NO.	DESCRIPTION		
1	Valve Cover Gasket Set	2001-99	VS 50574 R	w/Grommets & Spark plug tube seals; PermaDry® molded rubber gskt. incl.		
QTY	VALVE STEM SEAL SET	YEARS	PART NO.	DESCRIPTION		
1	Valve Stem Seal Set	2001-99	SS 72802	Premium valve stem seals incl.		
QTY	WATER OUTLET GASKET	YEARS	PART NO.	DESCRIPTION		
1	Water Outlet Gasket	2001-99	35570	Water Outlet; Coolant housing to head; Must be used w/11760		
1	Water Pump Gasket	2001-99	11760	Water Outlet; Thermostat housing to head; Must be used w/35570		
QTY	WATER PUMP	YEARS	PART NO.	DESCRIPTION		
1	Water Pump Gasket	2001-99	35569	Mounting		
QTY	TIMING COVER	YEARS	PART NO.	DESCRIPTION		
1	Crankshaft Front Seal Set	2001-99	TCS 45936			
1	Camshaft Front Seal Set	2001-99	TCS 45860			
QTY	CARB & FUEL INJECTION	YEARS	PART NO.	DESCRIPTION		
1	Fuel Injector O-Ring Set	2001-99	ES 70600			
1	Throttle Body Gasket	2001-99	60964			
QTY	EXHAUST GAS RECIRCULATION	YEARS	PART NO.	DESCRIPTION		
1	EGR Gasket	2001-99	70431			
13		1996 - 1991; 1.8L 112.2 (1839cc) SOHC L4 (16 Valve) 83mm Bore			13	
MFI; Gasoline; Naturally Aspirated Mazda Eng.; Eng. Code BP-ZD						
QTY	CYLINDER HEAD	YEARS	PART NO.	DESCRIPTION		
1	Head Gasket	1996-91	9717 PT	Head bolts not incl.; Head bolt replacement recommended; PermaTorqueMLS®		
1	Head Set	1996-91	HS 9718 PT	Head bolts not incl.; Head bolt replacement recommended; PermaDry® molded rubber valve cover gskt. incl.; Premium valve stem seals incl.		
1	Head Bolt Set	1996-91	ES 72846	Replacement recommended; New Part Number - Check for Availability		
QTY	CONVERSION SET	YEARS	PART NO.	DESCRIPTION		
1	Gasket Conversion Set	1996-92	CS 9696-1	RTV sealant incl. for oil pan gskt.		
1	Gasket Conversion Set	1991	CS 9696-1	From Ser. No. 260402; RTV sealant incl. for oil pan gskt.		
QTY	MANIFOLD - INT. & EXH.	YEARS	PART NO.	DESCRIPTION		
1	Int. Manifold Gasket Set	1996-91	MS 94608	Upper set incl.		
1	Exh. Manifold Gasket Set	1996-91	MS 94610			
QTY	EXHAUST PIPE FLANGE	YEARS	PART NO.	DESCRIPTION		
1	Exhaust Pipe Gasket	1996-91	60620	Loc. Rear; Converter		
1	Exhaust Pipe Gasket	1996-91	60798	Flange		
1	Exhaust Pipe Gasket	1996-91	60867	Loc. Front; Converter		
QTY	OIL PAN	YEARS	PART NO.	DESCRIPTION		
1	Oil Pan Gasket Set	1996-91	OS 30631 R	RTV Black silicone w/Rubber end seals		

Mazda Car (Cont.)

13 (cont.)		1996 - 1991; 1.8L 112.2 (1839cc) SOHC L4 (16 Valve) 83mm Bore			13 (cont.)
MFI; Gasoline; Naturally Aspirated Mazda Eng.; Eng. Code BP-ZD					
QTY	CRANKSHAFT REAR SEAL	YEARS	PART NO.	DESCRIPTION	
1	Rear Main Seal Set	1996-91	BS 40634	Rubber; One-piece	
QTY	VALVE COVER	YEARS	PART NO.	DESCRIPTION	
1	Valve Cover Gasket Set	1996-91	VS 50389 R	PermaDry® molded rubber gskt. incl.	
QTY	VALVE STEM SEAL SET	YEARS	PART NO.	DESCRIPTION	
1	Valve Stem Seal Set	1996-91	SS 72782	Premium valve stem seals incl.	
QTY	WATER OUTLET GASKET	YEARS	PART NO.	DESCRIPTION	
1	Water Outlet Gasket	1996-91	35251	Water Outlet	
QTY	WATER PUMP	YEARS	PART NO.	DESCRIPTION	
1	Water Pump Gasket	1996-91	35456	Mounting	
1	Water Pump Gasket	1996-91	35457	Inlet	
QTY	TIMING COVER	YEARS	PART NO.	DESCRIPTION	
1	Crankshaft Front Seal Set	1996-92	TCS 45921	Must be used w/OS 30631R	
1	Crankshaft Front Seal Set	1991	TCS 45722	To Ser. No. 260401; Must be used w/OS 30631R	
1	Crankshaft Front Seal Set	1991	TCS 45921	From Ser. No. 260402; Must be used w/OS 30631R	
1	Camshaft Front Seal Set	1996-91	TCS 45724		
QTY	CARB & FUEL INJECTION	YEARS	PART NO.	DESCRIPTION	
1	Fuel Injector O-Ring Set	1996-91	ES 70600		
1	Throttle Body Gasket	1996-91	60874		
QTY	DISTRIBUTOR MOUNTING	YEARS	PART NO.	DESCRIPTION	
1	O-Ring	1996-91	35608	Distributor Mounting	
QTY	EXHAUST GAS RECIRCULATION	YEARS	PART NO.	DESCRIPTION	
1	EGR Gasket	1996-91	70431		
14		2003 - 1993; 2.0L 121.5 (1991cc) DOHC L4 (16 Valve) 83mm Bore			14
MFI; Gasoline; Naturally Aspirated Mazda Eng.; Eng. Code FS-DE					
QTY	CYLINDER HEAD	YEARS	PART NO.	DESCRIPTION	
1	Head Gasket	2003-00	26194 PT	Head bolts not incl.; Head bolt replacement required; PermaTorqueMLS® LaserWeld® Technology	
1	Head Gasket	1999-93	9711 PT	Head bolts not incl.; Head bolt replacement required; PermaTorqueMLS®	
1	Head Set	2003-00	HS 26194 PT	Head bolts not incl.; Head bolt replacement required; PermaDry® molded rubber valve cover gskt. incl.; Premium valve stem seals incl.	
1	Head Set	1999-98	HS 9711 PT-1	Head bolts not incl.; Head bolt replacement required; PermaDry® molded rubber valve cover gskt. incl.; Premium valve stem seals incl.	
1	Head Set	1997-96	HS 9711 PT	Head bolts & exh. pipe flange not incl.; Head bolt replacement required; PermaDry® molded rubber valve cover gskt. incl.; Premium valve stem seals incl.	
1	Head Set	1995-93	HS 9711 PT	Head bolts not incl.; Head bolt replacement required; PermaDry® molded rubber valve cover gskt. incl.; Premium valve stem seals incl.	
1	Head Bolt Set	2003-93	ES 74020	Replacement required	
QTY	CONVERSION SET	YEARS	PART NO.	DESCRIPTION	
1	Gasket Conversion Set	2003-93	CS 9711	RTV sealant incl. for Upper oil pan gskt.	
QTY	MANIFOLD - INT. & EXH.	YEARS	PART NO.	DESCRIPTION	
1	Int. Manifold Gasket Set	2003-93	MS 96149	Lower set; Improved design	
1	Plenum Gasket Set	2003	MS 96145	Upper set	
1	Plenum Gasket Set	2002-01	MS 96145	Exc. Mazda 626 ES, LX; Upper set	
1	Exh. Manifold Gasket Set	2003-93	MS 95425		
QTY	EXHAUST PIPE FLANGE	YEARS	PART NO.	DESCRIPTION	
1	Exhaust Pipe Gasket	2003-96	61044	Flange	
1	Exhaust Pipe Gasket	1997-96	60831	Loc. Front; Converter	
1	Exhaust Pipe Gasket	1997-96	60868	Loc. Rear; Converter	
2	Exhaust Pipe Gasket	1995-94	60868	Converter; California	
1	Exhaust Pipe Gasket	1995-94	60868	Loc. Rear; Converter; Exc. California	
1	Exhaust Pipe Gasket	1995-93	60967	Flange	
1	Exhaust Pipe Gasket	1995-94	60831	Loc. Front; Converter; Exc. California	
1	Exhaust Pipe Gasket	1993	60831	Loc. Front; Converter	
1	Exhaust Pipe Gasket	1993	60868	Loc. Rear; Converter	
QTY	OIL PAN	YEARS	PART NO.	DESCRIPTION	
1	Oil Pan Gasket Set	2003-93	OS 30908 C	Loc. Lower	
1	Drain Plug Gasket	2003-93	72515		
QTY	CRANKSHAFT REAR SEAL	YEARS	PART NO.	DESCRIPTION	
1	Rear Main Seal Set	2003-93	BS 40667	Rubber; One-piece	
QTY	VALVE COVER	YEARS	PART NO.	DESCRIPTION	
1	Valve Cover Gasket Set	2003-98	VS 50574 R	w/Grommets & Spark plug tube seals; PermaDry® molded rubber gskt. incl.	

14 (cont.)		2003 - 1993; 2.0L 121.5 (1991cc) DOHC L4 (16 Valve) 83mm Bore			14 (cont.)
		MFI; Gasoline; Naturally Aspirated Mazda Eng.; Eng. Code FS-DE			
QTY	VALVE COVER	YEARS	PART NO.	DESCRIPTION	
1	Valve Cover Gasket Set	1997-93	VS 50428 R	w/Spark plug tube seals; PermaDry® molded rubber gskt. incl.	
QTY	VALVE STEM SEAL SET	YEARS	PART NO.	DESCRIPTION	
1	Valve Stem Seal Set	2003-93	SS 72802	Premium valve stem seals incl.	
QTY	WATER OUTLET GASKET	YEARS	PART NO.	DESCRIPTION	
1	Water Outlet Gasket	2003-93	35570	Water Outlet; Coolant housing to head; Must be used w/11760	
1	Water Pump Gasket	2003-93	11760	Water Outlet; Thermostat housing to head; Must be used w/35570	
QTY	WATER PUMP	YEARS	PART NO.	DESCRIPTION	
1	Water Pump Gasket	2003-93	35569	Mounting	
QTY	TIMING COVER	YEARS	PART NO.	DESCRIPTION	
1	Crankshaft Front Seal Set	2003-93	TCS 45936	Oil pump mounting seals incl.; Oil cooler mounting seals incl.	
1	Crankshaft Front Seal Set	2003-93	TCS 46165	Crankshaft front seal only; New Part Number - Check for Availability	
1	Camshaft Front Seal Set	2003-93	TCS 45860		
QTY	CARB & FUEL INJECTION	YEARS	PART NO.	DESCRIPTION	
1	Throttle Body Gasket	2003-93	60964	Throttle body mounting	
1	Throttle Body Gasket	2003-98	73003	Throttle body adapter; New Part Number - Check for Availability	
QTY	DISTRIBUTOR MOUNTING	YEARS	PART NO.	DESCRIPTION	
1	O-Ring	2003-93	418	Distributor Mounting	
QTY	EXHAUST GAS RECIRCULATION	YEARS	PART NO.	DESCRIPTION	
1	EGR Gasket	2003-93	70431		
15		2003; 2.0L 121.5 (1991cc) DOHC L4 (16 Valve) 83mm Bore			15
		MFI; Gasoline; Turbo - Intercooled Mazda Eng.; Eng. Code FS-DET			
QTY	CYLINDER HEAD	YEARS	PART NO.	DESCRIPTION	
1	Head Gasket	2003	26194 PT	Head bolts not incl.; Head bolt replacement required; PermaTorqueMLS® LaserWeld® Technology	
1	Head Set	2003	HS 26194 PT	Head bolts not incl.; Head bolt replacement required; PermaDry® molded rubber valve cover gskt. incl.; Premium valve stem seals incl.	
1	Head Bolt Set	2003	ES 74020	Replacement required	
QTY	CONVERSION SET	YEARS	PART NO.	DESCRIPTION	
1	Gasket Conversion Set	2003	CS 9711	RTV sealant incl. for Upper oil pan gskt.	
QTY	MANIFOLD - INT. & EXH.	YEARS	PART NO.	DESCRIPTION	
1	Int. Manifold Gasket Set	2003	MS 96149	Lower set; Improved design	
1	Plenum Gasket Set	2003	MS 96145	Upper set	
1	Exh. Manifold Gasket Set	2003	MS 95425		
QTY	EXHAUST PIPE FLANGE	YEARS	PART NO.	DESCRIPTION	
1	Exhaust Pipe Gasket	2003	61044	Flange	
QTY	OIL PAN	YEARS	PART NO.	DESCRIPTION	
1	Oil Pan Gasket Set	2003	OS 30908 C	Loc. Lower	
1	Drain Plug Gasket	2003	72515		
QTY	CRANKSHAFT REAR SEAL	YEARS	PART NO.	DESCRIPTION	
1	Rear Main Seal Set	2003	BS 40667	Rubber; One-piece	
QTY	VALVE COVER	YEARS	PART NO.	DESCRIPTION	
1	Valve Cover Gasket Set	2003	VS 50574 R	w/Grommets & Spark plug tube seals; PermaDry® molded rubber gskt. incl.	
QTY	VALVE STEM SEAL SET	YEARS	PART NO.	DESCRIPTION	
1	Valve Stem Seal Set	2003	SS 72802	Premium valve stem seals incl.	
QTY	WATER OUTLET GASKET	YEARS	PART NO.	DESCRIPTION	
1	Water Outlet Gasket	2003	35570	Water Outlet; Coolant housing to head; Must be used w/11760	
1	Water Pump Gasket	2003	11760	Water Outlet; Thermostat housing to head; Must be used w/35570	
QTY	WATER PUMP	YEARS	PART NO.	DESCRIPTION	
1	Water Pump Gasket	2003	35569	Mounting	
QTY	TIMING COVER	YEARS	PART NO.	DESCRIPTION	
1	Crankshaft Front Seal Set	2003	TCS 45936	Oil pump mounting seals incl.; Oil cooler mounting seals incl.	
1	Crankshaft Front Seal Set	2003	TCS 46165	Crankshaft front seal only; New Part Number - Check for Availability	
1	Camshaft Front Seal Set	2003	TCS 45860		
QTY	CARB & FUEL INJECTION	YEARS	PART NO.	DESCRIPTION	
1	Throttle Body Gasket	2003	60964	Throttle body mounting	
1	Throttle Body Gasket	2003	73003	Throttle body adapter; New Part Number - Check for Availability	
QTY	DISTRIBUTOR MOUNTING	YEARS	PART NO.	DESCRIPTION	
1	O-Ring	2003	418	Distributor Mounting	
QTY	EXHAUST GAS RECIRCULATION	YEARS	PART NO.	DESCRIPTION	
1	EGR Gasket	2003	70431		

Mazda Car (Cont.)

16		2013 - 2012; 2.0L 121.9 (1998cc) DOHC L4 (16 Valve) 83.5mm Bore SkyActiv-G VVT DI; Gasoline; Naturally Aspirated Mazda Eng.; Eng. Code PE-VPS			16
QTY	CYLINDER HEAD	YEARS	PART NO.	DESCRIPTION	
1	Head Bolt Set	2013-12	ES 72207	Replacement recommended	
QTY	EXHAUST PIPE FLANGE	YEARS	PART NO.	DESCRIPTION	
1	Exhaust Pipe Gasket	2013-12	61593	Flange	
1	Exhaust Pipe Gasket	2013-12	61593	Loc. Front; Rear converter	
QTY	OIL COOLER	YEARS	PART NO.	DESCRIPTION	
1	Oil Cooler Gasket	2013-12	72941	Oil cooler mounting; Press-in-Place molded rubber gskt.; New Part Number - Check for Availability	
17		2013 - 2004; 2.0L 122 (1999cc) DOHC L4 (16 Valve) 87.5mm Bore Duratec MFI; Gasoline; Naturally Aspirated Ford Eng.; Eng. Code LFD			17
QTY	CYLINDER HEAD	YEARS	PART NO.	DESCRIPTION	
1	Head Gasket	2013-06	26409 PT	Head bolts not incl.; Head bolt replacement recommended; PermaTorqueMLS®	
1	Head Gasket	2005-04	26250 PT	Head bolts not incl.; Head bolt replacement recommended; PermaTorqueMLS® LaserWeld® Technology	
1	Head Set	2013-10	HS 26409 PT-1	Exc. Mazda 3 GS, GX, i, i Sport, i SV, i Touring; Head bolts not incl.; Head bolt replacement recommended; PermaDry® molded rubber valve cover gskt. incl.; Premium valve stem seals incl.	
1	Head Set	2013-10	HS 26409 PT-2	Mazda 3 GS, GX, i, i Sport, i SV, i Touring; Head bolts not incl.; Head bolt replacement recommended; PermaDry® molded rubber valve cover gskt. incl.; Premium valve stem seals incl.	
1	Head Set	2009-07	HS 26409 PT-1	Exc. Mazda 3 i, i Sport, i Touring; Head bolts not incl.; Head bolt replacement recommended; PermaDry® molded rubber valve cover gskt. incl.; Premium valve stem seals incl.	
1	Head Set	2009-07	HS 26409 PT-2	Mazda 3 i, i Sport, i Touring; Head bolts not incl.; Head bolt replacement recommended; PermaDry® molded rubber valve cover gskt. incl.; Premium valve stem seals incl.	
1	Head Set	2006	HS 26409 PT-1	Exc. Mazda 3 i, i Touring; Head bolts not incl.; Head bolt replacement recommended; PermaDry® molded rubber valve cover gskt. incl.; Premium valve stem seals incl.	
1	Head Set	2006	HS 26409 PT-2	Mazda 3 i, i Touring; Head bolts not incl.; Head bolt replacement recommended; PermaDry® molded rubber valve cover gskt. incl.; Premium valve stem seals incl.	
1	Head Set	2005-04	HS 26250 PT-4	Head bolts not incl.; Head bolt replacement recommended; PermaDry® molded rubber valve cover gskt. incl.; Premium valve stem seals incl.; Consolidated design	
1	Head Bolt Set	2013-04	ES 72207	Replacement recommended	
QTY	CONVERSION SET	YEARS	PART NO.	DESCRIPTION	
1	Gasket Conversion Set	2013-04	CS 26409	RTV sealant incl. for oil pan gskt.	
QTY	MANIFOLD - INT. & EXH.	YEARS	PART NO.	DESCRIPTION	
1	Int. Manifold Gasket Set	2013-10	MS 96634	Mazda 3 GS, GX, i, i Sport, i SV, i Touring	
1	Int. Manifold Gasket Set	2013-10	MS 97058	Exc. Mazda 3 GS, GX, i, i Sport, i SV, i Touring; Upper set incl.	
1	Int. Manifold Gasket Set	2009-07	MS 96634	Mazda 3 i, i Sport, i Touring	
1	Int. Manifold Gasket Set	2009-07	MS 97058	Exc. Mazda 3 i, i Sport, i Touring; Upper set incl.	
1	Int. Manifold Gasket Set	2006	MS 96634	Mazda 3 i, i Touring	
1	Int. Manifold Gasket Set	2006	MS 97058	Exc. Mazda 3 i, i Touring; Upper set incl.	
1	Int. Manifold Gasket Set	2005-04	MS 96634		
1	Exh. Manifold Gasket Set	2013-04	MS 96656	Gskt. w/Heat shield	
QTY	EXHAUST PIPE FLANGE	YEARS	PART NO.	DESCRIPTION	
1	Exhaust Pipe Gasket	2013-06	61593	Converter	
1	Exhaust Pipe Gasket	2013-10	61348	Exc. Mazda 3 GS, GX, i, i Sport, i SV, i Touring; Flange	
1	Exhaust Pipe Gasket	2013-10	61569	Mazda 3 GS, GX, i, i Sport, i SV, i Touring; Flange	
1	Exhaust Pipe Gasket	2009-07	61348	Exc. Mazda 3 i, i Sport, i Touring; Flange	
1	Exhaust Pipe Gasket	2009-07	61569	Mazda 3 i, i Sport, i Touring; Flange	
1	Exhaust Pipe Gasket	2006	61348	Exc. Mazda 3 i, i Touring; Flange	
1	Exhaust Pipe Gasket	2006	61569	Mazda 3 i, i Touring; Flange	
1	Exhaust Pipe Gasket	2005-04	61569	Flange	
QTY	CRANKSHAFT REAR SEAL	YEARS	PART NO.	DESCRIPTION	
1	Rear Main Seal Set	2013-04	BS 40689	PTFE Rubber; One-piece	
QTY	VALVE COVER	YEARS	PART NO.	DESCRIPTION	
1	Valve Cover Gasket Set	2013-04	VS 50639 R	PermaDry® molded rubber gskt. incl.; Old design	
1	Valve Cover Gasket Set	2013-04	VS 50639 R-1	PermaDry® molded rubber gskt. incl.; Improved design	
QTY	VALVE STEM SEAL SET	YEARS	PART NO.	DESCRIPTION	
1	Valve Stem Seal Set	2013-04	SS 72917	Premium valve stem seals incl.	

17		2013 - 2004; 2.0L 122 (1999cc) DOHC L4 (16 Valve) 87.5mm Bore Duratec			17	
(cont.)		MFI; Gasoline; Naturally Aspirated Ford Eng.; Eng. Code LFD			(cont.)	
QTY	THERMOSTAT HOUSING	YEARS	PART NO.	DESCRIPTION		
1	Thermostat Gasket	2013-04	35771	Thermostat Housing; Thermostat housing to head		
1	Thermostat Gasket	2013-04	35776	Thermostat Housing; Thermostat seal		
1	Thermostat Gasket	2013-04	35833	Thermostat Housing; Thermostat housing to block		
QTY	WATER OUTLET GASKET	YEARS	PART NO.	DESCRIPTION		
1	Water Outlet Gasket	2013-10	35906	Mazda 3 GS, GX, i, i Sport, i SV, i Touring; Water Outlet		
1	Water Outlet Gasket	2013-10	35909	Exc. Mazda 3 GS, GX, i, i Sport, i SV, i Touring; Water Outlet		
1	Water Outlet Gasket	2009-07	35906	Mazda 3 i, i Sport, i Touring; Water Outlet		
1	Water Outlet Gasket	2009-07	35909	Exc. Mazda 3 i, i Sport, i Touring; Water Outlet		
1	Water Outlet Gasket	2006	35906	Mazda 3 i, i Touring; Water Outlet		
1	Water Outlet Gasket	2006	35909	Exc. Mazda 3 i, i Touring; Water Outlet		
1	Water Outlet Gasket	2005-04	35906	Water Outlet		
QTY	WATER PUMP	YEARS	PART NO.	DESCRIPTION		
1	O-Ring	2013-04	35772	Water Pump		
QTY	TIMING COVER	YEARS	PART NO.	DESCRIPTION		
1	Crankshaft Front Seal Set	2013-04	TCS 46132	Improved design		
QTY	CARB & FUEL INJECTION	YEARS	PART NO.	DESCRIPTION		
1	Fuel Injector O-Ring Set	2013-06	ES 70599	Upper set; Injectors to fuel rail; Improved design		
2	Fuel Injector O-Ring Set	2005-04	ES 70599	Improved design		
1	Throttle Body Gasket	2013-10	61413	Mazda 3 GS, GX, i, i Sport, i SV, i Touring		
1	Throttle Body Gasket	2013-10	61595	Exc. Mazda 3 GS, GX, i, i Sport, i SV, i Touring		
1	Throttle Body Gasket	2009-07	61413	Mazda 3 i, i Sport, i Touring		
1	Throttle Body Gasket	2009-07	61595	Exc. Mazda 3 i, i Sport, i Touring		
1	Throttle Body Gasket	2006	61413	Mazda 3 i, i Touring		
1	Throttle Body Gasket	2006	61595	Exc. Mazda 3 i, i Touring		
1	Throttle Body Gasket	2005-04	61413			
QTY	EXHAUST GAS RECIRCULATION	YEARS	PART NO.	DESCRIPTION		
1	EGR Gasket	2013-04	71224	Valve		
1	EGR Gasket	2013-04	71227	Connector seal		
QTY	OIL FILTER MOUNTING	YEARS	PART NO.	DESCRIPTION		
1	Oil Filter Adapter Gasket	2013-04	72949	Oil filter adapter; New Part Number - Check for Availability		
QTY	OIL PUMP COVER	YEARS	PART NO.	DESCRIPTION		
1	Oil Pump Gasket	2013-04	72705	Oil pump body; New Part Number - Check for Availability		
QTY	CYLINDER BLOCK	YEARS	PART NO.	DESCRIPTION		
1	Crankcase Breather Gasket	2013-04	72950	Cylinder Block; Crankcase vent cover seal; New Part Number - Check for Availability		
QTY	OIL COOLER	YEARS	PART NO.	DESCRIPTION		
1	Oil Cooler Gasket	2013-04	72709	Oil cooler mounting; Plastic carrier gskt. w/Silicone beading; New Part Number - Check for Availability		
1	Oil Cooler Gasket	2013-04	72941	Oil cooler mounting; Press-in-Place molded rubber gskt.; New Part Number - Check for Availability		
18		1992 - 1991; 2.2L 133 (2184cc) SOHC L4 (12 Valve) 86mm Bore			18	
		MFI; Gasoline; Naturally Aspirated Mazda Eng.; Eng. Code F2				
QTY	CYLINDER HEAD	YEARS	PART NO.	DESCRIPTION		
1	Head Gasket	1992-91	9572 PT			
1	Head Set	1992-91	HS 9572 PT-2	Exh. manifold heat shield not incl.; PermaDry® molded rubber valve cover gskt. incl.; Premium valve stem seals incl.		
1	Head Installation Set	1992-91	HIS 9572 PT-2	Exh. manifold heat shield & exh. pipe flange not incl.; PermaDry® molded rubber valve cover gskt. incl.		
QTY	CONVERSION SET	YEARS	PART NO.	DESCRIPTION		
1	Gasket Conversion Set	1992-91	CS 9513	RTV sealant incl. for Upper oil pan gskt.		
QTY	MANIFOLD - INT. & EXH.	YEARS	PART NO.	DESCRIPTION		
1	Int. Manifold Gasket Set	1992-91	MS 94199	Upper set incl.		
1	Exh. Manifold Gasket Set	1992-91	MS 94197			
QTY	EXHAUST PIPE FLANGE	YEARS	PART NO.	DESCRIPTION		
1	Exhaust Pipe Gasket	1992-91	60620	Loc. Front; Converter; w/M/T		
1	Exhaust Pipe Gasket	1992-91	60620	Loc. Rear; Converter		
1	Exhaust Pipe Gasket	1992-91	60665	Flange		
1	Exhaust Pipe Gasket	1992-91	60868	Loc. Front; Converter; w/A/T		
QTY	FUEL PUMP	YEARS	PART NO.	DESCRIPTION		
2	Fuel Pump Mounting Gasket	1992-91	72611			
QTY	OIL PAN	YEARS	PART NO.	DESCRIPTION		
1	Oil Pan Gasket Set	1992-91	OS 30467 C	Loc. Lower		

Mazda Car (Cont.)

18 (cont.)		1992 - 1991; 2.2L 133 (2184cc) SOHC L4 (12 Valve) 86mm Bore			18 (cont.)
MFI; Gasoline; Naturally Aspirated Mazda Eng.; Eng. Code F2					
QTY	CRANKSHAFT REAR SEAL	YEARS	PART NO.	DESCRIPTION	
1	Rear Main Seal Set	1992-91	BS 40421	Rubber; One-piece	
1	Repair Sleeve Tool	1992-91	16300	Crankshaft	
QTY	VALVE COVER	YEARS	PART NO.	DESCRIPTION	
1	Valve Cover Gasket Set	1992-91	VS 50027 R	PermaDry® molded rubber gskt. incl.	
QTY	VALVE STEM SEAL SET	YEARS	PART NO.	DESCRIPTION	
1	Valve Stem Seal Set	1992-91	SS 72680-1	Premium valve stem seals incl.	
QTY	WATER OUTLET GASKET	YEARS	PART NO.	DESCRIPTION	
1	Water Outlet Gasket	1992-91	35251	Water Outlet	
QTY	WATER PUMP	YEARS	PART NO.	DESCRIPTION	
1	Water Pump Gasket	1992-91	35458		
QTY	TIMING COVER	YEARS	PART NO.	DESCRIPTION	
1	Timing Cover Set	1992-91	TCS 45723	Camshaft; Front seal set	
1	Timing Cover Set	1992-91	TCS 45723	Crankshaft; Front seal set	
1	Timing Cover Dust Seal Set	1992-91	ES 72855		
1	Repair Sleeve	1992-91	16272	Timing Cover; Use w/installation tool	
QTY	CARB & FUEL INJECTION	YEARS	PART NO.	DESCRIPTION	
1	Fuel Injector O-Ring Set	1992-91	ES 70600		
1	Throttle Body Gasket	1992-91	60862		
QTY	EXHAUST GAS RECIRCULATION	YEARS	PART NO.	DESCRIPTION	
1	EGR Gasket	1992-91	72606	w/A/T	
19		1992 - 1991; 2.2L 133 (2184cc) SOHC L4 (12 Valve) 86mm Bore			19
MFI; Gasoline; Turbo - Intercooled Mazda Eng.; Eng. Code F2-T					
QTY	CYLINDER HEAD	YEARS	PART NO.	DESCRIPTION	
1	Head Gasket	1992-91	9572 PT		
1	Head Set	1992-91	HS 9572 PT	Exh. manifold heat shield not incl.; PermaDry® molded rubber valve cover gskt. incl.; Premium valve stem seals incl.	
QTY	CONVERSION SET	YEARS	PART NO.	DESCRIPTION	
1	Gasket Conversion Set	1992-91	CS 9513	RTV sealant incl. for Upper oil pan gskt.	
QTY	MANIFOLD - INT. & EXH.	YEARS	PART NO.	DESCRIPTION	
1	Int. Manifold Gasket Set	1992-91	MS 94199	Upper set incl.	
1	Exh. Manifold Gasket Set	1992-91	MS 94197		
1	Exh. Manifold Gasket Set	1992-91	MS 94213	Heat shield	
QTY	EXHAUST PIPE FLANGE	YEARS	PART NO.	DESCRIPTION	
1	Exhaust Pipe Gasket	1992-91	60620	Loc. Rear; Converter	
1	Exhaust Pipe Gasket	1992-91	60798	Flange	
1	Exhaust Pipe Gasket	1992-91	60800	Loc. Front; Converter	
QTY	FUEL PUMP	YEARS	PART NO.	DESCRIPTION	
2	Fuel Pump Mounting Gasket	1992-91	72611		
QTY	OIL PAN	YEARS	PART NO.	DESCRIPTION	
1	Oil Pan Gasket Set	1992-91	OS 30467 C	Loc. Lower	
QTY	CRANKSHAFT REAR SEAL	YEARS	PART NO.	DESCRIPTION	
1	Rear Main Seal Set	1992-91	BS 40421	Rubber; One-piece	
1	Repair Sleeve Tool	1992-91	16300	Crankshaft	
QTY	VALVE COVER	YEARS	PART NO.	DESCRIPTION	
1	Valve Cover Gasket Set	1992-91	VS 50027 R	PermaDry® molded rubber gskt. incl.	
QTY	VALVE STEM SEAL SET	YEARS	PART NO.	DESCRIPTION	
1	Valve Stem Seal Set	1992-91	SS 72680-1	Premium valve stem seals incl.	
QTY	WATER OUTLET GASKET	YEARS	PART NO.	DESCRIPTION	
1	Water Outlet Gasket	1992-91	35251	Water Outlet	
QTY	WATER PUMP	YEARS	PART NO.	DESCRIPTION	
1	Water Pump Gasket	1992-91	35458		
QTY	TIMING COVER	YEARS	PART NO.	DESCRIPTION	
1	Timing Cover Set	1992-91	TCS 45723	Camshaft; Front seal set	
1	Timing Cover Set	1992-91	TCS 45723	Crankshaft; Front seal set	
1	Timing Cover Dust Seal Set	1992-91	ES 72855		
1	Repair Sleeve	1992-91	16272	Timing Cover; Use w/installation tool	
QTY	CARB & FUEL INJECTION	YEARS	PART NO.	DESCRIPTION	
1	Fuel Injector O-Ring Set	1992-91	ES 70600		
1	Throttle Body Gasket	1992-91	60862		
QTY	EXHAUST GAS RECIRCULATION	YEARS	PART NO.	DESCRIPTION	
1	EGR Gasket	1992-91	70122		

20		2002 - 1995; 2.3L 137.5 (2254cc) DOHC V6 (24 Valve) 80.3mm Bore			20
MFI; Gasoline; Supercharged Mazda Eng.; Eng. Code EJ					
QTY	MANIFOLD - INT. & EXH.	YEARS	PART NO.	DESCRIPTION	
1	Exh. Manifold Gasket Set	2002-95	MS 95428		
QTY	EXHAUST PIPE FLANGE	YEARS	PART NO.	DESCRIPTION	
2	Exhaust Pipe Gasket	2002-95	23591	Loc. Rear; Converter; 1 31/32" ID x 2 35/64" OD	
2	Exhaust Pipe Gasket	2002-95	61044	Loc. Front; Converter	
2	Exhaust Pipe Gasket	2002-95	61044	Pipe to manifold	
QTY	CRANKSHAFT REAR SEAL	YEARS	PART NO.	DESCRIPTION	
1	Rear Main Seal Set	2002-95	BS 40387	Rubber; One-piece	
QTY	VALVE COVER	YEARS	PART NO.	DESCRIPTION	
1	Grommet Set	2002-95	ES 70718	Valve Cover	
1	Circular Plug	2002-95	ES 72756	Valve Cover; Camshaft plug seal set; New Part Number - Check for Availability	
QTY	VALVE STEM SEAL SET	YEARS	PART NO.	DESCRIPTION	
1	Valve Stem Seal Set	2002-95	SS 72802-1	Premium valve stem seals incl.	
QTY	THERMOSTAT HOUSING	YEARS	PART NO.	DESCRIPTION	
1	Water Outlet Gasket	2002-95	35251	Thermostat Housing; Thermostat cover	
1	Thermostat Gasket	2002-95	35952	Thermostat Housing; Thermostat housing to head; New Part Number - Check for Availability	
QTY	WATER OUTLET GASKET	YEARS	PART NO.	DESCRIPTION	
1	Water Crossover Mounting Set	2002-95	ES 70717		
QTY	TIMING COVER	YEARS	PART NO.	DESCRIPTION	
1	Crankshaft Front Seal Set	2002-95	TCS 45936	Oil pump mounting seals incl.; Oil cooler mounting seals incl.	
1	Crankshaft Front Seal Set	2002-95	TCS 46165	Crankshaft front seal only; New Part Number - Check for Availability	
2	Camshaft Front Seal Set	2002-95	TCS 45724		
QTY	CARB & FUEL INJECTION	YEARS	PART NO.	DESCRIPTION	
1	Fuel Injector O-Ring Set	2002-95	ES 70713		
QTY	EXHAUST GAS RECIRCULATION	YEARS	PART NO.	DESCRIPTION	
1	EGR Gasket	2002-95	70714		
QTY	OIL FILTER MOUNTING	YEARS	PART NO.	DESCRIPTION	
1	Oil Filter Adapter Gasket	2002-95	70716		
21		2011 - 2003; 2.3L 138 (2261cc) DOHC L4 (16 Valve) 87.5mm Bore Duratec			21
MFI; Gasoline; Naturally Aspirated Ford Eng.; Eng. Code MZR					
QTY	CYLINDER HEAD	YEARS	PART NO.	DESCRIPTION	
1	Head Gasket	2009-08	26409 PT	Head bolts not incl.; Head bolt replacement recommended; PermaTorqueMLS®	
1	Head Gasket	2007	26250 PT	Mazda 5 Grand Touring, Sport, Touring; Head bolts not incl.; Head bolt replacement recommended; PermaTorqueMLS® LaserWeld® Technology	
1	Head Gasket	2007	26409 PT	Exc. Mazda 5 Grand Touring, Sport, Touring; Head bolts not incl.; Head bolt replacement recommended; PermaTorqueMLS®	
1	Head Gasket	2006	26250 PT	Mazda 5 Sport, Touring; Head bolts not incl.; Head bolt replacement recommended; PermaTorqueMLS® LaserWeld® Technology	
1	Head Gasket	2006	26409 PT	Exc. Mazda 5 Sport, Touring; Head bolts not incl.; Head bolt replacement recommended; PermaTorqueMLS®	
1	Head Gasket	2005-03	26250 PT	Head bolts not incl.; Head bolt replacement recommended; PermaTorqueMLS® LaserWeld® Technology	
1	Head Set	2009-08	HS 26409 PT	Head bolts not incl.; Head bolt replacement recommended; PermaDry® molded rubber valve cover gskt. incl.; Premium valve stem seals incl.	
1	Head Set	2007	HS 26250 PT-4	Mazda 5 Grand Touring, Sport, Touring; Head bolts not incl.; Head bolt replacement recommended; PermaDry® molded rubber valve cover gskt. incl.; Premium valve stem seals incl.; Consolidated design	
1	Head Set	2007	HS 26409 PT	Exc. Mazda 5 Grand Touring, Sport, Touring; Head bolts not incl.; Head bolt replacement recommended; PermaDry® molded rubber valve cover gskt. incl.; Premium valve stem seals incl.	
1	Head Set	2006	HS 26250 PT-4	Mazda 5 Sport, Touring; Head bolts not incl.; Head bolt replacement recommended; PermaDry® molded rubber valve cover gskt. incl.; Premium valve stem seals incl.; Consolidated design	
1	Head Set	2006	HS 26409 PT	Exc. Mazda 5 Sport, Touring; Head bolts not incl.; Head bolt replacement recommended; PermaDry® molded rubber valve cover gskt. incl.; Premium valve stem seals incl.	
1	Head Set	2005	HS 26250 PT-4	Exc. Mazda 3 s, s Sport, SP23; w/Plastic valve cover; Head bolts not incl.; Head bolt replacement recommended; PermaDry® molded rubber valve cover gskt. incl.; Premium valve stem seals incl.; Consolidated design	

Mazda Car (Cont.)

21 (cont.)		2011 - 2003; 2.3L 138 (2261cc) DOHC L4 (16 Valve) 87.5mm Bore Duratec			21 (cont.)
MFI; Gasoline; Naturally Aspirated Ford Eng.; Eng. Code MZR					
QTY	CYLINDER HEAD	YEARS	PART NO.	DESCRIPTION	
1	Head Set	2005	HS 26250 PT-7	Exc. Mazda 3 s, s Sport, SP23; w/Glass mounted antenna; w/Aluminum valve cover; Head bolts not incl.; Head bolt replacement recommended; PermaDry® molded rubber valve cover gskt. incl.; Premium valve stem seals incl.	
1	Head Set	2005	HS 26250 PT-4	Mazda 3 s, s Sport, SP23; Head bolts not incl.; Head bolt replacement recommended; PermaDry® molded rubber valve cover gskt. incl.; Premium valve stem seals incl.; Consolidated design	
1	Head Set	2004	HS 26250 PT-4	Mazda 3 s, s Sport; Head bolts not incl.; Head bolt replacement recommended; PermaDry® molded rubber valve cover gskt. incl.; Premium valve stem seals incl.; Consolidated design	
1	Head Set	2004	HS 26250 PT-4	Mazda 6 i, i Sport; w/Roof mounted antenna; w/Plastic valve cover; Head bolts not incl.; Head bolt replacement recommended; PermaDry® molded rubber valve cover gskt. incl.; Premium valve stem seals incl.; Consolidated design	
1	Head Set	2004	HS 26250 PT-7	Mazda 6 i, i Sport; w/Glass mounted antenna; w/Aluminum valve cover; Head bolts not incl.; Head bolt replacement recommended; PermaDry® molded rubber valve cover gskt. incl.; Premium valve stem seals incl.	
1	Head Set	2003	HS 26250 PT-4	w/Roof mounted antenna; w/Plastic valve cover; Head bolts not incl.; Head bolt replacement recommended; PermaDry® molded rubber valve cover gskt. incl.; Premium valve stem seals incl.; Consolidated design	
1	Head Set	2003	HS 26250 PT-7	w/Glass mounted antenna; w/Aluminum valve cover; Head bolts not incl.; Head bolt replacement recommended; PermaDry® molded rubber valve cover gskt. incl.; Premium valve stem seals incl.	
1	Head Bolt Set	2009-03	ES 72207	Replacement recommended	
QTY	CONVERSION SET	YEARS	PART NO.	DESCRIPTION	
1	Gasket Conversion Set	2009	CS 26409	RTV sealant incl. for oil pan gskt.	
1	Gasket Conversion Set	2008-07	CS 26250	Mazda 6 i, i Grand Sport, i Grand Touring, i Sport, i Touring; RTV sealant incl. for oil pan gskt.	
1	Gasket Conversion Set	2008-07	CS 26409	Exc. Mazda 6 i, i Grand Sport, i Grand Touring, i Sport, i Touring; RTV sealant incl. for oil pan gskt.	
1	Gasket Conversion Set	2006	CS 26250	Mazda 3 s, s Grand Touring, s Sport, s Touring; RTV sealant incl. for oil pan gskt.	
1	Gasket Conversion Set	2006	CS 26250	Mazda 6 i, i Grand Sport, i Grand Touring, i Sport; RTV sealant incl. for oil pan gskt.	
1	Gasket Conversion Set	2006	CS 26250	Mazda 5 Sport, Touring; To 06/12/06; RTV sealant incl. for oil pan gskt.	
1	Gasket Conversion Set	2006	CS 26409	Mazda 5 Sport, Touring; From 06/13/06; RTV sealant incl. for oil pan gskt.	
1	Gasket Conversion Set	2005-03	CS 26250	RTV sealant incl. for oil pan gskt.	
QTY	MANIFOLD - INT. & EXH.	YEARS	PART NO.	DESCRIPTION	
1	Int. Manifold Gasket Set	2009-03	MS 96634		
1	Exh. Manifold Gasket Set	2009-03	MS 96656	Gskt. w/Heat shield	
QTY	EXHAUST PIPE FLANGE	YEARS	PART NO.	DESCRIPTION	
1	Exhaust Pipe Gasket	2009-07	61571	Mazda 5 Grand Touring, Sport, Touring; Converter	
1	Exhaust Pipe Gasket	2009	61569	Flange	
1	Exhaust Pipe Gasket	2008-07	23626	Mazda 6 i, i Grand Sport, i Grand Touring, i Sport, i Touring; Converter; California; w/M/T	
1	Exhaust Pipe Gasket	2008-07	23626	Mazda 6 i, i Grand Sport, i Grand Touring, i Sport, i Touring; Converter; Exc. California	
1	Exhaust Pipe Gasket	2008-07	61016	Mazda 6 i, i Grand Sport, i Grand Touring, i Sport, i Touring; Converter; California; w/A/T; Improved design	
1	Exhaust Pipe Gasket	2008-07	61348	Mazda 6 i, i Grand Sport, i Grand Touring, i Sport, i Touring; Flange	
1	Exhaust Pipe Gasket	2008-07	61569	Exc. Mazda 6 i, i Grand Sport, i Grand Touring, i Sport, i Touring; Flange	
1	Exhaust Pipe Gasket	2006	23626	Mazda 6 i, i Grand Sport, i Grand Touring, i Sport; Converter; California; w/M/T	
1	Exhaust Pipe Gasket	2006	23626	Mazda 6 i, i Grand Sport, i Grand Touring, i Sport; Converter; Exc. California	
1	Exhaust Pipe Gasket	2006	61016	Mazda 6 i, i Grand Sport, i Grand Touring, i Sport; Converter; California; w/A/T; Improved design	
1	Exhaust Pipe Gasket	2006	61348	Mazda 6 i, i Grand Sport, i Grand Touring, i Sport; Flange	
1	Exhaust Pipe Gasket	2006	61569	Exc. Mazda 6 i, i Grand Sport, i Grand Touring, i Sport; Flange	
1	Exhaust Pipe Gasket	2006	61571	Mazda 5 Sport, Touring; Converter	
1	Exhaust Pipe Gasket	2005	23626	Exc. Mazda 3 s, s Sport, SP23; Converter	
1	Exhaust Pipe Gasket	2005	61348	Exc. Mazda 3 s, s Sport, SP23; Flange	
1	Exhaust Pipe Gasket	2005	61569	Mazda 3 s, s Sport, SP23; Flange	
1	Exhaust Pipe Gasket	2004	23626	Mazda 6 i, i Sport; Converter	
1	Exhaust Pipe Gasket	2004	61348	Mazda 6 i, i Sport; Flange	
1	Exhaust Pipe Gasket	2004	61569	Mazda 3 s, s Sport; Flange	

21 (cont.)		2011 - 2003; 2.3L 138 (2261cc) DOHC L4 (16 Valve) 87.5mm Bore Duratec MFI; Gasoline; Naturally Aspirated Ford Eng.; Eng. Code MZR			21 (cont.)
QTY	EXHAUST PIPE FLANGE	YEARS	PART NO.	DESCRIPTION	
1	Exhaust Pipe Gasket	2003	23626	Converter	
1	Exhaust Pipe Gasket	2003	61348	Flange	
QTY	CRANKSHAFT REAR SEAL	YEARS	PART NO.	DESCRIPTION	
1	Rear Main Seal Set	2009-03	BS 40689	PTFE Rubber; One-piece	
QTY	VALVE COVER	YEARS	PART NO.	DESCRIPTION	
1	Valve Cover Gasket Set	2009-06	VS 50639 R	PermaDry® molded rubber gskt. incl.; Old design	
1	Valve Cover Gasket Set	2009-06	VS 50639 R-1	PermaDry® molded rubber gskt. incl.; Improved design	
1	Valve Cover Gasket Set	2005	VS 50638 R	Exc. Mazda 3 s, s Sport, SP23; w/Glass mounted antenna; w/Aluminum valve cover; PermaDry® molded rubber gskt. incl.	
1	Valve Cover Gasket Set	2005	VS 50639 R	Mazda 3 s, s Sport, SP23; PermaDry® molded rubber gskt. incl.; Old design	
1	Valve Cover Gasket Set	2005	VS 50639 R	Exc. Mazda 3 s, s Sport, SP23; w/Roof mounted antenna; w/Plastic valve cover; PermaDry® molded rubber gskt. incl.; Old design	
1	Valve Cover Gasket Set	2005	VS 50639 R-1	Mazda 3 s, s Sport, SP23; PermaDry® molded rubber gskt. incl.; Improved design	
1	Valve Cover Gasket Set	2005	VS 50639 R-1	Exc. Mazda 3 s, s Sport, SP23; w/Roof mounted antenna; w/Plastic valve cover; PermaDry® molded rubber gskt. incl.; Improved design	
1	Valve Cover Gasket Set	2004	VS 50638 R	Mazda 6 i, i Sport; w/Glass mounted antenna; w/Aluminum valve cover; PermaDry® molded rubber gskt. incl.	
1	Valve Cover Gasket Set	2004	VS 50639 R	Mazda 3 s, s Sport; PermaDry® molded rubber gskt. incl.; Old design	
1	Valve Cover Gasket Set	2004	VS 50639 R	Mazda 6 i, i Sport; w/Roof mounted antenna; w/Plastic valve cover; PermaDry® molded rubber gskt. incl.; Old design	
1	Valve Cover Gasket Set	2004	VS 50639 R-1	Mazda 3 s, s Sport; PermaDry® molded rubber gskt. incl.; Improved design	
1	Valve Cover Gasket Set	2004	VS 50639 R-1	Mazda 6 i, i Sport; w/Roof mounted antenna; w/Plastic valve cover; PermaDry® molded rubber gskt. incl.; Improved design	
1	Valve Cover Gasket Set	2003	VS 50638 R	w/Glass mounted antenna; w/Aluminum valve cover; PermaDry® molded rubber gskt. incl.	
1	Valve Cover Gasket Set	2003	VS 50639 R	w/Roof mounted antenna; w/Plastic valve cover; PermaDry® molded rubber gskt. incl.; Old design	
1	Valve Cover Gasket Set	2003	VS 50639 R-1	w/Roof mounted antenna; w/Plastic valve cover; PermaDry® molded rubber gskt. incl.; Improved design	
QTY	VALVE STEM SEAL SET	YEARS	PART NO.	DESCRIPTION	
1	Valve Stem Seal Set	2009-03	SS 72917	Premium valve stem seals incl.	
QTY	THERMOSTAT HOUSING	YEARS	PART NO.	DESCRIPTION	
1	Thermostat Gasket	2009-03	35771	Thermostat Housing; Thermostat housing to head	
1	Thermostat Gasket	2009-03	35776	Thermostat Housing; Thermostat seal	
1	Thermostat Gasket	2009-03	35833	Thermostat Housing; Thermostat housing to block	
QTY	WATER OUTLET GASKET	YEARS	PART NO.	DESCRIPTION	
1	Water Outlet Gasket	2009	35906	Water Outlet	
1	Water Outlet Gasket	2008	35906	Exc. Mazda 6 i, i Grand Sport, i Grand Touring, i Sport, i Touring; Water Outlet	
QTY	WATER PUMP	YEARS	PART NO.	DESCRIPTION	
1	O-Ring	2009-03	35772	Water Pump	
QTY	TIMING COVER	YEARS	PART NO.	DESCRIPTION	
1	Crankshaft Front Seal Set	2009-07	TCS 46132	Improved design	
1	Crankshaft Front Seal Set	2008-07	TCS 46059	Mazda 6 i, i Grand Sport, i Grand Touring, i Sport, i Touring; Old design	
1	Crankshaft Front Seal Set	2006	TCS 46059	Mazda 3 s, s Grand Touring, s Sport, s Touring; Old design	
1	Crankshaft Front Seal Set	2006	TCS 46059	Mazda 6 i, i Grand Sport, i Grand Touring, i Sport; Old design	
1	Crankshaft Front Seal Set	2006	TCS 46059	Mazda 5 Sport, Touring; To 06/12/06; Old design	
1	Crankshaft Front Seal Set	2006	TCS 46132	Mazda 5 Sport; From 06/13/06; Improved design	
1	Crankshaft Front Seal Set	2006	TCS 46132	Mazda 5 Touring; From 06/13/06; Improved design	
1	Crankshaft Front Seal Set	2006	TCS 46132	Mazda 3 s, s Grand Touring, s Sport, s Touring; Improved design	
1	Crankshaft Front Seal Set	2006	TCS 46132	Mazda 6 i, i Grand Sport, i Grand Touring, i Sport; Improved design	
1	Crankshaft Front Seal Set	2006	TCS 46132	Mazda 5 Sport; To 06/12/06; Improved design	
1	Crankshaft Front Seal Set	2006	TCS 46132	Mazda 5 Touring; To 06/12/06; Improved design	
1	Crankshaft Front Seal Set	2005-03	TCS 46059	Old design	
1	Crankshaft Front Seal Set	2005-03	TCS 46132	Improved design	
QTY	CARB & FUEL INJECTION	YEARS	PART NO.	DESCRIPTION	
1	Fuel Injector O-Ring Set	2009-08	ES 70599	Upper set; Injectors to fuel rail; Improved design	
2	Fuel Injector O-Ring Set	2007	ES 70599	Mazda 5 Grand Touring, Sport, Touring; Improved design	
1	Fuel Injector O-Ring Set	2007	ES 70599	Exc. Mazda 5 Grand Touring, Sport, Touring; Upper set; Injectors to fuel rail; Improved design	
2	Fuel Injector O-Ring Set	2006	ES 70599	Mazda 5 Sport, Touring; Improved design	
1	Fuel Injector O-Ring Set	2006	ES 70599	Exc. Mazda 5 Sport, Touring; Upper set; Injectors to fuel rail; Improved design	

Mazda Car (Cont.)

21		2011 - 2003; 2.3L 138 (2261cc) DOHC L4 (16 Valve) 87.5mm Bore Duratec			21	
(cont.)		MFI; Gasoline; Naturally Aspirated Ford Eng.; Eng. Code MZR			(cont.)	
QTY	CARB & FUEL INJECTION	YEARS	PART NO.	DESCRIPTION		
2	Fuel Injector O-Ring Set	2005-03	ES 70599	Improved design		
1	Throttle Body Gasket	2009-08	61413			
1	Throttle Body Gasket	2007	61413	Exc. Mazda 5 Grand Touring, Sport, Touring		
1	Throttle Body Gasket	2007	61580	Mazda 5 Grand Touring, Sport, Touring		
1	Throttle Body Gasket	2006	61413	Exc. Mazda 5 Sport, Touring		
1	Throttle Body Gasket	2006	61579	Mazda 5 Sport, Touring; To 03/31/06		
1	Throttle Body Gasket	2006	61580	Mazda 5 Sport, Touring; From 04/01/06		
1	Throttle Body Gasket	2005	61413	Mazda 3 s, s Sport, SP23		
1	Throttle Body Gasket	2005	61579	Exc. Mazda 3 s, s Sport, SP23		
1	Throttle Body Gasket	2004	61413	Mazda 3 s, s Sport		
1	Throttle Body Gasket	2004	61579	Mazda 6 i, i Sport		
1	Throttle Body Gasket	2003	61579			
QTY	EXHAUST GAS RECIRCULATION	YEARS	PART NO.	DESCRIPTION		
1	EGR Gasket	2009-03	71224	Valve		
1	EGR Gasket	2009-03	71227	Connector seal		
QTY	OIL FILTER MOUNTING	YEARS	PART NO.	DESCRIPTION		
1	Oil Filter Adapter Gasket	2009-03	72949	Oil filter adapter; New Part Number - Check for Availability		
QTY	OIL PUMP COVER	YEARS	PART NO.	DESCRIPTION		
1	Oil Pump Gasket	2009-03	72705	Oil pump body; New Part Number - Check for Availability		
QTY	CYLINDER BLOCK	YEARS	PART NO.	DESCRIPTION		
1	Crankcase Breather Gasket	2009-03	72950	Cylinder Block; Crankcase vent cover seal; New Part Number - Check for Availability		
QTY	OIL COOLER	YEARS	PART NO.	DESCRIPTION		
1	Oil Cooler Gasket	2011-03	72709	Oil cooler mounting; Plastic carrier gskt. w/Silicone beading; New Part Number - Check for Availability		
1	Oil Cooler Gasket	2011-03	72941	Oil cooler mounting; Press-in-Place molded rubber gskt.; New Part Number - Check for Availability		
22		2013 - 2006; 2.3L 138 (2261cc) DOHC L4 (16 Valve) 87.5mm Bore Duratec			22	
		MFI; Gasoline; Turbo - Intercooled Ford Eng.; Eng. Code MZR-T				
QTY	CYLINDER HEAD	YEARS	PART NO.	DESCRIPTION		
1	Head Gasket	2009-06	26407 PT	Head bolts not incl.; Head bolt replacement recommended; PermaTorqueMLS®		
1	Head Set	2009-06	HS 26407 PT	Head bolts not incl.; Head bolt replacement recommended; PermaDry® molded rubber valve cover gskt. incl.; Premium valve stem seals incl.		
1	Head Bolt Set	2009-06	ES 72207	Replacement recommended		
QTY	CONVERSION SET	YEARS	PART NO.	DESCRIPTION		
1	Gasket Conversion Set	2009-06	CS 26250	RTV sealant incl. for oil pan gskt.		
QTY	MANIFOLD - INT. & EXH.	YEARS	PART NO.	DESCRIPTION		
1	Int. Manifold Gasket Set	2009-06	MS 97054			
1	Exh. Manifold Gasket Set	2009-06	MS 97052			
QTY	EXHAUST PIPE FLANGE	YEARS	PART NO.	DESCRIPTION		
1	Exhaust Pipe Gasket	2009-06	60512	Loc. Rear; Converter; Improved design		
1	Exhaust Pipe Gasket	2009-06	61348	Loc. Front; Converter		
1	Exhaust Pipe Gasket	2009-06	61348	Packing		
1	Exhaust Pipe Gasket	2009-06	61572	Loc. Rear; Converter; Old design		
QTY	CRANKSHAFT REAR SEAL	YEARS	PART NO.	DESCRIPTION		
1	Rear Main Seal Set	2009-06	BS 40689	PTFE Rubber; One-piece		
QTY	VALVE COVER	YEARS	PART NO.	DESCRIPTION		
1	Valve Cover Gasket Set	2013-06	VS 50757 R	PermaDry® molded rubber gskt. incl.		
QTY	VALVE STEM SEAL SET	YEARS	PART NO.	DESCRIPTION		
1	Valve Stem Seal Set	2009-06	SS 72917	Premium valve stem seals incl.		
QTY	THERMOSTAT HOUSING	YEARS	PART NO.	DESCRIPTION		
1	Thermostat Gasket	2009-06	35776	Thermostat Housing; Thermostat seal		
QTY	WATER OUTLET GASKET	YEARS	PART NO.	DESCRIPTION		
1	Water Outlet Gasket	2009-06	35905	Water Outlet		
QTY	WATER PUMP	YEARS	PART NO.	DESCRIPTION		
1	O-Ring	2009-06	35772	Water Pump		
QTY	TIMING COVER	YEARS	PART NO.	DESCRIPTION		
1	Crankshaft Front Seal Set	2009-06	TCS 46059	Old design		
1	Crankshaft Front Seal Set	2009-06	TCS 46132	Improved design		
QTY	CARB & FUEL INJECTION	YEARS	PART NO.	DESCRIPTION		
1	Throttle Body Gasket	2009-06	61578	Mounting		

22		2013 - 2006; 2.3L 138 (2261cc) DOHC L4 (16 Valve) 87.5mm Bore Duratec			22	
(cont.)		MFI; Gasoline; Turbo - Intercooled Ford Eng.; Eng. Code MZR-T			(cont.)	
QTY	EXHAUST GAS RECIRCULATION	YEARS	PART NO.	DESCRIPTION		
1	EGR Gasket	2009-06	72336	Valve		
QTY	OIL FILTER MOUNTING	YEARS	PART NO.	DESCRIPTION		
1	Oil Filter Adapter Gasket	2009-06	72949	Oil filter adapter; New Part Number - Check for Availability		
QTY	OIL PUMP COVER	YEARS	PART NO.	DESCRIPTION		
1	Oil Pump Gasket	2009-06	72705	Oil pump body; New Part Number - Check for Availability		
QTY	CYLINDER BLOCK	YEARS	PART NO.	DESCRIPTION		
1	Crankcase Breather Gasket	2009-06	72950	Cylinder Block; Crankcase vent cover seal; New Part Number - Check for Availability		
QTY	OIL COOLER	YEARS	PART NO.	DESCRIPTION		
1	Oil Cooler Gasket	2013-06	72709	Oil cooler mounting; Plastic carrier gskt. w/Silicone beading; New Part Number - Check for Availability		
1	Oil Cooler Gasket	2013-06	72941	Oil cooler mounting; Press-in-Place molded rubber gskt.; New Part Number - Check for Availability		
23		2013 - 2009; 2.5L 151.8 (2488cc) DOHC L4 (16 Valve) 89mm Bore Duratec			23	
(cont.)		MFI; Gasoline; Naturally Aspirated Ford Eng.; Eng. Code MZR			(cont.)	
QTY	THERMOSTAT HOUSING	YEARS	PART NO.	DESCRIPTION		
1	Thermostat Gasket	2011-09	35776	Thermostat Housing; Thermostat seal		
QTY	TIMING COVER	YEARS	PART NO.	DESCRIPTION		
1	Crankshaft Front Seal Set	2011-09	TCS 46151			
QTY	OIL FILTER MOUNTING	YEARS	PART NO.	DESCRIPTION		
1	Oil Filter Adapter Gasket	2013-09	72949	Oil filter adapter; New Part Number - Check for Availability		
QTY	CYLINDER BLOCK	YEARS	PART NO.	DESCRIPTION		
1	Crankcase Breather Gasket	2013-09	72950	Cylinder Block; Crankcase vent cover seal; New Part Number - Check for Availability		
QTY	OIL COOLER	YEARS	PART NO.	DESCRIPTION		
1	Oil Cooler Gasket	2013-09	72709	Oil cooler mounting; Plastic carrier gskt. w/Silicone beading; New Part Number - Check for Availability		
1	Oil Cooler Gasket	2013-09	72941	Oil cooler mounting; Press-in-Place molded rubber gskt.; New Part Number - Check for Availability		
24		2002 - 1993; 2.5L 152 (2497cc) DOHC V6 (24 Valve) 84.5mm Bore			24	
(cont.)		MFI; Gasoline; Naturally Aspirated Mazda Eng.; Eng. Code KL-ZE			(cont.)	
QTY	CYLINDER HEAD	YEARS	PART NO.	DESCRIPTION		
1	Head Gasket	2002-93	9921 PT	Loc. L.H.; Head bolts not incl.; Head bolt replacement recommended; PermaTorqueMLS®		
1	Head Gasket	2002-93	9923 PT	Loc. R.H.; Head bolts not incl.; Head bolt replacement recommended; PermaTorqueMLS®		
1	Head Set	2002-98	HS 9921 PT	Mazda 626 ES, LX; Head bolts & exh. pipe flange not incl.; Head bolt replacement recommended; PermaDry® molded rubber valve cover gskts. incl.; Premium valve stem seals incl.		
1	Head Set	2002-98	HS 9921 PT	Exc. Mazda 626 ES, LX; Int. manifold gskts., head bolts, exh. pipe flange not incl.; Head bolt replacement recommended; PermaDry® molded rubber valve cover gskts. incl.; Premium valve stem seals incl.		
1	Head Set	1997-95	HS 9921 PT	Mazda Millenia Base, L; Int. manifold gskts., head bolts, exh. pipe flange not incl.; Head bolt replacement recommended; PermaDry® molded rubber valve cover gskts. incl.; Premium valve stem seals incl.		
1	Head Set	1997-96	HS 9921 PT	Exc. Mazda Millenia Base, L; Head bolts & exh. pipe flange not incl.; Head bolt replacement recommended; PermaDry® molded rubber valve cover gskts. incl.; Premium valve stem seals incl.		
1	Head Set	1995	HS 9921 PT	Mazda 626 ES, LX, MX-6 LS; Head bolts & exh. pipe flange not incl.; Head bolt replacement recommended; PermaDry® molded rubber valve cover gskts. incl.; Premium valve stem seals incl.		
1	Head Set	1994-93	HS 9921 PT	Head bolts & exh. pipe flange not incl.; Head bolt replacement recommended; PermaDry® molded rubber valve cover gskts. incl.; Premium valve stem seals incl.		
2	Head Bolt Set	2002-93	ES 72475	Replacement recommended; New Part Number - Check for Availability		
QTY	CONVERSION SET	YEARS	PART NO.	DESCRIPTION		
1	Gasket Conversion Set	2002-93	CS 9921			
QTY	MANIFOLD - INT. & EXH.	YEARS	PART NO.	DESCRIPTION		
1	Int. Manifold Gasket Set	2002-98	MS 95422	Mazda 626 ES, LX		
1	Int. Manifold Gasket Set	2002-98	MS 97198	Exc. Mazda 626 ES, LX; Lower set; Upper set incl.; New Part Number - Check for Availability		

Mazda Car (Cont.)

24 (cont.)		2002 - 1993; 2.5L 152 (2497cc) DOHC V6 (24 Valve) 84.5mm Bore			24 (cont.)
MFI; Gasoline; Naturally Aspirated Mazda Eng.; Eng. Code KL-ZE					
QTY	MANIFOLD - INT. & EXH.	YEARS	PART NO.	DESCRIPTION	
1	Int. Manifold Gasket Set	1997-95	MS 97198	Mazda Millenia Base, L; Lower set; Upper set incl.; New Part Number - Check for Availability	
1	Int. Manifold Gasket Set	1997-96	MS 95422	Exc. Mazda Millenia Base, L	
1	Int. Manifold Gasket Set	1995	MS 95422	Mazda 626 ES, LX, MX-6 LS	
1	Int. Manifold Gasket Set	1994-93	MS 95422		
1	Exh. Manifold Gasket Set	2002-93	MS 95428		
QTY	EXHAUST PIPE FLANGE	YEARS	PART NO.	DESCRIPTION	
1	Exhaust Pipe Gasket	2002-98	60512	Exc. Mazda 626 ES, LX; Loc. Rear; Converter; Improved design	
1	Exhaust Pipe Gasket	2002-98	60572	Exc. Mazda 626 ES, LX; Loc. Front; Converter; 2.165" ID	
1	Exhaust Pipe Gasket	2002-98	60831	Mazda 626 ES, LX; Loc. Front; Converter	
1	Exhaust Pipe Gasket	2002-98	60868	Mazda 626 ES, LX; Loc. Rear; Converter	
1	Exhaust Pipe Gasket	2002-98	60967	Mazda 626 ES, LX; Flange	
1	Exhaust Pipe Gasket	1997-95	60512	Mazda Millenia Base, L; Loc. Rear; Converter; Improved design	
1	Exhaust Pipe Gasket	1997-95	60572	Mazda Millenia Base, L; Loc. Front; Converter; 2.165" ID	
1	Exhaust Pipe Gasket	1997-96	60831	Exc. Mazda Millenia Base, L; Loc. Front; Converter	
1	Exhaust Pipe Gasket	1997-96	60868	Exc. Mazda Millenia Base, L; Loc. Rear; Converter	
1	Exhaust Pipe Gasket	1997-96	60967	Exc. Mazda Millenia Base, L; Flange	
1	Exhaust Pipe Gasket	1995	60831	Mazda 626 ES, LX, MX-6 LS; Loc. Front; Converter	
1	Exhaust Pipe Gasket	1995	60868	Mazda 626 ES, LX, MX-6 LS; Loc. Rear; Converter	
1	Exhaust Pipe Gasket	1995	60967	Mazda 626 ES, LX, MX-6 LS; Flange	
2	Exhaust Pipe Gasket	1994-93	60868	Converter	
1	Exhaust Pipe Gasket	1994-93	60967	Flange	
QTY	OIL PAN	YEARS	PART NO.	DESCRIPTION	
1	Oil Pan Gasket Set	2002-93	OS 30909 C		
QTY	CRANKSHAFT REAR SEAL	YEARS	PART NO.	DESCRIPTION	
1	Rear Main Seal Set	2002-93	BS 40387	Rubber; One-piece	
QTY	VALVE COVER	YEARS	PART NO.	DESCRIPTION	
1	Valve Cover Gasket Set	2002-98	VS 50426 R	Mazda 626 ES, LX; w/Isolators & Grommets & Spark plug tube seals; Must be used w/MS 95422; PermaDry® molded rubber gskts. incl.	
1	Valve Cover Gasket Set	2002-98	VS 50426 R	Exc. Mazda 626 ES, LX; w/Isolators & Grommets & Spark plug tube seals; Must be used w/MS 97198; PermaDry® molded rubber gskts. incl.	
1	Valve Cover Gasket Set	1997-95	VS 50426 R	Mazda Millenia Base, L; w/Isolators & Grommets & Spark plug tube seals; Must be used w/MS 97198; PermaDry® molded rubber gskts. incl.	
1	Valve Cover Gasket Set	1997-96	VS 50426 R	Exc. Mazda Millenia Base, L; w/Isolators & Grommets & Spark plug tube seals; Must be used w/MS 95422; PermaDry® molded rubber gskts. incl.	
1	Valve Cover Gasket Set	1995	VS 50426 R	Mazda 626 ES, LX, MX-6 LS; w/Isolators & Grommets & Spark plug tube seals; Must be used w/MS 95422; PermaDry® molded rubber gskts. incl.	
1	Valve Cover Gasket Set	1994-93	VS 50426 R	w/Isolators & Grommets & Spark plug tube seals; Must be used w/MS 95422; PermaDry® molded rubber gskts. incl.	
1	Grommet Set	2002-93	ES 70718	Valve Cover	
1	Isolator Set	2002-93	ES 70719	Valve Cover	
1	Circular Plug	2002-93	ES 72756	Valve Cover; Camshaft plug seal set; New Part Number - Check for Availability	
QTY	VALVE STEM SEAL SET	YEARS	PART NO.	DESCRIPTION	
1	Valve Stem Seal Set	2002-93	SS 72802-1	Premium valve stem seals incl.	
QTY	THERMOSTAT HOUSING	YEARS	PART NO.	DESCRIPTION	
1	Water Outlet Gasket	2002-93	35251	Thermostat Housing; Thermostat cover	
QTY	WATER OUTLET GASKET	YEARS	PART NO.	DESCRIPTION	
1	Water Crossover Mounting Set	2002-93	ES 70717		
QTY	WATER PUMP	YEARS	PART NO.	DESCRIPTION	
1	Water Pump Gasket	2002-93	35578		
QTY	TIMING COVER	YEARS	PART NO.	DESCRIPTION	
1	Crankshaft Front Seal Set	2002-93	TCS 45936	Oil pump mounting seals incl.; Oil cooler mounting seals incl.	
1	Crankshaft Front Seal Set	2002-93	TCS 46165	Crankshaft front seal only; New Part Number - Check for Availability	
2	Camshaft Front Seal Set	2002-93	TCS 45724		
QTY	CARB & FUEL INJECTION	YEARS	PART NO.	DESCRIPTION	
1	Fuel Injector O-Ring Set	2002-93	ES 70713		
1	Throttle Body Gasket	2002-99	61610		
1	Throttle Body Gasket	1998	61512	Exc. Mazda 626 ES, LX	
1	Throttle Body Gasket	1998	61610	Mazda 626 ES, LX	
1	Throttle Body Gasket	1997-95	61512	Mazda Millenia Base, L	
1	Throttle Body Gasket	1997-96	60965	Exc. Mazda Millenia Base, L	
1	Throttle Body Gasket	1995	60965	Mazda 626 ES, LX, MX-6 LS	
1	Throttle Body Gasket	1994-93	60965		

24 (cont.)		2002 - 1993; 2.5L 152 (2497cc) DOHC V6 (24 Valve) 84.5mm Bore			24 (cont.)
		MFI; Gasoline; Naturally Aspirated Mazda Eng.; Eng. Code KL-ZE			
QTY	EXHAUST GAS RECIRCULATION	YEARS	PART NO.	DESCRIPTION	
1	EGR Gasket	2002-98	70431	Exc. Mazda 626 ES, LX	
1	EGR Gasket	2002-98	70714	Mazda 626 ES, LX	
1	EGR Gasket	1997-95	70431	Mazda Millenia Base, L	
1	EGR Gasket	1997-96	70714	Exc. Mazda Millenia Base, L	
1	EGR Gasket	1995	70714	Mazda 626 ES, LX, MX-6 LS	
1	EGR Gasket	1994-93	70714		
QTY	OIL FILTER MOUNTING	YEARS	PART NO.	DESCRIPTION	
1	Oil Filter Adapter Gasket	2002-93	70716		
25		1991; 3.0L 180.3 (2954cc) DOHC V6 (24 Valve) 90mm Bore			25
		MFI; Gasoline; Naturally Aspirated Mazda Eng.; Eng. Code JE-27			
QTY	CYLINDER HEAD	YEARS	PART NO.	DESCRIPTION	
1	Head Gasket	1991	9649 PT	Loc. L.H.; Head bolts not incl.; Head bolt replacement recommended; PermaTorqueMLS®	
1	Head Gasket	1991	9650 PT	Loc. R.H.; Head bolts not incl.; Head bolt replacement recommended; PermaTorqueMLS®	
QTY	CONVERSION SET	YEARS	PART NO.	DESCRIPTION	
1	Gasket Conversion Set	1991	CS 9649-1		
QTY	MANIFOLD - INT. & EXH.	YEARS	PART NO.	DESCRIPTION	
1	Int. Manifold Gasket Set	1991	MS 94854	Upper set incl.	
1	Exh. Manifold Gasket Set	1991	MS 94857		
QTY	EXHAUST PIPE FLANGE	YEARS	PART NO.	DESCRIPTION	
2	Exhaust Pipe Gasket	1991	60831	Converter	
1	Exhaust Pipe Gasket	1991	60902	Flange	
QTY	OIL PAN	YEARS	PART NO.	DESCRIPTION	
1	Oil Pan Gasket Set	1991	OS 34304 C		
QTY	CRANKSHAFT REAR SEAL	YEARS	PART NO.	DESCRIPTION	
1	Rear Main Seal Set	1991	BS 40597	Rubber; One-piece	
QTY	VALVE COVER	YEARS	PART NO.	DESCRIPTION	
1	Valve Cover Gasket Set	1991	VS 50379 R	w/Grommets; PermaDry® molded rubber gskts. incl.	
1	Grommet Set	1991	ES 72652	Valve Cover; New Part Number - Check for Availability	
QTY	VALVE STEM SEAL SET	YEARS	PART NO.	DESCRIPTION	
1	Valve Stem Seal Set	1991	SS 72819	Premium valve stem seals incl.	
QTY	THERMOSTAT HOUSING	YEARS	PART NO.	DESCRIPTION	
1	Thermostat Gasket	1991	35439	Thermostat Housing	
1	O-Ring	1991	35555	Thermostat Housing	
QTY	WATER PUMP	YEARS	PART NO.	DESCRIPTION	
1	Water Pump Gasket	1991	35501		
QTY	TIMING COVER	YEARS	PART NO.	DESCRIPTION	
1	Crankshaft Front Seal Set	1991	TCS 45850		
1	Camshaft Front Seal Set	1991	TCS 45917		
QTY	CARB & FUEL INJECTION	YEARS	PART NO.	DESCRIPTION	
2	Fuel Injector O-Ring Set	1991	ES 70600		
QTY	EXHAUST GAS RECIRCULATION	YEARS	PART NO.	DESCRIPTION	
1	EGR Gasket	1991	70431		
26		1995 - 1992; 3.0L 180.3 (2954cc) DOHC V6 (24 Valve) 90mm Bore			26
		MFI; Gasoline; Naturally Aspirated Mazda Eng.; Eng. Code JE-48			
QTY	CYLINDER HEAD	YEARS	PART NO.	DESCRIPTION	
1	Head Gasket	1995-92	9649 PT	Loc. L.H.; Head bolts not incl.; Head bolt replacement recommended; PermaTorqueMLS®	
1	Head Gasket	1995-92	9650 PT	Loc. R.H.; Head bolts not incl.; Head bolt replacement recommended; PermaTorqueMLS®	
QTY	EXHAUST PIPE FLANGE	YEARS	PART NO.	DESCRIPTION	
2	Exhaust Pipe Gasket	1995-92	60620	Flange	
2	Exhaust Pipe Gasket	1995-92	60831	Converter	
QTY	CRANKSHAFT REAR SEAL	YEARS	PART NO.	DESCRIPTION	
1	Rear Main Seal Set	1995-92	BS 40597	Rubber; One-piece	
QTY	VALVE COVER	YEARS	PART NO.	DESCRIPTION	
1	Grommet Set	1995-92	ES 72652	Valve Cover; New Part Number - Check for Availability	
QTY	VALVE STEM SEAL SET	YEARS	PART NO.	DESCRIPTION	
1	Valve Stem Seal Set	1995-92	SS 72819	Premium valve stem seals incl.	

Mazda Car (Cont.)

26 (cont.)		1995 - 1992; 3.0L 180.3 (2954cc) DOHC V6 (24 Valve) 90mm Bore			26 (cont.)
		MFI; Gasoline; Naturally Aspirated Mazda Eng.; Eng. Code JE-48			
QTY	THERMOSTAT HOUSING	YEARS	PART NO.	DESCRIPTION	
1	Thermostat Gasket	1995-92	35439	Thermostat Housing	
1	O-Ring	1995-92	35555	Thermostat Housing	
QTY	WATER PUMP	YEARS	PART NO.	DESCRIPTION	
1	Water Pump Gasket	1995-92	35501		
QTY	TIMING COVER	YEARS	PART NO.	DESCRIPTION	
1	Crankshaft Front Seal Set	1995-92	TCS 45850		
1	Camshaft Front Seal Set	1995-92	TCS 45917		
QTY	CARB & FUEL INJECTION	YEARS	PART NO.	DESCRIPTION	
1	Fuel Injector O-Ring Set	1995-92	ES 70713		
QTY	EXHAUST GAS RECIRCULATION	YEARS	PART NO.	DESCRIPTION	
1	EGR Gasket	1995-92	70431		
27		1995 - 1991; 3.0L 180.3 (2954cc) DOHC V6 (24 Valve) 90mm Bore			27
		MFI; Gasoline; Naturally Aspirated Mazda Eng.; Eng. Code JE-ZE			
QTY	CYLINDER HEAD	YEARS	PART NO.	DESCRIPTION	
1	Head Gasket	1995-91	9649 PT	Loc. L.H.; Head bolts not incl.; Head bolt replacement recommended; PermaTorqueMLS®	
1	Head Gasket	1995-91	9650 PT	Loc. R.H.; Head bolts not incl.; Head bolt replacement recommended; PermaTorqueMLS®	
QTY	CONVERSION SET	YEARS	PART NO.	DESCRIPTION	
1	Gasket Conversion Set	1991	CS 9649-1		
QTY	MANIFOLD - INT. & EXH.	YEARS	PART NO.	DESCRIPTION	
1	Int. Manifold Gasket Set	1991	MS 94854	Upper set incl.	
1	Exh. Manifold Gasket Set	1991	MS 94857		
QTY	EXHAUST PIPE FLANGE	YEARS	PART NO.	DESCRIPTION	
2	Exhaust Pipe Gasket	1995-91	60831	Converter	
2	Exhaust Pipe Gasket	1995-92	60620	Flange	
1	Exhaust Pipe Gasket	1991	60902	Flange	
QTY	OIL PAN	YEARS	PART NO.	DESCRIPTION	
1	Oil Pan Gasket Set	1991	OS 34304 C		
QTY	CRANKSHAFT REAR SEAL	YEARS	PART NO.	DESCRIPTION	
1	Rear Main Seal Set	1995-91	BS 40597	Rubber; One-piece	
QTY	VALVE COVER	YEARS	PART NO.	DESCRIPTION	
1	Valve Cover Gasket Set	1991	VS 50379 R	w/Grommets; PermaDry® molded rubber gsks. incl.	
1	Grommet Set	1995-91	ES 72652	Valve Cover; New Part Number - Check for Availability	
QTY	VALVE STEM SEAL SET	YEARS	PART NO.	DESCRIPTION	
1	Valve Stem Seal Set	1995-91	SS 72819	Premium valve stem seals incl.	
QTY	THERMOSTAT HOUSING	YEARS	PART NO.	DESCRIPTION	
1	Thermostat Gasket	1995-91	35439	Thermostat Housing	
1	O-Ring	1995-91	35555	Thermostat Housing	
QTY	WATER PUMP	YEARS	PART NO.	DESCRIPTION	
1	Water Pump Gasket	1995-91	35501		
QTY	TIMING COVER	YEARS	PART NO.	DESCRIPTION	
1	Crankshaft Front Seal Set	1995-91	TCS 45850		
1	Camshaft Front Seal Set	1995-91	TCS 45917		
QTY	CARB & FUEL INJECTION	YEARS	PART NO.	DESCRIPTION	
1	Fuel Injector O-Ring Set	1995-92	ES 70713		
2	Fuel Injector O-Ring Set	1991	ES 70600		
QTY	EXHAUST GAS RECIRCULATION	YEARS	PART NO.	DESCRIPTION	
1	EGR Gasket	1995-91	70431		
28		1991; 3.0L 180.3 (2954cc) SOHC V6 (18 Valve) 90mm Bore			28
		MFI; Gasoline; Naturally Aspirated Mazda Eng.; Eng. Code JE			
QTY	CYLINDER HEAD	YEARS	PART NO.	DESCRIPTION	
1	Head Gasket	1991	9649 PT	Loc. L.H.; Head bolts not incl.; Head bolt replacement recommended; PermaTorqueMLS®	
1	Head Gasket	1991	9650 PT	Loc. R.H.; Head bolts not incl.; Head bolt replacement recommended; PermaTorqueMLS®	
1	Head Set	1991	HS 9649 PT-1	Head bolts not incl.; Head bolt replacement recommended; PermaDry® molded rubber valve cover gsks. incl.; Premium valve stem seals incl.	
QTY	CONVERSION SET	YEARS	PART NO.	DESCRIPTION	
1	Gasket Conversion Set	1991	CS 9649-1		

28 (cont.)		1991; 3.0L 180.3 (2954cc) SOHC V6 (18 Valve) 90mm Bore			28 (cont.)
		MFI; Gasoline; Naturally Aspirated Mazda Eng.; Eng. Code JE			
QTY	MANIFOLD - INT. & EXH.	YEARS	PART NO.	DESCRIPTION	
1	Int. Manifold Gasket Set	1991	MS 94547	Lower set	
1	Plenum Gasket Set	1991	MS 94421	Upper set	
1	Exh. Manifold Gasket Set	1991	MS 94418		
QTY	EXHAUST PIPE FLANGE	YEARS	PART NO.	DESCRIPTION	
1	Exhaust Pipe Gasket	1991	60817	Pipe to manifold	
2	Exhaust Pipe Gasket	1991	60831	Converter	
1	Exhaust Pipe Gasket	1991	60832	Crossover pipe flange	
1	Exhaust Pipe Gasket	1991	60872	Ring	
QTY	OIL PAN	YEARS	PART NO.	DESCRIPTION	
1	Oil Pan Gasket Set	1991	OS 34304 C		
QTY	CRANKSHAFT REAR SEAL	YEARS	PART NO.	DESCRIPTION	
1	Rear Main Seal Set	1991	BS 40597	Rubber; One-piece	
QTY	VALVE COVER	YEARS	PART NO.	DESCRIPTION	
1	Valve Cover Gasket Set	1991	VS 50336 R	w/Grommets; PermaDry® molded rubber gskts. incl.	
1	Grommet Set	1991	ES 72652	Valve Cover; New Part Number - Check for Availability	
QTY	VALVE STEM SEAL SET	YEARS	PART NO.	DESCRIPTION	
1	Valve Stem Seal Set	1991	SS 72512	Loc. Exh.; Premium valve stem seals incl.	
1	Valve Stem Seal Set	1991	SS 72680-1	Loc. Int.; Premium valve stem seals incl.	
QTY	THERMOSTAT HOUSING	YEARS	PART NO.	DESCRIPTION	
1	Thermostat Gasket	1991	35439	Thermostat Housing	
1	O-Ring	1991	35555	Thermostat Housing	
QTY	WATER OUTLET GASKET	YEARS	PART NO.	DESCRIPTION	
1	Water Outlet Gasket	1991	35436	Water Outlet; Loc. Inner	
1	Water Outlet Gasket	1991	35437	Water Outlet; Loc. Outer	
QTY	WATER PUMP	YEARS	PART NO.	DESCRIPTION	
1	Water Pump Gasket	1991	35501		
QTY	TIMING COVER	YEARS	PART NO.	DESCRIPTION	
1	Crankshaft Front Seal Set	1991	TCS 45850		
1	Camshaft Front Seal Set	1991	TCS 45884		
QTY	CARB & FUEL INJECTION	YEARS	PART NO.	DESCRIPTION	
2	Fuel Injector O-Ring Set	1991	ES 70600		
1	Throttle Body Gasket	1991	60873		
QTY	EXHAUST GAS RECIRCULATION	YEARS	PART NO.	DESCRIPTION	
1	EGR Mounting Set	1991	ES 72825	Mounting & Pipe gskts. incl.	
29		1991; 3.0L 180.3 (2954cc) SOHC V6 (18 Valve) 90mm Bore			29
		MFI; Gasoline; Naturally Aspirated Mazda Eng.; Eng. Code JE-39			
QTY	CYLINDER HEAD	YEARS	PART NO.	DESCRIPTION	
1	Head Gasket	1991	9649 PT	Loc. L.H.; Head bolts not incl.; Head bolt replacement recommended; PermaTorqueMLS®	
1	Head Gasket	1991	9650 PT	Loc. R.H.; Head bolts not incl.; Head bolt replacement recommended; PermaTorqueMLS®	
1	Head Set	1991	HS 9649 PT-1	Head bolts not incl.; Head bolt replacement recommended; PermaDry® molded rubber valve cover gskts. incl.; Premium valve stem seals incl.	
QTY	CONVERSION SET	YEARS	PART NO.	DESCRIPTION	
1	Gasket Conversion Set	1991	CS 9649-1		
QTY	MANIFOLD - INT. & EXH.	YEARS	PART NO.	DESCRIPTION	
1	Int. Manifold Gasket Set	1991	MS 94547	Lower set	
1	Plenum Gasket Set	1991	MS 94421	Upper set	
1	Exh. Manifold Gasket Set	1991	MS 94418		
QTY	EXHAUST PIPE FLANGE	YEARS	PART NO.	DESCRIPTION	
1	Exhaust Pipe Gasket	1991	60817	Pipe to manifold	
2	Exhaust Pipe Gasket	1991	60831	Converter	
1	Exhaust Pipe Gasket	1991	60832	Crossover pipe flange	
1	Exhaust Pipe Gasket	1991	60872	Ring	
QTY	OIL PAN	YEARS	PART NO.	DESCRIPTION	
1	Oil Pan Gasket Set	1991	OS 34304 C		
QTY	CRANKSHAFT REAR SEAL	YEARS	PART NO.	DESCRIPTION	
1	Rear Main Seal Set	1991	BS 40597	Rubber; One-piece	
QTY	VALVE COVER	YEARS	PART NO.	DESCRIPTION	
1	Valve Cover Gasket Set	1991	VS 50336 R	w/Grommets; PermaDry® molded rubber gskts. incl.	
1	Grommet Set	1991	ES 72652	Valve Cover; New Part Number - Check for Availability	

Mazda Car (Cont.)

29		1991; 3.0L 180.3 (2954cc) SOHC V6 (18 Valve) 90mm Bore			29	
(cont.)		MFI; Gasoline; Naturally Aspirated Mazda Eng.; Eng. Code JE-39			(cont.)	
QTY	VALVE STEM SEAL SET	YEARS	PART NO.	DESCRIPTION		
1	Valve Stem Seal Set	1991	SS 72512	Loc. Exh.; Premium valve stem seals incl.		
1	Valve Stem Seal Set	1991	SS 72680-1	Loc. Int.; Premium valve stem seals incl.		
QTY	THERMOSTAT HOUSING	YEARS	PART NO.	DESCRIPTION		
1	Thermostat Gasket	1991	35439	Thermostat Housing		
1	O-Ring	1991	35555	Thermostat Housing		
QTY	WATER OUTLET GASKET	YEARS	PART NO.	DESCRIPTION		
1	Water Outlet Gasket	1991	35436	Water Outlet; Loc. Inner		
1	Water Outlet Gasket	1991	35437	Water Outlet; Loc. Outer		
QTY	WATER PUMP	YEARS	PART NO.	DESCRIPTION		
1	Water Pump Gasket	1991	35501			
QTY	TIMING COVER	YEARS	PART NO.	DESCRIPTION		
1	Crankshaft Front Seal Set	1991	TCS 45850			
1	Camshaft Front Seal Set	1991	TCS 45884			
QTY	CARB & FUEL INJECTION	YEARS	PART NO.	DESCRIPTION		
2	Fuel Injector O-Ring Set	1991	ES 70600			
1	Throttle Body Gasket	1991	60873			
QTY	EXHAUST GAS RECIRCULATION	YEARS	PART NO.	DESCRIPTION		
1	EGR Mounting Set	1991	ES 72825	Mounting & Pipe gskts. incl.		
30		2008 - 2003; 3.0L 181 (2967cc) DOHC V6 (24 Valve) 89mm Bore Duratec			30	
		MFI; Gasoline; Naturally Aspirated Ford Eng.; Eng. Code MZI				
QTY	CYLINDER HEAD	YEARS	PART NO.	DESCRIPTION		
1	Head Gasket	2008-03	26212 PT	Loc. R.H.; Head bolts not incl.; Head bolt replacement required; PermaTorqueMLS®		
1	Head Gasket	2008-03	26233 PT	Loc. L.H.; Head bolts not incl.; Head bolt replacement required; PermaTorqueMLS®		
1	Head Set	2008-05	HS 26233 PT-4	Head bolts not incl.; Head bolt replacement required; PermaDry® molded rubber valve cover gskts. incl.; Premium valve stem seals incl.		
1	Head Set	2004	HS 26233 PT-3	Head bolts not incl.; Head bolt replacement required; PermaDry® molded rubber valve cover gskts. incl.; Premium valve stem seals incl.		
1	Head Set	2003	HS 26233 PT-2	Head bolts not incl.; Head bolt replacement required; PermaDry® molded rubber valve cover gskts. incl.; Premium valve stem seals incl.		
2	Head Bolt Set	2008-03	ES 72159	Head bolts w/Washers; Replacement required		
QTY	CONVERSION SET	YEARS	PART NO.	DESCRIPTION		
1	Gasket Conversion Set	2008-04	CS 9038-2	PermaDry® molded rubber oil pan gskt. incl.		
1	Gasket Conversion Set	2003	CS 9038-1	PermaDry® molded rubber oil pan gskt. incl.; Consolidated design		
QTY	MANIFOLD - INT. & EXH.	YEARS	PART NO.	DESCRIPTION		
1	Int. Manifold Gasket Set	2008-05	MS 92586-1	Lower set; Upper set incl.		
1	Int. Manifold Gasket Set	2004	MS 96841-2	Lower set; Upper set incl.		
1	Int. Manifold Gasket Set	2003	MS 96841-1	Lower set; Upper set incl.		
1	Plenum Gasket Set	2008-04	MS 96252	Upper set		
1	Plenum Gasket Set	2003	MS 96124-1	Upper set		
1	Exh. Manifold Gasket Set	2008-03	MS 95715			
QTY	OIL PAN	YEARS	PART NO.	DESCRIPTION		
1	Oil Pan Gasket Set	2008-04	OS 30729 R	PermaDry® molded rubber gskt. incl.		
1	Oil Pan Gasket Set	2003	OS 30697 R	PermaDry® molded rubber gskt. incl.; Improved design		
1	Drain Plug Gasket	2008-03	72515			
QTY	CRANKSHAFT REAR SEAL	YEARS	PART NO.	DESCRIPTION		
1	Rear Main Seal Set	2008-03	BS 40620	Rubber; One-piece; Improved design		
1	Rear Main Seal Set	2008-03	BS 40644	PTFE Rubber; One-piece		
QTY	VALVE COVER	YEARS	PART NO.	DESCRIPTION		
1	Valve Cover Gasket Set	2008-03	VS 50706 R	w/Spark plug tube seals; PermaDry® molded rubber gskts. incl.		
QTY	VALVE STEM SEAL SET	YEARS	PART NO.	DESCRIPTION		
1	Valve Stem Seal Set	2008-03	SS 72873-1	Premium valve stem seals incl.		
QTY	THERMOSTAT HOUSING	YEARS	PART NO.	DESCRIPTION		
1	Water Outlet Gasket	2008-03	35489	Thermostat Housing; Thermostat seal		
QTY	WATER OUTLET GASKET	YEARS	PART NO.	DESCRIPTION		
1	Water Outlet Gasket	2008-03	35489	Water Outlet		
QTY	WATER PUMP	YEARS	PART NO.	DESCRIPTION		
1	Water Pump Gasket	2008-03	35663	Improved design		
QTY	TIMING COVER	YEARS	PART NO.	DESCRIPTION		
1	Timing Cover Set	2008-04	TCS 46016	Must be used w/OS 30729R; Improved design		
1	Timing Cover Set	2003	TCS 46016	Must be used w/OS 30697R; Improved design		
1	Crankshaft Front Seal Set	2008-03	TCS 46114			

30 (cont.)		2008 - 2003; 3.0L 181 (2967cc) DOHC V6 (24 Valve) 89mm Bore Duratec			30 (cont.)
MFI; Gasoline; Naturally Aspirated Ford Eng.; Eng. Code MZI					
QTY	TIMING COVER	YEARS	PART NO.	DESCRIPTION	
1	Camshaft Rear Seal Set	2008-03	TCS 45966		
QTY	CARB & FUEL INJECTION	YEARS	PART NO.	DESCRIPTION	
2	Fuel Injector O-Ring Set	2008-03	ES 70599	Improved design	
1	Throttle Body Gasket	2008-03	61158	Mounting	
1	Throttle Body Gasket	2008-03	72302	Air bypass valve	
QTY	EXHAUST GAS RECIRCULATION	YEARS	PART NO.	DESCRIPTION	
1	EGR Gasket	2008-03	71276	Valve	
31		2013 - 2009; 3.7L 227 (3721cc) DOHC V6 (24 Valve) 95.5mm Bore Duratec Cyclone			31
MFI; Gasoline; Naturally Aspirated Ford Eng.; Eng. Code MZI					
QTY	CYLINDER HEAD	YEARS	PART NO.	DESCRIPTION	
1	Head Gasket	2013-09	26543 PT	Loc. R.H.; Head bolts not incl.; Head bolt replacement recommended; PermaTorqueMLS®; New Part Number - Check for Availability	
1	Head Gasket	2013-09	26544 PT	Loc. L.H.; Head bolts not incl.; Head bolt replacement recommended; PermaTorqueMLS®; New Part Number - Check for Availability	
1	Head Set	2013-09	HS 26543 PT-1	Head bolts not incl.; Head bolt replacement recommended; PermaDry® molded rubber valve cover gskts. incl.; Premium valve stem seals incl.; New Part Number - Check for Availability	
2	Head Bolt Set	2013-09	ES 72478	Replacement recommended; New Part Number - Check for Availability	
QTY	CONVERSION SET	YEARS	PART NO.	DESCRIPTION	
1	Gasket Conversion Set	2013-09	CS 26543	RTV sealant incl. for oil pan gskt.; New Part Number - Check for Availability	
QTY	MANIFOLD - INT. & EXH.	YEARS	PART NO.	DESCRIPTION	
1	Int. Manifold Gasket Set	2013-09	MS 97118	Lower set; Upper set incl.; New Part Number - Check for Availability	
1	Plenum Gasket Set	2013-09	MS 97120	Upper set	
1	Exh. Manifold Gasket Set	2013-09	MS 97121		
QTY	EXHAUST PIPE FLANGE	YEARS	PART NO.	DESCRIPTION	
1	Exhaust Pipe Gasket	2013-09	61236	Loc. Center; Converter	
QTY	CRANKSHAFT REAR SEAL	YEARS	PART NO.	DESCRIPTION	
1	Rear Main Seal Set	2013-09	BS 40729	Rubber; One-piece	
QTY	VALVE COVER	YEARS	PART NO.	DESCRIPTION	
1	Valve Cover Gasket Set	2013-09	VS 50767 R	w/Grommets & Spark plug tube seals; PermaDry® molded rubber gskts. incl.; New Part Number - Check for Availability	
QTY	VALVE STEM SEAL SET	YEARS	PART NO.	DESCRIPTION	
1	Valve Stem Seal Set	2013-09	SS 71327	Premium valve stem seals incl.	
QTY	THERMOSTAT HOUSING	YEARS	PART NO.	DESCRIPTION	
1	Thermostat Gasket	2013-09	35934	Thermostat case	
QTY	WATER OUTLET GASKET	YEARS	PART NO.	DESCRIPTION	
1	Water Outlet Gasket	2013-09	35489	Thermostat seal	
QTY	WATER PUMP	YEARS	PART NO.	DESCRIPTION	
1	Water Pump Gasket	2013-09	35930	Loc. Outer	
1	Water Pump Gasket	2013-09	35932	Loc. Inner	
1	Water Pump Gasket	2013-09	35995	Loc. Outer; New Part Number - Check for Availability	
1	Water Pump Gasket	2013-09	35996	Loc. Inner; New Part Number - Check for Availability	
QTY	TIMING COVER	YEARS	PART NO.	DESCRIPTION	
1	Crankshaft Front Seal Set	2013-09	TCS 46117		
QTY	CARB & FUEL INJECTION	YEARS	PART NO.	DESCRIPTION	
2	Fuel Injector O-Ring Set	2013-09	ES 70599	Upper set; Injectors to fuel rail; Improved design	
1	Throttle Body Gasket	2013-09	61466		

Mazda Minivans - See Mazda Truck

Mazda SUV's - See Mazda Truck

Mazda Truck (Incl. Minivans and SUV's)

Engine Finding Index				
Engine	Years	Code	Line No.	
2.0L 121 (1988cc) DOHC L4 (16 Valve) 84.8mm Bore Zetec; MFI; Gasoline; Naturally Aspirated Ford Eng.	2004-01	B	1	
2.0L 121.9 (1998cc) DOHC L4 (16 Valve) 83.5mm Bore SkyActiv-G VVT; DI; Gasoline; Naturally Aspirated Mazda Eng.	2013	PE-VPS	2	
2.2L 133 (2184cc) SOHC L4 (8 Valve) 86mm Bore; MFI; Gasoline; Naturally Aspirated Mazda Eng.	1993-91	F2G	3	
2.2L 133 (2184cc) SOHC L4 (8 Valve) 86mm Bore; 2 Bbl.; Gasoline; Naturally Aspirated Mazda Eng.	1993-91	F2L	4	

Mazda Truck (Incl. Minivans and SUV's) (Cont.)

Engine Finding Index (Cont.)

Engine	Years	Code	Line No.
2.3L 138 (2261cc) DOHC L4 (16 Valve) 87.5mm Bore Duratec; MFI; Gasoline; Naturally Aspirated Ford Eng.	2010-01	D	5
2.3L 138 (2261cc) DOHC L4 (16 Valve) 87.5mm Bore Duratec; MFI; Gasoline; Naturally Aspirated Ford Eng.	2008-05	MZR	6
2.3L 138 (2261cc) DOHC L4 (16 Valve) 87.5mm Bore Duratec; MFI; Hybrid (Gas/Electric); Naturally Aspirated Ford Eng.	2008	MZR	7
2.3L 138 (2261cc) DOHC L4 (16 Valve) 87.5mm Bore Duratec; MFI; Gasoline; Turbo - Intercooled Ford Eng.	2012-07	MZR-T	8
2.3L 140 (2302cc) SOHC L4 (8 Valve) 96mm Bore; MFI; Gasoline; Naturally Aspirated Ford Eng.	1997-94	A	9
2.5L 151.8 (2488cc) DOHC L4 (16 Valve) 89mm Bore Duratec; MFI; Gasoline; Naturally Aspirated Ford Eng.	2012-09	MZR	10
2.5L 151.8 (2488cc) DOHC L4 (16 Valve) 89mm Bore Duratec; MFI; Hybrid (Gas/Electric); Naturally Aspirated Ford Eng.	2011-09	MZR	11
2.5L 152 (2495cc) DOHC V6 (24 Valve) 81.6mm Bore Duratec; MFI; Gasoline; Naturally Aspirated Ford Eng.	2001-00	G	12
2.5L 153 (2503cc) SOHC L4 (8 Valve) 96mm Bore; MFI; Gasoline; Naturally Aspirated Ford Eng.	2001-98	C	13
2.6L 159 (2606cc) SOHC L4 (12 Valve) 92mm Bore; MFI; Gasoline; Naturally Aspirated Mazda Eng.	1994-91	G6	14
3.0L 180.3 (2954cc) SOHC V6 (18 Valve) 90mm Bore; MFI; Gasoline; Naturally Aspirated Mazda Eng.	1993-91	JE	15
3.0L 180.3 (2954cc) SOHC V6 (18 Valve) 90mm Bore; MFI; Gasoline; Naturally Aspirated Mazda Eng.	1999-94	JE-E	16
3.0L 181 (2967cc) DOHC V6 (24 Valve) 89mm Bore Duratec; MFI; Gasoline; Naturally Aspirated Ford Eng.	2005-02	1	17
3.0L 181 (2967cc) DOHC V6 (24 Valve) 89mm Bore Duratec; MFI; Gasoline; Naturally Aspirated Ford Eng.	2008-01	1	18
3.0L 181 (2967cc) DOHC V6 (24 Valve) 89mm Bore Duratec VVT; MFI; Gasoline; Naturally Aspirated Ford Eng.	2011-09	1	19
3.0L 181 (2967cc) DOHC V6 (24 Valve) 89mm Bore Duratec VVT; MFI; Flex Fuel; Naturally Aspirated Ford Eng.	2011	G	20
3.0L 183 (2982cc) OHV V6 (12 Valve) 89mm Bore Vulcan; MFI; Gasoline; Naturally Aspirated Ford Eng.	2008-94	U	21
3.0L 183 (2982cc) OHV V6 (12 Valve) 89mm Bore Vulcan; MFI; Flex Fuel; Naturally Aspirated Ford Eng.	2003-99	V	22
3.5L 213.3 (3496cc) DOHC V6 (24 Valve) 92.5mm Bore Duratec Cyclone; MFI; Gasoline; Naturally Aspirated Ford Eng.	2007	MZI	23
3.7L 227 (3721cc) DOHC V6 (24 Valve) 95.5mm Bore Duratec Cyclone; MFI; Gasoline; Naturally Aspirated Ford Eng.	2013-08	MZI	24
4.0L 244 (4015cc) OHV V6 (12 Valve) 100.4mm Bore; MFI; Gasoline; Naturally Aspirated Ford Eng.	2000-94	X	25
4.0L 244 (4015cc) OHV V6 (12 Valve) 100.4mm Bore; MFI; Gasoline; Naturally Aspirated Ford Eng.	1993-91	X	26
4.0L 244 (4015cc) SOHC V6 (12 Valve) 100.4mm Bore; MFI; Gasoline; Naturally Aspirated Ford Eng.	2010-01	E	27

Engine Code Index

Code	Engine	Line No.
8A	2.3L 140 (2302cc) SOHC L4 (8 Valve) 96mm Bore; MFI; Gasoline; Naturally Aspirated Ford Eng.	9
8U	3.0L 183 (2982cc) OHV V6 (12 Valve) 89mm Bore Vulcan; MFI; Gasoline; Naturally Aspirated Ford Eng.	21
8U	3.0L 183 (2982cc) OHV V6 (12 Valve) 89mm Bore Vulcan; MFI; Flex Fuel; Naturally Aspirated Ford Eng.	22
8X	4.0L 244 (4015cc) OHV V6 (12 Valve) 100.4mm Bore; MFI; Gasoline; Naturally Aspirated Ford Eng.	25
ADJ	3.0L 181 (2967cc) DOHC V6 (24 Valve) 89mm Bore Duratec; MFI; Gasoline; Naturally Aspirated Ford Eng.	17
AJ	3.0L 181 (2967cc) DOHC V6 (24 Valve) 89mm Bore Duratec; MFI; Gasoline; Naturally Aspirated Ford Eng.	18
AJ	3.0L 181 (2967cc) DOHC V6 (24 Valve) 89mm Bore Duratec VVT; MFI; Gasoline; Naturally Aspirated Ford Eng.	19
AJ	3.0L 181 (2967cc) DOHC V6 (24 Valve) 89mm Bore Duratec VVT; MFI; Flex Fuel; Naturally Aspirated Ford Eng.	20
F2G	2.2L 133 (2184cc) SOHC L4 (8 Valve) 86mm Bore; MFI; Gasoline; Naturally Aspirated Mazda Eng.	3
F2L	2.2L 133 (2184cc) SOHC L4 (8 Valve) 86mm Bore; 2 Bbl.; Gasoline; Naturally Aspirated Mazda Eng.	4
G6	2.6L 159 (2606cc) SOHC L4 (12 Valve) 92mm Bore; MFI; Gasoline; Naturally Aspirated Mazda Eng.	14
GY	2.5L 152 (2495cc) DOHC V6 (24 Valve) 81.6mm Bore Duratec; MFI; Gasoline; Naturally Aspirated Ford Eng.	12
JE	3.0L 180.3 (2954cc) SOHC V6 (18 Valve) 90mm Bore; MFI; Gasoline; Naturally Aspirated Mazda Eng.	15
JE-E	3.0L 180.3 (2954cc) SOHC V6 (18 Valve) 90mm Bore; MFI; Gasoline; Naturally Aspirated Mazda Eng.	16
MZI	3.5L 213.3 (3496cc) DOHC V6 (24 Valve) 92.5mm Bore Duratec Cyclone; MFI; Gasoline; Naturally Aspirated Ford Eng.	23
MZI	3.7L 227 (3721cc) DOHC V6 (24 Valve) 95.5mm Bore Duratec Cyclone; MFI; Gasoline; Naturally Aspirated Ford Eng.	24
MZR	2.3L 138 (2261cc) DOHC L4 (16 Valve) 87.5mm Bore Duratec; MFI; Gasoline; Naturally Aspirated Ford Eng.	6
MZR	2.3L 138 (2261cc) DOHC L4 (16 Valve) 87.5mm Bore Duratec; MFI; Hybrid (Gas/Electric); Naturally Aspirated Ford Eng.	7
MZR	2.5L 151.8 (2488cc) DOHC L4 (16 Valve) 89mm Bore Duratec; MFI; Gasoline; Naturally Aspirated Ford Eng.	10
MZR	2.5L 151.8 (2488cc) DOHC L4 (16 Valve) 89mm Bore Duratec; MFI; Hybrid (Gas/Electric); Naturally Aspirated Ford Eng.	11
MZR-T	2.3L 138 (2261cc) DOHC L4 (16 Valve) 87.5mm Bore Duratec; MFI; Gasoline; Turbo - Intercooled Ford Eng.	8
PE-VPS	2.0L 121.9 (1998cc) DOHC L4 (16 Valve) 83.5mm Bore SkyActiv-G VVT; DI; Gasoline; Naturally Aspirated Mazda Eng.	2
YF	2.0L 121 (1988cc) DOHC L4 (16 Valve) 84.8mm Bore Zetec; MFI; Gasoline; Naturally Aspirated Ford Eng.	1
ZZL	4.0L 244 (4015cc) OHV V6 (12 Valve) 100.4mm Bore; MFI; Gasoline; Naturally Aspirated Ford Eng.	26

Model Index

Engine (VIN Code / Eng. Code)	Year	Engine (VIN Code / Eng. Code)	Year	Engine (VIN Code / Eng. Code)	Year
Mazda Truck		Mazda Truck (cont.)		Mazda Truck (cont.)	
B1600 (Mini-Pickup)		B2300 (4WD Compact Pickup)		B3000 (4WD Compact Pickup)	
L4 1586cc 1.6L SOHC (NA)	76-72	L4 2302cc 2.3L SOHC (8A)	97-94	V6 2982cc 3.0L OHV (12 Valve) (8U)	08-94
B1800 (Mini-Pickup)		B2500 (2WD Compact Pickup)		B4000 (2WD Compact Pickup)	
L4 1796cc 1.8L SOHC (VB)	78-77	L4 2503cc 2.5L SOHC (C)	01-98	V6 4015cc 4.0L OHV (8X)	00-94
B2000 (Mini-Pickup)		B2600 (2WD Mini-Pickup)		V6 4015cc 4.0L SOHC (12 Valve) (E)	10-01
L4 1970cc 2.0L SOHC (MA)	84-79	L4 2555cc 2.6L SOHC (8 Valve) (AM1)	88-87	B4000 (4WD Compact Pickup)	
L4 1998cc 2.0L SOHC (8 Valve) (FE)	87-86	L4 2555cc 2.6L SOHC (8 Valve) (G54B)	88-87	V6 4015cc 4.0L OHV (8X)	00-94
B2200 (Mini-Pickup)		L4 2606cc 2.6L SOHC (12 Valve) (G6)	93-89	V6 4015cc 4.0L SOHC (12 Valve) (E)	10-01
L4 2184cc 2.2L SOHC (8 Valve) (F2G)	93-90	B2600 (4WD Mini-Pickup)		CX-5 (AWD Compact SUV)	
L4 2184cc 2.2L SOHC (8 Valve) (F2L)	93-87	L4 2555cc 2.6L SOHC (8 Valve) (AM1)	88-87	L4 1998cc 2.0L DOHC (16 Valve) (PE-VPS)	13
L4 2209cc 2.2L OHV Diesel (S2)	84-82	L4 2555cc 2.6L SOHC (8 Valve) (G54B)	88-87	CX-5 (FWD Compact SUV)	
B2300 (2WD Compact Pickup)		L4 2606cc 2.6L SOHC (12 Valve) (G6)	93-89	L4 1998cc 2.0L DOHC (16 Valve) (PE-VPS)	13
L4 2261cc 2.3L DOHC (16 Valve) (D)	10-01	B3000 (2WD Compact Pickup)		CX-7 (AWD Mid-Size SUV)	
L4 2302cc 2.3L SOHC (8A)	97-94	V6 2982cc 3.0L OHV (12 Valve) (8U)	08-94	L4 2261cc 2.3L DOHC Turbo (16 Valve)	12-07

(MZR-T)

Mazda Truck (Incl. Minivans and SUV's) (Cont.)

Model Index (Cont.)					
Engine (VIN Code / Eng. Code)	Year	Engine (VIN Code / Eng. Code)	Year	Engine (VIN Code / Eng. Code)	Year
Mazda Truck (cont.)		Mazda Truck (cont.)		Mazda Truck (cont.)	
CX-7 (FWD Mid-Size SUV)		MPV (FWD Minivan)		Tribute (FWD Compact SUV)	
L4 2261cc 2.3L DOHC Turbo (16 Valve) (MZR-T)	12-07	V6 2495cc 2.5L DOHC (24 Valve) (GY)	01-00	L4 1988cc 2.0L DOHC (16 Valve) (YF)	04-01
L4 2488cc 2.5L DOHC (16 Valve) (MZR)	12-10	V6 2967cc 3.0L DOHC (24 Valve) (ADJ)	05-02	L4 2261cc 2.3L DOHC (16 Valve) (MZR)	08-05
		V6 2967cc 3.0L DOHC (24 Valve) (AJ)	06-02	L4 2488cc 2.5L DOHC (16 Valve) (MZR)	11-09
CX-9 (AWD Mid-Size SUV)		Navajo (2WD Mid-Size SUV)		Tribute (FWD Compact SUV)	
V6 3496cc 3.5L DOHC (24 Valve) (MZI)	07	V6 4015cc 4.0L OHV (8X)	95-94	V6 2967cc 3.0L DOHC (24 Valve) (AJ)	11-01
V6 3721cc 3.7L DOHC (24 Valve) (MZI)	13-08	V6 4015cc 4.0L OHV (Z2L)	93-91	V6 2967cc 3.0L DOHC (24 Valve) (Flex Fuel) (AJ)	11
CX-9 (FWD Mid-Size SUV)		Navajo (4WD Mid-Size SUV)		Tribute Hybrid (AWD Compact SUV)	
V6 3496cc 3.5L DOHC (24 Valve) (MZI)	07	V6 4015cc 4.0L OHV (8X)	95-94	L4 2261cc 2.3L DOHC (16 Valve) (MZR)	08
V6 3721cc 3.7L DOHC (24 Valve) (MZI)	13-08	V6 4015cc 4.0L OHV (Z2L)	93-91	L4 2488cc 2.5L DOHC (16 Valve) (MZR)	11-09
MPV (2WD Minivan)		Tribute (AWD Compact SUV)		Tribute Hybrid (FWD Compact SUV)	
L4 2606cc 2.6L SOHC (12 Valve) (G6)	94-89	L4 1988cc 2.0L DOHC (16 Valve) (YF)	04-01	L4 2261cc 2.3L DOHC (16 Valve) (MZR)	08
V6 2954cc 3.0L SOHC (18 Valve) (JE)	93-89	L4 2261cc 2.3L DOHC (16 Valve) (MZR)	08-05	L4 2488cc 2.5L DOHC (16 Valve) (MZR)	11-09
V6 2954cc 3.0L SOHC (18 Valve) (JE-E)	99-94	L4 2488cc 2.5L DOHC (16 Valve) (MZR)	11-09		
MPV (4WD Minivan)		Tribute (AWD Compact SUV)		Tribute Hybrid (FWD Compact SUV)	
V6 2954cc 3.0L SOHC (18 Valve) (JE)	93-89	V6 2967cc 3.0L DOHC (24 Valve) (AJ)	11-01		
V6 2954cc 3.0L SOHC (18 Valve) (JE-E)	99-94	V6 2967cc 3.0L DOHC (24 Valve) (Flex Fuel) (AJ)	11		
1 2004 - 2001; 2.0L 121 (1988cc) DOHC L4 (16 Valve) 84.8mm Bore Zetec MFI; Gasoline; Naturally Aspirated Ford Eng.; VIN Code B, Eng. Code YF 1					
QTY	CYLINDER HEAD	YEARS	PART NO.	DESCRIPTION	
1	Head Gasket	2004	9005 PT-1	Head bolts not incl.; Head bolt replacement required; PermaTorqueMLS®	
1	Head Gasket	2003-02	9005 PT	To 07/06/02; Head bolts not incl.; Head bolt replacement required; PermaTorqueMLS®	
1	Head Gasket	2003-02	9005 PT-1	From 07/07/02; Head bolts not incl.; Head bolt replacement required; PermaTorqueMLS®	
1	Head Gasket	2001	9005 PT	Head bolts not incl.; Head bolt replacement required; PermaTorqueMLS®	
1	Head Set	2004	HS 9005 PT-5	Head bolts not incl.; Head bolt replacement required; PermaDry® molded rubber valve cover gskt. incl.; Premium valve stem seals incl.	
1	Head Set	2003-02	HS 9005 PT-5	From 07/07/02; Head bolts not incl.; Head bolt replacement required; PermaDry® molded rubber valve cover gskt. incl.; Premium valve stem seals incl.	
1	Head Set	2003-02	HS 9005 PT-6	To 07/06/02; Head bolts not incl.; Head bolt replacement required; PermaDry® molded rubber valve cover gskt. incl.; Premium valve stem seals incl.	
1	Head Set	2001	HS 9005 PT-6	Head bolts not incl.; Head bolt replacement required; PermaDry® molded rubber valve cover gskt. incl.; Premium valve stem seals incl.	
1	Head Bolt Set	2004-01	ES 72175	Replacement required	
QTY	CONVERSION SET	YEARS	PART NO.	DESCRIPTION	
1	Gasket Conversion Set	2004-01	CS 9005-2	Lower oil pan gskt. incl.; PermaDry® molded rubber oil pan gskt. incl.	
QTY	MANIFOLD - INT. & EXH.	YEARS	PART NO.	DESCRIPTION	
1	Int. Manifold Gasket Set	2004-01	MS 96763	Square port w/o tab	
1	Exh. Manifold Gasket Set	2004-01	MS 94427		
QTY	EXHAUST PIPE FLANGE	YEARS	PART NO.	DESCRIPTION	
1	Exhaust Pipe Gasket	2004-01	61191	Pipe to manifold	
1	Exhaust Pipe Gasket	2004-01	61192	Loc. Front; Converter	
1	Exhaust Pipe Gasket	2004-01	61194	Loc. Rear; Converter	
QTY	OIL PAN	YEARS	PART NO.	DESCRIPTION	
1	Oil Pan Gasket Set	2004-01	OS 30711 R	Loc. Upper; PermaDry® molded rubber gskt. incl.	
1	Oil Pan Gasket Set	2004-01	OS 30831	Loc. Lower	
1	Drain Plug Gasket	2004-01	72515		
QTY	CRANKSHAFT REAR SEAL	YEARS	PART NO.	DESCRIPTION	
1	Rear Main Seal Set	2004-01	BS 40618	Rubber; One-piece	
1	Rear Main Seal Set	2004-01	BS 40646	PTFE Rubber; One-piece	
QTY	VALVE COVER	YEARS	PART NO.	DESCRIPTION	
1	Valve Cover Gasket Set	2004-01	VS 50553 R	PermaDry® molded rubber gskt. incl.	
QTY	VALVE STEM SEAL SET	YEARS	PART NO.	DESCRIPTION	
1	Valve Stem Seal Set	2004-01	SS 72889	Premium valve stem seals incl.; Improved design	
QTY	WATER OUTLET GASKET	YEARS	PART NO.	DESCRIPTION	
1	Water Outlet Gasket	2004-01	35404	Water Outlet	
QTY	WATER PUMP	YEARS	PART NO.	DESCRIPTION	
1	Water Pump Gasket	2004-01	35619		
QTY	TIMING COVER	YEARS	PART NO.	DESCRIPTION	
1	Crankshaft Front Seal Set	2004-01	TCS 46015	Must be used w/OS 30711R	
1	Camshaft Front Seal Set	2004-01	TCS 45963		

Mazda Truck (Incl. Minivans and SUV's) (Cont.)

1		2004 - 2001; 2.0L 121 (1988cc) DOHC L4 (16 Valve) 84.8mm Bore Zetec			1	
(cont.)		MFI; Gasoline; Naturally Aspirated Ford Eng.; VIN Code B, Eng. Code YF			(cont.)	
QTY	CARB & FUEL INJECTION	YEARS	PART NO.	DESCRIPTION		
2	Fuel Injector O-Ring Set	2004-01	ES 70599	Improved design		
1	Throttle Body Gasket	2004-01	61159			
QTY	EXHAUST GAS RECIRCULATION	YEARS	PART NO.	DESCRIPTION		
1	EGR Gasket	2004-01	70697			
2		2013; 2.0L 121.9 (1998cc) DOHC L4 (16 Valve) 83.5mm Bore SkyActiv-G VVT			2	
		DI; Gasoline; Naturally Aspirated Mazda Eng.; Eng. Code PE-VPS				
QTY	CYLINDER HEAD	YEARS	PART NO.	DESCRIPTION		
1	Head Bolt Set	2013	ES 72207	Replacement recommended		
QTY	EXHAUST PIPE FLANGE	YEARS	PART NO.	DESCRIPTION		
1	Exhaust Pipe Gasket	2013	61593	Flange		
1	Exhaust Pipe Gasket	2013	61593	Loc. Front; Rear converter		
QTY	OIL COOLER	YEARS	PART NO.	DESCRIPTION		
1	Oil Cooler Gasket	2013	72941	Oil cooler mounting; Press-in-Place molded rubber gskt.; New Part Number - Check for Availability		
3		1993 - 1991; 2.2L 133 (2184cc) SOHC L4 (8 Valve) 86mm Bore			3	
		MFI; Gasoline; Naturally Aspirated Mazda Eng.; Eng. Code F2G				
QTY	CYLINDER HEAD	YEARS	PART NO.	DESCRIPTION		
1	Head Gasket	1993-91	9572 PT			
1	Head Set	1993-91	HS 9572 PT-1	Exh. manifold gskt. & exh. pipe flange not incl.; PermaDry® molded rubber valve cover gskt. incl.; Premium valve stem seals incl.		
1	Head Installation Set	1993-91	HIS 9572 PT-1	Exh. manifold gskt. & exh. pipe flange not incl.; PermaDry® molded rubber valve cover gskt. incl.		
QTY	CONVERSION SET	YEARS	PART NO.	DESCRIPTION		
1	Gasket Conversion Set	1993-91	CS 9513	RTV sealant incl. for Upper oil pan gskt.		
QTY	MANIFOLD - INT. & EXH.	YEARS	PART NO.	DESCRIPTION		
1	Int. Manifold Gasket Set	1993-91	MS 93248	Upper set incl.		
1	Exh. Manifold Gasket Set	1993-91	MS 94697			
QTY	EXHAUST PIPE FLANGE	YEARS	PART NO.	DESCRIPTION		
1	Exhaust Pipe Gasket	1993-91	60817	Flange		
2	Exhaust Pipe Gasket	1993-91	60831	Converter		
QTY	FUEL PUMP	YEARS	PART NO.	DESCRIPTION		
2	Fuel Pump Mounting Gasket	1993-91	72611			
QTY	OIL PAN	YEARS	PART NO.	DESCRIPTION		
1	Oil Pan Gasket Set	1993-91	OS 30467 C	Loc. Lower		
QTY	CRANKSHAFT REAR SEAL	YEARS	PART NO.	DESCRIPTION		
1	Rear Main Seal Set	1993-91	BS 40421	Rubber; One-piece		
1	Repair Sleeve Tool	1993-91	16300	Crankshaft		
QTY	VALVE COVER	YEARS	PART NO.	DESCRIPTION		
1	Valve Cover Gasket Set	1993-91	VS 50238 R	w/o Grommets; Circular plug not incl.; PermaDry® molded rubber gskt. incl.		
1	Valve Cover Gasket Set	1993-91	VS 50424 R	w/Grommets; Circular plug not incl.; PermaDry® molded rubber gskt. incl.		
1	Grommet Set	1993-91	ES 70341	Valve Cover		
1	Circular Plug	1993-91	CP 75019	Valve Cover		
QTY	VALVE STEM SEAL SET	YEARS	PART NO.	DESCRIPTION		
1	Valve Stem Seal Set	1993-91	SS 72512	Premium valve stem seals incl.		
QTY	WATER OUTLET GASKET	YEARS	PART NO.	DESCRIPTION		
1	Water Outlet Gasket	1993-91	35251	Water Outlet		
QTY	WATER PUMP	YEARS	PART NO.	DESCRIPTION		
1	Water Pump Gasket	1993-91	35458			
QTY	TIMING COVER	YEARS	PART NO.	DESCRIPTION		
1	Timing Cover Set	1993-91	TCS 45723	Camshaft; Front seal set		
1	Timing Cover Set	1993-91	TCS 45723	Crankshaft; Front seal set		
1	Timing Cover Dust Seal Set	1993-91	ES 72855			
1	Repair Sleeve	1993-91	16272	Timing Cover; Use w/installation tool		
QTY	CARB & FUEL INJECTION	YEARS	PART NO.	DESCRIPTION		
1	Fuel Injector O-Ring Set	1993-91	ES 70600			
1	Throttle Body Gasket	1993-91	60907			
QTY	EXHAUST GAS RECIRCULATION	YEARS	PART NO.	DESCRIPTION		
1	EGR Gasket	1993-91	70122			

Mazda Truck (Incl. Minivans and SUV's) (Cont.)

4		1993 - 1991; 2.2L 133 (2184cc) SOHC L4 (8 Valve) 86mm Bore 2 Bbl.; Gasoline; Naturally Aspirated Mazda Eng.; Eng. Code F2L			4
QTY	CYLINDER HEAD	YEARS	PART NO.	DESCRIPTION	
1	Head Gasket	1993-91	9572 PT		
1	Head Set	1993-91	HS 9572 PT-1	PermaDry® molded rubber valve cover gskt. incl.; Premium valve stem seals incl.	
1	Head Installation Set	1993-91	HIS 9572 PT-1	Exh. pipe flange not incl.; PermaDry® molded rubber valve cover gskt. incl.	
QTY	CONVERSION SET	YEARS	PART NO.	DESCRIPTION	
1	Gasket Conversion Set	1993-91	CS 9513	RTV sealant incl. for Upper oil pan gskt.	
QTY	MANIFOLD - INT. & EXH.	YEARS	PART NO.	DESCRIPTION	
1	Int. Manifold Gasket Set	1993-91	MS 93248	Upper set incl.	
1	Exh. Manifold Gasket Set	1993-91	MS 93353		
QTY	EXHAUST PIPE FLANGE	YEARS	PART NO.	DESCRIPTION	
1	Exhaust Pipe Gasket	1993-91	60286	Flange	
2	Exhaust Pipe Gasket	1993-91	60620	Converter	
QTY	FUEL PUMP	YEARS	PART NO.	DESCRIPTION	
2	Fuel Pump Mounting Gasket	1993-91	72611		
QTY	OIL PAN	YEARS	PART NO.	DESCRIPTION	
1	Oil Pan Gasket Set	1993-91	OS 30467 C	Loc. Lower	
QTY	CRANKSHAFT REAR SEAL	YEARS	PART NO.	DESCRIPTION	
1	Rear Main Seal Set	1993-91	BS 40421	Rubber; One-piece	
1	Repair Sleeve Tool	1993-91	16300	Crankshaft	
QTY	VALVE COVER	YEARS	PART NO.	DESCRIPTION	
1	Valve Cover Gasket Set	1993-91	VS 50238 R	w/o Grommets; Circular plug not incl.; PermaDry® molded rubber gskt. incl.	
1	Valve Cover Gasket Set	1993-91	VS 50424 R	w/Grommets; Circular plug not incl.; PermaDry® molded rubber gskt. incl.	
1	Grommet Set	1993-91	ES 70341	Valve Cover	
1	Circular Plug	1993-91	CP 75019	Valve Cover	
QTY	VALVE STEM SEAL SET	YEARS	PART NO.	DESCRIPTION	
1	Valve Stem Seal Set	1993-91	SS 72512	Premium valve stem seals incl.	
QTY	WATER OUTLET GASKET	YEARS	PART NO.	DESCRIPTION	
1	Water Outlet Gasket	1993-91	35251	Water Outlet	
QTY	WATER PUMP	YEARS	PART NO.	DESCRIPTION	
1	Water Pump Gasket	1993-91	35458		
QTY	TIMING COVER	YEARS	PART NO.	DESCRIPTION	
1	Timing Cover Set	1993-91	TCS 45723	Camshaft; Front seal set	
1	Timing Cover Set	1993-91	TCS 45723	Crankshaft; Front seal set	
1	Timing Cover Dust Seal Set	1993-91	ES 72855		
1	Repair Sleeve	1993-91	16272	Timing Cover; Use w/installation tool	
QTY	CARB & FUEL INJECTION	YEARS	PART NO.	DESCRIPTION	
2	Carb. Mounting Gasket	1993-91	60727	w/o Heated insulator	
1	Carb. Mounting Gasket	1993-91	60891	w/Heated insulator	
QTY	EXHAUST GAS RECIRCULATION	YEARS	PART NO.	DESCRIPTION	
1	EGR Gasket	1993-91	70122		
5		2010 - 2001; 2.3L 138 (2261cc) DOHC L4 (16 Valve) 87.5mm Bore Duratec MFI; Gasoline; Naturally Aspirated Ford Eng.; VIN Code D			5
QTY	CYLINDER HEAD	YEARS	PART NO.	DESCRIPTION	
1	Head Gasket	2010-01	26250 PT	Head bolts not incl.; Head bolt replacement recommended; PermaTorqueMLS® LaserWeld® Technology	
1	Head Set	2010-04	HS 26250 PT-1	Head bolts not incl.; Head bolt replacement recommended; PermaDry® molded rubber valve cover gskt. incl.; Premium valve stem seals incl.	
1	Head Set	2003-02	HS 26250 PT	Head bolts not incl.; Head bolt replacement recommended; PermaDry® molded rubber valve cover gskt. incl.; Premium valve stem seals incl.	
1	Head Set	2001	HS 26250 PT	From 02/01/01; Head bolts not incl.; Head bolt replacement recommended; PermaDry® molded rubber valve cover gskt. incl.; Premium valve stem seals incl.	
1	Head Set	2001	HS 26250 PT	To 01/31/01; Exh. manifold gskt. & head bolts not incl.; Head bolt replacement recommended; PermaDry® molded rubber valve cover gskt. incl.; Premium valve stem seals incl.	
1	Head Bolt Set	2010-01	ES 72207	Replacement recommended	
QTY	CONVERSION SET	YEARS	PART NO.	DESCRIPTION	
1	Gasket Conversion Set	2010-01	CS 26250	RTV sealant incl. for oil pan gskt.	
QTY	MANIFOLD - INT. & EXH.	YEARS	PART NO.	DESCRIPTION	
1	Int. Manifold Gasket Set	2010-01	MS 96634		
1	Exh. Manifold Gasket Set	2010-02	MS 96655		
1	Exh. Manifold Gasket Set	2001	MS 96655	From 02/01/01	

Mazda Truck (Incl. Minivans and SUV's) (Cont.)

5		2010 - 2001; 2.3L 138 (2261cc) DOHC L4 (16 Valve) 87.5mm Bore Duratec			5
(cont.)		MFI; Gasoline; Naturally Aspirated Ford Eng.; VIN Code D			(cont.)
QTY	MANIFOLD - INT. & EXH.	YEARS	PART NO.	DESCRIPTION	
1	Exh. Manifold Gasket Set	2001	MS 96656	To 01/31/01; Gskt. w/Heat shield	
QTY	EXHAUST PIPE FLANGE	YEARS	PART NO.	DESCRIPTION	
1	Exhaust Pipe Gasket	2010-01	60641	Converter	
QTY	CRANKSHAFT REAR SEAL	YEARS	PART NO.	DESCRIPTION	
1	Rear Main Seal Set	2010-01	BS 40689	PTFE Rubber; One-piece	
QTY	VALVE COVER	YEARS	PART NO.	DESCRIPTION	
1	Valve Cover Gasket Set	2010-04	VS 50639 R	PermaDry® molded rubber gskt. incl.; Old design	
1	Valve Cover Gasket Set	2010-04	VS 50639 R-1	PermaDry® molded rubber gskt. incl.; Improved design	
1	Valve Cover Gasket Set	2003-01	VS 50638 R	PermaDry® molded rubber gskt. incl.	
QTY	VALVE STEM SEAL SET	YEARS	PART NO.	DESCRIPTION	
1	Valve Stem Seal Set	2010-01	SS 72917	Premium valve stem seals incl.	
QTY	THERMOSTAT HOUSING	YEARS	PART NO.	DESCRIPTION	
1	Thermostat Gasket	2010-01	35771	Thermostat Housing; Thermostat housing to head	
1	Thermostat Gasket	2010-01	35776	Thermostat Housing; Thermostat seal	
QTY	WATER PUMP	YEARS	PART NO.	DESCRIPTION	
1	O-Ring	2010-01	35772	Water Pump	
QTY	TIMING COVER	YEARS	PART NO.	DESCRIPTION	
1	Crankshaft Front Seal Set	2010-01	TCS 46059	Old design	
1	Crankshaft Front Seal Set	2010-01	TCS 46132	Improved design	
QTY	CARB & FUEL INJECTION	YEARS	PART NO.	DESCRIPTION	
2	Fuel Injector O-Ring Set	2010-01	ES 70599	Improved design	
1	Throttle Body Gasket	2010-01	61253		
QTY	EXHAUST GAS RECIRCULATION	YEARS	PART NO.	DESCRIPTION	
1	EGR Gasket	2010-01	71224	Valve	
1	EGR Gasket	2010-01	71226	Tube seal	
QTY	OIL FILTER MOUNTING	YEARS	PART NO.	DESCRIPTION	
1	Oil Filter Adapter Gasket	2010-01	72949	Oil filter adapter; New Part Number - Check for Availability	
QTY	OIL PUMP COVER	YEARS	PART NO.	DESCRIPTION	
1	Oil Pump Gasket	2010-01	72705	Oil pump body; New Part Number - Check for Availability	
QTY	CYLINDER BLOCK	YEARS	PART NO.	DESCRIPTION	
1	Crankcase Breather Gasket	2010-01	72950	Cylinder Block; Crankcase vent cover seal; New Part Number - Check for Availability	
QTY	OIL COOLER	YEARS	PART NO.	DESCRIPTION	
1	Oil Cooler Gasket	2010-01	72709	Oil cooler mounting; Plastic carrier gskt. w/Silicone beading; New Part Number - Check for Availability	
1	Oil Cooler Gasket	2010-01	72941	Oil cooler mounting; Press-in-Place molded rubber gskt.; New Part Number - Check for Availability	
6		2008 - 2005; 2.3L 138 (2261cc) DOHC L4 (16 Valve) 87.5mm Bore Duratec			6
(cont.)		MFI; Gasoline; Naturally Aspirated Ford Eng.; Eng. Code MZR			(cont.)
QTY	CYLINDER HEAD	YEARS	PART NO.	DESCRIPTION	
1	Head Gasket	2008-05	26250 PT	Head bolts not incl.; Head bolt replacement recommended; PermaTorqueMLS® LaserWeld® Technology	
1	Head Set	2008	HS 26250 PT-1	Exh. manifold gskt. & head bolts not incl.; Head bolt replacement recommended; PermaDry® molded rubber valve cover gskt. incl.; Premium valve stem seals incl.	
1	Head Set	2007-05	HS 26250 PT-1	Head bolts not incl.; Head bolt replacement recommended; PermaDry® molded rubber valve cover gskt. incl.; Premium valve stem seals incl.	
1	Head Bolt Set	2008-05	ES 72207	Replacement recommended	
QTY	CONVERSION SET	YEARS	PART NO.	DESCRIPTION	
1	Gasket Conversion Set	2008-05	CS 26250	RTV sealant incl. for oil pan gskt.	
QTY	MANIFOLD - INT. & EXH.	YEARS	PART NO.	DESCRIPTION	
1	Int. Manifold Gasket Set	2008-05	MS 96634		
1	Exh. Manifold Gasket Set	2008	MS 96901		
1	Exh. Manifold Gasket Set	2007-05	MS 96655		
QTY	EXHAUST PIPE FLANGE	YEARS	PART NO.	DESCRIPTION	
1	Exhaust Pipe Gasket	2008-05	61395	Flange	
1	Exhaust Pipe Gasket	2008-05	61396	Converter	
QTY	CRANKSHAFT REAR SEAL	YEARS	PART NO.	DESCRIPTION	
1	Rear Main Seal Set	2008-05	BS 40689	PTFE Rubber; One-piece	
QTY	VALVE COVER	YEARS	PART NO.	DESCRIPTION	
1	Valve Cover Gasket Set	2008-05	VS 50639 R	PermaDry® molded rubber gskt. incl.; Old design	

Mazda Truck (Incl. Minivans and SUV's) (Cont.)

6		2008 - 2005; 2.3L 138 (2261cc) DOHC L4 (16 Valve) 87.5mm Bore Duratec			6	
(cont.)		MFI; Gasoline; Naturally Aspirated Ford Eng.; Eng. Code MZR			(cont.)	
QTY	VALVE COVER	YEARS	PART NO.	DESCRIPTION		
1	Valve Cover Gasket Set	2008-05	VS 50639 R-1	PermaDry® molded rubber gskt. incl.; Improved design		
QTY	VALVE STEM SEAL SET	YEARS	PART NO.	DESCRIPTION		
1	Valve Stem Seal Set	2008-05	SS 72917	Premium valve stem seals incl.		
QTY	THERMOSTAT HOUSING	YEARS	PART NO.	DESCRIPTION		
1	Thermostat Gasket	2008-05	35771	Thermostat Housing; Thermostat housing to head		
1	Thermostat Gasket	2008-05	35776	Thermostat Housing; Thermostat seal		
QTY	WATER PUMP	YEARS	PART NO.	DESCRIPTION		
1	O-Ring	2008-05	35772	Water Pump		
QTY	TIMING COVER	YEARS	PART NO.	DESCRIPTION		
1	Crankshaft Front Seal Set	2008-05	TCS 46059	Old design		
1	Crankshaft Front Seal Set	2008-05	TCS 46132	Improved design		
QTY	CARB & FUEL INJECTION	YEARS	PART NO.	DESCRIPTION		
2	Fuel Injector O-Ring Set	2008-05	ES 70599	Improved design		
1	Throttle Body Gasket	2008-05	61253			
QTY	EXHAUST GAS RECIRCULATION	YEARS	PART NO.	DESCRIPTION		
1	EGR Gasket	2008-05	71223	Valve		
1	EGR Gasket	2008-05	71226	Tube seal		
1	EGR Gasket	2008-05	71227	Connector seal		
QTY	OIL FILTER MOUNTING	YEARS	PART NO.	DESCRIPTION		
1	Oil Filter Adapter Gasket	2008-05	72949	Oil filter adapter; New Part Number - Check for Availability		
QTY	OIL PUMP COVER	YEARS	PART NO.	DESCRIPTION		
1	Oil Pump Gasket	2008-05	72705	Oil pump body; New Part Number - Check for Availability		
QTY	CYLINDER BLOCK	YEARS	PART NO.	DESCRIPTION		
1	Crankcase Breather Gasket	2008-05	72950	Cylinder Block; Crankcase vent cover seal; New Part Number - Check for Availability		
QTY	OIL COOLER	YEARS	PART NO.	DESCRIPTION		
1	Oil Cooler Gasket	2008-05	72709	Oil cooler mounting; Plastic carrier gskt. w/Silicone beading; New Part Number - Check for Availability		
1	Oil Cooler Gasket	2008-05	72941	Oil cooler mounting; Press-in-Place molded rubber gskt.; New Part Number - Check for Availability		
7		2008; 2.3L 138 (2261cc) DOHC L4 (16 Valve) 87.5mm Bore Duratec			7	
(cont.)		MFI; Hybrid (Gas/Electric); Naturally Aspirated Ford Eng.; Eng. Code MZR			(cont.)	
QTY	CYLINDER HEAD	YEARS	PART NO.	DESCRIPTION		
1	Head Gasket	2008	26250 PT	Head bolts not incl.; Head bolt replacement recommended; PermaTorqueMLS® LaserWeld® Technology		
1	Head Set	2008	HS 26250 PT-1	Exh. manifold gskt. & head bolts not incl.; Head bolt replacement recommended; PermaDry® molded rubber valve cover gskt. incl.; Premium valve stem seals incl.		
1	Head Bolt Set	2008	ES 72207	Replacement recommended		
QTY	CONVERSION SET	YEARS	PART NO.	DESCRIPTION		
1	Gasket Conversion Set	2008	CS 26250	RTV sealant incl. for oil pan gskt.		
QTY	MANIFOLD - INT. & EXH.	YEARS	PART NO.	DESCRIPTION		
1	Int. Manifold Gasket Set	2008	MS 96634			
1	Exh. Manifold Gasket Set	2008	MS 96901			
QTY	EXHAUST PIPE FLANGE	YEARS	PART NO.	DESCRIPTION		
1	Exhaust Pipe Gasket	2008	61395	Flange		
1	Exhaust Pipe Gasket	2008	61396	Converter		
QTY	CRANKSHAFT REAR SEAL	YEARS	PART NO.	DESCRIPTION		
1	Rear Main Seal Set	2008	BS 40689	PTFE Rubber; One-piece		
QTY	VALVE COVER	YEARS	PART NO.	DESCRIPTION		
1	Valve Cover Gasket Set	2008	VS 50639 R	PermaDry® molded rubber gskt. incl.; Old design		
1	Valve Cover Gasket Set	2008	VS 50639 R-1	PermaDry® molded rubber gskt. incl.; Improved design		
QTY	VALVE STEM SEAL SET	YEARS	PART NO.	DESCRIPTION		
1	Valve Stem Seal Set	2008	SS 72917	Premium valve stem seals incl.		
QTY	THERMOSTAT HOUSING	YEARS	PART NO.	DESCRIPTION		
1	Thermostat Gasket	2008	35771	Thermostat Housing; Thermostat housing to head		
1	Thermostat Gasket	2008	35776	Thermostat Housing; Thermostat seal		
QTY	WATER PUMP	YEARS	PART NO.	DESCRIPTION		
1	O-Ring	2008	35772	Water Pump		
QTY	TIMING COVER	YEARS	PART NO.	DESCRIPTION		
1	Crankshaft Front Seal Set	2008	TCS 46059	Old design		

Mazda Truck (Incl. Minivans and SUV's) (Cont.)

7		2008; 2.3L 138 (2261cc) DOHC L4 (16 Valve) 87.5mm Bore Duratec			7
(cont.)		MFI; Hybrid (Gas/Electric); Naturally Aspirated Ford Eng.; Eng. Code MZR			(cont.)
QTY	TIMING COVER	YEARS	PART NO.	DESCRIPTION	
1	Crankshaft Front Seal Set	2008	TCS 46132	Improved design	
QTY	CARB & FUEL INJECTION	YEARS	PART NO.	DESCRIPTION	
2	Fuel Injector O-Ring Set	2008	ES 70599	Improved design	
1	Throttle Body Gasket	2008	61391		
QTY	EXHAUST GAS RECIRCULATION	YEARS	PART NO.	DESCRIPTION	
1	EGR Gasket	2008	71223	Valve	
1	EGR Gasket	2008	71226	Tube seal	
1	EGR Gasket	2008	71227	Connector seal	
QTY	OIL FILTER MOUNTING	YEARS	PART NO.	DESCRIPTION	
1	Oil Filter Adapter Gasket	2008	72949	Oil filter adapter; New Part Number - Check for Availability	
QTY	OIL PUMP COVER	YEARS	PART NO.	DESCRIPTION	
1	Oil Pump Gasket	2008	72705	Oil pump body; New Part Number - Check for Availability	
QTY	CYLINDER BLOCK	YEARS	PART NO.	DESCRIPTION	
1	Crankcase Breather Gasket	2008	72950	Cylinder Block; Crankcase vent cover seal; New Part Number - Check for Availability	
QTY	OIL COOLER	YEARS	PART NO.	DESCRIPTION	
1	Oil Cooler Gasket	2008	72709	Oil cooler mounting; Plastic carrier gskt. w/Silicone beading; New Part Number - Check for Availability	
1	Oil Cooler Gasket	2008	72941	Oil cooler mounting; Press-in-Place molded rubber gskt.; New Part Number - Check for Availability	
8		2012 - 2007; 2.3L 138 (2261cc) DOHC L4 (16 Valve) 87.5mm Bore Duratec			8
(cont.)		MFI; Gasoline; Turbo - Intercooled Ford Eng.; Eng. Code MZR-T			(cont.)
QTY	CYLINDER HEAD	YEARS	PART NO.	DESCRIPTION	
1	Head Gasket	2009-07	26407 PT	Head bolts not incl.; Head bolt replacement recommended; PermaTorqueMLS®	
1	Head Set	2009-07	HS 26407 PT	Head bolts not incl.; Head bolt replacement recommended; PermaDry® molded rubber valve cover gskt. incl.; Premium valve stem seals incl.	
1	Head Bolt Set	2009-07	ES 72207	Replacement recommended	
QTY	CONVERSION SET	YEARS	PART NO.	DESCRIPTION	
1	Gasket Conversion Set	2009-07	CS 26250	RTV sealant incl. for oil pan gskt.	
QTY	MANIFOLD - INT. & EXH.	YEARS	PART NO.	DESCRIPTION	
1	Int. Manifold Gasket Set	2009-07	MS 97054		
1	Exh. Manifold Gasket Set	2009-07	MS 97052		
QTY	EXHAUST PIPE FLANGE	YEARS	PART NO.	DESCRIPTION	
1	Exhaust Pipe Gasket	2009-07	61348	Loc. Rear; Converter	
1	Exhaust Pipe Gasket	2009-07	61573	Loc. Front; Converter	
1	Exhaust Pipe Gasket	2009-07	61573	Ring	
QTY	CRANKSHAFT REAR SEAL	YEARS	PART NO.	DESCRIPTION	
1	Rear Main Seal Set	2009-07	BS 40689	PTFE Rubber; One-piece	
QTY	VALVE COVER	YEARS	PART NO.	DESCRIPTION	
1	Valve Cover Gasket Set	2012-07	VS 50757 R	PermaDry® molded rubber gskt. incl.	
QTY	VALVE STEM SEAL SET	YEARS	PART NO.	DESCRIPTION	
1	Valve Stem Seal Set	2009-07	SS 72917	Premium valve stem seals incl.	
QTY	THERMOSTAT HOUSING	YEARS	PART NO.	DESCRIPTION	
1	Thermostat Gasket	2009-07	35776	Thermostat Housing; Thermostat seal	
QTY	WATER OUTLET GASKET	YEARS	PART NO.	DESCRIPTION	
1	Water Outlet Gasket	2009-07	35905	Water Outlet	
QTY	WATER PUMP	YEARS	PART NO.	DESCRIPTION	
1	O-Ring	2009-07	35772	Water Pump	
QTY	TIMING COVER	YEARS	PART NO.	DESCRIPTION	
1	Crankshaft Front Seal Set	2009-07	TCS 46059	Old design	
1	Crankshaft Front Seal Set	2009-07	TCS 46132	Improved design	
QTY	CARB & FUEL INJECTION	YEARS	PART NO.	DESCRIPTION	
1	Throttle Body Gasket	2009-07	61578	Mounting	
QTY	EXHAUST GAS RECIRCULATION	YEARS	PART NO.	DESCRIPTION	
1	EGR Gasket	2009-07	72336	Valve	
QTY	OIL FILTER MOUNTING	YEARS	PART NO.	DESCRIPTION	
1	Oil Filter Adapter Gasket	2009-07	72949	Oil filter adapter; New Part Number - Check for Availability	
QTY	OIL PUMP COVER	YEARS	PART NO.	DESCRIPTION	
1	Oil Pump Gasket	2009-07	72705	Oil pump body; New Part Number - Check for Availability	

Mazda Truck (Incl. Minivans and SUV's) (Cont.)

8		2012 - 2007; 2.3L 138 (2261cc) DOHC L4 (16 Valve) 87.5mm Bore Duratec			8	
(cont.)		MFI; Gasoline; Turbo - Intercooled Ford Eng.; Eng. Code MZR-T			(cont.)	
QTY	CYLINDER BLOCK	YEARS	PART NO.	DESCRIPTION		
1	Crankcase Breather Gasket	2009-07	72950	Cylinder Block; Crankcase vent cover seal; New Part Number - Check for Availability		
QTY	OIL COOLER	YEARS	PART NO.	DESCRIPTION		
1	Oil Cooler Gasket	2012-07	72709	Oil cooler mounting; Plastic carrier gskt. w/Silicone beading; New Part Number - Check for Availability		
1	Oil Cooler Gasket	2012-07	72941	Oil cooler mounting; Press-in-Place molded rubber gskt.; New Part Number - Check for Availability		
9		1997 - 1994; 2.3L 140 (2302cc) SOHC L4 (8 Valve) 96mm Bore			9	
		MFI; Gasoline; Naturally Aspirated Ford Eng.; VIN Code A, Eng. Code 8A				
QTY	CYLINDER HEAD	YEARS	PART NO.	DESCRIPTION		
1	Head Gasket	1997-94	8993 PT-1	Head bolts not incl.; Head bolt replacement recommended; PermaTorque®		
1	Head Gasket Spacer Shim	1997-94	8471 SP	HeadSaver®		
1	Head Set	1997-95	HS 8993 PT-7	Head bolts not incl.; Head bolt replacement recommended; PermaDry® molded rubber valve cover gskt. incl.; Premium valve stem seals incl.		
1	Head Set	1994	HS 8993 PT-6	Head bolts not incl.; Head bolt replacement recommended; PermaDry® molded rubber valve cover gskt. incl.; Premium valve stem seals incl.		
1	Head Installation Set	1994	HIS 8993 PT-6	Head bolts not incl.; Head bolt replacement recommended; PermaDry® molded rubber valve cover gskt. incl.		
1	Head Bolt Set	1997-94	ES 72137	Replacement recommended		
QTY	CONVERSION SET	YEARS	PART NO.	DESCRIPTION		
1	Gasket Conversion Set	1997-95	CS 8471-6	PermaDry® molded rubber oil pan gskt. incl.		
1	Gasket Conversion Set	1994	CS 8471-5	PermaDry® molded rubber oil pan gskt. incl.		
QTY	MANIFOLD - INT. & EXH.	YEARS	PART NO.	DESCRIPTION		
1	Int. Manifold Gasket Set	1997-95	MS 93391-1	Lower set; Upper set incl.		
1	Int. Manifold Gasket Set	1994	MS 93391	Lower set; Upper set incl.		
1	Plenum Gasket Set	1997-95	MS 95737	Upper set		
1	Plenum Gasket Set	1994	MS 94263	Upper set		
1	Exh. Manifold Gasket Set	1997-94	MS 92424			
QTY	EXHAUST PIPE FLANGE	YEARS	PART NO.	DESCRIPTION		
1	Exhaust Pipe Gasket	1997-94	60641	Converter		
QTY	OIL PAN	YEARS	PART NO.	DESCRIPTION		
1	Oil Pan Gasket Set	1997-94	OS 30914 R	PermaDry® molded rubber gskt. incl.		
1	Drain Plug Gasket	1997-94	72515			
QTY	CRANKSHAFT REAR SEAL	YEARS	PART NO.	DESCRIPTION		
1	Rear Main Seal Set	1997-94	BS 40620	Rubber; One-piece; Improved design		
1	Rear Main Seal Set	1997-94	BS 40644	PTFE Rubber; One-piece		
1	Repair Sleeve	1997-94	16255-1	Crankshaft; 1.105" - 1.135" sleeve length; Use w/installation tool; Improved design		
1	Repair Sleeve Tool	1997-94	16306	Crankshaft		
QTY	VALVE COVER	YEARS	PART NO.	DESCRIPTION		
1	Valve Cover Gasket Set	1997-95	VS 50043 R-2	Int. manifold upper set incl.; PermaDry® molded rubber gskt. incl.		
1	Valve Cover Gasket Set	1994	VS 50043 R-1	Int. manifold upper set incl.; PermaDry® molded rubber gskt. incl.		
QTY	VALVE STEM SEAL SET	YEARS	PART NO.	DESCRIPTION		
1	Valve Stem Seal Set	1997-95	SS 72875	Premium valve stem seals incl.		
1	Valve Stem Seal Set	1994	SS 72683	Premium valve stem seals incl.		
QTY	WATER OUTLET GASKET	YEARS	PART NO.	DESCRIPTION		
1	Water Outlet Gasket	1997-94	35114	Water Outlet		
1	Water Outlet Gasket	1997-94	35114 T	Water Outlet; PermaDryPlus®		
QTY	WATER PUMP	YEARS	PART NO.	DESCRIPTION		
1	Water Pump Gasket	1994	35381			
1	O-Ring	1997-95	35634	Water Pump; Improved design		
QTY	TIMING COVER	YEARS	PART NO.	DESCRIPTION		
1	Timing Cover Dust Seal Set	1997-94	ES 72734			
1	Crankshaft Front Seal Set	1997-94	TCS 45940	Must be used w/OS 30914R		
1	Camshaft Front Seal Set	1997-94	TCS 45108			
1	Auxiliary Shaft Seal Set	1997-94	TCS 45109			
QTY	CARB & FUEL INJECTION	YEARS	PART NO.	DESCRIPTION		
1	Fuel Injector O-Ring Set	1997-94	ES 70599	Improved design		
1	Throttle Body Gasket	1997-94	60847	Mounting		
1	Throttle Body Gasket	1997-94	71216	Air bypass valve		
QTY	EXHAUST GAS RECIRCULATION	YEARS	PART NO.	DESCRIPTION		
1	EGR Gasket	1997-95	70149			
1	EGR Gasket	1994	72649			

Mazda Truck (Incl. Minivans and SUV's) (Cont.)

10		2012 - 2009; 2.5L 151.8 (2488cc) DOHC L4 (16 Valve) 89mm Bore Duratec			10
MFI; Gasoline; Naturally Aspirated Ford Eng.; Eng. Code MZR					
QTY	THERMOSTAT HOUSING	YEARS	PART NO.	DESCRIPTION	
1	Thermostat Gasket	2011-09	35776	Thermostat Housing; Thermostat seal	
QTY	TIMING COVER	YEARS	PART NO.	DESCRIPTION	
1	Crankshaft Front Seal Set	2011-09	TCS 46151		
QTY	OIL FILTER MOUNTING	YEARS	PART NO.	DESCRIPTION	
1	Oil Filter Adapter Gasket	2012-09	72949	Oil filter adapter; New Part Number - Check for Availability	
QTY	CYLINDER BLOCK	YEARS	PART NO.	DESCRIPTION	
1	Crankcase Breather Gasket	2012-09	72950	Cylinder Block; Crankcase vent cover seal; New Part Number - Check for Availability	
QTY	OIL COOLER	YEARS	PART NO.	DESCRIPTION	
1	Oil Cooler Gasket	2012-09	72709	Oil cooler mounting; Plastic carrier gskt. w/Silicone beading; New Part Number - Check for Availability	
1	Oil Cooler Gasket	2012-09	72941	Oil cooler mounting; Press-in-Place molded rubber gskt.; New Part Number - Check for Availability	
11		2011 - 2009; 2.5L 151.8 (2488cc) DOHC L4 (16 Valve) 89mm Bore Duratec			11
MFI; Hybrid (Gas/Electric); Naturally Aspirated Ford Eng.; Eng. Code MZR					
QTY	THERMOSTAT HOUSING	YEARS	PART NO.	DESCRIPTION	
1	Thermostat Gasket	2011-09	35776	Thermostat Housing; Thermostat seal	
QTY	TIMING COVER	YEARS	PART NO.	DESCRIPTION	
1	Crankshaft Front Seal Set	2011-09	TCS 46151		
QTY	OIL FILTER MOUNTING	YEARS	PART NO.	DESCRIPTION	
1	Oil Filter Adapter Gasket	2011-09	72949	Oil filter adapter; New Part Number - Check for Availability	
QTY	CYLINDER BLOCK	YEARS	PART NO.	DESCRIPTION	
1	Crankcase Breather Gasket	2011-09	72950	Cylinder Block; Crankcase vent cover seal; New Part Number - Check for Availability	
QTY	OIL COOLER	YEARS	PART NO.	DESCRIPTION	
1	Oil Cooler Gasket	2011-09	72709	Oil cooler mounting; Plastic carrier gskt. w/Silicone beading; New Part Number - Check for Availability	
1	Oil Cooler Gasket	2011-09	72941	Oil cooler mounting; Press-in-Place molded rubber gskt.; New Part Number - Check for Availability	
12		2001 - 2000; 2.5L 152 (2495cc) DOHC V6 (24 Valve) 81.6mm Bore Duratec			12
MFI; Gasoline; Naturally Aspirated Ford Eng.; VIN Code G, Eng. Code GY					
QTY	CYLINDER HEAD	YEARS	PART NO.	DESCRIPTION	
1	Head Gasket	2001	26165 PT	Loc. L.H.; Head bolts not incl.; Head bolt replacement required; PermaTorqueMLS®	
1	Head Gasket	2001	26166 PT	Loc. R.H.; Head bolts not incl.; Head bolt replacement required; PermaTorqueMLS®	
1	Head Gasket	2000	9038 PT	Loc. L.H.; Head bolts not incl.; Head bolt replacement required; PermaTorqueMLS®	
1	Head Gasket	2000	9039 PT	Loc. R.H.; Head bolts not incl.; Head bolt replacement required; PermaTorqueMLS®	
1	Head Set	2001	HS 26165 PT	Head bolts not incl.; Head bolt replacement required; PermaDry® molded rubber valve cover gskts. incl.; Premium valve stem seals incl.	
1	Head Set	2000	HS 9038 PT	Head bolts not incl.; Head bolt replacement required; PermaDry® molded rubber valve cover gskts. incl.; Premium valve stem seals incl.	
2	Head Bolt Set	2001-00	ES 72159	Head bolts w/Washers; Replacement required	
QTY	CONVERSION SET	YEARS	PART NO.	DESCRIPTION	
1	Gasket Conversion Set	2001-00	CS 9038-1	PermaDry® molded rubber oil pan gskt. incl.; Consolidated design	
QTY	MANIFOLD - INT. & EXH.	YEARS	PART NO.	DESCRIPTION	
1	Int. Manifold Gasket Set	2001-00	MS 95726	Lower set; Upper set incl.	
1	Plenum Gasket Set	2001-00	MS 95727	Upper set	
1	Exh. Manifold Gasket Set	2001-00	MS 95715		
QTY	OIL PAN	YEARS	PART NO.	DESCRIPTION	
1	Oil Pan Gasket Set	2001-00	OS 30697 R	PermaDry® molded rubber gskt. incl.; Improved design	
1	Drain Plug Gasket	2001-00	72515		
QTY	CRANKSHAFT REAR SEAL	YEARS	PART NO.	DESCRIPTION	
1	Rear Main Seal Set	2001-00	BS 40620	Rubber; One-piece; Improved design	
1	Rear Main Seal Set	2001-00	BS 40644	PTFE Rubber; One-piece	
QTY	VALVE COVER	YEARS	PART NO.	DESCRIPTION	
1	Valve Cover Gasket Set	2001-00	VS 50462 R	w/Grommets & Spark plug tube seals; PermaDry® molded rubber gskts. incl.	
QTY	VALVE STEM SEAL SET	YEARS	PART NO.	DESCRIPTION	
1	Valve Stem Seal Set	2001-00	SS 72873-1	Premium valve stem seals incl.	

Mazda Truck (Incl. Minivans and SUV's) (Cont.)

12 (cont.)		2001 - 2000; 2.5L 152 (2495cc) DOHC V6 (24 Valve) 81.6mm Bore Duratec MFI; Gasoline; Naturally Aspirated Ford Eng.; VIN Code G, Eng. Code GY			12 (cont.)	
QTY	WATER OUTLET GASKET	YEARS	PART NO.	DESCRIPTION		
1	Water Outlet Gasket	2001-00	35489	Water Outlet		
QTY	WATER PUMP	YEARS	PART NO.	DESCRIPTION		
1	Water Pump Gasket	2001-00	35663	Improved design		
QTY	TIMING COVER	YEARS	PART NO.	DESCRIPTION		
1	Timing Cover Set	2001-00	TCS 45967	Must be used w/OS 30697R; Old design		
1	Timing Cover Set	2001-00	TCS 46016	Must be used w/OS 30697R; Improved design		
1	Crankshaft Front Seal Set	2001-00	TCS 46114			
2	Camshaft Rear Seal Set	2001-00	TCS 45966			
QTY	CARB & FUEL INJECTION	YEARS	PART NO.	DESCRIPTION		
2	Fuel Injector O-Ring Set	2001-00	ES 70599	Improved design		
1	Throttle Body Gasket	2001-00	61006	Mounting		
1	Throttle Body Gasket	2001-00	71216	Air bypass valve		
QTY	EXHAUST GAS RECIRCULATION	YEARS	PART NO.	DESCRIPTION		
1	EGR Gasket	2001-00	70149			
13		2001 - 1998; 2.5L 153 (2503cc) SOHC L4 (8 Valve) 96mm Bore MFI; Gasoline; Naturally Aspirated Ford Eng.; VIN Code C			13	
QTY	CYLINDER HEAD	YEARS	PART NO.	DESCRIPTION		
1	Head Gasket	2001-98	8993 PT-1	Head bolts not incl.; Head bolt replacement recommended; PermaTorque®		
1	Head Gasket Spacer Shim	2001-98	8471 SP	HeadSaver®		
1	Head Set	2001-99	HS 8993 PT-8	Head bolts not incl.; Head bolt replacement recommended; PermaDry® molded rubber valve cover gskt. incl.; Premium valve stem seals incl.		
1	Head Set	1998	HS 8993 PT-7	Head bolts not incl.; Head bolt replacement recommended; PermaDry® molded rubber valve cover gskt. incl.; Premium valve stem seals incl.		
1	Head Bolt Set	2001-98	ES 72137	Replacement recommended		
QTY	CONVERSION SET	YEARS	PART NO.	DESCRIPTION		
1	Gasket Conversion Set	2001-98	CS 8471-7	PermaDry® molded rubber oil pan gskt. incl.		
QTY	MANIFOLD - INT. & EXH.	YEARS	PART NO.	DESCRIPTION		
1	Int. Manifold Gasket Set	2001-98	MS 93391-1	Lower set; Upper set incl.		
1	Plenum Gasket Set	2001-98	MS 95737	Upper set		
1	Exh. Manifold Gasket Set	2001-98	MS 92424			
QTY	OIL PAN	YEARS	PART NO.	DESCRIPTION		
1	Oil Pan Gasket Set	2001-98	OS 30814 R	PermaDry® molded rubber gskt. incl.		
1	Drain Plug Gasket	2001-98	72515			
QTY	CRANKSHAFT REAR SEAL	YEARS	PART NO.	DESCRIPTION		
1	Rear Main Seal Set	2001-98	BS 40620	Rubber; One-piece; Improved design		
1	Rear Main Seal Set	2001-98	BS 40644	PTFE Rubber; One-piece		
1	Repair Sleeve	2001-98	16255-1	Crankshaft; 1.105" - 1.135" sleeve length; Use w/installation tool; Improved design		
1	Repair Sleeve Tool	2001-98	16306	Crankshaft		
QTY	VALVE COVER	YEARS	PART NO.	DESCRIPTION		
1	Valve Cover Gasket Set	2001-98	VS 50043 R-2	Int. manifold upper set incl.; PermaDry® molded rubber gskt. incl.		
QTY	VALVE STEM SEAL SET	YEARS	PART NO.	DESCRIPTION		
1	Valve Stem Seal Set	2001-99	SS 70864	Std. Top-Hat Design; Premium valve stem seals incl.		
1	Valve Stem Seal Set	2001-99	SS 72875	Opt. Positive type seal; w/.600" OD; Premium valve stem seals incl.		
1	Valve Stem Seal Set	1998	SS 72875	Premium valve stem seals incl.		
QTY	THERMOSTAT HOUSING	YEARS	PART NO.	DESCRIPTION		
1	Thermostat Gasket	2001-98	35625	Thermostat Housing; Thermostat seal		
QTY	WATER PUMP	YEARS	PART NO.	DESCRIPTION		
1	O-Ring	2001-98	35634	Water Pump; Improved design		
QTY	TIMING COVER	YEARS	PART NO.	DESCRIPTION		
1	Crankshaft Front Seal Set	2001-98	TCS 45940	Must be used w/OS 30914R		
1	Camshaft Front Seal Set	2001-98	TCS 45108			
1	Auxiliary Shaft Seal Set	2001-98	TCS 45109			
QTY	CARB & FUEL INJECTION	YEARS	PART NO.	DESCRIPTION		
1	Fuel Injector O-Ring Set	2001-98	ES 70599	Improved design		
1	Throttle Body Gasket	2001-98	60847	Mounting		
1	Throttle Body Gasket	2001-98	71216	Air bypass valve		
QTY	EXHAUST GAS RECIRCULATION	YEARS	PART NO.	DESCRIPTION		
1	EGR Gasket	2001-98	70149			

Mazda Truck (Incl. Minivans and SUV's) (Cont.)

14		1994 - 1991; 2.6L 159 (2606cc) SOHC L4 (12 Valve) 92mm Bore			14
		MFI; Gasoline; Naturally Aspirated Mazda Eng.; Eng. Code G6			
QTY	CYLINDER HEAD	YEARS	PART NO.	DESCRIPTION	
1	Head Gasket	1994-91	9637 PT		
1	Head Set	1994-91	HS 9637 PT	PermaDry® molded rubber valve cover gskt. incl.; Premium valve stem seals incl.	
QTY	CONVERSION SET	YEARS	PART NO.	DESCRIPTION	
1	Gasket Conversion Set	1994-91	CS 9637		
QTY	MANIFOLD - INT. & EXH.	YEARS	PART NO.	DESCRIPTION	
1	Int. Manifold Gasket Set	1994-91	MS 94439	Upper set incl.	
1	Exh. Manifold Gasket Set	1994-91	MS 94349		
QTY	EXHAUST PIPE FLANGE	YEARS	PART NO.	DESCRIPTION	
1	Exhaust Pipe Gasket	1994-91	60817	Flange	
2	Exhaust Pipe Gasket	1994-91	60831	Converter	
QTY	OIL PAN	YEARS	PART NO.	DESCRIPTION	
1	Oil Pan Gasket Set	1994-91	OS 30614 C		
QTY	CRANKSHAFT REAR SEAL	YEARS	PART NO.	DESCRIPTION	
1	Rear Main Seal Set	1994-91	BS 40598	Rubber; One-piece	
QTY	VALVE COVER	YEARS	PART NO.	DESCRIPTION	
1	Valve Cover Gasket Set	1994-91	VS 50340 R	w/Semi-circular plugs; PermaDry® molded rubber gskt. incl.	
QTY	VALVE STEM SEAL SET	YEARS	PART NO.	DESCRIPTION	
1	Valve Stem Seal Set	1994-91	SS 72680-1	Premium valve stem seals incl.	
QTY	THERMOSTAT HOUSING	YEARS	PART NO.	DESCRIPTION	
1	Water Outlet Gasket	1994-91	35251	Thermostat Housing	
1	Water Outlet Gasket	1994-91	35442	Thermostat Housing; Housing to head	
QTY	WATER PUMP	YEARS	PART NO.	DESCRIPTION	
1	Water Pump Gasket	1994-91	35441		
QTY	TIMING COVER	YEARS	PART NO.	DESCRIPTION	
1	Timing Cover Set	1994-91	TCS 45886	Must be used w/OS 30614C	
QTY	CARB & FUEL INJECTION	YEARS	PART NO.	DESCRIPTION	
1	Throttle Body Gasket	1994-91	60907		
15		1993 - 1991; 3.0L 180.3 (2954cc) SOHC V6 (18 Valve) 90mm Bore			15
		MFI; Gasoline; Naturally Aspirated Mazda Eng.; Eng. Code JE			
QTY	CYLINDER HEAD	YEARS	PART NO.	DESCRIPTION	
1	Head Gasket	1993-91	9649 PT	Loc. L.H.; Head bolts not incl.; Head bolt replacement recommended; PermaTorqueMLS®	
1	Head Gasket	1993-91	9650 PT	Loc. R.H.; Head bolts not incl.; Head bolt replacement recommended; PermaTorqueMLS®	
1	Head Set	1993-91	HS 9649 PT-1	Head bolts not incl.; Head bolt replacement recommended; PermaDry® molded rubber valve cover gskts. incl.; Premium valve stem seals incl.	
QTY	CONVERSION SET	YEARS	PART NO.	DESCRIPTION	
1	Gasket Conversion Set	1993-91	CS 9649-1		
QTY	MANIFOLD - INT. & EXH.	YEARS	PART NO.	DESCRIPTION	
1	Int. Manifold Gasket Set	1993-91	MS 94547	Lower set	
1	Plenum Gasket Set	1993-91	MS 94421	Upper set	
1	Exh. Manifold Gasket Set	1993-91	MS 94418		
QTY	EXHAUST PIPE FLANGE	YEARS	PART NO.	DESCRIPTION	
1	Exhaust Pipe Gasket	1993-91	60817	Pipe to manifold	
2	Exhaust Pipe Gasket	1993-91	60831	Converter	
1	Exhaust Pipe Gasket	1993-91	60832	Crossover pipe flange	
1	Exhaust Pipe Gasket	1993-91	60872	Ring	
QTY	OIL PAN	YEARS	PART NO.	DESCRIPTION	
1	Oil Pan Gasket Set	1993-91	OS 34304 C		
QTY	CRANKSHAFT REAR SEAL	YEARS	PART NO.	DESCRIPTION	
1	Rear Main Seal Set	1993-91	BS 40597	Rubber; One-piece	
QTY	VALVE COVER	YEARS	PART NO.	DESCRIPTION	
1	Valve Cover Gasket Set	1993-91	VS 50336 R	w/Grommets; PermaDry® molded rubber gskts. incl.	
1	Grommet Set	1993-91	ES 72652	Valve Cover; New Part Number - Check for Availability	
QTY	VALVE STEM SEAL SET	YEARS	PART NO.	DESCRIPTION	
1	Valve Stem Seal Set	1993-91	SS 72512	Loc. Exh.; Premium valve stem seals incl.	
1	Valve Stem Seal Set	1993-91	SS 72680-1	Loc. Int.; Premium valve stem seals incl.	
QTY	THERMOSTAT HOUSING	YEARS	PART NO.	DESCRIPTION	
1	Thermostat Gasket	1993-91	35439	Thermostat Housing	
1	O-Ring	1993-91	35555	Thermostat Housing	

Mazda Truck (Incl. Minivans and SUV's) (Cont.)

15 (cont.)		1993 - 1991; 3.0L 180.3 (2954cc) SOHC V6 (18 Valve) 90mm Bore			15 (cont.)
MFI; Gasoline; Naturally Aspirated Mazda Eng.; Eng. Code JE					
QTY	WATER OUTLET GASKET	YEARS	PART NO.	DESCRIPTION	
1	Water Outlet Gasket	1993-91	35436	Water Outlet; Loc. Inner	
1	Water Outlet Gasket	1993-91	35437	Water Outlet; Loc. Outer	
QTY	WATER PUMP	YEARS	PART NO.	DESCRIPTION	
1	Water Pump Gasket	1993-91	35501		
QTY	TIMING COVER	YEARS	PART NO.	DESCRIPTION	
1	Crankshaft Front Seal Set	1993-91	TCS 45850		
1	Camshaft Front Seal Set	1993-91	TCS 45884		
QTY	CARB & FUEL INJECTION	YEARS	PART NO.	DESCRIPTION	
2	Fuel Injector O-Ring Set	1993-91	ES 70600		
1	Throttle Body Gasket	1993-91	60873		
QTY	EXHAUST GAS RECIRCULATION	YEARS	PART NO.	DESCRIPTION	
1	EGR Mounting Set	1993-91	ES 72825	Mounting & Pipe gskts. incl.	
16		1999 - 1994; 3.0L 180.3 (2954cc) SOHC V6 (18 Valve) 90mm Bore			16
MFI; Gasoline; Naturally Aspirated Mazda Eng.; Eng. Code JE-E					
QTY	CYLINDER HEAD	YEARS	PART NO.	DESCRIPTION	
1	Head Gasket	1999-94	9649 PT	Loc. L.H.; Head bolts not incl.; Head bolt replacement recommended; PermaTorqueMLS®	
1	Head Gasket	1999-94	9650 PT	Loc. R.H.; Head bolts not incl.; Head bolt replacement recommended; PermaTorqueMLS®	
1	Head Set	1999-96	HS 9649 PT-1	Upper int. manifold gskts. & head bolts not incl.; Head bolt replacement recommended; PermaDry® molded rubber valve cover gskts. incl.; Premium valve stem seals incl.	
1	Head Set	1995-94	HS 9649 PT-1	Head bolts not incl.; Head bolt replacement recommended; PermaDry® molded rubber valve cover gskts. incl.; Premium valve stem seals incl.	
QTY	CONVERSION SET	YEARS	PART NO.	DESCRIPTION	
1	Gasket Conversion Set	1999-94	CS 9649-1		
QTY	MANIFOLD - INT. & EXH.	YEARS	PART NO.	DESCRIPTION	
1	Int. Manifold Gasket Set	1999-94	MS 94547	Lower set	
1	Plenum Gasket Set	1995-94	MS 94421	Upper set	
1	Exh. Manifold Gasket Set	1999-94	MS 94418		
QTY	EXHAUST PIPE FLANGE	YEARS	PART NO.	DESCRIPTION	
1	Exhaust Pipe Gasket	1999-94	60817	Pipe to manifold	
2	Exhaust Pipe Gasket	1999-94	60831	Converter	
1	Exhaust Pipe Gasket	1999-94	60832	Crossover pipe flange	
1	Exhaust Pipe Gasket	1995-94	60872	Ring	
QTY	OIL PAN	YEARS	PART NO.	DESCRIPTION	
1	Oil Pan Gasket Set	1999-94	OS 34304 C		
QTY	CRANKSHAFT REAR SEAL	YEARS	PART NO.	DESCRIPTION	
1	Rear Main Seal Set	1999-94	BS 40597	Rubber; One-piece	
QTY	VALVE COVER	YEARS	PART NO.	DESCRIPTION	
1	Valve Cover Gasket Set	1999-94	VS 50336 R	w/Grommets; PermaDry® molded rubber gskts. incl.	
1	Grommet Set	1999-94	ES 72652	Valve Cover; New Part Number - Check for Availability	
QTY	VALVE STEM SEAL SET	YEARS	PART NO.	DESCRIPTION	
1	Valve Stem Seal Set	1999-94	SS 72512	Loc. Exh.; Premium valve stem seals incl.	
1	Valve Stem Seal Set	1999-94	SS 72680-1	Loc. Int.; Premium valve stem seals incl.	
QTY	THERMOSTAT HOUSING	YEARS	PART NO.	DESCRIPTION	
1	Water Outlet Gasket	1999-96	35251	Thermostat Housing; Thermostat gskt.	
1	Thermostat Gasket	1999-96	35951	Thermostat Housing; Thermostat seal; New Part Number - Check for Availability	
1	Thermostat Gasket	1999-96	35952	Thermostat Housing; Thermostat housing to head; New Part Number - Check for Availability	
1	Thermostat Gasket	1995-94	35439	Thermostat Housing; Thermostat gskt.	
1	O-Ring	1995-94	35555	Thermostat Housing; Thermostat seal	
QTY	WATER OUTLET GASKET	YEARS	PART NO.	DESCRIPTION	
1	Water Outlet Gasket	1999-94	35436	Water Outlet; Loc. Inner	
1	Water Outlet Gasket	1999-94	35437	Water Outlet; Loc. Outer	
QTY	WATER PUMP	YEARS	PART NO.	DESCRIPTION	
1	Water Pump Gasket	1999-94	35501		
QTY	TIMING COVER	YEARS	PART NO.	DESCRIPTION	
1	Crankshaft Front Seal Set	1999-94	TCS 45850		
1	Camshaft Front Seal Set	1999-94	TCS 45884		
QTY	CARB & FUEL INJECTION	YEARS	PART NO.	DESCRIPTION	
2	Fuel Injector O-Ring Set	1999-94	ES 70600		

Mazda Truck (Incl. Minivans and SUV's) (Cont.)

16 (cont.)		1999 - 1994; 3.0L 180.3 (2954cc) SOHC V6 (18 Valve) 90mm Bore MFI; Gasoline; Naturally Aspirated Mazda Eng.; Eng. Code JE-E			16 (cont.)
QTY	CARB & FUEL INJECTION	YEARS	PART NO.	DESCRIPTION	
1	Throttle Body Gasket	1999-96	61660	New Part Number - Check for Availability	
1	Throttle Body Gasket	1995-94	60873		
QTY	EXHAUST GAS RECIRCULATION	YEARS	PART NO.	DESCRIPTION	
1	EGR Mounting Set	1999-94	ES 72825	Mounting & Pipe gsks. incl.	
17		2005 - 2002; 3.0L 181 (2967cc) DOHC V6 (24 Valve) 89mm Bore Duratec MFI; Gasoline; Naturally Aspirated Ford Eng.; VIN Code 1, Eng. Code ADJ			17
QTY	CYLINDER HEAD	YEARS	PART NO.	DESCRIPTION	
1	Head Gasket	2005-02	26207 PT	Loc. L.H.; Head bolts not incl.; Head bolt replacement required; PermaTorqueMLS®	
1	Head Gasket	2005-02	26212 PT	Loc. R.H.; Head bolts not incl.; Head bolt replacement required; PermaTorqueMLS®	
1	Head Set	2005-04	HS 26207 PT-5	Head bolts not incl.; Head bolt replacement recommended; PermaDry® molded rubber valve cover gsks. incl.; Premium valve stem seals incl.	
1	Head Set	2003	HS 26207 PT-3	To 02/01/03; Head bolts not incl.; Head bolt replacement recommended; PermaDry® molded rubber valve cover gsks. incl.; Premium valve stem seals incl.	
1	Head Set	2003	HS 26207 PT-4	From 02/02/03; Head bolts not incl.; Head bolt replacement recommended; PermaDry® molded rubber valve cover gsks. incl.; Premium valve stem seals incl.	
1	Head Set	2002	HS 26207 PT-3	Head bolts not incl.; Head bolt replacement recommended; PermaDry® molded rubber valve cover gsks. incl.; Premium valve stem seals incl.	
2	Head Bolt Set	2005-02	ES 72159	Head bolts w/Washers; Replacement required	
QTY	CONVERSION SET	YEARS	PART NO.	DESCRIPTION	
1	Gasket Conversion Set	2005-04	CS 9038-2	PermaDry® molded rubber oil pan gskt. incl.	
1	Gasket Conversion Set	2003-02	CS 9038-1	PermaDry® molded rubber oil pan gskt. incl.; Consolidated design	
QTY	MANIFOLD - INT. & EXH.	YEARS	PART NO.	DESCRIPTION	
1	Int. Manifold Gasket Set	2005-02	MS 96841	Lower set; Upper set incl.	
1	Plenum Gasket Set	2005-02	MS 96868	Upper set	
1	Exh. Manifold Gasket Set	2005-04	MS 96899		
1	Exh. Manifold Gasket Set	2003	MS 95715	To 02/01/03	
1	Exh. Manifold Gasket Set	2003	MS 96899	From 02/02/03	
1	Exh. Manifold Gasket Set	2002	MS 95715		
QTY	EXHAUST PIPE FLANGE	YEARS	PART NO.	DESCRIPTION	
2	Exhaust Pipe Gasket	2005-02	60967	Flange	
QTY	OIL PAN	YEARS	PART NO.	DESCRIPTION	
1	Oil Pan Gasket Set	2005-04	OS 30729 R	PermaDry® molded rubber gskt. incl.	
1	Oil Pan Gasket Set	2003-02	OS 30697 R	PermaDry® molded rubber gskt. incl.; Improved design	
1	Drain Plug Gasket	2005-04	71067		
1	Drain Plug Gasket	2003-02	72515		
QTY	CRANKSHAFT REAR SEAL	YEARS	PART NO.	DESCRIPTION	
1	Rear Main Seal Set	2005-02	BS 40620	Rubber; One-piece; Improved design	
1	Rear Main Seal Set	2005-02	BS 40644	PTFE Rubber; One-piece	
QTY	VALVE COVER	YEARS	PART NO.	DESCRIPTION	
1	Valve Cover Gasket Set	2005-04	VS 50579 R	w/Grommets & Spark plug tube seals; PermaDry® molded rubber gsks. incl.	
1	Valve Cover Gasket Set	2003-02	VS 50551 R	w/Grommets & Spark plug tube seals; PermaDry® molded rubber gsks. incl.	
QTY	VALVE STEM SEAL SET	YEARS	PART NO.	DESCRIPTION	
1	Valve Stem Seal Set	2005-02	SS 72873-1	Premium valve stem seals incl.	
QTY	WATER OUTLET GASKET	YEARS	PART NO.	DESCRIPTION	
1	Water Outlet Gasket	2005-02	35489	Water Outlet	
QTY	WATER PUMP	YEARS	PART NO.	DESCRIPTION	
1	Water Pump Gasket	2005-02	35663	Improved design	
QTY	TIMING COVER	YEARS	PART NO.	DESCRIPTION	
1	Timing Cover Set	2005	TCS 46016	Must be used w/OS 30729R; Improved design	
1	Timing Cover Set	2004-02	TCS 45967	Must be used w/OS 30697R or w/OS 30729R; Old design	
1	Timing Cover Set	2004-02	TCS 46016	Must be used w/OS 30697R or w/OS 30729R; Improved design	
1	Crankshaft Front Seal Set	2005-02	TCS 46114		
1	Camshaft Rear Seal Set	2005-02	TCS 45966		
QTY	CARB & FUEL INJECTION	YEARS	PART NO.	DESCRIPTION	
2	Fuel Injector O-Ring Set	2005-02	ES 70599	Improved design	
1	Throttle Body Gasket	2005-02	61489	Mounting	
1	Throttle Body Gasket	2005-02	72302	Air bypass valve	
QTY	EXHAUST GAS RECIRCULATION	YEARS	PART NO.	DESCRIPTION	
1	EGR Gasket	2005-02	71280	Valve	

Mazda Truck (Incl. Minivans and SUV's) (Cont.)

18		2008 - 2001; 3.0L 181 (2967cc) DOHC V6 (24 Valve) 89mm Bore Duratec MFI; Gasoline; Naturally Aspirated Ford Eng.; VIN Code 1, Eng. Code AJ			18
QTY	CYLINDER HEAD	YEARS	PART NO.	DESCRIPTION	
1	Head Gasket	2008-05	26212 PT	Loc. R.H.; Head bolts not incl.; Head bolt replacement required; PermaTorqueMLS®	
1	Head Gasket	2008	26233 PT	Loc. L.H.; Head bolts not incl.; Head bolt replacement required; PermaTorqueMLS®	
1	Head Gasket	2007-05	26207 PT	Loc. L.H.; Head bolts not incl.; Head bolt replacement required; PermaTorqueMLS®	
1	Head Gasket	2004	26207 PT	Mazda MPV ES, LX; Loc. L.H.; Head bolts not incl.; Head bolt replacement required; PermaTorqueMLS®	
1	Head Gasket	2004	26212 PT	Mazda MPV ES, LX; Loc. R.H.; Head bolts not incl.; Head bolt replacement required; PermaTorqueMLS®	
1	Head Gasket	2004	9540 PT	Exc. Mazda MPV ES, LX; Loc. L.H.; Head bolts not incl.; Head bolt replacement required; PermaTorqueMLS®	
1	Head Gasket	2004	9541 PT	Exc. Mazda MPV ES, LX; Loc. R.H.; Head bolts not incl.; Head bolt replacement required; PermaTorqueMLS®	
1	Head Gasket	2003-02	9540 PT	Mazda Tribute DX, ES, LX; Loc. L.H.; Head bolts not incl.; Head bolt replacement required; PermaTorqueMLS®	
1	Head Gasket	2003-02	9541 PT	Mazda Tribute DX, ES, LX; Loc. R.H.; Head bolts not incl.; Head bolt replacement required; PermaTorqueMLS®	
1	Head Gasket	2003	26207 PT	Mazda MPV ES, EX, LS, LX; Loc. L.H.; Head bolts not incl.; Head bolt replacement required; PermaTorqueMLS®	
1	Head Gasket	2003	26212 PT	Mazda MPV ES, EX, LS, LX; Loc. R.H.; Head bolts not incl.; Head bolt replacement required; PermaTorqueMLS®	
1	Head Gasket	2002	26207 PT	Mazda MPV DX, ES, EX, LS, LX; Loc. L.H.; Head bolts not incl.; Head bolt replacement required; PermaTorqueMLS®	
1	Head Gasket	2002	26212 PT	Mazda MPV DX, ES, EX, LS, LX; Loc. R.H.; Head bolts not incl.; Head bolt replacement required; PermaTorqueMLS®	
1	Head Gasket	2001	9540 PT	Loc. L.H.; Head bolts not incl.; Head bolt replacement required; PermaTorqueMLS®	
1	Head Gasket	2001	9541 PT	Loc. R.H.; Head bolts not incl.; Head bolt replacement required; PermaTorqueMLS®	
1	Head Set	2008	HS 26233 PT-5	Head bolts not incl.; Head bolt replacement required; PermaDry® molded rubber valve cover gskts. incl.; Premium valve stem seals incl.	
1	Head Set	2007	HS 26207 PT	Head bolts not incl.; Head bolt replacement required; PermaDry® molded rubber valve cover gskts. incl.; Premium valve stem seals incl.	
1	Head Set	2006-05	HS 26207 PT	Mazda Tribute s; Head bolts not incl.; Head bolt replacement required; PermaDry® molded rubber valve cover gskts. incl.; Premium valve stem seals incl.	
1	Head Set	2006	HS 26207 PT-5	Exc. Mazda Tribute s; Head bolts not incl.; Head bolt replacement recommended; PermaDry® molded rubber valve cover gskts. incl.; Premium valve stem seals incl.	
1	Head Set	2005-04	HS 26207 PT-5	Mazda MPV ES, LX; Head bolts not incl.; Head bolt replacement recommended; PermaDry® molded rubber valve cover gskts. incl.; Premium valve stem seals incl.	
1	Head Set	2004	HS 9540 PT-3	Exc. Mazda MPV ES, LX; Head bolts not incl.; Head bolt replacement required; PermaDry® molded rubber valve cover gskts. incl.; Premium valve stem seals incl.	
1	Head Set	2003-02	HS 9540 PT-3	Mazda Tribute DX, ES, LX; Head bolts not incl.; Head bolt replacement required; PermaDry® molded rubber valve cover gskts. incl.; Premium valve stem seals incl.	
1	Head Set	2003	HS 26207 PT-3	Mazda MPV ES, EX, LS, LX; To 02/01/03; Head bolts not incl.; Head bolt replacement recommended; PermaDry® molded rubber valve cover gskts. incl.; Premium valve stem seals incl.	
1	Head Set	2003	HS 26207 PT-4	Mazda MPV ES, EX, LS, LX; From 02/02/03; Head bolts not incl.; Head bolt replacement recommended; PermaDry® molded rubber valve cover gskts. incl.; Premium valve stem seals incl.	
1	Head Set	2002	HS 26207 PT-3	Mazda MPV DX, ES, EX, LS, LX; Head bolts not incl.; Head bolt replacement recommended; PermaDry® molded rubber valve cover gskts. incl.; Premium valve stem seals incl.	
1	Head Set	2001	HS 9540 PT-3	Head bolts not incl.; Head bolt replacement required; PermaDry® molded rubber valve cover gskts. incl.; Premium valve stem seals incl.	
2	Head Bolt Set	2008-01	ES 72159	Head bolts w/Washers; Replacement required	
QTY	CONVERSION SET	YEARS	PART NO.	DESCRIPTION	
1	Gasket Conversion Set	2008-05	CS 9038-2	PermaDry® molded rubber oil pan gskt. incl.	
1	Gasket Conversion Set	2004	CS 9038-1	Exc. Mazda MPV ES, LX; PermaDry® molded rubber oil pan gskt. incl.; Consolidated design	

Mazda Truck (Incl. Minivans and SUV's) (Cont.)

18 (cont.)		2008 - 2001; 3.0L 181 (2967cc) DOHC V6 (24 Valve) 89mm Bore Duratec MFI; Gasoline; Naturally Aspirated Ford Eng.; VIN Code 1, Eng. Code AJ			18 (cont.)
QTY	CONVERSION SET	YEARS	PART NO.	DESCRIPTION	
1	Gasket Conversion Set	2004	CS 9038-2	Mazda MPV ES, LX; PermaDry® molded rubber oil pan gskt. incl.	
1	Gasket Conversion Set	2003-01	CS 9038-1	PermaDry® molded rubber oil pan gskt. incl.; Consolidated design	
QTY	MANIFOLD - INT. & EXH.	YEARS	PART NO.	DESCRIPTION	
1	Int. Manifold Gasket Set	2008-07	MS 92586-1	Lower set; Upper set incl.	
1	Int. Manifold Gasket Set	2006-05	MS 92586-1	Mazda Tribute s; Lower set; Upper set incl.	
1	Int. Manifold Gasket Set	2006	MS 96841	Exc. Mazda Tribute s; Lower set; Upper set incl.	
1	Int. Manifold Gasket Set	2005-04	MS 96841	Mazda MPV ES, LX; Lower set; Upper set incl.	
1	Int. Manifold Gasket Set	2004	MS 96124	Exc. Mazda MPV ES, LX; Lower set; Upper set incl.	
1	Int. Manifold Gasket Set	2003-02	MS 96124	Mazda Tribute DX, ES, LX; Lower set; Upper set incl.	
1	Int. Manifold Gasket Set	2003	MS 96841	Mazda MPV ES, EX, LS, LX; Lower set; Upper set incl.	
1	Int. Manifold Gasket Set	2002	MS 96841	Mazda MPV DX, ES, EX, LS, LX; Lower set; Upper set incl.	
1	Int. Manifold Gasket Set	2001	MS 96124	Lower set; Upper set incl.	
1	Plenum Gasket Set	2008-07	MS 96252	Upper set	
1	Plenum Gasket Set	2006-05	MS 96252	Mazda Tribute s; Upper set	
1	Plenum Gasket Set	2006	MS 96868	Exc. Mazda Tribute s; Upper set	
1	Plenum Gasket Set	2005-04	MS 96868	Mazda MPV ES, LX; Upper set	
1	Plenum Gasket Set	2004	MS 96124-1	Exc. Mazda MPV ES, LX; Upper set	
1	Plenum Gasket Set	2003-02	MS 96124-1	Mazda Tribute DX, ES, LX; Upper set	
1	Plenum Gasket Set	2003	MS 96868	Mazda MPV ES, EX, LS, LX; Upper set	
1	Plenum Gasket Set	2002	MS 96868	Mazda MPV DX, ES, EX, LS, LX; Upper set	
1	Plenum Gasket Set	2001	MS 96124-1	Upper set	
1	Exh. Manifold Gasket Set	2008-07	MS 95715		
1	Exh. Manifold Gasket Set	2006-05	MS 95715	Mazda Tribute s	
1	Exh. Manifold Gasket Set	2006	MS 96899	Exc. Mazda Tribute s	
1	Exh. Manifold Gasket Set	2005-04	MS 96899	Mazda MPV ES, LX	
1	Exh. Manifold Gasket Set	2004	MS 95715	Exc. Mazda MPV ES, LX	
1	Exh. Manifold Gasket Set	2003	MS 95715	Mazda Tribute DX, ES, LX	
1	Exh. Manifold Gasket Set	2003	MS 95715	Mazda MPV ES, EX, LS, LX; To 02/01/03	
1	Exh. Manifold Gasket Set	2003	MS 96899	Mazda MPV ES, EX, LS, LX; From 02/02/03	
1	Exh. Manifold Gasket Set	2002-01	MS 95715		
QTY	EXHAUST PIPE FLANGE	YEARS	PART NO.	DESCRIPTION	
2	Exhaust Pipe Gasket	2008-07	61395	Flange	
2	Exhaust Pipe Gasket	2008	61194	Converter	
2	Exhaust Pipe Gasket	2007	61396	Converter	
2	Exhaust Pipe Gasket	2006-05	61395	Mazda Tribute s; Flange	
2	Exhaust Pipe Gasket	2006-05	61396	Mazda Tribute s; Converter	
2	Exhaust Pipe Gasket	2006	60967	Exc. Mazda Tribute s; Flange	
2	Exhaust Pipe Gasket	2005-04	60967	Mazda MPV ES, LX; Flange	
2	Exhaust Pipe Gasket	2004	61194	Exc. Mazda MPV ES, LX; Flange	
2	Exhaust Pipe Gasket	2003-02	61194	Mazda Tribute DX, ES, LX; Flange	
2	Exhaust Pipe Gasket	2003	60967	Mazda MPV ES, EX, LS, LX; Flange	
2	Exhaust Pipe Gasket	2002	60967	Mazda MPV DX, ES, EX, LS, LX; Flange	
2	Exhaust Pipe Gasket	2001	61194	Flange	
QTY	OIL PAN	YEARS	PART NO.	DESCRIPTION	
1	Oil Pan Gasket Set	2008-05	OS 30729 R	PermaDry® molded rubber gskt. incl.	
1	Oil Pan Gasket Set	2004	OS 30697 R	Exc. Mazda MPV ES, LX; PermaDry® molded rubber gskt. incl.; Improved design	
1	Oil Pan Gasket Set	2004	OS 30729 R	Mazda MPV ES, LX; PermaDry® molded rubber gskt. incl.	
1	Oil Pan Gasket Set	2003-01	OS 30697 R	PermaDry® molded rubber gskt. incl.; Improved design	
1	Drain Plug Gasket	2008-05	71067		
1	Drain Plug Gasket	2004	71067	Mazda MPV ES, LX	
1	Drain Plug Gasket	2004	72515	Exc. Mazda MPV ES, LX	
1	Drain Plug Gasket	2003-01	72515		
QTY	CRANKSHAFT REAR SEAL	YEARS	PART NO.	DESCRIPTION	
1	Rear Main Seal Set	2008-01	BS 40620	Rubber; One-piece; Improved design	
1	Rear Main Seal Set	2008-01	BS 40644	PTFE Rubber; One-piece	
QTY	VALVE COVER	YEARS	PART NO.	DESCRIPTION	
1	Valve Cover Gasket Set	2008	VS 50708 R	w/Grommets & Spark plug tube seals; PermaDry® molded rubber gskts. incl.	
1	Valve Cover Gasket Set	2007-05	VS 50579 R	w/Grommets & Spark plug tube seals; PermaDry® molded rubber gskts. incl.	
1	Valve Cover Gasket Set	2004	VS 50551 R	Exc. Mazda MPV ES, LX; w/Grommets & Spark plug tube seals; PermaDry® molded rubber gskts. incl.	
1	Valve Cover Gasket Set	2004	VS 50579 R	Mazda MPV ES, LX; w/Grommets & Spark plug tube seals; PermaDry® molded rubber gskts. incl.	
1	Valve Cover Gasket Set	2003-01	VS 50551 R	w/Grommets & Spark plug tube seals; PermaDry® molded rubber gskts. incl.	

Mazda Truck (Incl. Minivans and SUV's) (Cont.)

18 (cont.)		2008 - 2001; 3.0L 181 (2967cc) DOHC V6 (24 Valve) 89mm Bore Duratec MFI; Gasoline; Naturally Aspirated Ford Eng.; VIN Code 1, Eng. Code AJ			18 (cont.)
QTY	VALVE STEM SEAL SET	YEARS	PART NO.	DESCRIPTION	
1	Valve Stem Seal Set	2008-01	SS 72873-1	Premium valve stem seals incl.	
QTY	WATER OUTLET GASKET	YEARS	PART NO.	DESCRIPTION	
1	Water Outlet Gasket	2008-01	35489	Water Outlet	
QTY	WATER PUMP	YEARS	PART NO.	DESCRIPTION	
1	Water Pump Gasket	2008-02	35663	Improved design	
1	Water Pump Gasket	2001	35640		
QTY	TIMING COVER	YEARS	PART NO.	DESCRIPTION	
1	Timing Cover Set	2008-05	TCS 46016	Must be used w/OS 30729R; Improved design	
1	Timing Cover Set	2004-01	TCS 45967	Must be used w/OS 30697R or w/OS 30729R; Old design	
1	Timing Cover Set	2004-01	TCS 46016	Must be used w/OS 30697R or w/OS 30729R; Improved design	
1	Crankshaft Front Seal Set	2008-01	TCS 46114		
1	Camshaft Rear Seal Set	2008	TCS 46071		
1	Camshaft Rear Seal Set	2007-01	TCS 45966		
QTY	CARB & FUEL INJECTION	YEARS	PART NO.	DESCRIPTION	
2	Fuel Injector O-Ring Set	2008-01	ES 70599	Improved design	
1	Throttle Body Gasket	2008-01	72302	Air bypass valve	
1	Throttle Body Gasket	2008-07	61158	Mounting	
1	Throttle Body Gasket	2006-05	61158	Mazda Tribute s; Mounting	
1	Throttle Body Gasket	2006	61489	Exc. Mazda Tribute s; Mounting	
1	Throttle Body Gasket	2005-04	61489	Mazda MPV ES, LX; Mounting	
1	Throttle Body Gasket	2004	61158	Exc. Mazda MPV ES, LX; Mounting	
1	Throttle Body Gasket	2003-02	61158	Mazda Tribute DX, ES, LX; Mounting	
1	Throttle Body Gasket	2003	61489	Mazda MPV ES, EX, LS, LX; Mounting	
1	Throttle Body Gasket	2002	61489	Mazda MPV DX, ES, EX, LS, LX; Mounting	
1	Throttle Body Gasket	2001	61158	Mounting	
QTY	EXHAUST GAS RECIRCULATION	YEARS	PART NO.	DESCRIPTION	
1	EGR Gasket	2008-07	70149	Valve	
2	EGR Gasket	2008-07	71278	Tube seal	
1	EGR Gasket	2006-05	70149	Mazda Tribute s; Valve	
2	EGR Gasket	2006-05	71278	Mazda Tribute s; Tube seal	
1	EGR Gasket	2006	71280	Exc. Mazda Tribute s; Valve	
1	EGR Gasket	2005-04	71280	Mazda MPV ES, LX; Valve	
1	EGR Gasket	2004	70149	Exc. Mazda MPV ES, LX; Valve	
2	EGR Gasket	2004	71278	Exc. Mazda MPV ES, LX; Tube seal	
1	EGR Gasket	2003-02	70149	Mazda Tribute DX, ES, LX; Valve	
2	EGR Gasket	2003-02	71278	Mazda Tribute DX, ES, LX; Tube seal	
1	EGR Gasket	2003	71280	Mazda MPV ES, EX, LS, LX; Valve	
1	EGR Gasket	2002	71280	Mazda MPV DX, ES, EX, LS, LX; Valve	
1	EGR Gasket	2001	70149	Valve	
2	EGR Gasket	2001	71278	Tube seal	
19		2011 - 2009; 3.0L 181 (2967cc) DOHC V6 (24 Valve) 89mm Bore Duratec VVT MFI; Gasoline; Naturally Aspirated Ford Eng.; VIN Code 1, Eng. Code AJ			19
QTY	CYLINDER HEAD	YEARS	PART NO.	DESCRIPTION	
1	Head Gasket	2011-10	26545 PT	Loc. L.H.; Head bolts not incl.; Head bolt replacement required; PermaTorqueMLS®; New Part Number - Check for Availability	
1	Head Gasket	2011-10	26546 PT	Loc. R.H.; Head bolts not incl.; Head bolt replacement required; PermaTorqueMLS®; New Part Number - Check for Availability	
1	Head Gasket	2009	26212 PT	Loc. R.H.; Head bolts not incl.; Head bolt replacement required; PermaTorqueMLS®	
1	Head Gasket	2009	26233 PT	Loc. L.H.; Head bolts not incl.; Head bolt replacement required; PermaTorqueMLS®	
1	Head Set	2011-10	HS 26545 PT	Head bolts not incl.; Head bolt replacement required; PermaDry® molded rubber valve cover gskts. incl.; Premium valve stem seals incl.; New Part Number - Check for Availability	
2	Head Bolt Set	2009	ES 72159	Head bolts w/Washers; Replacement required	
QTY	CONVERSION SET	YEARS	PART NO.	DESCRIPTION	
1	Gasket Conversion Set	2011-09	CS 9038-2	PermaDry® molded rubber oil pan gskt. incl.	
QTY	MANIFOLD - INT. & EXH.	YEARS	PART NO.	DESCRIPTION	
1	Int. Manifold Gasket Set	2011-09	MS 97193	Lower set; Upper set incl.; New Part Number - Check for Availability	
1	Plenum Gasket Set	2011-09	MS 97194	Upper set; New Part Number - Check for Availability	
1	Exh. Manifold Gasket Set	2011-09	MS 95715		
QTY	EXHAUST PIPE FLANGE	YEARS	PART NO.	DESCRIPTION	
1	Exhaust Pipe Gasket	2011-09	60641	Secondary converter	

Mazda Truck (Incl. Minivans and SUV's) (Cont.)

19		2011 - 2009; 3.0L 181 (2967cc) DOHC V6 (24 Valve) 89mm Bore Duratec VVT			19
(cont.)		MFI; Gasoline; Naturally Aspirated Ford Eng.; VIN Code 1, Eng. Code AJ			(cont.)
QTY	EXHAUST PIPE FLANGE	YEARS	PART NO.	DESCRIPTION	
1	Exhaust Pipe Gasket	2011-09	60714	Loc. Front; Exh. connector	
2	Exhaust Pipe Gasket	2011-09	61684	Flange; New Part Number - Check for Availability	
2	Exhaust Pipe Gasket	2009	61194	Converter	
QTY	OIL PAN	YEARS	PART NO.	DESCRIPTION	
1	Oil Pan Gasket Set	2011-09	OS 30729 R	PermaDry® molded rubber gskt. incl.	
1	Drain Plug Gasket	2011-09	71067		
QTY	CRANKSHAFT REAR SEAL	YEARS	PART NO.	DESCRIPTION	
1	Rear Main Seal Set	2011-09	BS 40620	Rubber; One-piece; Improved design	
1	Rear Main Seal Set	2011-09	BS 40644	PTFE Rubber; One-piece	
QTY	VALVE COVER	YEARS	PART NO.	DESCRIPTION	
1	Valve Cover Gasket Set	2011-09	VS 50801 R	w/Grommets & Spark plug tube seals; PermaDry® molded rubber gskts. incl.; New Part Number - Check for Availability	
1	Grommet Set	2011-09	ES 71426	Valve Cover; VCT seals set; New Part Number - Check for Availability	
QTY	VALVE STEM SEAL SET	YEARS	PART NO.	DESCRIPTION	
1	Valve Stem Seal Set	2011-09	SS 72873-1	Premium valve stem seals incl.	
QTY	THERMOSTAT HOUSING	YEARS	PART NO.	DESCRIPTION	
1	Thermostat Gasket	2011-09	35971	Thermostat Housing; Thermostat gskt.; New Part Number - Check for Availability	
QTY	WATER OUTLET GASKET	YEARS	PART NO.	DESCRIPTION	
1	Water Outlet Gasket	2011-09	35489	Water Outlet	
QTY	WATER PUMP	YEARS	PART NO.	DESCRIPTION	
1	Water Pump Gasket	2011-09	35973	Housing to block; New Part Number - Check for Availability	
1	Water Pump Gasket	2011-09	35976	Mounting; New Part Number - Check for Availability	
QTY	TIMING COVER	YEARS	PART NO.	DESCRIPTION	
1	Timing Cover Set	2011-09	TCS 46016	Must be used w/OS 30729R; Improved design	
1	Crankshaft Front Seal Set	2011-09	TCS 46114		
1	Camshaft Rear Seal Set	2011-09	TCS 46071		
QTY	CARB & FUEL INJECTION	YEARS	PART NO.	DESCRIPTION	
2	Fuel Injector O-Ring Set	2011-09	ES 70599	Improved design	
1	Throttle Body Gasket	2011-09	61377	Mounting	
1	Throttle Body Gasket	2011-09	72302	Air bypass valve	
QTY	EXHAUST GAS RECIRCULATION	YEARS	PART NO.	DESCRIPTION	
1	EGR Gasket	2011-09	70149	Valve	
2	EGR Gasket	2011-09	71278	Tube seal	
20		2011; 3.0L 181 (2967cc) DOHC V6 (24 Valve) 89mm Bore Duratec VVT			20
(cont.)		MFI; Flex Fuel; Naturally Aspirated Ford Eng.; VIN Code G, Eng. Code AJ			(cont.)
QTY	CYLINDER HEAD	YEARS	PART NO.	DESCRIPTION	
1	Head Gasket	2011	26545 PT	Loc. L.H.; Head bolts not incl.; Head bolt replacement required; PermaTorqueMLS®; New Part Number - Check for Availability	
1	Head Gasket	2011	26546 PT	Loc. R.H.; Head bolts not incl.; Head bolt replacement required; PermaTorqueMLS®; New Part Number - Check for Availability	
1	Head Set	2011	HS 26545 PT	Head bolts not incl.; Head bolt replacement required; PermaDry® molded rubber valve cover gskts. incl.; Premium valve stem seals incl.; New Part Number - Check for Availability	
QTY	CONVERSION SET	YEARS	PART NO.	DESCRIPTION	
1	Gasket Conversion Set	2011	CS 9038-2	PermaDry® molded rubber oil pan gskt. incl.	
QTY	MANIFOLD - INT. & EXH.	YEARS	PART NO.	DESCRIPTION	
1	Int. Manifold Gasket Set	2011	MS 97193	Lower set; Upper set incl.; New Part Number - Check for Availability	
1	Plenum Gasket Set	2011	MS 97194	Upper set; New Part Number - Check for Availability	
1	Exh. Manifold Gasket Set	2011	MS 95715		
QTY	EXHAUST PIPE FLANGE	YEARS	PART NO.	DESCRIPTION	
1	Exhaust Pipe Gasket	2011	60641	Secondary converter	
1	Exhaust Pipe Gasket	2011	60714	Loc. Front; Exh. connector	
2	Exhaust Pipe Gasket	2011	61684	Flange; New Part Number - Check for Availability	
QTY	OIL PAN	YEARS	PART NO.	DESCRIPTION	
1	Oil Pan Gasket Set	2011	OS 30729 R	PermaDry® molded rubber gskt. incl.	
1	Drain Plug Gasket	2011	71067		
QTY	CRANKSHAFT REAR SEAL	YEARS	PART NO.	DESCRIPTION	
1	Rear Main Seal Set	2011	BS 40620	Rubber; One-piece; Improved design	
1	Rear Main Seal Set	2011	BS 40644	PTFE Rubber; One-piece	
QTY	VALVE COVER	YEARS	PART NO.	DESCRIPTION	
1	Valve Cover Gasket Set	2011	VS 50801 R	w/Grommets & Spark plug tube seals; PermaDry® molded rubber gskts. incl.; New Part Number - Check for Availability	

Mazda Truck (Incl. Minivans and SUV's) (Cont.)

20 (cont.)		2011; 3.0L 181 (2967cc) DOHC V6 (24 Valve) 89mm Bore Duratec VVT			20 (cont.)
MFI; Flex Fuel; Naturally Aspirated Ford Eng.; VIN Code G, Eng. Code AJ					
QTY	VALVE COVER	YEARS	PART NO.	DESCRIPTION	
1	Grommet Set	2011	ES 71426	Valve Cover; VCT seals set; New Part Number - Check for Availability	
QTY	VALVE STEM SEAL SET	YEARS	PART NO.	DESCRIPTION	
1	Valve Stem Seal Set	2011	SS 72873-1	Premium valve stem seals incl.	
QTY	THERMOSTAT HOUSING	YEARS	PART NO.	DESCRIPTION	
1	Thermostat Gasket	2011	35971	Thermostat Housing; Thermostat gskt.; New Part Number - Check for Availability	
QTY	WATER OUTLET GASKET	YEARS	PART NO.	DESCRIPTION	
1	Water Outlet Gasket	2011	35489	Water Outlet	
QTY	WATER PUMP	YEARS	PART NO.	DESCRIPTION	
1	Water Pump Gasket	2011	35973	Housing to block; New Part Number - Check for Availability	
1	Water Pump Gasket	2011	35976	Mounting; New Part Number - Check for Availability	
QTY	TIMING COVER	YEARS	PART NO.	DESCRIPTION	
1	Timing Cover Set	2011	TCS 46016	Must be used w/OS 30729R; Improved design	
1	Crankshaft Front Seal Set	2011	TCS 46114		
1	Camshaft Rear Seal Set	2011	TCS 46071		
QTY	CARB & FUEL INJECTION	YEARS	PART NO.	DESCRIPTION	
2	Fuel Injector O-Ring Set	2011	ES 70599	Improved design	
1	Throttle Body Gasket	2011	61377	Mounting	
1	Throttle Body Gasket	2011	72302	Air bypass valve	
QTY	EXHAUST GAS RECIRCULATION	YEARS	PART NO.	DESCRIPTION	
1	EGR Gasket	2011	70149	Valve	
2	EGR Gasket	2011	71278	Tube seal	
21		2008 - 1994; 3.0L 183 (2982cc) OHV V6 (12 Valve) 89mm Bore Vulcan			21
MFI; Gasoline; Naturally Aspirated Ford Eng.; VIN Code U, Eng. Code 8U					
QTY	CYLINDER HEAD	YEARS	PART NO.	DESCRIPTION	
1	Head Gasket	2008-94	9902 PT	Loc. L.H.; Head bolts not incl.; Head bolt replacement recommended	
1	Head Gasket	2008-94	9903 PT	Loc. R.H.; Head bolts not incl.; Head bolt replacement recommended	
1	Head Set	2008-02	HS 9902 PT-5	Head bolts not incl.; Head bolt replacement required; PermaDry® molded rubber valve cover gskts. incl.; Premium valve stem seals incl.	
1	Head Set	2001	HS 9902 PT-4	Head bolts not incl.; Head bolt replacement required; PermaDry® molded rubber valve cover gskts. incl.; Premium valve stem seals incl.	
1	Head Set	2000-99	HS 9902 PT-3	To 07/26/99; Head bolts not incl.; Head bolt replacement required; PermaDry® molded rubber valve cover gskts. incl.; Premium valve stem seals incl.; Consolidated design	
1	Head Set	2000-99	HS 9902 PT-4	From 07/27/99; Head bolts not incl.; Head bolt replacement required; PermaDry® molded rubber valve cover gskts. incl.; Premium valve stem seals incl.	
1	Head Set	1998-96	HS 9902 PT-3	Head bolts not incl.; Head bolt replacement recommended; PermaDry® molded rubber valve cover gskts. incl.; Premium valve stem seals incl.; Consolidated design	
1	Head Set	1995-94	HS 9902 PT	Head bolts not incl.; Head bolt replacement recommended; PermaDry® molded rubber valve cover gskts. incl.; Premium valve stem seals incl.	
2	Head Bolt Set	2008-00	ES 72174	Replacement required	
1	Head Bolt Set	1999-98	ES 72136	To 07/13/98; Replacement recommended	
2	Head Bolt Set	1999-98	ES 72174	From 07/14/98; Replacement required	
1	Head Bolt Set	1997-94	ES 72136	Replacement recommended	
QTY	CONVERSION SET	YEARS	PART NO.	DESCRIPTION	
1	Gasket Conversion Set	2008-02	CS 9368-3	PermaDry® molded rubber oil pan gskt. incl.	
1	Gasket Conversion Set	2001-94	CS 9368-2	PermaDry® molded rubber oil pan gskt. incl.	
QTY	MANIFOLD - INT. & EXH.	YEARS	PART NO.	DESCRIPTION	
1	Int. Manifold Gasket Set	2008-02	MS 95372-1	Lower set; Upper set incl.; Must be used w/VS 50374R	
1	Int. Manifold Gasket Set	2001-94	MS 95372	Lower set; Upper set incl.; Must be used w/VS 50374R	
1	Plenum Gasket Set	2008-02	MS 94429	Upper set	
1	Plenum Gasket Set	2001-94	MS 93491	Upper set	
1	Exh. Manifold Gasket Set	2008-96	MS 95939	Improved design	
1	Exh. Manifold Gasket Set	1995-94	MS 93850		
QTY	EXHAUST PIPE FLANGE	YEARS	PART NO.	DESCRIPTION	
1	Exhaust Pipe Gasket	2008-94	60641	Loc. Rear; Converter	
1	Exhaust Pipe Gasket	2008-94	60796	Loc. Front; Converter	
1	Exhaust Pipe Gasket	2008-01	61407	Inlet pipe to converter	
1	Exhaust Pipe Gasket	2008-02	61183	Ring	
QTY	OIL PAN	YEARS	PART NO.	DESCRIPTION	
1	Oil Pan Gasket Set	2008-02	OS 30712 R	PermaDry® molded rubber gskt. incl.	

Mazda Truck (Incl. Minivans and SUV's) (Cont.)

21		2008 - 1994; 3.0L 183 (2982cc) OHV V6 (12 Valve) 89mm Bore Vulcan			21	
(cont.)		MFI; Gasoline; Naturally Aspirated Ford Eng.; VIN Code U, Eng. Code 8U			(cont.)	
QTY	OIL PAN	YEARS	PART NO.	DESCRIPTION		
1	Oil Pan Gasket Set	2001-94	OS 30620 R	PermaDry® molded rubber gskt. incl.		
1	Oil Pan Gasket Set	2001-94	OS 30717 R	Oil pan bolts incl.; PermaDryPlus®		
1	Oil Pan Bolt Set	2001-94	ES 72214			
1	Drain Plug Gasket	2008-94	72515			
QTY	CRANKSHAFT REAR SEAL	YEARS	PART NO.	DESCRIPTION		
1	Rear Main Seal Set	2008-94	BS 40158	Rubber; One-piece		
1	Rear Main Seal Set	2008-94	BS 40646	PTFE Rubber; One-piece		
QTY	VALVE COVER	YEARS	PART NO.	DESCRIPTION		
1	Valve Cover Gasket Set	2008-94	VS 50374 R	w/o Grommets; PermaDry® molded rubber gskts. incl.		
2	Grommet Set	2008-94	ES 72180	Valve Cover		
QTY	VALVE STEM SEAL SET	YEARS	PART NO.	DESCRIPTION		
1	Valve Stem Seal Set	2008-01	SS 70964	Premium valve stem seals incl.		
1	Valve Stem Seal Set	2000-99	SS 70819	To 07/26/99; Premium valve stem seals incl.; Improved design		
1	Valve Stem Seal Set	2000-99	SS 70964	From 07/27/99; Premium valve stem seals incl.		
1	Valve Stem Seal Set	1998-94	SS 70819	Premium valve stem seals incl.; Improved design		
QTY	WATER OUTLET GASKET	YEARS	PART NO.	DESCRIPTION		
1	Water Outlet Gasket	2008-94	35390	Water Outlet		
1	Water Outlet Gasket	2008-94	35390 T	Water Outlet; PermaDryPlus®		
QTY	WATER PUMP	YEARS	PART NO.	DESCRIPTION		
1	Water Pump Gasket	2008-94	35379			
QTY	TIMING COVER	YEARS	PART NO.	DESCRIPTION		
1	Timing Cover Set	2008-94	TCS 45771	w/o Sleeve 'N' Seal®; Must be used w/OS 30620R or w/OS 30712R or w/OS 30717R		
1	Timing Set w/Sleeve & Seal	2008-94	TCS 45973	w/Sleeve 'N' Seal®; Must be used w/OS 30620R or w/OS 30712R or w/OS 30717R		
1	Repair Sleeve	2008-94	16217	Timing Cover; Use w/installation tool		
1	Repair Sleeve Tool	2008-94	16310	Timing Cover		
QTY	CARB & FUEL INJECTION	YEARS	PART NO.	DESCRIPTION		
2	Fuel Injector O-Ring Set	2008-94	ES 70599	Improved design		
1	Throttle Body Gasket	2008-02	61160	Mounting		
1	Throttle Body Gasket	2008-02	71428	Air bypass valve; New Part Number - Check for Availability		
1	Throttle Body Gasket	2001-94	60913	Mounting		
1	Throttle Body Gasket	2001-94	71216	Air bypass valve		
QTY	EXHAUST GAS RECIRCULATION	YEARS	PART NO.	DESCRIPTION		
1	EGR Gasket	2008-94	70149			
22		2003 - 1999; 3.0L 183 (2982cc) OHV V6 (12 Valve) 89mm Bore Vulcan			22	
		MFI; Flex Fuel; Naturally Aspirated Ford Eng.; VIN Code V, Eng. Code 8U				
QTY	CYLINDER HEAD	YEARS	PART NO.	DESCRIPTION		
1	Head Gasket	2003-99	9902 PT	Loc. L.H.; Head bolts not incl.; Head bolt replacement recommended		
1	Head Gasket	2003-99	9903 PT	Loc. R.H.; Head bolts not incl.; Head bolt replacement recommended		
1	Head Set	2003-02	HS 9902 PT-5	Head bolts not incl.; Head bolt replacement required; PermaDry® molded rubber valve cover gskts. incl.; Premium valve stem seals incl.		
1	Head Set	2001	HS 9902 PT-4	Head bolts not incl.; Head bolt replacement required; PermaDry® molded rubber valve cover gskts. incl.; Premium valve stem seals incl.		
1	Head Set	2000-99	HS 9902 PT-3	To 07/26/99; Head bolts not incl.; Head bolt replacement required; PermaDry® molded rubber valve cover gskts. incl.; Premium valve stem seals incl.; Consolidated design		
1	Head Set	2000-99	HS 9902 PT-4	From 07/27/99; Head bolts not incl.; Head bolt replacement required; PermaDry® molded rubber valve cover gskts. incl.; Premium valve stem seals incl.		
2	Head Bolt Set	2003-00	ES 72174	Replacement required		
1	Head Bolt Set	1999	ES 72136	To 07/13/98; Replacement recommended		
2	Head Bolt Set	1999	ES 72174	From 07/14/98; Replacement required		
QTY	CONVERSION SET	YEARS	PART NO.	DESCRIPTION		
1	Gasket Conversion Set	2003-02	CS 9368-3	PermaDry® molded rubber oil pan gskt. incl.		
1	Gasket Conversion Set	2001-99	CS 9368-2	PermaDry® molded rubber oil pan gskt. incl.		
QTY	MANIFOLD - INT. & EXH.	YEARS	PART NO.	DESCRIPTION		
1	Int. Manifold Gasket Set	2003-02	MS 95372-1	Lower set; Upper set incl.; Must be used w/VS 50374R		
1	Int. Manifold Gasket Set	2001-99	MS 95372	Lower set; Upper set incl.; Must be used w/VS 50374R		
1	Plenum Gasket Set	2003-02	MS 94429	Upper set		
1	Plenum Gasket Set	2001-99	MS 93491	Upper set		
1	Exh. Manifold Gasket Set	2003-99	MS 95939	Improved design		

Mazda Truck (Incl. Minivans and SUV's) (Cont.)

22 (cont.)		2003 - 1999; 3.0L 183 (2982cc) OHV V6 (12 Valve) 89mm Bore Vulcan			22 (cont.)
MFI; Flex Fuel; Naturally Aspirated Ford Eng.; VIN Code V, Eng. Code 8U					
QTY	EXHAUST PIPE FLANGE	YEARS	PART NO.	DESCRIPTION	
1	Exhaust Pipe Gasket	2003-99	60641	Loc. Rear; Converter	
1	Exhaust Pipe Gasket	2003-99	60796	Loc. Front; Converter	
1	Exhaust Pipe Gasket	2003-01	61407	Inlet pipe to converter	
1	Exhaust Pipe Gasket	2003-02	61183	Ring	
QTY	OIL PAN	YEARS	PART NO.	DESCRIPTION	
1	Oil Pan Gasket Set	2003-02	OS 30712 R	PermaDry® molded rubber gskt. incl.	
1	Oil Pan Gasket Set	2001-99	OS 30620 R	PermaDry® molded rubber gskt. incl.	
1	Oil Pan Gasket Set	2001-99	OS 30717 R	Oil pan bolts incl.; PermaDryPlus®	
1	Oil Pan Bolt Set	2001-99	ES 72214		
1	Drain Plug Gasket	2003-99	72515		
QTY	CRANKSHAFT REAR SEAL	YEARS	PART NO.	DESCRIPTION	
1	Rear Main Seal Set	2003-99	BS 40158	Rubber; One-piece	
1	Rear Main Seal Set	2003-99	BS 40646	PTFE Rubber; One-piece	
QTY	VALVE COVER	YEARS	PART NO.	DESCRIPTION	
1	Valve Cover Gasket Set	2003-99	VS 50374 R	w/o Grommets; PermaDry® molded rubber gskts. incl.	
2	Grommet Set	2003-99	ES 72180	Valve Cover	
QTY	VALVE STEM SEAL SET	YEARS	PART NO.	DESCRIPTION	
1	Valve Stem Seal Set	2003-01	SS 70964	Premium valve stem seals incl.	
1	Valve Stem Seal Set	2000-99	SS 70819	To 07/26/99; Premium valve stem seals incl.; Improved design	
1	Valve Stem Seal Set	2000-99	SS 70964	From 07/27/99; Premium valve stem seals incl.	
QTY	WATER OUTLET GASKET	YEARS	PART NO.	DESCRIPTION	
1	Water Outlet Gasket	2003-99	35390	Water Outlet	
1	Water Outlet Gasket	2003-99	35390 T	Water Outlet; PermaDryPlus®	
QTY	WATER PUMP	YEARS	PART NO.	DESCRIPTION	
1	Water Pump Gasket	2003-99	35379		
QTY	TIMING COVER	YEARS	PART NO.	DESCRIPTION	
1	Timing Cover Set	2003-99	TCS 45771	w/o Sleeve 'N' Seal®; Must be used w/OS 30620R or w/OS 30712R or w/OS 30717R	
1	Timing Set w/Sleeve & Seal	2003-99	TCS 45973	w/Sleeve 'N' Seal®; Must be used w/OS 30620R or w/OS 30712R or w/OS 30717R	
1	Repair Sleeve	2003-99	16217	Timing Cover; Use w/installation tool	
1	Repair Sleeve Tool	2003-99	16310	Timing Cover	
QTY	CARB & FUEL INJECTION	YEARS	PART NO.	DESCRIPTION	
2	Fuel Injector O-Ring Set	2003-99	ES 70599	Improved design	
1	Throttle Body Gasket	2003-02	61160	Mounting	
1	Throttle Body Gasket	2003-02	71428	Air bypass valve; New Part Number - Check for Availability	
1	Throttle Body Gasket	2001-99	60913	Mounting	
1	Throttle Body Gasket	2001-99	71216	Air bypass valve	
QTY	EXHAUST GAS RECIRCULATION	YEARS	PART NO.	DESCRIPTION	
1	EGR Gasket	2003-99	70149		
23		2007; 3.5L 213.3 (3496cc) DOHC V6 (24 Valve) 92.5mm Bore Duratec Cyclone			23
MFI; Gasoline; Naturally Aspirated Ford Eng.; Eng. Code MZI					
QTY	CYLINDER HEAD	YEARS	PART NO.	DESCRIPTION	
1	Head Gasket	2007	26487 PT	Loc. L.H.; Head bolts not incl.; Head bolt replacement recommended; PermaTorqueMLS®	
1	Head Gasket	2007	26488 PT	Loc. R.H.; Head bolts not incl.; Head bolt replacement recommended; PermaTorqueMLS®	
1	Head Set	2007	HS 26487 PT	Head bolts not incl.; Head bolt replacement recommended; PermaDry® molded rubber valve cover gskts. incl.; Premium valve stem seals incl.; New Part Number - Check for Availability	
2	Head Bolt Set	2007	ES 71320	Replacement recommended	
QTY	CONVERSION SET	YEARS	PART NO.	DESCRIPTION	
1	Gasket Conversion Set	2007	CS 26487	RTV sealant incl. for oil pan gskt.; New Part Number - Check for Availability	
QTY	MANIFOLD - INT. & EXH.	YEARS	PART NO.	DESCRIPTION	
1	Int. Manifold Gasket Set	2007	MS 97118	Lower set; Upper set incl.; New Part Number - Check for Availability	
1	Plenum Gasket Set	2007	MS 97120	Upper set	
1	Exh. Manifold Gasket Set	2007	MS 97121		
QTY	EXHAUST PIPE FLANGE	YEARS	PART NO.	DESCRIPTION	
1	Exhaust Pipe Gasket	2007	61236	Loc. Rear No. 1; Converter	
1	Exhaust Pipe Gasket	2007	61525	Loc. Rear No. 2; Converter; Improved design	
2	Exhaust Pipe Gasket	2007	61620	Ring	
1	Exhaust Pipe Gasket	2007	61621	Exh. connector	

Mazda Truck (Incl. Minivans and SUV's) (Cont.)

23		2007; 3.5L 213.3 (3496cc) DOHC V6 (24 Valve) 92.5mm Bore Duratec Cyclone			23
(cont.)		MFI; Gasoline; Naturally Aspirated Ford Eng.; Eng. Code MZI			(cont.)
QTY	CRANKSHAFT REAR SEAL	YEARS	PART NO.	DESCRIPTION	
1	Rear Main Seal Set	2007	BS 40729	Rubber; One-piece	
QTY	VALVE COVER	YEARS	PART NO.	DESCRIPTION	
1	Valve Cover Gasket Set	2007	VS 50767 R	w/Grommets & Spark plug tube seals; PermaDry® molded rubber gskts. incl.; New Part Number - Check for Availability	
QTY	VALVE STEM SEAL SET	YEARS	PART NO.	DESCRIPTION	
1	Valve Stem Seal Set	2007	SS 71327	Premium valve stem seals incl.	
QTY	THERMOSTAT HOUSING	YEARS	PART NO.	DESCRIPTION	
1	Thermostat Gasket	2007	35934	Thermostat case	
QTY	WATER OUTLET GASKET	YEARS	PART NO.	DESCRIPTION	
1	Water Outlet Gasket	2007	35489	Thermostat seal	
QTY	WATER PUMP	YEARS	PART NO.	DESCRIPTION	
1	Water Pump Gasket	2007	35930	Loc. Outer	
1	Water Pump Gasket	2007	35932	Loc. Inner	
QTY	TIMING COVER	YEARS	PART NO.	DESCRIPTION	
1	Crankshaft Front Seal Set	2007	TCS 46117		
QTY	CARB & FUEL INJECTION	YEARS	PART NO.	DESCRIPTION	
2	Fuel Injector O-Ring Set	2007	ES 70599	Improved design	
1	Throttle Body Gasket	2007	61466		
QTY	OIL FILTER MOUNTING	YEARS	PART NO.	DESCRIPTION	
1	Oil Filter Adapter Gasket	2007	71312	Oil filter adapter; New Part Number - Check for Availability	
QTY	OIL COOLER	YEARS	PART NO.	DESCRIPTION	
1	Oil Cooler Gasket	2007	71316	Oil cooler O-ring; New Part Number - Check for Availability	
24		2013 - 2008; 3.7L 227 (3721cc) DOHC V6 (24 Valve) 95.5mm Bore Duratec Cyclone			24
		MFI; Gasoline; Naturally Aspirated Ford Eng.; Eng. Code MZI			
QTY	CYLINDER HEAD	YEARS	PART NO.	DESCRIPTION	
1	Head Gasket	2013-08	26543 PT	Loc. R.H.; Head bolts not incl.; Head bolt replacement recommended; PermaTorqueMLS®; New Part Number - Check for Availability	
1	Head Gasket	2013-08	26544 PT	Loc. L.H.; Head bolts not incl.; Head bolt replacement recommended; PermaTorqueMLS®; New Part Number - Check for Availability	
1	Head Set	2013-08	HS 26543 PT-1	Head bolts not incl.; Head bolt replacement recommended; PermaDry® molded rubber valve cover gskts. incl.; Premium valve stem seals incl.; New Part Number - Check for Availability	
2	Head Bolt Set	2013-08	ES 72478	Replacement recommended; New Part Number - Check for Availability	
QTY	CONVERSION SET	YEARS	PART NO.	DESCRIPTION	
1	Gasket Conversion Set	2013-08	CS 26543	RTV sealant incl. for oil pan gskt.; New Part Number - Check for Availability	
QTY	MANIFOLD - INT. & EXH.	YEARS	PART NO.	DESCRIPTION	
1	Int. Manifold Gasket Set	2013-08	MS 97118	Lower set; Upper set incl.; New Part Number - Check for Availability	
1	Plenum Gasket Set	2013-08	MS 97120	Upper set	
1	Exh. Manifold Gasket Set	2013-08	MS 97121		
QTY	EXHAUST PIPE FLANGE	YEARS	PART NO.	DESCRIPTION	
2	Exhaust Pipe Gasket	2013-08	23591	Muffler; 1 31/32" ID x 2 35/64" OD	
1	Exhaust Pipe Gasket	2013-08	60906	Silencer	
1	Exhaust Pipe Gasket	2013-08	61236	Loc. Center; Converter	
1	Exhaust Pipe Gasket	2013-08	61525	Loc. Rear; Converter; Improved design	
2	Exhaust Pipe Gasket	2013-08	61620	Loc. Front; Converter	
QTY	CRANKSHAFT REAR SEAL	YEARS	PART NO.	DESCRIPTION	
1	Rear Main Seal Set	2013-08	BS 40729	Rubber; One-piece	
QTY	VALVE COVER	YEARS	PART NO.	DESCRIPTION	
1	Valve Cover Gasket Set	2013-08	VS 50767 R	w/Grommets & Spark plug tube seals; PermaDry® molded rubber gskts. incl.; New Part Number - Check for Availability	
QTY	VALVE STEM SEAL SET	YEARS	PART NO.	DESCRIPTION	
1	Valve Stem Seal Set	2013-08	SS 71327	Premium valve stem seals incl.	
QTY	THERMOSTAT HOUSING	YEARS	PART NO.	DESCRIPTION	
1	Thermostat Gasket	2013-08	35934	Thermostat case	
QTY	WATER OUTLET GASKET	YEARS	PART NO.	DESCRIPTION	
1	Water Outlet Gasket	2013-08	35489	Thermostat seal	
QTY	WATER PUMP	YEARS	PART NO.	DESCRIPTION	
1	Water Pump Gasket	2013-08	35930	Loc. Outer	
1	Water Pump Gasket	2013-08	35932	Loc. Inner	
1	Water Pump Gasket	2013-08	35995	Loc. Outer; New Part Number - Check for Availability	
1	Water Pump Gasket	2013-08	35996	Loc. Inner; New Part Number - Check for Availability	
QTY	TIMING COVER	YEARS	PART NO.	DESCRIPTION	
1	Crankshaft Front Seal Set	2013-08	TCS 46117		

Mazda Truck (Incl. Minivans and SUV's) (Cont.)

24 (cont.)	2013 - 2008; 3.7L 227 (3721cc) DOHC V6 (24 Valve) 95.5mm Bore Duratec Cyclone				24 (cont.)
25	2000 - 1994; 4.0L 244 (4015cc) OHV V6 (12 Valve) 100.4mm Bore				25
MFI; Gasoline; Naturally Aspirated Ford Eng.; Eng. Code MZI					
QTY	CARB & FUEL INJECTION	YEARS	PART NO.	DESCRIPTION	
2	Fuel Injector O-Ring Set	2013-08	ES 70599	Upper set; Injectors to fuel rail; Improved design	
1	Throttle Body Gasket	2013-08	61466		
MFI; Gasoline; Naturally Aspirated Ford Eng.; VIN Code X, Eng. Code 8X					
QTY	CYLINDER HEAD	YEARS	PART NO.	DESCRIPTION	
1	Head Gasket	2000-94	544 SD	Loc. L.H.; Head bolts not incl.; Head bolt replacement recommended; PermaTorque Severe Duty®	
1	Head Gasket	2000-94	545 SD	Loc. R.H.; Head bolts not incl.; Head bolt replacement recommended; PermaTorque Severe Duty®	
1	Head Gasket	2000-94	9724 PT-2	Loc. L.H.; Head bolts not incl.; Head bolt replacement recommended; PermaTorque®; Improved design	
1	Head Gasket	2000-94	9725 PT-2	Loc. R.H.; Head bolts not incl.; Head bolt replacement recommended; PermaTorque®; Improved design	
1	Head Set	2000-97	HS 9081 PT-1	Head bolts not incl.; Head bolt replacement recommended; PermaDryPlus® int. manifold gsks. incl.; Premium valve stem seals incl.	
1	Head Set	2000-97	HST 9081 PT-1	Head bolts not incl.; Head bolt replacement recommended; PermaTorque Severe Duty® head gsks. incl.; PermaDryPlus® int. manifold gsks. incl.; PermaDryPlus® molded rubber valve cover gsks. incl.; Premium valve stem seals incl.	
1	Head Set	1996-95	HS 9081 PT	Upper int. manifold gsks. & head bolts not incl.; Head bolt replacement recommended; PermaDryPlus® int. manifold gsks. incl.; Premium valve stem seals incl.	
1	Head Set	1994	HS 9724 PT-1	Head bolts not incl.; Head bolt replacement recommended; Premium valve stem seals incl.	
1	Head Installation Set	1996	HIS 9081 PT	Upper int. manifold gsks. & head bolts not incl.; Head bolt replacement recommended; PermaDryPlus® int. manifold gsks. incl.	
1	Head Installation Set	1995	HIS 9081 PT	Head bolts not incl.; Head bolt replacement recommended; PermaDryPlus® int. manifold gsks. incl.	
1	Head Installation Set	1994	HIS 9724 PT-1	Head bolts not incl.; Head bolt replacement recommended	
1	Head Bolt Set	2000-94	ES 72794	Replacement recommended	
QTY	CONVERSION SET	YEARS	PART NO.	DESCRIPTION	
1	Gasket Conversion Set	2000-95	CS 9724-1	PermaDry® molded rubber oil pan gskt. incl.	
1	Gasket Conversion Set	1994	CS 9724-1	Rear main brg. seal not incl.; PermaDry® molded rubber oil pan gskt. incl.	
QTY	MANIFOLD - INT. & EXH.	YEARS	PART NO.	DESCRIPTION	
1	Int. Manifold Gasket Set	2000-97	MS 90728	Lower set; Must be used w/VS 50368C or w/VS 50368T	
1	Int. Manifold Gasket Set	2000-98	MS 98006 T	Valve cover gsks. & Upper set incl.; PermaDryPlus® int. manifold gsks. incl.	
1	Int. Manifold Gasket Set	1997-94	MS 98005 T	Valve cover gsks. & Upper set incl.; PermaDryPlus® int. manifold gsks. incl.	
1	Int. Manifold Gasket Set	1996	MS 95739	Lower set; Must be used w/VS 50368C or w/VS 50368T	
1	Int. Manifold Gasket Set	1995	MS 94682-1	Lower set; Upper set incl.; Must be used w/VS 50368C or w/VS 50368T	
1	Int. Manifold Gasket Set	1994	MS 94682	Lower set; Upper set incl.; Must be used w/VS 50368C or w/VS 50368T	
1	Plenum Gasket Set	2000-98	MS 90732	Upper set	
1	Plenum Gasket Set	1997-96	MS 90733	Upper set	
1	Plenum Gasket Set	1995-94	MS 94683	Upper set	
1	Exh. Manifold Gasket Set	2000-97	MS 95960		
1	Exh. Manifold Gasket Set	1996-94	MS 94764		
QTY	EXHAUST PIPE FLANGE	YEARS	PART NO.	DESCRIPTION	
1	Exhaust Pipe Gasket	2000-94	60641	Converter to muffler	
1	Exhaust Pipe Gasket	1994	60796	Inlet pipe to converter	
QTY	OIL PAN	YEARS	PART NO.	DESCRIPTION	
1	Oil Pan Gasket Set	2000-94	OS 34309 R	PermaDry® molded rubber gskt. incl.	
1	Drain Plug Gasket	2000-94	72515		
QTY	CRANKSHAFT REAR SEAL	YEARS	PART NO.	DESCRIPTION	
1	Rear Main Seal Set	2000-94	BS 40647	PTFE Rubber; One-piece	
1	Rear Main Seal Set	2000-95	BS 40619	Wear sleeve incl.; Rubber; One-piece	
1	Rear Main Seal Set	1994	BS 40419	Rubber; One-piece	
QTY	VALVE COVER	YEARS	PART NO.	DESCRIPTION	
1	Valve Cover Gasket Set	2000-96	VS 50368 C	Int. manifold upper set not incl.; Cork	
1	Valve Cover Gasket Set	2000-96	VS 50368 T	Int. manifold upper set not incl.; PermaDryPlus®	
1	Valve Cover Gasket Set	1995-94	VS 50368 C	Int. manifold upper set incl.; Cork	
1	Valve Cover Gasket Set	1995-94	VS 50368 T	Int. manifold upper set incl.; PermaDryPlus®	
QTY	VALVE STEM SEAL SET	YEARS	PART NO.	DESCRIPTION	
1	Valve Stem Seal Set	2000-94	SS 72686	Premium valve stem seals incl.	

Mazda Truck (Incl. Minivans and SUV's) (Cont.)

25 (cont.)		2000 - 1994; 4.0L 244 (4015cc) OHV V6 (12 Valve) 100.4mm Bore			25 (cont.)
MFI; Gasoline; Naturally Aspirated Ford Eng.; VIN Code X, Eng. Code 8X					
QTY	WATER OUTLET GASKET	YEARS	PART NO.	DESCRIPTION	
1	Water Outlet Gasket	2000-94	35404	Water Outlet	
QTY	WATER PUMP	YEARS	PART NO.	DESCRIPTION	
1	Water Pump Gasket	2000-94	35474		
QTY	TIMING COVER	YEARS	PART NO.	DESCRIPTION	
1	Timing Cover Set	2000-94	TCS 45867	w/o Sleeve 'N' Seal®; Must be used w/OS 34309R	
1	Timing Set w/Sleeve & Seal	2000-94	TCS 45291	w/Sleeve 'N' Seal®; Must be used w/OS 34309R	
QTY	CARB & FUEL INJECTION	YEARS	PART NO.	DESCRIPTION	
3	Fuel Injector O-Ring Set	2000-94	ES 70599	Improved design	
1	Throttle Body Gasket	2000-94	71216	Air bypass valve	
1	Throttle Body Gasket	2000-95	61055	O-ring	
1	Throttle Body Gasket	1995-94	60886	Gskt.	
QTY	EXHAUST GAS RECIRCULATION	YEARS	PART NO.	DESCRIPTION	
1	EGR Gasket	2000-94	70149		
2	EGR Gasket	1997-95	72266	Tube seal	
QTY	OIL FILTER MOUNTING	YEARS	PART NO.	DESCRIPTION	
1	Oil Filter Adapter Gasket	2000-94	72884	.141" width; 2.482" ID	
26		1993 - 1991; 4.0L 244 (4015cc) OHV V6 (12 Valve) 100.4mm Bore			26
MFI; Gasoline; Naturally Aspirated Ford Eng.; VIN Code X, Eng. Code ZZL					
QTY	CYLINDER HEAD	YEARS	PART NO.	DESCRIPTION	
1	Head Gasket	1993-91	544 SD	Loc. L.H.; Head bolts not incl.; Head bolt replacement recommended; PermaTorque Severe Duty®	
1	Head Gasket	1993-91	545 SD	Loc. R.H.; Head bolts not incl.; Head bolt replacement recommended; PermaTorque Severe Duty®	
1	Head Gasket	1993-91	9724 PT-2	Loc. L.H.; Head bolts not incl.; Head bolt replacement recommended; PermaTorque®; Improved design	
1	Head Gasket	1993-91	9725 PT-2	Loc. R.H.; Head bolts not incl.; Head bolt replacement recommended; PermaTorque®; Improved design	
1	Head Set	1993-91	HS 9724 PT-1	Head bolts not incl.; Head bolt replacement recommended; Premium valve stem seals incl.	
1	Head Installation Set	1993-91	HIS 9724 PT-1	Head bolts not incl.; Head bolt replacement recommended	
1	Head Bolt Set	1993-91	ES 72794	Replacement recommended	
QTY	CONVERSION SET	YEARS	PART NO.	DESCRIPTION	
1	Gasket Conversion Set	1993-91	CS 9724	PermaDry® molded rubber oil pan gskt. incl.	
QTY	MANIFOLD - INT. & EXH.	YEARS	PART NO.	DESCRIPTION	
1	Int. Manifold Gasket Set	1993-91	MS 94682	Lower set; Upper set incl.; Must be used w/VS 50368C or w/VS 50368T	
1	Int. Manifold Gasket Set	1993-91	MS 98005 T	Valve cover gskts. & Upper set incl.; PermaDryPlus® int. manifold gskts. incl.	
1	Plenum Gasket Set	1993-91	MS 94683	Upper set	
1	Exh. Manifold Gasket Set	1993-91	MS 94764		
QTY	EXHAUST PIPE FLANGE	YEARS	PART NO.	DESCRIPTION	
1	Exhaust Pipe Gasket	1993-91	60641	Converter to muffler	
1	Exhaust Pipe Gasket	1993-91	60796	Inlet pipe to converter	
QTY	OIL PAN	YEARS	PART NO.	DESCRIPTION	
1	Oil Pan Gasket Set	1993-91	OS 30634 R	PermaDry® molded rubber gskt. incl.	
1	Drain Plug Gasket	1993-91	72515		
QTY	CRANKSHAFT REAR SEAL	YEARS	PART NO.	DESCRIPTION	
1	Rear Main Seal Set	1993-91	BS 40419	Rubber; One-piece	
1	Rear Main Seal Set	1993-91	BS 40647	PTFE Rubber; One-piece	
QTY	VALVE COVER	YEARS	PART NO.	DESCRIPTION	
1	Valve Cover Gasket Set	1993-91	VS 50368 C	Int. manifold upper set incl.; Cork	
1	Valve Cover Gasket Set	1993-91	VS 50368 T	Int. manifold upper set incl.; PermaDryPlus®	
QTY	VALVE STEM SEAL SET	YEARS	PART NO.	DESCRIPTION	
1	Valve Stem Seal Set	1993-91	SS 72686	Premium valve stem seals incl.	
QTY	WATER OUTLET GASKET	YEARS	PART NO.	DESCRIPTION	
1	Water Outlet Gasket	1993-91	35404	Water Outlet	
QTY	WATER PUMP	YEARS	PART NO.	DESCRIPTION	
1	Water Pump Gasket	1993-91	35474		
QTY	TIMING COVER	YEARS	PART NO.	DESCRIPTION	
1	Timing Cover Set	1993-91	TCS 45867	w/o Sleeve 'N' Seal®; Must be used w/OS 30634R	
1	Timing Set w/Sleeve & Seal	1993-91	TCS 45291	w/Sleeve 'N' Seal®; Must be used w/OS 30634R	
QTY	CARB & FUEL INJECTION	YEARS	PART NO.	DESCRIPTION	
3	Fuel Injector O-Ring Set	1993-91	ES 70599	Improved design	

Mazda Truck (Incl. Minivans and SUV's) (Cont.)

26 (cont.)		1993 - 1991; 4.0L 244 (4015cc) OHV V6 (12 Valve) 100.4mm Bore			26 (cont.)
MFI; Gasoline; Naturally Aspirated Ford Eng.; VIN Code X, Eng. Code ZZL					
QTY	CARB & FUEL INJECTION	YEARS	PART NO.	DESCRIPTION	
1	Throttle Body Gasket	1993-91	60886	Gskt.	
1	Throttle Body Gasket	1993-91	71216	Air bypass valve	
QTY	EXHAUST GAS RECIRCULATION	YEARS	PART NO.	DESCRIPTION	
1	EGR Gasket	1993	70149		
QTY	OIL FILTER MOUNTING	YEARS	PART NO.	DESCRIPTION	
1	Oil Filter Adapter Gasket	1993-91	72884	.141" width; 2.482" ID	
27		2010 - 2001; 4.0L 244 (4015cc) SOHC V6 (12 Valve) 100.4mm Bore			27
MFI; Gasoline; Naturally Aspirated Ford Eng.; VIN Code E					
QTY	CYLINDER HEAD	YEARS	PART NO.	DESCRIPTION	
1	Head Gasket	2010-01	26300 PT	Loc. L.H.; Head bolts not incl.; Head bolt replacement required; PermaTorqueMLS® LaserWeld® Technology; Improved design	
1	Head Gasket	2010-01	26301 PT	Loc. R.H.; Head bolts not incl.; Head bolt replacement required; PermaTorqueMLS® LaserWeld® Technology; Improved design	
1	Head Set	2010-04	HS 26300 PT	Head bolts not incl.; Head bolt replacement required; PermaDry® molded rubber valve cover gskts. incl.; Premium valve stem seals incl.	
1	Head Set	2003-01	HS 9293 PT-2	Head bolts not incl.; Head bolt replacement required; PermaDry® molded rubber valve cover gskts. incl.; Premium valve stem seals incl.	
2	Head Bolt Set	2010-01	ES 72171	Replacement required	
QTY	CONVERSION SET	YEARS	PART NO.	DESCRIPTION	
1	Gasket Conversion Set	2010-05	CS 9293-1	PermaDry® molded rubber oil pan gskt. incl.	
1	Gasket Conversion Set	2004	CS 9293	To 02/28/04; PermaDry® molded rubber oil pan gskt. incl.	
1	Gasket Conversion Set	2004	CS 9293-1	From 03/01/04; PermaDry® molded rubber oil pan gskt. incl.	
1	Gasket Conversion Set	2003-01	CS 9293	PermaDry® molded rubber oil pan gskt. incl.	
QTY	MANIFOLD - INT. & EXH.	YEARS	PART NO.	DESCRIPTION	
1	Int. Manifold Gasket Set	2010-01	MS 96123	Lower set	
1	Exh. Manifold Gasket Set	2010-01	MS 90779		
QTY	EXHAUST PIPE FLANGE	YEARS	PART NO.	DESCRIPTION	
1	Exhaust Pipe Gasket	2010-01	60641	Loc. Rear; Converter	
1	Exhaust Pipe Gasket	2010-01	61407	Loc. Front; Converter	
QTY	OIL PAN	YEARS	PART NO.	DESCRIPTION	
1	Oil Pan Gasket Set	2010-01	OS 30687 R	Loc. Lower; PermaDry® molded rubber gskt. incl.	
1	Oil Pan Gasket Set	2010-01	OS 34309 R	Loc. Upper; PermaDry® molded rubber gskt. incl.	
QTY	CRANKSHAFT REAR SEAL	YEARS	PART NO.	DESCRIPTION	
1	Rear Main Seal Set	2010-01	BS 40619	Wear sleeve incl.; Rubber; One-piece	
1	Rear Main Seal Set	2010-01	BS 40647	PTFE Rubber; One-piece	
QTY	VALVE COVER	YEARS	PART NO.	DESCRIPTION	
1	Valve Cover Gasket Set	2010-01	VS 50529 R	w/Grommets; PermaDry® molded rubber gskts. incl.	
QTY	VALVE STEM SEAL SET	YEARS	PART NO.	DESCRIPTION	
1	Valve Stem Seal Set	2010-01	SS 70858	Premium valve stem seals incl.	
QTY	THERMOSTAT HOUSING	YEARS	PART NO.	DESCRIPTION	
1	Thermostat Gasket	2010-02	35673	Thermostat Housing; Thermostat housing to manifold	
1	Thermostat Gasket	2001	35673	Thermostat Housing; From 07/24/00; Thermostat housing to manifold	
1	O-Ring	2010-01	35617	Thermostat Housing	
QTY	WATER PUMP	YEARS	PART NO.	DESCRIPTION	
1	Water Pump Gasket	2010-01	35474		
QTY	TIMING COVER	YEARS	PART NO.	DESCRIPTION	
1	Timing Cover Set	2010-05	TCS 46061		
1	Timing Cover Set	2004	TCS 45986	To 02/28/04	
1	Timing Cover Set	2004	TCS 46061	From 03/01/04	
1	Timing Cover Set	2003-01	TCS 45986		
QTY	CARB & FUEL INJECTION	YEARS	PART NO.	DESCRIPTION	
3	Fuel Injector O-Ring Set	2010-01	ES 70599	Improved design	
1	Throttle Body Gasket	2010-01	72302	Air bypass valve	
1	Throttle Body Gasket	2010-02	61208	Mounting	
1	Throttle Body Gasket	2010-02	61347	Throttle body to spacer; Gskt.	
1	Throttle Body Gasket	2001	61056	Spacer to manifold; O-ring	
1	Throttle Body Gasket	2001	61057	Throttle body to spacer; Gskt.	
QTY	EXHAUST GAS RECIRCULATION	YEARS	PART NO.	DESCRIPTION	
1	EGR Gasket	2010-01	70149	Valve	
1	EGR Gasket	2010-01	71202	Tube seal	
QTY	OIL COOLER	YEARS	PART NO.	DESCRIPTION	
1	Oil Cooler Gasket	2010-01	72796	Oil cooler O-ring; New Part Number - Check for Availability	

Mercedes-Benz Car (Incl. Maybach, Mercedes-Benz, Smart)

Engine Finding Index

Engine	Years	Code	Line No.
1.8L 109.5 (1796cc) DOHC L4 (16 Valve) 82mm Bore; MFI; Gasoline; Supercharged Mercedes-Benz Eng.	2005-03	111.983	1
2.2L 134.1 (2199cc) DOHC L4 (16 Valve) 89.9mm Bore; MFI; Gasoline; Naturally Aspirated Mercedes-Benz Eng.	1996-94	111.961	2
2.3L 140 (2295cc) DOHC L4 (16 Valve) 90.9mm Bore; MFI; Gasoline; Supercharged Mercedes-Benz Eng.	2004-98	111.973	3
2.3L 140 (2295cc) DOHC L4 (16 Valve) 90.9mm Bore; MFI; Gasoline; Naturally Aspirated Mercedes-Benz Eng.	1998-97	111.974	4
2.3L 140 (2295cc) DOHC L4 (16 Valve) 90.9mm Bore; MFI; Gasoline; Supercharged Mercedes-Benz Eng.	2002-99	111.975	5
2.3L 140 (2295cc) DOHC L4 (16 Valve) 90.9mm Bore; MFI; Gasoline; Supercharged Mercedes-Benz Eng.	2005-02	111.983	6
2.3L 140.2 (2299cc) SOHC L4 (8 Valve) 95.5mm Bore; MFI; Gasoline; Naturally Aspirated Mercedes-Benz Eng.	1993-91	102.985	7
2.6L 158.4 (2597cc) SOHC V6 (18 Valve) 89.9mm Bore; MFI; Gasoline; Naturally Aspirated Mercedes-Benz Eng.	2005-01	112.912	8
2.6L 158.4 (2597cc) SOHC V6 (18 Valve) 89.9mm Bore; MFI; Gasoline; Naturally Aspirated Mercedes-Benz Eng.	2005-03	112.916	9
2.6L 158.5 (2599cc) SOHC L6 (12 Valve) 82.9mm Bore; MFI; Gasoline; Naturally Aspirated Mercedes-Benz Eng.	1992-91	103.940	10
2.6L 158.5 (2599cc) SOHC L6 (12 Valve) 82.9mm Bore; MFI; Gasoline; Naturally Aspirated Mercedes-Benz Eng.	1993-91	103.942	11
2.8L 170.7 (2799cc) DOHC L6 (24 Valve) 89.9mm Bore; MFI; Gasoline; Naturally Aspirated Mercedes-Benz Eng.	1995-94	104.941	12
2.8L 170.7 (2799cc) DOHC L6 (24 Valve) 89.9mm Bore; MFI; Gasoline; Naturally Aspirated Mercedes-Benz Eng.	1993	104.942	13
2.8L 170.7 (2799cc) DOHC L6 (24 Valve) 89.9mm Bore; MFI; Gasoline; Naturally Aspirated Mercedes-Benz Eng.	1997-96	104.961	14
2.8L 170.7 (2799cc) SOHC V6 (18 Valve) 89.9mm Bore; MFI; Gasoline; Naturally Aspirated Mercedes-Benz Eng.	2000-98	112.920	15
3.0L 180.6 (2962cc) SOHC L6 (12 Valve) 88.5mm Bore; MFI; Gasoline; Naturally Aspirated Mercedes-Benz Eng.	1991	103.981	16
3.0L 180.6 (2962cc) SOHC L6 (12 Valve) 88.5mm Bore; MFI; Gasoline; Naturally Aspirated Mercedes-Benz Eng.	1993-91	103.983	17
3.0L 180.6 (2962cc) SOHC L6 (12 Valve) 88.5mm Bore; MFI; Gasoline; Naturally Aspirated Mercedes-Benz Eng.	1993-91	103.985	18
3.0L 182.8 (2996cc) DOHC L6 (24 Valve) 87mm Bore; MFI; Diesel; Naturally Aspirated Mercedes-Benz Eng.	1997-94	606.912	19
3.0L 182.8 (2996cc) DOHC Turbo - Intercooled L6 (24 Valve) 87mm Bore; MFI; Diesel; Turbo - Intercooled Mercedes-Benz Eng.	1999-98	606.962	20
3.0L 182.8 (2996cc) DOHC V6 (24 Valve) 88mm Bore; MFI; Gasoline; Naturally Aspirated Mercedes-Benz Eng.	2013-06	272.940	21
3.0L 182.8 (2996cc) DOHC V6 (24 Valve) 88mm Bore; MFI; Gasoline; Naturally Aspirated Mercedes-Benz Eng.	2013-06	272.941	22
3.0L 182.8 (2996cc) DOHC V6 (24 Valve) 88mm Bore; MFI; Gasoline; Naturally Aspirated Mercedes-Benz Eng.	2011-06	272.942	23
3.2L 195.1 (3199cc) SOHC V6 (18 Valve) 89.9mm Bore; MFI; Gasoline; Naturally Aspirated Mercedes-Benz Eng.	2005-98	112.940	24
3.2L 195.1 (3199cc) SOHC V6 (18 Valve) 89.9mm Bore; MFI; Gasoline; Naturally Aspirated Mercedes-Benz Eng.	2005-98	112.941	25
3.2L 195.1 (3199cc) SOHC V6 (18 Valve) 89.9mm Bore; MFI; Flex Fuel; Naturally Aspirated Mercedes-Benz Eng.	2005-04	112.946	26
3.2L 195.1 (3199cc) SOHC V6 (18 Valve) 89.9mm Bore; MFI; Gasoline; Naturally Aspirated Mercedes-Benz Eng.	2005-01	112.946	27
3.2L 195.1 (3199cc) SOHC V6 (18 Valve) 89.9mm Bore; MFI; Gasoline; Naturally Aspirated Mercedes-Benz Eng.	2004-01	112.947	28
3.2L 195.1 (3199cc) SOHC V6 (18 Valve) 89.9mm Bore; MFI; Gasoline; Naturally Aspirated Mercedes-Benz Eng.	2005-03	112.953	29
3.2L 195.1 (3199cc) SOHC V6 (18 Valve) 89.9mm Bore; MFI; Gasoline; Naturally Aspirated Mercedes-Benz Eng.	2005-04	112.955	30
3.2L 195.1 (3199cc) SOHC V6 (18 Valve) 89.9mm Bore; MFI; Gasoline; Supercharged Mercedes-Benz Eng.	2004-02	112.960	31
3.2L 195.2 (3199cc) DOHC L6 (24 Valve) 89.9mm Bore; MFI; Gasoline; Naturally Aspirated Mercedes-Benz Eng.	1993-92	104.990	32
3.2L 195.2 (3199cc) DOHC L6 (24 Valve) 89.9mm Bore; MFI; Gasoline; Naturally Aspirated Mercedes-Benz Eng.	1997-94	104.991	33
3.2L 195.2 (3199cc) DOHC L6 (24 Valve) 89.9mm Bore; MFI; Gasoline; Naturally Aspirated Mercedes-Benz Eng.	1995-93	104.992	34
3.2L 195.2 (3199cc) DOHC L6 (24 Valve) 89.9mm Bore; MFI; Gasoline; Naturally Aspirated Mercedes-Benz Eng.	1999-96	104.994	35
3.2L 195.2 (3199cc) DOHC L6 (24 Valve) 89.9mm Bore; MFI; Gasoline; Naturally Aspirated Mercedes-Benz Eng.	1997-96	104.995	36
3.2L 197 (3222cc) DOHC Turbo - Intercooled L6 (24 Valve) 88mm Bore; DI; Diesel; Turbo - Intercooled Mercedes-Benz Eng.	2006-05	648.961	37
3.5L 213.4 (3498cc) DOHC V6 (24 Valve) 92.9mm Bore; MFI; Gasoline; Naturally Aspirated Mercedes-Benz Eng.	2013-06	272.056	38
3.5L 213.4 (3498cc) DOHC V6 (24 Valve) 92.9mm Bore; MFI; Gasoline; Naturally Aspirated Mercedes-Benz Eng.	2013-06	272.087	39
3.5L 213.4 (3498cc) DOHC V6 (24 Valve) 92.9mm Bore; MFI; Gasoline; Naturally Aspirated Mercedes-Benz Eng.	2009-06	272.960	40
3.5L 213.4 (3498cc) DOHC V6 (24 Valve) 92.9mm Bore; MFI; Gasoline; Naturally Aspirated Mercedes-Benz Eng.	2013-10	272.961	41
3.5L 213.4 (3498cc) DOHC V6 (24 Valve) 92.9mm Bore; MFI; Gasoline; Naturally Aspirated Mercedes-Benz Eng.	2009-05	272.963	42
3.5L 213.4 (3498cc) DOHC V6 (24 Valve) 92.9mm Bore; MFI; Gasoline; Naturally Aspirated Mercedes-Benz Eng.	2009-06	272.964	43
3.5L 213.4 (3498cc) DOHC V6 (24 Valve) 92.9mm Bore; MFI; Gasoline; Naturally Aspirated Mercedes-Benz Eng.	2011-09	272.969	44
3.5L 213.4 (3498cc) DOHC V6 (24 Valve) 92.9mm Bore; MFI; Gasoline; Naturally Aspirated Mercedes-Benz Eng.	2009-06	272.972	45
3.5L 213.4 (3498cc) DOHC V6 (24 Valve) 92.9mm Bore; MFI; Hybrid (Gas/Electric); Naturally Aspirated Mercedes-Benz Eng.	2013-10	272.974	46
3.5L 213.4 (3498cc) DOHC V6 (24 Valve) 92.9mm Bore; MFI; Gasoline; Naturally Aspirated Mercedes-Benz Eng.	2013-10	272.977	47
3.5L 213.4 (3498cc) DOHC V6 (24 Valve) 92.9mm Bore; MFI; Gasoline; Naturally Aspirated Mercedes-Benz Eng.	2013-10	272.980	48
4.2L 256.1 (4196cc) DOHC V8 (32 Valve) 92mm Bore; MFI; Gasoline; Naturally Aspirated Mercedes-Benz Eng.	1995-92	119.971	49
4.2L 256.1 (4196cc) DOHC V8 (32 Valve) 92mm Bore; MFI; Gasoline; Naturally Aspirated Mercedes-Benz Eng.	1998-92	119.975	50
4.2L 256.1 (4196cc) DOHC V8 (32 Valve) 92mm Bore; MFI; Gasoline; Naturally Aspirated Mercedes-Benz Eng.	1999-96	119.981	51
4.2L 256.1 (4196cc) SOHC V8 (16 Valve) 92mm Bore; MFI; Gasoline; Naturally Aspirated Mercedes-Benz Eng.	1991	116.965	52
4.3L 260 (4266cc) SOHC V8 (24 Valve) 89.9mm Bore; MFI; Gasoline; Naturally Aspirated Mercedes-Benz Eng.	2002-98	113.940	53
4.3L 260 (4266cc) SOHC V8 (24 Valve) 89.9mm Bore; MFI; Gasoline; Naturally Aspirated Mercedes-Benz Eng.	2006-00	113.941	54
4.3L 260 (4266cc) SOHC V8 (24 Valve) 89.9mm Bore; MFI; Gasoline; Naturally Aspirated Mercedes-Benz Eng.	2003-99	113.943	55
4.3L 260 (4266cc) SOHC V8 (24 Valve) 89.9mm Bore; MFI; Gasoline; Naturally Aspirated Mercedes-Benz Eng.	2000-98	113.944	56
4.3L 260 (4266cc) SOHC V8 (24 Valve) 89.9mm Bore; MFI; Gasoline; Naturally Aspirated Mercedes-Benz Eng.	2006-03	113.948	57
5.0L 303 (4966cc) SOHC V8 (24 Valve) 96.8mm Bore; MFI; Gasoline; Naturally Aspirated Mercedes-Benz Eng.	2006-00	113.960	58
5.0L 303 (4966cc) SOHC V8 (24 Valve) 96.8mm Bore; MFI; Gasoline; Naturally Aspirated Mercedes-Benz Eng.	2006-99	113.961	59
5.0L 303 (4966cc) SOHC V8 (24 Valve) 96.8mm Bore; MFI; Gasoline; Naturally Aspirated Mercedes-Benz Eng.	2006-03	113.966	60
5.0L 303 (4966cc) SOHC V8 (24 Valve) 96.8mm Bore; MFI; Gasoline; Naturally Aspirated Mercedes-Benz Eng.	2006-04	113.969	61
5.0L 303.5 (4973cc) DOHC V8 (32 Valve) 96.5mm Bore; MFI; Gasoline; Naturally Aspirated Mercedes-Benz Eng.	1992-91	119.960	62
5.0L 303.5 (4973cc) DOHC V8 (32 Valve) 96.5mm Bore; MFI; Gasoline; Naturally Aspirated Mercedes-Benz Eng.	1995-92	119.970	63
5.0L 303.5 (4973cc) DOHC V8 (32 Valve) 96.5mm Bore; MFI; Gasoline; Naturally Aspirated Mercedes-Benz Eng.	1995-93	119.972	64

Mercedes-Benz Car (Incl. Maybach, Mercedes-Benz, Smart) (Cont.)

Engine Finding Index (Cont.)			
<i>Engine</i>	<i>Years</i>	<i>Code</i>	<i>Line No.</i>
5.0L 303.5 (4973cc) DOHC V8 (32 Valve) 96.5mm Bore; MFI; Gasoline; Naturally Aspirated Mercedes-Benz Eng.	1994-93	119.974	65
5.0L 303.5 (4973cc) DOHC V8 (32 Valve) 96.5mm Bore; MFI; Gasoline; Naturally Aspirated Mercedes-Benz Eng.	1999-96	119.980	66
5.0L 303.5 (4973cc) DOHC V8 (32 Valve) 96.5mm Bore; MFI; Gasoline; Naturally Aspirated Mercedes-Benz Eng.	1998-96	119.982	67
5.4L 329.5 (5439cc) SOHC V8 (24 Valve) 96.5mm Bore; MFI; Gasoline; Naturally Aspirated Mercedes-Benz Eng.	2003-99	113.980	68
5.4L 329.5 (5439cc) SOHC V8 (24 Valve) 96.5mm Bore; MFI; Gasoline; Supercharged Mercedes-Benz Eng.	2007-03	113.980	69
5.4L 329.5 (5439cc) SOHC V8 (24 Valve) 96.5mm Bore; MFI; Gasoline; Naturally Aspirated Mercedes-Benz Eng.	2010-01	113.982	70
5.4L 329.5 (5439cc) SOHC V8 (24 Valve) 96.5mm Bore; MFI; Gasoline; Supercharged Mercedes-Benz Eng.	2007-03	113.982	71
5.4L 329.5 (5439cc) SOHC V8 (24 Valve) 96.5mm Bore; MFI; Gasoline; Naturally Aspirated Mercedes-Benz Eng.	2007-01	113.984	72
5.4L 329.5 (5439cc) SOHC V8 (24 Valve) 96.5mm Bore; MFI; Gasoline; Supercharged Mercedes-Benz Eng.	2006-03	113.987	73
5.4L 329.5 (5439cc) SOHC V8 (24 Valve) 96.5mm Bore; MFI; Gasoline; Naturally Aspirated Mercedes-Benz Eng.	2006-05	113.988	74
5.4L 329.5 (5439cc) SOHC V8 (24 Valve) 96.5mm Bore; MFI; Gasoline; Naturally Aspirated Mercedes-Benz Eng.	2010-05	113.989	75
5.4L 329.5 (5439cc) SOHC V8 (24 Valve) 96.5mm Bore; MFI; Gasoline; Supercharged Mercedes-Benz Eng.	2008-07	113.992	76
5.4L 329.5 (5439cc) SOHC V8 (24 Valve) 96.5mm Bore; MFI; Gasoline; Supercharged Mercedes-Benz Eng.	2009-03	155.980	77
5.5L 333.2 (5461cc) DOHC V8 (32 Valve) 98mm Bore; MFI; Gasoline; Naturally Aspirated Mercedes-Benz Eng.	2009-07	273.960	78
5.5L 333.2 (5461cc) DOHC V8 (32 Valve) 98mm Bore; MFI; Gasoline; Naturally Aspirated Mercedes-Benz Eng.	2011-07	273.961	79
5.5L 333.2 (5461cc) DOHC V8 (32 Valve) 98mm Bore; MFI; Gasoline; Naturally Aspirated Mercedes-Benz Eng.	2009-07	273.962	80
5.5L 333.2 (5461cc) DOHC V8 (32 Valve) 98mm Bore; MFI; Gasoline; Naturally Aspirated Mercedes-Benz Eng.	2012-07	273.965	81
5.5L 333.2 (5461cc) DOHC V8 (32 Valve) 98mm Bore; MFI; Gasoline; Naturally Aspirated Mercedes-Benz Eng.	2011-10	273.966	82
5.5L 333.2 (5461cc) DOHC V8 (32 Valve) 98mm Bore; MFI; Gasoline; Naturally Aspirated Mercedes-Benz Eng.	2011-07	273.967	83
5.5L 333.2 (5461cc) DOHC V8 (32 Valve) 98mm Bore; MFI; Gasoline; Naturally Aspirated Mercedes-Benz Eng.	2011-10	273.970	84
5.5L 333.2 (5461cc) DOHC V8 (32 Valve) 98mm Bore; MFI; Gasoline; Naturally Aspirated Mercedes-Benz Eng.	2011-10	273.971	85
5.6L 338 (5547cc) SOHC V8 (16 Valve) 96.5mm Bore; MFI; Gasoline; Naturally Aspirated Mercedes-Benz Eng.	1991	117.968	86
Engine Code Index			
<i>Code</i>	<i>Engine</i>		<i>Line No.</i>
102.985	2.3L 140.2 (2299cc) SOHC L4 (8 Valve) 95.5mm Bore; MFI; Gasoline; Naturally Aspirated Mercedes-Benz Eng.		7
103.940	2.6L 158.5 (2599cc) SOHC L6 (12 Valve) 82.9mm Bore; MFI; Gasoline; Naturally Aspirated Mercedes-Benz Eng.		10
103.942	2.6L 158.5 (2599cc) SOHC L6 (12 Valve) 82.9mm Bore; MFI; Gasoline; Naturally Aspirated Mercedes-Benz Eng.		11
103.981	3.0L 180.6 (2962cc) SOHC L6 (12 Valve) 88.5mm Bore; MFI; Gasoline; Naturally Aspirated Mercedes-Benz Eng.		16
103.983	3.0L 180.6 (2962cc) SOHC L6 (12 Valve) 88.5mm Bore; MFI; Gasoline; Naturally Aspirated Mercedes-Benz Eng.		17
103.985	3.0L 180.6 (2962cc) SOHC L6 (12 Valve) 88.5mm Bore; MFI; Gasoline; Naturally Aspirated Mercedes-Benz Eng.		18
104.941	2.8L 170.7 (2799cc) DOHC L6 (24 Valve) 89.9mm Bore; MFI; Gasoline; Naturally Aspirated Mercedes-Benz Eng.		12
104.942	2.8L 170.7 (2799cc) DOHC L6 (24 Valve) 89.9mm Bore; MFI; Gasoline; Naturally Aspirated Mercedes-Benz Eng.		13
104.961	2.8L 170.7 (2799cc) DOHC L6 (24 Valve) 89.9mm Bore; MFI; Gasoline; Naturally Aspirated Mercedes-Benz Eng.		14
104.990	3.2L 195.2 (3199cc) DOHC L6 (24 Valve) 89.9mm Bore; MFI; Gasoline; Naturally Aspirated Mercedes-Benz Eng.		32
104.991	3.2L 195.2 (3199cc) DOHC L6 (24 Valve) 89.9mm Bore; MFI; Gasoline; Naturally Aspirated Mercedes-Benz Eng.		33
104.992	3.2L 195.2 (3199cc) DOHC L6 (24 Valve) 89.9mm Bore; MFI; Gasoline; Naturally Aspirated Mercedes-Benz Eng.		34
104.994	3.2L 195.2 (3199cc) DOHC L6 (24 Valve) 89.9mm Bore; MFI; Gasoline; Naturally Aspirated Mercedes-Benz Eng.		35
104.995	3.2L 195.2 (3199cc) DOHC L6 (24 Valve) 89.9mm Bore; MFI; Gasoline; Naturally Aspirated Mercedes-Benz Eng.		36
111.961	2.2L 134.1 (2199cc) DOHC L4 (16 Valve) 89.9mm Bore; MFI; Gasoline; Naturally Aspirated Mercedes-Benz Eng.		2
111.973	2.3L 140 (2295cc) DOHC L4 (16 Valve) 90.9mm Bore; MFI; Gasoline; Supercharged Mercedes-Benz Eng.		3
111.974	2.3L 140 (2295cc) DOHC L4 (16 Valve) 90.9mm Bore; MFI; Gasoline; Naturally Aspirated Mercedes-Benz Eng.		4
111.975	2.3L 140 (2295cc) DOHC L4 (16 Valve) 90.9mm Bore; MFI; Gasoline; Supercharged Mercedes-Benz Eng.		5
111.983	1.8L 109.5 (1796cc) DOHC L4 (16 Valve) 82mm Bore; MFI; Gasoline; Supercharged Mercedes-Benz Eng.		1
111.983	2.3L 140 (2295cc) DOHC L4 (16 Valve) 90.9mm Bore; MFI; Gasoline; Supercharged Mercedes-Benz Eng.		6
112.912	2.6L 158.4 (2597cc) SOHC V6 (18 Valve) 89.9mm Bore; MFI; Gasoline; Naturally Aspirated Mercedes-Benz Eng.		8
112.916	2.6L 158.4 (2597cc) SOHC V6 (18 Valve) 89.9mm Bore; MFI; Gasoline; Naturally Aspirated Mercedes-Benz Eng.		9
112.920	2.8L 170.7 (2799cc) SOHC V6 (18 Valve) 89.9mm Bore; MFI; Gasoline; Naturally Aspirated Mercedes-Benz Eng.		15
112.940	3.2L 195.1 (3199cc) SOHC V6 (18 Valve) 89.9mm Bore; MFI; Gasoline; Naturally Aspirated Mercedes-Benz Eng.		24
112.941	3.2L 195.1 (3199cc) SOHC V6 (18 Valve) 89.9mm Bore; MFI; Gasoline; Naturally Aspirated Mercedes-Benz Eng.		25
112.946	3.2L 195.1 (3199cc) SOHC V6 (18 Valve) 89.9mm Bore; MFI; Flex Fuel; Naturally Aspirated Mercedes-Benz Eng.		26
112.946	3.2L 195.1 (3199cc) SOHC V6 (18 Valve) 89.9mm Bore; MFI; Gasoline; Naturally Aspirated Mercedes-Benz Eng.		27
112.947	3.2L 195.1 (3199cc) SOHC V6 (18 Valve) 89.9mm Bore; MFI; Gasoline; Naturally Aspirated Mercedes-Benz Eng.		28
112.953	3.2L 195.1 (3199cc) SOHC V6 (18 Valve) 89.9mm Bore; MFI; Gasoline; Naturally Aspirated Mercedes-Benz Eng.		29
112.955	3.2L 195.1 (3199cc) SOHC V6 (18 Valve) 89.9mm Bore; MFI; Gasoline; Naturally Aspirated Mercedes-Benz Eng.		30
112.960	3.2L 195.1 (3199cc) SOHC V6 (18 Valve) 89.9mm Bore; MFI; Gasoline; Supercharged Mercedes-Benz Eng.		31
113.940	4.3L 260 (4266cc) SOHC V8 (24 Valve) 89.9mm Bore; MFI; Gasoline; Naturally Aspirated Mercedes-Benz Eng.		53
113.941	4.3L 260 (4266cc) SOHC V8 (24 Valve) 89.9mm Bore; MFI; Gasoline; Naturally Aspirated Mercedes-Benz Eng.		54
113.943	4.3L 260 (4266cc) SOHC V8 (24 Valve) 89.9mm Bore; MFI; Gasoline; Naturally Aspirated Mercedes-Benz Eng.		55
113.944	4.3L 260 (4266cc) SOHC V8 (24 Valve) 89.9mm Bore; MFI; Gasoline; Naturally Aspirated Mercedes-Benz Eng.		56
113.948	4.3L 260 (4266cc) SOHC V8 (24 Valve) 89.9mm Bore; MFI; Gasoline; Naturally Aspirated Mercedes-Benz Eng.		57
113.960	5.0L 303 (4966cc) SOHC V8 (24 Valve) 96.8mm Bore; MFI; Gasoline; Naturally Aspirated Mercedes-Benz Eng.		58
113.961	5.0L 303 (4966cc) SOHC V8 (24 Valve) 96.8mm Bore; MFI; Gasoline; Naturally Aspirated Mercedes-Benz Eng.		59
113.966	5.0L 303 (4966cc) SOHC V8 (24 Valve) 96.8mm Bore; MFI; Gasoline; Naturally Aspirated Mercedes-Benz Eng.		60

Mercedes-Benz Car (Incl. Maybach, Mercedes-Benz, Smart) (Cont.)

Engine Code Index (Cont.)

Code	Engine	Line No.
113.969	5.0L 303 (4966cc) SOHC V8 (24 Valve) 96.8mm Bore; MFI; Gasoline; Naturally Aspirated Mercedes-Benz Eng.	61
113.980	5.4L 329.5 (5439cc) SOHC V8 (24 Valve) 96.5mm Bore; MFI; Gasoline; Naturally Aspirated Mercedes-Benz Eng.	68
113.980	5.4L 329.5 (5439cc) SOHC V8 (24 Valve) 96.5mm Bore; MFI; Gasoline; Supercharged Mercedes-Benz Eng.	69
113.982	5.4L 329.5 (5439cc) SOHC V8 (24 Valve) 96.5mm Bore; MFI; Gasoline; Naturally Aspirated Mercedes-Benz Eng.	70
113.982	5.4L 329.5 (5439cc) SOHC V8 (24 Valve) 96.5mm Bore; MFI; Gasoline; Supercharged Mercedes-Benz Eng.	71
113.984	5.4L 329.5 (5439cc) SOHC V8 (24 Valve) 96.5mm Bore; MFI; Gasoline; Naturally Aspirated Mercedes-Benz Eng.	72
113.987	5.4L 329.5 (5439cc) SOHC V8 (24 Valve) 96.5mm Bore; MFI; Gasoline; Supercharged Mercedes-Benz Eng.	73
113.988	5.4L 329.5 (5439cc) SOHC V8 (24 Valve) 96.5mm Bore; MFI; Gasoline; Naturally Aspirated Mercedes-Benz Eng.	74
113.989	5.4L 329.5 (5439cc) SOHC V8 (24 Valve) 96.5mm Bore; MFI; Gasoline; Naturally Aspirated Mercedes-Benz Eng.	75
113.992	5.4L 329.5 (5439cc) SOHC V8 (24 Valve) 96.5mm Bore; MFI; Gasoline; Supercharged Mercedes-Benz Eng.	76
116.965	4.2L 256.1 (4196cc) SOHC V8 (16 Valve) 92mm Bore; MFI; Gasoline; Naturally Aspirated Mercedes-Benz Eng.	52
117.968	5.6L 338 (5547cc) SOHC V8 (16 Valve) 96.5mm Bore; MFI; Gasoline; Naturally Aspirated Mercedes-Benz Eng.	86
119.960	5.0L 303.5 (4973cc) DOHC V8 (32 Valve) 96.5mm Bore; MFI; Gasoline; Naturally Aspirated Mercedes-Benz Eng.	62
119.970	5.0L 303.5 (4973cc) DOHC V8 (32 Valve) 96.5mm Bore; MFI; Gasoline; Naturally Aspirated Mercedes-Benz Eng.	63
119.971	4.2L 256.1 (4196cc) DOHC V8 (32 Valve) 92mm Bore; MFI; Gasoline; Naturally Aspirated Mercedes-Benz Eng.	49
119.972	5.0L 303.5 (4973cc) DOHC V8 (32 Valve) 96.5mm Bore; MFI; Gasoline; Naturally Aspirated Mercedes-Benz Eng.	64
119.974	5.0L 303.5 (4973cc) DOHC V8 (32 Valve) 96.5mm Bore; MFI; Gasoline; Naturally Aspirated Mercedes-Benz Eng.	65
119.975	4.2L 256.1 (4196cc) DOHC V8 (32 Valve) 92mm Bore; MFI; Gasoline; Naturally Aspirated Mercedes-Benz Eng.	50
119.980	5.0L 303.5 (4973cc) DOHC V8 (32 Valve) 96.5mm Bore; MFI; Gasoline; Naturally Aspirated Mercedes-Benz Eng.	66
119.981	4.2L 256.1 (4196cc) DOHC V8 (32 Valve) 92mm Bore; MFI; Gasoline; Naturally Aspirated Mercedes-Benz Eng.	51
119.982	5.0L 303.5 (4973cc) DOHC V8 (32 Valve) 96.5mm Bore; MFI; Gasoline; Naturally Aspirated Mercedes-Benz Eng.	67
155.980	5.4L 329.5 (5439cc) SOHC V8 (24 Valve) 96.5mm Bore; MFI; Gasoline; Supercharged Mercedes-Benz Eng.	77
272.056	3.5L 213.4 (3498cc) DOHC V6 (24 Valve) 92.9mm Bore; MFI; Gasoline; Naturally Aspirated Mercedes-Benz Eng.	38
272.087	3.5L 213.4 (3498cc) DOHC V6 (24 Valve) 92.9mm Bore; MFI; Gasoline; Naturally Aspirated Mercedes-Benz Eng.	39
272.940	3.0L 182.8 (2996cc) DOHC V6 (24 Valve) 88mm Bore; MFI; Gasoline; Naturally Aspirated Mercedes-Benz Eng.	21
272.941	3.0L 182.8 (2996cc) DOHC V6 (24 Valve) 88mm Bore; MFI; Gasoline; Naturally Aspirated Mercedes-Benz Eng.	22
272.942	3.0L 182.8 (2996cc) DOHC V6 (24 Valve) 88mm Bore; MFI; Gasoline; Naturally Aspirated Mercedes-Benz Eng.	23
272.960	3.5L 213.4 (3498cc) DOHC V6 (24 Valve) 92.9mm Bore; MFI; Gasoline; Naturally Aspirated Mercedes-Benz Eng.	40
272.961	3.5L 213.4 (3498cc) DOHC V6 (24 Valve) 92.9mm Bore; MFI; Gasoline; Naturally Aspirated Mercedes-Benz Eng.	41
272.963	3.5L 213.4 (3498cc) DOHC V6 (24 Valve) 92.9mm Bore; MFI; Gasoline; Naturally Aspirated Mercedes-Benz Eng.	42
272.964	3.5L 213.4 (3498cc) DOHC V6 (24 Valve) 92.9mm Bore; MFI; Gasoline; Naturally Aspirated Mercedes-Benz Eng.	43
272.969	3.5L 213.4 (3498cc) DOHC V6 (24 Valve) 92.9mm Bore; MFI; Gasoline; Naturally Aspirated Mercedes-Benz Eng.	44
272.972	3.5L 213.4 (3498cc) DOHC V6 (24 Valve) 92.9mm Bore; MFI; Gasoline; Naturally Aspirated Mercedes-Benz Eng.	45
272.974	3.5L 213.4 (3498cc) DOHC V6 (24 Valve) 92.9mm Bore; MFI; Hybrid (Gas/Electric); Naturally Aspirated Mercedes-Benz Eng.	46
272.977	3.5L 213.4 (3498cc) DOHC V6 (24 Valve) 92.9mm Bore; MFI; Gasoline; Naturally Aspirated Mercedes-Benz Eng.	47
272.980	3.5L 213.4 (3498cc) DOHC V6 (24 Valve) 92.9mm Bore; MFI; Gasoline; Naturally Aspirated Mercedes-Benz Eng.	48
273.960	5.5L 333.2 (5461cc) DOHC V8 (32 Valve) 98mm Bore; MFI; Gasoline; Naturally Aspirated Mercedes-Benz Eng.	78
273.961	5.5L 333.2 (5461cc) DOHC V8 (32 Valve) 98mm Bore; MFI; Gasoline; Naturally Aspirated Mercedes-Benz Eng.	79
273.962	5.5L 333.2 (5461cc) DOHC V8 (32 Valve) 98mm Bore; MFI; Gasoline; Naturally Aspirated Mercedes-Benz Eng.	80
273.965	5.5L 333.2 (5461cc) DOHC V8 (32 Valve) 98mm Bore; MFI; Gasoline; Naturally Aspirated Mercedes-Benz Eng.	81
273.966	5.5L 333.2 (5461cc) DOHC V8 (32 Valve) 98mm Bore; MFI; Gasoline; Naturally Aspirated Mercedes-Benz Eng.	82
273.967	5.5L 333.2 (5461cc) DOHC V8 (32 Valve) 98mm Bore; MFI; Gasoline; Naturally Aspirated Mercedes-Benz Eng.	83
273.970	5.5L 333.2 (5461cc) DOHC V8 (32 Valve) 98mm Bore; MFI; Gasoline; Naturally Aspirated Mercedes-Benz Eng.	84
273.971	5.5L 333.2 (5461cc) DOHC V8 (32 Valve) 98mm Bore; MFI; Gasoline; Naturally Aspirated Mercedes-Benz Eng.	85
606.912	3.0L 182.8 (2996cc) DOHC L6 (24 Valve) 87mm Bore; MFI; Diesel; Naturally Aspirated Mercedes-Benz Eng.	19
606.962	3.0L 182.8 (2996cc) DOHC Turbo - Intercooled L6 (24 Valve) 87mm Bore; MFI; Diesel; Turbo - Intercooled Mercedes-Benz Eng.	20
648.961	3.2L 197 (3222cc) DOHC Turbo - Intercooled L6 (24 Valve) 88mm Bore; DI; Diesel; Turbo - Intercooled Mercedes-Benz Eng.	37

Model Index

Engine (VIN Code / Eng. Code)	Year	Engine (VIN Code / Eng. Code)	Year	Engine (VIN Code / Eng. Code)	Year
Maybach		Mercedes-Benz (cont.)		Mercedes-Benz (cont.)	
57		190E (cont.)		280SE (cont.)	
V12 5513cc 5.5L SOHC Turbo (36 Valve) (285.950)	12-03	L4 2298cc 2.3L SOHC (8 Valve) (102.961)	84	V8 4520cc 4.5L SOHC (117.981)	73-72
V12 5980cc 6.0L SOHC Turbo (36 Valve) (275.980)	12-06	L4 2298cc 2.3L SOHC (8 Valve) (102.985)	93-91	V8 4520cc 4.5L SOHC (117.982)	73-72
		L4 2298cc 2.3L SOHC (8 Valve) (102.985)	88-85	V8 4520cc 4.5L SOHC (117.984)	73-72
		L6 2599cc 2.6L SOHC (12 Valve) (103.942)	93-87	V8 4520cc 4.5L SOHC (117.981)	73-72
				V8 4520cc 4.5L SOHC (117.982)	73-72
62		240D		300CD	
V12 5513cc 5.5L SOHC Turbo (36 Valve) (285.950)	12-03	L4 2404cc 2.4L SOHC Diesel (616.912)	83-77	V8 4520cc 4.5L SOHC (117.981)	73-72
V12 5980cc 6.0L SOHC Turbo (36 Valve) (275.980)	12-06	L4 2404cc 2.4L SOHC Diesel (616.916)	76-74	V8 4520cc 4.5L SOHC (117.982)	73-72
				V8 4520cc 4.5L SOHC (117.984)	73-72
		280		300CDT	
		L6 2746cc 2.7L DOHC (12 Valve) (110.921)	76-73	L5 3005cc 3.0L SOHC Diesel (617.912)	81-78
		L6 2746cc 2.7L DOHC (12 Valve) (110.921)	76-73	300CE	
		L6 2746cc 2.7L DOHC (12 Valve) (110.985)	81-78	L5 3005cc 3.0L SOHC Turbo-Diesel (617.952)	85-82
		L6 2746cc 2.7L DOHC (12 Valve) (110.984)	77	300CE	
		L6 2746cc 2.7L DOHC (12 Valve) (110.985)	81-78	L6 2962cc 3.0L DOHC (24 Valve) (104.980)	92-90
		L6 2746cc 2.7L DOHC (12 Valve) (110.922)	76-75	L6 3199cc 3.2L DOHC (24 Valve) (104.992)	93
		L6 2746cc 2.7L DOHC (12 Valve) (110.984)	81-78		
		L6 2746cc 2.7L DOHC (12 Valve) (110.985)	77		
Mercedes-Benz		190E			
L4 2298cc 2.3L DOHC (16 Valve) (102.983)	88-86				

Mercedes-Benz Car (Incl. Maybach, Mercedes-Benz, Smart) (Cont.)

Model Index (Cont.)					
Engine (VIN Code / Eng. Code)	Year	Engine (VIN Code / Eng. Code)	Year	Engine (VIN Code / Eng. Code)	Year
Mercedes-Benz (cont.)		Mercedes-Benz (cont.)		Mercedes-Benz (cont.)	
300D		600SEC		CL63 AMG	
L5 2497cc 2.5L SOHC Turbo-Diesel (602.962)	93-90	V12 5987cc 6.0L DOHC (48 Valve) (120.980)	93	V8 5461cc 5.5L DOHC Turbo (32 Valve) (157.980)	13-11
L5 3005cc 3.0L SOHC Diesel (617.910)	76-75	600SEL		V8 5461cc 5.5L DOHC Turbo (32 Valve) (157.981)	13-12
L5 3005cc 3.0L SOHC Diesel (617.912)	81-77	V12 5987cc 6.0L DOHC (48 Valve) (120.980)	93-92	V8 6208cc 6.2L DOHC (32 Valve) (156.984)	10-07
300E		C220		CL65 AMG	
L6 2599cc 2.6L SOHC (12 Valve) (103.940)	92-90	L4 2199cc 2.2L DOHC (16 Valve) (111.961)	96-94	V12 5980cc 6.0L SOHC Turbo (36 Valve) (275.980)	10-05
L6 2799cc 2.8L DOHC (24 Valve) (104.942)	93	C230		V12 5980cc 6.0L SOHC Turbo (36 Valve) (275.982)	13-11
L6 2962cc 3.0L SOHC (12 Valve) (103.983)	93-86	L4 1796cc 1.8L DOHC Supercharged (16 Valve) (111.983)	05-03	CLK320	
L6 2962cc 3.0L SOHC (12 Valve) (103.985)	93-90	L4 2295cc 2.3L DOHC (16 Valve) (111.974)	98-97	V6 3199cc 3.2L SOHC (18 Valve) (112.940)	05-98
L6 3199cc 3.2L DOHC (24 Valve) (104.992)	93	L4 2295cc 2.3L DOHC Supercharged (16 Valve) (111.975)	00-99	CLK350	
300SD		L4 2295cc 2.3L DOHC Supercharged (16 Valve) (111.983)	02	V6 3498cc 3.5L DOHC (24 Valve) (272.960)	09-06
L5 3005cc 3.0L SOHC Turbo-Diesel (617.951)	85-83	V6 2496cc 2.5L DOHC (24 Valve) (272.920)	07-06	CLK430	
L5 3005cc 3.0L SOHC Turbo-Diesel (617.952)	82-78	C240		V8 4266cc 4.3L SOHC (24 Valve) (113.943)	03-99
L6 3449cc 3.5L SOHC Turbo-Diesel (12 Valve) (603.971)	93-92	V6 2597cc 2.6L SOHC (18 Valve) (112.912)	05-01	CLK500	
300SE		C250		V8 4966cc 5.0L SOHC (24 Valve) (113.961)	06-03
L6 2962cc 3.0L SOHC (12 Valve) (103.981)	91-90	L4 1796cc 1.8L DOHC Turbo (16 Valve) (271.820)	13-12	CLK55 AMG	
L6 3199cc 3.2L DOHC (24 Valve) (104.990)	93-92	L4 1796cc 1.8L DOHC Turbo (16 Valve) (271.860)	13-12	V8 5439cc 5.4L SOHC (24 Valve) (113.984)	06-01
300SEL		C280		CLK550	
L6 2962cc 3.0L SOHC (12 Valve) (103.981)	91-88	L6 2799cc 2.8L DOHC (24 Valve) (104.941)	95-94	V8 5461cc 5.5L DOHC (32 Valve) (273.967)	09-07
V8 4520cc 4.5L SOHC (117.984)	73-72	L6 2799cc 2.8L DOHC (24 Valve) (104.961)	97-96	CLK63 AMG	
300SL		V6 2799cc 2.8L SOHC (18 Valve) (112.920)	00-98	V8 6208cc 6.2L DOHC (32 Valve) (156.982)	09-07
L6 2962cc 3.0L DOHC (24 Valve) (104.981)	93-90	V6 2996cc 3.0L DOHC (24 Valve) (272.940)	07-06	CLS500	
300TD		V6 2996cc 3.0L DOHC (24 Valve) (272.941)	07-06	V8 4966cc 5.0L SOHC (24 Valve) (113.961)	06
L5 3005cc 3.0L SOHC Turbo-Diesel (617.952)	85-79	C300		CLS55 AMG	
300TE		V6 2996cc 3.0L DOHC (24 Valve) (272.940)	13-08	V8 5439cc 5.4L SOHC Supercharged (24 Valve) (113.980)	06
L6 2962cc 3.0L SOHC (12 Valve) (103.983)	93-88	V6 2996cc 3.0L DOHC (24 Valve) (272.941)	13-08	CLS550	
L6 3199cc 3.2L DOHC (24 Valve) (104.992)	93	C32 AMG		V8 4663cc 4.7L DOHC Turbo (32 Valve) (278.922)	13-12
350SD		V6 3199cc 3.2L SOHC Supercharged (18 Valve) (112.960)	04-02	V8 5461cc 5.5L DOHC (32 Valve) (273.967)	11-07
L6 3449cc 3.5L SOHC Turbo-Diesel (12 Valve) (603.970)	91-90	C320		CLS63 AMG	
350SDL		V6 3199cc 3.2L SOHC (18 Valve) (112.946)	05-01	V8 5461cc 5.5L DOHC Turbo (32 Valve) (157.980)	13-11
L6 3449cc 3.5L SOHC Turbo-Diesel (12 Valve) (603.970)	91-90	C350		V8 5461cc 5.5L DOHC Turbo (32 Valve) (157.981)	13-12
350SL		V6 3498cc 3.5L DOHC (24 Valve) (272.056)	13-06	V8 6208cc 6.2L DOHC (32 Valve) (156.983)	11-07
V8 4520cc 4.5L SOHC (117.982)	73-72	V6 3498cc 3.5L DOHC (24 Valve) (272.087)	13-06	E300D	
400E		V6 3498cc 3.5L DOHC (24 Valve) (276.957)	13-12	L6 2996cc 3.0L DOHC Diesel (24 Valve) (606.912)	97-94
V8 4196cc 4.2L DOHC (32 Valve) (119.975)	93-92	C36 AMG		E300TD	
400SE		L6 3606cc 3.6L DOHC (24 Valve) (104.941)	97-95	L6 2996cc 3.0L DOHC Turbo-Diesel (24 Valve) (606.962)	99-98
V8 4196cc 4.2L DOHC (32 Valve) (119.971)	92	C43 AMG		E320	
400SEL		V8 4266cc 4.3L SOHC (24 Valve) (113.944)	00-99	L6 3199cc 3.2L DOHC (24 Valve) (104.992)	95-94
V8 4196cc 4.2L DOHC (32 Valve) (119.971)	93	C55 AMG		L6 3199cc 3.2L DOHC (24 Valve) (104.995)	97-96
420SEL		V8 5439cc 5.4L SOHC (24 Valve) (113.988)	06-05	L6 3222cc 3.2L DOHC Turbo-Diesel (24 Valve) (648.961)	06-05
V8 4196cc 4.2L SOHC (16 Valve) (116.965)	91-90	C63 AMG		V6 2987cc 3.0L DOHC Turbo-Diesel (24 Valve) (642.920)	09-07
450SEL		V8 6208cc 6.2L DOHC (32 Valve) (156.985)	13-08	V6 3199cc 3.2L SOHC (18 Valve) (112.941)	05-98
V8 4520cc 4.5L SOHC (117.982)	80-73	CL500		E350	
V8 4520cc 4.5L SOHC (117.983)	75-73	V8 4966cc 5.0L SOHC (24 Valve) (113.960)	06-00	V6 2987cc 3.0L DOHC Turbo-Diesel (24 Valve) (642.920)	13-10
V8 4520cc 4.5L SOHC (117.986)	80-76	V8 4973cc 5.0L DOHC (32 Valve) (119.980)	99-98	V6 3498cc 3.5L DOHC (24 Valve) (272.961)	13-10
450SL		CL55 AMG		V6 3498cc 3.5L DOHC (24 Valve) (272.964)	09-06
V8 4520cc 4.5L SOHC (117.982)	75-73	V8 5439cc 5.4L SOHC (24 Valve) (113.982)	02-01	V6 3498cc 3.5L DOHC (24 Valve) (272.972)	09-06
V8 4520cc 4.5L SOHC (117.985)	80-76	V8 5439cc 5.4L SOHC Supercharged (24 Valve) (113.982)	06-03	V6 3498cc 3.5L DOHC (24 Valve) (272.977)	13-10
500E		V8 5439cc 5.4L SOHC Supercharged (24 Valve) (113.987)	06-03	V6 3498cc 3.5L DOHC (24 Valve) (272.980)	13-10
V8 4973cc 5.0L DOHC (32 Valve) (119.974)	93	CL550		V6 3498cc 3.5L DOHC (24 Valve) (276.952)	13-12
500SEC		V8 4663cc 4.7L DOHC Turbo (32 Valve) (278.920)	13-11	V6 3498cc 3.5L DOHC (24 Valve) (276.957)	13-12
V8 4973cc 5.0L DOHC (32 Valve) (119.970)	93	V8 5461cc 5.5L DOHC (32 Valve) (273.961)	10-07	E400 Hybrid	
500SEL		CL600		V6 3498cc 3.5L DOHC (24 Valve) (272.974)	13
V8 4973cc 5.0L DOHC (32 Valve) (119.970)	93-92	V12 5513cc 5.5L SOHC Turbo (36 Valve) (285.950)	13-03		
500SL		V12 5786cc 5.8L SOHC (36 Valve) (137.970)	02-01		
V8 4973cc 5.0L DOHC (32 Valve) (119.960)	92-90	V12 5987cc 6.0L DOHC (48 Valve) (120.983)	99-98		
V8 4973cc 5.0L DOHC (32 Valve) (119.972)	93				
560SEC					
V8 5547cc 5.6L SOHC (16 Valve) (117.968)	91-90				
560SEL					
V8 5547cc 5.6L SOHC (16 Valve) (117.968)	91-90				

Mercedes-Benz Car (Incl. Maybach, Mercedes-Benz, Smart) (Cont.)

Model Index (Cont.)					
Engine (VIN Code / Eng. Code)	Year	Engine (VIN Code / Eng. Code)	Year	Engine (VIN Code / Eng. Code)	Year
Mercedes-Benz (cont.)		Mercedes-Benz (cont.)		Mercedes-Benz (cont.)	
E420		S63 AMG		SLR McLaren	
V8 4196cc 4.2L DOHC (32 Valve) (119.971)	95-94	V8 5461cc 5.5L DOHC Turbo (32 Valve) (157.980)	13-11	V8 5439cc 5.4L SOHC Supercharged (24 Valve) (115.980)	09-05
V8 4196cc 4.2L DOHC (32 Valve) (119.975)	98-96	V8 5461cc 5.5L DOHC Turbo (32 Valve) (157.981)	13-12	SLS AMG	
E430		V8 6208cc 6.2L DOHC (32 Valve) (156.984)	10-07	V8 6208cc 6.2L DOHC (32 Valve) (159.980)	13-11
V8 4266cc 4.3L SOHC (24 Valve) (113.940)	02-99	S65 AMG		Smart	
E500		V12 5980cc 6.0L SOHC Turbo (36 Valve) (275.980)	10-06	fortwo	
V8 4966cc 5.0L SOHC (24 Valve) (113.961)	06-03	V12 5980cc 6.0L SOHC Turbo (36 Valve) (275.982)	13-06	L3 799cc 0.8L SOHC Turbo-Diesel (6 Valve)	13-05
V8 4966cc 5.0L SOHC (24 Valve) (113.969)	06-04	SL320		L3 993cc 1.0L DOHC (12 Valve)	13-08
V8 4973cc 5.0L DOHC (32 Valve) (119.974)	94	L6 3199cc 3.2L DOHC (24 Valve) (104.991)	97-94		
E55 AMG		SL500			
V8 5439cc 5.4L SOHC (24 Valve) (113.980)	02-99	V8 4966cc 5.0L SOHC (24 Valve) (113.961)	06-99		
V8 5439cc 5.4L SOHC Supercharged (24 Valve) (113.980)	06-03	V8 4973cc 5.0L DOHC (32 Valve) (119.972)	95-94		
E550		V8 4973cc 5.0L DOHC (32 Valve) (119.982)	98-96		
V8 4663cc 4.7L DOHC Turbo (32 Valve) (278.922)	13-12	SL55 AMG			
V8 5461cc 5.5L DOHC (32 Valve) (273.960)	09-07	V8 5439cc 5.4L SOHC Supercharged (24 Valve) (113.982)	06-03		
V8 5461cc 5.5L DOHC (32 Valve) (273.962)	09-07	V8 5439cc 5.4L SOHC Supercharged (24 Valve) (113.992)	08-07		
V8 5461cc 5.5L DOHC (32 Valve) (273.966)	11-10	SL550			
V8 5461cc 5.5L DOHC (32 Valve) (273.970)	11-10	V8 4663cc 4.7L DOHC Turbo (32 Valve) (278.927)	13		
V8 5461cc 5.5L DOHC (32 Valve) (273.971)	11-10	V8 5461cc 5.5L DOHC (32 Valve) (273.965)	12-07		
E63 AMG		SL600			
V8 5461cc 5.5L DOHC Turbo (32 Valve) (157.980)	13-12	V12 5513cc 5.5L SOHC Turbo (36 Valve) (285.950)	12-04		
V8 5461cc 5.5L DOHC Turbo (32 Valve) (157.981)	13-12	V12 5987cc 6.0L DOHC (48 Valve) (120.981)	95-94		
V8 6208cc 6.2L DOHC (32 Valve) (156.983)	09-07	V12 5987cc 6.0L DOHC (48 Valve) (120.983)	02-96		
V8 6208cc 6.2L DOHC (32 Valve) (156.985)	11-10	SL63 AMG			
S320		V8 5461cc 5.5L DOHC Turbo (32 Valve) (157.983)	13		
L6 3199cc 3.2L DOHC (24 Valve) (104.991)	95-94	V8 6208cc 6.2L DOHC (32 Valve) (156.981)	12-09		
L6 3199cc 3.2L DOHC (24 Valve) (104.994)	99-96	SL65 AMG			
S350		V12 5980cc 6.0L SOHC Turbo (36 Valve) (275.980)	12-05		
V6 2987cc 3.0L DOHC Turbo-Diesel (24 Valve) (642.920)	13-11	V12 5980cc 6.0L SOHC Turbo (36 Valve) (275.981)	12-05		
V6 3724cc 3.7L SOHC (18 Valve) (112.972)	06	V12 5980cc 6.0L SOHC Turbo (36 Valve) (279.981)	13		
S350TD		SLK230			
L6 3449cc 3.5L SOHC Turbo-Diesel (12 Valve) (603.971)	95-94	L4 2295cc 2.3L DOHC Supercharged (16 Valve) (111.973)	04-98		
S400 Hybrid		L4 2295cc 2.3L DOHC Supercharged (16 Valve) (111.983)	04-03		
V6 3498cc 3.5L DOHC (24 Valve) (272.974)	13-10	SLK250			
S420		L4 1796cc 1.8L DOHC Turbo (16 Valve) (271.861)	13-12		
V8 4196cc 4.2L DOHC (32 Valve) (119.971)	95-94	SLK280			
V8 4196cc 4.2L DOHC (32 Valve) (119.981)	99-96	V6 2996cc 3.0L DOHC (24 Valve) (272.942)	08-06		
S430		SLK300			
V8 4266cc 4.3L SOHC (24 Valve) (113.941)	06-00	V6 2996cc 3.0L DOHC (24 Valve) (272.942)	11-09		
V8 4266cc 4.3L SOHC (24 Valve) (113.948)	06-03	SLK32 AMG			
S500		V6 3199cc 3.2L SOHC Supercharged (18 Valve) (112.960)	04-02		
V8 4966cc 5.0L SOHC (24 Valve) (113.960)	06-00	SLK320			
V8 4966cc 5.0L SOHC (24 Valve) (113.966)	06-03	V6 3199cc 3.2L SOHC (18 Valve) (112.947)	04-01		
V8 4973cc 5.0L DOHC (32 Valve) (119.970)	95-94	SLK350			
V8 4973cc 5.0L DOHC (32 Valve) (119.980)	99-96	V6 3498cc 3.5L DOHC (24 Valve) (272.963)	08-05		
S55 AMG		V6 3498cc 3.5L DOHC (24 Valve) (272.969)	11-09		
V8 5439cc 5.4L SOHC (24 Valve) (113.982)	02-01	V6 3498cc 3.5L DOHC (24 Valve) (276.956)	13-12		
V8 5439cc 5.4L SOHC Supercharged (24 Valve) (113.982)	06-03	SLK55 AMG			
S550		V8 5439cc 5.4L SOHC (24 Valve) (113.989)	10-05		
V8 4663cc 4.7L DOHC Turbo (32 Valve) (278.932)	13-12	V8 5461cc 5.5L DOHC (32 Valve) (152.980)	13-12		
V8 5461cc 5.5L DOHC (32 Valve) (273.961)	11-07				
S600					
V12 5513cc 5.5L SOHC Turbo (36 Valve) (285.950)	13-03				
V12 5786cc 5.8L SOHC (36 Valve) (137.970)	02-01				
V12 5987cc 6.0L DOHC (48 Valve) (120.980)	95-94				
V12 5987cc 6.0L DOHC (48 Valve) (120.982)	99-96				

Mercedes-Benz Car (Incl. Maybach, Mercedes-Benz, Smart) (Cont.)

1	2005 - 2003; 1.8L 109.5 (1796cc) DOHC L4 (16 Valve) 82mm Bore				1
MFI; Gasoline; Supercharged Mercedes-Benz Eng.; Eng. Code 111.983					
QTY	CYLINDER HEAD	YEARS	PART NO.	DESCRIPTION	
1	Head Gasket	2005-03	26650 PT	Head bolts not incl.; Head bolt replacement recommended; PermaTorqueMLS®; New Part Number - Check for Availability	
QTY	MANIFOLD - INT. & EXH.	YEARS	PART NO.	DESCRIPTION	
1	Exh. Manifold Gasket Set	2005-03	MS 97272	New Part Number - Check for Availability	
QTY	CRANKSHAFT REAR SEAL	YEARS	PART NO.	DESCRIPTION	
1	Rear Main Seal Set	2005-03	BS 40749	Retainer w/Seal; Rubber; One-piece; New Part Number - Check for Availability	
QTY	VALVE COVER	YEARS	PART NO.	DESCRIPTION	
1	Valve Cover Gasket Set	2005-03	VS 50852 R	w/Spark plug tube seals; PermaDry® molded rubber gskt. incl.; New Part Number - Check for Availability	
QTY	WATER OUTLET GASKET	YEARS	PART NO.	DESCRIPTION	
2	Water Outlet Gasket	2005-03	36050	Water Outlet; Water outlet seal; New Part Number - Check for Availability	
1	Water Outlet Gasket	2005-03	36051	Water Outlet; Cylinder head water hole seal; New Part Number - Check for Availability	
1	Water Outlet Gasket	2005-03	36052	Water Outlet; Water inlet pipe seal; New Part Number - Check for Availability	
QTY	WATER PUMP	YEARS	PART NO.	DESCRIPTION	
1	Water Pump Gasket	2005-03	36062	New Part Number - Check for Availability	
QTY	TIMING COVER	YEARS	PART NO.	DESCRIPTION	
1	Crankshaft Front Seal Set	2005-03	TCS 46188	Seal only; New Part Number - Check for Availability	
QTY	CARB & FUEL INJECTION	YEARS	PART NO.	DESCRIPTION	
1	Throttle Body Gasket	2005-03	61750	Supercharger throttle body; New Part Number - Check for Availability	
QTY	EXHAUST GAS RECIRCULATION	YEARS	PART NO.	DESCRIPTION	
2	EGR Gasket	2005-03	73002	EGR valve; New Part Number - Check for Availability	
QTY	OIL FILTER MOUNTING	YEARS	PART NO.	DESCRIPTION	
1	Oil Filter Adapter Gasket	2005-03	72991	Oil filter adapter seal; New Part Number - Check for Availability	
QTY	OIL COOLER	YEARS	PART NO.	DESCRIPTION	
1	Oil Cooler Gasket	2005-03	72990	Oil cooler mounting; New Part Number - Check for Availability	
QTY	TURBO MOUNTING SET	YEARS	PART NO.	DESCRIPTION	
1	Turbo Mtg. Gasket Set	2005-03	61749	Supercharger mounting; New Part Number - Check for Availability	
2	1996 - 1994; 2.2L 134.1 (2199cc) DOHC L4 (16 Valve) 89.9mm Bore				2
MFI; Gasoline; Naturally Aspirated Mercedes-Benz Eng.; Eng. Code 111.961					
QTY	CYLINDER HEAD	YEARS	PART NO.	DESCRIPTION	
1	Head Gasket	1996-94	26573 PT	Head bolts not incl.; Head bolt replacement recommended; New Part Number - Check for Availability	
QTY	MANIFOLD - INT. & EXH.	YEARS	PART NO.	DESCRIPTION	
1	Int. Manifold Gasket Set	1996-94	MS 97310	Lower set; New Part Number - Check for Availability	
1	Exh. Manifold Gasket Set	1996-94	MS 97275	New Part Number - Check for Availability	
QTY	OIL PAN	YEARS	PART NO.	DESCRIPTION	
1	Oil Pan Gasket Set	1996-94	OS 30855	New Part Number - Check for Availability	
QTY	VALVE COVER	YEARS	PART NO.	DESCRIPTION	
1	Valve Cover Gasket Set	1996-94	VS 50871 R	w/Spark plug tube seals; PermaDry® molded rubber gskt. incl.; New Part Number - Check for Availability	
QTY	WATER PUMP	YEARS	PART NO.	DESCRIPTION	
1	Water Pump Gasket	1996-94	36061	New Part Number - Check for Availability	
QTY	TIMING COVER	YEARS	PART NO.	DESCRIPTION	
1	Camshaft Front Seal Set	1996-94	TCS 46189	New Part Number - Check for Availability	
3	2004 - 1998; 2.3L 140 (2295cc) DOHC L4 (16 Valve) 90.9mm Bore				3
MFI; Gasoline; Supercharged Mercedes-Benz Eng.; Eng. Code 111.973					
QTY	CYLINDER HEAD	YEARS	PART NO.	DESCRIPTION	
1	Head Gasket	2004-98	26579 PT	Standard bore size; Head bolts not incl.; Head bolt replacement recommended; New Part Number - Check for Availability	
1	Head Gasket	2004-98	26646 PT	Engine w/Oversized 91.40mm housing bore; Head bolts not incl.; Head bolt replacement recommended; New Part Number - Check for Availability	
1	Head Set	2004-01	HS 26579 PT	Standard bore size; Head bolts not incl.; Head bolt replacement recommended; PermaDry® molded rubber valve cover gskt. incl.; Premium valve stem seals incl.; New Part Number - Check for Availability	
1	Head Set	2004-01	HS 26646 PT	Engine w/Oversized 91.40mm housing bore; Head bolts not incl.; Head bolt replacement recommended; PermaDry® molded rubber valve cover gskt. incl.; Premium valve stem seals incl.; New Part Number - Check for Availability	

Mercedes-Benz Car (Incl. Maybach, Mercedes-Benz, Smart) (Cont.)

3		2004 - 1998; 2.3L 140 (2295cc) DOHC L4 (16 Valve) 90.9mm Bore			3
(cont.)		MFI; Gasoline; Supercharged Mercedes-Benz Eng.; Eng. Code 111.973			(cont.)
QTY	MANIFOLD - INT. & EXH.	YEARS	PART NO.	DESCRIPTION	
1	Int. Manifold Gasket Set	2000-98	MS 97300	Lower set; New Part Number - Check for Availability	
1	Exh. Manifold Gasket Set	2004-98	MS 97265	New Part Number - Check for Availability	
QTY	OIL PAN	YEARS	PART NO.	DESCRIPTION	
1	Oil Pan Gasket Set	2004-98	OS 30855	New Part Number - Check for Availability	
QTY	VALVE COVER	YEARS	PART NO.	DESCRIPTION	
1	Valve Cover Gasket Set	2004-98	VS 50871 R	w/Spark plug tube seals; PermaDry® molded rubber gskt. incl.; New Part Number - Check for Availability	
QTY	WATER PUMP	YEARS	PART NO.	DESCRIPTION	
1	Water Pump Gasket	2004-98	36061	New Part Number - Check for Availability	
QTY	TIMING COVER	YEARS	PART NO.	DESCRIPTION	
1	Camshaft Front Seal Set	2004-98	TCS 46189	New Part Number - Check for Availability	
4		1998 - 1997; 2.3L 140 (2295cc) DOHC L4 (16 Valve) 90.9mm Bore			4
(cont.)		MFI; Gasoline; Naturally Aspirated Mercedes-Benz Eng.; Eng. Code 111.974			(cont.)
QTY	CYLINDER HEAD	YEARS	PART NO.	DESCRIPTION	
1	Head Gasket	1998-97	26646 PT	To Ser. No. 005269; w/M/T; Head bolts not incl.; Head bolt replacement recommended; New Part Number - Check for Availability	
1	Head Gasket	1998-97	26646 PT	To Ser. No. 034486; w/A/T; Head bolts not incl.; Head bolt replacement recommended; New Part Number - Check for Availability	
1	Head Gasket	1998-97	26653 PT	From Ser. No. 005270; w/M/T; Head bolts not incl.; Head bolt replacement recommended; New Part Number - Check for Availability	
1	Head Gasket	1998-97	26653 PT	From Ser. No. 034487; w/A/T; Head bolts not incl.; Head bolt replacement recommended; New Part Number - Check for Availability	
1	Head Set	1998-97	HS 26349 PT	From Ser. No. 005270; w/M/T; Head bolts not incl.; Head bolt replacement recommended; PermaDry® molded rubber valve cover gskt. incl.; Premium valve stem seals incl.	
1	Head Set	1998-97	HS 26349 PT	From Ser. No. 034487; w/A/T; Head bolts not incl.; Head bolt replacement recommended; PermaDry® molded rubber valve cover gskt. incl.; Premium valve stem seals incl.	
QTY	CONVERSION SET	YEARS	PART NO.	DESCRIPTION	
1	Gasket Conversion Set	1998-97	CS 26349	PermaDry® molded rubber oil pan gskt. incl.	
QTY	MANIFOLD - INT. & EXH.	YEARS	PART NO.	DESCRIPTION	
1	Int. Manifold Gasket Set	1998-97	MS 97300	Lower set; New Part Number - Check for Availability	
1	Exh. Manifold Gasket Set	1998-97	MS 97265	New Part Number - Check for Availability	
QTY	OIL PAN	YEARS	PART NO.	DESCRIPTION	
1	Oil Pan Gasket Set	1998-97	OS 30855	New Part Number - Check for Availability	
QTY	VALVE COVER	YEARS	PART NO.	DESCRIPTION	
1	Valve Cover Gasket Set	1998-97	VS 50871 R	w/Spark plug tube seals; PermaDry® molded rubber gskt. incl.; New Part Number - Check for Availability	
QTY	WATER PUMP	YEARS	PART NO.	DESCRIPTION	
1	Water Pump Gasket	1998-97	36061	New Part Number - Check for Availability	
QTY	TIMING COVER	YEARS	PART NO.	DESCRIPTION	
1	Camshaft Front Seal Set	1998-97	TCS 46189	New Part Number - Check for Availability	
5		2002 - 1999; 2.3L 140 (2295cc) DOHC L4 (16 Valve) 90.9mm Bore			5
(cont.)		MFI; Gasoline; Supercharged Mercedes-Benz Eng.; Eng. Code 111.975			(cont.)
QTY	CYLINDER HEAD	YEARS	PART NO.	DESCRIPTION	
1	Head Gasket	2002-99	26579 PT	Standard bore size; Head bolts not incl.; Head bolt replacement recommended; New Part Number - Check for Availability	
1	Head Gasket	2002-99	26646 PT	Engine w/Oversized 91.40mm housing bore; Head bolts not incl.; Head bolt replacement recommended; New Part Number - Check for Availability	
1	Head Set	2002-01	HS 26579 PT	Standard bore size; Head bolts not incl.; Head bolt replacement recommended; PermaDry® molded rubber valve cover gskt. incl.; Premium valve stem seals incl.; New Part Number - Check for Availability	
1	Head Set	2002-01	HS 26646 PT	Engine w/Oversized 91.40mm housing bore; Head bolts not incl.; Head bolt replacement recommended; PermaDry® molded rubber valve cover gskt. incl.; Premium valve stem seals incl.; New Part Number - Check for Availability	
QTY	MANIFOLD - INT. & EXH.	YEARS	PART NO.	DESCRIPTION	
1	Int. Manifold Gasket Set	2000-99	MS 97300	Lower set; New Part Number - Check for Availability	
1	Exh. Manifold Gasket Set	2002-99	MS 97265	New Part Number - Check for Availability	
QTY	OIL PAN	YEARS	PART NO.	DESCRIPTION	
1	Oil Pan Gasket Set	2002-99	OS 30855	New Part Number - Check for Availability	

Mercedes-Benz Car (Incl. Maybach, Mercedes-Benz, Smart) (Cont.)

5 (cont.)	2002 - 1999; 2.3L 140 (2295cc) DOHC L4 (16 Valve) 90.9mm Bore			5 (cont.)
	MFI; Gasoline; Supercharged Mercedes-Benz Eng.; Eng. Code 111.975			
QTY	VALVE COVER	YEARS	PART NO.	DESCRIPTION
1	Valve Cover Gasket Set	2002-99	VS 50871 R	w/Spark plug tube seals; PermaDry® molded rubber gskt. incl.; New Part Number - Check for Availability
QTY	WATER PUMP	YEARS	PART NO.	DESCRIPTION
1	Water Pump Gasket	2002-99	36061	New Part Number - Check for Availability
QTY	TIMING COVER	YEARS	PART NO.	DESCRIPTION
1	Camshaft Front Seal Set	2002-99	TCS 46189	New Part Number - Check for Availability
6	2005 - 2002; 2.3L 140 (2295cc) DOHC L4 (16 Valve) 90.9mm Bore			6
	MFI; Gasoline; Supercharged Mercedes-Benz Eng.; Eng. Code 111.983			
QTY	CYLINDER HEAD	YEARS	PART NO.	DESCRIPTION
1	Head Gasket	2005-02	26579 PT	Standard bore size; Head bolts not incl.; Head bolt replacement recommended; New Part Number - Check for Availability
1	Head Gasket	2005-02	26646 PT	Engine w/Oversized 91.40mm housing bore; Head bolts not incl.; Head bolt replacement recommended; New Part Number - Check for Availability
1	Head Set	2005-02	HS 26579 PT	Standard bore size; Head bolts not incl.; Head bolt replacement recommended; PermaDry® molded rubber valve cover gskt. incl.; Premium valve stem seals incl.; New Part Number - Check for Availability
1	Head Set	2005-02	HS 26646 PT	Engine w/Oversized 91.40mm housing bore; Head bolts not incl.; Head bolt replacement recommended; PermaDry® molded rubber valve cover gskt. incl.; Premium valve stem seals incl.; New Part Number - Check for Availability
QTY	MANIFOLD - INT. & EXH.	YEARS	PART NO.	DESCRIPTION
1	Exh. Manifold Gasket Set	2005-02	MS 97265	New Part Number - Check for Availability
QTY	OIL PAN	YEARS	PART NO.	DESCRIPTION
1	Oil Pan Gasket Set	2005-02	OS 30855	New Part Number - Check for Availability
QTY	VALVE COVER	YEARS	PART NO.	DESCRIPTION
1	Valve Cover Gasket Set	2005-02	VS 50871 R	w/Spark plug tube seals; PermaDry® molded rubber gskt. incl.; New Part Number - Check for Availability
QTY	WATER PUMP	YEARS	PART NO.	DESCRIPTION
1	Water Pump Gasket	2005-02	36061	New Part Number - Check for Availability
QTY	TIMING COVER	YEARS	PART NO.	DESCRIPTION
1	Camshaft Front Seal Set	2005-02	TCS 46189	New Part Number - Check for Availability
7	1993 - 1991; 2.3L 140.2 (2299cc) SOHC L4 (8 Valve) 95.5mm Bore			7
	MFI; Gasoline; Naturally Aspirated Mercedes-Benz Eng.; Eng. Code 102.985			
QTY	WATER PUMP	YEARS	PART NO.	DESCRIPTION
1	Water Pump Gasket	1993-91	36063	New Part Number - Check for Availability
8	2005 - 2001; 2.6L 158.4 (2597cc) SOHC V6 (18 Valve) 89.9mm Bore			8
	MFI; Gasoline; Naturally Aspirated Mercedes-Benz Eng.; Eng. Code 112.912			
QTY	TIMING COVER	YEARS	PART NO.	DESCRIPTION
1	Crankshaft Front Seal Set	2005-01	TCS 46188	New Part Number - Check for Availability
QTY	OIL COOLER	YEARS	PART NO.	DESCRIPTION
1	Oil Cooler Gasket	2005-01	72977	Loc. Upper; Oil cooler mounting; New Part Number - Check for Availability
1	Oil Cooler Gasket	2005-01	72978	Loc. Lower; Oil cooler mounting; New Part Number - Check for Availability
9	2005 - 2003; 2.6L 158.4 (2597cc) SOHC V6 (18 Valve) 89.9mm Bore			9
	MFI; Gasoline; Naturally Aspirated Mercedes-Benz Eng.; Eng. Code 112.916			
QTY	TIMING COVER	YEARS	PART NO.	DESCRIPTION
1	Crankshaft Front Seal Set	2005-03	TCS 46188	New Part Number - Check for Availability
QTY	OIL COOLER	YEARS	PART NO.	DESCRIPTION
1	Oil Cooler Gasket	2005-03	72977	Loc. Upper; Oil cooler mounting; New Part Number - Check for Availability
1	Oil Cooler Gasket	2005-03	72978	Loc. Lower; Oil cooler mounting; New Part Number - Check for Availability
10	1992 - 1991; 2.6L 158.5 (2599cc) SOHC L6 (12 Valve) 82.9mm Bore			10
	MFI; Gasoline; Naturally Aspirated Mercedes-Benz Eng.; Eng. Code 103.940			
QTY	CYLINDER HEAD	YEARS	PART NO.	DESCRIPTION
1	Head Set	1992-91	HS 26285 PT	Valve cover gskt., valve stem seals, head bolts not incl.; Head bolt replacement recommended
QTY	CONVERSION SET	YEARS	PART NO.	DESCRIPTION
1	Gasket Conversion Set	1992-91	CS 26285	Consolidated design
QTY	VALVE COVER	YEARS	PART NO.	DESCRIPTION
1	Valve Cover Gasket Set	1992-91	VS 50642 R	PermaDry® molded rubber gskt. incl.

Mercedes-Benz Car (Incl. Maybach, Mercedes-Benz, Smart) (Cont.)

10 (cont.)	1992 - 1991; 2.6L 158.5 (2599cc) SOHC L6 (12 Valve) 82.9mm Bore				10 (cont.)
MFI; Gasoline; Naturally Aspirated Mercedes-Benz Eng.; Eng. Code 103.940					
QTY	VALVE STEM SEAL SET	YEARS	PART NO.	DESCRIPTION	
1	Valve Stem Seal Set	1992-91	SS 72920	Premium valve stem seals incl.	
11	1993 - 1991; 2.6L 158.5 (2599cc) SOHC L6 (12 Valve) 82.9mm Bore				11
MFI; Gasoline; Naturally Aspirated Mercedes-Benz Eng.; Eng. Code 103.942					
QTY	CYLINDER HEAD	YEARS	PART NO.	DESCRIPTION	
1	Head Set	1993-91	HS 26285 PT	Valve cover gskt., valve stem seals, head bolts not incl.; Head bolt replacement recommended	
QTY	CONVERSION SET	YEARS	PART NO.	DESCRIPTION	
1	Gasket Conversion Set	1993-91	CS 26285	Consolidated design	
QTY	VALVE COVER	YEARS	PART NO.	DESCRIPTION	
1	Valve Cover Gasket Set	1993-91	VS 50642 R	PermaDry® molded rubber gskt. incl.	
QTY	VALVE STEM SEAL SET	YEARS	PART NO.	DESCRIPTION	
1	Valve Stem Seal Set	1993-91	SS 72920	Premium valve stem seals incl.	
12	1995 - 1994; 2.8L 170.7 (2799cc) DOHC L6 (24 Valve) 89.9mm Bore				12
MFI; Gasoline; Naturally Aspirated Mercedes-Benz Eng.; Eng. Code 104.941					
QTY	CYLINDER HEAD	YEARS	PART NO.	DESCRIPTION	
1	Head Set	1995-94	HS 26289 PT	Valve cover gskt., valve stem seals, head bolts not incl.; Head bolt replacement recommended	
QTY	CONVERSION SET	YEARS	PART NO.	DESCRIPTION	
1	Gasket Conversion Set	1995-94	CS 26289		
QTY	MANIFOLD - INT. & EXH.	YEARS	PART NO.	DESCRIPTION	
1	Int. Manifold Gasket Set	1995-94	MS 97305	Lower set; New Part Number - Check for Availability	
1	Exh. Manifold Gasket Set	1995-94	MS 97271	New Part Number - Check for Availability	
QTY	OIL PAN	YEARS	PART NO.	DESCRIPTION	
1	Oil Pan Gasket Set	1995-94	OS 30859	New Part Number - Check for Availability	
QTY	VALVE COVER	YEARS	PART NO.	DESCRIPTION	
1	Valve Cover Gasket Set	1995-94	VS 50637 R	PermaDry® molded rubber gskt. incl.	
QTY	VALVE STEM SEAL SET	YEARS	PART NO.	DESCRIPTION	
1	Valve Stem Seal Set	1995-94	SS 72919	Premium valve stem seals incl.	
13	1993; 2.8L 170.7 (2799cc) DOHC L6 (24 Valve) 89.9mm Bore				13
MFI; Gasoline; Naturally Aspirated Mercedes-Benz Eng.; Eng. Code 104.942					
QTY	CYLINDER HEAD	YEARS	PART NO.	DESCRIPTION	
1	Head Set	1993	HS 26289 PT	Valve cover gskt., valve stem seals, head bolts not incl.; Head bolt replacement recommended	
QTY	CONVERSION SET	YEARS	PART NO.	DESCRIPTION	
1	Gasket Conversion Set	1993	CS 26289		
QTY	MANIFOLD - INT. & EXH.	YEARS	PART NO.	DESCRIPTION	
1	Int. Manifold Gasket Set	1993	MS 97305	Lower set; New Part Number - Check for Availability	
1	Exh. Manifold Gasket Set	1993	MS 97271	New Part Number - Check for Availability	
QTY	OIL PAN	YEARS	PART NO.	DESCRIPTION	
1	Oil Pan Gasket Set	1993	OS 30859	New Part Number - Check for Availability	
QTY	VALVE COVER	YEARS	PART NO.	DESCRIPTION	
1	Valve Cover Gasket Set	1993	VS 50637 R	PermaDry® molded rubber gskt. incl.	
QTY	VALVE STEM SEAL SET	YEARS	PART NO.	DESCRIPTION	
1	Valve Stem Seal Set	1993	SS 72919	Premium valve stem seals incl.	
14	1997 - 1996; 2.8L 170.7 (2799cc) DOHC L6 (24 Valve) 89.9mm Bore				14
MFI; Gasoline; Naturally Aspirated Mercedes-Benz Eng.; Eng. Code 104.961					
QTY	CYLINDER HEAD	YEARS	PART NO.	DESCRIPTION	
1	Head Set	1997-96	HS 26289 PT	Valve cover gskt., valve stem seals, head bolts not incl.; Head bolt replacement recommended	
QTY	CONVERSION SET	YEARS	PART NO.	DESCRIPTION	
1	Gasket Conversion Set	1997-96	CS 26289		
QTY	MANIFOLD - INT. & EXH.	YEARS	PART NO.	DESCRIPTION	
1	Int. Manifold Gasket Set	1997-96	MS 97305	Lower set; New Part Number - Check for Availability	
1	Exh. Manifold Gasket Set	1997-96	MS 97271	New Part Number - Check for Availability	
QTY	OIL PAN	YEARS	PART NO.	DESCRIPTION	
1	Oil Pan Gasket Set	1997-96	OS 30859	New Part Number - Check for Availability	
QTY	VALVE COVER	YEARS	PART NO.	DESCRIPTION	
1	Valve Cover Gasket Set	1997-96	VS 50637 R	PermaDry® molded rubber gskt. incl.	

Mercedes-Benz Car (Incl. Maybach, Mercedes-Benz, Smart) (Cont.)

14 (cont.)	1997 - 1996; 2.8L 170.7 (2799cc) DOHC L6 (24 Valve) 89.9mm Bore			14 (cont.)
MFI; Gasoline; Naturally Aspirated Mercedes-Benz Eng.; Eng. Code 104.961				
QTY	VALVE STEM SEAL SET	YEARS	PART NO.	DESCRIPTION
1	Valve Stem Seal Set	1997-96	SS 72919	Premium valve stem seals incl.
15	2000 - 1998; 2.8L 170.7 (2799cc) SOHC V6 (18 Valve) 89.9mm Bore			15
MFI; Gasoline; Naturally Aspirated Mercedes-Benz Eng.; Eng. Code 112.920				
QTY	TIMING COVER	YEARS	PART NO.	DESCRIPTION
1	Crankshaft Front Seal Set	2000-98	TCS 46188	New Part Number - Check for Availability
QTY	OIL COOLER	YEARS	PART NO.	DESCRIPTION
1	Oil Cooler Gasket	2000-98	72977	Loc. Upper; Oil cooler mounting; New Part Number - Check for Availability
1	Oil Cooler Gasket	2000-98	72978	Loc. Lower; Oil cooler mounting; New Part Number - Check for Availability
16	1991; 3.0L 180.6 (2962cc) SOHC L6 (12 Valve) 88.5mm Bore			16
MFI; Gasoline; Naturally Aspirated Mercedes-Benz Eng.; Eng. Code 103.981				
QTY	CYLINDER HEAD	YEARS	PART NO.	DESCRIPTION
1	Head Set	1991	HS 26291 PT	Valve cover gskt., valve stem seals, head bolts not incl.; Head bolt replacement recommended
QTY	CONVERSION SET	YEARS	PART NO.	DESCRIPTION
1	Gasket Conversion Set	1991	CS 26285	Consolidated design
QTY	VALVE COVER	YEARS	PART NO.	DESCRIPTION
1	Valve Cover Gasket Set	1991	VS 50642 R	PermaDry® molded rubber gskt. incl.
QTY	VALVE STEM SEAL SET	YEARS	PART NO.	DESCRIPTION
1	Valve Stem Seal Set	1991	SS 72920	Premium valve stem seals incl.
17	1993 - 1991; 3.0L 180.6 (2962cc) SOHC L6 (12 Valve) 88.5mm Bore			17
MFI; Gasoline; Naturally Aspirated Mercedes-Benz Eng.; Eng. Code 103.983				
QTY	CYLINDER HEAD	YEARS	PART NO.	DESCRIPTION
1	Head Set	1993-91	HS 26291 PT	Valve cover gskt., valve stem seals, head bolts not incl.; Head bolt replacement recommended
QTY	CONVERSION SET	YEARS	PART NO.	DESCRIPTION
1	Gasket Conversion Set	1993-91	CS 26285	Consolidated design
QTY	VALVE COVER	YEARS	PART NO.	DESCRIPTION
1	Valve Cover Gasket Set	1993-91	VS 50642 R	PermaDry® molded rubber gskt. incl.
QTY	VALVE STEM SEAL SET	YEARS	PART NO.	DESCRIPTION
1	Valve Stem Seal Set	1993-91	SS 72920	Premium valve stem seals incl.
18	1993 - 1991; 3.0L 180.6 (2962cc) SOHC L6 (12 Valve) 88.5mm Bore			18
MFI; Gasoline; Naturally Aspirated Mercedes-Benz Eng.; Eng. Code 103.985				
QTY	CYLINDER HEAD	YEARS	PART NO.	DESCRIPTION
1	Head Set	1993-91	HS 26291 PT	Valve cover gskt., valve stem seals, head bolts not incl.; Head bolt replacement recommended
QTY	CONVERSION SET	YEARS	PART NO.	DESCRIPTION
1	Gasket Conversion Set	1993-91	CS 26285	Consolidated design
QTY	VALVE COVER	YEARS	PART NO.	DESCRIPTION
1	Valve Cover Gasket Set	1993-91	VS 50642 R	PermaDry® molded rubber gskt. incl.
QTY	VALVE STEM SEAL SET	YEARS	PART NO.	DESCRIPTION
1	Valve Stem Seal Set	1993-91	SS 72920	Premium valve stem seals incl.
19	1997 - 1994; 3.0L 182.8 (2996cc) DOHC L6 (24 Valve) 87mm Bore			19
MFI; Diesel; Naturally Aspirated Mercedes-Benz Eng.; Eng. Code 606.912				
QTY	MANIFOLD - INT. & EXH.	YEARS	PART NO.	DESCRIPTION
1	Int. Manifold Gasket Set	1997-94	MS 97313	Lower set; New Part Number - Check for Availability
1	Exh. Manifold Gasket Set	1997-94	MS 97280	New Part Number - Check for Availability
QTY	OIL PAN	YEARS	PART NO.	DESCRIPTION
1	Oil Pan Gasket Set	1997-94	OS 30859	New Part Number - Check for Availability
QTY	VALVE COVER	YEARS	PART NO.	DESCRIPTION
1	Valve Cover Gasket Set	1997-94	VS 50858 R	w/Spark plug tube seals; PermaDry® molded rubber gskt. incl.; New Part Number - Check for Availability
QTY	WATER PUMP	YEARS	PART NO.	DESCRIPTION
1	Water Pump Gasket	1997-94	36065	New Part Number - Check for Availability
QTY	TIMING COVER	YEARS	PART NO.	DESCRIPTION
1	Crankshaft Front Seal Set	1997-94	TCS 46188	New Part Number - Check for Availability

Mercedes-Benz Car (Incl. Maybach, Mercedes-Benz, Smart) (Cont.)

20 1999 - 1998; 3.0L 182.8 (2996cc) DOHC Turbo - Intercooled L6 (24 Valve) 87mm Bore 20				
MFI; Diesel; Turbo - Intercooled Mercedes-Benz Eng.; Eng. Code 606.962				
QTY	MANIFOLD - INT. & EXH.	YEARS	PART NO.	DESCRIPTION
1	Int. Manifold Gasket Set	1999-98	MS 97313	Lower set; New Part Number - Check for Availability
1	Exh. Manifold Gasket Set	1999-98	MS 97281	New Part Number - Check for Availability
QTY	OIL PAN	YEARS	PART NO.	DESCRIPTION
1	Oil Pan Gasket Set	1999-98	OS 30859	New Part Number - Check for Availability
QTY	VALVE COVER	YEARS	PART NO.	DESCRIPTION
1	Valve Cover Gasket Set	1999-98	VS 50858 R	w/Spark plug tube seals; PermaDry® molded rubber gskt. incl.; New Part Number - Check for Availability
QTY	WATER PUMP	YEARS	PART NO.	DESCRIPTION
1	Water Pump Gasket	1999-98	36065	New Part Number - Check for Availability
QTY	TIMING COVER	YEARS	PART NO.	DESCRIPTION
1	Crankshaft Front Seal Set	1999-98	TCS 46188	New Part Number - Check for Availability
21 2013 - 2006; 3.0L 182.8 (2996cc) DOHC V6 (24 Valve) 88mm Bore 21				
MFI; Gasoline; Naturally Aspirated Mercedes-Benz Eng.; Eng. Code 272.940				
QTY	CYLINDER HEAD	YEARS	PART NO.	DESCRIPTION
1	Head Gasket	2013-06	26619 PT	Loc. L.H.; Head bolts not incl.; Head bolt replacement recommended; PermaTorqueMLS®; New Part Number - Check for Availability
1	Head Gasket	2013-06	26632 PT	Loc. R.H.; Head bolts not incl.; Head bolt replacement recommended; PermaTorqueMLS®; New Part Number - Check for Availability
QTY	CONVERSION SET	YEARS	PART NO.	DESCRIPTION
1	Gasket Conversion Set	2013-06	CS 26610	RTV sealant incl. for oil pan gskt.; New Part Number - Check for Availability
QTY	MANIFOLD - INT. & EXH.	YEARS	PART NO.	DESCRIPTION
1	Int. Manifold Gasket Set	2013-06	MS 97292	Lower set; New Part Number - Check for Availability
1	Exh. Manifold Gasket Set	2013-06	MS 97263	New Part Number - Check for Availability
QTY	WATER PUMP	YEARS	PART NO.	DESCRIPTION
1	Water Pump Gasket	2006	36060	To 03/02/05; New Part Number - Check for Availability
QTY	OIL COOLER	YEARS	PART NO.	DESCRIPTION
1	Oil Cooler Gasket	2013-06	72979	Oil cooler to housing; New Part Number - Check for Availability
22 2013 - 2006; 3.0L 182.8 (2996cc) DOHC V6 (24 Valve) 88mm Bore 22				
MFI; Gasoline; Naturally Aspirated Mercedes-Benz Eng.; Eng. Code 272.941				
QTY	CYLINDER HEAD	YEARS	PART NO.	DESCRIPTION
1	Head Gasket	2013-06	26619 PT	Loc. L.H.; Head bolts not incl.; Head bolt replacement recommended; PermaTorqueMLS®; New Part Number - Check for Availability
1	Head Gasket	2013-06	26632 PT	Loc. R.H.; Head bolts not incl.; Head bolt replacement recommended; PermaTorqueMLS®; New Part Number - Check for Availability
QTY	CONVERSION SET	YEARS	PART NO.	DESCRIPTION
1	Gasket Conversion Set	2013-06	CS 26610	RTV sealant incl. for oil pan gskt.; New Part Number - Check for Availability
QTY	MANIFOLD - INT. & EXH.	YEARS	PART NO.	DESCRIPTION
1	Int. Manifold Gasket Set	2013-06	MS 97292	Lower set; New Part Number - Check for Availability
1	Exh. Manifold Gasket Set	2013-06	MS 97263	New Part Number - Check for Availability
QTY	WATER PUMP	YEARS	PART NO.	DESCRIPTION
1	Water Pump Gasket	2006	36060	To 03/02/05; New Part Number - Check for Availability
QTY	OIL COOLER	YEARS	PART NO.	DESCRIPTION
1	Oil Cooler Gasket	2013-06	72979	Oil cooler to housing; New Part Number - Check for Availability
23 2011 - 2006; 3.0L 182.8 (2996cc) DOHC V6 (24 Valve) 88mm Bore 23				
MFI; Gasoline; Naturally Aspirated Mercedes-Benz Eng.; Eng. Code 272.942				
QTY	CYLINDER HEAD	YEARS	PART NO.	DESCRIPTION
1	Head Gasket	2011-06	26619 PT	Loc. L.H.; Head bolts not incl.; Head bolt replacement recommended; PermaTorqueMLS®; New Part Number - Check for Availability
1	Head Gasket	2011-06	26632 PT	Loc. R.H.; Head bolts not incl.; Head bolt replacement recommended; PermaTorqueMLS®; New Part Number - Check for Availability
QTY	CONVERSION SET	YEARS	PART NO.	DESCRIPTION
1	Gasket Conversion Set	2011-06	CS 26610	RTV sealant incl. for oil pan gskt.; New Part Number - Check for Availability
QTY	MANIFOLD - INT. & EXH.	YEARS	PART NO.	DESCRIPTION
1	Int. Manifold Gasket Set	2011-06	MS 97292	Lower set; New Part Number - Check for Availability
1	Exh. Manifold Gasket Set	2011-06	MS 97263	New Part Number - Check for Availability
QTY	WATER PUMP	YEARS	PART NO.	DESCRIPTION
1	Water Pump Gasket	2006	36060	To 03/02/05; New Part Number - Check for Availability
QTY	OIL COOLER	YEARS	PART NO.	DESCRIPTION
1	Oil Cooler Gasket	2011-06	72979	Oil cooler to housing; New Part Number - Check for Availability

Mercedes-Benz Car (Incl. Maybach, Mercedes-Benz, Smart) (Cont.)

24		2005 - 1998; 3.2L 195.1 (3199cc) SOHC V6 (18 Valve) 89.9mm Bore			24
		MFI; Gasoline; Naturally Aspirated Mercedes-Benz Eng.; Eng. Code 112.940			
QTY	CYLINDER HEAD	YEARS	PART NO.	DESCRIPTION	
1	Head Gasket	2005-98	26433 PT	Loc. L.H.; Head bolts not incl.; Head bolt replacement recommended; PermaTorqueMLS®	
1	Head Gasket	2005-98	26434 PT	Loc. R.H.; Head bolts not incl.; Head bolt replacement recommended; PermaTorqueMLS®	
1	Head Set	2005-98	HS 26433 PT	Head bolts not incl.; Head bolt replacement recommended; PermaDry® molded rubber valve cover gskts. incl.; Premium valve stem seals incl.	
2	Head Bolt Set	2005-98	ES 71307	Replacement recommended	
QTY	CONVERSION SET	YEARS	PART NO.	DESCRIPTION	
1	Gasket Conversion Set	2005-98	CS 26433-1	RTV sealant incl. for oil pan gskt.	
QTY	MANIFOLD - INT. & EXH.	YEARS	PART NO.	DESCRIPTION	
1	Int. Manifold Gasket Set	2005-98	MS 97091		
1	Exh. Manifold Gasket Set	2005-98	MS 97095		
QTY	EXHAUST PIPE FLANGE	YEARS	PART NO.	DESCRIPTION	
2	Exhaust Pipe Gasket	2005-98	61588	Flange	
2	Exhaust Pipe Gasket	2005-98	61590	Converter; New Part Number - Check for Availability	
QTY	CRANKSHAFT REAR SEAL	YEARS	PART NO.	DESCRIPTION	
1	Rear Main Seal Set	2005-98	BS 40722	Rubber; One-piece	
QTY	VALVE COVER	YEARS	PART NO.	DESCRIPTION	
1	Valve Cover Gasket Set	2005-98	VS 50758 R	PermaDry® molded rubber gskts. incl.	
QTY	VALVE STEM SEAL SET	YEARS	PART NO.	DESCRIPTION	
1	Valve Stem Seal Set	2005-98	SS 72919-2	Premium valve stem seals incl.	
QTY	THERMOSTAT HOUSING	YEARS	PART NO.	DESCRIPTION	
1	O-Ring	2005-98	35908	Thermostat Housing; Thermostat seal	
QTY	WATER PUMP	YEARS	PART NO.	DESCRIPTION	
1	Water Pump Gasket	2005-98	35910	Loc. Lower	
1	Water Pump Gasket	2005-01	35912	Loc. Upper	
QTY	TIMING COVER	YEARS	PART NO.	DESCRIPTION	
1	Crankshaft Front Seal Set	2005-98	TCS 46123	Mounting set	
1	Crankshaft Front Seal Set	2005-98	TCS 46188	Seal only; New Part Number - Check for Availability	
QTY	CARB & FUEL INJECTION	YEARS	PART NO.	DESCRIPTION	
3	Fuel Injector O-Ring Set	2005-98	ES 70599	Improved design	
1	Throttle Body Gasket	2005-98	61592		
QTY	EXHAUST GAS RECIRCULATION	YEARS	PART NO.	DESCRIPTION	
1	EGR Gasket	2005-98	72361		
QTY	OIL COOLER	YEARS	PART NO.	DESCRIPTION	
1	Oil Cooler Gasket	2005-98	72977	Loc. Upper; Oil cooler mounting; New Part Number - Check for Availability	
1	Oil Cooler Gasket	2005-98	72978	Loc. Lower; Oil cooler mounting; New Part Number - Check for Availability	
25		2005 - 1998; 3.2L 195.1 (3199cc) SOHC V6 (18 Valve) 89.9mm Bore			25
		MFI; Gasoline; Naturally Aspirated Mercedes-Benz Eng.; Eng. Code 112.941			
QTY	CYLINDER HEAD	YEARS	PART NO.	DESCRIPTION	
1	Head Gasket	2005-98	26433 PT	Loc. L.H.; Head bolts not incl.; Head bolt replacement recommended; PermaTorqueMLS®	
1	Head Gasket	2005-98	26434 PT	Loc. R.H.; Head bolts not incl.; Head bolt replacement recommended; PermaTorqueMLS®	
1	Head Set	2005-98	HS 26433 PT	Head bolts not incl.; Head bolt replacement recommended; PermaDry® molded rubber valve cover gskts. incl.; Premium valve stem seals incl.	
2	Head Bolt Set	2005-98	ES 71307	Replacement recommended	
QTY	CONVERSION SET	YEARS	PART NO.	DESCRIPTION	
1	Gasket Conversion Set	2005-98	CS 26433-1	RTV sealant incl. for oil pan gskt.	
QTY	MANIFOLD - INT. & EXH.	YEARS	PART NO.	DESCRIPTION	
1	Int. Manifold Gasket Set	2005-98	MS 97091		
1	Exh. Manifold Gasket Set	2005-98	MS 97095		
QTY	EXHAUST PIPE FLANGE	YEARS	PART NO.	DESCRIPTION	
2	Exhaust Pipe Gasket	2005-98	61588	Flange	
2	Exhaust Pipe Gasket	2005-98	61590	Converter; New Part Number - Check for Availability	
QTY	CRANKSHAFT REAR SEAL	YEARS	PART NO.	DESCRIPTION	
1	Rear Main Seal Set	2005-98	BS 40722	Rubber; One-piece	
QTY	VALVE COVER	YEARS	PART NO.	DESCRIPTION	
1	Valve Cover Gasket Set	2005-98	VS 50758 R	PermaDry® molded rubber gskts. incl.	
QTY	VALVE STEM SEAL SET	YEARS	PART NO.	DESCRIPTION	
1	Valve Stem Seal Set	2005-98	SS 72919-2	Premium valve stem seals incl.	

Mercedes-Benz Car (Incl. Maybach, Mercedes-Benz, Smart) (Cont.)

25		2005 - 1998; 3.2L 195.1 (3199cc) SOHC V6 (18 Valve) 89.9mm Bore			25	
(cont.)		MFI; Gasoline; Naturally Aspirated Mercedes-Benz Eng.; Eng. Code 112.941			(cont.)	
QTY	THERMOSTAT HOUSING	YEARS	PART NO.	DESCRIPTION		
1	O-Ring	2005-98	35908	Thermostat Housing; Thermostat seal		
QTY	WATER PUMP	YEARS	PART NO.	DESCRIPTION		
1	Water Pump Gasket	2005-98	35910	Loc. Lower		
1	Water Pump Gasket	2005-01	35912	Loc. Upper		
QTY	TIMING COVER	YEARS	PART NO.	DESCRIPTION		
1	Crankshaft Front Seal Set	2005-98	TCS 46123	Mounting set		
1	Crankshaft Front Seal Set	2005-98	TCS 46188	Seal only; New Part Number - Check for Availability		
QTY	CARB & FUEL INJECTION	YEARS	PART NO.	DESCRIPTION		
3	Fuel Injector O-Ring Set	2005-98	ES 70599	Improved design		
1	Throttle Body Gasket	2005-98	61592			
QTY	EXHAUST GAS RECIRCULATION	YEARS	PART NO.	DESCRIPTION		
1	EGR Gasket	2005-98	72361			
QTY	OIL COOLER	YEARS	PART NO.	DESCRIPTION		
1	Oil Cooler Gasket	2005-98	72977	Loc. Upper; Oil cooler mounting; New Part Number - Check for Availability		
1	Oil Cooler Gasket	2005-98	72978	Loc. Lower; Oil cooler mounting; New Part Number - Check for Availability		
26		2005 - 2004; 3.2L 195.1 (3199cc) SOHC V6 (18 Valve) 89.9mm Bore			26	
		MFI; Flex Fuel; Naturally Aspirated Mercedes-Benz Eng.; Eng. Code 112.946				
QTY	CYLINDER HEAD	YEARS	PART NO.	DESCRIPTION		
1	Head Gasket	2005-04	26433 PT	Loc. L.H.; Head bolts not incl.; Head bolt replacement recommended; PermaTorqueMLS®		
1	Head Gasket	2005-04	26434 PT	Loc. R.H.; Head bolts not incl.; Head bolt replacement recommended; PermaTorqueMLS®		
1	Head Set	2005-04	HS 26433 PT	Head bolts not incl.; Head bolt replacement recommended; PermaDry® molded rubber valve cover gskts. incl.; Premium valve stem seals incl.		
2	Head Bolt Set	2005-04	ES 71307	Replacement recommended		
QTY	CONVERSION SET	YEARS	PART NO.	DESCRIPTION		
1	Gasket Conversion Set	2005-04	CS 26433-1	RTV sealant incl. for oil pan gskt.		
QTY	MANIFOLD - INT. & EXH.	YEARS	PART NO.	DESCRIPTION		
1	Int. Manifold Gasket Set	2005-04	MS 97091			
1	Exh. Manifold Gasket Set	2005-04	MS 97095			
QTY	EXHAUST PIPE FLANGE	YEARS	PART NO.	DESCRIPTION		
2	Exhaust Pipe Gasket	2005-04	61588	Flange		
2	Exhaust Pipe Gasket	2005-04	61590	Converter; New Part Number - Check for Availability		
QTY	CRANKSHAFT REAR SEAL	YEARS	PART NO.	DESCRIPTION		
1	Rear Main Seal Set	2005-04	BS 40722	Rubber; One-piece		
QTY	VALVE COVER	YEARS	PART NO.	DESCRIPTION		
1	Valve Cover Gasket Set	2005-04	VS 50758 R	PermaDry® molded rubber gskts. incl.		
QTY	VALVE STEM SEAL SET	YEARS	PART NO.	DESCRIPTION		
1	Valve Stem Seal Set	2005-04	SS 72919-2	Premium valve stem seals incl.		
QTY	THERMOSTAT HOUSING	YEARS	PART NO.	DESCRIPTION		
1	O-Ring	2005-04	35908	Thermostat Housing; Thermostat seal		
QTY	WATER PUMP	YEARS	PART NO.	DESCRIPTION		
1	Water Pump Gasket	2005-04	35910	Loc. Lower		
1	Water Pump Gasket	2005-04	35912	Loc. Upper		
QTY	TIMING COVER	YEARS	PART NO.	DESCRIPTION		
1	Crankshaft Front Seal Set	2005-04	TCS 46123	Mounting set		
1	Crankshaft Front Seal Set	2005-04	TCS 46188	Seal only; New Part Number - Check for Availability		
QTY	CARB & FUEL INJECTION	YEARS	PART NO.	DESCRIPTION		
3	Fuel Injector O-Ring Set	2005-04	ES 70599	Improved design		
1	Throttle Body Gasket	2005-04	61592			
QTY	EXHAUST GAS RECIRCULATION	YEARS	PART NO.	DESCRIPTION		
1	EGR Gasket	2005-04	72361			
QTY	OIL COOLER	YEARS	PART NO.	DESCRIPTION		
1	Oil Cooler Gasket	2005-04	72977	Loc. Upper; Oil cooler mounting; New Part Number - Check for Availability		
1	Oil Cooler Gasket	2005-04	72978	Loc. Lower; Oil cooler mounting; New Part Number - Check for Availability		
27		2005 - 2001; 3.2L 195.1 (3199cc) SOHC V6 (18 Valve) 89.9mm Bore			27	
		MFI; Gasoline; Naturally Aspirated Mercedes-Benz Eng.; Eng. Code 112.946				
QTY	CYLINDER HEAD	YEARS	PART NO.	DESCRIPTION		
1	Head Gasket	2005-01	26433 PT	Loc. L.H.; Head bolts not incl.; Head bolt replacement recommended; PermaTorqueMLS®		

Mercedes-Benz Car (Incl. Maybach, Mercedes-Benz, Smart) (Cont.)

27 (cont.)		2005 - 2001; 3.2L 195.1 (3199cc) SOHC V6 (18 Valve) 89.9mm Bore			27 (cont.)
		MFI; Gasoline; Naturally Aspirated Mercedes-Benz Eng.; Eng. Code 112.946			
QTY	CYLINDER HEAD	YEARS	PART NO.	DESCRIPTION	
1	Head Gasket	2005-01	26434 PT	Loc. R.H.; Head bolts not incl.; Head bolt replacement recommended; PermaTorqueMLS®	
1	Head Set	2005-01	HS 26433 PT	Head bolts not incl.; Head bolt replacement recommended; PermaDry® molded rubber valve cover gskts. incl.; Premium valve stem seals incl.	
2	Head Bolt Set	2005-01	ES 71307	Replacement recommended	
QTY	CONVERSION SET	YEARS	PART NO.	DESCRIPTION	
1	Gasket Conversion Set	2005-01	CS 26433-1	RTV sealant incl. for oil pan gskt.	
QTY	MANIFOLD - INT. & EXH.	YEARS	PART NO.	DESCRIPTION	
1	Int. Manifold Gasket Set	2005-01	MS 97091		
1	Exh. Manifold Gasket Set	2005-01	MS 97095		
QTY	EXHAUST PIPE FLANGE	YEARS	PART NO.	DESCRIPTION	
2	Exhaust Pipe Gasket	2005-01	61588	Flange	
2	Exhaust Pipe Gasket	2005-01	61590	Converter; New Part Number - Check for Availability	
QTY	CRANKSHAFT REAR SEAL	YEARS	PART NO.	DESCRIPTION	
1	Rear Main Seal Set	2005-01	BS 40722	Rubber; One-piece	
QTY	VALVE COVER	YEARS	PART NO.	DESCRIPTION	
1	Valve Cover Gasket Set	2005-01	VS 50758 R	PermaDry® molded rubber gskts. incl.	
QTY	VALVE STEM SEAL SET	YEARS	PART NO.	DESCRIPTION	
1	Valve Stem Seal Set	2005-01	SS 72919-2	Premium valve stem seals incl.	
QTY	THERMOSTAT HOUSING	YEARS	PART NO.	DESCRIPTION	
1	O-Ring	2005-01	35908	Thermostat Housing; Thermostat seal	
QTY	WATER PUMP	YEARS	PART NO.	DESCRIPTION	
1	Water Pump Gasket	2005-01	35910	Loc. Lower	
1	Water Pump Gasket	2005-01	35912	Loc. Upper	
QTY	TIMING COVER	YEARS	PART NO.	DESCRIPTION	
1	Crankshaft Front Seal Set	2005-01	TCS 46123	Mounting set	
1	Crankshaft Front Seal Set	2005-01	TCS 46188	Seal only; New Part Number - Check for Availability	
QTY	CARB & FUEL INJECTION	YEARS	PART NO.	DESCRIPTION	
3	Fuel Injector O-Ring Set	2005-01	ES 70599	Improved design	
1	Throttle Body Gasket	2005-01	61592		
QTY	EXHAUST GAS RECIRCULATION	YEARS	PART NO.	DESCRIPTION	
1	EGR Gasket	2005-01	72361		
QTY	OIL COOLER	YEARS	PART NO.	DESCRIPTION	
1	Oil Cooler Gasket	2005-01	72977	Loc. Upper; Oil cooler mounting; New Part Number - Check for Availability	
1	Oil Cooler Gasket	2005-01	72978	Loc. Lower; Oil cooler mounting; New Part Number - Check for Availability	

28		2004 - 2001; 3.2L 195.1 (3199cc) SOHC V6 (18 Valve) 89.9mm Bore			28
		MFI; Gasoline; Naturally Aspirated Mercedes-Benz Eng.; Eng. Code 112.947			
QTY	CYLINDER HEAD	YEARS	PART NO.	DESCRIPTION	
1	Head Gasket	2004-01	26433 PT	Loc. L.H.; Head bolts not incl.; Head bolt replacement recommended; PermaTorqueMLS®	
1	Head Gasket	2004-01	26434 PT	Loc. R.H.; Head bolts not incl.; Head bolt replacement recommended; PermaTorqueMLS®	
1	Head Set	2004-01	HS 26433 PT	Head bolts not incl.; Head bolt replacement recommended; PermaDry® molded rubber valve cover gskts. incl.; Premium valve stem seals incl.	
2	Head Bolt Set	2004-01	ES 71307	Replacement recommended	
QTY	CONVERSION SET	YEARS	PART NO.	DESCRIPTION	
1	Gasket Conversion Set	2004-01	CS 26433-1	RTV sealant incl. for oil pan gskt.	
QTY	MANIFOLD - INT. & EXH.	YEARS	PART NO.	DESCRIPTION	
1	Int. Manifold Gasket Set	2004-01	MS 97091		
1	Exh. Manifold Gasket Set	2004-01	MS 97095		
QTY	EXHAUST PIPE FLANGE	YEARS	PART NO.	DESCRIPTION	
2	Exhaust Pipe Gasket	2004-01	61588	Flange	
2	Exhaust Pipe Gasket	2004-01	61590	Converter; New Part Number - Check for Availability	
QTY	CRANKSHAFT REAR SEAL	YEARS	PART NO.	DESCRIPTION	
1	Rear Main Seal Set	2004-01	BS 40722	Rubber; One-piece	
QTY	VALVE COVER	YEARS	PART NO.	DESCRIPTION	
1	Valve Cover Gasket Set	2004-01	VS 50758 R	PermaDry® molded rubber gskts. incl.	
QTY	VALVE STEM SEAL SET	YEARS	PART NO.	DESCRIPTION	
1	Valve Stem Seal Set	2004-01	SS 72919-2	Premium valve stem seals incl.	
QTY	THERMOSTAT HOUSING	YEARS	PART NO.	DESCRIPTION	
1	O-Ring	2004-01	35908	Thermostat Housing; Thermostat seal	

Mercedes-Benz Car (Incl. Maybach, Mercedes-Benz, Smart) (Cont.)

28		2004 - 2001; 3.2L 195.1 (3199cc) SOHC V6 (18 Valve) 89.9mm Bore			28	
(cont.)		MFI; Gasoline; Naturally Aspirated Mercedes-Benz Eng.; Eng. Code 112.947			(cont.)	
QTY	WATER PUMP	YEARS	PART NO.	DESCRIPTION		
1	Water Pump Gasket	2004-01	35910	Loc. Lower		
1	Water Pump Gasket	2004-01	35912	Loc. Upper		
QTY	TIMING COVER	YEARS	PART NO.	DESCRIPTION		
1	Crankshaft Front Seal Set	2004-01	TCS 46123	Mounting set		
1	Crankshaft Front Seal Set	2004-01	TCS 46188	Seal only; New Part Number - Check for Availability		
QTY	CARB & FUEL INJECTION	YEARS	PART NO.	DESCRIPTION		
3	Fuel Injector O-Ring Set	2004-01	ES 70599	Improved design		
1	Throttle Body Gasket	2004-01	61592			
QTY	EXHAUST GAS RECIRCULATION	YEARS	PART NO.	DESCRIPTION		
1	EGR Gasket	2004-01	72361			
QTY	OIL COOLER	YEARS	PART NO.	DESCRIPTION		
1	Oil Cooler Gasket	2004-01	72977	Loc. Upper; Oil cooler mounting; New Part Number - Check for Availability		
1	Oil Cooler Gasket	2004-01	72978	Loc. Lower; Oil cooler mounting; New Part Number - Check for Availability		
29		2005 - 2003; 3.2L 195.1 (3199cc) SOHC V6 (18 Valve) 89.9mm Bore			29	
		MFI; Gasoline; Naturally Aspirated Mercedes-Benz Eng.; Eng. Code 112.953				
QTY	CYLINDER HEAD	YEARS	PART NO.	DESCRIPTION		
1	Head Gasket	2005-03	26433 PT	Loc. L.H.; Head bolts not incl.; Head bolt replacement recommended; PermaTorqueMLS®		
1	Head Gasket	2005-03	26434 PT	Loc. R.H.; Head bolts not incl.; Head bolt replacement recommended; PermaTorqueMLS®		
1	Head Set	2005-03	HS 26433 PT	Head bolts not incl.; Head bolt replacement recommended; PermaDry® molded rubber valve cover gskts. incl.; Premium valve stem seals incl.		
2	Head Bolt Set	2005-03	ES 71307	Replacement recommended		
QTY	CONVERSION SET	YEARS	PART NO.	DESCRIPTION		
1	Gasket Conversion Set	2005-03	CS 26433-1	RTV sealant incl. for oil pan gskt.		
QTY	MANIFOLD - INT. & EXH.	YEARS	PART NO.	DESCRIPTION		
1	Int. Manifold Gasket Set	2005-03	MS 97091			
1	Exh. Manifold Gasket Set	2005-03	MS 97095			
QTY	EXHAUST PIPE FLANGE	YEARS	PART NO.	DESCRIPTION		
2	Exhaust Pipe Gasket	2005-03	61588	Flange		
2	Exhaust Pipe Gasket	2005-03	61590	Converter; New Part Number - Check for Availability		
QTY	CRANKSHAFT REAR SEAL	YEARS	PART NO.	DESCRIPTION		
1	Rear Main Seal Set	2005-03	BS 40722	Rubber; One-piece		
QTY	VALVE COVER	YEARS	PART NO.	DESCRIPTION		
1	Valve Cover Gasket Set	2005-03	VS 50758 R	PermaDry® molded rubber gskts. incl.		
QTY	VALVE STEM SEAL SET	YEARS	PART NO.	DESCRIPTION		
1	Valve Stem Seal Set	2005-03	SS 72919-2	Premium valve stem seals incl.		
QTY	THERMOSTAT HOUSING	YEARS	PART NO.	DESCRIPTION		
1	O-Ring	2005-03	35908	Thermostat Housing; Thermostat seal		
QTY	WATER PUMP	YEARS	PART NO.	DESCRIPTION		
1	Water Pump Gasket	2005-03	35910	Loc. Lower		
1	Water Pump Gasket	2005-03	35912	Loc. Upper		
QTY	TIMING COVER	YEARS	PART NO.	DESCRIPTION		
1	Crankshaft Front Seal Set	2005-03	TCS 46123	Mounting set		
1	Crankshaft Front Seal Set	2005-03	TCS 46188	Seal only; New Part Number - Check for Availability		
QTY	CARB & FUEL INJECTION	YEARS	PART NO.	DESCRIPTION		
3	Fuel Injector O-Ring Set	2005-03	ES 70599	Improved design		
1	Throttle Body Gasket	2005-03	61592			
QTY	EXHAUST GAS RECIRCULATION	YEARS	PART NO.	DESCRIPTION		
1	EGR Gasket	2005-03	72361			
QTY	OIL COOLER	YEARS	PART NO.	DESCRIPTION		
1	Oil Cooler Gasket	2005-03	72977	Loc. Upper; Oil cooler mounting; New Part Number - Check for Availability		
1	Oil Cooler Gasket	2005-03	72978	Loc. Lower; Oil cooler mounting; New Part Number - Check for Availability		
30		2005 - 2004; 3.2L 195.1 (3199cc) SOHC V6 (18 Valve) 89.9mm Bore			30	
		MFI; Gasoline; Naturally Aspirated Mercedes-Benz Eng.; Eng. Code 112.955				
QTY	CYLINDER HEAD	YEARS	PART NO.	DESCRIPTION		
1	Head Gasket	2005-04	26433 PT	Loc. L.H.; Head bolts not incl.; Head bolt replacement recommended; PermaTorqueMLS®		
1	Head Gasket	2005-04	26434 PT	Loc. R.H.; Head bolts not incl.; Head bolt replacement recommended; PermaTorqueMLS®		

Mercedes-Benz Car (Incl. Maybach, Mercedes-Benz, Smart) (Cont.)

30 (cont.)		2005 - 2004; 3.2L 195.1 (3199cc) SOHC V6 (18 Valve) 89.9mm Bore			30 (cont.)
		MFI; Gasoline; Naturally Aspirated Mercedes-Benz Eng.; Eng. Code 112.955			
QTY	CYLINDER HEAD	YEARS	PART NO.	DESCRIPTION	
1	Head Set	2005-04	HS 26433 PT	Head bolts not incl.; Head bolt replacement recommended; PermaDry® molded rubber valve cover gskts. incl.; Premium valve stem seals incl.	
2	Head Bolt Set	2005-04	ES 71307	Replacement recommended	
QTY	CONVERSION SET	YEARS	PART NO.	DESCRIPTION	
1	Gasket Conversion Set	2005-04	CS 26433-1	RTV sealant incl. for oil pan gskt.	
QTY	MANIFOLD - INT. & EXH.	YEARS	PART NO.	DESCRIPTION	
1	Int. Manifold Gasket Set	2005-04	MS 97091		
1	Exh. Manifold Gasket Set	2005-04	MS 97095		
QTY	EXHAUST PIPE FLANGE	YEARS	PART NO.	DESCRIPTION	
2	Exhaust Pipe Gasket	2005-04	61588	Flange	
2	Exhaust Pipe Gasket	2005-04	61590	Converter; New Part Number - Check for Availability	
QTY	CRANKSHAFT REAR SEAL	YEARS	PART NO.	DESCRIPTION	
1	Rear Main Seal Set	2005-04	BS 40722	Rubber; One-piece	
QTY	VALVE COVER	YEARS	PART NO.	DESCRIPTION	
1	Valve Cover Gasket Set	2005-04	VS 50758 R	PermaDry® molded rubber gskts. incl.	
QTY	VALVE STEM SEAL SET	YEARS	PART NO.	DESCRIPTION	
1	Valve Stem Seal Set	2005-04	SS 72919-2	Premium valve stem seals incl.	
QTY	THERMOSTAT HOUSING	YEARS	PART NO.	DESCRIPTION	
1	O-Ring	2005-04	35908	Thermostat Housing; Thermostat seal	
QTY	WATER PUMP	YEARS	PART NO.	DESCRIPTION	
1	Water Pump Gasket	2005-04	35910	Loc. Lower	
1	Water Pump Gasket	2005-04	35912	Loc. Upper	
QTY	TIMING COVER	YEARS	PART NO.	DESCRIPTION	
1	Crankshaft Front Seal Set	2005-04	TCS 46123	Mounting set	
1	Crankshaft Front Seal Set	2005-04	TCS 46188	Seal only; New Part Number - Check for Availability	
QTY	CARB & FUEL INJECTION	YEARS	PART NO.	DESCRIPTION	
3	Fuel Injector O-Ring Set	2005-04	ES 70599	Improved design	
1	Throttle Body Gasket	2005-04	61592		
QTY	EXHAUST GAS RECIRCULATION	YEARS	PART NO.	DESCRIPTION	
1	EGR Gasket	2005-04	72361		
QTY	OIL COOLER	YEARS	PART NO.	DESCRIPTION	
1	Oil Cooler Gasket	2005-04	72977	Loc. Upper; Oil cooler mounting; New Part Number - Check for Availability	
1	Oil Cooler Gasket	2005-04	72978	Loc. Lower; Oil cooler mounting; New Part Number - Check for Availability	
31		2004 - 2002; 3.2L 195.1 (3199cc) SOHC V6 (18 Valve) 89.9mm Bore			31
		MFI; Gasoline; Supercharged Mercedes-Benz Eng.; Eng. Code 112.960			
QTY	CYLINDER HEAD	YEARS	PART NO.	DESCRIPTION	
1	Head Gasket	2004-02	26433 PT	Loc. L.H.; Head bolts not incl.; Head bolt replacement recommended; PermaTorqueMLS®	
1	Head Gasket	2004-02	26434 PT	Loc. R.H.; Head bolts not incl.; Head bolt replacement recommended; PermaTorqueMLS®	
1	Head Set	2004-02	HS 26433 PT	Head bolts not incl.; Head bolt replacement recommended; PermaDry® molded rubber valve cover gskts. incl.; Premium valve stem seals incl.	
2	Head Bolt Set	2004-02	ES 71307	Replacement recommended	
QTY	CONVERSION SET	YEARS	PART NO.	DESCRIPTION	
1	Gasket Conversion Set	2004-02	CS 26433-1	RTV sealant incl. for oil pan gskt.	
QTY	MANIFOLD - INT. & EXH.	YEARS	PART NO.	DESCRIPTION	
1	Int. Manifold Gasket Set	2004-02	MS 97091		
1	Exh. Manifold Gasket Set	2004-02	MS 97095		
QTY	EXHAUST PIPE FLANGE	YEARS	PART NO.	DESCRIPTION	
2	Exhaust Pipe Gasket	2004-02	61588	Flange	
2	Exhaust Pipe Gasket	2004-02	61590	Converter; New Part Number - Check for Availability	
QTY	CRANKSHAFT REAR SEAL	YEARS	PART NO.	DESCRIPTION	
1	Rear Main Seal Set	2004-02	BS 40722	Rubber; One-piece	
QTY	VALVE COVER	YEARS	PART NO.	DESCRIPTION	
1	Valve Cover Gasket Set	2004-02	VS 50758 R	PermaDry® molded rubber gskts. incl.	
QTY	VALVE STEM SEAL SET	YEARS	PART NO.	DESCRIPTION	
1	Valve Stem Seal Set	2004-02	SS 72919-2	Premium valve stem seals incl.	
QTY	THERMOSTAT HOUSING	YEARS	PART NO.	DESCRIPTION	
1	O-Ring	2004-02	35908	Thermostat Housing; Thermostat seal	
QTY	WATER PUMP	YEARS	PART NO.	DESCRIPTION	
1	Water Pump Gasket	2004-02	35910	Loc. Lower	

Mercedes-Benz Car (Incl. Maybach, Mercedes-Benz, Smart) (Cont.)

31		2004 - 2002; 3.2L 195.1 (3199cc) SOHC V6 (18 Valve) 89.9mm Bore			31
(cont.)		MFI; Gasoline; Supercharged Mercedes-Benz Eng.; Eng. Code 112.960			(cont.)
QTY	WATER PUMP	YEARS	PART NO.	DESCRIPTION	
1	Water Pump Gasket	2004-02	35912	Loc. Upper	
QTY	TIMING COVER	YEARS	PART NO.	DESCRIPTION	
1	Crankshaft Front Seal Set	2004-02	TCS 46123	Mounting set	
1	Crankshaft Front Seal Set	2004-02	TCS 46188	Seal only; New Part Number - Check for Availability	
QTY	CARB & FUEL INJECTION	YEARS	PART NO.	DESCRIPTION	
3	Fuel Injector O-Ring Set	2004-02	ES 70599	Improved design	
1	Throttle Body Gasket	2004-02	61594		
QTY	EXHAUST GAS RECIRCULATION	YEARS	PART NO.	DESCRIPTION	
1	EGR Gasket	2004-02	72361		
QTY	OIL COOLER	YEARS	PART NO.	DESCRIPTION	
1	Oil Cooler Gasket	2004-02	72977	Loc. Upper; Oil cooler mounting; New Part Number - Check for Availability	
1	Oil Cooler Gasket	2004-02	72978	Loc. Lower; Oil cooler mounting; New Part Number - Check for Availability	
32		1993 - 1992; 3.2L 195.2 (3199cc) DOHC L6 (24 Valve) 89.9mm Bore			32
(cont.)		MFI; Gasoline; Naturally Aspirated Mercedes-Benz Eng.; Eng. Code 104.990			(cont.)
QTY	CYLINDER HEAD	YEARS	PART NO.	DESCRIPTION	
1	Head Set	1993-92	HS 26287 PT	Valve cover gskt., valve stem seals, head bolts not incl.; Head bolt replacement recommended	
QTY	CONVERSION SET	YEARS	PART NO.	DESCRIPTION	
1	Gasket Conversion Set	1993-92	CS 26289		
QTY	MANIFOLD - INT. & EXH.	YEARS	PART NO.	DESCRIPTION	
1	Int. Manifold Gasket Set	1993-92	MS 97305	Lower set; New Part Number - Check for Availability	
1	Exh. Manifold Gasket Set	1993-92	MS 97271	New Part Number - Check for Availability	
QTY	OIL PAN	YEARS	PART NO.	DESCRIPTION	
1	Oil Pan Gasket Set	1993-92	OS 30859	New Part Number - Check for Availability	
QTY	VALVE COVER	YEARS	PART NO.	DESCRIPTION	
1	Valve Cover Gasket Set	1993-92	VS 50655 R	PermaDry® molded rubber gskt. incl.	
QTY	VALVE STEM SEAL SET	YEARS	PART NO.	DESCRIPTION	
1	Valve Stem Seal Set	1993-92	SS 72919	From Eng. Ser. No. 001567; Premium valve stem seals incl.	
33		1997 - 1994; 3.2L 195.2 (3199cc) DOHC L6 (24 Valve) 89.9mm Bore			33
(cont.)		MFI; Gasoline; Naturally Aspirated Mercedes-Benz Eng.; Eng. Code 104.991			(cont.)
QTY	CYLINDER HEAD	YEARS	PART NO.	DESCRIPTION	
1	Head Set	1997-94	HS 26289 PT	Valve cover gskt., valve stem seals, head bolts not incl.; Head bolt replacement recommended	
QTY	CONVERSION SET	YEARS	PART NO.	DESCRIPTION	
1	Gasket Conversion Set	1997-94	CS 26289		
QTY	MANIFOLD - INT. & EXH.	YEARS	PART NO.	DESCRIPTION	
1	Int. Manifold Gasket Set	1997-94	MS 97305	Lower set; New Part Number - Check for Availability	
1	Exh. Manifold Gasket Set	1997-94	MS 97271	New Part Number - Check for Availability	
QTY	OIL PAN	YEARS	PART NO.	DESCRIPTION	
1	Oil Pan Gasket Set	1997-94	OS 30859	New Part Number - Check for Availability	
QTY	VALVE COVER	YEARS	PART NO.	DESCRIPTION	
1	Valve Cover Gasket Set	1997-94	VS 50637 R	PermaDry® molded rubber gskt. incl.	
QTY	VALVE STEM SEAL SET	YEARS	PART NO.	DESCRIPTION	
1	Valve Stem Seal Set	1997-94	SS 72919	Premium valve stem seals incl.	
34		1995 - 1993; 3.2L 195.2 (3199cc) DOHC L6 (24 Valve) 89.9mm Bore			34
(cont.)		MFI; Gasoline; Naturally Aspirated Mercedes-Benz Eng.; Eng. Code 104.992			(cont.)
QTY	CYLINDER HEAD	YEARS	PART NO.	DESCRIPTION	
1	Head Set	1995-93	HS 26289 PT	Valve cover gskt., valve stem seals, head bolts not incl.; Head bolt replacement recommended	
QTY	CONVERSION SET	YEARS	PART NO.	DESCRIPTION	
1	Gasket Conversion Set	1995-93	CS 26289		
QTY	MANIFOLD - INT. & EXH.	YEARS	PART NO.	DESCRIPTION	
1	Int. Manifold Gasket Set	1995-93	MS 97305	Lower set; New Part Number - Check for Availability	
1	Exh. Manifold Gasket Set	1995-93	MS 97271	New Part Number - Check for Availability	
QTY	OIL PAN	YEARS	PART NO.	DESCRIPTION	
1	Oil Pan Gasket Set	1995-93	OS 30859	New Part Number - Check for Availability	
QTY	VALVE COVER	YEARS	PART NO.	DESCRIPTION	
1	Valve Cover Gasket Set	1995-93	VS 50637 R	PermaDry® molded rubber gskt. incl.	
QTY	VALVE STEM SEAL SET	YEARS	PART NO.	DESCRIPTION	
1	Valve Stem Seal Set	1995-93	SS 72919	Premium valve stem seals incl.	

Mercedes-Benz Car (Incl. Maybach, Mercedes-Benz, Smart) (Cont.)

35		1999 - 1996; 3.2L 195.2 (3199cc) DOHC L6 (24 Valve) 89.9mm Bore			35
MFI; Gasoline; Naturally Aspirated Mercedes-Benz Eng.; Eng. Code 104.994					
QTY	CYLINDER HEAD	YEARS	PART NO.	DESCRIPTION	
1	Head Set	1999-96	HS 26289 PT	Valve cover gskt., valve stem seals, head bolts not incl.; Head bolt replacement recommended	
QTY	CONVERSION SET	YEARS	PART NO.	DESCRIPTION	
1	Gasket Conversion Set	1999-96	CS 26289		
QTY	MANIFOLD - INT. & EXH.	YEARS	PART NO.	DESCRIPTION	
1	Int. Manifold Gasket Set	1999-96	MS 97305	Lower set; New Part Number - Check for Availability	
1	Exh. Manifold Gasket Set	1999-96	MS 97271	New Part Number - Check for Availability	
QTY	OIL PAN	YEARS	PART NO.	DESCRIPTION	
1	Oil Pan Gasket Set	1999-96	OS 30859	New Part Number - Check for Availability	
QTY	VALVE COVER	YEARS	PART NO.	DESCRIPTION	
1	Valve Cover Gasket Set	1999-96	VS 50637 R	PermaDry® molded rubber gskt. incl.	
QTY	VALVE STEM SEAL SET	YEARS	PART NO.	DESCRIPTION	
1	Valve Stem Seal Set	1999-96	SS 72919	Premium valve stem seals incl.	
36		1997 - 1996; 3.2L 195.2 (3199cc) DOHC L6 (24 Valve) 89.9mm Bore			36
MFI; Gasoline; Naturally Aspirated Mercedes-Benz Eng.; Eng. Code 104.995					
QTY	CYLINDER HEAD	YEARS	PART NO.	DESCRIPTION	
1	Head Set	1997-96	HS 26289 PT	Valve cover gskt., valve stem seals, head bolts not incl.; Head bolt replacement recommended	
QTY	CONVERSION SET	YEARS	PART NO.	DESCRIPTION	
1	Gasket Conversion Set	1997-96	CS 26289		
QTY	MANIFOLD - INT. & EXH.	YEARS	PART NO.	DESCRIPTION	
1	Int. Manifold Gasket Set	1997-96	MS 97305	Lower set; New Part Number - Check for Availability	
1	Exh. Manifold Gasket Set	1997-96	MS 97271	New Part Number - Check for Availability	
QTY	OIL PAN	YEARS	PART NO.	DESCRIPTION	
1	Oil Pan Gasket Set	1997-96	OS 30859	New Part Number - Check for Availability	
QTY	VALVE COVER	YEARS	PART NO.	DESCRIPTION	
1	Valve Cover Gasket Set	1997-96	VS 50637 R	PermaDry® molded rubber gskt. incl.	
QTY	VALVE STEM SEAL SET	YEARS	PART NO.	DESCRIPTION	
1	Valve Stem Seal Set	1997-96	SS 72919	Premium valve stem seals incl.	
37		2006 - 2005; 3.2L 197 (3222cc) DOHC Turbo - Intercooled L6 (24 Valve) 88mm Bore			37
DI; Diesel; Turbo - Intercooled Mercedes-Benz Eng.; Eng. Code 648.961					
QTY	CYLINDER HEAD	YEARS	PART NO.	DESCRIPTION	
1	Head Gasket	2006-05	26647 PT	Head bolts not incl.; Head bolt replacement recommended; PermaTorqueMLS®; New Part Number - Check for Availability	
QTY	MANIFOLD - INT. & EXH.	YEARS	PART NO.	DESCRIPTION	
1	Int. Manifold Gasket Set	2006-05	MS 97299	Lower set; New Part Number - Check for Availability	
1	Exh. Manifold Gasket Set	2006-05	MS 97267	New Part Number - Check for Availability	
QTY	OIL PAN	YEARS	PART NO.	DESCRIPTION	
1	Oil Pan Gasket Set	2006-05	OS 30856	New Part Number - Check for Availability	
QTY	VALVE COVER	YEARS	PART NO.	DESCRIPTION	
1	Valve Cover Gasket Set	2006	VS 50845 R	PermaDry® molded rubber gskt. incl.; New Part Number - Check for Availability	
1	Valve Cover Gasket Set	2005	VS 50844 R	To Ser. No. 30063210; To 02/26/04; PermaDry® molded rubber gskt. incl.; New Part Number - Check for Availability	
1	Valve Cover Gasket Set	2005	VS 50845 R	From Ser. No. 30063211; From 02/27/04; PermaDry® molded rubber gskt. incl.; New Part Number - Check for Availability	
QTY	TIMING COVER	YEARS	PART NO.	DESCRIPTION	
1	Crankshaft Front Seal Set	2006-05	TCS 46188	Seal only; New Part Number - Check for Availability	
38		2013 - 2006; 3.5L 213.4 (3498cc) DOHC V6 (24 Valve) 92.9mm Bore			38
MFI; Gasoline; Naturally Aspirated Mercedes-Benz Eng.; Eng. Code 272.056					
QTY	CYLINDER HEAD	YEARS	PART NO.	DESCRIPTION	
1	Head Gasket	2013-06	26610 PT	Loc. L.H.; Head bolts not incl.; Head bolt replacement recommended; PermaTorqueMLS®; New Part Number - Check for Availability	
1	Head Gasket	2013-06	26623 PT	Loc. R.H.; Head bolts not incl.; Head bolt replacement recommended; PermaTorqueMLS®; New Part Number - Check for Availability	
1	Head Set	2013-06	HS 26610 PT	Head bolts not incl.; Head bolt replacement recommended; RTV sealant incl. for valve cover gskts.; Premium valve stem seals incl.; New Part Number - Check for Availability	
QTY	CONVERSION SET	YEARS	PART NO.	DESCRIPTION	
1	Gasket Conversion Set	2013-06	CS 26610	RTV sealant incl. for oil pan gskt.; New Part Number - Check for Availability	

Mercedes-Benz Car (Incl. Maybach, Mercedes-Benz, Smart) (Cont.)

38		2013 - 2006; 3.5L 213.4 (3498cc) DOHC V6 (24 Valve) 92.9mm Bore			38
(cont.)		MFI; Gasoline; Naturally Aspirated Mercedes-Benz Eng.; Eng. Code 272.056			(cont.)
QTY	MANIFOLD - INT. & EXH.	YEARS	PART NO.	DESCRIPTION	
1	Int. Manifold Gasket Set	2013-06	MS 97292	Lower set; New Part Number - Check for Availability	
1	Exh. Manifold Gasket Set	2013-06	MS 97263	New Part Number - Check for Availability	
QTY	WATER PUMP	YEARS	PART NO.	DESCRIPTION	
1	Water Pump Gasket	2006	36060	To Ser. No. 30058493; New Part Number - Check for Availability	
QTY	OIL COOLER	YEARS	PART NO.	DESCRIPTION	
1	Oil Cooler Gasket	2013-06	72979	Oil cooler to housing; New Part Number - Check for Availability	
39		2013 - 2006; 3.5L 213.4 (3498cc) DOHC V6 (24 Valve) 92.9mm Bore			39
		MFI; Gasoline; Naturally Aspirated Mercedes-Benz Eng.; Eng. Code 272.087			
QTY	CYLINDER HEAD	YEARS	PART NO.	DESCRIPTION	
1	Head Gasket	2013-06	26610 PT	Loc. L.H.; Head bolts not incl.; Head bolt replacement recommended; PermaTorqueMLS®; New Part Number - Check for Availability	
1	Head Gasket	2013-06	26623 PT	Loc. R.H.; Head bolts not incl.; Head bolt replacement recommended; PermaTorqueMLS®; New Part Number - Check for Availability	
1	Head Set	2013-06	HS 26610 PT	Head bolts not incl.; Head bolt replacement recommended; RTV sealant incl. for valve cover gskts.; Premium valve stem seals incl.; New Part Number - Check for Availability	
QTY	CONVERSION SET	YEARS	PART NO.	DESCRIPTION	
1	Gasket Conversion Set	2013-06	CS 26610	RTV sealant incl. for oil pan gskt.; New Part Number - Check for Availability	
QTY	MANIFOLD - INT. & EXH.	YEARS	PART NO.	DESCRIPTION	
1	Int. Manifold Gasket Set	2013-06	MS 97292	Lower set; New Part Number - Check for Availability	
1	Exh. Manifold Gasket Set	2013-06	MS 97263	New Part Number - Check for Availability	
QTY	WATER PUMP	YEARS	PART NO.	DESCRIPTION	
1	Water Pump Gasket	2006	36060	To Ser. No. 30058493; New Part Number - Check for Availability	
QTY	OIL COOLER	YEARS	PART NO.	DESCRIPTION	
1	Oil Cooler Gasket	2013-06	72979	Oil cooler to housing; New Part Number - Check for Availability	
40		2009 - 2006; 3.5L 213.4 (3498cc) DOHC V6 (24 Valve) 92.9mm Bore			40
		MFI; Gasoline; Naturally Aspirated Mercedes-Benz Eng.; Eng. Code 272.960			
QTY	CYLINDER HEAD	YEARS	PART NO.	DESCRIPTION	
1	Head Gasket	2009-06	26610 PT	Loc. L.H.; Head bolts not incl.; Head bolt replacement recommended; PermaTorqueMLS®; New Part Number - Check for Availability	
1	Head Gasket	2009-06	26623 PT	Loc. R.H.; Head bolts not incl.; Head bolt replacement recommended; PermaTorqueMLS®; New Part Number - Check for Availability	
1	Head Set	2009-06	HS 26610 PT	Head bolts not incl.; Head bolt replacement recommended; RTV sealant incl. for valve cover gskts.; Premium valve stem seals incl.; New Part Number - Check for Availability	
QTY	CONVERSION SET	YEARS	PART NO.	DESCRIPTION	
1	Gasket Conversion Set	2009-06	CS 26610	RTV sealant incl. for oil pan gskt.; New Part Number - Check for Availability	
QTY	MANIFOLD - INT. & EXH.	YEARS	PART NO.	DESCRIPTION	
1	Int. Manifold Gasket Set	2009-06	MS 97292	Lower set; New Part Number - Check for Availability	
1	Exh. Manifold Gasket Set	2009-06	MS 97263	New Part Number - Check for Availability	
QTY	WATER PUMP	YEARS	PART NO.	DESCRIPTION	
1	Water Pump Gasket	2006	36060	To Ser. No. 30058493; New Part Number - Check for Availability	
QTY	OIL COOLER	YEARS	PART NO.	DESCRIPTION	
1	Oil Cooler Gasket	2009-06	72979	Oil cooler to housing; New Part Number - Check for Availability	
41		2013 - 2010; 3.5L 213.4 (3498cc) DOHC V6 (24 Valve) 92.9mm Bore			41
		MFI; Gasoline; Naturally Aspirated Mercedes-Benz Eng.; Eng. Code 272.961			
QTY	CYLINDER HEAD	YEARS	PART NO.	DESCRIPTION	
1	Head Gasket	2013-10	26610 PT	Loc. L.H.; Head bolts not incl.; Head bolt replacement recommended; PermaTorqueMLS®; New Part Number - Check for Availability	
1	Head Gasket	2013-10	26623 PT	Loc. R.H.; Head bolts not incl.; Head bolt replacement recommended; PermaTorqueMLS®; New Part Number - Check for Availability	
1	Head Set	2013-10	HS 26610 PT	Head bolts not incl.; Head bolt replacement recommended; RTV sealant incl. for valve cover gskts.; Premium valve stem seals incl.; New Part Number - Check for Availability	
QTY	CONVERSION SET	YEARS	PART NO.	DESCRIPTION	
1	Gasket Conversion Set	2013-10	CS 26610	RTV sealant incl. for oil pan gskt.; New Part Number - Check for Availability	
QTY	MANIFOLD - INT. & EXH.	YEARS	PART NO.	DESCRIPTION	
1	Int. Manifold Gasket Set	2013-10	MS 97292	Lower set; New Part Number - Check for Availability	
1	Exh. Manifold Gasket Set	2013-10	MS 97263	New Part Number - Check for Availability	
QTY	OIL COOLER	YEARS	PART NO.	DESCRIPTION	
1	Oil Cooler Gasket	2013-10	72979	Oil cooler to housing; New Part Number - Check for Availability	

Mercedes-Benz Car (Incl. Maybach, Mercedes-Benz, Smart) (Cont.)

42		2009 - 2005; 3.5L 213.4 (3498cc) DOHC V6 (24 Valve) 92.9mm Bore			42
MFI; Gasoline; Naturally Aspirated Mercedes-Benz Eng.; Eng. Code 272.963					
QTY	CYLINDER HEAD	YEARS	PART NO.	DESCRIPTION	
1	Head Gasket	2009-05	26610 PT	Loc. L.H.; Head bolts not incl.; Head bolt replacement recommended; PermaTorqueMLS®; New Part Number - Check for Availability	
1	Head Gasket	2009-05	26623 PT	Loc. R.H.; Head bolts not incl.; Head bolt replacement recommended; PermaTorqueMLS®; New Part Number - Check for Availability	
1	Head Set	2009-05	HS 26610 PT	Head bolts not incl.; Head bolt replacement recommended; RTV sealant incl. for valve cover gskts.; Premium valve stem seals incl.; New Part Number - Check for Availability	
QTY	CONVERSION SET	YEARS	PART NO.	DESCRIPTION	
1	Gasket Conversion Set	2009-05	CS 26610	RTV sealant incl. for oil pan gskt.; New Part Number - Check for Availability	
QTY	MANIFOLD - INT. & EXH.	YEARS	PART NO.	DESCRIPTION	
1	Int. Manifold Gasket Set	2009-05	MS 97292	Lower set; New Part Number - Check for Availability	
1	Exh. Manifold Gasket Set	2009-05	MS 97263	New Part Number - Check for Availability	
QTY	WATER PUMP	YEARS	PART NO.	DESCRIPTION	
1	Water Pump Gasket	2006	36060	To Ser. No. 30058493; New Part Number - Check for Availability	
1	Water Pump Gasket	2005	36060	New Part Number - Check for Availability	
QTY	OIL COOLER	YEARS	PART NO.	DESCRIPTION	
1	Oil Cooler Gasket	2009-05	72979	Oil cooler to housing; New Part Number - Check for Availability	
43		2009 - 2006; 3.5L 213.4 (3498cc) DOHC V6 (24 Valve) 92.9mm Bore			43
MFI; Gasoline; Naturally Aspirated Mercedes-Benz Eng.; Eng. Code 272.964					
QTY	CYLINDER HEAD	YEARS	PART NO.	DESCRIPTION	
1	Head Gasket	2009-06	26610 PT	Loc. L.H.; Head bolts not incl.; Head bolt replacement recommended; PermaTorqueMLS®; New Part Number - Check for Availability	
1	Head Gasket	2009-06	26623 PT	Loc. R.H.; Head bolts not incl.; Head bolt replacement recommended; PermaTorqueMLS®; New Part Number - Check for Availability	
1	Head Set	2009-06	HS 26610 PT	Head bolts not incl.; Head bolt replacement recommended; RTV sealant incl. for valve cover gskts.; Premium valve stem seals incl.; New Part Number - Check for Availability	
QTY	CONVERSION SET	YEARS	PART NO.	DESCRIPTION	
1	Gasket Conversion Set	2009-06	CS 26610	RTV sealant incl. for oil pan gskt.; New Part Number - Check for Availability	
QTY	MANIFOLD - INT. & EXH.	YEARS	PART NO.	DESCRIPTION	
1	Int. Manifold Gasket Set	2009-06	MS 97292	Lower set; New Part Number - Check for Availability	
1	Exh. Manifold Gasket Set	2009-06	MS 97263	New Part Number - Check for Availability	
QTY	WATER PUMP	YEARS	PART NO.	DESCRIPTION	
1	Water Pump Gasket	2006	36060	To Ser. No. 30058493; New Part Number - Check for Availability	
QTY	OIL COOLER	YEARS	PART NO.	DESCRIPTION	
1	Oil Cooler Gasket	2009-06	72979	Oil cooler to housing; New Part Number - Check for Availability	
44		2011 - 2009; 3.5L 213.4 (3498cc) DOHC V6 (24 Valve) 92.9mm Bore			44
MFI; Gasoline; Naturally Aspirated Mercedes-Benz Eng.; Eng. Code 272.969					
QTY	CYLINDER HEAD	YEARS	PART NO.	DESCRIPTION	
1	Head Gasket	2011-09	26610 PT	Loc. L.H.; Head bolts not incl.; Head bolt replacement recommended; PermaTorqueMLS®; New Part Number - Check for Availability	
1	Head Gasket	2011-09	26623 PT	Loc. R.H.; Head bolts not incl.; Head bolt replacement recommended; PermaTorqueMLS®; New Part Number - Check for Availability	
1	Head Set	2011-09	HS 26610 PT	Head bolts not incl.; Head bolt replacement recommended; RTV sealant incl. for valve cover gskts.; Premium valve stem seals incl.; New Part Number - Check for Availability	
QTY	CONVERSION SET	YEARS	PART NO.	DESCRIPTION	
1	Gasket Conversion Set	2011-09	CS 26610	RTV sealant incl. for oil pan gskt.; New Part Number - Check for Availability	
QTY	MANIFOLD - INT. & EXH.	YEARS	PART NO.	DESCRIPTION	
1	Int. Manifold Gasket Set	2011-09	MS 97292	Lower set; New Part Number - Check for Availability	
1	Exh. Manifold Gasket Set	2011-09	MS 97263	New Part Number - Check for Availability	
QTY	OIL COOLER	YEARS	PART NO.	DESCRIPTION	
1	Oil Cooler Gasket	2011-09	72979	Oil cooler to housing; New Part Number - Check for Availability	
45		2009 - 2006; 3.5L 213.4 (3498cc) DOHC V6 (24 Valve) 92.9mm Bore			45
MFI; Gasoline; Naturally Aspirated Mercedes-Benz Eng.; Eng. Code 272.972					
QTY	CYLINDER HEAD	YEARS	PART NO.	DESCRIPTION	
1	Head Gasket	2009-06	26610 PT	Loc. L.H.; Head bolts not incl.; Head bolt replacement recommended; PermaTorqueMLS®; New Part Number - Check for Availability	
1	Head Gasket	2009-06	26623 PT	Loc. R.H.; Head bolts not incl.; Head bolt replacement recommended; PermaTorqueMLS®; New Part Number - Check for Availability	

Mercedes-Benz Car (Incl. Maybach, Mercedes-Benz, Smart) (Cont.)

45 (cont.)		2009 - 2006; 3.5L 213.4 (3498cc) DOHC V6 (24 Valve) 92.9mm Bore			45 (cont.)
MFI; Gasoline; Naturally Aspirated Mercedes-Benz Eng.; Eng. Code 272.972					
QTY	CYLINDER HEAD	YEARS	PART NO.	DESCRIPTION	
1	Head Set	2009-06	HS 26610 PT	Head bolts not incl.; Head bolt replacement recommended; RTV sealant incl. for valve cover gskts.; Premium valve stem seals incl.; New Part Number - Check for Availability	
QTY	CONVERSION SET	YEARS	PART NO.	DESCRIPTION	
1	Gasket Conversion Set	2009-06	CS 26610	RTV sealant incl. for oil pan gskt.; New Part Number - Check for Availability	
QTY	MANIFOLD - INT. & EXH.	YEARS	PART NO.	DESCRIPTION	
1	Int. Manifold Gasket Set	2009-06	MS 97292	Lower set; New Part Number - Check for Availability	
1	Exh. Manifold Gasket Set	2009-06	MS 97263	New Part Number - Check for Availability	
QTY	WATER PUMP	YEARS	PART NO.	DESCRIPTION	
1	Water Pump Gasket	2006	36060	To Ser. No. 30058493; New Part Number - Check for Availability	
QTY	OIL COOLER	YEARS	PART NO.	DESCRIPTION	
1	Oil Cooler Gasket	2009-06	72979	Oil cooler to housing; New Part Number - Check for Availability	
46		2013 - 2010; 3.5L 213.4 (3498cc) DOHC V6 (24 Valve) 92.9mm Bore			46
MFI; Hybrid (Gas/Electric); Naturally Aspirated Mercedes-Benz Eng.; Eng. Code 272.974					
QTY	CYLINDER HEAD	YEARS	PART NO.	DESCRIPTION	
1	Head Gasket	2013-10	26610 PT	Loc. L.H.; Head bolts not incl.; Head bolt replacement recommended; PermaTorqueMLS®; New Part Number - Check for Availability	
1	Head Gasket	2013-10	26623 PT	Loc. R.H.; Head bolts not incl.; Head bolt replacement recommended; PermaTorqueMLS®; New Part Number - Check for Availability	
1	Head Set	2013-10	HS 26610 PT	Head bolts not incl.; Head bolt replacement recommended; RTV sealant incl. for valve cover gskts.; Premium valve stem seals incl.; New Part Number - Check for Availability	
QTY	CONVERSION SET	YEARS	PART NO.	DESCRIPTION	
1	Gasket Conversion Set	2013-10	CS 26610	RTV sealant incl. for oil pan gskt.; New Part Number - Check for Availability	
QTY	MANIFOLD - INT. & EXH.	YEARS	PART NO.	DESCRIPTION	
1	Int. Manifold Gasket Set	2013-10	MS 97292	Lower set; New Part Number - Check for Availability	
1	Exh. Manifold Gasket Set	2013-10	MS 97263	New Part Number - Check for Availability	
QTY	OIL COOLER	YEARS	PART NO.	DESCRIPTION	
1	Oil Cooler Gasket	2013-10	72979	Oil cooler to housing; New Part Number - Check for Availability	
47		2013 - 2010; 3.5L 213.4 (3498cc) DOHC V6 (24 Valve) 92.9mm Bore			47
MFI; Gasoline; Naturally Aspirated Mercedes-Benz Eng.; Eng. Code 272.977					
QTY	CYLINDER HEAD	YEARS	PART NO.	DESCRIPTION	
1	Head Gasket	2013-10	26610 PT	Loc. L.H.; Head bolts not incl.; Head bolt replacement recommended; PermaTorqueMLS®; New Part Number - Check for Availability	
1	Head Gasket	2013-10	26623 PT	Loc. R.H.; Head bolts not incl.; Head bolt replacement recommended; PermaTorqueMLS®; New Part Number - Check for Availability	
1	Head Set	2013-10	HS 26610 PT	Head bolts not incl.; Head bolt replacement recommended; RTV sealant incl. for valve cover gskts.; Premium valve stem seals incl.; New Part Number - Check for Availability	
QTY	CONVERSION SET	YEARS	PART NO.	DESCRIPTION	
1	Gasket Conversion Set	2013-10	CS 26610	RTV sealant incl. for oil pan gskt.; New Part Number - Check for Availability	
QTY	MANIFOLD - INT. & EXH.	YEARS	PART NO.	DESCRIPTION	
1	Int. Manifold Gasket Set	2013-10	MS 97292	Lower set; New Part Number - Check for Availability	
1	Exh. Manifold Gasket Set	2013-10	MS 97263	New Part Number - Check for Availability	
QTY	OIL COOLER	YEARS	PART NO.	DESCRIPTION	
1	Oil Cooler Gasket	2013-10	72979	Oil cooler to housing; New Part Number - Check for Availability	
48		2013 - 2010; 3.5L 213.4 (3498cc) DOHC V6 (24 Valve) 92.9mm Bore			48
MFI; Gasoline; Naturally Aspirated Mercedes-Benz Eng.; Eng. Code 272.980					
QTY	CYLINDER HEAD	YEARS	PART NO.	DESCRIPTION	
1	Head Gasket	2013-10	26610 PT	Loc. L.H.; Head bolts not incl.; Head bolt replacement recommended; PermaTorqueMLS®; New Part Number - Check for Availability	
1	Head Gasket	2013-10	26623 PT	Loc. R.H.; Head bolts not incl.; Head bolt replacement recommended; PermaTorqueMLS®; New Part Number - Check for Availability	
1	Head Set	2013-10	HS 26610 PT	Head bolts not incl.; Head bolt replacement recommended; RTV sealant incl. for valve cover gskts.; Premium valve stem seals incl.; New Part Number - Check for Availability	
QTY	CONVERSION SET	YEARS	PART NO.	DESCRIPTION	
1	Gasket Conversion Set	2013-10	CS 26610	RTV sealant incl. for oil pan gskt.; New Part Number - Check for Availability	
QTY	MANIFOLD - INT. & EXH.	YEARS	PART NO.	DESCRIPTION	
1	Int. Manifold Gasket Set	2013-10	MS 97292	Lower set; New Part Number - Check for Availability	

Mercedes-Benz Car (Incl. Maybach, Mercedes-Benz, Smart) (Cont.)

48 (cont.)	2013 - 2010; 3.5L 213.4 (3498cc) DOHC V6 (24 Valve) 92.9mm Bore				48 (cont.)
	MFI; Gasoline; Naturally Aspirated Mercedes-Benz Eng.; Eng. Code 272.980				
QTY	MANIFOLD - INT. & EXH.	YEARS	PART NO.	DESCRIPTION	
1	Exh. Manifold Gasket Set	2013-10	MS 97263	New Part Number - Check for Availability	
QTY	OIL COOLER	YEARS	PART NO.	DESCRIPTION	
1	Oil Cooler Gasket	2013-10	72979	Oil cooler to housing; New Part Number - Check for Availability	
49	1995 - 1992; 4.2L 256.1 (4196cc) DOHC V8 (32 Valve) 92mm Bore				49
	MFI; Gasoline; Naturally Aspirated Mercedes-Benz Eng.; Eng. Code 119.971				
QTY	CONVERSION SET	YEARS	PART NO.	DESCRIPTION	
1	Gasket Conversion Set	1995-92	CS 26350	PermaDry® molded rubber Upper oil pan gskt. incl.	
QTY	MANIFOLD - INT. & EXH.	YEARS	PART NO.	DESCRIPTION	
1	Exh. Manifold Gasket Set	1995-92	MS 97277	New Part Number - Check for Availability	
QTY	OIL PAN	YEARS	PART NO.	DESCRIPTION	
1	Oil Pan Gasket Set	1995-92	OS 30862	Loc. Lower; New Part Number - Check for Availability	
1	Oil Pan Gasket Set	1995-92	OS 30863	Loc. Upper; OEM style; New Part Number - Check for Availability	
QTY	VALVE COVER	YEARS	PART NO.	DESCRIPTION	
1	Valve Cover Gasket Set	1995-92	VS 50711 R	Loc. L.H.; w/Spark plug tube seals; PermaDry® molded rubber gskt. incl.	
1	Valve Cover Gasket Set	1995-92	VS 50712 R	Loc. R.H.; w/Spark plug tube seals; PermaDry® molded rubber gskt. incl.	
QTY	WATER PUMP	YEARS	PART NO.	DESCRIPTION	
1	Water Pump Gasket	1995-92	36064	New Part Number - Check for Availability	
QTY	OIL FILTER MOUNTING	YEARS	PART NO.	DESCRIPTION	
1	Oil Filter Adapter Gasket	1995-92	72995	Oil filter adapter to block; New Part Number - Check for Availability	
50	1998 - 1992; 4.2L 256.1 (4196cc) DOHC V8 (32 Valve) 92mm Bore				50
	MFI; Gasoline; Naturally Aspirated Mercedes-Benz Eng.; Eng. Code 119.975				
QTY	CONVERSION SET	YEARS	PART NO.	DESCRIPTION	
1	Gasket Conversion Set	1993-92	CS 26350	PermaDry® molded rubber Upper oil pan gskt. incl.	
QTY	MANIFOLD - INT. & EXH.	YEARS	PART NO.	DESCRIPTION	
1	Exh. Manifold Gasket Set	1998-96	MS 97277	New Part Number - Check for Availability	
1	Exh. Manifold Gasket Set	1993-92	MS 97277	New Part Number - Check for Availability	
QTY	OIL PAN	YEARS	PART NO.	DESCRIPTION	
1	Oil Pan Gasket Set	1998-96	OS 30863	Loc. Upper; OEM style; New Part Number - Check for Availability	
1	Oil Pan Gasket Set	1998-96	OS 30871 PR	Loc. Lower; New Part Number - Check for Availability	
1	Oil Pan Gasket Set	1993-92	OS 30862	Loc. Lower; New Part Number - Check for Availability	
1	Oil Pan Gasket Set	1993-92	OS 30863	Loc. Upper; OEM style; New Part Number - Check for Availability	
QTY	VALVE COVER	YEARS	PART NO.	DESCRIPTION	
1	Valve Cover Gasket Set	1998-96	VS 50711 R	Loc. L.H.; w/Spark plug tube seals; PermaDry® molded rubber gskt. incl.	
1	Valve Cover Gasket Set	1998-96	VS 50712 R	Loc. R.H.; w/Spark plug tube seals; PermaDry® molded rubber gskt. incl.	
1	Valve Cover Gasket Set	1993-92	VS 50711 R	Loc. L.H.; w/Spark plug tube seals; PermaDry® molded rubber gskt. incl.	
1	Valve Cover Gasket Set	1993-92	VS 50712 R	Loc. R.H.; w/Spark plug tube seals; PermaDry® molded rubber gskt. incl.	
QTY	WATER PUMP	YEARS	PART NO.	DESCRIPTION	
1	Water Pump Gasket	1998-96	36064	New Part Number - Check for Availability	
1	Water Pump Gasket	1993-92	36064	New Part Number - Check for Availability	
QTY	OIL FILTER MOUNTING	YEARS	PART NO.	DESCRIPTION	
1	Oil Filter Adapter Gasket	1998-96	72995	Oil filter adapter to block; New Part Number - Check for Availability	
1	Oil Filter Adapter Gasket	1993-92	72995	Oil filter adapter to block; New Part Number - Check for Availability	
51	1999 - 1996; 4.2L 256.1 (4196cc) DOHC V8 (32 Valve) 92mm Bore				51
	MFI; Gasoline; Naturally Aspirated Mercedes-Benz Eng.; Eng. Code 119.981				
QTY	CYLINDER HEAD	YEARS	PART NO.	DESCRIPTION	
1	Head Set	1999-96	HS 26350 PT-1	Loc. L.H.; Head bolts not incl.; Head bolt replacement recommended; PermaDry® molded rubber valve cover gskts. incl.; Premium valve stem seals incl.	
1	Head Set	1999-96	HS 26351 PT-1	Loc. R.H.; Head bolts not incl.; Head bolt replacement recommended; PermaDry® molded rubber valve cover gskts. incl.; Premium valve stem seals incl.	
QTY	MANIFOLD - INT. & EXH.	YEARS	PART NO.	DESCRIPTION	
1	Exh. Manifold Gasket Set	1999-96	MS 97277	New Part Number - Check for Availability	
QTY	OIL PAN	YEARS	PART NO.	DESCRIPTION	
1	Oil Pan Gasket Set	1999-96	OS 30863	Loc. Upper; OEM style; New Part Number - Check for Availability	
1	Oil Pan Gasket Set	1999-96	OS 30871 PR	Loc. Lower; New Part Number - Check for Availability	
QTY	VALVE COVER	YEARS	PART NO.	DESCRIPTION	
1	Valve Cover Gasket Set	1999-96	VS 50711 R	Loc. L.H.; w/Spark plug tube seals; PermaDry® molded rubber gskt. incl.	
1	Valve Cover Gasket Set	1999-96	VS 50712 R	Loc. R.H.; w/Spark plug tube seals; PermaDry® molded rubber gskt. incl.	
QTY	WATER PUMP	YEARS	PART NO.	DESCRIPTION	
1	Water Pump Gasket	1999-96	36064	New Part Number - Check for Availability	

Mercedes-Benz Car (Incl. Maybach, Mercedes-Benz, Smart) (Cont.)

51 (cont.)	1999 - 1996; 4.2L 256.1 (4196cc) DOHC V8 (32 Valve) 92mm Bore			51 (cont.)
MFI; Gasoline; Naturally Aspirated Mercedes-Benz Eng.; Eng. Code 119.981				
QTY	OIL FILTER MOUNTING	YEARS	PART NO.	DESCRIPTION
1	Oil Filter Adapter Gasket	1999-96	72995	Oil filter adapter to block; New Part Number - Check for Availability
52	1991; 4.2L 256.1 (4196cc) SOHC V8 (16 Valve) 92mm Bore			52
MFI; Gasoline; Naturally Aspirated Mercedes-Benz Eng.; Eng. Code 116.965				
QTY	VALVE COVER	YEARS	PART NO.	DESCRIPTION
1	Valve Cover Gasket Set	1991	VS 50404 R	PermaDry® molded rubber gskts. incl.
53	2002 - 1998; 4.3L 260 (4266cc) SOHC V8 (24 Valve) 89.9mm Bore			53
MFI; Gasoline; Naturally Aspirated Mercedes-Benz Eng.; Eng. Code 113.940				
QTY	CYLINDER HEAD	YEARS	PART NO.	DESCRIPTION
1	Head Gasket	2002-98	26612 PT	Loc. L.H.; Head bolts not incl.; Head bolt replacement recommended; PermaTorqueMLS®; New Part Number - Check for Availability
1	Head Gasket	2002-98	26625 PT	Loc. R.H.; Head bolts not incl.; Head bolt replacement recommended; PermaTorqueMLS®; New Part Number - Check for Availability
1	Head Set	2002-98	HS 26612 PT	Head bolts not incl.; Head bolt replacement recommended; PermaDry® molded rubber valve cover gskts. incl.; Premium valve stem seals incl.; New Part Number - Check for Availability
QTY	MANIFOLD - INT. & EXH.	YEARS	PART NO.	DESCRIPTION
1	Int. Manifold Gasket Set	2002-98	MS 97298	Lower set; New Part Number - Check for Availability
1	Exh. Manifold Gasket Set	2002-98	MS 97260	New Part Number - Check for Availability
QTY	VALVE COVER	YEARS	PART NO.	DESCRIPTION
1	Valve Cover Gasket Set	2002-98	VS 50842 R	PermaDry® molded rubber gskts. incl.; New Part Number - Check for Availability
QTY	TIMING COVER	YEARS	PART NO.	DESCRIPTION
1	Crankshaft Front Seal Set	2002-98	TCS 46188	New Part Number - Check for Availability
QTY	OIL COOLER	YEARS	PART NO.	DESCRIPTION
1	Oil Cooler Gasket	2002-98	72977	Loc. Upper; Oil cooler mounting; New Part Number - Check for Availability
1	Oil Cooler Gasket	2002-98	72978	Loc. Lower; Oil cooler mounting; New Part Number - Check for Availability
54	2006 - 2000; 4.3L 260 (4266cc) SOHC V8 (24 Valve) 89.9mm Bore			54
MFI; Gasoline; Naturally Aspirated Mercedes-Benz Eng.; Eng. Code 113.941				
QTY	CYLINDER HEAD	YEARS	PART NO.	DESCRIPTION
1	Head Gasket	2006-00	26612 PT	Loc. L.H.; Head bolts not incl.; Head bolt replacement recommended; PermaTorqueMLS®; New Part Number - Check for Availability
1	Head Gasket	2006-00	26625 PT	Loc. R.H.; Head bolts not incl.; Head bolt replacement recommended; PermaTorqueMLS®; New Part Number - Check for Availability
1	Head Set	2006-00	HS 26612 PT	Head bolts not incl.; Head bolt replacement recommended; PermaDry® molded rubber valve cover gskts. incl.; Premium valve stem seals incl.; New Part Number - Check for Availability
QTY	MANIFOLD - INT. & EXH.	YEARS	PART NO.	DESCRIPTION
1	Int. Manifold Gasket Set	2006-00	MS 97298	Lower set; New Part Number - Check for Availability
1	Exh. Manifold Gasket Set	2006-00	MS 97260	New Part Number - Check for Availability
QTY	VALVE COVER	YEARS	PART NO.	DESCRIPTION
1	Valve Cover Gasket Set	2006-00	VS 50842 R	PermaDry® molded rubber gskts. incl.; New Part Number - Check for Availability
QTY	TIMING COVER	YEARS	PART NO.	DESCRIPTION
1	Crankshaft Front Seal Set	2006-00	TCS 46188	New Part Number - Check for Availability
QTY	OIL COOLER	YEARS	PART NO.	DESCRIPTION
1	Oil Cooler Gasket	2006-00	72977	Loc. Upper; Oil cooler mounting; New Part Number - Check for Availability
1	Oil Cooler Gasket	2006-00	72978	Loc. Lower; Oil cooler mounting; New Part Number - Check for Availability
55	2003 - 1999; 4.3L 260 (4266cc) SOHC V8 (24 Valve) 89.9mm Bore			55
MFI; Gasoline; Naturally Aspirated Mercedes-Benz Eng.; Eng. Code 113.943				
QTY	CYLINDER HEAD	YEARS	PART NO.	DESCRIPTION
1	Head Gasket	2003-99	26612 PT	Loc. L.H.; Head bolts not incl.; Head bolt replacement recommended; PermaTorqueMLS®; New Part Number - Check for Availability
1	Head Gasket	2003-99	26625 PT	Loc. R.H.; Head bolts not incl.; Head bolt replacement recommended; PermaTorqueMLS®; New Part Number - Check for Availability
1	Head Set	2003-99	HS 26612 PT	Head bolts not incl.; Head bolt replacement recommended; PermaDry® molded rubber valve cover gskts. incl.; Premium valve stem seals incl.; New Part Number - Check for Availability
QTY	MANIFOLD - INT. & EXH.	YEARS	PART NO.	DESCRIPTION
1	Int. Manifold Gasket Set	2003-99	MS 97298	Lower set; New Part Number - Check for Availability

Mercedes-Benz Car (Incl. Maybach, Mercedes-Benz, Smart) (Cont.)

55 (cont.)	2003 - 1999; 4.3L 260 (4266cc) SOHC V8 (24 Valve) 89.9mm Bore				55 (cont.)
MFI; Gasoline; Naturally Aspirated Mercedes-Benz Eng.; Eng. Code 113.943					
QTY	MANIFOLD - INT. & EXH.	YEARS	PART NO.	DESCRIPTION	
1	Exh. Manifold Gasket Set	2003-99	MS 97260	New Part Number - Check for Availability	
QTY	VALVE COVER	YEARS	PART NO.	DESCRIPTION	
1	Valve Cover Gasket Set	2003-99	VS 50842 R	PermaDry® molded rubber gsks. incl.; New Part Number - Check for Availability	
QTY	TIMING COVER	YEARS	PART NO.	DESCRIPTION	
1	Crankshaft Front Seal Set	2003-99	TCS 46188	New Part Number - Check for Availability	
QTY	OIL COOLER	YEARS	PART NO.	DESCRIPTION	
1	Oil Cooler Gasket	2003-99	72977	Loc. Upper; Oil cooler mounting; New Part Number - Check for Availability	
1	Oil Cooler Gasket	2003-99	72978	Loc. Lower; Oil cooler mounting; New Part Number - Check for Availability	
56	2000 - 1998; 4.3L 260 (4266cc) SOHC V8 (24 Valve) 89.9mm Bore				56
MFI; Gasoline; Naturally Aspirated Mercedes-Benz Eng.; Eng. Code 113.944					
QTY	CYLINDER HEAD	YEARS	PART NO.	DESCRIPTION	
1	Head Gasket	2000-98	26612 PT	Loc. L.H.; Head bolts not incl.; Head bolt replacement recommended; PermaTorqueMLS®; New Part Number - Check for Availability	
1	Head Gasket	2000-98	26625 PT	Loc. R.H.; Head bolts not incl.; Head bolt replacement recommended; PermaTorqueMLS®; New Part Number - Check for Availability	
1	Head Set	2000-98	HS 26612 PT	Head bolts not incl.; Head bolt replacement recommended; PermaDry® molded rubber valve cover gsks. incl.; Premium valve stem seals incl.; New Part Number - Check for Availability	
QTY	MANIFOLD - INT. & EXH.	YEARS	PART NO.	DESCRIPTION	
1	Int. Manifold Gasket Set	2000-98	MS 97298	Lower set; New Part Number - Check for Availability	
1	Exh. Manifold Gasket Set	2000-98	MS 97260	New Part Number - Check for Availability	
QTY	VALVE COVER	YEARS	PART NO.	DESCRIPTION	
1	Valve Cover Gasket Set	2000-98	VS 50842 R	PermaDry® molded rubber gsks. incl.; New Part Number - Check for Availability	
QTY	TIMING COVER	YEARS	PART NO.	DESCRIPTION	
1	Crankshaft Front Seal Set	2000-98	TCS 46188	New Part Number - Check for Availability	
QTY	OIL COOLER	YEARS	PART NO.	DESCRIPTION	
1	Oil Cooler Gasket	2000-98	72977	Loc. Upper; Oil cooler mounting; New Part Number - Check for Availability	
1	Oil Cooler Gasket	2000-98	72978	Loc. Lower; Oil cooler mounting; New Part Number - Check for Availability	
57	2006 - 2003; 4.3L 260 (4266cc) SOHC V8 (24 Valve) 89.9mm Bore				57
MFI; Gasoline; Naturally Aspirated Mercedes-Benz Eng.; Eng. Code 113.948					
QTY	CYLINDER HEAD	YEARS	PART NO.	DESCRIPTION	
1	Head Gasket	2006-03	26612 PT	Loc. L.H.; Head bolts not incl.; Head bolt replacement recommended; PermaTorqueMLS®; New Part Number - Check for Availability	
1	Head Gasket	2006-03	26625 PT	Loc. R.H.; Head bolts not incl.; Head bolt replacement recommended; PermaTorqueMLS®; New Part Number - Check for Availability	
1	Head Set	2006-03	HS 26612 PT	Head bolts not incl.; Head bolt replacement recommended; PermaDry® molded rubber valve cover gsks. incl.; Premium valve stem seals incl.; New Part Number - Check for Availability	
QTY	MANIFOLD - INT. & EXH.	YEARS	PART NO.	DESCRIPTION	
1	Int. Manifold Gasket Set	2006-03	MS 97298	Lower set; New Part Number - Check for Availability	
1	Exh. Manifold Gasket Set	2006-03	MS 97260	New Part Number - Check for Availability	
QTY	VALVE COVER	YEARS	PART NO.	DESCRIPTION	
1	Valve Cover Gasket Set	2006-03	VS 50842 R	PermaDry® molded rubber gsks. incl.; New Part Number - Check for Availability	
QTY	TIMING COVER	YEARS	PART NO.	DESCRIPTION	
1	Crankshaft Front Seal Set	2006-03	TCS 46188	New Part Number - Check for Availability	
QTY	OIL COOLER	YEARS	PART NO.	DESCRIPTION	
1	Oil Cooler Gasket	2006-03	72977	Loc. Upper; Oil cooler mounting; New Part Number - Check for Availability	
1	Oil Cooler Gasket	2006-03	72978	Loc. Lower; Oil cooler mounting; New Part Number - Check for Availability	
58	2006 - 2000; 5.0L 303 (4966cc) SOHC V8 (24 Valve) 96.8mm Bore				58
MFI; Gasoline; Naturally Aspirated Mercedes-Benz Eng.; Eng. Code 113.960					
QTY	CYLINDER HEAD	YEARS	PART NO.	DESCRIPTION	
1	Head Gasket	2006-00	26611 PT	Loc. L.H.; Head bolts not incl.; Head bolt replacement recommended; PermaTorqueMLS®; New Part Number - Check for Availability	
1	Head Gasket	2006-00	26624 PT	Loc. R.H.; Head bolts not incl.; Head bolt replacement recommended; PermaTorqueMLS®; New Part Number - Check for Availability	

Mercedes-Benz Car (Incl. Maybach, Mercedes-Benz, Smart) (Cont.)

58 (cont.)		2006 - 2000; 5.0L 303 (4966cc) SOHC V8 (24 Valve) 96.8mm Bore			58 (cont.)	
MFI; Gasoline; Naturally Aspirated Mercedes-Benz Eng.; Eng. Code 113.960						
QTY	CYLINDER HEAD	YEARS	PART NO.	DESCRIPTION		
1	Head Set	2006-00	HS 26611 PT	Head bolts not incl.; Head bolt replacement recommended; PermaDry® molded rubber valve cover gskts. incl.; Premium valve stem seals incl.; New Part Number - Check for Availability		
QTY	MANIFOLD - INT. & EXH.	YEARS	PART NO.	DESCRIPTION		
1	Int. Manifold Gasket Set	2006-00	MS 97298	Lower set; New Part Number - Check for Availability		
1	Exh. Manifold Gasket Set	2006-00	MS 97260	New Part Number - Check for Availability		
QTY	VALVE COVER	YEARS	PART NO.	DESCRIPTION		
1	Valve Cover Gasket Set	2006-00	VS 50842 R	PermaDry® molded rubber gskts. incl.; New Part Number - Check for Availability		
QTY	TIMING COVER	YEARS	PART NO.	DESCRIPTION		
1	Crankshaft Front Seal Set	2006-00	TCS 46188	New Part Number - Check for Availability		
QTY	OIL COOLER	YEARS	PART NO.	DESCRIPTION		
1	Oil Cooler Gasket	2006-00	72977	Loc. Upper; Oil cooler mounting; New Part Number - Check for Availability		
1	Oil Cooler Gasket	2006-00	72978	Loc. Lower; Oil cooler mounting; New Part Number - Check for Availability		
59		2006 - 1999; 5.0L 303 (4966cc) SOHC V8 (24 Valve) 96.8mm Bore				59
MFI; Gasoline; Naturally Aspirated Mercedes-Benz Eng.; Eng. Code 113.961						
QTY	CYLINDER HEAD	YEARS	PART NO.	DESCRIPTION		
1	Head Gasket	2006-99	26611 PT	Loc. L.H.; Head bolts not incl.; Head bolt replacement recommended; PermaTorqueMLS®; New Part Number - Check for Availability		
1	Head Gasket	2006-99	26624 PT	Loc. R.H.; Head bolts not incl.; Head bolt replacement recommended; PermaTorqueMLS®; New Part Number - Check for Availability		
1	Head Set	2006-99	HS 26611 PT	Head bolts not incl.; Head bolt replacement recommended; PermaDry® molded rubber valve cover gskts. incl.; Premium valve stem seals incl.; New Part Number - Check for Availability		
QTY	MANIFOLD - INT. & EXH.	YEARS	PART NO.	DESCRIPTION		
1	Int. Manifold Gasket Set	2006-99	MS 97298	Lower set; New Part Number - Check for Availability		
1	Exh. Manifold Gasket Set	2006-99	MS 97260	New Part Number - Check for Availability		
QTY	VALVE COVER	YEARS	PART NO.	DESCRIPTION		
1	Valve Cover Gasket Set	2006-99	VS 50842 R	PermaDry® molded rubber gskts. incl.; New Part Number - Check for Availability		
QTY	TIMING COVER	YEARS	PART NO.	DESCRIPTION		
1	Crankshaft Front Seal Set	2006-99	TCS 46188	New Part Number - Check for Availability		
QTY	OIL COOLER	YEARS	PART NO.	DESCRIPTION		
1	Oil Cooler Gasket	2006-99	72977	Loc. Upper; Oil cooler mounting; New Part Number - Check for Availability		
1	Oil Cooler Gasket	2006-99	72978	Loc. Lower; Oil cooler mounting; New Part Number - Check for Availability		
60		2006 - 2003; 5.0L 303 (4966cc) SOHC V8 (24 Valve) 96.8mm Bore				60
MFI; Gasoline; Naturally Aspirated Mercedes-Benz Eng.; Eng. Code 113.966						
QTY	CYLINDER HEAD	YEARS	PART NO.	DESCRIPTION		
1	Head Gasket	2006-03	26611 PT	Loc. L.H.; Head bolts not incl.; Head bolt replacement recommended; PermaTorqueMLS®; New Part Number - Check for Availability		
1	Head Gasket	2006-03	26624 PT	Loc. R.H.; Head bolts not incl.; Head bolt replacement recommended; PermaTorqueMLS®; New Part Number - Check for Availability		
1	Head Set	2006-03	HS 26611 PT	Head bolts not incl.; Head bolt replacement recommended; PermaDry® molded rubber valve cover gskts. incl.; Premium valve stem seals incl.; New Part Number - Check for Availability		
QTY	MANIFOLD - INT. & EXH.	YEARS	PART NO.	DESCRIPTION		
1	Int. Manifold Gasket Set	2006-03	MS 97298	Lower set; New Part Number - Check for Availability		
1	Exh. Manifold Gasket Set	2006-03	MS 97260	New Part Number - Check for Availability		
QTY	VALVE COVER	YEARS	PART NO.	DESCRIPTION		
1	Valve Cover Gasket Set	2006-03	VS 50842 R	PermaDry® molded rubber gskts. incl.; New Part Number - Check for Availability		
QTY	TIMING COVER	YEARS	PART NO.	DESCRIPTION		
1	Crankshaft Front Seal Set	2006-03	TCS 46188	New Part Number - Check for Availability		
QTY	OIL COOLER	YEARS	PART NO.	DESCRIPTION		
1	Oil Cooler Gasket	2006-03	72977	Loc. Upper; Oil cooler mounting; New Part Number - Check for Availability		
1	Oil Cooler Gasket	2006-03	72978	Loc. Lower; Oil cooler mounting; New Part Number - Check for Availability		
61		2006 - 2004; 5.0L 303 (4966cc) SOHC V8 (24 Valve) 96.8mm Bore				61
MFI; Gasoline; Naturally Aspirated Mercedes-Benz Eng.; Eng. Code 113.969						
QTY	CYLINDER HEAD	YEARS	PART NO.	DESCRIPTION		
1	Head Gasket	2006-04	26611 PT	Loc. L.H.; Head bolts not incl.; Head bolt replacement recommended; PermaTorqueMLS®; New Part Number - Check for Availability		

Mercedes-Benz Car (Incl. Maybach, Mercedes-Benz, Smart) (Cont.)

61		2006 - 2004; 5.0L 303 (4966cc) SOHC V8 (24 Valve) 96.8mm Bore			61
(cont.)		MFI; Gasoline; Naturally Aspirated Mercedes-Benz Eng.; Eng. Code 113.969			(cont.)
QTY	CYLINDER HEAD	YEARS	PART NO.	DESCRIPTION	
1	Head Gasket	2006-04	26624 PT	Loc. R.H.; Head bolts not incl.; Head bolt replacement recommended; PermaTorqueMLS®; New Part Number - Check for Availability	
1	Head Set	2006-04	HS 26611 PT	Head bolts not incl.; Head bolt replacement recommended; PermaDry® molded rubber valve cover gskts. incl.; Premium valve stem seals incl.; New Part Number - Check for Availability	
QTY	MANIFOLD - INT. & EXH.	YEARS	PART NO.	DESCRIPTION	
1	Int. Manifold Gasket Set	2006-04	MS 97298	Lower set; New Part Number - Check for Availability	
1	Exh. Manifold Gasket Set	2006-04	MS 97260	New Part Number - Check for Availability	
QTY	VALVE COVER	YEARS	PART NO.	DESCRIPTION	
1	Valve Cover Gasket Set	2006-04	VS 50842 R	PermaDry® molded rubber gskts. incl.; New Part Number - Check for Availability	
QTY	TIMING COVER	YEARS	PART NO.	DESCRIPTION	
1	Crankshaft Front Seal Set	2006-04	TCS 46188	New Part Number - Check for Availability	
QTY	OIL COOLER	YEARS	PART NO.	DESCRIPTION	
1	Oil Cooler Gasket	2006-04	72977	Loc. Upper; Oil cooler mounting; New Part Number - Check for Availability	
1	Oil Cooler Gasket	2006-04	72978	Loc. Lower; Oil cooler mounting; New Part Number - Check for Availability	
62		1992 - 1991; 5.0L 303.5 (4973cc) DOHC V8 (32 Valve) 96.5mm Bore			62
(cont.)		MFI; Gasoline; Naturally Aspirated Mercedes-Benz Eng.; Eng. Code 119.960			(cont.)
QTY	CYLINDER HEAD	YEARS	PART NO.	DESCRIPTION	
1	Head Set	1992-91	HS 26353 PT	Loc. L.H.; Head bolts not incl.; Head bolt replacement recommended; PermaDry® molded rubber valve cover gskts. incl.; Premium valve stem seals incl.	
1	Head Set	1992-91	HS 26354 PT	Loc. R.H.; Head bolts not incl.; Head bolt replacement recommended; PermaDry® molded rubber valve cover gskts. incl.; Premium valve stem seals incl.	
QTY	CONVERSION SET	YEARS	PART NO.	DESCRIPTION	
1	Gasket Conversion Set	1992-91	CS 26353	PermaDry® molded rubber Upper oil pan gskt. incl.	
QTY	MANIFOLD - INT. & EXH.	YEARS	PART NO.	DESCRIPTION	
1	Exh. Manifold Gasket Set	1992-91	MS 97277	New Part Number - Check for Availability	
QTY	OIL PAN	YEARS	PART NO.	DESCRIPTION	
1	Oil Pan Gasket Set	1992-91	OS 30863	Loc. Upper; OEM style; New Part Number - Check for Availability	
1	Oil Pan Gasket Set	1992-91	OS 30871 PR	Loc. Lower; New Part Number - Check for Availability	
QTY	WATER PUMP	YEARS	PART NO.	DESCRIPTION	
1	Water Pump Gasket	1992-91	36064	New Part Number - Check for Availability	
QTY	OIL FILTER MOUNTING	YEARS	PART NO.	DESCRIPTION	
1	Oil Filter Adapter Gasket	1992-91	72995	Oil filter adapter to block; New Part Number - Check for Availability	
63		1995 - 1992; 5.0L 303.5 (4973cc) DOHC V8 (32 Valve) 96.5mm Bore			63
(cont.)		MFI; Gasoline; Naturally Aspirated Mercedes-Benz Eng.; Eng. Code 119.970			(cont.)
QTY	CYLINDER HEAD	YEARS	PART NO.	DESCRIPTION	
1	Head Set	1995-92	HS 26358 PT	Loc. L.H.; Head bolts not incl.; Head bolt replacement recommended; PermaDry® molded rubber valve cover gskts. incl.; Premium valve stem seals incl.	
1	Head Set	1995-92	HS 26359 PT	Loc. R.H.; Head bolts not incl.; Head bolt replacement recommended; PermaDry® molded rubber valve cover gskts. incl.; Premium valve stem seals incl.	
QTY	CONVERSION SET	YEARS	PART NO.	DESCRIPTION	
1	Gasket Conversion Set	1995-92	CS 26350	PermaDry® molded rubber Upper oil pan gskt. incl.	
QTY	MANIFOLD - INT. & EXH.	YEARS	PART NO.	DESCRIPTION	
1	Exh. Manifold Gasket Set	1995-92	MS 97277	New Part Number - Check for Availability	
QTY	OIL PAN	YEARS	PART NO.	DESCRIPTION	
1	Oil Pan Gasket Set	1995-92	OS 30862	Loc. Lower; New Part Number - Check for Availability	
1	Oil Pan Gasket Set	1995-92	OS 30863	Loc. Upper; OEM style; New Part Number - Check for Availability	
QTY	WATER PUMP	YEARS	PART NO.	DESCRIPTION	
1	Water Pump Gasket	1995-92	36064	New Part Number - Check for Availability	
QTY	OIL FILTER MOUNTING	YEARS	PART NO.	DESCRIPTION	
1	Oil Filter Adapter Gasket	1995-92	72995	Oil filter adapter to block; New Part Number - Check for Availability	

Mercedes-Benz Car (Incl. Maybach, Mercedes-Benz, Smart) (Cont.)

64		1995 - 1993; 5.0L 303.5 (4973cc) DOHC V8 (32 Valve) 96.5mm Bore			64
MFI; Gasoline; Naturally Aspirated Mercedes-Benz Eng.; Eng. Code 119.972					
QTY	CYLINDER HEAD	YEARS	PART NO.	DESCRIPTION	
1	Head Set	1995-93	HS 26358 PT	Loc. L.H.; Head bolts not incl.; Head bolt replacement recommended; PermaDry® molded rubber valve cover gskts. incl.; Premium valve stem seals incl.	
1	Head Set	1995-93	HS 26359 PT	Loc. R.H.; Head bolts not incl.; Head bolt replacement recommended; PermaDry® molded rubber valve cover gskts. incl.; Premium valve stem seals incl.	
QTY	MANIFOLD - INT. & EXH.	YEARS	PART NO.	DESCRIPTION	
1	Exh. Manifold Gasket Set	1995-93	MS 97277	New Part Number - Check for Availability	
QTY	OIL PAN	YEARS	PART NO.	DESCRIPTION	
1	Oil Pan Gasket Set	1995-93	OS 30863	Loc. Upper; OEM style; New Part Number - Check for Availability	
1	Oil Pan Gasket Set	1995-93	OS 30871 PR	Loc. Lower; New Part Number - Check for Availability	
QTY	WATER PUMP	YEARS	PART NO.	DESCRIPTION	
1	Water Pump Gasket	1995-93	36064	New Part Number - Check for Availability	
QTY	OIL FILTER MOUNTING	YEARS	PART NO.	DESCRIPTION	
1	Oil Filter Adapter Gasket	1995-93	72995	Oil filter adapter to block; New Part Number - Check for Availability	
65		1994 - 1993; 5.0L 303.5 (4973cc) DOHC V8 (32 Valve) 96.5mm Bore			65
MFI; Gasoline; Naturally Aspirated Mercedes-Benz Eng.; Eng. Code 119.974					
QTY	CYLINDER HEAD	YEARS	PART NO.	DESCRIPTION	
1	Head Set	1994-93	HS 26358 PT	Loc. L.H.; Head bolts not incl.; Head bolt replacement recommended; PermaDry® molded rubber valve cover gskts. incl.; Premium valve stem seals incl.	
1	Head Set	1994-93	HS 26359 PT	Loc. R.H.; Head bolts not incl.; Head bolt replacement recommended; PermaDry® molded rubber valve cover gskts. incl.; Premium valve stem seals incl.	
QTY	MANIFOLD - INT. & EXH.	YEARS	PART NO.	DESCRIPTION	
1	Exh. Manifold Gasket Set	1994-93	MS 97277	New Part Number - Check for Availability	
QTY	OIL PAN	YEARS	PART NO.	DESCRIPTION	
1	Oil Pan Gasket Set	1994-93	OS 30863	Loc. Upper; OEM style; New Part Number - Check for Availability	
1	Oil Pan Gasket Set	1994-93	OS 30871 PR	Loc. Lower; New Part Number - Check for Availability	
QTY	WATER PUMP	YEARS	PART NO.	DESCRIPTION	
1	Water Pump Gasket	1994-93	36064	New Part Number - Check for Availability	
QTY	OIL FILTER MOUNTING	YEARS	PART NO.	DESCRIPTION	
1	Oil Filter Adapter Gasket	1994-93	72995	Oil filter adapter to block; New Part Number - Check for Availability	
66		1999 - 1996; 5.0L 303.5 (4973cc) DOHC V8 (32 Valve) 96.5mm Bore			66
MFI; Gasoline; Naturally Aspirated Mercedes-Benz Eng.; Eng. Code 119.980					
QTY	CYLINDER HEAD	YEARS	PART NO.	DESCRIPTION	
1	Head Set	1999-96	HS 26362 PT	Loc. L.H.; Head bolts not incl.; Head bolt replacement recommended; PermaDry® molded rubber valve cover gskts. incl.; Premium valve stem seals incl.	
1	Head Set	1999-96	HS 26363 PT	Loc. R.H.; Head bolts not incl.; Head bolt replacement recommended; PermaDry® molded rubber valve cover gskts. incl.; Premium valve stem seals incl.	
QTY	CONVERSION SET	YEARS	PART NO.	DESCRIPTION	
1	Gasket Conversion Set	1999-96	CS 26350	PermaDry® molded rubber Upper oil pan gskt. incl.	
QTY	MANIFOLD - INT. & EXH.	YEARS	PART NO.	DESCRIPTION	
1	Exh. Manifold Gasket Set	1999-96	MS 97277	New Part Number - Check for Availability	
QTY	OIL PAN	YEARS	PART NO.	DESCRIPTION	
1	Oil Pan Gasket Set	1999-96	OS 30862	Loc. Lower; New Part Number - Check for Availability	
1	Oil Pan Gasket Set	1999-96	OS 30863	Loc. Upper; OEM style; New Part Number - Check for Availability	
QTY	WATER PUMP	YEARS	PART NO.	DESCRIPTION	
1	Water Pump Gasket	1999-96	36064	New Part Number - Check for Availability	
QTY	OIL FILTER MOUNTING	YEARS	PART NO.	DESCRIPTION	
1	Oil Filter Adapter Gasket	1999-96	72995	Oil filter adapter to block; New Part Number - Check for Availability	
67		1998 - 1996; 5.0L 303.5 (4973cc) DOHC V8 (32 Valve) 96.5mm Bore			67
MFI; Gasoline; Naturally Aspirated Mercedes-Benz Eng.; Eng. Code 119.982					
QTY	CYLINDER HEAD	YEARS	PART NO.	DESCRIPTION	
1	Head Set	1998-96	HS 26362 PT	Loc. L.H.; Head bolts not incl.; Head bolt replacement recommended; PermaDry® molded rubber valve cover gskts. incl.; Premium valve stem seals incl.	

Mercedes-Benz Car (Incl. Maybach, Mercedes-Benz, Smart) (Cont.)

67 (cont.)	1998 - 1996; 5.0L 303.5 (4973cc) DOHC V8 (32 Valve) 96.5mm Bore				67 (cont.)
MFI; Gasoline; Naturally Aspirated Mercedes-Benz Eng.; Eng. Code 119.982					
QTY	CYLINDER HEAD	YEARS	PART NO.	DESCRIPTION	
1	Head Set	1998-96	HS 26363 PT	Loc. R.H.; Head bolts not incl.; Head bolt replacement recommended; PermaDry® molded rubber valve cover gskts. incl.; Premium valve stem seals incl.	
QTY	MANIFOLD - INT. & EXH.	YEARS	PART NO.	DESCRIPTION	
1	Exh. Manifold Gasket Set	1998-96	MS 97277	New Part Number - Check for Availability	
QTY	OIL PAN	YEARS	PART NO.	DESCRIPTION	
1	Oil Pan Gasket Set	1998-96	OS 30863	Loc. Upper; OEM style; New Part Number - Check for Availability	
1	Oil Pan Gasket Set	1998-96	OS 30871 PR	Loc. Lower; New Part Number - Check for Availability	
QTY	WATER PUMP	YEARS	PART NO.	DESCRIPTION	
1	Water Pump Gasket	1998-96	36064	New Part Number - Check for Availability	
QTY	OIL FILTER MOUNTING	YEARS	PART NO.	DESCRIPTION	
1	Oil Filter Adapter Gasket	1998-96	72995	Oil filter adapter to block; New Part Number - Check for Availability	
68	2003 - 1999; 5.4L 329.5 (5439cc) SOHC V8 (24 Valve) 96.5mm Bore				68
MFI; Gasoline; Naturally Aspirated Mercedes-Benz Eng.; Eng. Code 113.980					
QTY	MANIFOLD - INT. & EXH.	YEARS	PART NO.	DESCRIPTION	
1	Int. Manifold Gasket Set	2003-99	MS 97298	Lower set; New Part Number - Check for Availability	
69	2007 - 2003; 5.4L 329.5 (5439cc) SOHC V8 (24 Valve) 96.5mm Bore				69
MFI; Gasoline; Supercharged Mercedes-Benz Eng.; Eng. Code 113.980					
QTY	MANIFOLD - INT. & EXH.	YEARS	PART NO.	DESCRIPTION	
1	Int. Manifold Gasket Set	2007-03	MS 97298	Lower set; New Part Number - Check for Availability	
70	2010 - 2001; 5.4L 329.5 (5439cc) SOHC V8 (24 Valve) 96.5mm Bore				70
MFI; Gasoline; Naturally Aspirated Mercedes-Benz Eng.; Eng. Code 113.982					
QTY	MANIFOLD - INT. & EXH.	YEARS	PART NO.	DESCRIPTION	
1	Int. Manifold Gasket Set	2010-05	MS 97298	Lower set; New Part Number - Check for Availability	
1	Int. Manifold Gasket Set	2002-01	MS 97298	Lower set; New Part Number - Check for Availability	
71	2007 - 2003; 5.4L 329.5 (5439cc) SOHC V8 (24 Valve) 96.5mm Bore				71
MFI; Gasoline; Supercharged Mercedes-Benz Eng.; Eng. Code 113.982					
QTY	MANIFOLD - INT. & EXH.	YEARS	PART NO.	DESCRIPTION	
1	Int. Manifold Gasket Set	2007-03	MS 97298	Lower set; New Part Number - Check for Availability	
72	2007 - 2001; 5.4L 329.5 (5439cc) SOHC V8 (24 Valve) 96.5mm Bore				72
MFI; Gasoline; Naturally Aspirated Mercedes-Benz Eng.; Eng. Code 113.984					
QTY	MANIFOLD - INT. & EXH.	YEARS	PART NO.	DESCRIPTION	
1	Int. Manifold Gasket Set	2007-01	MS 97298	Lower set; New Part Number - Check for Availability	
73	2006 - 2003; 5.4L 329.5 (5439cc) SOHC V8 (24 Valve) 96.5mm Bore				73
MFI; Gasoline; Supercharged Mercedes-Benz Eng.; Eng. Code 113.987					
QTY	MANIFOLD - INT. & EXH.	YEARS	PART NO.	DESCRIPTION	
1	Int. Manifold Gasket Set	2006-03	MS 97298	Lower set; New Part Number - Check for Availability	
74	2006 - 2005; 5.4L 329.5 (5439cc) SOHC V8 (24 Valve) 96.5mm Bore				74
MFI; Gasoline; Naturally Aspirated Mercedes-Benz Eng.; Eng. Code 113.988					
QTY	MANIFOLD - INT. & EXH.	YEARS	PART NO.	DESCRIPTION	
1	Int. Manifold Gasket Set	2006-05	MS 97298	Lower set; New Part Number - Check for Availability	
75	2010 - 2005; 5.4L 329.5 (5439cc) SOHC V8 (24 Valve) 96.5mm Bore				75
MFI; Gasoline; Naturally Aspirated Mercedes-Benz Eng.; Eng. Code 113.989					
QTY	MANIFOLD - INT. & EXH.	YEARS	PART NO.	DESCRIPTION	
1	Int. Manifold Gasket Set	2010-05	MS 97298	Lower set; New Part Number - Check for Availability	
76	2008 - 2007; 5.4L 329.5 (5439cc) SOHC V8 (24 Valve) 96.5mm Bore				76
MFI; Gasoline; Supercharged Mercedes-Benz Eng.; Eng. Code 113.992					
QTY	MANIFOLD - INT. & EXH.	YEARS	PART NO.	DESCRIPTION	
1	Int. Manifold Gasket Set	2008-07	MS 97298	Lower set; New Part Number - Check for Availability	
77	2009 - 2003; 5.4L 329.5 (5439cc) SOHC V8 (24 Valve) 96.5mm Bore				77
MFI; Gasoline; Supercharged Mercedes-Benz Eng.; Eng. Code 155.980					
QTY	MANIFOLD - INT. & EXH.	YEARS	PART NO.	DESCRIPTION	
1	Int. Manifold Gasket Set	2009-03	MS 97298	Lower set; New Part Number - Check for Availability	

Mercedes-Benz Car (Incl. Maybach, Mercedes-Benz, Smart) (Cont.)

78		2009 - 2007; 5.5L 333.2 (5461cc) DOHC V8 (32 Valve) 98mm Bore			78
MFI; Gasoline; Naturally Aspirated Mercedes-Benz Eng.; Eng. Code 273.960					
QTY	CYLINDER HEAD	YEARS	PART NO.	DESCRIPTION	
1	Head Gasket	2009-07	26613 PT	Loc. L.H.; Head bolts not incl.; Head bolt replacement recommended; PermaTorqueMLS®; New Part Number - Check for Availability	
1	Head Gasket	2009-07	26626 PT	Loc. R.H.; Head bolts not incl.; Head bolt replacement recommended; PermaTorqueMLS®; New Part Number - Check for Availability	
1	Head Set	2009-07	HS 26613 PT	Head bolts not incl.; Head bolt replacement recommended; RTV sealant incl. for valve cover gskts.; Premium valve stem seals incl.; New Part Number - Check for Availability	
QTY	MANIFOLD - INT. & EXH.	YEARS	PART NO.	DESCRIPTION	
1	Int. Manifold Gasket Set	2009-07	MS 97297	Lower set; New Part Number - Check for Availability	
1	Exh. Manifold Gasket Set	2009-07	MS 97266	New Part Number - Check for Availability	
QTY	TIMING COVER	YEARS	PART NO.	DESCRIPTION	
1	Crankshaft Front Seal Set	2009-07	TCS 46188	New Part Number - Check for Availability	
QTY	OIL COOLER	YEARS	PART NO.	DESCRIPTION	
1	Oil Cooler Gasket	2009-07	72979	Oil cooler to housing; New Part Number - Check for Availability	
79		2011 - 2007; 5.5L 333.2 (5461cc) DOHC V8 (32 Valve) 98mm Bore			79
MFI; Gasoline; Naturally Aspirated Mercedes-Benz Eng.; Eng. Code 273.961					
QTY	CYLINDER HEAD	YEARS	PART NO.	DESCRIPTION	
1	Head Gasket	2011-07	26613 PT	Loc. L.H.; Head bolts not incl.; Head bolt replacement recommended; PermaTorqueMLS®; New Part Number - Check for Availability	
1	Head Gasket	2011-07	26626 PT	Loc. R.H.; Head bolts not incl.; Head bolt replacement recommended; PermaTorqueMLS®; New Part Number - Check for Availability	
1	Head Set	2011-07	HS 26613 PT	Head bolts not incl.; Head bolt replacement recommended; RTV sealant incl. for valve cover gskts.; Premium valve stem seals incl.; New Part Number - Check for Availability	
QTY	MANIFOLD - INT. & EXH.	YEARS	PART NO.	DESCRIPTION	
1	Int. Manifold Gasket Set	2011-07	MS 97297	Lower set; New Part Number - Check for Availability	
1	Exh. Manifold Gasket Set	2011-07	MS 97266	New Part Number - Check for Availability	
QTY	TIMING COVER	YEARS	PART NO.	DESCRIPTION	
1	Crankshaft Front Seal Set	2011-07	TCS 46188	New Part Number - Check for Availability	
QTY	OIL COOLER	YEARS	PART NO.	DESCRIPTION	
1	Oil Cooler Gasket	2011-07	72979	Oil cooler to housing; New Part Number - Check for Availability	
80		2009 - 2007; 5.5L 333.2 (5461cc) DOHC V8 (32 Valve) 98mm Bore			80
MFI; Gasoline; Naturally Aspirated Mercedes-Benz Eng.; Eng. Code 273.962					
QTY	CYLINDER HEAD	YEARS	PART NO.	DESCRIPTION	
1	Head Gasket	2009-07	26613 PT	Loc. L.H.; Head bolts not incl.; Head bolt replacement recommended; PermaTorqueMLS®; New Part Number - Check for Availability	
1	Head Gasket	2009-07	26626 PT	Loc. R.H.; Head bolts not incl.; Head bolt replacement recommended; PermaTorqueMLS®; New Part Number - Check for Availability	
1	Head Set	2009-07	HS 26613 PT	Head bolts not incl.; Head bolt replacement recommended; RTV sealant incl. for valve cover gskts.; Premium valve stem seals incl.; New Part Number - Check for Availability	
QTY	MANIFOLD - INT. & EXH.	YEARS	PART NO.	DESCRIPTION	
1	Int. Manifold Gasket Set	2009-07	MS 97297	Lower set; New Part Number - Check for Availability	
1	Exh. Manifold Gasket Set	2009-07	MS 97266	New Part Number - Check for Availability	
QTY	TIMING COVER	YEARS	PART NO.	DESCRIPTION	
1	Crankshaft Front Seal Set	2009-07	TCS 46188	New Part Number - Check for Availability	
QTY	OIL COOLER	YEARS	PART NO.	DESCRIPTION	
1	Oil Cooler Gasket	2009-07	72979	Oil cooler to housing; New Part Number - Check for Availability	
81		2012 - 2007; 5.5L 333.2 (5461cc) DOHC V8 (32 Valve) 98mm Bore			81
MFI; Gasoline; Naturally Aspirated Mercedes-Benz Eng.; Eng. Code 273.965					
QTY	CYLINDER HEAD	YEARS	PART NO.	DESCRIPTION	
1	Head Gasket	2012-07	26613 PT	Loc. L.H.; Head bolts not incl.; Head bolt replacement recommended; PermaTorqueMLS®; New Part Number - Check for Availability	
1	Head Gasket	2012-07	26626 PT	Loc. R.H.; Head bolts not incl.; Head bolt replacement recommended; PermaTorqueMLS®; New Part Number - Check for Availability	
1	Head Set	2012-07	HS 26613 PT	Head bolts not incl.; Head bolt replacement recommended; RTV sealant incl. for valve cover gskts.; Premium valve stem seals incl.; New Part Number - Check for Availability	
QTY	MANIFOLD - INT. & EXH.	YEARS	PART NO.	DESCRIPTION	
1	Int. Manifold Gasket Set	2012-07	MS 97297	Lower set; New Part Number - Check for Availability	

Mercedes-Benz Car (Incl. Maybach, Mercedes-Benz, Smart) (Cont.)

81		2012 - 2007; 5.5L 333.2 (5461cc) DOHC V8 (32 Valve) 98mm Bore			81
(cont.)		MFI; Gasoline; Naturally Aspirated Mercedes-Benz Eng.; Eng. Code 273.965			(cont.)
QTY	MANIFOLD - INT. & EXH.	YEARS	PART NO.	DESCRIPTION	
1	Exh. Manifold Gasket Set	2012-07	MS 97266	New Part Number - Check for Availability	
QTY	TIMING COVER	YEARS	PART NO.	DESCRIPTION	
1	Crankshaft Front Seal Set	2012-07	TCS 46188	New Part Number - Check for Availability	
QTY	OIL COOLER	YEARS	PART NO.	DESCRIPTION	
1	Oil Cooler Gasket	2012-07	72979	Oil cooler to housing; New Part Number - Check for Availability	
82		2011 - 2010; 5.5L 333.2 (5461cc) DOHC V8 (32 Valve) 98mm Bore			82
		MFI; Gasoline; Naturally Aspirated Mercedes-Benz Eng.; Eng. Code 273.966			
QTY	CYLINDER HEAD	YEARS	PART NO.	DESCRIPTION	
1	Head Gasket	2011-10	26613 PT	Loc. L.H.; Head bolts not incl.; Head bolt replacement recommended; PermaTorqueMLS®; New Part Number - Check for Availability	
1	Head Gasket	2011-10	26626 PT	Loc. R.H.; Head bolts not incl.; Head bolt replacement recommended; PermaTorqueMLS®; New Part Number - Check for Availability	
1	Head Set	2011-10	HS 26613 PT	Head bolts not incl.; Head bolt replacement recommended; RTV sealant incl. for valve cover gskts.; Premium valve stem seals incl.; New Part Number - Check for Availability	
QTY	MANIFOLD - INT. & EXH.	YEARS	PART NO.	DESCRIPTION	
1	Int. Manifold Gasket Set	2011-10	MS 97297	Lower set; New Part Number - Check for Availability	
1	Exh. Manifold Gasket Set	2011-10	MS 97266	New Part Number - Check for Availability	
QTY	TIMING COVER	YEARS	PART NO.	DESCRIPTION	
1	Crankshaft Front Seal Set	2011-10	TCS 46188	New Part Number - Check for Availability	
QTY	OIL COOLER	YEARS	PART NO.	DESCRIPTION	
1	Oil Cooler Gasket	2011-10	72979	Oil cooler to housing; New Part Number - Check for Availability	
83		2011 - 2007; 5.5L 333.2 (5461cc) DOHC V8 (32 Valve) 98mm Bore			83
		MFI; Gasoline; Naturally Aspirated Mercedes-Benz Eng.; Eng. Code 273.967			
QTY	CYLINDER HEAD	YEARS	PART NO.	DESCRIPTION	
1	Head Gasket	2011-07	26613 PT	Loc. L.H.; Head bolts not incl.; Head bolt replacement recommended; PermaTorqueMLS®; New Part Number - Check for Availability	
1	Head Gasket	2011-07	26626 PT	Loc. R.H.; Head bolts not incl.; Head bolt replacement recommended; PermaTorqueMLS®; New Part Number - Check for Availability	
1	Head Set	2011-07	HS 26613 PT	Head bolts not incl.; Head bolt replacement recommended; RTV sealant incl. for valve cover gskts.; Premium valve stem seals incl.; New Part Number - Check for Availability	
QTY	MANIFOLD - INT. & EXH.	YEARS	PART NO.	DESCRIPTION	
1	Int. Manifold Gasket Set	2011-07	MS 97297	Lower set; New Part Number - Check for Availability	
1	Exh. Manifold Gasket Set	2011-07	MS 97266	New Part Number - Check for Availability	
QTY	TIMING COVER	YEARS	PART NO.	DESCRIPTION	
1	Crankshaft Front Seal Set	2011-07	TCS 46188	New Part Number - Check for Availability	
QTY	OIL COOLER	YEARS	PART NO.	DESCRIPTION	
1	Oil Cooler Gasket	2011-07	72979	Oil cooler to housing; New Part Number - Check for Availability	
84		2011 - 2010; 5.5L 333.2 (5461cc) DOHC V8 (32 Valve) 98mm Bore			84
		MFI; Gasoline; Naturally Aspirated Mercedes-Benz Eng.; Eng. Code 273.970			
QTY	CYLINDER HEAD	YEARS	PART NO.	DESCRIPTION	
1	Head Gasket	2011-10	26613 PT	Loc. L.H.; Head bolts not incl.; Head bolt replacement recommended; PermaTorqueMLS®; New Part Number - Check for Availability	
1	Head Gasket	2011-10	26626 PT	Loc. R.H.; Head bolts not incl.; Head bolt replacement recommended; PermaTorqueMLS®; New Part Number - Check for Availability	
1	Head Set	2011-10	HS 26613 PT	Head bolts not incl.; Head bolt replacement recommended; RTV sealant incl. for valve cover gskts.; Premium valve stem seals incl.; New Part Number - Check for Availability	
QTY	MANIFOLD - INT. & EXH.	YEARS	PART NO.	DESCRIPTION	
1	Int. Manifold Gasket Set	2011-10	MS 97297	Lower set; New Part Number - Check for Availability	
1	Exh. Manifold Gasket Set	2011-10	MS 97266	New Part Number - Check for Availability	
QTY	TIMING COVER	YEARS	PART NO.	DESCRIPTION	
1	Crankshaft Front Seal Set	2011-10	TCS 46188	New Part Number - Check for Availability	
QTY	OIL COOLER	YEARS	PART NO.	DESCRIPTION	
1	Oil Cooler Gasket	2011-10	72979	Oil cooler to housing; New Part Number - Check for Availability	

Mercedes-Benz Car (Incl. Maybach, Mercedes-Benz, Smart) (Cont.)

85		2011 - 2010; 5.5L 333.2 (5461cc) DOHC V8 (32 Valve) 98mm Bore			85
MFI; Gasoline; Naturally Aspirated Mercedes-Benz Eng.; Eng. Code 273.971					
QTY	CYLINDER HEAD	YEARS	PART NO.	DESCRIPTION	
1	Head Gasket	2011-10	26613 PT	Loc. L.H.; Head bolts not incl.; Head bolt replacement recommended; PermaTorqueMLS®; New Part Number - Check for Availability	
1	Head Gasket	2011-10	26626 PT	Loc. R.H.; Head bolts not incl.; Head bolt replacement recommended; PermaTorqueMLS®; New Part Number - Check for Availability	
1	Head Set	2011-10	HS 26613 PT	Head bolts not incl.; Head bolt replacement recommended; RTV sealant incl. for valve cover gskts.; Premium valve stem seals incl.; New Part Number - Check for Availability	
QTY	MANIFOLD - INT. & EXH.	YEARS	PART NO.	DESCRIPTION	
1	Int. Manifold Gasket Set	2011-10	MS 97297	Lower set; New Part Number - Check for Availability	
1	Exh. Manifold Gasket Set	2011-10	MS 97266	New Part Number - Check for Availability	
QTY	TIMING COVER	YEARS	PART NO.	DESCRIPTION	
1	Crankshaft Front Seal Set	2011-10	TCS 46188	New Part Number - Check for Availability	
QTY	OIL COOLER	YEARS	PART NO.	DESCRIPTION	
1	Oil Cooler Gasket	2011-10	72979	Oil cooler to housing; New Part Number - Check for Availability	
86		1991; 5.6L 338 (5547cc) SOHC V8 (16 Valve) 96.5mm Bore			86
MFI; Gasoline; Naturally Aspirated Mercedes-Benz Eng.; Eng. Code 117.968					
QTY	VALVE COVER	YEARS	PART NO.	DESCRIPTION	
1	Valve Cover Gasket Set	1991	VS 50404 R	PermaDry® molded rubber gskts. incl.	

Mercedes-Benz SUV's - See Mercedes-Benz Truck

Mercedes-Benz Truck (Incl. SUV's)

Engine Finding Index				
Engine	Years	Code	Line No.	
3.2L 195.1 (3199cc) SOHC V6 (18 Valve) 89.9mm Bore; MFI; Gasoline; Naturally Aspirated Mercedes-Benz Eng.	2003-98	112.942	1	
3.5L 213.4 (3498cc) DOHC V6 (24 Valve) 92.9mm Bore; MFI; Gasoline; Naturally Aspirated Mercedes-Benz Eng.	2012-06	272.963	2	
3.5L 213.4 (3498cc) DOHC V6 (24 Valve) 92.9mm Bore; MFI; Gasoline; Naturally Aspirated Mercedes-Benz Eng.	2012-06	272.967	3	
3.5L 213.4 (3498cc) DOHC V6 (24 Valve) 92.9mm Bore; MFI; Gasoline; Naturally Aspirated Mercedes-Benz Eng.	2012-10	272.971	4	
3.5L 213.4 (3498cc) DOHC V6 (24 Valve) 92.9mm Bore; MFI; Hybrid (Gas/Electric); Naturally Aspirated Mercedes-Benz Eng.	2011-10	272.973	5	
3.5L 213.4 (3498cc) DOHC V6 (24 Valve) 92.9mm Bore; MFI; Gasoline; Naturally Aspirated Mercedes-Benz Eng.	2012-10	272.991	6	
4.3L 260 (4266cc) SOHC V8 (24 Valve) 89.9mm Bore; MFI; Gasoline; Naturally Aspirated Mercedes-Benz Eng.	2001-99	113.942	7	
5.0L 303 (4966cc) SOHC V8 (24 Valve) 96.8mm Bore; MFI; Gasoline; Naturally Aspirated Mercedes-Benz Eng.	2008-02	113.960	8	
5.0L 303 (4966cc) SOHC V8 (24 Valve) 96.8mm Bore; MFI; Gasoline; Naturally Aspirated Mercedes-Benz Eng.	2008-06	113.961	9	
5.0L 303 (4966cc) SOHC V8 (24 Valve) 96.8mm Bore; MFI; Gasoline; Naturally Aspirated Mercedes-Benz Eng.	2005-02	113.965	10	
5.4L 329.5 (5439cc) SOHC V8 (24 Valve) 96.5mm Bore; MFI; Gasoline; Supercharged Mercedes-Benz Eng.	2008-05	113.980	11	
5.4L 329.5 (5439cc) SOHC V8 (24 Valve) 96.5mm Bore; MFI; Gasoline; Naturally Aspirated Mercedes-Benz Eng.	2003-00	113.981	12	
5.4L 329.5 (5439cc) SOHC V8 (24 Valve) 96.5mm Bore; MFI; Gasoline; Naturally Aspirated Mercedes-Benz Eng.	2004-03	113.982	13	
5.4L 329.5 (5439cc) SOHC V8 (24 Valve) 96.5mm Bore; MFI; Gasoline; Supercharged - Intercooled Mercedes-Benz Eng.	2011-09	113.993	14	
5.4L 329.5 (5439cc) SOHC V8 (24 Valve) 96.5mm Bore; MFI; Gasoline; Supercharged Mercedes-Benz Eng.	2008-05	155.980	15	
5.5L 333.2 (5461cc) DOHC V8 (32 Valve) 98mm Bore; MFI; Gasoline; Naturally Aspirated Mercedes-Benz Eng.	2013-08	273.961	16	
5.5L 333.2 (5461cc) DOHC V8 (32 Valve) 98mm Bore; MFI; Gasoline; Naturally Aspirated Mercedes-Benz Eng.	2013-12	273.963	17	
Engine Code Index				
Code	Engine	Line No.		
112.942	3.2L 195.1 (3199cc) SOHC V6 (18 Valve) 89.9mm Bore; MFI; Gasoline; Naturally Aspirated Mercedes-Benz Eng.	1		
113.942	4.3L 260 (4266cc) SOHC V8 (24 Valve) 89.9mm Bore; MFI; Gasoline; Naturally Aspirated Mercedes-Benz Eng.	7		
113.960	5.0L 303 (4966cc) SOHC V8 (24 Valve) 96.8mm Bore; MFI; Gasoline; Naturally Aspirated Mercedes-Benz Eng.	8		
113.961	5.0L 303 (4966cc) SOHC V8 (24 Valve) 96.8mm Bore; MFI; Gasoline; Naturally Aspirated Mercedes-Benz Eng.	9		
113.965	5.0L 303 (4966cc) SOHC V8 (24 Valve) 96.8mm Bore; MFI; Gasoline; Naturally Aspirated Mercedes-Benz Eng.	10		
113.980	5.4L 329.5 (5439cc) SOHC V8 (24 Valve) 96.5mm Bore; MFI; Gasoline; Supercharged Mercedes-Benz Eng.	11		
113.981	5.4L 329.5 (5439cc) SOHC V8 (24 Valve) 96.5mm Bore; MFI; Gasoline; Naturally Aspirated Mercedes-Benz Eng.	12		
113.982	5.4L 329.5 (5439cc) SOHC V8 (24 Valve) 96.5mm Bore; MFI; Gasoline; Naturally Aspirated Mercedes-Benz Eng.	13		
113.993	5.4L 329.5 (5439cc) SOHC V8 (24 Valve) 96.5mm Bore; MFI; Gasoline; Supercharged - Intercooled Mercedes-Benz Eng.	14		
155.980	5.4L 329.5 (5439cc) SOHC V8 (24 Valve) 96.5mm Bore; MFI; Gasoline; Supercharged Mercedes-Benz Eng.	15		
272.963	3.5L 213.4 (3498cc) DOHC V6 (24 Valve) 92.9mm Bore; MFI; Gasoline; Naturally Aspirated Mercedes-Benz Eng.	2		
272.967	3.5L 213.4 (3498cc) DOHC V6 (24 Valve) 92.9mm Bore; MFI; Gasoline; Naturally Aspirated Mercedes-Benz Eng.	3		
272.971	3.5L 213.4 (3498cc) DOHC V6 (24 Valve) 92.9mm Bore; MFI; Gasoline; Naturally Aspirated Mercedes-Benz Eng.	4		
272.973	3.5L 213.4 (3498cc) DOHC V6 (24 Valve) 92.9mm Bore; MFI; Hybrid (Gas/Electric); Naturally Aspirated Mercedes-Benz Eng.	5		
272.991	3.5L 213.4 (3498cc) DOHC V6 (24 Valve) 92.9mm Bore; MFI; Gasoline; Naturally Aspirated Mercedes-Benz Eng.	6		
273.961	5.5L 333.2 (5461cc) DOHC V8 (32 Valve) 98mm Bore; MFI; Gasoline; Naturally Aspirated Mercedes-Benz Eng.	16		

Mercedes-Benz Truck (Incl. SUV's) (Cont.)

Engine Code Index (Cont.)

Code	Engine			Line No.		
273.963	5.5L 333.2 (5461cc) DOHC V8 (32 Valve) 98mm Bore; MFI; Gasoline; Naturally Aspirated Mercedes-Benz Eng.			17		
Model Index						
Engine (VIN Code / Eng. Code)	Year	Engine (VIN Code / Eng. Code)	Year	Engine (VIN Code / Eng. Code)	Year	
Mercedes-Benz Truck		Mercedes-Benz Truck (cont.)		Mercedes-Benz Truck (cont.)		
G500 (AWD Full-Size SUV)		GLK250 (AWD Compact SUV)		ML550 (AWD Full-Size SUV)		
V8 4966cc 5.0L SOHC (24 Valve) (113.960)	08-02	L4 2143cc 2.1L DOHC Turbo-Diesel (16 Valve)	13	V8 4663cc 4.7L DOHC Turbo (32 Valve) (278.922)	13-12	
G55 AMG (AWD Full-Size SUV)		GLK350 (2WD Compact SUV)		V8 4663cc 4.7L DOHC Turbo (32 Valve) (278.928)	13	
V8 5439cc 5.4L SOHC (24 Valve) (113.982)	04-03	V6 3498cc 3.5L DOHC (24 Valve) (272.991)	12-10	V8 5461cc 5.5L DOHC (32 Valve) (273.961)	11-08	
V8 5439cc 5.4L SOHC Supercharged (24 Valve) (113.980)	08-05	V6 3498cc 3.5L DOHC (24 Valve) (276.957)	13	ML63 AMG (AWD Mid-Size SUV)		
V8 5439cc 5.4L SOHC Supercharged (24 Valve) (113.993)	11-09	GLK350 (AWD Compact SUV)		V8 5461cc 5.5L DOHC Turbo (32 Valve) (157.980)	13-12	
G550 (AWD Full-Size SUV)		V6 3498cc 3.5L DOHC (24 Valve) (272.971)	12-10	V8 5461cc 5.5L DOHC Turbo (32 Valve) (157.981)	13-12	
V8 5461cc 5.5L DOHC (32 Valve) (273.961)	13-09	V6 3498cc 3.5L DOHC (24 Valve) (276.957)	13	V8 6208cc 6.2L DOHC (32 Valve) (156.980)	11-07	
V8 5461cc 5.5L DOHC (32 Valve) (273.963)	13	ML320 (AWD Mid-Size SUV)		R320 (AWD Mid-Size SUV)		
G63 AMG (AWD Full-Size SUV)		V6 2987cc 3.0L DOHC Turbo-Diesel (24 Valve) (642.940)	09-07	V6 2987cc 3.0L DOHC Turbo-Diesel (24 Valve) (642.950)	09-07	
V8 5461cc 5.5L DOHC Turbo (32 Valve) (157.984)	13	V6 3199cc 3.2L SOHC (18 Valve) (112.942)	03-98	R350 (AWD Mid-Size SUV)		
GL320 (AWD Full-Size SUV)		ML350 (2WD Mid-Size SUV)		V6 2987cc 3.0L DOHC Turbo-Diesel (24 Valve) (642.950)	13-10	
V6 2987cc 3.0L DOHC Turbo-Diesel (24 Valve) (642.940)	09-07	V6 3498cc 3.5L DOHC (24 Valve) (272.967)	12-09	V6 3498cc 3.5L DOHC (24 Valve) (272.967)	12-06	
GL350 (AWD Full-Size SUV)		V6 3498cc 3.5L DOHC (24 Valve) (276.955)	13-12	V6 3498cc 3.5L DOHC (24 Valve) (276.958)	13-12	
V6 2987cc 3.0L DOHC Turbo-Diesel (24 Valve) (642.826)	13	ML350 (AWD Mid-Size SUV)		R500 (AWD Mid-Size SUV)		
V6 2987cc 3.0L DOHC Turbo-Diesel (24 Valve) (642.940)	13-10	V6 2987cc 3.0L DOHC Turbo-Diesel (24 Valve) (642.826)	13-12	V8 4966cc 5.0L SOHC (24 Valve) (113.961)	08-06	
GL450 (AWD Full-Size SUV)		V6 2987cc 3.0L DOHC Turbo-Diesel (24 Valve) (642.940)	13-10	R63 AMG (AWD Mid-Size SUV)		
V8 4663cc 4.7L DOHC (32 Valve) (273.923)	13-07	V6 3498cc 3.5L DOHC (24 Valve) (272.967)	12-06	V8 6208cc 6.2L DOHC (32 Valve) (156.980)	08-07	
V8 4663cc 4.7L DOHC Turbo (32 Valve) (278.928)	13	V6 3498cc 3.5L DOHC (24 Valve) (276.955)	13-12	Sprinter 2500 (Mid-Size Van)		
GL500 (AWD Full-Size SUV)		V6 3724cc 3.7L SOHC (18 Valve) (112.M37)	05-03	V6 2987cc 3.0L DOHC Turbo-Diesel (24 Valve) (642.896)	13	
V8 5461cc 5.5L DOHC (32 Valve) (273.961)	13-08	ML430 (AWD Mid-Size SUV)		V6 2987cc 3.0L DOHC Turbo-Diesel (24 Valve) (642.898)	13-10	
GL63 AMG (AWD Full-Size SUV)		V8 4266cc 4.3L SOHC (24 Valve) (113.942)	01-99	Sprinter 3500 (Mid-Size Van)		
V8 5461cc 5.5L DOHC Turbo (32 Valve) (157.982)	13	ML450 Hybrid (AWD Mid-Size SUV)		V6 2987cc 3.0L DOHC Turbo-Diesel (24 Valve) (642.896)	13	
		V6 3498cc 3.5L DOHC (24 Valve) (272.973)	11-10	V6 2987cc 3.0L DOHC Turbo-Diesel (24 Valve) (642.898)	13-10	
		ML500 (AWD Mid-Size SUV)		Sprinter 3500 (Mid-Size Van)		
		V8 4966cc 5.0L SOHC (24 Valve) (113.961)	07-06	V6 2987cc 3.0L DOHC Turbo-Diesel (24 Valve) (642.896)	13	
		V8 4966cc 5.0L SOHC (24 Valve) (113.965)	05-02	V6 2987cc 3.0L DOHC Turbo-Diesel (24 Valve) (642.898)	13-10	
		ML55 AMG (AWD Mid-Size SUV)				
		V8 5439cc 5.4L SOHC (24 Valve) (113.981)	03-00			
1		2003 - 1998; 3.2L 195.1 (3199cc) SOHC V6 (18 Valve) 89.9mm Bore MFI; Gasoline; Naturally Aspirated Mercedes-Benz Eng.; Eng. Code 112.942				1
QTY	CYLINDER HEAD	YEARS	PART NO.	DESCRIPTION		
1	Head Gasket	2003-98	26433 PT	Loc. L.H.; Head bolts not incl.; Head bolt replacement recommended; PermaTorqueMLS®		
1	Head Gasket	2003-98	26434 PT	Loc. R.H.; Head bolts not incl.; Head bolt replacement recommended; PermaTorqueMLS®		
1	Head Set	2003-98	HS 26433 PT	Head bolts not incl.; Head bolt replacement recommended; PermaDry® molded rubber valve cover gskts. incl.; Premium valve stem seals incl.		
2	Head Bolt Set	2003-98	ES 71307	Replacement recommended		
QTY	CONVERSION SET	YEARS	PART NO.	DESCRIPTION		
1	Gasket Conversion Set	2003-98	CS 26433-1	RTV sealant incl. for oil pan gskt.		
QTY	MANIFOLD - INT. & EXH.	YEARS	PART NO.	DESCRIPTION		
1	Int. Manifold Gasket Set	2003-98	MS 97091			
1	Exh. Manifold Gasket Set	2003-98	MS 97095			
QTY	EXHAUST PIPE FLANGE	YEARS	PART NO.	DESCRIPTION		
2	Exhaust Pipe Gasket	2003-98	61588	Flange		
2	Exhaust Pipe Gasket	2003-98	61590	Converter; New Part Number - Check for Availability		
QTY	CRANKSHAFT REAR SEAL	YEARS	PART NO.	DESCRIPTION		
1	Rear Main Seal Set	2003-98	BS 40722	Rubber; One-piece		
QTY	VALVE COVER	YEARS	PART NO.	DESCRIPTION		
1	Valve Cover Gasket Set	2003-98	VS 50758 R	PermaDry® molded rubber gskts. incl.		
QTY	VALVE STEM SEAL SET	YEARS	PART NO.	DESCRIPTION		
1	Valve Stem Seal Set	2003-98	SS 72919-2	Premium valve stem seals incl.		
QTY	THERMOSTAT HOUSING	YEARS	PART NO.	DESCRIPTION		
1	O-Ring	2003-98	35908	Thermostat Housing; Thermostat seal		

Mercedes-Benz Truck (Incl. SUV's) (Cont.)

1		2003 - 1998; 3.2L 195.1 (3199cc) SOHC V6 (18 Valve) 89.9mm Bore			1	
(cont.)		MFI; Gasoline; Naturally Aspirated Mercedes-Benz Eng.; Eng. Code 112.942			(cont.)	
QTY	WATER PUMP	YEARS	PART NO.	DESCRIPTION		
1	Water Pump Gasket	2003-98	35910	Loc. Lower		
1	Water Pump Gasket	2003-01	35912	Loc. Upper		
QTY	TIMING COVER	YEARS	PART NO.	DESCRIPTION		
1	Crankshaft Front Seal Set	2003-98	TCS 46123	Mounting set		
1	Crankshaft Front Seal Set	2003-98	TCS 46188	Seal only; New Part Number - Check for Availability		
QTY	CARB & FUEL INJECTION	YEARS	PART NO.	DESCRIPTION		
3	Fuel Injector O-Ring Set	2003-98	ES 70599	Improved design		
1	Throttle Body Gasket	2003-98	61592			
QTY	EXHAUST GAS RECIRCULATION	YEARS	PART NO.	DESCRIPTION		
1	EGR Gasket	2003-98	72361			
QTY	OIL COOLER	YEARS	PART NO.	DESCRIPTION		
1	Oil Cooler Gasket	2003-98	72977	Loc. Lower; Oil cooler mounting; New Part Number - Check for Availability		
1	Oil Cooler Gasket	2003-98	72977	Loc. Upper; Oil cooler mounting; New Part Number - Check for Availability		
2		2012 - 2006; 3.5L 213.4 (3498cc) DOHC V6 (24 Valve) 92.9mm Bore			2	
(cont.)		MFI; Gasoline; Naturally Aspirated Mercedes-Benz Eng.; Eng. Code 272.963			(cont.)	
QTY	CYLINDER HEAD	YEARS	PART NO.	DESCRIPTION		
1	Head Gasket	2012-06	26610 PT	Loc. L.H.; Head bolts not incl.; Head bolt replacement recommended; PermaTorqueMLS®; New Part Number - Check for Availability		
1	Head Gasket	2012-06	26623 PT	Loc. R.H.; Head bolts not incl.; Head bolt replacement recommended; PermaTorqueMLS®; New Part Number - Check for Availability		
1	Head Set	2012-06	HS 26610 PT	Head bolts not incl.; Head bolt replacement recommended; RTV sealant incl. for valve cover gskts.; Premium valve stem seals incl.; New Part Number - Check for Availability		
QTY	CONVERSION SET	YEARS	PART NO.	DESCRIPTION		
1	Gasket Conversion Set	2012-06	CS 26610	RTV sealant incl. for oil pan gskt.; New Part Number - Check for Availability		
QTY	MANIFOLD - INT. & EXH.	YEARS	PART NO.	DESCRIPTION		
1	Int. Manifold Gasket Set	2012-06	MS 97292	Lower set; New Part Number - Check for Availability		
1	Exh. Manifold Gasket Set	2012-06	MS 97263	New Part Number - Check for Availability		
QTY	WATER PUMP	YEARS	PART NO.	DESCRIPTION		
1	Water Pump Gasket	2006	36060	To Ser. No. 30058493; New Part Number - Check for Availability		
QTY	OIL COOLER	YEARS	PART NO.	DESCRIPTION		
1	Oil Cooler Gasket	2012-06	72979	Oil cooler to housing; New Part Number - Check for Availability		
3		2012 - 2006; 3.5L 213.4 (3498cc) DOHC V6 (24 Valve) 92.9mm Bore			3	
(cont.)		MFI; Gasoline; Naturally Aspirated Mercedes-Benz Eng.; Eng. Code 272.967			(cont.)	
QTY	CYLINDER HEAD	YEARS	PART NO.	DESCRIPTION		
1	Head Gasket	2012-06	26610 PT	Loc. L.H.; Head bolts not incl.; Head bolt replacement recommended; PermaTorqueMLS®; New Part Number - Check for Availability		
1	Head Gasket	2012-06	26623 PT	Loc. R.H.; Head bolts not incl.; Head bolt replacement recommended; PermaTorqueMLS®; New Part Number - Check for Availability		
1	Head Set	2012-06	HS 26610 PT	Head bolts not incl.; Head bolt replacement recommended; RTV sealant incl. for valve cover gskts.; Premium valve stem seals incl.; New Part Number - Check for Availability		
QTY	CONVERSION SET	YEARS	PART NO.	DESCRIPTION		
1	Gasket Conversion Set	2012-06	CS 26610	RTV sealant incl. for oil pan gskt.; New Part Number - Check for Availability		
QTY	MANIFOLD - INT. & EXH.	YEARS	PART NO.	DESCRIPTION		
1	Int. Manifold Gasket Set	2012-06	MS 97292	Lower set; New Part Number - Check for Availability		
1	Exh. Manifold Gasket Set	2012-06	MS 97263	New Part Number - Check for Availability		
QTY	WATER PUMP	YEARS	PART NO.	DESCRIPTION		
1	Water Pump Gasket	2006	36060	To Ser. No. 30058493; New Part Number - Check for Availability		
QTY	OIL COOLER	YEARS	PART NO.	DESCRIPTION		
1	Oil Cooler Gasket	2012-06	72979	Oil cooler to housing; New Part Number - Check for Availability		
4		2012 - 2010; 3.5L 213.4 (3498cc) DOHC V6 (24 Valve) 92.9mm Bore			4	
(cont.)		MFI; Gasoline; Naturally Aspirated Mercedes-Benz Eng.; Eng. Code 272.971			(cont.)	
QTY	CYLINDER HEAD	YEARS	PART NO.	DESCRIPTION		
1	Head Gasket	2012-10	26610 PT	Loc. L.H.; Head bolts not incl.; Head bolt replacement recommended; PermaTorqueMLS®; New Part Number - Check for Availability		
1	Head Gasket	2012-10	26623 PT	Loc. R.H.; Head bolts not incl.; Head bolt replacement recommended; PermaTorqueMLS®; New Part Number - Check for Availability		

Mercedes-Benz Truck (Incl. SUV's) (Cont.)

4		2012 - 2010; 3.5L 213.4 (3498cc) DOHC V6 (24 Valve) 92.9mm Bore			4
(cont.)		MFI; Gasoline; Naturally Aspirated Mercedes-Benz Eng.; Eng. Code 272.971			(cont.)
QTY	CYLINDER HEAD	YEARS	PART NO.	DESCRIPTION	
1	Head Set	2012-10	HS 26610 PT	Head bolts not incl.; Head bolt replacement recommended; RTV sealant incl. for valve cover gskts.; Premium valve stem seals incl.; New Part Number - Check for Availability	
QTY	CONVERSION SET	YEARS	PART NO.	DESCRIPTION	
1	Gasket Conversion Set	2012-10	CS 26610	RTV sealant incl. for oil pan gskt.; New Part Number - Check for Availability	
QTY	MANIFOLD - INT. & EXH.	YEARS	PART NO.	DESCRIPTION	
1	Int. Manifold Gasket Set	2012-10	MS 97292	Lower set; New Part Number - Check for Availability	
1	Exh. Manifold Gasket Set	2012-10	MS 97263	New Part Number - Check for Availability	
QTY	OIL COOLER	YEARS	PART NO.	DESCRIPTION	
1	Oil Cooler Gasket	2012-10	72979	Oil cooler to housing; New Part Number - Check for Availability	
5		2011 - 2010; 3.5L 213.4 (3498cc) DOHC V6 (24 Valve) 92.9mm Bore			5
(cont.)		MFI; Hybrid (Gas/Electric); Naturally Aspirated Mercedes-Benz Eng.; Eng. Code 272.973			(cont.)
QTY	CYLINDER HEAD	YEARS	PART NO.	DESCRIPTION	
1	Head Gasket	2011-10	26610 PT	Loc. L.H.; Head bolts not incl.; Head bolt replacement recommended; PermaTorqueMLS®; New Part Number - Check for Availability	
1	Head Gasket	2011-10	26623 PT	Loc. R.H.; Head bolts not incl.; Head bolt replacement recommended; PermaTorqueMLS®; New Part Number - Check for Availability	
1	Head Set	2011-10	HS 26610 PT	Head bolts not incl.; Head bolt replacement recommended; RTV sealant incl. for valve cover gskts.; Premium valve stem seals incl.; New Part Number - Check for Availability	
QTY	CONVERSION SET	YEARS	PART NO.	DESCRIPTION	
1	Gasket Conversion Set	2011-10	CS 26610	RTV sealant incl. for oil pan gskt.; New Part Number - Check for Availability	
QTY	MANIFOLD - INT. & EXH.	YEARS	PART NO.	DESCRIPTION	
1	Int. Manifold Gasket Set	2011-10	MS 97292	Lower set; New Part Number - Check for Availability	
1	Exh. Manifold Gasket Set	2011-10	MS 97263	New Part Number - Check for Availability	
QTY	OIL COOLER	YEARS	PART NO.	DESCRIPTION	
1	Oil Cooler Gasket	2011-10	72979	Oil cooler to housing; New Part Number - Check for Availability	
6		2012 - 2010; 3.5L 213.4 (3498cc) DOHC V6 (24 Valve) 92.9mm Bore			6
(cont.)		MFI; Gasoline; Naturally Aspirated Mercedes-Benz Eng.; Eng. Code 272.991			(cont.)
QTY	CYLINDER HEAD	YEARS	PART NO.	DESCRIPTION	
1	Head Gasket	2012-10	26610 PT	Loc. L.H.; Head bolts not incl.; Head bolt replacement recommended; PermaTorqueMLS®; New Part Number - Check for Availability	
1	Head Gasket	2012-10	26623 PT	Loc. R.H.; Head bolts not incl.; Head bolt replacement recommended; PermaTorqueMLS®; New Part Number - Check for Availability	
1	Head Set	2012-10	HS 26610 PT	Head bolts not incl.; Head bolt replacement recommended; RTV sealant incl. for valve cover gskts.; Premium valve stem seals incl.; New Part Number - Check for Availability	
QTY	CONVERSION SET	YEARS	PART NO.	DESCRIPTION	
1	Gasket Conversion Set	2012-10	CS 26610	RTV sealant incl. for oil pan gskt.; New Part Number - Check for Availability	
QTY	MANIFOLD - INT. & EXH.	YEARS	PART NO.	DESCRIPTION	
1	Int. Manifold Gasket Set	2012-10	MS 97292	Lower set; New Part Number - Check for Availability	
1	Exh. Manifold Gasket Set	2012-10	MS 97263	New Part Number - Check for Availability	
QTY	OIL COOLER	YEARS	PART NO.	DESCRIPTION	
1	Oil Cooler Gasket	2012-10	72979	Oil cooler to housing; New Part Number - Check for Availability	
7		2001 - 1999; 4.3L 260 (4266cc) SOHC V8 (24 Valve) 89.9mm Bore			7
(cont.)		MFI; Gasoline; Naturally Aspirated Mercedes-Benz Eng.; Eng. Code 113.942			(cont.)
QTY	CYLINDER HEAD	YEARS	PART NO.	DESCRIPTION	
1	Head Gasket	2001-99	26612 PT	Loc. L.H.; Head bolts not incl.; Head bolt replacement recommended; PermaTorqueMLS®; New Part Number - Check for Availability	
1	Head Gasket	2001-99	26625 PT	Loc. R.H.; Head bolts not incl.; Head bolt replacement recommended; PermaTorqueMLS®; New Part Number - Check for Availability	
1	Head Set	2001-99	HS 26612 PT	Head bolts not incl.; Head bolt replacement recommended; PermaDry® molded rubber valve cover gskts. incl.; Premium valve stem seals incl.; New Part Number - Check for Availability	
QTY	MANIFOLD - INT. & EXH.	YEARS	PART NO.	DESCRIPTION	
1	Int. Manifold Gasket Set	2001-99	MS 97298	Lower set; New Part Number - Check for Availability	
1	Exh. Manifold Gasket Set	2001-99	MS 97260	New Part Number - Check for Availability	
QTY	VALVE COVER	YEARS	PART NO.	DESCRIPTION	
1	Valve Cover Gasket Set	2001-99	VS 50842 R	PermaDry® molded rubber gskts. incl.; New Part Number - Check for Availability	

Mercedes-Benz Truck (Incl. SUV's) (Cont.)

7		2001 - 1999; 4.3L 260 (4266cc) SOHC V8 (24 Valve) 89.9mm Bore			7	
(cont.)		MFI; Gasoline; Naturally Aspirated Mercedes-Benz Eng.; Eng. Code 113.942			(cont.)	
QTY	TIMING COVER	YEARS	PART NO.	DESCRIPTION		
1	Crankshaft Front Seal Set	2001-99	TCS 46188	New Part Number - Check for Availability		
QTY	OIL COOLER	YEARS	PART NO.	DESCRIPTION		
1	Oil Cooler Gasket	2001-99	72977	Loc. Upper; Oil cooler mounting; New Part Number - Check for Availability		
1	Oil Cooler Gasket	2001-99	72978	Loc. Lower; Oil cooler mounting; New Part Number - Check for Availability		
8		2008 - 2002; 5.0L 303 (4966cc) SOHC V8 (24 Valve) 96.8mm Bore			8	
		MFI; Gasoline; Naturally Aspirated Mercedes-Benz Eng.; Eng. Code 113.960				
QTY	CYLINDER HEAD	YEARS	PART NO.	DESCRIPTION		
1	Head Gasket	2008-02	26611 PT	Loc. L.H.; Head bolts not incl.; Head bolt replacement recommended; PermaTorqueMLS®; New Part Number - Check for Availability		
1	Head Gasket	2008-02	26624 PT	Loc. R.H.; Head bolts not incl.; Head bolt replacement recommended; PermaTorqueMLS®; New Part Number - Check for Availability		
1	Head Set	2008-02	HS 26611 PT	Head bolts not incl.; Head bolt replacement recommended; PermaDry® molded rubber valve cover gskts. incl.; Premium valve stem seals incl.; New Part Number - Check for Availability		
QTY	MANIFOLD - INT. & EXH.	YEARS	PART NO.	DESCRIPTION		
1	Int. Manifold Gasket Set	2008-02	MS 97298	Lower set; New Part Number - Check for Availability		
1	Exh. Manifold Gasket Set	2008-02	MS 97260	New Part Number - Check for Availability		
QTY	VALVE COVER	YEARS	PART NO.	DESCRIPTION		
1	Valve Cover Gasket Set	2008-02	VS 50842 R	PermaDry® molded rubber gskts. incl.; New Part Number - Check for Availability		
QTY	TIMING COVER	YEARS	PART NO.	DESCRIPTION		
1	Crankshaft Front Seal Set	2008-02	TCS 46188	New Part Number - Check for Availability		
QTY	OIL COOLER	YEARS	PART NO.	DESCRIPTION		
1	Oil Cooler Gasket	2008-02	72977	Loc. Upper; Oil cooler mounting; New Part Number - Check for Availability		
1	Oil Cooler Gasket	2008-02	72978	Loc. Lower; Oil cooler mounting; New Part Number - Check for Availability		
9		2008 - 2006; 5.0L 303 (4966cc) SOHC V8 (24 Valve) 96.8mm Bore			9	
		MFI; Gasoline; Naturally Aspirated Mercedes-Benz Eng.; Eng. Code 113.961				
QTY	CYLINDER HEAD	YEARS	PART NO.	DESCRIPTION		
1	Head Gasket	2008-06	26611 PT	Loc. L.H.; Head bolts not incl.; Head bolt replacement recommended; PermaTorqueMLS®; New Part Number - Check for Availability		
1	Head Gasket	2008-06	26624 PT	Loc. R.H.; Head bolts not incl.; Head bolt replacement recommended; PermaTorqueMLS®; New Part Number - Check for Availability		
1	Head Set	2008-06	HS 26611 PT	Head bolts not incl.; Head bolt replacement recommended; PermaDry® molded rubber valve cover gskts. incl.; Premium valve stem seals incl.; New Part Number - Check for Availability		
QTY	MANIFOLD - INT. & EXH.	YEARS	PART NO.	DESCRIPTION		
1	Int. Manifold Gasket Set	2008-06	MS 97298	Lower set; New Part Number - Check for Availability		
1	Exh. Manifold Gasket Set	2008-06	MS 97260	New Part Number - Check for Availability		
QTY	VALVE COVER	YEARS	PART NO.	DESCRIPTION		
1	Valve Cover Gasket Set	2008-06	VS 50842 R	PermaDry® molded rubber gskts. incl.; New Part Number - Check for Availability		
QTY	TIMING COVER	YEARS	PART NO.	DESCRIPTION		
1	Crankshaft Front Seal Set	2008-06	TCS 46188	New Part Number - Check for Availability		
QTY	OIL COOLER	YEARS	PART NO.	DESCRIPTION		
1	Oil Cooler Gasket	2008-06	72977	Loc. Upper; Oil cooler mounting; New Part Number - Check for Availability		
1	Oil Cooler Gasket	2008-06	72978	Loc. Lower; Oil cooler mounting; New Part Number - Check for Availability		
10		2005 - 2002; 5.0L 303 (4966cc) SOHC V8 (24 Valve) 96.8mm Bore			10	
		MFI; Gasoline; Naturally Aspirated Mercedes-Benz Eng.; Eng. Code 113.965				
QTY	CYLINDER HEAD	YEARS	PART NO.	DESCRIPTION		
1	Head Gasket	2005-02	26611 PT	Loc. L.H.; Head bolts not incl.; Head bolt replacement recommended; PermaTorqueMLS®; New Part Number - Check for Availability		
1	Head Gasket	2005-02	26624 PT	Loc. R.H.; Head bolts not incl.; Head bolt replacement recommended; PermaTorqueMLS®; New Part Number - Check for Availability		
1	Head Set	2005-02	HS 26611 PT	Head bolts not incl.; Head bolt replacement recommended; PermaDry® molded rubber valve cover gskts. incl.; Premium valve stem seals incl.; New Part Number - Check for Availability		
QTY	MANIFOLD - INT. & EXH.	YEARS	PART NO.	DESCRIPTION		
1	Int. Manifold Gasket Set	2005-02	MS 97298	Lower set; New Part Number - Check for Availability		
1	Exh. Manifold Gasket Set	2005-02	MS 97260	New Part Number - Check for Availability		

Mercedes-Benz Truck (Incl. SUV's) (Cont.)

10 (cont.)	2005 - 2002; 5.0L 303 (4966cc) SOHC V8 (24 Valve) 96.8mm Bore			10 (cont.)
	MFI; Gasoline; Naturally Aspirated Mercedes-Benz Eng.; Eng. Code 113.965			
QTY	VALVE COVER	YEARS	PART NO.	DESCRIPTION
1	Valve Cover Gasket Set	2005-02	VS 50842 R	PermaDry® molded rubber gskts. incl.; New Part Number - Check for Availability
QTY	TIMING COVER	YEARS	PART NO.	DESCRIPTION
1	Crankshaft Front Seal Set	2005-02	TCS 46188	New Part Number - Check for Availability
QTY	OIL COOLER	YEARS	PART NO.	DESCRIPTION
1	Oil Cooler Gasket	2005-02	72977	Loc. Upper; Oil cooler mounting; New Part Number - Check for Availability
1	Oil Cooler Gasket	2005-02	72978	Loc. Lower; Oil cooler mounting; New Part Number - Check for Availability
11	2008 - 2005; 5.4L 329.5 (5439cc) SOHC V8 (24 Valve) 96.5mm Bore			11
	MFI; Gasoline; Supercharged Mercedes-Benz Eng.; Eng. Code 113.980			
QTY	MANIFOLD - INT. & EXH.	YEARS	PART NO.	DESCRIPTION
1	Int. Manifold Gasket Set	2008-05	MS 97298	Lower set; New Part Number - Check for Availability
12	2003 - 2000; 5.4L 329.5 (5439cc) SOHC V8 (24 Valve) 96.5mm Bore			12
	MFI; Gasoline; Naturally Aspirated Mercedes-Benz Eng.; Eng. Code 113.981			
QTY	MANIFOLD - INT. & EXH.	YEARS	PART NO.	DESCRIPTION
1	Int. Manifold Gasket Set	2003-00	MS 97298	Lower set; New Part Number - Check for Availability
13	2004 - 2003; 5.4L 329.5 (5439cc) SOHC V8 (24 Valve) 96.5mm Bore			13
	MFI; Gasoline; Naturally Aspirated Mercedes-Benz Eng.; Eng. Code 113.982			
QTY	MANIFOLD - INT. & EXH.	YEARS	PART NO.	DESCRIPTION
1	Int. Manifold Gasket Set	2004-03	MS 97298	Lower set; New Part Number - Check for Availability
14	2011 - 2009; 5.4L 329.5 (5439cc) SOHC V8 (24 Valve) 96.5mm Bore			14
	MFI; Gasoline; Supercharged - Intercooled Mercedes-Benz Eng.; Eng. Code 113.993			
QTY	MANIFOLD - INT. & EXH.	YEARS	PART NO.	DESCRIPTION
1	Int. Manifold Gasket Set	2011-09	MS 97298	Lower set; New Part Number - Check for Availability
15	2008 - 2005; 5.4L 329.5 (5439cc) SOHC V8 (24 Valve) 96.5mm Bore			15
	MFI; Gasoline; Supercharged Mercedes-Benz Eng.; Eng. Code 155.980			
QTY	MANIFOLD - INT. & EXH.	YEARS	PART NO.	DESCRIPTION
1	Int. Manifold Gasket Set	2008-05	MS 97298	Lower set; New Part Number - Check for Availability
16	2013 - 2008; 5.5L 333.2 (5461cc) DOHC V8 (32 Valve) 98mm Bore			16
	MFI; Gasoline; Naturally Aspirated Mercedes-Benz Eng.; Eng. Code 273.961			
QTY	CYLINDER HEAD	YEARS	PART NO.	DESCRIPTION
1	Head Gasket	2013-08	26613 PT	Loc. L.H.; Head bolts not incl.; Head bolt replacement recommended; PermaTorqueMLS®; New Part Number - Check for Availability
1	Head Gasket	2013-08	26626 PT	Loc. R.H.; Head bolts not incl.; Head bolt replacement recommended; PermaTorqueMLS®; New Part Number - Check for Availability
1	Head Set	2013-08	HS 26613 PT	Head bolts not incl.; Head bolt replacement recommended; RTV sealant incl. for valve cover gskts.; Premium valve stem seals incl.; New Part Number - Check for Availability
QTY	MANIFOLD - INT. & EXH.	YEARS	PART NO.	DESCRIPTION
1	Int. Manifold Gasket Set	2013-08	MS 97297	Lower set; New Part Number - Check for Availability
1	Exh. Manifold Gasket Set	2013-08	MS 97266	New Part Number - Check for Availability
QTY	TIMING COVER	YEARS	PART NO.	DESCRIPTION
1	Crankshaft Front Seal Set	2013-08	TCS 46188	New Part Number - Check for Availability
QTY	OIL COOLER	YEARS	PART NO.	DESCRIPTION
1	Oil Cooler Gasket	2013-08	72979	Oil cooler to housing; New Part Number - Check for Availability
17	2013 - 2012; 5.5L 333.2 (5461cc) DOHC V8 (32 Valve) 98mm Bore			17
	MFI; Gasoline; Naturally Aspirated Mercedes-Benz Eng.; Eng. Code 273.963			
QTY	CYLINDER HEAD	YEARS	PART NO.	DESCRIPTION
1	Head Gasket	2013-12	26613 PT	Loc. L.H.; Head bolts not incl.; Head bolt replacement recommended; PermaTorqueMLS®; New Part Number - Check for Availability
1	Head Gasket	2013-12	26626 PT	Loc. R.H.; Head bolts not incl.; Head bolt replacement recommended; PermaTorqueMLS®; New Part Number - Check for Availability
1	Head Set	2013-12	HS 26613 PT	Head bolts not incl.; Head bolt replacement recommended; RTV sealant incl. for valve cover gskts.; Premium valve stem seals incl.; New Part Number - Check for Availability
QTY	MANIFOLD - INT. & EXH.	YEARS	PART NO.	DESCRIPTION
1	Int. Manifold Gasket Set	2013-12	MS 97297	Lower set; New Part Number - Check for Availability

Mercedes-Benz Truck (Incl. SUV's) (Cont.)

17 (cont.)		2013 - 2012; 5.5L 333.2 (5461cc) DOHC V8 (32 Valve) 98mm Bore MFI; Gasoline; Naturally Aspirated Mercedes-Benz Eng.; Eng. Code 273.963			17 (cont.)	
QTY	MANIFOLD - INT. & EXH.	YEARS	PART NO.	DESCRIPTION		
1	Exh. Manifold Gasket Set	2013-12	MS 97266	New Part Number - Check for Availability		
QTY	TIMING COVER	YEARS	PART NO.	DESCRIPTION		
1	Crankshaft Front Seal Set	2013-12	TCS 46188	New Part Number - Check for Availability		
QTY	OIL COOLER	YEARS	PART NO.	DESCRIPTION		
1	Oil Cooler Gasket	2013-12	72979	Oil cooler to housing; New Part Number - Check for Availability		

Mercury Car - See Ford Car

Mercury Minivans - See Ford Truck

Mercury SUV's - See Ford Truck

Mini - See BMW Car

Mitsubishi Car

Engine Finding Index

Engine	Years	Code	Line No.
1.5L 89.6 (1468cc) SOHC L4 (12 Valve) 75.5mm Bore; MFI; Gasoline; Naturally Aspirated Mitsubishi Eng.	2002-91	4G15	1
1.5L 89.6 (1468cc) SOHC L4 (8 Valve) 75.5mm Bore; MFI; Gasoline; Naturally Aspirated Mitsubishi Eng.	1994-91	G4DJ	2
1.6L 97.3 (1595cc) DOHC L4 (16 Valve) 82.3mm Bore; MFI; Gasoline; Naturally Aspirated Mitsubishi Eng.	1992-91	4G61	3
1.8L 107.1 (1755cc) SOHC L4 (8 Valve) 80.6mm Bore; MFI; Gasoline; Naturally Aspirated Mitsubishi Eng.	1994-91	4G37	4
1.8L 111.8 (1834cc) SOHC L4 (16 Valve) 81mm Bore; MFI; Gasoline; Naturally Aspirated Mitsubishi Eng.	2002-92	4G93	5
2.0L 122 (1996cc) DOHC L4 (16 Valve) 87.5mm Bore; MFI; Gasoline; Naturally Aspirated Chrysler Eng.	1999-95	420A	6
2.0L 122 (1996cc) DOHC L4 (16 Valve) 87.5mm Bore; MFI; Gasoline; Naturally Aspirated Chrysler Eng.	1999-95	A588	7
2.0L 122 (1997cc) DOHC L4 (16 Valve) 85mm Bore; MFI; Gasoline; Naturally Aspirated Mitsubishi Eng.	1994-91	4G63	8
2.0L 122 (1997cc) DOHC L4 (16 Valve) 85mm Bore; MFI; Gasoline; Turbo - Intercooled Mitsubishi Eng.	1999-91	4G63-T	9
2.0L 122 (1997cc) SOHC L4 (16 Valve) 85mm Bore; MFI; Gasoline; Naturally Aspirated Mitsubishi Eng.	1993	4G63	10
2.0L 122 (1997cc) SOHC L4 (8 Valve) 85mm Bore; MFI; Gasoline; Naturally Aspirated Mitsubishi Eng.	1992-91	4G63	11
2.0L 122 (1998cc) DOHC L4 (16 Valve) 86mm Bore MIVEC; MFI; Gasoline; Naturally Aspirated Mitsubishi Eng.	2013-08	4B11	12
2.0L 122 (1998cc) DOHC L4 (16 Valve) 86mm Bore MIVEC; MFI; Gasoline; Turbo - Intercooled Mitsubishi Eng.	2011-08	4B11T	13
2.0L 122 (1999cc) DOHC L4 (16 Valve) 81.5mm Bore; MFI; Gasoline; Turbo - Intercooled Mitsubishi Eng.	2007-03	4G94-T	14
2.0L 122 (1999cc) SOHC L4 (16 Valve) 81.5mm Bore; MFI; Gasoline; Naturally Aspirated Mitsubishi Eng.	2007-02	4G94	15
2.4L 143.4 (2351cc) DOHC L4 (16 Valve) 86.5mm Bore; MFI; Gasoline; Naturally Aspirated Mitsubishi Eng.	1997-94	4G64	16
2.4L 143.4 (2351cc) SOHC L4 (16 Valve) 86.5mm Bore; MFI; Gasoline; Naturally Aspirated Mitsubishi Eng.	2005-93	4G64	17
2.4L 143.4 (2351cc) SOHC L4 (8 Valve) 86.5mm Bore; MFI; Gasoline; Naturally Aspirated Mitsubishi Eng.	1992	4G64	18
2.4L 144 (2359cc) DOHC L4 (16 Valve) 88mm Bore MIVEC; MFI; Gasoline; Naturally Aspirated Mitsubishi Eng.	2013-09	4B12	19
2.4L 145.1 (2378cc) SOHC L4 (16 Valve) 87mm Bore; MFI; Gasoline; Naturally Aspirated Mitsubishi Eng.	2009-04	4G69	20
2.5L 152.2 (2497cc) SOHC V6 (24 Valve) 83.5mm Bore; MFI; Gasoline; Naturally Aspirated Mitsubishi Eng.	1998-95	6G73	21
3.0L 181.1 (2972cc) DOHC V6 (24 Valve) 91.1mm Bore; MFI; Gasoline; Naturally Aspirated Mitsubishi Eng.	1999-91	6G72	22
3.0L 181.1 (2972cc) DOHC V6 (24 Valve) 91.1mm Bore; MFI; Gasoline; Turbo - Intercooled Mitsubishi Eng.	1999-91	6G72-T	23
3.0L 181.1 (2972cc) SOHC V6 (12 Valve) 91.1mm Bore; MFI; Gasoline; Naturally Aspirated Mitsubishi Eng.	1999-91	6G72	24
3.0L 181.1 (2972cc) SOHC V6 (24 Valve) 91.1mm Bore; MFI; Gasoline; Naturally Aspirated Mitsubishi Eng.	2005-99	6G72	25
3.5L 213.3 (3497cc) SOHC V6 (24 Valve) 93mm Bore; MFI; Gasoline; Naturally Aspirated Mitsubishi Eng.	2005-97	6G74	26
3.8L 234 (3828cc) SOHC V6 (24 Valve) 95mm Bore; MFI; Gasoline; Naturally Aspirated Mitsubishi Eng.	2012-04	6G75	27

Engine Code Index

Code	Engine	Line No.
420A	2.0L 122 (1996cc) DOHC L4 (16 Valve) 87.5mm Bore; MFI; Gasoline; Naturally Aspirated Chrysler Eng.	6
4B11	2.0L 122 (1998cc) DOHC L4 (16 Valve) 86mm Bore MIVEC; MFI; Gasoline; Naturally Aspirated Mitsubishi Eng.	12
4B11T	2.0L 122 (1998cc) DOHC L4 (16 Valve) 86mm Bore MIVEC; MFI; Gasoline; Turbo - Intercooled Mitsubishi Eng.	13
4B12	2.4L 144 (2359cc) DOHC L4 (16 Valve) 88mm Bore MIVEC; MFI; Gasoline; Naturally Aspirated Mitsubishi Eng.	19
4G15	1.5L 89.6 (1468cc) SOHC L4 (12 Valve) 75.5mm Bore; MFI; Gasoline; Naturally Aspirated Mitsubishi Eng.	1
4G37	1.8L 107.1 (1755cc) SOHC L4 (8 Valve) 80.6mm Bore; MFI; Gasoline; Naturally Aspirated Mitsubishi Eng.	4
4G61	1.6L 97.3 (1595cc) DOHC L4 (16 Valve) 82.3mm Bore; MFI; Gasoline; Naturally Aspirated Mitsubishi Eng.	3
4G63	2.0L 122 (1997cc) DOHC L4 (16 Valve) 85mm Bore; MFI; Gasoline; Naturally Aspirated Mitsubishi Eng.	8
4G63	2.0L 122 (1997cc) SOHC L4 (16 Valve) 85mm Bore; MFI; Gasoline; Naturally Aspirated Mitsubishi Eng.	10
4G63	2.0L 122 (1997cc) SOHC L4 (8 Valve) 85mm Bore; MFI; Gasoline; Naturally Aspirated Mitsubishi Eng.	11
4G63-T	2.0L 122 (1997cc) DOHC L4 (16 Valve) 85mm Bore; MFI; Gasoline; Turbo - Intercooled Mitsubishi Eng.	9
4G64	2.4L 143.4 (2351cc) DOHC L4 (16 Valve) 86.5mm Bore; MFI; Gasoline; Naturally Aspirated Mitsubishi Eng.	16
4G64	2.4L 143.4 (2351cc) SOHC L4 (16 Valve) 86.5mm Bore; MFI; Gasoline; Naturally Aspirated Mitsubishi Eng.	17
4G64	2.4L 143.4 (2351cc) SOHC L4 (8 Valve) 86.5mm Bore; MFI; Gasoline; Naturally Aspirated Mitsubishi Eng.	18
4G69	2.4L 145.1 (2378cc) SOHC L4 (16 Valve) 87mm Bore; MFI; Gasoline; Naturally Aspirated Mitsubishi Eng.	20
4G93	1.8L 111.8 (1834cc) SOHC L4 (16 Valve) 81mm Bore; MFI; Gasoline; Naturally Aspirated Mitsubishi Eng.	5

Engine Code Index (Cont.)

Code	Engine	Line No.
4G94	2.0L 122 (1999cc) SOHC L4 (16 Valve) 81.5mm Bore; MFI; Gasoline; Naturally Aspirated Mitsubishi Eng.	15
4G94-T	2.0L 122 (1999cc) DOHC L4 (16 Valve) 81.5mm Bore; MFI; Gasoline; Turbo - Intercooled Mitsubishi Eng.	14
6G72	3.0L 181.1 (2972cc) DOHC V6 (24 Valve) 91.1mm Bore; MFI; Gasoline; Naturally Aspirated Mitsubishi Eng.	22
6G72	3.0L 181.1 (2972cc) SOHC V6 (12 Valve) 91.1mm Bore; MFI; Gasoline; Naturally Aspirated Mitsubishi Eng.	24
6G72	3.0L 181.1 (2972cc) SOHC V6 (24 Valve) 91.1mm Bore; MFI; Gasoline; Naturally Aspirated Mitsubishi Eng.	25
6G72-T	3.0L 181.1 (2972cc) DOHC V6 (24 Valve) 91.1mm Bore; MFI; Gasoline; Turbo - Intercooled Mitsubishi Eng.	23
6G73	2.5L 152.2 (2497cc) SOHC V6 (24 Valve) 83.5mm Bore; MFI; Gasoline; Naturally Aspirated Mitsubishi Eng.	21
6G74	3.5L 213.3 (3497cc) SOHC V6 (24 Valve) 93mm Bore; MFI; Gasoline; Naturally Aspirated Mitsubishi Eng.	26
6G75	3.8L 234 (3828cc) SOHC V6 (24 Valve) 95mm Bore; MFI; Gasoline; Naturally Aspirated Mitsubishi Eng.	27
A588	2.0L 122 (1996cc) DOHC L4 (16 Valve) 87.5mm Bore; MFI; Gasoline; Naturally Aspirated Chrysler Eng.	7
G4DJ	1.5L 89.6 (1468cc) SOHC L4 (8 Valve) 75.5mm Bore; MFI; Gasoline; Naturally Aspirated Mitsubishi Eng.	2

Model Index

Engine (VIN Code / Eng. Code)	Year	Engine (VIN Code / Eng. Code)	Year	Engine (VIN Code / Eng. Code)	Year
Mitsubishi		Mitsubishi (cont.)		Mitsubishi (cont.)	
3000GT		Expo (cont.)		Lancer (cont.)	
V6 2972cc 3.0L DOHC (24 Valve) (6G72)	99-91	L4 2351cc 2.4L SOHC (8 Valve) (4G64)	92	L4 1999cc 2.0L DOHC Turbo (16 Valve) (4G94-T)	07-03
V6 2972cc 3.0L SOHC (12 Valve) (6G72)	99-97	Expo AWD		L4 1999cc 2.0L SOHC (16 Valve) (4G94)	07-02
3000GT AWD		L4 1834cc 1.8L SOHC (16 Valve) (4G93)	93-92	L4 2359cc 2.4L DOHC (16 Valve) (4B12)	13-09
V6 2972cc 3.0L DOHC Turbo (24 Valve) (6G72-T)	99-91	L4 2351cc 2.4L SOHC (16 Valve) (4G64)	95-93	L4 2378cc 2.4L SOHC (16 Valve) (4G69)	07-04
Cordia		Expo LRV		Mirage	
L4 1795cc 1.8L SOHC (8 Valve) (G62B)	83	L4 1834cc 1.8L SOHC (16 Valve) (4G93)	96-92	L4 1468cc 1.5L SOHC (12 Valve) (4G15)	02-91
L4 1795cc 1.8L SOHC Turbo (8 Valve) (G62B-T)	88-84	L4 2351cc 2.4L SOHC (16 Valve) (4G64)	96-93	L4 1468cc 1.5L SOHC (8 Valve) (4G15)	90-89
Diamante		Galant		L4 1468cc 1.5L SOHC (8 Valve) (G15B)	88-85
L4 1997cc 2.0L SOHC (8 Valve) (G63B)	88-84	L4 1997cc 2.0L DOHC (16 Valve) (4G63)	92-89	L4 1595cc 1.6L DOHC (16 Valve) (4G61)	92-90
V6 2972cc 3.0L DOHC (24 Valve) (6G72)	96-92	L4 1997cc 2.0L DOHC Turbo (16 Valve) (4G63-T)	92-89	L4 1595cc 1.6L DOHC Turbo (16 Valve) (4G61-T)	89
V6 2972cc 3.0L SOHC (12 Valve) (6G72)	96-92	L4 1997cc 2.0L SOHC (16 Valve) (4G63)	93	L4 1597cc 1.6L SOHC Turbo (8 Valve) (G32B-T)	88-85
V6 3497cc 3.5L SOHC (24 Valve) (6G74)	05-97	L4 1997cc 2.0L SOHC (8 Valve) (4G63)	92-89	L4 1834cc 1.8L SOHC (16 Valve) (4G93)	02-93
Eclipse		L4 2351cc 2.4L DOHC (16 Valve) (4G64)	97-94	Precis	
L4 1755cc 1.8L SOHC (8 Valve) (4G37)	94-89	L4 2351cc 2.4L SOHC (16 Valve) (4G64)	03-94	L4 1468cc 1.5L SOHC (8 Valve) (G4AJ)	89-87
L4 1996cc 2.0L DOHC (16 Valve) (420A)	99-95	L4 2351cc 2.4L SOHC (8 Valve) (G64B)	87-85	L4 1468cc 1.5L SOHC (8 Valve) (G4DJ)	94-90
L4 1997cc 2.0L DOHC (16 Valve) (4G63)	94-89	L4 2378cc 2.4L SOHC (16 Valve) (4G69)	12-04	Sigma	
L4 1997cc 2.0L DOHC Turbo (16 Valve) (4G63-T)	99-89	V6 2497cc 2.5L SOHC (24 Valve) (6G73)	98-95	V6 2972cc 3.0L SOHC (12 Valve) (6G72)	91-88
L4 2351cc 2.4L SOHC (16 Valve) (4G64)	05-96	V6 2972cc 3.0L SOHC (24 Valve) (6G72)	03-99	Space Wagon	
L4 2378cc 2.4L SOHC (16 Valve) (4G69)	12-06	V6 3828cc 3.8L SOHC (24 Valve) (6G75)	09-04	L4 1997cc 2.0L SOHC (8 Valve) (4G63)	91-89
L4 2972cc 3.0L SOHC (24 Valve) (6G72)	05-00	Galant AWD		Starion	
V6 3828cc 3.8L SOHC (24 Valve) (6G75)	12-06	L4 1997cc 2.0L DOHC Turbo (16 Valve) (4G63-T)	92-90	L4 2555cc 2.6L SOHC Turbo (8 Valve) (G54B-T)	89-83
Eclipse AWD		Galant Sigma		Tredia	
L4 1997cc 2.0L DOHC Turbo (16 Valve) (4G63-T)	99-89	V6 2972cc 3.0L SOHC (12 Valve) (6G72)	91-88	L4 1795cc 1.8L SOHC (8 Valve) (G62B)	83
Expo		Lancer		L4 1795cc 1.8L SOHC Turbo (8 Valve) (G62B-T)	88-84
L4 1834cc 1.8L SOHC (16 Valve) (4G93)	96-92	L4 1998cc 2.0L DOHC (16 Valve) (4B11)	13-08	L4 1997cc 2.0L SOHC (8 Valve) (G63B)	88-84
L4 2351cc 2.4L SOHC (16 Valve) (4G64)	96-93	L4 1998cc 2.0L DOHC Turbo (16 Valve) (4B11-T)	13-08		

1

2002 - 1991; 1.5L 89.6 (1468cc) SOHC L4 (12 Valve) 75.5mm Bore MFI; Gasoline; Naturally Aspirated Mitsubishi Eng.; Eng. Code 4G15

1

QTY	CYLINDER HEAD	YEARS	PART NO.	DESCRIPTION
1	Head Gasket	2002-97	26184 PT	Head bolts not incl.; Head bolt replacement recommended; PermaTorqueMLS®
1	Head Gasket	1996-91	9758 PT	
1	Head Set	2002-97	HS 26184 PT	Head bolts not incl.; Head bolt replacement recommended; PermaDry® molded rubber valve cover gskt. incl.; Premium valve stem seals incl.
1	Head Set	1996-91	HS 9758 PT	PermaDry® molded rubber valve cover gskt. incl.; Premium valve stem seals incl.
1	Head Installation Set	1996-91	HIS 9758 PT	Exh. pipe flange not incl.; PermaDry® molded rubber valve cover gskt. incl.
1	Head Bolt Set	2002-95	ES 71206	9mm Head bolts; Head bolts w/Washers; Replacement recommended
QTY	CONVERSION SET	YEARS	PART NO.	DESCRIPTION
1	Gasket Conversion Set	2002-97	CS 26184-1	
1	Gasket Conversion Set	1996-95	CS 26184	
1	Gasket Conversion Set	1994-91	CS 8767-1	
QTY	MANIFOLD - INT. & EXH.	YEARS	PART NO.	DESCRIPTION
1	Int. Manifold Gasket Set	2002-97	MS 96135	
1	Int. Manifold Gasket Set	1996-91	MS 94789	
1	Exh. Manifold Gasket Set	2002-91	MS 94763	

Mitsubishi Car (Cont.)

1		2002 - 1991; 1.5L 89.6 (1468cc) SOHC L4 (12 Valve) 75.5mm Bore			1	
(cont.)		MFI; Gasoline; Naturally Aspirated Mitsubishi Eng.; Eng. Code 4G15			(cont.)	
QTY	EXHAUST PIPE FLANGE	YEARS	PART NO.	DESCRIPTION		
1	Exhaust Pipe Gasket	2002-01	60620	Exh. connector		
1	Exhaust Pipe Gasket	2002-01	61267	Flange		
1	Exhaust Pipe Gasket	2000-95	60496-1	Flange; California		
1	Exhaust Pipe Gasket	2000-95	60620	Flange; Exc. California		
1	Exhaust Pipe Gasket	1997-93	60496-1	Loc. Front; Converter		
1	Exhaust Pipe Gasket	1997-93	60620	Loc. Rear; Converter		
1	Exhaust Pipe Gasket	1994-93	60620	Flange		
2	Exhaust Pipe Gasket	1992-91	60620	Converter		
1	Exhaust Pipe Gasket	1992-91	60680	Flange		
QTY	OIL PAN	YEARS	PART NO.	DESCRIPTION		
1	Oil Pan Gasket Set	2002-97	OS 30720			
1	Oil Pan Gasket Set	1996-91	OS 30414 C			
QTY	CRANKSHAFT REAR SEAL	YEARS	PART NO.	DESCRIPTION		
1	Rear Main Seal Set	2002-95	BS 40672	Rubber; One-piece		
1	Rear Main Seal Set	1994-91	BS 40097-1	Rubber; One-piece		
1	Repair Sleeve	2002-91	16275	Crankshaft; Use w/installation tool		
QTY	VALVE COVER	YEARS	PART NO.	DESCRIPTION		
1	Valve Cover Gasket Set	2002-97	VS 50537 R	PermaDry® molded rubber gskt. incl.		
1	Valve Cover Gasket Set	1996-91	VS 50382 R	PermaDry® molded rubber gskt. incl.		
QTY	VALVE STEM SEAL SET	YEARS	PART NO.	DESCRIPTION		
1	Valve Stem Seal Set	2002-91	SS 72805	Loc. Int. & Exh.; Premium valve stem seals incl.		
QTY	THERMOSTAT HOUSING	YEARS	PART NO.	DESCRIPTION		
1	Thermostat Gasket	2002-97	35682	Thermostat Housing; Thermostat case to head		
QTY	WATER OUTLET GASKET	YEARS	PART NO.	DESCRIPTION		
1	Water Outlet Gasket	1996-91	35336	Water Outlet		
1	O-Ring	2002-97	35524	Water Outlet		
QTY	WATER PUMP	YEARS	PART NO.	DESCRIPTION		
1	Water Pump Gasket	2002-97	35688			
1	Water Pump Gasket	1996-91	35225			
1	Water Pump Gasket	1996-91	ES 72872	O-ring		
QTY	TIMING COVER	YEARS	PART NO.	DESCRIPTION		
1	Crankshaft Front Seal Set	2002-95	TCS 46027			
1	Crankshaft Front Seal Set	1994-91	TCS 45482-1			
1	Camshaft Front Seal Set	2002-97	TCS 45704-1			
1	Camshaft Front Seal Set	1996-91	TCS 45483			
QTY	AIR CLEANER MOUNTING	YEARS	PART NO.	DESCRIPTION		
1	Air Cleaner Gasket	1994-91	60756			
QTY	CARB & FUEL INJECTION	YEARS	PART NO.	DESCRIPTION		
1	Fuel Injector O-Ring Set	2002-91	ES 70600			
1	Throttle Body Gasket	2002-93	60968	Throttle body		
1	Throttle Body Gasket	2002-97	61252	Idle air control		
1	Throttle Body Gasket	1992-91	60855	Throttle body		
QTY	EXHAUST GAS RECIRCULATION	YEARS	PART NO.	DESCRIPTION		
1	EGR Gasket	2002-91	70152			
2		1994 - 1991; 1.5L 89.6 (1468cc) SOHC L4 (8 Valve) 75.5mm Bore			2	
(cont.)		MFI; Gasoline; Naturally Aspirated Mitsubishi Eng.; Eng. Code G4DJ			(cont.)	
QTY	CYLINDER HEAD	YEARS	PART NO.	DESCRIPTION		
1	Head Gasket	1994-91	9352 PT	PermaTorque®		
1	Head Set	1994-91	HS 9352 PT-2	PermaDry® molded rubber valve cover gskt. incl.; Premium valve stem seals incl.		
QTY	CONVERSION SET	YEARS	PART NO.	DESCRIPTION		
1	Gasket Conversion Set	1994-91	CS 8767-1			
QTY	MANIFOLD - INT. & EXH.	YEARS	PART NO.	DESCRIPTION		
1	Int. Manifold Gasket Set	1994-91	MS 94825	Upper set incl.		
1	Exh. Manifold Gasket Set	1994-91	MS 94763			
QTY	EXHAUST PIPE FLANGE	YEARS	PART NO.	DESCRIPTION		
1	Exhaust Pipe Gasket	1994-91	60680	Flange		
1	Exhaust Pipe Gasket	1994-93	60496-1	Loc. Front; Converter		
1	Exhaust Pipe Gasket	1994-93	60620	Loc. Rear; Converter		
2	Exhaust Pipe Gasket	1992-91	60620	Converter		
QTY	OIL PAN	YEARS	PART NO.	DESCRIPTION		
1	Oil Pan Gasket Set	1994-91	OS 30414 C			

2		1994 - 1991; 1.5L 89.6 (1468cc) SOHC L4 (8 Valve) 75.5mm Bore			2	
(cont.)		MFI; Gasoline; Naturally Aspirated Mitsubishi Eng.; Eng. Code G4DJ			(cont.)	
QTY	CRANKSHAFT REAR SEAL	YEARS	PART NO.	DESCRIPTION		
1	Rear Main Seal Set	1994-91	BS 40097-1	Rubber; One-piece		
1	Repair Sleeve	1994-91	16275	Crankshaft; Use w/installation tool		
QTY	VALVE COVER	YEARS	PART NO.	DESCRIPTION		
1	Valve Cover Gasket Set	1994-91	VS 50195 R	PermaDry® molded rubber gskt. incl.		
QTY	VALVE STEM SEAL SET	YEARS	PART NO.	DESCRIPTION		
1	Valve Stem Seal Set	1994-91	SS 72524	Loc. Int. & Exh.; Premium valve stem seals incl.		
QTY	WATER OUTLET GASKET	YEARS	PART NO.	DESCRIPTION		
1	Water Outlet Gasket	1994-91	35336	Water Outlet		
QTY	WATER PUMP	YEARS	PART NO.	DESCRIPTION		
1	Water Pump Gasket	1994-91	35225			
1	Water Pump Gasket	1994-91	ES 72872	O-ring		
QTY	TIMING COVER	YEARS	PART NO.	DESCRIPTION		
1	Crankshaft Front Seal Set	1994-91	TCS 45482-1			
1	Camshaft Front Seal Set	1994-91	TCS 45483			
QTY	AIR CLEANER MOUNTING	YEARS	PART NO.	DESCRIPTION		
1	Air Cleaner Gasket	1994-91	60756			
QTY	CARB & FUEL INJECTION	YEARS	PART NO.	DESCRIPTION		
1	Fuel Injector O-Ring Set	1994-91	ES 70600			
1	Throttle Body Gasket	1994-91	60855			
QTY	EXHAUST GAS RECIRCULATION	YEARS	PART NO.	DESCRIPTION		
1	EGR Gasket	1994-91	70152			
3		1992 - 1991; 1.6L 97.3 (1595cc) DOHC L4 (16 Valve) 82.3mm Bore			3	
(cont.)		MFI; Gasoline; Naturally Aspirated Mitsubishi Eng.; Eng. Code 4G61			(cont.)	
QTY	CYLINDER HEAD	YEARS	PART NO.	DESCRIPTION		
1	Head Gasket	1992-91	9627 PT			
1	Head Set	1992-91	HS 9627 PT	Exh. pipe flange not incl.; PermaDry® molded rubber valve cover gskt. incl.; Premium valve stem seals incl.		
QTY	CONVERSION SET	YEARS	PART NO.	DESCRIPTION		
1	Gasket Conversion Set	1992-91	CS 9086			
QTY	MANIFOLD - INT. & EXH.	YEARS	PART NO.	DESCRIPTION		
1	Int. Manifold Gasket Set	1992-91	MS 94328			
1	Exh. Manifold Gasket Set	1992-91	MS 95470			
QTY	EXHAUST PIPE FLANGE	YEARS	PART NO.	DESCRIPTION		
2	Exhaust Pipe Gasket	1992-91	60620	Converter		
1	Exhaust Pipe Gasket	1992-91	60680	Flange		
QTY	OIL PAN	YEARS	PART NO.	DESCRIPTION		
1	Oil Pan Gasket Set	1992-91	OS 30460 A			
QTY	CRANKSHAFT REAR SEAL	YEARS	PART NO.	DESCRIPTION		
1	Rear Main Seal Set	1992-91	BS 40408-1	Rubber; One-piece		
1	Repair Sleeve	1992-91	16275	Crankshaft; Use w/installation tool		
QTY	VALVE COVER	YEARS	PART NO.	DESCRIPTION		
1	Valve Cover Gasket Set	1992-91	VS 50041 R	w/Semi-circular plug & Spark plug tube seals; PermaDry® molded rubber gskt. incl.		
1	Semi-Circular Plug	1992-91	CP 75013	Valve Cover		
QTY	VALVE STEM SEAL SET	YEARS	PART NO.	DESCRIPTION		
1	Valve Stem Seal Set	1992-91	SS 70359	Premium valve stem seals incl.		
QTY	WATER OUTLET GASKET	YEARS	PART NO.	DESCRIPTION		
1	Water Outlet Gasket	1992-91	35336	Water Outlet		
QTY	WATER PUMP	YEARS	PART NO.	DESCRIPTION		
1	Water Pump Gasket	1992-91	ES 72872	O-ring		
QTY	TIMING COVER	YEARS	PART NO.	DESCRIPTION		
2	Camshaft Front Seal Set	1992-91	TCS 45483			
QTY	AIR CLEANER MOUNTING	YEARS	PART NO.	DESCRIPTION		
1	Air Cleaner Gasket	1992-91	60756			
QTY	CARB & FUEL INJECTION	YEARS	PART NO.	DESCRIPTION		
1	Fuel Injector O-Ring Set	1992-91	ES 70600			
1	Throttle Body Gasket	1992-91	60889			
QTY	EXHAUST GAS RECIRCULATION	YEARS	PART NO.	DESCRIPTION		
1	EGR Gasket	1992-91	70152			

Mitsubishi Car (Cont.)

4		1994 - 1991; 1.8L 107.1 (1755cc) SOHC L4 (8 Valve) 80.6mm Bore			4
		MFI; Gasoline; Naturally Aspirated Mitsubishi Eng.; Eng. Code 4G37			
QTY	CYLINDER HEAD	YEARS	PART NO.	DESCRIPTION	
1	Head Gasket	1994-91	9846 PT	Head bolts not incl.; Head bolt replacement recommended	
1	Head Set	1994-91	HS 9846 B	Head bolts not incl.; Head bolt replacement recommended; PermaDry® molded rubber valve cover gskt. incl.; Premium valve stem seals incl.	
1	Head Bolt Set	1994-91	ES 71174	10mm Head bolts; Replacement recommended	
1	Head Bolt Set	1994-91	ES 71175	12mm Head bolts; Replacement recommended	
QTY	CONVERSION SET	YEARS	PART NO.	DESCRIPTION	
1	Gasket Conversion Set	1994-91	CS 9846		
QTY	MANIFOLD - INT. & EXH.	YEARS	PART NO.	DESCRIPTION	
1	Int. Manifold Gasket Set	1994-91	MS 94630	Upper set incl.	
1	Exh. Manifold Gasket Set	1994-91	MS 94631		
QTY	EXHAUST PIPE FLANGE	YEARS	PART NO.	DESCRIPTION	
1	Exhaust Pipe Gasket	1994-91	60496-1	Loc. Front; Converter	
1	Exhaust Pipe Gasket	1994-91	60620	Loc. Rear; Converter	
1	Exhaust Pipe Gasket	1994-91	60680	Flange	
QTY	OIL PAN	YEARS	PART NO.	DESCRIPTION	
1	Oil Pan Gasket Set	1994-91	OS 30397 A		
QTY	CRANKSHAFT REAR SEAL	YEARS	PART NO.	DESCRIPTION	
1	Rear Main Seal Set	1994-91	BS 40097-1	Rubber; One-piece	
1	Repair Sleeve	1994-91	16275	Crankshaft; Use w/installation tool	
QTY	VALVE COVER	YEARS	PART NO.	DESCRIPTION	
1	Valve Cover Gasket Set	1994-91	VS 50103 R	w/Semi-circular plug & Grommets; PermaDry® molded rubber gskt. incl.	
1	Valve Cover Gasket Set	1994-91	VS 50203 R	w/o Semi-circular plug & Grommets; PermaDry® molded rubber gskt. incl.	
1	Grommet Set	1994-91	ES 70342	Valve Cover	
1	Semi-Circular Plug	1994-91	CP 75001	Valve Cover	
QTY	VALVE STEM SEAL SET	YEARS	PART NO.	DESCRIPTION	
1	Valve Stem Seal Set	1994-91	SS 70598	Premium valve stem seals incl.; Improved design	
QTY	WATER OUTLET GASKET	YEARS	PART NO.	DESCRIPTION	
1	Water Outlet Gasket	1994-91	35336	Water Outlet	
QTY	WATER PUMP	YEARS	PART NO.	DESCRIPTION	
1	Water Pump Gasket	1994-91	35479		
1	Water Pump Gasket	1994-91	ES 72872	O-ring	
QTY	TIMING COVER	YEARS	PART NO.	DESCRIPTION	
1	Crankshaft Front Seal Set	1994-91	TCS 45910	Must be used w/OS 30397A	
1	Camshaft Front Seal Set	1994-91	TCS 45483		
QTY	AIR CLEANER MOUNTING	YEARS	PART NO.	DESCRIPTION	
1	Air Cleaner Gasket	1994-91	60756		
QTY	CARB & FUEL INJECTION	YEARS	PART NO.	DESCRIPTION	
1	Fuel Injector O-Ring Set	1994-91	ES 70600		
1	Throttle Body Gasket	1994-91	60855		
QTY	EXHAUST GAS RECIRCULATION	YEARS	PART NO.	DESCRIPTION	
1	EGR Gasket	1994-91	70152		
5		2002 - 1992; 1.8L 111.8 (1834cc) SOHC L4 (16 Valve) 81mm Bore			5
		MFI; Gasoline; Naturally Aspirated Mitsubishi Eng.; Eng. Code 4G93			
QTY	CYLINDER HEAD	YEARS	PART NO.	DESCRIPTION	
1	Head Gasket	2002-97	26183 PT	Head bolts not incl.; Head bolt replacement recommended; PermaTorqueMLS®	
1	Head Gasket	1996-92	9887 PT	Head bolts not incl.; Head bolt replacement recommended	
1	Head Set	2002-97	HS 26183 PT	Head bolts not incl.; Head bolt replacement recommended; PermaDry® molded rubber valve cover gskt. incl.; Premium valve stem seals incl.	
1	Head Set	1996-93	HS 9887 PT	Head bolts & California exh. pipe flange not incl.; Head bolt replacement recommended; PermaDry® molded rubber valve cover gskt. incl.; Premium valve stem seals incl.; Consolidated design	
1	Head Set	1992	HS 9887 PT	Head bolts not incl.; Head bolt replacement recommended; PermaDry® molded rubber valve cover gskt. incl.; Premium valve stem seals incl.; Consolidated design	
1	Head Bolt Set	2002-92	ES 71209	Replacement recommended	
QTY	CONVERSION SET	YEARS	PART NO.	DESCRIPTION	
1	Gasket Conversion Set	2002-97	CS 26183		
1	Gasket Conversion Set	1996-92	CS 9887		
QTY	MANIFOLD - INT. & EXH.	YEARS	PART NO.	DESCRIPTION	
1	Int. Manifold Gasket Set	2002-97	MS 96137		
1	Int. Manifold Gasket Set	1996-92	MS 95313		
1	Exh. Manifold Gasket Set	2002-92	MS 95314		

5		2002 - 1992; 1.8L 111.8 (1834cc) SOHC L4 (16 Valve) 81mm Bore			5	
(cont.)		MFI; Gasoline; Naturally Aspirated Mitsubishi Eng.; Eng. Code 4G93			(cont.)	
QTY	EXHAUST PIPE FLANGE	YEARS	PART NO.	DESCRIPTION		
1	Exhaust Pipe Gasket	2002-01	61267	Flange		
1	Exhaust Pipe Gasket	2000-97	60496-1	Flange		
1	Exhaust Pipe Gasket	1996-95	60680	Flange; Exc. California		
1	Exhaust Pipe Gasket	1996	60496-1	Exc. Mitsubishi Mirage LS; Flange; California		
1	Exhaust Pipe Gasket	1996	60496-1	Mitsubishi Mirage LS; Flange; California; 4-door		
1	Exhaust Pipe Gasket	1996	60496-1	Mitsubishi Mirage LS; Loc. Front; Converter		
1	Exhaust Pipe Gasket	1996	60496-1	Mitsubishi Mirage LS; Loc. Rear; Converter; California		
1	Exhaust Pipe Gasket	1996	60620	Mitsubishi Mirage LS; Flange; California; 2-door		
1	Exhaust Pipe Gasket	1996	60620	Mitsubishi Mirage LS; Loc. Rear; Converter; Exc. California		
1	Exhaust Pipe Gasket	1995-93	60496-1	Mitsubishi Mirage ES, LS; Loc. Front; Converter		
1	Exhaust Pipe Gasket	1995-93	60620	Exc. Mitsubishi Mirage ES, LS; Loc. Front; Converter		
1	Exhaust Pipe Gasket	1995	60496-1	Exc. Mitsubishi Mirage ES, LS; Flange; California		
1	Exhaust Pipe Gasket	1995	60496-1	Mitsubishi Mirage ES, LS; Flange; California; 4-door		
1	Exhaust Pipe Gasket	1995	60496-1	Mitsubishi Mirage ES, LS; Loc. Rear; Converter; California		
1	Exhaust Pipe Gasket	1995	60620	Mitsubishi Mirage ES, LS; Flange; California; 2-door		
1	Exhaust Pipe Gasket	1995	60620	Exc. Mitsubishi Mirage ES, LS; Loc. Rear; Converter		
1	Exhaust Pipe Gasket	1995	60620	Mitsubishi Mirage ES, LS; Loc. Rear; Converter; Exc. California		
1	Exhaust Pipe Gasket	1994-92	60620	Loc. Rear; Converter		
1	Exhaust Pipe Gasket	1994-92	60680	Flange		
1	Exhaust Pipe Gasket	1992	60620	Loc. Front; Converter		
QTY	OIL PAN	YEARS	PART NO.	DESCRIPTION		
1	Oil Pan Gasket Set	2002-97	OS 30719			
1	Oil Pan Gasket Set	1996-92	OS 30655 C			
QTY	CRANKSHAFT REAR SEAL	YEARS	PART NO.	DESCRIPTION		
1	Rear Main Seal Set	2002-97	BS 40663	Rubber; One-piece		
1	Rear Main Seal Set	1996-92	BS 40648	Rubber; One-piece		
1	Repair Sleeve	2002-92	16275	Crankshaft; Use w/installation tool		
QTY	VALVE COVER	YEARS	PART NO.	DESCRIPTION		
1	Valve Cover Gasket Set	2002-97	VS 50535 R	w/Spark plug tube seals; PermaDry® molded rubber gskt. incl.		
1	Valve Cover Gasket Set	1996-92	VS 50415 R	w/Spark plug tube seals; PermaDry® molded rubber gskt. incl.		
1	Spark Plug Tube Seal Set	2002-92	ES 72120	Valve Cover		
QTY	VALVE STEM SEAL SET	YEARS	PART NO.	DESCRIPTION		
1	Valve Stem Seal Set	2002-92	SS 70660	Premium valve stem seals incl.; Improved design		
QTY	THERMOSTAT HOUSING	YEARS	PART NO.	DESCRIPTION		
1	Thermostat Gasket	1996-92	35554	Thermostat Housing; Seal		
QTY	WATER OUTLET GASKET	YEARS	PART NO.	DESCRIPTION		
1	O-Ring	2002-92	35524	Water Outlet		
QTY	WATER PUMP	YEARS	PART NO.	DESCRIPTION		
1	Water Pump Gasket	2002-97	35690			
1	Water Pump Gasket	1996-92	35551			
QTY	TIMING COVER	YEARS	PART NO.	DESCRIPTION		
1	Crankshaft Front Seal Set	2002-97	TCS 45931	Must be used w/OS 30719		
1	Crankshaft Front Seal Set	1996-92	TCS 45931	Must be used w/OS 30655C		
1	Camshaft Front Seal Set	2002-97	TCS 45704-1			
1	Camshaft Front Seal Set	1996-92	TCS 45483			
QTY	CARB & FUEL INJECTION	YEARS	PART NO.	DESCRIPTION		
1	Fuel Injector O-Ring Set	2002-92	ES 70600			
1	Throttle Body Gasket	2002-93	60966	Throttle body		
1	Throttle Body Gasket	2002-97	61252	Idle air control		
1	Throttle Body Gasket	1992	60855	Throttle body		
QTY	EXHAUST GAS RECIRCULATION	YEARS	PART NO.	DESCRIPTION		
1	EGR Gasket	2002-92	70152			
6		1999 - 1995; 2.0L 122 (1996cc) DOHC L4 (16 Valve) 87.5mm Bore			6	
(cont.)		MFI; Gasoline; Naturally Aspirated Chrysler Eng.; Eng. Code 420A			(cont.)	
QTY	CYLINDER HEAD	YEARS	PART NO.	DESCRIPTION		
1	Head Gasket	1999-95	26501 PT	.010" thicker for use when head is refaced; Head bolts not incl.; Head bolt replacement recommended; PermaTorqueMLS®		
1	Head Gasket	1999-95	9922 PT	Head bolts not incl.; Head bolt replacement recommended; PermaTorqueMLS®		
1	Head Set	1999-95	HS 9922 PT	Head bolts not incl.; Head bolt replacement recommended; PermaDry® molded rubber valve cover gskt. incl.; Premium valve stem seals incl.		

Mitsubishi Car (Cont.)

6		1999 - 1995; 2.0L 122 (1996cc) DOHC L4 (16 Valve) 87.5mm Bore			6	
(cont.)		MFI; Gasoline; Naturally Aspirated Chrysler Eng.; Eng. Code 420A			(cont.)	
QTY	CYLINDER HEAD	YEARS	PART NO.	DESCRIPTION		
1	Head Installation Set	1999-95	HIS 9922 PT	Head bolts & exh. pipe to manifold gskt. not incl.; Head bolt replacement recommended; PermaDry® molded rubber valve cover gskt. incl.		
1	Head Bolt Set	1999-95	ES 72166	Head bolts w/Washers; Replacement recommended		
QTY	CONVERSION SET	YEARS	PART NO.	DESCRIPTION		
1	Gasket Conversion Set	1999-95	CS 9922	PermaDry® molded rubber oil pan gskt. incl.		
QTY	MANIFOLD - INT. & EXH.	YEARS	PART NO.	DESCRIPTION		
1	Int. Manifold Gasket Set	1999-95	MS 95660-1	Upper set incl.		
1	Exh. Manifold Gasket Set	1999-95	MS 95692			
QTY	EXHAUST PIPE FLANGE	YEARS	PART NO.	DESCRIPTION		
1	Exhaust Pipe Gasket	1999-95	60810	Pipe to manifold		
QTY	OIL PAN	YEARS	PART NO.	DESCRIPTION		
1	Oil Pan Gasket Set	1999-95	OS 30673 R	PermaDry® molded rubber gskt. incl.		
QTY	CRANKSHAFT REAR SEAL	YEARS	PART NO.	DESCRIPTION		
1	Rear Main Seal Set	1999-95	BS 40182	Rubber; One-piece		
1	Rear Main Seal Set	1999-95	BS 40627	PTFE Rubber; One-piece		
QTY	VALVE COVER	YEARS	PART NO.	DESCRIPTION		
1	Valve Cover Gasket Set	1999-95	VS 50455 R	w/Spark plug tube seals; PermaDry® molded rubber gskt. incl.		
1	Spark Plug Tube Seal Set	1999-95	ES 72753	Valve Cover; New Part Number - Check for Availability		
QTY	VALVE STEM SEAL SET	YEARS	PART NO.	DESCRIPTION		
1	Valve Stem Seal Set	1999-95	SS 72871	Premium valve stem seals incl.		
QTY	THERMOSTAT HOUSING	YEARS	PART NO.	DESCRIPTION		
1	Thermostat Gasket	1999-95	35585	Thermostat Housing		
1	Thermostat Gasket	1999-95	35588	Thermostat Housing; Thermostat seal		
QTY	WATER OUTLET GASKET	YEARS	PART NO.	DESCRIPTION		
1	Water Outlet Gasket	1999-95	35365	Water Outlet; Water outlet connection		
QTY	WATER PUMP	YEARS	PART NO.	DESCRIPTION		
1	Water Pump Gasket	1999-95	35131	Seal		
1	Water Pump Gasket	1999-95	35586	O-ring		
QTY	TIMING COVER	YEARS	PART NO.	DESCRIPTION		
1	Crankshaft Front Seal Set	1999-95	TCS 45962			
2	Camshaft Front Seal Set	1999-95	TCS 45961			
1	Camshaft Sensor Seal	1999-95	70725			
1	Repair Sleeve	1999-95	16224	Timing Cover; Use w/installation tool		
1	Repair Sleeve Tool	1999-95	16325	Timing Cover		
QTY	CARB & FUEL INJECTION	YEARS	PART NO.	DESCRIPTION		
2	Fuel Injector O-Ring Set	1999-95	ES 70599	Improved design		
1	Throttle Body Gasket	1999-95	61001			
QTY	EXHAUST GAS RECIRCULATION	YEARS	PART NO.	DESCRIPTION		
1	EGR Gasket	1999-95	70720	Valve		
1	EGR Gasket	1999-95	70721	Tube flange		
7		1999 - 1995; 2.0L 122 (1996cc) DOHC L4 (16 Valve) 87.5mm Bore			7	
(cont.)		MFI; Gasoline; Naturally Aspirated Chrysler Eng.; Eng. Code A588			(cont.)	
QTY	CYLINDER HEAD	YEARS	PART NO.	DESCRIPTION		
1	Head Gasket	1999-95	26501 PT	.010" thicker for use when head is refaced; Head bolts not incl.; Head bolt replacement recommended; PermaTorqueMLS®		
1	Head Gasket	1999-95	9922 PT	Head bolts not incl.; Head bolt replacement recommended; PermaTorqueMLS®		
1	Head Set	1999-95	HS 9922 PT	Head bolts not incl.; Head bolt replacement recommended; PermaDry® molded rubber valve cover gskt. incl.; Premium valve stem seals incl.		
1	Head Installation Set	1999-95	HIS 9922 PT	Head bolts & exh. pipe to manifold gskt. not incl.; Head bolt replacement recommended; PermaDry® molded rubber valve cover gskt. incl.		
1	Head Bolt Set	1999-95	ES 72166	Head bolts w/Washers; Replacement recommended		
QTY	CONVERSION SET	YEARS	PART NO.	DESCRIPTION		
1	Gasket Conversion Set	1999-95	CS 9922	PermaDry® molded rubber oil pan gskt. incl.		
QTY	MANIFOLD - INT. & EXH.	YEARS	PART NO.	DESCRIPTION		
1	Int. Manifold Gasket Set	1999-95	MS 95660-1	Upper set incl.		
1	Exh. Manifold Gasket Set	1999-95	MS 95692			
QTY	EXHAUST PIPE FLANGE	YEARS	PART NO.	DESCRIPTION		
1	Exhaust Pipe Gasket	1999-95	60810	Pipe to manifold		
QTY	OIL PAN	YEARS	PART NO.	DESCRIPTION		
1	Oil Pan Gasket Set	1999-95	OS 30673 R	PermaDry® molded rubber gskt. incl.		

7		1999 - 1995; 2.0L 122 (1996cc) DOHC L4 (16 Valve) 87.5mm Bore			7
(cont.)		MFI; Gasoline; Naturally Aspirated Chrysler Eng.; Eng. Code A588			(cont.)
QTY	CRANKSHAFT REAR SEAL	YEARS	PART NO.	DESCRIPTION	
1	Rear Main Seal Set	1999-95	BS 40182	Rubber; One-piece	
1	Rear Main Seal Set	1999-95	BS 40627	PTFE Rubber; One-piece	
QTY	VALVE COVER	YEARS	PART NO.	DESCRIPTION	
1	Valve Cover Gasket Set	1999-95	VS 50455 R	w/Spark plug tube seals; PermaDry® molded rubber gskt. incl.	
1	Spark Plug Tube Seal Set	1999-95	ES 72753	Valve Cover; New Part Number - Check for Availability	
QTY	VALVE STEM SEAL SET	YEARS	PART NO.	DESCRIPTION	
1	Valve Stem Seal Set	1999-95	SS 72871	Premium valve stem seals incl.	
QTY	THERMOSTAT HOUSING	YEARS	PART NO.	DESCRIPTION	
1	Thermostat Gasket	1999-95	35585	Thermostat Housing	
1	Thermostat Gasket	1999-95	35588	Thermostat Housing; Thermostat seal	
QTY	WATER OUTLET GASKET	YEARS	PART NO.	DESCRIPTION	
1	Water Outlet Gasket	1999-95	35365	Water Outlet; Water outlet connection	
QTY	WATER PUMP	YEARS	PART NO.	DESCRIPTION	
1	Water Pump Gasket	1999-95	35131	Seal	
1	Water Pump Gasket	1999-95	35586	O-ring	
QTY	TIMING COVER	YEARS	PART NO.	DESCRIPTION	
1	Crankshaft Front Seal Set	1999-95	TCS 45962		
2	Camshaft Front Seal Set	1999-95	TCS 45961		
1	Camshaft Sensor Seal	1999-95	70725		
1	Repair Sleeve	1999-95	16224	Timing Cover; Use w/installation tool	
1	Repair Sleeve Tool	1999-95	16325	Timing Cover	
QTY	CARB & FUEL INJECTION	YEARS	PART NO.	DESCRIPTION	
2	Fuel Injector O-Ring Set	1999-95	ES 70599	Improved design	
1	Throttle Body Gasket	1999-95	61001		
QTY	EXHAUST GAS RECIRCULATION	YEARS	PART NO.	DESCRIPTION	
1	EGR Gasket	1999-95	70720	Valve	
1	EGR Gasket	1999-95	70721	Tube flange	
8		1994 - 1991; 2.0L 122 (1997cc) DOHC L4 (16 Valve) 85mm Bore			8
(cont.)		MFI; Gasoline; Naturally Aspirated Mitsubishi Eng.; Eng. Code 4G63			(cont.)
QTY	CYLINDER HEAD	YEARS	PART NO.	DESCRIPTION	
1	Head Gasket	1994-91	9627 PT	Head bolts not incl.; Head bolt replacement recommended	
1	Head Set	1994-93	HS 9627 PT-1	Head bolts & exh. pipe flange not incl.; Head bolt replacement recommended; PermaDry® molded rubber valve cover gskt. incl.; Premium valve stem seals incl.	
1	Head Set	1992-91	HS 9627 PT	Head bolts & exh. pipe flange not incl.; Head bolt replacement recommended; PermaDry® molded rubber valve cover gskt. incl.; Premium valve stem seals incl.	
1	Head Bolt Set	1994-91	ES 71175	Replacement recommended	
QTY	CONVERSION SET	YEARS	PART NO.	DESCRIPTION	
1	Gasket Conversion Set	1994-93	CS 9086-1		
1	Gasket Conversion Set	1992-91	CS 9086		
QTY	MANIFOLD - INT. & EXH.	YEARS	PART NO.	DESCRIPTION	
1	Int. Manifold Gasket Set	1994-91	MS 94328		
1	Exh. Manifold Gasket Set	1994-91	MS 95470		
QTY	EXHAUST PIPE FLANGE	YEARS	PART NO.	DESCRIPTION	
1	Exhaust Pipe Gasket	1994-91	60496-1	Loc. Front; Converter	
1	Exhaust Pipe Gasket	1994-91	60620	Loc. Rear; Converter	
1	Exhaust Pipe Gasket	1994-91	60680	Flange	
QTY	FUEL PUMP	YEARS	PART NO.	DESCRIPTION	
1	Fuel Pump Mounting Gasket	1992-91	35226-1		
QTY	OIL PAN	YEARS	PART NO.	DESCRIPTION	
1	Oil Pan Gasket Set	1994-93	OS 30665 C		
1	Oil Pan Gasket Set	1992-91	OS 30460 A		
QTY	CRANKSHAFT REAR SEAL	YEARS	PART NO.	DESCRIPTION	
1	Rear Main Seal Set	1994-93	BS 40648	Rubber; One-piece	
1	Rear Main Seal Set	1992-91	BS 40408-1	Rubber; One-piece	
1	Repair Sleeve	1994-91	16275	Crankshaft; Use w/installation tool	
QTY	VALVE COVER	YEARS	PART NO.	DESCRIPTION	
1	Valve Cover Gasket Set	1994-93	VS 50434 R	w/Semi-circular plug & Spark plug tube seals; PermaDry® molded rubber gskt. incl.	
1	Valve Cover Gasket Set	1992-91	VS 50041 R	w/Semi-circular plug & Spark plug tube seals; PermaDry® molded rubber gskt. incl.	

Mitsubishi Car (Cont.)

8		1994 - 1991; 2.0L 122 (1997cc) DOHC L4 (16 Valve) 85mm Bore			8	
(cont.)		MFI; Gasoline; Naturally Aspirated Mitsubishi Eng.; Eng. Code 4G63			(cont.)	
QTY	VALVE COVER	YEARS	PART NO.	DESCRIPTION		
1	Semi-Circular Plug	1994-91	CP 75013	Valve Cover		
1	Spark Plug Tube Seal Set	1994-93	ES 72845	Valve Cover		
QTY	VALVE STEM SEAL SET	YEARS	PART NO.	DESCRIPTION		
1	Valve Stem Seal Set	1994-91	SS 70359	Premium valve stem seals incl.		
QTY	WATER OUTLET GASKET	YEARS	PART NO.	DESCRIPTION		
1	Water Outlet Gasket	1994-91	35336	Water Outlet		
QTY	WATER PUMP	YEARS	PART NO.	DESCRIPTION		
1	Water Pump Gasket	1994-91	35273			
1	Water Pump Gasket	1994-91	ES 72872	O-ring		
QTY	TIMING COVER	YEARS	PART NO.	DESCRIPTION		
1	Crankshaft Front Seal Set	1994-93	TCS 45941	Must be used w/OS 30665C		
1	Crankshaft Front Seal Set	1992-91	TCS 45565-1	Must be used w/OS 30460A		
2	Camshaft Front Seal Set	1994-91	TCS 45483			
QTY	AIR CLEANER MOUNTING	YEARS	PART NO.	DESCRIPTION		
1	Air Cleaner Gasket	1994-91	60756			
QTY	CARB & FUEL INJECTION	YEARS	PART NO.	DESCRIPTION		
1	Fuel Injector O-Ring Set	1994-91	ES 70600			
1	Throttle Body Gasket	1994-91	60879			
QTY	EXHAUST GAS RECIRCULATION	YEARS	PART NO.	DESCRIPTION		
1	EGR Gasket	1994-91	70152			
9		1999 - 1991; 2.0L 122 (1997cc) DOHC L4 (16 Valve) 85mm Bore			9	
(cont.)		MFI; Gasoline; Turbo - Intercooled Mitsubishi Eng.; Eng. Code 4G63-T			(cont.)	
QTY	CYLINDER HEAD	YEARS	PART NO.	DESCRIPTION		
1	Head Gasket	1999-91	9627 PT	Head bolts not incl.; Head bolt replacement recommended		
1	Head Set	1999-95	HS 9627 PT-3	Turbo mounting gsks., head bolts, exh. pipe flange not incl.; Head bolt replacement recommended; PermaDry® molded rubber valve cover gskt. incl.; Premium valve stem seals incl.		
1	Head Set	1994-93	HS 9627 PT-1	Turbo mounting gsks., head bolts, exh. pipe flange not incl.; Head bolt replacement recommended; PermaDry® molded rubber valve cover gskt. incl.; Premium valve stem seals incl.		
1	Head Set	1992-91	HS 9627 PT	Turbo mounting gsks., head bolts, exh. pipe flange not incl.; Head bolt replacement recommended; PermaDry® molded rubber valve cover gskt. incl.; Premium valve stem seals incl.		
1	Head Bolt Set	1999-95	ES 71177	Head bolts w/Washers; Replacement recommended		
1	Head Bolt Set	1994-91	ES 71175	Replacement recommended		
QTY	CONVERSION SET	YEARS	PART NO.	DESCRIPTION		
1	Gasket Conversion Set	1999-93	CS 9086-1			
1	Gasket Conversion Set	1992-91	CS 9086			
QTY	MANIFOLD - INT. & EXH.	YEARS	PART NO.	DESCRIPTION		
1	Int. Manifold Gasket Set	1999-95	MS 91837			
1	Int. Manifold Gasket Set	1994-91	MS 94328			
1	Exh. Manifold Gasket Set	1999-91	MS 95470			
QTY	EXHAUST PIPE FLANGE	YEARS	PART NO.	DESCRIPTION		
1	Exhaust Pipe Gasket	1999-95	61080	Flange		
2	Exhaust Pipe Gasket	1998-95	60496-1	Converter		
1	Exhaust Pipe Gasket	1994-91	60496-1	Flange		
1	Exhaust Pipe Gasket	1994-91	60496-1	Loc. Front; Converter		
1	Exhaust Pipe Gasket	1994-91	60620	Loc. Rear; Converter		
QTY	FUEL PUMP	YEARS	PART NO.	DESCRIPTION		
1	Fuel Pump Mounting Gasket	1992-91	35226-1			
QTY	OIL PAN	YEARS	PART NO.	DESCRIPTION		
1	Oil Pan Gasket Set	1999-93	OS 30665 C			
1	Oil Pan Gasket Set	1992-91	OS 30460 A			
QTY	CRANKSHAFT REAR SEAL	YEARS	PART NO.	DESCRIPTION		
1	Rear Main Seal Set	1999-93	BS 40648	Rubber; One-piece		
1	Rear Main Seal Set	1992-91	BS 40408-1	Rubber; One-piece		
1	Repair Sleeve	1999-91	16275	Crankshaft; Use w/installation tool		
QTY	VALVE COVER	YEARS	PART NO.	DESCRIPTION		
1	Valve Cover Gasket Set	1999-93	VS 50434 R	w/Semi-circular plug & Spark plug tube seals; PermaDry® molded rubber gskt. incl.		
1	Valve Cover Gasket Set	1992-91	VS 50041 R	w/Semi-circular plug & Spark plug tube seals; PermaDry® molded rubber gskt. incl.		

9		1999 - 1991; 2.0L 122 (1997cc) DOHC L4 (16 Valve) 85mm Bore			9	
(cont.)		MFI; Gasoline; Turbo - Intercooled Mitsubishi Eng.; Eng. Code 4G63-T			(cont.)	
QTY	VALVE COVER	YEARS	PART NO.	DESCRIPTION		
1	Semi-Circular Plug	1999-91	CP 75013	Valve Cover		
1	Spark Plug Tube Seal Set	1999-93	ES 72845	Valve Cover		
QTY	VALVE STEM SEAL SET	YEARS	PART NO.	DESCRIPTION		
1	Valve Stem Seal Set	1999-91	SS 70359	Premium valve stem seals incl.		
QTY	WATER OUTLET GASKET	YEARS	PART NO.	DESCRIPTION		
1	Water Outlet Gasket	1994-91	35336	Water Outlet		
1	O-Ring	1999-95	35524	Water Outlet		
QTY	WATER PUMP	YEARS	PART NO.	DESCRIPTION		
1	Water Pump Gasket	1999-91	ES 72872	O-ring		
1	Water Pump Gasket	1999-95	35003			
1	Water Pump Gasket	1994-91	35273			
QTY	TIMING COVER	YEARS	PART NO.	DESCRIPTION		
1	Crankshaft Front Seal Set	1999-93	TCS 45941	Must be used w/OS 30665C		
1	Crankshaft Front Seal Set	1992-91	TCS 45565-1	Must be used w/OS 30460A		
2	Camshaft Front Seal Set	1999-91	TCS 45483			
QTY	AIR CLEANER MOUNTING	YEARS	PART NO.	DESCRIPTION		
1	Air Cleaner Gasket	1994-91	60756			
QTY	CARB & FUEL INJECTION	YEARS	PART NO.	DESCRIPTION		
1	Fuel Injector O-Ring Set	1999-91	ES 70600			
1	Throttle Body Gasket	1999-97	60889			
1	Throttle Body Gasket	1996-95	60870			
1	Throttle Body Gasket	1994-91	60879			
QTY	EXHAUST GAS RECIRCULATION	YEARS	PART NO.	DESCRIPTION		
1	EGR Gasket	1999-91	70152			
QTY	TURBO MOUNTING SET	YEARS	PART NO.	DESCRIPTION		
1	Turbo Mtg. Gasket Set	1999-91	ES 72787			
10		1993; 2.0L 122 (1997cc) SOHC L4 (16 Valve) 85mm Bore			10	
(cont.)		MFI; Gasoline; Naturally Aspirated Mitsubishi Eng.; Eng. Code 4G63			(cont.)	
QTY	CYLINDER HEAD	YEARS	PART NO.	DESCRIPTION		
1	Head Gasket	1993	9932 PT			
1	Head Set	1993	HS 9932 PT	PermaDry® molded rubber valve cover gskt. incl.; Premium valve stem seals incl.; Consolidated design		
QTY	CONVERSION SET	YEARS	PART NO.	DESCRIPTION		
1	Gasket Conversion Set	1993	CS 9086-1			
QTY	MANIFOLD - INT. & EXH.	YEARS	PART NO.	DESCRIPTION		
1	Int. Manifold Gasket Set	1993	MS 95471			
1	Exh. Manifold Gasket Set	1993	MS 95470			
QTY	EXHAUST PIPE FLANGE	YEARS	PART NO.	DESCRIPTION		
1	Exhaust Pipe Gasket	1993	60496-1	Loc. Front; Converter		
1	Exhaust Pipe Gasket	1993	60620	Loc. Rear; Converter		
1	Exhaust Pipe Gasket	1993	60680	Flange		
QTY	OIL PAN	YEARS	PART NO.	DESCRIPTION		
1	Oil Pan Gasket Set	1993	OS 30665 C			
QTY	CRANKSHAFT REAR SEAL	YEARS	PART NO.	DESCRIPTION		
1	Rear Main Seal Set	1993	BS 40648	Rubber; One-piece		
1	Repair Sleeve	1993	16275	Crankshaft; Use w/installation tool		
QTY	VALVE COVER	YEARS	PART NO.	DESCRIPTION		
1	Valve Cover Gasket Set	1993	VS 50435 R	w/Spark plug tube seals; PermaDry® molded rubber gskt. incl.		
1	Spark Plug Tube Seal Set	1993	ES 72120	Valve Cover		
QTY	VALVE STEM SEAL SET	YEARS	PART NO.	DESCRIPTION		
1	Valve Stem Seal Set	1993	SS 70660	Premium valve stem seals incl.; Improved design		
QTY	WATER OUTLET GASKET	YEARS	PART NO.	DESCRIPTION		
1	O-Ring	1993	35524	Water Outlet		
QTY	WATER PUMP	YEARS	PART NO.	DESCRIPTION		
1	Water Pump Gasket	1993	35003			
1	Water Pump Gasket	1993	ES 72872	O-ring		
QTY	TIMING COVER	YEARS	PART NO.	DESCRIPTION		
1	Crankshaft Front Seal Set	1993	TCS 45941	Must be used w/OS 30665C		
1	Camshaft Front Seal Set	1993	TCS 45483			
QTY	AIR CLEANER MOUNTING	YEARS	PART NO.	DESCRIPTION		
1	Air Cleaner Gasket	1993	60756			
QTY	CARB & FUEL INJECTION	YEARS	PART NO.	DESCRIPTION		
1	Fuel Injector O-Ring Set	1993	ES 70600			

Mitsubishi Car (Cont.)

10		1993; 2.0L 122 (1997cc) SOHC L4 (16 Valve) 85mm Bore			10
(cont.)		MFI; Gasoline; Naturally Aspirated Mitsubishi Eng.; Eng. Code 4G63			(cont.)
QTY	CARB & FUEL INJECTION	YEARS	PART NO.	DESCRIPTION	
1	Throttle Body Gasket	1993	60870		
QTY	EXHAUST GAS RECIRCULATION	YEARS	PART NO.	DESCRIPTION	
1	EGR Gasket	1993	70152		
11		1992 - 1991; 2.0L 122 (1997cc) SOHC L4 (8 Valve) 85mm Bore			11
		MFI; Gasoline; Naturally Aspirated Mitsubishi Eng.; Eng. Code 4G63			
QTY	CYLINDER HEAD	YEARS	PART NO.	DESCRIPTION	
1	Head Gasket	1992-91	9086 PT		
1	Head Set	1992-91	HS 9086 B-1	Exh. pipe flange not incl.; PermaDry® molded rubber valve cover gskt. incl.; Premium valve stem seals incl.	
QTY	CONVERSION SET	YEARS	PART NO.	DESCRIPTION	
1	Gasket Conversion Set	1992-91	CS 9086		
QTY	MANIFOLD - INT. & EXH.	YEARS	PART NO.	DESCRIPTION	
1	Int. Manifold Gasket Set	1992-91	MS 91657	Lower set; Upper set not incl.	
1	Exh. Manifold Gasket Set	1992-91	MS 92029		
QTY	EXHAUST PIPE FLANGE	YEARS	PART NO.	DESCRIPTION	
1	Exhaust Pipe Gasket	1992-91	60496-1	Loc. Front; Converter	
1	Exhaust Pipe Gasket	1992-91	60620	Loc. Rear; Converter	
1	Exhaust Pipe Gasket	1992-91	60680	Flange	
QTY	FUEL PUMP	YEARS	PART NO.	DESCRIPTION	
1	Fuel Pump Mounting Gasket	1992-91	35226-1		
QTY	OIL PAN	YEARS	PART NO.	DESCRIPTION	
1	Oil Pan Gasket Set	1992-91	OS 30460 A		
QTY	CRANKSHAFT REAR SEAL	YEARS	PART NO.	DESCRIPTION	
1	Rear Main Seal Set	1992-91	BS 40408-1	Rubber; One-piece	
1	Repair Sleeve	1992-91	16275	Crankshaft; Use w/installation tool	
QTY	VALVE COVER	YEARS	PART NO.	DESCRIPTION	
1	Valve Cover Gasket Set	1992-91	VS 50132 R	w/Semi-circular plug & Grommets; PermaDry® molded rubber gskt. incl.	
1	Valve Cover Gasket Set	1992-91	VS 50234 R	w/o Semi-circular plug & Grommets; PermaDry® molded rubber gskt. incl.	
1	Grommet Set	1992-91	ES 70342	Valve Cover	
1	Semi-Circular Plug	1992-91	CP 75001	Valve Cover	
QTY	VALVE STEM SEAL SET	YEARS	PART NO.	DESCRIPTION	
1	Valve Stem Seal Set	1992-91	SS 72630	Loc. Int. & Exh.; Premium valve stem seals incl.	
QTY	WATER OUTLET GASKET	YEARS	PART NO.	DESCRIPTION	
1	Water Outlet Gasket	1992-91	35336	Water Outlet	
QTY	WATER PUMP	YEARS	PART NO.	DESCRIPTION	
1	Water Pump Gasket	1992-91	35273		
1	Water Pump Gasket	1992-91	ES 72872	O-ring	
QTY	TIMING COVER	YEARS	PART NO.	DESCRIPTION	
1	Timing Cover Dust Seal Set	1992-91	ES 72772		
1	Crankshaft Front Seal Set	1992-91	TCS 45565-1	Must be used w/OS 30460A	
1	Camshaft Front Seal Set	1992-91	TCS 45483		
QTY	AIR CLEANER MOUNTING	YEARS	PART NO.	DESCRIPTION	
1	Air Cleaner Gasket	1992-91	60756		
QTY	CARB & FUEL INJECTION	YEARS	PART NO.	DESCRIPTION	
1	Fuel Injector O-Ring Set	1992-91	ES 70600		
1	Throttle Body Gasket	1992-91	60855		
QTY	EXHAUST GAS RECIRCULATION	YEARS	PART NO.	DESCRIPTION	
1	EGR Gasket	1992-91	70152		
12		2013 - 2008; 2.0L 122 (1998cc) DOHC L4 (16 Valve) 86mm Bore MIVEC			12
		MFI; Gasoline; Naturally Aspirated Mitsubishi Eng.; Eng. Code 4B11			
QTY	CYLINDER HEAD	YEARS	PART NO.	DESCRIPTION	
1	Head Gasket	2013-08	26557 PT	Head bolts not incl.; Head bolt replacement recommended; PermaTorqueMLS®; Improved design; New Part Number - Check for Availability	
1	Head Gasket	2012-08	26449 PT	Head bolts not incl.; Head bolt replacement recommended; PermaTorqueMLS®; Old design	
1	Head Set	2012	HS 26449 PT	Mitsubishi Lancer DE, ES, SE; Head bolts not incl.; Head bolt replacement recommended; PermaDry® molded rubber valve cover gskt. incl.; Premium valve stem seals incl.; New Part Number - Check for Availability	

12 (cont.)		2013 - 2008; 2.0L 122 (1998cc) DOHC L4 (16 Valve) 86mm Bore MIVEC MFI; Gasoline; Naturally Aspirated Mitsubishi Eng.; Eng. Code 4B11			12 (cont.)
QTY	CYLINDER HEAD	YEARS	PART NO.	DESCRIPTION	
1	Head Set	2012	HS 26449 PT-1	Mitsubishi Lancer Sportback ES; Head bolts not incl.; Head bolt replacement recommended; PermaDry® molded rubber valve cover gskt. incl.; Premium valve stem seals incl.; New Part Number - Check for Availability	
1	Head Set	2011-08	HS 26449 PT	Head bolts not incl.; Head bolt replacement recommended; PermaDry® molded rubber valve cover gskt. incl.; Premium valve stem seals incl.; New Part Number - Check for Availability	
1	Head Bolt Set	2012-08	ES 72472	Replacement recommended; New Part Number - Check for Availability	
QTY	CONVERSION SET	YEARS	PART NO.	DESCRIPTION	
1	Gasket Conversion Set	2012-08	CS 26449	New Part Number - Check for Availability	
QTY	MANIFOLD - INT. & EXH.	YEARS	PART NO.	DESCRIPTION	
1	Int. Manifold Gasket Set	2012-08	MS 97114	Improved design	
1	Int. Manifold Gasket Set	2009	MS 97107	To 06/02/09; Old design	
1	Int. Manifold Gasket Set	2008	MS 97107	Old design	
1	Exh. Manifold Gasket Set	2012	MS 96902	Mitsubishi Lancer DE, ES, SE	
1	Exh. Manifold Gasket Set	2012	MS 97209	Mitsubishi Lancer Sportback ES; New Part Number - Check for Availability	
1	Exh. Manifold Gasket Set	2011-08	MS 96902		
QTY	EXHAUST PIPE FLANGE	YEARS	PART NO.	DESCRIPTION	
1	Exhaust Pipe Gasket	2012-08	61016	Loc. Rear; Converter; Improved design	
1	Exhaust Pipe Gasket	2012-08	61106	Pipe to manifold; 2.40" ID	
1	Exhaust Pipe Gasket	2012-08	61250	Loc. Front; Converter	
1	Exhaust Pipe Gasket	2012-08	61334	Flange	
QTY	OIL PAN	YEARS	PART NO.	DESCRIPTION	
1	Oil Pan Gasket Set	2012-08	OS 30824		
QTY	CRANKSHAFT REAR SEAL	YEARS	PART NO.	DESCRIPTION	
1	Rear Main Seal Set	2012-08	BS 40728	Rubber; One-piece; New Part Number - Check for Availability	
QTY	VALVE COVER	YEARS	PART NO.	DESCRIPTION	
1	Valve Cover Gasket Set	2012-08	VS 50765 R	w/Spark plug tube seals; PermaDry® molded rubber gskt. incl.	
QTY	VALVE STEM SEAL SET	YEARS	PART NO.	DESCRIPTION	
1	Valve Stem Seal Set	2012-08	SS 71314	Premium valve stem seals incl.; New Part Number - Check for Availability	
QTY	THERMOSTAT HOUSING	YEARS	PART NO.	DESCRIPTION	
1	Thermostat Gasket	2012-08	35865	Thermostat Housing; Thermostat case to block	
QTY	WATER PUMP	YEARS	PART NO.	DESCRIPTION	
1	Water Pump Gasket	2012-08	35813	To block; Improved design	
1	Water Pump Gasket	2012-08	35822	To block; Old design	
1	Water Pump Gasket	2012-08	35877	Thermostat Housing; Thermostat case to outlet	
1	Water Pump Gasket	2012-08	35877	To coolant pipe	
QTY	TIMING COVER	YEARS	PART NO.	DESCRIPTION	
1	Crankshaft Front Seal Set	2012-08	TCS 46087		
QTY	CARB & FUEL INJECTION	YEARS	PART NO.	DESCRIPTION	
1	Fuel Injector O-Ring Set	2012-08	ES 70599	Improved design	
1	Throttle Body Gasket	2012	61607	Mitsubishi Lancer DE, ES, SE	
1	Throttle Body Gasket	2012	61688	Mitsubishi Lancer Sportback ES; New Part Number - Check for Availability	
1	Throttle Body Gasket	2011-08	61607		
QTY	EXHAUST GAS RECIRCULATION	YEARS	PART NO.	DESCRIPTION	
1	EGR Gasket	2012-08	71210		
13		2011 - 2008; 2.0L 122 (1998cc) DOHC L4 (16 Valve) 86mm Bore MIVEC MFI; Gasoline; Turbo - Intercooled Mitsubishi Eng.; Eng. Code 4B11T			13
QTY	CYLINDER HEAD	YEARS	PART NO.	DESCRIPTION	
1	Head Gasket	2011-08	26447 PT	Head bolts not incl.; Head bolt replacement recommended; PermaTorqueMLS®	
1	Head Set	2011-08	HS 26447 PT	Head bolts not incl.; Head bolt replacement recommended; PermaDry® molded rubber valve cover gskt. incl.; Premium valve stem seals incl.; New Part Number - Check for Availability	
QTY	CONVERSION SET	YEARS	PART NO.	DESCRIPTION	
1	Gasket Conversion Set	2011-08	CS 26447	New Part Number - Check for Availability	
QTY	MANIFOLD - INT. & EXH.	YEARS	PART NO.	DESCRIPTION	
1	Int. Manifold Gasket Set	2011-08	MS 97111		
1	Exh. Manifold Gasket Set	2011-08	MS 97109		
QTY	EXHAUST PIPE FLANGE	YEARS	PART NO.	DESCRIPTION	
1	Exhaust Pipe Gasket	2011-08	61016	Loc. Rear; Converter; Improved design	
1	Exhaust Pipe Gasket	2011-08	61106	Pipe to manifold; 2.40" ID	
1	Exhaust Pipe Gasket	2011-08	61250	Loc. Front; Converter	

Mitsubishi Car (Cont.)

13		2011 - 2008; 2.0L 122 (1998cc) DOHC L4 (16 Valve) 86mm Bore MIVEC			13	
(cont.)		MFI; Gasoline; Turbo - Intercooled Mitsubishi Eng.; Eng. Code 4B11T			(cont.)	
QTY	EXHAUST PIPE FLANGE	YEARS	PART NO.	DESCRIPTION		
1	Exhaust Pipe Gasket	2011-08	61348	Turbo mounting inlet		
1	Exhaust Pipe Gasket	2011-08	61509	Exh. connector		
1	Exhaust Pipe Gasket	2011-08	61511	Turbo mounting outlet		
QTY	OIL PAN	YEARS	PART NO.	DESCRIPTION		
1	Oil Pan Gasket Set	2011-08	OS 30826			
QTY	CRANKSHAFT REAR SEAL	YEARS	PART NO.	DESCRIPTION		
1	Rear Main Seal Set	2011-08	BS 40726	Rubber; One-piece; New Part Number - Check for Availability		
QTY	VALVE COVER	YEARS	PART NO.	DESCRIPTION		
1	Valve Cover Gasket Set	2011-08	VS 50765 R	w/Spark plug tube seals; PermaDry® molded rubber gskt. incl.		
QTY	VALVE STEM SEAL SET	YEARS	PART NO.	DESCRIPTION		
1	Valve Stem Seal Set	2011-08	SS 71314	Premium valve stem seals incl.; New Part Number - Check for Availability		
QTY	WATER OUTLET GASKET	YEARS	PART NO.	DESCRIPTION		
1	Water Outlet Gasket	2011-08	35926	Water Outlet		
QTY	WATER PUMP	YEARS	PART NO.	DESCRIPTION		
1	Water Pump Gasket	2011-08	35813	To block; Improved design		
1	Water Pump Gasket	2011-08	35822	To block; Old design		
1	Water Pump Gasket	2011-08	35877	To coolant pipe		
QTY	TIMING COVER	YEARS	PART NO.	DESCRIPTION		
1	Crankshaft Front Seal Set	2011-08	TCS 46087			
QTY	CARB & FUEL INJECTION	YEARS	PART NO.	DESCRIPTION		
1	Fuel Injector O-Ring Set	2011-08	ES 70599	Improved design		
1	Throttle Body Gasket	2011-08	61432	Throttle body		
14		2007 - 2003; 2.0L 122 (1999cc) DOHC L4 (16 Valve) 81.5mm Bore			14	
		MFI; Gasoline; Turbo - Intercooled Mitsubishi Eng.; Eng. Code 4G94-T				
QTY	CYLINDER HEAD	YEARS	PART NO.	DESCRIPTION		
1	Head Gasket	2007	26367 PT	Head bolts not incl.; Head bolt replacement recommended; PermaTorqueMLS®		
1	Head Gasket	2006-05	26365 PT	To 07/31/05; Head bolts not incl.; Head bolt replacement recommended; PermaTorqueMLS®		
1	Head Gasket	2006-05	26367 PT	From 08/01/05; Head bolts not incl.; Head bolt replacement recommended; PermaTorqueMLS®		
1	Head Gasket	2004-03	26365 PT	Head bolts not incl.; Head bolt replacement recommended; PermaTorqueMLS®		
1	Head Set	2007	HS 26367 PT	Head bolts not incl.; Head bolt replacement recommended; RTV sealant incl. for thermostat gskt.; PermaDry® molded rubber valve cover gskt. incl.; Premium valve stem seals incl.		
1	Head Set	2006-05	HS 26365 PT	To 07/31/05; Head bolts not incl.; Head bolt replacement recommended; RTV sealant incl. for thermostat gskt.; PermaDry® molded rubber valve cover gskt. incl.; Premium valve stem seals incl.		
1	Head Set	2006-05	HS 26367 PT	From 08/01/05; Head bolts not incl.; Head bolt replacement recommended; RTV sealant incl. for thermostat gskt.; PermaDry® molded rubber valve cover gskt. incl.; Premium valve stem seals incl.		
1	Head Set	2004-03	HS 26365 PT	Head bolts not incl.; Head bolt replacement recommended; RTV sealant incl. for thermostat gskt.; PermaDry® molded rubber valve cover gskt. incl.; Premium valve stem seals incl.		
QTY	CONVERSION SET	YEARS	PART NO.	DESCRIPTION		
1	Gasket Conversion Set	2007-03	CS 26365			
QTY	MANIFOLD - INT. & EXH.	YEARS	PART NO.	DESCRIPTION		
1	Int. Manifold Gasket Set	2007-03	MS 96633			
1	Exh. Manifold Gasket Set	2007-03	MS 96935			
QTY	EXHAUST PIPE FLANGE	YEARS	PART NO.	DESCRIPTION		
1	Exhaust Pipe Gasket	2007-03	60917	Exh. connector		
1	Exhaust Pipe Gasket	2007-03	61348	Flange		
1	Exhaust Pipe Gasket	2007-03	61501	Turbo mounting inlet		
1	Exhaust Pipe Gasket	2007-03	61509	Converter		
1	Exhaust Pipe Gasket	2007-03	61511	Turbo mounting outlet		
QTY	OIL PAN	YEARS	PART NO.	DESCRIPTION		
1	Oil Pan Gasket Set	2007-03	OS 30715			
QTY	CRANKSHAFT REAR SEAL	YEARS	PART NO.	DESCRIPTION		
1	Rear Main Seal Set	2007-03	BS 40663	Rubber; One-piece		
QTY	VALVE COVER	YEARS	PART NO.	DESCRIPTION		
1	Valve Cover Gasket Set	2007	VS 50721 R	w/Spark plug tube seals; PermaDry® molded rubber gskt. incl.		

14 (cont.)		2007 - 2003; 2.0L 122 (1999cc) DOHC L4 (16 Valve) 81.5mm Bore			14 (cont.)
MFI; Gasoline; Turbo - Intercooled Mitsubishi Eng.; Eng. Code 4G94-T					
QTY	VALVE COVER	YEARS	PART NO.	DESCRIPTION	
1	Valve Cover Gasket Set	2006-05	VS 50721 R	From 08/01/05; w/Spark plug tube seals; PermaDry® molded rubber gskt. incl.	
1	Valve Cover Gasket Set	2006-05	VS 50723 R	To 07/31/05; w/Spark plug tube seals; PermaDry® molded rubber gskt. incl.	
1	Valve Cover Gasket Set	2004-03	VS 50723 R	w/Spark plug tube seals; PermaDry® molded rubber gskt. incl.	
1	Spark Plug Tube Seal Set	2007-03	ES 72845	Valve Cover	
QTY	VALVE STEM SEAL SET	YEARS	PART NO.	DESCRIPTION	
1	Valve Stem Seal Set	2007-03	SS 71179-2	Premium valve stem seals incl.	
QTY	WATER PUMP	YEARS	PART NO.	DESCRIPTION	
1	Water Pump Gasket	2007-03	35737		
QTY	TIMING COVER	YEARS	PART NO.	DESCRIPTION	
1	Crankshaft Front Seal Set	2007-03	TCS 46137	Must be used w/OS 30715	
1	Camshaft Front Seal Set	2007-03	TCS 45704		
QTY	CARB & FUEL INJECTION	YEARS	PART NO.	DESCRIPTION	
1	Fuel Injector O-Ring Set	2007-03	ES 70600		
1	Throttle Body Gasket	2007-03	60922	Idle air control	
1	Throttle Body Gasket	2007	61432	Throttle body	
1	Throttle Body Gasket	2006-05	60879	To 07/31/05; Throttle body	
1	Throttle Body Gasket	2006-05	61432	From 08/01/05; Throttle body	
1	Throttle Body Gasket	2004-03	60879	Throttle body	
QTY	EXHAUST GAS RECIRCULATION	YEARS	PART NO.	DESCRIPTION	
1	EGR Gasket	2007-03	70152		
15		2007 - 2002; 2.0L 122 (1999cc) SOHC L4 (16 Valve) 81.5mm Bore			15
MFI; Gasoline; Naturally Aspirated Mitsubishi Eng.; Eng. Code 4G94					
QTY	CYLINDER HEAD	YEARS	PART NO.	DESCRIPTION	
1	Head Gasket	2007-02	26288 PT	Head bolts not incl.; Head bolt replacement recommended; PermaTorqueMLS®	
1	Head Set	2007-02	HS 26288 PT	Head bolts not incl.; Head bolt replacement recommended; PermaDry® molded rubber valve cover gskt. incl.; Premium valve stem seals incl.	
QTY	CONVERSION SET	YEARS	PART NO.	DESCRIPTION	
1	Gasket Conversion Set	2007-02	CS 26288	RTV sealant incl. for oil pan gskt.	
QTY	MANIFOLD - INT. & EXH.	YEARS	PART NO.	DESCRIPTION	
1	Int. Manifold Gasket Set	2007-02	MS 96137		
1	Exh. Manifold Gasket Set	2007-02	MS 96659		
QTY	EXHAUST PIPE FLANGE	YEARS	PART NO.	DESCRIPTION	
1	Exhaust Pipe Gasket	2007-02	60496-1	Converter	
1	Exhaust Pipe Gasket	2007-02	61267	Exh. connector	
1	Exhaust Pipe Gasket	2007-05	61334	Flange	
1	Exhaust Pipe Gasket	2004	60496-1	To 03/31/04; Flange	
1	Exhaust Pipe Gasket	2004	61334	From 04/01/04; Flange	
1	Exhaust Pipe Gasket	2003-02	60496-1	Flange	
QTY	OIL PAN	YEARS	PART NO.	DESCRIPTION	
1	Oil Pan Gasket Set	2007-02	OS 30757	RTV sealant incl. for oil pan gskt.	
QTY	CRANKSHAFT REAR SEAL	YEARS	PART NO.	DESCRIPTION	
1	Rear Main Seal Set	2007-02	BS 40663	Rubber; One-piece	
QTY	VALVE COVER	YEARS	PART NO.	DESCRIPTION	
1	Valve Cover Gasket Set	2007-02	VS 50535 R	w/Spark plug tube seals; PermaDry® molded rubber gskt. incl.	
1	Spark Plug Tube Seal Set	2007-02	ES 72120	Valve Cover	
QTY	VALVE STEM SEAL SET	YEARS	PART NO.	DESCRIPTION	
1	Valve Stem Seal Set	2007-02	SS 70660	Premium valve stem seals incl.; Improved design	
QTY	THERMOSTAT HOUSING	YEARS	PART NO.	DESCRIPTION	
1	O-Ring	2007	35928	Thermostat Housing; Thermostat seal	
1	O-Ring	2006-02	35524	Thermostat Housing; Thermostat seal	
QTY	WATER PUMP	YEARS	PART NO.	DESCRIPTION	
1	Water Pump Gasket	2007	35877		
1	Water Pump Gasket	2006-02	35690		
QTY	TIMING COVER	YEARS	PART NO.	DESCRIPTION	
1	Crankshaft Front Seal Set	2007-02	TCS 45931	Must be used w/OS 30757	
1	Camshaft Front Seal Set	2007-02	TCS 45704-1		
QTY	CARB & FUEL INJECTION	YEARS	PART NO.	DESCRIPTION	
1	Fuel Injector O-Ring Set	2007-02	ES 70600		
1	Throttle Body Gasket	2007-02	61397	Throttle body	
QTY	EXHAUST GAS RECIRCULATION	YEARS	PART NO.	DESCRIPTION	
1	EGR Gasket	2007-02	70152		

Mitsubishi Car (Cont.)

16		1997 - 1994; 2.4L 143.4 (2351cc) DOHC L4 (16 Valve) 86.5mm Bore			16
MFI; Gasoline; Naturally Aspirated Mitsubishi Eng.; Eng. Code 4G64					
QTY	CONVERSION SET	YEARS	PART NO.	DESCRIPTION	
1	Gasket Conversion Set	1997-94	CS 9086-1		
QTY	MANIFOLD - INT. & EXH.	YEARS	PART NO.	DESCRIPTION	
1	Int. Manifold Gasket Set	1997-94	MS 91837		
1	Exh. Manifold Gasket Set	1997-94	MS 95470		
QTY	EXHAUST PIPE FLANGE	YEARS	PART NO.	DESCRIPTION	
2	Exhaust Pipe Gasket	1997-94	60496-1	Converter	
1	Exhaust Pipe Gasket	1997-94	60680	Flange	
QTY	OIL PAN	YEARS	PART NO.	DESCRIPTION	
1	Oil Pan Gasket Set	1997-94	OS 30665 C		
QTY	CRANKSHAFT REAR SEAL	YEARS	PART NO.	DESCRIPTION	
1	Rear Main Seal Set	1997-94	BS 40648	Rubber; One-piece	
1	Repair Sleeve	1997-94	16275	Crankshaft; Use w/installation tool	
QTY	VALVE COVER	YEARS	PART NO.	DESCRIPTION	
1	Valve Cover Gasket Set	1997-94	VS 50434 R	w/Semi-circular plug & Spark plug tube seals; PermaDry® molded rubber gskt. incl.	
1	Semi-Circular Plug	1997-94	CP 75013	Valve Cover	
1	Spark Plug Tube Seal Set	1997-94	ES 72845	Valve Cover	
QTY	VALVE STEM SEAL SET	YEARS	PART NO.	DESCRIPTION	
1	Valve Stem Seal Set	1997-94	SS 70359	Premium valve stem seals incl.	
QTY	WATER OUTLET GASKET	YEARS	PART NO.	DESCRIPTION	
1	O-Ring	1997-94	35524	Water Outlet	
QTY	WATER PUMP	YEARS	PART NO.	DESCRIPTION	
1	Water Pump Gasket	1997-94	35003		
1	Water Pump Gasket	1997-94	ES 72872	O-ring	
QTY	TIMING COVER	YEARS	PART NO.	DESCRIPTION	
1	Crankshaft Front Seal Set	1997-94	TCS 45941	Must be used w/OS 30665C	
2	Camshaft Front Seal Set	1997-94	TCS 45483		
QTY	CARB & FUEL INJECTION	YEARS	PART NO.	DESCRIPTION	
1	Fuel Injector O-Ring Set	1997-94	ES 70600		
1	Throttle Body Gasket	1997-94	60879		
QTY	EXHAUST GAS RECIRCULATION	YEARS	PART NO.	DESCRIPTION	
1	EGR Gasket	1997-94	70152		
17		2005 - 1993; 2.4L 143.4 (2351cc) SOHC L4 (16 Valve) 86.5mm Bore			17
MFI; Gasoline; Naturally Aspirated Mitsubishi Eng.; Eng. Code 4G64					
QTY	CYLINDER HEAD	YEARS	PART NO.	DESCRIPTION	
1	Head Gasket	2005-00	26172 PT	Head bolts not incl.; Head bolt replacement recommended; PermaTorqueMLS® LaserWeld® Technology	
1	Head Gasket	1999	26172 PT	Mitsubishi Galant DE, ES; Head bolts not incl.; Head bolt replacement recommended; PermaTorqueMLS® LaserWeld® Technology	
1	Head Gasket	1999	9932 PT	Mitsubishi Eclipse Spyder GS; Head bolts not incl.; Head bolt replacement recommended	
1	Head Gasket	1998-93	9932 PT	Head bolts not incl.; Head bolt replacement recommended	
1	Head Set	2005-00	HS 26172 PT	Head bolts not incl.; Head bolt replacement recommended; PermaDry® molded rubber valve cover gskt. incl.; Premium valve stem seals incl.	
1	Head Set	1999	HS 9932 PT	Mitsubishi Eclipse Spyder GS; Head bolts & California exh. pipe flange not incl.; Head bolt replacement recommended; PermaDry® molded rubber valve cover gskt. incl.; Premium valve stem seals incl.; Consolidated design	
1	Head Set	1999	HS 26172 PT	Mitsubishi Galant DE, ES; Head bolts not incl.; Head bolt replacement recommended; PermaDry® molded rubber valve cover gskt. incl.; Premium valve stem seals incl.	
1	Head Set	1998-95	HS 9932 PT	Head bolts & California exh. pipe flange not incl.; Head bolt replacement recommended; PermaDry® molded rubber valve cover gskt. incl.; Premium valve stem seals incl.; Consolidated design	
1	Head Set	1994-93	HS 9932 PT	Head bolts not incl.; Head bolt replacement recommended; PermaDry® molded rubber valve cover gskt. incl.; Premium valve stem seals incl.; Consolidated design	
1	Head Bolt Set	2005-00	ES 71177	Head bolts w/Washers; Replacement recommended	
1	Head Bolt Set	1999	ES 71177	Mitsubishi Galant DE, ES; Head bolts w/Washers; Replacement recommended	
QTY	CONVERSION SET	YEARS	PART NO.	DESCRIPTION	
1	Gasket Conversion Set	2005-00	CS 26172		
1	Gasket Conversion Set	1999	CS 26172	Mitsubishi Galant DE, ES	

17 (cont.)		2005 - 1993; 2.4L 143.4 (2351cc) SOHC L4 (16 Valve) 86.5mm Bore MFI; Gasoline; Naturally Aspirated Mitsubishi Eng.; Eng. Code 4G64			17 (cont.)	
QTY	CONVERSION SET	YEARS	PART NO.	DESCRIPTION		
1	Gasket Conversion Set	1999	CS 9086-1	Mitsubishi Eclipse Spyder GS		
1	Gasket Conversion Set	1998-93	CS 9086-1			
QTY	MANIFOLD - INT. & EXH.	YEARS	PART NO.	DESCRIPTION		
1	Int. Manifold Gasket Set	2005-00	MS 96075			
1	Int. Manifold Gasket Set	1999	MS 95471	Mitsubishi Eclipse Spyder GS		
1	Int. Manifold Gasket Set	1999	MS 96075	Mitsubishi Galant DE, ES		
1	Int. Manifold Gasket Set	1998-93	MS 95471			
1	Exh. Manifold Gasket Set	2005-93	MS 95470			
QTY	EXHAUST PIPE FLANGE	YEARS	PART NO.	DESCRIPTION		
2	Exhaust Pipe Gasket	2005-93	60496-1	Converter		
2	Exhaust Pipe Gasket	2005-00	60817	Pipe to manifold		
1	Exhaust Pipe Gasket	2005-00	61080	Pipe to muffler		
1	Exhaust Pipe Gasket	1999-96	60680	Mitsubishi Eclipse Spyder GS; Flange		
1	Exhaust Pipe Gasket	1999	60496-1	Mitsubishi Galant DE, ES; Flange; California		
1	Exhaust Pipe Gasket	1999	60680	Mitsubishi Galant DE, ES; Flange; Exc. California		
1	Exhaust Pipe Gasket	1998-97	60496-1	Mitsubishi Galant DE, ES, LS; Flange; California		
1	Exhaust Pipe Gasket	1998-97	60680	Mitsubishi Galant DE, ES, LS; Flange; Exc. California		
1	Exhaust Pipe Gasket	1996	60496-1	Exc. Mitsubishi Eclipse Spyder GS; Flange; California		
1	Exhaust Pipe Gasket	1996	60496-1	Mitsubishi Expo Base, Expo LRV Base, Sport; Flange; California; FWD		
1	Exhaust Pipe Gasket	1996	60680	Mitsubishi Expo Base, Expo LRV Base, Sport; Flange; California; AWD		
1	Exhaust Pipe Gasket	1996	60680	Exc. Mitsubishi Eclipse Spyder GS; Flange; Exc. California		
1	Exhaust Pipe Gasket	1995	60496-1	Flange; California		
1	Exhaust Pipe Gasket	1995	60496-1	Exc. Mitsubishi Galant ES, LS, S; Flange; California; FWD		
1	Exhaust Pipe Gasket	1995	60680	Exc. Mitsubishi Galant ES, LS, S; Flange; California; AWD		
1	Exhaust Pipe Gasket	1995	60680	Flange; Exc. California		
1	Exhaust Pipe Gasket	1994-93	60680	Flange		
QTY	OIL PAN	YEARS	PART NO.	DESCRIPTION		
1	Oil Pan Gasket Set	2005-00	OS 30715			
1	Oil Pan Gasket Set	1999	OS 30665 C	Mitsubishi Eclipse Spyder GS		
1	Oil Pan Gasket Set	1999	OS 30715	Mitsubishi Galant DE, ES		
1	Oil Pan Gasket Set	1998-93	OS 30665 C			
QTY	CRANKSHAFT REAR SEAL	YEARS	PART NO.	DESCRIPTION		
1	Rear Main Seal Set	2005-93	BS 40648	Rubber; One-piece		
1	Repair Sleeve	2005-93	16275	Crankshaft; Use w/installation tool		
QTY	VALVE COVER	YEARS	PART NO.	DESCRIPTION		
1	Valve Cover Gasket Set	2005-00	VS 50562 R	w/Spark plug tube seals; PermaDry® molded rubber gskt. incl.		
1	Valve Cover Gasket Set	1999	VS 50435 R	Mitsubishi Eclipse Spyder GS; w/Spark plug tube seals; PermaDry® molded rubber gskt. incl.		
1	Valve Cover Gasket Set	1999	VS 50562 R	Mitsubishi Galant DE, ES; w/Spark plug tube seals; PermaDry® molded rubber gskt. incl.		
1	Valve Cover Gasket Set	1998-93	VS 50435 R	w/Spark plug tube seals; PermaDry® molded rubber gskt. incl.		
1	Spark Plug Tube Seal Set	2005-93	ES 72120	Valve Cover		
QTY	VALVE STEM SEAL SET	YEARS	PART NO.	DESCRIPTION		
1	Valve Stem Seal Set	2005-93	SS 70660	Premium valve stem seals incl.; Improved design		
QTY	THERMOSTAT HOUSING	YEARS	PART NO.	DESCRIPTION		
2	Thermostat Gasket	2005-98	35589	Thermostat Housing; Thermostat case to head		
QTY	WATER OUTLET GASKET	YEARS	PART NO.	DESCRIPTION		
2	Water Outlet Gasket	2005-00	35959	Water Outlet; Water pipe; O-ring		
2	Water Outlet Gasket	1999	35959	Mitsubishi Galant DE, ES; Water Outlet; Water pipe; O-ring		
1	Water Outlet Gasket	1993	35336	Water Outlet		
1	O-Ring	2005-93	35524	Water Outlet		
QTY	WATER PUMP	YEARS	PART NO.	DESCRIPTION		
1	Water Pump Gasket	2005-93	35003			
1	Water Pump Gasket	2005-93	ES 72872	O-ring		
QTY	TIMING COVER	YEARS	PART NO.	DESCRIPTION		
1	Crankshaft Front Seal Set	2005-00	TCS 46024	Must be used w/OS 30715		
1	Crankshaft Front Seal Set	1999	TCS 45941	Mitsubishi Eclipse Spyder GS; Must be used w/OS 30665C		
1	Crankshaft Front Seal Set	1999	TCS 46024	Mitsubishi Galant DE, ES; Must be used w/OS 30715		
1	Crankshaft Front Seal Set	1998-93	TCS 45941	Must be used w/OS 30665C		
1	Camshaft Front Seal Set	2005-93	TCS 45483			
QTY	CARB & FUEL INJECTION	YEARS	PART NO.	DESCRIPTION		
1	Fuel Injector O-Ring Set	2005-93	ES 70600			
1	Throttle Body Gasket	2005-03	60922	Idle air control		

Mitsubishi Car (Cont.)

17		2005 - 1993; 2.4L 143.4 (2351cc) SOHC L4 (16 Valve) 86.5mm Bore			17
(cont.)		MFI; Gasoline; Naturally Aspirated Mitsubishi Eng.; Eng. Code 4G64			(cont.)
QTY	CARB & FUEL INJECTION	YEARS	PART NO.	DESCRIPTION	
1	Throttle Body Gasket	2005	60889	Throttle body	
1	Throttle Body Gasket	2004-02	60966	Throttle body	
1	Throttle Body Gasket	2001-96	60889	Throttle body	
1	Throttle Body Gasket	1995-94	60889	Exc. Mitsubishi Galant ES, LS, S	
1	Throttle Body Gasket	1995	60870	Mitsubishi Galant ES, LS, S; To 09/30/94	
1	Throttle Body Gasket	1995	60889	Mitsubishi Galant ES, LS, S; From 10/01/94	
1	Throttle Body Gasket	1994	60870	Mitsubishi Galant ES, LS, S	
1	Throttle Body Gasket	1993	60889		
QTY	EXHAUST GAS RECIRCULATION	YEARS	PART NO.	DESCRIPTION	
1	EGR Gasket	2005-93	70152		
18		1992; 2.4L 143.4 (2351cc) SOHC L4 (8 Valve) 86.5mm Bore			18
(cont.)		MFI; Gasoline; Naturally Aspirated Mitsubishi Eng.; Eng. Code 4G64			(cont.)
QTY	CYLINDER HEAD	YEARS	PART NO.	DESCRIPTION	
1	Head Gasket	1992	9388 PT		
1	Head Set	1992	HS 9388 PT-2	PermaDry® molded rubber valve cover gskt. incl.; Premium valve stem seals incl.	
QTY	CONVERSION SET	YEARS	PART NO.	DESCRIPTION	
1	Gasket Conversion Set	1992	CS 9388-1		
QTY	MANIFOLD - INT. & EXH.	YEARS	PART NO.	DESCRIPTION	
1	Int. Manifold Gasket Set	1992	MS 92964-4	Lower set; Upper set incl.	
1	Exh. Manifold Gasket Set	1992	MS 92029		
QTY	EXHAUST PIPE FLANGE	YEARS	PART NO.	DESCRIPTION	
2	Exhaust Pipe Gasket	1992	60620	Converter	
1	Exhaust Pipe Gasket	1992	60680	Flange	
QTY	OIL PAN	YEARS	PART NO.	DESCRIPTION	
1	Oil Pan Gasket Set	1992	OS 30460 A		
QTY	CRANKSHAFT REAR SEAL	YEARS	PART NO.	DESCRIPTION	
1	Rear Main Seal Set	1992	BS 40408-1	Rubber; One-piece	
1	Repair Sleeve	1992	16275	Crankshaft; Use w/installation tool	
QTY	VALVE COVER	YEARS	PART NO.	DESCRIPTION	
1	Valve Cover Gasket Set	1992	VS 50132 R	w/Semi-circular plug & Grommets; PermaDry® molded rubber gskt. incl.	
1	Valve Cover Gasket Set	1992	VS 50234 R	w/o Semi-circular plug & Grommets; PermaDry® molded rubber gskt. incl.	
1	Grommet Set	1992	ES 70342	Valve Cover	
1	Semi-Circular Plug	1992	CP 75001	Valve Cover	
QTY	VALVE STEM SEAL SET	YEARS	PART NO.	DESCRIPTION	
1	Valve Stem Seal Set	1992	SS 72630	Loc. Int. & Exh.; Premium valve stem seals incl.	
1	Valve Stem Seal Set	1992	SS 72681	Loc. Aux.; Premium valve stem seals incl.	
QTY	WATER OUTLET GASKET	YEARS	PART NO.	DESCRIPTION	
1	Water Outlet Gasket	1992	35336	Water Outlet	
QTY	WATER PUMP	YEARS	PART NO.	DESCRIPTION	
1	Water Pump Gasket	1992	35273		
1	Water Pump Gasket	1992	ES 72872	O-ring	
QTY	TIMING COVER	YEARS	PART NO.	DESCRIPTION	
1	Camshaft Front Seal Set	1992	TCS 45483		
QTY	CARB & FUEL INJECTION	YEARS	PART NO.	DESCRIPTION	
1	Fuel Injector O-Ring Set	1992	ES 70600		
1	Throttle Body Gasket	1992	60855		
QTY	EXHAUST GAS RECIRCULATION	YEARS	PART NO.	DESCRIPTION	
1	EGR Gasket	1992	70152		
19		2013 - 2009; 2.4L 144 (2359cc) DOHC L4 (16 Valve) 88mm Bore MIVEC			19
(cont.)		MFI; Gasoline; Naturally Aspirated Mitsubishi Eng.; Eng. Code 4B12			(cont.)
QTY	CYLINDER HEAD	YEARS	PART NO.	DESCRIPTION	
1	Head Gasket	2013-09	26557 PT	Head bolts not incl.; Head bolt replacement recommended; PermaTorqueMLS®; Improved design; New Part Number - Check for Availability	
1	Head Gasket	2011-09	26484 PT	Head bolts not incl.; Head bolt replacement recommended; PermaTorqueMLS®; Old design	
1	Head Set	2011-09	HS 26484 PT	Head bolts not incl.; Head bolt replacement recommended; PermaDry® molded rubber valve cover gskt. incl.; Premium valve stem seals incl.; New Part Number - Check for Availability	
QTY	CONVERSION SET	YEARS	PART NO.	DESCRIPTION	
1	Gasket Conversion Set	2011-09	CS 26449	New Part Number - Check for Availability	

19 (cont.)		2013 - 2009; 2.4L 144 (2359cc) DOHC L4 (16 Valve) 88mm Bore MIVEC MFI; Gasoline; Naturally Aspirated Mitsubishi Eng.; Eng. Code 4B12			19 (cont.)	
QTY	MANIFOLD - INT. & EXH.	YEARS	PART NO.	DESCRIPTION		
1	Int. Manifold Gasket Set	2011-09	MS 97114	Improved design		
1	Int. Manifold Gasket Set	2009	MS 97107	To 06/02/09; Old design		
1	Exh. Manifold Gasket Set	2011-09	MS 96902			
QTY	EXHAUST PIPE FLANGE	YEARS	PART NO.	DESCRIPTION		
1	Exhaust Pipe Gasket	2011-09	61016	Loc. Rear; Converter; Improved design		
1	Exhaust Pipe Gasket	2011-09	61106	Pipe to manifold; 2.40" ID		
1	Exhaust Pipe Gasket	2011-09	61334	Loc. Front; Converter		
QTY	OIL PAN	YEARS	PART NO.	DESCRIPTION		
1	Oil Pan Gasket Set	2011-09	OS 30824			
QTY	CRANKSHAFT REAR SEAL	YEARS	PART NO.	DESCRIPTION		
1	Rear Main Seal Set	2011-09	BS 40728	Rubber; One-piece; New Part Number - Check for Availability		
QTY	VALVE COVER	YEARS	PART NO.	DESCRIPTION		
1	Valve Cover Gasket Set	2011-09	VS 50765 R	w/Spark plug tube seals; PermaDry® molded rubber gskt. incl.		
QTY	VALVE STEM SEAL SET	YEARS	PART NO.	DESCRIPTION		
1	Valve Stem Seal Set	2011-09	SS 71314	Premium valve stem seals incl.; New Part Number - Check for Availability		
QTY	THERMOSTAT HOUSING	YEARS	PART NO.	DESCRIPTION		
1	Thermostat Gasket	2011-09	35865	Thermostat Housing; Thermostat case to block		
QTY	WATER PUMP	YEARS	PART NO.	DESCRIPTION		
1	Water Pump Gasket	2011-09	35813	To block; Improved design		
1	Water Pump Gasket	2011-09	35822	To block; Old design		
1	Water Pump Gasket	2011-09	35877	Thermostat Housing; Thermostat case to outlet		
1	Water Pump Gasket	2011-09	35877	To coolant pipe		
QTY	TIMING COVER	YEARS	PART NO.	DESCRIPTION		
1	Crankshaft Front Seal Set	2011-09	TCS 46087			
QTY	CARB & FUEL INJECTION	YEARS	PART NO.	DESCRIPTION		
1	Fuel Injector O-Ring Set	2011-09	ES 70599	Improved design		
1	Throttle Body Gasket	2011-09	61607			
QTY	EXHAUST GAS RECIRCULATION	YEARS	PART NO.	DESCRIPTION		
1	EGR Gasket	2011-09	71210			
20		2009 - 2004; 2.4L 145.1 (2378cc) SOHC L4 (16 Valve) 87mm Bore MFI; Gasoline; Naturally Aspirated Mitsubishi Eng.; Eng. Code 4G69			20	
QTY	CYLINDER HEAD	YEARS	PART NO.	DESCRIPTION		
1	Head Gasket	2009-04	26235 PT	Head bolts not incl.; Head bolt replacement recommended; PermaTorqueMLS®		
1	Head Set	2009-04	HS 26235 PT	Head bolts not incl.; Head bolt replacement recommended; RTV sealant incl. for thermostat gskt.; PermaDry® molded rubber valve cover gskt. incl.; Premium valve stem seals incl.		
QTY	CONVERSION SET	YEARS	PART NO.	DESCRIPTION		
1	Gasket Conversion Set	2009-04	CS 26172			
QTY	MANIFOLD - INT. & EXH.	YEARS	PART NO.	DESCRIPTION		
1	Int. Manifold Gasket Set	2009-04	MS 96424			
1	Exh. Manifold Gasket Set	2009-04	MS 96420			
QTY	EXHAUST PIPE FLANGE	YEARS	PART NO.	DESCRIPTION		
1	Exhaust Pipe Gasket	2009-04	60496-1	Converter		
1	Exhaust Pipe Gasket	2009-08	61016	Exh. connector; Improved design		
1	Exhaust Pipe Gasket	2009-08	61375	Flange		
1	Exhaust Pipe Gasket	2009	61378	Mitsubishi Galant ES, Sport Edition; Exh. connector		
1	Exhaust Pipe Gasket	2008	61378	Mitsubishi Galant DE, ES; Exh. connector		
1	Exhaust Pipe Gasket	2007-04	61378	Mitsubishi Galant DE, ES, SE; Exh. connector		
1	Exhaust Pipe Gasket	2007-05	60680	Mitsubishi Lancer Ralliart; Flange		
1	Exhaust Pipe Gasket	2007-05	61334	Mitsubishi Lancer Ralliart; Exh. connector		
1	Exhaust Pipe Gasket	2007-06	61016	Exc. Mitsubishi Lancer Ralliart; Exh. connector; Improved design		
1	Exhaust Pipe Gasket	2007-06	61375	Exc. Mitsubishi Lancer Ralliart; Flange		
1	Exhaust Pipe Gasket	2005-04	61016	Mitsubishi Galant DE, ES, SE; Exh. connector; Improved design		
1	Exhaust Pipe Gasket	2005-04	61375	Mitsubishi Galant DE, ES, SE; Flange		
1	Exhaust Pipe Gasket	2004	60496-1	Exc. Mitsubishi Galant DE, ES, SE; To 12/31/03; Exh. connector		
1	Exhaust Pipe Gasket	2004	60680	Exc. Mitsubishi Galant DE, ES, SE; Flange		
1	Exhaust Pipe Gasket	2004	61334	Exc. Mitsubishi Galant DE, ES, SE; From 01/01/04; Exh. connector		
QTY	OIL PAN	YEARS	PART NO.	DESCRIPTION		
1	Oil Pan Gasket Set	2009-04	OS 30715			
QTY	CRANKSHAFT REAR SEAL	YEARS	PART NO.	DESCRIPTION		
1	Rear Main Seal Set	2009-04	BS 40648	Rubber; One-piece		

Mitsubishi Car (Cont.)

20 (cont.)		2009 - 2004; 2.4L 145.1 (2378cc) SOHC L4 (16 Valve) 87mm Bore			20 (cont.)
MFI; Gasoline; Naturally Aspirated Mitsubishi Eng.; Eng. Code 4G69					
QTY	CRANKSHAFT REAR SEAL	YEARS	PART NO.	DESCRIPTION	
1	Repair Sleeve	2009-04	16275	Crankshaft; Use w/installation tool	
QTY	VALVE COVER	YEARS	PART NO.	DESCRIPTION	
1	Valve Cover Gasket Set	2009-04	VS 50604 R	w/Spark plug tube seals; PermaDry® molded rubber gskt. incl.	
1	Spark Plug Tube Seal Set	2009-04	ES 72120	Valve Cover	
QTY	VALVE STEM SEAL SET	YEARS	PART NO.	DESCRIPTION	
1	Valve Stem Seal Set	2009-04	SS 70660	Premium valve stem seals incl.; Improved design	
QTY	WATER PUMP	YEARS	PART NO.	DESCRIPTION	
1	Water Pump Gasket	2009-04	35737		
1	Water Pump Gasket	2009-04	ES 72872	O-ring	
QTY	TIMING COVER	YEARS	PART NO.	DESCRIPTION	
1	Crankshaft Front Seal Set	2009-04	TCS 46024	Must be used w/OS 30715	
1	Camshaft Front Seal Set	2009-04	TCS 45704-1		
QTY	CARB & FUEL INJECTION	YEARS	PART NO.	DESCRIPTION	
1	Fuel Injector O-Ring Set	2009-04	ES 70600		
1	Throttle Body Gasket	2009-04	60922	Idle air control	
1	Throttle Body Gasket	2009-04	61432	Throttle body	
QTY	EXHAUST GAS RECIRCULATION	YEARS	PART NO.	DESCRIPTION	
1	EGR Gasket	2009-04	71210		
21		1998 - 1995; 2.5L 152.2 (2497cc) SOHC V6 (24 Valve) 83.5mm Bore			21
MFI; Gasoline; Naturally Aspirated Mitsubishi Eng.; Eng. Code 6G73					
QTY	CYLINDER HEAD	YEARS	PART NO.	DESCRIPTION	
2	Head Gasket	1998-95	9037 PT	Head bolts not incl.; Head bolt replacement recommended	
1	Head Set	1998-95	HS 9037 PT	Head bolts & exh. pipe flange not incl.; Head bolt replacement recommended; PermaDry® molded rubber valve cover gskts. incl.; Premium valve stem seals incl.	
1	Head Bolt Set	1998-95	ES 72859	Head bolts w/Washers; Replacement recommended	
QTY	CONVERSION SET	YEARS	PART NO.	DESCRIPTION	
1	Gasket Conversion Set	1998-95	CS 9037		
QTY	MANIFOLD - INT. & EXH.	YEARS	PART NO.	DESCRIPTION	
1	Int. Manifold Gasket Set	1998-95	MS 95709	Lower set; Upper set incl.	
1	Plenum Gasket Set	1998-95	MS 95708	Upper set	
1	Exh. Manifold Gasket Set	1998-95	MS 95711		
QTY	EXHAUST PIPE FLANGE	YEARS	PART NO.	DESCRIPTION	
2	Exhaust Pipe Gasket	1998-95	60496-1	Converter	
1	Exhaust Pipe Gasket	1998-95	60496-1	Flange	
1	Exhaust Pipe Gasket	1998-95	60917	Pipe to muffler	
QTY	OIL PAN	YEARS	PART NO.	DESCRIPTION	
1	Oil Pan Gasket Set	1998-95	OS 30672 C		
QTY	CRANKSHAFT REAR SEAL	YEARS	PART NO.	DESCRIPTION	
1	Rear Main Seal Set	1998-95	BS 40562	Rubber; One-piece	
1	Rear Main Seal Set	1998-95	BS 40627	PTFE Rubber; One-piece	
QTY	VALVE COVER	YEARS	PART NO.	DESCRIPTION	
1	Valve Cover Gasket Set	1998-95	VS 50461 R	w/Spark plug tube seals; PermaDry® molded rubber gskts. incl.	
1	Spark Plug Tube Seal Set	1998-95	ES 72120-1	Valve Cover	
QTY	VALVE STEM SEAL SET	YEARS	PART NO.	DESCRIPTION	
1	Valve Stem Seal Set	1998-95	SS 70795	Premium valve stem seals incl.	
QTY	THERMOSTAT HOUSING	YEARS	PART NO.	DESCRIPTION	
1	Thermostat Gasket	1998-95	35589	Thermostat Housing; Thermostat case to head	
QTY	WATER OUTLET GASKET	YEARS	PART NO.	DESCRIPTION	
1	Water Outlet Gasket	1998-95	35520	Water Outlet; Inlet	
2	Water Outlet Gasket	1998-95	35959	Water Outlet; Water pipe; O-ring	
1	O-Ring	1998-95	35555	Water Outlet	
QTY	WATER PUMP	YEARS	PART NO.	DESCRIPTION	
1	Water Pump Gasket	1998-95	35584		
QTY	TIMING COVER	YEARS	PART NO.	DESCRIPTION	
1	Crankshaft Front Seal Set	1998-95	TCS 45965		
2	Camshaft Front Seal Set	1998-95	TCS 45483		
QTY	CARB & FUEL INJECTION	YEARS	PART NO.	DESCRIPTION	
2	Fuel Injector O-Ring Set	1998-95	ES 70600		
1	Throttle Body Gasket	1998-95	60999		
QTY	EXHAUST GAS RECIRCULATION	YEARS	PART NO.	DESCRIPTION	
1	EGR Gasket	1998-95	70561	Valve	

21 (cont.)		1998 - 1995; 2.5L 152.2 (2497cc) SOHC V6 (24 Valve) 83.5mm Bore			21 (cont.)
		MFI; Gasoline; Naturally Aspirated Mitsubishi Eng.; Eng. Code 6G73			
QTY	EXHAUST GAS RECIRCULATION	YEARS	PART NO.	DESCRIPTION	
2	EGR Gasket	1998-95	70721	Tube flange	
22		1999 - 1991; 3.0L 181.1 (2972cc) DOHC V6 (24 Valve) 91.1mm Bore			22
		MFI; Gasoline; Naturally Aspirated Mitsubishi Eng.; Eng. Code 6G72			
QTY	CYLINDER HEAD	YEARS	PART NO.	DESCRIPTION	
2	Head Gasket	1999-91	26186 PT	Head bolts not incl.; Head bolt replacement recommended; PermaTorqueMLS® LaserWeld® Technology; Improved design	
2	Head Gasket	1993-91	9842 PT	Head bolts not incl.; Head bolt replacement recommended; Old design	
1	Head Set	1999-96	HS 26186 PT-1	Head bolts not incl.; Head bolt replacement recommended; PermaDry® molded rubber valve cover gskts. incl.; Premium valve stem seals incl.	
1	Head Set	1995	HS 26186 PT	To 10/03/94; Head bolts not incl.; Head bolt replacement recommended; PermaDry® molded rubber valve cover gskts. incl.; Premium valve stem seals incl.	
1	Head Set	1995	HS 26186 PT-1	From 10/04/94; Head bolts not incl.; Head bolt replacement recommended; PermaDry® molded rubber valve cover gskts. incl.; Premium valve stem seals incl.	
1	Head Set	1994	HS 26186 PT	Head bolts not incl.; Head bolt replacement recommended; PermaDry® molded rubber valve cover gskts. incl.; Premium valve stem seals incl.	
1	Head Set	1993-91	HS 9842 PT	Head bolts not incl.; Head bolt replacement recommended; PermaDry® molded rubber valve cover gskts. incl.; Premium valve stem seals incl.	
1	Head Bolt Set	1999-91	ES 72859	Head bolts w/Washers; Replacement recommended	
QTY	CONVERSION SET	YEARS	PART NO.	DESCRIPTION	
1	Gasket Conversion Set	1999-93	CS 26186	RTV sealant incl. for oil pan gskt.	
1	Gasket Conversion Set	1992-91	CS 9842		
QTY	MANIFOLD - INT. & EXH.	YEARS	PART NO.	DESCRIPTION	
1	Int. Manifold Gasket Set	1999-91	MS 94946	Lower set; Upper set incl.	
1	Plenum Gasket Set	1999-91	MS 95008	Upper set	
1	Exh. Manifold Gasket Set	1999-91	MS 95082		
QTY	EXHAUST PIPE FLANGE	YEARS	PART NO.	DESCRIPTION	
2	Exhaust Pipe Gasket	1999-91	60496-1	Pipe to manifold	
1	Exhaust Pipe Gasket	1999-91	60917	Pipe to muffler	
1	Exhaust Pipe Gasket	1999-94	60496-1	Loc. R.H.; Converter	
1	Exhaust Pipe Gasket	1999-94	61268	Loc. L.H.; Converter	
2	Exhaust Pipe Gasket	1993-91	60496-1	Converter	
QTY	OIL PAN	YEARS	PART NO.	DESCRIPTION	
1	Oil Pan Gasket Set	1992-91	OS 30570 C	Cork	
1	Oil Pan Gasket Set	1992-91	OS 30570 T	PermaDryPlus®; Oil Pan SnapUps® incl.	
QTY	CRANKSHAFT REAR SEAL	YEARS	PART NO.	DESCRIPTION	
1	Rear Main Seal Set	1999-93	BS 40660	Rubber; One-piece	
1	Rear Main Seal Set	1992-91	BS 40562	Rubber; One-piece	
1	Rear Main Seal Set	1992-91	BS 40627	PTFE Rubber; One-piece	
1	Repair Sleeve Tool	1999-91	16300	Crankshaft	
QTY	VALVE COVER	YEARS	PART NO.	DESCRIPTION	
1	Valve Cover Gasket Set	1999-91	VS 50390 R	w/Spark plug tube seals; PermaDry® molded rubber gskts. incl.	
4	Circular Plug	1999-91	CP 75023	Valve Cover	
1	Spark Plug Tube Seal Set	1999-91	ES 72812	Valve Cover	
QTY	VALVE STEM SEAL SET	YEARS	PART NO.	DESCRIPTION	
1	Valve Stem Seal Set	1999-96	SS 71179	Premium valve stem seals incl.	
1	Valve Stem Seal Set	1995	SS 71179	From 10/04/94; Premium valve stem seals incl.	
2	Valve Stem Seal Set	1995	SS 72805	To 10/03/94; Premium valve stem seals incl.	
2	Valve Stem Seal Set	1994-91	SS 72805	Premium valve stem seals incl.	
QTY	THERMOSTAT HOUSING	YEARS	PART NO.	DESCRIPTION	
2	Thermostat Gasket	1999-91	35313	Thermostat Housing; Thermostat case to head	
1	Thermostat Gasket	1991	35565	Thermostat Housing; To 09/30/90	
1	O-Ring	1999-92	35555	Thermostat Housing	
1	O-Ring	1991	35555	Thermostat Housing; From 10/01/90	
QTY	WATER OUTLET GASKET	YEARS	PART NO.	DESCRIPTION	
1	Water Outlet Gasket	1993-91	35336	Water Outlet	
1	Water Outlet Gasket	1993-91	35520	Water Outlet; Inlet	
2	Water Outlet Gasket	1993-91	35959	Water Outlet; Water pipe; O-ring	
QTY	WATER PUMP	YEARS	PART NO.	DESCRIPTION	
1	Water Pump Gasket	1999-91	35495		
QTY	TIMING COVER	YEARS	PART NO.	DESCRIPTION	
1	Crankshaft Front Seal Set	1999-91	TCS 45911		

Mitsubishi Car (Cont.)

22		1999 - 1991; 3.0L 181.1 (2972cc) DOHC V6 (24 Valve) 91.1mm Bore			22	
(cont.)		MFI; Gasoline; Naturally Aspirated Mitsubishi Eng.; Eng. Code 6G72			(cont.)	
QTY	TIMING COVER	YEARS	PART NO.	DESCRIPTION		
4	Camshaft Front Seal Set	1999-91	TCS 45901	Must be used w/VS 50390R		
QTY	CARB & FUEL INJECTION	YEARS	PART NO.	DESCRIPTION		
2	Fuel Injector O-Ring Set	1999-91	ES 70600			
1	Throttle Body Gasket	1999-91	60879			
QTY	EXHAUST GAS RECIRCULATION	YEARS	PART NO.	DESCRIPTION		
1	EGR Gasket	1999-91	70568			
23		1999 - 1991; 3.0L 181.1 (2972cc) DOHC V6 (24 Valve) 91.1mm Bore			23	
		MFI; Gasoline; Turbo - Intercooled Mitsubishi Eng.; Eng. Code 6G72-T				
QTY	CYLINDER HEAD	YEARS	PART NO.	DESCRIPTION		
2	Head Gasket	1999-91	26186 PT	Head bolts not incl.; Head bolt replacement recommended; PermaTorqueMLS® LaserWeld® Technology; Improved design		
1	Head Set	1999-96	HS 26186 PT-1	Turbo mounting gsks. & head bolts not incl.; Head bolt replacement recommended; PermaDry® molded rubber valve cover gsks. incl.; Premium valve stem seals incl.		
1	Head Set	1995	HS 26186 PT	To 10/03/94; Turbo mounting gsks. & head bolts not incl.; Head bolt replacement recommended; PermaDry® molded rubber valve cover gsks. incl.; Premium valve stem seals incl.		
1	Head Set	1995	HS 26186 PT-1	From 10/04/94; Turbo mounting gsks. & head bolts not incl.; Head bolt replacement recommended; PermaDry® molded rubber valve cover gsks. incl.; Premium valve stem seals incl.		
1	Head Set	1994-91	HS 26186 PT	Turbo mounting gsks. & head bolts not incl.; Head bolt replacement recommended; PermaDry® molded rubber valve cover gsks. incl.; Premium valve stem seals incl.		
1	Head Bolt Set	1999-91	ES 72859	Head bolts w/Washers; Replacement recommended		
QTY	CONVERSION SET	YEARS	PART NO.	DESCRIPTION		
1	Gasket Conversion Set	1999-93	CS 26186	RTV sealant incl. for oil pan gskt.		
1	Gasket Conversion Set	1992-91	CS 26186-1			
QTY	MANIFOLD - INT. & EXH.	YEARS	PART NO.	DESCRIPTION		
1	Int. Manifold Gasket Set	1999-91	MS 94946	Lower set; Upper set incl.		
1	Plenum Gasket Set	1999-91	MS 95008	Upper set		
1	Exh. Manifold Gasket Set	1999-91	MS 95082			
QTY	EXHAUST PIPE FLANGE	YEARS	PART NO.	DESCRIPTION		
2	Exhaust Pipe Gasket	1999-91	60496-1	Pipe to manifold		
1	Exhaust Pipe Gasket	1999-94	60496-1	Loc. R.H.; Converter		
1	Exhaust Pipe Gasket	1999-94	61268	Loc. L.H.; Converter		
2	Exhaust Pipe Gasket	1993-91	60496-1	Converter		
QTY	OIL PAN	YEARS	PART NO.	DESCRIPTION		
1	Oil Pan Gasket Set	1992-91	OS 30570 C	Cork		
1	Oil Pan Gasket Set	1992-91	OS 30570 T	PermaDryPlus®; Oil Pan SnapUps® incl.		
QTY	CRANKSHAFT REAR SEAL	YEARS	PART NO.	DESCRIPTION		
1	Rear Main Seal Set	1999-91	BS 40660	Rubber; One-piece		
QTY	VALVE COVER	YEARS	PART NO.	DESCRIPTION		
1	Valve Cover Gasket Set	1999-91	VS 50390 R	w/Spark plug tube seals; PermaDry® molded rubber gsks. incl.		
4	Circular Plug	1999-91	CP 75023	Valve Cover		
1	Spark Plug Tube Seal Set	1999-91	ES 72812	Valve Cover		
QTY	VALVE STEM SEAL SET	YEARS	PART NO.	DESCRIPTION		
1	Valve Stem Seal Set	1999-96	SS 71179	Premium valve stem seals incl.		
1	Valve Stem Seal Set	1995	SS 71179	From 10/04/94; Premium valve stem seals incl.		
2	Valve Stem Seal Set	1995	SS 72805	To 10/03/94; Premium valve stem seals incl.		
2	Valve Stem Seal Set	1994-91	SS 72805	Premium valve stem seals incl.		
QTY	THERMOSTAT HOUSING	YEARS	PART NO.	DESCRIPTION		
2	Thermostat Gasket	1999-91	35313	Thermostat Housing; Thermostat case to head		
1	Thermostat Gasket	1991	35565	Thermostat Housing; To 09/30/90		
1	O-Ring	1999-92	35555	Thermostat Housing		
1	O-Ring	1991	35555	Thermostat Housing; From 10/01/90		
QTY	WATER OUTLET GASKET	YEARS	PART NO.	DESCRIPTION		
1	Water Outlet Gasket	1993-91	35336	Water Outlet		
1	Water Outlet Gasket	1993-91	35520	Water Outlet; Inlet		
2	Water Outlet Gasket	1992-91	35959	Water Outlet; Water pipe; O-ring		
QTY	WATER PUMP	YEARS	PART NO.	DESCRIPTION		
1	Water Pump Gasket	1999-91	35495			
QTY	TIMING COVER	YEARS	PART NO.	DESCRIPTION		
1	Crankshaft Front Seal Set	1999-91	TCS 45911			

23		1999 - 1991; 3.0L 181.1 (2972cc) DOHC V6 (24 Valve) 91.1mm Bore			23	
(cont.)		MFI; Gasoline; Turbo - Intercooled Mitsubishi Eng.; Eng. Code 6G72-T			(cont.)	
QTY	TIMING COVER	YEARS	PART NO.	DESCRIPTION		
4	Camshaft Front Seal Set	1999-91	TCS 45901	Must be used w/VS 50390R		
QTY	CARB & FUEL INJECTION	YEARS	PART NO.	DESCRIPTION		
2	Fuel Injector O-Ring Set	1999-91	ES 70600			
1	Throttle Body Gasket	1999-91	60879			
QTY	EXHAUST GAS RECIRCULATION	YEARS	PART NO.	DESCRIPTION		
1	EGR Gasket	1999-91	70152			
QTY	TURBO MOUNTING SET	YEARS	PART NO.	DESCRIPTION		
1	Turbo Mtg. Gasket Set	1999-91	ES 72817			
24		1999 - 1991; 3.0L 181.1 (2972cc) SOHC V6 (12 Valve) 91.1mm Bore			24	
		MFI; Gasoline; Naturally Aspirated Mitsubishi Eng.; Eng. Code 6G72				
QTY	CYLINDER HEAD	YEARS	PART NO.	DESCRIPTION		
2	Head Gasket	1999-97	9112 PT	Head bolts not incl.; Head bolt replacement recommended		
2	Head Gasket	1996-95	26215 PT	Head bolts not incl.; Head bolt replacement recommended; PermaTorqueMLS®		
2	Head Gasket	1994	26215 PT	California; Head bolts not incl.; Head bolt replacement recommended; PermaTorqueMLS®		
2	Head Gasket	1994	9112 PT	Exc. California; Head bolts not incl.; Head bolt replacement recommended		
2	Head Gasket	1993-91	9112 PT	Head bolts not incl.; Head bolt replacement recommended		
1	Head Set	1999-97	HS 9112 PT-4	Head bolts & exh. pipe flange not incl.; Head bolt replacement recommended; PermaDry® molded rubber valve cover gskts. incl.; Premium valve stem seals incl.		
1	Head Set	1996-95	HS 26215 PT	Head bolts & exh. pipe flange not incl.; Head bolt replacement recommended; PermaDry® molded rubber valve cover gskts. incl.; Premium valve stem seals incl.		
1	Head Set	1994	HS 26215 PT	California; Head bolts & exh. pipe flange not incl.; Head bolt replacement recommended; PermaDry® molded rubber valve cover gskts. incl.; Premium valve stem seals incl.		
1	Head Set	1994	HS 9112 PT-5	Exc. California; Head bolts & exh. pipe flange not incl.; Head bolt replacement recommended; PermaDry® molded rubber valve cover gskts. incl.; Premium valve stem seals incl.		
1	Head Set	1993	HS 9112 PT-5	Head bolts & exh. pipe flange not incl.; Head bolt replacement recommended; PermaDry® molded rubber valve cover gskts. incl.; Premium valve stem seals incl.		
1	Head Set	1992	HS 9112 PT-2	Head bolts & exh. pipe flange not incl.; Head bolt replacement recommended; PermaDry® molded rubber valve cover gskts. incl.; Premium valve stem seals incl.		
1	Head Set	1991	HS 9112 PT-1	Head bolts not incl.; Head bolt replacement recommended; PermaDry® molded rubber valve cover gskts. incl.; Premium valve stem seals incl.		
1	Head Bolt Set	1999-91	ES 72859	Head bolts w/Washers; Replacement recommended		
QTY	CONVERSION SET	YEARS	PART NO.	DESCRIPTION		
1	Gasket Conversion Set	1999-97	CS 9112-2	RTV sealant incl. for oil pan gskt.		
1	Gasket Conversion Set	1996	CS 9112	Rear main brg. seal not incl.		
1	Gasket Conversion Set	1995-91	CS 9112			
QTY	MANIFOLD - INT. & EXH.	YEARS	PART NO.	DESCRIPTION		
1	Int. Manifold Gasket Set	1999-92	MS 93795-3	Upper set incl.		
1	Int. Manifold Gasket Set	1991	MS 94599	Upper set incl.		
1	Exh. Manifold Gasket Set	1999-97	MS 91815-1			
1	Exh. Manifold Gasket Set	1996-93	MS 91815			
1	Exh. Manifold Gasket Set	1992-91	MS 93797			
QTY	EXHAUST PIPE FLANGE	YEARS	PART NO.	DESCRIPTION		
2	Exhaust Pipe Gasket	1999-91	60496-1	Converter		
2	Exhaust Pipe Gasket	1999-91	60496-1	Flange		
1	Exh. Flange Bolt & Spring Kit	1999-91	ES 72143			
QTY	OIL PAN	YEARS	PART NO.	DESCRIPTION		
1	Oil Pan Gasket Set	1996-91	OS 30570 C	Cork		
1	Oil Pan Gasket Set	1996-91	OS 30570 T	PermaDryPlus®; Oil Pan SnapUps® incl.		
QTY	CRANKSHAFT REAR SEAL	YEARS	PART NO.	DESCRIPTION		
1	Rear Main Seal Set	1999-96	BS 40660	Rubber; One-piece		
1	Rear Main Seal Set	1995-91	BS 40562	Rubber; One-piece		
1	Rear Main Seal Set	1995-91	BS 40627	PTFE Rubber; One-piece		
1	Repair Sleeve Tool	1995-91	16300	Crankshaft		
QTY	VALVE COVER	YEARS	PART NO.	DESCRIPTION		
1	Valve Cover Gasket Set	1999-95	VS 50573 R	w/o Circular plugs & Grommets; PermaDry® molded rubber gskts. incl.		

Mitsubishi Car (Cont.)

24 (cont.)		1999 - 1991; 3.0L 181.1 (2972cc) SOHC V6 (12 Valve) 91.1mm Bore			24 (cont.)
		MFI; Gasoline; Naturally Aspirated Mitsubishi Eng.; Eng. Code 6G72			
QTY	VALVE COVER	YEARS	PART NO.	DESCRIPTION	
1	Valve Cover Gasket Set	1994	VS 50026 R-1	Exc. California; w/o Circular plugs & Grommets; PermaDry® molded rubber gskts. incl.	
1	Valve Cover Gasket Set	1994	VS 50173 R	Exc. California; w/Circular plugs & Grommets; PermaDry® molded rubber gskts. incl.	
1	Valve Cover Gasket Set	1994	VS 50573 R	California; w/o Circular plugs & Grommets; PermaDry® molded rubber gskts. incl.	
1	Valve Cover Gasket Set	1993-91	VS 50026 R-1	w/o Circular plugs & Grommets; PermaDry® molded rubber gskts. incl.	
1	Valve Cover Gasket Set	1993-91	VS 50173 R	w/Circular plugs & Grommets; PermaDry® molded rubber gskts. incl.	
2	Grommet Set	1999-91	ES 70342	Valve Cover	
2	Circular Plug	1999-91	CP 75018	Valve Cover	
QTY	VALVE STEM SEAL SET	YEARS	PART NO.	DESCRIPTION	
1	Valve Stem Seal Set	1999-91	SS 70710	Premium valve stem seals incl.; Improved design	
QTY	WATER OUTLET GASKET	YEARS	PART NO.	DESCRIPTION	
1	Water Outlet Gasket	1999-91	35336	Water Outlet	
QTY	WATER PUMP	YEARS	PART NO.	DESCRIPTION	
1	Water Pump Gasket	1999-91	35468	Inlet	
1	Water Pump Gasket	1999-91	35603	To cover	
1	Water Pump Gasket	1999-91	ES 72872	O-ring	
1	Water Pump Gasket	1999-97	35584	To block	
1	Water Pump Gasket	1996-91	35399	To block	
QTY	TIMING COVER	YEARS	PART NO.	DESCRIPTION	
1	Timing Cover Dust Seal Set	1999-91	TCS 45835		
1	Crankshaft Front Seal Set	1996-91	TCS 45750		
1	Camshaft Front Seal Set	1999-95	TCS 45704	Must be used w/VS 50573R	
2	Camshaft Front Seal Set	1994	TCS 45483	Exc. California; Must be used w/VS 50173R or w/VS 50026R-1	
1	Camshaft Front Seal Set	1994	TCS 45704	California; Must be used w/VS 50573R	
2	Camshaft Front Seal Set	1993-91	TCS 45483	Must be used w/VS 50173R or w/VS 50026R-1	
QTY	CARB & FUEL INJECTION	YEARS	PART NO.	DESCRIPTION	
2	Fuel Injector O-Ring Set	1999-91	ES 70600		
1	Throttle Body Gasket	1999-97	60889		
1	Throttle Body Gasket	1996-91	60879		
QTY	EXHAUST GAS RECIRCULATION	YEARS	PART NO.	DESCRIPTION	
1	EGR Gasket	1999-98	70152		
1	EGR Gasket	1997-92	70568		
1	EGR Gasket	1991	70152		
25		2005 - 1999; 3.0L 181.1 (2972cc) SOHC V6 (24 Valve) 91.1mm Bore			25
		MFI; Gasoline; Naturally Aspirated Mitsubishi Eng.; Eng. Code 6G72			
QTY	CYLINDER HEAD	YEARS	PART NO.	DESCRIPTION	
2	Head Gasket	2005-99	9537 PT	Head bolts not incl.; Head bolt replacement recommended; PermaTorqueMLS® LaserWeld® Technology	
1	Head Set	2005-99	HS 9537 PT	Head bolts not incl.; Head bolt replacement recommended; PermaDry® molded rubber valve cover gskts. incl.; Premium valve stem seals incl.	
1	Head Bolt Set	2005-99	ES 72859	Head bolts w/Washers; Replacement recommended	
QTY	CONVERSION SET	YEARS	PART NO.	DESCRIPTION	
1	Gasket Conversion Set	2005-99	CS 9537	RTV sealant incl. for Upper oil pan gskt.	
QTY	MANIFOLD - INT. & EXH.	YEARS	PART NO.	DESCRIPTION	
1	Int. Manifold Gasket Set	2005-99	MS 95709	Lower set; Upper set incl.	
1	Plenum Gasket Set	2005-99	MS 95708	Upper set	
1	Exh. Manifold Gasket Set	2005-99	MS 95711		
QTY	EXHAUST PIPE FLANGE	YEARS	PART NO.	DESCRIPTION	
1	Exhaust Pipe Gasket	2005-99	60917	Pipe to muffler	
2	Exhaust Pipe Gasket	2005-01	61234	Converter	
1	Exhaust Pipe Gasket	2005-01	61236	Loc. Rear; Pipe to manifold	
1	Exhaust Pipe Gasket	2005-03	60817	Loc. Front; Pipe to manifold	
1	Exhaust Pipe Gasket	2002-99	60496-1	Loc. Front; Pipe to manifold	
QTY	OIL PAN	YEARS	PART NO.	DESCRIPTION	
1	Oil Pan Gasket Set	2005-99	OS 30707	Loc. Lower	
QTY	CRANKSHAFT REAR SEAL	YEARS	PART NO.	DESCRIPTION	
1	Rear Main Seal Set	2005-99	BS 40660	Rubber; One-piece	
QTY	VALVE COVER	YEARS	PART NO.	DESCRIPTION	
1	Valve Cover Gasket Set	2005-99	VS 50461 R	w/Spark plug tube seals; PermaDry® molded rubber gskts. incl.	
1	Spark Plug Tube Seal Set	2005-99	ES 72120-1	Valve Cover	

25 (cont.)		2005 - 1999; 3.0L 181.1 (2972cc) SOHC V6 (24 Valve) 91.1mm Bore			25 (cont.)
		MFI; Gasoline; Naturally Aspirated Mitsubishi Eng.; Eng. Code 6G72			
QTY	VALVE STEM SEAL SET	YEARS	PART NO.	DESCRIPTION	
1	Valve Stem Seal Set	2005-99	SS 70795	Premium valve stem seals incl.	
QTY	THERMOSTAT HOUSING	YEARS	PART NO.	DESCRIPTION	
1	Water Outlet Gasket	2005-00	35520	Thermostat Housing; Adapter to head	
1	Water Outlet Gasket	1999	35336	Thermostat Housing; Adapter to head	
2	Thermostat Gasket	2005-99	35589	Thermostat Housing; Thermostat case to head	
2	Thermostat Gasket	2005-01	35667	Thermostat Housing; Outlet to head	
1	O-Ring	2005-99	35555	Thermostat Housing; Thermostat O-ring	
QTY	WATER OUTLET GASKET	YEARS	PART NO.	DESCRIPTION	
2	Water Outlet Gasket	2005-99	35959	Water Outlet; Water pipe; O-ring	
QTY	WATER PUMP	YEARS	PART NO.	DESCRIPTION	
1	Water Pump Gasket	2005-99	35584		
QTY	TIMING COVER	YEARS	PART NO.	DESCRIPTION	
1	Crankshaft Front Seal Set	2005-99	TCS 45965		
2	Camshaft Front Seal Set	2005-99	TCS 45483		
QTY	CARB & FUEL INJECTION	YEARS	PART NO.	DESCRIPTION	
2	Fuel Injector O-Ring Set	2005-99	ES 70600		
1	Throttle Body Gasket	2005-99	60879		
QTY	EXHAUST GAS RECIRCULATION	YEARS	PART NO.	DESCRIPTION	
1	EGR Gasket	2005-99	70152		
26		2005 - 1997; 3.5L 213.3 (3497cc) SOHC V6 (24 Valve) 93mm Bore			26
		MFI; Gasoline; Naturally Aspirated Mitsubishi Eng.; Eng. Code 6G74			
QTY	CYLINDER HEAD	YEARS	PART NO.	DESCRIPTION	
2	Head Gasket	2005-97	26193 PT	Head bolts not incl.; Head bolt replacement recommended; PermaTorqueMLS®	
1	Head Set	2005-97	HS 26193 PT-1	Head bolts not incl.; Head bolt replacement recommended; PermaDry® molded rubber valve cover gskts. incl.; Premium valve stem seals incl.	
1	Head Bolt Set	2005-97	ES 72859	Head bolts w/Washers; Replacement recommended	
QTY	CONVERSION SET	YEARS	PART NO.	DESCRIPTION	
1	Gasket Conversion Set	2005-97	CS 26193-2	RTV sealant incl. for oil pan gskt.	
QTY	MANIFOLD - INT. & EXH.	YEARS	PART NO.	DESCRIPTION	
1	Int. Manifold Gasket Set	2005-97	MS 95709	Lower set; Upper set incl.	
1	Plenum Gasket Set	2005-97	MS 95708	Upper set	
1	Exh. Manifold Gasket Set	2005-97	MS 95711		
QTY	EXHAUST PIPE FLANGE	YEARS	PART NO.	DESCRIPTION	
1	Exhaust Pipe Gasket	2005-97	60496-1	Converter	
1	Exhaust Pipe Gasket	2005-97	60917	Exh. connector	
1	Exhaust Pipe Gasket	2005-97	61250	Pipe to manifold	
QTY	OIL PAN	YEARS	PART NO.	DESCRIPTION	
1	Oil Pan Gasket Set	2005-97	OS 30745	RTV sealant incl. for oil pan gskt.	
QTY	CRANKSHAFT REAR SEAL	YEARS	PART NO.	DESCRIPTION	
1	Rear Main Seal Set	2005-97	BS 40660	Rubber; One-piece	
QTY	VALVE COVER	YEARS	PART NO.	DESCRIPTION	
1	Valve Cover Gasket Set	2005-97	VS 50461 R	w/Spark plug tube seals; PermaDry® molded rubber gskts. incl.	
1	Spark Plug Tube Seal Set	2005-97	ES 72120-1	Valve Cover	
QTY	VALVE STEM SEAL SET	YEARS	PART NO.	DESCRIPTION	
1	Valve Stem Seal Set	2005-97	SS 70795	Premium valve stem seals incl.	
QTY	THERMOSTAT HOUSING	YEARS	PART NO.	DESCRIPTION	
1	Water Outlet Gasket	2005-97	35520	Thermostat Housing; Adapter to head	
2	Thermostat Gasket	2005-97	35667	Thermostat Housing; Outlet to head	
QTY	WATER PUMP	YEARS	PART NO.	DESCRIPTION	
1	Water Pump Gasket	2005-97	35584		
QTY	TIMING COVER	YEARS	PART NO.	DESCRIPTION	
1	Crankshaft Front Seal Set	2005-97	TCS 45911		
1	Camshaft Front Seal Set	2005-97	TCS 45704		
QTY	CARB & FUEL INJECTION	YEARS	PART NO.	DESCRIPTION	
2	Fuel Injector O-Ring Set	2005-97	ES 70600		
1	Throttle Body Gasket	2005-97	61254		
QTY	EXHAUST GAS RECIRCULATION	YEARS	PART NO.	DESCRIPTION	
1	EGR Gasket	2005-97	70152		

Mitsubishi Car (Cont.)

27		2012 - 2004; 3.8L 234 (3828cc) SOHC V6 (24 Valve) 95mm Bore			27
MFI; Gasoline; Naturally Aspirated Mitsubishi Eng.; Eng. Code 6G75					
QTY	CYLINDER HEAD	YEARS	PART NO.	DESCRIPTION	
2	Head Gasket	2011-04	26313 PT	Head bolts not incl.; Head bolt replacement recommended; PermaTorqueMLS®	
1	Head Set	2011-10	HS 26313 PT-1	Head bolts not incl.; Head bolt replacement recommended; PermaDry® molded rubber valve cover gskts. incl.; Premium valve stem seals incl.	
1	Head Set	2009	HS 26313 PT-1	Mitsubishi Eclipse GT, Spyder GT; Head bolts not incl.; Head bolt replacement recommended; PermaDry® molded rubber valve cover gskts. incl.; Premium valve stem seals incl.	
1	Head Set	2009	HS 26313 PT-3	Mitsubishi Galant Ralliart, Sport V6; Head bolts not incl.; Head bolt replacement recommended; PermaDry® molded rubber valve cover gskts. incl.; Premium valve stem seals incl.	
1	Head Set	2008	HS 26313 PT	Mitsubishi Galant Ralliart; Head bolts not incl.; Head bolt replacement recommended; PermaDry® molded rubber valve cover gskts. incl.; Premium valve stem seals incl.	
1	Head Set	2008	HS 26313 PT-1	Exc. Mitsubishi Galant Ralliart; Head bolts not incl.; Head bolt replacement recommended; PermaDry® molded rubber valve cover gskts. incl.; Premium valve stem seals incl.	
1	Head Set	2007	HS 26313 PT	Mitsubishi Galant GTS, Ralliart; Head bolts not incl.; Head bolt replacement recommended; PermaDry® molded rubber valve cover gskts. incl.; Premium valve stem seals incl.	
1	Head Set	2007	HS 26313 PT-1	Mitsubishi Eclipse GT, Spyder GT; Head bolts not incl.; Head bolt replacement recommended; PermaDry® molded rubber valve cover gskts. incl.; Premium valve stem seals incl.	
1	Head Set	2006	HS 26313 PT	Mitsubishi Galant GTS, LS; Head bolts not incl.; Head bolt replacement recommended; PermaDry® molded rubber valve cover gskts. incl.; Premium valve stem seals incl.	
1	Head Set	2006	HS 26313 PT-1	Mitsubishi Eclipse GT; Head bolts not incl.; Head bolt replacement recommended; PermaDry® molded rubber valve cover gskts. incl.; Premium valve stem seals incl.	
1	Head Set	2005-04	HS 26313 PT	Head bolts not incl.; Head bolt replacement recommended; PermaDry® molded rubber valve cover gskts. incl.; Premium valve stem seals incl.	
1	Head Bolt Set	2012-04	ES 72859	Head bolts w/Washers; Replacement recommended	
QTY	CONVERSION SET	YEARS	PART NO.	DESCRIPTION	
1	Gasket Conversion Set	2011-04	CS 26313	RTV sealant incl. for oil pan gskt.	
QTY	MANIFOLD - INT. & EXH.	YEARS	PART NO.	DESCRIPTION	
1	Int. Manifold Gasket Set	2011-09	MS 96900	Lower set; Upper set incl.	
1	Int. Manifold Gasket Set	2008	MS 95709-1	Mitsubishi Galant Ralliart; Lower set; Upper set incl.	
1	Int. Manifold Gasket Set	2008	MS 96900	Exc. Mitsubishi Galant Ralliart; Lower set; Upper set incl.	
1	Int. Manifold Gasket Set	2007	MS 95709-1	Mitsubishi Galant GTS, Ralliart; Lower set; Upper set incl.	
1	Int. Manifold Gasket Set	2007	MS 96900	Mitsubishi Eclipse GT, Spyder GT; Lower set; Upper set incl.	
1	Int. Manifold Gasket Set	2006	MS 95709-1	Mitsubishi Galant GTS, LS; Lower set; Upper set incl.	
1	Int. Manifold Gasket Set	2006	MS 96900	Mitsubishi Eclipse GT; Lower set; Upper set incl.	
1	Int. Manifold Gasket Set	2005-04	MS 95709-1	Lower set; Upper set incl.	
1	Plenum Gasket Set	2011-09	MS 96898	Upper set; New Part Number - Check for Availability	
1	Plenum Gasket Set	2008	MS 96272	Mitsubishi Galant Ralliart; Upper set; New Part Number - Check for Availability	
1	Plenum Gasket Set	2008	MS 96898	Exc. Mitsubishi Galant Ralliart; Upper set; New Part Number - Check for Availability	
1	Plenum Gasket Set	2007	MS 96272	Mitsubishi Galant GTS, Ralliart; Upper set; New Part Number - Check for Availability	
1	Plenum Gasket Set	2007	MS 96898	Mitsubishi Eclipse GT, Spyder GT; Upper set; New Part Number - Check for Availability	
1	Plenum Gasket Set	2006	MS 96272	Mitsubishi Galant GTS, LS; Upper set; New Part Number - Check for Availability	
1	Plenum Gasket Set	2006	MS 96898	Mitsubishi Eclipse GT; Upper set; New Part Number - Check for Availability	
1	Plenum Gasket Set	2005-04	MS 96272	Upper set; New Part Number - Check for Availability	
1	Exh. Manifold Gasket Set	2011-04	MS 96781-1		
QTY	EXHAUST PIPE FLANGE	YEARS	PART NO.	DESCRIPTION	
1	Exhaust Pipe Gasket	2011-04	61461	Converter	
2	Exhaust Pipe Gasket	2011-10	61106	Flange; 2.40" ID	
1	Exhaust Pipe Gasket	2011-10	61451	Exh. connector	
1	Exhaust Pipe Gasket	2009	61451	Mitsubishi Eclipse GT, Spyder GT; Exh. connector	
1	Exhaust Pipe Gasket	2009	61016	Mitsubishi Galant Ralliart, Sport V6; Exh. connector; Improved design	
1	Exhaust Pipe Gasket	2009	61106	Mitsubishi Galant Ralliart, Sport V6; Exh. connector; 2.40" ID	
2	Exhaust Pipe Gasket	2009	61106	Mitsubishi Eclipse GT, Spyder GT; Flange; 2.40" ID	
2	Exhaust Pipe Gasket	2009	61378	Mitsubishi Galant Ralliart, Sport V6; Flange	

27 (cont.)		2012 - 2004; 3.8L 234 (3828cc) SOHC V6 (24 Valve) 95mm Bore MFI; Gasoline; Naturally Aspirated Mitsubishi Eng.; Eng. Code 6G75			27 (cont.)
QTY	EXHAUST PIPE FLANGE	YEARS	PART NO.	DESCRIPTION	
1	Exhaust Pipe Gasket	2008	61016	Mitsubishi Galant Ralliart; Exh. connector; Improved design	
1	Exhaust Pipe Gasket	2008	61106	Mitsubishi Galant Ralliart; Exh. connector; 2.40" ID	
2	Exhaust Pipe Gasket	2008	61106	Exc. Mitsubishi Galant Ralliart; Flange; 2.40" ID	
2	Exhaust Pipe Gasket	2008	61378	Mitsubishi Galant Ralliart; Flange	
1	Exhaust Pipe Gasket	2008	61451	Exc. Mitsubishi Galant Ralliart; Exh. connector	
1	Exhaust Pipe Gasket	2007	61016	Mitsubishi Galant GTS, Ralliart; Exh. connector; Improved design	
1	Exhaust Pipe Gasket	2007	61106	Mitsubishi Galant GTS, Ralliart; Exh. connector; 2.40" ID	
2	Exhaust Pipe Gasket	2007	61106	Mitsubishi Eclipse GT, Spyder GT; Flange; 2.40" ID	
2	Exhaust Pipe Gasket	2007	61378	Mitsubishi Galant GTS, Ralliart; Flange	
1	Exhaust Pipe Gasket	2007	61451	Mitsubishi Eclipse GT, Spyder GT; Exh. connector	
1	Exhaust Pipe Gasket	2006	61016	Mitsubishi Galant GTS, LS; Exh. connector; Improved design	
1	Exhaust Pipe Gasket	2006	61106	Mitsubishi Galant GTS, LS; Exh. connector; 2.40" ID	
2	Exhaust Pipe Gasket	2006	61106	Mitsubishi Eclipse GT; Flange; 2.40" ID	
2	Exhaust Pipe Gasket	2006	61378	Mitsubishi Galant GTS, LS; Flange	
1	Exhaust Pipe Gasket	2006	61451	Mitsubishi Eclipse GT; Exh. connector	
1	Exhaust Pipe Gasket	2005-04	61016	Exh. connector; Improved design	
1	Exhaust Pipe Gasket	2005-04	61106	Exh. connector; 2.40" ID	
2	Exhaust Pipe Gasket	2005-04	61378	Flange	
QTY	OIL PAN	YEARS	PART NO.	DESCRIPTION	
1	Oil Pan Gasket Set	2011-04	OS 30764	RTV sealant incl. for oil pan gskt.	
QTY	CRANKSHAFT REAR SEAL	YEARS	PART NO.	DESCRIPTION	
1	Rear Main Seal Set	2011-04	BS 40660	Rubber; One-piece	
QTY	VALVE COVER	YEARS	PART NO.	DESCRIPTION	
1	Valve Cover Gasket Set	2011-10	VS 50716 R	w/Spark plug tube seals; PermaDry® molded rubber gskts. incl.	
1	Valve Cover Gasket Set	2009	VS 50461 R	Mitsubishi Galant Ralliart, Sport V6; w/Spark plug tube seals; PermaDry® molded rubber gskts. incl.	
1	Valve Cover Gasket Set	2009	VS 50716 R	Mitsubishi Eclipse GT, Spyder GT; w/Spark plug tube seals; PermaDry® molded rubber gskts. incl.	
1	Valve Cover Gasket Set	2008	VS 50461 R	Mitsubishi Galant Ralliart; w/Spark plug tube seals; PermaDry® molded rubber gskts. incl.	
1	Valve Cover Gasket Set	2008	VS 50716 R	Exc. Mitsubishi Galant Ralliart; w/Spark plug tube seals; PermaDry® molded rubber gskts. incl.	
1	Valve Cover Gasket Set	2007	VS 50461 R	Mitsubishi Galant GTS, Ralliart; w/Spark plug tube seals; PermaDry® molded rubber gskts. incl.	
1	Valve Cover Gasket Set	2007	VS 50716 R	Mitsubishi Eclipse GT, Spyder GT; w/Spark plug tube seals; PermaDry® molded rubber gskts. incl.	
1	Valve Cover Gasket Set	2006	VS 50461 R	Mitsubishi Galant GTS, LS; w/Spark plug tube seals; PermaDry® molded rubber gskts. incl.	
1	Valve Cover Gasket Set	2006	VS 50716 R	Mitsubishi Eclipse GT; w/Spark plug tube seals; PermaDry® molded rubber gskts. incl.	
1	Valve Cover Gasket Set	2005-04	VS 50461 R	w/Spark plug tube seals; PermaDry® molded rubber gskts. incl.	
1	Spark Plug Tube Seal Set	2011-04	ES 72120-1	Valve Cover	
QTY	VALVE STEM SEAL SET	YEARS	PART NO.	DESCRIPTION	
1	Valve Stem Seal Set	2011-04	SS 70795	Premium valve stem seals incl.	
QTY	THERMOSTAT HOUSING	YEARS	PART NO.	DESCRIPTION	
2	Thermostat Gasket	2011-04	35667	Outlet to head	
QTY	WATER OUTLET GASKET	YEARS	PART NO.	DESCRIPTION	
2	Water Outlet Gasket	2011-04	35959	Water Outlet; Water pipe; O-ring	
QTY	WATER PUMP	YEARS	PART NO.	DESCRIPTION	
1	Water Pump Gasket	2011-04	35584		
QTY	TIMING COVER	YEARS	PART NO.	DESCRIPTION	
1	Crankshaft Front Seal Set	2011-04	TCS 46074	Old design	
1	Crankshaft Front Seal Set	2011-04	TCS 46085	Improved design	
1	Camshaft Front Seal Set	2011-04	TCS 45704		
QTY	CARB & FUEL INJECTION	YEARS	PART NO.	DESCRIPTION	
2	Fuel Injector O-Ring Set	2011-04	ES 70600		
1	Throttle Body Gasket	2011-10	61490		
1	Throttle Body Gasket	2009	61432	Mitsubishi Galant Ralliart, Sport V6	
1	Throttle Body Gasket	2009	61490	Mitsubishi Eclipse GT, Spyder GT	
1	Throttle Body Gasket	2008	61432	Mitsubishi Galant Ralliart	
1	Throttle Body Gasket	2008	61490	Exc. Mitsubishi Galant Ralliart	
1	Throttle Body Gasket	2007	61432	Mitsubishi Galant GTS, Ralliart	
1	Throttle Body Gasket	2007	61490	Mitsubishi Eclipse GT, Spyder GT	
1	Throttle Body Gasket	2006	61432	Mitsubishi Galant GTS, LS	

Mitsubishi Car (Cont.)

27 (cont.)		2012 - 2004; 3.8L 234 (3828cc) SOHC V6 (24 Valve) 95mm Bore			27 (cont.)	
MFI; Gasoline; Naturally Aspirated Mitsubishi Eng.; Eng. Code 6G75						
QTY	CARB & FUEL INJECTION	YEARS	PART NO.	DESCRIPTION		
1	Throttle Body Gasket	2006	61490	Mitsubishi Eclipse GT		
1	Throttle Body Gasket	2005-04	61432			
QTY	EXHAUST GAS RECIRCULATION	YEARS	PART NO.	DESCRIPTION		
1	EGR Gasket	2011-09	71210			
1	EGR Gasket	2008	71210	Exc. Mitsubishi Galant Ralliart		
1	EGR Gasket	2008	71242	Mitsubishi Galant Ralliart		
1	EGR Gasket	2007	71210	Mitsubishi Eclipse GT, Spyder GT		
1	EGR Gasket	2007	71242	Mitsubishi Galant GTS, Ralliart		
1	EGR Gasket	2006	71210	Mitsubishi Eclipse GT		
1	EGR Gasket	2006	71242	Mitsubishi Galant GTS, LS		
1	EGR Gasket	2005-04	71242			

Mitsubishi Minivans - See Mitsubishi Truck

Mitsubishi SUV's - See Mitsubishi Truck

Mitsubishi Truck (Incl. Minivans and SUV's)

Engine Finding Index			
Engine	Years	Code	Line No.
2.0L 122 (1998cc) DOHC L4 (16 Valve) 86mm Bore MIVEC; MFI; Gasoline; Naturally Aspirated Mitsubishi Eng.	2013-11	4B11	1
2.4L 143.4 (2351cc) SOHC L4 (16 Valve) 86.5mm Bore; MFI; Gasoline; Naturally Aspirated Mitsubishi Eng.	2003-97	4G64	2
2.4L 143.4 (2351cc) SOHC L4 (8 Valve) 86.5mm Bore; MFI; Gasoline; Naturally Aspirated Mitsubishi Eng.	1996-91	4G64	3
2.4L 144 (2359cc) DOHC L4 (16 Valve) 88mm Bore MIVEC; MFI; Gasoline; Naturally Aspirated Mitsubishi Eng.	2013-08	4B12	4
2.4L 145.1 (2378cc) SOHC L4 (16 Valve) 87mm Bore; MFI; Gasoline; Naturally Aspirated Mitsubishi Eng.	2006-04	4G69	5
3.0L 181.1 (2972cc) SOHC V6 (12 Valve) 91.1mm Bore; MFI; Gasoline; Naturally Aspirated Mitsubishi Eng.	1995-91	6G72	6
3.0L 181.1 (2972cc) SOHC V6 (24 Valve) 91.1mm Bore; MFI; Gasoline; Naturally Aspirated Mitsubishi Eng.	2003-95	6G72	7
3.0L 182.9 (2998cc) SOHC V6 (24 Valve) 87.6mm Bore MIVEC; MFI; Gasoline; Naturally Aspirated Mitsubishi Eng.	2009-07	6B31	8
3.5L 213.3 (3497cc) DOHC V6 (24 Valve) 93mm Bore; MFI; Gasoline; Naturally Aspirated Mitsubishi Eng.	1996-94	6G74	9
3.5L 213.3 (3497cc) SOHC V6 (24 Valve) 93mm Bore; MFI; Gasoline; Naturally Aspirated Mitsubishi Eng.	2004-97	6G74	10
3.7L 226 (3704cc) SOHC V6 (12 Valve) 93mm Bore; MFI; Gasoline; Naturally Aspirated Chrysler Eng.	2010-06	K	11
3.8L 234 (3828cc) SOHC V6 (24 Valve) 95mm Bore; MFI; Gasoline; Naturally Aspirated Mitsubishi Eng.	2011-03	6G75	12
4.7L 287 (4703cc) SOHC V8 (16 Valve) 93mm Bore; MFI; Gasoline; Naturally Aspirated Chrysler Eng.	2010-06	N	13
4.7L 287 (4703cc) SOHC V8 (16 Valve) 93mm Bore; MFI; Flex Fuel; Naturally Aspirated Chrysler Eng.	2010-07	P	14

Engine Code Index			
Code	Engine	Line No.	
4B11	2.0L 122 (1998cc) DOHC L4 (16 Valve) 86mm Bore MIVEC; MFI; Gasoline; Naturally Aspirated Mitsubishi Eng.	1	
4B12	2.4L 144 (2359cc) DOHC L4 (16 Valve) 88mm Bore MIVEC; MFI; Gasoline; Naturally Aspirated Mitsubishi Eng.	4	
4G64	2.4L 143.4 (2351cc) SOHC L4 (16 Valve) 86.5mm Bore; MFI; Gasoline; Naturally Aspirated Mitsubishi Eng.	2	
4G64	2.4L 143.4 (2351cc) SOHC L4 (8 Valve) 86.5mm Bore; MFI; Gasoline; Naturally Aspirated Mitsubishi Eng.	3	
4G69	2.4L 145.1 (2378cc) SOHC L4 (16 Valve) 87mm Bore; MFI; Gasoline; Naturally Aspirated Mitsubishi Eng.	5	
6B31	3.0L 182.9 (2998cc) SOHC V6 (24 Valve) 87.6mm Bore MIVEC; MFI; Gasoline; Naturally Aspirated Mitsubishi Eng.	8	
6G72	3.0L 181.1 (2972cc) SOHC V6 (12 Valve) 91.1mm Bore; MFI; Gasoline; Naturally Aspirated Mitsubishi Eng.	6	
6G72	3.0L 181.1 (2972cc) SOHC V6 (24 Valve) 91.1mm Bore; MFI; Gasoline; Naturally Aspirated Mitsubishi Eng.	7	
6G74	3.5L 213.3 (3497cc) DOHC V6 (24 Valve) 93mm Bore; MFI; Gasoline; Naturally Aspirated Mitsubishi Eng.	9	
6G74	3.5L 213.3 (3497cc) SOHC V6 (24 Valve) 93mm Bore; MFI; Gasoline; Naturally Aspirated Mitsubishi Eng.	10	
6G75	3.8L 234 (3828cc) SOHC V6 (24 Valve) 95mm Bore; MFI; Gasoline; Naturally Aspirated Mitsubishi Eng.	12	

Model Index					
Engine (VIN Code / Eng. Code)	Year	Engine (VIN Code / Eng. Code)	Year	Engine (VIN Code / Eng. Code)	Year
Mitsubishi Truck		Mitsubishi Truck (cont.)		Mitsubishi Truck (cont.)	
Endeavor (AWD Mid-Size SUV)		FG439 (Forward Control Chassis) (cont.)		Mighty Max (4WD Mini-Pickup) (cont.)	
V6 3828cc 3.8L SOHC (24 Valve) (6G75)	11-04	L4 3907cc 3.9L OHV Turbo-Diesel (4D34-T3)	95-92	L4 2555cc 2.6L SOHC (8 Valve) (G54B)	89-83
Endeavor (FWD Mid-Size SUV)		FG639 (Forward Control Chassis)		V6 2972cc 3.0L SOHC (12 Valve) (6G72) 95-90	
V6 3828cc 3.8L SOHC (24 Valve) (6G75)	11-04	L4 3907cc 3.9L OHV Turbo-Diesel (4D34-T)	99-96	Montero (4WD Full-Size SUV)	
FE439 (Forward Control Chassis)		L4 3907cc 3.9L OHV Turbo-Diesel (4D34-T3) 99-96		L4 2555cc 2.6L SOHC (8 Valve) (G54B) 89-83	
L4 3907cc 3.9L OHV Turbo-Diesel (4D34-T)	95-92	Mighty Max (2WD Mini-Pickup)		V6 2972cc 3.0L SOHC (12 Valve) (6G72) 94-89	
L4 3907cc 3.9L OHV Turbo-Diesel (4D34-T3)	95-92	L4 1997cc 2.0L SOHC (8 Valve) (G63B)	89-83	V6 2972cc 3.0L SOHC (24 Valve) (6G72) 96-95	
FE449 (Forward Control Chassis)		L4 2346cc 2.3L SOHC Turbo-Diesel (4D55-T)	85-83	V6 3497cc 3.5L DOHC (24 Valve) (6G74) 96-94	
L4 3907cc 3.9L OHV Turbo-Diesel (4D34-T)	95-92	L4 2351cc 2.4L SOHC (8 Valve) (4G64)	96-90	V6 3497cc 3.5L SOHC (24 Valve) (6G74) 02-97	
L4 3907cc 3.9L OHV Turbo-Diesel (4D34-T3)	95-92	L4 2555cc 2.6L SOHC (8 Valve) (G54B)	89-83	V6 3828cc 3.8L SOHC (24 Valve) (6G75) 06-03	
FE639 (Forward Control Chassis)		V6 2972cc 3.0L SOHC (12 Valve) (6G72) 95-90		Montero Sport (2WD Mid-Size SUV)	
L4 3907cc 3.9L OHV Turbo-Diesel (4D34-T)	99-96	Mighty Max (4WD Mini-Pickup)		L4 2351cc 2.4L SOHC (16 Valve) (4G64) 99-97	
L4 3907cc 3.9L OHV Turbo-Diesel (4D34-T3)	99-96	L4 1997cc 2.0L SOHC (8 Valve) (G63B)	89-83	V6 2972cc 3.0L SOHC (24 Valve) (6G72) 03-97	
FG439 (Forward Control Chassis)		L4 2346cc 2.3L SOHC Turbo-Diesel (4D55-T)	85-83	V6 3497cc 3.5L SOHC (24 Valve) (6G74) 04-99	
L4 3907cc 3.9L OHV Turbo-Diesel (4D34-T)	95-92	L4 2351cc 2.4L SOHC (8 Valve) (4G64)	93-90		

Mitsubishi Truck (Incl. Minivans and SUV's) (Cont.)

Model Index (Cont.)					
Engine (VIN Code / Eng. Code)	Year	Engine (VIN Code / Eng. Code)	Year	Engine (VIN Code / Eng. Code)	Year
Mitsubishi Truck (cont.)		Mitsubishi Truck (cont.)		Mitsubishi Truck (cont.)	
Montero Sport (4WD Mid-Size SUV)		Outlander (FWD Compact SUV) (cont.)		Space Wagon (2WD Minivan)	
V6 2972cc 3.0L SOHC (24 Valve) (6G72)	03-97	L4 2359cc 2.4L DOHC (16 Valve) (4B12)	13-08	L4 2351cc 2.4L SOHC (8 Valve) (4G64)	91-89
V6 3497cc 3.5L SOHC (24 Valve) (6G74)	04-99	L4 2378cc 2.4L SOHC (16 Valve) (4G69)	06-04	Van (2WD Minivan)	
Nativa (2WD Compact SUV)		V6 2998cc 3.0L SOHC (24 Valve) (6B31)	13-07	L4 2351cc 2.4L SOHC (8 Valve) (G64B)	90-87
L4 2351cc 2.4L SOHC (16 Valve) (4G64)	03-97	Outlander Sport (AWD Compact SUV)		Wagon (2WD Minivan)	
V6 2972cc 3.0L SOHC (24 Valve) (6G72)	03-97	L4 1998cc 2.0L DOHC (16 Valve) (4B11)	13-11	L4 2351cc 2.4L SOHC (8 Valve) (G64B)	90-87
Nativa (4WD Compact SUV)		Outlander Sport (FWD Compact SUV)			
V6 2972cc 3.0L SOHC (24 Valve) (6G72)	03-97	L4 1998cc 2.0L DOHC (16 Valve) (4B11)	13-11		
Outlander (AWD Compact SUV)		Raider (2WD Mid-Size Pickup)			
L4 2351cc 2.4L SOHC (16 Valve) (4G64)	03	V6 3704cc 3.7L SOHC (12 Valve) (K)	10-06		
L4 2359cc 2.4L DOHC (16 Valve) (4B12)	13-08	V8 4703cc 4.7L SOHC (16 Valve) (N)	08-06		
L4 2378cc 2.4L SOHC (16 Valve) (4G69)	06-04	Raider (4WD Mid-Size Pickup)			
V6 2998cc 3.0L SOHC (24 Valve) (6B31)	13-07	V6 3704cc 3.7L SOHC (12 Valve) (K)	10-06		
Outlander (FWD Compact SUV)		V8 4703cc 4.7L SOHC (16 Valve) (N)	08-06		
L4 2351cc 2.4L SOHC (16 Valve) (4G64)	03				

1					1
2013 - 2011; 2.0L 122 (1998cc) DOHC L4 (16 Valve) 86mm Bore MIVEC					
MFI; Gasoline; Naturally Aspirated Mitsubishi Eng.; Eng. Code 4B11					
QTY	CYLINDER HEAD	YEARS	PART NO.	DESCRIPTION	
1	Head Gasket	2013-11	26557 PT	Head bolts not incl.; Head bolt replacement recommended; PermaTorqueMLS®; Improved design; New Part Number - Check for Availability	
1	Head Gasket	2012-11	26449 PT	Head bolts not incl.; Head bolt replacement recommended; PermaTorqueMLS®; Old design	
1	Head Set	2012-11	HS 26449 PT	Mitsubishi RVR Base, ES, SE; Head bolts not incl.; Head bolt replacement recommended; PermaDry® molded rubber valve cover gskt. incl.; Premium valve stem seals incl.; New Part Number - Check for Availability	
1	Head Set	2012-11	HS 26449 PT-1	Exc. Mitsubishi RVR Base, ES, SE; Head bolts not incl.; Head bolt replacement recommended; PermaDry® molded rubber valve cover gskt. incl.; Premium valve stem seals incl.; New Part Number - Check for Availability	
1	Head Bolt Set	2012-11	ES 72472	Replacement recommended; New Part Number - Check for Availability	
QTY	CONVERSION SET	YEARS	PART NO.	DESCRIPTION	
1	Gasket Conversion Set	2012-11	CS 26449	New Part Number - Check for Availability	
QTY	MANIFOLD - INT. & EXH.	YEARS	PART NO.	DESCRIPTION	
1	Int. Manifold Gasket Set	2012-11	MS 97114	Improved design	
1	Exh. Manifold Gasket Set	2012-11	MS 96902	Mitsubishi RVR Base, ES, SE	
1	Exh. Manifold Gasket Set	2012-11	MS 97209	Exc. Mitsubishi RVR Base, ES, SE; New Part Number - Check for Availability	
QTY	EXHAUST PIPE FLANGE	YEARS	PART NO.	DESCRIPTION	
1	Exhaust Pipe Gasket	2012-11	61016	Loc. Rear; Converter; Improved design	
1	Exhaust Pipe Gasket	2012-11	61106	Pipe to manifold; 2.40" ID	
1	Exhaust Pipe Gasket	2012-11	61250	Loc. Front; Converter	
1	Exhaust Pipe Gasket	2012-11	61334	Flange	
QTY	OIL PAN	YEARS	PART NO.	DESCRIPTION	
1	Oil Pan Gasket Set	2012-11	OS 30824		
QTY	CRANKSHAFT REAR SEAL	YEARS	PART NO.	DESCRIPTION	
1	Rear Main Seal Set	2012-11	BS 40728	Rubber; One-piece; New Part Number - Check for Availability	
QTY	VALVE COVER	YEARS	PART NO.	DESCRIPTION	
1	Valve Cover Gasket Set	2012-11	VS 50765 R	w/Spark plug tube seals; PermaDry® molded rubber gskt. incl.	
QTY	VALVE STEM SEAL SET	YEARS	PART NO.	DESCRIPTION	
1	Valve Stem Seal Set	2012-11	SS 71314	Premium valve stem seals incl.; New Part Number - Check for Availability	
QTY	THERMOSTAT HOUSING	YEARS	PART NO.	DESCRIPTION	
1	Thermostat Gasket	2012-11	35865	Thermostat Housing; Thermostat case to block	
QTY	WATER PUMP	YEARS	PART NO.	DESCRIPTION	
1	Water Pump Gasket	2012-11	35813	To block; Improved design	
1	Water Pump Gasket	2012-11	35822	To block; Old design	
1	Water Pump Gasket	2012-11	35877	Thermostat Housing; Thermostat case to outlet	
1	Water Pump Gasket	2012-11	35877	To coolant pipe	
QTY	TIMING COVER	YEARS	PART NO.	DESCRIPTION	
1	Crankshaft Front Seal Set	2012-11	TCS 46087		
QTY	CARB & FUEL INJECTION	YEARS	PART NO.	DESCRIPTION	
1	Fuel Injector O-Ring Set	2012-11	ES 70599	Improved design	
1	Throttle Body Gasket	2012-11	61688	Exc. Mitsubishi RVR Base, ES, SE; New Part Number - Check for Availability	

Mitsubishi Truck (Incl. Minivans and SUV's) (Cont.)

1		2013 - 2011; 2.0L 122 (1998cc) DOHC L4 (16 Valve) 86mm Bore MIVEC			1	
(cont.)		MFI; Gasoline; Naturally Aspirated Mitsubishi Eng.; Eng. Code 4B11			(cont.)	
QTY	CARB & FUEL INJECTION	YEARS	PART NO.	DESCRIPTION		
1	Throttle Body Gasket	2012	61607	Mitsubishi RVR Base, ES, SE		
1	Throttle Body Gasket	2011	61607			
QTY	EXHAUST GAS RECIRCULATION	YEARS	PART NO.	DESCRIPTION		
1	EGR Gasket	2012-11	71210			
2		2003 - 1997; 2.4L 143.4 (2351cc) SOHC L4 (16 Valve) 86.5mm Bore			2	
		MFI; Gasoline; Naturally Aspirated Mitsubishi Eng.; Eng. Code 4G64				
QTY	CYLINDER HEAD	YEARS	PART NO.	DESCRIPTION		
1	Head Gasket	2003-00	26172 PT	Head bolts not incl.; Head bolt replacement recommended; PermaTorqueMLS® LaserWeld® Technology		
1	Head Gasket	1999-97	26312 PT	Head bolts not incl.; Head bolt replacement recommended		
1	Head Set	2003-00	HS 26172 PT	Head bolts not incl.; Head bolt replacement recommended; PermaDry® molded rubber valve cover gskt. incl.; Premium valve stem seals incl.		
1	Head Set	1999-97	HS 26312 PT	Head bolts not incl.; Head bolt replacement recommended; PermaDry® molded rubber valve cover gskt. incl.; Premium valve stem seals incl.		
1	Head Bolt Set	2003-00	ES 71177	Head bolts w/Washers; Replacement recommended		
QTY	CONVERSION SET	YEARS	PART NO.	DESCRIPTION		
1	Gasket Conversion Set	2003-00	CS 26172			
1	Gasket Conversion Set	1999-97	CS 9086-1			
QTY	MANIFOLD - INT. & EXH.	YEARS	PART NO.	DESCRIPTION		
1	Int. Manifold Gasket Set	2003-00	MS 96075			
1	Int. Manifold Gasket Set	1999-97	MS 96147			
1	Exh. Manifold Gasket Set	2003-97	MS 95470			
QTY	EXHAUST PIPE FLANGE	YEARS	PART NO.	DESCRIPTION		
2	Exhaust Pipe Gasket	2003-97	60496-1	Converter		
1	Exhaust Pipe Gasket	2003-97	60496-1	Exh. connector		
1	Exhaust Pipe Gasket	2003-97	60680	Flange		
1	Exhaust Pipe Gasket	2003-97	61080	Pipe to muffler		
QTY	OIL PAN	YEARS	PART NO.	DESCRIPTION		
1	Oil Pan Gasket Set	2003-00	OS 30715			
1	Oil Pan Gasket Set	1999-97	OS 30665 C			
QTY	CRANKSHAFT REAR SEAL	YEARS	PART NO.	DESCRIPTION		
1	Rear Main Seal Set	2003-97	BS 40648	Rubber; One-piece		
1	Repair Sleeve	2003-97	16275	Crankshaft; Use w/installation tool		
QTY	VALVE COVER	YEARS	PART NO.	DESCRIPTION		
1	Valve Cover Gasket Set	2003-00	VS 50562 R	w/Spark plug tube seals; PermaDry® molded rubber gskt. incl.		
1	Valve Cover Gasket Set	1999-97	VS 50435 R	w/Spark plug tube seals; PermaDry® molded rubber gskt. incl.		
1	Spark Plug Tube Seal Set	2003-97	ES 72120	Valve Cover		
QTY	VALVE STEM SEAL SET	YEARS	PART NO.	DESCRIPTION		
1	Valve Stem Seal Set	2003-97	SS 70660	Premium valve stem seals incl.; Improved design		
QTY	THERMOSTAT HOUSING	YEARS	PART NO.	DESCRIPTION		
2	Thermostat Gasket	2003-98	35589	Thermostat Housing; Thermostat case to head		
QTY	WATER OUTLET GASKET	YEARS	PART NO.	DESCRIPTION		
2	Water Outlet Gasket	2003-00	35959	Water Outlet; Water pipe; O-ring		
1	O-Ring	2003-97	35524	Water Outlet		
QTY	WATER PUMP	YEARS	PART NO.	DESCRIPTION		
1	Water Pump Gasket	2003	35694			
1	Water Pump Gasket	2002-97	35003			
1	Water Pump Gasket	2002-97	ES 72872	O-ring		
QTY	TIMING COVER	YEARS	PART NO.	DESCRIPTION		
1	Crankshaft Front Seal Set	2003-00	TCS 46024	Must be used w/OS 30715		
1	Crankshaft Front Seal Set	1999-97	TCS 45941	Must be used w/OS 30665C		
1	Camshaft Front Seal Set	2003-97	TCS 45483			
QTY	CARB & FUEL INJECTION	YEARS	PART NO.	DESCRIPTION		
1	Fuel Injector O-Ring Set	2003-97	ES 70600			
1	Throttle Body Gasket	2003-97	60889			
QTY	EXHAUST GAS RECIRCULATION	YEARS	PART NO.	DESCRIPTION		
1	EGR Gasket	2003-97	70152			
3		1996 - 1991; 2.4L 143.4 (2351cc) SOHC L4 (8 Valve) 86.5mm Bore			3	
		MFI; Gasoline; Naturally Aspirated Mitsubishi Eng.; Eng. Code 4G64				
QTY	CYLINDER HEAD	YEARS	PART NO.	DESCRIPTION		
1	Head Gasket	1996-91	9388 PT			

Mitsubishi Truck (Incl. Minivans and SUV's) (Cont.)

3 (cont.)		1996 - 1991; 2.4L 143.4 (2351cc) SOHC L4 (8 Valve) 86.5mm Bore			3 (cont.)
MFI; Gasoline; Naturally Aspirated Mitsubishi Eng.; Eng. Code 4G64					
QTY	CYLINDER HEAD	YEARS	PART NO.	DESCRIPTION	
1	Head Set	1996-93	HS 9388 PT-3	Exh. pipe flange not incl.; PermaDry® molded rubber valve cover gskt. incl.; Premium valve stem seals incl.	
1	Head Set	1992-91	HS 9388 PT	PermaDry® molded rubber valve cover gskt. incl.; Premium valve stem seals incl.	
QTY	CONVERSION SET	YEARS	PART NO.	DESCRIPTION	
1	Gasket Conversion Set	1996-93	CS 9086-2		
1	Gasket Conversion Set	1992-91	CS 9388-1		
QTY	MANIFOLD - INT. & EXH.	YEARS	PART NO.	DESCRIPTION	
1	Int. Manifold Gasket Set	1996-91	MS 92964-3	Lower set; Upper set incl.	
1	Exh. Manifold Gasket Set	1996-93	MS 94841		
1	Exh. Manifold Gasket Set	1992-91	MS 92029		
QTY	EXHAUST PIPE FLANGE	YEARS	PART NO.	DESCRIPTION	
1	Exhaust Pipe Gasket	1996-91	60494	Flange	
2	Exhaust Pipe Gasket	1996-91	60620	Converter	
QTY	OIL PAN	YEARS	PART NO.	DESCRIPTION	
1	Oil Pan Gasket Set	1996-93	OS 30665 C		
1	Oil Pan Gasket Set	1992-91	OS 30460 A		
QTY	CRANKSHAFT REAR SEAL	YEARS	PART NO.	DESCRIPTION	
1	Rear Main Seal Set	1996-93	BS 40648	Rubber; One-piece	
1	Rear Main Seal Set	1992-91	BS 40408-1	Rubber; One-piece	
1	Repair Sleeve	1996-91	16275	Crankshaft; Use w/installation tool	
QTY	VALVE COVER	YEARS	PART NO.	DESCRIPTION	
1	Valve Cover Gasket Set	1996-91	VS 50132 R	w/Semi-circular plug & Grommets; PermaDry® molded rubber gskt. incl.	
1	Valve Cover Gasket Set	1996-91	VS 50234 R	w/o Semi-circular plug & Grommets; PermaDry® molded rubber gskt. incl.	
1	Grommet Set	1996-91	ES 70342	Valve Cover	
1	Semi-Circular Plug	1996-91	CP 75001	Valve Cover	
QTY	VALVE STEM SEAL SET	YEARS	PART NO.	DESCRIPTION	
1	Valve Stem Seal Set	1996-93	SS 70598	Loc. Int. & Exh.; Premium valve stem seals incl.; Improved design	
1	Valve Stem Seal Set	1992-91	SS 72630	Loc. Int. & Exh.; Premium valve stem seals incl.	
1	Valve Stem Seal Set	1992-91	SS 72681	Loc. Aux.; Premium valve stem seals incl.	
QTY	THERMOSTAT HOUSING	YEARS	PART NO.	DESCRIPTION	
1	Thermostat Gasket	1996-91	35523	Thermostat Housing; Case to manifold	
QTY	WATER OUTLET GASKET	YEARS	PART NO.	DESCRIPTION	
1	Water Outlet Gasket	1996-91	35336	Water Outlet	
QTY	WATER PUMP	YEARS	PART NO.	DESCRIPTION	
1	Water Pump Gasket	1996-91	35273		
1	Water Pump Gasket	1996-91	ES 72872	O-ring	
QTY	TIMING COVER	YEARS	PART NO.	DESCRIPTION	
1	Crankshaft Front Seal Set	1996-93	TCS 45946	Must be used w/OS 30665C	
1	Crankshaft Front Seal Set	1992-91	TCS 45565-1	Must be used w/OS 30460A	
1	Camshaft Front Seal Set	1996-91	TCS 45483		
QTY	CARB & FUEL INJECTION	YEARS	PART NO.	DESCRIPTION	
1	Fuel Injector O-Ring Set	1996-91	ES 70600		
1	Throttle Body Gasket	1996	60966		
1	Throttle Body Gasket	1995-93	60855	Exc. California	
1	Throttle Body Gasket	1995-93	60966	California	
1	Throttle Body Gasket	1992-91	60855		
QTY	EXHAUST GAS RECIRCULATION	YEARS	PART NO.	DESCRIPTION	
1	EGR Gasket	1996-91	70152		
4		2013 - 2008; 2.4L 144 (2359cc) DOHC L4 (16 Valve) 88mm Bore MIVEC			4
MFI; Gasoline; Naturally Aspirated Mitsubishi Eng.; Eng. Code 4B12					
QTY	CYLINDER HEAD	YEARS	PART NO.	DESCRIPTION	
1	Head Gasket	2013-08	26557 PT	Head bolts not incl.; Head bolt replacement recommended; PermaTorqueMLS®; Improved design; New Part Number - Check for Availability	
1	Head Gasket	2011-08	26484 PT	Head bolts not incl.; Head bolt replacement recommended; PermaTorqueMLS®; Old design	
1	Head Set	2011-08	HS 26484 PT	Head bolts not incl.; Head bolt replacement recommended; PermaDry® molded rubber valve cover gskt. incl.; Premium valve stem seals incl.; New Part Number - Check for Availability	
QTY	CONVERSION SET	YEARS	PART NO.	DESCRIPTION	
1	Gasket Conversion Set	2011-08	CS 26449	New Part Number - Check for Availability	

Mitsubishi Truck (Incl. Minivans and SUV's) (Cont.)

4		2013 - 2008; 2.4L 144 (2359cc) DOHC L4 (16 Valve) 88mm Bore MIVEC			4	
(cont.)		MFI; Gasoline; Naturally Aspirated Mitsubishi Eng.; Eng. Code 4B12			(cont.)	
QTY	MANIFOLD - INT. & EXH.	YEARS	PART NO.	DESCRIPTION		
1	Int. Manifold Gasket Set	2011-08	MS 97114	Improved design		
1	Int. Manifold Gasket Set	2009	MS 97107	To 06/02/09; Old design		
1	Int. Manifold Gasket Set	2008	MS 97107	Old design		
QTY	EXHAUST PIPE FLANGE	YEARS	PART NO.	DESCRIPTION		
1	Exhaust Pipe Gasket	2011-08	61016	Loc. Rear; Converter; Improved design		
1	Exhaust Pipe Gasket	2011-08	61106	Pipe to manifold; 2.40" ID		
1	Exhaust Pipe Gasket	2011-08	61334	Loc. Front; Converter		
QTY	OIL PAN	YEARS	PART NO.	DESCRIPTION		
1	Oil Pan Gasket Set	2011-08	OS 30824			
QTY	CRANKSHAFT REAR SEAL	YEARS	PART NO.	DESCRIPTION		
1	Rear Main Seal Set	2011-08	BS 40728	Rubber; One-piece; New Part Number - Check for Availability		
QTY	VALVE COVER	YEARS	PART NO.	DESCRIPTION		
1	Valve Cover Gasket Set	2011-08	VS 50765 R	w/Spark plug tube seals; PermaDry® molded rubber gskt. incl.		
QTY	VALVE STEM SEAL SET	YEARS	PART NO.	DESCRIPTION		
1	Valve Stem Seal Set	2011-08	SS 71314	Premium valve stem seals incl.; New Part Number - Check for Availability		
QTY	THERMOSTAT HOUSING	YEARS	PART NO.	DESCRIPTION		
1	Thermostat Gasket	2011-08	35865	Thermostat Housing; Thermostat case to block		
QTY	WATER PUMP	YEARS	PART NO.	DESCRIPTION		
1	Water Pump Gasket	2011-08	35813	To block; Improved design		
1	Water Pump Gasket	2011-08	35822	To block; Old design		
1	Water Pump Gasket	2011-08	35877	Thermostat Housing; Thermostat case to outlet		
1	Water Pump Gasket	2011-08	35877	To coolant pipe		
QTY	TIMING COVER	YEARS	PART NO.	DESCRIPTION		
1	Crankshaft Front Seal Set	2011-08	TCS 46087			
QTY	CARB & FUEL INJECTION	YEARS	PART NO.	DESCRIPTION		
1	Fuel Injector O-Ring Set	2011-08	ES 70599	Improved design		
1	Throttle Body Gasket	2011-08	61607			
QTY	EXHAUST GAS RECIRCULATION	YEARS	PART NO.	DESCRIPTION		
1	EGR Gasket	2011-08	71210			
5		2006 - 2004; 2.4L 145.1 (2378cc) SOHC L4 (16 Valve) 87mm Bore			5	
(cont.)		MFI; Gasoline; Naturally Aspirated Mitsubishi Eng.; Eng. Code 4G69			(cont.)	
QTY	CYLINDER HEAD	YEARS	PART NO.	DESCRIPTION		
1	Head Gasket	2006-04	26235 PT	Head bolts not incl.; Head bolt replacement recommended; PermaTorqueMLS®		
1	Head Set	2006-04	HS 26235 PT	Head bolts not incl.; Head bolt replacement recommended; RTV sealant incl. for thermostat gskt.; PermaDry® molded rubber valve cover gskt. incl.; Premium valve stem seals incl.		
QTY	CONVERSION SET	YEARS	PART NO.	DESCRIPTION		
1	Gasket Conversion Set	2006-04	CS 26172	FWD		
1	Gasket Conversion Set	2006-04	CS 26235	AWD		
QTY	MANIFOLD - INT. & EXH.	YEARS	PART NO.	DESCRIPTION		
1	Int. Manifold Gasket Set	2006-04	MS 96424			
1	Exh. Manifold Gasket Set	2006-04	MS 96420			
QTY	EXHAUST PIPE FLANGE	YEARS	PART NO.	DESCRIPTION		
1	Exhaust Pipe Gasket	2006-04	60680	Flange		
1	Exhaust Pipe Gasket	2006-04	61334	Converter		
1	Exhaust Pipe Gasket	2006-05	61334	Exh. connector		
1	Exhaust Pipe Gasket	2004	61080	To 12/31/03; Exh. connector		
1	Exhaust Pipe Gasket	2004	61334	From 01/01/04; Exh. connector		
QTY	OIL PAN	YEARS	PART NO.	DESCRIPTION		
1	Oil Pan Gasket Set	2006-04	OS 30715	FWD		
1	Oil Pan Gasket Set	2006-04	OS 30756	AWD		
QTY	CRANKSHAFT REAR SEAL	YEARS	PART NO.	DESCRIPTION		
1	Rear Main Seal Set	2006-04	BS 40648	Rubber; One-piece		
1	Repair Sleeve	2006-04	16275	Crankshaft; Use w/installation tool		
QTY	VALVE COVER	YEARS	PART NO.	DESCRIPTION		
1	Valve Cover Gasket Set	2006-04	VS 50604 R	w/Spark plug tube seals; PermaDry® molded rubber gskt. incl.		
1	Spark Plug Tube Seal Set	2006-04	ES 72120	Valve Cover		
QTY	VALVE STEM SEAL SET	YEARS	PART NO.	DESCRIPTION		
1	Valve Stem Seal Set	2006-04	SS 70660	Premium valve stem seals incl.; Improved design		
QTY	WATER PUMP	YEARS	PART NO.	DESCRIPTION		
1	Water Pump Gasket	2006-04	35737			

Mitsubishi Truck (Incl. Minivans and SUV's) (Cont.)

5		2006 - 2004; 2.4L 145.1 (2378cc) SOHC L4 (16 Valve) 87mm Bore			5
(cont.)		MFI; Gasoline; Naturally Aspirated Mitsubishi Eng.; Eng. Code 4G69			(cont.)
QTY	WATER PUMP	YEARS	PART NO.	DESCRIPTION	
1	Water Pump Gasket	2006-04	ES 72872	O-ring	
QTY	TIMING COVER	YEARS	PART NO.	DESCRIPTION	
1	Crankshaft Front Seal Set	2006-04	TCS 46024	Must be used w/OS 30715 or w/OS 30756	
1	Camshaft Front Seal Set	2006-04	TCS 45704-1		
QTY	CARB & FUEL INJECTION	YEARS	PART NO.	DESCRIPTION	
1	Fuel Injector O-Ring Set	2006-04	ES 70600		
1	Throttle Body Gasket	2006-04	60922	Idle air control	
1	Throttle Body Gasket	2006-04	61432	Throttle body	
QTY	EXHAUST GAS RECIRCULATION	YEARS	PART NO.	DESCRIPTION	
1	EGR Gasket	2006-04	71210		
6		1995 - 1991; 3.0L 181.1 (2972cc) SOHC V6 (12 Valve) 91.1mm Bore			6
(cont.)		MFI; Gasoline; Naturally Aspirated Mitsubishi Eng.; Eng. Code 6G72			(cont.)
QTY	CYLINDER HEAD	YEARS	PART NO.	DESCRIPTION	
2	Head Gasket	1995-91	9112 PT	Head bolts not incl.; Head bolt replacement recommended	
1	Head Set	1995-91	HS 9112 PT-1	Head bolts not incl.; Head bolt replacement recommended; PermaDry® molded rubber valve cover gskts. incl.; Premium valve stem seals incl.	
1	Head Bolt Set	1995-91	ES 72859	Head bolts w/Washers; Replacement recommended	
QTY	CONVERSION SET	YEARS	PART NO.	DESCRIPTION	
1	Gasket Conversion Set	1995-91	CS 9112		
QTY	MANIFOLD - INT. & EXH.	YEARS	PART NO.	DESCRIPTION	
1	Int. Manifold Gasket Set	1995-91	MS 93795-2	Upper set incl.	
1	Exh. Manifold Gasket Set	1995-91	MS 93797		
QTY	EXHAUST PIPE FLANGE	YEARS	PART NO.	DESCRIPTION	
2	Exhaust Pipe Gasket	1995-91	60496-1	Flange	
2	Exhaust Pipe Gasket	1995-92	60496-1	Converter	
2	Exhaust Pipe Gasket	1991	60496-1	Exc. Mitsubishi Montero Base, LS, RS; Converter	
1	Exhaust Pipe Gasket	1991	60496-1	Mitsubishi Montero Base, LS, RS; Loc. Front; Converter	
1	Exhaust Pipe Gasket	1991	60620	Mitsubishi Montero Base, LS, RS; Loc. Rear; Converter	
1	Exh. Flange Bolt & Spring Kit	1995-91	ES 72143		
QTY	OIL PAN	YEARS	PART NO.	DESCRIPTION	
1	Oil Pan Gasket Set	1995-91	OS 30570 C	Cork	
1	Oil Pan Gasket Set	1995-91	OS 30570 T	PermaDryPlus®; Oil Pan SnapUps® incl.	
QTY	CRANKSHAFT REAR SEAL	YEARS	PART NO.	DESCRIPTION	
1	Rear Main Seal Set	1995-91	BS 40562	Rubber; One-piece	
1	Rear Main Seal Set	1995-91	BS 40627	PTFE Rubber; One-piece	
1	Repair Sleeve Tool	1995-91	16300	Crankshaft	
QTY	VALVE COVER	YEARS	PART NO.	DESCRIPTION	
1	Valve Cover Gasket Set	1995-91	VS 50026 R-1	w/o Circular plugs & Grommets; PermaDry® molded rubber gskts. incl.	
1	Valve Cover Gasket Set	1995-91	VS 50173 R	w/Circular plugs & Grommets; PermaDry® molded rubber gskts. incl.	
2	Grommet Set	1995-91	ES 70342	Valve Cover	
2	Circular Plug	1995-91	CP 75018	Valve Cover	
QTY	VALVE STEM SEAL SET	YEARS	PART NO.	DESCRIPTION	
1	Valve Stem Seal Set	1995-91	SS 70710	Premium valve stem seals incl.; Improved design	
QTY	WATER OUTLET GASKET	YEARS	PART NO.	DESCRIPTION	
1	Water Outlet Gasket	1995-91	35336	Water Outlet	
QTY	WATER PUMP	YEARS	PART NO.	DESCRIPTION	
1	Water Pump Gasket	1995-91	35399	To block	
1	Water Pump Gasket	1995-91	35468	Inlet	
1	Water Pump Gasket	1995-91	35603	To cover	
1	Water Pump Gasket	1995-91	ES 72872	O-ring	
QTY	TIMING COVER	YEARS	PART NO.	DESCRIPTION	
1	Timing Cover Dust Seal Set	1995-91	TCS 45835		
1	Crankshaft Front Seal Set	1995-91	TCS 45750		
2	Camshaft Front Seal Set	1995-91	TCS 45483	Must be used w/VS 50173R or w/VS 50026R-1	
QTY	CARB & FUEL INJECTION	YEARS	PART NO.	DESCRIPTION	
2	Fuel Injector O-Ring Set	1995-91	ES 70600		
1	Throttle Body Gasket	1995-91	60870		
QTY	EXHAUST GAS RECIRCULATION	YEARS	PART NO.	DESCRIPTION	
1	EGR Gasket	1995-91	70152		

Mitsubishi Truck (Incl. Minivans and SUV's) (Cont.)

7		2003 - 1995; 3.0L 181.1 (2972cc) SOHC V6 (24 Valve) 91.1mm Bore			7
		MFI; Gasoline; Naturally Aspirated Mitsubishi Eng.; Eng. Code 6G72			
QTY	CYLINDER HEAD	YEARS	PART NO.	DESCRIPTION	
2	Head Gasket	2003-99	9537 PT	Head bolts not incl.; Head bolt replacement recommended; PermaTorqueMLS® LaserWeld® Technology	
2	Head Gasket	1998-95	26186 PT	Head bolts not incl.; Head bolt replacement recommended; PermaTorqueMLS® LaserWeld® Technology; Improved design	
1	Head Set	2003-99	HS 9537 PT	Head bolts not incl.; Head bolt replacement recommended; PermaDry® molded rubber valve cover gskts. incl.; Premium valve stem seals incl.	
1	Head Set	1998-95	HS 26186 PT-2	Head bolts not incl.; Head bolt replacement recommended; PermaDry® molded rubber valve cover gskts. incl.; Premium valve stem seals incl.	
1	Head Bolt Set	2003-95	ES 72859	Head bolts w/Washers; Replacement recommended	
QTY	CONVERSION SET	YEARS	PART NO.	DESCRIPTION	
1	Gasket Conversion Set	2003-01	CS 9537-1	RTV sealant incl. for oil pan gskt.	
1	Gasket Conversion Set	2000-97	CS 26186-3	RTV sealant incl. for oil pan gskt.	
1	Gasket Conversion Set	1996-95	CS 26186-2	RTV sealant incl. for oil pan gskt.	
QTY	MANIFOLD - INT. & EXH.	YEARS	PART NO.	DESCRIPTION	
1	Int. Manifold Gasket Set	2003-95	MS 95709	Lower set; Upper set incl.	
1	Plenum Gasket Set	2003-95	MS 95708	Upper set	
1	Exh. Manifold Gasket Set	2003-95	MS 95711		
QTY	EXHAUST PIPE FLANGE	YEARS	PART NO.	DESCRIPTION	
1	Exhaust Pipe Gasket	2003-95	60917	Pipe to muffler	
2	Exhaust Pipe Gasket	2003-95	61234	Loc. Front; Converter	
1	Exhaust Pipe Gasket	2003-01	61106	Loc. Rear; Converter; 2.40" ID	
1	Exhaust Pipe Gasket	2003	60496-1	Pipe to manifold	
1	Exhaust Pipe Gasket	2002-95	61250	Pipe to manifold	
QTY	OIL PAN	YEARS	PART NO.	DESCRIPTION	
1	Oil Pan Gasket Set	2000-97	OS 30731	RTV sealant incl. for oil pan gskt.	
QTY	CRANKSHAFT REAR SEAL	YEARS	PART NO.	DESCRIPTION	
1	Rear Main Seal Set	2003-95	BS 40660	Rubber; One-piece	
QTY	VALVE COVER	YEARS	PART NO.	DESCRIPTION	
1	Valve Cover Gasket Set	2003-95	VS 50461 R	w/Spark plug tube seals; PermaDry® molded rubber gskts. incl.	
1	Spark Plug Tube Seal Set	2003-95	ES 72120-1	Valve Cover	
QTY	VALVE STEM SEAL SET	YEARS	PART NO.	DESCRIPTION	
1	Valve Stem Seal Set	2003-95	SS 70795	Premium valve stem seals incl.	
QTY	THERMOSTAT HOUSING	YEARS	PART NO.	DESCRIPTION	
1	Water Outlet Gasket	2003-00	35520	Thermostat Housing	
1	Water Outlet Gasket	1999-95	35336	Thermostat Housing	
1	Thermostat Gasket	2003-95	35680	Thermostat Housing; Thermostat case to head	
1	O-Ring	2003-95	35555	Thermostat Housing; Thermostat O-ring	
QTY	WATER OUTLET GASKET	YEARS	PART NO.	DESCRIPTION	
1	Water Outlet Gasket	2003-95	35700	Water Outlet; Adapter to housing	
2	Thermostat Gasket	2003-95	35695	Water Outlet	
QTY	WATER PUMP	YEARS	PART NO.	DESCRIPTION	
1	Water Pump Gasket	2003-95	35584		
QTY	TIMING COVER	YEARS	PART NO.	DESCRIPTION	
1	Crankshaft Front Seal Set	2003-95	TCS 45965		
2	Camshaft Front Seal Set	2003-99	TCS 45483		
1	Camshaft Front Seal Set	1998-95	TCS 45704		
QTY	CARB & FUEL INJECTION	YEARS	PART NO.	DESCRIPTION	
2	Fuel Injector O-Ring Set	2003-95	ES 70600		
1	Throttle Body Gasket	2003-95	60879		
QTY	EXHAUST GAS RECIRCULATION	YEARS	PART NO.	DESCRIPTION	
1	EGR Gasket	2003-95	70152		
8		2009 - 2007; 3.0L 182.9 (2998cc) SOHC V6 (24 Valve) 87.6mm Bore MIVEC			8
		MFI; Gasoline; Naturally Aspirated Mitsubishi Eng.; Eng. Code 6B31			
QTY	CYLINDER HEAD	YEARS	PART NO.	DESCRIPTION	
2	Head Gasket	2009-07	26410 PT	Head bolts not incl.; Head bolt replacement recommended; PermaTorqueMLS®	
1	Head Set	2009-07	HS 26410 PT	Head bolts not incl.; Head bolt replacement recommended; PermaDry® molded rubber valve cover gskts. incl.; Premium valve stem seals incl.	
QTY	CONVERSION SET	YEARS	PART NO.	DESCRIPTION	
1	Gasket Conversion Set	2009-07	CS 26410	RTV sealant incl. for oil pan gskt.	
QTY	MANIFOLD - INT. & EXH.	YEARS	PART NO.	DESCRIPTION	
1	Int. Manifold Gasket Set	2009-07	MS 97075	Lower set; Upper set incl.	
1	Exh. Manifold Gasket Set	2009-07	MS 97073		

Mitsubishi Truck (Incl. Minivans and SUV's) (Cont.)

8				
2009 - 2007; 3.0L 182.9 (2998cc) SOHC V6 (24 Valve) 87.6mm Bore MIVEC				
MFI; Gasoline; Naturally Aspirated Mitsubishi Eng.; Eng. Code 6B31				
				8
				(cont.)
QTY	EXHAUST PIPE FLANGE	YEARS	PART NO.	DESCRIPTION
1	Exhaust Pipe Gasket	2009-07	60917	Loc. Rear; Converter pipe
1	Exhaust Pipe Gasket	2009-07	61106	Loc. Front; Converter; 2.40" ID
2	Exhaust Pipe Gasket	2009-07	61334	Pipe to manifold converter
1	Exhaust Pipe Gasket	2009-07	61563	Exh. connector
QTY	OIL PAN	YEARS	PART NO.	DESCRIPTION
1	Oil Pan Gasket Set	2009-07	OS 30807	RTV sealant incl. for oil pan gskt.
QTY	CRANKSHAFT REAR SEAL	YEARS	PART NO.	DESCRIPTION
1	Rear Main Seal Set	2009-07	BS 40717	Rubber; One-piece
QTY	VALVE COVER	YEARS	PART NO.	DESCRIPTION
1	Valve Cover Gasket Set	2009-07	VS 50752 R	PermaDry® molded rubber gskts. incl.
QTY	VALVE STEM SEAL SET	YEARS	PART NO.	DESCRIPTION
1	Valve Stem Seal Set	2009-07	SS 70795	Premium valve stem seals incl.
QTY	THERMOSTAT HOUSING	YEARS	PART NO.	DESCRIPTION
1	Thermostat Gasket	2009-07	35667	Thermostat Housing; Thermostat seal
1	Thermostat Gasket	2009-07	35895	Thermostat Housing; Thermostat housing
QTY	WATER OUTLET GASKET	YEARS	PART NO.	DESCRIPTION
2	Water Outlet Gasket	2009-07	35959	Water Outlet; Water pipe; O-ring
QTY	WATER PUMP	YEARS	PART NO.	DESCRIPTION
1	Water Pump Gasket	2009-07	35897	
QTY	TIMING COVER	YEARS	PART NO.	DESCRIPTION
1	Crankshaft Front Seal Set	2009-07	TCS 46120	
1	Camshaft Front Seal Set	2009-07	TCS 45704	
QTY	CARB & FUEL INJECTION	YEARS	PART NO.	DESCRIPTION
2	Fuel Injector O-Ring Set	2009-07	ES 70599	Improved design
1	Throttle Body Gasket	2009-07	61565	
QTY	EXHAUST GAS RECIRCULATION	YEARS	PART NO.	DESCRIPTION
1	EGR Gasket	2009-07	71210	
9				
1996 - 1994; 3.5L 213.3 (3497cc) DOHC V6 (24 Valve) 93mm Bore				
MFI; Gasoline; Naturally Aspirated Mitsubishi Eng.; Eng. Code 6G74				
				9
QTY	CONVERSION SET	YEARS	PART NO.	DESCRIPTION
1	Gasket Conversion Set	1996-94	CS 26193	RTV sealant incl. for oil pan gskt.
QTY	MANIFOLD - INT. & EXH.	YEARS	PART NO.	DESCRIPTION
1	Int. Manifold Gasket Set	1996-94	MS 97287	Lower set; Upper set incl.; New Part Number - Check for Availability
1	Exh. Manifold Gasket Set	1996-94	MS 95082	
QTY	OIL PAN	YEARS	PART NO.	DESCRIPTION
1	Oil Pan Gasket Set	1996-94	OS 30727	RTV sealant incl. for oil pan gskt.
QTY	CRANKSHAFT REAR SEAL	YEARS	PART NO.	DESCRIPTION
1	Rear Main Seal Set	1996-94	BS 40660	Rubber; One-piece
QTY	VALVE COVER	YEARS	PART NO.	DESCRIPTION
1	Valve Cover Gasket Set	1996-94	VS 50390 R	w/Spark plug tube seals; PermaDry® molded rubber gskts. incl.
4	Circular Plug	1996-94	CP 75023	Valve Cover
1	Spark Plug Tube Seal Set	1996-94	ES 72812	Valve Cover
QTY	VALVE STEM SEAL SET	YEARS	PART NO.	DESCRIPTION
2	Valve Stem Seal Set	1996-94	SS 72805	Premium valve stem seals incl.
QTY	WATER PUMP	YEARS	PART NO.	DESCRIPTION
1	Water Pump Gasket	1996-94	35584	
QTY	TIMING COVER	YEARS	PART NO.	DESCRIPTION
1	Crankshaft Front Seal Set	1996-94	TCS 45911	
QTY	CARB & FUEL INJECTION	YEARS	PART NO.	DESCRIPTION
2	Fuel Injector O-Ring Set	1996-94	ES 70600	
1	Throttle Body Gasket	1996-94	60879	
10				
2004 - 1997; 3.5L 213.3 (3497cc) SOHC V6 (24 Valve) 93mm Bore				
MFI; Gasoline; Naturally Aspirated Mitsubishi Eng.; Eng. Code 6G74				
				10
QTY	CYLINDER HEAD	YEARS	PART NO.	DESCRIPTION
2	Head Gasket	2004-97	26193 PT	Head bolts not incl.; Head bolt replacement recommended; PermaTorqueMLS®
1	Head Set	2004-03	HS 26193 PT	Head bolts & exh. pipe flange not incl.; Head bolt replacement recommended; PermaDry® molded rubber valve cover gskts. incl.; Premium valve stem seals incl.

Mitsubishi Truck (Incl. Minivans and SUV's) (Cont.)

10 (cont.)		2004 - 1997; 3.5L 213.3 (3497cc) SOHC V6 (24 Valve) 93mm Bore			10 (cont.)	
MFI; Gasoline; Naturally Aspirated Mitsubishi Eng.; Eng. Code 6G74						
QTY	CYLINDER HEAD	YEARS	PART NO.	DESCRIPTION		
1	Head Set	2002-97	HS 26193 PT	Head bolts not incl.; Head bolt replacement recommended; PermaDry® molded rubber valve cover gskts. incl.; Premium valve stem seals incl.		
1	Head Bolt Set	2004-97	ES 72859	Head bolts w/Washers; Replacement recommended		
QTY	CONVERSION SET	YEARS	PART NO.	DESCRIPTION		
1	Gasket Conversion Set	2004-03	CS 26193-1	RTV sealant incl. for oil pan gskt.		
1	Gasket Conversion Set	2002-97	CS 26193	RTV sealant incl. for oil pan gskt.		
QTY	MANIFOLD - INT. & EXH.	YEARS	PART NO.	DESCRIPTION		
1	Int. Manifold Gasket Set	2004-97	MS 95709	Lower set; Upper set incl.		
1	Plenum Gasket Set	2004-97	MS 95708	Upper set		
1	Exh. Manifold Gasket Set	2004-97	MS 95711			
QTY	EXHAUST PIPE FLANGE	YEARS	PART NO.	DESCRIPTION		
1	Exhaust Pipe Gasket	2004-97	60496-1	Converter to manifold		
1	Exhaust Pipe Gasket	2004-97	61080	Exh. connector		
1	Exhaust Pipe Gasket	2004-03	60496-1	Loc. Rear; Converter		
2	Exhaust Pipe Gasket	2004-03	60496-1	Pipe to manifold		
1	Exhaust Pipe Gasket	2003-01	61106	Loc. Center; Converter; 2.40" ID		
2	Exhaust Pipe Gasket	2002-97	61250	Pipe to manifold		
QTY	OIL PAN	YEARS	PART NO.	DESCRIPTION		
1	Oil Pan Gasket Set	2004-03	OS 30737	RTV sealant incl. for oil pan gskt.		
1	Oil Pan Gasket Set	2002-97	OS 30727	RTV sealant incl. for oil pan gskt.		
QTY	CRANKSHAFT REAR SEAL	YEARS	PART NO.	DESCRIPTION		
1	Rear Main Seal Set	2004-97	BS 40660	Rubber; One-piece		
QTY	VALVE COVER	YEARS	PART NO.	DESCRIPTION		
1	Valve Cover Gasket Set	2004-97	VS 50461 R	w/Spark plug tube seals; PermaDry® molded rubber gskts. incl.		
1	Spark Plug Tube Seal Set	2004-97	ES 72120-1	Valve Cover		
QTY	VALVE STEM SEAL SET	YEARS	PART NO.	DESCRIPTION		
1	Valve Stem Seal Set	2004-97	SS 70795	Premium valve stem seals incl.		
QTY	THERMOSTAT HOUSING	YEARS	PART NO.	DESCRIPTION		
2	Thermostat Gasket	2004-97	35667	Thermostat Housing; Outlet to head		
1	Thermostat Gasket	2004-97	35680	Thermostat Housing; Thermostat case to head		
QTY	WATER OUTLET GASKET	YEARS	PART NO.	DESCRIPTION		
1	Water Outlet Gasket	2004-97	35693	Water Outlet		
1	Water Outlet Gasket	2004-97	35700	Water Outlet; Adapter to housing		
2	Thermostat Gasket	2004-97	35695	Water Outlet		
QTY	WATER PUMP	YEARS	PART NO.	DESCRIPTION		
1	Water Pump Gasket	2004-03	35584			
1	Water Pump Gasket	2002-01	35679			
1	Water Pump Gasket	2000-97	35584			
QTY	TIMING COVER	YEARS	PART NO.	DESCRIPTION		
1	Crankshaft Front Seal Set	2004-97	TCS 45911			
1	Camshaft Front Seal Set	2004-97	TCS 45704			
QTY	CARB & FUEL INJECTION	YEARS	PART NO.	DESCRIPTION		
2	Fuel Injector O-Ring Set	2004-97	ES 70600			
1	Throttle Body Gasket	2004-97	60879			
QTY	EXHAUST GAS RECIRCULATION	YEARS	PART NO.	DESCRIPTION		
1	EGR Gasket	2004-97	70152			
11		2010 - 2006; 3.7L 226 (3704cc) SOHC V6 (12 Valve) 93mm Bore				11
MFI; Gasoline; Naturally Aspirated Chrysler Eng.; VIN Code K						
QTY	CYLINDER HEAD	YEARS	PART NO.	DESCRIPTION		
2	Head Gasket	2010-06	26229 PT	Head bolts not incl.; Head bolt replacement recommended; PermaTorqueMLS®		
1	Head Set	2010-06	HS 26229 PT-1	w/Plastic valve covers; Head bolts not incl.; Head bolt replacement recommended; Must be used w/TCS 46022; PermaDry® molded rubber valve cover gskts. incl.; Premium valve stem seals incl.		
2	Head Bolt Set	2010-06	ES 71129-1	Head bolts w/Washers; Replacement recommended		
QTY	CONVERSION SET	YEARS	PART NO.	DESCRIPTION		
1	Gasket Conversion Set	2010-06	CS 26229	PermaDry® molded rubber oil pan gskt. incl.		
QTY	MANIFOLD - INT. & EXH.	YEARS	PART NO.	DESCRIPTION		
1	Int. Manifold Gasket Set	2010-06	MS 93205-1			
1	Exh. Manifold Gasket Set	2010-06	MS 96344-1	Improved design		
1	Exh. Manifold Gasket Set	2006	MS 96344	Old design		
QTY	EXHAUST PIPE FLANGE	YEARS	PART NO.	DESCRIPTION		
1	Exhaust Pipe Gasket	2010-06	61240	Flange		

Mitsubishi Truck (Incl. Minivans and SUV's) (Cont.)

11 (cont.)	2010 - 2006; 3.7L 226 (3704cc) SOHC V6 (12 Valve) 93mm Bore				11 (cont.)
QTY	EXHAUST PIPE FLANGE	YEARS	PART NO.	DESCRIPTION	
1	Exhaust Pipe Gasket	2010-06	61289	Ring	
QTY	OIL PAN	YEARS	PART NO.	DESCRIPTION	
1	Oil Pan Gasket Set	2010-06	OS 30743 R	PermaDry® molded rubber gskt. incl.	
QTY	CRANKSHAFT REAR SEAL	YEARS	PART NO.	DESCRIPTION	
1	Rear Main Seal Set	2010-06	BS 40186	Rubber; One-piece	
1	Repair Sleeve	2010-06	16230	Crankshaft; Use w/installation tool	
1	Repair Sleeve Tool	2010-06	16328	Crankshaft	
QTY	VALVE COVER	YEARS	PART NO.	DESCRIPTION	
1	Valve Cover Gasket Set	2010-06	VS 50652 R	w/Plastic valve covers; w/Grommets; PermaDry® molded rubber gskts. incl.	
QTY	VALVE STEM SEAL SET	YEARS	PART NO.	DESCRIPTION	
1	Valve Stem Seal Set	2010-06	SS 71041-1	Premium valve stem seals incl.	
QTY	THERMOSTAT HOUSING	YEARS	PART NO.	DESCRIPTION	
1	Thermostat Gasket	2010-06	35692	Thermostat Housing; Thermostat seal	
QTY	WATER PUMP	YEARS	PART NO.	DESCRIPTION	
1	Water Pump Gasket	2010-06	35655		
QTY	TIMING COVER	YEARS	PART NO.	DESCRIPTION	
1	Timing Cover Set	2010-06	TCS 46022		
QTY	CARB & FUEL INJECTION	YEARS	PART NO.	DESCRIPTION	
2	Fuel Injector O-Ring Set	2010-06	ES 70599	Improved design	
1	Throttle Body Gasket	2010-06	61324	Idle air control; 21mm ID	
1	Throttle Body Gasket	2010-06	61326	Idle air control; 30mm ID	
1	Throttle Body Gasket	2010-07	61467	Mounting	
1	Throttle Body Gasket	2006	61225	Mounting	
QTY	EXHAUST GAS RECIRCULATION	YEARS	PART NO.	DESCRIPTION	
2	EGR Gasket	2010-06	70721	Tube flange	
1	EGR Gasket	2010-06	72251	Valve	
12	2011 - 2003; 3.8L 234 (3828cc) SOHC V6 (24 Valve) 95mm Bore				12
QTY	CYLINDER HEAD	YEARS	PART NO.	DESCRIPTION	
2	Head Gasket	2011-03	26313 PT	Head bolts not incl.; Head bolt replacement recommended; PermaTorqueMLS®	
1	Head Set	2011-07	HS 26313 PT	PermaDry® molded rubber valve cover gskts. incl.; Premium valve stem seals incl.	
1	Head Set	2006-05	HS 26313 PT	Exc. Mitsubishi Montero Limited; Head bolts not incl.; Head bolt replacement recommended; PermaDry® molded rubber valve cover gskts. incl.; Premium valve stem seals incl.	
1	Head Set	2006-05	HS 26313 PT-2	Mitsubishi Montero Limited; Head bolts not incl.; Head bolt replacement recommended; PermaDry® molded rubber valve cover gskts. incl.; Premium valve stem seals incl.	
1	Head Set	2004	HS 26313 PT	Exc. Mitsubishi Montero Limited, XLS; Head bolts not incl.; Head bolt replacement recommended; PermaDry® molded rubber valve cover gskts. incl.; Premium valve stem seals incl.	
1	Head Set	2004	HS 26313 PT-2	Mitsubishi Montero Limited, XLS; Head bolts not incl.; Head bolt replacement recommended; PermaDry® molded rubber valve cover gskts. incl.; Premium valve stem seals incl.	
1	Head Set	2003	HS 26313 PT-2	Head bolts not incl.; Head bolt replacement recommended; PermaDry® molded rubber valve cover gskts. incl.; Premium valve stem seals incl.	
1	Head Bolt Set	2011-03	ES 72859	Head bolts w/Washers; Replacement recommended	
QTY	CONVERSION SET	YEARS	PART NO.	DESCRIPTION	
1	Gasket Conversion Set	2011-03	CS 26313	RTV sealant incl. for oil pan gskt.	
QTY	MANIFOLD - INT. & EXH.	YEARS	PART NO.	DESCRIPTION	
1	Int. Manifold Gasket Set	2011-07	MS 95709-1	Lower set; Upper set incl.	
1	Int. Manifold Gasket Set	2006-05	MS 95709	Mitsubishi Montero Limited; Lower set; Upper set not incl.	
1	Int. Manifold Gasket Set	2006-05	MS 95709-1	Exc. Mitsubishi Montero Limited; Lower set; Upper set incl.	
1	Int. Manifold Gasket Set	2004	MS 95709	Mitsubishi Montero Limited, XLS; Lower set; Upper set not incl.	
1	Int. Manifold Gasket Set	2004	MS 95709-1	Exc. Mitsubishi Montero Limited, XLS; Lower set; Upper set incl.	
1	Int. Manifold Gasket Set	2003	MS 95709	Lower set; Upper set not incl.	
1	Plenum Gasket Set	2011-07	MS 96272	Upper set; New Part Number - Check for Availability	
1	Plenum Gasket Set	2006-05	MS 96272	Exc. Mitsubishi Montero Limited; Upper set; New Part Number - Check for Availability	
1	Plenum Gasket Set	2006-05	MS 96740	Mitsubishi Montero Limited; Upper set	

Mitsubishi Truck (Incl. Minivans and SUV's) (Cont.)

12 (cont.)		2011 - 2003; 3.8L 234 (3828cc) SOHC V6 (24 Valve) 95mm Bore MFI; Gasoline; Naturally Aspirated Mitsubishi Eng.; Eng. Code 6G75			12 (cont.)
QTY	MANIFOLD - INT. & EXH.	YEARS	PART NO.	DESCRIPTION	
1	Plenum Gasket Set	2004	MS 96272	Exc. Mitsubishi Montero Limited, XLS; Upper set; New Part Number - Check for Availability	
1	Plenum Gasket Set	2004	MS 96740	Mitsubishi Montero Limited, XLS; Upper set	
1	Plenum Gasket Set	2003	MS 96740	Upper set	
1	Exh. Manifold Gasket Set	2011-07	MS 96781-1		
1	Exh. Manifold Gasket Set	2006-05	MS 95711	Mitsubishi Montero Limited	
1	Exh. Manifold Gasket Set	2006-05	MS 96781-1	Exc. Mitsubishi Montero Limited	
1	Exh. Manifold Gasket Set	2004	MS 95711	Mitsubishi Montero Limited, XLS	
1	Exh. Manifold Gasket Set	2004	MS 96781-1	Exc. Mitsubishi Montero Limited, XLS	
1	Exh. Manifold Gasket Set	2003	MS 95711		
QTY	EXHAUST PIPE FLANGE	YEARS	PART NO.	DESCRIPTION	
2	Exhaust Pipe Gasket	2011-06	61106	Flange; 2.40" ID	
1	Exhaust Pipe Gasket	2011-07	61461	Converter	
1	Exhaust Pipe Gasket	2006-05	60917	Mitsubishi Montero Limited; Loc. Rear; Exh. connector	
1	Exhaust Pipe Gasket	2006-05	61106	Mitsubishi Montero Limited; Converter; 2.40" ID	
1	Exhaust Pipe Gasket	2006-05	61250	Mitsubishi Montero Limited; Loc. Front; Exh. connector	
1	Exhaust Pipe Gasket	2006-05	61461	Exc. Mitsubishi Montero Limited; Converter	
2	Exhaust Pipe Gasket	2005	61106	Exc. Mitsubishi Montero Limited; Flange; 2.40" ID	
2	Exhaust Pipe Gasket	2005	61250	Mitsubishi Montero Limited; Flange	
1	Exhaust Pipe Gasket	2004	60917	Mitsubishi Montero Limited, XLS; Loc. Rear; Exh. connector	
1	Exhaust Pipe Gasket	2004	61106	Mitsubishi Montero Limited, XLS; Converter; 2.40" ID	
2	Exhaust Pipe Gasket	2004	61106	Exc. Mitsubishi Montero Limited, XLS; Flange; 2.40" ID	
2	Exhaust Pipe Gasket	2004	61250	Mitsubishi Montero Limited, XLS; Flange	
1	Exhaust Pipe Gasket	2004	61250	Mitsubishi Montero Limited, XLS; Loc. Front; Exh. connector	
1	Exhaust Pipe Gasket	2004	61461	Exc. Mitsubishi Montero Limited, XLS; Converter	
1	Exhaust Pipe Gasket	2003	60917	Loc. Rear; Exh. connector	
1	Exhaust Pipe Gasket	2003	61106	Converter; 2.40" ID	
2	Exhaust Pipe Gasket	2003	61250	Flange	
1	Exhaust Pipe Gasket	2003	61250	Loc. Front; Exh. connector	
QTY	OIL PAN	YEARS	PART NO.	DESCRIPTION	
1	Oil Pan Gasket Set	2011-03	OS 30764	RTV sealant incl. for oil pan gskt.	
QTY	CRANKSHAFT REAR SEAL	YEARS	PART NO.	DESCRIPTION	
1	Rear Main Seal Set	2011-03	BS 40660	Rubber; One-piece	
QTY	VALVE COVER	YEARS	PART NO.	DESCRIPTION	
1	Valve Cover Gasket Set	2011-03	VS 50461 R	w/Spark plug tube seals; PermaDry® molded rubber gskts. incl.	
1	Spark Plug Tube Seal Set	2011-03	ES 72120-1	Valve Cover	
QTY	VALVE STEM SEAL SET	YEARS	PART NO.	DESCRIPTION	
1	Valve Stem Seal Set	2011-03	SS 70795	Premium valve stem seals incl.	
QTY	THERMOSTAT HOUSING	YEARS	PART NO.	DESCRIPTION	
1	Water Outlet Gasket	2006-05	35693	Mitsubishi Montero Limited; Thermostat Housing	
1	Water Outlet Gasket	2004	35693	Mitsubishi Montero Limited, XLS; Thermostat Housing	
1	Water Outlet Gasket	2003	35693	Thermostat Housing	
2	Thermostat Gasket	2011-03	35667	Outlet to head	
QTY	WATER OUTLET GASKET	YEARS	PART NO.	DESCRIPTION	
2	Water Outlet Gasket	2011-03	35959	Water Outlet; Water pipe; O-ring	
QTY	WATER PUMP	YEARS	PART NO.	DESCRIPTION	
1	Water Pump Gasket	2011-07	35584		
1	Water Pump Gasket	2006-05	35584	Exc. Mitsubishi Montero Limited	
1	Water Pump Gasket	2006-05	35679	Mitsubishi Montero Limited	
1	Water Pump Gasket	2004	35584	Exc. Mitsubishi Montero Limited, XLS	
1	Water Pump Gasket	2004	35679	Mitsubishi Montero Limited, XLS	
1	Water Pump Gasket	2003	35679		
QTY	TIMING COVER	YEARS	PART NO.	DESCRIPTION	
1	Crankshaft Front Seal Set	2011-03	TCS 46074	Old design	
1	Crankshaft Front Seal Set	2011-03	TCS 46085	Improved design	
1	Camshaft Front Seal Set	2011-03	TCS 45704		
QTY	CARB & FUEL INJECTION	YEARS	PART NO.	DESCRIPTION	
2	Fuel Injector O-Ring Set	2011-03	ES 70600		
1	Throttle Body Gasket	2011-07	61452		
1	Throttle Body Gasket	2006-05	61450	Mitsubishi Montero Limited	
1	Throttle Body Gasket	2006-05	61452	Exc. Mitsubishi Montero Limited	
1	Throttle Body Gasket	2004	61450	Mitsubishi Montero Limited, XLS	
1	Throttle Body Gasket	2004	61452	Exc. Mitsubishi Montero Limited, XLS	
1	Throttle Body Gasket	2003	61450		
QTY	EXHAUST GAS RECIRCULATION	YEARS	PART NO.	DESCRIPTION	
1	EGR Gasket	2011-07	71242		

Mitsubishi Truck (Incl. Minivans and SUV's) (Cont.)

12 (cont.)	2011 - 2003; 3.8L 234 (3828cc) SOHC V6 (24 Valve) 95mm Bore				12 (cont.)
12 (cont.)	MFI; Gasoline; Naturally Aspirated Mitsubishi Eng.; Eng. Code 6G75				12 (cont.)
QTY	EXHAUST GAS RECIRCULATION	YEARS	PART NO.	DESCRIPTION	
1	EGR Gasket	2006-05	71210	Mitsubishi Montero Limited	
1	EGR Gasket	2006-05	71242	Exc. Mitsubishi Montero Limited	
1	EGR Gasket	2004	71210	Mitsubishi Montero Limited, XLS	
1	EGR Gasket	2004	71242	Exc. Mitsubishi Montero Limited, XLS	
1	EGR Gasket	2003	71210		
QTY	OIL COOLER	YEARS	PART NO.	DESCRIPTION	
2	Oil Cooler Gasket	2006-05	72986	Mitsubishi Montero Limited; Oil cooler mounting O-ring; New Part Number - Check for Availability	
2	Oil Cooler Gasket	2004	72986	Mitsubishi Montero Limited, XLS; Oil cooler mounting O-ring; New Part Number - Check for Availability	
2	Oil Cooler Gasket	2003	72986	Oil cooler mounting O-ring; New Part Number - Check for Availability	
13	2010 - 2006; 4.7L 287 (4703cc) SOHC V8 (16 Valve) 93mm Bore				13
13	MFI; Gasoline; Naturally Aspirated Chrysler Eng.; VIN Code N				13
QTY	CYLINDER HEAD	YEARS	PART NO.	DESCRIPTION	
2	Head Gasket	2010-06	26157 PT	Head bolts not incl.; Head bolt replacement recommended; PermaTorqueMLS®	
1	Head Set	2010-08	HS 26157 PT-2	Unified valve spring/seal not incl.; Head bolts not incl.; Head bolt replacement recommended; Must be used w/TCS 46022; PermaDry® molded rubber valve cover gskts. incl.; Premium valve stem seals incl.	
1	Head Set	2007-06	HS 26157 PT-1	Head bolts not incl.; Head bolt replacement recommended; Must be used w/TCS 46022; PermaDry® molded rubber valve cover gskts. incl.; Premium valve stem seals incl.	
2	Head Bolt Set	2010-06	ES 71129	Head bolts w/Washers; Replacement recommended	
QTY	CONVERSION SET	YEARS	PART NO.	DESCRIPTION	
1	Gasket Conversion Set	2010-06	CS 26157	RTV sealant incl. for timing cover gskt.; PermaDry® molded rubber oil pan gskt. incl.	
QTY	MANIFOLD - INT. & EXH.	YEARS	PART NO.	DESCRIPTION	
1	Int. Manifold Gasket Set	2010-08	MS 96998		
1	Int. Manifold Gasket Set	2007-06	MS 93205		
1	Exh. Manifold Gasket Set	2010-08	MS 96994		
1	Exh. Manifold Gasket Set	2007-06	MS 93217		
QTY	OIL PAN	YEARS	PART NO.	DESCRIPTION	
1	Oil Pan Gasket Set	2010-06	OS 30709 R	w/Windage tray; PermaDry® molded rubber gskt. incl.	
QTY	CRANKSHAFT REAR SEAL	YEARS	PART NO.	DESCRIPTION	
1	Rear Main Seal Set	2010-06	BS 40186	Rubber; One-piece	
1	Repair Sleeve	2010-06	16230	Crankshaft; Use w/installation tool	
1	Repair Sleeve Tool	2010-06	16328	Crankshaft	
QTY	VALVE COVER	YEARS	PART NO.	DESCRIPTION	
1	Valve Cover Gasket Set	2010-08	VS 50733 R	w/Grommets; PermaDry® molded rubber gskts. incl.	
1	Valve Cover Gasket Set	2007-06	VS 50577 R	w/Grommets; PermaDry® molded rubber gskts. incl.	
QTY	VALVE STEM SEAL SET	YEARS	PART NO.	DESCRIPTION	
1	Valve Stem Seal Set	2010-08	SS 71041	Replaces unified valve spring/seal; Premium valve stem seals incl.	
1	Valve Stem Seal Set	2010-08	SS 72446	Unified valve spring/seal; Premium valve stem seals incl.; New Part Number - Check for Availability	
1	Valve Stem Seal Set	2007-06	SS 71041	Premium valve stem seals incl.	
QTY	THERMOSTAT HOUSING	YEARS	PART NO.	DESCRIPTION	
1	Thermostat Gasket	2010-06	35692	Thermostat Housing; Thermostat seal	
QTY	WATER PUMP	YEARS	PART NO.	DESCRIPTION	
1	Water Pump Gasket	2010-06	35655		
QTY	TIMING COVER	YEARS	PART NO.	DESCRIPTION	
1	Timing Cover Set	2010-06	TCS 46022	RTV sealant incl. for timing cover gskt.	
QTY	AIR CLEANER MOUNTING	YEARS	PART NO.	DESCRIPTION	
1	Air Cleaner Gasket	2010-06	61216		
QTY	CARB & FUEL INJECTION	YEARS	PART NO.	DESCRIPTION	
2	Fuel Injector O-Ring Set	2010-06	ES 70599	Lower set; Injectors to cylinder head; Improved design	
2	Fuel Injector O-Ring Set	2010-06	ES 70599	Upper set; Injectors to fuel rail; Improved design	
1	Throttle Body Gasket	2010-06	61324	Idle air control; 21mm ID	
1	Throttle Body Gasket	2010-06	61326	Idle air control; 30mm ID	
1	Throttle Body Gasket	2010-08	61438	Mounting	
1	Throttle Body Gasket	2007-06	61182	Loc. Lower; Mounting	
1	Throttle Body Gasket	2007-06	61398	Loc. Upper; Mounting	
QTY	EXHAUST GAS RECIRCULATION	YEARS	PART NO.	DESCRIPTION	
2	EGR Gasket	2010-06	70721	Tube flange	

Mitsubishi Truck (Incl. Minivans and SUV's) (Cont.)

13 (cont.)		2010 - 2006; 4.7L 287 (4703cc) SOHC V8 (16 Valve) 93mm Bore			13 (cont.)
MFI; Gasoline; Naturally Aspirated Chrysler Eng.; VIN Code N					
QTY	EXHAUST GAS RECIRCULATION	YEARS	PART NO.	DESCRIPTION	
2	EGR Gasket	2010-06	72928	Tube seal	
1	EGR Gasket	2010-08	71221	Valve	
1	EGR Gasket	2010-08	72251	Flange	
1	EGR Gasket	2007-06	71238	Valve	
1	EGR Gasket	2007-06	71240	Flange	
14		2010 - 2007; 4.7L 287 (4703cc) SOHC V8 (16 Valve) 93mm Bore			14
MFI; Flex Fuel; Naturally Aspirated Chrysler Eng.; VIN Code P					
QTY	CYLINDER HEAD	YEARS	PART NO.	DESCRIPTION	
2	Head Gasket	2010-07	26157 PT	Head bolts not incl.; Head bolt replacement recommended; PermaTorqueMLS®	
1	Head Set	2010-08	HS 26157 PT-2	Unified valve spring/seal not incl.; Head bolts not incl.; Head bolt replacement recommended; Must be used w/TCS 46022; PermaDry® molded rubber valve cover gskts. incl.; Premium valve stem seals incl.	
1	Head Set	2007	HS 26157 PT-1	Head bolts not incl.; Head bolt replacement recommended; Must be used w/TCS 46022; PermaDry® molded rubber valve cover gskts. incl.; Premium valve stem seals incl.	
2	Head Bolt Set	2010-07	ES 71129	Head bolts w/Washers; Replacement recommended	
QTY	CONVERSION SET	YEARS	PART NO.	DESCRIPTION	
1	Gasket Conversion Set	2010-07	CS 26157	RTV sealant incl. for timing cover gskt.; PermaDry® molded rubber oil pan gskt. incl.	
QTY	MANIFOLD - INT. & EXH.	YEARS	PART NO.	DESCRIPTION	
1	Int. Manifold Gasket Set	2010-08	MS 96998		
1	Int. Manifold Gasket Set	2007	MS 93205		
1	Exh. Manifold Gasket Set	2010-08	MS 96994		
1	Exh. Manifold Gasket Set	2007	MS 93217		
QTY	OIL PAN	YEARS	PART NO.	DESCRIPTION	
1	Oil Pan Gasket Set	2010-07	OS 30709 R	w/Windage tray; PermaDry® molded rubber gskt. incl.	
QTY	CRANKSHAFT REAR SEAL	YEARS	PART NO.	DESCRIPTION	
1	Rear Main Seal Set	2010-07	BS 40186	Rubber; One-piece	
1	Repair Sleeve	2010-07	16230	Crankshaft; Use w/installation tool	
1	Repair Sleeve Tool	2010-07	16328	Crankshaft	
QTY	VALVE COVER	YEARS	PART NO.	DESCRIPTION	
1	Valve Cover Gasket Set	2010-08	VS 50733 R	w/Grommets; PermaDry® molded rubber gskts. incl.	
1	Valve Cover Gasket Set	2007	VS 50577 R	w/Grommets; PermaDry® molded rubber gskts. incl.	
QTY	VALVE STEM SEAL SET	YEARS	PART NO.	DESCRIPTION	
1	Valve Stem Seal Set	2010-08	SS 71041	Replaces unified valve spring/seal; Premium valve stem seals incl.	
1	Valve Stem Seal Set	2010-08	SS 72446	Unified valve spring/seal; Premium valve stem seals incl.; New Part Number - Check for Availability	
1	Valve Stem Seal Set	2007	SS 71041	Premium valve stem seals incl.	
QTY	THERMOSTAT HOUSING	YEARS	PART NO.	DESCRIPTION	
1	Thermostat Gasket	2010-07	35692	Thermostat Housing; Thermostat seal	
QTY	WATER PUMP	YEARS	PART NO.	DESCRIPTION	
1	Water Pump Gasket	2010-07	35655		
QTY	TIMING COVER	YEARS	PART NO.	DESCRIPTION	
1	Timing Cover Set	2010-07	TCS 46022	RTV sealant incl. for timing cover gskt.	
QTY	AIR CLEANER MOUNTING	YEARS	PART NO.	DESCRIPTION	
1	Air Cleaner Gasket	2010-07	61216		
QTY	CARB & FUEL INJECTION	YEARS	PART NO.	DESCRIPTION	
2	Fuel Injector O-Ring Set	2010-07	ES 70599	Lower set; Injectors to cylinder head; Improved design	
2	Fuel Injector O-Ring Set	2010-07	ES 70599	Upper set; Injectors to fuel rail; Improved design	
1	Throttle Body Gasket	2010-07	61324	Idle air control; 21mm ID	
1	Throttle Body Gasket	2010-07	61326	Idle air control; 30mm ID	
1	Throttle Body Gasket	2010-08	61438	Mounting	
1	Throttle Body Gasket	2007	61182	Loc. Lower; Mounting	
1	Throttle Body Gasket	2007	61398	Loc. Upper; Mounting	
QTY	EXHAUST GAS RECIRCULATION	YEARS	PART NO.	DESCRIPTION	
2	EGR Gasket	2010-07	70721	Tube flange	
2	EGR Gasket	2010-07	72928	Tube seal	
1	EGR Gasket	2010-08	71221	Valve	
1	EGR Gasket	2010-08	72251	Flange	
1	EGR Gasket	2007	71238	Valve	
1	EGR Gasket	2007	71240	Flange	

Engine Finding Index

Engine	Years	Code	Line No.
1.6L 98 (1597cc) SOHC L4 (8 Valve) 80mm Bore; 2 Bbl.; Gasoline; Naturally Aspirated Ford Eng.	1994-91		1
3.9L 241 (3948cc) OHV V8 (16 Valve) 94mm Bore; MFI; Gasoline; Naturally Aspirated Rover Eng.; Buick	2004-02	56D	2

Engine Code Index

Code	Engine	Line No.
56D	3.9L 241 (3948cc) OHV V8 (16 Valve) 94mm Bore; MFI; Gasoline; Naturally Aspirated Rover Eng.; Buick	2

Model Index

Engine (VIN Code / Eng. Code)	Year	Engine (VIN Code / Eng. Code)	Year	Engine (VIN Code / Eng. Code)	Year
Morgan		Morgan (cont.)		Morgan (cont.)	
4/4		Plus 8		Plus 8 (cont.)	
L4 1597cc 1.6L SOHC	94-82	V8 3528cc 3.5L OHV	96-68	V8 3948cc 3.9L OHV	04-02
Aero 8		V8 3528cc 3.5L OHV	03		
V8 4398cc 4.4L DOHC (32 Valve)	07-04	V8 3948cc 3.9L OHV	72		

1

**1994 - 1991; 1.6L 98 (1597cc) SOHC L4 (8 Valve) 80mm Bore
2 Bbl.; Gasoline; Naturally Aspirated Ford Eng.**

1

QTY	CYLINDER HEAD	YEARS	PART NO.	DESCRIPTION
1	Head Gasket	1994-91	9309 PT-2	Head bolts not incl.; Head bolt replacement required; PermaTorque®
1	Head Gasket Spacer Shim	1994-91	9309 SP-2	HeadSaver®
1	Head Set	1994-91	HS 9118 PT	w/Head bolts; Premium valve stem seals incl.
1	Head Bolt Set	1994-91	ES 72672	Replacement required
QTY	MANIFOLD - INT. & EXH.	YEARS	PART NO.	DESCRIPTION
1	Exh. Manifold Gasket Set	1994-91	MS 92057	
QTY	EXHAUST PIPE FLANGE	YEARS	PART NO.	DESCRIPTION
1	Exhaust Pipe Gasket	1994-91	60480	Pipe to manifold
1	Exhaust Pipe Gasket	1994-91	60583	Converter
1	Exh. Flange Bolt & Spring Kit	1994-91	ES 72142	
QTY	FUEL PUMP	YEARS	PART NO.	DESCRIPTION
1	Fuel Pump Mounting Gasket	1994-91	72517	
QTY	OIL PAN	YEARS	PART NO.	DESCRIPTION
1	Oil Pan Gasket Set	1994-91	OS 30536 R	w/Aluminum oil pan; PermaDry® molded rubber gskt. incl.
1	Drain Plug Gasket	1994-91	72515	
QTY	CRANKSHAFT REAR SEAL	YEARS	PART NO.	DESCRIPTION
1	Rear Main Seal Set	1994-91	BS 40158	Rubber; One-piece
1	Rear Main Seal Set	1994-91	BS 40646	PTFE Rubber; One-piece
QTY	VALVE COVER	YEARS	PART NO.	DESCRIPTION
1	Valve Cover Gasket Set	1994-91	VS 50193 C	Cork
QTY	VALVE STEM SEAL SET	YEARS	PART NO.	DESCRIPTION
1	Valve Stem Seal Set	1994-91	SS 70654	Opt. Top-Hat Design; Premium valve stem seals incl.
1	Valve Stem Seal Set	1994-91	SS 72514-2	Std.; Premium valve stem seals incl.
QTY	THERMOSTAT HOUSING	YEARS	PART NO.	DESCRIPTION
1	Thermostat Gasket	1994-91	35266	Thermostat Housing
1	O-Ring	1994-91	35361	Thermostat Housing
QTY	WATER PUMP	YEARS	PART NO.	DESCRIPTION
1	Water Pump Gasket	1994-91	35359	Inlet
1	Water Pump Gasket	1994-91	35360	Cover
QTY	TIMING COVER	YEARS	PART NO.	DESCRIPTION
1	Camshaft Front Seal Set	1994-91	TCS 45473	
1	Repair Sleeve Tool	1994-91	16303	Timing Cover
QTY	CARB & FUEL INJECTION	YEARS	PART NO.	DESCRIPTION
1	Carb. Mounting Gasket	1994-91	60530	Carb. to manifold
QTY	EXHAUST GAS RECIRCULATION	YEARS	PART NO.	DESCRIPTION
1	EGR Gasket	1994-91	70020	
QTY	CYLINDER BLOCK	YEARS	PART NO.	DESCRIPTION
1	O-Ring	1994-91	TCS 45483	Crankcase Vent Cover; Front seal set; Repair sleeve not incl.

2

**2004 - 2002; 3.9L 241 (3948cc) OHV V8 (16 Valve) 94mm Bore
MFI; Gasoline; Naturally Aspirated Rover Eng.; Buick; Eng. Code 56D**

2

QTY	CYLINDER HEAD	YEARS	PART NO.	DESCRIPTION
2	Head Gasket	2004-02	26532 PT	Head bolts not incl.; Head bolt replacement recommended; New Part Number - Check for Availability
1	Head Set	2004-02	HS 26436 PT	Head bolts not incl.; Head bolt replacement recommended; PermaDry® molded rubber valve cover gskts. incl.; Premium valve stem seals incl.
QTY	CONVERSION SET	YEARS	PART NO.	DESCRIPTION
1	Gasket Conversion Set	2004-02	CS 26436	

Morgan (Cont.)

2		2004 - 2002; 3.9L 241 (3948cc) OHV V8 (16 Valve) 94mm Bore			2	
(cont.)		MFI; Gasoline; Naturally Aspirated Rover Eng.; Buick; Eng. Code 56D			(cont.)	
QTY	MANIFOLD - INT. & EXH.	YEARS	PART NO.	DESCRIPTION		
1	Valley Pan Gasket Set	2004-02	MS 97186	Lower set; New Part Number - Check for Availability		
1	Plenum Gasket Set	2004-02	MS 97221	Upper set; New Part Number - Check for Availability		
1	Exh. Manifold Gasket Set	2004-02	MS 97185			
QTY	CRANKSHAFT REAR SEAL	YEARS	PART NO.	DESCRIPTION		
1	Rear Main Seal Set	2004-02	BS 40750	Rubber; One-piece; New Part Number - Check for Availability		
QTY	VALVE COVER	YEARS	PART NO.	DESCRIPTION		
1	Valve Cover Gasket Set	2004-02	VS 50789 R	PermaDry® molded rubber gsks. incl.		
QTY	WATER PUMP	YEARS	PART NO.	DESCRIPTION		
1	Water Pump Gasket	2004-02	35911	New Part Number - Check for Availability		
QTY	TIMING COVER	YEARS	PART NO.	DESCRIPTION		
1	Crankshaft Front Seal Set	2004-02	TCS 46190	New Part Number - Check for Availability		

Mosler

Engine Finding Index							
Engine	Years	Code	Line No.				
5.7L 346 (5665cc) OHV V8 (16 Valve) 99mm Bore LS-6; MFI; Gasoline; Naturally Aspirated GMC Eng.; Chevrolet	2007-02		1				
Model Index							
Engine (VIN Code / Eng. Code)	Year	Engine (VIN Code / Eng. Code)	Year	Engine (VIN Code / Eng. Code)	Year		
Mosler		Mosler (cont.)					
		MT900					
		V8 346CI 5.7L OHV	07-02				
1		2007 - 2002; 5.7L 346 (5665cc) OHV V8 (16 Valve) 99mm Bore LS-6				1	
		MFI; Gasoline; Naturally Aspirated GMC Eng.; Chevrolet					
QTY	CYLINDER HEAD	YEARS	PART NO.	DESCRIPTION			
2	Head Gasket	2007-02	26190 PT	Head bolts not incl.; Head bolt replacement recommended; PermaTorqueMLS® LaserWeld® Technology			
1	Head Set	2007-02	HS 26190 PT	Head bolts not incl.; Head bolt replacement recommended; PermaDry® molded rubber valve cover gsks. incl.; Premium valve stem seals incl.			
2	Head Bolt Set	2007-04	ES 72220	2nd Design; Replacement recommended			
2	Head Bolt Set	2004-02	ES 72173	1st Design; Replacement recommended			
QTY	CONVERSION SET	YEARS	PART NO.	DESCRIPTION			
1	Gasket Conversion Set	2007-02	CS 9284	Lower oil pan gskt. not incl.; PermaDry® molded rubber oil pan gskt. incl.			
QTY	MANIFOLD - INT. & EXH.	YEARS	PART NO.	DESCRIPTION			
1	Int. Manifold Gasket Set	2007-02	MS 92438				
1	Int. Manifold Gasket Set	2007-02	MS 92465	Lifter valley cover set			
1	Exh. Manifold Gasket Set	2007-02	MS 92904				
QTY	OIL PAN	YEARS	PART NO.	DESCRIPTION			
1	Oil Pan Gasket Set	2007-02	OS 30693 R	Loc. Upper; PermaDry® molded rubber gskt. incl.			
1	Oil Pan Gasket Set	2007-02	OS 30703 R	Loc. Lower; PermaDry® molded rubber gskt. incl.			
QTY	CRANKSHAFT REAR SEAL	YEARS	PART NO.	DESCRIPTION			
1	Rear Main Seal Set	2007-02	BS 40640	PTFE Rubber; One-piece			
1	Repair Sleeve	2007-02	16228	Crankshaft; Narrow lip; .780" sleeve length; Requires crankshaft machining due to clearance issues; Use w/installation tool			
1	Repair Sleeve	2007-02	16229	Crankshaft; Wide lip; 1.156" sleeve length; Requires crankshaft machining due to clearance issues; Use w/installation tool			
1	Repair Sleeve Tool	2007-02	16329	Crankshaft			
QTY	VALVE COVER	YEARS	PART NO.	DESCRIPTION			
1	Valve Cover Gasket Set	2007-02	VS 50504 R	w/o Grommets; PermaDry® molded rubber gsks. incl.			
1	Valve Cover Gasket Set	2007-02	VS 50504 R-1	w/Grommets; PermaDry® molded rubber gsks. incl.; New Part Number - Check for Availability			
1	Grommet Set	2007-02	ES 72233	Valve Cover			
QTY	VALVE STEM SEAL SET	YEARS	PART NO.	DESCRIPTION			
1	Valve Stem Seal Set	2007-02	SS 71039	Premium valve stem seals incl.			
QTY	THERMOSTAT HOUSING	YEARS	PART NO.	DESCRIPTION			
1	Thermostat Gasket	2003-02	35632	Thermostat Housing; Thermostat O-ring			
1	O-Ring	2007-04	35720	Thermostat Housing			
QTY	WATER PUMP	YEARS	PART NO.	DESCRIPTION			
2	Water Pump Gasket	2007-02	35635				
1	O-Ring	2007-02	35633	Water Pump			
1	Water Pump Mounting Set	2007-02	ES 73010	Mounting gasket set; New Part Number - Check for Availability			
QTY	TIMING COVER	YEARS	PART NO.	DESCRIPTION			
1	Timing Cover Set	2007-02	TCS 45993	Must be used w/OS 30693R or w/OS 30703R			

1				
2007 - 2002; 5.7L 346 (5665cc) OHV V8 (16 Valve) 99mm Bore LS-6				
MFI; Gasoline; Naturally Aspirated GMC Eng.; Chevrolet				
1				
(cont.)				
QTY	CARB & FUEL INJECTION	YEARS	PART NO.	DESCRIPTION
1	Throttle Body Gasket	2007-02	61069	
QTY	EXHAUST GAS RECIRCULATION	YEARS	PART NO.	DESCRIPTION
1	EGR Gasket	2007-02	70895	Pipe; O-ring
1	EGR Gasket	2007-02	70914	Valve
1	EGR Gasket	2007-02	70947	Pipe
QTY	OIL FILTER MOUNTING	YEARS	PART NO.	DESCRIPTION
1	Oil Cooler Gasket	2007-02	72462	Oil Filter; Center tube; Dual round port
QTY	OIL PUMP COVER	YEARS	PART NO.	DESCRIPTION
1	O-Ring	2007-02	72401	Oil Pump; Inlet tube
QTY	OIL COOLER	YEARS	PART NO.	DESCRIPTION
1	Oil Cooler Gasket	2007-02	72435	Oval port
1	Oil Cooler Gasket	2007-02	72462	Dual round port

Nissan Car (Incl. Datsun, Infiniti, Nissan)

Engine Finding Index				
Engine	Years	Code	Line No.	
1.6L 97.5 (1597cc) DOHC L4 (16 Valve) 76mm Bore; MFI; Gasoline; Naturally Aspirated Nissan Eng.	1999-91	GA16DE	1	
1.6L 97.5 (1598cc) DOHC L4 (16 Valve) 78mm Bore; MFI; Gasoline; Naturally Aspirated Nissan Eng.	2013-08	HR16DE	2	
1.8L 107.9 (1769cc) DOHC L4 (16 Valve) 80mm Bore; MFI; Gasoline; Naturally Aspirated Nissan Eng.	2006-00	QG18DE	3	
1.8L 109.6 (1797cc) DOHC L4 (16 Valve) 84mm Bore; MFI; Gasoline; Naturally Aspirated Nissan Eng.	2013-07	MR18DE	4	
1.8L 109.7 (1798cc) DOHC L4 (16 Valve) 79.7mm Bore VVT; MFI; Gasoline; Naturally Aspirated Nissan Eng.	2013	MRA8DE	5	
2.0L 122 (1997cc) DOHC L4 (16 Valve) 84mm Bore; MFI; Gasoline; Naturally Aspirated Nissan Eng.	2012-07	MR20DE	6	
2.0L 122 (1998cc) DOHC L4 (16 Valve) 86mm Bore; MFI; Gasoline; Naturally Aspirated Nissan Eng.	2002-91	SR20DE	7	
2.4L 146 (2389cc) DOHC L4 (16 Valve) 89mm Bore; MFI; Gasoline; Naturally Aspirated Nissan Eng.	2001-91	KA24DE	8	
2.4L 146 (2389cc) SOHC L4 (12 Valve) 89mm Bore; MFI; Gasoline; Naturally Aspirated Nissan Eng.	1992-91	KA24E	9	
2.5L 151.8 (2488cc) DOHC L4 (16 Valve) 89mm Bore; MFI; Gasoline; Naturally Aspirated Nissan Eng.	2013-02	QR25DE	10	
2.5L 151.8 (2488cc) DOHC L4 (16 Valve) 89mm Bore; MFI; Hybrid (Gas/Electric); Naturally Aspirated Nissan Eng.	2012-07	QR25DE	11	
2.5L 152.3 (2496cc) DOHC V6 (24 Valve) 85mm Bore VVT; MFI; Gasoline; Naturally Aspirated Nissan Eng.	2013-11	VQ25HR	12	
3.0L 181 (2960cc) DOHC V6 (24 Valve) 87mm Bore; MFI; Gasoline; Naturally Aspirated Nissan Eng.	1994-92	VE30DE	13	
3.0L 181 (2960cc) DOHC V6 (24 Valve) 87mm Bore; MFI; Gasoline; Naturally Aspirated Nissan Eng.	1996-91	VG30D	14	
3.0L 181 (2960cc) DOHC V6 (24 Valve) 87mm Bore; MFI; Gasoline; Naturally Aspirated Nissan Eng.	1997-91	VG30DE	15	
3.0L 181 (2960cc) DOHC V6 (24 Valve) 87mm Bore; MFI; Gasoline; Turbo - Intercooled Nissan Eng.	1996-91	VG30DETT	16	
3.0L 181 (2960cc) DOHC V6 (24 Valve) 87mm Bore; MFI; Gasoline; Turbo - Intercooled Nissan Eng.	1996-91	VG30DDT	17	
3.0L 181 (2960cc) SOHC V6 (12 Valve) 87mm Bore; MFI; Gasoline; Naturally Aspirated Nissan Eng.	1992-91	VG30	18	
3.0L 181 (2960cc) SOHC V6 (12 Valve) 87mm Bore; MFI; Gasoline; Naturally Aspirated Nissan Eng.	1994-91	VG30E	19	
3.0L 181 (2988cc) DOHC V6 (24 Valve) 93mm Bore; MFI; Gasoline; Naturally Aspirated Nissan Eng.	2001-95	VQ30DE	20	
3.5L 214 (3498cc) DOHC V6 (24 Valve) 95.5mm Bore; MFI; Gasoline; Naturally Aspirated Nissan Eng.	2013-02	VQ35DE	21	
3.5L 214 (3498cc) DOHC V6 (24 Valve) 95.5mm Bore; MFI; Gasoline; Naturally Aspirated Nissan Eng.	2010-07	VQ35HR	22	
3.5L 214 (3498cc) DOHC V6 (24 Valve) 95.5mm Bore; MFI; Hybrid (Gas/Electric); Naturally Aspirated Nissan Eng.	2013-12	VQ35HR	23	
3.7L 225.5 (3696cc) DOHC V6 (24 Valve) 95.5mm Bore VVEL; MFI; Gasoline; Naturally Aspirated Nissan Eng.	2013-08	VQ37VHR	24	
3.8L 231.8 (3799cc) DOHC V6 (24 Valve) 95.5mm Bore; MFI; Gasoline; Turbo - Intercooled Nissan Eng.	2013-09	VR38DETT	25	
4.1L 252 (4130cc) DOHC V8 (32 Valve) 93mm Bore; MFI; Gasoline; Naturally Aspirated Nissan Eng.	2001-97	VH41DE	26	
4.5L 274 (4494cc) DOHC V8 (32 Valve) 93mm Bore; MFI; Gasoline; Naturally Aspirated Nissan Eng.	1996-91	VH45DE	27	
4.5L 274 (4494cc) DOHC V8 (32 Valve) 93mm Bore; MFI; Gasoline; Naturally Aspirated Nissan Eng.	2010-02	VK45DE	28	
Engine Code Index				
Code	Engine		Line No.	
GA16DE	1.6L 97.5 (1597cc) DOHC L4 (16 Valve) 76mm Bore; MFI; Gasoline; Naturally Aspirated Nissan Eng.		1	
HR16DE	1.6L 97.5 (1598cc) DOHC L4 (16 Valve) 78mm Bore; MFI; Gasoline; Naturally Aspirated Nissan Eng.		2	
KA24DE	2.4L 146 (2389cc) DOHC L4 (16 Valve) 89mm Bore; MFI; Gasoline; Naturally Aspirated Nissan Eng.		8	
KA24E	2.4L 146 (2389cc) SOHC L4 (12 Valve) 89mm Bore; MFI; Gasoline; Naturally Aspirated Nissan Eng.		9	
MR18DE	1.8L 109.6 (1797cc) DOHC L4 (16 Valve) 84mm Bore; MFI; Gasoline; Naturally Aspirated Nissan Eng.		4	
MR20DE	2.0L 122 (1997cc) DOHC L4 (16 Valve) 84mm Bore; MFI; Gasoline; Naturally Aspirated Nissan Eng.		6	
MRA8DE	1.8L 109.7 (1798cc) DOHC L4 (16 Valve) 79.7mm Bore VVT; MFI; Gasoline; Naturally Aspirated Nissan Eng.		5	
QG18DE	1.8L 107.9 (1769cc) DOHC L4 (16 Valve) 80mm Bore; MFI; Gasoline; Naturally Aspirated Nissan Eng.		3	
QR25DE	2.5L 151.8 (2488cc) DOHC L4 (16 Valve) 89mm Bore; MFI; Gasoline; Naturally Aspirated Nissan Eng.		10	
QR25DE	2.5L 151.8 (2488cc) DOHC L4 (16 Valve) 89mm Bore; MFI; Hybrid (Gas/Electric); Naturally Aspirated Nissan Eng.		11	
SR20DE	2.0L 122 (1998cc) DOHC L4 (16 Valve) 86mm Bore; MFI; Gasoline; Naturally Aspirated Nissan Eng.		7	
VE30DE	3.0L 181 (2960cc) DOHC V6 (24 Valve) 87mm Bore; MFI; Gasoline; Naturally Aspirated Nissan Eng.		13	
VG30	3.0L 181 (2960cc) SOHC V6 (12 Valve) 87mm Bore; MFI; Gasoline; Naturally Aspirated Nissan Eng.		18	
VG30D	3.0L 181 (2960cc) DOHC V6 (24 Valve) 87mm Bore; MFI; Gasoline; Naturally Aspirated Nissan Eng.		14	

Nissan Car (Incl. Datsun, Infiniti, Nissan) (Cont.)

Engine Code Index (Cont.)

Code	Engine	Line No.
VG30DE	3.0L 181 (2960cc) DOHC V6 (24 Valve) 87mm Bore; MFI; Gasoline; Naturally Aspirated Nissan Eng.	15
VG30DETT	3.0L 181 (2960cc) DOHC V6 (24 Valve) 87mm Bore; MFI; Gasoline; Turbo - Intercooled Nissan Eng.	16
VG30DTT	3.0L 181 (2960cc) DOHC V6 (24 Valve) 87mm Bore; MFI; Gasoline; Turbo - Intercooled Nissan Eng.	17
VG30E	3.0L 181 (2960cc) SOHC V6 (12 Valve) 87mm Bore; MFI; Gasoline; Naturally Aspirated Nissan Eng.	19
VH41DE	4.1L 252 (4130cc) DOHC V8 (32 Valve) 93mm Bore; MFI; Gasoline; Naturally Aspirated Nissan Eng.	26
VH45DE	4.5L 274 (4494cc) DOHC V8 (32 Valve) 93mm Bore; MFI; Gasoline; Naturally Aspirated Nissan Eng.	27
VK45DE	4.5L 274 (4494cc) DOHC V8 (32 Valve) 93mm Bore; MFI; Gasoline; Naturally Aspirated Nissan Eng.	28
VQ25HR	2.5L 152.3 (2496cc) DOHC V6 (24 Valve) 85mm Bore VVT; MFI; Gasoline; Naturally Aspirated Nissan Eng.	12
VQ30DE	3.0L 181 (2988cc) DOHC V6 (24 Valve) 93mm Bore; MFI; Gasoline; Naturally Aspirated Nissan Eng.	20
VQ35DE	3.5L 214 (3498cc) DOHC V6 (24 Valve) 95.5mm Bore; MFI; Gasoline; Naturally Aspirated Nissan Eng.	21
VQ35HR	3.5L 214 (3498cc) DOHC V6 (24 Valve) 95.5mm Bore; MFI; Gasoline; Naturally Aspirated Nissan Eng.	22
VQ35HR	3.5L 214 (3498cc) DOHC V6 (24 Valve) 95.5mm Bore; MFI; Hybrid (Gas/Electric); Naturally Aspirated Nissan Eng.	23
VQ37VHR	3.7L 225.5 (3696cc) DOHC V6 (24 Valve) 95.5mm Bore VVEL; MFI; Gasoline; Naturally Aspirated Nissan Eng.	24
VR38DETT	3.8L 231.8 (3799cc) DOHC V6 (24 Valve) 95.5mm Bore; MFI; Gasoline; Turbo - Intercooled Nissan Eng.	25

Model Index

Engine (VIN Code / Eng. Code)	Year	Engine (VIN Code / Eng. Code)	Year	Engine (VIN Code / Eng. Code)	Year
Infiniti		Nissan		Nissan (cont.)	
G20		1000		350Z	
L4 1998cc 2.0L DOHC (16 Valve) (SR20DE)	96-91	L4 988cc 1.0L OHV (A10)	71-65	V6 3498cc 3.5L DOHC (24 Valve) (VQ35DE)	07-03
L4 1998cc 2.0L DOHC (16 Valve) (SR20DE)	02-99	1200		V6 3498cc 3.5L DOHC (24 Valve) (VQ35HR)	09-07
G25 Sedan		L4 1171cc 1.2L OHV (A12)	73-71	370Z	
V6 2496cc 2.5L DOHC (24 Valve) (VQ25HR)	13-11	1300		V6 3696cc 3.7L DOHC (24 Valve)	13-09
G35 Coupe		L4 1288cc 1.3L OHV (A13)	73-72	(VQ37VHR)	
V6 3498cc 3.5L DOHC (24 Valve) (VQ35DE)	07-03	200SX (FWD)		510	
G35 Sedan		L4 1597cc 1.6L DOHC (16 Valve) (GA16DE)	98-95	L4 1595cc 1.6L SOHC (L16)	73-68
V6 3498cc 3.5L DOHC (24 Valve) (VQ35DE)	06-03	L4 1998cc 2.0L DOHC (16 Valve) (SR20DE)	98-95	L4 1952cc 2.0L SOHC (L20B)	79-78
V6 3498cc 3.5L DOHC (24 Valve) (VQ35HR)	08-07	200SX (RWD)		L4 1952cc 2.0L SOHC (Z20S)	81-80
G37 Convertible		L4 1809cc 1.8L SOHC Turbo (8 Valve) (CA18ET)	87-84	610	
V6 3696cc 3.7L DOHC (24 Valve) (VQ37VHR)	13-09	L4 1952cc 2.0L SOHC (L20B)	79-77	L4 1770cc 1.8L SOHC (L18)	73
G37 Coupe		L4 1952cc 2.0L SOHC (Z20E)	81-80	L4 1952cc 2.0L SOHC (L20B)	76-74
V6 3696cc 3.7L DOHC (24 Valve) (VQ37VHR)	13-08	L4 1974cc 2.0L SOHC (CA20E)	88-84	L4 1770cc 1.8L SOHC (L18)	74
G37 Sedan		L4 2187cc 2.2L SOHC (Z22E)	83-82	L4 1952cc 2.0L SOHC (L20B)	77-75
V6 3696cc 3.7L DOHC (24 Valve) (VQ37VHR)	13-09	V6 2960cc 3.0L SOHC (12 Valve) (VG30E)	88-87	810	
I30		210		L6 2393cc 2.4L SOHC (L24E)	81-77
V6 2988cc 3.0L DOHC (24 Valve) (VQ30DE)	01-96	L4 1237cc 1.2L OHV (A12A)	82-80	L6 2793cc 2.8L SOHC Diesel (LD28)	81
I35		L4 1397cc 1.4L OHV (A14)	82-79	Altima	
V6 3498cc 3.5L DOHC (24 Valve) (VQ35DE)	04-02	L4 1487cc 1.5L OHV (A15)	82-79	L4 2389cc 2.4L DOHC (16 Valve) (KA24DE)	01-93
IPL G Convertible		240SX		L4 2488cc 2.5L DOHC (16 Valve) (QR25DE)	13-02
V6 3696cc 3.7L DOHC (24 Valve) (VQ37VHR)	13	L4 2389cc 2.4L DOHC (16 Valve) (KA24DE)	98-91	V6 3498cc 3.5L DOHC (24 Valve) (VQ35DE)	13-02
IPL G Coupe		L4 2389cc 2.4L SOHC (12 Valve) (KA24E)	90-89	Altima Hybrid	
V6 3696cc 3.7L DOHC (24 Valve) (VQ37VHR)	13-11	240Z		L4 2488cc 2.5L DOHC (16 Valve) (QR25DE)	12-07
J30		L6 2393cc 2.4L SOHC (L24)	73-70	B110	
V6 2960cc 3.0L DOHC (24 Valve) (VG30DE)	97-93	L6 2565cc 2.6L SOHC (L26)	74	B210	
M30		280Z		L4 1288cc 1.3L OHV (A13)	74
V6 2960cc 3.0L SOHC (12 Valve) (VG30E)	92-90	L6 2753cc 2.8L SOHC (L28E)	78-75	L4 1397cc 1.4L OHV (A14)	78-75
M35		280ZX		Cube	
V6 3498cc 3.5L DOHC (24 Valve) (VQ35DE)	08-06	L6 2753cc 2.8L SOHC (L28E)	83-79	L4 1797cc 1.8L DOHC (16 Valve) (MR18DE)	13-09
V6 3498cc 3.5L DOHC (24 Valve) (VQ35HR)	10-09	L6 2753cc 2.8L SOHC Turbo (L28ET)	83-81	F10	
M35h Hybrid		300ZX		L4 1397cc 1.4L OHV (A14)	78-76
V6 3498cc 3.5L DOHC (24 Valve) (VQ35HR)	13-12	V6 2960cc 3.0L DOHC (24 Valve) (VG30DE)	96-90	GT-R	
V6 3696cc 3.7L DOHC (24 Valve) (VQ37VHR)	13-11	V6 2960cc 3.0L DOHC Turbo (24 Valve) (VG30DETT)	96-90	V6 3799cc 3.8L DOHC Turbo (24 Valve) (VR38DETT)	13-09
M37		V6 2960cc 3.0L SOHC (12 Valve) (VG30E)	89-84	Maxima (FWD)	
V6 3696cc 3.7L DOHC (24 Valve) (VQ37VHR)	13-11	V6 2960cc 3.0L SOHC Turbo (12 Valve) (VG30T)	89-84	V6 2960cc 3.0L DOHC (24 Valve) (VE30DE)	94-92
M45		310		V6 2960cc 3.0L SOHC (12 Valve) (VG30E)	94-85
V8 4494cc 4.5L DOHC (32 Valve) (VK45DE)	10-03	L4 1397cc 1.4L OHV (A14)	80-79	V6 2988cc 3.0L DOHC (24 Valve) (VQ30DE)	01-95
M56		L4 1487cc 1.5L OHV (A15)	81	V6 3498cc 3.5L DOHC (24 Valve) (VQ35DE)	13-02
V8 5552cc 5.6L DOHC (32 Valve) (VK56VDS)	13-11	L4 1487cc 1.5L SOHC (E15)	82	Maxima (RWD)	
Q45		350Z		L6 2393cc 2.4L SOHC (L24E)	84-82
V8 4130cc 4.1L DOHC (32 Valve) (VH41DE)	01-97	370Z		L6 2793cc 2.8L SOHC Diesel (LD28)	83-82
V8 4494cc 4.5L DOHC (32 Valve) (VH45DE)	96-90	380Z			
V8 4494cc 4.5L DOHC (32 Valve) (VK45DE)	06-02	390Z			

Nissan Car (Incl. Datsun, Infiniti, Nissan) (Cont.)

Model Index (Cont.)

<i>Engine (VIN Code / Eng. Code)</i>	<i>Year</i>	<i>Engine (VIN Code / Eng. Code)</i>	<i>Year</i>	<i>Engine (VIN Code / Eng. Code)</i>	<i>Year</i>
Nissan (cont.)					
Multi Wagon (Canada)					
L4 1974cc 2.0L SOHC (CA20E)	88-86				
Multi Wagon AWD (Canada)					
L4 1974cc 2.0L SOHC (CA20E)	88-86				
NX1600					
L4 1597cc 1.6L DOHC (16 Valve) (GA16DE)	93-91				
NX2000					
L4 1998cc 2.0L DOHC (16 Valve) (SR20DE)	93-91				
Pulsar					
L4 1487cc 1.5L SOHC Turbo (E15ET)	84-83				
L4 1487cc 1.5L SOHC Turbo (E15T)	84-83				
L4 1597cc 1.6L SOHC (12 Valve) (GA16I)	90-89				
L4 1597cc 1.6L SOHC (8 Valve) (E16)	87-83				
L4 1597cc 1.6L SOHC (8 Valve) (E16I)	88-87				
L4 1598cc 1.6L DOHC (16 Valve) (CA16DE)	87				
L4 1809cc 1.8L DOHC (16 Valve) (CA18DE)	90-88				
Sentra					
L4 1487cc 1.5L SOHC (E15)	83-82				
L4 1597cc 1.6L DOHC (16 Valve) (GA16DE)	99-91				
L4 1597cc 1.6L SOHC (12 Valve) (GA16I)	90-89				
L4 1597cc 1.6L SOHC (8 Valve) (E16)	87-83				
L4 1597cc 1.6L SOHC (8 Valve) (E16I)	88-86				
L4 1597cc 1.6L SOHC (8 Valve) (E16S)	88-86				
L4 1680cc 1.7L SOHC Diesel (CD17)	87-83				
L4 1769cc 1.8L DOHC (16 Valve) (QG18DE)	06-00				
L4 1798cc 1.8L DOHC (16 Valve) (MRA8DE)	13				
L4 1997cc 2.0L DOHC (16 Valve) (MR20DE)	12-07				
L4 1998cc 2.0L DOHC (16 Valve) (SR20DE)	94-91				
L4 1998cc 2.0L DOHC (16 Valve) (SR20DE)	01-98				
L4 2488cc 2.5L DOHC (16 Valve) (QR25DE)	12-02				
Sentra AWD					
L4 1597cc 1.6L SOHC (12 Valve) (GA16I)	89				
L4 1597cc 1.6L SOHC (8 Valve) (E16I)	88-87				
L4 1597cc 1.6L SOHC (8 Valve) (E16S)	88-87				
Stanza					
L4 1974cc 2.0L SOHC (CA20E)	89-84				
L4 1974cc 2.0L SOHC (CA20S)	86-82				
L4 2389cc 2.4L SOHC (12 Valve) (KA24E)	92-90				
Stanza Wagon					
L4 1974cc 2.0L SOHC (CA20E)	88-86				
Stanza Wagon AWD					
L4 1974cc 2.0L SOHC (CA20E)	88-86				
Versa					
L4 1598cc 1.6L DOHC (16 Valve) (HR16DE)	13-08				
L4 1797cc 1.8L DOHC (16 Valve) (MR18DE)	13-07				

1

**1999 - 1991; 1.6L 97.5 (1597cc) DOHC L4 (16 Valve) 76mm Bore
MFI; Gasoline; Naturally Aspirated Nissan Eng.; Eng. Code GA16DE**

1

QTY	CYLINDER HEAD	YEARS	PART NO.	DESCRIPTION
1	Head Gasket	1999-91	9819 PT	
1	Head Set	1999-95	HS 9819 PT-1	PermaDry® molded rubber valve cover gskt. incl.; Premium valve stem seals incl.
1	Head Set	1994-91	HS 9819 PT	PermaDry® molded rubber valve cover gskt. incl.; Premium valve stem seals incl.
QTY	CONVERSION SET	YEARS	PART NO.	DESCRIPTION
1	Gasket Conversion Set	1999-95	CS 9645-1	
1	Gasket Conversion Set	1994-91	CS 9645	
QTY	MANIFOLD - INT. & EXH.	YEARS	PART NO.	DESCRIPTION
1	Int. Manifold Gasket Set	1999-95	MS 96126	Upper set incl.
1	Int. Manifold Gasket Set	1994-91	MS 94811	Upper set incl.
1	Exh. Manifold Gasket Set	1999-91	MS 96343	Improved design
QTY	EXHAUST PIPE FLANGE	YEARS	PART NO.	DESCRIPTION
2	Exhaust Pipe Gasket	1999-91	60458	Converter
1	Exhaust Pipe Gasket	1999-91	60567	Pipe to muffler
1	Exhaust Pipe Gasket	1999-91	60569	Pipe to manifold
QTY	OIL PAN	YEARS	PART NO.	DESCRIPTION
1	Oil Pan Gasket Set	1999-91	OS 30619 C	

Nissan Car (Incl. Datsun, Infiniti, Nissan) (Cont.)

1		1999 - 1991; 1.6L 97.5 (1597cc) DOHC L4 (16 Valve) 76mm Bore			1
(cont.)		MFI; Gasoline; Naturally Aspirated Nissan Eng.; Eng. Code GA16DE			(cont.)
QTY	CRANKSHAFT REAR SEAL	YEARS	PART NO.	DESCRIPTION	
1	Rear Main Seal Set	1999-95	BS 40609	Rubber; One-piece	
1	Rear Main Seal Set	1994-91	BS 40628	Rubber; One-piece	
QTY	VALVE COVER	YEARS	PART NO.	DESCRIPTION	
1	Valve Cover Gasket Set	1999-95	VS 50570 R	w/o Spark plug tube seals; PermaDry® molded rubber gskt. incl.	
1	Valve Cover Gasket Set	1994-91	VS 50383 R	w/o Spark plug tube seals & w/Grommets; PermaDry® molded rubber gskt. incl.	
1	Spark Plug Tube Seal Set	1994-91	ES 70745	Valve Cover	
QTY	VALVE STEM SEAL SET	YEARS	PART NO.	DESCRIPTION	
1	Valve Stem Seal Set	1999-91	SS 72800	Premium valve stem seals incl.	
QTY	THERMOSTAT HOUSING	YEARS	PART NO.	DESCRIPTION	
1	Thermostat Gasket	1999-91	35476	Thermostat Housing	
QTY	WATER OUTLET GASKET	YEARS	PART NO.	DESCRIPTION	
1	Water Outlet Gasket	1999-91	35450	Water Outlet	
QTY	WATER PUMP	YEARS	PART NO.	DESCRIPTION	
1	Water Pump Gasket	1999-91	35496		
QTY	TIMING COVER	YEARS	PART NO.	DESCRIPTION	
1	Timing Cover Set	1999-95	TCS 45864	Must be used w/OS 30619C & w/VS 50570R	
1	Timing Cover Set	1994-91	TCS 45864	Must be used w/OS 30619C & w/VS 50383R & w/ES 70745	
1	Repair Sleeve	1999-91	16220	Timing Cover; Use w/installation tool; Improved design	
QTY	CARB & FUEL INJECTION	YEARS	PART NO.	DESCRIPTION	
1	Throttle Body Gasket	1999-95	61212		
1	Throttle Body Gasket	1994-91	60689		
QTY	EXHAUST GAS RECIRCULATION	YEARS	PART NO.	DESCRIPTION	
1	EGR Gasket	1999-91	72521		
2		2013 - 2008; 1.6L 97.5 (1598cc) DOHC L4 (16 Valve) 78mm Bore			2
(cont.)		MFI; Gasoline; Naturally Aspirated Nissan Eng.; Eng. Code HR16DE			(cont.)
QTY	CONVERSION SET	YEARS	PART NO.	DESCRIPTION	
1	Gasket Conversion Set	2013-08	CS 26338	RTV sealant incl. for Upper oil pan gskt.	
QTY	EXHAUST PIPE FLANGE	YEARS	PART NO.	DESCRIPTION	
1	Exhaust Pipe Gasket	2013-08	61016	Loc. Rear; Converter; Improved design	
1	Exhaust Pipe Gasket	2013-08	61367	Loc. Front; Converter	
1	Exhaust Pipe Gasket	2013-12	60567	Loc. Rear; Exh. connector	
1	Exhaust Pipe Gasket	2011	60567	Loc. Rear; From 06/02/11; Exh. connector	
1	Exhaust Pipe Gasket	2011	60569	Loc. Rear; To 06/01/11; Exh. connector	
1	Exhaust Pipe Gasket	2010-08	60569	Loc. Rear; Exh. connector	
QTY	OIL PAN	YEARS	PART NO.	DESCRIPTION	
1	Oil Pan Gasket Set	2013-08	OS 30805	Loc. Lower	
QTY	CRANKSHAFT REAR SEAL	YEARS	PART NO.	DESCRIPTION	
1	Rear Main Seal Set	2013-08	BS 40714	Rubber; One-piece	
QTY	VALVE COVER	YEARS	PART NO.	DESCRIPTION	
1	Valve Cover Gasket Set	2013-08	VS 50847 R	w/Spark plug tube seals; PermaDry® molded rubber gskt. incl.; New Part Number - Check for Availability	
QTY	THERMOSTAT HOUSING	YEARS	PART NO.	DESCRIPTION	
1	Thermostat Gasket	2013-08	35445	Thermostat Housing; Thermostat seal	
QTY	WATER PUMP	YEARS	PART NO.	DESCRIPTION	
1	Water Pump Gasket	2013-08	35883		
QTY	TIMING COVER	YEARS	PART NO.	DESCRIPTION	
1	Crankshaft Front Seal Set	2013-08	TCS 46130		
QTY	CARB & FUEL INJECTION	YEARS	PART NO.	DESCRIPTION	
1	Fuel Injector O-Ring Set	2013-08	ES 70599	Upper set; Injectors to fuel rail; Improved design	
3		2006 - 2000; 1.8L 107.9 (1769cc) DOHC L4 (16 Valve) 80mm Bore			3
(cont.)		MFI; Gasoline; Naturally Aspirated Nissan Eng.; Eng. Code QG18DE			(cont.)
QTY	CYLINDER HEAD	YEARS	PART NO.	DESCRIPTION	
1	Head Gasket	2006-00	26255 PT	Head bolts not incl.; Head bolt replacement recommended; PermaTorqueMLS®	
1	Head Set	2006-04	HS 26255 PT-1	Head bolts not incl.; Head bolt replacement recommended; PermaDry® molded rubber valve cover gskt. incl.; Premium valve stem seals incl.	
1	Head Set	2003	HS 26255 PT	To 03/31/03; Head bolts & exh. pipe packing not incl.; Head bolt replacement recommended; PermaDry® molded rubber valve cover gskt. incl.; Premium valve stem seals incl.	

Nissan Car (Incl. Datsun, Infiniti, Nissan) (Cont.)

3		2006 - 2000; 1.8L 107.9 (1769cc) DOHC L4 (16 Valve) 80mm Bore			3
(cont.)		MFI; Gasoline; Naturally Aspirated Nissan Eng.; Eng. Code QG18DE			(cont.)
QTY	CYLINDER HEAD	YEARS	PART NO.	DESCRIPTION	
1	Head Set	2003	HS 26255 PT-1	From 04/01/03; Head bolts not incl.; Head bolt replacement recommended; PermaDry® molded rubber valve cover gskt. incl.; Premium valve stem seals incl.	
1	Head Set	2002-00	HS 26255 PT	Head bolts & exh. pipe packing not incl.; Head bolt replacement recommended; PermaDry® molded rubber valve cover gskt. incl.; Premium valve stem seals incl.	
1	Head Bolt Set	2006-00	ES 72203	Replacement recommended	
QTY	CONVERSION SET	YEARS	PART NO.	DESCRIPTION	
1	Gasket Conversion Set	2006-00	CS 26255		
QTY	MANIFOLD - INT. & EXH.	YEARS	PART NO.	DESCRIPTION	
1	Int. Manifold Gasket Set	2006-00	MS 96514	Upper set incl.	
1	Exh. Manifold Gasket Set	2006-00	MS 96343	Improved design	
QTY	EXHAUST PIPE FLANGE	YEARS	PART NO.	DESCRIPTION	
2	Exhaust Pipe Gasket	2006-00	60458	Converter	
2	Exhaust Pipe Gasket	2006-03	60905	Pipe to manifold	
2	Exhaust Pipe Gasket	2002-00	60567	Pipe to manifold	
QTY	OIL PAN	YEARS	PART NO.	DESCRIPTION	
1	Oil Pan Gasket Set	2006-00	OS 30619 C		
QTY	CRANKSHAFT REAR SEAL	YEARS	PART NO.	DESCRIPTION	
1	Rear Main Seal Set	2006-00	BS 40609	Rubber; One-piece	
QTY	VALVE COVER	YEARS	PART NO.	DESCRIPTION	
1	Valve Cover Gasket Set	2006-04	VS 50617 R	PermaDry® molded rubber gskt. incl.	
1	Valve Cover Gasket Set	2003	VS 50617 R	From 04/01/03; PermaDry® molded rubber gskt. incl.	
1	Valve Cover Gasket Set	2003	VS 50618 R	To 03/31/03; PermaDry® molded rubber gskt. incl.	
1	Valve Cover Gasket Set	2002-00	VS 50618 R	PermaDry® molded rubber gskt. incl.	
QTY	VALVE STEM SEAL SET	YEARS	PART NO.	DESCRIPTION	
1	Valve Stem Seal Set	2006-00	SS 72800	Premium valve stem seals incl.	
QTY	THERMOSTAT HOUSING	YEARS	PART NO.	DESCRIPTION	
1	Thermostat Gasket	2006-00	35745	Thermostat Housing; Thermostat housing to head	
1	Thermostat Gasket	2006-00	35748	Thermostat Housing; Thermostat seal	
QTY	WATER PUMP	YEARS	PART NO.	DESCRIPTION	
1	Water Pump Gasket	2006-00	35746		
QTY	TIMING COVER	YEARS	PART NO.	DESCRIPTION	
1	Crankshaft Front Seal Set	2006-04	TCS 46063	Must be used w/OS 30619C & w/VS 50617R	
1	Crankshaft Front Seal Set	2003	TCS 46063	From 04/01/03; Must be used w/OS 30619C & w/VS 50617R	
1	Crankshaft Front Seal Set	2003	TCS 46063	To 03/31/03; Must be used w/OS 30619C & w/VS 50618R	
1	Crankshaft Front Seal Set	2002-00	TCS 46063	Must be used w/OS 30619C & w/VS 50618R	
QTY	CARB & FUEL INJECTION	YEARS	PART NO.	DESCRIPTION	
2	Fuel Injector O-Ring Set	2006-00	ES 70599	Improved design	
1	Throttle Body Gasket	2006-03	61354		
1	Throttle Body Gasket	2002-01	61353	Exc. Nissan Sentra CA	
1	Throttle Body Gasket	2002-01	61354	Nissan Sentra CA	
1	Throttle Body Gasket	2000	61353		
QTY	EXHAUST GAS RECIRCULATION	YEARS	PART NO.	DESCRIPTION	
1	EGR Gasket	2002-00	70893	Tube	
1	EGR Gasket	2002-00	70893	Valve	
4		2013 - 2007; 1.8L 109.6 (1797cc) DOHC L4 (16 Valve) 84mm Bore			4
(cont.)		MFI; Gasoline; Naturally Aspirated Nissan Eng.; Eng. Code MR18DE			(cont.)
QTY	CYLINDER HEAD	YEARS	PART NO.	DESCRIPTION	
1	Head Gasket	2013-07	26338 PT	Head bolts not incl.; Head bolt replacement recommended; PermaTorqueMLS®	
1	Head Set	2013-07	HS 26338 PT	Head bolts not incl.; Head bolt replacement recommended; PermaDry® molded rubber valve cover gskt. incl.; Premium valve stem seals incl.	
QTY	CONVERSION SET	YEARS	PART NO.	DESCRIPTION	
1	Gasket Conversion Set	2013-07	CS 26338	RTV sealant incl. for Upper oil pan gskt.	
QTY	MANIFOLD - INT. & EXH.	YEARS	PART NO.	DESCRIPTION	
1	Int. Manifold Gasket Set	2013-09	MS 97038	Exc. California	
1	Int. Manifold Gasket Set	2008-07	MS 97038		
1	Exh. Manifold Gasket Set	2013-07	MS 97030		
QTY	EXHAUST PIPE FLANGE	YEARS	PART NO.	DESCRIPTION	
1	Exhaust Pipe Gasket	2013-07	61016	Converter; Improved design	
1	Exhaust Pipe Gasket	2013-07	61367	Packing	

Nissan Car (Incl. Datsun, Infiniti, Nissan) (Cont.)

4		2013 - 2007; 1.8L 109.6 (1797cc) DOHC L4 (16 Valve) 84mm Bore			4
(cont.)		MFI; Gasoline; Naturally Aspirated Nissan Eng.; Eng. Code MR18DE			(cont.)
QTY	EXHAUST PIPE FLANGE	YEARS	PART NO.	DESCRIPTION	
1	Exhaust Pipe Gasket	2013-09	60569	Nissan Versa 1.8 S, 1.8 SL, S, SL; Exh. connector	
1	Exhaust Pipe Gasket	2013-09	60835	Nissan Cube Base, Krom, S, SL; Exh. connector; Improved design	
1	Exhaust Pipe Gasket	2008-07	60569	Exh. connector	
QTY	OIL PAN	YEARS	PART NO.	DESCRIPTION	
1	Oil Pan Gasket Set	2013-07	OS 30805	Loc. Lower	
QTY	CRANKSHAFT REAR SEAL	YEARS	PART NO.	DESCRIPTION	
1	Rear Main Seal Set	2013-07	BS 40714	Rubber; One-piece	
QTY	VALVE COVER	YEARS	PART NO.	DESCRIPTION	
1	Valve Cover Gasket Set	2013-07	VS 50746 R	PermaDry® molded rubber gskt. incl.	
QTY	VALVE STEM SEAL SET	YEARS	PART NO.	DESCRIPTION	
1	Valve Stem Seal Set	2013-07	SS 72800	Premium valve stem seals incl.	
QTY	THERMOSTAT HOUSING	YEARS	PART NO.	DESCRIPTION	
1	Thermostat Gasket	2013-07	35445	Thermostat Housing; Thermostat seal	
1	Thermostat Gasket	2013-09	35887	Nissan Versa 1.8 S, 1.8 SL, S, SL; Thermostat Housing; Thermostat housing to block	
1	Thermostat Gasket	2008-07	35887	Thermostat Housing; Thermostat housing to block	
QTY	WATER PUMP	YEARS	PART NO.	DESCRIPTION	
1	Water Pump Gasket	2013-07	35883		
QTY	TIMING COVER	YEARS	PART NO.	DESCRIPTION	
1	Crankshaft Front Seal Set	2013-07	TCS 46130		
QTY	CARB & FUEL INJECTION	YEARS	PART NO.	DESCRIPTION	
2	Fuel Injector O-Ring Set	2013-07	ES 70599	Improved design	
1	Throttle Body Gasket	2013-07	61552		
5		2013; 1.8L 109.7 (1798cc) DOHC L4 (16 Valve) 79.7mm Bore VVT			5
(cont.)		MFI; Gasoline; Naturally Aspirated Nissan Eng.; Eng. Code MRA8DE			(cont.)
QTY	EXHAUST PIPE FLANGE	YEARS	PART NO.	DESCRIPTION	
1	Exhaust Pipe Gasket	2013	60835	Exh. connector; Improved design	
1	Exhaust Pipe Gasket	2013	61016	Loc. Rear; Converter; Improved design	
1	Exhaust Pipe Gasket	2013	61367	Pipe to manifold	
QTY	OIL PAN	YEARS	PART NO.	DESCRIPTION	
1	Oil Pan Gasket Set	2013	OS 30847	New Part Number - Check for Availability	
QTY	CRANKSHAFT REAR SEAL	YEARS	PART NO.	DESCRIPTION	
1	Rear Main Seal Set	2013	BS 40714	Rubber; One-piece	
QTY	VALVE COVER	YEARS	PART NO.	DESCRIPTION	
1	Valve Cover Gasket Set	2013	VS 50746 R	PermaDry® molded rubber gskt. incl.	
QTY	VALVE STEM SEAL SET	YEARS	PART NO.	DESCRIPTION	
1	Valve Stem Seal Set	2013	SS 72800	Premium valve stem seals incl.	
QTY	THERMOSTAT HOUSING	YEARS	PART NO.	DESCRIPTION	
1	Thermostat Gasket	2013	35445	Thermostat Housing; Thermostat seal	
QTY	CARB & FUEL INJECTION	YEARS	PART NO.	DESCRIPTION	
1	Fuel Injector O-Ring Set	2013	ES 70599	Upper set; Injectors to fuel rail; Improved design	
1	Fuel Injector O-Ring Set	2013	ES 72004	Lower set; Injectors to cylinder head	
1	Throttle Body Gasket	2013	61552		
6		2012 - 2007; 2.0L 122 (1997cc) DOHC L4 (16 Valve) 84mm Bore			6
(cont.)		MFI; Gasoline; Naturally Aspirated Nissan Eng.; Eng. Code MR20DE			(cont.)
QTY	CYLINDER HEAD	YEARS	PART NO.	DESCRIPTION	
1	Head Gasket	2012-07	26338 PT	Head bolts not incl.; Head bolt replacement recommended; PermaTorqueMLS®	
1	Head Set	2012-07	HS 26338 PT	Head bolts not incl.; Head bolt replacement recommended; PermaDry® molded rubber valve cover gskt. incl.; Premium valve stem seals incl.	
QTY	CONVERSION SET	YEARS	PART NO.	DESCRIPTION	
1	Gasket Conversion Set	2012-07	CS 26338	RTV sealant incl. for Upper oil pan gskt.	
QTY	MANIFOLD - INT. & EXH.	YEARS	PART NO.	DESCRIPTION	
1	Int. Manifold Gasket Set	2012-07	MS 97038		
1	Exh. Manifold Gasket Set	2012-07	MS 97030		
QTY	EXHAUST PIPE FLANGE	YEARS	PART NO.	DESCRIPTION	
1	Exhaust Pipe Gasket	2012-07	60871	Exh. connector	
1	Exhaust Pipe Gasket	2012-07	61016	Pipe to manifold; Improved design	
1	Exhaust Pipe Gasket	2012-07	61367	Converter	
1	Exhaust Pipe Gasket	2012-07	61367	Packing	

Nissan Car (Incl. Datsun, Infiniti, Nissan) (Cont.)

6		2012 - 2007; 2.0L 122 (1997cc) DOHC L4 (16 Valve) 84mm Bore			6
(cont.)		MFI; Gasoline; Naturally Aspirated Nissan Eng.; Eng. Code MR20DE			(cont.)
QTY	OIL PAN	YEARS	PART NO.	DESCRIPTION	
1	Oil Pan Gasket Set	2012-07	OS 30805	Loc. Lower	
QTY	CRANKSHAFT REAR SEAL	YEARS	PART NO.	DESCRIPTION	
1	Rear Main Seal Set	2012-07	BS 40714	Rubber; One-piece	
QTY	VALVE COVER	YEARS	PART NO.	DESCRIPTION	
1	Valve Cover Gasket Set	2012-07	VS 50746 R	PermaDry® molded rubber gskt. incl.	
QTY	VALVE STEM SEAL SET	YEARS	PART NO.	DESCRIPTION	
1	Valve Stem Seal Set	2012-07	SS 72800	Premium valve stem seals incl.	
QTY	THERMOSTAT HOUSING	YEARS	PART NO.	DESCRIPTION	
1	Thermostat Gasket	2012-07	35445	Thermostat Housing; Thermostat seal	
1	Thermostat Gasket	2012-07	35887	Thermostat Housing; Thermostat housing to block	
QTY	WATER PUMP	YEARS	PART NO.	DESCRIPTION	
1	Water Pump Gasket	2012-07	35883		
QTY	TIMING COVER	YEARS	PART NO.	DESCRIPTION	
1	Crankshaft Front Seal Set	2012-07	TCS 46130		
QTY	CARB & FUEL INJECTION	YEARS	PART NO.	DESCRIPTION	
2	Fuel Injector O-Ring Set	2012-07	ES 70599	Improved design	
1	Throttle Body Gasket	2012-07	61552		
7		2002 - 1991; 2.0L 122 (1998cc) DOHC L4 (16 Valve) 86mm Bore			7
		MFI; Gasoline; Naturally Aspirated Nissan Eng.; Eng. Code SR20DE			
QTY	CYLINDER HEAD	YEARS	PART NO.	DESCRIPTION	
1	Head Gasket	2002-91	9816 PT	Head bolts not incl.; Head bolt replacement recommended	
1	Head Set	2002-00	HS 9816 PT-3	Head bolts not incl.; Head bolt replacement recommended; PermaDry® molded rubber valve cover gskt. incl.; Premium valve stem seals incl.	
1	Head Set	1999-97	HS 9816 PT-2	Head bolts not incl.; Head bolt replacement recommended; PermaDry® molded rubber valve cover gskt. incl.; Premium valve stem seals incl.	
1	Head Set	1996-95	HS 9816 PT-1	Head bolts not incl.; Head bolt replacement recommended; PermaDry® molded rubber valve cover gskt. incl.; Premium valve stem seals incl.	
1	Head Set	1994	HS 9816 PT	Infiniti G20 Base, t; To 01/31/94; Throttle body below int. manifold; Head bolts & exh. pipe to muffler gskt. not incl.; Head bolt replacement recommended; PermaDry® molded rubber valve cover gskt. incl.; Premium valve stem seals incl.	
1	Head Set	1994	HS 9816 PT-1	Infiniti G20 Base, t; From 02/01/94; Throttle body above int. manifold; Head bolts not incl.; Head bolt replacement recommended; PermaDry® molded rubber valve cover gskt. incl.; Premium valve stem seals incl.	
1	Head Set	1994	HS 9816 PT-1	Nissan Sentra SE, SE-R; Throttle body above int. manifold; Head bolts not incl.; Head bolt replacement recommended; PermaDry® molded rubber valve cover gskt. incl.; Premium valve stem seals incl.	
1	Head Set	1993-91	HS 9816 PT	Head bolts & exh. pipe to muffler gskt. not incl.; Head bolt replacement recommended; PermaDry® molded rubber valve cover gskt. incl.; Premium valve stem seals incl.	
1	Head Bolt Set	2002-91	ES 72192	Head bolts w/Washers; Replacement recommended	
QTY	CONVERSION SET	YEARS	PART NO.	DESCRIPTION	
1	Gasket Conversion Set	2002-00	CS 9816-1	RTV sealant incl. for Upper oil pan gskt.	
1	Gasket Conversion Set	1999-91	CS 9816	RTV sealant incl. for Upper oil pan gskt.	
QTY	MANIFOLD - INT. & EXH.	YEARS	PART NO.	DESCRIPTION	
1	Int. Manifold Gasket Set	2002-00	MS 95590-1	Upper set incl.	
1	Int. Manifold Gasket Set	1999-95	MS 95590	Upper set incl.	
1	Int. Manifold Gasket Set	1994	MS 94814	Infiniti G20 Base, t; To 01/31/94; Throttle body below int. manifold; Upper set incl.	
1	Int. Manifold Gasket Set	1994	MS 95590	Infiniti G20 Base, t; From 02/01/94; Throttle body above int. manifold; Upper set incl.	
1	Int. Manifold Gasket Set	1994	MS 95590	Nissan Sentra SE, SE-R; Throttle body above int. manifold; Upper set incl.	
1	Int. Manifold Gasket Set	1993-91	MS 94814	Upper set incl.	
1	Exh. Manifold Gasket Set	2002-91	MS 96113	Improved design	
QTY	EXHAUST PIPE FLANGE	YEARS	PART NO.	DESCRIPTION	
2	Exhaust Pipe Gasket	2002-91	60458	Converter	
1	Exhaust Pipe Gasket	2002-91	60905	Pipe to muffler	
2	Exhaust Pipe Gasket	2002-00	60905	Pipe to manifold	
2	Exhaust Pipe Gasket	1999-91	60835	Pipe to manifold; Improved design	
QTY	OIL PAN	YEARS	PART NO.	DESCRIPTION	
1	Oil Pan Gasket Set	2002-00	OS 30735 C	Loc. Lower	
1	Oil Pan Gasket Set	1999-91	OS 30646 C	Loc. Lower	

Nissan Car (Incl. Datsun, Infiniti, Nissan) (Cont.)

7		2002 - 1991; 2.0L 122 (1998cc) DOHC L4 (16 Valve) 86mm Bore			7
(cont.)		MFI; Gasoline; Naturally Aspirated Nissan Eng.; Eng. Code SR20DE			(cont.)
QTY	CRANKSHAFT REAR SEAL	YEARS	PART NO.	DESCRIPTION	
1	Rear Main Seal Set	2002-00	BS 40609	Rubber; One-piece	
1	Rear Main Seal Set	1999-91	BS 40628	Rubber; One-piece	
QTY	VALVE COVER	YEARS	PART NO.	DESCRIPTION	
1	Valve Cover Gasket Set	2002-97	VS 50571 R	w/Grommets & Spark plug tube seals; PermaDry® molded rubber gskt. incl.	
1	Valve Cover Gasket Set	1996-91	VS 50384 R	w/Grommets & Spark plug tube seals; PermaDry® molded rubber gskt. incl.	
QTY	VALVE STEM SEAL SET	YEARS	PART NO.	DESCRIPTION	
1	Valve Stem Seal Set	2002-91	SS 70157	Premium valve stem seals incl.	
QTY	THERMOSTAT HOUSING	YEARS	PART NO.	DESCRIPTION	
1	Water Outlet Gasket	2002-91	25583	Thermostat Housing	
QTY	WATER OUTLET GASKET	YEARS	PART NO.	DESCRIPTION	
1	Water Outlet Gasket	2002-91	35509	Water Outlet; Connector	
1	Water Outlet Gasket	2002-91	35510	Water Outlet	
QTY	WATER PUMP	YEARS	PART NO.	DESCRIPTION	
1	Water Pump Gasket	2002-91	35503		
QTY	TIMING COVER	YEARS	PART NO.	DESCRIPTION	
1	Crankshaft Front Seal Set	2002-00	TCS 45903	Must be used w/OS 30735C & w/VS 50571R	
1	Crankshaft Front Seal Set	1999-97	TCS 45903	Must be used w/OS 30646C & w/VS 50571R	
1	Crankshaft Front Seal Set	1996-91	TCS 45903	Must be used w/OS 30646C & w/VS 50384R	
QTY	CARB & FUEL INJECTION	YEARS	PART NO.	DESCRIPTION	
1	Throttle Body Gasket	2002-00	61275		
1	Throttle Body Gasket	1999-91	60818		
QTY	DISTRIBUTOR MOUNTING	YEARS	PART NO.	DESCRIPTION	
1	Fuel Pump Mounting Gasket	2002-91	70015	Distributor Mounting	
QTY	EXHAUST GAS RECIRCULATION	YEARS	PART NO.	DESCRIPTION	
1	EGR Gasket	2002-00	70893	Tube	
1	EGR Gasket	2002-00	70893	Valve	
1	EGR Gasket	1999-91	70368	Tube	
1	EGR Gasket	1999-94	72521	Mounting	
1	EGR Gasket	1993-91	70978	Mounting	
8		2001 - 1991; 2.4L 146 (2389cc) DOHC L4 (16 Valve) 89mm Bore			8
(cont.)		MFI; Gasoline; Naturally Aspirated Nissan Eng.; Eng. Code KA24DE			(cont.)
QTY	CYLINDER HEAD	YEARS	PART NO.	DESCRIPTION	
1	Head Gasket	2001-99	9942 PT	Head bolts not incl.; Head bolt replacement recommended	
1	Head Gasket	1998-97	26171 PT	Nissan 240SX Base, LE, SE; Head bolts not incl.; Head bolt replacement recommended	
1	Head Gasket	1998-97	9942 PT	Exc. Nissan 240SX Base, LE, SE; Head bolts not incl.; Head bolt replacement recommended	
1	Head Gasket	1996-93	9942 PT	Exc. Nissan 240SX Base, SE; Head bolts not incl.; Head bolt replacement recommended	
1	Head Gasket	1996-95	26171 PT	Nissan 240SX Base, SE; Head bolts not incl.; Head bolt replacement recommended	
1	Head Gasket	1994-93	9820 PT	Nissan 240SX Base, SE; Head bolts not incl.; Head bolt replacement recommended	
1	Head Gasket	1992-91	9820 PT	Head bolts not incl.; Head bolt replacement recommended	
1	Head Set	2001-99	HS 9942 PT-1	Head bolts & exh. pipe flange not incl.; Head bolt replacement recommended; PermaDry® molded rubber valve cover gskt. incl.; Premium valve stem seals incl.	
1	Head Set	1998-97	HS 26171 PT	Nissan 240SX Base, LE, SE; Head bolts not incl.; Head bolt replacement recommended; PermaDry® molded rubber valve cover gskt. incl.; Premium valve stem seals incl.	
1	Head Set	1998-97	HS 9942 PT-1	Exc. Nissan 240SX Base, LE, SE; Head bolts & exh. pipe flange not incl.; Head bolt replacement recommended; PermaDry® molded rubber valve cover gskt. incl.; Premium valve stem seals incl.	
1	Head Set	1996-95	HS 26171 PT	Nissan 240SX Base, SE; Head bolts not incl.; Head bolt replacement recommended; PermaDry® molded rubber valve cover gskt. incl.; Premium valve stem seals incl.	
1	Head Set	1996	HS 9942 PT-1	Exc. Nissan 240SX Base, SE; Head bolts & exh. pipe flange not incl.; Head bolt replacement recommended; PermaDry® molded rubber valve cover gskt. incl.; Premium valve stem seals incl.	
1	Head Set	1995-93	HS 9942 PT	Exc. Nissan 240SX Base, SE; Head bolts & exh. pipe flange not incl.; Head bolt replacement recommended; PermaDry® molded rubber valve cover gskt. incl.; Premium valve stem seals incl.	

Nissan Car (Incl. Datsun, Infiniti, Nissan) (Cont.)

8 (cont.)		2001 - 1991; 2.4L 146 (2389cc) DOHC L4 (16 Valve) 89mm Bore			8 (cont.)
MFI; Gasoline; Naturally Aspirated Nissan Eng.; Eng. Code KA24DE					
QTY	CYLINDER HEAD	YEARS	PART NO.	DESCRIPTION	
1	Head Set	1994-93	HS 9820 PT	Nissan 240SX Base, SE; Head bolts not incl.; Head bolt replacement recommended; PermaDry® molded rubber valve cover gskt. incl.; Premium valve stem seals incl.	
1	Head Set	1992-91	HS 9820 PT	Head bolts not incl.; Head bolt replacement recommended; PermaDry® molded rubber valve cover gskt. incl.; Premium valve stem seals incl.	
1	Head Bolt Set	2001-91	ES 72231	Head bolts w/Washers; Replacement recommended	
QTY	CONVERSION SET	YEARS	PART NO.	DESCRIPTION	
1	Gasket Conversion Set	2001-99	CS 9942	RTV sealant incl. for Upper oil pan gskt.	
1	Gasket Conversion Set	1998-97	CS 9820	Nissan 240SX Base, LE, SE	
1	Gasket Conversion Set	1998-97	CS 9942	Exc. Nissan 240SX Base, LE, SE; RTV sealant incl. for Upper oil pan gskt.	
1	Gasket Conversion Set	1996-93	CS 9820	Nissan 240SX Base, SE	
1	Gasket Conversion Set	1996-93	CS 9942	Exc. Nissan 240SX Base, SE; RTV sealant incl. for Upper oil pan gskt.	
1	Gasket Conversion Set	1992-91	CS 9820		
QTY	MANIFOLD - INT. & EXH.	YEARS	PART NO.	DESCRIPTION	
1	Int. Manifold Gasket Set	2001-99	MS 95459-1	Upper set incl.; Improved design	
1	Int. Manifold Gasket Set	1998-97	MS 94357	Nissan 240SX Base, LE, SE; Upper set incl.	
1	Int. Manifold Gasket Set	1998-97	MS 95459-1	Exc. Nissan 240SX Base, LE, SE; Upper set incl.; Improved design	
1	Int. Manifold Gasket Set	1996-93	MS 95459-1	Exc. Nissan 240SX Base, SE; Upper set incl.; Improved design	
1	Int. Manifold Gasket Set	1996-95	MS 94357	Nissan 240SX Base, SE; Upper set incl.	
1	Int. Manifold Gasket Set	1994-93	MS 94813	Nissan 240SX Base, SE; Upper set incl.	
1	Int. Manifold Gasket Set	1992-91	MS 94813	Upper set incl.	
1	Exh. Manifold Gasket Set	2001-91	MS 94803		
QTY	EXHAUST PIPE FLANGE	YEARS	PART NO.	DESCRIPTION	
1	Exhaust Pipe Gasket	2001-99	60905	Flange	
2	Exhaust Pipe Gasket	1998-97	60458	Nissan 240SX Base, LE, SE; Converter	
1	Exhaust Pipe Gasket	1998-97	60905	Exc. Nissan 240SX Base, LE, SE; Flange	
1	Exhaust Pipe Gasket	1998-97	60937	Nissan 240SX Base, LE, SE; Flange	
2	Exhaust Pipe Gasket	1996-93	60458	Nissan 240SX Base, SE; Converter	
1	Exhaust Pipe Gasket	1996-95	60905	Exc. Nissan 240SX Base, SE; Flange	
1	Exhaust Pipe Gasket	1996-95	60937	Nissan 240SX Base, SE; Flange	
2	Exhaust Pipe Gasket	1994	60835	Nissan 240SX Base, SE; Flange; Improved design	
1	Exhaust Pipe Gasket	1994	60835	Exc. Nissan 240SX Base, SE; Flange; w/A/T; Exc. California; Improved design	
1	Exhaust Pipe Gasket	1994	60905	Exc. Nissan 240SX Base, SE; Flange; w/A/T; California	
1	Exhaust Pipe Gasket	1994	60905	Exc. Nissan 240SX Base, SE; Flange; w/M/T	
2	Exhaust Pipe Gasket	1993-91	60835	Flange; Improved design	
1	Exhaust Pipe Gasket	1993	60835	Flange; Improved design	
2	Exhaust Pipe Gasket	1992-91	60458	Converter	
QTY	OIL PAN	YEARS	PART NO.	DESCRIPTION	
1	Oil Pan Gasket Set	2001-99	OS 30651 C	Loc. Lower	
1	Oil Pan Gasket Set	2001-99	OS 30852	Loc. Upper; New Part Number - Check for Availability	
1	Oil Pan Gasket Set	1998-97	OS 30644 C	Nissan 240SX Base, LE, SE	
1	Oil Pan Gasket Set	1998-97	OS 30651 C	Exc. Nissan 240SX Base, LE, SE; Loc. Lower	
1	Oil Pan Gasket Set	1998-97	OS 30852	Exc. Nissan 240SX Base, LE, SE; Loc. Upper; New Part Number - Check for Availability	
1	Oil Pan Gasket Set	1996-93	OS 30644 C	Nissan 240SX Base, SE	
1	Oil Pan Gasket Set	1996-93	OS 30651 C	Exc. Nissan 240SX Base, SE; Loc. Lower	
1	Oil Pan Gasket Set	1996-93	OS 30852	Exc. Nissan 240SX Base, SE; Loc. Upper; New Part Number - Check for Availability	
1	Oil Pan Gasket Set	1992-91	OS 30644 C		
QTY	CRANKSHAFT REAR SEAL	YEARS	PART NO.	DESCRIPTION	
1	Rear Main Seal Set	2001-99	BS 40664	Rubber; One-piece	
1	Rear Main Seal Set	1998-97	BS 40384	Nissan 240SX Base, LE, SE; Rubber; One-piece	
1	Rear Main Seal Set	1998-97	BS 40664	Exc. Nissan 240SX Base, LE, SE; Rubber; One-piece	
1	Rear Main Seal Set	1996-93	BS 40384	Nissan 240SX Base, SE; Rubber; One-piece	
1	Rear Main Seal Set	1996-93	BS 40664	Exc. Nissan 240SX Base, SE; Rubber; One-piece	
1	Rear Main Seal Set	1992-91	BS 40384	Rubber; One-piece	
1	Repair Sleeve	2001-91	16275	Crankshaft; Use w/installation tool	
QTY	VALVE COVER	YEARS	PART NO.	DESCRIPTION	
1	Valve Cover Gasket Set	2001-99	VS 50517 R	w/Grommets & Spark plug tube seals; PermaDry® molded rubber gskt. incl.; Improved design	
1	Valve Cover Gasket Set	1998-97	VS 50517 R	Exc. Nissan 240SX Base, LE, SE; w/Grommets & Spark plug tube seals; PermaDry® molded rubber gskt. incl.; Improved design	

Nissan Car (Incl. Datsun, Infiniti, Nissan) (Cont.)

8		2001 - 1991; 2.4L 146 (2389cc) DOHC L4 (16 Valve) 89mm Bore			8	
(cont.)		MFI; Gasoline; Naturally Aspirated Nissan Eng.; Eng. Code KA24DE			(cont.)	
QTY	VALVE COVER	YEARS	PART NO.	DESCRIPTION		
1	Valve Cover Gasket Set	1998-97	VS 50550 R	Nissan 240SX Base, LE, SE; w/Spark plug tube seals; PermaDry® molded rubber gskt. incl.		
1	Valve Cover Gasket Set	1996-93	VS 50517 R	Exc. Nissan 240SX Base, SE; w/Grommets & Spark plug tube seals; PermaDry® molded rubber gskt. incl.; Improved design		
1	Valve Cover Gasket Set	1996-95	VS 50550 R	Nissan 240SX Base, SE; w/Spark plug tube seals; PermaDry® molded rubber gskt. incl.		
1	Valve Cover Gasket Set	1994-93	VS 50385 R	Nissan 240SX Base, SE; PermaDry® molded rubber gskt. incl.		
1	Valve Cover Gasket Set	1992-91	VS 50385 R	PermaDry® molded rubber gskt. incl.		
QTY	VALVE STEM SEAL SET	YEARS	PART NO.	DESCRIPTION		
2	Valve Stem Seal Set	2001-91	SS 72547	Premium valve stem seals incl.		
QTY	THERMOSTAT HOUSING	YEARS	PART NO.	DESCRIPTION		
1	Water Outlet Gasket	2001-99	35228	Thermostat Housing		
1	Water Outlet Gasket	1998-97	35228	Exc. Nissan 240SX Base, LE, SE; Thermostat Housing		
1	Water Outlet Gasket	1996-93	35228	Exc. Nissan 240SX Base, SE; Thermostat Housing		
1	Thermostat Gasket	1998-97	35466	Nissan 240SX Base, LE, SE; Thermostat Housing		
1	Thermostat Gasket	1996-93	35466	Nissan 240SX Base, SE; Thermostat Housing		
1	Thermostat Gasket	1992-91	35466	Thermostat Housing		
QTY	WATER OUTLET GASKET	YEARS	PART NO.	DESCRIPTION		
1	Water Outlet Gasket	1998-97	35511	Nissan 240SX Base, LE, SE; Water Outlet; Connector		
1	Water Outlet Gasket	1996-93	35010	Exc. Nissan 240SX Base, SE; Water Outlet		
1	Water Outlet Gasket	1996-93	35511	Nissan 240SX Base, SE; Water Outlet; Connector		
1	Water Outlet Gasket	1992-91	35511	Water Outlet; Connector		
QTY	WATER PUMP	YEARS	PART NO.	DESCRIPTION		
1	Water Pump Gasket	2001-99	35662	Improved design		
1	Water Pump Gasket	1998-97	35465	Nissan 240SX Base, LE, SE		
1	Water Pump Gasket	1998-97	35662	Exc. Nissan 240SX Base, LE, SE; Improved design		
1	Water Pump Gasket	1996-93	35465	Nissan 240SX Base, SE		
1	Water Pump Gasket	1996-93	35662	Exc. Nissan 240SX Base, SE; Improved design		
1	Water Pump Gasket	1992-91	35465			
QTY	TIMING COVER	YEARS	PART NO.	DESCRIPTION		
1	Crankshaft Front Seal Set	2001-99	TCS 45903	Must be used w/OS 30651C & w/VS 50517R		
1	Crankshaft Front Seal Set	1998-97	TCS 45903	Nissan 240SX Base, LE, SE; Must be used w/OS 30644C & w/VS 50550R		
1	Crankshaft Front Seal Set	1998-97	TCS 45903	Exc. Nissan 240SX Base, LE, SE; Must be used w/OS 30651C & w/VS 50517R		
1	Crankshaft Front Seal Set	1996-93	TCS 45903	Exc. Nissan 240SX Base, SE; Must be used w/OS 30651C & w/VS 50517R		
1	Crankshaft Front Seal Set	1996-95	TCS 45903	Nissan 240SX Base, SE; Must be used w/OS 30644C & w/VS 50550R		
1	Crankshaft Front Seal Set	1994-93	TCS 45903	Nissan 240SX Base, SE; Must be used w/OS 30644C & w/VS 50385R		
1	Crankshaft Front Seal Set	1992-91	TCS 45903	Must be used w/OS 30644C & w/VS 50385R		
QTY	CARB & FUEL INJECTION	YEARS	PART NO.	DESCRIPTION		
1	Throttle Body Gasket	2001-91	60818			
QTY	EXHAUST GAS RECIRCULATION	YEARS	PART NO.	DESCRIPTION		
1	EGR Gasket	2001-95	72521			
1	EGR Gasket	1994-93	70978	Exc. Nissan 240SX Base, SE		
1	EGR Gasket	1994-93	72521	Nissan 240SX Base, SE		
1	EGR Gasket	1992-91	72521			
9		1992 - 1991; 2.4L 146 (2389cc) SOHC L4 (12 Valve) 89mm Bore			9	
(cont.)		MFI; Gasoline; Naturally Aspirated Nissan Eng.; Eng. Code KA24E			(cont.)	
QTY	CYLINDER HEAD	YEARS	PART NO.	DESCRIPTION		
1	Head Gasket	1992-91	9646 PT	Head bolts not incl.; Head bolt replacement recommended		
1	Head Set	1992-91	HS 9646 PT-1	Head bolts not incl.; Head bolt replacement recommended; PermaDry® molded rubber valve cover gskt. incl.; Premium valve stem seals incl.		
1	Head Bolt Set	1992-91	ES 74026	Head bolts w/Washers; Replacement recommended		
QTY	CONVERSION SET	YEARS	PART NO.	DESCRIPTION		
1	Gasket Conversion Set	1992-91	CS 9646			
QTY	MANIFOLD - INT. & EXH.	YEARS	PART NO.	DESCRIPTION		
1	Int. Manifold Gasket Set	1992-91	MS 94572	Upper set incl.		
1	Exh. Manifold Gasket Set	1992-91	MS 94444			
QTY	EXHAUST PIPE FLANGE	YEARS	PART NO.	DESCRIPTION		
2	Exhaust Pipe Gasket	1992-91	60674	Converter		
1	Exhaust Pipe Gasket	1992-91	60835	Flange; Improved design		
QTY	OIL PAN	YEARS	PART NO.	DESCRIPTION		
1	Oil Pan Gasket Set	1992-91	OS 30629 C			

Nissan Car (Incl. Datsun, Infiniti, Nissan) (Cont.)

9 (cont.)	1992 - 1991; 2.4L 146 (2389cc) SOHC L4 (12 Valve) 89mm Bore			9 (cont.)
QTY	CRANKSHAFT REAR SEAL	YEARS	PART NO.	DESCRIPTION
1	Rear Main Seal Set	1992-91	BS 40384	Rubber; One-piece
1	Repair Sleeve	1992-91	16275	Crankshaft; Use w/installation tool
QTY	VALVE COVER	YEARS	PART NO.	DESCRIPTION
1	Valve Cover Gasket Set	1992-91	VS 50360 R	w/Semi-circular plug; PermaDry® molded rubber gskt. incl.
1	Semi-Circular Plug	1992-91	CP 75003	Valve Cover
QTY	VALVE STEM SEAL SET	YEARS	PART NO.	DESCRIPTION
1	Valve Stem Seal Set	1992-91	SS 72776	Premium valve stem seals incl.
QTY	THERMOSTAT HOUSING	YEARS	PART NO.	DESCRIPTION
1	Thermostat Gasket	1992-91	35502	Thermostat Housing
QTY	WATER PUMP	YEARS	PART NO.	DESCRIPTION
1	Water Pump Gasket	1992-91	35471	
QTY	TIMING COVER	YEARS	PART NO.	DESCRIPTION
1	Timing Cover Set	1992-91	TCS 45887-1	Must be used w/OS 30629C & w/VS 50360R
QTY	CARB & FUEL INJECTION	YEARS	PART NO.	DESCRIPTION
1	Throttle Body Gasket	1992-91	60818	
QTY	DISTRIBUTOR MOUNTING	YEARS	PART NO.	DESCRIPTION
1	Fuel Pump Mounting Gasket	1992-91	70015	Distributor Mounting
QTY	EXHAUST GAS RECIRCULATION	YEARS	PART NO.	DESCRIPTION
1	EGR Gasket	1992-91	72633	
QTY	OIL PUMP COVER	YEARS	PART NO.	DESCRIPTION
1	Oil Pump Gasket	1992-91	72436	Mounting
10	2013 - 2002; 2.5L 151.8 (2488cc) DOHC L4 (16 Valve) 89mm Bore			10
QTY	CYLINDER HEAD	YEARS	PART NO.	DESCRIPTION
1	Head Gasket	2013	26659 PT	Head bolts not incl.; Head bolt replacement recommended; PermaTorqueMLS®; New Part Number - Check for Availability
1	Head Gasket	2012-07	26519 PT	Head bolts not incl.; Head bolt replacement recommended; PermaTorqueMLS®; New Part Number - Check for Availability
1	Head Gasket	2006-02	26261 PT	Head bolts not incl.; Head bolt replacement recommended; PermaTorqueMLS®
1	Head Set	2012-07	HS 26519 PT	Head bolts not incl.; Head bolt replacement recommended; PermaDry® molded rubber valve cover gskt. incl.; Premium valve stem seals incl.; New Part Number - Check for Availability
1	Head Set	2006-02	HS 26261 PT	Head bolts not incl.; Head bolt replacement recommended; PermaDry® molded rubber valve cover gskt. incl.; Premium valve stem seals incl.
1	Head Bolt Set	2012-07	ES 71354	Head bolts w/Washers; Replacement recommended; New Part Number - Check for Availability
1	Head Bolt Set	2006-02	ES 72198	Head bolts w/Washers; Replacement recommended
QTY	CONVERSION SET	YEARS	PART NO.	DESCRIPTION
1	Gasket Conversion Set	2012-02	CS 26261	RTV sealant incl. for oil pan gskt.
QTY	MANIFOLD - INT. & EXH.	YEARS	PART NO.	DESCRIPTION
1	Int. Manifold Gasket Set	2013	MS 97249	Lower set; New Part Number - Check for Availability
1	Int. Manifold Gasket Set	2012-07	MS 97147	Lower set; Upper set incl.; New Part Number - Check for Availability
1	Int. Manifold Gasket Set	2006-02	MS 96536	Lower set; Upper set incl.
1	Exh. Manifold Gasket Set	2012-07	MS 97148	
1	Exh. Manifold Gasket Set	2006-02	MS 96539	
QTY	EXHAUST PIPE FLANGE	YEARS	PART NO.	DESCRIPTION
1	Exhaust Pipe Gasket	2013-07	60905	Exh. connector
1	Exhaust Pipe Gasket	2013-07	61646	Converter
1	Exhaust Pipe Gasket	2013-07	61647	Pipe to manifold; New Part Number - Check for Availability
2	Exhaust Pipe Gasket	2013	61728	Converter; New Part Number - Check for Availability
2	Exhaust Pipe Gasket	2006-02	60458	Converter
1	Exhaust Pipe Gasket	2006-02	61367	Packing
QTY	CRANKSHAFT REAR SEAL	YEARS	PART NO.	DESCRIPTION
1	Rear Main Seal Set	2012-02	BS 40694	Rubber; One-piece
QTY	VALVE COVER	YEARS	PART NO.	DESCRIPTION
1	Valve Cover Gasket Set	2012-07	VS 50777 R	PermaDry® molded rubber gskt. incl.; New Part Number - Check for Availability
1	Valve Cover Gasket Set	2006-02	VS 50623 R	PermaDry® molded rubber gskt. incl.
QTY	VALVE STEM SEAL SET	YEARS	PART NO.	DESCRIPTION
1	Valve Stem Seal Set	2013-02	SS 70157	Premium valve stem seals incl.
QTY	THERMOSTAT HOUSING	YEARS	PART NO.	DESCRIPTION
1	Thermostat Gasket	2013-07	35445	Thermostat Housing; Thermostat inlet

Nissan Car (Incl. Datsun, Infiniti, Nissan) (Cont.)

10		2013 - 2002; 2.5L 151.8 (2488cc) DOHC L4 (16 Valve) 89mm Bore			10	
(cont.)		MFI; Gasoline; Naturally Aspirated Nissan Eng.; Eng. Code QR25DE			(cont.)	
QTY	THERMOSTAT HOUSING	YEARS	PART NO.	DESCRIPTION		
1	Thermostat Gasket	2013-07	35769	Thermostat Housing; Thermostat O-ring		
1	O-Ring	2006-02	35533	Thermostat Housing		
QTY	WATER OUTLET GASKET	YEARS	PART NO.	DESCRIPTION		
1	Water Outlet Gasket	2013-02	35752	Water Outlet		
1	Water Outlet Gasket	2013-02	35753	Water Outlet; Inlet		
QTY	WATER PUMP	YEARS	PART NO.	DESCRIPTION		
1	Water Pump Gasket	2013-02	35754	Housing to block		
1	Water Pump Gasket	2013-02	35755	Housing		
QTY	TIMING COVER	YEARS	PART NO.	DESCRIPTION		
1	Crankshaft Front Seal Set	2013-02	TCS 45056			
QTY	CARB & FUEL INJECTION	YEARS	PART NO.	DESCRIPTION		
1	Fuel Injector O-Ring Set	2013-07	ES 70599	Improved design		
1	Throttle Body Gasket	2013-07	61552	Adapter to manifold		
1	Throttle Body Gasket	2013-07	61645	Throttle body to adapter		
1	Throttle Body Gasket	2013	61552	Mounting		
1	Throttle Body Gasket	2006-02	61354			
11		2012 - 2007; 2.5L 151.8 (2488cc) DOHC L4 (16 Valve) 89mm Bore			11	
		MFI; Hybrid (Gas/Electric); Naturally Aspirated Nissan Eng.; Eng. Code QR25DE				
QTY	CYLINDER HEAD	YEARS	PART NO.	DESCRIPTION		
1	Head Gasket	2012-07	26519 PT	Head bolts not incl.; Head bolt replacement recommended; PermaTorqueMLS®; New Part Number - Check for Availability		
1	Head Set	2012-07	HS 26519 PT	Head bolts not incl.; Head bolt replacement recommended; PermaDry® molded rubber valve cover gskt. incl.; Premium valve stem seals incl.; New Part Number - Check for Availability		
1	Head Bolt Set	2012-07	ES 71354	Head bolts w/Washers; Replacement recommended; New Part Number - Check for Availability		
QTY	CONVERSION SET	YEARS	PART NO.	DESCRIPTION		
1	Gasket Conversion Set	2012-07	CS 26261	RTV sealant incl. for oil pan gskt.		
QTY	MANIFOLD - INT. & EXH.	YEARS	PART NO.	DESCRIPTION		
1	Int. Manifold Gasket Set	2012-07	MS 97147	Lower set; Upper set incl.; New Part Number - Check for Availability		
1	Exh. Manifold Gasket Set	2012-07	MS 97148			
QTY	EXHAUST PIPE FLANGE	YEARS	PART NO.	DESCRIPTION		
1	Exhaust Pipe Gasket	2012-07	61647	Pipe to manifold; New Part Number - Check for Availability		
QTY	CRANKSHAFT REAR SEAL	YEARS	PART NO.	DESCRIPTION		
1	Rear Main Seal Set	2012-07	BS 40694	Rubber; One-piece		
QTY	VALVE COVER	YEARS	PART NO.	DESCRIPTION		
1	Valve Cover Gasket Set	2012-07	VS 50777 R	PermaDry® molded rubber gskt. incl.; New Part Number - Check for Availability		
QTY	VALVE STEM SEAL SET	YEARS	PART NO.	DESCRIPTION		
1	Valve Stem Seal Set	2012-07	SS 70157	Premium valve stem seals incl.		
QTY	THERMOSTAT HOUSING	YEARS	PART NO.	DESCRIPTION		
1	Thermostat Gasket	2012-07	35445	Thermostat Housing; Thermostat inlet		
QTY	WATER OUTLET GASKET	YEARS	PART NO.	DESCRIPTION		
1	Water Outlet Gasket	2012-07	35752	Water Outlet		
1	Water Outlet Gasket	2012-07	35753	Water Outlet; Inlet		
QTY	WATER PUMP	YEARS	PART NO.	DESCRIPTION		
1	Water Pump Gasket	2012-07	35754	Housing to block		
1	Water Pump Gasket	2012-07	35755	Housing		
QTY	TIMING COVER	YEARS	PART NO.	DESCRIPTION		
1	Crankshaft Front Seal Set	2012-07	TCS 45056			
QTY	CARB & FUEL INJECTION	YEARS	PART NO.	DESCRIPTION		
1	Fuel Injector O-Ring Set	2012-07	ES 70599	Improved design		
1	Throttle Body Gasket	2012-07	61645			
12		2013 - 2011; 2.5L 152.3 (2496cc) DOHC V6 (24 Valve) 85mm Bore VVT			12	
		MFI; Gasoline; Naturally Aspirated Nissan Eng.; Eng. Code VQ25HR				
QTY	CYLINDER HEAD	YEARS	PART NO.	DESCRIPTION		
2	Head Bolt Set	2013-11	ES 72900	Head bolts w/Washers; Replacement recommended		
QTY	MANIFOLD - INT. & EXH.	YEARS	PART NO.	DESCRIPTION		
1	Exh. Manifold Gasket Set	2013-11	MS 91459			
QTY	EXHAUST PIPE FLANGE	YEARS	PART NO.	DESCRIPTION		
1	Exhaust Pipe Gasket	2013-11	60458	Loc. Front; Exh. connector		

Nissan Car (Incl. Datsun, Infiniti, Nissan) (Cont.)

12		2013 - 2011; 2.5L 152.3 (2496cc) DOHC V6 (24 Valve) 85mm Bore VVT			12
(cont.)		MFI; Gasoline; Naturally Aspirated Nissan Eng.; Eng. Code VQ25HR			(cont.)
QTY	EXHAUST PIPE FLANGE	YEARS	PART NO.	DESCRIPTION	
2	Exhaust Pipe Gasket	2013-11	61647	Loc. Front; Converter; New Part Number - Check for Availability	
QTY	CRANKSHAFT REAR SEAL	YEARS	PART NO.	DESCRIPTION	
1	Rear Main Seal Set	2013-11	BS 40730	Rubber; One-piece	
QTY	VALVE STEM SEAL SET	YEARS	PART NO.	DESCRIPTION	
1	Valve Stem Seal Set	2013-11	SS 72821	Premium valve stem seals incl.	
QTY	WATER OUTLET GASKET	YEARS	PART NO.	DESCRIPTION	
2	Water Outlet Gasket	2013-11	35620	Water Outlet	
1	Water Outlet Gasket	2013-11	35622	Water Outlet; Inlet	
1	Water Outlet Gasket	2013-11	35869	Water Outlet; Upper inlet connector	
QTY	CARB & FUEL INJECTION	YEARS	PART NO.	DESCRIPTION	
3	Fuel Injector O-Ring Set	2013-11	ES 70599	Improved design	
13		1994 - 1992; 3.0L 181 (2960cc) DOHC V6 (24 Valve) 87mm Bore			13
(cont.)		MFI; Gasoline; Naturally Aspirated Nissan Eng.; Eng. Code VE30DE			(cont.)
QTY	EXHAUST PIPE FLANGE	YEARS	PART NO.	DESCRIPTION	
2	Exhaust Pipe Gasket	1994-92	60674	Converter	
2	Exhaust Pipe Gasket	1994-92	60811	Pipe to manifold	
QTY	OIL PAN	YEARS	PART NO.	DESCRIPTION	
1	Oil Pan Gasket Set	1994-92	OS 30591	RTV Black silicone w/Rubber end seals	
QTY	CRANKSHAFT REAR SEAL	YEARS	PART NO.	DESCRIPTION	
1	Rear Main Seal Set	1994-92	BS 40628	Rubber; One-piece	
QTY	VALVE STEM SEAL SET	YEARS	PART NO.	DESCRIPTION	
1	Valve Stem Seal Set	1994-92	SS 72821	Premium valve stem seals incl.	
QTY	CARB & FUEL INJECTION	YEARS	PART NO.	DESCRIPTION	
1	Throttle Body Gasket	1994-92	60818		
QTY	EXHAUST GAS RECIRCULATION	YEARS	PART NO.	DESCRIPTION	
1	EGR Gasket	1994-92	70712		
14		1996 - 1991; 3.0L 181 (2960cc) DOHC V6 (24 Valve) 87mm Bore			14
(cont.)		MFI; Gasoline; Naturally Aspirated Nissan Eng.; Eng. Code VG30D			(cont.)
QTY	CYLINDER HEAD	YEARS	PART NO.	DESCRIPTION	
2	Head Gasket	1996-91	9703 PT		
1	Head Set	1996-93	HS 9703 PT	Int. manifold gsks. not incl.; PermaDry® molded rubber valve cover gsks. incl.; Premium valve stem seals incl.	
1	Head Set	1992-91	HS 9703 PT	PermaDry® molded rubber valve cover gsks. incl.; Premium valve stem seals incl.	
QTY	CONVERSION SET	YEARS	PART NO.	DESCRIPTION	
1	Gasket Conversion Set	1996-91	CS 9703	RTV sealant incl. for oil pan gskt.	
QTY	MANIFOLD - INT. & EXH.	YEARS	PART NO.	DESCRIPTION	
1	Int. Manifold Gasket Set	1996-95	MS 97224	Lower set; Upper set incl.; New Part Number - Check for Availability	
1	Int. Manifold Gasket Set	1994	MS 97224	From 01/01/94; Lower set; Upper set incl.; New Part Number - Check for Availability	
1	Int. Manifold Gasket Set	1992-91	MS 94626	Lower set; Upper set incl.	
1	Plenum Gasket Set	1996-91	MS 94627	Upper set	
1	Exh. Manifold Gasket Set	1996-91	MS 94628		
QTY	EXHAUST PIPE FLANGE	YEARS	PART NO.	DESCRIPTION	
2	Exhaust Pipe Gasket	1996-91	60871	Flange	
QTY	OIL PAN	YEARS	PART NO.	DESCRIPTION	
1	Oil Pan Gasket Set	1996-91	OS 30591	RTV Black silicone w/Rubber end seals	
QTY	CRANKSHAFT REAR SEAL	YEARS	PART NO.	DESCRIPTION	
1	Rear Main Seal Set	1996-91	BS 40628	Rubber; One-piece	
QTY	VALVE COVER	YEARS	PART NO.	DESCRIPTION	
1	Valve Cover Gasket Set	1996-91	VS 50366 R	w/o Semi-circular plugs & Grommets; PermaDry® molded rubber gsks. incl.	
1	Semi-Circular Plug	1996-91	CP 75016	Valve Cover	
QTY	VALVE STEM SEAL SET	YEARS	PART NO.	DESCRIPTION	
1	Valve Stem Seal Set	1996-91	SS 72821	Premium valve stem seals incl.	
QTY	THERMOSTAT HOUSING	YEARS	PART NO.	DESCRIPTION	
1	Thermostat Gasket	1996-91	35483	Thermostat Housing	
QTY	WATER PUMP	YEARS	PART NO.	DESCRIPTION	
1	Water Pump Gasket	1996-91	35415	Improved design	
QTY	TIMING COVER	YEARS	PART NO.	DESCRIPTION	
1	Camshaft Front Seal Set	1996-91	TCS 45696	Crankshaft; Front seal set; Must be used w/OS 30591	
2	Camshaft Front Seal Set	1996-91	TCS 45786		

Nissan Car (Incl. Datsun, Infiniti, Nissan) (Cont.)

14		1996 - 1991; 3.0L 181 (2960cc) DOHC V6 (24 Valve) 87mm Bore			14
(cont.)		MFI; Gasoline; Naturally Aspirated Nissan Eng.; Eng. Code VG30D			(cont.)
QTY	CARB & FUEL INJECTION	YEARS	PART NO.	DESCRIPTION	
2	Throttle Body Gasket	1996-91	60869		
QTY	EXHAUST GAS RECIRCULATION	YEARS	PART NO.	DESCRIPTION	
2	EGR Mounting Set	1993-91	ES 70389	1 or 2 Req'd.	
15		1997 - 1991; 3.0L 181 (2960cc) DOHC V6 (24 Valve) 87mm Bore			15
(cont.)		MFI; Gasoline; Naturally Aspirated Nissan Eng.; Eng. Code VG30DE			(cont.)
QTY	CYLINDER HEAD	YEARS	PART NO.	DESCRIPTION	
2	Head Gasket	1997-91	9703 PT		
1	Head Set	1997-93	HS 9703 PT	Int. manifold gskts. not incl.; PermaDry® molded rubber valve cover gskts. incl.; Premium valve stem seals incl.	
1	Head Set	1992-91	HS 9703 PT	PermaDry® molded rubber valve cover gskts. incl.; Premium valve stem seals incl.	
QTY	CONVERSION SET	YEARS	PART NO.	DESCRIPTION	
1	Gasket Conversion Set	1997-91	CS 9703	RTV sealant incl. for oil pan gskt.	
QTY	MANIFOLD - INT. & EXH.	YEARS	PART NO.	DESCRIPTION	
1	Int. Manifold Gasket Set	1997-95	MS 97224	Lower set; Upper set incl.; New Part Number - Check for Availability	
1	Int. Manifold Gasket Set	1994	MS 97224	From 01/01/94; Lower set; Upper set incl.; New Part Number - Check for Availability	
1	Int. Manifold Gasket Set	1992-91	MS 94626	Lower set; Upper set incl.	
1	Plenum Gasket Set	1997-91	MS 94627	Upper set	
1	Exh. Manifold Gasket Set	1997-91	MS 94628		
QTY	EXHAUST PIPE FLANGE	YEARS	PART NO.	DESCRIPTION	
2	Exhaust Pipe Gasket	1997-91	60871	Flange	
QTY	OIL PAN	YEARS	PART NO.	DESCRIPTION	
1	Oil Pan Gasket Set	1997-91	OS 30591	RTV Black silicone w/Rubber end seals	
QTY	CRANKSHAFT REAR SEAL	YEARS	PART NO.	DESCRIPTION	
1	Rear Main Seal Set	1997-91	BS 40628	Rubber; One-piece	
QTY	VALVE COVER	YEARS	PART NO.	DESCRIPTION	
1	Valve Cover Gasket Set	1997-91	VS 50366 R	w/o Semi-circular plugs & Grommets; PermaDry® molded rubber gskts. incl.	
1	Semi-Circular Plug	1997-91	CP 75016	Valve Cover	
QTY	VALVE STEM SEAL SET	YEARS	PART NO.	DESCRIPTION	
1	Valve Stem Seal Set	1997-91	SS 72821	Premium valve stem seals incl.	
QTY	THERMOSTAT HOUSING	YEARS	PART NO.	DESCRIPTION	
1	Thermostat Gasket	1997-91	35483	Thermostat Housing	
QTY	WATER PUMP	YEARS	PART NO.	DESCRIPTION	
1	Water Pump Gasket	1997-91	35415	Improved design	
QTY	TIMING COVER	YEARS	PART NO.	DESCRIPTION	
1	Camshaft Front Seal Set	1997-91	TCS 45696	Crankshaft; Front seal set; Must be used w/OS 30591	
2	Camshaft Front Seal Set	1997-91	TCS 45786		
QTY	CARB & FUEL INJECTION	YEARS	PART NO.	DESCRIPTION	
2	Throttle Body Gasket	1997-91	60869		
QTY	EXHAUST GAS RECIRCULATION	YEARS	PART NO.	DESCRIPTION	
2	EGR Mounting Set	1993-91	ES 70389	1 or 2 Req'd.	
16		1996 - 1991; 3.0L 181 (2960cc) DOHC V6 (24 Valve) 87mm Bore			16
(cont.)		MFI; Gasoline; Turbo - Intercooled Nissan Eng.; Eng. Code VG30DETT			(cont.)
QTY	CYLINDER HEAD	YEARS	PART NO.	DESCRIPTION	
2	Head Gasket	1996-91	26575 PT	Head bolts not incl.; Head bolt replacement recommended; New Part Number - Check for Availability	
QTY	CONVERSION SET	YEARS	PART NO.	DESCRIPTION	
1	Gasket Conversion Set	1996-91	CS 9703	RTV sealant incl. for oil pan gskt.	
QTY	MANIFOLD - INT. & EXH.	YEARS	PART NO.	DESCRIPTION	
1	Int. Manifold Gasket Set	1996-95	MS 97224	Lower set; Upper set incl.; New Part Number - Check for Availability	
1	Int. Manifold Gasket Set	1994	MS 97224	From 01/01/94; Lower set; Upper set incl.; New Part Number - Check for Availability	
1	Int. Manifold Gasket Set	1992-91	MS 94626	Lower set; Upper set incl.	
1	Plenum Gasket Set	1996-91	MS 94627	Upper set	
1	Exh. Manifold Gasket Set	1996-91	MS 94628		
QTY	EXHAUST PIPE FLANGE	YEARS	PART NO.	DESCRIPTION	
2	Exhaust Pipe Gasket	1996-91	60871	Flange	
QTY	OIL PAN	YEARS	PART NO.	DESCRIPTION	
1	Oil Pan Gasket Set	1996-91	OS 30591	RTV Black silicone w/Rubber end seals	

Nissan Car (Incl. Datsun, Infiniti, Nissan) (Cont.)

16 (cont.)		1996 - 1991; 3.0L 181 (2960cc) DOHC V6 (24 Valve) 87mm Bore			16 (cont.)
		MFI; Gasoline; Turbo - Intercooled Nissan Eng.; Eng. Code VG30DETT			
QTY	CRANKSHAFT REAR SEAL	YEARS	PART NO.	DESCRIPTION	
1	Rear Main Seal Set	1996-91	BS 40628	Rubber; One-piece	
QTY	VALVE COVER	YEARS	PART NO.	DESCRIPTION	
1	Valve Cover Gasket Set	1996-91	VS 50366 R	w/o Semi-circular plugs & Grommets; PermaDry® molded rubber gskts. incl.	
1	Semi-Circular Plug	1996-91	CP 75016	Valve Cover	
QTY	VALVE STEM SEAL SET	YEARS	PART NO.	DESCRIPTION	
1	Valve Stem Seal Set	1996-91	SS 72821	Premium valve stem seals incl.	
QTY	THERMOSTAT HOUSING	YEARS	PART NO.	DESCRIPTION	
1	Thermostat Gasket	1996-91	35483	Thermostat Housing	
QTY	WATER PUMP	YEARS	PART NO.	DESCRIPTION	
1	Water Pump Gasket	1996-91	35415	Improved design	
QTY	TIMING COVER	YEARS	PART NO.	DESCRIPTION	
1	Camshaft Front Seal Set	1996-91	TCS 45696	Crankshaft; Front seal set; Must be used w/OS 30591	
2	Camshaft Front Seal Set	1996-91	TCS 45786		
QTY	CARB & FUEL INJECTION	YEARS	PART NO.	DESCRIPTION	
2	Throttle Body Gasket	1996-91	60869		
QTY	EXHAUST GAS RECIRCULATION	YEARS	PART NO.	DESCRIPTION	
2	EGR Mounting Set	1993-91	ES 70389	1 or 2 Req'd.	
17		1996 - 1991; 3.0L 181 (2960cc) DOHC V6 (24 Valve) 87mm Bore			17
		MFI; Gasoline; Turbo - Intercooled Nissan Eng.; Eng. Code VG30DTT			
QTY	CYLINDER HEAD	YEARS	PART NO.	DESCRIPTION	
2	Head Gasket	1996-91	26575 PT	Head bolts not incl.; Head bolt replacement recommended; New Part Number - Check for Availability	
QTY	CONVERSION SET	YEARS	PART NO.	DESCRIPTION	
1	Gasket Conversion Set	1996-91	CS 9703	RTV sealant incl. for oil pan gskt.	
QTY	MANIFOLD - INT. & EXH.	YEARS	PART NO.	DESCRIPTION	
1	Int. Manifold Gasket Set	1996-95	MS 97224	Lower set; Upper set incl.; New Part Number - Check for Availability	
1	Int. Manifold Gasket Set	1994	MS 97224	From 01/01/94; Lower set; Upper set incl.; New Part Number - Check for Availability	
1	Int. Manifold Gasket Set	1992-91	MS 94626	Lower set; Upper set incl.	
1	Plenum Gasket Set	1996-91	MS 94627	Upper set	
1	Exh. Manifold Gasket Set	1996-91	MS 94628		
QTY	EXHAUST PIPE FLANGE	YEARS	PART NO.	DESCRIPTION	
2	Exhaust Pipe Gasket	1996-91	60871	Flange	
QTY	OIL PAN	YEARS	PART NO.	DESCRIPTION	
1	Oil Pan Gasket Set	1996-91	OS 30591	RTV Black silicone w/Rubber end seals	
QTY	CRANKSHAFT REAR SEAL	YEARS	PART NO.	DESCRIPTION	
1	Rear Main Seal Set	1996-91	BS 40628	Rubber; One-piece	
QTY	VALVE COVER	YEARS	PART NO.	DESCRIPTION	
1	Valve Cover Gasket Set	1996-91	VS 50366 R	w/o Semi-circular plugs & Grommets; PermaDry® molded rubber gskts. incl.	
1	Semi-Circular Plug	1996-91	CP 75016	Valve Cover	
QTY	VALVE STEM SEAL SET	YEARS	PART NO.	DESCRIPTION	
1	Valve Stem Seal Set	1996-91	SS 72821	Premium valve stem seals incl.	
QTY	THERMOSTAT HOUSING	YEARS	PART NO.	DESCRIPTION	
1	Thermostat Gasket	1996-91	35483	Thermostat Housing	
QTY	WATER PUMP	YEARS	PART NO.	DESCRIPTION	
1	Water Pump Gasket	1996-91	35415	Improved design	
QTY	TIMING COVER	YEARS	PART NO.	DESCRIPTION	
1	Camshaft Front Seal Set	1996-91	TCS 45696	Crankshaft; Front seal set; Must be used w/OS 30591	
2	Camshaft Front Seal Set	1996-91	TCS 45786		
QTY	CARB & FUEL INJECTION	YEARS	PART NO.	DESCRIPTION	
2	Throttle Body Gasket	1996-91	60869		
QTY	EXHAUST GAS RECIRCULATION	YEARS	PART NO.	DESCRIPTION	
2	EGR Mounting Set	1993-91	ES 70389	1 or 2 Req'd.	
18		1992 - 1991; 3.0L 181 (2960cc) SOHC V6 (12 Valve) 87mm Bore			18
		MFI; Gasoline; Naturally Aspirated Nissan Eng.; Eng. Code VG30			
QTY	CYLINDER HEAD	YEARS	PART NO.	DESCRIPTION	
2	Head Gasket	1992-91	9571 PT	Head bolts not incl.; Head bolt replacement recommended; Improved design	
1	Head Set	1992-91	HS 9571 PT	Head bolts, exh. pipe to manifold gskt., valve cover grommets not incl.; Head bolt replacement recommended; PermaDry® molded rubber valve cover gskts. incl.; Premium valve stem seals incl.	

Nissan Car (Incl. Datsun, Infiniti, Nissan) (Cont.)

18 (cont.)		1992 - 1991; 3.0L 181 (2960cc) SOHC V6 (12 Valve) 87mm Bore			18 (cont.)
MFI; Gasoline; Naturally Aspirated Nissan Eng.; Eng. Code VG30					
QTY	CONVERSION SET	YEARS	PART NO.	DESCRIPTION	
1	Gasket Conversion Set	1992-91	CS 9228-1	RTV sealant incl. for oil pan gskt.	
QTY	MANIFOLD - INT. & EXH.	YEARS	PART NO.	DESCRIPTION	
1	Int. Manifold Gasket Set	1992-91	MS 92270-2	Lower set; Upper set incl.	
1	Plenum Gasket Set	1992-91	MS 92273-2	Upper set	
1	Exh. Manifold Gasket Set	1992-91	MS 92272		
QTY	EXHAUST PIPE FLANGE	YEARS	PART NO.	DESCRIPTION	
2	Exhaust Pipe Gasket	1992-91	60674	Converter	
2	Exhaust Pipe Gasket	1992-91	60811	Pipe to manifold	
QTY	OIL PAN	YEARS	PART NO.	DESCRIPTION	
1	Oil Pan Gasket Set	1992-91	OS 30591	RTV Black silicone w/Rubber end seals	
QTY	CRANKSHAFT REAR SEAL	YEARS	PART NO.	DESCRIPTION	
1	Rear Main Seal Set	1992-91	BS 40628	Rubber; One-piece	
QTY	VALVE COVER	YEARS	PART NO.	DESCRIPTION	
1	Valve Cover Gasket Set	1992-91	VS 50251 R	w/o Grommets; PermaDry® molded rubber gskts. incl.	
1	Valve Cover Gasket Set	1992-91	VS 50251 R-1	w/Grommets; PermaDry® molded rubber gskts. incl.	
1	Grommet Set	1992-91	ES 72840	Valve Cover	
QTY	VALVE STEM SEAL SET	YEARS	PART NO.	DESCRIPTION	
1	Valve Stem Seal Set	1992-91	SS 72629	Premium valve stem seals incl.	
QTY	THERMOSTAT HOUSING	YEARS	PART NO.	DESCRIPTION	
1	Thermostat Gasket	1992-91	35497	Thermostat Housing	
QTY	WATER PUMP	YEARS	PART NO.	DESCRIPTION	
1	Water Pump Gasket	1992-91	35415	Improved design	
QTY	TIMING COVER	YEARS	PART NO.	DESCRIPTION	
1	Timing Cover Dust Seal Set	1992-91	TCS 45834		
1	Crankshaft Front Seal Set	1992-91	TCS 45634	Must be used w/OS 30591	
2	Camshaft Front Seal Set	1992-91	TCS 45635		
QTY	AIR CLEANER MOUNTING	YEARS	PART NO.	DESCRIPTION	
1	Air Cleaner Gasket	1992-91	60852	To throttle body	
QTY	CARB & FUEL INJECTION	YEARS	PART NO.	DESCRIPTION	
1	Throttle Body Gasket	1992-91	60851		
QTY	DISTRIBUTOR MOUNTING	YEARS	PART NO.	DESCRIPTION	
1	O-Ring	1992-91	417	Distributor Mounting	
QTY	EXHAUST GAS RECIRCULATION	YEARS	PART NO.	DESCRIPTION	
2	EGR Gasket	1992-91	72521	1 or 2 Req'd.	
19		1994 - 1991; 3.0L 181 (2960cc) SOHC V6 (12 Valve) 87mm Bore			19
MFI; Gasoline; Naturally Aspirated Nissan Eng.; Eng. Code VG30E					
QTY	CYLINDER HEAD	YEARS	PART NO.	DESCRIPTION	
2	Head Gasket	1994-91	9571 PT	Head bolts not incl.; Head bolt replacement recommended; Improved design	
1	Head Set	1994-91	HS 9571 PT	Head bolts, exh. pipe to manifold gskt., valve cover grommets not incl.; Head bolt replacement recommended; PermaDry® molded rubber valve cover gskts. incl.; Premium valve stem seals incl.	
QTY	CONVERSION SET	YEARS	PART NO.	DESCRIPTION	
1	Gasket Conversion Set	1994-91	CS 9228-1	RTV sealant incl. for oil pan gskt.	
QTY	MANIFOLD - INT. & EXH.	YEARS	PART NO.	DESCRIPTION	
1	Int. Manifold Gasket Set	1994-93	MS 92270-2	Lower set; Upper set incl.	
1	Int. Manifold Gasket Set	1992-91	MS 92270-1	Infiniti M30 Base; Lower set; Upper set incl.	
1	Int. Manifold Gasket Set	1992	MS 92270-2	Nissan Maxima GXE; Lower set; Upper set incl.	
1	Int. Manifold Gasket Set	1991	MS 92270-2	Nissan Maxima GXE, SE; Lower set; Upper set incl.	
1	Plenum Gasket Set	1994-93	MS 92273-2	Upper set	
1	Plenum Gasket Set	1992-91	MS 92273-1	Infiniti M30 Base; Upper set	
1	Plenum Gasket Set	1992	MS 92273-2	Nissan Maxima GXE; Upper set	
1	Plenum Gasket Set	1991	MS 92273-2	Nissan Maxima GXE, SE; Upper set	
1	Exh. Manifold Gasket Set	1994-91	MS 92272		
QTY	EXHAUST PIPE FLANGE	YEARS	PART NO.	DESCRIPTION	
2	Exhaust Pipe Gasket	1994-93	60674	Converter	
2	Exhaust Pipe Gasket	1994-93	60811	Pipe to manifold	
2	Exhaust Pipe Gasket	1992-91	60458	Infiniti M30 Base; Converter	
1	Exhaust Pipe Gasket	1992-91	60637	Infiniti M30 Base; Pipe to manifold	
1	Exhaust Pipe Gasket	1992-91	60660	Infiniti M30 Base; Crossover	
2	Exhaust Pipe Gasket	1992	60674	Nissan Maxima GXE; Converter	
2	Exhaust Pipe Gasket	1992	60811	Nissan Maxima GXE; Pipe to manifold	
2	Exhaust Pipe Gasket	1991	60674	Nissan Maxima GXE, SE; Converter	

Nissan Car (Incl. Datsun, Infiniti, Nissan) (Cont.)

19 (cont.)	1994 - 1991; 3.0L 181 (2960cc) SOHC V6 (12 Valve) 87mm Bore				19 (cont.)
QTY	EXHAUST PIPE FLANGE	YEARS	PART NO.	DESCRIPTION	
2	Exhaust Pipe Gasket	1991	60811	Nissan Maxima GXE, SE; Pipe to manifold	
QTY	OIL PAN	YEARS	PART NO.	DESCRIPTION	
1	Oil Pan Gasket Set	1994-91	OS 30591	RTV Black silicone w/Rubber end seals	
QTY	CRANKSHAFT REAR SEAL	YEARS	PART NO.	DESCRIPTION	
1	Rear Main Seal Set	1994-91	BS 40628	Rubber; One-piece	
QTY	VALVE COVER	YEARS	PART NO.	DESCRIPTION	
1	Valve Cover Gasket Set	1994-91	VS 50251 R	w/o Grommets; PermaDry® molded rubber gskts. incl.	
1	Valve Cover Gasket Set	1994-91	VS 50251 R-1	w/Grommets; PermaDry® molded rubber gskts. incl.	
1	Grommet Set	1994-91	ES 72840	Valve Cover	
QTY	VALVE STEM SEAL SET	YEARS	PART NO.	DESCRIPTION	
1	Valve Stem Seal Set	1994-91	SS 72629	Premium valve stem seals incl.	
QTY	THERMOSTAT HOUSING	YEARS	PART NO.	DESCRIPTION	
1	Thermostat Gasket	1994-93	35497	Thermostat Housing	
1	Thermostat Gasket	1992-91	35312	Infiniti M30 Base; Thermostat Housing; Thermostat housing to manifold	
1	Thermostat Gasket	1992-91	35369	Infiniti M30 Base; Thermostat Housing	
1	Thermostat Gasket	1992	35497	Nissan Maxima GXE; Thermostat Housing	
1	Thermostat Gasket	1991	35497	Nissan Maxima GXE, SE; Thermostat Housing	
QTY	WATER PUMP	YEARS	PART NO.	DESCRIPTION	
1	Water Pump Gasket	1994-91	35415	Improved design	
QTY	TIMING COVER	YEARS	PART NO.	DESCRIPTION	
1	Timing Cover Dust Seal Set	1994-91	TCS 45834		
1	Crankshaft Front Seal Set	1994-91	TCS 45634	Must be used w/OS 30591	
2	Camshaft Front Seal Set	1994-91	TCS 45635		
QTY	AIR CLEANER MOUNTING	YEARS	PART NO.	DESCRIPTION	
1	Air Cleaner Gasket	1994-91	60852	To throttle body	
QTY	CARB & FUEL INJECTION	YEARS	PART NO.	DESCRIPTION	
1	Throttle Body Gasket	1994-91	60851		
QTY	DISTRIBUTOR MOUNTING	YEARS	PART NO.	DESCRIPTION	
1	O-Ring	1994-91	417	Distributor Mounting	
QTY	EXHAUST GAS RECIRCULATION	YEARS	PART NO.	DESCRIPTION	
2	EGR Gasket	1994-91	72521	1 or 2 Req'd.	
20	2001 - 1995; 3.0L 181 (2988cc) DOHC V6 (24 Valve) 93mm Bore				20
QTY	CYLINDER HEAD	YEARS	PART NO.	DESCRIPTION	
1	Head Gasket	2001-00	26383 PT	Loc. L.H.; Head bolts not incl.; Head bolt replacement recommended; PermaTorqueMLS®	
1	Head Gasket	2001-00	26384 PT	Loc. R.H.; Head bolts not incl.; Head bolt replacement recommended; PermaTorqueMLS®	
1	Head Gasket	1999-95	9508 PT	Loc. L.H.; Head bolts not incl.; Head bolt replacement recommended; PermaTorqueMLS®	
1	Head Gasket	1999-95	9509 PT	Loc. R.H.; Head bolts not incl.; Head bolt replacement recommended; PermaTorqueMLS®	
1	Head Set	2001-00	HS 26383 PT	Head bolts not incl.; Head bolt replacement recommended; PermaDry® molded rubber valve cover gskts. incl.; Premium valve stem seals incl.	
1	Head Set	1999-95	HS 9508 PT	Head bolts not incl.; Head bolt replacement recommended; PermaDry® molded rubber valve cover gskts. incl.; Premium valve stem seals incl.	
2	Head Bolt Set	2001-95	ES 72900	Head bolts w/Washers; Replacement recommended	
QTY	CONVERSION SET	YEARS	PART NO.	DESCRIPTION	
1	Gasket Conversion Set	2001-95	CS 9508	Rear main brg. seal not incl.; RTV sealant incl. for Upper oil pan gskt.	
QTY	MANIFOLD - INT. & EXH.	YEARS	PART NO.	DESCRIPTION	
1	Int. Manifold Gasket Set	2001-00	MS 91241-2	Lower set; Upper set incl.	
1	Int. Manifold Gasket Set	1999-95	MS 91241	Lower set; Upper set incl.	
1	Plenum Gasket Set	2001-00	MS 97002	Upper set	
1	Plenum Gasket Set	1999-95	MS 91253	Upper set	
1	Exh. Manifold Gasket Set	2001-95	MS 91459		
QTY	EXHAUST PIPE FLANGE	YEARS	PART NO.	DESCRIPTION	
1	Exhaust Pipe Gasket	2001-00	60811	Loc. Rear; Flange	
1	Exhaust Pipe Gasket	2001-00	60905	Loc. Front; Flange	
2	Exhaust Pipe Gasket	1999-95	60811	Pipe to manifold	
QTY	OIL PAN	YEARS	PART NO.	DESCRIPTION	
1	Oil Pan Gasket Set	2001-95	OS 30688	Loc. Lower	
1	Oil Pan Gasket Set	2001-95	OS 30696	Loc. Upper; RTV Black silicone w/Rubber end seals	

Nissan Car (Incl. Datsun, Infiniti, Nissan) (Cont.)

20 (cont.)		2001 - 1995; 3.0L 181 (2988cc) DOHC V6 (24 Valve) 93mm Bore			20 (cont.)
MFI; Gasoline; Naturally Aspirated Nissan Eng.; Eng. Code VQ30DE					
QTY	CRANKSHAFT REAR SEAL	YEARS	PART NO.	DESCRIPTION	
1	Rear Main Seal Set	2001-95	BS 40631	Rubber; One-piece	
QTY	VALVE COVER	YEARS	PART NO.	DESCRIPTION	
1	Valve Cover Gasket Set	2001-00	VS 50494 R-1	w/Grommets & Spark plug tube seals; PermaDry® molded rubber gskts. incl.	
1	Valve Cover Gasket Set	1999-95	VS 50494 R	w/Grommets & Spark plug tube seals; PermaDry® molded rubber gskts. incl.	
1	Spark Plug Tube Seal Set	2001-95	ES 72481	Valve Cover; For use with removable PCV Valve baffles only; New Part Number - Check for Availability	
QTY	VALVE STEM SEAL SET	YEARS	PART NO.	DESCRIPTION	
1	Valve Stem Seal Set	2001-95	SS 72821	Premium valve stem seals incl.	
QTY	WATER OUTLET GASKET	YEARS	PART NO.	DESCRIPTION	
2	Water Outlet Gasket	2001-95	35620	Water Outlet	
1	Water Outlet Gasket	2001-95	35621	Water Outlet; Inlet connector	
1	Water Outlet Gasket	2001-95	35622	Water Outlet; Inlet	
1	Water Outlet Gasket	2001-00	35869	Water Outlet; Upper inlet connector	
QTY	WATER PUMP	YEARS	PART NO.	DESCRIPTION	
1	Water Pump Mounting Set	2001-95	ES 70894		
QTY	TIMING COVER	YEARS	PART NO.	DESCRIPTION	
1	Timing Cover Set	2001-95	TCS 45997		
QTY	CARB & FUEL INJECTION	YEARS	PART NO.	DESCRIPTION	
3	Fuel Injector O-Ring Set	2001-00	ES 70599	Improved design	
1	Fuel Injector Insulator Set	2001-95	ES 71045		
1	Throttle Body Gasket	2001-00	61530	O-ring	
1	Throttle Body Gasket	2001-00	61531	Mounting	
1	Throttle Body Gasket	1999-95	61064	Mounting	
QTY	EXHAUST GAS RECIRCULATION	YEARS	PART NO.	DESCRIPTION	
1	EGR Gasket	2001-95	70885	EGR spacer	
1	EGR Gasket	2001-95	70893	EGR tube	
1	EGR Gasket	2001-95	72521	EGR valve	
QTY	OIL COOLER	YEARS	PART NO.	DESCRIPTION	
1	Oil Cooler Gasket	2001-95	72493	Oil cooler seal; New Part Number - Check for Availability	
21		2013 - 2002; 3.5L 214 (3498cc) DOHC V6 (24 Valve) 95.5mm Bore			21
MFI; Gasoline; Naturally Aspirated Nissan Eng.; Eng. Code VQ35DE					
QTY	CYLINDER HEAD	YEARS	PART NO.	DESCRIPTION	
1	Head Gasket	2013-09	26511 PT	Loc. L.H.; Head bolts not incl.; Head bolt replacement recommended; PermaTorqueMLS®; New Part Number - Check for Availability	
1	Head Gasket	2013-09	26512 PT	Loc. R.H.; Head bolts not incl.; Head bolt replacement recommended; PermaTorqueMLS®; New Part Number - Check for Availability	
1	Head Gasket	2008-07	26239 PT	Nissan Maxima SE, SL; Loc. L.H.; Head bolts not incl.; Head bolt replacement recommended; PermaTorqueMLS®	
1	Head Gasket	2008-07	26240 PT	Nissan Maxima SE, SL; Loc. R.H.; Head bolts not incl.; Head bolt replacement recommended; PermaTorqueMLS®	
1	Head Gasket	2008	26370 PT	Infiniti M35 Base, Sport, X; Loc. L.H.; Head bolts not incl.; Head bolt replacement recommended; PermaTorqueMLS®	
1	Head Gasket	2008	26371 PT	Infiniti M35 Base, Sport, X; Loc. R.H.; Head bolts not incl.; Head bolt replacement recommended; PermaTorqueMLS®	
1	Head Gasket	2008	26511 PT	Nissan Altima 3.5 SE, 3.5 SL, SE, SL; Loc. L.H.; Head bolts not incl.; Head bolt replacement recommended; PermaTorqueMLS®; New Part Number - Check for Availability	
1	Head Gasket	2008	26512 PT	Nissan Altima 3.5 SE, 3.5 SL, SE, SL; Loc. R.H.; Head bolts not incl.; Head bolt replacement recommended; PermaTorqueMLS®; New Part Number - Check for Availability	
1	Head Gasket	2007	26370 PT	Exc. Nissan Altima 3.5 SE, 3.5 SL, SE, SE-R, SL, Maxima SE, SL; Loc. L.H.; Head bolts not incl.; Head bolt replacement recommended; PermaTorqueMLS®	
1	Head Gasket	2007	26371 PT	Exc. Nissan Altima 3.5 SE, 3.5 SL, SE, SE-R, SL, Maxima SE, SL; Loc. R.H.; Head bolts not incl.; Head bolt replacement recommended; PermaTorqueMLS®	
1	Head Gasket	2007	26511 PT	Nissan Altima 3.5 SE, 3.5 SL, SE, SE-R, SL; Loc. L.H.; Head bolts not incl.; Head bolt replacement recommended; PermaTorqueMLS®; New Part Number - Check for Availability	
1	Head Gasket	2007	26512 PT	Nissan Altima 3.5 SE, 3.5 SL, SE, SE-R, SL; Loc. R.H.; Head bolts not incl.; Head bolt replacement recommended; PermaTorqueMLS®; New Part Number - Check for Availability	

Nissan Car (Incl. Datsun, Infiniti, Nissan) (Cont.)

21 (cont.)	2013 - 2002; 3.5L 214 (3498cc) DOHC V6 (24 Valve) 95.5mm Bore				21 (cont.)
QTY	CYLINDER HEAD	YEARS	PART NO.	DESCRIPTION	
1	Head Gasket	2006	26239 PT	Exc. Infiniti G35 Base, X, M35 Base, Sport, X; Loc. L.H.; Head bolts not incl.; Head bolt replacement recommended; PermaTorqueMLS®	
1	Head Gasket	2006	26240 PT	Exc. Infiniti G35 Base, X, M35 Base, Sport, X; Loc. R.H.; Head bolts not incl.; Head bolt replacement recommended; PermaTorqueMLS®	
1	Head Gasket	2006	26370 PT	Infiniti G35 Base, X, M35 Base, Sport, X; Loc. L.H.; Head bolts not incl.; Head bolt replacement recommended; PermaTorqueMLS®	
1	Head Gasket	2006	26371 PT	Infiniti G35 Base, X, M35 Base, Sport, X; Loc. R.H.; Head bolts not incl.; Head bolt replacement recommended; PermaTorqueMLS®	
1	Head Gasket	2005	26239 PT	Exc. Infiniti G35 Base, X; Loc. L.H.; Head bolts not incl.; Head bolt replacement recommended; PermaTorqueMLS®	
1	Head Gasket	2005	26240 PT	Exc. Infiniti G35 Base, X; Loc. R.H.; Head bolts not incl.; Head bolt replacement recommended; PermaTorqueMLS®	
1	Head Gasket	2005	26370 PT	Infiniti G35 Base, X; Loc. L.H.; Head bolts not incl.; Head bolt replacement recommended; PermaTorqueMLS®	
1	Head Gasket	2005	26371 PT	Infiniti G35 Base, X; Loc. R.H.; Head bolts not incl.; Head bolt replacement recommended; PermaTorqueMLS®	
1	Head Gasket	2004-02	26239 PT	Loc. L.H.; Head bolts not incl.; Head bolt replacement recommended; PermaTorqueMLS®	
1	Head Gasket	2004-02	26240 PT	Loc. R.H.; Head bolts not incl.; Head bolt replacement recommended; PermaTorqueMLS®	
1	Head Set	2013-09	HS 26511 PT	Head bolts & exh. pipe flange not incl.; Head bolt replacement recommended; PermaDry® molded rubber valve cover gskts. incl.; Premium valve stem seals incl.; New Part Number - Check for Availability	
1	Head Set	2008-07	HS 26239 PT-1	Nissan Maxima SE, SL; Head bolts & exh. pipe flange not incl.; Head bolt replacement recommended; PermaDry® molded rubber valve cover gskts. incl.; Premium valve stem seals incl.	
1	Head Set	2008	HS 26370 PT-1	Infiniti M35 Base, Sport, X; Head bolts & exh. pipe flange not incl.; Head bolt replacement recommended; PermaDry® molded rubber valve cover gskts. incl.; Premium valve stem seals incl.	
1	Head Set	2008	HS 26511 PT	Nissan Altima 3.5 SE, 3.5 SL, SE, SL; Head bolts & exh. pipe flange not incl.; Head bolt replacement recommended; PermaDry® molded rubber valve cover gskts. incl.; Premium valve stem seals incl.; New Part Number - Check for Availability	
1	Head Set	2007	HS 26370 PT-1	Exc. Nissan Altima 3.5 SE, 3.5 SL, SE, SE-R, SL, Maxima SE, SL; Head bolts & exh. pipe flange not incl.; Head bolt replacement recommended; PermaDry® molded rubber valve cover gskts. incl.; Premium valve stem seals incl.	
1	Head Set	2007	HS 26511 PT	Nissan Altima 3.5 SE, 3.5 SL, SE, SE-R, SL; Head bolts & exh. pipe flange not incl.; Head bolt replacement recommended; PermaDry® molded rubber valve cover gskts. incl.; Premium valve stem seals incl.; New Part Number - Check for Availability	
1	Head Set	2006-05	HS 26239 PT-1	Nissan Altima 3.5 SE, 3.5 SL, SE, SE-R, SL, Maxima SE, SL; Head bolts & exh. pipe flange not incl.; Head bolt replacement recommended; PermaDry® molded rubber valve cover gskts. incl.; Premium valve stem seals incl.	
1	Head Set	2006	HS 26239 PT	Nissan 350Z Base, Enthusiast, Grand Touring, Touring, Track; Head bolts & exh. pipe flange not incl.; Head bolt replacement recommended; PermaDry® molded rubber valve cover gskts. incl.; Premium valve stem seals incl.	
1	Head Set	2006	HS 26370 PT-1	Infiniti G35 Base, X, M35 Base, Sport, X; Head bolts & exh. pipe flange not incl.; Head bolt replacement recommended; PermaDry® molded rubber valve cover gskts. incl.; Premium valve stem seals incl.	
1	Head Set	2005	HS 26239 PT	Exc. Infiniti G35 Base, X Nissan Altima 3.5 SE, 3.5 SL, SE, SE-R, SL, Maxima SE, SL; Head bolts & exh. pipe flange not incl.; Head bolt replacement recommended; PermaDry® molded rubber valve cover gskts. incl.; Premium valve stem seals incl.	
1	Head Set	2005	HS 26370 PT-1	Infiniti G35 Base, X; Head bolts & exh. pipe flange not incl.; Head bolt replacement recommended; PermaDry® molded rubber valve cover gskts. incl.; Premium valve stem seals incl.	
1	Head Set	2004	HS 26239 PT	Exc. Infiniti I35 Base Nissan Altima SE, SL, Maxima SE, SL; Head bolts & exh. pipe flange not incl.; Head bolt replacement recommended; PermaDry® molded rubber valve cover gskts. incl.; Premium valve stem seals incl.	
1	Head Set	2004	HS 26239 PT-1	Infiniti I35 Base Nissan Altima SE, SL, Maxima SE, SL; Head bolts & exh. pipe flange not incl.; Head bolt replacement recommended; PermaDry® molded rubber valve cover gskts. incl.; Premium valve stem seals incl.	

Nissan Car (Incl. Datsun, Infiniti, Nissan) (Cont.)

21 (cont.)		2013 - 2002; 3.5L 214 (3498cc) DOHC V6 (24 Valve) 95.5mm Bore			21 (cont.)
MFI; Gasoline; Naturally Aspirated Nissan Eng.; Eng. Code VQ35DE					
QTY	CYLINDER HEAD	YEARS	PART NO.	DESCRIPTION	
1	Head Set	2003	HS 26239 PT	Exc. Infiniti I35 Base Nissan Altima Base, S, SE, SL, Maxima GLE, GXE, SE; Head bolts & exh. pipe flange not incl.; Head bolt replacement recommended; PermaDry® molded rubber valve cover gskts. incl.; Premium valve stem seals incl.	
1	Head Set	2003	HS 26239 PT-1	Infiniti I35 Base Nissan Altima Base, S, SE, SL, Maxima GLE, GXE, SE; Head bolts & exh. pipe flange not incl.; Head bolt replacement recommended; PermaDry® molded rubber valve cover gskts. incl.; Premium valve stem seals incl.	
1	Head Set	2002	HS 26239 PT-1	Head bolts & exh. pipe flange not incl.; Head bolt replacement recommended; PermaDry® molded rubber valve cover gskts. incl.; Premium valve stem seals incl.	
2	Head Bolt Set	2013-09	ES 72900	Head bolts w/Washers; Replacement recommended	
2	Head Bolt Set	2008	ES 72900	Exc. Infiniti M35 Base, Sport, X; Head bolts w/Washers; Replacement recommended	
2	Head Bolt Set	2007	ES 72900	Nissan Altima 3.5 SE, 3.5 SL, SE, SE-R, SL, Maxima SE, SL; Head bolts w/Washers; Replacement recommended	
2	Head Bolt Set	2006	ES 72900	Exc. Infiniti G35 Base, X, M35 Base, Sport, X; Head bolts w/Washers; Replacement recommended	
2	Head Bolt Set	2005	ES 72900	Exc. Infiniti G35 Base, X; Head bolts w/Washers; Replacement recommended	
2	Head Bolt Set	2004-02	ES 72900	Head bolts w/Washers; Replacement recommended	
QTY	CONVERSION SET	YEARS	PART NO.	DESCRIPTION	
1	Gasket Conversion Set	2013-09	CS 26511	RTV sealant incl. for Upper oil pan gskt.; New Part Number - Check for Availability	
1	Gasket Conversion Set	2008	CS 26511	Exc. Infiniti M35 Base, Sport, X; RTV sealant incl. for Upper oil pan gskt.; New Part Number - Check for Availability	
1	Gasket Conversion Set	2008	CS 9508	Infiniti M35 Base, Sport, X; Rear main brg. seal not incl.; RTV sealant incl. for Upper oil pan gskt.	
1	Gasket Conversion Set	2007	CS 26511	Nissan Altima 3.5 SE, 3.5 SL, SE, SE-R, SL, Maxima SE, SL; RTV sealant incl. for Upper oil pan gskt.; New Part Number - Check for Availability	
1	Gasket Conversion Set	2007	CS 9508	Exc. Nissan Altima 3.5 SE, 3.5 SL, SE, SE-R, SL, Maxima SE, SL; Rear main brg. seal not incl.; RTV sealant incl. for Upper oil pan gskt.	
1	Gasket Conversion Set	2006-02	CS 9508	Rear main brg. seal not incl.; RTV sealant incl. for Upper oil pan gskt.	
QTY	MANIFOLD - INT. & EXH.	YEARS	PART NO.	DESCRIPTION	
1	Int. Manifold Gasket Set	2013-09	MS 97143	Lower set; Upper set incl.	
1	Int. Manifold Gasket Set	2008-07	MS 96454	Nissan Maxima SE, SL; Upper set incl.	
1	Int. Manifold Gasket Set	2008	MS 96454-1	Infiniti M35 Base, Sport, X; Upper set incl.	
1	Int. Manifold Gasket Set	2008	MS 97143	Nissan Altima 3.5 SE, 3.5 SL, SE, SL; Lower set; Upper set incl.	
1	Int. Manifold Gasket Set	2007-05	MS 96454-1	Exc. Nissan Altima 3.5 SE, 3.5 SL, SE, SE-R, SL, Maxima SE, SL; Upper set incl.	
1	Int. Manifold Gasket Set	2007	MS 97143	Nissan Altima 3.5 SE, 3.5 SL, SE, SE-R, SL; Lower set; Upper set incl.	
1	Int. Manifold Gasket Set	2006-05	MS 96454	Nissan Altima 3.5 SE, 3.5 SL, SE, SE-R, SL, Maxima SE, SL; Upper set incl.	
1	Int. Manifold Gasket Set	2004	MS 96454	Infiniti I35 Base Nissan Altima SE, SL, Maxima SE, SL; Upper set incl.	
1	Int. Manifold Gasket Set	2004	MS 96454-1	Exc. Infiniti I35 Base Nissan Altima SE, SL, Maxima SE, SL; Upper set incl.	
1	Int. Manifold Gasket Set	2003	MS 96454	Infiniti I35 Base Nissan Altima Base, S, SE, SL, Maxima GLE, GXE, SE; Upper set incl.	
1	Int. Manifold Gasket Set	2003	MS 96454-1	Exc. Infiniti I35 Base Nissan Altima Base, S, SE, SL, Maxima GLE, GXE, SE; Upper set incl.	
1	Int. Manifold Gasket Set	2002	MS 96454	Upper set incl.	
1	Plenum Gasket Set	2013-09	MS 97220	Upper set; New Part Number - Check for Availability	
1	Plenum Gasket Set	2008-07	MS 96471	Nissan Maxima SE, SL; Upper set	
1	Plenum Gasket Set	2008	MS 96456	Infiniti M35 Base, Sport, X; Upper set	
1	Plenum Gasket Set	2008	MS 97220	Nissan Altima 3.5 SE, 3.5 SL, SE, SL; Upper set; New Part Number - Check for Availability	
1	Plenum Gasket Set	2007-05	MS 96456	Exc. Nissan Altima 3.5 SE, 3.5 SL, SE, SE-R, SL, Maxima SE, SL; Upper set	
1	Plenum Gasket Set	2007	MS 97220	Nissan Altima 3.5 SE, 3.5 SL, SE, SE-R, SL; Upper set; New Part Number - Check for Availability	
1	Plenum Gasket Set	2006-05	MS 96471	Nissan Altima 3.5 SE, 3.5 SL, SE, SE-R, SL, Maxima SE, SL; Upper set	
1	Plenum Gasket Set	2004	MS 96456	Exc. Infiniti I35 Base Nissan Altima SE, SL, Maxima SE, SL; Upper set	
1	Plenum Gasket Set	2004	MS 96471	Infiniti I35 Base Nissan Altima SE, SL, Maxima SE, SL; Upper set	
1	Plenum Gasket Set	2003	MS 96456	Exc. Infiniti I35 Base Nissan Altima Base, S, SE, SL, Maxima GLE, GXE, SE; Upper set	
1	Plenum Gasket Set	2003	MS 96471	Infiniti I35 Base Nissan Altima Base, S, SE, SL, Maxima GLE, GXE, SE; Upper set	

Nissan Car (Incl. Datsun, Infiniti, Nissan) (Cont.)

21 (cont.)	2013 - 2002; 3.5L 214 (3498cc) DOHC V6 (24 Valve) 95.5mm Bore				21 (cont.)
QTY	MANIFOLD - INT. & EXH.	YEARS	PART NO.	DESCRIPTION	
1	Plenum Gasket Set	2002	MS 96471	Upper set	
1	Exh. Manifold Gasket Set	2013-02	MS 91459		
QTY	EXHAUST PIPE FLANGE	YEARS	PART NO.	DESCRIPTION	
1	Exhaust Pipe Gasket	2013-02	60458	Pipe to muffler	
1	Exhaust Pipe Gasket	2013-09	60458	Loc. Front; Exh. connector	
2	Exhaust Pipe Gasket	2013-09	60905	Secondary converter	
1	Exhaust Pipe Gasket	2013-09	61629	Loc. Front; Pipe to manifold; New Part Number - Check for Availability	
1	Exhaust Pipe Gasket	2013-09	61629	Loc. R.H.; Converter to manifold; New Part Number - Check for Availability	
1	Exhaust Pipe Gasket	2013-09	61630	Loc. L.H.; Converter to manifold; New Part Number - Check for Availability	
1	Exhaust Pipe Gasket	2013-09	61630	Loc. Rear; Pipe to manifold; New Part Number - Check for Availability	
1	Exhaust Pipe Gasket	2013	60905	Exc. Nissan Altima 3.5 S, 3.5 SL, 3.5 SR, 3.5 SV, S, SL, SR, SV; Loc. Rear; Exh. connector	
1	Exhaust Pipe Gasket	2013	61646	Nissan Altima 3.5 S, 3.5 SL, 3.5 SR, 3.5 SV, S, SL, SR, SV; Loc. Rear; Exh. connector	
1	Exhaust Pipe Gasket	2012	60905	Exc. Nissan Altima 3.5 S, 3.5 SE, 3.5 SL, 3.5 SR, S, SE, SL, SR; Loc. Rear; Exh. connector	
1	Exhaust Pipe Gasket	2012	61646	Nissan Altima 3.5 S, 3.5 SE, 3.5 SL, 3.5 SR, S, SE, SL, SR; Loc. Rear; Exh. connector	
1	Exhaust Pipe Gasket	2011	60905	Nissan Maxima 3.5 S, 3.5 SV, S, Sport, SV; Loc. Rear; Exh. connector	
1	Exhaust Pipe Gasket	2011	61646	Exc. Nissan Maxima 3.5 S, 3.5 SV, S, Sport, SV; Loc. Rear; Exh. connector	
1	Exhaust Pipe Gasket	2010-09	60905	Nissan Maxima 3.5 S, 3.5 SV, S, SV; Loc. Rear; Exh. connector	
1	Exhaust Pipe Gasket	2010	61646	Exc. Nissan Maxima 3.5 S, 3.5 SV, S, SV; Loc. Rear; Exh. connector	
1	Exhaust Pipe Gasket	2009-08	61646	Nissan Altima 3.5 SE, 3.5 SL, SE, SL; Loc. Rear; Exh. connector	
2	Exhaust Pipe Gasket	2008-07	60835	Nissan Maxima SE, SL; Flange; Improved design	
2	Exhaust Pipe Gasket	2008-07	61338	Nissan Maxima SE, SL; Converter	
1	Exhaust Pipe Gasket	2008	60458	Nissan Altima 3.5 SE, 3.5 SL, SE, SL; Loc. Front; Exh. connector	
2	Exhaust Pipe Gasket	2008	60674	Infiniti M35 Base, Sport, X; Flange	
2	Exhaust Pipe Gasket	2008	60905	Nissan Altima 3.5 SE, 3.5 SL, SE, SL; Secondary converter	
2	Exhaust Pipe Gasket	2008	61341	Infiniti M35 Base, Sport, X; Converter	
1	Exhaust Pipe Gasket	2008	61629	Nissan Altima 3.5 SE, 3.5 SL, SE, SL; Loc. Front; Pipe to manifold; New Part Number - Check for Availability	
1	Exhaust Pipe Gasket	2008	61629	Nissan Altima 3.5 SE, 3.5 SL, SE, SL; Loc. R.H.; Converter to manifold; New Part Number - Check for Availability	
1	Exhaust Pipe Gasket	2008	61630	Nissan Altima 3.5 SE, 3.5 SL, SE, SL; Loc. L.H.; Converter to manifold; New Part Number - Check for Availability	
1	Exhaust Pipe Gasket	2008	61630	Nissan Altima 3.5 SE, 3.5 SL, SE, SL; Loc. Rear; Pipe to manifold; New Part Number - Check for Availability	
2	Exhaust Pipe Gasket	2007-05	60674	Exc. Nissan Altima 3.5 SE, 3.5 SL, SE, SE-R, SL, Maxima SE, SL; Flange	
2	Exhaust Pipe Gasket	2007-05	61341	Exc. Nissan Altima 3.5 SE, 3.5 SL, SE, SE-R, SL, Maxima SE, SL; Converter	
1	Exhaust Pipe Gasket	2007	60458	Nissan Altima 3.5 SE, 3.5 SL, SE, SE-R, SL; Loc. Front; Exh. connector	
2	Exhaust Pipe Gasket	2007	60905	Nissan Altima 3.5 SE, 3.5 SL, SE, SE-R, SL; Secondary converter	
1	Exhaust Pipe Gasket	2007	61629	Nissan Altima 3.5 SE, 3.5 SL, SE, SE-R, SL; Loc. Front; Pipe to manifold; New Part Number - Check for Availability	
1	Exhaust Pipe Gasket	2007	61629	Nissan Altima 3.5 SE, 3.5 SL, SE, SE-R, SL; Loc. R.H.; Converter to manifold; New Part Number - Check for Availability	
1	Exhaust Pipe Gasket	2007	61630	Nissan Altima 3.5 SE, 3.5 SL, SE, SE-R, SL; Loc. L.H.; Converter to manifold; New Part Number - Check for Availability	
1	Exhaust Pipe Gasket	2007	61630	Nissan Altima 3.5 SE, 3.5 SL, SE, SE-R, SL; Loc. Rear; Pipe to manifold; New Part Number - Check for Availability	
1	Exhaust Pipe Gasket	2007	61646	Nissan Altima 3.5 SE, 3.5 SL, SE, SE-R, SL; Loc. Rear; Exh. connector	
2	Exhaust Pipe Gasket	2006-05	60835	Nissan Altima 3.5 SE, 3.5 SL, SE, SE-R, SL, Maxima SE, SL; Flange; Improved design	
2	Exhaust Pipe Gasket	2006-05	61338	Nissan Altima 3.5 SE, 3.5 SL, SE, SE-R, SL, Maxima SE, SL; Converter	
1	Exhaust Pipe Gasket	2004-02	60871	Infiniti I35 Base; Loc. Rear; Flange	
1	Exhaust Pipe Gasket	2004-02	60905	Infiniti I35 Base; Loc. Front; Flange	
2	Exhaust Pipe Gasket	2004	60674	Exc. Infiniti I35 Base Nissan Altima SE, SL, Maxima SE, SL; Flange	
2	Exhaust Pipe Gasket	2004	60835	Nissan Altima SE, SL, Maxima SE, SL; Flange; Improved design	
2	Exhaust Pipe Gasket	2004	61338	Infiniti I35 Base Nissan Altima SE, SL, Maxima SE, SL; Converter	
2	Exhaust Pipe Gasket	2004	61341	Exc. Infiniti I35 Base Nissan Altima SE, SL, Maxima SE, SL; Converter	
2	Exhaust Pipe Gasket	2003	60674	Exc. Infiniti I35 Base Nissan Altima Base, S, SE, SL, Maxima GLE, GXE, SE; Flange	
2	Exhaust Pipe Gasket	2003	60835	Nissan Altima Base, S, SE, SL, Maxima GLE, GXE, SE; Flange; Improved design	

Nissan Car (Incl. Datsun, Infiniti, Nissan) (Cont.)

21 (cont.)		2013 - 2002; 3.5L 214 (3498cc) DOHC V6 (24 Valve) 95.5mm Bore MFI; Gasoline; Naturally Aspirated Nissan Eng.; Eng. Code VQ35DE			21 (cont.)
QTY	EXHAUST PIPE FLANGE	YEARS	PART NO.	DESCRIPTION	
2	Exhaust Pipe Gasket	2003	61338	Infiniti I35 Base Nissan Altima Base, S, SE, SL, Maxima GLE, GXE, SE; Converter	
2	Exhaust Pipe Gasket	2003	61341	Exc. Infiniti I35 Base Nissan Altima Base, S, SE, SL, Maxima GLE, GXE, SE; Converter	
2	Exhaust Pipe Gasket	2002	60835	Exc. Infiniti I35 Base; Flange; Improved design	
2	Exhaust Pipe Gasket	2002	61338	Converter	
QTY	OIL PAN	YEARS	PART NO.	DESCRIPTION	
1	Oil Pan Gasket Set	2013-02	OS 30688	Loc. Lower	
1	Oil Pan Gasket Set	2013-02	OS 30696	Loc. Upper; RTV Black silicone w/Rubber end seals	
QTY	CRANKSHAFT REAR SEAL	YEARS	PART NO.	DESCRIPTION	
1	Rear Main Seal Set	2013-09	BS 40730	Rubber; One-piece	
1	Rear Main Seal Set	2008	BS 40631	Infiniti M35 Base, Sport, X; Rubber; One-piece	
1	Rear Main Seal Set	2008	BS 40730	Exc. Infiniti M35 Base, Sport, X; Rubber; One-piece	
1	Rear Main Seal Set	2007	BS 40631	Exc. Nissan Altima 3.5 SE, 3.5 SL, SE, SE-R, SL, Maxima SE, SL; Rubber; One-piece	
1	Rear Main Seal Set	2007	BS 40730	Nissan Altima 3.5 SE, 3.5 SL, SE, SE-R, SL, Maxima SE, SL; Rubber; One-piece	
1	Rear Main Seal Set	2006-02	BS 40631	Rubber; One-piece	
QTY	VALVE COVER	YEARS	PART NO.	DESCRIPTION	
1	Valve Cover Gasket Set	2013-09	VS 50770 R	VCT seals, camshaft position sensor O-ring, oil pump inlet seal incl.; PermaDry® molded rubber gskts. incl.; New Part Number - Check for Availability	
1	Valve Cover Gasket Set	2008	VS 50608 R	Exc. Nissan Altima 3.5 SE, 3.5 SL, SE, SL; PermaDry® molded rubber gskts. incl.	
1	Valve Cover Gasket Set	2008	VS 50770 R	Nissan Altima 3.5 SE, 3.5 SL, SE, SL; VCT seals, camshaft position sensor O-ring, oil pump inlet seal incl.; PermaDry® molded rubber gskts. incl.; New Part Number - Check for Availability	
1	Valve Cover Gasket Set	2007	VS 50608 R	Exc. Nissan Altima 3.5 SE, 3.5 SL, SE, SE-R, SL; PermaDry® molded rubber gskts. incl.	
1	Valve Cover Gasket Set	2007	VS 50770 R	Nissan Altima 3.5 SE, 3.5 SL, SE, SE-R, SL; VCT seals, camshaft position sensor O-ring, oil pump inlet seal incl.; PermaDry® molded rubber gskts. incl.; New Part Number - Check for Availability	
1	Valve Cover Gasket Set	2006-02	VS 50608 R	PermaDry® molded rubber gskts. incl.	
1	Spark Plug Tube Seal Set	2008	ES 72481	Exc. Nissan Altima 3.5 SE, 3.5 SL, SE, SL; Valve Cover; For use with removable PCV Valve baffles only; New Part Number - Check for Availability	
1	Spark Plug Tube Seal Set	2007	ES 72481	Exc. Nissan Altima 3.5 SE, 3.5 SL, SE, SE-R, SL; Valve Cover; For use with removable PCV Valve baffles only; New Part Number - Check for Availability	
1	Spark Plug Tube Seal Set	2006-02	ES 72481	Valve Cover; For use with removable PCV Valve baffles only; New Part Number - Check for Availability	
QTY	VALVE STEM SEAL SET	YEARS	PART NO.	DESCRIPTION	
1	Valve Stem Seal Set	2013-02	SS 72821	Premium valve stem seals incl.	
QTY	WATER OUTLET GASKET	YEARS	PART NO.	DESCRIPTION	
2	Water Outlet Gasket	2013-02	35620	Water Outlet	
1	Water Outlet Gasket	2013-02	35622	Water Outlet; Inlet	
1	Water Outlet Gasket	2008	35869	Infiniti M35 Base, Sport, X; Water Outlet; Upper inlet connector	
1	Water Outlet Gasket	2007-05	35869	Exc. Nissan Altima 3.5 SE, 3.5 SL, SE, SE-R, SL, Maxima SE, SL; Water Outlet; Upper inlet connector	
1	Water Outlet Gasket	2004	35869	Exc. Infiniti I35 Base Nissan Altima SE, SL, Maxima SE, SL; Water Outlet; Upper inlet connector	
1	Water Outlet Gasket	2003	35869	Exc. Infiniti I35 Base Nissan Altima Base, S, SE, SL, Maxima GLE, GXE, SE; Water Outlet; Upper inlet connector	
QTY	WATER PUMP	YEARS	PART NO.	DESCRIPTION	
1	Water Pump Mounting Set	2013-02	ES 70894		
QTY	TIMING COVER	YEARS	PART NO.	DESCRIPTION	
1	Timing Cover Set	2013-02	TCS 45997		
QTY	CARB & FUEL INJECTION	YEARS	PART NO.	DESCRIPTION	
3	Fuel Injector O-Ring Set	2013-09	ES 70599	Improved design	
3	Fuel Injector O-Ring Set	2008	ES 70599	Exc. Infiniti M35 Base, Sport, X; Improved design	
2	Fuel Injector O-Ring Set	2008	ES 70599	Infiniti M35 Base, Sport, X; Upper set; Injectors to fuel rail; Improved design	
3	Fuel Injector O-Ring Set	2007	ES 70599	Exc. Infiniti G35 Base, Journey, Sport, X, M35 Base, Sport, X; Improved design	
2	Fuel Injector O-Ring Set	2007	ES 70599	Infiniti G35 Base, Journey, Sport, X, M35 Base, Sport, X; Upper set; Injectors to fuel rail; Improved design	
3	Fuel Injector O-Ring Set	2006	ES 70599	Exc. Infiniti G35 Base, X, M35 Base, Sport, X; Improved design	

Nissan Car (Incl. Datsun, Infiniti, Nissan) (Cont.)

21 (cont.)	2013 - 2002; 3.5L 214 (3498cc) DOHC V6 (24 Valve) 95.5mm Bore				21 (cont.)
QTY	CARB & FUEL INJECTION	YEARS	PART NO.	DESCRIPTION	
2	Fuel Injector O-Ring Set	2006	ES 70599	Infiniti G35 Base, X, M35 Base, Sport, X; Upper set; Injectors to fuel rail; Improved design	
3	Fuel Injector O-Ring Set	2005	ES 70599	Exc. Infiniti G35 Base, X; Improved design	
2	Fuel Injector O-Ring Set	2005	ES 70599	Infiniti G35 Base, X; Upper set; Injectors to fuel rail; Improved design	
3	Fuel Injector O-Ring Set	2004-02	ES 70599	Improved design	
1	Throttle Body Gasket	2013	61631	Nissan Altima 3.5 S, 3.5 SL, 3.5 SR, 3.5 SV, S, SL, SR, SV; Throttle body mounting; New Part Number - Check for Availability	
1	Throttle Body Gasket	2013	61632	Exc. Nissan Altima 3.5 S, 3.5 SL, 3.5 SR, 3.5 SV, S, SL, SR, SV; Throttle body mounting	
1	Throttle Body Gasket	2012	61631	Nissan Altima 3.5 S, 3.5 SE, 3.5 SL, 3.5 SR, S, SE, SL, SR; Throttle body mounting; New Part Number - Check for Availability	
1	Throttle Body Gasket	2012	61632	Exc. Nissan Altima 3.5 S, 3.5 SE, 3.5 SL, 3.5 SR, S, SE, SL, SR; Throttle body mounting	
1	Throttle Body Gasket	2011	61631	Exc. Nissan Maxima 3.5 S, 3.5 SV, S, Sport, SV; Throttle body mounting; New Part Number - Check for Availability	
1	Throttle Body Gasket	2011	61632	Nissan Maxima 3.5 S, 3.5 SV, S, Sport, SV; Throttle body mounting	
1	Throttle Body Gasket	2010-09	61632	Nissan Maxima 3.5 S, 3.5 SV, S, SV; Throttle body mounting	
1	Throttle Body Gasket	2010	61631	Exc. Nissan Maxima 3.5 S, 3.5 SV, S, SV; Throttle body mounting; New Part Number - Check for Availability	
1	Throttle Body Gasket	2009-08	61631	Nissan Altima 3.5 SE, 3.5 SL, SE, SL; Throttle body mounting; New Part Number - Check for Availability	
1	Throttle Body Gasket	2008-07	61342	Nissan Maxima SE, SL; Throttle body to collector	
1	Throttle Body Gasket	2008-07	61345	Nissan Maxima SE, SL; Throttle body collector to plenum	
1	Throttle Body Gasket	2008	61342	Infiniti M35 Base, Sport, X; Throttle body mounting	
1	Throttle Body Gasket	2007-05	61342	Exc. Nissan Altima 3.5 SE, 3.5 SL, SE, SE-R, SL, Maxima SE, SL; Throttle body mounting	
1	Throttle Body Gasket	2007	61631	Nissan Altima 3.5 SE, 3.5 SL, SE, SE-R, SL; Throttle body mounting; New Part Number - Check for Availability	
1	Throttle Body Gasket	2006-05	61342	Nissan Altima 3.5 SE, 3.5 SL, SE, SE-R, SL, Maxima SE, SL; Throttle body to collector	
1	Throttle Body Gasket	2006-05	61345	Nissan Altima 3.5 SE, 3.5 SL, SE, SE-R, SL, Maxima SE, SL; Throttle body collector to plenum	
1	Throttle Body Gasket	2004	61342	Exc. Infiniti I35 Base Nissan Altima SE, SL, Maxima SE, SL; Throttle body mounting	
1	Throttle Body Gasket	2004	61342	Infiniti I35 Base Nissan Altima SE, SL, Maxima SE, SL; Throttle body to collector	
1	Throttle Body Gasket	2004	61345	Infiniti I35 Base Nissan Altima SE, SL, Maxima SE, SL; Throttle body collector to plenum	
1	Throttle Body Gasket	2003	61342	Exc. Infiniti I35 Base Nissan Altima Base, S, SE, SL, Maxima GLE, GXE, SE; Throttle body mounting	
1	Throttle Body Gasket	2003	61342	Infiniti I35 Base Nissan Altima Base, S, SE, SL, Maxima GLE, GXE, SE; Throttle body to collector	
1	Throttle Body Gasket	2003	61345	Infiniti I35 Base Nissan Altima Base, S, SE, SL, Maxima GLE, GXE, SE; Throttle body collector to plenum	
1	Throttle Body Gasket	2002	61342	Throttle body to collector	
1	Throttle Body Gasket	2002	61345	Throttle body collector to plenum	
QTY	EXHAUST GAS RECIRCULATION	YEARS	PART NO.	DESCRIPTION	
1	EGR Gasket	2008-02	70893	Valve	
QTY	OIL COOLER	YEARS	PART NO.	DESCRIPTION	
1	Oil Cooler Gasket	2013-02	72493	Oil cooler seal; New Part Number - Check for Availability	
22	2010 - 2007; 3.5L 214 (3498cc) DOHC V6 (24 Valve) 95.5mm Bore				22
QTY	CYLINDER HEAD	YEARS	PART NO.	DESCRIPTION	
1	Head Gasket	2010-07	26511 PT	Loc. L.H.; Head bolts not incl.; Head bolt replacement recommended; PermaTorqueMLS®; New Part Number - Check for Availability	
1	Head Gasket	2010-07	26512 PT	Loc. R.H.; Head bolts not incl.; Head bolt replacement recommended; PermaTorqueMLS®; New Part Number - Check for Availability	
QTY	MANIFOLD - INT. & EXH.	YEARS	PART NO.	DESCRIPTION	
1	Int. Manifold Gasket Set	2010-07	MS 97143	Lower set	
1	Exh. Manifold Gasket Set	2010-07	MS 91459		
QTY	EXHAUST PIPE FLANGE	YEARS	PART NO.	DESCRIPTION	
1	Exhaust Pipe Gasket	2010-07	60458	Loc. Front; Exh. connector	
2	Exhaust Pipe Gasket	2010-07	60674	Pipe to muffler	

Nissan Car (Incl. Datsun, Infiniti, Nissan) (Cont.)

22 (cont.)		2010 - 2007; 3.5L 214 (3498cc) DOHC V6 (24 Valve) 95.5mm Bore			22 (cont.)
MFI; Gasoline; Naturally Aspirated Nissan Eng.; Eng. Code VQ35HR					
QTY	EXHAUST PIPE FLANGE	YEARS	PART NO.	DESCRIPTION	
2	Exhaust Pipe Gasket	2010-07	61647	Loc. Front; Converter; New Part Number - Check for Availability	
2	Exhaust Pipe Gasket	2010	60871	Loc. Rear; Exh. connector	
2	Exhaust Pipe Gasket	2009	60674	Exc. Infiniti M35 Base, Sport, X; Loc. Rear; Exh. connector	
2	Exhaust Pipe Gasket	2009	60871	Infiniti M35 Base, Sport, X; Loc. Rear; Exh. connector	
2	Exhaust Pipe Gasket	2009	61515	Exc. Infiniti M35 Base, Sport, X; Loc. Rear; Pipe to muffler	
2	Exhaust Pipe Gasket	2008-07	60674	Loc. Rear; Exh. connector	
2	Exhaust Pipe Gasket	2008-07	61515	Exc. Infiniti G35 Base, Journey, Sport, X; Loc. Rear; Pipe to muffler	
QTY	CRANKSHAFT REAR SEAL	YEARS	PART NO.	DESCRIPTION	
1	Rear Main Seal Set	2010-07	BS 40694	Rubber; One-piece	
QTY	VALVE COVER	YEARS	PART NO.	DESCRIPTION	
1	Valve Cover Gasket Set	2010-07	VS 50770 R	VCT seals, camshaft position sensor O-ring, oil pump inlet seal incl.; PermaDry® molded rubber gskts. incl.; New Part Number - Check for Availability	
1	Valve Cover Gasket Set	2010-07	VS 50848 R	w/Spark plug tube seals; PermaDry® molded rubber gskts. incl.; New Part Number - Check for Availability	
QTY	VALVE STEM SEAL SET	YEARS	PART NO.	DESCRIPTION	
1	Valve Stem Seal Set	2010-07	SS 72821	Premium valve stem seals incl.	
QTY	WATER OUTLET GASKET	YEARS	PART NO.	DESCRIPTION	
2	Water Outlet Gasket	2010-07	35620	Water Outlet	
1	Water Outlet Gasket	2010-07	35622	Water Outlet; Inlet	
1	Water Outlet Gasket	2010-07	35869	Water Outlet; Upper inlet connector	
23		2013 - 2012; 3.5L 214 (3498cc) DOHC V6 (24 Valve) 95.5mm Bore			23
MFI; Hybrid (Gas/Electric); Naturally Aspirated Nissan Eng.; Eng. Code VQ35HR					
QTY	CYLINDER HEAD	YEARS	PART NO.	DESCRIPTION	
1	Head Gasket	2013-12	26511 PT	Loc. L.H.; Head bolts not incl.; Head bolt replacement recommended; PermaTorqueMLS®; New Part Number - Check for Availability	
1	Head Gasket	2013-12	26512 PT	Loc. R.H.; Head bolts not incl.; Head bolt replacement recommended; PermaTorqueMLS®; New Part Number - Check for Availability	
QTY	MANIFOLD - INT. & EXH.	YEARS	PART NO.	DESCRIPTION	
1	Int. Manifold Gasket Set	2013-12	MS 97143	Lower set	
1	Exh. Manifold Gasket Set	2013-12	MS 91459		
QTY	EXHAUST PIPE FLANGE	YEARS	PART NO.	DESCRIPTION	
1	Exhaust Pipe Gasket	2013-12	60458	Loc. Front; Exh. connector	
2	Exhaust Pipe Gasket	2013-12	60674	Pipe to muffler	
2	Exhaust Pipe Gasket	2013-12	60871	Loc. Rear; Exh. connector	
2	Exhaust Pipe Gasket	2013-12	61647	Loc. Front; Converter; New Part Number - Check for Availability	
QTY	CRANKSHAFT REAR SEAL	YEARS	PART NO.	DESCRIPTION	
1	Rear Main Seal Set	2013-12	BS 40694	Rubber; One-piece	
QTY	VALVE COVER	YEARS	PART NO.	DESCRIPTION	
1	Valve Cover Gasket Set	2013-12	VS 50770 R	VCT seals, camshaft position sensor O-ring, oil pump inlet seal incl.; PermaDry® molded rubber gskts. incl.; New Part Number - Check for Availability	
1	Valve Cover Gasket Set	2013-12	VS 50848 R	w/Spark plug tube seals; PermaDry® molded rubber gskts. incl.; New Part Number - Check for Availability	
QTY	VALVE STEM SEAL SET	YEARS	PART NO.	DESCRIPTION	
1	Valve Stem Seal Set	2013-12	SS 72821	Premium valve stem seals incl.	
QTY	WATER OUTLET GASKET	YEARS	PART NO.	DESCRIPTION	
2	Water Outlet Gasket	2013-12	35620	Water Outlet	
1	Water Outlet Gasket	2013-12	35622	Water Outlet; Inlet	
1	Water Outlet Gasket	2013-12	35869	Water Outlet; Upper inlet connector	
24		2013 - 2008; 3.7L 225.5 (3696cc) DOHC V6 (24 Valve) 95.5mm Bore VVEL			24
MFI; Gasoline; Naturally Aspirated Nissan Eng.; Eng. Code VQ37VHR					
QTY	MANIFOLD - INT. & EXH.	YEARS	PART NO.	DESCRIPTION	
1	Exh. Manifold Gasket Set	2013-08	MS 91459		
QTY	EXHAUST PIPE FLANGE	YEARS	PART NO.	DESCRIPTION	
1	Exhaust Pipe Gasket	2013-08	60458	Loc. Front; Exh. connector	
2	Exhaust Pipe Gasket	2013-08	60674	Loc. Rear; Converter	
2	Exhaust Pipe Gasket	2013-08	61647	Loc. Front; Converter; New Part Number - Check for Availability	
2	Exhaust Pipe Gasket	2013-11	60674	Exc. Infiniti M37 Base, Sport, X; Loc. Rear; Exh. connector	
2	Exhaust Pipe Gasket	2013-11	60871	Infiniti M37 Base, Sport, X; Loc. Rear; Exh. connector	
2	Exhaust Pipe Gasket	2010-08	60674	Loc. Rear; Exh. connector	

Nissan Car (Incl. Datsun, Infiniti, Nissan) (Cont.)

24		2013 - 2008; 3.7L 225.5 (3696cc) DOHC V6 (24 Valve) 95.5mm Bore VVEL			24
(cont.)		MFI; Gasoline; Naturally Aspirated Nissan Eng.; Eng. Code VQ37VHR			(cont.)
QTY	CRANKSHAFT REAR SEAL	YEARS	PART NO.	DESCRIPTION	
1	Rear Main Seal Set	2013-08	BS 40694	Rubber; One-piece	
QTY	VALVE STEM SEAL SET	YEARS	PART NO.	DESCRIPTION	
1	Valve Stem Seal Set	2013-08	SS 72821	Premium valve stem seals incl.	
QTY	WATER OUTLET GASKET	YEARS	PART NO.	DESCRIPTION	
2	Water Outlet Gasket	2013-08	35620	Water Outlet	
1	Water Outlet Gasket	2013-08	35622	Water Outlet; Inlet	
1	Water Outlet Gasket	2013-08	35869	Water Outlet; Upper inlet connector	
25		2013 - 2009; 3.8L 231.8 (3799cc) DOHC V6 (24 Valve) 95.5mm Bore			25
		MFI; Gasoline; Turbo - Intercooled Nissan Eng.; Eng. Code VR38DETT			
QTY	CRANKSHAFT REAR SEAL	YEARS	PART NO.	DESCRIPTION	
1	Rear Main Seal Set	2013-09	BS 40694	Rubber; One-piece	
QTY	VALVE COVER	YEARS	PART NO.	DESCRIPTION	
1	Valve Cover Gasket Set	2013-09	VS 50846 R	PermaDry® molded rubber gskts. incl.; New Part Number - Check for Availability	
QTY	VALVE STEM SEAL SET	YEARS	PART NO.	DESCRIPTION	
1	Valve Stem Seal Set	2013-09	SS 72821	Premium valve stem seals incl.	
QTY	WATER OUTLET GASKET	YEARS	PART NO.	DESCRIPTION	
2	Water Outlet Gasket	2013-09	35620	Water Outlet	
1	Water Outlet Gasket	2013-09	35622	Water Outlet; Inlet	
1	Water Outlet Gasket	2013-09	35869	Water Outlet; Upper inlet connector	
QTY	CARB & FUEL INJECTION	YEARS	PART NO.	DESCRIPTION	
2	Throttle Body Gasket	2013-09	61645		
26		2001 - 1997; 4.1L 252 (4130cc) DOHC V8 (32 Valve) 93mm Bore			26
		MFI; Gasoline; Naturally Aspirated Nissan Eng.; Eng. Code VH41DE			
QTY	CYLINDER HEAD	YEARS	PART NO.	DESCRIPTION	
1	Head Gasket	2001-97	26636 PT	Loc. R.H.; Head bolts not incl.; Head bolt replacement recommended; New Part Number - Check for Availability	
1	Head Gasket	2001-97	26637 PT	Loc. L.H.; Head bolts not incl.; Head bolt replacement recommended; New Part Number - Check for Availability	
27		1996 - 1991; 4.5L 274 (4494cc) DOHC V8 (32 Valve) 93mm Bore			27
		MFI; Gasoline; Naturally Aspirated Nissan Eng.; Eng. Code VH45DE			
QTY	CYLINDER HEAD	YEARS	PART NO.	DESCRIPTION	
1	Head Gasket	1996-91	9848 PT	Loc. R.H.; Head bolts not incl.; Head bolt replacement recommended	
1	Head Set	1993-91	HS 9848 PT	Head bolts not incl.; Head bolt replacement recommended; RTV sealant incl. for valve cover gskts.; Premium valve stem seals incl.	
QTY	MANIFOLD - INT. & EXH.	YEARS	PART NO.	DESCRIPTION	
1	Int. Manifold Gasket Set	1993-91	MS 95243	Lower set; Upper set incl.	
1	Plenum Gasket Set	1996-91	MS 95245	Upper set; New Part Number - Check for Availability	
1	Exh. Manifold Gasket Set	1996-91	MS 95244		
QTY	EXHAUST PIPE FLANGE	YEARS	PART NO.	DESCRIPTION	
2	Exhaust Pipe Gasket	1996-91	60937	Flange	
1	Exhaust Pipe Gasket	1993-91	60308	Converter; 2 11/32" ID	
QTY	OIL PAN	YEARS	PART NO.	DESCRIPTION	
1	Oil Pan Gasket Set	1996-91	OS 30653 C		
QTY	CRANKSHAFT REAR SEAL	YEARS	PART NO.	DESCRIPTION	
1	Rear Main Seal Set	1996-91	BS 40628	Rubber; One-piece	
QTY	VALVE COVER	YEARS	PART NO.	DESCRIPTION	
1	Valve Cover Gasket Set	1993-91	VS 50402 R	w/Semi-circular plugs & Grommets; RTV Black silicone	
QTY	VALVE STEM SEAL SET	YEARS	PART NO.	DESCRIPTION	
4	Valve Stem Seal Set	1993-91	SS 72776	Premium valve stem seals incl.	
QTY	THERMOSTAT HOUSING	YEARS	PART NO.	DESCRIPTION	
1	Thermostat Gasket	1996-91	35538	Thermostat Housing	
QTY	TIMING COVER	YEARS	PART NO.	DESCRIPTION	
1	Crankshaft Front Seal Set	1996-91	TCS 45913		
QTY	CARB & FUEL INJECTION	YEARS	PART NO.	DESCRIPTION	
1	Throttle Body Gasket	1996-91	60938		
QTY	EXHAUST GAS RECIRCULATION	YEARS	PART NO.	DESCRIPTION	
1	EGR Gasket	1993-91	72521		

Nissan Car (Incl. Datsun, Infiniti, Nissan) (Cont.)

28		2010 - 2002; 4.5L 274 (4494cc) DOHC V8 (32 Valve) 93mm Bore			28
MFI; Gasoline; Naturally Aspirated Nissan Eng.; Eng. Code VK45DE					
QTY	CYLINDER HEAD	YEARS	PART NO.	DESCRIPTION	
1	Head Gasket	2010-02	26586 PT	Loc. L.H.; Head bolts not incl.; Head bolt replacement recommended; PermaTorqueMLS®; New Part Number - Check for Availability	
1	Head Gasket	2010-02	26642 PT	Loc. R.H.; Head bolts not incl.; Head bolt replacement recommended; PermaTorqueMLS®; New Part Number - Check for Availability	
1	Head Set	2010-07	HS 26586 PT	Head bolts not incl.; Head bolt replacement recommended; PermaDry® molded rubber valve cover gskts. incl.; Premium valve stem seals incl.; New Part Number - Check for Availability	
1	Head Set	2006	HS 26586 PT	Infiniti M45 Base, Sport; Head bolts not incl.; Head bolt replacement recommended; PermaDry® molded rubber valve cover gskts. incl.; Premium valve stem seals incl.; New Part Number - Check for Availability	
1	Head Set	2006	HS 26642 PT	Infiniti Q45 Base, Sport; Head bolts not incl.; Head bolt replacement recommended; PermaDry® molded rubber valve cover gskts. incl.; Premium valve stem seals incl.; New Part Number - Check for Availability	
1	Head Set	2005-02	HS 26642 PT	Head bolts not incl.; Head bolt replacement recommended; PermaDry® molded rubber valve cover gskts. incl.; Premium valve stem seals incl.; New Part Number - Check for Availability	
2	Head Bolt Set	2010-02	ES 71354	Head bolts w/Washers; Replacement recommended; New Part Number - Check for Availability	
QTY	CONVERSION SET	YEARS	PART NO.	DESCRIPTION	
1	Gasket Conversion Set	2010-02	CS 26586	Timing cover gskts. not incl.; RTV sealant incl. for oil pan gskt.; New Part Number - Check for Availability	
QTY	MANIFOLD - INT. & EXH.	YEARS	PART NO.	DESCRIPTION	
1	Int. Manifold Gasket Set	2010-07	MS 97295	Lower set; Upper set incl.; New Part Number - Check for Availability	
1	Int. Manifold Gasket Set	2006	MS 97294	Infiniti Q45 Base, Sport; Lower set; Upper set incl.; New Part Number - Check for Availability	
1	Int. Manifold Gasket Set	2006	MS 97295	Infiniti M45 Base, Sport; Lower set; Upper set incl.; New Part Number - Check for Availability	
1	Int. Manifold Gasket Set	2005-02	MS 97294	Lower set; Upper set incl.; New Part Number - Check for Availability	
1	Exh. Manifold Gasket Set	2010-02	MS 97264	New Part Number - Check for Availability	
QTY	EXHAUST PIPE FLANGE	YEARS	PART NO.	DESCRIPTION	
2	Exhaust Pipe Gasket	2010-02	60458	Loc. Front; Exh. connector	
2	Exhaust Pipe Gasket	2010-02	60674	Loc. Rear; Exh. connector	
2	Exhaust Pipe Gasket	2010-02	61515	Loc. Front; Converter	
2	Exhaust Pipe Gasket	2010-07	60871	Loc. Rear; Converter	
2	Exhaust Pipe Gasket	2006	60871	Infiniti M45 Base, Sport; Loc. Rear; Converter	
2	Exhaust Pipe Gasket	2006	61515	Infiniti Q45 Base, Sport; Loc. Rear; Converter	
2	Exhaust Pipe Gasket	2005-03	60871	Infiniti M45 Base; Loc. Rear; Converter	
2	Exhaust Pipe Gasket	2005-04	61515	Infiniti Q45 Base; Loc. Rear; Converter	
2	Exhaust Pipe Gasket	2003	61515	Exc. Infiniti M45 Base; Loc. Rear; Converter	
2	Exhaust Pipe Gasket	2002	61515	Loc. Rear; Converter	
QTY	VALVE COVER	YEARS	PART NO.	DESCRIPTION	
1	Valve Cover Gasket Set	2010-02	VS 50843 R	PermaDry® molded rubber gskts. incl.; New Part Number - Check for Availability	
QTY	VALVE STEM SEAL SET	YEARS	PART NO.	DESCRIPTION	
2	Valve Stem Seal Set	2010-02	SS 70157	Premium valve stem seals incl.	
QTY	CARB & FUEL INJECTION	YEARS	PART NO.	DESCRIPTION	
2	Fuel Injector O-Ring Set	2010-02	ES 70599	Lower set; Injectors to cylinder head; Improved design	
2	Fuel Injector O-Ring Set	2010-02	ES 70599	Upper set; Injectors to fuel rail; Improved design	

Nissan Minivans - See Nissan Truck

Nissan SUV's - See Nissan Truck

Nissan Truck (Incl. Minivans and SUV's)

Engine Finding Index

Engine	Years	Code	Line No.
1.6L 98.7 (1618cc) DOHC L4 (16 Valve) 79.7mm Bore VVT; DI; Gasoline; Turbo - Intercooled Nissan Eng.	2013-11	MR16DDT	1
2.0L 122 (1997cc) DOHC L4 (16 Valve) 84mm Bore; MFI; Gasoline; Naturally Aspirated Nissan Eng.	2013	MR20DE	2
2.4L 146 (2389cc) DOHC L4 (16 Valve) 89mm Bore; MFI; Gasoline; Naturally Aspirated Nissan Eng.	2004-98	KA24DE	3
2.4L 146 (2389cc) SOHC L4 (12 Valve) 89mm Bore; MFI; Gasoline; Naturally Aspirated Nissan Eng.	1997-91	KA24E	4
2.5L 151.8 (2488cc) DOHC L4 (16 Valve) 89mm Bore; MFI; Gasoline; Naturally Aspirated Nissan Eng.	2013-05	QR25DE	5

Nissan Truck (Incl. Minivans and SUV's) (Cont.)

Engine Finding Index (Cont.)

Engine	Years	Code	Line No.
3.0L 181 (2960cc) SOHC V6 (12 Valve) 87mm Bore; MFI; Gasoline; Naturally Aspirated Nissan Eng.	1998-91	VG30E	6
3.3L 199.8 (3274cc) SOHC V6 (12 Valve) 91.5mm Bore; MFI; Gasoline; Naturally Aspirated Nissan Eng.	2004-96	VG33E	7
3.3L 199.8 (3274cc) SOHC V6 (12 Valve) 91.5mm Bore; MFI; Gasoline; Supercharged Nissan Eng.	2004-01	VG33ER	8
3.5L 214 (3498cc) DOHC V6 (24 Valve) 95.5mm Bore; MFI; Gasoline; Naturally Aspirated Nissan Eng.	2013-01	VQ35DE	9
3.5L 214 (3498cc) DOHC V6 (24 Valve) 95.5mm Bore; MFI; Gasoline; Naturally Aspirated Nissan Eng.	2012-08	VQ35HR	10
3.7L 225.5 (3696cc) DOHC V6 (24 Valve) 95.5mm Bore VVEL; MFI; Gasoline; Naturally Aspirated Nissan Eng.	2013	VQ37VHR	11
4.0L 241.3 (3954cc) DOHC V6 (24 Valve) 95.5mm Bore; MFI; Gasoline; Naturally Aspirated Nissan Eng.	2013-05	VQ40DE	12
4.5L 274 (4494cc) DOHC V8 (32 Valve) 93mm Bore; MFI; Gasoline; Naturally Aspirated Nissan Eng.	2008-03	VK45DE	13
5.0L 306.7 (5026cc) DOHC V8 (32 Valve) 95.5mm Bore VVEL; MFI; Gasoline; Naturally Aspirated Nissan Eng.	2013-09	VK50VE	14
5.6L 339 (5552cc) DOHC V8 (32 Valve) 98mm Bore; MFI; Flex Fuel; Naturally Aspirated Nissan Eng.	2013-05	VK56DE	15
5.6L 339 (5552cc) DOHC V8 (32 Valve) 98mm Bore; MFI; Gasoline; Naturally Aspirated Nissan Eng.	2013-04	VK56DE	16

Engine Code Index

Code	Engine	Line No.
KA24DE	2.4L 146 (2389cc) DOHC L4 (16 Valve) 89mm Bore; MFI; Gasoline; Naturally Aspirated Nissan Eng.	3
KA24E	2.4L 146 (2389cc) SOHC L4 (12 Valve) 89mm Bore; MFI; Gasoline; Naturally Aspirated Nissan Eng.	4
MR16DDT	1.6L 98.7 (1618cc) DOHC L4 (16 Valve) 79.7mm Bore VVT; DI; Gasoline; Turbo - Intercooled Nissan Eng.	1
MR20DE	2.0L 122 (1997cc) DOHC L4 (16 Valve) 84mm Bore; MFI; Gasoline; Naturally Aspirated Nissan Eng.	2
QR25DE	2.5L 151.8 (2488cc) DOHC L4 (16 Valve) 89mm Bore; MFI; Gasoline; Naturally Aspirated Nissan Eng.	5
VG30E	3.0L 181 (2960cc) SOHC V6 (12 Valve) 87mm Bore; MFI; Gasoline; Naturally Aspirated Nissan Eng.	6
VG33E	3.3L 199.8 (3274cc) SOHC V6 (12 Valve) 91.5mm Bore; MFI; Gasoline; Naturally Aspirated Nissan Eng.	7
VG33ER	3.3L 199.8 (3274cc) SOHC V6 (12 Valve) 91.5mm Bore; MFI; Gasoline; Supercharged Nissan Eng.	8
VK45DE	4.5L 274 (4494cc) DOHC V8 (32 Valve) 93mm Bore; MFI; Gasoline; Naturally Aspirated Nissan Eng.	13
VK50VE	5.0L 306.7 (5026cc) DOHC V8 (32 Valve) 95.5mm Bore VVEL; MFI; Gasoline; Naturally Aspirated Nissan Eng.	14
VK56DE	5.6L 339 (5552cc) DOHC V8 (32 Valve) 98mm Bore; MFI; Flex Fuel; Naturally Aspirated Nissan Eng.	15
VK56DE	5.6L 339 (5552cc) DOHC V8 (32 Valve) 98mm Bore; MFI; Gasoline; Naturally Aspirated Nissan Eng.	16
VQ35DE	3.5L 214 (3498cc) DOHC V6 (24 Valve) 95.5mm Bore; MFI; Gasoline; Naturally Aspirated Nissan Eng.	9
VQ35HR	3.5L 214 (3498cc) DOHC V6 (24 Valve) 95.5mm Bore; MFI; Gasoline; Naturally Aspirated Nissan Eng.	10
VQ37VHR	3.7L 225.5 (3696cc) DOHC V6 (24 Valve) 95.5mm Bore VVEL; MFI; Gasoline; Naturally Aspirated Nissan Eng.	11
VQ40DE	4.0L 241.3 (3954cc) DOHC V6 (24 Valve) 95.5mm Bore; MFI; Gasoline; Naturally Aspirated Nissan Eng.	12

Model Index

Engine (VIN Code / Eng. Code)	Year	Engine (VIN Code / Eng. Code)	Year	Engine (VIN Code / Eng. Code)	Year
Infiniti Truck		Infiniti Truck (cont.)		Nissan Truck (cont.)	
EX35 (2WD Compact SUV)		QX4 (4WD Mid-Size SUV) (cont.)		Frontier (2WD Compact Pickup)	
V6 3498cc 3.5L DOHC (24 Valve) (VQ35HR)	12-08	V6 3498cc 3.5L DOHC (24 Valve) (VQ35DE)	03-01	L4 2389cc 2.4L DOHC (16 Valve) (KA24DE)	04-98
EX35 (AWD Compact SUV)		QX56 (2WD Full-Size SUV)		L4 2488cc 2.5L DOHC (16 Valve) (QR25DE)	13-05
V6 3498cc 3.5L DOHC (24 Valve) (VQ35HR)	12-08	V8 5552cc 5.6L DOHC (32 Valve) (VK56DE)	10-04	V6 3274cc 3.3L SOHC (12 Valve) (VG33E)	04-99
EX37 (2WD Compact SUV)		V8 5552cc 5.6L DOHC (32 Valve) (VK56VD)	13-11	V6 3274cc 3.3L SOHC Supercharged (12 Valve) (VG33ER)	04-01
V6 3696cc 3.7L DOHC (24 Valve) (VQ37VHR)	13	QX56 (AWD Full-Size SUV)		V6 3954cc 4.0L DOHC (24 Valve) (VQ40DE)	13-05
EX37 (AWD Compact SUV)		V8 5552cc 5.6L DOHC (32 Valve) (VK56DE)	10-04	Frontier (4WD Compact Pickup)	
V6 3696cc 3.7L DOHC (24 Valve) (VQ37VHR)	13	V8 5552cc 5.6L DOHC (32 Valve) (VK56VD)	13-11	L4 2389cc 2.4L DOHC (16 Valve) (KA24DE)	04-98
FX35 (2WD Mid-Size SUV)		Nissan Truck		L4 2488cc 2.5L DOHC (16 Valve) (QR25DE)	13-05
V6 3498cc 3.5L DOHC (24 Valve) (VQ35DE)	08-03	521 (Mini-Pickup)		V6 3274cc 3.3L SOHC (12 Valve) (VG33E)	04-99
V6 3498cc 3.5L DOHC (24 Valve) (VQ35HR)	12-09	L4 1595cc 1.6L SOHC (L16)	72-69	V6 3274cc 3.3L SOHC Supercharged (12 Valve) (VG33ER)	04-01
FX35 (AWD Mid-Size SUV)		620 (Mini-Pickup)		V6 3954cc 4.0L DOHC (24 Valve) (VQ40DE)	13-05
V6 3498cc 3.5L DOHC (24 Valve) (VQ35DE)	08-03	L4 1595cc 1.6L SOHC (L16)	73-72	Hardbody (2WD Compact Pickup)	
V6 3498cc 3.5L DOHC (24 Valve) (VQ35HR)	12-09	L4 1770cc 1.8L SOHC (L18)	74	L4 2389cc 2.4L SOHC (12 Valve) (KA24E)	97-90
FX37 (2WD Mid-Size SUV)		L4 1952cc 2.0L SOHC (L20B)	79-75	L4 2389cc 2.4L SOHC (8 Valve) (Z24)	89-86
V6 3696cc 3.7L DOHC (24 Valve) (VQ37VHR)	13	720 (Mini-Pickup)		L4 2389cc 2.4L SOHC (8 Valve) (Z24I)	89-86
FX37 (AWD Mid-Size SUV)		L4 1952cc 2.0L SOHC (L20B)	80	L4 2389cc 2.4L SOHC (8 Valve) (Z24S)	89-86
V6 3696cc 3.7L DOHC (24 Valve) (VQ37VHR)	13	L4 1952cc 2.0L SOHC (Z20)	87-83	V6 2960cc 3.0L SOHC (12 Valve) (VG30E)	97-90
FX45 (AWD Mid-Size SUV)		L4 2164cc 2.2L OHV Diesel (SD22)	83-81	V6 2960cc 3.0L SOHC (12 Valve) (VG30I)	89-86
V8 4494cc 4.5L DOHC (32 Valve) (VK45DE)	08-03	L4 2187cc 2.2L SOHC (Z22S)	83-81	Hardbody (4WD Compact Pickup)	
FX50 (AWD Mid-Size SUV)		L4 2389cc 2.4L SOHC (8 Valve) (Z24)	87-83	L4 2389cc 2.4L SOHC (12 Valve) (KA24E)	97-90
V8 5026cc 5.0L DOHC (32 Valve) (VK50VE)	13-09	L4 2389cc 2.4L SOHC (8 Valve) (Z24I)	87-85	L4 2389cc 2.4L SOHC (8 Valve) (Z24)	89-86
JX35 (AWD Mid-Size SUV)		L4 2389cc 2.4L SOHC (8 Valve) (Z24S)	87-85	L4 2389cc 2.4L SOHC (8 Valve) (Z24I)	89-86
V6 3498cc 3.5L DOHC (24 Valve) (VQ35DE)	13	L4 2488cc 2.5L OHV Diesel (SD25)	86-83	L4 2389cc 2.4L SOHC (8 Valve) (Z24S)	89-86
JX35 (FWD Mid-Size SUV)		V6 2960cc 3.0L SOHC (12 Valve) (VG30I)	87-86	L4 2389cc 2.4L SOHC (8 Valve) (Z24S)	89-86
V6 3498cc 3.5L DOHC (24 Valve) (VQ35DE)	13	Axxess (AWD Minivan)		V6 2960cc 3.0L SOHC (12 Valve) (VG30E)	97-90
QX4 (2WD Mid-Size SUV)		L4 2389cc 2.4L SOHC (12 Valve) (KA24E)	92-90	V6 2960cc 3.0L SOHC (12 Valve) (VG30I)	89-86
V6 3498cc 3.5L DOHC (24 Valve) (VQ35DE)	03-01	Axxess (FWD Minivan)			
QX4 (4WD Mid-Size SUV)		L4 2389cc 2.4L SOHC (12 Valve) (KA24E)	92-90		
V6 3274cc 3.3L SOHC (12 Valve) (VG33E)	00-97				

Nissan Truck (Incl. Minivans and SUV's) (Cont.)

Model Index (Cont.)

Engine (VIN Code / Eng. Code)	Year	Engine (VIN Code / Eng. Code)	Year	Engine (VIN Code / Eng. Code)	Year
Nissan Truck (cont.)		Nissan Truck (cont.)		Nissan Truck (cont.)	
Juke (AWD Compact SUV)		Pathfinder (4WD Mid-Size SUV) (cont.)		Titan (4WD Full-Size Pickup)	
L4 1618cc 1.6L DOHC Turbo (16 Valve) (MR16DDT)	13-11	V6 2960cc 3.0L SOHC (12 Valve) (VG30I)	89-87	V8 5552cc 5.6L DOHC (32 Valve) (VK56DE)	13-04
Juke (FWD Compact SUV)		V6 3274cc 3.3L SOHC (12 Valve) (VG33E)	00-96	V8 5552cc 5.6L DOHC (32 Valve) (Flex Fuel) (VK56DE)	13-05
L4 1618cc 1.6L DOHC Turbo (16 Valve) (MR16DDT)	13-11	V6 3498cc 3.5L DOHC (24 Valve) (VQ35DE)	04-01	Van (2WD Minivan)	
Murano (AWD Mid-Size SUV)		V6 3954cc 4.0L DOHC (24 Valve) (VQ40DE)	12-05	L4 2389cc 2.4L SOHC (8 Valve) (Z24I)	
V6 3498cc 3.5L DOHC (24 Valve) (VQ35DE)	13-03	V8 5552cc 5.6L DOHC (32 Valve) (VK56DE)	12-08	X-Trail (AWD Compact SUV) (Canada)	
Murano (FWD Mid-Size SUV)		Pathfinder (AWD Mid-Size SUV)		L4 2488cc 2.5L DOHC (16 Valve) (QR25DE)	
V6 3498cc 3.5L DOHC (24 Valve) (VQ35DE)	13-03	V6 3498cc 3.5L DOHC (24 Valve) (VQ35DE)	13	X-Trail (FWD Compact SUV) (Canada)	
NV1500 (Full-Size Van)		Pathfinder (FWD Mid-Size SUV)		L4 2488cc 2.5L DOHC (16 Valve) (QR25DE)	
V6 3954cc 4.0L DOHC (24 Valve) (VQ40DE)	13-11	V6 3498cc 3.5L DOHC (24 Valve) (VQ35DE)	13	Xterra (2WD Mid-Size SUV)	
NV200 (FWD Minivan)		Pathfinder Armada (2WD Full-Size SUV)		L4 2389cc 2.4L DOHC (16 Valve) (KA24DE)	
L4 1997cc 2.0L DOHC (16 Valve) (MR20DE)	13	V8 5552cc 5.6L DOHC (32 Valve) (VK56DE)	13-04	V6 3274cc 3.3L SOHC (12 Valve) (VG33E)	04-00
NV2500 (Full-Size Van)		V8 5552cc 5.6L DOHC (32 Valve) (Flex Fuel) (VK56DE)	13-07	V6 3274cc 3.3L SOHC Supercharged (12 Valve) (VG33ER)	04-01
V6 3954cc 4.0L DOHC (24 Valve) (VQ40DE)	13-11	Pathfinder Armada (4WD Full-Size SUV)		V6 3954cc 4.0L DOHC (24 Valve) (VQ40DE)	13-05
V8 5552cc 5.6L DOHC (32 Valve) (VK56DE)	13-11	V8 5552cc 5.6L DOHC (32 Valve) (VK56DE)	13-04	Xterra (4WD Mid-Size SUV)	
NV3500 (Full-Size Van)		V8 5552cc 5.6L DOHC (32 Valve) (Flex Fuel) (VK56DE)	13-07	V6 3274cc 3.3L SOHC (12 Valve) (VG33E)	04-00
V6 3954cc 4.0L DOHC (24 Valve) (VQ40DE)	13-11	Quest (FWD Minivan)		V6 3274cc 3.3L SOHC Supercharged (12 Valve) (VG33ER)	04-01
V8 5552cc 5.6L DOHC (32 Valve) (VK56DE)	13-11	V6 2960cc 3.0L SOHC (12 Valve) (VG30E)	98-93	V6 3954cc 4.0L DOHC (24 Valve) (VQ40DE)	13-05
Pathfinder (2WD Mid-Size SUV)		V6 3274cc 3.3L SOHC (12 Valve) (VG33E)	02-99	Xterra (4WD Mid-Size SUV)	
V6 2960cc 3.0L SOHC (12 Valve) (VG30E)	95-90	V6 3498cc 3.5L DOHC (24 Valve) (VQ35DE)	13-04	V6 3274cc 3.3L SOHC (12 Valve) (VG33E)	04-00
V6 2960cc 3.0L SOHC (12 Valve) (VG30I)	89-87	Rogue (AWD Compact SUV)		V6 3274cc 3.3L SOHC Supercharged (12 Valve) (VG33ER)	04-01
V6 3274cc 3.3L SOHC (12 Valve) (VG33E)	00-96	L4 2488cc 2.5L DOHC (16 Valve) (QR25DE)	13-08	Xterra (4WD Mid-Size SUV)	
V6 3498cc 3.5L DOHC (24 Valve) (VQ35DE)	04-01	Rogue (FWD Compact SUV)		V6 3954cc 4.0L DOHC (24 Valve) (VQ40DE)	13-05
V6 3954cc 4.0L DOHC (24 Valve) (VQ40DE)	12-05	L4 2488cc 2.5L DOHC (16 Valve) (QR25DE)	13-08	Xterra (4WD Mid-Size SUV)	
V8 5552cc 5.6L DOHC (32 Valve) (VK56DE)	12-08	Titan (2WD Full-Size Pickup)		V6 3274cc 3.3L SOHC (12 Valve) (VG33E)	04-00
Pathfinder (4WD Mid-Size SUV)		V8 5552cc 5.6L DOHC (32 Valve) (VK56DE)	13-04	V6 3274cc 3.3L SOHC Supercharged (12 Valve) (VG33ER)	04-01
L4 2389cc 2.4L SOHC (8 Valve) (Z24I)	89-87	V8 5552cc 5.6L DOHC (32 Valve) (Flex Fuel) (VK56DE)	13-05	Xterra (4WD Mid-Size SUV)	
V6 2960cc 3.0L SOHC (12 Valve) (VG30E)	95-90			V6 3954cc 4.0L DOHC (24 Valve) (VQ40DE)	13-05

1 **2013 - 2011; 1.6L 98.7 (1618cc) DOHC L4 (16 Valve) 79.7mm Bore VVT DI; Gasoline; Turbo - Intercooled Nissan Eng.; Eng. Code MR16DDT** **1**

QTY	EXHAUST PIPE FLANGE	YEARS	PART NO.	DESCRIPTION
1	Exhaust Pipe Gasket	2013-11	60871	Loc. Rear; Exh. connector
1	Exhaust Pipe Gasket	2013-11	60937	Loc. Front; Converter
1	Exhaust Pipe Gasket	2013-11	61016	Loc. Rear; Converter; Improved design
QTY	THERMOSTAT HOUSING	YEARS	PART NO.	DESCRIPTION
1	Thermostat Gasket	2013-11	35769	Thermostat Housing; Thermostat seal

2 **2013; 2.0L 122 (1997cc) DOHC L4 (16 Valve) 84mm Bore MFI; Gasoline; Naturally Aspirated Nissan Eng.; Eng. Code MR20DE** **2**

QTY	CYLINDER HEAD	YEARS	PART NO.	DESCRIPTION
1	Head Gasket	2013	26338 PT	Head bolts not incl.; Head bolt replacement recommended; PermaTorqueMLS®
1	Head Set	2013	HS 26338 PT	Head bolts not incl.; Head bolt replacement recommended; PermaDry® molded rubber valve cover gskt. incl.; Premium valve stem seals incl.
QTY	MANIFOLD - INT. & EXH.	YEARS	PART NO.	DESCRIPTION
1	Int. Manifold Gasket Set	2013	MS 97038	
1	Exh. Manifold Gasket Set	2013	MS 97030	
QTY	EXHAUST PIPE FLANGE	YEARS	PART NO.	DESCRIPTION
1	Exhaust Pipe Gasket	2013	60871	Exh. connector
1	Exhaust Pipe Gasket	2013	61016	Converter; Improved design
1	Exhaust Pipe Gasket	2013	61367	Packing
QTY	OIL PAN	YEARS	PART NO.	DESCRIPTION
1	Oil Pan Gasket Set	2013	OS 30849	New Part Number - Check for Availability
QTY	CRANKSHAFT REAR SEAL	YEARS	PART NO.	DESCRIPTION
1	Rear Main Seal Set	2013	BS 40714	Rubber; One-piece
QTY	VALVE COVER	YEARS	PART NO.	DESCRIPTION
1	Valve Cover Gasket Set	2013	VS 50746 R	PermaDry® molded rubber gskt. incl.
QTY	VALVE STEM SEAL SET	YEARS	PART NO.	DESCRIPTION
1	Valve Stem Seal Set	2013	SS 72800	Premium valve stem seals incl.
QTY	THERMOSTAT HOUSING	YEARS	PART NO.	DESCRIPTION
1	Thermostat Gasket	2013	35445	Thermostat Housing; Thermostat seal

Nissan Truck (Incl. Minivans and SUV's) (Cont.)

2		2013; 2.0L 122 (1997cc) DOHC L4 (16 Valve) 84mm Bore			2
(cont.)		MFI; Gasoline; Naturally Aspirated Nissan Eng.; Eng. Code MR20DE			(cont.)
QTY	THERMOSTAT HOUSING	YEARS	PART NO.	DESCRIPTION	
1	Thermostat Gasket	2013	35887	Thermostat Housing; Thermostat housing to block	
QTY	WATER PUMP	YEARS	PART NO.	DESCRIPTION	
1	Water Pump Gasket	2013	35883		
QTY	TIMING COVER	YEARS	PART NO.	DESCRIPTION	
1	Crankshaft Front Seal Set	2013	TCS 46130		
QTY	CARB & FUEL INJECTION	YEARS	PART NO.	DESCRIPTION	
2	Fuel Injector O-Ring Set	2013	ES 70599	Improved design	
1	Throttle Body Gasket	2013	61552		
3		2004 - 1998; 2.4L 146 (2389cc) DOHC L4 (16 Valve) 89mm Bore			3
(cont.)		MFI; Gasoline; Naturally Aspirated Nissan Eng.; Eng. Code KA24DE			(cont.)
QTY	CYLINDER HEAD	YEARS	PART NO.	DESCRIPTION	
1	Head Gasket	2004-98	26171 PT	Head bolts not incl.; Head bolt replacement recommended	
1	Head Set	2004-99	HS 26171 PT-1	Head bolts not incl.; Head bolt replacement recommended; PermaDry® molded rubber valve cover gskt. incl.; Premium valve stem seals incl.; Improved design	
1	Head Set	2004-99	HS 26171 PT-2	Head bolts not incl.; Head bolt replacement recommended; PermaDry® molded rubber valve cover gskt. incl.; Premium valve stem seals incl.; Old design	
1	Head Set	1998	HS 26171 PT-1	Nissan Frontier Base; From 09/01/98; Head bolts not incl.; Head bolt replacement recommended; PermaDry® molded rubber valve cover gskt. incl.; Premium valve stem seals incl.; Improved design	
1	Head Set	1998	HS 26171 PT-1	Nissan Frontier SE, XE; From 09/01/98; Head bolts not incl.; Head bolt replacement recommended; PermaDry® molded rubber valve cover gskt. incl.; Premium valve stem seals incl.; Improved design	
1	Head Set	1998	HS 26171 PT-1	Nissan Frontier Base; To 08/31/98; Head bolts not incl.; Head bolt replacement recommended; PermaDry® molded rubber valve cover gskt. incl.; Premium valve stem seals incl.; Improved design	
1	Head Set	1998	HS 26171 PT-1	Nissan Frontier SE; To 08/31/98; Head bolts not incl.; Head bolt replacement recommended; PermaDry® molded rubber valve cover gskt. incl.; Premium valve stem seals incl.; Improved design	
1	Head Set	1998	HS 26171 PT-1	Nissan Frontier XE; To 08/31/98; Head bolts not incl.; Head bolt replacement recommended; PermaDry® molded rubber valve cover gskt. incl.; Premium valve stem seals incl.; Improved design	
1	Head Set	1998	HS 26171 PT-2	From 09/01/98; Head bolts not incl.; Head bolt replacement recommended; PermaDry® molded rubber valve cover gskt. incl.; Premium valve stem seals incl.; Old design	
1	Head Bolt Set	2004-98	ES 72231	Head bolts w/Washers; Replacement recommended	
QTY	CONVERSION SET	YEARS	PART NO.	DESCRIPTION	
1	Gasket Conversion Set	2004	CS 26171-1	Nissan Xterra SE, XE	
1	Gasket Conversion Set	2004	CS 26171-1	Exc. Nissan Xterra SE, XE; To 05/31/04	
1	Gasket Conversion Set	2004	CS 26171-2	Exc. Nissan Xterra SE, XE; From 06/01/04	
1	Gasket Conversion Set	2003-02	CS 26171-1		
1	Gasket Conversion Set	2001-98	CS 26171		
QTY	MANIFOLD - INT. & EXH.	YEARS	PART NO.	DESCRIPTION	
1	Int. Manifold Gasket Set	2004-98	MS 96854		
1	Exh. Manifold Gasket Set	2004-98	MS 94803		
QTY	EXHAUST PIPE FLANGE	YEARS	PART NO.	DESCRIPTION	
2	Exhaust Pipe Gasket	2004-98	60458	Converter	
1	Exhaust Pipe Gasket	2004-98	60905	Flange	
QTY	OIL PAN	YEARS	PART NO.	DESCRIPTION	
1	Oil Pan Gasket Set	2004-98	OS 30617 C		
QTY	CRANKSHAFT REAR SEAL	YEARS	PART NO.	DESCRIPTION	
1	Rear Main Seal Set	2004-98	BS 40664	Rubber; One-piece	
QTY	VALVE COVER	YEARS	PART NO.	DESCRIPTION	
1	Valve Cover Gasket Set	2004-99	VS 50550 R-1	w/Grommets & Spark plug tube seals; PermaDry® molded rubber gskt. incl.; Old design	
1	Valve Cover Gasket Set	2004-99	VS 50696 R	w/Grommets & Spark plug tube seals; PermaDry® molded rubber gskt. incl.; Improved design	
1	Valve Cover Gasket Set	1998	VS 50550 R-1	From 09/01/98; w/Grommets & Spark plug tube seals; PermaDry® molded rubber gskt. incl.; Old design	
1	Valve Cover Gasket Set	1998	VS 50696 R	Nissan Frontier Base; From 09/01/98; w/Grommets & Spark plug tube seals; PermaDry® molded rubber gskt. incl.; Improved design	

Nissan Truck (Incl. Minivans and SUV's) (Cont.)

3 (cont.)		2004 - 1998; 2.4L 146 (2389cc) DOHC L4 (16 Valve) 89mm Bore			3 (cont.)
MFI; Gasoline; Naturally Aspirated Nissan Eng.; Eng. Code KA24DE					
QTY	VALVE COVER	YEARS	PART NO.	DESCRIPTION	
1	Valve Cover Gasket Set	1998	VS 50696 R	Nissan Frontier SE; From 09/01/98; w/Grommets & Spark plug tube seals; PermaDry® molded rubber gskt. incl.; Improved design	
1	Valve Cover Gasket Set	1998	VS 50696 R	Nissan Frontier XE; From 09/01/98; w/Grommets & Spark plug tube seals; PermaDry® molded rubber gskt. incl.; Improved design	
1	Valve Cover Gasket Set	1998	VS 50696 R	Nissan Frontier Base; To 08/31/98; w/Grommets & Spark plug tube seals; PermaDry® molded rubber gskt. incl.; Improved design	
1	Valve Cover Gasket Set	1998	VS 50696 R	Nissan Frontier SE; To 08/31/98; w/Grommets & Spark plug tube seals; PermaDry® molded rubber gskt. incl.; Improved design	
1	Valve Cover Gasket Set	1998	VS 50696 R	Nissan Frontier XE; To 08/31/98; w/Grommets & Spark plug tube seals; PermaDry® molded rubber gskt. incl.; Improved design	
QTY	VALVE STEM SEAL SET	YEARS	PART NO.	DESCRIPTION	
2	Valve Stem Seal Set	2004-98	SS 72547	Premium valve stem seals incl.	
QTY	THERMOSTAT HOUSING	YEARS	PART NO.	DESCRIPTION	
1	Thermostat Gasket	2004-98	35466	Thermostat Housing	
QTY	WATER PUMP	YEARS	PART NO.	DESCRIPTION	
1	Water Pump Gasket	2004-98	35465		
QTY	TIMING COVER	YEARS	PART NO.	DESCRIPTION	
1	Timing Cover Set	2004	TCS 46090	Nissan Xterra SE, XE; Must be used w/OS 30617C & w/VS 50550R-1	
1	Timing Cover Set	2004	TCS 46090	Exc. Nissan Xterra SE, XE; To 05/31/04; Must be used w/OS 30617C & w/VS 50550R-1	
1	Timing Cover Set	2004	TCS 46092	Exc. Nissan Xterra SE, XE; From 06/01/04; Must be used w/OS 30617C & w/VS 50550R-1	
1	Timing Cover Set	2003-02	TCS 46090	Must be used w/OS 30617C & w/VS 50550R-1	
1	Timing Cover Set	2001-99	TCS 45887	Must be used w/OS 30617C & w/VS 50550R-1	
1	Timing Cover Set	1998	TCS 45887	From 09/01/98; Must be used w/OS 30617C & w/VS 50550R-1	
1	Timing Cover Set	1998	TCS 45887	To 08/31/98; Must be used w/OS 30617C & w/VS 50696R	
QTY	CARB & FUEL INJECTION	YEARS	PART NO.	DESCRIPTION	
1	Throttle Body Gasket	2004-98	61468	Throttle body to spacer	
1	Throttle Body Gasket	2004-98	61470	Spacer to manifold	
1	Throttle Body Gasket	2004-98	61471	Throttle body chamber	
QTY	EXHAUST GAS RECIRCULATION	YEARS	PART NO.	DESCRIPTION	
1	EGR Gasket	2004-98	72234	EGR passage	
1	EGR Gasket	2004-98	72521	EGR valve	
QTY	OIL PUMP COVER	YEARS	PART NO.	DESCRIPTION	
1	Oil Pump Gasket	2004-98	72436	Mounting	
4		1997 - 1991; 2.4L 146 (2389cc) SOHC L4 (12 Valve) 89mm Bore			4
MFI; Gasoline; Naturally Aspirated Nissan Eng.; Eng. Code KA24E					
QTY	CYLINDER HEAD	YEARS	PART NO.	DESCRIPTION	
1	Head Gasket	1997-91	9646 PT	Head bolts not incl.; Head bolt replacement recommended	
1	Head Set	1997-95	HS 9646 PT-2	California adapter to int. manifold gskt. & head bolts not incl.; Head bolt replacement recommended; PermaDry® molded rubber valve cover gskt. incl.; Premium valve stem seals incl.	
1	Head Set	1994-93	HS 9646 PT	Exc. California; Head bolts not incl.; Head bolt replacement recommended; PermaDry® molded rubber valve cover gskt. incl.; Premium valve stem seals incl.	
1	Head Set	1994-93	HS 9646 PT-2	California; Head bolts not incl.; Head bolt replacement recommended; PermaDry® molded rubber valve cover gskt. incl.; Premium valve stem seals incl.	
1	Head Set	1992-91	HS 9646 PT	Exc. Nissan Axxess 4X4, Base; Head bolts not incl.; Head bolt replacement recommended; PermaDry® molded rubber valve cover gskt. incl.; Premium valve stem seals incl.	
1	Head Set	1992-91	HS 9646 PT-1	Nissan Axxess 4X4, Base; Head bolts not incl.; Head bolt replacement recommended; PermaDry® molded rubber valve cover gskt. incl.; Premium valve stem seals incl.	
1	Head Bolt Set	1997-91	ES 74026	Head bolts w/Washers; Replacement recommended	
QTY	CONVERSION SET	YEARS	PART NO.	DESCRIPTION	
1	Gasket Conversion Set	1997	CS 9646	RTV sealant incl. for oil pan gskt.	
1	Gasket Conversion Set	1996	CS 9646	From 01/02/96; RTV sealant incl. for oil pan gskt.	
1	Gasket Conversion Set	1996	CS 9646	To 01/01/96	
1	Gasket Conversion Set	1995-91	CS 9646		
QTY	MANIFOLD - INT. & EXH.	YEARS	PART NO.	DESCRIPTION	
1	Int. Manifold Gasket Set	1997-95	MS 95472	California adapter to int. manifold gskt. not incl.; Upper set incl.	
1	Int. Manifold Gasket Set	1994-93	MS 94568	Exc. California; Upper set incl.	

Nissan Truck (Incl. Minivans and SUV's) (Cont.)

4 (cont.)	1997 - 1991; 2.4L 146 (2389cc) SOHC L4 (12 Valve) 89mm Bore				4 (cont.)
MFI; Gasoline; Naturally Aspirated Nissan Eng.; Eng. Code KA24E					
QTY	MANIFOLD - INT. & EXH.	YEARS	PART NO.	DESCRIPTION	
1	Int. Manifold Gasket Set	1994-93	MS 95472	California; Upper set incl.	
1	Int. Manifold Gasket Set	1992-91	MS 94568	Exc. Nissan Axxess 4X4, Base; Upper set incl.	
1	Int. Manifold Gasket Set	1992-91	MS 94572	Nissan Axxess 4X4, Base; Upper set incl.	
1	Exh. Manifold Gasket Set	1997-91	MS 94444		
QTY	EXHAUST PIPE FLANGE	YEARS	PART NO.	DESCRIPTION	
2	Exhaust Pipe Gasket	1997-91	60674	Converter	
2	Exhaust Pipe Gasket	1997-91	60835	Flange; Improved design	
QTY	OIL PAN	YEARS	PART NO.	DESCRIPTION	
1	Oil Pan Gasket Set	1997	OS 30617 C	RTV sealant not incl. for oil pan gskt.	
1	Oil Pan Gasket Set	1996	OS 30617 C	From 01/01/96; RTV sealant not incl. for oil pan gskt.	
1	Oil Pan Gasket Set	1996	OS 30617 C	To 01/01/96	
1	Oil Pan Gasket Set	1995-93	OS 30617 C		
1	Oil Pan Gasket Set	1992-91	OS 30617 C	Exc. Nissan Axxess 4X4, Base	
1	Oil Pan Gasket Set	1992-91	OS 30629 C	Nissan Axxess 4X4, Base	
QTY	CRANKSHAFT REAR SEAL	YEARS	PART NO.	DESCRIPTION	
1	Rear Main Seal Set	1997-91	BS 40384	Rubber; One-piece	
1	Repair Sleeve	1997-91	16275	Crankshaft; Use w/installation tool	
QTY	VALVE COVER	YEARS	PART NO.	DESCRIPTION	
1	Valve Cover Gasket Set	1997-93	VS 50042 R	w/Semi-circular plugs; PermaDry® molded rubber gskt. incl.	
1	Valve Cover Gasket Set	1992-91	VS 50042 R	Exc. Nissan Axxess 4X4, Base; w/Semi-circular plugs; PermaDry® molded rubber gskt. incl.	
1	Valve Cover Gasket Set	1992-91	VS 50360 R	Nissan Axxess 4X4, Base; w/Semi-circular plug; PermaDry® molded rubber gskt. incl.	
1	Semi-Circular Plug	1997-91	CP 75003	Valve Cover	
QTY	VALVE STEM SEAL SET	YEARS	PART NO.	DESCRIPTION	
1	Valve Stem Seal Set	1997-93	SS 72731	Premium valve stem seals incl.	
1	Valve Stem Seal Set	1992-91	SS 72731	Exc. Nissan Axxess 4X4, Base; Premium valve stem seals incl.	
1	Valve Stem Seal Set	1992-91	SS 72776	Nissan Axxess 4X4, Base; Premium valve stem seals incl.	
QTY	THERMOSTAT HOUSING	YEARS	PART NO.	DESCRIPTION	
1	Water Outlet Gasket	1992-91	25583	Nissan Axxess 4X4, Base; Thermostat Housing	
1	Thermostat Gasket	1997-93	35466	Thermostat Housing; Thermostat inlet	
1	Thermostat Gasket	1992-91	35466	Exc. Nissan Axxess 4X4, Base; Thermostat Housing; Thermostat inlet	
QTY	WATER PUMP	YEARS	PART NO.	DESCRIPTION	
1	Water Pump Gasket	1997-93	35465		
1	Water Pump Gasket	1992-91	35465	Exc. Nissan Axxess 4X4, Base	
1	Water Pump Gasket	1992-91	35471	Nissan Axxess 4X4, Base	
QTY	TIMING COVER	YEARS	PART NO.	DESCRIPTION	
1	Timing Cover Set	1997-93	TCS 45887	Must be used w/OS 30617C & w/VS 50042R	
1	Timing Cover Set	1992-91	TCS 45887	Exc. Nissan Axxess 4X4, Base; Must be used w/OS 30617C & w/VS 50042R	
1	Timing Cover Set	1992-91	TCS 45887-1	Nissan Axxess 4X4, Base; Must be used w/OS 30629C & w/VS 50360R	
QTY	CARB & FUEL INJECTION	YEARS	PART NO.	DESCRIPTION	
1	Throttle Body Gasket	1997-93	60861		
1	Throttle Body Gasket	1992-91	60818	Nissan Axxess 4X4, Base	
1	Throttle Body Gasket	1992-91	60861	Exc. Nissan Axxess 4X4, Base	
QTY	DISTRIBUTOR MOUNTING	YEARS	PART NO.	DESCRIPTION	
1	Fuel Pump Mounting Gasket	1997-91	70015	Distributor Mounting	
QTY	EXHAUST GAS RECIRCULATION	YEARS	PART NO.	DESCRIPTION	
1	EGR Gasket	1997-93	72521		
1	EGR Gasket	1992	72521	From 01/01/92	
1	EGR Gasket	1992	72633	To 01/01/92	
1	EGR Gasket	1991	72633		
QTY	OIL PUMP COVER	YEARS	PART NO.	DESCRIPTION	
1	Oil Pump Gasket	1997-91	72436	Mounting	
5	2013 - 2005; 2.5L 151.8 (2488cc) DOHC L4 (16 Valve) 89mm Bore				5
MFI; Gasoline; Naturally Aspirated Nissan Eng.; Eng. Code QR25DE					
QTY	CYLINDER HEAD	YEARS	PART NO.	DESCRIPTION	
1	Head Gasket	2013-11	26519 PT	Exc. Nissan Frontier S, SE, SV, XE; Head bolts not incl.; Head bolt replacement recommended; PermaTorqueMLS®; New Part Number - Check for Availability	
1	Head Gasket	2013-11	26520 PT	Nissan Frontier S, SE, SV, XE; Head bolts not incl.; Head bolt replacement recommended; PermaTorqueMLS®	

Nissan Truck (Incl. Minivans and SUV's) (Cont.)

5 (cont.)		2013 - 2005; 2.5L 151.8 (2488cc) DOHC L4 (16 Valve) 89mm Bore			5 (cont.)
MFI; Gasoline; Naturally Aspirated Nissan Eng.; Eng. Code QR25DE					
QTY	CYLINDER HEAD	YEARS	PART NO.	DESCRIPTION	
1	Head Gasket	2010-08	26520 PT	Nissan Frontier SE, XE; Head bolts not incl.; Head bolt replacement recommended; PermaTorqueMLS®	
1	Head Gasket	2010	26519 PT	Nissan Rogue Krom, S, SL; Head bolts not incl.; Head bolt replacement recommended; PermaTorqueMLS®; New Part Number - Check for Availability	
1	Head Gasket	2009-08	26519 PT	Exc. Nissan Frontier SE, XE; Head bolts not incl.; Head bolt replacement recommended; PermaTorqueMLS®; New Part Number - Check for Availability	
1	Head Gasket	2007-05	26520 PT	Nissan Frontier XE; Head bolts not incl.; Head bolt replacement recommended; PermaTorqueMLS®	
1	Head Gasket	2007	26519 PT	Exc. Nissan Frontier XE; Head bolts not incl.; Head bolt replacement recommended; PermaTorqueMLS®; New Part Number - Check for Availability	
1	Head Gasket	2006-05	26261 PT	Exc. Nissan Frontier XE; Head bolts not incl.; Head bolt replacement recommended; PermaTorqueMLS®	
1	Head Set	2013-11	HS 26519 PT	Exc. Nissan Frontier S, SE, SV, XE; Head bolts not incl.; Head bolt replacement recommended; PermaDry® molded rubber valve cover gskt. incl.; Premium valve stem seals incl.; New Part Number - Check for Availability	
1	Head Set	2013-11	HS 26520 PT	Nissan Frontier S, SE, SV, XE; Head bolts not incl.; Head bolt replacement recommended; PermaDry® molded rubber valve cover gskt. incl.; Premium valve stem seals incl.; New Part Number - Check for Availability	
1	Head Set	2010-08	HS 26520 PT	Nissan Frontier SE, XE; Head bolts not incl.; Head bolt replacement recommended; PermaDry® molded rubber valve cover gskt. incl.; Premium valve stem seals incl.; New Part Number - Check for Availability	
1	Head Set	2010	HS 26519 PT	Nissan Rogue Krom, S, SL; Head bolts not incl.; Head bolt replacement recommended; PermaDry® molded rubber valve cover gskt. incl.; Premium valve stem seals incl.; New Part Number - Check for Availability	
1	Head Set	2009-08	HS 26519 PT	Exc. Nissan Frontier SE, XE; Head bolts not incl.; Head bolt replacement recommended; PermaDry® molded rubber valve cover gskt. incl.; Premium valve stem seals incl.; New Part Number - Check for Availability	
1	Head Set	2007-05	HS 26520 PT	Nissan Frontier XE; Head bolts not incl.; Head bolt replacement recommended; PermaDry® molded rubber valve cover gskt. incl.; Premium valve stem seals incl.; New Part Number - Check for Availability	
1	Head Set	2007	HS 26519 PT	Exc. Nissan Frontier XE; Head bolts not incl.; Head bolt replacement recommended; PermaDry® molded rubber valve cover gskt. incl.; Premium valve stem seals incl.; New Part Number - Check for Availability	
1	Head Set	2006-05	HS 26261 PT	Exc. Nissan Frontier XE; Head bolts not incl.; Head bolt replacement recommended; PermaDry® molded rubber valve cover gskt. incl.; Premium valve stem seals incl.	
1	Head Bolt Set	2013-11	ES 71354	Exc. Nissan Frontier S, SE, SV, XE; Head bolts w/Washers; Replacement recommended; New Part Number - Check for Availability	
1	Head Bolt Set	2013-11	ES 72198	Nissan Frontier S, SE, SV, XE; Head bolts w/Washers; Replacement recommended	
1	Head Bolt Set	2010-08	ES 72198	Nissan Frontier SE, XE; Head bolts w/Washers; Replacement recommended	
1	Head Bolt Set	2010	ES 71354	Nissan Rogue Krom, S, SL; Head bolts w/Washers; Replacement recommended; New Part Number - Check for Availability	
1	Head Bolt Set	2009-08	ES 71354	Exc. Nissan Frontier SE, XE; Head bolts w/Washers; Replacement recommended; New Part Number - Check for Availability	
1	Head Bolt Set	2007	ES 71354	Exc. Nissan Frontier XE; Head bolts w/Washers; Replacement recommended; New Part Number - Check for Availability	
1	Head Bolt Set	2007	ES 72198	Nissan Frontier XE; Head bolts w/Washers; Replacement recommended	
1	Head Bolt Set	2006-05	ES 72198	Head bolts w/Washers; Replacement recommended	
QTY	CONVERSION SET	YEARS	PART NO.	DESCRIPTION	
1	Gasket Conversion Set	2013-11	CS 26261-2	Exc. Nissan Frontier S, SE, SV, XE; RTV sealant incl. for oil pan gskt.; New Part Number - Check for Availability	
1	Gasket Conversion Set	2013	CS 26261-1	RTV sealant incl. for oil pan gskt.; New Part Number - Check for Availability	
1	Gasket Conversion Set	2012-11	CS 26261-1	Nissan Frontier S, SE, SV, XE; RTV sealant incl. for oil pan gskt.; New Part Number - Check for Availability	
1	Gasket Conversion Set	2010-08	CS 26261-1	Nissan Frontier SE, XE; RTV sealant incl. for oil pan gskt.; New Part Number - Check for Availability	
1	Gasket Conversion Set	2010	CS 26261-2	Nissan Rogue Krom, S, SL; RTV sealant incl. for oil pan gskt.; New Part Number - Check for Availability	
1	Gasket Conversion Set	2009-08	CS 26261-2	Exc. Nissan Frontier SE, XE; RTV sealant incl. for oil pan gskt.; New Part Number - Check for Availability	

Nissan Truck (Incl. Minivans and SUV's) (Cont.)

5 (cont.)	2013 - 2005; 2.5L 151.8 (2488cc) DOHC L4 (16 Valve) 89mm Bore				5 (cont.)
QTY	CONVERSION SET	YEARS	PART NO.	DESCRIPTION	
1	Gasket Conversion Set	2007-05	CS 26261-1	Nissan Frontier XE; RTV sealant incl. for oil pan gskt.; New Part Number - Check for Availability	
1	Gasket Conversion Set	2007	CS 26261-2	Exc. Nissan Frontier XE; RTV sealant incl. for oil pan gskt.; New Part Number - Check for Availability	
1	Gasket Conversion Set	2006-05	CS 26261	Exc. Nissan Frontier XE; RTV sealant incl. for oil pan gskt.	
QTY	MANIFOLD - INT. & EXH.	YEARS	PART NO.	DESCRIPTION	
1	Int. Manifold Gasket Set	2013-11	MS 97147	Exc. Nissan Frontier S, SE, SV, XE; Lower set; Upper set incl.; New Part Number - Check for Availability	
1	Int. Manifold Gasket Set	2013-11	MS 97149	Nissan Frontier S, SE, SV, XE; Lower set	
1	Int. Manifold Gasket Set	2010-08	MS 97149	Nissan Frontier SE, XE; Lower set	
1	Int. Manifold Gasket Set	2010	MS 97147	Nissan Rogue Krom, S, SL; Lower set; Upper set incl.; New Part Number - Check for Availability	
1	Int. Manifold Gasket Set	2009-08	MS 97147	Exc. Nissan Frontier SE, XE; Lower set; Upper set incl.; New Part Number - Check for Availability	
1	Int. Manifold Gasket Set	2007-05	MS 97149	Nissan Frontier XE; Lower set	
1	Int. Manifold Gasket Set	2007	MS 97147	Exc. Nissan Frontier XE; Lower set; Upper set incl.; New Part Number - Check for Availability	
1	Int. Manifold Gasket Set	2006-05	MS 96536	Exc. Nissan Frontier XE; Lower set; Upper set incl.	
1	Exh. Manifold Gasket Set	2013-11	MS 96539	Nissan Frontier S, SE, SV, XE	
1	Exh. Manifold Gasket Set	2013-11	MS 97148	Exc. Nissan Frontier S, SE, SV, XE	
1	Exh. Manifold Gasket Set	2010-08	MS 96539	Nissan Frontier SE, XE	
1	Exh. Manifold Gasket Set	2010	MS 97148	Nissan Rogue Krom, S, SL	
1	Exh. Manifold Gasket Set	2009-08	MS 97148	Exc. Nissan Frontier SE, XE	
1	Exh. Manifold Gasket Set	2007	MS 96539	Nissan Frontier XE	
1	Exh. Manifold Gasket Set	2007	MS 97148	Exc. Nissan Frontier XE	
1	Exh. Manifold Gasket Set	2006-05	MS 96539		
QTY	EXHAUST PIPE FLANGE	YEARS	PART NO.	DESCRIPTION	
2	Exhaust Pipe Gasket	2013-11	60871	Nissan Frontier S, SE, SV, XE; Converter	
1	Exhaust Pipe Gasket	2013-11	60905	Exc. Nissan Frontier S, SE, SV, XE; Exh. connector	
1	Exhaust Pipe Gasket	2013-11	61646	Exc. Nissan Frontier S, SE, SV, XE; Converter	
1	Exhaust Pipe Gasket	2013-11	61647	Exc. Nissan Frontier S, SE, SV, XE; Pipe to manifold; New Part Number - Check for Availability	
2	Exhaust Pipe Gasket	2010-08	60871	Nissan Frontier SE, XE; Converter	
1	Exhaust Pipe Gasket	2010	60905	Nissan Rogue Krom, S, SL; Exh. connector	
1	Exhaust Pipe Gasket	2010	61646	Nissan Rogue Krom, S, SL; Converter	
1	Exhaust Pipe Gasket	2010	61647	Nissan Rogue Krom, S, SL; Pipe to manifold; New Part Number - Check for Availability	
1	Exhaust Pipe Gasket	2009-08	60905	Exc. Nissan Frontier SE, XE; Exh. connector	
1	Exhaust Pipe Gasket	2009-08	61646	Exc. Nissan Frontier SE, XE; Converter	
1	Exhaust Pipe Gasket	2009-08	61647	Exc. Nissan Frontier SE, XE; Pipe to manifold; New Part Number - Check for Availability	
2	Exhaust Pipe Gasket	2007-05	60871	Nissan Frontier XE; Converter	
1	Exhaust Pipe Gasket	2007	60905	Exc. Nissan Frontier XE; Exh. connector	
1	Exhaust Pipe Gasket	2007	61646	Exc. Nissan Frontier XE; Converter	
1	Exhaust Pipe Gasket	2007	61647	Exc. Nissan Frontier XE; Pipe to manifold; New Part Number - Check for Availability	
2	Exhaust Pipe Gasket	2006-05	60458	Exc. Nissan Frontier XE; Converter	
1	Exhaust Pipe Gasket	2006-05	61367	Exc. Nissan Frontier XE; Packing	
QTY	CRANKSHAFT REAR SEAL	YEARS	PART NO.	DESCRIPTION	
1	Rear Main Seal Set	2013-05	BS 40694	Rubber; One-piece	
QTY	VALVE COVER	YEARS	PART NO.	DESCRIPTION	
1	Valve Cover Gasket Set	2013-11	VS 50623 R	Nissan Frontier S, SE, SV, XE; PermaDry® molded rubber gskt. incl.	
1	Valve Cover Gasket Set	2013-11	VS 50777 R	Exc. Nissan Frontier S, SE, SV, XE; PermaDry® molded rubber gskt. incl.; New Part Number - Check for Availability	
1	Valve Cover Gasket Set	2010-08	VS 50623 R	Nissan Frontier SE, XE; PermaDry® molded rubber gskt. incl.	
1	Valve Cover Gasket Set	2010	VS 50777 R	Nissan Rogue Krom, S, SL; PermaDry® molded rubber gskt. incl.; New Part Number - Check for Availability	
1	Valve Cover Gasket Set	2009-08	VS 50777 R	Exc. Nissan Frontier SE, XE; PermaDry® molded rubber gskt. incl.; New Part Number - Check for Availability	
1	Valve Cover Gasket Set	2007	VS 50623 R	Nissan Frontier XE; PermaDry® molded rubber gskt. incl.	
1	Valve Cover Gasket Set	2007	VS 50777 R	Exc. Nissan Frontier XE; PermaDry® molded rubber gskt. incl.; New Part Number - Check for Availability	
1	Valve Cover Gasket Set	2006-05	VS 50623 R	PermaDry® molded rubber gskt. incl.	
QTY	VALVE STEM SEAL SET	YEARS	PART NO.	DESCRIPTION	
1	Valve Stem Seal Set	2013-05	SS 70157	Premium valve stem seals incl.	

Nissan Truck (Incl. Minivans and SUV's) (Cont.)

5 (cont.)		2013 - 2005; 2.5L 151.8 (2488cc) DOHC L4 (16 Valve) 89mm Bore			5 (cont.)
MFI; Gasoline; Naturally Aspirated Nissan Eng.; Eng. Code QR25DE					
QTY	THERMOSTAT HOUSING	YEARS	PART NO.	DESCRIPTION	
1	Thermostat Gasket	2013-11	35445	Exc. Nissan Frontier S, SE, SV, XE; Thermostat Housing; Thermostat inlet	
1	Thermostat Gasket	2013-11	35769	Exc. Nissan Frontier S, SE, SV, XE; Thermostat Housing; Thermostat O-ring	
1	Thermostat Gasket	2010	35445	Nissan Rogue Krom, S, SL; Thermostat Housing; Thermostat inlet	
1	Thermostat Gasket	2010	35769	Nissan Rogue Krom, S, SL; Thermostat Housing; Thermostat O-ring	
1	Thermostat Gasket	2009-08	35445	Exc. Nissan Frontier SE, XE; Thermostat Housing; Thermostat inlet	
1	Thermostat Gasket	2009-08	35769	Exc. Nissan Frontier SE, XE; Thermostat Housing; Thermostat O-ring	
1	Thermostat Gasket	2007	35445	Exc. Nissan Frontier XE; Thermostat Housing; Thermostat inlet	
1	Thermostat Gasket	2007	35769	Exc. Nissan Frontier XE; Thermostat Housing; Thermostat O-ring	
1	O-Ring	2006-05	35533	Exc. Nissan Frontier XE; Thermostat Housing	
QTY	WATER OUTLET GASKET	YEARS	PART NO.	DESCRIPTION	
1	Water Outlet Gasket	2013-11	35752	Exc. Nissan Frontier S, SE, SV, XE; Water Outlet	
1	Water Outlet Gasket	2013-11	35753	Exc. Nissan Frontier S, SE, SV, XE; Water Outlet; Inlet	
1	Water Outlet Gasket	2013-11	35943	Nissan Frontier S, SE, SV, XE; Water Outlet; Loc. Rear	
1	Water Outlet Gasket	2013-11	35945	Nissan Frontier S, SE, SV, XE; Water Outlet; Loc. Front; New Part Number - Check for Availability	
1	Water Outlet Gasket	2010-08	35943	Nissan Frontier SE, XE; Water Outlet; Loc. Rear	
1	Water Outlet Gasket	2010-08	35945	Nissan Frontier SE, XE; Water Outlet; Loc. Front; New Part Number - Check for Availability	
1	Water Outlet Gasket	2010	35752	Nissan Rogue Krom, S, SL; Water Outlet	
1	Water Outlet Gasket	2010	35753	Nissan Rogue Krom, S, SL; Water Outlet; Inlet	
1	Water Outlet Gasket	2009-08	35752	Exc. Nissan Frontier SE, XE; Water Outlet	
1	Water Outlet Gasket	2009-08	35753	Exc. Nissan Frontier SE, XE; Water Outlet; Inlet	
1	Water Outlet Gasket	2007-05	35752	Exc. Nissan Frontier XE; Water Outlet	
1	Water Outlet Gasket	2007-05	35753	Exc. Nissan Frontier XE; Water Outlet; Inlet	
1	Water Outlet Gasket	2007-05	35943	Nissan Frontier XE; Water Outlet; Loc. Rear	
1	Water Outlet Gasket	2007-05	35945	Nissan Frontier XE; Water Outlet; Loc. Front; New Part Number - Check for Availability	
1	Thermostat Gasket	2013-11	35445	Nissan Frontier S, SE, SV, XE; Water Outlet; Water inlet	
1	Thermostat Gasket	2010-08	35445	Nissan Frontier SE, XE; Water Outlet; Water inlet	
1	Thermostat Gasket	2007-05	35445	Nissan Frontier XE; Water Outlet; Water inlet	
QTY	WATER PUMP	YEARS	PART NO.	DESCRIPTION	
1	Water Pump Gasket	2013-11	35755	Exc. Nissan Frontier S, SE, SV, XE; Housing	
1	Water Pump Gasket	2013-11	35944	Exc. Nissan Frontier S, SE, SV, XE; Housing to block	
1	Water Pump Gasket	2013-11	35946	Nissan Frontier S, SE, SV, XE; Mounting	
1	Water Pump Gasket	2013-11	35947	Nissan Frontier S, SE, SV, XE; Housing	
1	Water Pump Gasket	2010-08	35946	Nissan Frontier SE, XE; Mounting	
1	Water Pump Gasket	2010-08	35947	Nissan Frontier SE, XE; Housing	
1	Water Pump Gasket	2010	35755	Nissan Rogue Krom, S, SL; Housing	
1	Water Pump Gasket	2010	35944	Nissan Rogue Krom, S, SL; Housing to block	
1	Water Pump Gasket	2009-08	35755	Exc. Nissan Frontier SE, XE; Housing	
1	Water Pump Gasket	2009-08	35944	Exc. Nissan Frontier SE, XE; Housing to block	
1	Water Pump Gasket	2007-05	35755	Exc. Nissan Frontier XE; Housing	
1	Water Pump Gasket	2007-05	35946	Nissan Frontier XE; Mounting	
1	Water Pump Gasket	2007-05	35947	Nissan Frontier XE; Housing	
1	Water Pump Gasket	2007	35944	Exc. Nissan Frontier XE; Housing to block	
1	Water Pump Gasket	2006-05	35754	Exc. Nissan Frontier XE; Housing to block	
QTY	TIMING COVER	YEARS	PART NO.	DESCRIPTION	
1	Crankshaft Front Seal Set	2013-05	TCS 45056		
QTY	CARB & FUEL INJECTION	YEARS	PART NO.	DESCRIPTION	
1	Fuel Injector O-Ring Set	2013-11	ES 70599	Exc. Nissan Frontier S, SE, SV, XE; Improved design	
1	Fuel Injector O-Ring Set	2013-11	ES 70599	Nissan Frontier S, SE, SV, XE; Upper set; Injectors to fuel rail; Improved design	
1	Fuel Injector O-Ring Set	2010-08	ES 70599	Nissan Frontier SE, XE; Upper set; Injectors to fuel rail; Improved design	
1	Fuel Injector O-Ring Set	2010	ES 70599	Nissan Rogue Krom, S, SL; Improved design	
1	Fuel Injector O-Ring Set	2009-08	ES 70599	Exc. Nissan Frontier SE, XE; Improved design	
1	Fuel Injector O-Ring Set	2007-05	ES 70599	Nissan Frontier XE; Upper set; Injectors to fuel rail; Improved design	
1	Fuel Injector O-Ring Set	2007	ES 70599	Exc. Nissan Frontier XE; Improved design	
1	Throttle Body Gasket	2013-11	61552	Exc. Nissan Frontier S, SE, SV, XE; Adapter to manifold	
1	Throttle Body Gasket	2013-11	61645	Exc. Nissan Frontier S, SE, SV, XE; Throttle body to adapter	
1	Throttle Body Gasket	2013-11	61648	Nissan Frontier S, SE, SV, XE; New Part Number - Check for Availability	
1	Throttle Body Gasket	2010-08	61648	Nissan Frontier SE, XE; New Part Number - Check for Availability	
1	Throttle Body Gasket	2010	61552	Nissan Rogue Krom, S, SL; Adapter to manifold	
1	Throttle Body Gasket	2010	61645	Nissan Rogue Krom, S, SL; Throttle body to adapter	
1	Throttle Body Gasket	2009-08	61552	Exc. Nissan Frontier SE, XE; Adapter to manifold	

Nissan Truck (Incl. Minivans and SUV's) (Cont.)

5		2013 - 2005; 2.5L 151.8 (2488cc) DOHC L4 (16 Valve) 89mm Bore			5
(cont.)		MFI; Gasoline; Naturally Aspirated Nissan Eng.; Eng. Code QR25DE			(cont.)
QTY	CARB & FUEL INJECTION	YEARS	PART NO.	DESCRIPTION	
1	Throttle Body Gasket	2009-08	61645	Exc. Nissan Frontier SE, XE; Throttle body to adapter	
1	Throttle Body Gasket	2007-05	61648	Nissan Frontier XE; New Part Number - Check for Availability	
1	Throttle Body Gasket	2007	61552	Exc. Nissan Frontier XE; Adapter to manifold	
1	Throttle Body Gasket	2007	61645	Exc. Nissan Frontier XE; Throttle body to adapter	
1	Throttle Body Gasket	2006-05	61354	Exc. Nissan Frontier XE	
6		1998 - 1991; 3.0L 181 (2960cc) SOHC V6 (12 Valve) 87mm Bore			6
(cont.)		MFI; Gasoline; Naturally Aspirated Nissan Eng.; Eng. Code VG30E			(cont.)
QTY	CYLINDER HEAD	YEARS	PART NO.	DESCRIPTION	
2	Head Gasket	1998-91	9571 PT	Improved design	
1	Head Set	1998	HS 9972 PT	PermaDry® molded rubber valve cover gsks. incl.; Premium valve stem seals incl.	
1	Head Set	1997-95	HS 9972 PT	Nissan Quest GXE, XE; PermaDry® molded rubber valve cover gsks. incl.; Premium valve stem seals incl.	
1	Head Set	1997-96	HS 9571 PT-2	Exc. Nissan Quest GXE, XE; Valve stem seals, valve cover grommets, exh. pipe flange not incl.; PermaDry® molded rubber valve cover gsks. incl.	
1	Head Set	1995	HS 9571 PT-2	Nissan Pathfinder LE, SE, XE; Valve cover grommets & exh. pipe flange not incl.; PermaDry® molded rubber valve cover gsks. incl.; Premium valve stem seals incl.	
1	Head Set	1995	HS 9571 PT-2	Nissan Pickup SE, Short Bed E, Short Bed XE, XE; Valve stem seals, valve cover grommets, exh. pipe flange not incl.; PermaDry® molded rubber valve cover gsks. incl.	
1	Head Set	1994	HS 9571 PT-2	Exc. Nissan Pathfinder LE, SE, XE, Quest GXE, XE; From 11/01/93; Valve stem seals, valve cover grommets, exh. pipe flange not incl.; PermaDry® molded rubber valve cover gsks. incl.	
1	Head Set	1994	HS 9571 PT-2	Nissan D21 Hardbody Pickup Base, SE, XE; To 11/01/93; Valve cover grommets & exh. pipe flange not incl.; PermaDry® molded rubber valve cover gsks. incl.; Premium valve stem seals incl.	
1	Head Set	1994	HS 9571 PT-2	Nissan Pickup SE, Short Bed XE, XE; To 11/01/93; Valve cover grommets & exh. pipe flange not incl.; PermaDry® molded rubber valve cover gsks. incl.; Premium valve stem seals incl.	
1	Head Set	1994	HS 9571 PT-2	Nissan Pathfinder LE, SE, XE; Valve cover grommets & exh. pipe flange not incl.; PermaDry® molded rubber valve cover gsks. incl.; Premium valve stem seals incl.	
1	Head Set	1994	HS 9571 PT-5	Nissan Quest GXE, XE; To 11/01/93; Valve cover grommets not incl.; PermaDry® molded rubber valve cover gsks. incl.; Premium valve stem seals incl.	
1	Head Set	1994	HS 9972 PT	Nissan Quest GXE, XE; From 11/01/93; PermaDry® molded rubber valve cover gsks. incl.; Premium valve stem seals incl.	
1	Head Set	1993	HS 9571 PT-2	Exc. Nissan Quest GXE, XE; Valve cover grommets & exh. pipe flange not incl.; PermaDry® molded rubber valve cover gsks. incl.; Premium valve stem seals incl.	
1	Head Set	1993	HS 9571 PT-5	Nissan Quest GXE, XE; Valve cover grommets not incl.; PermaDry® molded rubber valve cover gsks. incl.; Premium valve stem seals incl.	
1	Head Set	1992-91	HS 9571 PT-2	Valve cover grommets & exh. pipe flange not incl.; PermaDry® molded rubber valve cover gsks. incl.; Premium valve stem seals incl.	
QTY	CONVERSION SET	YEARS	PART NO.	DESCRIPTION	
1	Gasket Conversion Set	1998	CS 9228-3	RTV sealant incl. for oil pan gskt.	
1	Gasket Conversion Set	1997-93	CS 9228-1	Exc. Nissan Quest GXE, XE; RTV sealant incl. for oil pan gskt.	
1	Gasket Conversion Set	1997-96	CS 9228-3	Nissan Quest GXE, XE; RTV sealant incl. for oil pan gskt.	
1	Gasket Conversion Set	1995-93	CS 9228-2	Nissan Quest GXE, XE; RTV sealant incl. for oil pan gskt.	
1	Gasket Conversion Set	1992-91	CS 9228-1	RTV sealant incl. for oil pan gskt.	
QTY	MANIFOLD - INT. & EXH.	YEARS	PART NO.	DESCRIPTION	
1	Int. Manifold Gasket Set	1998-91	MS 92270-4	Lower set; Upper set incl.	
1	Plenum Gasket Set	1998-91	MS 92273	Upper set	
1	Exh. Manifold Gasket Set	1998	MS 95583		
1	Exh. Manifold Gasket Set	1997-93	MS 92271	Exc. Nissan Quest GXE, XE	
1	Exh. Manifold Gasket Set	1997-95	MS 95583	Nissan Quest GXE, XE	
1	Exh. Manifold Gasket Set	1994	MS 92272	Nissan Quest GXE, XE; To 11/01/93	
1	Exh. Manifold Gasket Set	1994	MS 95583	Nissan Quest GXE, XE; From 11/01/93	
1	Exh. Manifold Gasket Set	1993	MS 92272	Nissan Quest GXE, XE	
1	Exh. Manifold Gasket Set	1992-91	MS 92271		
QTY	EXHAUST PIPE FLANGE	YEARS	PART NO.	DESCRIPTION	
2	Exhaust Pipe Gasket	1998-91	60674	Converter	

Nissan Truck (Incl. Minivans and SUV's) (Cont.)

6 (cont.)		1998 - 1991; 3.0L 181 (2960cc) SOHC V6 (12 Valve) 87mm Bore			6 (cont.)
MFI; Gasoline; Naturally Aspirated Nissan Eng.; Eng. Code VG30E					
QTY	EXHAUST PIPE FLANGE	YEARS	PART NO.	DESCRIPTION	
2	Exhaust Pipe Gasket	1998	60568	Pipe to manifold	
2	Exhaust Pipe Gasket	1998	60660	Crossover	
2	Exhaust Pipe Gasket	1997-93	60660	Nissan Quest GXE, XE; Crossover	
2	Exhaust Pipe Gasket	1997-93	60871	Exc. Nissan Quest GXE, XE; Flange	
2	Exhaust Pipe Gasket	1997-95	60568	Nissan Quest GXE, XE; Pipe to manifold	
2	Exhaust Pipe Gasket	1994	60568	Nissan Quest GXE, XE; From 11/01/93; Pipe to manifold	
2	Exhaust Pipe Gasket	1994	60811	Nissan Quest GXE, XE; To 11/01/93; Pipe to manifold	
2	Exhaust Pipe Gasket	1993	60811	Nissan Quest GXE, XE; Pipe to manifold	
2	Exhaust Pipe Gasket	1992-91	60582	Flange	
QTY	OIL PAN	YEARS	PART NO.	DESCRIPTION	
1	Oil Pan Gasket Set	1998-91	OS 30591	RTV Black silicone w/Rubber end seals	
QTY	CRANKSHAFT REAR SEAL	YEARS	PART NO.	DESCRIPTION	
1	Rear Main Seal Set	1998	BS 40609	Rubber; One-piece	
1	Rear Main Seal Set	1997-93	BS 40609	Nissan Quest GXE, XE; Rubber; One-piece	
1	Rear Main Seal Set	1997-93	BS 40628	Exc. Nissan Quest GXE, XE; Rubber; One-piece	
1	Rear Main Seal Set	1992-91	BS 40628	Rubber; One-piece	
QTY	VALVE COVER	YEARS	PART NO.	DESCRIPTION	
1	Valve Cover Gasket Set	1998-91	VS 50251 R	w/o Grommets; PermaDry® molded rubber gskts. incl.	
1	Valve Cover Gasket Set	1998-91	VS 50251 R-1	w/Grommets; PermaDry® molded rubber gskts. incl.	
1	Grommet Set	1998-91	ES 72840	Valve Cover	
QTY	VALVE STEM SEAL SET	YEARS	PART NO.	DESCRIPTION	
1	Valve Stem Seal Set	1998-96	SS 72868	Premium valve stem seals incl.	
1	Valve Stem Seal Set	1995	SS 72629	Nissan Pathfinder LE, SE, XE; Premium valve stem seals incl.	
1	Valve Stem Seal Set	1995	SS 72868	Exc. Nissan Pathfinder LE, SE, XE; Premium valve stem seals incl.	
1	Valve Stem Seal Set	1994	SS 72629	Nissan Pathfinder LE, SE, XE; Premium valve stem seals incl.	
1	Valve Stem Seal Set	1994	SS 72629	Nissan D21 Hardbody Pickup Base, SE, XE; To 11/01/93; Premium valve stem seals incl.	
1	Valve Stem Seal Set	1994	SS 72629	Nissan Pickup SE, Short Bed XE, XE, Quest GXE, XE; To 11/01/93; Premium valve stem seals incl.	
1	Valve Stem Seal Set	1994	SS 72868	Exc. Nissan Pathfinder LE, SE, XE; From 11/01/93; Premium valve stem seals incl.	
1	Valve Stem Seal Set	1993-91	SS 72629	Premium valve stem seals incl.	
QTY	THERMOSTAT HOUSING	YEARS	PART NO.	DESCRIPTION	
1	Thermostat Gasket	1998-91	35312	Thermostat Housing; Thermostat housing to manifold	
1	Thermostat Gasket	1998	35497	Thermostat Housing; Inlet	
1	Thermostat Gasket	1997-93	35369	Exc. Nissan Quest GXE, XE; Thermostat Housing; Inlet	
1	Thermostat Gasket	1997-93	35497	Nissan Quest GXE, XE; Thermostat Housing; Inlet	
1	Thermostat Gasket	1992-91	35369	Thermostat Housing; Inlet	
QTY	WATER OUTLET GASKET	YEARS	PART NO.	DESCRIPTION	
1	Thermostat Gasket	1998-91	35368	Water Outlet	
QTY	WATER PUMP	YEARS	PART NO.	DESCRIPTION	
1	Water Pump Gasket	1998	35415	Improved design	
1	Water Pump Gasket	1997-93	35367	Exc. Nissan Quest GXE, XE; 4WD	
1	Water Pump Gasket	1997-93	35415	Nissan Quest GXE, XE; Improved design	
1	Water Pump Gasket	1997-93	35415	Exc. Nissan Quest GXE, XE; RWD; Improved design	
1	Water Pump Gasket	1992-91	35367	4WD	
1	Water Pump Gasket	1992-91	35415	RWD; Improved design	
QTY	TIMING COVER	YEARS	PART NO.	DESCRIPTION	
1	Timing Cover Dust Seal Set	1998-91	TCS 45834		
1	Crankshaft Front Seal Set	1998-96	TCS 45975	Must be used w/OS 30591	
1	Crankshaft Front Seal Set	1995-91	TCS 45634	Must be used w/OS 30591	
2	Camshaft Front Seal Set	1998-91	TCS 45635		
QTY	CARB & FUEL INJECTION	YEARS	PART NO.	DESCRIPTION	
1	Throttle Body Gasket	1998	61058		
1	Throttle Body Gasket	1997-93	60853	Exc. Nissan Quest GXE, XE	
1	Throttle Body Gasket	1997-93	61058	Nissan Quest GXE, XE	
1	Throttle Body Gasket	1992-91	60853		
QTY	DISTRIBUTOR MOUNTING	YEARS	PART NO.	DESCRIPTION	
1	O-Ring	1998-91	417	Distributor Mounting	
QTY	EXHAUST GAS RECIRCULATION	YEARS	PART NO.	DESCRIPTION	
2	EGR Gasket	1998	70712		
2	EGR Gasket	1997-93	70712	Nissan Quest GXE, XE	
2	EGR Gasket	1997-93	72521	Exc. Nissan Quest GXE, XE	
2	EGR Gasket	1992-91	72521		

Nissan Truck (Incl. Minivans and SUV's) (Cont.)

7		2004 - 1996; 3.3L 199.8 (3274cc) SOHC V6 (12 Valve) 91.5mm Bore			7
		MFI; Gasoline; Naturally Aspirated Nissan Eng.; Eng. Code VG33E			
QTY	CYLINDER HEAD	YEARS	PART NO.	DESCRIPTION	
2	Head Gasket	2004-96	26219 PT	Head bolts not incl.; Head bolt replacement recommended	
1	Head Set	2004-03	HS 26219 PT-1	Head bolts not incl.; Head bolt replacement recommended; PermaDry® molded rubber valve cover gskts. incl.; Premium valve stem seals incl.	
1	Head Set	2002-99	HS 26219 PT	Nissan Quest GLE, GXE, SE; Head bolts not incl.; Head bolt replacement recommended; PermaDry® molded rubber valve cover gskts. incl.; Premium valve stem seals incl.	
1	Head Set	2002-99	HS 26219 PT-1	Exc. Nissan Quest GLE, GXE, SE; Head bolts not incl.; Head bolt replacement recommended; PermaDry® molded rubber valve cover gskts. incl.; Premium valve stem seals incl.	
1	Head Set	1998-96	HS 26219 PT-1	Head bolts not incl.; Head bolt replacement recommended; PermaDry® molded rubber valve cover gskts. incl.; Premium valve stem seals incl.	
2	Head Bolt Set	2004-96	ES 72194	Head bolts w/Washers; Replacement recommended	
QTY	CONVERSION SET	YEARS	PART NO.	DESCRIPTION	
1	Gasket Conversion Set	2004-03	CS 26219-2	RTV sealant incl. for oil pan gskt.	
1	Gasket Conversion Set	2002-99	CS 26219	Nissan Quest GLE, GXE, SE; RTV sealant incl. for oil pan gskt.	
1	Gasket Conversion Set	2002	CS 26219-2	Exc. Nissan Quest GLE, GXE, SE; RTV sealant incl. for oil pan gskt.	
1	Gasket Conversion Set	2001-99	CS 26219-1	Exc. Nissan Quest GLE, GXE, SE; RTV sealant incl. for oil pan gskt.	
1	Gasket Conversion Set	1998-96	CS 26219-1	RTV sealant incl. for oil pan gskt.	
QTY	MANIFOLD - INT. & EXH.	YEARS	PART NO.	DESCRIPTION	
1	Int. Manifold Gasket Set	2004-03	MS 92270-4	Lower set; Upper set incl.	
1	Int. Manifold Gasket Set	2002-99	MS 92270-3	Nissan Quest GLE, GXE, SE; Lower set; Upper set incl.	
1	Int. Manifold Gasket Set	2002-99	MS 92270-4	Exc. Nissan Quest GLE, GXE, SE; Lower set; Upper set incl.	
1	Int. Manifold Gasket Set	1998-96	MS 92270-4	Lower set; Upper set incl.	
1	Plenum Gasket Set	2004-03	MS 92273	Upper set	
1	Plenum Gasket Set	2002-99	MS 92273	Exc. Nissan Quest GLE, GXE, SE; Upper set	
1	Plenum Gasket Set	2002-99	MS 92273-3	Nissan Quest GLE, GXE, SE; Upper set	
1	Plenum Gasket Set	1998-96	MS 92273	Upper set	
1	Exh. Manifold Gasket Set	2004-96	MS 96300		
QTY	EXHAUST PIPE FLANGE	YEARS	PART NO.	DESCRIPTION	
2	Exhaust Pipe Gasket	2004-03	60835	Pipe to manifold; Improved design	
2	Exhaust Pipe Gasket	2002-99	60568	Nissan Quest GLE, GXE, SE; Pipe to manifold; Exc. California	
2	Exhaust Pipe Gasket	2002-99	60777	Nissan Quest GLE, GXE, SE; Pipe to manifold; California	
2	Exhaust Pipe Gasket	2002-99	60835	Exc. Nissan Quest GLE, GXE, SE; Pipe to manifold; Improved design	
2	Exhaust Pipe Gasket	2002-99	61303	Nissan Quest GLE, GXE, SE; Crossover	
2	Exhaust Pipe Gasket	2002-01	60674	Nissan Quest GLE, GXE, SE; Converter	
2	Exhaust Pipe Gasket	2000	60674	Exc. Nissan Frontier SE, XE, Xterra SE, XE; Converter	
2	Exhaust Pipe Gasket	1999	60674	Exc. Nissan Frontier SE, XE; Converter	
2	Exhaust Pipe Gasket	1998-96	60674	Converter	
2	Exhaust Pipe Gasket	1998-96	60835	Pipe to manifold; Improved design	
QTY	OIL PAN	YEARS	PART NO.	DESCRIPTION	
1	Oil Pan Gasket Set	2004-96	OS 30591	RTV Black silicone w/Rubber end seals	
QTY	CRANKSHAFT REAR SEAL	YEARS	PART NO.	DESCRIPTION	
1	Rear Main Seal Set	2004-96	BS 40609	Rubber; One-piece	
QTY	VALVE COVER	YEARS	PART NO.	DESCRIPTION	
1	Valve Cover Gasket Set	2004-96	VS 50251 R	w/o Grommets; PermaDry® molded rubber gskts. incl.	
1	Valve Cover Gasket Set	2004-96	VS 50251 R-1	w/Grommets; PermaDry® molded rubber gskts. incl.	
1	Grommet Set	2004-96	ES 72840	Valve Cover	
QTY	VALVE STEM SEAL SET	YEARS	PART NO.	DESCRIPTION	
1	Valve Stem Seal Set	2004-96	SS 72629	Premium valve stem seals incl.	
QTY	THERMOSTAT HOUSING	YEARS	PART NO.	DESCRIPTION	
1	Thermostat Gasket	2004-96	35312	Thermostat Housing; Thermostat housing to manifold	
1	Thermostat Gasket	2004-03	35369	Thermostat Housing	
1	Thermostat Gasket	2002-01	35369	Exc. Nissan Quest GLE, GXE, SE; Thermostat Housing	
1	Thermostat Gasket	2002-01	35497	Nissan Quest GLE, GXE, SE; Thermostat Housing	
1	Thermostat Gasket	2000	35369	Nissan Frontier SE, XE, Xterra SE, XE; Thermostat Housing	
1	Thermostat Gasket	2000	35497	Exc. Nissan Frontier SE, XE, Xterra SE, XE; Thermostat Housing	
1	Thermostat Gasket	1999	35369	Nissan Frontier SE, XE; Thermostat Housing	
1	Thermostat Gasket	1999	35497	Exc. Nissan Frontier SE, XE; Thermostat Housing	
1	Thermostat Gasket	1998-96	35497	Thermostat Housing	
QTY	WATER OUTLET GASKET	YEARS	PART NO.	DESCRIPTION	
1	Thermostat Gasket	2004-96	35368	Water Outlet	
QTY	WATER PUMP	YEARS	PART NO.	DESCRIPTION	
1	Water Pump Gasket	2004-03	35715		
1	Water Pump Gasket	2002-99	35415	Nissan Quest GLE, GXE, SE; Improved design	

Nissan Truck (Incl. Minivans and SUV's) (Cont.)

7		2004 - 1996; 3.3L 199.8 (3274cc) SOHC V6 (12 Valve) 91.5mm Bore			7	
(cont.)		MFI; Gasoline; Naturally Aspirated Nissan Eng.; Eng. Code VG33E			(cont.)	
QTY	WATER PUMP	YEARS	PART NO.	DESCRIPTION		
1	Water Pump Gasket	2002-99	35715	Exc. Nissan Quest GLE, GXE, SE		
1	Water Pump Gasket	1998-96	35715			
QTY	TIMING COVER	YEARS	PART NO.	DESCRIPTION		
1	Crankshaft Front Seal Set	2004-03	TCS 46043	Must be used w/OS 30591		
1	Crankshaft Front Seal Set	2002-99	TCS 46033	Nissan Quest GLE, GXE, SE; Must be used w/OS 30591		
1	Crankshaft Front Seal Set	2002	TCS 46043	Exc. Nissan Quest GLE, GXE, SE; Must be used w/OS 30591		
1	Crankshaft Front Seal Set	2001-99	TCS 46034	Exc. Nissan Quest GLE, GXE, SE; Must be used w/OS 30591		
1	Crankshaft Front Seal Set	1998-96	TCS 46034	Must be used w/OS 30591		
2	Camshaft Front Seal Set	2004-96	TCS 45635			
QTY	CARB & FUEL INJECTION	YEARS	PART NO.	DESCRIPTION		
1	Throttle Body Gasket	2004-03	61269			
1	Throttle Body Gasket	2002-99	61269	Exc. Nissan Quest GLE, GXE, SE		
1	Throttle Body Gasket	2002-99	61274	Nissan Quest GLE, GXE, SE		
1	Throttle Body Gasket	1998-96	61269			
QTY	DISTRIBUTOR MOUNTING	YEARS	PART NO.	DESCRIPTION		
1	O-Ring	2004-96	417	Distributor Mounting		
QTY	EXHAUST GAS RECIRCULATION	YEARS	PART NO.	DESCRIPTION		
1	EGR Gasket	2004-03	70893	Valve		
1	EGR Gasket	2004-03	72521	Tube		
1	EGR Gasket	2002-99	70893	Exc. Nissan Quest GLE, GXE, SE; Valve		
1	EGR Gasket	2002-99	71197	Nissan Quest GLE, GXE, SE; Spacer to manifold		
1	EGR Gasket	2002-99	72521	Exc. Nissan Quest GLE, GXE, SE; Tube		
1	EGR Gasket	2002-99	72521	Nissan Quest GLE, GXE, SE; Valve to spacer		
1	EGR Gasket	1998-96	70893	Valve		
1	EGR Gasket	1998-96	72521	Tube		
8		2004 - 2001; 3.3L 199.8 (3274cc) SOHC V6 (12 Valve) 91.5mm Bore			8	
		MFI; Gasoline; Supercharged Nissan Eng.; Eng. Code VG33ER				
QTY	CYLINDER HEAD	YEARS	PART NO.	DESCRIPTION		
2	Head Gasket	2004-01	26219 PT	Head bolts not incl.; Head bolt replacement recommended		
1	Head Set	2004-01	HS 26219 PT-3	Head bolts not incl.; Head bolt replacement recommended; PermaDry® molded rubber valve cover gskts. incl.; Premium valve stem seals incl.		
2	Head Bolt Set	2004-01	ES 72194	Head bolts w/Washers; Replacement recommended		
QTY	CONVERSION SET	YEARS	PART NO.	DESCRIPTION		
1	Gasket Conversion Set	2004-02	CS 26219-2	RTV sealant incl. for oil pan gskt.		
1	Gasket Conversion Set	2001	CS 26219-1	RTV sealant incl. for oil pan gskt.		
QTY	MANIFOLD - INT. & EXH.	YEARS	PART NO.	DESCRIPTION		
1	Int. Manifold Gasket Set	2004-01	MS 92270-6	Upper set incl.		
1	Exh. Manifold Gasket Set	2004-01	MS 96300			
QTY	EXHAUST PIPE FLANGE	YEARS	PART NO.	DESCRIPTION		
2	Exhaust Pipe Gasket	2004-01	60835	Pipe to manifold; Improved design		
QTY	OIL PAN	YEARS	PART NO.	DESCRIPTION		
1	Oil Pan Gasket Set	2004-01	OS 30591	RTV Black silicone w/Rubber end seals		
QTY	CRANKSHAFT REAR SEAL	YEARS	PART NO.	DESCRIPTION		
1	Rear Main Seal Set	2004-01	BS 40609	Rubber; One-piece		
QTY	VALVE COVER	YEARS	PART NO.	DESCRIPTION		
1	Valve Cover Gasket Set	2004-01	VS 50251 R	w/o Grommets; PermaDry® molded rubber gskts. incl.		
1	Valve Cover Gasket Set	2004-01	VS 50251 R-1	w/Grommets; PermaDry® molded rubber gskts. incl.		
1	Grommet Set	2004-01	ES 72840	Valve Cover		
QTY	VALVE STEM SEAL SET	YEARS	PART NO.	DESCRIPTION		
1	Valve Stem Seal Set	2004-01	SS 72629	Premium valve stem seals incl.		
QTY	THERMOSTAT HOUSING	YEARS	PART NO.	DESCRIPTION		
1	Thermostat Gasket	2004-01	35312	Thermostat Housing; Thermostat housing to manifold		
1	Thermostat Gasket	2004-01	35369	Thermostat Housing		
QTY	WATER OUTLET GASKET	YEARS	PART NO.	DESCRIPTION		
1	Thermostat Gasket	2004-01	35368	Water Outlet		
QTY	WATER PUMP	YEARS	PART NO.	DESCRIPTION		
1	Water Pump Gasket	2004-01	35715			
QTY	TIMING COVER	YEARS	PART NO.	DESCRIPTION		
1	Crankshaft Front Seal Set	2004-02	TCS 46043	Must be used w/OS 30591		
1	Crankshaft Front Seal Set	2001	TCS 46034	Must be used w/OS 30591		
2	Camshaft Front Seal Set	2004-01	TCS 45635			
QTY	CARB & FUEL INJECTION	YEARS	PART NO.	DESCRIPTION		
1	Throttle Body Gasket	2004-01	61269			

Nissan Truck (Incl. Minivans and SUV's) (Cont.)

8		2004 - 2001; 3.3L 199.8 (3274cc) SOHC V6 (12 Valve) 91.5mm Bore			8
(cont.)		MFI; Gasoline; Supercharged Nissan Eng.; Eng. Code VG33ER			(cont.)
QTY	DISTRIBUTOR MOUNTING	YEARS	PART NO.	DESCRIPTION	
1	O-Ring	2004-01	417	Distributor Mounting	
QTY	EXHAUST GAS RECIRCULATION	YEARS	PART NO.	DESCRIPTION	
1	EGR Gasket	2004-01	70893	Valve	
1	EGR Gasket	2004-01	72521	Tube	
9		2013 - 2001; 3.5L 214 (3498cc) DOHC V6 (24 Valve) 95.5mm Bore			9
(cont.)		MFI; Gasoline; Naturally Aspirated Nissan Eng.; Eng. Code VQ35DE			(cont.)
QTY	CYLINDER HEAD	YEARS	PART NO.	DESCRIPTION	
1	Head Gasket	2013-10	26511 PT	Loc. L.H.; Head bolts not incl.; Head bolt replacement recommended; PermaTorqueMLS®; New Part Number - Check for Availability	
1	Head Gasket	2013-10	26512 PT	Loc. R.H.; Head bolts not incl.; Head bolt replacement recommended; PermaTorqueMLS®; New Part Number - Check for Availability	
1	Head Gasket	2009	26239 PT	Exc. Nissan Murano LE, S, SL; Loc. L.H.; Head bolts not incl.; Head bolt replacement recommended; PermaTorqueMLS®	
1	Head Gasket	2009	26240 PT	Exc. Nissan Murano LE, S, SL; Loc. R.H.; Head bolts not incl.; Head bolt replacement recommended; PermaTorqueMLS®	
1	Head Gasket	2009	26511 PT	Nissan Murano LE, S, SL; Loc. L.H.; Head bolts not incl.; Head bolt replacement recommended; PermaTorqueMLS®; New Part Number - Check for Availability	
1	Head Gasket	2009	26512 PT	Nissan Murano LE, S, SL; Loc. R.H.; Head bolts not incl.; Head bolt replacement recommended; PermaTorqueMLS®; New Part Number - Check for Availability	
1	Head Gasket	2008-05	26370 PT	Infiniti FX35 Base; Loc. L.H.; Head bolts not incl.; Head bolt replacement recommended; PermaTorqueMLS®	
1	Head Gasket	2008-05	26371 PT	Infiniti FX35 Base; Loc. R.H.; Head bolts not incl.; Head bolt replacement recommended; PermaTorqueMLS®	
1	Head Gasket	2008	26239 PT	Nissan Quest Base, S, SE, SL; Loc. L.H.; Head bolts not incl.; Head bolt replacement recommended; PermaTorqueMLS®	
1	Head Gasket	2008	26240 PT	Nissan Quest Base, S, SE, SL; Loc. R.H.; Head bolts not incl.; Head bolt replacement recommended; PermaTorqueMLS®	
1	Head Gasket	2008	26511 PT	Nissan Murano S, SE, SL; Loc. L.H.; Head bolts not incl.; Head bolt replacement recommended; PermaTorqueMLS®; New Part Number - Check for Availability	
1	Head Gasket	2008	26512 PT	Nissan Murano S, SE, SL; Loc. R.H.; Head bolts not incl.; Head bolt replacement recommended; PermaTorqueMLS®; New Part Number - Check for Availability	
1	Head Gasket	2007-05	26239 PT	Exc. Infiniti FX35 Base; Loc. L.H.; Head bolts not incl.; Head bolt replacement recommended; PermaTorqueMLS®	
1	Head Gasket	2007-05	26240 PT	Exc. Infiniti FX35 Base; Loc. R.H.; Head bolts not incl.; Head bolt replacement recommended; PermaTorqueMLS®	
1	Head Gasket	2004	26239 PT	Exc. Nissan Pathfinder LE, SE; Loc. L.H.; Head bolts not incl.; Head bolt replacement recommended; PermaTorqueMLS®	
1	Head Gasket	2004	26240 PT	Exc. Nissan Pathfinder LE, SE; Loc. R.H.; Head bolts not incl.; Head bolt replacement recommended; PermaTorqueMLS®	
1	Head Gasket	2004	26241 PT	Nissan Pathfinder LE, SE; Loc. L.H.; Head bolts not incl.; Head bolt replacement recommended; PermaTorqueMLS®	
1	Head Gasket	2004	26242 PT	Nissan Pathfinder LE, SE; Loc. R.H.; Head bolts not incl.; Head bolt replacement recommended; PermaTorqueMLS®	
1	Head Gasket	2003	26239 PT	Infiniti FX35 Base Nissan Murano SE, SL; Loc. L.H.; Head bolts not incl.; Head bolt replacement recommended; PermaTorqueMLS®	
1	Head Gasket	2003	26240 PT	Infiniti FX35 Base Nissan Murano SE, SL; Loc. R.H.; Head bolts not incl.; Head bolt replacement recommended; PermaTorqueMLS®	
1	Head Gasket	2003	26241 PT	Infiniti QX4 Base Nissan Pathfinder LE, SE; Loc. L.H.; Head bolts not incl.; Head bolt replacement recommended; PermaTorqueMLS®	
1	Head Gasket	2003	26242 PT	Infiniti QX4 Base Nissan Pathfinder LE, SE; Loc. R.H.; Head bolts not incl.; Head bolt replacement recommended; PermaTorqueMLS®	
1	Head Gasket	2002-01	26241 PT	Loc. L.H.; Head bolts not incl.; Head bolt replacement recommended; PermaTorqueMLS®	
1	Head Gasket	2002-01	26242 PT	Loc. R.H.; Head bolts not incl.; Head bolt replacement recommended; PermaTorqueMLS®	
1	Head Set	2013-10	HS 26511 PT	Head bolts & exh. pipe flange not incl.; Head bolt replacement recommended; PermaDry® molded rubber valve cover gskts. incl.; Premium valve stem seals incl.; New Part Number - Check for Availability	

Nissan Truck (Incl. Minivans and SUV's) (Cont.)

9 (cont.)		2013 - 2001; 3.5L 214 (3498cc) DOHC V6 (24 Valve) 95.5mm Bore			9 (cont.)
MFI; Gasoline; Naturally Aspirated Nissan Eng.; Eng. Code VQ35DE					
QTY	CYLINDER HEAD	YEARS	PART NO.	DESCRIPTION	
1	Head Set	2009	HS 26239 PT-1	Exc. Nissan Murano LE, S, SL; Head bolts & exh. pipe flange not incl.; Head bolt replacement recommended; PermaDry® molded rubber valve cover gskts. incl.; Premium valve stem seals incl.	
1	Head Set	2009	HS 26511 PT	Nissan Murano LE, S, SL; Head bolts & exh. pipe flange not incl.; Head bolt replacement recommended; PermaDry® molded rubber valve cover gskts. incl.; Premium valve stem seals incl.; New Part Number - Check for Availability	
1	Head Set	2008-05	HS 26370 PT-1	Infiniti FX35 Base; Head bolts & exh. pipe flange not incl.; Head bolt replacement recommended; PermaDry® molded rubber valve cover gskts. incl.; Premium valve stem seals incl.	
1	Head Set	2008	HS 26239 PT-1	Nissan Quest Base, S, SE, SL; Head bolts & exh. pipe flange not incl.; Head bolt replacement recommended; PermaDry® molded rubber valve cover gskts. incl.; Premium valve stem seals incl.	
1	Head Set	2008	HS 26511 PT	Nissan Murano S, SE, SL; Head bolts & exh. pipe flange not incl.; Head bolt replacement recommended; PermaDry® molded rubber valve cover gskts. incl.; Premium valve stem seals incl.; New Part Number - Check for Availability	
1	Head Set	2007-05	HS 26239 PT-1	Exc. Infiniti FX35 Base; Head bolts & exh. pipe flange not incl.; Head bolt replacement recommended; PermaDry® molded rubber valve cover gskts. incl.; Premium valve stem seals incl.	
1	Head Set	2004-03	HS 26239 PT	Infiniti FX35 Base; Head bolts & exh. pipe flange not incl.; Head bolt replacement recommended; PermaDry® molded rubber valve cover gskts. incl.; Premium valve stem seals incl.	
1	Head Set	2004	HS 26239 PT-1	Nissan Murano SE, SL, Quest S, SE, SL; Head bolts & exh. pipe flange not incl.; Head bolt replacement recommended; PermaDry® molded rubber valve cover gskts. incl.; Premium valve stem seals incl.	
1	Head Set	2004	HS 26241 PT	Nissan Pathfinder LE, SE; Head bolts & exh. pipe flange not incl.; Head bolt replacement recommended; PermaDry® molded rubber valve cover gskts. incl.; Premium valve stem seals incl.	
1	Head Set	2003	HS 26239 PT-1	Nissan Murano SE, SL; Head bolts & exh. pipe flange not incl.; Head bolt replacement recommended; PermaDry® molded rubber valve cover gskts. incl.; Premium valve stem seals incl.	
1	Head Set	2003	HS 26241 PT	Infiniti QX4 Base Nissan Pathfinder LE, SE; Head bolts & exh. pipe flange not incl.; Head bolt replacement recommended; PermaDry® molded rubber valve cover gskts. incl.; Premium valve stem seals incl.	
1	Head Set	2002-01	HS 26241 PT	Head bolts & exh. pipe flange not incl.; Head bolt replacement recommended; PermaDry® molded rubber valve cover gskts. incl.; Premium valve stem seals incl.	
2	Head Bolt Set	2013-09	ES 72900	Head bolts w/Washers; Replacement recommended	
2	Head Bolt Set	2008-05	ES 72900	Exc. Infiniti FX35 Base; Head bolts w/Washers; Replacement recommended	
2	Head Bolt Set	2004-01	ES 72900	Head bolts w/Washers; Replacement recommended	
QTY	CONVERSION SET	YEARS	PART NO.	DESCRIPTION	
1	Gasket Conversion Set	2013-09	CS 26511	RTV sealant incl. for Upper oil pan gskt.; New Part Number - Check for Availability	
1	Gasket Conversion Set	2008-07	CS 26511	Exc. Infiniti FX35 Base; RTV sealant incl. for Upper oil pan gskt.; New Part Number - Check for Availability	
1	Gasket Conversion Set	2008-07	CS 9508	Infiniti FX35 Base; Rear main brg. seal not incl.; RTV sealant incl. for Upper oil pan gskt.	
1	Gasket Conversion Set	2006-05	CS 9508	Rear main brg. seal not incl.; RTV sealant incl. for Upper oil pan gskt.	
1	Gasket Conversion Set	2004	CS 26241	Nissan Pathfinder LE, SE; Rear main brg. seal not incl.; RTV sealant incl. for Upper oil pan gskt.	
1	Gasket Conversion Set	2004	CS 9508	Exc. Nissan Pathfinder LE, SE; Rear main brg. seal not incl.; RTV sealant incl. for Upper oil pan gskt.	
1	Gasket Conversion Set	2003	CS 26241	Infiniti QX4 Base Nissan Pathfinder LE, SE; Rear main brg. seal not incl.; RTV sealant incl. for Upper oil pan gskt.	
1	Gasket Conversion Set	2003	CS 9508	Infiniti FX35 Base Nissan Murano SE, SL; Rear main brg. seal not incl.; RTV sealant incl. for Upper oil pan gskt.	
1	Gasket Conversion Set	2002-01	CS 26241	Rear main brg. seal not incl.; RTV sealant incl. for Upper oil pan gskt.	
QTY	MANIFOLD - INT. & EXH.	YEARS	PART NO.	DESCRIPTION	
1	Int. Manifold Gasket Set	2013-10	MS 97143	Lower set; Upper set incl.	
1	Int. Manifold Gasket Set	2009	MS 96454	Exc. Nissan Murano LE, S, SL; Upper set incl.	
1	Int. Manifold Gasket Set	2009	MS 97143	Nissan Murano LE, S, SL; Lower set; Upper set incl.	
1	Int. Manifold Gasket Set	2008-03	MS 96454-1	Infiniti FX35 Base; Upper set incl.	
1	Int. Manifold Gasket Set	2008	MS 96454	Nissan Quest Base, S, SE, SL; Upper set incl.	
1	Int. Manifold Gasket Set	2008	MS 97143	Nissan Murano S, SE, SL; Lower set; Upper set incl.	

Nissan Truck (Incl. Minivans and SUV's) (Cont.)

9 (cont.)	2013 - 2001; 3.5L 214 (3498cc) DOHC V6 (24 Valve) 95.5mm Bore				9 (cont.)
QTY	MANIFOLD - INT. & EXH.	YEARS	PART NO.	DESCRIPTION	
1	Int. Manifold Gasket Set	2007-05	MS 96454	Exc. Infiniti FX35 Base; Upper set incl.	
1	Int. Manifold Gasket Set	2004	MS 91241-1	Nissan Pathfinder LE, SE; Upper set incl.	
1	Int. Manifold Gasket Set	2004	MS 96454	Nissan Murano SE, SL, Quest S, SE, SL; Upper set incl.	
1	Int. Manifold Gasket Set	2003	MS 91241-1	Infiniti QX4 Base Nissan Pathfinder LE, SE; Upper set incl.	
1	Int. Manifold Gasket Set	2003	MS 96454	Nissan Murano SE, SL; Upper set incl.	
1	Int. Manifold Gasket Set	2002-01	MS 91241-1	Upper set incl.	
1	Plenum Gasket Set	2013-10	MS 97220	Upper set; New Part Number - Check for Availability	
1	Plenum Gasket Set	2009	MS 96471	Exc. Nissan Murano LE, S, SL; Upper set	
1	Plenum Gasket Set	2009	MS 97220	Nissan Murano LE, S, SL; Upper set; New Part Number - Check for Availability	
1	Plenum Gasket Set	2008-03	MS 96456	Infiniti FX35 Base; Upper set	
1	Plenum Gasket Set	2008	MS 96471	Nissan Quest Base, S, SE, SL; Upper set	
1	Plenum Gasket Set	2008	MS 97220	Nissan Murano S, SE, SL; Upper set; New Part Number - Check for Availability	
1	Plenum Gasket Set	2007-05	MS 96471	Exc. Infiniti FX35 Base; Upper set	
1	Plenum Gasket Set	2004	MS 96455	Nissan Pathfinder LE, SE; Upper set	
1	Plenum Gasket Set	2004	MS 96471	Nissan Murano SE, SL, Quest S, SE, SL; Upper set	
1	Plenum Gasket Set	2003	MS 96455	Infiniti QX4 Base Nissan Pathfinder LE, SE; Upper set	
1	Plenum Gasket Set	2003	MS 96471	Nissan Murano SE, SL; Upper set	
1	Plenum Gasket Set	2002-01	MS 96455	Upper set	
1	Exh. Manifold Gasket Set	2013-01	MS 91459		
QTY	EXHAUST PIPE FLANGE	YEARS	PART NO.	DESCRIPTION	
1	Exhaust Pipe Gasket	2013-05	60458	Pipe to muffler	
2	Exhaust Pipe Gasket	2013-10	60905	Secondary converter	
1	Exhaust Pipe Gasket	2013-10	61629	Loc. R.H.; Converter to manifold; New Part Number - Check for Availability	
1	Exhaust Pipe Gasket	2013-10	61630	Loc. L.H.; Converter to manifold; New Part Number - Check for Availability	
1	Exhaust Pipe Gasket	2013-11	61629	Loc. Front; Pipe to manifold; New Part Number - Check for Availability	
1	Exhaust Pipe Gasket	2013-11	61630	Loc. Rear; Pipe to manifold; New Part Number - Check for Availability	
1	Exhaust Pipe Gasket	2013	60458	Nissan Murano CrossCabriolet, LE, S, SL, SV; Loc. Front; Exh. connector	
2	Exhaust Pipe Gasket	2013	60871	Nissan Murano CrossCabriolet, LE, S, SL, SV; Loc. Rear; Exh. connector	
1	Exhaust Pipe Gasket	2013	61367	Exc. Nissan Murano CrossCabriolet, LE, S, SL, SV; Loc. Front; Exh. connector	
1	Exhaust Pipe Gasket	2012-11	60458	Exc. Nissan Quest LE, S, SE, SL, SV; Loc. Front; Exh. connector	
2	Exhaust Pipe Gasket	2012-11	60871	Exc. Nissan Quest LE, S, SE, SL, SV; Loc. Rear; Exh. connector	
1	Exhaust Pipe Gasket	2012-11	61367	Nissan Quest LE, S, SE, SL, SV; Loc. Front; Exh. connector	
1	Exhaust Pipe Gasket	2010-09	60458	Nissan Murano LE, S, SL; Loc. Front; Exh. connector	
2	Exhaust Pipe Gasket	2010-09	60835	Exc. Nissan Murano LE, S, SL; Flange; Improved design	
2	Exhaust Pipe Gasket	2010-09	60871	Nissan Murano LE, S, SL; Loc. Rear; Exh. connector	
2	Exhaust Pipe Gasket	2010-09	61338	Exc. Nissan Murano LE, S, SL; Converter	
1	Exhaust Pipe Gasket	2010-09	61629	Nissan Murano LE, S, SL; Loc. Front; Pipe to manifold; New Part Number - Check for Availability	
1	Exhaust Pipe Gasket	2010-09	61630	Nissan Murano LE, S, SL; Loc. Rear; Pipe to manifold; New Part Number - Check for Availability	
1	Exhaust Pipe Gasket	2010	61367	Exc. Nissan Murano LE, S, SL; Loc. Front; Exh. connector	
2	Exhaust Pipe Gasket	2009	60905	Nissan Murano LE, S, SL; Secondary converter	
1	Exhaust Pipe Gasket	2009	61629	Nissan Murano LE, S, SL; Loc. R.H.; Converter to manifold; New Part Number - Check for Availability	
1	Exhaust Pipe Gasket	2009	61630	Nissan Murano LE, S, SL; Loc. L.H.; Converter to manifold; New Part Number - Check for Availability	
2	Exhaust Pipe Gasket	2008-03	60674	Infiniti FX35 Base; Flange	
2	Exhaust Pipe Gasket	2008-03	60835	Exc. Infiniti FX35 Base; Flange; Improved design	
2	Exhaust Pipe Gasket	2008-03	61341	Infiniti FX35 Base; Converter	
2	Exhaust Pipe Gasket	2008-05	61338	Exc. Infiniti FX35 Base; Converter	
1	Exhaust Pipe Gasket	2008	60458	Nissan Murano S, SE, SL; Loc. Front; Exh. connector	
2	Exhaust Pipe Gasket	2008	60871	Nissan Murano S, SE, SL; Loc. Rear; Exh. connector	
2	Exhaust Pipe Gasket	2008	60905	Nissan Murano S, SE, SL; Secondary converter	
1	Exhaust Pipe Gasket	2008	61629	Nissan Murano S, SE, SL; Loc. R.H.; Converter to manifold; New Part Number - Check for Availability	
1	Exhaust Pipe Gasket	2008	61630	Nissan Murano S, SE, SL; Loc. L.H.; Converter to manifold; New Part Number - Check for Availability	
1	Exhaust Pipe Gasket	2004	60458	Exc. Nissan Pathfinder LE, SE; Pipe to muffler	
1	Exhaust Pipe Gasket	2004	60674	Nissan Pathfinder LE, SE; Pipe to muffler	
2	Exhaust Pipe Gasket	2004	61338	Nissan Murano SE, SL, Quest S, SE, SL; Converter	
2	Exhaust Pipe Gasket	2004	61339	Nissan Pathfinder LE, SE; Converter	
1	Exhaust Pipe Gasket	2003	60458	Infiniti FX35 Base Nissan Murano SE, SL; Pipe to muffler	

Nissan Truck (Incl. Minivans and SUV's) (Cont.)

9		2013 - 2001; 3.5L 214 (3498cc) DOHC V6 (24 Valve) 95.5mm Bore			9	
(cont.)		MFI; Gasoline; Naturally Aspirated Nissan Eng.; Eng. Code VQ35DE			(cont.)	
QTY	EXHAUST PIPE FLANGE	YEARS	PART NO.	DESCRIPTION		
1	Exhaust Pipe Gasket	2003	60674	Infiniti QX4 Base Nissan Pathfinder LE, SE; Pipe to muffler		
2	Exhaust Pipe Gasket	2003	61338	Nissan Murano SE, SL; Converter		
2	Exhaust Pipe Gasket	2003	61339	Infiniti QX4 Base Nissan Pathfinder LE, SE; Converter		
1	Exhaust Pipe Gasket	2002-01	60674	Pipe to muffler		
2	Exhaust Pipe Gasket	2002-01	60835	Flange; Improved design		
2	Exhaust Pipe Gasket	2002-01	61339	Converter		
QTY	OIL PAN	YEARS	PART NO.	DESCRIPTION		
1	Oil Pan Gasket Set	2013-01	OS 30696	Loc. Upper; RTV Black silicone w/Rubber end seals		
1	Oil Pan Gasket Set	2013-05	OS 30688	Loc. Lower		
1	Oil Pan Gasket Set	2004	OS 30688	Exc. Nissan Pathfinder LE, SE; Loc. Lower		
1	Oil Pan Gasket Set	2004	OS 30777	Nissan Pathfinder LE, SE; Loc. Lower		
1	Oil Pan Gasket Set	2003	OS 30688	Infiniti FX35 Base Nissan Murano SE, SL; Loc. Lower		
1	Oil Pan Gasket Set	2003	OS 30777	Infiniti QX4 Base Nissan Pathfinder LE, SE; Loc. Lower		
1	Oil Pan Gasket Set	2002-01	OS 30777	Loc. Lower		
QTY	CRANKSHAFT REAR SEAL	YEARS	PART NO.	DESCRIPTION		
1	Rear Main Seal Set	2013-09	BS 40730	Rubber; One-piece		
1	Rear Main Seal Set	2008-07	BS 40631	Infiniti FX35 Base; Rubber; One-piece		
1	Rear Main Seal Set	2008-07	BS 40730	Exc. Infiniti FX35 Base; Rubber; One-piece		
1	Rear Main Seal Set	2006-01	BS 40631	Rubber; One-piece		
QTY	VALVE COVER	YEARS	PART NO.	DESCRIPTION		
1	Valve Cover Gasket Set	2013-10	VS 50770 R	VCT seals, camshaft position sensor O-ring, oil pump inlet seal incl.; PermaDry® molded rubber gskts. incl.; New Part Number - Check for Availability		
1	Valve Cover Gasket Set	2009	VS 50608 R	Exc. Nissan Murano LE, S, SL; PermaDry® molded rubber gskts. incl.		
1	Valve Cover Gasket Set	2009	VS 50770 R	Nissan Murano LE, S, SL; VCT seals, camshaft position sensor O-ring, oil pump inlet seal incl.; PermaDry® molded rubber gskts. incl.; New Part Number - Check for Availability		
1	Valve Cover Gasket Set	2008	VS 50608 R	Exc. Nissan Murano S, SE, SL; PermaDry® molded rubber gskts. incl.		
1	Valve Cover Gasket Set	2008	VS 50770 R	Nissan Murano S, SE, SL; VCT seals, camshaft position sensor O-ring, oil pump inlet seal incl.; PermaDry® molded rubber gskts. incl.; New Part Number - Check for Availability		
1	Valve Cover Gasket Set	2007-01	VS 50608 R	PermaDry® molded rubber gskts. incl.		
1	Spark Plug Tube Seal Set	2009	ES 72481	Exc. Nissan Murano LE, S, SL; Valve Cover; For use with removable PCV Valve baffles only; New Part Number - Check for Availability		
1	Spark Plug Tube Seal Set	2008	ES 72481	Exc. Nissan Murano S, SE, SL; Valve Cover; For use with removable PCV Valve baffles only; New Part Number - Check for Availability		
1	Spark Plug Tube Seal Set	2007-01	ES 72481	Valve Cover; For use with removable PCV Valve baffles only; New Part Number - Check for Availability		
QTY	VALVE STEM SEAL SET	YEARS	PART NO.	DESCRIPTION		
1	Valve Stem Seal Set	2013-01	SS 72821	Premium valve stem seals incl.		
QTY	WATER OUTLET GASKET	YEARS	PART NO.	DESCRIPTION		
2	Water Outlet Gasket	2013-01	35620	Water Outlet		
1	Water Outlet Gasket	2013-01	35622	Water Outlet; Inlet		
1	Water Outlet Gasket	2013-05	35621	Water Outlet; Inlet connector		
1	Water Outlet Gasket	2008-03	35869	Infiniti FX35 Base; Water Outlet; Upper inlet connector		
1	Water Outlet Gasket	2004	35621	Exc. Nissan Pathfinder LE, SE; Water Outlet; Inlet connector		
1	Water Outlet Gasket	2003	35621	Infiniti FX35 Base Nissan Murano SE, SL; Water Outlet; Inlet connector		
QTY	WATER PUMP	YEARS	PART NO.	DESCRIPTION		
1	Water Pump Mounting Set	2013-01	ES 70894			
QTY	TIMING COVER	YEARS	PART NO.	DESCRIPTION		
1	Timing Cover Set	2013-01	TCS 45997			
QTY	CARB & FUEL INJECTION	YEARS	PART NO.	DESCRIPTION		
3	Fuel Injector O-Ring Set	2013-09	ES 70599	Improved design		
3	Fuel Injector O-Ring Set	2008-05	ES 70599	Exc. Infiniti FX35 Base; Improved design		
2	Fuel Injector O-Ring Set	2008-05	ES 70599	Infiniti FX35 Base; Upper set; Injectors to fuel rail; Improved design		
3	Fuel Injector O-Ring Set	2004-01	ES 70599	Improved design		
1	Throttle Body Gasket	2013-10	61631	Throttle body mounting; New Part Number - Check for Availability		
1	Throttle Body Gasket	2009	61342	Exc. Nissan Murano LE, S, SL; Throttle body to collector		
1	Throttle Body Gasket	2009	61345	Exc. Nissan Murano LE, S, SL; Throttle body collector to plenum		
1	Throttle Body Gasket	2009	61631	Nissan Murano LE, S, SL; Throttle body mounting; New Part Number - Check for Availability		
1	Throttle Body Gasket	2008-05	61342	Infiniti FX35 Base; Throttle body mounting		
1	Throttle Body Gasket	2008	61342	Nissan Quest Base, S, SE, SL; Throttle body to collector		
1	Throttle Body Gasket	2008	61345	Nissan Quest Base, S, SE, SL; Throttle body collector to plenum		

Nissan Truck (Incl. Minivans and SUV's) (Cont.)

9 (cont.)		2013 - 2001; 3.5L 214 (3498cc) DOHC V6 (24 Valve) 95.5mm Bore			9 (cont.)
		MFI; Gasoline; Naturally Aspirated Nissan Eng.; Eng. Code VQ35DE			
QTY	CARB & FUEL INJECTION	YEARS	PART NO.	DESCRIPTION	
1	Throttle Body Gasket	2008	61631	Nissan Murano S, SE, SL; Throttle body mounting; New Part Number - Check for Availability	
1	Throttle Body Gasket	2007-05	61342	Exc. Infiniti FX35 Base; Throttle body to collector	
1	Throttle Body Gasket	2007-05	61345	Exc. Infiniti FX35 Base; Throttle body collector to plenum	
1	Throttle Body Gasket	2004	61342	Exc. Nissan Murano SE, SL, Quest S, SE, SL; Throttle body mounting	
1	Throttle Body Gasket	2004	61342	Nissan Murano SE, SL, Quest S, SE, SL; Throttle body to collector	
1	Throttle Body Gasket	2004	61345	Nissan Murano SE, SL, Quest S, SE, SL; Throttle body collector to plenum	
1	Throttle Body Gasket	2003	61342	Exc. Nissan Murano SE, SL; Throttle body mounting	
1	Throttle Body Gasket	2003	61342	Nissan Murano SE, SL; Throttle body to collector	
1	Throttle Body Gasket	2003	61345	Nissan Murano SE, SL; Throttle body collector to plenum	
1	Throttle Body Gasket	2002-01	61343	Throttle body mounting	
QTY	EXHAUST GAS RECIRCULATION	YEARS	PART NO.	DESCRIPTION	
1	EGR Gasket	2009	70893	Exc. Nissan Murano LE, S, SL; Valve	
1	EGR Gasket	2008	70893	Nissan Quest Base, S, SE, SL; Valve	
1	EGR Gasket	2007-05	70893	Exc. Infiniti FX35 Base; Valve	
1	EGR Gasket	2004	70893	Nissan Murano SE, SL, Quest S, SE, SL; Valve	
1	EGR Gasket	2003	70893	Nissan Murano SE, SL; Valve	
QTY	OIL COOLER	YEARS	PART NO.	DESCRIPTION	
1	Oil Cooler Gasket	2013-01	72493	Oil cooler seal; New Part Number - Check for Availability	
10		2012 - 2008; 3.5L 214 (3498cc) DOHC V6 (24 Valve) 95.5mm Bore			10
		MFI; Gasoline; Naturally Aspirated Nissan Eng.; Eng. Code VQ35HR			
QTY	CYLINDER HEAD	YEARS	PART NO.	DESCRIPTION	
1	Head Gasket	2012-08	26511 PT	Loc. L.H.; Head bolts not incl.; Head bolt replacement recommended; PermaTorqueMLS®; New Part Number - Check for Availability	
1	Head Gasket	2012-08	26512 PT	Loc. R.H.; Head bolts not incl.; Head bolt replacement recommended; PermaTorqueMLS®; New Part Number - Check for Availability	
QTY	MANIFOLD - INT. & EXH.	YEARS	PART NO.	DESCRIPTION	
1	Int. Manifold Gasket Set	2012-08	MS 97143	Lower set	
1	Exh. Manifold Gasket Set	2012-08	MS 91459		
QTY	EXHAUST PIPE FLANGE	YEARS	PART NO.	DESCRIPTION	
1	Exhaust Pipe Gasket	2012-08	60458	Loc. Front; Exh. connector	
2	Exhaust Pipe Gasket	2012-08	60674	Loc. Rear; Exh. connector	
2	Exhaust Pipe Gasket	2012-08	60674	Pipe to muffler	
2	Exhaust Pipe Gasket	2012-08	61647	Loc. Front; Converter; New Part Number - Check for Availability	
QTY	CRANKSHAFT REAR SEAL	YEARS	PART NO.	DESCRIPTION	
1	Rear Main Seal Set	2012-08	BS 40694	Rubber; One-piece	
QTY	VALVE COVER	YEARS	PART NO.	DESCRIPTION	
1	Valve Cover Gasket Set	2012-08	VS 50770 R	VCT seals, camshaft position sensor O-ring, oil pump inlet seal incl.; PermaDry® molded rubber gskts. incl.; New Part Number - Check for Availability	
1	Valve Cover Gasket Set	2012-08	VS 50848 R	w/Spark plug tube seals; PermaDry® molded rubber gskts. incl.; New Part Number - Check for Availability	
QTY	VALVE STEM SEAL SET	YEARS	PART NO.	DESCRIPTION	
1	Valve Stem Seal Set	2012-08	SS 72821	Premium valve stem seals incl.	
QTY	WATER OUTLET GASKET	YEARS	PART NO.	DESCRIPTION	
2	Water Outlet Gasket	2012-08	35620	Water Outlet	
1	Water Outlet Gasket	2012-08	35622	Water Outlet; Inlet	
1	Water Outlet Gasket	2012-08	35869	Water Outlet; Upper inlet connector	
11		2013; 3.7L 225.5 (3696cc) DOHC V6 (24 Valve) 95.5mm Bore VVEL			11
		MFI; Gasoline; Naturally Aspirated Nissan Eng.; Eng. Code VQ37VHR			
QTY	MANIFOLD - INT. & EXH.	YEARS	PART NO.	DESCRIPTION	
1	Exh. Manifold Gasket Set	2013	MS 91459		
QTY	EXHAUST PIPE FLANGE	YEARS	PART NO.	DESCRIPTION	
1	Exhaust Pipe Gasket	2013	60458	Loc. Front; Exh. connector	
2	Exhaust Pipe Gasket	2013	60674	Loc. Rear; Converter	
2	Exhaust Pipe Gasket	2013	60674	Loc. Rear; Exh. connector	
2	Exhaust Pipe Gasket	2013	61647	Loc. Front; Converter; New Part Number - Check for Availability	
QTY	CRANKSHAFT REAR SEAL	YEARS	PART NO.	DESCRIPTION	
1	Rear Main Seal Set	2013	BS 40694	Rubber; One-piece	
QTY	VALVE STEM SEAL SET	YEARS	PART NO.	DESCRIPTION	
1	Valve Stem Seal Set	2013	SS 72821	Premium valve stem seals incl.	

Nissan Truck (Incl. Minivans and SUV's) (Cont.)

11		2013; 3.7L 225.5 (3696cc) DOHC V6 (24 Valve) 95.5mm Bore VVEL			11	
(cont.)		MFI; Gasoline; Naturally Aspirated Nissan Eng.; Eng. Code VQ37VHR			(cont.)	
QTY	WATER OUTLET GASKET	YEARS	PART NO.	DESCRIPTION		
2	Water Outlet Gasket	2013	35620	Water Outlet		
1	Water Outlet Gasket	2013	35622	Water Outlet; Inlet		
1	Water Outlet Gasket	2013	35869	Water Outlet; Upper inlet connector		
12		2013 - 2005; 4.0L 241.3 (3954cc) DOHC V6 (24 Valve) 95.5mm Bore			12	
		MFI; Gasoline; Naturally Aspirated Nissan Eng.; Eng. Code VQ40DE				
QTY	CYLINDER HEAD	YEARS	PART NO.	DESCRIPTION		
1	Head Gasket	2013-05	26370 PT	Loc. L.H.; Head bolts not incl.; Head bolt replacement recommended; PermaTorqueMLS®		
1	Head Gasket	2013-05	26371 PT	Loc. R.H.; Head bolts not incl.; Head bolt replacement recommended; PermaTorqueMLS®		
1	Head Set	2013-05	HS 26370 PT	Head bolts not incl.; Head bolt replacement recommended; PermaDry® molded rubber valve cover gskts. incl.; Premium valve stem seals incl.		
2	Head Bolt Set	2013-05	ES 72900	Head bolts w/Washers; Replacement recommended		
QTY	CONVERSION SET	YEARS	PART NO.	DESCRIPTION		
1	Gasket Conversion Set	2013-05	CS 26370	RTV sealant incl. for Upper oil pan gskt.		
QTY	MANIFOLD - INT. & EXH.	YEARS	PART NO.	DESCRIPTION		
1	Int. Manifold Gasket Set	2013-05	MS 96454-2	Lower set; Upper set incl.		
1	Plenum Gasket Set	2013-05	MS 96943	Upper set		
1	Exh. Manifold Gasket Set	2013-05	MS 91459			
QTY	EXHAUST PIPE FLANGE	YEARS	PART NO.	DESCRIPTION		
2	Exhaust Pipe Gasket	2013-05	60458	Exh. connector		
2	Exhaust Pipe Gasket	2013-05	60871	Converter		
2	Exhaust Pipe Gasket	2013-05	60871	Flange		
QTY	OIL PAN	YEARS	PART NO.	DESCRIPTION		
1	Oil Pan Gasket Set	2013-05	OS 30787	Loc. Lower		
QTY	CRANKSHAFT REAR SEAL	YEARS	PART NO.	DESCRIPTION		
1	Rear Main Seal Set	2013-05	BS 40694	Rubber; One-piece		
QTY	VALVE COVER	YEARS	PART NO.	DESCRIPTION		
1	Valve Cover Gasket Set	2013-05	VS 50608 R	PermaDry® molded rubber gskts. incl.		
1	Spark Plug Tube Seal Set	2013-05	ES 72481	Valve Cover; For use with removable PCV Valve baffles only; New Part Number - Check for Availability		
QTY	VALVE STEM SEAL SET	YEARS	PART NO.	DESCRIPTION		
1	Valve Stem Seal Set	2013-05	SS 72821	Premium valve stem seals incl.		
QTY	WATER OUTLET GASKET	YEARS	PART NO.	DESCRIPTION		
2	Water Outlet Gasket	2013-05	35620	Water Outlet; To block		
2	Water Outlet Gasket	2013-05	35620	Water Outlet; To manifold		
1	Water Outlet Gasket	2013-05	35621	Water Outlet; Inlet connector; To block		
1	Water Outlet Gasket	2013-05	35621	Water Outlet; Inlet connector; To manifold		
1	Water Outlet Gasket	2013-05	35622	Water Outlet; Inlet		
QTY	WATER PUMP	YEARS	PART NO.	DESCRIPTION		
1	Water Pump Mounting Set	2013-05	ES 70894			
QTY	TIMING COVER	YEARS	PART NO.	DESCRIPTION		
1	Timing Cover Set	2013-05	TCS 45997			
QTY	CARB & FUEL INJECTION	YEARS	PART NO.	DESCRIPTION		
2	Fuel Injector O-Ring Set	2013-05	ES 70599	Upper set; Injectors to fuel rail; Improved design		
2	Fuel Injector O-Ring Set	2013-05	ES 72004	Lower set; Injectors to cylinder head		
1	Throttle Body Gasket	2013-05	61513			
13		2008 - 2003; 4.5L 274 (4494cc) DOHC V8 (32 Valve) 93mm Bore			13	
		MFI; Gasoline; Naturally Aspirated Nissan Eng.; Eng. Code VK45DE				
QTY	CYLINDER HEAD	YEARS	PART NO.	DESCRIPTION		
1	Head Gasket	2008-03	26586 PT	Loc. L.H.; Head bolts not incl.; Head bolt replacement recommended; PermaTorqueMLS®; New Part Number - Check for Availability		
1	Head Gasket	2008-03	26642 PT	Loc. R.H.; Head bolts not incl.; Head bolt replacement recommended; PermaTorqueMLS®; New Part Number - Check for Availability		
1	Head Set	2008-07	HS 26586 PT	Head bolts not incl.; Head bolt replacement recommended; PermaDry® molded rubber valve cover gskts. incl.; Premium valve stem seals incl.; New Part Number - Check for Availability		
1	Head Set	2006	HS 26586 PT	From 11/01/05; Head bolts not incl.; Head bolt replacement recommended; PermaDry® molded rubber valve cover gskts. incl.; Premium valve stem seals incl.; New Part Number - Check for Availability		

Nissan Truck (Incl. Minivans and SUV's) (Cont.)

13 (cont.)		2008 - 2003; 4.5L 274 (4494cc) DOHC V8 (32 Valve) 93mm Bore			13 (cont.)
MFI; Gasoline; Naturally Aspirated Nissan Eng.; Eng. Code VK45DE					
QTY	CYLINDER HEAD	YEARS	PART NO.	DESCRIPTION	
1	Head Set	2006	HS 26642 PT	To 10/31/05; Head bolts not incl.; Head bolt replacement recommended; PermaDry® molded rubber valve cover gskts. incl.; Premium valve stem seals incl.; New Part Number - Check for Availability	
1	Head Set	2005-03	HS 26642 PT	Head bolts not incl.; Head bolt replacement recommended; PermaDry® molded rubber valve cover gskts. incl.; Premium valve stem seals incl.; New Part Number - Check for Availability	
2	Head Bolt Set	2008-03	ES 71354	Head bolts w/Washers; Replacement recommended; New Part Number - Check for Availability	
QTY	CONVERSION SET	YEARS	PART NO.	DESCRIPTION	
1	Gasket Conversion Set	2008-03	CS 26586	Timing cover gskts. not incl.; RTV sealant incl. for oil pan gskt.; New Part Number - Check for Availability	
QTY	MANIFOLD - INT. & EXH.	YEARS	PART NO.	DESCRIPTION	
1	Int. Manifold Gasket Set	2008-07	MS 97295	Lower set; Upper set incl.; New Part Number - Check for Availability	
1	Int. Manifold Gasket Set	2006	MS 97294	To 10/31/05; Lower set; Upper set incl.; New Part Number - Check for Availability	
1	Int. Manifold Gasket Set	2006	MS 97295	From 11/01/05; Lower set; Upper set incl.; New Part Number - Check for Availability	
1	Int. Manifold Gasket Set	2005-03	MS 97294	Lower set; Upper set incl.; New Part Number - Check for Availability	
1	Exh. Manifold Gasket Set	2008-03	MS 97264	New Part Number - Check for Availability	
QTY	EXHAUST PIPE FLANGE	YEARS	PART NO.	DESCRIPTION	
2	Exhaust Pipe Gasket	2008-03	60458	Loc. Front; Exh. connector	
2	Exhaust Pipe Gasket	2008-03	60674	Loc. Rear; Converter	
2	Exhaust Pipe Gasket	2008-03	61515	Loc. Front; Converter	
2	Exhaust Pipe Gasket	2008-03	61515	Loc. Rear; Exh. connector	
QTY	VALVE COVER	YEARS	PART NO.	DESCRIPTION	
1	Valve Cover Gasket Set	2008-03	VS 50843 R	PermaDry® molded rubber gskts. incl.; New Part Number - Check for Availability	
QTY	VALVE STEM SEAL SET	YEARS	PART NO.	DESCRIPTION	
2	Valve Stem Seal Set	2008-03	SS 70157	Premium valve stem seals incl.	
QTY	CARB & FUEL INJECTION	YEARS	PART NO.	DESCRIPTION	
2	Fuel Injector O-Ring Set	2008-03	ES 70599	Lower set; Injectors to cylinder head; Improved design	
2	Fuel Injector O-Ring Set	2008-03	ES 70599	Upper set; Injectors to fuel rail; Improved design	
14		2013 - 2009; 5.0L 306.7 (5026cc) DOHC V8 (32 Valve) 95.5mm Bore VVEL			14
MFI; Gasoline; Naturally Aspirated Nissan Eng.; Eng. Code VK50VE					
QTY	EXHAUST PIPE FLANGE	YEARS	PART NO.	DESCRIPTION	
2	Exhaust Pipe Gasket	2013-09	60458	Loc. Front; Exh. connector	
2	Exhaust Pipe Gasket	2013-09	60674	Loc. Rear; Converter	
2	Exhaust Pipe Gasket	2013-09	60674	Loc. Rear; Exh. connector	
2	Exhaust Pipe Gasket	2013-09	61515	Loc. Front; Converter	
QTY	VALVE STEM SEAL SET	YEARS	PART NO.	DESCRIPTION	
2	Valve Stem Seal Set	2013-09	SS 70157	Premium valve stem seals incl.	
QTY	WATER OUTLET GASKET	YEARS	PART NO.	DESCRIPTION	
1	Water Outlet Gasket	2013-09	35622	Water Outlet; Inlet	
QTY	CARB & FUEL INJECTION	YEARS	PART NO.	DESCRIPTION	
2	Fuel Injector O-Ring Set	2013-09	ES 70599	Lower set; Injectors to cylinder head; Improved design	
2	Fuel Injector O-Ring Set	2013-09	ES 70599	Upper set; Injectors to fuel rail; Improved design	
15		2013 - 2005; 5.6L 339 (5552cc) DOHC V8 (32 Valve) 98mm Bore			15
MFI; Flex Fuel; Naturally Aspirated Nissan Eng.; Eng. Code VK56DE					
QTY	CYLINDER HEAD	YEARS	PART NO.	DESCRIPTION	
1	Head Gasket	2013-05	26372 PT	Loc. L.H.; Head bolts not incl.; Head bolt replacement recommended; PermaTorqueMLS®	
1	Head Gasket	2013-05	26373 PT	Loc. R.H.; Head bolts not incl.; Head bolt replacement recommended; PermaTorqueMLS®	
1	Head Set	2013-05	HS 26372 PT	Head bolts not incl.; Head bolt replacement recommended; PermaDry® molded rubber valve cover gskts. incl.; Premium valve stem seals incl.	
2	Head Bolt Set	2013-05	ES 72198	Head bolts w/Washers; Replacement recommended	
QTY	CONVERSION SET	YEARS	PART NO.	DESCRIPTION	
1	Gasket Conversion Set	2013-05	CS 26372	RTV sealant incl. for Upper oil pan gskt.	
QTY	MANIFOLD - INT. & EXH.	YEARS	PART NO.	DESCRIPTION	
1	Int. Manifold Gasket Set	2013-05	MS 96945	Upper set incl.	
1	Exh. Manifold Gasket Set	2013-05	MS 96946		

Nissan Truck (Incl. Minivans and SUV's) (Cont.)

15 (cont.)		2013 - 2005; 5.6L 339 (5552cc) DOHC V8 (32 Valve) 98mm Bore			15 (cont.)
MFI; Flex Fuel; Naturally Aspirated Nissan Eng.; Eng. Code VK56DE					
QTY	EXHAUST PIPE FLANGE	YEARS	PART NO.	DESCRIPTION	
2	Exhaust Pipe Gasket	2013-05	60458	Exh. connector	
2	Exhaust Pipe Gasket	2013-05	60871	Flange	
2	Exhaust Pipe Gasket	2013-05	61515	Converter	
QTY	OIL PAN	YEARS	PART NO.	DESCRIPTION	
1	Oil Pan Gasket Set	2013-05	OS 30788	Loc. Lower	
QTY	CRANKSHAFT REAR SEAL	YEARS	PART NO.	DESCRIPTION	
1	Rear Main Seal Set	2013-05	BS 40694	Rubber; One-piece	
QTY	VALVE COVER	YEARS	PART NO.	DESCRIPTION	
1	Valve Cover Gasket Set	2013-05	VS 50720 R	PermaDry® molded rubber gskts. incl.	
QTY	VALVE STEM SEAL SET	YEARS	PART NO.	DESCRIPTION	
2	Valve Stem Seal Set	2013-05	SS 70157	Premium valve stem seals incl.	
QTY	THERMOSTAT HOUSING	YEARS	PART NO.	DESCRIPTION	
2	Thermostat Gasket	2013-05	35853	Thermostat housing	
1	Thermostat Gasket	2013-05	35854	Thermostat housing to manifold	
QTY	WATER PUMP	YEARS	PART NO.	DESCRIPTION	
1	Water Pump Gasket	2013-05	35851		
QTY	TIMING COVER	YEARS	PART NO.	DESCRIPTION	
1	Crankshaft Front Seal Set	2013-05	TCS 46135		
QTY	CARB & FUEL INJECTION	YEARS	PART NO.	DESCRIPTION	
2	Fuel Injector O-Ring Set	2013-05	ES 70599	Lower set; Injectors to cylinder head; Improved design	
2	Fuel Injector O-Ring Set	2013-05	ES 72004	Upper set; Injectors to fuel rail	
1	Throttle Body Gasket	2013-05	61514		
16		2013 - 2004; 5.6L 339 (5552cc) DOHC V8 (32 Valve) 98mm Bore			16
MFI; Gasoline; Naturally Aspirated Nissan Eng.; Eng. Code VK56DE					
QTY	CYLINDER HEAD	YEARS	PART NO.	DESCRIPTION	
1	Head Gasket	2013-04	26372 PT	Loc. L.H.; Head bolts not incl.; Head bolt replacement recommended; PermaTorqueMLS®	
1	Head Gasket	2013-04	26373 PT	Loc. R.H.; Head bolts not incl.; Head bolt replacement recommended; PermaTorqueMLS®	
1	Head Set	2013-04	HS 26372 PT	Head bolts not incl.; Head bolt replacement recommended; PermaDry® molded rubber valve cover gskts. incl.; Premium valve stem seals incl.	
2	Head Bolt Set	2013-04	ES 72198	Head bolts w/Washers; Replacement recommended	
QTY	CONVERSION SET	YEARS	PART NO.	DESCRIPTION	
1	Gasket Conversion Set	2013-04	CS 26372	RTV sealant incl. for Upper oil pan gskt.	
QTY	MANIFOLD - INT. & EXH.	YEARS	PART NO.	DESCRIPTION	
1	Int. Manifold Gasket Set	2013-04	MS 96945	Upper set incl.	
1	Exh. Manifold Gasket Set	2013-04	MS 96946		
QTY	EXHAUST PIPE FLANGE	YEARS	PART NO.	DESCRIPTION	
2	Exhaust Pipe Gasket	2013-04	60458	Exh. connector	
2	Exhaust Pipe Gasket	2013-04	60871	Flange	
2	Exhaust Pipe Gasket	2013-04	61515	Converter	
QTY	OIL PAN	YEARS	PART NO.	DESCRIPTION	
1	Oil Pan Gasket Set	2013-04	OS 30788	Loc. Lower	
QTY	CRANKSHAFT REAR SEAL	YEARS	PART NO.	DESCRIPTION	
1	Rear Main Seal Set	2013-04	BS 40694	Rubber; One-piece	
QTY	VALVE COVER	YEARS	PART NO.	DESCRIPTION	
1	Valve Cover Gasket Set	2013-04	VS 50720 R	PermaDry® molded rubber gskts. incl.	
QTY	VALVE STEM SEAL SET	YEARS	PART NO.	DESCRIPTION	
2	Valve Stem Seal Set	2013-04	SS 70157	Premium valve stem seals incl.	
QTY	THERMOSTAT HOUSING	YEARS	PART NO.	DESCRIPTION	
2	Thermostat Gasket	2013-04	35853	Thermostat housing	
1	Thermostat Gasket	2013-04	35854	Thermostat housing to manifold	
QTY	WATER PUMP	YEARS	PART NO.	DESCRIPTION	
1	Water Pump Gasket	2013-04	35851		
QTY	TIMING COVER	YEARS	PART NO.	DESCRIPTION	
1	Crankshaft Front Seal Set	2013-04	TCS 46135		
QTY	CARB & FUEL INJECTION	YEARS	PART NO.	DESCRIPTION	
2	Fuel Injector O-Ring Set	2013-04	ES 70599	Lower set; Injectors to cylinder head; Improved design	
2	Fuel Injector O-Ring Set	2013-04	ES 72004	Upper set; Injectors to fuel rail	
1	Throttle Body Gasket	2013-04	61514		

Oldsmobile Car - See GM Car
Oldsmobile Minivans - See GMC Truck
Oldsmobile SUV's - See GMC Truck
Panoz

Engine Finding Index					
<i>Engine</i>	<i>Years</i>	<i>Code</i>	<i>Line No.</i>		
4.6L 281 (4605cc) DOHC V8 (32 Valve) 90.2mm Bore Intech; MFI; Gasoline; Naturally Aspirated Ford Eng.	2007-99	V	1		
4.6L 281 (4605cc) DOHC V8 (32 Valve) 90.2mm Bore Intech; MFI; Gasoline; Supercharged Ford Eng.	2007-04	Y	2		
Model Index					
<i>Engine (VIN Code / Eng. Code)</i>	<i>Year</i>	<i>Engine (VIN Code / Eng. Code)</i>	<i>Year</i>	<i>Engine (VIN Code / Eng. Code)</i>	<i>Year</i>
Panoz		Panoz (cont.)		Panoz (cont.)	
Esperante		Esperante (cont.)		Roadster	
V8 281CI 4.6L DOHC (32 Valve) (V)	07-00	V8 281CI 4.6L DOHC Supercharged (32 Valve) (Y)	07-04	V8 281CI 4.6L DOHC (32 Valve) (V)	01-99
1	2007 - 1999; 4.6L 281 (4605cc) DOHC V8 (32 Valve) 90.2mm Bore Intech MFI; Gasoline; Naturally Aspirated Ford Eng.; VIN Code V				1
QTY	CYLINDER HEAD	YEARS	PART NO.	DESCRIPTION	
1	Head Gasket	2007-99	9790 PT-2	Loc. R.H.; Head bolts not incl.; Head bolt replacement recommended; PermaTorqueMLS®; Improved design	
1	Head Gasket	2007-99	9792 PT-2	Loc. L.H.; Head bolts not incl.; Head bolt replacement recommended; PermaTorqueMLS®; Improved design	
1	Head Set	2007-99	HS 9790 PT-3	Int. manifold upper & lower gskts., valve cover gskts., head bolts not incl.; Head bolt replacement recommended; Premium valve stem seals incl.	
2	Head Bolt Set	2007-99	ES 71328	Head bolts w/Washers; Replacement recommended; Improved design	
2	Head Bolt Set	2007-99	ES 72798	Head bolts w/Washers; Replacement recommended; May use ES 71328 instead; Old design	
QTY	CONVERSION SET	YEARS	PART NO.	DESCRIPTION	
1	Gasket Conversion Set	2007-99	CS 9790-4	PermaDry® molded rubber oil pan gskt. incl.; Consolidated design	
QTY	MANIFOLD - INT. & EXH.	YEARS	PART NO.	DESCRIPTION	
1	Int. Manifold Gasket Set	2007-03	MS 96139	Lower set; Upper set incl.	
1	Int. Manifold Gasket Set	2002-99	MS 92562	Lower set	
1	Plenum Gasket Set	2007-03	MS 96108	Upper set	
1	Plenum Gasket Set	2002-99	MS 95925-2	Upper set	
1	Exh. Manifold Gasket Set	2007-99	MS 95949		
QTY	EXHAUST PIPE FLANGE	YEARS	PART NO.	DESCRIPTION	
1	Exhaust Pipe Gasket	2007-99	61203	Flange	
QTY	OIL PAN	YEARS	PART NO.	DESCRIPTION	
1	Oil Pan Gasket Set	2007-99	OS 30725 R	PermaDry® molded rubber gskt. incl.; Improved design	
1	Drain Plug Gasket	2007-99	72515		
QTY	CRANKSHAFT REAR SEAL	YEARS	PART NO.	DESCRIPTION	
1	Rear Main Seal Set	2007-99	BS 40620	Rubber; One-piece; Improved design	
1	Rear Main Seal Set	2007-99	BS 40644	PTFE Rubber; One-piece	
1	Repair Sleeve	2007-99	16255-1	Crankshaft; 1.105" - 1.135" sleeve length; Use w/installation tool; Improved design	
1	Repair Sleeve Tool	2007-99	16306	Crankshaft	
QTY	VALVE COVER	YEARS	PART NO.	DESCRIPTION	
1	Valve Cover Gasket Set	2007-99	VS 50477 R	w/Grommets & Spark plug tube seals; PermaDry® molded rubber gskts. incl.; Improved design	
QTY	VALVE STEM SEAL SET	YEARS	PART NO.	DESCRIPTION	
1	Valve Stem Seal Set	2007-99	SS 72888	Premium valve stem seals incl.	
QTY	WATER OUTLET GASKET	YEARS	PART NO.	DESCRIPTION	
1	Water Outlet Gasket	2007-99	35489	Water Outlet	
QTY	WATER PUMP	YEARS	PART NO.	DESCRIPTION	
1	Water Pump Gasket	2007-99	35478		
2	O-Ring	2007-99	413	Water Pump; Water pump bypass pipe O-ring	
QTY	TIMING COVER	YEARS	PART NO.	DESCRIPTION	
1	Timing Cover Set	2007-99	TCS 45980	Repair sleeve not incl.	
1	Crankshaft Front Seal Set	2007-99	TCS 46114		
1	Repair Sleeve	2007-99	16207	Timing Cover; Use w/installation tool	
1	Repair Sleeve Tool	2007-99	16310	Timing Cover	
QTY	CARB & FUEL INJECTION	YEARS	PART NO.	DESCRIPTION	
4	Fuel Injector O-Ring Set	2007-99	ES 70599	Improved design	
1	Throttle Body Gasket	2007-99	61042	Mounting	
1	Throttle Body Gasket	2007-99	71216	Air bypass valve	
QTY	EXHAUST GAS RECIRCULATION	YEARS	PART NO.	DESCRIPTION	
1	EGR Gasket	2007-99	70149		

Panoz (Cont.)

1 (cont.) 2007 - 1999; 4.6L 281 (4605cc) DOHC V8 (32 Valve) 90.2mm Bore Intech MFI; Gasoline; Naturally Aspirated Ford Eng.; VIN Code V					1 (cont.)
QTY	OIL FILTER MOUNTING	YEARS	PART NO.	DESCRIPTION	
1	Oil Filter Adapter Gasket	2007-99	70415		
2 2007 - 2004; 4.6L 281 (4605cc) DOHC V8 (32 Valve) 90.2mm Bore Intech MFI; Gasoline; Supercharged Ford Eng.; VIN Code Y					2
QTY	CYLINDER HEAD	YEARS	PART NO.	DESCRIPTION	
1	Head Gasket	2007-04	26187 PT	Loc. L.H.; Head bolts not incl.; Head bolt replacement recommended; PermaTorqueMLS®	
1	Head Gasket	2007-04	26222 PT	Loc. R.H.; Head bolts not incl.; Head bolt replacement recommended; PermaTorqueMLS®	
1	Head Set	2007-04	HS 26187 PT	Head bolts not incl.; Head bolt replacement recommended; PermaDry® molded rubber valve cover gskts. incl.; Premium valve stem seals incl.	
2	Head Bolt Set	2007-04	ES 71173	Head bolts w/Washers; Replacement recommended	
QTY	CONVERSION SET	YEARS	PART NO.	DESCRIPTION	
1	Gasket Conversion Set	2007-04	CS 9790-4	PermaDry® molded rubber oil pan gskt. incl.; Consolidated design	
QTY	MANIFOLD - INT. & EXH.	YEARS	PART NO.	DESCRIPTION	
1	Int. Manifold Gasket Set	2007-04	MS 96114	Lower set	
1	Plenum Gasket Set	2007-04	MS 96110	Upper set	
1	Exh. Manifold Gasket Set	2007-04	MS 95949		
QTY	EXHAUST PIPE FLANGE	YEARS	PART NO.	DESCRIPTION	
1	Exhaust Pipe Gasket	2007-04	61203	Flange	
QTY	OIL PAN	YEARS	PART NO.	DESCRIPTION	
1	Oil Pan Gasket Set	2007-04	OS 30725 R	PermaDry® molded rubber gskt. incl.; Improved design	
1	Drain Plug Gasket	2007-04	72515		
QTY	CRANKSHAFT REAR SEAL	YEARS	PART NO.	DESCRIPTION	
1	Rear Main Seal Set	2007-04	BS 40620	Rubber; One-piece; Improved design	
1	Rear Main Seal Set	2007-04	BS 40644	PTFE Rubber; One-piece	
1	Repair Sleeve	2007-04	16255-1	Crankshaft; 1.105" - 1.135" sleeve length; Use w/installation tool; Improved design	
1	Repair Sleeve Tool	2007-04	16306	Crankshaft	
QTY	VALVE COVER	YEARS	PART NO.	DESCRIPTION	
1	Valve Cover Gasket Set	2007-04	VS 50477 R	w/Grommets & Spark plug tube seals; PermaDry® molded rubber gskts. incl.; Improved design	
QTY	VALVE STEM SEAL SET	YEARS	PART NO.	DESCRIPTION	
1	Valve Stem Seal Set	2007-04	SS 72888	Premium valve stem seals incl.	
QTY	WATER OUTLET GASKET	YEARS	PART NO.	DESCRIPTION	
1	Water Outlet Gasket	2007-04	35489	Water Outlet	
QTY	WATER PUMP	YEARS	PART NO.	DESCRIPTION	
1	Water Pump Gasket	2007-04	35478		
2	O-Ring	2007-04	413	Water Pump; Water pump bypass pipe O-ring	
QTY	TIMING COVER	YEARS	PART NO.	DESCRIPTION	
1	Timing Cover Set	2007-04	TCS 45980-1	Repair sleeve not incl.	
1	Crankshaft Front Seal Set	2007-04	TCS 46114		
1	Repair Sleeve	2007-04	16207	Timing Cover; Use w/installation tool	
1	Repair Sleeve Tool	2007-04	16310	Timing Cover	
QTY	CARB & FUEL INJECTION	YEARS	PART NO.	DESCRIPTION	
4	Fuel Injector O-Ring Set	2007-04	ES 70599	Improved design	
1	Throttle Body Gasket	2007-04	61042	Throttle body to spacer	
1	Throttle Body Gasket	2007-04	61202	Spacer to manifold	
1	Throttle Body Gasket	2007-04	71216	Air bypass valve	
QTY	EXHAUST GAS RECIRCULATION	YEARS	PART NO.	DESCRIPTION	
1	EGR Gasket	2007-04	70149		
QTY	OIL FILTER MOUNTING	YEARS	PART NO.	DESCRIPTION	
1	Oil Filter Adapter Gasket	2007-04	70415		

Passport Car - See GM Car

Peugeot

Engine Finding Index

Engine	Years	Code	Line No.
2.2L 131.5 (2155cc) SOHC L4 (8 Valve) 91.7mm Bore; MFI; Gasoline; Turbo - Intercooled Peugeot Eng.	1992-91	N9-TE	1

Engine Finding Index (Cont.)							
Engine					Years	Code	Line No.
2.2L 132 (2165cc) SOHC L4 (8 Valve) 88mm Bore; MFI; Gasoline; Naturally Aspirated Renault Eng.					1992-91	ZD-JL	2
Engine Code Index							
Code	Engine					Line No.	
N9-TE	2.2L 131.5 (2155cc) SOHC L4 (8 Valve) 91.7mm Bore; MFI; Gasoline; Turbo - Intercooled Peugeot Eng.					1	
ZD-JL	2.2L 132 (2165cc) SOHC L4 (8 Valve) 88mm Bore; MFI; Gasoline; Naturally Aspirated Renault Eng.					2	
Model Index							
Engine (VIN Code / Eng. Code)	Year	Engine (VIN Code / Eng. Code)	Year	Engine (VIN Code / Eng. Code)	Year		
Peugeot		Peugeot (cont.)		Peugeot (cont.)			
405		504 (cont.)		505 (cont.)			
L4 1905cc 1.9L DOHC (16 Valve) (XU-9J4)	92-89	L4 2304cc 2.3L OHV Diesel (XD-2)	83-77	L4 2304cc 2.3L OHV Turbo-Diesel (XD-2S)	86-81		
L4 1905cc 1.9L SOHC (8 Valve) (XU-9J2)	92-89	505		L4 2498cc 2.5L OHV Turbo-Diesel (XD-3T)	88-85		
504		L4 1971cc 2.0L OHV (XN-2)	87-80	V6 2849cc 2.8L SOHC (ZN-3J)	90-87		
L4 1971cc 2.0L OHV (XN-1)	79-71	L4 1971cc 2.0L OHV (XN-6)	87-80	604			
L4 1971cc 2.0L OHV (XN-2)	83-80	L4 2155cc 2.2L SOHC Turbo (N9-T)	88-85	L4 2304cc 2.3L OHV Turbo-Diesel (XD-2S)	84-82		
L4 1971cc 2.0L OHV (XN-6)	83-80	L4 2155cc 2.2L SOHC Turbo (N9-TE)	92-89	V6 2664cc 2.7L SOHC (ZM)	78-77		
L4 1971cc 2.0L OHV (XN-6)	79-71	L4 2165cc 2.2L SOHC (ZD-JL)	92-87	V6 2849cc 2.8L SOHC (ZN)	81-79		
L4 2112cc 2.1L OHV Diesel (XD-90)	76-74	L4 2304cc 2.3L OHV Diesel (XD-2)	83-80				
1	1992 - 1991; 2.2L 131.5 (2155cc) SOHC L4 (8 Valve) 91.7mm Bore MFI; Gasoline; Turbo - Intercooled Peugeot Eng.; Eng. Code N9-TE					1	
QTY	WATER OUTLET GASKET	YEARS	PART NO.	DESCRIPTION			
1	Water Outlet Gasket	1992-91	35298-1	Water Outlet			
2	1992 - 1991; 2.2L 132 (2165cc) SOHC L4 (8 Valve) 88mm Bore MFI; Gasoline; Naturally Aspirated Renault Eng.; Eng. Code ZD-JL					2	
QTY	EXHAUST PIPE FLANGE	YEARS	PART NO.	DESCRIPTION			
1	Exhaust Pipe Gasket	1992-91	60478	Converter			
QTY	TIMING COVER	YEARS	PART NO.	DESCRIPTION			
1	Camshaft Front Seal Set	1992-91	TCS 45725				
QTY	EXHAUST GAS RECIRCULATION	YEARS	PART NO.	DESCRIPTION			
1	EGR Gasket	1992-91	71098				

Plymouth Car - See Chrysler Car
 Plymouth Minivans - See Dodge Truck
 Pontiac Car - See GM Car
 Pontiac Minivans - See GMC Truck
 Pontiac SUV's - See GMC Truck
 Porsche Car

Engine Finding Index							
Engine					Years	Code	Line No.
3.0L 182.8 (2995cc) DOHC Supercharged - Intercooled V6 (24 Valve) 84.5mm Bore VVT; DI; Hybrid (Gas/Electric); Supercharged - Intercooled Audi Eng.					2013-12	M06.EC	1
Engine Code Index							
Code	Engine					Line No.	
M06.EC	3.0L 182.8 (2995cc) DOHC Supercharged - Intercooled V6 (24 Valve) 84.5mm Bore VVT; DI; Hybrid (Gas/Electric); Supercharged - Intercooled Audi Eng.					1	
Model Index							
Engine (VIN Code / Eng. Code)	Year	Engine (VIN Code / Eng. Code)	Year	Engine (VIN Code / Eng. Code)	Year		
Porsche		Porsche (cont.)		Porsche (cont.)			
911 Carrera		911 Carrera (cont.)		914 (cont.)			
H6 3164cc 3.2L SOHC (930.21)	89-84	H6 3996cc 4.0L DOHC (24 Valve)	12	H4 1679cc 1.7L OHV (W80)	72-70		
H6 3164cc 3.2L SOHC (930.25)	89-84	911 Turbo		H4 1795cc 1.8L OHV (EC76)	75-74		
H6 3387cc 3.4L DOHC (24 Valve)	02-99	H6 3608cc 3.6L DOHC Turbo (24 Valve)	12-11	H4 1970cc 2.0L OHV (GA95)	74-73		
H6 3436cc 3.4L DOHC (24 Valve)	13-12	H6 3608cc 3.6L DOHC Turbo (24 Valve)	09-01	H4 1970cc 2.0L OHV (GC88)	76-75		
H6 3596cc 3.6L DOHC (24 Valve)	08-02	H6 3800cc 3.8L DOHC Turbo (24 Valve)	13-10	924			
H6 3608cc 3.6L DOHC (24 Valve)	09-03	912E		L4 1984cc 2.0L SOHC (VC)	82-80		
H6 3614cc 3.6L DOHC (24 Valve)	12-09	H4 1970cc 2.0L OHV (406)	76	L4 1984cc 2.0L SOHC (XE)	79-77		
H6 3797cc 3.8L DOHC (24 Valve)	13-10	914		L4 1984cc 2.0L SOHC (XF)	77		
H6 3800cc 3.8L DOHC (24 Valve)	13-09	H4 1679cc 1.7L OHV (EA80)	73-72	L4 1984cc 2.0L SOHC (XG)	79-77		
H6 3824cc 3.8L DOHC (24 Valve)	08-05	H4 1679cc 1.7L OHV (EB80)	73	L4 1984cc 2.0L SOHC (XH)	77		

Porsche Car (Cont.)

Model Index (Cont.)					
Engine (VIN Code / Eng. Code)	Year	Engine (VIN Code / Eng. Code)	Year	Engine (VIN Code / Eng. Code)	Year
Porsche (cont.)		Porsche (cont.)		Porsche (cont.)	
924S (cont.)		Boxster (cont.)		Cayman (cont.)	
L4 2479cc 2.5L SOHC (43H)	87	H6 2687cc 2.7L DOHC (24 Valve) (M96.22)	09-00	H6 3436cc 3.4L DOHC (24 Valve)	13-09
L4 2479cc 2.5L SOHC (46J)	88	H6 2687cc 2.7L DOHC (24 Valve) (M96.23)	09-00	Panamera	
944		H6 2706cc 2.7L DOHC (24 Valve)	13	V6 3605cc 3.6L DOHC (24 Valve) (M46.20)	13-11
L4 2479cc 2.5L SOHC (M44/02)	84-83	H6 2893cc 2.9L DOHC (24 Valve)	12-09	V6 3605cc 3.6L DOHC (24 Valve) (M46.40)	13-11
L4 2479cc 2.5L SOHC (M44/07)	87-85	H6 3179cc 3.2L DOHC (24 Valve)	06-00	V8 4806cc 4.8L DOHC (32 Valve) (M48.20)	13-10
L4 2479cc 2.5L SOHC (M44/09)	88	H6 3387cc 3.4L DOHC (24 Valve) (M97.21)	09-07	V8 4806cc 4.8L DOHC (32 Valve) (M48.40)	13-10
L4 2688cc 2.7L SOHC (M44/11)	89	H6 3436cc 3.4L DOHC (24 Valve)	13-09	V8 4806cc 4.8L DOHC Turbo (32 Valve)	13-10
L4 2688cc 2.7L SOHC (M44/12)	89	Cayman		(M48.70)	
L4 2479cc 2.5L DOHC (42H)	87	H6 2687cc 2.7L DOHC (24 Valve) (M96.22)	09-06	Panamera Hybrid	
L4 2479cc 2.5L DOHC (42J)	88	H6 2706cc 2.7L DOHC (24 Valve)	13	V6 2995cc 3.0L DOHC Supercharged (24	13-12
Boxster		H6 2893cc 2.9L DOHC (24 Valve)	12-09	Valve) (M06.EC)	
H6 2480cc 2.5L DOHC (24 Valve) (M96.20)	99-97	H6 3387cc 3.4L DOHC (24 Valve) (M97.21)	09-06		

1 2013 - 2012; 3.0L 182.8 (2995cc) DOHC Supercharged - Intercooled V6 (24 Valve) 84.5mm Bore VVT 1

DI; Hybrid (Gas/Electric); Supercharged - Intercooled Audi Eng.; Eng. Code M06.EC

QTY	VALVE COVER	YEARS	PART NO.	DESCRIPTION
1	Valve Cover Gasket Set	2013-12	VS 50865 R	w/Spark plug tube seals; PermaDry® molded rubber gskts. incl.; New Part Number - Check for Availability

Porsche SUV's - See Porsche Truck

Porsche Truck (Incl. SUV's)

Engine Finding Index				
Engine	Years	Code	Line No.	
3.0L 181.6 (2967cc) DOHC Turbo - Intercooled V6 (24 Valve) 83mm Bore VVT; DI; Diesel; Turbo - Intercooled Audi Eng.	2013-12	CASA	1	
3.0L 182.8 (2995cc) DOHC Supercharged - Intercooled V6 (24 Valve) 84.5mm Bore VVT; DI; Hybrid (Gas/Electric); Supercharged - Intercooled Audi Eng.	2013-11	M06.EC	2	
3.2L 195 (3189cc) DOHC V6 (24 Valve) 84mm Bore; MFI; Gasoline; Naturally Aspirated VW Eng.	2005-04	BAA	3	
3.2L 195 (3189cc) DOHC V6 (24 Valve) 84mm Bore; MFI; Gasoline; Naturally Aspirated VW Eng.	2007-05	BMX	4	

Engine Code Index

Code	Engine	Line No.
BAA	3.2L 195 (3189cc) DOHC V6 (24 Valve) 84mm Bore; MFI; Gasoline; Naturally Aspirated VW Eng.	3
BMX	3.2L 195 (3189cc) DOHC V6 (24 Valve) 84mm Bore; MFI; Gasoline; Naturally Aspirated VW Eng.	4
CASA	3.0L 181.6 (2967cc) DOHC Turbo - Intercooled V6 (24 Valve) 83mm Bore VVT; DI; Diesel; Turbo - Intercooled Audi Eng.	1
M06.EC	3.0L 182.8 (2995cc) DOHC Supercharged - Intercooled V6 (24 Valve) 84.5mm Bore VVT; DI; Hybrid (Gas/Electric); Supercharged - Intercooled Audi Eng.	2

Model Index

Engine (VIN Code / Eng. Code)	Year	Engine (VIN Code / Eng. Code)	Year	Engine (VIN Code / Eng. Code)	Year
Porsche Truck		Porsche Truck (cont.)		Porsche Truck (cont.)	
Cayenne (AWD Mid-Size SUV)		Cayenne (AWD Mid-Size SUV) (cont.)		Cayenne (AWD Mid-Size SUV) (cont.)	
V6 2967cc 3.0L DOHC Turbo-Diesel (24 Valve) (CASA)	13-12	V8 4511cc 4.5L DOHC Turbo (32 Valve)	07-03	V8 4806cc 4.8L DOHC Turbo (32 Valve)	13-11
V6 3189cc 3.2L DOHC (24 Valve) (BAA)	05-04	V8 4806cc 4.8L DOHC (32 Valve) (M48.01)	13-07	(M48.52)	
V6 3189cc 3.2L DOHC (24 Valve) (BMX)	07-05	V8 4806cc 4.8L DOHC (32 Valve) (M48.02)	13-11	Cayenne Hybrid (AWD Mid-Size SUV)	
V6 3597cc 3.6L DOHC (24 Valve) (BHL)	13-07	V8 4806cc 4.8L DOHC Turbo (32 Valve) (M48.51)	13-07	V6 2995cc 3.0L DOHC Supercharged (24	13-11
V8 4511cc 4.5L DOHC (32 Valve)	07-03			Valve) (M06.EC)	

1 2013 - 2012; 3.0L 181.6 (2967cc) DOHC Turbo - Intercooled V6 (24 Valve) 83mm Bore VVT 1
DI; Diesel; Turbo - Intercooled Audi Eng.; Eng. Code CASA

QTY	TIMING COVER	YEARS	PART NO.	DESCRIPTION
2	Camshaft Front Seal Set	2013-12	ES 72806	Camshaft circular plug; New Part Number - Check for Availability

2 2013 - 2011; 3.0L 182.8 (2995cc) DOHC Supercharged - Intercooled V6 (24 Valve) 84.5mm Bore VVT 2

DI; Hybrid (Gas/Electric); Supercharged - Intercooled Audi Eng.; Eng. Code M06.EC

QTY	VALVE COVER	YEARS	PART NO.	DESCRIPTION
1	Valve Cover Gasket Set	2013-11	VS 50865 R	w/Spark plug tube seals; PermaDry® molded rubber gskts. incl.; New Part Number - Check for Availability

Porsche Truck (Incl. SUV's) (Cont.)

3		2005 - 2004; 3.2L 195 (3189cc) DOHC V6 (24 Valve) 84mm Bore MFI; Gasoline; Naturally Aspirated VW Eng.; Eng. Code BAA			3
QTY	CYLINDER HEAD	YEARS	PART NO.	DESCRIPTION	
1	Head Gasket	2005-04	26648 PT	Head bolts not incl.; Head bolt replacement recommended; PermaTorqueMLS®; New Part Number - Check for Availability	
QTY	OIL FILTER MOUNTING	YEARS	PART NO.	DESCRIPTION	
1	Oil Filter Adapter Gasket	2005-04	72982	Oil filter adapter seal; New Part Number - Check for Availability	
4		2007 - 2005; 3.2L 195 (3189cc) DOHC V6 (24 Valve) 84mm Bore MFI; Gasoline; Naturally Aspirated VW Eng.; Eng. Code BMX			4
QTY	CYLINDER HEAD	YEARS	PART NO.	DESCRIPTION	
1	Head Gasket	2007-05	26648 PT	Head bolts not incl.; Head bolt replacement recommended; PermaTorqueMLS®; New Part Number - Check for Availability	
QTY	OIL FILTER MOUNTING	YEARS	PART NO.	DESCRIPTION	
1	Oil Filter Adapter Gasket	2007-05	72982	Oil filter adapter seal; New Part Number - Check for Availability	

Qvale - See DeTomaso

Rolls-Royce (Incl. Bentley, Rolls-Royce)

Engine Finding Index					
Engine	Years	Code	Line No.		
4.4L 268.4 (4398cc) DOHC V8 (32 Valve) 92mm Bore; MFI; Gasoline; Turbo - Intercooled BMW Eng.	2001-99	M62B44	1		
Engine Code Index					
Code	Engine	Line No.			
M62B44	4.4L 268.4 (4398cc) DOHC V8 (32 Valve) 92mm Bore; MFI; Gasoline; Turbo - Intercooled BMW Eng.	1			
Model Index					
Engine (VIN Code / Eng. Code)	Year	Engine (VIN Code / Eng. Code)	Year	Engine (VIN Code / Eng. Code)	Year
Bentley		Bentley (cont.)		Rolls-Royce	
Arnage		Continental (cont.)		Ghost	
V12 5379cc 5.4L SOHC (24 Valve)	01-99	W12 5998cc 6.0L DOHC Turbo (48 Valve)	13-11	V12 6592cc 6.6L DOHC Turbo (48 Valve)	13-10
V8 4398cc 4.4L DOHC Turbo (32 Valve)	01-99	(Flex Fuel)		Park Ward	
Continental				V12 5379cc 5.4L SOHC (24 Valve)	02
W12 5998cc 6.0L DOHC Turbo (48 Valve)	13-03			Phantom	
				V12 6749cc 6.8L DOHC (48 Valve)	13-04

Rolls-Royce (Incl. Bentley, Rolls-Royce) (Cont.)

Model Index (Cont.)

Engine (VIN Code / Eng. Code)	Year	Engine (VIN Code / Eng. Code)	Year	Engine (VIN Code / Eng. Code)	Year
Rolls-Royce (cont.)					
Silver Seraph					
V12 5379cc 5.4L SOHC (24 Valve)	02-99				
1 2001 - 1999; 4.4L 268.4 (4398cc) DOHC V8 (32 Valve) 92mm Bore MFI; Gasoline; Turbo - Intercooled BMW Eng.; Eng. Code M62B44					1
QTY	CYLINDER HEAD	YEARS	PART NO.	DESCRIPTION	
2	Head Bolt Set	2001-99	ES 72439	Head bolts w/Washers; Replacement recommended; New Part Number - Check for Availability	

Saab Car

Engine Finding Index

Engine	Years	Code	Line No.
2.0L 121.1 (1985cc) DOHC L4 (16 Valve) 90mm Bore; MFI; Gasoline; Turbo - Intercooled Saab Eng.	1994-91	B202L	1
2.0L 121.1 (1985cc) DOHC L4 (16 Valve) 90mm Bore; MFI; Gasoline; Turbo - Intercooled Saab Eng.	1998-94	B204L	2
2.0L 121.1 (1985cc) DOHC L4 (16 Valve) 90mm Bore; MFI; Gasoline; Turbo - Intercooled Saab Eng.	2001-99	B205L	3
2.0L 121.1 (1985cc) DOHC L4 (16 Valve) 90mm Bore; MFI; Gasoline; Turbo - Intercooled Saab Eng.	2003-99	B205R	4
2.0L 121.7 (1994cc) DOHC H4 (16 Valve) 92mm Bore; MFI; Gasoline; Turbo - Intercooled Subaru Eng.	2005	EJ205	5
2.0L 121.7 (1994cc) DOHC H4 (16 Valve) 92mm Bore; MFI; Gasoline; Turbo - Intercooled Subaru Eng.	2005	EJ20T	6
2.0L 122 (1998cc) DOHC L4 (16 Valve) 86mm Bore; MFI; Gasoline; Turbo - Intercooled Opel Eng.	2005-03	B207L	7
2.0L 122 (1998cc) DOHC L4 (16 Valve) 86mm Bore; MFI; Gasoline; Turbo - Intercooled Opel Eng.	2012-03	B207R	8
2.3L 139.7 (2290cc) DOHC L4 (16 Valve) 90mm Bore; MFI; Gasoline; Turbo - Intercooled Saab Eng.	1998-95	B234E	9
2.3L 139.7 (2290cc) DOHC L4 (16 Valve) 90mm Bore; MFI; Gasoline; Naturally Aspirated Saab Eng.	1998-91	B234I	10
2.3L 139.7 (2290cc) DOHC L4 (16 Valve) 90mm Bore; MFI; Gasoline; Turbo - Intercooled Saab Eng.	1998-91	B234L	11
2.3L 139.7 (2290cc) DOHC L4 (16 Valve) 90mm Bore; MFI; Gasoline; Turbo - Intercooled Saab Eng.	1998-93	B234R	12
2.3L 139.7 (2290cc) DOHC L4 (16 Valve) 90mm Bore; MFI; Gasoline; Turbo - Intercooled Saab Eng.	2005-99	B235E	13
2.3L 139.7 (2290cc) DOHC L4 (16 Valve) 90mm Bore; MFI; Gasoline; Turbo - Intercooled Saab Eng.	2010-06	B235L	14
2.3L 139.7 (2290cc) DOHC L4 (16 Valve) 90mm Bore; MFI; Gasoline; Turbo - Intercooled Saab Eng.	2005-99	B235R	15
2.5L 150 (2457cc) DOHC H4 (16 Valve) 99.5mm Bore; MFI; Gasoline; Turbo - Intercooled Subaru Eng.	2006	EJ255	16
2.5L 150 (2457cc) SOHC H4 (16 Valve) 99.5mm Bore; MFI; Gasoline; Naturally Aspirated Subaru Eng.	2005	EJ251	17
2.5L 150 (2457cc) SOHC H4 (16 Valve) 99.5mm Bore; MFI; Gasoline; Naturally Aspirated Subaru Eng.	2006-05	EJ253	18
2.5L 152 (2498cc) DOHC V6 (24 Valve) 81.6mm Bore; MFI; Gasoline; Naturally Aspirated Opel Eng.	1997-94	B258I	19
2.8L 171 (2792cc) DOHC V6 (24 Valve) 89mm Bore; MFI; Gasoline; Turbo - Intercooled Opel Eng.	2010-06	B284L	20
2.8L 171 (2792cc) DOHC V6 (24 Valve) 89mm Bore; MFI; Gasoline; Turbo - Intercooled Opel Eng.	2012-08	B284R	21
3.0L 181 (2962cc) DOHC V6 (24 Valve) 86mm Bore; MFI; Gasoline; Turbo - Intercooled Opel Eng.	2004-99	B308E	22
3.0L 181 (2962cc) DOHC V6 (24 Valve) 86mm Bore; MFI; Gasoline; Naturally Aspirated Opel Eng.	2000-95	B308I	23

Engine Code Index

Code	Engine	Line No.
B202L	2.0L 121.1 (1985cc) DOHC L4 (16 Valve) 90mm Bore; MFI; Gasoline; Turbo - Intercooled Saab Eng.	1
B204L	2.0L 121.1 (1985cc) DOHC L4 (16 Valve) 90mm Bore; MFI; Gasoline; Turbo - Intercooled Saab Eng.	2
B205L	2.0L 121.1 (1985cc) DOHC L4 (16 Valve) 90mm Bore; MFI; Gasoline; Turbo - Intercooled Saab Eng.	3
B205R	2.0L 121.1 (1985cc) DOHC L4 (16 Valve) 90mm Bore; MFI; Gasoline; Turbo - Intercooled Saab Eng.	4
B207L	2.0L 122 (1998cc) DOHC L4 (16 Valve) 86mm Bore; MFI; Gasoline; Turbo - Intercooled Opel Eng.	7
B207R	2.0L 122 (1998cc) DOHC L4 (16 Valve) 86mm Bore; MFI; Gasoline; Turbo - Intercooled Opel Eng.	8
B234E	2.3L 139.7 (2290cc) DOHC L4 (16 Valve) 90mm Bore; MFI; Gasoline; Turbo - Intercooled Saab Eng.	9
B234I	2.3L 139.7 (2290cc) DOHC L4 (16 Valve) 90mm Bore; MFI; Gasoline; Naturally Aspirated Saab Eng.	10
B234L	2.3L 139.7 (2290cc) DOHC L4 (16 Valve) 90mm Bore; MFI; Gasoline; Turbo - Intercooled Saab Eng.	11
B234R	2.3L 139.7 (2290cc) DOHC L4 (16 Valve) 90mm Bore; MFI; Gasoline; Turbo - Intercooled Saab Eng.	12
B235E	2.3L 139.7 (2290cc) DOHC L4 (16 Valve) 90mm Bore; MFI; Gasoline; Turbo - Intercooled Saab Eng.	13
B235L	2.3L 139.7 (2290cc) DOHC L4 (16 Valve) 90mm Bore; MFI; Gasoline; Turbo - Intercooled Saab Eng.	14
B235R	2.3L 139.7 (2290cc) DOHC L4 (16 Valve) 90mm Bore; MFI; Gasoline; Turbo - Intercooled Saab Eng.	15
B258I	2.5L 152 (2498cc) DOHC V6 (24 Valve) 81.6mm Bore; MFI; Gasoline; Naturally Aspirated Opel Eng.	19
B284L	2.8L 171 (2792cc) DOHC V6 (24 Valve) 89mm Bore; MFI; Gasoline; Turbo - Intercooled Opel Eng.	20
B284R	2.8L 171 (2792cc) DOHC V6 (24 Valve) 89mm Bore; MFI; Gasoline; Turbo - Intercooled Opel Eng.	21
B308E	3.0L 181 (2962cc) DOHC V6 (24 Valve) 86mm Bore; MFI; Gasoline; Turbo - Intercooled Opel Eng.	22
B308I	3.0L 181 (2962cc) DOHC V6 (24 Valve) 86mm Bore; MFI; Gasoline; Naturally Aspirated Opel Eng.	23
EJ205	2.0L 121.7 (1994cc) DOHC H4 (16 Valve) 92mm Bore; MFI; Gasoline; Turbo - Intercooled Subaru Eng.	5
EJ20T	2.0L 121.7 (1994cc) DOHC H4 (16 Valve) 92mm Bore; MFI; Gasoline; Turbo - Intercooled Subaru Eng.	6
EJ251	2.5L 150 (2457cc) SOHC H4 (16 Valve) 99.5mm Bore; MFI; Gasoline; Naturally Aspirated Subaru Eng.	17
EJ253	2.5L 150 (2457cc) SOHC H4 (16 Valve) 99.5mm Bore; MFI; Gasoline; Naturally Aspirated Subaru Eng.	18
EJ255	2.5L 150 (2457cc) DOHC H4 (16 Valve) 99.5mm Bore; MFI; Gasoline; Turbo - Intercooled Subaru Eng.	16

Model Index

Engine (VIN Code / Eng. Code)	Year	Engine (VIN Code / Eng. Code)	Year	Engine (VIN Code / Eng. Code)	Year
Saab					
9-2X					
H4 1994cc 2.0L DOHC Turbo (16 Valve)	05	H4 1994cc 2.0L DOHC Turbo (16 Valve)	05	H4 2457cc 2.5L DOHC Turbo (16 Valve)	06
(EJ205)		(EJ20T)		(EJ255)	

Model Index (Cont.)						
Engine (VIN Code / Eng. Code)	Year	Engine (VIN Code / Eng. Code)	Year	Engine (VIN Code / Eng. Code)	Year	
Saab (cont.)		Saab (cont.)		Saab (cont.)		
9-2X (cont.)		9-5		900 (cont.)		
H4 2457cc 2.5L SOHC (16 Valve) (EJ251)	05	L4 1998cc 2.0L DOHC Turbo (16 Valve) (B207R)	12-10	L4 2119cc 2.1L DOHC (16 Valve) (B212I)	94-91	
H4 2457cc 2.5L SOHC (16 Valve) (EJ253)	06-05	L4 2290cc 2.3L DOHC Turbo (16 Valve) (B235E)	05-99	L4 2290cc 2.3L DOHC (16 Valve) (B234I)	98-94	
9-3		L4 2290cc 2.3L DOHC Turbo (16 Valve) (B235L)	10-06	V6 2498cc 2.5L DOHC (24 Valve) (B258I)	97-94	
L4 1985cc 2.0L DOHC Turbo (16 Valve) (B205L)	01-99	L4 2290cc 2.3L DOHC Turbo (16 Valve) (B235R)	05-00	9000		
L4 1985cc 2.0L DOHC Turbo (16 Valve) (B205R)	03-99	V6 2792cc 2.8L DOHC Turbo (24 Valve) (B284R)	12-10	L4 1985cc 2.0L DOHC (16 Valve) (B202I)	90-87	
L4 1998cc 2.0L DOHC Turbo (16 Valve) (B207L)	05-03	V6 2962cc 3.0L DOHC Turbo (24 Valve) (B308E)	03-99	L4 1985cc 2.0L DOHC Turbo (16 Valve) (B202L)	90-86	
L4 1998cc 2.0L DOHC Turbo (16 Valve) (B207R)	12-03	900		L4 2290cc 2.3L DOHC (16 Valve) (B234I)	94-90	
L4 2290cc 2.3L DOHC Turbo (16 Valve) (B235R)	02-99	L4 1985cc 2.0L DOHC (16 Valve) (B202I)	90-86	L4 2290cc 2.3L DOHC Turbo (16 Valve) (B234E)	98-95	
V6 2792cc 2.8L DOHC Turbo (24 Valve) (B284L)	08-06	L4 1985cc 2.0L DOHC Turbo (16 Valve) (B202L)	94-85	L4 2290cc 2.3L DOHC Turbo (16 Valve) (B234L)	98-91	
V6 2792cc 2.8L DOHC Turbo (24 Valve) (B284R)	10-08	L4 1985cc 2.0L DOHC Turbo (16 Valve) (B204L)	98-94	L4 2290cc 2.3L DOHC Turbo (16 Valve) (B234R)	98-94	
9-3X		L4 1985cc 2.0L SOHC (8 Valve) (B201I)	88-79	V6 2962cc 3.0L DOHC (24 Valve) (B308I)	97-95	
L4 1998cc 2.0L DOHC Turbo (16 Valve) (B207R)	12-10	L4 1985cc 2.0L SOHC Turbo (8 Valve) (B201L)	84-79	99		
1		1994 - 1991; 2.0L 121.1 (1985cc) DOHC L4 (16 Valve) 90mm Bore MFI; Gasoline; Turbo - Intercooled Saab Eng.; Eng. Code B202L				1
QTY	CYLINDER HEAD	YEARS	PART NO.	DESCRIPTION		
1	Head Gasket	1994-91	9879 PT	Head bolts not incl.; Head bolt replacement recommended		
1	Head Set	1994-91	HS 9879 PT	Head bolts not incl.; Head bolt replacement recommended; PermaDry® molded rubber valve cover gskt. incl.; Premium valve stem seals incl.		
QTY	MANIFOLD - INT. & EXH.	YEARS	PART NO.	DESCRIPTION		
1	Int. Manifold Gasket Set	1994-91	MS 95279			
1	Exh. Manifold Gasket Set	1994-91	MS 95022			
QTY	EXHAUST PIPE FLANGE	YEARS	PART NO.	DESCRIPTION		
2	Exhaust Pipe Gasket	1994-91	60943	Flange		
QTY	OIL PAN	YEARS	PART NO.	DESCRIPTION		
1	Oil Pan Gasket Set	1994-91	OS 30659	Loc. Upper		
QTY	CRANKSHAFT REAR SEAL	YEARS	PART NO.	DESCRIPTION		
1	Rear Main Seal Set	1994-91	BS 40607	From Eng. Ser. No. N312960; Rubber; One-piece		
QTY	VALVE COVER	YEARS	PART NO.	DESCRIPTION		
1	Valve Cover Gasket Set	1994-91	VS 50409 R	PermaDry® molded rubber gskt. incl.		
QTY	VALVE STEM SEAL SET	YEARS	PART NO.	DESCRIPTION		
1	Valve Stem Seal Set	1994-91	SS 72682	Premium valve stem seals incl.; Improved design		
QTY	THERMOSTAT HOUSING	YEARS	PART NO.	DESCRIPTION		
1	Water Outlet Gasket	1994-91	25565	Thermostat Housing		
QTY	WATER OUTLET GASKET	YEARS	PART NO.	DESCRIPTION		
1	Water Outlet Gasket	1994-91	35546	Water Outlet		
QTY	WATER PUMP	YEARS	PART NO.	DESCRIPTION		
1	Water Pump Gasket	1994-91	35542			
QTY	TIMING COVER	YEARS	PART NO.	DESCRIPTION		
1	Crankshaft Front Seal Set	1994-91	TCS 45948	From Eng. Ser. No. N312960		
2		1998 - 1994; 2.0L 121.1 (1985cc) DOHC L4 (16 Valve) 90mm Bore MFI; Gasoline; Turbo - Intercooled Saab Eng.; Eng. Code B204L				2
QTY	CYLINDER HEAD	YEARS	PART NO.	DESCRIPTION		
1	Head Gasket	1998-95	26431 PT	Head bolts not incl.; Head bolt replacement recommended; PermaTorqueMLS®		
1	Head Gasket	1994	9879 PT	Head bolts not incl.; Head bolt replacement recommended		
1	Head Set	1998-95	HS 26431 PT	Head bolts not incl.; Head bolt replacement recommended; PermaDry® molded rubber valve cover gskt. incl.; Premium valve stem seals incl.		
1	Head Set	1994	HS 9879 PT	Head bolts not incl.; Head bolt replacement recommended; PermaDry® molded rubber valve cover gskt. incl.; Premium valve stem seals incl.		
QTY	CONVERSION SET	YEARS	PART NO.	DESCRIPTION		
1	Gasket Conversion Set	1998-95	CS 26431			
QTY	MANIFOLD - INT. & EXH.	YEARS	PART NO.	DESCRIPTION		
1	Int. Manifold Gasket Set	1998-95	MS 97096			

Saab Car (Cont.)

2		1998 - 1994; 2.0L 121.1 (1985cc) DOHC L4 (16 Valve) 90mm Bore			2	
(cont.)		MFI; Gasoline; Turbo - Intercooled Saab Eng.; Eng. Code B204L			(cont.)	
QTY	MANIFOLD - INT. & EXH.	YEARS	PART NO.	DESCRIPTION		
1	Int. Manifold Gasket Set	1994	MS 95279			
1	Exh. Manifold Gasket Set	1998-95	MS 97092			
1	Exh. Manifold Gasket Set	1994	MS 95022			
QTY	EXHAUST PIPE FLANGE	YEARS	PART NO.	DESCRIPTION		
1	Exhaust Pipe Gasket	1998-95	61582	Turbo flange		
2	Exhaust Pipe Gasket	1994	60943	Flange		
QTY	OIL PAN	YEARS	PART NO.	DESCRIPTION		
1	Oil Pan Gasket Set	1998-95	OS 30809			
1	Oil Pan Gasket Set	1994	OS 30659	Loc. Upper		
QTY	CRANKSHAFT REAR SEAL	YEARS	PART NO.	DESCRIPTION		
1	Rear Main Seal Set	1998-95	BS 40607	Rubber; One-piece		
1	Rear Main Seal Set	1994	BS 40607	From Eng. Ser. No. N312960; Rubber; One-piece		
QTY	VALVE COVER	YEARS	PART NO.	DESCRIPTION		
1	Valve Cover Gasket Set	1998-94	VS 50409 R	PermaDry® molded rubber gskt. incl.		
QTY	VALVE STEM SEAL SET	YEARS	PART NO.	DESCRIPTION		
1	Valve Stem Seal Set	1998-94	SS 72682	Premium valve stem seals incl.; Improved design		
QTY	THERMOSTAT HOUSING	YEARS	PART NO.	DESCRIPTION		
1	Water Outlet Gasket	1998-94	25565	Thermostat Housing		
QTY	WATER OUTLET GASKET	YEARS	PART NO.	DESCRIPTION		
1	Water Outlet Gasket	1998-95	36047	Water Outlet; Water inlet pipe to water pump housing; New Part Number - Check for Availability		
2	Water Outlet Gasket	1998-95	36048	Water Outlet; Water inlet pipe from water pump housing; New Part Number - Check for Availability		
1	Water Outlet Gasket	1994	35546	Water Outlet		
QTY	WATER PUMP	YEARS	PART NO.	DESCRIPTION		
1	Water Pump Gasket	1998-95	35914			
1	Water Pump Gasket	1994	35542			
QTY	TIMING COVER	YEARS	PART NO.	DESCRIPTION		
1	Crankshaft Front Seal Set	1998-95	TCS 46125			
1	Crankshaft Front Seal Set	1994	TCS 45948	From Eng. Ser. No. N312960		
QTY	CARB & FUEL INJECTION	YEARS	PART NO.	DESCRIPTION		
2	Fuel Injector O-Ring Set	1998-95	ES 70599	Improved design		
1	Throttle Body Gasket	1998-95	61185	Loc. Lower		
1	Throttle Body Gasket	1998-95	61616	Loc. Upper		
QTY	OIL PUMP COVER	YEARS	PART NO.	DESCRIPTION		
1	Oil Pump Gasket	1998-95	72470	Oil pump cover; New Part Number - Check for Availability		
1	Oil Pump Gasket	1998-95	72981	Oil pump mounting seal; New Part Number - Check for Availability		
3		2001 - 1999; 2.0L 121.1 (1985cc) DOHC L4 (16 Valve) 90mm Bore			3	
		MFI; Gasoline; Turbo - Intercooled Saab Eng.; Eng. Code B205L				
QTY	CYLINDER HEAD	YEARS	PART NO.	DESCRIPTION		
1	Head Gasket	2001-00	26428 PT	Head bolts not incl.; Head bolt replacement recommended; PermaTorqueMLS®		
1	Head Gasket	1999	26431 PT	Head bolts not incl.; Head bolt replacement recommended; PermaTorqueMLS®		
1	Head Set	2001-00	HS 26428 PT	Head bolts not incl.; Head bolt replacement recommended; PermaDry® molded rubber valve cover gskt. incl.; Premium valve stem seals incl.		
1	Head Set	1999	HS 26431 PT	Head bolts not incl.; Head bolt replacement recommended; PermaDry® molded rubber valve cover gskt. incl.; Premium valve stem seals incl.		
QTY	CONVERSION SET	YEARS	PART NO.	DESCRIPTION		
1	Gasket Conversion Set	2001	CS 26428			
1	Gasket Conversion Set	2000-99	CS 26431			
QTY	MANIFOLD - INT. & EXH.	YEARS	PART NO.	DESCRIPTION		
1	Int. Manifold Gasket Set	2001-00	MS 97094	Lower set		
1	Int. Manifold Gasket Set	1999	MS 97096			
1	Plenum Gasket Set	2001-00	MS 97199	Upper set; New Part Number - Check for Availability		
1	Exh. Manifold Gasket Set	2001-99	MS 97092			
QTY	EXHAUST PIPE FLANGE	YEARS	PART NO.	DESCRIPTION		
1	Exhaust Pipe Gasket	2001-99	61582	Turbo flange		
QTY	OIL PAN	YEARS	PART NO.	DESCRIPTION		
1	Oil Pan Gasket Set	2001	OS 30811			
1	Oil Pan Gasket Set	2000-99	OS 30809			
QTY	CRANKSHAFT REAR SEAL	YEARS	PART NO.	DESCRIPTION		
1	Rear Main Seal Set	2001-99	BS 40607	Rubber; One-piece		

3 (cont.)		2001 - 1999; 2.0L 121.1 (1985cc) DOHC L4 (16 Valve) 90mm Bore MFI; Gasoline; Turbo - Intercooled Saab Eng.; Eng. Code B205L			3 (cont.)
QTY	VALVE COVER	YEARS	PART NO.	DESCRIPTION	
1	Valve Cover Gasket Set	2001-99	VS 50409 R	PermaDry® molded rubber gskt. incl.	
QTY	VALVE STEM SEAL SET	YEARS	PART NO.	DESCRIPTION	
1	Valve Stem Seal Set	2001-00	SS 72925	Premium valve stem seals incl.	
1	Valve Stem Seal Set	1999	SS 72682	Premium valve stem seals incl.; Improved design	
QTY	THERMOSTAT HOUSING	YEARS	PART NO.	DESCRIPTION	
1	Water Outlet Gasket	2001-99	25565	Thermostat Housing	
QTY	WATER OUTLET GASKET	YEARS	PART NO.	DESCRIPTION	
1	Water Outlet Gasket	2001-99	36047	Water Outlet; Water inlet pipe to water pump housing; New Part Number - Check for Availability	
2	Water Outlet Gasket	2001-99	36048	Water Outlet; Water inlet pipe from water pump housing; New Part Number - Check for Availability	
QTY	WATER PUMP	YEARS	PART NO.	DESCRIPTION	
1	Water Pump Gasket	2001-99	35914		
QTY	TIMING COVER	YEARS	PART NO.	DESCRIPTION	
1	Crankshaft Front Seal Set	2001-99	TCS 46125		
QTY	CARB & FUEL INJECTION	YEARS	PART NO.	DESCRIPTION	
2	Fuel Injector O-Ring Set	2001-99	ES 70599	Improved design	
1	Throttle Body Gasket	2001-99	61185	Loc. Lower	
1	Throttle Body Gasket	2001-99	61616	Loc. Upper	
QTY	OIL PUMP COVER	YEARS	PART NO.	DESCRIPTION	
1	Oil Pump Gasket	2001-99	72470	Oil pump cover; New Part Number - Check for Availability	
1	Oil Pump Gasket	2001-99	72981	Oil pump mounting seal; New Part Number - Check for Availability	
4		2003 - 1999; 2.0L 121.1 (1985cc) DOHC L4 (16 Valve) 90mm Bore MFI; Gasoline; Turbo - Intercooled Saab Eng.; Eng. Code B205R			4
QTY	CYLINDER HEAD	YEARS	PART NO.	DESCRIPTION	
1	Head Gasket	2003-00	26428 PT	Head bolts not incl.; Head bolt replacement recommended; PermaTorqueMLS®	
1	Head Gasket	1999	26431 PT	Head bolts not incl.; Head bolt replacement recommended; PermaTorqueMLS®	
1	Head Set	2003-00	HS 26428 PT	Head bolts not incl.; Head bolt replacement recommended; PermaDry® molded rubber valve cover gskt. incl.; Premium valve stem seals incl.	
1	Head Set	1999	HS 26431 PT	Head bolts not incl.; Head bolt replacement recommended; PermaDry® molded rubber valve cover gskt. incl.; Premium valve stem seals incl.	
QTY	CONVERSION SET	YEARS	PART NO.	DESCRIPTION	
1	Gasket Conversion Set	2003-01	CS 26428		
1	Gasket Conversion Set	2000-99	CS 26431		
QTY	MANIFOLD - INT. & EXH.	YEARS	PART NO.	DESCRIPTION	
1	Int. Manifold Gasket Set	2003-00	MS 97094	Lower set	
1	Int. Manifold Gasket Set	1999	MS 97096		
1	Plenum Gasket Set	2003-00	MS 97199	Upper set; New Part Number - Check for Availability	
1	Exh. Manifold Gasket Set	2003-99	MS 97092		
QTY	EXHAUST PIPE FLANGE	YEARS	PART NO.	DESCRIPTION	
1	Exhaust Pipe Gasket	2003-99	61582	Turbo flange	
QTY	OIL PAN	YEARS	PART NO.	DESCRIPTION	
1	Oil Pan Gasket Set	2003-01	OS 30811		
1	Oil Pan Gasket Set	2000-99	OS 30809		
QTY	CRANKSHAFT REAR SEAL	YEARS	PART NO.	DESCRIPTION	
1	Rear Main Seal Set	2003-99	BS 40607	Rubber; One-piece	
QTY	VALVE COVER	YEARS	PART NO.	DESCRIPTION	
1	Valve Cover Gasket Set	2003-99	VS 50409 R	PermaDry® molded rubber gskt. incl.	
QTY	VALVE STEM SEAL SET	YEARS	PART NO.	DESCRIPTION	
1	Valve Stem Seal Set	2003-00	SS 72925	Premium valve stem seals incl.	
1	Valve Stem Seal Set	1999	SS 72682	Premium valve stem seals incl.; Improved design	
QTY	THERMOSTAT HOUSING	YEARS	PART NO.	DESCRIPTION	
1	Water Outlet Gasket	2003-99	25565	Thermostat Housing	
QTY	WATER OUTLET GASKET	YEARS	PART NO.	DESCRIPTION	
1	Water Outlet Gasket	2003-99	36047	Water Outlet; Water inlet pipe to water pump housing; New Part Number - Check for Availability	
2	Water Outlet Gasket	2003-99	36048	Water Outlet; Water inlet pipe from water pump housing; New Part Number - Check for Availability	
QTY	WATER PUMP	YEARS	PART NO.	DESCRIPTION	
1	Water Pump Gasket	2003-99	35914		

Saab Car (Cont.)

4		2003 - 1999; 2.0L 121.1 (1985cc) DOHC L4 (16 Valve) 90mm Bore			4	
(cont.)		MFI; Gasoline; Turbo - Intercooled Saab Eng.; Eng. Code B205R			(cont.)	
QTY	TIMING COVER	YEARS	PART NO.	DESCRIPTION		
1	Crankshaft Front Seal Set	2003-99	TCS 46125			
QTY	CARB & FUEL INJECTION	YEARS	PART NO.	DESCRIPTION		
2	Fuel Injector O-Ring Set	2003-99	ES 70599	Improved design		
1	Throttle Body Gasket	2003-99	61185	Loc. Lower		
1	Throttle Body Gasket	2003-99	61616	Loc. Upper		
QTY	OIL PUMP COVER	YEARS	PART NO.	DESCRIPTION		
1	Oil Pump Gasket	2003-99	72470	Oil pump cover; New Part Number - Check for Availability		
1	Oil Pump Gasket	2003-99	72981	Oil pump mounting seal; New Part Number - Check for Availability		
5		2005; 2.0L 121.7 (1994cc) DOHC H4 (16 Valve) 92mm Bore			5	
		MFI; Gasoline; Turbo - Intercooled Subaru Eng.; Eng. Code EJ205				
QTY	CYLINDER HEAD	YEARS	PART NO.	DESCRIPTION		
2	Head Gasket	2005	26537 PT	Head bolts not incl.; Head bolt replacement required; PermaTorqueMLS®; New Part Number - Check for Availability		
1	Head Set	2005	HS 26537 PT	Head bolts not incl.; Head bolt replacement required; PermaDry® molded rubber valve cover gskts. incl.; Premium valve stem seals incl.; New Part Number - Check for Availability		
QTY	CONVERSION SET	YEARS	PART NO.	DESCRIPTION		
1	Gasket Conversion Set	2005	CS 26170			
QTY	MANIFOLD - INT. & EXH.	YEARS	PART NO.	DESCRIPTION		
1	Int. Manifold Gasket Set	2005	MS 96523	Lower set; Upper set incl.		
1	Exh. Manifold Gasket Set	2005	MS 95088			
QTY	EXHAUST PIPE FLANGE	YEARS	PART NO.	DESCRIPTION		
2	Exhaust Pipe Gasket	2005	60957	Crossover		
1	Exhaust Pipe Gasket	2005	61106	Loc. Front; Exh. connector; 2.40" ID		
1	Exhaust Pipe Gasket	2005	61365	Loc. Front; Converter		
1	Exhaust Pipe Gasket	2005	61366	Loc. Rear; Converter		
1	Exhaust Pipe Gasket	2005	61668	Loc. Rear; Exh. connector		
QTY	OIL PAN	YEARS	PART NO.	DESCRIPTION		
1	Oil Pan Gasket Set	2005	OS 30656 C			
QTY	CRANKSHAFT REAR SEAL	YEARS	PART NO.	DESCRIPTION		
1	Rear Main Seal Set	2005	BS 40666	Rubber; One-piece; Improved design		
QTY	VALVE COVER	YEARS	PART NO.	DESCRIPTION		
1	Valve Cover Gasket Set	2005	VS 50799 R	w/Grommets & Spark plug tube seals; PermaDry® molded rubber gskts. incl.; New Part Number - Check for Availability		
QTY	VALVE STEM SEAL SET	YEARS	PART NO.	DESCRIPTION		
1	Valve Stem Seal Set	2005	SS 72814	Premium valve stem seals incl.		
QTY	WATER OUTLET GASKET	YEARS	PART NO.	DESCRIPTION		
2	Water Outlet Gasket	2005	36024	Water Outlet; Water crossover O-ring; New Part Number - Check for Availability		
1	O-Ring	2005	35524	Water Outlet; Water outlet		
QTY	WATER PUMP	YEARS	PART NO.	DESCRIPTION		
1	Water Pump Gasket	2005	35747	Improved design		
QTY	TIMING COVER	YEARS	PART NO.	DESCRIPTION		
1	Crankshaft Front Seal Set	2005	TCS 46009			
2	Camshaft Front Seal Set	2005	TCS 46150	New Part Number - Check for Availability		
QTY	CARB & FUEL INJECTION	YEARS	PART NO.	DESCRIPTION		
1	Throttle Body Gasket	2005	61670	Throttle body		
1	Throttle Body Gasket	2005	73001	Idle air control; New Part Number - Check for Availability		
QTY	TURBO MOUNTING SET	YEARS	PART NO.	DESCRIPTION		
1	Turbo Mtg. Gasket Set	2005	ES 72745	New Part Number - Check for Availability		
6		2005; 2.0L 121.7 (1994cc) DOHC H4 (16 Valve) 92mm Bore			6	
		MFI; Gasoline; Turbo - Intercooled Subaru Eng.; Eng. Code EJ20T				
QTY	CYLINDER HEAD	YEARS	PART NO.	DESCRIPTION		
2	Head Gasket	2005	26537 PT	Head bolts not incl.; Head bolt replacement required; PermaTorqueMLS®; New Part Number - Check for Availability		
1	Head Set	2005	HS 26537 PT	Head bolts not incl.; Head bolt replacement required; PermaDry® molded rubber valve cover gskts. incl.; Premium valve stem seals incl.; New Part Number - Check for Availability		
QTY	CONVERSION SET	YEARS	PART NO.	DESCRIPTION		
1	Gasket Conversion Set	2005	CS 26170			
QTY	MANIFOLD - INT. & EXH.	YEARS	PART NO.	DESCRIPTION		
1	Int. Manifold Gasket Set	2005	MS 96523	Lower set; Upper set incl.		

6		2005; 2.0L 121.7 (1994cc) DOHC H4 (16 Valve) 92mm Bore			6	
(cont.)		MFI; Gasoline; Turbo - Intercooled Subaru Eng.; Eng. Code EJ20T			(cont.)	
QTY	MANIFOLD - INT. & EXH.	YEARS	PART NO.	DESCRIPTION		
1	Exh. Manifold Gasket Set	2005	MS 95088			
QTY	EXHAUST PIPE FLANGE	YEARS	PART NO.	DESCRIPTION		
2	Exhaust Pipe Gasket	2005	60957	Crossover		
1	Exhaust Pipe Gasket	2005	61106	Loc. Front; Exh. connector; 2.40" ID		
1	Exhaust Pipe Gasket	2005	61365	Loc. Front; Converter		
1	Exhaust Pipe Gasket	2005	61366	Loc. Rear; Converter		
1	Exhaust Pipe Gasket	2005	61668	Loc. Rear; Exh. connector		
QTY	OIL PAN	YEARS	PART NO.	DESCRIPTION		
1	Oil Pan Gasket Set	2005	OS 30656 C			
QTY	CRANKSHAFT REAR SEAL	YEARS	PART NO.	DESCRIPTION		
1	Rear Main Seal Set	2005	BS 40666	Rubber; One-piece; Improved design		
QTY	VALVE COVER	YEARS	PART NO.	DESCRIPTION		
1	Valve Cover Gasket Set	2005	VS 50799 R	w/Grommets & Spark plug tube seals; PermaDry® molded rubber gskts. incl.; New Part Number - Check for Availability		
QTY	VALVE STEM SEAL SET	YEARS	PART NO.	DESCRIPTION		
1	Valve Stem Seal Set	2005	SS 72814	Premium valve stem seals incl.		
QTY	WATER OUTLET GASKET	YEARS	PART NO.	DESCRIPTION		
2	Water Outlet Gasket	2005	36024	Water Outlet; Water crossover O-ring; New Part Number - Check for Availability		
1	O-Ring	2005	35524	Water Outlet; Water outlet		
QTY	WATER PUMP	YEARS	PART NO.	DESCRIPTION		
1	Water Pump Gasket	2005	35747	Improved design		
QTY	TIMING COVER	YEARS	PART NO.	DESCRIPTION		
1	Crankshaft Front Seal Set	2005	TCS 46009			
2	Camshaft Front Seal Set	2005	TCS 46150	New Part Number - Check for Availability		
QTY	CARB & FUEL INJECTION	YEARS	PART NO.	DESCRIPTION		
1	Throttle Body Gasket	2005	61670	Throttle body		
1	Throttle Body Gasket	2005	73001	Idle air control; New Part Number - Check for Availability		
QTY	TURBO MOUNTING SET	YEARS	PART NO.	DESCRIPTION		
1	Turbo Mtg. Gasket Set	2005	ES 72745	New Part Number - Check for Availability		
7		2005 - 2003; 2.0L 122 (1998cc) DOHC L4 (16 Valve) 86mm Bore			7	
		MFI; Gasoline; Turbo - Intercooled Opel Eng.; Eng. Code B207L				
QTY	CYLINDER HEAD	YEARS	PART NO.	DESCRIPTION		
1	Head Gasket	2005-03	26584 PT	Head bolts not incl.; Head bolt replacement recommended; PermaTorqueMLS®; New Part Number - Check for Availability		
QTY	MANIFOLD - INT. & EXH.	YEARS	PART NO.	DESCRIPTION		
1	Int. Manifold Gasket Set	2005-03	MS 97127			
1	Exh. Manifold Gasket Set	2005-03	MS 97128	w/Secondary Air Injection Pump		
1	Exh. Manifold Gasket Set	2005-03	MS 97268	w/o Secondary Air Injection Pump; New Part Number - Check for Availability		
QTY	VALVE COVER	YEARS	PART NO.	DESCRIPTION		
1	Valve Cover Gasket Set	2005-03	VS 50772 R	w/Grommets & Spark plug tube seals; PermaDry® molded rubber gskt. incl.; New Part Number - Check for Availability		
QTY	VALVE STEM SEAL SET	YEARS	PART NO.	DESCRIPTION		
1	Valve Stem Seal Set	2005-03	SS 71198	Premium valve stem seals incl.		
QTY	TIMING COVER	YEARS	PART NO.	DESCRIPTION		
1	Timing Cover Set	2005-03	TCS 46041			
1	Crankshaft Front Seal Set	2005-03	TCS 46112			
8		2012 - 2003; 2.0L 122 (1998cc) DOHC L4 (16 Valve) 86mm Bore			8	
		MFI; Gasoline; Turbo - Intercooled Opel Eng.; Eng. Code B207R				
QTY	CYLINDER HEAD	YEARS	PART NO.	DESCRIPTION		
1	Head Gasket	2012-03	26584 PT	Head bolts not incl.; Head bolt replacement recommended; PermaTorqueMLS®; New Part Number - Check for Availability		
QTY	MANIFOLD - INT. & EXH.	YEARS	PART NO.	DESCRIPTION		
1	Int. Manifold Gasket Set	2012-03	MS 97127			
1	Exh. Manifold Gasket Set	2012-03	MS 97128	w/Secondary Air Injection Pump		
1	Exh. Manifold Gasket Set	2012-03	MS 97268	w/o Secondary Air Injection Pump; New Part Number - Check for Availability		
QTY	VALVE COVER	YEARS	PART NO.	DESCRIPTION		
1	Valve Cover Gasket Set	2012-03	VS 50772 R	w/Grommets & Spark plug tube seals; PermaDry® molded rubber gskt. incl.; New Part Number - Check for Availability		
QTY	VALVE STEM SEAL SET	YEARS	PART NO.	DESCRIPTION		
1	Valve Stem Seal Set	2012-03	SS 71198	Premium valve stem seals incl.		

Saab Car (Cont.)

8 (cont.)	2012 - 2003; 2.0L 122 (1998cc) DOHC L4 (16 Valve) 86mm Bore MFI; Gasoline; Turbo - Intercooled Opel Eng.; Eng. Code B207R			8 (cont.)
QTY	TIMING COVER	YEARS	PART NO.	DESCRIPTION
1	Timing Cover Set	2012-03	TCS 46041	
1	Crankshaft Front Seal Set	2012-03	TCS 46112	
9	1998 - 1995; 2.3L 139.7 (2290cc) DOHC L4 (16 Valve) 90mm Bore MFI; Gasoline; Turbo - Intercooled Saab Eng.; Eng. Code B234E			9
QTY	OIL PAN	YEARS	PART NO.	DESCRIPTION
1	Oil Pan Gasket Set	1998-95	OS 30860	New Part Number - Check for Availability
10	1998 - 1991; 2.3L 139.7 (2290cc) DOHC L4 (16 Valve) 90mm Bore MFI; Gasoline; Naturally Aspirated Saab Eng.; Eng. Code B234I			10
QTY	OIL PAN	YEARS	PART NO.	DESCRIPTION
1	Oil Pan Gasket Set	1998-91	OS 30860	New Part Number - Check for Availability
11	1998 - 1991; 2.3L 139.7 (2290cc) DOHC L4 (16 Valve) 90mm Bore MFI; Gasoline; Turbo - Intercooled Saab Eng.; Eng. Code B234L			11
QTY	OIL PAN	YEARS	PART NO.	DESCRIPTION
1	Oil Pan Gasket Set	1998-91	OS 30860	New Part Number - Check for Availability
12	1998 - 1993; 2.3L 139.7 (2290cc) DOHC L4 (16 Valve) 90mm Bore MFI; Gasoline; Turbo - Intercooled Saab Eng.; Eng. Code B234R			12
QTY	OIL PAN	YEARS	PART NO.	DESCRIPTION
1	Oil Pan Gasket Set	1998-93	OS 30860	New Part Number - Check for Availability
13	2005 - 1999; 2.3L 139.7 (2290cc) DOHC L4 (16 Valve) 90mm Bore MFI; Gasoline; Turbo - Intercooled Saab Eng.; Eng. Code B235E			13
QTY	CYLINDER HEAD	YEARS	PART NO.	DESCRIPTION
1	Head Gasket	2005-99	26428 PT	Head bolts not incl.; Head bolt replacement recommended; PermaTorqueMLS®
1	Head Set	2005-99	HS 26428 PT	Head bolts not incl.; Head bolt replacement recommended; PermaDry® molded rubber valve cover gskt. incl.; Premium valve stem seals incl.
QTY	CONVERSION SET	YEARS	PART NO.	DESCRIPTION
1	Gasket Conversion Set	2005-99	CS 26431	
QTY	MANIFOLD - INT. & EXH.	YEARS	PART NO.	DESCRIPTION
1	Int. Manifold Gasket Set	2005-99	MS 97094	Lower set
1	Int. Manifold Gasket Set	2005-99	MS 97308	Lower set; OEM style; New Part Number - Check for Availability
1	Plenum Gasket Set	2005-99	MS 97199	Upper set; New Part Number - Check for Availability
1	Exh. Manifold Gasket Set	2005-99	MS 97092	
QTY	EXHAUST PIPE FLANGE	YEARS	PART NO.	DESCRIPTION
1	Exhaust Pipe Gasket	2005-99	61582	Turbo flange
QTY	OIL PAN	YEARS	PART NO.	DESCRIPTION
1	Oil Pan Gasket Set	2005-99	OS 30809	
QTY	CRANKSHAFT REAR SEAL	YEARS	PART NO.	DESCRIPTION
1	Rear Main Seal Set	2005-99	BS 40607	Rubber; One-piece
QTY	VALVE COVER	YEARS	PART NO.	DESCRIPTION
1	Valve Cover Gasket Set	2005-99	VS 50409 R	PermaDry® molded rubber gskt. incl.
QTY	VALVE STEM SEAL SET	YEARS	PART NO.	DESCRIPTION
1	Valve Stem Seal Set	2005-99	SS 72925	Premium valve stem seals incl.
QTY	THERMOSTAT HOUSING	YEARS	PART NO.	DESCRIPTION
1	Water Outlet Gasket	2005-99	25565	Thermostat Housing
QTY	WATER OUTLET GASKET	YEARS	PART NO.	DESCRIPTION
1	Water Outlet Gasket	2005-99	36047	Water Outlet; Water inlet pipe to water pump housing; New Part Number - Check for Availability
2	Water Outlet Gasket	2005-99	36048	Water Outlet; Water inlet pipe from water pump housing; New Part Number - Check for Availability
QTY	WATER PUMP	YEARS	PART NO.	DESCRIPTION
1	Water Pump Gasket	2005-99	35914	
QTY	TIMING COVER	YEARS	PART NO.	DESCRIPTION
1	Crankshaft Front Seal Set	2005-99	TCS 46125	
QTY	CARB & FUEL INJECTION	YEARS	PART NO.	DESCRIPTION
2	Fuel Injector O-Ring Set	2005-99	ES 70599	Improved design
1	Throttle Body Gasket	2005-99	61185	Loc. Lower
1	Throttle Body Gasket	2005-99	61616	Loc. Upper
1	Throttle Body Gasket	2005-99	61675	Mounting; New Part Number - Check for Availability

13		2005 - 1999; 2.3L 139.7 (2290cc) DOHC L4 (16 Valve) 90mm Bore			13	
(cont.)		MFI; Gasoline; Turbo - Intercooled Saab Eng.; Eng. Code B235E			(cont.)	
QTY	OIL PUMP COVER	YEARS	PART NO.	DESCRIPTION		
1	Oil Pump Gasket	2005-99	72470	Oil pump cover; New Part Number - Check for Availability		
1	Oil Pump Gasket	2005-99	72981	Oil pump mounting seal; New Part Number - Check for Availability		
14		2010 - 2006; 2.3L 139.7 (2290cc) DOHC L4 (16 Valve) 90mm Bore			14	
		MFI; Gasoline; Turbo - Intercooled Saab Eng.; Eng. Code B235L				
QTY	CYLINDER HEAD	YEARS	PART NO.	DESCRIPTION		
1	Head Gasket	2010-06	26428 PT	Head bolts not incl.; Head bolt replacement recommended; PermaTorqueMLS®		
1	Head Set	2010-06	HS 26428 PT	Head bolts not incl.; Head bolt replacement recommended; PermaDry® molded rubber valve cover gskt. incl.; Premium valve stem seals incl.		
QTY	CONVERSION SET	YEARS	PART NO.	DESCRIPTION		
1	Gasket Conversion Set	2010-06	CS 26431			
QTY	MANIFOLD - INT. & EXH.	YEARS	PART NO.	DESCRIPTION		
1	Int. Manifold Gasket Set	2010-06	MS 97094	Lower set		
1	Int. Manifold Gasket Set	2010-06	MS 97308	Lower set; OEM style; New Part Number - Check for Availability		
1	Plenum Gasket Set	2010-06	MS 97199	Upper set; New Part Number - Check for Availability		
1	Exh. Manifold Gasket Set	2010-06	MS 97092			
QTY	EXHAUST PIPE FLANGE	YEARS	PART NO.	DESCRIPTION		
1	Exhaust Pipe Gasket	2010-06	61582	Turbo flange		
QTY	OIL PAN	YEARS	PART NO.	DESCRIPTION		
1	Oil Pan Gasket Set	2010-06	OS 30809			
QTY	CRANKSHAFT REAR SEAL	YEARS	PART NO.	DESCRIPTION		
1	Rear Main Seal Set	2010-06	BS 40607	Rubber; One-piece		
QTY	VALVE COVER	YEARS	PART NO.	DESCRIPTION		
1	Valve Cover Gasket Set	2010-06	VS 50409 R	PermaDry® molded rubber gskt. incl.		
QTY	VALVE STEM SEAL SET	YEARS	PART NO.	DESCRIPTION		
1	Valve Stem Seal Set	2010-06	SS 72925	Premium valve stem seals incl.		
QTY	THERMOSTAT HOUSING	YEARS	PART NO.	DESCRIPTION		
1	Water Outlet Gasket	2010-06	25565	Thermostat Housing		
QTY	WATER OUTLET GASKET	YEARS	PART NO.	DESCRIPTION		
1	Water Outlet Gasket	2010-06	36047	Water Outlet; Water inlet pipe to water pump housing; New Part Number - Check for Availability		
2	Water Outlet Gasket	2010-06	36048	Water Outlet; Water inlet pipe from water pump housing; New Part Number - Check for Availability		
QTY	WATER PUMP	YEARS	PART NO.	DESCRIPTION		
1	Water Pump Gasket	2010-06	35914			
QTY	TIMING COVER	YEARS	PART NO.	DESCRIPTION		
1	Crankshaft Front Seal Set	2010-06	TCS 46125			
QTY	CARB & FUEL INJECTION	YEARS	PART NO.	DESCRIPTION		
2	Fuel Injector O-Ring Set	2010-06	ES 70599	Improved design		
1	Throttle Body Gasket	2010-06	61185	Loc. Lower		
1	Throttle Body Gasket	2010-06	61616	Loc. Upper		
1	Throttle Body Gasket	2010-06	61675	Mounting; New Part Number - Check for Availability		
QTY	OIL PUMP COVER	YEARS	PART NO.	DESCRIPTION		
1	Oil Pump Gasket	2010-06	72470	Oil pump cover; New Part Number - Check for Availability		
1	Oil Pump Gasket	2010-06	72981	Oil pump mounting seal; New Part Number - Check for Availability		
15		2005 - 1999; 2.3L 139.7 (2290cc) DOHC L4 (16 Valve) 90mm Bore			15	
		MFI; Gasoline; Turbo - Intercooled Saab Eng.; Eng. Code B235R				
QTY	CYLINDER HEAD	YEARS	PART NO.	DESCRIPTION		
1	Head Gasket	2005-00	26428 PT	Head bolts not incl.; Head bolt replacement recommended; PermaTorqueMLS®		
1	Head Gasket	1999	26431 PT	Head bolts not incl.; Head bolt replacement recommended; PermaTorqueMLS®		
1	Head Set	2005-00	HS 26428 PT	Head bolts not incl.; Head bolt replacement recommended; PermaDry® molded rubber valve cover gskt. incl.; Premium valve stem seals incl.		
1	Head Set	1999	HS 26431 PT	Head bolts not incl.; Head bolt replacement recommended; PermaDry® molded rubber valve cover gskt. incl.; Premium valve stem seals incl.		
QTY	CONVERSION SET	YEARS	PART NO.	DESCRIPTION		
1	Gasket Conversion Set	2005-99	CS 26431			
QTY	MANIFOLD - INT. & EXH.	YEARS	PART NO.	DESCRIPTION		
1	Int. Manifold Gasket Set	2005-00	MS 97094	Lower set		
1	Int. Manifold Gasket Set	2005-00	MS 97308	Lower set; OEM style; New Part Number - Check for Availability		
1	Int. Manifold Gasket Set	1999	MS 97096			

Saab Car (Cont.)

15 (cont.)		2005 - 1999; 2.3L 139.7 (2290cc) DOHC L4 (16 Valve) 90mm Bore			15 (cont.)
		MFI; Gasoline; Turbo - Intercooled Saab Eng.; Eng. Code B235R			
QTY	MANIFOLD - INT. & EXH.	YEARS	PART NO.	DESCRIPTION	
1	Plenum Gasket Set	2005-00	MS 97199	Upper set; New Part Number - Check for Availability	
1	Exh. Manifold Gasket Set	2005-99	MS 97092		
QTY	EXHAUST PIPE FLANGE	YEARS	PART NO.	DESCRIPTION	
1	Exhaust Pipe Gasket	2005-99	61582	Turbo flange	
QTY	OIL PAN	YEARS	PART NO.	DESCRIPTION	
1	Oil Pan Gasket Set	2005-99	OS 30809		
QTY	CRANKSHAFT REAR SEAL	YEARS	PART NO.	DESCRIPTION	
1	Rear Main Seal Set	2005-99	BS 40607	Rubber; One-piece	
QTY	VALVE COVER	YEARS	PART NO.	DESCRIPTION	
1	Valve Cover Gasket Set	2005-99	VS 50409 R	PermaDry® molded rubber gskt. incl.	
QTY	VALVE STEM SEAL SET	YEARS	PART NO.	DESCRIPTION	
1	Valve Stem Seal Set	2005-00	SS 72925	Premium valve stem seals incl.	
1	Valve Stem Seal Set	1999	SS 72682	Premium valve stem seals incl.; Improved design	
QTY	THERMOSTAT HOUSING	YEARS	PART NO.	DESCRIPTION	
1	Water Outlet Gasket	2005-99	25565	Thermostat Housing	
QTY	WATER OUTLET GASKET	YEARS	PART NO.	DESCRIPTION	
1	Water Outlet Gasket	2005-99	36047	Water Outlet; Water inlet pipe to water pump housing; New Part Number - Check for Availability	
2	Water Outlet Gasket	2005-99	36048	Water Outlet; Water inlet pipe from water pump housing; New Part Number - Check for Availability	
QTY	WATER PUMP	YEARS	PART NO.	DESCRIPTION	
1	Water Pump Gasket	2005-99	35914		
QTY	TIMING COVER	YEARS	PART NO.	DESCRIPTION	
1	Crankshaft Front Seal Set	2005-99	TCS 46125		
QTY	CARB & FUEL INJECTION	YEARS	PART NO.	DESCRIPTION	
2	Fuel Injector O-Ring Set	2005-99	ES 70599	Improved design	
1	Throttle Body Gasket	2005-99	61185	Loc. Lower	
1	Throttle Body Gasket	2005-99	61616	Loc. Upper	
1	Throttle Body Gasket	2005-99	61675	Mounting; New Part Number - Check for Availability	
QTY	OIL PUMP COVER	YEARS	PART NO.	DESCRIPTION	
1	Oil Pump Gasket	2005-99	72470	Oil pump cover; New Part Number - Check for Availability	
1	Oil Pump Gasket	2005-99	72981	Oil pump mounting seal; New Part Number - Check for Availability	
16		2006; 2.5L 150 (2457cc) DOHC H4 (16 Valve) 99.5mm Bore			16
		MFI; Gasoline; Turbo - Intercooled Subaru Eng.; Eng. Code EJ255			
QTY	CYLINDER HEAD	YEARS	PART NO.	DESCRIPTION	
2	Head Gasket	2006	26531 PT	Head bolts not incl.; Head bolt replacement required; PermaTorqueMLS® LaserWeld® Technology; New Part Number - Check for Availability	
1	Head Set	2006	HS 26531 PT	Head bolts not incl.; Head bolt replacement required; PermaTorqueMLS® Improved design head gskts. incl.; PermaDry® molded rubber valve cover gskts. incl.; Premium valve stem seals incl.; New Part Number - Check for Availability	
2	Head Bolt Set	2006	ES 72905	Head bolts w/Washers; Replacement required	
QTY	CONVERSION SET	YEARS	PART NO.	DESCRIPTION	
1	Gasket Conversion Set	2006	CS 26170		
QTY	MANIFOLD - INT. & EXH.	YEARS	PART NO.	DESCRIPTION	
1	Int. Manifold Gasket Set	2006	MS 96523	Lower set; Upper set incl.	
1	Exh. Manifold Gasket Set	2006	MS 95088		
QTY	EXHAUST PIPE FLANGE	YEARS	PART NO.	DESCRIPTION	
1	Exhaust Pipe Gasket	2006	61365	Exh. connector	
1	Exhaust Pipe Gasket	2006	61365	Flange	
1	Exhaust Pipe Gasket	2006	61366	Converter	
QTY	OIL PAN	YEARS	PART NO.	DESCRIPTION	
1	Oil Pan Gasket Set	2006	OS 30656 C		
QTY	CRANKSHAFT REAR SEAL	YEARS	PART NO.	DESCRIPTION	
1	Rear Main Seal Set	2006	BS 40666	Rubber; One-piece; Improved design	
QTY	VALVE COVER	YEARS	PART NO.	DESCRIPTION	
1	Valve Cover Gasket Set	2006	VS 50620 R	w/Spark plug tube seals; PermaDry® molded rubber gskts. incl.	
2	Circular Plug	2006	ES 72418	Valve Cover; New Part Number - Check for Availability	
QTY	VALVE STEM SEAL SET	YEARS	PART NO.	DESCRIPTION	
1	Valve Stem Seal Set	2006	SS 72814	Premium valve stem seals incl.	

16 (cont.)		2006; 2.5L 150 (2457cc) DOHC H4 (16 Valve) 99.5mm Bore			16 (cont.)
MFI; Gasoline; Turbo - Intercooled Subaru Eng.; Eng. Code EJ255					
QTY	WATER OUTLET GASKET	YEARS	PART NO.	DESCRIPTION	
2	Water Outlet Gasket	2006	36024	Water Outlet; Water crossover O-ring; New Part Number - Check for Availability	
1	O-Ring	2006	35524	Water Outlet; Water outlet	
QTY	WATER PUMP	YEARS	PART NO.	DESCRIPTION	
1	Water Pump Gasket	2006	35747	Improved design	
QTY	TIMING COVER	YEARS	PART NO.	DESCRIPTION	
1	Crankshaft Front Seal Set	2006	TCS 46009		
2	Camshaft Front Seal Set	2006	TCS 46140	New Part Number - Check for Availability	
QTY	CARB & FUEL INJECTION	YEARS	PART NO.	DESCRIPTION	
1	Throttle Body Gasket	2006	61359		
QTY	EXHAUST GAS RECIRCULATION	YEARS	PART NO.	DESCRIPTION	
1	EGR Gasket	2006	71218		
QTY	TURBO MOUNTING SET	YEARS	PART NO.	DESCRIPTION	
1	Turbo Mtg. Gasket Set	2006	ES 72745	New Part Number - Check for Availability	
17		2005; 2.5L 150 (2457cc) SOHC H4 (16 Valve) 99.5mm Bore			17
MFI; Gasoline; Naturally Aspirated Subaru Eng.; Eng. Code EJ251					
QTY	CYLINDER HEAD	YEARS	PART NO.	DESCRIPTION	
2	Head Gasket	2005	26170 PT	Head bolts not incl.; Head bolt replacement required; PermaTorque®; Old design	
2	Head Gasket	2005	26415 PT	Head bolts not incl.; Head bolt replacement required; PermaTorqueMLS® LaserWeld® Technology; Improved design	
1	Head Set	2005	HS 26170 PT-1	Upper int. manifold gskts. & head bolts not incl.; California exh. manifold gskts. not incl.; Head bolt replacement required; PermaTorqueMLS® Improved design head gskts. incl.; PermaDry® molded rubber valve cover gskts. incl.; Premium valve stem seals inc	
2	Head Bolt Set	2005	ES 72212	Head bolts w/Washers; Replacement required	
QTY	CONVERSION SET	YEARS	PART NO.	DESCRIPTION	
1	Gasket Conversion Set	2005	CS 26170		
QTY	MANIFOLD - INT. & EXH.	YEARS	PART NO.	DESCRIPTION	
1	Int. Manifold Gasket Set	2005	MS 96106	Lower set	
1	Plenum Gasket Set	2005	MS 96746	California; Upper set	
1	Plenum Gasket Set	2005	MS 96747	Exc. California; Upper set	
1	Exh. Manifold Gasket Set	2005	MS 95088	Exc. California	
1	Exh. Manifold Gasket Set	2005	MS 97210	California; OEM style; New Part Number - Check for Availability	
QTY	OIL PAN	YEARS	PART NO.	DESCRIPTION	
1	Oil Pan Gasket Set	2005	OS 30656 C		
QTY	CRANKSHAFT REAR SEAL	YEARS	PART NO.	DESCRIPTION	
1	Rear Main Seal Set	2005	BS 40666	Rubber; One-piece; Improved design	
QTY	VALVE COVER	YEARS	PART NO.	DESCRIPTION	
1	Valve Cover Gasket Set	2005	VS 50561 R	w/Grommets & Spark plug tube seals; PermaDry® molded rubber gskts. incl.; Improved design	
1	Valve Cover Gasket Set	2005	VS 50561 R-1	w/Grommets & Spark plug tube seals; PermaDry® molded rubber gskts. incl.; Old design; Superseded - When depleted use VS 50561 R	
1	Circular Plug	2005	ES 72418	Valve Cover; New Part Number - Check for Availability	
QTY	VALVE STEM SEAL SET	YEARS	PART NO.	DESCRIPTION	
1	Valve Stem Seal Set	2005	SS 72814	Premium valve stem seals incl.	
QTY	WATER OUTLET GASKET	YEARS	PART NO.	DESCRIPTION	
2	Water Outlet Gasket	2005	36024	Water Outlet; Water crossover O-ring; New Part Number - Check for Availability	
1	O-Ring	2005	35524	Water Outlet; Water outlet	
QTY	WATER PUMP	YEARS	PART NO.	DESCRIPTION	
1	Water Pump Gasket	2005	35747	Improved design	
QTY	TIMING COVER	YEARS	PART NO.	DESCRIPTION	
1	Crankshaft Front Seal Set	2005	TCS 46009		
1	Camshaft Front Seal Set	2005	TCS 46008		
QTY	CARB & FUEL INJECTION	YEARS	PART NO.	DESCRIPTION	
1	Fuel Injector O-Ring Set	2005	ES 70599	Improved design	
1	Throttle Body Gasket	2005	61500		
QTY	EXHAUST GAS RECIRCULATION	YEARS	PART NO.	DESCRIPTION	
1	EGR Gasket	2005	71218		

Saab Car (Cont.)

18		2006 - 2005; 2.5L 150 (2457cc) SOHC H4 (16 Valve) 99.5mm Bore MFI; Gasoline; Naturally Aspirated Subaru Eng.; Eng. Code EJ253			18
QTY	CYLINDER HEAD	YEARS	PART NO.	DESCRIPTION	
2	Head Gasket	2006-05	26170 PT	Head bolts not incl.; Head bolt replacement required; PermaTorque®; Old design	
2	Head Gasket	2006-05	26415 PT	Head bolts not incl.; Head bolt replacement required; PermaTorqueMLS® LaserWeld® Technology; Improved design	
1	Head Set	2006	HS 26415 PT-1	California; Upper int. manifold gskts. & head bolts not incl.; Head bolt replacement required; PermaTorqueMLS® Improved design head gskts. incl.; PermaDry® molded rubber valve cover gskts. incl.; Premium valve stem seals incl.; New Part Number - Check for	
1	Head Set	2006	HS 26415 PT-1	Exc. California; Head bolts not incl.; Head bolt replacement required; PermaTorqueMLS® Improved design head gskts. incl.; PermaDry® molded rubber valve cover gskts. incl.; Premium valve stem seals incl.; New Part Number - Check for Availability	
1	Head Set	2005	HS 26170 PT-1	Upper int. manifold gskts. & head bolts not incl.; California exh. manifold gskts. not incl.; Head bolt replacement required; PermaTorqueMLS® Improved design head gskts. incl.; PermaDry® molded rubber valve cover gskts. incl.; Premium valve stem seals inc	
2	Head Bolt Set	2006-05	ES 72212	Head bolts w/Washers; Replacement required	
QTY	CONVERSION SET	YEARS	PART NO.	DESCRIPTION	
1	Gasket Conversion Set	2006-05	CS 26170		
QTY	MANIFOLD - INT. & EXH.	YEARS	PART NO.	DESCRIPTION	
1	Int. Manifold Gasket Set	2006-05	MS 96106	Lower set	
1	Plenum Gasket Set	2006-05	MS 96746	California; Upper set	
1	Plenum Gasket Set	2006-05	MS 96747	Exc. California; Upper set	
1	Exh. Manifold Gasket Set	2006	MS 95088		
1	Exh. Manifold Gasket Set	2005	MS 95088	Exc. California	
1	Exh. Manifold Gasket Set	2005	MS 97210	California; OEM style; New Part Number - Check for Availability	
QTY	EXHAUST PIPE FLANGE	YEARS	PART NO.	DESCRIPTION	
2	Exhaust Pipe Gasket	2006	60992	Converter to manifold	
2	Exhaust Pipe Gasket	2006	61106	Converter; 2.40" ID	
1	Exhaust Pipe Gasket	2006	61106	Exh. connector; 2.40" ID	
QTY	OIL PAN	YEARS	PART NO.	DESCRIPTION	
1	Oil Pan Gasket Set	2006-05	OS 30656 C		
QTY	CRANKSHAFT REAR SEAL	YEARS	PART NO.	DESCRIPTION	
1	Rear Main Seal Set	2006-05	BS 40666	Rubber; One-piece; Improved design	
QTY	VALVE COVER	YEARS	PART NO.	DESCRIPTION	
1	Valve Cover Gasket Set	2006	VS 50780 R	w/Spark plug tube seals; PermaDry® molded rubber gskts. incl.; New Part Number - Check for Availability	
1	Valve Cover Gasket Set	2005	VS 50561 R	w/Grommets & Spark plug tube seals; PermaDry® molded rubber gskts. incl.; Improved design	
1	Valve Cover Gasket Set	2005	VS 50561 R-1	w/Grommets & Spark plug tube seals; PermaDry® molded rubber gskts. incl.; Old design; Superseded - When depleted use VS 50561 R	
1	Circular Plug	2006-05	ES 72418	Valve Cover; New Part Number - Check for Availability	
QTY	VALVE STEM SEAL SET	YEARS	PART NO.	DESCRIPTION	
1	Valve Stem Seal Set	2006-05	SS 72814	Premium valve stem seals incl.	
QTY	WATER OUTLET GASKET	YEARS	PART NO.	DESCRIPTION	
2	Water Outlet Gasket	2006-05	36024	Water Outlet; Water crossover O-ring; New Part Number - Check for Availability	
1	O-Ring	2006-05	35524	Water Outlet; Water outlet	
QTY	WATER PUMP	YEARS	PART NO.	DESCRIPTION	
1	Water Pump Gasket	2006-05	35747	Improved design	
QTY	TIMING COVER	YEARS	PART NO.	DESCRIPTION	
1	Crankshaft Front Seal Set	2006-05	TCS 46009		
1	Camshaft Front Seal Set	2006-05	TCS 46008		
QTY	CARB & FUEL INJECTION	YEARS	PART NO.	DESCRIPTION	
1	Fuel Injector O-Ring Set	2006-05	ES 70599	Improved design	
1	Throttle Body Gasket	2006-05	61500		
QTY	EXHAUST GAS RECIRCULATION	YEARS	PART NO.	DESCRIPTION	
1	EGR Gasket	2006-05	71218		
19		1997 - 1994; 2.5L 152 (2498cc) DOHC V6 (24 Valve) 81.6mm Bore MFI; Gasoline; Naturally Aspirated Opel Eng.; Eng. Code B2581			19
QTY	CYLINDER HEAD	YEARS	PART NO.	DESCRIPTION	
2	Head Gasket	1997-94	26649 PT	Head bolts not incl.; Head bolt replacement recommended; New Part Number - Check for Availability	

19 (cont.)		1997 - 1994; 2.5L 152 (2498cc) DOHC V6 (24 Valve) 81.6mm Bore MFI; Gasoline; Naturally Aspirated Opel Eng.; Eng. Code B258I			19 (cont.)
QTY	MANIFOLD - INT. & EXH.	YEARS	PART NO.	DESCRIPTION	
1	Int. Manifold Gasket Set	1997-94	MS 97304	Lower set; New Part Number - Check for Availability	
20		2010 - 2006; 2.8L 171 (2792cc) DOHC V6 (24 Valve) 89mm Bore MFI; Gasoline; Turbo - Intercooled Opel Eng.; Eng. Code B284L			20
QTY	CYLINDER HEAD	YEARS	PART NO.	DESCRIPTION	
2	Head Bolt Set	2010-06	ES 72274	Replacement recommended	
QTY	CONVERSION SET	YEARS	PART NO.	DESCRIPTION	
1	Gasket Conversion Set	2010-06	CS 26376-1	RTV sealant incl. for oil pan gskt.; Improved design	
QTY	MANIFOLD - INT. & EXH.	YEARS	PART NO.	DESCRIPTION	
1	Int. Manifold Gasket Set	2010-06	MS 96969	Lower set; Upper set incl.	
1	Plenum Gasket Set	2010-06	MS 96976	Upper set	
QTY	CRANKSHAFT REAR SEAL	YEARS	PART NO.	DESCRIPTION	
1	Rear Main Seal Set	2010-06	BS 40711	PTFE Rubber; One-piece; Improved design	
QTY	VALVE COVER	YEARS	PART NO.	DESCRIPTION	
1	Valve Cover Gasket Set	2010-06	VS 50726 R	w/o Spark plug tube seals & w/Grommets; PermaDry® molded rubber gskts. incl.	
1	Spark Plug Tube Seal Set	2010-06	ES 72393	Valve Cover; New Part Number - Check for Availability	
QTY	VALVE STEM SEAL SET	YEARS	PART NO.	DESCRIPTION	
1	Valve Stem Seal Set	2010-06	SS 72923	Premium valve stem seals incl.	
QTY	THERMOSTAT HOUSING	YEARS	PART NO.	DESCRIPTION	
1	Thermostat Gasket	2010-06	35858	Thermostat Housing; Thermostat seal	
1	Thermostat Gasket	2010-06	35871	Thermostat Housing; Thermostat housing to head	
QTY	WATER PUMP	YEARS	PART NO.	DESCRIPTION	
1	Water Pump Gasket	2010-06	35859		
QTY	TIMING COVER	YEARS	PART NO.	DESCRIPTION	
1	Timing Cover Set	2010-06	TCS 46108		
QTY	CARB & FUEL INJECTION	YEARS	PART NO.	DESCRIPTION	
2	Fuel Injector O-Ring Set	2010-06	ES 70599	Upper set; Injectors to fuel rail; Improved design	
2	Fuel Injector O-Ring Set	2010-06	ES 72004	Lower set; Injectors to cylinder head	
21		2012 - 2008; 2.8L 171 (2792cc) DOHC V6 (24 Valve) 89mm Bore MFI; Gasoline; Turbo - Intercooled Opel Eng.; Eng. Code B284R			21
QTY	CYLINDER HEAD	YEARS	PART NO.	DESCRIPTION	
2	Head Bolt Set	2012-08	ES 72274	Replacement recommended	
QTY	CONVERSION SET	YEARS	PART NO.	DESCRIPTION	
1	Gasket Conversion Set	2012-08	CS 26376-1	RTV sealant incl. for oil pan gskt.; Improved design	
QTY	MANIFOLD - INT. & EXH.	YEARS	PART NO.	DESCRIPTION	
1	Int. Manifold Gasket Set	2012-08	MS 96969	Lower set; Upper set incl.	
1	Plenum Gasket Set	2012-08	MS 96976	Upper set	
QTY	CRANKSHAFT REAR SEAL	YEARS	PART NO.	DESCRIPTION	
1	Rear Main Seal Set	2012-08	BS 40711	PTFE Rubber; One-piece; Improved design	
QTY	VALVE COVER	YEARS	PART NO.	DESCRIPTION	
1	Valve Cover Gasket Set	2012-08	VS 50726 R	w/o Spark plug tube seals & w/Grommets; PermaDry® molded rubber gskts. incl.	
1	Spark Plug Tube Seal Set	2012-08	ES 72393	Valve Cover; New Part Number - Check for Availability	
QTY	VALVE STEM SEAL SET	YEARS	PART NO.	DESCRIPTION	
1	Valve Stem Seal Set	2012-08	SS 72923	Premium valve stem seals incl.	
QTY	THERMOSTAT HOUSING	YEARS	PART NO.	DESCRIPTION	
1	Thermostat Gasket	2012-08	35858	Thermostat Housing; Thermostat seal	
1	Thermostat Gasket	2012-08	35871	Thermostat Housing; Thermostat housing to head	
QTY	WATER PUMP	YEARS	PART NO.	DESCRIPTION	
1	Water Pump Gasket	2012-08	35859		
QTY	TIMING COVER	YEARS	PART NO.	DESCRIPTION	
1	Timing Cover Set	2012-08	TCS 46108		
QTY	CARB & FUEL INJECTION	YEARS	PART NO.	DESCRIPTION	
2	Fuel Injector O-Ring Set	2012-08	ES 70599	Upper set; Injectors to fuel rail; Improved design	
2	Fuel Injector O-Ring Set	2012-08	ES 72004	Lower set; Injectors to cylinder head	
22		2004 - 1999; 3.0L 181 (2962cc) DOHC V6 (24 Valve) 86mm Bore MFI; Gasoline; Turbo - Intercooled Opel Eng.; Eng. Code B308E			22
QTY	CYLINDER HEAD	YEARS	PART NO.	DESCRIPTION	
2	Head Gasket	2004-01	26173 PT	Head bolts not incl.; Head bolt replacement recommended; PermaTorqueMLS® LaserWeld® Technology	

Saab Car (Cont.)

22 (cont.)		2004 - 1999; 3.0L 181 (2962cc) DOHC V6 (24 Valve) 86mm Bore MFI; Gasoline; Turbo - Intercooled Opel Eng.; Eng. Code B308E			22 (cont.)
QTY	CYLINDER HEAD	YEARS	PART NO.	DESCRIPTION	
2	Head Gasket	2000-99	26189 PT	Head bolts not incl.; Head bolt replacement recommended	
1	Head Set	2004-01	HS 26173 PT-2	Head bolts not incl.; Head bolt replacement recommended; PermaDry® molded rubber valve cover gskts. incl.; Premium valve stem seals incl.	
1	Head Set	2000-99	HS 26189 PT-1	Head bolts not incl.; Head bolt replacement recommended; PermaDry® molded rubber valve cover gskts. incl.; Premium valve stem seals incl.	
2	Head Bolt Set	2004-99	ES 72906	Head bolts w/Washers; Replacement recommended	
QTY	CONVERSION SET	YEARS	PART NO.	DESCRIPTION	
1	Gasket Conversion Set	2004-99	CS 26173-2	PermaDry® molded rubber oil pan gskt. incl.	
QTY	MANIFOLD - INT. & EXH.	YEARS	PART NO.	DESCRIPTION	
1	Int. Manifold Gasket Set	2004-99	MS 96103-1	Lower set; Upper set incl.	
1	Plenum Gasket Set	2004-99	MS 96091	Upper set	
1	Exh. Manifold Gasket Set	2004-01	MS 96090		
1	Exh. Manifold Gasket Set	2000-99	MS 96088-1		
QTY	EXHAUST PIPE FLANGE	YEARS	PART NO.	DESCRIPTION	
2	Exhaust Pipe Gasket	2004-99	61206	Pipe to manifold	
QTY	OIL PAN	YEARS	PART NO.	DESCRIPTION	
1	Oil Pan Gasket Set	2004-99	OS 30723 R	PermaDry® molded rubber gskt. incl.	
QTY	CRANKSHAFT REAR SEAL	YEARS	PART NO.	DESCRIPTION	
1	Rear Main Seal Set	2004-99	BS 40671	Rubber; One-piece; Improved design	
1	Rear Main Seal Set	2004-99	BS 40739	Rubber; One-piece; New Improved design; New Part Number - Check for Availability	
QTY	VALVE COVER	YEARS	PART NO.	DESCRIPTION	
1	Valve Cover Gasket Set	2004-99	VS 50567 R	w/o Spark plug tube seals & w/Grommets; PermaDry® molded rubber gskts. incl.	
1	Spark Plug Tube Seal Set	2004-99	ES 71205	Valve Cover	
QTY	VALVE STEM SEAL SET	YEARS	PART NO.	DESCRIPTION	
1	Valve Stem Seal Set	2004-99	SS 71163	Premium valve stem seals incl.	
QTY	THERMOSTAT HOUSING	YEARS	PART NO.	DESCRIPTION	
1	O-Ring	2004-99	35669	Thermostat Housing	
QTY	WATER PUMP	YEARS	PART NO.	DESCRIPTION	
1	Water Pump Gasket	2004-99	35665	O-ring	
QTY	TIMING COVER	YEARS	PART NO.	DESCRIPTION	
1	Crankshaft Front Seal Set	2004-99	TCS 46014		
4	Camshaft Front Seal Set	2004-99	TCS 45603		
QTY	CARB & FUEL INJECTION	YEARS	PART NO.	DESCRIPTION	
1	Throttle Body Gasket	2004-99	61185		
23		2000 - 1995; 3.0L 181 (2962cc) DOHC V6 (24 Valve) 86mm Bore MFI; Gasoline; Naturally Aspirated Opel Eng.; Eng. Code B308I			23
QTY	CYLINDER HEAD	YEARS	PART NO.	DESCRIPTION	
2	Head Gasket	2000-99	26189 PT	Head bolts not incl.; Head bolt replacement recommended	
2	Head Gasket	1997-95	26189 PT	Head bolts not incl.; Head bolt replacement recommended	
1	Head Set	2000-99	HS 26189 PT-1	Head bolts not incl.; Head bolt replacement recommended; PermaDry® molded rubber valve cover gskts. incl.; Premium valve stem seals incl.	
1	Head Set	1997-95	HS 26189 PT	Head bolts not incl.; Head bolt replacement recommended; PermaDry® molded rubber valve cover gskts. incl.; Premium valve stem seals incl.	
2	Head Bolt Set	2000-99	ES 72906	Head bolts w/Washers; Replacement recommended	
2	Head Bolt Set	1997-95	ES 72906	Head bolts w/Washers; Replacement recommended	
QTY	CONVERSION SET	YEARS	PART NO.	DESCRIPTION	
1	Gasket Conversion Set	2000-99	CS 26173-2	PermaDry® molded rubber oil pan gskt. incl.	
1	Gasket Conversion Set	1997-95	CS 26173-1		
QTY	MANIFOLD - INT. & EXH.	YEARS	PART NO.	DESCRIPTION	
1	Int. Manifold Gasket Set	2000-99	MS 96103-1	Lower set; Upper set incl.	
1	Int. Manifold Gasket Set	1997-95	MS 96103	Lower set; Upper set incl.	
1	Plenum Gasket Set	2000-99	MS 96091	Upper set	
1	Plenum Gasket Set	1997-95	MS 96062	Upper set	
1	Exh. Manifold Gasket Set	2000-99	MS 96088-1		
1	Exh. Manifold Gasket Set	1997-95	MS 96088		
QTY	EXHAUST PIPE FLANGE	YEARS	PART NO.	DESCRIPTION	
2	Exhaust Pipe Gasket	2000-99	61206	Pipe to manifold	
2	Exhaust Pipe Gasket	1997-95	61199	Pipe to manifold	
QTY	OIL PAN	YEARS	PART NO.	DESCRIPTION	
1	Oil Pan Gasket Set	2000-99	OS 30723 R	PermaDry® molded rubber gskt. incl.	

23 (cont.)		2000 - 1995; 3.0L 181 (2962cc) DOHC V6 (24 Valve) 86mm Bore MFI; Gasoline; Naturally Aspirated Opel Eng.; Eng. Code B308I			23 (cont.)
QTY	OIL PAN	YEARS	PART NO.	DESCRIPTION	
1	Oil Pan Gasket Set	1997-95	OS 30721 C	Cork	
QTY	CRANKSHAFT REAR SEAL	YEARS	PART NO.	DESCRIPTION	
1	Rear Main Seal Set	2000-99	BS 40671	Rubber; One-piece; Improved design	
1	Rear Main Seal Set	2000-99	BS 40739	Rubber; One-piece; New Improved design; New Part Number - Check for Availability	
1	Rear Main Seal Set	1997-95	BS 40671	Rubber; One-piece; Improved design	
1	Rear Main Seal Set	1997-95	BS 40739	Rubber; One-piece; New Improved design; New Part Number - Check for Availability	
QTY	VALVE COVER	YEARS	PART NO.	DESCRIPTION	
1	Valve Cover Gasket Set	2000-99	VS 50567 R	w/o Spark plug tube seals & w/Grommets; PermaDry® molded rubber gskts. incl.	
1	Valve Cover Gasket Set	1997-95	VS 50566 R	w/o Spark plug tube seals & w/Grommets; PermaDry® molded rubber gskts. incl.	
1	Spark Plug Tube Seal Set	2000-99	ES 71205	Valve Cover	
1	Spark Plug Tube Seal Set	1997-95	ES 71205	Valve Cover	
QTY	VALVE STEM SEAL SET	YEARS	PART NO.	DESCRIPTION	
1	Valve Stem Seal Set	2000-99	SS 71163	Premium valve stem seals incl.	
1	Valve Stem Seal Set	1997-95	SS 71163	Premium valve stem seals incl.	
QTY	THERMOSTAT HOUSING	YEARS	PART NO.	DESCRIPTION	
1	O-Ring	2000-99	35669	Thermostat Housing	
1	O-Ring	1997-95	35669	Thermostat Housing	
QTY	WATER PUMP	YEARS	PART NO.	DESCRIPTION	
1	Water Pump Gasket	2000-99	35665	O-ring	
1	Water Pump Gasket	1997-95	35665	O-ring	
QTY	TIMING COVER	YEARS	PART NO.	DESCRIPTION	
1	Crankshaft Front Seal Set	2000-99	TCS 46014		
1	Crankshaft Front Seal Set	1997-95	TCS 46014		
4	Camshaft Front Seal Set	2000-99	TCS 45603		
4	Camshaft Front Seal Set	1997-95	TCS 45603		
QTY	CARB & FUEL INJECTION	YEARS	PART NO.	DESCRIPTION	
1	Throttle Body Gasket	2000-99	61185		
2	Throttle Body Gasket	1997-95	61184		

**Saab SUV's - See Saab Truck
Saab Truck (Incl. SUV's)**

Engine Finding Index					
Engine	Years	Code	Line No.		
2.8L 171 (2792cc) DOHC V6 (24 Valve) 89mm Bore; MFI; Gasoline; Turbo - Intercooled Opel Eng.	2012-11	B284R	1		
3.0L 182.9 (2997cc) DOHC V6 (24 Valve) 89mm Bore VVT; DI; Gasoline; Naturally Aspirated Opel Eng.	2012-11	B304I	2		
4.2L 254 (4160cc) DOHC L6 (24 Valve) 93mm Bore Vortec; MFI; Gasoline; Naturally Aspirated GMC Eng.; Chevrolet	2009-05	S	3		
5.3L 325 (5328cc) OHV V8 (16 Valve) 96mm Bore Vortec; MFI; Gasoline; Naturally Aspirated GMC Eng.; Chevrolet	2009-05	M	4		
6.0L 364 (5967cc) OHV V8 (16 Valve) 101.6mm Bore Vortec LS-2; MFI; Gasoline; Naturally Aspirated GMC Eng.; Chevrolet	2009-08	H	5		
Engine Code Index					
Code	Engine	Line No.			
B284R	2.8L 171 (2792cc) DOHC V6 (24 Valve) 89mm Bore; MFI; Gasoline; Turbo - Intercooled Opel Eng.	1			
B304I	3.0L 182.9 (2997cc) DOHC V6 (24 Valve) 89mm Bore VVT; DI; Gasoline; Naturally Aspirated Opel Eng.	2			
Model Index					
Engine (VIN Code / Eng. Code)	Year	Engine (VIN Code / Eng. Code)	Year	Engine (VIN Code / Eng. Code)	Year
Saab Truck		Saab Truck (cont.)			
9-4X (AWD Mid-Size SUV)		9-7X (AWD Mid-Size SUV)			
V6 2792cc 2.8L DOHC Turbo (24 Valve) (B284R)	12-11	L6 4160cc 4.2L DOHC (24 Valve) (S)	09-05		
		V8 5328cc 5.3L OHV (M)	09-05		
V6 2997cc 3.0L DOHC (24 Valve) (B304E)	12-11	V8 5967cc 6.0L OHV (H)	09-08		
1		2012 - 2011; 2.8L 171 (2792cc) DOHC V6 (24 Valve) 89mm Bore MFI; Gasoline; Turbo - Intercooled Opel Eng.; Eng. Code B284R			1
QTY	CYLINDER HEAD	YEARS	PART NO.	DESCRIPTION	
2	Head Bolt Set	2012-11	ES 72274	Replacement recommended	
QTY	CONVERSION SET	YEARS	PART NO.	DESCRIPTION	
1	Gasket Conversion Set	2012-11	CS 26376-1	RTV sealant incl. for oil pan gskt.; Improved design	
QTY	MANIFOLD - INT. & EXH.	YEARS	PART NO.	DESCRIPTION	
1	Int. Manifold Gasket Set	2012-11	MS 96969	Lower set; Upper set incl.	

Saab Truck (Incl. SUV's) (Cont.)

1		2012 - 2011; 2.8L 171 (2792cc) DOHC V6 (24 Valve) 89mm Bore MFI; Gasoline; Turbo - Intercooled Opel Eng.; Eng. Code B284R			1
(cont.)					(cont.)
QTY	MANIFOLD - INT. & EXH.	YEARS	PART NO.	DESCRIPTION	
1	Plenum Gasket Set	2012-11	MS 96976	Upper set	
1	Exh. Manifold Gasket Set	2012-11	MS 96970		
QTY	EXHAUST PIPE FLANGE	YEARS	PART NO.	DESCRIPTION	
2	Exhaust Pipe Gasket	2012-11	61615	Pipe to manifold	
2	Exhaust Pipe Gasket	2012-11	61636	Converter	
QTY	CRANKSHAFT REAR SEAL	YEARS	PART NO.	DESCRIPTION	
1	Rear Main Seal Set	2012-11	BS 40711	PTFE Rubber; One-piece; Improved design	
QTY	VALVE COVER	YEARS	PART NO.	DESCRIPTION	
1	Valve Cover Gasket Set	2012-11	VS 50726 R	w/o Spark plug tube seals & w/Grommets; PermaDry® molded rubber gsks. incl.	
1	Spark Plug Tube Seal Set	2012-11	ES 72393	Valve Cover; New Part Number - Check for Availability	
QTY	VALVE STEM SEAL SET	YEARS	PART NO.	DESCRIPTION	
1	Valve Stem Seal Set	2012-11	SS 72923	Premium valve stem seals incl.	
QTY	THERMOSTAT HOUSING	YEARS	PART NO.	DESCRIPTION	
1	Thermostat Gasket	2012-11	35858	Thermostat Housing; Thermostat seal	
1	Thermostat Gasket	2012-11	35871	Thermostat Housing; Thermostat housing to head	
QTY	WATER PUMP	YEARS	PART NO.	DESCRIPTION	
1	Water Pump Gasket	2012-11	35859		
QTY	TIMING COVER	YEARS	PART NO.	DESCRIPTION	
1	Timing Cover Set	2012-11	TCS 46108		
QTY	CARB & FUEL INJECTION	YEARS	PART NO.	DESCRIPTION	
2	Fuel Injector O-Ring Set	2012-11	ES 70599	Upper set; Injectors to fuel rail; Improved design	
2	Fuel Injector O-Ring Set	2012-11	ES 72004	Lower set; Injectors to cylinder head	
1	Throttle Body Gasket	2012-11	61520		
2		2012 - 2011; 3.0L 182.9 (2997cc) DOHC V6 (24 Valve) 89mm Bore VVT DI; Gasoline; Naturally Aspirated Opel Eng.; Eng. Code B304I			2
QTY	CYLINDER HEAD	YEARS	PART NO.	DESCRIPTION	
2	Head Bolt Set	2012-11	ES 72274	Replacement recommended	
QTY	CONVERSION SET	YEARS	PART NO.	DESCRIPTION	
1	Gasket Conversion Set	2012-11	CS 26376-1	RTV sealant incl. for oil pan gskt.; Improved design	
QTY	EXHAUST PIPE FLANGE	YEARS	PART NO.	DESCRIPTION	
1	Exhaust Pipe Gasket	2012-11	61465	Loc. Rear; Converter	
1	Exhaust Pipe Gasket	2012-11	61708	Loc. Front; Converter; New Part Number - Check for Availability	
QTY	OIL PAN	YEARS	PART NO.	DESCRIPTION	
1	Drain Plug Gasket	2012-11	70820		
QTY	CRANKSHAFT REAR SEAL	YEARS	PART NO.	DESCRIPTION	
1	Rear Main Seal Set	2012-11	BS 40711	PTFE Rubber; One-piece; Improved design	
QTY	VALVE COVER	YEARS	PART NO.	DESCRIPTION	
1	Valve Cover Gasket Set	2012-11	VS 50808 R	w/Grommets & Spark plug tube seals; PermaDry® molded rubber gsks. incl.; New Part Number - Check for Availability	
1	Spark Plug Tube Seal Set	2012-11	ES 72393	Valve Cover; New Part Number - Check for Availability	
QTY	THERMOSTAT HOUSING	YEARS	PART NO.	DESCRIPTION	
1	Thermostat Gasket	2012-11	35858	Thermostat Housing; Thermostat seal	
1	Thermostat Gasket	2012-11	35871	Thermostat Housing; Thermostat housing to head	
QTY	WATER PUMP	YEARS	PART NO.	DESCRIPTION	
1	Water Pump Gasket	2012-11	35859		
QTY	TIMING COVER	YEARS	PART NO.	DESCRIPTION	
1	Timing Cover Set	2012-11	TCS 46108		
QTY	CARB & FUEL INJECTION	YEARS	PART NO.	DESCRIPTION	
2	Fuel Injector O-Ring Set	2012-11	ES 70599	Upper set; Injectors to fuel rail; Improved design	
2	Fuel Injector O-Ring Set	2012-11	ES 72004	Lower set; Injectors to cylinder head	
1	Throttle Body Gasket	2012-11	61699	New Part Number - Check for Availability	
3		2009 - 2005; 4.2L 254 (4160cc) DOHC L6 (24 Valve) 93mm Bore Vortec MFI; Gasoline; Naturally Aspirated GMC Eng.; Chevrolet; VIN Code S			3
QTY	CYLINDER HEAD	YEARS	PART NO.	DESCRIPTION	
1	Head Gasket	2009-05	26214 PT	Head bolts not incl.; Head bolt replacement recommended; PermaTorqueMLS®; Improved design	
1	Head Set	2009-06	HS 26214 PT-2	Head bolts not incl.; Head bolt replacement recommended; PermaDry® molded rubber valve cover gskt. incl.; Premium valve stem seals incl.	

Saab Truck (Incl. SUV's) (Cont.)

3 (cont.)		2009 - 2005; 4.2L 254 (4160cc) DOHC L6 (24 Valve) 93mm Bore Vortec			3 (cont.)
		MFI; Gasoline; Naturally Aspirated GMC Eng.; Chevrolet; VIN Code S			
QTY	CYLINDER HEAD	YEARS	PART NO.	DESCRIPTION	
1	Head Set	2005	HS 26214 PT-1	Head bolts not incl.; Head bolt replacement recommended; PermaDry® molded rubber valve cover gskt. incl.; Premium valve stem seals incl.	
1	Head Bolt Set	2009-05	ES 71334	Head bolts w/Washers; Replacement recommended; Improved design	
1	Head Bolt Set	2009-05	ES 72195	Head bolts w/Washers; Replacement recommended; Old design	
QTY	CONVERSION SET	YEARS	PART NO.	DESCRIPTION	
1	Gasket Conversion Set	2009-05	CS 26213-1	2nd Design; Balancer w/step on hub; RTV sealant incl. for oil pan gskt.	
1	Gasket Conversion Set	2005	CS 26213	1st Design; Balancer w/o step on hub; RTV sealant incl. for oil pan gskt.	
QTY	MANIFOLD - INT. & EXH.	YEARS	PART NO.	DESCRIPTION	
1	Int. Manifold Gasket Set	2009-05	MS 96440		
1	Exh. Manifold Gasket Set	2009-06	MS 96707		
1	Exh. Manifold Gasket Set	2005	MS 96302		
QTY	EXHAUST PIPE FLANGE	YEARS	PART NO.	DESCRIPTION	
1	Exhaust Pipe Gasket	2009-05	61255	Flange	
QTY	CRANKSHAFT REAR SEAL	YEARS	PART NO.	DESCRIPTION	
1	Rear Main Seal Set	2009-05	BS 40678	PTFE Rubber; One-piece	
QTY	VALVE COVER	YEARS	PART NO.	DESCRIPTION	
1	Valve Cover Gasket Set	2009-06	VS 50667 R	w/Grommets & Spark plug tube seals; Must be used w/MS 96440; PermaDry® molded rubber gskt. incl.	
1	Valve Cover Gasket Set	2005	VS 50584 R	w/Grommets & Spark plug tube seals; Must be used w/MS 96440; PermaDry® molded rubber gskt. incl.	
QTY	VALVE STEM SEAL SET	YEARS	PART NO.	DESCRIPTION	
1	Valve Stem Seal Set	2009-06	SS 71237	Premium valve stem seals incl.	
1	Valve Stem Seal Set	2005	SS 71043-1	Premium valve stem seals incl.	
QTY	THERMOSTAT HOUSING	YEARS	PART NO.	DESCRIPTION	
1	Thermostat Gasket	2009-05	35632	Thermostat Housing; Thermostat O-ring	
QTY	WATER OUTLET GASKET	YEARS	PART NO.	DESCRIPTION	
1	Water Outlet Gasket	2009-06	36017	Water Outlet; Coolant outlet seal; New Part Number - Check for Availability	
1	Water Outlet Gasket	2005	36009	Water Outlet; Coolant outlet seal; New Part Number - Check for Availability	
QTY	WATER PUMP	YEARS	PART NO.	DESCRIPTION	
1	Water Pump Gasket	2009-05	35704		
QTY	TIMING COVER	YEARS	PART NO.	DESCRIPTION	
1	Timing Cover Set	2009-05	TCS 45052	2nd Design; Balancer w/step on hub	
1	Timing Cover Set	2005	TCS 45051	1st Design; Balancer w/o step on hub	
QTY	CARB & FUEL INJECTION	YEARS	PART NO.	DESCRIPTION	
2	Fuel Injector O-Ring Set	2009-05	ES 70599	Upper set; Injectors to fuel rail; Improved design	
2	Fuel Injector O-Ring Set	2009-05	ES 71190	Lower set; Injectors to cylinder head	
2	Fuel Injector O-Ring Set	2009-05	ES 71192	Upper set; Injectors to fuel rail; Old design	
1	Throttle Body Gasket	2009-05	61337	Improved design	
QTY	EXHAUST GAS RECIRCULATION	YEARS	PART NO.	DESCRIPTION	
1	EGR Gasket	2009-05	72755	EGR tube; New Part Number - Check for Availability	
4		2009 - 2005; 5.3L 325 (5328cc) OHV V8 (16 Valve) 96mm Bore Vortec			4
		MFI; Gasoline; Naturally Aspirated GMC Eng.; Chevrolet; VIN Code M			
QTY	CYLINDER HEAD	YEARS	PART NO.	DESCRIPTION	
2	Head Gasket	2009-05	26190 PT	Head bolts not incl.; Head bolt replacement recommended; PermaTorqueMLS® LaserWeld® Technology	
1	Head Set	2009-05	HS 26190 PT-2	Head bolts not incl.; Head bolt replacement recommended; When servicing Displacement-On-Demand solenoids use w/Lifter valley cover set MS 96871; PermaDryPlus® int. manifold gskts. incl.; PermaDry® molded rubber valve cover gskts. incl.; Premium valve stem	
2	Head Bolt Set	2009-05	ES 72220	Replacement recommended	
QTY	CONVERSION SET	YEARS	PART NO.	DESCRIPTION	
1	Gasket Conversion Set	2009-05	CS 9284	PermaDry® molded rubber oil pan gskt. incl.	
QTY	MANIFOLD - INT. & EXH.	YEARS	PART NO.	DESCRIPTION	
1	Int. Manifold Gasket Set	2009-05	MS 96587		
1	Int. Manifold Gasket Set	2009-05	MS 96857	Lifter valley cover set; Perimeter seal only	
1	Int. Manifold Gasket Set	2009-05	MS 96871	Lifter valley cover set; For use when servicing Displacement-On-Demand solenoids	
1	Int. Manifold Gasket Set	2009-05	MS 98016 T	PermaDryPlus® int. manifold gskts. incl.	
1	Exh. Manifold Gasket Set	2009-05	MS 92467		
QTY	EXHAUST PIPE FLANGE	YEARS	PART NO.	DESCRIPTION	
1	Exhaust Pipe Gasket	2009-05	61074	Loc. L.H.; Pipe to manifold	
1	Exhaust Pipe Gasket	2009-05	61089	Loc. R.H.; Pipe to manifold	

Saab Truck (Incl. SUV's) (Cont.)

4		2009 - 2005; 5.3L 325 (5328cc) OHV V8 (16 Valve) 96mm Bore Vortec			4	
(cont.)		MFI; Gasoline; Naturally Aspirated GMC Eng.; Chevrolet; VIN Code M			(cont.)	
QTY	OIL PAN	YEARS	PART NO.	DESCRIPTION		
1	Oil Pan Gasket Set	2009-05	OS 30693 R	PermaDry® molded rubber gskt. incl.		
QTY	CRANKSHAFT REAR SEAL	YEARS	PART NO.	DESCRIPTION		
1	Rear Main Seal Set	2009-05	BS 40640	PTFE Rubber; One-piece		
1	Repair Sleeve	2009-05	16228	Crankshaft; Narrow lip; .780" sleeve length; Requires crankshaft machining due to clearance issues; Use w/installation tool		
1	Repair Sleeve	2009-05	16229	Crankshaft; Wide lip; 1.156" sleeve length; Requires crankshaft machining due to clearance issues; Use w/installation tool		
1	Repair Sleeve Tool	2009-05	16329	Crankshaft		
QTY	VALVE COVER	YEARS	PART NO.	DESCRIPTION		
1	Valve Cover Gasket Set	2009-05	VS 50504 R	w/o Grommets; PermaDry® molded rubber gskts. incl.		
1	Valve Cover Gasket Set	2009-05	VS 50504 R-1	w/Grommets; PermaDry® molded rubber gskts. incl.; New Part Number - Check for Availability		
1	Grommet Set	2009-05	ES 72233	Valve Cover		
QTY	VALVE STEM SEAL SET	YEARS	PART NO.	DESCRIPTION		
1	Valve Stem Seal Set	2009-05	SS 71039	Premium valve stem seals incl.		
QTY	THERMOSTAT HOUSING	YEARS	PART NO.	DESCRIPTION		
1	O-Ring	2009-05	35720	Thermostat Housing		
QTY	WATER PUMP	YEARS	PART NO.	DESCRIPTION		
2	Water Pump Gasket	2009-05	35635			
1	O-Ring	2009-05	35633	Water Pump		
1	Water Pump Mounting Set	2009-05	ES 73010	Mounting gasket set; New Part Number - Check for Availability		
QTY	TIMING COVER	YEARS	PART NO.	DESCRIPTION		
1	Timing Cover Set	2009-05	TCS 45993	Must be used w/OS 30693R		
QTY	CARB & FUEL INJECTION	YEARS	PART NO.	DESCRIPTION		
2	Fuel Injector O-Ring Set	2009-05	ES 70599	Upper set; Injectors to fuel rail; Improved design		
2	Fuel Injector O-Ring Set	2009-05	ES 71190	Lower set; Injectors to cylinder head		
2	Fuel Injector O-Ring Set	2009-05	ES 71192	Upper set; Injectors to fuel rail; Old design		
1	Throttle Body Gasket	2009-06	61469			
1	Throttle Body Gasket	2005	61454			
QTY	EXHAUST GAS RECIRCULATION	YEARS	PART NO.	DESCRIPTION		
1	EGR Gasket	2009-05	70895	Pipe; O-ring		
1	EGR Gasket	2009-05	70914	Valve		
1	EGR Gasket	2009-05	70947	Pipe		
QTY	OIL FILTER MOUNTING	YEARS	PART NO.	DESCRIPTION		
1	Oil Cooler Gasket	2009-05	72462	Oil Filter; Center tube; Dual round port		
QTY	OIL PUMP COVER	YEARS	PART NO.	DESCRIPTION		
1	O-Ring	2009-05	72401	Oil Pump; Inlet tube		
QTY	OIL COOLER	YEARS	PART NO.	DESCRIPTION		
1	Oil Cooler Gasket	2009-05	72435	Oval port		
1	Oil Cooler Gasket	2009-05	72462	Dual round port		
5		2009 - 2008; 6.0L 364 (5967cc) OHV V8 (16 Valve) 101.6mm Bore Vortec LS-2			5	
(cont.)		MFI; Gasoline; Naturally Aspirated GMC Eng.; Chevrolet; VIN Code H			(cont.)	
QTY	CYLINDER HEAD	YEARS	PART NO.	DESCRIPTION		
2	Head Gasket	2009-08	26192 PT	Head bolts not incl.; Head bolt replacement recommended; PermaTorqueMLS® LaserWeld® Technology		
1	Head Set	2009-08	HS 26192 PT-4	Head bolts not incl.; Head bolt replacement recommended; PermaDryPlus® int. manifold gskts. incl.; PermaDry® molded rubber valve cover gskts. incl.; Premium valve stem seals incl.		
2	Head Bolt Set	2009-08	ES 72220	Replacement recommended		
QTY	CONVERSION SET	YEARS	PART NO.	DESCRIPTION		
1	Gasket Conversion Set	2009-08	CS 9284	PermaDry® molded rubber oil pan gskt. incl.		
QTY	MANIFOLD - INT. & EXH.	YEARS	PART NO.	DESCRIPTION		
1	Int. Manifold Gasket Set	2009-08	MS 96169	Lifter valley cover set		
1	Int. Manifold Gasket Set	2009-08	MS 96587			
1	Int. Manifold Gasket Set	2009-08	MS 98016 T	PermaDryPlus® int. manifold gskts. incl.		
1	Exh. Manifold Gasket Set	2009-08	MS 92467			
QTY	EXHAUST PIPE FLANGE	YEARS	PART NO.	DESCRIPTION		
1	Exhaust Pipe Gasket	2009-08	61089	Loc. R.H.; Pipe to manifold		
1	Exhaust Pipe Gasket	2009-08	61287	Converter		
1	Exhaust Pipe Gasket	2009-08	61323	Loc. L.H.; Pipe to manifold		
QTY	OIL PAN	YEARS	PART NO.	DESCRIPTION		
1	Oil Pan Gasket Set	2009-08	OS 30693 R	PermaDry® molded rubber gskt. incl.		

Saab Truck (Incl. SUV's) (Cont.)

5				
2009 - 2008; 6.0L 364 (5967cc) OHV V8 (16 Valve) 101.6mm Bore Vortec LS-2				
MFI; Gasoline; Naturally Aspirated GMC Eng.; Chevrolet; VIN Code H				
5				(cont.)
QTY	CRANKSHAFT REAR SEAL	YEARS	PART NO.	DESCRIPTION
1	Rear Main Seal Set	2009-08	BS 40640	PTFE Rubber; One-piece
1	Repair Sleeve	2009-08	16228	Crankshaft; Narrow lip; .780" sleeve length; Requires crankshaft machining due to clearance issues; Use w/installation tool
1	Repair Sleeve	2009-08	16229	Crankshaft; Wide lip; 1.156" sleeve length; Requires crankshaft machining due to clearance issues; Use w/installation tool
1	Repair Sleeve Tool	2009-08	16329	Crankshaft
QTY	VALVE COVER	YEARS	PART NO.	DESCRIPTION
1	Valve Cover Gasket Set	2009-08	VS 50504 R	w/o Grommets; PermaDry® molded rubber gskts. incl.
1	Valve Cover Gasket Set	2009-08	VS 50504 R-1	w/Grommets; PermaDry® molded rubber gskts. incl.; New Part Number - Check for Availability
1	Grommet Set	2009-08	ES 72233	Valve Cover
QTY	VALVE STEM SEAL SET	YEARS	PART NO.	DESCRIPTION
1	Valve Stem Seal Set	2009-08	SS 71039	Premium valve stem seals incl.
QTY	THERMOSTAT HOUSING	YEARS	PART NO.	DESCRIPTION
1	O-Ring	2009-08	35720	Thermostat Housing
QTY	WATER PUMP	YEARS	PART NO.	DESCRIPTION
2	Water Pump Gasket	2009-08	35635	
1	O-Ring	2009-08	35633	Water Pump
1	Water Pump Mounting Set	2009-08	ES 73010	Mounting gasket set; New Part Number - Check for Availability
QTY	TIMING COVER	YEARS	PART NO.	DESCRIPTION
1	Timing Cover Set	2009-08	TCS 45993	Must be used w/OS 30693R
QTY	CARB & FUEL INJECTION	YEARS	PART NO.	DESCRIPTION
2	Fuel Injector O-Ring Set	2009-08	ES 70599	Upper set; Injectors to fuel rail; Improved design
2	Fuel Injector O-Ring Set	2009-08	ES 71190	Lower set; Injectors to cylinder head
2	Fuel Injector O-Ring Set	2009-08	ES 71192	Upper set; Injectors to fuel rail; Old design
1	Throttle Body Gasket	2009-08	61469	
QTY	EXHAUST GAS RECIRCULATION	YEARS	PART NO.	DESCRIPTION
1	EGR Gasket	2009-08	70895	Pipe; O-ring
1	EGR Gasket	2009-08	70914	Valve
1	EGR Gasket	2009-08	70947	Pipe
QTY	OIL FILTER MOUNTING	YEARS	PART NO.	DESCRIPTION
1	Oil Cooler Gasket	2009-08	72462	Oil Filter; Center tube; Dual round port
QTY	OIL PUMP COVER	YEARS	PART NO.	DESCRIPTION
1	O-Ring	2009-08	72401	Oil Pump; Inlet tube
QTY	OIL COOLER	YEARS	PART NO.	DESCRIPTION
1	Oil Cooler Gasket	2009-08	72435	Oval port
1	Oil Cooler Gasket	2009-08	72462	Dual round port

Saturn Car - See GM Car
Saturn Minivans - See GMC Truck
Saturn SUV's - See GMC Truck
Scion Car - See Toyota Car
Shelby - See AC Cobra
Smart Car - See Mercedes-Benz Car
Sterling

Engine Finding Index					
Engine	Years	Code	Line No.		
2.7L 163.2 (2675cc) SOHC V6 (24 Valve) 87mm Bore; MFI; Gasoline; Naturally Aspirated Honda Eng.	1991	C27A1	1		
Engine Code Index					
Code	Engine	Line No.			
C27A1	2.7L 163.2 (2675cc) SOHC V6 (24 Valve) 87mm Bore; MFI; Gasoline; Naturally Aspirated Honda Eng.	1			
Model Index					
Engine (VIN Code / Eng. Code)	Year	Engine (VIN Code / Eng. Code)	Year	Engine (VIN Code / Eng. Code)	Year
Sterling		Sterling (cont.)		Sterling (cont.)	
		825		827	
		V6 2494cc 2.5L SOHC (24 Valve) (C25A1)	88-87	V6 2675cc 2.7L SOHC (24 Valve) (C27A1)	91-89

Sterling (Cont.)

1		1991; 2.7L 163.2 (2675cc) SOHC V6 (24 Valve) 87mm Bore MFI; Gasoline; Naturally Aspirated Honda Eng.; Eng. Code C27A1			1
QTY	CYLINDER HEAD	YEARS	PART NO.	DESCRIPTION	
2	Head Gasket	1991	9531 PT		
1	Head Set	1991	HS 9531 PT	PermaDry® molded rubber valve cover gskts. incl.; Premium valve stem seals incl.	
QTY	CONVERSION SET	YEARS	PART NO.	DESCRIPTION	
1	Gasket Conversion Set	1991	CS 9450	PermaDry® molded rubber oil pan gskt. incl.	
QTY	MANIFOLD - INT. & EXH.	YEARS	PART NO.	DESCRIPTION	
1	Int. Manifold Gasket Set	1991	MS 93770	Upper set incl.	
1	Exh. Manifold Gasket Set	1991	MS 93361		
QTY	EXHAUST PIPE FLANGE	YEARS	PART NO.	DESCRIPTION	
1	Exhaust Pipe Gasket	1991	23624	Loc. Front	
2	Exhaust Pipe Gasket	1991	60517	Converter	
1	Exhaust Pipe Gasket	1991	60578	Loc. Rear	
QTY	OIL PAN	YEARS	PART NO.	DESCRIPTION	
1	Oil Pan Gasket Set	1991	OS 30544 R	PermaDry® molded rubber gskt. incl.	
QTY	CRANKSHAFT REAR SEAL	YEARS	PART NO.	DESCRIPTION	
1	Rear Main Seal Set	1991	BS 40535	Rubber; One-piece; Improved design	
1	Repair Sleeve	1991	16275	Crankshaft; Use w/installation tool	
QTY	VALVE COVER	YEARS	PART NO.	DESCRIPTION	
1	Valve Cover Gasket Set	1991	VS 50299 R-1	w/o Circular plugs; PermaDry® molded rubber gskts. incl.	
2	Circular Plug	1991	CP 75015	Valve Cover	
QTY	THERMOSTAT HOUSING	YEARS	PART NO.	DESCRIPTION	
1	O-Ring	1991	35315	Thermostat Housing	
QTY	WATER PUMP	YEARS	PART NO.	DESCRIPTION	
1	Water Pump Gasket	1991	35372		
QTY	TIMING COVER	YEARS	PART NO.	DESCRIPTION	
1	Crankshaft Front Seal Set	1991	TCS 45703		
1	Camshaft Front Seal Set	1991	TCS 45704		
QTY	EXHAUST GAS RECIRCULATION	YEARS	PART NO.	DESCRIPTION	
1	EGR Gasket	1991	70978		

Subaru Car

Engine Finding Index				
Engine	Years	Code	Line No.	
1.2L 73 (1189cc) SOHC L3 (9 Valve) 78mm Bore; 2 Bbl.; Gasoline; Naturally Aspirated Subaru Eng.	1992-91	EF12	1	
1.2L 73 (1189cc) SOHC L3 (9 Valve) 78mm Bore; MFI; Gasoline; Naturally Aspirated Subaru Eng.	1994-91	EF12	2	
1.8L 109 (1781cc) SOHC H4 (8 Valve) 92mm Bore; MFI; Gasoline; Naturally Aspirated Subaru Eng.	1994-91	EA82	3	
1.8L 109 (1781cc) SOHC H4 (8 Valve) 92mm Bore; TBI; Gasoline; Naturally Aspirated Subaru Eng.	1994-91	EA82	4	
1.8L 111 (1820cc) SOHC H4 (16 Valve) 87.9mm Bore; MFI; Gasoline; Naturally Aspirated Subaru Eng.	1997-93	EJ18E	5	
2.0L 121.7 (1994cc) DOHC H4 (16 Valve) 92mm Bore; MFI; Gasoline; Turbo - Intercooled Subaru Eng.	2005-02	EJ205	6	
2.0L 121.7 (1994cc) DOHC H4 (16 Valve) 92mm Bore; MFI; Gasoline; Turbo - Intercooled Subaru Eng.	2005-02	EJ20T	7	
2.2L 135 (2212cc) SOHC H4 (16 Valve) 96.9mm Bore; MFI; Gasoline; Naturally Aspirated Subaru Eng.	2001-99	EJ222	8	
2.2L 135 (2212cc) SOHC H4 (16 Valve) 96.9mm Bore; MFI; Gasoline; Naturally Aspirated Subaru Eng.	2001-91	EJ22E	9	
2.2L 135 (2212cc) SOHC H4 (16 Valve) 96.9mm Bore; MFI; Gasoline; Naturally Aspirated Subaru Eng.	2001-97	EJ22EZ	10	
2.2L 135 (2212cc) SOHC H4 (16 Valve) 96.9mm Bore; MFI; Gasoline; Turbo Subaru Eng.	1995-91	EJ22T	11	
2.5L 150 (2457cc) DOHC H4 (16 Valve) 99.5mm Bore; MFI; Gasoline; Turbo - Intercooled Subaru Eng.	2013-05	EJ255	12	
2.5L 150 (2457cc) DOHC H4 (16 Valve) 99.5mm Bore; MFI; Gasoline; Turbo - Intercooled Subaru Eng.	2013-04	EJ257	13	
2.5L 150 (2457cc) DOHC H4 (16 Valve) 99.5mm Bore; MFI; Gasoline; Naturally Aspirated Subaru Eng.	1999-96	EJ25D	14	
2.5L 150 (2457cc) DOHC H4 (16 Valve) 99.5mm Bore; MFI; Gasoline; Turbo - Intercooled Subaru Eng.	2005-04	EJ25T	15	
2.5L 150 (2457cc) SOHC H4 (16 Valve) 99.5mm Bore; MFI; Gasoline; Naturally Aspirated Subaru Eng.	2005-99	EJ251	16	
2.5L 150 (2457cc) SOHC H4 (16 Valve) 99.5mm Bore; MFI; Gasoline; Naturally Aspirated Subaru Eng.	2000	EJ252	17	
2.5L 150 (2457cc) SOHC H4 (16 Valve) 99.5mm Bore; MFI; Gasoline; Naturally Aspirated Subaru Eng.	2012-99	EJ253	18	
2.5L 152.4 (2498cc) DOHC H4 (16 Valve) 94mm Bore VVT; MFI; Gasoline; Naturally Aspirated Subaru Eng.	2013	FB25BA	19	
2.5L 152.4 (2498cc) DOHC H4 (16 Valve) 94mm Bore VVT; MFI; Gasoline; Naturally Aspirated Subaru Eng.	2013	FB25BC	20	
2.7L 163 (2672cc) SOHC H6 (12 Valve) 92mm Bore; MFI; Gasoline; Naturally Aspirated Subaru Eng.	1991	ER27	21	
3.0L 183 (2999cc) DOHC H6 (24 Valve) 89.2mm Bore; MFI; Gasoline; Naturally Aspirated Subaru Eng.	2009-01	EZ30D	22	
3.3L 202.5 (3318cc) DOHC H6 (24 Valve) 96.9mm Bore; MFI; Gasoline; Naturally Aspirated Subaru Eng.	1997-92	EG33D	23	
3.6L 221.5 (3630cc) DOHC H6 (24 Valve) 92mm Bore AVCS; MFI; Gasoline; Naturally Aspirated Subaru Eng.	2013-10	EZ36D	24	

Engine Code Index		
Code	Engine	Line No.
EA82	1.8L 109 (1781cc) SOHC H4 (8 Valve) 92mm Bore; MFI; Gasoline; Naturally Aspirated Subaru Eng.	3
EA82	1.8L 109 (1781cc) SOHC H4 (8 Valve) 92mm Bore; TBI; Gasoline; Naturally Aspirated Subaru Eng.	4
EF12	1.2L 73 (1189cc) SOHC L3 (9 Valve) 78mm Bore; 2 Bbl.; Gasoline; Naturally Aspirated Subaru Eng.	1
EF12	1.2L 73 (1189cc) SOHC L3 (9 Valve) 78mm Bore; MFI; Gasoline; Naturally Aspirated Subaru Eng.	2
EG33D	3.3L 202.5 (3318cc) DOHC H6 (24 Valve) 96.9mm Bore; MFI; Gasoline; Naturally Aspirated Subaru Eng.	23
EJ18E	1.8L 111 (1820cc) SOHC H4 (16 Valve) 87.9mm Bore; MFI; Gasoline; Naturally Aspirated Subaru Eng.	5
EJ205	2.0L 121.7 (1994cc) DOHC H4 (16 Valve) 92mm Bore; MFI; Gasoline; Turbo - Intercooled Subaru Eng.	6
EJ20T	2.0L 121.7 (1994cc) DOHC H4 (16 Valve) 92mm Bore; MFI; Gasoline; Turbo - Intercooled Subaru Eng.	7
EJ222	2.2L 135 (2212cc) SOHC H4 (16 Valve) 96.9mm Bore; MFI; Gasoline; Naturally Aspirated Subaru Eng.	8
EJ22E	2.2L 135 (2212cc) SOHC H4 (16 Valve) 96.9mm Bore; MFI; Gasoline; Naturally Aspirated Subaru Eng.	9
EJ22EZ	2.2L 135 (2212cc) SOHC H4 (16 Valve) 96.9mm Bore; MFI; Gasoline; Naturally Aspirated Subaru Eng.	10
EJ22T	2.2L 135 (2212cc) SOHC H4 (16 Valve) 96.9mm Bore; MFI; Gasoline; Turbo Subaru Eng.	11
EJ251	2.5L 150 (2457cc) SOHC H4 (16 Valve) 99.5mm Bore; MFI; Gasoline; Naturally Aspirated Subaru Eng.	16
EJ252	2.5L 150 (2457cc) SOHC H4 (16 Valve) 99.5mm Bore; MFI; Gasoline; Naturally Aspirated Subaru Eng.	17
EJ253	2.5L 150 (2457cc) SOHC H4 (16 Valve) 99.5mm Bore; MFI; Gasoline; Naturally Aspirated Subaru Eng.	18
EJ255	2.5L 150 (2457cc) DOHC H4 (16 Valve) 99.5mm Bore; MFI; Gasoline; Turbo - Intercooled Subaru Eng.	12
EJ257	2.5L 150 (2457cc) DOHC H4 (16 Valve) 99.5mm Bore; MFI; Gasoline; Turbo - Intercooled Subaru Eng.	13
EJ25D	2.5L 150 (2457cc) DOHC H4 (16 Valve) 99.5mm Bore; MFI; Gasoline; Naturally Aspirated Subaru Eng.	14
EJ25T	2.5L 150 (2457cc) DOHC H4 (16 Valve) 99.5mm Bore; MFI; Gasoline; Turbo - Intercooled Subaru Eng.	15
ER27	2.7L 163 (2672cc) SOHC H6 (12 Valve) 92mm Bore; MFI; Gasoline; Naturally Aspirated Subaru Eng.	21
EZ30D	3.0L 183 (2999cc) DOHC H6 (24 Valve) 89.2mm Bore; MFI; Gasoline; Naturally Aspirated Subaru Eng.	22
EZ36D	3.6L 221.5 (3630cc) DOHC H6 (24 Valve) 92mm Bore AVCS; MFI; Gasoline; Naturally Aspirated Subaru Eng.	24
FB25BA	2.5L 152.4 (2498cc) DOHC H4 (16 Valve) 94mm Bore VVT; MFI; Gasoline; Naturally Aspirated Subaru Eng.	19
FB25BC	2.5L 152.4 (2498cc) DOHC H4 (16 Valve) 94mm Bore VVT; MFI; Gasoline; Naturally Aspirated Subaru Eng.	20

Model Index

Engine (VIN Code / Eng. Code)	Year	Engine (VIN Code / Eng. Code)	Year	Engine (VIN Code / Eng. Code)	Year
Subaru		Subaru (cont.)		Subaru (cont.)	
1600		GLF		Legacy 4WD (cont.)	
H4 1595cc 1.6L OHV (EA71)	88-76	H4 1595cc 1.6L OHV (EA71)	80	H4 2212cc 2.2L SOHC (16 Valve) (EJ22EZ)	99-97
H4 1595cc 1.6L OHV (EA71)	88-76	H4 1781cc 1.8L OHV (EA81)	82-80	H4 2212cc 2.2L SOHC Turbo (16 Valve) (EJ22T)	95-90
1800		Hatchback		H4 2457cc 2.5L DOHC (16 Valve) (EJ25D)	99-96
H4 1781cc 1.8L OHC Turbo (EA82T)	89-85	H4 1595cc 1.6L OHV (EA71)	88-77	H4 2457cc 2.5L DOHC Turbo (16 Valve) (EJ255)	12-05
H4 1781cc 1.8L OHV (EA81)	89-81	Impreza		H4 2457cc 2.5L DOHC Turbo (16 Valve) (EJ25T)	05
H4 1781cc 1.8L OHV Turbo (EA81T)	84-83	H4 1820cc 1.8L SOHC (16 Valve) (EJ18E)	97-93	H4 2457cc 2.5L SOHC (16 Valve) (EJ251)	04-00
H4 1781cc 1.8L OHC (EA82)	89-85	Impreza 4WD		H4 2457cc 2.5L SOHC (16 Valve) (EJ252)	00
H4 1781cc 1.8L OHC Turbo (EA82T)	89-85	H4 1820cc 1.8L SOHC (16 Valve) (EJ18E)	97-93	H4 2457cc 2.5L SOHC (16 Valve) (EJ253)	12-00
H4 1781cc 1.8L OHV (EA81)	84-81	H4 1995cc 2.0L DOHC (16 Valve) (FB20)	13-12	H4 2498cc 2.5L DOHC (16 Valve) (FB25BA)	13
H4 1781cc 1.8L OHV Turbo (EA81T)	84-83	H4 2212cc 2.2L SOHC (16 Valve) (EJ22E)	01-95	H4 2498cc 2.5L DOHC (16 Valve) (FB25BC)	13
BRZ		H4 2212cc 2.2L SOHC (16 Valve) (EJ22EZ)	01-97	H6 2999cc 3.0L DOHC (24 Valve) (EZ30D)	09-08
H4 1995cc 2.0L DOHC (16 Valve) (FA20)	13-12	H4 2457cc 2.5L DOHC (16 Valve) (EJ25D)	99-98	H6 3630cc 3.6L DOHC (24 Valve) (EZ36D)	13-10
DL		H4 2457cc 2.5L DOHC Turbo (16 Valve) (EJ255)	11-09	Loyale	
H4 1595cc 1.6L OHV (EA71)	84-76	H4 2457cc 2.5L SOHC (16 Valve) (EJ251)	05-99	H4 1781cc 1.8L OHC (EA82)	94-90
H4 1781cc 1.8L OHC (EA82)	88-85	H4 2457cc 2.5L SOHC (16 Valve) (EJ252)	00	H4 1781cc 1.8L OHC Turbo (EA82T)	90
H4 1781cc 1.8L OHV (EA81)	84-80	H4 2457cc 2.5L SOHC (16 Valve) (EJ253)	11-99	Loyale 4WD	
DL 4WD		Impreza WRX		H4 1781cc 1.8L OHC (EA82)	94-90
H4 1595cc 1.6L OHV (EA71)	80-77	H4 1994cc 2.0L DOHC Turbo (16 Valve) (EJ205)	05-02	H4 1781cc 1.8L OHC Turbo (EA82T)	90
H4 1781cc 1.8L OHC (EA82)	88-85	H4 1994cc 2.0L DOHC Turbo (16 Valve) (EJ20T)	05-02	Outback Sedan	
H4 1781cc 1.8L OHV (EA81)	84-81	H4 2457cc 2.5L DOHC Turbo (16 Valve) (EJ255)	13-06	H4 2457cc 2.5L DOHC (16 Valve) (EJ25D)	99
FE		H4 2457cc 2.5L DOHC Turbo (16 Valve) (EJ257)	13-04	H4 2457cc 2.5L DOHC Turbo (16 Valve) (EJ25T)	05
H4 1595cc 1.6L OHV (EA71)	79	H4 2457cc 2.5L DOHC Turbo (16 Valve) (EJ25T)	05-04	H4 2457cc 2.5L SOHC (16 Valve) (EJ251)	04-00
GF		Justy		H4 2457cc 2.5L SOHC (16 Valve) (EJ252)	00
H4 1595cc 1.6L OHV (EA71)	79-76	L3 1189cc 1.2L (9 Valve) (EF12)	94-87	H4 2457cc 2.5L SOHC (16 Valve) (EJ253)	08-00
GL		Justy 4WD		H6 2999cc 3.0L DOHC (24 Valve) (EZ30D)	08
H4 1595cc 1.6L OHV (EA71)	84-76	L3 1189cc 1.2L (9 Valve) (EF12)	94-88	Outback Sport Wagon	
H4 1781cc 1.8L OHC (EA82)	88-85	Legacy		H4 2212cc 2.2L SOHC (16 Valve) (EJ22E)	01-97
H4 1781cc 1.8L OHV (EA81)	84-81	H4 2212cc 2.2L SOHC (16 Valve) (EJ22E)	99-90	H4 2212cc 2.2L SOHC (16 Valve) (EJ22EZ)	01-97
H4 1781cc 1.8L OHV Turbo (EA81T)	84-83	H4 2212cc 2.2L SOHC (16 Valve) (EJ22EZ)	99-97	H4 2457cc 2.5L SOHC (16 Valve) (EJ251)	05-02
GL-10		H4 2212cc 2.2L SOHC Turbo (16 Valve) (EJ22T)	95-90	H4 2457cc 2.5L SOHC (16 Valve) (EJ253)	11-02
H4 1781cc 1.8L OHC (EA82)	88-85	Legacy 4WD		Outback Wagon	
H4 1781cc 1.8L OHC Turbo (EA82T)	88-86	H4 2212cc 2.2L SOHC (16 Valve) (EJ22E)	99-90	H4 2212cc 2.2L SOHC (16 Valve) (EJ22E)	99-95
GL-10 4WD		H4 2212cc 2.2L SOHC (16 Valve) (EJ22E)	99-90	H4 2212cc 2.2L SOHC (16 Valve) (EJ22EZ)	99-97
H4 1781cc 1.8L OHC Turbo (EA82T)	88-86				

Subaru Car (Cont.)

Model Index (Cont.)

Engine (VIN Code / Eng. Code)	Year	Engine (VIN Code / Eng. Code)	Year	Engine (VIN Code / Eng. Code)	Year
Subaru (cont.)					
Outback Wagon (cont.)					
H4 2457cc 2.5L DOHC (16 Valve) (EJ25D)	99-96				
H4 2457cc 2.5L DOHC Turbo (16 Valve) (EJ255)	09-05				
H4 2457cc 2.5L DOHC Turbo (16 Valve) (EJ25T)	05				
H4 2457cc 2.5L SOHC (16 Valve) (EJ251)	04-00				
H4 2457cc 2.5L SOHC (16 Valve) (EJ252)	00				
H4 2457cc 2.5L SOHC (16 Valve) (EJ253)	12-00				
H4 2498cc 2.5L DOHC (16 Valve) (FB25BA)	13				
H4 2498cc 2.5L DOHC (16 Valve) (FB25BC)	13				
H6 2999cc 3.0L DOHC (24 Valve) (EZ30D)	09-01				
H6 3630cc 3.6L DOHC (24 Valve) (EZ36D)	13-10				
RX					
H4 1781cc 1.8L OHC Turbo (EA82T)	89-85				
Sedan					
H4 1595cc 1.6L OHV (EA71)	79-77				
Sedan 4WD					
H4 1595cc 1.6L OHV (EA71)	80				
H4 1781cc 1.8L OHV (EA81)	82-81				
Sport Utility Sedan					
H4 2457cc 2.5L DOHC (16 Valve) (EJ25D)	99				
SVX					
H6 3318cc 3.3L DOHC (24 Valve) (EG33D)	97-92				
XT					
H4 1781cc 1.8L OHC (EA82)	91-85				
H4 1781cc 1.8L OHC Turbo (EA82T)	90-85				
XT 4WD					
H4 1781cc 1.8L OHC (EA82)	91-85				
H4 1781cc 1.8L OHC Turbo (EA82T)	90-85				
XT6					
H6 2672cc 2.7L SOHC (12 Valve) (ER27)	91-88				
XT6 4WD					
H6 2672cc 2.7L SOHC (12 Valve) (ER27)	91-88				
XV Crosstrek					
H4 1995cc 2.0L DOHC (16 Valve) (FB20)	13				

1

1992 - 1991; 1.2L 73 (1189cc) SOHC L3 (9 Valve) 78mm Bore

1

2 Bbl.; Gasoline; Naturally Aspirated Subaru Eng.; Eng. Code EF12

QTY	CYLINDER HEAD	YEARS	PART NO.	DESCRIPTION
1	Head Gasket	1992-91	9528 PT	Head bolts not incl.; Head bolt replacement recommended
1	Head Set	1992-91	HS 9528 PT	Head bolts not incl.; Head bolt replacement recommended; PermaDry® molded rubber valve cover gskt. incl.; Premium valve stem seals incl.
QTY	CONVERSION SET	YEARS	PART NO.	DESCRIPTION
1	Gasket Conversion Set	1992-91	CS 9528	
QTY	MANIFOLD - INT. & EXH.	YEARS	PART NO.	DESCRIPTION
1	Int. Manifold Gasket Set	1992-91	MS 93814	
1	Exh. Manifold Gasket Set	1992-91	MS 94304	
QTY	EXHAUST PIPE FLANGE	YEARS	PART NO.	DESCRIPTION
1	Exhaust Pipe Gasket	1992-91	60710	Flange
QTY	OIL PAN	YEARS	PART NO.	DESCRIPTION
1	Oil Pan Gasket Set	1992-91	OS 30581 C	
QTY	VALVE COVER	YEARS	PART NO.	DESCRIPTION
1	Valve Cover Gasket Set	1992-91	VS 50317 R	w/o Grommets; PermaDry® molded rubber gskt. incl.
1	Grommet Set	1992-91	ES 72124	Valve Cover
QTY	WATER OUTLET GASKET	YEARS	PART NO.	DESCRIPTION
1	Water Outlet Gasket	1992-91	35395	Water Outlet
QTY	TIMING COVER	YEARS	PART NO.	DESCRIPTION
1	Crankshaft Front Seal Set	1992-91	TCS 45794	
1	Camshaft Front Seal Set	1992-91	TCS 45745	

2

1994 - 1991; 1.2L 73 (1189cc) SOHC L3 (9 Valve) 78mm Bore

2

MFI; Gasoline; Naturally Aspirated Subaru Eng.; Eng. Code EF12

QTY	CYLINDER HEAD	YEARS	PART NO.	DESCRIPTION
1	Head Gasket	1994-91	9528 PT	Head bolts not incl.; Head bolt replacement recommended

2		1994 - 1991; 1.2L 73 (1189cc) SOHC L3 (9 Valve) 78mm Bore			2	
(cont.)		MFI; Gasoline; Naturally Aspirated Subaru Eng.; Eng. Code EF12			(cont.)	
QTY	CYLINDER HEAD	YEARS	PART NO.	DESCRIPTION		
1	Head Set	1994-91	HS 9528 PT-1	Head bolts & thermostat O-ring not incl.; Head bolt replacement recommended; PermaDry® molded rubber valve cover gskt. incl.; Premium valve stem seals incl.		
QTY	CONVERSION SET	YEARS	PART NO.	DESCRIPTION		
1	Gasket Conversion Set	1994-91	CS 9528			
QTY	MANIFOLD - INT. & EXH.	YEARS	PART NO.	DESCRIPTION		
1	Int. Manifold Gasket Set	1994-91	MS 94257			
1	Exh. Manifold Gasket Set	1994-91	MS 94304			
QTY	EXHAUST PIPE FLANGE	YEARS	PART NO.	DESCRIPTION		
1	Exhaust Pipe Gasket	1994-91	60710	Flange		
QTY	OIL PAN	YEARS	PART NO.	DESCRIPTION		
1	Oil Pan Gasket Set	1994-91	OS 30581 C			
QTY	VALVE COVER	YEARS	PART NO.	DESCRIPTION		
1	Valve Cover Gasket Set	1994-91	VS 50317 R	w/o Grommets; PermaDry® molded rubber gskt. incl.		
1	Grommet Set	1994-91	ES 72124	Valve Cover		
QTY	TIMING COVER	YEARS	PART NO.	DESCRIPTION		
1	Crankshaft Front Seal Set	1994-91	TCS 45794			
1	Camshaft Front Seal Set	1994-91	TCS 45745			
3		1994 - 1991; 1.8L 109 (1781cc) SOHC H4 (8 Valve) 92mm Bore			3	
		MFI; Gasoline; Naturally Aspirated Subaru Eng.; Eng. Code EA82				
QTY	CYLINDER HEAD	YEARS	PART NO.	DESCRIPTION		
2	Head Gasket	1994-91	9392 PT			
1	Head Set	1994-91	HS 9392 PT-2	PermaDry® molded rubber valve cover gskts. incl.; Premium valve stem seals incl.		
QTY	CONVERSION SET	YEARS	PART NO.	DESCRIPTION		
1	Gasket Conversion Set	1994-91	CS 9390			
QTY	MANIFOLD - INT. & EXH.	YEARS	PART NO.	DESCRIPTION		
1	Int. Manifold Gasket Set	1994-91	MS 92993			
1	Exh. Manifold Gasket Set	1994-91	MS 93227			
QTY	EXHAUST PIPE FLANGE	YEARS	PART NO.	DESCRIPTION		
1	Exhaust Pipe Gasket	1994-91	60459	Loc. Rear; Converter		
1	Exhaust Pipe Gasket	1994-91	60460	Loc. Front; Converter		
QTY	OIL PAN	YEARS	PART NO.	DESCRIPTION		
1	Oil Pan Gasket Set	1994-91	OS 30509 C			
QTY	CRANKSHAFT REAR SEAL	YEARS	PART NO.	DESCRIPTION		
1	Rear Main Seal Set	1994-91	BS 40387	Rubber; One-piece		
QTY	VALVE COVER	YEARS	PART NO.	DESCRIPTION		
1	Valve Cover Gasket Set	1994-91	VS 50273 R	w/Grommets; PermaDry® molded rubber gskts. incl.		
QTY	VALVE STEM SEAL SET	YEARS	PART NO.	DESCRIPTION		
1	Valve Stem Seal Set	1994-91	SS 72658	Premium valve stem seals incl.		
QTY	WATER OUTLET GASKET	YEARS	PART NO.	DESCRIPTION		
1	Water Outlet Gasket	1994-91	35298-1	Water Outlet		
QTY	WATER PUMP	YEARS	PART NO.	DESCRIPTION		
1	Water Pump Gasket	1994-91	35343			
QTY	TIMING COVER	YEARS	PART NO.	DESCRIPTION		
1	Timing Cover Dust Seal Set	1994-91	ES 72760			
1	Crankshaft Front Seal Set	1994-91	TCS 45540			
1	Camshaft Front Seal Set	1994-91	TCS 45687			
QTY	EXHAUST GAS RECIRCULATION	YEARS	PART NO.	DESCRIPTION		
1	EGR Gasket	1994-91	70004			
4		1994 - 1991; 1.8L 109 (1781cc) SOHC H4 (8 Valve) 92mm Bore			4	
		TBI; Gasoline; Naturally Aspirated Subaru Eng.; Eng. Code EA82				
QTY	CYLINDER HEAD	YEARS	PART NO.	DESCRIPTION		
2	Head Gasket	1994-91	9392 PT			
1	Head Set	1994-91	HS 9392 PT-2	PermaDry® molded rubber valve cover gskts. incl.; Premium valve stem seals incl.		
QTY	CONVERSION SET	YEARS	PART NO.	DESCRIPTION		
1	Gasket Conversion Set	1994-91	CS 9390			
QTY	MANIFOLD - INT. & EXH.	YEARS	PART NO.	DESCRIPTION		
1	Int. Manifold Gasket Set	1994-91	MS 22764			
1	Exh. Manifold Gasket Set	1994-91	MS 93227			

Subaru Car (Cont.)

4		1994 - 1991; 1.8L 109 (1781cc) SOHC H4 (8 Valve) 92mm Bore			4	
(cont.)		TBI; Gasoline; Naturally Aspirated Subaru Eng.; Eng. Code EA82			(cont.)	
QTY	EXHAUST PIPE FLANGE	YEARS	PART NO.	DESCRIPTION		
1	Exhaust Pipe Gasket	1994-91	60459	Loc. Rear; Converter		
1	Exhaust Pipe Gasket	1994-91	60460	Loc. Front; Converter		
QTY	OIL PAN	YEARS	PART NO.	DESCRIPTION		
1	Oil Pan Gasket Set	1994-91	OS 30509 C			
QTY	CRANKSHAFT REAR SEAL	YEARS	PART NO.	DESCRIPTION		
1	Rear Main Seal Set	1994-91	BS 40387	Rubber; One-piece		
QTY	VALVE COVER	YEARS	PART NO.	DESCRIPTION		
1	Valve Cover Gasket Set	1994-91	VS 50273 R	w/Grommets; PermaDry® molded rubber gskts. incl.		
QTY	VALVE STEM SEAL SET	YEARS	PART NO.	DESCRIPTION		
1	Valve Stem Seal Set	1994-91	SS 72658	Premium valve stem seals incl.		
QTY	WATER OUTLET GASKET	YEARS	PART NO.	DESCRIPTION		
1	Water Outlet Gasket	1994-91	35298-1	Water Outlet		
QTY	WATER PUMP	YEARS	PART NO.	DESCRIPTION		
1	Water Pump Gasket	1994-91	35343			
QTY	TIMING COVER	YEARS	PART NO.	DESCRIPTION		
1	Timing Cover Dust Seal Set	1994-91	ES 72760			
1	Crankshaft Front Seal Set	1994-91	TCS 45540			
1	Camshaft Front Seal Set	1994-91	TCS 45687			
QTY	EXHAUST GAS RECIRCULATION	YEARS	PART NO.	DESCRIPTION		
1	EGR Gasket	1994-91	70004			
5		1997 - 1993; 1.8L 111 (1820cc) SOHC H4 (16 Valve) 87.9mm Bore			5	
		MFI; Gasoline; Naturally Aspirated Subaru Eng.; Eng. Code EJ18E				
QTY	CYLINDER HEAD	YEARS	PART NO.	DESCRIPTION		
2	Head Gasket	1997-93	9618 PT	Head bolts not incl.; Head bolt replacement required		
1	Head Set	1997-93	HS 9618 PT	Head bolts not incl.; Head bolt replacement required; PermaDry® molded rubber valve cover gskts. incl.; Premium valve stem seals incl.		
2	Head Bolt Set	1997-93	ES 72212	Head bolts w/Washers; Replacement required		
QTY	CONVERSION SET	YEARS	PART NO.	DESCRIPTION		
1	Gasket Conversion Set	1997-93	CS 9618			
QTY	MANIFOLD - INT. & EXH.	YEARS	PART NO.	DESCRIPTION		
1	Int. Manifold Gasket Set	1997-93	MS 94987			
1	Exh. Manifold Gasket Set	1997-93	MS 95088			
QTY	EXHAUST PIPE FLANGE	YEARS	PART NO.	DESCRIPTION		
2	Exhaust Pipe Gasket	1997-93	60479	Converter		
QTY	OIL PAN	YEARS	PART NO.	DESCRIPTION		
1	Oil Pan Gasket Set	1997-93	OS 30656 C			
QTY	CRANKSHAFT REAR SEAL	YEARS	PART NO.	DESCRIPTION		
1	Rear Main Seal Set	1997-93	BS 40666	Rubber; One-piece; Improved design		
QTY	VALVE COVER	YEARS	PART NO.	DESCRIPTION		
1	Valve Cover Gasket Set	1997-93	VS 50395 R	w/Grommets; PermaDry® molded rubber gskts. incl.		
QTY	VALVE STEM SEAL SET	YEARS	PART NO.	DESCRIPTION		
1	Valve Stem Seal Set	1997-93	SS 72814	Premium valve stem seals incl.		
QTY	WATER OUTLET GASKET	YEARS	PART NO.	DESCRIPTION		
2	Water Outlet Gasket	1997-93	36024	Water Outlet; Water crossover O-ring; New Part Number - Check for Availability		
1	O-Ring	1997-93	35524	Water Outlet; Water outlet		
QTY	WATER PUMP	YEARS	PART NO.	DESCRIPTION		
1	Water Pump Gasket	1997-93	35747	Improved design		
QTY	TIMING COVER	YEARS	PART NO.	DESCRIPTION		
1	Crankshaft Front Seal Set	1997-93	TCS 45957			
1	Camshaft Front Seal Set	1997-93	TCS 45918			
QTY	CARB & FUEL INJECTION	YEARS	PART NO.	DESCRIPTION		
1	Throttle Body Gasket	1997-93	60920			
QTY	EXHAUST GAS RECIRCULATION	YEARS	PART NO.	DESCRIPTION		
1	EGR Gasket	1997-93	70004			
6		2005 - 2002; 2.0L 121.7 (1994cc) DOHC H4 (16 Valve) 92mm Bore			6	
		MFI; Gasoline; Turbo - Intercooled Subaru Eng.; Eng. Code EJ205				
QTY	CYLINDER HEAD	YEARS	PART NO.	DESCRIPTION		
2	Head Gasket	2005-02	26537 PT	Head bolts not incl.; Head bolt replacement required; PermaTorqueMLS®; New Part Number - Check for Availability		

6 (cont.)		2005 - 2002; 2.0L 121.7 (1994cc) DOHC H4 (16 Valve) 92mm Bore			6 (cont.)
		MFI; Gasoline; Turbo - Intercooled Subaru Eng.; Eng. Code EJ205			
QTY	CYLINDER HEAD	YEARS	PART NO.	DESCRIPTION	
1	Head Set	2005-02	HS 26537 PT	Head bolts not incl.; Head bolt replacement required; PermaDry® molded rubber valve cover gskts. incl.; Premium valve stem seals incl.; New Part Number - Check for Availability	
QTY	CONVERSION SET	YEARS	PART NO.	DESCRIPTION	
1	Gasket Conversion Set	2005-02	CS 26170		
QTY	MANIFOLD - INT. & EXH.	YEARS	PART NO.	DESCRIPTION	
1	Int. Manifold Gasket Set	2005-02	MS 96523	Lower set; Upper set incl.	
1	Exh. Manifold Gasket Set	2005-02	MS 95088		
QTY	EXHAUST PIPE FLANGE	YEARS	PART NO.	DESCRIPTION	
2	Exhaust Pipe Gasket	2005-02	60957	Crossover	
1	Exhaust Pipe Gasket	2005-02	61106	Loc. Front; Exh. connector; 2.40" ID	
1	Exhaust Pipe Gasket	2005-02	61365	Loc. Front; Converter	
1	Exhaust Pipe Gasket	2005-02	61366	Loc. Rear; Converter	
1	Exhaust Pipe Gasket	2005-02	61668	Loc. Rear; Exh. connector	
QTY	OIL PAN	YEARS	PART NO.	DESCRIPTION	
1	Oil Pan Gasket Set	2005-02	OS 30656 C		
QTY	CRANKSHAFT REAR SEAL	YEARS	PART NO.	DESCRIPTION	
1	Rear Main Seal Set	2005-02	BS 40666	Rubber; One-piece; Improved design	
QTY	VALVE COVER	YEARS	PART NO.	DESCRIPTION	
1	Valve Cover Gasket Set	2005-02	VS 50799 R	w/Grommets & Spark plug tube seals; PermaDry® molded rubber gskts. incl.; New Part Number - Check for Availability	
QTY	VALVE STEM SEAL SET	YEARS	PART NO.	DESCRIPTION	
1	Valve Stem Seal Set	2005-02	SS 72814	Premium valve stem seals incl.	
QTY	WATER OUTLET GASKET	YEARS	PART NO.	DESCRIPTION	
2	Water Outlet Gasket	2005-02	36024	Water Outlet; Water crossover O-ring; New Part Number - Check for Availability	
1	O-Ring	2005-02	35524	Water Outlet; Water outlet	
QTY	WATER PUMP	YEARS	PART NO.	DESCRIPTION	
1	Water Pump Gasket	2005-02	35747	Improved design	
QTY	TIMING COVER	YEARS	PART NO.	DESCRIPTION	
1	Crankshaft Front Seal Set	2005-02	TCS 46009		
2	Camshaft Front Seal Set	2005-02	TCS 46150	New Part Number - Check for Availability	
QTY	CARB & FUEL INJECTION	YEARS	PART NO.	DESCRIPTION	
1	Throttle Body Gasket	2005-02	61670	Throttle body	
1	Throttle Body Gasket	2005-02	73001	Idle air control; New Part Number - Check for Availability	
QTY	TURBO MOUNTING SET	YEARS	PART NO.	DESCRIPTION	
1	Turbo Mtg. Gasket Set	2005-02	ES 72745	New Part Number - Check for Availability	
7		2005 - 2002; 2.0L 121.7 (1994cc) DOHC H4 (16 Valve) 92mm Bore			7
		MFI; Gasoline; Turbo - Intercooled Subaru Eng.; Eng. Code EJ20T			
QTY	CYLINDER HEAD	YEARS	PART NO.	DESCRIPTION	
2	Head Gasket	2005-02	26537 PT	Head bolts not incl.; Head bolt replacement required; PermaTorqueMLS®; New Part Number - Check for Availability	
1	Head Set	2005-02	HS 26537 PT	Head bolts not incl.; Head bolt replacement required; PermaDry® molded rubber valve cover gskts. incl.; Premium valve stem seals incl.; New Part Number - Check for Availability	
QTY	CONVERSION SET	YEARS	PART NO.	DESCRIPTION	
1	Gasket Conversion Set	2005-02	CS 26170		
QTY	MANIFOLD - INT. & EXH.	YEARS	PART NO.	DESCRIPTION	
1	Int. Manifold Gasket Set	2005-02	MS 96523	Lower set; Upper set incl.	
1	Exh. Manifold Gasket Set	2005-02	MS 95088		
QTY	EXHAUST PIPE FLANGE	YEARS	PART NO.	DESCRIPTION	
2	Exhaust Pipe Gasket	2005-02	60957	Crossover	
1	Exhaust Pipe Gasket	2005-02	61106	Loc. Front; Exh. connector; 2.40" ID	
1	Exhaust Pipe Gasket	2005-02	61365	Loc. Front; Converter	
1	Exhaust Pipe Gasket	2005-02	61366	Loc. Rear; Converter	
1	Exhaust Pipe Gasket	2005-02	61668	Loc. Rear; Exh. connector	
QTY	OIL PAN	YEARS	PART NO.	DESCRIPTION	
1	Oil Pan Gasket Set	2005-02	OS 30656 C		
QTY	CRANKSHAFT REAR SEAL	YEARS	PART NO.	DESCRIPTION	
1	Rear Main Seal Set	2005-02	BS 40666	Rubber; One-piece; Improved design	

Subaru Car (Cont.)

7		2005 - 2002; 2.0L 121.7 (1994cc) DOHC H4 (16 Valve) 92mm Bore			7
(cont.)		MFI; Gasoline; Turbo - Intercooled Subaru Eng.; Eng. Code EJ20T			(cont.)
QTY	VALVE COVER	YEARS	PART NO.	DESCRIPTION	
1	Valve Cover Gasket Set	2005-02	VS 50799 R	w/Grommets & Spark plug tube seals; PermaDry® molded rubber gskts. incl.; New Part Number - Check for Availability	
QTY	VALVE STEM SEAL SET	YEARS	PART NO.	DESCRIPTION	
1	Valve Stem Seal Set	2005-02	SS 72814	Premium valve stem seals incl.	
QTY	WATER OUTLET GASKET	YEARS	PART NO.	DESCRIPTION	
2	Water Outlet Gasket	2005-02	36024	Water Outlet; Water crossover O-ring; New Part Number - Check for Availability	
1	O-Ring	2005-02	35524	Water Outlet; Water outlet	
QTY	WATER PUMP	YEARS	PART NO.	DESCRIPTION	
1	Water Pump Gasket	2005-02	35747	Improved design	
QTY	TIMING COVER	YEARS	PART NO.	DESCRIPTION	
1	Crankshaft Front Seal Set	2005-02	TCS 46009		
2	Camshaft Front Seal Set	2005-02	TCS 46150	New Part Number - Check for Availability	
QTY	CARB & FUEL INJECTION	YEARS	PART NO.	DESCRIPTION	
1	Throttle Body Gasket	2005-02	61670	Throttle body	
1	Throttle Body Gasket	2005-02	73001	Idle air control; New Part Number - Check for Availability	
QTY	TURBO MOUNTING SET	YEARS	PART NO.	DESCRIPTION	
1	Turbo Mtg. Gasket Set	2005-02	ES 72745	New Part Number - Check for Availability	
8		2001 - 1999; 2.2L 135 (2212cc) SOHC H4 (16 Valve) 96.9mm Bore			8
(cont.)		MFI; Gasoline; Naturally Aspirated Subaru Eng.; Eng. Code EJ222			(cont.)
QTY	CYLINDER HEAD	YEARS	PART NO.	DESCRIPTION	
2	Head Gasket	2001-99	26415 PT	Head bolts not incl.; Head bolt replacement required; PermaTorqueMLS® LaserWeld® Technology; Improved design	
1	Head Set	2001-99	HS 26415 PT	Head bolts not incl.; Head bolt replacement required; PermaTorqueMLS® Improved design head gskts. incl.; PermaDry® molded rubber valve cover gskts. incl.; Premium valve stem seals incl.	
2	Head Bolt Set	2001-99	ES 72212	Head bolts w/Washers; Replacement required	
QTY	CONVERSION SET	YEARS	PART NO.	DESCRIPTION	
1	Gasket Conversion Set	2001-99	CS 9854		
QTY	MANIFOLD - INT. & EXH.	YEARS	PART NO.	DESCRIPTION	
1	Int. Manifold Gasket Set	2001-99	MS 96106		
1	Exh. Manifold Gasket Set	2001-99	MS 97055		
QTY	EXHAUST PIPE FLANGE	YEARS	PART NO.	DESCRIPTION	
2	Exhaust Pipe Gasket	2001-99	60902	Converter	
QTY	OIL PAN	YEARS	PART NO.	DESCRIPTION	
1	Oil Pan Gasket Set	2001-99	OS 30656 C		
QTY	CRANKSHAFT REAR SEAL	YEARS	PART NO.	DESCRIPTION	
1	Rear Main Seal Set	2001-99	BS 40666	Rubber; One-piece; Improved design	
QTY	VALVE COVER	YEARS	PART NO.	DESCRIPTION	
1	Valve Cover Gasket Set	2001-99	VS 50561 R	w/Grommets & Spark plug tube seals; PermaDry® molded rubber gskts. incl.; Improved design	
QTY	VALVE STEM SEAL SET	YEARS	PART NO.	DESCRIPTION	
1	Valve Stem Seal Set	2001-99	SS 72814	Premium valve stem seals incl.	
QTY	WATER OUTLET GASKET	YEARS	PART NO.	DESCRIPTION	
2	Water Outlet Gasket	2001-99	36024	Water Outlet; Water crossover O-ring; New Part Number - Check for Availability	
1	O-Ring	2001-99	35524	Water Outlet; Water outlet	
QTY	WATER PUMP	YEARS	PART NO.	DESCRIPTION	
1	Water Pump Gasket	2001-99	35747	Improved design	
QTY	TIMING COVER	YEARS	PART NO.	DESCRIPTION	
1	Crankshaft Front Seal Set	2001-99	TCS 45919		
1	Camshaft Front Seal Set	2001-99	TCS 46008		
QTY	CARB & FUEL INJECTION	YEARS	PART NO.	DESCRIPTION	
1	Throttle Body Gasket	2001-99	61360		
9		2001 - 1991; 2.2L 135 (2212cc) SOHC H4 (16 Valve) 96.9mm Bore			9
(cont.)		MFI; Gasoline; Naturally Aspirated Subaru Eng.; Eng. Code EJ22E			(cont.)
QTY	CYLINDER HEAD	YEARS	PART NO.	DESCRIPTION	
2	Head Gasket	2001-99	26415 PT	Head bolts not incl.; Head bolt replacement required; PermaTorqueMLS® LaserWeld® Technology; Improved design	

9 (cont.)		2001 - 1991; 2.2L 135 (2212cc) SOHC H4 (16 Valve) 96.9mm Bore			9 (cont.)
		MFI; Gasoline; Naturally Aspirated Subaru Eng.; Eng. Code EJ22E			
QTY	CYLINDER HEAD	YEARS	PART NO.	DESCRIPTION	
2	Head Gasket	1998	26415 PT	Subaru Legacy Brighton, L, Postal; From 06/01/98; Head bolts not incl.; Head bolt replacement required; PermaTorqueMLS® LaserWeld® Technology; Improved design	
2	Head Gasket	1998	26415 PT	Exc. Subaru Legacy Brighton, L, Postal; From 07/01/98; Head bolts not incl.; Head bolt replacement required; PermaTorqueMLS® LaserWeld® Technology; Improved design	
2	Head Gasket	1998	9854 PT	Subaru Legacy Brighton, L, Postal; To 05/31/98; Head bolts not incl.; Head bolt replacement required	
2	Head Gasket	1998	9854 PT	Exc. Subaru Legacy Brighton, L, Postal; To 06/30/98; Head bolts not incl.; Head bolt replacement required	
2	Head Gasket	1997-91	9854 PT	Head bolts not incl.; Head bolt replacement required	
1	Head Set	2001-99	HS 26415 PT	Head bolts not incl.; Head bolt replacement required; PermaTorqueMLS® Improved design head gskts. incl.; PermaDry® molded rubber valve cover gskts. incl.; Premium valve stem seals incl.	
1	Head Set	1998	HS 26415 PT	Subaru Legacy Brighton, L, Postal; From 06/01/98; Head bolts not incl.; Head bolt replacement required; PermaTorqueMLS® Improved design head gskts. incl.; PermaDry® molded rubber valve cover gskts. incl.; Premium valve stem seals incl.	
1	Head Set	1998	HS 26415 PT	Exc. Subaru Legacy Brighton, L, Postal; From 07/01/98; Head bolts not incl.; Head bolt replacement required; PermaTorqueMLS® Improved design head gskts. incl.; PermaDry® molded rubber valve cover gskts. incl.; Premium valve stem seals incl.	
1	Head Set	1998	HS 9854 PT-1	Subaru Legacy Brighton, L, Postal; To 05/31/98; Head bolts not incl.; Head bolt replacement required; PermaDry® molded rubber valve cover gskts. incl.; Premium valve stem seals incl.	
1	Head Set	1998	HS 9854 PT-1	Exc. Subaru Legacy Brighton, L, Postal; To 06/30/98; Head bolts not incl.; Head bolt replacement required; PermaDry® molded rubber valve cover gskts. incl.; Premium valve stem seals incl.	
1	Head Set	1997-96	HS 9854 PT-1	Head bolts not incl.; Head bolt replacement required; PermaDry® molded rubber valve cover gskts. incl.; Premium valve stem seals incl.	
1	Head Set	1995-91	HS 9854 PT	Head bolts not incl.; Head bolt replacement required; PermaDry® molded rubber valve cover gskts. incl.; Premium valve stem seals incl.	
2	Head Bolt Set	2001-91	ES 72212	Head bolts w/Washers; Replacement required	
QTY	CONVERSION SET	YEARS	PART NO.	DESCRIPTION	
1	Gasket Conversion Set	2001-91	CS 9854		
QTY	MANIFOLD - INT. & EXH.	YEARS	PART NO.	DESCRIPTION	
1	Int. Manifold Gasket Set	2001-99	MS 96106		
1	Int. Manifold Gasket Set	1998	MS 94987	Subaru Legacy Brighton, L, Postal; To 05/31/98	
1	Int. Manifold Gasket Set	1998	MS 94987	Exc. Subaru Legacy Brighton, L, Postal; To 06/30/98	
1	Int. Manifold Gasket Set	1998	MS 96106	Subaru Legacy Brighton, L, Postal; From 06/01/98	
1	Int. Manifold Gasket Set	1998	MS 96106	Exc. Subaru Legacy Brighton, L, Postal; From 07/01/98	
1	Int. Manifold Gasket Set	1997-91	MS 94987		
1	Exh. Manifold Gasket Set	2001-96	MS 97055		
1	Exh. Manifold Gasket Set	1995-91	MS 95088		
QTY	EXHAUST PIPE FLANGE	YEARS	PART NO.	DESCRIPTION	
2	Exhaust Pipe Gasket	2001-96	60902	Converter	
1	Exhaust Pipe Gasket	1995-91	60723	Converter	
1	Exhaust Pipe Gasket	1995-91	60871	To front pipe	
1	Exhaust Pipe Gasket	1995-91	60957	Crossover	
1	Exhaust Pipe Gasket	1995-91	60992	To manifold	
QTY	OIL PAN	YEARS	PART NO.	DESCRIPTION	
1	Oil Pan Gasket Set	2001-91	OS 30656 C		
QTY	CRANKSHAFT REAR SEAL	YEARS	PART NO.	DESCRIPTION	
1	Rear Main Seal Set	2001-91	BS 40666	Rubber; One-piece; Improved design	
QTY	VALVE COVER	YEARS	PART NO.	DESCRIPTION	
1	Valve Cover Gasket Set	2001-99	VS 50561 R	w/Grommets & Spark plug tube seals; PermaDry® molded rubber gskts. incl.; Improved design	
1	Valve Cover Gasket Set	1998	VS 50395 R	Subaru Legacy Brighton, L, Postal; To 05/31/98; w/Grommets; PermaDry® molded rubber gskts. incl.	
1	Valve Cover Gasket Set	1998	VS 50395 R	Exc. Subaru Legacy Brighton, L, Postal; To 06/30/98; w/Grommets; PermaDry® molded rubber gskts. incl.	
1	Valve Cover Gasket Set	1998	VS 50561 R	Subaru Legacy Brighton, L, Postal; From 06/01/98; w/Grommets & Spark plug tube seals; PermaDry® molded rubber gskts. incl.; Improved design	

Subaru Car (Cont.)

9 (cont.)		2001 - 1991; 2.2L 135 (2212cc) SOHC H4 (16 Valve) 96.9mm Bore			9 (cont.)
MFI; Gasoline; Naturally Aspirated Subaru Eng.; Eng. Code EJ22E					
QTY	VALVE COVER	YEARS	PART NO.	DESCRIPTION	
1	Valve Cover Gasket Set	1998	VS 50561 R	Exc. Subaru Legacy Brighton, L, Postal; From 07/01/98; w/Grommets & Spark plug tube seals; PermaDry® molded rubber gskts. incl.; Improved design	
1	Valve Cover Gasket Set	1997-91	VS 50395 R	w/Grommets; PermaDry® molded rubber gskts. incl.	
QTY	VALVE STEM SEAL SET	YEARS	PART NO.	DESCRIPTION	
1	Valve Stem Seal Set	2001-91	SS 72814	Premium valve stem seals incl.	
QTY	WATER OUTLET GASKET	YEARS	PART NO.	DESCRIPTION	
2	Water Outlet Gasket	2001-91	36024	Water Outlet; Water crossover O-ring; New Part Number - Check for Availability	
1	O-Ring	2001-91	35524	Water Outlet; Water outlet	
QTY	WATER PUMP	YEARS	PART NO.	DESCRIPTION	
1	Water Pump Gasket	2001-91	35747	Improved design	
QTY	TIMING COVER	YEARS	PART NO.	DESCRIPTION	
1	Crankshaft Front Seal Set	2001-91	TCS 45919		
1	Camshaft Front Seal Set	2001-99	TCS 46008		
1	Camshaft Front Seal Set	1998	TCS 45918	Subaru Legacy Brighton, L, Postal; To 05/31/98	
1	Camshaft Front Seal Set	1998	TCS 45918	Exc. Subaru Legacy Brighton, L, Postal; To 06/30/98	
1	Camshaft Front Seal Set	1998	TCS 46008	Subaru Legacy Brighton, L, Postal; From 06/01/98	
1	Camshaft Front Seal Set	1998	TCS 46008	Exc. Subaru Legacy Brighton, L, Postal; From 07/01/98	
1	Camshaft Front Seal Set	1997-91	TCS 45918		
QTY	CARB & FUEL INJECTION	YEARS	PART NO.	DESCRIPTION	
1	Throttle Body Gasket	2001-99	61360		
1	Throttle Body Gasket	1998	61360	Subaru Legacy Brighton, L, Postal; From 06/01/98	
1	Throttle Body Gasket	1998	61360	Exc. Subaru Legacy Brighton, L, Postal; From 07/01/98	
1	Throttle Body Gasket	1998	61587	Subaru Legacy Brighton, L, Postal; To 05/31/98	
1	Throttle Body Gasket	1998	61587	Exc. Subaru Legacy Brighton, L, Postal; To 06/30/98	
1	Throttle Body Gasket	1997	61587		
1	Throttle Body Gasket	1996	60920	Exc. Subaru Impreza L, LX, Outback	
1	Throttle Body Gasket	1996	60920	Subaru Impreza L, LX, Outback; To 01/31/96	
1	Throttle Body Gasket	1996	61587	Subaru Impreza L, LX, Outback; From 02/01/96	
1	Throttle Body Gasket	1995-91	60920		
QTY	EXHAUST GAS RECIRCULATION	YEARS	PART NO.	DESCRIPTION	
1	EGR Gasket	1996-91	70004		
10		2001 - 1997; 2.2L 135 (2212cc) SOHC H4 (16 Valve) 96.9mm Bore			10
MFI; Gasoline; Naturally Aspirated Subaru Eng.; Eng. Code EJ22E					
QTY	CYLINDER HEAD	YEARS	PART NO.	DESCRIPTION	
2	Head Gasket	2001-99	26415 PT	Head bolts not incl.; Head bolt replacement required; PermaTorqueMLS® LaserWeld® Technology; Improved design	
2	Head Gasket	1998	26415 PT	Subaru Legacy Brighton, L, Postal; From 06/01/98; Head bolts not incl.; Head bolt replacement required; PermaTorqueMLS® LaserWeld® Technology; Improved design	
2	Head Gasket	1998	26415 PT	Exc. Subaru Legacy Brighton, L, Postal; From 07/01/98; Head bolts not incl.; Head bolt replacement required; PermaTorqueMLS® LaserWeld® Technology; Improved design	
2	Head Gasket	1998	9854 PT	Subaru Legacy Brighton, L, Postal; To 05/31/98; Head bolts not incl.; Head bolt replacement required	
2	Head Gasket	1998	9854 PT	Exc. Subaru Legacy Brighton, L, Postal; To 06/30/98; Head bolts not incl.; Head bolt replacement required	
2	Head Gasket	1997	9854 PT	Head bolts not incl.; Head bolt replacement required	
1	Head Set	2001-99	HS 26415 PT	Head bolts not incl.; Head bolt replacement required; PermaTorqueMLS® Improved design head gskts. incl.; PermaDry® molded rubber valve cover gskts. incl.; Premium valve stem seals incl.	
1	Head Set	1998	HS 26415 PT	Subaru Legacy Brighton, L, Postal; From 06/01/98; Head bolts not incl.; Head bolt replacement required; PermaTorqueMLS® Improved design head gskts. incl.; PermaDry® molded rubber valve cover gskts. incl.; Premium valve stem seals incl.	
1	Head Set	1998	HS 26415 PT	Exc. Subaru Legacy Brighton, L, Postal; From 07/01/98; Head bolts not incl.; Head bolt replacement required; PermaTorqueMLS® Improved design head gskts. incl.; PermaDry® molded rubber valve cover gskts. incl.; Premium valve stem seals incl.	
1	Head Set	1998	HS 9854 PT-1	Subaru Legacy Brighton, L, Postal; To 05/31/98; Head bolts not incl.; Head bolt replacement required; PermaDry® molded rubber valve cover gskts. incl.; Premium valve stem seals incl.	

10 (cont.)		2001 - 1997; 2.2L 135 (2212cc) SOHC H4 (16 Valve) 96.9mm Bore			10 (cont.)
		MFI; Gasoline; Naturally Aspirated Subaru Eng.; Eng. Code EJ22EZ			
QTY	CYLINDER HEAD	YEARS	PART NO.	DESCRIPTION	
1	Head Set	1998	HS 9854 PT-1	Exc. Subaru Legacy Brighton, L, Postal; To 06/30/98; Head bolts not incl.; Head bolt replacement required; PermaDry® molded rubber valve cover gskts. incl.; Premium valve stem seals incl.	
1	Head Set	1997	HS 9854 PT-1	Head bolts not incl.; Head bolt replacement required; PermaDry® molded rubber valve cover gskts. incl.; Premium valve stem seals incl.	
2	Head Bolt Set	2001-97	ES 72212	Head bolts w/Washers; Replacement required	
QTY	CONVERSION SET	YEARS	PART NO.	DESCRIPTION	
1	Gasket Conversion Set	2001-97	CS 9854		
QTY	MANIFOLD - INT. & EXH.	YEARS	PART NO.	DESCRIPTION	
1	Int. Manifold Gasket Set	2001-99	MS 96106		
1	Int. Manifold Gasket Set	1998	MS 94987	Subaru Legacy Brighton, L, Postal; To 05/31/98	
1	Int. Manifold Gasket Set	1998	MS 94987	Exc. Subaru Legacy Brighton, L, Postal; To 06/30/98	
1	Int. Manifold Gasket Set	1998	MS 96106	Subaru Legacy Brighton, L, Postal; From 06/01/98	
1	Int. Manifold Gasket Set	1998	MS 96106	Exc. Subaru Legacy Brighton, L, Postal; From 07/01/98	
1	Int. Manifold Gasket Set	1997	MS 94987		
1	Exh. Manifold Gasket Set	2001-97	MS 97055		
QTY	EXHAUST PIPE FLANGE	YEARS	PART NO.	DESCRIPTION	
2	Exhaust Pipe Gasket	2001-97	60902	Converter	
QTY	OIL PAN	YEARS	PART NO.	DESCRIPTION	
1	Oil Pan Gasket Set	2001-97	OS 30656 C		
QTY	CRANKSHAFT REAR SEAL	YEARS	PART NO.	DESCRIPTION	
1	Rear Main Seal Set	2001-97	BS 40666	Rubber; One-piece; Improved design	
QTY	VALVE COVER	YEARS	PART NO.	DESCRIPTION	
1	Valve Cover Gasket Set	2001-99	VS 50561 R	w/Grommets & Spark plug tube seals; PermaDry® molded rubber gskts. incl.; Improved design	
1	Valve Cover Gasket Set	1998	VS 50395 R	Subaru Legacy Brighton, L, Postal; To 05/31/98; w/Grommets; PermaDry® molded rubber gskts. incl.	
1	Valve Cover Gasket Set	1998	VS 50395 R	Exc. Subaru Legacy Brighton, L, Postal; To 06/30/98; w/Grommets; PermaDry® molded rubber gskts. incl.	
1	Valve Cover Gasket Set	1998	VS 50561 R	Subaru Legacy Brighton, L, Postal; From 06/01/98; w/Grommets & Spark plug tube seals; PermaDry® molded rubber gskts. incl.; Improved design	
1	Valve Cover Gasket Set	1998	VS 50561 R	Exc. Subaru Legacy Brighton, L, Postal; From 07/01/98; w/Grommets & Spark plug tube seals; PermaDry® molded rubber gskts. incl.; Improved design	
1	Valve Cover Gasket Set	1997	VS 50395 R	w/Grommets; PermaDry® molded rubber gskts. incl.	
QTY	VALVE STEM SEAL SET	YEARS	PART NO.	DESCRIPTION	
1	Valve Stem Seal Set	2001-97	SS 72814	Premium valve stem seals incl.	
QTY	WATER OUTLET GASKET	YEARS	PART NO.	DESCRIPTION	
2	Water Outlet Gasket	2001-97	36024	Water Outlet; Water crossover O-ring; New Part Number - Check for Availability	
1	O-Ring	2001-97	35524	Water Outlet; Water outlet	
QTY	WATER PUMP	YEARS	PART NO.	DESCRIPTION	
1	Water Pump Gasket	2001-97	35747	Improved design	
QTY	TIMING COVER	YEARS	PART NO.	DESCRIPTION	
1	Crankshaft Front Seal Set	2001-97	TCS 45919		
1	Camshaft Front Seal Set	2001-99	TCS 46008		
1	Camshaft Front Seal Set	1998	TCS 45918	Subaru Legacy Brighton, L, Postal; To 05/31/98	
1	Camshaft Front Seal Set	1998	TCS 45918	Exc. Subaru Legacy Brighton, L, Postal; To 06/30/98	
1	Camshaft Front Seal Set	1998	TCS 46008	Subaru Legacy Brighton, L, Postal; From 06/01/98	
1	Camshaft Front Seal Set	1998	TCS 46008	Exc. Subaru Legacy Brighton, L, Postal; From 07/01/98	
1	Camshaft Front Seal Set	1997	TCS 45918		
QTY	CARB & FUEL INJECTION	YEARS	PART NO.	DESCRIPTION	
1	Throttle Body Gasket	2001-99	61360		
1	Throttle Body Gasket	1998	61360	Subaru Legacy Brighton, L, Postal; From 06/01/98	
1	Throttle Body Gasket	1998	61360	Exc. Subaru Legacy Brighton, L, Postal; From 07/01/98	
1	Throttle Body Gasket	1998	61587	Subaru Legacy Brighton, L, Postal; To 05/31/98	
1	Throttle Body Gasket	1998	61587	Exc. Subaru Legacy Brighton, L, Postal; To 06/30/98	
1	Throttle Body Gasket	1997	61587		
11		1995 - 1991; 2.2L 135 (2212cc) SOHC H4 (16 Valve) 96.9mm Bore			11
		MFI; Gasoline; Turbo Subaru Eng.; Eng. Code EJ22T			
QTY	CYLINDER HEAD	YEARS	PART NO.	DESCRIPTION	
2	Head Gasket	1995-91	9856 PT	Head bolts not incl.; Head bolt replacement required; PermaTorqueMLS®	

Subaru Car (Cont.)

11 (cont.)		1995 - 1991; 2.2L 135 (2212cc) SOHC H4 (16 Valve) 96.9mm Bore			11 (cont.)
MFI; Gasoline; Turbo Subaru Eng.; Eng. Code EJ22T					
QTY	CYLINDER HEAD	YEARS	PART NO.	DESCRIPTION	
1	Head Set	1995-91	HS 9856 PT	Head bolts not incl.; Head bolt replacement required; PermaDry® molded rubber valve cover gskts. incl.; Premium valve stem seals incl.	
2	Head Bolt Set	1995-91	ES 72212	Head bolts w/Washers; Replacement required	
QTY	CONVERSION SET	YEARS	PART NO.	DESCRIPTION	
1	Gasket Conversion Set	1995-91	CS 9854		
QTY	MANIFOLD - INT. & EXH.	YEARS	PART NO.	DESCRIPTION	
1	Int. Manifold Gasket Set	1995-91	MS 94987		
1	Exh. Manifold Gasket Set	1995-91	MS 95088		
QTY	EXHAUST PIPE FLANGE	YEARS	PART NO.	DESCRIPTION	
1	Exhaust Pipe Gasket	1995-91	60957	Crossover	
QTY	OIL PAN	YEARS	PART NO.	DESCRIPTION	
1	Oil Pan Gasket Set	1995-91	OS 30656 C		
QTY	CRANKSHAFT REAR SEAL	YEARS	PART NO.	DESCRIPTION	
1	Rear Main Seal Set	1995-91	BS 40666	Rubber; One-piece; Improved design	
QTY	VALVE COVER	YEARS	PART NO.	DESCRIPTION	
1	Valve Cover Gasket Set	1995-91	VS 50395 R	w/Grommets; PermaDry® molded rubber gskts. incl.	
QTY	VALVE STEM SEAL SET	YEARS	PART NO.	DESCRIPTION	
1	Valve Stem Seal Set	1995-91	SS 72814	Premium valve stem seals incl.	
QTY	WATER OUTLET GASKET	YEARS	PART NO.	DESCRIPTION	
2	Water Outlet Gasket	1995-91	36024	Water Outlet; Water crossover O-ring; New Part Number - Check for Availability	
1	O-Ring	1995-91	35524	Water Outlet; Water outlet	
QTY	WATER PUMP	YEARS	PART NO.	DESCRIPTION	
1	Water Pump Gasket	1995-91	35747	Improved design	
QTY	TIMING COVER	YEARS	PART NO.	DESCRIPTION	
1	Crankshaft Front Seal Set	1995-91	TCS 45919		
1	Camshaft Front Seal Set	1995-91	TCS 45918		
QTY	CARB & FUEL INJECTION	YEARS	PART NO.	DESCRIPTION	
1	Throttle Body Gasket	1995-91	60920		
QTY	EXHAUST GAS RECIRCULATION	YEARS	PART NO.	DESCRIPTION	
1	EGR Gasket	1995-91	70004		
12		2013 - 2005; 2.5L 150 (2457cc) DOHC H4 (16 Valve) 99.5mm Bore			12
MFI; Gasoline; Turbo - Intercooled Subaru Eng.; Eng. Code EJ255					
QTY	CYLINDER HEAD	YEARS	PART NO.	DESCRIPTION	
2	Head Gasket	2012-07	26531 PT	Head bolts not incl.; Head bolt replacement required; PermaTorqueMLS® LaserWeld® Technology; New Part Number - Check for Availability	
2	Head Gasket	2006	26259 PT	Exc. Subaru Impreza WRX, WRX Limited, WRX TR; Head bolts not incl.; Head bolt replacement required; PermaTorqueMLS®; Old design; Superseded - When depleted use 26415 PT	
2	Head Gasket	2006	26415 PT	Exc. Subaru Impreza WRX, WRX Limited, WRX TR; Head bolts not incl.; Head bolt replacement required; PermaTorqueMLS® LaserWeld® Technology; Improved design	
2	Head Gasket	2006	26531 PT	Subaru Impreza WRX, WRX Limited, WRX TR; Head bolts not incl.; Head bolt replacement required; PermaTorqueMLS® LaserWeld® Technology; New Part Number - Check for Availability	
2	Head Gasket	2005	26259 PT	Head bolts not incl.; Head bolt replacement required; PermaTorqueMLS®; Old design; Superseded - When depleted use 26415 PT	
2	Head Gasket	2005	26415 PT	Head bolts not incl.; Head bolt replacement required; PermaTorqueMLS® LaserWeld® Technology; Improved design	
1	Head Set	2012	HS 26531 PT-1	Subaru Impreza WRX, WRX Limited, WRX Premium; Head bolts not incl.; Head bolt replacement required; PermaTorqueMLS® Improved design head gskts. incl.; PermaDry® molded rubber valve cover gskts. incl.; Premium valve stem seals incl.; New Part Number - Check for Availability	
1	Head Set	2012	HS 26531 PT-2	Exc. Subaru Impreza WRX, WRX Limited, WRX Premium; Head bolts not incl.; Head bolt replacement required; PermaTorqueMLS® Improved design head gskts. incl.; PermaDry® molded rubber valve cover gskts. incl.; Premium valve stem seals incl.; New Part Number - Check for Availability	
1	Head Set	2011-10	HS 26531 PT-1	Subaru Impreza 2.5GT, WRX, WRX Limited, WRX Premium; Head bolts not incl.; Head bolt replacement required; PermaTorqueMLS® Improved design head gskts. incl.; PermaDry® molded rubber valve cover gskts. incl.; Premium valve stem seals incl.; New Part Number - Check for Availability	

12 (cont.)		2013 - 2005; 2.5L 150 (2457cc) DOHC H4 (16 Valve) 99.5mm Bore MFI; Gasoline; Turbo - Intercooled Subaru Eng.; Eng. Code EJ255			12 (cont.)
QTY	CYLINDER HEAD	YEARS	PART NO.	DESCRIPTION	
1	Head Set	2011-10	HS 26531 PT-2	Exc. Subaru Impreza 2.5GT, WRX, WRX Limited, WRX Premium; Head bolts not incl.; Head bolt replacement required; PermaTorqueMLS® Improved design head gskts. incl.; PermaDry® molded rubber valve cover gskts. incl.; Premium valve stem seals incl.; New Part Number - Check for Availability	
1	Head Set	2009-08	HS 26531 PT-1	Head bolts not incl.; Head bolt replacement required; PermaTorqueMLS® Improved design head gskts. incl.; PermaDry® molded rubber valve cover gskts. incl.; Premium valve stem seals incl.; New Part Number - Check for Availability	
1	Head Set	2007-06	HS 26531 PT	Subaru Impreza WRX, WRX Limited, WRX TR; Head bolts not incl.; Head bolt replacement required; PermaTorqueMLS® Improved design head gskts. incl.; PermaDry® molded rubber valve cover gskts. incl.; Premium valve stem seals incl.; New Part Number - Check for Availability	
1	Head Set	2007	HS 26531 PT-1	Exc. Subaru Impreza WRX, WRX Limited, WRX TR; Head bolts not incl.; Head bolt replacement required; PermaTorqueMLS® Improved design head gskts. incl.; PermaDry® molded rubber valve cover gskts. incl.; Premium valve stem seals incl.; New Part Number - Check for Availability	
1	Head Set	2006	HS 26259 PT-1	Exc. Subaru Impreza WRX, WRX Limited, WRX TR; Head bolts not incl.; Head bolt replacement required; PermaTorqueMLS® Improved design head gskts. incl.; PermaDry® molded rubber valve cover gskts. incl.; Premium valve stem seals incl.	
1	Head Set	2005	HS 26259 PT-1	Head bolts not incl.; Head bolt replacement required; PermaTorqueMLS® Improved design head gskts. incl.; PermaDry® molded rubber valve cover gskts. incl.; Premium valve stem seals incl.	
2	Head Bolt Set	2012-05	ES 72905	Head bolts w/Washers; Replacement required	
QTY	CONVERSION SET	YEARS	PART NO.	DESCRIPTION	
1	Gasket Conversion Set	2009-05	CS 26170		
QTY	MANIFOLD - INT. & EXH.	YEARS	PART NO.	DESCRIPTION	
1	Int. Manifold Gasket Set	2012-08	MS 96523-1	Lower set; Upper set incl.; New Part Number - Check for Availability	
1	Int. Manifold Gasket Set	2007-06	MS 96523	Subaru Impreza WRX, WRX Limited, WRX TR; Lower set; Upper set incl.	
1	Int. Manifold Gasket Set	2007	MS 96523-1	Exc. Subaru Impreza WRX, WRX Limited, WRX TR; Lower set; Upper set incl.; New Part Number - Check for Availability	
1	Int. Manifold Gasket Set	2006	MS 96758	Exc. Subaru Impreza WRX, WRX Limited, WRX TR; Lower set; Upper set incl.	
1	Int. Manifold Gasket Set	2005	MS 96758	Lower set; Upper set incl.	
1	Exh. Manifold Gasket Set	2012-05	MS 95088		
QTY	EXHAUST PIPE FLANGE	YEARS	PART NO.	DESCRIPTION	
1	Exhaust Pipe Gasket	2012-05	61365	Exh. connector	
1	Exhaust Pipe Gasket	2012-05	61365	Flange	
1	Exhaust Pipe Gasket	2012-05	61366	Converter	
QTY	OIL PAN	YEARS	PART NO.	DESCRIPTION	
1	Oil Pan Gasket Set	2009-05	OS 30656 C		
QTY	CRANKSHAFT REAR SEAL	YEARS	PART NO.	DESCRIPTION	
1	Rear Main Seal Set	2009-05	BS 40666	Rubber; One-piece; Improved design	
QTY	VALVE COVER	YEARS	PART NO.	DESCRIPTION	
1	Valve Cover Gasket Set	2012	VS 50620 R	Subaru Impreza WRX, WRX Limited, WRX Premium; w/Spark plug tube seals; PermaDry® molded rubber gskts. incl.	
1	Valve Cover Gasket Set	2012	VS 50781 R	Exc. Subaru Impreza WRX, WRX Limited, WRX Premium; w/Spark plug tube seals; PermaDry® molded rubber gskts. incl.; New Part Number - Check for Availability	
1	Valve Cover Gasket Set	2011-10	VS 50620 R	Subaru Impreza 2.5GT, WRX, WRX Limited, WRX Premium; w/Spark plug tube seals; PermaDry® molded rubber gskts. incl.	
1	Valve Cover Gasket Set	2011-10	VS 50781 R	Exc. Subaru Impreza 2.5GT, WRX, WRX Limited, WRX Premium; w/Spark plug tube seals; PermaDry® molded rubber gskts. incl.; New Part Number - Check for Availability	
1	Valve Cover Gasket Set	2009-05	VS 50620 R	w/Spark plug tube seals; PermaDry® molded rubber gskts. incl.	
2	Circular Plug	2012-05	ES 72418	Valve Cover; New Part Number - Check for Availability	
QTY	VALVE STEM SEAL SET	YEARS	PART NO.	DESCRIPTION	
1	Valve Stem Seal Set	2012-05	SS 72814	Premium valve stem seals incl.	
QTY	WATER OUTLET GASKET	YEARS	PART NO.	DESCRIPTION	
2	Water Outlet Gasket	2013-05	36024	Water Outlet; Water crossover O-ring; New Part Number - Check for Availability	
1	O-Ring	2012-05	35524	Water Outlet; Water outlet	
QTY	WATER PUMP	YEARS	PART NO.	DESCRIPTION	
1	Water Pump Gasket	2009-05	35747	Improved design	

Subaru Car (Cont.)

12 (cont.)		2013 - 2005; 2.5L 150 (2457cc) DOHC H4 (16 Valve) 99.5mm Bore			12 (cont.)
MFI; Gasoline; Turbo - Intercooled Subaru Eng.; Eng. Code EJ255					
QTY	TIMING COVER	YEARS	PART NO.	DESCRIPTION	
1	Crankshaft Front Seal Set	2009-05	TCS 46009		
2	Camshaft Front Seal Set	2012	TCS 46140	Subaru Impreza WRX, WRX Limited, WRX Premium; New Part Number - Check for Availability	
2	Camshaft Front Seal Set	2012	TCS 46140-1	Exc. Subaru Impreza WRX, WRX Limited, WRX Premium; New Part Number - Check for Availability	
2	Camshaft Front Seal Set	2011-10	TCS 46140	Subaru Impreza 2.5GT, WRX, WRX Limited, WRX Premium; New Part Number - Check for Availability	
2	Camshaft Front Seal Set	2011-10	TCS 46140-1	Exc. Subaru Impreza 2.5GT, WRX, WRX Limited, WRX Premium; New Part Number - Check for Availability	
2	Camshaft Front Seal Set	2009-05	TCS 46140	New Part Number - Check for Availability	
QTY	CARB & FUEL INJECTION	YEARS	PART NO.	DESCRIPTION	
1	Throttle Body Gasket	2012-08	61634	New Part Number - Check for Availability	
1	Throttle Body Gasket	2007-06	61359	Subaru Impreza WRX, WRX Limited, WRX TR	
1	Throttle Body Gasket	2007-06	61634	Exc. Subaru Impreza WRX, WRX Limited, WRX TR; New Part Number - Check for Availability	
1	Throttle Body Gasket	2005	61634	New Part Number - Check for Availability	
QTY	EXHAUST GAS RECIRCULATION	YEARS	PART NO.	DESCRIPTION	
1	EGR Gasket	2012-05	71218		
QTY	TURBO MOUNTING SET	YEARS	PART NO.	DESCRIPTION	
1	Turbo Mtg. Gasket Set	2012-05	ES 72745	New Part Number - Check for Availability	
13		2013 - 2004; 2.5L 150 (2457cc) DOHC H4 (16 Valve) 99.5mm Bore			13
MFI; Gasoline; Turbo - Intercooled Subaru Eng.; Eng. Code EJ257					
QTY	CYLINDER HEAD	YEARS	PART NO.	DESCRIPTION	
2	Head Gasket	2012-07	26531 PT	Head bolts not incl.; Head bolt replacement required; PermaTorqueMLS® LaserWeld® Technology; New Part Number - Check for Availability	
2	Head Gasket	2006-04	26259 PT	Head bolts not incl.; Head bolt replacement required; PermaTorqueMLS®; Old design; Superseded - When depleted use 26415 PT	
2	Head Gasket	2006-04	26415 PT	Head bolts not incl.; Head bolt replacement required; PermaTorqueMLS® LaserWeld® Technology; Improved design	
1	Head Set	2009-07	HS 26531 PT	Head bolts not incl.; Head bolt replacement required; PermaTorqueMLS® Improved design head gskts. incl.; PermaDry® molded rubber valve cover gskts. incl.; Premium valve stem seals incl.; New Part Number - Check for Availability	
1	Head Set	2006-04	HS 26259 PT	Head bolts not incl.; Head bolt replacement required; PermaTorqueMLS® Improved design head gskts. incl.; PermaDry® molded rubber valve cover gskts. incl.; Premium valve stem seals incl.	
2	Head Bolt Set	2012-04	ES 72905	Head bolts w/Washers; Replacement required	
QTY	CONVERSION SET	YEARS	PART NO.	DESCRIPTION	
1	Gasket Conversion Set	2009-04	CS 26170		
QTY	MANIFOLD - INT. & EXH.	YEARS	PART NO.	DESCRIPTION	
1	Int. Manifold Gasket Set	2009-04	MS 96523	Lower set; Upper set incl.	
1	Exh. Manifold Gasket Set	2012-04	MS 95088		
QTY	EXHAUST PIPE FLANGE	YEARS	PART NO.	DESCRIPTION	
1	Exhaust Pipe Gasket	2009-04	61365	Exh. connector	
1	Exhaust Pipe Gasket	2009-04	61365	Flange	
1	Exhaust Pipe Gasket	2009-04	61366	Converter	
QTY	OIL PAN	YEARS	PART NO.	DESCRIPTION	
1	Oil Pan Gasket Set	2009-04	OS 30656 C		
QTY	CRANKSHAFT REAR SEAL	YEARS	PART NO.	DESCRIPTION	
1	Rear Main Seal Set	2009-04	BS 40666	Rubber; One-piece; Improved design	
QTY	VALVE COVER	YEARS	PART NO.	DESCRIPTION	
1	Valve Cover Gasket Set	2012-04	VS 50620 R	w/Spark plug tube seals; PermaDry® molded rubber gskts. incl.	
2	Circular Plug	2012-04	ES 72418	Valve Cover; New Part Number - Check for Availability	
QTY	VALVE STEM SEAL SET	YEARS	PART NO.	DESCRIPTION	
1	Valve Stem Seal Set	2012-04	SS 72814	Premium valve stem seals incl.	
QTY	WATER OUTLET GASKET	YEARS	PART NO.	DESCRIPTION	
2	Water Outlet Gasket	2013-04	36024	Water Outlet; Water crossover O-ring; New Part Number - Check for Availability	
1	O-Ring	2012-04	35524	Water Outlet; Water outlet	
QTY	WATER PUMP	YEARS	PART NO.	DESCRIPTION	
1	Water Pump Gasket	2009-04	35747	Improved design	
QTY	TIMING COVER	YEARS	PART NO.	DESCRIPTION	
1	Crankshaft Front Seal Set	2009-04	TCS 46009		

13		2013 - 2004; 2.5L 150 (2457cc) DOHC H4 (16 Valve) 99.5mm Bore			13	
(cont.)		MFI; Gasoline; Turbo - Intercooled Subaru Eng.; Eng. Code EJ257			(cont.)	
QTY	TIMING COVER	YEARS	PART NO.	DESCRIPTION		
2	Camshaft Front Seal Set	2012-04	TCS 46140	New Part Number - Check for Availability		
QTY	CARB & FUEL INJECTION	YEARS	PART NO.	DESCRIPTION		
1	Throttle Body Gasket	2012-04	61359			
QTY	EXHAUST GAS RECIRCULATION	YEARS	PART NO.	DESCRIPTION		
1	EGR Gasket	2009-04	71218			
QTY	TURBO MOUNTING SET	YEARS	PART NO.	DESCRIPTION		
1	Turbo Mtg. Gasket Set	2012-04	ES 72745	New Part Number - Check for Availability		
14		1999 - 1996; 2.5L 150 (2457cc) DOHC H4 (16 Valve) 99.5mm Bore			14	
(cont.)		MFI; Gasoline; Naturally Aspirated Subaru Eng.; Eng. Code EJ25D			(cont.)	
QTY	CYLINDER HEAD	YEARS	PART NO.	DESCRIPTION		
2	Head Gasket	1999-96	26167 PT	Head bolts not incl.; Head bolt replacement required; PermaTorqueMLS® LaserWeld® Technology		
1	Head Set	1999	HS 26167 PT-2	Head bolts not incl.; Head bolt replacement required; PermaDry® molded rubber valve cover gskts. incl.; Premium valve stem seals incl.		
1	Head Set	1999	HS 26167 PT-3	w/Valve cover housing No. 13264-AA190; Head bolts not incl.; Head bolt replacement required; PermaDry® molded rubber valve cover gskts. incl.; Premium valve stem seals incl.		
1	Head Set	1999	HS 26167 PT-3	w/Valve cover housing No. 13278-AA170; Head bolts not incl.; Head bolt replacement required; PermaDry® molded rubber valve cover gskts. incl.; Premium valve stem seals incl.		
1	Head Set	1998	HS 26167 PT-1	From Eng. Ser. No. 993723 to 047282; Head bolts not incl.; Head bolt replacement required; PermaDry® molded rubber valve cover gskts. incl.; Premium valve stem seals incl.		
1	Head Set	1998	HS 26167 PT-1	To Eng. Ser. No. 989330; Head bolts not incl.; Head bolt replacement required; PermaDry® molded rubber valve cover gskts. incl.; Premium valve stem seals incl.		
1	Head Set	1998	HS 26167 PT-2	From Eng. Ser. No. 015320 to 015923; Head bolts not incl.; Head bolt replacement required; PermaDry® molded rubber valve cover gskts. incl.; Premium valve stem seals incl.		
1	Head Set	1998	HS 26167 PT-2	From Eng. Ser. No. 023456 to 064058; Head bolts not incl.; Head bolt replacement required; PermaDry® molded rubber valve cover gskts. incl.; Premium valve stem seals incl.		
1	Head Set	1998	HS 26167 PT-2	From Eng. Ser. No. 047283 to 285351; Head bolts not incl.; Head bolt replacement required; PermaDry® molded rubber valve cover gskts. incl.; Premium valve stem seals incl.		
1	Head Set	1998	HS 26167 PT-2	From Eng. Ser. No. 989331 to 993722; Head bolts not incl.; Head bolt replacement required; PermaDry® molded rubber valve cover gskts. incl.; Premium valve stem seals incl.		
1	Head Set	1998	HS 26167 PT-2	To Eng. Ser. No. 993722; Head bolts not incl.; Head bolt replacement required; PermaDry® molded rubber valve cover gskts. incl.; Premium valve stem seals incl.		
1	Head Set	1997	HS 26167 PT-1	Head bolts not incl.; Head bolt replacement required; PermaDry® molded rubber valve cover gskts. incl.; Premium valve stem seals incl.		
1	Head Set	1996	HS 26167 PT	Head bolts not incl.; Head bolt replacement required; PermaDry® molded rubber valve cover gskts. incl.; Premium valve stem seals incl.		
2	Head Bolt Set	1999-96	ES 72905	Head bolts w/Washers; Replacement required		
QTY	CONVERSION SET	YEARS	PART NO.	DESCRIPTION		
1	Gasket Conversion Set	1999	CS 26170			
1	Gasket Conversion Set	1998-96	CS 26167			
QTY	MANIFOLD - INT. & EXH.	YEARS	PART NO.	DESCRIPTION		
1	Int. Manifold Gasket Set	1999-96	MS 96105	Lower set		
1	Exh. Manifold Gasket Set	1999-96	MS 95088			
QTY	OIL PAN	YEARS	PART NO.	DESCRIPTION		
1	Oil Pan Gasket Set	1999-96	OS 30656 C			
QTY	CRANKSHAFT REAR SEAL	YEARS	PART NO.	DESCRIPTION		
1	Rear Main Seal Set	1999-96	BS 40666	Rubber; One-piece; Improved design		
QTY	VALVE COVER	YEARS	PART NO.	DESCRIPTION		
1	Valve Cover Gasket Set	1999	VS 50662 R	w/Grommets & Spark plug tube seals; PermaDry® molded rubber gskts. incl.		
1	Valve Cover Gasket Set	1999	VS 50672 R	w/Valve cover housing No. 13264-AA190; w/Grommets & Spark plug tube seals; PermaDry® molded rubber gskts. incl.		
1	Valve Cover Gasket Set	1999	VS 50672 R	w/Valve cover housing No. 13278-AA170; w/Grommets & Spark plug tube seals; PermaDry® molded rubber gskts. incl.		

Subaru Car (Cont.)

14 (cont.)		1999 - 1996; 2.5L 150 (2457cc) DOHC H4 (16 Valve) 99.5mm Bore			14 (cont.)	
MFI; Gasoline; Naturally Aspirated Subaru Eng.; Eng. Code EJ25D						
QTY	VALVE COVER	YEARS	PART NO.	DESCRIPTION		
1	Valve Cover Gasket Set	1998	VS 50557 R	From Eng. Ser. No. 993723 to 047282; w/Grommets & Spark plug tube seals; PermaDry® molded rubber gskts. incl.		
1	Valve Cover Gasket Set	1998	VS 50557 R	To Eng. Ser. No. 989330; w/Grommets & Spark plug tube seals; PermaDry® molded rubber gskts. incl.		
1	Valve Cover Gasket Set	1998	VS 50662 R	From Eng. Ser. No. 015320 to 015923; w/Grommets & Spark plug tube seals; PermaDry® molded rubber gskts. incl.		
1	Valve Cover Gasket Set	1998	VS 50662 R	From Eng. Ser. No. 023456 to 064058; w/Grommets & Spark plug tube seals; PermaDry® molded rubber gskts. incl.		
1	Valve Cover Gasket Set	1998	VS 50662 R	From Eng. Ser. No. 047283 to 285351; w/Grommets & Spark plug tube seals; PermaDry® molded rubber gskts. incl.		
1	Valve Cover Gasket Set	1998	VS 50662 R	From Eng. Ser. No. 989331 to 993722; w/Grommets & Spark plug tube seals; PermaDry® molded rubber gskts. incl.		
1	Valve Cover Gasket Set	1998	VS 50662 R	To Eng. Ser. No. 993722; w/Grommets & Spark plug tube seals; PermaDry® molded rubber gskts. incl.		
1	Valve Cover Gasket Set	1997	VS 50557 R	w/Grommets & Spark plug tube seals; PermaDry® molded rubber gskts. incl.		
1	Valve Cover Gasket Set	1996	VS 50555 R	w/Grommets & Spark plug tube seals; PermaDry® molded rubber gskts. incl.		
QTY	VALVE STEM SEAL SET	YEARS	PART NO.	DESCRIPTION		
1	Valve Stem Seal Set	1999-96	SS 72814	Premium valve stem seals incl.		
QTY	WATER OUTLET GASKET	YEARS	PART NO.	DESCRIPTION		
2	Water Outlet Gasket	1999-96	36024	Water Outlet; Water crossover O-ring; New Part Number - Check for Availability		
1	O-Ring	1999-96	35524	Water Outlet; Water outlet		
QTY	WATER PUMP	YEARS	PART NO.	DESCRIPTION		
1	Water Pump Gasket	1999-96	35747	Improved design		
QTY	TIMING COVER	YEARS	PART NO.	DESCRIPTION		
1	Crankshaft Front Seal Set	1999	TCS 46009			
1	Crankshaft Front Seal Set	1998-96	TCS 45957			
2	Camshaft Front Seal Set	1999-96	TCS 46008			
QTY	CARB & FUEL INJECTION	YEARS	PART NO.	DESCRIPTION		
1	Throttle Body Gasket	1999-96	60920			
QTY	EXHAUST GAS RECIRCULATION	YEARS	PART NO.	DESCRIPTION		
1	EGR Gasket	1999-96	70004			
15		2005 - 2004; 2.5L 150 (2457cc) DOHC H4 (16 Valve) 99.5mm Bore			15	
MFI; Gasoline; Turbo - Intercooled Subaru Eng.; Eng. Code EJ25T						
QTY	CYLINDER HEAD	YEARS	PART NO.	DESCRIPTION		
2	Head Gasket	2005-04	26259 PT	Head bolts not incl.; Head bolt replacement required; PermaTorqueMLS®; Old design; Superseded - When depleted use 26415 PT		
2	Head Gasket	2005-04	26415 PT	Head bolts not incl.; Head bolt replacement required; PermaTorqueMLS® LaserWeld® Technology; Improved design		
1	Head Set	2005	HS 26259 PT	Subaru Impreza WRX STi; Head bolts not incl.; Head bolt replacement required; PermaTorqueMLS® Improved design head gskts. incl.; PermaDry® molded rubber valve cover gskts. incl.; Premium valve stem seals incl.		
1	Head Set	2005	HS 26259 PT-1	Exc. Subaru Impreza WRX STi; Head bolts not incl.; Head bolt replacement required; PermaTorqueMLS® Improved design head gskts. incl.; PermaDry® molded rubber valve cover gskts. incl.; Premium valve stem seals incl.		
1	Head Set	2004	HS 26259 PT	Head bolts not incl.; Head bolt replacement required; PermaTorqueMLS® Improved design head gskts. incl.; PermaDry® molded rubber valve cover gskts. incl.; Premium valve stem seals incl.		
2	Head Bolt Set	2005-04	ES 72905	Head bolts w/Washers; Replacement required		
QTY	CONVERSION SET	YEARS	PART NO.	DESCRIPTION		
1	Gasket Conversion Set	2005-04	CS 26170			
QTY	MANIFOLD - INT. & EXH.	YEARS	PART NO.	DESCRIPTION		
1	Int. Manifold Gasket Set	2005	MS 96523	Subaru Impreza WRX STi; Lower set; Upper set incl.		
1	Int. Manifold Gasket Set	2005	MS 96758	Exc. Subaru Impreza WRX STi; Lower set; Upper set incl.		
1	Int. Manifold Gasket Set	2004	MS 96523	Lower set; Upper set incl.		
1	Exh. Manifold Gasket Set	2005-04	MS 95088			
QTY	EXHAUST PIPE FLANGE	YEARS	PART NO.	DESCRIPTION		
1	Exhaust Pipe Gasket	2005-04	61365	Exh. connector		
1	Exhaust Pipe Gasket	2005-04	61365	Flange		
1	Exhaust Pipe Gasket	2005-04	61366	Converter		
QTY	OIL PAN	YEARS	PART NO.	DESCRIPTION		
1	Oil Pan Gasket Set	2005-04	OS 30656 C			

15 (cont.)		2005 - 2004; 2.5L 150 (2457cc) DOHC H4 (16 Valve) 99.5mm Bore			15 (cont.)
		MFI; Gasoline; Turbo - Intercooled Subaru Eng.; Eng. Code EJ25T			
QTY	CRANKSHAFT REAR SEAL	YEARS	PART NO.	DESCRIPTION	
1	Rear Main Seal Set	2005-04	BS 40666	Rubber; One-piece; Improved design	
QTY	VALVE COVER	YEARS	PART NO.	DESCRIPTION	
1	Valve Cover Gasket Set	2005-04	VS 50620 R	w/Spark plug tube seals; PermaDry® molded rubber gskts. incl.	
2	Circular Plug	2005-04	ES 72418	Valve Cover; New Part Number - Check for Availability	
QTY	VALVE STEM SEAL SET	YEARS	PART NO.	DESCRIPTION	
1	Valve Stem Seal Set	2005-04	SS 72814	Premium valve stem seals incl.	
QTY	WATER OUTLET GASKET	YEARS	PART NO.	DESCRIPTION	
2	Water Outlet Gasket	2005-04	36024	Water Outlet; Water crossover O-ring; New Part Number - Check for Availability	
1	O-Ring	2005-04	35524	Water Outlet; Water outlet	
QTY	WATER PUMP	YEARS	PART NO.	DESCRIPTION	
1	Water Pump Gasket	2005-04	35747	Improved design	
QTY	TIMING COVER	YEARS	PART NO.	DESCRIPTION	
1	Crankshaft Front Seal Set	2005-04	TCS 46009		
2	Camshaft Front Seal Set	2005-04	TCS 46140	New Part Number - Check for Availability	
QTY	CARB & FUEL INJECTION	YEARS	PART NO.	DESCRIPTION	
1	Throttle Body Gasket	2005	61359	Subaru Impreza WRX STi	
1	Throttle Body Gasket	2005	61634	Exc. Subaru Impreza WRX STi; New Part Number - Check for Availability	
1	Throttle Body Gasket	2004	61359		
QTY	EXHAUST GAS RECIRCULATION	YEARS	PART NO.	DESCRIPTION	
1	EGR Gasket	2005-04	71218		
QTY	TURBO MOUNTING SET	YEARS	PART NO.	DESCRIPTION	
1	Turbo Mtg. Gasket Set	2005-04	ES 72745	New Part Number - Check for Availability	
16		2005 - 1999; 2.5L 150 (2457cc) SOHC H4 (16 Valve) 99.5mm Bore			16
		MFI; Gasoline; Naturally Aspirated Subaru Eng.; Eng. Code EJ25I			
QTY	CYLINDER HEAD	YEARS	PART NO.	DESCRIPTION	
2	Head Gasket	2005-99	26170 PT	Head bolts not incl.; Head bolt replacement required; PermaTorque®; Old design	
2	Head Gasket	2005-99	26415 PT	Head bolts not incl.; Head bolt replacement required; PermaTorqueMLS® LaserWeld® Technology; Improved design	
1	Head Set	2005	HS 26170 PT-1	Upper int. manifold gskts. & head bolts not incl.; California exh. manifold gskts. not incl.; Head bolt replacement required; PermaTorqueMLS® Improved design head gskts. incl.; PermaDry® molded rubber valve cover gskts. incl.; Premium valve stem seals inc	
1	Head Set	2004	HS 26170 PT-1	Exc. Subaru Impreza Outback, Outback Sport, RS, TS; Head bolts not incl.; California exh. manifold gskts. not incl.; Head bolt replacement required; PermaTorqueMLS® Improved design head gskts. incl.; PermaDry® molded rubber valve cover gskts. incl.; Premium valve stem seals incl.; Consolidated design	
1	Head Set	2004	HS 26170 PT-1	Subaru Impreza Outback, Outback Sport, RS, TS; Int. manifold gskts. & head bolts not incl.; California exh. manifold gskts. not incl.; Head bolt replacement required; PermaTorqueMLS® Improved design head gskts. incl.; PermaDry® molded rubber valve cover gskts. incl.; Premium valve stem seals incl.; Co	
1	Head Set	2003-99	HS 26170 PT-1	Head bolts not incl.; Head bolt replacement required; PermaTorqueMLS® Improved design head gskts. incl.; PermaDry® molded rubber valve cover gskts. incl.; Premium valve stem seals incl.; Consolidated design	
2	Head Bolt Set	2005-99	ES 72212	Head bolts w/Washers; Replacement required	
QTY	CONVERSION SET	YEARS	PART NO.	DESCRIPTION	
1	Gasket Conversion Set	2005-99	CS 26170		
QTY	MANIFOLD - INT. & EXH.	YEARS	PART NO.	DESCRIPTION	
1	Int. Manifold Gasket Set	2005	MS 96106	Lower set	
1	Int. Manifold Gasket Set	2004	MS 96106	Exc. Subaru Impreza Outback, Outback Sport, RS, TS; Lower set	
1	Int. Manifold Gasket Set	2004	MS 96750	Subaru Impreza Outback, Outback Sport, RS, TS; Lower set	
1	Int. Manifold Gasket Set	2003-99	MS 96106	Lower set	
1	Plenum Gasket Set	2005	MS 96746	California; Upper set	
1	Plenum Gasket Set	2005	MS 96747	Exc. California; Upper set	
1	Exh. Manifold Gasket Set	2005-04	MS 95088	Exc. California	
1	Exh. Manifold Gasket Set	2005-04	MS 97210	California; OEM style; New Part Number - Check for Availability	
1	Exh. Manifold Gasket Set	2003-99	MS 95088		
QTY	OIL PAN	YEARS	PART NO.	DESCRIPTION	
1	Oil Pan Gasket Set	2005-99	OS 30656 C		

Subaru Car (Cont.)

16 (cont.)		2005 - 1999; 2.5L 150 (2457cc) SOHC H4 (16 Valve) 99.5mm Bore			16 (cont.)
MFI; Gasoline; Naturally Aspirated Subaru Eng.; Eng. Code EJ251					
QTY	CRANKSHAFT REAR SEAL	YEARS	PART NO.	DESCRIPTION	
1	Rear Main Seal Set	2005-99	BS 40666	Rubber; One-piece; Improved design	
QTY	VALVE COVER	YEARS	PART NO.	DESCRIPTION	
1	Valve Cover Gasket Set	2005-99	VS 50561 R	w/Grommets & Spark plug tube seals; PermaDry® molded rubber gskts. incl.; Improved design	
1	Valve Cover Gasket Set	2005	VS 50561 R-1	Exc. Subaru Outback Sport; w/Grommets & Spark plug tube seals; PermaDry® molded rubber gskts. incl.; Old design; Superseded - When depleted use VS 50561 R	
1	Valve Cover Gasket Set	2004-02	VS 50561 R-1	Subaru Impreza Outback, Outback Sport, RS, TS; w/Grommets & Spark plug tube seals; PermaDry® molded rubber gskts. incl.; Old design; Superseded - When depleted use VS 50561 R	
1	Circular Plug	2005-99	ES 72418	Valve Cover; New Part Number - Check for Availability	
QTY	VALVE STEM SEAL SET	YEARS	PART NO.	DESCRIPTION	
1	Valve Stem Seal Set	2005-99	SS 72814	Premium valve stem seals incl.	
QTY	WATER OUTLET GASKET	YEARS	PART NO.	DESCRIPTION	
2	Water Outlet Gasket	2005-99	36024	Water Outlet; Water crossover O-ring; New Part Number - Check for Availability	
1	O-Ring	1999	35524	Water Outlet; Water outlet	
QTY	WATER PUMP	YEARS	PART NO.	DESCRIPTION	
1	Water Pump Gasket	2005-99	35747	Improved design	
QTY	TIMING COVER	YEARS	PART NO.	DESCRIPTION	
1	Crankshaft Front Seal Set	2005-99	TCS 46009		
1	Camshaft Front Seal Set	2005-99	TCS 46008		
QTY	CARB & FUEL INJECTION	YEARS	PART NO.	DESCRIPTION	
1	Fuel Injector O-Ring Set	2005-99	ES 70599	Improved design	
1	Throttle Body Gasket	2005	61500		
1	Throttle Body Gasket	2004	61492		
1	Throttle Body Gasket	2003-99	61360		
QTY	EXHAUST GAS RECIRCULATION	YEARS	PART NO.	DESCRIPTION	
1	EGR Gasket	2005-02	71218		
1	EGR Gasket	2001-99	70004		
17		2000; 2.5L 150 (2457cc) SOHC H4 (16 Valve) 99.5mm Bore			17
MFI; Gasoline; Naturally Aspirated Subaru Eng.; Eng. Code EJ252					
QTY	CYLINDER HEAD	YEARS	PART NO.	DESCRIPTION	
2	Head Gasket	2000	26170 PT	Head bolts not incl.; Head bolt replacement required; PermaTorque®; Old design	
2	Head Gasket	2000	26415 PT	Head bolts not incl.; Head bolt replacement required; PermaTorqueMLS® LaserWeld® Technology; Improved design	
1	Head Set	2000	HS 26170 PT-1	Head bolts not incl.; Head bolt replacement required; PermaTorqueMLS® Improved design head gskts. incl.; PermaDry® molded rubber valve cover gskts. incl.; Premium valve stem seals incl.; Consolidated design	
2	Head Bolt Set	2000	ES 72212	Head bolts w/Washers; Replacement required	
QTY	CONVERSION SET	YEARS	PART NO.	DESCRIPTION	
1	Gasket Conversion Set	2000	CS 26170		
QTY	MANIFOLD - INT. & EXH.	YEARS	PART NO.	DESCRIPTION	
1	Int. Manifold Gasket Set	2000	MS 96106	Lower set	
1	Exh. Manifold Gasket Set	2000	MS 95088		
QTY	OIL PAN	YEARS	PART NO.	DESCRIPTION	
1	Oil Pan Gasket Set	2000	OS 30656 C		
QTY	CRANKSHAFT REAR SEAL	YEARS	PART NO.	DESCRIPTION	
1	Rear Main Seal Set	2000	BS 40666	Rubber; One-piece; Improved design	
QTY	VALVE COVER	YEARS	PART NO.	DESCRIPTION	
1	Valve Cover Gasket Set	2000	VS 50561 R	w/Grommets & Spark plug tube seals; PermaDry® molded rubber gskts. incl.; Improved design	
1	Circular Plug	2000	ES 72418	Valve Cover; New Part Number - Check for Availability	
QTY	VALVE STEM SEAL SET	YEARS	PART NO.	DESCRIPTION	
1	Valve Stem Seal Set	2000	SS 72814	Premium valve stem seals incl.	
QTY	WATER OUTLET GASKET	YEARS	PART NO.	DESCRIPTION	
2	Water Outlet Gasket	2000	36024	Water Outlet; Water crossover O-ring; New Part Number - Check for Availability	
1	O-Ring	2000	35524	Water Outlet; Water outlet	
QTY	WATER PUMP	YEARS	PART NO.	DESCRIPTION	
1	Water Pump Gasket	2000	35747	Improved design	
QTY	TIMING COVER	YEARS	PART NO.	DESCRIPTION	
1	Crankshaft Front Seal Set	2000	TCS 46009		

17		2000; 2.5L 150 (2457cc) SOHC H4 (16 Valve) 99.5mm Bore			17	
(cont.)		MFI; Gasoline; Naturally Aspirated Subaru Eng.; Eng. Code EJ252			(cont.)	
QTY	TIMING COVER	YEARS	PART NO.	DESCRIPTION		
1	Camshaft Front Seal Set	2000	TCS 46008			
QTY	CARB & FUEL INJECTION	YEARS	PART NO.	DESCRIPTION		
1	Fuel Injector O-Ring Set	2000	ES 70599	Improved design		
1	Throttle Body Gasket	2000	61360			
QTY	EXHAUST GAS RECIRCULATION	YEARS	PART NO.	DESCRIPTION		
1	EGR Gasket	2000	70004			
18		2012 - 1999; 2.5L 150 (2457cc) SOHC H4 (16 Valve) 99.5mm Bore			18	
(cont.)		MFI; Gasoline; Naturally Aspirated Subaru Eng.; Eng. Code EJ253			(cont.)	
QTY	CYLINDER HEAD	YEARS	PART NO.	DESCRIPTION		
2	Head Gasket	2012	26531 PT	Head bolts not incl.; Head bolt replacement required; PermaTorqueMLS® LaserWeld® Technology; New Part Number - Check for Availability		
2	Head Gasket	2011-10	26170 PT	Subaru Impreza 2.5i, 2.5i Limited, 2.5i Premium, Outback Sport; Head bolts not incl.; Head bolt replacement required; PermaTorque®; Old design		
2	Head Gasket	2011-10	26415 PT	Subaru Impreza 2.5i, 2.5i Limited, 2.5i Premium, Outback Sport; Head bolts not incl.; Head bolt replacement required; PermaTorqueMLS® LaserWeld® Technology; Improved design		
2	Head Gasket	2011-10	26531 PT	Exc. Subaru Impreza 2.5i, 2.5i Limited, 2.5i Premium, Outback Sport; Head bolts not incl.; Head bolt replacement required; PermaTorqueMLS® LaserWeld® Technology; New Part Number - Check for Availability		
2	Head Gasket	2009-99	26170 PT	Head bolts not incl.; Head bolt replacement required; PermaTorque®; Old design		
2	Head Gasket	2009-99	26415 PT	Head bolts not incl.; Head bolt replacement required; PermaTorqueMLS® LaserWeld® Technology; Improved design		
1	Head Set	2012	HS 26531 PT-3	Head bolts not incl.; Head bolt replacement required; PermaTorqueMLS® Improved design head gskts. incl.; PermaDry® molded rubber valve cover gskts. incl.; Premium valve stem seals incl.; New Part Number - Check for Availability		
1	Head Set	2011-10	HS 26415 PT-1	Subaru Impreza 2.5i, 2.5i Limited, 2.5i Premium, Outback Sport; California; Upper int. manifold gskts. & head bolts not incl.; Head bolt replacement required; PermaTorqueMLS® Improved design head gskts. incl.; PermaDry® molded rubber valve cover gskts. incl.; Premium valve stem seals incl.; New Part Number - Check for		
1	Head Set	2011-10	HS 26415 PT-1	Subaru Impreza 2.5i, 2.5i Limited, 2.5i Premium, Outback Sport; Exc. California; Head bolts not incl.; Head bolt replacement required; PermaTorqueMLS® Improved design head gskts. incl.; PermaDry® molded rubber valve cover gskts. incl.; Premium valve stem seals incl.; New Part Number - Check for Availability		
1	Head Set	2011-10	HS 26531 PT-3	Exc. Subaru Impreza 2.5i, 2.5i Limited, 2.5i Premium, Outback Sport; Head bolts not incl.; Head bolt replacement required; PermaTorqueMLS® Improved design head gskts. incl.; PermaDry® molded rubber valve cover gskts. incl.; Premium valve stem seals incl.; New Part Number - Check for Availability		
1	Head Set	2009-06	HS 26415 PT-1	California; Upper int. manifold gskts. & head bolts not incl.; Head bolt replacement required; PermaTorqueMLS® Improved design head gskts. incl.; PermaDry® molded rubber valve cover gskts. incl.; Premium valve stem seals incl.; New Part Number - Check for		
1	Head Set	2009-06	HS 26415 PT-1	Exc. California; Head bolts not incl.; Head bolt replacement required; PermaTorqueMLS® Improved design head gskts. incl.; PermaDry® molded rubber valve cover gskts. incl.; Premium valve stem seals incl.; New Part Number - Check for Availability		
1	Head Set	2005	HS 26170 PT-1	Upper int. manifold gskts. & head bolts not incl.; California exh. manifold gskts. not incl.; Head bolt replacement required; PermaTorqueMLS® Improved design head gskts. incl.; PermaDry® molded rubber valve cover gskts. incl.; Premium valve stem seals inc		
1	Head Set	2004	HS 26170 PT-1	Head bolts not incl.; California exh. manifold gskts. not incl.; Head bolt replacement required; PermaTorqueMLS® Improved design head gskts. incl.; PermaDry® molded rubber valve cover gskts. incl.; Premium valve stem seals incl.; Consolidated design		
1	Head Set	2003-99	HS 26170 PT-1	Head bolts not incl.; Head bolt replacement required; PermaTorqueMLS® Improved design head gskts. incl.; PermaDry® molded rubber valve cover gskts. incl.; Premium valve stem seals incl.; Consolidated design		
2	Head Bolt Set	2012-99	ES 72212	Head bolts w/Washers; Replacement required		
QTY	CONVERSION SET	YEARS	PART NO.	DESCRIPTION		
1	Gasket Conversion Set	2012-99	CS 26170			

Subaru Car (Cont.)

18 (cont.)		2012 - 1999; 2.5L 150 (2457cc) SOHC H4 (16 Valve) 99.5mm Bore			18 (cont.)
MFI; Gasoline; Naturally Aspirated Subaru Eng.; Eng. Code EJ253					
QTY	MANIFOLD - INT. & EXH.	YEARS	PART NO.	DESCRIPTION	
1	Int. Manifold Gasket Set	2012	MS 97164	Lower set; New Part Number - Check for Availability	
1	Int. Manifold Gasket Set	2011-10	MS 96106	Subaru Impreza 2.5i, 2.5i Limited, 2.5i Premium, Outback Sport; Lower set	
1	Int. Manifold Gasket Set	2011-10	MS 97164	Exc. Subaru Impreza 2.5i, 2.5i Limited, 2.5i Premium, Outback Sport; Lower set; New Part Number - Check for Availability	
1	Int. Manifold Gasket Set	2009-99	MS 96106	Lower set	
1	Plenum Gasket Set	2011-10	MS 96746	Subaru Impreza 2.5i, 2.5i Limited, 2.5i Premium, Outback Sport; California; Upper set	
1	Plenum Gasket Set	2011-10	MS 96747	Subaru Impreza 2.5i, 2.5i Limited, 2.5i Premium, Outback Sport; Exc. California; Upper set	
1	Plenum Gasket Set	2009-05	MS 96746	California; Upper set	
1	Plenum Gasket Set	2009-05	MS 96747	Exc. California; Upper set	
1	Exh. Manifold Gasket Set	2012-06	MS 95088		
1	Exh. Manifold Gasket Set	2005-04	MS 95088	Exc. California	
1	Exh. Manifold Gasket Set	2005-04	MS 97210	California; OEM style; New Part Number - Check for Availability	
1	Exh. Manifold Gasket Set	2003-99	MS 95088		
QTY	EXHAUST PIPE FLANGE	YEARS	PART NO.	DESCRIPTION	
2	Exhaust Pipe Gasket	2012-06	60992	Converter to manifold	
2	Exhaust Pipe Gasket	2012-06	61106	Converter; 2.40" ID	
1	Exhaust Pipe Gasket	2012-06	61106	Exh. connector; 2.40" ID	
QTY	OIL PAN	YEARS	PART NO.	DESCRIPTION	
1	Oil Pan Gasket Set	2012-99	OS 30656 C		
QTY	CRANKSHAFT REAR SEAL	YEARS	PART NO.	DESCRIPTION	
1	Rear Main Seal Set	2012-99	BS 40666	Rubber; One-piece; Improved design	
QTY	VALVE COVER	YEARS	PART NO.	DESCRIPTION	
1	Valve Cover Gasket Set	2012-06	VS 50780 R	w/Spark plug tube seals; PermaDry® molded rubber gskts. incl.; New Part Number - Check for Availability	
1	Valve Cover Gasket Set	2005-99	VS 50561 R	w/Grommets & Spark plug tube seals; PermaDry® molded rubber gskts. incl.; Improved design	
1	Valve Cover Gasket Set	2005	VS 50561 R-1	Subaru Impreza 2.5i, Outback, Outback Sport, RS; w/Grommets & Spark plug tube seals; PermaDry® molded rubber gskts. incl.; Old design; Superseded - When depleted use VS 50561 R	
1	Valve Cover Gasket Set	2004-02	VS 50561 R-1	Subaru Impreza Outback, Outback Sport, RS, TS; w/Grommets & Spark plug tube seals; PermaDry® molded rubber gskts. incl.; Old design; Superseded - When depleted use VS 50561 R	
1	Circular Plug	2012-99	ES 72418	Valve Cover; New Part Number - Check for Availability	
QTY	VALVE STEM SEAL SET	YEARS	PART NO.	DESCRIPTION	
1	Valve Stem Seal Set	2012-99	SS 72814	Premium valve stem seals incl.	
QTY	WATER OUTLET GASKET	YEARS	PART NO.	DESCRIPTION	
2	Water Outlet Gasket	2012-99	36024	Water Outlet; Water crossover O-ring; New Part Number - Check for Availability	
1	O-Ring	2012-99	35524	Water Outlet; Water outlet	
QTY	WATER PUMP	YEARS	PART NO.	DESCRIPTION	
1	Water Pump Gasket	2012-99	35747	Improved design	
QTY	TIMING COVER	YEARS	PART NO.	DESCRIPTION	
1	Crankshaft Front Seal Set	2012-99	TCS 46009		
1	Camshaft Front Seal Set	2012-99	TCS 46008		
QTY	CARB & FUEL INJECTION	YEARS	PART NO.	DESCRIPTION	
1	Fuel Injector O-Ring Set	2012-99	ES 70599	Improved design	
1	Throttle Body Gasket	2012-10	61657		
1	Throttle Body Gasket	2009-07	61359	Subaru Impreza 2.5i, Outback Sport	
1	Throttle Body Gasket	2009-07	61500	Exc. Subaru Impreza 2.5i, Outback Sport	
1	Throttle Body Gasket	2006-05	61500		
1	Throttle Body Gasket	2004	61492		
1	Throttle Body Gasket	2003-99	61360		
QTY	EXHAUST GAS RECIRCULATION	YEARS	PART NO.	DESCRIPTION	
1	EGR Gasket	2012-02	71218		
1	EGR Gasket	2001-99	70004		
19		2013; 2.5L 152.4 (2498cc) DOHC H4 (16 Valve) 94mm Bore VVT			19
MFI; Gasoline; Naturally Aspirated Subaru Eng.; Eng. Code FB25BA					
QTY	MANIFOLD - INT. & EXH.	YEARS	PART NO.	DESCRIPTION	
1	Int. Manifold Gasket Set	2013	MS 97161	Lower set; Upper set incl.; New Part Number - Check for Availability	

19		2013; 2.5L 152.4 (2498cc) DOHC H4 (16 Valve) 94mm Bore VVT			19	
(cont.)		MFI; Gasoline; Naturally Aspirated Subaru Eng.; Eng. Code FB25BA			(cont.)	
QTY	WATER OUTLET GASKET	YEARS	PART NO.	DESCRIPTION		
2	Water Outlet Gasket	2013	36024	Water Outlet; Water crossover O-ring; New Part Number - Check for Availability		
20		2013; 2.5L 152.4 (2498cc) DOHC H4 (16 Valve) 94mm Bore VVT			20	
(cont.)		MFI; Gasoline; Naturally Aspirated Subaru Eng.; Eng. Code FB25BC			(cont.)	
QTY	MANIFOLD - INT. & EXH.	YEARS	PART NO.	DESCRIPTION		
1	Int. Manifold Gasket Set	2013	MS 97161	Lower set; Upper set incl.; New Part Number - Check for Availability		
QTY	WATER OUTLET GASKET	YEARS	PART NO.	DESCRIPTION		
2	Water Outlet Gasket	2013	36024	Water Outlet; Water crossover O-ring; New Part Number - Check for Availability		
21		1991; 2.7L 163 (2672cc) SOHC H6 (12 Valve) 92mm Bore			21	
(cont.)		MFI; Gasoline; Naturally Aspirated Subaru Eng.; Eng. Code ER27			(cont.)	
QTY	EXHAUST PIPE FLANGE	YEARS	PART NO.	DESCRIPTION		
1	Exhaust Pipe Gasket	1991	60460	Converter		
QTY	CRANKSHAFT REAR SEAL	YEARS	PART NO.	DESCRIPTION		
1	Rear Main Seal Set	1991	BS 40387	Rubber; One-piece		
QTY	WATER OUTLET GASKET	YEARS	PART NO.	DESCRIPTION		
1	Water Outlet Gasket	1991	35298-1	Water Outlet		
QTY	WATER PUMP	YEARS	PART NO.	DESCRIPTION		
1	Water Pump Gasket	1991	35343			
QTY	TIMING COVER	YEARS	PART NO.	DESCRIPTION		
1	Crankshaft Front Seal Set	1991	TCS 45540			
1	Camshaft Front Seal Set	1991	TCS 45687			
QTY	EXHAUST GAS RECIRCULATION	YEARS	PART NO.	DESCRIPTION		
1	EGR Gasket	1991	70004			
22		2009 - 2001; 3.0L 183 (2999cc) DOHC H6 (24 Valve) 89.2mm Bore			22	
(cont.)		MFI; Gasoline; Naturally Aspirated Subaru Eng.; Eng. Code EZ30D			(cont.)	
QTY	CYLINDER HEAD	YEARS	PART NO.	DESCRIPTION		
1	Head Gasket	2009-05	26534 PT	Loc. L.H.; Head bolts not incl.; Head bolt replacement required; PermaTorqueMLS®; New Part Number - Check for Availability		
1	Head Gasket	2009-05	26536 PT	Loc. R.H.; Head bolts not incl.; Head bolt replacement required; PermaTorqueMLS®; New Part Number - Check for Availability		
1	Head Gasket	2004-01	26533 PT	Loc. L.H.; Head bolts not incl.; Head bolt replacement required; PermaTorqueMLS®; New Part Number - Check for Availability		
1	Head Gasket	2004-01	26535 PT	Loc. R.H.; Head bolts not incl.; Head bolt replacement required; PermaTorqueMLS®; New Part Number - Check for Availability		
1	Head Set	2009-05	HS 26534 PT	Head bolts not incl.; Head bolt replacement required; PermaDry® molded rubber valve cover gskts. incl.; Premium valve stem seals incl.; New Part Number - Check for Availability		
1	Head Set	2004-01	HS 26533 PT	Head bolts not incl.; Head bolt replacement required; PermaDry® molded rubber valve cover gskts. incl.; Premium valve stem seals incl.; New Part Number - Check for Availability		
2	Head Bolt Set	2009-05	ES 72463	Head bolts w/Washers; Replacement required; New Part Number - Check for Availability		
2	Head Bolt Set	2004-01	ES 72464	Head bolts w/Washers; Replacement required; New Part Number - Check for Availability		
QTY	CONVERSION SET	YEARS	PART NO.	DESCRIPTION		
1	Gasket Conversion Set	2009	CS 26533-1	Premium material oil pan gskt. incl.; New Part Number - Check for Availability		
1	Gasket Conversion Set	2008	CS 26533	To 11/30/07; Premium material oil pan gskt. incl.; New Part Number - Check for Availability		
1	Gasket Conversion Set	2008	CS 26533-1	From 12/01/07; Premium material oil pan gskt. incl.; New Part Number - Check for Availability		
1	Gasket Conversion Set	2007-01	CS 26533	Premium material oil pan gskt. incl.; New Part Number - Check for Availability		
QTY	MANIFOLD - INT. & EXH.	YEARS	PART NO.	DESCRIPTION		
1	Int. Manifold Gasket Set	2009-05	MS 97192	New Part Number - Check for Availability		
1	Int. Manifold Gasket Set	2004-01	MS 97188			
1	Exh. Manifold Gasket Set	2009-05	MS 97190			
1	Exh. Manifold Gasket Set	2004-01	MS 97191			
QTY	EXHAUST PIPE FLANGE	YEARS	PART NO.	DESCRIPTION		
1	Exhaust Pipe Gasket	2009-01	61667	Loc. L.H.; Converter; New Part Number - Check for Availability		

Subaru Car (Cont.)

22 (cont.)		2009 - 2001; 3.0L 183 (2999cc) DOHC H6 (24 Valve) 89.2mm Bore			22 (cont.)
MFI; Gasoline; Naturally Aspirated Subaru Eng.; Eng. Code EZ30D					
QTY	EXHAUST PIPE FLANGE	YEARS	PART NO.	DESCRIPTION	
1	Exhaust Pipe Gasket	2009-08	61666	Loc. R.H.; Converter	
1	Exhaust Pipe Gasket	2007-01	61365	Loc. R.H.; Converter	
QTY	OIL PAN	YEARS	PART NO.	DESCRIPTION	
1	Oil Pan Gasket Set	2009-01	OS 30832	Premium material gskt. incl.	
QTY	CRANKSHAFT REAR SEAL	YEARS	PART NO.	DESCRIPTION	
1	Rear Main Seal Set	2009	BS 40733	Rubber; One-piece; New Part Number - Check for Availability	
1	Rear Main Seal Set	2008	BS 40666	To 11/30/07; Rubber; One-piece; Improved design	
1	Rear Main Seal Set	2008	BS 40733	From 12/01/07; Rubber; One-piece; New Part Number - Check for Availability	
1	Rear Main Seal Set	2007-01	BS 40666	Rubber; One-piece; Improved design	
QTY	VALVE COVER	YEARS	PART NO.	DESCRIPTION	
1	Valve Cover Gasket Set	2009-05	VS 50796 R	w/Spark plug tube seals; PermaDry® molded rubber gskts. incl.; New Part Number - Check for Availability	
1	Valve Cover Gasket Set	2004-01	VS 50794 R	w/Spark plug tube seals; PermaDry® molded rubber gskts. incl.; New Part Number - Check for Availability	
QTY	VALVE STEM SEAL SET	YEARS	PART NO.	DESCRIPTION	
1	Valve Stem Seal Set	2009-05	SS 72933	Premium valve stem seals incl.; New Part Number - Check for Availability	
1	Valve Stem Seal Set	2004-01	SS 72934	Premium valve stem seals incl.; New Part Number - Check for Availability	
QTY	WATER OUTLET GASKET	YEARS	PART NO.	DESCRIPTION	
1	O-Ring	2009-01	35524	Water Outlet; Water outlet	
QTY	WATER PUMP	YEARS	PART NO.	DESCRIPTION	
1	Water Pump Gasket	2009-01	35968	Mounting	
1	Water Pump Gasket	2009-01	35969	Loc. Outer; New Part Number - Check for Availability	
1	Water Pump Gasket	2009-01	35970	Loc. Inner; New Part Number - Check for Availability	
QTY	TIMING COVER	YEARS	PART NO.	DESCRIPTION	
1	Crankshaft Front Seal Set	2009-01	TCS 46126	New Part Number - Check for Availability	
QTY	CARB & FUEL INJECTION	YEARS	PART NO.	DESCRIPTION	
1	Throttle Body Gasket	2009-05	61672	Throttle body; New Part Number - Check for Availability	
1	Throttle Body Gasket	2004-01	61669	Throttle body	
1	Throttle Body Gasket	2004-01	73001	Idle air control; New Part Number - Check for Availability	
QTY	EXHAUST GAS RECIRCULATION	YEARS	PART NO.	DESCRIPTION	
1	EGR Gasket	2009-01	71218	EGR adapter	
1	EGR Gasket	2009-01	71402	EGR valve	
1	EGR Gasket	2009-01	71409	EGR tube; New Part Number - Check for Availability	
1	EGR Gasket	2009-01	73000	EGR pipe; New Part Number - Check for Availability	
QTY	OIL FILTER MOUNTING	YEARS	PART NO.	DESCRIPTION	
1	Oil Pressure Relief Valve	2009-05	72988	Oil pressure relief valve gskt.; New Part Number - Check for Availability	
QTY	OIL PUMP COVER	YEARS	PART NO.	DESCRIPTION	
1	Oil Pump Gasket	2004-01	72989	Oil pump mounting gskt.; New Part Number - Check for Availability	
23		1997 - 1992; 3.3L 202.5 (3318cc) DOHC H6 (24 Valve) 96.9mm Bore			23
MFI; Gasoline; Naturally Aspirated Subaru Eng.; Eng. Code EG33D					
QTY	CYLINDER HEAD	YEARS	PART NO.	DESCRIPTION	
2	Head Gasket	1997-92	26581 PT	Head bolts not incl.; Head bolt replacement required; New Part Number - Check for Availability	
24		2013 - 2010; 3.6L 221.5 (3630cc) DOHC H6 (24 Valve) 92mm Bore AVCS			24
MFI; Gasoline; Naturally Aspirated Subaru Eng.; Eng. Code EZ36D					
QTY	CYLINDER HEAD	YEARS	PART NO.	DESCRIPTION	
2	Head Bolt Set	2013-10	ES 72463	Head bolts w/Washers; Replacement required; New Part Number - Check for Availability	
QTY	MANIFOLD - INT. & EXH.	YEARS	PART NO.	DESCRIPTION	
1	Int. Manifold Gasket Set	2013-10	MS 97192	New Part Number - Check for Availability	
1	Exh. Manifold Gasket Set	2013-10	MS 97190		
QTY	EXHAUST PIPE FLANGE	YEARS	PART NO.	DESCRIPTION	
1	Exhaust Pipe Gasket	2013-10	61106	Loc. L.H.; Converter; 2.40" ID	
1	Exhaust Pipe Gasket	2013-10	61666	Loc. R.H.; Converter	
QTY	VALVE STEM SEAL SET	YEARS	PART NO.	DESCRIPTION	
1	Valve Stem Seal Set	2013-10	SS 72933	Premium valve stem seals incl.; New Part Number - Check for Availability	
QTY	WATER OUTLET GASKET	YEARS	PART NO.	DESCRIPTION	
1	O-Ring	2013-10	35524	Water Outlet; Water outlet	
QTY	CARB & FUEL INJECTION	YEARS	PART NO.	DESCRIPTION	
1	Throttle Body Gasket	2013-10	61672	Throttle body; New Part Number - Check for Availability	

24 (cont.)	2013 - 2010; 3.6L 221.5 (3630cc) DOHC H6 (24 Valve) 92mm Bore AVCS MFI; Gasoline; Naturally Aspirated Subaru Eng.; Eng. Code EZ36D				24 (cont.)
QTY	EXHAUST GAS RECIRCULATION	YEARS	PART NO.	DESCRIPTION	
1	EGR Gasket	2013-10	71218	EGR valve	

**Subaru SUV's - See Subaru Truck
Subaru Truck (Incl. SUV's)**

Engine Finding Index			
Engine	Years	Code	Line No.
2.5L 150 (2457cc) DOHC H4 (16 Valve) 99.5mm Bore; MFI; Gasoline; Turbo - Intercooled Subaru Eng.	2013-04	EJ255	1
2.5L 150 (2457cc) DOHC H4 (16 Valve) 99.5mm Bore; MFI; Gasoline; Naturally Aspirated Subaru Eng.	1999-98	EJ25D	2
2.5L 150 (2457cc) DOHC H4 (16 Valve) 99.5mm Bore; MFI; Gasoline; Turbo - Intercooled Subaru Eng.	2005-04	EJ25T	3
2.5L 150 (2457cc) SOHC H4 (16 Valve) 99.5mm Bore; MFI; Gasoline; Naturally Aspirated Subaru Eng.	2005-99	EJ251	4
2.5L 150 (2457cc) SOHC H4 (16 Valve) 99.5mm Bore; MFI; Gasoline; Naturally Aspirated Subaru Eng.	2000	EJ252	5
2.5L 150 (2457cc) SOHC H4 (16 Valve) 99.5mm Bore; MFI; Gasoline; Naturally Aspirated Subaru Eng.	2010-99	EJ253	6
2.5L 152.4 (2498cc) DOHC H4 (16 Valve) 94mm Bore VVT; MFI; Gasoline; Naturally Aspirated Subaru Eng.	2013-11	FB25BA	7
2.5L 152.4 (2498cc) DOHC H4 (16 Valve) 94mm Bore VVT; MFI; Gasoline; Naturally Aspirated Subaru Eng.	2013-11	FB25BC	8
3.0L 183 (2999cc) DOHC H6 (24 Valve) 89.2mm Bore; MFI; Gasoline; Naturally Aspirated Subaru Eng.	2007-06	EZ30D	9
3.6L 221.5 (3630cc) DOHC H6 (24 Valve) 92mm Bore AVCS; MFI; Gasoline; Naturally Aspirated Subaru Eng.	2013-08	EZ36D	10

Engine Code Index			
Code	Engine		Line No.
EJ251	2.5L 150 (2457cc) SOHC H4 (16 Valve) 99.5mm Bore; MFI; Gasoline; Naturally Aspirated Subaru Eng.		4
EJ252	2.5L 150 (2457cc) SOHC H4 (16 Valve) 99.5mm Bore; MFI; Gasoline; Naturally Aspirated Subaru Eng.		5
EJ253	2.5L 150 (2457cc) SOHC H4 (16 Valve) 99.5mm Bore; MFI; Gasoline; Naturally Aspirated Subaru Eng.		6
EJ255	2.5L 150 (2457cc) DOHC H4 (16 Valve) 99.5mm Bore; MFI; Gasoline; Turbo - Intercooled Subaru Eng.		1
EJ25D	2.5L 150 (2457cc) DOHC H4 (16 Valve) 99.5mm Bore; MFI; Gasoline; Naturally Aspirated Subaru Eng.		2
EJ25T	2.5L 150 (2457cc) DOHC H4 (16 Valve) 99.5mm Bore; MFI; Gasoline; Turbo - Intercooled Subaru Eng.		3
EZ30D	3.0L 183 (2999cc) DOHC H6 (24 Valve) 89.2mm Bore; MFI; Gasoline; Naturally Aspirated Subaru Eng.		9
EZ36D	3.6L 221.5 (3630cc) DOHC H6 (24 Valve) 92mm Bore AVCS; MFI; Gasoline; Naturally Aspirated Subaru Eng.		10
FB25BA	2.5L 152.4 (2498cc) DOHC H4 (16 Valve) 94mm Bore VVT; MFI; Gasoline; Naturally Aspirated Subaru Eng.		7
FB25BC	2.5L 152.4 (2498cc) DOHC H4 (16 Valve) 94mm Bore VVT; MFI; Gasoline; Naturally Aspirated Subaru Eng.		8

Model Index					
Engine (VIN Code / Eng. Code)	Year	Engine (VIN Code / Eng. Code)	Year	Engine (VIN Code / Eng. Code)	Year
Subaru Truck		Subaru Truck (cont.)		Subaru Truck (cont.)	
B9 Tribeca (AWD Mid-Size SUV)		Brat (Mini-Pickup)		Forester (AWD Compact SUV) (cont.)	
H6 2999cc 3.0L DOHC (24 Valve) (EZ30D)	07-06	H4 1595cc 1.6L OHV (EA71)	80-78	H4 2457cc 2.5L SOHC (16 Valve) (EJ251)	05-99
Baja (AWD Compact SUV)		H4 1781cc 1.8L OHV (EA81)	87-80	H4 2457cc 2.5L SOHC (16 Valve) (EJ252)	00
H4 2457cc 2.5L DOHC Turbo (16 Valve) (EJ255)	06-04	H4 1781cc 1.8L OHV Turbo (EA81T)	84-83	H4 2457cc 2.5L SOHC (16 Valve) (EJ253)	10-99
		Forester (AWD Compact SUV)		H4 2498cc 2.5L DOHC (16 Valve) (FB25BA)	13-11
H4 2457cc 2.5L DOHC Turbo (16 Valve) (EJ25T)	05-04	H4 2457cc 2.5L DOHC (16 Valve) (EJ25D)	99-98	H4 2498cc 2.5L DOHC (16 Valve) (FB25BC)	13-11
H4 2457cc 2.5L SOHC (16 Valve) (EJ251)	05-03	H4 2457cc 2.5L DOHC Turbo (16 Valve) (EJ255)	13-04	Tribeca (AWD Mid-Size SUV)	
H4 2457cc 2.5L SOHC (16 Valve) (EJ253)	06-03	H4 2457cc 2.5L DOHC Turbo (16 Valve) (EJ25T)	05-04	H6 3630cc 3.6L DOHC (24 Valve) (EZ36D)	13-08

1	2013 - 2004; 2.5L 150 (2457cc) DOHC H4 (16 Valve) 99.5mm Bore MFI; Gasoline; Turbo - Intercooled Subaru Eng.; Eng. Code EJ255				1
QTY	CYLINDER HEAD	YEARS	PART NO.	DESCRIPTION	
2	Head Gasket	2012-07	26531 PT	Head bolts not incl.; Head bolt replacement required; PermaTorqueMLS® LaserWeld® Technology; New Part Number - Check for Availability	
2	Head Gasket	2006	26259 PT	Subaru Baja Turbo; Head bolts not incl.; Head bolt replacement required; PermaTorqueMLS®; Old design; Superseded - When depleted use 26415 PT	
2	Head Gasket	2006	26415 PT	Subaru Baja Turbo; Head bolts not incl.; Head bolt replacement required; PermaTorqueMLS® LaserWeld® Technology; Improved design	
2	Head Gasket	2006	26531 PT	Exc. Subaru Baja Turbo; Head bolts not incl.; Head bolt replacement required; PermaTorqueMLS® LaserWeld® Technology; New Part Number - Check for Availability	
2	Head Gasket	2005-04	26259 PT	Head bolts not incl.; Head bolt replacement required; PermaTorqueMLS®; Old design; Superseded - When depleted use 26415 PT	
2	Head Gasket	2005-04	26415 PT	Head bolts not incl.; Head bolt replacement required; PermaTorqueMLS® LaserWeld® Technology; Improved design	

Subaru Truck (Incl. SUV's) (Cont.)

1		2013 - 2004; 2.5L 150 (2457cc) DOHC H4 (16 Valve) 99.5mm Bore			1	
(cont.)		MFI; Gasoline; Turbo - Intercooled Subaru Eng.; Eng. Code EJ255			(cont.)	
QTY	CYLINDER HEAD	YEARS	PART NO.	DESCRIPTION		
1	Head Set	2012-08	HS 26531 PT-1	Head bolts not incl.; Head bolt replacement required; PermaTorqueMLS® Improved design head gskts. incl.; PermaDry® molded rubber valve cover gskts. incl.; Premium valve stem seals incl.; New Part Number - Check for Availability		
1	Head Set	2007	HS 26531 PT	Head bolts not incl.; Head bolt replacement required; PermaTorqueMLS® Improved design head gskts. incl.; PermaDry® molded rubber valve cover gskts. incl.; Premium valve stem seals incl.; New Part Number - Check for Availability		
1	Head Set	2006	HS 26259 PT-1	Subaru Baja Turbo; Head bolts not incl.; Head bolt replacement required; PermaTorqueMLS® Improved design head gskts. incl.; PermaDry® molded rubber valve cover gskts. incl.; Premium valve stem seals incl.		
1	Head Set	2006	HS 26531 PT	Exc. Subaru Baja Turbo; Head bolts not incl.; Head bolt replacement required; PermaTorqueMLS® Improved design head gskts. incl.; PermaDry® molded rubber valve cover gskts. incl.; Premium valve stem seals incl.; New Part Number - Check for Availability		
1	Head Set	2005-04	HS 26259 PT-1	Head bolts not incl.; Head bolt replacement required; PermaTorqueMLS® Improved design head gskts. incl.; PermaDry® molded rubber valve cover gskts. incl.; Premium valve stem seals incl.		
2	Head Bolt Set	2012-04	ES 72905	Head bolts w/Washers; Replacement required		
QTY	CONVERSION SET	YEARS	PART NO.	DESCRIPTION		
1	Gasket Conversion Set	2009-04	CS 26170			
QTY	MANIFOLD - INT. & EXH.	YEARS	PART NO.	DESCRIPTION		
1	Int. Manifold Gasket Set	2012-08	MS 96523-1	Lower set; Upper set incl.; New Part Number - Check for Availability		
1	Int. Manifold Gasket Set	2007	MS 96523	Lower set; Upper set incl.		
1	Int. Manifold Gasket Set	2006	MS 96523	Exc. Subaru Baja Turbo; Lower set; Upper set incl.		
1	Int. Manifold Gasket Set	2006	MS 96758	Subaru Baja Turbo; Lower set; Upper set incl.		
1	Int. Manifold Gasket Set	2005-04	MS 96758	Lower set; Upper set incl.		
1	Exh. Manifold Gasket Set	2012-04	MS 95088			
QTY	EXHAUST PIPE FLANGE	YEARS	PART NO.	DESCRIPTION		
1	Exhaust Pipe Gasket	2012-04	61365	Exh. connector		
1	Exhaust Pipe Gasket	2012-04	61365	Flange		
1	Exhaust Pipe Gasket	2012-04	61366	Converter		
QTY	OIL PAN	YEARS	PART NO.	DESCRIPTION		
1	Oil Pan Gasket Set	2009-04	OS 30656 C			
QTY	CRANKSHAFT REAR SEAL	YEARS	PART NO.	DESCRIPTION		
1	Rear Main Seal Set	2009-04	BS 40666	Rubber; One-piece; Improved design		
QTY	VALVE COVER	YEARS	PART NO.	DESCRIPTION		
1	Valve Cover Gasket Set	2012-04	VS 50620 R	w/Spark plug tube seals; PermaDry® molded rubber gskts. incl.		
2	Circular Plug	2012-04	ES 72418	Valve Cover; New Part Number - Check for Availability		
QTY	VALVE STEM SEAL SET	YEARS	PART NO.	DESCRIPTION		
1	Valve Stem Seal Set	2012-04	SS 72814	Premium valve stem seals incl.		
QTY	WATER OUTLET GASKET	YEARS	PART NO.	DESCRIPTION		
2	Water Outlet Gasket	2013-04	36024	Water Outlet; Water crossover O-ring; New Part Number - Check for Availability		
1	O-Ring	2012-04	35524	Water Outlet; Water outlet		
QTY	WATER PUMP	YEARS	PART NO.	DESCRIPTION		
1	Water Pump Gasket	2009-04	35747	Improved design		
QTY	TIMING COVER	YEARS	PART NO.	DESCRIPTION		
1	Crankshaft Front Seal Set	2009-04	TCS 46009			
2	Camshaft Front Seal Set	2012-04	TCS 46140	New Part Number - Check for Availability		
QTY	CARB & FUEL INJECTION	YEARS	PART NO.	DESCRIPTION		
1	Throttle Body Gasket	2012-07	61634	New Part Number - Check for Availability		
1	Throttle Body Gasket	2006-04	61359			
QTY	EXHAUST GAS RECIRCULATION	YEARS	PART NO.	DESCRIPTION		
1	EGR Gasket	2012-04	71218			
QTY	TURBO MOUNTING SET	YEARS	PART NO.	DESCRIPTION		
1	Turbo Mtg. Gasket Set	2012-04	ES 72745	New Part Number - Check for Availability		
2		1999 - 1998; 2.5L 150 (2457cc) DOHC H4 (16 Valve) 99.5mm Bore			2	
(cont.)		MFI; Gasoline; Naturally Aspirated Subaru Eng.; Eng. Code EJ25D			(cont.)	
QTY	CYLINDER HEAD	YEARS	PART NO.	DESCRIPTION		
2	Head Gasket	1999-98	26167 PT	Head bolts not incl.; Head bolt replacement required; PermaTorqueMLS® LaserWeld® Technology		

Subaru Truck (Incl. SUV's) (Cont.)

2 (cont.)		1999 - 1998; 2.5L 150 (2457cc) DOHC H4 (16 Valve) 99.5mm Bore			2 (cont.)
		MFI; Gasoline; Naturally Aspirated Subaru Eng.; Eng. Code EJ25D			
QTY	CYLINDER HEAD	YEARS	PART NO.	DESCRIPTION	
1	Head Set	1999	HS 26167 PT-2	Head bolts not incl.; Head bolt replacement required; PermaDry® molded rubber valve cover gskts. incl.; Premium valve stem seals incl.	
1	Head Set	1999	HS 26167 PT-3	w/Valve cover housing No. 13264-AA190; Head bolts not incl.; Head bolt replacement required; PermaDry® molded rubber valve cover gskts. incl.; Premium valve stem seals incl.	
1	Head Set	1999	HS 26167 PT-3	w/Valve cover housing No. 13278-AA170; Head bolts not incl.; Head bolt replacement required; PermaDry® molded rubber valve cover gskts. incl.; Premium valve stem seals incl.	
1	Head Set	1998	HS 26167 PT-1	From Eng. Ser. No. 993723 to 047282; Head bolts not incl.; Head bolt replacement required; PermaDry® molded rubber valve cover gskts. incl.; Premium valve stem seals incl.	
1	Head Set	1998	HS 26167 PT-1	To Eng. Ser. No. 989330; Head bolts not incl.; Head bolt replacement required; PermaDry® molded rubber valve cover gskts. incl.; Premium valve stem seals incl.	
1	Head Set	1998	HS 26167 PT-2	From Eng. Ser. No. 047283 to 285351; Head bolts not incl.; Head bolt replacement required; PermaDry® molded rubber valve cover gskts. incl.; Premium valve stem seals incl.	
1	Head Set	1998	HS 26167 PT-2	From Eng. Ser. No. 989331 to 993722; Head bolts not incl.; Head bolt replacement required; PermaDry® molded rubber valve cover gskts. incl.; Premium valve stem seals incl.	
2	Head Bolt Set	1999-98	ES 72905	Head bolts w/Washers; Replacement required	
QTY	CONVERSION SET	YEARS	PART NO.	DESCRIPTION	
1	Gasket Conversion Set	1999	CS 26170		
1	Gasket Conversion Set	1998	CS 26167		
QTY	MANIFOLD - INT. & EXH.	YEARS	PART NO.	DESCRIPTION	
1	Int. Manifold Gasket Set	1999-98	MS 96105	Lower set	
1	Exh. Manifold Gasket Set	1999-98	MS 95088		
QTY	OIL PAN	YEARS	PART NO.	DESCRIPTION	
1	Oil Pan Gasket Set	1999-98	OS 30656 C		
QTY	CRANKSHAFT REAR SEAL	YEARS	PART NO.	DESCRIPTION	
1	Rear Main Seal Set	1999-98	BS 40666	Rubber; One-piece; Improved design	
QTY	VALVE COVER	YEARS	PART NO.	DESCRIPTION	
1	Valve Cover Gasket Set	1999	VS 50662 R	w/Grommets & Spark plug tube seals; PermaDry® molded rubber gskts. incl.	
1	Valve Cover Gasket Set	1999	VS 50672 R	w/Valve cover housing No. 13264-AA190; w/Grommets & Spark plug tube seals; PermaDry® molded rubber gskts. incl.	
1	Valve Cover Gasket Set	1999	VS 50672 R	w/Valve cover housing No. 13278-AA170; w/Grommets & Spark plug tube seals; PermaDry® molded rubber gskts. incl.	
1	Valve Cover Gasket Set	1998	VS 50557 R	From Eng. Ser. No. 993723 to 047282; w/Grommets & Spark plug tube seals; PermaDry® molded rubber gskts. incl.	
1	Valve Cover Gasket Set	1998	VS 50557 R	To Eng. Ser. No. 989330; w/Grommets & Spark plug tube seals; PermaDry® molded rubber gskts. incl.	
1	Valve Cover Gasket Set	1998	VS 50662 R	From Eng. Ser. No. 047283 to 285351; w/Grommets & Spark plug tube seals; PermaDry® molded rubber gskts. incl.	
1	Valve Cover Gasket Set	1998	VS 50662 R	From Eng. Ser. No. 989331 to 993722; w/Grommets & Spark plug tube seals; PermaDry® molded rubber gskts. incl.	
QTY	VALVE STEM SEAL SET	YEARS	PART NO.	DESCRIPTION	
1	Valve Stem Seal Set	1999-98	SS 72814	Premium valve stem seals incl.	
QTY	WATER OUTLET GASKET	YEARS	PART NO.	DESCRIPTION	
2	Water Outlet Gasket	1999-98	36024	Water Outlet; Water crossover O-ring; New Part Number - Check for Availability	
1	O-Ring	1999-98	35524	Water Outlet; Water outlet	
QTY	WATER PUMP	YEARS	PART NO.	DESCRIPTION	
1	Water Pump Gasket	1999-98	35747	Improved design	
QTY	TIMING COVER	YEARS	PART NO.	DESCRIPTION	
1	Crankshaft Front Seal Set	1999	TCS 46009		
1	Crankshaft Front Seal Set	1998	TCS 45957		
2	Camshaft Front Seal Set	1999-98	TCS 46008		
QTY	CARB & FUEL INJECTION	YEARS	PART NO.	DESCRIPTION	
1	Throttle Body Gasket	1999-98	60920		
QTY	EXHAUST GAS RECIRCULATION	YEARS	PART NO.	DESCRIPTION	
1	EGR Gasket	1999-98	70004		

Subaru Truck (Incl. SUV's) (Cont.)

3		2005 - 2004; 2.5L 150 (2457cc) DOHC H4 (16 Valve) 99.5mm Bore			3
		MFI; Gasoline; Turbo - Intercooled Subaru Eng.; Eng. Code EJ25T			
QTY	CYLINDER HEAD	YEARS	PART NO.	DESCRIPTION	
2	Head Gasket	2005-04	26259 PT	Head bolts not incl.; Head bolt replacement required; PermaTorqueMLS®; Old design; Superseded - When depleted use 26415 PT	
2	Head Gasket	2005-04	26415 PT	Head bolts not incl.; Head bolt replacement required; PermaTorqueMLS® LaserWeld® Technology; Improved design	
1	Head Set	2005-04	HS 26259 PT-1	Head bolts not incl.; Head bolt replacement required; PermaTorqueMLS® Improved design head gskts. incl.; PermaDry® molded rubber valve cover gskts. incl.; Premium valve stem seals incl.	
2	Head Bolt Set	2005-04	ES 72905	Head bolts w/Washers; Replacement required	
QTY	CONVERSION SET	YEARS	PART NO.	DESCRIPTION	
1	Gasket Conversion Set	2005-04	CS 26170		
QTY	MANIFOLD - INT. & EXH.	YEARS	PART NO.	DESCRIPTION	
1	Int. Manifold Gasket Set	2005-04	MS 96758	Lower set; Upper set incl.	
1	Exh. Manifold Gasket Set	2005-04	MS 95088		
QTY	EXHAUST PIPE FLANGE	YEARS	PART NO.	DESCRIPTION	
1	Exhaust Pipe Gasket	2005-04	61365	Exh. connector	
1	Exhaust Pipe Gasket	2005-04	61365	Flange	
1	Exhaust Pipe Gasket	2005-04	61366	Converter	
QTY	OIL PAN	YEARS	PART NO.	DESCRIPTION	
1	Oil Pan Gasket Set	2005-04	OS 30656 C		
QTY	CRANKSHAFT REAR SEAL	YEARS	PART NO.	DESCRIPTION	
1	Rear Main Seal Set	2005-04	BS 40666	Rubber; One-piece; Improved design	
QTY	VALVE COVER	YEARS	PART NO.	DESCRIPTION	
1	Valve Cover Gasket Set	2005-04	VS 50620 R	w/Spark plug tube seals; PermaDry® molded rubber gskts. incl.	
2	Circular Plug	2005-04	ES 72418	Valve Cover; New Part Number - Check for Availability	
QTY	VALVE STEM SEAL SET	YEARS	PART NO.	DESCRIPTION	
1	Valve Stem Seal Set	2005-04	SS 72814	Premium valve stem seals incl.	
QTY	WATER OUTLET GASKET	YEARS	PART NO.	DESCRIPTION	
2	Water Outlet Gasket	2005-04	36024	Water Outlet; Water crossover O-ring; New Part Number - Check for Availability	
1	O-Ring	2005-04	35524	Water Outlet; Water outlet	
QTY	WATER PUMP	YEARS	PART NO.	DESCRIPTION	
1	Water Pump Gasket	2005-04	35747	Improved design	
QTY	TIMING COVER	YEARS	PART NO.	DESCRIPTION	
1	Crankshaft Front Seal Set	2005-04	TCS 46009		
2	Camshaft Front Seal Set	2005-04	TCS 46140	New Part Number - Check for Availability	
QTY	CARB & FUEL INJECTION	YEARS	PART NO.	DESCRIPTION	
1	Throttle Body Gasket	2005-04	61359		
QTY	EXHAUST GAS RECIRCULATION	YEARS	PART NO.	DESCRIPTION	
1	EGR Gasket	2005-04	71218		
QTY	TURBO MOUNTING SET	YEARS	PART NO.	DESCRIPTION	
1	Turbo Mtg. Gasket Set	2005-04	ES 72745	New Part Number - Check for Availability	
4		2005 - 1999; 2.5L 150 (2457cc) SOHC H4 (16 Valve) 99.5mm Bore			4
		MFI; Gasoline; Naturally Aspirated Subaru Eng.; Eng. Code EJ251			
QTY	CYLINDER HEAD	YEARS	PART NO.	DESCRIPTION	
2	Head Gasket	2005-99	26170 PT	Head bolts not incl.; Head bolt replacement required; PermaTorque®; Old design	
2	Head Gasket	2005-99	26415 PT	Head bolts not incl.; Head bolt replacement required; PermaTorqueMLS® LaserWeld® Technology; Improved design	
1	Head Set	2005	HS 26170 PT-1	Upper int. manifold gskts. & head bolts not incl.; California exh. manifold gskts. not incl.; Head bolt replacement required; PermaTorqueMLS® Improved design head gskts. incl.; PermaDry® molded rubber valve cover gskts. incl.; Premium valve stem seals inc	
1	Head Set	2004	HS 26170 PT-1	Head bolts not incl.; California exh. manifold gskts. not incl.; Head bolt replacement required; PermaTorqueMLS® Improved design head gskts. incl.; PermaDry® molded rubber valve cover gskts. incl.; Premium valve stem seals incl.; Consolidated design	
1	Head Set	2003-99	HS 26170 PT-1	Head bolts not incl.; Head bolt replacement required; PermaTorqueMLS® Improved design head gskts. incl.; PermaDry® molded rubber valve cover gskts. incl.; Premium valve stem seals incl.; Consolidated design	
2	Head Bolt Set	2005-99	ES 72212	Head bolts w/Washers; Replacement required	
QTY	CONVERSION SET	YEARS	PART NO.	DESCRIPTION	
1	Gasket Conversion Set	2005-99	CS 26170		

Subaru Truck (Incl. SUV's) (Cont.)

4		2005 - 1999; 2.5L 150 (2457cc) SOHC H4 (16 Valve) 99.5mm Bore			4	
(cont.)		MFI; Gasoline; Naturally Aspirated Subaru Eng.; Eng. Code EJ251			(cont.)	
QTY	MANIFOLD - INT. & EXH.	YEARS	PART NO.	DESCRIPTION		
1	Int. Manifold Gasket Set	2005-99	MS 96106	Lower set		
1	Plenum Gasket Set	2005	MS 96746	California; Upper set		
1	Plenum Gasket Set	2005	MS 96747	Exc. California; Upper set		
1	Exh. Manifold Gasket Set	2005-04	MS 95088	Exc. California		
1	Exh. Manifold Gasket Set	2005-04	MS 97210	California; OEM style; New Part Number - Check for Availability		
1	Exh. Manifold Gasket Set	2003-99	MS 95088			
QTY	OIL PAN	YEARS	PART NO.	DESCRIPTION		
1	Oil Pan Gasket Set	2005-99	OS 30656 C			
QTY	CRANKSHAFT REAR SEAL	YEARS	PART NO.	DESCRIPTION		
1	Rear Main Seal Set	2005-99	BS 40666	Rubber; One-piece; Improved design		
QTY	VALVE COVER	YEARS	PART NO.	DESCRIPTION		
1	Valve Cover Gasket Set	2005-99	VS 50561 R	w/Grommets & Spark plug tube seals; PermaDry® molded rubber gskts. incl.; Improved design		
1	Circular Plug	2005-99	ES 72418	Valve Cover; New Part Number - Check for Availability		
QTY	VALVE STEM SEAL SET	YEARS	PART NO.	DESCRIPTION		
1	Valve Stem Seal Set	2005-99	SS 72814	Premium valve stem seals incl.		
QTY	WATER OUTLET GASKET	YEARS	PART NO.	DESCRIPTION		
2	Water Outlet Gasket	2005-99	36024	Water Outlet; Water crossover O-ring; New Part Number - Check for Availability		
1	O-Ring	2005-99	35524	Water Outlet; Water outlet		
QTY	WATER PUMP	YEARS	PART NO.	DESCRIPTION		
1	Water Pump Gasket	2005-99	35747	Improved design		
QTY	TIMING COVER	YEARS	PART NO.	DESCRIPTION		
1	Crankshaft Front Seal Set	2005-99	TCS 46009			
1	Camshaft Front Seal Set	2005-99	TCS 46008			
QTY	CARB & FUEL INJECTION	YEARS	PART NO.	DESCRIPTION		
1	Fuel Injector O-Ring Set	2005-99	ES 70599	Improved design		
1	Throttle Body Gasket	2005	61500			
1	Throttle Body Gasket	2004	61492			
1	Throttle Body Gasket	2003-99	61360			
QTY	EXHAUST GAS RECIRCULATION	YEARS	PART NO.	DESCRIPTION		
1	EGR Gasket	2005-02	71218			
1	EGR Gasket	2001-99	70004			
5		2000; 2.5L 150 (2457cc) SOHC H4 (16 Valve) 99.5mm Bore			5	
(cont.)		MFI; Gasoline; Naturally Aspirated Subaru Eng.; Eng. Code EJ252			(cont.)	
QTY	CYLINDER HEAD	YEARS	PART NO.	DESCRIPTION		
2	Head Gasket	2000	26170 PT	Head bolts not incl.; Head bolt replacement required; PermaTorque®; Old design		
2	Head Gasket	2000	26415 PT	Head bolts not incl.; Head bolt replacement required; PermaTorqueMLS® LaserWeld® Technology; Improved design		
1	Head Set	2000	HS 26170 PT-1	Head bolts not incl.; Head bolt replacement required; PermaTorqueMLS® Improved design head gskts. incl.; PermaDry® molded rubber valve cover gskts. incl.; Premium valve stem seals incl.; Consolidated design		
2	Head Bolt Set	2000	ES 72212	Head bolts w/Washers; Replacement required		
QTY	CONVERSION SET	YEARS	PART NO.	DESCRIPTION		
1	Gasket Conversion Set	2000	CS 26170			
QTY	MANIFOLD - INT. & EXH.	YEARS	PART NO.	DESCRIPTION		
1	Int. Manifold Gasket Set	2000	MS 96106	Lower set		
1	Exh. Manifold Gasket Set	2000	MS 95088			
QTY	OIL PAN	YEARS	PART NO.	DESCRIPTION		
1	Oil Pan Gasket Set	2000	OS 30656 C			
QTY	CRANKSHAFT REAR SEAL	YEARS	PART NO.	DESCRIPTION		
1	Rear Main Seal Set	2000	BS 40666	Rubber; One-piece; Improved design		
QTY	VALVE COVER	YEARS	PART NO.	DESCRIPTION		
1	Valve Cover Gasket Set	2000	VS 50561 R	w/Grommets & Spark plug tube seals; PermaDry® molded rubber gskts. incl.; Improved design		
1	Circular Plug	2000	ES 72418	Valve Cover; New Part Number - Check for Availability		
QTY	VALVE STEM SEAL SET	YEARS	PART NO.	DESCRIPTION		
1	Valve Stem Seal Set	2000	SS 72814	Premium valve stem seals incl.		
QTY	WATER OUTLET GASKET	YEARS	PART NO.	DESCRIPTION		
2	Water Outlet Gasket	2000	36024	Water Outlet; Water crossover O-ring; New Part Number - Check for Availability		

Subaru Truck (Incl. SUV's) (Cont.)

5				
2000; 2.5L 150 (2457cc) SOHC H4 (16 Valve) 99.5mm Bore				
MFI; Gasoline; Naturally Aspirated Subaru Eng.; Eng. Code EJ252				
				5
				(cont.)
QTY	WATER OUTLET GASKET	YEARS	PART NO.	DESCRIPTION
1	O-Ring	2000	35524	Water Outlet; Water outlet
QTY	WATER PUMP	YEARS	PART NO.	DESCRIPTION
1	Water Pump Gasket	2000	35747	Improved design
QTY	TIMING COVER	YEARS	PART NO.	DESCRIPTION
1	Crankshaft Front Seal Set	2000	TCS 46009	
1	Camshaft Front Seal Set	2000	TCS 46008	
QTY	CARB & FUEL INJECTION	YEARS	PART NO.	DESCRIPTION
1	Fuel Injector O-Ring Set	2000	ES 70599	Improved design
1	Throttle Body Gasket	2000	61360	
QTY	EXHAUST GAS RECIRCULATION	YEARS	PART NO.	DESCRIPTION
1	EGR Gasket	2000	70004	
6				
2010 - 1999; 2.5L 150 (2457cc) SOHC H4 (16 Valve) 99.5mm Bore				
MFI; Gasoline; Naturally Aspirated Subaru Eng.; Eng. Code EJ253				
				6
QTY	CYLINDER HEAD	YEARS	PART NO.	DESCRIPTION
2	Head Gasket	2010-99	26170 PT	Head bolts not incl.; Head bolt replacement required; PermaTorque®; Old design
2	Head Gasket	2010-99	26415 PT	Head bolts not incl.; Head bolt replacement required; PermaTorqueMLS® LaserWeld® Technology; Improved design
1	Head Set	2010-06	HS 26415 PT-1	California; Upper int. manifold gskts. & head bolts not incl.; Head bolt replacement required; PermaTorqueMLS® Improved design head gskts. incl.; PermaDry® molded rubber valve cover gskts. incl.; Premium valve stem seals incl.; New Part Number - Check for
1	Head Set	2010-06	HS 26415 PT-1	Exc. California; Head bolts not incl.; Head bolt replacement required; PermaTorqueMLS® Improved design head gskts. incl.; PermaDry® molded rubber valve cover gskts. incl.; Premium valve stem seals incl.; New Part Number - Check for Availability
1	Head Set	2005	HS 26170 PT-1	Upper int. manifold gskts. & head bolts not incl.; California exh. manifold gskts. not incl.; Head bolt replacement required; PermaTorqueMLS® Improved design head gskts. incl.; PermaDry® molded rubber valve cover gskts. incl.; Premium valve stem seals inc
1	Head Set	2004	HS 26170 PT-1	Head bolts not incl.; California exh. manifold gskts. not incl.; Head bolt replacement required; PermaTorqueMLS® Improved design head gskts. incl.; PermaDry® molded rubber valve cover gskts. incl.; Premium valve stem seals incl.; Consolidated design
1	Head Set	2003-99	HS 26170 PT-1	Head bolts not incl.; Head bolt replacement required; PermaTorqueMLS® Improved design head gskts. incl.; PermaDry® molded rubber valve cover gskts. incl.; Premium valve stem seals incl.; Consolidated design
2	Head Bolt Set	2010-99	ES 72212	Head bolts w/Washers; Replacement required
QTY	CONVERSION SET	YEARS	PART NO.	DESCRIPTION
1	Gasket Conversion Set	2010-99	CS 26170	
QTY	MANIFOLD - INT. & EXH.	YEARS	PART NO.	DESCRIPTION
1	Int. Manifold Gasket Set	2010-99	MS 96106	Lower set
1	Plenum Gasket Set	2010-05	MS 96746	California; Upper set
1	Plenum Gasket Set	2010-05	MS 96747	Exc. California; Upper set
1	Exh. Manifold Gasket Set	2010-06	MS 95088	
1	Exh. Manifold Gasket Set	2005-04	MS 95088	Exc. California
1	Exh. Manifold Gasket Set	2005-04	MS 97210	California; OEM style; New Part Number - Check for Availability
1	Exh. Manifold Gasket Set	2003-99	MS 95088	
QTY	EXHAUST PIPE FLANGE	YEARS	PART NO.	DESCRIPTION
2	Exhaust Pipe Gasket	2010-06	60992	Converter to manifold
2	Exhaust Pipe Gasket	2010-06	61106	Converter; 2.40" ID
1	Exhaust Pipe Gasket	2010-06	61106	Exh. connector; 2.40" ID
QTY	OIL PAN	YEARS	PART NO.	DESCRIPTION
1	Oil Pan Gasket Set	2010-99	OS 30656 C	
QTY	CRANKSHAFT REAR SEAL	YEARS	PART NO.	DESCRIPTION
1	Rear Main Seal Set	2010-99	BS 40666	Rubber; One-piece; Improved design
QTY	VALVE COVER	YEARS	PART NO.	DESCRIPTION
1	Valve Cover Gasket Set	2010-06	VS 50780 R	w/Spark plug tube seals; PermaDry® molded rubber gskts. incl.; New Part Number - Check for Availability
1	Valve Cover Gasket Set	2005-99	VS 50561 R	w/Grommets & Spark plug tube seals; PermaDry® molded rubber gskts. incl.; Improved design
1	Circular Plug	2010-99	ES 72418	Valve Cover; New Part Number - Check for Availability

Subaru Truck (Incl. SUV's) (Cont.)

6		2010 - 1999; 2.5L 150 (2457cc) SOHC H4 (16 Valve) 99.5mm Bore			6	
(cont.)		MFI; Gasoline; Naturally Aspirated Subaru Eng.; Eng. Code EJ253			(cont.)	
QTY	VALVE STEM SEAL SET	YEARS	PART NO.	DESCRIPTION		
1	Valve Stem Seal Set	2010-99	SS 72814	Premium valve stem seals incl.		
QTY	WATER OUTLET GASKET	YEARS	PART NO.	DESCRIPTION		
2	Water Outlet Gasket	2010-99	36024	Water Outlet; Water crossover O-ring; New Part Number - Check for Availability		
1	O-Ring	2010-99	35524	Water Outlet; Water outlet		
QTY	WATER PUMP	YEARS	PART NO.	DESCRIPTION		
1	Water Pump Gasket	2010-99	35747	Improved design		
QTY	TIMING COVER	YEARS	PART NO.	DESCRIPTION		
1	Crankshaft Front Seal Set	2010-99	TCS 46009			
1	Camshaft Front Seal Set	2010-99	TCS 46008			
QTY	CARB & FUEL INJECTION	YEARS	PART NO.	DESCRIPTION		
1	Fuel Injector O-Ring Set	2010-99	ES 70599	Improved design		
1	Throttle Body Gasket	2010	61657			
1	Throttle Body Gasket	2009-07	61359			
1	Throttle Body Gasket	2006-05	61500			
1	Throttle Body Gasket	2004	61492			
1	Throttle Body Gasket	2003-99	61360			
QTY	EXHAUST GAS RECIRCULATION	YEARS	PART NO.	DESCRIPTION		
1	EGR Gasket	2010-02	71218			
1	EGR Gasket	2001-99	70004			
7		2013 - 2011; 2.5L 152.4 (2498cc) DOHC H4 (16 Valve) 94mm Bore VVT			7	
		MFI; Gasoline; Naturally Aspirated Subaru Eng.; Eng. Code FB25BA				
QTY	CYLINDER HEAD	YEARS	PART NO.	DESCRIPTION		
1	Head Gasket	2012-11	26524 PT	Loc. R.H.; Head bolts not incl.; Head bolt replacement required; PermaTorqueMLS®; New Part Number - Check for Availability		
1	Head Gasket	2012-11	26525 PT	Loc. L.H.; Head bolts not incl.; Head bolt replacement required; PermaTorqueMLS®; New Part Number - Check for Availability		
QTY	MANIFOLD - INT. & EXH.	YEARS	PART NO.	DESCRIPTION		
1	Int. Manifold Gasket Set	2013-11	MS 97161	Lower set; Upper set incl.; New Part Number - Check for Availability		
QTY	WATER OUTLET GASKET	YEARS	PART NO.	DESCRIPTION		
2	Water Outlet Gasket	2013-11	36024	Water Outlet; Water crossover O-ring; New Part Number - Check for Availability		
QTY	CARB & FUEL INJECTION	YEARS	PART NO.	DESCRIPTION		
1	Throttle Body Gasket	2012-11	61659	New Part Number - Check for Availability		
8		2013 - 2011; 2.5L 152.4 (2498cc) DOHC H4 (16 Valve) 94mm Bore VVT			8	
		MFI; Gasoline; Naturally Aspirated Subaru Eng.; Eng. Code FB25BC				
QTY	CYLINDER HEAD	YEARS	PART NO.	DESCRIPTION		
1	Head Gasket	2012-11	26524 PT	Loc. R.H.; Head bolts not incl.; Head bolt replacement required; PermaTorqueMLS®; New Part Number - Check for Availability		
1	Head Gasket	2012-11	26525 PT	Loc. L.H.; Head bolts not incl.; Head bolt replacement required; PermaTorqueMLS®; New Part Number - Check for Availability		
QTY	MANIFOLD - INT. & EXH.	YEARS	PART NO.	DESCRIPTION		
1	Int. Manifold Gasket Set	2013-11	MS 97161	Lower set; Upper set incl.; New Part Number - Check for Availability		
QTY	WATER OUTLET GASKET	YEARS	PART NO.	DESCRIPTION		
2	Water Outlet Gasket	2013-11	36024	Water Outlet; Water crossover O-ring; New Part Number - Check for Availability		
QTY	CARB & FUEL INJECTION	YEARS	PART NO.	DESCRIPTION		
1	Throttle Body Gasket	2012-11	61659	New Part Number - Check for Availability		
9		2007 - 2006; 3.0L 183 (2999cc) DOHC H6 (24 Valve) 89.2mm Bore			9	
		MFI; Gasoline; Naturally Aspirated Subaru Eng.; Eng. Code EZ30D				
QTY	CYLINDER HEAD	YEARS	PART NO.	DESCRIPTION		
1	Head Gasket	2007-06	26534 PT	Loc. L.H.; Head bolts not incl.; Head bolt replacement required; PermaTorqueMLS®; New Part Number - Check for Availability		
1	Head Gasket	2007-06	26536 PT	Loc. R.H.; Head bolts not incl.; Head bolt replacement required; PermaTorqueMLS®; New Part Number - Check for Availability		
1	Head Set	2007-06	HS 26534 PT	Head bolts not incl.; Head bolt replacement required; PermaDry® molded rubber valve cover gskts. incl.; Premium valve stem seals incl.; New Part Number - Check for Availability		
2	Head Bolt Set	2007-06	ES 72463	Head bolts w/Washers; Replacement required; New Part Number - Check for Availability		

Subaru Truck (Incl. SUV's) (Cont.)

9 (cont.)		2007 - 2006; 3.0L 183 (2999cc) DOHC H6 (24 Valve) 89.2mm Bore			9 (cont.)
MFI; Gasoline; Naturally Aspirated Subaru Eng.; Eng. Code EZ30D					
QTY	CONVERSION SET	YEARS	PART NO.	DESCRIPTION	
1	Gasket Conversion Set	2007-06	CS 26533	Premium material oil pan gskt. incl.; New Part Number - Check for Availability	
QTY	MANIFOLD - INT. & EXH.	YEARS	PART NO.	DESCRIPTION	
1	Int. Manifold Gasket Set	2007-06	MS 97192	New Part Number - Check for Availability	
1	Exh. Manifold Gasket Set	2007-06	MS 97190		
QTY	EXHAUST PIPE FLANGE	YEARS	PART NO.	DESCRIPTION	
1	Exhaust Pipe Gasket	2007-06	61365	Loc. R.H.; Converter	
1	Exhaust Pipe Gasket	2007-06	61667	Loc. L.H.; Converter; New Part Number - Check for Availability	
QTY	OIL PAN	YEARS	PART NO.	DESCRIPTION	
1	Oil Pan Gasket Set	2007-06	OS 30832	Premium material gskt. incl.	
QTY	CRANKSHAFT REAR SEAL	YEARS	PART NO.	DESCRIPTION	
1	Rear Main Seal Set	2007-06	BS 40666	Rubber; One-piece; Improved design	
QTY	VALVE COVER	YEARS	PART NO.	DESCRIPTION	
1	Valve Cover Gasket Set	2007-06	VS 50796 R	w/Spark plug tube seals; PermaDry® molded rubber gskts. incl.; New Part Number - Check for Availability	
QTY	VALVE STEM SEAL SET	YEARS	PART NO.	DESCRIPTION	
1	Valve Stem Seal Set	2007-06	SS 72933	Premium valve stem seals incl.; New Part Number - Check for Availability	
QTY	WATER OUTLET GASKET	YEARS	PART NO.	DESCRIPTION	
1	O-Ring	2007-06	35524	Water Outlet; Water outlet	
QTY	WATER PUMP	YEARS	PART NO.	DESCRIPTION	
1	Water Pump Gasket	2007-06	35968	Mounting	
1	Water Pump Gasket	2007-06	35969	Loc. Outer; New Part Number - Check for Availability	
1	Water Pump Gasket	2007-06	35970	Loc. Inner; New Part Number - Check for Availability	
QTY	TIMING COVER	YEARS	PART NO.	DESCRIPTION	
1	Crankshaft Front Seal Set	2007-06	TCS 46126	New Part Number - Check for Availability	
QTY	CARB & FUEL INJECTION	YEARS	PART NO.	DESCRIPTION	
1	Throttle Body Gasket	2007-06	61672	Throttle body; New Part Number - Check for Availability	
QTY	EXHAUST GAS RECIRCULATION	YEARS	PART NO.	DESCRIPTION	
1	EGR Gasket	2007-06	71218	EGR adapter	
1	EGR Gasket	2007-06	71402	EGR valve	
1	EGR Gasket	2007-06	71409	EGR tube; New Part Number - Check for Availability	
1	EGR Gasket	2007-06	73000	EGR pipe; New Part Number - Check for Availability	
QTY	OIL FILTER MOUNTING	YEARS	PART NO.	DESCRIPTION	
1	Oil Pressure Relief Valve	2007-06	72988	Oil pressure relief valve gskt.; New Part Number - Check for Availability	
10		2013 - 2008; 3.6L 221.5 (3630cc) DOHC H6 (24 Valve) 92mm Bore AVCS			10
MFI; Gasoline; Naturally Aspirated Subaru Eng.; Eng. Code EZ36D					
QTY	CYLINDER HEAD	YEARS	PART NO.	DESCRIPTION	
2	Head Bolt Set	2013-08	ES 72463	Head bolts w/Washers; Replacement required; New Part Number - Check for Availability	
QTY	MANIFOLD - INT. & EXH.	YEARS	PART NO.	DESCRIPTION	
1	Int. Manifold Gasket Set	2013-08	MS 97192	New Part Number - Check for Availability	
1	Exh. Manifold Gasket Set	2013-08	MS 97190		
QTY	EXHAUST PIPE FLANGE	YEARS	PART NO.	DESCRIPTION	
1	Exhaust Pipe Gasket	2013-08	61106	Loc. L.H.; Converter; 2.40" ID	
1	Exhaust Pipe Gasket	2013-08	61666	Loc. R.H.; Converter	
QTY	VALVE STEM SEAL SET	YEARS	PART NO.	DESCRIPTION	
1	Valve Stem Seal Set	2013-08	SS 72933	Premium valve stem seals incl.; New Part Number - Check for Availability	
QTY	WATER OUTLET GASKET	YEARS	PART NO.	DESCRIPTION	
1	O-Ring	2013-08	35524	Water Outlet; Water outlet	
QTY	CARB & FUEL INJECTION	YEARS	PART NO.	DESCRIPTION	
1	Throttle Body Gasket	2013-08	61672	Throttle body; New Part Number - Check for Availability	
QTY	EXHAUST GAS RECIRCULATION	YEARS	PART NO.	DESCRIPTION	
1	EGR Gasket	2013-08	71218	EGR valve	

Suzuki Car

Engine Finding Index

Engine	Years	Code	Line No.
1.0L 61 (993cc) SOHC L3 (6 Valve) 74mm Bore; TBI; Gasoline; Naturally Aspirated Suzuki Eng.	1994-92	G10	1

Engine Finding Index (Cont.)

Engine	Years	Code	Line No.
1.3L 79 (1298cc) DOHC L4 (16 Valve) 74mm Bore; MFI; Gasoline; Naturally Aspirated Suzuki Eng.	1994-91	G13B	2
1.3L 81 (1324cc) SOHC L4 (16 Valve) 74mm Bore; MFI; Gasoline; Naturally Aspirated Suzuki Eng.	2001-98	SW413	3
1.3L 81 (1324cc) SOHC L4 (8 Valve) 74mm Bore; TBI; Gasoline; Naturally Aspirated Suzuki Eng.	1997-91	G13A	4
1.6L 97 (1590cc) SOHC L4 (16 Valve) 75mm Bore; MFI; Gasoline; Naturally Aspirated Suzuki Eng.	2002-92	G16KV	5
1.8L 109.2 (1788cc) DOHC L4 (16 Valve) 84mm Bore; MFI; Gasoline; Naturally Aspirated Suzuki Eng.	2002-99	SY418	6
2.0L 121.7 (1995cc) DOHC L4 (16 Valve) 84mm Bore; MFI; Gasoline; Naturally Aspirated Suzuki Eng.	2009-02	J20A	7
2.0L 122 (1998cc) DOHC L4 (16 Valve) 86mm Bore; MFI; Gasoline; Naturally Aspirated Opel Eng.	2008-04	A20DMS	8
2.3L 139.7 (2290cc) DOHC L4 (16 Valve) 90mm Bore; MFI; Gasoline; Naturally Aspirated Suzuki Eng.	2007-04	J23A	9

Engine Code Index

Code	Engine	Line No.
A20DMS	2.0L 122 (1998cc) DOHC L4 (16 Valve) 86mm Bore; MFI; Gasoline; Naturally Aspirated Opel Eng.	8
G10	1.0L 61 (993cc) SOHC L3 (6 Valve) 74mm Bore; TBI; Gasoline; Naturally Aspirated Suzuki Eng.	1
G13A	1.3L 81 (1324cc) SOHC L4 (8 Valve) 74mm Bore; TBI; Gasoline; Naturally Aspirated Suzuki Eng.	4
G13B	1.3L 79 (1298cc) DOHC L4 (16 Valve) 74mm Bore; MFI; Gasoline; Naturally Aspirated Suzuki Eng.	2
G16KV	1.6L 97 (1590cc) SOHC L4 (16 Valve) 75mm Bore; MFI; Gasoline; Naturally Aspirated Suzuki Eng.	5
J20A	2.0L 121.7 (1995cc) DOHC L4 (16 Valve) 84mm Bore; MFI; Gasoline; Naturally Aspirated Suzuki Eng.	7
J23A	2.3L 139.7 (2290cc) DOHC L4 (16 Valve) 90mm Bore; MFI; Gasoline; Naturally Aspirated Suzuki Eng.	9
SW413	1.3L 81 (1324cc) SOHC L4 (16 Valve) 74mm Bore; MFI; Gasoline; Naturally Aspirated Suzuki Eng.	3
SY418	1.8L 109.2 (1788cc) DOHC L4 (16 Valve) 84mm Bore; MFI; Gasoline; Naturally Aspirated Suzuki Eng.	6

Model Index

Engine (VIN Code / Eng. Code)	Year	Engine (VIN Code / Eng. Code)	Year	Engine (VIN Code / Eng. Code)	Year
Suzuki		Suzuki (cont.)		Suzuki (cont.)	
Aerio		Kizashi		Swift (cont.)	
L4 1995cc 2.0L DOHC (16 Valve) (J20A)	03-02	L4 2393cc 2.4L DOHC (16 Valve) (J24B)	13-10	L4 1324cc 1.3L SOHC (8 Valve) (G13A)	97-89
L4 2290cc 2.3L DOHC (16 Valve) (J23A)	07-04	Reno		L4 1586cc 1.6L DOHC (16 Valve) (M16A)	08-04
Esteem		L4 1998cc 2.0L DOHC (16 Valve) (A20DMS)	08-05	L4 1598cc 1.6L DOHC (16 Valve) (LXV)	11-09
L4 1590cc 1.6L SOHC (16 Valve) (G16KV)	02-95	SA310		SX4	
L4 1788cc 1.8L DOHC (16 Valve) (SY418)	02-00	L3 993cc 1.0L SOHC (G10)	85	L4 1995cc 2.0L DOHC (16 Valve) (J20A)	09-07
Forenza		L3 993cc 1.0L SOHC Turbo (G10-T)	85	L4 1995cc 2.0L DOHC (16 Valve) (J20B)	13-10
L4 1998cc 2.0L DOHC (16 Valve) (A20DMS)	08-04	Swift		Verona	
Forsa		L3 993cc 1.0L SOHC (G10)	94-92	L6 2492cc 2.5L DOHC (24 Valve) (RP625)	06-04
L3 993cc 1.0L SOHC (G10)	88-85	L4 1298cc 1.3L DOHC (16 Valve) (G13B)	94-89		
L3 993cc 1.0L SOHC Turbo (G10-T)	88-86	L4 1324cc 1.3L SOHC (16 Valve) (SW413)	01-98		

1

**1994 - 1992; 1.0L 61 (993cc) SOHC L3 (6 Valve) 74mm Bore
TBI; Gasoline; Naturally Aspirated Suzuki Eng.; Eng. Code G10**

1

QTY	CYLINDER HEAD	YEARS	PART NO.	DESCRIPTION
1	Head Gasket	1994-92	9651 PT	Head bolts not incl.; Head bolt replacement recommended
1	Head Set	1994-92	HS 9651 PT	Head bolts & exh. pipe packing not incl.; Head bolt replacement recommended; PermaDry® molded rubber valve cover gskt. incl.; Premium valve stem seals incl.
1	Head Installation Set	1994-92	HIS 9651 PT	Head bolts & exh. pipe packing not incl.; Head bolt replacement recommended; PermaDry® molded rubber valve cover gskt. incl.
1	Head Bolt Set	1994-92	ES 74021	Head bolts w/Washers; Replacement recommended
QTY	CONVERSION SET	YEARS	PART NO.	DESCRIPTION
1	Gasket Conversion Set	1994-92	CS 9435	
QTY	MANIFOLD - INT. & EXH.	YEARS	PART NO.	DESCRIPTION
1	Int. Manifold Gasket Set	1994-92	MS 94370	
1	Exh. Manifold Gasket Set	1994-92	MS 94371	
QTY	EXHAUST PIPE FLANGE	YEARS	PART NO.	DESCRIPTION
1	Exhaust Pipe Gasket	1994-92	60566	Packing
1	Exhaust Pipe Gasket	1994-92	60816	Muffler
QTY	OIL PAN	YEARS	PART NO.	DESCRIPTION
1	Oil Pan Gasket Set	1994-92	OS 30540 C	
QTY	CRANKSHAFT REAR SEAL	YEARS	PART NO.	DESCRIPTION
1	Rear Main Seal Set	1994-92	BS 40522	Rubber; One-piece
QTY	VALVE COVER	YEARS	PART NO.	DESCRIPTION
1	Valve Cover Gasket Set	1994-92	VS 50333 R	w/Grommets; PermaDry® molded rubber gskt. incl.
QTY	VALVE STEM SEAL SET	YEARS	PART NO.	DESCRIPTION
1	Valve Stem Seal Set	1994-92	SS 72710	Premium valve stem seals incl.
QTY	THERMOSTAT HOUSING	YEARS	PART NO.	DESCRIPTION
1	Thermostat Gasket	1994-92	35451	Thermostat Housing; Improved design
QTY	WATER OUTLET GASKET	YEARS	PART NO.	DESCRIPTION
1	Water Outlet Gasket	1994-92	35365	Water Outlet
QTY	WATER PUMP	YEARS	PART NO.	DESCRIPTION
1	Water Pump Gasket	1994-92	35366	

Suzuki Car (Cont.)

1 1 (cont.) (cont.) 1994 - 1992; 1.0L 61 (993cc) SOHC L3 (6 Valve) 74mm Bore TBI; Gasoline; Naturally Aspirated Suzuki Eng.; Eng. Code G10				
QTY	TIMING COVER	YEARS	PART NO.	DESCRIPTION
1	Timing Cover Dust Seal Set	1994-92	ES 72778	
1	Crankshaft Front Seal Set	1994-92	TCS 45461	
1	Camshaft Front Seal Set	1994-92	TCS 45852	
QTY	CARB & FUEL INJECTION	YEARS	PART NO.	DESCRIPTION
1	Throttle Body Gasket	1994	61030	California
1	Throttle Body Gasket	1994	61031	Exc. California
1	Throttle Body Gasket	1993	60921	1st Design; To Eng. Block No. G10P-119923
1	Throttle Body Gasket	1993	61031	2nd Design; From Eng. Block No. G10P-119924
1	Throttle Body Gasket	1992	60921	
QTY	EXHAUST GAS RECIRCULATION	YEARS	PART NO.	DESCRIPTION
1	EGR Gasket	1994-92	71164	
2 2 1994 - 1991; 1.3L 79 (1298cc) DOHC L4 (16 Valve) 74mm Bore MFI; Gasoline; Naturally Aspirated Suzuki Eng.; Eng. Code G13B				
QTY	CYLINDER HEAD	YEARS	PART NO.	DESCRIPTION
1	Head Gasket	1994-91	9623 PT	
1	Head Set	1994-91	HS 9623 PT	PermaDry® molded rubber valve cover gskt. incl.; Premium valve stem seals incl.
QTY	CONVERSION SET	YEARS	PART NO.	DESCRIPTION
1	Gasket Conversion Set	1994-91	CS 9117	
QTY	MANIFOLD - INT. & EXH.	YEARS	PART NO.	DESCRIPTION
1	Int. Manifold Gasket Set	1994-91	MS 94325	
1	Exh. Manifold Gasket Set	1994-91	MS 95249	
QTY	EXHAUST PIPE FLANGE	YEARS	PART NO.	DESCRIPTION
1	Exhaust Pipe Gasket	1994-91	60566	Loc. Front; Converter
1	Exhaust Pipe Gasket	1994-91	60816	Loc. Rear; Converter
QTY	OIL PAN	YEARS	PART NO.	DESCRIPTION
1	Oil Pan Gasket Set	1994-91	OS 30594 C	
QTY	CRANKSHAFT REAR SEAL	YEARS	PART NO.	DESCRIPTION
1	Rear Main Seal Set	1994-91	BS 40522	Rubber; One-piece
QTY	VALVE COVER	YEARS	PART NO.	DESCRIPTION
1	Valve Cover Gasket Set	1994-91	VS 50332 R	w/o Semi-circular plug; PermaDry® molded rubber gskt. incl.
QTY	VALVE STEM SEAL SET	YEARS	PART NO.	DESCRIPTION
1	Valve Stem Seal Set	1994-91	SS 70360	Premium valve stem seals incl.; Improved design
QTY	THERMOSTAT HOUSING	YEARS	PART NO.	DESCRIPTION
1	Water Outlet Gasket	1994-91	35365	Thermostat Housing
QTY	WATER PUMP	YEARS	PART NO.	DESCRIPTION
1	Water Pump Gasket	1994-91	35366	
QTY	TIMING COVER	YEARS	PART NO.	DESCRIPTION
1	Crankshaft Front Seal Set	1994-91	TCS 45461	Must be used w/OS 30594C
2	Camshaft Front Seal Set	1994-91	TCS 45852	
QTY	EXHAUST GAS RECIRCULATION	YEARS	PART NO.	DESCRIPTION
1	EGR Gasket	1994-91	71164	
3 3 2001 - 1998; 1.3L 81 (1324cc) SOHC L4 (16 Valve) 74mm Bore MFI; Gasoline; Naturally Aspirated Suzuki Eng.; Eng. Code SW413				
QTY	CYLINDER HEAD	YEARS	PART NO.	DESCRIPTION
1	Head Gasket	2001-98	9623 PT	
1	Head Set	2001-98	HS 9623 PT-2	PermaDry® molded rubber valve cover gskt. incl.; Premium valve stem seals incl.
QTY	CONVERSION SET	YEARS	PART NO.	DESCRIPTION
1	Gasket Conversion Set	2001-98	CS 9117-1	RTV sealant incl. for oil pan gskt.
QTY	MANIFOLD - INT. & EXH.	YEARS	PART NO.	DESCRIPTION
1	Int. Manifold Gasket Set	2001-98	MS 95402	
1	Exh. Manifold Gasket Set	2001-98	MS 95032	
QTY	EXHAUST PIPE FLANGE	YEARS	PART NO.	DESCRIPTION
2	Exhaust Pipe Gasket	2001-98	60816	Converter
QTY	FUEL PUMP	YEARS	PART NO.	DESCRIPTION
1	Fuel Pump Mounting Gasket	1999-98	70030	
QTY	CRANKSHAFT REAR SEAL	YEARS	PART NO.	DESCRIPTION
1	Rear Main Seal Set	2001-98	BS 40522	Rubber; One-piece
QTY	VALVE COVER	YEARS	PART NO.	DESCRIPTION
1	Valve Cover Gasket Set	2001-98	VS 50473 R	w/Spark plug tube seals; PermaDry® molded rubber gskt. incl.

3		2001 - 1998; 1.3L 81 (1324cc) SOHC L4 (16 Valve) 74mm Bore			3	
(cont.)		MFI; Gasoline; Naturally Aspirated Suzuki Eng.; Eng. Code SW413			(cont.)	
QTY	VALVE STEM SEAL SET	YEARS	PART NO.	DESCRIPTION		
1	Valve Stem Seal Set	2001-98	SS 70360	Premium valve stem seals incl.; Improved design		
QTY	THERMOSTAT HOUSING	YEARS	PART NO.	DESCRIPTION		
1	Thermostat Gasket	2001-98	35451	Thermostat Housing; Improved design		
QTY	WATER OUTLET GASKET	YEARS	PART NO.	DESCRIPTION		
1	Water Outlet Gasket	2001-98	35365	Water Outlet		
QTY	WATER PUMP	YEARS	PART NO.	DESCRIPTION		
1	Water Pump Gasket	2001-98	35366			
QTY	TIMING COVER	YEARS	PART NO.	DESCRIPTION		
1	Crankshaft Front Seal Set	2001-98	TCS 45461			
1	Camshaft Front Seal Set	2001-98	TCS 45852			
QTY	CARB & FUEL INJECTION	YEARS	PART NO.	DESCRIPTION		
1	Throttle Body Gasket	2001-98	61094			
QTY	EXHAUST GAS RECIRCULATION	YEARS	PART NO.	DESCRIPTION		
1	EGR Gasket	2001-98	71164			
4		1997 - 1991; 1.3L 81 (1324cc) SOHC L4 (8 Valve) 74mm Bore			4	
		TBI; Gasoline; Naturally Aspirated Suzuki Eng.; Eng. Code G13A				
QTY	CYLINDER HEAD	YEARS	PART NO.	DESCRIPTION		
1	Head Gasket	1997-91	9623 PT			
1	Head Set	1997-95	HS 9623 PT-1	PermaDry® molded rubber valve cover gskt. incl.; Premium valve stem seals incl.		
1	Head Set	1994-91	HS 9117 PT-1	Premium valve stem seals incl.		
QTY	CONVERSION SET	YEARS	PART NO.	DESCRIPTION		
1	Gasket Conversion Set	1997-96	CS 9117-1	RTV sealant incl. for oil pan gskt.		
1	Gasket Conversion Set	1995-91	CS 9117			
QTY	MANIFOLD - INT. & EXH.	YEARS	PART NO.	DESCRIPTION		
1	Int. Manifold Gasket Set	1997-95	MS 95837			
1	Int. Manifold Gasket Set	1994-91	MS 94326			
1	Exh. Manifold Gasket Set	1997-91	MS 94324			
QTY	EXHAUST PIPE FLANGE	YEARS	PART NO.	DESCRIPTION		
1	Exhaust Pipe Gasket	1997-91	60566	Flange		
2	Exhaust Pipe Gasket	1997-91	60816	Converter		
QTY	FUEL PUMP	YEARS	PART NO.	DESCRIPTION		
1	Fuel Pump Mounting Gasket	1997-91	70030			
QTY	OIL PAN	YEARS	PART NO.	DESCRIPTION		
1	Oil Pan Gasket Set	1997-96	OS 30683 C			
1	Oil Pan Gasket Set	1995-91	OS 30594 C			
QTY	CRANKSHAFT REAR SEAL	YEARS	PART NO.	DESCRIPTION		
1	Rear Main Seal Set	1997-91	BS 40522	Rubber; One-piece		
QTY	VALVE COVER	YEARS	PART NO.	DESCRIPTION		
1	Valve Cover Gasket Set	1997-95	VS 50375 R	w/Grommets; PermaDry® molded rubber gskt. incl.		
1	Valve Cover Gasket Set	1994-91	VS 50323 C	w/Grommets; Cork		
QTY	VALVE STEM SEAL SET	YEARS	PART NO.	DESCRIPTION		
1	Valve Stem Seal Set	1997-91	SS 72675-1	Premium valve stem seals incl.		
QTY	THERMOSTAT HOUSING	YEARS	PART NO.	DESCRIPTION		
1	Thermostat Gasket	1997-91	35451	Thermostat Housing; Improved design		
QTY	WATER OUTLET GASKET	YEARS	PART NO.	DESCRIPTION		
1	Water Outlet Gasket	1997-91	35365	Water Outlet		
QTY	WATER PUMP	YEARS	PART NO.	DESCRIPTION		
1	Water Pump Gasket	1997-91	35366			
QTY	TIMING COVER	YEARS	PART NO.	DESCRIPTION		
1	Crankshaft Front Seal Set	1997-96	TCS 45461	Must be used w/OS 30683C		
1	Crankshaft Front Seal Set	1995-91	TCS 45461	Must be used w/OS 30594C		
1	Camshaft Front Seal Set	1997-91	TCS 45852			
QTY	CARB & FUEL INJECTION	YEARS	PART NO.	DESCRIPTION		
1	Throttle Body Gasket	1997-95	61030	Loc. Upper		
1	Throttle Body Gasket	1997-95	61095	Loc. Lower		
1	Throttle Body Gasket	1994	60921			
1	Throttle Body Gasket	1993	60921	1st Design; To Eng. Block No. G13P-107961		
1	Throttle Body Gasket	1993	61031	2nd Design; From Eng. Block No. G13P-107962		
1	Throttle Body Gasket	1992-91	60921			
QTY	EXHAUST GAS RECIRCULATION	YEARS	PART NO.	DESCRIPTION		
1	EGR Gasket	1997-91	71164			

Suzuki Car (Cont.)

5		2002 - 1992; 1.6L 97 (1590cc) SOHC L4 (16 Valve) 75mm Bore			5
		MFI; Gasoline; Naturally Aspirated Suzuki Eng.; Eng. Code G16KV			
QTY	CYLINDER HEAD	YEARS	PART NO.	DESCRIPTION	
1	Head Gasket	2002-92	9683 PT-1		
1	Head Set	2002-92	HS 9683 PT-1	Exh. pipe packing not incl.; PermaDry® molded rubber valve cover gskt. incl.; Premium valve stem seals incl.	
QTY	CONVERSION SET	YEARS	PART NO.	DESCRIPTION	
1	Gasket Conversion Set	2002-96	CS 9683-1	RTV sealant incl. for oil pan gskt.	
1	Gasket Conversion Set	1995-92	CS 9683		
QTY	MANIFOLD - INT. & EXH.	YEARS	PART NO.	DESCRIPTION	
1	Int. Manifold Gasket Set	2002-92	MS 95402		
1	Exh. Manifold Gasket Set	2002-92	MS 95032		
QTY	EXHAUST PIPE FLANGE	YEARS	PART NO.	DESCRIPTION	
1	Exhaust Pipe Gasket	2002-94	61015	Loc. Rear; Converter	
1	Exhaust Pipe Gasket	2002-94	61016	Flange; Improved design	
1	Exhaust Pipe Gasket	2002-94	61016	Loc. Front; Converter; Improved design	
1	Exhaust Pipe Gasket	1993-92	23566	Packing; Exc. California	
1	Exhaust Pipe Gasket	1993-92	60566	Converter	
QTY	OIL PAN	YEARS	PART NO.	DESCRIPTION	
1	Oil Pan Gasket Set	1997-96	OS 30698 C		
1	Oil Pan Gasket Set	1995-92	OS 30594 C		
QTY	CRANKSHAFT REAR SEAL	YEARS	PART NO.	DESCRIPTION	
1	Rear Main Seal Set	2002-92	BS 40603	Rubber; One-piece	
QTY	VALVE COVER	YEARS	PART NO.	DESCRIPTION	
1	Valve Cover Gasket Set	2002-92	VS 50473 R	w/Spark plug tube seals; PermaDry® molded rubber gskt. incl.	
QTY	VALVE STEM SEAL SET	YEARS	PART NO.	DESCRIPTION	
1	Valve Stem Seal Set	2002-92	SS 70360	Premium valve stem seals incl.; Improved design	
QTY	THERMOSTAT HOUSING	YEARS	PART NO.	DESCRIPTION	
1	Thermostat Gasket	2002-92	35432	Thermostat Housing; Thermostat seal	
QTY	WATER OUTLET GASKET	YEARS	PART NO.	DESCRIPTION	
1	Thermostat Gasket	2002-92	35451	Water Outlet; Improved design	
QTY	WATER PUMP	YEARS	PART NO.	DESCRIPTION	
1	Water Pump Gasket	2002-92	35366		
QTY	TIMING COVER	YEARS	PART NO.	DESCRIPTION	
1	Crankshaft Front Seal Set	2002-92	TCS 45895		
1	Camshaft Front Seal Set	2002-92	TCS 45852		
QTY	CARB & FUEL INJECTION	YEARS	PART NO.	DESCRIPTION	
1	Throttle Body Gasket	2002-92	61033		
QTY	EXHAUST GAS RECIRCULATION	YEARS	PART NO.	DESCRIPTION	
1	EGR Gasket	2002-95	71026	Pipe	
1	EGR Gasket	2002-99	70984	Valve	
1	EGR Gasket	1998-95	71164	Valve	
1	EGR Gasket	1994-92	71164		
6		2002 - 1999; 1.8L 109.2 (1788cc) DOHC L4 (16 Valve) 84mm Bore			6
		MFI; Gasoline; Naturally Aspirated Suzuki Eng.; Eng. Code SY418			
QTY	CYLINDER HEAD	YEARS	PART NO.	DESCRIPTION	
1	Head Gasket	2002-99	26278 PT	Head bolts not incl.; Head bolt replacement recommended; PermaTorqueMLS®	
1	Head Bolt Set	2002-99	ES 72206	Head bolts w/Washers; Replacement recommended	
QTY	VALVE COVER	YEARS	PART NO.	DESCRIPTION	
1	Valve Cover Gasket Set	2002-99	VS 50633 R	w/Semi-circular plug & Grommets & Spark plug tube seals; PermaDry® molded rubber gskt. incl.	
7		2009 - 2002; 2.0L 121.7 (1995cc) DOHC L4 (16 Valve) 84mm Bore			7
		MFI; Gasoline; Naturally Aspirated Suzuki Eng.; Eng. Code J20A			
QTY	CYLINDER HEAD	YEARS	PART NO.	DESCRIPTION	
1	Head Gasket	2009-07	26278 PT	Head bolts not incl.; Head bolt replacement recommended; PermaTorqueMLS®	
1	Head Gasket	2003-02	26278 PT	Head bolts not incl.; Head bolt replacement recommended; PermaTorqueMLS®	
1	Head Set	2009-07	HS 26278 PT-1	Head bolts not incl.; Head bolt replacement recommended; PermaDry® molded rubber valve cover gskt. incl.; Premium valve stem seals incl.	
1	Head Set	2003-02	HS 26278 PT	Head bolts not incl.; Head bolt replacement recommended; PermaDry® molded rubber valve cover gskt. incl.; Premium valve stem seals incl.	
1	Head Bolt Set	2009-07	ES 72206	Head bolts w/Washers; Replacement recommended	

7		2009 - 2002; 2.0L 121.7 (1995cc) DOHC L4 (16 Valve) 84mm Bore			7	
(cont.)		MFI; Gasoline; Naturally Aspirated Suzuki Eng.; Eng. Code J20A			(cont.)	
QTY	CYLINDER HEAD	YEARS	PART NO.	DESCRIPTION		
1	Head Bolt Set	2003-02	ES 72206	Head bolts w/Washers; Replacement recommended		
QTY	CONVERSION SET	YEARS	PART NO.	DESCRIPTION		
1	Gasket Conversion Set	2009-07	CS 26278	RTV sealant incl. for oil pan gskt.		
1	Gasket Conversion Set	2003-02	CS 26278			
QTY	MANIFOLD - INT. & EXH.	YEARS	PART NO.	DESCRIPTION		
1	Int. Manifold Gasket Set	2009-07	MS 97051			
1	Int. Manifold Gasket Set	2003-02	MS 96603			
1	Exh. Manifold Gasket Set	2009-07	MS 96602			
1	Exh. Manifold Gasket Set	2003-02	MS 96602			
QTY	EXHAUST PIPE FLANGE	YEARS	PART NO.	DESCRIPTION		
1	Exhaust Pipe Gasket	2009-07	61558	Flange		
1	Exhaust Pipe Gasket	2003-02	60566	Exh. connector		
1	Exhaust Pipe Gasket	2003-02	61386	Ring		
1	Exhaust Pipe Gasket	2003-02	61387	Converter		
QTY	OIL PAN	YEARS	PART NO.	DESCRIPTION		
1	Oil Pan Gasket Set	2003-02	OS 30765			
QTY	CRANKSHAFT REAR SEAL	YEARS	PART NO.	DESCRIPTION		
1	Rear Main Seal Set	2009-07	BS 40687	Rubber; One-piece		
1	Rear Main Seal Set	2003-02	BS 40687	Rubber; One-piece		
QTY	VALVE COVER	YEARS	PART NO.	DESCRIPTION		
1	Valve Cover Gasket Set	2009-07	VS 50756 R	w/Semi-circular plugs & Grommets & Spark plug tube seals; PermaDry® molded rubber gskt. incl.		
1	Valve Cover Gasket Set	2003-02	VS 50633 R	w/Semi-circular plug & Grommets & Spark plug tube seals; PermaDry® molded rubber gskt. incl.		
QTY	VALVE STEM SEAL SET	YEARS	PART NO.	DESCRIPTION		
1	Valve Stem Seal Set	2009-07	SS 70283-1	Premium valve stem seals incl.		
1	Valve Stem Seal Set	2003-02	SS 70283-1	Premium valve stem seals incl.		
QTY	THERMOSTAT HOUSING	YEARS	PART NO.	DESCRIPTION		
1	Thermostat Gasket	2009-07	35769	Thermostat Housing; Thermostat seal		
1	Thermostat Gasket	2003-02	35769	Thermostat Housing; Thermostat seal		
QTY	WATER OUTLET GASKET	YEARS	PART NO.	DESCRIPTION		
1	Water Outlet Gasket	2009-07	35766	Water Outlet		
1	Water Outlet Gasket	2003-02	35766	Water Outlet		
QTY	WATER PUMP	YEARS	PART NO.	DESCRIPTION		
1	O-Ring	2009-07	35768	Water Pump		
1	O-Ring	2003-02	35768	Water Pump		
QTY	TIMING COVER	YEARS	PART NO.	DESCRIPTION		
1	Crankshaft Front Seal Set	2009-07	TCS 46056			
1	Crankshaft Front Seal Set	2003-02	TCS 46056			
QTY	CARB & FUEL INJECTION	YEARS	PART NO.	DESCRIPTION		
1	Fuel Injector O-Ring Set	2003-02	ES 70599	Upper set; Injectors to fuel rail; Improved design		
1	Fuel Injector O-Ring Set	2003-02	ES 71190	Lower set; Injectors to cylinder head		
1	Throttle Body Gasket	2009-07	61564			
1	Throttle Body Gasket	2003-02	61385			
QTY	EXHAUST GAS RECIRCULATION	YEARS	PART NO.	DESCRIPTION		
1	EGR Gasket	2003-02	71026	Pipe		
1	EGR Gasket	2003-02	71218	Valve		
8		2008 - 2004; 2.0L 122 (1998cc) DOHC L4 (16 Valve) 86mm Bore			8	
		MFI; Gasoline; Naturally Aspirated Opel Eng.; Eng. Code A20DMS				
QTY	CYLINDER HEAD	YEARS	PART NO.	DESCRIPTION		
1	Head Gasket	2008-04	26317 PT	Head bolts not incl.; Head bolt replacement recommended		
1	Head Set	2008-06	HS 26317 PT	Head bolts not incl.; Head bolt replacement recommended; EGR adapter gskt. NOT INCLUDED; PermaDry® molded rubber valve cover gskt. incl.; Premium valve stem seals incl.		
1	Head Set	2008-06	HS 26317 PT-2	Head bolts not incl.; Head bolt replacement recommended; EGR adapter gskt. INCLUDED; PermaDry® molded rubber valve cover gskt. incl.; Premium valve stem seals incl.; New Part Number - Check for Availability		
1	Head Set	2005-04	HS 26317 PT	Head bolts not incl.; Head bolt replacement recommended; PermaDry® molded rubber valve cover gskt. incl.; Premium valve stem seals incl.		
1	Head Bolt Set	2008-04	ES 72906-1	Head bolts w/Washers; Replacement recommended		
QTY	CONVERSION SET	YEARS	PART NO.	DESCRIPTION		
1	Gasket Conversion Set	2008-04	CS 26317	RTV sealant incl. for oil pan gskt.		
QTY	MANIFOLD - INT. & EXH.	YEARS	PART NO.	DESCRIPTION		
1	Int. Manifold Gasket Set	2008-04	MS 96859			

Suzuki Car (Cont.)

8		2008 - 2004; 2.0L 122 (1998cc) DOHC L4 (16 Valve) 86mm Bore			8
(cont.)		MFI; Gasoline; Naturally Aspirated Opel Eng.; Eng. Code A20DMS			(cont.)
QTY	MANIFOLD - INT. & EXH.	YEARS	PART NO.	DESCRIPTION	
1	Exh. Manifold Gasket Set	2008-04	MS 96815		
QTY	EXHAUST PIPE FLANGE	YEARS	PART NO.	DESCRIPTION	
1	Exhaust Pipe Gasket	2008-04	61473	Ring	
1	Exhaust Pipe Gasket	2008-04	61475	Exh. connector; 3-bolt	
1	Exhaust Pipe Gasket	2008-04	61488	Exh. connector; 2-bolt	
QTY	CRANKSHAFT REAR SEAL	YEARS	PART NO.	DESCRIPTION	
1	Rear Main Seal Set	2008-04	BS 40555	Rubber; One-piece	
QTY	VALVE COVER	YEARS	PART NO.	DESCRIPTION	
1	Valve Cover Gasket Set	2008-04	VS 50692 R	w/Grommets & Spark plug tube seals; PermaDry® molded rubber gskt. incl.	
QTY	VALVE STEM SEAL SET	YEARS	PART NO.	DESCRIPTION	
1	Valve Stem Seal Set	2008-04	SS 71163-1	Premium valve stem seals incl.	
QTY	THERMOSTAT HOUSING	YEARS	PART NO.	DESCRIPTION	
1	Thermostat Gasket	2008-04	35820	Thermostat Housing; Thermostat seal	
QTY	WATER OUTLET GASKET	YEARS	PART NO.	DESCRIPTION	
1	Water Outlet Gasket	2008-04	35821	Water Outlet	
QTY	WATER PUMP	YEARS	PART NO.	DESCRIPTION	
1	Water Pump Gasket	2008-04	35302	O-ring	
QTY	TIMING COVER	YEARS	PART NO.	DESCRIPTION	
1	Crankshaft Front Seal Set	2008-04	TCS 46097		
1	Camshaft Front Seal Set	2008-04	TCS 46094		
QTY	CARB & FUEL INJECTION	YEARS	PART NO.	DESCRIPTION	
1	Fuel Injector O-Ring Set	2008-04	ES 70599	Upper set; Injectors to fuel rail; Improved design	
1	Fuel Injector O-Ring Set	2008-04	ES 71190	Lower set; Injectors to cylinder head	
1	Throttle Body Gasket	2008-04	61384		
QTY	EXHAUST GAS RECIRCULATION	YEARS	PART NO.	DESCRIPTION	
1	EGR Gasket	2008-04	71269	Valve	
1	EGR Gasket	2008-06	71379	Adapter; New Part Number - Check for Availability	
1	EGR Gasket	2005-04	71270	Adapter	
9		2007 - 2004; 2.3L 139.7 (2290cc) DOHC L4 (16 Valve) 90mm Bore			9
(cont.)		MFI; Gasoline; Naturally Aspirated Suzuki Eng.; Eng. Code J23A			(cont.)
QTY	CYLINDER HEAD	YEARS	PART NO.	DESCRIPTION	
1	Head Gasket	2007-04	26279 PT	Head bolts not incl.; Head bolt replacement recommended; PermaTorqueMLS®	
1	Head Set	2007-04	HS 26279 PT	Head bolts not incl.; Head bolt replacement recommended; PermaDry® molded rubber valve cover gskt. incl.; Premium valve stem seals incl.	
1	Head Bolt Set	2007-04	ES 72206	Head bolts w/Washers; Replacement recommended	
QTY	CONVERSION SET	YEARS	PART NO.	DESCRIPTION	
1	Gasket Conversion Set	2007-04	CS 26279		
QTY	MANIFOLD - INT. & EXH.	YEARS	PART NO.	DESCRIPTION	
1	Int. Manifold Gasket Set	2007-04	MS 96603		
1	Exh. Manifold Gasket Set	2007-04	MS 96602		
QTY	EXHAUST PIPE FLANGE	YEARS	PART NO.	DESCRIPTION	
1	Exhaust Pipe Gasket	2007-04	60566	Exh. connector	
1	Exhaust Pipe Gasket	2007-04	61386	Ring	
1	Exhaust Pipe Gasket	2007-04	61387	Converter	
QTY	OIL PAN	YEARS	PART NO.	DESCRIPTION	
1	Oil Pan Gasket Set	2007-04	OS 30765		
QTY	CRANKSHAFT REAR SEAL	YEARS	PART NO.	DESCRIPTION	
1	Rear Main Seal Set	2007-04	BS 40687	Rubber; One-piece	
QTY	VALVE COVER	YEARS	PART NO.	DESCRIPTION	
1	Valve Cover Gasket Set	2007-04	VS 50633 R	w/Semi-circular plug & Grommets & Spark plug tube seals; PermaDry® molded rubber gskt. incl.	
QTY	VALVE STEM SEAL SET	YEARS	PART NO.	DESCRIPTION	
1	Valve Stem Seal Set	2007-04	SS 70283-1	Premium valve stem seals incl.	
QTY	THERMOSTAT HOUSING	YEARS	PART NO.	DESCRIPTION	
1	Thermostat Gasket	2007-04	35769	Thermostat Housing; Thermostat seal	
QTY	WATER OUTLET GASKET	YEARS	PART NO.	DESCRIPTION	
1	Water Outlet Gasket	2007-04	35766	Water Outlet	
QTY	WATER PUMP	YEARS	PART NO.	DESCRIPTION	
1	O-Ring	2007-04	35768	Water Pump	
QTY	TIMING COVER	YEARS	PART NO.	DESCRIPTION	
1	Crankshaft Front Seal Set	2007-04	TCS 46081		

9 2007 - 2004; 2.3L 139.7 (2290cc) DOHC L4 (16 Valve) 90mm Bore 9				
(cont.) MFI; Gasoline; Naturally Aspirated Suzuki Eng.; Eng. Code J23A (cont.)				
QTY	CARB & FUEL INJECTION	YEARS	PART NO.	DESCRIPTION
1	Throttle Body Gasket	2007-04	61455	
QTY	EXHAUST GAS RECIRCULATION	YEARS	PART NO.	DESCRIPTION
1	EGR Gasket	2007-04	71026	Pipe
1	EGR Gasket	2007-04	71218	Valve

**Suzuki SUV's - See Suzuki Truck
Suzuki Truck (Incl. SUV's)**

Engine Finding Index				
Engine	Years	Code	Line No.	
1.3L 81 (1324cc) SOHC L4 (8 Valve) 74mm Bore; TBI; Gasoline; Naturally Aspirated Suzuki Eng.	1995-91	G13A	1	
1.6L 97 (1590cc) SOHC L4 (16 Valve) 75mm Bore; MFI; Gasoline; Naturally Aspirated Suzuki Eng.	2001-92	G16KV	2	
1.6L 97 (1590cc) SOHC L4 (8 Valve) 75mm Bore; TBI; Gasoline; Naturally Aspirated Suzuki Eng.	1995-91	G16KC	3	
1.8L 109.2 (1788cc) DOHC L4 (16 Valve) 84mm Bore; MFI; Gasoline; Naturally Aspirated Suzuki Eng.	1998-96	G18KV	4	
2.0L 121.7 (1995cc) DOHC L4 (16 Valve) 84mm Bore; MFI; Gasoline; Naturally Aspirated Suzuki Eng.	2004-99	J20A	5	
2.5L 151.8 (2488cc) DOHC L4 (16 Valve) 89mm Bore; MFI; Gasoline; Naturally Aspirated Nissan Eng.	2013-09	QR25DE	6	
2.5L 152 (2492cc) DOHC V6 (24 Valve) 84mm Bore; MFI; Gasoline; Naturally Aspirated Suzuki Eng.	2005-99	H25A	7	
2.7L 167 (2736cc) DOHC V6 (24 Valve) 88mm Bore; MFI; Gasoline; Naturally Aspirated Suzuki Eng.	2008-01	H27A	8	
3.6L 217 (3564cc) DOHC V6 (24 Valve) 94mm Bore; MFI; Gasoline; Naturally Aspirated Opel Eng.	2009-07	N36A	9	
4.0L 241.3 (3954cc) DOHC V6 (24 Valve) 95.5mm Bore; MFI; Gasoline; Naturally Aspirated Nissan Eng.	2013-09	VQ40DE	10	

Engine Code Index				
Code	Engine	Line No.		
G13A	1.3L 81 (1324cc) SOHC L4 (8 Valve) 74mm Bore; TBI; Gasoline; Naturally Aspirated Suzuki Eng.	1		
G16KC	1.6L 97 (1590cc) SOHC L4 (8 Valve) 75mm Bore; TBI; Gasoline; Naturally Aspirated Suzuki Eng.	3		
G16KV	1.6L 97 (1590cc) SOHC L4 (16 Valve) 75mm Bore; MFI; Gasoline; Naturally Aspirated Suzuki Eng.	2		
G18KV	1.8L 109.2 (1788cc) DOHC L4 (16 Valve) 84mm Bore; MFI; Gasoline; Naturally Aspirated Suzuki Eng.	4		
H25A	2.5L 152 (2492cc) DOHC V6 (24 Valve) 84mm Bore; MFI; Gasoline; Naturally Aspirated Suzuki Eng.	7		
H27A	2.7L 167 (2736cc) DOHC V6 (24 Valve) 88mm Bore; MFI; Gasoline; Naturally Aspirated Suzuki Eng.	8		
J20A	2.0L 121.7 (1995cc) DOHC L4 (16 Valve) 84mm Bore; MFI; Gasoline; Naturally Aspirated Suzuki Eng.	5		
N36A	3.6L 217 (3564cc) DOHC V6 (24 Valve) 94mm Bore; MFI; Gasoline; Naturally Aspirated Opel Eng.	9		
QR25DE	2.5L 151.8 (2488cc) DOHC L4 (16 Valve) 89mm Bore; MFI; Gasoline; Naturally Aspirated Nissan Eng.	6		
VQ40DE	4.0L 241.3 (3954cc) DOHC V6 (24 Valve) 95.5mm Bore; MFI; Gasoline; Naturally Aspirated Nissan Eng.	10		

Model Index					
Engine (VIN Code / Eng. Code)	Year	Engine (VIN Code / Eng. Code)	Year	Engine (VIN Code / Eng. Code)	Year
Suzuki Truck		Suzuki Truck (cont.)		Suzuki Truck (cont.)	
Equator (2WD Compact Pickup)		Samurai (4WD Compact SUV)		Vitara (4WD Compact SUV)	
L4 2488cc 2.5L DOHC (16 Valve) (QR25DE)	13-09	L4 1324cc 1.3L SOHC (8 Valve) (G13A)	95-86	L4 1590cc 1.6L SOHC (16 Valve) (G16KV)	01-99
V6 3954cc 4.0L DOHC (24 Valve) (VQ40DE)	13-09	Sidekick (2WD Compact SUV)		L4 1995cc 2.0L DOHC (16 Valve) (J20A)	03-99
Equator (4WD Compact Pickup)		L4 1324cc 1.3L SOHC (8 Valve) (G13A)	89	V6 2492cc 2.5L DOHC (24 Valve) (H25A)	04
L4 2488cc 2.5L DOHC (16 Valve) (QR25DE)	13-09	L4 1590cc 1.6L SOHC (16 Valve) (G16KV)	98-92	X-90 (2WD Compact SUV)	
V6 3954cc 4.0L DOHC (24 Valve) (VQ40DE)	13-09	L4 1590cc 1.6L SOHC (8 Valve) (G16KC)	95-89	L4 1590cc 1.6L SOHC (16 Valve) (G16KV)	98-96
Grand Vitara (2WD Compact SUV)		Sidekick (4WD Compact SUV)		X-90 (4WD Compact SUV)	
L4 2393cc 2.4L DOHC (16 Valve) (J24B)	13-09	L4 1324cc 1.3L SOHC (8 Valve) (G13A)	89	L4 1590cc 1.6L SOHC (16 Valve) (G16KV)	98-96
V6 2492cc 2.5L DOHC (24 Valve) (H25A)	05-99	L4 1590cc 1.6L SOHC (16 Valve) (G16KV)	98-92	XL-7 (2WD Mid-Size SUV)	
V6 2736cc 2.7L DOHC (24 Valve) (H27A)	08-06	L4 1590cc 1.6L SOHC (8 Valve) (G16KC)	95-89	V6 2736cc 2.7L DOHC (24 Valve) (H27A)	06-01
V6 3195cc 3.2L DOHC (24 Valve) (N32A)	13-09	Sidekick Sport (4WD Compact SUV)		V6 3564cc 3.6L DOHC (24 Valve) (N36A)	09-07
Grand Vitara (4WD Compact SUV)		L4 1788cc 1.8L DOHC (16 Valve) (G18KV)	98-96	XL-7 (4WD Mid-Size SUV)	
L4 2393cc 2.4L DOHC (16 Valve) (J24B)	13-09	SJ413 (Compact SUV)		V6 2736cc 2.7L DOHC (24 Valve) (H27A)	06-01
V6 2492cc 2.5L DOHC (24 Valve) (H25A)	05-99	L4 1324cc 1.3L SOHC (8 Valve) (G13A)	85	V6 3564cc 3.6L DOHC (24 Valve) (N36A)	09-07
V6 2736cc 2.7L DOHC (24 Valve) (H27A)	08-06	Vitara (2WD Compact SUV)			
V6 3195cc 3.2L DOHC (24 Valve) (N32A)	13-09	L4 1590cc 1.6L SOHC (16 Valve) (G16KV)	01-99		
Samurai (2WD Compact SUV)		L4 1995cc 2.0L DOHC (16 Valve) (J20A)	03-99		
L4 1324cc 1.3L SOHC (8 Valve) (G13A)	93-91	V6 2492cc 2.5L DOHC (24 Valve) (H25A)	04		

1 1995 - 1991; 1.3L 81 (1324cc) SOHC L4 (8 Valve) 74mm Bore 1				
TBI; Gasoline; Naturally Aspirated Suzuki Eng.; Eng. Code G13A				
QTY	CYLINDER HEAD	YEARS	PART NO.	DESCRIPTION
1	Head Gasket	1995-91	9623 PT	
1	Head Set	1995-91	HS 9117 PT	Premium valve stem seals incl.
QTY	CONVERSION SET	YEARS	PART NO.	DESCRIPTION
1	Gasket Conversion Set	1995-91	CS 9117	
QTY	MANIFOLD - INT. & EXH.	YEARS	PART NO.	DESCRIPTION
1	Int. Manifold Gasket Set	1995-91	MS 94065	

Suzuki Truck (Incl. SUV's) (Cont.)

1		1995 - 1991; 1.3L 81 (1324cc) SOHC L4 (8 Valve) 74mm Bore			1	
(cont.)		TBI; Gasoline; Naturally Aspirated Suzuki Eng.; Eng. Code G13A			(cont.)	
QTY	MANIFOLD - INT. & EXH.	YEARS	PART NO.	DESCRIPTION		
1	Exh. Manifold Gasket Set	1995-91	MS 94478	Improved design		
QTY	EXHAUST PIPE FLANGE	YEARS	PART NO.	DESCRIPTION		
1	Exhaust Pipe Gasket	1995-91	60566	Flange		
2	Exhaust Pipe Gasket	1995-91	60816	Converter		
QTY	FUEL PUMP	YEARS	PART NO.	DESCRIPTION		
1	Fuel Pump Mounting Gasket	1995-91	70030			
QTY	OIL PAN	YEARS	PART NO.	DESCRIPTION		
1	Oil Pan Gasket Set	1995-91	OS 30594 C			
QTY	CRANKSHAFT REAR SEAL	YEARS	PART NO.	DESCRIPTION		
1	Rear Main Seal Set	1995-91	BS 40522	Rubber; One-piece		
QTY	VALVE COVER	YEARS	PART NO.	DESCRIPTION		
1	Valve Cover Gasket Set	1995-91	VS 50323 C	w/Grommets; Cork		
QTY	VALVE STEM SEAL SET	YEARS	PART NO.	DESCRIPTION		
1	Valve Stem Seal Set	1995-91	SS 72675-1	Premium valve stem seals incl.		
QTY	THERMOSTAT HOUSING	YEARS	PART NO.	DESCRIPTION		
1	Thermostat Gasket	1995-91	35416	Thermostat Housing		
QTY	WATER PUMP	YEARS	PART NO.	DESCRIPTION		
1	Water Pump Gasket	1995-91	35366			
QTY	TIMING COVER	YEARS	PART NO.	DESCRIPTION		
1	Crankshaft Front Seal Set	1995-91	TCS 45461	Must be used w/OS 30594C		
1	Camshaft Front Seal Set	1995-91	TCS 45852			
QTY	CARB & FUEL INJECTION	YEARS	PART NO.	DESCRIPTION		
1	Throttle Body Gasket	1995-91	60840			
QTY	EXHAUST GAS RECIRCULATION	YEARS	PART NO.	DESCRIPTION		
1	EGR Gasket	1995-91	71164			
2		2001 - 1992; 1.6L 97 (1590cc) SOHC L4 (16 Valve) 75mm Bore			2	
		MFI; Gasoline; Naturally Aspirated Suzuki Eng.; Eng. Code G16KV				
QTY	CYLINDER HEAD	YEARS	PART NO.	DESCRIPTION		
1	Head Gasket	2001-92	9683 PT-1			
1	Head Set	2001-92	HS 9683 PT-1	Exh. pipe packing not incl.; PermaDry® molded rubber valve cover gskt. incl.; Premium valve stem seals incl.		
QTY	CONVERSION SET	YEARS	PART NO.	DESCRIPTION		
1	Gasket Conversion Set	2001-96	CS 9683-1	RTV sealant incl. for oil pan gskt.		
1	Gasket Conversion Set	1995-92	CS 9683			
QTY	MANIFOLD - INT. & EXH.	YEARS	PART NO.	DESCRIPTION		
1	Int. Manifold Gasket Set	2001-92	MS 95402			
1	Exh. Manifold Gasket Set	2001-92	MS 95032			
QTY	EXHAUST PIPE FLANGE	YEARS	PART NO.	DESCRIPTION		
1	Exhaust Pipe Gasket	2001-94	61015	Loc. Rear; Converter		
1	Exhaust Pipe Gasket	2001-94	61016	Flange; Improved design		
1	Exhaust Pipe Gasket	2001-94	61016	Loc. Front; Converter; Improved design		
1	Exhaust Pipe Gasket	1993-92	23566	Packing; Exc. California		
1	Exhaust Pipe Gasket	1993-92	60566	Converter		
QTY	OIL PAN	YEARS	PART NO.	DESCRIPTION		
1	Oil Pan Gasket Set	1997-96	OS 30698 C			
1	Oil Pan Gasket Set	1995-92	OS 30594 C			
QTY	CRANKSHAFT REAR SEAL	YEARS	PART NO.	DESCRIPTION		
1	Rear Main Seal Set	2001-92	BS 40603	Rubber; One-piece		
QTY	VALVE COVER	YEARS	PART NO.	DESCRIPTION		
1	Valve Cover Gasket Set	2001-92	VS 50473 R	w/Spark plug tube seals; PermaDry® molded rubber gskt. incl.		
QTY	VALVE STEM SEAL SET	YEARS	PART NO.	DESCRIPTION		
1	Valve Stem Seal Set	2001-92	SS 70360	Premium valve stem seals incl.; Improved design		
QTY	THERMOSTAT HOUSING	YEARS	PART NO.	DESCRIPTION		
1	Thermostat Gasket	2001-92	35432	Thermostat Housing; Thermostat seal		
QTY	WATER OUTLET GASKET	YEARS	PART NO.	DESCRIPTION		
1	Thermostat Gasket	2001-92	35451	Water Outlet; Improved design		
QTY	WATER PUMP	YEARS	PART NO.	DESCRIPTION		
1	Water Pump Gasket	2001-92	35366			
QTY	TIMING COVER	YEARS	PART NO.	DESCRIPTION		
1	Crankshaft Front Seal Set	2001-92	TCS 45895			
1	Camshaft Front Seal Set	2001-92	TCS 45852			
QTY	CARB & FUEL INJECTION	YEARS	PART NO.	DESCRIPTION		
1	Throttle Body Gasket	2001-92	61033			

Suzuki Truck (Incl. SUV's) (Cont.)

2		2001 - 1992; 1.6L 97 (1590cc) SOHC L4 (16 Valve) 75mm Bore			2	
(cont.)		MFI; Gasoline; Naturally Aspirated Suzuki Eng.; Eng. Code G16KV			(cont.)	
QTY	EXHAUST GAS RECIRCULATION	YEARS	PART NO.	DESCRIPTION		
1	EGR Gasket	2001-95	71026	Pipe		
1	EGR Gasket	2001-99	70984	Valve		
1	EGR Gasket	1998-95	71164	Valve		
1	EGR Gasket	1994-92	71164			
3		1995 - 1991; 1.6L 97 (1590cc) SOHC L4 (8 Valve) 75mm Bore			3	
		TBI; Gasoline; Naturally Aspirated Suzuki Eng.; Eng. Code G16KC				
QTY	CYLINDER HEAD	YEARS	PART NO.	DESCRIPTION		
1	Head Gasket	1995-91	9683 PT-1			
1	Head Set	1995-91	HS 9683 PT	Premium valve stem seals incl.		
QTY	CONVERSION SET	YEARS	PART NO.	DESCRIPTION		
1	Gasket Conversion Set	1995-91	CS 9683			
QTY	MANIFOLD - INT. & EXH.	YEARS	PART NO.	DESCRIPTION		
1	Int. Manifold Gasket Set	1995-91	MS 94477			
1	Exh. Manifold Gasket Set	1995-91	MS 94478	Improved design		
QTY	EXHAUST PIPE FLANGE	YEARS	PART NO.	DESCRIPTION		
1	Exhaust Pipe Gasket	1995-91	60566	Converter		
1	Exhaust Pipe Gasket	1995-94	23566	Packing		
1	Exhaust Pipe Gasket	1993	23566	Packing; Exc. California		
1	Exhaust Pipe Gasket	1992-91	23566	Packing		
QTY	OIL PAN	YEARS	PART NO.	DESCRIPTION		
1	Oil Pan Gasket Set	1995-91	OS 30594 C			
QTY	CRANKSHAFT REAR SEAL	YEARS	PART NO.	DESCRIPTION		
1	Rear Main Seal Set	1995-91	BS 40603	Rubber; One-piece		
QTY	VALVE COVER	YEARS	PART NO.	DESCRIPTION		
1	Valve Cover Gasket Set	1995-91	VS 50323 C	w/Grommets; Cork		
QTY	VALVE STEM SEAL SET	YEARS	PART NO.	DESCRIPTION		
1	Valve Stem Seal Set	1995-91	SS 72675-1	Premium valve stem seals incl.		
QTY	THERMOSTAT HOUSING	YEARS	PART NO.	DESCRIPTION		
1	Thermostat Gasket	1995-91	35416	Thermostat Housing		
QTY	WATER PUMP	YEARS	PART NO.	DESCRIPTION		
1	Water Pump Gasket	1995-91	35366			
QTY	TIMING COVER	YEARS	PART NO.	DESCRIPTION		
1	Timing Cover Dust Seal Set	1995-91	ES 72778			
1	Crankshaft Front Seal Set	1995-91	TCS 45895			
1	Camshaft Front Seal Set	1995-91	TCS 45852			
QTY	CARB & FUEL INJECTION	YEARS	PART NO.	DESCRIPTION		
1	Throttle Body Gasket	1995-91	60840			
QTY	EXHAUST GAS RECIRCULATION	YEARS	PART NO.	DESCRIPTION		
1	EGR Gasket	1995-91	71164			
4		1998 - 1996; 1.8L 109.2 (1788cc) DOHC L4 (16 Valve) 84mm Bore			4	
		MFI; Gasoline; Naturally Aspirated Suzuki Eng.; Eng. Code G18KV				
QTY	CYLINDER HEAD	YEARS	PART NO.	DESCRIPTION		
1	Head Gasket	1998-96	26278 PT	Head bolts not incl.; Head bolt replacement recommended; PermaTorqueMLS®		
1	Head Bolt Set	1998-96	ES 72206	Head bolts w/Washers; Replacement recommended		
QTY	VALVE COVER	YEARS	PART NO.	DESCRIPTION		
1	Valve Cover Gasket Set	1998-96	VS 50633 R	w/Semi-circular plug & Grommets & Spark plug tube seals; PermaDry® molded rubber gsckt. incl.		
5		2004 - 1999; 2.0L 121.7 (1995cc) DOHC L4 (16 Valve) 84mm Bore			5	
		MFI; Gasoline; Naturally Aspirated Suzuki Eng.; Eng. Code J20A				
QTY	CYLINDER HEAD	YEARS	PART NO.	DESCRIPTION		
1	Head Gasket	2004-99	26278 PT	Head bolts not incl.; Head bolt replacement recommended; PermaTorqueMLS®		
1	Head Set	2004-99	HS 26278 PT	Head bolts not incl.; Head bolt replacement recommended; PermaDry® molded rubber valve cover gsckt. incl.; Premium valve stem seals incl.		
1	Head Bolt Set	2004-99	ES 72206	Head bolts w/Washers; Replacement recommended		
QTY	CONVERSION SET	YEARS	PART NO.	DESCRIPTION		
1	Gasket Conversion Set	2004-99	CS 26278			
QTY	MANIFOLD - INT. & EXH.	YEARS	PART NO.	DESCRIPTION		
1	Int. Manifold Gasket Set	2004-99	MS 96603			

Suzuki Truck (Incl. SUV's) (Cont.)

5 (cont.)		2004 - 1999; 2.0L 121.7 (1995cc) DOHC L4 (16 Valve) 84mm Bore			5 (cont.)
		MFI; Gasoline; Naturally Aspirated Suzuki Eng.; Eng. Code J20A			
QTY	MANIFOLD - INT. & EXH.	YEARS	PART NO.	DESCRIPTION	
1	Exh. Manifold Gasket Set	2004-99	MS 96602		
QTY	EXHAUST PIPE FLANGE	YEARS	PART NO.	DESCRIPTION	
1	Exhaust Pipe Gasket	2004-99	61016	Exh. connector; Improved design	
1	Exhaust Pipe Gasket	2004-99	61386	Ring	
1	Exhaust Pipe Gasket	2004-99	61387	Converter	
QTY	OIL PAN	YEARS	PART NO.	DESCRIPTION	
1	Oil Pan Gasket Set	2004-99	OS 30765		
QTY	CRANKSHAFT REAR SEAL	YEARS	PART NO.	DESCRIPTION	
1	Rear Main Seal Set	2004-99	BS 40687	Rubber; One-piece	
QTY	VALVE COVER	YEARS	PART NO.	DESCRIPTION	
1	Valve Cover Gasket Set	2004-99	VS 50633 R	w/Semi-circular plug & Grommets & Spark plug tube seals; PermaDry® molded rubber gskt. incl.	
QTY	VALVE STEM SEAL SET	YEARS	PART NO.	DESCRIPTION	
1	Valve Stem Seal Set	2004-99	SS 70283-1	Premium valve stem seals incl.	
QTY	THERMOSTAT HOUSING	YEARS	PART NO.	DESCRIPTION	
1	Thermostat Gasket	2004-99	35769	Thermostat Housing; Thermostat seal	
QTY	WATER OUTLET GASKET	YEARS	PART NO.	DESCRIPTION	
1	Water Outlet Gasket	2004-99	35766	Water Outlet	
QTY	WATER PUMP	YEARS	PART NO.	DESCRIPTION	
1	O-Ring	2004-99	35768	Water Pump	
QTY	TIMING COVER	YEARS	PART NO.	DESCRIPTION	
1	Crankshaft Front Seal Set	2004-99	TCS 46056		
QTY	CARB & FUEL INJECTION	YEARS	PART NO.	DESCRIPTION	
1	Fuel Injector O-Ring Set	2004-99	ES 70599	Upper set; Injectors to fuel rail; Improved design	
1	Fuel Injector O-Ring Set	2004-99	ES 71190	Lower set; Injectors to cylinder head	
1	Throttle Body Gasket	2004-99	61090		
QTY	EXHAUST GAS RECIRCULATION	YEARS	PART NO.	DESCRIPTION	
1	EGR Gasket	2004-99	71026	Pipe	
1	EGR Gasket	2004-99	71218	Valve	
6		2013 - 2009; 2.5L 151.8 (2488cc) DOHC L4 (16 Valve) 89mm Bore			6
		MFI; Gasoline; Naturally Aspirated Nissan Eng.; Eng. Code QR25DE			
QTY	CYLINDER HEAD	YEARS	PART NO.	DESCRIPTION	
1	Head Gasket	2013-09	26520 PT	Head bolts not incl.; Head bolt replacement recommended; PermaTorqueMLS®	
1	Head Set	2013-09	HS 26520 PT	Head bolts not incl.; Head bolt replacement recommended; PermaDry® molded rubber valve cover gskt. incl.; Premium valve stem seals incl.; New Part Number - Check for Availability	
1	Head Bolt Set	2013-09	ES 72198	Head bolts w/Washers; Replacement recommended	
QTY	CONVERSION SET	YEARS	PART NO.	DESCRIPTION	
1	Gasket Conversion Set	2013-09	CS 26261-1	RTV sealant incl. for oil pan gskt.; New Part Number - Check for Availability	
QTY	MANIFOLD - INT. & EXH.	YEARS	PART NO.	DESCRIPTION	
1	Int. Manifold Gasket Set	2013-09	MS 97149	Lower set	
1	Exh. Manifold Gasket Set	2013-09	MS 96539		
QTY	EXHAUST PIPE FLANGE	YEARS	PART NO.	DESCRIPTION	
2	Exhaust Pipe Gasket	2013-09	60871	Converter	
QTY	CRANKSHAFT REAR SEAL	YEARS	PART NO.	DESCRIPTION	
1	Rear Main Seal Set	2013-09	BS 40694	Rubber; One-piece	
QTY	VALVE COVER	YEARS	PART NO.	DESCRIPTION	
1	Valve Cover Gasket Set	2013-09	VS 50623 R	PermaDry® molded rubber gskt. incl.	
QTY	VALVE STEM SEAL SET	YEARS	PART NO.	DESCRIPTION	
1	Valve Stem Seal Set	2013-09	SS 70157	Premium valve stem seals incl.	
QTY	WATER OUTLET GASKET	YEARS	PART NO.	DESCRIPTION	
1	Water Outlet Gasket	2013-09	35943	Water Outlet; Loc. Rear	
1	Water Outlet Gasket	2013-09	35945	Water Outlet; Loc. Front; New Part Number - Check for Availability	
1	Thermostat Gasket	2013-09	35445	Water Outlet; Water inlet	
QTY	WATER PUMP	YEARS	PART NO.	DESCRIPTION	
1	Water Pump Gasket	2013-09	35946	Mounting	
1	Water Pump Gasket	2013-09	35947	Housing	
QTY	TIMING COVER	YEARS	PART NO.	DESCRIPTION	
1	Crankshaft Front Seal Set	2013-09	TCS 45056		
QTY	CARB & FUEL INJECTION	YEARS	PART NO.	DESCRIPTION	
1	Fuel Injector O-Ring Set	2013-09	ES 70599	Upper set; Injectors to fuel rail; Improved design	

Suzuki Truck (Incl. SUV's) (Cont.)

6		2013 - 2009; 2.5L 151.8 (2488cc) DOHC L4 (16 Valve) 89mm Bore			6
(cont.)		MFI; Gasoline; Naturally Aspirated Nissan Eng.; Eng. Code QR25DE			(cont.)
QTY	CARB & FUEL INJECTION	YEARS	PART NO.	DESCRIPTION	
1	Throttle Body Gasket	2013-09	61648	New Part Number - Check for Availability	
7		2005 - 1999; 2.5L 152 (2492cc) DOHC V6 (24 Valve) 84mm Bore			7
(cont.)		MFI; Gasoline; Naturally Aspirated Suzuki Eng.; Eng. Code H25A			(cont.)
QTY	CYLINDER HEAD	YEARS	PART NO.	DESCRIPTION	
1	Head Gasket	2005-99	26386 PT	Loc. L.H.; Head bolts not incl.; Head bolt replacement recommended	
1	Head Gasket	2005-99	26387 PT	Loc. R.H.; Head bolts not incl.; Head bolt replacement recommended	
1	Head Set	2005-99	HS 26386 PT	Head bolts not incl.; Head bolt replacement recommended; PermaDry® molded rubber valve cover gskts. incl.; Premium valve stem seals incl.	
2	Head Bolt Set	2005-99	ES 72206	Head bolts w/Washers; Replacement recommended	
QTY	CONVERSION SET	YEARS	PART NO.	DESCRIPTION	
1	Gasket Conversion Set	2005-99	CS 26386	RTV sealant incl. for Upper oil pan gskt.	
QTY	MANIFOLD - INT. & EXH.	YEARS	PART NO.	DESCRIPTION	
1	Int. Manifold Gasket Set	2005-99	MS 97028	Lower set; Upper set incl.	
1	Exh. Manifold Gasket Set	2005-99	MS 97043		
QTY	EXHAUST PIPE FLANGE	YEARS	PART NO.	DESCRIPTION	
2	Exhaust Pipe Gasket	2005-99	61387	Pipe to manifold	
2	Exhaust Pipe Gasket	2005-04	61016	Converter; Improved design	
1	Exhaust Pipe Gasket	2003-99	61016	Loc. Front; Converter; Improved design	
1	Exhaust Pipe Gasket	2003	61387	Loc. Rear; Converter	
1	Exhaust Pipe Gasket	2002	61387	Loc. Rear; From Ser. No. 24151392; RWD; Converter	
1	Exhaust Pipe Gasket	2002	61387	Loc. Rear; From Ser. No. 24153267; 4WD; Converter	
1	Exhaust Pipe Gasket	2002	61554	Loc. Rear; To Ser. No. 24151391; RWD; Converter	
1	Exhaust Pipe Gasket	2002	61554	Loc. Rear; To Ser. No. 24153266; 4WD; Converter	
1	Exhaust Pipe Gasket	2001-99	61554	Loc. Rear; Converter	
QTY	OIL PAN	YEARS	PART NO.	DESCRIPTION	
1	Oil Pan Gasket Set	2005-99	OS 30802	Loc. Lower	
QTY	CRANKSHAFT REAR SEAL	YEARS	PART NO.	DESCRIPTION	
1	Rear Main Seal Set	2005-99	BS 40687	Rubber; One-piece	
QTY	VALVE COVER	YEARS	PART NO.	DESCRIPTION	
1	Valve Cover Gasket Set	2005-99	VS 50736 R	w/Grommets & Spark plug tube seals; PermaDry® molded rubber gskts. incl.	
1	Semi-Circular Plug	2005-99	CP 75024	Valve Cover; New Part Number - Check for Availability	
QTY	VALVE STEM SEAL SET	YEARS	PART NO.	DESCRIPTION	
2	Valve Stem Seal Set	2005-99	SS 70283-2	Premium valve stem seals incl.	
QTY	THERMOSTAT HOUSING	YEARS	PART NO.	DESCRIPTION	
1	O-Ring	2005-99	35768	Thermostat Housing; Thermostat seal	
QTY	WATER OUTLET GASKET	YEARS	PART NO.	DESCRIPTION	
1	Water Outlet Gasket	2005-99	35878	Water Outlet; Loc. Front	
QTY	WATER PUMP	YEARS	PART NO.	DESCRIPTION	
1	Water Pump Gasket	2005-99	35875	O-ring	
QTY	TIMING COVER	YEARS	PART NO.	DESCRIPTION	
1	Crankshaft Front Seal Set	2005-99	TCS 46136		
QTY	CARB & FUEL INJECTION	YEARS	PART NO.	DESCRIPTION	
1	Throttle Body Gasket	2005-99	61385		
QTY	EXHAUST GAS RECIRCULATION	YEARS	PART NO.	DESCRIPTION	
1	EGR Gasket	2005-99	71026	Pipe	
1	EGR Gasket	2005-99	71218	Valve	
8		2008 - 2001; 2.7L 167 (2736cc) DOHC V6 (24 Valve) 88mm Bore			8
(cont.)		MFI; Gasoline; Naturally Aspirated Suzuki Eng.; Eng. Code H27A			(cont.)
QTY	CYLINDER HEAD	YEARS	PART NO.	DESCRIPTION	
1	Head Gasket	2008-01	26395 PT	Loc. L.H.; Head bolts not incl.; Head bolt replacement recommended; PermaTorqueMLS®	
1	Head Gasket	2008-01	26396 PT	Loc. R.H.; Head bolts not incl.; Head bolt replacement recommended; PermaTorqueMLS®	
1	Head Set	2008-07	HS 26395 PT-1	Head bolts not incl.; Head bolt replacement recommended; PermaDry® molded rubber valve cover gskts. incl.; Premium valve stem seals incl.	
1	Head Set	2006	HS 26395 PT	Suzuki XL-7 Base, Premium; Head bolts not incl.; Head bolt replacement recommended; PermaDry® molded rubber valve cover gskts. incl.; Premium valve stem seals incl.	
1	Head Set	2006	HS 26395 PT-1	Exc. Suzuki XL-7 Base, Premium; Head bolts not incl.; Head bolt replacement recommended; PermaDry® molded rubber valve cover gskts. incl.; Premium valve stem seals incl.	

Suzuki Truck (Incl. SUV's) (Cont.)

8		2008 - 2001; 2.7L 167 (2736cc) DOHC V6 (24 Valve) 88mm Bore			8	
(cont.)		MFI; Gasoline; Naturally Aspirated Suzuki Eng.; Eng. Code H27A			(cont.)	
QTY	CYLINDER HEAD	YEARS	PART NO.	DESCRIPTION		
1	Head Set	2005-01	HS 26395 PT	Head bolts not incl.; Head bolt replacement recommended; PermaDry® molded rubber valve cover gskts. incl.; Premium valve stem seals incl.		
2	Head Bolt Set	2008-01	ES 72206	Head bolts w/Washers; Replacement recommended		
QTY	CONVERSION SET	YEARS	PART NO.	DESCRIPTION		
1	Gasket Conversion Set	2008-07	CS 26395	RTV sealant incl. for Upper oil pan gskt.		
1	Gasket Conversion Set	2006	CS 26386	Suzuki XL-7 Base, Premium; RTV sealant incl. for Upper oil pan gskt.		
1	Gasket Conversion Set	2006	CS 26395	Exc. Suzuki XL-7 Base, Premium; RTV sealant incl. for Upper oil pan gskt.		
1	Gasket Conversion Set	2005-01	CS 26386	RTV sealant incl. for Upper oil pan gskt.		
QTY	MANIFOLD - INT. & EXH.	YEARS	PART NO.	DESCRIPTION		
1	Int. Manifold Gasket Set	2008-01	MS 97028-1	Lower set; Upper set incl.		
1	Exh. Manifold Gasket Set	2008-01	MS 97043			
QTY	EXHAUST PIPE FLANGE	YEARS	PART NO.	DESCRIPTION		
1	Exhaust Pipe Gasket	2008-01	61016	Loc. Front; Converter; Improved design		
1	Exhaust Pipe Gasket	2008-01	61554	Loc. Rear; Converter		
2	Exhaust Pipe Gasket	2008-04	61553	Pipe to manifold		
2	Exhaust Pipe Gasket	2003-01	61387	Pipe to manifold		
QTY	OIL PAN	YEARS	PART NO.	DESCRIPTION		
1	Oil Pan Gasket Set	2008-07	OS 30806	Loc. Lower; RTV sealant incl. for Upper oil pan gskt.		
1	Oil Pan Gasket Set	2006	OS 30802	Suzuki XL-7 Base, Premium; Loc. Lower		
1	Oil Pan Gasket Set	2006	OS 30806	Exc. Suzuki XL-7 Base, Premium; Loc. Lower; RTV sealant incl. for Upper oil pan gskt.		
1	Oil Pan Gasket Set	2005-01	OS 30802	Loc. Lower		
QTY	CRANKSHAFT REAR SEAL	YEARS	PART NO.	DESCRIPTION		
1	Rear Main Seal Set	2008-01	BS 40687	Rubber; One-piece		
QTY	VALVE COVER	YEARS	PART NO.	DESCRIPTION		
1	Valve Cover Gasket Set	2008-07	VS 50744 R	w/Grommets; PermaDry® molded rubber gskts. incl.		
1	Valve Cover Gasket Set	2006	VS 50736 R	Suzuki XL-7 Base, Premium; w/Grommets & Spark plug tube seals; PermaDry® molded rubber gskts. incl.		
1	Valve Cover Gasket Set	2006	VS 50744 R	Exc. Suzuki XL-7 Base, Premium; w/Grommets; PermaDry® molded rubber gskts. incl.		
1	Valve Cover Gasket Set	2005-01	VS 50736 R	w/Grommets & Spark plug tube seals; PermaDry® molded rubber gskts. incl.		
1	Semi-Circular Plug	2006	CP 75024	Suzuki XL-7 Base, Premium; Valve Cover; New Part Number - Check for Availability		
1	Semi-Circular Plug	2005-01	CP 75024	Valve Cover; New Part Number - Check for Availability		
QTY	VALVE STEM SEAL SET	YEARS	PART NO.	DESCRIPTION		
2	Valve Stem Seal Set	2008-01	SS 70283-2	Premium valve stem seals incl.		
QTY	THERMOSTAT HOUSING	YEARS	PART NO.	DESCRIPTION		
1	O-Ring	2008-01	35768	Thermostat Housing; Thermostat seal		
QTY	WATER OUTLET GASKET	YEARS	PART NO.	DESCRIPTION		
1	Water Outlet Gasket	2008-01	35878	Water Outlet; Loc. Front		
QTY	WATER PUMP	YEARS	PART NO.	DESCRIPTION		
1	Water Pump Gasket	2008-01	35875	O-ring		
QTY	TIMING COVER	YEARS	PART NO.	DESCRIPTION		
1	Crankshaft Front Seal Set	2008-01	TCS 46136			
QTY	CARB & FUEL INJECTION	YEARS	PART NO.	DESCRIPTION		
1	Throttle Body Gasket	2008-07	61541			
1	Throttle Body Gasket	2006	61455	Suzuki XL-7 Base, Premium		
1	Throttle Body Gasket	2006	61541	Exc. Suzuki XL-7 Base, Premium		
1	Throttle Body Gasket	2005-01	61455			
QTY	EXHAUST GAS RECIRCULATION	YEARS	PART NO.	DESCRIPTION		
1	EGR Gasket	2008-01	71026	Pipe		
1	EGR Gasket	2008-01	71218	Valve		
9		2009 - 2007; 3.6L 217 (3564cc) DOHC V6 (24 Valve) 94mm Bore			9	
(cont.)		MFI; Gasoline; Naturally Aspirated Opel Eng.; Eng. Code N36A			(cont.)	
QTY	CYLINDER HEAD	YEARS	PART NO.	DESCRIPTION		
1	Head Gasket	2009-07	26376 PT	Loc. L.H.; Head bolts not incl.; Head bolt replacement recommended; PermaTorqueMLS®		
1	Head Gasket	2009-07	26377 PT	Loc. R.H.; Head bolts not incl.; Head bolt replacement recommended; PermaTorqueMLS®		
1	Head Set	2009-07	HS 26376 PT-2	Head bolts not incl.; Head bolt replacement recommended; PermaDry® molded rubber valve cover gskts. incl.; Premium valve stem seals incl.		
2	Head Bolt Set	2009-07	ES 72274	Replacement recommended		

Suzuki Truck (Incl. SUV's) (Cont.)

9 (cont.)		2009 - 2007; 3.6L 217 (3564cc) DOHC V6 (24 Valve) 94mm Bore			9 (cont.)
		MFI; Gasoline; Naturally Aspirated Opel Eng.; Eng. Code N36A			
QTY	CONVERSION SET	YEARS	PART NO.	DESCRIPTION	
1	Gasket Conversion Set	2009-07	CS 26376-1	RTV sealant incl. for oil pan gskt.; Improved design	
1	Gasket Conversion Set	2007	CS 26376	RTV sealant incl. for oil pan gskt.; Old design; New Part Number - Check for Availability	
QTY	MANIFOLD - INT. & EXH.	YEARS	PART NO.	DESCRIPTION	
1	Int. Manifold Gasket Set	2009-07	MS 96969	Lower set; Upper set incl.	
1	Plenum Gasket Set	2009-07	MS 96976	Upper set	
1	Exh. Manifold Gasket Set	2009-07	MS 96973		
QTY	EXHAUST PIPE FLANGE	YEARS	PART NO.	DESCRIPTION	
2	Exhaust Pipe Gasket	2009-07	61054	Pipe to manifold	
2	Exhaust Pipe Gasket	2009-07	61618	Converter	
QTY	CRANKSHAFT REAR SEAL	YEARS	PART NO.	DESCRIPTION	
1	Rear Main Seal Set	2009-07	BS 40711	PTFE Rubber; One-piece; Improved design	
QTY	VALVE COVER	YEARS	PART NO.	DESCRIPTION	
1	Valve Cover Gasket Set	2009-07	VS 50726 R	w/o Spark plug tube seals & w/Grommets; PermaDry® molded rubber gskts. incl.	
1	Spark Plug Tube Seal Set	2009-07	ES 72393	Valve Cover; New Part Number - Check for Availability	
QTY	VALVE STEM SEAL SET	YEARS	PART NO.	DESCRIPTION	
1	Valve Stem Seal Set	2009-07	SS 72923	Premium valve stem seals incl.	
QTY	THERMOSTAT HOUSING	YEARS	PART NO.	DESCRIPTION	
1	Thermostat Gasket	2009-07	35871	Thermostat Housing; Thermostat housing to head	
QTY	WATER OUTLET GASKET	YEARS	PART NO.	DESCRIPTION	
1	Water Outlet Gasket	2009-07	35855	Water Outlet; Water outlet O-ring; New Part Number - Check for Availability	
1	Water Outlet Gasket	2009-07	35856	Water Outlet; Water outlet seal; New Part Number - Check for Availability	
QTY	WATER PUMP	YEARS	PART NO.	DESCRIPTION	
1	Water Pump Gasket	2009-07	35859		
QTY	TIMING COVER	YEARS	PART NO.	DESCRIPTION	
1	Timing Cover Set	2009-07	TCS 46108		
QTY	CARB & FUEL INJECTION	YEARS	PART NO.	DESCRIPTION	
2	Fuel Injector O-Ring Set	2009-07	ES 70599	Upper set; Injectors to fuel rail; Improved design	
2	Fuel Injector O-Ring Set	2009-07	ES 72004	Lower set; Injectors to cylinder head	
1	Fuel Injector O-Ring Set	2009-07	ES 72761	Complete set; Upper & lower injector seals incl.; New Part Number - Check for Availability	
1	Throttle Body Gasket	2009-07	61614		
QTY	OIL FILTER MOUNTING	YEARS	PART NO.	DESCRIPTION	
1	Oil Filter Adapter Gasket	2009-07	72968	Oil filter adapter; New Part Number - Check for Availability	
10		2013 - 2009; 4.0L 241.3 (3954cc) DOHC V6 (24 Valve) 95.5mm Bore			10
		MFI; Gasoline; Naturally Aspirated Nissan Eng.; Eng. Code VQ40DE			
QTY	CYLINDER HEAD	YEARS	PART NO.	DESCRIPTION	
1	Head Gasket	2013-09	26370 PT	Loc. L.H.; Head bolts not incl.; Head bolt replacement recommended; PermaTorqueMLS®	
1	Head Gasket	2013-09	26371 PT	Loc. R.H.; Head bolts not incl.; Head bolt replacement recommended; PermaTorqueMLS®	
1	Head Set	2013-09	HS 26370 PT	Head bolts not incl.; Head bolt replacement recommended; PermaDry® molded rubber valve cover gskts. incl.; Premium valve stem seals incl.	
2	Head Bolt Set	2013-09	ES 72900	Head bolts w/Washers; Replacement recommended	
QTY	CONVERSION SET	YEARS	PART NO.	DESCRIPTION	
1	Gasket Conversion Set	2013-09	CS 26370	RTV sealant incl. for Upper oil pan gskt.	
QTY	MANIFOLD - INT. & EXH.	YEARS	PART NO.	DESCRIPTION	
1	Int. Manifold Gasket Set	2013-09	MS 96454-2	Lower set; Upper set incl.	
1	Plenum Gasket Set	2013-09	MS 96943	Upper set	
1	Exh. Manifold Gasket Set	2013-09	MS 91459		
QTY	EXHAUST PIPE FLANGE	YEARS	PART NO.	DESCRIPTION	
2	Exhaust Pipe Gasket	2013-09	60458	Exh. connector	
2	Exhaust Pipe Gasket	2013-09	60871	Converter	
2	Exhaust Pipe Gasket	2013-09	60871	Flange	
QTY	OIL PAN	YEARS	PART NO.	DESCRIPTION	
1	Oil Pan Gasket Set	2013-09	OS 30787	Loc. Lower	
QTY	CRANKSHAFT REAR SEAL	YEARS	PART NO.	DESCRIPTION	
1	Rear Main Seal Set	2013-09	BS 40694	Rubber; One-piece	
QTY	VALVE COVER	YEARS	PART NO.	DESCRIPTION	
1	Valve Cover Gasket Set	2013-09	VS 50608 R	PermaDry® molded rubber gskts. incl.	

Suzuki Truck (Incl. SUV's) (Cont.)

10 (cont.)		2013 - 2009; 4.0L 241.3 (3954cc) DOHC V6 (24 Valve) 95.5mm Bore MFI; Gasoline; Naturally Aspirated Nissan Eng.; Eng. Code VQ40DE			10 (cont.)
QTY	VALVE COVER	YEARS	PART NO.	DESCRIPTION	
1	Spark Plug Tube Seal Set	2013-09	ES 72481	Valve Cover; For use with removable PCV Valve baffles only; New Part Number - Check for Availability	
QTY	VALVE STEM SEAL SET	YEARS	PART NO.	DESCRIPTION	
1	Valve Stem Seal Set	2013-09	SS 72821	Premium valve stem seals incl.	
QTY	WATER OUTLET GASKET	YEARS	PART NO.	DESCRIPTION	
2	Water Outlet Gasket	2013-09	35620	Water Outlet; To block	
2	Water Outlet Gasket	2013-09	35620	Water Outlet; To manifold	
1	Water Outlet Gasket	2013-09	35621	Water Outlet; Inlet connector; To block	
1	Water Outlet Gasket	2013-09	35621	Water Outlet; Inlet connector; To manifold	
1	Water Outlet Gasket	2013-09	35622	Water Outlet; Inlet	
QTY	WATER PUMP	YEARS	PART NO.	DESCRIPTION	
1	Water Pump Mounting Set	2013-09	ES 70894		
QTY	TIMING COVER	YEARS	PART NO.	DESCRIPTION	
1	Timing Cover Set	2013-09	TCS 45997		
QTY	CARB & FUEL INJECTION	YEARS	PART NO.	DESCRIPTION	
2	Fuel Injector O-Ring Set	2013-09	ES 70599	Upper set; Injectors to fuel rail; Improved design	
2	Fuel Injector O-Ring Set	2013-09	ES 72004	Lower set; Injectors to cylinder head	
1	Throttle Body Gasket	2013-09	61513		

Toyota Car (Incl. Lexus, Scion, Toyota)

Engine Finding Index				
Engine	Years	Code	Line No.	
1.5L 88.9 (1456cc) SOHC L4 (12 Valve) 73mm Bore; MFI; Gasoline; Naturally Aspirated Toyota Eng.	1994-91	3EE	1	
1.5L 91.4 (1497cc) DOHC L4 (16 Valve) 74mm Bore; MFI; Gasoline; Naturally Aspirated Toyota Eng.	1999-92	5EFE	2	
1.5L 91.4 (1497cc) DOHC L4 (16 Valve) 75mm Bore VVT-i; MFI; Gasoline; Naturally Aspirated Toyota Eng.	2013-00	1NZFE	3	
1.5L 91.4 (1497cc) DOHC L4 (16 Valve) 75mm Bore VVT-i; MFI; Hybrid (Gas/Electric); Naturally Aspirated Toyota Eng.	2013-01	1NZFXE	4	
1.6L 96.8 (1587cc) DOHC L4 (16 Valve) 81mm Bore; MFI; Gasoline; Naturally Aspirated Toyota Eng.	1997-91	4AFE	5	
1.6L 96.8 (1587cc) DOHC L4 (16 Valve) 81mm Bore; MFI; Gasoline; Naturally Aspirated Toyota Eng.	1991	4AGE	6	
1.8L 107.5 (1762cc) DOHC L4 (16 Valve) 81mm Bore; MFI; Gasoline; Naturally Aspirated Toyota Eng.	1997-93	7AFE	7	
1.8L 109.4 (1794cc) DOHC L4 (16 Valve) 79mm Bore; MFI; Gasoline; Naturally Aspirated Toyota Eng.	1999-98	1ZZFE	8	
1.8L 109.4 (1794cc) DOHC L4 (16 Valve) 79mm Bore VVT-i; MFI; Gasoline; Naturally Aspirated Toyota Eng.	2008-00	1ZZFE	9	
1.8L 109.5 (1796cc) DOHC L4 (16 Valve) 82mm Bore VVT-i; MFI; Gasoline; Naturally Aspirated Toyota Eng.	2006-00	2ZZGE	10	
1.8L 109.7 (1798cc) DOHC L4 (16 Valve) 80.5mm Bore VVT-i; MFI; Gasoline; Naturally Aspirated Toyota Eng.	2013-08	2ZRFE	11	
1.8L 109.7 (1798cc) DOHC L4 (16 Valve) 80.5mm Bore VVT-i; MFI; Hybrid (Gas/Electric); Naturally Aspirated Toyota Eng.	2013-10	2ZRFXE	12	
2.0L 122 (1998cc) DOHC L4 (16 Valve) 86mm Bore; MFI; Gasoline; Naturally Aspirated Toyota Eng.	1992-91	3SFE	13	
2.0L 122 (1998cc) DOHC L4 (16 Valve) 86mm Bore; MFI; Gasoline; Turbo - Intercooled Toyota Eng.	1995-91	3SGTE	14	
2.2L 132 (2164cc) DOHC L4 (16 Valve) 87mm Bore; MFI; Gasoline; Naturally Aspirated Toyota Eng.	2001-91	5SFE	15	
2.2L 132 (2164cc) DOHC L4 (16 Valve) 87mm Bore; MFI; Natural Gas; Naturally Aspirated Toyota Eng.	2001-00	5SNFE	16	
2.4L 144 (2362cc) DOHC L4 (16 Valve) 88.5mm Bore VVT-i; MFI; Gasoline; Naturally Aspirated Toyota Eng.	2013-02	2AZFE	17	
2.4L 144 (2362cc) DOHC L4 (16 Valve) 88.5mm Bore VVT-i; MFI; Hybrid (Gas/Electric); Naturally Aspirated Toyota Eng.	2012-07	2AZFXE	18	
2.5L 152.2 (2494cc) DOHC L4 (16 Valve) 90mm Bore VVT-i; MFI; Gasoline; Naturally Aspirated Toyota Eng.	2013-10	2ARFE	19	
2.5L 152.2 (2494cc) DOHC L4 (16 Valve) 90mm Bore VVT-i; MFI; Hybrid (Gas/Electric); Naturally Aspirated Toyota Eng.	2013-12	2ARFXE	20	
2.5L 152.4 (2499cc) DOHC V6 (24 Valve) 83mm Bore VVT-i; DI; Gasoline; Naturally Aspirated Toyota Eng.	2013-06	4GRFSE	21	
2.5L 152.9 (2507cc) DOHC V6 (24 Valve) 87.5mm Bore; MFI; Gasoline; Naturally Aspirated Toyota Eng.	1992-91	2VZFE	22	
3.0L 180.3 (2954cc) DOHC L6 (24 Valve) 83mm Bore; MFI; Gasoline; Naturally Aspirated Toyota Eng.	1992-91	7MGE	23	
3.0L 180.3 (2954cc) DOHC L6 (24 Valve) 83mm Bore; MFI; Gasoline; Turbo - Intercooled Toyota Eng.	1992-91	7MGTE	24	
3.0L 180.5 (2958cc) DOHC V6 (24 Valve) 87.5mm Bore; MFI; Gasoline; Naturally Aspirated Toyota Eng.	1993-92	3VZFE	25	
3.0L 182.6 (2995cc) DOHC V6 (24 Valve) 87.5mm Bore; MFI; Gasoline; Naturally Aspirated Toyota Eng.	2005-94	1MZFE	26	
3.0L 182.6 (2995cc) DOHC V6 (24 Valve) 87.5mm Bore VVT-i; MFI; Gasoline; Naturally Aspirated Toyota Eng.	2006-99	1MZFE	27	
3.0L 182.6 (2995cc) DOHC V6 (24 Valve) 87.5mm Bore VVT-i; DI; Gasoline; Naturally Aspirated Toyota Eng.	2006	3GRFSE	28	
3.0L 182.9 (2997cc) DOHC L6 (24 Valve) 86mm Bore; MFI; Gasoline; Naturally Aspirated Toyota Eng.	1998-92	2JZGE	29	
3.0L 182.9 (2997cc) DOHC L6 (24 Valve) 86mm Bore; MFI; Gasoline; Turbo - Intercooled Toyota Eng.	1998-93	2JZGTE	30	
3.0L 182.9 (2997cc) DOHC L6 (24 Valve) 86mm Bore VVT-i; MFI; Gasoline; Naturally Aspirated Toyota Eng.	2005-98	2JZGE	31	
3.3L 202 (3311cc) DOHC V6 (24 Valve) 92mm Bore VVT-i; MFI; Gasoline; Naturally Aspirated Toyota Eng.	2009-04	3MZFE	32	
3.5L 211 (3456cc) DOHC V6 (24 Valve) 94mm Bore VVT-i; MFI; Gasoline; Naturally Aspirated Toyota Eng.	2013-05	2GRFE	33	
3.5L 211 (3456cc) DOHC V6 (24 Valve) 94mm Bore VVT-i; DI; Gasoline; Naturally Aspirated Toyota Eng.	2013-06	2GRFSE	34	
3.5L 211 (3456cc) DOHC V6 (24 Valve) 94mm Bore VVT-i; DI; Hybrid (Gas/Electric); Naturally Aspirated Toyota Eng.	2013-07	2GRFSE	35	
4.0L 241.6 (3968cc) DOHC V8 (32 Valve) 87.5mm Bore; MFI; Gasoline; Naturally Aspirated Toyota Eng.	1997-91	1UZFE	36	
4.0L 241.6 (3968cc) DOHC V8 (32 Valve) 87.5mm Bore VVT-i; MFI; Gasoline; Naturally Aspirated Toyota Eng.	2000-98	1UZFE	37	
4.3L 262 (4293cc) DOHC V8 (32 Valve) 91mm Bore VVT-i; MFI; Gasoline; Naturally Aspirated Toyota Eng.	2010-01	3UZFE	38	

Toyota Car (Incl. Lexus, Scion, Toyota) (Cont.)

Engine Code Index

Code	Engine	Line No.
1MZFE	3.0L 182.6 (2995cc) DOHC V6 (24 Valve) 87.5mm Bore; MFI; Gasoline; Naturally Aspirated Toyota Eng.	26
1MZFE	3.0L 182.6 (2995cc) DOHC V6 (24 Valve) 87.5mm Bore VVT-i; MFI; Gasoline; Naturally Aspirated Toyota Eng.	27
1NZFE	1.5L 91.4 (1497cc) DOHC L4 (16 Valve) 75mm Bore VVT-i; MFI; Gasoline; Naturally Aspirated Toyota Eng.	3
1NZFXE	1.5L 91.4 (1497cc) DOHC L4 (16 Valve) 75mm Bore VVT-i; MFI; Hybrid (Gas/Electric); Naturally Aspirated Toyota Eng.	4
1UZFE	4.0L 241.6 (3968cc) DOHC V8 (32 Valve) 87.5mm Bore; MFI; Gasoline; Naturally Aspirated Toyota Eng.	36
1UZFE	4.0L 241.6 (3968cc) DOHC V8 (32 Valve) 87.5mm Bore VVT-i; MFI; Gasoline; Naturally Aspirated Toyota Eng.	37
1ZZFE	1.8L 109.4 (1794cc) DOHC L4 (16 Valve) 79mm Bore; MFI; Gasoline; Naturally Aspirated Toyota Eng.	8
1ZZFE	1.8L 109.4 (1794cc) DOHC L4 (16 Valve) 79mm Bore VVT-i; MFI; Gasoline; Naturally Aspirated Toyota Eng.	9
2ARFE	2.5L 152.2 (2494cc) DOHC L4 (16 Valve) 90mm Bore VVT-i; MFI; Gasoline; Naturally Aspirated Toyota Eng.	19
2ARFXE	2.5L 152.2 (2494cc) DOHC L4 (16 Valve) 90mm Bore VVT-i; MFI; Hybrid (Gas/Electric); Naturally Aspirated Toyota Eng.	20
2AZFE	2.4L 144 (2362cc) DOHC L4 (16 Valve) 88.5mm Bore VVT-i; MFI; Gasoline; Naturally Aspirated Toyota Eng.	17
2AZFXE	2.4L 144 (2362cc) DOHC L4 (16 Valve) 88.5mm Bore VVT-i; MFI; Hybrid (Gas/Electric); Naturally Aspirated Toyota Eng.	18
2GRFE	3.5L 211 (3456cc) DOHC V6 (24 Valve) 94mm Bore VVT-i; MFI; Gasoline; Naturally Aspirated Toyota Eng.	33
2GRFSE	3.5L 211 (3456cc) DOHC V6 (24 Valve) 94mm Bore VVT-i; DI; Gasoline; Naturally Aspirated Toyota Eng.	34
2GRFSE	3.5L 211 (3456cc) DOHC V6 (24 Valve) 94mm Bore VVT-i; DI; Hybrid (Gas/Electric); Naturally Aspirated Toyota Eng.	35
2JZGE	3.0L 182.9 (2997cc) DOHC L6 (24 Valve) 86mm Bore; MFI; Gasoline; Naturally Aspirated Toyota Eng.	29
2JZGE	3.0L 182.9 (2997cc) DOHC L6 (24 Valve) 86mm Bore VVT-i; MFI; Gasoline; Naturally Aspirated Toyota Eng.	31
2JZGTE	3.0L 182.9 (2997cc) DOHC L6 (24 Valve) 86mm Bore; MFI; Gasoline; Turbo - Intercooled Toyota Eng.	30
2VZFE	2.5L 152.9 (2507cc) DOHC V6 (24 Valve) 87.5mm Bore; MFI; Gasoline; Naturally Aspirated Toyota Eng.	22
2ZRFE	1.8L 109.7 (1798cc) DOHC L4 (16 Valve) 80.5mm Bore VVT-i; MFI; Gasoline; Naturally Aspirated Toyota Eng.	11
2ZRFXE	1.8L 109.7 (1798cc) DOHC L4 (16 Valve) 80.5mm Bore VVT-i; MFI; Hybrid (Gas/Electric); Naturally Aspirated Toyota Eng.	12
2ZZGE	1.8L 109.5 (1796cc) DOHC L4 (16 Valve) 82mm Bore VVT-i; MFI; Gasoline; Naturally Aspirated Toyota Eng.	10
3EE	1.5L 88.9 (1456cc) SOHC L4 (12 Valve) 73mm Bore; MFI; Gasoline; Naturally Aspirated Toyota Eng.	1
3GRFSE	3.0L 182.6 (2995cc) DOHC V6 (24 Valve) 87.5mm Bore VVT-i; DI; Gasoline; Naturally Aspirated Toyota Eng.	28
3MZFE	3.3L 202 (3311cc) DOHC V6 (24 Valve) 92mm Bore VVT-i; MFI; Gasoline; Naturally Aspirated Toyota Eng.	32
3SFE	2.0L 122 (1998cc) DOHC L4 (16 Valve) 86mm Bore; MFI; Gasoline; Naturally Aspirated Toyota Eng.	13
3SGTE	2.0L 122 (1998cc) DOHC L4 (16 Valve) 86mm Bore; MFI; Gasoline; Turbo - Intercooled Toyota Eng.	14
3UZFE	4.3L 262 (4293cc) DOHC V8 (32 Valve) 91mm Bore VVT-i; MFI; Gasoline; Naturally Aspirated Toyota Eng.	38
3VZFE	3.0L 180.5 (2958cc) DOHC V6 (24 Valve) 87.5mm Bore; MFI; Gasoline; Naturally Aspirated Toyota Eng.	25
4AFE	1.6L 96.8 (1587cc) DOHC L4 (16 Valve) 81mm Bore; MFI; Gasoline; Naturally Aspirated Toyota Eng.	5
4AGE	1.6L 96.8 (1587cc) DOHC L4 (16 Valve) 81mm Bore; MFI; Gasoline; Naturally Aspirated Toyota Eng.	6
4GRFSE	2.5L 152.4 (2499cc) DOHC V6 (24 Valve) 83mm Bore VVT-i; DI; Gasoline; Naturally Aspirated Toyota Eng.	21
5EFE	1.5L 91.4 (1497cc) DOHC L4 (16 Valve) 74mm Bore; MFI; Gasoline; Naturally Aspirated Toyota Eng.	2
5SFE	2.2L 132 (2164cc) DOHC L4 (16 Valve) 87mm Bore; MFI; Gasoline; Naturally Aspirated Toyota Eng.	15
5SNFE	2.2L 132 (2164cc) DOHC L4 (16 Valve) 87mm Bore; MFI; Natural Gas; Naturally Aspirated Toyota Eng.	16
7AFE	1.8L 107.5 (1762cc) DOHC L4 (16 Valve) 81mm Bore; MFI; Gasoline; Naturally Aspirated Toyota Eng.	7
7MGE	3.0L 180.3 (2954cc) DOHC L6 (24 Valve) 83mm Bore; MFI; Gasoline; Naturally Aspirated Toyota Eng.	23
7MGTE	3.0L 180.3 (2954cc) DOHC L6 (24 Valve) 83mm Bore; MFI; Gasoline; Turbo - Intercooled Toyota Eng.	24

Model Index

Engine (VIN Code / Eng. Code)	Year	Engine (VIN Code / Eng. Code)	Year	Engine (VIN Code / Eng. Code)	Year
Lexus		Lexus (cont.)		Scion	
ES 250		IS 250		FR-S Coupe	
V6 2507cc 2.5L DOHC (24 Valve) (2VZFE)	91-90	V6 2499cc 2.5L DOHC (24 Valve) (4GRFSE)	13-06	H4 1995cc 2.0L DOHC (16 Valve) (FA20)	13-12
ES 300		IS 300		iQ Coupe	
V6 2958cc 3.0L DOHC (24 Valve) (3VZFE)	93-92	L6 2997cc 3.0L DOHC (24 Valve) (2JZGE)	05-01	L4 1329cc 1.3L DOHC (16 Valve) (1NRFE)	13-11
V6 2995cc 3.0L DOHC (24 Valve) (1MZFE)	03-94	IS 350		tC Coupe	
ES 300h Hybrid		V6 3456cc 3.5L DOHC (24 Valve) (2GRFSE)	13-06	L4 2362cc 2.4L DOHC (16 Valve) (2AZFE)	10-05
L4 2494cc 2.5L DOHC (16 Valve) (2ARFXE)	13	IS F		L4 2494cc 2.5L DOHC (16 Valve) (2ARFE)	13-11
ES 330		V8 4968cc 5.0L DOHC (32 Valve) (2URGSE)	13-08	xA Hatchback	
V6 3311cc 3.3L DOHC (24 Valve) (3MZFE)	06-04	LFA		L4 1497cc 1.5L DOHC (16 Valve) (1NZFE)	07-03
ES 350		V10 4805cc 4.8L DOHC (40 Valve) (1LRGSE)	13-11	xB Wagon	
V6 3456cc 3.5L DOHC (24 Valve) (2GRFE)	13-07	LS 400		L4 1497cc 1.5L DOHC (16 Valve) (1NZFE)	07-03
GS 300		V8 3968cc 4.0L DOHC (32 Valve) (1UZFE)	00-90	L4 2362cc 2.4L DOHC (16 Valve) (2AZFE)	13-08
L6 2997cc 3.0L DOHC (24 Valve) (2JZGE)	05-93	LS 430		xD Hatchback	
V6 2995cc 3.0L DOHC (24 Valve) (3GRFSE)	06	V8 4293cc 4.3L DOHC (32 Valve) (3UZFE)	06-01	L4 1798cc 1.8L DOHC (16 Valve) (2ZRFE)	13-08
GS 350		LS 460		Toyota	
V6 3456cc 3.5L DOHC (24 Valve) (2GRFSE)	13-07	V8 4608cc 4.6L DOHC (32 Valve) (1URFSE)	13-07	Avalon	
GS 400		LS 460 L		V6 2995cc 3.0L DOHC (24 Valve) (1MZFE)	04-95
V8 3968cc 4.0L DOHC (32 Valve) (1UZFE)	00-98	V8 4608cc 4.6L DOHC (32 Valve) (1URFSE)	13-07	V6 3456cc 3.5L DOHC (24 Valve) (2GRFE)	13-05
GS 430		LS 600h L Hybrid		Avalon Hybrid	
V8 4293cc 4.3L DOHC (32 Valve) (3UZFE)	08-01	V8 4968cc 5.0L DOHC (32 Valve) (2URFSE)	13-07	L4 2494cc 2.5L DOHC (16 Valve) (2ARFXE)	13
GS 450h Hybrid		SC 300		Camry	
V6 3456cc 3.5L DOHC (24 Valve) (2GRFSE)	13-07	L6 2997cc 3.0L DOHC (24 Valve) (2JZGE)	00-92	L4 1839cc 1.8L SOHC Turbo-Diesel (1CTLC)	86-84
GS 460		SC 400		L4 1974cc 2.0L SOHC Turbo-Diesel (2CTLC)	86
V8 4608cc 4.6L DOHC (32 Valve) (1URFSE)	12-08	V8 3968cc 4.0L DOHC (32 Valve) (1UZFE)	00-92	L4 1995cc 2.0L SOHC (8 Valve) (2SELC)	86-83
HS 250h Hybrid		SC 430		L4 1998cc 2.0L DOHC (16 Valve) (3SFE)	92-87
L4 2362cc 2.4L DOHC (16 Valve) (2AZFXE)	12-10	V8 4293cc 4.3L DOHC (32 Valve) (3UZFE)	10-02	L4 2164cc 2.2L DOHC (16 Valve) (5SFE)	01-92

Toyota Car (Incl. Lexus, Scion, Toyota) (Cont.)

Model Index (Cont.)

Engine (VIN Code / Eng. Code)	Year	Engine (VIN Code / Eng. Code)	Year	Engine (VIN Code / Eng. Code)	Year
Toyota (cont.)		Toyota (cont.)		Toyota (cont.)	
Camry (cont.)		Corolla (RWD)		MR2 (cont.)	
L4 2362cc 2.4L DOHC (16 Valve) (2AZFE)	09-02	L4 1077cc 1.1L OHV (KC)	69-68	L4 1587cc 1.6L DOHC Supercharged (16 Valve) (4AGZE)	89-88
L4 2494cc 2.5L DOHC (16 Valve) (2ARFE)	13-10	L4 1166cc 1.2L OHV (3KC)	79-69	L4 1998cc 2.0L DOHC Turbo (16 Valve) (3SGTE)	95-90
V6 2507cc 2.5L DOHC (24 Valve) (2VZFE)	92-88	L4 1587cc 1.6L DOHC (16 Valve) (4AGEC)	87-85	L4 2164cc 2.2L DOHC (16 Valve) (5SFE)	95-90
V6 2958cc 3.0L DOHC (24 Valve) (3VZFE)	93-92	L4 1587cc 1.6L SOHC (8 Valve) (4AC)	87-83	MR2 Spyder	
V6 2995cc 3.0L DOHC (24 Valve) (1MZFE)	06-94	L4 1588cc 1.6L OHV (2T)	71	L4 1794cc 1.8L DOHC (16 Valve) (1ZZFE)	05-00
V6 3311cc 3.3L DOHC (24 Valve) (3MZFE)	06-04	L4 1588cc 1.6L OHV (2TC)	79-71	Paseo	
V6 3456cc 3.5L DOHC (24 Valve) (2GRFE)	13-07	L4 1770cc 1.8L OHV (3TC)	82-80	L4 1497cc 1.5L DOHC (16 Valve) (5EFE)	99-92
Camry AWD		Corolla AWD		Prius c Hybrid	
L4 1998cc 2.0L DOHC (16 Valve) (3SFE)	91-88	L4 1587cc 1.6L DOHC (16 Valve) (4AFE)	92-88	L4 1497cc 1.5L DOHC (16 Valve) (1NZFXE)	13-12
Camry Hybrid		Corolla FX		Prius Hybrid	
L4 2362cc 2.4L DOHC (16 Valve) (2AZFXE)	11-07	L4 1587cc 1.6L DOHC (16 Valve) (4AGELC)	88-86	L4 1497cc 1.5L DOHC (16 Valve) (1NZFXE)	09-01
L4 2494cc 2.5L DOHC (16 Valve) (2ARFXE)	13-12	L4 1587cc 1.6L SOHC (8 Valve) (4ALC)	88-86	L4 1798cc 1.8L DOHC (16 Valve) (2ZRFXE)	13-10
Carina		Corona		Prius v Hybrid	
L4 1588cc 1.6L OHV (2TC)	73-71	L4 1858cc 1.9L SOHC (8RC)	71-70	L4 1798cc 1.8L DOHC (16 Valve) (2ZRFXE)	13-12
Celica (FWD)		Corona Mark II		Solara	
L4 1587cc 1.6L DOHC (16 Valve) (4AFE)	93-90	L4 1968cc 2.0L SOHC (18RC)	74-72	L4 2164cc 2.2L DOHC (16 Valve) (5SFE)	01-99
L4 1762cc 1.8L DOHC (16 Valve) (7AFE)	97-94	L4 2189cc 2.2L SOHC (20R)	80-75	L4 2362cc 2.4L DOHC (16 Valve) (2AZFE)	09-02
L4 1794cc 1.8L DOHC (16 Valve) (1ZZFE)	05-00	L4 2366cc 2.4L SOHC (22R)	82-81	V6 2995cc 3.0L DOHC (24 Valve) (1MZFE)	03-99
L4 1796cc 1.8L DOHC (16 Valve) (2ZZGE)	05-00	Cressida		V6 3311cc 3.3L DOHC (24 Valve) (3MZFE)	09-04
L4 1995cc 2.0L SOHC (8 Valve) (2SELC)	86	L4 1858cc 1.9L SOHC (8R)	71-69	Starlet	
L4 1998cc 2.0L DOHC (16 Valve) (3SFE)	89-87	L4 1858cc 1.9L SOHC (8RC)	71-69	L4 1290cc 1.3L OHV (4KC)	82-81
L4 1998cc 2.0L DOHC (16 Valve) (3SGELC)	89-86	L4 1968cc 2.0L SOHC (18RC)	72	L4 1290cc 1.3L OHV (4KE)	84-83
L4 2164cc 2.2L DOHC (16 Valve) (5SFE)	98-90	L6 2253cc 2.3L SOHC (2M)	72	Supra	
Celica (RWD)		L6 2563cc 2.6L SOHC (4M)	79-78	L6 2563cc 2.6L SOHC (4ME)	80-79
L4 1858cc 1.9L SOHC (8RC)	71	L6 2759cc 2.8L DOHC (12 Valve) (5MGE)	88-83	L6 2759cc 2.8L DOHC (12 Valve) (5MGE)	86-82
L4 1968cc 2.0L SOHC (18RC)	74-72	L6 2759cc 2.8L SOHC (12 Valve) (5ME)	82-81	L6 2954cc 3.0L DOHC (24 Valve) (7MGE)	92-86
L4 2189cc 2.2L SOHC (20R)	80-75	L6 2954cc 3.0L DOHC (24 Valve) (7MGE)	92-89	L6 2954cc 3.0L DOHC Turbo (24 Valve) (7MGTE)	92-87
L4 2366cc 2.4L SOHC (22R)	85-81	Crown		L6 2997cc 3.0L DOHC (24 Valve) (2JZGE)	98-93
L4 2366cc 2.4L SOHC (22REC)	85-83	L6 2253cc 2.3L SOHC (2M)	70-68	L6 2997cc 3.0L DOHC Turbo (24 Valve) (2JZGTE)	98-93
Celica AWD		L6 2563cc 2.6L SOHC (4M)	72-71	Tercel	
L4 1998cc 2.0L DOHC Turbo (16 Valve) (3SGTE)	93-88	Echo		L4 1452cc 1.5L SOHC (8 Valve) (1AC)	80
Corolla (FWD)		L4 1497cc 1.5L DOHC (16 Valve) (1NZFE)	05-00	L4 1452cc 1.5L SOHC (8 Valve) (3AC)	88-81
L4 1587cc 1.6L DOHC (16 Valve) (4AF)	89-88	Matrix (FWD)		L4 1456cc 1.5L SOHC (12 Valve) (3E)	90-87
L4 1587cc 1.6L DOHC (16 Valve) (4AFE)	97-88	L4 1794cc 1.8L DOHC (16 Valve) (1ZZFE)	08-03	L4 1456cc 1.5L SOHC (12 Valve) (3EE)	94-90
L4 1587cc 1.6L DOHC (16 Valve) (4AGE)	91-88	L4 1796cc 1.8L DOHC (16 Valve) (2ZZGE)	06-03	L4 1497cc 1.5L DOHC (16 Valve) (5EFE)	99-95
L4 1587cc 1.6L SOHC (8 Valve) (4ALC)	87-84	L4 1798cc 1.8L DOHC (16 Valve) (2ZRFE)	13-09	Tercel Wagon 4WD	
L4 1762cc 1.8L DOHC (16 Valve) (7AFE)	97-93	L4 2362cc 2.4L DOHC (16 Valve) (2AZFE)	13-09	L4 1452cc 1.5L SOHC (8 Valve) (3AC)	88-83
L4 1794cc 1.8L DOHC (16 Valve) (1ZZFE)	08-98	Matrix AWD		Yaris	
L4 1796cc 1.8L DOHC (16 Valve) (2ZZGE)	06-05	L4 1794cc 1.8L DOHC (16 Valve) (1ZZFE)	06-03	L4 1497cc 1.5L DOHC (16 Valve) (1NZFE)	13-06
L4 1798cc 1.8L DOHC (16 Valve) (2ZRFE)	13-09	L4 2362cc 2.4L DOHC (16 Valve) (2AZFE)	13-09		
L4 1839cc 1.8L SOHC Diesel (1CLC)	85-84	MR2			
L4 2362cc 2.4L DOHC (16 Valve) (2AZFE)	13-09	L4 1587cc 1.6L DOHC (16 Valve) (4AGELC)	89-85		

1 1994 - 1991; 1.5L 88.9 (1456cc) SOHC L4 (12 Valve) 73mm Bore MFI; Gasoline; Naturally Aspirated Toyota Eng.; Eng. Code 3EE 1

QTY	CYLINDER HEAD	YEARS	PART NO.	DESCRIPTION
1	Head Gasket	1994-91	9483 PT	Head bolts not incl.; Head bolt replacement recommended
1	Head Set	1994-91	HS 9483 PT	Head bolts not incl.; Head bolt replacement recommended; PermaDry® molded rubber valve cover gskt. incl.; Premium valve stem seals incl.
1	Head Installation Set	1994-91	HIS 9483 PT	Head bolts & exh. pipe flange not incl.; Head bolt replacement recommended; PermaDry® molded rubber valve cover gskt. incl.
1	Head Bolt Set	1994-91	ES 74027	Replacement recommended
QTY	CONVERSION SET	YEARS	PART NO.	DESCRIPTION
1	Gasket Conversion Set	1994-91	CS 9483	
QTY	MANIFOLD - INT. & EXH.	YEARS	PART NO.	DESCRIPTION
1	Int. Manifold Gasket Set	1994-91	MS 93548	
1	Exh. Manifold Gasket Set	1994-91	MS 93553	
QTY	EXHAUST PIPE FLANGE	YEARS	PART NO.	DESCRIPTION
2	Exhaust Pipe Gasket	1994-91	60908	Converter
1	Exhaust Pipe Gasket	1994-92	23561	Flange; 1 49/64" ID x 2 17/64" OD
1	Exhaust Pipe Gasket	1991	60610	Flange
QTY	OIL PAN	YEARS	PART NO.	DESCRIPTION
1	Oil Pan Gasket Set	1994-91	OS 30553 C	

Toyota Car (Incl. Lexus, Scion, Toyota) (Cont.)

1 (cont.)		1994 - 1991; 1.5L 88.9 (1456cc) SOHC L4 (12 Valve) 73mm Bore			1 (cont.)
		MFI; Gasoline; Naturally Aspirated Toyota Eng.; Eng. Code 3EE			
QTY	CRANKSHAFT REAR SEAL	YEARS	PART NO.	DESCRIPTION	
1	Rear Main Seal Set	1994-91	BS 40450	Rubber; One-piece	
QTY	VALVE COVER	YEARS	PART NO.	DESCRIPTION	
1	Valve Cover Gasket Set	1994-91	VS 50305 R	w/Grommets; PermaDry® molded rubber gskt. incl.	
QTY	VALVE STEM SEAL SET	YEARS	PART NO.	DESCRIPTION	
1	Valve Stem Seal Set	1994-91	SS 72830	Premium valve stem seals incl.	
QTY	WATER OUTLET GASKET	YEARS	PART NO.	DESCRIPTION	
1	O-Ring	1994-91	35292	Water Outlet	
QTY	WATER PUMP	YEARS	PART NO.	DESCRIPTION	
1	Water Pump Gasket	1994-91	35386		
QTY	TIMING COVER	YEARS	PART NO.	DESCRIPTION	
1	Crankshaft Front Seal Set	1994-91	TCS 45729		
1	Camshaft Front Seal Set	1994-91	TCS 45592		
1	Repair Sleeve	1994-91	16221	Timing Cover; Use w/installation tool	
QTY	CARB & FUEL INJECTION	YEARS	PART NO.	DESCRIPTION	
1	Fuel Injector O-Ring Set	1994-91	ES 70600		
1	Throttle Body Gasket	1994-91	60664		
QTY	DISTRIBUTOR MOUNTING	YEARS	PART NO.	DESCRIPTION	
1	Distributor Mounting Gasket	1994-91	72438	O-ring	
QTY	EXHAUST GAS RECIRCULATION	YEARS	PART NO.	DESCRIPTION	
1	EGR Gasket	1994-93	70492		
1	EGR Gasket	1992	70690		
1	EGR Gasket	1991	70492		
2		1999 - 1992; 1.5L 91.4 (1497cc) DOHC L4 (16 Valve) 74mm Bore			2
		MFI; Gasoline; Naturally Aspirated Toyota Eng.; Eng. Code 5EFE			
QTY	CYLINDER HEAD	YEARS	PART NO.	DESCRIPTION	
1	Head Gasket	1999-96	9494 PT	Head bolts not incl.; Head bolt replacement recommended	
1	Head Gasket	1995	9494 PT	Toyota Paseo Base; California; Head bolts not incl.; Head bolt replacement recommended	
1	Head Gasket	1995	9494 PT	Toyota Tercel DX, STD; Head bolts not incl.; Head bolt replacement recommended	
1	Head Gasket	1995	9963 PT	Toyota Paseo Base; Exc. California; Head bolts not incl.; Head bolt replacement recommended	
1	Head Gasket	1994-92	9963 PT	Head bolts not incl.; Head bolt replacement recommended	
1	Head Set	1999-96	HS 9494 PT	Head bolts not incl.; Head bolt replacement recommended; PermaDry® molded rubber valve cover gskt. incl.; Premium valve stem seals incl.	
1	Head Set	1995	HS 9494 PT	Toyota Paseo Base; California; Head bolts not incl.; Head bolt replacement recommended; PermaDry® molded rubber valve cover gskt. incl.; Premium valve stem seals incl.	
1	Head Set	1995	HS 9494 PT	Toyota Tercel DX, STD; Head bolts not incl.; Head bolt replacement recommended; PermaDry® molded rubber valve cover gskt. incl.; Premium valve stem seals incl.	
1	Head Set	1995	HS 9963 PT	Toyota Paseo Base; Exc. California; Head bolts not incl.; Head bolt replacement recommended; PermaDry® molded rubber valve cover gskt. incl.; Premium valve stem seals incl.	
1	Head Set	1994-92	HS 9963 PT	Head bolts not incl.; Head bolt replacement recommended; PermaDry® molded rubber valve cover gskt. incl.; Premium valve stem seals incl.	
1	Head Bolt Set	1999-92	ES 72181	Head bolts w/o Washers; Replacement recommended	
1	Head Bolt Washer Set	1999-92	ES 72184	Replacement recommended	
QTY	CONVERSION SET	YEARS	PART NO.	DESCRIPTION	
1	Gasket Conversion Set	1999-96	CS 9494		
1	Gasket Conversion Set	1995	CS 9483	Toyota Paseo Base; Exc. California	
1	Gasket Conversion Set	1995	CS 9494	Toyota Tercel DX, STD	
1	Gasket Conversion Set	1995	CS 9494	Toyota Paseo Base; California	
1	Gasket Conversion Set	1994-92	CS 9483		
QTY	MANIFOLD - INT. & EXH.	YEARS	PART NO.	DESCRIPTION	
1	Int. Manifold Gasket Set	1999-96	MS 92837		
1	Int. Manifold Gasket Set	1995	MS 92837	Toyota Tercel DX, STD	
1	Int. Manifold Gasket Set	1995	MS 92837	Toyota Paseo Base; California	
1	Int. Manifold Gasket Set	1995	MS 95403	Toyota Paseo Base; Exc. California	
1	Int. Manifold Gasket Set	1994-92	MS 95403		
1	Exh. Manifold Gasket Set	1999-92	MS 95404		
QTY	EXHAUST PIPE FLANGE	YEARS	PART NO.	DESCRIPTION	
1	Exhaust Pipe Gasket	1999-96	60668	Converter	

Toyota Car (Incl. Lexus, Scion, Toyota) (Cont.)

2		1999 - 1992; 1.5L 91.4 (1497cc) DOHC L4 (16 Valve) 74mm Bore			2	
(cont.)		MFI; Gasoline; Naturally Aspirated Toyota Eng.; Eng. Code 5EFE			(cont.)	
QTY	EXHAUST PIPE FLANGE	YEARS	PART NO.	DESCRIPTION		
1	Exhaust Pipe Gasket	1999-96	61099	Flange		
1	Exhaust Pipe Gasket	1995	23561	Toyota Paseo Base; Flange; Exc. California; 1 49/64" ID x 2 17/64" OD		
2	Exhaust Pipe Gasket	1995	23591	Toyota Paseo Base; Converter; Exc. California; 1 31/32" ID x 2 35/64" OD		
1	Exhaust Pipe Gasket	1995	60668	Toyota Tercel DX, STD; Converter		
1	Exhaust Pipe Gasket	1995	60668	Toyota Paseo Base; Converter; California		
1	Exhaust Pipe Gasket	1995	61099	Toyota Tercel DX, STD; Flange		
1	Exhaust Pipe Gasket	1995	61099	Toyota Paseo Base; Flange; California		
1	Exhaust Pipe Gasket	1994-92	23561	Flange; 1 49/64" ID x 2 17/64" OD		
2	Exhaust Pipe Gasket	1994-92	23591	Converter; 1 31/32" ID x 2 35/64" OD		
QTY	OIL PAN	YEARS	PART NO.	DESCRIPTION		
1	Oil Pan Gasket Set	1999-92	OS 30553 C			
1	Drain Plug Gasket	1999-92	70822			
QTY	CRANKSHAFT REAR SEAL	YEARS	PART NO.	DESCRIPTION		
1	Rear Main Seal Set	1999-92	BS 40450	Rubber; One-piece		
QTY	VALVE COVER	YEARS	PART NO.	DESCRIPTION		
1	Valve Cover Gasket Set	1999-96	VS 50514 R	w/Grommets & Spark plug tube seals; PermaDry® molded rubber gskt. incl.		
1	Valve Cover Gasket Set	1995	VS 50423 R	Toyota Paseo Base; Exc. California; w/Grommets & Spark plug tube seals; PermaDry® molded rubber gskt. incl.		
1	Valve Cover Gasket Set	1995	VS 50514 R	Toyota Paseo Base; California; w/Grommets & Spark plug tube seals; PermaDry® molded rubber gskt. incl.		
1	Valve Cover Gasket Set	1995	VS 50514 R	Toyota Tercel DX, STD; w/Grommets & Spark plug tube seals; PermaDry® molded rubber gskt. incl.		
1	Valve Cover Gasket Set	1994-92	VS 50423 R	w/Grommets & Spark plug tube seals; PermaDry® molded rubber gskt. incl.		
1	Spark Plug Tube Seal Set	1999-92	ES 72105	Valve Cover		
QTY	VALVE STEM SEAL SET	YEARS	PART NO.	DESCRIPTION		
1	Valve Stem Seal Set	1999-92	SS 72831	Premium valve stem seals incl.		
QTY	WATER OUTLET GASKET	YEARS	PART NO.	DESCRIPTION		
1	O-Ring	1999-92	35292	Water Outlet		
QTY	WATER PUMP	YEARS	PART NO.	DESCRIPTION		
1	Water Pump Gasket	1999-92	35386			
QTY	TIMING COVER	YEARS	PART NO.	DESCRIPTION		
1	Crankshaft Front Seal Set	1999-97	TCS 45019			
1	Crankshaft Front Seal Set	1996-92	TCS 45729			
1	Camshaft Front Seal Set	1999-92	TCS 45592			
1	Repair Sleeve	1999-92	16221	Timing Cover; Use w/installation tool		
QTY	CARB & FUEL INJECTION	YEARS	PART NO.	DESCRIPTION		
1	Fuel Injector O-Ring Set	1999-92	ES 70600			
1	Throttle Body Gasket	1999-95	61097			
1	Throttle Body Gasket	1994-92	60664			
QTY	EXHAUST GAS RECIRCULATION	YEARS	PART NO.	DESCRIPTION		
1	EGR Gasket	1999-96	70041			
1	EGR Gasket	1995	70041	Toyota Tercel DX, STD		
1	EGR Gasket	1995	70041	Toyota Paseo Base; California		
1	EGR Gasket	1995	70690	Toyota Paseo Base; Exc. California		
1	EGR Gasket	1994-92	70690			
3		2013 - 2000; 1.5L 91.4 (1497cc) DOHC L4 (16 Valve) 75mm Bore VVT-i			3	
		MFI; Gasoline; Naturally Aspirated Toyota Eng.; Eng. Code 1N2FE				
QTY	CYLINDER HEAD	YEARS	PART NO.	DESCRIPTION		
1	Head Gasket	2013-00	26258 PT	Head bolts not incl.; Head bolt replacement recommended; PermaTorqueMLS®		
1	Head Set	2013-00	HS 26258 PT	Head bolts not incl.; Head bolt replacement recommended; PermaDry® molded rubber valve cover gskt. incl.; Premium valve stem seals incl.		
1	Head Bolt Set	2013-00	ES 72197	Head bolts w/o Washers; Replacement recommended		
1	Head Bolt Washer Set	2013-00	ES 72184	Replacement recommended		
QTY	CONVERSION SET	YEARS	PART NO.	DESCRIPTION		
1	Gasket Conversion Set	2013-00	CS 26258	RTV sealant incl. for Upper oil pan gskt.		
QTY	MANIFOLD - INT. & EXH.	YEARS	PART NO.	DESCRIPTION		
1	Int. Manifold Gasket Set	2013-00	MS 96510			
1	Exh. Manifold Gasket Set	2013-00	MS 96527			
QTY	EXHAUST PIPE FLANGE	YEARS	PART NO.	DESCRIPTION		
1	Exhaust Pipe Gasket	2013-00	60668	Loc. Rear; Exh. connector		
1	Exhaust Pipe Gasket	2013-00	61124	Ring; 1.92" ID		

Toyota Car (Incl. Lexus, Scion, Toyota) (Cont.)

3		2013 - 2000; 1.5L 91.4 (1497cc) DOHC L4 (16 Valve) 75mm Bore VVT-i			3	
(cont.)		MFI; Gasoline; Naturally Aspirated Toyota Eng.; Eng. Code 1NZFE			(cont.)	
QTY	EXHAUST PIPE FLANGE	YEARS	PART NO.	DESCRIPTION		
1	Exhaust Pipe Gasket	2013-06	61498	Loc. Front; Exh. connector		
1	Exhaust Pipe Gasket	2013-08	61502	Flange		
1	Exhaust Pipe Gasket	2007-06	61502	Exc. Scion xA Base, xB Base; Flange		
QTY	OIL PAN	YEARS	PART NO.	DESCRIPTION		
1	Oil Pan Gasket Set	2013-00	OS 30751	Loc. Lower; RTV sealant incl. for Upper oil pan gskt.		
1	Drain Plug Gasket	2013-00	70822			
QTY	CRANKSHAFT REAR SEAL	YEARS	PART NO.	DESCRIPTION		
1	Rear Main Seal Set	2013-00	BS 40682	Rubber; One-piece		
QTY	VALVE COVER	YEARS	PART NO.	DESCRIPTION		
1	Valve Cover Gasket Set	2013-00	VS 50624 R	w/Grommets & Spark plug tube seals; PermaDry® molded rubber gskt. incl.		
QTY	VALVE STEM SEAL SET	YEARS	PART NO.	DESCRIPTION		
1	Valve Stem Seal Set	2013-00	SS 72913	Premium valve stem seals incl.		
QTY	THERMOSTAT HOUSING	YEARS	PART NO.	DESCRIPTION		
1	Thermostat Gasket	2013-00	35445	Thermostat Housing; Thermostat inlet		
QTY	WATER PUMP	YEARS	PART NO.	DESCRIPTION		
1	Water Pump Gasket	2013-00	35743			
QTY	TIMING COVER	YEARS	PART NO.	DESCRIPTION		
1	Crankshaft Front Seal Set	2013-00	TCS 46046	Must be used w/VS 50624R		
QTY	CARB & FUEL INJECTION	YEARS	PART NO.	DESCRIPTION		
1	Throttle Body Gasket	2013-00	61128	Idle air control		
1	Throttle Body Gasket	2013-08	61463	Mounting		
1	Throttle Body Gasket	2007-06	61364	Scion xA Base, xB Base; Mounting		
1	Throttle Body Gasket	2007-06	61463	Exc. Scion xA Base, xB Base; Mounting		
1	Throttle Body Gasket	2005-04	61364	Mounting		
1	Throttle Body Gasket	2003	61363	To 12/31/02; Mounting		
1	Throttle Body Gasket	2003	61364	From 01/01/03; Mounting		
1	Throttle Body Gasket	2002-00	61363	Mounting		
4		2013 - 2001; 1.5L 91.4 (1497cc) DOHC L4 (16 Valve) 75mm Bore VVT-i			4	
(cont.)		MFI; Hybrid (Gas/Electric); Naturally Aspirated Toyota Eng.; Eng. Code 1NZFXE			(cont.)	
QTY	CYLINDER HEAD	YEARS	PART NO.	DESCRIPTION		
1	Head Gasket	2013-12	26258 PT	Head bolts not incl.; Head bolt replacement recommended; PermaTorqueMLS®		
1	Head Gasket	2009-01	26258 PT	Head bolts not incl.; Head bolt replacement recommended; PermaTorqueMLS®		
1	Head Set	2013-12	HS 26258 PT-2	Head bolts not incl.; Head bolt replacement recommended; PermaDry® molded rubber valve cover gskt. incl.; Premium valve stem seals incl.; New Part Number - Check for Availability		
1	Head Set	2009-01	HS 26258 PT-1	Head bolts & exh. pipe packing not incl.; Head bolt replacement recommended; PermaDry® molded rubber valve cover gskt. incl.; Premium valve stem seals incl.		
1	Head Bolt Set	2013-12	ES 72197	Head bolts w/o Washers; Replacement recommended		
1	Head Bolt Set	2009-01	ES 72197	Head bolts w/o Washers; Replacement recommended		
1	Head Bolt Washer Set	2013-12	ES 72184	Replacement recommended		
1	Head Bolt Washer Set	2009-01	ES 72184	Replacement recommended		
QTY	CONVERSION SET	YEARS	PART NO.	DESCRIPTION		
1	Gasket Conversion Set	2013-12	CS 26258-1	RTV sealant incl. for Upper oil pan gskt.; New Part Number - Check for Availability		
1	Gasket Conversion Set	2009-01	CS 26258	RTV sealant incl. for Upper oil pan gskt.		
QTY	MANIFOLD - INT. & EXH.	YEARS	PART NO.	DESCRIPTION		
1	Int. Manifold Gasket Set	2013-12	MS 97233	New Part Number - Check for Availability		
1	Int. Manifold Gasket Set	2009-01	MS 96526			
1	Exh. Manifold Gasket Set	2013-12	MS 96527			
1	Exh. Manifold Gasket Set	2009-01	MS 96527			
QTY	EXHAUST PIPE FLANGE	YEARS	PART NO.	DESCRIPTION		
1	Exhaust Pipe Gasket	2013-12	61502	Flange		
1	Exhaust Pipe Gasket	2009-01	61357	Packing		
1	Exhaust Pipe Gasket	2009-01	61358	Exh. connector		
QTY	OIL PAN	YEARS	PART NO.	DESCRIPTION		
1	Oil Pan Gasket Set	2013-12	OS 30751	Loc. Lower; RTV sealant incl. for Upper oil pan gskt.		
1	Oil Pan Gasket Set	2009-01	OS 30751	Loc. Lower; RTV sealant incl. for Upper oil pan gskt.		
1	Drain Plug Gasket	2013-12	70822			
1	Drain Plug Gasket	2009-01	70822			

Toyota Car (Incl. Lexus, Scion, Toyota) (Cont.)

4		2013 - 2001; 1.5L 91.4 (1497cc) DOHC L4 (16 Valve) 75mm Bore VVT-i			4	
(cont.)		MFI; Hybrid (Gas/Electric); Naturally Aspirated Toyota Eng.; Eng. Code 1NZFXE			(cont.)	
QTY	CRANKSHAFT REAR SEAL	YEARS	PART NO.	DESCRIPTION		
1	Rear Main Seal Set	2013-12	BS 40682	Rubber; One-piece		
1	Rear Main Seal Set	2009-01	BS 40682	Rubber; One-piece		
QTY	VALVE COVER	YEARS	PART NO.	DESCRIPTION		
1	Valve Cover Gasket Set	2013-12	VS 50624 R	w/Grommets & Spark plug tube seals; PermaDry® molded rubber gskt. incl.		
1	Valve Cover Gasket Set	2009-01	VS 50624 R	w/Grommets & Spark plug tube seals; PermaDry® molded rubber gskt. incl.		
QTY	VALVE STEM SEAL SET	YEARS	PART NO.	DESCRIPTION		
1	Valve Stem Seal Set	2013-12	SS 72913	Premium valve stem seals incl.		
1	Valve Stem Seal Set	2009-01	SS 72913	Premium valve stem seals incl.		
QTY	THERMOSTAT HOUSING	YEARS	PART NO.	DESCRIPTION		
1	Thermostat Gasket	2013-12	35445	Thermostat Housing; Thermostat inlet		
1	Thermostat Gasket	2013-12	36006	Thermostat Housing; Thermostat seal; New Part Number - Check for Availability		
1	Thermostat Gasket	2009-01	35445	Thermostat Housing; Thermostat inlet		
QTY	WATER OUTLET GASKET	YEARS	PART NO.	DESCRIPTION		
1	Water Outlet Gasket	2013-12	35729	Water Outlet; Heater return		
1	Water Outlet Gasket	2009-01	35729	Water Outlet; Heater return		
QTY	WATER PUMP	YEARS	PART NO.	DESCRIPTION		
1	Water Pump Gasket	2013-12	36010	Mounting; New Part Number - Check for Availability		
1	Water Pump Gasket	2013-12	36012	Inlet; New Part Number - Check for Availability		
1	Water Pump Gasket	2009-01	35743			
QTY	TIMING COVER	YEARS	PART NO.	DESCRIPTION		
1	Crankshaft Front Seal Set	2013-12	TCS 46046	Must be used w/VS 50624R		
1	Crankshaft Front Seal Set	2009-01	TCS 46046	Must be used w/VS 50624R		
QTY	CARB & FUEL INJECTION	YEARS	PART NO.	DESCRIPTION		
1	Throttle Body Gasket	2013-12	61715	Mounting; New Part Number - Check for Availability		
1	Throttle Body Gasket	2009-01	61352	Mounting		
QTY	EXHAUST GAS RECIRCULATION	YEARS	PART NO.	DESCRIPTION		
1	EGR Gasket	2013-12	72694	EGR valve to int. manifold; New Part Number - Check for Availability		
1	EGR Gasket	2013-12	72695	EGR cooler to exh. manifold; New Part Number - Check for Availability		
1	EGR Gasket	2013-12	72707	EGR valve to pipe; New Part Number - Check for Availability		
1	EGR Gasket	2013-12	72735	EGR cooler to pipe; New Part Number - Check for Availability		
1	EGR Gasket	2013-12	72736	EGR valve to cooler; New Part Number - Check for Availability		
5		1997 - 1991; 1.6L 96.8 (1587cc) DOHC L4 (16 Valve) 81mm Bore			5	
(cont.)		MFI; Gasoline; Naturally Aspirated Toyota Eng.; Eng. Code 4AFE			(cont.)	
QTY	CYLINDER HEAD	YEARS	PART NO.	DESCRIPTION		
1	Head Gasket	1997-94	9604 PT	Head bolts not incl.; Head bolt replacement recommended		
1	Head Gasket	1993	8188 PT	Toyota Celica ST; Head bolts not incl.; Head bolt replacement recommended		
1	Head Gasket	1993	9604 PT	Toyota Corolla Base; Head bolts not incl.; Head bolt replacement recommended		
1	Head Gasket	1992-91	8188 PT	Head bolts not incl.; Head bolt replacement recommended		
1	Head Set	1997-94	HS 9604 PT	Head bolts not incl.; Head bolt replacement recommended; PermaDry® molded rubber valve cover gskt. incl.; Premium valve stem seals incl.		
1	Head Set	1993	HS 8188 PT	Toyota Celica ST; Head bolts not incl.; Head bolt replacement recommended; PermaDry® molded rubber valve cover gskt. incl.; Premium valve stem seals incl.		
1	Head Set	1993	HS 9604 PT	Toyota Corolla Base; Head bolts not incl.; Head bolt replacement recommended; PermaDry® molded rubber valve cover gskt. incl.; Premium valve stem seals incl.		
1	Head Set	1992-91	HS 8188 PT	Head bolts not incl.; Head bolt replacement recommended; PermaDry® molded rubber valve cover gskt. incl.; Premium valve stem seals incl.		
1	Head Installation Set	1993	HIS 8188 PT	Toyota Celica ST; Head bolts & exh. pipe flange not incl.; Head bolt replacement recommended; PermaDry® molded rubber valve cover gskt. incl.		
1	Head Installation Set	1992-91	HIS 8188 PT	Head bolts & exh. pipe flange not incl.; Head bolt replacement recommended; PermaDry® molded rubber valve cover gskt. incl.		
1	Head Bolt Set	1997-94	ES 72489	Head bolts w/Washers; Replacement recommended; New Part Number - Check for Availability		
1	Head Bolt Set	1993	ES 72489	Toyota Corolla Base; Head bolts w/Washers; Replacement recommended; New Part Number - Check for Availability		
QTY	CONVERSION SET	YEARS	PART NO.	DESCRIPTION		
1	Gasket Conversion Set	1997-94	CS 9604			
1	Gasket Conversion Set	1993-91	CS 8188	Toyota Celica ST		

Toyota Car (Incl. Lexus, Scion, Toyota) (Cont.)

5 (cont.)		1997 - 1991; 1.6L 96.8 (1587cc) DOHC L4 (16 Valve) 81mm Bore			5 (cont.)
		MFI; Gasoline; Naturally Aspirated Toyota Eng.; Eng. Code 4AFE			
QTY	CONVERSION SET	YEARS	PART NO.	DESCRIPTION	
1	Gasket Conversion Set	1993	CS 9604	Toyota Corolla Base	
1	Gasket Conversion Set	1992-91	CS 9604	Toyota Corolla DLX All-Trac, SR5 All-Trac; AWD	
1	Gasket Conversion Set	1992	CS 8188	Toyota Corolla Base, DLX, LE, LSX, SR5; FWD	
1	Gasket Conversion Set	1991	CS 8188	Toyota Corolla Base, DLX, LE, SR5; FWD	
QTY	MANIFOLD - INT. & EXH.	YEARS	PART NO.	DESCRIPTION	
1	Int. Manifold Gasket Set	1997-94	MS 95516		
1	Int. Manifold Gasket Set	1993	MS 94135	Toyota Celica ST	
1	Int. Manifold Gasket Set	1993	MS 95516	Toyota Corolla Base	
1	Int. Manifold Gasket Set	1992-91	MS 94135		
1	Exh. Manifold Gasket Set	1997-91	MS 94129		
QTY	EXHAUST PIPE FLANGE	YEARS	PART NO.	DESCRIPTION	
2	Exhaust Pipe Gasket	1997-94	23591	Flange; 1 31/32" ID x 2 35/64" OD	
2	Exhaust Pipe Gasket	1997-96	23591	Converter; Exc. California; 1 31/32" ID x 2 35/64" OD	
1	Exhaust Pipe Gasket	1997-96	23591	Loc. Rear; Converter; California; 1 31/32" ID x 2 35/64" OD	
1	Exhaust Pipe Gasket	1997-96	23626	Loc. Front; Converter; California	
1	Exhaust Pipe Gasket	1995-94	23591	Loc. Rear; Converter; 1 31/32" ID x 2 35/64" OD	
1	Exhaust Pipe Gasket	1995-94	60908	Loc. Front; Converter	
1	Exhaust Pipe Gasket	1993-91	23561	Toyota Celica ST; Flange; California; 1 49/64" ID x 2 17/64" OD	
1	Exhaust Pipe Gasket	1993-91	23588	Toyota Celica ST; Flange; Exc. California; 1 37/64" ID x 2 3/32" OD	
1	Exhaust Pipe Gasket	1993-91	23626	Toyota Celica ST; Loc. Front; Converter	
1	Exhaust Pipe Gasket	1993-91	60908	Toyota Celica ST; Loc. Rear; Converter	
1	Exhaust Pipe Gasket	1993	23591	Toyota Corolla Base; Flange; 1 31/32" ID x 2 35/64" OD	
1	Exhaust Pipe Gasket	1993	23591	Toyota Corolla Base; Loc. Rear; Converter; 1 31/32" ID x 2 35/64" OD	
1	Exhaust Pipe Gasket	1993	60908	Toyota Corolla Base; Loc. Front; Converter	
1	Exhaust Pipe Gasket	1992-91	23591	Exc. Toyota Celica ST; Flange; 1 31/32" ID x 2 35/64" OD	
1	Exhaust Pipe Gasket	1992-91	23591	Exc. Toyota Celica ST; Loc. Rear; Converter; 1 31/32" ID x 2 35/64" OD	
1	Exhaust Pipe Gasket	1992	23561	Exc. Toyota Celica ST; Loc. Front; Converter; 1 49/64" ID x 2 17/64" OD	
1	Exhaust Pipe Gasket	1991	23561	Toyota Corolla Base, DLX, LE; Loc. Front; Converter; Sedan; 1 49/64" ID x 2 17/64" OD	
1	Exhaust Pipe Gasket	1991	23561	Exc. Toyota Celica ST, Corolla Base, LE, SR5; Loc. Front; Converter; Wagon; 1 49/64" ID x 2 17/64" OD	
1	Exhaust Pipe Gasket	1991	23591	Toyota Corolla SR5; Loc. Front; Converter; Coupe; 1 31/32" ID x 2 35/64" OD	
QTY	OIL PAN	YEARS	PART NO.	DESCRIPTION	
1	Oil Pan Gasket Set	1997-94	OS 30639		
1	Oil Pan Gasket Set	1993-91	OS 30510 A	Toyota Celica ST	
1	Oil Pan Gasket Set	1993	OS 30639	Toyota Corolla Base	
1	Oil Pan Gasket Set	1992-91	OS 30639	Toyota Corolla DLX All-Trac, SR5 All-Trac; AWD	
1	Oil Pan Gasket Set	1992	OS 30510 A	Toyota Corolla Base, DLX, LE, LSX, SR5; FWD	
1	Oil Pan Gasket Set	1991	OS 30510 A	Toyota Corolla Base, DLX, LE, SR5; FWD	
1	Drain Plug Gasket	1997-91	70822		
QTY	CRANKSHAFT REAR SEAL	YEARS	PART NO.	DESCRIPTION	
1	Rear Main Seal Set	1997-91	BS 40409	Rubber; One-piece	
1	Repair Sleeve	1997-91	16277	Crankshaft; Use w/installation tool	
QTY	VALVE COVER	YEARS	PART NO.	DESCRIPTION	
1	Valve Cover Gasket Set	1997-94	VS 50440 R	w/Grommets & Spark plug tube seals; PermaDry® molded rubber gskt. incl.	
1	Valve Cover Gasket Set	1993	VS 50324 R	Toyota Celica ST; w/o Grommets & Spark plug tube seals; PermaDry® molded rubber gskt. incl.	
1	Valve Cover Gasket Set	1993	VS 50324 R-1	Toyota Celica ST; w/o Grommets & w/Spark plug tube seals; PermaDry® molded rubber gskt. incl.	
1	Valve Cover Gasket Set	1993	VS 50440 R	Toyota Corolla Base; w/Grommets & Spark plug tube seals; PermaDry® molded rubber gskt. incl.	
1	Valve Cover Gasket Set	1992-91	VS 50324 R	w/o Grommets & Spark plug tube seals; PermaDry® molded rubber gskt. incl.	
1	Valve Cover Gasket Set	1992-91	VS 50324 R-1	w/o Grommets & w/Spark plug tube seals; PermaDry® molded rubber gskt. incl.	
1	Grommet Set	1993	ES 72123	Toyota Celica ST; Valve Cover	
1	Grommet Set	1992-91	ES 72123	Valve Cover	
1	Spark Plug Tube Seal Set	1997-91	ES 72105	Valve Cover	
QTY	VALVE STEM SEAL SET	YEARS	PART NO.	DESCRIPTION	
1	Valve Stem Seal Set	1997-94	SS 72810	Premium valve stem seals incl.	
1	Valve Stem Seal Set	1993	SS 72656	Toyota Celica ST; Premium valve stem seals incl.	
1	Valve Stem Seal Set	1993	SS 72810	Toyota Corolla Base; Premium valve stem seals incl.	
1	Valve Stem Seal Set	1992-91	SS 72656	Premium valve stem seals incl.	

Toyota Car (Incl. Lexus, Scion, Toyota) (Cont.)

5		1997 - 1991; 1.6L 96.8 (1587cc) DOHC L4 (16 Valve) 81mm Bore			5	
(cont.)		MFI; Gasoline; Naturally Aspirated Toyota Eng.; Eng. Code 4AFE			(cont.)	
QTY	THERMOSTAT HOUSING	YEARS	PART NO.	DESCRIPTION		
1	Thermostat Gasket	1997-94	35592	Thermostat Housing; Thermostat inlet		
1	Thermostat Gasket	1993	35592	Toyota Corolla Base; Thermostat Housing; Thermostat inlet		
QTY	WATER OUTLET GASKET	YEARS	PART NO.	DESCRIPTION		
1	O-Ring	1997-91	35292	Water Outlet		
QTY	WATER PUMP	YEARS	PART NO.	DESCRIPTION		
1	Water Pump Gasket	1997-91	35235			
1	Water Pump Mounting Set	1997-91	ES 72073			
QTY	TIMING COVER	YEARS	PART NO.	DESCRIPTION		
1	Timing Cover Dust Seal Set	1997-91	ES 72747			
1	Crankshaft Front Seal Set	1997-91	TCS 45624			
1	Camshaft Front Seal Set	1997-91	TCS 45592			
1	Repair Sleeve	1997-91	16225	Timing Cover; Use w/installation tool		
1	Repair Sleeve Tool	1997-91	16325	Timing Cover		
QTY	CARB & FUEL INJECTION	YEARS	PART NO.	DESCRIPTION		
1	Fuel Injector O-Ring Set	1997-91	ES 70600			
1	Throttle Body Gasket	1997-94	60977			
1	Throttle Body Gasket	1993	60839	Toyota Celica ST		
1	Throttle Body Gasket	1993	60977	Toyota Corolla Base		
1	Throttle Body Gasket	1992-91	60839			
QTY	DISTRIBUTOR MOUNTING	YEARS	PART NO.	DESCRIPTION		
1	Distributor Mounting Gasket	1997-91	72438	O-ring		
QTY	EXHAUST GAS RECIRCULATION	YEARS	PART NO.	DESCRIPTION		
1	EGR Gasket	1997-96	70264			
1	EGR Gasket	1995-94	72554			
1	EGR Gasket	1993	70264	Toyota Celica ST		
1	EGR Gasket	1993	72554	Toyota Corolla Base		
1	EGR Gasket	1992-91	70264			
6		1991; 1.6L 96.8 (1587cc) DOHC L4 (16 Valve) 81mm Bore			6	
(cont.)		MFI; Gasoline; Naturally Aspirated Toyota Eng.; Eng. Code 4AGE			(cont.)	
QTY	CYLINDER HEAD	YEARS	PART NO.	DESCRIPTION		
1	Head Gasket	1991	9661 PT	Head bolts not incl.; Head bolt replacement recommended		
QTY	CONVERSION SET	YEARS	PART NO.	DESCRIPTION		
1	Gasket Conversion Set	1991	CS 9383			
QTY	MANIFOLD - INT. & EXH.	YEARS	PART NO.	DESCRIPTION		
1	Exh. Manifold Gasket Set	1991	MS 92939			
QTY	EXHAUST PIPE FLANGE	YEARS	PART NO.	DESCRIPTION		
2	Exhaust Pipe Gasket	1991	23591	Converter; 1 31/32" ID x 2 35/64" OD		
QTY	OIL PAN	YEARS	PART NO.	DESCRIPTION		
1	Oil Pan Gasket Set	1991	OS 30510 A			
1	Drain Plug Gasket	1991	70822			
QTY	CRANKSHAFT REAR SEAL	YEARS	PART NO.	DESCRIPTION		
1	Rear Main Seal Set	1991	BS 40409	Rubber; One-piece		
1	Repair Sleeve	1991	16277	Crankshaft; Use w/installation tool		
QTY	VALVE COVER	YEARS	PART NO.	DESCRIPTION		
1	Valve Cover Gasket Set	1991	VS 50268 R	w/o Grommets; PermaDry® molded rubber gskts. incl.		
1	Grommet Set	1991	ES 72133	Valve Cover		
QTY	VALVE STEM SEAL SET	YEARS	PART NO.	DESCRIPTION		
1	Valve Stem Seal Set	1991	SS 72656	Premium valve stem seals incl.		
QTY	THERMOSTAT HOUSING	YEARS	PART NO.	DESCRIPTION		
1	O-Ring	1991	35292	Thermostat Housing; Thermostat inlet		
QTY	WATER OUTLET GASKET	YEARS	PART NO.	DESCRIPTION		
1	Water Outlet Gasket	1991	35337	Water Outlet		
QTY	WATER PUMP	YEARS	PART NO.	DESCRIPTION		
1	Water Pump Gasket	1991	35235			
1	Water Pump Mounting Set	1991	ES 72073			
QTY	TIMING COVER	YEARS	PART NO.	DESCRIPTION		
1	Timing Cover Dust Seal Set	1991	ES 72759			
1	Crankshaft Front Seal Set	1991	TCS 45624			
1	Camshaft Front Seal Set	1991	TCS 45424			
1	Repair Sleeve	1991	16225	Timing Cover; Use w/installation tool		
1	Repair Sleeve Tool	1991	16325	Timing Cover		
QTY	CARB & FUEL INJECTION	YEARS	PART NO.	DESCRIPTION		
1	Fuel Injector O-Ring Set	1991	ES 70600			

Toyota Car (Incl. Lexus, Scion, Toyota) (Cont.)

6		1991; 1.6L 96.8 (1587cc) DOHC L4 (16 Valve) 81mm Bore			6
(cont.)		MFI; Gasoline; Naturally Aspirated Toyota Eng.; Eng. Code 4AGE			(cont.)
QTY	CARB & FUEL INJECTION	YEARS	PART NO.	DESCRIPTION	
1	Throttle Body Gasket	1991	60790		
QTY	DISTRIBUTOR MOUNTING	YEARS	PART NO.	DESCRIPTION	
1	Distributor Mounting Gasket	1991	72438	O-ring	
QTY	EXHAUST GAS RECIRCULATION	YEARS	PART NO.	DESCRIPTION	
1	EGR Gasket	1991	70264		
7		1997 - 1993; 1.8L 107.5 (1762cc) DOHC L4 (16 Valve) 81mm Bore			7
(cont.)		MFI; Gasoline; Naturally Aspirated Toyota Eng.; Eng. Code 7AFE			(cont.)
QTY	CYLINDER HEAD	YEARS	PART NO.	DESCRIPTION	
1	Head Gasket	1997-93	9955 PT	Head bolts not incl.; Head bolt replacement recommended; PermaTorqueMLS®	
1	Head Set	1997-93	HS 9955 PT	Head bolts not incl.; Head bolt replacement recommended; PermaDry® molded rubber valve cover gskt. incl.; Premium valve stem seals incl.	
1	Head Bolt Set	1997-93	ES 72489	Head bolts w/Washers; Replacement recommended; New Part Number - Check for Availability	
QTY	CONVERSION SET	YEARS	PART NO.	DESCRIPTION	
1	Gasket Conversion Set	1997-93	CS 9955	RTV sealant incl. for Upper oil pan gskt.	
QTY	MANIFOLD - INT. & EXH.	YEARS	PART NO.	DESCRIPTION	
1	Int. Manifold Gasket Set	1997-93	MS 95516		
1	Exh. Manifold Gasket Set	1997-93	MS 94129		
QTY	EXHAUST PIPE FLANGE	YEARS	PART NO.	DESCRIPTION	
1	Exhaust Pipe Gasket	1997-93	23591	Flange; 1 31/32" ID x 2 35/64" OD	
1	Exhaust Pipe Gasket	1997-93	23591	Loc. Rear; Converter; 1 31/32" ID x 2 35/64" OD	
1	Exhaust Pipe Gasket	1997-95	23626	Loc. Front; Converter	
1	Exhaust Pipe Gasket	1994-93	60908	Loc. Front; Converter	
QTY	OIL PAN	YEARS	PART NO.	DESCRIPTION	
1	Oil Pan Gasket Set	1997-93	OS 30917 C	Loc. Lower	
1	Drain Plug Gasket	1997-93	70822		
QTY	CRANKSHAFT REAR SEAL	YEARS	PART NO.	DESCRIPTION	
1	Rear Main Seal Set	1997-93	BS 40409	Rubber; One-piece	
1	Repair Sleeve	1997-93	16277	Crankshaft; Use w/installation tool	
QTY	VALVE COVER	YEARS	PART NO.	DESCRIPTION	
1	Valve Cover Gasket Set	1997-93	VS 50440 R	w/Grommets & Spark plug tube seals; PermaDry® molded rubber gskt. incl.	
1	Spark Plug Tube Seal Set	1997-93	ES 72105	Valve Cover	
QTY	VALVE STEM SEAL SET	YEARS	PART NO.	DESCRIPTION	
1	Valve Stem Seal Set	1997-93	SS 72810	Premium valve stem seals incl.	
QTY	THERMOSTAT HOUSING	YEARS	PART NO.	DESCRIPTION	
1	Thermostat Gasket	1997-93	35592	Thermostat Housing; Thermostat inlet	
QTY	WATER OUTLET GASKET	YEARS	PART NO.	DESCRIPTION	
1	O-Ring	1997-93	35292	Water Outlet	
QTY	WATER PUMP	YEARS	PART NO.	DESCRIPTION	
1	Water Pump Gasket	1997-93	35235		
1	Water Pump Mounting Set	1997-93	ES 72073		
QTY	TIMING COVER	YEARS	PART NO.	DESCRIPTION	
1	Timing Cover Dust Seal Set	1997-93	ES 72747		
1	Crankshaft Front Seal Set	1997-93	TCS 45955		
1	Camshaft Front Seal Set	1997-93	TCS 45592		
QTY	CARB & FUEL INJECTION	YEARS	PART NO.	DESCRIPTION	
1	Fuel Injector O-Ring Set	1997-93	ES 70600		
1	Throttle Body Gasket	1997-93	60977		
QTY	DISTRIBUTOR MOUNTING	YEARS	PART NO.	DESCRIPTION	
1	Distributor Mounting Gasket	1997-93	72438	O-ring	
QTY	EXHAUST GAS RECIRCULATION	YEARS	PART NO.	DESCRIPTION	
1	EGR Gasket	1997-96	70264		
1	EGR Gasket	1995	70264	Toyota Corolla DX, LE	
1	EGR Gasket	1995	72554	Toyota Celica Base, ST	
1	EGR Gasket	1994-93	72554		
8		1999 - 1998; 1.8L 109.4 (1794cc) DOHC L4 (16 Valve) 79mm Bore			8
(cont.)		MFI; Gasoline; Naturally Aspirated Toyota Eng.; Eng. Code 1ZZFE			(cont.)
QTY	CYLINDER HEAD	YEARS	PART NO.	DESCRIPTION	
1	Head Gasket	1999-98	26158 PT-1	Head bolts not incl.; Head bolt replacement recommended; PermaTorqueMLS®; Improved design	

Toyota Car (Incl. Lexus, Scion, Toyota) (Cont.)

8		1999 - 1998; 1.8L 109.4 (1794cc) DOHC L4 (16 Valve) 79mm Bore			8	
(cont.)		MFI; Gasoline; Naturally Aspirated Toyota Eng.; Eng. Code 1ZZFE			(cont.)	
QTY	CYLINDER HEAD	YEARS	PART NO.	DESCRIPTION		
1	Head Set	1999-98	HS 26158 PT	Head bolts not incl.; Head bolt replacement recommended; PermaDry® molded rubber valve cover gskt. incl.; Premium valve stem seals incl.		
1	Head Bolt Set	1999-98	ES 71066	Head bolts w/Washers; Replacement recommended		
QTY	CONVERSION SET	YEARS	PART NO.	DESCRIPTION		
1	Gasket Conversion Set	1999-98	CS 26158			
QTY	MANIFOLD - INT. & EXH.	YEARS	PART NO.	DESCRIPTION		
1	Int. Manifold Gasket Set	1999-98	MS 93856			
1	Exh. Manifold Gasket Set	1999-98	MS 93909			
QTY	EXHAUST PIPE FLANGE	YEARS	PART NO.	DESCRIPTION		
2	Exhaust Pipe Gasket	1999-98	23591	Center pipe to muffler; 1 31/32" ID x 2 35/64" OD		
1	Exhaust Pipe Gasket	1999-98	61116	Converter		
1	Exhaust Pipe Gasket	1999-98	61124	Ring; 1.92" ID		
QTY	OIL PAN	YEARS	PART NO.	DESCRIPTION		
1	Oil Pan Gasket Set	1999-98	OS 30705 C			
1	Drain Plug Gasket	1999-98	70822			
QTY	CRANKSHAFT REAR SEAL	YEARS	PART NO.	DESCRIPTION		
1	Rear Main Seal Set	1999-98	BS 40661	Rubber; One-piece		
QTY	VALVE COVER	YEARS	PART NO.	DESCRIPTION		
1	Valve Cover Gasket Set	1999-98	VS 50544 R	w/Grommets & Spark plug tube seals; PermaDry® molded rubber gskt. incl.		
QTY	VALVE STEM SEAL SET	YEARS	PART NO.	DESCRIPTION		
1	Valve Stem Seal Set	1999-98	SS 72878-1	Premium valve stem seals incl.		
QTY	THERMOSTAT HOUSING	YEARS	PART NO.	DESCRIPTION		
1	Thermostat Gasket	1999-98	35445	Thermostat Housing; Thermostat inlet		
QTY	WATER PUMP	YEARS	PART NO.	DESCRIPTION		
1	Water Pump Gasket	1999-98	35672	O-ring		
QTY	TIMING COVER	YEARS	PART NO.	DESCRIPTION		
1	Crankshaft Front Seal Set	1999-98	TCS 45054			
QTY	CARB & FUEL INJECTION	YEARS	PART NO.	DESCRIPTION		
1	Throttle Body Gasket	1999-98	61128	Throttle body cover		
1	Throttle Body Gasket	1999-98	61134	Throttle body mounting		
QTY	OIL PUMP COVER	YEARS	PART NO.	DESCRIPTION		
1	Oil Pump Gasket	1999-98	72749	Oil pump mounting; New Part Number - Check for Availability		
9		2008 - 2000; 1.8L 109.4 (1794cc) DOHC L4 (16 Valve) 79mm Bore VVT-i			9	
		MFI; Gasoline; Naturally Aspirated Toyota Eng.; Eng. Code 1ZZFE				
QTY	CYLINDER HEAD	YEARS	PART NO.	DESCRIPTION		
1	Head Gasket	2008-00	26158 PT-1	Head bolts not incl.; Head bolt replacement recommended; PermaTorqueMLS®; Improved design		
1	Head Set	2008-03	HS 26158 PT-2	Head bolts not incl.; Head bolt replacement recommended; PermaDry® molded rubber valve cover gskt. incl.; Premium valve stem seals incl.		
1	Head Set	2002-01	HS 26158 PT-1	Toyota Corolla CE, LE, S; Head bolts not incl.; Head bolt replacement recommended; PermaDry® molded rubber valve cover gskt. incl.; Premium valve stem seals incl.		
1	Head Set	2002-01	HS 26158 PT-2	Exc. Toyota Corolla CE, LE, S; Head bolts not incl.; Head bolt replacement recommended; PermaDry® molded rubber valve cover gskt. incl.; Premium valve stem seals incl.		
1	Head Set	2000	HS 26158 PT-1	Toyota Corolla CE, LE, VE; Head bolts not incl.; Head bolt replacement recommended; PermaDry® molded rubber valve cover gskt. incl.; Premium valve stem seals incl.		
1	Head Set	2000	HS 26158 PT-2	Exc. Toyota Corolla CE, LE, VE; Head bolts not incl.; Head bolt replacement recommended; PermaDry® molded rubber valve cover gskt. incl.; Premium valve stem seals incl.		
1	Head Bolt Set	2008-00	ES 71066	Head bolts w/Washers; Replacement recommended		
QTY	CONVERSION SET	YEARS	PART NO.	DESCRIPTION		
1	Gasket Conversion Set	2008-00	CS 26158			
QTY	MANIFOLD - INT. & EXH.	YEARS	PART NO.	DESCRIPTION		
1	Int. Manifold Gasket Set	2008-03	MS 93942			
1	Int. Manifold Gasket Set	2002-01	MS 93856	Toyota Corolla CE, LE, S		
1	Int. Manifold Gasket Set	2002-01	MS 93942	Exc. Toyota Corolla CE, LE, S		
1	Int. Manifold Gasket Set	2000	MS 93856	Toyota Corolla CE, LE, VE		
1	Int. Manifold Gasket Set	2000	MS 93942	Exc. Toyota Corolla CE, LE, VE		
1	Exh. Manifold Gasket Set	2008-00	MS 93909			
QTY	EXHAUST PIPE FLANGE	YEARS	PART NO.	DESCRIPTION		
1	Exhaust Pipe Gasket	2008-03	60479	Toyota Matrix Base, XR; Converter		

Toyota Car (Incl. Lexus, Scion, Toyota) (Cont.)

9 (cont.)	2008 - 2000; 1.8L 109.4 (1794cc) DOHC L4 (16 Valve) 79mm Bore VVT-i				9 (cont.)
QTY	EXHAUST PIPE FLANGE	YEARS	PART NO.	DESCRIPTION	
1	Exhaust Pipe Gasket	2008-03	61106	Toyota Matrix Base, XR; Flange; FWD; 2.40" ID	
1	Exhaust Pipe Gasket	2008-03	61124	Toyota Corolla CE, LE, S; Exh. connector; 1.92" ID	
1	Exhaust Pipe Gasket	2008-06	61016	Toyota Matrix Base, XR; Exh. connector; FWD; Improved design	
1	Exhaust Pipe Gasket	2008-06	61106	Toyota Corolla CE, LE, S; Flange; 2.40" ID	
1	Exhaust Pipe Gasket	2006-03	60668	Toyota Matrix Base, XR; Exh. connector; AWD	
1	Exhaust Pipe Gasket	2006-03	61124	Toyota Matrix Base, XR; Flange; AWD; 1.92" ID	
2	Exhaust Pipe Gasket	2005-00	23591	Toyota MR2 Spyder Base; Flange; 1 31/32" ID x 2 35/64" OD	
1	Exhaust Pipe Gasket	2005-00	61016	Toyota Celica GT; Center pipe to muffler; Improved design	
1	Exhaust Pipe Gasket	2005-00	61016	Toyota MR2 Spyder Base; Exh. connector; Improved design	
1	Exhaust Pipe Gasket	2005-03	61106	Toyota Celica GT, Corolla CE, LE, S; Flange; 2.40" ID	
1	Exhaust Pipe Gasket	2005	61016	Toyota Matrix Base, XR; From 04/01/05; Exh. connector; FWD; Improved design	
1	Exhaust Pipe Gasket	2005	61124	Toyota Matrix Base, XR; To 03/31/05; Exh. connector; FWD; 1.92" ID	
1	Exhaust Pipe Gasket	2004-03	61124	Toyota Matrix Base, XR; Exh. connector; FWD; 1.92" ID	
1	Exhaust Pipe Gasket	2002-00	61106	Toyota Celica GT; Flange; 2.40" ID	
2	Exhaust Pipe Gasket	2002-01	23591	Toyota Corolla CE, LE, S; Center pipe to muffler; 1 31/32" ID x 2 35/64" OD	
1	Exhaust Pipe Gasket	2002-01	61116	Toyota Corolla CE, LE, S; Converter	
1	Exhaust Pipe Gasket	2002-01	61124	Toyota Corolla CE, LE, S; Ring; 1.92" ID	
2	Exhaust Pipe Gasket	2000	23591	Toyota Corolla CE, LE, VE; Center pipe to muffler; 1 31/32" ID x 2 35/64" OD	
1	Exhaust Pipe Gasket	2000	61116	Toyota Corolla CE, LE, VE; Converter	
1	Exhaust Pipe Gasket	2000	61124	Toyota Corolla CE, LE, VE; Ring; 1.92" ID	
QTY	OIL PAN	YEARS	PART NO.	DESCRIPTION	
1	Oil Pan Gasket Set	2008-00	OS 30705 C		
1	Drain Plug Gasket	2008-00	70822		
QTY	CRANKSHAFT REAR SEAL	YEARS	PART NO.	DESCRIPTION	
1	Rear Main Seal Set	2008-00	BS 40661	Rubber; One-piece	
QTY	VALVE COVER	YEARS	PART NO.	DESCRIPTION	
1	Valve Cover Gasket Set	2008-00	VS 50542 R	w/Grommets & Spark plug tube seals; PermaDry® molded rubber gskt. incl.	
QTY	VALVE STEM SEAL SET	YEARS	PART NO.	DESCRIPTION	
1	Valve Stem Seal Set	2008-00	SS 72878-1	Premium valve stem seals incl.	
QTY	THERMOSTAT HOUSING	YEARS	PART NO.	DESCRIPTION	
1	Thermostat Gasket	2008-00	35445	Thermostat Housing; Thermostat inlet	
QTY	WATER PUMP	YEARS	PART NO.	DESCRIPTION	
1	Water Pump Gasket	2008-00	35672	O-ring	
QTY	TIMING COVER	YEARS	PART NO.	DESCRIPTION	
1	Crankshaft Front Seal Set	2008-00	TCS 45054		
QTY	CARB & FUEL INJECTION	YEARS	PART NO.	DESCRIPTION	
1	Throttle Body Gasket	2008-03	61128	Throttle body cover	
1	Throttle Body Gasket	2008-04	61421	Toyota Matrix Base, XR; Throttle body mounting; FWD	
1	Throttle Body Gasket	2008-05	61421	Toyota Corolla CE, LE, S; Throttle body mounting	
1	Throttle Body Gasket	2006-04	61134	Toyota Matrix Base, XR; Throttle body mounting; AWD	
1	Throttle Body Gasket	2005-03	61134	Toyota MR2 Spyder Base; Loc. Inner; Throttle body mounting	
1	Throttle Body Gasket	2005-03	61313	Toyota MR2 Spyder Base; Loc. Outer; Throttle body mounting	
1	Throttle Body Gasket	2005	61134	Toyota Celica GT; Throttle body mounting	
1	Throttle Body Gasket	2004	61134	Toyota Celica GT, Corolla CE, LE, S; Throttle body mounting	
1	Throttle Body Gasket	2003	61134	Exc. Toyota MR2 Spyder Base; Throttle body mounting	
1	Throttle Body Gasket	2002-01	61085	Toyota Corolla CE, LE, S; Throttle body cover	
1	Throttle Body Gasket	2002-01	61128	Exc. Toyota Corolla CE, LE, S; Throttle body cover	
1	Throttle Body Gasket	2002-01	61134	Exc. Toyota Corolla CE, LE, S; Throttle body mounting	
1	Throttle Body Gasket	2002-01	61286	Toyota Corolla CE, LE, S; Throttle body mounting	
1	Throttle Body Gasket	2000	61128	Throttle body cover	
1	Throttle Body Gasket	2000	61134	Throttle body mounting	
QTY	OIL PUMP COVER	YEARS	PART NO.	DESCRIPTION	
1	Oil Pump Gasket	2008-00	72749	Oil pump mounting; New Part Number - Check for Availability	
10	2006 - 2000; 1.8L 109.5 (1796cc) DOHC L4 (16 Valve) 82mm Bore VVT-i				10
QTY	CYLINDER HEAD	YEARS	PART NO.	DESCRIPTION	
1	Head Gasket	2006-00	26154 PT	Head bolts not incl.; Head bolt replacement recommended; PermaTorqueMLS®	
1	Head Set	2006-04	HS 26154 PT-1	Head bolts not incl.; Head bolt replacement recommended; PermaDry® molded rubber valve cover gskt. incl.; Premium valve stem seals incl.	

Toyota Car (Incl. Lexus, Scion, Toyota) (Cont.)

10 (cont.)		2006 - 2000; 1.8L 109.5 (1796cc) DOHC L4 (16 Valve) 82mm Bore VVT-i			10 (cont.)
MFI; Gasoline; Naturally Aspirated Toyota Eng.; Eng. Code 2ZZGE					
QTY	CYLINDER HEAD	YEARS	PART NO.	DESCRIPTION	
1	Head Set	2003	HS 26154 PT	Toyota Celica GT-S; To 03/01/03; Head bolts not incl.; Head bolt replacement recommended; PermaDry® molded rubber valve cover gskt. incl.; Premium valve stem seals incl.	
1	Head Set	2003	HS 26154 PT	Toyota Matrix XRS; To 05/01/03; Head bolts not incl.; Head bolt replacement recommended; PermaDry® molded rubber valve cover gskt. incl.; Premium valve stem seals incl.	
1	Head Set	2003	HS 26154 PT-1	Toyota Celica GT-S; From 03/01/03; Head bolts not incl.; Head bolt replacement recommended; PermaDry® molded rubber valve cover gskt. incl.; Premium valve stem seals incl.	
1	Head Set	2003	HS 26154 PT-1	Toyota Matrix XRS; From 05/01/03; Head bolts not incl.; Head bolt replacement recommended; PermaDry® molded rubber valve cover gskt. incl.; Premium valve stem seals incl.	
1	Head Set	2002-00	HS 26154 PT	Head bolts not incl.; Head bolt replacement recommended; PermaDry® molded rubber valve cover gskt. incl.; Premium valve stem seals incl.	
1	Head Bolt Set	2006-00	ES 71066	Head bolts w/Washers; Replacement recommended	
QTY	CONVERSION SET	YEARS	PART NO.	DESCRIPTION	
1	Gasket Conversion Set	2006-00	CS 26154		
QTY	MANIFOLD - INT. & EXH.	YEARS	PART NO.	DESCRIPTION	
1	Int. Manifold Gasket Set	2006-00	MS 93867		
1	Exh. Manifold Gasket Set	2006-04	MS 96398		
1	Exh. Manifold Gasket Set	2003	MS 93931	Toyota Celica GT-S; To 03/01/03	
1	Exh. Manifold Gasket Set	2003	MS 93931	Toyota Matrix XRS; To 05/01/03	
1	Exh. Manifold Gasket Set	2003	MS 96398	Toyota Celica GT-S; From 03/01/03	
1	Exh. Manifold Gasket Set	2003	MS 96398	Toyota Matrix XRS; From 05/01/03	
1	Exh. Manifold Gasket Set	2002-00	MS 93931		
QTY	EXHAUST PIPE FLANGE	YEARS	PART NO.	DESCRIPTION	
1	Exhaust Pipe Gasket	2006-00	61106	Converter; 2.40" ID	
1	Exhaust Pipe Gasket	2006-00	61190	Flange	
QTY	OIL PAN	YEARS	PART NO.	DESCRIPTION	
1	Oil Pan Gasket Set	2006-00	OS 30705 C		
1	Drain Plug Gasket	2006-00	70822		
QTY	CRANKSHAFT REAR SEAL	YEARS	PART NO.	DESCRIPTION	
1	Rear Main Seal Set	2006-00	BS 40665	Rubber; One-piece	
QTY	VALVE COVER	YEARS	PART NO.	DESCRIPTION	
1	Valve Cover Gasket Set	2006-00	VS 50546 R	w/Spark plug tube seals; PermaDry® molded rubber gskt. incl.	
1	Spark Plug Tube Seal Set	2006-00	ES 72105	Valve Cover	
QTY	VALVE STEM SEAL SET	YEARS	PART NO.	DESCRIPTION	
1	Valve Stem Seal Set	2006-00	SS 71053	Premium valve stem seals incl.	
QTY	THERMOSTAT HOUSING	YEARS	PART NO.	DESCRIPTION	
1	Thermostat Gasket	2006-00	35445	Thermostat Housing; Thermostat inlet	
1	O-Ring	2006-00	35717	Thermostat Housing; Thermostat seal	
QTY	WATER PUMP	YEARS	PART NO.	DESCRIPTION	
1	O-Ring	2006-00	35717	Water Pump; Mounting O-ring	
QTY	TIMING COVER	YEARS	PART NO.	DESCRIPTION	
1	Timing Cover Set	2006-00	TCS 45047		
QTY	CARB & FUEL INJECTION	YEARS	PART NO.	DESCRIPTION	
1	Fuel Injector O-Ring Set	2006-00	ES 70600		
1	Throttle Body Gasket	2006-00	61128	Throttle body cover	
1	Throttle Body Gasket	2006	61193	Throttle body mounting	
1	Throttle Body Gasket	2005-03	61312	Toyota Celica GT-S; Throttle body mounting	
1	Throttle Body Gasket	2005	61193	Exc. Toyota Celica GT-S; Throttle body mounting	
1	Throttle Body Gasket	2004-03	61193	Toyota Matrix XRS; Throttle body mounting	
1	Throttle Body Gasket	2002-00	61193	Throttle body mounting	
11		2013 - 2008; 1.8L 109.7 (1798cc) DOHC L4 (16 Valve) 80.5mm Bore VVT-i			11
MFI; Gasoline; Naturally Aspirated Toyota Eng.; Eng. Code 2ZRFE					
QTY	CYLINDER HEAD	YEARS	PART NO.	DESCRIPTION	
1	Head Gasket	2013-08	26515 PT	Head bolts not incl.; Head bolt replacement recommended; PermaTorqueMLS®; Improved design	
1	Head Set	2013-08	HS 26515 PT	Head bolts not incl.; Head bolt replacement recommended; PermaDry® molded rubber valve cover gskt. incl.; Premium valve stem seals incl.; Improved design; New Part Number - Check for Availability	

Toyota Car (Incl. Lexus, Scion, Toyota) (Cont.)

11 (cont.)		2013 - 2008; 1.8L 109.7 (1798cc) DOHC L4 (16 Valve) 80.5mm Bore VVT-i			11 (cont.)
		MFI; Gasoline; Naturally Aspirated Toyota Eng.; Eng. Code 2ZRFE			
QTY	CONVERSION SET	YEARS	PART NO.	DESCRIPTION	
1	Gasket Conversion Set	2013-08	CS 26515	PermaDry® molded rubber oil pan gskt. incl.; New Part Number - Check for Availability	
QTY	MANIFOLD - INT. & EXH.	YEARS	PART NO.	DESCRIPTION	
1	Int. Manifold Gasket Set	2013-08	MS 97144	New Part Number - Check for Availability	
1	Exh. Manifold Gasket Set	2013-08	MS 97146		
QTY	EXHAUST PIPE FLANGE	YEARS	PART NO.	DESCRIPTION	
1	Exhaust Pipe Gasket	2013-08	61106	Flange; 2.40" ID	
1	Exhaust Pipe Gasket	2013-10	61598	Converter	
1	Exhaust Pipe Gasket	2009-08	61016	Converter; Improved design	
QTY	OIL PAN	YEARS	PART NO.	DESCRIPTION	
1	Oil Pan Gasket Set	2013-08	OS 30829	Rubber; Improved design; New Part Number - Check for Availability	
1	Oil Pan Gasket Set	2013-08	OS 30829 R	PermaDry® molded rubber gskt. incl.; Old design; Superseded - When depleted use OS 30829	
1	Drain Plug Gasket	2013-08	70822		
QTY	CRANKSHAFT REAR SEAL	YEARS	PART NO.	DESCRIPTION	
1	Rear Main Seal Set	2013-08	BS 40732	Rubber; One-piece; New Part Number - Check for Availability	
QTY	VALVE COVER	YEARS	PART NO.	DESCRIPTION	
1	Valve Cover Gasket Set	2013-08	VS 50776 R	w/Grommets & Spark plug tube seals; PermaDry® molded rubber gskt. incl.; New Part Number - Check for Availability	
QTY	VALVE STEM SEAL SET	YEARS	PART NO.	DESCRIPTION	
1	Valve Stem Seal Set	2013-08	SS 72878-2	Premium valve stem seals incl.	
QTY	THERMOSTAT HOUSING	YEARS	PART NO.	DESCRIPTION	
1	Thermostat Gasket	2013-08	35445	Thermostat Housing; Thermostat inlet	
1	Thermostat Gasket	2013-08	35949	Thermostat Housing	
QTY	WATER OUTLET GASKET	YEARS	PART NO.	DESCRIPTION	
1	Water Outlet Gasket	2013-08	35866		
QTY	WATER PUMP	YEARS	PART NO.	DESCRIPTION	
1	Water Pump Gasket	2013-08	35873		
QTY	TIMING COVER	YEARS	PART NO.	DESCRIPTION	
1	Crankshaft Front Seal Set	2013-08	TCS 46148	New Part Number - Check for Availability	
QTY	CARB & FUEL INJECTION	YEARS	PART NO.	DESCRIPTION	
1	Throttle Body Gasket	2013-08	61421		
12		2013 - 2010; 1.8L 109.7 (1798cc) DOHC L4 (16 Valve) 80.5mm Bore VVT-i			12
		MFI; Hybrid (Gas/Electric); Naturally Aspirated Toyota Eng.; Eng. Code 2ZRFXE			
QTY	CYLINDER HEAD	YEARS	PART NO.	DESCRIPTION	
1	Head Gasket	2013-10	26515 PT	Head bolts not incl.; Head bolt replacement recommended; PermaTorqueMLS®; Improved design	
1	Head Set	2013-10	HS 26515 PT-1	Head bolts not incl.; Head bolt replacement recommended; PermaDry® molded rubber valve cover gskt. incl.; Premium valve stem seals incl.; New Part Number - Check for Availability	
QTY	CONVERSION SET	YEARS	PART NO.	DESCRIPTION	
1	Gasket Conversion Set	2013-10	CS 26515	PermaDry® molded rubber oil pan gskt. incl.; New Part Number - Check for Availability	
QTY	MANIFOLD - INT. & EXH.	YEARS	PART NO.	DESCRIPTION	
1	Int. Manifold Gasket Set	2013-10	MS 97144	New Part Number - Check for Availability	
1	Exh. Manifold Gasket Set	2013-10	MS 97146		
QTY	EXHAUST PIPE FLANGE	YEARS	PART NO.	DESCRIPTION	
1	Exhaust Pipe Gasket	2013-10	61106	Flange; 2.40" ID	
1	Exhaust Pipe Gasket	2013-10	61598	Converter	
QTY	OIL PAN	YEARS	PART NO.	DESCRIPTION	
1	Oil Pan Gasket Set	2013-10	OS 30829	Rubber; Improved design; New Part Number - Check for Availability	
1	Oil Pan Gasket Set	2013-10	OS 30829 R	PermaDry® molded rubber gskt. incl.; Old design; Superseded - When depleted use OS 30829	
1	Drain Plug Gasket	2013-10	70822		
QTY	CRANKSHAFT REAR SEAL	YEARS	PART NO.	DESCRIPTION	
1	Rear Main Seal Set	2013-10	BS 40732	Rubber; One-piece; New Part Number - Check for Availability	
QTY	VALVE COVER	YEARS	PART NO.	DESCRIPTION	
1	Valve Cover Gasket Set	2013-10	VS 50823 R	w/Grommets & Spark plug tube seals; PermaDry® molded rubber gskt. incl.; New Part Number - Check for Availability	
QTY	VALVE STEM SEAL SET	YEARS	PART NO.	DESCRIPTION	
1	Valve Stem Seal Set	2013-10	SS 72878-1	Premium valve stem seals incl.	

Toyota Car (Incl. Lexus, Scion, Toyota) (Cont.)

12		2013 - 2010; 1.8L 109.7 (1798cc) DOHC L4 (16 Valve) 80.5mm Bore VVT-i			12	
(cont.)		MFI; Hybrid (Gas/Electric); Naturally Aspirated Toyota Eng.; Eng. Code 2ZRFXE			(cont.)	
QTY	THERMOSTAT HOUSING	YEARS	PART NO.	DESCRIPTION		
1	Thermostat Gasket	2013-10	35445	Thermostat Housing; Thermostat inlet		
1	Thermostat Gasket	2013-10	36007	Thermostat Housing; Thermostat seal; New Part Number - Check for Availability		
QTY	WATER OUTLET GASKET	YEARS	PART NO.	DESCRIPTION		
1	Water Outlet Gasket	2013-10	35866			
QTY	WATER PUMP	YEARS	PART NO.	DESCRIPTION		
1	Water Pump Gasket	2013-10	36010	Mounting; New Part Number - Check for Availability		
QTY	TIMING COVER	YEARS	PART NO.	DESCRIPTION		
1	Crankshaft Front Seal Set	2013-10	TCS 46148-1	New Part Number - Check for Availability		
QTY	CARB & FUEL INJECTION	YEARS	PART NO.	DESCRIPTION		
1	Throttle Body Gasket	2013-10	61711	New Part Number - Check for Availability		
QTY	EXHAUST GAS RECIRCULATION	YEARS	PART NO.	DESCRIPTION		
1	EGR Gasket	2013-10	72565	EGR tube to exh. manifold; New Part Number - Check for Availability		
1	EGR Gasket	2013-10	72636	EGR valve to cooler; New Part Number - Check for Availability		
1	EGR Gasket	2013-10	72651	EGR valve to pipe; New Part Number - Check for Availability		
1	EGR Gasket	2013-10	72694	EGR valve to int. manifold; New Part Number - Check for Availability		
13		1992 - 1991; 2.0L 122 (1998cc) DOHC L4 (16 Valve) 86mm Bore			13	
		MFI; Gasoline; Naturally Aspirated Toyota Eng.; Eng. Code 3SFE				
QTY	CYLINDER HEAD	YEARS	PART NO.	DESCRIPTION		
1	Head Gasket	1992-91	9861 PT	Head bolts not incl.; Head bolt replacement recommended		
1	Head Set	1992-91	HS 9861 PT	Head bolts not incl.; Head bolt replacement recommended; PermaDry® molded rubber valve cover gskt. incl.; Premium valve stem seals incl.; Consolidated design		
1	Head Bolt Set	1992-91	ES 72154	Head bolts w/Washers; Replacement recommended		
1	Head Bolt Washer Set	1992-91	ES 72183	Replacement recommended		
QTY	CONVERSION SET	YEARS	PART NO.	DESCRIPTION		
1	Gasket Conversion Set	1992-91	CS 9418			
QTY	MANIFOLD - INT. & EXH.	YEARS	PART NO.	DESCRIPTION		
1	Int. Manifold Gasket Set	1992-91	MS 93550-1			
1	Exh. Manifold Gasket Set	1992-91	MS 94976			
QTY	EXHAUST PIPE FLANGE	YEARS	PART NO.	DESCRIPTION		
1	Exhaust Pipe Gasket	1992-91	23591	Converter; 1 31/32" ID x 2 35/64" OD		
1	Exhaust Pipe Gasket	1992-91	23626	Flange		
QTY	OIL PAN	YEARS	PART NO.	DESCRIPTION		
1	Oil Pan Gasket Set	1992-91	OS 30468 C			
1	Drain Plug Gasket	1992-91	70822			
QTY	CRANKSHAFT REAR SEAL	YEARS	PART NO.	DESCRIPTION		
1	Rear Main Seal Set	1992-91	BS 40427	Rubber; One-piece; Improved design		
1	Repair Sleeve	1992-91	16278	Crankshaft; Use w/installation tool		
QTY	VALVE COVER	YEARS	PART NO.	DESCRIPTION		
1	Valve Cover Gasket Set	1992-91	VS 50304 R	w/o Spark plug tube seals; PermaDry® molded rubber gskt. incl.		
1	Valve Cover Gasket Set	1992-91	VS 50304 R-1	w/Spark plug tube seals; PermaDry® molded rubber gskt. incl.		
1	Spark Plug Tube Seal Set	1992-91	ES 70739	Valve Cover		
QTY	VALVE STEM SEAL SET	YEARS	PART NO.	DESCRIPTION		
1	Valve Stem Seal Set	1992-91	SS 72810	Premium valve stem seals incl.		
QTY	THERMOSTAT HOUSING	YEARS	PART NO.	DESCRIPTION		
1	O-Ring	1992-91	35292	Thermostat Housing; Thermostat inlet		
QTY	WATER OUTLET GASKET	YEARS	PART NO.	DESCRIPTION		
1	Water Outlet Gasket	1992-91	35488	Water Outlet		
QTY	WATER PUMP	YEARS	PART NO.	DESCRIPTION		
1	Water Pump Gasket	1992-91	35294			
QTY	TIMING COVER	YEARS	PART NO.	DESCRIPTION		
1	Crankshaft Front Seal Set	1992-91	TCS 45413	w/o Dust seals		
1	Crankshaft Front Seal Set	1992-91	TCS 45734	w/Dust seals		
1	Camshaft Front Seal Set	1992-91	TCS 45641	w/o Dust seals		
1	Camshaft Front Seal Set	1992-91	TCS 45733	w/Dust seals		
1	Repair Sleeve	1992-91	16227	Timing Cover; Use w/installation tool		
1	Repair Sleeve Tool	1992-91	16327	Timing Cover		
QTY	CARB & FUEL INJECTION	YEARS	PART NO.	DESCRIPTION		
1	Fuel Injector O-Ring Set	1992-91	ES 70600			
1	Throttle Body Gasket	1992-91	60687			

Toyota Car (Incl. Lexus, Scion, Toyota) (Cont.)

13		1992 - 1991; 2.0L 122 (1998cc) DOHC L4 (16 Valve) 86mm Bore			13
(cont.)		MFI; Gasoline; Naturally Aspirated Toyota Eng.; Eng. Code 3SFE			(cont.)
QTY	DISTRIBUTOR MOUNTING	YEARS	PART NO.	DESCRIPTION	
1	Distributor Mounting Gasket	1992-91	72438	O-ring	
QTY	EXHAUST GAS RECIRCULATION	YEARS	PART NO.	DESCRIPTION	
1	EGR Gasket	1992-91	72610		
QTY	OIL PUMP COVER	YEARS	PART NO.	DESCRIPTION	
1	Oil Pump Gasket	1992-91	72518	Oil pump O-ring; New Part Number - Check for Availability	
1	Oil Pump Gasket	1992-91	72663	Oil pump cover; New Part Number - Check for Availability	
14		1995 - 1991; 2.0L 122 (1998cc) DOHC L4 (16 Valve) 86mm Bore			14
		MFI; Gasoline; Turbo - Intercooled Toyota Eng.; Eng. Code 3SGTE			
QTY	CYLINDER HEAD	YEARS	PART NO.	DESCRIPTION	
1	Head Gasket	1995-91	9853 PT	Head bolts not incl.; Head bolt replacement recommended	
1	Head Set	1995-94	HS 9853 PT-2	Head bolts not incl.; Head bolt replacement recommended; PermaDry® molded rubber valve cover gskts. incl.; Premium valve stem seals incl.	
1	Head Set	1993-91	HS 9853 PT	Head bolts not incl.; Head bolt replacement recommended; PermaDry® molded rubber valve cover gskts. incl.; Premium valve stem seals incl.	
QTY	CONVERSION SET	YEARS	PART NO.	DESCRIPTION	
1	Gasket Conversion Set	1995-91	CS 9853		
QTY	MANIFOLD - INT. & EXH.	YEARS	PART NO.	DESCRIPTION	
1	Int. Manifold Gasket Set	1995-91	MS 93233		
1	Exh. Manifold Gasket Set	1995-91	MS 94976		
QTY	EXHAUST PIPE FLANGE	YEARS	PART NO.	DESCRIPTION	
1	Exhaust Pipe Gasket	1995-91	60915	Flange	
2	Exhaust Pipe Gasket	1995-94	60572	Converter; 2.165" ID	
2	Exhaust Pipe Gasket	1993-91	60512	Exc. Toyota MR2 Turbo; Converter; Improved design	
1	Exhaust Pipe Gasket	1993-91	60572	Toyota MR2 Turbo; Converter; 2.165" ID	
QTY	OIL PAN	YEARS	PART NO.	DESCRIPTION	
1	Oil Pan Gasket Set	1995-91	OS 30468 C		
1	Drain Plug Gasket	1995-91	70822		
QTY	CRANKSHAFT REAR SEAL	YEARS	PART NO.	DESCRIPTION	
1	Rear Main Seal Set	1995-91	BS 40629	Rubber; One-piece	
QTY	VALVE COVER	YEARS	PART NO.	DESCRIPTION	
1	Valve Cover Gasket Set	1995-91	VS 50393 R	w/Grommets; PermaDry® molded rubber gskts. incl.	
QTY	VALVE STEM SEAL SET	YEARS	PART NO.	DESCRIPTION	
1	Valve Stem Seal Set	1995-94	SS 72826	Premium valve stem seals incl.	
1	Valve Stem Seal Set	1993-91	SS 72809	Premium valve stem seals incl.	
QTY	THERMOSTAT HOUSING	YEARS	PART NO.	DESCRIPTION	
1	Thermostat Gasket	1995-91	35445	Thermostat Housing; Thermostat inlet	
QTY	WATER OUTLET GASKET	YEARS	PART NO.	DESCRIPTION	
1	Water Outlet Gasket	1995-91	35500	Water Outlet	
QTY	WATER PUMP	YEARS	PART NO.	DESCRIPTION	
1	Water Pump Gasket	1995-91	35294		
QTY	TIMING COVER	YEARS	PART NO.	DESCRIPTION	
1	Crankshaft Front Seal Set	1995-91	TCS 45900		
1	Camshaft Front Seal Set	1995-91	TCS 45424		
QTY	CARB & FUEL INJECTION	YEARS	PART NO.	DESCRIPTION	
1	Throttle Body Gasket	1995-91	60916		
QTY	OIL PUMP COVER	YEARS	PART NO.	DESCRIPTION	
1	Oil Pump Gasket	1995-91	72518	Oil pump O-ring; New Part Number - Check for Availability	
1	Oil Pump Gasket	1995-91	72663	Oil pump cover; New Part Number - Check for Availability	
15		2001 - 1991; 2.2L 132 (2164cc) DOHC L4 (16 Valve) 87mm Bore			15
		MFI; Gasoline; Naturally Aspirated Toyota Eng.; Eng. Code 5SFE			
QTY	CYLINDER HEAD	YEARS	PART NO.	DESCRIPTION	
1	Head Gasket	2001-98	9468 PT	Head bolts not incl.; Head bolt replacement recommended; PermaTorqueMLS® LaserWeld® Technology	
1	Head Gasket	1997	9468 PT	From 12/01/96; Head bolts not incl.; Head bolt replacement recommended; PermaTorqueMLS® LaserWeld® Technology	
1	Head Gasket	1997	9861 PT	To 12/01/96; Head bolts not incl.; Head bolt replacement recommended	
1	Head Gasket	1996-91	9861 PT	Head bolts not incl.; Head bolt replacement recommended	
1	Head Set	2001-98	HS 9468 PT	Head bolts not incl.; Head bolt replacement recommended; PermaDry® molded rubber valve cover gskt. incl.; Premium valve stem seals incl.	

Toyota Car (Incl. Lexus, Scion, Toyota) (Cont.)

15 (cont.)		2001 - 1991; 2.2L 132 (2164cc) DOHC L4 (16 Valve) 87mm Bore			15 (cont.)
MFI; Gasoline; Naturally Aspirated Toyota Eng.; Eng. Code 5SFE					
QTY	CYLINDER HEAD	YEARS	PART NO.	DESCRIPTION	
1	Head Set	1997	HS 9468 PT	From 12/01/96; Head bolts not incl.; Head bolt replacement recommended; PermaDry® molded rubber valve cover gskt. incl.; Premium valve stem seals incl.	
1	Head Set	1997	HS 9861 PT	To 12/01/96; Head bolts not incl.; Head bolt replacement recommended; PermaDry® molded rubber valve cover gskt. incl.; Premium valve stem seals incl.; Consolidated design	
1	Head Set	1996-91	HS 9861 PT	Head bolts not incl.; Head bolt replacement recommended; PermaDry® molded rubber valve cover gskt. incl.; Premium valve stem seals incl.; Consolidated design	
1	Head Bolt Set	2001-91	ES 72154	Head bolts w/Washers; Replacement recommended	
1	Head Bolt Washer Set	2001-91	ES 72183	Replacement recommended	
QTY	CONVERSION SET	YEARS	PART NO.	DESCRIPTION	
1	Gasket Conversion Set	2001-91	CS 9861		
QTY	MANIFOLD - INT. & EXH.	YEARS	PART NO.	DESCRIPTION	
1	Int. Manifold Gasket Set	2001-91	MS 93550-1		
1	Exh. Manifold Gasket Set	2001-91	MS 94976		
QTY	EXHAUST PIPE FLANGE	YEARS	PART NO.	DESCRIPTION	
1	Exhaust Pipe Gasket	2001-91	23626	Pipe to manifold	
1	Exhaust Pipe Gasket	2001-96	23591	Pipe to muffler; 1 31/32" ID x 2 35/64" OD	
1	Exhaust Pipe Gasket	2001-00	61088	Converter to manifold	
1	Exhaust Pipe Gasket	2000	60906	Converter	
1	Exhaust Pipe Gasket	1999-95	23591	Toyota Celica GT; Loc. Rear; Converter; 1 31/32" ID x 2 35/64" OD	
1	Exhaust Pipe Gasket	1999-95	60908	Toyota Celica GT; Loc. Front; Converter	
1	Exhaust Pipe Gasket	1999-97	60906	Exc. Toyota Celica GT; Converter	
1	Exhaust Pipe Gasket	1999-97	61088	Exc. Toyota Celica GT; Converter to manifold	
1	Exhaust Pipe Gasket	1996	23591	Exc. Toyota Celica GT; Converter; 1 31/32" ID x 2 35/64" OD	
1	Exhaust Pipe Gasket	1995-91	23591	Exc. Toyota MR2 Base; Pipe to muffler; 1 31/32" ID x 2 35/64" OD	
1	Exhaust Pipe Gasket	1995-91	60572	Toyota MR2 Base; Converter; 2.165" ID	
1	Exhaust Pipe Gasket	1995-94	23591	Toyota Camry Base, DX, LE, XLE; Converter; 1 31/32" ID x 2 35/64" OD	
1	Exhaust Pipe Gasket	1994	23591	Toyota Celica GT; Converter; Exc. California; 1 31/32" ID x 2 35/64" OD	
1	Exhaust Pipe Gasket	1994	23591	Toyota Celica GT; Loc. Rear; Converter; California; 1 31/32" ID x 2 35/64" OD	
1	Exhaust Pipe Gasket	1994	60908	Toyota Celica GT; Loc. Front; Converter; California	
1	Exhaust Pipe Gasket	1993-92	23591	Toyota Celica GT, GT-S, GT-S Sport; Converter; 1 31/32" ID x 2 35/64" OD	
1	Exhaust Pipe Gasket	1993	23591	Toyota Camry Base, DX, LE, XLE; Converter; California; 1 31/32" ID x 2 35/64" OD	
1	Exhaust Pipe Gasket	1993	60461	Toyota Camry Base, DX, LE, XLE; Loc. Front; Converter; Exc. California	
1	Exhaust Pipe Gasket	1993	60512	Toyota Camry Base, DX, LE, XLE; Loc. Rear; Converter; Exc. California; Improved design	
1	Exhaust Pipe Gasket	1992	23591	Toyota Camry Base, DLX, LE, XLE; Converter; California; 1 31/32" ID x 2 35/64" OD	
1	Exhaust Pipe Gasket	1992	60461	Toyota Camry Base, DLX, LE, XLE; Loc. Front; Converter; Exc. California	
1	Exhaust Pipe Gasket	1992	60512	Toyota Camry Base, DLX, LE, XLE; Loc. Rear; Converter; Exc. California; Improved design	
1	Exhaust Pipe Gasket	1991	23591	Exc. Toyota MR2 Base; Converter; 1 31/32" ID x 2 35/64" OD	
QTY	OIL PAN	YEARS	PART NO.	DESCRIPTION	
1	Oil Pan Gasket Set	2001-91	OS 30468 C		
1	Drain Plug Gasket	2001-91	70822		
QTY	CRANKSHAFT REAR SEAL	YEARS	PART NO.	DESCRIPTION	
1	Rear Main Seal Set	2001-91	BS 40427	Rubber; One-piece; Improved design	
1	Repair Sleeve	2001-91	16278	Crankshaft; Use w/installation tool	
QTY	VALVE COVER	YEARS	PART NO.	DESCRIPTION	
1	Valve Cover Gasket Set	2001-91	VS 50304 R	w/o Spark plug tube seals; PermaDry® molded rubber gskt. incl.	
1	Valve Cover Gasket Set	2001-91	VS 50304 R-1	w/Spark plug tube seals; PermaDry® molded rubber gskt. incl.	
1	Spark Plug Tube Seal Set	2001-91	ES 70739	Valve Cover	
QTY	VALVE STEM SEAL SET	YEARS	PART NO.	DESCRIPTION	
1	Valve Stem Seal Set	2001-91	SS 72810	Premium valve stem seals incl.	
QTY	THERMOSTAT HOUSING	YEARS	PART NO.	DESCRIPTION	
1	Thermostat Gasket	1995-92	35445	Toyota MR2 Base; Thermostat Housing; Thermostat inlet	
1	Thermostat Gasket	1991	35445	Thermostat Housing; Thermostat inlet	
1	O-Ring	2001-96	35292	Thermostat Housing; Thermostat inlet	
1	O-Ring	1995-92	35292	Exc. Toyota MR2 Base; Thermostat Housing; Thermostat inlet	
QTY	WATER OUTLET GASKET	YEARS	PART NO.	DESCRIPTION	
1	Water Outlet Gasket	2001-00	35645	Water Outlet	

Toyota Car (Incl. Lexus, Scion, Toyota) (Cont.)

15 (cont.)		2001 - 1991; 2.2L 132 (2164cc) DOHC L4 (16 Valve) 87mm Bore			15 (cont.)
MFI; Gasoline; Naturally Aspirated Toyota Eng.; Eng. Code 5SFE					
QTY	WATER OUTLET GASKET	YEARS	PART NO.	DESCRIPTION	
1	Water Outlet Gasket	1999-97	35488	Toyota Celica GT; Water Outlet	
1	Water Outlet Gasket	1999-97	35645	Exc. Toyota Celica GT; Water Outlet	
1	Water Outlet Gasket	1996-91	35488	Water Outlet	
QTY	WATER PUMP	YEARS	PART NO.	DESCRIPTION	
1	Water Pump Gasket	2001-91	35294		
QTY	TIMING COVER	YEARS	PART NO.	DESCRIPTION	
1	Crankshaft Front Seal Set	2001-99	TCS 45920	Exc. Toyota Solara SE	
1	Crankshaft Front Seal Set	2001-99	TCS 46004	Toyota Solara SE	
1	Crankshaft Front Seal Set	1998-91	TCS 45920		
1	Camshaft Front Seal Set	2001-91	TCS 45641		
1	Repair Sleeve	2001-91	16227	Timing Cover; Use w/installation tool	
1	Repair Sleeve Tool	2001-91	16327	Timing Cover	
QTY	CARB & FUEL INJECTION	YEARS	PART NO.	DESCRIPTION	
1	Fuel Injector O-Ring Set	2001-91	ES 70600		
1	Throttle Body Gasket	2001-00	61083	Throttle body	
1	Throttle Body Gasket	2001-00	61084	Idle air control; California	
1	Throttle Body Gasket	2001-00	61085	Idle air control; Exc. California	
1	Throttle Body Gasket	1999-96	61084	Exc. Toyota Celica GT; Idle air control; California	
1	Throttle Body Gasket	1999-96	61085	Exc. Toyota Celica GT; Idle air control; Exc. California	
1	Throttle Body Gasket	1999-97	60687	Toyota Celica GT; Throttle body	
1	Throttle Body Gasket	1999-97	61083	Exc. Toyota Celica GT; Throttle body	
1	Throttle Body Gasket	1996-91	60687	Throttle body	
QTY	DISTRIBUTOR MOUNTING	YEARS	PART NO.	DESCRIPTION	
1	Distributor Mounting Gasket	2001-91	72438	O-ring	
QTY	EXHAUST GAS RECIRCULATION	YEARS	PART NO.	DESCRIPTION	
1	EGR Gasket	2001-91	72610		
QTY	OIL PUMP COVER	YEARS	PART NO.	DESCRIPTION	
1	Oil Pump Gasket	2001-91	72518	Oil pump O-ring; New Part Number - Check for Availability	
1	Oil Pump Gasket	2001-91	72663	Oil pump cover; New Part Number - Check for Availability	
1	Oil Pump Gasket	2001-91	ES 72499	Mounting set; New Part Number - Check for Availability	
16		2001 - 2000; 2.2L 132 (2164cc) DOHC L4 (16 Valve) 87mm Bore			16
MFI; Natural Gas; Naturally Aspirated Toyota Eng.; Eng. Code 5SNFE					
QTY	CYLINDER HEAD	YEARS	PART NO.	DESCRIPTION	
1	Head Gasket	2001-00	9468 PT	Head bolts not incl.; Head bolt replacement recommended; PermaTorqueMLS® LaserWeld® Technology	
1	Head Set	2001-00	HS 9468 PT	Head bolts not incl.; Head bolt replacement recommended; PermaDry® molded rubber valve cover gskt. incl.; Premium valve stem seals incl.	
1	Head Bolt Set	2001-00	ES 72154	Head bolts w/Washers; Replacement recommended	
1	Head Bolt Washer Set	2001-00	ES 72183	Replacement recommended	
QTY	CONVERSION SET	YEARS	PART NO.	DESCRIPTION	
1	Gasket Conversion Set	2001-00	CS 9861		
QTY	MANIFOLD - INT. & EXH.	YEARS	PART NO.	DESCRIPTION	
1	Int. Manifold Gasket Set	2001-00	MS 93550-1		
1	Exh. Manifold Gasket Set	2001-00	MS 94976		
QTY	EXHAUST PIPE FLANGE	YEARS	PART NO.	DESCRIPTION	
1	Exhaust Pipe Gasket	2001-00	23591	Pipe to muffler; 1 31/32" ID x 2 35/64" OD	
1	Exhaust Pipe Gasket	2001-00	23626	Pipe to manifold	
1	Exhaust Pipe Gasket	2001-00	61088	Converter to manifold	
1	Exhaust Pipe Gasket	2000	60906	Converter	
QTY	OIL PAN	YEARS	PART NO.	DESCRIPTION	
1	Oil Pan Gasket Set	2001-00	OS 30468 C		
1	Drain Plug Gasket	2001-00	70822		
QTY	CRANKSHAFT REAR SEAL	YEARS	PART NO.	DESCRIPTION	
1	Rear Main Seal Set	2001-00	BS 40427	Rubber; One-piece; Improved design	
1	Repair Sleeve	2001-00	16278	Crankshaft; Use w/installation tool	
QTY	VALVE COVER	YEARS	PART NO.	DESCRIPTION	
1	Valve Cover Gasket Set	2001-00	VS 50304 R	w/o Spark plug tube seals; PermaDry® molded rubber gskt. incl.	
1	Valve Cover Gasket Set	2001-00	VS 50304 R-1	w/Spark plug tube seals; PermaDry® molded rubber gskt. incl.	
1	Spark Plug Tube Seal Set	2001-00	ES 70739	Valve Cover	
QTY	VALVE STEM SEAL SET	YEARS	PART NO.	DESCRIPTION	
1	Valve Stem Seal Set	2001-00	SS 72810	Premium valve stem seals incl.	
QTY	THERMOSTAT HOUSING	YEARS	PART NO.	DESCRIPTION	
1	O-Ring	2001-00	35292	Thermostat Housing; Thermostat inlet	

Toyota Car (Incl. Lexus, Scion, Toyota) (Cont.)

16 (cont.)		2001 - 2000; 2.2L 132 (2164cc) DOHC L4 (16 Valve) 87mm Bore			16 (cont.)
MFI; Natural Gas; Naturally Aspirated Toyota Eng.; Eng. Code 5SNFE					
QTY	WATER OUTLET GASKET	YEARS	PART NO.	DESCRIPTION	
1	Water Outlet Gasket	2001-00	35645	Water Outlet	
QTY	WATER PUMP	YEARS	PART NO.	DESCRIPTION	
1	Water Pump Gasket	2001-00	35294		
QTY	TIMING COVER	YEARS	PART NO.	DESCRIPTION	
1	Crankshaft Front Seal Set	2001-00	TCS 45920		
1	Camshaft Front Seal Set	2001-00	TCS 45641		
1	Repair Sleeve	2001-00	16227	Timing Cover; Use w/installation tool	
1	Repair Sleeve Tool	2001-00	16327	Timing Cover	
QTY	CARB & FUEL INJECTION	YEARS	PART NO.	DESCRIPTION	
1	Fuel Injector O-Ring Set	2001-00	ES 70600		
1	Throttle Body Gasket	2001-00	61083	Throttle body	
1	Throttle Body Gasket	2001-00	61084	Idle air control; California	
1	Throttle Body Gasket	2001-00	61085	Idle air control; Exc. California	
QTY	DISTRIBUTOR MOUNTING	YEARS	PART NO.	DESCRIPTION	
1	Distributor Mounting Gasket	2001-00	72438	O-ring	
QTY	EXHAUST GAS RECIRCULATION	YEARS	PART NO.	DESCRIPTION	
1	EGR Gasket	2001-00	72610		
QTY	OIL PUMP COVER	YEARS	PART NO.	DESCRIPTION	
1	Oil Pump Gasket	2001-00	72518	Oil pump O-ring; New Part Number - Check for Availability	
1	Oil Pump Gasket	2001-00	72663	Oil pump cover; New Part Number - Check for Availability	
1	Oil Pump Gasket	2001-00	ES 72499	Mounting set; New Part Number - Check for Availability	
17		2013 - 2002; 2.4L 144 (2362cc) DOHC L4 (16 Valve) 88.5mm Bore VVT-i			17
MFI; Gasoline; Naturally Aspirated Toyota Eng.; Eng. Code 2AZFE					
QTY	CYLINDER HEAD	YEARS	PART NO.	DESCRIPTION	
1	Head Gasket	2013-02	26323 PT	Head bolts not incl.; Head bolt replacement recommended; PermaTorqueMLS® LaserWeld® Technology; Improved design	
1	Head Gasket	2006-02	26232 PT	Head bolts not incl.; Head bolt replacement recommended; PermaTorqueMLS®; Old design	
1	Head Set	2013-10	HS 26323 PT	Head bolts not incl.; Head bolt replacement recommended; Must be used w/TCS 46020 & w/OS 30713; PermaDry® molded rubber valve cover gskt. incl.; Premium valve stem seals incl.; Improved design	
1	Head Set	2009-07	HS 26323 PT	Toyota Camry CE, LE, SE, XLE; California; Int. manifold gskt. & head bolts not incl.; Head bolt replacement recommended; Must be used w/TCS 46020 & w/OS 30713; PermaDry® molded rubber valve cover gskt. incl.; Premium valve stem seals incl.; Improved design	
1	Head Set	2009-07	HS 26323 PT	Toyota Camry CE, LE, SE, XLE; Exc. California; Head bolts not incl.; Head bolt replacement recommended; Must be used w/TCS 46020 & w/OS 30713; PermaDry® molded rubber valve cover gskt. incl.; Premium valve stem seals incl.; Improved design	
1	Head Set	2009-07	HS 26323 PT	Exc. Toyota Camry CE, LE, SE, XLE; Head bolts not incl.; Head bolt replacement recommended; Must be used w/TCS 46020 & w/OS 30713; PermaDry® molded rubber valve cover gskt. incl.; Premium valve stem seals incl.; Improved design	
1	Head Set	2006-05	HS 26232 PT	Toyota Camry Base, LE, SE, XLE; California; Int. manifold gskt. & head bolts not incl.; Head bolt replacement recommended; Must be used w/TCS 46020 & w/OS 30713; PermaDry® molded rubber valve cover gskt. incl.; Premium valve stem seals incl.; Old design	
1	Head Set	2006-05	HS 26232 PT	Toyota Camry Base, LE, SE, XLE; Exc. California; Head bolts not incl.; Head bolt replacement recommended; Must be used w/TCS 46020 & w/OS 30713; PermaDry® molded rubber valve cover gskt. incl.; Premium valve stem seals incl.; Old design	
1	Head Set	2006-05	HS 26232 PT	Exc. Toyota Camry Base, LE, SE, XLE; Head bolts not incl.; Head bolt replacement recommended; Must be used w/TCS 46020 & w/OS 30713; PermaDry® molded rubber valve cover gskt. incl.; Premium valve stem seals incl.; Old design	
1	Head Set	2006-05	HS 26323 PT	Exc. Toyota Solara SE, SE Sport, SLE; California; Int. manifold gskt. & head bolts not incl.; Head bolt replacement recommended; Must be used w/TCS 46020 & w/OS 30713; PermaDry® molded rubber valve cover gskt. incl.; Premium valve stem seals incl.; Improved design	
1	Head Set	2006-05	HS 26323 PT	Exc. Toyota Solara SE, SE Sport, SLE; Exc. California; Head bolts not incl.; Head bolt replacement recommended; Must be used w/TCS 46020 & w/OS 30713; PermaDry® molded rubber valve cover gskt. incl.; Premium valve stem seals incl.; Improved design	

Toyota Car (Incl. Lexus, Scion, Toyota) (Cont.)

17 (cont.)	2013 - 2002; 2.4L 144 (2362cc) DOHC L4 (16 Valve) 88.5mm Bore VVT-i MFI; Gasoline; Naturally Aspirated Toyota Eng.; Eng. Code 2AZFE				17 (cont.)
QTY	CYLINDER HEAD	YEARS	PART NO.	DESCRIPTION	
1	Head Set	2006-05	HS 26323 PT	Toyota Solara SE, SE Sport, SLE; Head bolts not incl.; Head bolt replacement recommended; Must be used w/TCS 46020 & w/OS 30713; PermaDry® molded rubber valve cover gskt. incl.; Premium valve stem seals incl.; Improved design	
1	Head Set	2004	HS 26232 PT	Toyota Camry LE, SE, XLE; California; Int. manifold gskt. & head bolts not incl.; Head bolt replacement recommended; Must be used w/TCS 46020 & w/OS 30713; PermaDry® molded rubber valve cover gskt. incl.; Premium valve stem seals incl.; Old design	
1	Head Set	2004	HS 26232 PT	Toyota Camry LE, SE, XLE; Exc. California; Head bolts not incl.; Head bolt replacement recommended; Must be used w/TCS 46020 & w/OS 30713; PermaDry® molded rubber valve cover gskt. incl.; Premium valve stem seals incl.; Old design	
1	Head Set	2004	HS 26232 PT	Exc. Toyota Camry LE, SE, XLE; Head bolts not incl.; Head bolt replacement recommended; Must be used w/TCS 46020 & w/OS 30713; PermaDry® molded rubber valve cover gskt. incl.; Premium valve stem seals incl.; Old design	
1	Head Set	2004	HS 26323 PT	Toyota Camry LE, SE, XLE; California; Int. manifold gskt. & head bolts not incl.; Head bolt replacement recommended; Must be used w/TCS 46020 & w/OS 30713; PermaDry® molded rubber valve cover gskt. incl.; Premium valve stem seals incl.; Improved design	
1	Head Set	2004	HS 26323 PT	Toyota Camry LE, SE, XLE; Exc. California; Head bolts not incl.; Head bolt replacement recommended; Must be used w/TCS 46020 & w/OS 30713; PermaDry® molded rubber valve cover gskt. incl.; Premium valve stem seals incl.; Improved design	
1	Head Set	2004	HS 26323 PT	Exc. Toyota Camry LE, SE, XLE; Head bolts not incl.; Head bolt replacement recommended; Must be used w/TCS 46020 & w/OS 30713; PermaDry® molded rubber valve cover gskt. incl.; Premium valve stem seals incl.; Improved design	
1	Head Set	2003	HS 26232 PT	Exc. Toyota Solara SE; California; Int. manifold gskt. & head bolts not incl.; Head bolt replacement recommended; Must be used w/TCS 46020 & w/OS 30713; PermaDry® molded rubber valve cover gskt. incl.; Premium valve stem seals incl.; Old design	
1	Head Set	2003	HS 26232 PT	Exc. Toyota Solara SE; Exc. California; Head bolts not incl.; Head bolt replacement recommended; Must be used w/TCS 46020 & w/OS 30713; PermaDry® molded rubber valve cover gskt. incl.; Premium valve stem seals incl.; Old design	
1	Head Set	2003	HS 26232 PT	Toyota Solara SE; Head bolts not incl.; Head bolt replacement recommended; Must be used w/TCS 46020 & w/OS 30713; PermaDry® molded rubber valve cover gskt. incl.; Premium valve stem seals incl.; Old design	
1	Head Set	2003	HS 26323 PT	Exc. Toyota Solara SE; California; Int. manifold gskt. & head bolts not incl.; Head bolt replacement recommended; Must be used w/TCS 46020 & w/OS 30713; PermaDry® molded rubber valve cover gskt. incl.; Premium valve stem seals incl.; Improved design	
1	Head Set	2003	HS 26323 PT	Exc. Toyota Solara SE; Exc. California; Head bolts not incl.; Head bolt replacement recommended; Must be used w/TCS 46020 & w/OS 30713; PermaDry® molded rubber valve cover gskt. incl.; Premium valve stem seals incl.; Improved design	
1	Head Set	2003	HS 26323 PT	Toyota Solara SE; Head bolts not incl.; Head bolt replacement recommended; Must be used w/TCS 46020 & w/OS 30713; PermaDry® molded rubber valve cover gskt. incl.; Premium valve stem seals incl.; Improved design	
1	Head Set	2002	HS 26232 PT	Head bolts not incl.; Head bolt replacement recommended; Must be used w/TCS 46020 & w/OS 30713; PermaDry® molded rubber valve cover gskt. incl.; Premium valve stem seals incl.; Old design	
1	Head Set	2002	HS 26323 PT	Head bolts not incl.; Head bolt replacement recommended; Must be used w/TCS 46020 & w/OS 30713; PermaDry® molded rubber valve cover gskt. incl.; Premium valve stem seals incl.; Improved design	
1	Head Bolt Set	2013-07	ES 72249-2	Head bolts w/Washers; Replacement recommended	
1	Head Bolt Set	2006-02	ES 71183	Head bolts w/Washers; Replacement recommended	
1	Head Bolt Washer Set	2013-02	ES 72899	Replacement recommended	
QTY	CONVERSION SET	YEARS	PART NO.	DESCRIPTION	
1	Gasket Conversion Set	2013-02	CS 26232	RTV sealant incl. for oil pan gskt.; RTV sealant incl. for water pump gskt.	
QTY	MANIFOLD - INT. & EXH.	YEARS	PART NO.	DESCRIPTION	
1	Int. Manifold Gasket Set	2013-10	MS 94295	Consolidated design	

Toyota Car (Incl. Lexus, Scion, Toyota) (Cont.)

17 (cont.)		2013 - 2002; 2.4L 144 (2362cc) DOHC L4 (16 Valve) 88.5mm Bore VVT-i MFI; Gasoline; Naturally Aspirated Toyota Eng.; Eng. Code 2AZFE			17 (cont.)
QTY	MANIFOLD - INT. & EXH.	YEARS	PART NO.	DESCRIPTION	
1	Int. Manifold Gasket Set	2009-07	MS 94295	Exc. Toyota Camry CE, LE, SE, XLE; Consolidated design	
1	Int. Manifold Gasket Set	2009-07	MS 94295	Toyota Camry CE, LE, SE, XLE; Exc. California; Consolidated design	
1	Int. Manifold Gasket Set	2009-07	MS 96438	Toyota Camry CE, LE, SE, XLE; California; Upper set incl.	
1	Int. Manifold Gasket Set	2006-05	MS 94295	Exc. Toyota Camry Base, LE, SE, XLE; Consolidated design	
1	Int. Manifold Gasket Set	2006-05	MS 94295	Toyota Camry Base, LE, SE, XLE; Exc. California; Consolidated design	
1	Int. Manifold Gasket Set	2006-05	MS 96438	Toyota Camry Base, LE, SE, XLE; California; Upper set incl.	
1	Int. Manifold Gasket Set	2004	MS 94295	Exc. Toyota Camry LE, SE, XLE; Consolidated design	
1	Int. Manifold Gasket Set	2004	MS 94295	Toyota Camry LE, SE, XLE; Exc. California; Consolidated design	
1	Int. Manifold Gasket Set	2004	MS 96438	Toyota Camry LE, SE, XLE; California; Upper set incl.	
1	Int. Manifold Gasket Set	2003	MS 94295	Toyota Solara SE; Consolidated design	
1	Int. Manifold Gasket Set	2003	MS 94295	Exc. Toyota Solara SE; Exc. California; Consolidated design	
1	Int. Manifold Gasket Set	2003	MS 96438	Exc. Toyota Solara SE; California; Upper set incl.	
1	Int. Manifold Gasket Set	2002	MS 94295	Consolidated design	
1	Exh. Manifold Gasket Set	2013-02	MS 94140-1		
QTY	EXHAUST PIPE FLANGE	YEARS	PART NO.	DESCRIPTION	
1	Exhaust Pipe Gasket	2013-10	60906	Converter	
1	Exhaust Pipe Gasket	2013-10	61601	Flange	
1	Exhaust Pipe Gasket	2013	61106	Scion xB Base, RS 10, RS 9.0; Pipe to manifold; 2.40" ID	
1	Exhaust Pipe Gasket	2013	61603	Scion xB Base, RS 10, RS 9.0; Exh. connector	
1	Exhaust Pipe Gasket	2012	61106	Scion xB Base, RS 9.0; Pipe to manifold; 2.40" ID	
1	Exhaust Pipe Gasket	2012	61603	Scion xB Base, RS 9.0; Exh. connector	
1	Exhaust Pipe Gasket	2011	61106	Scion xB Base; Pipe to manifold; 2.40" ID	
1	Exhaust Pipe Gasket	2011	61603	Scion xB Base; Exh. connector	
1	Exhaust Pipe Gasket	2010	61106	Scion tC Base, RS 5.0, xB Base; Pipe to manifold; 2.40" ID	
1	Exhaust Pipe Gasket	2010	61603	Scion tC Base, RS 5.0, xB Base; Exh. connector	
1	Exhaust Pipe Gasket	2009-02	60495	Flange	
1	Exhaust Pipe Gasket	2009-02	61459	Converter	
1	Exhaust Pipe Gasket	2009-08	23591	Toyota Camry CE, LE, SE, XLE; Converter; 1 31/32" ID x 2 35/64" OD	
1	Exhaust Pipe Gasket	2009-08	61039	Toyota Solara SE, SE Sport, SLE, Sport; Loc. Rear; Exh. connector; Exc. California	
1	Exhaust Pipe Gasket	2009-08	61598	Toyota Camry CE, LE, SE, XLE; Loc. Rear; Exh. connector	
1	Exhaust Pipe Gasket	2009-08	61601	Toyota Camry CE, LE, SE, XLE; Loc. Front; Exh. connector	
1	Exhaust Pipe Gasket	2009	60906	Toyota Camry CE, LE, SE, XLE, Solara SE, SE Sport, SLE, Sport; Loc. Center; Exh. connector	
1	Exhaust Pipe Gasket	2009	61106	Scion tC Base, xB Base; Pipe to manifold; 2.40" ID	
1	Exhaust Pipe Gasket	2009	61603	Scion tC Base, xB Base; Exh. connector	
1	Exhaust Pipe Gasket	2008	60906	Exc. Scion tC Base, Spec Package, xB Base; Loc. Center; Exh. connector	
1	Exhaust Pipe Gasket	2008	61106	Scion tC Base, Spec Package, xB Base; Pipe to manifold; 2.40" ID	
1	Exhaust Pipe Gasket	2008	61603	Scion tC Base, Spec Package, xB Base; Exh. connector	
1	Exhaust Pipe Gasket	2007	60906	Exc. Scion tC Base, Spec Package; Loc. Center; Exh. connector	
1	Exhaust Pipe Gasket	2007	60911	Toyota Camry CE, LE, SE, XLE; Loc. Rear; Exh. connector; California	
1	Exhaust Pipe Gasket	2007	61039	Toyota Solara SE, SE Sport, SLE, Sport; Loc. Rear; Exh. connector	
1	Exhaust Pipe Gasket	2007	61039	Toyota Camry CE, LE, SE, XLE; Loc. Rear; Exh. connector; Exc. California	
1	Exhaust Pipe Gasket	2007	61106	Scion tC Base, Spec Package; Pipe to manifold; 2.40" ID	
1	Exhaust Pipe Gasket	2007	61603	Scion tC Base, Spec Package; Exh. connector	
1	Exhaust Pipe Gasket	2006-05	60906	Exc. Scion tC Base; Loc. Center; Exh. connector	
1	Exhaust Pipe Gasket	2006-05	60911	Toyota Camry Base, LE, SE, XLE; Loc. Rear; Exh. connector; California	
1	Exhaust Pipe Gasket	2006-05	61039	Toyota Solara SE, SE Sport, SLE; Loc. Rear; Exh. connector	
1	Exhaust Pipe Gasket	2006-05	61039	Toyota Camry Base, LE, SE, XLE; Loc. Rear; Exh. connector; Exc. California	
1	Exhaust Pipe Gasket	2006-05	61106	Scion tC Base; Pipe to manifold; 2.40" ID	
1	Exhaust Pipe Gasket	2006-05	61603	Scion tC Base; Exh. connector	
1	Exhaust Pipe Gasket	2004-02	60906	Loc. Center; Exh. connector	
1	Exhaust Pipe Gasket	2004	60911	Toyota Camry LE, SE, XLE; Loc. Rear; Exh. connector; California	
1	Exhaust Pipe Gasket	2004	61039	Exc. Toyota Camry LE, SE, XLE; Loc. Rear; Exh. connector	
1	Exhaust Pipe Gasket	2004	61039	Toyota Camry LE, SE, XLE; Loc. Rear; Exh. connector; Exc. California	
1	Exhaust Pipe Gasket	2003-02	23591	Toyota Solara SE; Loc. Rear; Exh. connector; 1 31/32" ID x 2 35/64" OD	
1	Exhaust Pipe Gasket	2003-02	60911	Exc. Toyota Solara SE; Loc. Rear; Exh. connector; California	
1	Exhaust Pipe Gasket	2003-02	61039	Exc. Toyota Solara SE; Loc. Rear; Exh. connector; Exc. California	
QTY	OIL PAN	YEARS	PART NO.	DESCRIPTION	
1	Oil Pan Gasket Set	2013-02	OS 30713	RTV sealant incl. for oil pan gskt.	
1	Drain Plug Gasket	2013-02	70822		
QTY	CRANKSHAFT REAR SEAL	YEARS	PART NO.	DESCRIPTION	
1	Rear Main Seal Set	2013-02	BS 40629	Rubber; One-piece	
QTY	VALVE COVER	YEARS	PART NO.	DESCRIPTION	
1	Valve Cover Gasket Set	2013-02	VS 50530 R	PermaDry® molded rubber gskt. incl.	

Toyota Car (Incl. Lexus, Scion, Toyota) (Cont.)

17		2013 - 2002; 2.4L 144 (2362cc) DOHC L4 (16 Valve) 88.5mm Bore VVT-i			17
(cont.)		MFI; Gasoline; Naturally Aspirated Toyota Eng.; Eng. Code 2AZFE			(cont.)
QTY	VALVE STEM SEAL SET	YEARS	PART NO.	DESCRIPTION	
1	Valve Stem Seal Set	2013-02	SS 72878-1	Premium valve stem seals incl.	
QTY	THERMOSTAT HOUSING	YEARS	PART NO.	DESCRIPTION	
1	Thermostat Gasket	2013-02	35445	Thermostat Housing	
QTY	WATER OUTLET GASKET	YEARS	PART NO.	DESCRIPTION	
1	Water Outlet Gasket	2013-02	35729	Water Outlet; Heater return	
QTY	TIMING COVER	YEARS	PART NO.	DESCRIPTION	
1	Crankshaft Front Seal Set	2013-02	TCS 46020		
QTY	CARB & FUEL INJECTION	YEARS	PART NO.	DESCRIPTION	
1	Throttle Body Gasket	2013-06	61421		
1	Throttle Body Gasket	2005-02	61173		
18		2012 - 2007; 2.4L 144 (2362cc) DOHC L4 (16 Valve) 88.5mm Bore VVT-i			18
		MFI; Hybrid (Gas/Electric); Naturally Aspirated Toyota Eng.; Eng. Code 2AZFXE			
QTY	CYLINDER HEAD	YEARS	PART NO.	DESCRIPTION	
1	Head Gasket	2012-07	26323 PT	Head bolts not incl.; Head bolt replacement recommended; PermaTorqueMLS® LaserWeld® Technology; Improved design	
1	Head Set	2012-07	HS 26323 PT	California; Int. manifold gskt. & head bolts not incl.; Head bolt replacement recommended; Must be used w/TCS 46020 & w/OS 30713; PermaDry® molded rubber valve cover gskt. incl.; Premium valve stem seals incl.; Improved design	
1	Head Set	2012-07	HS 26323 PT	Exc. California; Head bolts not incl.; Head bolt replacement recommended; Must be used w/TCS 46020 & w/OS 30713; PermaDry® molded rubber valve cover gskt. incl.; Premium valve stem seals incl.; Improved design	
1	Head Bolt Set	2012-07	ES 72249-2	Head bolts w/Washers; Replacement recommended	
1	Head Bolt Washer Set	2012-07	ES 72899	Replacement recommended	
QTY	CONVERSION SET	YEARS	PART NO.	DESCRIPTION	
1	Gasket Conversion Set	2012-07	CS 26232	RTV sealant incl. for oil pan gskt.; RTV sealant incl. for water pump gskt.	
QTY	MANIFOLD - INT. & EXH.	YEARS	PART NO.	DESCRIPTION	
1	Int. Manifold Gasket Set	2012-07	MS 94295	Exc. California; Consolidated design	
1	Int. Manifold Gasket Set	2012-07	MS 96438	California; Upper set incl.	
1	Exh. Manifold Gasket Set	2012-07	MS 94140-1		
QTY	EXHAUST PIPE FLANGE	YEARS	PART NO.	DESCRIPTION	
1	Exhaust Pipe Gasket	2012-07	23591	Converter; 1 31/32" ID x 2 35/64" OD	
1	Exhaust Pipe Gasket	2012-07	60495	Flange	
1	Exhaust Pipe Gasket	2012-07	60906	Loc. Center; Exh. connector	
1	Exhaust Pipe Gasket	2012-07	61459	Converter	
1	Exhaust Pipe Gasket	2012-07	61601	Loc. Front; Exh. connector	
1	Exhaust Pipe Gasket	2012-08	61598	Loc. Rear; Exh. connector	
1	Exhaust Pipe Gasket	2007	60911	Loc. Rear; Exh. connector; California	
1	Exhaust Pipe Gasket	2007	61039	Loc. Rear; Exh. connector; Exc. California	
QTY	OIL PAN	YEARS	PART NO.	DESCRIPTION	
1	Oil Pan Gasket Set	2012-07	OS 30713	RTV sealant incl. for oil pan gskt.	
1	Drain Plug Gasket	2012-07	70822		
QTY	CRANKSHAFT REAR SEAL	YEARS	PART NO.	DESCRIPTION	
1	Rear Main Seal Set	2012-07	BS 40629	Rubber; One-piece	
QTY	VALVE COVER	YEARS	PART NO.	DESCRIPTION	
1	Valve Cover Gasket Set	2012-07	VS 50530 R	PermaDry® molded rubber gskt. incl.	
QTY	VALVE STEM SEAL SET	YEARS	PART NO.	DESCRIPTION	
1	Valve Stem Seal Set	2012-07	SS 72878-1	Premium valve stem seals incl.	
QTY	THERMOSTAT HOUSING	YEARS	PART NO.	DESCRIPTION	
1	Thermostat Gasket	2012-07	35445	Thermostat Housing	
QTY	WATER OUTLET GASKET	YEARS	PART NO.	DESCRIPTION	
1	Water Outlet Gasket	2012-07	35729	Water Outlet; Heater return	
QTY	TIMING COVER	YEARS	PART NO.	DESCRIPTION	
1	Crankshaft Front Seal Set	2012-07	TCS 46020		
QTY	CARB & FUEL INJECTION	YEARS	PART NO.	DESCRIPTION	
1	Throttle Body Gasket	2012-07	61421		
19		2013 - 2010; 2.5L 152.2 (2494cc) DOHC L4 (16 Valve) 90mm Bore VVT-i			19
		MFI; Gasoline; Naturally Aspirated Toyota Eng.; Eng. Code 2ARFE			
QTY	CYLINDER HEAD	YEARS	PART NO.	DESCRIPTION	
1	Head Gasket	2013-10	26562 PT	Head bolts not incl.; Head bolt replacement recommended; PermaTorqueMLS®; New Part Number - Check for Availability	

Toyota Car (Incl. Lexus, Scion, Toyota) (Cont.)

19		2013 - 2010; 2.5L 152.2 (2494cc) DOHC L4 (16 Valve) 90mm Bore VVT-i			19	
(cont.)		MFI; Gasoline; Naturally Aspirated Toyota Eng.; Eng. Code 2ARFE			(cont.)	
QTY	CONVERSION SET	YEARS	PART NO.	DESCRIPTION		
1	Gasket Conversion Set	2013-10	CS 26562	New Part Number - Check for Availability		
QTY	MANIFOLD - INT. & EXH.	YEARS	PART NO.	DESCRIPTION		
1	Int. Manifold Gasket Set	2013-10	MS 97232	New Part Number - Check for Availability		
1	Exh. Manifold Gasket Set	2013-10	MS 97234	New Part Number - Check for Availability		
QTY	EXHAUST PIPE FLANGE	YEARS	PART NO.	DESCRIPTION		
1	Exhaust Pipe Gasket	2013-10	61716	Pipe to manifold; New Part Number - Check for Availability		
QTY	OIL PAN	YEARS	PART NO.	DESCRIPTION		
1	Oil Pan Gasket Set	2013-10	OS 30842	New Part Number - Check for Availability		
1	Drain Plug Gasket	2013-10	70822			
QTY	CRANKSHAFT REAR SEAL	YEARS	PART NO.	DESCRIPTION		
1	Rear Main Seal Set	2013-10	BS 40741	Rubber; One-piece; New Part Number - Check for Availability		
QTY	WATER PUMP	YEARS	PART NO.	DESCRIPTION		
1	Water Pump Gasket	2013-10	36011	Pump to block; New Part Number - Check for Availability		
1	Water Pump Gasket	2013-10	36013	Pump to housing; New Part Number - Check for Availability		
QTY	TIMING COVER	YEARS	PART NO.	DESCRIPTION		
1	Crankshaft Front Seal Set	2013-10	TCS 46168	New Part Number - Check for Availability		
20		2013 - 2012; 2.5L 152.2 (2494cc) DOHC L4 (16 Valve) 90mm Bore VVT-i			20	
		MFI; Hybrid (Gas/Electric); Naturally Aspirated Toyota Eng.; Eng. Code 2ARFXE				
QTY	CYLINDER HEAD	YEARS	PART NO.	DESCRIPTION		
1	Head Gasket	2013-12	26667 PT	Head bolts not incl.; Head bolt replacement recommended; PermaTorqueMLS®; New Part Number - Check for Availability		
QTY	CONVERSION SET	YEARS	PART NO.	DESCRIPTION		
1	Gasket Conversion Set	2013-12	CS 26562	New Part Number - Check for Availability		
QTY	MANIFOLD - INT. & EXH.	YEARS	PART NO.	DESCRIPTION		
1	Exh. Manifold Gasket Set	2013-12	MS 97234	New Part Number - Check for Availability		
QTY	EXHAUST PIPE FLANGE	YEARS	PART NO.	DESCRIPTION		
1	Exhaust Pipe Gasket	2013-12	61716	Pipe to manifold; New Part Number - Check for Availability		
QTY	OIL PAN	YEARS	PART NO.	DESCRIPTION		
1	Oil Pan Gasket Set	2013-12	OS 30842	New Part Number - Check for Availability		
1	Drain Plug Gasket	2013-12	70822			
QTY	CRANKSHAFT REAR SEAL	YEARS	PART NO.	DESCRIPTION		
1	Rear Main Seal Set	2013-12	BS 40741	Rubber; One-piece; New Part Number - Check for Availability		
QTY	WATER PUMP	YEARS	PART NO.	DESCRIPTION		
1	Water Pump Gasket	2013-12	36011	Pump to block; New Part Number - Check for Availability		
1	Water Pump Gasket	2013-12	36013	Pump to housing; New Part Number - Check for Availability		
1	Water Pump Gasket	2013-12	36030	Mounting; New Part Number - Check for Availability		
QTY	TIMING COVER	YEARS	PART NO.	DESCRIPTION		
1	Crankshaft Front Seal Set	2013-12	TCS 46168	New Part Number - Check for Availability		
QTY	CARB & FUEL INJECTION	YEARS	PART NO.	DESCRIPTION		
1	Throttle Body Gasket	2013-12	61729	New Part Number - Check for Availability		
21		2013 - 2006; 2.5L 152.4 (2499cc) DOHC V6 (24 Valve) 83mm Bore VVT-i			21	
		DI; Gasoline; Naturally Aspirated Toyota Eng.; Eng. Code 4GRFSE				
QTY	CYLINDER HEAD	YEARS	PART NO.	DESCRIPTION		
1	Head Gasket	2013-06	26419 PT	Loc. R.H.; Head bolts not incl.; Head bolt replacement recommended; PermaTorqueMLS®		
1	Head Gasket	2013-06	26421 PT	Loc. L.H.; Head bolts not incl.; Head bolt replacement recommended; PermaTorqueMLS®		
1	Head Set	2013-06	HS 26419 PT	Head bolts not incl.; Head bolt replacement recommended; PermaDry® molded rubber valve cover gskts. incl.; Premium valve stem seals incl.		
QTY	CONVERSION SET	YEARS	PART NO.	DESCRIPTION		
1	Gasket Conversion Set	2013-06	CS 26419	AWD; RTV sealant incl. for oil pan gskt.		
1	Gasket Conversion Set	2013-06	CS 26419-1	RWD; RTV sealant incl. for oil pan gskt.		
QTY	MANIFOLD - INT. & EXH.	YEARS	PART NO.	DESCRIPTION		
1	Int. Manifold Gasket Set	2013-06	MS 97084	Lower set; Upper set incl.		
1	Exh. Manifold Gasket Set	2013-06	MS 96795	Improved design		
1	Exh. Manifold Gasket Set	2013-06	MS 97080	Old design		
QTY	EXHAUST PIPE FLANGE	YEARS	PART NO.	DESCRIPTION		
2	Exhaust Pipe Gasket	2013-06	60906	Pipe to manifold		
2	Exhaust Pipe Gasket	2013-06	61460	Exh. connector; 2.40" ID		
QTY	OIL PAN	YEARS	PART NO.	DESCRIPTION		
1	Oil Pan Gasket Set	2013-06	OS 30808	AWD; RTV sealant incl. for oil pan gskt.		

Toyota Car (Incl. Lexus, Scion, Toyota) (Cont.)

21 (cont.)		2013 - 2006; 2.5L 152.4 (2499cc) DOHC V6 (24 Valve) 83mm Bore VVT-i DI; Gasoline; Naturally Aspirated Toyota Eng.; Eng. Code 4GRFSE			21 (cont.)
QTY	OIL PAN	YEARS	PART NO.	DESCRIPTION	
1	Oil Pan Gasket Set	2013-06	OS 30810	RWD; RTV sealant incl. for oil pan gskt.	
1	Drain Plug Gasket	2013-06	70822		
QTY	CRANKSHAFT REAR SEAL	YEARS	PART NO.	DESCRIPTION	
1	Rear Main Seal Set	2013-06	BS 40701	Rubber; One-piece	
QTY	VALVE COVER	YEARS	PART NO.	DESCRIPTION	
1	Valve Cover Gasket Set	2013-06	VS 50690 R	w/Spark plug tube seals; PermaDry® molded rubber gskts. incl.	
1	Spark Plug Tube Seal Set	2013-06	ES 72701	Valve Cover; New Part Number - Check for Availability	
QTY	VALVE STEM SEAL SET	YEARS	PART NO.	DESCRIPTION	
1	Valve Stem Seal Set	2013-06	SS 72878	Premium valve stem seals incl.	
QTY	THERMOSTAT HOUSING	YEARS	PART NO.	DESCRIPTION	
1	Thermostat Gasket	2013-06	35801	Thermostat Housing; Thermostat seal	
QTY	WATER OUTLET GASKET	YEARS	PART NO.	DESCRIPTION	
2	Water Outlet Gasket	2013-06	35767	Water Outlet; Outlet; Improved design	
1	Water Outlet Gasket	2013-06	35809	Water Outlet; Water inlet O-ring; New Part Number - Check for Availability	
QTY	WATER PUMP	YEARS	PART NO.	DESCRIPTION	
1	Water Pump Gasket	2013-06	35817		
QTY	TIMING COVER	YEARS	PART NO.	DESCRIPTION	
1	Crankshaft Front Seal Set	2013-06	TCS 46080		
QTY	CARB & FUEL INJECTION	YEARS	PART NO.	DESCRIPTION	
1	Throttle Body Gasket	2013-06	61583		
22		1992 - 1991; 2.5L 152.9 (2507cc) DOHC V6 (24 Valve) 87.5mm Bore MFI; Gasoline; Naturally Aspirated Toyota Eng.; Eng. Code 2VZFE			22
QTY	CYLINDER HEAD	YEARS	PART NO.	DESCRIPTION	
1	Head Gasket	1992-91	9656 PT	Loc. L.H.; Head bolts not incl.; Head bolt replacement recommended	
1	Head Gasket	1992-91	9657 PT	Loc. R.H.; Head bolts not incl.; Head bolt replacement recommended	
1	Head Set	1992-91	HS 9656 PT	Head bolts not incl.; Head bolt replacement recommended; PermaDry® molded rubber valve cover gskts. incl.; Premium valve stem seals incl.	
QTY	MANIFOLD - INT. & EXH.	YEARS	PART NO.	DESCRIPTION	
1	Int. Manifold Gasket Set	1992-91	MS 94456	Lower set; Upper set incl.	
1	Exh. Manifold Gasket Set	1992-91	MS 94471		
QTY	EXHAUST PIPE FLANGE	YEARS	PART NO.	DESCRIPTION	
2	Exhaust Pipe Gasket	1992-91	23561	Crossover; 1 49/64" ID x 2 17/64" OD	
2	Exhaust Pipe Gasket	1992-91	23591	Converter; 1 31/32" ID x 2 35/64" OD	
1	Exhaust Pipe Gasket	1992-91	23626	Ring	
QTY	OIL PAN	YEARS	PART NO.	DESCRIPTION	
1	Oil Pan Gasket Set	1992-91	OS 30623 C-1	Improved design	
1	Drain Plug Gasket	1992-91	70822		
QTY	CRANKSHAFT REAR SEAL	YEARS	PART NO.	DESCRIPTION	
1	Rear Main Seal Set	1992-91	BS 40674	Viton®; One-piece; Improved design	
QTY	VALVE COVER	YEARS	PART NO.	DESCRIPTION	
1	Valve Cover Gasket Set	1992-91	VS 50338 R	w/o Grommets & Spark plug tube seals; PermaDry® molded rubber gskts. incl.	
1	Valve Cover Gasket Set	1992-91	VS 50338 R-1	w/Grommets & Spark plug tube seals; PermaDry® molded rubber gskts. incl.	
3	Grommet Set	1992-91	ES 72123	Valve Cover	
1	Spark Plug Tube Seal Set	1992-91	ES 72836	Valve Cover	
QTY	VALVE STEM SEAL SET	YEARS	PART NO.	DESCRIPTION	
1	Valve Stem Seal Set	1992-91	SS 72656-1	Premium valve stem seals incl.	
QTY	THERMOSTAT HOUSING	YEARS	PART NO.	DESCRIPTION	
1	Thermostat Gasket	1992-91	35445	Thermostat Housing; Thermostat inlet	
1	O-Ring	1992-91	35654	Thermostat Housing; Improved design	
QTY	WATER OUTLET GASKET	YEARS	PART NO.	DESCRIPTION	
1	Water Outlet Gasket	1992-91	35449	Water Outlet	
QTY	TIMING COVER	YEARS	PART NO.	DESCRIPTION	
1	Timing Cover Set	1992-91	TCS 45890		
1	Crankshaft Front Seal Set	1992-91	TCS 46195	New Part Number - Check for Availability	
1	Camshaft Front Seal Set	1992-91	TCS 45889		
1	Repair Sleeve	1992-91	16220	Timing Cover; Use w/installation tool; Improved design	
1	Repair Sleeve	1992-91	16223	Timing Cover; Use w/installation tool; May use 16220 instead; Old design; Superseded - When depleted use 16220	
1	Repair Sleeve Tool	1992-91	16323	Timing Cover	
QTY	CARB & FUEL INJECTION	YEARS	PART NO.	DESCRIPTION	
2	Fuel Injector O-Ring Set	1992-91	ES 70600		

Toyota Car (Incl. Lexus, Scion, Toyota) (Cont.)

22		1992 - 1991; 2.5L 152.9 (2507cc) DOHC V6 (24 Valve) 87.5mm Bore			22
(cont.)		MFI; Gasoline; Naturally Aspirated Toyota Eng.; Eng. Code 2VZFE			(cont.)
QTY	CARB & FUEL INJECTION	YEARS	PART NO.	DESCRIPTION	
1	Throttle Body Gasket	1992-91	60838		
QTY	EXHAUST GAS RECIRCULATION	YEARS	PART NO.	DESCRIPTION	
1	EGR Gasket	1992-91	70367		
23		1992 - 1991; 3.0L 180.3 (2954cc) DOHC L6 (24 Valve) 83mm Bore			23
(cont.)		MFI; Gasoline; Naturally Aspirated Toyota Eng.; Eng. Code 7MGE			(cont.)
QTY	CYLINDER HEAD	YEARS	PART NO.	DESCRIPTION	
1	Head Gasket	1992-91	9473 PT		
1	Head Set	1992-91	HS 9473 PT	PermaDry® molded rubber valve cover gskts. incl.; Premium valve stem seals incl.	
QTY	CONVERSION SET	YEARS	PART NO.	DESCRIPTION	
1	Gasket Conversion Set	1992-91	CS 9473		
QTY	MANIFOLD - INT. & EXH.	YEARS	PART NO.	DESCRIPTION	
1	Int. Manifold Gasket Set	1992-91	MS 93544	Lower set; Upper set incl.	
1	Plenum Gasket Set	1992-91	MS 93545	Upper set	
1	Exh. Manifold Gasket Set	1992-91	MS 92327		
QTY	EXHAUST PIPE FLANGE	YEARS	PART NO.	DESCRIPTION	
2	Exhaust Pipe Gasket	1992-91	23561	Flange; 1 49/64" ID x 2 17/64" OD	
1	Exhaust Pipe Gasket	1992-91	60461	Loc. Front; Converter	
1	Exhaust Pipe Gasket	1992-91	60512	Loc. Rear; Converter; Improved design	
QTY	OIL PAN	YEARS	PART NO.	DESCRIPTION	
1	Oil Pan Gasket Set	1992-91	OS 34405		
QTY	CRANKSHAFT REAR SEAL	YEARS	PART NO.	DESCRIPTION	
1	Rear Main Seal Set	1992-91	BS 40345-1	Rubber; One-piece	
QTY	VALVE COVER	YEARS	PART NO.	DESCRIPTION	
1	Valve Cover Gasket Set	1992-91	VS 50303 R	w/o Grommets; Must be used w/Int. manifold upper set MS 93545; PermaDry® molded rubber gskts. incl.	
1	Grommet Set	1992-91	ES 72133	Valve Cover	
QTY	VALVE STEM SEAL SET	YEARS	PART NO.	DESCRIPTION	
1	Valve Stem Seal Set	1992-91	SS 72656-1	Premium valve stem seals incl.	
QTY	WATER OUTLET GASKET	YEARS	PART NO.	DESCRIPTION	
1	Water Outlet Gasket	1992-91	35278	Water Outlet	
QTY	WATER PUMP	YEARS	PART NO.	DESCRIPTION	
1	Water Pump Gasket	1992-91	35385		
QTY	TIMING COVER	YEARS	PART NO.	DESCRIPTION	
1	Crankshaft Front Seal Set	1992-91	TCS 45732		
1	Camshaft Front Seal Set	1992-91	TCS 45424		
QTY	CARB & FUEL INJECTION	YEARS	PART NO.	DESCRIPTION	
2	Fuel Injector O-Ring Set	1992-91	ES 70600		
1	Throttle Body Gasket	1992-91	60682	Toyota Supra Base	
1	Throttle Body Gasket	1992-91	60683	Exc. Toyota Supra Base	
QTY	EXHAUST GAS RECIRCULATION	YEARS	PART NO.	DESCRIPTION	
1	EGR Gasket	1992-91	70154		
24		1992 - 1991; 3.0L 180.3 (2954cc) DOHC L6 (24 Valve) 83mm Bore			24
(cont.)		MFI; Gasoline; Turbo - Intercooled Toyota Eng.; Eng. Code 7MGTE			(cont.)
QTY	CYLINDER HEAD	YEARS	PART NO.	DESCRIPTION	
1	Head Gasket	1992-91	9473 PT		
1	Head Set	1992-91	HS 9473 PT-1	PermaDry® molded rubber valve cover gskts. incl.; Premium valve stem seals incl.	
QTY	CONVERSION SET	YEARS	PART NO.	DESCRIPTION	
1	Gasket Conversion Set	1992-91	CS 9473		
QTY	MANIFOLD - INT. & EXH.	YEARS	PART NO.	DESCRIPTION	
1	Int. Manifold Gasket Set	1992-91	MS 93544	Lower set; Upper set incl.	
1	Plenum Gasket Set	1992-91	MS 93545	Upper set	
1	Exh. Manifold Gasket Set	1992-91	MS 92327		
QTY	EXHAUST PIPE FLANGE	YEARS	PART NO.	DESCRIPTION	
1	Exhaust Pipe Gasket	1992-91	60461	Loc. Front; Converter	
1	Exhaust Pipe Gasket	1992-91	60495	Flange	
1	Exhaust Pipe Gasket	1992-91	60512	Loc. Rear; Converter; Improved design	
QTY	OIL PAN	YEARS	PART NO.	DESCRIPTION	
1	Oil Pan Gasket Set	1992-91	OS 34405		

Toyota Car (Incl. Lexus, Scion, Toyota) (Cont.)

24 (cont.)		1992 - 1991; 3.0L 180.3 (2954cc) DOHC L6 (24 Valve) 83mm Bore			24 (cont.)
		MFI; Gasoline; Turbo - Intercooled Toyota Eng.; Eng. Code 7MGTE			
QTY	CRANKSHAFT REAR SEAL	YEARS	PART NO.	DESCRIPTION	
1	Rear Main Seal Set	1992-91	BS 40345-1	Rubber; One-piece	
QTY	VALVE COVER	YEARS	PART NO.	DESCRIPTION	
1	Valve Cover Gasket Set	1992-91	VS 50303 R	w/o Grommets; Must be used w/Int. manifold upper set MS 93545; PermaDry® molded rubber gskts. incl.	
1	Grommet Set	1992-91	ES 72133	Valve Cover	
QTY	VALVE STEM SEAL SET	YEARS	PART NO.	DESCRIPTION	
1	Valve Stem Seal Set	1992-91	SS 72656-1	Premium valve stem seals incl.	
QTY	WATER OUTLET GASKET	YEARS	PART NO.	DESCRIPTION	
1	Water Outlet Gasket	1992-91	35278	Water Outlet	
QTY	WATER PUMP	YEARS	PART NO.	DESCRIPTION	
1	Water Pump Gasket	1992-91	35385		
QTY	TIMING COVER	YEARS	PART NO.	DESCRIPTION	
1	Crankshaft Front Seal Set	1992-91	TCS 45732		
1	Camshaft Front Seal Set	1992-91	TCS 45424		
QTY	CARB & FUEL INJECTION	YEARS	PART NO.	DESCRIPTION	
2	Fuel Injector O-Ring Set	1992-91	ES 70600		
1	Throttle Body Gasket	1992-91	60683		
QTY	EXHAUST GAS RECIRCULATION	YEARS	PART NO.	DESCRIPTION	
1	EGR Gasket	1992-91	70154		
25		1993 - 1992; 3.0L 180.5 (2958cc) DOHC V6 (24 Valve) 87.5mm Bore			25
		MFI; Gasoline; Naturally Aspirated Toyota Eng.; Eng. Code 3VZFE			
QTY	CYLINDER HEAD	YEARS	PART NO.	DESCRIPTION	
1	Head Gasket	1993-92	9904 PT	Loc. L.H.; Head bolts not incl.; Head bolt replacement recommended	
1	Head Gasket	1993-92	9905 PT	Loc. R.H.; Head bolts not incl.; Head bolt replacement recommended	
1	Head Set	1993-92	HS 9904 PT	Head bolts not incl.; Head bolt replacement recommended; PermaDry® molded rubber valve cover gskts. incl.; Premium valve stem seals incl.	
QTY	CONVERSION SET	YEARS	PART NO.	DESCRIPTION	
1	Gasket Conversion Set	1993-92	CS 9904		
QTY	MANIFOLD - INT. & EXH.	YEARS	PART NO.	DESCRIPTION	
1	Int. Manifold Gasket Set	1993-92	MS 95406	Lower set; Upper set incl.	
1	Plenum Gasket Set	1993-92	MS 95407	Upper set	
1	Plenum Gasket Set	1993-92	MS 95407-1	Upper set; Plenum gskt. only; New Part Number - Check for Availability	
1	Exh. Manifold Gasket Set	1993-92	MS 95405		
QTY	EXHAUST PIPE FLANGE	YEARS	PART NO.	DESCRIPTION	
2	Exhaust Pipe Gasket	1993-92	23591	Flange; 1 31/32" ID x 2 35/64" OD	
2	Exhaust Pipe Gasket	1993-92	60512	Converter; Improved design	
QTY	OIL PAN	YEARS	PART NO.	DESCRIPTION	
1	Oil Pan Gasket Set	1993-92	OS 30405 C		
1	Drain Plug Gasket	1993-92	70822		
QTY	CRANKSHAFT REAR SEAL	YEARS	PART NO.	DESCRIPTION	
1	Rear Main Seal Set	1993-92	BS 40674	Viton®; One-piece; Improved design	
QTY	VALVE COVER	YEARS	PART NO.	DESCRIPTION	
1	Valve Cover Gasket Set	1993-92	VS 50422 R	w/Spark plug tube seals; PermaDry® molded rubber gskts. incl.	
1	Spark Plug Tube Seal Set	1993-92	ES 72701	Valve Cover; New Part Number - Check for Availability	
QTY	VALVE STEM SEAL SET	YEARS	PART NO.	DESCRIPTION	
1	Valve Stem Seal Set	1993-92	SS 72832	Premium valve stem seals incl.	
QTY	THERMOSTAT HOUSING	YEARS	PART NO.	DESCRIPTION	
1	Thermostat Gasket	1993-92	35445	Thermostat Housing; Thermostat inlet	
QTY	WATER OUTLET GASKET	YEARS	PART NO.	DESCRIPTION	
1	Water Outlet Gasket	1993-92	35566	Water Outlet	
QTY	WATER PUMP	YEARS	PART NO.	DESCRIPTION	
1	Water Pump Gasket	1993-92	35519		
QTY	TIMING COVER	YEARS	PART NO.	DESCRIPTION	
1	Timing Cover Set	1993-92	TCS 45890		
1	Crankshaft Front Seal Set	1993-92	TCS 46195		New Part Number - Check for Availability
1	Camshaft Front Seal Set	1993-92	TCS 45889		
1	Repair Sleeve	1993-92	16220	Timing Cover; Use w/installation tool; Improved design	
1	Repair Sleeve	1993-92	16223	Timing Cover; Use w/installation tool; May use 16220 instead; Old design; Superseded - When depleted use 16220	
1	Repair Sleeve Tool	1993-92	16323	Timing Cover	
QTY	CARB & FUEL INJECTION	YEARS	PART NO.	DESCRIPTION	
2	Fuel Injector O-Ring Set	1993-92	ES 70600		

Toyota Car (Incl. Lexus, Scion, Toyota) (Cont.)

26		2005 - 1994; 3.0L 182.6 (2995cc) DOHC V6 (24 Valve) 87.5mm Bore			26
		MFI; Gasoline; Naturally Aspirated Toyota Eng.; Eng. Code 1MZF6			
QTY	CYLINDER HEAD	YEARS	PART NO.	DESCRIPTION	
1	Head Gasket	2005-04	9592 PT	Loc. R.H.; Head bolts not incl.; Head bolt replacement recommended; PermaTorqueMLS®	
1	Head Gasket	2005-04	9594 PT	Loc. L.H.; Head bolts not incl.; Head bolt replacement recommended; PermaTorqueMLS®	
1	Head Gasket	2003-01	9489 PT	Loc. R.H.; Head bolts not incl.; Head bolt replacement recommended; PermaTorqueMLS®	
1	Head Gasket	2003-01	9490 PT	Loc. L.H.; Head bolts not incl.; Head bolt replacement recommended; PermaTorqueMLS®	
1	Head Gasket	2000	9201 PT	Loc. L.H.; To 01/01/00; Head bolts not incl.; Head bolt replacement recommended	
1	Head Gasket	2000	9203 PT	Loc. R.H.; To 01/01/00; Head bolts not incl.; Head bolt replacement recommended	
1	Head Gasket	2000	9489 PT	Loc. R.H.; From 01/01/00; Head bolts not incl.; Head bolt replacement recommended; PermaTorqueMLS®	
1	Head Gasket	2000	9490 PT	Loc. L.H.; From 01/01/00; Head bolts not incl.; Head bolt replacement recommended; PermaTorqueMLS®	
1	Head Gasket	1999	9201 PT	Exc. Toyota Avalon XL, XLS; Loc. L.H.; Head bolts not incl.; Head bolt replacement recommended	
1	Head Gasket	1999	9201 PT	Toyota Avalon XL, XLS; Loc. L.H.; To 08/01/99; Head bolts not incl.; Head bolt replacement recommended	
1	Head Gasket	1999	9203 PT	Exc. Toyota Avalon XL, XLS; Loc. R.H.; Head bolts not incl.; Head bolt replacement recommended	
1	Head Gasket	1999	9203 PT	Toyota Avalon XL, XLS; Loc. R.H.; To 08/01/99; Head bolts not incl.; Head bolt replacement recommended	
1	Head Gasket	1999	9592 PT	Toyota Avalon XL, XLS; Loc. R.H.; From 08/01/99; Head bolts not incl.; Head bolt replacement recommended; PermaTorqueMLS®	
1	Head Gasket	1999	9594 PT	Toyota Avalon XL, XLS; Loc. L.H.; From 08/01/99; Head bolts not incl.; Head bolt replacement recommended; PermaTorqueMLS®	
1	Head Gasket	1998-94	9201 PT	Loc. L.H.; Head bolts not incl.; Head bolt replacement recommended	
1	Head Gasket	1998-94	9203 PT	Loc. R.H.; Head bolts not incl.; Head bolt replacement recommended	
1	Head Set	2005-04	HS 9592 PT-1	Head bolts not incl.; Head bolt replacement recommended; PermaDry® molded rubber valve cover gskts. incl.; Premium valve stem seals incl.	
1	Head Set	2003-02	HS 9489 PT	Toyota Solara SE, SLE; Head bolts not incl.; Head bolt replacement recommended; PermaDry® molded rubber valve cover gskts. incl.; Premium valve stem seals incl.	
1	Head Set	2003-02	HS 9489 PT-1	Toyota Camry LE, SE, XLE; Head bolts not incl.; Head bolt replacement recommended; PermaDry® molded rubber valve cover gskts. incl.; Premium valve stem seals incl.	
1	Head Set	2001	HS 9489 PT	Head bolts not incl.; Head bolt replacement recommended; PermaDry® molded rubber valve cover gskts. incl.; Premium valve stem seals incl.	
1	Head Set	2000	HS 9201 PT	To 01/01/00; Head bolts not incl.; Head bolt replacement recommended; PermaDry® molded rubber valve cover gskts. incl.; Premium valve stem seals incl.	
1	Head Set	2000	HS 9489 PT	From 01/01/00; Head bolts not incl.; Head bolt replacement recommended; PermaDry® molded rubber valve cover gskts. incl.; Premium valve stem seals incl.	
1	Head Set	1999	HS 9201 PT	Exc. Toyota Avalon XL, XLS; Head bolts not incl.; Head bolt replacement recommended; PermaDry® molded rubber valve cover gskts. incl.; Premium valve stem seals incl.	
1	Head Set	1999	HS 9201 PT	Toyota Avalon XL, XLS; To 08/01/99; Head bolts not incl.; Head bolt replacement recommended; PermaDry® molded rubber valve cover gskts. incl.; Premium valve stem seals incl.	
1	Head Set	1999	HS 9592 PT	Toyota Avalon XL, XLS; From 08/01/99; Head bolts not incl.; Head bolt replacement recommended; PermaDry® molded rubber valve cover gskts. incl.; Premium valve stem seals incl.	
1	Head Set	1998-94	HS 9201 PT	Head bolts not incl.; Head bolt replacement recommended; PermaDry® molded rubber valve cover gskts. incl.; Premium valve stem seals incl.	
2	Head Bolt Set	2005-94	ES 71036	Head bolts w/Washers; Replacement recommended	
QTY	CONVERSION SET	YEARS	PART NO.	DESCRIPTION	
1	Gasket Conversion Set	2005-94	CS 9201	RTV sealant incl. for Upper oil pan gskt.	
QTY	MANIFOLD - INT. & EXH.	YEARS	PART NO.	DESCRIPTION	
1	Int. Manifold Gasket Set	2005-94	MS 92766	Lower set; Upper set incl.	
1	Plenum Gasket Set	2005-94	MS 95407	Upper set	
1	Plenum Gasket Set	2005-94	MS 95407-1	Upper set; Plenum gskt. only; New Part Number - Check for Availability	
1	Exh. Manifold Gasket Set	2005-04	MS 96083		

Toyota Car (Incl. Lexus, Scion, Toyota) (Cont.)

26 (cont.)		2005 - 1994; 3.0L 182.6 (2995cc) DOHC V6 (24 Valve) 87.5mm Bore			26 (cont.)
		MFI; Gasoline; Naturally Aspirated Toyota Eng.; Eng. Code 1MZFE			
QTY	MANIFOLD - INT. & EXH.	YEARS	PART NO.	DESCRIPTION	
1	Exh. Manifold Gasket Set	2003-02	MS 95819	Toyota Solara SE, SLE	
1	Exh. Manifold Gasket Set	2003-02	MS 96083	Toyota Camry LE, SE, XLE	
1	Exh. Manifold Gasket Set	2001-94	MS 95819		
QTY	EXHAUST PIPE FLANGE	YEARS	PART NO.	DESCRIPTION	
2	Exhaust Pipe Gasket	2005-94	60554	Pipe to manifold	
1	Exhaust Pipe Gasket	2005-94	60906	Muffler	
2	Exhaust Pipe Gasket	2005-97	60906	Converter; 1 or 2 Req'd.	
1	Exhaust Pipe Gasket	2005-04	60906	Loc. Center; Exh. connector	
1	Exhaust Pipe Gasket	2005-04	61039	Converter	
1	Exhaust Pipe Gasket	2005-04	61039	Loc. Rear; Exh. connector	
2	Exhaust Pipe Gasket	2005-04	61040	Flange; 1.98" ID	
1	Exhaust Pipe Gasket	2003-01	61040	Toyota Solara SE, SLE; Exh. connector; 1.98" ID	
2	Exhaust Pipe Gasket	2003-02	23591	Toyota Solara SE, SLE; Flange; 1 31/32" ID x 2 35/64" OD	
1	Exhaust Pipe Gasket	2003-02	60906	Toyota Camry LE, SE, XLE; Loc. Center; Exh. connector	
2	Exhaust Pipe Gasket	2003-02	61040	Toyota Camry LE, SE, XLE; Flange; 1.98" ID	
1	Exhaust Pipe Gasket	2003	61039	Toyota Camry LE, SE, XLE; Loc. Rear; Exh. connector	
2	Exhaust Pipe Gasket	2001-94	23591	Flange; 1 31/32" ID x 2 35/64" OD	
1	Exhaust Pipe Gasket	2001	60906	Toyota Camry LE, XLE; Loc. Center; Exh. connector	
2	Exhaust Pipe Gasket	1996-94	60512	Converter; 1 or 2 Req'd.; Improved design	
QTY	OIL PAN	YEARS	PART NO.	DESCRIPTION	
1	Oil Pan Gasket Set	2005-94	OS 30681 C	Loc. Lower	
1	Drain Plug Gasket	2005-94	70822		
QTY	CRANKSHAFT REAR SEAL	YEARS	PART NO.	DESCRIPTION	
1	Rear Main Seal Set	2005-94	BS 40643	Rubber; One-piece	
QTY	VALVE COVER	YEARS	PART NO.	DESCRIPTION	
1	Valve Cover Gasket Set	2005-04	VS 50588 R	w/Spark plug tube seals; PermaDry® molded rubber gskts. incl.; Improved design	
1	Valve Cover Gasket Set	2003-00	VS 50471 R	w/Spark plug tube seals; PermaDry® molded rubber gskts. incl.	
1	Valve Cover Gasket Set	1999	VS 50471 R	Toyota Avalon XL, XLS; To 08/01/99; w/Spark plug tube seals; PermaDry® molded rubber gskts. incl.	
1	Valve Cover Gasket Set	1999	VS 50471 R	Exc. Toyota Avalon XL, XLS; w/Spark plug tube seals; PermaDry® molded rubber gskts. incl.	
1	Valve Cover Gasket Set	1999	VS 50588 R	Toyota Avalon XL, XLS; From 08/01/99; w/Spark plug tube seals; PermaDry® molded rubber gskts. incl.; Improved design	
1	Valve Cover Gasket Set	1998-94	VS 50471 R	w/Spark plug tube seals; PermaDry® molded rubber gskts. incl.	
1	Spark Plug Tube Seal Set	2005-94	ES 72701	Valve Cover; New Part Number - Check for Availability	
QTY	VALVE STEM SEAL SET	YEARS	PART NO.	DESCRIPTION	
1	Valve Stem Seal Set	2005-94	SS 72878	Premium valve stem seals incl.	
QTY	THERMOSTAT HOUSING	YEARS	PART NO.	DESCRIPTION	
1	Thermostat Gasket	2005-94	35445	Thermostat Housing	
QTY	WATER OUTLET GASKET	YEARS	PART NO.	DESCRIPTION	
1	Water Outlet Gasket	2005-94	35648	Water Outlet; Loc. Front	
1	Water Outlet Gasket	2005-94	35649	Water Outlet; Loc. Rear	
1	O-Ring	2005-94	35654	Water Outlet; Inlet; Improved design	
QTY	WATER PUMP	YEARS	PART NO.	DESCRIPTION	
1	Water Pump Gasket	2005-94	35594		
QTY	TIMING COVER	YEARS	PART NO.	DESCRIPTION	
1	Timing Cover Set	2005-94	TCS 45890		
1	Crankshaft Front Seal Set	2005-94	TCS 46195	New Part Number - Check for Availability	
1	Camshaft Front Seal Set	2005-94	TCS 45889		
1	Repair Sleeve	2005-94	16220	Timing Cover; Use w/installation tool; Improved design	
1	Repair Sleeve	2005-94	16223	Timing Cover; Use w/installation tool; May use 16220 instead; Old design; Superseded - When depleted use 16220	
1	Repair Sleeve Tool	2005-94	16323	Timing Cover	
QTY	CARB & FUEL INJECTION	YEARS	PART NO.	DESCRIPTION	
3	Fuel Injector O-Ring Set	2005-94	ES 70600		
1	Throttle Body Gasket	2005-96	61084	Idle air control	
1	Throttle Body Gasket	2005-04	61276	Mounting	
1	Throttle Body Gasket	2003-01	61020	Toyota Solara SE, SLE; Mounting	
1	Throttle Body Gasket	2003	61276	Toyota Camry LE, SE, XLE; From 01/01/03; Mounting	
1	Throttle Body Gasket	2003	61333	Toyota Camry LE, SE, XLE; To 01/01/03; Mounting	
1	Throttle Body Gasket	2002	61333	Toyota Camry LE, SE, XLE; Mounting	
1	Throttle Body Gasket	2001-00	61091	Toyota Camry LE, XLE; From 08/01/00; Mounting	
1	Throttle Body Gasket	2001	61020	Toyota Camry LE, XLE; To 08/01/00; Mounting	

Toyota Car (Incl. Lexus, Scion, Toyota) (Cont.)

26 (cont.)		2005 - 1994; 3.0L 182.6 (2995cc) DOHC V6 (24 Valve) 87.5mm Bore			26 (cont.)
		MFI; Gasoline; Naturally Aspirated Toyota Eng.; Eng. Code 1MZFE			
QTY	CARB & FUEL INJECTION	YEARS	PART NO.	DESCRIPTION	
1	Throttle Body Gasket	2000	61020	Toyota Solara SE, SLE; Mounting	
1	Throttle Body Gasket	2000	61020	Toyota Camry LE, XLE; To 08/01/00; Mounting	
1	Throttle Body Gasket	1999-94	61020	Mounting	
QTY	EXHAUST GAS RECIRCULATION	YEARS	PART NO.	DESCRIPTION	
1	EGR Gasket	2005-00	72898	Valve	
1	EGR Gasket	1999-95	72898	Exc. Toyota Avalon XL, XLS; Valve	
2	EGR Gasket	1999-95	72898	Toyota Avalon XL, XLS; Valve & adapter	
1	EGR Gasket	1994	72898	Valve	
27		2006 - 1999; 3.0L 182.6 (2995cc) DOHC V6 (24 Valve) 87.5mm Bore VVT-i			27
		MFI; Gasoline; Naturally Aspirated Toyota Eng.; Eng. Code 1MZFE			
QTY	CYLINDER HEAD	YEARS	PART NO.	DESCRIPTION	
1	Head Gasket	2006-01	9592 PT	Loc. R.H.; Head bolts not incl.; Head bolt replacement recommended; PermaTorqueMLS®	
1	Head Gasket	2006-01	9594 PT	Loc. L.H.; Head bolts not incl.; Head bolt replacement recommended; PermaTorqueMLS®	
1	Head Gasket	2000	9201 PT	Exc. Lexus ES300 Base; Loc. L.H.; To 08/01/99; Head bolts not incl.; Head bolt replacement recommended	
1	Head Gasket	2000	9203 PT	Exc. Lexus ES300 Base; Loc. R.H.; To 08/01/99; Head bolts not incl.; Head bolt replacement recommended	
1	Head Gasket	2000	9592 PT	Exc. Lexus ES300 Base; Loc. R.H.; From 08/01/99; Head bolts not incl.; Head bolt replacement recommended; PermaTorqueMLS®	
1	Head Gasket	2000	9592 PT	Lexus ES300 Base; Loc. R.H.; Head bolts not incl.; Head bolt replacement recommended; PermaTorqueMLS®	
1	Head Gasket	2000	9594 PT	Exc. Lexus ES300 Base; Loc. L.H.; From 08/01/99; Head bolts not incl.; Head bolt replacement recommended; PermaTorqueMLS®	
1	Head Gasket	2000	9594 PT	Lexus ES300 Base; Loc. L.H.; Head bolts not incl.; Head bolt replacement recommended; PermaTorqueMLS®	
1	Head Gasket	1999	9592 PT	Loc. R.H.; Head bolts not incl.; Head bolt replacement recommended; PermaTorqueMLS®	
1	Head Gasket	1999	9594 PT	Loc. L.H.; Head bolts not incl.; Head bolt replacement recommended; PermaTorqueMLS®	
1	Head Set	2006-03	HS 9592 PT-1	Head bolts not incl.; Head bolt replacement recommended; PermaDry® molded rubber valve cover gskts. incl.; Premium valve stem seals incl.	
1	Head Set	2002	HS 9592 PT	Exc. Lexus ES300 Base; Head bolts not incl.; Head bolt replacement recommended; PermaDry® molded rubber valve cover gskts. incl.; Premium valve stem seals incl.	
1	Head Set	2002	HS 9592 PT-1	Lexus ES300 Base; Head bolts not incl.; Head bolt replacement recommended; PermaDry® molded rubber valve cover gskts. incl.; Premium valve stem seals incl.	
1	Head Set	2001	HS 9592 PT	Head bolts not incl.; Head bolt replacement recommended; PermaDry® molded rubber valve cover gskts. incl.; Premium valve stem seals incl.	
1	Head Set	2000	HS 9201 PT	Exc. Lexus ES300 Base; To 08/01/99; Head bolts not incl.; Head bolt replacement recommended; PermaDry® molded rubber valve cover gskts. incl.; Premium valve stem seals incl.	
1	Head Set	2000	HS 9592 PT	Exc. Lexus ES300 Base; From 08/01/99; Head bolts not incl.; Head bolt replacement recommended; PermaDry® molded rubber valve cover gskts. incl.; Premium valve stem seals incl.	
1	Head Set	2000	HS 9592 PT	Lexus ES300 Base; Head bolts not incl.; Head bolt replacement recommended; PermaDry® molded rubber valve cover gskts. incl.; Premium valve stem seals incl.	
1	Head Set	1999	HS 9592 PT	Head bolts not incl.; Head bolt replacement recommended; PermaDry® molded rubber valve cover gskts. incl.; Premium valve stem seals incl.	
2	Head Bolt Set	2006-99	ES 71036	Head bolts w/Washers; Replacement recommended	
QTY	CONVERSION SET	YEARS	PART NO.	DESCRIPTION	
1	Gasket Conversion Set	2006-99	CS 9201	RTV sealant incl. for Upper oil pan gskt.	
QTY	MANIFOLD - INT. & EXH.	YEARS	PART NO.	DESCRIPTION	
1	Int. Manifold Gasket Set	2006-99	MS 92766	Lower set; Upper set incl.	
1	Plenum Gasket Set	2006-99	MS 95407	Upper set	
1	Plenum Gasket Set	2006-99	MS 95407-1	Upper set; Plenum gskt. only; New Part Number - Check for Availability	
1	Exh. Manifold Gasket Set	2006-05	MS 96083		
1	Exh. Manifold Gasket Set	2004	MS 95819	Toyota Avalon XL, XLS	
1	Exh. Manifold Gasket Set	2004	MS 96083	Toyota Camry LE, XLE	
1	Exh. Manifold Gasket Set	2003-02	MS 95819	Exc. Lexus ES300 Base	

Toyota Car (Incl. Lexus, Scion, Toyota) (Cont.)

27 (cont.)	2006 - 1999; 3.0L 182.6 (2995cc) DOHC V6 (24 Valve) 87.5mm Bore VVT-i MFI; Gasoline; Naturally Aspirated Toyota Eng.; Eng. Code 1MZF E				27 (cont.)
QTY	MANIFOLD - INT. & EXH.	YEARS	PART NO.	DESCRIPTION	
1	Exh. Manifold Gasket Set	2003-02	MS 96083	Lexus ES300 Base	
1	Exh. Manifold Gasket Set	2001-99	MS 95819		
QTY	EXHAUST PIPE FLANGE	YEARS	PART NO.	DESCRIPTION	
2	Exhaust Pipe Gasket	2006-99	60554	Pipe to manifold	
2	Exhaust Pipe Gasket	2006-99	60906	Converter; 1 or 2 Req'd.	
1	Exhaust Pipe Gasket	2006-99	60906	Muffler	
2	Exhaust Pipe Gasket	2006-02	61040	Flange; 1.98" ID	
1	Exhaust Pipe Gasket	2006-05	60906	Loc. Center; Exh. connector	
1	Exhaust Pipe Gasket	2006-05	61039	Converter	
1	Exhaust Pipe Gasket	2006-05	61039	Loc. Rear; Exh. connector	
1	Exhaust Pipe Gasket	2004	60906	Toyota Camry LE, XLE; Loc. Center; Exh. connector	
1	Exhaust Pipe Gasket	2004	61016	Toyota Avalon XL, XLS; Loc. Center; Exh. connector; Improved design	
1	Exhaust Pipe Gasket	2004	61039	Toyota Camry LE, XLE; Converter	
1	Exhaust Pipe Gasket	2004	61039	Toyota Camry LE, XLE; Loc. Rear; Exh. connector	
1	Exhaust Pipe Gasket	2004	61106	Toyota Avalon XL, XLS; Loc. Rear; Exh. connector; 2.40" ID	
1	Exhaust Pipe Gasket	2003-02	60906	Lexus ES300 Base; Loc. Center; Exh. connector	
1	Exhaust Pipe Gasket	2003-02	61016	Exc. Lexus ES300 Base; Loc. Center; Exh. connector; Improved design	
1	Exhaust Pipe Gasket	2003-02	61039	Lexus ES300 Base; Loc. Rear; Exh. connector	
1	Exhaust Pipe Gasket	2003-02	61106	Exc. Lexus ES300 Base; Loc. Rear; Exh. connector; 2.40" ID	
2	Exhaust Pipe Gasket	2001-99	23591	Flange; 1 31/32" ID x 2 35/64" OD	
1	Exhaust Pipe Gasket	2001	61016	Loc. Center; Exh. connector; Improved design	
1	Exhaust Pipe Gasket	2001	61106	Loc. Rear; Exh. connector; 2.40" ID	
QTY	OIL PAN	YEARS	PART NO.	DESCRIPTION	
1	Oil Pan Gasket Set	2006-99	OS 30681 C	Loc. Lower	
1	Drain Plug Gasket	2006-99	70822		
QTY	CRANKSHAFT REAR SEAL	YEARS	PART NO.	DESCRIPTION	
1	Rear Main Seal Set	2006-99	BS 40643	Rubber; One-piece	
QTY	VALVE COVER	YEARS	PART NO.	DESCRIPTION	
1	Valve Cover Gasket Set	2006-01	VS 50588 R	w/Spark plug tube seals; PermaDry® molded rubber gskts. incl.; Improved design	
1	Valve Cover Gasket Set	2000	VS 50471 R	Exc. Lexus ES300 Base; To 08/01/99; w/Spark plug tube seals; PermaDry® molded rubber gskts. incl.	
1	Valve Cover Gasket Set	2000	VS 50588 R	Exc. Lexus ES300 Base; From 08/01/99; w/Spark plug tube seals; PermaDry® molded rubber gskts. incl.; Improved design	
1	Valve Cover Gasket Set	2000	VS 50588 R	Lexus ES300 Base; w/Spark plug tube seals; PermaDry® molded rubber gskts. incl.; Improved design	
1	Valve Cover Gasket Set	1999	VS 50588 R	w/Spark plug tube seals; PermaDry® molded rubber gskts. incl.; Improved design	
1	Spark Plug Tube Seal Set	2006-99	ES 72701	Valve Cover; New Part Number - Check for Availability	
QTY	VALVE STEM SEAL SET	YEARS	PART NO.	DESCRIPTION	
1	Valve Stem Seal Set	2006-99	SS 72878	Premium valve stem seals incl.	
QTY	THERMOSTAT HOUSING	YEARS	PART NO.	DESCRIPTION	
1	Thermostat Gasket	2006-99	35445	Thermostat Housing	
QTY	WATER OUTLET GASKET	YEARS	PART NO.	DESCRIPTION	
1	Water Outlet Gasket	2006-99	35648	Water Outlet; Loc. Front	
1	Water Outlet Gasket	2006-99	35649	Water Outlet; Loc. Rear	
1	O-Ring	2006-99	35654	Water Outlet; Inlet; Improved design	
QTY	WATER PUMP	YEARS	PART NO.	DESCRIPTION	
1	Water Pump Gasket	2006-99	35594		
QTY	TIMING COVER	YEARS	PART NO.	DESCRIPTION	
1	Timing Cover Set	2006-99	TCS 45890		
1	Crankshaft Front Seal Set	2006-99	TCS 46195	New Part Number - Check for Availability	
1	Camshaft Front Seal Set	2006-99	TCS 45889		
1	Repair Sleeve	2006-99	16220	Timing Cover; Use w/installation tool; Improved design	
1	Repair Sleeve	2006-99	16223	Timing Cover; Use w/installation tool; May use 16220 instead; Old design; Superseded - When depleted use 16220	
1	Repair Sleeve Tool	2006-99	16323	Timing Cover	
QTY	CARB & FUEL INJECTION	YEARS	PART NO.	DESCRIPTION	
3	Fuel Injector O-Ring Set	2006-99	ES 70600		
1	Throttle Body Gasket	2006-99	61084	Idle air control	
1	Throttle Body Gasket	2006-05	61276	Mounting	
1	Throttle Body Gasket	2004	61091	Toyota Avalon XL, XLS; Mounting	
1	Throttle Body Gasket	2004	61276	Toyota Camry LE, XLE; Mounting	
1	Throttle Body Gasket	2003-01	61276	Lexus ES300 Base; Mounting	

Toyota Car (Incl. Lexus, Scion, Toyota) (Cont.)

27		2006 - 1999; 3.0L 182.6 (2995cc) DOHC V6 (24 Valve) 87.5mm Bore VVT-i			27
(cont.)		MFI; Gasoline; Naturally Aspirated Toyota Eng.; Eng. Code 1MZF E			(cont.)
QTY	CARB & FUEL INJECTION	YEARS	PART NO.	DESCRIPTION	
1	Throttle Body Gasket	2003-02	61091	Exc. Lexus ES300 Base; Mounting	
1	Throttle Body Gasket	2001	61020	Exc. Lexus ES300 Base; To 08/01/00; Mounting	
1	Throttle Body Gasket	2001	61091	Exc. Lexus ES300 Base; From 08/01/00; Mounting	
1	Throttle Body Gasket	2000	61020	To 08/01/00; Mounting	
1	Throttle Body Gasket	2000	61091	From 08/01/00; Mounting	
1	Throttle Body Gasket	1999	61020	Mounting	
QTY	EXHAUST GAS RECIRCULATION	YEARS	PART NO.	DESCRIPTION	
1	EGR Gasket	2006-05	72898	Valve	
1	EGR Gasket	2004	72898	Toyota Camry LE, XLE; Valve	
2	EGR Gasket	2004	72898	Toyota Avalon XL, XLS; Valve & adapter	
1	EGR Gasket	2003-00	72898	Lexus ES300 Base; Valve	
2	EGR Gasket	2003-00	72898	Exc. Lexus ES300 Base; Valve & adapter	
1	EGR Gasket	1999	72898	Valve	
28		2006; 3.0L 182.6 (2995cc) DOHC V6 (24 Valve) 87.5mm Bore VVT-i			28
		DI; Gasoline; Naturally Aspirated Toyota Eng.; Eng. Code 3GRFSE			
QTY	CYLINDER HEAD	YEARS	PART NO.	DESCRIPTION	
1	Head Bolt Set	2006	ES 72249	Head bolts w/Washers; Replacement recommended	
QTY	CONVERSION SET	YEARS	PART NO.	DESCRIPTION	
1	Gasket Conversion Set	2006	CS 26419	AWD; RTV sealant incl. for oil pan gskt.	
1	Gasket Conversion Set	2006	CS 26419-1	RWD; RTV sealant incl. for oil pan gskt.	
QTY	MANIFOLD - INT. & EXH.	YEARS	PART NO.	DESCRIPTION	
1	Int. Manifold Gasket Set	2006	MS 97084	Lower set; Upper set incl.	
1	Exh. Manifold Gasket Set	2006	MS 96795	Improved design	
1	Exh. Manifold Gasket Set	2006	MS 97080	Old design	
QTY	EXHAUST PIPE FLANGE	YEARS	PART NO.	DESCRIPTION	
2	Exhaust Pipe Gasket	2006	60906	Converter	
2	Exhaust Pipe Gasket	2006	61460	Exh. connector; 2.40" ID	
QTY	OIL PAN	YEARS	PART NO.	DESCRIPTION	
1	Oil Pan Gasket Set	2006	OS 30808	AWD; RTV sealant incl. for oil pan gskt.	
1	Oil Pan Gasket Set	2006	OS 30810	RWD; RTV sealant incl. for oil pan gskt.	
1	Drain Plug Gasket	2006	70822		
QTY	CRANKSHAFT REAR SEAL	YEARS	PART NO.	DESCRIPTION	
1	Rear Main Seal Set	2006	BS 40701	Rubber; One-piece	
QTY	VALVE COVER	YEARS	PART NO.	DESCRIPTION	
1	Valve Cover Gasket Set	2006	VS 50690 R	w/Spark plug tube seals; PermaDry® molded rubber gskts. incl.	
1	Spark Plug Tube Seal Set	2006	ES 72701	Valve Cover; New Part Number - Check for Availability	
QTY	VALVE STEM SEAL SET	YEARS	PART NO.	DESCRIPTION	
1	Valve Stem Seal Set	2006	SS 72878	Premium valve stem seals incl.	
QTY	THERMOSTAT HOUSING	YEARS	PART NO.	DESCRIPTION	
1	Thermostat Gasket	2006	35801	Thermostat Housing; Thermostat seal	
QTY	WATER OUTLET GASKET	YEARS	PART NO.	DESCRIPTION	
2	Water Outlet Gasket	2006	35767	Water Outlet; Outlet; Improved design	
1	Water Outlet Gasket	2006	35809	Water Outlet; Water inlet O-ring; New Part Number - Check for Availability	
QTY	WATER PUMP	YEARS	PART NO.	DESCRIPTION	
1	Water Pump Gasket	2006	35817		
QTY	TIMING COVER	YEARS	PART NO.	DESCRIPTION	
1	Crankshaft Front Seal Set	2006	TCS 46080		
QTY	CARB & FUEL INJECTION	YEARS	PART NO.	DESCRIPTION	
1	Throttle Body Gasket	2006	61583		
29		1998 - 1992; 3.0L 182.9 (2997cc) DOHC L6 (24 Valve) 86mm Bore			29
		MFI; Gasoline; Naturally Aspirated Toyota Eng.; Eng. Code 2JZGE			
QTY	CYLINDER HEAD	YEARS	PART NO.	DESCRIPTION	
1	Head Gasket	1998-92	26297 PT	Head bolts not incl.; Head bolt replacement recommended; PermaTorqueMLS®	
1	Head Set	1998-92	HS 26297 PT-1	Head bolts not incl.; Head bolt replacement recommended; PermaDry® molded rubber valve cover gskts. incl.; Premium valve stem seals incl.	
1	Head Bolt Set	1998-92	ES 72213	Head bolts w/Washers; Replacement recommended	
QTY	CONVERSION SET	YEARS	PART NO.	DESCRIPTION	
1	Gasket Conversion Set	1998-92	CS 26297	RTV sealant incl. for oil pan gskt.	
QTY	MANIFOLD - INT. & EXH.	YEARS	PART NO.	DESCRIPTION	
1	Int. Manifold Gasket Set	1998-92	MS 96690	Lower set; Upper set incl.	
1	Exh. Manifold Gasket Set	1998-92	MS 96686		

Toyota Car (Incl. Lexus, Scion, Toyota) (Cont.)

29 (cont.)		1998 - 1992; 3.0L 182.9 (2997cc) DOHC L6 (24 Valve) 86mm Bore			29 (cont.)
MFI; Gasoline; Naturally Aspirated Toyota Eng.; Eng. Code 2JZGE					
QTY	EXHAUST PIPE FLANGE	YEARS	PART NO.	DESCRIPTION	
2	Exhaust Pipe Gasket	1998-92	23591	Flange; 1 31/32" ID x 2 35/64" OD	
QTY	OIL PAN	YEARS	PART NO.	DESCRIPTION	
1	Oil Pan Gasket Set	1998-92	OS 30763	RTV sealant incl. for oil pan gskt.	
1	Drain Plug Gasket	1998-92	70822		
QTY	CRANKSHAFT REAR SEAL	YEARS	PART NO.	DESCRIPTION	
1	Rear Main Seal Set	1998-92	BS 40695	Rubber; One-piece	
QTY	VALVE COVER	YEARS	PART NO.	DESCRIPTION	
1	Valve Cover Gasket Set	1998-97	VS 50669 R	w/Aluminum valve covers; Baffle gskts. not incl.; PermaDry® molded rubber gskts. incl.	
1	Valve Cover Gasket Set	1998-97	VS 50669 R	w/Magnesium valve covers; PermaDry® molded rubber gskts. incl.	
1	Valve Cover Gasket Set	1996-92	VS 50669 R	PermaDry® molded rubber gskts. incl.	
QTY	VALVE STEM SEAL SET	YEARS	PART NO.	DESCRIPTION	
1	Valve Stem Seal Set	1998-92	SS 72810-1	Premium valve stem seals incl.	
QTY	THERMOSTAT HOUSING	YEARS	PART NO.	DESCRIPTION	
1	Thermostat Gasket	1998-92	35445	Thermostat Housing; Thermostat inlet	
1	Thermostat Gasket	1998-92	35788	Thermostat Housing	
QTY	WATER PUMP	YEARS	PART NO.	DESCRIPTION	
1	Water Pump Gasket	1998-92	35790		
QTY	TIMING COVER	YEARS	PART NO.	DESCRIPTION	
1	Crankshaft Front Seal Set	1998-92	TCS 46070		
2	Camshaft Front Seal Set	1998-92	TCS 46185	New Part Number - Check for Availability	
QTY	CARB & FUEL INJECTION	YEARS	PART NO.	DESCRIPTION	
1	Throttle Body Gasket	1998-92	61424	Mounting	
1	Throttle Body Gasket	1998-92	61428	O-ring	
QTY	DISTRIBUTOR MOUNTING	YEARS	PART NO.	DESCRIPTION	
1	Distributor Mounting Gasket	1998-92	72815	Distributor seal; New Part Number - Check for Availability	
QTY	EXHAUST GAS RECIRCULATION	YEARS	PART NO.	DESCRIPTION	
1	EGR Gasket	1998-92	71234		
30		1998 - 1993; 3.0L 182.9 (2997cc) DOHC L6 (24 Valve) 86mm Bore			30
MFI; Gasoline; Turbo - Intercooled Toyota Eng.; Eng. Code 2JZGTE					
QTY	CYLINDER HEAD	YEARS	PART NO.	DESCRIPTION	
1	Head Bolt Set	1998-93	ES 72213	Head bolts w/Washers; Replacement recommended	
QTY	CONVERSION SET	YEARS	PART NO.	DESCRIPTION	
1	Gasket Conversion Set	1998-93	CS 26297	RTV sealant incl. for oil pan gskt.	
QTY	MANIFOLD - INT. & EXH.	YEARS	PART NO.	DESCRIPTION	
1	Exh. Manifold Gasket Set	1998-93	MS 96686		
QTY	EXHAUST PIPE FLANGE	YEARS	PART NO.	DESCRIPTION	
2	Exhaust Pipe Gasket	1998-93	23591	Flange; 1 31/32" ID x 2 35/64" OD	
QTY	OIL PAN	YEARS	PART NO.	DESCRIPTION	
1	Oil Pan Gasket Set	1998-93	OS 30763	RTV sealant incl. for oil pan gskt.	
1	Drain Plug Gasket	1998-93	70822		
QTY	CRANKSHAFT REAR SEAL	YEARS	PART NO.	DESCRIPTION	
1	Rear Main Seal Set	1998-93	BS 40695	Rubber; One-piece	
QTY	VALVE COVER	YEARS	PART NO.	DESCRIPTION	
1	Valve Cover Gasket Set	1998-97	VS 50669 R	w/Aluminum valve covers; Baffle gskts. not incl.; PermaDry® molded rubber gskts. incl.	
1	Valve Cover Gasket Set	1998-97	VS 50669 R	w/Magnesium valve covers; PermaDry® molded rubber gskts. incl.	
1	Valve Cover Gasket Set	1996-93	VS 50669 R	PermaDry® molded rubber gskts. incl.	
QTY	VALVE STEM SEAL SET	YEARS	PART NO.	DESCRIPTION	
1	Valve Stem Seal Set	1998-93	SS 72810-1	Premium valve stem seals incl.	
QTY	THERMOSTAT HOUSING	YEARS	PART NO.	DESCRIPTION	
1	Thermostat Gasket	1998-93	35445	Thermostat Housing; Thermostat inlet	
1	Thermostat Gasket	1998-93	35788	Thermostat Housing	
QTY	WATER PUMP	YEARS	PART NO.	DESCRIPTION	
1	Water Pump Gasket	1998-93	35790		
QTY	TIMING COVER	YEARS	PART NO.	DESCRIPTION	
1	Crankshaft Front Seal Set	1998-93	TCS 46070		
2	Camshaft Front Seal Set	1998-93	TCS 46185	New Part Number - Check for Availability	
QTY	CARB & FUEL INJECTION	YEARS	PART NO.	DESCRIPTION	
1	Throttle Body Gasket	1998-93	61424	Mounting	
1	Throttle Body Gasket	1998-93	61428	O-ring	

Toyota Car (Incl. Lexus, Scion, Toyota) (Cont.)

30		1998 - 1993; 3.0L 182.9 (2997cc) DOHC L6 (24 Valve) 86mm Bore			30
(cont.)		MFI; Gasoline; Turbo - Intercooled Toyota Eng.; Eng. Code 2JZGTE			(cont.)
QTY	DISTRIBUTOR MOUNTING	YEARS	PART NO.	DESCRIPTION	
1	Distributor Mounting Gasket	1998-93	72815	Distributor seal; New Part Number - Check for Availability	
QTY	EXHAUST GAS RECIRCULATION	YEARS	PART NO.	DESCRIPTION	
1	EGR Gasket	1998-93	71234		
31		2005 - 1998; 3.0L 182.9 (2997cc) DOHC L6 (24 Valve) 86mm Bore VVT-i			31
(cont.)		MFI; Gasoline; Naturally Aspirated Toyota Eng.; Eng. Code 2JZGE			(cont.)
QTY	CYLINDER HEAD	YEARS	PART NO.	DESCRIPTION	
1	Head Gasket	2005-98	26297 PT	Head bolts not incl.; Head bolt replacement recommended; PermaTorqueMLS®	
1	Head Set	2005-98	HS 26297 PT	Head bolts not incl.; Head bolt replacement recommended; PermaDry® molded rubber valve cover gskts. incl.; Premium valve stem seals incl.	
1	Head Bolt Set	2005-98	ES 72213	Head bolts w/Washers; Replacement recommended	
QTY	CONVERSION SET	YEARS	PART NO.	DESCRIPTION	
1	Gasket Conversion Set	2005-98	CS 26297	RTV sealant incl. for oil pan gskt.	
QTY	MANIFOLD - INT. & EXH.	YEARS	PART NO.	DESCRIPTION	
1	Int. Manifold Gasket Set	2005-98	MS 96688	Lower set; Upper set incl.	
1	Exh. Manifold Gasket Set	2005-98	MS 96686		
QTY	EXHAUST PIPE FLANGE	YEARS	PART NO.	DESCRIPTION	
2	Exhaust Pipe Gasket	2005-98	23591	Flange; 1 31/32" ID x 2 35/64" OD	
QTY	OIL PAN	YEARS	PART NO.	DESCRIPTION	
1	Oil Pan Gasket Set	2005-98	OS 30763	RTV sealant incl. for oil pan gskt.	
1	Drain Plug Gasket	2005-98	70822		
QTY	CRANKSHAFT REAR SEAL	YEARS	PART NO.	DESCRIPTION	
1	Rear Main Seal Set	2005-98	BS 40695	Rubber; One-piece	
QTY	VALVE COVER	YEARS	PART NO.	DESCRIPTION	
1	Valve Cover Gasket Set	2005-98	VS 50660 R	PermaDry® molded rubber gskts. incl.	
QTY	VALVE STEM SEAL SET	YEARS	PART NO.	DESCRIPTION	
1	Valve Stem Seal Set	2005-98	SS 72810-1	Premium valve stem seals incl.	
QTY	THERMOSTAT HOUSING	YEARS	PART NO.	DESCRIPTION	
1	Thermostat Gasket	2005-98	35445	Thermostat Housing; Thermostat inlet	
1	Thermostat Gasket	2005-98	35788	Thermostat Housing	
QTY	WATER PUMP	YEARS	PART NO.	DESCRIPTION	
1	Water Pump Gasket	2005-98	35790		
QTY	TIMING COVER	YEARS	PART NO.	DESCRIPTION	
1	Crankshaft Front Seal Set	2005-98	TCS 46070		
2	Camshaft Front Seal Set	2005-98	TCS 46185	New Part Number - Check for Availability	
QTY	CARB & FUEL INJECTION	YEARS	PART NO.	DESCRIPTION	
1	Throttle Body Gasket	2005-98	61424	Mounting	
1	Throttle Body Gasket	2005-98	61428	O-ring	
QTY	DISTRIBUTOR MOUNTING	YEARS	PART NO.	DESCRIPTION	
1	Distributor Mounting Gasket	2005-98	72815	Distributor seal; New Part Number - Check for Availability	
QTY	EXHAUST GAS RECIRCULATION	YEARS	PART NO.	DESCRIPTION	
1	EGR Gasket	2005-98	71234		
32		2009 - 2004; 3.3L 202 (3311cc) DOHC V6 (24 Valve) 92mm Bore VVT-i			32
(cont.)		MFI; Gasoline; Naturally Aspirated Toyota Eng.; Eng. Code 3MZFE			(cont.)
QTY	CYLINDER HEAD	YEARS	PART NO.	DESCRIPTION	
1	Head Gasket	2009-04	26266 PT	Loc. R.H.; Head bolts not incl.; Head bolt replacement recommended; PermaTorqueMLS®	
1	Head Gasket	2009-04	26267 PT	Loc. L.H.; Head bolts not incl.; Head bolt replacement recommended; PermaTorqueMLS®	
1	Head Set	2009-04	HS 26266 PT	Head bolts not incl.; Head bolt replacement recommended; PermaDry® molded rubber valve cover gskts. incl.; Premium valve stem seals incl.	
2	Head Bolt Set	2009-04	ES 71036	Head bolts w/Washers; Replacement recommended	
QTY	CONVERSION SET	YEARS	PART NO.	DESCRIPTION	
1	Gasket Conversion Set	2009-04	CS 9201	RTV sealant incl. for Upper oil pan gskt.	
QTY	MANIFOLD - INT. & EXH.	YEARS	PART NO.	DESCRIPTION	
1	Int. Manifold Gasket Set	2009-04	MS 92766-1	Lower set; Upper set incl.	
1	Plenum Gasket Set	2009-04	MS 96586	Upper set	
1	Exh. Manifold Gasket Set	2009-04	MS 96083		
QTY	EXHAUST PIPE FLANGE	YEARS	PART NO.	DESCRIPTION	
1	Exhaust Pipe Gasket	2009-04	60906	Loc. Center; Exh. connector	

Toyota Car (Incl. Lexus, Scion, Toyota) (Cont.)

32 (cont.)		2009 - 2004; 3.3L 202 (3311cc) DOHC V6 (24 Valve) 92mm Bore VVT-i			32 (cont.)
		MFI; Gasoline; Naturally Aspirated Toyota Eng.; Eng. Code 3MZFE			
QTY	EXHAUST PIPE FLANGE	YEARS	PART NO.	DESCRIPTION	
1	Exhaust Pipe Gasket	2009-04	61039	Converter	
2	Exhaust Pipe Gasket	2009-04	61040	Flange; 1.98" ID	
1	Exhaust Pipe Gasket	2009-07	61016	Loc. Front; Exh. connector; Improved design	
1	Exhaust Pipe Gasket	2006-04	61016	Exc. Lexus ES330 Base; Loc. Front; Exh. connector; Improved design	
1	Exhaust Pipe Gasket	2006-04	61039	Lexus ES330 Base Toyota Camry SE; Loc. Rear; Exh. connector	
QTY	OIL PAN	YEARS	PART NO.	DESCRIPTION	
1	Oil Pan Gasket Set	2009-04	OS 30681 C	Loc. Lower	
1	Drain Plug Gasket	2009-04	70822		
QTY	CRANKSHAFT REAR SEAL	YEARS	PART NO.	DESCRIPTION	
1	Rear Main Seal Set	2009-04	BS 40643	Rubber; One-piece	
QTY	VALVE COVER	YEARS	PART NO.	DESCRIPTION	
1	Valve Cover Gasket Set	2009-04	VS 50588 R	w/Spark plug tube seals; PermaDry® molded rubber gsks. incl.; Improved design	
1	Spark Plug Tube Seal Set	2009-04	ES 72701	Valve Cover; New Part Number - Check for Availability	
QTY	VALVE STEM SEAL SET	YEARS	PART NO.	DESCRIPTION	
1	Valve Stem Seal Set	2009-04	SS 72878-3	Premium valve stem seals incl.	
QTY	THERMOSTAT HOUSING	YEARS	PART NO.	DESCRIPTION	
1	Thermostat Gasket	2009-04	35445	Thermostat Housing	
QTY	WATER OUTLET GASKET	YEARS	PART NO.	DESCRIPTION	
1	O-Ring	2009-04	35654	Water Outlet; Inlet; Improved design	
QTY	WATER PUMP	YEARS	PART NO.	DESCRIPTION	
1	Water Pump Gasket	2009-04	35594		
QTY	TIMING COVER	YEARS	PART NO.	DESCRIPTION	
1	Timing Cover Set	2009-04	TCS 45890		
1	Crankshaft Front Seal Set	2009-04	TCS 46195	New Part Number - Check for Availability	
1	Camshaft Front Seal Set	2009-04	TCS 45889		
1	Repair Sleeve	2009-04	16220	Timing Cover; Use w/installation tool; Improved design	
1	Repair Sleeve	2009-04	16223	Timing Cover; Use w/installation tool; May use 16220 instead; Old design; Superseded - When depleted use 16220	
1	Repair Sleeve Tool	2009-04	16323	Timing Cover	
QTY	CARB & FUEL INJECTION	YEARS	PART NO.	DESCRIPTION	
1	Throttle Body Gasket	2009-04	61276	Mounting	
1	Throttle Body Gasket	2009-04	61373	Idle air control	
33		2013 - 2005; 3.5L 211 (3456cc) DOHC V6 (24 Valve) 94mm Bore VVT-i			33
		MFI; Gasoline; Naturally Aspirated Toyota Eng.; Eng. Code 2GRFE			
QTY	CYLINDER HEAD	YEARS	PART NO.	DESCRIPTION	
1	Head Gasket	2013-05	26321 PT	Loc. L.H.; Head bolts not incl.; Head bolt replacement recommended; PermaTorqueMLS®	
1	Head Gasket	2013-05	26322 PT	Loc. R.H.; Head bolts not incl.; Head bolt replacement recommended; PermaTorqueMLS®	
1	Head Set	2013-05	HS 26321 PT	Head bolts not incl.; Head bolt replacement recommended; PermaDry® molded rubber valve cover gsks. incl.; Premium valve stem seals incl.	
1	Head Bolt Set	2013-05	ES 72249	Head bolts w/Washers; Replacement recommended	
QTY	CONVERSION SET	YEARS	PART NO.	DESCRIPTION	
1	Gasket Conversion Set	2013-12	CS 26321-1	RTV sealant incl. for oil pan gskt.	
1	Gasket Conversion Set	2011-05	CS 26321	RTV sealant incl. for oil pan gskt.	
QTY	MANIFOLD - INT. & EXH.	YEARS	PART NO.	DESCRIPTION	
1	Int. Manifold Gasket Set	2013-05	MS 96790	Lower set; Upper set incl.	
1	Plenum Gasket Set	2013-05	MS 96786	Upper set; New Part Number - Check for Availability	
1	Exh. Manifold Gasket Set	2013-05	MS 96795	Improved design	
QTY	EXHAUST PIPE FLANGE	YEARS	PART NO.	DESCRIPTION	
1	Exhaust Pipe Gasket	2013-05	23591	Exh. connector; 1 31/32" ID x 2 35/64" OD	
1	Exhaust Pipe Gasket	2013-05	61039	Converter	
1	Exhaust Pipe Gasket	2013-05	61040	Exh. connector; 1.98" ID	
QTY	OIL PAN	YEARS	PART NO.	DESCRIPTION	
1	Oil Pan Gasket Set	2013-05	OS 30770	RTV sealant incl. for oil pan gskt.; Improved design	
1	Oil Pan Gasket Set	2013-08	OS 30817	RTV sealant incl. for oil pan gskt.; Old design	
1	Drain Plug Gasket	2013-05	70822		
QTY	CRANKSHAFT REAR SEAL	YEARS	PART NO.	DESCRIPTION	
1	Rear Main Seal Set	2013-12	BS 40643	Rubber; One-piece	
1	Rear Main Seal Set	2011-05	BS 40701	Rubber; One-piece	
QTY	VALVE COVER	YEARS	PART NO.	DESCRIPTION	
1	Valve Cover Gasket Set	2013-05	VS 50682 R	w/Spark plug tube seals; PermaDry® molded rubber gsks. incl.	

Toyota Car (Incl. Lexus, Scion, Toyota) (Cont.)

33		2013 - 2005; 3.5L 211 (3456cc) DOHC V6 (24 Valve) 94mm Bore VVT-i			33
(cont.)		MFI; Gasoline; Naturally Aspirated Toyota Eng.; Eng. Code 2GRFE			(cont.)
QTY	VALVE COVER	YEARS	PART NO.	DESCRIPTION	
1	Spark Plug Tube Seal Set	2013-05	ES 72701	Valve Cover; New Part Number - Check for Availability	
QTY	VALVE STEM SEAL SET	YEARS	PART NO.	DESCRIPTION	
1	Valve Stem Seal Set	2013-05	SS 72878	Premium valve stem seals incl.	
QTY	THERMOSTAT HOUSING	YEARS	PART NO.	DESCRIPTION	
1	Thermostat Gasket	2013-05	35445	Thermostat Housing; Thermostat	
QTY	WATER OUTLET GASKET	YEARS	PART NO.	DESCRIPTION	
2	Water Outlet Gasket	2013-05	35767	Water Outlet; Outlet; Improved design	
1	Water Outlet Gasket	2013-05	35809	Water Outlet; Water inlet O-ring; New Part Number - Check for Availability	
2	Water Outlet Gasket	2013-05	35811	Water Outlet; Outlet; Old design	
1	Thermostat Gasket	2013-05	35801	Water Outlet; Inlet	
QTY	WATER PUMP	YEARS	PART NO.	DESCRIPTION	
1	Water Pump Gasket	2013-05	35807		
QTY	TIMING COVER	YEARS	PART NO.	DESCRIPTION	
1	Crankshaft Front Seal Set	2013-05	TCS 46080		
QTY	CARB & FUEL INJECTION	YEARS	PART NO.	DESCRIPTION	
1	Throttle Body Gasket	2013-05	61445		
34		2013 - 2006; 3.5L 211 (3456cc) DOHC V6 (24 Valve) 94mm Bore VVT-i			34
		DI; Gasoline; Naturally Aspirated Toyota Eng.; Eng. Code 2GRFSE			
QTY	CYLINDER HEAD	YEARS	PART NO.	DESCRIPTION	
1	Head Gasket	2013-06	26321 PT	Loc. L.H.; Head bolts not incl.; Head bolt replacement recommended; PermaTorqueMLS®	
1	Head Gasket	2013-06	26322 PT	Loc. R.H.; Head bolts not incl.; Head bolt replacement recommended; PermaTorqueMLS®	
1	Head Set	2013-06	HS 26321 PT-1	Head bolts not incl.; Head bolt replacement recommended; PermaDry® molded rubber valve cover gsks. incl.; Premium valve stem seals incl.	
1	Head Bolt Set	2013-06	ES 72249	Head bolts w/Washers; Replacement recommended	
QTY	CONVERSION SET	YEARS	PART NO.	DESCRIPTION	
1	Gasket Conversion Set	2013-06	CS 26419	AWD; RTV sealant incl. for oil pan gskt.	
1	Gasket Conversion Set	2013-06	CS 26419-1	RWD; RTV sealant incl. for oil pan gskt.	
QTY	MANIFOLD - INT. & EXH.	YEARS	PART NO.	DESCRIPTION	
1	Int. Manifold Gasket Set	2013-06	MS 96851	Lower set; Upper set incl.	
1	Exh. Manifold Gasket Set	2013-06	MS 96795	Improved design	
QTY	EXHAUST PIPE FLANGE	YEARS	PART NO.	DESCRIPTION	
1	Exhaust Pipe Gasket	2013-06	60906	Exh. connector	
1	Exhaust Pipe Gasket	2013-06	61460	Converter; 2.40" ID	
QTY	OIL PAN	YEARS	PART NO.	DESCRIPTION	
1	Oil Pan Gasket Set	2013-06	OS 30808	AWD; RTV sealant incl. for oil pan gskt.	
1	Oil Pan Gasket Set	2013-06	OS 30810	RWD; RTV sealant incl. for oil pan gskt.	
1	Drain Plug Gasket	2013-06	70822		
QTY	CRANKSHAFT REAR SEAL	YEARS	PART NO.	DESCRIPTION	
1	Rear Main Seal Set	2013-06	BS 40701	Rubber; One-piece	
QTY	VALVE COVER	YEARS	PART NO.	DESCRIPTION	
1	Valve Cover Gasket Set	2013-06	VS 50690 R	w/Spark plug tube seals; PermaDry® molded rubber gsks. incl.	
1	Spark Plug Tube Seal Set	2013-06	ES 72701	Valve Cover; New Part Number - Check for Availability	
QTY	VALVE STEM SEAL SET	YEARS	PART NO.	DESCRIPTION	
1	Valve Stem Seal Set	2013-06	SS 72878	Premium valve stem seals incl.	
QTY	THERMOSTAT HOUSING	YEARS	PART NO.	DESCRIPTION	
1	Thermostat Gasket	2013-06	35445	Thermostat Housing; Thermostat	
QTY	WATER OUTLET GASKET	YEARS	PART NO.	DESCRIPTION	
2	Water Outlet Gasket	2013-06	35767	Water Outlet; Outlet; Improved design	
1	Water Outlet Gasket	2013-06	35809	Water Outlet; Water inlet O-ring; New Part Number - Check for Availability	
2	Water Outlet Gasket	2013-06	35811	Water Outlet; Outlet; Old design	
1	Thermostat Gasket	2013-06	35801	Water Outlet; Inlet	
QTY	WATER PUMP	YEARS	PART NO.	DESCRIPTION	
1	Water Pump Gasket	2013-06	35817		
QTY	TIMING COVER	YEARS	PART NO.	DESCRIPTION	
1	Crankshaft Front Seal Set	2013-06	TCS 46080		
QTY	CARB & FUEL INJECTION	YEARS	PART NO.	DESCRIPTION	
1	Throttle Body Gasket	2013-06	61472		

Toyota Car (Incl. Lexus, Scion, Toyota) (Cont.)

35		2013 - 2007; 3.5L 211 (3456cc) DOHC V6 (24 Valve) 94mm Bore VVT-i			35
DI; Hybrid (Gas/Electric); Naturally Aspirated Toyota Eng.; Eng. Code 2GRFSE					
QTY	CYLINDER HEAD	YEARS	PART NO.	DESCRIPTION	
1	Head Gasket	2013-07	26321 PT	Loc. L.H.; Head bolts not incl.; Head bolt replacement recommended; PermaTorqueMLS®	
1	Head Gasket	2013-07	26322 PT	Loc. R.H.; Head bolts not incl.; Head bolt replacement recommended; PermaTorqueMLS®	
1	Head Set	2013-07	HS 26321 PT-1	Head bolts not incl.; Head bolt replacement recommended; PermaDry® molded rubber valve cover gskts. incl.; Premium valve stem seals incl.	
1	Head Bolt Set	2013-07	ES 72249	Head bolts w/Washers; Replacement recommended	
QTY	CONVERSION SET	YEARS	PART NO.	DESCRIPTION	
1	Gasket Conversion Set	2013-07	CS 26419	AWD; RTV sealant incl. for oil pan gskt.	
1	Gasket Conversion Set	2013-07	CS 26419-1	RWD; RTV sealant incl. for oil pan gskt.	
QTY	MANIFOLD - INT. & EXH.	YEARS	PART NO.	DESCRIPTION	
1	Int. Manifold Gasket Set	2013-07	MS 96851	Lower set; Upper set incl.	
1	Exh. Manifold Gasket Set	2013-07	MS 96795	Improved design	
QTY	EXHAUST PIPE FLANGE	YEARS	PART NO.	DESCRIPTION	
1	Exhaust Pipe Gasket	2013-07	60906	Exh. connector	
1	Exhaust Pipe Gasket	2013-07	61460	Converter; 2.40" ID	
QTY	OIL PAN	YEARS	PART NO.	DESCRIPTION	
1	Oil Pan Gasket Set	2013-07	OS 30808	AWD; RTV sealant incl. for oil pan gskt.	
1	Oil Pan Gasket Set	2013-07	OS 30810	RWD; RTV sealant incl. for oil pan gskt.	
1	Drain Plug Gasket	2013-07	70822		
QTY	CRANKSHAFT REAR SEAL	YEARS	PART NO.	DESCRIPTION	
1	Rear Main Seal Set	2013-07	BS 40701	Rubber; One-piece	
QTY	VALVE COVER	YEARS	PART NO.	DESCRIPTION	
1	Valve Cover Gasket Set	2013-07	VS 50690 R	w/Spark plug tube seals; PermaDry® molded rubber gskts. incl.	
1	Spark Plug Tube Seal Set	2013-07	ES 72701	Valve Cover; New Part Number - Check for Availability	
QTY	VALVE STEM SEAL SET	YEARS	PART NO.	DESCRIPTION	
1	Valve Stem Seal Set	2013-07	SS 72878	Premium valve stem seals incl.	
QTY	THERMOSTAT HOUSING	YEARS	PART NO.	DESCRIPTION	
1	Thermostat Gasket	2013-07	35445	Thermostat Housing; Thermostat	
QTY	WATER OUTLET GASKET	YEARS	PART NO.	DESCRIPTION	
2	Water Outlet Gasket	2013-07	35767	Water Outlet; Outlet; Improved design	
1	Water Outlet Gasket	2013-07	35809	Water Outlet; Water inlet O-ring; New Part Number - Check for Availability	
2	Water Outlet Gasket	2013-07	35811	Water Outlet; Outlet; Old design	
1	Thermostat Gasket	2013-07	35801	Water Outlet; Inlet	
QTY	WATER PUMP	YEARS	PART NO.	DESCRIPTION	
1	Water Pump Gasket	2013-07	35817		
QTY	TIMING COVER	YEARS	PART NO.	DESCRIPTION	
1	Crankshaft Front Seal Set	2013-07	TCS 46080		
QTY	CARB & FUEL INJECTION	YEARS	PART NO.	DESCRIPTION	
1	Throttle Body Gasket	2013-07	61472		
36		1997 - 1991; 4.0L 241.6 (3968cc) DOHC V8 (32 Valve) 87.5mm Bore			36
MFI; Gasoline; Naturally Aspirated Toyota Eng.; Eng. Code 1UZFE					
QTY	CYLINDER HEAD	YEARS	PART NO.	DESCRIPTION	
1	Head Gasket	1997-91	9805 PT	Loc. L.H.; Head bolts not incl.; Head bolt replacement recommended	
1	Head Gasket	1997-91	9806 PT	Loc. R.H.; Head bolts not incl.; Head bolt replacement recommended	
1	Head Set	1997-92	HS 9805 PT	Lexus SC400 Base; Exh. manifold gskts. & head bolts not incl.; Head bolt replacement recommended; PermaDry® molded rubber valve cover gskts. incl.; Premium valve stem seals incl.	
1	Head Set	1997-92	HS 9805 PT	Lexus LS400 Base; Head bolts not incl.; Head bolt replacement recommended; PermaDry® molded rubber valve cover gskts. incl.; Premium valve stem seals incl.	
1	Head Set	1991	HS 9805 PT	Head bolts not incl.; Head bolt replacement recommended; PermaDry® molded rubber valve cover gskts. incl.; Premium valve stem seals incl.	
QTY	CONVERSION SET	YEARS	PART NO.	DESCRIPTION	
1	Gasket Conversion Set	1997-91	CS 9805	RTV sealant incl. for Upper oil pan gskt.	
QTY	MANIFOLD - INT. & EXH.	YEARS	PART NO.	DESCRIPTION	
1	Int. Manifold Gasket Set	1997-91	MS 94753	Lower set; Upper set incl.	
1	Plenum Gasket Set	1997-91	MS 96628	Upper set; New Part Number - Check for Availability	
1	Exh. Manifold Gasket Set	1997-92	MS 94754	Lexus LS400 Base	
1	Exh. Manifold Gasket Set	1997-92	MS 95439	Lexus SC400 Base	
1	Exh. Manifold Gasket Set	1991	MS 94754		
QTY	EXHAUST PIPE FLANGE	YEARS	PART NO.	DESCRIPTION	
2	Exhaust Pipe Gasket	1997-91	60461	Flange	

Toyota Car (Incl. Lexus, Scion, Toyota) (Cont.)

36 (cont.)		1997 - 1991; 4.0L 241.6 (3968cc) DOHC V8 (32 Valve) 87.5mm Bore MFI; Gasoline; Naturally Aspirated Toyota Eng.; Eng. Code 1UZF			36 (cont.)
QTY	EXHAUST PIPE FLANGE	YEARS	PART NO.	DESCRIPTION	
1	Exhaust Pipe Gasket	1997-91	60512	Loc. Front; Converter; Improved design	
1	Exhaust Pipe Gasket	1997-92	60461	Lexus LS400 Base; Loc. Rear; Converter	
1	Exhaust Pipe Gasket	1997-92	60495	Lexus SC400 Base; Loc. Rear; Converter	
1	Exhaust Pipe Gasket	1991	60461	Loc. Rear; Converter	
QTY	OIL PAN	YEARS	PART NO.	DESCRIPTION	
1	Oil Pan Gasket Set	1997-92	OS 30654 C	Lexus LS400 Base; Loc. Lower	
1	Oil Pan Gasket Set	1997-92	OS 30846	Lexus SC400 Base; Loc. Lower; New Part Number - Check for Availability	
1	Oil Pan Gasket Set	1991	OS 30654 C	Loc. Lower	
1	Drain Plug Gasket	1997-91	70822		
QTY	CRANKSHAFT REAR SEAL	YEARS	PART NO.	DESCRIPTION	
1	Rear Main Seal Set	1997-91	BS 40659	Rubber; One-piece	
QTY	VALVE COVER	YEARS	PART NO.	DESCRIPTION	
1	Valve Cover Gasket Set	1997-91	VS 50376 R	w/o Spark plug tube seals & w/Grommets; PermaDry® molded rubber gskts. incl.	
2	Grommet Set	1997-91	ES 72133	Valve Cover	
2	Spark Plug Tube Seal Set	1997-91	ES 72105	Valve Cover	
QTY	VALVE STEM SEAL SET	YEARS	PART NO.	DESCRIPTION	
2	Valve Stem Seal Set	1997-91	SS 72837	Premium valve stem seals incl.	
QTY	THERMOSTAT HOUSING	YEARS	PART NO.	DESCRIPTION	
1	Thermostat Gasket	1996-91	35445	Thermostat Housing; Thermostat inlet	
1	O-Ring	1997	35555	Thermostat Housing	
QTY	WATER PUMP	YEARS	PART NO.	DESCRIPTION	
1	Water Pump Gasket	1997	35718		
1	Water Pump Gasket	1996-91	35552	Inlet	
QTY	TIMING COVER	YEARS	PART NO.	DESCRIPTION	
1	Crankshaft Front Seal Set	1997-91	TCS 45916		
2	Camshaft Front Seal Set	1997-91	TCS 45641-1		
1	Camshaft Rear Seal Plug Set	1997-91	TCS 45979		
QTY	CARB & FUEL INJECTION	YEARS	PART NO.	DESCRIPTION	
2	Fuel Injector O-Ring Set	1997-91	ES 70600		
1	Throttle Body Gasket	1997-91	60893		
QTY	EXHAUST GAS RECIRCULATION	YEARS	PART NO.	DESCRIPTION	
1	EGR Gasket	1997-91	70475	Valve	
37		2000 - 1998; 4.0L 241.6 (3968cc) DOHC V8 (32 Valve) 87.5mm Bore VVT-i MFI; Gasoline; Naturally Aspirated Toyota Eng.; Eng. Code 1UZF			37
QTY	CYLINDER HEAD	YEARS	PART NO.	DESCRIPTION	
1	Head Gasket	2000-98	26295 PT	Loc. L.H.; Head bolts not incl.; Head bolt replacement recommended; PermaTorqueMLS®	
1	Head Gasket	2000-98	26296 PT	Loc. R.H.; Head bolts not incl.; Head bolt replacement recommended; PermaTorqueMLS®	
1	Head Set	2000-98	HS 26295 PT	Head bolts not incl.; Head bolt replacement recommended; PermaDry® molded rubber valve cover gskts. incl.; Premium valve stem seals incl.	
2	Head Bolt Set	2000-98	ES 72202	Replacement recommended	
QTY	CONVERSION SET	YEARS	PART NO.	DESCRIPTION	
1	Gasket Conversion Set	2000-98	CS 9805	RTV sealant incl. for Upper oil pan gskt.	
QTY	MANIFOLD - INT. & EXH.	YEARS	PART NO.	DESCRIPTION	
1	Int. Manifold Gasket Set	2000-98	MS 96334	Lower set; Upper set incl.	
1	Plenum Gasket Set	2000-98	MS 96333	Upper set	
1	Exh. Manifold Gasket Set	2000-98	MS 95439		
QTY	EXHAUST PIPE FLANGE	YEARS	PART NO.	DESCRIPTION	
2	Exhaust Pipe Gasket	2000-98	60906	Center pipe to muffler	
2	Exhaust Pipe Gasket	2000-98	60906	Converter to front pipe	
1	Exhaust Pipe Gasket	2000-98	61039	Front pipe to center pipe	
2	Exhaust Pipe Gasket	2000-98	61086	Flange; 2.448" ID	
QTY	OIL PAN	YEARS	PART NO.	DESCRIPTION	
1	Oil Pan Gasket Set	2000-98	OS 30654 C	Exc. Lexus SC400 Base; Loc. Lower	
1	Oil Pan Gasket Set	2000-98	OS 30846	Lexus SC400 Base; Loc. Lower; New Part Number - Check for Availability	
1	Drain Plug Gasket	2000-98	70822		
QTY	CRANKSHAFT REAR SEAL	YEARS	PART NO.	DESCRIPTION	
1	Rear Main Seal Set	2000-98	BS 40659	Rubber; One-piece	
QTY	VALVE COVER	YEARS	PART NO.	DESCRIPTION	
1	Valve Cover Gasket Set	2000-98	VS 50592 R	w/Grommets & Spark plug tube seals; PermaDry® molded rubber gskts. incl.	

Toyota Car (Incl. Lexus, Scion, Toyota) (Cont.)

37 (cont.)		2000 - 1998; 4.0L 241.6 (3968cc) DOHC V8 (32 Valve) 87.5mm Bore VVT-i			37 (cont.)
		MFI; Gasoline; Naturally Aspirated Toyota Eng.; Eng. Code 1UZF			
QTY	VALVE COVER	YEARS	PART NO.	DESCRIPTION	
2	Grommet Set	2000-98	ES 72133	Valve Cover	
QTY	VALVE STEM SEAL SET	YEARS	PART NO.	DESCRIPTION	
1	Valve Stem Seal Set	2000-98	SS 72910	Premium valve stem seals incl.	
QTY	THERMOSTAT HOUSING	YEARS	PART NO.	DESCRIPTION	
1	O-Ring	2000-98	35555	Thermostat Housing	
QTY	WATER OUTLET GASKET	YEARS	PART NO.	DESCRIPTION	
2	Water Outlet Gasket	2000-98	35941	Water Outlet; Loc. Front; Water bypass	
2	Water Outlet Gasket	2000-98	35941	Water Outlet; Loc. Rear; Water bypass	
QTY	WATER PUMP	YEARS	PART NO.	DESCRIPTION	
1	Water Pump Gasket	2000-98	35718		
QTY	TIMING COVER	YEARS	PART NO.	DESCRIPTION	
1	Crankshaft Front Seal Set	2000-98	TCS 45916		
1	Camshaft Front Seal Set	2000-98	TCS 46050		
QTY	CARB & FUEL INJECTION	YEARS	PART NO.	DESCRIPTION	
1	Throttle Body Gasket	2000-98	61281		
QTY	EXHAUST GAS RECIRCULATION	YEARS	PART NO.	DESCRIPTION	
1	EGR Gasket	2000-98	70475	Valve	
38		2010 - 2001; 4.3L 262 (4293cc) DOHC V8 (32 Valve) 91mm Bore VVT-i			38
		MFI; Gasoline; Naturally Aspirated Toyota Eng.; Eng. Code 3UZFE			
QTY	CYLINDER HEAD	YEARS	PART NO.	DESCRIPTION	
1	Head Gasket	2010-01	26262 PT	Loc. L.H.; Head bolts not incl.; Head bolt replacement recommended; PermaTorqueMLS®	
1	Head Gasket	2010-01	26263 PT	Loc. R.H.; Head bolts not incl.; Head bolt replacement recommended; PermaTorqueMLS®	
1	Head Set	2010-01	HS 26262 PT	Head bolts not incl.; Head bolt replacement recommended; PermaDry® molded rubber valve cover gskts. incl.; Premium valve stem seals incl.	
2	Head Bolt Set	2010-01	ES 72202	Replacement recommended	
QTY	CONVERSION SET	YEARS	PART NO.	DESCRIPTION	
1	Gasket Conversion Set	2010-07	CS 26262-1		
1	Gasket Conversion Set	2006	CS 26262	Lexus LS430 Base	
1	Gasket Conversion Set	2006	CS 26262-1	Exc. Lexus LS430 Base	
1	Gasket Conversion Set	2005-01	CS 26262		
QTY	MANIFOLD - INT. & EXH.	YEARS	PART NO.	DESCRIPTION	
1	Int. Manifold Gasket Set	2010-01	MS 96334	Lower set; Upper set incl.	
1	Plenum Gasket Set	2010-01	MS 96333	Upper set	
1	Exh. Manifold Gasket Set	2010-01	MS 95439		
QTY	EXHAUST PIPE FLANGE	YEARS	PART NO.	DESCRIPTION	
1	Exhaust Pipe Gasket	2010-01	60906	Center pipe to muffler	
1	Exhaust Pipe Gasket	2010-01	61039	Front pipe to center pipe	
2	Exhaust Pipe Gasket	2010-01	61086	Flange; 2.448" ID	
1	Exhaust Pipe Gasket	2010-01	61434	Exh. connector	
2	Exhaust Pipe Gasket	2010-01	61437	Loc. Front; Converter	
1	Exhaust Pipe Gasket	2010-01	61460	Loc. Rear; Converter; 2.40" ID	
QTY	OIL PAN	YEARS	PART NO.	DESCRIPTION	
1	Oil Pan Gasket Set	2010-01	OS 30749		
1	Drain Plug Gasket	2010-01	70822		
QTY	CRANKSHAFT REAR SEAL	YEARS	PART NO.	DESCRIPTION	
1	Rear Main Seal Set	2010-07	BS 40679	Rubber; One-piece	
1	Rear Main Seal Set	2006	BS 40679	Exc. Lexus LS430 Base; Rubber; One-piece	
1	Rear Main Seal Set	2006	BS 40696	Lexus LS430 Base; Rubber; One-piece	
1	Rear Main Seal Set	2005-01	BS 40696	Rubber; One-piece	
QTY	VALVE COVER	YEARS	PART NO.	DESCRIPTION	
1	Valve Cover Gasket Set	2010-01	VS 50592 R	w/Grommets & Spark plug tube seals; PermaDry® molded rubber gskts. incl.	
2	Grommet Set	2010-01	ES 72133	Valve Cover	
QTY	VALVE STEM SEAL SET	YEARS	PART NO.	DESCRIPTION	
1	Valve Stem Seal Set	2010-01	SS 72910	Premium valve stem seals incl.	
QTY	THERMOSTAT HOUSING	YEARS	PART NO.	DESCRIPTION	
1	O-Ring	2010-01	35555	Thermostat Housing	
QTY	WATER OUTLET GASKET	YEARS	PART NO.	DESCRIPTION	
2	Water Outlet Gasket	2010-01	35941	Water Outlet; Loc. Front; Water bypass	
2	Water Outlet Gasket	2010-01	35941	Water Outlet; Loc. Rear; Water bypass	
QTY	WATER PUMP	YEARS	PART NO.	DESCRIPTION	
1	Water Pump Gasket	2010-01	35718		

Toyota Car (Incl. Lexus, Scion, Toyota) (Cont.)

38 (cont.)		2010 - 2001; 4.3L 262 (4293cc) DOHC V8 (32 Valve) 91mm Bore VVT-i MFI; Gasoline; Naturally Aspirated Toyota Eng.; Eng. Code 3UZFE			38 (cont.)	
QTY	TIMING COVER	YEARS	PART NO.	DESCRIPTION		
1	Crankshaft Front Seal Set	2010-01	TCS 46035			
1	Camshaft Front Seal Set	2010-01	TCS 46050			
QTY	CARB & FUEL INJECTION	YEARS	PART NO.	DESCRIPTION		
1	Throttle Body Gasket	2010-01	61281			

Toyota Minivans - See Toyota Truck

Toyota SUV's - See Toyota Truck

Toyota Truck (Incl. Minivans and SUV's)

Engine Finding Index				
Engine	Years	Code	Line No.	
2.0L 122 (1998cc) DOHC L4 (16 Valve) 86mm Bore; MFI; Gasoline; Naturally Aspirated Toyota Eng.	2000-96	3SFE	1	
2.0L 122 (1998cc) DOHC L4 (16 Valve) 86mm Bore VVT-i; MFI; Gasoline; Naturally Aspirated Toyota Eng.	2003-01	1AZFE	2	
2.4L 144 (2362cc) DOHC L4 (16 Valve) 88.5mm Bore VVT-i; MFI; Gasoline; Naturally Aspirated Toyota Eng.	2008-01	2AZFE	3	
2.4L 144.4 (2366cc) SOHC L4 (8 Valve) 92mm Bore; MFI; Gasoline; Naturally Aspirated Toyota Eng.	1995-91	22RE	4	
2.4L 148.7 (2438cc) DOHC L4 (16 Valve) 95mm Bore; MFI; Gasoline; Naturally Aspirated Toyota Eng.	2004-95	2RZFE	5	
2.4L 148.7 (2438cc) DOHC L4 (16 Valve) 95mm Bore; MFI; Gasoline; Naturally Aspirated Toyota Eng.	1996-91	2TZFE	6	
2.4L 148.7 (2438cc) DOHC L4 (16 Valve) 95mm Bore; MFI; Gasoline; Supercharged Toyota Eng.	1997-94	2TZFZE	7	
2.5L 152.2 (2494cc) DOHC L4 (16 Valve) 90mm Bore VVT-i; MFI; Gasoline; Naturally Aspirated Toyota Eng.	2013-09	2ARFE	8	
2.7L 164.3 (2693cc) DOHC L4 (16 Valve) 95mm Bore; MFI; Gasoline; Naturally Aspirated Toyota Eng.	2005-94	3RZFE	9	
2.7L 164.3 (2693cc) DOHC L4 (16 Valve) 95mm Bore VVT-i; MFI; Gasoline; Naturally Aspirated Toyota Eng.	2013-05	2TRFE	10	
3.0L 180.5 (2958cc) SOHC V6 (12 Valve) 87.5mm Bore; MFI; Gasoline; Naturally Aspirated Toyota Eng.	1995-91	3VZE	11	
3.0L 182.6 (2995cc) DOHC V6 (24 Valve) 87.5mm Bore; MFI; Gasoline; Naturally Aspirated Toyota Eng.	2000-98	1MZFE	12	
3.0L 182.6 (2995cc) DOHC V6 (24 Valve) 87.5mm Bore VVT-i; MFI; Gasoline; Naturally Aspirated Toyota Eng.	2003-99	1MZFE	13	
3.3L 202 (3311cc) DOHC V6 (24 Valve) 92mm Bore VVT-i; MFI; Gasoline; Naturally Aspirated Toyota Eng.	2007-04	3MZFE	14	
3.3L 202 (3311cc) DOHC V6 (24 Valve) 92mm Bore VVT-i; MFI; Hybrid (Gas/Electric); Naturally Aspirated Toyota Eng.	2010-06	3MZFXE	15	
3.4L 206.1 (3378cc) DOHC V6 (24 Valve) 93.5mm Bore; MFI; Gasoline; Naturally Aspirated Toyota Eng.	2005-95	5VZFE	16	
3.5L 211 (3456cc) DOHC V6 (24 Valve) 94mm Bore VVT-i; MFI; Gasoline; Naturally Aspirated Toyota Eng.	2013-06	2GRFE	17	
3.5L 211 (3456cc) DOHC V6 (24 Valve) 94mm Bore VVT-i; MFI; Hybrid (Gas/Electric); Naturally Aspirated Toyota Eng.	2013-10	2GRFXE	18	
4.0L 241.3 (3955cc) DOHC V6 (24 Valve) 94mm Bore; MFI; Gasoline; Naturally Aspirated Toyota Eng.	2013-03	1GRFE	19	
4.0L 241.3 (3955cc) DOHC V6 (24 Valve) 94mm Bore VVT-i; MFI; Gasoline; Naturally Aspirated Toyota Eng.	2013-10	1GRFE	20	
4.0L 241.4 (3956cc) OHV L6 (12 Valve) 94mm Bore; MFI; Gasoline; Naturally Aspirated Toyota Eng.	1992-91	3FE	21	
4.5L 273 (4476cc) DOHC L6 (24 Valve) 100mm Bore; MFI; Gasoline; Naturally Aspirated Toyota Eng.	1997-93	1FZFE	22	
4.7L 285 (4664cc) DOHC V8 (32 Valve) 94mm Bore; MFI; Gasoline; Naturally Aspirated Toyota Eng.	2005-98	2UZFE	23	
4.7L 285 (4664cc) DOHC V8 (32 Valve) 94mm Bore VVT-i; MFI; Gasoline; Naturally Aspirated Toyota Eng.	2009-05	2UZFE	24	
5.7L 346 (5663cc) DOHC V8 (32 Valve) 94mm Bore i-Force VVT-i; MFI; Flex Fuel; Naturally Aspirated Toyota Eng.	2013-09	3URFBE	25	
5.7L 346 (5663cc) DOHC V8 (32 Valve) 94mm Bore i-Force VVT-i; MFI; Gasoline; Naturally Aspirated Toyota Eng.	2013-07	3URFE	26	
Engine Code Index				
Code	Engine	Line No.		
1AZFE	2.0L 122 (1998cc) DOHC L4 (16 Valve) 86mm Bore VVT-i; MFI; Gasoline; Naturally Aspirated Toyota Eng.	2		
1FZFE	4.5L 273 (4476cc) DOHC L6 (24 Valve) 100mm Bore; MFI; Gasoline; Naturally Aspirated Toyota Eng.	22		
1GRFE	4.0L 241.3 (3955cc) DOHC V6 (24 Valve) 94mm Bore; MFI; Gasoline; Naturally Aspirated Toyota Eng.	19		
1GRFE	4.0L 241.3 (3955cc) DOHC V6 (24 Valve) 94mm Bore VVT-i; MFI; Gasoline; Naturally Aspirated Toyota Eng.	20		
1MZFE	3.0L 182.6 (2995cc) DOHC V6 (24 Valve) 87.5mm Bore; MFI; Gasoline; Naturally Aspirated Toyota Eng.	12		
1MZFE	3.0L 182.6 (2995cc) DOHC V6 (24 Valve) 87.5mm Bore VVT-i; MFI; Gasoline; Naturally Aspirated Toyota Eng.	13		
22RE	2.4L 144.4 (2366cc) SOHC L4 (8 Valve) 92mm Bore; MFI; Gasoline; Naturally Aspirated Toyota Eng.	4		
2ARFE	2.5L 152.2 (2494cc) DOHC L4 (16 Valve) 90mm Bore VVT-i; MFI; Gasoline; Naturally Aspirated Toyota Eng.	8		
2AZFE	2.4L 144 (2362cc) DOHC L4 (16 Valve) 88.5mm Bore VVT-i; MFI; Gasoline; Naturally Aspirated Toyota Eng.	3		
2GRFE	3.5L 211 (3456cc) DOHC V6 (24 Valve) 94mm Bore VVT-i; MFI; Gasoline; Naturally Aspirated Toyota Eng.	17		
2GRFXE	3.5L 211 (3456cc) DOHC V6 (24 Valve) 94mm Bore VVT-i; MFI; Hybrid (Gas/Electric); Naturally Aspirated Toyota Eng.	18		
2RZFE	2.4L 148.7 (2438cc) DOHC L4 (16 Valve) 95mm Bore; MFI; Gasoline; Naturally Aspirated Toyota Eng.	5		
2TRFE	2.7L 164.3 (2693cc) DOHC L4 (16 Valve) 95mm Bore VVT-i; MFI; Gasoline; Naturally Aspirated Toyota Eng.	10		
2TZFE	2.4L 148.7 (2438cc) DOHC L4 (16 Valve) 95mm Bore; MFI; Gasoline; Naturally Aspirated Toyota Eng.	6		
2TZFZE	2.4L 148.7 (2438cc) DOHC L4 (16 Valve) 95mm Bore; MFI; Gasoline; Supercharged Toyota Eng.	7		
2UZFE	4.7L 285 (4664cc) DOHC V8 (32 Valve) 94mm Bore; MFI; Gasoline; Naturally Aspirated Toyota Eng.	23		
2UZFE	4.7L 285 (4664cc) DOHC V8 (32 Valve) 94mm Bore VVT-i; MFI; Gasoline; Naturally Aspirated Toyota Eng.	24		
3FE	4.0L 241.4 (3956cc) OHV L6 (12 Valve) 94mm Bore; MFI; Gasoline; Naturally Aspirated Toyota Eng.	21		
3MZFE	3.3L 202 (3311cc) DOHC V6 (24 Valve) 92mm Bore VVT-i; MFI; Gasoline; Naturally Aspirated Toyota Eng.	14		
3MZFXE	3.3L 202 (3311cc) DOHC V6 (24 Valve) 92mm Bore VVT-i; MFI; Hybrid (Gas/Electric); Naturally Aspirated Toyota Eng.	15		
3RZFE	2.7L 164.3 (2693cc) DOHC L4 (16 Valve) 95mm Bore; MFI; Gasoline; Naturally Aspirated Toyota Eng.	9		

Toyota Truck (Incl. Minivans and SUV's) (Cont.)

Engine Code Index (Cont.)

<i>Code</i>	<i>Engine</i>		<i>Line No.</i>
3SFE	2.0L 122 (1998cc) DOHC L4 (16 Valve) 86mm Bore; MFI; Gasoline; Naturally Aspirated Toyota Eng.		1
3URFBE	5.7L 346 (5663cc) DOHC V8 (32 Valve) 94mm Bore i-Force VVT-i; MFI; Flex Fuel; Naturally Aspirated Toyota Eng.		25
3URFE	5.7L 346 (5663cc) DOHC V8 (32 Valve) 94mm Bore i-Force VVT-i; MFI; Gasoline; Naturally Aspirated Toyota Eng.		26
3VZE	3.0L 180.5 (2958cc) SOHC V6 (12 Valve) 87.5mm Bore; MFI; Gasoline; Naturally Aspirated Toyota Eng.		11
5VZFE	3.4L 206.1 (3378cc) DOHC V6 (24 Valve) 93.5mm Bore; MFI; Gasoline; Naturally Aspirated Toyota Eng.		16
Model Index			
<i>Engine (VIN Code / Eng. Code)</i>	<i>Year</i>	<i>Engine (VIN Code / Eng. Code)</i>	<i>Year</i>
Lexus Truck		Toyota Truck (cont.)	
GX 460 (AWD Mid-Size SUV)		Highlander (AWD Mid-Size SUV) (cont.)	
V8 4608cc 4.6L DOHC (32 Valve) (1URFE)	13-10	L4 2672cc 2.7L DOHC (16 Valve) (1ARFE)	13-09
GX 470 (AWD Mid-Size SUV)		L4 2362cc 2.4L DOHC (16 Valve) (2AZFE)	08-04
V8 4664cc 4.7L DOHC (32 Valve) (2UZFE)	09-03	V6 3311cc 3.3L DOHC (24 Valve) (3MZFE)	07-04
LX 450 (AWD Full-Size SUV)		V6 3456cc 3.5L DOHC (24 Valve) (2GRFE)	13-08
L6 4476cc 4.5L DOHC (24 Valve) (1FZFE)	97-96	Highlander (FWD Mid-Size SUV)	
LX 470 (AWD Full-Size SUV)		L4 2362cc 2.4L DOHC (16 Valve) (2AZFE)	07-01
V8 4664cc 4.7L DOHC (32 Valve) (2UZFE)	07-98	L4 2672cc 2.7L DOHC (16 Valve) (1ARFE)	13-09
LX 570 (AWD Full-Size SUV)		V6 2995cc 3.0L DOHC (24 Valve) (1MZFE)	03-01
V8 5663cc 5.7L DOHC (32 Valve) (3URFE)	13-08	V6 3311cc 3.3L DOHC (24 Valve) (3MZFE)	07-04
RX 300 (AWD Mid-Size SUV)		V6 3456cc 3.5L DOHC (24 Valve) (2GRFE)	13-08
V6 2995cc 3.0L DOHC (24 Valve) (1MZFE)	03-99	Highlander Hybrid (AWD Mid-Size SUV)	
RX 300 (FWD Mid-Size SUV)		V6 3311cc 3.3L DOHC (24 Valve) (3MZFXE)	10-06
V6 2995cc 3.0L DOHC (24 Valve) (1MZFE)	03-99	V6 3456cc 3.5L DOHC (24 Valve) (2GRFXE)	13-11
RX 330 (AWD Mid-Size SUV)		Highlander Hybrid (FWD Mid-Size SUV)	
V6 3311cc 3.3L DOHC (24 Valve) (3MZFE)	06-04	V6 3311cc 3.3L DOHC (24 Valve) (3MZFXE)	10-06
RX 330 (FWD Mid-Size SUV)		V6 3456cc 3.5L DOHC (24 Valve) (2GRFXE)	13-11
V6 3311cc 3.3L DOHC (24 Valve) (3MZFE)	06-04	Landcruiser (AWD Full-Size SUV)	
RX 350 (AWD Mid-Size SUV)		L6 3878cc 3.9L OHV (F)	74-69
V6 3456cc 3.5L DOHC (24 Valve) (2GRFE)	13-07	L6 3955cc 4.0L OHV (3FE)	92-88
RX 350 (FWD Mid-Size SUV)		L6 4230cc 4.2L OHV (2F)	87-75
V6 3456cc 3.5L DOHC (24 Valve) (2GRFE)	13-07	L6 4476cc 4.5L DOHC (24 Valve) (1FZFE)	97-93
RX 400h Hybrid (AWD Mid-Size SUV)		V8 4664cc 4.7L DOHC (32 Valve) (2UZFE)	07-98
V6 3311cc 3.3L DOHC (24 Valve) (3MZFXE)	09-06	V8 5663cc 5.7L DOHC (32 Valve) (3URFE)	13-08
RX 400h Hybrid (FWD Mid-Size SUV)		Pickup (2WD Compact Pickup)	
V6 3311cc 3.3L DOHC (24 Valve) (3MZFXE)	09-06	L4 2188cc 2.2L SOHC Diesel (L)	83-81
RX 450h Hybrid (AWD Mid-Size SUV)		L4 2189cc 2.2L SOHC (20R)	80-75
V6 3456cc 3.5L DOHC (24 Valve) (2GRFXE)	13-10	L4 2366cc 2.4L SOHC (22R)	90-81
RX 450h Hybrid (FWD Mid-Size SUV)		L4 2366cc 2.4L SOHC (22RE)	95-89
V6 3456cc 3.5L DOHC (24 Valve) (2GRFXE)	13-10	L4 2366cc 2.4L SOHC (22REC)	88-83
		L4 2366cc 2.4L SOHC Turbo (22RTEC)	89-85
Toyota Truck		L4 2446cc 2.4L SOHC Diesel (2L)	87-84
4Runner (2WD Mid-Size SUV)		L4 2446cc 2.4L SOHC Turbo-Diesel (2LT)	87-85
L4 2366cc 2.4L SOHC (22R)	90	V6 2958cc 3.0L SOHC (12 Valve) (3VZE)	95-88
L4 2366cc 2.4L SOHC (22RE)	95-90	Pickup (4WD Compact Pickup)	
L4 2693cc 2.7L DOHC (16 Valve) (2TRFE)	13-10	L4 2189cc 2.2L SOHC (20R)	80-75
L4 2693cc 2.7L DOHC (16 Valve) (3RZFE)	00-96	L4 2366cc 2.4L SOHC (22R)	90-81
V6 2958cc 3.0L SOHC (12 Valve) (3VZE)	95-90	L4 2366cc 2.4L SOHC (22RE)	95-89
V6 3378cc 3.4L DOHC (24 Valve) (5VZFE)	02-96	L4 2366cc 2.4L SOHC (22REC)	88-83
V6 3955cc 4.0L DOHC (24 Valve) (1GRFE)	13-03	L4 2366cc 2.4L SOHC Turbo (22RTEC)	89-85
V8 4664cc 4.7L DOHC (32 Valve) (2UZFE)	09-03	L4 2446cc 2.4L SOHC Diesel (2L)	84
4Runner (4WD Mid-Size SUV)		L4 2446cc 2.4L SOHC Turbo-Diesel (2LT)	87-85
L4 2366cc 2.4L SOHC (22R)	90-84	V6 2958cc 3.0L SOHC (12 Valve) (3VZE)	95-88
L4 2366cc 2.4L SOHC (22RE)	95-89	Previa (2WD Minivan)	
L4 2366cc 2.4L SOHC (22REC)	88-84	L4 2438cc 2.4L DOHC (16 Valve) (2TZFE)	96-91
L4 2366cc 2.4L SOHC Turbo (22RTEC)	87-85	L4 2438cc 2.4L DOHC Supercharged (16 Valve) (2TZFZE)	97-94
L4 2446cc 2.4L SOHC Diesel (2L)	84	Previa (4WD Minivan)	
L4 2446cc 2.4L SOHC Turbo-Diesel (2LT)	85-84	L4 2438cc 2.4L DOHC (16 Valve) (2TZFE)	96-91
V6 2958cc 3.0L SOHC (12 Valve) (3VZE)	95-88	L4 2438cc 2.4L DOHC Supercharged (16 Valve) (2TZFZE)	97-94
V6 3378cc 3.4L DOHC (24 Valve) (5VZFE)	02-96	RAV4 (AWD Compact SUV)	
V6 3955cc 4.0L DOHC (24 Valve) (1GRFE)	13-03	L4 1998cc 2.0L DOHC (16 Valve) (1AZFE)	03-01
V8 4664cc 4.7L DOHC (32 Valve) (2UZFE)	09-03	L4 1998cc 2.0L DOHC (16 Valve) (3SFE)	00-96
FJ Cruiser (2WD Mid-Size SUV)		L4 2362cc 2.4L DOHC (16 Valve) (2AZFE)	08-04
V6 3955cc 4.0L DOHC (24 Valve) (1GRFE)	13-07	L4 2494cc 2.5L DOHC (16 Valve) (2ARFE)	13-09
FJ Cruiser (4WD Mid-Size SUV)		V6 3456cc 3.5L DOHC (24 Valve) (2GRFE)	12-06
V6 3955cc 4.0L DOHC (24 Valve) (1GRFE)	13-07	RAV4 (FWD Compact SUV)	
Hi-Lux (Mini-Pickup)		L4 1998cc 2.0L DOHC (16 Valve) (1AZFE)	03-01
L4 1858cc 1.9L SOHC (8RC)	71-70	RAV4 (AWD Compact SUV)	
L4 1968cc 2.0L SOHC (18RC)	74-72	L4 1998cc 2.0L DOHC (16 Valve) (1AZFE)	03-01
Highlander (AWD Mid-Size SUV)		RAV4 (FWD Compact SUV)	
L4 2362cc 2.4L DOHC (16 Valve) (2AZFE)	07-01	L4 1998cc 2.0L DOHC (16 Valve) (1AZFE)	03-01
		Highlander (AWD Mid-Size SUV) (cont.)	
		V6 2995cc 3.0L DOHC (24 Valve) (1MZFE)	03-01
		V6 3311cc 3.3L DOHC (24 Valve) (3MZFE)	07-04
		V6 3456cc 3.5L DOHC (24 Valve) (2GRFE)	13-08
		Highlander (FWD Mid-Size SUV)	
		L4 2362cc 2.4L DOHC (16 Valve) (2AZFE)	07-01
		L4 2672cc 2.7L DOHC (16 Valve) (1ARFE)	13-09
		V6 2995cc 3.0L DOHC (24 Valve) (1MZFE)	03-01
		V6 3311cc 3.3L DOHC (24 Valve) (3MZFE)	07-04
		V6 3456cc 3.5L DOHC (24 Valve) (2GRFE)	13-08
		Highlander Hybrid (AWD Mid-Size SUV)	
		V6 3311cc 3.3L DOHC (24 Valve) (3MZFXE)	10-06
		V6 3456cc 3.5L DOHC (24 Valve) (2GRFXE)	13-11
		Highlander Hybrid (FWD Mid-Size SUV)	
		V6 3311cc 3.3L DOHC (24 Valve) (3MZFXE)	10-06
		V6 3456cc 3.5L DOHC (24 Valve) (2GRFXE)	13-11
		Landcruiser (AWD Full-Size SUV)	
		L6 3878cc 3.9L OHV (F)	74-69
		L6 3955cc 4.0L OHV (3FE)	92-88
		L6 4230cc 4.2L OHV (2F)	87-75
		L6 4476cc 4.5L DOHC (24 Valve) (1FZFE)	97-93
		V8 4664cc 4.7L DOHC (32 Valve) (2UZFE)	07-98
		V8 5663cc 5.7L DOHC (32 Valve) (3URFE)	13-08
		Pickup (2WD Compact Pickup)	
		L4 2188cc 2.2L SOHC Diesel (L)	83-81
		L4 2189cc 2.2L SOHC (20R)	80-75
		L4 2366cc 2.4L SOHC (22R)	90-81
		L4 2366cc 2.4L SOHC (22RE)	95-89
		L4 2366cc 2.4L SOHC (22REC)	88-83
		L4 2366cc 2.4L SOHC Turbo (22RTEC)	89-85
		L4 2446cc 2.4L SOHC Diesel (2L)	87-84
		L4 2446cc 2.4L SOHC Turbo-Diesel (2LT)	87-85
		V6 2958cc 3.0L SOHC (12 Valve) (3VZE)	95-88
		Pickup (4WD Compact Pickup)	
		L4 2189cc 2.2L SOHC (20R)	80-75
		L4 2366cc 2.4L SOHC (22R)	90-81
		L4 2366cc 2.4L SOHC (22RE)	95-89
		L4 2366cc 2.4L SOHC (22REC)	88-83
		L4 2366cc 2.4L SOHC Turbo (22RTEC)	89-85
		L4 2446cc 2.4L SOHC Diesel (2L)	84
		L4 2446cc 2.4L SOHC Turbo-Diesel (2LT)	87-85
		V6 2958cc 3.0L SOHC (12 Valve) (3VZE)	95-88
		Previa (2WD Minivan)	
		L4 2438cc 2.4L DOHC (16 Valve) (2TZFE)	96-91
		L4 2438cc 2.4L DOHC Supercharged (16 Valve) (2TZFZE)	97-94
		Previa (4WD Minivan)	
		L4 2438cc 2.4L DOHC (16 Valve) (2TZFE)	96-91
		L4 2438cc 2.4L DOHC Supercharged (16 Valve) (2TZFZE)	97-94
		RAV4 (AWD Compact SUV)	
		L4 1998cc 2.0L DOHC (16 Valve) (1AZFE)	03-01
		L4 1998cc 2.0L DOHC (16 Valve) (3SFE)	00-96
		L4 2362cc 2.4L DOHC (16 Valve) (2AZFE)	08-04
		L4 2494cc 2.5L DOHC (16 Valve) (2ARFE)	13-09
		V6 3456cc 3.5L DOHC (24 Valve) (2GRFE)	12-06
		RAV4 (FWD Compact SUV)	
		L4 1998cc 2.0L DOHC (16 Valve) (1AZFE)	03-01
		RAV4 (AWD Compact SUV) (cont.)	
		L4 1998cc 2.0L DOHC (16 Valve) (3SFE)	00-96
		L4 2362cc 2.4L DOHC (16 Valve) (2AZFE)	08-04
		L4 2494cc 2.5L DOHC (16 Valve) (2ARFE)	13-09
		V6 3456cc 3.5L DOHC (24 Valve) (2GRFE)	12-06
		Sequoia (2WD Full-Size SUV)	
		V8 4608cc 4.6L DOHC (32 Valve) (1URFE)	12-10
		V8 4664cc 4.7L DOHC (32 Valve) (2UZFE)	09-01
		V8 5663cc 5.7L DOHC (32 Valve) (3URFE)	13-08
		V8 5663cc 5.7L DOHC (32 Valve) (Flex Fuel) (3URFBE)	13-09
		Sequoia (4WD Full-Size SUV)	
		V8 4608cc 4.6L DOHC (32 Valve) (1URFE)	12-10
		V8 4664cc 4.7L DOHC (32 Valve) (2UZFE)	09-01
		V8 5663cc 5.7L DOHC (32 Valve) (3URFE)	13-08
		V8 5663cc 5.7L DOHC (32 Valve) (Flex Fuel) (3URFBE)	13-09
		Sienna (AWD Minivan)	
		V6 3311cc 3.3L DOHC (24 Valve) (3MZFE)	06-04
		V6 3456cc 3.5L DOHC (24 Valve) (2GRFE)	13-07
		Sienna (FWD Minivan)	
		L4 2672cc 2.7L DOHC (16 Valve) (1ARFE)	13-11
		V6 2995cc 3.0L DOHC (24 Valve) (1MZFE)	03-98
		V6 3311cc 3.3L DOHC (24 Valve) (3MZFE)	06-04
		V6 3456cc 3.5L DOHC (24 Valve) (2GRFE)	13-07
		T100 (2WD Mid-Size Pickup)	
		L4 2693cc 2.7L DOHC (16 Valve) (3RZFE)	98-94
		V6 2958cc 3.0L SOHC (12 Valve) (3VZE)	94-93
		V6 3378cc 3.4L DOHC (24 Valve) (5VZFE)	98-95
		T100 (4WD Mid-Size Pickup)	
		V6 2958cc 3.0L SOHC (12 Valve) (3VZE)	94-93
		V6 3378cc 3.4L DOHC (24 Valve) (5VZFE)	98-95
		Tacoma (2WD Compact Pickup)	
		L4 2438cc 2.4L DOHC (16 Valve) (2RZFE)	04-95
		L4 2693cc 2.7L DOHC (16 Valve) (2TRFE)	13-05
		L4 2693cc 2.7L DOHC (16 Valve) (3RZFE)	04-99
		V6 3378cc 3.4L DOHC (24 Valve) (5VZFE)	04-95
		V6 3378cc 3.4L DOHC Supercharged (24 Valve) (5VZFE)	02-00
		V6 3456cc 3.5L DOHC (24 Valve) (1GRFE)	13-05
		Tacoma (4WD Compact Pickup)	
		L4 2693cc 2.7L DOHC (16 Valve) (2TRFE)	13-05
		L4 2693cc 2.7L DOHC (16 Valve) (3RZFE)	04-95
		V6 3378cc 3.4L DOHC (24 Valve) (5VZFE)	04-95
		V6 3378cc 3.4L DOHC Supercharged (24 Valve) (5VZFE)	02-00
		V6 3456cc 3.5L DOHC (24 Valve) (1GRFE)	13-05
		Tundra (2WD Full-Size Pickup)	
		V6 3378cc 3.4L DOHC (24 Valve) (5VZFE)	04-99
		V6 3456cc 3.5L DOHC (24 Valve) (1GRFE)	13-05
		V8 4608cc 4.6L DOHC (32 Valve) (1URFE)	13-10
		V8 4664cc 4.7L DOHC (32 Valve) (2UZFE)	09-99
		V8 5663cc 5.7L DOHC (32 Valve) (3URFE)	13-07
		Tundra (4WD Full-Size Pickup)	
		V6 3378cc 3.4L DOHC (24 Valve) (5VZFE)	04-99
		V6 3456cc 3.5L DOHC (24 Valve) (1GRFE)	13-05
		V8 4608cc 4.6L DOHC (32 Valve) (1URFE)	13-10
		V8 4664cc 4.7L DOHC (32 Valve) (2UZFE)	09-99
		V8 5663cc 5.7L DOHC (32 Valve) (3URFE)	13-07

Toyota Truck (Incl. Minivans and SUV's) (Cont.)

Model Index (Cont.)

Engine (VIN Code / Eng. Code)	Year	Engine (VIN Code / Eng. Code)	Year	Engine (VIN Code / Eng. Code)	Year
Toyota Truck (cont.)					
Van Wagon (2WD Minivan)					
L4 1998cc 2.0L OHV (3YEC)	85-84				
L4 2237cc 2.2L OHV (4YEC)	90-86				
Van Wagon (4WD Minivan)					
L4 2237cc 2.2L OHV (4YEC)	90-87				
Venza (AWD Mid-Size SUV)					
L4 2672cc 2.7L DOHC (16 Valve) (1ARFE)	13-09				
V6 3456cc 3.5L DOHC (24 Valve) (2GRFE)	13-09				
Venza (FWD Mid-Size SUV)					
L4 2672cc 2.7L DOHC (16 Valve) (1ARFE)	13-09				
V6 3456cc 3.5L DOHC (24 Valve) (2GRFE)	13-09				

1 2000 - 1996; 2.0L 122 (1998cc) DOHC L4 (16 Valve) 86mm Bore MFI; Gasoline; Naturally Aspirated Toyota Eng.; Eng. Code 3SFE 1

QTY	CYLINDER HEAD	YEARS	PART NO.	DESCRIPTION
1	Head Gasket	2000-97	9797 PT	Head bolts not incl.; Head bolt replacement recommended; PermaTorqueMLS®
1	Head Gasket	1996	9861 PT	Head bolts not incl.; Head bolt replacement recommended
1	Head Set	2000-97	HS 9797 PT	Head bolts not incl.; Head bolt replacement recommended; PermaDry® molded rubber valve cover gskt. incl.; Premium valve stem seals incl.
1	Head Set	1996	HS 9861 PT	Head bolts not incl.; Head bolt replacement recommended; PermaDry® molded rubber valve cover gskt. incl.; Premium valve stem seals incl.; Consolidated design
1	Head Bolt Set	2000-96	ES 72154	Head bolts w/Washers; Replacement recommended
1	Head Bolt Washer Set	2000-96	ES 72183	Replacement recommended
QTY	CONVERSION SET	YEARS	PART NO.	DESCRIPTION
1	Gasket Conversion Set	2000-98	CS 9797-1	
1	Gasket Conversion Set	1997	CS 9797	
1	Gasket Conversion Set	1996	CS 9861	
QTY	MANIFOLD - INT. & EXH.	YEARS	PART NO.	DESCRIPTION
1	Int. Manifold Gasket Set	2000-96	MS 93550-1	
1	Exh. Manifold Gasket Set	2000-96	MS 94976	
QTY	EXHAUST PIPE FLANGE	YEARS	PART NO.	DESCRIPTION
1	Exhaust Pipe Gasket	2000-96	23591	Center pipe to muffler; 1 31/32" ID x 2 35/64" OD
1	Exhaust Pipe Gasket	2000-98	23591	Flange; 1 31/32" ID x 2 35/64" OD
1	Exhaust Pipe Gasket	1997-96	23626	Flange
1	Exhaust Pipe Gasket	1997-96	61088	Converter to manifold
QTY	OIL PAN	YEARS	PART NO.	DESCRIPTION
1	Oil Pan Gasket Set	2000-96	OS 30468 C	
1	Drain Plug Gasket	2000-96	70822	
QTY	CRANKSHAFT REAR SEAL	YEARS	PART NO.	DESCRIPTION
1	Rear Main Seal Set	2000-96	BS 40427	Rubber; One-piece; Improved design
1	Repair Sleeve	2000-96	16278	Crankshaft; Use w/installation tool
QTY	VALVE COVER	YEARS	PART NO.	DESCRIPTION
1	Valve Cover Gasket Set	2000-96	VS 50304 R	w/o Spark plug tube seals; PermaDry® molded rubber gskt. incl.
1	Valve Cover Gasket Set	2000-96	VS 50304 R-1	w/Spark plug tube seals; PermaDry® molded rubber gskt. incl.
1	Spark Plug Tube Seal Set	2000-96	ES 70739	Valve Cover
QTY	VALVE STEM SEAL SET	YEARS	PART NO.	DESCRIPTION
1	Valve Stem Seal Set	2000-96	SS 72810	Premium valve stem seals incl.
QTY	THERMOSTAT HOUSING	YEARS	PART NO.	DESCRIPTION
1	O-Ring	2000-96	35292	Thermostat Housing; Thermostat inlet
QTY	WATER OUTLET GASKET	YEARS	PART NO.	DESCRIPTION
1	Water Outlet Gasket	2000-96	35488	Water Outlet
QTY	WATER PUMP	YEARS	PART NO.	DESCRIPTION
1	Water Pump Gasket	2000-96	35294	
QTY	TIMING COVER	YEARS	PART NO.	DESCRIPTION
1	Crankshaft Front Seal Set	2000-98	TCS 45907	
1	Crankshaft Front Seal Set	1997	TCS 45906	
1	Crankshaft Front Seal Set	1996	TCS 45920	
1	Camshaft Front Seal Set	2000-96	TCS 45641	
1	Repair Sleeve	2000-96	16227	Timing Cover; Use w/installation tool
1	Repair Sleeve Tool	2000-96	16327	Timing Cover
QTY	CARB & FUEL INJECTION	YEARS	PART NO.	DESCRIPTION
1	Fuel Injector O-Ring Set	2000-96	ES 70600	
1	Throttle Body Gasket	2000-98	61083	

Toyota Truck (Incl. Minivans and SUV's) (Cont.)

1		2000 - 1996; 2.0L 122 (1998cc) DOHC L4 (16 Valve) 86mm Bore			1
(cont.)		MFI; Gasoline; Naturally Aspirated Toyota Eng.; Eng. Code 3SFE			(cont.)
QTY	CARB & FUEL INJECTION	YEARS	PART NO.	DESCRIPTION	
1	Throttle Body Gasket	1997-96	60687		
QTY	DISTRIBUTOR MOUNTING	YEARS	PART NO.	DESCRIPTION	
1	Distributor Mounting Gasket	2000-96	72438	O-ring	
QTY	EXHAUST GAS RECIRCULATION	YEARS	PART NO.	DESCRIPTION	
1	EGR Gasket	2000-96	72610		
QTY	OIL PUMP COVER	YEARS	PART NO.	DESCRIPTION	
1	Oil Pump Gasket	2000-96	72518	Oil pump O-ring; New Part Number - Check for Availability	
1	Oil Pump Gasket	2000-96	72663	Oil pump cover; New Part Number - Check for Availability	
1	Oil Pump Gasket	1996	ES 72499	Mounting set; New Part Number - Check for Availability	
2		2003 - 2001; 2.0L 122 (1998cc) DOHC L4 (16 Valve) 86mm Bore VVT-i			2
(cont.)		MFI; Gasoline; Naturally Aspirated Toyota Eng.; Eng. Code 1AZFE			(cont.)
QTY	CYLINDER HEAD	YEARS	PART NO.	DESCRIPTION	
1	Head Gasket	2003-01	26160 PT	Head bolts not incl.; Head bolt replacement recommended; PermaTorqueMLS®	
1	Head Set	2003-01	HS 26160 PT	Head bolts not incl.; Head bolt replacement recommended; PermaDry® molded rubber valve cover gskt. incl.; Premium valve stem seals incl.	
1	Head Bolt Set	2003-01	ES 71183	Head bolts w/Washers; Replacement recommended	
1	Head Bolt Washer Set	2003-01	ES 72899	Replacement recommended	
QTY	CONVERSION SET	YEARS	PART NO.	DESCRIPTION	
1	Gasket Conversion Set	2003	CS 9797-2	To 12/01/02; RTV sealant incl. for oil pan gskt.; RTV sealant incl. for water pump gskt.	
1	Gasket Conversion Set	2003	CS 9797-3	From 12/01/02; RTV sealant incl. for oil pan gskt.; RTV sealant incl. for water pump gskt.	
1	Gasket Conversion Set	2002-01	CS 9797-2	RTV sealant incl. for oil pan gskt.; RTV sealant incl. for water pump gskt.	
QTY	MANIFOLD - INT. & EXH.	YEARS	PART NO.	DESCRIPTION	
1	Int. Manifold Gasket Set	2003-01	MS 94295	Consolidated design	
1	Exh. Manifold Gasket Set	2003-01	MS 94140-1		
QTY	EXHAUST PIPE FLANGE	YEARS	PART NO.	DESCRIPTION	
1	Exhaust Pipe Gasket	2003-01	23591	Center pipe to muffler; 1 31/32" ID x 2 35/64" OD	
1	Exhaust Pipe Gasket	2003-01	60906	Rear pipe to muffler	
1	Exhaust Pipe Gasket	2003-01	61106	Flange; 2.40" ID	
QTY	OIL PAN	YEARS	PART NO.	DESCRIPTION	
1	Oil Pan Gasket Set	2003-01	OS 30713	RTV sealant incl. for oil pan gskt.	
1	Drain Plug Gasket	2003-01	70822		
QTY	CRANKSHAFT REAR SEAL	YEARS	PART NO.	DESCRIPTION	
1	Rear Main Seal Set	2003-01	BS 40629	Rubber; One-piece	
QTY	VALVE COVER	YEARS	PART NO.	DESCRIPTION	
1	Valve Cover Gasket Set	2003-01	VS 50530 R	PermaDry® molded rubber gskt. incl.	
QTY	VALVE STEM SEAL SET	YEARS	PART NO.	DESCRIPTION	
1	Valve Stem Seal Set	2003-01	SS 72878-1	Premium valve stem seals incl.	
QTY	THERMOSTAT HOUSING	YEARS	PART NO.	DESCRIPTION	
1	Thermostat Gasket	2003-01	35445	Thermostat Housing; Thermostat inlet	
QTY	WATER OUTLET GASKET	YEARS	PART NO.	DESCRIPTION	
1	Water Outlet Gasket	2003-01	35729	Water Outlet	
QTY	TIMING COVER	YEARS	PART NO.	DESCRIPTION	
1	Crankshaft Front Seal Set	2003	TCS 46020	To 12/01/02	
1	Crankshaft Front Seal Set	2003	TCS 46042	From 12/01/02	
1	Crankshaft Front Seal Set	2002-01	TCS 46020		
1	Camshaft Front Seal Set	2003-01	TCS 46002		
QTY	CARB & FUEL INJECTION	YEARS	PART NO.	DESCRIPTION	
1	Fuel Injector O-Ring Set	2003-01	ES 70600		
1	Throttle Body Gasket	2003-01	61173		
3		2008 - 2001; 2.4L 144 (2362cc) DOHC L4 (16 Valve) 88.5mm Bore VVT-i			3
(cont.)		MFI; Gasoline; Naturally Aspirated Toyota Eng.; Eng. Code 2AZFE			(cont.)
QTY	CYLINDER HEAD	YEARS	PART NO.	DESCRIPTION	
1	Head Gasket	2008-01	26323 PT	Head bolts not incl.; Head bolt replacement recommended; PermaTorqueMLS® LaserWeld® Technology; Improved design	
1	Head Gasket	2006-01	26232 PT	Head bolts not incl.; Head bolt replacement recommended; PermaTorqueMLS®; Old design	

Toyota Truck (Incl. Minivans and SUV's) (Cont.)

3 (cont.)		2008 - 2001; 2.4L 144 (2362cc) DOHC L4 (16 Valve) 88.5mm Bore VVT-i			3 (cont.)
MFI; Gasoline; Naturally Aspirated Toyota Eng.; Eng. Code 2AZFE					
QTY	CYLINDER HEAD	YEARS	PART NO.	DESCRIPTION	
1	Head Set	2008-04	HS 26323 PT	Head bolts not incl.; Head bolt replacement recommended; Must be used w/TCS 46042 & w/OS 30713; PermaDry® molded rubber valve cover gskt. incl.; Premium valve stem seals incl.; Improved design	
1	Head Set	2006-04	HS 26232 PT	Head bolts not incl.; Head bolt replacement recommended; Must be used w/TCS 46042 & w/OS 30713; PermaDry® molded rubber valve cover gskt. incl.; Premium valve stem seals incl.; Old design	
1	Head Set	2003	HS 26232 PT	From 12/01/02; Head bolts not incl.; Head bolt replacement recommended; Must be used w/TCS 46042 & w/OS 30713; PermaDry® molded rubber valve cover gskt. incl.; Premium valve stem seals incl.; Old design	
1	Head Set	2003	HS 26232 PT	To 12/01/02; Head bolts not incl.; Head bolt replacement recommended; Must be used w/TCS 46020 & w/OS 30713; PermaDry® molded rubber valve cover gskt. incl.; Premium valve stem seals incl.; Old design	
1	Head Set	2003	HS 26323 PT	From 12/01/02; Head bolts not incl.; Head bolt replacement recommended; Must be used w/TCS 46042 & w/OS 30713; PermaDry® molded rubber valve cover gskt. incl.; Premium valve stem seals incl.; Improved design	
1	Head Set	2003	HS 26323 PT	To 12/01/02; Head bolts not incl.; Head bolt replacement recommended; Must be used w/TCS 46020 & w/OS 30713; PermaDry® molded rubber valve cover gskt. incl.; Premium valve stem seals incl.; Improved design	
1	Head Set	2002-01	HS 26232 PT	Head bolts not incl.; Head bolt replacement recommended; Must be used w/TCS 46020 & w/OS 30713; PermaDry® molded rubber valve cover gskt. incl.; Premium valve stem seals incl.; Old design	
1	Head Set	2002-01	HS 26323 PT	Head bolts not incl.; Head bolt replacement recommended; Must be used w/TCS 46020 & w/OS 30713; PermaDry® molded rubber valve cover gskt. incl.; Premium valve stem seals incl.; Improved design	
1	Head Bolt Set	2008	ES 72249-2	Head bolts w/Washers; Replacement recommended	
1	Head Bolt Set	2007-06	ES 71183	Toyota Highlander Base; Head bolts w/Washers; Replacement recommended	
1	Head Bolt Set	2007-06	ES 72249-2	Exc. Toyota Highlander Base; Head bolts w/Washers; Replacement recommended	
1	Head Bolt Set	2005-01	ES 71183	Head bolts w/Washers; Replacement recommended	
1	Head Bolt Washer Set	2008-01	ES 72899	Replacement recommended	
QTY	CONVERSION SET	YEARS	PART NO.	DESCRIPTION	
1	Gasket Conversion Set	2008-04	CS 26232-1	RTV sealant incl. for oil pan gskt.; RTV sealant incl. for water pump gskt.	
1	Gasket Conversion Set	2003	CS 26232	To 12/01/02; RTV sealant incl. for oil pan gskt.; RTV sealant incl. for water pump gskt.	
1	Gasket Conversion Set	2003	CS 26232-1	From 12/01/02; RTV sealant incl. for oil pan gskt.; RTV sealant incl. for water pump gskt.	
1	Gasket Conversion Set	2002-01	CS 26232	RTV sealant incl. for oil pan gskt.; RTV sealant incl. for water pump gskt.	
QTY	MANIFOLD - INT. & EXH.	YEARS	PART NO.	DESCRIPTION	
1	Int. Manifold Gasket Set	2008-01	MS 94295	Consolidated design	
1	Exh. Manifold Gasket Set	2008-01	MS 94140-1		
QTY	EXHAUST PIPE FLANGE	YEARS	PART NO.	DESCRIPTION	
1	Exhaust Pipe Gasket	2008-06	61459	Converter	
1	Exhaust Pipe Gasket	2008	23591	Loc. Center; Exh. connector; 1 31/32" ID x 2 35/64" OD	
1	Exhaust Pipe Gasket	2008	60906	Loc. Rear; Exh. connector	
1	Exhaust Pipe Gasket	2008	61016	Flange; Improved design	
1	Exhaust Pipe Gasket	2008	61040	Exh. connector; 1.98" ID	
1	Exhaust Pipe Gasket	2008	61460	Exh. connector; 2.40" ID	
1	Exhaust Pipe Gasket	2007-04	60911	Toyota Highlander Base; Loc. Rear; Exh. connector	
1	Exhaust Pipe Gasket	2007-04	61016	Toyota Highlander Base; Loc. Center; Exh. connector; Improved design	
1	Exhaust Pipe Gasket	2007-04	61016	Toyota Highlander Base; Loc. Front; Exh. connector; Improved design	
1	Exhaust Pipe Gasket	2007-04	61106	Toyota Highlander Base; Flange; 2.40" ID	
1	Exhaust Pipe Gasket	2007-06	23591	Exc. Toyota Highlander Base; Loc. Center; Exh. connector; 1 31/32" ID x 2 35/64" OD	
1	Exhaust Pipe Gasket	2007-06	60906	Exc. Toyota Highlander Base; Loc. Rear; Exh. connector	
1	Exhaust Pipe Gasket	2007-06	61016	Exc. Toyota Highlander Base; Flange; Improved design	
1	Exhaust Pipe Gasket	2007-06	61040	Exc. Toyota Highlander Base; Exh. connector; 1.98" ID	
1	Exhaust Pipe Gasket	2007-06	61460	Exc. Toyota Highlander Base; Exh. connector; 2.40" ID	
1	Exhaust Pipe Gasket	2005-01	23591	Converter; 1 31/32" ID x 2 35/64" OD	
1	Exhaust Pipe Gasket	2005-04	23591	Toyota RAV4 Base, L, Sport; Loc. Center; Exh. connector; 1 31/32" ID x 2 35/64" OD	
1	Exhaust Pipe Gasket	2005-04	60906	Toyota RAV4 Base, L, Sport; Loc. Rear; Exh. connector	
1	Exhaust Pipe Gasket	2005-04	61016	Toyota RAV4 Base, L, Sport; Flange; Improved design	
1	Exhaust Pipe Gasket	2003-01	61016	Loc. Front; Exh. connector; Improved design	
1	Exhaust Pipe Gasket	2003-01	61039	Loc. Rear; Exh. connector	

Toyota Truck (Incl. Minivans and SUV's) (Cont.)

3		2008 - 2001; 2.4L 144 (2362cc) DOHC L4 (16 Valve) 88.5mm Bore VVT-i			3
(cont.)		MFI; Gasoline; Naturally Aspirated Toyota Eng.; Eng. Code 2AZFE			(cont.)
QTY	EXHAUST PIPE FLANGE	YEARS	PART NO.	DESCRIPTION	
1	Exhaust Pipe Gasket	2003-01	61106	Flange; 2.40" ID	
QTY	OIL PAN	YEARS	PART NO.	DESCRIPTION	
1	Oil Pan Gasket Set	2008-01	OS 30713	RTV sealant incl. for oil pan gskt.	
1	Drain Plug Gasket	2008-01	70822		
QTY	CRANKSHAFT REAR SEAL	YEARS	PART NO.	DESCRIPTION	
1	Rear Main Seal Set	2008-01	BS 40629	Rubber; One-piece	
QTY	VALVE COVER	YEARS	PART NO.	DESCRIPTION	
1	Valve Cover Gasket Set	2008-01	VS 50530 R	PermaDry® molded rubber gskt. incl.	
QTY	VALVE STEM SEAL SET	YEARS	PART NO.	DESCRIPTION	
1	Valve Stem Seal Set	2008-01	SS 72878-1	Premium valve stem seals incl.	
QTY	THERMOSTAT HOUSING	YEARS	PART NO.	DESCRIPTION	
1	Thermostat Gasket	2008-01	35445	Thermostat Housing	
QTY	WATER OUTLET GASKET	YEARS	PART NO.	DESCRIPTION	
1	Water Outlet Gasket	2008-01	35729	Water Outlet; Heater return	
QTY	TIMING COVER	YEARS	PART NO.	DESCRIPTION	
1	Crankshaft Front Seal Set	2008-04	TCS 46042		
1	Crankshaft Front Seal Set	2003	TCS 46020	To 12/01/02	
1	Crankshaft Front Seal Set	2003	TCS 46042	From 12/01/02	
1	Crankshaft Front Seal Set	2002-01	TCS 46020		
QTY	CARB & FUEL INJECTION	YEARS	PART NO.	DESCRIPTION	
1	Throttle Body Gasket	2008-06	61421		
1	Throttle Body Gasket	2005-01	61173		
4		1995 - 1991; 2.4L 144.4 (2366cc) SOHC L4 (8 Valve) 92mm Bore			4
		MFI; Gasoline; Naturally Aspirated Toyota Eng.; Eng. Code 22RE			
QTY	CYLINDER HEAD	YEARS	PART NO.	DESCRIPTION	
1	Head Gasket	1995-91	26185 PT	Head bolts not incl.; Head bolt replacement recommended; PermaTorque®; Improved design	
1	Head Gasket Spacer Shim	1995-91	8807 SP	HeadSaver®	
1	Head Set	1995-92	HS 26185 PT-2	Head bolts & w/M/T exh. pipe flange not incl.; Head bolt replacement recommended; PermaDry® molded rubber valve cover gskt. incl.; Premium valve stem seals incl.; Improved design	
1	Head Set	1991	HS 26185 PT-2	Head bolts not incl.; Head bolt replacement recommended; PermaDry® molded rubber valve cover gskt. incl.; Premium valve stem seals incl.; Improved design	
1	Head Installation Set	1995-91	HIS 8807 PT-2	Head bolts & exh. pipe flange not incl.; Head bolt replacement recommended; PermaDry® molded rubber valve cover gskt. incl.	
1	Head Bolt Set	1995-91	ES 71178	Replacement recommended	
QTY	CONVERSION SET	YEARS	PART NO.	DESCRIPTION	
1	Gasket Conversion Set	1995	CS 8807-2		
1	Gasket Conversion Set	1994	CS 8807-1	To 11/01/93	
1	Gasket Conversion Set	1994	CS 8807-2	From 11/01/93	
1	Gasket Conversion Set	1993-91	CS 8807-1		
QTY	MANIFOLD - INT. & EXH.	YEARS	PART NO.	DESCRIPTION	
1	Int. Manifold Gasket Set	1995-91	MS 91679	Lower set; Upper set incl.	
1	Plenum Gasket Set	1995-91	MS 91724	Upper set; New Part Number - Check for Availability	
1	Exh. Manifold Gasket Set	1995-91	MS 92968		
QTY	EXHAUST PIPE FLANGE	YEARS	PART NO.	DESCRIPTION	
1	Exhaust Pipe Gasket	1995-91	23591	Loc. Rear; Converter; 1 31/32" ID x 2 35/64" OD	
1	Exhaust Pipe Gasket	1995-91	23626	Loc. Front; Converter; RWD	
1	Exhaust Pipe Gasket	1995-91	60572	Loc. Front; Converter; 4WD; 2.165" ID	
2	Exhaust Pipe Gasket	1995-92	23588	Flange; w/A/T; 1 37/64" ID x 2 3/32" OD	
2	Exhaust Pipe Gasket	1995-92	23626	Flange; w/M/T	
2	Exhaust Pipe Gasket	1991	23588	Flange; 1 37/64" ID x 2 3/32" OD	
QTY	OIL PAN	YEARS	PART NO.	DESCRIPTION	
1	Oil Pan Gasket Set	1995-91	OS 20102 C		
QTY	CRANKSHAFT REAR SEAL	YEARS	PART NO.	DESCRIPTION	
1	Rear Main Seal Set	1995-91	BS 40345-1	Rubber; One-piece	
QTY	VALVE COVER	YEARS	PART NO.	DESCRIPTION	
1	Valve Cover Gasket Set	1995-91	VS 26081 R	w/o Semi-circular plugs & Grommets; PermaDry® molded rubber gskt. incl.	
1	Valve Cover Gasket Set	1995-91	VS 50358 R	w/Semi-circular plugs & Grommets; PermaDry® molded rubber gskt. incl.	
1	Grommet Set	1995-91	ES 70356	Valve Cover	
1	Semi-Circular Plug	1995-91	CP 75005	Valve Cover	

Toyota Truck (Incl. Minivans and SUV's) (Cont.)

4		1995 - 1991; 2.4L 144.4 (2366cc) SOHC L4 (8 Valve) 92mm Bore			4	
(cont.)		MFI; Gasoline; Naturally Aspirated Toyota Eng.; Eng. Code 22RE			(cont.)	
QTY	VALVE STEM SEAL SET	YEARS	PART NO.	DESCRIPTION		
1	Valve Stem Seal Set	1995-91	SS 70598	Premium valve stem seals incl.; Improved design		
QTY	WATER OUTLET GASKET	YEARS	PART NO.	DESCRIPTION		
1	Water Outlet Gasket	1995-91	35278	Water Outlet		
QTY	WATER PUMP	YEARS	PART NO.	DESCRIPTION		
1	Water Pump Gasket	1995-91	35340			
QTY	TIMING COVER	YEARS	PART NO.	DESCRIPTION		
1	Timing Cover Set	1995	TCS 45039	w/o Sleeve 'N' Seal®		
1	Timing Cover Set	1994	TCS 45039	From 11/01/93; w/o Sleeve 'N' Seal®		
1	Timing Cover Set	1994	TCS 45685	To 11/01/93; w/o Sleeve 'N' Seal®		
1	Timing Cover Set	1993-91	TCS 45685	w/o Sleeve 'N' Seal®		
1	Timing Set w/Sleeve & Seal	1994	TCS 45934	To 11/01/93; w/Sleeve 'N' Seal®		
1	Timing Set w/Sleeve & Seal	1993-91	TCS 45934	w/Sleeve 'N' Seal®		
1	Repair Sleeve	1994	16214	Timing Cover; To 11/01/93; Use w/installation tool		
1	Repair Sleeve	1993-91	16214	Timing Cover; Use w/installation tool		
1	Repair Sleeve Tool	1994	16312	Timing Cover; To 11/01/93		
1	Repair Sleeve Tool	1993-91	16312	Timing Cover		
QTY	CARB & FUEL INJECTION	YEARS	PART NO.	DESCRIPTION		
1	Fuel Injector O-Ring Set	1995-91	ES 70600			
1	Throttle Body Gasket	1995-91	60876			
QTY	OIL PUMP COVER	YEARS	PART NO.	DESCRIPTION		
1	Oil Pump Gasket	1995-91	72437	Mounting		
5		2004 - 1995; 2.4L 148.7 (2438cc) DOHC L4 (16 Valve) 95mm Bore			5	
		MFI; Gasoline; Naturally Aspirated Toyota Eng.; Eng. Code 2RZFE				
QTY	CYLINDER HEAD	YEARS	PART NO.	DESCRIPTION		
1	Head Gasket	2004-95	9465 PT	Head bolts not incl.; Head bolt replacement recommended		
1	Head Set	2004-95	HS 9465 PT	Exc. California; Head bolts not incl.; Head bolt replacement recommended; PermaDry® molded rubber valve cover gskt. incl.; Premium valve stem seals incl.		
1	Head Set	2004-95	HS 9465 PT-1	California; Head bolts not incl.; Head bolt replacement recommended; PermaDry® molded rubber valve cover gskt. incl.; Premium valve stem seals incl.		
1	Head Bolt Set	2004-95	ES 72182	Head bolts w/Washers; Replacement recommended		
QTY	CONVERSION SET	YEARS	PART NO.	DESCRIPTION		
1	Gasket Conversion Set	2004-95	CS 9465			
QTY	MANIFOLD - INT. & EXH.	YEARS	PART NO.	DESCRIPTION		
1	Int. Manifold Gasket Set	2004-95	MS 92672	California; Upper set incl.		
1	Int. Manifold Gasket Set	2004-95	MS 92692	Exc. California; Upper set incl.		
1	Exh. Manifold Gasket Set	2004-95	MS 92721			
QTY	EXHAUST PIPE FLANGE	YEARS	PART NO.	DESCRIPTION		
2	Exhaust Pipe Gasket	2004-95	23561	Flange; Exc. California; 1 49/64" ID x 2 17/64" OD		
1	Exhaust Pipe Gasket	2004-95	60495	Flange; California		
1	Exhaust Pipe Gasket	2004-98	60911	To muffler		
1	Exhaust Pipe Gasket	2004-99	60512	Converter; Improved design		
1	Exhaust Pipe Gasket	2004-99	61138	Converter; Old design		
1	Exhaust Pipe Gasket	1998-95	23626	Converter		
QTY	OIL PAN	YEARS	PART NO.	DESCRIPTION		
1	Oil Pan Gasket Set	2004-95	OS 30642 C			
1	Drain Plug Gasket	2004-95	70822			
QTY	CRANKSHAFT REAR SEAL	YEARS	PART NO.	DESCRIPTION		
1	Rear Main Seal Set	2004-95	BS 40637	Rubber; One-piece		
QTY	VALVE COVER	YEARS	PART NO.	DESCRIPTION		
1	Valve Cover Gasket Set	2004-95	VS 50512 R	w/o Spark plug tube seals & w/Grommets; PermaDry® molded rubber gskt. incl.		
1	Grommet Set	2004-95	ES 72133	Valve Cover		
1	Spark Plug Tube Seal Set	2004-95	ES 72105	Valve Cover		
QTY	VALVE STEM SEAL SET	YEARS	PART NO.	DESCRIPTION		
1	Valve Stem Seal Set	2004-95	SS 72810	Premium valve stem seals incl.		
QTY	THERMOSTAT HOUSING	YEARS	PART NO.	DESCRIPTION		
1	Thermostat Gasket	2004-95	35644	Thermostat Housing		
1	Thermostat Gasket	2004-98	35445	Thermostat Housing; Water inlet		
1	Thermostat Gasket	1997	35445	Thermostat Housing; From 09/01/96; Water inlet		
QTY	WATER OUTLET GASKET	YEARS	PART NO.	DESCRIPTION		
1	Water Outlet Gasket	2004-95	35520	Water Outlet; Water outlet coolant pipe		

Toyota Truck (Incl. Minivans and SUV's) (Cont.)

5		2004 - 1995; 2.4L 148.7 (2438cc) DOHC L4 (16 Valve) 95mm Bore			5
(cont.)		MFI; Gasoline; Naturally Aspirated Toyota Eng.; Eng. Code 2RZFE			(cont.)
QTY	WATER OUTLET GASKET	YEARS	PART NO.	DESCRIPTION	
1	Water Outlet Gasket	2004-95	35642	Water Outlet	
QTY	WATER PUMP	YEARS	PART NO.	DESCRIPTION	
1	Water Pump Gasket	2004-95	35643		
QTY	TIMING COVER	YEARS	PART NO.	DESCRIPTION	
1	Timing Cover Set	2004-95	TCS 45897		
QTY	CARB & FUEL INJECTION	YEARS	PART NO.	DESCRIPTION	
1	Fuel Injector O-Ring Set	2004-95	ES 70600		
1	Throttle Body Gasket	2004-95	61079	Throttle body mounting	
1	Throttle Body Gasket	2004-95	61128	Throttle body cover; California	
1	Throttle Body Gasket	2004-95	61152	Throttle body cover; Exc. California	
QTY	EXHAUST GAS RECIRCULATION	YEARS	PART NO.	DESCRIPTION	
1	EGR Gasket	2004-95	70961		
6		1996 - 1991; 2.4L 148.7 (2438cc) DOHC L4 (16 Valve) 95mm Bore			6
		MFI; Gasoline; Naturally Aspirated Toyota Eng.; Eng. Code 2TZFE			
QTY	CYLINDER HEAD	YEARS	PART NO.	DESCRIPTION	
1	Head Gasket	1996-91	9831 PT	Head bolts not incl.; Head bolt replacement recommended	
1	Head Set	1996-91	HS 9831 PT	Head bolts not incl.; Head bolt replacement recommended; PermaDry® molded rubber valve cover gskts. incl.; Premium valve stem seals incl.	
QTY	CONVERSION SET	YEARS	PART NO.	DESCRIPTION	
1	Gasket Conversion Set	1996-91	CS 9831		
QTY	MANIFOLD - INT. & EXH.	YEARS	PART NO.	DESCRIPTION	
1	Int. Manifold Gasket Set	1996-91	MS 94935		
1	Exh. Manifold Gasket Set	1996-91	MS 94929		
QTY	EXHAUST PIPE FLANGE	YEARS	PART NO.	DESCRIPTION	
2	Exhaust Pipe Gasket	1996-91	23561	Flange; 1 49/64" ID x 2 17/64" OD	
1	Exhaust Pipe Gasket	1996-91	60911	Converter	
QTY	OIL PAN	YEARS	PART NO.	DESCRIPTION	
1	Oil Pan Gasket Set	1996-91	OS 30640 C	Sump	
1	Oil Pan Gasket Set	1996-91	OS 30642 C	Crankcase cover	
QTY	CRANKSHAFT REAR SEAL	YEARS	PART NO.	DESCRIPTION	
1	Rear Main Seal Set	1996-91	BS 40637	Rubber; One-piece	
QTY	VALVE COVER	YEARS	PART NO.	DESCRIPTION	
1	Valve Cover Gasket Set	1996-91	VS 50386 R	w/Spark plug tube seals; PermaDry® molded rubber gskts. incl.	
1	Spark Plug Tube Seal Set	1996-91	ES 72105	Valve Cover	
QTY	VALVE STEM SEAL SET	YEARS	PART NO.	DESCRIPTION	
1	Valve Stem Seal Set	1996-91	SS 72809	Premium valve stem seals incl.	
QTY	THERMOSTAT HOUSING	YEARS	PART NO.	DESCRIPTION	
1	Thermostat Gasket	1996-91	35445	Thermostat Housing; Thermostat inlet	
QTY	WATER OUTLET GASKET	YEARS	PART NO.	DESCRIPTION	
1	Water Outlet Gasket	1996-91	35493	Water Outlet	
QTY	WATER PUMP	YEARS	PART NO.	DESCRIPTION	
1	Water Pump Gasket	1996-91	35492		
QTY	TIMING COVER	YEARS	PART NO.	DESCRIPTION	
1	Timing Cover Set	1996-91	TCS 45897		
QTY	CARB & FUEL INJECTION	YEARS	PART NO.	DESCRIPTION	
1	Throttle Body Gasket	1996-91	60909		
QTY	DISTRIBUTOR MOUNTING	YEARS	PART NO.	DESCRIPTION	
1	Distributor Mounting Gasket	1996-91	72438	O-ring	
QTY	EXHAUST GAS RECIRCULATION	YEARS	PART NO.	DESCRIPTION	
1	EGR Mounting Set	1996-91	ES 72801		
7		1997 - 1994; 2.4L 148.7 (2438cc) DOHC L4 (16 Valve) 95mm Bore			7
		MFI; Gasoline; Supercharged Toyota Eng.; Eng. Code 2TZFE			
QTY	CYLINDER HEAD	YEARS	PART NO.	DESCRIPTION	
1	Head Gasket	1997-94	9831 PT	Head bolts not incl.; Head bolt replacement recommended	
1	Head Set	1997-94	HS 9831 PT	Head bolts not incl.; Head bolt replacement recommended; PermaDry® molded rubber valve cover gskts. incl.; Premium valve stem seals incl.	
QTY	CONVERSION SET	YEARS	PART NO.	DESCRIPTION	
1	Gasket Conversion Set	1997-94	CS 9831		
QTY	MANIFOLD - INT. & EXH.	YEARS	PART NO.	DESCRIPTION	
1	Int. Manifold Gasket Set	1997-94	MS 94935		
1	Exh. Manifold Gasket Set	1997-94	MS 94929		

Toyota Truck (Incl. Minivans and SUV's) (Cont.)

7		1997 - 1994; 2.4L 148.7 (2438cc) DOHC L4 (16 Valve) 95mm Bore			7
(cont.)		MFI; Gasoline; Supercharged Toyota Eng.; Eng. Code 2TZFE			(cont.)
QTY	EXHAUST PIPE FLANGE	YEARS	PART NO.	DESCRIPTION	
2	Exhaust Pipe Gasket	1997-94	23561	Flange; 1 49/64" ID x 2 17/64" OD	
1	Exhaust Pipe Gasket	1997-94	60911	Converter	
QTY	OIL PAN	YEARS	PART NO.	DESCRIPTION	
1	Oil Pan Gasket Set	1997-94	OS 30640 C	Sump	
1	Oil Pan Gasket Set	1997-94	OS 30642 C	Crankcase cover	
QTY	CRANKSHAFT REAR SEAL	YEARS	PART NO.	DESCRIPTION	
1	Rear Main Seal Set	1997-94	BS 40637	Rubber; One-piece	
QTY	VALVE COVER	YEARS	PART NO.	DESCRIPTION	
1	Valve Cover Gasket Set	1997-94	VS 50386 R	w/Spark plug tube seals; PermaDry® molded rubber gskts. incl.	
1	Spark Plug Tube Seal Set	1997-94	ES 72105	Valve Cover	
QTY	VALVE STEM SEAL SET	YEARS	PART NO.	DESCRIPTION	
1	Valve Stem Seal Set	1997-94	SS 72809	Premium valve stem seals incl.	
QTY	THERMOSTAT HOUSING	YEARS	PART NO.	DESCRIPTION	
1	Thermostat Gasket	1997-94	35445	Thermostat Housing; Thermostat inlet	
QTY	WATER OUTLET GASKET	YEARS	PART NO.	DESCRIPTION	
1	Water Outlet Gasket	1997-94	35493	Water Outlet	
QTY	WATER PUMP	YEARS	PART NO.	DESCRIPTION	
1	Water Pump Gasket	1997-94	35492		
QTY	TIMING COVER	YEARS	PART NO.	DESCRIPTION	
1	Timing Cover Set	1997-94	TCS 45897		
QTY	CARB & FUEL INJECTION	YEARS	PART NO.	DESCRIPTION	
1	Throttle Body Gasket	1997-94	60909		
QTY	DISTRIBUTOR MOUNTING	YEARS	PART NO.	DESCRIPTION	
1	Distributor Mounting Gasket	1997-94	72438	O-ring	
QTY	EXHAUST GAS RECIRCULATION	YEARS	PART NO.	DESCRIPTION	
1	EGR Mounting Set	1997-94	ES 72801		
8		2013 - 2009; 2.5L 152.2 (2494cc) DOHC L4 (16 Valve) 90mm Bore VVT-i			8
		MFI; Gasoline; Naturally Aspirated Toyota Eng.; Eng. Code 2ARFE			
QTY	CYLINDER HEAD	YEARS	PART NO.	DESCRIPTION	
1	Head Gasket	2013-09	26562 PT	Head bolts not incl.; Head bolt replacement recommended; PermaTorqueMLS®; New Part Number - Check for Availability	
QTY	CONVERSION SET	YEARS	PART NO.	DESCRIPTION	
1	Gasket Conversion Set	2013-09	CS 26562	New Part Number - Check for Availability	
QTY	MANIFOLD - INT. & EXH.	YEARS	PART NO.	DESCRIPTION	
1	Int. Manifold Gasket Set	2013-09	MS 97232	New Part Number - Check for Availability	
1	Exh. Manifold Gasket Set	2013-09	MS 97234	New Part Number - Check for Availability	
QTY	EXHAUST PIPE FLANGE	YEARS	PART NO.	DESCRIPTION	
1	Exhaust Pipe Gasket	2013-09	61716	Pipe to manifold; New Part Number - Check for Availability	
QTY	OIL PAN	YEARS	PART NO.	DESCRIPTION	
1	Oil Pan Gasket Set	2013-09	OS 30842	New Part Number - Check for Availability	
1	Drain Plug Gasket	2013-09	70822		
QTY	CRANKSHAFT REAR SEAL	YEARS	PART NO.	DESCRIPTION	
1	Rear Main Seal Set	2013-09	BS 40741	Rubber; One-piece; New Part Number - Check for Availability	
QTY	WATER PUMP	YEARS	PART NO.	DESCRIPTION	
1	Water Pump Gasket	2013-09	36011	Pump to block; New Part Number - Check for Availability	
1	Water Pump Gasket	2013-09	36013	Pump to housing; New Part Number - Check for Availability	
QTY	TIMING COVER	YEARS	PART NO.	DESCRIPTION	
1	Crankshaft Front Seal Set	2013-09	TCS 46168	New Part Number - Check for Availability	
9		2005 - 1994; 2.7L 164.3 (2693cc) DOHC L4 (16 Valve) 95mm Bore			9
		MFI; Gasoline; Naturally Aspirated Toyota Eng.; Eng. Code 3RZFE			
QTY	CYLINDER HEAD	YEARS	PART NO.	DESCRIPTION	
1	Head Gasket	2005-94	9465 PT	Head bolts not incl.; Head bolt replacement recommended	
1	Head Set	2005-94	HS 9465 PT-2	Exc. California; Head bolts not incl.; Head bolt replacement recommended; PermaDry® molded rubber valve cover gskt. incl.; Premium valve stem seals incl.	
1	Head Set	2005-94	HS 9465 PT-3	California; Head bolts not incl.; Head bolt replacement recommended; PermaDry® molded rubber valve cover gskt. incl.; Premium valve stem seals incl.	
1	Head Bolt Set	2005-94	ES 72182	Head bolts w/Washers; Replacement recommended	
QTY	CONVERSION SET	YEARS	PART NO.	DESCRIPTION	
1	Gasket Conversion Set	2005-94	CS 9465		

Toyota Truck (Incl. Minivans and SUV's) (Cont.)

9 (cont.)	2005 - 1994; 2.7L 164.3 (2693cc) DOHC L4 (16 Valve) 95mm Bore MFI; Gasoline; Naturally Aspirated Toyota Eng.; Eng. Code 3RZFE				9 (cont.)
QTY	MANIFOLD - INT. & EXH.	YEARS	PART NO.	DESCRIPTION	
1	Int. Manifold Gasket Set	2005-94	MS 92672	California; Upper set incl.	
1	Int. Manifold Gasket Set	2005-94	MS 92692	Exc. California; Upper set incl.	
1	Exh. Manifold Gasket Set	2005-94	MS 92721		
QTY	EXHAUST PIPE FLANGE	YEARS	PART NO.	DESCRIPTION	
2	Exhaust Pipe Gasket	2005-94	23561	Flange; 1 49/64" ID x 2 17/64" OD	
1	Exhaust Pipe Gasket	2005-94	60495	Ring	
1	Exhaust Pipe Gasket	2005-98	60911	To muffler	
2	Exhaust Pipe Gasket	2005-01	60512	Converter; Improved design	
2	Exhaust Pipe Gasket	2005-01	61138	Converter; Old design	
2	Exhaust Pipe Gasket	2000-96	61039	Converter	
QTY	OIL PAN	YEARS	PART NO.	DESCRIPTION	
1	Oil Pan Gasket Set	2005-94	OS 30642 C		
1	Drain Plug Gasket	2005-94	70822		
QTY	CRANKSHAFT REAR SEAL	YEARS	PART NO.	DESCRIPTION	
1	Rear Main Seal Set	2005-94	BS 40637	Rubber; One-piece	
QTY	VALVE COVER	YEARS	PART NO.	DESCRIPTION	
1	Valve Cover Gasket Set	2005-94	VS 50512 R	w/o Spark plug tube seals & w/Grommets; PermaDry® molded rubber gskt. incl.	
1	Grommet Set	2005-94	ES 72133	Valve Cover	
1	Spark Plug Tube Seal Set	2005-94	ES 72105	Valve Cover	
QTY	VALVE STEM SEAL SET	YEARS	PART NO.	DESCRIPTION	
1	Valve Stem Seal Set	2005-94	SS 72810	Premium valve stem seals incl.	
QTY	THERMOSTAT HOUSING	YEARS	PART NO.	DESCRIPTION	
1	Thermostat Gasket	2005-94	35445	Thermostat Housing; Water inlet	
1	Thermostat Gasket	2005-94	35644	Thermostat Housing	
QTY	WATER OUTLET GASKET	YEARS	PART NO.	DESCRIPTION	
1	Water Outlet Gasket	2005-94	35520	Water Outlet	
QTY	WATER PUMP	YEARS	PART NO.	DESCRIPTION	
1	Water Pump Gasket	2005-94	35643		
QTY	TIMING COVER	YEARS	PART NO.	DESCRIPTION	
1	Timing Cover Set	2005-94	TCS 46006		
QTY	CARB & FUEL INJECTION	YEARS	PART NO.	DESCRIPTION	
1	Fuel Injector O-Ring Set	2005-94	ES 70600		
1	Throttle Body Gasket	2005-94	61079	Throttle body mounting	
1	Throttle Body Gasket	2005-94	61128	Throttle body cover; California	
1	Throttle Body Gasket	2005-94	61152	Throttle body cover; Exc. California	
QTY	EXHAUST GAS RECIRCULATION	YEARS	PART NO.	DESCRIPTION	
1	EGR Gasket	2005-94	70961	Valve	
2	EGR Gasket	2005-96	70410	Inlet	
10	2013 - 2005; 2.7L 164.3 (2693cc) DOHC L4 (16 Valve) 95mm Bore VVT-i MFI; Gasoline; Naturally Aspirated Toyota Eng.; Eng. Code 2TRFE				10
QTY	CYLINDER HEAD	YEARS	PART NO.	DESCRIPTION	
1	Head Gasket	2013-05	26357 PT	Head bolts not incl.; Head bolt replacement recommended; PermaTorqueMLS®	
1	Head Set	2013-05	HS 26357 PT	Head bolts not incl.; Head bolt replacement recommended; PermaDry® molded rubber valve cover gskt. incl.; Premium valve stem seals incl.	
1	Head Bolt Set	2013-05	ES 72182	Head bolts w/Washers; Replacement recommended	
QTY	CONVERSION SET	YEARS	PART NO.	DESCRIPTION	
1	Gasket Conversion Set	2013-08	CS 26357-1	RTV sealant incl. for oil pan gskt.	
1	Gasket Conversion Set	2007	CS 26357	To 04/30/07; RTV sealant incl. for oil pan gskt.	
1	Gasket Conversion Set	2007	CS 26357-1	From 05/01/07; RTV sealant incl. for oil pan gskt.	
1	Gasket Conversion Set	2006-05	CS 26357	RTV sealant incl. for oil pan gskt.	
QTY	MANIFOLD - INT. & EXH.	YEARS	PART NO.	DESCRIPTION	
1	Int. Manifold Gasket Set	2013-05	MS 96924	Upper set incl.	
1	Exh. Manifold Gasket Set	2013-05	MS 96921		
QTY	EXHAUST PIPE FLANGE	YEARS	PART NO.	DESCRIPTION	
1	Exhaust Pipe Gasket	2013-05	61039	Converter	
1	Exhaust Pipe Gasket	2013-05	61106	Pipe to manifold; 2.40" ID	
QTY	OIL PAN	YEARS	PART NO.	DESCRIPTION	
1	Oil Pan Gasket Set	2013-05	OS 30784	RTV sealant incl. for oil pan gskt.	
1	Drain Plug Gasket	2013-05	70822		
QTY	CRANKSHAFT REAR SEAL	YEARS	PART NO.	DESCRIPTION	
1	Rear Main Seal Set	2013-05	BS 40637	Rubber; One-piece	

Toyota Truck (Incl. Minivans and SUV's) (Cont.)

10		2013 - 2005; 2.7L 164.3 (2693cc) DOHC L4 (16 Valve) 95mm Bore VVT-i			10	
(cont.)		MFI; Gasoline; Naturally Aspirated Toyota Eng.; Eng. Code 2TRFE			(cont.)	
QTY	VALVE COVER	YEARS	PART NO.	DESCRIPTION		
1	Valve Cover Gasket Set	2013-05	VS 50717 R	w/Spark plug tube seals; PermaDry® molded rubber gskt. incl.		
QTY	VALVE STEM SEAL SET	YEARS	PART NO.	DESCRIPTION		
1	Valve Stem Seal Set	2013-05	SS 72878-1	Premium valve stem seals incl.		
QTY	THERMOSTAT HOUSING	YEARS	PART NO.	DESCRIPTION		
1	Thermostat Gasket	2013-05	35445	Thermostat Housing; Water inlet		
1	Thermostat Gasket	2013-05	35842	Thermostat Housing		
QTY	WATER PUMP	YEARS	PART NO.	DESCRIPTION		
1	Water Pump Gasket	2013-05	35643			
QTY	TIMING COVER	YEARS	PART NO.	DESCRIPTION		
1	Crankshaft Front Seal Set	2013-08	TCS 46131			
1	Crankshaft Front Seal Set	2007	TCS 46129	To 04/30/07		
1	Crankshaft Front Seal Set	2007	TCS 46131	From 05/01/07		
1	Crankshaft Front Seal Set	2006-05	TCS 46129			
QTY	CARB & FUEL INJECTION	YEARS	PART NO.	DESCRIPTION		
1	Throttle Body Gasket	2013-12	61714	New Part Number - Check for Availability		
1	Throttle Body Gasket	2011-05	61421			
11		1995 - 1991; 3.0L 180.5 (2958cc) SOHC V6 (12 Valve) 87.5mm Bore			11	
		MFI; Gasoline; Naturally Aspirated Toyota Eng.; Eng. Code 3VZE				
QTY	CYLINDER HEAD	YEARS	PART NO.	DESCRIPTION		
1	Head Gasket	1995-91	9728 PT	Loc. R.H.; Head bolts not incl.; Head bolt replacement recommended		
1	Head Gasket	1995-91	9815 PT	Loc. L.H.; Head bolts not incl.; Head bolt replacement recommended		
1	Head Set	1995-91	HS 9728 PT-1	Head bolts not incl.; Head bolt replacement recommended; PermaDry® molded rubber valve cover gskts. incl.; Premium valve stem seals incl.		
2	Head Bolt Set	1995-91	ES 72185	Replacement recommended		
QTY	CONVERSION SET	YEARS	PART NO.	DESCRIPTION		
1	Gasket Conversion Set	1995-91	CS 9728			
QTY	MANIFOLD - INT. & EXH.	YEARS	PART NO.	DESCRIPTION		
1	Int. Manifold Gasket Set	1995-91	MS 94727	Lower set; Upper set incl.		
1	Plenum Gasket Set	1995-91	MS 94711	Upper set		
1	Exh. Manifold Gasket Set	1995-91	MS 94708-1			
QTY	EXHAUST PIPE FLANGE	YEARS	PART NO.	DESCRIPTION		
2	Exhaust Pipe Gasket	1995-91	23561	Crossover; 1 49/64" ID x 2 17/64" OD		
1	Exhaust Pipe Gasket	1995-91	23591	Loc. Rear; Converter; 1 31/32" ID x 2 35/64" OD		
1	Exhaust Pipe Gasket	1995-91	23626	Loc. Front; Converter		
2	Exhaust Pipe Gasket	1995-91	23626	Pipe to manifold		
QTY	OIL PAN	YEARS	PART NO.	DESCRIPTION		
1	Oil Pan Gasket Set	1995-91	OS 30623 C-1	Improved design		
1	Drain Plug Gasket	1995-91	70822			
QTY	CRANKSHAFT REAR SEAL	YEARS	PART NO.	DESCRIPTION		
1	Rear Main Seal Set	1995-91	BS 40674	Viton®; One-piece; Improved design		
QTY	VALVE COVER	YEARS	PART NO.	DESCRIPTION		
1	Valve Cover Gasket Set	1995-91	VS 50371 R	Must be used w/Int. manifold upper set MS 94711; Circular plugs not incl.; PermaDry® molded rubber gskts. incl.		
1	Circular Plug	1995-91	ES 72308	Valve Cover; Camshaft rear seal plug set		
QTY	VALVE STEM SEAL SET	YEARS	PART NO.	DESCRIPTION		
1	Valve Stem Seal Set	1995-91	SS 72841	Premium valve stem seals incl.		
QTY	THERMOSTAT HOUSING	YEARS	PART NO.	DESCRIPTION		
1	Water Outlet Gasket	1995-91	35278	Thermostat Housing		
QTY	WATER PUMP	YEARS	PART NO.	DESCRIPTION		
1	Water Pump Gasket	1995-91	35519			
QTY	TIMING COVER	YEARS	PART NO.	DESCRIPTION		
1	Timing Cover Set	1995-91	TCS 45890			
1	Crankshaft Front Seal Set	1995-91	TCS 46195	New Part Number - Check for Availability		
1	Camshaft Front Seal Set	1995-91	TCS 45914			
1	Repair Sleeve	1995-91	16220	Timing Cover; Use w/installation tool; Improved design		
1	Repair Sleeve	1995-91	16223	Timing Cover; Use w/installation tool; May use 16220 instead; Old design; Superseded - When depleted use 16220		
1	Repair Sleeve Tool	1995-91	16323	Timing Cover		
QTY	CARB & FUEL INJECTION	YEARS	PART NO.	DESCRIPTION		
2	Fuel Injector O-Ring Set	1995-91	ES 70600			
1	Throttle Body Gasket	1995-91	60904			
QTY	DISTRIBUTOR MOUNTING	YEARS	PART NO.	DESCRIPTION		
1	Distributor Mounting Gasket	1995-91	72438	O-ring		

Toyota Truck (Incl. Minivans and SUV's) (Cont.)

11		1995 - 1991; 3.0L 180.5 (2958cc) SOHC V6 (12 Valve) 87.5mm Bore			11
(cont.)		MFI; Gasoline; Naturally Aspirated Toyota Eng.; Eng. Code 3VZE			(cont.)
QTY	EXHAUST GAS RECIRCULATION	YEARS	PART NO.	DESCRIPTION	
1	EGR Mounting Set	1995-91	ES 70435		
12		2000 - 1998; 3.0L 182.6 (2995cc) DOHC V6 (24 Valve) 87.5mm Bore			12
(cont.)		MFI; Gasoline; Naturally Aspirated Toyota Eng.; Eng. Code 1MZF			(cont.)
QTY	CYLINDER HEAD	YEARS	PART NO.	DESCRIPTION	
1	Head Gasket	2000	9201 PT	Loc. L.H.; To 01/01/00; Head bolts not incl.; Head bolt replacement recommended	
1	Head Gasket	2000	9203 PT	Loc. R.H.; To 01/01/00; Head bolts not incl.; Head bolt replacement recommended	
1	Head Gasket	2000	9489 PT	Loc. R.H.; From 01/01/00 to 08/01/00; Head bolts not incl.; Head bolt replacement recommended; PermaTorqueMLS®	
1	Head Gasket	2000	9490 PT	Loc. L.H.; From 01/01/00 to 08/01/00; Head bolts not incl.; Head bolt replacement recommended; PermaTorqueMLS®	
1	Head Gasket	2000	9592 PT	Loc. R.H.; From 08/01/00; Head bolts not incl.; Head bolt replacement recommended; PermaTorqueMLS®	
1	Head Gasket	2000	9594 PT	Loc. L.H.; From 08/01/00; Head bolts not incl.; Head bolt replacement recommended; PermaTorqueMLS®	
1	Head Gasket	1999-98	9201 PT	Loc. L.H.; Head bolts not incl.; Head bolt replacement recommended	
1	Head Gasket	1999-98	9203 PT	Loc. R.H.; Head bolts not incl.; Head bolt replacement recommended	
1	Head Set	2000	HS 9201 PT	To 01/01/00; Head bolts not incl.; Head bolt replacement recommended; PermaDry® molded rubber valve cover gskts. incl.; Premium valve stem seals incl.	
1	Head Set	2000	HS 9489 PT	From 01/01/00 to 08/01/00; Head bolts not incl.; Head bolt replacement recommended; PermaDry® molded rubber valve cover gskts. incl.; Premium valve stem seals incl.	
1	Head Set	2000	HS 9592 PT	From 08/01/00; Head bolts not incl.; Head bolt replacement recommended; PermaDry® molded rubber valve cover gskts. incl.; Premium valve stem seals incl.	
1	Head Set	1999-98	HS 9201 PT	Head bolts not incl.; Head bolt replacement recommended; PermaDry® molded rubber valve cover gskts. incl.; Premium valve stem seals incl.	
2	Head Bolt Set	2000-98	ES 71036	Head bolts w/Washers; Replacement recommended	
QTY	CONVERSION SET	YEARS	PART NO.	DESCRIPTION	
1	Gasket Conversion Set	2000-98	CS 9201	RTV sealant incl. for Upper oil pan gskt.	
QTY	MANIFOLD - INT. & EXH.	YEARS	PART NO.	DESCRIPTION	
1	Int. Manifold Gasket Set	2000-98	MS 92766	Lower set; Upper set incl.	
1	Plenum Gasket Set	2000-98	MS 95407	Upper set	
1	Plenum Gasket Set	2000-98	MS 95407-1	Upper set; Plenum gskt. only; New Part Number - Check for Availability	
1	Exh. Manifold Gasket Set	2000-98	MS 95819		
QTY	EXHAUST PIPE FLANGE	YEARS	PART NO.	DESCRIPTION	
1	Exhaust Pipe Gasket	2000-98	23591	Loc. Front; Converter; 1 31/32" ID x 2 35/64" OD	
2	Exhaust Pipe Gasket	2000-98	60554	Flange	
1	Exhaust Pipe Gasket	2000-98	60906	Loc. Center; Exh. connector	
1	Exhaust Pipe Gasket	2000-98	60906	Loc. Rear; Converter	
1	Exhaust Pipe Gasket	2000-98	61016	Center pipe to muffler; Improved design	
1	Exhaust Pipe Gasket	2000-98	61016	Loc. Rear; Exh. connector; Improved design	
1	Exhaust Pipe Gasket	2000-98	61106	Rear exh. pipe; 2.40" ID	
QTY	OIL PAN	YEARS	PART NO.	DESCRIPTION	
1	Oil Pan Gasket Set	2000-98	OS 30681 C	Loc. Lower	
1	Drain Plug Gasket	2000-98	70822		
QTY	CRANKSHAFT REAR SEAL	YEARS	PART NO.	DESCRIPTION	
1	Rear Main Seal Set	2000-98	BS 40643	Rubber; One-piece	
QTY	VALVE COVER	YEARS	PART NO.	DESCRIPTION	
1	Valve Cover Gasket Set	2000	VS 50471 R	To 08/01/00; w/Spark plug tube seals; PermaDry® molded rubber gskts. incl.	
1	Valve Cover Gasket Set	2000	VS 50588 R	From 08/01/00; w/Spark plug tube seals; PermaDry® molded rubber gskts. incl.; Improved design	
1	Valve Cover Gasket Set	1999-98	VS 50471 R	w/Spark plug tube seals; PermaDry® molded rubber gskts. incl.	
1	Spark Plug Tube Seal Set	2000-98	ES 72701	Valve Cover; New Part Number - Check for Availability	
QTY	VALVE STEM SEAL SET	YEARS	PART NO.	DESCRIPTION	
1	Valve Stem Seal Set	2000-98	SS 72878	Premium valve stem seals incl.	
QTY	THERMOSTAT HOUSING	YEARS	PART NO.	DESCRIPTION	
1	Thermostat Gasket	2000-98	35445	Thermostat Housing	
QTY	WATER OUTLET GASKET	YEARS	PART NO.	DESCRIPTION	
1	Water Outlet Gasket	2000-98	35648	Water Outlet; Loc. Front	
1	Water Outlet Gasket	2000-98	35649	Water Outlet; Loc. Rear	

Toyota Truck (Incl. Minivans and SUV's) (Cont.)

12		2000 - 1998; 3.0L 182.6 (2995cc) DOHC V6 (24 Valve) 87.5mm Bore			12	
(cont.)		MFI; Gasoline; Naturally Aspirated Toyota Eng.; Eng. Code 1MZFE			(cont.)	
QTY	WATER OUTLET GASKET	YEARS	PART NO.	DESCRIPTION		
1	O-Ring	2000-98	35654	Water Outlet; Inlet; Improved design		
QTY	WATER PUMP	YEARS	PART NO.	DESCRIPTION		
1	Water Pump Gasket	2000-98	35594			
QTY	TIMING COVER	YEARS	PART NO.	DESCRIPTION		
1	Timing Cover Set	2000-98	TCS 45890			
1	Crankshaft Front Seal Set	2000-98	TCS 46195	New Part Number - Check for Availability		
1	Camshaft Front Seal Set	2000-98	TCS 45889			
1	Repair Sleeve	2000-98	16220	Timing Cover; Use w/installation tool; Improved design		
1	Repair Sleeve	2000-98	16223	Timing Cover; Use w/installation tool; May use 16220 instead; Old design; Superseded - When depleted use 16220		
1	Repair Sleeve Tool	2000-98	16323	Timing Cover		
QTY	CARB & FUEL INJECTION	YEARS	PART NO.	DESCRIPTION		
3	Fuel Injector O-Ring Set	2000-98	ES 70600			
1	Throttle Body Gasket	2000-98	61084	Idle air control		
1	Throttle Body Gasket	2000-98	61091	Throttle body mounting		
QTY	EXHAUST GAS RECIRCULATION	YEARS	PART NO.	DESCRIPTION		
1	EGR Gasket	2000-98	72898	Valve		
13		2003 - 1999; 3.0L 182.6 (2995cc) DOHC V6 (24 Valve) 87.5mm Bore VVT-i			13	
(cont.)		MFI; Gasoline; Naturally Aspirated Toyota Eng.; Eng. Code 1MZFE			(cont.)	
QTY	CYLINDER HEAD	YEARS	PART NO.	DESCRIPTION		
1	Head Gasket	2003-02	9592 PT	Loc. R.H.; Head bolts not incl.; Head bolt replacement recommended; PermaTorqueMLS®		
1	Head Gasket	2003-02	9594 PT	Loc. L.H.; Head bolts not incl.; Head bolt replacement recommended; PermaTorqueMLS®		
1	Head Gasket	2001	9489 PT	Toyota Sienna CE, LE, XLE; Loc. R.H.; To 08/01/00; Head bolts not incl.; Head bolt replacement recommended; PermaTorqueMLS®		
1	Head Gasket	2001	9490 PT	Toyota Sienna CE, LE, XLE; Loc. L.H.; To 08/01/00; Head bolts not incl.; Head bolt replacement recommended; PermaTorqueMLS®		
1	Head Gasket	2001	9592 PT	Toyota Sienna CE, LE, XLE; Loc. R.H.; From 08/01/00; Head bolts not incl.; Head bolt replacement recommended; PermaTorqueMLS®		
1	Head Gasket	2001	9592 PT	Exc. Toyota Sienna CE, LE, XLE; Loc. R.H.; Head bolts not incl.; Head bolt replacement recommended; PermaTorqueMLS®		
1	Head Gasket	2001	9594 PT	Toyota Sienna CE, LE, XLE; Loc. L.H.; From 08/01/00; Head bolts not incl.; Head bolt replacement recommended; PermaTorqueMLS®		
1	Head Gasket	2001	9594 PT	Exc. Toyota Sienna CE, LE, XLE; Loc. L.H.; Head bolts not incl.; Head bolt replacement recommended; PermaTorqueMLS®		
1	Head Gasket	2000-99	9592 PT	Loc. R.H.; Head bolts not incl.; Head bolt replacement recommended; PermaTorqueMLS®		
1	Head Gasket	2000-99	9594 PT	Loc. L.H.; Head bolts not incl.; Head bolt replacement recommended; PermaTorqueMLS®		
1	Head Set	2003	HS 9592 PT-2	Head bolts not incl.; Head bolt replacement recommended; PermaDry® molded rubber valve cover gskts. incl.; Premium valve stem seals incl.		
1	Head Set	2002-01	HS 9592 PT-2	Exc. Toyota Sienna CE, LE, XLE; Head bolts not incl.; Head bolt replacement recommended; PermaDry® molded rubber valve cover gskts. incl.; Premium valve stem seals incl.		
1	Head Set	2002	HS 9592 PT	Toyota Sienna CE, LE, XLE; Head bolts not incl.; Head bolt replacement recommended; PermaDry® molded rubber valve cover gskts. incl.; Premium valve stem seals incl.		
1	Head Set	2001	HS 9489 PT	Toyota Sienna CE, LE, XLE; To 08/01/00; Head bolts not incl.; Head bolt replacement recommended; PermaDry® molded rubber valve cover gskts. incl.; Premium valve stem seals incl.		
1	Head Set	2001	HS 9592 PT	Toyota Sienna CE, LE, XLE; From 08/01/00; Head bolts not incl.; Head bolt replacement recommended; PermaDry® molded rubber valve cover gskts. incl.; Premium valve stem seals incl.		
1	Head Set	2000-99	HS 9592 PT-2	Head bolts not incl.; Head bolt replacement recommended; PermaDry® molded rubber valve cover gskts. incl.; Premium valve stem seals incl.		
2	Head Bolt Set	2003-99	ES 71036	Head bolts w/Washers; Replacement recommended		
QTY	CONVERSION SET	YEARS	PART NO.	DESCRIPTION		
1	Gasket Conversion Set	2003-99	CS 9201	RTV sealant incl. for Upper oil pan gskt.		
QTY	MANIFOLD - INT. & EXH.	YEARS	PART NO.	DESCRIPTION		
1	Int. Manifold Gasket Set	2003-99	MS 92766	Lower set; Upper set incl.		
1	Plenum Gasket Set	2003-99	MS 95407	Upper set		
1	Plenum Gasket Set	2003-99	MS 95407-1	Upper set; Plenum gskt. only; New Part Number - Check for Availability		
1	Exh. Manifold Gasket Set	2003-99	MS 95819			

Toyota Truck (Incl. Minivans and SUV's) (Cont.)

13 (cont.)	2003 - 1999; 3.0L 182.6 (2995cc) DOHC V6 (24 Valve) 87.5mm Bore VVT-i MFI; Gasoline; Naturally Aspirated Toyota Eng.; Eng. Code 1MZF E				13 (cont.)
QTY	EXHAUST PIPE FLANGE	YEARS	PART NO.	DESCRIPTION	
1	Exhaust Pipe Gasket	2003-99	23591	Loc. Front; Converter; 1 31/32" ID x 2 35/64" OD	
1	Exhaust Pipe Gasket	2003-99	60906	Loc. Rear; Converter	
1	Exhaust Pipe Gasket	2003-99	61016	Center pipe to muffler; Improved design	
1	Exhaust Pipe Gasket	2003-99	61016	Loc. Rear; Exh. connector; Improved design	
1	Exhaust Pipe Gasket	2003-99	61106	Rear exh. pipe; 2.40" ID	
1	Exhaust Pipe Gasket	2003-01	60906	Toyota Sienna CE, LE, XLE; Loc. Center; Exh. connector	
1	Exhaust Pipe Gasket	2003-01	61106	Exc. Toyota Sienna CE, LE, XLE; Loc. Center; Exh. connector; 2.40" ID	
1	Exhaust Pipe Gasket	2003-02	23591	Exc. Toyota Sienna CE, LE, XLE; Loc. Front No. 2; Exh. connector; 1 31/32" ID x 2 35/64" OD	
1	Exhaust Pipe Gasket	2003-02	60906	Exc. Toyota Sienna CE, LE, XLE; Loc. Front No. 1; Exh. connector	
2	Exhaust Pipe Gasket	2003	60554	Exc. Toyota Sienna CE, LE, XLE; Flange	
2	Exhaust Pipe Gasket	2003	61040	Toyota Sienna CE, LE, XLE; Flange; 1.98" ID	
1	Exhaust Pipe Gasket	2003	61040	Toyota Sienna CE, LE, XLE; Loc. Front; Exh. connector; 1.98" ID	
2	Exhaust Pipe Gasket	2002-99	60554	Flange	
1	Exhaust Pipe Gasket	2001	23591	Toyota Highlander Base, Limited; Loc. Front No. 2; Exh. connector; 1 31/32" ID x 2 35/64" OD	
1	Exhaust Pipe Gasket	2001	60906	Toyota Highlander Base, Limited; Loc. Front No. 1; Exh. connector	
1	Exhaust Pipe Gasket	2000-99	61106	Loc. Center; Exh. connector; 2.40" ID	
QTY	OIL PAN	YEARS	PART NO.	DESCRIPTION	
1	Oil Pan Gasket Set	2003-99	OS 30681 C	Loc. Lower	
1	Drain Plug Gasket	2003-99	70822		
QTY	CRANKSHAFT REAR SEAL	YEARS	PART NO.	DESCRIPTION	
1	Rear Main Seal Set	2003-99	BS 40643	Rubber; One-piece	
QTY	VALVE COVER	YEARS	PART NO.	DESCRIPTION	
1	Valve Cover Gasket Set	2003-02	VS 50588 R	w/Spark plug tube seals; PermaDry® molded rubber gskts. incl.; Improved design	
1	Valve Cover Gasket Set	2001	VS 50471 R	Toyota Sienna CE, LE, XLE; To 08/01/00; w/Spark plug tube seals; PermaDry® molded rubber gskts. incl.	
1	Valve Cover Gasket Set	2001	VS 50588 R	Toyota Sienna CE, LE, XLE; From 08/01/00; w/Spark plug tube seals; PermaDry® molded rubber gskts. incl.; Improved design	
1	Valve Cover Gasket Set	2001	VS 50588 R	Exc. Toyota Sienna CE, LE, XLE; w/Spark plug tube seals; PermaDry® molded rubber gskts. incl.; Improved design	
1	Valve Cover Gasket Set	2000-99	VS 50588 R	w/Spark plug tube seals; PermaDry® molded rubber gskts. incl.; Improved design	
1	Spark Plug Tube Seal Set	2003-99	ES 72701	Valve Cover; New Part Number - Check for Availability	
QTY	VALVE STEM SEAL SET	YEARS	PART NO.	DESCRIPTION	
1	Valve Stem Seal Set	2003-99	SS 72878	Premium valve stem seals incl.	
QTY	THERMOSTAT HOUSING	YEARS	PART NO.	DESCRIPTION	
1	Thermostat Gasket	2003-99	35445	Thermostat Housing	
QTY	WATER OUTLET GASKET	YEARS	PART NO.	DESCRIPTION	
1	Water Outlet Gasket	2003-99	35648	Water Outlet; Loc. Front	
1	Water Outlet Gasket	2003-99	35649	Water Outlet; Loc. Rear	
1	O-Ring	2003-99	35654	Water Outlet; Inlet; Improved design	
QTY	WATER PUMP	YEARS	PART NO.	DESCRIPTION	
1	Water Pump Gasket	2003-99	35594		
QTY	TIMING COVER	YEARS	PART NO.	DESCRIPTION	
1	Timing Cover Set	2003-99	TCS 45890		
1	Crankshaft Front Seal Set	2003-99	TCS 46195	New Part Number - Check for Availability	
1	Camshaft Front Seal Set	2003-99	TCS 45889		
1	Repair Sleeve	2003-99	16220	Timing Cover; Use w/installation tool; Improved design	
1	Repair Sleeve	2003-99	16223	Timing Cover; Use w/installation tool; May use 16220 instead; Old design; Superseded - When depleted use 16220	
1	Repair Sleeve Tool	2003-99	16323	Timing Cover	
QTY	CARB & FUEL INJECTION	YEARS	PART NO.	DESCRIPTION	
3	Fuel Injector O-Ring Set	2003-99	ES 70600		
1	Throttle Body Gasket	2003-99	61084	Idle air control	
1	Throttle Body Gasket	2003-99	61091	Throttle body mounting	
1	Throttle Body Gasket	2003-01	61020	Exc. Toyota Sienna CE, LE, XLE; Adapter to manifold	
1	Throttle Body Gasket	2000-99	61020	Adapter to manifold	
QTY	EXHAUST GAS RECIRCULATION	YEARS	PART NO.	DESCRIPTION	
1	EGR Gasket	2003-99	72898	Valve	

Toyota Truck (Incl. Minivans and SUV's) (Cont.)

14		2007 - 2004; 3.3L 202 (3311cc) DOHC V6 (24 Valve) 92mm Bore VVT-i			14
MFI; Gasoline; Naturally Aspirated Toyota Eng.; Eng. Code 3MZFE					
QTY	CYLINDER HEAD	YEARS	PART NO.	DESCRIPTION	
1	Head Gasket	2007-04	26266 PT	Loc. R.H.; Head bolts not incl.; Head bolt replacement recommended; PermaTorqueMLS®	
1	Head Gasket	2007-04	26267 PT	Loc. L.H.; Head bolts not incl.; Head bolt replacement recommended; PermaTorqueMLS®	
1	Head Set	2007-04	HS 26266 PT	Head bolts not incl.; Head bolt replacement recommended; PermaDry® molded rubber valve cover gskts. incl.; Premium valve stem seals incl.	
2	Head Bolt Set	2007-04	ES 71036	Head bolts w/Washers; Replacement recommended	
QTY	CONVERSION SET	YEARS	PART NO.	DESCRIPTION	
1	Gasket Conversion Set	2007-04	CS 9201	RTV sealant incl. for Upper oil pan gskt.	
QTY	MANIFOLD - INT. & EXH.	YEARS	PART NO.	DESCRIPTION	
1	Int. Manifold Gasket Set	2007-04	MS 92766-1	Lower set; Upper set incl.	
1	Plenum Gasket Set	2007-04	MS 96586	Upper set	
1	Exh. Manifold Gasket Set	2007-04	MS 96083		
QTY	EXHAUST PIPE FLANGE	YEARS	PART NO.	DESCRIPTION	
1	Exhaust Pipe Gasket	2007-04	61039	Converter	
2	Exhaust Pipe Gasket	2007-04	61040	Flange; 1.98" ID	
2	Exhaust Pipe Gasket	2007	23591	Loc. Front; Exh. connector; 1 31/32" ID x 2 35/64" OD	
1	Exhaust Pipe Gasket	2007	61016	Loc. Rear No. 1; Exh. connector; Improved design	
1	Exhaust Pipe Gasket	2007	61016	Loc. Rear No. 2; Exh. connector; Improved design	
1	Exhaust Pipe Gasket	2007	61106	Loc. Center; Exh. connector; 2.40" ID	
2	Exhaust Pipe Gasket	2006	23591	Exc. Toyota Sienna CE, LE, Limited, XLE, XLE Limited; Loc. Front; Exh. connector; 1 31/32" ID x 2 35/64" OD	
1	Exhaust Pipe Gasket	2006	60906	Toyota Sienna CE, LE, Limited, XLE, XLE Limited; Loc. Center; Exh. connector	
1	Exhaust Pipe Gasket	2006	61016	Exc. Toyota Sienna CE, LE, Limited, XLE, XLE Limited; Loc. Rear No. 1; Exh. connector; Improved design	
1	Exhaust Pipe Gasket	2006	61016	Exc. Toyota Sienna CE, LE, Limited, XLE, XLE Limited; Loc. Rear No. 2; Exh. connector; Improved design	
1	Exhaust Pipe Gasket	2006	61106	Exc. Toyota Sienna CE, LE, Limited, XLE, XLE Limited; Loc. Center; Exh. connector; 2.40" ID	
1	Exhaust Pipe Gasket	2006	61106	Toyota Sienna CE, LE, Limited, XLE, XLE Limited; Loc. Rear; Exh. connector; 2.40" ID	
2	Exhaust Pipe Gasket	2005-04	23591	Exc. Toyota Sienna CE, LE, XLE, XLE Limited; Loc. Front; Exh. connector; 1 31/32" ID x 2 35/64" OD	
1	Exhaust Pipe Gasket	2005-04	60906	Toyota Sienna CE, LE, XLE, XLE Limited; Loc. Center; Exh. connector	
1	Exhaust Pipe Gasket	2005-04	61016	Exc. Toyota Sienna CE, LE, XLE, XLE Limited; Loc. Rear No. 1; Exh. connector; Improved design	
1	Exhaust Pipe Gasket	2005-04	61016	Exc. Toyota Sienna CE, LE, XLE, XLE Limited; Loc. Rear No. 2; Exh. connector; Improved design	
1	Exhaust Pipe Gasket	2005-04	61106	Exc. Toyota Sienna CE, LE, XLE, XLE Limited; Loc. Center; Exh. connector; 2.40" ID	
1	Exhaust Pipe Gasket	2005-04	61106	Toyota Sienna CE, LE, XLE, XLE Limited; Loc. Rear; Exh. connector; 2.40" ID	
QTY	OIL PAN	YEARS	PART NO.	DESCRIPTION	
1	Oil Pan Gasket Set	2007-04	OS 30681 C	Loc. Lower	
1	Drain Plug Gasket	2007-04	70822		
QTY	CRANKSHAFT REAR SEAL	YEARS	PART NO.	DESCRIPTION	
1	Rear Main Seal Set	2007-04	BS 40643	Rubber; One-piece	
QTY	VALVE COVER	YEARS	PART NO.	DESCRIPTION	
1	Valve Cover Gasket Set	2007-04	VS 50588 R	w/Spark plug tube seals; PermaDry® molded rubber gskts. incl.; Improved design	
1	Spark Plug Tube Seal Set	2007-04	ES 72701	Valve Cover; New Part Number - Check for Availability	
QTY	VALVE STEM SEAL SET	YEARS	PART NO.	DESCRIPTION	
1	Valve Stem Seal Set	2007-04	SS 72878-3	Premium valve stem seals incl.	
QTY	THERMOSTAT HOUSING	YEARS	PART NO.	DESCRIPTION	
1	Thermostat Gasket	2007-04	35445	Thermostat Housing	
QTY	WATER OUTLET GASKET	YEARS	PART NO.	DESCRIPTION	
1	O-Ring	2007-04	35654	Water Outlet; Inlet; Improved design	
QTY	WATER PUMP	YEARS	PART NO.	DESCRIPTION	
1	Water Pump Gasket	2007-04	35594		
QTY	TIMING COVER	YEARS	PART NO.	DESCRIPTION	
1	Timing Cover Set	2007-04	TCS 45890		
1	Crankshaft Front Seal Set	2007-04	TCS 46195	New Part Number - Check for Availability	
1	Camshaft Front Seal Set	2007-04	TCS 45889		

Toyota Truck (Incl. Minivans and SUV's) (Cont.)

14		2007 - 2004; 3.3L 202 (3311cc) DOHC V6 (24 Valve) 92mm Bore VVT-i			14
(cont.)		MFI; Gasoline; Naturally Aspirated Toyota Eng.; Eng. Code 3MZFE			(cont.)
QTY	TIMING COVER	YEARS	PART NO.	DESCRIPTION	
1	Repair Sleeve	2007-04	16220	Timing Cover; Use w/installation tool; Improved design	
1	Repair Sleeve	2007-04	16223	Timing Cover; Use w/installation tool; May use 16220 instead; Old design; Superseded - When depleted use 16220	
1	Repair Sleeve Tool	2007-04	16323	Timing Cover	
QTY	CARB & FUEL INJECTION	YEARS	PART NO.	DESCRIPTION	
1	Throttle Body Gasket	2007-04	61276	Mounting	
1	Throttle Body Gasket	2007-04	61373	Idle air control	
15		2010 - 2006; 3.3L 202 (3311cc) DOHC V6 (24 Valve) 92mm Bore VVT-i			15
(cont.)		MFI; Hybrid (Gas/Electric); Naturally Aspirated Toyota Eng.; Eng. Code 3MZFEX			(cont.)
QTY	CYLINDER HEAD	YEARS	PART NO.	DESCRIPTION	
1	Head Gasket	2010-06	26266 PT	Loc. R.H.; Head bolts not incl.; Head bolt replacement recommended; PermaTorqueMLS®	
1	Head Gasket	2010-06	26267 PT	Loc. L.H.; Head bolts not incl.; Head bolt replacement recommended; PermaTorqueMLS®	
1	Head Set	2010-06	HS 26266 PT	Head bolts not incl.; Head bolt replacement recommended; PermaDry® molded rubber valve cover gskts. incl.; Premium valve stem seals incl.	
2	Head Bolt Set	2010-06	ES 71036	Head bolts w/Washers; Replacement recommended	
QTY	CONVERSION SET	YEARS	PART NO.	DESCRIPTION	
1	Gasket Conversion Set	2010-06	CS 9201	RTV sealant incl. for Upper oil pan gskt.	
QTY	MANIFOLD - INT. & EXH.	YEARS	PART NO.	DESCRIPTION	
1	Int. Manifold Gasket Set	2010-06	MS 92766-1	Lower set; Upper set incl.	
1	Plenum Gasket Set	2010-06	MS 96586	Upper set	
1	Exh. Manifold Gasket Set	2010-06	MS 96083		
QTY	EXHAUST PIPE FLANGE	YEARS	PART NO.	DESCRIPTION	
2	Exhaust Pipe Gasket	2010-06	23591	Loc. Front; Exh. connector; 1 31/32" ID x 2 35/64" OD	
1	Exhaust Pipe Gasket	2010-06	61016	Loc. Rear No. 1; Exh. connector; Improved design	
1	Exhaust Pipe Gasket	2010-06	61016	Loc. Rear No. 2; Exh. connector; Improved design	
1	Exhaust Pipe Gasket	2010-06	61039	Converter	
2	Exhaust Pipe Gasket	2010-06	61040	Flange; 1.98" ID	
1	Exhaust Pipe Gasket	2010-06	61106	Loc. Center; Exh. connector; 2.40" ID	
QTY	OIL PAN	YEARS	PART NO.	DESCRIPTION	
1	Oil Pan Gasket Set	2010-06	OS 30681 C	Loc. Lower	
1	Drain Plug Gasket	2010-06	70822		
QTY	CRANKSHAFT REAR SEAL	YEARS	PART NO.	DESCRIPTION	
1	Rear Main Seal Set	2010-06	BS 40643	Rubber; One-piece	
QTY	VALVE COVER	YEARS	PART NO.	DESCRIPTION	
1	Valve Cover Gasket Set	2010-06	VS 50588 R	w/Spark plug tube seals; PermaDry® molded rubber gskts. incl.; Improved design	
1	Spark Plug Tube Seal Set	2010-06	ES 72701	Valve Cover; New Part Number - Check for Availability	
QTY	VALVE STEM SEAL SET	YEARS	PART NO.	DESCRIPTION	
1	Valve Stem Seal Set	2010-06	SS 72878-3	Premium valve stem seals incl.	
QTY	THERMOSTAT HOUSING	YEARS	PART NO.	DESCRIPTION	
1	Thermostat Gasket	2010-06	35445	Thermostat Housing	
QTY	WATER OUTLET GASKET	YEARS	PART NO.	DESCRIPTION	
1	O-Ring	2010-06	35654	Water Outlet; Inlet; Improved design	
QTY	WATER PUMP	YEARS	PART NO.	DESCRIPTION	
1	Water Pump Gasket	2010-06	35594		
QTY	TIMING COVER	YEARS	PART NO.	DESCRIPTION	
1	Timing Cover Set	2010-06	TCS 45890		
1	Crankshaft Front Seal Set	2010-06	TCS 46195	New Part Number - Check for Availability	
1	Camshaft Front Seal Set	2010-06	TCS 45889		
1	Repair Sleeve	2010-06	16220	Timing Cover; Use w/installation tool; Improved design	
1	Repair Sleeve	2010-06	16223	Timing Cover; Use w/installation tool; May use 16220 instead; Old design; Superseded - When depleted use 16220	
1	Repair Sleeve Tool	2010-06	16323	Timing Cover	
QTY	CARB & FUEL INJECTION	YEARS	PART NO.	DESCRIPTION	
1	Throttle Body Gasket	2010-06	61276	Mounting	
1	Throttle Body Gasket	2010-06	61373	Idle air control	

Toyota Truck (Incl. Minivans and SUV's) (Cont.)

16		2005 - 1995; 3.4L 206.1 (3378cc) DOHC V6 (24 Valve) 93.5mm Bore			16
		MFI; Gasoline; Naturally Aspirated Toyota Eng.; Eng. Code 5VZFE			
QTY	CYLINDER HEAD	YEARS	PART NO.	DESCRIPTION	
1	Head Gasket	2005-95	9227 PT-1	Loc. L.H.; Head bolts not incl.; Head bolt replacement recommended; PermaTorqueMLS®; Improved design	
1	Head Gasket	2005-95	9229 PT-1	Loc. R.H.; Head bolts not incl.; Head bolt replacement recommended; PermaTorqueMLS®; Improved design	
1	Head Set	2005-95	HS 9227 PT-1	Head bolts not incl.; Head bolt replacement recommended; PermaDry® molded rubber valve cover gskts. incl.; Premium valve stem seals incl.; Consolidated design	
2	Head Bolt Set	2005-95	ES 72168	Head bolts w/Washers; Replacement recommended	
2	Head Bolt Washer Set	2005-95	ES 72899	Replacement recommended	
QTY	CONVERSION SET	YEARS	PART NO.	DESCRIPTION	
1	Gasket Conversion Set	2005-95	CS 9227		
QTY	MANIFOLD - INT. & EXH.	YEARS	PART NO.	DESCRIPTION	
1	Int. Manifold Gasket Set	2005-95	MS 95898	Lower set; Upper set incl.	
1	Plenum Gasket Set	2005-95	MS 95899	Upper set	
1	Exh. Manifold Gasket Set	2005-99	MS 92732	California; Improved design	
1	Exh. Manifold Gasket Set	2005-99	MS 92732	Exc. California; Improved design	
1	Exh. Manifold Gasket Set	1998-95	MS 92732	Improved design	
QTY	EXHAUST PIPE FLANGE	YEARS	PART NO.	DESCRIPTION	
1	Exhaust Pipe Gasket	2005-95	61039	Converter	
2	Exhaust Pipe Gasket	2005-95	61040	Crossover; 1.98" ID	
1	Exhaust Pipe Gasket	2005-95	61086	Packing; 2.448" ID	
1	Exhaust Pipe Gasket	2005-96	60512	Muffler to tail pipe; Improved design	
1	Exhaust Pipe Gasket	2005-98	60911	Center pipe to muffler	
1	Exhaust Pipe Gasket	2005-01	60495	Flange	
1	Exhaust Pipe Gasket	2000-99	23591	To 08/31/99; Flange; 1 31/32" ID x 2 35/64" OD	
1	Exhaust Pipe Gasket	2000	60495	From 09/01/99; Flange	
1	Exhaust Pipe Gasket	1998-95	23591	Flange; 1 31/32" ID x 2 35/64" OD	
QTY	OIL PAN	YEARS	PART NO.	DESCRIPTION	
1	Oil Pan Gasket Set	2005-95	OS 30623 C-1	Improved design	
1	Drain Plug Gasket	2005-95	70822		
QTY	CRANKSHAFT REAR SEAL	YEARS	PART NO.	DESCRIPTION	
1	Rear Main Seal Set	2005-95	BS 40674	Viton®; One-piece; Improved design	
QTY	VALVE COVER	YEARS	PART NO.	DESCRIPTION	
1	Valve Cover Gasket Set	2005-95	VS 50422 R	w/o Grommets & w/Spark plug tube seals; PermaDry® molded rubber gskts. incl.	
1	Grommet Set	2005-95	ES 72422	Valve Cover	
1	Spark Plug Tube Seal Set	2005-95	ES 72701	Valve Cover; New Part Number - Check for Availability	
QTY	VALVE STEM SEAL SET	YEARS	PART NO.	DESCRIPTION	
1	Valve Stem Seal Set	2005-95	SS 72832	Premium valve stem seals incl.	
QTY	THERMOSTAT HOUSING	YEARS	PART NO.	DESCRIPTION	
1	Thermostat Gasket	2005-95	35445	Thermostat Housing; Thermostat inlet	
1	Thermostat Gasket	2005-95	35646	Thermostat Housing	
QTY	WATER OUTLET GASKET	YEARS	PART NO.	DESCRIPTION	
1	Water Outlet Gasket	2005-95	35602	Water Outlet	
QTY	WATER PUMP	YEARS	PART NO.	DESCRIPTION	
1	Water Pump Gasket	2005	35718		
1	Water Pump Gasket	2004	35718	Toyota Tundra Base, SR5	
1	Water Pump Gasket	2004	35728	Exc. Toyota Tundra Base, SR5	
1	Water Pump Gasket	2003-95	35519		
QTY	TIMING COVER	YEARS	PART NO.	DESCRIPTION	
1	Timing Cover Set	2005-95	TCS 45009	Must be used w/OS 30623C-1	
1	Crankshaft Front Seal Set	2005-95	TCS 46195	New Part Number - Check for Availability	
1	Camshaft Front Seal Set	2005-95	TCS 45018		
1	Camshaft Rear Seal Plug Set	2005-95	TCS 45979		
1	Repair Sleeve	2005-95	16220	Timing Cover; Use w/installation tool; Improved design	
1	Repair Sleeve	2005-95	16223	Timing Cover; Use w/installation tool; May use 16220 instead; Old design; Superseded - When depleted use 16220	
1	Repair Sleeve Tool	2005-95	16323	Timing Cover	
QTY	CARB & FUEL INJECTION	YEARS	PART NO.	DESCRIPTION	
2	Fuel Injector O-Ring Set	2005-95	ES 70600		
1	Throttle Body Gasket	2005-95	61038	Mounting	
1	Throttle Body Gasket	2005-95	61087	Cover	
QTY	EXHAUST GAS RECIRCULATION	YEARS	PART NO.	DESCRIPTION	
1	EGR Gasket	2005-95	72887		

Toyota Truck (Incl. Minivans and SUV's) (Cont.)

17		2013 - 2006; 3.5L 211 (3456cc) DOHC V6 (24 Valve) 94mm Bore VVT-i			17
MFI; Gasoline; Naturally Aspirated Toyota Eng.; Eng. Code 2GRFE					
QTY	CYLINDER HEAD	YEARS	PART NO.	DESCRIPTION	
1	Head Gasket	2013-06	26321 PT	Loc. L.H.; Head bolts not incl.; Head bolt replacement recommended; PermaTorqueMLS®	
1	Head Gasket	2013-06	26322 PT	Loc. R.H.; Head bolts not incl.; Head bolt replacement recommended; PermaTorqueMLS®	
1	Head Set	2013-06	HS 26321 PT	Head bolts not incl.; Head bolt replacement recommended; PermaDry® molded rubber valve cover gskts. incl.; Premium valve stem seals incl.	
1	Head Bolt Set	2013-06	ES 72249	Head bolts w/Washers; Replacement recommended	
QTY	CONVERSION SET	YEARS	PART NO.	DESCRIPTION	
1	Gasket Conversion Set	2013-12	CS 26321-1	RTV sealant incl. for oil pan gskt.	
1	Gasket Conversion Set	2011-06	CS 26321	RTV sealant incl. for oil pan gskt.	
QTY	MANIFOLD - INT. & EXH.	YEARS	PART NO.	DESCRIPTION	
1	Int. Manifold Gasket Set	2013-06	MS 96790	Lower set; Upper set incl.	
1	Plenum Gasket Set	2013-06	MS 96786	Upper set; New Part Number - Check for Availability	
1	Exh. Manifold Gasket Set	2013-06	MS 96795	Improved design	
QTY	EXHAUST PIPE FLANGE	YEARS	PART NO.	DESCRIPTION	
1	Exhaust Pipe Gasket	2013-12	61039	Lexus RX350 Base, F Sport; Converter	
1	Exhaust Pipe Gasket	2013-12	61460	Exc. Lexus RX350 Base, F Sport Toyota Venza AWD, Base, LE, Limited, XLE; Converter; 2.40" ID	
1	Exhaust Pipe Gasket	2013	60906	Toyota Sienna Base, L, LE, Limited, SE, XLE, XLE Limited; Loc. Front; Exh. connector	
1	Exhaust Pipe Gasket	2013	61106	Toyota Sienna Base, L, LE, Limited, SE, XLE, XLE Limited; Loc. Rear; Exh. connector; 2.40" ID	
1	Exhaust Pipe Gasket	2012-07	61040	Toyota RAV4 Base, Limited, Sport; Exh. connector; 1.98" ID	
1	Exhaust Pipe Gasket	2012-07	61106	Toyota RAV4 Base, Limited, Sport; Exh. connector; 2.40" ID	
1	Exhaust Pipe Gasket	2012-11	60906	Toyota Sienna Base, LE, Limited, SE, XLE, XLE Limited; Loc. Front; Exh. connector	
1	Exhaust Pipe Gasket	2012-11	61106	Toyota Sienna Base, LE, Limited, SE, XLE, XLE Limited; Loc. Rear; Exh. connector; 2.40" ID	
1	Exhaust Pipe Gasket	2011-07	61039	Lexus RX350 Base; Converter	
1	Exhaust Pipe Gasket	2011-09	61460	Exc. Lexus RX350 Base Toyota Venza Base; Converter; 2.40" ID	
1	Exhaust Pipe Gasket	2010-07	60906	Toyota Sienna CE, LE, Limited, XLE, XLE Limited; Loc. Front; Exh. connector	
1	Exhaust Pipe Gasket	2010-07	61106	Toyota Sienna CE, LE, Limited, XLE, XLE Limited; Loc. Rear; Exh. connector; 2.40" ID	
1	Exhaust Pipe Gasket	2008-07	61460	Exc. Lexus RX350 Base; Converter; 2.40" ID	
1	Exhaust Pipe Gasket	2006	61040	Exh. connector; 1.98" ID	
1	Exhaust Pipe Gasket	2006	61106	Exh. connector; 2.40" ID	
1	Exhaust Pipe Gasket	2006	61460	Converter; 2.40" ID	
QTY	OIL PAN	YEARS	PART NO.	DESCRIPTION	
1	Oil Pan Gasket Set	2013-06	OS 30770	RTV sealant incl. for oil pan gskt.; Improved design	
1	Oil Pan Gasket Set	2013-09	OS 30817	RTV sealant incl. for oil pan gskt.; Old design	
1	Drain Plug Gasket	2013-06	70822		
QTY	CRANKSHAFT REAR SEAL	YEARS	PART NO.	DESCRIPTION	
1	Rear Main Seal Set	2013-12	BS 40643	Rubber; One-piece	
1	Rear Main Seal Set	2011-06	BS 40701	Rubber; One-piece	
QTY	VALVE COVER	YEARS	PART NO.	DESCRIPTION	
1	Valve Cover Gasket Set	2013-06	VS 50682 R	w/Spark plug tube seals; PermaDry® molded rubber gskts. incl.	
1	Spark Plug Tube Seal Set	2013-06	ES 72701	Valve Cover; New Part Number - Check for Availability	
QTY	VALVE STEM SEAL SET	YEARS	PART NO.	DESCRIPTION	
1	Valve Stem Seal Set	2013-06	SS 72878	Premium valve stem seals incl.	
QTY	THERMOSTAT HOUSING	YEARS	PART NO.	DESCRIPTION	
1	Thermostat Gasket	2013-06	35445	Thermostat Housing; Thermostat	
QTY	WATER OUTLET GASKET	YEARS	PART NO.	DESCRIPTION	
2	Water Outlet Gasket	2013-06	35767	Water Outlet; Outlet; Improved design	
1	Water Outlet Gasket	2013-06	35809	Water Outlet; Water inlet O-ring; New Part Number - Check for Availability	
2	Water Outlet Gasket	2013-06	35811	Water Outlet; Outlet; Old design	
1	Thermostat Gasket	2013-06	35801	Water Outlet; Inlet	
QTY	WATER PUMP	YEARS	PART NO.	DESCRIPTION	
1	Water Pump Gasket	2013-06	35807		
QTY	TIMING COVER	YEARS	PART NO.	DESCRIPTION	
1	Crankshaft Front Seal Set	2013-06	TCS 46080		
QTY	CARB & FUEL INJECTION	YEARS	PART NO.	DESCRIPTION	
1	Throttle Body Gasket	2013-06	61445		

Toyota Truck (Incl. Minivans and SUV's) (Cont.)

18		2013 - 2010; 3.5L 211 (3456cc) DOHC V6 (24 Valve) 94mm Bore VVT-i			18
MFI; Hybrid (Gas/Electric); Naturally Aspirated Toyota Eng.; Eng. Code 2GRFXE					
QTY	CYLINDER HEAD	YEARS	PART NO.	DESCRIPTION	
1	Head Gasket	2013-10	26321 PT	Loc. L.H.; Head bolts not incl.; Head bolt replacement recommended; PermaTorqueMLS®	
1	Head Gasket	2013-10	26322 PT	Loc. R.H.; Head bolts not incl.; Head bolt replacement recommended; PermaTorqueMLS®	
1	Head Set	2013-10	HS 26321 PT	Head bolts not incl.; Head bolt replacement recommended; PermaDry® molded rubber valve cover gskts. incl.; Premium valve stem seals incl.	
1	Head Bolt Set	2013-10	ES 72249	Head bolts w/Washers; Replacement recommended	
QTY	CONVERSION SET	YEARS	PART NO.	DESCRIPTION	
1	Gasket Conversion Set	2013-12	CS 26321-1	RTV sealant incl. for oil pan gskt.	
1	Gasket Conversion Set	2011-10	CS 26321	RTV sealant incl. for oil pan gskt.	
QTY	MANIFOLD - INT. & EXH.	YEARS	PART NO.	DESCRIPTION	
1	Int. Manifold Gasket Set	2013-10	MS 96790	Lower set; Upper set incl.	
1	Plenum Gasket Set	2013-10	MS 96786	Upper set; New Part Number - Check for Availability	
1	Exh. Manifold Gasket Set	2013-10	MS 96795	Improved design	
QTY	EXHAUST PIPE FLANGE	YEARS	PART NO.	DESCRIPTION	
1	Exhaust Pipe Gasket	2013-11	61039	Lexus RX450h Base; Converter	
1	Exhaust Pipe Gasket	2013-11	61460	Exc. Lexus RX450h Base; Converter; 2.40" ID	
1	Exhaust Pipe Gasket	2010	61039	Converter	
QTY	OIL PAN	YEARS	PART NO.	DESCRIPTION	
1	Oil Pan Gasket Set	2013-10	OS 30770	RTV sealant incl. for oil pan gskt.; Improved design	
1	Drain Plug Gasket	2013-10	70822		
QTY	CRANKSHAFT REAR SEAL	YEARS	PART NO.	DESCRIPTION	
1	Rear Main Seal Set	2013-12	BS 40643	Rubber; One-piece	
1	Rear Main Seal Set	2011-10	BS 40701	Rubber; One-piece	
QTY	VALVE COVER	YEARS	PART NO.	DESCRIPTION	
1	Valve Cover Gasket Set	2013-10	VS 50682 R	w/Spark plug tube seals; PermaDry® molded rubber gskts. incl.	
1	Spark Plug Tube Seal Set	2013-10	ES 72701	Valve Cover; New Part Number - Check for Availability	
QTY	VALVE STEM SEAL SET	YEARS	PART NO.	DESCRIPTION	
1	Valve Stem Seal Set	2013-10	SS 72878	Premium valve stem seals incl.	
QTY	THERMOSTAT HOUSING	YEARS	PART NO.	DESCRIPTION	
1	Thermostat Gasket	2013-10	35445	Thermostat Housing; Thermostat	
QTY	WATER OUTLET GASKET	YEARS	PART NO.	DESCRIPTION	
2	Water Outlet Gasket	2013-10	35767	Water Outlet; Outlet; Improved design	
1	Water Outlet Gasket	2013-10	35809	Water Outlet; Water inlet O-ring; New Part Number - Check for Availability	
1	Thermostat Gasket	2013-10	35801	Water Outlet; Inlet	
QTY	WATER PUMP	YEARS	PART NO.	DESCRIPTION	
1	Water Pump Gasket	2013-10	35807		
QTY	TIMING COVER	YEARS	PART NO.	DESCRIPTION	
1	Crankshaft Front Seal Set	2013-10	TCS 46080		
QTY	CARB & FUEL INJECTION	YEARS	PART NO.	DESCRIPTION	
1	Throttle Body Gasket	2013-10	61445		

19		2013 - 2003; 4.0L 241.3 (3955cc) DOHC V6 (24 Valve) 94mm Bore			19
MFI; Gasoline; Naturally Aspirated Toyota Eng.; Eng. Code 1GRFE					
QTY	CYLINDER HEAD	YEARS	PART NO.	DESCRIPTION	
1	Head Gasket	2013-07	26330 PT	Loc. L.H.; Head bolts not incl.; Head bolt replacement recommended; PermaTorqueMLS®; Improved design	
1	Head Gasket	2013-07	26331 PT	Loc. R.H.; Head bolts not incl.; Head bolt replacement recommended; PermaTorqueMLS®; Improved design	
1	Head Gasket	2006	26330 PT	Toyota 4Runner Sport, Tacoma Access Cab; Loc. L.H.; From 10/01/05; Head bolts not incl.; Head bolt replacement recommended; PermaTorqueMLS®; Improved design	
1	Head Gasket	2006	26330 PT	Toyota Tacoma Base; Loc. L.H.; From 10/01/05; Head bolts not incl.; Head bolt replacement recommended; PermaTorqueMLS®; Improved design	
1	Head Gasket	2006	26330 PT	Toyota Tacoma Double Cab; Loc. L.H.; From 10/01/05; Head bolts not incl.; Head bolt replacement recommended; PermaTorqueMLS®; Improved design	
1	Head Gasket	2006	26330 PT	Toyota Tacoma Pre Runner, SR5; Loc. L.H.; From 10/01/05; Head bolts not incl.; Head bolt replacement recommended; PermaTorqueMLS®; Improved design	
1	Head Gasket	2006	26330 PT	Toyota Tacoma X-Runner, Tundra Access Cab; Loc. L.H.; From 10/01/05; Head bolts not incl.; Head bolt replacement recommended; PermaTorqueMLS®; Improved design	

Toyota Truck (Incl. Minivans and SUV's) (Cont.)

19 (cont.)	2013 - 2003; 4.0L 241.3 (3955cc) DOHC V6 (24 Valve) 94mm Bore				19 (cont.)
QTY	CYLINDER HEAD	YEARS	PART NO.	DESCRIPTION	
1	Head Gasket	2006	26330 PT	Toyota Tundra Base, SR5; Loc. L.H.; From 10/01/05; Head bolts not incl.; Head bolt replacement recommended; PermaTorqueMLS®; Improved design	
1	Head Gasket	2006	26290 PT	Loc. L.H.; To 09/30/05; Head bolts not incl.; Head bolt replacement recommended; PermaTorqueMLS®; Old design	
1	Head Gasket	2006	26292 PT	Loc. R.H.; To 09/30/05; Head bolts not incl.; Head bolt replacement recommended; PermaTorqueMLS®; Old design	
1	Head Gasket	2006	26330 PT	Toyota 4Runner Limited, SR5; Loc. L.H.; From 10/01/05; Head bolts not incl.; Head bolt replacement recommended; PermaTorqueMLS®; Improved design	
1	Head Gasket	2006	26330 PT	Toyota 4Runner Limited; Loc. L.H.; To 09/30/05; Head bolts not incl.; Head bolt replacement recommended; PermaTorqueMLS®; Improved design	
1	Head Gasket	2006	26330 PT	Toyota 4Runner Sport, SR5; Loc. L.H.; To 09/30/05; Head bolts not incl.; Head bolt replacement recommended; PermaTorqueMLS®; Improved design	
1	Head Gasket	2006	26330 PT	Toyota Tacoma Access Cab, Base; Loc. L.H.; To 09/30/05; Head bolts not incl.; Head bolt replacement recommended; PermaTorqueMLS®; Improved design	
1	Head Gasket	2006	26330 PT	Toyota Tacoma Double Cab; Loc. L.H.; To 09/30/05; Head bolts not incl.; Head bolt replacement recommended; PermaTorqueMLS®; Improved design	
1	Head Gasket	2006	26330 PT	Toyota Tacoma Pre Runner; Loc. L.H.; To 09/30/05; Head bolts not incl.; Head bolt replacement recommended; PermaTorqueMLS®; Improved design	
1	Head Gasket	2006	26330 PT	Toyota Tacoma SR5, X-Runner; Loc. L.H.; To 09/30/05; Head bolts not incl.; Head bolt replacement recommended; PermaTorqueMLS®; Improved design	
1	Head Gasket	2006	26330 PT	Toyota Tundra Access Cab, Base; Loc. L.H.; To 09/30/05; Head bolts not incl.; Head bolt replacement recommended; PermaTorqueMLS®; Improved design	
1	Head Gasket	2006	26330 PT	Toyota Tundra SR5; Loc. L.H.; To 09/30/05; Head bolts not incl.; Head bolt replacement recommended; PermaTorqueMLS®; Improved design	
1	Head Gasket	2006	26331 PT	Toyota 4Runner Limited; Loc. R.H.; From 10/01/05; Head bolts not incl.; Head bolt replacement recommended; PermaTorqueMLS®; Improved design	
1	Head Gasket	2006	26331 PT	Toyota 4Runner Sport; Loc. R.H.; From 10/01/05; Head bolts not incl.; Head bolt replacement recommended; PermaTorqueMLS®; Improved design	
1	Head Gasket	2006	26331 PT	Toyota 4Runner SR5; Loc. R.H.; From 10/01/05; Head bolts not incl.; Head bolt replacement recommended; PermaTorqueMLS®; Improved design	
1	Head Gasket	2006	26331 PT	Toyota Tacoma Access Cab; Loc. R.H.; From 10/01/05; Head bolts not incl.; Head bolt replacement recommended; PermaTorqueMLS®; Improved design	
1	Head Gasket	2006	26331 PT	Toyota Tacoma Base; Loc. R.H.; From 10/01/05; Head bolts not incl.; Head bolt replacement recommended; PermaTorqueMLS®; Improved design	
1	Head Gasket	2006	26331 PT	Toyota Tacoma Double Cab; Loc. R.H.; From 10/01/05; Head bolts not incl.; Head bolt replacement recommended; PermaTorqueMLS®; Improved design	
1	Head Gasket	2006	26331 PT	Toyota Tacoma Pre Runner, SR5; Loc. R.H.; From 10/01/05; Head bolts not incl.; Head bolt replacement recommended; PermaTorqueMLS®; Improved design	
1	Head Gasket	2006	26331 PT	Toyota Tacoma X-Runner; Loc. R.H.; From 10/01/05; Head bolts not incl.; Head bolt replacement recommended; PermaTorqueMLS®; Improved design	
1	Head Gasket	2006	26331 PT	Toyota Tundra Access Cab; Loc. R.H.; From 10/01/05; Head bolts not incl.; Head bolt replacement recommended; PermaTorqueMLS®; Improved design	
1	Head Gasket	2006	26331 PT	Toyota Tundra Base; Loc. R.H.; From 10/01/05; Head bolts not incl.; Head bolt replacement recommended; PermaTorqueMLS®; Improved design	
1	Head Gasket	2006	26331 PT	Toyota Tundra SR5; Loc. R.H.; From 10/01/05; Head bolts not incl.; Head bolt replacement recommended; PermaTorqueMLS®; Improved design	
1	Head Gasket	2006	26331 PT	Toyota 4Runner Limited; Loc. R.H.; To 09/30/05; Head bolts not incl.; Head bolt replacement recommended; PermaTorqueMLS®; Improved design	
1	Head Gasket	2006	26331 PT	Toyota 4Runner Sport, Tacoma Access Cab; Loc. R.H.; To 09/30/05; Head bolts not incl.; Head bolt replacement recommended; PermaTorqueMLS®; Improved design	

Toyota Truck (Incl. Minivans and SUV's) (Cont.)

19 (cont.)		2013 - 2003; 4.0L 241.3 (3955cc) DOHC V6 (24 Valve) 94mm Bore			19 (cont.)
		MFI; Gasoline; Naturally Aspirated Toyota Eng.; Eng. Code 1GRFE			
QTY	CYLINDER HEAD	YEARS	PART NO.	DESCRIPTION	
1	Head Gasket	2006	26331 PT	Toyota 4Runner SR5; Loc. R.H.; To 09/30/05; Head bolts not incl.; Head bolt replacement recommended; PermaTorqueMLS®; Improved design	
1	Head Gasket	2006	26331 PT	Toyota Tacoma Base; Loc. R.H.; To 09/30/05; Head bolts not incl.; Head bolt replacement recommended; PermaTorqueMLS®; Improved design	
1	Head Gasket	2006	26331 PT	Toyota Tacoma Double Cab; Loc. R.H.; To 09/30/05; Head bolts not incl.; Head bolt replacement recommended; PermaTorqueMLS®; Improved design	
1	Head Gasket	2006	26331 PT	Toyota Tacoma Pre Runner; Loc. R.H.; To 09/30/05; Head bolts not incl.; Head bolt replacement recommended; PermaTorqueMLS®; Improved design	
1	Head Gasket	2006	26331 PT	Toyota Tacoma SR5, X-Runner; Loc. R.H.; To 09/30/05; Head bolts not incl.; Head bolt replacement recommended; PermaTorqueMLS®; Improved design	
1	Head Gasket	2006	26331 PT	Toyota Tundra Access Cab; Loc. R.H.; To 09/30/05; Head bolts not incl.; Head bolt replacement recommended; PermaTorqueMLS®; Improved design	
1	Head Gasket	2006	26331 PT	Toyota Tundra Base; Loc. R.H.; To 09/30/05; Head bolts not incl.; Head bolt replacement recommended; PermaTorqueMLS®; Improved design	
1	Head Gasket	2006	26331 PT	Toyota Tundra SR5; Loc. R.H.; To 09/30/05; Head bolts not incl.; Head bolt replacement recommended; PermaTorqueMLS®; Improved design	
1	Head Gasket	2005-03	26290 PT	Loc. L.H.; Head bolts not incl.; Head bolt replacement recommended; PermaTorqueMLS®; Old design	
1	Head Gasket	2005-03	26292 PT	Loc. R.H.; Head bolts not incl.; Head bolt replacement recommended; PermaTorqueMLS®; Old design	
1	Head Gasket	2005-03	26330 PT	Loc. L.H.; Head bolts not incl.; Head bolt replacement recommended; PermaTorqueMLS®; Improved design	
1	Head Gasket	2005-03	26331 PT	Loc. R.H.; Head bolts not incl.; Head bolt replacement recommended; PermaTorqueMLS®; Improved design	
1	Head Set	2009-08	HS 26330 PT	Exc. Toyota Tundra Access Cab, Base, DX, SR5, Tundra Grade; Head bolts not incl.; Head bolt replacement recommended; PermaDry® molded rubber valve cover gskts. incl.; Premium valve stem seals incl.; Improved design	
1	Head Set	2009-08	HS 26330 PT-1	Toyota Tundra Access Cab, Base, DX, SR5, Tundra Grade; Head bolts not incl.; Head bolt replacement recommended; PermaDry® molded rubber valve cover gskts. incl.; Premium valve stem seals incl.	
1	Head Set	2007	HS 26330 PT	Exc. Toyota Tundra Access Cab, Base, SR5; Head bolts not incl.; Head bolt replacement recommended; PermaDry® molded rubber valve cover gskts. incl.; Premium valve stem seals incl.; Improved design	
1	Head Set	2007	HS 26330 PT-1	Toyota Tundra Access Cab, Base, SR5; Head bolts not incl.; Head bolt replacement recommended; PermaDry® molded rubber valve cover gskts. incl.; Premium valve stem seals incl.	
1	Head Set	2006	HS 26290 PT	To 09/30/05; Head bolts not incl.; Head bolt replacement recommended; PermaDry® molded rubber valve cover gskts. incl.; Premium valve stem seals incl.; Old design	
1	Head Set	2006	HS 26330 PT	Toyota 4Runner Limited; From 10/01/05; Head bolts not incl.; Head bolt replacement recommended; PermaDry® molded rubber valve cover gskts. incl.; Premium valve stem seals incl.; Improved design	
1	Head Set	2006	HS 26330 PT	Toyota 4Runner Sport; From 10/01/05; Head bolts not incl.; Head bolt replacement recommended; PermaDry® molded rubber valve cover gskts. incl.; Premium valve stem seals incl.; Improved design	
1	Head Set	2006	HS 26330 PT	Toyota 4Runner SR5; From 10/01/05; Head bolts not incl.; Head bolt replacement recommended; PermaDry® molded rubber valve cover gskts. incl.; Premium valve stem seals incl.; Improved design	
1	Head Set	2006	HS 26330 PT	Toyota Tacoma Access Cab; From 10/01/05; Head bolts not incl.; Head bolt replacement recommended; PermaDry® molded rubber valve cover gskts. incl.; Premium valve stem seals incl.; Improved design	
1	Head Set	2006	HS 26330 PT	Toyota Tacoma Base, Double Cab; From 10/01/05; Head bolts not incl.; Head bolt replacement recommended; PermaDry® molded rubber valve cover gskts. incl.; Premium valve stem seals incl.; Improved design	
1	Head Set	2006	HS 26330 PT	Toyota Tacoma Pre Runner; From 10/01/05; Head bolts not incl.; Head bolt replacement recommended; PermaDry® molded rubber valve cover gskts. incl.; Premium valve stem seals incl.; Improved design	
1	Head Set	2006	HS 26330 PT	Toyota Tacoma SR5, X-Runner; From 10/01/05; Head bolts not incl.; Head bolt replacement recommended; PermaDry® molded rubber valve cover gskts. incl.; Premium valve stem seals incl.; Improved design	

Toyota Truck (Incl. Minivans and SUV's) (Cont.)

19 (cont.)	2013 - 2003; 4.0L 241.3 (3955cc) DOHC V6 (24 Valve) 94mm Bore				19 (cont.)
QTY	CYLINDER HEAD	YEARS	PART NO.	DESCRIPTION	
1	Head Set	2006	HS 26330 PT	Toyota Tundra Access Cab; From 10/01/05; Head bolts not incl.; Head bolt replacement recommended; PermaDry® molded rubber valve cover gsks. incl.; Premium valve stem seals incl.; Improved design	
1	Head Set	2006	HS 26330 PT	Toyota Tundra Base, SR5; From 10/01/05; Head bolts not incl.; Head bolt replacement recommended; PermaDry® molded rubber valve cover gsks. incl.; Premium valve stem seals incl.; Improved design	
1	Head Set	2006	HS 26330 PT	Toyota 4Runner Limited; To 09/30/05; Head bolts not incl.; Head bolt replacement recommended; PermaDry® molded rubber valve cover gsks. incl.; Premium valve stem seals incl.; Improved design	
1	Head Set	2006	HS 26330 PT	Toyota 4Runner Sport; To 09/30/05; Head bolts not incl.; Head bolt replacement recommended; PermaDry® molded rubber valve cover gsks. incl.; Premium valve stem seals incl.; Improved design	
1	Head Set	2006	HS 26330 PT	Toyota 4Runner SR5; To 09/30/05; Head bolts not incl.; Head bolt replacement recommended; PermaDry® molded rubber valve cover gsks. incl.; Premium valve stem seals incl.; Improved design	
1	Head Set	2006	HS 26330 PT	Toyota Tacoma Access Cab, Base; To 09/30/05; Head bolts not incl.; Head bolt replacement recommended; PermaDry® molded rubber valve cover gsks. incl.; Premium valve stem seals incl.; Improved design	
1	Head Set	2006	HS 26330 PT	Toyota Tacoma Double Cab, Pre Runner; To 09/30/05; Head bolts not incl.; Head bolt replacement recommended; PermaDry® molded rubber valve cover gsks. incl.; Premium valve stem seals incl.; Improved design	
1	Head Set	2006	HS 26330 PT	Toyota Tacoma SR5; To 09/30/05; Head bolts not incl.; Head bolt replacement recommended; PermaDry® molded rubber valve cover gsks. incl.; Premium valve stem seals incl.; Improved design	
1	Head Set	2006	HS 26330 PT	Toyota Tacoma X-Runner, Tundra Access Cab; To 09/30/05; Head bolts not incl.; Head bolt replacement recommended; PermaDry® molded rubber valve cover gsks. incl.; Premium valve stem seals incl.; Improved design	
1	Head Set	2006	HS 26330 PT	Toyota Tundra Base; To 09/30/05; Head bolts not incl.; Head bolt replacement recommended; PermaDry® molded rubber valve cover gsks. incl.; Premium valve stem seals incl.; Improved design	
1	Head Set	2006	HS 26330 PT	Toyota Tundra SR5; To 09/30/05; Head bolts not incl.; Head bolt replacement recommended; PermaDry® molded rubber valve cover gsks. incl.; Premium valve stem seals incl.; Improved design	
1	Head Set	2005-03	HS 26290 PT	Head bolts not incl.; Head bolt replacement recommended; PermaDry® molded rubber valve cover gsks. incl.; Premium valve stem seals incl.; Old design	
1	Head Set	2005-03	HS 26330 PT	Head bolts not incl.; Head bolt replacement recommended; PermaDry® molded rubber valve cover gsks. incl.; Premium valve stem seals incl.; Improved design	
1	Head Bolt Set	2013-03	ES 72249	Head bolts w/Washers; Replacement recommended	
QTY	CONVERSION SET	YEARS	PART NO.	DESCRIPTION	
1	Gasket Conversion Set	2009-08	CS 26290	Toyota Tundra Access Cab, Base, DX, SR5, Tundra Grade; RTV sealant incl. for oil pan gskt.	
1	Gasket Conversion Set	2009-08	CS 26330	Exc. Toyota Tundra Access Cab, Base, DX, SR5, Tundra Grade; RTV sealant incl. for oil pan gskt.	
1	Gasket Conversion Set	2007-03	CS 26290	RTV sealant incl. for oil pan gskt.	
QTY	MANIFOLD - INT. & EXH.	YEARS	PART NO.	DESCRIPTION	
1	Int. Manifold Gasket Set	2013-03	MS 96671	Lower set; Upper set incl.	
1	Exh. Manifold Gasket Set	2013	MS 96913		
1	Exh. Manifold Gasket Set	2012-11	MS 96614	To 09/30/11	
1	Exh. Manifold Gasket Set	2012-11	MS 96913	From 10/01/11	
1	Exh. Manifold Gasket Set	2010	MS 96614	Toyota Tacoma Access Cab, Base, Double Cab, Pre Runner, SR5, X-Runner	
1	Exh. Manifold Gasket Set	2010	MS 96913	Toyota Tundra Access Cab, Base, Double Cab, SR5, Tundra Grade, Work	
1	Exh. Manifold Gasket Set	2009-08	MS 96614	Exc. Toyota Tundra Access Cab, Base, DX, SR5, Tundra Grade	
1	Exh. Manifold Gasket Set	2009-08	MS 96913	Toyota Tundra Access Cab, Base, DX, SR5, Tundra Grade	
1	Exh. Manifold Gasket Set	2007	MS 96614	Exc. Toyota Tundra Access Cab, Base, SR5	
1	Exh. Manifold Gasket Set	2007	MS 96913	Toyota Tundra Access Cab, Base, SR5	
1	Exh. Manifold Gasket Set	2006-03	MS 96614		
QTY	EXHAUST PIPE FLANGE	YEARS	PART NO.	DESCRIPTION	
1	Exhaust Pipe Gasket	2013-11	61040	Loc. R.H.; Converter; 1.98" ID	
2	Exhaust Pipe Gasket	2013-11	61040	Pipe to manifold; 1.98" ID	
1	Exhaust Pipe Gasket	2013-11	61106	Loc. L.H.; Converter; 2.40" ID	
1	Exhaust Pipe Gasket	2010-07	61040	Toyota Tacoma Access Cab, Base, Double Cab, Pre Runner, SR5, X-Runner; Loc. R.H.; Converter; 1.98" ID	

Toyota Truck (Incl. Minivans and SUV's) (Cont.)

19 (cont.)		2013 - 2003; 4.0L 241.3 (3955cc) DOHC V6 (24 Valve) 94mm Bore MFI; Gasoline; Naturally Aspirated Toyota Eng.; Eng. Code 1GRFE			19 (cont.)
QTY	EXHAUST PIPE FLANGE	YEARS	PART NO.	DESCRIPTION	
1	Exhaust Pipe Gasket	2010-07	61106	Toyota Tacoma Access Cab, Base, Double Cab, Pre Runner, SR5, X-Runner; Loc. L.H.; Converter; 2.40" ID	
1	Exhaust Pipe Gasket	2010	60572	Toyota Tundra Access Cab, Base, Double Cab, SR5, Tundra Grade, Work; Exh. connector; 2.165" ID	
2	Exhaust Pipe Gasket	2010	60572	Toyota Tundra Access Cab, Base, Double Cab, SR5, Tundra Grade, Work; Pipe to manifold; 2.165" ID	
2	Exhaust Pipe Gasket	2010	61040	Toyota Tundra Access Cab, Base, Double Cab, SR5, Tundra Grade, Work; Converter; 1.98" ID	
2	Exhaust Pipe Gasket	2010	61040	Toyota Tacoma Access Cab, Base, Double Cab, Pre Runner, SR5, X-Runner; Pipe to manifold; 1.98" ID	
1	Exhaust Pipe Gasket	2010	61086	Toyota Tundra Access Cab, Base, Double Cab, SR5, Tundra Grade, Work; Exh. connector; 2.448" ID	
1	Exhaust Pipe Gasket	2009-05	61040	Toyota 4Runner Limited, Sport, SR5; Loc. Center; Converter; 1.98" ID	
1	Exhaust Pipe Gasket	2009-05	61106	Toyota 4Runner Limited, Sport, SR5; Loc. Rear; Converter; 2.40" ID	
1	Exhaust Pipe Gasket	2009-07	60512	Toyota 4Runner Limited, Sport, SR5, FJ Cruiser Base; Exh. connector; Improved design	
1	Exhaust Pipe Gasket	2009-07	61040	Toyota FJ Cruiser Base; Loc. L.H.; Converter; 1.98" ID	
1	Exhaust Pipe Gasket	2009-07	61106	Toyota FJ Cruiser Base; Loc. R.H.; Converter; 2.40" ID	
1	Exhaust Pipe Gasket	2009-08	60572	Toyota Tundra Access Cab, Base, DX, SR5, Tundra Grade; Exh. connector; 2.165" ID	
2	Exhaust Pipe Gasket	2009-08	60572	Toyota Tundra Access Cab, Base, DX, SR5, Tundra Grade; Pipe to manifold; 2.165" ID	
2	Exhaust Pipe Gasket	2009-08	61040	Toyota Tundra Access Cab, Base, DX, SR5, Tundra Grade; Converter; 1.98" ID	
2	Exhaust Pipe Gasket	2009-08	61040	Exc. Toyota Tundra Access Cab, Base, DX, SR5, Tundra Grade; Pipe to manifold; 1.98" ID	
1	Exhaust Pipe Gasket	2009-08	61086	Toyota Tundra Access Cab, Base, DX, SR5, Tundra Grade; Exh. connector; 2.448" ID	
1	Exhaust Pipe Gasket	2007-05	60572	Toyota Tundra Access Cab, Base, SR5; Exh. connector; 2.165" ID	
1	Exhaust Pipe Gasket	2007-05	61086	Toyota Tundra Access Cab, Base, SR5; Exh. connector; 2.448" ID	
2	Exhaust Pipe Gasket	2007	60572	Toyota Tundra Access Cab, Base, SR5; Pipe to manifold; 2.165" ID	
2	Exhaust Pipe Gasket	2007	61040	Toyota Tundra Access Cab, Base, SR5; Converter; 1.98" ID	
2	Exhaust Pipe Gasket	2007	61040	Exc. Toyota Tundra Access Cab, Base, SR5; Pipe to manifold; 1.98" ID	
2	Exhaust Pipe Gasket	2006-03	61040	Pipe to manifold; 1.98" ID	
1	Exhaust Pipe Gasket	2006-05	60512	Toyota 4Runner Limited, Sport, SR5; Exh. connector; Improved design	
1	Exhaust Pipe Gasket	2006-05	61040	Toyota Tundra Access Cab, Base, SR5; Converter; 1.98" ID	
1	Exhaust Pipe Gasket	2006-05	61040	Exc. Toyota 4Runner Limited, Sport, SR5, Tundra Access Cab, Base, SR5; Loc. R.H.; Converter; 1.98" ID	
1	Exhaust Pipe Gasket	2006-05	61106	Exc. Toyota 4Runner Limited, Sport, SR5, Tundra Access Cab, Base, SR5; Loc. L.H.; Converter; 2.40" ID	
1	Exhaust Pipe Gasket	2006-05	61124	Toyota Tundra Access Cab, Base, SR5; Converter; 1.92" ID	
1	Exhaust Pipe Gasket	2004-03	60512	Exh. connector; Improved design	
1	Exhaust Pipe Gasket	2004-03	61040	Loc. Center; Converter; 1.98" ID	
1	Exhaust Pipe Gasket	2004-03	61106	Loc. Rear; Converter; 2.40" ID	
QTY	OIL PAN	YEARS	PART NO.	DESCRIPTION	
1	Oil Pan Gasket Set	2013-11	OS 30819	RTV sealant incl. for oil pan gskt.	
1	Oil Pan Gasket Set	2010	OS 30752	Toyota Tundra Access Cab, Base, Double Cab, SR5, Tundra Grade, Work; RTV sealant incl. for oil pan gskt.	
1	Oil Pan Gasket Set	2010	OS 30819	Toyota Tacoma Access Cab, Base, Double Cab, Pre Runner, SR5, X-Runner; RTV sealant incl. for oil pan gskt.	
1	Oil Pan Gasket Set	2009-08	OS 30752	Toyota Tundra Access Cab, Base, DX, SR5, Tundra Grade; RTV sealant incl. for oil pan gskt.	
1	Oil Pan Gasket Set	2009-08	OS 30819	Exc. Toyota Tundra Access Cab, Base, DX, SR5, Tundra Grade; RTV sealant incl. for oil pan gskt.	
1	Oil Pan Gasket Set	2007-03	OS 30752	RTV sealant incl. for oil pan gskt.	
1	Drain Plug Gasket	2013-03	70822		
QTY	CRANKSHAFT REAR SEAL	YEARS	PART NO.	DESCRIPTION	
1	Rear Main Seal Set	2013-03	BS 40686	Rubber; One-piece	
QTY	VALVE COVER	YEARS	PART NO.	DESCRIPTION	
1	Valve Cover Gasket Set	2009-03	VS 50634 R	w/Grommets & Spark plug tube seals; PermaDry® molded rubber gskts. incl.	
1	Spark Plug Tube Seal Set	2013-03	ES 72701	Valve Cover; New Part Number - Check for Availability	
QTY	VALVE STEM SEAL SET	YEARS	PART NO.	DESCRIPTION	
1	Valve Stem Seal Set	2013-03	SS 72878-3	Premium valve stem seals incl.	
QTY	THERMOSTAT HOUSING	YEARS	PART NO.	DESCRIPTION	
1	Thermostat Gasket	2013-06	35801	Thermostat Housing; Thermostat seal	

Toyota Truck (Incl. Minivans and SUV's) (Cont.)

19 (cont.)	2013 - 2003; 4.0L 241.3 (3955cc) DOHC V6 (24 Valve) 94mm Bore				19 (cont.)
QTY	THERMOSTAT HOUSING	YEARS	PART NO.	DESCRIPTION	
1	Thermostat Gasket	2005-03	35774	Thermostat Housing; Thermostat seal	
QTY	WATER OUTLET GASKET	YEARS	PART NO.	DESCRIPTION	
1	Water Outlet Gasket	2013-03	35809	Water Outlet; Water inlet O-ring; New Part Number - Check for Availability	
2	Water Outlet Gasket	2013-05	35767	Water Outlet; Japan Built; Improved design	
2	Water Outlet Gasket	2013-08	35767	Water Outlet; U. S. Built; Improved design	
2	Water Outlet Gasket	2013-08	35811	Water Outlet; U. S. Built; Old design	
2	Water Outlet Gasket	2007	35767	Toyota Tacoma Access Cab, Base, Double Cab, Pre Runner, SR5, X-Runner; Water Outlet; U. S. Built; Improved design	
2	Water Outlet Gasket	2007	35811	Toyota Tacoma Access Cab, Base, Double Cab, Pre Runner, SR5, X-Runner; Water Outlet; U. S. Built; Old design	
2	Water Outlet Gasket	2006-05	35767	Exc. Toyota 4Runner Limited, Sport, SR5, Tundra Access Cab, Base, SR5; Water Outlet; U. S. Built; Improved design	
2	Water Outlet Gasket	2006-05	35811	Exc. Toyota 4Runner Limited, Sport, SR5, Tundra Access Cab, Base, SR5; Water Outlet; U. S. Built; Old design	
2	Water Outlet Gasket	2004-03	35767	Water Outlet; Improved design	
1	O-Ring	2013-11	35654	Water Outlet; Inlet; Improved design	
1	O-Ring	2010	35654	Toyota Tacoma Access Cab, Base, Double Cab, Pre Runner, SR5, X-Runner; Water Outlet; Inlet; Improved design	
1	O-Ring	2009-08	35654	Exc. Toyota FJ Cruiser Base, Tundra Access Cab, Base, DX, SR5, Tundra Grade; Water Outlet; Inlet; Improved design	
1	O-Ring	2007	35654	Exc. Toyota FJ Cruiser Base, Tundra Access Cab, Base, SR5; Water Outlet; Inlet; Improved design	
1	O-Ring	2006	35654	Exc. Toyota Tundra Access Cab, Base, SR5; Water Outlet; Inlet; Improved design	
QTY	WATER PUMP	YEARS	PART NO.	DESCRIPTION	
1	Water Pump Gasket	2013-03	35781		
QTY	TIMING COVER	YEARS	PART NO.	DESCRIPTION	
1	Crankshaft Front Seal Set	2009-03	TCS 46080		
QTY	CARB & FUEL INJECTION	YEARS	PART NO.	DESCRIPTION	
1	Throttle Body Gasket	2013-03	61392	Improved design	
1	Throttle Body Gasket	2009-07	61435	Exc. Toyota 4Runner Limited, Sport, SR5, FJ Cruiser Base; May use 61392 instead; Old design; Superseded - When depleted use 61392	
1	Throttle Body Gasket	2006-05	61435	Exc. Toyota 4Runner Limited, Sport, SR5; May use 61392 instead; Old design; Superseded - When depleted use 61392	
20	2013 - 2010; 4.0L 241.3 (3955cc) DOHC V6 (24 Valve) 94mm Bore VVT-i				20
QTY	CYLINDER HEAD	YEARS	PART NO.	DESCRIPTION	
1	Head Gasket	2013-10	26563 PT	Loc. L.H.; Head bolts not incl.; Head bolt replacement recommended; PermaTorqueMLS®; New Part Number - Check for Availability	
1	Head Gasket	2013-10	26564 PT	Loc. R.H.; Head bolts not incl.; Head bolt replacement recommended; PermaTorqueMLS®; New Part Number - Check for Availability	
1	Head Set	2013-10	HS 26563 PT	Head bolts not incl.; Head bolt replacement recommended; PermaDry® molded rubber valve cover gskts. incl.; Premium valve stem seals incl.; New Part Number - Check for Availability	
1	Head Bolt Set	2013-10	ES 72249	Head bolts w/Washers; Replacement recommended	
QTY	MANIFOLD - INT. & EXH.	YEARS	PART NO.	DESCRIPTION	
1	Int. Manifold Gasket Set	2013-10	MS 97237	Lower set; Upper set incl.; New Part Number - Check for Availability	
1	Plenum Gasket Set	2013-10	MS 97236	Upper set; New Part Number - Check for Availability	
1	Exh. Manifold Gasket Set	2013-10	MS 97235	New Part Number - Check for Availability	
QTY	EXHAUST PIPE FLANGE	YEARS	PART NO.	DESCRIPTION	
1	Exhaust Pipe Gasket	2013-11	61040	Toyota 4Runner Limited, SR5, Trail; Loc. Center; Converter; 1.98" ID	
1	Exhaust Pipe Gasket	2013-11	61106	Toyota 4Runner Limited, SR5, Trail; Loc. Rear; Converter; 2.40" ID	
1	Exhaust Pipe Gasket	2013-12	60495	Toyota 4Runner Limited, SR5, Trail, FJ Cruiser Base, GS, SE; Exh. connector	
1	Exhaust Pipe Gasket	2013-12	60572	Exc. Toyota 4Runner Limited, SR5, Trail, FJ Cruiser Base, GS, SE; Exh. connector; 2.165" ID	
2	Exhaust Pipe Gasket	2013-12	60572	Exc. Toyota 4Runner Limited, SR5, Trail, FJ Cruiser Base, GS, SE; Pipe to manifold; 2.165" ID	
2	Exhaust Pipe Gasket	2013-12	61040	Exc. Toyota 4Runner Limited, SR5, Trail, FJ Cruiser Base, GS, SE; Converter; 1.98" ID	
1	Exhaust Pipe Gasket	2013-12	61040	Toyota FJ Cruiser Base, GS, SE; Loc. L.H.; Converter; 1.98" ID	
2	Exhaust Pipe Gasket	2013-12	61040	Toyota 4Runner Limited, SR5, Trail, FJ Cruiser Base, GS, SE; Pipe to manifold; 1.98" ID	

Toyota Truck (Incl. Minivans and SUV's) (Cont.)

20 (cont.)		2013 - 2010; 4.0L 241.3 (3955cc) DOHC V6 (24 Valve) 94mm Bore VVT-i			20 (cont.)
MFI; Gasoline; Naturally Aspirated Toyota Eng.; Eng. Code 1GRFE					
QTY	EXHAUST PIPE FLANGE	YEARS	PART NO.	DESCRIPTION	
1	Exhaust Pipe Gasket	2013-12	61086	Exc. Toyota 4Runner Limited, SR5, Trail, FJ Cruiser Base, GS, SE; Exh. connector; 2.448" ID	
1	Exhaust Pipe Gasket	2013-12	61106	Toyota FJ Cruiser Base, GS, SE; Loc. R.H.; Converter; 2.40" ID	
1	Exhaust Pipe Gasket	2011-10	61040	Toyota FJ Cruiser Base; Loc. L.H.; Converter; 1.98" ID	
1	Exhaust Pipe Gasket	2011-10	61106	Toyota FJ Cruiser Base; Loc. R.H.; Converter; 2.40" ID	
1	Exhaust Pipe Gasket	2011	60495	Toyota 4Runner Limited, SR5, Trail, FJ Cruiser Base; Exh. connector	
1	Exhaust Pipe Gasket	2011	60572	Exc. Toyota 4Runner Limited, SR5, Trail, FJ Cruiser Base; Exh. connector; 2.165" ID	
2	Exhaust Pipe Gasket	2011	60572	Exc. Toyota 4Runner Limited, SR5, Trail, FJ Cruiser Base; Pipe to manifold; 2.165" ID	
2	Exhaust Pipe Gasket	2011	61040	Exc. Toyota 4Runner Limited, SR5, Trail, FJ Cruiser Base; Converter; 1.98" ID	
2	Exhaust Pipe Gasket	2011	61040	Toyota 4Runner Limited, SR5, Trail, FJ Cruiser Base; Pipe to manifold; 1.98" ID	
1	Exhaust Pipe Gasket	2011	61086	Exc. Toyota 4Runner Limited, SR5, Trail, FJ Cruiser Base; Exh. connector; 2.448" ID	
1	Exhaust Pipe Gasket	2010	60495	Exh. connector	
1	Exhaust Pipe Gasket	2010	61040	Exc. Toyota FJ Cruiser Base; Loc. Center; Converter; 1.98" ID	
2	Exhaust Pipe Gasket	2010	61040	Pipe to manifold; 1.98" ID	
1	Exhaust Pipe Gasket	2010	61106	Exc. Toyota FJ Cruiser Base; Loc. Rear; Converter; 2.40" ID	
QTY	OIL PAN	YEARS	PART NO.	DESCRIPTION	
1	Oil Pan Gasket Set	2013-12	OS 30752	Exc. Toyota 4Runner Limited, SR5, Trail, FJ Cruiser Base, GS, SE; RTV sealant incl. for oil pan gskt.	
1	Oil Pan Gasket Set	2013-12	OS 30819	Toyota 4Runner Limited, SR5, Trail, FJ Cruiser Base, GS, SE; RTV sealant incl. for oil pan gskt.	
1	Oil Pan Gasket Set	2011	OS 30752	Exc. Toyota 4Runner Limited, SR5, Trail, FJ Cruiser Base; RTV sealant incl. for oil pan gskt.	
1	Oil Pan Gasket Set	2011	OS 30819	Toyota 4Runner Limited, SR5, Trail, FJ Cruiser Base; RTV sealant incl. for oil pan gskt.	
1	Oil Pan Gasket Set	2010	OS 30819	RTV sealant incl. for oil pan gskt.	
1	Drain Plug Gasket	2013-10	70822		
QTY	CRANKSHAFT REAR SEAL	YEARS	PART NO.	DESCRIPTION	
1	Rear Main Seal Set	2013-10	BS 40686	Rubber; One-piece	
QTY	VALVE COVER	YEARS	PART NO.	DESCRIPTION	
1	Valve Cover Gasket Set	2013-10	VS 50826 R	w/Grommets & Spark plug tube seals; PermaDry® molded rubber gskts. incl.; New Part Number - Check for Availability	
1	Spark Plug Tube Seal Set	2013-10	ES 72701	Valve Cover; New Part Number - Check for Availability	
QTY	VALVE STEM SEAL SET	YEARS	PART NO.	DESCRIPTION	
1	Valve Stem Seal Set	2013-10	SS 72878-3	Premium valve stem seals incl.	
QTY	THERMOSTAT HOUSING	YEARS	PART NO.	DESCRIPTION	
1	Thermostat Gasket	2013-10	35801	Thermostat Housing; Thermostat seal	
QTY	WATER OUTLET GASKET	YEARS	PART NO.	DESCRIPTION	
2	Water Outlet Gasket	2013-10	35767	Water Outlet; Japan Built; Improved design	
2	Water Outlet Gasket	2013-10	35767	Water Outlet; U.S. Built; Improved design	
1	Water Outlet Gasket	2013-10	35809	Water Outlet; Water inlet O-ring; New Part Number - Check for Availability	
2	Water Outlet Gasket	2013-10	35811	Water Outlet; U.S. Built; Old design	
1	O-Ring	2013-11	35654	Toyota 4Runner Limited, SR5, Trail; Water Outlet; Inlet; Improved design	
1	O-Ring	2010	35654	Exc. Toyota FJ Cruiser Base; Water Outlet; Inlet; Improved design	
QTY	WATER PUMP	YEARS	PART NO.	DESCRIPTION	
1	Water Pump Gasket	2013-10	36014	New Part Number - Check for Availability	
QTY	CARB & FUEL INJECTION	YEARS	PART NO.	DESCRIPTION	
1	Throttle Body Gasket	2013-12	61392	Exc. Toyota 4Runner Limited, SR5, Trail, FJ Cruiser Base, GS, SE; Improved design	
1	Throttle Body Gasket	2013-12	61445	Toyota 4Runner Limited, SR5, Trail, FJ Cruiser Base, GS, SE	
1	Throttle Body Gasket	2011	61392	Exc. Toyota 4Runner Limited, SR5, Trail, FJ Cruiser Base; Improved design	
1	Throttle Body Gasket	2011	61445	Toyota 4Runner Limited, SR5, Trail, FJ Cruiser Base	
1	Throttle Body Gasket	2010	61445		
21		1992 - 1991; 4.0L 241.4 (3956cc) OHV L6 (12 Valve) 94mm Bore			21
MFI; Gasoline; Naturally Aspirated Toyota Eng.; Eng. Code 3FE					
QTY	CYLINDER HEAD	YEARS	PART NO.	DESCRIPTION	
1	Head Gasket	1992-91	9833 PT		
1	Head Set	1992-91	HS 9833 PT	PermaDry® molded rubber valve cover gskt. incl.; Premium valve stem seals incl.	
QTY	CONVERSION SET	YEARS	PART NO.	DESCRIPTION	
1	Gasket Conversion Set	1992-91	CS 9833		

Toyota Truck (Incl. Minivans and SUV's) (Cont.)

21 (cont.)	1992 - 1991; 4.0L 241.4 (3956cc) OHV L6 (12 Valve) 94mm Bore				21 (cont.)
QTY	MANIFOLD - INT. & EXH.	YEARS	PART NO.	DESCRIPTION	
1	Plenum Gasket Set	1992-91	MS 94731	Upper set	
1	Int. & Exh. Gasket Set	1992-91	MS 94710	Lower set; Upper set incl.	
QTY	EXHAUST PIPE FLANGE	YEARS	PART NO.	DESCRIPTION	
1	Exhaust Pipe Gasket	1992-91	23561	Loc. R.H.; Pipe to manifold; 1 49/64" ID x 2 17/64" OD	
2	Exhaust Pipe Gasket	1992-91	23591	Converter; 1 31/32" ID x 2 35/64" OD	
1	Exhaust Pipe Gasket	1992-91	60572	Loc. L.H.; Pipe to manifold; 2.165" ID	
1	Exhaust Pipe Gasket	1992-91	60572	Pipe to muffler; 2.165" ID	
QTY	OIL PAN	YEARS	PART NO.	DESCRIPTION	
1	Oil Pan Gasket Set	1992-91	OS 34210 C		
QTY	CRANKSHAFT REAR SEAL	YEARS	PART NO.	DESCRIPTION	
1	Rear Main Seal Set	1992-91	BS 40617	Rubber; One-piece	
QTY	VALVE COVER	YEARS	PART NO.	DESCRIPTION	
1	Valve Cover Gasket Set	1992-91	VS 50372 R	PermaDry® molded rubber gskt. incl.	
QTY	PUSH ROD COVER	YEARS	PART NO.	DESCRIPTION	
1	Push Rod Cover Gasket Set	1992-91	PS 50373 C		
QTY	VALVE STEM SEAL SET	YEARS	PART NO.	DESCRIPTION	
1	Valve Stem Seal Set	1992-91	SS 27504	Premium valve stem seals incl.	
QTY	THERMOSTAT HOUSING	YEARS	PART NO.	DESCRIPTION	
1	Water Outlet Gasket	1992-91	35307	Thermostat Housing	
QTY	WATER OUTLET GASKET	YEARS	PART NO.	DESCRIPTION	
1	Water Outlet Gasket	1992-91	35494	Water Outlet; Housing to head	
QTY	WATER PUMP	YEARS	PART NO.	DESCRIPTION	
1	Water Pump Gasket	1992-91	35484	Plate to block	
1	Water Pump Gasket	1992-91	35491	Pump to plate	
QTY	TIMING COVER	YEARS	PART NO.	DESCRIPTION	
1	Timing Cover Set	1992-91	TCS 45613		
QTY	CARB & FUEL INJECTION	YEARS	PART NO.	DESCRIPTION	
2	Fuel Injector O-Ring Set	1992-91	ES 70600		
1	Throttle Body Gasket	1992-91	60910		
QTY	EXHAUST GAS RECIRCULATION	YEARS	PART NO.	DESCRIPTION	
1	EGR Gasket	1992-91	70410		
22	1997 - 1993; 4.5L 273 (4476cc) DOHC L6 (24 Valve) 100mm Bore				22
QTY	CYLINDER HEAD	YEARS	PART NO.	DESCRIPTION	
1	Head Gasket	1997-93	26582 PT	Head bolts not incl.; Head bolt replacement recommended; New Part Number - Check for Availability	
QTY	MANIFOLD - INT. & EXH.	YEARS	PART NO.	DESCRIPTION	
1	Int. Manifold Gasket Set	1997-93	MS 97317	Lower set; Upper set incl.; New Part Number - Check for Availability	
1	Exh. Manifold Gasket Set	1997-93	MS 97284	New Part Number - Check for Availability	
QTY	CRANKSHAFT REAR SEAL	YEARS	PART NO.	DESCRIPTION	
1	Rear Main Seal Set	1997-93	BS 40751	Rubber; One-piece; New Part Number - Check for Availability	
QTY	VALVE COVER	YEARS	PART NO.	DESCRIPTION	
1	Valve Cover Gasket Set	1997-93	VS 50861 R	PermaDry® molded rubber gskt. incl.; New Part Number - Check for Availability	
23	2005 - 1998; 4.7L 285 (4664cc) DOHC V8 (32 Valve) 94mm Bore				23
QTY	CYLINDER HEAD	YEARS	PART NO.	DESCRIPTION	
1	Head Gasket	2005-98	26298 PT	Loc. L.H.; Head bolts not incl.; Head bolt replacement recommended; PermaTorqueMLS®; Improved design	
1	Head Gasket	2005-98	26299 PT	Loc. R.H.; Head bolts not incl.; Head bolt replacement recommended; PermaTorqueMLS®; Improved design	
1	Head Gasket	2004-98	26226 PT	Loc. L.H.; Head bolts not incl.; Head bolt replacement recommended; PermaTorqueMLS®; Old design	
1	Head Gasket	2004-98	26227 PT	Loc. R.H.; Head bolts not incl.; Head bolt replacement recommended; PermaTorqueMLS®; Old design; Superseded - When depleted use 26299 PT	
1	Head Set	2005	HS 26298 PT	From 11/01/04; Head bolts not incl.; Head bolt replacement recommended; PermaDry® molded rubber valve cover gskts. incl.; Premium valve stem seals incl.	

Toyota Truck (Incl. Minivans and SUV's) (Cont.)

23 (cont.)		2005 - 1998; 4.7L 285 (4664cc) DOHC V8 (32 Valve) 94mm Bore			23 (cont.)
MFI; Gasoline; Naturally Aspirated Toyota Eng.; Eng. Code 2UZFE					
QTY	CYLINDER HEAD	YEARS	PART NO.	DESCRIPTION	
1	Head Set	2005	HS 26298 PT	To 10/31/04; Int. manifold & exh. manifold gskts., front camshaft seals, head bolts not incl.; Head bolt replacement recommended; PermaDry® molded rubber valve cover gskts. incl.; Premium valve stem seals incl.	
1	Head Set	2004-98	HS 26226 PT	Head bolts not incl.; Head bolt replacement recommended; PermaDry® molded rubber valve cover gskts. incl.; Premium valve stem seals incl.	
2	Head Bolt Set	2005-98	ES 74035	Replacement recommended	
QTY	CONVERSION SET	YEARS	PART NO.	DESCRIPTION	
1	Gasket Conversion Set	2005	CS 26226	RTV sealant incl. for oil pan gskt.	
1	Gasket Conversion Set	2004-99	CS 26226	Lexus LX470 Base Toyota LandCruiser Base; RTV sealant incl. for oil pan gskt.	
1	Gasket Conversion Set	2004-03	CS 26226-2	Lexus GX470 Base Toyota 4Runner Limited, Sport, SR5; RTV sealant incl. for oil pan gskt.	
1	Gasket Conversion Set	2004	CS 26226-1	Toyota Sequoia Limited, SR5, Tundra Access Cab, Double Cab, Limited, SR5; RTV sealant incl. for oil pan gskt.	
1	Gasket Conversion Set	2003	CS 26226-1	Toyota Sequoia Limited, SR5, Tundra Access Cab, Limited, SR5; RTV sealant incl. for oil pan gskt.	
1	Gasket Conversion Set	2002-01	CS 26226-1	Exc. Lexus LX470 Base Toyota LandCruiser Base; RTV sealant incl. for oil pan gskt.	
1	Gasket Conversion Set	2000-99	CS 26226-1	Toyota Tundra Access Cab, Limited, SR5; RTV sealant incl. for oil pan gskt.	
1	Gasket Conversion Set	1998	CS 26226	RTV sealant incl. for oil pan gskt.	
QTY	MANIFOLD - INT. & EXH.	YEARS	PART NO.	DESCRIPTION	
1	Int. Manifold Gasket Set	2005	MS 96334	To 10/31/04; Lower set; Upper set incl.	
1	Int. Manifold Gasket Set	2005	MS 96672	From 11/01/04; Lower set; Upper set not incl.	
1	Int. Manifold Gasket Set	2004-98	MS 96334	Lower set; Upper set incl.	
1	Plenum Gasket Set	2005-98	MS 96333	Upper set	
1	Exh. Manifold Gasket Set	2005	MS 95439	To 10/31/04	
1	Exh. Manifold Gasket Set	2005	MS 96701	From 11/01/04	
1	Exh. Manifold Gasket Set	2004-98	MS 95439		
QTY	EXHAUST PIPE FLANGE	YEARS	PART NO.	DESCRIPTION	
2	Exhaust Pipe Gasket	2005-98	23591	Loc. Front; Converter; 1 31/32" ID x 2 35/64" OD	
1	Exhaust Pipe Gasket	2005-98	61040	Loc. Center; Exh. connector; 1.98" ID	
1	Exhaust Pipe Gasket	2005-98	61086	Center pipe; 2.448" ID	
1	Exhaust Pipe Gasket	2005-03	60512	Loc. Front; Exh. connector; Improved design	
2	Exhaust Pipe Gasket	2005-03	61040	Flange; 1.98" ID	
1	Exhaust Pipe Gasket	2005-03	61106	Loc. Rear; Converter; 2.40" ID	
1	Exhaust Pipe Gasket	2005-03	61138	Loc. Front; Exh. connector; Old design	
3	Exhaust Pipe Gasket	2005	23591	Converter to muffler; 1 31/32" ID x 2 35/64" OD	
3	Exhaust Pipe Gasket	2004-99	23591	Lexus LX470 Base Toyota LandCruiser Base; Converter to muffler; 1 31/32" ID x 2 35/64" OD	
2	Exhaust Pipe Gasket	2002-98	23591	Flange; 1 31/32" ID x 2 35/64" OD	
3	Exhaust Pipe Gasket	1998	23591	Converter to muffler; 1 31/32" ID x 2 35/64" OD	
QTY	OIL PAN	YEARS	PART NO.	DESCRIPTION	
1	Oil Pan Gasket Set	2005	OS 30741	RTV sealant incl. for oil pan gskt.	
1	Oil Pan Gasket Set	2004-99	OS 30741	Lexus LX470 Base Toyota LandCruiser Base; RTV sealant incl. for oil pan gskt.	
1	Oil Pan Gasket Set	2004-03	OS 30742	Lexus GX470 Base Toyota 4Runner Limited, Sport, SR5; RTV sealant incl. for oil pan gskt.	
1	Oil Pan Gasket Set	2004	OS 30739	Toyota Sequoia Limited, SR5, Tundra Access Cab, Double Cab, Limited, SR5; RTV sealant incl. for oil pan gskt.	
1	Oil Pan Gasket Set	2003	OS 30739	Toyota Sequoia Limited, SR5, Tundra Access Cab, Limited, SR5; RTV sealant incl. for oil pan gskt.	
1	Oil Pan Gasket Set	2002-01	OS 30739	Exc. Lexus LX470 Base Toyota LandCruiser Base; RTV sealant incl. for oil pan gskt.	
1	Oil Pan Gasket Set	2000-99	OS 30739	Toyota Tundra Access Cab, Limited, SR5; RTV sealant incl. for oil pan gskt.	
1	Oil Pan Gasket Set	1998	OS 30741	RTV sealant incl. for oil pan gskt.	
1	Drain Plug Gasket	2005-98	70822		
QTY	CRANKSHAFT REAR SEAL	YEARS	PART NO.	DESCRIPTION	
1	Rear Main Seal Set	2005-98	BS 40679	Rubber; One-piece	
QTY	VALVE COVER	YEARS	PART NO.	DESCRIPTION	
1	Valve Cover Gasket Set	2005-98	VS 50592 R	w/Grommets & Spark plug tube seals; PermaDry® molded rubber gskts. incl.	
2	Grommet Set	2005-98	ES 72133	Valve Cover	
QTY	VALVE STEM SEAL SET	YEARS	PART NO.	DESCRIPTION	
1	Valve Stem Seal Set	2005-98	SS 72910	Premium valve stem seals incl.	
QTY	THERMOSTAT HOUSING	YEARS	PART NO.	DESCRIPTION	
1	O-Ring	2005-98	35555	Thermostat Housing	

Toyota Truck (Incl. Minivans and SUV's) (Cont.)

23 (cont.)		2005 - 1998; 4.7L 285 (4664cc) DOHC V8 (32 Valve) 94mm Bore			23 (cont.)
		MFI; Gasoline; Naturally Aspirated Toyota Eng.; Eng. Code 2UZFE			
QTY	WATER OUTLET GASKET	YEARS	PART NO.	DESCRIPTION	
2	Water Outlet Gasket	2005-98	35941	Water Outlet; Loc. Front; Water bypass	
2	Water Outlet Gasket	2005-98	35941	Water Outlet; Loc. Rear; Water bypass	
QTY	WATER PUMP	YEARS	PART NO.	DESCRIPTION	
1	Water Pump Gasket	2005	35718		
1	Water Pump Gasket	2004	35718	Exc. Toyota Sequoia Limited, SR5	
1	Water Pump Gasket	2004	35728	Toyota Sequoia Limited, SR5	
1	Water Pump Gasket	2003-98	35718		
QTY	TIMING COVER	YEARS	PART NO.	DESCRIPTION	
1	Crankshaft Front Seal Set	2005-98	TCS 46035		
1	Camshaft Front Seal Set	2005	TCS 46036	To 10/31/04	
1	Camshaft Front Seal Set	2005	TCS 46050	From 11/01/04	
1	Camshaft Front Seal Set	2004-98	TCS 46036		
QTY	CARB & FUEL INJECTION	YEARS	PART NO.	DESCRIPTION	
1	Throttle Body Gasket	2005	61281	To 10/31/04	
1	Throttle Body Gasket	2005	61412	From 11/01/04	
1	Throttle Body Gasket	2004-98	61281		
QTY	OIL FILTER MOUNTING	YEARS	PART NO.	DESCRIPTION	
1	Oil Filter Adapter Gasket	2005-98	72973	Oil filter adapter seal; New Part Number - Check for Availability	
24		2009 - 2005; 4.7L 285 (4664cc) DOHC V8 (32 Valve) 94mm Bore VVT-i			24
		MFI; Gasoline; Naturally Aspirated Toyota Eng.; Eng. Code 2UZFE			
QTY	CYLINDER HEAD	YEARS	PART NO.	DESCRIPTION	
1	Head Gasket	2009-05	26298 PT	Loc. L.H.; Head bolts not incl.; Head bolt replacement recommended; PermaTorqueMLS®; Improved design	
1	Head Gasket	2009-05	26299 PT	Loc. R.H.; Head bolts not incl.; Head bolt replacement recommended; PermaTorqueMLS®; Improved design	
1	Head Set	2009-06	HS 26298 PT	Head bolts not incl.; Head bolt replacement recommended; PermaDry® molded rubber valve cover gskts. incl.; Premium valve stem seals incl.	
1	Head Set	2005	HS 26298 PT	From 11/01/04; Head bolts not incl.; Head bolt replacement recommended; PermaDry® molded rubber valve cover gskts. incl.; Premium valve stem seals incl.	
1	Head Set	2005	HS 26298 PT	To 10/31/04; Int. manifold & exh. manifold gskts., front camshaft seals, head bolts not incl.; Head bolt replacement recommended; PermaDry® molded rubber valve cover gskts. incl.; Premium valve stem seals incl.	
2	Head Bolt Set	2009-05	ES 74035	Replacement recommended	
QTY	CONVERSION SET	YEARS	PART NO.	DESCRIPTION	
1	Gasket Conversion Set	2009-05	CS 26226-2	Lexus GX470 Base Toyota 4Runner Limited, Sport, SR5; RTV sealant incl. for oil pan gskt.	
1	Gasket Conversion Set	2009-08	CS 26226-3	Exc. Lexus GX470 Base Toyota 4Runner Limited, Sport, SR5; RTV sealant incl. for oil pan gskt.	
1	Gasket Conversion Set	2007-06	CS 26226	Lexus LX470 Base Toyota LandCruiser Base; RTV sealant incl. for oil pan gskt.	
1	Gasket Conversion Set	2007	CS 26226-1	Exc. Lexus GX470 Base, LX470 Base Toyota 4Runner Limited, Sport, SR5, LandCruiser Base; RTV sealant incl. for oil pan gskt.	
1	Gasket Conversion Set	2006	CS 26226-1	Toyota Sequoia Limited, SR5, Tundra Access Cab, Base, Double Cab, Limited, SR5, Work; RTV sealant incl. for oil pan gskt.	
1	Gasket Conversion Set	2005	CS 26226-1	Exc. Lexus GX470 Base Toyota 4Runner Limited, Sport, SR5; RTV sealant incl. for oil pan gskt.	
QTY	MANIFOLD - INT. & EXH.	YEARS	PART NO.	DESCRIPTION	
1	Int. Manifold Gasket Set	2009-06	MS 96672	Lower set; Upper set not incl.	
1	Int. Manifold Gasket Set	2005	MS 96334	To 10/31/04; Lower set; Upper set incl.	
1	Int. Manifold Gasket Set	2005	MS 96672	From 11/01/04; Lower set; Upper set not incl.	
1	Plenum Gasket Set	2009-05	MS 96333	Upper set	
1	Exh. Manifold Gasket Set	2009-06	MS 96701		
1	Exh. Manifold Gasket Set	2005	MS 95439	To 10/31/04	
1	Exh. Manifold Gasket Set	2005	MS 96701	From 11/01/04	
QTY	EXHAUST PIPE FLANGE	YEARS	PART NO.	DESCRIPTION	
2	Exhaust Pipe Gasket	2009-05	23591	Loc. Front; Converter; 1 31/32" ID x 2 35/64" OD	
1	Exhaust Pipe Gasket	2009-05	60512	Loc. Front; Exh. connector; Improved design	
2	Exhaust Pipe Gasket	2009-05	61040	Flange; 1.98" ID	
1	Exhaust Pipe Gasket	2009-05	61040	Loc. Center; Exh. connector; 1.98" ID	
1	Exhaust Pipe Gasket	2009-05	61086	Center pipe; 2.448" ID	
1	Exhaust Pipe Gasket	2009-05	61106	Loc. Rear; Converter; 2.40" ID	
1	Exhaust Pipe Gasket	2009-05	61138	Loc. Front; Exh. connector; Old design	

Toyota Truck (Incl. Minivans and SUV's) (Cont.)

24 (cont.)		2009 - 2005; 4.7L 285 (4664cc) DOHC V8 (32 Valve) 94mm Bore VVT-i			24 (cont.)
MFI; Gasoline; Naturally Aspirated Toyota Eng.; Eng. Code 2UZFE					
QTY	EXHAUST PIPE FLANGE	YEARS	PART NO.	DESCRIPTION	
2	Exhaust Pipe Gasket	2009-08	60572	Exc. Lexus GX470 Base Toyota 4Runner Limited, Sport, SR5, Sequoia Limited, SR5; Pipe to manifold; 2.165" ID	
3	Exhaust Pipe Gasket	2007-06	23591	Lexus LX470 Base Toyota LandCruiser Base; Converter to muffler; 1 31/32" ID x 2 35/64" OD	
2	Exhaust Pipe Gasket	2007	60572	Toyota Tundra Access Cab, Base, CrewMax, Double Cab, Limited, SR5, Work; Pipe to manifold; 2.165" ID	
QTY	OIL PAN	YEARS	PART NO.	DESCRIPTION	
1	Oil Pan Gasket Set	2009-05	OS 30742	Lexus GX470 Base Toyota 4Runner Limited, Sport, SR5; RTV sealant incl. for oil pan gskt.	
1	Oil Pan Gasket Set	2009-08	OS 30815	Exc. Lexus GX470 Base Toyota 4Runner Limited, Sport, SR5; RTV sealant incl. for oil pan gskt.	
1	Oil Pan Gasket Set	2007-06	OS 30741	Lexus LX470 Base Toyota LandCruiser Base; RTV sealant incl. for oil pan gskt.	
1	Oil Pan Gasket Set	2007	OS 30739	Exc. Lexus GX470 Base, LX470 Base Toyota 4Runner Limited, Sport, SR5, LandCruiser Base; RTV sealant incl. for oil pan gskt.	
1	Oil Pan Gasket Set	2006	OS 30739	Toyota Sequoia Limited, SR5, Tundra Access Cab, Base, Double Cab, Limited, SR5, Work; RTV sealant incl. for oil pan gskt.	
1	Oil Pan Gasket Set	2005	OS 30739	Exc. Lexus GX470 Base Toyota 4Runner Limited, Sport, SR5; RTV sealant incl. for oil pan gskt.	
1	Drain Plug Gasket	2009-05	70822		
QTY	CRANKSHAFT REAR SEAL	YEARS	PART NO.	DESCRIPTION	
1	Rear Main Seal Set	2009-05	BS 40679	Rubber; One-piece	
QTY	VALVE COVER	YEARS	PART NO.	DESCRIPTION	
1	Valve Cover Gasket Set	2009-05	VS 50592 R	w/Grommets & Spark plug tube seals; PermaDry® molded rubber gskts. incl.	
2	Grommet Set	2009-05	ES 72133	Valve Cover	
QTY	VALVE STEM SEAL SET	YEARS	PART NO.	DESCRIPTION	
1	Valve Stem Seal Set	2009-05	SS 72910	Premium valve stem seals incl.	
QTY	THERMOSTAT HOUSING	YEARS	PART NO.	DESCRIPTION	
1	O-Ring	2009-05	35555	Thermostat Housing	
QTY	WATER OUTLET GASKET	YEARS	PART NO.	DESCRIPTION	
2	Water Outlet Gasket	2009-05	35941	Water Outlet; Loc. Front; Water bypass	
2	Water Outlet Gasket	2009-05	35941	Water Outlet; Loc. Rear; Water bypass	
QTY	WATER PUMP	YEARS	PART NO.	DESCRIPTION	
1	Water Pump Gasket	2009-08	35718		
1	Water Pump Gasket	2007-05	35718	Exc. Toyota Sequoia Limited, SR5	
1	Water Pump Gasket	2007-05	35728	Toyota Sequoia Limited, SR5	
QTY	TIMING COVER	YEARS	PART NO.	DESCRIPTION	
1	Crankshaft Front Seal Set	2009-05	TCS 46035		
1	Camshaft Front Seal Set	2009-06	TCS 46050		
1	Camshaft Front Seal Set	2005	TCS 46036	To 10/31/04	
1	Camshaft Front Seal Set	2005	TCS 46050	From 11/01/04	
QTY	CARB & FUEL INJECTION	YEARS	PART NO.	DESCRIPTION	
1	Throttle Body Gasket	2009-06	61412		
1	Throttle Body Gasket	2005	61281	To 10/31/04	
1	Throttle Body Gasket	2005	61412	From 11/01/04	
QTY	OIL FILTER MOUNTING	YEARS	PART NO.	DESCRIPTION	
1	Oil Filter Adapter Gasket	2009-05	72973	Oil filter adapter seal; New Part Number - Check for Availability	
25		2013 - 2009; 5.7L 346 (5663cc) DOHC V8 (32 Valve) 94mm Bore i-Force VVT-i			25
MFI; Flex Fuel; Naturally Aspirated Toyota Eng.; Eng. Code 3URFBE					
QTY	CYLINDER HEAD	YEARS	PART NO.	DESCRIPTION	
1	Head Gasket	2013-09	26393 PT	Loc. R.H.; Head bolts not incl.; Head bolt replacement recommended; PermaTorqueMLS®	
1	Head Gasket	2013-09	26394 PT	Loc. L.H.; Head bolts not incl.; Head bolt replacement recommended; PermaTorqueMLS®	
1	Head Set	2013-09	HS 26394 PT	Head bolts not incl.; Head bolt replacement recommended; PermaDry® molded rubber valve cover gskts. incl.; Premium valve stem seals incl.	
1	Head Bolt Set	2013-09	ES 72249-1	Head bolts w/Washers; Replacement recommended	
QTY	CONVERSION SET	YEARS	PART NO.	DESCRIPTION	
1	Gasket Conversion Set	2013-09	CS 26394	RTV sealant incl. for oil pan gskt.	
QTY	MANIFOLD - INT. & EXH.	YEARS	PART NO.	DESCRIPTION	
1	Int. Manifold Gasket Set	2013-09	MS 97044		
1	Exh. Manifold Gasket Set	2013-09	MS 97029		

Toyota Truck (Incl. Minivans and SUV's) (Cont.)

25 (cont.)	2013 - 2009; 5.7L 346 (5663cc) DOHC V8 (32 Valve) 94mm Bore i-Force VVT-i				25 (cont.)
MFI; Flex Fuel; Naturally Aspirated Toyota Eng.; Eng. Code 3URFBE					
QTY	EXHAUST PIPE FLANGE	YEARS	PART NO.	DESCRIPTION	
2	Exhaust Pipe Gasket	2013-09	60572	Converter; 2.165" ID	
2	Exhaust Pipe Gasket	2013-09	60572	Pipe to manifold; 2.165" ID	
1	Exhaust Pipe Gasket	2013-09	60906	Loc. L.H.; Converter	
1	Exhaust Pipe Gasket	2013-09	61106	Loc. R.H.; Converter; 2.40" ID	
1	Exhaust Pipe Gasket	2013-09	61540	Exh. connector	
QTY	OIL PAN	YEARS	PART NO.	DESCRIPTION	
1	Oil Pan Gasket Set	2013-09	OS 30803	RTV sealant incl. for oil pan gskt.	
1	Drain Plug Gasket	2013-09	70822		
QTY	CRANKSHAFT REAR SEAL	YEARS	PART NO.	DESCRIPTION	
1	Rear Main Seal Set	2013-09	BS 40679	Rubber; One-piece	
QTY	VALVE COVER	YEARS	PART NO.	DESCRIPTION	
1	Valve Cover Gasket Set	2013-09	VS 50742 R	w/Spark plug tube seals; PermaDry® molded rubber gskts. incl.	
QTY	VALVE STEM SEAL SET	YEARS	PART NO.	DESCRIPTION	
1	Valve Stem Seal Set	2013-09	SS 72910	Premium valve stem seals incl.	
QTY	THERMOSTAT HOUSING	YEARS	PART NO.	DESCRIPTION	
1	Thermostat Gasket	2013-09	35891	Thermostat Housing	
QTY	WATER OUTLET GASKET	YEARS	PART NO.	DESCRIPTION	
1	Water Outlet Gasket	2013-09	35893	Water Outlet; Water inlet	
2	Thermostat Gasket	2013-09	35886	Water Outlet	
QTY	WATER PUMP	YEARS	PART NO.	DESCRIPTION	
1	Water Pump Gasket	2013-09	35889		
QTY	TIMING COVER	YEARS	PART NO.	DESCRIPTION	
1	Crankshaft Front Seal Set	2013-09	TCS 46122		
QTY	CARB & FUEL INJECTION	YEARS	PART NO.	DESCRIPTION	
1	Throttle Body Gasket	2013-09	61556		
26	2013 - 2007; 5.7L 346 (5663cc) DOHC V8 (32 Valve) 94mm Bore i-Force VVT-i				26
MFI; Gasoline; Naturally Aspirated Toyota Eng.; Eng. Code 3URFE					
QTY	CYLINDER HEAD	YEARS	PART NO.	DESCRIPTION	
1	Head Gasket	2013-07	26393 PT	Loc. R.H.; Head bolts not incl.; Head bolt replacement recommended; PermaTorqueMLS®	
1	Head Gasket	2013-07	26394 PT	Loc. L.H.; Head bolts not incl.; Head bolt replacement recommended; PermaTorqueMLS®	
1	Head Set	2013-07	HS 26394 PT	Head bolts not incl.; Head bolt replacement recommended; PermaDry® molded rubber valve cover gskts. incl.; Premium valve stem seals incl.	
1	Head Bolt Set	2013-07	ES 72249-1	Head bolts w/Washers; Replacement recommended	
QTY	CONVERSION SET	YEARS	PART NO.	DESCRIPTION	
1	Gasket Conversion Set	2013-07	CS 26394	RTV sealant incl. for oil pan gskt.	
QTY	MANIFOLD - INT. & EXH.	YEARS	PART NO.	DESCRIPTION	
1	Int. Manifold Gasket Set	2013-07	MS 97044		
1	Exh. Manifold Gasket Set	2013-07	MS 97029		
QTY	EXHAUST PIPE FLANGE	YEARS	PART NO.	DESCRIPTION	
1	Exhaust Pipe Gasket	2013-07	60906	Loc. L.H.; Converter	
1	Exhaust Pipe Gasket	2013-07	61106	Loc. R.H.; Converter; 2.40" ID	
1	Exhaust Pipe Gasket	2013-07	61540	Exh. connector	
2	Exhaust Pipe Gasket	2013-07	60572	Converter; 2.165" ID	
2	Exhaust Pipe Gasket	2013-07	60572	Pipe to manifold; 2.165" ID	
QTY	OIL PAN	YEARS	PART NO.	DESCRIPTION	
1	Oil Pan Gasket Set	2013-07	OS 30803	RTV sealant incl. for oil pan gskt.	
1	Drain Plug Gasket	2013-07	70822		
QTY	CRANKSHAFT REAR SEAL	YEARS	PART NO.	DESCRIPTION	
1	Rear Main Seal Set	2013-07	BS 40679	Rubber; One-piece	
QTY	VALVE COVER	YEARS	PART NO.	DESCRIPTION	
1	Valve Cover Gasket Set	2013-07	VS 50742 R	w/Spark plug tube seals; PermaDry® molded rubber gskts. incl.	
QTY	VALVE STEM SEAL SET	YEARS	PART NO.	DESCRIPTION	
1	Valve Stem Seal Set	2013-07	SS 72910	Premium valve stem seals incl.	
QTY	THERMOSTAT HOUSING	YEARS	PART NO.	DESCRIPTION	
1	Thermostat Gasket	2013-07	35891	Thermostat Housing	
QTY	WATER OUTLET GASKET	YEARS	PART NO.	DESCRIPTION	
1	Water Outlet Gasket	2013-07	35893	Water Outlet; Water inlet	
2	Thermostat Gasket	2013-07	35886	Water Outlet	
QTY	WATER PUMP	YEARS	PART NO.	DESCRIPTION	
1	Water Pump Gasket	2013-07	35889		

Toyota Truck (Incl. Minivans and SUV's) (Cont.)

26 (cont.)	2013 - 2007; 5.7L 346 (5663cc) DOHC V8 (32 Valve) 94mm Bore i-Force VVT-i			26 (cont.)
MFI; Gasoline; Naturally Aspirated Toyota Eng.; Eng. Code 3URFE				
QTY	TIMING COVER	YEARS	PART NO.	DESCRIPTION
1	Crankshaft Front Seal Set	2013-07	TCS 46122	
QTY	CARB & FUEL INJECTION	YEARS	PART NO.	DESCRIPTION
1	Throttle Body Gasket	2013-07	61556	

Volvo Car

Engine Finding Index				
Engine	Years	Code	Line No.	
1.9L 118.9 (1948cc) DOHC L4 (16 Valve) 83mm Bore; MFI; Gasoline; Turbo - Intercooled Volvo Eng.	2004-00	B4194T	1	
1.9L 118.9 (1948cc) DOHC L4 (16 Valve) 83mm Bore; MFI; Gasoline; Turbo - Intercooled Volvo Eng.	2002-00	B4204T2	2	
1.9L 118.9 (1948cc) DOHC L4 (16 Valve) 83mm Bore; MFI; Gasoline; Turbo - Intercooled Volvo Eng.	2004-01	B4204T3	3	
2.3L 141 (2316cc) DOHC L4 (16 Valve) 96mm Bore; MFI; Gasoline; Naturally Aspirated Volvo Eng.	1991	B234F	4	
2.3L 141 (2316cc) SOHC L4 (8 Valve) 96mm Bore; MFI; Gasoline; Naturally Aspirated Volvo Eng.	1995-91	B230F	5	
2.3L 141 (2316cc) SOHC L4 (8 Valve) 96mm Bore; MFI; Gasoline; Naturally Aspirated Volvo Eng.	1995-93	B230FD	6	
2.3L 141 (2316cc) SOHC L4 (8 Valve) 96mm Bore; MFI; Gasoline; Naturally Aspirated Volvo Eng.	1995-93	B230FS	7	
2.3L 141 (2316cc) SOHC L4 (8 Valve) 96mm Bore; MFI; Gasoline; Turbo - Intercooled Volvo Eng.	1995-91	B230FT	8	
2.3L 141 (2316cc) SOHC L4 (8 Valve) 96mm Bore; MFI; Gasoline; Turbo - Intercooled Volvo Eng.	1995-91	B234FT	9	
2.3L 141 (2316cc) SOHC L4 (8 Valve) 96mm Bore; MFI; Gasoline; Turbo - Intercooled Volvo Eng.	1995-91	B234T	10	
2.3L 142 (2319cc) DOHC L5 (20 Valve) 81mm Bore; MFI; Gasoline; Turbo - Intercooled Volvo Eng.	2005-98	B5234FT	11	
2.3L 142 (2319cc) DOHC L5 (20 Valve) 81mm Bore; MFI; Gasoline; Turbo - Intercooled Volvo Eng.	1997-94	B5234T	12	
2.3L 142 (2319cc) DOHC L5 (20 Valve) 81mm Bore; MFI; Gasoline; Turbo - Intercooled Volvo Eng.	2010-98	B5234T3	13	
2.4L 146.6 (2401cc) DOHC L5 (20 Valve) 81mm Bore; MFI; Gasoline; Turbo - Intercooled Volvo Eng.	2010-05	B5244T5	14	
2.4L 148.6 (2435cc) DOHC L5 (20 Valve) 83mm Bore; MFI; Gasoline; Naturally Aspirated Volvo Eng.	2005-01	B5244FS	15	
2.4L 148.6 (2435cc) DOHC L5 (20 Valve) 83mm Bore; MFI; Gasoline; Naturally Aspirated Volvo Eng.	2008-01	B5244S	16	
2.4L 148.6 (2435cc) DOHC L5 (20 Valve) 83mm Bore; MFI; Gasoline; Naturally Aspirated Volvo Eng.	2010-04	B5244S4	17	
2.4L 148.6 (2435cc) DOHC L5 (20 Valve) 83mm Bore; MFI; Gasoline; Naturally Aspirated Volvo Eng.	2010-04	B5244S5	18	
2.4L 148.6 (2435cc) DOHC L5 (20 Valve) 83mm Bore; MFI; Gasoline; Naturally Aspirated Volvo Eng.	2008-06	B5244S6	19	
2.4L 148.6 (2435cc) DOHC L5 (20 Valve) 83mm Bore; MFI; Gasoline; Naturally Aspirated Volvo Eng.	2010-06	B5244S7	20	
2.4L 148.6 (2435cc) DOHC L5 (20 Valve) 83mm Bore; MFI; Gasoline; Turbo - Intercooled Volvo Eng.	2002	B5244T	21	
2.4L 148.6 (2435cc) DOHC L5 (20 Valve) 83mm Bore; MFI; Gasoline; Turbo - Intercooled Volvo Eng.	2000-98	B5244T2	22	
2.4L 148.6 (2435cc) DOHC L5 (20 Valve) 83mm Bore; MFI; Gasoline; Turbo - Intercooled Volvo Eng.	2008-99	B5244T3	23	
2.4L 148.6 (2435cc) DOHC L5 (20 Valve) 83mm Bore; MFI; Gasoline; Naturally Aspirated Volvo Eng.	2005-93	B5254FS	24	
2.4L 148.6 (2435cc) DOHC L5 (20 Valve) 83mm Bore; MFI; Gasoline; Turbo - Intercooled Volvo Eng.	2008-98	B5254FT	25	
2.4L 148.6 (2435cc) DOHC L5 (20 Valve) 83mm Bore; MFI; Gasoline; Naturally Aspirated Volvo Eng.	2005-93	B5254S	26	
2.4L 148.6 (2435cc) DOHC L5 (20 Valve) 83mm Bore; MFI; Gasoline; Turbo - Intercooled Volvo Eng.	2008-97	B5254T	27	
2.5L 153.8 (2521cc) DOHC L5 (20 Valve) 83mm Bore; MFI; Gasoline; Turbo - Intercooled Volvo Eng.	2010-03	B5254T2	28	
2.5L 153.8 (2521cc) DOHC L5 (20 Valve) 83mm Bore; MFI; Gasoline; Turbo - Intercooled Volvo Eng.	2012-04	B5254T3	29	
2.5L 153.8 (2521cc) DOHC L5 (20 Valve) 83mm Bore; MFI; Gasoline; Turbo - Intercooled Volvo Eng.	2008-06	B5254T4	30	
2.5L 153.8 (2521cc) DOHC L5 (20 Valve) 83mm Bore; MFI; Gasoline; Turbo - Intercooled Volvo Eng.	2012	B5254T5	31	
2.5L 153.8 (2521cc) DOHC L5 (20 Valve) 83mm Bore; MFI; Gasoline; Turbo - Intercooled Volvo Eng.	2012-08	B5254T7	32	
2.8L 170 (2783cc) DOHC L6 (24 Valve) 81mm Bore; MFI; Gasoline; Turbo - Intercooled Volvo Eng.	2004-99	B6284T	33	
2.9L 178.4 (2922cc) DOHC L6 (24 Valve) 83mm Bore; MFI; Gasoline; Naturally Aspirated Volvo Eng.	2006-99	B6294S	34	
2.9L 178.4 (2922cc) DOHC L6 (24 Valve) 83mm Bore; MFI; Gasoline; Turbo - Intercooled Volvo Eng.	2006-04	B6294T	35	
2.9L 178.4 (2922cc) DOHC L6 (24 Valve) 83mm Bore; MFI; Gasoline; Naturally Aspirated Volvo Eng.	1998-92	B6304F	36	
2.9L 178.4 (2922cc) DOHC L6 (24 Valve) 83mm Bore; MFI; Gasoline; Naturally Aspirated Volvo Eng.	2006-92	B6304S	37	
2.9L 178.4 (2922cc) DOHC L6 (24 Valve) 83mm Bore; MFI; Gasoline; Naturally Aspirated Volvo Eng.	1999-98	B6304S3	38	
3.0L 180.2 (2953cc) DOHC L6 (24 Valve) 82mm Bore; MFI; Gasoline; Turbo - Intercooled Volvo Eng.	2010-08	B6304T2	39	
3.2L 194.8 (3192cc) DOHC L6 (24 Valve) 84mm Bore; MFI; Gasoline; Naturally Aspirated Volvo Eng.	2010-07	B6324S	40	
4.4L 269 (4414cc) DOHC V8 (32 Valve) 94mm Bore; MFI; Gasoline; Naturally Aspirated Yamaha Eng.	2010-07	B8444S	41	
Engine Code Index				
Code	Engine		Line No.	
B230F	2.3L 141 (2316cc) SOHC L4 (8 Valve) 96mm Bore; MFI; Gasoline; Naturally Aspirated Volvo Eng.		5	
B230FD	2.3L 141 (2316cc) SOHC L4 (8 Valve) 96mm Bore; MFI; Gasoline; Naturally Aspirated Volvo Eng.		6	
B230FS	2.3L 141 (2316cc) SOHC L4 (8 Valve) 96mm Bore; MFI; Gasoline; Naturally Aspirated Volvo Eng.		7	
B230FT	2.3L 141 (2316cc) SOHC L4 (8 Valve) 96mm Bore; MFI; Gasoline; Turbo - Intercooled Volvo Eng.		8	
B234F	2.3L 141 (2316cc) DOHC L4 (16 Valve) 96mm Bore; MFI; Gasoline; Naturally Aspirated Volvo Eng.		4	
B234FT	2.3L 141 (2316cc) SOHC L4 (8 Valve) 96mm Bore; MFI; Gasoline; Turbo - Intercooled Volvo Eng.		9	
B234T	2.3L 141 (2316cc) SOHC L4 (8 Valve) 96mm Bore; MFI; Gasoline; Turbo - Intercooled Volvo Eng.		10	
B4194T	1.9L 118.9 (1948cc) DOHC L4 (16 Valve) 83mm Bore; MFI; Gasoline; Turbo - Intercooled Volvo Eng.		1	
B4204T2	1.9L 118.9 (1948cc) DOHC L4 (16 Valve) 83mm Bore; MFI; Gasoline; Turbo - Intercooled Volvo Eng.		2	
B4204T3	1.9L 118.9 (1948cc) DOHC L4 (16 Valve) 83mm Bore; MFI; Gasoline; Turbo - Intercooled Volvo Eng.		3	
B5234FT	2.3L 142 (2319cc) DOHC L5 (20 Valve) 81mm Bore; MFI; Gasoline; Turbo - Intercooled Volvo Eng.		11	

Engine Code Index (Cont.)

Code	Engine	Line No.
B5234T	2.3L 142 (2319cc) DOHC L5 (20 Valve) 81mm Bore; MFI; Gasoline; Turbo - Intercooled Volvo Eng.	12
B5234T3	2.3L 142 (2319cc) DOHC L5 (20 Valve) 81mm Bore; MFI; Gasoline; Turbo - Intercooled Volvo Eng.	13
B5244FS	2.4L 148.6 (2435cc) DOHC L5 (20 Valve) 83mm Bore; MFI; Gasoline; Naturally Aspirated Volvo Eng.	15
B5244S	2.4L 148.6 (2435cc) DOHC L5 (20 Valve) 83mm Bore; MFI; Gasoline; Naturally Aspirated Volvo Eng.	16
B5244S4	2.4L 148.6 (2435cc) DOHC L5 (20 Valve) 83mm Bore; MFI; Gasoline; Naturally Aspirated Volvo Eng.	17
B5244S5	2.4L 148.6 (2435cc) DOHC L5 (20 Valve) 83mm Bore; MFI; Gasoline; Naturally Aspirated Volvo Eng.	18
B5244S6	2.4L 148.6 (2435cc) DOHC L5 (20 Valve) 83mm Bore; MFI; Gasoline; Naturally Aspirated Volvo Eng.	19
B5244S7	2.4L 148.6 (2435cc) DOHC L5 (20 Valve) 83mm Bore; MFI; Gasoline; Naturally Aspirated Volvo Eng.	20
B5244T	2.4L 148.6 (2435cc) DOHC L5 (20 Valve) 83mm Bore; MFI; Gasoline; Turbo - Intercooled Volvo Eng.	21
B5244T2	2.4L 148.6 (2435cc) DOHC L5 (20 Valve) 83mm Bore; MFI; Gasoline; Turbo - Intercooled Volvo Eng.	22
B5244T3	2.4L 148.6 (2435cc) DOHC L5 (20 Valve) 83mm Bore; MFI; Gasoline; Turbo - Intercooled Volvo Eng.	23
B5244T5	2.4L 146.6 (2401cc) DOHC L5 (20 Valve) 81mm Bore; MFI; Gasoline; Turbo - Intercooled Volvo Eng.	14
B5254FS	2.4L 148.6 (2435cc) DOHC L5 (20 Valve) 83mm Bore; MFI; Gasoline; Naturally Aspirated Volvo Eng.	24
B5254FT	2.4L 148.6 (2435cc) DOHC L5 (20 Valve) 83mm Bore; MFI; Gasoline; Turbo - Intercooled Volvo Eng.	25
B5254S	2.4L 148.6 (2435cc) DOHC L5 (20 Valve) 83mm Bore; MFI; Gasoline; Naturally Aspirated Volvo Eng.	26
B5254T	2.4L 148.6 (2435cc) DOHC L5 (20 Valve) 83mm Bore; MFI; Gasoline; Turbo - Intercooled Volvo Eng.	27
B5254T2	2.5L 153.8 (2521cc) DOHC L5 (20 Valve) 83mm Bore; MFI; Gasoline; Turbo - Intercooled Volvo Eng.	28
B5254T3	2.5L 153.8 (2521cc) DOHC L5 (20 Valve) 83mm Bore; MFI; Gasoline; Turbo - Intercooled Volvo Eng.	29
B5254T4	2.5L 153.8 (2521cc) DOHC L5 (20 Valve) 83mm Bore; MFI; Gasoline; Turbo - Intercooled Volvo Eng.	30
B5254T5	2.5L 153.8 (2521cc) DOHC L5 (20 Valve) 83mm Bore; MFI; Gasoline; Turbo - Intercooled Volvo Eng.	31
B5254T7	2.5L 153.8 (2521cc) DOHC L5 (20 Valve) 83mm Bore; MFI; Gasoline; Turbo - Intercooled Volvo Eng.	32
B6284T	2.8L 170 (2783cc) DOHC L6 (24 Valve) 81mm Bore; MFI; Gasoline; Turbo - Intercooled Volvo Eng.	33
B6294S	2.9L 178.4 (2922cc) DOHC L6 (24 Valve) 83mm Bore; MFI; Gasoline; Naturally Aspirated Volvo Eng.	34
B6294T	2.9L 178.4 (2922cc) DOHC L6 (24 Valve) 83mm Bore; MFI; Gasoline; Turbo - Intercooled Volvo Eng.	35
B6304F	2.9L 178.4 (2922cc) DOHC L6 (24 Valve) 83mm Bore; MFI; Gasoline; Naturally Aspirated Volvo Eng.	36
B6304S	2.9L 178.4 (2922cc) DOHC L6 (24 Valve) 83mm Bore; MFI; Gasoline; Naturally Aspirated Volvo Eng.	37
B6304S3	2.9L 178.4 (2922cc) DOHC L6 (24 Valve) 83mm Bore; MFI; Gasoline; Naturally Aspirated Volvo Eng.	38
B6304T2	3.0L 180.2 (2953cc) DOHC L6 (24 Valve) 82mm Bore; MFI; Gasoline; Turbo - Intercooled Volvo Eng.	39
B6324S	3.2L 194.8 (3192cc) DOHC L6 (24 Valve) 84mm Bore; MFI; Gasoline; Naturally Aspirated Volvo Eng.	40
B8444S	4.4L 269 (4414cc) DOHC V8 (32 Valve) 94mm Bore; MFI; Gasoline; Naturally Aspirated Yamaha Eng.	41

Model Index

Engine (VIN Code / Eng. Code)	Year	Engine (VIN Code / Eng. Code)	Year	Engine (VIN Code / Eng. Code)	Year
Volvo		Volvo (cont.)		Volvo (cont.)	
122		1800 (cont.)		245 (cont.)	
L4 1580cc 1.6L OHV (B16A)	61-60	L4 1780cc 1.8L OHV (B18B)	68-64	L4 2316cc 2.3L SOHC (8 Valve) (B230F)	93-85
L4 1580cc 1.6L OHV (B16B)	61-60	L4 1780cc 1.8L OHV (B18D)	68-64	L4 2316cc 2.3L SOHC (8 Valve) (B23E)	82-81
L4 1580cc 1.6L OHV (B16D)	61-60	L4 1986cc 2.0L OHV (B20A)	71-69	L4 2316cc 2.3L SOHC (8 Valve) (B23F)	84-83
L4 1780cc 1.8L OHV (B18A)	68-62	L4 1986cc 2.0L OHV (B20B)	73-69	L6 2383cc 2.4L SOHC Diesel (D24)	85-80
L4 1780cc 1.8L OHV (B18B)	68-62	L4 1986cc 2.0L OHV (B20E)	73-70	262	
L4 1780cc 1.8L OHV (B18D)	68-62	L4 1986cc 2.0L OHV (B20F)	73-72	V6 2664cc 2.7L SOHC (B27F)	79-76
142		240 Series		V6 2849cc 2.8L SOHC (B28F)	81-80
L4 1780cc 1.8L OHV (B18A)	68-67	L4 1986cc 2.0L OHV (B20F)	75	264	
L4 1780cc 1.8L OHV (B18B)	68-67	L4 2127cc 2.2L SOHC (B21F)	82-76	L6 2383cc 2.4L SOHC Diesel (D24)	82
L4 1780cc 1.8L OHV (B18D)	68-67	L4 2127cc 2.2L SOHC Turbo (B21FT)	85-81	V6 2664cc 2.7L SOHC (B27F)	79-75
L4 1986cc 2.0L OHV (B20A)	70-69	L4 2316cc 2.3L SOHC (8 Valve) (B230F)	93-85	V6 2849cc 2.8L SOHC (B28F)	82-80
L4 1986cc 2.0L OHV (B20B)	74-69	L4 2316cc 2.3L SOHC (8 Valve) (B23E)	82-81	265	
L4 1986cc 2.0L OHV (B20E)	71	L4 2316cc 2.3L SOHC (8 Valve) (B23F)	84-83	L6 2383cc 2.4L SOHC Diesel (D24)	81
L4 1986cc 2.0L OHV (B20F)	74-72	L6 2383cc 2.4L SOHC Diesel (D24)	85-80	V6 2664cc 2.7L SOHC (B27F)	79-76
144		242		V6 2849cc 2.8L SOHC (B28F)	81-80
L4 1780cc 1.8L OHV (B18A)	68-67	L4 1986cc 2.0L OHV (B20F)	75	740 Series	
L4 1780cc 1.8L OHV (B18B)	68-67	L4 2127cc 2.1L SOHC (B21F)	82-76	L4 2316cc 2.3L DOHC (16 Valve) (B234F)	90-89
L4 1780cc 1.8L OHV (B18D)	68-67	L4 2127cc 2.1L SOHC Turbo (B21FT)	84-81	L4 2316cc 2.3L SOHC (8 Valve) (B230F)	92-85
L4 1986cc 2.0L OHV (B20A)	71-69	L4 2316cc 2.3L SOHC (8 Valve) (B23F)	84-83	L4 2316cc 2.3L SOHC (8 Valve) (B23F)	84
L4 1986cc 2.0L OHV (B20B)	74-69	244		L4 2316cc 2.3L SOHC Turbo (8 Valve)	88-85
L4 1986cc 2.0L OHV (B20F)	74-72	L4 1986cc 2.0L OHV (B20F)	75	(B230FT)	
145		L4 2127cc 2.1L SOHC (B21E)	84-76	L4 2316cc 2.3L SOHC Turbo (8 Valve)	92-89
L4 1780cc 1.8L OHV (B18A)	68	L4 2127cc 2.1L SOHC (B21F)	84-76	(B234FT)	
L4 1780cc 1.8L OHV (B18B)	68	L4 2127cc 2.1L SOHC Turbo (B21FT)	85-81	L4 2316cc 2.3L SOHC Turbo (8 Valve)	84
L4 1986cc 2.0L OHV (B20A)	71-69	L4 2316cc 2.3L SOHC (8 Valve) (B230F)	93-85	(B23FT)	
L4 1986cc 2.0L OHV (B20B)	74-69	L4 2316cc 2.3L SOHC (8 Valve) (B23E)	82-81	L6 2383cc 2.4L SOHC Turbo-Diesel (D24T)	86-85
L4 1986cc 2.0L OHV (B20F)	74-72	L4 2316cc 2.3L SOHC (8 Valve) (B23F)	84-83	760 Series	
164		L6 2383cc 2.4L SOHC Diesel (D24)	85-80	L4 2316cc 2.3L SOHC Turbo (8 Valve)	90-85
L6 2980cc 3.0L OHV (B30A)	72-69	245		(B230FT)	
L6 2980cc 3.0L OHV (B30E)	75-71	L4 1986cc 2.0L OHV (B20F)	75	L4 2316cc 2.3L SOHC Turbo (8 Valve)	84
L6 2980cc 3.0L OHV (B30F)	75-71	L4 2127cc 2.1L SOHC (B21E)	83-76	(B23FT)	
1800		L4 2127cc 2.1L SOHC (B21F)	83-76	L6 2383cc 2.4L SOHC Turbo-Diesel (D24T)	86-83
L4 1780cc 1.8L OHV (B18A)	68-64	L4 2127cc 2.1L SOHC Turbo (B21FT)	85-82	V6 2849cc 2.8L SOHC (B280F)	90-87

Volvo Car (Cont.)

Model Index (Cont.)

Engine (VIN Code / Eng. Code)	Year	Engine (VIN Code / Eng. Code)	Year	Engine (VIN Code / Eng. Code)	Year
Volvo (cont.)		Volvo (cont.)		Volvo (cont.)	
760 Series (cont.)		S40 (cont.)		S80 (cont.)	
V6 2849cc 2.8L SOHC (B28F)	86-82	L4 1948cc 1.9L DOHC Turbo (16 Valve) (B4204T3)	04-01	L6 3192cc 3.2L DOHC (24 Valve) (B6324S)	09-07
780 Series		L5 2435cc 2.4L DOHC (20 Valve) (B5244S4)	10-04	L6 3192cc 3.2L DOHC (24 Valve) (B6324S4)	13-10
L4 2316cc 2.3L SOHC Turbo (8 Valve) (B230FT)	90-86	L5 2435cc 2.4L DOHC (20 Valve) (B5244S7)	10-06	L6 3192cc 3.2L DOHC (24 Valve) (B6324S5)	13-10
V6 2849cc 2.8L SOHC (B280F)	91-86	L5 2521cc 2.5L DOHC Turbo (20 Valve) (B5254T3)	11-04	V8 4414cc 4.4L DOHC (32 Valve) (B8444S)	10-07
850 Series		L5 2521cc 2.5L DOHC Turbo (20 Valve) (B5254T7)	11-08	S80 AWD	
L5 2319cc 2.3L DOHC Turbo (20 Valve) (B5234T)	97-94	S40 AWD		L5 2521cc 2.5L DOHC Turbo (20 Valve) (B5254T2)	06-04
L5 2435cc 2.4L DOHC (20 Valve) (B5254S)	97-93	L5 2521cc 2.5L DOHC Turbo (20 Valve) (B5254T3)	11-05	L6 3192cc 3.2L DOHC (24 Valve) (B6324S)	09-07
L5 2435cc 2.4L DOHC Turbo (20 Valve) (B5254T)	97	L5 2521cc 2.5L DOHC Turbo (20 Valve) (B5254T7)	11-08	L6 3192cc 3.2L DOHC (24 Valve) (B6324S4)	13-10
940 Series		S60		L6 3192cc 3.2L DOHC (24 Valve) (B6324S5)	13-10
L4 2316cc 2.3L DOHC (16 Valve) (B234F)	91	L5 2319cc 2.3L DOHC Turbo (20 Valve) (B5234FT)	05-01	V8 4414cc 4.4L DOHC (32 Valve) (B8444S)	10-07
L4 2316cc 2.3L SOHC (8 Valve) (B230F)	95-92	L5 2319cc 2.3L DOHC Turbo (20 Valve) (B5234T3)	10-01	S90	
L4 2316cc 2.3L SOHC Turbo (8 Valve) (B234T)	95-91	L5 2401cc 2.4L DOHC Turbo (20 Valve) (B5244T5)	10-05	L6 2922cc 2.9L DOHC (24 Valve) (B6304F)	98
960 Series		L5 2435cc 2.4L DOHC (20 Valve) (B5244S)	08-01	L6 2922cc 2.9L DOHC (24 Valve) (B6304S)	98
L6 2922cc 2.9L DOHC (24 Valve) (B6304F)	97-92	L5 2435cc 2.4L DOHC (20 Valve) (B5244S6)	08-06	V40	
L6 2922cc 2.9L DOHC (24 Valve) (B6304S)	97-92	L5 2435cc 2.4L DOHC Turbo (20 Valve) (B5244T3)	03-01	L4 1948cc 1.9L DOHC Turbo (16 Valve) (B4194T)	04-00
C30		L5 2521cc 2.5L DOHC Turbo (20 Valve) (B5254T2)	10-03	L4 1948cc 1.9L DOHC Turbo (16 Valve) (B4204T2)	02-00
L5 2521cc 2.5L DOHC Turbo (20 Valve) (B5254T3)	13-08	L5 2521cc 2.5L DOHC Turbo (20 Valve) (B5254T4)	08-06	L4 1948cc 1.9L DOHC Turbo (16 Valve) (B4204T3)	04-01
L5 2521cc 2.5L DOHC Turbo (20 Valve) (B5254T5)	13	L5 2521cc 2.5L DOHC Turbo (20 Valve) (B5254T5)	13-12	V50	
L5 2521cc 2.5L DOHC Turbo (20 Valve) (B5254T7)	13-08	L6 2953cc 3.0L DOHC Turbo (24 Valve) (B6304T4)	13-11	L5 2435cc 2.4L DOHC (20 Valve) (B5244S4)	10-05
C70		S60 AWD		L5 2435cc 2.4L DOHC (20 Valve) (B5244S7)	10-06
L5 2319cc 2.3L DOHC Turbo (20 Valve) (B5234FT)	05-98	L5 2435cc 2.4L DOHC Turbo (20 Valve) (B5244T3)	02-01	L5 2521cc 2.5L DOHC Turbo (20 Valve) (B5254T3)	11-05
L5 2319cc 2.3L DOHC Turbo (20 Valve) (B5234T3)	05-98	L5 2521cc 2.5L DOHC Turbo (20 Valve) (B5254T2)	10-03	L5 2521cc 2.5L DOHC Turbo (20 Valve) (B5254T7)	11-08
L5 2435cc 2.4L DOHC Turbo (20 Valve) (B5244T3)	05-99	S70		L5 2521cc 2.5L DOHC Turbo (20 Valve) (B5254T4)	11-08
L5 2435cc 2.4L DOHC Turbo (20 Valve) (B5254T)	05-99	L5 2319cc 2.3L DOHC Turbo (20 Valve) (B5234FT)	00-98	V50 AWD	
L5 2521cc 2.5L DOHC Turbo (20 Valve) (B5254T3)	13-06	L5 2319cc 2.3L DOHC Turbo (20 Valve) (B5234T3)	00-98	L5 2521cc 2.5L DOHC Turbo (20 Valve) (B5254T3)	11-05
L5 2521cc 2.5L DOHC Turbo (20 Valve) (B5254T5)	13-12	L5 2435cc 2.4L DOHC (20 Valve) (B5254FS)	00-98	L5 2521cc 2.5L DOHC Turbo (20 Valve) (B5254T7)	11-08
L5 2521cc 2.5L DOHC Turbo (20 Valve) (B5254T7)	13-08	L5 2435cc 2.4L DOHC Turbo (20 Valve) (B5254FT)	00-98	V70	
Coupe		L5 2435cc 2.4L DOHC Turbo (20 Valve) (B5254T)	00-98	L5 2319cc 2.3L DOHC Turbo (20 Valve) (B5234FT)	05-98
L4 2316cc 2.3L DOHC (16 Valve) (B234F)	91	S70 AWD		L5 2319cc 2.3L DOHC Turbo (20 Valve) (B5234T3)	05-98
L4 2316cc 2.3L SOHC Turbo (8 Valve) (B234FT)	91	L5 2435cc 2.4L DOHC Turbo (20 Valve) (B5254FT)	00-98	L5 2401cc 2.4L DOHC Turbo (20 Valve) (B5244T5)	08-05
P1800		L5 2435cc 2.4L DOHC Turbo (20 Valve) (B5254T)	00-98	L5 2435cc 2.4L DOHC (20 Valve) (B5244S)	08-01
L4 1780cc 1.8L OHV (B18A)	63-61	S80		L5 2435cc 2.4L DOHC (20 Valve) (B5244S6)	08-06
L4 1780cc 1.8L OHV (B18B)	63-61	L5 2521cc 2.5L DOHC Turbo (20 Valve) (B5254T)	06-04	L5 2435cc 2.4L DOHC (20 Valve) (B5254FS)	00-98
L4 1780cc 1.8L OHV (B18D)	63-61	L5 2521cc 2.5L DOHC Turbo (20 Valve) (B5254T2)	06-04	L5 2435cc 2.4L DOHC Turbo (20 Valve) (B5244T3)	03-01
PV444		L5 2521cc 2.5L DOHC Turbo (20 Valve) (B5254T2)	06-04	L5 2435cc 2.4L DOHC Turbo (20 Valve) (B5254FT)	00-98
L4 1580cc 1.6L OHV (B16A)	61-57	L6 2783cc 2.8L DOHC Turbo (24 Valve) (B6284T)	03-99	L5 2435cc 2.4L DOHC Turbo (20 Valve) (B5254T)	00-98
L4 1580cc 1.6L OHV (B16B)	61-57	L6 2922cc 2.9L DOHC (24 Valve) (B6294S)	04-99	L5 2435cc 2.4L DOHC Turbo (20 Valve) (B5254T2)	08-04
L4 1580cc 1.6L OHV (B16D)	61-57	L6 2922cc 2.9L DOHC (24 Valve) (B6304S)	04-99	L5 2521cc 2.5L DOHC Turbo (20 Valve) (B5254T4)	08-06
PV544		L6 2922cc 2.9L DOHC Turbo (24 Valve) (B6294T)	05-04	L6 3192cc 3.2L DOHC (24 Valve) (B6324S)	09-08
L4 1580cc 1.6L OHV (B16A)	61-58	L6 2953cc 3.0L DOHC Turbo (24 Valve) (B6304T2)	10-08	L6 3192cc 3.2L DOHC (24 Valve) (B6324S4)	11-10
L4 1580cc 1.6L OHV (B16B)	61-58	L6 2953cc 3.0L DOHC Turbo (24 Valve) (B6304T4)	13-11	L6 3192cc 3.2L DOHC (24 Valve) (B6324S5)	11-10
L4 1580cc 1.6L OHV (B16D)	61-58	S80 AWD		V70 AWD	
L4 1780cc 1.8L OHV (B18A)	67-62	L5 2319cc 2.3L DOHC Turbo (20 Valve) (B5234FT)	00-98	L5 2319cc 2.3L DOHC Turbo (20 Valve) (B5234FT)	00-98
L4 1780cc 1.8L OHV (B18B)	67-62	L5 2319cc 2.3L DOHC Turbo (20 Valve) (B5234T3)	00-98	L5 2319cc 2.3L DOHC Turbo (20 Valve) (B5234T3)	00-98
L4 1780cc 1.8L OHV (B18D)	67-62	L5 2435cc 2.4L DOHC Turbo (20 Valve) (B5244T3)	02-01	L5 2435cc 2.4L DOHC Turbo (20 Valve) (B5244T3)	02-01
S40		L5 2435cc 2.4L DOHC Turbo (20 Valve) (B5254FT)	00-98	L5 2435cc 2.4L DOHC Turbo (20 Valve) (B5254FT)	00-98
L4 1948cc 1.9L DOHC Turbo (16 Valve) (B4194T)	04-00	S80		L5 2435cc 2.4L DOHC Turbo (20 Valve) (B5254T)	00-98
L4 1948cc 1.9L DOHC Turbo (16 Valve) (B4204T2)	02-00	L5 2521cc 2.5L DOHC Turbo (20 Valve) (B5254T)	06-04	L6 3192cc 3.2L DOHC (24 Valve) (B6324S)	09-08
		L5 2521cc 2.5L DOHC Turbo (20 Valve) (B5254T2)	06-04	L6 3192cc 3.2L DOHC (24 Valve) (B6324S4)	11-10
		L6 2783cc 2.8L DOHC Turbo (24 Valve) (B6284T)	03-99	L6 3192cc 3.2L DOHC (24 Valve) (B6324S5)	11-10
		L6 2922cc 2.9L DOHC (24 Valve) (B6294S)	04-99	V70 AWD	
		L6 2922cc 2.9L DOHC Turbo (24 Valve) (B6294T)	05-04	L5 2319cc 2.3L DOHC Turbo (20 Valve) (B5234FT)	00-98
		L6 2953cc 3.0L DOHC Turbo (24 Valve) (B6304T2)	10-08	L5 2319cc 2.3L DOHC Turbo (20 Valve) (B5234T3)	00-98
		L6 2953cc 3.0L DOHC Turbo (24 Valve) (B6304T4)	13-11	L5 2435cc 2.4L DOHC Turbo (20 Valve) (B5244T3)	02-01
				L5 2435cc 2.4L DOHC Turbo (20 Valve) (B5254FT)	00-98

Model Index (Cont.)					
Engine (VIN Code / Eng. Code)	Year	Engine (VIN Code / Eng. Code)	Year	Engine (VIN Code / Eng. Code)	Year
Volvo (cont.)					
V70 AWD (cont.)					
L5 2435cc 2.4L DOHC Turbo (20 Valve) (B5254T)	00-98				
L5 2521cc 2.5L DOHC Turbo (20 Valve) (B5254T2)	05-03				
L6 3192cc 3.2L DOHC (24 Valve) (B6324S)	09-08				
L6 3192cc 3.2L DOHC (24 Valve) (B6324S4)	11-10				
L6 3192cc 3.2L DOHC (24 Valve) (B6324S5)	11-10				
V70 XC AWD					
L5 2435cc 2.4L DOHC Turbo (20 Valve) (B5244T2)	00-98				
L5 2435cc 2.4L DOHC Turbo (20 Valve) (B5244T3)	02-01				
L5 2435cc 2.4L DOHC Turbo (20 Valve) (B5254T)	00-98				
V90					
L6 2922cc 2.9L DOHC (24 Valve) (B6304F)	98				
L6 2922cc 2.9L DOHC (24 Valve) (B6304S)	98				
XC70					
L5 2521cc 2.5L DOHC Turbo (20 Valve) (B5254T2)	08-03				
L6 2953cc 3.0L DOHC Turbo (24 Valve) (B6304T2)	10-09				
L6 2953cc 3.0L DOHC Turbo (24 Valve) (B6304T4)	13-11				
L6 3192cc 3.2L DOHC (24 Valve) (B6324S)	10-08				
L6 3192cc 3.2L DOHC (24 Valve) (B6324S4)	13-11				
L6 3192cc 3.2L DOHC (24 Valve) (B6324S5)	13-11				

Volvo Car (Cont.)

1		2004 - 2000; 1.9L 118.9 (1948cc) DOHC L4 (16 Valve) 83mm Bore			1
MFI; Gasoline; Turbo - Intercooled Volvo Eng.; Eng. Code B4194T					
QTY	CYLINDER HEAD	YEARS	PART NO.	DESCRIPTION	
1	Head Gasket	2004-01	26641 PT	Head bolts not incl.; Head bolt replacement recommended; New Part Number - Check for Availability	
1	Head Gasket	2000	26583 PT	Head bolts not incl.; Head bolt replacement recommended; New Part Number - Check for Availability	
QTY	CONVERSION SET	YEARS	PART NO.	DESCRIPTION	
1	Gasket Conversion Set	2004-00	CS 26597	RTV sealant incl. for oil pan gskt.; New Part Number - Check for Availability	
QTY	MANIFOLD - INT. & EXH.	YEARS	PART NO.	DESCRIPTION	
1	Int. Manifold Gasket Set	2004-00	MS 97289	Lower set; New Part Number - Check for Availability	
1	Exh. Manifold Gasket Set	2004-00	MS 97259	New Part Number - Check for Availability	
2		2002 - 2000; 1.9L 118.9 (1948cc) DOHC L4 (16 Valve) 83mm Bore			2
MFI; Gasoline; Turbo - Intercooled Volvo Eng.; Eng. Code B4204T2					
QTY	CYLINDER HEAD	YEARS	PART NO.	DESCRIPTION	
1	Head Gasket	2002-01	26641 PT	Head bolts not incl.; Head bolt replacement recommended; New Part Number - Check for Availability	
1	Head Gasket	2000	26583 PT	Head bolts not incl.; Head bolt replacement recommended; New Part Number - Check for Availability	
QTY	CONVERSION SET	YEARS	PART NO.	DESCRIPTION	
1	Gasket Conversion Set	2002-00	CS 26597	RTV sealant incl. for oil pan gskt.; New Part Number - Check for Availability	
QTY	MANIFOLD - INT. & EXH.	YEARS	PART NO.	DESCRIPTION	
1	Int. Manifold Gasket Set	2002-00	MS 97289	Lower set; New Part Number - Check for Availability	
1	Exh. Manifold Gasket Set	2002-00	MS 97259	New Part Number - Check for Availability	
3		2004 - 2001; 1.9L 118.9 (1948cc) DOHC L4 (16 Valve) 83mm Bore			3
MFI; Gasoline; Turbo - Intercooled Volvo Eng.; Eng. Code B4204T3					
QTY	CYLINDER HEAD	YEARS	PART NO.	DESCRIPTION	
1	Head Gasket	2004-01	26641 PT	Head bolts not incl.; Head bolt replacement recommended; New Part Number - Check for Availability	
QTY	CONVERSION SET	YEARS	PART NO.	DESCRIPTION	
1	Gasket Conversion Set	2004-01	CS 26597	RTV sealant incl. for oil pan gskt.; New Part Number - Check for Availability	
QTY	MANIFOLD - INT. & EXH.	YEARS	PART NO.	DESCRIPTION	
1	Int. Manifold Gasket Set	2004-01	MS 97289	Lower set; New Part Number - Check for Availability	
1	Exh. Manifold Gasket Set	2004-01	MS 97259	New Part Number - Check for Availability	
4		1991; 2.3L 141 (2316cc) DOHC L4 (16 Valve) 96mm Bore			4
MFI; Gasoline; Naturally Aspirated Volvo Eng.; Eng. Code B234F					
QTY	CYLINDER HEAD	YEARS	PART NO.	DESCRIPTION	
1	Head Gasket	1991	8190 PT	Head bolts not incl.; Head bolt replacement recommended	
1	Head Set	1991	HS 8190 PT-2	Head bolts not incl.; Head bolt replacement recommended; Premium valve stem seals incl.	
1	Head Bolt Set	1991	ES 72599	Replacement recommended; New Part Number - Check for Availability	
QTY	MANIFOLD - INT. & EXH.	YEARS	PART NO.	DESCRIPTION	
1	Int. Manifold Gasket Set	1991	MS 95263		
1	Exh. Manifold Gasket Set	1991	MS 95264		
QTY	EXHAUST PIPE FLANGE	YEARS	PART NO.	DESCRIPTION	
1	Exhaust Pipe Gasket	1991	23563	Flange	
QTY	OIL PAN	YEARS	PART NO.	DESCRIPTION	
1	Oil Pan Gasket Set	1991	OS 21574 D		
QTY	CRANKSHAFT REAR SEAL	YEARS	PART NO.	DESCRIPTION	
1	Rear Main Seal Set	1991	BS 40643	Rubber; One-piece	
QTY	VALVE COVER	YEARS	PART NO.	DESCRIPTION	
1	Valve Cover Gasket Set	1991	VS 50408	w/o Semi-circular plug	
1	Semi-Circular Plug	1991	CP 75010	Valve Cover	
QTY	VALVE STEM SEAL SET	YEARS	PART NO.	DESCRIPTION	
1	Valve Stem Seal Set	1991	SS 72848	Premium valve stem seals incl.	
QTY	WATER OUTLET GASKET	YEARS	PART NO.	DESCRIPTION	
1	Water Outlet Gasket	1991	25565	Water Outlet	
QTY	WATER PUMP	YEARS	PART NO.	DESCRIPTION	
1	Water Pump Gasket	1991	35426	Must be used w/25565	
QTY	TIMING COVER	YEARS	PART NO.	DESCRIPTION	
1	Crankshaft Front Seal Set	1991	TCS 45925		
2	Camshaft Front Seal Set	1991	TCS 45725		

5		1995 - 1991; 2.3L 141 (2316cc) SOHC L4 (8 Valve) 96mm Bore			5
MFI; Gasoline; Naturally Aspirated Volvo Eng.; Eng. Code B230F					
QTY	CYLINDER HEAD	YEARS	PART NO.	DESCRIPTION	
1	Head Gasket	1995-91	8190 PT	Head bolts not incl.; Head bolt replacement recommended	
1	Head Set	1995-91	HS 8190 PT-1	Head bolts not incl.; Head bolt replacement recommended; Premium valve stem seals incl.	
1	Head Bolt Set	1995-91	ES 72599	Replacement recommended; New Part Number - Check for Availability	
QTY	CONVERSION SET	YEARS	PART NO.	DESCRIPTION	
1	Gasket Conversion Set	1993-91	CS 21202		
QTY	MANIFOLD - INT. & EXH.	YEARS	PART NO.	DESCRIPTION	
1	Int. Manifold Gasket Set	1995-91	MS 22777		
1	Exh. Manifold Gasket Set	1995-91	MS 22776		
QTY	EXHAUST PIPE FLANGE	YEARS	PART NO.	DESCRIPTION	
1	Exhaust Pipe Gasket	1995-91	23563	Flange	
QTY	OIL PAN	YEARS	PART NO.	DESCRIPTION	
1	Oil Pan Gasket Set	1995-91	OS 21574 D		
QTY	CRANKSHAFT REAR SEAL	YEARS	PART NO.	DESCRIPTION	
1	Rear Main Seal Set	1995-94	BS 40643	Rubber; One-piece	
1	Rear Main Seal Set	1993-91	BS 40433	Rubber; One-piece	
QTY	VALVE COVER	YEARS	PART NO.	DESCRIPTION	
1	Valve Cover Gasket Set	1995-91	VS 50037 F		
QTY	VALVE STEM SEAL SET	YEARS	PART NO.	DESCRIPTION	
1	Valve Stem Seal Set	1995-91	SS 70310	Loc. Int.; w/o Valve silencer; Premium valve stem seals incl.	
1	Valve Stem Seal Set	1995-91	SS 70310-1	Loc. Int.; w/Valve silencer; Premium valve stem seals incl.	
QTY	WATER OUTLET GASKET	YEARS	PART NO.	DESCRIPTION	
1	Water Outlet Gasket	1995-91	25565	Water Outlet	
QTY	WATER PUMP	YEARS	PART NO.	DESCRIPTION	
1	Water Pump Gasket	1993-91	35426	Must be used w/25565	
QTY	TIMING COVER	YEARS	PART NO.	DESCRIPTION	
1	Crankshaft Front Seal Set	1993-91	TCS 45924		
1	Camshaft Front Seal Set	1995-91	TCS 45725		
6		1995 - 1993; 2.3L 141 (2316cc) SOHC L4 (8 Valve) 96mm Bore			6
MFI; Gasoline; Naturally Aspirated Volvo Eng.; Eng. Code B230FD					
QTY	CYLINDER HEAD	YEARS	PART NO.	DESCRIPTION	
1	Head Gasket	1995-93	8190 PT	Head bolts not incl.; Head bolt replacement recommended	
1	Head Set	1995-93	HS 8190 PT-1	Head bolts not incl.; Head bolt replacement recommended; Premium valve stem seals incl.	
1	Head Bolt Set	1995-93	ES 72599	Replacement recommended; New Part Number - Check for Availability	
QTY	CONVERSION SET	YEARS	PART NO.	DESCRIPTION	
1	Gasket Conversion Set	1993	CS 21202		
QTY	MANIFOLD - INT. & EXH.	YEARS	PART NO.	DESCRIPTION	
1	Int. Manifold Gasket Set	1995-93	MS 22777		
1	Exh. Manifold Gasket Set	1995-93	MS 22776		
QTY	EXHAUST PIPE FLANGE	YEARS	PART NO.	DESCRIPTION	
1	Exhaust Pipe Gasket	1995-93	23563	Flange	
QTY	OIL PAN	YEARS	PART NO.	DESCRIPTION	
1	Oil Pan Gasket Set	1995-93	OS 21574 D		
QTY	CRANKSHAFT REAR SEAL	YEARS	PART NO.	DESCRIPTION	
1	Rear Main Seal Set	1995-94	BS 40643	Rubber; One-piece	
1	Rear Main Seal Set	1993	BS 40433	Rubber; One-piece	
QTY	VALVE COVER	YEARS	PART NO.	DESCRIPTION	
1	Valve Cover Gasket Set	1995-93	VS 50037 F		
QTY	VALVE STEM SEAL SET	YEARS	PART NO.	DESCRIPTION	
1	Valve Stem Seal Set	1995-93	SS 70310	Loc. Int.; w/o Valve silencer; Premium valve stem seals incl.	
1	Valve Stem Seal Set	1995-93	SS 70310-1	Loc. Int.; w/Valve silencer; Premium valve stem seals incl.	
QTY	WATER OUTLET GASKET	YEARS	PART NO.	DESCRIPTION	
1	Water Outlet Gasket	1995-93	25565	Water Outlet	
QTY	WATER PUMP	YEARS	PART NO.	DESCRIPTION	
1	Water Pump Gasket	1993	35426	Must be used w/25565	
QTY	TIMING COVER	YEARS	PART NO.	DESCRIPTION	
1	Crankshaft Front Seal Set	1993	TCS 45924		
1	Camshaft Front Seal Set	1995-93	TCS 45725		

Volvo Car (Cont.)

7		1995 - 1993; 2.3L 141 (2316cc) SOHC L4 (8 Valve) 96mm Bore			7
MFI; Gasoline; Naturally Aspirated Volvo Eng.; Eng. Code B230FS					
QTY	CYLINDER HEAD	YEARS	PART NO.	DESCRIPTION	
1	Head Gasket	1995-93	8190 PT	Head bolts not incl.; Head bolt replacement recommended	
1	Head Set	1995-93	HS 8190 PT-1	Head bolts not incl.; Head bolt replacement recommended; Premium valve stem seals incl.	
1	Head Bolt Set	1995-93	ES 72599	Replacement recommended; New Part Number - Check for Availability	
QTY	CONVERSION SET	YEARS	PART NO.	DESCRIPTION	
1	Gasket Conversion Set	1993	CS 21202		
QTY	MANIFOLD - INT. & EXH.	YEARS	PART NO.	DESCRIPTION	
1	Int. Manifold Gasket Set	1995-93	MS 22777		
1	Exh. Manifold Gasket Set	1995-93	MS 22776		
QTY	EXHAUST PIPE FLANGE	YEARS	PART NO.	DESCRIPTION	
1	Exhaust Pipe Gasket	1995-93	23563	Flange	
QTY	OIL PAN	YEARS	PART NO.	DESCRIPTION	
1	Oil Pan Gasket Set	1995-93	OS 21574 D		
QTY	CRANKSHAFT REAR SEAL	YEARS	PART NO.	DESCRIPTION	
1	Rear Main Seal Set	1995-94	BS 40643	Rubber; One-piece	
1	Rear Main Seal Set	1993	BS 40433	Rubber; One-piece	
QTY	VALVE COVER	YEARS	PART NO.	DESCRIPTION	
1	Valve Cover Gasket Set	1995-93	VS 50037 F		
QTY	VALVE STEM SEAL SET	YEARS	PART NO.	DESCRIPTION	
1	Valve Stem Seal Set	1995-93	SS 70310	Loc. Int.; w/o Valve silencer; Premium valve stem seals incl.	
1	Valve Stem Seal Set	1995-93	SS 70310-1	Loc. Int.; w/Valve silencer; Premium valve stem seals incl.	
QTY	WATER OUTLET GASKET	YEARS	PART NO.	DESCRIPTION	
1	Water Outlet Gasket	1995-93	25565	Water Outlet	
QTY	WATER PUMP	YEARS	PART NO.	DESCRIPTION	
1	Water Pump Gasket	1993	35426	Must be used w/25565	
QTY	TIMING COVER	YEARS	PART NO.	DESCRIPTION	
1	Crankshaft Front Seal Set	1993	TCS 45924		
1	Camshaft Front Seal Set	1995-93	TCS 45725		
8		1995 - 1991; 2.3L 141 (2316cc) SOHC L4 (8 Valve) 96mm Bore			8
MFI; Gasoline; Turbo - Intercooled Volvo Eng.; Eng. Code B230FT					
QTY	CYLINDER HEAD	YEARS	PART NO.	DESCRIPTION	
1	Head Gasket	1995-91	8190 PT	Head bolts not incl.; Head bolt replacement recommended	
1	Head Set	1995-91	HS 8190 PT-1	Turbo mounting gskts. & head bolts not incl.; Head bolt replacement recommended; Premium valve stem seals incl.	
1	Head Bolt Set	1995-91	ES 72599	Replacement recommended; New Part Number - Check for Availability	
QTY	CONVERSION SET	YEARS	PART NO.	DESCRIPTION	
1	Gasket Conversion Set	1993-91	CS 21202		
QTY	MANIFOLD - INT. & EXH.	YEARS	PART NO.	DESCRIPTION	
1	Int. Manifold Gasket Set	1995-91	MS 22777		
1	Exh. Manifold Gasket Set	1995-91	MS 22776		
QTY	EXHAUST PIPE FLANGE	YEARS	PART NO.	DESCRIPTION	
1	Exhaust Pipe Gasket	1995-91	23563	Flange	
QTY	OIL PAN	YEARS	PART NO.	DESCRIPTION	
1	Oil Pan Gasket Set	1995-91	OS 21574 D		
QTY	CRANKSHAFT REAR SEAL	YEARS	PART NO.	DESCRIPTION	
1	Rear Main Seal Set	1995-94	BS 40643	Rubber; One-piece	
1	Rear Main Seal Set	1993-91	BS 40433	Rubber; One-piece	
QTY	VALVE COVER	YEARS	PART NO.	DESCRIPTION	
1	Valve Cover Gasket Set	1995-91	VS 50037 F		
QTY	VALVE STEM SEAL SET	YEARS	PART NO.	DESCRIPTION	
1	Valve Stem Seal Set	1995-91	SS 70310	Loc. Int.; w/o Valve silencer; Premium valve stem seals incl.	
1	Valve Stem Seal Set	1995-91	SS 70310-1	Loc. Int.; w/Valve silencer; Premium valve stem seals incl.	
QTY	WATER OUTLET GASKET	YEARS	PART NO.	DESCRIPTION	
1	Water Outlet Gasket	1995-91	25565	Water Outlet	
QTY	WATER PUMP	YEARS	PART NO.	DESCRIPTION	
1	Water Pump Gasket	1993-91	35426	Must be used w/25565	
QTY	TIMING COVER	YEARS	PART NO.	DESCRIPTION	
1	Crankshaft Front Seal Set	1993-91	TCS 45924		
1	Camshaft Front Seal Set	1995-91	TCS 45725		

9		1995 - 1991; 2.3L 141 (2316cc) SOHC L4 (8 Valve) 96mm Bore			9
		MFI; Gasoline; Turbo - Intercooled Volvo Eng.; Eng. Code B234FT			
QTY	CYLINDER HEAD	YEARS	PART NO.	DESCRIPTION	
1	Head Gasket	1995-91	8190 PT	Head bolts not incl.; Head bolt replacement recommended	
1	Head Set	1995-91	HS 8190 PT-1	Turbo mounting gskts. & head bolts not incl.; Head bolt replacement recommended; Premium valve stem seals incl.	
1	Head Bolt Set	1995-91	ES 72599	Replacement recommended; New Part Number - Check for Availability	
QTY	CONVERSION SET	YEARS	PART NO.	DESCRIPTION	
1	Gasket Conversion Set	1993-91	CS 21202		
QTY	MANIFOLD - INT. & EXH.	YEARS	PART NO.	DESCRIPTION	
1	Int. Manifold Gasket Set	1995-91	MS 22777		
1	Exh. Manifold Gasket Set	1995-91	MS 22776		
QTY	EXHAUST PIPE FLANGE	YEARS	PART NO.	DESCRIPTION	
1	Exhaust Pipe Gasket	1995-91	23563	Flange	
QTY	OIL PAN	YEARS	PART NO.	DESCRIPTION	
1	Oil Pan Gasket Set	1995-91	OS 21574 D		
QTY	CRANKSHAFT REAR SEAL	YEARS	PART NO.	DESCRIPTION	
1	Rear Main Seal Set	1995-94	BS 40643	Rubber; One-piece	
1	Rear Main Seal Set	1993-91	BS 40433	Rubber; One-piece	
QTY	VALVE COVER	YEARS	PART NO.	DESCRIPTION	
1	Valve Cover Gasket Set	1995-91	VS 50037 F		
QTY	VALVE STEM SEAL SET	YEARS	PART NO.	DESCRIPTION	
1	Valve Stem Seal Set	1995-91	SS 70310	Loc. Int.; w/o Valve silencer; Premium valve stem seals incl.	
1	Valve Stem Seal Set	1995-91	SS 70310-1	Loc. Int.; w/Valve silencer; Premium valve stem seals incl.	
QTY	WATER OUTLET GASKET	YEARS	PART NO.	DESCRIPTION	
1	Water Outlet Gasket	1995-91	25565	Water Outlet	
QTY	WATER PUMP	YEARS	PART NO.	DESCRIPTION	
1	Water Pump Gasket	1993-91	35426	Must be used w/25565	
QTY	TIMING COVER	YEARS	PART NO.	DESCRIPTION	
1	Crankshaft Front Seal Set	1993-91	TCS 45924		
1	Camshaft Front Seal Set	1995-91	TCS 45725		
10		1995 - 1991; 2.3L 141 (2316cc) SOHC L4 (8 Valve) 96mm Bore			10
		MFI; Gasoline; Turbo - Intercooled Volvo Eng.; Eng. Code B234T			
QTY	CYLINDER HEAD	YEARS	PART NO.	DESCRIPTION	
1	Head Gasket	1995-91	8190 PT	Head bolts not incl.; Head bolt replacement recommended	
1	Head Set	1995-91	HS 8190 PT-1	Turbo mounting gskts. & head bolts not incl.; Head bolt replacement recommended; Premium valve stem seals incl.	
1	Head Bolt Set	1995-91	ES 72599	Replacement recommended; New Part Number - Check for Availability	
QTY	CONVERSION SET	YEARS	PART NO.	DESCRIPTION	
1	Gasket Conversion Set	1993-91	CS 21202		
QTY	MANIFOLD - INT. & EXH.	YEARS	PART NO.	DESCRIPTION	
1	Int. Manifold Gasket Set	1995-91	MS 22777		
1	Exh. Manifold Gasket Set	1995-91	MS 22776		
QTY	EXHAUST PIPE FLANGE	YEARS	PART NO.	DESCRIPTION	
1	Exhaust Pipe Gasket	1995-91	23563	Flange	
QTY	OIL PAN	YEARS	PART NO.	DESCRIPTION	
1	Oil Pan Gasket Set	1995-91	OS 21574 D		
QTY	CRANKSHAFT REAR SEAL	YEARS	PART NO.	DESCRIPTION	
1	Rear Main Seal Set	1995-94	BS 40643	Rubber; One-piece	
1	Rear Main Seal Set	1993-91	BS 40433	Rubber; One-piece	
QTY	VALVE COVER	YEARS	PART NO.	DESCRIPTION	
1	Valve Cover Gasket Set	1995-91	VS 50037 F		
QTY	VALVE STEM SEAL SET	YEARS	PART NO.	DESCRIPTION	
1	Valve Stem Seal Set	1995-91	SS 70310	Loc. Int.; w/o Valve silencer; Premium valve stem seals incl.	
1	Valve Stem Seal Set	1995-91	SS 70310-1	Loc. Int.; w/Valve silencer; Premium valve stem seals incl.	
QTY	WATER OUTLET GASKET	YEARS	PART NO.	DESCRIPTION	
1	Water Outlet Gasket	1995-91	25565	Water Outlet	
QTY	WATER PUMP	YEARS	PART NO.	DESCRIPTION	
1	Water Pump Gasket	1993-91	35426	Must be used w/25565	
QTY	TIMING COVER	YEARS	PART NO.	DESCRIPTION	
1	Crankshaft Front Seal Set	1993-91	TCS 45924		
1	Camshaft Front Seal Set	1995-91	TCS 45725		

Volvo Car (Cont.)

11		2005 - 1998; 2.3L 142 (2319cc) DOHC L5 (20 Valve) 81mm Bore			11
		MFI; Gasoline; Turbo - Intercooled Volvo Eng.; Eng. Code B5234FT			
QTY	CYLINDER HEAD	YEARS	PART NO.	DESCRIPTION	
1	Head Gasket	2005-00	26205 PT	Head bolts not incl.; Head bolt replacement recommended; PermaTorque®	
1	Head Gasket	1999	26204 PT	Head bolts not incl.; Head bolt replacement recommended; PermaTorque®	
1	Head Gasket	1998	26203 PT	Volvo V70 R, R AWD, T-5; Head bolts not incl.; Head bolt replacement recommended; PermaTorque®	
1	Head Gasket	1998	26204 PT	Volvo C70 Base, S70 R, T-5; Head bolts not incl.; Head bolt replacement recommended; PermaTorque®	
1	Head Set	2005-00	HS 26205 PT	Head bolts & exh. pipe flange not incl.; Head bolt replacement recommended; RTV sealant incl. for valve cover gskt.; Premium valve stem seals incl.	
1	Head Set	1999	HS 26204 PT-1	Head bolts not incl.; Head bolt replacement recommended; RTV sealant incl. for valve cover gskt.; Premium valve stem seals incl.	
1	Head Set	1998	HS 26203 PT-1	Volvo V70 R, R AWD, T-5; Head bolts not incl.; Head bolt replacement recommended; RTV sealant incl. for valve cover gskt.; Premium valve stem seals incl.	
1	Head Set	1998	HS 26204 PT	Volvo C70 Base, S70 R, T-5; Head bolts not incl.; Head bolt replacement recommended; RTV sealant incl. for valve cover gskt.; Premium valve stem seals incl.	
1	Head Bolt Set	2005-98	ES 72908	Replacement recommended	
QTY	CONVERSION SET	YEARS	PART NO.	DESCRIPTION	
1	Gasket Conversion Set	2005-98	CS 26203	RTV sealant incl. for oil pan gskt.	
QTY	MANIFOLD - INT. & EXH.	YEARS	PART NO.	DESCRIPTION	
1	Int. Manifold Gasket Set	2005-99	MS 96154		
1	Int. Manifold Gasket Set	1998	MS 96153		
1	Exh. Manifold Gasket Set	2005-98	MS 96277		
QTY	EXHAUST PIPE FLANGE	YEARS	PART NO.	DESCRIPTION	
1	Exhaust Pipe Gasket	2005-00	61374	Flange	
QTY	CRANKSHAFT REAR SEAL	YEARS	PART NO.	DESCRIPTION	
1	Rear Main Seal Set	2005-98	BS 40677	Rubber; One-piece	
QTY	VALVE COVER	YEARS	PART NO.	DESCRIPTION	
1	Spark Plug Tube Seal Set	2005-98	ES 72477	Valve Cover; New Part Number - Check for Availability	
QTY	VALVE STEM SEAL SET	YEARS	PART NO.	DESCRIPTION	
1	Valve Stem Seal Set	2005-99	SS 71180	Premium valve stem seals incl.	
1	Valve Stem Seal Set	1998	SS 72848-1	Premium valve stem seals incl.	
QTY	WATER OUTLET GASKET	YEARS	PART NO.	DESCRIPTION	
1	Water Outlet Gasket	2005-98	25565	Water Outlet	
QTY	WATER PUMP	YEARS	PART NO.	DESCRIPTION	
1	Water Pump Gasket	2005-98	35676		
QTY	TIMING COVER	YEARS	PART NO.	DESCRIPTION	
1	Crankshaft Front Seal Set	2005-98	TCS 46040		
1	Camshaft Front Seal Set	2005-99	TCS 46038		
1	Camshaft Front Seal Set	1998	TCS 46037		
1	Camshaft Rear Seal Set	2005-98	TCS 46039		
QTY	CARB & FUEL INJECTION	YEARS	PART NO.	DESCRIPTION	
1	Throttle Body Gasket	2005-99	61370		
1	Throttle Body Gasket	1998	61211		
QTY	EXHAUST GAS RECIRCULATION	YEARS	PART NO.	DESCRIPTION	
1	EGR Gasket	1998	70982		
12		1997 - 1994; 2.3L 142 (2319cc) DOHC L5 (20 Valve) 81mm Bore			12
		MFI; Gasoline; Turbo - Intercooled Volvo Eng.; Eng. Code B5234T			
QTY	CYLINDER HEAD	YEARS	PART NO.	DESCRIPTION	
1	Head Gasket	1997-94	26204 PT	Head bolts not incl.; Head bolt replacement recommended; PermaTorque®	
1	Head Set	1997-94	HS 26204 PT	Head bolts not incl.; Head bolt replacement recommended; RTV sealant incl. for valve cover gskt.; Premium valve stem seals incl.	
1	Head Bolt Set	1997-94	ES 72908	Replacement recommended	
QTY	CONVERSION SET	YEARS	PART NO.	DESCRIPTION	
1	Gasket Conversion Set	1997-94	CS 26203	RTV sealant incl. for oil pan gskt.	
QTY	MANIFOLD - INT. & EXH.	YEARS	PART NO.	DESCRIPTION	
1	Int. Manifold Gasket Set	1997-94	MS 96153		
1	Exh. Manifold Gasket Set	1997-94	MS 96277		
QTY	CRANKSHAFT REAR SEAL	YEARS	PART NO.	DESCRIPTION	
1	Rear Main Seal Set	1997-94	BS 40677	Rubber; One-piece	
QTY	VALVE COVER	YEARS	PART NO.	DESCRIPTION	
1	Spark Plug Tube Seal Set	1997-94	ES 72477	Valve Cover; New Part Number - Check for Availability	

12		1997 - 1994; 2.3L 142 (2319cc) DOHC L5 (20 Valve) 81mm Bore			12	
(cont.)		MFI; Gasoline; Turbo - Intercooled Volvo Eng.; Eng. Code B5234T			(cont.)	
QTY	VALVE STEM SEAL SET	YEARS	PART NO.	DESCRIPTION		
1	Valve Stem Seal Set	1997-94	SS 72848-1	Premium valve stem seals incl.		
QTY	WATER OUTLET GASKET	YEARS	PART NO.	DESCRIPTION		
1	Water Outlet Gasket	1997-94	25565	Water Outlet		
QTY	WATER PUMP	YEARS	PART NO.	DESCRIPTION		
1	Water Pump Gasket	1997-94	35676			
QTY	TIMING COVER	YEARS	PART NO.	DESCRIPTION		
1	Crankshaft Front Seal Set	1997-94	TCS 46040			
1	Camshaft Front Seal Set	1997-94	TCS 46037			
1	Camshaft Rear Seal Set	1997-94	TCS 46039			
QTY	CARB & FUEL INJECTION	YEARS	PART NO.	DESCRIPTION		
1	Throttle Body Gasket	1997-94	61211			
QTY	EXHAUST GAS RECIRCULATION	YEARS	PART NO.	DESCRIPTION		
1	EGR Gasket	1997-94	70982			
13		2010 - 1998; 2.3L 142 (2319cc) DOHC L5 (20 Valve) 81mm Bore			13	
		MFI; Gasoline; Turbo - Intercooled Volvo Eng.; Eng. Code B5234T3				
QTY	CYLINDER HEAD	YEARS	PART NO.	DESCRIPTION		
1	Head Gasket	2010-00	26205 PT	Head bolts not incl.; Head bolt replacement recommended; PermaTorque®		
1	Head Gasket	1999-98	26204 PT	Head bolts not incl.; Head bolt replacement recommended; PermaTorque®		
1	Head Set	2010-00	HS 26205 PT	Head bolts & exh. pipe flange not incl.; Head bolt replacement recommended; RTV sealant incl. for valve cover gskt.; Premium valve stem seals incl.		
1	Head Set	1999	HS 26204 PT-1	Head bolts not incl.; Head bolt replacement recommended; RTV sealant incl. for valve cover gskt.; Premium valve stem seals incl.		
1	Head Set	1998	HS 26204 PT	Head bolts not incl.; Head bolt replacement recommended; RTV sealant incl. for valve cover gskt.; Premium valve stem seals incl.		
1	Head Bolt Set	2010-98	ES 72908	Replacement recommended		
QTY	CONVERSION SET	YEARS	PART NO.	DESCRIPTION		
1	Gasket Conversion Set	2010-98	CS 26203	RTV sealant incl. for oil pan gskt.		
QTY	MANIFOLD - INT. & EXH.	YEARS	PART NO.	DESCRIPTION		
1	Int. Manifold Gasket Set	2010-99	MS 96154			
1	Int. Manifold Gasket Set	1998	MS 96153			
1	Exh. Manifold Gasket Set	2010-98	MS 96277			
QTY	EXHAUST PIPE FLANGE	YEARS	PART NO.	DESCRIPTION		
1	Exhaust Pipe Gasket	2010-00	61374	Flange		
QTY	CRANKSHAFT REAR SEAL	YEARS	PART NO.	DESCRIPTION		
1	Rear Main Seal Set	2010-98	BS 40677	Rubber; One-piece		
QTY	VALVE COVER	YEARS	PART NO.	DESCRIPTION		
1	Spark Plug Tube Seal Set	2010-98	ES 72477	Valve Cover; New Part Number - Check for Availability		
QTY	VALVE STEM SEAL SET	YEARS	PART NO.	DESCRIPTION		
1	Valve Stem Seal Set	2010-99	SS 71180	Premium valve stem seals incl.		
1	Valve Stem Seal Set	1998	SS 72848-1	Premium valve stem seals incl.		
QTY	WATER OUTLET GASKET	YEARS	PART NO.	DESCRIPTION		
1	Water Outlet Gasket	2010-98	25565	Water Outlet		
QTY	WATER PUMP	YEARS	PART NO.	DESCRIPTION		
1	Water Pump Gasket	2010-98	35676			
QTY	TIMING COVER	YEARS	PART NO.	DESCRIPTION		
1	Crankshaft Front Seal Set	2010-98	TCS 46040			
1	Camshaft Front Seal Set	2010-99	TCS 46038			
1	Camshaft Front Seal Set	1998	TCS 46037			
1	Camshaft Rear Seal Set	2010-98	TCS 46039			
QTY	CARB & FUEL INJECTION	YEARS	PART NO.	DESCRIPTION		
1	Throttle Body Gasket	2010-99	61370			
1	Throttle Body Gasket	1998	61211			
QTY	EXHAUST GAS RECIRCULATION	YEARS	PART NO.	DESCRIPTION		
1	EGR Gasket	1998	70982			
14		2010 - 2005; 2.4L 146.6 (2401cc) DOHC L5 (20 Valve) 81mm Bore			14	
		MFI; Gasoline; Turbo - Intercooled Volvo Eng.; Eng. Code B5244T5				
QTY	CYLINDER HEAD	YEARS	PART NO.	DESCRIPTION		
1	Head Gasket	2010-05	26205 PT	Head bolts not incl.; Head bolt replacement recommended; PermaTorque®		

Volvo Car (Cont.)

14 (cont.)		2010 - 2005; 2.4L 146.6 (2401cc) DOHC L5 (20 Valve) 81mm Bore			14 (cont.)
MFI; Gasoline; Turbo - Intercooled Volvo Eng.; Eng. Code B5244T5					
QTY	CYLINDER HEAD	YEARS	PART NO.	DESCRIPTION	
1	Head Set	2010-05	HS 26205 PT	Head bolts & exh. pipe flange not incl.; Head bolt replacement recommended; RTV sealant incl. for valve cover gskt.; Premium valve stem seals incl.	
1	Head Bolt Set	2010-05	ES 72908	Replacement recommended	
QTY	CONVERSION SET	YEARS	PART NO.	DESCRIPTION	
1	Gasket Conversion Set	2010-05	CS 26203	RTV sealant incl. for oil pan gskt.	
QTY	MANIFOLD - INT. & EXH.	YEARS	PART NO.	DESCRIPTION	
1	Int. Manifold Gasket Set	2010-05	MS 96154		
1	Exh. Manifold Gasket Set	2010-05	MS 96277		
QTY	EXHAUST PIPE FLANGE	YEARS	PART NO.	DESCRIPTION	
1	Exhaust Pipe Gasket	2010-05	61374	Flange	
QTY	CRANKSHAFT REAR SEAL	YEARS	PART NO.	DESCRIPTION	
1	Rear Main Seal Set	2010-05	BS 40677	Rubber; One-piece	
QTY	VALVE COVER	YEARS	PART NO.	DESCRIPTION	
1	Spark Plug Tube Seal Set	2010-05	ES 72477	Valve Cover; New Part Number - Check for Availability	
QTY	VALVE STEM SEAL SET	YEARS	PART NO.	DESCRIPTION	
1	Valve Stem Seal Set	2010-05	SS 71180	Premium valve stem seals incl.	
QTY	WATER OUTLET GASKET	YEARS	PART NO.	DESCRIPTION	
1	Water Outlet Gasket	2010-05	25565	Water Outlet	
QTY	WATER PUMP	YEARS	PART NO.	DESCRIPTION	
1	Water Pump Gasket	2010-05	35676		
QTY	TIMING COVER	YEARS	PART NO.	DESCRIPTION	
1	Crankshaft Front Seal Set	2010-05	TCS 46040		
1	Camshaft Front Seal Set	2010-05	TCS 46038		
1	Camshaft Rear Seal Set	2010-05	TCS 46039		
QTY	CARB & FUEL INJECTION	YEARS	PART NO.	DESCRIPTION	
1	Throttle Body Gasket	2010-05	61370		
15		2005 - 2001; 2.4L 148.6 (2435cc) DOHC L5 (20 Valve) 83mm Bore			15
MFI; Gasoline; Naturally Aspirated Volvo Eng.; Eng. Code B5244F5					
QTY	CYLINDER HEAD	YEARS	PART NO.	DESCRIPTION	
1	Head Gasket	2005-01	26256 PT	Head bolts not incl.; Head bolt replacement recommended; PermaTorque®	
1	Head Set	2005-01	HS 26256 PT	Head bolts & exh. pipe flange not incl.; Head bolt replacement recommended; RTV sealant incl. for valve cover gskt.; Premium valve stem seals incl.	
1	Head Bolt Set	2005-01	ES 72908	Replacement recommended	
QTY	CONVERSION SET	YEARS	PART NO.	DESCRIPTION	
1	Gasket Conversion Set	2005-01	CS 26203	RTV sealant incl. for oil pan gskt.	
QTY	MANIFOLD - INT. & EXH.	YEARS	PART NO.	DESCRIPTION	
1	Int. Manifold Gasket Set	2005-01	MS 96154		
1	Exh. Manifold Gasket Set	2005-01	MS 96277		
QTY	EXHAUST PIPE FLANGE	YEARS	PART NO.	DESCRIPTION	
1	Exhaust Pipe Gasket	2005-03	61369	Flange	
1	Exhaust Pipe Gasket	2002-01	61368	Flange	
QTY	CRANKSHAFT REAR SEAL	YEARS	PART NO.	DESCRIPTION	
1	Rear Main Seal Set	2005-01	BS 40677	Rubber; One-piece	
QTY	VALVE COVER	YEARS	PART NO.	DESCRIPTION	
1	Spark Plug Tube Seal Set	2005-01	ES 72477	Valve Cover; New Part Number - Check for Availability	
QTY	VALVE STEM SEAL SET	YEARS	PART NO.	DESCRIPTION	
1	Valve Stem Seal Set	2005-01	SS 71180	Premium valve stem seals incl.	
QTY	WATER OUTLET GASKET	YEARS	PART NO.	DESCRIPTION	
1	Water Outlet Gasket	2005-01	25565	Water Outlet	
QTY	WATER PUMP	YEARS	PART NO.	DESCRIPTION	
1	Water Pump Gasket	2005-01	35676		
QTY	TIMING COVER	YEARS	PART NO.	DESCRIPTION	
1	Crankshaft Front Seal Set	2005-01	TCS 46040		
1	Camshaft Front Seal Set	2005-01	TCS 46038		
1	Camshaft Rear Seal Set	2005-01	TCS 46039		
QTY	CARB & FUEL INJECTION	YEARS	PART NO.	DESCRIPTION	
1	Throttle Body Gasket	2005-01	61370		

16		2008 - 2001; 2.4L 148.6 (2435cc) DOHC L5 (20 Valve) 83mm Bore			16
MFI; Gasoline; Naturally Aspirated Volvo Eng.; Eng. Code B5244S					
QTY	CYLINDER HEAD	YEARS	PART NO.	DESCRIPTION	
1	Head Gasket	2008-01	26256 PT	Head bolts not incl.; Head bolt replacement recommended; PermaTorque®	
1	Head Bolt Set	2008-01	ES 72908	Replacement recommended	
QTY	CONVERSION SET	YEARS	PART NO.	DESCRIPTION	
1	Gasket Conversion Set	2008-01	CS 26203	RTV sealant incl. for oil pan gskt.	
QTY	MANIFOLD - INT. & EXH.	YEARS	PART NO.	DESCRIPTION	
1	Int. Manifold Gasket Set	2008-01	MS 96154		
1	Exh. Manifold Gasket Set	2008-01	MS 96277		
QTY	EXHAUST PIPE FLANGE	YEARS	PART NO.	DESCRIPTION	
1	Exhaust Pipe Gasket	2008-03	61369	Flange	
1	Exhaust Pipe Gasket	2002-01	61368	Flange	
QTY	CRANKSHAFT REAR SEAL	YEARS	PART NO.	DESCRIPTION	
1	Rear Main Seal Set	2008-01	BS 40677	Rubber; One-piece	
QTY	VALVE COVER	YEARS	PART NO.	DESCRIPTION	
1	Spark Plug Tube Seal Set	2008-01	ES 72477	Valve Cover; New Part Number - Check for Availability	
QTY	VALVE STEM SEAL SET	YEARS	PART NO.	DESCRIPTION	
1	Valve Stem Seal Set	2008-01	SS 71180	Premium valve stem seals incl.	
QTY	WATER OUTLET GASKET	YEARS	PART NO.	DESCRIPTION	
1	Water Outlet Gasket	2008-01	25565	Water Outlet	
QTY	WATER PUMP	YEARS	PART NO.	DESCRIPTION	
1	Water Pump Gasket	2008-01	35676		
QTY	TIMING COVER	YEARS	PART NO.	DESCRIPTION	
1	Crankshaft Front Seal Set	2008-01	TCS 46040		
1	Camshaft Front Seal Set	2008-01	TCS 46038		
1	Camshaft Rear Seal Set	2008-01	TCS 46039		
QTY	CARB & FUEL INJECTION	YEARS	PART NO.	DESCRIPTION	
1	Throttle Body Gasket	2008-01	61370		
17		2010 - 2004; 2.4L 148.6 (2435cc) DOHC L5 (20 Valve) 83mm Bore			17
MFI; Gasoline; Naturally Aspirated Volvo Eng.; Eng. Code B5244S4					
QTY	CYLINDER HEAD	YEARS	PART NO.	DESCRIPTION	
1	Head Bolt Set	2010-04	ES 72908	Replacement recommended	
QTY	CONVERSION SET	YEARS	PART NO.	DESCRIPTION	
1	Gasket Conversion Set	2010-04	CS 26203	RTV sealant incl. for oil pan gskt.	
QTY	MANIFOLD - INT. & EXH.	YEARS	PART NO.	DESCRIPTION	
1	Int. Manifold Gasket Set	2010-04	MS 96154		
1	Exh. Manifold Gasket Set	2010-04	MS 96277		
QTY	EXHAUST PIPE FLANGE	YEARS	PART NO.	DESCRIPTION	
1	Exhaust Pipe Gasket	2010-04	61369	Flange	
QTY	CRANKSHAFT REAR SEAL	YEARS	PART NO.	DESCRIPTION	
1	Rear Main Seal Set	2010-04	BS 40677	Rubber; One-piece	
QTY	VALVE COVER	YEARS	PART NO.	DESCRIPTION	
1	Spark Plug Tube Seal Set	2010-04	ES 72477	Valve Cover; New Part Number - Check for Availability	
QTY	VALVE STEM SEAL SET	YEARS	PART NO.	DESCRIPTION	
1	Valve Stem Seal Set	2010-04	SS 71180	Premium valve stem seals incl.	
QTY	WATER OUTLET GASKET	YEARS	PART NO.	DESCRIPTION	
1	Water Outlet Gasket	2010-04	25565	Water Outlet	
QTY	WATER PUMP	YEARS	PART NO.	DESCRIPTION	
1	Water Pump Gasket	2010-04	35676		
QTY	TIMING COVER	YEARS	PART NO.	DESCRIPTION	
1	Crankshaft Front Seal Set	2010-04	TCS 46040		
1	Camshaft Front Seal Set	2010-04	TCS 46038		
1	Camshaft Rear Seal Set	2010-04	TCS 46039		
QTY	CARB & FUEL INJECTION	YEARS	PART NO.	DESCRIPTION	
1	Throttle Body Gasket	2010-04	61370		
18		2010 - 2004; 2.4L 148.6 (2435cc) DOHC L5 (20 Valve) 83mm Bore			18
MFI; Gasoline; Naturally Aspirated Volvo Eng.; Eng. Code B5244S5					
QTY	CYLINDER HEAD	YEARS	PART NO.	DESCRIPTION	
1	Head Gasket	2010-04	26256 PT	Head bolts not incl.; Head bolt replacement recommended; PermaTorque®	
1	Head Set	2010-04	HS 26256 PT	Head bolts & exh. pipe flange not incl.; Head bolt replacement recommended; RTV sealant incl. for valve cover gskt.; Premium valve stem seals incl.	

Volvo Car (Cont.)

18		2010 - 2004; 2.4L 148.6 (2435cc) DOHC L5 (20 Valve) 83mm Bore			18	
(cont.)		MFI; Gasoline; Naturally Aspirated Volvo Eng.; Eng. Code B5244S5			(cont.)	
QTY	CYLINDER HEAD	YEARS	PART NO.	DESCRIPTION		
1	Head Bolt Set	2010-04	ES 72908	Replacement recommended		
QTY	CONVERSION SET	YEARS	PART NO.	DESCRIPTION		
1	Gasket Conversion Set	2010-04	CS 26203	RTV sealant incl. for oil pan gskt.		
QTY	MANIFOLD - INT. & EXH.	YEARS	PART NO.	DESCRIPTION		
1	Int. Manifold Gasket Set	2010-04	MS 96154			
1	Exh. Manifold Gasket Set	2010-04	MS 96277			
QTY	EXHAUST PIPE FLANGE	YEARS	PART NO.	DESCRIPTION		
1	Exhaust Pipe Gasket	2010-04	61369	Flange		
QTY	CRANKSHAFT REAR SEAL	YEARS	PART NO.	DESCRIPTION		
1	Rear Main Seal Set	2010-04	BS 40677	Rubber; One-piece		
QTY	VALVE COVER	YEARS	PART NO.	DESCRIPTION		
1	Spark Plug Tube Seal Set	2010-04	ES 72477	Valve Cover; New Part Number - Check for Availability		
QTY	VALVE STEM SEAL SET	YEARS	PART NO.	DESCRIPTION		
1	Valve Stem Seal Set	2010-04	SS 71180	Premium valve stem seals incl.		
QTY	WATER OUTLET GASKET	YEARS	PART NO.	DESCRIPTION		
1	Water Outlet Gasket	2010-04	25565	Water Outlet		
QTY	WATER PUMP	YEARS	PART NO.	DESCRIPTION		
1	Water Pump Gasket	2010-04	35676			
QTY	TIMING COVER	YEARS	PART NO.	DESCRIPTION		
1	Crankshaft Front Seal Set	2010-04	TCS 46040			
1	Camshaft Front Seal Set	2010-04	TCS 46038			
1	Camshaft Rear Seal Set	2010-04	TCS 46039			
QTY	CARB & FUEL INJECTION	YEARS	PART NO.	DESCRIPTION		
1	Throttle Body Gasket	2010-04	61370			
19		2008 - 2006; 2.4L 148.6 (2435cc) DOHC L5 (20 Valve) 83mm Bore			19	
		MFI; Gasoline; Naturally Aspirated Volvo Eng.; Eng. Code B5244S6				
QTY	CYLINDER HEAD	YEARS	PART NO.	DESCRIPTION		
1	Head Gasket	2008-06	26256 PT	Head bolts not incl.; Head bolt replacement recommended; PermaTorque®		
1	Head Set	2008-06	HS 26256 PT	Head bolts & exh. pipe flange not incl.; Head bolt replacement recommended; RTV sealant incl. for valve cover gskt.; Premium valve stem seals incl.		
1	Head Bolt Set	2008-06	ES 72908	Replacement recommended		
QTY	CONVERSION SET	YEARS	PART NO.	DESCRIPTION		
1	Gasket Conversion Set	2008-06	CS 26203	RTV sealant incl. for oil pan gskt.		
QTY	MANIFOLD - INT. & EXH.	YEARS	PART NO.	DESCRIPTION		
1	Int. Manifold Gasket Set	2008-06	MS 96154			
1	Exh. Manifold Gasket Set	2008-06	MS 96277			
QTY	EXHAUST PIPE FLANGE	YEARS	PART NO.	DESCRIPTION		
1	Exhaust Pipe Gasket	2008-06	61369	Flange		
QTY	CRANKSHAFT REAR SEAL	YEARS	PART NO.	DESCRIPTION		
1	Rear Main Seal Set	2008-06	BS 40677	Rubber; One-piece		
QTY	VALVE COVER	YEARS	PART NO.	DESCRIPTION		
1	Spark Plug Tube Seal Set	2008-06	ES 72477	Valve Cover; New Part Number - Check for Availability		
QTY	VALVE STEM SEAL SET	YEARS	PART NO.	DESCRIPTION		
1	Valve Stem Seal Set	2008-06	SS 71180	Premium valve stem seals incl.		
QTY	WATER OUTLET GASKET	YEARS	PART NO.	DESCRIPTION		
1	Water Outlet Gasket	2008-06	25565	Water Outlet		
QTY	WATER PUMP	YEARS	PART NO.	DESCRIPTION		
1	Water Pump Gasket	2008-06	35676			
QTY	TIMING COVER	YEARS	PART NO.	DESCRIPTION		
1	Crankshaft Front Seal Set	2008-06	TCS 46040			
1	Camshaft Front Seal Set	2008-06	TCS 46038			
1	Camshaft Rear Seal Set	2008-06	TCS 46039			
QTY	CARB & FUEL INJECTION	YEARS	PART NO.	DESCRIPTION		
1	Throttle Body Gasket	2008-06	61370			
20		2010 - 2006; 2.4L 148.6 (2435cc) DOHC L5 (20 Valve) 83mm Bore			20	
		MFI; Gasoline; Naturally Aspirated Volvo Eng.; Eng. Code B5244S7				
QTY	CYLINDER HEAD	YEARS	PART NO.	DESCRIPTION		
1	Head Bolt Set	2010-06	ES 72908	Replacement recommended		
QTY	CONVERSION SET	YEARS	PART NO.	DESCRIPTION		
1	Gasket Conversion Set	2010-06	CS 26203	RTV sealant incl. for oil pan gskt.		

20 (cont.)		2010 - 2006; 2.4L 148.6 (2435cc) DOHC L5 (20 Valve) 83mm Bore			20 (cont.)
		MFI; Gasoline; Naturally Aspirated Volvo Eng.; Eng. Code B5244S7			
QTY	MANIFOLD - INT. & EXH.	YEARS	PART NO.	DESCRIPTION	
1	Int. Manifold Gasket Set	2010-06	MS 96154		
1	Exh. Manifold Gasket Set	2010-06	MS 96277		
QTY	EXHAUST PIPE FLANGE	YEARS	PART NO.	DESCRIPTION	
1	Exhaust Pipe Gasket	2010-06	61369	Flange	
QTY	CRANKSHAFT REAR SEAL	YEARS	PART NO.	DESCRIPTION	
1	Rear Main Seal Set	2010-06	BS 40677	Rubber; One-piece	
QTY	VALVE COVER	YEARS	PART NO.	DESCRIPTION	
1	Spark Plug Tube Seal Set	2010-06	ES 72477	Valve Cover; New Part Number - Check for Availability	
QTY	VALVE STEM SEAL SET	YEARS	PART NO.	DESCRIPTION	
1	Valve Stem Seal Set	2010-06	SS 71180	Premium valve stem seals incl.	
QTY	WATER OUTLET GASKET	YEARS	PART NO.	DESCRIPTION	
1	Water Outlet Gasket	2010-06	25565	Water Outlet	
QTY	WATER PUMP	YEARS	PART NO.	DESCRIPTION	
1	Water Pump Gasket	2010-06	35676		
QTY	TIMING COVER	YEARS	PART NO.	DESCRIPTION	
1	Crankshaft Front Seal Set	2010-06	TCS 46040		
1	Camshaft Front Seal Set	2010-06	TCS 46038		
1	Camshaft Rear Seal Set	2010-06	TCS 46039		
QTY	CARB & FUEL INJECTION	YEARS	PART NO.	DESCRIPTION	
1	Throttle Body Gasket	2010-06	61370		
21		2002; 2.4L 148.6 (2435cc) DOHC L5 (20 Valve) 83mm Bore			21
		MFI; Gasoline; Turbo - Intercooled Volvo Eng.; Eng. Code B5244T			
QTY	CYLINDER HEAD	YEARS	PART NO.	DESCRIPTION	
1	Head Gasket	2002	26205 PT	Exc. Volvo S60 2.4T, 2.4T AWD, 2.4T FWD, AWD, GLT; Head bolts not incl.; Head bolt replacement recommended; PermaTorque®	
1	Head Gasket	2002	26256 PT	Volvo S60 2.4T, 2.4T AWD, 2.4T FWD, AWD, GLT; Head bolts not incl.; Head bolt replacement recommended; PermaTorque®	
1	Head Set	2002	HS 26205 PT	Exc. Volvo S60 2.4T, 2.4T AWD, 2.4T FWD, AWD, GLT; Head bolts & exh. pipe flange not incl.; Head bolt replacement recommended; RTV sealant incl. for valve cover gskt.; Premium valve stem seals incl.	
1	Head Set	2002	HS 26256 PT	Volvo S60 2.4T, 2.4T AWD, 2.4T FWD, AWD, GLT; Head bolts & exh. pipe flange not incl.; Head bolt replacement recommended; RTV sealant incl. for valve cover gskt.; Premium valve stem seals incl.	
1	Head Bolt Set	2002	ES 72908	Replacement recommended	
QTY	CONVERSION SET	YEARS	PART NO.	DESCRIPTION	
1	Gasket Conversion Set	2002	CS 26203	RTV sealant incl. for oil pan gskt.	
QTY	MANIFOLD - INT. & EXH.	YEARS	PART NO.	DESCRIPTION	
1	Int. Manifold Gasket Set	2002	MS 96154		
1	Exh. Manifold Gasket Set	2002	MS 96277		
QTY	EXHAUST PIPE FLANGE	YEARS	PART NO.	DESCRIPTION	
1	Exhaust Pipe Gasket	2002	61374	Flange	
QTY	CRANKSHAFT REAR SEAL	YEARS	PART NO.	DESCRIPTION	
1	Rear Main Seal Set	2002	BS 40677	Rubber; One-piece	
QTY	VALVE COVER	YEARS	PART NO.	DESCRIPTION	
1	Spark Plug Tube Seal Set	2002	ES 72477	Valve Cover; New Part Number - Check for Availability	
QTY	VALVE STEM SEAL SET	YEARS	PART NO.	DESCRIPTION	
1	Valve Stem Seal Set	2002	SS 71180	Premium valve stem seals incl.	
QTY	WATER OUTLET GASKET	YEARS	PART NO.	DESCRIPTION	
1	Water Outlet Gasket	2002	25565	Water Outlet	
QTY	WATER PUMP	YEARS	PART NO.	DESCRIPTION	
1	Water Pump Gasket	2002	35676		
QTY	TIMING COVER	YEARS	PART NO.	DESCRIPTION	
1	Crankshaft Front Seal Set	2002	TCS 46040		
1	Camshaft Front Seal Set	2002	TCS 46038		
1	Camshaft Rear Seal Set	2002	TCS 46039		
QTY	CARB & FUEL INJECTION	YEARS	PART NO.	DESCRIPTION	
1	Throttle Body Gasket	2002	61370		
22		2000 - 1998; 2.4L 148.6 (2435cc) DOHC L5 (20 Valve) 83mm Bore			22
		MFI; Gasoline; Turbo - Intercooled Volvo Eng.; Eng. Code B5244T2			
QTY	CYLINDER HEAD	YEARS	PART NO.	DESCRIPTION	
1	Head Gasket	2000	26203 PT	Head bolts not incl.; Head bolt replacement recommended; PermaTorque®	

Volvo Car (Cont.)

22 (cont.)		2000 - 1998; 2.4L 148.6 (2435cc) DOHC L5 (20 Valve) 83mm Bore			22 (cont.)
MFI; Gasoline; Turbo - Intercooled Volvo Eng.; Eng. Code B5244T2					
QTY	CYLINDER HEAD	YEARS	PART NO.	DESCRIPTION	
1	Head Gasket	1999-98	26204 PT	Head bolts not incl.; Head bolt replacement recommended; PermaTorque®	
1	Head Set	2000	HS 26203 PT-2	Head bolts not incl.; Head bolt replacement recommended; RTV sealant incl. for valve cover gskt.; Premium valve stem seals incl.	
1	Head Set	1999	HS 26204 PT-1	Head bolts not incl.; Head bolt replacement recommended; RTV sealant incl. for valve cover gskt.; Premium valve stem seals incl.	
1	Head Set	1998	HS 26204 PT	Head bolts not incl.; Head bolt replacement recommended; RTV sealant incl. for valve cover gskt.; Premium valve stem seals incl.	
1	Head Bolt Set	2000-98	ES 72908	Replacement recommended	
QTY	CONVERSION SET	YEARS	PART NO.	DESCRIPTION	
1	Gasket Conversion Set	2000-98	CS 26203	RTV sealant incl. for oil pan gskt.	
QTY	MANIFOLD - INT. & EXH.	YEARS	PART NO.	DESCRIPTION	
1	Int. Manifold Gasket Set	2000-99	MS 96154		
1	Int. Manifold Gasket Set	1998	MS 96153		
1	Exh. Manifold Gasket Set	2000-98	MS 96277		
QTY	CRANKSHAFT REAR SEAL	YEARS	PART NO.	DESCRIPTION	
1	Rear Main Seal Set	2000-98	BS 40677	Rubber; One-piece	
QTY	VALVE COVER	YEARS	PART NO.	DESCRIPTION	
1	Spark Plug Tube Seal Set	2000-98	ES 72477	Valve Cover; New Part Number - Check for Availability	
QTY	VALVE STEM SEAL SET	YEARS	PART NO.	DESCRIPTION	
1	Valve Stem Seal Set	2000-99	SS 71180	Premium valve stem seals incl.	
1	Valve Stem Seal Set	1998	SS 72848-1	Premium valve stem seals incl.	
QTY	WATER OUTLET GASKET	YEARS	PART NO.	DESCRIPTION	
1	Water Outlet Gasket	2000-98	25565	Water Outlet	
QTY	WATER PUMP	YEARS	PART NO.	DESCRIPTION	
1	Water Pump Gasket	2000-98	35676		
QTY	TIMING COVER	YEARS	PART NO.	DESCRIPTION	
1	Crankshaft Front Seal Set	2000-98	TCS 46040		
1	Camshaft Front Seal Set	2000-99	TCS 46038		
1	Camshaft Front Seal Set	1998	TCS 46037		
1	Camshaft Rear Seal Set	2000-98	TCS 46039		
QTY	CARB & FUEL INJECTION	YEARS	PART NO.	DESCRIPTION	
1	Throttle Body Gasket	2000-99	61370		
1	Throttle Body Gasket	1998	61211		
QTY	EXHAUST GAS RECIRCULATION	YEARS	PART NO.	DESCRIPTION	
1	EGR Gasket	1998	70982		

23		2008 - 1999; 2.4L 148.6 (2435cc) DOHC L5 (20 Valve) 83mm Bore			23
MFI; Gasoline; Turbo - Intercooled Volvo Eng.; Eng. Code B5244T3					
QTY	CYLINDER HEAD	YEARS	PART NO.	DESCRIPTION	
1	Head Gasket	2008-04	26256 PT	Volvo S60 2.4T; Head bolts not incl.; Head bolt replacement recommended; PermaTorque®	
1	Head Gasket	2008-06	26205 PT	Volvo V70 2.4T; Head bolts not incl.; Head bolt replacement recommended; PermaTorque®	
1	Head Gasket	2005-04	26205 PT	Exc. Volvo S60 2.4T; Head bolts not incl.; Head bolt replacement recommended; PermaTorque®	
1	Head Gasket	2003	26205 PT	Exc. Volvo S60 2.4T, AWD; Head bolts not incl.; Head bolt replacement recommended; PermaTorque®	
1	Head Gasket	2003	26256 PT	Volvo S60 2.4T, AWD; Head bolts not incl.; Head bolt replacement recommended; PermaTorque®	
1	Head Gasket	2002	26205 PT	Exc. Volvo S60 2.4T, 2.4T AWD, 2.4T FWD, AWD, GLT; Head bolts not incl.; Head bolt replacement recommended; PermaTorque®	
1	Head Gasket	2002	26256 PT	Volvo S60 2.4T, 2.4T AWD, 2.4T FWD, AWD, GLT; Head bolts not incl.; Head bolt replacement recommended; PermaTorque®	
1	Head Gasket	2001	26205 PT	Exc. Volvo S60 2.4T, 2.4T AWD, 2.4T FWD, GLT; Head bolts not incl.; Head bolt replacement recommended; PermaTorque®	
1	Head Gasket	2001	26256 PT	Volvo S60 2.4T, 2.4T AWD, 2.4T FWD, GLT; Head bolts not incl.; Head bolt replacement recommended; PermaTorque®	
1	Head Gasket	2000	26203 PT	Exc. Volvo S70 GLT, GLT SE, V70 GLT, GLT SE; Head bolts not incl.; Head bolt replacement recommended; PermaTorque®	
1	Head Gasket	2000	26256 PT	Volvo S70 GLT, GLT SE, V70 GLT, GLT SE; Head bolts not incl.; Head bolt replacement recommended; PermaTorque®	
1	Head Gasket	1999	26204 PT	Head bolts not incl.; Head bolt replacement recommended; PermaTorque®	

23 (cont.)		2008 - 1999; 2.4L 148.6 (2435cc) DOHC L5 (20 Valve) 83mm Bore			23 (cont.)
		MFI; Gasoline; Turbo - Intercooled Volvo Eng.; Eng. Code B5244T3			
QTY	CYLINDER HEAD	YEARS	PART NO.	DESCRIPTION	
1	Head Set	2008-04	HS 26256 PT	Volvo S60 2.4T; Head bolts & exh. pipe flange not incl.; Head bolt replacement recommended; RTV sealant incl. for valve cover gskt.; Premium valve stem seals incl.	
1	Head Set	2008-06	HS 26205 PT	Volvo V70 2.4T; Head bolts & exh. pipe flange not incl.; Head bolt replacement recommended; RTV sealant incl. for valve cover gskt.; Premium valve stem seals incl.	
1	Head Set	2005-04	HS 26205 PT	Exc. Volvo S60 2.4T; Head bolts & exh. pipe flange not incl.; Head bolt replacement recommended; RTV sealant incl. for valve cover gskt.; Premium valve stem seals incl.	
1	Head Set	2003	HS 26205 PT	Exc. Volvo S60 2.4T, AWD; Head bolts & exh. pipe flange not incl.; Head bolt replacement recommended; RTV sealant incl. for valve cover gskt.; Premium valve stem seals incl.	
1	Head Set	2003	HS 26256 PT	Volvo S60 2.4T, AWD; Head bolts & exh. pipe flange not incl.; Head bolt replacement recommended; RTV sealant incl. for valve cover gskt.; Premium valve stem seals incl.	
1	Head Set	2002	HS 26205 PT	Exc. Volvo S60 2.4T, 2.4T AWD, 2.4T FWD, AWD, GLT; Head bolts & exh. pipe flange not incl.; Head bolt replacement recommended; RTV sealant incl. for valve cover gskt.; Premium valve stem seals incl.	
1	Head Set	2002	HS 26256 PT	Volvo S60 2.4T, 2.4T AWD, 2.4T FWD, AWD, GLT; Head bolts & exh. pipe flange not incl.; Head bolt replacement recommended; RTV sealant incl. for valve cover gskt.; Premium valve stem seals incl.	
1	Head Set	2001	HS 26205 PT	Exc. Volvo S60 2.4T, 2.4T AWD, 2.4T FWD, GLT; Head bolts & exh. pipe flange not incl.; Head bolt replacement recommended; RTV sealant incl. for valve cover gskt.; Premium valve stem seals incl.	
1	Head Set	2001	HS 26256 PT	Volvo S60 2.4T, 2.4T AWD, 2.4T FWD, GLT; Head bolts & exh. pipe flange not incl.; Head bolt replacement recommended; RTV sealant incl. for valve cover gskt.; Premium valve stem seals incl.	
1	Head Set	2000	HS 26203 PT-2	Exc. Volvo S70 GLT, GLT SE, V70 GLT, GLT SE; Head bolts not incl.; Head bolt replacement recommended; RTV sealant incl. for valve cover gskt.; Premium valve stem seals incl.	
1	Head Set	2000	HS 26256 PT	Volvo S70 GLT, GLT SE, V70 GLT, GLT SE; Head bolts not incl.; Head bolt replacement recommended; RTV sealant incl. for valve cover gskt.; Premium valve stem seals incl.	
1	Head Set	1999	HS 26204 PT-1	Head bolts not incl.; Head bolt replacement recommended; RTV sealant incl. for valve cover gskt.; Premium valve stem seals incl.	
1	Head Bolt Set	2008-99	ES 72908	Replacement recommended	
QTY	CONVERSION SET	YEARS	PART NO.	DESCRIPTION	
1	Gasket Conversion Set	2008-99	CS 26203	RTV sealant incl. for oil pan gskt.	
QTY	MANIFOLD - INT. & EXH.	YEARS	PART NO.	DESCRIPTION	
1	Int. Manifold Gasket Set	2008-99	MS 96154		
1	Exh. Manifold Gasket Set	2008-99	MS 96277		
QTY	EXHAUST PIPE FLANGE	YEARS	PART NO.	DESCRIPTION	
1	Exhaust Pipe Gasket	2008-01	61374	Flange	
QTY	CRANKSHAFT REAR SEAL	YEARS	PART NO.	DESCRIPTION	
1	Rear Main Seal Set	2008-99	BS 40677	Rubber; One-piece	
QTY	VALVE COVER	YEARS	PART NO.	DESCRIPTION	
1	Spark Plug Tube Seal Set	2008-99	ES 72477	Valve Cover; New Part Number - Check for Availability	
QTY	VALVE STEM SEAL SET	YEARS	PART NO.	DESCRIPTION	
1	Valve Stem Seal Set	2008-99	SS 71180	Premium valve stem seals incl.	
QTY	WATER OUTLET GASKET	YEARS	PART NO.	DESCRIPTION	
1	Water Outlet Gasket	2008-99	25565	Water Outlet	
QTY	WATER PUMP	YEARS	PART NO.	DESCRIPTION	
1	Water Pump Gasket	2008-99	35676		
QTY	TIMING COVER	YEARS	PART NO.	DESCRIPTION	
1	Crankshaft Front Seal Set	2008-99	TCS 46040		
1	Camshaft Front Seal Set	2008-99	TCS 46038		
1	Camshaft Rear Seal Set	2008-99	TCS 46039		
QTY	CARB & FUEL INJECTION	YEARS	PART NO.	DESCRIPTION	
1	Throttle Body Gasket	2008-99	61370		
24		2005 - 1993; 2.4L 148.6 (2435cc) DOHC L5 (20 Valve) 83mm Bore			24
		MFI; Gasoline; Naturally Aspirated Volvo Eng.; Eng. Code B5254FS			
QTY	CYLINDER HEAD	YEARS	PART NO.	DESCRIPTION	
1	Head Gasket	2005-00	26256 PT	Head bolts not incl.; Head bolt replacement recommended; PermaTorque®	

Volvo Car (Cont.)

24 (cont.)		2005 - 1993; 2.4L 148.6 (2435cc) DOHC L5 (20 Valve) 83mm Bore			24 (cont.)
		MFI; Gasoline; Naturally Aspirated Volvo Eng.; Eng. Code B5254FS			
QTY	CYLINDER HEAD	YEARS	PART NO.	DESCRIPTION	
1	Head Gasket	1999	26204 PT	Head bolts not incl.; Head bolt replacement recommended; PermaTorque®	
1	Head Gasket	1998-93	26203 PT	Head bolts not incl.; Head bolt replacement recommended; PermaTorque®	
1	Head Set	2005-00	HS 26256 PT	Head bolts & exh. pipe flange not incl.; Head bolt replacement recommended; RTV sealant incl. for valve cover gskt.; Premium valve stem seals incl.	
1	Head Set	1999	HS 26204 PT-1	Head bolts not incl.; Head bolt replacement recommended; RTV sealant incl. for valve cover gskt.; Premium valve stem seals incl.	
1	Head Set	1998	HS 26203 PT-1	Head bolts not incl.; Head bolt replacement recommended; RTV sealant incl. for valve cover gskt.; Premium valve stem seals incl.	
1	Head Set	1997-93	HS 26203 PT	Head bolts not incl.; Head bolt replacement recommended; RTV sealant incl. for valve cover gskt.; Premium valve stem seals incl.	
1	Head Bolt Set	2005-93	ES 72908	Replacement recommended	
QTY	CONVERSION SET	YEARS	PART NO.	DESCRIPTION	
1	Gasket Conversion Set	2005-93	CS 26203	RTV sealant incl. for oil pan gskt.	
QTY	MANIFOLD - INT. & EXH.	YEARS	PART NO.	DESCRIPTION	
1	Int. Manifold Gasket Set	2005-99	MS 96154		
1	Int. Manifold Gasket Set	1998	MS 96153		
1	Int. Manifold Gasket Set	1997-93	MS 96152		
1	Exh. Manifold Gasket Set	2005-93	MS 96277		
QTY	EXHAUST PIPE FLANGE	YEARS	PART NO.	DESCRIPTION	
1	Exhaust Pipe Gasket	2005-03	61369	Flange	
1	Exhaust Pipe Gasket	2002-00	61368	Flange	
1	Exhaust Pipe Gasket	1997-93	61264	Flange	
QTY	CRANKSHAFT REAR SEAL	YEARS	PART NO.	DESCRIPTION	
1	Rear Main Seal Set	2005-93	BS 40677	Rubber; One-piece	
QTY	VALVE COVER	YEARS	PART NO.	DESCRIPTION	
1	Spark Plug Tube Seal Set	2005-93	ES 72477	Valve Cover; New Part Number - Check for Availability	
QTY	VALVE STEM SEAL SET	YEARS	PART NO.	DESCRIPTION	
1	Valve Stem Seal Set	2005-99	SS 71180	Premium valve stem seals incl.	
1	Valve Stem Seal Set	1998-93	SS 72848-1	Premium valve stem seals incl.	
QTY	WATER OUTLET GASKET	YEARS	PART NO.	DESCRIPTION	
1	Water Outlet Gasket	2005-93	25565	Water Outlet	
QTY	WATER PUMP	YEARS	PART NO.	DESCRIPTION	
1	Water Pump Gasket	2005-93	35676		
QTY	TIMING COVER	YEARS	PART NO.	DESCRIPTION	
1	Crankshaft Front Seal Set	2005-93	TCS 46040		
1	Camshaft Front Seal Set	2005-99	TCS 46038		
1	Camshaft Front Seal Set	1998-93	TCS 46037		
1	Camshaft Rear Seal Set	2005-93	TCS 46039		
QTY	CARB & FUEL INJECTION	YEARS	PART NO.	DESCRIPTION	
1	Throttle Body Gasket	2005-99	61370		
1	Throttle Body Gasket	1998-93	61211		
QTY	EXHAUST GAS RECIRCULATION	YEARS	PART NO.	DESCRIPTION	
1	EGR Gasket	1998-93	70982		
25		2008 - 1998; 2.4L 148.6 (2435cc) DOHC L5 (20 Valve) 83mm Bore			25
		MFI; Gasoline; Turbo - Intercooled Volvo Eng.; Eng. Code B5254FT			
QTY	CYLINDER HEAD	YEARS	PART NO.	DESCRIPTION	
1	Head Gasket	2008-04	26256 PT	Volvo S60 2.4T; Head bolts not incl.; Head bolt replacement recommended; PermaTorque®	
1	Head Gasket	2008-06	26205 PT	Volvo V70 2.4T; Head bolts not incl.; Head bolt replacement recommended; PermaTorque®	
1	Head Gasket	2005	26205 PT	Exc. Volvo S60 2.4T; Head bolts not incl.; Head bolt replacement recommended; PermaTorque®	
1	Head Gasket	2004	26205 PT	Volvo V70 2.4T; Head bolts not incl.; Head bolt replacement recommended; PermaTorque®	
1	Head Gasket	2003	26205 PT	Volvo V70 2.4T, AWD; Head bolts not incl.; Head bolt replacement recommended; PermaTorque®	
1	Head Gasket	2003	26256 PT	Volvo S60 2.4T, AWD; Head bolts not incl.; Head bolt replacement recommended; PermaTorque®	
1	Head Gasket	2002	26205 PT	Volvo V70 2.4T, 2.4T AWD, 2.4T FWD, AWD, XC; Head bolts not incl.; Head bolt replacement recommended; PermaTorque®	

25 (cont.)		2008 - 1998; 2.4L 148.6 (2435cc) DOHC L5 (20 Valve) 83mm Bore MFI; Gasoline; Turbo - Intercooled Volvo Eng.; Eng. Code B5254FT			25 (cont.)
QTY	CYLINDER HEAD	YEARS	PART NO.	DESCRIPTION	
1	Head Gasket	2002	26256 PT	Volvo S60 2.4T, 2.4T AWD, 2.4T FWD, AWD, GLT; Head bolts not incl.; Head bolt replacement recommended; PermaTorque®	
1	Head Gasket	2001	26205 PT	Volvo V70 2.4T, 2.4T AWD, 2.4T FWD, XC; Head bolts not incl.; Head bolt replacement recommended; PermaTorque®	
1	Head Gasket	2001	26256 PT	Volvo S60 2.4T, 2.4T AWD, 2.4T FWD, GLT; Head bolts not incl.; Head bolt replacement recommended; PermaTorque®	
1	Head Gasket	2000	26203 PT	Volvo S70 AWD, V70 AWD, XC AWD, XC AWD SE; Head bolts not incl.; Head bolt replacement recommended; PermaTorque®	
1	Head Gasket	2000	26256 PT	Volvo S70 GLT, GLT SE, V70 GLT, GLT SE; Head bolts not incl.; Head bolt replacement recommended; PermaTorque®	
1	Head Gasket	1999-98	26204 PT	Head bolts not incl.; Head bolt replacement recommended; PermaTorque®	
1	Head Set	2008-04	HS 26256 PT	Volvo S60 2.4T; Head bolts & exh. pipe flange not incl.; Head bolt replacement recommended; RTV sealant incl. for valve cover gskt.; Premium valve stem seals incl.	
1	Head Set	2008-06	HS 26205 PT	Volvo V70 2.4T; Head bolts & exh. pipe flange not incl.; Head bolt replacement recommended; RTV sealant incl. for valve cover gskt.; Premium valve stem seals incl.	
1	Head Set	2005	HS 26205 PT	Exc. Volvo S60 2.4T; Head bolts & exh. pipe flange not incl.; Head bolt replacement recommended; RTV sealant incl. for valve cover gskt.; Premium valve stem seals incl.	
1	Head Set	2004	HS 26205 PT	Volvo V70 2.4T; Head bolts & exh. pipe flange not incl.; Head bolt replacement recommended; RTV sealant incl. for valve cover gskt.; Premium valve stem seals incl.	
1	Head Set	2003	HS 26205 PT	Volvo V70 2.4T, AWD; Head bolts & exh. pipe flange not incl.; Head bolt replacement recommended; RTV sealant incl. for valve cover gskt.; Premium valve stem seals incl.	
1	Head Set	2003	HS 26256 PT	Volvo S60 2.4T, AWD; Head bolts & exh. pipe flange not incl.; Head bolt replacement recommended; RTV sealant incl. for valve cover gskt.; Premium valve stem seals incl.	
1	Head Set	2002	HS 26205 PT	Volvo V70 2.4T, 2.4T AWD, 2.4T FWD, AWD, XC; Head bolts & exh. pipe flange not incl.; Head bolt replacement recommended; RTV sealant incl. for valve cover gskt.; Premium valve stem seals incl.	
1	Head Set	2002	HS 26256 PT	Volvo S60 2.4T, 2.4T AWD, 2.4T FWD, AWD, GLT; Head bolts & exh. pipe flange not incl.; Head bolt replacement recommended; RTV sealant incl. for valve cover gskt.; Premium valve stem seals incl.	
1	Head Set	2001	HS 26205 PT	Volvo V70 2.4T, 2.4T AWD, 2.4T FWD, XC; Head bolts & exh. pipe flange not incl.; Head bolt replacement recommended; RTV sealant incl. for valve cover gskt.; Premium valve stem seals incl.	
1	Head Set	2001	HS 26256 PT	Volvo S60 2.4T, 2.4T AWD, 2.4T FWD, GLT; Head bolts & exh. pipe flange not incl.; Head bolt replacement recommended; RTV sealant incl. for valve cover gskt.; Premium valve stem seals incl.	
1	Head Set	2000	HS 26203 PT-2	Volvo S70 AWD, V70 AWD, XC AWD, XC AWD SE; Head bolts not incl.; Head bolt replacement recommended; RTV sealant incl. for valve cover gskt.; Premium valve stem seals incl.	
1	Head Set	2000	HS 26256 PT	Volvo S70 GLT, GLT SE, V70 GLT, GLT SE; Head bolts not incl.; Head bolt replacement recommended; RTV sealant incl. for valve cover gskt.; Premium valve stem seals incl.	
1	Head Set	1999	HS 26204 PT-1	Head bolts not incl.; Head bolt replacement recommended; RTV sealant incl. for valve cover gskt.; Premium valve stem seals incl.	
1	Head Set	1998	HS 26204 PT	Head bolts not incl.; Head bolt replacement recommended; RTV sealant incl. for valve cover gskt.; Premium valve stem seals incl.	
1	Head Bolt Set	2008-98	ES 72908	Replacement recommended	
QTY	CONVERSION SET	YEARS	PART NO.	DESCRIPTION	
1	Gasket Conversion Set	2008-98	CS 26203	RTV sealant incl. for oil pan gskt.	
QTY	MANIFOLD - INT. & EXH.	YEARS	PART NO.	DESCRIPTION	
1	Int. Manifold Gasket Set	2008-99	MS 96154		
1	Int. Manifold Gasket Set	1998	MS 96153		
1	Exh. Manifold Gasket Set	2008-98	MS 96277		
QTY	EXHAUST PIPE FLANGE	YEARS	PART NO.	DESCRIPTION	
1	Exhaust Pipe Gasket	2008-01	61374	Flange	
QTY	CRANKSHAFT REAR SEAL	YEARS	PART NO.	DESCRIPTION	
1	Rear Main Seal Set	2008-98	BS 40677	Rubber; One-piece	
QTY	VALVE COVER	YEARS	PART NO.	DESCRIPTION	
1	Spark Plug Tube Seal Set	2008-98	ES 72477	Valve Cover; New Part Number - Check for Availability	

Volvo Car (Cont.)

25		2008 - 1998; 2.4L 148.6 (2435cc) DOHC L5 (20 Valve) 83mm Bore			25	
(cont.)		MFI; Gasoline; Turbo - Intercooled Volvo Eng.; Eng. Code B5254FT			(cont.)	
QTY	VALVE STEM SEAL SET	YEARS	PART NO.	DESCRIPTION		
1	Valve Stem Seal Set	2008-99	SS 71180	Premium valve stem seals incl.		
1	Valve Stem Seal Set	1998	SS 72848-1	Premium valve stem seals incl.		
QTY	WATER OUTLET GASKET	YEARS	PART NO.	DESCRIPTION		
1	Water Outlet Gasket	2008-98	25565	Water Outlet		
QTY	WATER PUMP	YEARS	PART NO.	DESCRIPTION		
1	Water Pump Gasket	2008-98	35676			
QTY	TIMING COVER	YEARS	PART NO.	DESCRIPTION		
1	Crankshaft Front Seal Set	2008-98	TCS 46040			
1	Camshaft Front Seal Set	2008-99	TCS 46038			
1	Camshaft Front Seal Set	1998	TCS 46037			
1	Camshaft Rear Seal Set	2008-98	TCS 46039			
QTY	CARB & FUEL INJECTION	YEARS	PART NO.	DESCRIPTION		
1	Throttle Body Gasket	2008-99	61370			
1	Throttle Body Gasket	1998	61211			
QTY	EXHAUST GAS RECIRCULATION	YEARS	PART NO.	DESCRIPTION		
1	EGR Gasket	1998	70982			
26		2005 - 1993; 2.4L 148.6 (2435cc) DOHC L5 (20 Valve) 83mm Bore			26	
		MFI; Gasoline; Naturally Aspirated Volvo Eng.; Eng. Code B5254S				
QTY	CYLINDER HEAD	YEARS	PART NO.	DESCRIPTION		
1	Head Gasket	2005-00	26256 PT	Head bolts not incl.; Head bolt replacement recommended; PermaTorque®		
1	Head Gasket	1999	26204 PT	Head bolts not incl.; Head bolt replacement recommended; PermaTorque®		
1	Head Gasket	1998-93	26203 PT	Head bolts not incl.; Head bolt replacement recommended; PermaTorque®		
1	Head Set	2005-00	HS 26256 PT	Head bolts & exh. pipe flange not incl.; Head bolt replacement recommended; RTV sealant incl. for valve cover gskt.; Premium valve stem seals incl.		
1	Head Set	1999	HS 26204 PT-1	Head bolts not incl.; Head bolt replacement recommended; RTV sealant incl. for valve cover gskt.; Premium valve stem seals incl.		
1	Head Set	1998	HS 26203 PT-1	Head bolts not incl.; Head bolt replacement recommended; RTV sealant incl. for valve cover gskt.; Premium valve stem seals incl.		
1	Head Set	1997-93	HS 26203 PT	Head bolts not incl.; Head bolt replacement recommended; RTV sealant incl. for valve cover gskt.; Premium valve stem seals incl.		
1	Head Bolt Set	2005-93	ES 72908	Replacement recommended		
QTY	CONVERSION SET	YEARS	PART NO.	DESCRIPTION		
1	Gasket Conversion Set	2005-93	CS 26203	RTV sealant incl. for oil pan gskt.		
QTY	MANIFOLD - INT. & EXH.	YEARS	PART NO.	DESCRIPTION		
1	Int. Manifold Gasket Set	2005-99	MS 96154			
1	Int. Manifold Gasket Set	1998	MS 96153			
1	Int. Manifold Gasket Set	1997-93	MS 96152			
1	Exh. Manifold Gasket Set	2005-93	MS 96277			
QTY	EXHAUST PIPE FLANGE	YEARS	PART NO.	DESCRIPTION		
1	Exhaust Pipe Gasket	2005-03	61369	Flange		
1	Exhaust Pipe Gasket	2002-00	61368	Flange		
1	Exhaust Pipe Gasket	1997-93	61264	Flange		
QTY	CRANKSHAFT REAR SEAL	YEARS	PART NO.	DESCRIPTION		
1	Rear Main Seal Set	2005-93	BS 40677	Rubber; One-piece		
QTY	VALVE COVER	YEARS	PART NO.	DESCRIPTION		
1	Spark Plug Tube Seal Set	2005-93	ES 72477	Valve Cover; New Part Number - Check for Availability		
QTY	VALVE STEM SEAL SET	YEARS	PART NO.	DESCRIPTION		
1	Valve Stem Seal Set	2005-99	SS 71180	Premium valve stem seals incl.		
1	Valve Stem Seal Set	1998-93	SS 72848-1	Premium valve stem seals incl.		
QTY	WATER OUTLET GASKET	YEARS	PART NO.	DESCRIPTION		
1	Water Outlet Gasket	2005-93	25565	Water Outlet		
QTY	WATER PUMP	YEARS	PART NO.	DESCRIPTION		
1	Water Pump Gasket	2005-93	35676			
QTY	TIMING COVER	YEARS	PART NO.	DESCRIPTION		
1	Crankshaft Front Seal Set	2005-93	TCS 46040			
1	Camshaft Front Seal Set	2005-99	TCS 46038			
1	Camshaft Front Seal Set	1998-93	TCS 46037			
1	Camshaft Rear Seal Set	2005-93	TCS 46039			
QTY	CARB & FUEL INJECTION	YEARS	PART NO.	DESCRIPTION		
1	Throttle Body Gasket	2005-99	61370			
1	Throttle Body Gasket	1998-93	61211			
QTY	EXHAUST GAS RECIRCULATION	YEARS	PART NO.	DESCRIPTION		
1	EGR Gasket	1998-93	70982			

27		2008 - 1997; 2.4L 148.6 (2435cc) DOHC L5 (20 Valve) 83mm Bore MFI; Gasoline; Turbo - Intercooled Volvo Eng.; Eng. Code B5254T			27
QTY	CYLINDER HEAD	YEARS	PART NO.	DESCRIPTION	
1	Head Gasket	2008-04	26256 PT	Volvo S60 2.4T; Head bolts not incl.; Head bolt replacement recommended; PermaTorque®	
1	Head Gasket	2008-06	26205 PT	Volvo V70 2.4T; Head bolts not incl.; Head bolt replacement recommended; PermaTorque®	
1	Head Gasket	2005-04	26205 PT	Exc. Volvo S60 2.4T; Head bolts not incl.; Head bolt replacement recommended; PermaTorque®	
1	Head Gasket	2003	26205 PT	Exc. Volvo S60 2.4T, AWD; Head bolts not incl.; Head bolt replacement recommended; PermaTorque®	
1	Head Gasket	2003	26256 PT	Volvo S60 2.4T, AWD; Head bolts not incl.; Head bolt replacement recommended; PermaTorque®	
1	Head Gasket	2002	26205 PT	Exc. Volvo S60 2.4T, 2.4T AWD, 2.4T FWD, AWD, GLT; Head bolts not incl.; Head bolt replacement recommended; PermaTorque®	
1	Head Gasket	2002	26256 PT	Volvo S60 2.4T, 2.4T AWD, 2.4T FWD, AWD, GLT; Head bolts not incl.; Head bolt replacement recommended; PermaTorque®	
1	Head Gasket	2001	26205 PT	Exc. Volvo S60 2.4T, 2.4T AWD, 2.4T FWD, GLT; Head bolts not incl.; Head bolt replacement recommended; PermaTorque®	
1	Head Gasket	2001	26256 PT	Volvo S60 2.4T, 2.4T AWD, 2.4T FWD, GLT; Head bolts not incl.; Head bolt replacement recommended; PermaTorque®	
1	Head Gasket	2000	26203 PT	Exc. Volvo S70 GLT, GLT SE, V70 GLT, GLT SE; Head bolts not incl.; Head bolt replacement recommended; PermaTorque®	
1	Head Gasket	2000	26256 PT	Volvo S70 GLT, GLT SE, V70 GLT, GLT SE; Head bolts not incl.; Head bolt replacement recommended; PermaTorque®	
1	Head Gasket	1999-98	26204 PT	Head bolts not incl.; Head bolt replacement recommended; PermaTorque®	
1	Head Gasket	1997	26203 PT	Head bolts not incl.; Head bolt replacement recommended; PermaTorque®	
1	Head Set	2008-04	HS 26256 PT	Volvo S60 2.4T; Head bolts & exh. pipe flange not incl.; Head bolt replacement recommended; RTV sealant incl. for valve cover gskt.; Premium valve stem seals incl.	
1	Head Set	2008-06	HS 26205 PT	Volvo V70 2.4T; Head bolts & exh. pipe flange not incl.; Head bolt replacement recommended; RTV sealant incl. for valve cover gskt.; Premium valve stem seals incl.	
1	Head Set	2005-04	HS 26205 PT	Exc. Volvo S60 2.4T; Head bolts & exh. pipe flange not incl.; Head bolt replacement recommended; RTV sealant incl. for valve cover gskt.; Premium valve stem seals incl.	
1	Head Set	2003	HS 26205 PT	Exc. Volvo S60 2.4T, AWD; Head bolts & exh. pipe flange not incl.; Head bolt replacement recommended; RTV sealant incl. for valve cover gskt.; Premium valve stem seals incl.	
1	Head Set	2003	HS 26256 PT	Volvo S60 2.4T, AWD; Head bolts & exh. pipe flange not incl.; Head bolt replacement recommended; RTV sealant incl. for valve cover gskt.; Premium valve stem seals incl.	
1	Head Set	2002	HS 26205 PT	Exc. Volvo S60 2.4T, 2.4T AWD, 2.4T FWD, AWD, GLT; Head bolts & exh. pipe flange not incl.; Head bolt replacement recommended; RTV sealant incl. for valve cover gskt.; Premium valve stem seals incl.	
1	Head Set	2002	HS 26256 PT	Volvo S60 2.4T, 2.4T AWD, 2.4T FWD, AWD, GLT; Head bolts & exh. pipe flange not incl.; Head bolt replacement recommended; RTV sealant incl. for valve cover gskt.; Premium valve stem seals incl.	
1	Head Set	2001	HS 26205 PT	Exc. Volvo S60 2.4T, 2.4T AWD, 2.4T FWD, GLT; Head bolts & exh. pipe flange not incl.; Head bolt replacement recommended; RTV sealant incl. for valve cover gskt.; Premium valve stem seals incl.	
1	Head Set	2001	HS 26256 PT	Volvo S60 2.4T, 2.4T AWD, 2.4T FWD, GLT; Head bolts & exh. pipe flange not incl.; Head bolt replacement recommended; RTV sealant incl. for valve cover gskt.; Premium valve stem seals incl.	
1	Head Set	2000	HS 26203 PT-2	Exc. Volvo S70 GLT, GLT SE, V70 GLT, GLT SE; Head bolts not incl.; Head bolt replacement recommended; RTV sealant incl. for valve cover gskt.; Premium valve stem seals incl.	
1	Head Set	2000	HS 26256 PT	Volvo S70 GLT, GLT SE, V70 GLT, GLT SE; Head bolts not incl.; Head bolt replacement recommended; RTV sealant incl. for valve cover gskt.; Premium valve stem seals incl.	
1	Head Set	1999	HS 26204 PT-1	Head bolts not incl.; Head bolt replacement recommended; RTV sealant incl. for valve cover gskt.; Premium valve stem seals incl.	
1	Head Set	1998	HS 26204 PT	Head bolts not incl.; Head bolt replacement recommended; RTV sealant incl. for valve cover gskt.; Premium valve stem seals incl.	
1	Head Set	1997	HS 26203 PT	Head bolts not incl.; Head bolt replacement recommended; RTV sealant incl. for valve cover gskt.; Premium valve stem seals incl.	
1	Head Bolt Set	2008-97	ES 72908	Replacement recommended	
QTY	CONVERSION SET	YEARS	PART NO.	DESCRIPTION	
1	Gasket Conversion Set	2008-97	CS 26203	RTV sealant incl. for oil pan gskt.	

Volvo Car (Cont.)

27 (cont.)		2008 - 1997; 2.4L 148.6 (2435cc) DOHC L5 (20 Valve) 83mm Bore			27 (cont.)
		MFI; Gasoline; Turbo - Intercooled Volvo Eng.; Eng. Code B5254T			
QTY	MANIFOLD - INT. & EXH.	YEARS	PART NO.	DESCRIPTION	
1	Int. Manifold Gasket Set	2008-99	MS 96154		
1	Int. Manifold Gasket Set	1998	MS 96153		
1	Int. Manifold Gasket Set	1997	MS 96152		
1	Exh. Manifold Gasket Set	2008-97	MS 96277		
QTY	EXHAUST PIPE FLANGE	YEARS	PART NO.	DESCRIPTION	
1	Exhaust Pipe Gasket	2008-01	61374	Flange	
1	Exhaust Pipe Gasket	1997	61264	Flange	
QTY	CRANKSHAFT REAR SEAL	YEARS	PART NO.	DESCRIPTION	
1	Rear Main Seal Set	2008-97	BS 40677	Rubber; One-piece	
QTY	VALVE COVER	YEARS	PART NO.	DESCRIPTION	
1	Spark Plug Tube Seal Set	2008-97	ES 72477	Valve Cover; New Part Number - Check for Availability	
QTY	VALVE STEM SEAL SET	YEARS	PART NO.	DESCRIPTION	
1	Valve Stem Seal Set	2008-99	SS 71180	Premium valve stem seals incl.	
1	Valve Stem Seal Set	1998-97	SS 72848-1	Premium valve stem seals incl.	
QTY	WATER OUTLET GASKET	YEARS	PART NO.	DESCRIPTION	
1	Water Outlet Gasket	2008-97	25565	Water Outlet	
QTY	WATER PUMP	YEARS	PART NO.	DESCRIPTION	
1	Water Pump Gasket	2008-97	35676		
QTY	TIMING COVER	YEARS	PART NO.	DESCRIPTION	
1	Crankshaft Front Seal Set	2008-97	TCS 46040		
1	Camshaft Front Seal Set	2008-99	TCS 46038		
1	Camshaft Front Seal Set	1998-97	TCS 46037		
1	Camshaft Rear Seal Set	2008-97	TCS 46039		
QTY	CARB & FUEL INJECTION	YEARS	PART NO.	DESCRIPTION	
1	Throttle Body Gasket	2008-99	61370		
1	Throttle Body Gasket	1998-97	61211		
QTY	EXHAUST GAS RECIRCULATION	YEARS	PART NO.	DESCRIPTION	
1	EGR Gasket	1998-97	70982		
28		2010 - 2003; 2.5L 153.8 (2521cc) DOHC L5 (20 Valve) 83mm Bore			28
		MFI; Gasoline; Turbo - Intercooled Volvo Eng.; Eng. Code B5254T2			
QTY	CYLINDER HEAD	YEARS	PART NO.	DESCRIPTION	
1	Head Gasket	2010-03	26639 PT	Head bolts not incl.; Head bolt replacement recommended; PermaTorqueMLS®; New Part Number - Check for Availability	
1	Head Gasket	2010-07	26256 PT	Head bolts not incl.; Head bolt replacement recommended; PermaTorque®	
1	Head Gasket	2006-04	26205 PT	Volvo S80 2.5T, 2.5T AWD, 2.5T FWD; Head bolts not incl.; Head bolt replacement recommended; PermaTorque®	
1	Head Gasket	2006-04	26256 PT	Exc. Volvo S80 2.5T, 2.5T AWD, 2.5T FWD; Head bolts not incl.; Head bolt replacement recommended; PermaTorque®	
1	Head Gasket	2003	26256 PT	Head bolts not incl.; Head bolt replacement recommended; PermaTorque®	
1	Head Set	2010-07	HS 26256 PT	Head bolts, VVT front camshaft seals, exh. pipe flange not incl.; Head bolt replacement recommended; RTV sealant incl. for valve cover gskt.; Premium valve stem seals incl.	
1	Head Set	2006-04	HS 26205 PT	Volvo S80 2.5T, 2.5T AWD, 2.5T FWD; Head bolts, 7mm valve stem diameter seals, VVT front camshaft seals, exh. pipe flange not incl.; Head bolt replacement recommended; RTV sealant incl. for valve cover gskt.; Premium valve stem seals incl.	
1	Head Set	2006-04	HS 26256 PT	Exc. Volvo S80 2.5T, 2.5T AWD, 2.5T FWD; Head bolts, VVT front camshaft seals, exh. pipe flange not incl.; Head bolt replacement recommended; RTV sealant incl. for valve cover gskt.; Premium valve stem seals incl.	
1	Head Set	2003	HS 26256 PT	Head bolts, VVT front camshaft seals, exh. pipe flange not incl.; Head bolt replacement recommended; RTV sealant incl. for valve cover gskt.; Premium valve stem seals incl.	
1	Head Bolt Set	2010-03	ES 72908	Replacement recommended	
QTY	CONVERSION SET	YEARS	PART NO.	DESCRIPTION	
1	Gasket Conversion Set	2010-03	CS 26203	RTV sealant incl. for oil pan gskt.	
QTY	MANIFOLD - INT. & EXH.	YEARS	PART NO.	DESCRIPTION	
1	Int. Manifold Gasket Set	2010-03	MS 96154		
1	Exh. Manifold Gasket Set	2010-03	MS 96277		
QTY	EXHAUST PIPE FLANGE	YEARS	PART NO.	DESCRIPTION	
1	Exhaust Pipe Gasket	2010-03	61451	Loc. Rear; Converter	
1	Exhaust Pipe Gasket	2010-03	61655	Flange; New Part Number - Check for Availability	
QTY	CRANKSHAFT REAR SEAL	YEARS	PART NO.	DESCRIPTION	
1	Rear Main Seal Set	2010-03	BS 40677	Rubber; One-piece	

28 (cont.)		2010 - 2003; 2.5L 153.8 (2521cc) DOHC L5 (20 Valve) 83mm Bore			28 (cont.)
		MFI; Gasoline; Turbo - Intercooled Volvo Eng.; Eng. Code B5254T2			
QTY	VALVE COVER	YEARS	PART NO.	DESCRIPTION	
1	Spark Plug Tube Seal Set	2010-03	ES 72477	Valve Cover; New Part Number - Check for Availability	
QTY	VALVE STEM SEAL SET	YEARS	PART NO.	DESCRIPTION	
1	Valve Stem Seal Set	2010-03	SS 71180	6mm valve stem diameter; Premium valve stem seals incl.	
1	Valve Stem Seal Set	2006-04	SS 72848-1	Volvo S80 2.5T, 2.5T AWD, 2.5T FWD; 7mm valve stem diameter; Premium valve stem seals incl.	
QTY	THERMOSTAT HOUSING	YEARS	PART NO.	DESCRIPTION	
1	Thermostat Gasket	2010-03	35955	Thermostat Housing; New Part Number - Check for Availability	
QTY	WATER OUTLET GASKET	YEARS	PART NO.	DESCRIPTION	
1	Water Outlet Gasket	2010-03	25565	Water Outlet	
QTY	WATER PUMP	YEARS	PART NO.	DESCRIPTION	
1	Water Pump Gasket	2010-03	35676		
QTY	TIMING COVER	YEARS	PART NO.	DESCRIPTION	
1	Crankshaft Front Seal Set	2010-03	TCS 46040		
1	Camshaft Front Seal Set	2010-03	TCS 46038	w/o VVT	
1	Camshaft Front Seal Set	2010-03	TCS 46187	w/VVT; New Part Number - Check for Availability	
1	Camshaft Rear Seal Set	2010-03	TCS 46039		
QTY	CARB & FUEL INJECTION	YEARS	PART NO.	DESCRIPTION	
1	Throttle Body Gasket	2010-03	61370		
29		2012 - 2004; 2.5L 153.8 (2521cc) DOHC L5 (20 Valve) 83mm Bore			29
		MFI; Gasoline; Turbo - Intercooled Volvo Eng.; Eng. Code B5254T3			
QTY	CYLINDER HEAD	YEARS	PART NO.	DESCRIPTION	
1	Head Gasket	2011-04	26640 PT	Head bolts not incl.; Head bolt replacement recommended; OEM style; PermaTorqueMLS®; New Part Number - Check for Availability	
1	Head Bolt Set	2011-04	ES 72908	Replacement recommended	
QTY	CONVERSION SET	YEARS	PART NO.	DESCRIPTION	
1	Gasket Conversion Set	2011-04	CS 26203	RTV sealant incl. for oil pan gskt.	
QTY	EXHAUST PIPE FLANGE	YEARS	PART NO.	DESCRIPTION	
1	Exhaust Pipe Gasket	2011-04	61653	Flange; New Part Number - Check for Availability	
1	Exhaust Pipe Gasket	2011-04	61654	Loc. Rear; Converter; New Part Number - Check for Availability	
QTY	CRANKSHAFT REAR SEAL	YEARS	PART NO.	DESCRIPTION	
1	Rear Main Seal Set	2011-04	BS 40677	Rubber; One-piece	
QTY	VALVE COVER	YEARS	PART NO.	DESCRIPTION	
1	Spark Plug Tube Seal Set	2012-04	ES 72477	Valve Cover; New Part Number - Check for Availability	
QTY	VALVE STEM SEAL SET	YEARS	PART NO.	DESCRIPTION	
1	Valve Stem Seal Set	2011-04	SS 71180	6mm valve stem diameter; Premium valve stem seals incl.	
QTY	THERMOSTAT HOUSING	YEARS	PART NO.	DESCRIPTION	
1	Thermostat Gasket	2011-04	35955	Thermostat Housing; New Part Number - Check for Availability	
QTY	WATER OUTLET GASKET	YEARS	PART NO.	DESCRIPTION	
1	Water Outlet Gasket	2011-04	25565	Water Outlet	
QTY	WATER PUMP	YEARS	PART NO.	DESCRIPTION	
1	Water Pump Gasket	2011-04	35676		
QTY	TIMING COVER	YEARS	PART NO.	DESCRIPTION	
1	Crankshaft Front Seal Set	2011-04	TCS 46040		
1	Camshaft Front Seal Set	2011-04	TCS 46038	w/o VVT	
1	Camshaft Front Seal Set	2011-04	TCS 46187	w/VVT; New Part Number - Check for Availability	
1	Camshaft Rear Seal Set	2011-04	TCS 46039		
QTY	CARB & FUEL INJECTION	YEARS	PART NO.	DESCRIPTION	
1	Throttle Body Gasket	2012-04	61651	New Part Number - Check for Availability	
30		2008 - 2006; 2.5L 153.8 (2521cc) DOHC L5 (20 Valve) 83mm Bore			30
		MFI; Gasoline; Turbo - Intercooled Volvo Eng.; Eng. Code B5254T4			
QTY	CYLINDER HEAD	YEARS	PART NO.	DESCRIPTION	
1	Head Gasket	2008-06	26639 PT	Head bolts not incl.; Head bolt replacement recommended; PermaTorqueMLS®; New Part Number - Check for Availability	
1	Head Bolt Set	2008-06	ES 72908	Replacement recommended	
QTY	CONVERSION SET	YEARS	PART NO.	DESCRIPTION	
1	Gasket Conversion Set	2008-06	CS 26203	RTV sealant incl. for oil pan gskt.	
QTY	MANIFOLD - INT. & EXH.	YEARS	PART NO.	DESCRIPTION	
1	Int. Manifold Gasket Set	2008-06	MS 96154		
1	Exh. Manifold Gasket Set	2008-06	MS 96277		
QTY	EXHAUST PIPE FLANGE	YEARS	PART NO.	DESCRIPTION	
1	Exhaust Pipe Gasket	2008-06	61451	Loc. Rear; Converter	

Volvo Car (Cont.)

30 (cont.)		2008 - 2006; 2.5L 153.8 (2521cc) DOHC L5 (20 Valve) 83mm Bore			30 (cont.)
MFI; Gasoline; Turbo - Intercooled Volvo Eng.; Eng. Code B5254T4					
QTY	EXHAUST PIPE FLANGE	YEARS	PART NO.	DESCRIPTION	
1	Exhaust Pipe Gasket	2008-06	61655	Flange; New Part Number - Check for Availability	
QTY	CRANKSHAFT REAR SEAL	YEARS	PART NO.	DESCRIPTION	
1	Rear Main Seal Set	2008-06	BS 40677	Rubber; One-piece	
QTY	VALVE COVER	YEARS	PART NO.	DESCRIPTION	
1	Spark Plug Tube Seal Set	2008-06	ES 72477	Valve Cover; New Part Number - Check for Availability	
QTY	VALVE STEM SEAL SET	YEARS	PART NO.	DESCRIPTION	
1	Valve Stem Seal Set	2008-06	SS 71180	6mm valve stem diameter; Premium valve stem seals incl.	
QTY	THERMOSTAT HOUSING	YEARS	PART NO.	DESCRIPTION	
1	Thermostat Gasket	2008-06	35955	Thermostat Housing; New Part Number - Check for Availability	
QTY	WATER OUTLET GASKET	YEARS	PART NO.	DESCRIPTION	
1	Water Outlet Gasket	2008-06	25565	Water Outlet	
QTY	WATER PUMP	YEARS	PART NO.	DESCRIPTION	
1	Water Pump Gasket	2008-06	35676		
QTY	TIMING COVER	YEARS	PART NO.	DESCRIPTION	
1	Crankshaft Front Seal Set	2008-06	TCS 46040		
1	Camshaft Front Seal Set	2008-06	TCS 46038	w/o VVT	
1	Camshaft Front Seal Set	2008-06	TCS 46187	w/VVT; New Part Number - Check for Availability	
1	Camshaft Rear Seal Set	2008-06	TCS 46039		
QTY	CARB & FUEL INJECTION	YEARS	PART NO.	DESCRIPTION	
1	Throttle Body Gasket	2008-06	61370		
31		2012; 2.5L 153.8 (2521cc) DOHC L5 (20 Valve) 83mm Bore			31
MFI; Gasoline; Turbo - Intercooled Volvo Eng.; Eng. Code B5254T5					
QTY	VALVE COVER	YEARS	PART NO.	DESCRIPTION	
1	Spark Plug Tube Seal Set	2012	ES 72477	Valve Cover; New Part Number - Check for Availability	
QTY	CARB & FUEL INJECTION	YEARS	PART NO.	DESCRIPTION	
1	Throttle Body Gasket	2012	61651	New Part Number - Check for Availability	
32		2012 - 2008; 2.5L 153.8 (2521cc) DOHC L5 (20 Valve) 83mm Bore			32
MFI; Gasoline; Turbo - Intercooled Volvo Eng.; Eng. Code B5254T7					
QTY	CYLINDER HEAD	YEARS	PART NO.	DESCRIPTION	
1	Head Gasket	2011-08	26640 PT	Head bolts not incl.; Head bolt replacement recommended; OEM style; PermaTorqueMLS®; New Part Number - Check for Availability	
1	Head Bolt Set	2011-08	ES 72908	Replacement recommended	
QTY	CONVERSION SET	YEARS	PART NO.	DESCRIPTION	
1	Gasket Conversion Set	2011-08	CS 26203	RTV sealant incl. for oil pan gskt.	
QTY	EXHAUST PIPE FLANGE	YEARS	PART NO.	DESCRIPTION	
1	Exhaust Pipe Gasket	2011-08	61653	Flange; New Part Number - Check for Availability	
1	Exhaust Pipe Gasket	2011-08	61654	Loc. Rear; Converter; New Part Number - Check for Availability	
QTY	CRANKSHAFT REAR SEAL	YEARS	PART NO.	DESCRIPTION	
1	Rear Main Seal Set	2011-08	BS 40677	Rubber; One-piece	
QTY	VALVE COVER	YEARS	PART NO.	DESCRIPTION	
1	Spark Plug Tube Seal Set	2012-08	ES 72477	Valve Cover; New Part Number - Check for Availability	
QTY	VALVE STEM SEAL SET	YEARS	PART NO.	DESCRIPTION	
1	Valve Stem Seal Set	2011-08	SS 71180	6mm valve stem diameter; Premium valve stem seals incl.	
QTY	THERMOSTAT HOUSING	YEARS	PART NO.	DESCRIPTION	
1	Thermostat Gasket	2011-08	35955	Thermostat Housing; New Part Number - Check for Availability	
QTY	WATER OUTLET GASKET	YEARS	PART NO.	DESCRIPTION	
1	Water Outlet Gasket	2011-08	25565	Water Outlet	
QTY	WATER PUMP	YEARS	PART NO.	DESCRIPTION	
1	Water Pump Gasket	2011-08	35676		
QTY	TIMING COVER	YEARS	PART NO.	DESCRIPTION	
1	Crankshaft Front Seal Set	2011-08	TCS 46040		
1	Camshaft Front Seal Set	2011-08	TCS 46038	w/o VVT	
1	Camshaft Front Seal Set	2011-08	TCS 46187	w/VVT; New Part Number - Check for Availability	
1	Camshaft Rear Seal Set	2011-08	TCS 46039		
QTY	CARB & FUEL INJECTION	YEARS	PART NO.	DESCRIPTION	
1	Throttle Body Gasket	2012-08	61651	New Part Number - Check for Availability	

33		2004 - 1999; 2.8L 170 (2783cc) DOHC L6 (24 Valve) 81mm Bore MFI; Gasoline; Turbo - Intercooled Volvo Eng.; Eng. Code B6284T			33
QTY	CYLINDER HEAD	YEARS	PART NO.	DESCRIPTION	
1	Head Gasket	2004-00	26577 PT	Head bolts not incl.; Head bolt replacement recommended; New Part Number - Check for Availability	
1	Head Gasket	1999	26654 PT	Head bolts not incl.; Head bolt replacement recommended; New Part Number - Check for Availability	
QTY	CONVERSION SET	YEARS	PART NO.	DESCRIPTION	
1	Gasket Conversion Set	2004-99	CS 26595	RTV sealant incl. for oil pan gskt.; New Part Number - Check for Availability	
QTY	MANIFOLD - INT. & EXH.	YEARS	PART NO.	DESCRIPTION	
1	Exh. Manifold Gasket Set	2004-99	MS 97258	New Part Number - Check for Availability	
34		2006 - 1999; 2.9L 178.4 (2922cc) DOHC L6 (24 Valve) 83mm Bore MFI; Gasoline; Naturally Aspirated Volvo Eng.; Eng. Code B6294S			34
QTY	CYLINDER HEAD	YEARS	PART NO.	DESCRIPTION	
1	Head Gasket	2006-00	26576 PT	Head bolts not incl.; Head bolt replacement recommended; New Part Number - Check for Availability	
1	Head Gasket	1999	26578 PT	Head bolts not incl.; Head bolt replacement recommended; New Part Number - Check for Availability	
QTY	CONVERSION SET	YEARS	PART NO.	DESCRIPTION	
1	Gasket Conversion Set	2006-99	CS 26595	RTV sealant incl. for oil pan gskt.; New Part Number - Check for Availability	
QTY	MANIFOLD - INT. & EXH.	YEARS	PART NO.	DESCRIPTION	
1	Exh. Manifold Gasket Set	2006-99	MS 97258	New Part Number - Check for Availability	
35		2006 - 2004; 2.9L 178.4 (2922cc) DOHC L6 (24 Valve) 83mm Bore MFI; Gasoline; Turbo - Intercooled Volvo Eng.; Eng. Code B6294T			35
QTY	CYLINDER HEAD	YEARS	PART NO.	DESCRIPTION	
1	Head Gasket	2006-04	26574 PT	Head bolts not incl.; Head bolt replacement recommended; New Part Number - Check for Availability	
QTY	CONVERSION SET	YEARS	PART NO.	DESCRIPTION	
1	Gasket Conversion Set	2006-04	CS 26595	RTV sealant incl. for oil pan gskt.; New Part Number - Check for Availability	
QTY	MANIFOLD - INT. & EXH.	YEARS	PART NO.	DESCRIPTION	
1	Exh. Manifold Gasket Set	2006-04	MS 97258	New Part Number - Check for Availability	
36		1998 - 1992; 2.9L 178.4 (2922cc) DOHC L6 (24 Valve) 83mm Bore MFI; Gasoline; Naturally Aspirated Volvo Eng.; Eng. Code B6304F			36
QTY	CYLINDER HEAD	YEARS	PART NO.	DESCRIPTION	
1	Head Gasket	1998-92	26578 PT	Head bolts not incl.; Head bolt replacement recommended; New Part Number - Check for Availability	
QTY	MANIFOLD - INT. & EXH.	YEARS	PART NO.	DESCRIPTION	
1	Exh. Manifold Gasket Set	1998-92	MS 97258	New Part Number - Check for Availability	
37		2006 - 1992; 2.9L 178.4 (2922cc) DOHC L6 (24 Valve) 83mm Bore MFI; Gasoline; Naturally Aspirated Volvo Eng.; Eng. Code B6304S			37
QTY	CYLINDER HEAD	YEARS	PART NO.	DESCRIPTION	
1	Head Gasket	2006-00	26576 PT	Head bolts not incl.; Head bolt replacement recommended; New Part Number - Check for Availability	
1	Head Gasket	1999-92	26578 PT	Head bolts not incl.; Head bolt replacement recommended; New Part Number - Check for Availability	
QTY	CONVERSION SET	YEARS	PART NO.	DESCRIPTION	
1	Gasket Conversion Set	2006-99	CS 26595	RTV sealant incl. for oil pan gskt.; New Part Number - Check for Availability	
QTY	MANIFOLD - INT. & EXH.	YEARS	PART NO.	DESCRIPTION	
1	Exh. Manifold Gasket Set	2006-92	MS 97258	New Part Number - Check for Availability	
38		1999 - 1998; 2.9L 178.4 (2922cc) DOHC L6 (24 Valve) 83mm Bore MFI; Gasoline; Naturally Aspirated Volvo Eng.; Eng. Code B6304S3			38
QTY	CYLINDER HEAD	YEARS	PART NO.	DESCRIPTION	
1	Head Gasket	1999-98	26578 PT	Head bolts not incl.; Head bolt replacement recommended; New Part Number - Check for Availability	
QTY	CONVERSION SET	YEARS	PART NO.	DESCRIPTION	
1	Gasket Conversion Set	1999	CS 26595	RTV sealant incl. for oil pan gskt.; New Part Number - Check for Availability	
QTY	MANIFOLD - INT. & EXH.	YEARS	PART NO.	DESCRIPTION	
1	Exh. Manifold Gasket Set	1999-98	MS 97258	New Part Number - Check for Availability	

Volvo Car (Cont.)

39		2010 - 2008; 3.0L 180.2 (2953cc) DOHC L6 (24 Valve) 82mm Bore			39
MFI; Gasoline; Turbo - Intercooled Volvo Eng.; Eng. Code B6304T2					
QTY	CYLINDER HEAD	YEARS	PART NO.	DESCRIPTION	
1	Head Gasket	2010-08	26603 PT	Head bolts not incl.; Head bolt replacement recommended; PermaTorqueMLS®; New Part Number - Check for Availability	
1	Head Set	2010-08	HS 26603 PT	Head bolts not incl.; Head bolt replacement recommended; RTV sealant incl. for valve cover gskt.; PermaDry® molded rubber valve cover gskt. incl.; Premium valve stem seals incl.; New Part Number - Check for Availability	
QTY	MANIFOLD - INT. & EXH.	YEARS	PART NO.	DESCRIPTION	
1	Int. Manifold Gasket Set	2010-08	MS 97312	Lower set; New Part Number - Check for Availability	
1	Exh. Manifold Gasket Set	2010-08	MS 97279	New Part Number - Check for Availability	
QTY	VALVE COVER	YEARS	PART NO.	DESCRIPTION	
1	Valve Cover Gasket Set	2010-08	VS 50856 R	w/Grommets & Spark plug tube seals; RTV sealant incl. for valve cover gskt.; PermaDry® molded rubber gskt. incl.; New Part Number - Check for Availability	
40		2010 - 2007; 3.2L 194.8 (3192cc) DOHC L6 (24 Valve) 84mm Bore			40
MFI; Gasoline; Naturally Aspirated Volvo Eng.; Eng. Code B6324S					
QTY	CYLINDER HEAD	YEARS	PART NO.	DESCRIPTION	
1	Head Gasket	2010	26602 PT	Volvo XC70 3.2; Head bolts not incl.; Head bolt replacement recommended; PermaTorqueMLS®; New Part Number - Check for Availability	
1	Head Gasket	2009-07	26602 PT	Head bolts not incl.; Head bolt replacement recommended; PermaTorqueMLS®; New Part Number - Check for Availability	
QTY	CONVERSION SET	YEARS	PART NO.	DESCRIPTION	
1	Gasket Conversion Set	2010	CS 26602	Volvo XC70 3.2; Rear main brg. seal not incl.; RTV sealant incl. for oil pan gskt.; New Part Number - Check for Availability	
1	Gasket Conversion Set	2009-07	CS 26602	Rear main brg. seal not incl.; RTV sealant incl. for oil pan gskt.; New Part Number - Check for Availability	
QTY	MANIFOLD - INT. & EXH.	YEARS	PART NO.	DESCRIPTION	
1	Exh. Manifold Gasket Set	2010	MS 97279	Volvo XC70 3.2; New Part Number - Check for Availability	
1	Exh. Manifold Gasket Set	2009-07	MS 97279	New Part Number - Check for Availability	
QTY	VALVE COVER	YEARS	PART NO.	DESCRIPTION	
1	Valve Cover Gasket Set	2010	VS 50856 R	Volvo XC70 3.2; w/Grommets & Spark plug tube seals; RTV sealant incl. for valve cover gskt.; PermaDry® molded rubber gskt. incl.; New Part Number - Check for Availability	
1	Valve Cover Gasket Set	2009-07	VS 50856 R	w/Grommets & Spark plug tube seals; RTV sealant incl. for valve cover gskt.; PermaDry® molded rubber gskt. incl.; New Part Number - Check for Availability	
41		2010 - 2007; 4.4L 269 (4414cc) DOHC V8 (32 Valve) 94mm Bore			41
MFI; Gasoline; Naturally Aspirated Yamaha Eng.; Eng. Code B8444S					
QTY	CYLINDER HEAD	YEARS	PART NO.	DESCRIPTION	
1	Head Gasket	2010-07	26609 PT	Loc. L.H.; Head bolts not incl.; Head bolt replacement recommended; PermaTorqueMLS®; New Part Number - Check for Availability	
1	Head Gasket	2010-07	26622 PT	Loc. R.H.; Head bolts not incl.; Head bolt replacement recommended; PermaTorqueMLS®; New Part Number - Check for Availability	
QTY	VALVE COVER	YEARS	PART NO.	DESCRIPTION	
1	Valve Cover Gasket Set	2010-07	VS 50854 R	Loc. R.H.; w/Grommets & Spark plug tube seals; PermaDry® molded rubber gskt. incl.; New Part Number - Check for Availability	
1	Valve Cover Gasket Set	2010-07	VS 50855 R	Loc. L.H.; w/Grommets & Spark plug tube seals; PermaDry® molded rubber gskt. incl.; New Part Number - Check for Availability	

Volvo SUV's - See Volvo Truck

Volvo Truck (Incl. SUV's)

Engine Finding Index				
Engine	Years	Code	Line No.	
2.5L 153.8 (2521cc) DOHC L5 (20 Valve) 83mm Bore; MFI; Gasoline; Turbo - Intercooled Volvo Eng.	2008-03	B5254T2	1	
2.9L 178.4 (2922cc) DOHC L6 (24 Valve) 83mm Bore; MFI; Gasoline; Turbo - Intercooled Volvo Eng.	2006-03	B6294T	2	
3.0L 180.2 (2953cc) DOHC L6 (24 Valve) 82mm Bore; MFI; Gasoline; Turbo - Intercooled Volvo Eng.	2010-09	B6304T2	3	
3.2L 194.8 (3192cc) DOHC L6 (24 Valve) 84mm Bore; MFI; Gasoline; Naturally Aspirated Volvo Eng.	2010-07	B6324S	4	
4.4L 269 (4414cc) DOHC V8 (32 Valve) 94mm Bore; MFI; Gasoline; Naturally Aspirated Yamaha Eng.	2011-05	B8444S	5	

Volvo Truck (Incl. SUV's) (Cont.)

Engine Code Index

Code	Engine	Line No.
B5254T2	2.5L 153.8 (2521cc) DOHC L5 (20 Valve) 83mm Bore; MFI; Gasoline; Turbo - Intercooled Volvo Eng.	1
B6294T	2.9L 178.4 (2922cc) DOHC L6 (24 Valve) 83mm Bore; MFI; Gasoline; Turbo - Intercooled Volvo Eng.	2
B6304T2	3.0L 180.2 (2953cc) DOHC L6 (24 Valve) 82mm Bore; MFI; Gasoline; Turbo - Intercooled Volvo Eng.	3
B6324S	3.2L 194.8 (3192cc) DOHC L6 (24 Valve) 84mm Bore; MFI; Gasoline; Naturally Aspirated Volvo Eng.	4
B8444S	4.4L 269 (4414cc) DOHC V8 (32 Valve) 94mm Bore; MFI; Gasoline; Naturally Aspirated Yamaha Eng.	5

Model Index

Engine (VIN Code / Eng. Code)	Year	Engine (VIN Code / Eng. Code)	Year	Engine (VIN Code / Eng. Code)	Year
Volvo Truck		Volvo Truck (cont.)		Volvo Truck (cont.)	
XC60 (AWD Mid-Size SUV)		XC60 (FWD Mid-Size SUV) (cont.)		XC90 (AWD Mid-Size SUV) (cont.)	
L6 2953cc 3.0L DOHC Turbo (24 Valve) (B6304T2)	10-09	L6 2953cc 3.0L DOHC Turbo (24 Valve) (B6304T4)	13-11	L6 3192cc 3.2L DOHC (24 Valve) (B6324S5)	13-11
L6 2953cc 3.0L DOHC Turbo (24 Valve) (B6304T4)	13-11	L6 3192cc 3.2L DOHC (24 Valve) (B6324S)	09	V8 4414cc 4.4L DOHC (32 Valve) (B8444S)	11-05
L6 3192cc 3.2L DOHC (24 Valve) (B6324S)	09	L6 3192cc 3.2L DOHC (24 Valve) (B6324S4)	13-10	XC90 (FWD Mid-Size SUV)	
L6 3192cc 3.2L DOHC (24 Valve) (B6324S4)	13-10	L6 3192cc 3.2L DOHC (24 Valve) (B6324S5)	13-10	L5 2521cc 2.5L DOHC Turbo (20 Valve) (B5254T2)	07-03
L6 3192cc 3.2L DOHC (24 Valve) (B6324S5)	13-10	XC90 (AWD Mid-Size SUV)		L6 2922cc 2.9L DOHC Turbo (24 Valve) (B6294T)	06-03
XC60 (FWD Mid-Size SUV)		L5 2521cc 2.5L DOHC Turbo (20 Valve) (B5254T2)	07-03	L6 3192cc 3.2L DOHC (24 Valve) (B6324S)	10-07
L6 2953cc 3.0L DOHC Turbo (24 Valve) (B6304T2)	10-09	L6 2922cc 2.9L DOHC Turbo (24 Valve) (B6294T)	06-03	L6 3192cc 3.2L DOHC (24 Valve) (B6324S5)	13-11
		L6 3192cc 3.2L DOHC (24 Valve) (B6324S)	10-07	V8 4414cc 4.4L DOHC (32 Valve) (B8444S)	11-05

1 2008 - 2003; 2.5L 153.8 (2521cc) DOHC L5 (20 Valve) 83mm Bore MFI; Gasoline; Turbo - Intercooled Volvo Eng.; Eng. Code B5254T2 1

QTY	CYLINDER HEAD	YEARS	PART NO.	DESCRIPTION
1	Head Gasket	2008-03	26256 PT	Head bolts not incl.; Head bolt replacement recommended; PermaTorque®
1	Head Gasket	2008-03	26639 PT	Head bolts not incl.; Head bolt replacement recommended; PermaTorqueMLS®; New Part Number - Check for Availability
1	Head Set	2008-03	HS 26256 PT	Head bolts, VVT front camshaft seals, exh. pipe flange not incl.; Head bolt replacement recommended; RTV sealant incl. for valve cover gskt.; Premium valve stem seals incl.
1	Head Bolt Set	2008-03	ES 72908	Replacement recommended
QTY	CONVERSION SET	YEARS	PART NO.	DESCRIPTION
1	Gasket Conversion Set	2008-03	CS 26203	RTV sealant incl. for oil pan gskt.
QTY	MANIFOLD - INT. & EXH.	YEARS	PART NO.	DESCRIPTION
1	Int. Manifold Gasket Set	2008-03	MS 96154	
1	Exh. Manifold Gasket Set	2008-03	MS 96277	
QTY	EXHAUST PIPE FLANGE	YEARS	PART NO.	DESCRIPTION
1	Exhaust Pipe Gasket	2008-03	61655	Flange; New Part Number - Check for Availability
1	Exhaust Pipe Gasket	2008-03	61656	Loc. Rear; Converter; New Part Number - Check for Availability
QTY	CRANKSHAFT REAR SEAL	YEARS	PART NO.	DESCRIPTION
1	Rear Main Seal Set	2008-03	BS 40677	Rubber; One-piece
QTY	VALVE COVER	YEARS	PART NO.	DESCRIPTION
1	Spark Plug Tube Seal Set	2008-03	ES 72477	Valve Cover; New Part Number - Check for Availability
QTY	VALVE STEM SEAL SET	YEARS	PART NO.	DESCRIPTION
1	Valve Stem Seal Set	2008-03	SS 71180	6mm valve stem diameter; Premium valve stem seals incl.
QTY	THERMOSTAT HOUSING	YEARS	PART NO.	DESCRIPTION
1	Thermostat Gasket	2008-03	35955	Thermostat Housing; New Part Number - Check for Availability
QTY	WATER OUTLET GASKET	YEARS	PART NO.	DESCRIPTION
1	Water Outlet Gasket	2008-03	25565	Water Outlet
QTY	WATER PUMP	YEARS	PART NO.	DESCRIPTION
1	Water Pump Gasket	2008-03	35676	
QTY	TIMING COVER	YEARS	PART NO.	DESCRIPTION
1	Crankshaft Front Seal Set	2008-03	TCS 46040	
1	Camshaft Front Seal Set	2008-03	TCS 46038	w/o VVT
1	Camshaft Front Seal Set	2008-03	TCS 46187	w/VVT; New Part Number - Check for Availability
1	Camshaft Rear Seal Set	2008-03	TCS 46039	
QTY	CARB & FUEL INJECTION	YEARS	PART NO.	DESCRIPTION
1	Throttle Body Gasket	2008-03	61370	

2 2006 - 2003; 2.9L 178.4 (2922cc) DOHC L6 (24 Valve) 83mm Bore MFI; Gasoline; Turbo - Intercooled Volvo Eng.; Eng. Code B6294T 2

QTY	CYLINDER HEAD	YEARS	PART NO.	DESCRIPTION
1	Head Gasket	2006-03	26574 PT	Head bolts not incl.; Head bolt replacement recommended; New Part Number - Check for Availability

Volvo Truck (Incl. SUV's) (Cont.)

2		2006 - 2003; 2.9L 178.4 (2922cc) DOHC L6 (24 Valve) 83mm Bore			2	
(cont.)		MFI; Gasoline; Turbo - Intercooled Volvo Eng.; Eng. Code B6294T			(cont.)	
QTY	CONVERSION SET	YEARS	PART NO.	DESCRIPTION		
1	Gasket Conversion Set	2006-03	CS 26595	RTV sealant incl. for oil pan gskt.; New Part Number - Check for Availability		
QTY	MANIFOLD - INT. & EXH.	YEARS	PART NO.	DESCRIPTION		
1	Exh. Manifold Gasket Set	2006-03	MS 97258	New Part Number - Check for Availability		
3		2010 - 2009; 3.0L 180.2 (2953cc) DOHC L6 (24 Valve) 82mm Bore			3	
		MFI; Gasoline; Turbo - Intercooled Volvo Eng.; Eng. Code B6304T2				
QTY	CYLINDER HEAD	YEARS	PART NO.	DESCRIPTION		
1	Head Gasket	2010-09	26603 PT	Head bolts not incl.; Head bolt replacement recommended; PermaTorqueMLS®; New Part Number - Check for Availability		
1	Head Set	2010-09	HS 26603 PT	Head bolts not incl.; Head bolt replacement recommended; RTV sealant incl. for valve cover gskt.; PermaDry® molded rubber valve cover gskt. incl.; Premium valve stem seals incl.; New Part Number - Check for Availability		
QTY	MANIFOLD - INT. & EXH.	YEARS	PART NO.	DESCRIPTION		
1	Int. Manifold Gasket Set	2010-09	MS 97312	Lower set; New Part Number - Check for Availability		
1	Exh. Manifold Gasket Set	2010-09	MS 97279	New Part Number - Check for Availability		
QTY	VALVE COVER	YEARS	PART NO.	DESCRIPTION		
1	Valve Cover Gasket Set	2010-09	VS 50856 R	w/Grommets & Spark plug tube seals; RTV sealant incl. for valve cover gskt.; PermaDry® molded rubber gskt. incl.; New Part Number - Check for Availability		
4		2010 - 2007; 3.2L 194.8 (3192cc) DOHC L6 (24 Valve) 84mm Bore			4	
		MFI; Gasoline; Naturally Aspirated Volvo Eng.; Eng. Code B6324S				
QTY	CYLINDER HEAD	YEARS	PART NO.	DESCRIPTION		
1	Head Gasket	2010	26602 PT	Exc. Volvo XC60 3.2; Head bolts not incl.; Head bolt replacement recommended; PermaTorqueMLS®; New Part Number - Check for Availability		
1	Head Gasket	2009-07	26602 PT	Head bolts not incl.; Head bolt replacement recommended; PermaTorqueMLS®; New Part Number - Check for Availability		
QTY	CONVERSION SET	YEARS	PART NO.	DESCRIPTION		
1	Gasket Conversion Set	2010	CS 26602	Exc. Volvo XC60 3.2; Rear main brg. seal not incl.; RTV sealant incl. for oil pan gskt.; New Part Number - Check for Availability		
1	Gasket Conversion Set	2009-07	CS 26602	Rear main brg. seal not incl.; RTV sealant incl. for oil pan gskt.; New Part Number - Check for Availability		
QTY	MANIFOLD - INT. & EXH.	YEARS	PART NO.	DESCRIPTION		
1	Exh. Manifold Gasket Set	2010	MS 97279	Exc. Volvo XC60 3.2; New Part Number - Check for Availability		
1	Exh. Manifold Gasket Set	2009-07	MS 97279	New Part Number - Check for Availability		
QTY	VALVE COVER	YEARS	PART NO.	DESCRIPTION		
1	Valve Cover Gasket Set	2010	VS 50856 R	Exc. Volvo XC60 3.2; w/Grommets & Spark plug tube seals; RTV sealant incl. for valve cover gskt.; PermaDry® molded rubber gskt. incl.; New Part Number - Check for Availability		
1	Valve Cover Gasket Set	2009-07	VS 50856 R	w/Grommets & Spark plug tube seals; RTV sealant incl. for valve cover gskt.; PermaDry® molded rubber gskt. incl.; New Part Number - Check for Availability		
5		2011 - 2005; 4.4L 269 (4414cc) DOHC V8 (32 Valve) 94mm Bore			5	
		MFI; Gasoline; Naturally Aspirated Yamaha Eng.; Eng. Code B8444S				
QTY	CYLINDER HEAD	YEARS	PART NO.	DESCRIPTION		
1	Head Gasket	2011-05	26609 PT	Loc. L.H.; Head bolts not incl.; Head bolt replacement recommended; PermaTorqueMLS®; New Part Number - Check for Availability		
1	Head Gasket	2011-05	26622 PT	Loc. R.H.; Head bolts not incl.; Head bolt replacement recommended; PermaTorqueMLS®; New Part Number - Check for Availability		
QTY	VALVE COVER	YEARS	PART NO.	DESCRIPTION		
1	Valve Cover Gasket Set	2011-05	VS 50854 R	Loc. R.H.; w/Grommets & Spark plug tube seals; PermaDry® molded rubber gskt. incl.; New Part Number - Check for Availability		
1	Valve Cover Gasket Set	2011-05	VS 50855 R	Loc. L.H.; w/Grommets & Spark plug tube seals; PermaDry® molded rubber gskt. incl.; New Part Number - Check for Availability		

Engine Finding Index				
Engine	Years	Code	Line No.	
4.6L 281 (4605cc) SOHC V8 (16 Valve) 90.2mm Bore Triton; MFI; Gasoline; Naturally Aspirated Ford Eng.	2013-12	6	1	
4.6L 281 (4605cc) SOHC V8 (16 Valve) 90.2mm Bore Triton; MFI; Natural Gas; Naturally Aspirated Ford Eng.	2013-12	6	2	
1	2013 - 2012; 4.6L 281 (4605cc) SOHC V8 (16 Valve) 90.2mm Bore Triton MFI; Gasoline; Naturally Aspirated Ford Eng.; VIN Code 6			1
QTY	WATER PUMP	YEARS	PART NO.	DESCRIPTION
2	O-Ring	2013-12	413	Water Pump; Water pump bypass pipe O-ring
2	2013 - 2012; 4.6L 281 (4605cc) SOHC V8 (16 Valve) 90.2mm Bore Triton MFI; Natural Gas; Naturally Aspirated Ford Eng.; VIN Code 6			2
QTY	WATER PUMP	YEARS	PART NO.	DESCRIPTION
2	O-Ring	2013-12	413	Water Pump; Water pump bypass pipe O-ring

VW Car

Engine Finding Index				
Engine	Years	Code	Line No.	
1.6L 96.9 (1588cc) SOHC L4 (8 Valve) 76.5mm Bore; MFI; Diesel; Naturally Aspirated VW Eng.	1992-91	1V	1	
1.6L 96.9 (1588cc) SOHC L4 (8 Valve) 76.5mm Bore; MFI; Diesel; Naturally Aspirated VW Eng.	1992-91	ME	2	
1.6L 96.9 (1588cc) SOHC Turbo L4 (8 Valve) 76.5mm Bore; MFI; Diesel; Turbo VW Eng.	1992-91	MF	3	
1.8L 108.6 (1780cc) DOHC L4 (20 Valve) 81mm Bore; MFI; Gasoline; Turbo - Intercooled VW Eng.	2005-98	AEB	4	
1.8L 108.6 (1780cc) DOHC L4 (20 Valve) 81mm Bore; MFI; Gasoline; Turbo - Intercooled VW Eng.	2005-99	APH	5	
1.8L 108.6 (1780cc) DOHC L4 (20 Valve) 81mm Bore; MFI; Gasoline; Turbo - Intercooled VW Eng.	2001-00	ATW	6	
1.8L 108.6 (1780cc) DOHC L4 (20 Valve) 81mm Bore; MFI; Gasoline; Turbo - Intercooled VW Eng.	2001-00	AUG	7	
1.8L 108.6 (1780cc) DOHC L4 (20 Valve) 81mm Bore; MFI; Gasoline; Turbo - Intercooled VW Eng.	2005-00	AWD	8	
1.8L 108.6 (1780cc) DOHC L4 (20 Valve) 81mm Bore; MFI; Gasoline; Turbo - Intercooled VW Eng.	2005-01	AWM	9	
1.8L 108.6 (1780cc) DOHC L4 (20 Valve) 81mm Bore; MFI; Gasoline; Turbo - Intercooled VW Eng.	2006-02	AWP	10	
1.8L 108.6 (1780cc) DOHC L4 (20 Valve) 81mm Bore; MFI; Gasoline; Turbo - Intercooled VW Eng.	2005-01	AWV	11	
1.8L 108.6 (1780cc) DOHC L4 (20 Valve) 81mm Bore; MFI; Gasoline; Turbo - Intercooled VW Eng.	2005-00	AWW	12	
1.8L 108.6 (1780cc) DOHC L4 (20 Valve) 81mm Bore; MFI; Gasoline; Turbo - Intercooled VW Eng.	2005	BNU	13	
1.8L 108.6 (1780cc) SOHC L4 (8 Valve) 81mm Bore; MFI; Gasoline; Naturally Aspirated VW Eng.	1993-91	2H	14	
1.8L 108.6 (1780cc) SOHC L4 (8 Valve) 81mm Bore; MFI; Gasoline; Naturally Aspirated VW Eng.	1993-91	ABG	15	
1.8L 108.6 (1780cc) SOHC L4 (8 Valve) 81mm Bore; TBI; Gasoline; Naturally Aspirated VW Eng.	1999-93	ACC	16	
1.8L 108.6 (1780cc) SOHC L4 (8 Valve) 81mm Bore; MFI; Gasoline; Naturally Aspirated VW Eng.	1992-91	PF	17	
1.8L 108.6 (1780cc) SOHC L4 (8 Valve) 81mm Bore; MFI; Gasoline; Supercharged VW Eng.	1994-91	PG	18	
1.8L 108.6 (1780cc) SOHC L4 (8 Valve) 81mm Bore; MFI; Gasoline; Naturally Aspirated VW Eng.	1992-91	RV	19	
1.9L 115.7 (1896cc) SOHC Turbo - Intercooled L4 (8 Valve) 79.5mm Bore; MFI; Diesel; Turbo - Intercooled VW Eng.	1998-96	AAZ	20	
1.9L 115.7 (1896cc) SOHC Turbo - Intercooled L4 (8 Valve) 79.5mm Bore; MFI; Diesel; Turbo - Intercooled VW Eng.	1998-96	AHU	21	
1.9L 115.7 (1896cc) SOHC Turbo - Intercooled L4 (8 Valve) 79.5mm Bore; MFI; Diesel; Turbo - Intercooled VW Eng.	2006-98	ALH	22	
1.9L 115.7 (1896cc) SOHC Turbo - Intercooled L4 (8 Valve) 79.5mm Bore; MFI; Diesel; Turbo - Intercooled VW Eng.	2007-04	BEW	23	
1.9L 115.7 (1896cc) SOHC Turbo - Intercooled L4 (8 Valve) 79.5mm Bore; MFI; Diesel; Turbo - Intercooled VW Eng.	2007-05	BRM	24	
2.0L 120.1 (1969cc) SOHC Turbo - Intercooled L4 (8 Valve) 81mm Bore; MFI; Diesel; Turbo - Intercooled VW Eng.	2007-04	BHW	25	
2.0L 121 (1984cc) DOHC L4 (16 Valve) 82.5mm Bore; MFI; Gasoline; Naturally Aspirated VW Eng.	1994-91	9A	26	
2.0L 121 (1984cc) DOHC L4 (16 Valve) 82.5mm Bore; DI; Gasoline; Turbo - Intercooled VW Eng.	2012-06	BPY	27	
2.0L 121 (1984cc) DOHC L4 (16 Valve) 82.5mm Bore; DI; Gasoline; Turbo - Intercooled VW Eng.	2013-12	CBFA	28	
2.0L 121 (1984cc) DOHC L4 (16 Valve) 82.5mm Bore; DI; Gasoline; Turbo - Intercooled VW Eng.	2013-12	CCTA	29	
2.0L 121 (1984cc) SOHC L4 (8 Valve) 82.5mm Bore; MFI; Gasoline; Naturally Aspirated VW Eng.	2002-93	ABA	30	
2.0L 121 (1984cc) SOHC L4 (8 Valve) 82.5mm Bore; MFI; Gasoline; Naturally Aspirated VW Eng.	2006-98	AEG	31	
2.0L 121 (1984cc) SOHC L4 (8 Valve) 82.5mm Bore; MFI; Gasoline; Naturally Aspirated VW Eng.	2005-01	AVH	32	
2.0L 121 (1984cc) SOHC L4 (8 Valve) 82.5mm Bore; MFI; Gasoline; Naturally Aspirated VW Eng.	2005-01	AZG	33	
2.0L 121 (1984cc) SOHC L4 (8 Valve) 82.5mm Bore; MFI; Gasoline; Naturally Aspirated VW Eng.	2005	BBW	34	
2.0L 121 (1984cc) SOHC L4 (8 Valve) 82.5mm Bore; MFI; Gasoline; Naturally Aspirated VW Eng.	2004-03	BDC	35	
2.0L 121 (1984cc) SOHC L4 (8 Valve) 82.5mm Bore; MFI; Gasoline; Naturally Aspirated VW Eng.	2009-04	BEV	36	
2.0L 121 (1984cc) SOHC L4 (8 Valve) 82.5mm Bore; MFI; Gasoline; Naturally Aspirated VW Eng.	2005-04	BGD	37	
2.5L 151.3 (2480cc) DOHC L5 (20 Valve) 82.5mm Bore; MFI; Gasoline; Naturally Aspirated VW Eng.	2011-05	BGP	38	
2.5L 151.3 (2480cc) DOHC L5 (20 Valve) 82.5mm Bore; MFI; Gasoline; Naturally Aspirated VW Eng.	2011-05	BGQ	39	
2.5L 151.3 (2480cc) DOHC L5 (20 Valve) 82.5mm Bore; MFI; Gasoline; Naturally Aspirated VW Eng.	2010-06	BPR	40	
2.5L 151.3 (2480cc) DOHC L5 (20 Valve) 82.5mm Bore; MFI; Gasoline; Naturally Aspirated VW Eng.	2010-06	BPS	41	
2.8L 169 (2771cc) DOHC V6 (30 Valve) 82.5mm Bore; MFI; Gasoline; Naturally Aspirated Audi Eng.	2005-98	AHA	42	
2.8L 169 (2771cc) DOHC V6 (30 Valve) 82.5mm Bore; MFI; Gasoline; Naturally Aspirated Audi Eng.	2005	AMX	43	
2.8L 169 (2771cc) DOHC V6 (30 Valve) 82.5mm Bore; MFI; Gasoline; Naturally Aspirated Audi Eng.	2005-00	ATQ	44	
2.8L 170.7 (2792cc) DOHC V6 (24 Valve) 81mm Bore; MFI; Gasoline; Naturally Aspirated VW Eng.	2005-01	AFP	45	
2.8L 170.7 (2792cc) DOHC V6 (24 Valve) 81mm Bore; MFI; Gasoline; Naturally Aspirated VW Eng.	2005-02	BDF	46	
2.8L 170.7 (2792cc) SOHC V6 (12 Valve) 81mm Bore; MFI; Gasoline; Naturally Aspirated VW Eng.	2002-92	AAA	47	

VW Car (Cont.)

Engine Finding Index (Cont.)

Engine	Years	Code	Line No.
2.8L 170.7 (2792cc) SOHC V6 (12 Valve) 81mm Bore; MFI; Gasoline; Naturally Aspirated VW Eng.	2002-99	AFP	48
2.8L 170.7 (2792cc) SOHC V6 (12 Valve) 81mm Bore; MFI; Gasoline; Naturally Aspirated VW Eng.	1995-92	VR6	49
3.2L 195 (3189cc) DOHC V6 (24 Valve) 84mm Bore; MFI; Gasoline; Naturally Aspirated VW Eng.	2005-04	BJS	50
3.2L 195 (3189cc) DOHC V6 (24 Valve) 84mm Bore; MFI; Gasoline; Naturally Aspirated VW Eng.	2008-07	BUB	51
4.2L 254.5 (4172cc) DOHC V8 (40 Valve) 84.5mm Bore; MFI; Gasoline; Naturally Aspirated Audi Eng.	2006-04	BGH	52
4.2L 254.5 (4172cc) DOHC V8 (40 Valve) 84.5mm Bore; MFI; Gasoline; Naturally Aspirated Audi Eng.	2005-04	BHX	53

Engine Code Index

Code	Engine	Line No.
1V	1.6L 96.9 (1588cc) SOHC L4 (8 Valve) 76.5mm Bore; MFI; Diesel; Naturally Aspirated VW Eng.	1
2H	1.8L 108.6 (1780cc) SOHC L4 (8 Valve) 81mm Bore; MFI; Gasoline; Naturally Aspirated VW Eng.	14
9A	2.0L 121 (1984cc) DOHC L4 (16 Valve) 82.5mm Bore; MFI; Gasoline; Naturally Aspirated VW Eng.	26
AAA	2.8L 170.7 (2792cc) SOHC V6 (12 Valve) 81mm Bore; MFI; Gasoline; Naturally Aspirated VW Eng.	47
AAZ	1.9L 115.7 (1896cc) SOHC Turbo - Intercooled L4 (8 Valve) 79.5mm Bore; MFI; Diesel; Turbo - Intercooled VW Eng.	20
ABA	2.0L 121 (1984cc) SOHC L4 (8 Valve) 82.5mm Bore; MFI; Gasoline; Naturally Aspirated VW Eng.	30
ABG	1.8L 108.6 (1780cc) SOHC L4 (8 Valve) 81mm Bore; MFI; Gasoline; Naturally Aspirated VW Eng.	15
ACC	1.8L 108.6 (1780cc) SOHC L4 (8 Valve) 81mm Bore; TBI; Gasoline; Naturally Aspirated VW Eng.	16
AEB	1.8L 108.6 (1780cc) DOHC L4 (20 Valve) 81mm Bore; MFI; Gasoline; Turbo - Intercooled VW Eng.	4
AEG	2.0L 121 (1984cc) SOHC L4 (8 Valve) 82.5mm Bore; MFI; Gasoline; Naturally Aspirated VW Eng.	31
AFP	2.8L 170.7 (2792cc) DOHC V6 (24 Valve) 81mm Bore; MFI; Gasoline; Naturally Aspirated VW Eng.	45
AFP	2.8L 170.7 (2792cc) SOHC V6 (12 Valve) 81mm Bore; MFI; Gasoline; Naturally Aspirated VW Eng.	48
AHA	2.8L 169 (2771cc) DOHC V6 (30 Valve) 82.5mm Bore; MFI; Gasoline; Naturally Aspirated Audi Eng.	42
AHU	1.9L 115.7 (1896cc) SOHC Turbo - Intercooled L4 (8 Valve) 79.5mm Bore; MFI; Diesel; Turbo - Intercooled VW Eng.	21
ALH	1.9L 115.7 (1896cc) SOHC Turbo - Intercooled L4 (8 Valve) 79.5mm Bore; MFI; Diesel; Turbo - Intercooled VW Eng.	22
AMX	2.8L 169 (2771cc) DOHC V6 (30 Valve) 82.5mm Bore; MFI; Gasoline; Naturally Aspirated Audi Eng.	43
APH	1.8L 108.6 (1780cc) DOHC L4 (20 Valve) 81mm Bore; MFI; Gasoline; Turbo - Intercooled VW Eng.	5
ATQ	2.8L 169 (2771cc) DOHC V6 (30 Valve) 82.5mm Bore; MFI; Gasoline; Naturally Aspirated Audi Eng.	44
ATW	1.8L 108.6 (1780cc) DOHC L4 (20 Valve) 81mm Bore; MFI; Gasoline; Turbo - Intercooled VW Eng.	6
AUG	1.8L 108.6 (1780cc) DOHC L4 (20 Valve) 81mm Bore; MFI; Gasoline; Turbo - Intercooled VW Eng.	7
AVH	2.0L 121 (1984cc) SOHC L4 (8 Valve) 82.5mm Bore; MFI; Gasoline; Naturally Aspirated VW Eng.	32
AWD	1.8L 108.6 (1780cc) DOHC L4 (20 Valve) 81mm Bore; MFI; Gasoline; Turbo - Intercooled VW Eng.	8
AWM	1.8L 108.6 (1780cc) DOHC L4 (20 Valve) 81mm Bore; MFI; Gasoline; Turbo - Intercooled VW Eng.	9
AWP	1.8L 108.6 (1780cc) DOHC L4 (20 Valve) 81mm Bore; MFI; Gasoline; Turbo - Intercooled VW Eng.	10
AWV	1.8L 108.6 (1780cc) DOHC L4 (20 Valve) 81mm Bore; MFI; Gasoline; Turbo - Intercooled VW Eng.	11
AWW	1.8L 108.6 (1780cc) DOHC L4 (20 Valve) 81mm Bore; MFI; Gasoline; Turbo - Intercooled VW Eng.	12
AZG	2.0L 121 (1984cc) SOHC L4 (8 Valve) 82.5mm Bore; MFI; Gasoline; Naturally Aspirated VW Eng.	33
BBW	2.0L 121 (1984cc) SOHC L4 (8 Valve) 82.5mm Bore; MFI; Gasoline; Naturally Aspirated VW Eng.	34
BDC	2.0L 121 (1984cc) SOHC L4 (8 Valve) 82.5mm Bore; MFI; Gasoline; Naturally Aspirated VW Eng.	35
BDF	2.8L 170.7 (2792cc) DOHC V6 (24 Valve) 81mm Bore; MFI; Gasoline; Naturally Aspirated VW Eng.	46
BEV	2.0L 121 (1984cc) SOHC L4 (8 Valve) 82.5mm Bore; MFI; Gasoline; Naturally Aspirated VW Eng.	36
BEW	1.9L 115.7 (1896cc) SOHC Turbo - Intercooled L4 (8 Valve) 79.5mm Bore; MFI; Diesel; Turbo - Intercooled VW Eng.	23
BGD	2.0L 121 (1984cc) SOHC L4 (8 Valve) 82.5mm Bore; MFI; Gasoline; Naturally Aspirated VW Eng.	37
BGH	4.2L 254.5 (4172cc) DOHC V8 (40 Valve) 84.5mm Bore; MFI; Gasoline; Naturally Aspirated Audi Eng.	52
BGP	2.5L 151.3 (2480cc) DOHC L5 (20 Valve) 82.5mm Bore; MFI; Gasoline; Naturally Aspirated VW Eng.	38
BGQ	2.5L 151.3 (2480cc) DOHC L5 (20 Valve) 82.5mm Bore; MFI; Gasoline; Naturally Aspirated VW Eng.	39
BHW	2.0L 120.1 (1969cc) SOHC Turbo - Intercooled L4 (8 Valve) 81mm Bore; MFI; Diesel; Turbo - Intercooled VW Eng.	25
BHX	4.2L 254.5 (4172cc) DOHC V8 (40 Valve) 84.5mm Bore; MFI; Gasoline; Naturally Aspirated Audi Eng.	53
BJS	3.2L 195 (3189cc) DOHC V6 (24 Valve) 84mm Bore; MFI; Gasoline; Naturally Aspirated VW Eng.	50
BNU	1.8L 108.6 (1780cc) DOHC L4 (20 Valve) 81mm Bore; MFI; Gasoline; Turbo - Intercooled VW Eng.	13
BPR	2.5L 151.3 (2480cc) DOHC L5 (20 Valve) 82.5mm Bore; MFI; Gasoline; Naturally Aspirated VW Eng.	40
BPS	2.5L 151.3 (2480cc) DOHC L5 (20 Valve) 82.5mm Bore; MFI; Gasoline; Naturally Aspirated VW Eng.	41
BPY	2.0L 121 (1984cc) DOHC L4 (16 Valve) 82.5mm Bore; DI; Gasoline; Turbo - Intercooled VW Eng.	27
BRM	1.9L 115.7 (1896cc) SOHC Turbo - Intercooled L4 (8 Valve) 79.5mm Bore; MFI; Diesel; Turbo - Intercooled VW Eng.	24
BUB	3.2L 195 (3189cc) DOHC V6 (24 Valve) 84mm Bore; MFI; Gasoline; Naturally Aspirated VW Eng.	51
CBFA	2.0L 121 (1984cc) DOHC L4 (16 Valve) 82.5mm Bore; DI; Gasoline; Turbo - Intercooled VW Eng.	28
CCTA	2.0L 121 (1984cc) DOHC L4 (16 Valve) 82.5mm Bore; DI; Gasoline; Turbo - Intercooled VW Eng.	29
ME	1.6L 96.9 (1588cc) SOHC L4 (8 Valve) 76.5mm Bore; MFI; Diesel; Naturally Aspirated VW Eng.	2
MF	1.6L 96.9 (1588cc) SOHC Turbo L4 (8 Valve) 76.5mm Bore; MFI; Diesel; Turbo VW Eng.	3
PF	1.8L 108.6 (1780cc) SOHC L4 (8 Valve) 81mm Bore; MFI; Gasoline; Naturally Aspirated VW Eng.	17
PG	1.8L 108.6 (1780cc) SOHC L4 (8 Valve) 81mm Bore; MFI; Gasoline; Supercharged VW Eng.	18
RV	1.8L 108.6 (1780cc) SOHC L4 (8 Valve) 81mm Bore; MFI; Gasoline; Naturally Aspirated VW Eng.	19
VR6	2.8L 170.7 (2792cc) SOHC V6 (12 Valve) 81mm Bore; MFI; Gasoline; Naturally Aspirated VW Eng.	49

Model Index

Engine (VIN Code / Eng. Code)	Year	Engine (VIN Code / Eng. Code)	Year	Engine (VIN Code / Eng. Code)	Year
Bugatti		Volkswagen		Volkswagen (cont.)	
EB16.4		411		411 (cont.)	
W16 7993cc 8.0L DOHC Turbo (64 Valve)	13-04	H4 1679cc 1.7L OHV (EA)	73-72	H4 1679cc 1.7L OHV (W)	71

Model Index (Cont.)					
Engine (VIN Code / Eng. Code)	Year	Engine (VIN Code / Eng. Code)	Year	Engine (VIN Code / Eng. Code)	Year
Volkswagen (cont.)		Volkswagen (cont.)		Volkswagen (cont.)	
412		Golf (cont.)		Jetta (cont.)	
H4 1679cc 1.7L OHV (EA)	74-73	L4 1896cc 1.9L SOHC Turbo-Diesel (8 Valve) (ALH)	03-98	L4 1896cc 1.9L SOHC Turbo-Diesel (8 Valve) (ALH)	03-98
H4 1795cc 1.8L OHV (AW)	75-74	L4 1896cc 1.9L SOHC Turbo-Diesel (8 Valve) (BEW)	06-04	L4 1896cc 1.9L SOHC Turbo-Diesel (8 Valve) (BEW)	05-04
H4 1795cc 1.8L OHV (EC)	74	L4 1969cc 2.0L DOHC Turbo-Diesel (16 Valve) (CBAB)	13-10	L4 1896cc 1.9L SOHC Turbo-Diesel (8 Valve) (BRM)	07-05
Beetle		L4 1969cc 2.0L DOHC Turbo-Diesel (16 Valve) (CJAA)	13-12	L4 1969cc 2.0L DOHC Turbo-Diesel (16 Valve) (CBEA)	13-09
H4 1192cc 1.2L OHV	65-54	L4 1984cc 2.0L DOHC (16 Valve) (9A)	92-90	L4 1969cc 2.0L DOHC Turbo-Diesel (16 Valve) (CJAA)	13-12
H4 1285cc 1.3L OHV	66	L4 1984cc 2.0L DOHC Turbo (16 Valve) (BPY)	13-06	L4 1984cc 2.0L DOHC (16 Valve) (9A)	92-90
H4 1493cc 1.5L OHV	69-67	L4 1984cc 2.0L DOHC Turbo (16 Valve) (CBFA)	13-12	L4 1984cc 2.0L DOHC Turbo (16 Valve) (BPY)	13-06
H4 1584cc 1.6L OHV (AE)	72-70	L4 1984cc 2.0L DOHC Turbo (16 Valve) (CCTA)	13-12	L4 1984cc 2.0L DOHC Turbo (16 Valve) (CBFA)	13-12
H4 1584cc 1.6L OHV (AH)	74-72	L4 1984cc 2.0L DOHC Turbo (16 Valve) (CRZA)	13-12	L4 1984cc 2.0L DOHC Turbo (16 Valve) (CCTA)	13-12
H4 1584cc 1.6L OHV (AJ)	79-75	L4 1984cc 2.0L SOHC (8 Valve) (ABA)	99-93	L4 1984cc 2.0L SOHC (8 Valve) (ABA)	99-93
Cabrio		L4 1984cc 2.0L SOHC (8 Valve) (AEG)	06-99	L4 1984cc 2.0L SOHC (8 Valve) (AEG)	05-99
L4 1984cc 2.0L SOHC (8 Valve) (ABA)	02-95	L4 1984cc 2.0L SOHC (8 Valve) (AVH)	05-01	L4 1984cc 2.0L SOHC (8 Valve) (AVH)	05-01
Cabriolet		L4 1984cc 2.0L SOHC (8 Valve) (AZG)	05-01	L4 1984cc 2.0L SOHC (8 Valve) (AZG)	05-01
L4 1780cc 1.8L SOHC (8 Valve) (2H)	93-90	L4 1984cc 2.0L SOHC (8 Valve) (BEV)	06-04	L4 1984cc 2.0L SOHC (8 Valve) (BEV)	05-04
L4 1780cc 1.8L SOHC (8 Valve) (JH)	89-85	L5 2480cc 2.5L DOHC (20 Valve) (BGP)	11-06	L4 1984cc 2.0L SOHC (8 Valve) (CBPA)	13-11
CC		L5 2480cc 2.5L DOHC (20 Valve) (BGQ)	11-06	L5 2480cc 2.5L DOHC (20 Valve) (BGP)	11-05
L4 1984cc 2.0L DOHC Turbo (16 Valve) (BPY)	13-09	L5 2480cc 2.5L DOHC (20 Valve) (CBTA)	13-12	L5 2480cc 2.5L DOHC (20 Valve) (BGQ)	11-05
L4 1984cc 2.0L DOHC Turbo (16 Valve) (CBFA)	13-12	L5 2480cc 2.5L DOHC (20 Valve) (CUBA)	13-12	L5 2480cc 2.5L DOHC (20 Valve) (CBTA)	13-12
L4 1984cc 2.0L DOHC Turbo (16 Valve) (CCTA)	13-12	V6 2792cc 2.8L DOHC (24 Valve) (AFP)	05-01	L5 2480cc 2.5L DOHC (20 Valve) (CUBA)	13-12
V6 3597cc 3.6L DOHC (24 Valve) (BLV)	12-09	V6 2792cc 2.8L DOHC (24 Valve) (BDF)	05-02	V6 2792cc 2.8L DOHC (24 Valve) (AFP)	05-01
V6 3597cc 3.6L DOHC (24 Valve) (CNNA)	13-12	V6 2792cc 2.8L SOHC (12 Valve) (AAA)	02-93	V6 2792cc 2.8L DOHC (24 Valve) (BDF)	05-02
Corrado		V6 2792cc 2.8L SOHC (12 Valve) (AFP)	02-99	V6 2792cc 2.8L SOHC (12 Valve) (AAA)	02-93
L4 1780cc 1.8L SOHC Supercharged (8 Valve) (PG)	94-90	V6 3189cc 3.2L DOHC (24 Valve) (BJS)	05-04	V6 2792cc 2.8L SOHC (12 Valve) (AFP)	02-99
V6 2792cc 2.8L SOHC (12 Valve) (AAA)	94-92	V6 3189cc 3.2L DOHC (24 Valve) (BUB)	08	Jetta Hybrid	
Dasher		GTI		L4 1395cc 1.4L DOHC Turbo (16 Valve) (CNLA)	13
L4 1471cc 1.5L SOHC (XS)	75	L4 1984cc 2.0L DOHC Turbo (16 Valve) (BPY)	13-06	Karmann Ghia	
L4 1471cc 1.5L SOHC (XW)	74	L4 1984cc 2.0L DOHC Turbo (16 Valve) (CBFA)	13-12	H4 1192cc 1.2L OHV	65-55
L4 1471cc 1.5L SOHC (XZ)	74	L4 1984cc 2.0L DOHC Turbo (16 Valve) (CCTA)	13-12	H4 1285cc 1.3L OHV	66
L4 1471cc 1.5L SOHC Diesel (CK)	80-78	L4 1984cc 2.0L DOHC Turbo (16 Valve) (CRZA)	13-12	H4 1493cc 1.5L OHV	69-67
L4 1588cc 1.6L SOHC (YG)	80-77	V6 3189cc 3.2L DOHC (24 Valve) (BUB)	08	H4 1584cc 1.6L OHV (AD)	74-70
L4 1588cc 1.6L SOHC (YK)	76	Jetta		New Beetle	
L4 1588cc 1.6L SOHC Diesel (CR)	81	L4 1471cc 1.5L SOHC Diesel (CK)	80	L4 1780cc 1.8L DOHC Turbo (20 Valve) (APH)	05-99
L4 1715cc 1.7L SOHC (EN)	81	L4 1588cc 1.6L SOHC (EJ)	80	L4 1780cc 1.8L DOHC Turbo (20 Valve) (AWP)	05-02
Eos		L4 1588cc 1.6L SOHC Diesel (CR)	82-81	L4 1780cc 1.8L DOHC Turbo (20 Valve) (BNU)	05
L4 1984cc 2.0L DOHC Turbo (16 Valve) (BPY)	13-07	L4 1588cc 1.6L SOHC Diesel (JK)	84-83	L4 1896cc 1.9L SOHC Turbo-Diesel (ALH)	03-98
L4 1984cc 2.0L DOHC Turbo (16 Valve) (CBFA)	13-12	L4 1588cc 1.6L SOHC Diesel (ME)	92-85	L4 1896cc 1.9L SOHC Turbo-Diesel (BEW)	07-04
L4 1984cc 2.0L DOHC Turbo (16 Valve) (CCTA)	13-12	L4 1588cc 1.6L SOHC Turbo-Diesel (CR)	84-83	L4 1896cc 1.9L SOHC Turbo-Diesel (BRM)	07-06
V6 3189cc 3.2L DOHC (24 Valve) (BUB)	08-07	L4 1588cc 1.6L SOHC Turbo-Diesel (CS)	84-83	L4 1969cc 2.0L DOHC Turbo-Diesel (16 Valve) (CJAA)	13-12
Fastback		L4 1588cc 1.6L SOHC Turbo-Diesel (MF)	92-85	L4 1984cc 2.0L DOHC Turbo (16 Valve) (CBFA)	13-12
H4 1584cc 1.6L OHV (AD)	73-66	L4 1715cc 1.7L SOHC (EN)	82-81	L4 1984cc 2.0L DOHC Turbo (16 Valve) (CCTA)	13-12
Fox		L4 1715cc 1.7L SOHC (JF)	84-82	L4 1984cc 2.0L SOHC (8 Valve) (AEG)	05-98
L4 1780cc 1.8L SOHC (8 Valve) (ABG)	93-91	L4 1780cc 1.8L DOHC (16 Valve) (PL)	89-87	L4 1984cc 2.0L SOHC (8 Valve) (AVH)	05-01
L4 1780cc 1.8L SOHC (8 Valve) (JN)	90-87	L4 1780cc 1.8L DOHC Turbo (20 Valve) (AWP)	05-02	L4 1984cc 2.0L SOHC (8 Valve) (AZG)	05-01
Golf		L4 1780cc 1.8L DOHC Turbo (20 Valve) (AWP)	01-00	L4 1984cc 2.0L SOHC (8 Valve) (BEV)	05-04
L4 1588cc 1.6L SOHC Diesel (ME)	92-85	L4 1780cc 1.8L DOHC Turbo (20 Valve) (AWW)	01-00	L5 2480cc 2.5L DOHC (20 Valve) (BPR)	10-06
L4 1780cc 1.8L DOHC (16 Valve) (PL)	89-87	L4 1780cc 1.8L SOHC (8 Valve) (GX)	87-85	L5 2480cc 2.5L DOHC (20 Valve) (BPS)	10-06
L4 1780cc 1.8L DOHC Turbo (20 Valve) (AWP)	06-02	L4 1780cc 1.8L SOHC (8 Valve) (HT)	85-84	L5 2480cc 2.5L DOHC (20 Valve) (CBTA)	13-12
L4 1780cc 1.8L DOHC Turbo (20 Valve) (AWW)	01-00	L4 1780cc 1.8L SOHC (8 Valve) (JH)	85-84	L5 2480cc 2.5L DOHC (20 Valve) (CUBA)	13-12
L4 1780cc 1.8L SOHC (8 Valve) (GX)	87-85	L4 1780cc 1.8L SOHC (8 Valve) (PF)	92-88	L5 2480cc 2.5L DOHC (20 Valve) (CUBA)	13-12
L4 1780cc 1.8L SOHC (8 Valve) (HT)	86-85	L4 1780cc 1.8L SOHC (8 Valve) (RV)	92-88	New Beetle Cabrio	
L4 1780cc 1.8L SOHC (8 Valve) (PF)	92-88	L4 1780cc 1.8L SOHC (8 Valve) (RV)	92-88	L4 1780cc 1.8L DOHC Turbo (20 Valve) (APH)	05-03
L4 1780cc 1.8L SOHC (8 Valve) (RD)	87-85	L4 1896cc 1.9L SOHC Diesel (8 Valve) (AZZ)	95-93		
L4 1780cc 1.8L SOHC (8 Valve) (RV)	92-88	L4 1896cc 1.9L SOHC Turbo-Diesel (8 Valve) (AHU)	97-96		
L4 1896cc 1.9L SOHC Diesel (8 Valve) (AZZ)	95-93				
L4 1896cc 1.9L SOHC Turbo-Diesel (8 Valve) (AHU)	97-96				

VW Car (Cont.)

Model Index (Cont.)

Engine (VIN Code / Eng. Code)	Year	Engine (VIN Code / Eng. Code)	Year	Engine (VIN Code / Eng. Code)	Year
Volkswagen (cont.)		Volkswagen (cont.)			
New Beetle Cabrio (cont.)		Rabbit (cont.)			
L4 1984cc 2.0L SOHC (8 Valve) (AEG)	05-03	L4 1588cc 1.6L SOHC Diesel (JK)	84-83		
L4 1984cc 2.0L SOHC (8 Valve) (AVH)	05-03	L4 1588cc 1.6L SOHC Turbo-Diesel (CY)	84-83		
L4 1984cc 2.0L SOHC (8 Valve) (AZG)	05-03	L4 1715cc 1.7L SOHC (EN)	82-81		
L4 1984cc 2.0L SOHC (8 Valve) (BEV)	05-04	L4 1715cc 1.7L SOHC (JF)	84-82		
L5 2480cc 2.5L DOHC (20 Valve) (BPR)	10-06	L4 1780cc 1.8L SOHC (8 Valve) (JH)	84-83		
L5 2480cc 2.5L DOHC (20 Valve) (BPS)	10-06	L5 2480cc 2.5L DOHC (20 Valve) (BGP)	09-06		
		L5 2480cc 2.5L DOHC (20 Valve) (BGQ)	09-06		
Passat		Scirocco			
L4 1780cc 1.8L DOHC Turbo (20 Valve) (AEB)	05-98	L4 1457cc 1.5L SOHC (EN)	78		
L4 1780cc 1.8L DOHC Turbo (20 Valve) (AWM)	05-01	L4 1471cc 1.5L SOHC (FC)	75		
L4 1780cc 1.8L SOHC Supercharged (8 Valve) (PG)	94-93	L4 1471cc 1.5L SOHC (FG)	75		
L4 1896cc 1.9L SOHC Diesel (8 Valve) (AZZ)	95-92	L4 1588cc 1.6L SOHC (EE)	78-76		
L4 1896cc 1.9L SOHC Turbo-Diesel (8 Valve) (AAZ)	98-97	L4 1588cc 1.6L SOHC (EJ)	80-79		
L4 1896cc 1.9L SOHC Turbo-Diesel (8 Valve) (AHU)	96	L4 1588cc 1.6L SOHC (FN)	75		
L4 1969cc 2.0L DOHC Turbo-Diesel (16 Valve) (CKRA)	13-12	L4 1715cc 1.7L SOHC (EN)	82-81		
L4 1969cc 2.0L SOHC Turbo-Diesel (8 Valve) (BHW)	06-04	L4 1715cc 1.7L SOHC (JF)	83-82		
L4 1984cc 2.0L DOHC (16 Valve) (9A)	94-90	L4 1780cc 1.8L DOHC (16 Valve) (PL)	89-86		
L4 1984cc 2.0L DOHC Turbo (16 Valve) (BPY)	10-06	L4 1780cc 1.8L SOHC (8 Valve) (JH)	89-83		
L4 1984cc 2.0L SOHC (8 Valve) (ABA)	97-95	Squareback			
L5 2480cc 2.5L DOHC (20 Valve) (CBTA)	13-12	H4 1584cc 1.6L OHV (AD)	73-66		
L5 2480cc 2.5L DOHC (20 Valve) (CBLA)	13-12	Super Beetle			
V6 2771cc 2.8L DOHC (30 Valve) (AHA)	05-98	H4 1584cc 1.6L OHV (AD)	74-71		
V6 2771cc 2.8L DOHC (30 Valve) (AMX)	05	H4 1584cc 1.6L OHV (AJ)	79-75		
V6 2771cc 2.8L DOHC (30 Valve) (ATQ)	05-00	Thing			
V6 2792cc 2.8L SOHC (12 Valve) (AAA)	97-92	H4 1584cc 1.6L OHV (AH)	74-73		
V6 3597cc 3.6L DOHC (24 Valve) (BLV)	08-06				
V6 3597cc 3.6L DOHC (24 Valve) (CDVB)	13-12				
V8 3998cc 4.0L DOHC (32 Valve) (BDP)	05-02				
Passat Syncro					
V6 2771cc 2.8L DOHC (30 Valve) (AHA)	01-98				
Phaeton					
V8 4172cc 4.2L DOHC (40 Valve) (BGH)	06-04				
V8 4172cc 4.2L DOHC (40 Valve) (BHX)	06-04				
W12 5998cc 6.0L DOHC (48 Valve) (BAP)	05-04				
W12 5998cc 6.0L DOHC (48 Valve) (BRP)	06				
Quantum					
L4 1588cc 1.6L SOHC Diesel (CR)	82				
L4 1588cc 1.6L SOHC Diesel (JK)	84-83				
L4 1588cc 1.6L SOHC Diesel (ME)	85				
L4 1588cc 1.6L SOHC Turbo-Diesel (CY)	84-82				
L4 1588cc 1.6L SOHC Turbo-Diesel (MD)	85				
L4 1715cc 1.7L SOHC (WT)	83-82				
L4 1780cc 1.8L SOHC (8 Valve) (JN)	85-84				
L5 2144cc 2.1L SOHC (KM)	84				
L5 2144cc 2.1L SOHC (WE)	83				
L5 2226cc 2.2L SOHC (10 Valve) (KX)	88-85				
Quantum Syncro					
L5 2226cc 2.2L SOHC (10 Valve) (JT)	88-85				
Rabbit					
L4 1457cc 1.5L SOHC (EH)	80-78				
L4 1457cc 1.5L SOHC (FX)	80-78				
L4 1471cc 1.5L SOHC (FC)	75				
L4 1471cc 1.5L SOHC (FG)	75				
L4 1471cc 1.5L SOHC Diesel (CK)	80-77				
L4 1588cc 1.6L SOHC (EE)	78-76				
L4 1588cc 1.6L SOHC (EJ)	80-79				
L4 1588cc 1.6L SOHC (FN)	75				
L4 1588cc 1.6L SOHC Diesel (CR)	82-81				

1					1992 - 1991; 1.6L 96.9 (1588cc) SOHC L4 (8 Valve) 76.5mm Bore					1				
					MFI; Diesel; Naturally Aspirated VW Eng.; Eng. Code 1V									
QTY	CYLINDER HEAD	YEARS	PART NO.	DESCRIPTION										
1	Head Gasket	1992-91	9437 B-1	1 hole; Head bolts not incl.; Head bolt replacement recommended										
1	Head Gasket	1992-91	9438 B-1	2 holes; Head bolts not incl.; Head bolt replacement recommended										
1	Head Gasket	1992-91	9439 B-1	3 holes; Head bolts not incl.; Head bolt replacement recommended										
1	Head Set w/o Head Gasket	1992-91	HSU 21225	Head gskt., head bolts, exh. pipe flange not incl.; Head bolt replacement recommended; Premium valve stem seals incl.										
QTY	CONVERSION SET	YEARS	PART NO.	DESCRIPTION										
1	Gasket Conversion Set	1992-91	CS 21225											
QTY	MANIFOLD - INT. & EXH.	YEARS	PART NO.	DESCRIPTION										
1	Int. Manifold Gasket Set	1992-91	MS 22755											
1	Exh. Manifold Gasket Set	1992-91	MS 94063											
QTY	EXHAUST PIPE FLANGE	YEARS	PART NO.	DESCRIPTION										
1	Exhaust Pipe Gasket	1992-91	60576	Ring										
QTY	OIL PAN	YEARS	PART NO.	DESCRIPTION										
1	Oil Pan Gasket Set	1992-91	OS 20101 C											
QTY	CRANKSHAFT REAR SEAL	YEARS	PART NO.	DESCRIPTION										
1	Rear Main Seal Set	1992-91	BS 40427	Rubber; One-piece; Improved design										
QTY	VALVE COVER	YEARS	PART NO.	DESCRIPTION										
1	Valve Cover Gasket Set	1992-91	VS 50107 C	w/Semi-circular plug										
1	Valve Cover Gasket Set	1992-91	VS 50200 C	w/o Semi-circular plug										
1	Semi-Circular Plug	1992-91	CP 75002	Valve Cover										
QTY	VALVE STEM SEAL SET	YEARS	PART NO.	DESCRIPTION										
1	Valve Stem Seal Set	1992-91	SS 72567	Premium valve stem seals incl.										
QTY	WATER OUTLET GASKET	YEARS	PART NO.	DESCRIPTION										
1	O-Ring	1992-91	25598	Water Outlet										
QTY	WATER PUMP	YEARS	PART NO.	DESCRIPTION										
1	Water Pump Gasket	1992-91	25609	8-bolt gskt.										
1	O-Ring	1992-91	25598	Water Pump; Housing										
QTY	TIMING COVER	YEARS	PART NO.	DESCRIPTION										
1	Crankshaft Front Seal Set	1992-91	TCS 24551											
1	Camshaft Front Seal Set	1992-91	TCS 45357											
1	Auxiliary Shaft Seal Set	1992-91	TCS 45288											
2					1992 - 1991; 1.6L 96.9 (1588cc) SOHC L4 (8 Valve) 76.5mm Bore					2				
					MFI; Diesel; Naturally Aspirated VW Eng.; Eng. Code ME									
QTY	CYLINDER HEAD	YEARS	PART NO.	DESCRIPTION										
1	Head Gasket	1992-91	9437 B-1	1 hole; Head bolts not incl.; Head bolt replacement recommended										
1	Head Gasket	1992-91	9438 B-1	2 holes; Head bolts not incl.; Head bolt replacement recommended										
1	Head Gasket	1992-91	9439 B-1	3 holes; Head bolts not incl.; Head bolt replacement recommended										
1	Head Set w/o Head Gasket	1992-91	HSU 21225	Head gskt., head bolts, exh. pipe flange not incl.; Head bolt replacement recommended; Premium valve stem seals incl.										
QTY	CONVERSION SET	YEARS	PART NO.	DESCRIPTION										
1	Gasket Conversion Set	1992-91	CS 21225											
QTY	MANIFOLD - INT. & EXH.	YEARS	PART NO.	DESCRIPTION										
1	Int. Manifold Gasket Set	1992-91	MS 22755											
1	Exh. Manifold Gasket Set	1992-91	MS 94063											
QTY	EXHAUST PIPE FLANGE	YEARS	PART NO.	DESCRIPTION										
1	Exhaust Pipe Gasket	1992-91	60576	Ring										
QTY	OIL PAN	YEARS	PART NO.	DESCRIPTION										
1	Oil Pan Gasket Set	1992-91	OS 20101 C											
QTY	CRANKSHAFT REAR SEAL	YEARS	PART NO.	DESCRIPTION										
1	Rear Main Seal Set	1992-91	BS 40427	Rubber; One-piece; Improved design										
QTY	VALVE COVER	YEARS	PART NO.	DESCRIPTION										
1	Valve Cover Gasket Set	1992-91	VS 50107 C	w/Semi-circular plug										
1	Valve Cover Gasket Set	1992-91	VS 50200 C	w/o Semi-circular plug										
1	Semi-Circular Plug	1992-91	CP 75002	Valve Cover										
QTY	VALVE STEM SEAL SET	YEARS	PART NO.	DESCRIPTION										
1	Valve Stem Seal Set	1992-91	SS 72567	Premium valve stem seals incl.										
QTY	WATER OUTLET GASKET	YEARS	PART NO.	DESCRIPTION										
1	O-Ring	1992-91	25598	Water Outlet										
QTY	WATER PUMP	YEARS	PART NO.	DESCRIPTION										
1	Water Pump Gasket	1992-91	25609	8-bolt gskt.										
1	O-Ring	1992-91	25598	Water Pump; Housing										
QTY	TIMING COVER	YEARS	PART NO.	DESCRIPTION										
1	Crankshaft Front Seal Set	1992-91	TCS 24551											

VW Car (Cont.)

2		1992 - 1991; 1.6L 96.9 (1588cc) SOHC L4 (8 Valve) 76.5mm Bore			2	
(cont.)		MFI; Diesel; Naturally Aspirated VW Eng.; Eng. Code ME			(cont.)	
QTY	TIMING COVER	YEARS	PART NO.	DESCRIPTION		
1	Camshaft Front Seal Set	1992-91	TCS 45357			
1	Auxiliary Shaft Seal Set	1992-91	TCS 45288			
3		1992 - 1991; 1.6L 96.9 (1588cc) SOHC Turbo L4 (8 Valve) 76.5mm Bore			3	
		MFI; Diesel; Turbo VW Eng.; Eng. Code MF				
QTY	CYLINDER HEAD	YEARS	PART NO.	DESCRIPTION		
1	Head Gasket	1992-91	9437 B-1	1 hole; Head bolts not incl.; Head bolt replacement recommended		
1	Head Gasket	1992-91	9438 B-1	2 holes; Head bolts not incl.; Head bolt replacement recommended		
1	Head Gasket	1992-91	9439 B-1	3 holes; Head bolts not incl.; Head bolt replacement recommended		
1	Head Set w/o Head Gasket	1992-91	HSU 21225	Head gskt., head bolts, exh. pipe flange not incl.; Head bolt replacement recommended; Premium valve stem seals incl.		
QTY	CONVERSION SET	YEARS	PART NO.	DESCRIPTION		
1	Gasket Conversion Set	1992-91	CS 21225			
QTY	MANIFOLD - INT. & EXH.	YEARS	PART NO.	DESCRIPTION		
1	Int. Manifold Gasket Set	1992-91	MS 22755			
1	Exh. Manifold Gasket Set	1992-91	MS 94063			
QTY	EXHAUST PIPE FLANGE	YEARS	PART NO.	DESCRIPTION		
1	Exhaust Pipe Gasket	1992-91	60576	Ring		
QTY	OIL PAN	YEARS	PART NO.	DESCRIPTION		
1	Oil Pan Gasket Set	1992-91	OS 20101 C			
QTY	CRANKSHAFT REAR SEAL	YEARS	PART NO.	DESCRIPTION		
1	Rear Main Seal Set	1992-91	BS 40427	Rubber; One-piece; Improved design		
QTY	VALVE COVER	YEARS	PART NO.	DESCRIPTION		
1	Valve Cover Gasket Set	1992-91	VS 50107 C	w/Semi-circular plug		
1	Valve Cover Gasket Set	1992-91	VS 50200 C	w/o Semi-circular plug		
1	Semi-Circular Plug	1992-91	CP 75002	Valve Cover		
QTY	VALVE STEM SEAL SET	YEARS	PART NO.	DESCRIPTION		
1	Valve Stem Seal Set	1992-91	SS 72567	Premium valve stem seals incl.		
QTY	WATER OUTLET GASKET	YEARS	PART NO.	DESCRIPTION		
1	O-Ring	1992-91	25598	Water Outlet		
QTY	WATER PUMP	YEARS	PART NO.	DESCRIPTION		
1	Water Pump Gasket	1992-91	25609	8-bolt gskt.		
1	O-Ring	1992-91	25598	Water Pump; Housing		
QTY	TIMING COVER	YEARS	PART NO.	DESCRIPTION		
1	Crankshaft Front Seal Set	1992-91	TCS 24551			
1	Camshaft Front Seal Set	1992-91	TCS 45357			
1	Auxiliary Shaft Seal Set	1992-91	TCS 45288			
4		2005 - 1998; 1.8L 108.6 (1780cc) DOHC L4 (20 Valve) 81mm Bore			4	
		MFI; Gasoline; Turbo - Intercooled VW Eng.; Eng. Code AEB				
QTY	CYLINDER HEAD	YEARS	PART NO.	DESCRIPTION		
1	Head Gasket	2005-98	26182 PT	Head bolts not incl.; Head bolt replacement recommended; PermaTorqueMLS®		
1	Head Set	2005-98	HS 26182 PT	Head bolts not incl.; Head bolt replacement recommended; PermaDry® molded rubber valve cover gskt. incl.; Premium valve stem seals incl.		
1	Head Bolt Set	2005-98	ES 71172	Replacement recommended		
QTY	CONVERSION SET	YEARS	PART NO.	DESCRIPTION		
1	Gasket Conversion Set	2005-01	CS 26182-2	Crankshaft front seal not incl.; PermaDry® molded rubber oil pan gskt. incl.		
1	Gasket Conversion Set	2000-98	CS 26182-2	PermaDry® molded rubber oil pan gskt. incl.		
QTY	MANIFOLD - INT. & EXH.	YEARS	PART NO.	DESCRIPTION		
1	Int. Manifold Gasket Set	2005-98	MS 96151			
1	Exh. Manifold Gasket Set	2005-98	MS 96116			
QTY	EXHAUST PIPE FLANGE	YEARS	PART NO.	DESCRIPTION		
1	Exhaust Pipe Gasket	2005-98	61171	Flange		
QTY	OIL PAN	YEARS	PART NO.	DESCRIPTION		
1	Oil Pan Gasket Set	2005-01	OS 30736	PermaDry® molded rubber gskt. incl.		
1	Oil Pan Gasket Set	2000-98	OS 30791 R	PermaDry® molded rubber gskt. incl.		
QTY	CRANKSHAFT REAR SEAL	YEARS	PART NO.	DESCRIPTION		
1	Rear Main Seal Set	2005-98	BS 40187	w/7mm bolt holes; PTFE Rubber; One-piece		
1	Rear Main Seal Set	2005-98	BS 40724	w/6mm bolt holes; PTFE Rubber; One-piece		
QTY	VALVE COVER	YEARS	PART NO.	DESCRIPTION		
1	Valve Cover Gasket Set	2005-98	VS 50531 R	w/Spark plug tube seals; PermaDry® molded rubber gskt. incl.		

4		2005 - 1998; 1.8L 108.6 (1780cc) DOHC L4 (20 Valve) 81mm Bore			4	
(cont.)		MFI; Gasoline; Turbo - Intercooled VW Eng.; Eng. Code AEB			(cont.)	
QTY	VALVE STEM SEAL SET	YEARS	PART NO.	DESCRIPTION		
1	Valve Stem Seal Set	2005-98	SS 71074	Premium valve stem seals incl.		
QTY	THERMOSTAT HOUSING	YEARS	PART NO.	DESCRIPTION		
1	O-Ring	2005-03	35716	Thermostat Housing		
1	O-Ring	2002-98	25598	Thermostat Housing		
QTY	WATER PUMP	YEARS	PART NO.	DESCRIPTION		
1	Water Pump Gasket	2005-98	35549			
QTY	TIMING COVER	YEARS	PART NO.	DESCRIPTION		
1	Crankshaft Front Seal Set	2005-01	TCS 45038			
1	Crankshaft Front Seal Set	2000-98	TCS 46021			
1	Camshaft Front Seal Set	2005-98	TCS 46005			
QTY	CARB & FUEL INJECTION	YEARS	PART NO.	DESCRIPTION		
2	Fuel Injector O-Ring Set	2005-98	ES 70599	Improved design		
1	Throttle Body Gasket	2005-98	61092			
QTY	OIL FILTER MOUNTING	YEARS	PART NO.	DESCRIPTION		
1	Oil Filter Adapter Gasket	2005-98	72969	Oil filter adapter; New Part Number - Check for Availability		
QTY	OIL COOLER	YEARS	PART NO.	DESCRIPTION		
1	Oil Cooler Gasket	2005-98	72485	Oil cooler O-ring; New Part Number - Check for Availability		
5		2005 - 1999; 1.8L 108.6 (1780cc) DOHC L4 (20 Valve) 81mm Bore			5	
		MFI; Gasoline; Turbo - Intercooled VW Eng.; Eng. Code APH				
QTY	CYLINDER HEAD	YEARS	PART NO.	DESCRIPTION		
1	Head Gasket	2005-99	26182 PT	Head bolts not incl.; Head bolt replacement recommended; PermaTorqueMLS®		
1	Head Set	2005-99	HS 26182 PT	Head bolts not incl.; Head bolt replacement recommended; PermaDry® molded rubber valve cover gskt. incl.; Premium valve stem seals incl.		
1	Head Bolt Set	2005-99	ES 71193	Replacement recommended		
QTY	CONVERSION SET	YEARS	PART NO.	DESCRIPTION		
1	Gasket Conversion Set	2005-99	CS 26182-1	Crankshaft front seal not incl.; PermaDry® molded rubber oil pan gskt. incl.		
QTY	MANIFOLD - INT. & EXH.	YEARS	PART NO.	DESCRIPTION		
1	Int. Manifold Gasket Set	2005-99	MS 96151			
1	Exh. Manifold Gasket Set	2005-99	MS 96116			
QTY	EXHAUST PIPE FLANGE	YEARS	PART NO.	DESCRIPTION		
1	Exhaust Pipe Gasket	2005-99	61171	Flange		
QTY	OIL PAN	YEARS	PART NO.	DESCRIPTION		
1	Oil Pan Gasket Set	2005-99	OS 30708 R	PermaDry® molded rubber gskt. incl.		
QTY	CRANKSHAFT REAR SEAL	YEARS	PART NO.	DESCRIPTION		
1	Rear Main Seal Set	2005-99	BS 40187	w/7mm bolt holes; PTFE Rubber; One-piece		
1	Rear Main Seal Set	2005-99	BS 40724	w/6mm bolt holes; PTFE Rubber; One-piece		
QTY	VALVE COVER	YEARS	PART NO.	DESCRIPTION		
1	Valve Cover Gasket Set	2005-99	VS 50531 R	w/Spark plug tube seals; PermaDry® molded rubber gskt. incl.		
QTY	VALVE STEM SEAL SET	YEARS	PART NO.	DESCRIPTION		
1	Valve Stem Seal Set	2005-99	SS 71074	Premium valve stem seals incl.		
QTY	THERMOSTAT HOUSING	YEARS	PART NO.	DESCRIPTION		
1	O-Ring	2005-03	35716	Thermostat Housing		
1	O-Ring	2002-99	25598	Thermostat Housing		
QTY	WATER PUMP	YEARS	PART NO.	DESCRIPTION		
1	O-Ring	2005-99	35675	Water Pump; Housing		
QTY	TIMING COVER	YEARS	PART NO.	DESCRIPTION		
1	Crankshaft Front Seal Set	2005-99	TCS 45038			
1	Camshaft Front Seal Set	2005-99	TCS 46005			
QTY	CARB & FUEL INJECTION	YEARS	PART NO.	DESCRIPTION		
2	Fuel Injector O-Ring Set	2005-99	ES 70599	Improved design		
1	Throttle Body Gasket	2005-99	61092			
QTY	OIL FILTER MOUNTING	YEARS	PART NO.	DESCRIPTION		
1	Oil Filter Adapter Gasket	2005-99	72969	Oil filter adapter; New Part Number - Check for Availability		
QTY	OIL COOLER	YEARS	PART NO.	DESCRIPTION		
1	Oil Cooler Gasket	2005-99	72485	Oil cooler O-ring; New Part Number - Check for Availability		
6		2001 - 2000; 1.8L 108.6 (1780cc) DOHC L4 (20 Valve) 81mm Bore			6	
		MFI; Gasoline; Turbo - Intercooled VW Eng.; Eng. Code ATW				
QTY	CYLINDER HEAD	YEARS	PART NO.	DESCRIPTION		
1	Head Gasket	2001-00	26182 PT	Head bolts not incl.; Head bolt replacement recommended; PermaTorqueMLS®		

VW Car (Cont.)

6		2001 - 2000; 1.8L 108.6 (1780cc) DOHC L4 (20 Valve) 81mm Bore			6	
(cont.)		MFI; Gasoline; Turbo - Intercooled VW Eng.; Eng. Code ATW			(cont.)	
QTY	CYLINDER HEAD	YEARS	PART NO.	DESCRIPTION		
1	Head Set	2001-00	HS 26182 PT	Head bolts not incl.; Head bolt replacement recommended; PermaDry® molded rubber valve cover gskt. incl.; Premium valve stem seals incl.		
1	Head Bolt Set	2001-00	ES 71172	Replacement recommended		
QTY	CONVERSION SET	YEARS	PART NO.	DESCRIPTION		
1	Gasket Conversion Set	2001	CS 26182-2	Crankshaft front seal not incl.; PermaDry® molded rubber oil pan gskt. incl.		
1	Gasket Conversion Set	2000	CS 26182-2	PermaDry® molded rubber oil pan gskt. incl.		
QTY	MANIFOLD - INT. & EXH.	YEARS	PART NO.	DESCRIPTION		
1	Int. Manifold Gasket Set	2001-00	MS 96151			
1	Exh. Manifold Gasket Set	2001-00	MS 96116			
QTY	EXHAUST PIPE FLANGE	YEARS	PART NO.	DESCRIPTION		
1	Exhaust Pipe Gasket	2001-00	61171	Flange		
QTY	OIL PAN	YEARS	PART NO.	DESCRIPTION		
1	Oil Pan Gasket Set	2001	OS 30736	PermaDry® molded rubber gskt. incl.		
1	Oil Pan Gasket Set	2000	OS 30791 R	PermaDry® molded rubber gskt. incl.		
QTY	CRANKSHAFT REAR SEAL	YEARS	PART NO.	DESCRIPTION		
1	Rear Main Seal Set	2001-00	BS 40187	w/7mm bolt holes; PTFE Rubber; One-piece		
1	Rear Main Seal Set	2001-00	BS 40724	w/6mm bolt holes; PTFE Rubber; One-piece		
QTY	VALVE COVER	YEARS	PART NO.	DESCRIPTION		
1	Valve Cover Gasket Set	2001-00	VS 50531 R	w/Spark plug tube seals; PermaDry® molded rubber gskt. incl.		
QTY	VALVE STEM SEAL SET	YEARS	PART NO.	DESCRIPTION		
1	Valve Stem Seal Set	2001-00	SS 71074	Premium valve stem seals incl.		
QTY	THERMOSTAT HOUSING	YEARS	PART NO.	DESCRIPTION		
1	O-Ring	2001-00	25598	Thermostat Housing		
QTY	WATER PUMP	YEARS	PART NO.	DESCRIPTION		
1	Water Pump Gasket	2001-00	35549			
QTY	TIMING COVER	YEARS	PART NO.	DESCRIPTION		
1	Crankshaft Front Seal Set	2001	TCS 45038			
1	Crankshaft Front Seal Set	2000	TCS 46021			
1	Camshaft Front Seal Set	2001-00	TCS 46005			
QTY	CARB & FUEL INJECTION	YEARS	PART NO.	DESCRIPTION		
2	Fuel Injector O-Ring Set	2001-00	ES 70599	Improved design		
1	Throttle Body Gasket	2001-00	61092			
QTY	EXHAUST GAS RECIRCULATION	YEARS	PART NO.	DESCRIPTION		
2	EGR Gasket	2001-00	72803	Air pump gskt.; New Part Number - Check for Availability		
QTY	OIL FILTER MOUNTING	YEARS	PART NO.	DESCRIPTION		
1	Oil Filter Adapter Gasket	2001-00	72969	Oil filter adapter; New Part Number - Check for Availability		
QTY	OIL COOLER	YEARS	PART NO.	DESCRIPTION		
1	Oil Cooler Gasket	2001-00	72485	Oil cooler O-ring; New Part Number - Check for Availability		
7		2001 - 2000; 1.8L 108.6 (1780cc) DOHC L4 (20 Valve) 81mm Bore			7	
(cont.)		MFI; Gasoline; Turbo - Intercooled VW Eng.; Eng. Code AUG			(cont.)	
QTY	CYLINDER HEAD	YEARS	PART NO.	DESCRIPTION		
1	Head Gasket	2001-00	26182 PT	Head bolts not incl.; Head bolt replacement recommended; PermaTorqueMLS®		
1	Head Set	2001-00	HS 26182 PT	Head bolts not incl.; Head bolt replacement recommended; PermaDry® molded rubber valve cover gskt. incl.; Premium valve stem seals incl.		
1	Head Bolt Set	2001-00	ES 71193	Replacement recommended		
QTY	CONVERSION SET	YEARS	PART NO.	DESCRIPTION		
1	Gasket Conversion Set	2001-00	CS 26182-2	Crankshaft front seal not incl.; PermaDry® molded rubber oil pan gskt. incl.		
QTY	MANIFOLD - INT. & EXH.	YEARS	PART NO.	DESCRIPTION		
1	Int. Manifold Gasket Set	2001-00	MS 96151			
1	Exh. Manifold Gasket Set	2001-00	MS 96116			
QTY	EXHAUST PIPE FLANGE	YEARS	PART NO.	DESCRIPTION		
1	Exhaust Pipe Gasket	2001-00	61197	Turbo inlet		
1	Exhaust Pipe Gasket	2001-00	61198	Flange		
QTY	OIL PAN	YEARS	PART NO.	DESCRIPTION		
1	Oil Pan Gasket Set	2001	OS 30736	PermaDry® molded rubber gskt. incl.		
1	Oil Pan Gasket Set	2000	OS 30791 R	PermaDry® molded rubber gskt. incl.		
QTY	CRANKSHAFT REAR SEAL	YEARS	PART NO.	DESCRIPTION		
1	Rear Main Seal Set	2001-00	BS 40187	w/7mm bolt holes; PTFE Rubber; One-piece		
1	Rear Main Seal Set	2001-00	BS 40724	w/6mm bolt holes; PTFE Rubber; One-piece		
QTY	VALVE COVER	YEARS	PART NO.	DESCRIPTION		
1	Valve Cover Gasket Set	2001-00	VS 50531 R	w/Spark plug tube seals; PermaDry® molded rubber gskt. incl.		

7		2001 - 2000; 1.8L 108.6 (1780cc) DOHC L4 (20 Valve) 81mm Bore			7	
(cont.)		MFI; Gasoline; Turbo - Intercooled VW Eng.; Eng. Code AUG			(cont.)	
QTY	VALVE STEM SEAL SET	YEARS	PART NO.	DESCRIPTION		
1	Valve Stem Seal Set	2001-00	SS 71074	Premium valve stem seals incl.		
QTY	THERMOSTAT HOUSING	YEARS	PART NO.	DESCRIPTION		
1	O-Ring	2001-00	35705	Thermostat Housing		
QTY	WATER PUMP	YEARS	PART NO.	DESCRIPTION		
1	Water Pump Gasket	2001-00	35549			
QTY	TIMING COVER	YEARS	PART NO.	DESCRIPTION		
1	Crankshaft Front Seal Set	2001-00	TCS 45038			
1	Camshaft Front Seal Set	2001-00	TCS 46005			
QTY	CARB & FUEL INJECTION	YEARS	PART NO.	DESCRIPTION		
2	Fuel Injector O-Ring Set	2001-00	ES 70599	Improved design		
1	Throttle Body Gasket	2001-00	61092			
QTY	OIL FILTER MOUNTING	YEARS	PART NO.	DESCRIPTION		
1	Oil Filter Adapter Gasket	2001-00	72969	Oil filter adapter; New Part Number - Check for Availability		
QTY	OIL COOLER	YEARS	PART NO.	DESCRIPTION		
1	Oil Cooler Gasket	2001-00	72485	Oil cooler O-ring; New Part Number - Check for Availability		
8		2005 - 2000; 1.8L 108.6 (1780cc) DOHC L4 (20 Valve) 81mm Bore			8	
		MFI; Gasoline; Turbo - Intercooled VW Eng.; Eng. Code AWD				
QTY	CYLINDER HEAD	YEARS	PART NO.	DESCRIPTION		
1	Head Gasket	2005-00	26182 PT	Head bolts not incl.; Head bolt replacement recommended; PermaTorqueMLS®		
1	Head Set	2005-00	HS 26182 PT	Head bolts not incl.; Head bolt replacement recommended; PermaDry® molded rubber valve cover gskt. incl.; Premium valve stem seals incl.		
1	Head Bolt Set	2005-00	ES 71193	Replacement recommended		
QTY	CONVERSION SET	YEARS	PART NO.	DESCRIPTION		
1	Gasket Conversion Set	2005-00	CS 26182	Crankshaft front seal not incl.; PermaDry® molded rubber oil pan gskt. incl.		
QTY	MANIFOLD - INT. & EXH.	YEARS	PART NO.	DESCRIPTION		
1	Int. Manifold Gasket Set	2005-00	MS 96151			
1	Exh. Manifold Gasket Set	2005-00	MS 96116			
QTY	EXHAUST PIPE FLANGE	YEARS	PART NO.	DESCRIPTION		
1	Exhaust Pipe Gasket	2005-00	61197	Flange		
QTY	OIL PAN	YEARS	PART NO.	DESCRIPTION		
1	Oil Pan Gasket Set	2005-00	OS 30708 R	PermaDry® molded rubber gskt. incl.		
QTY	CRANKSHAFT REAR SEAL	YEARS	PART NO.	DESCRIPTION		
1	Rear Main Seal Set	2005-00	BS 40187	w/7mm bolt holes; PTFE Rubber; One-piece		
1	Rear Main Seal Set	2005-00	BS 40724	w/6mm bolt holes; PTFE Rubber; One-piece		
QTY	VALVE COVER	YEARS	PART NO.	DESCRIPTION		
1	Valve Cover Gasket Set	2005-00	VS 50531 R	w/Spark plug tube seals; PermaDry® molded rubber gskt. incl.		
QTY	VALVE STEM SEAL SET	YEARS	PART NO.	DESCRIPTION		
1	Valve Stem Seal Set	2005-00	SS 71074	Premium valve stem seals incl.		
QTY	THERMOSTAT HOUSING	YEARS	PART NO.	DESCRIPTION		
1	O-Ring	2005-03	35716	Thermostat Housing		
1	O-Ring	2002-00	25598	Thermostat Housing		
QTY	WATER PUMP	YEARS	PART NO.	DESCRIPTION		
1	Water Pump Gasket	2005-00	35549			
QTY	TIMING COVER	YEARS	PART NO.	DESCRIPTION		
1	Crankshaft Front Seal Set	2005-00	TCS 45038			
1	Camshaft Front Seal Set	2005-00	TCS 46005			
QTY	CARB & FUEL INJECTION	YEARS	PART NO.	DESCRIPTION		
2	Fuel Injector O-Ring Set	2005-00	ES 70599	Improved design		
1	Throttle Body Gasket	2005-00	61092			
QTY	OIL FILTER MOUNTING	YEARS	PART NO.	DESCRIPTION		
1	Oil Filter Adapter Gasket	2005-00	72969	Oil filter adapter; New Part Number - Check for Availability		
QTY	OIL COOLER	YEARS	PART NO.	DESCRIPTION		
1	Oil Cooler Gasket	2005-00	72485	Oil cooler O-ring; New Part Number - Check for Availability		
9		2005 - 2001; 1.8L 108.6 (1780cc) DOHC L4 (20 Valve) 81mm Bore			9	
		MFI; Gasoline; Turbo - Intercooled VW Eng.; Eng. Code AWM				
QTY	CYLINDER HEAD	YEARS	PART NO.	DESCRIPTION		
1	Head Gasket	2005-01	26182 PT	Head bolts not incl.; Head bolt replacement recommended; PermaTorqueMLS®		

VW Car (Cont.)

9 (cont.)		2005 - 2001; 1.8L 108.6 (1780cc) DOHC L4 (20 Valve) 81mm Bore			9 (cont.)
MFI; Gasoline; Turbo - Intercooled VW Eng.; Eng. Code AWM					
QTY	CYLINDER HEAD	YEARS	PART NO.	DESCRIPTION	
1	Head Set	2005-01	HS 26182 PT	Head bolts not incl.; Head bolt replacement recommended; PermaDry® molded rubber valve cover gskt. incl.; Premium valve stem seals incl.	
1	Head Bolt Set	2005-01	ES 71193	Replacement recommended	
QTY	CONVERSION SET	YEARS	PART NO.	DESCRIPTION	
1	Gasket Conversion Set	2005-01	CS 26182-2	Crankshaft front seal not incl.; PermaDry® molded rubber oil pan gskt. incl.	
QTY	MANIFOLD - INT. & EXH.	YEARS	PART NO.	DESCRIPTION	
1	Int. Manifold Gasket Set	2005-01	MS 96151		
1	Exh. Manifold Gasket Set	2005-01	MS 96116		
QTY	EXHAUST PIPE FLANGE	YEARS	PART NO.	DESCRIPTION	
1	Exhaust Pipe Gasket	2005-01	61197	Turbo inlet	
1	Exhaust Pipe Gasket	2005-01	61198	Flange	
QTY	OIL PAN	YEARS	PART NO.	DESCRIPTION	
1	Oil Pan Gasket Set	2005-01	OS 30736	PermaDry® molded rubber gskt. incl.	
QTY	CRANKSHAFT REAR SEAL	YEARS	PART NO.	DESCRIPTION	
1	Rear Main Seal Set	2005-01	BS 40187	w/7mm bolt holes; PTFE Rubber; One-piece	
1	Rear Main Seal Set	2005-01	BS 40724	w/6mm bolt holes; PTFE Rubber; One-piece	
QTY	VALVE COVER	YEARS	PART NO.	DESCRIPTION	
1	Valve Cover Gasket Set	2005-01	VS 50531 R	w/Spark plug tube seals; PermaDry® molded rubber gskt. incl.	
QTY	VALVE STEM SEAL SET	YEARS	PART NO.	DESCRIPTION	
1	Valve Stem Seal Set	2005-01	SS 71074	Premium valve stem seals incl.	
QTY	THERMOSTAT HOUSING	YEARS	PART NO.	DESCRIPTION	
1	O-Ring	2005-01	35705	Thermostat Housing	
QTY	WATER PUMP	YEARS	PART NO.	DESCRIPTION	
1	Water Pump Gasket	2005-01	35549		
QTY	TIMING COVER	YEARS	PART NO.	DESCRIPTION	
1	Crankshaft Front Seal Set	2005-01	TCS 45038		
1	Camshaft Front Seal Set	2005-01	TCS 46005		
QTY	CARB & FUEL INJECTION	YEARS	PART NO.	DESCRIPTION	
2	Fuel Injector O-Ring Set	2005-01	ES 70599	Improved design	
1	Throttle Body Gasket	2005-01	61092		
QTY	EXHAUST GAS RECIRCULATION	YEARS	PART NO.	DESCRIPTION	
2	EGR Gasket	2005-01	72803	Air pump gskt.; New Part Number - Check for Availability	
QTY	OIL FILTER MOUNTING	YEARS	PART NO.	DESCRIPTION	
1	Oil Filter Adapter Gasket	2005-01	72969	Oil filter adapter; New Part Number - Check for Availability	
QTY	OIL COOLER	YEARS	PART NO.	DESCRIPTION	
1	Oil Cooler Gasket	2005-01	72485	Oil cooler O-ring; New Part Number - Check for Availability	
10		2006 - 2002; 1.8L 108.6 (1780cc) DOHC L4 (20 Valve) 81mm Bore			10
MFI; Gasoline; Turbo - Intercooled VW Eng.; Eng. Code AWP					
QTY	CYLINDER HEAD	YEARS	PART NO.	DESCRIPTION	
1	Head Gasket	2006-02	26182 PT	Head bolts not incl.; Head bolt replacement recommended; PermaTorqueMLS®	
1	Head Set	2006-02	HS 26182 PT	Head bolts not incl.; Head bolt replacement recommended; PermaDry® molded rubber valve cover gskt. incl.; Premium valve stem seals incl.	
1	Head Bolt Set	2006-02	ES 71193	Replacement recommended	
QTY	CONVERSION SET	YEARS	PART NO.	DESCRIPTION	
1	Gasket Conversion Set	2006-02	CS 26182	Crankshaft front seal not incl.; PermaDry® molded rubber oil pan gskt. incl.	
QTY	MANIFOLD - INT. & EXH.	YEARS	PART NO.	DESCRIPTION	
1	Int. Manifold Gasket Set	2006-02	MS 96151		
1	Exh. Manifold Gasket Set	2006-02	MS 96116		
QTY	EXHAUST PIPE FLANGE	YEARS	PART NO.	DESCRIPTION	
1	Exhaust Pipe Gasket	2006-02	61197	Flange	
QTY	OIL PAN	YEARS	PART NO.	DESCRIPTION	
1	Oil Pan Gasket Set	2006-02	OS 30708 R	PermaDry® molded rubber gskt. incl.	
QTY	CRANKSHAFT REAR SEAL	YEARS	PART NO.	DESCRIPTION	
1	Rear Main Seal Set	2006-02	BS 40187	w/7mm bolt holes; PTFE Rubber; One-piece	
1	Rear Main Seal Set	2006-02	BS 40724	w/6mm bolt holes; PTFE Rubber; One-piece	
QTY	VALVE COVER	YEARS	PART NO.	DESCRIPTION	
1	Valve Cover Gasket Set	2006-02	VS 50531 R	w/Spark plug tube seals; PermaDry® molded rubber gskt. incl.	
QTY	VALVE STEM SEAL SET	YEARS	PART NO.	DESCRIPTION	
1	Valve Stem Seal Set	2006-02	SS 71074	Premium valve stem seals incl.	
QTY	THERMOSTAT HOUSING	YEARS	PART NO.	DESCRIPTION	
1	Thermostat Gasket	2006-02	35744	Thermostat Housing; Thermostat seal	

10 (cont.)		2006 - 2002; 1.8L 108.6 (1780cc) DOHC L4 (20 Valve) 81mm Bore			10 (cont.)	
MFI; Gasoline; Turbo - Intercooled VW Eng.; Eng. Code AWP						
QTY	THERMOSTAT HOUSING	YEARS	PART NO.	DESCRIPTION		
1	Thermostat Gasket	2006-02	35750	Thermostat Housing; Thermostat O-ring		
QTY	WATER PUMP	YEARS	PART NO.	DESCRIPTION		
1	Water Pump Gasket	2006-02	35549			
1	O-Ring	2006-02	35675	Water Pump; Housing		
QTY	TIMING COVER	YEARS	PART NO.	DESCRIPTION		
1	Crankshaft Front Seal Set	2006-02	TCS 45038			
1	Camshaft Front Seal Set	2006-02	TCS 46005			
QTY	CARB & FUEL INJECTION	YEARS	PART NO.	DESCRIPTION		
2	Fuel Injector O-Ring Set	2006-02	ES 70599	Improved design		
1	Throttle Body Gasket	2006-02	61092			
QTY	OIL FILTER MOUNTING	YEARS	PART NO.	DESCRIPTION		
1	Oil Filter Adapter Gasket	2006-02	72969	Oil filter adapter; New Part Number - Check for Availability		
QTY	OIL COOLER	YEARS	PART NO.	DESCRIPTION		
1	Oil Cooler Gasket	2006-02	72485	Oil cooler O-ring; New Part Number - Check for Availability		
11		2005 - 2001; 1.8L 108.6 (1780cc) DOHC L4 (20 Valve) 81mm Bore			11	
MFI; Gasoline; Turbo - Intercooled VW Eng.; Eng. Code AWW						
QTY	CYLINDER HEAD	YEARS	PART NO.	DESCRIPTION		
1	Head Gasket	2005-01	26182 PT	Head bolts not incl.; Head bolt replacement recommended; PermaTorqueMLS®		
1	Head Set	2005-01	HS 26182 PT	Head bolts not incl.; Head bolt replacement recommended; PermaDry® molded rubber valve cover gskt. incl.; Premium valve stem seals incl.		
1	Head Bolt Set	2005-01	ES 71193	Replacement recommended		
QTY	CONVERSION SET	YEARS	PART NO.	DESCRIPTION		
1	Gasket Conversion Set	2005-01	CS 26182-1	Crankshaft front seal not incl.; PermaDry® molded rubber oil pan gskt. incl.		
QTY	MANIFOLD - INT. & EXH.	YEARS	PART NO.	DESCRIPTION		
1	Int. Manifold Gasket Set	2005-01	MS 96151			
1	Exh. Manifold Gasket Set	2005-01	MS 96116			
QTY	EXHAUST PIPE FLANGE	YEARS	PART NO.	DESCRIPTION		
1	Exhaust Pipe Gasket	2005-01	61197	Flange		
QTY	OIL PAN	YEARS	PART NO.	DESCRIPTION		
1	Oil Pan Gasket Set	2005-01	OS 30708 R	PermaDry® molded rubber gskt. incl.		
QTY	CRANKSHAFT REAR SEAL	YEARS	PART NO.	DESCRIPTION		
1	Rear Main Seal Set	2005-01	BS 40187	w/7mm bolt holes; PTFE Rubber; One-piece		
1	Rear Main Seal Set	2005-01	BS 40724	w/6mm bolt holes; PTFE Rubber; One-piece		
QTY	VALVE COVER	YEARS	PART NO.	DESCRIPTION		
1	Valve Cover Gasket Set	2005-01	VS 50531 R	w/Spark plug tube seals; PermaDry® molded rubber gskt. incl.		
QTY	VALVE STEM SEAL SET	YEARS	PART NO.	DESCRIPTION		
1	Valve Stem Seal Set	2005-01	SS 71074	Premium valve stem seals incl.		
QTY	THERMOSTAT HOUSING	YEARS	PART NO.	DESCRIPTION		
1	O-Ring	2005-03	35716	Thermostat Housing		
1	O-Ring	2002-01	25598	Thermostat Housing		
QTY	WATER PUMP	YEARS	PART NO.	DESCRIPTION		
1	O-Ring	2005-01	35675	Water Pump; Housing		
QTY	TIMING COVER	YEARS	PART NO.	DESCRIPTION		
1	Crankshaft Front Seal Set	2005-01	TCS 45038			
1	Camshaft Front Seal Set	2005-01	TCS 46005			
QTY	CARB & FUEL INJECTION	YEARS	PART NO.	DESCRIPTION		
2	Fuel Injector O-Ring Set	2005-01	ES 70599	Improved design		
1	Throttle Body Gasket	2005-01	61092			
QTY	OIL FILTER MOUNTING	YEARS	PART NO.	DESCRIPTION		
1	Oil Filter Adapter Gasket	2005-01	72969	Oil filter adapter; New Part Number - Check for Availability		
QTY	OIL COOLER	YEARS	PART NO.	DESCRIPTION		
1	Oil Cooler Gasket	2005-01	72485	Oil cooler O-ring; New Part Number - Check for Availability		
12		2005 - 2000; 1.8L 108.6 (1780cc) DOHC L4 (20 Valve) 81mm Bore			12	
MFI; Gasoline; Turbo - Intercooled VW Eng.; Eng. Code AWW						
QTY	CYLINDER HEAD	YEARS	PART NO.	DESCRIPTION		
1	Head Gasket	2005-00	26182 PT	Head bolts not incl.; Head bolt replacement recommended; PermaTorqueMLS®		
1	Head Set	2005-00	HS 26182 PT	Head bolts not incl.; Head bolt replacement recommended; PermaDry® molded rubber valve cover gskt. incl.; Premium valve stem seals incl.		

VW Car (Cont.)

12		2005 - 2000; 1.8L 108.6 (1780cc) DOHC L4 (20 Valve) 81mm Bore			12	
(cont.)		MFI; Gasoline; Turbo - Intercooled VW Eng.; Eng. Code AWW			(cont.)	
QTY	CYLINDER HEAD	YEARS	PART NO.	DESCRIPTION		
1	Head Bolt Set	2005-00	ES 71193	Replacement recommended		
QTY	CONVERSION SET	YEARS	PART NO.	DESCRIPTION		
1	Gasket Conversion Set	2005-00	CS 26182-1	Crankshaft front seal not incl.; PermaDry® molded rubber oil pan gskt. incl.		
QTY	MANIFOLD - INT. & EXH.	YEARS	PART NO.	DESCRIPTION		
1	Int. Manifold Gasket Set	2005-00	MS 96151			
1	Exh. Manifold Gasket Set	2005-00	MS 96116			
QTY	EXHAUST PIPE FLANGE	YEARS	PART NO.	DESCRIPTION		
1	Exhaust Pipe Gasket	2005-00	61197	Flange		
QTY	OIL PAN	YEARS	PART NO.	DESCRIPTION		
1	Oil Pan Gasket Set	2005-00	OS 30708 R	PermaDry® molded rubber gskt. incl.		
QTY	CRANKSHAFT REAR SEAL	YEARS	PART NO.	DESCRIPTION		
1	Rear Main Seal Set	2005-00	BS 40187	w/7mm bolt holes; PTFE Rubber; One-piece		
1	Rear Main Seal Set	2005-00	BS 40724	w/6mm bolt holes; PTFE Rubber; One-piece		
QTY	VALVE COVER	YEARS	PART NO.	DESCRIPTION		
1	Valve Cover Gasket Set	2005-00	VS 50531 R	w/Spark plug tube seals; PermaDry® molded rubber gskt. incl.		
QTY	VALVE STEM SEAL SET	YEARS	PART NO.	DESCRIPTION		
1	Valve Stem Seal Set	2005-00	SS 71074	Premium valve stem seals incl.		
QTY	THERMOSTAT HOUSING	YEARS	PART NO.	DESCRIPTION		
1	O-Ring	2005-03	35716	Thermostat Housing		
1	O-Ring	2002-00	25598	Thermostat Housing		
QTY	WATER PUMP	YEARS	PART NO.	DESCRIPTION		
1	Water Pump Gasket	2005-00	35549			
QTY	TIMING COVER	YEARS	PART NO.	DESCRIPTION		
1	Crankshaft Front Seal Set	2005-00	TCS 45038			
1	Camshaft Front Seal Set	2005-00	TCS 46005			
QTY	CARB & FUEL INJECTION	YEARS	PART NO.	DESCRIPTION		
2	Fuel Injector O-Ring Set	2005-00	ES 70599	Improved design		
1	Throttle Body Gasket	2005-00	61092			
QTY	OIL FILTER MOUNTING	YEARS	PART NO.	DESCRIPTION		
1	Oil Filter Adapter Gasket	2005-00	72969	Oil filter adapter; New Part Number - Check for Availability		
QTY	OIL COOLER	YEARS	PART NO.	DESCRIPTION		
1	Oil Cooler Gasket	2005-00	72485	Oil cooler O-ring; New Part Number - Check for Availability		
13		2005; 1.8L 108.6 (1780cc) DOHC L4 (20 Valve) 81mm Bore			13	
		MFI; Gasoline; Turbo - Intercooled VW Eng.; Eng. Code BNU				
QTY	CYLINDER HEAD	YEARS	PART NO.	DESCRIPTION		
1	Head Gasket	2005	26182 PT	Head bolts not incl.; Head bolt replacement recommended; PermaTorqueMLS®		
1	Head Set	2005	HS 26182 PT	Head bolts not incl.; Head bolt replacement recommended; PermaDry® molded rubber valve cover gskt. incl.; Premium valve stem seals incl.		
1	Head Bolt Set	2005	ES 71193	Replacement recommended		
QTY	CONVERSION SET	YEARS	PART NO.	DESCRIPTION		
1	Gasket Conversion Set	2005	CS 26182-1	Crankshaft front seal not incl.; PermaDry® molded rubber oil pan gskt. incl.		
QTY	MANIFOLD - INT. & EXH.	YEARS	PART NO.	DESCRIPTION		
1	Int. Manifold Gasket Set	2005	MS 96151			
1	Exh. Manifold Gasket Set	2005	MS 96116			
QTY	EXHAUST PIPE FLANGE	YEARS	PART NO.	DESCRIPTION		
1	Exhaust Pipe Gasket	2005	61197	Flange		
QTY	OIL PAN	YEARS	PART NO.	DESCRIPTION		
1	Oil Pan Gasket Set	2005	OS 30708 R	PermaDry® molded rubber gskt. incl.		
QTY	CRANKSHAFT REAR SEAL	YEARS	PART NO.	DESCRIPTION		
1	Rear Main Seal Set	2005	BS 40187	w/7mm bolt holes; PTFE Rubber; One-piece		
1	Rear Main Seal Set	2005	BS 40724	w/6mm bolt holes; PTFE Rubber; One-piece		
QTY	VALVE COVER	YEARS	PART NO.	DESCRIPTION		
1	Valve Cover Gasket Set	2005	VS 50531 R	w/Spark plug tube seals; PermaDry® molded rubber gskt. incl.		
QTY	VALVE STEM SEAL SET	YEARS	PART NO.	DESCRIPTION		
1	Valve Stem Seal Set	2005	SS 71074	Premium valve stem seals incl.		
QTY	THERMOSTAT HOUSING	YEARS	PART NO.	DESCRIPTION		
1	O-Ring	2005	35716	Thermostat Housing		
QTY	WATER PUMP	YEARS	PART NO.	DESCRIPTION		
1	O-Ring	2005	35675	Water Pump; Housing		
QTY	TIMING COVER	YEARS	PART NO.	DESCRIPTION		
1	Crankshaft Front Seal Set	2005	TCS 45038			

13 (cont.)		2005; 1.8L 108.6 (1780cc) DOHC L4 (20 Valve) 81mm Bore			13 (cont.)
		MFI; Gasoline; Turbo - Intercooled VW Eng.; Eng. Code BNU			
QTY	TIMING COVER	YEARS	PART NO.	DESCRIPTION	
1	Camshaft Front Seal Set	2005	TCS 46005		
QTY	CARB & FUEL INJECTION	YEARS	PART NO.	DESCRIPTION	
2	Fuel Injector O-Ring Set	2005	ES 70599	Improved design	
1	Throttle Body Gasket	2005	61092		
QTY	OIL FILTER MOUNTING	YEARS	PART NO.	DESCRIPTION	
1	Oil Filter Adapter Gasket	2005	72969	Oil filter adapter; New Part Number - Check for Availability	
QTY	OIL COOLER	YEARS	PART NO.	DESCRIPTION	
1	Oil Cooler Gasket	2005	72485	Oil cooler O-ring; New Part Number - Check for Availability	
14		1993 - 1991; 1.8L 108.6 (1780cc) SOHC L4 (8 Valve) 81mm Bore			14
		MFI; Gasoline; Naturally Aspirated VW Eng.; Eng. Code 2H			
QTY	CYLINDER HEAD	YEARS	PART NO.	DESCRIPTION	
1	Head Gasket	1993-91	9090 PT	Head bolts not incl.; Head bolt replacement recommended	
1	Head Set	1993-91	HS 9090 B	Head bolts & exh. pipe flange not incl.; Head bolt replacement recommended; Premium valve stem seals incl.	
1	Head Bolt Set	1993-91	ES 74029	Head bolts w/Washers; Replacement recommended	
QTY	CONVERSION SET	YEARS	PART NO.	DESCRIPTION	
1	Gasket Conversion Set	1993-91	CS 9090	9-bolt water pump gskt. not incl.	
QTY	MANIFOLD - INT. & EXH.	YEARS	PART NO.	DESCRIPTION	
1	Int. Manifold Gasket Set	1993-91	MS 22755		
1	Exh. Manifold Gasket Set	1993-91	MS 94063		
QTY	EXHAUST PIPE FLANGE	YEARS	PART NO.	DESCRIPTION	
1	Exhaust Pipe Gasket	1993-91	60576	Ring	
1	Exhaust Pipe Gasket	1993-91	60693	Flange	
QTY	OIL PAN	YEARS	PART NO.	DESCRIPTION	
1	Oil Pan Gasket Set	1993-91	OS 20101 C		
QTY	CRANKSHAFT REAR SEAL	YEARS	PART NO.	DESCRIPTION	
1	Rear Main Seal Set	1993-91	BS 40427	Rubber; One-piece; Improved design	
QTY	VALVE COVER	YEARS	PART NO.	DESCRIPTION	
1	Valve Cover Gasket Set	1993-91	VS 50107 C	w/Semi-circular plug	
1	Valve Cover Gasket Set	1993-91	VS 50200 C	w/o Semi-circular plug	
1	Semi-Circular Plug	1993-91	CP 75002	Valve Cover	
QTY	VALVE STEM SEAL SET	YEARS	PART NO.	DESCRIPTION	
1	Valve Stem Seal Set	1993-91	SS 72567	Premium valve stem seals incl.	
QTY	WATER OUTLET GASKET	YEARS	PART NO.	DESCRIPTION	
1	O-Ring	1993-91	25598	Water Outlet	
QTY	WATER PUMP	YEARS	PART NO.	DESCRIPTION	
1	Water Pump Gasket	1993-91	25609	8-bolt gskt.	
1	Water Pump Gasket	1993-91	35549	9-bolt gskt.	
1	O-Ring	1993-91	25598	Water Pump; Housing	
QTY	TIMING COVER	YEARS	PART NO.	DESCRIPTION	
1	Crankshaft Front Seal Set	1993-91	TCS 24551		
1	Camshaft Front Seal Set	1993-91	TCS 45357		
1	Auxiliary Shaft Seal Set	1993-91	TCS 45288		
QTY	CARB & FUEL INJECTION	YEARS	PART NO.	DESCRIPTION	
1	Throttle Body Gasket	1993-91	23623		
QTY	EXHAUST GAS RECIRCULATION	YEARS	PART NO.	DESCRIPTION	
1	EGR Gasket	1993-91	70982		
15		1993 - 1991; 1.8L 108.6 (1780cc) SOHC L4 (8 Valve) 81mm Bore			15
		MFI; Gasoline; Naturally Aspirated VW Eng.; Eng. Code ABG			
QTY	CYLINDER HEAD	YEARS	PART NO.	DESCRIPTION	
1	Head Gasket	1993-91	9090 PT	Head bolts not incl.; Head bolt replacement recommended	
1	Head Set	1993-91	HS 9090 B	Head bolts & exh. pipe flange not incl.; Head bolt replacement recommended; Premium valve stem seals incl.	
1	Head Bolt Set	1993-91	ES 74029	Head bolts w/Washers; Replacement recommended	
QTY	CONVERSION SET	YEARS	PART NO.	DESCRIPTION	
1	Gasket Conversion Set	1993-91	CS 9090	9-bolt water pump gskt. not incl.	
QTY	MANIFOLD - INT. & EXH.	YEARS	PART NO.	DESCRIPTION	
1	Int. Manifold Gasket Set	1993-91	MS 22755		
1	Exh. Manifold Gasket Set	1993-91	MS 94063		
QTY	EXHAUST PIPE FLANGE	YEARS	PART NO.	DESCRIPTION	
1	Exhaust Pipe Gasket	1993-91	60704	Flange	

VW Car (Cont.)

15		1993 - 1991; 1.8L 108.6 (1780cc) SOHC L4 (8 Valve) 81mm Bore			15	
(cont.)		MFI; Gasoline; Naturally Aspirated VW Eng.; Eng. Code ABG			(cont.)	
QTY	OIL PAN	YEARS	PART NO.	DESCRIPTION		
1	Oil Pan Gasket Set	1993-91	OS 20101 C			
QTY	CRANKSHAFT REAR SEAL	YEARS	PART NO.	DESCRIPTION		
1	Rear Main Seal Set	1993-91	BS 40427	Rubber; One-piece; Improved design		
QTY	VALVE COVER	YEARS	PART NO.	DESCRIPTION		
1	Valve Cover Gasket Set	1993-91	VS 50107 C	w/Semi-circular plug		
1	Valve Cover Gasket Set	1993-91	VS 50200 C	w/o Semi-circular plug		
1	Semi-Circular Plug	1993-91	CP 75002	Valve Cover		
QTY	VALVE STEM SEAL SET	YEARS	PART NO.	DESCRIPTION		
1	Valve Stem Seal Set	1993-91	SS 72567	Premium valve stem seals incl.		
QTY	WATER OUTLET GASKET	YEARS	PART NO.	DESCRIPTION		
1	O-Ring	1993-91	25598	Water Outlet		
QTY	WATER PUMP	YEARS	PART NO.	DESCRIPTION		
1	Water Pump Gasket	1993-91	25609	8-bolt gskt.		
1	Water Pump Gasket	1993-91	35549	9-bolt gskt.		
1	O-Ring	1993-91	25598	Water Pump; Housing		
QTY	TIMING COVER	YEARS	PART NO.	DESCRIPTION		
1	Crankshaft Front Seal Set	1993-91	TCS 24551			
1	Camshaft Front Seal Set	1993-91	TCS 45357			
1	Auxiliary Shaft Seal Set	1993-91	TCS 45288			
QTY	CARB & FUEL INJECTION	YEARS	PART NO.	DESCRIPTION		
1	Throttle Body Gasket	1993-91	23623			
QTY	EXHAUST GAS RECIRCULATION	YEARS	PART NO.	DESCRIPTION		
1	EGR Gasket	1993-91	70982			
16		1999 - 1993; 1.8L 108.6 (1780cc) SOHC L4 (8 Valve) 81mm Bore			16	
		TBI; Gasoline; Naturally Aspirated VW Eng.; Eng. Code ACC				
QTY	CYLINDER HEAD	YEARS	PART NO.	DESCRIPTION		
1	Head Gasket	1999-93	9090 PT	Head bolts not incl.; Head bolt replacement recommended		
1	Head Set	1999-93	HS 9090 B	Head bolts & exh. pipe flange not incl.; Head bolt replacement recommended; Premium valve stem seals incl.		
1	Head Bolt Set	1999-93	ES 74029	Head bolts w/Washers; Replacement recommended		
QTY	CONVERSION SET	YEARS	PART NO.	DESCRIPTION		
1	Gasket Conversion Set	1999-93	CS 9090	9-bolt water pump gskt. not incl.		
QTY	MANIFOLD - INT. & EXH.	YEARS	PART NO.	DESCRIPTION		
1	Int. Manifold Gasket Set	1999-93	MS 22755			
1	Exh. Manifold Gasket Set	1999-93	MS 94063			
QTY	OIL PAN	YEARS	PART NO.	DESCRIPTION		
1	Oil Pan Gasket Set	1999-93	OS 20101 C			
QTY	CRANKSHAFT REAR SEAL	YEARS	PART NO.	DESCRIPTION		
1	Rear Main Seal Set	1999-93	BS 40427	Rubber; One-piece; Improved design		
QTY	VALVE COVER	YEARS	PART NO.	DESCRIPTION		
1	Valve Cover Gasket Set	1999-93	VS 50107 C	w/Semi-circular plug		
1	Valve Cover Gasket Set	1999-93	VS 50200 C	w/o Semi-circular plug		
1	Semi-Circular Plug	1999-93	CP 75002	Valve Cover		
QTY	VALVE STEM SEAL SET	YEARS	PART NO.	DESCRIPTION		
1	Valve Stem Seal Set	1999-93	SS 72567	Premium valve stem seals incl.		
QTY	WATER OUTLET GASKET	YEARS	PART NO.	DESCRIPTION		
1	O-Ring	1999-93	25598	Water Outlet		
QTY	WATER PUMP	YEARS	PART NO.	DESCRIPTION		
1	Water Pump Gasket	1999-93	25609	8-bolt gskt.		
1	Water Pump Gasket	1999-93	35549	9-bolt gskt.		
1	O-Ring	1999-93	25598	Water Pump; Housing		
QTY	TIMING COVER	YEARS	PART NO.	DESCRIPTION		
1	Crankshaft Front Seal Set	1999-93	TCS 24551			
1	Camshaft Front Seal Set	1999-93	TCS 45357			
1	Auxiliary Shaft Seal Set	1999-93	TCS 45288			
QTY	EXHAUST GAS RECIRCULATION	YEARS	PART NO.	DESCRIPTION		
1	EGR Gasket	1999-93	70982			
17		1992 - 1991; 1.8L 108.6 (1780cc) SOHC L4 (8 Valve) 81mm Bore			17	
		MFI; Gasoline; Naturally Aspirated VW Eng.; Eng. Code PF				
QTY	CYLINDER HEAD	YEARS	PART NO.	DESCRIPTION		
1	Head Gasket	1992-91	9090 PT	Head bolts not incl.; Head bolt replacement recommended		

17 (cont.)		1992 - 1991; 1.8L 108.6 (1780cc) SOHC L4 (8 Valve) 81mm Bore			17 (cont.)
MFI; Gasoline; Naturally Aspirated VW Eng.; Eng. Code PF					
QTY	CYLINDER HEAD	YEARS	PART NO.	DESCRIPTION	
1	Head Set	1992-91	HS 9090 B	Head bolts & exh. pipe flange not incl.; Head bolt replacement recommended; Premium valve stem seals incl.	
1	Head Bolt Set	1992-91	ES 74029	Head bolts w/Washers; Replacement recommended	
QTY	CONVERSION SET	YEARS	PART NO.	DESCRIPTION	
1	Gasket Conversion Set	1992-91	CS 9090	9-bolt water pump gskt. not incl.	
QTY	MANIFOLD - INT. & EXH.	YEARS	PART NO.	DESCRIPTION	
1	Int. Manifold Gasket Set	1992-91	MS 22755		
1	Exh. Manifold Gasket Set	1992-91	MS 94063		
QTY	EXHAUST PIPE FLANGE	YEARS	PART NO.	DESCRIPTION	
1	Exhaust Pipe Gasket	1992-91	60576	Ring	
1	Exhaust Pipe Gasket	1992-91	60693	Flange	
QTY	OIL PAN	YEARS	PART NO.	DESCRIPTION	
1	Oil Pan Gasket Set	1992-91	OS 20101 C		
QTY	CRANKSHAFT REAR SEAL	YEARS	PART NO.	DESCRIPTION	
1	Rear Main Seal Set	1992-91	BS 40427	Rubber; One-piece; Improved design	
QTY	VALVE COVER	YEARS	PART NO.	DESCRIPTION	
1	Valve Cover Gasket Set	1992-91	VS 50107 C	w/Semi-circular plug	
1	Valve Cover Gasket Set	1992-91	VS 50200 C	w/o Semi-circular plug	
1	Semi-Circular Plug	1992-91	CP 75002	Valve Cover	
QTY	VALVE STEM SEAL SET	YEARS	PART NO.	DESCRIPTION	
1	Valve Stem Seal Set	1992-91	SS 72567	Premium valve stem seals incl.	
QTY	WATER OUTLET GASKET	YEARS	PART NO.	DESCRIPTION	
1	O-Ring	1992-91	25598	Water Outlet	
QTY	WATER PUMP	YEARS	PART NO.	DESCRIPTION	
1	Water Pump Gasket	1992-91	25609	8-bolt gskt.	
1	Water Pump Gasket	1992-91	35549	9-bolt gskt.	
1	O-Ring	1992-91	25598	Water Pump; Housing	
QTY	TIMING COVER	YEARS	PART NO.	DESCRIPTION	
1	Crankshaft Front Seal Set	1992-91	TCS 24551		
1	Camshaft Front Seal Set	1992-91	TCS 45357		
1	Auxiliary Shaft Seal Set	1992-91	TCS 45288		
QTY	CARB & FUEL INJECTION	YEARS	PART NO.	DESCRIPTION	
1	Throttle Body Gasket	1992-91	23623		
QTY	EXHAUST GAS RECIRCULATION	YEARS	PART NO.	DESCRIPTION	
1	EGR Gasket	1992-91	70982		
18		1994 - 1991; 1.8L 108.6 (1780cc) SOHC L4 (8 Valve) 81mm Bore			18
MFI; Gasoline; Supercharged VW Eng.; Eng. Code PG					
QTY	CYLINDER HEAD	YEARS	PART NO.	DESCRIPTION	
1	Head Set	1994-91	HS 26210 PT	Head bolts not incl.; Head bolt replacement recommended; PermaDry® molded rubber valve cover gskt. incl.; Premium valve stem seals incl.	
QTY	CONVERSION SET	YEARS	PART NO.	DESCRIPTION	
1	Gasket Conversion Set	1994-91	CS 9090	9-bolt water pump gskt. not incl.	
QTY	MANIFOLD - INT. & EXH.	YEARS	PART NO.	DESCRIPTION	
1	Int. Manifold Gasket Set	1994-91	MS 22755		
1	Exh. Manifold Gasket Set	1994-91	MS 94063		
QTY	EXHAUST PIPE FLANGE	YEARS	PART NO.	DESCRIPTION	
1	Exhaust Pipe Gasket	1994-91	60576	Ring	
1	Exhaust Pipe Gasket	1994-91	60693	Flange	
QTY	OIL PAN	YEARS	PART NO.	DESCRIPTION	
1	Oil Pan Gasket Set	1994-91	OS 20101 C		
QTY	CRANKSHAFT REAR SEAL	YEARS	PART NO.	DESCRIPTION	
1	Rear Main Seal Set	1994-91	BS 40427	Rubber; One-piece; Improved design	
QTY	VALVE STEM SEAL SET	YEARS	PART NO.	DESCRIPTION	
1	Valve Stem Seal Set	1994-91	SS 72567	Premium valve stem seals incl.	
QTY	THERMOSTAT HOUSING	YEARS	PART NO.	DESCRIPTION	
1	Thermostat Gasket	1994-91	35026	Thermostat Housing; Thermostat inlet	
QTY	WATER OUTLET GASKET	YEARS	PART NO.	DESCRIPTION	
1	O-Ring	1994-91	25598	Water Outlet	
QTY	WATER PUMP	YEARS	PART NO.	DESCRIPTION	
1	Water Pump Gasket	1994-91	25609	8-bolt gskt.	
1	Water Pump Gasket	1994-91	35549	9-bolt gskt.	

VW Car (Cont.)

18		1994 - 1991; 1.8L 108.6 (1780cc) SOHC L4 (8 Valve) 81mm Bore			18
(cont.)		MFI; Gasoline; Supercharged VW Eng.; Eng. Code PG			(cont.)
QTY	WATER PUMP	YEARS	PART NO.	DESCRIPTION	
1	O-Ring	1994-91	25598	Water Pump; Housing	
QTY	TIMING COVER	YEARS	PART NO.	DESCRIPTION	
1	Crankshaft Front Seal Set	1994-91	TCS 24551		
1	Camshaft Front Seal Set	1994-91	TCS 45357		
1	Auxiliary Shaft Seal Set	1994-91	TCS 45288		
QTY	CARB & FUEL INJECTION	YEARS	PART NO.	DESCRIPTION	
1	Throttle Body Gasket	1994-91	23623		
QTY	EXHAUST GAS RECIRCULATION	YEARS	PART NO.	DESCRIPTION	
1	EGR Gasket	1994-91	70982		
19		1992 - 1991; 1.8L 108.6 (1780cc) SOHC L4 (8 Valve) 81mm Bore			19
		MFI; Gasoline; Naturally Aspirated VW Eng.; Eng. Code RV			
QTY	CYLINDER HEAD	YEARS	PART NO.	DESCRIPTION	
1	Head Gasket	1992-91	9090 PT	Head bolts not incl.; Head bolt replacement recommended	
1	Head Set	1992-91	HS 9090 B	Head bolts & exh. pipe flange not incl.; Head bolt replacement recommended; Premium valve stem seals incl.	
1	Head Bolt Set	1992-91	ES 74029	Head bolts w/Washers; Replacement recommended	
QTY	CONVERSION SET	YEARS	PART NO.	DESCRIPTION	
1	Gasket Conversion Set	1992-91	CS 9090	9-bolt water pump gskt. not incl.	
QTY	MANIFOLD - INT. & EXH.	YEARS	PART NO.	DESCRIPTION	
1	Int. Manifold Gasket Set	1992-91	MS 22755		
1	Exh. Manifold Gasket Set	1992-91	MS 94063		
QTY	EXHAUST PIPE FLANGE	YEARS	PART NO.	DESCRIPTION	
1	Exhaust Pipe Gasket	1992-91	60576	Ring	
1	Exhaust Pipe Gasket	1992-91	60693	Flange	
QTY	OIL PAN	YEARS	PART NO.	DESCRIPTION	
1	Oil Pan Gasket Set	1992-91	OS 20101 C		
QTY	CRANKSHAFT REAR SEAL	YEARS	PART NO.	DESCRIPTION	
1	Rear Main Seal Set	1992-91	BS 40427	Rubber; One-piece; Improved design	
QTY	VALVE COVER	YEARS	PART NO.	DESCRIPTION	
1	Valve Cover Gasket Set	1992-91	VS 50107 C	w/Semi-circular plug	
1	Valve Cover Gasket Set	1992-91	VS 50200 C	w/o Semi-circular plug	
1	Semi-Circular Plug	1992-91	CP 75002	Valve Cover	
QTY	VALVE STEM SEAL SET	YEARS	PART NO.	DESCRIPTION	
1	Valve Stem Seal Set	1992-91	SS 72567	Premium valve stem seals incl.	
QTY	WATER OUTLET GASKET	YEARS	PART NO.	DESCRIPTION	
1	O-Ring	1992-91	25598	Water Outlet	
QTY	WATER PUMP	YEARS	PART NO.	DESCRIPTION	
1	Water Pump Gasket	1992-91	25609	8-bolt gskt.	
1	Water Pump Gasket	1992-91	35549	9-bolt gskt.	
1	O-Ring	1992-91	25598	Water Pump; Housing	
QTY	TIMING COVER	YEARS	PART NO.	DESCRIPTION	
1	Crankshaft Front Seal Set	1992-91	TCS 24551		
1	Camshaft Front Seal Set	1992-91	TCS 45357		
1	Auxiliary Shaft Seal Set	1992-91	TCS 45288		
QTY	CARB & FUEL INJECTION	YEARS	PART NO.	DESCRIPTION	
1	Throttle Body Gasket	1992-91	23623		
QTY	EXHAUST GAS RECIRCULATION	YEARS	PART NO.	DESCRIPTION	
1	EGR Gasket	1992-91	70982		
20		1998 - 1996; 1.9L 115.7 (1896cc) SOHC Turbo - Intercooled L4 (8 Valve) 79.5mm Bore			20
		MFI; Diesel; Turbo - Intercooled VW Eng.; Eng. Code AAZ			
QTY	CYLINDER HEAD	YEARS	PART NO.	DESCRIPTION	
1	Head Gasket	1998-96	26442 PT	2 holes; 1.57mm thick; Head bolts not incl.; Head bolt replacement recommended; PermaTorqueMLS®; Improved design	
1	Head Gasket	1998-96	26443 PT	3 holes; 1.67mm thick; Head bolts not incl.; Head bolt replacement recommended; PermaTorqueMLS®	
1	Head Gasket	1998-96	26445 PT	1 hole; 1.47mm thick; Head bolts not incl.; Head bolt replacement recommended; PermaTorqueMLS®	
QTY	MANIFOLD - INT. & EXH.	YEARS	PART NO.	DESCRIPTION	
1	Exh. Manifold Gasket Set	1998-96	MS 97196	New Part Number - Check for Availability	

21		1998 - 1996; 1.9L 115.7 (1896cc) SOHC Turbo - Intercooled L4 (8 Valve) 79.5mm Bore			21
MFI; Diesel; Turbo - Intercooled VW Eng.; Eng. Code AHU					
QTY	CYLINDER HEAD	YEARS	PART NO.	DESCRIPTION	
1	Head Gasket	1998-96	26444 PT	3 holes; 1.61mm thick; Head bolts not incl.; Head bolt replacement recommended; PermaTorqueMLS®	
1	Head Gasket	1998-96	26446 PT	1 hole; 1.45mm thick; Head bolts not incl.; Head bolt replacement recommended; PermaTorqueMLS®	
QTY	MANIFOLD - INT. & EXH.	YEARS	PART NO.	DESCRIPTION	
1	Exh. Manifold Gasket Set	1998-96	MS 97196	New Part Number - Check for Availability	
22		2006 - 1998; 1.9L 115.7 (1896cc) SOHC Turbo - Intercooled L4 (8 Valve) 79.5mm Bore			22
MFI; Diesel; Turbo - Intercooled VW Eng.; Eng. Code ALH					
QTY	CYLINDER HEAD	YEARS	PART NO.	DESCRIPTION	
1	Head Gasket	2006-01	26145 PT	3 holes; 1.6mm thick; Head bolts not incl.; Head bolt replacement recommended; PermaTorqueMLS®	
1	Head Gasket	2006-98	26442 PT	2 holes; 1.57mm thick; Head bolts not incl.; Head bolt replacement recommended; PermaTorqueMLS®; Improved design	
1	Head Gasket	2006-01	26143 PT	1 hole; 1.4mm thick; Head bolts not incl.; Head bolt replacement recommended; PermaTorqueMLS®	
1	Head Gasket	2006-01	26144 PT	2 holes; 1.5mm thick; Head bolts not incl.; Head bolt replacement recommended; PermaTorqueMLS®; Old design; Superseded - When depleted use 26442 PT	
1	Head Gasket	2000-98	26443 PT	3 holes; 1.67mm thick; Head bolts not incl.; Head bolt replacement recommended; PermaTorqueMLS®	
1	Head Gasket	2000-98	26445 PT	1 hole; 1.47mm thick; Head bolts not incl.; Head bolt replacement recommended; PermaTorqueMLS®	
1	Head Set w/o Head Gasket	2006-01	HSU 26143	Head gskt., valve cover gskt., & head bolts not incl.; Head bolt replacement recommended; Premium valve stem seals incl.	
QTY	CONVERSION SET	YEARS	PART NO.	DESCRIPTION	
1	Gasket Conversion Set	2006-01	CS 26143	Oil pan gskt. not incl.	
QTY	MANIFOLD - INT. & EXH.	YEARS	PART NO.	DESCRIPTION	
1	Int. Manifold Gasket Set	2006-98	MS 97290	Lower set; New Part Number - Check for Availability	
1	Exh. Manifold Gasket Set	2006-98	MS 97196	New Part Number - Check for Availability	
QTY	OIL PAN	YEARS	PART NO.	DESCRIPTION	
1	Oil Pan Gasket Set	2006-01	OS 30781	w/o Oil level sensor	
1	Oil Pan Gasket Set	2006-01	OS 30783	w/Oil level sensor	
23		2007 - 2004; 1.9L 115.7 (1896cc) SOHC Turbo - Intercooled L4 (8 Valve) 79.5mm Bore			23
MFI; Diesel; Turbo - Intercooled VW Eng.; Eng. Code BEW					
QTY	CYLINDER HEAD	YEARS	PART NO.	DESCRIPTION	
1	Head Gasket	2007-04	26143 PT	1 hole; 1.4mm thick; Head bolts not incl.; Head bolt replacement recommended; PermaTorqueMLS®	
1	Head Gasket	2007-04	26144 PT	2 holes; 1.5mm thick; Head bolts not incl.; Head bolt replacement recommended; PermaTorqueMLS®; Old design; Superseded - When depleted use 26442 PT	
1	Head Gasket	2007-04	26145 PT	3 holes; 1.6mm thick; Head bolts not incl.; Head bolt replacement recommended; PermaTorqueMLS®	
1	Head Gasket	2007-04	26442 PT	2 holes; 1.57mm thick; Head bolts not incl.; Head bolt replacement recommended; PermaTorqueMLS®; Improved design	
1	Head Set w/o Head Gasket	2007-04	HSU 26143	Head gskt., valve cover gskt., & head bolts not incl.; Head bolt replacement recommended; Premium valve stem seals incl.	
1	Head Bolt Set	2007-04	ES 72879	Replacement recommended; New Part Number - Check for Availability	
QTY	CONVERSION SET	YEARS	PART NO.	DESCRIPTION	
1	Gasket Conversion Set	2007-04	CS 26143	Oil pan gskt. not incl.	
QTY	MANIFOLD - INT. & EXH.	YEARS	PART NO.	DESCRIPTION	
1	Int. Manifold Gasket Set	2007-04	MS 97290	Lower set; New Part Number - Check for Availability	
1	Exh. Manifold Gasket Set	2007-04	MS 97196	New Part Number - Check for Availability	
QTY	OIL PAN	YEARS	PART NO.	DESCRIPTION	
1	Oil Pan Gasket Set	2007-04	OS 30781	w/o Oil level sensor	
1	Oil Pan Gasket Set	2007-04	OS 30783	w/Oil level sensor	
24		2007 - 2005; 1.9L 115.7 (1896cc) SOHC Turbo - Intercooled L4 (8 Valve) 79.5mm Bore			24
MFI; Diesel; Turbo - Intercooled VW Eng.; Eng. Code BRM					
QTY	CYLINDER HEAD	YEARS	PART NO.	DESCRIPTION	
1	Head Gasket	2007-05	26143 PT	1 hole; 1.4mm thick; Head bolts not incl.; Head bolt replacement recommended; PermaTorqueMLS®	

VW Car (Cont.)

24		2007 - 2005; 1.9L 115.7 (1896cc) SOHC Turbo - Intercooled L4 (8 Valve) 79.5mm Bore			24	
(cont.)		MFI; Diesel; Turbo - Intercooled VW Eng.; Eng. Code BRM			(cont.)	
QTY	CYLINDER HEAD	YEARS	PART NO.	DESCRIPTION		
1	Head Gasket	2007-05	26144 PT	2 holes; 1.5mm thick; Head bolts not incl.; Head bolt replacement recommended; PermaTorqueMLS®; Old design; Superseded - When depleted use 26442 PT		
1	Head Gasket	2007-05	26145 PT	3 holes; 1.6mm thick; Head bolts not incl.; Head bolt replacement recommended; PermaTorqueMLS®		
1	Head Gasket	2007-05	26442 PT	2 holes; 1.57mm thick; Head bolts not incl.; Head bolt replacement recommended; PermaTorqueMLS®; Improved design		
1	Head Set w/o Head Gasket	2007-05	HSU 26143	Head gskt., valve cover gskt., & head bolts not incl.; Head bolt replacement recommended; Premium valve stem seals incl.		
1	Head Bolt Set	2007-05	ES 72879	Replacement recommended; New Part Number - Check for Availability		
QTY	CONVERSION SET	YEARS	PART NO.	DESCRIPTION		
1	Gasket Conversion Set	2007-05	CS 26143	Oil pan gskt. not incl.		
QTY	MANIFOLD - INT. & EXH.	YEARS	PART NO.	DESCRIPTION		
1	Int. Manifold Gasket Set	2007-05	MS 97290	Lower set; New Part Number - Check for Availability		
1	Exh. Manifold Gasket Set	2007-05	MS 97196	Gskt. w/o Heat shield; New Part Number - Check for Availability		
1	Exh. Manifold Gasket Set	2007-05	MS 97261	Gskt. w/Heat shield; New Part Number - Check for Availability		
QTY	OIL PAN	YEARS	PART NO.	DESCRIPTION		
1	Oil Pan Gasket Set	2007-05	OS 30781	w/o Oil level sensor		
1	Oil Pan Gasket Set	2007-05	OS 30783	w/Oil level sensor		
QTY	VALVE COVER	YEARS	PART NO.	DESCRIPTION		
1	Valve Cover Gasket Set	2007-05	VS 50841 R	PermaDry® molded rubber gskt. incl.; New Part Number - Check for Availability		
25		2007 - 2004; 2.0L 120.1 (1969cc) SOHC Turbo - Intercooled L4 (8 Valve) 81mm Bore			25	
		MFI; Diesel; Turbo - Intercooled VW Eng.; Eng. Code BHW				
QTY	CYLINDER HEAD	YEARS	PART NO.	DESCRIPTION		
1	Head Gasket	2007-04	26643 PT	1 hole; 1.45mm thick; Head bolts not incl.; Head bolt replacement recommended; PermaTorqueMLS®; New Part Number - Check for Availability		
1	Head Gasket	2007-04	26644 PT	2 holes; 1.53mm thick; Head bolts not incl.; Head bolt replacement recommended; PermaTorqueMLS®; New Part Number - Check for Availability		
1	Head Gasket	2007-04	26645 PT	3 holes; 1.61mm thick; Head bolts not incl.; Head bolt replacement recommended; PermaTorqueMLS®; New Part Number - Check for Availability		
1	Head Bolt Set	2007-04	ES 72879	Replacement recommended; New Part Number - Check for Availability		
26		1994 - 1991; 2.0L 121 (1984cc) DOHC L4 (16 Valve) 82.5mm Bore			26	
		MFI; Gasoline; Naturally Aspirated VW Eng.; Eng. Code 9A				
QTY	CYLINDER HEAD	YEARS	PART NO.	DESCRIPTION		
1	Head Gasket	1994-91	9570 PT	Head bolts not incl.; Head bolt replacement recommended		
1	Head Set	1994-91	HS 9570 PT-1	Head bolts not incl.; Head bolt replacement recommended; PermaDry® molded rubber valve cover gskts. incl.; Premium valve stem seals incl.		
QTY	CONVERSION SET	YEARS	PART NO.	DESCRIPTION		
1	Gasket Conversion Set	1994-91	CS 9570	Water pump gskt. not incl.		
QTY	MANIFOLD - INT. & EXH.	YEARS	PART NO.	DESCRIPTION		
1	Int. Manifold Gasket Set	1994-91	MS 93613	Upper set incl.		
1	Exh. Manifold Gasket Set	1994-91	MS 93615			
QTY	EXHAUST PIPE FLANGE	YEARS	PART NO.	DESCRIPTION		
1	Exhaust Pipe Gasket	1994-91	60693	Flange		
QTY	OIL PAN	YEARS	PART NO.	DESCRIPTION		
1	Oil Pan Gasket Set	1994-91	OS 20101 C			
QTY	CRANKSHAFT REAR SEAL	YEARS	PART NO.	DESCRIPTION		
1	Rear Main Seal Set	1994-91	BS 40427	Rubber; One-piece; Improved design		
QTY	VALVE COVER	YEARS	PART NO.	DESCRIPTION		
1	Valve Cover Gasket Set	1994-91	VS 50306 R	w/Semi-circular plugs & Spark plug tube seals; PermaDry® molded rubber gskts. incl.		
2	Semi-Circular Plug	1994-91	CP 75002	Valve Cover		
QTY	VALVE STEM SEAL SET	YEARS	PART NO.	DESCRIPTION		
1	Valve Stem Seal Set	1994-91	SS 72682	Premium valve stem seals incl.; Improved design		
QTY	THERMOSTAT HOUSING	YEARS	PART NO.	DESCRIPTION		
1	Thermostat Gasket	1994-91	35026	Thermostat Housing; Thermostat inlet		
QTY	WATER OUTLET GASKET	YEARS	PART NO.	DESCRIPTION		
1	O-Ring	1994-91	25598	Water Outlet		

26 (cont.)		1994 - 1991; 2.0L 121 (1984cc) DOHC L4 (16 Valve) 82.5mm Bore MFI; Gasoline; Naturally Aspirated VW Eng.; Eng. Code 9A			26 (cont.)
QTY	WATER PUMP	YEARS	PART NO.	DESCRIPTION	
1	Water Pump Gasket	1994-91	35549	9-bolt gskt.	
1	O-Ring	1994-91	25598	Water Pump; Housing	
QTY	TIMING COVER	YEARS	PART NO.	DESCRIPTION	
1	Crankshaft Front Seal Set	1994-91	TCS 24551		
2	Camshaft Front Seal Set	1994-91	TCS 45357		
1	Auxiliary Shaft Seal Set	1994-91	TCS 45288		
QTY	CARB & FUEL INJECTION	YEARS	PART NO.	DESCRIPTION	
2	Throttle Body Gasket	1994-91	23623		
QTY	EXHAUST GAS RECIRCULATION	YEARS	PART NO.	DESCRIPTION	
1	EGR Gasket	1994-91	70982		
27		2012 - 2006; 2.0L 121 (1984cc) DOHC L4 (16 Valve) 82.5mm Bore DI; Gasoline; Turbo - Intercooled VW Eng.; Eng. Code BPY			27
QTY	CYLINDER HEAD	YEARS	PART NO.	DESCRIPTION	
1	Head Gasket	2012	26547 PT	w/Timing chain; Head bolts not incl.; Head bolt replacement recommended; PermaTorqueMLS®; New Part Number - Check for Availability	
1	Head Gasket	2011-08	26455 PT	w/Timing chain; Head bolts not incl.; Head bolt replacement recommended; PermaTorqueMLS®	
1	Head Gasket	2007-06	26318 PT	w/Timing belt; Head bolts not incl.; Head bolt replacement recommended; PermaTorqueMLS®	
1	Head Set	2011-08	HS 26455 PT	w/Timing chain; Head bolts not incl.; Head bolt replacement recommended; RTV sealant incl. for Lower valve cover housing; PermaDry® molded rubber valve cover gskt. incl.; Premium valve stem seals incl.	
1	Head Set	2007-06	HS 26318 PT	w/Timing belt; Head bolts not incl.; Head bolt replacement recommended; PermaDry® molded rubber valve cover gskt. incl.; Premium valve stem seals incl.; Consolidated design	
QTY	CONVERSION SET	YEARS	PART NO.	DESCRIPTION	
1	Gasket Conversion Set	2012-08	CS 26455	RTV sealant incl. for oil pan gskt.; New Part Number - Check for Availability	
1	Gasket Conversion Set	2007-06	CS 26318	RTV sealant incl. for oil pan gskt.	
QTY	MANIFOLD - INT. & EXH.	YEARS	PART NO.	DESCRIPTION	
1	Int. Manifold Gasket Set	2011-06	MS 96780		
1	Exh. Manifold Gasket Set	2011-06	MS 96784		
QTY	EXHAUST PIPE FLANGE	YEARS	PART NO.	DESCRIPTION	
1	Exhaust Pipe Gasket	2011-06	61458	Flange	
1	Exhaust Pipe Gasket	2011-06	61458	Turbo inlet	
QTY	OIL PAN	YEARS	PART NO.	DESCRIPTION	
1	Oil Pan Gasket Set	2012-06	OS 30821		
QTY	CRANKSHAFT REAR SEAL	YEARS	PART NO.	DESCRIPTION	
1	Rear Main Seal Set	2012-08	BS 40725	PTFE Rubber; One-piece; New Part Number - Check for Availability	
1	Rear Main Seal Set	2007-06	BS 40187	PTFE Rubber; One-piece	
QTY	VALVE COVER	YEARS	PART NO.	DESCRIPTION	
1	Valve Cover Gasket Set	2011-08	VS 50762 R	w/Timing chain; RTV sealant incl. for Lower valve cover housing; PermaDry® molded rubber gskt. incl.	
1	Valve Cover Gasket Set	2007-06	VS 50685 R	w/Timing belt; w/Spark plug tube seals; PermaDry® molded rubber gskt. incl.	
QTY	VALVE STEM SEAL SET	YEARS	PART NO.	DESCRIPTION	
1	Valve Stem Seal Set	2011-06	SS 71074-1	Premium valve stem seals incl.	
QTY	THERMOSTAT HOUSING	YEARS	PART NO.	DESCRIPTION	
1	Thermostat Gasket	2011-06	35838	Thermostat Housing; Thermostat housing O-ring	
1	O-Ring	2011-06	35924	Thermostat Housing; Thermostat seal	
QTY	WATER PUMP	YEARS	PART NO.	DESCRIPTION	
1	Water Pump Gasket	2012-08	35872	Housing	
1	O-Ring	2007-06	35675	Water Pump; Housing	
QTY	TIMING COVER	YEARS	PART NO.	DESCRIPTION	
1	Crankshaft Front Seal Set	2012-08	TCS 46138		
1	Crankshaft Front Seal Set	2007-06	TCS 45038		
1	Camshaft Front Seal Set	2011-06	TCS 46005		
QTY	CARB & FUEL INJECTION	YEARS	PART NO.	DESCRIPTION	
1	Throttle Body Gasket	2011-06	61462		
QTY	OIL COOLER	YEARS	PART NO.	DESCRIPTION	
1	Oil Cooler Gasket	2012-06	72485	Oil cooler O-ring; New Part Number - Check for Availability	

VW Car (Cont.)

28		2013 - 2012; 2.0L 121 (1984cc) DOHC L4 (16 Valve) 82.5mm Bore DI; Gasoline; Turbo - Intercooled VW Eng.; Eng. Code CBFA			28
QTY	CYLINDER HEAD	YEARS	PART NO.	DESCRIPTION	
1	Head Gasket	2013-12	26547 PT	Head bolts not incl.; Head bolt replacement recommended; PermaTorqueMLS®; New Part Number - Check for Availability	
QTY	CONVERSION SET	YEARS	PART NO.	DESCRIPTION	
1	Gasket Conversion Set	2012	CS 26455	RTV sealant incl. for oil pan gskt.; New Part Number - Check for Availability	
QTY	OIL PAN	YEARS	PART NO.	DESCRIPTION	
1	Oil Pan Gasket Set	2012	OS 30821		
QTY	CRANKSHAFT REAR SEAL	YEARS	PART NO.	DESCRIPTION	
1	Rear Main Seal Set	2012	BS 40725	PTFE Rubber; One-piece; New Part Number - Check for Availability	
QTY	WATER PUMP	YEARS	PART NO.	DESCRIPTION	
1	Water Pump Gasket	2012	35872	Housing	
QTY	TIMING COVER	YEARS	PART NO.	DESCRIPTION	
1	Crankshaft Front Seal Set	2012	TCS 46138		
QTY	OIL COOLER	YEARS	PART NO.	DESCRIPTION	
1	Oil Cooler Gasket	2012	72485	Oil cooler O-ring; New Part Number - Check for Availability	
29		2013 - 2012; 2.0L 121 (1984cc) DOHC L4 (16 Valve) 82.5mm Bore DI; Gasoline; Turbo - Intercooled VW Eng.; Eng. Code CCTA			29
QTY	CYLINDER HEAD	YEARS	PART NO.	DESCRIPTION	
1	Head Gasket	2013-12	26547 PT	Head bolts not incl.; Head bolt replacement recommended; PermaTorqueMLS®; New Part Number - Check for Availability	
QTY	CONVERSION SET	YEARS	PART NO.	DESCRIPTION	
1	Gasket Conversion Set	2012	CS 26455	RTV sealant incl. for oil pan gskt.; New Part Number - Check for Availability	
QTY	OIL PAN	YEARS	PART NO.	DESCRIPTION	
1	Oil Pan Gasket Set	2012	OS 30821		
QTY	CRANKSHAFT REAR SEAL	YEARS	PART NO.	DESCRIPTION	
1	Rear Main Seal Set	2012	BS 40725	PTFE Rubber; One-piece; New Part Number - Check for Availability	
QTY	WATER PUMP	YEARS	PART NO.	DESCRIPTION	
1	Water Pump Gasket	2012	35872	Housing	
QTY	TIMING COVER	YEARS	PART NO.	DESCRIPTION	
1	Crankshaft Front Seal Set	2012	TCS 46138		
QTY	OIL COOLER	YEARS	PART NO.	DESCRIPTION	
1	Oil Cooler Gasket	2012	72485	Oil cooler O-ring; New Part Number - Check for Availability	
30		2002 - 1993; 2.0L 121 (1984cc) SOHC L4 (8 Valve) 82.5mm Bore MFI; Gasoline; Naturally Aspirated VW Eng.; Eng. Code ABA			30
QTY	CYLINDER HEAD	YEARS	PART NO.	DESCRIPTION	
1	Head Gasket	2002-93	26164 PT	Head bolts not incl.; Head bolt replacement recommended; PermaTorqueMLS® LaserWeld® Technology	
1	Head Set	2002-93	HS 26164 PT	Head bolts not incl.; Head bolt replacement recommended; PermaDry® molded rubber valve cover gskt. incl.; Premium valve stem seals incl.; Improved design	
1	Head Set	1997-93	HS 26164 PT-1	Head bolts not incl.; Head bolt replacement recommended; PermaDry® molded rubber valve cover gskt. incl.; Premium valve stem seals incl.; Old design; Superseded - When depleted use HS 26164 PT	
1	Head Bolt Set	2002-93	ES 74029	Head bolts w/Washers; Replacement recommended	
QTY	CONVERSION SET	YEARS	PART NO.	DESCRIPTION	
1	Gasket Conversion Set	2002-93	CS 26164	PermaDry® molded rubber oil pan gskt. incl.	
QTY	MANIFOLD - INT. & EXH.	YEARS	PART NO.	DESCRIPTION	
1	Int. Manifold Gasket Set	2002-93	MS 93223	Lower set; Upper set incl.	
1	Plenum Gasket Set	2002-93	MS 93224	Upper set; New Part Number - Check for Availability	
1	Exh. Manifold Gasket Set	2002-93	MS 94063	OEM style multi-piece design	
1	Exh. Manifold Gasket Set	2002-93	MS 97196	Opt. one-piece design; New Part Number - Check for Availability	
QTY	EXHAUST PIPE FLANGE	YEARS	PART NO.	DESCRIPTION	
1	Exhaust Pipe Gasket	2002-93	60693	Flange	
1	Exhaust Pipe Gasket	2002-93	61140	Converter	
QTY	OIL PAN	YEARS	PART NO.	DESCRIPTION	
1	Oil Pan Gasket Set	2002-93	OS 30706 R	PermaDry® molded rubber gskt. incl.	
QTY	CRANKSHAFT REAR SEAL	YEARS	PART NO.	DESCRIPTION	
1	Rear Main Seal Set	2002-93	BS 40427	Rubber; One-piece; Improved design	
QTY	VALVE COVER	YEARS	PART NO.	DESCRIPTION	
1	Valve Cover Gasket Set	2002-93	VS 50528 R	Int. manifold upper set incl.; PermaDry® molded rubber gskt. incl.	
QTY	VALVE STEM SEAL SET	YEARS	PART NO.	DESCRIPTION	
1	Valve Stem Seal Set	2002-93	SS 72682-2	Premium valve stem seals incl.	

30 (cont.)		2002 - 1993; 2.0L 121 (1984cc) SOHC L4 (8 Valve) 82.5mm Bore			30 (cont.)
MFI; Gasoline; Naturally Aspirated VW Eng.; Eng. Code ABA					
QTY	THERMOSTAT HOUSING	YEARS	PART NO.	DESCRIPTION	
1	O-Ring	2002-93	25598	Thermostat Housing	
QTY	WATER OUTLET GASKET	YEARS	PART NO.	DESCRIPTION	
1	Water Outlet Gasket	2002-93	35653	Water Outlet	
QTY	WATER PUMP	YEARS	PART NO.	DESCRIPTION	
1	Water Pump Gasket	2002-93	35549		
QTY	TIMING COVER	YEARS	PART NO.	DESCRIPTION	
1	Crankshaft Front Seal Set	2002-93	TCS 24551		
1	Camshaft Front Seal Set	2002-93	TCS 45357		
QTY	CARB & FUEL INJECTION	YEARS	PART NO.	DESCRIPTION	
1	Fuel Injector O-Ring Set	2002-93	ES 70599	Improved design	
1	Throttle Body Gasket	2002-98	61092		
1	Throttle Body Gasket	1997-93	60983		
QTY	EXHAUST GAS RECIRCULATION	YEARS	PART NO.	DESCRIPTION	
1	EGR Gasket	2002-93	70982		
31		2006 - 1998; 2.0L 121 (1984cc) SOHC L4 (8 Valve) 82.5mm Bore			31
MFI; Gasoline; Naturally Aspirated VW Eng.; Eng. Code AEG					
QTY	CYLINDER HEAD	YEARS	PART NO.	DESCRIPTION	
1	Head Gasket	2006-98	26161 PT	Head bolts not incl.; Head bolt replacement recommended; PermaTorqueMLS® LaserWeld® Technology	
1	Head Set	2006-02	HS 26161 PT-1	Head bolts not incl.; Head bolt replacement recommended; PermaDry® molded rubber valve cover gskt. incl.; Premium valve stem seals incl.	
1	Head Set	2001-98	HS 26161 PT	Head bolts not incl.; Head bolt replacement recommended; PermaDry® molded rubber valve cover gskt. incl.; Premium valve stem seals incl.	
1	Head Bolt Set	2006-98	ES 72189	Head bolts w/Washers; Replacement recommended	
QTY	CONVERSION SET	YEARS	PART NO.	DESCRIPTION	
1	Gasket Conversion Set	2006-98	CS 26161	PermaDry® molded rubber oil pan gskt. incl.	
QTY	MANIFOLD - INT. & EXH.	YEARS	PART NO.	DESCRIPTION	
1	Int. Manifold Gasket Set	2006-98	MS 93223	Lower set; Upper set incl.	
1	Exh. Manifold Gasket Set	2006-98	MS 94356		
QTY	EXHAUST PIPE FLANGE	YEARS	PART NO.	DESCRIPTION	
1	Exhaust Pipe Gasket	2006-98	60693	Flange	
1	Exhaust Pipe Gasket	2006-98	61140	Converter	
QTY	OIL PAN	YEARS	PART NO.	DESCRIPTION	
1	Oil Pan Gasket Set	2006-98	OS 30708 R	PermaDry® molded rubber gskt. incl.	
QTY	CRANKSHAFT REAR SEAL	YEARS	PART NO.	DESCRIPTION	
1	Rear Main Seal Set	2006-98	BS 40187	PTFE Rubber; One-piece	
QTY	VALVE COVER	YEARS	PART NO.	DESCRIPTION	
1	Valve Cover Gasket Set	2006-02	VS 50533 R	Int. manifold upper set incl.; PermaDry® molded rubber gskt. incl.	
1	Valve Cover Gasket Set	2001-98	VS 50528 R-1	Int. manifold upper set incl.; PermaDry® molded rubber gskt. incl.	
QTY	VALVE STEM SEAL SET	YEARS	PART NO.	DESCRIPTION	
1	Valve Stem Seal Set	2006-98	SS 72682-2	Premium valve stem seals incl.	
QTY	THERMOSTAT HOUSING	YEARS	PART NO.	DESCRIPTION	
1	O-Ring	2006-98	25598	Thermostat Housing	
QTY	WATER OUTLET GASKET	YEARS	PART NO.	DESCRIPTION	
1	Water Outlet Gasket	2006-98	35653	Water Outlet	
1	O-Ring	2006-98	416	Water Outlet; Water outlet connection O-ring	
QTY	WATER PUMP	YEARS	PART NO.	DESCRIPTION	
1	O-Ring	2006-98	35675	Water Pump; Housing	
QTY	TIMING COVER	YEARS	PART NO.	DESCRIPTION	
1	Crankshaft Front Seal Set	2006-98	TCS 45038		
1	Camshaft Front Seal Set	2006-98	TCS 45357		
QTY	CARB & FUEL INJECTION	YEARS	PART NO.	DESCRIPTION	
1	Fuel Injector O-Ring Set	2006-98	ES 70599	Improved design	
1	Throttle Body Gasket	2006-98	61092		
QTY	OIL FILTER MOUNTING	YEARS	PART NO.	DESCRIPTION	
1	Oil Filter Adapter Gasket	2006-98	72969	Oil filter adapter; New Part Number - Check for Availability	
QTY	OIL COOLER	YEARS	PART NO.	DESCRIPTION	
1	Oil Cooler Gasket	2006-98	72485	Oil cooler O-ring; New Part Number - Check for Availability	

VW Car (Cont.)

32		2005 - 2001; 2.0L 121 (1984cc) SOHC L4 (8 Valve) 82.5mm Bore			32
MFI; Gasoline; Naturally Aspirated VW Eng.; Eng. Code AVH					
QTY	CYLINDER HEAD	YEARS	PART NO.	DESCRIPTION	
1	Head Gasket	2005-01	26161 PT	Head bolts not incl.; Head bolt replacement recommended; PermaTorqueMLS® LaserWeld® Technology	
1	Head Set	2005-02	HS 26161 PT-1	Head bolts not incl.; Head bolt replacement recommended; PermaDry® molded rubber valve cover gskt. incl.; Premium valve stem seals incl.	
1	Head Set	2001	HS 26161 PT	Head bolts not incl.; Head bolt replacement recommended; PermaDry® molded rubber valve cover gskt. incl.; Premium valve stem seals incl.	
1	Head Bolt Set	2005-01	ES 72189	Head bolts w/Washers; Replacement recommended	
QTY	CONVERSION SET	YEARS	PART NO.	DESCRIPTION	
1	Gasket Conversion Set	2005-01	CS 26161	PermaDry® molded rubber oil pan gskt. incl.	
QTY	MANIFOLD - INT. & EXH.	YEARS	PART NO.	DESCRIPTION	
1	Int. Manifold Gasket Set	2005-01	MS 93223	Lower set; Upper set incl.	
1	Exh. Manifold Gasket Set	2005-01	MS 94356		
QTY	EXHAUST PIPE FLANGE	YEARS	PART NO.	DESCRIPTION	
1	Exhaust Pipe Gasket	2005-01	60693	Flange	
1	Exhaust Pipe Gasket	2005-01	61140	Converter	
1	Exhaust Pipe Gasket	2005-01	61705	Exh. connector; New Part Number - Check for Availability	
QTY	OIL PAN	YEARS	PART NO.	DESCRIPTION	
1	Oil Pan Gasket Set	2005-01	OS 30708 R	PermaDry® molded rubber gskt. incl.	
QTY	CRANKSHAFT REAR SEAL	YEARS	PART NO.	DESCRIPTION	
1	Rear Main Seal Set	2005-01	BS 40187	PTFE Rubber; One-piece	
QTY	VALVE COVER	YEARS	PART NO.	DESCRIPTION	
1	Valve Cover Gasket Set	2005-02	VS 50533 R	Int. manifold upper set incl.; PermaDry® molded rubber gskt. incl.	
1	Valve Cover Gasket Set	2001	VS 50528 R-1	Int. manifold upper set incl.; PermaDry® molded rubber gskt. incl.	
QTY	VALVE STEM SEAL SET	YEARS	PART NO.	DESCRIPTION	
1	Valve Stem Seal Set	2005-01	SS 72682-2	Premium valve stem seals incl.	
QTY	THERMOSTAT HOUSING	YEARS	PART NO.	DESCRIPTION	
1	Thermostat Gasket	2005-01	35744	Thermostat Housing; Thermostat seal	
1	O-Ring	2005-01	25598	Thermostat Housing; Thermostat housing O-ring	
1	O-Ring	2005-01	35705	Thermostat Housing; Thermostat O-ring	
QTY	WATER OUTLET GASKET	YEARS	PART NO.	DESCRIPTION	
1	Water Outlet Gasket	2005-01	35653	Water Outlet	
1	O-Ring	2005-01	416	Water Outlet; Water outlet connection O-ring	
QTY	WATER PUMP	YEARS	PART NO.	DESCRIPTION	
1	O-Ring	2005-01	35675	Water Pump; Housing	
QTY	TIMING COVER	YEARS	PART NO.	DESCRIPTION	
1	Crankshaft Front Seal Set	2005-01	TCS 45038		
1	Camshaft Front Seal Set	2005-01	TCS 45357		
QTY	CARB & FUEL INJECTION	YEARS	PART NO.	DESCRIPTION	
1	Fuel Injector O-Ring Set	2005-01	ES 70599	Improved design	
1	Throttle Body Gasket	2005-01	61092		
QTY	OIL FILTER MOUNTING	YEARS	PART NO.	DESCRIPTION	
1	Oil Filter Adapter Gasket	2005-01	72969	Oil filter adapter; New Part Number - Check for Availability	
QTY	OIL COOLER	YEARS	PART NO.	DESCRIPTION	
1	Oil Cooler Gasket	2005-01	72485	Oil cooler O-ring; New Part Number - Check for Availability	
33		2005 - 2001; 2.0L 121 (1984cc) SOHC L4 (8 Valve) 82.5mm Bore			33
MFI; Gasoline; Naturally Aspirated VW Eng.; Eng. Code AZG					
QTY	CYLINDER HEAD	YEARS	PART NO.	DESCRIPTION	
1	Head Gasket	2005-01	26161 PT	Head bolts not incl.; Head bolt replacement recommended; PermaTorqueMLS® LaserWeld® Technology	
1	Head Set	2005-02	HS 26161 PT-1	Head bolts not incl.; Head bolt replacement recommended; PermaDry® molded rubber valve cover gskt. incl.; Premium valve stem seals incl.	
1	Head Set	2001	HS 26161 PT	Head bolts not incl.; Head bolt replacement recommended; PermaDry® molded rubber valve cover gskt. incl.; Premium valve stem seals incl.	
1	Head Bolt Set	2005-01	ES 72189	Head bolts w/Washers; Replacement recommended	
QTY	CONVERSION SET	YEARS	PART NO.	DESCRIPTION	
1	Gasket Conversion Set	2005-01	CS 26161	PermaDry® molded rubber oil pan gskt. incl.	
QTY	MANIFOLD - INT. & EXH.	YEARS	PART NO.	DESCRIPTION	
1	Int. Manifold Gasket Set	2005-01	MS 93223	Lower set; Upper set incl.	
1	Exh. Manifold Gasket Set	2005-01	MS 94356		
QTY	EXHAUST PIPE FLANGE	YEARS	PART NO.	DESCRIPTION	
1	Exhaust Pipe Gasket	2005-01	60693	Flange	

33 (cont.)		2005 - 2001; 2.0L 121 (1984cc) SOHC L4 (8 Valve) 82.5mm Bore			33 (cont.)
MFI; Gasoline; Naturally Aspirated VW Eng.; Eng. Code AZG					
QTY	EXHAUST PIPE FLANGE	YEARS	PART NO.	DESCRIPTION	
1	Exhaust Pipe Gasket	2005-01	61140	Converter	
1	Exhaust Pipe Gasket	2005-01	61705	Exh. connector; New Part Number - Check for Availability	
QTY	OIL PAN	YEARS	PART NO.	DESCRIPTION	
1	Oil Pan Gasket Set	2005-01	OS 30708 R	PermaDry® molded rubber gskt. incl.	
QTY	CRANKSHAFT REAR SEAL	YEARS	PART NO.	DESCRIPTION	
1	Rear Main Seal Set	2005-01	BS 40187	PTFE Rubber; One-piece	
QTY	VALVE COVER	YEARS	PART NO.	DESCRIPTION	
1	Valve Cover Gasket Set	2005-02	VS 50533 R	Int. manifold upper set incl.; PermaDry® molded rubber gskt. incl.	
1	Valve Cover Gasket Set	2001	VS 50528 R-1	Int. manifold upper set incl.; PermaDry® molded rubber gskt. incl.	
QTY	VALVE STEM SEAL SET	YEARS	PART NO.	DESCRIPTION	
1	Valve Stem Seal Set	2005-01	SS 72682-2	Premium valve stem seals incl.	
QTY	THERMOSTAT HOUSING	YEARS	PART NO.	DESCRIPTION	
1	O-Ring	2005-01	25598	Thermostat Housing; Thermostat housing O-ring	
1	O-Ring	2005-01	35705	Thermostat Housing; Thermostat O-ring	
QTY	WATER OUTLET GASKET	YEARS	PART NO.	DESCRIPTION	
1	Water Outlet Gasket	2005-01	35653	Water Outlet	
1	O-Ring	2005-01	416	Water Outlet; Water outlet connection O-ring	
QTY	WATER PUMP	YEARS	PART NO.	DESCRIPTION	
1	O-Ring	2005-01	35675	Water Pump; Housing	
QTY	TIMING COVER	YEARS	PART NO.	DESCRIPTION	
1	Crankshaft Front Seal Set	2005-01	TCS 45038		
1	Camshaft Front Seal Set	2005-01	TCS 45357		
QTY	CARB & FUEL INJECTION	YEARS	PART NO.	DESCRIPTION	
1	Fuel Injector O-Ring Set	2005-01	ES 70599	Improved design	
1	Throttle Body Gasket	2005-01	61092		
QTY	OIL FILTER MOUNTING	YEARS	PART NO.	DESCRIPTION	
1	Oil Filter Adapter Gasket	2005-01	72969	Oil filter adapter; New Part Number - Check for Availability	
QTY	OIL COOLER	YEARS	PART NO.	DESCRIPTION	
1	Oil Cooler Gasket	2005-01	72485	Oil cooler O-ring; New Part Number - Check for Availability	
34		2005; 2.0L 121 (1984cc) SOHC L4 (8 Valve) 82.5mm Bore			34
MFI; Gasoline; Naturally Aspirated VW Eng.; Eng. Code BBW					
QTY	CYLINDER HEAD	YEARS	PART NO.	DESCRIPTION	
1	Head Gasket	2005	26161 PT	Head bolts not incl.; Head bolt replacement recommended; PermaTorqueMLS® LaserWeld® Technology	
1	Head Set	2005	HS 26161 PT-1	Head bolts & camshaft front seal not incl.; Head bolt replacement recommended; PermaDry® molded rubber valve cover gskt. incl.; Premium valve stem seals incl.	
1	Head Bolt Set	2005	ES 72189	Head bolts w/Washers; Replacement recommended	
QTY	CONVERSION SET	YEARS	PART NO.	DESCRIPTION	
1	Gasket Conversion Set	2005	CS 26161	PermaDry® molded rubber oil pan gskt. incl.	
QTY	MANIFOLD - INT. & EXH.	YEARS	PART NO.	DESCRIPTION	
1	Int. Manifold Gasket Set	2005	MS 93223	Lower set; Upper set incl.	
1	Exh. Manifold Gasket Set	2005	MS 94356		
QTY	EXHAUST PIPE FLANGE	YEARS	PART NO.	DESCRIPTION	
1	Exhaust Pipe Gasket	2005	60693	Flange	
1	Exhaust Pipe Gasket	2005	61140	Converter	
1	Exhaust Pipe Gasket	2005	61705	Exh. connector; New Part Number - Check for Availability	
QTY	OIL PAN	YEARS	PART NO.	DESCRIPTION	
1	Oil Pan Gasket Set	2005	OS 30708 R	PermaDry® molded rubber gskt. incl.	
QTY	CRANKSHAFT REAR SEAL	YEARS	PART NO.	DESCRIPTION	
1	Rear Main Seal Set	2005	BS 40187	PTFE Rubber; One-piece	
QTY	VALVE COVER	YEARS	PART NO.	DESCRIPTION	
1	Valve Cover Gasket Set	2005	VS 50533 R	Int. manifold upper set incl.; PermaDry® molded rubber gskt. incl.	
QTY	VALVE STEM SEAL SET	YEARS	PART NO.	DESCRIPTION	
1	Valve Stem Seal Set	2005	SS 72682-2	Premium valve stem seals incl.	
QTY	THERMOSTAT HOUSING	YEARS	PART NO.	DESCRIPTION	
1	O-Ring	2005	25598	Thermostat Housing; Thermostat housing O-ring	
QTY	WATER OUTLET GASKET	YEARS	PART NO.	DESCRIPTION	
1	Water Outlet Gasket	2005	35653	Water Outlet	
1	O-Ring	2005	416	Water Outlet; Water outlet connection O-ring	
QTY	WATER PUMP	YEARS	PART NO.	DESCRIPTION	
1	O-Ring	2005	35675	Water Pump; Housing	

VW Car (Cont.)

34 (cont.)		2005; 2.0L 121 (1984cc) SOHC L4 (8 Valve) 82.5mm Bore			34 (cont.)
		MFI; Gasoline; Naturally Aspirated VW Eng.; Eng. Code BBW			
QTY	TIMING COVER	YEARS	PART NO.	DESCRIPTION	
1	Crankshaft Front Seal Set	2005	TCS 45038		
1	Camshaft Front Seal Set	2005	TCS 46152	New Part Number - Check for Availability	
QTY	CARB & FUEL INJECTION	YEARS	PART NO.	DESCRIPTION	
1	Fuel Injector O-Ring Set	2005	ES 70599	Improved design	
1	Throttle Body Gasket	2005	61092		
QTY	OIL FILTER MOUNTING	YEARS	PART NO.	DESCRIPTION	
1	Oil Filter Adapter Gasket	2005	72969	Oil filter adapter; New Part Number - Check for Availability	
QTY	OIL COOLER	YEARS	PART NO.	DESCRIPTION	
1	Oil Cooler Gasket	2005	72485	Oil cooler O-ring; New Part Number - Check for Availability	
35		2004 - 2003; 2.0L 121 (1984cc) SOHC L4 (8 Valve) 82.5mm Bore			35
		MFI; Gasoline; Naturally Aspirated VW Eng.; Eng. Code BDC			
QTY	CYLINDER HEAD	YEARS	PART NO.	DESCRIPTION	
1	Head Gasket	2004-03	26161 PT	Head bolts not incl.; Head bolt replacement recommended; PermaTorqueMLS® LaserWeld® Technology	
1	Head Set	2004-03	HS 26161 PT-1	Head bolts not incl.; Head bolt replacement recommended; PermaDry® molded rubber valve cover gskt. incl.; Premium valve stem seals incl.	
1	Head Bolt Set	2004-03	ES 72189	Head bolts w/Washers; Replacement recommended	
QTY	CONVERSION SET	YEARS	PART NO.	DESCRIPTION	
1	Gasket Conversion Set	2004-03	CS 26161	PermaDry® molded rubber oil pan gskt. incl.	
QTY	MANIFOLD - INT. & EXH.	YEARS	PART NO.	DESCRIPTION	
1	Int. Manifold Gasket Set	2004-03	MS 93223	Lower set; Upper set incl.	
1	Int. Manifold Gasket Set	2004-03	MS 97293	Lower set; Upper set incl.; OEM style; New Part Number - Check for Availability	
1	Exh. Manifold Gasket Set	2004-03	MS 94356		
QTY	EXHAUST PIPE FLANGE	YEARS	PART NO.	DESCRIPTION	
1	Exhaust Pipe Gasket	2004-03	60693	Flange	
1	Exhaust Pipe Gasket	2004-03	61140	Converter	
1	Exhaust Pipe Gasket	2004-03	61705	Exh. connector; New Part Number - Check for Availability	
QTY	OIL PAN	YEARS	PART NO.	DESCRIPTION	
1	Oil Pan Gasket Set	2004-03	OS 30708 R	PermaDry® molded rubber gskt. incl.	
QTY	CRANKSHAFT REAR SEAL	YEARS	PART NO.	DESCRIPTION	
1	Rear Main Seal Set	2004-03	BS 40187	PTFE Rubber; One-piece	
QTY	VALVE COVER	YEARS	PART NO.	DESCRIPTION	
1	Valve Cover Gasket Set	2004-03	VS 50533 R	Int. manifold upper set incl.; PermaDry® molded rubber gskt. incl.	
QTY	VALVE STEM SEAL SET	YEARS	PART NO.	DESCRIPTION	
1	Valve Stem Seal Set	2004-03	SS 72682-2	Premium valve stem seals incl.	
QTY	THERMOSTAT HOUSING	YEARS	PART NO.	DESCRIPTION	
1	O-Ring	2004-03	25598	Thermostat Housing; Thermostat housing O-ring	
QTY	WATER OUTLET GASKET	YEARS	PART NO.	DESCRIPTION	
1	Water Outlet Gasket	2004-03	35653	Water Outlet	
1	O-Ring	2004-03	416	Water Outlet; Water outlet connection O-ring	
QTY	WATER PUMP	YEARS	PART NO.	DESCRIPTION	
1	O-Ring	2004-03	35675	Water Pump; Housing	
QTY	TIMING COVER	YEARS	PART NO.	DESCRIPTION	
1	Crankshaft Front Seal Set	2004-03	TCS 45038		
1	Camshaft Front Seal Set	2004-03	TCS 45357		
QTY	CARB & FUEL INJECTION	YEARS	PART NO.	DESCRIPTION	
1	Fuel Injector O-Ring Set	2004-03	ES 70599	Improved design	
1	Throttle Body Gasket	2004-03	61092		
QTY	OIL FILTER MOUNTING	YEARS	PART NO.	DESCRIPTION	
1	Oil Filter Adapter Gasket	2004-03	72969	Oil filter adapter; New Part Number - Check for Availability	
QTY	OIL COOLER	YEARS	PART NO.	DESCRIPTION	
1	Oil Cooler Gasket	2004-03	72485	Oil cooler O-ring; New Part Number - Check for Availability	
36		2009 - 2004; 2.0L 121 (1984cc) SOHC L4 (8 Valve) 82.5mm Bore			36
		MFI; Gasoline; Naturally Aspirated VW Eng.; Eng. Code BEV			
QTY	CYLINDER HEAD	YEARS	PART NO.	DESCRIPTION	
1	Head Gasket	2006-04	26161 PT	Head bolts not incl.; Head bolt replacement recommended; PermaTorqueMLS® LaserWeld® Technology	
1	Head Set	2006-04	HS 26161 PT-1	Head bolts not incl.; Head bolt replacement recommended; PermaDry® molded rubber valve cover gskt. incl.; Premium valve stem seals incl.	

36 (cont.)		2009 - 2004; 2.0L 121 (1984cc) SOHC L4 (8 Valve) 82.5mm Bore			36 (cont.)
MFI; Gasoline; Naturally Aspirated VW Eng.; Eng. Code BEV					
QTY	CYLINDER HEAD	YEARS	PART NO.	DESCRIPTION	
1	Head Bolt Set	2006-04	ES 72189	Head bolts w/Washers; Replacement recommended	
QTY	CONVERSION SET	YEARS	PART NO.	DESCRIPTION	
1	Gasket Conversion Set	2006-04	CS 26161	PermaDry® molded rubber oil pan gskt. incl.	
QTY	MANIFOLD - INT. & EXH.	YEARS	PART NO.	DESCRIPTION	
1	Int. Manifold Gasket Set	2006-04	MS 93223	Lower set; Upper set incl.	
1	Exh. Manifold Gasket Set	2006-04	MS 94356		
QTY	EXHAUST PIPE FLANGE	YEARS	PART NO.	DESCRIPTION	
1	Exhaust Pipe Gasket	2006-04	60693	Flange	
1	Exhaust Pipe Gasket	2006-04	61140	Converter	
1	Exhaust Pipe Gasket	2006-04	61705	Exh. connector; New Part Number - Check for Availability	
QTY	OIL PAN	YEARS	PART NO.	DESCRIPTION	
1	Oil Pan Gasket Set	2006-04	OS 30708 R	PermaDry® molded rubber gskt. incl.	
QTY	CRANKSHAFT REAR SEAL	YEARS	PART NO.	DESCRIPTION	
1	Rear Main Seal Set	2006-04	BS 40187	PTFE Rubber; One-piece	
QTY	VALVE COVER	YEARS	PART NO.	DESCRIPTION	
1	Valve Cover Gasket Set	2006-04	VS 50533 R	Int. manifold upper set incl.; PermaDry® molded rubber gskt. incl.	
QTY	VALVE STEM SEAL SET	YEARS	PART NO.	DESCRIPTION	
1	Valve Stem Seal Set	2006-04	SS 72682-2	Premium valve stem seals incl.	
QTY	THERMOSTAT HOUSING	YEARS	PART NO.	DESCRIPTION	
1	O-Ring	2006-04	25598	Thermostat Housing; Thermostat housing O-ring	
QTY	WATER OUTLET GASKET	YEARS	PART NO.	DESCRIPTION	
1	Water Outlet Gasket	2006-04	35653	Water Outlet	
1	O-Ring	2006-04	416	Water Outlet; Water outlet connection O-ring	
QTY	WATER PUMP	YEARS	PART NO.	DESCRIPTION	
1	O-Ring	2006-04	35675	Water Pump; Housing	
QTY	TIMING COVER	YEARS	PART NO.	DESCRIPTION	
1	Crankshaft Front Seal Set	2006-04	TCS 45038		
1	Camshaft Front Seal Set	2006-04	TCS 45357		
QTY	CARB & FUEL INJECTION	YEARS	PART NO.	DESCRIPTION	
1	Fuel Injector O-Ring Set	2006-04	ES 70599	Improved design	
1	Throttle Body Gasket	2006-04	61092		
QTY	OIL FILTER MOUNTING	YEARS	PART NO.	DESCRIPTION	
1	Oil Filter Adapter Gasket	2009-04	72969	Oil filter adapter; New Part Number - Check for Availability	
QTY	OIL COOLER	YEARS	PART NO.	DESCRIPTION	
1	Oil Cooler Gasket	2009-04	72485	Oil cooler O-ring; New Part Number - Check for Availability	
37		2005 - 2004; 2.0L 121 (1984cc) SOHC L4 (8 Valve) 82.5mm Bore			37
MFI; Gasoline; Naturally Aspirated VW Eng.; Eng. Code BGD					
QTY	CYLINDER HEAD	YEARS	PART NO.	DESCRIPTION	
1	Head Gasket	2005-04	26161 PT	Head bolts not incl.; Head bolt replacement recommended; PermaTorqueMLS® LaserWeld® Technology	
1	Head Set	2005-04	HS 26161 PT-1	Head bolts not incl.; Head bolt replacement recommended; PermaDry® molded rubber valve cover gskt. incl.; Premium valve stem seals incl.	
1	Head Bolt Set	2005-04	ES 72189	Head bolts w/Washers; Replacement recommended	
QTY	CONVERSION SET	YEARS	PART NO.	DESCRIPTION	
1	Gasket Conversion Set	2005-04	CS 26161	PermaDry® molded rubber oil pan gskt. incl.	
QTY	MANIFOLD - INT. & EXH.	YEARS	PART NO.	DESCRIPTION	
1	Int. Manifold Gasket Set	2005-04	MS 93223	Lower set; Upper set incl.	
1	Int. Manifold Gasket Set	2005-04	MS 97293	Lower set; Upper set incl.; OEM style; New Part Number - Check for Availability	
1	Exh. Manifold Gasket Set	2005-04	MS 94356		
QTY	EXHAUST PIPE FLANGE	YEARS	PART NO.	DESCRIPTION	
1	Exhaust Pipe Gasket	2005-04	60693	Flange	
1	Exhaust Pipe Gasket	2005-04	61140	Converter	
1	Exhaust Pipe Gasket	2005-04	61705	Exh. connector; New Part Number - Check for Availability	
QTY	OIL PAN	YEARS	PART NO.	DESCRIPTION	
1	Oil Pan Gasket Set	2005-04	OS 30708 R	PermaDry® molded rubber gskt. incl.	
QTY	CRANKSHAFT REAR SEAL	YEARS	PART NO.	DESCRIPTION	
1	Rear Main Seal Set	2005-04	BS 40187	PTFE Rubber; One-piece	
QTY	VALVE COVER	YEARS	PART NO.	DESCRIPTION	
1	Valve Cover Gasket Set	2005-04	VS 50533 R	Int. manifold upper set incl.; PermaDry® molded rubber gskt. incl.	
QTY	VALVE STEM SEAL SET	YEARS	PART NO.	DESCRIPTION	
1	Valve Stem Seal Set	2005-04	SS 72682-2	Premium valve stem seals incl.	

VW Car (Cont.)

37		2005 - 2004; 2.0L 121 (1984cc) SOHC L4 (8 Valve) 82.5mm Bore			37	
(cont.)		MFI; Gasoline; Naturally Aspirated VW Eng.; Eng. Code BGD			(cont.)	
QTY	THERMOSTAT HOUSING	YEARS	PART NO.	DESCRIPTION		
1	O-Ring	2005-04	25598	Thermostat Housing; Thermostat housing O-ring		
QTY	WATER OUTLET GASKET	YEARS	PART NO.	DESCRIPTION		
1	Water Outlet Gasket	2005-04	35653	Water Outlet		
1	O-Ring	2005-04	416	Water Outlet; Water outlet connection O-ring		
QTY	WATER PUMP	YEARS	PART NO.	DESCRIPTION		
1	O-Ring	2005-04	35675	Water Pump; Housing		
QTY	TIMING COVER	YEARS	PART NO.	DESCRIPTION		
1	Crankshaft Front Seal Set	2005-04	TCS 45038			
1	Camshaft Front Seal Set	2005-04	TCS 45357			
QTY	CARB & FUEL INJECTION	YEARS	PART NO.	DESCRIPTION		
1	Fuel Injector O-Ring Set	2005-04	ES 70599	Improved design		
1	Throttle Body Gasket	2005-04	61092			
QTY	OIL FILTER MOUNTING	YEARS	PART NO.	DESCRIPTION		
1	Oil Filter Adapter Gasket	2005-04	72969	Oil filter adapter; New Part Number - Check for Availability		
QTY	OIL COOLER	YEARS	PART NO.	DESCRIPTION		
1	Oil Cooler Gasket	2005-04	72485	Oil cooler O-ring; New Part Number - Check for Availability		
38		2011 - 2005; 2.5L 151.3 (2480cc) DOHC L5 (20 Valve) 82.5mm Bore			38	
		MFI; Gasoline; Naturally Aspirated VW Eng.; Eng. Code BGP				
QTY	CYLINDER HEAD	YEARS	PART NO.	DESCRIPTION		
1	Head Gasket	2009-05	26388 PT	Head bolts not incl.; Head bolt replacement recommended; PermaTorqueMLS®		
1	Head Set	2009-05	HS 26388 PT	Head bolts not incl.; Head bolt replacement recommended; PermaDry® molded rubber valve cover gskt. incl.; Premium valve stem seals incl.		
1	Head Bolt Set	2009-05	ES 72310	Replacement recommended		
QTY	CONVERSION SET	YEARS	PART NO.	DESCRIPTION		
1	Gasket Conversion Set	2009-05	CS 26388	RTV sealant incl. for Upper oil pan gskt.		
QTY	MANIFOLD - INT. & EXH.	YEARS	PART NO.	DESCRIPTION		
1	Int. Manifold Gasket Set	2009-05	MS 97007			
1	Exh. Manifold Gasket Set	2009-05	MS 97034			
QTY	EXHAUST PIPE FLANGE	YEARS	PART NO.	DESCRIPTION		
1	Exhaust Pipe Gasket	2009-05	61458	Flange		
QTY	OIL PAN	YEARS	PART NO.	DESCRIPTION		
1	Oil Pan Gasket Set	2009-05	OS 30804	RTV sealant incl. for Upper oil pan gskt.		
QTY	CRANKSHAFT REAR SEAL	YEARS	PART NO.	DESCRIPTION		
1	Rear Main Seal Set	2009-05	BS 40712	Rubber; One-piece		
QTY	VALVE COVER	YEARS	PART NO.	DESCRIPTION		
1	Valve Cover Gasket Set	2009-05	VS 50735 R	PermaDry® molded rubber gskt. incl.		
QTY	VALVE STEM SEAL SET	YEARS	PART NO.	DESCRIPTION		
1	Valve Stem Seal Set	2009-05	SS 71074	Premium valve stem seals incl.		
QTY	THERMOSTAT HOUSING	YEARS	PART NO.	DESCRIPTION		
1	O-Ring	2011-05	35879	Thermostat Housing; Thermostat seal		
QTY	TIMING COVER	YEARS	PART NO.	DESCRIPTION		
1	Crankshaft Front Seal Set	2009-05	TCS 46107			
QTY	CARB & FUEL INJECTION	YEARS	PART NO.	DESCRIPTION		
1	Throttle Body Gasket	2009-05	61491			
QTY	OIL FILTER MOUNTING	YEARS	PART NO.	DESCRIPTION		
1	Oil Filter Adapter Gasket	2011-05	72993	Oil filter adapter seal; New Part Number - Check for Availability		
39		2011 - 2005; 2.5L 151.3 (2480cc) DOHC L5 (20 Valve) 82.5mm Bore			39	
		MFI; Gasoline; Naturally Aspirated VW Eng.; Eng. Code BGQ				
QTY	CYLINDER HEAD	YEARS	PART NO.	DESCRIPTION		
1	Head Gasket	2009-05	26388 PT	Head bolts not incl.; Head bolt replacement recommended; PermaTorqueMLS®		
1	Head Set	2009-05	HS 26388 PT	Head bolts not incl.; Head bolt replacement recommended; PermaDry® molded rubber valve cover gskt. incl.; Premium valve stem seals incl.		
1	Head Bolt Set	2009-05	ES 72310	Replacement recommended		
QTY	CONVERSION SET	YEARS	PART NO.	DESCRIPTION		
1	Gasket Conversion Set	2009-05	CS 26388	RTV sealant incl. for Upper oil pan gskt.		
QTY	MANIFOLD - INT. & EXH.	YEARS	PART NO.	DESCRIPTION		
1	Int. Manifold Gasket Set	2009-05	MS 97007			
1	Exh. Manifold Gasket Set	2009-05	MS 97034			

39 (cont.)		2011 - 2005; 2.5L 151.3 (2480cc) DOHC L5 (20 Valve) 82.5mm Bore			39 (cont.)
MFI; Gasoline; Naturally Aspirated VW Eng.; Eng. Code BGQ					
QTY	EXHAUST PIPE FLANGE	YEARS	PART NO.	DESCRIPTION	
1	Exhaust Pipe Gasket	2009-05	61458	Flange	
QTY	OIL PAN	YEARS	PART NO.	DESCRIPTION	
1	Oil Pan Gasket Set	2009-05	OS 30804	RTV sealant incl. for Upper oil pan gskt.	
QTY	CRANKSHAFT REAR SEAL	YEARS	PART NO.	DESCRIPTION	
1	Rear Main Seal Set	2009-05	BS 40712	Rubber; One-piece	
QTY	VALVE COVER	YEARS	PART NO.	DESCRIPTION	
1	Valve Cover Gasket Set	2009-05	VS 50735 R	PermaDry® molded rubber gskt. incl.	
QTY	VALVE STEM SEAL SET	YEARS	PART NO.	DESCRIPTION	
1	Valve Stem Seal Set	2009-05	SS 71074	Premium valve stem seals incl.	
QTY	THERMOSTAT HOUSING	YEARS	PART NO.	DESCRIPTION	
1	O-Ring	2011-05	35879	Thermostat Housing; Thermostat seal	
QTY	TIMING COVER	YEARS	PART NO.	DESCRIPTION	
1	Crankshaft Front Seal Set	2009-05	TCS 46107		
QTY	CARB & FUEL INJECTION	YEARS	PART NO.	DESCRIPTION	
1	Throttle Body Gasket	2009-05	61491		
QTY	OIL FILTER MOUNTING	YEARS	PART NO.	DESCRIPTION	
1	Oil Filter Adapter Gasket	2011-05	72993	Oil filter adapter seal; New Part Number - Check for Availability	
40		2010 - 2006; 2.5L 151.3 (2480cc) DOHC L5 (20 Valve) 82.5mm Bore			40
MFI; Gasoline; Naturally Aspirated VW Eng.; Eng. Code BPR					
QTY	CYLINDER HEAD	YEARS	PART NO.	DESCRIPTION	
1	Head Gasket	2009-06	26388 PT	Head bolts not incl.; Head bolt replacement recommended; PermaTorqueMLS®	
1	Head Set	2009-06	HS 26388 PT	Head bolts not incl.; Head bolt replacement recommended; PermaDry® molded rubber valve cover gskt. incl.; Premium valve stem seals incl.	
1	Head Bolt Set	2009-06	ES 72310	Replacement recommended	
QTY	CONVERSION SET	YEARS	PART NO.	DESCRIPTION	
1	Gasket Conversion Set	2009-06	CS 26388	RTV sealant incl. for Upper oil pan gskt.	
QTY	MANIFOLD - INT. & EXH.	YEARS	PART NO.	DESCRIPTION	
1	Int. Manifold Gasket Set	2009-06	MS 97007		
1	Exh. Manifold Gasket Set	2009-06	MS 97034		
QTY	EXHAUST PIPE FLANGE	YEARS	PART NO.	DESCRIPTION	
1	Exhaust Pipe Gasket	2009-06	61535	Flange	
QTY	OIL PAN	YEARS	PART NO.	DESCRIPTION	
1	Oil Pan Gasket Set	2009-06	OS 30804	RTV sealant incl. for Upper oil pan gskt.	
QTY	CRANKSHAFT REAR SEAL	YEARS	PART NO.	DESCRIPTION	
1	Rear Main Seal Set	2009-06	BS 40712	Rubber; One-piece	
QTY	VALVE COVER	YEARS	PART NO.	DESCRIPTION	
1	Valve Cover Gasket Set	2009-06	VS 50735 R	PermaDry® molded rubber gskt. incl.	
QTY	VALVE STEM SEAL SET	YEARS	PART NO.	DESCRIPTION	
1	Valve Stem Seal Set	2009-06	SS 71074	Premium valve stem seals incl.	
QTY	THERMOSTAT HOUSING	YEARS	PART NO.	DESCRIPTION	
1	O-Ring	2009-06	35879	Thermostat Housing; Thermostat seal	
QTY	TIMING COVER	YEARS	PART NO.	DESCRIPTION	
1	Crankshaft Front Seal Set	2009-06	TCS 46107		
QTY	CARB & FUEL INJECTION	YEARS	PART NO.	DESCRIPTION	
1	Throttle Body Gasket	2009-06	61491		
QTY	OIL FILTER MOUNTING	YEARS	PART NO.	DESCRIPTION	
1	Oil Filter Adapter Gasket	2010-06	72993	Oil filter adapter seal; New Part Number - Check for Availability	
41		2010 - 2006; 2.5L 151.3 (2480cc) DOHC L5 (20 Valve) 82.5mm Bore			41
MFI; Gasoline; Naturally Aspirated VW Eng.; Eng. Code BPS					
QTY	CYLINDER HEAD	YEARS	PART NO.	DESCRIPTION	
1	Head Gasket	2009-06	26388 PT	Head bolts not incl.; Head bolt replacement recommended; PermaTorqueMLS®	
1	Head Set	2009-06	HS 26388 PT	Head bolts not incl.; Head bolt replacement recommended; PermaDry® molded rubber valve cover gskt. incl.; Premium valve stem seals incl.	
1	Head Bolt Set	2009-06	ES 72310	Replacement recommended	
QTY	CONVERSION SET	YEARS	PART NO.	DESCRIPTION	
1	Gasket Conversion Set	2009-06	CS 26388	RTV sealant incl. for Upper oil pan gskt.	
QTY	MANIFOLD - INT. & EXH.	YEARS	PART NO.	DESCRIPTION	
1	Int. Manifold Gasket Set	2009-06	MS 97007		
1	Exh. Manifold Gasket Set	2009-06	MS 97034		

VW Car (Cont.)

41		2010 - 2006; 2.5L 151.3 (2480cc) DOHC L5 (20 Valve) 82.5mm Bore			41	
(cont.)		MFI; Gasoline; Naturally Aspirated VW Eng.; Eng. Code BPS			(cont.)	
QTY	EXHAUST PIPE FLANGE	YEARS	PART NO.	DESCRIPTION		
1	Exhaust Pipe Gasket	2009-06	61535	Flange		
QTY	OIL PAN	YEARS	PART NO.	DESCRIPTION		
1	Oil Pan Gasket Set	2009-06	OS 30804	RTV sealant incl. for Upper oil pan gskt.		
QTY	CRANKSHAFT REAR SEAL	YEARS	PART NO.	DESCRIPTION		
1	Rear Main Seal Set	2009-06	BS 40712	Rubber; One-piece		
QTY	VALVE COVER	YEARS	PART NO.	DESCRIPTION		
1	Valve Cover Gasket Set	2009-06	VS 50735 R	PermaDry® molded rubber gskt. incl.		
QTY	VALVE STEM SEAL SET	YEARS	PART NO.	DESCRIPTION		
1	Valve Stem Seal Set	2009-06	SS 71074	Premium valve stem seals incl.		
QTY	THERMOSTAT HOUSING	YEARS	PART NO.	DESCRIPTION		
1	O-Ring	2009-06	35879	Thermostat Housing; Thermostat seal		
QTY	TIMING COVER	YEARS	PART NO.	DESCRIPTION		
1	Crankshaft Front Seal Set	2009-06	TCS 46107			
QTY	CARB & FUEL INJECTION	YEARS	PART NO.	DESCRIPTION		
1	Throttle Body Gasket	2009-06	61491			
QTY	OIL FILTER MOUNTING	YEARS	PART NO.	DESCRIPTION		
1	Oil Filter Adapter Gasket	2010-06	72993	Oil filter adapter seal; New Part Number - Check for Availability		
42		2005 - 1998; 2.8L 169 (2771cc) DOHC V6 (30 Valve) 82.5mm Bore			42	
		MFI; Gasoline; Naturally Aspirated Audi Eng.; Eng. Code AHA				
QTY	CYLINDER HEAD	YEARS	PART NO.	DESCRIPTION		
2	Head Gasket	2005-98	26328 PT	Head bolts not incl.; Head bolt replacement recommended; PermaTorqueMLS®		
1	Head Set	2005-98	HS 26328 PT	Head bolts not incl.; Head bolt replacement recommended; PermaDry® molded rubber valve cover gskts. incl.; Premium valve stem seals incl.		
1	Head Bolt Set	2005-98	ES 72870	OEM style; Replacement recommended; New Part Number - Check for Availability		
QTY	CONVERSION SET	YEARS	PART NO.	DESCRIPTION		
1	Gasket Conversion Set	2005-98	CS 26328	RTV sealant incl. for Upper oil pan gskt.		
QTY	MANIFOLD - INT. & EXH.	YEARS	PART NO.	DESCRIPTION		
1	Int. Manifold Gasket Set	2005-98	MS 96890			
1	Exh. Manifold Gasket Set	2005-00	MS 96882			
1	Exh. Manifold Gasket Set	1999-98	MS 97276	New Part Number - Check for Availability		
QTY	EXHAUST PIPE FLANGE	YEARS	PART NO.	DESCRIPTION		
2	Exhaust Pipe Gasket	2005-98	61171	Flange		
QTY	OIL PAN	YEARS	PART NO.	DESCRIPTION		
1	Oil Pan Gasket Set	2005-98	OS 30779	RTV sealant incl. for Upper oil pan gskt.		
QTY	CRANKSHAFT REAR SEAL	YEARS	PART NO.	DESCRIPTION		
1	Rear Main Seal Set	2005-98	BS 40704	PTFE Rubber; One-piece		
QTY	VALVE COVER	YEARS	PART NO.	DESCRIPTION		
1	Valve Cover Gasket Set	2005-98	VS 50702 R	w/Spark plug tube seals; PermaDry® molded rubber gskts. incl.		
QTY	VALVE STEM SEAL SET	YEARS	PART NO.	DESCRIPTION		
1	Valve Stem Seal Set	2005-98	SS 71074-2	Premium valve stem seals incl.		
QTY	THERMOSTAT HOUSING	YEARS	PART NO.	DESCRIPTION		
1	Water Outlet Gasket	2005-98	25589	Thermostat Housing; Thermostat O-ring; New Improved design		
1	O-Ring	2005-98	35327	Thermostat Housing; Thermostat O-ring; Old design		
1	O-Ring	2005-98	35763	Thermostat Housing; Thermostat O-ring; Improved design		
QTY	WATER PUMP	YEARS	PART NO.	DESCRIPTION		
1	Water Pump Gasket	2005-98	35829			
QTY	TIMING COVER	YEARS	PART NO.	DESCRIPTION		
1	Crankshaft Front Seal Set	2005-98	TCS 45038-1			
2	Camshaft Front Seal Set	2005-98	ES 72806	Camshaft circular plug; New Part Number - Check for Availability		
2	Camshaft Rear Seal Set	2005-03	TCS 46186	New Part Number - Check for Availability		
2	Camshaft Rear Seal Set	2002	TCS 46186	From Chassis No. 3B-2-135-001; New Part Number - Check for Availability		
QTY	CARB & FUEL INJECTION	YEARS	PART NO.	DESCRIPTION		
3	Fuel Injector O-Ring Set	2005-98	ES 70599	Improved design		
1	Throttle Body Gasket	2005-98	61491			
QTY	EXHAUST GAS RECIRCULATION	YEARS	PART NO.	DESCRIPTION		
4	EGR Gasket	2005-98	72803	Air pump gskt.; New Part Number - Check for Availability		

43		2005; 2.8L 169 (2771cc) DOHC V6 (30 Valve) 82.5mm Bore			43
MFI; Gasoline; Naturally Aspirated Audi Eng.; Eng. Code AMX					
QTY	CYLINDER HEAD	YEARS	PART NO.	DESCRIPTION	
2	Head Gasket	2005	26328 PT	Head bolts not incl.; Head bolt replacement recommended; PermaTorqueMLS®	
1	Head Set	2005	HS 26328 PT	Head bolts not incl.; Head bolt replacement recommended; PermaDry® molded rubber valve cover gskts. incl.; Premium valve stem seals incl.	
1	Head Bolt Set	2005	ES 72870	OEM style; Replacement recommended; New Part Number - Check for Availability	
QTY	CONVERSION SET	YEARS	PART NO.	DESCRIPTION	
1	Gasket Conversion Set	2005	CS 26328	RTV sealant incl. for Upper oil pan gskt.	
QTY	MANIFOLD - INT. & EXH.	YEARS	PART NO.	DESCRIPTION	
1	Int. Manifold Gasket Set	2005	MS 96890		
1	Exh. Manifold Gasket Set	2005	MS 96882		
QTY	EXHAUST PIPE FLANGE	YEARS	PART NO.	DESCRIPTION	
2	Exhaust Pipe Gasket	2005	61171	Flange	
QTY	OIL PAN	YEARS	PART NO.	DESCRIPTION	
1	Oil Pan Gasket Set	2005	OS 30779	RTV sealant incl. for Upper oil pan gskt.	
QTY	CRANKSHAFT REAR SEAL	YEARS	PART NO.	DESCRIPTION	
1	Rear Main Seal Set	2005	BS 40704	PTFE Rubber; One-piece	
QTY	VALVE COVER	YEARS	PART NO.	DESCRIPTION	
1	Valve Cover Gasket Set	2005	VS 50702 R	w/Spark plug tube seals; PermaDry® molded rubber gskts. incl.	
QTY	VALVE STEM SEAL SET	YEARS	PART NO.	DESCRIPTION	
1	Valve Stem Seal Set	2005	SS 71074-2	Premium valve stem seals incl.	
QTY	THERMOSTAT HOUSING	YEARS	PART NO.	DESCRIPTION	
1	Water Outlet Gasket	2005	25589	Thermostat Housing; Thermostat O-ring; New Improved design	
1	O-Ring	2005	35327	Thermostat Housing; Thermostat O-ring; Old design	
1	O-Ring	2005	35763	Thermostat Housing; Thermostat O-ring; Improved design	
QTY	WATER PUMP	YEARS	PART NO.	DESCRIPTION	
1	Water Pump Gasket	2005	35829		
QTY	TIMING COVER	YEARS	PART NO.	DESCRIPTION	
1	Crankshaft Front Seal Set	2005	TCS 45038-1		
2	Camshaft Front Seal Set	2005	ES 72806	Camshaft circular plug; New Part Number - Check for Availability	
2	Camshaft Rear Seal Set	2005	TCS 46186	New Part Number - Check for Availability	
QTY	CARB & FUEL INJECTION	YEARS	PART NO.	DESCRIPTION	
3	Fuel Injector O-Ring Set	2005	ES 70599	Improved design	
1	Throttle Body Gasket	2005	61491		
QTY	EXHAUST GAS RECIRCULATION	YEARS	PART NO.	DESCRIPTION	
4	EGR Gasket	2005	72803	Air pump gskt.; New Part Number - Check for Availability	
44		2005 - 2000; 2.8L 169 (2771cc) DOHC V6 (30 Valve) 82.5mm Bore			44
MFI; Gasoline; Naturally Aspirated Audi Eng.; Eng. Code ATQ					
QTY	CYLINDER HEAD	YEARS	PART NO.	DESCRIPTION	
2	Head Gasket	2005-00	26328 PT	Head bolts not incl.; Head bolt replacement recommended; PermaTorqueMLS®	
1	Head Set	2005-00	HS 26328 PT	Head bolts not incl.; Head bolt replacement recommended; PermaDry® molded rubber valve cover gskts. incl.; Premium valve stem seals incl.	
1	Head Bolt Set	2005-00	ES 72870	OEM style; Replacement recommended; New Part Number - Check for Availability	
QTY	CONVERSION SET	YEARS	PART NO.	DESCRIPTION	
1	Gasket Conversion Set	2005-00	CS 26328	RTV sealant incl. for Upper oil pan gskt.	
QTY	MANIFOLD - INT. & EXH.	YEARS	PART NO.	DESCRIPTION	
1	Int. Manifold Gasket Set	2005-00	MS 96890		
1	Exh. Manifold Gasket Set	2005-00	MS 96882		
QTY	EXHAUST PIPE FLANGE	YEARS	PART NO.	DESCRIPTION	
2	Exhaust Pipe Gasket	2005-00	61171	Flange	
QTY	OIL PAN	YEARS	PART NO.	DESCRIPTION	
1	Oil Pan Gasket Set	2005-00	OS 30779	RTV sealant incl. for Upper oil pan gskt.	
QTY	CRANKSHAFT REAR SEAL	YEARS	PART NO.	DESCRIPTION	
1	Rear Main Seal Set	2005-00	BS 40704	PTFE Rubber; One-piece	
QTY	VALVE COVER	YEARS	PART NO.	DESCRIPTION	
1	Valve Cover Gasket Set	2005-00	VS 50702 R	w/Spark plug tube seals; PermaDry® molded rubber gskts. incl.	
QTY	VALVE STEM SEAL SET	YEARS	PART NO.	DESCRIPTION	
1	Valve Stem Seal Set	2005-00	SS 71074-2	Premium valve stem seals incl.	
QTY	THERMOSTAT HOUSING	YEARS	PART NO.	DESCRIPTION	
1	Water Outlet Gasket	2005-00	25589	Thermostat Housing; Thermostat O-ring; New Improved design	

VW Car (Cont.)

44 (cont.)		2005 - 2000; 2.8L 169 (2771cc) DOHC V6 (30 Valve) 82.5mm Bore			44 (cont.)
MFI; Gasoline; Naturally Aspirated Audi Eng.; Eng. Code ATQ					
QTY	THERMOSTAT HOUSING	YEARS	PART NO.	DESCRIPTION	
1	O-Ring	2005-00	35327	Thermostat Housing; Thermostat O-ring; Old design	
1	O-Ring	2005-00	35763	Thermostat Housing; Thermostat O-ring; Improved design	
QTY	WATER PUMP	YEARS	PART NO.	DESCRIPTION	
1	Water Pump Gasket	2005-00	35829		
QTY	TIMING COVER	YEARS	PART NO.	DESCRIPTION	
1	Crankshaft Front Seal Set	2005-00	TCS 45038-1		
2	Camshaft Front Seal Set	2005-00	ES 72806	Camshaft circular plug; New Part Number - Check for Availability	
2	Camshaft Rear Seal Set	2005-03	TCS 46186	New Part Number - Check for Availability	
2	Camshaft Rear Seal Set	2002	TCS 46186	From Chassis No. 3B-2-135-001; New Part Number - Check for Availability	
QTY	CARB & FUEL INJECTION	YEARS	PART NO.	DESCRIPTION	
3	Fuel Injector O-Ring Set	2005-00	ES 70599	Improved design	
1	Throttle Body Gasket	2005-00	61491		
QTY	EXHAUST GAS RECIRCULATION	YEARS	PART NO.	DESCRIPTION	
4	EGR Gasket	2005-00	72803	Air pump gskt.; New Part Number - Check for Availability	
45		2005 - 2001; 2.8L 170.7 (2792cc) DOHC V6 (24 Valve) 81mm Bore			45
MFI; Gasoline; Naturally Aspirated VW Eng.; Eng. Code AFP					
QTY	CYLINDER HEAD	YEARS	PART NO.	DESCRIPTION	
1	Head Gasket	2005-01	26142 PT	Head bolts not incl.; Head bolt replacement recommended; PermaTorqueMLS®	
1	Head Set w/o Head Gasket	2005-01	HSU 26140	Head gskt., int. manifold gskt., head bolts not incl.; Head bolt replacement recommended; PermaDry® molded rubber valve cover gskt. incl.; Premium valve stem seals incl.	
1	Head Bolt Set	2005-01	ES 72483	Replacement recommended; New Part Number - Check for Availability	
QTY	CONVERSION SET	YEARS	PART NO.	DESCRIPTION	
1	Gasket Conversion Set	2005-01	CS 26140	PermaDry® molded rubber oil pan gskt. incl.	
QTY	MANIFOLD - INT. & EXH.	YEARS	PART NO.	DESCRIPTION	
1	Int. Manifold Gasket Set	2005-01	MS 97125	New Part Number - Check for Availability	
1	Exh. Manifold Gasket Set	2005-01	MS 97139	New Part Number - Check for Availability	
QTY	EXHAUST PIPE FLANGE	YEARS	PART NO.	DESCRIPTION	
2	Exhaust Pipe Gasket	2005-01	61641	Flange	
QTY	OIL PAN	YEARS	PART NO.	DESCRIPTION	
1	Oil Pan Gasket Set	2005-01	OS 30853 R	OEM style; PermaDry® molded rubber gskt. incl.; New Part Number - Check for Availability	
QTY	VALVE STEM SEAL SET	YEARS	PART NO.	DESCRIPTION	
1	Valve Stem Seal Set	2005-01	SS 72682-3	Premium valve stem seals incl.	
QTY	THERMOSTAT HOUSING	YEARS	PART NO.	DESCRIPTION	
1	Thermostat Gasket	2005-01	35950	Thermostat Housing; Thermostat housing to head; New Part Number - Check for Availability	
QTY	WATER PUMP	YEARS	PART NO.	DESCRIPTION	
1	Water Pump Gasket	2005-01	35999	New Part Number - Check for Availability	
QTY	TIMING COVER	YEARS	PART NO.	DESCRIPTION	
1	Camshaft Front Seal Set	2005-01	TCS 46145	New Part Number - Check for Availability	
QTY	CARB & FUEL INJECTION	YEARS	PART NO.	DESCRIPTION	
1	Throttle Body Gasket	2005-01	62010	Throttle body mounting; New Part Number - Check for Availability	
QTY	EXHAUST GAS RECIRCULATION	YEARS	PART NO.	DESCRIPTION	
1	EGR Gasket	2005-01	71352	Secondary air pump; O-ring	
1	EGR Gasket	2005-01	71353	Secondary air pump; Flange	
46		2005 - 2002; 2.8L 170.7 (2792cc) DOHC V6 (24 Valve) 81mm Bore			46
MFI; Gasoline; Naturally Aspirated VW Eng.; Eng. Code BDF					
QTY	CYLINDER HEAD	YEARS	PART NO.	DESCRIPTION	
1	Head Gasket	2005-02	26142 PT	Head bolts not incl.; Head bolt replacement recommended; PermaTorqueMLS®	
1	Head Set w/o Head Gasket	2005-02	HSU 26140	Head gskt., int. manifold gskt., head bolts not incl.; Head bolt replacement recommended; PermaDry® molded rubber valve cover gskt. incl.; Premium valve stem seals incl.	
1	Head Bolt Set	2005-02	ES 72483	Replacement recommended; New Part Number - Check for Availability	
QTY	CONVERSION SET	YEARS	PART NO.	DESCRIPTION	
1	Gasket Conversion Set	2005-02	CS 26140	PermaDry® molded rubber oil pan gskt. incl.	
QTY	MANIFOLD - INT. & EXH.	YEARS	PART NO.	DESCRIPTION	
1	Int. Manifold Gasket Set	2005-02	MS 97125	New Part Number - Check for Availability	

46 (cont.)		2005 - 2002; 2.8L 170.7 (2792cc) DOHC V6 (24 Valve) 81mm Bore			46 (cont.)
MFI; Gasoline; Naturally Aspirated VW Eng.; Eng. Code BDF					
QTY	MANIFOLD - INT. & EXH.	YEARS	PART NO.	DESCRIPTION	
1	Exh. Manifold Gasket Set	2005-02	MS 97139	New Part Number - Check for Availability	
QTY	EXHAUST PIPE FLANGE	YEARS	PART NO.	DESCRIPTION	
2	Exhaust Pipe Gasket	2005-02	61641	Flange	
QTY	OIL PAN	YEARS	PART NO.	DESCRIPTION	
1	Oil Pan Gasket Set	2005-02	OS 30853 R	OEM style; PermaDry® molded rubber gskt. incl.; New Part Number - Check for Availability	
QTY	VALVE STEM SEAL SET	YEARS	PART NO.	DESCRIPTION	
1	Valve Stem Seal Set	2005-02	SS 72682-3	Premium valve stem seals incl.	
QTY	THERMOSTAT HOUSING	YEARS	PART NO.	DESCRIPTION	
1	Thermostat Gasket	2005-02	35950	Thermostat Housing; Thermostat housing to head; New Part Number - Check for Availability	
QTY	WATER PUMP	YEARS	PART NO.	DESCRIPTION	
1	Water Pump Gasket	2005-02	35999	New Part Number - Check for Availability	
QTY	TIMING COVER	YEARS	PART NO.	DESCRIPTION	
1	Camshaft Front Seal Set	2005-02	TCS 46145	New Part Number - Check for Availability	
QTY	CARB & FUEL INJECTION	YEARS	PART NO.	DESCRIPTION	
1	Throttle Body Gasket	2005-02	62010	Throttle body mounting; New Part Number - Check for Availability	
QTY	EXHAUST GAS RECIRCULATION	YEARS	PART NO.	DESCRIPTION	
1	EGR Gasket	2005-02	71352	Secondary air pump; O-ring	
1	EGR Gasket	2005-02	71353	Secondary air pump; Flange	
47		2002 - 1992; 2.8L 170.7 (2792cc) SOHC V6 (12 Valve) 81mm Bore			47
MFI; Gasoline; Naturally Aspirated VW Eng.; Eng. Code AAA					
QTY	CYLINDER HEAD	YEARS	PART NO.	DESCRIPTION	
1	Head Gasket	2002-92	26140 PT	Head bolts not incl.; Head bolt replacement recommended	
1	Head Set w/o Head Gasket	2002-92	HSU 26140	Head gskt. & head bolts not incl.; Head bolt replacement recommended; PermaDry® molded rubber valve cover gskt. incl.; Premium valve stem seals incl.	
1	Head Bolt Set	2002-92	ES 72442	Replacement recommended; New Part Number - Check for Availability	
QTY	CONVERSION SET	YEARS	PART NO.	DESCRIPTION	
1	Gasket Conversion Set	2002-92	CS 26140	PermaDry® molded rubber oil pan gskt. incl.	
QTY	MANIFOLD - INT. & EXH.	YEARS	PART NO.	DESCRIPTION	
1	Exh. Manifold Gasket Set	2002-92	MS 91963		
QTY	EXHAUST PIPE FLANGE	YEARS	PART NO.	DESCRIPTION	
2	Exhaust Pipe Gasket	2002-92	61640	Flange	
2	Exhaust Pipe Gasket	2002-92	61644	Converter	
QTY	OIL PAN	YEARS	PART NO.	DESCRIPTION	
1	Oil Pan Gasket Set	2002-92	OS 30853 R	OEM style; PermaDry® molded rubber gskt. incl.; New Part Number - Check for Availability	
QTY	VALVE COVER	YEARS	PART NO.	DESCRIPTION	
1	Valve Cover Gasket Set	2002-95	VS 50643 R	PermaDry® molded rubber gskt. incl.	
1	Valve Cover Gasket Set	1994-92	VS 50674 R	PermaDry® molded rubber gskt. incl.	
QTY	THERMOSTAT HOUSING	YEARS	PART NO.	DESCRIPTION	
1	Thermostat Gasket	2002-92	35950	Thermostat Housing; Thermostat housing to head; New Part Number - Check for Availability	
QTY	WATER PUMP	YEARS	PART NO.	DESCRIPTION	
1	Water Pump Gasket	2002-92	35999	New Part Number - Check for Availability	
QTY	CARB & FUEL INJECTION	YEARS	PART NO.	DESCRIPTION	
1	Throttle Body Gasket	2002-92	62011	Throttle body mounting; New Part Number - Check for Availability	
QTY	EXHAUST GAS RECIRCULATION	YEARS	PART NO.	DESCRIPTION	
1	EGR Gasket	2002-99	71353	Secondary air pump; Flange	
48		2002 - 1999; 2.8L 170.7 (2792cc) SOHC V6 (12 Valve) 81mm Bore			48
MFI; Gasoline; Naturally Aspirated VW Eng.; Eng. Code AFP					
QTY	CYLINDER HEAD	YEARS	PART NO.	DESCRIPTION	
1	Head Gasket	2002-99	26140 PT	Head bolts not incl.; Head bolt replacement recommended	
1	Head Set	2002-99	HS 26140 PT-2	Head bolts not incl.; Head bolt replacement recommended; PermaDry® molded rubber valve cover gskt. incl.; Premium valve stem seals incl.; New Part Number - Check for Availability	
1	Head Set w/o Head Gasket	2002-99	HSU 26140	Head gskt., int. manifold gskts. & head bolts not incl.; Head bolt replacement recommended; PermaDry® molded rubber valve cover gskt. incl.; Premium valve stem seals incl.	

VW Car (Cont.)

48 (cont.)		2002 - 1999; 2.8L 170.7 (2792cc) SOHC V6 (12 Valve) 81mm Bore			48 (cont.)
MFI; Gasoline; Naturally Aspirated VW Eng.; Eng. Code AFP					
QTY	CYLINDER HEAD	YEARS	PART NO.	DESCRIPTION	
1	Head Bolt Set	2002-99	ES 72442	Replacement recommended; New Part Number - Check for Availability	
1	Head Bolt Set	2002-99	ES 72886	Head bolts w/Washers; OEM style; Replacement recommended; New Part Number - Check for Availability	
QTY	CONVERSION SET	YEARS	PART NO.	DESCRIPTION	
1	Gasket Conversion Set	2002-99	CS 26140	PermaDry® molded rubber oil pan gskt. incl.	
QTY	MANIFOLD - INT. & EXH.	YEARS	PART NO.	DESCRIPTION	
1	Int. Manifold Gasket Set	2002-99	MS 97123	Upper set incl.; New Part Number - Check for Availability	
1	Exh. Manifold Gasket Set	2002-99	MS 91963		
QTY	EXHAUST PIPE FLANGE	YEARS	PART NO.	DESCRIPTION	
2	Exhaust Pipe Gasket	2002-99	61640	Flange	
QTY	OIL PAN	YEARS	PART NO.	DESCRIPTION	
1	Oil Pan Gasket Set	2002-99	OS 30853 R	OEM style; PermaDry® molded rubber gskt. incl.; New Part Number - Check for Availability	
QTY	VALVE COVER	YEARS	PART NO.	DESCRIPTION	
1	Valve Cover Gasket Set	2002-99	VS 50643 R	PermaDry® molded rubber gskt. incl.	
QTY	THERMOSTAT HOUSING	YEARS	PART NO.	DESCRIPTION	
1	Water Outlet Gasket	2002-99	25589	Thermostat Housing; Thermostat seal; New Improved design	
1	Thermostat Gasket	2002-99	35950	Thermostat Housing; Thermostat housing to head; New Part Number - Check for Availability	
1	O-Ring	2002-99	35763	Thermostat Housing; Thermostat seal; Improved design	
QTY	WATER PUMP	YEARS	PART NO.	DESCRIPTION	
1	Water Pump Gasket	2002-99	35999	New Part Number - Check for Availability	
QTY	CARB & FUEL INJECTION	YEARS	PART NO.	DESCRIPTION	
3	Fuel Injector O-Ring Set	2002-99	ES 70599	Improved design	
1	Throttle Body Gasket	2002-99	61643	Throttle body mounting	
QTY	EXHAUST GAS RECIRCULATION	YEARS	PART NO.	DESCRIPTION	
1	EGR Gasket	2002-99	71353	Secondary air pump; Flange	
49		1995 - 1992; 2.8L 170.7 (2792cc) SOHC V6 (12 Valve) 81mm Bore			49
MFI; Gasoline; Naturally Aspirated VW Eng.; Eng. Code VR6					
QTY	CYLINDER HEAD	YEARS	PART NO.	DESCRIPTION	
1	Head Gasket	1995-92	26140 PT	Head bolts not incl.; Head bolt replacement recommended	
1	Head Set w/o Head Gasket	1995-92	HSU 26140	Head gskt. & head bolts not incl.; Head bolt replacement recommended; PermaDry® molded rubber valve cover gskt. incl.; Premium valve stem seals incl.	
1	Head Bolt Set	1995-92	ES 72442	Replacement recommended; New Part Number - Check for Availability	
QTY	CONVERSION SET	YEARS	PART NO.	DESCRIPTION	
1	Gasket Conversion Set	1995-92	CS 26140	PermaDry® molded rubber oil pan gskt. incl.	
QTY	MANIFOLD - INT. & EXH.	YEARS	PART NO.	DESCRIPTION	
1	Exh. Manifold Gasket Set	1995-92	MS 91963		
QTY	EXHAUST PIPE FLANGE	YEARS	PART NO.	DESCRIPTION	
2	Exhaust Pipe Gasket	1995-92	61640	Flange	
2	Exhaust Pipe Gasket	1995-92	61644	Converter	
QTY	OIL PAN	YEARS	PART NO.	DESCRIPTION	
1	Oil Pan Gasket Set	1995-92	OS 30853 R	OEM style; PermaDry® molded rubber gskt. incl.; New Part Number - Check for Availability	
QTY	VALVE COVER	YEARS	PART NO.	DESCRIPTION	
1	Valve Cover Gasket Set	1995	VS 50643 R	PermaDry® molded rubber gskt. incl.	
1	Valve Cover Gasket Set	1994-92	VS 50674 R	PermaDry® molded rubber gskt. incl.	
QTY	THERMOSTAT HOUSING	YEARS	PART NO.	DESCRIPTION	
1	Thermostat Gasket	1995-92	35950	Thermostat Housing; Thermostat housing to head; New Part Number - Check for Availability	
QTY	WATER PUMP	YEARS	PART NO.	DESCRIPTION	
1	Water Pump Gasket	1995-92	35999	New Part Number - Check for Availability	
QTY	CARB & FUEL INJECTION	YEARS	PART NO.	DESCRIPTION	
1	Throttle Body Gasket	1995-92	62011	Throttle body mounting; New Part Number - Check for Availability	
50		2005 - 2004; 3.2L 195 (3189cc) DOHC V6 (24 Valve) 84mm Bore			50
MFI; Gasoline; Naturally Aspirated VW Eng.; Eng. Code BJS					
QTY	CYLINDER HEAD	YEARS	PART NO.	DESCRIPTION	
1	Head Gasket	2005-04	26648 PT	Head bolts not incl.; Head bolt replacement recommended; PermaTorqueMLS®; New Part Number - Check for Availability	

50 (cont.)		2005 - 2004; 3.2L 195 (3189cc) DOHC V6 (24 Valve) 84mm Bore			50 (cont.)
MFI; Gasoline; Naturally Aspirated VW Eng.; Eng. Code BJS					
QTY	OIL FILTER MOUNTING	YEARS	PART NO.	DESCRIPTION	
1	Oil Filter Adapter Gasket	2005-04	72980	Loc. Front; Oil filter adapter seal; New Part Number - Check for Availability	
51		2008 - 2007; 3.2L 195 (3189cc) DOHC V6 (24 Valve) 84mm Bore			51
MFI; Gasoline; Naturally Aspirated VW Eng.; Eng. Code BUB					
QTY	CYLINDER HEAD	YEARS	PART NO.	DESCRIPTION	
1	Head Gasket	2008-07	26648 PT	Head bolts not incl.; Head bolt replacement recommended; PermaTorqueMLS®; New Part Number - Check for Availability	
QTY	TIMING COVER	YEARS	PART NO.	DESCRIPTION	
2	Camshaft Front Seal Set	2008-07	TCS 46183	New Part Number - Check for Availability	
QTY	OIL FILTER MOUNTING	YEARS	PART NO.	DESCRIPTION	
1	Oil Filter Adapter Gasket	2008-07	72980	Loc. Front; Oil filter adapter seal; New Part Number - Check for Availability	
52		2006 - 2004; 4.2L 254.5 (4172cc) DOHC V8 (40 Valve) 84.5mm Bore			52
MFI; Gasoline; Naturally Aspirated Audi Eng.; Eng. Code BGH					
QTY	CYLINDER HEAD	YEARS	PART NO.	DESCRIPTION	
1	Head Gasket	2006-04	26615 PT	Loc. L.H.; Head bolts not incl.; Head bolt replacement recommended; PermaTorqueMLS®; New Part Number - Check for Availability	
1	Head Gasket	2006-04	26628 PT	Loc. R.H.; Head bolts not incl.; Head bolt replacement recommended; PermaTorqueMLS®; New Part Number - Check for Availability	
1	Head Set	2006-04	HS 26669 PT	Valve stem seals & head bolts not incl.; Head bolt replacement recommended; PermaDry® molded rubber valve cover gskts. incl.; New Part Number - Check for Availability	
2	Head Bolt Set	2006-04	ES 72827	Replacement recommended; New Part Number - Check for Availability	
QTY	MANIFOLD - INT. & EXH.	YEARS	PART NO.	DESCRIPTION	
1	Int. Manifold Gasket Set	2006-04	MS 97302	Lower set; New Part Number - Check for Availability	
1	Exh. Manifold Gasket Set	2006-04	MS 97269	New Part Number - Check for Availability	
QTY	VALVE COVER	YEARS	PART NO.	DESCRIPTION	
2	Valve Cover Gasket Set	2006-04	VS 50851 R	w/Semi-circular plug & Grommets & Spark plug tube seals; PermaDry® molded rubber gskt. incl.; New Part Number - Check for Availability	
QTY	TIMING COVER	YEARS	PART NO.	DESCRIPTION	
4	Camshaft Front Seal Set	2006-04	ES 72806	Camshaft circular plug; New Part Number - Check for Availability	
53		2005 - 2004; 4.2L 254.5 (4172cc) DOHC V8 (40 Valve) 84.5mm Bore			53
MFI; Gasoline; Naturally Aspirated Audi Eng.; Eng. Code BHX					
QTY	CYLINDER HEAD	YEARS	PART NO.	DESCRIPTION	
1	Head Gasket	2005-04	26615 PT	Loc. L.H.; Head bolts not incl.; Head bolt replacement recommended; PermaTorqueMLS®; New Part Number - Check for Availability	
1	Head Gasket	2005-04	26628 PT	Loc. R.H.; Head bolts not incl.; Head bolt replacement recommended; PermaTorqueMLS®; New Part Number - Check for Availability	
1	Head Set	2005-04	HS 26669 PT	Valve stem seals & head bolts not incl.; Head bolt replacement recommended; PermaDry® molded rubber valve cover gskts. incl.; New Part Number - Check for Availability	
2	Head Bolt Set	2005-04	ES 72827	Replacement recommended; New Part Number - Check for Availability	
QTY	MANIFOLD - INT. & EXH.	YEARS	PART NO.	DESCRIPTION	
1	Int. Manifold Gasket Set	2005-04	MS 97302	Lower set; New Part Number - Check for Availability	
1	Exh. Manifold Gasket Set	2005-04	MS 97269	New Part Number - Check for Availability	
QTY	VALVE COVER	YEARS	PART NO.	DESCRIPTION	
2	Valve Cover Gasket Set	2005-04	VS 50851 R	w/Semi-circular plug & Grommets & Spark plug tube seals; PermaDry® molded rubber gskt. incl.; New Part Number - Check for Availability	
QTY	TIMING COVER	YEARS	PART NO.	DESCRIPTION	
4	Camshaft Front Seal Set	2005-04	ES 72806	Camshaft circular plug; New Part Number - Check for Availability	

VW Minivans - See VW Truck

VW SUV's - See VW Truck

VW Truck (Incl. Minivans and SUV's)

Engine Finding Index				
Engine	Years	Code	Line No.	
2.0L 121 (1984cc) DOHC L4 (16 Valve) 82.5mm Bore; DI; Gasoline; Turbo - Intercooled VW Eng.	2011-09	BPY	1	

VW Truck (Incl. Minivans and SUV's) (Cont.)

Engine Finding Index (Cont.)

Engine	Years	Code	Line No.
2.0L 121 (1984cc) DOHC L4 (16 Valve) 82.5mm Bore; DI; Gasoline; Turbo - Intercooled VW Eng.	2013-12	CBFA	2
2.0L 121 (1984cc) DOHC L4 (16 Valve) 82.5mm Bore; DI; Gasoline; Turbo - Intercooled VW Eng.	2013-12	CCTA	3
2.1L 129 (2109cc) OHV H4 (8 Valve) 94mm Bore Water Cooled; MFI; Gasoline; Naturally Aspirated VW Eng.	1991	MV	4
2.8L 170.7 (2792cc) DOHC V6 (24 Valve) 81mm Bore; MFI; Gasoline; Naturally Aspirated VW Eng.	2004-01	AXK	5
2.8L 170.7 (2792cc) SOHC V6 (12 Valve) 81mm Bore; MFI; Gasoline; Naturally Aspirated VW Eng.	2000-97	AES	6
3.0L 181.6 (2967cc) DOHC Turbo - Intercooled V6 (24 Valve) 83mm Bore; DI; Diesel; Turbo - Intercooled Audi Eng.	2012-09	CATA	7
3.0L 181.6 (2967cc) DOHC Turbo - Intercooled V6 (24 Valve) 83mm Bore; DI; Diesel; Turbo - Intercooled Audi Eng.	2012-11	CNRA	8
3.0L 181.6 (2967cc) DOHC Turbo - Intercooled V6 (24 Valve) 83mm Bore; DI; Diesel; Turbo - Intercooled Audi Eng.	2013	CNRB	9
3.0L 182.8 (2995cc) DOHC Supercharged - Intercooled V6 (24 Valve) 84.5mm Bore VVT; DI; Hybrid (Gas/Electric); Supercharged - Intercooled Audi Eng.	2013-11	CGFA	10
3.2L 195 (3189cc) DOHC V6 (24 Valve) 84mm Bore; MFI; Gasoline; Naturally Aspirated VW Eng.	2005-03	BAA	11
3.2L 195 (3189cc) DOHC V6 (24 Valve) 84mm Bore; MFI; Gasoline; Naturally Aspirated VW Eng.	2006-05	BMX	12
3.6L 219.9 (3604cc) DOHC V6 (24 Valve) 96mm Bore Pentastar VVT; MFI; Flex Fuel; Naturally Aspirated Chrysler Eng.	2013-11	G	13
3.8L 231 (3785cc) OHV V6 (12 Valve) 96mm Bore; MFI; Gasoline; Naturally Aspirated Chrysler Eng.	2010-09	1	14
4.0L 241.1 (3952cc) SOHC V6 (24 Valve) 96mm Bore; MFI; Gasoline; Naturally Aspirated Chrysler Eng.	2010-09	X	15
4.2L 254.5 (4163cc) DOHC V8 (40 Valve) 84.5mm Bore; DI; Gasoline; Naturally Aspirated Audi Eng.	2010-07	BAR	16
4.2L 254.5 (4172cc) DOHC V8 (40 Valve) 84.5mm Bore; MFI; Gasoline; Naturally Aspirated Audi Eng.	2007-05	AXQ	17
4.2L 254.5 (4172cc) DOHC V8 (40 Valve) 84.5mm Bore; MFI; Gasoline; Naturally Aspirated Audi Eng.	2005-03	BAS	18
4.2L 254.5 (4172cc) DOHC V8 (40 Valve) 84.5mm Bore; MFI; Gasoline; Naturally Aspirated Audi Eng.	2005-03	BHX	19

Engine Code Index

Code	Engine	Line No.
AES	2.8L 170.7 (2792cc) SOHC V6 (12 Valve) 81mm Bore; MFI; Gasoline; Naturally Aspirated VW Eng.	6
AXK	2.8L 170.7 (2792cc) DOHC V6 (24 Valve) 81mm Bore; MFI; Gasoline; Naturally Aspirated VW Eng.	5
AXQ	4.2L 254.5 (4172cc) DOHC V8 (40 Valve) 84.5mm Bore; MFI; Gasoline; Naturally Aspirated Audi Eng.	17
BAA	3.2L 195 (3189cc) DOHC V6 (24 Valve) 84mm Bore; MFI; Gasoline; Naturally Aspirated VW Eng.	11
BAR	4.2L 254.5 (4163cc) DOHC V8 (40 Valve) 84.5mm Bore; DI; Gasoline; Naturally Aspirated Audi Eng.	16
BAS	4.2L 254.5 (4172cc) DOHC V8 (40 Valve) 84.5mm Bore; MFI; Gasoline; Naturally Aspirated Audi Eng.	18
BHX	4.2L 254.5 (4172cc) DOHC V8 (40 Valve) 84.5mm Bore; MFI; Gasoline; Naturally Aspirated Audi Eng.	19
BMX	3.2L 195 (3189cc) DOHC V6 (24 Valve) 84mm Bore; MFI; Gasoline; Naturally Aspirated VW Eng.	12
BPY	2.0L 121 (1984cc) DOHC L4 (16 Valve) 82.5mm Bore; DI; Gasoline; Turbo - Intercooled VW Eng.	1
CATA	3.0L 181.6 (2967cc) DOHC Turbo - Intercooled V6 (24 Valve) 83mm Bore; DI; Diesel; Turbo - Intercooled Audi Eng.	7
CBFA	2.0L 121 (1984cc) DOHC L4 (16 Valve) 82.5mm Bore; DI; Gasoline; Turbo - Intercooled VW Eng.	2
CCTA	2.0L 121 (1984cc) DOHC L4 (16 Valve) 82.5mm Bore; DI; Gasoline; Turbo - Intercooled VW Eng.	3
CGFA	3.0L 182.8 (2995cc) DOHC Supercharged - Intercooled V6 (24 Valve) 84.5mm Bore VVT; DI; Hybrid (Gas/Electric); Supercharged - Intercooled Audi Eng.	10
CJRA	3.6L 219.9 (3604cc) DOHC V6 (24 Valve) 96mm Bore Pentastar VVT; MFI; Flex Fuel; Naturally Aspirated Chrysler Eng.	13
CNRA	3.0L 181.6 (2967cc) DOHC Turbo - Intercooled V6 (24 Valve) 83mm Bore; DI; Diesel; Turbo - Intercooled Audi Eng.	8
CNRB	3.0L 181.6 (2967cc) DOHC Turbo - Intercooled V6 (24 Valve) 83mm Bore; DI; Diesel; Turbo - Intercooled Audi Eng.	9
MV	2.1L 129 (2109cc) OHV H4 (8 Valve) 94mm Bore Water Cooled; MFI; Gasoline; Naturally Aspirated VW Eng.	4

Model Index

Engine (VIN Code / Eng. Code)	Year	Engine (VIN Code / Eng. Code)	Year	Engine (VIN Code / Eng. Code)	Year
Volkswagen Truck		Volkswagen Truck (cont.)		Volkswagen Truck (cont.)	
EuroVan (Minivan)		Tiguan (AWD Compact SUV) (cont.)		Touareg (AWD Mid-Size SUV) (cont.)	
L5 2461cc 2.5L SOHC (10 Valve) (AAF)	94-92	L4 1984cc 2.0L DOHC Turbo (16 Valve) (CBFA)	13-12	V6 3597cc 3.6L DOHC (24 Valve) (BHK)	10-08
L5 2461cc 2.5L SOHC (10 Valve) (ACU)	96-94			V6 3597cc 3.6L DOHC (24 Valve) (BHL)	10-06
V6 2792cc 2.8L DOHC (24 Valve) (AXK)	04-01	L4 1984cc 2.0L DOHC Turbo (16 Valve) (CCTA)	13-12	V6 3597cc 3.6L DOHC (24 Valve) (CGBA)	13-11
V6 2792cc 2.8L SOHC (12 Valve) (AES)	00-97			V6 3597cc 3.6L DOHC (24 Valve) (CGRA)	13-12
Rabbit (Mini-Pickup)		Tiguan (FWD Compact SUV)		V8 3998cc 4.0L DOHC (32 Valve) (BDP)	04-03
L4 1457cc 1.5L SOHC (EH)	80	L4 1984cc 2.0L DOHC Turbo (16 Valve) (BPY)	13-09	V8 4163cc 4.2L DOHC (40 Valve) (BAR)	09-07
L4 1457cc 1.5L SOHC (FX)	80			V8 4172cc 4.2L DOHC (40 Valve) (AXQ)	07-05
L4 1471cc 1.5L SOHC Diesel (CK)	80	L4 1984cc 2.0L DOHC Turbo (16 Valve) (CBFA)	13-12	V8 4172cc 4.2L DOHC (40 Valve) (BAS)	05-03
L4 1588cc 1.6L SOHC (EJ)	80			V8 4172cc 4.2L DOHC (40 Valve) (BHX)	05-03
L4 1588cc 1.6L SOHC Diesel (CR)	82-81	L4 1984cc 2.0L DOHC Turbo (16 Valve) (CCTA)	13-12	Touareg Hybrid (AWD Mid-Size SUV)	
L4 1588cc 1.6L SOHC Diesel (JK)	83			V6 2995cc 3.0L DOHC Supercharged (24 Valve) (CGFA)	13-11
L4 1715cc 1.7L SOHC (EN)	82-81	Touareg (AWD Mid-Size SUV)		Transporter (Minivan)	
L4 1715cc 1.7L SOHC (JF)	83-82	V10 4921cc 4.9L SOHC Turbo-Diesel (BKW)	07-04	H4 1192cc 1.2L OHV	65-59
Routan (FWD Minivan)		V10 4921cc 4.9L SOHC Turbo-Diesel (BPH)	07-04	H4 1493cc 1.5L OHV	67-63
V6 220CI 3.6L DOHC (24 Valve) (Flex Fuel) (CJRA)	13-11	V10 4921cc 4.9L SOHC Turbo-Diesel (BWF)	09-08	H4 1584cc 1.6L OHV	71-68
V6 220CI 3.6L DOHC (24 Valve) (Flex Fuel) (G)	13-11	V6 2967cc 3.0L DOHC Turbo-Diesel (24 Valve) (CATA)	10-09	H4 1679cc 1.7L OHV (CB)	73
V6 231CI 3.8L OHV (12 Valve) (1)	10-09	V6 2967cc 3.0L DOHC Turbo-Diesel (24 Valve) (CNRA)	12-11	H4 1679cc 1.7L OHV (CD)	73
V6 241CI 4.0L SOHC (24 Valve) (X)	10-09	V6 2967cc 3.0L DOHC Turbo-Diesel (24 Valve) (CNRB)	13	H4 1679cc 1.7L OHV (EA)	73-72
Tiguan (AWD Compact SUV)		V6 2967cc 3.0L DOHC Turbo-Diesel (24 Valve) (CNRB)		H4 1795cc 1.8L OHV (AW)	75-74
L4 1984cc 2.0L DOHC Turbo (16 Valve) (BPY)	13-09	V6 3189cc 3.2L DOHC (24 Valve) (BAA)	05-03	H4 1795cc 1.8L OHV (ED)	75-74
		V6 3189cc 3.2L DOHC (24 Valve) (BMX)	06-05	H4 1970cc 2.0L OHV (CJ)	79-76

VW Truck (Incl. Minivans and SUV's) (Cont.)

Model Index (Cont.)					
Engine (VIN Code / Eng. Code)	Year	Engine (VIN Code / Eng. Code)	Year	Engine (VIN Code / Eng. Code)	Year
Volkswagen Truck (cont.)					
Transporter (Minivan) (cont.)					
H4 1970cc 2.0L OHV (GD)	77-76				
H4 1970cc 2.0L OHV (GE)	79-77				
Vanagon (Minivan)					
H4 1915cc 1.9L OHV (DH)	85-83				
H4 1970cc 2.0L OHV (CV)	83-80				
H4 2109cc 2.1L OHV (MV)	91-86				
L4 1588cc 1.6L SOHC Diesel (CS)	84-82				
Vanagon Syncro (Minivan)					
H4 2109cc 2.1L OHV (MV)	91-86				
1	2011 - 2009; 2.0L 121 (1984cc) DOHC L4 (16 Valve) 82.5mm Bore DI; Gasoline; Turbo - Intercooled VW Eng.; Eng. Code BPY				1
QTY	CYLINDER HEAD	YEARS	PART NO.	DESCRIPTION	
1	Head Gasket	2011-09	26455 PT	w/Timing chain; Head bolts not incl.; Head bolt replacement recommended; PermaTorqueMLS®	
1	Head Set	2011-09	HS 26455 PT	w/Timing chain; Head bolts not incl.; Head bolt replacement recommended; RTV sealant incl. for Lower valve cover housing; PermaDry® molded rubber valve cover gskt. incl.; Premium valve stem seals incl.	
QTY	CONVERSION SET	YEARS	PART NO.	DESCRIPTION	
1	Gasket Conversion Set	2011-09	CS 26455	RTV sealant incl. for oil pan gskt.; New Part Number - Check for Availability	
QTY	MANIFOLD - INT. & EXH.	YEARS	PART NO.	DESCRIPTION	
1	Int. Manifold Gasket Set	2011-09	MS 96780		
1	Exh. Manifold Gasket Set	2011-09	MS 96784		
QTY	EXHAUST PIPE FLANGE	YEARS	PART NO.	DESCRIPTION	
1	Exhaust Pipe Gasket	2011-09	61458	Flange	
1	Exhaust Pipe Gasket	2011-09	61458	Turbo inlet	
QTY	OIL PAN	YEARS	PART NO.	DESCRIPTION	
1	Oil Pan Gasket Set	2011-09	OS 30821		
QTY	CRANKSHAFT REAR SEAL	YEARS	PART NO.	DESCRIPTION	
1	Rear Main Seal Set	2011-09	BS 40725	PTFE Rubber; One-piece; New Part Number - Check for Availability	
QTY	VALVE COVER	YEARS	PART NO.	DESCRIPTION	
1	Valve Cover Gasket Set	2011-09	VS 50762 R	w/Timing chain; RTV sealant incl. for Lower valve cover housing; PermaDry® molded rubber gskt. incl.	
QTY	VALVE STEM SEAL SET	YEARS	PART NO.	DESCRIPTION	
1	Valve Stem Seal Set	2011-09	SS 71074-1	Premium valve stem seals incl.	
QTY	THERMOSTAT HOUSING	YEARS	PART NO.	DESCRIPTION	
1	Thermostat Gasket	2011-09	35838	Thermostat Housing; Thermostat housing O-ring	
1	O-Ring	2011-09	35924	Thermostat Housing; Thermostat seal	
QTY	WATER PUMP	YEARS	PART NO.	DESCRIPTION	
1	Water Pump Gasket	2011-09	35872	Housing	
QTY	TIMING COVER	YEARS	PART NO.	DESCRIPTION	
1	Crankshaft Front Seal Set	2011-09	TCS 46138		
1	Camshaft Front Seal Set	2011-09	TCS 46005		
QTY	CARB & FUEL INJECTION	YEARS	PART NO.	DESCRIPTION	
1	Throttle Body Gasket	2011-09	61462		
QTY	OIL COOLER	YEARS	PART NO.	DESCRIPTION	
1	Oil Cooler Gasket	2011-09	72485	Oil cooler O-ring; New Part Number - Check for Availability	
2	2013 - 2012; 2.0L 121 (1984cc) DOHC L4 (16 Valve) 82.5mm Bore DI; Gasoline; Turbo - Intercooled VW Eng.; Eng. Code CBFA				2
QTY	CYLINDER HEAD	YEARS	PART NO.	DESCRIPTION	
1	Head Gasket	2013-12	26547 PT	Head bolts not incl.; Head bolt replacement recommended; PermaTorqueMLS®; New Part Number - Check for Availability	
QTY	CONVERSION SET	YEARS	PART NO.	DESCRIPTION	
1	Gasket Conversion Set	2012	CS 26455	RTV sealant incl. for oil pan gskt.; New Part Number - Check for Availability	
QTY	OIL PAN	YEARS	PART NO.	DESCRIPTION	
1	Oil Pan Gasket Set	2012	OS 30821		
QTY	CRANKSHAFT REAR SEAL	YEARS	PART NO.	DESCRIPTION	
1	Rear Main Seal Set	2012	BS 40725	PTFE Rubber; One-piece; New Part Number - Check for Availability	
QTY	WATER PUMP	YEARS	PART NO.	DESCRIPTION	
1	Water Pump Gasket	2012	35872	Housing	
QTY	TIMING COVER	YEARS	PART NO.	DESCRIPTION	
1	Crankshaft Front Seal Set	2012	TCS 46138		

VW Truck (Incl. Minivans and SUV's) (Cont.)

2 (cont.)	2013 - 2012; 2.0L 121 (1984cc) DOHC L4 (16 Valve) 82.5mm Bore			2 (cont.)
DI; Gasoline; Turbo - Intercooled VW Eng.; Eng. Code CBFA				
QTY	OIL COOLER	YEARS	PART NO.	DESCRIPTION
1	Oil Cooler Gasket	2012	72485	Oil cooler O-ring; New Part Number - Check for Availability
3	2013 - 2012; 2.0L 121 (1984cc) DOHC L4 (16 Valve) 82.5mm Bore			3
DI; Gasoline; Turbo - Intercooled VW Eng.; Eng. Code CCTA				
QTY	CYLINDER HEAD	YEARS	PART NO.	DESCRIPTION
1	Head Gasket	2013-12	26547 PT	Head bolts not incl.; Head bolt replacement recommended; PermaTorqueMLS®; New Part Number - Check for Availability
QTY	CONVERSION SET	YEARS	PART NO.	DESCRIPTION
1	Gasket Conversion Set	2012	CS 26455	RTV sealant incl. for oil pan gskt.; New Part Number - Check for Availability
QTY	OIL PAN	YEARS	PART NO.	DESCRIPTION
1	Oil Pan Gasket Set	2012	OS 30821	
QTY	CRANKSHAFT REAR SEAL	YEARS	PART NO.	DESCRIPTION
1	Rear Main Seal Set	2012	BS 40725	PTFE Rubber; One-piece; New Part Number - Check for Availability
QTY	WATER PUMP	YEARS	PART NO.	DESCRIPTION
1	Water Pump Gasket	2012	35872	Housing
QTY	TIMING COVER	YEARS	PART NO.	DESCRIPTION
1	Crankshaft Front Seal Set	2012	TCS 46138	
QTY	OIL COOLER	YEARS	PART NO.	DESCRIPTION
1	Oil Cooler Gasket	2012	72485	Oil cooler O-ring; New Part Number - Check for Availability
4	1991; 2.1L 129 (2109cc) OHV H4 (8 Valve) 94mm Bore Water Cooled			4
MFI; Gasoline; Naturally Aspirated VW Eng.; Eng. Code MV				
QTY	MANIFOLD - INT. & EXH.	YEARS	PART NO.	DESCRIPTION
1	Exh. Manifold Gasket Set	1991	MS 97223	New Part Number - Check for Availability
QTY	CRANKSHAFT REAR SEAL	YEARS	PART NO.	DESCRIPTION
1	Rear Main Seal Set	1991	BS 25034	Rubber; One-piece
QTY	VALVE COVER	YEARS	PART NO.	DESCRIPTION
1	Valve Cover Gasket Set	1991	VS 26062 C	Cork; Improved design; New Part Number - Check for Availability
1	Valve Cover Gasket Set	1991	VS 26062 R	Rubber; Old design; Superseded - When depleted use VS 26062 C
QTY	THERMOSTAT HOUSING	YEARS	PART NO.	DESCRIPTION
1	O-Ring	1991	35327	Thermostat Housing; Thermostat seal; Old design
5	2004 - 2001; 2.8L 170.7 (2792cc) DOHC V6 (24 Valve) 81mm Bore			5
MFI; Gasoline; Naturally Aspirated VW Eng.; Eng. Code AXK				
QTY	CYLINDER HEAD	YEARS	PART NO.	DESCRIPTION
1	Head Gasket	2004-01	26142 PT	Head bolts not incl.; Head bolt replacement recommended; PermaTorqueMLS®
1	Head Set w/o Head Gasket	2004-01	HSU 26140	Head gskt., int. manifold gskt., head bolts not incl.; Head bolt replacement recommended; PermaDry® molded rubber valve cover gskt. incl.; Premium valve stem seals incl.
1	Head Bolt Set	2004-01	ES 72483	Replacement recommended; New Part Number - Check for Availability
QTY	CONVERSION SET	YEARS	PART NO.	DESCRIPTION
1	Gasket Conversion Set	2004-01	CS 26140	PermaDry® molded rubber oil pan gskt. incl.
QTY	MANIFOLD - INT. & EXH.	YEARS	PART NO.	DESCRIPTION
1	Exh. Manifold Gasket Set	2004-01	MS 97139	New Part Number - Check for Availability
QTY	EXHAUST PIPE FLANGE	YEARS	PART NO.	DESCRIPTION
2	Exhaust Pipe Gasket	2004-01	61639	Flange
QTY	OIL PAN	YEARS	PART NO.	DESCRIPTION
1	Oil Pan Gasket Set	2004-01	OS 30853 R	OEM style; PermaDry® molded rubber gskt. incl.; New Part Number - Check for Availability
QTY	VALVE STEM SEAL SET	YEARS	PART NO.	DESCRIPTION
1	Valve Stem Seal Set	2004-01	SS 72682-3	Premium valve stem seals incl.
QTY	THERMOSTAT HOUSING	YEARS	PART NO.	DESCRIPTION
1	Thermostat Gasket	2004-01	35950	Thermostat Housing; Thermostat housing to head; New Part Number - Check for Availability
QTY	WATER PUMP	YEARS	PART NO.	DESCRIPTION
1	Water Pump Gasket	2004-01	35999	New Part Number - Check for Availability
QTY	TIMING COVER	YEARS	PART NO.	DESCRIPTION
1	Camshaft Front Seal Set	2004-01	TCS 46145	New Part Number - Check for Availability
QTY	CARB & FUEL INJECTION	YEARS	PART NO.	DESCRIPTION
1	Throttle Body Gasket	2004-01	61642	Adapter to manifold

VW Truck (Incl. Minivans and SUV's) (Cont.)

6	2000 - 1997; 2.8L 170.7 (2792cc) SOHC V6 (12 Valve) 81mm Bore			6
	MFI; Gasoline; Naturally Aspirated VW Eng.; Eng. Code AES			
QTY	CYLINDER HEAD	YEARS	PART NO.	DESCRIPTION
1	Head Gasket	2000-97	26140 PT	Head bolts not incl.; Head bolt replacement recommended
1	Head Set w/o Head Gasket	2000-97	HSU 26140	Head gskt., int. manifold gskts. & head bolts not incl.; Head bolt replacement recommended; PermaDry® molded rubber valve cover gskt. incl.; Premium valve stem seals incl.
1	Head Bolt Set	2000-97	ES 72442	Replacement recommended; New Part Number - Check for Availability
1	Head Bolt Set	2000-97	ES 72886	Head bolts w/Washers; OEM style; Replacement recommended; New Part Number - Check for Availability
QTY	CONVERSION SET	YEARS	PART NO.	DESCRIPTION
1	Gasket Conversion Set	2000-97	CS 26140	PermaDry® molded rubber oil pan gskt. incl.
QTY	MANIFOLD - INT. & EXH.	YEARS	PART NO.	DESCRIPTION
1	Exh. Manifold Gasket Set	2000-97	MS 91963	
QTY	EXHAUST PIPE FLANGE	YEARS	PART NO.	DESCRIPTION
2	Exhaust Pipe Gasket	2000-97	61640	Flange
QTY	OIL PAN	YEARS	PART NO.	DESCRIPTION
1	Oil Pan Gasket Set	2000-97	OS 30853 R	OEM style; PermaDry® molded rubber gskt. incl.; New Part Number - Check for Availability
QTY	VALVE COVER	YEARS	PART NO.	DESCRIPTION
1	Valve Cover Gasket Set	2000-97	VS 50643 R	PermaDry® molded rubber gskt. incl.
QTY	THERMOSTAT HOUSING	YEARS	PART NO.	DESCRIPTION
1	Thermostat Gasket	2000-97	35950	Thermostat Housing; Thermostat housing to head; New Part Number - Check for Availability
QTY	WATER PUMP	YEARS	PART NO.	DESCRIPTION
1	Water Pump Gasket	2000-97	35999	New Part Number - Check for Availability
7	2012 - 2009; 3.0L 181.6 (2967cc) DOHC Turbo - Intercooled V6 (24 Valve) 83mm Bore			7
	DI; Diesel; Turbo - Intercooled Audi Eng.; Eng. Code CATA			
QTY	TIMING COVER	YEARS	PART NO.	DESCRIPTION
2	Camshaft Front Seal Set	2012-09	ES 72806	Camshaft circular plug; New Part Number - Check for Availability
8	2012 - 2011; 3.0L 181.6 (2967cc) DOHC Turbo - Intercooled V6 (24 Valve) 83mm Bore			8
	DI; Diesel; Turbo - Intercooled Audi Eng.; Eng. Code CNRA			
QTY	TIMING COVER	YEARS	PART NO.	DESCRIPTION
2	Camshaft Front Seal Set	2012-11	ES 72806	Camshaft circular plug; New Part Number - Check for Availability
9	2013; 3.0L 181.6 (2967cc) DOHC Turbo - Intercooled V6 (24 Valve) 83mm Bore			9
	DI; Diesel; Turbo - Intercooled Audi Eng.; Eng. Code CNRB			
QTY	TIMING COVER	YEARS	PART NO.	DESCRIPTION
2	Camshaft Front Seal Set	2013	ES 72806	Camshaft circular plug; New Part Number - Check for Availability
10	2013 - 2011; 3.0L 182.8 (2995cc) DOHC Supercharged - Intercooled V6 (24 Valve) 84.5mm Bore			10
	VVT			
	DI; Hybrid (Gas/Electric); Supercharged - Intercooled Audi Eng.; Eng. Code CGFA			
QTY	VALVE COVER	YEARS	PART NO.	DESCRIPTION
1	Valve Cover Gasket Set	2013-11	VS 50865 R	w/Spark plug tube seals; PermaDry® molded rubber gskts. incl.; New Part Number - Check for Availability
11	2005 - 2003; 3.2L 195 (3189cc) DOHC V6 (24 Valve) 84mm Bore			11
	MFI; Gasoline; Naturally Aspirated VW Eng.; Eng. Code BAA			
QTY	CYLINDER HEAD	YEARS	PART NO.	DESCRIPTION
1	Head Gasket	2005-03	26648 PT	Head bolts not incl.; Head bolt replacement recommended; PermaTorqueMLS®; New Part Number - Check for Availability
QTY	OIL FILTER MOUNTING	YEARS	PART NO.	DESCRIPTION
1	Oil Filter Adapter Gasket	2005-03	72982	Oil filter adapter seal; New Part Number - Check for Availability
12	2006 - 2005; 3.2L 195 (3189cc) DOHC V6 (24 Valve) 84mm Bore			12
	MFI; Gasoline; Naturally Aspirated VW Eng.; Eng. Code BMX			
QTY	CYLINDER HEAD	YEARS	PART NO.	DESCRIPTION
1	Head Gasket	2006-05	26648 PT	Head bolts not incl.; Head bolt replacement recommended; PermaTorqueMLS®; New Part Number - Check for Availability
QTY	OIL FILTER MOUNTING	YEARS	PART NO.	DESCRIPTION
1	Oil Filter Adapter Gasket	2006-05	72982	Oil filter adapter seal; New Part Number - Check for Availability

VW Truck (Incl. Minivans and SUV's) (Cont.)

13		2013 - 2011; 3.6L 219.9 (3604cc) DOHC V6 (24 Valve) 96mm Bore Pentastar VVT			13
MFI; Flex Fuel; Naturally Aspirated Chrysler Eng.; VIN Code G, Eng. Code CJRA					
QTY	CYLINDER HEAD	YEARS	PART NO.	DESCRIPTION	
1	Head Gasket	2013-11	26541 PT	Loc. R.H.; Head bolts not incl.; Head bolt replacement recommended; PermaTorqueMLS®; New Part Number - Check for Availability	
1	Head Gasket	2013-11	26542 PT	Loc. L.H.; Head bolts not incl.; Head bolt replacement recommended; PermaTorqueMLS®; New Part Number - Check for Availability	
1	Head Set	2013-11	HS 26541 PT	Head bolts not incl.; Head bolt replacement recommended; PermaDry® molded rubber valve cover gskts. incl.; Premium valve stem seals incl.; New Part Number - Check for Availability	
2	Head Bolt Set	2013-11	ES 72467	Replacement recommended; New Part Number - Check for Availability	
QTY	MANIFOLD - INT. & EXH.	YEARS	PART NO.	DESCRIPTION	
1	Int. Manifold Gasket Set	2013-11	MS 97204	Lower set; Upper set incl.; New Part Number - Check for Availability	
1	Plenum Gasket Set	2013-11	MS 97205	Upper set; New Part Number - Check for Availability	
1	Exh. Manifold Gasket Set	2013-11	MS 97197	New Part Number - Check for Availability	
QTY	EXHAUST PIPE FLANGE	YEARS	PART NO.	DESCRIPTION	
2	Exhaust Pipe Gasket	2013-11	61494	Crossover	
QTY	OIL PAN	YEARS	PART NO.	DESCRIPTION	
1	Oil Pan Gasket Set	2013-11	OS 30833	Loc. Lower; New Part Number - Check for Availability	
QTY	CRANKSHAFT REAR SEAL	YEARS	PART NO.	DESCRIPTION	
1	Rear Main Seal Set	2013-11	BS 40737	Rubber; One-piece; New Part Number - Check for Availability	
QTY	VALVE COVER	YEARS	PART NO.	DESCRIPTION	
1	Valve Cover Gasket Set	2013-11	VS 50805 R	w/Spark plug tube seals; PermaDry® molded rubber gskts. incl.; New Part Number - Check for Availability	
QTY	VALVE STEM SEAL SET	YEARS	PART NO.	DESCRIPTION	
1	Valve Stem Seal Set	2013-11	SS 71074-3	Premium valve stem seals incl.; New Part Number - Check for Availability	
QTY	THERMOSTAT HOUSING	YEARS	PART NO.	DESCRIPTION	
1	Thermostat Gasket	2013-11	35974	Thermostat Housing; Thermostat gskt.; New Part Number - Check for Availability	
QTY	WATER OUTLET GASKET	YEARS	PART NO.	DESCRIPTION	
1	Water Outlet Gasket	2013-11	35975	Water Outlet; Water outlet crossover; New Part Number - Check for Availability	
QTY	WATER PUMP	YEARS	PART NO.	DESCRIPTION	
1	Water Pump Gasket	2013-11	35982	New Part Number - Check for Availability	
QTY	TIMING COVER	YEARS	PART NO.	DESCRIPTION	
1	Timing Cover Set	2013-11	TCS 46162	New Part Number - Check for Availability	
QTY	CARB & FUEL INJECTION	YEARS	PART NO.	DESCRIPTION	
1	Throttle Body Gasket	2013-11	61679	New Part Number - Check for Availability	
14		2010 - 2009; 3.8L 231 (3785cc) OHV V6 (12 Valve) 96mm Bore			14
MFI; Gasoline; Naturally Aspirated Chrysler Eng.; VIN Code 1					
QTY	CYLINDER HEAD	YEARS	PART NO.	DESCRIPTION	
1	Head Gasket	2010-09	9996 PT	Loc. R.H.; Head bolts not incl.; Head bolt replacement recommended; PermaTorqueMLS®	
1	Head Gasket	2010-09	9997 PT	Loc. L.H.; Head bolts not incl.; Head bolt replacement recommended; PermaTorqueMLS®	
1	Head Set	2010-09	HS 9996 PT-2	w/Plastic valve covers; Int. manifold gskt., head bolts, exh. pipe to manifold gskt. not incl.; Head bolt replacement recommended; PermaDry® molded rubber valve cover gskts. incl.; Premium valve stem seals incl.	
2	Head Bolt Set	2010-09	ES 72163	Head bolts w/Washers; Replacement recommended	
QTY	CONVERSION SET	YEARS	PART NO.	DESCRIPTION	
1	Gasket Conversion Set	2010-09	CS 26326-1	PermaDry® molded rubber oil pan gskt. incl.	
QTY	MANIFOLD - INT. & EXH.	YEARS	PART NO.	DESCRIPTION	
1	Int. Manifold Gasket Set	2010-09	MS 92808-1	Upper set incl.	
1	Plenum Gasket Set	2010-09	MS 96176	Upper set	
1	Exh. Manifold Gasket Set	2010-09	MS 94666		
QTY	EXHAUST PIPE FLANGE	YEARS	PART NO.	DESCRIPTION	
2	Exhaust Pipe Gasket	2010-09	61213	Crossover; May use 61453 instead; Old design	
1	Exhaust Pipe Gasket	2010-09	61229	Converter	
2	Exhaust Pipe Gasket	2010-09	61453	Crossover; Improved design	
1	Exhaust Pipe Gasket	2010-09	61701	Connector; New Part Number - Check for Availability	
QTY	OIL PAN	YEARS	PART NO.	DESCRIPTION	
1	Oil Pan Gasket Set	2010-09	OS 30622 R	PermaDry® molded rubber gskt. incl.	
QTY	CRANKSHAFT REAR SEAL	YEARS	PART NO.	DESCRIPTION	
1	Rear Main Seal Set	2010-09	BS 40713	Rubber; One-piece	
QTY	VALVE COVER	YEARS	PART NO.	DESCRIPTION	
1	Valve Cover Gasket Set	2010-09	VS 50599 R	w/Plastic valve covers; w/Grommets; PermaDry® molded rubber gskts. incl.	

VW Truck (Incl. Minivans and SUV's) (Cont.)

14 (cont.)		2010 - 2009; 3.8L 231 (3785cc) OHV V6 (12 Valve) 96mm Bore			14 (cont.)
		MFI; Gasoline; Naturally Aspirated Chrysler Eng.; VIN Code 1			
QTY	VALVE STEM SEAL SET	YEARS	PART NO.	DESCRIPTION	
1	Valve Stem Seal Set	2010-09	SS 71035	Premium valve stem seals incl.	
QTY	THERMOSTAT HOUSING	YEARS	PART NO.	DESCRIPTION	
1	Thermostat Gasket	2010-09	35651	Thermostat Housing; Thermostat gskt.	
1	O-Ring	2010-09	35861	Thermostat Housing; Thermostat seal	
QTY	WATER OUTLET GASKET	YEARS	PART NO.	DESCRIPTION	
1	Water Outlet Gasket	2010-09	35286	Water Outlet	
1	Water Outlet Gasket	2010-09	35286 T	Water Outlet; PermaDryPlus®	
QTY	WATER PUMP	YEARS	PART NO.	DESCRIPTION	
1	Water Pump Gasket	2010-09	35586	O-ring	
1	Water Pump Gasket	2010-09	35691	Seal to front cover	
1	Water Pump Gasket	2010-09	35780	Gskt.	
QTY	TIMING COVER	YEARS	PART NO.	DESCRIPTION	
1	Timing Cover Set	2010-09	TCS 46023-1	Must be used w/OS 30622R	
1	Timing Cover Gasket	2010-09	72706	New Part Number - Check for Availability	
QTY	CARB & FUEL INJECTION	YEARS	PART NO.	DESCRIPTION	
3	Fuel Injector O-Ring Set	2010-09	ES 70599	Improved design	
1	Throttle Body Gasket	2010-09	61324	Idle air control; 21mm ID	
1	Throttle Body Gasket	2010-09	61326	Idle air control; 30mm ID	
1	Throttle Body Gasket	2010-09	61467	Mounting; Flush mount	
1	Throttle Body Gasket	2010-09	61700	Mounting; Recessed lip; New Part Number - Check for Availability	
QTY	EXHAUST GAS RECIRCULATION	YEARS	PART NO.	DESCRIPTION	
2	EGR Gasket	2010-09	70696	Tube seal	
2	EGR Gasket	2010-09	70721	Tube flange	
1	EGR Gasket	2010-09	71185	Valve	
15		2010 - 2009; 4.0L 241.1 (3952cc) SOHC V6 (24 Valve) 96mm Bore			15
		MFI; Gasoline; Naturally Aspirated Chrysler Eng.; VIN Code X			
QTY	CYLINDER HEAD	YEARS	PART NO.	DESCRIPTION	
1	Head Gasket	2010-09	26208 PT	Loc. R.H.; Head bolts not incl.; Head bolt replacement recommended; PermaTorqueMLS® LaserWeld® Technology; Improved design	
1	Head Gasket	2010-09	26209 PT	Loc. L.H.; Head bolts not incl.; Head bolt replacement recommended; PermaTorqueMLS® LaserWeld® Technology; Improved design	
1	Head Gasket	2010-09	26368 PT	Loc. R.H.; Head bolts not incl.; Head bolt replacement recommended; PermaTorqueMLS®; May use 26208PT instead; Old design; Superseded - When depleted use 26208 PT	
1	Head Gasket	2010-09	26369 PT	Loc. L.H.; Head bolts not incl.; Head bolt replacement recommended; PermaTorqueMLS®; May use 26209PT instead; Old design; Superseded - When depleted use 26209 PT	
1	Head Set	2010-09	HS 26368 PT	Head bolts not incl.; Head bolt replacement recommended; PermaDry® molded rubber valve cover gskts. incl.; Premium valve stem seals incl.	
2	Head Bolt Set	2010-09	ES 72895	Head bolts w/Washers; Replacement recommended	
QTY	CONVERSION SET	YEARS	PART NO.	DESCRIPTION	
1	Gasket Conversion Set	2010-09	CS 9505-2	One-piece rear main retainer w/Seal not incl.; PermaDry® molded rubber oil pan gskt. incl.	
QTY	MANIFOLD - INT. & EXH.	YEARS	PART NO.	DESCRIPTION	
1	Int. Manifold Gasket Set	2010-09	MS 92165-1	Upper set incl.	
1	Plenum Gasket Set	2010-09	MS 96324	Upper set	
1	Exh. Manifold Gasket Set	2010-09	MS 95446		
QTY	EXHAUST PIPE FLANGE	YEARS	PART NO.	DESCRIPTION	
1	Exhaust Pipe Gasket	2010-09	61495	Flange	
QTY	OIL PAN	YEARS	PART NO.	DESCRIPTION	
1	Oil Pan Gasket Set	2010-09	OS 30754 R	PermaDry® molded rubber gskt. incl.	
1	Drain Plug Gasket	2010-09	70822		
QTY	CRANKSHAFT REAR SEAL	YEARS	PART NO.	DESCRIPTION	
1	Rear Main Seal Set	2010-09	BS 40168-1	w/Aluminum housing; w/Separate seal; Rubber; One-piece	
1	Rear Main Seal Set	2010-09	BS 40627	w/Aluminum housing; w/Separate seal; PTFE Rubber; One-piece	
1	Rear Main Seal Set	2010-09	BS 40734	w/Steel housing; Retainer w/Seal; Rubber; One-piece; New Part Number - Check for Availability	
1	Repair Sleeve Tool	2010-09	16300	Crankshaft	
QTY	VALVE COVER	YEARS	PART NO.	DESCRIPTION	
1	Valve Cover Gasket Set	2010-09	VS 50689 R	w/o Grommets & w/Spark plug tube seals; PermaDry® molded rubber gskts. incl.	

VW Truck (Incl. Minivans and SUV's) (Cont.)

15 (cont.)		2010 - 2009; 4.0L 241.1 (3952cc) SOHC V6 (24 Valve) 96mm Bore			15 (cont.)
MFI; Gasoline; Naturally Aspirated Chrysler Eng.; VIN Code X					
QTY	VALVE COVER	YEARS	PART NO.	DESCRIPTION	
2	Grommet Set	2010-09	ES 71071	Valve Cover; May use ES 71105-1 instead; Old design; Superseded - When depleted use ES 71105-1	
2	Grommet Set	2010-09	ES 71105-1	Valve Cover; Improved design	
QTY	VALVE STEM SEAL SET	YEARS	PART NO.	DESCRIPTION	
2	Valve Stem Seal Set	2010-09	SS 72842	Premium valve stem seals incl.	
QTY	THERMOSTAT HOUSING	YEARS	PART NO.	DESCRIPTION	
1	O-Ring	2010-09	35861	Thermostat Housing; Thermostat seal	
QTY	WATER PUMP	YEARS	PART NO.	DESCRIPTION	
1	Water Pump Gasket	2010-09	35499	O-ring; Improved design	
1	Water Pump Gasket	2010-09	35785	Mounting	
QTY	TIMING COVER	YEARS	PART NO.	DESCRIPTION	
1	Crankshaft Front Seal Set	2010-09	TCS 45992-1	Must be used w/OS 30754R; Old design	
1	Crankshaft Front Seal Set	2010-09	TCS 46147	Must be used w/OS 30754R; Improved design	
2	Camshaft Front Seal Set	2010-09	TCS 45939		
QTY	CARB & FUEL INJECTION	YEARS	PART NO.	DESCRIPTION	
2	Fuel Injector O-Ring Set	2010-09	ES 70599	Improved design	
1	Throttle Body Gasket	2010-09	61324	Idle air control; 21mm ID	
1	Throttle Body Gasket	2010-09	61326	Idle air control; 30mm ID	
1	Throttle Body Gasket	2010-09	61389	Mounting	
QTY	EXHAUST GAS RECIRCULATION	YEARS	PART NO.	DESCRIPTION	
2	EGR Gasket	2010-09	70721	Tube flange	
1	EGR Gasket	2010-09	71185	Valve	
2	EGR Gasket	2010-09	72928	Tube seal	
16		2010 - 2007; 4.2L 254.5 (4163cc) DOHC V8 (40 Valve) 84.5mm Bore			16
DI; Gasoline; Naturally Aspirated Audi Eng.; Eng. Code BAR					
QTY	CYLINDER HEAD	YEARS	PART NO.	DESCRIPTION	
1	Head Gasket	2010-07	26616 PT	Loc. L.H.; Head bolts not incl.; Head bolt replacement recommended; PermaTorqueMLS®; New Part Number - Check for Availability	
1	Head Gasket	2010-07	26629 PT	Loc. R.H.; Head bolts not incl.; Head bolt replacement recommended; PermaTorqueMLS®; New Part Number - Check for Availability	
17		2007 - 2005; 4.2L 254.5 (4172cc) DOHC V8 (40 Valve) 84.5mm Bore			17
MFI; Gasoline; Naturally Aspirated Audi Eng.; Eng. Code AXQ					
QTY	CYLINDER HEAD	YEARS	PART NO.	DESCRIPTION	
1	Head Gasket	2007-05	26615 PT	Loc. L.H.; Head bolts not incl.; Head bolt replacement recommended; PermaTorqueMLS®; New Part Number - Check for Availability	
1	Head Gasket	2007-05	26628 PT	Loc. R.H.; Head bolts not incl.; Head bolt replacement recommended; PermaTorqueMLS®; New Part Number - Check for Availability	
1	Head Set	2007-05	HS 26669 PT	Valve stem seals & head bolts not incl.; Head bolt replacement recommended; PermaDry® molded rubber valve cover gskts. incl.; New Part Number - Check for Availability	
2	Head Bolt Set	2007-05	ES 72827	Replacement recommended; New Part Number - Check for Availability	
QTY	MANIFOLD - INT. & EXH.	YEARS	PART NO.	DESCRIPTION	
1	Int. Manifold Gasket Set	2007-05	MS 97302	Lower set; New Part Number - Check for Availability	
1	Exh. Manifold Gasket Set	2007-05	MS 97269	New Part Number - Check for Availability	
QTY	VALVE COVER	YEARS	PART NO.	DESCRIPTION	
2	Valve Cover Gasket Set	2007-05	VS 50851 R	w/Semi-circular plug & Grommets & Spark plug tube seals; PermaDry® molded rubber gskt. incl.; New Part Number - Check for Availability	
QTY	TIMING COVER	YEARS	PART NO.	DESCRIPTION	
4	Camshaft Front Seal Set	2007-05	ES 72806	Camshaft circular plug; New Part Number - Check for Availability	
18		2005 - 2003; 4.2L 254.5 (4172cc) DOHC V8 (40 Valve) 84.5mm Bore			18
MFI; Gasoline; Naturally Aspirated Audi Eng.; Eng. Code BAS					
QTY	CYLINDER HEAD	YEARS	PART NO.	DESCRIPTION	
1	Head Gasket	2005-03	26615 PT	Loc. L.H.; Head bolts not incl.; Head bolt replacement recommended; PermaTorqueMLS®; New Part Number - Check for Availability	
1	Head Gasket	2005-03	26628 PT	Loc. R.H.; Head bolts not incl.; Head bolt replacement recommended; PermaTorqueMLS®; New Part Number - Check for Availability	
1	Head Set	2005-03	HS 26669 PT	Valve stem seals & head bolts not incl.; Head bolt replacement recommended; PermaDry® molded rubber valve cover gskts. incl.; New Part Number - Check for Availability	
2	Head Bolt Set	2005-03	ES 72827	Replacement recommended; New Part Number - Check for Availability	

VW Truck (Incl. Minivans and SUV's) (Cont.)

18 (cont.)	2005 - 2003; 4.2L 254.5 (4172cc) DOHC V8 (40 Valve) 84.5mm Bore MFI; Gasoline; Naturally Aspirated Audi Eng.; Eng. Code BAS				18 (cont.)
QTY	MANIFOLD - INT. & EXH.	YEARS	PART NO.	DESCRIPTION	
1	Int. Manifold Gasket Set	2005-03	MS 97302	Lower set; New Part Number - Check for Availability	
1	Exh. Manifold Gasket Set	2005-03	MS 97269	New Part Number - Check for Availability	
QTY	VALVE COVER	YEARS	PART NO.	DESCRIPTION	
2	Valve Cover Gasket Set	2005-03	VS 50851 R	w/Semi-circular plug & Grommets & Spark plug tube seals; PermaDry® molded rubber gskt. incl.; New Part Number - Check for Availability	
QTY	TIMING COVER	YEARS	PART NO.	DESCRIPTION	
4	Camshaft Front Seal Set	2005-03	ES 72806	Camshaft circular plug; New Part Number - Check for Availability	
19	2005 - 2003; 4.2L 254.5 (4172cc) DOHC V8 (40 Valve) 84.5mm Bore MFI; Gasoline; Naturally Aspirated Audi Eng.; Eng. Code BHX				19
QTY	CYLINDER HEAD	YEARS	PART NO.	DESCRIPTION	
1	Head Gasket	2005-03	26615 PT	Loc. L.H.; Head bolts not incl.; Head bolt replacement recommended; PermaTorqueMLS®; New Part Number - Check for Availability	
1	Head Gasket	2005-03	26628 PT	Loc. R.H.; Head bolts not incl.; Head bolt replacement recommended; PermaTorqueMLS®; New Part Number - Check for Availability	
1	Head Set	2005-03	HS 26669 PT	Valve stem seals & head bolts not incl.; Head bolt replacement recommended; PermaDry® molded rubber valve cover gskts. incl.; New Part Number - Check for Availability	
2	Head Bolt Set	2005-03	ES 72827	Replacement recommended; New Part Number - Check for Availability	
QTY	MANIFOLD - INT. & EXH.	YEARS	PART NO.	DESCRIPTION	
1	Int. Manifold Gasket Set	2005-03	MS 97302	Lower set; New Part Number - Check for Availability	
1	Exh. Manifold Gasket Set	2005-03	MS 97269	New Part Number - Check for Availability	
QTY	VALVE COVER	YEARS	PART NO.	DESCRIPTION	
2	Valve Cover Gasket Set	2005-03	VS 50851 R	w/Semi-circular plug & Grommets & Spark plug tube seals; PermaDry® molded rubber gskt. incl.; New Part Number - Check for Availability	
QTY	TIMING COVER	YEARS	PART NO.	DESCRIPTION	
4	Camshaft Front Seal Set	2005-03	ES 72806	Camshaft circular plug; New Part Number - Check for Availability	

Winnebago Truck

Engine Finding Index					
Engine	Years	Code	Line No.		
2.2L 132 (2165cc) SOHC L4 (8 Valve) 88mm Bore; MFI; Gasoline; Naturally Aspirated Renault Eng.	1992-91	J7T	1		
5.8L 351 (5753cc) OHV V8 (16 Valve) 4" Bore Windsor; MFI; Gasoline; Naturally Aspirated Ford Eng.	1992-91		2		
Engine Code Index					
Code	Engine	Line No.			
J7T	2.2L 132 (2165cc) SOHC L4 (8 Valve) 88mm Bore; MFI; Gasoline; Naturally Aspirated Renault Eng.	1			
Model Index					
Engine (VIN Code / Eng. Code)	Year	Engine (VIN Code / Eng. Code)	Year	Engine (VIN Code / Eng. Code)	Year
Winnebago Truck		Winnebago Truck (cont.)		Winnebago Truck (cont.)	
Le Sharo/Phasar		Rialta		W800	
L4 2068cc 2.1L SOHC Turbo-Diesel (852)	86-83	L5 2461cc 2.5L SOHC (10 Valve) (ACU)	96-95	L4 3921cc 3.9L OHV Turbo-Diesel (4BTA3.9)	91-90
L4 2165cc 2.2L SOHC (J7T)	92-85			V8 351CI 5.8L OHV (Windsor)	92-90
1	1992 - 1991; 2.2L 132 (2165cc) SOHC L4 (8 Valve) 88mm Bore MFI; Gasoline; Naturally Aspirated Renault Eng.; Eng. Code J7T				1
QTY	EXHAUST PIPE FLANGE	YEARS	PART NO.	DESCRIPTION	
1	Exhaust Pipe Gasket	1992-91	60478	Converter	
QTY	TIMING COVER	YEARS	PART NO.	DESCRIPTION	
1	Camshaft Front Seal Set	1992-91	TCS 45725		
QTY	EXHAUST GAS RECIRCULATION	YEARS	PART NO.	DESCRIPTION	
1	EGR Gasket	1992-91	70978		
2	1992 - 1991; 5.8L 351 (5753cc) OHV V8 (16 Valve) 4" Bore Windsor MFI; Gasoline; Naturally Aspirated Ford Eng.				2
QTY	CYLINDER HEAD	YEARS	PART NO.	DESCRIPTION	
2	Head Gasket	1992-91	8548 PT-2	PermaTorque®	
2	Head Gasket	1992-91	9333 PT-1	H/D eng.	
2	Head Gasket Spacer Shim	1992-91	8548 SP-1	HeadSaver®	
1	Head Set	1992-91	HS 8548 PT-9	Premium valve stem seals incl.	
QTY	CONVERSION SET	YEARS	PART NO.	DESCRIPTION	
1	Gasket Conversion Set	1992-91	CS 8548-7	Water pump to plate gskt. not incl.; Multi-piece oil pan gskt. incl.	

Winnebago Truck (Cont.)

2 (cont.)		1992 - 1991; 5.8L 351 (5753cc) OHV V8 (16 Valve) 4" Bore Windsor			2 (cont.)	
MFI; Gasoline; Naturally Aspirated Ford Eng.						
QTY	MANIFOLD - INT. & EXH.	YEARS	PART NO.	DESCRIPTION		
1	Int. Manifold Gasket Set	1992-91	MS 90361	Lower set; Upper set not incl.		
1	Plenum Gasket Set	1992-91	MS 94176	Upper set		
1	Exh. Manifold Gasket Set	1992-91	MS 90000			
QTY	EXHAUST PIPE FLANGE	YEARS	PART NO.	DESCRIPTION		
1	Exhaust Pipe Gasket	1992-91	60712	Inlet pipe to converter		
QTY	OIL PAN	YEARS	PART NO.	DESCRIPTION		
1	Oil Pan Gasket Set	1992-91	OS 30214 C	Multi-piece; Cork		
1	Oil Pan Gasket Set	1992-91	OS 30616 R	PermaDry® one-piece molded rubber gskt. incl.		
1	Drain Plug Gasket	1992-91	70822			
QTY	CRANKSHAFT REAR SEAL	YEARS	PART NO.	DESCRIPTION		
1	Rear Main Seal Set	1992-91	BS 40592	Rubber; One-piece		
1	Rear Main Seal Set	1992-91	BS 40645	PTFE Rubber; One-piece		
1	Repair Sleeve	1992-91	16251	Crankshaft; Use w/installation tool		
1	Repair Sleeve Tool	1992-91	16301	Crankshaft		
QTY	VALVE COVER	YEARS	PART NO.	DESCRIPTION		
1	Valve Cover Gasket Set	1992-91	VS 13264 T	PermaDryPlus®; Improved design		
1	Valve Cover Gasket Set	1992-91	VS 50029 C	Hi-Temp.; w/Compression stops		
QTY	VALVE STEM SEAL SET	YEARS	PART NO.	DESCRIPTION		
1	Valve Stem Seal Set	1992-91	SS 70070	Loc. Int.; Premium valve stem seals incl.		
1	Valve Stem Seal Set	1992-91	SS 70373	Loc. Exh.; Premium valve stem seals incl.		
QTY	WATER OUTLET GASKET	YEARS	PART NO.	DESCRIPTION		
1	Water Outlet Gasket	1992-91	35440	Water Outlet		
QTY	WATER PUMP	YEARS	PART NO.	DESCRIPTION		
1	Water Pump Gasket	1992-91	35380	Pump to plate		
1	Water Pump Gasket	1992-91	35397	Plate to block		
QTY	TIMING COVER	YEARS	PART NO.	DESCRIPTION		
1	Timing Cover Set	1992-91	TCS 45449	w/o Sleeve 'N' Seal®; Eng. w/one-piece oil pan gskt. must be used w/OS 30616R; Water pump to plate gskt. not incl.		
1	Timing Set w/Sleeve & Seal	1992-91	TCS 45450	w/Sleeve 'N' Seal®; Eng. w/one-piece oil pan gskt. must be used w/OS 30616R; Water pump to plate gskt. not incl.		
1	Repair Sleeve	1992-91	16213	Timing Cover; Use w/installation tool		
1	Repair Sleeve Tool	1992-91	16310	Timing Cover		
QTY	CARB & FUEL INJECTION	YEARS	PART NO.	DESCRIPTION		
2	Fuel Injector O-Ring Set	1992-91	ES 70599	Improved design		
1	Throttle Body Gasket	1992-91	60845	Mounting		
1	Throttle Body Gasket	1992-91	71216	Air bypass valve		
QTY	DISTRIBUTOR MOUNTING	YEARS	PART NO.	DESCRIPTION		
1	O-Ring	1992-91	5511	Distributor Mounting		
QTY	EXHAUST GAS RECIRCULATION	YEARS	PART NO.	DESCRIPTION		
1	EGR Gasket	1992-91	72649			
QTY	OIL PUMP COVER	YEARS	PART NO.	DESCRIPTION		
1	Oil Pump Gasket	1992-91	72607	Inlet tube		
1	Oil Pump Gasket	1992-91	72607	Mounting		

Workhorse Truck

Engine Finding Index						
Engine	Years	Code	Line No.			
5.7L 350 (5736cc) OHV V8 (16 Valve) 4" Bore Vortec; CPI; Gasoline; Naturally Aspirated GMC Eng.; Chevrolet	2002-01	R	1			
6.5L 395 (6468cc) OHV Turbo V8 (16 Valve) 103mm Bore; MFI; Diesel; Turbo GMC Eng.; Chevrolet	2003-99	F	2			
7.4L 454 (7441cc) OHV V8 (16 Valve) 4.25" Bore Vortec; CPI; Gasoline; Naturally Aspirated GMC Eng.; Chevrolet	2000-99	J	3			
8.1L 496 (8129cc) OHV V8 (16 Valve) 4.25" Bore Vortec; MFI; Gasoline; Naturally Aspirated GMC Eng.; Chevrolet	2006-01	G	4			
Model Index						
Engine (VIN Code / Eng. Code)	Year	Engine (VIN Code / Eng. Code)	Year	Engine (VIN Code / Eng. Code)	Year	
Workhorse Truck		Workhorse Truck (cont.)				
P32 (Custom Chassis)		P32 (Custom Chassis) (cont.)				
V8 350CI 5.7L (R)	02-01	V8 454CI 7.4L (J)	00-99			
V8 395CI 6.5L Turbo-Diesel (F)	03-99	V8 496CI 8.1L (G)	06-01			

1		2002 - 2001; 5.7L 350 (5736cc) OHV V8 (16 Valve) 4" Bore Vortec CPI; Gasoline; Naturally Aspirated GMC Eng.; Chevrolet; VIN Code R			1
QTY	CYLINDER HEAD	YEARS	PART NO.	DESCRIPTION	
2	Head Gasket	2002-01	501 SD	Head bolts not incl.; Head bolt replacement recommended; PermaTorque Severe Duty®	
2	Head Gasket	2002-01	7733 PT-2	Head bolts not incl.; Head bolt replacement recommended; PermaTorque®	
2	Head Gasket Spacer Shim	2002-01	7733 SP	HeadSaver®	
1	Head Set	2002-01	HS 7733 PT-16	Head bolts & exh. pipe packing not incl.; Head bolt replacement recommended; PermaDry® molded rubber valve cover gskts. incl.; Premium valve stem seals incl.	
1	Head Set	2002-01	HST 7733 PT-16	Head bolts & exh. pipe packing not incl.; Head bolt replacement recommended; PermaTorque Severe Duty® head gskts. incl.; PermaDryPlus® int. manifold gskts. incl.; PermaDry® molded rubber valve cover gskts. incl.; Premium valve stem seals incl.	
2	Head Bolt Set	2002-01	ES 72856	Replacement recommended	
QTY	CONVERSION SET	YEARS	PART NO.	DESCRIPTION	
1	Gasket Conversion Set	2002-01	CS 8510-1	Plastic timing cover not incl.; PermaDry® molded rubber oil pan gskt. incl.	
QTY	MANIFOLD - INT. & EXH.	YEARS	PART NO.	DESCRIPTION	
1	Int. Manifold Gasket Set	2002-01	MS 90131	Lower set; Upper set incl.; Manifold bolts not incl.; Manifold bolt replacement recommended	
1	Int. Manifold Gasket Set	2002-01	MS 90131-2	Lower set only; Upper set not incl.; Manifold bolts not incl.; Manifold bolt replacement recommended	
1	Int. Manifold Gasket Set	2002-01	MS 98000 T	Single valve cover gskt. incl.; Upper set incl.; PermaDryPlus® int. manifold gskts. incl.; When servicing second valve cover use VS 50293R if required; Manifold bolts not incl.; Manifold bolt replacement recommended	
1	Plenum Gasket Set	2002-01	MS 90269	Upper set	
1	Int. Manifold Bolt Set	2002-01	ES 72224	Loc. Lower; Replacement recommended	
1	Exh. Manifold Gasket Set	2002-01	MS 94054		
QTY	EXHAUST PIPE FLANGE	YEARS	PART NO.	DESCRIPTION	
2	Exhaust Pipe Gasket	2002-01	61014	Pipe to manifold	
1	Exhaust Pipe Gasket	2002-01	61559	Converter; 3-bolt	
1	Exhaust Pipe Gasket	2002-01	61561	Converter; 2-bolt	
1	Exhaust Pipe Gasket	2002-01	61683	Exh. connector; New Part Number - Check for Availability	
QTY	FUEL PUMP	YEARS	PART NO.	DESCRIPTION	
1	Fuel Pump Mounting Gasket	2002-01	5182	Plate	
QTY	OIL PAN	YEARS	PART NO.	DESCRIPTION	
1	Oil Pan Gasket Set	2002-01	OS 34500 R	PermaDry® molded rubber gskt. incl.	
1	Drain Plug Gasket	2002-01	70820		
QTY	CRANKSHAFT REAR SEAL	YEARS	PART NO.	DESCRIPTION	
1	Rear Main Seal Set	2002-01	BS 40656	PTFE Rubber; One-piece; Improved design	
QTY	VALVE COVER	YEARS	PART NO.	DESCRIPTION	
1	Valve Cover Gasket Set	2002-01	VS 50088 R	Services both covers; PermaDry® molded rubber gskts. incl.	
2	Valve Cover Gasket Set	2002-01	VS 50293 R	Services one cover only; PermaDry® molded rubber gskt. incl.	
QTY	VALVE STEM SEAL SET	YEARS	PART NO.	DESCRIPTION	
1	Valve Stem Seal Set	2002-01	SS 72861	Loc. Int. & Exh.; Premium valve stem seals incl.; Improved design	
QTY	THERMOSTAT HOUSING	YEARS	PART NO.	DESCRIPTION	
1	O-Ring	2002-01	35710	Thermostat Housing; 1.954" ID; Improved design	
QTY	WATER PUMP	YEARS	PART NO.	DESCRIPTION	
1	Water Pump Gasket	2002-01	13032	To plate	
2	Water Pump Gasket	2002-01	5152	To block	
QTY	TIMING COVER	YEARS	PART NO.	DESCRIPTION	
1	Timing Cover Set	2002-01	TCS 46093	Eng. w/2.42" OD timing cover seal; Must be used w/OS 34500R	
QTY	CARB & FUEL INJECTION	YEARS	PART NO.	DESCRIPTION	
1	Throttle Body Gasket	2002-01	61036		
QTY	DISTRIBUTOR MOUNTING	YEARS	PART NO.	DESCRIPTION	
1	Distributor Mounting Gasket	2002-01	70194		
QTY	EXHAUST GAS RECIRCULATION	YEARS	PART NO.	DESCRIPTION	
1	EGR Gasket	2002-01	70789		
QTY	OIL PUMP RETAINER	YEARS	PART NO.	DESCRIPTION	
1	Oil Pump Shaft Guide	2002-01	72665	Distributor to oil pump shaft retainer	
QTY	OIL COOLER	YEARS	PART NO.	DESCRIPTION	
1	Oil Cooler Mounting Set	2002-01	ES 72671		

Workhorse Truck (Cont.)

2		2003 - 1999; 6.5L 395 (6468cc) OHV Turbo V8 (16 Valve) 103mm Bore			2
MFI; Diesel; Turbo GMC Eng.; Chevrolet; VIN Code F					
QTY	CYLINDER HEAD	YEARS	PART NO.	DESCRIPTION	
2	Head Gasket	2003-99	9521 PT	.010" thicker for use when block is refaced; Head bolts not incl.; Head bolt replacement recommended	
2	Head Gasket	2003-99	9701 PT	Standard thickness; Head bolts not incl.; Head bolt replacement recommended	
1	Head Set w/o Head Gasket	2003-99	HSU 8726	Head gskts., head bolts, exh. pipe packing, positive control exh. valve stem seals not incl.; Upper int. manifold gskt. not incl.; Head bolt replacement recommended	
2	Head Bolt Set	2003-99	ES 72724	Replacement recommended	
QTY	CONVERSION SET	YEARS	PART NO.	DESCRIPTION	
1	Gasket Conversion Set	2003-99	CS 8726-2		
QTY	MANIFOLD - INT. & EXH.	YEARS	PART NO.	DESCRIPTION	
1	Int. Manifold Gasket Set	2003-99	MS 91585	Lower set	
1	Plenum Gasket Set	2003-99	MS 90176-1	Upper set	
1	Exh. Manifold Gasket Set	2003-99	MS 91587		
QTY	EXHAUST PIPE FLANGE	YEARS	PART NO.	DESCRIPTION	
2	Exhaust Pipe Gasket	2003-99	60556	Pipe to manifold; 1 3/4" ID	
2	Exhaust Pipe Gasket	2003-99	60718	Crossover; 2 3/32" ID Steel sleeve	
QTY	FUEL PUMP	YEARS	PART NO.	DESCRIPTION	
1	Fuel Pump Mounting Gasket	2003-99	5182	Plate	
1	Fuel Pump Mounting Gasket	2003-99	6579	Mounting; May also be used as a fuel pump block-off plate gasket if desired	
1	Fuel Pump Mounting Gasket	2003-99	70150	Injection pump mounting	
QTY	OIL PAN	YEARS	PART NO.	DESCRIPTION	
1	Oil Pan Gasket Set	2003-99	OS 34406		
1	Drain Plug Gasket	2003-99	70822		
QTY	CRANKSHAFT REAR SEAL	YEARS	PART NO.	DESCRIPTION	
1	Rear Main Seal Set	2003-99	BS 40604	Rubber; One-piece	
QTY	VALVE COVER	YEARS	PART NO.	DESCRIPTION	
1	Valve Cover Gasket Set	2003-99	VS 50228 C		
QTY	VALVE STEM SEAL SET	YEARS	PART NO.	DESCRIPTION	
1	Valve Stem Seal Set	2003-99	SS 5112	Loc. Int. & Exh.; O-ring	
1	Valve Stem Seal Set	2003-99	SS 72711	Loc. Exh.; Positive control; Premium valve stem seals incl.	
QTY	THERMOSTAT HOUSING	YEARS	PART NO.	DESCRIPTION	
2	O-Ring	2003-99	35710	Thermostat Housing; 1.954" ID; Improved design	
QTY	WATER OUTLET GASKET	YEARS	PART NO.	DESCRIPTION	
2	Water Outlet Gasket	2003-99	35357	Water Crossover	
QTY	WATER PUMP	YEARS	PART NO.	DESCRIPTION	
1	Water Pump Mounting Set	2003-99	ES 72674		
QTY	TIMING COVER	YEARS	PART NO.	DESCRIPTION	
1	Timing Cover Set	2003-99	TCS 45554	w/o Sleeve 'N' Seal®	
1	Timing Set w/Sleeve & Seal	2001-99	TCS 45686	w/Sleeve 'N' Seal®	
1	Repair Sleeve	2001-99	16209	Timing Cover; Use w/installation tool	
1	Repair Sleeve Tool	2001-99	16311	Timing Cover	
QTY	EXHAUST GAS RECIRCULATION	YEARS	PART NO.	DESCRIPTION	
1	EGR Gasket	2003-99	70781		
3		2000 - 1999; 7.4L 454 (7441cc) OHV V8 (16 Valve) 4.25" Bore Vortec			3
CPI; Gasoline; Naturally Aspirated GMC Eng.; Chevrolet; VIN Code J					
QTY	CYLINDER HEAD	YEARS	PART NO.	DESCRIPTION	
2	Head Gasket	2000-99	9502 PT	PermaTorque®	
1	Head Set	2000-99	HS 9502 PT	Exh. pipe packing not incl.; PermaDry® molded rubber valve cover gskts. incl.; Premium valve stem seals incl.	
2	Head Bolt Set	2000-99	ES 72264	Replacement recommended	
QTY	CONVERSION SET	YEARS	PART NO.	DESCRIPTION	
1	Gasket Conversion Set	2000-99	CS 8523	PermaDry® molded rubber oil pan gskt. incl.	
QTY	MANIFOLD - INT. & EXH.	YEARS	PART NO.	DESCRIPTION	
1	Int. Manifold Gasket Set	2000-99	MS 95826	Lower set	
1	Plenum Gasket Set	2000-99	MS 95787	Upper set	
1	Exh. Manifold Gasket Set	2000-99	MS 95840		
QTY	EXHAUST PIPE FLANGE	YEARS	PART NO.	DESCRIPTION	
2	Exhaust Pipe Gasket	2000-99	61012	Packing	
QTY	OIL PAN	YEARS	PART NO.	DESCRIPTION	
1	Oil Pan Gasket Set	2000-99	OS 34407 R	PermaDry® molded rubber gskt. incl.	
1	Drain Plug Gasket	2000-99	70820		

Workhorse Truck (Cont.)

3		2000 - 1999; 7.4L 454 (7441cc) OHV V8 (16 Valve) 4.25" Bore Vortec			3	
(cont.)		CPI; Gasoline; Naturally Aspirated GMC Eng.; Chevrolet; VIN Code J			(cont.)	
QTY	CRANKSHAFT REAR SEAL	YEARS	PART NO.	DESCRIPTION		
1	Rear Main Seal Set	2000-99	BS 40622	Viton®; One-piece		
1	Repair Sleeve	2000-99	16269-1	Crankshaft; 1.280" - 1.310" sleeve length; Use w/installation tool; Improved design		
1	Repair Sleeve Tool	2000-99	16316	Crankshaft		
QTY	VALVE COVER	YEARS	PART NO.	DESCRIPTION		
1	Valve Cover Gasket Set	2000-99	VS 50388 R	PermaDry® molded rubber gsks. incl.		
QTY	VALVE STEM SEAL SET	YEARS	PART NO.	DESCRIPTION		
1	Valve Stem Seal Set	2000-99	SS 72823	Premium valve stem seals incl.		
QTY	THERMOSTAT HOUSING	YEARS	PART NO.	DESCRIPTION		
1	Thermostat Gasket	2000-99	35614	Thermostat Housing; Thermostat seal; Improved design		
QTY	WATER PUMP	YEARS	PART NO.	DESCRIPTION		
1	Water Pump Gasket	2000-99	11725	To plate		
2	Water Pump Gasket	2000-99	30060	To block		
QTY	TIMING COVER	YEARS	PART NO.	DESCRIPTION		
1	Timing Cover Set	2000-99	TCS 45969	w/o Sleeve 'N' Seal®; Must be used w/OS 34407R		
1	Timing Set w/Sleeve & Seal	2000-99	TCS 45053	w/Sleeve 'N' Seal®; Must be used w/OS 34407R		
QTY	CARB & FUEL INJECTION	YEARS	PART NO.	DESCRIPTION		
4	Fuel Injector O-Ring Set	2000-99	ES 70599	Improved design		
1	Throttle Body Gasket	2000-99	61178	Improved design		
QTY	DISTRIBUTOR MOUNTING	YEARS	PART NO.	DESCRIPTION		
1	Distributor Mounting Gasket	2000-99	70194			
QTY	EXHAUST GAS RECIRCULATION	YEARS	PART NO.	DESCRIPTION		
1	EGR Gasket	2000-99	70788			
QTY	OIL PUMP COVER	YEARS	PART NO.	DESCRIPTION		
1	Oil Pump Gasket	2000-99	71012	Oil pump mounting; New Part Number - Check for Availability		
QTY	OIL PUMP RETAINER	YEARS	PART NO.	DESCRIPTION		
1	Oil Pump Shaft Guide	2000-99	72665	Distributor to oil pump shaft retainer		
QTY	OIL COOLER	YEARS	PART NO.	DESCRIPTION		
1	Oil Cooler Mounting Set	2000-99	ES 72671			
4		2006 - 2001; 8.1L 496 (8129cc) OHV V8 (16 Valve) 4.25" Bore Vortec			4	
		MFI; Gasoline; Naturally Aspirated GMC Eng.; Chevrolet; VIN Code G				
QTY	CYLINDER HEAD	YEARS	PART NO.	DESCRIPTION		
1	Head Gasket	2006-01	26168 PT	Loc. L.H.; Head bolts not incl.; Head bolt replacement recommended		
1	Head Gasket	2006-01	26169 PT	Loc. R.H.; Head bolts not incl.; Head bolt replacement recommended		
1	Head Set	2006-01	HS 26168 PT	Head bolts & exh. pipe packing not incl.; Head bolt replacement recommended; PermaDry® molded rubber valve cover gsks. incl.; Premium valve stem seals incl.		
2	Head Bolt Set	2006-01	ES 72188	Replacement recommended		
QTY	CONVERSION SET	YEARS	PART NO.	DESCRIPTION		
1	Gasket Conversion Set	2006-01	CS 26168	PermaDry® molded rubber oil pan gskt. incl.		
QTY	MANIFOLD - INT. & EXH.	YEARS	PART NO.	DESCRIPTION		
1	Int. Manifold Gasket Set	2006-01	MS 96057			
1	Exh. Manifold Gasket Set	2006-01	MS 95840			
QTY	EXHAUST PIPE FLANGE	YEARS	PART NO.	DESCRIPTION		
2	Exhaust Pipe Gasket	2006-01	61258	Cab & Chaassis model; Pipe to manifold		
1	Exhaust Pipe Gasket	2006-01	61287	Converter		
2	Exhaust Pipe Gasket	2006-01	61323	Exc. Cab & Chaassis model; Pipe to manifold		
QTY	OIL PAN	YEARS	PART NO.	DESCRIPTION		
1	Oil Pan Gasket Set	2006-01	OS 30714 R	PermaDry® molded rubber gskt. incl.		
1	Drain Plug Gasket	2006-01	70820			
QTY	CRANKSHAFT REAR SEAL	YEARS	PART NO.	DESCRIPTION		
1	Rear Main Seal Set	2006-01	BS 40673	Wear sleeve incl.; PTFE Rubber; One-piece		
QTY	VALVE COVER	YEARS	PART NO.	DESCRIPTION		
1	Valve Cover Gasket Set	2006-01	VS 50554 R	w/Grommets; PermaDry® molded rubber gsks. incl.		
QTY	VALVE STEM SEAL SET	YEARS	PART NO.	DESCRIPTION		
1	Valve Stem Seal Set	2006-01	SS 70579-1	Premium valve stem seals incl.		
QTY	THERMOSTAT HOUSING	YEARS	PART NO.	DESCRIPTION		
1	Thermostat Gasket	2006-01	35614	Thermostat Housing; Thermostat seal; Improved design		
QTY	WATER PUMP	YEARS	PART NO.	DESCRIPTION		
2	Water Pump Gasket	2006-01	35664			
QTY	TIMING COVER	YEARS	PART NO.	DESCRIPTION		
1	Timing Cover Set	2006-01	TCS 46007			

Workhorse Truck (Cont.)

4 (cont.)		2006 - 2001; 8.1L 496 (8129cc) OHV V8 (16 Valve) 4.25" Bore Vortec MFI; Gasoline; Naturally Aspirated GMC Eng.; Chevrolet; VIN Code G			4 (cont.)	
QTY	CARB & FUEL INJECTION	YEARS	PART NO.	DESCRIPTION		
2	Fuel Injector O-Ring Set	2006-01	ES 70599	Upper set; Injectors to fuel rail; Improved design		
2	Fuel Injector O-Ring Set	2006-01	ES 71190	Lower set; Injectors to cylinder head		
2	Fuel Injector O-Ring Set	2006-01	ES 71192	Upper set; Injectors to fuel rail; Old design		
1	Throttle Body Gasket	2006-01	61178	Improved design		
QTY	EXHAUST GAS RECIRCULATION	YEARS	PART NO.	DESCRIPTION		
1	EGR Gasket	2006-01	70783	Valve		
1	EGR Gasket	2006-01	71081	Pipe; Large hole		
1	EGR Gasket	2006-01	71093	Pipe; Small hole		

NUMERICAL LIST ABBREVIATIONS

Abbrev	Full Name	Abbrev	Full Name	Abbrev	Full Name
ACO	AC Cobra	HY	Hyundai Car	PEU	Peugeot
AMG	AM General Truck	HYT	Hyundai Truck	PNZ	Panoz
AUD	Audi Car	IS	Isuzu Car	POR	Porsche Car
AUT	Audi Truck	IST	Isuzu Truck	POT	Porsche Truck
AV	Avanti	JAG	Jaguar	RR	Rolls-Royce
BMT	BMW Truck	JEE	Jeep Truck	SAB	Saab Car
BMW	BMW Car	KIA	Kia Car	SAT	Saab Truck
CAL	Callaway	KIT	Kia Truck	SB	Subaru Car
CHR	Chrysler Car	LAF	LaForza Truck	SBT	Subaru Truck
DAE	Daewoo Car	LOT	Lotus	STE	Sterling
DET	DeTomaso	LRT	Land Rover Truck	SZ	Suzuki Car
DT	Dodge Truck	MB	Mercedes-Benz Car	SZT	Suzuki Truck
EXC	Excalibur	MBT	Mercedes-Benz Truck	TO	Toyota Car
FO	Ford Car	MI	Mitsubishi Car	TOT	Toyota Truck
FOT	Ford Truck	MIT	Mitsubishi Truck	VOL	Volvo Car
FRT	Freightliner Truck	MOR	Morgan	VOT	Volvo Truck
GM	GM Car	MOS	Mosler	VPG	VPG Truck
GMT	GMC Truck	MZ	Mazda Car	VW	VW Car
GRU	Grumman Truck	MZT	Mazda Truck	VWT	VW Truck
HO	Honda Car	NI	Nissan Car	WIN	Winnebago Truck
HOT	Honda Truck	NIT	Nissan Truck	WRK	Workhorse Truck

NUMERICAL LIST

10740 FOT: 41, 42, 43	16274 DT: 54, 55, 56, 57, 58, 59, 60, 65, 66	23591 GM: 9, 10, 18, 19, 20; LOT: 5, 6; MZ: 5, 20;
11528 GMT: 19, 20; GRU: 2, 3	16275 CHR: 1, 2, 3, 4, 5, 6, 8, 9, 15, 16, 17, 18, 19, 20, 21, 22, 26, 27; DT: 2, 3; GM: 17; HO: 5, 6, 7, 8, 9, 10, 15, 17, 18, 19, 20, 21, 22, 23, 24, 25, 26, 27, 28, 29, 34, 35, 36, 42, 43, 44, 45, 46, 47, 48, 49, 51, 52, 53, 54, 63; HOT: 1, 2, 3, 4; HY: 1, 2, 20; IST: 1, 5; MI: 1, 2, 3, 4, 5, 8, 9, 10, 11, 16, 17, 18, 20; MIT: 2, 3, 5; NI: 8, 9; NIT: 4; STE: 1	23623 AUD: 18, 19, 20, 21; VW: 14, 15, 17, 18, 19, 26
11725 GMT: 100, 101, 102; WRK: 3	16276 GM: 65, 77, 78, 79, 80, 81, 82; GMT: 45	23624 HO: 5, 6, 7, 15, 34, 42, 61, 62, 63, 69, 70, 79; HOT: 1; STE: 1
11760 FO: 10; MZ: 12, 14, 15	16277 GM: 9, 10, 18; TO: 5, 6, 7	23626 MZ: 21; TO: 5, 7, 13, 15, 16, 22; TOT: 1, 4, 5, 11
13032 AMG: 1, 2; AV: 3, 4, 5; GM: 88, 97, 98, 102, 103; GMT: 50, 51, 52, 53, 54, 59, 60, 73, 74; IST: 20, 21, 24, 25; WRK: 1	16278 TO: 13, 15, 16; TOT: 1	25538 HY: 12, 15; HYT: 1; KIA: 12; KIT: 1
13816 FOT: 41, 42, 43	16300 CHR: 25, 40, 41, 42, 47, 49, 51, 52, 53, 59, 60, 61, 62, 63, 64, 65, 66, 68; DT: 14, 15, 18, 19, 22, 24, 25, 26, 27, 28, 29, 31, 32, 33, 37, 38, 41; FO: 15, 16, 46, 47, 48, 60, 61, 62, 63; FOT: 29, 30, 34, 44, 45, 46, 48, 49; GM: 33, 34; HY: 28; LAF: 1, 2; MZ: 18, 19; MZT: 3, 4; MI: 22, 24; MIT: 6; VWT: 15	25565 SAB: 1, 2, 3, 4, 13, 14, 15; VOL: 4, 5, 6, 7, 8, 9, 10, 11, 12, 13, 14, 15, 16, 17, 18, 19, 20, 21, 22, 23, 24, 25, 26, 27, 28, 29, 30, 32; VOT: 1
13877 JEE: 7, 11	16301 AMG: 2; AV: 3, 4, 5; EXC: 1; FO: 69; FOT: 41, 42, 43, 59, 60, 68, 69, 71; GM: 88, 89, 97, 98, 102, 103, 104, 105; GMT: 50, 51, 52, 54, 59, 73; IST: 25; WIN: 2	25581 IST: 6, 8
16201 DT: 39, 40, 45, 46, 47, 61, 62, 63, 64; JEE: 16, 20	16303 FO: 5, 9; GM: 33, 34; MOR: 1	25583 NI: 7; NIT: 4
16202 AMG: 2; AV: 3, 4, 5; EXC: 1; GM: 35, 36, 52, 53, 88, 89, 97, 98, 102, 103, 104, 105; GMT: 7, 8, 19, 20, 50, 51, 52, 59, 73; GRU: 1, 2, 3; IST: 2, 3, 25	16304 DT: 13; GM: 26, 27, 28, 35, 36, 52, 53, 60, 61, 62, 63, 67, 68; GMT: 7, 8, 19, 20, 25, 30, 32; GRU: 1, 2, 3; IST: 2, 3, 10, 12; JEE: 6, 7	25589 AUD: 18, 19, 20, 21, 22, 23, 24, 25; AUT: 2, 3; BMW: 12, 15, 16; VW: 42, 43, 44, 48
16204 JEE: 19	16306 AV: 2; DET: 1; FO: 18, 51, 52, 53, 54, 55, 56, 57, 58, 59; FOT: 7, 11, 35, 36, 40; MZT: 9, 13; PNZ: 1, 2	25598 AUD: 1, 2, 3, 4, 5; VW: 1, 2, 3, 4, 5, 6, 8, 11, 12, 14, 15, 16, 17, 18, 19, 26, 30, 31, 32, 33, 34, 35, 36, 37
16205 GMT: 100	16308 GM: 65, 77, 78, 79, 80, 81, 82; GMT: 45; JEE: 19	25609 VW: 1, 2, 3, 14, 15, 16, 17, 18, 19
16207 DET: 1; FO: 51, 52, 53, 54, 55, 56, 57, 58; FOT: 35, 36, 37, 38, 39, 41, 42, 43, 48, 49, 50, 51, 52, 53, 54, 66, 67; PNZ: 1, 2	16310 DET: 1; FO: 34, 35, 36, 46, 47, 51, 52, 53, 54, 55, 56, 57, 58, 60, 61, 62, 63, 69; FOT: 18, 19, 35, 36, 37, 38, 39, 41, 42, 43, 44, 45, 46, 48, 49, 50, 51, 52, 53, 54, 59, 60, 66, 67, 72; LAF: 1, 2; MZT: 21, 22; PNZ: 1, 2; WIN: 2	25615 AUD: 18, 20, 21
16209 AMG: 3, 4, 5; GMT: 86, 87, 88, 90, 91, 92; WRK: 2	16311 AMG: 3, 4, 5; GMT: 86, 87, 88, 90, 91, 92, 100; WRK: 2	26140 PT VW: 47, 48, 49; VWT: 6
16210 DT: 13; JEE: 6, 7, 11, 12	16312 AMG: 2; AV: 3, 4, 5; DT: 13; EXC: 1; GM: 35, 36, 52, 53, 60, 61, 62, 63, 67, 68, 88, 89, 97, 98, 102, 103, 104, 105; GMT: 7, 8, 19, 20, 25, 30, 31, 32, 33, 50, 51, 52, 59, 73; GRU: 1, 2, 3; IST: 2, 3, 10, 12, 25; JEE: 6, 7, 11, 12; TOT: 4	26142 PT VW: 45, 46; VWT: 5
16212 GM: 62, 63, 68; GMT: 25, 30; IST: 10, 12	16316 GMT: 100, 101, 102; WRK: 3	26143 PT VW: 22, 23, 24
16213 FO: 46, 47, 60, 61, 62, 63, 69; FOT: 44, 45, 46, 59, 60, 72; LAF: 1, 2; WIN: 2	16318 DT: 54, 55, 56, 57, 58, 59, 60, 65, 66	26144 PT VW: 22, 23, 24
16214 TOT: 4	16319 DT: 54, 55, 56, 57, 58, 59, 60, 65, 66	26145 PT VW: 22, 23, 24
16215 GM: 60, 61, 62, 63, 67; GMT: 31, 32, 33	16323 HO: 43, 44, 45, 46, 47, 51, 52, 53; HOT: 3, 4, 12; IST: 1, 5, 6, 7, 8; TO: 22, 25, 26, 27, 32; TOT: 11, 12, 13, 14, 15, 16	26150 PT GM: 91, 92, 93, 95
16216 GM: 65, 77, 78, 79, 80, 81, 82; GMT: 45	16325 CHR: 10, 11, 12, 13, 14, 33, 34, 35, 36, 37, 43, 44, 45, 46; DT: 1, 6, 7, 8, 9, 10, 11, 12; GM: 9, 10; JEE: 5; MI: 6, 7; TO: 5, 6	26151 PT GM: 91, 92, 93, 95
16217 FO: 34, 35, 36; FOT: 18, 19; MZT: 21, 22	16326 CHR: 59, 60, 61, 68; DT: 22, 24, 25, 26, 27, 28, 29, 37, 38; JEE: 10	26152 PT ACO: 1, 2; GM: 87
16219 DT: 54, 55, 56, 57, 58, 59, 60, 65, 66	16327 TO: 13, 15, 16; TOT: 1	26153 PT ACO: 1, 2; GM: 87
16220 HOT: 12; IST: 6, 7, 8; NI: 1; TO: 22, 25, 26, 27, 32; TOT: 11, 12, 13, 14, 15, 16	16328 CHR: 69, 70, 71, 72, 73; DT: 35, 42, 43, 44, 48, 49, 50, 51, 52, 53; JEE: 9, 13, 14, 15, 17, 18, 21, 22; MIT: 11, 13, 14	26154 PT GM: 21; LOT: 2, 3, 4; TO: 10
16221 TO: 1, 2	16329 AV: 6; CAL: 1; GM: 99, 100, 101, 106, 107, 108, 109, 110, 111; GMT: 56, 57, 58, 61, 62, 63, 64, 65, 66, 67, 68, 69, 70, 71, 72, 75, 76, 77, 78, 79, 80, 81, 82, 83, 84, 85; IST: 22, 23; MOS: 1; SAT: 4, 5	26157 PT DT: 42, 43, 44; JEE: 13, 14, 15; MIT: 13, 14
16222 HO: 43, 44, 45, 46, 47, 51, 52, 53; HOT: 3, 4; IST: 1, 5	23561 GM: 9; MZ: 4; TO: 1, 2, 5, 22, 23; TOT: 5, 6, 7, 9, 11, 21	26158 PT-1 GM: 19, 20; TO: 8, 9
16223 HOT: 12; IST: 6, 7, 8; TO: 22, 25, 26, 27, 32; TOT: 11, 12, 13, 14, 15, 16	23563 VOL: 4, 5, 6, 7, 8, 9, 10	26159 PT HOT: 1, 2
16224 CHR: 10, 11, 12, 13, 14, 33, 34, 35, 36, 37, 43, 44, 45, 46; DT: 1, 6, 7, 8, 9, 10, 11, 12; JEE: 5; MI: 6, 7	23566 GMT: 3; SZ: 5; SZT: 2, 3	26160 PT TOT: 2
16225 GM: 9, 10; TO: 5, 6	23588 TO: 5; TOT: 4	26161 PT VW: 31, 32, 33, 34, 35, 36, 37
16227 TO: 13, 15, 16; TOT: 1		26164 PT VW: 30
16228 AV: 6; CAL: 1; GM: 99, 100, 101, 106, 107, 108, 109, 110, 111; GMT: 56, 57, 58, 61, 62, 63, 64, 65, 66, 67, 68, 69, 70, 71, 72, 75, 76, 77, 78, 79, 80, 81, 82, 83, 84, 85; IST: 22, 23; MOS: 1; SAT: 4, 5		26165 PT FO: 24, 25; MZT: 12
16229 AV: 6; CAL: 1; GM: 99, 100, 101, 106, 107, 108, 109, 110, 111; GMT: 56, 57, 58, 61, 62, 63, 64, 65, 66, 67, 68, 69, 70, 71, 72, 75, 76, 77, 78, 79, 80, 81, 82, 83, 84, 85; IST: 22, 23; MOS: 1; SAT: 4, 5		26166 PT FO: 24, 25; MZT: 12
16230 CHR: 69, 70, 71, 72, 73; DT: 35, 42, 43, 44, 48, 49, 50, 51, 52, 53; JEE: 9, 13, 14, 15, 17, 18, 21, 22; MIT: 11, 13, 14		26167 PT SB: 14; SBT: 2
16250 FO: 46, 47, 48, 60, 61, 62, 63; FOT: 29, 30, 34, 44, 45, 46; LAF: 1, 2		26168 PT GMT: 103; WRK: 4
16251 FO: 69; FOT: 41, 42, 43, 59, 60; WIN: 2		26169 PT GMT: 103; WRK: 4
16255-1 AV: 2; DET: 1; FO: 18, 51, 52, 53, 54, 55, 56, 57, 58, 59; FOT: 7, 11, 35, 36, 40; MZT: 9, 13; PNZ: 1, 2		26170 PT SAB: 17, 18; SB: 16, 17, 18; SBT: 4, 5, 6
16256 FOT: 68, 69, 71		26171 PT NI: 8; NIT: 3
16258 AMG: 2; AV: 3, 4, 5; EXC: 1; GM: 88, 89, 97, 98, 102, 103, 104, 105; GMT: 50, 51, 52, 54, 59, 73; IST: 25		26172 PT CHR: 26; MI: 17; MIT: 2
16259 GM: 52, 53; GMT: 19, 20; GRU: 2, 3		26173 PT GM: 56; GMT: 27; SAB: 22
16269-1 GMT: 100, 101, 102; WRK: 3		26174 PT FO: 6
16270 FOT: 37, 38, 39, 48, 49, 50, 51, 52, 53, 54, 55, 56, 58, 66, 67		26179 PT DT: 45, 46, 47; JEE: 16
16272 FO: 15, 16; KIT: 4; MZ: 18, 19; MZT: 3, 4		26180 PT HY: 12, 15
		26181 PT HY: 15; HYT: 1; KIA: 12; KIT: 1
		26182 PT AUD: 1, 2, 3, 4, 5, 6, 7, 8; VW: 4, 5, 6, 7, 8, 9, 10, 11, 12, 13
		26183 PT MI: 5
		26184 PT MI: 1
		26185 PT TOT: 4
		26186 PT CHR: 47, 48, 49, 50; MI: 22, 23; MIT: 7
		26187 PT FO: 53; PNZ: 2
		26188 PT FO: 51; FOT: 36
		26189 PT GM: 56; SAB: 22, 23
		26190 PT AV: 6; GM: 99, 100, 101; GMT: 56, 58, 61, 62, 63, 64, 65, 66, 70, 71, 72; IST: 22; MOS: 1; SAT: 4
		26191 PT GMT: 57, 67, 68, 69; IST: 23
		26192 PT GM: 106, 107, 108, 109, 110, 111; GMT: 75, 76, 77, 78, 79, 80, 81, 82, 83, 84, 85; SAT: 5
		26193 PT MI: 26; MIT: 10
		26194 PT MZ: 14, 15
		26195 PT HY: 4, 5
		26196 PT HO: 65

NUMERICAL LIST

26197 PT	HY: 4	26274 PT-1	GMT: 93, 94, 95, 96, 99	26361 PT	FO: 49
26200 PT	FOT: 29	26275 PT	BMW: 14, 17; BMT: 1, 2	26364 PT	FO: 49
26202 PT	CHR: 12, 33, 34, 35, 36, 37; DT: 1, 6, 7, 8, 9, 10, 11, 12; JEE: 5	26276 PT	HY: 26; HYT: 7; KIA: 22; KIT: 7	26365 PT	MI: 14
26203 PT	VOL: 11, 22, 23, 24, 25, 26, 27	26277 PT	HY: 26; HYT: 7; KIA: 22; KIT: 7	26366 PT	CHR: 73; JEE: 21, 22
26204 PT	VOL: 11, 12, 13, 22, 23, 24, 25, 26, 27	26278 PT	GMT: 4; SZ: 6, 7; SZT: 4, 5	26367 PT	MI: 14
26205 PT	VOL: 11, 13, 14, 21, 23, 25, 27, 28	26279 PT	SZ: 9	26368 PT	DT: 41; VWT: 15
26206 PT	CHR: 12, 35, 37; DT: 1, 8, 12; JEE: 5	26281 PT	FO: 32	26369 PT	DT: 41; VWT: 15
26207 PT	FO: 30, 32; FOT: 15; MZT: 17, 18	26282 PT	HY: 19; HYT: 4; KIA: 16	26370 PT	NI: 21; NIT: 9, 12; SZT: 10
26208 PT	CHR: 62, 63, 64, 65, 66; DT: 31, 32, 33, 41; VWT: 15	26283 PT	CHR: 74; DT: 68	26371 PT	NI: 21; NIT: 9, 12; SZT: 10
26209 PT	CHR: 62, 63, 64, 65, 66; DT: 31, 32, 33, 41; VWT: 15	26284 PT	CHR: 70, 71; DT: 48, 50, 51; JEE: 17	26372 PT	NIT: 15, 16
26211 PT	JEE: 11, 12	26286 PT	CHR: 70, 71; DT: 48, 50, 51; JEE: 17	26373 PT	NIT: 15, 16
26212 PT	FO: 30, 32; FOT: 15, 17; MZ: 30; MZT: 17, 18, 19	26288 PT	MI: 15	26374 PT	FOT: 61
26213 PT	GMT: 49; IST: 19	26290 PT	TOT: 19	26375 PT	FOT: 61
26214 PT	GMT: 49; IST: 19; SAT: 3	26292 PT	TOT: 19	26376 PT	GM: 73, 74, 75, 76; GMT: 39, 40, 41, 42, 43; SZT: 9
26215 PT	MI: 24	26293 PT	HY: 31; HYT: 10; KIA: 23; KIT: 10	26377 PT	GM: 73, 74, 75, 76; GMT: 39, 40, 41, 42, 43; SZT: 9
26216 PT	DT: 57, 58, 59, 60	26294 PT	HY: 31; HYT: 10; KIA: 23; KIT: 10	26378 PT	GM: 14
26217 PT	FO: 51; FOT: 36	26295 PT	TO: 37	26379 PT	GM: 13
26218 PT	DT: 57, 58, 59, 60	26296 PT	TO: 37	26380 PT	GM: 94; GMT: 55
26219 PT	FOT: 20; NIT: 7, 8	26297 PT	TO: 29, 31	26381 PT	GM: 94; GMT: 55
26220 PT	KIT: 2	26298 PT	TOT: 23, 24	26382 PT	BMW: 7, 8
26221 PT	KIA: 10	26299 PT	TOT: 23, 24	26383 PT	NI: 20
26222 PT	FO: 53; PNZ: 2	26300 PT	AV: 1; FO: 50; FOT: 32, 33; LRT: 10; MZT: 27	26384 PT	NI: 20
26223 PT	GM: 37, 38, 39; GMT: 10	26301 PT	AV: 1; FO: 50; FOT: 32, 33; LRT: 10; MZT: 27	26385 PT	DAE: 1
26224 PT	HY: 9, 10, 11; KIA: 8, 9	26302 PT	FOT: 67	26386 PT	GMT: 21; SZT: 7
26226 PT	TOT: 23	26303 PT	FOT: 67	26387 PT	GMT: 21; SZT: 7
26227 PT	TOT: 23	26304 PT	FOT: 66	26388 PT	VW: 38, 39, 40, 41
26229 PT	DT: 35; JEE: 9; MIT: 11	26305 PT	FOT: 66	26389 PT	GMT: 26; IST: 11
26230 PT	GM: 70	26306 PT	FOT: 40, 55, 56, 58	26390 PT	GMT: 44; IST: 17
26231 PT	GM: 70	26307 PT	FOT: 40, 55, 56, 58	26391 PT	MZ: 5
26232 PT	TO: 17; TOT: 3	26308 PT	AV: 2; FO: 59	26392 PT	MZ: 5
26233 PT	FO: 30; FOT: 15, 17; MZ: 30; MZT: 18, 19	26309 PT	AV: 2; FO: 59	26393 PT	TOT: 25, 26
26234 PT	MZ: 9, 10	26312 PT	MIT: 2	26394 PT	TOT: 25, 26
26235 PT	MI: 20; MIT: 5	26313 PT	MI: 27; MIT: 12	26395 PT	SZT: 8
26236 PT	HO: 23, 24, 25, 26	26314 PT	GM: 69; GMT: 36, 37	26396 PT	SZT: 8
26237 PT	FOT: 38	26315 PT	KIA: 1, 4	26397 PT	HO: 30, 31, 32, 33
26238 PT	FOT: 38	26316 PT	FO: 17	26399 PT	HO: 38, 40
26239 PT	NI: 21; NIT: 9	26317 PT	DAE: 2, 3; GM: 31; IST: 4; SZ: 8	26401 PT	GMT: 93, 94, 95, 96, 97, 98, 99
26240 PT	NI: 21; NIT: 9	26318 PT	AUD: 9, 10, 11; VW: 27	26402 PT	GMT: 93, 94, 95, 96, 97, 98, 99
26241 PT	NIT: 9	26319 PT	DT: 16, 17; FRT: 1	26403 PT	HO: 39
26242 PT	NIT: 9	26320 PT	HO: 5, 6, 7, 9, 10, 15	26404 PT	HO: 41
26243 PT	HO: 56; HOT: 6	26321 PT	LOT: 5, 6; TO: 33, 34, 35; TOT: 17, 18	26405 PT	GMT: 93, 94, 95, 96, 97, 98, 99
26244 PT	HOT: 5	26322 PT	LOT: 5, 6; TO: 33, 34, 35; TOT: 17, 18	26406 PT	GMT: 93, 94, 95, 96, 97, 98, 99
26245 PT	BMW: 13, 14, 16, 17; BMT: 1, 2	26323 PT	GM: 44; TO: 17, 18; TOT: 3	26407 PT	MZ: 22; MZT: 8
26248 PT	FO: 32; JAG: 2	26324 PT	GM: 71, 72, 83, 84, 85, 86; GMT: 38, 47, 48	26408 PT	HO: 48
26249 PT	FO: 32; JAG: 2	26325 PT	GM: 71, 72, 83, 84, 85, 86; GMT: 38, 47, 48	26409 PT	MZ: 17, 21
26250 PT	FO: 11, 17; FOT: 2, 4, 5, 6; MZ: 17, 21; MZT: 5, 6, 7	26326 PT	JEE: 10	26410 PT	MIT: 8
26252 PT	BMW: 12, 13, 16	26327 PT	JEE: 10	26411 PT	HO: 49
26255 PT	NI: 3	26328 PT	AUD: 24, 25; VW: 42, 43, 44	26412 PT	HO: 62
26256 PT	VOL: 15, 16, 18, 19, 21, 23, 24, 25, 26, 27, 28; VOT: 1	26329 PT	HO: 74	26413 PT	HO: 61
26258 PT	TO: 3, 4	26330 PT	TOT: 19	26414 PT	HY: 32; HYT: 11; KIA: 24; KIT: 11
26259 PT	SB: 12, 13, 15; SBT: 1, 3	26331 PT	TOT: 19	26415 PT	SAB: 17, 18; SB: 8, 9, 10, 12, 13, 15, 16, 17, 18; SBT: 1, 3, 4, 5, 6
26260 PT	HO: 65, 71, 72; HOT: 15, 16, 17	26332 PT	CHR: 28, 29, 31; DT: 4, 5; JEE: 3, 4	26416 PT	HY: 32, 33; HYT: 11; KIA: 24; KIT: 11
26261 PT	NI: 10; NIT: 5	26333 PT	HY: 21, 24; HYT: 6; KIA: 17, 20; KIT: 6	26417 PT	IST: 16
26262 PT	TO: 38	26334 PT	HO: 66, 67, 68	26418 PT	IST: 16
26263 PT	TO: 38	26335 PT	GMT: 22; IST: 9	26419 PT	TO: 21
26264 PT	BMW: 12, 16	26336 PT	GMT: 34; IST: 15	26420 PT	HY: 32, 33; HYT: 11; KIA: 24; KIT: 11
26265 PT	GMT: 35; HO: 73; HOT: 18, 19, 21, 22, 25	26337 PT	HO: 55, 57; HOT: 7, 9	26421 PT	TO: 21
26266 PT	TO: 32; TOT: 14, 15	26338 PT	NI: 4, 6; NIT: 2	26422 PT	HY: 29; HYT: 8
26267 PT	TO: 32; TOT: 14, 15	26339 PT	BMW: 26	26423 PT	CHR: 69, 72; DT: 49, 52, 53; JEE: 18
26269 PT-1	GMT: 93, 94, 95, 96, 99	26340 PT	HYT: 7	26424 PT	HY: 29; HYT: 8
26270 PT-1	GMT: 93, 94, 95, 96, 99	26341 PT	HYT: 7	26426 PT	CHR: 69, 72; DT: 49, 52, 53; JEE: 18
26271 PT-1	GMT: 93, 94, 95, 96, 99	26342 PT	BMW: 26	26427 PT	HY: 29, 30; HYT: 8, 9; KIT: 8, 9
26272 PT-1	GMT: 93, 94, 95, 96, 99	26343 PT	BMW: 26	26428 PT	SAB: 3, 4, 13, 14, 15
26273 PT-1	GMT: 93, 94, 95, 96, 99	26344 PT	BMW: 26	26429 PT	HY: 29, 30; HYT: 8, 9; KIT: 8, 9
		26345 PT	BMW: 28; BMT: 6; LRT: 13	26431 PT	SAB: 2, 3, 4, 15
		26346 PT	BMW: 28; BMT: 6; LRT: 13	26432 PT	KIA: 10
		26355 PT	BMW: 28		
		26356 PT	BMW: 28		
		26357 PT	TOT: 10		
		26360 PT	CHR: 7, 23, 24; JEE: 1, 2		

NUMERICAL LIST

26433 PT	CHR: 56, 57; MB: 24, 25, 26, 27, 28, 29, 30, 31; MBT: 1	26546 PT	FO: 31; FOT: 16, 17; MZT: 19, 20	26638 PT	HO: 1
26434 PT	CHR: 56, 57; MB: 24, 25, 26, 27, 28, 29, 30, 31; MBT: 1	26547 PT	AUD: 9, 10, 11, 12, 13, 14, 15, 16, 17; AUT: 1; VW: 27, 28, 29; VWT: 2, 3	26639 PT	VOL: 28, 30; VOT: 1
26435 PT	HO: 58, 59, 60; HOT: 8, 10, 11	26550 PT	FO: 64; FOT: 47	26640 PT	VOL: 29, 32
26437 PT	HYT: 7; KIA: 22	26551 PT	FO: 64; FOT: 47	26641 PT	VOL: 1, 2, 3
26438 PT	KIA: 5	26552 PT	FO: 65	26642 PT	NI: 28; NIT: 13
26439 PT	HYT: 7; KIA: 22	26553 PT	FO: 65	26643 PT	VW: 25
26442 PT	VW: 20, 22, 23, 24	26554 PT	HY: 6; KIA: 2, 3	26644 PT	VW: 25
26443 PT	VW: 20, 22	26555 PT	CHR: 7, 23, 24, 28, 29, 31; DT: 4, 5; JEE: 1, 2, 3, 4; MI: 12, 19; MIT: 1, 4	26645 PT	VW: 25
26444 PT	VW: 21	26562 PT	TO: 19; TOT: 8	26646 PT	MB: 3, 4, 5, 6
26445 PT	VW: 20, 22	26563 PT	TOT: 20	26647 PT	MB: 37
26446 PT	VW: 21	26564 PT	TOT: 20	26648 PT	AUD: 39, 40; POT: 3, 4; VW: 50, 51; VWT: 11, 12
26447 PT	MI: 13	26565 PT	FOT: 64	26649 PT	SAB: 19
26449 PT	MI: 12; MIT: 1	26573 PT	MB: 2	26650 PT	MB: 1
26453 PT	BMW: 1, 3	26574 PT	VOL: 35; VOT: 2	26651 PT	LRT: 3, 4, 5, 6, 11
26454 PT	BMW: 2, 4	26575 PT	NI: 16, 17	26652 PT	LRT: 1
26455 PT	AUD: 9, 10, 11; AUT: 1; VW: 27; VWT: 1	26576 PT	VOL: 34, 37	26653 PT	MB: 4
26457 PT	BMW: 2, 4	26577 PT	VOL: 33	26654 PT	VOL: 33
26458 PT	BMW: 1, 3	26578 PT	VOL: 34, 36, 37, 38	26656 PT	BMW: 21; BMT: 5
26465 PT	CHR: 30, 32	26579 PT	MB: 3, 5, 6	26659 PT	NI: 10
26466 PT	GM: 40, 45, 46, 47, 48, 50; GMT: 9, 11, 13, 14, 15, 16	26580 PT	BMW: 25	26667 PT	TO: 20
26482 PT	FO: 54, 55, 56; FOT: 37, 38, 51, 52, 54	26581 PT	SB: 23	30060	GMT: 100, 101, 102; WRK: 3
26483 PT	FO: 54, 55, 56; FOT: 37, 38, 51, 52, 54	26582 PT	TOT: 22	35003	CHR: 16, 19, 20, 26; MI: 9, 10, 16, 17; MIT: 2
26484 PT	MI: 19; MIT: 4	26583 PT	VOL: 1, 2	35005	HO: 48, 49, 54
26487 PT	FO: 38, 39, 40, 41; FOT: 21, 22, 23, 24; MZT: 23	26584 PT	SAB: 7, 8	35009	HO: 7, 10
26488 PT	FO: 38, 39, 40, 41; FOT: 21, 22, 23, 24; MZT: 23	26585 PT	BMW: 10	35010	NI: 8
26489 PT	GM: 64	26586 PT	NI: 28; NIT: 13	35014	JEE: 19
26500 PT	CHR: 13, 14	26601 PT	HO: 37, 50	35024	DT: 13; JEE: 6, 7, 11, 12
26501 PT	CHR: 10, 11; MI: 6, 7	26602 PT	LRT: 2; VOL: 40; VOT: 4	35026	VW: 18, 26
26502 PT	CHR: 37; DT: 8	26603 PT	VOL: 39; VOT: 3	35039	FOT: 72
26505 PT	FO: 46, 48; FOT: 29, 30, 34	26604 PT	FOT: 64	35041	FOT: 72
26506 PT	FO: 46, 48; FOT: 29, 30, 34	26606 PT	BMW: 20, 23	35041 T	FOT: 72
26509 PT	HO: 75, 76, 77, 78; HOT: 20, 23, 24, 25, 26, 27	26607 PT	AUD: 22, 23; AUT: 2, 3	35044	FOT: 72
26510 PT	HO: 75, 76, 77, 78; HOT: 20, 23, 24, 25, 26, 27	26608 PT	AUD: 28, 29	35062	AMG: 2; AV: 3, 4, 5; GM: 88, 97, 98, 102, 103; GMT: 50, 51, 52, 59, 73, 100; IST: 25
26511 PT	NI: 21, 22, 23; NIT: 9, 10	26609 PT	VOL: 41; VOT: 5	35064	DT: 39, 40, 45, 46, 47, 61, 62, 63, 64; JEE: 16, 20
26512 PT	NI: 21, 22, 23; NIT: 9, 10	26610 PT	DT: 30; FRT: 4; MB: 38, 39, 40, 41, 42, 43, 44, 45, 46, 47, 48; MBT: 2, 3, 4, 5, 6	35072	EXC: 1; GM: 89, 104, 105
26513 PT	GM: 24	26611 PT	MB: 58, 59, 60, 61; MBT: 8, 9, 10	35084	HY: 14, 18, 20
26515 PT	GM: 24; TO: 11, 12	26612 PT	MB: 53, 54, 55, 56, 57; MBT: 7	35087	GM: 26, 27, 28
26516 PT	GM: 15, 16, 23	26613 PT	MB: 78, 79, 80, 81, 82, 83, 84, 85; MBT: 16, 17	35090	GM: 26, 27, 28
26517 PT	GM: 49; GMT: 17, 18	26614 PT	GM: 55	35114	FO: 18, 19, 20, 27; FOT: 7; MZT: 9
26519 PT	NI: 10, 11; NIT: 5	26615 PT	AUD: 50, 51, 52, 53, 54, 55; AUT: 18; VW: 52, 53; VWT: 17, 18, 19	35114 T	FO: 18, 19, 20, 27; FOT: 7; MZT: 9
26520 PT	NIT: 5; SZT: 6	26616 PT	AUD: 41, 42, 43, 44, 45, 46, 47; AUT: 17; VWT: 16	35126	GM: 80
26521 PT	FO: 21, 22	26617 PT	AUD: 56	35130	JEE: 19
26522 PT	FO: 21, 22; FOT: 8, 9	26618 PT	AUD: 48, 49	35131	CHR: 10, 11, 12, 13, 14; DT: 1; MI: 6, 7
26524 PT	SBT: 7, 8	26619 PT	MB: 21, 22, 23	35162	GMT: 35; HO: 49, 65, 66, 67, 68, 69, 70, 71, 72, 73, 74, 75, 76, 77, 78, 79, 80, 81; HOT: 15, 16, 17, 18, 19, 20, 21, 22, 23, 24, 25, 26, 27, 29, 30
26525 PT	SBT: 7, 8	26620 PT	BMW: 29; BMT: 7	35167	HO: 69
26527 PT	HO: 3	26621 PT	BMW: 29; BMT: 7	35193	FOT: 68, 69, 71
26528 PT	HO: 2	26622 PT	VOL: 41; VOT: 5	35211	FO: 60, 61, 62, 63, 69
26529 PT	HO: 4, 12, 13, 14	26623 PT	DT: 30; FRT: 4; MB: 38, 39, 40, 41, 42, 43, 44, 45, 46, 47, 48; MBT: 2, 3, 4, 5, 6	35215	GM: 53
26530 PT	HO: 11	26624 PT	MB: 58, 59, 60, 61; MBT: 8, 9, 10	35217	HO: 69, 70
26531 PT	SAB: 16; SB: 12, 13, 18; SBT: 1	26625 PT	MB: 53, 54, 55, 56, 57; MBT: 7	35224	CHR: 25, 40, 41, 42; DT: 13, 14, 15
26532 PT	LRT: 3, 4, 5, 7, 8, 9, 11, 12, 14; MOR: 2	26626 PT	MB: 78, 79, 80, 81, 82, 83, 84, 85; MBT: 16, 17	35225	CHR: 1, 2, 3, 4; HY: 1, 2; MI: 1, 2
26533 PT	SB: 22	26627 PT	GM: 55	35226-1	CHR: 4, 17, 18, 21, 22; MI: 8, 9, 11
26534 PT	SB: 22; SBT: 9	26628 PT	AUD: 50, 51, 52, 53, 54, 55; AUT: 18; VW: 52, 53; VWT: 17, 18, 19	35228	NI: 8
26535 PT	SB: 22	26629 PT	AUD: 41, 42, 43, 44, 45, 46, 47; AUT: 17; VWT: 16	35235	GM: 9, 10, 18; TO: 5, 6, 7
26536 PT	SB: 22; SBT: 9	26630 PT	AUD: 56	35251	FO: 1, 2, 3, 4, 15, 16, 26; KIA: 1, 4, 5, 6, 7, 10, 11; KIT: 4; MZ: 2, 4, 5, 6, 7, 8, 9, 10, 11, 13, 18, 19, 20, 24; MZT: 3, 4, 14, 16
26537 PT	SAB: 5, 6; SB: 6, 7	26631 PT	AUD: 48, 49	35258	GM: 62, 66; GMT: 25, 30; IST: 10, 12
26538 PT	JAG: 1	26632 PT	MB: 21, 22, 23	35261	GM: 33, 34
26539 PT	JAG: 1	26633 PT	BMW: 29; BMT: 7	35266	MOR: 1
26540 PT	GM: 5, 6, 7, 8; GMT: 1	26634 PT	BMW: 29; BMT: 7	35268	FOT: 68, 69, 71
26541 PT	CHR: 67; DT: 34; JEE: 8; VWT: 13	26635 PT	HO: 64	35270	FOT: 68, 69, 71
26542 PT	CHR: 67; DT: 34; JEE: 8; VWT: 13	26636 PT	NI: 26	35271	AMG: 3, 4, 5; GMT: 86, 87, 88, 90, 91, 92
26543 PT	FO: 43, 44, 45; FOT: 26, 27, 28; MZ: 31; MZT: 24	26637 PT	NI: 26		
26544 PT	FO: 43, 44, 45; FOT: 26, 27, 28; MZ: 31; MZT: 24				
26545 PT	FO: 31; FOT: 16, 17; MZT: 19, 20				

35273	CHR: 15, 16, 17, 18, 21, 22, 26, 27; DT: 2, 3; HY: 14, 18, 20; MI: 8, 9, 11, 18; MIT: 3	35392	GM: 35, 36; GMT: 7, 8; GRU: 1; IST: 2, 3	35479	CHR: 5, 6; MI: 4
35278	TO: 23, 24; TOT: 4, 11	35393	GM: 35; GMT: 7; GRU: 1; IST: 2	35480	HO: 2, 4, 7, 8, 10, 12, 13, 14, 17, 18, 19, 20, 21, 22, 27, 28, 29, 34, 35, 43, 44, 45, 46, 47, 51, 52, 53, 54; HOT: 1, 2, 3, 4; IST: 1, 5
35282	FO: 6, 7, 28, 29	35395	SB: 1	35482	HO: 51, 52, 53; HOT: 4; IST: 5
35284	FO: 6, 7, 8	35397	FOT: 44, 46, 59, 60; LAF: 1; WIN: 2	35483	NI: 14, 15, 16, 17
35286	CHR: 25, 37, 40, 41, 42, 59, 60, 61, 62, 68; DT: 8, 13, 14, 15, 22, 23, 24, 25, 26, 27, 28, 36, 37, 38; VWT: 14	35399	CHR: 51, 52, 53; DT: 18, 19; HY: 28; MI: 24; MIT: 6	35484	TOT: 21
35286 T	CHR: 25, 37, 40, 41, 42, 59, 60, 61, 62, 68; DT: 8, 13, 14, 15, 22, 23, 24, 25, 26, 27, 28, 36, 37, 38; VWT: 14	35400	FOT: 12	35485	FO: 33, 37
35289	GMT: 86, 87, 88, 90, 91, 92	35403	GM: 60, 61, 62, 63, 66, 67, 69; GMT: 30, 31, 32, 33, 36, 37	35488	TO: 13, 15; TOT: 1
35291	KIT: 4	35404	FO: 6, 8; FOT: 1, 12, 31; MZT: 1, 25, 26	35489	AV: 2; DET: 1; FO: 24, 25, 28, 29, 30, 31, 32, 38, 39, 40, 41, 43, 44, 51, 52, 53, 54, 55, 56, 57, 58, 59; FOT: 15, 16, 17, 21, 22, 23, 24, 26, 27, 35, 36, 37, 38, 39, 40, 48, 49, 50, 51, 52, 53, 54, 55, 56, 58, 66, 67; JAG: 2; MZ: 30, 31; MZT: 12, 17, 18, 19, 20, 23, 24; PNZ: 1, 2
35292	GM: 9, 10, 18; TO: 1, 2, 5, 6, 7, 13, 15, 16; TOT: 1	35409	GM: 62, 68; GMT: 25; IST: 10, 12	35490	GMT: 19, 20; GRU: 2, 3
35294	TO: 13, 14, 15, 16; TOT: 1	35410	DAE: 1; GM: 17	35491	TOT: 21
35298-1	PEU: 1; SB: 3, 4, 21	35411	DAE: 1; GM: 13, 14, 17	35492	TOT: 6, 7
35299	GM: 53	35413	GM: 52	35493	TOT: 6, 7
35302	DAE: 2, 3; GM: 31, 33, 34; IST: 4; SZ: 8	35414	FO: 46, 47; FOT: 29	35494	TOT: 21
35307	TOT: 21	35415	FOT: 13, 14, 20; NI: 14, 15, 16, 17, 18, 19; NIT: 6, 7	35495	CHR: 47, 48, 49, 50; MI: 22, 23
35312	FOT: 13, 14, 20; NI: 19; NIT: 6, 7, 8	35416	GMT: 3; SZT: 1, 3	35496	NI: 1
35313	CHR: 47, 48, 49, 50; MI: 22, 23	35423	HO: 36, 42	35497	FOT: 13, 14, 20; NI: 18, 19; NIT: 6, 7
35315	HO: 36, 42; STE: 1	35424	HO: 5, 6, 9, 15	35498	HO: 5, 6, 7, 9, 10, 15
35326	BMW: 15	35426	VOL: 4, 5, 6, 7, 8, 9, 10	35499	CHR: 58, 62, 63, 64, 65, 66; DT: 31, 41; GM: 91, 92, 93, 95; HO: 21, 28, 29, 34, 35; HOT: 1, 2; VWT: 15
35327	AUD: 18, 19, 20, 21, 24, 25; BMW: 15; FOT: 32; VW: 42, 43, 44; VWT: 4	35427	GM: 41, 42, 43; GMT: 12	35500	TO: 14
35336	CHR: 1, 2, 3, 4, 5, 6, 8, 15, 16, 17, 18, 21, 22, 26, 27, 47, 48, 49, 50, 51, 52, 53; DT: 2, 3, 18, 19; HY: 1, 2, 8, 28; MI: 1, 2, 3, 4, 8, 9, 11, 17, 18, 22, 23, 24, 25; MIT: 3, 6, 7	35431	FO: 46, 48; FOT: 29, 30, 34	35501	MZ: 25, 26, 27, 28, 29; MZT: 15, 16
35337	GM: 9; TO: 6	35432	GMT: 2; SZ: 5; SZT: 2	35502	NI: 9
35340	TOT: 4	35434	BMW: 25	35503	NI: 7
35343	SB: 3, 4, 21	35435	GM: 33, 34	35508	HO: 36, 42
35345	GM: 90, 96	35436	MZ: 28, 29; MZT: 15, 16	35509	NI: 7
35346	ACO: 1, 2; GM: 29, 30, 32, 37, 38, 39, 40, 45, 46, 47, 48, 49, 50, 87, 90, 92, 93, 96; GMT: 5, 6, 9, 10, 11, 13, 14, 15, 16, 17, 18, 53	35437	MZ: 28, 29; MZT: 15, 16	35510	NI: 7
35351	GM: 65, 77, 78, 79, 80, 81, 82; GMT: 45	35439	MZ: 25, 26, 27, 28, 29; MZT: 15, 16	35511	NI: 8
35352	FO: 61, 63; FOT: 45; LAF: 1, 2	35440	FO: 60, 61, 62, 63, 69; FOT: 44, 45, 46, 59, 60; LAF: 1, 2; WIN: 2	35518	GM: 52
35355	FOT: 41, 42, 43	35441	MZT: 14	35519	TO: 25; TOT: 11, 16
35357	AMG: 3, 4, 5; GMT: 86, 87, 88, 89, 90, 91, 92; WRK: 2	35442	MZT: 14	35520	CHR: 38, 39, 47, 48, 49, 50, 54; MI: 21, 22, 23, 25, 26; MIT: 7; TOT: 5, 9
35359	MOR: 1	35444	CHR: 25, 40, 41, 42; DT: 13, 14, 15	35523	DT: 2, 3; MIT: 3
35360	MOR: 1	35445	GM: 19, 20, 21, 24, 44; LOT: 2, 3, 4, 5, 6; NI: 2, 4, 5, 6, 10, 11; NIT: 2, 5; SZT: 6; TO: 3, 4, 8, 9, 30, 31, 32, 33, 34, 35, 36; TOT: 2, 3, 5, 6, 7, 9, 10, 12, 13, 14, 15, 16, 17, 18	35524	CHR: 8, 9, 16, 19, 20, 26; MI: 1, 5, 9, 10, 15, 16, 17; MIT: 2; SAB: 5, 6, 16, 17, 18; SB: 5, 6, 7, 8, 9, 10, 11, 12, 13, 14, 15, 16, 17, 18, 22, 24; SBT: 1, 2, 3, 4, 5, 6, 9, 10
35361	MOR: 1	35446	CHR: 59, 60, 61, 68; DT: 22, 24, 26, 27, 28, 37	35525	DT: 54, 55, 56, 57, 58, 59, 60, 65, 66
35362	FO: 19, 20, 27	35448	GM: 65	35526	DT: 54, 55
35364	GM: 11, 12; HOT: 12; IS: 1, 2, 3; IST: 6, 7, 8; LOT: 1	35449	TO: 22	35533	GM: 52, 53; NI: 10; NIT: 5
35365	CHR: 11; GM: 1, 2, 3, 4; MI: 6, 7; SZ: 1, 2, 3, 4	35450	NI: 1	35534	GM: 77, 82; GMT: 45
35366	GM: 1, 2, 3, 4; GMT: 2, 3; SZ: 1, 2, 3, 4, 5; SZT: 1, 2, 3	35451	GM: 1, 2, 3, 4; GMT: 2; SZ: 1, 3, 4, 5; SZT: 2	35535	HO: 34, 35
35367	NIT: 6	35452	GM: 11; IS: 1, 2; LOT: 1	35538	NI: 27
35368	FOT: 13, 14, 20; HY: 17, 21, 22, 23; HYT: 3, 5; KIA: 14, 17, 18, 19; KIT: 5; NIT: 6, 7, 8	35454	GM: 11, 12, 25; IS: 1, 2, 3, 4; LOT: 1	35540	DT: 39, 45, 46, 47, 61, 63; JEE: 16, 20
35369	NI: 19; NIT: 6, 7, 8	35455	GM: 12; IS: 3	35542	SAB: 1, 2
35371	HO: 5, 6, 7, 9, 10, 15	35456	FO: 1, 2, 3, 4; KIA: 5, 6, 7, 11; MZ: 2, 4, 5, 6, 7, 8, 9, 10, 11, 13	35543	GMT: 19, 20; GRU: 2, 3
35372	HO: 63; STE: 1	35457	FO: 1, 2, 3, 4; KIA: 5, 6, 7, 10, 11; KIT: 4; MZ: 2, 4, 5, 6, 7, 8, 9, 10, 11, 13	35546	SAB: 1, 2
35377	FO: 34, 35, 36; FOT: 18	35458	FO: 15, 16; KIT: 2; MZ: 18, 19; MZT: 3, 4	35549	BMW: 25
35379	FO: 34, 35, 36; FOT: 18, 19; MZT: 21, 22	35459	FO: 47	35549	AUD: 1, 2, 3, 4, 5, 6, 7, 8; VW: 4, 6, 7, 8, 9, 10, 12, 14, 15, 16, 17, 18, 19, 26, 30
35380	FO: 61, 62, 63, 69; FOT: 44, 45, 46, 59, 60; LAF: 1; WIN: 2	35460	FO: 36	35550	BMW: 15
35381	FO: 18; FOT: 7; MZT: 9	35465	NI: 8; NIT: 3, 4	35551	CHR: 8, 9; MI: 5
35384	CHR: 55	35466	NI: 8; NIT: 3, 4	35552	TO: 36
35385	TO: 23, 24	35468	CHR: 51, 52, 53; DT: 18, 19; HY: 28; MI: 24; MIT: 6	35554	CHR: 8, 9; MI: 5
35386	TO: 1, 2	35469	HO: 43, 44, 45, 46, 47, 48, 49, 51, 52, 53, 54; HOT: 3, 4; IST: 1, 5	35555	CHR: 38, 39, 54; HY: 26, 31; HYT: 7, 10; KIA: 22, 23; KIT: 7, 10; MZ: 25, 26, 27, 28, 29; MZT: 15, 16; MI: 21, 22, 23, 25; MIT: 7; TO: 36, 37, 38; TOT: 23, 24
35387	HOT: 12; IST: 6, 7, 8	35471	NI: 9; NIT: 4	35558	FO: 19, 20, 27
35388	GM: 90, 96	35474	AV: 1; FO: 50; FOT: 31, 32, 33; LRT: 10; MZT: 25, 26, 27	35559	GM: 25; IS: 4
35390	FO: 46, 48; FOT: 18, 19, 29, 30, 34; MZT: 21, 22	35475	FO: 60, 62	35560	GM: 35, 36; GMT: 7; GRU: 1; IST: 2
35390 T	FO: 46, 48; FOT: 18, 19, 29, 30, 34; MZT: 21, 22	35476	NI: 1	35562 T	AMG: 2; AV: 3, 4, 5; GM: 88, 97, 98, 102, 103; GMT: 50, 51, 52, 59, 73, 100; IST: 25
		35477	FO: 5, 9		
		35478	AV: 2; DET: 1; FO: 51, 52, 53, 54, 55, 56, 57, 58, 59, 64, 65; FOT: 35, 36, 37, 38, 39, 40, 47, 48, 49, 50, 51, 52, 53, 54, 55, 56, 58, 66, 67; PNZ: 1, 2		

NUMERICAL LIST

35565 MI: 22, 23	35635 AV: 6; CAL: 1; GM: 100, 101, 106, 107, 108, 109, 110, 111; GMT: 56, 57, 58, 61, 62, 63, 64, 65, 66, 67, 68, 69, 70, 71, 72, 75, 76, 77, 78, 79, 80, 81, 82, 83, 84, 85; IST: 22, 23; MOS: 1; SAT: 4, 5	35704 GMT: 22, 26, 34, 44, 49; IST: 9, 11, 15, 17, 19; SAT: 3
35566 TO: 25	35636 GM: 100	35705 AUD: 6; VW: 7, 9, 32, 33
35567 FO: 4	35639 DT: 55, 56, 57, 58, 60	35706 FO: 46
35568 GM: 52, 53; GMT: 19, 20; GRU: 2, 3	35640 FO: 32; FOT: 15; MZT: 18	35707 FO: 6, 8
35569 FO: 10; MZ: 12, 14, 15	35641 DT: 67	35708 FOT: 29, 34
35570 FO: 10; MZ: 12, 14, 15	35642 TOT: 5	35709 KIT: 2
35571 GM: 62, 63; GMT: 30; IST: 12	35643 TOT: 5, 9, 10	35710 AMG: 1, 2, 4, 5; EXC: 1; GM: 88, 89, 104, 105; GMT: 50, 51, 53, 54, 59, 60, 73, 74, 88, 89, 90, 92; IST: 20, 21, 24, 25; WRK: 1, 2
35578 FO: 26; MZ: 24	35644 TOT: 5, 9	35711 KIT: 2
35582 DT: 13; JEE: 6, 7, 11, 12	35645 TO: 15, 16	35712 KIT: 2
35584 CHR: 38, 39, 54; MI: 21, 24, 25, 26, 27; MIT: 7, 9, 10, 12	35646 TOT: 16	35713 KIA: 10
35585 CHR: 11; MI: 6, 7	35647 DT: 67	35714 KIA: 10
35586 CHR: 10, 11, 12, 13, 14, 33, 34, 35, 36, 37; DT: 1, 6, 7, 8, 9, 10, 11, 12, 22, 23, 24, 25, 28, 29, 36, 37, 38; JEE: 5; MI: 6, 7; VWT: 14	35648 TO: 26, 27; TOT: 12, 13	35715 NIT: 7, 8
35587 CHR: 33, 34, 35, 36, 37; DT: 6, 7, 8, 9, 10, 11, 12; JEE: 5	35649 TO: 26, 27; TOT: 12, 13	35716 AUD: 2, 3, 4; VW: 4, 5, 8, 11, 12, 13
35588 CHR: 10, 11, 12, 13, 14, 33, 34, 35, 36, 37; DT: 1, 6, 7, 8, 9, 10, 11, 12; MI: 6, 7	35650 CHR: 38	35717 FO: 6, 7, 8; GM: 21; LOT: 2, 3, 4; TO: 10
35589 CHR: 26, 38, 39, 54; MI: 17, 21, 25; MIT: 2	35651 DT: 8, 22, 23, 24, 25, 28, 29, 31, 36, 37, 38; JEE: 10; VWT: 14	35718 TO: 36, 37, 38; TOT: 16, 23, 24
35590 HOT: 14; IST: 13, 14	35652 CHR: 44, 45, 46	35719 HY: 3, 9, 10
35591 HOT: 14; IST: 13, 14	35653 VW: 30, 31, 32, 33, 34, 35, 36, 37	35720 AV: 6; GM: 99, 100, 101, 106, 107, 108, 109, 110, 111; GMT: 56, 57, 58, 61, 62, 63, 64, 65, 66, 67, 68, 69, 70, 71, 72, 75, 76, 77, 78, 79, 80, 81, 82, 83, 84, 85; IST: 22, 23; MOS: 1; SAT: 4, 5
35592 GM: 10, 18; TO: 5, 7	35654 GM: 25; IS: 4; TO: 22, 26, 27, 32; TOT: 12, 13, 14, 15, 19, 20	35721 GM: 29, 30, 32, 37, 38, 39, 40, 45, 46, 47, 48, 49, 50; GMT: 5, 6, 9, 10, 11, 13, 14, 15, 16, 17, 18
35593 HOT: 13, 14, 28; IST: 13, 14, 16	35655 DT: 35, 42, 43, 44; JEE: 9, 13, 14, 15; MIT: 11, 13, 14	35722 GM: 70
35594 TO: 26, 27, 32; TOT: 12, 13, 14, 15	35656 ACO: 1, 2; GM: 87, 91, 92, 93, 95	35723 GM: 70
35595 GM: 77, 81; GMT: 54	35658 ACO: 1; GM: 87, 92, 93	35724 GM: 29, 30, 32, 37, 38, 39, 40, 45, 46, 47, 48, 49, 50; GMT: 5, 6, 9, 10, 11, 13, 14, 15, 16, 17, 18
35597 GM: 41, 42, 43, 51; GMT: 12	35659 ACO: 1, 2; GM: 87, 91, 92, 93, 95	35725 GM: 38, 39, 91, 92, 93, 95
35598 GMT: 7; GRU: 1; IST: 2	35660 CHR: 44, 45, 46; GM: 94; GMT: 55	35726 GM: 70
35599 HOT: 14; IST: 13, 14	35661 FO: 9	35727 HY: 9, 10, 11; KIA: 8, 9
35602 TOT: 16	35662 NI: 8	35728 TOT: 16, 23, 24
35603 CHR: 51, 52, 53; DT: 18, 19; HY: 28; MI: 24; MIT: 6	35663 FO: 24, 25, 28, 29, 32; FOT: 15; JAG: 1, 2; MZ: 30; MZT: 12, 17, 18	35729 GM: 44; TO: 4, 17, 18; TOT: 2, 3
35606 FO: 6, 7, 8	35664 GMT: 103; WRK: 4	35730 HY: 9, 10, 11; KIA: 8, 9
35607 FO: 5, 9	35665 GM: 54, 56, 64; GMT: 27; SAB: 22, 23	35731 HO: 48, 49, 63
35608 FO: 1, 4, 46; GM: 80; KIA: 6, 7, 11; MZ: 2, 4, 6, 7, 8, 9, 10, 11, 13	35666 GM: 65, 77, 78, 79, 81, 82; GMT: 45, 54	35734 HO: 3, 11, 23, 24, 25, 26, 30, 31, 32, 33
35610-1 FOT: 70	35667 CHR: 54; MI: 25, 26, 27; MIT: 8, 10, 12	35737 MI: 14, 20; MIT: 5
35612 FOT: 70	35668 GM: 56; GMT: 27	35738 HO: 39, 55, 56, 57, 58, 59, 60; HOT: 5, 6, 7, 8, 9, 10, 11
35613 GMT: 7, 8; IST: 2, 3	35669 GM: 56; SAB: 22, 23	35739 HO: 38, 39, 40, 41, 55, 56, 57, 58, 59, 60; HOT: 6, 7, 8, 9, 10, 11
35614 GM: 35, 41, 42, 51, 60, 61, 62, 63, 66, 67, 68, 69, 71, 72, 83, 84, 85, 86; GMT: 7, 8, 12, 30, 31, 32, 33, 36, 37, 38, 47, 48, 100, 101, 102, 103; GRU: 1; IST: 2, 3, 12; WRK: 3, 4	35671 HY: 12, 15; HYT: 1; KIA: 12; KIT: 1	35740 HO: 38, 39, 40; HOT: 5
35615 HOT: 13, 28; IST: 13, 16	35672 GM: 19, 20; TO: 8, 9	35741 HO: 38, 39, 40, 41, 55, 56, 57, 58, 59, 60, 78; HOT: 5, 6, 7, 8, 9, 10, 11, 26
35617 AV: 1; FO: 50; FOT: 32, 33; LRT: 10; MZT: 27	35673 AV: 1; FO: 50; FOT: 32, 33; LRT: 10; MZT: 27	35742 FO: 32; JAG: 1, 2
35619 FO: 6, 7, 8; FOT: 1; MZT: 1	35674 HY: 4, 5	35743 TO: 3, 4
35620 NI: 12, 20, 21, 22, 23, 24, 25; NIT: 9, 10, 11, 12; SZT: 10	35675 AUD: 7, 8, 9, 10, 11; VW: 5, 10, 11, 13, 27, 31, 32, 33, 34, 35, 36, 37	35744 AUD: 7, 8; VW: 10, 32
35621 NI: 20; NIT: 9, 12; SZT: 10	35676 VOL: 11, 12, 13, 14, 15, 16, 17, 18, 19, 20, 21, 22, 23, 24, 25, 26, 27, 28, 29, 30, 32; VOT: 1	35745 NI: 3
35622 NI: 12, 20, 21, 22, 23, 24, 25; NIT: 9, 10, 11, 12, 14; SZT: 10	35677 GMT: 35; HO: 65, 66, 67, 68, 71, 72, 73, 74, 75, 76, 77, 78, 80, 81; HOT: 15, 16, 17, 18, 19, 20, 21, 22, 23, 24, 25, 26, 27, 29, 30	35746 NI: 3
35624 FO: 9	35678 JEE: 5	35747 SAB: 5, 6, 16, 17, 18; SB: 5, 6, 7, 8, 9, 10, 11, 12, 13, 14, 15, 16, 17, 18; SBT: 1, 2, 3, 4, 5, 6
35625 FOT: 11; MZT: 13	35679 MIT: 10, 12	35748 NI: 3
35626-1 HO: 22, 27	35680 MIT: 7, 10	35749 GM: 54, 56, 64; GMT: 27
35627 HO: 8, 17, 18, 19, 20, 23, 24, 25, 26	35681 CHR: 12, 13, 14, 33, 34, 35, 36, 37; DT: 1, 6, 7, 8, 9, 10, 11, 12	35750 AUD: 7, 8; VW: 10
35628 HY: 12, 15; HYT: 1; KIA: 12; KIT: 1	35682 MI: 1	35751 FO: 32; JAG: 1, 2
35629 DT: 13; JEE: 6, 7, 11, 12	35688 MI: 1	35752 NI: 10, 11; NIT: 5
35630 DT: 13; JEE: 6, 7, 11, 12	35690 MI: 5, 15	35753 NI: 10, 11; NIT: 5
35631 CHR: 58, 62, 63, 64, 65, 66; DT: 31, 32, 33, 37	35691 DT: 22, 23, 24, 25, 28, 29, 36, 37, 38; VWT: 14	35754 NI: 10, 11; NIT: 5
35632 AV: 6; CAL: 1; GM: 100, 101; GMT: 22, 26, 34, 44, 49, 57, 67, 68, 69, 78, 80; IST: 9, 11, 15, 17, 19, 23; MOS: 1; SAT: 3	35692 DT: 35, 42, 43, 44; JEE: 9, 13, 14, 15; MIT: 11, 13, 14	35755 NI: 10, 11; NIT: 5
35633 AV: 6; CAL: 1; GM: 99, 100, 101, 106, 107, 108, 109, 110, 111; GMT: 56, 57, 58, 61, 62, 63, 64, 65, 66, 67, 68, 69, 70, 71, 72, 75, 76, 77, 78, 79, 80, 81, 82, 83, 84, 85; IST: 22, 23; MOS: 1; SAT: 4, 5	35693 MIT: 10, 12	35756 GMT: 93, 94, 95, 96, 97, 98, 99
35634 FOT: 7, 11; MZT: 9, 13	35694 MIT: 2	35757 GMT: 93, 94, 95, 96, 97, 98, 99
	35695 MIT: 7, 10	35758 GMT: 93, 94, 95, 96, 97, 98, 99
	35697 HY: 4	35759 GMT: 93, 94, 95, 96, 97, 98, 99
	35699 HY: 3, 4, 5	35760 DT: 48, 50, 51
	35700 MIT: 7, 10	35761 BMW: 12, 13, 14, 16, 17; BMT: 1, 2
	35702 FOT: 70	35762 GMT: 93, 94, 95, 96, 97, 98, 99
	35703 DT: 57, 58, 59, 60, 65, 66	

NUMERICAL LIST

35763	AUD: 18, 19, 20, 21, 22, 23, 24, 25; AUT: 2, 3; BMW: 12, 15, 16; VW: 42, 43, 44, 48	35826	CHR: 7, 23, 24, 28, 29, 30, 31, 32; DT: 4, 5; JEE: 1, 2, 3, 4	35895	MIT: 8
35764	HY: 19, 25, 26, 27, 31; HYT: 7, 10; KIA: 16, 21, 22, 23; KIT: 7, 10	35827	HY: 9, 11; KIA: 8, 9	35896	HY: 29, 30, 32, 33; HYT: 8, 9, 11; KIA: 24; KIT: 8, 9, 11
35765	HY: 25, 26; HYT: 7; KIA: 21, 22; KIT: 7	35828	HO: 79	35897	MIT: 8
35766	GMT: 4; SZ: 7, 9; SZT: 5	35829	AUD: 22, 23, 24, 25; AUT: 2, 3; VW: 42, 43, 44	35900	HO: 61, 62
35767	LOT: 5, 6; TO: 21, 28, 33, 34, 35; TOT: 17, 18, 19, 20	35830	HY: 9, 11; KIA: 8, 9	35902	HO: 61, 62
35768	GMT: 4, 21; SZ: 7, 9; SZT: 5, 7, 8	35832	HO: 79	35903	HY: 29, 30, 32, 33; HYT: 8, 11; KIA: 24; KIT: 8, 11
35769	GMT: 4; NI: 10; NIT: 1, 5; SZ: 7, 9; SZT: 5	35833	FO: 11, 12, 13, 17, 22; FOT: 2, 9; MZ: 17, 21	35904	CHR: 43, 44, 45
35770	CHR: 43, 44, 45	35835	AV: 2; FO: 59; FOT: 40	35905	MZ: 22; MZT: 8
35771	FO: 11, 12, 13, 17, 21; FOT: 2, 4, 5, 6, 8; MZ: 17, 21; MZT: 5, 6, 7	35836	FO: 30	35906	MZ: 17, 21
35772	FO: 11, 12, 13, 14, 17, 21, 22, 23; FOT: 2, 3, 4, 5, 6, 8, 9, 10; MZ: 17, 21, 22; MZT: 5, 6, 7, 8	35837	CHR: 7, 23, 24, 28, 29, 30, 31, 32; DT: 4, 5; JEE: 1, 2, 3, 4	35907	CHR: 69, 72; DT: 49, 52, 53
35773	CHR: 74, 75; DT: 68	35838	AUD: 9, 10, 11; AUT: 1; VW: 27; VWT: 1	35908	CHR: 56, 57; MB: 24, 25, 26, 27, 28, 29, 30, 31; MBT: 1
35774	TOT: 19	35839	FO: 12, 14, 17, 21, 22; FOT: 2, 3	35909	MZ: 17
35775	CHR: 74, 75; DT: 68	35840	CHR: 69, 70, 71, 72; DT: 48, 49, 50, 51, 52, 53; JEE: 17, 18	35910	CHR: 56, 57; MB: 24, 25, 26, 27, 28, 29, 30, 31; MBT: 1
35776	FO: 11, 17; FOT: 4, 5, 6, 8, 9; MZ: 17, 21, 22, 23; MZT: 5, 6, 7, 8, 10, 11	35841	GMT: 53	35911	LRT: 3, 4, 5, 6, 7, 8, 9, 11, 12, 14; MOR: 2
35777	HY: 19; HYT: 4; KIA: 16	35842	TOT: 10	35912	MB: 24, 25, 26, 27, 28, 29, 30, 31; MBT: 1
35778	HY: 19; HYT: 4	35844	JEE: 10	35913	GM: 71, 72, 83, 85, 86; GMT: 38, 47, 48
35780	DT: 22, 23, 24, 25, 28, 36, 37, 38; VWT: 14	35845	FO: 49	35914	SAB: 2, 3, 4, 13, 14, 15
35781	TOT: 19	35846	FO: 49	35915	HY: 11; KIA: 9
35782	BMW: 12	35847	FO: 49	35916	HY: 33
35783	CHR: 70, 71, 73; JEE: 17, 18, 21, 22	35848	FO: 49	35917	HY: 27; HYT: 7; KIA: 22; KIT: 7
35785	CHR: 63, 65, 66; DT: 31, 32, 33, 41; VWT: 15	35851	NIT: 15, 16	35918	HY: 16, 22, 23, 24; HYT: 2, 3, 5, 6; KIA: 13, 14, 18, 19, 20; KIT: 3, 5, 6
35787	HY: 27, 31; HYT: 10; KIA: 23; KIT: 10	35852	GM: 99	35919	HYT: 7; KIT: 7
35788	TO: 29, 30, 31	35853	NIT: 15, 16	35920	HYT: 7; KIA: 22; KIT: 7
35789	FOT: 55, 56, 58, 67	35854	NIT: 15, 16	35921	HY: 16, 22, 23, 24; HYT: 2, 3, 5, 6; KIA: 13, 14, 18, 19, 20; KIT: 3, 5, 6
35790	TO: 29, 30, 31	35855	GM: 73, 74, 75, 76; GMT: 39, 40, 41, 42, 43; SZT: 9	35922	BMW: 1, 2, 3, 4, 5, 6
35791	FOT: 55, 56, 58, 67	35856	GM: 73, 74, 75, 76; GMT: 39, 40, 41, 42, 43; SZT: 9	35923	HY: 15; HYT: 1; KIA: 12; KIT: 1
35792	AV: 2; FO: 59; FOT: 40	35857	CHR: 73; JEE: 21, 22	35924	AUD: 9, 10, 11; AUT: 1; VW: 27; VWT: 1
35793	AV: 2; FO: 59	35858	GM: 55, 57, 58, 59, 73, 75, 76; GMT: 23, 24, 28, 29, 39; SAB: 20, 21; SAT: 1, 2	35925	HY: 15; HYT: 1; KIA: 12; KIT: 1
35794	ACO: 1, 2; GM: 87, 91, 92, 93, 95	35859	GM: 55, 57, 58, 59, 73, 74, 75, 76; GMT: 23, 24, 28, 29, 39, 40, 41, 42, 43; SAB: 20, 21; SAT: 1, 2; SZT: 9	35926	MI: 13
35796	JEE: 5	35860	GM: 94; GMT: 55	35927	HY: 21; KIA: 17
35797	KIA: 1, 4, 5	35861	DT: 22, 23, 24, 25, 28, 36, 37, 38, 41; JEE: 10; VWT: 14, 15	35928	MI: 15
35798	KIA: 1, 4	35862	DAE: 1; GM: 13, 14	35930	FO: 38, 39, 40, 41, 43, 44; FOT: 21, 22, 23, 24, 26, 27; MZ: 31; MZT: 23, 24
35799	CHR: 74, 75; DT: 68	35863	GM: 94; GMT: 55	35931	HY: 33
35801	LOT: 5, 6; TO: 21, 28, 33, 34, 35; TOT: 17, 18, 19, 20	35865	MI: 12, 19; MIT: 1, 4	35932	FO: 38, 39, 40, 41, 43, 44; FOT: 21, 22, 23, 24, 26, 27; MZ: 31; MZT: 23, 24
35802	HY: 16, 21, 22, 23, 24; HYT: 2, 3, 5, 6; KIA: 13, 14, 17, 18, 19, 20; KIT: 3, 5, 6	35866	GM: 24; TO: 11, 12	35933	HY: 29, 30, 32, 33; HYT: 8, 11; KIA: 24; KIT: 8, 11
35803	DT: 16, 17; FRT: 1	35868	HY: 29, 30, 32, 33; HYT: 8, 11; KIA: 24; KIT: 8, 11	35934	FO: 38, 39, 40, 41, 43, 44, 45; FOT: 21, 22, 23, 24, 26, 27, 28; MZ: 31; MZT: 23, 24
35804	GM: 77, 78, 79, 81	35869	NI: 12, 20, 21, 22, 23, 24, 25; NIT: 9, 10, 11	35935	HY: 32, 33; HYT: 9, 11; KIT: 9, 11
35805	DT: 16, 17; FRT: 1	35870	HY: 29, 30, 32, 33; HYT: 8, 11; KIA: 24; KIT: 8, 11	35937	GM: 15, 16, 22, 23
35806	KIA: 16	35871	GM: 55, 57, 58, 59, 73, 74, 75, 76; GMT: 23, 24, 28, 29, 39, 40, 41, 42, 43; SAB: 20, 21; SAT: 1, 2; SZT: 9	35938	GM: 15, 16, 22, 23
35807	LOT: 5, 6; TO: 33; TOT: 17, 18	35872	AUD: 9, 10, 11, 12, 13, 14, 15, 16, 17; AUT: 1; VW: 27, 28, 29; VWT: 1, 2, 3	35941	TO: 37, 38; TOT: 23, 24
35808	FOT: 61	35873	GM: 24; TO: 11	35943	NIT: 5; SZT: 6
35809	LOT: 5, 6; TO: 21, 28, 33, 34, 35; TOT: 17, 18, 19, 20	35875	GMT: 21; SZT: 7, 8	35944	NIT: 5
35810	DT: 16, 17; FRT: 1	35877	MI: 12, 13, 15, 19; MIT: 1, 4	35945	NIT: 5; SZT: 6
35811	TO: 33, 34, 35; TOT: 17, 19, 20	35878	GMT: 21; SZT: 7, 8	35946	NIT: 5; SZT: 6
35812	FOT: 61	35879	VW: 38, 39, 40, 41	35947	NIT: 5; SZT: 6
35813	CHR: 7, 23, 24, 28, 29, 30, 31, 32, 63, 65, 66; DT: 4, 5, 32, 33; HY: 16, 21, 22, 23, 24; HYT: 2, 3, 5, 6; JEE: 1, 2, 3, 4; KIA: 13, 14, 17, 18, 19, 20; KIT: 3, 5, 6; MI: 12, 13, 19; MIT: 1, 4	35883	NI: 2, 4, 6; NIT: 2	35948	HO: 23, 24, 25, 26
35814	GM: 71, 72, 83, 84, 85, 86; GMT: 38, 47, 48	35884	HO: 30, 31, 32, 33	35949	GM: 24; TO: 11
35815	GM: 71, 72, 83, 84, 85, 86; GMT: 38, 47, 48	35886	TOT: 25, 26	35950	VW: 45, 46, 47, 48, 49; VWT: 5, 6
35816	GM: 71, 72, 83, 84, 86; GMT: 38, 47, 48	35887	NI: 4, 6; NIT: 2	35951	MZT: 16
35817	TO: 21, 28, 34, 35	35888	HO: 38, 40, 41	35952	MZ: 20; MZT: 16
35819	HYT: 7; KIA: 22	35889	TOT: 25, 26	35955	VOL: 28, 29, 30, 32; VOT: 1
35820	DAE: 2, 3; GM: 31; IST: 4; SZ: 8	35890	HO: 58, 59, 60; HOT: 8, 10, 11	35957	FO: 54, 55, 56; FOT: 37, 38
35821	DAE: 2, 3; GM: 31; IST: 4; SZ: 8	35891	TOT: 25, 26	35958	FO: 54, 55, 56; FOT: 37, 38
35822	CHR: 7, 23, 24, 28, 29, 30, 31, 32; DT: 4, 5; HY: 16, 21, 22, 23, 24; HYT: 2, 3, 5, 6; JEE: 1, 2, 3, 4; KIA: 13, 14, 17, 18, 19, 20; KIT: 3, 5, 6; MI: 12, 13, 19; MIT: 1, 4	35893	TOT: 25, 26	35959	CHR: 26, 38, 39, 47, 48, 49, 54; HY: 27, 29, 30, 32, 33; HYT: 8, 11; KIA: 24; KIT: 8, 10, 11; MI: 17, 21, 22, 23, 25, 27; MIT: 2, 8, 12
35825	KIT: 10	35894	HY: 29, 30, 32, 33; HYT: 8, 11; KIA: 24; KIT: 8, 11	35960	HO: 2, 3
				35961	HO: 4, 12, 13
				35962	HO: 11
				35963	BMW: 1, 2, 3, 4, 5, 6

NUMERICAL LIST

35964	BMW: 7, 8	36061	MB: 2, 3, 4, 5, 6	60496-1	CHR: 1, 3, 5, 6, 8, 15, 16, 17, 18, 19, 20, 21, 22, 26, 38, 39, 47, 48, 49, 50, 52, 53, 54; DT: 2, 19; HY: 28; MI: 1, 2, 4, 5, 8, 9, 10, 11, 15, 16, 17, 20, 21, 22, 23, 24, 25, 26; MIT: 2, 6, 7, 10
35965	BMW: 7, 8	36062	MB: 1	60512	FO: 9; MZ: 22, 24; TO: 14, 15, 23, 24, 25, 26, 36; TOT: 5, 9, 16, 19, 23, 24
35966	BMW: 1, 2, 3, 4, 5, 6	36063	MB: 7	60517	HO: 5, 6, 7, 15, 23, 24, 25, 26, 27, 28, 34, 35, 36, 39, 42, 43, 44, 45, 46, 47, 49, 54, 61, 62, 63; HOT: 3; IST: 1; STE: 1
35967	HO: 14	36064	MB: 49, 50, 51, 62, 63, 64, 65, 66, 67	60525	GM: 33, 34, 35, 41, 42
35968	SB: 22; SBT: 9	36065	MB: 19, 20	60529	FO: 69
35969	SB: 22; SBT: 9	36066	BMW: 12, 13, 14, 16, 17, 23, 27, 31; BMT: 1, 2	60530	MOR: 1
35970	SB: 22; SBT: 9	413	AV: 2; DET: 1; FO: 46, 47, 48, 51, 52, 53, 54, 55, 56, 57, 58, 59, 66, 67, 68; FOT: 12, 29, 30, 34, 35, 36, 37, 38, 39, 40, 48, 49, 50, 51, 52, 53, 54, 55, 56, 57, 58, 66, 67; PNZ: 1, 2; VPG: 1, 2	60538	GM: 35, 36, 62, 63; GMT: 7, 25, 30; GRU: 1; IST: 10, 12
35971	FO: 31; FOT: 16, 17; MZT: 19, 20	416	VW: 31, 32, 33, 34, 35, 36, 37	60554	HOT: 12, 13, 14, 28; IST: 6, 7, 8, 12, 13, 14, 16; TO: 26, 27; TOT: 12, 13
35973	FO: 31; FOT: 16, 17; MZT: 19, 20	417	FOT: 13, 14, 20; NI: 18, 19; NIT: 6, 7, 8	60555	AMG: 3, 5; GMT: 86, 87, 91, 92
35974	CHR: 67; DT: 34; JEE: 8; VWT: 13	418	FO: 10; MZ: 14, 15	60556	AMG: 3, 4, 5; GMT: 86, 87, 88, 89, 90, 91, 92; WRK: 2
35975	CHR: 67; DT: 34; JEE: 8; VWT: 13	425 RR	GM: 90, 96	60566	GM: 1, 2, 4; GMT: 3; HO: 10, 15; SZ: 1, 2, 4, 5, 7, 9; SZT: 1, 2, 3
35976	FO: 31; FOT: 16, 17; MZT: 19, 20	447 RR	FOT: 72	60567	NI: 1, 2, 3
35979	GM: 5, 6, 7, 8; GMT: 1	501 SD	AMG: 1, 2; GM: 102, 103; GMT: 73, 74; IST: 24, 25; WRK: 1	60568	FOT: 13, 14, 20; HO: 5, 6, 9, 44; NIT: 6, 7
35980	GM: 5	505 SD	AV: 3, 4, 5; GM: 97, 98; GMT: 59, 60	60569	NI: 1, 2, 4
35981	GM: 6, 7, 8; GMT: 1	508 SD	GMT: 100	60572	MZ: 24; TO: 14, 15; TOT: 4, 19, 20, 21, 24, 25, 26
35982	CHR: 67; DT: 34; JEE: 8; VWT: 13	510 SD	GM: 88; GMT: 51, 52, 53, 54; IST: 20, 21	60576	VW: 1, 2, 3, 14, 17, 18, 19
35983	JAG: 1	511 SD	GM: 60, 61	60578	HO: 21, 22, 63, 65, 66, 67, 68, 71, 72, 73, 74, 75, 76, 77, 78, 80, 81; HOT: 15, 16, 17, 18, 19, 20, 21, 22, 23, 24, 25, 26, 27, 29, 30; STE: 1
35984	FO: 64, 65; FOT: 47; JAG: 1	512 SD	GM: 62; GMT: 25, 30; IST: 10, 12	60582	GM: 5, 22, 23; NIT: 6
35986	GM: 5, 6, 7, 8; GMT: 1	513 SD	GM: 62, 63	60583	FO: 19, 20, 27, 36; MOR: 1
35987	GM: 92, 93	515 SD	GM: 52; GMT: 19, 20; GRU: 2, 3	60584	AMG: 2; GMT: 73, 100; IST: 25
35989	FO: 45; FOT: 28	5152	AMG: 1, 2; AV: 3, 4, 5; GM: 88, 97, 98, 102, 103; GMT: 50, 51, 52, 53, 54, 59, 60, 73, 74; IST: 20, 21, 24, 25; WRK: 1	60592	GM: 52, 53; GMT: 19, 20; GRU: 2, 3
35990	FO: 45; FOT: 28	517 SD	DT: 40	60610	TO: 1
35991	FO: 13, 45, 64, 65; FOT: 28, 47	518 SD	DT: 39	60620	CHR: 1, 2, 3, 5, 6, 8, 9, 15, 16, 17, 18, 19, 20, 21, 22, 27; DT: 2, 3; FO: 1, 2, 3, 4, 15, 16; HY: 4, 8, 9, 10, 11, 14, 18; KIA: 4, 6, 7, 8, 9, 11; MZ: 4, 6, 7, 11, 13, 18, 19, 26, 27; MZT: 4; MI: 1, 2, 3, 4, 5, 8, 9, 10, 11, 18; MIT: 3, 6
35993	FO: 64, 65; FOT: 47	5182	AMG: 1, 2, 3, 4, 5; AV: 3, 4, 5; GM: 97, 98, 102, 103; GMT: 59, 60, 73, 74, 86, 87, 88, 89, 90, 91, 92; IST: 24, 25; WRK: 1, 2	60632	CHR: 25, 41, 42; DT: 15
35994	FO: 44; FOT: 27	519 SD	DT: 61, 63; JEE: 20	60637	NI: 19
35995	MZ: 31; MZT: 24	520 SD	FOT: 72	60639	FO: 19, 20
35996	FO: 45; FOT: 28; MZ: 31; MZT: 24	521 SD	DT: 62, 64	60640	GM: 66, 77, 81
35997	FO: 45; FOT: 28	522 SD	GM: 88; GMT: 51, 52, 53, 54; IST: 20, 21	60641	FO: 31, 33, 34, 36, 37, 46, 47; FOT: 4, 7, 12, 16, 17, 18, 19, 31, 32, 33; MZT: 5, 9, 19, 20, 21, 22, 25, 26, 27
35998	JEE: 10	525 SD	FOT: 41, 42, 43	60642	IST: 8
35999	VW: 45, 46, 47, 48, 49; VWT: 5, 6	530 SD	JEE: 11, 12	60655	EXC: 1; GM: 89, 104, 105
36000	FOT: 64	540 SD	DT: 45, 46, 47; JEE: 16	60660	NI: 19; NIT: 6
36001	CHR: 43, 44, 45	541 SD	GM: 67; GMT: 31, 32, 33	60661	GM: 81
36002	CHR: 43, 44, 45	544 SD	FOT: 31; MZT: 25, 26	60664	TO: 1, 2
36003	HY: 6, 7; KIA: 2, 3	545 SD	FOT: 31; MZT: 25, 26	60665	FO: 15; MZ: 18
36005	CHR: 7, 23, 24, 28, 29, 30, 31, 32; DT: 4, 5; JEE: 1, 2, 3, 4	5511	FO: 60, 61, 62, 63, 69, 70; FOT: 44, 45, 46, 59, 60, 72; LAF: 1, 2; WIN: 2	60666	GM: 37, 38, 39, 51; GMT: 10
36006	TO: 4	60038	AMG: 2; AV: 3, 4; DT: 39, 40, 45, 46, 47, 61, 62, 63, 64; GM: 88, 90, 97, 102; GMT: 25, 51, 52, 54, 59, 73; IST: 10, 12, 25; JEE: 16, 19, 20	60668	GM: 12, 20; IS: 3; TO: 2, 3, 9
36007	TO: 12	60102	JEE: 19	60669	HO: 5, 6, 7, 27, 28, 34, 35, 46, 47; HOT: 3; IST: 1
36009	GMT: 22, 34, 49; IST: 9, 15, 19; SAT: 3	60103-1	JEE: 19	60674	FOT: 13, 14, 20; NI: 9, 13, 18, 19, 21, 22, 23, 24, 28, 24, 28; NIT: 4, 6, 7, 9, 10, 11, 13, 14
36010	TO: 4, 12	60133	JEE: 19	60679	FOT: 18, 31, 68, 69, 71
36011	TO: 19, 20; TOT: 8	60286	FO: 1, 3; MZT: 4	60680	CHR: 1, 2, 3, 4, 5, 6, 8, 9, 15, 17, 19, 20, 21, 22, 26, 27; HY: 1, 2, 8, 14, 18, 20; MI: 1, 2, 3, 4, 5, 8, 10, 11, 16, 17, 18, 20; MIT: 2, 5
36012	TO: 4	60292	CHR: 55; JEE: 6, 7, 11, 12	60681	CHR: 21, 22
36013	TO: 19, 20; TOT: 8	60308	NI: 27	60682	TO: 23
36014	TOT: 20	60309	IST: 4	60683	TO: 23, 24
36015	HY: 13; KIA: 15	60320	JEE: 19	60687	TO: 13, 15; TOT: 1
36017	GMT: 26, 44, 49; IST: 11, 17, 19; SAT: 3	60379	FO: 69	60689	NI: 1
36020	FOT: 65	60458	NI: 1, 3, 7, 8, 10, 12, 19, 21, 22, 23, 24, 28; NIT: 3, 5, 9, 10, 11, 12, 13, 14, 15, 16; SZT: 10	60690	FO: 1; HO: 2, 3, 23, 24, 26
36021	GM: 77, 78, 79, 81	60459	SB: 3, 4		
36022	HO: 38, 39, 40, 41, 55, 56, 57, 58, 59, 60; HOT: 5, 6, 7, 8, 9, 10, 11	60460	SB: 3, 4, 21		
36023	GM: 77, 82; GMT: 45	60461	TO: 15, 23, 24, 36		
36024	SAB: 5, 6, 16, 17, 18; SB: 5, 6, 7, 8, 9, 10, 11, 12, 13, 14, 15, 16, 17, 18, 19, 20; SBT: 1, 2, 3, 4, 5, 6, 7, 8	60477	GM: 17, 35; HO: 11, 30, 31, 32, 33		
36025	GM: 35, 36; GMT: 7, 8; GRU: 1; IST: 2, 3	60478	HO: 4, 12, 13, 14; HOT: 10, 11; PEU: 2; WIN: 1		
36030	TO: 20	60479	GM: 20; SB: 5; TO: 9		
36047	SAB: 2, 3, 4, 13, 14, 15	60480	MOR: 1		
36048	SAB: 2, 3, 4, 13, 14, 15	60486	HO: 79		
36049	HY: 9, 10, 11, 15; HYT: 1; KIA: 8, 9, 12; KIT: 1	60494	DT: 3; MIT: 3		
36050	MB: 1	60495	TO: 17, 18, 24, 36; TOT: 5, 9, 16, 20		
36051	MB: 1				
36052	MB: 1				
36053	BMW: 22, 26, 28; BMT: 6, 7; LRT: 13				
36054	BMW: 22, 26, 28; BMT: 6, 7; LRT: 13				
36055	BMW: 22, 26, 28; BMT: 6, 7; LRT: 13				
36056	BMW: 21; BMT: 5				
36057	BMW: 21; BMT: 5				
36058	BMW: 13, 14, 16, 17; BMT: 1, 2				
36059	BMW: 23				
36060	MB: 21, 22, 23, 38, 39, 40, 42, 43, 45; MBT: 2, 3				

NUMERICAL LIST

60693	VW: 14, 17, 18, 19, 26, 30, 31, 32, 33, 34, 35, 36, 37	60832	MZ: 28, 29; MZT: 15, 16	60907	KIT: 4; MZT: 3, 14
60697	FO: 1, 2, 3	60835	NI: 4, 5, 7, 8, 9, 21; NIT: 4, 7, 8, 9	60908	GM: 10, 18; TO: 1, 5, 7, 15
60700	CHR: 40, 42, 51, 53; DT: 18	60836	DT: 13; GM: 52; JEE: 6, 7, 11, 12	60909	TOT: 6, 7
60703	IST: 6	60838	TO: 22	60910	TOT: 21
60704	VW: 15	60839	GM: 10; TO: 5	60911	TO: 17, 18; TOT: 3, 5, 6, 7, 9, 16
60706	GM: 17, 34, 52, 53	60840	GMT: 3; SZT: 1, 3	60913	FO: 46; FOT: 18, 19, 29; MZT: 21, 22
60708	AUD: 20, 21	60841	GM: 96	60914	HY: 9, 10, 11, 15, 26; HYT: 1; KIA: 8, 9, 12; KIT: 1
60710	SB: 1, 2	60842	GM: 11, 25; IS: 1, 2, 4; LOT: 1	60915	TO: 14
60712	FOT: 59, 60, 72; WIN: 2	60843	FO: 46	60916	TO: 14
60713	FOT: 18	60844	FO: 19, 20, 27; FOT: 12	60917	CHR: 38, 39, 47, 49, 54; MI: 14, 21, 22, 25, 26; MIT: 7, 8, 12
60714	FOT: 16, 17; MZT: 19, 20	60845	FOT: 44, 46, 59, 60, 72; LAF: 1; WIN: 2	60919	GM: 12; IS: 3
60718	AMG: 2, 3, 4, 5; GM: 88; GMT: 50, 51, 52, 54, 59, 73, 86, 87, 88, 89, 90, 91, 92; IST: 25; WRK: 2	60846	FOT: 41, 42, 43	60920	SB: 5, 9, 11, 14; SBT: 2
60720	GM: 35	60847	FO: 18; FOT: 7, 11; MZT: 9, 13	60921	GM: 2, 4; SZ: 1, 4
60721	IST: 8	60850	GM: 33, 34, 35, 36, 38, 39, 41, 42, 53, 65; GMT: 12	60922	MI: 14, 17, 20; MIT: 5
60723	SB: 9	60851	NI: 18, 19	60924	FO: 9, 54, 55, 56, 57, 58, 60, 61, 62, 63, 69
60727	MZT: 4	60852	NI: 18, 19	60928	DT: 54, 55
60728	GM: 62, 63	60853	NIT: 6	60937	NI: 8, 27; NIT: 1
60729	GMT: 7, 8; IST: 2, 3	60854	GM: 90, 96	60938	NI: 27
60737	HO: 15	60855	CHR: 1, 2, 3, 5, 6, 8, 9, 27; DT: 2, 3; HY: 1, 2, 20; MI: 1, 2, 4, 5, 11, 18; MIT: 3	60940	FO: 2
60738	CHR: 51, 53; DT: 18	60856	GM: 11, 12, 25; HOT: 12, 14; IS: 1, 2, 3, 4; IST: 6, 7, 8, 13, 14; LOT: 1	60943	SAB: 1, 2
60739	CHR: 4	60857	GM: 11, 25; IS: 1, 2, 4; IST: 8; LOT: 1	60944	FO: 5
60740	CHR: 4	60859	FO: 47, 61, 63	60948	DT: 13, 42; JEE: 5, 6, 7, 11, 12
60743	CHR: 25, 41; DT: 14, 15	60860	CHR: 59, 68; DT: 24, 26, 27, 28, 37	60954	GMT: 100
60744	CHR: 37, 59, 60, 61, 68; DT: 8, 24, 26, 27, 28, 37	60861	NIT: 4	60957	SAB: 5, 6; SB: 6, 7, 9, 11
60752	HY: 4	60862	FO: 15, 16; MZ: 18, 19	60958-1	DT: 39, 45, 46, 61, 63; JEE: 16, 20
60754	GM: 65, 77, 80, 82; GMT: 45	60863	GM: 34	60963	HY: 8, 28
60756	CHR: 1, 2, 3, 5, 6, 15, 16, 17, 18, 19, 20, 21, 22; HY: 1, 2, 8, 14, 18, 20, 28; MI: 1, 2, 3, 4, 8, 9, 10, 11	60865	KIA: 7; MZ: 7	60964	FO: 10; MZ: 12, 14, 15
60757	GM: 41, 42, 43; GMT: 12	60866	MZ: 4, 8, 11	60965	FO: 26; MZ: 24
60764	GM: 52, 53; GMT: 19, 20; GRU: 2, 3	60867	FO: 4; KIA: 6, 7, 11; MZ: 6, 7, 11, 13	60966	CHR: 8; DT: 2; MI: 5, 17; MIT: 3
60765	GM: 17	60868	FO: 10, 15, 26; MZ: 14, 18, 24	60967	FO: 10, 26; MZ: 11, 14, 24; MZT: 17, 18
60770	GMT: 25, 30; IST: 10, 12	60869	NI: 14, 15, 16, 17	60968	CHR: 1, 3; MI: 1
60771	GM: 88	60870	CHR: 16, 19, 20, 52, 53; DT: 19; MI: 9, 10, 17; MIT: 6	60971	HO: 27, 34
60774	GM: 80	60871	NI: 6, 14, 15, 16, 17, 21, 22, 23, 24, 28; NIT: 1, 2, 5, 6, 9, 12, 15, 16; SB: 9; SZT: 6, 10	60972	HO: 8, 10
60776	HO: 19, 20, 27, 28, 29, 32, 33, 34, 35, 36, 44, 47, 48, 49, 54; HOT: 1, 2, 3; IST: 1	60872	MZ: 28, 29; MZT: 15, 16	60973	HO: 22, 28, 35, 48, 49, 54; HOT: 2
60777	FOT: 20; HO: 34, 36; NIT: 7	60873	MZ: 28, 29; MZT: 15, 16	60974	GM: 33
60778	HO: 36, 42, 43, 44, 45	60874	FO: 4; KIA: 6; MZ: 4, 6, 11, 13	60976	CHR: 62
60782	HO: 5, 6	60875	HO: 34	60977	GM: 10, 18; TO: 5, 7
60785	GM: 36	60876	TOT: 4	60978	CHR: 51; DT: 18
60787	HO: 8, 9, 10, 17, 18	60877	HO: 43, 45, 46, 51, 52, 53; HOT: 4; IST: 5	60979	HO: 7, 20, 46, 47; HOT: 1, 3; IST: 1
60788	HO: 9	60878	HO: 43, 45	60980	GM: 61
60789	HO: 7, 8, 9	60879	CHR: 15, 16, 17, 18, 47, 48, 49, 50, 54; MI: 8, 9, 14, 16, 22, 23, 24, 25; MIT: 7, 9, 10	60982	GM: 35; GMT: 7; IST: 2
60790	GM: 9; TO: 6	60883	GM: 62	60983	GM: 60, 61, 67, 68; GMT: 32; VW: 30
60792	HO: 5, 6	60884	GM: 65, 77, 80, 82; GMT: 45; HO: 25, 30, 31, 32, 33, 60, 79	60984	KIA: 5, 11; MZ: 2, 4, 5, 8, 9, 10, 11
60796	FOT: 12, 18, 31; MZT: 21, 22, 25, 26	60885	FO: 46, 47; FOT: 18, 29	60988	AV: 6; CAL: 1; EXC: 1; GM: 89, 100, 104
60798	FO: 4, 16; KIA: 6, 7; MZ: 6, 7, 11, 13, 19	60886	FOT: 31; MZT: 25, 26	60989	FO: 1
60800	FO: 2, 3, 15, 16; MZ: 19	60889	CHR: 26, 52; MI: 3, 9, 17, 24; MIT: 2	60991	HOT: 12; IST: 7, 8
60807	GM: 36	60890	HO: 69, 70	60992	SAB: 18; SB: 9, 18; SBT: 6
60810	CHR: 10, 11, 13, 40, 51, 53, 59, 68; DT: 18, 26, 27, 28, 37; MI: 6, 7	60891	MZT: 4	60993	GM: 26
60811	FOT: 14; NI: 13, 18, 19, 20; NIT: 6	60893	TO: 36	60995	FO: 5
60813	HY: 14, 18	60894	FO: 56	60996	GM: 104
60816	GM: 2, 3, 4; SZ: 1, 2, 3, 4; SZT: 1	60896	FO: 33, 37	60997	GMT: 30
60817	CHR: 26, 54; GM: 35; KIT: 4; MZ: 28, 29; MZT: 3, 14, 15, 16; MI: 17, 25	60899	HY: 12, 15, 18, 19, 21, 22, 23, 24, 25, 26, 27, 29, 30, 31, 32, 33; HYT: 1, 4, 7, 8, 10; KIA: 14, 16, 17, 18, 19, 20, 21, 22, 23, 24; KIT: 1, 7, 8, 10	60998	GM: 28
60818	NI: 7, 8, 9, 13; NIT: 4	60902	MZ: 25, 27; SB: 8, 9, 10	60999	CHR: 37, 38, 39; MI: 21
60821	DT: 40, 47	60903	AMG: 2; AV: 3, 4; GM: 88, 97, 102; GMT: 51, 52, 59, 73; IST: 25	61000	CHR: 10, 11
60825	GM: 65	60904	TOT: 11	61001	CHR: 11, 13; MI: 6, 7
60826	AV: 5; GM: 98, 103	60905	NI: 3, 7, 8, 10, 20, 21; NIT: 3, 5, 9	61002	CHR: 7, 10, 11, 12, 13, 14, 23, 24, 28, 29, 30, 31, 32, 33, 34, 35, 36, 37, 38, 43, 44, 45, 46; DT: 1, 4, 5, 6, 7, 8, 9, 10, 11, 12, 24, 26, 27, 28, 37; JEE: 1, 2, 3, 4, 5
60827	GM: 65	60906	GM: 44; MZT: 24; TO: 15, 16, 17, 18, 21, 26, 27, 28, 32, 34, 35, 37, 38; TOT: 2, 3, 12, 13, 14, 17, 25, 26	61003	CHR: 13, 14
60828	GM: 41, 42, 43; GMT: 12			61004	FO: 6, 7
60829	GM: 65			61005	FO: 6, 7
60831	FO: 5, 10, 36; KIT: 4; MZ: 4, 8, 11, 14, 24, 25, 26, 27, 28, 29; MZT: 3, 14, 15, 16			61006	FO: 24, 28; MZT: 12

NUMERICAL LIST

61012	GM: 94, 108, 110, 111; GMT: 100, 101, 102; WRK: 3	61073	FO: 34, 35, 36	61184	GM: 54, 56, 64; SAB: 23
61013	GM: 90, 96	61074	GMT: 54, 57, 63, 65, 66, 67, 68, 69, 78; IST: 22, 23; SAT: 4	61185	SAB: 2, 3, 4, 13, 14, 15, 22, 23
61014	AMG: 1; GMT: 51, 53, 54, 60, 74; IST: 20, 21, 24; WRK: 1	61075	FO: 29, 32	61186	GM: 56
61015	GMT: 2, 4; HO: 30, 31, 75, 76, 77, 78, 80, 81; HOT: 8, 20, 23, 24, 26, 27, 29, 30; SZ: 5; SZT: 2	61076	FO: 32	61187	GM: 37, 39, 56; GMT: 27
61016	GM: 20, 24; GMT: 2, 4, 21; KIA: 5; MZ: 2, 4, 5, 21; MI: 12, 13, 19, 20, 27; MIT: 1, 4; NI: 2, 4, 5, 6; NIT: 1, 2; SZ: 5; SZT: 2, 5, 7, 8; TO: 9, 11, 27, 32; TOT: 3, 12, 13, 14, 15	61077	AV: 6; CAL: 1; GM: 100	61188	GM: 26, 27, 28
61017	DT: 31; GM: 77, 82, 87, 92, 93; GMT: 45	61078	DT: 67	61189	FO: 25, 29
61018	GM: 81	61079	TOT: 5, 9	61190	GM: 21; LOT: 2, 3, 4; TO: 10
61019	GM: 35	61080	CHR: 16, 26; MI: 9, 17; MIT: 2, 5, 10	61191	FO: 6; FOT: 1; MZT: 1
61020	TO: 26, 27; TOT: 13	61081	FOT: 45; LAF: 1, 2	61192	FOT: 1; MZT: 1
61021	GM: 35, 37, 39, 51; GMT: 7, 8; IST: 2, 3	61082	FOT: 45; LAF: 1, 2	61193	GM: 21; TO: 10
61023	GM: 61, 77, 82; GMT: 45	61083	TO: 15, 16; TOT: 1	61194	FOT: 1, 15, 17; MZT: 1, 18, 19
61024	GM: 77	61084	TO: 15, 16, 26, 27; TOT: 12, 13	61195	HY: 12, 15
61025	GM: 77	61085	GM: 20; TO: 9, 15, 16	61197	AUD: 2, 3, 4, 6, 7, 8; VW: 7, 8, 9, 10, 11, 12, 13
61027	GM: 81	61086	TO: 37, 38; TOT: 16, 19, 20, 23, 24	61198	AUD: 2, 6; VW: 7, 9
61028	GM: 66	61087	TOT: 16	61199	SAB: 23
61029	GM: 66	61088	TO: 15, 16; TOT: 1	61200	FOT: 50
61030	GM: 2, 4; SZ: 1, 4	61089	GMT: 53, 54, 56, 57, 58, 61, 62, 63, 64, 65, 66, 67, 68, 69, 70, 71, 72, 75, 76, 77, 79, 81, 82, 83, 84, 85; IST: 22, 23; SAT: 4, 5	61201	FO: 52
61031	GM: 2, 4; SZ: 1, 4	61090	GMT: 2, 4; SZT: 5	61202	FO: 53; PNZ: 2
61032	GM: 1	61091	TO: 26, 27; TOT: 12, 13	61203	DET: 1; FO: 51, 52, 53, 58; PNZ: 1, 2
61033	GMT: 2; SZ: 5; SZT: 2	61092	AUD: 1, 3, 4, 5, 6, 7, 8; VW: 4, 5, 6, 7, 8, 9, 10, 11, 12, 13, 30, 31, 32, 33, 34, 35, 36, 37	61204	FO: 58
61034	HOT: 12, 13, 14, 28; IST: 8, 13, 14, 16	61093	GM: 81	61205-1	FOT: 51, 52, 53, 54
61036	AMG: 1; GMT: 53, 54, 60, 74; IST: 20, 21, 24; WRK: 1	61094	GM: 3; SZ: 3	61206	GM: 56; SAB: 22, 23
61037	GM: 82; GMT: 45	61095	GM: 2, 4; SZ: 4	61208	FOT: 32, 33; LRT: 10; MZT: 27
61038	TOT: 16	61096	FO: 54, 55, 56, 57, 58; FOT: 38	61209	HO: 65
61039	LOT: 5, 6; TO: 17, 18, 26, 27, 32, 33, 37, 38; TOT: 3, 9, 10, 14, 15, 16, 17, 18	61097	TO: 2	61210	HO: 65
61040	LOT: 5, 6; TO: 26, 27, 32, 33; TOT: 3, 13, 14, 15, 16, 17, 19, 20, 23, 24	61098	CHR: 12, 35, 37; DT: 12	61211	VOL: 11, 12, 13, 22, 24, 25, 26, 27
61041	FO: 52	61099	TO: 2	61212	NI: 1
61042	DET: 1; FO: 51, 52, 53, 58; FOT: 48, 49; PNZ: 1, 2	61103	FOT: 51, 52, 53, 54	61213	DT: 22, 23, 24, 25, 28, 29, 36, 37, 38; VWT: 14
61043	FO: 9	61105	FO: 6, 7	61214	DT: 1, 7, 8; JEE: 5
61044	KIA: 1, 5, 10, 11; KIT: 2; MZ: 2, 4, 5, 12, 14, 15, 20	61106	GM: 20, 21, 24, 44; LOT: 2, 3, 4; MI: 12, 13, 19, 27; MIT: 1, 4, 7, 8, 10, 12; SAB: 5, 6, 18; SB: 6, 7, 18, 24; SBT: 6, 10; TO: 9, 10, 11, 12, 17, 27; TOT: 2, 3, 10, 12, 13, 14, 15, 17, 19, 20, 23, 24, 25, 26	61216	DT: 39, 42, 43, 44, 45, 46, 61, 63; JEE: 13, 14, 15; MIT: 13, 14
61046	FOT: 29, 30, 34	61107	CHR: 44, 45, 46	61217	HY: 15; HYT: 1; KIA: 12; KIT: 1
61048	FOT: 37, 38, 39, 51, 52, 54	61108	DT: 37	61225	DT: 35; JEE: 9; MIT: 11
61049	CHR: 38	61111	ACO: 1; GM: 87, 92, 93	61228	CHR: 33, 34, 36; DT: 8, 9, 11
61050	FO: 54, 55, 56, 57, 58; FOT: 35, 36, 37, 38, 39, 51, 52, 53, 54	61113	ACO: 1; GM: 87, 92, 93	61229	DT: 7, 8, 22, 23, 24, 25, 28, 29, 36, 37, 38; VWT: 14
61051	GM: 41, 42, 43; GMT: 12	61115	HO: 51, 52, 53; HOT: 4; IST: 5	61230	DT: 22, 24, 28, 29, 31, 37
61052	FO: 46, 48; FOT: 34	61116	GM: 19, 20; TO: 8, 9	61232	DT: 22, 24, 28, 29, 37
61053	GM: 60, 67; GMT: 32	61124	GM: 19, 20; TO: 3, 8, 9; TOT: 19	61234	CHR: 54; MI: 25; MIT: 7
61054	GM: 45, 46, 47, 48, 49, 60, 61, 66, 67, 69, 71, 72, 73, 75, 76, 101, 106; GMT: 17, 18, 31, 32, 33, 36, 37, 39, 40; SZT: 9	61125	ACO: 1, 2; GM: 87, 92, 93	61236	CHR: 54; FO: 11, 14, 38, 39, 40, 41, 43, 44, 45; FOT: 3, 21, 22, 23, 24, 26, 27, 28; MZ: 31; MZT: 23, 24; MI: 25
61055	FOT: 31; MZT: 25	61126	HO: 51, 52, 53	61237	CHR: 33, 34, 36; DT: 6, 9, 10, 11
61056	FOT: 32, 33; MZT: 27	61128	GM: 19, 20, 21; LOT: 2, 3, 4; TO: 3, 8, 9, 10; TOT: 5, 9	61240	CHR: 69, 70, 71, 72; DT: 35, 48, 49, 51, 52; JEE: 9, 17, 18; MIT: 11
61057	FOT: 32, 33; MZT: 27	61129	ACO: 1, 2; GM: 87, 92, 93	61241	JEE: 11, 12
61058	FOT: 13, 14; NIT: 6	61134	GM: 19, 20; TO: 8, 9	61244	HY: 3, 4, 5, 9, 10
61059	FO: 6, 7	61138	TOT: 5, 9, 23, 24	61245	HY: 9, 10, 15, 25, 26; HYT: 4, 7; KIA: 1, 4, 10, 21, 22; KIT: 7
61061	FOT: 32, 33	61140	VW: 30, 31, 32, 33, 34, 35, 36, 37	61248	DT: 6, 10
61062	FO: 6	61141	FO: 52; FOT: 66	61250	MI: 12, 13, 26; MIT: 1, 7, 10, 12
61063	FO: 54, 56, 57, 58	61142	FOT: 50, 66	61251	FO: 8
61064	NI: 20	61143	FOT: 66	61252	MI: 1, 5
61065	HO: 16, 17, 18, 19	61152	TOT: 5, 9	61253	FO: 8, 11; FOT: 4, 6; MZT: 5, 6
61066	HO: 16, 17, 18, 19; HOT: 1	61155	FOT: 66	61254	MI: 26
61067	HO: 21, 28, 29, 35; HOT: 2	61156	GM: 26	61255	GMT: 49; IST: 19; SAT: 3
61068	CHR: 58, 62, 63, 64, 65, 66	61157	FO: 9	61258	GM: 104, 105; GMT: 103; WRK: 4
61069	AV: 6; CAL: 1; GM: 100, 101; MOS: 1	61158	FO: 30, 32; FOT: 15; MZ: 30; MZT: 18	61259	KIT: 2
61070	GMT: 57, 63, 67, 68, 69, 78, 80; IST: 23	61159	FO: 6; FOT: 1; MZT: 1	61260	KIT: 2
61071	HO: 29	61160	FO: 35, 36; FOT: 18, 19; MZT: 21, 22	61261	CHR: 63, 64, 65, 66; DT: 31
61072	DT: 18	61171	AUD: 1, 3, 4, 5, 24, 25; DAE: 1; VW: 4, 5, 6, 42, 43, 44	61264	VOL: 24, 26, 27
		61173	TO: 17; TOT: 2, 3	61266	CHR: 63, 64, 65, 66; DT: 31, 32, 33
		61177	GM: 26, 27	61267	MI: 1, 5, 15
		61178	GMT: 101, 102, 103; WRK: 3, 4	61268	CHR: 49, 50; KIA: 23; KIT: 2, 10; MI: 22, 23
		61182	DT: 42, 43, 44; JEE: 13, 14, 15; MIT: 13, 14	61269	NIT: 7, 8
		61183	FO: 30, 35, 36; FOT: 15, 18, 19; MZT: 21, 22	61270	KIT: 2
				61271	KIA: 10
				61272	KIA: 1, 10
				61273	KIA: 10
				61274	FOT: 20; NIT: 7

61275	NI: 7	61348	GM: 30, 47; GMT: 22, 26, 34, 44; HO: 39, 56, 57; HOT: 5, 6, 7; IST: 9, 11, 15, 17; MZ: 1, 17, 21, 22; MZT: 8; MI: 13, 14	61415	CHR: 70, 71; DT: 48, 50, 51; JEE: 17
61276	TO: 26, 27, 32; TOT: 14, 15	61349	HO: 55, 56; HOT: 6	61416	HY: 27, 31; HYT: 10; KIA: 23; KIT: 10
61281	TO: 37, 38; TOT: 23, 24	61350	HO: 39; HOT: 5	61417	FOT: 67
61282	DT: 67	61351	JAG: 2	61418	FOT: 67
61283	CHR: 43, 44, 45, 46	61352	TO: 4	61419	HY: 31; HYT: 10
61284	CHR: 44, 45, 46	61353	NI: 3	61420	FOT: 66, 67
61286	GM: 20; TO: 9	61354	NI: 3, 10; NIT: 5	61421	GM: 20, 24, 44; TO: 9, 11, 17, 18; TOT: 3, 10
61287	GMT: 75, 76, 77, 78, 79, 80, 81, 82, 83, 84, 85, 103; SAT: 5; WRK: 4	61355	FO: 32	61422	HOT: 5
61289	DT: 35; JEE: 9; MIT: 11	61356	AV: 1; FO: 17, 32, 50	61423	HY: 31; HYT: 10
61294	HY: 3, 19; KIA: 16	61357	TO: 4	61424	TO: 29, 30, 31
61295	HY: 3, 4, 5	61358	TO: 4	61425	FOT: 66
61296	HY: 4	61359	SAB: 16; SB: 12, 13, 15, 18; SBT: 1, 3, 6	61426	AV: 2; FO: 59
61302	HY: 3, 4, 9, 10, 11; KIA: 8, 9	61360	SB: 8, 9, 10, 16, 17, 18; SBT: 4, 5, 6	61428	TO: 29, 30, 31
61303	FOT: 20; NIT: 7	61361	GM: 39; GMT: 10	61429	HY: 27, 31; HYT: 10; KIA: 23; KIT: 10
61304	GM: 70	61362	GM: 29, 39, 40, 47; GMT: 9, 10, 11, 13, 14, 15	61430	FO: 30
61305	GM: 70	61363	TO: 3	61431	ACO: 1, 2; GM: 87, 91, 92, 93, 95, 108, 111
61306	GM: 70	61364	TO: 3	61432	MI: 13, 14, 20, 27; MIT: 5
61307	GM: 70	61365	SAB: 5, 6, 16; SB: 6, 7, 12, 13, 15, 22; SBT: 1, 3, 9	61433	GM: 19, 20
61308	GM: 37, 39	61366	SAB: 5, 6, 16; SB: 6, 7, 12, 13, 15; SBT: 1, 3	61434	TO: 38
61309	GM: 38, 39; GMT: 10	61367	NI: 2, 4, 5, 6, 10; NIT: 2, 5, 9	61435	TOT: 19
61310	GM: 55, 70, 71, 72, 73, 77, 78, 79, 81, 83, 84, 85, 86, 99; GMT: 38, 47, 48	61368	VOL: 15, 16, 24, 26	61436	GM: 91, 92, 93, 94, 95, 106, 107, 108, 109, 110, 111; GMT: 55
61311	GM: 70, 91, 92, 93, 94, 95; GMT: 55	61369	VOL: 15, 16, 17, 18, 19, 20, 24, 26	61437	TO: 38
61312	LOT: 2, 3, 4; TO: 10	61370	VOL: 11, 13, 14, 15, 16, 17, 18, 19, 20, 21, 22, 23, 24, 25, 26, 27, 28, 30; VOT: 1	61438	DT: 42, 43; FOT: 40, 55, 56, 58; JEE: 13, 14; MIT: 13, 14
61313	TO: 9	61371	BMW: 12, 13, 16	61439	GMT: 35
61314	GM: 60, 67, 70, 73, 83, 85; GMT: 31, 32, 33, 36, 37, 47, 48	61372	CHR: 69, 70, 71, 72, 73; DT: 48, 49, 50, 51, 52, 53; JEE: 17, 18, 21, 22	61440	GM: 29, 39, 40, 47; GMT: 9, 10, 11, 13, 14, 15
61315	FO: 32	61373	TO: 32; TOT: 14, 15	61441	GM: 69
61316	HO: 71; HOT: 15	61374	VOL: 11, 13, 14, 21, 23, 25, 27	61442	GM: 45, 46, 47, 48, 69, 72, 73
61317	HO: 71; HOT: 15	61375	MI: 20	61443	GM: 50, 69, 71, 72, 73, 83; GMT: 39
61318	GM: 87, 92, 93	61376	JAG: 2	61445	LOT: 5, 6; TO: 33; TOT: 17, 18, 20
61319	HO: 72; HOT: 16, 17	61377	FO: 12, 13, 14, 30, 31; FOT: 3, 15, 16, 17; MZT: 19, 20	61446	GM: 39, 46, 47
61320	HO: 66, 68; HOT: 18, 19, 25	61378	MI: 20, 27	61447	GM: 78, 79
61321	HO: 24	61379	GMT: 93, 94, 95, 96, 97, 98, 99	61448	KIA: 1, 4
61322	HO: 23, 25, 26	61380	HY: 25, 26; HYT: 7; KIA: 21, 22; KIT: 7	61449	KIA: 1, 4
61323	GMT: 53, 54, 56, 57, 58, 61, 62, 64, 67, 68, 69, 70, 71, 72, 75, 76, 77, 78, 79, 80, 81, 82, 83, 84, 85, 103; IST: 23; SAT: 5; WRK: 4	61381	HY: 25, 26; HYT: 7; KIA: 21, 22; KIT: 7	61450	MIT: 12
61324	CHR: 33, 34, 35, 36, 37, 43, 44, 45, 46, 63, 64, 65, 66, 73; DT: 6, 7, 8, 9, 10, 11, 12, 22, 23, 24, 25, 28, 29, 31, 32, 33, 35, 36, 37, 38, 41, 42, 43, 44; JEE: 5, 9, 10, 13, 14, 15, 21, 22; MIT: 11, 13, 14; VWV: 14, 15	61382	HY: 25, 26; KIA: 21	61451	DT: 52, 53; HY: 22, 23, 29, 30, 32, 33; HYT: 8, 10; KIA: 14, 18, 19, 24; KIT: 8; MI: 27; VOL: 28, 30
61326	CHR: 33, 34, 35, 36, 37, 43, 44, 45, 46, 63, 64, 65, 66; DT: 6, 7, 8, 9, 10, 11, 12, 22, 23, 24, 25, 28, 29, 31, 32, 33, 35, 36, 37, 38, 41, 42, 43, 44; JEE: 5, 9, 10, 13, 14, 15; MIT: 11, 13, 14; VWV: 14, 15	61383	HY: 27, 29, 30, 31, 32, 33; HYT: 10; KIA: 12, 16, 20, 22, 23, 24; KIT: 10, 11	61452	MIT: 12
61327	MZ: 9, 10	61384	DAE: 2, 3; GM: 31; IST: 4; SZ: 8	61453	DT: 22, 23, 24, 25, 28, 29, 36, 37, 38; VWV: 14
61330	AUD: 2	61385	SZ: 7; SZT: 7	61454	GMT: 66, 81; IST: 22; SAT: 4
61331	GMT: 35; HO: 67, 73, 74, 75, 76, 77, 78; HOT: 18, 19, 20, 21, 22, 23, 24, 25, 26, 27, 29	61386	GMT: 4; SZ: 7, 9; SZT: 5	61455	SZ: 9; SZT: 8
61333	TO: 26	61387	GMT: 4, 21; SZ: 7, 9; SZT: 5, 7, 8	61456	GM: 69; GMT: 31, 33, 36, 37
61334	MI: 12, 15, 19, 20; MIT: 1, 4, 5, 8	61388	JAG: 1, 2	61457	GMT: 93, 94, 95, 96, 97, 98, 99
61335	GMT: 27	61389	CHR: 43, 44, 45, 63, 65, 66; DT: 32, 33, 41; VWV: 15	61458	AUD: 9, 10, 11; AUT: 1; VW: 27, 38, 39; VWV: 1
61337	GM: 29, 99; GMT: 22, 26, 34, 44, 49; IST: 9, 11, 15, 17, 19; SAT: 3	61390	HY: 19; HYT: 4; KIA: 16	61459	TO: 17, 18; TOT: 3
61338	HO: 75, 76, 77, 78, 80, 81; HOT: 19, 20, 21, 22, 23, 24, 25, 26, 27, 29, 30; NI: 21; NIT: 9	61391	FO: 11; FOT: 2, 5; MZT: 7	61460	TO: 21, 28, 34, 35, 38; TOT: 3, 17, 18
61339	NIT: 9	61392	TOT: 19, 20	61461	MI: 27; MIT: 12
61341	NI: 21; NIT: 9	61393	CHR: 74; DT: 68	61462	AUD: 9, 10, 11; AUT: 1; VW: 27; VWV: 1
61342	NI: 21; NIT: 9	61394	GMT: 35	61463	TO: 3
61343	NIT: 9	61395	FOT: 5, 6, 8, 15; MZT: 6, 7, 18	61465	GM: 57, 58, 59, 71, 72, 83, 84, 85, 86, 99; GMT: 28, 29, 38; SAT: 2
61344	HO: 8, 58, 59, 60, 79; HOT: 8, 10, 11, 18, 19, 21, 22, 25	61396	FOT: 5, 6, 15; MZT: 6, 7, 18	61466	FO: 38, 39, 40, 41, 43, 44, 45; FOT: 21, 22, 23, 24, 26, 27, 28; GM: 71, 72, 83, 84, 85, 86; GMT: 31, 33, 38, 47, 48; MZ: 31; MZT: 23, 24
61345	NI: 21; NIT: 9	61397	MI: 15	61467	DT: 22, 23, 24, 25, 28, 35, 36, 37, 38; JEE: 9, 10; MIT: 11; VWV: 14
61347	FOT: 32, 33; LRT: 10; MZT: 27	61398	DT: 42, 43; MIT: 13, 14	61468	NIT: 3
		61399	HY: 19; HYT: 4	61469	GMT: 56, 58, 61, 62, 64, 65, 66, 70, 71, 72, 75, 76, 77, 79, 81, 82, 83, 84, 85; IST: 22; SAT: 4, 5
		61400	HY: 19; HYT: 4; KIA: 16	61470	NIT: 3
		61402	FO: 30; FOT: 15	61471	NIT: 3
		61403	FO: 30	61472	TO: 34, 35
		61404	HY: 12, 18	61473	DAE: 1, 2, 3; GM: 13, 14, 15, 16, 31; SZ: 8
		61406	FO: 11, 17, 21, 22, 43; FOT: 8, 9, 26	61474	FOT: 61
		61407	FOT: 18, 19, 32; MZT: 21, 22, 27	61475	DAE: 2, 3; GM: 31; SZ: 8
		61408	HOT: 5	61476	HY: 15; HYT: 1; KIA: 12; KIT: 1
		61410	HY: 8, 14, 18		
		61412	TOT: 23, 24		
		61413	FO: 17; MZ: 17, 21		

NUMERICAL LIST

61477	HY: 31	61545	HO: 61	61626	GM: 54, 64
61478	FOT: 61	61547	HO: 38, 39	61627	GM: 73, 75, 76
61479	HY: 21, 24, 29, 30, 32, 33; HYT: 8; KIA: 17, 20, 24; KIT: 8, 10, 11	61548	HO: 40	61629	NI: 21; NIT: 9
61480	CHR: 7, 23, 24, 28, 29, 30, 31, 32; DT: 4, 5; JEE: 1, 2, 3, 4	61549	HO: 41	61630	NI: 21; NIT: 9
61483	HO: 69, 70, 79	61550	HO: 38, 40, 41, 55, 58, 59, 60; HOT: 8, 9, 10, 11	61631	NI: 21; NIT: 9
61485	HY: 9, 11; KIA: 8, 9	61551	HO: 55; HOT: 7, 9	61632	NI: 21
61486	FO: 11, 17	61552	NI: 4, 5, 6, 10; NIT: 2, 5	61634	SB: 12, 15; SBT: 1
61488	DAE: 2, 3; GM: 31; SZ: 8	61553	SZT: 8	61635	HO: 77
61489	MZT: 17, 18	61554	SZT: 7, 8	61636	GM: 73, 75, 76; GMT: 23, 24, 39; SAT: 1
61490	MI: 27	61555	HO: 38, 40, 41, 48, 49	61637	GM: 54, 64
61491	AUD: 24, 25, 28, 29; VW: 38, 39, 40, 41, 42, 43, 44	61556	TOT: 25, 26	61638	GM: 15, 16, 23
61492	SB: 16, 18; SBT: 4, 6	61557	HO: 57, 58, 59, 60; HOT: 8, 10, 11	61639	VWT: 5
61493	FOT: 40	61558	SZ: 7	61640	VW: 47, 48, 49; VWT: 6
61494	CHR: 43, 44, 45, 67; DT: 34; JEE: 8; VWT: 13	61559	AMG: 1; GMT: 56, 58, 60, 70, 71, 72, 74, 77, 82; IST: 24; WRK: 1	61641	VW: 45, 46
61495	CHR: 63, 65, 66; DT: 32, 33, 41; VWT: 15	61560	HY: 32, 33; HYT: 8, 11; KIA: 24; KIT: 9, 11	61642	VWT: 5
61496	HYT: 7; KIA: 22	61561	AMG: 1; GMT: 53, 56, 57, 58, 60, 68, 69, 70, 74, 82; IST: 24; WRK: 1	61643	VW: 48
61498	TO: 3	61562	KIT: 8, 11	61644	VW: 47, 49
61499	HY: 15, 22, 23, 29, 30, 32, 33; HYT: 1, 3, 6, 7; KIA: 5, 12, 14, 18, 19, 24; KIT: 1, 3, 6, 9, 11, 12	61563	MIT: 8	61645	NI: 10, 11, 25; NIT: 5
61500	SAB: 17, 18; SB: 16, 18; SBT: 4, 6	61564	SZ: 7	61646	NI: 10, 21; NIT: 5
61501	MI: 14	61565	MIT: 8	61647	NI: 10, 11, 12, 22, 23, 24; NIT: 5, 10, 11
61502	TO: 3, 4	61566	HY: 29, 30, 33; HYT: 8, 9; KIT: 9	61648	NIT: 5; SZT: 6
61503	HY: 15, 22, 23, 34, 35; HYT: 3, 6, 7, 8, 9, 11; KIA: 12, 14, 15, 18, 19, 20; KIT: 6, 8, 9	61567	HYT: 11; KIA: 15; KIT: 11	61650	FOT: 2
61504	HY: 16, 21, 24; HYT: 2, 3, 6; KIA: 13, 14, 17, 20; KIT: 3, 6	61568	HYT: 11; KIA: 20; KIT: 11	61651	VOL: 29, 31, 32
61505	HYT: 7	61569	MZ: 17, 21	61653	VOL: 29, 32
61506	CHR: 7, 23, 24, 28, 29, 30, 31, 32; DT: 4, 5; JEE: 1, 2, 3, 4	61570	HYT: 8, 11; KIT: 8	61654	VOL: 29, 32
61507	GMT: 53	61571	MZ: 21	61655	VOL: 28, 30; VOT: 1
61509	MI: 13, 14	61572	MZ: 22	61656	VOT: 1
61510	FO: 49	61573	MZ: 1; MZT: 8	61657	SB: 18; SBT: 6
61511	MI: 13, 14	61577	IST: 16	61659	SBT: 7, 8
61512	MZ: 24	61578	MZ: 22; MZT: 8	61660	MZT: 16
61513	NIT: 12; SZT: 10	61579	MZ: 21	61663	HO: 2
61514	NIT: 15, 16	61580	MZ: 21	61664	HO: 4, 12, 13
61515	NI: 22, 28; NIT: 13, 14, 15, 16	61582	SAB: 2, 3, 4, 13, 14, 15	61665	BMW: 7, 8
61516	FO: 49	61583	TO: 21, 28	61666	SB: 22, 24; SBT: 10
61517	HOT: 13, 28; IST: 13, 16	61586	CHR: 69, 72; DT: 49, 52, 53; JEE: 18	61667	SB: 22; SBT: 9
61518	GM: 73; GMT: 39	61587	SB: 9, 10	61668	SAB: 5, 6; SB: 6, 7
61519	GM: 73, 107, 109, 111; GMT: 39, 42	61588	MB: 24, 25, 26, 27, 28, 29, 30, 31; MBT: 1	61669	SB: 22
61520	GM: 73; GMT: 23, 24, 39; SAT: 1	61590	CHR: 56, 57; MB: 24, 25, 26, 27, 28, 29, 30, 31; MBT: 1	61670	SAB: 5, 6; SB: 6, 7
61521	GM: 55, 73; GMT: 39	61592	MB: 24, 25, 26, 27, 28, 29, 30; MBT: 1	61671	FOT: 37, 38
61522	IST: 4	61593	MZ: 16, 17; MZT: 2	61672	SB: 22, 24; SBT: 9, 10
61523	IST: 4	61594	CHR: 56, 57; MB: 31	61674	FOT: 51, 52, 54
61524	CHR: 7, 23, 24, 28, 29, 30, 31, 32; DT: 4, 5; JEE: 1, 2, 3, 4	61595	FO: 21, 22; FOT: 8, 9; MZ: 17	61675	SAB: 13, 14, 15
61525	FO: 30, 31, 38, 39, 40, 41, 43; FOT: 21, 22, 23, 24, 26; GM: 54, 55, 64, 73, 94; GMT: 39, 55; MZT: 23, 24	61596	KIA: 10	61676	GM: 5, 6, 7, 8; GMT: 1
61526	GM: 13, 14	61598	GM: 24, 44; TO: 11, 12, 17, 18	61677	GM: 5, 6, 7, 8; GMT: 1
61527	GM: 13, 14, 15, 16, 30	61599	KIA: 5; KIT: 2	61678	JAG: 1
61528	GM: 94; GMT: 55	61600	KIA: 5	61679	CHR: 67; DT: 34; JEE: 8; VWT: 13
61529	BMW: 7	61601	TO: 17, 18	61680	GM: 22, 23
61530	NI: 20	61603	TO: 17	61681	GM: 5, 6, 7, 8; GMT: 1
61531	NI: 20	61604	HYT: 9; KIT: 9, 11	61682	HO: 14
61532	BMW: 8	61605	BMW: 1, 3	61683	AMG: 1; GMT: 60, 74; IST: 24; WRK: 1
61533	DAE: 1	61607	MI: 12, 19; MIT: 1, 4	61684	FO: 31; FOT: 16, 17; MZT: 19, 20
61534	GMT: 21	61608	BMW: 2, 4	61685	GM: 45, 46, 47, 48, 50; GMT: 13, 14, 15, 16
61535	VW: 40, 41	61610	MZ: 24	61686	FOT: 2
61536	GMT: 39, 42	61612	HY: 15, 33; KIA: 12	61688	MI: 12; MIT: 1
61537	MZ: 2, 5	61613	HY: 29; HYT: 11; KIT: 11	61689	JAG: 1
61539	GMT: 39	61614	GM: 75, 76; GMT: 39, 40, 42; SZT: 9	61690	GM: 49; GMT: 17, 18
61540	TOT: 25, 26	61615	GM: 73; GMT: 23, 24, 39; SAT: 1	61691	GM: 5, 6, 7, 8; GMT: 1
61541	SZT: 8	61616	SAB: 2, 3, 4, 13, 14, 15	61692	GMT: 96, 98
61542	HO: 3, 11, 30, 31, 32, 33	61617	GM: 73, 107, 109, 111	61693	GMT: 94, 96, 99
61544	HO: 62	61618	GMT: 39, 40; SZT: 9	61694	GMT: 77, 82
		61620	FO: 38, 39, 40, 41, 44; FOT: 21, 22, 23, 24, 27; MZT: 23, 24	61696	GMT: 96, 97, 98
		61621	FOT: 21; MZT: 23	61697	GMT: 96, 97, 98
		61622	FO: 38, 39, 40, 43; FOT: 22, 26	61698	FO: 64, 65; FOT: 47, 62, 63
		61623	FO: 40; FOT: 22	61699	GM: 57, 58, 59; GMT: 28, 29; SAT: 2
		61624	GM: 40, 47; GMT: 9, 11, 13	61700	DT: 22, 23, 24, 25, 28, 36, 37, 38; JEE: 10; VWT: 14
		61625	GM: 45, 47, 48, 50, 71, 72, 73	61701	DT: 22, 23, 24, 25, 28, 36, 37, 38; VWT: 14
				61702	DT: 35; JEE: 9
				61703	GM: 49
				61704	GMT: 13

61705	VW: 32, 33, 34, 35, 36, 37	70255	GM: 80	70799	CHR: 25, 40, 41, 42; DT: 14, 15; GM: 60, 67; GMT: 32
61706	KIA: 2, 3	70256	GM: 80	70800	FOT: 68, 69, 71; GM: 61, 62, 63, 68; GMT: 25, 30; IST: 10, 12
61707	HY: 6, 13, 15; KIA: 2	70257	GM: 80	70801	AV: 2; FO: 51, 52, 54, 55, 56, 57, 58, 59; FOT: 35, 36, 37, 38, 39, 40, 48, 49, 50, 51, 52, 53, 54, 55, 56, 58, 66, 67
61708	GM: 57, 58, 59; GMT: 28, 29; SAT: 2	70261	FO: 60, 63	70802	FOT: 48, 49, 50, 51, 52, 53, 54, 66
61709	GMT: 17, 18	70262	FO: 61, 62, 63	70803	GM: 51
61710	CHR: 69, 72; DT: 49, 52, 53; JEE: 18	70264	GM: 9, 10, 18; TO: 5, 6, 7	70804	GM: 60, 67, 69; GMT: 31, 32, 33, 36, 37
61711	TO: 12	70301	JEE: 11, 12	70805	GM: 35; GMT: 7, 8; IST: 2, 3
61712	HY: 6, 7; KIA: 2	70367	TO: 22	70808	GM: 35; GMT: 7, 8; IST: 2, 3
61713	HY: 13; KIA: 15	70368	GM: 10; NI: 7	70820	AMG: 1; GM: 29, 30, 35, 40, 57, 58, 59, 60, 61, 67, 70, 77, 78, 79, 81, 82; GMT: 6, 7, 8, 9, 11, 28, 29, 32, 45, 51, 53, 54, 59, 60, 73, 74, 100, 101, 102, 103; IST: 2, 3, 20, 21, 24; SAT: 2; WRK: 1, 3, 4
61714	TOT: 10	70372	GM: 11, 12, 25; HOT: 14; IS: 1, 2, 3, 4; IST: 13, 14; LOT: 1	70822	AMG: 2, 3, 4, 5; AV: 3, 4, 5; CHR: 25, 40, 41, 42, 59, 60, 61, 62, 63, 64, 65, 66, 68, 74, 75; DT: 14, 15, 22, 24, 26, 27, 28, 31, 32, 33, 37, 39, 40, 41, 45, 46, 47, 61, 62, 63, 64, 68; EXC: 1; FO: 60, 61, 62, 63, 69; FOT: 41, 42, 43, 44, 45, 46, 59, 60; GM: 9, 10, 17, 18, 19, 20, 21, 24, 35, 36, 41, 42, 43, 44, 62, 63, 65, 66, 68, 77, 80, 82, 88, 89, 90, 96, 97, 98, 102, 103, 104, 105; GMT: 7, 12, 19, 20, 25, 30, 45, 50, 51, 52, 54, 59, 73, 86, 87, 88, 89, 90, 91, 92; GRU: 1, 2, 3; IST: 2, 10, 12, 25; JEE: 16; LAF: 1, 2; LOT: 2, 3, 4, 5, 6; TO: 2, 3, 4, 5, 6, 7, 8, 9, 10, 11, 12, 13, 14, 15, 16, 17, 18, 19, 20, 21, 22, 25, 26, 27, 28, 29, 30, 31, 32, 33, 34, 35, 36, 37, 38; TOT: 1, 2, 3, 5, 8, 9, 10, 11, 12, 13, 14, 15, 16, 17, 18, 19, 20, 23, 24, 25, 26; VWT: 15; WIN: 2; WRK: 2
61716	TO: 19, 20; TOT: 8	70374	FOT: 41, 42, 43	70832	HOT: 14; IST: 14
61718	KIA: 3	70397	GM: 62, 63, 68	70885	NI: 20
61720	GMT: 93	70410	TOT: 9, 21	70893	NI: 3, 7, 20, 21; NIT: 7, 8, 9
61721	FOT: 65	70415	DET: 1; FO: 51, 52, 53, 54, 55, 56; PNZ: 1, 2	70895	AV: 6; CAL: 1; GM: 100, 101, 106, 108; GMT: 56, 57, 58, 61, 62, 63, 64, 65, 66, 67, 68, 69, 70, 71, 72, 75, 78, 80, 81, 84; IST: 22, 23; MOS: 1; SAT: 4, 5
61723	FOT: 65	70431	FO: 1, 4, 10; KIA: 5, 10, 11; KIT: 2; MZ: 2, 4, 5, 8, 9, 10, 11, 12, 13, 14, 15, 24, 25, 26, 27	70914	ACO: 1, 2; AV: 6; CAL: 1; GM: 87, 91, 92, 93, 94, 95, 100, 101, 106, 108; GMT: 55, 56, 57, 58, 61, 62, 63, 64, 65, 66, 67, 68, 69, 70, 71, 72, 75, 78, 80, 81, 84; IST: 22, 23; MOS: 1; SAT: 4, 5
61724	HO: 80, 81; HOT: 29, 30	70475	TO: 36, 37	70947	AV: 6; CAL: 1; GM: 100, 101, 106, 108; GMT: 56, 57, 58, 61, 62, 63, 64, 65, 66, 67, 68, 69, 70, 71, 72, 75, 78, 80, 81, 84; IST: 22, 23; MOS: 1; SAT: 4, 5
61728	NI: 10	70484-1	GM: 52, 53; GMT: 19, 20; GRU: 2, 3	70948	FO: 32
61729	TO: 20	70492	TO: 1	70954	AV: 5; GM: 28, 33, 34, 35, 36, 90, 96, 98, 103; GMT: 7, 25; GRU: 1; IST: 10, 12
61730	KIT: 9	70522	DT: 39, 40, 45, 46, 47, 61, 62, 63, 64; JEE: 16, 20	70961	TOT: 5, 9
61731	FO: 13	70561	CHR: 25, 38, 39, 40, 41, 42, 51, 59, 60, 61, 68; DT: 13, 14, 15, 18, 24, 26, 27, 28, 37, 39, 40, 45, 46, 47, 61, 62, 63, 64; JEE: 11, 12, 16, 20; MI: 21	70978	AMG: 2; AV: 3, 4; EXC: 1; GM: 26, 52, 53, 88, 89, 97, 102, 104, 105; GMT: 19, 20, 30, 35, 51, 52, 59, 73, 100; GRU: 2, 3; HO: 2, 3, 4, 5, 6, 7, 9, 10, 11, 12, 13, 14, 15, 23, 24, 25, 26, 30, 31, 32, 33, 34, 36, 41, 42, 43, 44, 45, 46, 47, 48, 49, 51, 52, 53, 54, 55, 56, 57, 58, 59, 60, 61, 62, 63, 65, 66, 67, 68, 69, 70, 71, 72, 73, 74, 75, 76, 77, 78, 80, 81; HOT: 3, 4, 5, 6, 7, 8, 9, 10, 11, 15, 16, 17, 18, 19, 20, 21, 22, 23, 24, 25, 26, 27, 29, 30; IST: 1, 5, 25; NI: 7, 8; STE: 1; WIN: 1
61746	GMT: 94, 95, 96, 97, 98	70568	CHR: 47, 49; HY: 27, 31; HYT: 10; KIA: 23; KIT: 10; MI: 22, 24	70982	AUD: 19; VOL: 11, 12, 13, 22, 24, 25, 26, 27; VW: 14, 15, 16, 17, 18, 19, 26, 30
61747	GMT: 96	70621	GM: 35; GMT: 7; IST: 2	70984	GMT: 2; SZ: 5; SZT: 2
61748	GMT: 99	70627	CHR: 25, 40, 41, 42; DT: 14, 15	71012	GMT: 100, 101, 102; WRK: 3
61749	MB: 1	70644	GM: 65, 77, 78, 79, 80, 81, 82; GMT: 45	71026	GMT: 2, 3, 4, 21; SZ: 5, 7, 9; SZT: 2, 5, 7, 8
61750	MB: 1	70672	GM: 61, 62, 63, 68; GMT: 25, 30; IST: 10, 12		
61751	HY: 22; KIA: 18	70690	TO: 1, 2		
62010	VW: 45, 46	70692	IST: 6		
62011	VW: 47, 49	70693	CHR: 43, 44, 45, 46		
62555	DAE: 1	70696	CHR: 43, 44, 45, 46; DT: 22, 23, 24, 25, 28, 29, 36, 37, 38; JEE: 10; VWT: 14		
6579	AMG: 2, 3, 4, 5; AV: 3, 4, 5; FOT: 68, 69, 71; GM: 97, 98, 102, 103; GMT: 59, 73, 86, 87, 88, 89, 90, 91, 92; IST: 25; JEE: 6, 7, 11, 12, 19; WRK: 2	70697	FO: 9; FOT: 1; GM: 25; IS: 4; MZT: 1		
6584	DT: 40, 47, 62, 64	70712	FOT: 13, 14; NI: 13; NIT: 6		
70004	SB: 3, 4, 5, 9, 11, 14, 16, 17, 18, 21; SBT: 2, 4, 5, 6	70714	FO: 26; MZ: 20, 24		
70015	GMT: 25; IST: 10; NI: 7, 9; NIT: 4	70716	FO: 26; MZ: 20, 24		
70020	FO: 60, 61, 62, 63, 69; FOT: 45, 60; MOR: 1	70720	CHR: 7, 10, 11, 12, 13, 14, 23, 24, 28, 29, 30, 31, 32, 33, 34, 35, 36, 37, 38, 58, 62, 63, 64, 65, 66; DT: 1, 4, 5, 6, 7, 8, 9, 10, 11, 12, 22, 24, 28, 37; JEE: 1, 2, 3, 4, 5; MI: 6, 7		
70030	FO: 2, 3; GM: 3, 4; MZ: 4; SZ: 3, 4; SZT: 1	70721	CHR: 10, 11, 12, 13, 14, 37, 38, 39, 58, 62, 63, 64, 65, 66, 69, 70, 71, 72; DT: 1, 8, 12, 22, 23, 24, 25, 28, 29, 31, 32, 33, 35, 36, 37, 38, 41, 42, 43, 44, 48, 49, 50, 51, 52, 53; JEE: 5, 9, 10, 13, 14, 15, 17, 18; MI: 6, 7, 21; MIT: 11, 13, 14; VWT: 14, 15		
70041	TO: 2	70725	CHR: 7, 10, 11, 12, 13, 14, 23, 24, 28, 29, 30, 31, 32, 33, 34, 35, 36, 37; DT: 1, 4, 5, 6, 7, 8, 9, 10, 11, 12; JEE: 1, 2, 3, 4, 5; MI: 6, 7		
70051	DT: 13; JEE: 6, 7, 11, 12, 19	70766	GM: 60, 61, 66, 67; GMT: 32		
70054	GM: 61	70781	AMG: 4; GMT: 88, 89, 90; WRK: 2		
70056	GM: 88, 97, 102	70783	GM: 77, 78, 79, 81; GMT: 103; WRK: 4		
70122	FO: 16; KIT: 4; MZ: 19; MZT: 3, 4	70784	GM: 77, 82; GMT: 45		
70132	FOT: 72	70786	GM: 77, 82; GMT: 45		
70149	DET: 1; FO: 5, 6, 7, 8, 9, 19, 20, 24, 25, 27, 28, 29, 30, 31, 32, 34, 35, 36, 46, 47, 48, 49, 51, 52, 53, 54, 56, 57, 58; FOT: 7, 11, 12, 15, 16, 17, 18, 19, 29, 31, 32, 33, 34, 38, 39, 45; JAG: 1, 2; LAF: 1, 2; LRT: 10; MZT: 9, 12, 13, 18, 19, 20, 21, 22, 25, 26, 27; PNZ: 1, 2	70788	ACO: 1; GM: 70, 87, 92, 93; GMT: 54, 100, 101, 102; WRK: 3		
70150	AMG: 3, 4, 5; GMT: 86, 87, 88, 89, 90, 91, 92; WRK: 2	70789	AMG: 1; DAE: 1; GM: 26, 27, 35, 51, 56; GMT: 7, 8, 27, 51, 53, 54, 60, 74; HOT: 13, 14, 28; IST: 2, 3, 4, 13, 14, 16, 20, 21, 24; WRK: 1		
70152	CHR: 1, 2, 3, 4, 5, 6, 8, 9, 15, 16, 17, 18, 19, 20, 21, 22, 26, 27, 48, 50, 52, 53, 54; DT: 2, 3, 19; HY: 1, 2, 8, 14, 18, 19, 20, 21, 24, 25, 26, 28; HYT: 4, 6, 7; KIA: 16, 17, 20, 21, 22; KIT: 6, 7; MI: 1, 2, 3, 4, 5, 8, 9, 10, 11, 14, 15, 16, 17, 18, 23, 24, 25, 26; MIT: 2, 3, 6, 7, 10	70790	GM: 60, 61, 66, 67; GMT: 32		
70154	TO: 23, 24	70791	GM: 66		
70159	IST: 6, 7	70793	GM: 66		
70194	AMG: 1, 2; AV: 3, 4, 5; GM: 98, 103; GMT: 50, 51, 52, 53, 54, 59, 60, 73, 74, 100, 101, 102; IST: 20, 21, 24, 25; WRK: 1, 3	70794	HOT: 13, 14, 28; IST: 13, 14, 16		
70208	GM: 62, 63	70796	GM: 68		
70234-1	GM: 61	70798	GM: 68		
70253	CHR: 55; JEE: 19				
70254	FO: 1				

NUMERICAL LIST

71067	FO: 9, 31; FOT: 15, 16, 17; MZT: 17, 18, 19, 20	71369	HO: 11	72515	AV: 2; DET: 1; FO: 5, 6, 7, 8, 9, 10, 18, 19, 20, 24, 25, 27, 28, 29, 30, 32, 33, 34, 35, 36, 37, 46, 47, 48, 51, 52, 53, 54, 55, 56, 57, 58, 59; FOT: 1, 7, 11, 12, 15, 18, 19, 29, 30, 31, 34, 35, 36, 37, 38, 39, 40, 48, 49, 50, 51, 52, 53, 54, 55, 56, 58, 72; HY: 4, 5, 15, 25, 26, 31; HYT: 1, 7, 10; KIA: 12, 21, 22, 23; KIT: 1, 7, 10; MZ: 12, 14, 15, 30; MZT: 1, 9, 12, 13, 17, 18, 21, 22, 25, 26; MOR: 1; PNZ: 1, 2
71081	GMT: 103; WRK: 4	71379	GM: 31; SZ: 8	72516	FO: 60, 61, 62, 63; FOT: 44, 45, 46, 72; LAF: 1, 2
71093	GMT: 103; WRK: 4	71402	SB: 22; SBT: 9	72517	MOR: 1
71097	GM: 88; GMT: 50, 51, 52	71409	SB: 22; SBT: 9	72518	TO: 13, 14, 15, 16; TOT: 1
71098	PEU: 2	71428	FO: 35, 36; FOT: 18, 19, 29; MZT: 21, 22	72521	FOT: 20; NI: 1, 7, 8, 18, 19, 20, 27; NIT: 3, 4, 6, 7, 8
71103	GM: 56; GMT: 27	71442	GMT: 96, 97, 98	72535	CHR: 69, 72; DT: 49, 52, 53; JEE: 18
71164	GM: 1, 2, 3, 4; GMT: 2, 3; SZ: 1, 2, 3, 4, 5; SZT: 1, 2, 3	71443	GMT: 96, 97, 98	72540	FO: 60, 63
71176	AV: 1; FO: 30, 32, 49, 50, 54, 55, 56; FOT: 15, 30, 32, 33, 34, 35, 36, 37, 38	71472	FOT: 64	72543	FO: 61, 62, 63
71182	DT: 8, 37	72218	CHR: 35, 37; DT: 12	72554	GM: 10, 18; TO: 5, 7
71185	CHR: 43, 44, 45, 46, 63, 66; DT: 22, 23, 24, 25, 28, 29, 31, 36, 37, 38, 41; JEE: 10; VWT: 14, 15	72219	DT: 16, 17; FRT: 1	72555	FOT: 64
71194	GM: 37, 38, 39; GMT: 10	72234	NIT: 3	72556	TO: 12
71197	FOT: 20; NIT: 7	72251	DT: 35, 42, 43; JEE: 9, 13, 14; MIT: 11, 13, 14	72580	FOT: 72
71202	AV: 1; FO: 50; FOT: 32, 33; LRT: 10; MZT: 27	72266	FOT: 31; MZT: 25	72585	FOT: 64
71210	MI: 12, 19, 20, 27; MIT: 1, 4, 5, 8, 12	72268	IST: 4	72590	JEE: 19
71216	DET: 1; FO: 5, 9, 18, 19, 20, 24, 25, 27, 28, 29, 32, 33, 34, 35, 36, 37, 46, 47, 51, 52, 53, 54, 55, 56, 57, 58, 60, 61, 62, 63; FOT: 7, 11, 12, 18, 19, 29, 31, 34, 35, 36, 37, 38, 39, 44, 45, 46, 48, 49, 50, 51, 52, 53, 54, 59, 60, 72; LAF: 1, 2; MZT: 9, 12, 13, 21, 22, 25, 26; PNZ: 1, 2; WIN: 2	72293	DAE: 1	72598	GM: 52, 53; GMT: 19, 20; GRU: 2, 3
71217	HO: 41, 55, 56, 57; HOT: 5, 6, 7, 9	72302	AV: 1; FO: 30, 31, 32, 48, 50; FOT: 15, 16, 17, 30, 32, 33, 34; JAG: 2; LRT: 10; MZ: 30; MZT: 17, 18, 19, 20, 27	72606	FO: 15; MZ: 18
71218	GMT: 4, 21; SAB: 16, 17, 18; SB: 12, 13, 15, 16, 18, 22, 24; SBT: 1, 3, 4, 6, 9, 10; SZ: 7, 9; SZT: 5, 7, 8	72305	CHR: 63, 65, 66; DT: 32, 33	72607	FO: 69; FOT: 59, 60; WIN: 2
71219	GMT: 93	72316	HO: 61	72610	TO: 13, 15, 16; TOT: 1
71220	GMT: 93	72336	MZ: 22; MZT: 8	72611	FO: 15, 16; KIT: 4; MZ: 18, 19; MZT: 3, 4
71221	CHR: 69, 70, 71, 72; DT: 42, 43, 48, 49, 50, 51, 52, 53; JEE: 13, 14, 17, 18; MIT: 13, 14	72343	GM: 60, 67; GMT: 31, 32, 33	72625	FOT: 12
71223	FO: 11, 17; FOT: 5, 6; MZT: 6, 7	72361	CHR: 56, 57; MB: 24, 25, 26, 27, 28, 29, 30, 31; MBT: 1	72633	NI: 9; NIT: 4
71224	FO: 11, 17, 21, 22; FOT: 2, 4, 8, 9; MZ: 17, 21; MZT: 5	72370	HO: 4, 12, 13, 14, 30, 31, 32, 33	72635	GM: 82
71226	FOT: 2, 4, 5, 6; MZT: 5, 6, 7	72371	HO: 4, 12, 13, 14, 30, 31, 32, 33, 75, 76, 77, 78, 80, 81; HOT: 20, 23, 24, 25, 26, 27, 29, 30	72636	TO: 12
71227	FO: 11, 17, 21, 22; FOT: 2, 5, 6, 8, 9; MZ: 17, 21; MZT: 6, 7	72401	AV: 6; CAL: 1; GM: 99, 100, 101, 106, 107, 108, 109, 110, 111; GMT: 56, 57, 58, 61, 62, 63, 64, 65, 66, 67, 68, 69, 70, 71, 72, 75, 76, 77, 78, 79, 80, 81, 82, 83, 84, 85; IST: 22, 23; MOS: 1; SAT: 4, 5	72649	FO: 18; FOT: 7, 18, 41, 42, 43, 44, 46, 59, 60, 72; LAF: 1; MZT: 9; WIN: 2
71234	TO: 29, 30, 31	72416	HO: 46, 47, 51, 52, 53, 65; HOT: 3, 4; IST: 1, 5	72651	TO: 12
71238	DT: 42, 43, 44; JEE: 13, 14, 15; MIT: 13, 14	72420	HO: 75, 76, 77, 78, 80, 81; HOT: 20, 23, 24, 25, 26, 27, 29, 30	72655	FO: 46, 47, 48; FOT: 29, 30, 34
71240	DT: 42, 43, 44; JEE: 13, 14, 15; MIT: 13, 14	72423	GM: 69, 71, 72, 83, 84, 85, 86; GMT: 36, 37, 38, 47, 48	72663	TO: 13, 14, 15, 16; TOT: 1
71242	MI: 27; MIT: 12	72435	AV: 6; CAL: 1; GM: 99, 100, 101, 106, 107, 108, 109, 110, 111; GMT: 56, 57, 58, 61, 62, 63, 64, 65, 66, 67, 68, 69, 70, 71, 72, 75, 76, 77, 78, 79, 80, 81, 82, 83, 84, 85; IST: 22, 23; MOS: 1; SAT: 4, 5	72665	AMG: 1, 2; AV: 3, 4, 5; EXC: 1; GM: 88, 89, 97, 98, 102, 103, 104, 105; GMT: 50, 51, 52, 53, 54, 59, 60, 73, 74, 100, 101, 102; IST: 20, 21, 24, 25; WRK: 1, 3
71243	GM: 69	72436	NI: 9; NIT: 3, 4	72670	GM: 60, 61, 62, 63, 67, 68, 69; GMT: 25, 30, 31, 32, 33, 36, 37; IST: 10, 12
71247	GM: 69; GMT: 36, 37	72437	TOT: 4	72673	ACO: 1, 2; GM: 87, 91, 92, 93, 95
71248	GMT: 94, 95, 96, 99	72438	GM: 9, 10, 18; TO: 1, 5, 6, 7, 13, 15, 16; TOT: 1, 6, 7, 11	72694	TO: 4, 12
71249	GMT: 94, 95, 96, 99	72454	HO: 5, 6, 7, 8, 9, 10, 15, 16, 17, 18, 19, 20, 21, 22, 28, 29, 34, 35, 36, 42, 43, 44, 45, 46, 47, 48, 49, 51, 52, 53, 54, 65; HOT: 1, 2, 3, 4; IST: 1, 5	72695	TO: 4
71250	GMT: 94	72462	AV: 6; CAL: 1; GM: 99, 100, 101, 106, 107, 108, 109, 110, 111; GMT: 56, 57, 58, 61, 62, 63, 64, 65, 66, 67, 68, 69, 70, 71, 72, 75, 76, 77, 78, 79, 80, 81, 82, 83, 84, 85; IST: 22, 23; MOS: 1; SAT: 4, 5	72696	GM: 62, 63, 68; GMT: 25, 30; IST: 10, 12
71251	GMT: 94, 95, 96, 99	72466	GM: 69; GMT: 36, 37	72704	DT: 22, 24, 28, 29, 37
71262	HY: 31; HYT: 10; KIA: 23; KIT: 10	72470	SAB: 2, 3, 4, 13, 14, 15	72705	FO: 11, 17; FOT: 2, 4, 5, 6; MZ: 17, 21, 22; MZT: 5, 6, 7, 8
71263	FOT: 61	72485	AUD: 1, 2, 3, 4, 5, 6, 7, 8, 9, 10, 11, 12, 13, 14, 15, 16, 17; AUT: 1; VW: 4, 5, 6, 7, 8, 9, 10, 11, 12, 13, 27, 28, 29, 31, 32, 33, 34, 35, 36, 37; VWT: 1, 2, 3	72706	DT: 22, 23, 24, 25, 28, 36, 37, 38; JEE: 10; VWT: 14
71265	FOT: 61	72491	BMW: 13, 14, 16, 17, 23, 24; BMT: 1, 2	72707	TO: 4
71269	DAE: 2, 3; GM: 31; SZ: 8	72493	NI: 20, 21; NIT: 9	72709	FO: 17; FOT: 2, 4, 5, 6; MZ: 17, 21, 22, 23; MZT: 5, 6, 7, 8, 10, 11
71270	DAE: 2, 3; GM: 31; SZ: 8	72494	FOT: 72	72735	TO: 4
71276	MZ: 30	72505	FOT: 72	72736	TO: 4
71278	FO: 31; FOT: 15, 16, 17; MZT: 18, 19, 20			72737	GM: 56; GMT: 27
71280	MZT: 17, 18			72739	GM: 35, 36; GMT: 7, 8; GRU: 1; IST: 2, 3
71285	GM: 13, 14			72743	FOT: 65
71286	GM: 13, 14			72744	FOT: 65
71287	DAE: 1; GM: 13, 14			72749	GM: 19, 20; TO: 8, 9
71288	GM: 94; GMT: 55			72754	FO: 46, 47, 48; FOT: 29, 30, 34
71312	FO: 39, 40; FOT: 21, 22; MZT: 23			72755	GMT: 22, 26, 34, 44, 49; IST: 9, 11, 15, 17, 19; SAT: 3
71316	FO: 39, 40; FOT: 21, 22; MZT: 23			72760	GM: 107, 109; GMT: 75, 76, 77, 79, 82, 83, 84, 85
71318	FO: 38, 39, 40, 41, 43, 44, 45; FOT: 21, 23, 24, 26, 27, 28			72762	GMT: 93
71319	FO: 38, 39, 40, 41, 43, 44, 45; FOT: 21, 23, 24, 26, 27, 28			72763	GMT: 94
71325	GM: 13, 14, 15, 16				
71352	VW: 45, 46				
71353	VW: 45, 46, 47, 48				

NUMERICAL LIST

72764	GMT: 94, 95, 96, 99	8548 PT-2	FO: 60, 61, 62, 63, 69; FOT: 44, 45, 46, 59, 60; LAF: 1, 2; WIN: 2	9313 PT	DT: 54, 55, 56
72767	GMT: 94, 96, 98	8548 SP-1	FO: 60, 61, 62, 63, 69; FOT: 44, 45, 46, 59, 60; LAF: 1, 2; WIN: 2	9332 PT	DT: 54, 55
72773	DT: 57, 58, 60	8553 PT	DT: 62, 64	9333 PT-1	FO: 60, 61, 62, 63, 69; FOT: 44, 45, 46, 59, 60; LAF: 1, 2; WIN: 2
72775	FOT: 65	8553 SP	DT: 62, 64	9352 PT	CHR: 4; HY: 1, 2; MI: 2
72795	FOT: 70	8558 PT-1	FOT: 72	9354 PT-1	GM: 88; GMT: 51, 52, 53, 54; IST: 20, 21
72796	AV: 1; FO: 50; FOT: 32, 33; LRT: 10; MZT: 27	8699 PT-2	GM: 62; GMT: 25, 30; IST: 10, 12	9388 PT	CHR: 27; DT: 2, 3; HY: 20; MI: 18; MIT: 3
72803	AUD: 2, 5, 6, 22, 23, 24, 25, 28, 29; AUT: 2, 3; VW: 6, 9, 42, 43, 44	8699 SP-1	GM: 62, 63; GMT: 25, 30; IST: 10, 12	9392 PT	SB: 3, 4
72815	TO: 29, 30, 31	8726 PT	AMG: 3; GMT: 86, 87	9397 B	BMW: 15
72884	FOT: 12, 31; MZT: 25, 26	8753 PT-1	GM: 90, 96	9405 PT-1	GM: 52; GMT: 19, 20; GRU: 2, 3
72887	TOT: 16	8807 SP	TOT: 4	9406 PT	GM: 53
72898	TO: 26, 27; TOT: 12, 13	8857 PT-1	FO: 46	9422 PT	KIT: 4
72928	CHR: 43, 44, 45, 58, 62, 63, 64, 65, 66, 69, 70, 71, 72; DT: 1, 8, 12, 31, 32, 33, 41, 42, 43, 44, 48, 49, 50, 51, 52, 53; JEE: 13, 14, 15, 17, 18; MIT: 13, 14; VWT: 15	8857 SP-1	FO: 46	9425 PT	CHR: 58
72941	MZ: 16, 17, 21, 22, 23; MZT: 2, 5, 6, 7, 8, 10, 11	8993 PT-1	FO: 18; FOT: 7, 11; MZT: 9, 13	9437 B-1	VW: 1, 2, 3
72946	GMT: 94, 95, 96, 99	9005 PT	FO: 6, 7, 8; FOT: 1; MZT: 1	9438 B-1	VW: 1, 2, 3
72949	FO: 11, 17, 21, 22, 23; FOT: 2, 4, 5, 6, 8, 9, 10; MZ: 17, 21, 22, 23; MZT: 5, 6, 7, 8, 10, 11	9005 PT-1	FO: 6, 7, 8; FOT: 1; MZT: 1	9439 B-1	VW: 1, 2, 3
72950	FO: 11, 17, 21, 22, 23; FOT: 2, 4, 5, 6, 8, 9, 10; MZ: 17, 21, 22, 23; MZT: 5, 6, 7, 8, 10, 11	9014 PT	GM: 33, 34	9455 PT	CHR: 58
72951	GMT: 35; HO: 66, 67, 68, 73, 74, 75, 76, 77, 78, 80, 81; HOT: 18, 19, 20, 21, 22, 23, 24, 25, 26, 27, 29, 30	9031 PT	HO: 69, 70, 79	9465 PT	TOT: 5, 9
72966	GM: 71, 72, 83, 84, 85, 86; GMT: 38, 47, 48	9032 PT	HO: 69, 70, 79	9468 PT	TO: 15, 16
72968	GM: 73, 75, 76; GMT: 39, 40, 42, 43; SZT: 9	9034 PT	DT: 67	9469 PT	GM: 35, 36
72969	AUD: 1, 2, 3, 4, 5, 6, 7, 8; VW: 4, 5, 6, 7, 8, 9, 10, 11, 12, 13, 31, 32, 33, 34, 35, 36, 37	9036 PT	CHR: 13, 14	9469 SP	GM: 35, 36
72973	TOT: 23, 24	9037 PT	CHR: 38, 39; MI: 21	9471 PT	GM: 62, 63
72977	MB: 8, 9, 15, 24, 25, 26, 27, 28, 29, 30, 31, 53, 54, 55, 56, 57, 58, 59, 60, 61; MBT: 1, 7, 8, 9, 10	9038 PT	FO: 28, 29; MZT: 12	9473 PT	TO: 23, 24
72978	MB: 8, 9, 15, 24, 25, 26, 27, 28, 29, 30, 31, 53, 54, 55, 56, 57, 58, 59, 60, 61; MBT: 7, 8, 9, 10	9039 PT	FO: 28, 29; MZT: 12	9481 PT	FO: 32
72979	DT: 30; FRT: 4; MB: 21, 22, 23, 38, 39, 40, 41, 42, 43, 44, 45, 46, 47, 48, 78, 79, 80, 81, 82, 83, 84, 85; MBT: 2, 3, 4, 5, 6, 16, 17	9047 PT	FOT: 68, 69, 71	9482 PT	FO: 32
72980	AUD: 39, 40; VW: 50, 51	9059 PT	GM: 51	9483 PT	TO: 1
72981	SAB: 2, 3, 4, 13, 14, 15	9071 PT	GM: 67; GMT: 31, 32, 33	9489 PT	TO: 26; TOT: 12, 13
72982	POT: 3, 4; VWT: 11, 12	9076 PT-1	JEE: 11, 12	9490 PT	TO: 26; TOT: 12, 13
72983	HY: 15; HYT: 1; KIA: 12; KIT: 1	9085 PT	GM: 89	9494 PT	TO: 2
72986	MIT: 12	9086 PT	CHR: 21, 22; MI: 11	9496 PT	IST: 6, 7
72988	SB: 22; SBT: 9	9088 PT	GM: 77	9502 PT	GMT: 100, 101, 102; WRK: 3
72989	SB: 22	9089 PT	GM: 77, 79	9505 PT	CHR: 62, 63, 64, 65, 66
72990	MB: 1	9090 PT	VW: 14, 15, 16, 17, 19	9507 PT	CHR: 62, 63, 64, 65, 66
72991	MB: 1	9105 PT	GM: 68	9508 PT	NI: 20
72993	VW: 38, 39, 40, 41	9111 PT	DT: 40	9509 PT	NI: 20
72995	MB: 49, 50, 51, 62, 63, 64, 65, 66, 67	9112 PT	CHR: 51, 52, 53; DT: 18, 19; HY: 28; MI: 24; MIT: 5	9510 PT	FOT: 12
72996	BMW: 10, 16, 22, 28; BMT: 6, 7; LRT: 13	9113 PT	GM: 66	9511 PT	FOT: 12
72997	HY: 21, 24; HYT: 6; KIA: 17, 20; KIT: 6	9115 PT	GM: 51	9514 PT	CHR: 43, 44, 45, 46
73000	SB: 22; SBT: 9	9123 PT	HO: 5, 6, 7, 9, 10, 15	9515 PT	GM: 41, 42, 43; GMT: 12
73001	SAB: 5, 6; SB: 6, 7, 22	9124 PT-1	HO: 36	9517 PT	CHR: 43, 44, 45, 46
73002	MB: 1	9124 PT-2	HO: 42	9521 PT	AMG: 4, 5; GMT: 88, 89, 90, 91, 92; WRK: 2
73003	MZ: 14, 15	9128 PT	AMG: 3; GMT: 86, 87	9522 PT	DT: 57, 58, 60
73009	GMT: 96, 97, 98	9158 PT	CHR: 38, 39	9523 PT	DT: 54, 55, 56
7733 PT-2	AMG: 1, 2; GM: 102, 103; GMT: 73, 74; IST: 24, 25; WRK: 1	9170 PT-1	GM: 35; GMT: 7, 8; GRU: 1; IST: 2, 3	9528 PT	SB: 1, 2
7733 SP	AMG: 1, 2; GM: 102, 103; GMT: 73, 74; IST: 24, 25; WRK: 1	9174 PT	HOT: 14; IST: 13, 14	9531 PT	HO: 63; STE: 1
8168 PT	FOT: 41, 42, 43	9196 PT	DT: 13; JEE: 6, 7	9534 PT	DT: 54, 55, 56
8168 SP	FOT: 41, 42, 43	9199 PT	GMT: 78	9535 PT	CHR: 68; DT: 37
8180 SP-1	GMT: 100	9201 PT	TO: 26, 27; TOT: 12	9536 PT	CHR: 68; DT: 37
8188 PT	GM: 10; TO: 5	9203 PT	TO: 26, 27; TOT: 12	9537 PT	CHR: 54; MI: 25; MIT: 7
8190 PT	VOL: 4, 5, 6, 7, 8, 9, 10	9213 PT	MZ: 2	9539 PT	FO: 9
8215 PT	HOT: 12; IST: 8	9227 PT-1	TOT: 16	9540 PT	FO: 32; FOT: 15; MZT: 18
8266 PT-1	JEE: 19	9229 PT-1	TOT: 16	9541 PT	FO: 32; FOT: 15; MZT: 18
8471 SP	FO: 18; FOT: 7, 11; MZT: 9, 13	9234 PT	FOT: 29	9553 PT	GM: 17
8510 PT	AV: 3, 4, 5; GM: 97, 98; GMT: 59, 60	9239 PT	FOT: 70	9555 PT	FO: 1
8523 PT-1	GMT: 100	9250 PT	FO: 46, 48; FOT: 29, 30, 34	9560 PT	FO: 46; FOT: 29
		9253 PT	FO: 46, 48; FOT: 29, 30, 34	9560 SP	FO: 46; FOT: 29
		9254 PT	HOT: 13, 28; IST: 13, 16	9570 PT	VW: 26
		9256 PT	HOT: 13, 28; IST: 13, 16	9571 PT	FOT: 13, 14; NI: 18, 19; NIT: 6
		9262 PT	FO: 46	9572 PT	FO: 15, 16; MZ: 18, 19; MZT: 3, 4
		9263 PT	FO: 46	9592 PT	TO: 26, 27; TOT: 12, 13
		9274 PT	HO: 21, 22, 27, 28, 29	9594 PT	TO: 26, 27; TOT: 12, 13
		9282 B	AUD: 18	9604 PT	GM: 10; TO: 5
		9284 PT	AV: 6; CAL: 1; GM: 100, 101	9618 PT	SB: 5
		9292 PT	GMT: 57, 68	9623 PT	GM: 3, 4; SZ: 2, 3, 4; SZT: 1
		9296 PT	CHR: 25, 40, 41, 42; DT: 14, 15	9627 PT	CHR: 15, 16, 17, 18; HY: 8, 14, 18; MI: 3, 8, 9
		9296 SP	CHR: 25, 40, 41, 42; DT: 14, 15	9637 PT	MZT: 14
		9309 PT-2	FO: 5, 9; MOR: 1	9642 PT-1	FO: 47
		9309 SP-2	FO: 5, 9; MOR: 1	9644 PT	GM: 65, 80, 82; GMT: 45
				9646 PT	NI: 9; NIT: 4
				9649 PT	MZ: 25, 26, 27, 28, 29; MZT: 15, 16

NUMERICAL LIST

9650 PT	MZ: 25, 26, 27, 28, 29; MZT: 15, 16	9958 PT-1	HO: 46, 47, 51, 52, 53; HOT: 3, 4; IST: 1, 5	BS 40555	DAE: 2, 3; GM: 31, 33, 34; SZ: 8
9651 PT	GM: 1, 2; SZ: 1	9963 PT	TO: 2	BS 40562	CHR: 38, 39, 47, 51, 52, 53; DT: 18, 19; HY: 25, 26, 27, 28, 31; HYT: 7, 9, 10; KIA: 21, 22, 23; KIT: 7, 9, 10; MI: 21, 22, 24; MIT: 6
9656 PT	TO: 22	9966 PT	EXC: 1; GM: 104, 105	BS 40578	DT: 13; GM: 52, 53; GMT: 19, 20; GRU: 2, 3; JEE: 6, 7
9657 PT	TO: 22	9968 PT	GM: 26	BS 40591	GM: 41, 42, 43, 51; GMT: 12
9661 PT	GM: 9; TO: 6	9971 PT	GM: 27, 28	BS 40592	FO: 69; FOT: 41, 42, 43, 59, 60; WIN: 2
9673 PT-1	CHR: 59, 60, 61; DT: 24, 26, 27, 28	9978 PT	DT: 22, 23, 24, 25, 28, 29	BS 40597	MZ: 25, 26, 27, 28, 29; MZT: 15, 16
9676 PT-1	CHR: 59, 60, 61; DT: 24, 26, 27, 28	9981 PT	DT: 22, 23, 24, 25, 28, 29	BS 40598	MZT: 14
9683 PT-1	GMT: 2, 3; SZ: 5; SZT: 2, 3	9996 PT	DT: 36, 37, 38; VWT: 14	BS 40603	GMT: 2, 3; SZ: 5; SZT: 2, 3
9684 PT	GM: 12; IS: 3	9997 PT	DT: 36, 37, 38; VWT: 14	BS 40604	AMG: 3, 4, 5; GMT: 86, 87, 88, 89, 90, 91, 92; WRK: 2
9685 PT-1	GM: 11; IS: 1, 2; LOT: 1	BS 15868-1	FOT: 68, 69, 71	BS 40607	SAB: 1, 2, 3, 4, 13, 14, 15
9691 PT	FO: 2, 3; MZ: 4	BS 25034	VWT: 4	BS 40609	FOT: 20; NI: 1, 3, 7; NIT: 6, 7, 8
9696 B	KIA: 7; MZ: 7	BS 40003	JEE: 19	BS 40612	JEE: 11, 12
9698 PT	HO: 34, 35	BS 40011	FOT: 68, 69, 71	BS 40617	TOT: 21
9701 PT	AMG: 4, 5; GMT: 88, 89, 90, 91, 92; WRK: 2	BS 40032	FOT: 72	BS 40618	FO: 6, 7, 8; FOT: 1; MZT: 1
9703 PT	NI: 14, 15	BS 40097-1	CHR: 1, 2, 3, 4, 5, 6; HY: 1, 2; MI: 1, 2, 4	BS 40619	AV: 1; FO: 50; FOT: 31, 32, 33; LRT: 10; MZT: 25, 27
9711 PT	FO: 10; MZ: 12, 14	BS 40158	FO: 5, 9, 34, 35, 36; FOT: 18, 19; MZT: 21, 22; MOR: 1	BS 40620	AV: 2; DET: 1; FO: 18, 24, 25, 28, 29, 30, 31, 32, 46, 47, 48, 51, 52, 53, 54, 55, 56, 57, 58, 59, 60, 61, 62, 63; FOT: 7, 11, 15, 16, 17, 29, 30, 34, 35, 36, 37, 38, 39, 40, 44, 45, 46, 48, 49, 50, 51, 52, 53, 54, 55, 56, 58, 66, 67; JAG: 1, 2; LAF: 1, 2; MZ: 30; MZT: 9, 12, 13, 17, 18, 19, 20; PNZ: 1, 2
9717 PT	FO: 4; KIA: 11; MZ: 8, 11, 13	BS 40168-1	CHR: 25, 40, 41, 42, 59, 60, 61, 62, 63, 64, 65, 66, 68; DT: 14, 15, 22, 24, 25, 26, 27, 28, 29, 31, 32, 33, 37, 38, 41; VWT: 15	BS 40621	GM: 65, 77, 80, 82; GMT: 45
9724 PT-2	FOT: 31; MZT: 25, 26	BS 40181	DT: 39, 45, 46; JEE: 16	BS 40621-1	GM: 77, 81
9725 PT-2	FOT: 31; MZT: 25, 26	BS 40182	CHR: 10, 11, 12, 13, 14, 33, 34, 35, 36, 37; DT: 1, 6, 7, 8, 9, 10, 11, 12; JEE: 5; MI: 6, 7	BS 40622	GMT: 100, 101, 102; WRK: 3
9728 PT	TOT: 11	BS 40183	JEE: 11, 12	BS 40623	FO: 33, 37
9758 PT	CHR: 1, 2, 3; MI: 1	BS 40186	DT: 35, 42, 43, 44; JEE: 9, 13, 14, 15; MIT: 11, 13, 14	BS 40624	HOT: 13, 14, 28; IST: 13, 14, 16
9790 PT-2	DET: 1; FO: 52, 54, 55, 56, 57, 58, 67, 68; FOT: 35, 37, 38, 39, 48, 49, 50, 51, 52, 53, 54; PNZ: 1	BS 40187	AUD: 1, 2, 3, 4, 5, 6, 7, 8, 9, 10, 11; VW: 4, 5, 6, 7, 8, 9, 10, 11, 12, 13, 27, 31, 32, 33, 34, 35, 36, 37	BS 40625	GM: 35, 36, 60, 61, 62, 63, 66, 67, 68, 69, 71, 72, 83, 84, 85, 86; GMT: 7, 8, 25, 30, 31, 32, 33, 36, 37, 38, 47, 48; GRU: 1; IST: 2, 3, 10, 12
9792 PT-2	DET: 1; FO: 52, 54, 55, 56, 57, 58, 67, 68; FOT: 35, 37, 38, 39, 48, 49, 50, 51, 52, 53, 54; PNZ: 1	BS 40188	KIT: 2	BS 40626	AMG: 2; AV: 3, 4, 5; EXC: 1; GM: 88, 89, 97, 98, 102, 103, 104, 105; GMT: 50, 51, 52, 54, 59, 73; IST: 25
9797 PT	TOT: 1	BS 40189	KIA: 10	BS 40627	CHR: 10, 11, 12, 13, 14, 25, 33, 34, 35, 36, 37, 38, 39, 40, 41, 42, 47, 51, 52, 53, 59, 60, 61, 62, 63, 64, 65, 66, 68; DT: 1, 6, 7, 8, 9, 10, 11, 12, 14, 15, 18, 19, 22, 24, 25, 26, 27, 28, 29, 31, 32, 33, 37, 38, 41; HY: 28; JEE: 5; MI: 6, 7, 21, 22, 24; MIT: 6; VWT: 15
9805 PT	TO: 36	BS 40190	GM: 77, 78, 79, 81	BS 40628	FOT: 13, 14; NI: 1, 7, 13, 14, 15, 16, 17, 18, 19, 27; NIT: 6
9806 PT	TO: 36	BS 40245	DT: 40, 47	BS 40629	GM: 44; TO: 14, 17, 18; TOT: 2, 3
9814 PT	FO: 19, 20, 27	BS 40345-1	TO: 23, 24; TOT: 4	BS 40631	NI: 20, 21; NIT: 9
9815 PT	TOT: 11	BS 40384	NI: 8, 9; NIT: 4	BS 40633	DT: 54, 55
9816 PT	NI: 7	BS 40387	FO: 26; MZ: 20, 24; SB: 3, 4, 21	BS 40634	FO: 1, 2, 3, 4; KIA: 1, 4, 5, 6, 7, 11; MZ: 2, 4, 5, 6, 7, 8, 9, 10, 11, 13
9819 PT	NI: 1	BS 40396	GM: 90, 96	BS 40637	TOT: 5, 6, 7, 9, 10
9820 PT	NI: 8	BS 40408-1	CHR: 17, 18, 21, 22, 27; DT: 3; HY: 20; MI: 3, 8, 9, 11, 18; MIT: 3	BS 40640	AV: 6; CAL: 1; GM: 99, 100, 101, 106, 107, 108, 109, 110, 111; GMT: 56, 57, 58, 61, 62, 63, 64, 65, 66, 67, 68, 69, 70, 71, 72, 75, 76, 77, 78, 79, 80, 81, 82, 83, 84, 85; IST: 22, 23; MOS: 1; SAT: 4, 5
9822 PT	TOT: 6, 7	BS 40409	GM: 9, 10, 18; TO: 5, 6, 7	BS 40643	LOT: 5, 6; TO: 26, 27, 32, 33; TOT: 12, 13, 14, 15, 17, 18; VOL: 4, 5, 6, 7, 8, 9, 10
9833 PT	TOT: 21	BS 40412-1	BMW: 25	BS 40644	AV: 2; DET: 1; FO: 18, 24, 25, 28, 29, 30, 31, 32, 46, 47, 48, 51, 52, 53, 54, 55, 56, 57, 58, 59, 60, 61, 62, 63; FOT: 7, 11, 15, 16, 17, 29, 30, 34, 35, 36, 37, 38, 39, 40, 44, 45, 46, 48, 49, 50, 51, 52, 53, 54, 55, 56, 58, 66, 67; JAG: 1, 2; LAF: 1, 2; MZ: 30; MZT: 9, 12, 13, 17, 18, 19, 20; PNZ: 1, 2
9842 PT	CHR: 47, 49; MI: 22	BS 40419	FOT: 12, 31; MZT: 25, 26	BS 40645	FO: 69; FOT: 41, 42, 43, 59, 60; WIN: 2
9846 PT	CHR: 5, 6; MI: 4	BS 40421	FO: 15, 16; KIT: 4; MZ: 18, 19; MZT: 3, 4	BS 40646	FO: 5, 6, 7, 8, 9, 19, 20, 27, 34, 35, 36; FOT: 1, 18, 19; MZT: 1, 21, 22; MOR: 1
9848 PT	NI: 27	BS 40427	AUD: 18, 19, 20, 21; TO: 13, 15, 16; TOT: 1; VW: 1, 2, 3, 14, 15, 16, 17, 18, 19, 26, 30		
9851 PT	HO: 43, 44, 45	BS 40430	HO: 5, 6, 7, 8, 9, 10, 15, 17, 18, 19, 20, 21, 22, 23, 24, 25, 26, 27, 28, 29, 34, 35, 36, 42, 43, 44, 45, 46, 47, 48, 49, 51, 52, 53, 54; HOT: 1, 2, 3, 4; IST: 1, 5		
9853 PT	TO: 14	BS 40433	VOL: 5, 6, 7, 8, 9, 10		
9854 PT	SB: 9, 10	BS 40436	FOT: 70		
9856 PT	SB: 11	BS 40444	HY: 8, 12, 14, 15, 18; HYT: 1; KIA: 12; KIT: 1		
9861 PT	TO: 13, 15; TOT: 1	BS 40449-1	HOT: 12; IST: 6, 7, 8		
9879 PT	SAB: 1, 2	BS 40450	TO: 1, 2		
9885 PT	FO: 34, 35, 36; FOT: 18	BS 40452	FO: 19, 20, 27		
9887 PT	CHR: 8, 9; MI: 5	BS 40464	GM: 26, 27, 28, 35, 36, 60, 61, 62, 63, 66, 67, 68; GMT: 7, 8, 25, 30, 32; GRU: 1; IST: 2, 3, 10, 12		
9898 PT	DT: 61, 63; JEE: 20	BS 40494	BMW: 15		
9902 PT	FOT: 18, 19; MZT: 21, 22	BS 40520	AMG: 2; AV: 3, 4, 5; EXC: 1; GM: 88, 89, 97, 98, 102, 103, 104, 105; GMT: 50, 51, 52, 54, 59, 73; IST: 25		
9903 PT	FOT: 18, 19; MZT: 21, 22	BS 40522	GM: 1, 2, 3, 4; SZ: 1, 2, 3, 4; SZT: 1		
9904 PT	TO: 25	BS 40524	GM: 11, 12, 25; IS: 1, 2, 3, 4; LOT: 1		
9905 PT	TO: 25	BS 40529	GMT: 86, 87		
9910 PT	DT: 39	BS 40535	DAE: 1; GM: 13, 14, 17; HO: 2, 3, 4, 11, 12, 13, 14, 30, 31, 32, 33, 38, 39, 40, 41, 55, 56, 57, 58, 59, 60, 63; HOT: 5, 6, 7, 8, 9, 10, 11; STE: 1		
9915 PT	HO: 8, 17, 18, 19, 20	BS 40535-1	HO: 69, 70, 79		
9917 PT	GM: 78, 81				
9918 PT	GM: 78, 81				
9919 PT	HO: 54				
9921 PT	FO: 26; MZ: 24				
9922 PT	CHR: 10, 11; MI: 6, 7				
9923 PT	FO: 26; MZ: 24				
9924 PT	CHR: 37; DT: 8				
9926 PT	CHR: 62				
9927 PT	CHR: 62				
9930 PT	KIA: 6; MZ: 6				
9932 PT	CHR: 19, 20, 26; MI: 10, 17				
9942 PT	NI: 8				
9946 PT	DT: 8				
9955 PT	GM: 18; TO: 7				
9957 PT	GM: 60, 61				

BS 40647	AV: 1; FO: 50; FOT: 12, 31, 32, 33; LRT: 10; MZT: 25, 26, 27	BS 40707	GMT: 53	CS 26155	HO: 51, 52, 53; HOT: 4; IST: 5
BS 40648	CHR: 8, 9, 15, 16, 17, 19, 20, 26; DT: 2; MI: 5, 8, 9, 10, 16, 17, 20; MIT: 2, 3, 5	BS 40708	GM: 78, 79, 81	CS 26157	DT: 42, 43, 44; JEE: 13, 14, 15; MIT: 13, 14
BS 40649	GM: 65, 77, 80, 81, 82; GMT: 45	BS 40710	BMW: 7, 8; HY: 29, 30, 32, 33; HYT: 8, 11; KIA: 24; KIT: 8, 11	CS 26158	GM: 19, 20; TO: 8, 9
BS 40650	DT: 55, 56, 57, 58, 59, 60, 65, 66	BS 40711	GM: 55, 57, 58, 59, 73, 74, 75, 76; GMT: 23, 24, 28, 29, 39, 40, 41, 42, 43; SAB: 20, 21; SAT: 1, 2; SZT: 9	CS 26161	VW: 31, 32, 33, 34, 35, 36, 37
BS 40651	DT: 61, 62, 63, 64; JEE: 20	BS 40712	VW: 38, 39, 40, 41	CS 26162	FOT: 66
BS 40654	FOT: 72	BS 40713	DT: 22, 23, 24, 25, 28, 36, 37, 38; JEE: 10; VWT: 14	CS 26162-2	FOT: 66, 67
BS 40656	AMG: 1; GM: 104; GMT: 51, 53, 54, 59, 60, 73, 74; IST: 20, 21, 24; WRK: 1	BS 40714	NI: 2, 4, 5, 6; NIT: 2	CS 26164	VW: 30
BS 40657	CHR: 44, 45, 46, 58	BS 40717	MIT: 8	CS 26167	SB: 14; SBT: 2
BS 40658	DT: 67	BS 40720	CHR: 56, 57	CS 26168	GMT: 103; WRK: 4
BS 40659	TO: 36, 37	BS 40721	BMW: 1, 2, 3, 4, 5, 6	CS 26170	SAB: 5, 6, 16, 17, 18; SB: 6, 7, 12, 13, 14, 15, 16, 17, 18; SBT: 1, 2, 3, 4, 5, 6
BS 40660	CHR: 48, 49, 50, 54; MI: 22, 23, 24, 25, 26, 27; MIT: 7, 9, 10, 12	BS 40722	MB: 24, 25, 26, 27, 28, 29, 30, 31; MBT: 1	CS 26171	NIT: 3
BS 40661	GM: 19, 20; TO: 8, 9	BS 40723	HO: 61, 62	CS 26171-1	NIT: 3
BS 40663	CHR: 7, 23, 24; HY: 19; HYT: 4; JEE: 1, 2; KIA: 16; MI: 5, 14, 15	BS 40724	AUD: 1, 2, 3, 4, 5, 6, 7, 8; VW: 4, 5, 6, 7, 8, 9, 10, 11, 12, 13	CS 26171-2	NIT: 3
BS 40664	NI: 8; NIT: 3	BS 40725	AUD: 9, 10, 11, 12, 13, 14, 15, 16, 17; AUT: 1; VW: 27, 28, 29; VWT: 1, 2, 3	CS 26172	CHR: 26; MI: 17, 20; MIT: 2, 5
BS 40665	GM: 21; LOT: 2, 3, 4; TO: 10	BS 40726	MI: 13	CS 26173	GM: 56
BS 40666	SAB: 5, 6, 16, 17, 18; SB: 5, 6, 7, 8, 9, 10, 11, 12, 13, 14, 15, 16, 17, 18, 22; SBT: 1, 2, 3, 4, 5, 6, 9	BS 40727	HY: 34; KIT: 11, 12	CS 26173-1	SAB: 23
BS 40667	FO: 10; MZ: 12, 14, 15	BS 40728	MI: 12, 19; MIT: 1, 4	CS 26173-2	SAB: 22, 23
BS 40669	GM: 87, 92, 93	BS 40729	FO: 38, 39, 40, 41, 43, 44, 45, 64, 65; FOT: 21, 22, 23, 24, 26, 27, 28, 47; MZ: 31; MZT: 23, 24	CS 26173-4	GM: 54, 56, 64; GMT: 27
BS 40670	ACO: 1, 2; GM: 70, 87, 91, 92, 93, 94, 95; GMT: 55	BS 40730	NI: 12, 21; NIT: 9	CS 26180	HY: 12, 15; HYT: 1; KIA: 12; KIT: 1
BS 40671	GM: 29, 30, 32, 37, 38, 39, 40, 45, 46, 47, 48, 49, 50, 54, 56, 64; GMT: 5, 6, 9, 10, 11, 13, 14, 15, 16, 17, 18, 27; IST: 4; SAB: 22, 23	BS 40731	GM: 15, 16, 22, 23	CS 26180-1	HY: 15; KIA: 12
BS 40672	CHR: 1, 3; HY: 3, 4, 5, 9, 10, 11; KIA: 8, 9; MI: 1	BS 40732	GM: 24; TO: 11, 12	CS 26182	AUD: 3, 4, 7, 8; VW: 8, 10
BS 40673	GMT: 103; WRK: 4	BS 40733	SB: 22	CS 26182-1	VW: 5, 11, 12, 13
BS 40674	TO: 22, 25; TOT: 11, 16	BS 40734	CHR: 63, 65, 66; DT: 31, 32, 33, 41; VWT: 15	CS 26182-2	AUD: 1, 2, 5, 6; VW: 4, 6, 7, 9
BS 40675	HO: 65, 71, 72; HOT: 15, 16, 17	BS 40735	CHR: 69, 70, 71, 72, 73; DT: 48, 49, 50, 51, 52, 53; JEE: 17, 18, 21, 22	CS 26183	MI: 5
BS 40677	VOL: 11, 12, 13, 14, 15, 16, 17, 18, 19, 20, 21, 22, 23, 24, 25, 26, 27, 28, 29, 30, 32; VOT: 1	BS 40737	CHR: 67; DT: 34; JEE: 8; VWT: 13	CS 26184	CHR: 1, 3; MI: 1
BS 40678	GMT: 49; IST: 19; SAT: 3	BS 40738	GM: 5, 6, 7, 8; GMT: 1	CS 26184-1	MI: 1
BS 40679	TO: 38; TOT: 23, 24, 25, 26	BS 40739	GM: 29, 30, 32, 37, 38, 39, 40, 45, 46, 47, 48, 49, 50, 54, 56, 64; GMT: 5, 6, 9, 10, 11, 13, 14, 15, 16, 17, 18, 27; IST: 4; SAB: 22, 23	CS 26186	CHR: 49, 50; MI: 22, 23
BS 40681	BMW: 12, 13, 14, 16, 17; BMT: 1, 2	BS 40740	HY: 6, 7; KIA: 2, 3	CS 26186-1	CHR: 48; MI: 23
BS 40682	TO: 3, 4	BS 40741	TO: 19, 20; TOT: 8	CS 26186-2	MIT: 7
BS 40683	GMT: 93, 94, 95, 96, 97, 98, 99	BS 40746	FOT: 62, 63	CS 26186-3	MIT: 7
BS 40684	CHR: 28, 29, 30, 31, 32, 69, 70, 71, 72, 73; DT: 4, 5, 48, 49, 50, 51, 52, 53; JEE: 3, 4, 17, 18, 21, 22	BS 40749	MB: 1	CS 26193	MIT: 9, 10
BS 40685	GMT: 35; HO: 66, 67, 68, 73, 74, 75, 76, 77, 78, 80, 81; HOT: 18, 19, 20, 21, 22, 23, 24, 25, 26, 27, 29, 30	BS 40750	LRT: 3, 4, 5, 6, 7, 8, 9, 11, 12, 14; MOR: 2	CS 26193-1	MIT: 10
BS 40686	TOT: 19, 20	BS 40751	TOT: 22	CS 26193-2	MI: 26
BS 40687	GMT: 4, 21; SZ: 7, 9; SZT: 5, 7, 8	CP 75001	CHR: 5, 6, 21, 22, 27; DT: 2, 3; HY: 20; MI: 4, 11, 18; MIT: 3	CS 26195	HY: 4, 5
BS 40688	CHR: 74, 75; DT: 68	CP 75002	AUD: 19; VW: 1, 2, 3, 14, 15, 16, 17, 19, 26	CS 26196	HO: 65, 71, 72; HOT: 15, 16, 17
BS 40689	FO: 11, 12, 13, 14, 17, 21, 22, 23; FOT: 2, 3, 4, 5, 6, 8, 9, 10; MZ: 17, 21, 22; MZT: 5, 6, 7, 8	CP 75003	HOT: 12; IST: 6, 7, 8; NI: 9; NIT: 4	CS 26196-1	CHR: 33, 34, 36; DT: 6, 7, 8, 9, 10, 11
BS 40690	CHR: 43, 44, 45	CP 75005	TOT: 4	CS 26203	VOL: 11, 12, 13, 14, 15, 16, 17, 18, 19, 20, 21, 22, 23, 24, 25, 26, 27, 28, 29, 30, 32; VOT: 1
BS 40692	DT: 57, 58, 59, 60	CP 75010	VOL: 4	CS 26208	DT: 31
BS 40694	NI: 10, 11, 22, 23, 24, 25; NIT: 5, 10, 11, 12, 15, 16; SZT: 6, 10	CP 75013	CHR: 15, 16, 17, 18; HY: 8, 12, 14, 18, 19; HYT: 4; KIA: 16; MI: 3, 8, 9, 16	CS 26213	GMT: 49; IST: 19; SAT: 3
BS 40695	TO: 29, 30, 31	CP 75015	HO: 63; STE: 1	CS 26213-1	GMT: 49; IST: 19; SAT: 3
BS 40696	TO: 38	CP 75016	NI: 14, 15, 16, 17	CS 26218	DT: 57, 58, 59, 60
BS 40697	FOT: 68, 69, 71	CP 75018	CHR: 51, 52, 53; DT: 18, 19; HY: 28; MI: 24; MIT: 6	CS 26219	FOT: 20; NIT: 7
BS 40698	GM: 69, 71, 72, 83, 84, 85, 86; GMT: 31, 33, 36, 37, 38, 47, 48	CP 75019	KIT: 4; MZT: 3, 4	CS 26219-1	NIT: 7, 8
BS 40699	DT: 16, 17; FRT: 1	CP 75023	CHR: 47, 48, 49, 50; HY: 3, 4, 5, 9, 10, 11, 25, 26, 27, 31; HYT: 7, 10; KIA: 8, 9, 21, 22, 23; KIT: 7, 10; MI: 22, 23; MIT: 9	CS 26219-2	NIT: 7, 8
BS 40700	FOT: 61	CP 75024	GMT: 21; SZT: 7, 8	CS 26220	KIT: 2
BS 40701	LOT: 5, 6; TO: 21, 28, 33, 34, 35; TOT: 17, 18	CS 21202	VOL: 5, 6, 7, 8, 9, 10	CS 26221	KIA: 11
BS 40702	HY: 16, 17, 21, 22, 23, 24; HYT: 2, 3, 5, 6; KIA: 13, 14, 17, 18, 19, 20; KIT: 3, 5, 6	CS 21225	VW: 1, 2, 3	CS 26221-1	KIA: 10
BS 40703	CHR: 28, 29, 30, 31, 32; DT: 4, 5; JEE: 3, 4	CS 26140	VW: 45, 46, 47, 48, 49; VWT: 5, 6	CS 26223	GM: 37, 38, 39; GMT: 10
BS 40704	AUD: 24, 25; VW: 42, 43, 44	CS 26143	VW: 22, 23, 24	CS 26223-1	GM: 39, 40, 45, 46, 47, 48, 49, 50; GMT: 9, 10, 11, 13, 14, 15, 16, 17, 18
BS 40705	GMT: 22, 26, 34, 44; IST: 9, 11, 15, 17	CS 26150	GM: 87, 92, 93	CS 26224	HY: 3, 9, 10
BS 40706	FO: 49	CS 26150-1	GM: 87, 92, 93	CS 26224-1	HY: 9, 10, 11; KIA: 8, 9
		CS 26150-2	ACO: 1; GM: 87, 92, 93	CS 26226	TOT: 23, 24
		CS 26150-3	ACO: 1, 2; GM: 87, 92, 93	CS 26226-1	TOT: 23, 24
		CS 26150-4	GM: 91, 92, 93, 95	CS 26226-2	TOT: 23, 24
		CS 26154	GM: 21; LOT: 2, 3, 4; TO: 10	CS 26226-3	TOT: 24
				CS 26229	DT: 35; JEE: 9; MIT: 11
				CS 26230	GM: 70
				CS 26232	TO: 17, 18; TOT: 3
				CS 26232-1	TOT: 3
				CS 26232-2	GM: 44
				CS 26235	MIT: 5
				CS 26236	HO: 23
				CS 26236-1	HO: 24, 25, 26
				CS 26241	NIT: 9
				CS 26243	HO: 55, 56, 57; HOT: 5, 6, 7, 9
				CS 26245	BMW: 13, 14, 16, 17; BMT: 1, 2
				CS 26246	BMW: 9

NUMERICAL LIST

CS 26248	FO: 32	CS 26370	NIT: 12; SZT: 10	CS 8471-7	FOT: 11; MZT: 13
CS 26248-1	JAG: 1, 2	CS 26372	NIT: 15, 16	CS 8510	AMG: 2; AV: 3, 4, 5; GM: 97, 98, 102, 103; GMT: 59, 73; IST: 25
CS 26250	FO: 11, 17; FOT: 2, 4, 5, 6; MZ: 21, 22; MZT: 5, 6, 7, 8	CS 26374	FOT: 61	CS 8510-1	AMG: 1; GMT: 59, 60, 73, 74; IST: 24; WRK: 1
CS 26251	BMW: 13, 16	CS 26374-1	FOT: 61	CS 8523	GMT: 100, 101, 102; WRK: 3
CS 26252	BMW: 12	CS 26376	GM: 73; GMT: 39; SZT: 9	CS 8548-2	FO: 60, 61, 62, 63; FOT: 44, 46; LAF: 1
CS 26253	BMW: 10	CS 26376-1	GM: 55, 57, 58, 59, 73, 74, 75, 76; GMT: 23, 24, 28, 29, 39, 40, 41, 42, 43; SAB: 20, 21; SAT: 1, 2; SZT: 9	CS 8548-7	FO: 69; FOT: 59, 60; WIN: 2
CS 26255	NI: 3	CS 26378	GM: 13, 14	CS 8548-8	FOT: 59, 60
CS 26258	TO: 3, 4	CS 26380	GM: 94; GMT: 55	CS 8548-9	FO: 60, 61, 62, 63; FOT: 44, 45, 46; LAF: 1, 2
CS 26258-1	TO: 4	CS 26382	BMW: 7, 8	CS 8553	DT: 47
CS 26261	NI: 10, 11; NIT: 5	CS 26385	DAE: 1	CS 8558-1	FOT: 72
CS 26261-1	NIT: 5; SZT: 6	CS 26386	GMT: 21; SZT: 7, 8	CS 8558-2	FOT: 72
CS 26261-2	NIT: 5	CS 26388	VW: 38, 39, 40, 41	CS 8686	GMT: 19, 20; GRU: 2, 3
CS 26262	TO: 38	CS 26394	TOT: 25, 26	CS 8726-1	GMT: 86, 87
CS 26262-1	TO: 38	CS 26395	SZT: 8	CS 8726-2	AMG: 3, 4, 5; GMT: 86, 87, 88, 89, 90, 91, 92; WRK: 2
CS 26265	GMT: 35; HO: 66, 67, 68, 73, 74, 75, 76, 77, 78, 80, 81; HOT: 18, 19, 20, 21, 22, 23, 24, 25, 26, 27, 29, 30	CS 26397	HO: 30, 31, 32, 33	CS 8753-2	GM: 90, 96
CS 26269	GMT: 93, 94, 95, 96, 99	CS 26399	HO: 38, 39, 40, 41, 58, 59, 60; HOT: 8, 10, 11	CS 8763-2	CHR: 25, 40, 41, 42; DT: 14, 15
CS 26269-2	GMT: 96, 97, 98	CS 26409	MZ: 17, 21	CS 8767-1	CHR: 1, 2, 3, 4; HY: 1, 2; MI: 1, 2
CS 26276	HY: 25, 26; HYT: 7; KIA: 21, 22; KIT: 7	CS 26410	MIT: 8	CS 8807-1	TOT: 4
CS 26278	GMT: 4; SZ: 7; SZT: 5	CS 26412	HO: 61, 62	CS 8807-2	TOT: 4
CS 26279	SZ: 9	CS 26414	HY: 29, 30, 32, 33; HYT: 8, 11; KIA: 24; KIT: 8, 11	CS 8857-5	FO: 46, 47
CS 26282	HY: 19; HYT: 4	CS 26419	TO: 21, 28, 34, 35	CS 8857-6	FO: 46, 47; FOT: 29
CS 26282-1	HY: 19; HYT: 4; KIA: 16	CS 26419-1	TO: 21, 28, 34, 35	CS 8891	FOT: 68, 69, 71
CS 26283	CHR: 74, 75; DT: 68	CS 26420-1	HY: 33	CS 9005-1	FO: 6, 7
CS 26284	DT: 48, 49, 50, 51, 52, 53	CS 26420-2	KIT: 11	CS 9005-2	FO: 6, 8; FOT: 1; MZT: 1
CS 26284-1	CHR: 69, 70, 71, 72; JEE: 17, 18	CS 26428	SAB: 3, 4	CS 9031	HO: 69, 70
CS 26284-2	JEE: 18	CS 26431	SAB: 2, 3, 4, 13, 14, 15	CS 9031-1	HO: 79
CS 26285	MB: 10, 11, 16, 17, 18	CS 26433	CHR: 56, 57	CS 9034	DT: 67
CS 26288	MI: 15	CS 26433-1	MB: 24, 25, 26, 27, 28, 29, 30, 31; MBT: 1	CS 9036	CHR: 13, 14
CS 26289	MB: 12, 13, 14, 32, 33, 34, 35, 36	CS 26435	HO: 58, 59, 60; HOT: 8, 10, 11	CS 9037	CHR: 38, 39; MI: 21
CS 26290	TOT: 19	CS 26436	LRT: 3, 4, 5, 7, 8, 9, 11, 12, 14; MOR: 2	CS 9038-1	FO: 24, 25, 28, 29, 32; FOT: 15; MZ: 30; MZT: 12, 17, 18
CS 26293	HY: 31; HYT: 10; KIA: 23	CS 26447	MI: 13	CS 9038-2	FO: 30, 31, 32; FOT: 15, 16, 17; MZ: 30; MZT: 17, 18, 19, 20
CS 26293-1	KIT: 10	CS 26449	MI: 12, 19; MIT: 1, 4	CS 9071	GMT: 31, 33
CS 26293-2	HY: 31; HYT: 10; KIA: 23; KIT: 10	CS 26453	BMW: 1, 2, 3, 4, 5, 6	CS 9086	CHR: 17, 18, 21, 22; MI: 3, 8, 9, 11
CS 26297	TO: 29, 30, 31	CS 26455	AUD: 9, 10, 11, 12, 13, 14, 15, 16, 17; AUT: 1; VW: 27, 28, 29; VWT: 1, 2, 3	CS 9086-1	CHR: 15, 16, 17, 19, 20, 26; MI: 8, 9, 10, 16, 17; MIT: 2
CS 26313	MI: 27; MIT: 12	CS 26487	FO: 38, 39, 40, 41; FOT: 21, 22, 23, 24; MZT: 23	CS 9086-2	DT: 2; MIT: 3
CS 26314	GM: 69; GMT: 36, 37	CS 26511	NI: 21; NIT: 9	CS 9088-1	GM: 77, 82; GMT: 45
CS 26314-1	GMT: 37	CS 26515	GM: 24; TO: 11, 12	CS 9090	VW: 14, 15, 16, 17, 18, 19
CS 26315	KIA: 1, 4, 5	CS 26516	GM: 15, 16, 22, 23	CS 9111	DT: 40
CS 26317	DAE: 2, 3; GM: 31; SZ: 8	CS 26521	FO: 21, 22, 23; FOT: 8, 9, 10	CS 9112	CHR: 51, 52, 53; DT: 18, 19; HY: 28; MI: 24; MIT: 6
CS 26317-1	IST: 4	CS 26529	HO: 2, 3, 4, 12, 13	CS 9112-2	MI: 24
CS 26318	AUD: 9, 10, 11; VW: 27	CS 26529-1	HO: 11, 14	CS 9113	GM: 66
CS 26319	DT: 16, 17; FRT: 1	CS 26533	SB: 22; SBT: 9	CS 9115	GM: 51
CS 26321	LOT: 5, 6; TO: 33; TOT: 17, 18	CS 26533-1	SB: 22	CS 9117	GM: 4; SZ: 2, 4; SZT: 1
CS 26321-1	LOT: 5, 6; TO: 33; TOT: 17, 18	CS 26540	GM: 5, 6, 7, 8; GMT: 1	CS 9117-1	GM: 3, 4; SZ: 3, 4
CS 26324	GM: 71, 72, 83, 84, 85, 86; GMT: 38, 47, 48	CS 26543	FO: 43, 44; FOT: 26, 27; MZ: 31; MZT: 24	CS 9123	HO: 5, 6, 7, 9, 10, 15
CS 26326	JEE: 10	CS 26543-1	FO: 45; FOT: 28	CS 9124-1	HO: 36, 42
CS 26326-1	DT: 22, 23, 24, 25, 28, 36, 37, 38; JEE: 10; VWT: 14	CS 26550	FO: 64, 65; FOT: 47	CS 9139	KIT: 4
CS 26328	AUD: 24, 25; VW: 42, 43, 44	CS 26554	HY: 6, 7; KIA: 2, 3	CS 9174	HOT: 14; IST: 13, 14
CS 26330	TOT: 19	CS 26562	TO: 19, 20; TOT: 8	CS 9195-3	FO: 19, 20, 27
CS 26332	CHR: 28, 29, 30, 31, 32; DT: 4, 5; JEE: 3, 4	CS 26586	NI: 28; NIT: 13	CS 9196	JEE: 7
CS 26332-1	CHR: 7, 23, 24; JEE: 1, 2	CS 26595	VOL: 33, 34, 35, 37, 38; VOT: 2	CS 9196-2	DT: 13; JEE: 6, 7
CS 26333	HY: 21; KIA: 17	CS 26597	VOL: 1, 2, 3	CS 9201	TO: 26, 27, 32; TOT: 12, 13, 14, 15
CS 26333-1	HY: 21, 24; HYT: 6; KIA: 17, 20; KIT: 6	CS 26602	LRT: 2; VOL: 40; VOT: 4	CS 9213	MZ: 2
CS 26335	GMT: 22, 26, 34, 44; IST: 9, 11, 15, 17	CS 26610	DT: 30; FRT: 4; MB: 21, 22, 23, 38, 39, 40, 41, 42, 43, 44, 45, 46, 47, 48; MBT: 2, 3, 4, 5, 6	CS 9227	TOT: 16
CS 26338	NI: 2, 4, 6	CS 8168-3	FOT: 41, 42, 43	CS 9228-1	FOT: 13, 14; NI: 18, 19; NIT: 6
CS 26339	BMW: 22, 26, 28; BMT: 6; LRT: 13	CS 8169-2	JEE: 11	CS 9228-2	NIT: 6
CS 26340	HYT: 7; KIA: 22	CS 8169-3	JEE: 11, 12	CS 9228-3	NIT: 6
CS 26349	MB: 4	CS 8169-4	JEE: 11, 12	CS 9239	FOT: 70
CS 26350	MB: 49, 50, 63, 66	CS 8180-2	GMT: 100	CS 9239-1	FOT: 70
CS 26353	MB: 62	CS 8188	GM: 10; TO: 5	CS 9250	FO: 46; FOT: 29, 34
CS 26357	TOT: 10	CS 8359-2	DT: 62, 64	CS 9250-1	FO: 46, 48; FOT: 29, 30, 34
CS 26357-1	TOT: 10	CS 8471-3	FO: 18; FOT: 7	CS 9254	HOT: 13, 28; IST: 13, 16
CS 26361	FO: 49	CS 8471-5	FO: 18; FOT: 7; MZT: 9	CS 9274	HO: 21, 22, 27, 28, 29
CS 26365	MI: 14	CS 8471-6	FOT: 7; MZT: 9		
CS 26366	CHR: 73				
CS 26366-1	JEE: 21, 22				

CS 9284	AV: 6; CAL: 1; GM: 99, 100, 101, 106, 107, 108, 109, 110, 111; GMT: 56, 57, 58, 61, 62, 63, 64, 65, 66, 67, 68, 69, 70, 71, 72, 75, 76, 77, 78, 79, 80, 81, 82, 83, 84, 85; IST: 22, 23; MOS: 1; SAT: 4, 5	CS 9698	HO: 34, 35; HOT: 1, 2	ES 70599	AUD: 1, 2, 3, 4, 5, 6, 7, 8, 24, 25; AV: 1, 2, 5; CHR: 7, 10, 11, 12, 13, 14, 23, 24, 28, 29, 30, 31, 32, 33, 34, 35, 36, 37, 40, 43, 44, 45, 46, 56, 57, 59, 60, 61, 62, 63, 64, 65, 66, 68, 69, 70, 71, 72, 73, 74; DAE: 1, 2, 3; DET: 1; DT: 1, 4, 5, 6, 7, 8, 9, 10, 11, 12, 13, 22, 23, 24, 25, 26, 27, 28, 29, 31, 32, 33, 35, 36, 37, 38, 39, 41, 42, 43, 44, 45, 46, 48, 49, 50, 51, 52, 53, 61, 63, 67, 68; EXC: 1; FO: 5, 6, 7, 8, 9, 11, 12, 13, 17, 18, 19, 20, 21, 22, 24, 25, 27, 28, 29, 31, 32, 34, 35, 36, 38, 39, 40, 41, 43, 44, 45, 46, 47, 48, 49, 50, 51, 52, 53, 54, 55, 56, 57, 58, 59, 60, 61, 62, 63, 64, 65; FOT: 1, 2, 4, 5, 6, 7, 8, 9, 11, 12, 15, 16, 17, 18, 19, 21, 22, 23, 24, 26, 27, 28, 29, 30, 31, 32, 33, 34, 35, 36, 37, 38, 39, 40, 41, 42, 43, 44, 45, 46, 47, 48, 49, 50, 51, 52, 53, 54, 55, 56, 58, 59, 60, 66, 67, 72; GM: 5, 6, 7, 8, 14, 23, 25, 31, 35, 37, 38, 39, 40, 41, 42, 43, 45, 46, 47, 48, 49, 50, 51, 54, 55, 57, 58, 59, 60, 61, 62, 63, 64, 65, 66, 67, 68, 69, 73, 77, 78, 79, 80, 81, 82, 87, 89, 90, 91, 92, 93, 94, 95, 96, 98, 99, 103, 104, 105, 106, 107, 108, 109, 110, 111; GMT: 1, 4, 7, 8, 9, 10, 11, 12, 13, 14, 15, 16, 17, 18, 22, 23, 24, 26, 27, 28, 29, 30, 31, 32, 33, 34, 35, 36, 37, 39, 40, 44, 45, 49, 55, 56, 57, 58, 61, 62, 63, 64, 65, 66, 67, 68, 69, 70, 71, 72, 75, 76, 77, 78, 79, 80, 81, 82, 83, 84, 85, 100, 101, 102, 103; HO: 2, 3, 4, 11, 12, 13, 14, 23, 25, 26, 30, 31, 32, 33, 38, 39, 40, 41, 55, 56, 57, 58, 59, 60, 73, 74, 75, 76, 77, 78; HOT: 5, 6, 7, 8, 9, 10, 11, 14, 18, 19, 20, 21, 22, 23, 24, 25, 26, 27; HY: 3, 4, 5, 9, 10, 11, 12, 15, 19, 21, 22, 23, 24, 25, 26; HYT: 1, 3, 4, 5, 6, 7, 9; IS: 4; IST: 2, 3, 4, 9, 11, 13, 14, 15, 17, 19, 22, 23; JAG: 2; JEE: 1, 2, 3, 4, 5, 6, 7, 9, 10, 11, 12, 13, 14, 15, 16, 17, 18, 19, 20, 21, 22; KIA: 8, 9, 10, 12, 14, 16, 17, 18, 19, 20, 21, 22; KIT: 1, 2, 5, 6, 7, 9, 10; LAF: 1, 2; LRT: 10; MZ: 17, 21, 30, 31; MZT: 1, 5, 6, 7, 9, 12, 13, 17, 18, 19, 20, 21, 22, 23, 24, 25, 26, 27; MB: 24, 25, 26, 27, 28, 29, 30, 31; MBT: 1; MI: 6, 7, 12, 13, 19; MIT: 1, 4, 8, 11, 13, 14; NI: 2, 3, 4, 5, 6, 10, 11, 12, 20, 21, 28; NIT: 2, 5, 9, 12, 13, 14, 15, 16; PNZ: 1, 2; SAB: 2, 3, 4, 13, 14, 15, 17, 18, 20, 21; SAT: 1, 2, 3, 4, 5; SB: 16, 17, 18; SBT: 4, 5, 6; SZ: 7, 8; SZT: 5, 6, 9, 10; VW: 4, 5, 6, 7, 8, 9, 10, 11, 12, 13, 30, 31, 32, 33, 34, 35, 36, 37, 42, 43, 44, 48; VWT: 14, 15; WIN: 2; WRK: 3, 4
CS 9293	FOT: 32, 33; MZT: 27	CS 9703	NI: 14, 15, 16, 17		
CS 9293-1	AV: 1; FO: 50; FOT: 32, 33; LRT: 10; MZT: 27	CS 9711	FO: 10; MZ: 12, 14, 15		
CS 9309-1	FO: 5	CS 9724	FOT: 31; MZT: 26		
CS 9309-2	FO: 5, 9	CS 9724-1	FOT: 31; MZT: 25		
CS 9313	DT: 55, 56	CS 9728	TOT: 11		
CS 9332	DT: 54, 55	CS 9759	BMW: 25		
CS 9354-1	GM: 88; GMT: 50, 51, 52, 54	CS 9790-1	FOT: 51, 52, 54		
CS 9354-3	GMT: 51, 53, 54; IST: 20, 21	CS 9790-4	DET: 1; FO: 51, 52, 53, 54, 55, 56, 57, 58; FOT: 35, 36, 37, 38, 39, 40, 48, 49; PNZ: 1, 2		
CS 9354-4	GMT: 53	CS 9790-5	AV: 2; FO: 57, 58, 59; FOT: 38, 39, 48, 49, 50, 51, 52, 53, 54, 55, 56, 58		
CS 9368-2	FO: 34, 35, 36; FOT: 18, 19; MZT: 21, 22	CS 9797	TOT: 1		
CS 9368-3	FO: 35, 36; FOT: 18, 19; MZT: 21, 22	CS 9797-1	TOT: 1		
CS 9383	GM: 9; TO: 6	CS 9797-2	TOT: 2		
CS 9388-1	CHR: 27; DT: 3; HY: 20; MI: 18; MIT: 3	CS 9797-3	TOT: 2		
CS 9390	SB: 3, 4	CS 9805	TO: 36, 37		
CS 9397	BMW: 15	CS 9816	NI: 7		
CS 9405	GM: 52, 53	CS 9816-1	NI: 7		
CS 9418	TO: 13	CS 9820	NI: 8		
CS 9425	CHR: 58	CS 9821	FO: 33, 37		
CS 9435	GM: 1, 2; SZ: 1	CS 9831	TOT: 6, 7		
CS 9435-1	GM: 2	CS 9833	TOT: 21		
CS 9450	HO: 63; STE: 1	CS 9842	CHR: 47; MI: 22		
CS 9461	FO: 1	CS 9846	CHR: 5, 6; MI: 4		
CS 9465	TOT: 5, 9	CS 9851	HO: 43, 44, 45, 46, 47; HOT: 3; IST: 1		
CS 9469	GM: 35, 36; GMT: 7, 8; GRU: 1; IST: 2, 3	CS 9851-1	HO: 48, 49, 54		
CS 9471	GM: 62, 63, 68; GMT: 25, 30; IST: 10, 12	CS 9853	TO: 14		
CS 9472	GM: 33, 34	CS 9854	SB: 8, 9, 10, 11		
CS 9473	TO: 23, 24	CS 9861	TO: 15, 16; TOT: 1		
CS 9483	TO: 1, 2	CS 9887	CHR: 8, 9; MI: 5		
CS 9494	TO: 2	CS 9898	DT: 45, 46; JEE: 16		
CS 9496-1	HOT: 12; IST: 6, 7, 8	CS 9898-1	DT: 61, 62, 63, 64		
CS 9505	CHR: 58, 62, 63, 64, 65, 66	CS 9898-2	DT: 61, 63; JEE: 20		
CS 9505-1	DT: 31	CS 9898-3	DT: 45, 46; JEE: 16		
CS 9505-2	CHR: 63, 65, 66; DT: 32, 33, 41; VWT: 15	CS 9904	TO: 25		
CS 9508	NI: 20, 21; NIT: 9	CS 9910	DT: 39		
CS 9510	FOT: 12	CS 9910-1	DT: 39		
CS 9513	FO: 15, 16; MZ: 18, 19; MZT: 3, 4	CS 9915	HO: 8, 20		
CS 9514	CHR: 44, 45, 46	CS 9915-1	HO: 17, 19		
CS 9514-1	CHR: 44, 45	CS 9915-2	HO: 18, 19		
CS 9514-2	CHR: 43	CS 9917	GM: 77, 81		
CS 9515	GM: 41, 42, 43; GMT: 12	CS 9917-1	GM: 77, 81		
CS 9515-1	GM: 41; GMT: 12	CS 9917-2	GM: 77, 81		
CS 9522	DT: 57, 58, 60	CS 9917-3	GM: 77, 78, 79, 81		
CS 9528	SB: 1, 2	CS 9917-4	GM: 78, 79, 81		
CS 9537	CHR: 54; MI: 25	CS 9921	FO: 26; MZ: 24		
CS 9537-1	MIT: 7	CS 9922	CHR: 10, 11, 12; DT: 1; MI: 6, 7		
CS 9570	VW: 26	CS 9924	CHR: 35, 37; DT: 8, 12; JEE: 5		
CS 9604	GM: 10; TO: 5	CS 9926	CHR: 62		
CS 9618	SB: 5	CS 9942	NI: 8		
CS 9627	HY: 8, 14, 18	CS 9946	DT: 8		
CS 9627-1	HY: 18	CS 9955	GM: 18; TO: 7		
CS 9637	MZT: 14	CS 9957	GM: 60, 61, 67; GMT: 32		
CS 9644	GM: 65, 77, 80, 82; GMT: 45	CS 9966	EXC: 1; GM: 89, 104, 105		
CS 9645	NI: 1	CS 9971	GM: 26, 27, 28		
CS 9645-1	NI: 1	ES 70016	GMT: 50, 51, 52, 53, 54; IST: 20, 21		
CS 9646	NI: 9; NIT: 4	ES 70260	CHR: 51, 53; DT: 18, 19		
CS 9649-1	MZ: 25, 27, 28, 29; MZT: 15, 16	ES 70280	HO: 5, 6, 7, 9, 10, 15		
CS 9673-2	CHR: 59, 60, 61, 68; DT: 22, 24, 25, 26, 27, 28, 29, 37, 38	ES 70341	KIT: 4; MZT: 3, 4		
CS 9683	GMT: 2, 3; SZ: 5; SZT: 2, 3	ES 70342	CHR: 5, 6, 21, 22, 27, 51, 52, 53; DT: 2, 3, 18, 19; HY: 20, 28; MI: 4, 11, 18, 24; MIT: 3, 6		
CS 9683-1	GMT: 2; SZ: 5; SZT: 2	ES 70356	TOT: 4		
CS 9685	GM: 11, 12; IS: 1, 2, 3; LOT: 1	ES 70362	HO: 5, 6, 7, 9, 10, 15		
CS 9691	FO: 2; MZ: 4	ES 70389	NI: 14, 15, 16, 17		
CS 9691-2	FO: 1, 3	ES 70425	FO: 33, 37		
CS 9691-3	FO: 1, 2; MZ: 4, 8, 11	ES 70426	FO: 33, 37		
CS 9696-1	FO: 4; KIA: 6, 7; MZ: 5, 6, 7, 9, 10, 11, 13	ES 70435	TOT: 11		
		ES 70511	FO: 2		
		ES 70687	EXC: 1; GM: 89, 104, 105		
		ES 70689	FOT: 68, 69, 71		
		ES 70691	HOT: 14; IST: 13, 14		
		ES 70711	FO: 19, 20, 27		
		ES 70713	FO: 26; MZ: 20, 24, 26, 27		
		ES 70717	FO: 26; MZ: 20, 24		
		ES 70718	FO: 26; MZ: 20, 24		
		ES 70719	FO: 26; MZ: 24		
		ES 70739	TO: 13, 15, 16; TOT: 1		

NUMERICAL LIST

<p>ES 70743 CHR: 62</p> <p>ES 70744 FO: 61, 62, 63; FOT: 44, 45; LAF: 1, 2</p> <p>ES 70745 NI: 1</p> <p>ES 70747 FO: 26</p>	<p>ES 71331 HO: 65, 66, 67, 68, 71, 72, 73, 74; HOT: 15, 16, 17, 18, 19, 21, 22, 25</p> <p>ES 71333 HO: 38, 39, 40, 41, 55, 56, 57; HOT: 5, 6, 7, 9</p> <p>ES 71334 GMT: 22, 26, 34, 44, 49; IST: 9, 11, 15, 17, 19; SAT: 3</p> <p>ES 71347 GMT: 93, 94, 95, 96, 97, 98, 99</p> <p>ES 71354 NI: 10, 11, 28; NIT: 5, 13</p> <p>ES 71426 AV: 2; FO: 31, 59; FOT: 16, 17, 40, 55, 56, 58; MZT: 19, 20</p> <p>ES 71451 CHR: 65, 66; DT: 33</p> <p>ES 72004 GM: 55, 57, 58, 59, 73, 91, 92, 93, 94, 95; GMT: 23, 24, 28, 29, 39, 40, 55; NI: 5; NIT: 12, 15, 16; SAB: 20, 21; SAT: 1, 2; SZT: 9, 10</p> <p>ES 72073 GM: 9, 10, 18; TO: 5, 6, 7</p> <p>ES 72102 GM: 41, 42, 43; GMT: 12</p> <p>ES 72103 GM: 51</p> <p>ES 72105 GM: 10, 18, 21; LOT: 2, 3, 4; TO: 2, 5, 7, 10, 36; TOT: 5, 6, 7, 9</p> <p>ES 72120 CHR: 8, 9, 19, 20, 26; MI: 5, 10, 15, 17, 20; MIT: 2, 5</p> <p>ES 72120-1 CHR: 38, 39, 54; MI: 21, 25, 26, 27; MIT: 7, 10, 12</p> <p>ES 72122 CHR: 51, 53; DT: 18</p> <p>ES 72123 GM: 10; TO: 5, 22</p> <p>ES 72124 SB: 1, 2</p> <p>ES 72125 GM: 62, 63</p> <p>ES 72131 FO: 46, 47; FOT: 29</p> <p>ES 72132 HO: 34, 35; HOT: 1, 2</p> <p>ES 72132-1 HO: 21, 22, 27, 28</p> <p>ES 72133 GM: 9; TO: 6, 23, 24, 36, 37, 38; TOT: 5, 9, 23, 24</p> <p>ES 72136 FO: 34, 35, 36; FOT: 18, 19; MZT: 21, 22</p> <p>ES 72137 FO: 18; FOT: 7, 11; MZT: 9, 13</p> <p>ES 72138 CHR: 62</p> <p>ES 72141 GM: 33, 34, 41, 42, 52, 53, 65, 80, 82, 90, 96; GMT: 12, 45</p> <p>ES 72142 FO: 5, 18, 19, 20, 33, 37, 46, 47, 60, 61, 62, 63; FOT: 29, 44, 45, 46; LAF: 1, 2; MOR: 1</p> <p>ES 72143 CHR: 25, 40, 41, 42, 51, 53, 59, 60, 61, 68; DT: 15, 18, 19, 26, 27, 28, 37; MI: 24; MIT: 6</p> <p>ES 72154 TO: 13, 15, 16; TOT: 1</p> <p>ES 72155 FO: 61, 62, 63; FOT: 44, 45, 46; LAF: 1, 2</p> <p>ES 72155-1 FOT: 41, 42, 43</p> <p>ES 72156 FO: 46; FOT: 29</p> <p>ES 72157 CHR: 13, 14</p> <p>ES 72159 FO: 24, 25, 28, 29, 30, 32; FOT: 15, 17; MZ: 30; MZT: 12, 17, 18, 19</p> <p>ES 72160 FO: 46, 48; FOT: 29, 30, 34</p> <p>ES 72161 FOT: 70</p> <p>ES 72163 CHR: 60; DT: 22, 23, 24, 25, 28, 29, 36, 37, 38; JEE: 10; VWT: 14</p> <p>ES 72164 GM: 35, 36</p> <p>ES 72165 GM: 51</p> <p>ES 72166 CHR: 10, 11, 12; DT: 1; MI: 6, 7</p> <p>ES 72167 GM: 77</p> <p>ES 72168 TOT: 16</p> <p>ES 72169 DT: 39, 45, 46, 61, 63; JEE: 16, 20</p> <p>ES 72170 GM: 35; GMT: 7, 8; IST: 2, 3</p> <p>ES 72171 AV: 1; FO: 50; FOT: 32, 33; LRT: 10; MZT: 27</p> <p>ES 72172 GM: 35; GMT: 7; GRU: 1; IST: 2</p> <p>ES 72173 AV: 6; CAL: 1; GM: 100, 101; GMT: 57, 67, 68, 69, 78, 80; IST: 23; MOS: 1</p> <p>ES 72174 FO: 34, 35, 36; FOT: 18, 19; MZT: 21, 22</p> <p>ES 72175 FO: 6, 7, 8; FOT: 1; MZT: 1</p> <p>ES 72176 CHR: 25, 40, 41, 42; DT: 14, 15</p> <p>ES 72176-1 CHR: 59, 60, 61, 68; DT: 26, 27, 28, 37</p> <p>ES 72177 GM: 66</p> <p>ES 72178 HO: 29</p> <p>ES 72179 HO: 21, 22, 27, 28, 29, 34, 35, 36, 42; HOT: 1, 2</p>	<p>ES 72180 FO: 34, 35, 36; FOT: 18, 19; MZT: 21, 22</p> <p>ES 72181 TO: 2</p> <p>ES 72182 TOT: 5, 9, 10</p> <p>ES 72183 TO: 13, 15, 16; TOT: 1</p> <p>ES 72184 TO: 2, 3, 4</p> <p>ES 72185 TOT: 11</p> <p>ES 72186 ACO: 1; GM: 87, 92, 93</p> <p>ES 72187 ACO: 1, 2; GM: 87, 92, 93</p> <p>ES 72188 GMT: 103; WRK: 4</p> <p>ES 72189 VW: 31, 32, 33, 34, 35, 36, 37</p> <p>ES 72191 GM: 70</p> <p>ES 72192 NI: 7</p> <p>ES 72193 DT: 57, 58, 59, 60, 65, 66</p> <p>ES 72194 FOT: 20; NIT: 7, 8</p> <p>ES 72195 GMT: 22, 26, 34, 44, 49; IST: 9, 11, 15, 17, 19; SAT: 3</p> <p>ES 72196 GM: 29, 30, 32, 37, 38, 39, 40, 45, 46, 47, 48, 49, 50; GMT: 5, 6, 9, 10, 11, 13, 14, 15, 16, 17, 18</p> <p>ES 72197 TO: 3, 4</p> <p>ES 72198 NI: 10; NIT: 5, 15, 16; SZT: 6</p> <p>ES 72199 GMT: 93, 94, 95, 96, 99</p> <p>ES 72200 CHR: 69, 70, 71, 72, 73; DT: 48, 49, 50, 51, 52, 53; JEE: 17, 18, 21, 22</p> <p>ES 72202 TO: 37, 38</p> <p>ES 72203 NI: 3</p> <p>ES 72204 FOT: 29, 30, 34</p> <p>ES 72205 HY: 25, 26; HYT: 7; KIA: 21, 22; KIT: 7</p> <p>ES 72206 GMT: 4, 21; SZ: 6, 7, 9; SZT: 4, 5, 7, 8</p> <p>ES 72207 FO: 11, 12, 13, 17, 21, 22; FOT: 2, 4, 5, 6, 8, 9; MZ: 16, 17, 17, 22; MZT: 2, 5, 6, 7, 8</p> <p>ES 72208 FO: 32; JAG: 1, 2</p> <p>ES 72209 CHR: 74; DT: 68</p> <p>ES 72210 FO: 2, 3</p> <p>ES 72211 HY: 19; HYT: 4; KIA: 16</p> <p>ES 72212 SAB: 17, 18; SB: 5, 8, 9, 10, 11, 16, 17, 18; SBT: 4, 5, 6</p> <p>ES 72213 TO: 29, 30, 31</p> <p>ES 72214 FO: 34, 35, 36; FOT: 18, 19; MZT: 21, 22</p> <p>ES 72217 GM: 91, 92, 93, 94, 95; GMT: 55</p> <p>ES 72220 AV: 6; GM: 99, 100, 101, 106, 108; GMT: 56, 57, 63, 65, 66, 67, 68, 69, 75, 77, 78, 79, 80, 81, 84; IST: 22, 23; MOS: 1; SAT: 4, 5</p> <p>ES 72221 GM: 35</p> <p>ES 72224 AMG: 1; GMT: 53, 54, 60, 74; IST: 20, 21, 24; WRK: 1</p> <p>ES 72225 GM: 60, 61, 67; GMT: 32</p> <p>ES 72226 GM: 60, 61, 67, 69, 71, 72, 83, 84, 85, 86; GMT: 31, 32, 33, 36, 37, 38, 47, 48</p> <p>ES 72227 KIA: 1, 4</p> <p>ES 72229 FOT: 61</p> <p>ES 72230 GM: 71, 72, 83, 84, 85, 86; GMT: 38, 47, 48</p> <p>ES 72230-1 GM: 71, 72, 83, 85; GMT: 38</p> <p>ES 72231 NI: 8; NIT: 3</p> <p>ES 72233 AV: 6; CAL: 1; GM: 99, 100, 101, 106, 107, 108, 109, 110, 111; GMT: 56, 57, 58, 61, 62, 63, 64, 65, 66, 67, 68, 69, 70, 71, 72, 75, 76, 77, 78, 79, 80, 81, 82, 83, 84, 85; IST: 22, 23; MOS: 1; SAT: 4, 5</p> <p>ES 72242 FOT: 61, 64</p> <p>ES 72244 DAE: 1; GM: 13, 14</p> <p>ES 72245 FOT: 61</p> <p>ES 72248 FOT: 61</p> <p>ES 72249 LOT: 5, 6; TO: 28, 33, 34, 35; TOT: 17, 18, 19, 20</p> <p>ES 72249-1 TOT: 25, 26</p> <p>ES 72249-2 GM: 44; TO: 17, 18; TOT: 3</p> <p>ES 72252 JEE: 10</p> <p>ES 72252-1 CHR: 7, 23, 24, 28, 29, 30, 31, 32; DT: 4, 5; JEE: 1, 2, 3, 4</p>
---	---	--

NUMERICAL LIST

ES 72256 CHR: 7, 23, 24; JEE: 1, 2	ES 72672 FO: 5, 9; MOR: 1	ES 72879 VW: 23, 24, 25
ES 72257 FOT: 61	ES 72674 AMG: 3, 4, 5; GMT: 86, 87, 88, 89, 90, 91, 92; WRK: 2	ES 72886 VW: 48; VWT: 6
ES 72260 FOT: 61	ES 72701 LOT: 5, 6; TO: 21, 25, 26, 27, 28, 32, 33, 34, 35; TOT: 12, 13, 14, 15, 16, 17, 18, 19, 20	ES 72892 GM: 60, 61, 67; GMT: 31, 32, 33, 36, 37
ES 72262 FO: 49	ES 72720 DT: 57, 58, 59, 60	ES 72894 DT: 67
ES 72264 GMT: 100, 101, 102; WRK: 3	ES 72723 CHR: 25, 40, 41, 42; DT: 14, 15	ES 72895 CHR: 58, 62, 63, 64, 65, 66; DT: 31, 32, 33, 41; VWT: 15
ES 72267 CHR: 7, 23, 24, 28, 29, 30, 31, 32; DT: 4, 5; JEE: 1, 2, 3, 4	ES 72724 AMG: 3, 4, 5; GMT: 86, 87, 88, 89, 90, 91, 92; WRK: 2	ES 72896 DT: 13; JEE: 6, 7
ES 72272 BMW: 7, 8	ES 72727 GM: 41, 42, 43; GMT: 12	ES 72897 CHR: 43, 44, 45, 46
ES 72274 GM: 55, 57, 58, 59, 73, 74, 75, 76; GMT: 23, 24, 28, 29, 39, 40, 41, 42, 43; SAB: 20, 21; SAT: 1, 2; SZT: 9	ES 72728 GM: 33, 34	ES 72899 GM: 44; TO: 17, 18; TOT: 2, 3, 16
ES 72284 HO: 30, 31, 32, 33, 58, 59, 60; HOT: 8, 10, 11	ES 72733 GM: 52; GMT: 19, 20; GRU: 2, 3	ES 72900 NI: 12, 20, 21; NIT: 9, 12; SZT: 10
ES 72291 HO: 31, 32	ES 72734 FO: 18; FOT: 7; MZT: 9	ES 72901 GMT: 30; IST: 12
ES 72303 GM: 69	ES 72738 FO: 49	ES 72902 GM: 27, 28
ES 72308 TOT: 11	ES 72745 SAB: 5, 6, 16; SB: 6, 7, 12, 13, 15; SBT: 1, 3	ES 72903 GM: 26
ES 72310 VW: 38, 39, 40, 41	ES 72747 GM: 10, 18; TO: 5, 7	ES 72904 DT: 67
ES 72344 GMT: 93, 94, 95, 96, 97, 98, 99	ES 72748 HO: 55, 56, 57; HOT: 5, 6, 7, 9	ES 72905 SAB: 16; SB: 12, 13, 14, 15; SBT: 1, 2, 3
ES 72357 CHR: 33, 34, 35, 36, 37; DT: 6, 7, 8, 9, 10, 11, 12; JEE: 5	ES 72750 KIT: 4	ES 72906 GM: 54, 56, 64; GMT: 27; SAB: 22, 23
ES 72366 HY: 29, 30, 32, 33; HYT: 8, 9, 11; KIA: 24; KIT: 8, 9, 11	ES 72753 CHR: 10, 11; MI: 6, 7	ES 72906-1 DAE: 2, 3; GM: 31; IST: 4; SZ: 8
ES 72376 DT: 57, 58, 59, 60	ES 72756 FO: 26; MZ: 20, 24	ES 72908 VOL: 11, 12, 13, 14, 15, 16, 17, 18, 19, 20, 21, 22, 23, 24, 25, 26, 27, 28, 29, 30, 32; VOT: 1
ES 72389 GM: 15, 16	ES 72758 GM: 91, 92, 93, 95	ES 72909 KIA: 10, 11
ES 72390 GM: 107, 109, 110, 111, 112; GMT: 58, 61, 62, 64, 70, 71, 72, 75, 76, 77, 79, 82, 83, 85	ES 72759 GM: 9; TO: 6	ES 72943 BMW: 13, 14, 16, 17; BMT: 1, 2
ES 72393 GM: 55, 57, 58, 59, 73, 74, 75, 76; GMT: 23, 24, 28, 29, 39, 40, 41, 42, 43; SAB: 20, 21; SAT: 1, 2; SZT: 9	ES 72760 SB: 3, 4	ES 72947 CHR: 12, 33, 34, 35, 36, 37; DT: 6, 8, 9, 10, 11, 12
ES 72418 SAB: 16, 17, 18; SB: 12, 13, 15, 16, 17, 18; SBT: 1, 3, 4, 5, 6	ES 72761 GM: 73; GMT: 39, 40; SZT: 9	ES 72948 CHR: 43, 44, 45, 46
ES 72422 TOT: 16	ES 72765 FO: 1; KIA: 7; MZ: 7	ES 72958 AUD: 26, 27
ES 72439 BMW: 22, 26, 28, 29, 30; BMT: 6, 7; LRT: 13; RR: 1	ES 72768 DT: 22, 24, 28, 29, 37	ES 72961 FOT: 61
ES 72440 BMW: 11, 12, 13, 14, 16, 17; BMT: 1, 2	ES 72772 CHR: 21, 22; MI: 11	ES 72962 JEE: 11, 12
ES 72442 VW: 47, 48, 49; VWT: 6	ES 72773 DT: 57, 58, 60	ES 72967 HO: 23, 24, 25, 26, 38, 39, 40, 41, 55, 56, 57, 58, 59, 60; HOT: 5, 6, 7, 8, 9, 10, 11
ES 72449 HO: 11, 12, 13	ES 72778 GM: 1, 2; GMT: 3; SZ: 1; SZT: 3	ES 72970 GM: 39, 40
ES 72449-1 HO: 2, 3, 4, 14	ES 72787 CHR: 16, 18; MI: 9	ES 72971 HY: 29, 30, 32, 33; HYT: 8, 11; KIA: 24; KIT: 8, 11
ES 72451 BMW: 1, 2, 3, 4, 5, 6	ES 72794 FOT: 12, 31; MZT: 25, 26	ES 72974 HY: 3, 9, 10, 11, 15; HYT: 1; KIA: 8, 9, 12; KIT: 1
ES 72463 SB: 22, 24; SBT: 9, 10	ES 72798 AV: 2; DET: 1; FO: 51, 52, 54, 55, 56, 57, 58, 59; FOT: 35, 36, 37, 38, 39, 40, 48, 49, 51, 52, 53, 54, 55, 56, 58; PNZ: 1	ES 72998 GMT: 35; HO: 65, 66, 67, 68, 71, 72, 73, 74, 75, 76, 77, 78, 80, 81; HOT: 15, 16, 17, 18, 19, 20, 21, 22, 23, 24, 25, 26, 27, 29, 30
ES 72464 SB: 22	ES 72798-1 FOT: 66, 67	ES 73006 HO: 58, 59, 60; HOT: 8, 9, 10, 11
ES 72465-1 HY: 16, 17, 21, 22, 23, 24; HYT: 2, 3, 5, 6; KIA: 13, 14, 17, 18, 19, 20; KIT: 3, 5, 6	ES 72801 TOT: 6, 7	ES 73007 HYT: 9; KIT: 9
ES 72467 CHR: 67; DT: 34; JEE: 8; VWT: 13	ES 72804 HO: 43, 44, 45, 46, 47; HOT: 3; IST: 1	ES 73008 FO: 17, 21, 22; FOT: 8, 9
ES 72468 FOT: 70	ES 72806 AUD: 22, 23, 24, 25, 26, 27, 52, 53, 54, 55, 56; AUT: 2, 3, 4, 5, 18; POT: 1; VW: 42, 43, 44, 52, 53; VWT: 7, 8, 9, 17, 18, 19	ES 73010 AV: 6; CAL: 1; GM: 100, 101, 106, 107, 108, 109, 110, 111; GMT: 56, 57, 58, 61, 62, 63, 64, 65, 66, 67, 68, 69, 70, 71, 72, 75, 76, 77, 78, 79, 80, 81, 82, 83, 84, 85; IST: 22, 23; MOS: 1; SAT: 4, 5
ES 72469 GM: 22, 23	ES 72812 CHR: 47, 48, 49, 50; MI: 22, 23; MIT: 9	ES 74016 GM: 35; GMT: 7; GRU: 1
ES 72471 GM: 5	ES 72817 CHR: 48, 50; MI: 23	ES 74017 GM: 60, 61, 62, 67
ES 72472 MI: 12; MIT: 1	ES 72825 MZ: 28, 29; MZT: 15, 16	ES 74018 GM: 62, 63
ES 72474 GM: 5, 6, 7, 8; GMT: 1	ES 72827 AUD: 52, 53, 54, 55, 56; AUT: 18; VW: 52, 53; VWT: 17, 18, 19	ES 74019 GM: 61
ES 72475 FO: 26; MZ: 24	ES 72833 GM: 65, 77, 78, 79, 80, 81, 82, 90, 96; GMT: 45	ES 74020 FO: 10; MZ: 14, 15
ES 72476 HO: 4, 12, 13, 14, 23, 24, 25, 26, 28, 29, 34, 35, 48, 49, 54; HOT: 1, 2	ES 72834 AUD: 28, 29	ES 74021 GM: 1, 2; SZ: 1
ES 72477 VOL: 11, 12, 13, 14, 15, 16, 17, 18, 19, 20, 21, 22, 23, 24, 25, 26, 27, 28, 29, 30, 31, 32; VOT: 1	ES 72836 TO: 22	ES 74026 NI: 9; NIT: 4
ES 72478 MZ: 31; MZT: 24	ES 72838 BMW: 9, 10	ES 74027 TO: 1
ES 72479 FO: 64, 65; FOT: 47	ES 72840 FOT: 13, 14, 20; NI: 18, 19; NIT: 6, 7, 8	ES 74029 VW: 14, 15, 16, 17, 19, 30
ES 72480 FO: 64, 65; FOT: 47	ES 72845 CHR: 15, 16, 17; MI: 8, 9, 14, 16	ES 74030 FO: 33, 37
ES 72481 NI: 20, 21; NIT: 9, 12; SZT: 10	ES 72846 FO: 4; KIA: 7; MZ: 7, 8, 9, 10, 11, 13	ES 74031 GM: 65, 80, 82; GMT: 45
ES 72483 VW: 45, 46; VWT: 5	ES 72849 CHR: 59, 60, 61, 68; DT: 26, 27, 28, 37	ES 74033 GM: 77, 78, 79, 81
ES 72486 HY: 13; KIA: 15	ES 72855 FO: 15, 16; MZ: 18, 19; MZT: 3, 4	ES 74034 GM: 88; GMT: 51, 52, 53, 54; IST: 20, 21
ES 72489 GM: 10, 18; TO: 5, 7	ES 72856 AMG: 1, 2; AV: 3, 4, 5; EXC: 1; GM: 89, 97, 98, 102, 103, 104, 105; GMT: 59, 60, 73, 74; IST: 24, 25; WRK: 1	ES 74035 TOT: 23, 24
ES 72490 BMW: 13, 14, 16, 17; BMT: 1, 2	ES 72857 GM: 62, 68; GMT: 25; IST: 10	FS 8266 PT-4 JEE: 19
ES 72499 TO: 15, 16; TOT: 1	ES 72858 GM: 53	FS 9015 B GMT: 46; IST: 18
ES 72519 FOT: 68, 69, 70, 71	ES 72859 CHR: 38, 39, 47, 48, 49, 50, 51, 52, 53, 54; DT: 18, 19; HY: 27, 28, 31; HYT: 10; KIA: 23; KIT: 10; MI: 21, 22, 23, 24, 25, 26, 27; MIT: 6, 7, 10, 12	HIS 8168 PT-7 FOT: 41, 42, 43
ES 72523 CHR: 13, 14	ES 72870 AUD: 22, 23, 24, 25; AUT: 2, 3; VW: 42, 43, 44	HIS 8188 PT GM: 10; TO: 5
ES 72581 FOT: 64	ES 72872 CHR: 1, 2, 3, 4, 5, 6, 15, 16, 17, 18, 19, 20, 21, 22, 26, 27, 51, 52, 53; DT: 2, 3, 18, 19; HY: 1, 2, 8, 14, 16, 18, 21, 22, 23, 24, 28; HYT: 2, 3, 5, 6; KIA: 13, 14, 17, 18, 19, 20; KIT: 3, 5, 6; MI: 1, 2, 3, 4, 8, 9, 10, 11, 16, 17, 18, 20, 24; MIT: 2, 3, 5, 6	HIS 8699 PT-6 GMT: 25; IST: 10
ES 72599 VOL: 4, 5, 6, 7, 8, 9, 10		HIS 8699 PT-7 GMT: 30; IST: 12
ES 72652 MZ: 25, 26, 27, 28, 29; MZT: 15, 16		HIS 8807 PT-2 TOT: 4
ES 72671 AMG: 1, 2; GMT: 59, 60, 73, 74, 100, 101, 102; IST: 24, 25; WRK: 1, 3		HIS 8857 PT-5 FO: 46
		HIS 8993 PT-6 FO: 18; FOT: 7; MZT: 9
		HIS 9036 PT CHR: 13
		HIS 9036 PT-1 CHR: 13

NUMERICAL LIST

HIS 9071 PT GM: 67; GMT: 32	HS 26171 PT NI: 8	HS 26207 PT-2 FO: 30; FOT: 15
HIS 9081 PT FOT: 31; MZT: 25	HS 26171 PT-1 NIT: 3	HS 26207 PT-3 MZT: 17, 18
HIS 9112 PT CHR: 51, 53; DT: 18	HS 26171 PT-2 NIT: 3	HS 26207 PT-4 MZT: 17, 18
HIS 9115 PT GM: 51	HS 26172 PT CHR: 26; MI: 17; MIT: 2	HS 26207 PT-5 MZT: 17, 18
HIS 9123 PT HO: 5, 6, 15	HS 26173 PT GM: 56	HS 26208 PT CHR: 62, 63, 64, 65, 66
HIS 9170 PT GMT: 7; GRU: 1; IST: 2	HS 26173 PT-1 GM: 56	HS 26208 PT-1 DT: 31
HIS 9188 PT-1 GM: 33, 34	HS 26173 PT-2 SAB: 22	HS 26208 PT-2 CHR: 63, 65, 66; DT: 32
HIS 9234 PT FOT: 29	HS 26173 PT-3 GMT: 27	HS 26208 PT-3 CHR: 65, 66; DT: 33
HIS 9296 PT-2 CHR: 25, 41, 42; DT: 14, 15	HS 26173 PT-4 GMT: 27	HS 26210 PT VW: 18
HIS 9309 PT-1 FO: 5	HS 26174 PT FO: 6	HS 26211 PT JEE: 11, 12
HIS 9469 PT GM: 36	HS 26179 PT DT: 47	HS 26213 PT GMT: 49; IST: 19
HIS 9469 PT-1 GM: 35	HS 26179 PT-1 DT: 45, 46; JEE: 16	HS 26214 PT GMT: 49; IST: 19
HIS 9469 PT-2 GM: 35	HS 26179 PT-2 DT: 45, 46; JEE: 16	HS 26214 PT-1 GMT: 49; IST: 19; SAT: 3
HIS 9471 PT-1 GM: 62, 63	HS 26180 PT HY: 12, 15	HS 26214 PT-2 GMT: 49; IST: 19; SAT: 3
HIS 9483 PT TO: 1	HS 26181 PT HY: 15	HS 26215 PT MI: 24
HIS 9510 PT-2 FOT: 12	HS 26181 PT-1 HY: 15; HYT: 1; KIA: 12; KIT: 1	HS 26218 PT DT: 57, 58, 59, 60
HIS 9515 PT GM: 41, 42	HS 26181 PT-3 HY: 15; HYT: 1; KIA: 12; KIT: 1	HS 26219 PT FOT: 20; NIT: 7
HIS 9515 PT-1 GM: 43	HS 26182 PT AUD: 1, 2, 3, 4, 5, 6, 7, 8; VW: 4, 5, 6, 7, 8, 9, 10, 11, 12, 13	HS 26219 PT-1 NIT: 7
HIS 9515 PT-2 GM: 41, 42; GMT: 12	HS 26183 PT MI: 5	HS 26219 PT-3 NIT: 8
HIS 9560 PT-1 FO: 46	HS 26184 PT MI: 1	HS 26220 PT KIT: 2
HIS 9560 PT-2 FO: 46; FOT: 29	HS 26185 PT-2 TOT: 4	HS 26221 PT KIA: 10
HIS 9572 PT-1 MZT: 3, 4	HS 26186 PT CHR: 48, 49, 50; MI: 22, 23	HS 26221 PT-1 KIA: 10
HIS 9572 PT-2 FO: 15; MZ: 18	HS 26186 PT-1 CHR: 49, 50; MI: 22, 23	HS 26223 PT GM: 37, 39
HIS 9651 PT GM: 2; SZ: 1	HS 26186 PT-2 MIT: 7	HS 26223 PT-1 GM: 38, 39; GMT: 10
HIS 9673 PT CHR: 59, 60, 61; DT: 26, 27, 28	HS 26187 PT FO: 53; PNZ: 2	HS 26223 PT-4 GM: 37, 39
HIS 9684 PT GM: 12; IS: 3	HS 26188 PT FO: 51	HS 26223 PT-5 GM: 39; GMT: 10
HIS 9724 PT-1 FOT: 31; MZT: 25, 26	HS 26188 PT-1 FOT: 36	HS 26224 PT HY: 9, 10
HIS 9758 PT CHR: 1, 2, 3; MI: 1	HS 26189 PT GM: 56; SAB: 23	HS 26224 PT-1 HY: 9, 10
HIS 9814 PT FO: 19, 20	HS 26189 PT-1 SAB: 22, 23	HS 26224 PT-2 HY: 9, 11; KIA: 8, 9
HIS 9851 PT HO: 43, 45	HS 26190 PT AV: 6; GM: 100, 101; MOS: 1	HS 26225 PT HY: 3
HIS 9922 PT CHR: 10, 11; MI: 6, 7	HS 26190 PT-1 GM: 100, 101	HS 26226 PT TOT: 23
HIS 9924 PT CHR: 37; DT: 8	HS 26190 PT-2 GMT: 56, 61, 62, 63, 64, 65, 66; IST: 22; SAT: 4	HS 26229 PT DT: 35; JEE: 9; MIT: 11
HIS 9957 PT GM: 61	HS 26190 PT-3 GM: 99	HS 26230 PT GM: 70
HIS 9957 PT-2 GM: 61	HS 26190 PT-4 GMT: 56, 58, 70, 71, 72	HS 26230 PT-1 GM: 70
HIS 9971 PT GM: 28	HS 26191 PT GMT: 57, 67, 68; IST: 23	HS 26232 PT TO: 17; TOT: 3
HS 26140 PT-2 VW: 48	HS 26191 PT-1 GMT: 57, 67, 68, 69; IST: 23	HS 26233 PT FOT: 15
HS 26150 PT GM: 92, 93	HS 26192 PT GMT: 78, 80	HS 26233 PT-1 FO: 30
HS 26150 PT-1 GM: 92, 93	HS 26192 PT-1 GMT: 78	HS 26233 PT-2 MZ: 30
HS 26150 PT-2 GM: 92, 93	HS 26192 PT-2 GMT: 78, 80	HS 26233 PT-3 MZ: 30
HS 26150 PT-3 GM: 92, 93	HS 26192 PT-3 GM: 106, 108	HS 26233 PT-4 MZ: 30
HS 26150 PT-4 GM: 91, 92, 93, 95	HS 26192 PT-4 GMT: 75, 81, 83; SAT: 5	HS 26233 PT-5 FOT: 15; MZT: 18
HS 26152 PT ACO: 1; GM: 87	HS 26192 PT-5 GMT: 77, 82, 83, 84	HS 26234 PT MZ: 9
HS 26152 PT-1 ACO: 1, 2; GM: 87	HS 26192 PT-6 GMT: 79, 84, 85	HS 26234 PT-1 MZ: 10
HS 26152 PT-2 ACO: 2; GM: 87	HS 26192 PT-7 GM: 107, 109	HS 26235 PT MI: 20; MIT: 5
HS 26154 PT TO: 10	HS 26192 PT-8 GMT: 75, 76	HS 26236 PT HO: 23
HS 26154 PT-1 LOT: 2, 3, 4; TO: 10	HS 26192 PT-9 GM: 110, 111	HS 26236 PT-1 HO: 24
HS 26154 PT-2 GM: 21	HS 26193 PT MIT: 10	HS 26236 PT-2 HO: 23, 25, 26
HS 26154 PT-3 GM: 21	HS 26193 PT-1 MI: 26	HS 26239 PT NI: 21; NIT: 9
HS 26155 PT HO: 51, 52, 53; HOT: 4; IST: 5	HS 26194 PT MZ: 14, 15	HS 26239 PT-1 NI: 21; NIT: 9
HS 26157 PT DT: 42; JEE: 13, 15	HS 26195 PT HY: 4	HS 26241 PT NIT: 9
HS 26157 PT-1 DT: 42, 43, 44; JEE: 13, 14, 15; MIT: 13, 14	HS 26195 PT-1 HY: 5	HS 26243 PT HO: 56; HOT: 6
HS 26157 PT-2 DT: 42, 43; JEE: 13, 14; MIT: 13, 14	HS 26196 PT HO: 65	HS 26244 PT HOT: 5
HS 26158 PT GM: 19; TO: 8	HS 26197 PT HY: 4	HS 26245 PT BMW: 14, 17; BMT: 1, 2
HS 26158 PT-1 GM: 20; TO: 9	HS 26202 PT CHR: 33, 34, 36; DT: 6, 9, 10, 11	HS 26245 PT-1 BMW: 13, 16
HS 26158 PT-2 TO: 9	HS 26202 PT-1 CHR: 35, 37; DT: 12	HS 26246 PT BMW: 9
HS 26158 PT-3 GM: 20	HS 26202 PT-2 DT: 8	HS 26247 PT BMW: 9
HS 26159 PT HOT: 1, 2	HS 26202 PT-3 DT: 7, 8; JEE: 5	HS 26248 PT FO: 32; JAG: 2
HS 26160 PT TOT: 2	HS 26203 PT VOL: 24, 26, 27	HS 26248 PT-1 JAG: 2
HS 26161 PT VW: 31, 32, 33	HS 26203 PT-1 VOL: 11, 24, 26	HS 26248 PT-2 JAG: 2
HS 26161 PT-1 VW: 31, 32, 33, 34, 35, 36, 37	HS 26203 PT-2 VOL: 22, 23, 25, 27	HS 26250 PT FOT: 4; MZT: 5
HS 26162 PT FOT: 66	HS 26204 PT VOL: 11, 12, 13, 22, 25, 27	HS 26250 PT-1 FOT: 4, 5, 6; MZT: 5, 6, 7
HS 26164 PT VW: 30	HS 26204 PT-1 VOL: 11, 13, 22, 23, 24, 25, 26, 27	HS 26250 PT-2 FO: 17
HS 26164 PT-1 VW: 30	HS 26205 PT VOL: 11, 13, 14, 21, 23, 25, 27, 28	HS 26250 PT-3 FO: 11, 17
HS 26165 PT FO: 24, 25; MZT: 12	HS 26206 PT CHR: 12, 35, 37; DT: 12	HS 26250 PT-4 FO: 11, 17; MZ: 17, 21
HS 26167 PT SB: 14	HS 26206 PT-1 DT: 1, 8; JEE: 5	HS 26250 PT-5 FO: 11
HS 26167 PT-1 SB: 14; SBT: 2	HS 26206 PT-2 DT: 8	HS 26250 PT-7 MZ: 22
HS 26167 PT-2 SB: 14; SBT: 2	HS 26207 PT FO: 32; MZT: 18	HS 26250 PT-8 FOT: 2
HS 26167 PT-3 SB: 14; SBT: 2	HS 26207 PT-1 FOT: 15	HS 26252 PT BMW: 12
HS 26168 PT GMT: 103; WRK: 4		
HS 26170 PT-1 SAB: 17, 18; SB: 16, 17, 18; SBT: 4, 5, 6		

NUMERICAL LIST

HS 26252 PT-1 BMW: 12 HS 26252 PT-2 BMW: 13, 16 HS 26253 PT BMW: 10 HS 26254 PT BMW: 9	HS 26315 PT-1 KIA: 4 HS 26315 PT-2 KIA: 4 HS 26316 PT FO: 17 HS 26316 PT-1 FO: 17	HS 26394 PT TOT: 25, 26 HS 26395 PT SZT: 8 HS 26395 PT-1 SZT: 8 HS 26397 PT HO: 30, 31, 32, 33
HS 26255 PT NI: 3 HS 26255 PT-1 NI: 3 HS 26256 PT VOL: 15, 18, 19, 21, 23, 24, 25, 26, 27, 28; VOT: 1 HS 26258 PT TO: 3	HS 26317 PT DAE: 2, 3; GM: 31; SZ: 8 HS 26317 PT-1 IST: 4 HS 26317 PT-2 GM: 31; SZ: 8 HS 26318 PT AUD: 9, 10, 11; VW: 27 HS 26319 PT DT: 16, 17; FRT: 1	HS 26399 PT HO: 38, 40 HS 26403 PT HO: 39 HS 26404 PT HO: 41 HS 26407 PT MZ: 22; MZT: 8
HS 26258 PT-1 TO: 4 HS 26258 PT-2 TO: 4 HS 26259 PT SB: 13, 15 HS 26259 PT-1 SB: 12, 15; SBT: 1, 3	HS 26321 PT LOT: 5, 6; TO: 33; TOT: 17, 18 HS 26321 PT-1 TO: 34, 35 HS 26323 PT TO: 17, 18; TOT: 3 HS 26323 PT-1 GM: 44	HS 26408 PT HO: 48 HS 26409 PT MZ: 21 HS 26409 PT-1 MZ: 17 HS 26409 PT-2 MZ: 17
HS 26260 PT HO: 71; HOT: 15 HS 26260 PT-1 HO: 71, 72 HS 26260 PT-2 HOT: 16, 17 HS 26261 PT NI: 10; NIT: 5	HS 26324 PT GM: 71, 72, 83, 84, 85, 86; GMT: 38, 47, 48 HS 26326 PT JEE: 10 HS 26328 PT AUD: 24, 25; VW: 42, 43, 44	HS 26410 PT MIT: 8 HS 26411 PT HO: 49 HS 26412 PT HO: 62 HS 26413 PT HO: 61
HS 26262 PT TO: 38 HS 26265 PT HOT: 19 HS 26265 PT-1 HO: 73 HS 26265 PT-2 HOT: 25	HS 26329 PT HO: 74 HS 26330 PT TOT: 19 HS 26330 PT-1 TOT: 19 HS 26332 PT CHR: 28, 29, 31; DT: 4, 5; JEE: 3, 4 HS 26332 PT-1 CHR: 28, 31	HS 26414 PT HY: 32; HYT: 11; KIA: 24; KIT: 11 HS 26415 PT SB: 8, 9, 10 HS 26415 PT-1 SAB: 18; SB: 18; SBT: 6 HS 26417 PT IST: 16
HS 26265 PT-3 GMT: 35 HS 26265 PT-4 HOT: 21 HS 26265 PT-5 HOT: 18, 19, 21 HS 26265 PT-6 HO: 73	HS 26333 PT HY: 21; KIA: 17 HS 26333 PT-1 HY: 24; KIA: 20 HS 26334 PT HO: 66, 67 HS 26334 PT-1 HO: 68	HS 26419 PT TO: 21 HS 26420 PT HY: 32; HYT: 11; KIA: 24; KIT: 11 HS 26420 PT-1 KIT: 11 HS 26420 PT-2 HYT: 11
HS 26265 PT-7 HOT: 22 HS 26266 PT TO: 32; TOT: 14, 15 HS 26276 PT HY: 26; HYT: 7; KIA: 22 HS 26276 PT-1 HY: 26; HYT: 7; KIA: 22; KIT: 7	HS 26335 PT GMT: 22; IST: 9 HS 26336 PT GMT: 34; IST: 15 HS 26337 PT HO: 55, 57; HOT: 7, 9 HS 26338 PT NI: 4, 6; NIT: 2	HS 26422 PT HY: 29; HYT: 8 HS 26423 PT CHR: 69, 72; DT: 49, 52, 53; JEE: 18 HS 26427 PT HY: 29; HYT: 8; KIT: 8
HS 26276 PT-2 HYT: 7; KIT: 7 HS 26278 PT GMT: 4; SZ: 7; SZT: 5 HS 26278 PT-1 SZ: 7 HS 26279 PT SZ: 9	HS 26340 PT HYT: 7 HS 26349 PT MB: 4 HS 26350 PT-1 MB: 51 HS 26351 PT-1 MB: 51	HS 26427 PT-1 KIT: 9 HS 26428 PT SAB: 3, 4, 13, 14, 15 HS 26431 PT SAB: 2, 3, 4, 15 HS 26432 PT KIA: 10
HS 26282 PT HY: 19; HYT: 4; KIA: 16 HS 26283 PT CHR: 74; DT: 68 HS 26284 PT CHR: 70, 71; DT: 48, 51; JEE: 17 HS 26284 PT-1 CHR: 70, 71; DT: 48, 50, 51; JEE: 17	HS 26353 PT MB: 62 HS 26354 PT MB: 62 HS 26357 PT TOT: 10 HS 26358 PT MB: 63, 64, 65 HS 26359 PT MB: 63, 64, 65	HS 26433 PT CHR: 56, 57; MB: 24, 25, 26, 27, 28, 29, 30, 31; MBT: 1 HS 26435 PT HO: 58, 59, 60; HOT: 8, 10, 11 HS 26436 PT LRT: 3, 4, 5, 7, 8, 9, 11, 12, 14; MOR: 2 HS 26437 PT HYT: 7; KIA: 22
HS 26285 PT MB: 10, 11 HS 26287 PT MB: 32 HS 26288 PT MI: 15 HS 26289 PT MB: 12, 13, 14, 33, 34, 35, 36	HS 26360 PT CHR: 7, 23, 24; JEE: 1, 2 HS 26361 PT FO: 49 HS 26361 PT-1 FO: 49	HS 26438 PT KIA: 5 HS 26447 PT MI: 13 HS 26449 PT MI: 12; MIT: 1 HS 26449 PT-1 MI: 12; MIT: 1
HS 26290 PT TOT: 19 HS 26291 PT MB: 16, 17, 18 HS 26293 PT HY: 31; HYT: 10; KIA: 23 HS 26293 PT-1 KIT: 10	HS 26362 PT MB: 66, 67 HS 26363 PT MB: 66, 67 HS 26365 PT MI: 14 HS 26366 PT CHR: 73; JEE: 21, 22	HS 26453 PT BMW: 1, 3 HS 26455 PT AUD: 9, 10, 11; AUT: 1; VW: 27; VWT: 1 HS 26458 PT BMW: 1, 3 HS 26465 PT CHR: 30, 32
HS 26293 PT-2 KIT: 10 HS 26295 PT TO: 37 HS 26297 PT TO: 31 HS 26297 PT-1 TO: 29	HS 26367 PT MI: 14 HS 26368 PT DT: 41; VWT: 15 HS 26370 PT NIT: 12; SZT: 10 HS 26370 PT-1 NI: 21; NIT: 9	HS 26466 PT GM: 46, 47; GMT: 13, 16 HS 26466 PT-1 GM: 40, 45, 46, 47, 48, 50; GMT: 9, 11, 13, 14, 15, 16 HS 26482 PT FO: 54, 55, 56 HS 26482 PT-1 FOT: 51, 52, 54
HS 26298 PT TOT: 23, 24 HS 26300 PT FOT: 32, 33; LRT: 10; MZT: 27 HS 26300 PT-1 AV: 1; FO: 50 HS 26302 PT FOT: 67	HS 26372 PT NIT: 15, 16 HS 26376 PT GM: 73; GMT: 39 HS 26376 PT-1 GMT: 39 HS 26376 PT-2 GM: 73; GMT: 39, 40; SZT: 9	HS 26484 PT MI: 19; MIT: 4 HS 26487 PT FO: 38, 39, 40; FOT: 21, 22; MZT: 23 HS 26489 PT GM: 64 HS 26509 PT HO: 75, 76, 77, 78; HOT: 20, 23, 24, 25, 26, 27
HS 26304 PT FOT: 66 HS 26306 PT FOT: 56, 58 HS 26306 PT-1 FOT: 40 HS 26306 PT-2 FOT: 55, 56, 58	HS 26376 PT-3 GM: 73 HS 26376 PT-4 GMT: 39 HS 26378 PT GM: 14 HS 26379 PT GM: 13	HS 26511 PT NI: 21; NIT: 9 HS 26513 PT GM: 24 HS 26515 PT GM: 24; TO: 11 HS 26515 PT-1 TO: 12
HS 26306 PT-3 FOT: 40 HS 26306 PT-4 FOT: 40 HS 26308 PT AV: 2; FO: 59 HS 26308 PT-1 AV: 2; FO: 59	HS 26380 PT GM: 94; GMT: 55 HS 26380 PT-1 GM: 94; GMT: 55 HS 26382 PT BMW: 7 HS 26382 PT-1 BMW: 8	HS 26516 PT GM: 15, 16 HS 26516 PT-1 GM: 23 HS 26517 PT GM: 49; GMT: 17, 18 HS 26519 PT NI: 10, 11; NIT: 5
HS 26308 PT-2 FO: 59 HS 26312 PT MIT: 2 HS 26313 PT MI: 27; MIT: 12 HS 26313 PT-1 MI: 27	HS 26385 PT DAE: 1 HS 26385 PT-1 DAE: 1 HS 26386 PT GMT: 21; SZT: 7 HS 26388 PT VW: 38, 39, 40, 41	HS 26520 PT NIT: 5; SZT: 6 HS 26521 PT FO: 21, 22 HS 26522 PT FO: 21, 22; FOT: 8, 9 HS 26527 PT HO: 3
HS 26313 PT-2 MIT: 12 HS 26313 PT-3 MI: 27 HS 26314 PT GM: 69; GMT: 36 HS 26314 PT-1 GMT: 37 HS 26315 PT KIA: 1	HS 26382 PT-1 BMW: 8 HS 26383 PT NI: 20 HS 26385 PT DAE: 1 HS 26385 PT-1 DAE: 1 HS 26386 PT GMT: 21; SZT: 7 HS 26388 PT VW: 38, 39, 40, 41 HS 26389 PT GMT: 26; IST: 11 HS 26390 PT GMT: 44; IST: 17 HS 26391 PT MZ: 5 HS 26392 PT MZ: 5	HS 26528 PT HO: 2 HS 26529 PT HO: 4 HS 26529 PT-1 HO: 14 HS 26529 PT-2 HO: 12, 13

NUMERICAL LIST

HS 26529 PT-3 HO: 4	HS 9005 PT-3 FO: 6	HS 9213 PT MZ: 2
HS 26530 PT HO: 11	HS 9005 PT-4 FO: 6	HS 9227 PT-1 TOT: 16
HS 26531 PT SAB: 16; SB: 12, 13; SBT: 1	HS 9005 PT-5 FO: 6; FOT: 1; MZT: 1	HS 9234 PT FOT: 29
HS 26531 PT-1 SB: 12; SBT: 1	HS 9005 PT-6 FOT: 1; MZT: 1	HS 9234 PT-1 FOT: 29
HS 26531 PT-2 SB: 12	HS 9005 PT-7 FO: 8	HS 9239 PT FOT: 70
HS 26531 PT-3 SB: 18	HS 9005 PT-8 FO: 8	HS 9250 PT FOT: 34
HS 26533 PT SB: 22	HS 9005 PT-9 FO: 6, 7	HS 9250 PT-1 FOT: 29
HS 26534 PT SB: 22; SBT: 9	HS 9031 PT HO: 69	HS 9250 PT-2 FO: 46, 48; FOT: 34
HS 26537 PT SAB: 5, 6; SB: 6, 7	HS 9031 PT-1 HO: 79	HS 9250 PT-3 FOT: 29
HS 26538 PT JAG: 1	HS 9034 PT DT: 67	HS 9250 PT-4 FOT: 29
HS 26540 PT GM: 5	HS 9036 PT CHR: 13	HS 9250 PT-5 FOT: 34
HS 26540 PT-1 GM: 6, 7, 8; GMT: 1	HS 9036 PT-1 CHR: 13	HS 9250 PT-6 FOT: 30, 34
HS 26541 PT CHR: 67; DT: 34; JEE: 8; VWT: 13	HS 9036 PT-2 CHR: 13	HS 9250 PT-7 FOT: 30, 34
HS 26543 PT FO: 45; FOT: 28	HS 9036 PT-3 CHR: 14	HS 9254 PT HOT: 13, 28; IST: 13, 16
HS 26543 PT-1 FO: 43; FOT: 26; MZ: 31; MZT: 24	HS 9037 PT CHR: 38, 39; MI: 21	HS 9262 PT FO: 46
HS 26545 PT FO: 31; FOT: 16, 17; MZT: 19, 20	HS 9038 PT FO: 28, 29; MZT: 12	HS 9274 PT HO: 21, 22
HS 26550 PT FO: 64; FOT: 47	HS 9047 PT FOT: 68, 69, 71	HS 9274 PT-2 HO: 28
HS 26563 PT TOT: 20	HS 9059 PT GM: 51	HS 9274 PT-3 HO: 27, 29
HS 26579 PT MB: 3, 5, 6	HS 9071 PT GM: 67; GMT: 32	HS 9280 PT-3 FO: 60, 61, 62, 63
HS 26586 PT NI: 28; NIT: 13	HS 9071 PT-1 GM: 67; GMT: 32	HS 9284 PT GM: 100
HS 26603 PT VOL: 39; VOT: 3	HS 9071 PT-2 GM: 67; GMT: 32	HS 9284 PT-1 CAL: 1; GM: 100
HS 26607 PT AUD: 22, 23; AUT: 2, 3	HS 9071 PT-3 GMT: 31, 33	HS 9284 PT-2 AV: 6; GM: 100, 101
HS 26608 PT AUD: 28, 29	HS 9076 PT-1 JEE: 11	HS 9292 PT GMT: 57, 68
HS 26610 PT DT: 30; FRT: 4; MB: 38, 39, 40, 41, 42, 43, 44, 45, 46, 47, 48; MBT: 2, 3, 4, 5, 6	HS 9076 PT-2 JEE: 11	HS 9292 PT-1 GMT: 57, 68
HS 26611 PT MB: 58, 59, 60, 61; MBT: 8, 9, 10	HS 9076 PT-3 JEE: 11, 12	HS 9293 PT FOT: 32, 33
HS 26612 PT MB: 53, 54, 55, 56, 57; MBT: 7	HS 9076 PT-4 JEE: 11, 12	HS 9293 PT-1 FOT: 32, 33
HS 26613 PT MB: 78, 79, 80, 81, 82, 83, 84, 85; MBT: 16, 17	HS 9081 PT FOT: 31; MZT: 25	HS 9293 PT-2 FOT: 32, 33; MZT: 27
HS 26642 PT NI: 28; NIT: 13	HS 9081 PT-1 FOT: 31; MZT: 25	HS 9296 PT-1 CHR: 40
HS 26646 PT MB: 3, 5, 6	HS 9085 PT GM: 89	HS 9296 PT-2 CHR: 25, 41, 42; DT: 14, 15
HS 26669 PT AUD: 50, 51, 52, 53, 54, 55; AUT: 18; VW: 52, 53; VWT: 17, 18, 19	HS 9086 B-1 CHR: 21, 22; MI: 11	HS 9296 PT-3 CHR: 25, 41, 42; DT: 14, 15
HS 26671 PT AUD: 48	HS 9088 PT GM: 77	HS 9309 PT-1 FO: 5
HS 26672 PT AUD: 49	HS 9089 PT-1 GM: 77	HS 9309 PT-2 FO: 9
HS 7733 PT-15 AMG: 2; GM: 102, 103; GMT: 73; IST: 25	HS 9089 PT-2 GM: 77	HS 9313 PT DT: 56
HS 7733 PT-16 AMG: 1; GMT: 74; IST: 24; WRK: 1	HS 9089 PT-3 GM: 79	HS 9313 PT-1 DT: 56
HS 7733 PT-9 GM: 103	HS 9089 PT-4 GM: 79	HS 9352 PT CHR: 4
HS 8168 PT-5 FOT: 41, 42	HS 9090 B VW: 14, 15, 16, 17, 19	HS 9352 PT-2 HY: 1, 2; MI: 2
HS 8168 PT-6 FOT: 41, 42	HS 9105 PT GM: 68	HS 9354 PT GM: 88
HS 8168 PT-7 FOT: 41, 42, 43	HS 9111 PT-2 DT: 40	HS 9354 PT-1 GM: 88; GMT: 51, 52
HS 8188 PT GM: 10; TO: 5	HS 9112 PT CHR: 51, 53; DT: 18	HS 9354 PT-2 GM: 88; GMT: 51
HS 8190 PT-1 VOL: 5, 6, 7, 8, 9, 10	HS 9112 PT-1 DT: 19; MI: 24; MIT: 6	HS 9354 PT-3 GMT: 54
HS 8190 PT-2 VOL: 4	HS 9112 PT-2 CHR: 52, 53; HY: 28; MI: 24	HS 9354 PT-4 GMT: 54
HS 8215 PT-2 HOT: 12; IST: 8	HS 9112 PT-3 DT: 18	HS 9354 PT-5 GMT: 51
HS 8266 PT-4 JEE: 19	HS 9112 PT-4 MI: 24	HS 9354 PT-6 GMT: 53, 54; IST: 20, 21
HS 8510 PT-4 AV: 3, 4; GM: 97; GMT: 59	HS 9112 PT-5 MI: 24	HS 9354 PT-7 GMT: 53
HS 8510 PT-5 AV: 5; GM: 98	HS 9113 PT-1 GM: 66	HS 9368 PT FOT: 18
HS 8510 PT-6 GMT: 60	HS 9113 PT-2 GM: 66	HS 9388 PT DT: 3; MIT: 3
HS 8523 PT-2 GMT: 100	HS 9115 PT GM: 51	HS 9388 PT-1 HY: 20
HS 8548 PT-13 FOT: 44, 46; LAF: 1	HS 9117 PT SZT: 1	HS 9388 PT-2 CHR: 27; MI: 18
HS 8548 PT-14 FOT: 45; LAF: 1, 2	HS 9117 PT-1 GM: 4; SZ: 4	HS 9388 PT-3 DT: 2; MIT: 3
HS 8548 PT-9 FO: 69; FOT: 59, 60; WIN: 2	HS 9118 PT MOR: 1	HS 9392 PT-2 SB: 3, 4
HS 8553 PT-15 DT: 62, 64	HS 9123 PT HO: 5, 6, 15	HS 9397 B-1 BMW: 15
HS 8558 PT-10 FOT: 72	HS 9123 PT-1 HO: 9	HS 9405 PT-4 GMT: 20; GRU: 3
HS 8558 PT-6 FOT: 72	HS 9123 PT-2 HO: 7	HS 9405 PT-5 GM: 52; GMT: 19; GRU: 2
HS 8699 PT-6 GMT: 25; IST: 10	HS 9123 PT-3 HO: 10	HS 9406 PT-3 GM: 53
HS 8699 PT-7 GM: 62; GMT: 30; IST: 12	HS 9124 PT-3 HO: 42	HS 9422 PT-2 KIT: 4
HS 8753 PT-4 GM: 90, 96	HS 9124 PT-4 HO: 36	HS 9425 PT CHR: 58
HS 8857 PT-5 FO: 46	HS 9158 PT CHR: 38, 39	HS 9465 PT TOT: 5
HS 8857 PT-6 FO: 46	HS 9170 PT GMT: 7; GRU: 1; IST: 2	HS 9465 PT-1 TOT: 5
HS 8857 PT-7 FO: 46	HS 9170 PT-1 GM: 35; GMT: 7; IST: 2	HS 9465 PT-2 TOT: 9
HS 8857 PT-8 FO: 46	HS 9170 PT-2 GMT: 7, 8; IST: 3	HS 9465 PT-3 TOT: 9
HS 8993 PT-6 FO: 18; FOT: 7; MZT: 9	HS 9174 PT IST: 13	HS 9468 PT TO: 15, 16
HS 8993 PT-7 FOT: 7, 11; MZT: 9, 13	HS 9174 PT-1 HOT: 14; IST: 14	HS 9469 PT GM: 36
HS 8993 PT-8 FOT: 11; MZT: 13	HS 9174 PT-2 HOT: 14; IST: 14	HS 9469 PT-1 GM: 35
HS 9005 PT FO: 6, 7	HS 9188 PT-1 GM: 33, 34	HS 9469 PT-2 GM: 35
HS 9005 PT-1 FO: 6, 7	HS 9196 PT-2 JEE: 7	HS 9471 PT-1 GM: 62, 63
HS 9005 PT-10 FO: 6	HS 9196 PT-3 DT: 13; JEE: 7	HS 9473 PT TO: 23
HS 9005 PT-11 FO: 6, 7	HS 9196 PT-4 JEE: 7	HS 9473 PT-1 TO: 24
HS 9005 PT-2 FO: 6, 7	HS 9196 PT-5 DT: 13; JEE: 6, 7	HS 9481 PT FO: 32
	HS 9199 PT GMT: 78	HS 9483 PT TO: 1
	HS 9201 PT TO: 26, 27; TOT: 12	HS 9489 PT TO: 26; TOT: 12, 13

NUMERICAL LIST

HS 9489 PT-1 TO: 26	HS 9685 PT GM: 11; IS: 1, 2; LOT: 1	HS 9885 PT FO: 34, 36; FOT: 18
HS 9494 PT TO: 2	HS 9691 PT MZ: 4	HS 9885 PT-3 FO: 34, 35, 36; FOT: 18
HS 9496 PT-3 IST: 6, 7	HS 9691 PT-1 FO: 3	HS 9885 PT-4 FO: 35, 36; FOT: 18
HS 9502 PT GMT: 100, 101, 102; WRK: 3	HS 9691 PT-2 FO: 2	HS 9885 PT-5 FO: 35, 36
HS 9505 PT CHR: 62, 63, 64, 65, 66	HS 9696 B KIA: 7; MZ: 7	HS 9887 PT CHR: 8, 9; MI: 5
HS 9508 PT NI: 20	HS 9698 PT-1 HO: 34, 35	HS 9898 PT-1 DT: 61, 63
HS 9510 PT-2 FOT: 12	HS 9703 PT NI: 14, 15	HS 9898 PT-2 DT: 61, 63; JEE: 20
HS 9514 PT CHR: 44, 46	HS 9711 PT FO: 10; MZ: 14	HS 9902 PT FOT: 18; MZT: 21
HS 9514 PT-1 CHR: 43, 44, 45, 46	HS 9711 PT-1 MZ: 12, 14	HS 9902 PT-3 FOT: 18, 19; MZT: 21, 22
HS 9515 PT GM: 41, 42	HS 9717 PT FO: 4; MZ: 11	HS 9902 PT-4 FOT: 18, 19; MZT: 21, 22
HS 9515 PT-1 GM: 43	HS 9717 PT-1 FO: 4; MZ: 11	HS 9902 PT-5 FOT: 18, 19; MZT: 21, 22
HS 9515 PT-2 GM: 41, 42; GMT: 12	HS 9717 PT-2 KIA: 11	HS 9904 PT TO: 25
HS 9515 PT-3 GM: 41; GMT: 12	HS 9717 PT-3 MZ: 8	HS 9910 PT DT: 39
HS 9522 PT DT: 57, 58, 60	HS 9718 PT MZ: 13	HS 9910 PT-1 DT: 39
HS 9528 PT SB: 1	HS 9724 PT-1 FOT: 31; MZT: 25, 26	HS 9915 PT HO: 20
HS 9528 PT-1 SB: 2	HS 9728 PT-1 TOT: 11	HS 9915 PT-1 HO: 17, 18, 19
HS 9531 PT STE: 1	HS 9758 PT CHR: 1, 2, 3; MI: 1	HS 9915 PT-2 HO: 19
HS 9531 PT-1 HO: 63	HS 9759 PT BMW: 25	HS 9917 PT GM: 81
HS 9535 PT DT: 37	HS 9790 PT FO: 56	HS 9917 PT-1 GM: 81
HS 9537 PT CHR: 54; MI: 25; MIT: 7	HS 9790 PT-10 FOT: 38	HS 9917 PT-2 GM: 81
HS 9539 PT FO: 9	HS 9790 PT-11 FOT: 51, 52, 54	HS 9917 PT-3 GM: 78, 81
HS 9539 PT-1 FO: 9	HS 9790 PT-12 FOT: 51, 52, 54	HS 9917 PT-4 GM: 78
HS 9540 PT FO: 32	HS 9790 PT-13 FOT: 51	HS 9919 PT HO: 54
HS 9540 PT-1 FO: 32	HS 9790 PT-14 FOT: 48, 49	HS 9920 PT DT: 61, 63; JEE: 20
HS 9540 PT-2 FO: 32	HS 9790 PT-15 FOT: 51, 52, 53, 54	HS 9921 PT FO: 26; MZ: 24
HS 9540 PT-3 FOT: 15; MZT: 18	HS 9790 PT-16 FO: 54, 56, 58	HS 9921 PT-1 FO: 26
HS 9540 PT-4 FO: 32	HS 9790 PT-17 FOT: 38	HS 9922 PT CHR: 10, 11; MI: 6, 7
HS 9555 B FO: 1	HS 9790 PT-18 FOT: 50	HS 9924 PT CHR: 37; DT: 8
HS 9555 B-1 FO: 1	HS 9790 PT-19 FOT: 50	HS 9924 PT-1 CHR: 37
HS 9560 PT-1 FO: 46	HS 9790 PT-20 FOT: 35	HS 9924 PT-2 DT: 8
HS 9560 PT-2 FO: 46; FOT: 29	HS 9790 PT-3 DET: 1; FO: 52; PNZ: 1	HS 9926 PT CHR: 62
HS 9570 PT-1 VW: 26	HS 9790 PT-4 FOT: 51, 52, 54	HS 9930 PT KIA: 6; MZ: 6
HS 9571 PT NI: 18, 19	HS 9790 PT-6 FO: 52	HS 9932 PT CHR: 19, 20, 26; MI: 10, 17
HS 9571 PT-2 NIT: 6	HS 9790 PT-7 FO: 54, 56, 58	HS 9942 PT NI: 8
HS 9571 PT-3 FOT: 14	HS 9790 PT-8 FOT: 38	HS 9942 PT-1 NI: 8
HS 9571 PT-5 NIT: 6	HS 9790 PT-9 FOT: 38	HS 9946 PT DT: 8
HS 9572 PT FO: 16; MZ: 19	HS 9792 PT FO: 57, 58	HS 9955 PT GM: 18; TO: 7
HS 9572 PT-1 MZT: 3, 4	HS 9792 PT-1 FO: 57, 58	HS 9957 PT GM: 61
HS 9572 PT-2 FO: 15; MZ: 18	HS 9792 PT-3 FOT: 39	HS 9957 PT-1 GM: 60
HS 9592 PT TO: 26, 27; TOT: 12, 13	HS 9792 PT-4 FOT: 39	HS 9957 PT-2 GM: 61
HS 9592 PT-1 TO: 26, 27	HS 9792 PT-5 FOT: 39	HS 9957 PT-3 GM: 60
HS 9592 PT-2 TOT: 13	HS 9792 PT-6 FO: 54, 56, 58	HS 9958 PT HO: 46; HOT: 3; IST: 1
HS 9604 PT GM: 10; TO: 5	HS 9792 PT-7 FOT: 51, 52, 53, 54	HS 9958 PT-1 HO: 47
HS 9618 PT SB: 5	HS 9792 PT-8 FO: 54, 55, 56; FOT: 38	HS 9958 PT-2 HO: 47
HS 9623 PT SZ: 2	HS 9792 PT-9 FOT: 37, 38	HS 9963 PT TO: 2
HS 9623 PT-1 GM: 4; SZ: 4	HS 9797 PT TOT: 1	HS 9966 PT EXC: 1; GM: 104
HS 9623 PT-2 GM: 3; SZ: 3	HS 9805 PT TO: 36	HS 9966 PT-2 EXC: 1; GM: 104, 105
HS 9627 PT CHR: 17, 18; HY: 8, 14, 18; MI: 3, 8, 9	HS 9814 PT FO: 19, 20	HS 9968 PT GM: 26
HS 9627 PT-1 CHR: 15, 16, 17; MI: 8, 9	HS 9816 PT NI: 7	HS 9968 PT-1 GM: 26
HS 9627 PT-2 HY: 8, 14, 18	HS 9816 PT-1 NI: 7	HS 9968 PT-2 GM: 26
HS 9627 PT-3 CHR: 16; MI: 9	HS 9816 PT-2 NI: 7	HS 9968 PT-3 GM: 26
HS 9627 PT-4 HY: 18	HS 9816 PT-3 NI: 7	HS 9968 PT-4 GM: 26
HS 9637 PT MZT: 14	HS 9819 PT NI: 1	HS 9971 PT GM: 28
HS 9642 PT FO: 47	HS 9819 PT-1 NI: 1	HS 9971 PT-1 GM: 27
HS 9642 PT-1 FO: 47	HS 9820 PT NI: 8	HS 9971 PT-2 GM: 27
HS 9644 PT GM: 65	HS 9830 PT CHR: 68; DT: 37	HS 9972 PT FOT: 13, 14; NIT: 6
HS 9644 PT-1 GM: 82; GMT: 45	HS 9831 PT TOT: 6, 7	HS 9978 PT DT: 22, 24, 28, 29
HS 9644 PT-2 GM: 80	HS 9833 PT TOT: 21	HS 9978 PT-1 DT: 22, 23, 24, 25, 28, 29
HS 9644 PT-3 GM: 65	HS 9842 PT CHR: 47, 49; MI: 22	HS 9996 PT DT: 37
HS 9646 PT NIT: 4	HS 9846 B CHR: 5, 6; MI: 4	HS 9996 PT-1 DT: 37
HS 9646 PT-1 NI: 9; NIT: 4	HS 9848 PT NI: 27	HS 9996 PT-2 DT: 36, 37, 38; VWT: 14
HS 9646 PT-2 NIT: 4	HS 9851 PT HO: 43, 45	HSB 9296 PT-1CHR: 40
HS 9649 PT-1 MZ: 28, 29; MZT: 15, 16	HS 9851 PT-1 HO: 44	HSB 9296 PT-2CHR: 25, 41, 42; DT: 14, 15
HS 9651 PT GM: 1, 2; SZ: 1	HS 9853 PT TO: 14	HST 7733 PT-16AMG: 1; GMT: 74; IST: 24; WRK: 1
HS 9656 PT TO: 22	HS 9853 PT-2 TO: 14	HST 8510 PT-6GMT: 60
HS 9673 PT CHR: 59, 60, 61; DT: 24, 26, 27, 28	HS 9854 PT SB: 9	HST 9071 PT GM: 67; GMT: 32
HS 9673 PT-1 DT: 24, 28	HS 9854 PT-1 SB: 9, 10	HST 9071 PT-1GM: 67; GMT: 32
HS 9683 PT GMT: 3; SZT: 3	HS 9856 PT SB: 11	HST 9081 PT-1FOT: 31; MZT: 25
HS 9683 PT-1 GMT: 2; SZ: 5; SZT: 2	HS 9861 PT TO: 13, 15; TOT: 1	HST 9354 PT-6GMT: 53, 54; IST: 20, 21
HS 9684 PT GM: 12; IS: 3	HS 9879 PT SAB: 1, 2	HST 9957 PT-1GM: 60

NUMERICAL LIST

HST 9957 PT-2GM: 61	MS 91476	CHR: 43, 44, 45, 46	MS 92721	TOT: 5, 9	
HSU 21225	VW: 1, 2, 3	MS 91481	GM: 61	MS 92732	TOT: 16
HSU 26140	VW: 45, 46, 47, 48, 49; VWT: 5, 6	MS 91483	CHR: 43, 44, 45, 46	MS 9275 B	AMG: 2; AV: 3, 4, 5; GM: 97, 98, 102, 103; GMT: 59, 73; IST: 25
HSU 26143	VW: 22, 23, 24	MS 91484	HO: 21, 22	MS 92766	TO: 26, 27; TOT: 12, 13
HSU 26269	GMT: 93	MS 91485	HO: 17, 18, 19	MS 92766-1	TO: 32; TOT: 14, 15
HSU 26269-1	GMT: 94, 95, 96, 99	MS 91553	HO: 19	MS 92794	GMT: 7, 8; IST: 3
HSU 26269-2	GMT: 96	MS 91585	AMG: 3, 4, 5; GMT: 87, 88, 89, 90, 91, 92; WRK: 2	MS 92808	DT: 37
HSU 26269-3	GMT: 96, 97, 98	MS 91586	AMG: 3; GMT: 86	MS 92808-1	DT: 22, 23, 24, 25, 28, 29, 36, 37, 38; JEE: 10; VWT: 14
HSU 26339	BMW: 22, 26	MS 91587	AMG: 3, 4, 5; GMT: 86, 87, 88, 89, 90, 91, 92; WRK: 2	MS 92836-1	FOT: 51, 52, 53, 54
HSU 26345	BMW: 28; BMT: 6; LRT: 13	MS 91657	CHR: 21, 22; MI: 11	MS 92837	TO: 2
HSU 26374	FOT: 61	MS 91679	TOT: 4	MS 92846	CHR: 12, 33, 34, 35, 36, 37; DT: 1, 6, 7, 8, 9, 10, 11, 12; JEE: 5
HSU 26453	BMW: 1, 3	MS 91724	TOT: 4	MS 92888	CHR: 12, 35, 37; DT: 12
HSU 26454	BMW: 2, 4	MS 91815	DT: 18; MI: 24	MS 92902	FOT: 48, 49
HSU 8726	AMG: 3, 4, 5; GMT: 87, 88, 89, 90, 91, 92; WRK: 2	MS 91815-1	DT: 18; MI: 24	MS 92904	AV: 6; GM: 100, 101; MOS: 1
HSU 8726-1	AMG: 3; GMT: 86	MS 91837	CHR: 16; MI: 9, 16	MS 92939	GM: 9; TO: 6
HSU 9332	DT: 54, 55	MS 91963	VW: 47, 48, 49; VWT: 6	MS 92947	DT: 37
MS 22755	VW: 1, 2, 3, 14, 15, 16, 17, 18, 19	MS 91990	CHR: 58, 62, 63, 64, 65, 66	MS 92964-1	HY: 20
MS 22764	SB: 4	MS 92029	CHR: 21, 22, 27; DT: 3; MI: 11, 18; MIT: 3	MS 92964-3	DT: 2, 3; MIT: 3
MS 22776	VOL: 5, 6, 7, 8, 9, 10	MS 92057	FO: 5, 9; MOR: 1	MS 92964-4	CHR: 27; MI: 18
MS 22777	VOL: 5, 6, 7, 8, 9, 10	MS 92081	GM: 33, 34	MS 92968	TOT: 4
MS 90000	FO: 60, 61, 62, 63, 69; FOT: 44, 46, 59; LAF: 1; WIN: 2	MS 92089	DT: 54, 55, 56	MS 92993	SB: 3
MS 90131	AMG: 1; GMT: 60, 74; IST: 24; WRK: 1	MS 92100	DT: 13; JEE: 6, 7	MS 93020	GM: 62, 68
MS 90131-2	AMG: 1; GMT: 60, 74; IST: 24; WRK: 1	MS 92121	FO: 57, 58	MS 93020-1	GM: 62, 68
MS 90166	JEE: 19	MS 92121-1	FOT: 38, 39	MS 93028	BMW: 15
MS 90176-1	AMG: 4; GMT: 88, 89, 90; WRK: 2	MS 92121-2	FOT: 38, 39, 51, 52, 54	MS 93035-1	AV: 5; GM: 98, 103
MS 90206	GMT: 100	MS 92121-3	FO: 54, 56, 58	MS 93040	GM: 88
MS 90269	AMG: 1; GMT: 60, 74; IST: 24; WRK: 1	MS 92121-4	FO: 58	MS 93094	JEE: 11, 12
MS 90278	GM: 51	MS 92165	CHR: 58, 62, 63, 64, 65, 66	MS 93160	AV: 5; GM: 98, 103
MS 90284	GM: 51	MS 92165-1	CHR: 65, 66; DT: 31, 32, 33, 41; VWT: 15	MS 93168	FOT: 48, 49
MS 90361	FO: 69; FOT: 59; WIN: 2	MS 92188	FOT: 38, 39, 51, 52, 54	MS 93205	DT: 42, 43, 44; JEE: 13, 14, 15; MIT: 13, 14
MS 90453	GM: 62, 68	MS 92188-1	FOT: 51, 52, 54	MS 93205-1	DT: 35; JEE: 9; MIT: 11
MS 90460	DT: 47, 62, 64	MS 92211	GMT: 57, 67, 68, 78, 80; IST: 23	MS 93217	DT: 42, 43, 44; JEE: 13, 14, 15; MIT: 13, 14
MS 90502	GMT: 100	MS 92270-1	NI: 19	MS 93219	DT: 1, 7, 8; JEE: 5
MS 90505	GM: 60, 67; GMT: 32	MS 92270-2	NI: 18, 19	MS 93220	DT: 1, 7, 8; JEE: 5
MS 90540	GM: 35; GMT: 7; IST: 2	MS 92270-3	FOT: 20; NIT: 7	MS 93222	ACO: 1; GM: 87, 92, 93
MS 90543	GM: 35; GMT: 7, 8; IST: 2, 3	MS 92270-4	FOT: 13, 14; NIT: 6, 7	MS 93223	VW: 30, 31, 32, 33, 34, 35, 36, 37
MS 90546	CHR: 37; DT: 8	MS 92270-6	NIT: 8	MS 93224	VW: 30
MS 90559	GM: 41, 42, 43; GMT: 12	MS 92271	NIT: 6	MS 93225	GM: 92, 93
MS 90562	GM: 61	MS 92272	FOT: 14; NI: 18, 19; NIT: 6	MS 93227	SB: 3, 4
MS 90565	GM: 60, 67; GMT: 32	MS 92273	FOT: 13, 14; NIT: 6, 7	MS 93233	TO: 14
MS 90573	GM: 41, 42, 43; GMT: 12	MS 92273-1	NI: 19	MS 93248	KIT: 4; MZT: 3, 4
MS 90610	HOT: 13, 28; IST: 13, 16	MS 92273-2	NI: 18, 19	MS 93313	ACO: 1, 2; GM: 87, 92, 93, 94; GMT: 55
MS 90708	CHR: 13	MS 92273-3	FOT: 20; NIT: 7	MS 93313-1	GM: 70
MS 90725	HOT: 13, 14, 28; IST: 13, 14, 16	MS 92327	TO: 23, 24	MS 93317	AMG: 2; AV: 3, 4; GM: 97, 102; GMT: 59, 73; IST: 25
MS 90728	FOT: 31; MZT: 25	MS 92424	FO: 18; FOT: 7, 11; MZT: 9, 13	MS 93318	GM: 103
MS 90732	FOT: 31; MZT: 25	MS 92438	AV: 6; CAL: 1; GM: 100, 101; MOS: 1	MS 93334	FO: 60, 62, 63
MS 90733	FOT: 31; MZT: 25	MS 92465	AV: 6; CAL: 1; GM: 100, 101; GMT: 56, 57, 63, 65, 67, 68, 69, 78, 80; IST: 23; MOS: 1	MS 93346	GM: 88; GMT: 51, 52
MS 90746	GM: 88; GMT: 51, 52	MS 92467	CAL: 1; GM: 99, 100, 101, 106, 107, 108, 109, 110, 111; GMT: 56, 57, 58, 61, 62, 63, 64, 65, 66, 67, 68, 69, 70, 71, 72, 75, 76, 77, 78, 79, 80, 81, 82, 83, 84, 85; IST: 22, 23; SAT: 4, 5	MS 93346-1	GM: 88; GMT: 51
MS 90762	FO: 54, 56, 57, 58	MS 92492	DT: 57, 58, 60	MS 93353	MZT: 4
MS 90779	AV: 1; FO: 50; FOT: 32, 33; LRT: 10; MZT: 27	MS 92504	HO: 28	MS 93361	HO: 63; STE: 1
MS 90812	FOT: 29	MS 92505	HO: 27, 29	MS 93371	ACO: 1, 2; GM: 87, 91, 92, 93, 95
MS 90864	GM: 62, 68; GMT: 25, 30; IST: 10, 12	MS 92506	HO: 34, 35; HOT: 1, 2	MS 93391	FO: 18; FOT: 7; MZT: 9
MS 90890	FOT: 32, 33	MS 92532	DT: 8	MS 93391-1	FOT: 7, 11; MZT: 9, 13
MS 90891	FO: 6, 7	MS 92542	DT: 67	MS 93455	ACO: 1; GM: 87, 92, 93
MS 90947	CHR: 25, 40, 41, 42; DT: 14, 15	MS 92544	DT: 67	MS 93483	FO: 19, 20
MS 90967	CHR: 4	MS 92552	DET: 1; FO: 52; PNZ: 1	MS 93489	FOT: 70
MS 90968	CHR: 4	MS 92568	FO: 54, 55, 56, 57, 58; FOT: 37, 38, 39, 50, 51, 52, 53, 54	MS 93491	FO: 34, 35, 36; FOT: 18, 19; MZT: 21, 22
MS 91022	GMT: 25, 30; IST: 10, 12	MS 92586	FO: 32	MS 93544	TO: 23, 24
MS 91130	GM: 41; GMT: 12	MS 92586-1	FO: 30, 32; FOT: 15; MZ: 30; MZT: 18	MS 93545	TO: 23, 24
MS 91241	NI: 20	MS 92587	FO: 32	MS 93548	TO: 1
MS 91241-1	NIT: 9	MS 92614	FOT: 37, 38, 39, 51, 52, 54	MS 93550-1	TO: 13, 15, 16; TOT: 1
MS 91241-2	NI: 20	MS 92672	TOT: 5, 9	MS 93553	TO: 1
MS 91242	FOT: 68, 69, 71	MS 92692	TOT: 5, 9	MS 93610	GM: 62
MS 91253	NI: 20			MS 93613	VW: 26
MS 91346	FO: 46, 47; FOT: 29			MS 93615	VW: 26
MS 91459	NI: 12, 20, 21, 22, 23, 24; NIT: 9, 10, 11, 12; SZT: 10			MS 93625	GM: 33, 34
MS 91473	CHR: 43, 44, 45, 46				

NUMERICAL LIST

MS 93657	IST: 6	MS 94177	FOT: 72	MS 94664	HO: 43, 45
MS 93657-1	HOT: 12; IST: 7, 8	MS 94179	HO: 9, 10	MS 94666	CHR: 59, 60, 61, 68; DT: 22, 23, 24, 25, 26, 27, 28, 29, 36, 37, 38; VWT: 14
MS 93688	GMT: 20; GRU: 3	MS 94184	HO: 46, 47, 51, 52, 53; HOT: 3, 4; IST: 1, 5	MS 94682	FOT: 31; MZT: 25, 26
MS 93689	GM: 52, 53; GMT: 19, 20; GRU: 2, 3	MS 94191	GM: 26	MS 94682-1	FOT: 31; MZT: 25
MS 93692	GM: 62, 63	MS 94197	FO: 15, 16; MZ: 18, 19	MS 94683	FOT: 31; MZT: 25, 26
MS 93754	FOT: 12	MS 94199	FO: 15, 16; MZ: 18, 19	MS 94697	KIT: 4; MZT: 3
MS 93770	STE: 1	MS 94204	FOT: 72	MS 94708-1	TOT: 11
MS 93770-1	HO: 63	MS 94213	FO: 16; MZ: 19	MS 94710	TOT: 21
MS 93771	FOT: 12	MS 94244	HOT: 12; IST: 6, 7, 8	MS 94711	TOT: 11
MS 93789	DT: 40	MS 94250	GM: 90, 96	MS 94727	TOT: 11
MS 93791	DT: 40	MS 94257	SB: 2	MS 94731	TOT: 21
MS 93795	CHR: 51, 53; DT: 18	MS 94263	FO: 18; FOT: 7; MZT: 9	MS 94750	MZ: 4
MS 93795-2	DT: 19; MIT: 6	MS 94270	GM: 25; IS: 4	MS 94753	TO: 36
MS 93795-3	CHR: 52, 53; MI: 24	MS 94278	GM: 52, 53; GMT: 19; GRU: 2	MS 94754	TO: 36
MS 93796	CHR: 51, 53; DT: 18	MS 94286	GM: 27	MS 94758	FO: 19, 20, 27
MS 93797	CHR: 51, 52, 53; DT: 18, 19; HY: 28; MI: 24; MIT: 6	MS 94295	GM: 44; TO: 17, 18; TOT: 2, 3	MS 94763	CHR: 1, 2, 3; HY: 1, 2; MI: 1, 2
MS 93811	GM: 36	MS 94304	SB: 1, 2	MS 94764	FOT: 31; MZT: 25, 26
MS 93812	GM: 35, 36; GMT: 7; GRU: 1; IST: 2	MS 94324	GM: 4; SZ: 4	MS 94781	HO: 44, 54
MS 93814	SB: 1	MS 94325	SZ: 2	MS 94781-1	HO: 44, 48, 49, 54
MS 93834	FOT: 44, 46; LAF: 1	MS 94326	GM: 4; SZ: 4	MS 94789	CHR: 1, 2, 3; MI: 1
MS 93837	FOT: 41, 42, 43	MS 94328	CHR: 15, 16, 17, 18; HY: 8, 14, 18; MI: 3, 8, 9	MS 94790	JEE: 11, 12
MS 93838	FOT: 41, 42, 43	MS 94349	MZT: 14	MS 94800	FO: 56
MS 93849	FOT: 12	MS 94356	VW: 31, 32, 33, 34, 35, 36, 37	MS 94801	FO: 56
MS 93850	FO: 34, 36; FOT: 18; MZT: 21	MS 94357	NI: 8	MS 94802	FO: 33, 37
MS 93856	GM: 19, 20; TO: 8, 9	MS 94370	GM: 1, 2; SZ: 1	MS 94803	NI: 8; NIT: 3
MS 93867	LOT: 2, 3, 4; TO: 10	MS 94371	GM: 1, 2; SZ: 1	MS 94811	NI: 1
MS 93867-1	GM: 21	MS 94377	DT: 62, 64	MS 94813	NI: 8
MS 93909	GM: 19, 20; TO: 8, 9	MS 94418	MZ: 28, 29; MZT: 15, 16	MS 94814	NI: 7
MS 93931	GM: 21; TO: 10	MS 94421	MZ: 28, 29; MZT: 15, 16	MS 94825	HY: 1, 2; MI: 2
MS 93935	FO: 5	MS 94427	FO: 6, 8; FOT: 1; MZT: 1	MS 94831	FO: 33, 37
MS 93942	GM: 20; TO: 9	MS 94429	FO: 35, 36; FOT: 18, 19; MZT: 21, 22	MS 94836	HO: 42
MS 94011-1	FOT: 66	MS 94432	FO: 9	MS 94841	DT: 2; HY: 20; MIT: 3
MS 94012-1	FOT: 66	MS 94439	MZT: 14	MS 94854	MZ: 25, 27
MS 94012-2	FOT: 66	MS 94444	NI: 9; NIT: 4	MS 94857	MZ: 25, 27
MS 94014-1	FOT: 66	MS 94452	FOT: 34	MS 94918-1	GM: 77, 82; GMT: 45
MS 94015	FOT: 66	MS 94456	TO: 22	MS 94929	TOT: 6, 7
MS 94018	FOT: 66	MS 94471	TO: 22	MS 94935	TOT: 6, 7
MS 94021	GM: 17	MS 94477	GMT: 3; SZT: 3	MS 94944	GM: 62, 63
MS 94022	GM: 17	MS 94478	GMT: 3; SZT: 1, 3	MS 94946	CHR: 47, 48, 49, 50; MI: 22, 23
MS 94025	FOT: 66	MS 94501	GM: 12; IS: 3	MS 94951	FOT: 44, 46; LAF: 1
MS 94027	FO: 1	MS 94503	GM: 12; IS: 3	MS 94959	HO: 44
MS 94028-1	FO: 1	MS 94504	GM: 11; IS: 1, 2; LOT: 1	MS 94964	DT: 47
MS 94028-2	FO: 1	MS 94506	GM: 11, 25; IS: 1, 2, 4; LOT: 1	MS 94976	TO: 13, 14, 15, 16; TOT: 1
MS 94032	FO: 19, 20	MS 94531	FOT: 72	MS 94987	SB: 5, 9, 10, 11
MS 94045	FO: 46; FOT: 29	MS 94532	FO: 2, 3; MZ: 4	MS 95008	CHR: 47, 48, 49, 50; HY: 27, 31; HYT: 10; KIA: 23; KIT: 10; MI: 22, 23
MS 94045-1	FO: 47	MS 94537	FO: 2, 3	MS 95022	SAB: 1, 2
MS 94046	FO: 46; FOT: 29	MS 94547	MZ: 28, 29; MZT: 15, 16	MS 95032	GM: 3; GMT: 2; SZ: 3, 5; SZT: 2
MS 94052	GM: 65, 77, 80, 82; GMT: 45	MS 94548	GM: 90	MS 95082	CHR: 47, 48, 49, 50; HY: 27, 31; HYT: 10; KIA: 23; KIT: 10; MI: 22, 23; MIT: 9
MS 94054	AMG: 1; GM: 103; GMT: 60, 74; IST: 24; WRK: 1	MS 94548-1	GM: 96	MS 95087	DT: 54, 55, 56, 57, 58, 60
MS 94063	AUD: 18, 20, 21; VW: 1, 2, 3, 14, 15, 16, 17, 18, 19, 30	MS 94555	FO: 60, 62, 63	MS 95088	SAB: 5, 6, 16, 17, 18; SB: 5, 6, 7, 9, 11, 12, 13, 14, 15, 16, 17, 18; SBT: 1, 2, 3, 4, 5, 6
MS 94065	SZT: 1	MS 94566	CHR: 59, 60, 61, 68; DT: 24, 26, 27, 28, 37	MS 95233	GM: 66
MS 94066	GM: 80	MS 94568	NIT: 4	MS 95243	NI: 27
MS 94066-1	GM: 65	MS 94569	KIA: 7; MZ: 7	MS 95244	NI: 27
MS 94066-2	GM: 65	MS 94570	KIA: 7, 11; MZ: 7	MS 95245	NI: 27
MS 94070	BMW: 15	MS 94572	NI: 9; NIT: 4	MS 95249	SZ: 2
MS 94073	AUD: 20, 21	MS 94599	HY: 28; MI: 24	MS 95255	GMT: 100
MS 94095-1	FOT: 66	MS 94602	HO: 21, 22, 27, 28, 29, 34, 35; HOT: 1, 2	MS 95263	VOL: 4
MS 94108-1	FOT: 66	MS 94608	MZ: 13	MS 95264	VOL: 4
MS 94118-1	HO: 5, 6, 7, 8, 9, 10, 15, 17, 18, 19, 20	MS 94610	MZ: 13	MS 95279	SAB: 1, 2
MS 94119-2	HO: 5, 6, 7, 15, 20	MS 94611	FO: 4; MZ: 8, 9, 10, 11	MS 95313	CHR: 8, 9; MI: 5
MS 94121	HO: 36	MS 94612	FO: 4; MZ: 11	MS 95314	CHR: 8, 9; MI: 5
MS 94125-1	HO: 52, 53; HOT: 4; IST: 5	MS 94612-1	MZ: 11	MS 95315	DT: 39
MS 94128	HO: 36, 42	MS 94612-2	KIA: 11	MS 95315-1	DT: 39
MS 94129	GM: 10, 18; TO: 5, 7	MS 94613	GM: 90	MS 95372	FO: 34, 35, 36; FOT: 18, 19; MZT: 21, 22
MS 94135	GM: 10; TO: 5	MS 94625	HO: 43, 45, 54	MS 95372-1	FO: 35, 36; FOT: 18, 19; MZT: 21, 22
MS 94140-1	GM: 44; TO: 17, 18; TOT: 2, 3	MS 94626	NI: 14, 15, 16, 17	MS 95392	DT: 45, 46, 61, 63; JEE: 16
MS 94175	FOT: 72	MS 94627	NI: 14, 15, 16, 17		
MS 94176	FOT: 59; WIN: 2	MS 94628	NI: 14, 15, 16, 17		
		MS 94630	CHR: 5, 6; MI: 4		
		MS 94631	CHR: 5, 6; MI: 4		

NUMERICAL LIST

MS 95392-1 DT: 45, 46, 61, 63; JEE: 16, 20	MS 95728-2 FO: 54, 56, 57, 58	MS 96018 FOT: 72
MS 95393 GM: 35; GMT: 7; GRU: 1; IST: 2	MS 95731 FO: 46	MS 96038 FOT: 68, 69, 71
MS 95397 GM: 35; GMT: 7; GRU: 1; IST: 2	MS 95736 FO: 52	MS 96041 GM: 62
MS 95402 GM: 3; GMT: 2; SZ: 3, 5; SZT: 2	MS 95737 FOT: 7, 11; MZT: 9, 13	MS 96042 CHR: 59, 60, 61, 68; DT: 24, 26, 27, 28, 37
MS 95403 TO: 2	MS 95739 FOT: 31; MZT: 25	MS 96046 GM: 62, 63
MS 95404 TO: 2	MS 95741 GM: 77	MS 96057 GMT: 103; WRK: 4
MS 95405 TO: 25	MS 95744 GM: 77	MS 96062 GM: 54, 56, 64; SAB: 23
MS 95406 TO: 25	MS 95745 GM: 66	MS 96075 CHR: 26; MI: 17; MIT: 2
MS 95407 TO: 25, 26, 27; TOT: 12, 13	MS 95746 GM: 81	MS 96081 FO: 32
MS 95407-1 TO: 25, 26, 27; TOT: 12, 13	MS 95751 HOT: 14; IST: 14	MS 96083 TO: 26, 27, 32; TOT: 14, 15
MS 95422 FO: 26; MZ: 24	MS 95751-1 HOT: 14; IST: 14	MS 96088 GM: 56; SAB: 23
MS 95425 FO: 10; MZ: 12, 14, 15	MS 95752 IST: 13	MS 96088-1 SAB: 22, 23
MS 95428 FO: 26; MZ: 20, 24	MS 95753 IST: 13	MS 96089 GM: 56
MS 95439 TO: 36, 37, 38; TOT: 23, 24	MS 95787 GMT: 101, 102; WRK: 3	MS 96090 SAB: 22
MS 95444 CHR: 62	MS 95802 GM: 66	MS 96091 SAB: 22, 23
MS 95445 CHR: 62	MS 95803 GM: 66	MS 96102 GM: 56
MS 95446 CHR: 58, 62, 63, 64, 65, 66; DT: 31, 32, 33, 41; VWT: 15	MS 95804 GM: 66	MS 96103 GM: 54, 56, 64; SAB: 23
MS 95459-1 NI: 8	MS 95808 GM: 77	MS 96103-1 SAB: 22, 23
MS 95462 DT: 45, 46, 61, 63; JEE: 16, 20	MS 95809 GM: 81	MS 96105 SB: 14; SBT: 2
MS 95463 DT: 39	MS 95809-1 GM: 78, 81	MS 96106 SAB: 17, 18; SB: 8, 9, 10, 16, 17, 18; SBT: 4, 5, 6
MS 95467 KIA: 6; MZ: 6	MS 95811 GM: 81	MS 96108 FO: 51, 52; PNZ: 1
MS 95469 KIA: 6; MZ: 6	MS 95812 GM: 81	MS 96110 FO: 53; PNZ: 2
MS 95470 CHR: 15, 16, 17, 18, 19, 20, 26; HY: 8, 14, 18, 19; HYT: 4; KIA: 16; MI: 3, 8, 9, 10, 16, 17; MIT: 2	MS 95813 HOT: 14; IST: 13, 14	MS 96113 NI: 7
MS 95471 CHR: 19, 20, 26; MI: 10, 17	MS 95816 GMT: 53, 54; IST: 20, 21	MS 96114 FO: 53; PNZ: 2
MS 95472 NIT: 4	MS 95817 GMT: 53, 54; IST: 20, 21	MS 96116 AUD: 1, 2, 3, 4, 5, 6, 7, 8; VW: 4, 5, 6, 7, 8, 9, 10, 11, 12, 13
MS 95480 DT: 45, 46, 61, 63; JEE: 16, 20	MS 95817-1 GMT: 53, 54; IST: 20, 21	MS 96117 GM: 27
MS 95516 GM: 10, 18; TO: 5, 7	MS 95818 GMT: 54	MS 96118 GM: 26
MS 95528 FO: 46	MS 95819 TO: 26, 27; TOT: 12, 13	MS 96123 FOT: 32, 33; LRT: 10; MZT: 27
MS 95533 HO: 47	MS 95822 GM: 66	MS 96124 FOT: 15; MZT: 18
MS 95536 GM: 61	MS 95826 GMT: 101, 102; WRK: 3	MS 96124-1 FOT: 15; MZ: 30; MZT: 18
MS 95573-1 EXC: 1; GM: 104, 105	MS 95829 GM: 78, 79, 81	MS 96126 NI: 1
MS 95580 EXC: 1; GM: 89, 104	MS 95830 GM: 82; GMT: 45	MS 96128 HY: 12, 15; HYT: 1; KIA: 12; KIT: 1
MS 95583 FOT: 13, 14; NIT: 6	MS 95832 GMT: 54	MS 96130 HY: 15
MS 95585 EXC: 1; GM: 89, 104	MS 95833 FO: 52	MS 96135 MI: 1
MS 95586 GM: 60, 61, 67; GMT: 31, 32, 33, 37	MS 95837 GM: 4; SZ: 4	MS 96137 MI: 5, 15
MS 95590 NI: 7	MS 95839 GM: 51	MS 96139 FO: 51; PNZ: 1
MS 95590-1 NI: 7	MS 95840 GMT: 100, 101, 102, 103; WRK: 3, 4	MS 96139-1 FO: 52
MS 95612 HO: 46, 47; HOT: 3; IST: 1	MS 95841 FO: 52	MS 96139-2 FOT: 35, 36
MS 95612-1 HO: 51	MS 95842 GMT: 50, 53, 54; IST: 20, 21	MS 96140 FOT: 50
MS 95627 FO: 1	MS 95898 TOT: 16	MS 96141 HY: 12, 15
MS 95629 GM: 28	MS 95899 TOT: 16	MS 96144 FOT: 38, 39
MS 95630 GM: 26	MS 95918 FO: 9	MS 96145 MZ: 14, 15
MS 95631 GM: 27, 28	MS 95922 MZ: 2	MS 96147 MIT: 2
MS 95632 GM: 26	MS 95923 MZ: 2	MS 96148 HY: 4, 5
MS 95647 FOT: 41, 42, 43	MS 95924 FO: 52	MS 96149 FO: 10; MZ: 12, 14, 15
MS 95660 CHR: 37; DT: 8	MS 95925 FO: 52	MS 96151 AUD: 1, 2, 3, 4, 5, 6, 7, 8; VW: 4, 5, 6, 7, 8, 9, 10, 11, 12, 13
MS 95660-1 CHR: 11; MI: 6, 7	MS 95925-1 FO: 52	MS 96152 VOL: 24, 26, 27
MS 95660-2 CHR: 10, 11	MS 95925-2 DET: 1; FO: 52; PNZ: 1	MS 96153 VOL: 11, 12, 13, 22, 24, 25, 26, 27
MS 95674 CHR: 13	MS 95932 FOT: 29	MS 96154 VOL: 11, 13, 14, 15, 16, 17, 18, 19, 20, 21, 22, 23, 24, 25, 26, 27, 28, 30; VOT: 1
MS 95682 HO: 69, 70, 79	MS 95932-1 FOT: 34	MS 96162 HY: 4, 5
MS 95683 HO: 69	MS 95934 FOT: 29	MS 96163 CHR: 14
MS 95692 CHR: 10, 11, 37; DT: 8; MI: 6, 7	MS 95939 FO: 34, 35, 36; FOT: 18, 19; MZT: 21, 22	MS 96166 HO: 65, 71, 72; HOT: 15, 16, 17
MS 95694 FO: 52	MS 95949 DET: 1; FO: 51, 52, 53; FOT: 35, 36, 48, 49; PNZ: 1, 2	MS 96167 HO: 65
MS 95695 CHR: 13	MS 95952 FO: 61; FOT: 45; LAF: 1, 2	MS 96167-1 HO: 71; HOT: 15
MS 95702 FO: 6, 7	MS 95952-1 FOT: 60	MS 96167-2 HO: 65, 71; HOT: 15
MS 95708 CHR: 38, 39, 54; MI: 21, 25, 26; MIT: 7, 10	MS 95953 FO: 61; FOT: 45, 60; LAF: 1, 2	MS 96168 HO: 65, 71; HOT: 15
MS 95709 CHR: 38, 39, 54; MI: 21, 25, 26; MIT: 7, 10, 12	MS 95954 FOT: 45, 60; LAF: 1, 2	MS 96169 GM: 106, 108, 110, 111; GMT: 56, 58, 70, 71, 72, 75, 77, 81, 82, 83, 84; SAT: 5
MS 95709-1 MI: 27; MIT: 12	MS 95956 FOT: 31; MZT: 25	MS 96172 CHR: 14
MS 95711 CHR: 38, 39, 54; MI: 21, 25, 26; MIT: 7, 10, 12	MS 95962 FOT: 38, 39, 51, 52, 54	MS 96176 DT: 22, 23, 24, 25, 28, 29, 36, 37, 38; JEE: 10; VWT: 14
MS 95714 FO: 52	MS 95968 FO: 46, 48; FOT: 29, 30, 34	MS 96198 CHR: 33, 34, 36; DT: 6, 9, 10, 11
MS 95715 FO: 24, 25, 28, 29, 30, 31, 32; FOT: 15, 16, 17; JAG: 1, 2; MZ: 30; MZT: 12, 17, 18, 19, 20	MS 95977 GM: 77	MS 96239 FOT: 30, 34
MS 95725 FO: 6, 7	MS 95977-1 GM: 77, 79	MS 96252 FO: 30, 32; FOT: 15; MZ: 30; MZT: 18
MS 95726 FO: 24, 25, 28, 29, 32; MZT: 12	MS 95981 FO: 46, 48; FOT: 34	MS 96266 FO: 8
MS 95727 FO: 24, 25, 28, 29, 32; MZT: 12	MS 95982 FOT: 34	MS 96272 MI: 27; MIT: 12
MS 95728 FO: 56	MS 95985 FO: 46, 48; FOT: 30, 34	
MS 95728-1 FOT: 38, 39, 51, 52, 54	MS 95985-1 FOT: 29	
	MS 95985-2 FOT: 29	
	MS 95985-3 FOT: 30, 34	
	MS 96011 JEE: 19	

NUMERICAL LIST

MS 96275	HY: 15; HYT: 1; KIA: 12; KIT: 1	MS 96447	HO: 23, 24, 25, 26	MS 96691	GM: 78
MS 96277	VOL: 11, 12, 13, 14, 15, 16, 17, 18, 19, 20, 21, 22, 23, 24, 25, 26, 27, 28, 30; VOT: 1	MS 96451	FOT: 30, 34	MS 96696	FOT: 55, 56, 58
MS 96279	DT: 57, 58, 59, 60, 65, 66	MS 96454	NI: 21; NIT: 9	MS 96701	TOT: 23, 24
MS 96281	FO: 54, 55, 56; FOT: 38, 51, 52, 53, 54	MS 96454-1	NI: 21; NIT: 9	MS 96707	GMT: 49; IST: 19; SAT: 3
MS 96281-1	FOT: 37, 38	MS 96454-2	NIT: 12; SZT: 10	MS 96716	GM: 91, 92, 93, 94, 95; GMT: 55
MS 96289	KIT: 2	MS 96455	NIT: 9	MS 96718	GM: 106, 108
MS 96290	KIT: 2	MS 96456	NI: 21; NIT: 9	MS 96727	GM: 69; GMT: 36
MS 96293	KIT: 2	MS 96460	HY: 27, 31; HYT: 10; KIA: 23; KIT: 10	MS 96730	GM: 69; GMT: 36, 37
MS 96294	GMT: 49; IST: 19	MS 96460-1	KIT: 10	MS 96730-1	GMT: 31, 33
MS 96300	FOT: 20; NIT: 7, 8	MS 96471	NI: 21; NIT: 9	MS 96733	KIA: 1, 4
MS 96302	GMT: 49; IST: 19; SAT: 3	MS 96473	HO: 55, 56, 57; HOT: 6, 7, 9	MS 96734	KIA: 1
MS 96310	KIA: 10	MS 96474	HO: 38, 39, 40, 41, 55, 56, 57; HOT: 5, 6, 7, 9	MS 96740	MIT: 12
MS 96311	KIA: 10	MS 96475	FO: 32; JAG: 2	MS 96741	KIT: 10
MS 96312	KIA: 10	MS 96476	HO: 41	MS 96746	SAB: 17, 18; SB: 16, 18; SBT: 4, 6
MS 96324	CHR: 65, 66; DT: 31, 32, 33, 41; VWT: 15	MS 96477	HO: 38, 39, 40	MS 96747	SAB: 17, 18; SB: 16, 18; SBT: 4, 6
MS 96329	GM: 60, 67; GMT: 32, 37	MS 96483	FO: 32	MS 96750	SB: 16
MS 96331	HY: 3, 9, 10, 11; KIA: 8, 9	MS 96484	JAG: 2	MS 96753	KIA: 4
MS 96332	HY: 3, 9, 10, 11; KIA: 8, 9	MS 96485	FO: 32; JAG: 1, 2	MS 96758	SB: 12, 15; SBT: 1, 3
MS 96333	TO: 37, 38; TOT: 23, 24	MS 96491	HO: 39; HOT: 5	MS 96763	FO: 6; FOT: 1; MZT: 1
MS 96334	TO: 37, 38; TOT: 23, 24	MS 96494	JAG: 1, 2	MS 96765	FO: 6, 7
MS 96340	GM: 37, 39	MS 96496	FO: 32	MS 96779	DT: 16, 17; FRT: 1
MS 96343	NI: 1, 3	MS 96510	TO: 3	MS 96780	AUD: 9, 10, 11; AUT: 1; VW: 27; VWT: 1
MS 96344	DT: 35; JEE: 9; MIT: 11	MS 96514	NI: 3	MS 96781-1	MI: 27; MIT: 12
MS 96344-1	TO: 35; JEE: 9; MIT: 11	MS 96521	BMW: 13, 14, 16, 17; BMT: 1, 2	MS 96784	AUD: 9, 10, 11; AUT: 1; VW: 27; VWT: 1
MS 96346	GM: 70	MS 96523	SAB: 5, 6, 16; SB: 6, 7, 12, 13, 15; SBT: 1	MS 96785	DT: 16, 17; FRT: 1
MS 96351	GM: 38, 39; GMT: 10	MS 96523-1	SB: 12; SBT: 1	MS 96786	LOT: 5, 6; TO: 33; TOT: 17, 18
MS 96351-1	GM: 40, 45, 46, 47, 48, 50; GMT: 9, 11, 13, 14, 15, 16	MS 96525	KIA: 11; MZ: 11	MS 96788	GMT: 94, 95, 96, 97, 98, 99
MS 96359	GM: 70	MS 96526	TO: 4	MS 96789	GM: 79
MS 96368	FOT: 50	MS 96527	TO: 3, 4	MS 96790	LOT: 5, 6; TO: 33; TOT: 17, 18
MS 96374	FOT: 50	MS 96532	CHR: 70, 71; DT: 48, 51; JEE: 17	MS 96792	FOT: 61
MS 96375	FOT: 50	MS 96536	NI: 10; NIT: 5	MS 96795	LOT: 5, 6; TO: 21, 28, 33, 34, 35; TOT: 17, 18
MS 96376	GM: 37, 39	MS 96538	GMT: 27	MS 96815	DAE: 2, 3; GM: 31; SZ: 8
MS 96377	GM: 37, 38, 39, 46, 47; GMT: 10, 13, 16	MS 96539	NI: 10; NIT: 5; SZT: 6	MS 96818	GM: 71, 72, 83, 84, 85, 86; GMT: 38, 47, 48
MS 96384	HOT: 16, 17	MS 96541	GMT: 93, 94	MS 96824	GM: 71, 72, 83, 84, 85, 86; GMT: 38, 47, 48
MS 96384-1	HO: 71	MS 96543	GMT: 93	MS 96833	FOT: 61
MS 96384-2	HO: 72	MS 96553	BMW: 13, 16	MS 96840	CHR: 7, 23, 24, 28, 29, 30, 31, 32; DT: 4, 5; JEE: 1, 2, 3, 4
MS 96384-3	HO: 71, 72; HOT: 16, 17	MS 96555	BMW: 12	MS 96841	MZT: 17, 18
MS 96386	GM: 105	MS 96574	CHR: 70, 71; DT: 48, 50, 51; JEE: 17	MS 96841-1	MZ: 30
MS 96390	HO: 23	MS 96586	TO: 32; TOT: 14, 15	MS 96841-2	MZ: 30
MS 96390-1	HO: 23, 25, 26	MS 96587	GMT: 56, 57, 58, 61, 62, 63, 64, 65, 66, 67, 68, 69, 70, 71, 72, 75, 76, 78, 80, 81, 83; IST: 22, 23; SAT: 4, 5	MS 96847	GM: 79
MS 96398	GM: 21; LOT: 2, 3, 4; TO: 10	MS 96591	HY: 25, 26; HYT: 7; KIA: 21, 22; KIT: 7	MS 96851	TO: 34, 35
MS 96404	MZ: 8, 9, 10	MS 96597	HY: 25, 26; HYT: 7; KIA: 21, 22; KIT: 7	MS 96854	NIT: 3
MS 96405	GMT: 35; HO: 66, 67, 68, 73, 74; HOT: 18, 19, 21, 22, 25	MS 96597-1	HYT: 7; KIA: 22	MS 96857	GM: 99, 107, 109; GMT: 61, 62, 64, 66, 75, 76, 79, 84, 85; IST: 22; SAT: 4
MS 96409	HO: 68	MS 96598	HY: 25, 26; HYT: 7; KIA: 21, 22; KIT: 7	MS 96859	DAE: 2, 3; GM: 31; IST: 4; SZ: 8
MS 96409-1	GMT: 35	MS 96602	GMT: 4; SZ: 7, 9; SZT: 5	MS 96868	MZT: 17, 18
MS 96409-2	HOT: 21	MS 96603	GMT: 4; SZ: 7, 9; SZT: 5	MS 96871	GM: 99; GMT: 61, 62, 64, 66; IST: 22; SAT: 4
MS 96409-3	HO: 68, 73, 74, 75, 76, 77, 78, 80, 81; HOT: 20, 23, 24, 25, 26, 27, 29, 30	MS 96614	TOT: 19	MS 96874	HY: 21, 22, 23, 24; HYT: 3, 5, 6; KIA: 14, 17, 18, 19, 20; KIT: 5, 6
MS 96410	HO: 66, 67, 73; HOT: 19	MS 96628	TO: 36	MS 96882	AUD: 22, 23, 24, 25, 28, 29; AUT: 2, 3; VW: 42, 43, 44
MS 96410-1	HOT: 18, 19, 21, 22	MS 96632	CHR: 74; DT: 68	MS 96888	GMT: 22; IST: 9
MS 96411	GMT: 35; HO: 66, 67, 68, 73, 74; HOT: 18, 19, 21, 22, 25, 29	MS 96633	HY: 19; HYT: 4; KIA: 16; MI: 14	MS 96889	GMT: 34; IST: 15
MS 96415	HO: 24	MS 96634	FO: 11, 17; FOT: 2, 4, 5, 6; MZ: 17, 21; MZT: 5, 6, 7	MS 96890	AUD: 24, 25, 28, 29; VW: 42, 43, 44
MS 96417	MZ: 5, 12	MS 96638	CHR: 74; DT: 68	MS 96892	FO: 11
MS 96418	MZ: 8	MS 96655	FO: 17; FOT: 4, 5, 6; MZT: 5, 6	MS 96898	MI: 27
MS 96419	MZ: 9, 10	MS 96656	FO: 11, 17; FOT: 4; MZ: 17, 21; MZT: 5	MS 96899	MZT: 17, 18
MS 96420	MI: 20; MIT: 5	MS 96659	MI: 15	MS 96900	MI: 27
MS 96424	MI: 20; MIT: 5	MS 96663	FO: 11, 17	MS 96901	FO: 21, 22; FOT: 2, 5, 6, 8, 9; MZT: 6, 7
MS 96425	GM: 54, 64; GMT: 27	MS 96669	AV: 1; FO: 50	MS 96902	CHR: 7, 23, 24, 28, 29, 31; DT: 4, 5; JEE: 1, 2, 3, 4; MI: 12, 19; MIT: 1
MS 96427	HO: 71, 72; HOT: 16, 17	MS 96671	TOT: 19	MS 96905	CHR: 70, 71; DT: 48, 50, 51; JEE: 17
MS 96430	BMW: 13, 16	MS 96672	TOT: 23, 24	MS 96908	JEE: 10
MS 96431	BMW: 13, 14, 16, 17; BMT: 1, 2	MS 96677	DT: 57, 58, 59, 60, 65, 66	MS 96912	DT: 8
MS 96432	BMW: 12	MS 96679	AV: 2; FO: 59; FOT: 40, 55, 56, 58	MS 96913	TOT: 19
MS 96438	TO: 17, 18	MS 96679-1	FOT: 67	MS 96916	CHR: 73; JEE: 21, 22
MS 96440	GMT: 49; IST: 19; SAT: 3	MS 96686	TO: 29, 30, 31	MS 96919	HO: 79
MS 96440-1	GMT: 22, 26; IST: 9, 11	MS 96687	FOT: 67	MS 96921	TOT: 10
MS 96440-2	GMT: 34, 44; IST: 15, 17	MS 96687-1	AV: 2; FO: 59; FOT: 40	MS 96922	FO: 49
		MS 96688	TO: 31		
		MS 96690	TO: 29		

NUMERICAL LIST

MS 96923	FO: 49	MS 97084	TO: 21, 28	MS 97178	HO: 12, 13
MS 96924	TOT: 10	MS 97086	HY: 29, 30, 32, 33; HYT: 8, 11; KIA: 24; KIT: 8, 11	MS 97180	HO: 14
MS 96925	FO: 49			MS 97181	FO: 59; FOT: 40
MS 96932	GMT: 53	MS 97086-1	KIT: 11	MS 97182	HO: 11
MS 96935	MI: 14	MS 97089	CHR: 69, 72; DT: 49, 52, 53; JEE: 18	MS 97184	HO: 14
MS 96936	FO: 49	MS 97091	CHR: 56, 57; MB: 24, 25, 26, 27, 28, 29, 30, 31; MBT: 1	MS 97185	LRT: 3, 4, 5, 7, 8, 9, 11, 12, 14; MOR: 2
MS 96941	GM: 99	MS 97092	SAB: 2, 3, 4, 13, 14, 15	MS 97186	LRT: 3, 4, 5, 6, 7, 8, 9, 11, 12, 14; MOR: 2
MS 96942	DAE: 1; GM: 13, 14	MS 97093	HO: 58, 59, 60; HOT: 8, 10, 11	MS 97187	BMW: 22, 26, 28; BMT: 6, 7; LRT: 13
MS 96943	NIT: 12; SZT: 10	MS 97094	SAB: 3, 4, 13, 14, 15	MS 97188	SB: 22
MS 96945	NIT: 15, 16	MS 97095	CHR: 56, 57; MB: 24, 25, 26, 27, 28, 29, 30, 31; MBT: 1	MS 97189	BMW: 5, 6
MS 96946	NIT: 15, 16			MS 97190	SB: 22, 24; SBT: 9, 10
MS 96961	CHR: 28, 31	MS 97096	SAB: 2, 3, 4, 15	MS 97191	SB: 22
MS 96964	CHR: 73; JEE: 21, 22	MS 97098	GM: 73	MS 97192	SB: 22, 24; SBT: 9, 10
MS 96968	IST: 4	MS 97099	KIT: 11	MS 97193	FO: 31; FOT: 16, 17; MZT: 19, 20
MS 96969	GM: 55, 73; GMT: 23, 24, 39, 40; SAB: 20, 21; SAT: 1; SZT: 9	MS 97100	HY: 24; HYT: 3, 6; KIA: 14, 20; KIT: 6	MS 97194	FO: 31; FOT: 16, 17; MZT: 19, 20
MS 96970	GM: 55, 73, 76; GMT: 23, 24, 39; SAT: 1	MS 97101	BMW: 1, 2, 3, 4	MS 97196	VW: 20, 21, 22, 23, 24, 30
MS 96970-1	GM: 75, 76; GMT: 39	MS 97102	HY: 15; HYT: 1; KIA: 12; KIT: 1	MS 97197	CHR: 67; DT: 34; JEE: 8; VWT: 13
MS 96973	GM: 73; GMT: 39, 40, 42; SZT: 9	MS 97103	BMW: 2, 4	MS 97198	MZ: 24
MS 96974	GMT: 39	MS 97104	HYT: 7; KIT: 7	MS 97199	SAB: 3, 4, 13, 14, 15
MS 96976	GM: 55, 73, 76; GMT: 23, 24, 39, 40; SAB: 20, 21; SAT: 1; SZT: 9	MS 97105	BMW: 1, 3	MS 97200	FOT: 51, 52, 54
MS 96977	GMT: 39	MS 97106	HY: 24; KIA: 14, 20	MS 97202	GM: 6, 7, 8; GMT: 1
MS 96994	DT: 42, 43; JEE: 13, 14; MIT: 13, 14	MS 97107	MI: 12, 19; MIT: 4	MS 97203	GM: 5
MS 96995	GM: 13, 14	MS 97109	MI: 13	MS 97204	CHR: 67; DT: 34; JEE: 8; VWT: 13
MS 96998	DT: 42, 43; JEE: 13, 14; MIT: 13, 14	MS 97111	MI: 13	MS 97205	CHR: 67; DT: 34; JEE: 8; VWT: 13
MS 96999	GM: 94; GMT: 55	MS 97112	CHR: 30, 32	MS 97206	GM: 23
MS 97001	BMW: 8	MS 97114	MI: 12, 19; MIT: 1, 4	MS 97207	GM: 83, 85
MS 97002	NI: 20	MS 97115	HY: 29, 30, 32, 33; HYT: 9, 11; KIT: 9, 11	MS 97208	GM: 49; GMT: 17, 18
MS 97003	BMW: 7, 8	MS 97116	HY: 21; KIA: 17	MS 97209	MI: 12; MIT: 1
MS 97004	DAE: 1	MS 97118	FO: 38, 39, 40, 43; FOT: 21, 22, 26; MZ: 31; MZT: 23, 24	MS 97210	SAB: 17, 18; SB: 16, 18; SBT: 4, 6
MS 97005	BMW: 7	MS 97118-1	FO: 41, 44, 45; FOT: 23, 24, 27, 28	MS 97211	GM: 5, 6, 7, 8; GMT: 1
MS 97006	DAE: 1			MS 97214	FO: 41, 44, 45; FOT: 23, 24, 27, 28
MS 97007	VW: 38, 39, 40, 41	MS 97120	FO: 38, 39, 40, 43; FOT: 21, 22, 26; MZ: 31; MZT: 23, 24	MS 97215	FO: 64, 65; FOT: 47
MS 97008	GMT: 26; IST: 11	MS 97121	FO: 38, 39, 40, 43; FOT: 21, 22, 26; MZ: 31; MZT: 23, 24	MS 97216	FO: 45; FOT: 28
MS 97009	GMT: 44; IST: 17			MS 97217	FO: 43, 44; FOT: 23, 24, 26, 27
MS 97023	HO: 30, 31, 32, 33	MS 97122	GM: 30, 32, 40, 45, 46, 47, 48, 49, 50; GMT: 5, 6, 9, 10, 11, 13, 14, 15, 16, 17, 18	MS 97218	FO: 42; FOT: 25
MS 97024	MZ: 5	MS 97123	VW: 48	MS 97219	FO: 64, 65; FOT: 47
MS 97025	MZ: 5	MS 97125	VW: 45, 46	MS 97220	NI: 21; NIT: 9
MS 97028	GMT: 21; SZT: 7	MS 97126	GMT: 77, 79, 82, 83, 84, 85	MS 97221	LRT: 7, 8, 9, 14; MOR: 2
MS 97028-1	SZT: 8	MS 97127	SAB: 7, 8	MS 97223	VWT: 4
MS 97029	TOT: 25, 26	MS 97128	SAB: 7, 8	MS 97224	NI: 14, 15, 16, 17
MS 97030	NI: 4, 6; NIT: 2	MS 97133	HO: 75, 76, 77, 78, 80, 81; HOT: 20, 23, 24, 25, 26, 27, 29, 30	MS 97227	HY: 29, 30, 32, 33; HYT: 8, 11; KIA: 24; KIT: 8, 11
MS 97032	GMT: 88, 90			MS 97228	HY: 6, 7; KIA: 2
MS 97033	HO: 39	MS 97135	KIT: 10	MS 97229	DT: 67
MS 97034	VW: 38, 39, 40, 41	MS 97136	HO: 75, 76, 77, 78, 80, 81; HOT: 20, 23, 24, 25, 26, 27, 29, 30	MS 97231	HY: 6; KIA: 2, 3
MS 97035	HO: 30, 31, 32, 33	MS 97138	GM: 15, 16	MS 97232	TO: 19; TOT: 8
MS 97036	HO: 58, 59, 60; HOT: 8, 10, 11	MS 97139	VW: 45, 46; VWT: 5	MS 97233	TO: 4
MS 97038	NI: 4, 6; NIT: 2	MS 97143	NI: 21, 22, 23; NIT: 9, 10	MS 97234	TO: 19, 20; TOT: 8
MS 97043	GMT: 21; SZT: 7, 8	MS 97144	GM: 24; TO: 11, 12	MS 97235	TOT: 20
MS 97044	TOT: 25, 26	MS 97146	GM: 24; TO: 11, 12	MS 97236	TOT: 20
MS 97045	HO: 48, 49	MS 97147	NI: 10, 11; NIT: 5	MS 97237	TOT: 20
MS 97046	HO: 48	MS 97148	NI: 10, 11; NIT: 5	MS 97239	HY: 13; KIA: 15
MS 97047	HO: 49	MS 97149	NIT: 5; SZT: 6	MS 97241	GMT: 41, 42
MS 97049	HO: 61, 62	MS 97151	GM: 107, 109, 110, 111	MS 97247	FOT: 65
MS 97050	HO: 61, 62	MS 97154	GM: 15, 16, 22, 23	MS 97248	DT: 54, 55, 56, 57, 58, 59, 60
MS 97051	SZ: 7	MS 97160	FO: 21, 22; FOT: 8, 9	MS 97249	NI: 10
MS 97052	MZ: 22; MZT: 8	MS 97161	SB: 19, 20; SBT: 7, 8	MS 97251	FOT: 62, 63
MS 97053	IST: 16	MS 97164	SB: 18	MS 97257	HO: 64
MS 97054	MZ: 22; MZT: 8	MS 97168	HO: 2	MS 97258	VOL: 33, 34, 35, 36, 37, 38; VOT: 2
MS 97055	SB: 8, 9, 10	MS 97169	HO: 3	MS 97259	VOL: 1, 2, 3
MS 97058	MZ: 17	MS 97170	HO: 2, 11	MS 97260	MB: 53, 54, 55, 56, 57, 58, 59, 60, 61; MBT: 7, 8, 9, 10
MS 97062	KIA: 5	MS 97171	HO: 3	MS 97261	VW: 24
MS 97063	KIA: 5	MS 97172	HO: 4, 12, 13, 14	MS 97263	DT: 30; FRT: 4; MB: 21, 22, 23, 38, 39, 40, 41, 42, 43, 44, 45, 46, 47, 48; MBT: 2, 3, 4, 5, 6
MS 97065	KIA: 5	MS 97173	HO: 11	MS 97264	NI: 28; NIT: 13
MS 97073	MIT: 8	MS 97174	HO: 12, 13	MS 97265	MB: 3, 4, 5, 6
MS 97074	HY: 29, 32; HYT: 8, 11; KIA: 24; KIT: 8, 11	MS 97175	HO: 3	MS 97266	MB: 78, 79, 80, 81, 82, 83, 84, 85; MBT: 16, 17
MS 97075	MIT: 8	MS 97177	HO: 4	MS 97267	MB: 37
MS 97080	TO: 21, 28			MS 97268	SAB: 7, 8
MS 97083	CHR: 69, 72; DT: 49, 52, 53; JEE: 18				

NUMERICAL LIST

MS 97269 AUD: 50, 51, 52, 53, 54, 55, 56; AUT: 18; VW: 52, 53; VWT: 17, 18, 19	MS 98011 T-1 FOT: 29	OS 30632 R HO: 43, 44, 45, 46, 47, 48, 49, 51, 52, 53, 54; HOT: 3, 4; IST: 1, 5
MS 97270 AUD: 49	MS 98011 T-2 FO: 46, 48; FOT: 34	OS 30633 R FO: 1, 2; MZ: 2, 4, 8, 11
MS 97271 MB: 12, 13, 14, 32, 33, 34, 35, 36	MS 98011 T-3 FOT: 34	OS 30634 R FOT: 31; MZT: 26
MS 97272 MB: 1	MS 98013 T GM: 69; GMT: 36, 37	OS 30636 R FO: 33, 37
MS 97274 BMW: 22, 26, 28, 29; BMT: 6, 7, 8; LRT: 13	MS 98014 T GM: 77, 78, 79, 81	OS 30639 GM: 10; TO: 5
MS 97275 MB: 2	MS 98015 T GM: 71, 72, 83, 84, 85, 86; GMT: 38, 47, 48	OS 30640 C TOT: 6, 7
MS 97276 AUD: 24; VW: 42	MS 98016 T GMT: 56, 57, 58, 61, 62, 63, 64, 65, 66, 67, 68, 69, 70, 71, 72, 75, 76, 78, 80, 81, 83; IST: 22, 23; SAT: 4, 5	OS 30642 C TOT: 5, 6, 7, 9
MS 97277 MB: 49, 50, 51, 62, 63, 64, 65, 66, 67	OS 13260 C FO: 60, 61, 62, 63; FOT: 44, 46; LAF: 1	OS 30644 C NI: 8
MS 97278 LRT: 1	OS 13881 C-1 JEE: 11	OS 30646 C NI: 7
MS 97279 LRT: 2; VOL: 39, 40; VOT: 3, 4	OS 20101 C VW: 1, 2, 3, 14, 15, 16, 17, 18, 19, 26	OS 30651 C NI: 8
MS 97280 MB: 19	OS 20102 C TOT: 4	OS 30653 C NI: 27
MS 97281 MB: 20	OS 21574 D VOL: 4, 5, 6, 7, 8, 9, 10	OS 30654 C TO: 36, 37
MS 97282 BMW: 10	OS 30187 C JEE: 19	OS 30655 C CHR: 8, 9; MI: 5
MS 97284 TOT: 22	OS 30214 C FO: 69; FOT: 59, 60; WIN: 2	OS 30656 C SAB: 5, 6, 16, 17, 18; SB: 5, 6, 7, 8, 9, 10, 11, 12, 13, 14, 15, 16, 17, 18; SBT: 1, 2, 3, 4, 5, 6
MS 97287 MIT: 9	OS 30397 A CHR: 5, 6; MI: 4	OS 30659 SAB: 1, 2
MS 97288 HO: 64	OS 30405 C TO: 25	OS 30665 C CHR: 15, 16, 17, 19, 20, 26; DT: 2; MI: 8, 9, 10, 16, 17; MIT: 2, 3
MS 97289 VOL: 1, 2, 3	OS 30409 C GMT: 19, 20; GRU: 2, 3	OS 30668 R GM: 60, 61, 67; GMT: 32
MS 97290 VW: 22, 23, 24	OS 30414 C CHR: 1, 2, 3, 4; HY: 1, 2; MI: 1, 2	OS 30672 C CHR: 38, 39; MI: 21
MS 97291 GMT: 94, 95, 99	OS 30460 A CHR: 17, 18, 21, 22, 27; DT: 3; HY: 8, 14, 18, 20; MI: 3, 8, 9, 11, 18; MIT: 3	OS 30673 R CHR: 10, 11, 12, 13, 14; DT: 1; MI: 6, 7
MS 97292 DT: 30; FRT: 4; MB: 21, 22, 23, 38, 39, 40, 41, 42, 43, 44, 45, 46, 47, 48; MBT: 2, 3, 4, 5, 6	OS 30467 C FO: 15, 16; KIT: 4; MZ: 18, 19; MZT: 3, 4	OS 30676 R CHR: 35, 37; DT: 8, 12; JEE: 5
MS 97293 VW: 35, 37	OS 30468 C TO: 13, 14, 15, 16; TOT: 1	OS 30678 R GM: 41, 51; GMT: 12
MS 97294 NI: 28; NIT: 13	OS 30476 C JEE: 7	OS 30679 C HOT: 14; IST: 13, 14
MS 97295 NI: 28; NIT: 13	OS 30481 R IST: 6, 7	OS 30680 R GMT: 51, 53, 54; IST: 20, 21
MS 97297 MB: 78, 79, 80, 81, 82, 83, 84, 85; MBT: 16, 17	OS 30509 C SB: 3, 4	OS 30681 C TO: 26, 27, 32; TOT: 12, 13, 14, 15
MS 97298 MB: 53, 54, 55, 56, 57, 58, 59, 60, 61, 68, 69, 70, 71, 72, 73, 74, 75, 76, 77; MBT: 7, 8, 9, 10, 11, 12, 13, 14, 15	OS 30510 A GM: 9, 10; TO: 5, 6	OS 30683 C GM: 4; SZ: 4
MS 97299 MB: 37	OS 30522 R GM: 65, 77, 80, 82; GMT: 45	OS 30684 C MZ: 2
MS 97300 MB: 3, 4, 5	OS 30522 T GM: 65, 77, 80, 82; GMT: 45	OS 30685 HOT: 13, 28; IST: 13, 16
MS 97302 AUD: 50, 51, 52, 53, 54, 55; AUT: 18; VW: 52, 53; VWT: 17, 18, 19	OS 30525 T GM: 90, 96	OS 30686 R FO: 6, 7
MS 97303 AUD: 56	OS 30527 C BMW: 15	OS 30687 R AV: 1; FO: 50; FOT: 32, 33; LRT: 10; MZT: 27
MS 97304 SAB: 19	OS 30536 R FO: 5; MOR: 1	OS 30688 NI: 20, 21; NIT: 9
MS 97305 MB: 12, 13, 14, 32, 33, 34, 35, 36	OS 30539 C GM: 11, 12; IS: 1, 2, 3; LOT: 1	OS 30689 R CHR: 44, 45, 46
MS 97308 SAB: 13, 14, 15	OS 30540 C GM: 1, 2; SZ: 1	OS 30690 R HO: 17, 19, 23
MS 97309 LRT: 1	OS 30542 R HO: 5, 6, 7, 8, 9, 10, 15, 20	OS 30691 R HO: 18, 19
MS 97310 MB: 2	OS 30544 R HO: 63; STE: 1	OS 30692 R CHR: 58, 62, 63, 64, 65, 66
MS 97311 JAG: 4	OS 30545 R FO: 18; FOT: 7	OS 30693 R AV: 6; CAL: 1; GM: 99, 100, 101, 106, 107, 108, 109, 110, 111; GMT: 56, 57, 58, 61, 62, 63, 64, 65, 66, 67, 68, 69, 70, 71, 72, 75, 76, 77, 78, 79, 80, 81, 82, 83, 84, 85; IST: 22, 23; MOS: 1; SAT: 4, 5
MS 97312 VOL: 39; VOT: 3	OS 30548 R FO: 1, 3	OS 30694 DT: 55, 56, 57, 58, 60
MS 97313 MB: 19, 20	OS 30553 C TO: 1, 2	OS 30695 R DT: 67
MS 97314 AUD: 22, 23; AUT: 2, 3	OS 30556 A HOT: 12; IST: 8	OS 30696 NI: 20, 21; NIT: 9
MS 97315 BMW: 10	OS 30569 C DT: 40	OS 30697 R FO: 24, 25, 28, 29, 32; FOT: 15; JAG: 1, 2; MZ: 30; MZT: 12, 17, 18
MS 97316 BMW: 21; BMT: 5	OS 30570 C CHR: 47, 48, 51, 52, 53; DT: 18, 19; HY: 28; MI: 22, 23, 24; MIT: 6	OS 30698 C GMT: 2; SZ: 5; SZT: 2
MS 97317 TOT: 22	OS 30570 T CHR: 47, 48, 51, 52, 53; DT: 18, 19; HY: 28; MI: 22, 23, 24; MIT: 6	OS 30699 R GM: 77, 81
MS 97318 GMT: 96	OS 30571 R FOT: 12	OS 30700 C GM: 2
MS 97319 HY: 22; KIA: 18	OS 30574 R GM: 34	OS 30701 R DT: 8
MS 97320 HYT: 11; KIT: 11	OS 30581 C SB: 1, 2	OS 30702 R FO: 46, 48; FOT: 29, 30, 34
MS 97321 KIT: 11	OS 30590 C GM: 17	OS 30703 R AV: 6; GM: 100, 101; MOS: 1
MS 97322 HYT: 9; KIT: 9	OS 30591 FOT: 13, 14, 20; NI: 13, 14, 15, 16, 17, 18, 19; NIT: 6, 7, 8	OS 30704 R ACO: 1, 2; GM: 87, 91, 92, 93, 95
MS 97333 HO: 23, 25, 26	OS 30594 C GM: 4; GMT: 2, 3; SZ: 2, 4, 5; SZT: 1, 2, 3	OS 30705 C GM: 19, 20, 21; LOT: 2, 3, 4; TO: 8, 9, 10
MS 98000 T AMG: 1; GMT: 60, 74; IST: 24; WRK: 1	OS 30598 R HO: 36, 42	OS 30706 R VW: 30
MS 98002 T GMT: 53, 54; IST: 20, 21	OS 30612 R CHR: 25, 40, 41, 42; DT: 14, 15	OS 30707 CHR: 54; MI: 25
MS 98002 T-1 GMT: 53	OS 30612 T CHR: 25, 40, 41, 42; DT: 14, 15	OS 30708 R AUD: 3, 4, 7, 8; VW: 5, 8, 10, 11, 12, 13, 31, 32, 33, 34, 35, 36, 37
MS 98003 T GM: 60, 67; GMT: 32	OS 30614 C MZT: 14	OS 30709 R DT: 42, 43, 44; JEE: 13, 14, 15; MIT: 13, 14
MS 98003 T-1 GMT: 31, 33	OS 30616 R FO: 69; FOT: 59, 60; WIN: 2	OS 30710 R FOT: 66, 67
MS 98004 T GM: 61	OS 30617 C NIT: 3, 4	OS 30711 R FO: 6, 8; FOT: 1; MZT: 1
MS 98005 T FOT: 31; MZT: 25, 26	OS 30619 C NI: 1, 3	OS 30712 R FO: 35, 36; FOT: 18, 19; MZT: 21, 22
MS 98006 T FOT: 31; MZT: 25	OS 30620 R FO: 34, 35, 36; FOT: 18, 19; MZT: 21, 22	OS 30713 GM: 44; TO: 17, 18; TOT: 2, 3
MS 98007 T FOT: 38, 39, 51, 52, 54	OS 30622 R CHR: 59, 60, 61, 68; DT: 22, 23, 24, 25, 26, 27, 28, 29, 36, 37, 38; JEE: 10; VWT: 14	OS 30714 R GMT: 103; WRK: 4
MS 98007 T-1 FO: 54, 56, 57, 58	OS 30623 C-1 TO: 22; TOT: 11, 16	OS 30715 CHR: 26; MI: 14, 17, 20; MIT: 2, 5
MS 98008 T FOT: 38, 39, 51, 52, 54	OS 30625 C FO: 46, 47; FOT: 29, 34	OS 30716 R GM: 56
MS 98008 T-1 FO: 54, 56, 58	OS 30629 C NI: 9; NIT: 4	OS 30717 R FO: 34, 35, 36; FOT: 18, 19; MZT: 21, 22
MS 98008 T-2 FOT: 38, 39	OS 30630 R HO: 21, 22, 27, 28, 29, 34, 35; HOT: 1, 2	OS 30718 HY: 12, 15
MS 98008 T-3 FOT: 50, 51, 52, 53, 54	OS 30631 R FO: 4; KIA: 6, 7, 11; MZ: 5, 6, 7, 9, 10, 11, 13	OS 30719 MI: 5
MS 98009 T FOT: 29		
MS 98010 T FOT: 34		
MS 98010 T-1 FOT: 34		
MS 98011 T FOT: 29		

NUMERICAL LIST

OS 30720 MI: 1	OS 30787 NIT: 12; SZT: 10	OS 30868 BMT: 6, 7
OS 30721 C SAB: 23	OS 30788 NIT: 15, 16	OS 30869 R BMW: 21; BMT: 5
OS 30722 R GM: 56	OS 30789 HYT: 7; KIA: 22	OS 30871 PR MB: 50, 51, 62, 64, 65, 67
OS 30723 R SAB: 22, 23	OS 30790 R FO: 49	OS 30908 C FO: 10; MZ: 12, 14, 15
OS 30724 HY: 18	OS 30791 R AUD: 1, 5; VW: 4, 6, 7	OS 30909 C FO: 26; MZ: 24
OS 30725 R AV: 2; DET: 1; FO: 51, 52, 53, 54, 55, 56, 57, 58, 59; FOT: 35, 36, 37, 38, 39, 40, 48, 49, 50, 51, 52, 53, 54, 55, 56, 58; PNZ: 1, 2	OS 30792 R IST: 4	OS 30914 R FO: 18; FOT: 7; MZT: 9
OS 30726 HY: 3, 4, 5, 9, 10	OS 30793 R JEE: 21, 22	OS 30915 R FO: 5, 9
OS 30727 MIT: 9, 10	OS 30794 R IST: 4	OS 30917 C GM: 18; TO: 7
OS 30728 R CHR: 33, 34, 36; DT: 6, 7, 8, 9, 10, 11	OS 30795 R CHR: 73	OS 34007 R DT: 13; JEE: 6, 7
OS 30729 R FO: 30, 31, 32; FOT: 15, 16, 17; MZ: 30; MZT: 17, 18, 19, 20	OS 30796 R GM: 94; GMT: 55	OS 34102 DT: 54, 55
OS 30731 MIT: 7	OS 30800 R BMW: 7, 8	OS 34200 C FOT: 68, 69, 71
OS 30733 R DT: 31	OS 30801 C DAE: 1	OS 34210 C TOT: 21
OS 30734 KIT: 2	OS 30802 GMT: 21; SZT: 7, 8	OS 34212 R CHR: 62
OS 30735 C NI: 7	OS 30803 TOT: 25, 26	OS 34300 C GM: 35, 36; GMT: 7, 8; GRU: 1; IST: 2, 3
OS 30736 AUD: 2, 6; VW: 4, 6, 7, 9	OS 30804 VW: 38, 39, 40, 41	OS 34304 C MZ: 25, 27, 28, 29; MZT: 15, 16
OS 30737 MIT: 10	OS 30805 NI: 2, 4, 6	OS 34308 R JEE: 11, 12
OS 30738 DT: 57, 58, 59, 60, 65, 66	OS 30806 SZT: 8	OS 34309 R AV: 1; FO: 50; FOT: 31, 32, 33; LRT: 10; MZT: 25, 27
OS 30739 TOT: 23, 24	OS 30807 MIT: 8	OS 34400 GMT: 86, 87
OS 30741 TOT: 23, 24	OS 30808 TO: 21, 28, 34, 35	OS 34405 TO: 23, 24
OS 30742 TOT: 23, 24	OS 30809 SAB: 2, 3, 4, 13, 14, 15	OS 34406 AMG: 3, 4, 5; GMT: 86, 87, 88, 89, 90, 91, 92; WRK: 2
OS 30743 R DT: 35; JEE: 9; MIT: 11	OS 30810 TO: 21, 28, 34, 35	OS 34407 R GMT: 100, 101, 102; WRK: 3
OS 30744 GM: 70	OS 30811 SAB: 3, 4	OS 34408 R DT: 45, 46; JEE: 16
OS 30745 MI: 26	OS 30812 HO: 61, 62	OS 34409 R DT: 61, 62, 63, 64; JEE: 20
OS 30746 HO: 38, 39, 40, 41, 55, 56, 57, 58, 59, 60; HOT: 5, 6, 7, 8, 9, 10, 11	OS 30813 CHR: 56, 57	OS 34500 R AMG: 1, 2; AV: 3, 4, 5; EXC: 1; GM: 89, 97, 98, 102, 103, 104, 105; GMT: 59, 60, 73, 74; IST: 24, 25; WRK: 1
OS 30747 R BMW: 12, 13, 14, 16, 17; BMT: 1, 2	OS 30814 R FOT: 11; MZT: 13	OS 34501 R GM: 62, 63, 66, 68; GMT: 25, 30; IST: 10, 12
OS 30748 GMT: 93, 94, 95, 96, 99	OS 30815 TOT: 24	OS 34502 R GM: 88; GMT: 50, 51, 52, 54
OS 30749 TO: 38	OS 30817 TO: 33; TOT: 17	OS 34503 R DT: 39
OS 30750 R DT: 48, 49, 50, 51, 52, 53	OS 30818 R CHR: 43	OS 34506 R FOT: 59, 60
OS 30751 TO: 3, 4	OS 30819 TOT: 19, 20	OS 34507 R FOT: 72
OS 30752 TOT: 19, 20	OS 30820 BMW: 1, 2, 3, 4, 5, 6	OS 34508 R FO: 60, 61, 62, 63; FOT: 44, 45, 46; LAF: 1, 2
OS 30753 HY: 25, 26; HYT: 7; KIA: 21, 22; KIT: 7	OS 30821 AUD: 9, 10, 11, 12, 13, 14, 15, 16, 17; AUT: 1; VW: 27, 28, 29; VWT: 1, 2, 3	OS 34511 HOT: 13, 28; IST: 13, 16
OS 30754 R CHR: 63, 65, 66; DT: 32, 33, 41; VWT: 15	OS 30822 HY: 29, 30, 32, 33; HYT: 8, 11; KIA: 24; KIT: 8, 11	OS 34600 R FOT: 72
OS 30755 CHR: 74, 75; DT: 68	OS 30823 HY: 33; KIT: 11	OS 34601 R FOT: 41, 42, 43
OS 30756 MIT: 5	OS 30824 MI: 12, 19; MIT: 1, 4	OS 6566 C-2 DT: 47
OS 30757 MI: 15	OS 30825 HY: 15; KIA: 12	PS 13809 C FOT: 41, 42, 43
OS 30758 HY: 19; HYT: 4	OS 30826 MI: 13	PS 13809 R FOT: 41, 42, 43
OS 30759 HY: 19; HYT: 4; KIA: 16	OS 30829 GM: 24; TO: 11, 12	PS 50276 C GM: 52, 53; GMT: 19, 20; GRU: 2, 3
OS 30760 R DT: 31	OS 30829 R GM: 24; TO: 11, 12	PS 50373 C TOT: 21
OS 30761 R CHR: 69, 70, 71, 72; JEE: 17, 18	OS 30831 FO: 6, 8; FOT: 1; MZT: 1	PS 50397 R DT: 54, 55, 56, 57, 58, 60
OS 30762 HY: 31; HYT: 10; KIA: 23; KIT: 10	OS 30832 SB: 22; SBT: 9	SS 13807 FOT: 41, 42
OS 30763 TO: 29, 30, 31	OS 30833 CHR: 67; DT: 34; VWT: 13	SS 27504 TOT: 21
OS 30764 MI: 27; MIT: 12	OS 30834 DT: 34; JEE: 8	SS 5112 AMG: 3, 4, 5; GMT: 86, 87, 88, 89, 90, 91, 92; WRK: 2
OS 30765 GMT: 4; SZ: 7, 9; SZT: 5	OS 30835 CHR: 67; JEE: 8	SS 70070 FO: 69; FOT: 59, 60, 72; WIN: 2
OS 30766 R GM: 69; GMT: 36, 37	OS 30837 R HO: 2, 3, 4, 11, 12, 13, 14	SS 70157 NI: 7, 10, 11, 28; NIT: 5, 13, 14, 15, 16; SZT: 6
OS 30767 R GM: 77, 78, 79, 81, 82; GMT: 45	OS 30838 GMT: 96, 97, 98	SS 70283 HO: 2, 3, 4, 9, 10, 14
OS 30768 KIA: 1, 4, 5	OS 30840 R FO: 64, 65; FOT: 47	SS 70283-1 GMT: 4; HO: 5, 6, 7, 8, 11, 12, 13, 15, 17, 18, 19, 20, 21, 22, 23, 24, 25, 26, 27, 28, 29, 30, 31, 32, 33, 38, 39, 40, 41, 43, 44, 45, 46, 47, 48, 49, 51, 52, 53, 55, 56, 57, 58, 59, 60; HOT: 3, 4, 5, 6, 7, 8, 9, 10, 11; IST: 1, 5; SZ: 7, 9; SZT: 5
OS 30769 DT: 16, 17; FRT: 1	OS 30841 R JEE: 18	SS 70283-2 GMT: 21, 35; HO: 1, 65, 66, 67, 68, 69, 70, 71, 72, 73, 74, 75, 76, 77, 78, 79, 80, 81; HOT: 15, 16, 17, 18, 19, 20, 21, 22, 23, 24, 25, 26, 27, 29, 30; SZT: 7, 8
OS 30770 LOT: 5, 6; TO: 33; TOT: 17, 18	OS 30842 TO: 19, 20; TOT: 8	SS 70283-3 HO: 61, 62
OS 30771 KIT: 10	OS 30843 FOT: 65	SS 70287 GM: 41, 42; GMT: 12
OS 30772 R GMT: 31, 33	OS 30846 TO: 36, 37	SS 70310 VOL: 5, 6, 7, 8, 9, 10
OS 30773 R FOT: 61	OS 30847 NI: 5	SS 70310-1 VOL: 5, 6, 7, 8, 9, 10
OS 30774 R FOT: 61	OS 30849 NIT: 2	SS 70359 CHR: 15, 16, 17, 18; HY: 8, 14, 18; MI: 3, 8, 9, 16
OS 30775 R FOT: 61	OS 30851 BMW: 25	SS 70360 GM: 3; GMT: 2; SZ: 2, 3, 5; SZT: 2
OS 30776 R GM: 71, 72, 83, 84, 85, 86; GMT: 38, 47, 48	OS 30852 NI: 8	SS 70373 FO: 69; FOT: 59, 60; WIN: 2
OS 30777 NIT: 9	OS 30853 R VW: 45, 46, 47, 48, 49; VWT: 5, 6	SS 70529 JEE: 19
OS 30778 HY: 21, 24; HYT: 6; KIA: 17, 20; KIT: 6	OS 30855 MB: 2, 3, 4, 5, 6	SS 70579-1 GMT: 103; WRK: 4
OS 30779 AUD: 24, 25; VW: 42, 43, 44	OS 30856 MB: 37	
OS 30780 HY: 9, 10, 11; KIA: 8, 9	OS 30857 PR AUD: 48, 49	
OS 30781 VW: 22, 23, 24	OS 30858 AUD: 48, 49	
OS 30782 CHR: 7, 23, 24, 28, 29, 30, 31, 32; DT: 4, 5; HY: 21, 24; HYT: 6; JEE: 1, 2, 3, 4; KIA: 17, 20; KIT: 6	OS 30859 MB: 12, 13, 14, 19, 20, 32, 33, 34, 35, 36	
OS 30783 VW: 22, 23, 24	OS 30860 SAB: 9, 10, 11, 12	
OS 30784 TOT: 10	OS 30861 R LRT: 7, 8, 9, 14	
OS 30785 R FOT: 61	OS 30862 MB: 49, 50, 63, 66	
OS 30786 R GMT: 53	OS 30863 MB: 49, 50, 51, 62, 63, 64, 65, 66, 67	
	OS 30864 AUD: 26, 27	
	OS 30865 AUD: 26, 27	
	OS 30866 R BMW: 22, 26, 28; LRT: 13	
	OS 30867 R BMT: 6, 7	

NUMERICAL LIST

SS 70598 CHR: 5, 6; DT: 2; HY: 20; MI: 4; MIT: 3; TOT: 4	SS 71327 FO: 38, 39, 40, 41, 43, 44, 45; FOT: 21, 22, 23, 24, 26, 27, 28; MZ: 31; MZT: 23, 24	SS 72810-1 TO: 29, 30, 31
SS 70654 FO: 5, 9; MOR: 1	SS 72144 GM: 77, 78, 79, 81	SS 72814 SAB: 5, 6, 16, 17, 18; SB: 5, 6, 7, 8, 9, 10, 11, 12, 13, 14, 15, 16, 17, 18; SBT: 1, 2, 3, 4, 5, 6
SS 70660 CHR: 8, 9, 19, 20, 26; MI: 5, 10, 15, 17, 20; MIT: 2, 5	SS 72298 HY: 29, 30, 32, 33; HYT: 8, 9, 11; KIA: 24; KIT: 8, 9, 11	SS 72819 HY: 25, 26; HYT: 7; KIA: 21, 22; KIT: 7; MZ: 25, 26, 27
SS 70710 CHR: 51, 52, 53; DT: 18, 19; HY: 28; MI: 24; MIT: 6	SS 72446 DT: 42, 43; JEE: 13, 14; MIT: 13, 14	SS 72821 NI: 12, 13, 14, 15, 16, 17, 20, 21, 22, 23, 24, 25; NIT: 9, 10, 11, 12; SZT: 10
SS 70795 CHR: 38, 39, 54; MI: 21, 25, 26, 27; MIT: 7, 8, 10, 12	SS 72512 KIT: 4; MZ: 28, 29; MZT: 3, 4, 15, 16	SS 72823 GMT: 100, 101, 102; WRK: 3
SS 70795-1 HY: 3, 9, 10, 11, 12, 15; HYT: 1; KIA: 8, 9, 12; KIT: 1	SS 72514-2 FO: 5; MOR: 1	SS 72826 TO: 14
SS 70795-2 HY: 4, 5	SS 72522 CHR: 25, 40, 41, 42; DT: 14, 15	SS 72829 HOT: 12; IST: 6, 7, 8
SS 70809 GM: 35; GMT: 7, 8; IST: 2, 3	SS 72524 CHR: 4; HY: 1, 2; MI: 2	SS 72830 FO: 33, 37; TO: 1
SS 70816 GM: 35, 36; JEE: 7	SS 72525 AMG: 2; GMT: 59, 73	SS 72831 TO: 2
SS 70819 FO: 34, 35, 36; FOT: 18, 19; JEE: 11; MZT: 21, 22	SS 72526 AMG: 2; AV: 3, 4, 5; GM: 97, 98, 102, 103; GMT: 59, 73; IST: 25	SS 72832 TO: 25; TOT: 16
SS 70819-1 DT: 54, 55, 56	SS 72527 AMG: 2; AV: 3, 4, 5; GM: 97, 98, 102, 103; GMT: 59, 73; IST: 25	SS 72835 DT: 39; JEE: 11, 12
SS 70829 GM: 60, 67, 69; GMT: 31, 32, 33, 36, 37	SS 72530 GM: 62, 68, 88; GMT: 25, 30, 50, 51, 52, 54; IST: 10, 12	SS 72837 TO: 36
SS 70857 FO: 52	SS 72546-1 HO: 36	SS 72839 FOT: 59, 60, 72
SS 70858 AV: 1; FO: 50; FOT: 32, 33; LRT: 10; MZT: 27	SS 72547 NI: 8; NIT: 3	SS 72841 TOT: 11
SS 70864 FOT: 11; MZT: 13	SS 72551 GMT: 96, 97, 98	SS 72842 CHR: 58, 62, 63, 64, 65, 66; DT: 31, 32, 33, 41; VWT: 15
SS 70864-1 FO: 46, 48; FOT: 29, 30, 34	SS 72564 GM: 90, 96	SS 72844 DT: 45, 46, 61, 63; JEE: 16, 20
SS 70937 DT: 57, 58, 60	SS 72567 VW: 1, 2, 3, 14, 15, 16, 17, 18, 19	SS 72848 VOL: 4
SS 70945 AV: 6; CAL: 1; GM: 100, 101; GMT: 57, 68, 78	SS 72623 FOT: 41, 42, 43	SS 72848-1 VOL: 11, 12, 13, 22, 24, 25, 26, 27, 28
SS 70964 FO: 35, 36; FOT: 18, 19; MZT: 21, 22	SS 72623-1 FOT: 41, 42	SS 72851 GM: 60, 61, 67; GMT: 32
SS 71035 DT: 22, 23, 24, 25, 28, 29, 36, 37, 38; JEE: 10; VWT: 12	SS 72628-1 FOT: 68, 69, 71	SS 72852 GM: 35; GMT: 7; GRU: 1; IST: 2
SS 71039 AV: 6; GM: 99, 100, 101, 106, 107, 108, 109, 110, 111; GMT: 56, 57, 58, 61, 62, 63, 64, 65, 66, 67, 68, 69, 70, 71, 72, 75, 76, 77, 78, 79, 80, 81, 82, 83, 84, 85; IST: 22, 23; MOS: 1; SAT: 4, 5	SS 72629 FOT: 20; NI: 18, 19; NIT: 6, 7, 8	SS 72854 DT: 13; JEE: 6, 7
SS 71039-1 GM: 71, 72, 83, 84, 85, 86; GMT: 38, 47, 48	SS 72630 CHR: 21, 22, 27; DT: 3; MI: 11, 18; MIT: 3	SS 72860 CHR: 74; DT: 68
SS 71041 DT: 42, 43, 44; JEE: 13, 14, 15; MIT: 13, 14	SS 72632-1 HO: 34, 35, 42, 54; HOT: 1, 2	SS 72861 AMG: 1; EXC: 1; GM: 89, 104, 105; GMT: 60, 74; IST: 24; WRK: 1
SS 71041-1 DT: 35; JEE: 9; MIT: 11	SS 72632-2 HO: 63	SS 72861-1 GMT: 51, 53, 54; IST: 20, 21
SS 71042 ACO: 1, 2; GM: 87, 92, 93	SS 72656 GM: 9, 10; TO: 5, 6	SS 72862 GM: 43, 66
SS 71043 ACO: 2; GM: 87, 91, 92, 93, 94, 95; GMT: 22, 55; IST: 9	SS 72656-1 TO: 22, 23, 24	SS 72867 GM: 26, 27, 28
SS 71043-1 GM: 70; GMT: 49; IST: 19; SAT: 3	SS 72658 SB: 3, 4	SS 72868 FOT: 13, 14; NIT: 6
SS 71043-2 GMT: 34; IST: 15	SS 72675-1 GM: 4; GMT: 3; SZ: 4; SZT: 1, 3	SS 72871 CHR: 10, 11, 12, 13, 14, 33, 34, 35, 36, 37; DT: 1, 6, 7, 8, 9, 10, 11, 12; JEE: 5; MI: 6, 7
SS 71051 GM: 26	SS 72680 FO: 1; KIA: 7; MZ: 7	SS 72871-1 CHR: 43, 44, 45, 46
SS 71053 GM: 21; LOT: 2, 3, 4; TO: 10	SS 72680-1 FO: 15, 16; MZ: 18, 19, 28, 29; MZT: 14, 15, 16	SS 72873 FO: 6, 7
SS 71074 AUD: 1, 2, 3, 4, 5, 6, 7, 8; VW: 4, 5, 6, 7, 8, 9, 10, 11, 12, 13, 38, 39, 40, 41	SS 72681 CHR: 4, 27; DT: 3; HY: 1, 2, 20; MI: 18; MIT: 3	SS 72873-1 FO: 24, 25, 28, 29, 30, 31, 32; FOT: 15, 16, 17; MZ: 30; MZT: 12, 17, 18, 19, 20
SS 71074-1 AUD: 9, 10, 11; AUT: 1; VW: 27; VWT: 1	SS 72682 BMW: 15; SAB: 1, 2, 3, 4, 15; VW: 26	SS 72875 FOT: 7, 11; MZT: 9, 13
SS 71074-2 AUD: 22, 23, 24, 25, 28, 29; AUT: 2, 3; VW: 42, 43, 44	SS 72682-2 VW: 30, 31, 32, 33, 34, 35, 36, 37	SS 72875-1 FO: 46; FOT: 29, 34
SS 71074-3 CHR: 67; DT: 34; JEE: 8; VWT: 13	SS 72682-3 BMW: 12; VW: 45, 46; VWT: 5	SS 72876 GM: 88; GMT: 50, 51, 52, 54
SS 71146 ACO: 1; GM: 87, 92, 93	SS 72683 FO: 18, 19, 20, 27, 60, 61, 62, 63; FOT: 7, 44, 45, 46; LAF: 1, 2; MZT: 9	SS 72877 AMG: 2; AV: 3, 4, 5; GM: 97, 98, 102, 103; GMT: 59, 73; IST: 25
SS 71163 GM: 54, 56, 64; GMT: 27; SAB: 22, 23	SS 72684 GM: 52, 53; GMT: 19, 20; GRU: 2, 3	SS 72878 LOT: 5, 6; TO: 21, 26, 27, 28, 33, 34, 35; TOT: 12, 13, 17, 18
SS 71163-1 DAE: 2, 3; GM: 31; IST: 4; SZ: 8	SS 72685 GM: 62, 63	SS 72878-1 GM: 19, 20; TO: 8, 9, 12, 17, 18; TOT: 2, 3, 10
SS 71179 CHR: 49, 50; HY: 27, 31; HYT: 10; KIA: 23; KIT: 10; MI: 22, 23	SS 72686 FOT: 12, 31; MZT: 25, 26	SS 72878-2 GM: 20, 24, 44; TO: 11
SS 71179-1 HY: 18	SS 72687 FOT: 72	SS 72878-3 TO: 32; TOT: 14, 15, 19, 20
SS 71179-2 HY: 19; HYT: 4; KIA: 16; MI: 14	SS 72698 GM: 17, 33, 34	SS 72882 GM: 77
SS 71180 VOL: 11, 13, 14, 15, 16, 17, 18, 19, 20, 21, 22, 23, 24, 25, 26, 27, 28, 29, 30, 32; VOT: 1	SS 72700 GM: 65, 77, 80, 82; GMT: 45	SS 72883 AMG: 2; GMT: 59, 73
SS 71186 DT: 57, 58, 59, 60, 65, 66	SS 72702 FOT: 72	SS 72885 MZ: 2
SS 71198 GM: 29, 30, 32, 37, 38, 39, 40, 45, 46, 47, 48, 49, 50; GMT: 5, 6, 9, 10, 11, 13, 14, 15, 16, 17, 18; SAB: 7, 8	SS 72708 FO: 46, 47; FOT: 29	SS 72888 DET: 1; FO: 51, 52, 53; FOT: 35, 36, 48, 49; PNZ: 1, 2
SS 71237 GMT: 49; IST: 19; SAT: 3	SS 72710 GM: 1, 2; SZ: 1	SS 72889 FO: 6, 7, 8; FOT: 1; MZT: 1
SS 71237-1 GMT: 26; IST: 11	SS 72711 AMG: 3, 4, 5; GMT: 86, 87, 88, 89, 90, 91, 92; WRK: 2	SS 72891 FO: 54, 55, 56, 57, 58; FOT: 37, 38, 39, 50, 51, 52, 53, 54
SS 71237-2 GMT: 44; IST: 17	SS 72721 GM: 12; HOT: 13, 14, 28; IS: 3; IST: 13, 14, 16	SS 72891-1 FOT: 66
SS 71245 KIA: 1, 4	SS 72729 DT: 40	SS 72893 FOT: 70
SS 71264 FOT: 61	SS 72730 DT: 47, 62, 64	SS 72910 TO: 37, 38; TOT: 23, 24, 25, 26
SS 71268 CHR: 7, 23, 24, 28, 29, 30, 31, 32; DT: 4, 5; HY: 13, 16, 17, 21, 22, 23, 24; HYT: 2, 3, 5, 6; JEE: 1, 2, 3, 4; KIA: 13, 14, 15, 17, 18, 19, 20; KIT: 3, 5, 6	SS 72731 NIT: 4	SS 72911 FO: 32; JAG: 1, 2
SS 71292 BMW: 7, 8	SS 72776 NI: 9, 27; NIT: 4	SS 72913 TO: 3, 4
SS 71314 MI: 12, 13, 19; MIT: 1, 4	SS 72782 FO: 2, 3, 4; KIA: 6; MZ: 4, 6, 11, 13	SS 72914 CHR: 70, 71; DT: 48, 50, 51; JEE: 17
	SS 72783 CHR: 59, 60, 61, 68; DT: 24, 26, 27, 28, 37	SS 72914-1 CHR: 73; JEE: 21, 22
	SS 72799 FO: 56	SS 72915 BMW: 12, 13, 14, 16, 17; BMT: 1, 2
	SS 72800 NI: 1, 3, 4, 5, 6; NIT: 2	SS 72916 GMT: 93, 94, 95, 96, 99
	SS 72802 FO: 4, 10; KIA: 5, 10, 11; KIT: 2; MZ: 4, 5, 8, 9, 10, 11, 12, 14, 15	SS 72917 FO: 11, 12, 13, 14, 17, 21, 22; FOT: 2, 3, 4, 5, 6, 8, 9; MZ: 3, 17, 21, 22; MZT: 5, 6, 7, 8
	SS 72802-1 FO: 26; MZ: 20, 24	SS 72919 MB: 12, 13, 14, 32, 33, 34, 35, 36
	SS 72805 CHR: 1, 2, 3, 47, 48, 49, 50; MI: 1, 22, 23; MIT: 9	SS 72919-1 DT: 16, 17; FRT: 1
	SS 72807 FO: 33, 37	
	SS 72807-1 GM: 51	
	SS 72808 DT: 67	
	SS 72809 TO: 14; TOT: 6, 7	
	SS 72810 GM: 10, 18; TO: 5, 7, 13, 15, 16; TOT: 1, 5, 9	

NUMERICAL LIST

SS 72919-2 CHR: 56, 57; MB: 24, 25, 26, 27, 28, 29, 30, 31; MBT: 1	TCS 45458 DT: 13; JEE: 6, 7, 11, 12	TCS 45834 FOT: 13, 14; NI: 18, 19; NIT: 6
SS 72920 MB: 10, 11, 16, 17, 18	TCS 45461 GM: 1, 2, 3, 4; SZ: 1, 2, 3, 4; SZT: 1	TCS 45835 CHR: 51, 53; DT: 18, 19; MI: 24; MIT: 6
SS 72921 FOT: 67	TCS 45472-1 FO: 5, 9	TCS 45840 GM: 65, 77, 80, 82; GMT: 45
SS 72921-1 AV: 2; FO: 59; FOT: 40, 55, 56, 58	TCS 45473 FO: 5, 9; MOR: 1	TCS 45843 GM: 41, 42; GMT: 12
SS 72922 FO: 49	TCS 45482-1 CHR: 1, 2, 3, 4; HY: 1, 2; MI: 1, 2	TCS 45844 HO: 5, 6, 7, 9, 10, 15
SS 72923 GM: 55, 73; GMT: 23, 24, 39, 40; SAB: 20, 21; SAT: 1; SZT: 9	TCS 45483 CHR: 1, 2, 3, 4, 5, 6, 8, 9, 15, 16, 17, 18, 19, 20, 21, 22, 26, 27, 38, 39, 51, 52, 53, 54; DT: 2, 3, 18, 19; HY: 1, 2, 8, 14, 18, 20, 28; IST: 16; MI: 1, 2, 3, 4, 5, 8, 9, 10, 11, 16, 17, 18, 21, 24, 25; MIT: 2, 3, 6, 7; MOR: 1	TCS 45845 HO: 5, 6, 7, 9, 10, 15
SS 72924 DAE: 1; GM: 13, 14	TCS 45495 CHR: 25, 40, 41, 42; DT: 14, 15	TCS 45846 GM: 52, 53
SS 72925 SAB: 3, 4, 13, 14, 15	TCS 45522-2 GM: 90, 96	TCS 45850 MZ: 25, 26, 27, 28, 29; MZT: 15, 16
SS 72929 CHR: 69, 72; DT: 49, 52, 53; JEE: 18	TCS 45540 SB: 3, 4, 21	TCS 45852 GM: 1, 2, 3, 4; GMT: 2, 3; SZ: 1, 2, 3, 4, 5; SZT: 1, 2, 3
SS 72930 BMW: 1, 2, 3, 4	TCS 45554 AMG: 3, 4, 5; GMT: 86, 87, 88, 89, 90, 91, 92; WRK: 2	TCS 45853 GM: 11, 12, 25; IS: 1, 2, 3, 4; LOT: 1
SS 72931 GM: 15, 16, 22, 23	TCS 45565-1 CHR: 17, 18, 21, 22; DT: 3; MI: 8, 9, 11; MIT: 3	TCS 45859 HOT: 13, 14, 28; IST: 13, 14, 16
SS 72933 SB: 22, 24; SBT: 9, 10	TCS 45575 FOT: 68, 69, 71	TCS 45860 FO: 2, 3, 4, 10; MZ: 2, 4, 5, 8, 10, 11, 12, 14, 15
SS 72934 SB: 22	TCS 45592 GM: 10, 18; TO: 1, 2, 5, 7	TCS 45864 NI: 1
SS 72935 GM: 5, 6, 7, 8; GMT: 1	TCS 45603 GM: 17, 33, 34, 54, 56, 64; GMT: 27; SAB: 22, 23	TCS 45866 HOT: 13, 14, 28; IST: 13, 14, 16
SS 72936 FO: 64, 65; FOT: 47	TCS 45604 GM: 33, 34	TCS 45867 FOT: 31; MZT: 25, 26
SS 72938 FOT: 68, 69, 71	TCS 45613 TOT: 21	TCS 45868 HOT: 13, 14, 28; IST: 13, 14, 16
SS 72939 HY: 6, 7; KIA: 2, 3	TCS 45620 HO: 5, 6, 7, 8, 9, 10, 15, 17, 18, 19, 20, 23, 24, 25, 26	TCS 45869 FO: 56
TCS 13198-2 GM: 52, 53; GMT: 19, 20; GRU: 2, 3	TCS 45624 GM: 9, 10; TO: 5, 6	TCS 45869-1 FO: 54, 55, 56, 57, 58; FOT: 37, 38, 39
TCS 24551 VW: 1, 2, 3, 14, 15, 16, 17, 18, 19, 26, 30	TCS 45626 FO: 19, 20, 27	TCS 45869-2 FO: 57, 58; FOT: 38, 39
TCS 45003 JEE: 19	TCS 45634 NI: 18, 19; NIT: 6	TCS 45870 FO: 33, 37
TCS 45009 TOT: 16	TCS 45635 FOT: 13, 14, 20; NI: 18, 19; NIT: 6, 7, 8	TCS 45871 FO: 33, 37
TCS 45016 FOT: 70	TCS 45641 TO: 13, 15, 16; TOT: 1	TCS 45873-1 HO: 36, 42
TCS 45017 FOT: 70	TCS 45641-1 TO: 36	TCS 45875 HO: 36, 42
TCS 45018 TOT: 16	TCS 45685 TOT: 4	TCS 45878 FO: 46, 47
TCS 45019 TO: 2	TCS 45686 AMG: 3, 4, 5; GMT: 86, 87, 88, 90, 91, 92; WRK: 2	TCS 45879 HO: 5, 6, 7, 9, 10, 15
TCS 45026 CHR: 25, 40, 41, 42; DT: 14, 15	TCS 45687 SB: 3, 4, 21	TCS 45881 FOT: 72
TCS 45035 CHR: 43, 44, 45, 46	TCS 45696 GM: 12; IS: 3; NI: 14, 15, 16, 17	TCS 45884 MZ: 28, 29; MZT: 15, 16
TCS 45038 AUD: 2, 3, 4, 6, 7, 8, 9, 10, 11; VW: 4, 5, 6, 7, 8, 9, 10, 11, 12, 13, 27, 31, 32, 33, 34, 35, 36, 37	TCS 45703 STE: 1	TCS 45886 MZT: 14
TCS 45038-1 AUD: 22, 23, 24, 25; AUT: 2, 3; VW: 42, 43, 44	TCS 45704 HO: 63, 69, 70; HY: 18, 19; HYT: 4; KIA: 16; MI: 14, 24, 26, 27; MIT: 7, 8, 10, 12; STE: 1	TCS 45887 NIT: 3, 4
TCS 45039 TOT: 4	TCS 45704-1 HY: 3, 4, 5, 9, 10, 11, 12, 15; HYT: 1; KIA: 8, 9, 12; KIT: 1; MI: 1, 5, 15, 20; MIT: 5	TCS 45887-1 NI: 9; NIT: 4
TCS 45047 GM: 21; LOT: 2, 3, 4; TO: 10	TCS 45718 HO: 34, 35, 36, 42; HOT: 1, 2	TCS 45889 TO: 22, 25, 26, 27, 32; TOT: 12, 13, 14, 15
TCS 45050 FOT: 70	TCS 45722 FO: 1, 2, 3, 4; MZ: 4, 7, 11, 13	TCS 45890 TO: 22, 25, 26, 27, 32; TOT: 11, 12, 13, 14, 15
TCS 45051 GMT: 49; IST: 19; SAT: 3	TCS 45723 FO: 15, 16; KIT: 4; MZ: 18, 19; MZT: 3, 4	TCS 45893-1 CHR: 59, 60, 61, 68; DT: 22, 24, 26, 27, 28, 37
TCS 45052 GMT: 22, 26, 34, 44, 49; IST: 9, 11, 15, 17, 19; SAT: 3	TCS 45724 FO: 1, 26; KIA: 6, 7; MZ: 6, 7, 13, 20, 24	TCS 45895 GMT: 2, 3; SZ: 5; SZT: 2, 3
TCS 45053 GMT: 100, 101, 102; WRK: 3	TCS 45725 PEU: 2; VOL: 4, 5, 6, 7, 8, 9, 10; WIN: 1	TCS 45897 TOT: 5, 6, 7
TCS 45054 GM: 19, 20; TO: 8, 9	TCS 45729 TO: 1, 2	TCS 45898 HO: 43, 44, 45, 46, 47, 51, 52, 53, 54; HOT: 3, 4; IST: 1, 5
TCS 45055 GMT: 93, 94, 95, 96, 97, 98, 99	TCS 45732 TO: 23, 24	TCS 45899 HO: 43, 44, 45, 46, 47, 51, 52, 53; HOT: 3, 4; IST: 1, 5
TCS 45056 NI: 10, 11; NIT: 5; SZT: 6	TCS 45733 TO: 13	TCS 45900 TO: 14
TCS 45060 GMT: 100	TCS 45734 TO: 13	TCS 45901 CHR: 47, 48, 49, 50; MI: 22, 23
TCS 45107 FO: 18; FOT: 7	TCS 45745 SB: 1, 2	TCS 45902 DT: 54, 55
TCS 45108 FO: 18; FOT: 7, 11; MZT: 9, 13	TCS 45750 CHR: 51, 52, 53; DT: 18, 19; HY: 28; MI: 24; MIT: 6	TCS 45903 NI: 7, 8
TCS 45109 FO: 18; FOT: 7, 11; MZT: 9, 13	TCS 45762 GM: 35, 36; GMT: 7, 8; GRU: 1; IST: 2, 3	TCS 45904 HO: 23, 24, 25, 26, 34, 35; HOT: 1, 2
TCS 45117 DT: 13; JEE: 6, 7, 11, 12	TCS 45771 FO: 34, 35, 36; FOT: 18, 19; MZT: 21, 22	TCS 45906 TOT: 1
TCS 45121 AMG: 2; AV: 3, 4, 5; GM: 88, 97, 98, 102, 103; GMT: 50, 51, 52, 59, 73; IST: 25	TCS 45782 HOT: 12; IST: 6, 7, 8	TCS 45907 TOT: 1
TCS 45128 IST: 4	TCS 45783 HOT: 12; IST: 6, 7, 8	TCS 45910 CHR: 5, 6; MI: 4
TCS 45129 FOT: 72	TCS 45786 NI: 14, 15, 16, 17	TCS 45911 CHR: 47, 48, 49, 50; HY: 25, 26; HYT: 7; KIA: 21, 22; KIT: 7; MI: 22, 23, 26; MIT: 9, 10
TCS 45131 CHR: 25, 40, 41, 42; DT: 14, 15	TCS 45789 DT: 40	TCS 45913 NI: 27
TCS 45264 GMT: 19, 20; GRU: 2, 3	TCS 45790 DT: 40	TCS 45914 TOT: 11
TCS 45265 AMG: 2; AV: 3, 4, 5; GM: 88, 97, 98, 102, 103; GMT: 50, 51, 52, 59, 73; IST: 25	TCS 45791 FOT: 12	TCS 45916 TO: 36, 37
TCS 45271 JEE: 19	TCS 45793 GM: 35, 36; GMT: 7, 8; GRU: 1; IST: 2, 3	TCS 45917 MZ: 25, 26, 27
TCS 45272 GMT: 100	TCS 45794 SB: 1, 2	TCS 45918 SB: 5, 9, 10, 11
TCS 45284 DT: 47, 62, 64	TCS 45826 FO: 46, 47	TCS 45919 SB: 8, 9, 10, 11
TCS 45288 VW: 1, 2, 3, 14, 15, 16, 17, 18, 19, 26	TCS 45827 GM: 62, 63, 68; GMT: 25, 30; IST: 10, 12	TCS 45920 TO: 15, 16; TOT: 1
TCS 45290 FOT: 12	TCS 45828 GM: 60, 61, 62, 63, 67, 68; GMT: 25, 30, 31, 32, 33; IST: 10, 12	TCS 45921 FO: 1, 2, 3, 4; KIA: 6, 7; MZ: 4, 5, 6, 7, 8, 9, 10, 11, 13
TCS 45291 FOT: 31; MZT: 25, 26	TCS 45829 FOT: 41, 42, 43	TCS 45924 VOL: 5, 6, 7, 8, 9, 10
TCS 45357 AUD: 18, 19, 20, 21; VW: 1, 2, 3, 14, 15, 16, 17, 18, 19, 26, 30, 31, 32, 33, 35, 36, 37	TCS 45830 FOT: 41, 42, 43	TCS 45925 VOL: 4
TCS 45413 TO: 13	TCS 45831 GM: 17	TCS 45931 CHR: 8, 9; MI: 5, 15
TCS 45424 GM: 9; TO: 6, 14, 23, 24	TCS 45833 CHR: 25, 40, 41, 42; DT: 14, 15	TCS 45934 TOT: 4
TCS 45449 FO: 60, 61, 62, 63, 69; FOT: 44, 45, 46, 59, 60; LAF: 1, 2; WIN: 2		TCS 45935 FOT: 13, 14
TCS 45450 FO: 60, 61, 62, 63, 69; FOT: 44, 45, 46, 59, 60; LAF: 1, 2; WIN: 2		TCS 45936 FO: 10, 26; MZ: 12, 14, 15, 20, 24
		TCS 45938 HY: 8, 14, 18
		TCS 45939 CHR: 58, 62, 63, 64, 65, 66; DT: 31, 32, 33, 41; VWT: 15
		TCS 45940 FO: 18; FOT: 7, 11; MZT: 9, 13

TCS 45941	CHR: 15, 16, 17, 19, 20, 26; MI: 8, 9, 10, 16, 17; MIT: 2	TCS 46006	TOT: 9	TCS 46059	FO: 11, 17; FOT: 4, 5, 6; MZ: 21, 22; MZT: 5, 6, 7, 8
TCS 45945	HO: 48, 49, 54	TCS 46007	GMT: 103; WRK: 4	TCS 46060	HO: 63
TCS 45946	DT: 2; MIT: 3	TCS 46008	SAB: 17, 18; SB: 8, 9, 10, 14, 16, 17, 18; SBT: 2, 4, 5, 6	TCS 46061	AV: 1; FO: 50; FOT: 32, 33; LRT: 10; MZT: 27
TCS 45947	GMT: 54	TCS 46009	SAB: 5, 6, 16, 17, 18; SB: 6, 7, 12, 13, 14, 15, 16, 17, 18; SBT: 1, 2, 3, 4, 5, 6	TCS 46062	HY: 19; HYT: 4; KIA: 16
TCS 45948	SAB: 1, 2	TCS 46010	FOT: 48, 49	TCS 46063	NI: 3
TCS 45949	DT: 39, 45, 46, 61, 62, 63, 64; JEE: 16	TCS 46010-1	FOT: 48, 49	TCS 46064	FOT: 38
TCS 45950	CHR: 62	TCS 46011	ACO: 1, 2; GM: 87, 91, 92, 93, 94, 95; GMT: 55	TCS 46065	FOT: 38
TCS 45951	FO: 46, 47; FOT: 29	TCS 46012	GM: 87, 92, 93	TCS 46066	MZ: 9
TCS 45952	DT: 39, 45, 46, 61, 62, 63, 64; JEE: 16	TCS 46013	ACO: 1, 2; GM: 87, 92, 93	TCS 46067	FOT: 67
TCS 45953	EXC: 1; GM: 104	TCS 46014	GM: 54, 56, 64; GMT: 27; SAB: 22, 23	TCS 46070	TO: 29, 30, 31
TCS 45954	GM: 41, 42; GMT: 12	TCS 46015	FO: 6, 8; FOT: 1; MZT: 1	TCS 46071	FO: 30, 31; FOT: 15, 16, 17; MZT: 18, 19, 20
TCS 45955	GM: 18; TO: 7	TCS 46016	FO: 24, 25, 28, 29, 30, 31, 32; FOT: 15, 16, 17; MZ: 30; MZT: 12, 17, 18, 19, 20	TCS 46072	AV: 2; FO: 59
TCS 45956	EXC: 1; GM: 89, 104, 105	TCS 46017	HY: 12, 15; HYT: 1; KIA: 12; KIT: 1	TCS 46072-1	AV: 2; FO: 59
TCS 45957	SB: 5, 14; SBT: 2	TCS 46018	ACO: 1; GM: 87, 92, 93	TCS 46074	HY: 31; HYT: 10; KIA: 23; MI: 27; MIT: 12
TCS 45958	GM: 26, 27, 28	TCS 46019	HY: 4, 5	TCS 46075	KIA: 1, 4
TCS 45959	HO: 69, 70, 79	TCS 46019-1	HY: 3, 9, 10, 11; KIA: 8, 9	TCS 46076	GM: 91, 92, 93, 95
TCS 45960	GM: 43	TCS 46020	TO: 17, 18; TOT: 2, 3	TCS 46076-1	GM: 94; GMT: 55
TCS 45961	CHR: 7, 10, 11, 12, 13, 14, 23, 24, 28, 29, 30, 31, 32, 33, 34, 35, 36, 37; DT: 1, 4, 5, 6, 7, 8, 9, 10, 11, 12; JEE: 1, 2, 3, 4, 5; MI: 6, 7	TCS 46021	AUD: 1, 5; VW: 4, 6	TCS 46077	GM: 78, 79, 81
TCS 45962	CHR: 10, 11, 12, 13, 14, 33, 34, 35, 36, 37; DT: 1, 6, 7, 8, 9, 10, 11, 12; JEE: 5; MI: 6, 7	TCS 46022	DT: 35, 42, 43, 44; JEE: 9, 13, 14, 15; MIT: 11, 13, 14	TCS 46078	FOT: 55, 56, 58
TCS 45963	FO: 6, 7; FOT: 1; MZT: 1	TCS 46023	DT: 22, 24, 28, 29, 37	TCS 46079	GM: 29, 30, 32, 39, 40, 45, 46, 47, 48, 49, 50; GMT: 5, 6, 9, 10, 11, 13, 14, 15, 16, 17, 18
TCS 45964	FO: 6, 7	TCS 46023-1	DT: 22, 23, 24, 25, 28, 36, 37, 38; JEE: 10; VWT: 14	TCS 46080	LOT: 5, 6; TO: 21, 28, 33, 34, 35; TOT: 17, 18, 19
TCS 45965	CHR: 38, 39, 54; MI: 21, 25; MIT: 7	TCS 46024	CHR: 26; MI: 17, 20; MIT: 2, 5	TCS 46081	SZ: 9
TCS 45966	FO: 24, 25, 28, 29, 32; FOT: 15; MZ: 30; MZT: 12, 17, 18	TCS 46025	GMT: 35; HO: 65, 66, 67, 68, 71, 72, 73, 74, 75, 76, 77, 78, 80, 81; HOT: 15, 16, 17, 18, 19, 20, 21, 22, 23, 24, 25, 26, 27, 29, 30	TCS 46085	HY: 31; HYT: 10; KIA: 23; KIT: 10; MI: 27; MIT: 12
TCS 45967	FO: 24, 25, 28, 29, 32; FOT: 15; MZT: 12, 17, 18	TCS 46026	GMT: 35; HO: 65, 66, 67, 68, 71, 72, 73, 74, 75, 76, 77, 78, 80, 81; HOT: 15, 16, 17, 18, 19, 20, 21, 22, 23, 24, 25, 26, 27, 29, 30	TCS 46086	DT: 16, 17; FRT: 1
TCS 45969	GMT: 100, 101, 102; WRK: 3	TCS 46027	CHR: 1, 3; MI: 1	TCS 46087	HY: 21; KIA: 17; MI: 12, 13, 19; MIT: 1, 4
TCS 45970	GM: 66	TCS 46028	KIA: 1, 4, 5, 10, 11	TCS 46088	GM: 69; GMT: 36, 37
TCS 45971	GM: 77, 78, 79, 81	TCS 46029	KIA: 5, 10, 11; KIT: 2	TCS 46089	GM: 71, 72, 83, 84, 85, 86; GMT: 38, 47, 48
TCS 45972	GM: 51	TCS 46030	KIT: 2	TCS 46090	NIT: 3
TCS 45973	FO: 34, 35, 36; FOT: 18, 19; MZT: 21, 22	TCS 46031	DT: 57, 58, 59, 60, 65, 66	TCS 46091	GMT: 51, 53, 54; IST: 20, 21
TCS 45974	GM: 65, 77, 80, 82; GMT: 45	TCS 46033	FOT: 20; NIT: 7	TCS 46092	NIT: 3
TCS 45975	NIT: 6	TCS 46034	NIT: 7, 8	TCS 46093	AMG: 1; GMT: 59, 60, 73, 74; IST: 24; WRK: 1
TCS 45976	GM: 60, 61, 62, 63, 67; GMT: 31, 32, 33	TCS 46035	TO: 38; TOT: 23, 24	TCS 46094	DAE: 2, 3; GM: 31; IST: 4; SZ: 8
TCS 45979	TO: 36; TOT: 16	TCS 46036	TOT: 23, 24	TCS 46095	HO: 79
TCS 45980	DET: 1; FO: 51, 52; FOT: 35, 36; PNZ: 1	TCS 46037	VOL: 11, 12, 13, 22, 24, 25, 26, 27	TCS 46096	FOT: 40
TCS 45980-1	FO: 53; PNZ: 2	TCS 46038	VOL: 11, 13, 14, 15, 16, 17, 18, 19, 20, 21, 22, 23, 24, 25, 26, 27, 28, 29, 30, 32; VOT: 1	TCS 46097	DAE: 2, 3; GM: 31; SZ: 8
TCS 45981	MZ: 2	TCS 46039	VOL: 11, 12, 13, 14, 15, 16, 17, 18, 19, 20, 21, 22, 23, 24, 25, 26, 27, 28, 29, 30, 32; VOT: 1	TCS 46098	CHR: 7, 23, 24, 28, 29, 30, 31, 32; DT: 4, 5; JEE: 1, 2, 3, 4
TCS 45982	FOT: 51, 52, 54, 66	TCS 46040	VOL: 11, 12, 13, 14, 15, 16, 17, 18, 19, 20, 21, 22, 23, 24, 25, 26, 27, 28, 29, 30, 32; VOT: 1	TCS 46099	GMT: 37
TCS 45982-1	FOT: 50, 51, 52, 53, 54, 66	TCS 46041	GM: 37, 38, 39; GMT: 10; SAB: 7, 8	TCS 46100	GMT: 53
TCS 45983	HOT: 13, 14, 28; IST: 13, 14, 16	TCS 46042	TOT: 2, 3	TCS 46103	FO: 49
TCS 45984	FO: 46, 48; FOT: 29, 30, 34	TCS 46043	NIT: 7, 8	TCS 46105	BMW: 7, 8
TCS 45985	FO: 6, 7, 8	TCS 46044	GM: 70	TCS 46106	FOT: 61
TCS 45986	FOT: 32, 33; MZT: 27	TCS 46046	TO: 3, 4	TCS 46107	VW: 38, 39, 40, 41
TCS 45987	HO: 21, 22, 27, 28, 29, 48, 49	TCS 46047	BMW: 12, 13, 16	TCS 46108	GM: 55, 57, 58, 59, 73, 74, 75, 76; GMT: 23, 24, 28, 29, 39, 40, 41, 42, 43; SAB: 20, 21; SAT: 1, 2; SZT: 9
TCS 45988	HO: 21, 22, 27, 28, 29	TCS 46048	BMW: 14; BMT: 1	TCS 46110	DAE: 1; GM: 13, 14
TCS 45989	HO: 8, 17, 18, 19, 20	TCS 46048-1	BMW: 13, 16, 17; BMT: 2	TCS 46111	HY: 29, 30, 32, 33; HYT: 8, 9, 11; KIA: 24; KIT: 8, 9, 11
TCS 45992	CHR: 58, 62, 63, 64, 65, 66; DT: 31	TCS 46049	CHR: 69, 70, 71, 72, 73; DT: 48, 49, 50, 51, 52, 53; JEE: 17, 18, 21, 22	TCS 46112	GM: 37, 38, 39; GMT: 10; SAB: 7, 8
TCS 45992-1	DT: 41; VWT: 15	TCS 46050	TO: 37, 38; TOT: 23, 24	TCS 46113	GM: 29, 30, 32, 39, 40, 45, 46, 47, 48, 49, 50; GMT: 5, 6, 9, 10, 11, 13, 14, 15, 16, 17, 18
TCS 45993	AV: 6; CAL: 1; GM: 99, 100, 101, 106, 107, 108, 109, 110, 111; GMT: 56, 57, 58, 61, 62, 63, 64, 65, 66, 67, 68, 69, 70, 71, 72, 75, 76, 77, 78, 79, 80, 81, 82, 83, 84, 85; IST: 22, 23; MOS: 1; SAT: 4, 5	TCS 46051	HO: 38, 39, 40, 41, 55, 56, 57, 58, 59, 60; HOT: 5, 6, 7, 8, 9, 10, 11	TCS 46114	DET: 1; FO: 24, 25, 28, 29, 30, 31, 32, 51, 52, 53, 54, 55, 56, 57, 58; FOT: 15, 16, 17, 35, 36, 37, 38, 39, 40, 48, 49, 51, 52, 54, 66; MZ: 30; MZT: 12, 17, 18, 19, 20; PNZ: 1, 2
TCS 45994	DT: 57, 58, 60	TCS 46052	HY: 25, 26; HYT: 7; KIA: 21, 22; KIT: 7	TCS 46116	DAE: 1; GM: 13, 14
TCS 45995	DT: 67	TCS 46053	HY: 25, 26, 27, 31; HYT: 7, 10; KIA: 21, 22, 23; KIT: 7, 10	TCS 46117	AV: 2; FO: 38, 39, 40, 41, 43, 44, 45, 57, 58, 59, 64, 65, 66; FOT: 21, 22, 23, 24, 26, 27, 28, 38, 39, 47, 48, 49, 50, 51, 52, 53, 54, 55, 56, 57, 58, 66, 67; MZ: 31; MZT: 23, 24
TCS 45996	DT: 39, 45, 46, 61, 63; JEE: 16, 20	TCS 46054	FO: 32	TCS 46118	HO: 30, 31, 32, 33
TCS 45997	NI: 20, 21; NIT: 9, 12; SZT: 10	TCS 46055	JAG: 1, 2	TCS 46120	MIT: 8
TCS 45999	DT: 39, 45, 46, 61, 63; JEE: 16, 20	TCS 46056	GMT: 4; SZ: 7; SZT: 5	TCS 46122	TOT: 25, 26
TCS 46000	DT: 42; JEE: 13, 15	TCS 46057	CHR: 74, 75; DT: 68	TCS 46123	CHR: 56, 57; MB: 24, 25, 26, 27, 28, 29, 30, 31; MBT: 1
TCS 46001	DT: 55, 56				
TCS 46002	TOT: 2				
TCS 46003	FO: 6, 7				
TCS 46004	TO: 15				
TCS 46005	AUD: 1, 2, 3, 4, 5, 6, 7, 8, 9, 10, 11; AUT: 1; VW: 4, 5, 6, 7, 8, 9, 10, 11, 12, 13, 27; VWT: 1				

NUMERICAL LIST

TCS 46125	SAB: 2, 3, 4, 13, 14, 15	VS 50001 C	JEE: 19	VS 50306 R	VW: 26
TCS 46126	SB: 22; SBT: 9	VS 50001 R	JEE: 19	VS 50309 R	FO: 1
TCS 46127	BMW: 1, 2, 3, 4, 5, 6	VS 50022 C-1	JEE: 11	VS 50311 R	HOT: 12; IST: 6, 7, 8
TCS 46128	HO: 61, 62	VS 50026 R-1	CHR: 51, 52, 53; DT: 18, 19; HY: 28; MI: 24; MIT: 6	VS 50312 C	FOT: 12
TCS 46129	TOT: 10	VS 50027 R	FO: 15, 16; MZ: 18, 19	VS 50312 R	FOT: 12
TCS 46130	NI: 2, 4, 6; NIT: 2	VS 50028 R	FOT: 41, 42, 43	VS 50312 T	FOT: 12
TCS 46131	TOT: 10	VS 50029 C	FO: 60, 61, 62, 63, 69; FOT: 44, 45, 46, 59, 60; LAF: 1, 2; WIN: 2	VS 50313 R	GM: 35, 36; GMT: 7; GRU: 1; IST: 2
TCS 46132	FO: 11, 12, 13, 14, 17; FOT: 2, 3, 4, 5, 6; MZ: 17, 21, 22; MZT: 5, 6, 7, 8	VS 50037 F	VOL: 5, 6, 7, 8, 9, 10	VS 50314 R	GM: 62, 63
TCS 46133	HY: 16, 17, 21, 22, 23, 24; HYT: 2, 3, 5, 6; KIA: 13, 14, 17, 18, 19, 20; KIT: 3, 5, 6	VS 50041 R	CHR: 17, 18; HY: 8, 14, 18; MI: 3, 8, 9	VS 50315 R	GM: 90, 96
TCS 46134	DT: 22, 24, 25, 28, 37, 38; JEE: 10	VS 50042 R	NIT: 4	VS 50317 R	SB: 1, 2
TCS 46135	NIT: 15, 16	VS 50043 R-1	FO: 18; FOT: 7; MZT: 9	VS 50320 R	GM: 65, 77, 78, 80, 81, 82; GMT: 45
TCS 46136	GMT: 21; SZT: 7, 8	VS 50043 R-2	FOT: 7, 11; MZT: 9, 13	VS 50321 R	FO: 46, 47
TCS 46137	MI: 14	VS 50053 R	GM: 12; IS: 3	VS 50323 C	GM: 4; GMT: 3; SZ: 4; SZT: 1, 3
TCS 46138	AUD: 9, 10, 11, 12, 13, 14, 15, 16, 17; AUT: 1; VW: 27, 28, 29; VWT: 1, 2, 3	VS 50064 R	GM: 11, 25; IS: 1, 2, 4; LOT: 1	VS 50324 R	GM: 10; TO: 5
TCS 46139	HO: 61, 62	VS 50066 R	FOT: 18	VS 50324 R-1	GM: 10; TO: 5
TCS 46140	SAB: 16; SB: 12, 13, 15; SBT: 1, 3	VS 50067 R	FOT: 72	VS 50325 R	GM: 41, 42; GMT: 12
TCS 46140-1	SB: 12	VS 50070 R	FO: 46, 47	VS 50326 R	HO: 5, 6, 7, 9, 10, 15
TCS 46142	GM: 15, 16, 22, 23	VS 50074 R	GM: 90, 96	VS 50326 R-1	HO: 5, 6, 7, 9, 10, 15
TCS 46144	GM: 15, 16, 22, 23	VS 50080 R	GM: 65, 77, 78, 80, 81, 82; GMT: 45	VS 50327 R	HO: 36, 42
TCS 46145	VW: 45, 46; VWT: 5	VS 50085 R	GM: 62, 63	VS 50329 C	GM: 52, 53; GMT: 19, 20; GRU: 2, 3
TCS 46147	CHR: 63, 65, 66; DT: 31, 32, 33, 41; VWT: 15	VS 50086 R	GM: 88; GMT: 50, 51, 52, 54	VS 50332 R	SZ: 2
TCS 46148	GM: 24, 44; TO: 11	VS 50088 R	AMG: 1, 2; AV: 3, 4, 5; EXC: 1; GM: 89, 97, 98, 102, 103, 104; GMT: 59, 60, 73, 74; IST: 24, 25; WRK: 1	VS 50333 R	GM: 1, 2; SZ: 1
TCS 46148-1	TO: 12	VS 50094 R	MZ: 4	VS 50334 R	CHR: 25, 40, 41, 42; DT: 14, 15
TCS 46149	BMW: 1, 2, 3, 4, 5, 6	VS 50103 R	CHR: 5, 6; MI: 4	VS 50336 R	MZ: 28, 29; MZT: 15, 16
TCS 46150	SAB: 5, 6; SB: 6, 7	VS 50107 C	VW: 1, 2, 3, 14, 15, 16, 17, 19	VS 50338 R	TO: 22
TCS 46151	FO: 21, 22, 23; FOT: 8, 9, 10; MZ: 23; MZT: 10, 11	VS 50132 R	CHR: 21, 22, 27; DT: 2, 3; HY: 20; MI: 11, 18; MIT: 3	VS 50338 R-1	TO: 22
TCS 46152	VW: 34	VS 50173 R	CHR: 51, 52, 53; DT: 18, 19; HY: 28; MI: 24; MIT: 6	VS 50339 R	CHR: 59, 60, 61, 68; DT: 24, 26, 27, 28, 37
TCS 46155	GM: 5	VS 50179 T	GM: 52, 53; GMT: 19, 20; GRU: 2, 3	VS 50340 R	MZT: 14
TCS 46156	GM: 6, 7, 8; GMT: 1	VS 50184 R	DT: 47, 62, 64	VS 50344 R	HOT: 12; IST: 6, 7, 8
TCS 46159	FO: 64, 65; FOT: 47	VS 50193 C	MOR: 1	VS 50358 R	TOT: 4
TCS 46162	CHR: 67; DT: 34; JEE: 8; VWT: 13	VS 50195 R	CHR: 4; HY: 1, 2; MI: 2	VS 50359 R	KIA: 6, 7; MZ: 6, 7
TCS 46164	CHR: 43, 44, 45, 46	VS 50200 C	VW: 1, 2, 3, 14, 15, 16, 17, 19	VS 50360 R	NI: 9; NIT: 4
TCS 46165	FO: 10, 26; MZ: 3, 14, 15, 20, 24	VS 50203 R	CHR: 5, 6; MI: 4	VS 50361 R	FO: 2, 3
TCS 46166	HY: 6, 7; KIA: 2, 3	VS 50205 C	CHR: 25, 41, 42; DT: 14, 15	VS 50362 R	HO: 34, 35; HOT: 1, 2
TCS 46168	TO: 19, 20; TOT: 8	VS 50205 T	CHR: 25, 41, 42; DT: 14, 15	VS 50365 R	HO: 43, 44, 45, 46; HOT: 3; IST: 1
TCS 46169	CHR: 69, 70, 71, 72, 73; DT: 48, 49, 50, 51, 52, 53; JEE: 17, 18, 21, 22	VS 50228 C	AMG: 3, 4, 5; GMT: 86, 87, 88, 89, 90, 91, 92; WRK: 2	VS 50365 R-1	HO: 43, 44, 45, 46; HOT: 3; IST: 1
TCS 46174	DT: 54, 55, 56, 57, 58, 59, 60	VS 50234 R	CHR: 21, 22, 27; DT: 2, 3; HY: 20; MI: 11, 18; MIT: 3	VS 50366 R	NI: 14, 15, 16, 17
TCS 46182	FO: 45; FOT: 28	VS 50236 C	AUD: 18, 20, 21	VS 50368 C	FOT: 31; MZT: 25, 26
TCS 46183	AUD: 40; VW: 51	VS 50238 R	KIT: 4; MZT: 3, 4	VS 50368 T	FOT: 31; MZT: 25, 26
TCS 46184	AUD: 28, 29	VS 50243 C	GM: 33, 34	VS 50369 R	FO: 5, 9
TCS 46185	TO: 29, 30, 31	VS 50243 T	GM: 33, 34	VS 50371 R	TOT: 11
TCS 46186	AUD: 22, 23; AUT: 2, 3; VW: 42, 43, 44	VS 50247 R	FOT: 68, 69, 71	VS 50372 R	TOT: 21
TCS 46187	VOL: 28, 29, 30, 32; VOT: 1	VS 50251 R	FOT: 13, 14, 20; NI: 18, 19; NIT: 6, 7, 8	VS 50374 R	FO: 34, 35, 36; FOT: 18, 19; MZT: 21, 22
TCS 46188	CHR: 56, 57; DT: 16, 17, 20, 21; FRT: 1, 2, 3; MB: 1, 8, 9, 15, 19, 20, 24, 25, 26, 27, 28, 29, 30, 31, 37, 53, 54, 55, 56, 57, 58, 59, 60, 61, 78, 79, 80, 81, 82, 83, 84, 85; MBT: 1, 7, 8, 9, 10, 16, 17	VS 50251 R-1	FOT: 13, 14, 20; NI: 18, 19; NIT: 6, 7, 8	VS 50375 R	GM: 4; SZ: 4
TCS 46189	MB: 2, 3, 4, 5, 6	VS 50266 R	HY: 8, 14, 18	VS 50376 R	TO: 36
TCS 46190	LRT: 3, 4, 5, 6, 7, 8, 9, 11, 12, 14; MOR: 2	VS 50268 R	GM: 9; TO: 6	VS 50377 R	FO: 54, 56, 58; FOT: 38
TCS 46191	LRT: 1	VS 50272 C	GM: 62, 68; GMT: 25, 30; IST: 10, 12	VS 50377 R-1	FO: 54, 56, 58; FOT: 38
TCS 46193	GMT: 93, 94, 95, 96, 97, 98, 99	VS 50272 R	GM: 62, 68; GMT: 25, 30; IST: 10, 12	VS 50378 R	FO: 33, 37
TCS 46194	CHR: 59, 60, 61, 62, 68; DT: 22, 24, 25, 26, 27, 28, 29, 37, 38; JEE: 10	VS 50272 T	GM: 62, 68; GMT: 25, 30; IST: 10, 12	VS 50379 R	MZ: 25, 27
TCS 46195	TO: 22, 25, 26, 27, 32; TOT: 11, 12, 13, 14, 15, 16	VS 50273 R	SB: 3, 4	VS 50382 R	CHR: 1, 2, 3; MI: 1
TCS 46196	FOT: 70	VS 50277 R	GM: 88; GMT: 50, 51, 52, 54	VS 50383 R	NI: 1
TCS 46197	FOT: 61	VS 50278 B	BMW: 25	VS 50384 R	NI: 7
TCS 46198	DT: 39, 45, 46, 61, 62, 63, 64; JEE: 16, 20	VS 50279 B	BMW: 15	VS 50385 R	NI: 8
TCS 6563-1	DT: 47, 62, 64	VS 50293 R	AMG: 1, 2; AV: 3, 4, 5; EXC: 1; GM: 89, 97, 98, 102, 103, 104; GMT: 59, 60, 73, 74; IST: 24, 25; WRK: 1	VS 50386 R	TOT: 6, 7
VS 13264 T	FO: 60, 61, 62, 63, 69; FOT: 44, 45, 46, 59, 60; LAF: 1, 2; WIN: 2	VS 50299 R-1	STE: 1	VS 50388 R	GMT: 100, 101, 102; WRK: 3
VS 26062 C	VWT: 4	VS 50299 R-2	HO: 63	VS 50389 R	MZ: 13
VS 26062 R	VWT: 4	VS 50303 R	TO: 23, 24	VS 50390 R	CHR: 47, 48, 49, 50; MI: 22, 23; MIT: 9
VS 26081 R	TOT: 4	VS 50304 R	TO: 13, 15, 16; TOT: 1	VS 50391 R	HO: 36, 42
		VS 50304 R-1	TO: 13, 15, 16; TOT: 1	VS 50393 R	TO: 14
		VS 50305 R	TO: 1	VS 50395 R	SB: 5, 9, 10, 11
				VS 50396 R	DT: 54, 55, 56
				VS 50396 R-1	DT: 54, 55, 56
				VS 50399 R	FO: 19, 20, 27
				VS 50402 R	NI: 27
				VS 50404 R	MB: 52, 86
				VS 50408 R	VOL: 4
				VS 50409 R	SAB: 1, 2, 3, 4, 13, 14, 15
				VS 50415 R	CHR: 8, 9; MI: 5
				VS 50419 R	DT: 45, 46, 61, 63; JEE: 16, 20
				VS 50420 R	DT: 39

VS 50421 C JEE: 7	VS 50501 R CHR: 58, 62, 63, 64, 65, 66; DT: 31	VS 50582 R DT: 57, 58, 60
VS 50422 R TO: 25; TOT: 16	VS 50502 R DT: 13; JEE: 6, 7	VS 50583 R HY: 15; HYT: 1; KIA: 12; KIT: 1
VS 50423 R TO: 2	VS 50503 R GM: 100	VS 50584 R GMT: 49; IST: 19; SAT: 3
VS 50424 R KIT: 4; MZT: 3, 4	VS 50504 R AV: 6; CAL: 1; GM: 99, 100, 101, 106, 107, 108, 109, 110, 111; GMT: 56, 57, 58, 61, 62, 63, 64, 65, 66, 67, 68, 69, 70, 71, 72, 75, 76, 77, 78, 79, 80, 81, 82, 83, 84, 85; IST: 22, 23; MOS: 1; SAT: 4, 5	VS 50585 R KIT: 2
VS 50426 R FO: 26; MZ: 24	VS 50504 R-1 AV: 6; CAL: 1; GM: 99, 100, 101, 106, 107, 108, 109, 110, 111; GMT: 56, 57, 58, 61, 62, 63, 64, 65, 66, 67, 68, 69, 70, 71, 72, 75, 76, 77, 78, 79, 80, 81, 82, 83, 84, 85; IST: 22, 23; MOS: 1; SAT: 4, 5	VS 50586 R KIA: 10
VS 50426 R-1 FO: 26	VS 50505 R DT: 56	VS 50588 R TO: 26, 27, 32; TOT: 12, 13, 14, 15
VS 50428 R FO: 10; MZ: 14	VS 50506 R DT: 57, 58, 60	VS 50589 R DT: 57, 58, 59, 60, 65, 66
VS 50429 R CHR: 62	VS 50507 R CHR: 13, 14	VS 50590 R HY: 5
VS 50430 C DT: 13; JEE: 7	VS 50508 R DT: 67	VS 50592 R TO: 37, 38; TOT: 23, 24
VS 50434 R CHR: 15, 16, 17; MI: 8, 9, 16	VS 50509 R FO: 32	VS 50593 R HY: 3, 9, 10
VS 50435 R CHR: 19, 20, 26; MI: 10, 17; MIT: 2	VS 50510 R FO: 32	VS 50594 R DT: 35; JEE: 9
VS 50436 R DT: 40	VS 50512 R TOT: 5, 9	VS 50596 R GM: 37, 38, 39; GMT: 10
VS 50437 R HO: 54	VS 50513 R DT: 22, 24, 28, 29, 37	VS 50597 R GM: 70
VS 50439 R FO: 1	VS 50514 R TO: 2	VS 50599 R DT: 22, 23, 24, 25, 28, 29, 36, 37, 38; JEE: 10; VWT: 14
VS 50440 R GM: 10, 18; TO: 5, 7	VS 50517 R NI: 8	VS 50600 R BMW: 12
VS 50441 R FO: 46, 47, 48; FOT: 29, 30, 34	VS 50518 R CHR: 35, 37; DT: 1, 7, 8, 12; JEE: 5	VS 50601 R BMW: 13, 16
VS 50441 R-1 FO: 46, 47, 48; FOT: 29, 30, 34	VS 50520 R CHR: 43, 44, 45, 46	VS 50602 R MZ: 9
VS 50442 R GM: 60, 61, 67, 69, 71, 72, 83, 84, 85, 86; GMT: 31, 32, 33, 36, 37, 38, 47, 48	VS 50521 R DT: 42; JEE: 13, 15	VS 50603 R FOT: 51, 52, 53, 54
VS 50443 R EXC: 1; GM: 104, 105	VS 50522 T JEE: 11	VS 50604 R MI: 20; MIT: 5
VS 50444 R GM: 41, 42, 43; GMT: 12	VS 50524 R ACO: 1; GM: 87, 92, 93	VS 50606 R HO: 23, 24, 25, 26
VS 50445 R GM: 41, 42, 51; GMT: 12	VS 50526 R ACO: 1, 2; GM: 87, 91, 92, 93, 95	VS 50606 R-1 HO: 23, 24, 25, 26
VS 50447 R GM: 27, 28	VS 50528 R VW: 30	VS 50607 R GMT: 35; HO: 66, 67, 73, 74; HOT: 18, 19, 21, 29
VS 50448 R HO: 69, 70, 79	VS 50528 R-1 VW: 31, 32, 33	VS 50607 R-1 HOT: 22, 25
VS 50449 R DT: 24, 28, 37	VS 50529 R FOT: 32, 33; LRT: 10; MZT: 27	VS 50608 R NI: 21; NIT: 9, 12; SZT: 10
VS 50451 R GM: 26	VS 50530 R GM: 44; TO: 17, 18; TOT: 2, 3	VS 50610 R FO: 32; JAG: 2
VS 50452 R GM: 43	VS 50531 R AUD: 1, 2, 3, 4, 5, 6, 7, 8; VW: 4, 5, 6, 7, 8, 9, 10, 11, 12, 13	VS 50612 R FO: 32; JAG: 2
VS 50453 R GM: 26	VS 50533 R VW: 31, 32, 33, 34, 35, 36, 37	VS 50614 R HO: 38, 39, 40, 41, 55, 56, 57, 58, 59, 60; HOT: 5, 6, 7, 8, 9, 10, 11
VS 50454 R GM: 26	VS 50534 R HY: 8, 14, 18	VS 50615 R JAG: 1, 2
VS 50455 R CHR: 10, 11; MI: 6, 7	VS 50535 R MI: 5, 15	VS 50617 R NI: 3
VS 50456 R CHR: 13	VS 50537 R MI: 1	VS 50618 R NI: 3
VS 50457 R CHR: 13	VS 50542 R GM: 20; TO: 9	VS 50619 R BMW: 12
VS 50458 R JEE: 11, 12	VS 50544 R GM: 19; TO: 8	VS 50620 R SAB: 16; SB: 12, 13, 15; SBT: 1, 3
VS 50459 R CHR: 12, 33, 34, 35, 36, 37; DT: 6, 8, 9, 10, 11, 12	VS 50546 R GM: 21; LOT: 2, 3, 4; TO: 10	VS 50622 R GMT: 93
VS 50460 R FO: 6, 7	VS 50547 R FOT: 66	VS 50623 R NI: 10; NIT: 5; SZT: 6
VS 50461 R CHR: 38, 39, 54; MI: 21, 25, 26, 27; MIT: 7, 10, 12	VS 50549 R GM: 26	VS 50624 R TO: 3, 4
VS 50462 R FO: 24, 25, 28, 29; MZT: 12	VS 50550 R NI: 8	VS 50625 R CHR: 69, 70, 71, 72, 73; DT: 48, 49, 50, 51, 52, 53; JEE: 17, 18, 21, 22
VS 50464 R GMT: 51, 53, 54; IST: 20, 21	VS 50550 R-1 NIT: 3	VS 50626 R BMW: 13, 14, 16, 17; BMT: 2
VS 50465 R GM: 77, 79	VS 50551 R FO: 32; FOT: 15; MZT: 17, 18	VS 50627 R HO: 56; HOT: 6
VS 50466 R GM: 66	VS 50552 R FO: 6	VS 50628 R GM: 54, 64; GMT: 27
VS 50468 R IST: 13	VS 50553 R FO: 6; FOT: 1; MZT: 1	VS 50629 R FO: 30; FOT: 15
VS 50469 R HOT: 14; IST: 14	VS 50554 R GMT: 103; WRK: 4	VS 50631 R BMW: 14, 17; BMT: 1, 2
VS 50471 R TO: 26, 27; TOT: 12, 13	VS 50555 R SB: 14	VS 50633 R GMT: 4; SZ: 6, 7, 9; SZT: 4, 5
VS 50472 R GM: 66	VS 50557 R SB: 14; SBT: 2	VS 50634 R TOT: 19
VS 50473 R GM: 3; GMT: 2; SZ: 3, 5; SZT: 2	VS 50561 R SAB: 17, 18; SB: 8, 9, 10, 16, 17, 18; SBT: 4, 5, 6	VS 50636 R CHR: 74; DT: 68
VS 50474 R FOT: 72	VS 50561 R-1 SAB: 17, 18; SB: 16, 18	VS 50637 R MB: 12, 13, 14, 33, 34, 35, 36
VS 50475 R MZ: 2	VS 50562 R CHR: 26; MI: 17; MIT: 2	VS 50638 R FO: 17; FOT: 4; MZ: 21; MZT: 5
VS 50476 R FO: 9	VS 50564 R FO: 54, 55, 56, 58; FOT: 37, 38	VS 50639 R FO: 11, 17; FOT: 4, 5, 6; MZ: 17, 21; MZT: 5, 6, 7
VS 50477 R DET: 1; FO: 51, 52, 53; FOT: 35, 36, 48, 49; PNZ: 1, 2	VS 50566 R GM: 56; GMT: 27; SAB: 23	VS 50639 R-1 FO: 11, 17, 21, 22; FOT: 2, 4, 5, 6, 8, 9; MZ: 17, 21; MZT: 5, 6, 7
VS 50477 R-1 FOT: 35, 36	VS 50567 R GM: 56; SAB: 22, 23	VS 50640 R HY: 25, 26; HYT: 7; KIA: 21, 22
VS 50479 R FO: 52	VS 50569 R FO: 4; KIA: 11; MZ: 8, 10, 11	VS 50641 R HY: 26; HYT: 7; KIA: 22; KIT: 7
VS 50481 R FO: 57, 58; FOT: 39, 50, 51, 52, 53, 54	VS 50570 R NI: 1	VS 50642 R MB: 10, 11, 16, 17, 18
VS 50483 R FOT: 70	VS 50571 R NI: 7	VS 50643 R VW: 47, 48, 49; VWT: 6
VS 50484 R FOT: 70	VS 50572 R HY: 12, 15	VS 50644 R FO: 30
VS 50485 R GM: 35; GMT: 7, 8; IST: 2, 3	VS 50573 R MI: 24	VS 50646 R AV: 1; FO: 50
VS 50486 R HOT: 13, 28; IST: 13, 16	VS 50574 R MZ: 12, 14, 15	VS 50651 R HY: 19; HYT: 4; KIA: 16
VS 50489 R FO: 6, 7	VS 50575 R HY: 4	VS 50652 R DT: 35; JEE: 9; MIT: 11
VS 50490 R GM: 51	VS 50576 R HO: 65, 71, 72; HOT: 15, 16, 17	VS 50655 R MB: 32
VS 50491 R FOT: 32, 33	VS 50577 R DT: 42, 43, 44; JEE: 13, 14, 15; MIT: 13, 14	VS 50656 R FOT: 67
VS 50493 R HO: 47, 51, 52, 53; HOT: 4; IST: 5	VS 50579 R FO: 32; FOT: 15; MZT: 17, 18	VS 50658 R HY: 27; HYT: 10
VS 50494 R NI: 20	VS 50581 R FO: 8	VS 50658 R-1 HY: 31; KIA: 23
VS 50494 R-1 NI: 20		VS 50658 R-2 KIT: 10
VS 50496 R CHR: 44, 46		VS 50660 R TO: 31
VS 50498 R HO: 21, 22, 27, 28		VS 50662 R SB: 14; SBT: 2
VS 50498 R-1 HO: 29		VS 50664 R AV: 2; FO: 59; FOT: 40, 56, 58
VS 50499 R HO: 8, 20		
VS 50500 R HO: 17, 18, 19		

NUMERICAL LIST

VS 50667 R GMT: 49; IST: 19; SAT: 3	VS 50762 R AUD: 9, 10, 11; AUT: 1; VW: 27; VWT: 1	VS 50859 R BMW: 21; BMT: 5
VS 50668 R DT: 59, 60, 65, 66	VS 50763 R BMW: 1, 3	VS 50860 R BMW: 21
VS 50669 R TO: 29, 30	VS 50764 R HY: 33; HYT: 9; KIT: 9, 11	VS 50861 R TOT: 22
VS 50670 R KIA: 1, 4	VS 50765 R MI: 12, 13, 19; MIT: 1, 4	VS 50862 R BMW: 30
VS 50671 R KIA: 4	VS 50767 R FO: 38, 39, 40, 43; FOT: 21, 22, 26; MZ: 31; MZT: 23, 24	VS 50863 R BMW: 30
VS 50672 R SB: 14; SBT: 2	VS 50769 R GM: 40, 45, 46, 47, 48, 50; GMT: 9, 11, 13, 14, 15, 16	VS 50864 R BMW: 19; BMT: 4
VS 50674 R VW: 47, 49	VS 50770 R NI: 21, 22, 23; NIT: 9, 10	VS 50865 R AUD: 30, 31, 32, 33, 34, 35, 36, 37, 38; AUT: 6, 7, 8, 9, 10, 11, 12, 13, 14, 15, 16; POR: 1; POT: 2; VWT: 10
VS 50680 R DT: 16, 17; FRT: 1	VS 50772 R GM: 29; SAB: 7, 8	VS 50866 R AUD: 38; AUT: 14
VS 50681 GMT: 94, 95, 96, 97, 98, 99	VS 50773 R HO: 75, 76, 77, 78, 80, 81; HOT: 20, 23, 24, 25, 26, 27, 29, 30	VS 50867 R BMW: 18; BMT: 3
VS 50682 R LOT: 5, 6; TO: 33; TOT: 17, 18	VS 50776 R GM: 24; TO: 11	VS 50868 R BMW: 24
VS 50684 R GMT: 94, 95, 96, 99	VS 50777 R NI: 10, 11; NIT: 5	VS 50869 R HY: 22; KIA: 18
VS 50685 R AUD: 9, 10, 11; VW: 27	VS 50778 R GM: 30, 49; GMT: 5, 6, 17, 18	VS 50871 R MB: 2, 3, 4, 5, 6
VS 50687 R AV: 2; FO: 59; FOT: 40, 55, 56, 58	VS 50779 R GM: 15, 16, 22, 23	
VS 50689 R CHR: 63, 65, 66; DT: 32, 33, 41; VWT: 15	VS 50780 R SAB: 18; SB: 18; SBT: 6	
VS 50690 R TO: 21, 28, 34, 35	VS 50781 R SB: 12	
VS 50691 R FOT: 61	VS 50782 R HO: 11	
VS 50692 R DAE: 2, 3; GM: 31; SZ: 8	VS 50783 R HO: 4, 14	
VS 50693 R HYT: 7; KIA: 22	VS 50784 R HO: 2	
VS 50695 R FOT: 61	VS 50785 R HO: 12, 13	
VS 50696 R NIT: 3	VS 50786 R HO: 3, 4	
VS 50697 R HY: 21, 24; KIA: 17, 20	VS 50787 R AUD: 26, 27	
VS 50698 R CHR: 7, 23, 24, 28, 29, 30, 31, 32; DT: 4, 5; JEE: 1, 2, 3, 4	VS 50788 R BMW: 6	
VS 50699 R HO: 68	VS 50789 R LRT: 3, 4, 5, 6, 7, 8, 9, 11, 12, 14; MOR: 2	
VS 50700 R HY: 9, 10	VS 50790 R BMW: 28, 29; BMT: 6, 7; LRT: 13	
VS 50701 R GM: 27, 28	VS 50791 R BMW: 28, 29; BMT: 6, 7; LRT: 13	
VS 50702 R AUD: 22, 23, 24, 25; AUT: 2, 3; VW: 42, 43, 44	VS 50792 R BMW: 22, 26, 28	
VS 50703 R GMT: 34; IST: 15	VS 50793 R BMW: 22, 26, 28	
VS 50704 R GMT: 22; IST: 9	VS 50794 R SB: 22	
VS 50705 R HY: 9, 11; KIA: 8, 9	VS 50796 R SB: 22; SBT: 9	
VS 50706 R MZ: 30	VS 50798 R BMW: 9, 10	
VS 50708 R FOT: 15; MZT: 18	VS 50799 R SAB: 5, 6; SB: 6, 7	
VS 50711 R MB: 49, 50, 51	VS 50801 R FO: 31; FOT: 16, 17; MZT: 19, 20	
VS 50712 R MB: 49, 50, 51	VS 50805 R CHR: 67; DT: 34; JEE: 8; VWT: 13	
VS 50716 R MI: 27	VS 50807 R GM: 5, 6, 7, 8; GMT: 1	
VS 50717 R TOT: 10	VS 50808 R GM: 57, 58, 59, 74, 75, 76; GMT: 28, 29, 41, 42, 43; SAT: 2	
VS 50718 R KIA: 5; MZ: 4	VS 50811 R FO: 64, 65; FOT: 47	
VS 50719 R GM: 39; GMT: 10	VS 50813 R GMT: 96, 97, 98	
VS 50720 R NIT: 15, 16	VS 50814 R FO: 44, 45; FOT: 27, 28	
VS 50721 R MI: 14	VS 50817 R KIA: 3	
VS 50722 R IST: 4	VS 50818 R HY: 6, 7; KIA: 2	
VS 50723 R MI: 14	VS 50820 R FOT: 64	
VS 50724 R FO: 49	VS 50821 R GMT: 94, 95, 96, 99	
VS 50726 R GM: 55, 73; GMT: 23, 24, 39, 40; SAB: 20, 21; SAT: 1; SZT: 9	VS 50822 R GMT: 93	
VS 50728 R GM: 94; GMT: 55	VS 50823 R TO: 12	
VS 50730 R DAE: 1; GM: 13, 14	VS 50826 R TOT: 20	
VS 50731 R BMW: 7, 8	VS 50839 R JAG: 3	
VS 50732 R DAE: 1	VS 50840 R HO: 64	
VS 50733 R DT: 42, 43; JEE: 13, 14; MIT: 13, 14	VS 50841 R VW: 24	
VS 50735 R VW: 38, 39, 40, 41	VS 50842 R MB: 53, 54, 55, 56, 57, 58, 59, 60, 61; MBT: 7, 8, 9, 10	
VS 50736 R GMT: 21; SZT: 7, 8	VS 50843 R NI: 28; NIT: 13	
VS 50738 R GMT: 26; IST: 11	VS 50844 R MB: 37	
VS 50739 R GMT: 44; IST: 17	VS 50845 R MB: 37	
VS 50740 R MZ: 5	VS 50846 R NI: 25	
VS 50741 R HO: 30, 31, 32, 33	VS 50847 R NI: 2	
VS 50742 R TOT: 25, 26	VS 50848 R NI: 22, 23; NIT: 10	
VS 50744 R SZT: 8	VS 50850 R AUD: 48, 49	
VS 50746 R NI: 4, 5, 6; NIT: 2	VS 50851 R AUD: 50, 51, 52, 53, 54, 55, 56; AUT: 18; VW: 52, 53; VWT: 17, 18, 19	
VS 50747 R HO: 48, 49	VS 50852 R MB: 1	
VS 50750 R HY: 29, 30, 32, 33; HYT: 8, 11; KIA: 24; KIT: 8, 11	VS 50853 R LRT: 1	
VS 50752 R MIT: 8	VS 50854 R VOL: 41; VOT: 5	
VS 50753 R HO: 61, 62	VS 50855 R VOL: 41; VOT: 5	
VS 50754 R IST: 16	VS 50856 R LRT: 2; VOL: 39, 40; VOT: 3, 4	
VS 50756 R SZ: 7	VS 50857 R AUD: 28, 29	
VS 50757 R MZ: 22; MZT: 8	VS 50858 R MB: 19, 20	
VS 50758 R CHR: 56, 57; MB: 24, 25, 26, 27, 28, 29, 30, 31; MBT: 1		
VS 50761 R BMW: 2, 4		

DRIVETRAIN GASKETS

Year	Part Type	Model Name	Description	Bolt Holes	Part Number
AC Cobra					
Automatic Transmission					
68-66	Oil Pan	Ford C6	3 Speed	17-Bolt	TOS 18628
Manual Transmission					
64-63	Transmission Kit	Borg-Warner T10M	4 Speed		TS 5135
68-64	Transmission Kit	Tremec 170F	4 Speed		TS 13405
AM General Truck					
Front Axle					
01-92	Housing Cover	Hummer	8.875" Ring Gear	12-Bolt	RDS 13889
Rear Axle					
01-92	Housing Cover	Hummer	8.875" Ring Gear	12-Bolt	RDS 13889
Automatic Transmission					
94-92	Oil Pan	GMC 3L80-HD	3 Speed	13-Bolt	TOS 18621
01-94	Oil Pan	GMC 4L80-E	4 Speed	17-Bolt	TOS 18698
American Motors Car					
Front Axle					
88-80	Housing Cover	Eagle		10-Bolt	RDS 55019
Rear Axle					
88-80	Housing Cover	Eagle		10-Bolt	RDS 13089
88-84	Differential Carrier	Eagle		10-Bolt	RDS 55019
88-61	Housing Cover	Full-Size		10-Bolt	RDS 13089
79-61	Housing Cover	Full-Size		12-Bolt	RDS 13889
58-50	Housing Cover	Full-Size	8.5" Ring Gear	10-Bolt	RDS 6629
78-70	Housing Cover	Gremlin		10-Bolt	RDS 13089
78-70	Housing Cover	Gremlin		12-Bolt	RDS 13889
80-75	Housing Cover	Pacer		10-Bolt	RDS 13089
80-75	Housing Cover	Pacer		12-Bolt	RDS 13889
83-79	Housing Cover	Spirit		10-Bolt	RDS 13089
83-79	Housing Cover	Spirit		12-Bolt	RDS 13889
Automatic Transaxle					
87-83	Oil Pan	Alliance, Encore	Renault MJ3	0-Bolt	TOS 18670 ¹
Automatic Transmission					
71-62	Oil Pan	Ford-O-Matic	2 Speed	14-Bolt	TOS 18109
57-50	Oil Pan	Hydramatic	2 Speed	12-Bolt	TOS 18024
79-72	Oil Pan	A727 (H/D)	3 Speed	14-Bolt	TOS 18583
88-80	Oil Pan	A904	3 Speed	14-Bolt	TOS 18667
79-72	Oil Pan	A904 (Exc. H/D)	3 Speed	14-Bolt	TOS 18667
57-56	Oil Pan	Flash-A-Way (Jetaway 315)	3 Speed	15-Bolt	TOS 18057
71-56	Oil Pan	Flash-O-Matic	3 Speed	14-Bolt	TOS 18106
Manual Transmission					
57-55	Transmission Kit	Borg-Warner T85, T86E	3 Speed		TS 5135-2
Aston Martin					
Automatic Transmission					
70-63	Oil Pan	Borg-Warner T8	3 Speed	14-Bolt	TOS 18106
89-71	Oil Pan	Chrysler A727	3 Speed	14-Bolt	TOS 18583
94-89	Oil Pan	Chrysler A518	4 Speed	14-Bolt	TOS 18583
Audi Car					
Automatic Transaxle					
01-96	Oil Pan	All Models (Including Quattro)	Audi 01N (4 Speed)	5-Bolt	TOS 18763
12-04	Oil Pan	All Models (Including Quattro)	Aisin 09G (6 Speed)	8-Bolt	TOS 18761
12-06	Oil Pan	All Models (Including Quattro)	Aisin 09M (6 Speed)	9-Bolt	TOS 18765
10-04	Oil Pan	All Models (Including Quattro)	VW DSG (DQ250 6 Speed)	5-Bolt	TOS 18759
06-96	Oil Pan	All Models (Including Quattro)	5HP-19FL, 5HP-19FLA	27-Bolt	TOS 18724
06-96	Case Rear Cover	All Models (Including Quattro)	5HP-19FL, 5HP-19FLA	15-Bolt	TOS 18734
92-73	Oil Pan	All Models (Including Quattro)	087, 089	0-Bolt	TOS 18649 ¹
Avanti					
Rear Axle					
03-01	Housing Cover	All Models	7.625" Ring Gear	10-Bolt	RDS 55072
91-87	Housing Cover	All Models	7.5" Ring Gear	10-Bolt	RDS 55072
91-87	Housing Cover	All Models	8.5" Ring Gear	10-Bolt	RDS 55028-1
86-65	Housing Cover	All Models	8.5" Ring Gear	10-Bolt	RDS 6629

¹Superseded or Discontinued

DRIVETRAIN GASKETS

Year	Part Type	Model Name	Description	Bolt Holes	Part Number
Avanti (Cont.)					
Automatic Transmission					
85-82	Oil Pan	GMC THM200-4R	3 Speed	16-Bolt	TOS 18662
81-71	Oil Pan	GMC THM350	3 Speed	13-Bolt	TOS 18633
86	Oil Pan	GMC THM400	3 Speed	13-Bolt	TOS 18621
70-65	Oil Pan	GMC THM400	3 Speed	13-Bolt	TOS 18621
91-87	Oil Pan	GMC THM700-R4	4 Speed	16-Bolt	TOS 18663
03-01	Oil Pan	GMC 4L60-E	4 Speed	16-Bolt	TOS 18663
Bentley					
Automatic Transmission					
90-68	Oil Pan	GMC THM400	3 Speed	13-Bolt	TOS 18621
07-91	Oil Pan	GMC 4L80-E	4 Speed	17-Bolt	TOS 18698
BMW Car					
Automatic Transaxle					
14-05	Oil Pan	Mini Cooper	Aisin TF-61SN (6 Speed)	8-Bolt	TOS 18761
Automatic Transmission					
00-91	Oil Pan	GMC 4L30-E	4 Speed	16-Bolt	TOS 18704
Bricklin					
Rear Axle					
76-74	Housing Cover	SV1	8.875" Ring Gear	12-Bolt	RDS 13889
Automatic Transmission					
76-74	Oil Pan	Ford FMX	3 Speed	14-Bolt	TOS 18106
British Leyland					
Automatic Transmission					
62-54	Oil Pan	Borg-Warner DG200	2 Speed	14-Bolt	TOS 18106
Checker					
Rear Axle					
82-60	Housing Cover	All Models	8.5" Ring Gear	10-Bolt	RDS 6629
Automatic Transmission					
75-60	Oil Pan	Borg-Warner Flash-O-Matic	3 Speed	14-Bolt	TOS 18106
82-69	Oil Pan	GMC THM400	3 Speed	13-Bolt	TOS 18621
Manual Transmission					
71-60	Transmission Kit	Borg-Warner T86	3 Speed		TS 5135-2
Chrysler Car					
Rear Axle					
89-75	Housing Cover	Chrysler Full-Size	7.25" Ring Gear	9-Bolt	RDS 12775
89-75	Housing Cover	Chrysler Full-Size	7.25" Ring Gear	10-Bolt	RDS 55392
89-75	Housing Cover	Chrysler Full-Size	7.5" Ring Gear	9-Bolt	RDS 12775
89-75	Housing Cover	Chrysler Full-Size	8.25" Ring Gear	10-Bolt	RDS 55047
89-75	Housing Cover	Chrysler Full-Size	8.5" Ring Gear	10-Bolt	RDS 55047
89-75	Housing Cover	Chrysler Full-Size	9.5" Ring Gear	12-Bolt	RDS 55073
89-75	Flange	Chrysler Full-Size	2 3/32" x 4 1/32"	5-Bolt	(2) 13800
89-75	Flange	Chrysler Full-Size	2 25/32" x 4 9/16"	4-Bolt	(2-4) 13802
89-75	Flange	Chrysler Full-Size	2 59/64" x 4 1/32"	5-Bolt	(2) 55032
74-61	Differential Carrier	Chrysler Full-Size	7.25" Ring Gear	10-Bolt	RDS 6583
74-61	Differential Carrier	Chrysler Full-Size	8.75" Ring Gear	10-Bolt	RDS 6583
74-61	Housing Cover	Chrysler Full-Size	7.25" Ring Gear	9-Bolt	RDS 12775
74-61	Housing Cover	Chrysler Full-Size	8.25" Ring Gear	10-Bolt	RDS 55047
74-61	Housing Cover	Chrysler Full-Size	9.75" Ring Gear	10-Bolt	RDS 6095-1
74-61	Flange	Chrysler Full-Size	2 3/32" x 4 1/32"	5-Bolt	(2) 13800
74-61	Flange	Chrysler Full-Size	2 25/32" x 4 9/16"	4-Bolt	(2-4) 13802
74-61	Flange	Chrysler Full-Size	2 59/64" x 4 1/32"	5-Bolt	(2) 55032
80-76	Differential Carrier	Arrow		10-Bolt	RDS 55336
80-76	Housing Cover	Aspen	7.25" Ring Gear	9-Bolt	RDS 12775
80-76	Housing Cover	Aspen	8.25" Ring Gear	10-Bolt	RDS 55047
80-76	Flange	Aspen	2 3/32" x 4 1/32"	5-Bolt	(2-4) 13800
80-76	Flange	Aspen	2 59/64" x 4 1/32"	5-Bolt	(2-4) 55032
83-78	Differential Carrier	Challenger		10-Bolt	RDS 55336
83-75	Housing Cover	Cordoba	7.25" Ring Gear	9-Bolt	RDS 12775
83-75	Housing Cover	Cordoba	8.25" Ring Gear	10-Bolt	RDS 55047
83-75	Housing Cover	Cordoba	9.25" Ring Gear	12-Bolt	RDS 55073

Year	Part Type	Model Name	Description	Bolt Holes	Part Number
Chrysler Car (Cont.)					
Rear Axle (Cont.)					
83-75	Flange	Cordoba	2 3/32" x 4 1/32"	5-Bolt	(2-4) 13800
83-75	Flange	Cordoba	2 59/64" x 4 1/32"	5-Bolt	(2-4) 55032
76-73	Housing Cover	Dart	7.25" Ring Gear	9-Bolt	RDS 12775
76-73	Housing Cover	Dart	8.25" Ring Gear	10-Bolt	RDS 55047
76-73	Flange	Dart	2 3/32" x 4 1/32"	5-Bolt	(2) 13800
76-73	Flange	Dart	2 25/32" x 4 9/16"	4-Bolt	(2-4) 13802
76-73	Flange	Dart	2 59/64" x 4 1/32"	5-Bolt	(2) 55032
72-67	Housing Cover	Dart	7.25" Ring Gear	9-Bolt	RDS 12775
72-67	Housing Cover	Dart	8.25" Ring Gear	10-Bolt	RDS 55047
72-67	Differential Carrier	Dart	8.75" Ring Gear	10-Bolt	RDS 6583
72-67	Flange	Dart	2 3/32" x 4 1/32"	5-Bolt	(2) 13800
72-67	Flange	Dart	2 25/32" x 4 9/16"	4-Bolt	(2-4) 13802
72-67	Flange	Dart	2 59/64" x 4 1/32"	5-Bolt	(2) 55032
66-63	Housing Cover	Dart	7.25" Ring Gear	9-Bolt	RDS 12775
66-63	Flange	Dart	2 25/32" x 4 9/16"	4-Bolt	(4) 13802
89-77	Housing Cover	Diplomat	7.25" Ring Gear	9-Bolt	RDS 12775
89-77	Housing Cover	Diplomat	8.25" Ring Gear	10-Bolt	RDS 55047
89-77	Flange	Diplomat	2 3/32" x 4 1/32"	5-Bolt	(2) 13800
89-77	Flange	Diplomat	2 25/32" x 4 9/16"	4-Bolt	(2-4) 13802
89-77	Flange	Diplomat	2 59/64" x 4 1/32"	5-Bolt	(2) 55032
83-81	Housing Cover	Imperial	7.25" Ring Gear	9-Bolt	RDS 12775
83-81	Housing Cover	Imperial	8.25" Ring Gear	10-Bolt	RDS 55047
83-81	Flange	Imperial	2 3/32" x 4 1/32"	5-Bolt	(2) 13800
83-81	Flange	Imperial	2 25/32" x 4 9/16"	4-Bolt	(2-4) 13802
83-81	Flange	Imperial	2 59/64" x 4 1/32"	5-Bolt	(2) 55032
75-74	Housing Cover	Imperial	9.5" Ring Gear	12-Bolt	RDS 55073
73-65	Differential Carrier	Imperial	8.75" Ring Gear	10-Bolt	RDS 6583
73-65	Flange	Imperial	2 3/32" x 4 1/32"	5-Bolt	(2) 13800
73-65	Flange	Imperial	2 25/32" x 4 9/16"	4-Bolt	(2-4) 13802
73-65	Flange	Imperial	2 59/64" x 4 1/32"	5-Bolt	(2) 55032
81-77	Housing Cover	LeBaron	7.25" Ring Gear	9-Bolt	RDS 12775
81-77	Housing Cover	LeBaron	8.25" Ring Gear	10-Bolt	RDS 55047
81-77	Flange	LeBaron	2 3/32" x 4 1/32"	5-Bolt	(2) 13800
81-77	Flange	LeBaron	2 25/32" x 4 9/16"	4-Bolt	(2-4) 13802
81-77	Flange	LeBaron	2 59/64" x 4 1/32"	5-Bolt	(2) 55032
83-80	Housing Cover	Mirada	7.25" Ring Gear	9-Bolt	RDS 12775
83-80	Housing Cover	Mirada	8.25" Ring Gear	10-Bolt	RDS 55047
83-80	Housing Cover	Mirada	9.25" Ring Gear	12-Bolt	RDS 55073
83-80	Flange	Mirada	2 3/32" x 4 1/32"	5-Bolt	(2) 13800
83-80	Flange	Mirada	2 25/32" x 4 9/16"	4-Bolt	(2-4) 13802
83-80	Flange	Mirada	2 59/64" x 4 1/32"	5-Bolt	(2) 55032
83-78	Differential Carrier	Sapporo		10-Bolt	RDS 55336
83-61	Housing Cover	Valiant	7.25" Ring Gear	9-Bolt	RDS 12775
83-61	Housing Cover	Valiant	8.25" Ring Gear	10-Bolt	RDS 55047
83-61	Differential Carrier	Valiant	8.75" Ring Gear	10-Bolt	RDS 6583
83-61	Flange	Valiant	2 3/32" x 4 1/32"	5-Bolt	(2) 13800
83-61	Flange	Valiant	2 25/32" x 4 9/16"	4-Bolt	(2-4) 13802
83-61	Flange	Valiant	2 59/64" x 4 1/32"	5-Bolt	(2) 55032
81-76	Housing Cover	Volare	7.25" Ring Gear	9-Bolt	RDS 12775
81-76	Housing Cover	Volare	8.25" Ring Gear	10-Bolt	RDS 55047
81-76	Flange	Volare	2 3/32" x 4 1/32"	5-Bolt	(2) 13800
81-76	Flange	Volare	2 25/32" x 4 9/16"	4-Bolt	(2-4) 13802
81-76	Flange	Volare	2 59/64" x 4 1/32"	5-Bolt	(2) 55032
Automatic Transaxle					
03-92	Differential Cover	31TH	3 Speed	10-Bolt	RDS 55351
03-92	End Cover	31TH	3 Speed	10-Bolt	RDS 55470
03-92	Oil Pan	31TH	3 Speed	14-Bolt	TOS 18658
92-78	Differential Cover	A404, A413, A470, A670	3 Speed	10-Bolt	RDS 55351
92-78	End Cover	A404, A413, A470, A670	3 Speed	10-Bolt	RDS 55470
92-78	Oil Pan	A404, A413, A470, A670	3 Speed	14-Bolt	TOS 18658
14-89	Differential Cover	A604, 40TE, 41AE, 41TE	4 Speed	12-Bolt	RDS 55481
14-89	Oil Pan	A604, 40TE, 41AE, 41TE	4 Speed	14-Bolt	TOS 18687
07-92	Oil Pan	A606, 42LE	4 Speed	13-Bolt	TOS 18705
15-07	Oil Pan	62TE	6 Speed	12-Bolt	TOS 18757
14-07	Oil Pan	Jatco JF011E	CVT (Continuous Variable Ratio)	18-Bolt	TOS 18755

DRIVETRAIN GASKETS

Year	Part Type	Model Name	Description	Bolt Holes	Part Number
Chrysler Car (Cont.)					
Automatic Transaxle (Cont.)					
96-81	Oil Pan	Champ, Colt, Summit		12-Bolt	TOS 18665
98-92	Oil Pan	Colt Vista, Summit Wagon	FWD	12-Bolt	TOS 18665
94-92	Oil Pan	Colt Vista, Summit Wagon	FWD	13-Bolt	TOS 18681 ¹
98-92	Oil Pan	Colt Vista, Summit Wagon	AWD	14-Bolt	TOS 18703
94-89	Oil Pan	Laser, Talon	Exc. Turbo	12-Bolt	TOS 18665
98-89	Oil Pan	Laser, Talon	Turbo	14-Bolt	TOS 18703
89-88	Oil Pan	Medallion	MJ3	0-Bolt	TOS 18670 ¹
96-90	Oil Pan	Stealth	FWD	14-Bolt	TOS 18703
Automatic Transmission					
61-53	Oil Pan	A323 Powerflite	2 Speed	18-Bolt	TOS 18407
83-74	Oil Pan	A94-1, A904 (Imports)	3 Speed	14-Bolt	TOS 18651 ¹
61-53	Oil Pan	A466 Torqueflite	3 Speed	18-Bolt	TOS 18333
89-62	Oil Pan	A727	3 Speed	14-Bolt	TOS 18583
89-62	Oil Pan	A904, A999	3 Speed	14-Bolt	TOS 18667
89-84	Oil Pan	Conquest	4 Speed	14-Bolt	TOS 18644
14-05	Oil Pan	42RLE	4 Speed	13-Bolt	TOS 18743
07-05	Oil Pan	45RFE	4 Speed	15-Bolt	TOS 18733
08-04	Oil Pan	W5A330	5 Speed	0-Bolt	TOS 18749 ¹
08-04	Oil Pan	W5A330	5 Speed	0-Bolt	TOS 18764
16-05	Oil Pan	W5A580	5 Speed	0-Bolt	TOS 18764
07-05	Oil Pan	5-45RFE	5 Speed	15-Bolt	TOS 18733
Manual Transmission					
78-66	Transmission Kit	A833	4 Speed		TS 13381-5
89-70	Transmission Kit	Mitsubishi	4 Speed		TS 80310-1
89-70	Transmission Kit	Mitsubishi	5 Speed		TS 80310-1
Dodge Truck					
Front Axle					
09-07	Differential Carrier	Aspen	8" Ring Gear	12-Bolt	RDS 55471
11-00	Differential Carrier	Dakota	8" Ring Gear	12-Bolt	RDS 55471
96-88	Differential Carrier	Dakota	7.25" Ring Gear	10-Bolt	RDS 55391
09-00	Differential Carrier	Durango	8" Ring Gear	12-Bolt	RDS 55471
14-02	Differential Carrier	Full-Size	8" Ring Gear	12-Bolt	RDS 55471
14-02	Differential Carrier	Full-Size	9.25" Ring Gear	14-Bolt	RDS 55474
02-91	Differential Carrier	Full-Size	Dana 44	10-Bolt	RDS 6629
02-91	Differential Carrier	Full-Size	Dana 60	10-Bolt	RDS 6095-1
90-75	Differential Carrier	Full-Size	Dana 60	10-Bolt	RDS 6095-1
Rear Axle					
09-07	Housing Cover	Aspen	8.25" Ring Gear	10-Bolt	RDS 55047
09-07	Housing Cover	Aspen	9.25" Ring Gear	12-Bolt	RDS 55073
11-99	Housing Cover	Dakota	8.25" Ring Gear	10-Bolt	RDS 55047
11-99	Housing Cover	Dakota	9.25" Ring Gear	12-Bolt	RDS 55073
98-87	Housing Cover	Dakota	7.25" Ring Gear	10-Bolt	RDS 55392
98-87	Housing Cover	Dakota	8.25" Ring Gear	10-Bolt	RDS 55047
98-87	Housing Cover	Dakota	9.25" Ring Gear	12-Bolt	RDS 55073
09-00	Housing Cover	Durango	8.25" Ring Gear	10-Bolt	RDS 55047
09-00	Housing Cover	Durango	9.25" Ring Gear	12-Bolt	RDS 55073
11-07	Housing Cover	Nitro	8.25" Ring Gear	10-Bolt	RDS 55047
14-03	Housing Cover	1/2 Ton	9.25" Ring Gear	12-Bolt	RDS 55073
14-03	Housing Cover	1/2 Ton	10.5" Ring Gear	14-Bolt	RDS 55472
02-99	Housing Cover	1/2 Ton	9.25" Ring Gear	12-Bolt	RDS 55073
98-91	Housing Cover	1/2 Ton	8.25" Ring Gear	10-Bolt	RDS 55047
98-91	Housing Cover	1/2 Ton	8.375" Ring Gear	10-Bolt	RDS 55047
98-91	Housing Cover	1/2 Ton	9.25" Ring Gear	12-Bolt	RDS 55073
98-91	Housing Cover	1/2 Ton	Dana 60	10-Bolt	RDS 6095-1
98-91	Housing Cover	1/2 Ton	Dana 70	10-Bolt	RDS 6095-1
90-84	Housing Cover	1/2 Ton	7.25" Ring Gear	10-Bolt	RDS 55392
90-84	Housing Cover	1/2 Ton	8.25" Ring Gear	10-Bolt	RDS 55047
90-84	Housing Cover	1/2 Ton	8.375" Ring Gear	10-Bolt	RDS 55047
90-84	Housing Cover	1/2 Ton	9.25" Ring Gear	12-Bolt	RDS 55073
90-84	Housing Cover	1/2 Ton	Dana 60	10-Bolt	RDS 6095-1
90-84	Flange	1/2 Ton	Dana 60	8-Bolt	(2) 12579
83-72	Housing Cover	1/2 Ton	8.375" Ring Gear	10-Bolt	RDS 55047
83-72	Differential Carrier	1/2 Ton	8.75" Ring Gear	10-Bolt	RDS 6583
83-72	Housing Cover	1/2 Ton	9.25" Ring Gear	12-Bolt	RDS 55073

Year	Part Type	Model Name	Description	Bolt Holes	Part Number
Dodge Truck (Cont.)					
Rear Axle (Cont.)					
71-69	Housing Cover	1/2 Ton	8.375" Ring Gear	10-Bolt	RDS 55047
71-69	Differential Carrier	1/2 Ton	8.75" Ring Gear	10-Bolt	RDS 6583
68-59	Differential Carrier	1/2 Ton	8.75" Ring Gear	10-Bolt	RDS 6583
68-59	Housing Cover	1/2 Ton	Dana 60	10-Bolt	RDS 6095-1
68-59	Flange	1/2 Ton	Dana 60	8-Bolt	(2) 12579
58-57	Differential Carrier	1/2 Ton	8.75" Ring Gear	10-Bolt	RDS 6583
14-03	Housing Cover	3/4 Ton	9.25" Ring Gear	12-Bolt	RDS 55073
14-03	Housing Cover	3/4 Ton	10.5" Ring Gear	14-Bolt	RDS 55472
14-03	Housing Cover	3/4 Ton	11.5" Ring Gear	14-Bolt	RDS 55473
14-03	Housing Cover	3/4 Ton	Dana 60	10-Bolt	RDS 6095-1
02-99	Housing Cover	3/4 Ton	9.25" Ring Gear	12-Bolt	RDS 55073
02-99	Housing Cover	3/4 Ton	Dana 60	10-Bolt	RDS 6095-1
98-91	Housing Cover	3/4 Ton	8.25" Ring Gear	10-Bolt	RDS 55047
98-91	Housing Cover	3/4 Ton	8.375" Ring Gear	10-Bolt	RDS 55047
98-91	Housing Cover	3/4 Ton	9.25" Ring Gear	12-Bolt	RDS 55073
98-91	Housing Cover	3/4 Ton	Dana 60	10-Bolt	RDS 6095-1
98-91	Housing Cover	3/4 Ton	Dana 70	10-Bolt	RDS 6095-1
98-91	Housing Cover	3/4 Ton	Dana 71	10-Bolt	RDS 6095-1
90-84	Housing Cover	3/4 Ton	8.25" Ring Gear	10-Bolt	RDS 55047
90-84	Housing Cover	3/4 Ton	8.375" Ring Gear	10-Bolt	RDS 55047
90-84	Housing Cover	3/4 Ton	9.25" Ring Gear	12-Bolt	RDS 55073
90-84	Housing Cover	3/4 Ton	Dana 60	10-Bolt	RDS 6095-1
90-84	Flange	3/4 Ton	Dana 60	8-Bolt	(2) 12579
83-78	Housing Cover	3/4 Ton	8.375" Ring Gear	10-Bolt	RDS 55047
83-78	Housing Cover	3/4 Ton	9.25" Ring Gear	12-Bolt	RDS 55073
83-78	Housing Cover	3/4 Ton	Dana 60	10-Bolt	RDS 6095-1
83-78	Flange	3/4 Ton	Dana 60	8-Bolt	(2) 12579
77-74	Housing Cover	3/4 Ton	8.375" Ring Gear	10-Bolt	RDS 55047
77-74	Differential Carrier	3/4 Ton	8.75" Ring Gear	10-Bolt	RDS 6583
77-74	Housing Cover	3/4 Ton	9.25" Ring Gear	12-Bolt	RDS 55073
77-74	Housing Cover	3/4 Ton	Dana 60	10-Bolt	RDS 6095-1
77-74	Flange	3/4 Ton	Dana 60	8-Bolt	(2) 12579
73-69	Housing Cover	3/4 Ton	8.375" Ring Gear	10-Bolt	RDS 55047
73-69	Differential Carrier	3/4 Ton	8.75" Ring Gear	10-Bolt	RDS 6583
73-69	Housing Cover	3/4 Ton	Dana 60	10-Bolt	RDS 6095-1
73-69	Housing Cover	3/4 Ton	Dana 70	10-Bolt	RDS 6095-1
73-69	Flange	3/4 Ton	Dana 60	8-Bolt	(2) 12579
73-69	Flange	3/4 Ton	Dana 70	8-Bolt	(2) 12579
68-63	Housing Cover	3/4 Ton	Dana 60	10-Bolt	RDS 6095-1
68-63	Housing Cover	3/4 Ton	Dana 70	10-Bolt	RDS 6095-1
68-63	Flange	3/4 Ton	Dana 60	8-Bolt	(2) 12579
68-63	Flange	3/4 Ton	Dana 70	8-Bolt	(2) 12579
62-61	Housing Cover	3/4 Ton	Dana 60	10-Bolt	RDS 6095-1
62-61	Flange	3/4 Ton	Dana 60	8-Bolt	(2) 12579
62-61	Flange	3/4 Ton	Chrysler	6-Bolt	(A/R) 4390
60-57	Flange	3/4 Ton	Chrysler	6-Bolt	(A/R) 4390
14-03	Housing Cover	1 Ton	9.25" Ring Gear	12-Bolt	RDS 55073
14-03	Housing Cover	1 Ton	10.5" Ring Gear	14-Bolt	RDS 55472
14-03	Housing Cover	1 Ton	11.5" Ring Gear	14-Bolt	RDS 55473
14-03	Housing Cover	1 Ton	Dana 60	10-Bolt	RDS 6095-1
02-99	Housing Cover	1 Ton	9.25" Ring Gear	12-Bolt	RDS 55073
02-99	Housing Cover	1 Ton	Dana 60	10-Bolt	RDS 6095-1
98-91	Housing Cover	1 Ton	8.25" Ring Gear	10-Bolt	RDS 55047
98-91	Housing Cover	1 Ton	8.375" Ring Gear	10-Bolt	RDS 55047
98-91	Housing Cover	1 Ton	9.25" Ring Gear	12-Bolt	RDS 55073
98-91	Housing Cover	1 Ton	Dana 60	10-Bolt	RDS 6095-1
98-91	Housing Cover	1 Ton	Dana 70	10-Bolt	RDS 6095-1
98-91	Housing Cover	1 Ton	Dana 71	10-Bolt	RDS 6095-1
90-86	Housing Cover	1 Ton	9.25" Ring Gear	12-Bolt	RDS 55073
90-86	Housing Cover	1 Ton	Dana 60	10-Bolt	RDS 6095-1
90-86	Housing Cover	1 Ton	Dana 70	10-Bolt	RDS 6095-1
90-86	Flange	1 Ton	Dana 60	8-Bolt	(2) 12579
90-86	Flange	1 Ton	Dana 70	8-Bolt	(2) 12579
85-84	Housing Cover	1 Ton	8.375" Ring Gear	10-Bolt	RDS 55047
85-84	Housing Cover	1 Ton	Dana 60	10-Bolt	RDS 6095-1
85-84	Housing Cover	1 Ton	Dana 70	10-Bolt	RDS 6095-1

DRIVETRAIN GASKETS

Year	Part Type	Model Name	Description	Bolt Holes	Part Number
Dodge Truck (Cont.)					
Rear Axle (Cont.)					
85-84	Flange	1 Ton	Dana 60	8-Bolt	(2) 12579
85-84	Flange	1 Ton	Dana 70	8-Bolt	(2) 12579
83-63	Housing Cover	1 Ton	Dana 60	10-Bolt	RDS 6095-1
83-63	Housing Cover	1 Ton	Dana 70	10-Bolt	RDS 6095-1
83-63	Flange	1 Ton	Dana 60	8-Bolt	(2) 12579
83-63	Flange	1 Ton	Dana 70	8-Bolt	(2) 12579
62-60	Housing Cover	1 Ton	Dana 60	10-Bolt	RDS 6095-1
62-60	Housing Cover	1 Ton	Dana 70	10-Bolt	RDS 6095-1
62-60	Flange	1 Ton	Dana 60	8-Bolt	(2) 12579
62-60	Flange	1 Ton	Dana 70	8-Bolt	(2) 12579
62-60	Flange	1 Ton	Chrysler	6-Bolt	(A/R) 4390
59-57	Flange	1 Ton	Chrysler	6-Bolt	(A/R) 4390
Power Take-Off (PTO)					
	Cover	Chelsea		6-Bolt	55372
	Mounting	Chelsea	(.010")	6-Bolt	55379
	Mounting	Chelsea	(.020")	6-Bolt	55380
	Mounting	Chelsea	(.010")	8-Bolt	55375
	Mounting	Chelsea	(.020")	8-Bolt	55377
Transfer Case					
79-74	Transfer Case Kit	New Process 203	Full-Time 2 Speed		TS 80683 ¹
Automatic Transaxle					
03-92	Differential Cover	31TH	3 Speed	10-Bolt	RDS 55351
03-92	End Cover	31TH	3 Speed	10-Bolt	RDS 55470
03-92	Oil Pan	31TH	3 Speed	14-Bolt	TOS 18658
92-82	Differential Cover	A404, A413, A470, A670	3 Speed	10-Bolt	RDS 55351
92-82	End Cover	A404, A413, A470, A670	3 Speed	10-Bolt	RDS 55470
92-82	Oil Pan	A404, A413, A470, A670	3 Speed	14-Bolt	TOS 18658
14-90	Differential Cover	A604, 40TE, 41AE, 41TE	4 Speed	12-Bolt	RDS 55481
14-90	Oil Pan	A604, 40TE, 41AE, 41TE	4 Speed	14-Bolt	TOS 18687
15-07	Oil Pan	62TE	6 Speed	12-Bolt	TOS 18757
Automatic Transmission					
58-54	Oil Pan	A323 Powerflite	2 Speed	18-Bolt	TOS 18407
83-79	Oil Pan	A94-1, A904 (Imports)	3 Speed	14-Bolt	TOS 18651 ¹
62-59	Oil Pan	A466 Loadflite	3 Speed	18-Bolt	TOS 18333
93-62	Oil Pan	A727	3 Speed	14-Bolt	TOS 18583
93-79	Oil Pan	A904, A998, A999	3 Speed	14-Bolt	TOS 18667
04-94	Oil Pan	31RH, 32RH	3 Speed	14-Bolt	TOS 18667
03-94	Oil Pan	36RH	3 Speed	14-Bolt	TOS 18583
93-90	Oil Pan	A500, A500SE	4 Speed	14-Bolt	TOS 18667
93-90	Oil Pan	A518	4 Speed	14-Bolt	TOS 18583
89-87	Oil Pan	Mitsubishi	4 Speed	7-Bolt	TOS 18754
89-87	Oil Pan	Mitsubishi	4 Speed	14-Bolt	TOS 18646
04-94	Oil Pan	42RE, 42RH, 44RE	4 Speed	14-Bolt	TOS 18667
12-04	Oil Pan	42RLE	4 Speed	13-Bolt	TOS 18743
14-99	Oil Pan	45RFE	4 Speed	15-Bolt	TOS 18733
10-94	Oil Pan	46RE, 46RH, 47RE, 47RH, 48RE	4 Speed	14-Bolt	TOS 18583
16-07	Oil Pan	W5A380	5 Speed	0-Bolt	TOS 18749 ¹
16-07	Oil Pan	W5A380	5 Speed	0-Bolt	TOS 18764
06-03	Oil Pan	W5A380	5 Speed	0-Bolt	TOS 18745 ¹
06-03	Oil Pan	W5A380	5 Speed	0-Bolt	TOS 18764
16-07	Oil Pan	W5A580	5 Speed	0-Bolt	TOS 18749 ¹
16-07	Oil Pan	W5A580	5 Speed	0-Bolt	TOS 18764
14-02	Oil Pan	5-45RFE	5 Speed	15-Bolt	TOS 18733
Manual Transmission					
83-68	Transmission Kit	A833	4 Speed		TS 13381-5
86-79	Transmission Kit	Mitsubishi	4 Speed		TS 80310-1
93-79	Transmission Kit	Mitsubishi	5 Speed		TS 80310-1
Fiat					
Automatic Transaxle					
89-84	Oil Pan	X 1/9	VW 010	0-Bolt	TOS 18649 ¹

Year	Part Type	Model Name	Description	Bolt Holes	Part Number
Ford Car					
Rear Axle					
80	Housing Cover	Bobcat	6.75" Ring Gear	8-Bolt	RDS 55323
80	Differential Carrier	Bobcat	8" Ring Gear	10-Bolt	RDS 13270
80	Flange	Bobcat	6.75" Ring Gear	4-Bolt	(2) 55319
80	Flange	Bobcat	8" Ring Gear	4-Bolt	(2) 55080
80	Flange	Bobcat	9" Ring Gear	4-Bolt	(2) 55080
79	Housing Cover	Bobcat	6.75" Ring Gear	8-Bolt	RDS 13073
79	Bearing Retainer	Bobcat		4-Bolt	(2) 55319
78-75	Housing Cover	Bobcat	6.75" Ring Gear	8-Bolt	RDS 13073
78-75	Differential Carrier	Bobcat	8" Ring Gear	10-Bolt	RDS 13270
78-75	Bearing Retainer	Bobcat	6.75" Ring Gear	4-Bolt	(2) 55319
78-75	Bearing Retainer	Bobcat	8" Ring Gear	4-Bolt	(2) 55319
74	Housing Cover	Bobcat	6.75" Ring Gear	8-Bolt	RDS 13073
74	Bearing Retainer	Bobcat		4-Bolt	(2) 55319
86-84	Housing Cover	Capri (From 05/01/84)	7.5" Ring Gear	10-Bolt	RDS 55081
84-83	Housing Cover	Capri (To 04/30/84)	7.5" Ring Gear	10-Bolt	RDS 55393
86-83	Housing Cover	Capri	8.8" Ring Gear	10-Bolt	RDS 55341
82-78	Housing Cover	Capri	6.75" Ring Gear	8-Bolt	RDS 55323
82-78	Housing Cover	Capri	7.5" Ring Gear	10-Bolt	RDS 55393
82-78	Bearing Retainer	Capri	6.75" Ring Gear	4-Bolt	(2) 55319
77-73	Differential Carrier	Comet	8" Ring Gear	10-Bolt	RDS 13270
77-73	Backing Plate	Comet		4-Bolt	(2) 55035
72-71	Differential Carrier	Comet	8" Ring Gear	10-Bolt	RDS 13270
72-71	Backing Plate	Comet		4-Bolt	(2) 4978
72-71	Backing Plate	Comet		4-Bolt	(2) 55035
70-69	Differential Carrier	Comet	8" Ring Gear	10-Bolt	RDS 13270
70-69	Differential Carrier	Comet	9" Ring Gear	10-Bolt	RDS 55074
70-69	Bearing Retainer	Comet		4-Bolt	(2) 4828
68-66	Housing Cover	Comet	7.25" Ring Gear	8-Bolt	RDS 13073
68-66	Differential Carrier	Comet	8" Ring Gear	10-Bolt	RDS 13270
68-66	Differential Carrier	Comet	9" Ring Gear	10-Bolt	RDS 55074
68-66	Backing Plate	Comet		4-Bolt	(2) 4828
68-66	Bearing Retainer	Comet		4-Bolt	(2) 55001
65-62	Housing Cover	Comet	7.25" Ring Gear	8-Bolt	RDS 13073
65-62	Differential Carrier	Comet	8" Ring Gear	10-Bolt	RDS 13270
65-62	Backing Plate	Comet		4-Bolt	(2) 4828
65-62	Backing Plate	Comet		4-Bolt	(2) 4978
65-62	Bearing Retainer	Comet		4-Bolt	(2) 5578
65-62	Bearing Retainer	Comet		4-Bolt	(2) 55001
61-60	Housing Cover	Comet	7.25" Ring Gear	8-Bolt	RDS 13073
61-60	Backing Plate	Comet		4-Bolt	(2) 4978
61-60	Bearing Retainer	Comet		4-Bolt	(2) 5578
97-89	Housing Cover	Cougar	7.5" Ring Gear	10-Bolt	RDS 55459
97-89	Housing Cover	Cougar	8.8" Ring Gear	10-Bolt	RDS 55460
88-86	Housing Cover	Cougar	7.5" Ring Gear	10-Bolt	RDS 55081
88-86	Housing Cover	Cougar	8.8" Ring Gear	10-Bolt	RDS 55341
85-84	Housing Cover	Cougar (From 05/01/84)	7.5" Ring Gear	10-Bolt	RDS 55081
84-80	Housing Cover	Cougar (To 04/30/84)	7.5" Ring Gear	10-Bolt	RDS 55393
79-73	Differential Carrier	Cougar	9" Ring Gear	10-Bolt	RDS 55074
79-73	Backing Plate	Cougar		4-Bolt	(2) 55065
73	Backing Plate	Cougar		4-Bolt	(2) 55035
72-67	Differential Carrier	Cougar	8" Ring Gear	10-Bolt	RDS 13270
72-67	Differential Carrier	Cougar	9" Ring Gear	10-Bolt	RDS 55074
72-70	Backing Plate	Cougar		4-Bolt	(2) 55035
69-67	Backing Plate	Cougar		4-Bolt	(2) 4828
68-67	Bearing Retainer	Cougar		4-Bolt	(2) 55001
71-67	Differential Carrier	Cyclone	8" Ring Gear	10-Bolt	RDS 13270
71-67	Differential Carrier	Cyclone	9" Ring Gear	10-Bolt	RDS 55074
71-70	Backing Plate	Cyclone (From 09/30/69)		4-Bolt	(2) 55035
70-67	Backing Plate	Cyclone (To 09/29/69)		4-Bolt	(2) 4828
66	Housing Cover	Cyclone	7.25" Ring Gear	8-Bolt	RDS 13073
66	Differential Carrier	Cyclone	8" Ring Gear	10-Bolt	RDS 13270
66	Differential Carrier	Cyclone	9" Ring Gear	10-Bolt	RDS 55074
66	Backing Plate	Cyclone		4-Bolt	(2) 4828
66	Bearing Retainer	Cyclone		4-Bolt	(2) 55001
65-64	Housing Cover	Cyclone	7.25" Ring Gear	8-Bolt	RDS 13073
65-64	Differential Carrier	Cyclone	8" Ring Gear	10-Bolt	RDS 13270

DRIVETRAIN GASKETS

Year	Part Type	Model Name	Description	Bolt Holes	Part Number
Ford Car (Cont.)					
Rear Axle (Cont.)					
65-64	Backing Plate	Cyclone		4-Bolt	(2) 4828
65-64	Bearing Retainer	Cyclone		4-Bolt	(2) 55001
70-69	Differential Carrier	Fairlane	8" Ring Gear	10-Bolt	RDS 13270
70-69	Differential Carrier	Fairlane	9" Ring Gear	10-Bolt	RDS 55074
70	Backing Plate	Fairlane		4-Bolt	(2) 55035
69	Backing Plate	Fairlane		4-Bolt	(2) 4828
70-69	Bearing Retainer	Fairlane		4-Bolt	(2) 55001
68	Housing Cover	Fairlane	8" Ring Gear	8-Bolt	RDS 13073
68	Housing Cover	Fairlane	9" Ring Gear	8-Bolt	RDS 13073
68	Differential Carrier	Fairlane	8" Ring Gear	10-Bolt	RDS 13270
68	Differential Carrier	Fairlane	9" Ring Gear	10-Bolt	RDS 55074
68	Backing Plate	Fairlane		4-Bolt	(2) 4828
68	Bearing Retainer	Fairlane		4-Bolt	(2) 55001
67-64	Differential Carrier	Fairlane	7.75" Ring Gear	10-Bolt	RDS 13270
67-64	Differential Carrier	Fairlane	8" Ring Gear	10-Bolt	RDS 13270
67-64	Differential Carrier	Fairlane	9" Ring Gear	10-Bolt	RDS 55074
67-64	Differential Carrier	Fairlane	9.375" Ring Gear	10-Bolt	RDS 55074
67-64	Backing Plate	Fairlane		4-Bolt	(2) 4828
67-64	Bearing Retainer	Fairlane		4-Bolt	(2) 55001
63-62	Differential Carrier	Fairlane	8" Ring Gear	10-Bolt	RDS 13270
63-62	Backing Plate	Fairlane		4-Bolt	(2) 4828
63-62	Bearing Retainer	Fairlane		4-Bolt	(2) 55001
62	Bearing Retainer	Fairlane		5-Bolt	(2) 10720
83	Housing Cover	Fairmont	6.75" Ring Gear	8-Bolt	RDS 55323
83	Bearing Retainer	Fairmont		4-Bolt	(2) 55319
82-78	Housing Cover	Fairmont	6.75" Ring Gear	8-Bolt	RDS 55323
82-78	Housing Cover	Fairmont	7.5" Ring Gear	10-Bolt	RDS 55393
82-78	Bearing Retainer	Fairmont		4-Bolt	(2) 55035
70	Housing Cover	Falcon	7.25" Ring Gear	8-Bolt	RDS 13073
70	Differential Carrier	Falcon	8" Ring Gear	10-Bolt	RDS 13270
70	Flange	Falcon		4-Bolt	(2) 4978
70	Flange	Falcon		4-Bolt	(2) 55035
69-63	Housing Cover	Falcon	7.25" Ring Gear	8-Bolt	RDS 13073
69-63	Differential Carrier	Falcon	8" Ring Gear	10-Bolt	RDS 13270
69-63	Backing Plate	Falcon		4-Bolt	(2) 4828
69-63	Backing Plate	Falcon		4-Bolt	(2) 4978
69-63	Bearing Retainer	Falcon		4-Bolt	(2) 5578
69-63	Bearing Retainer	Falcon		4-Bolt	(2) 55001
62-60	Housing Cover	Falcon	7.25" Ring Gear	8-Bolt	RDS 13073
62-60	Backing Plate	Falcon		4-Bolt	(2) 4978
11-97	Housing Cover	Ford Full-Size	8.8" Ring Gear	10-Bolt	RDS 55341
96-82	Housing Cover	Ford Full-Size	8.5" Ring Gear	10-Bolt	RDS 55341
96-82	Housing Cover	Ford Full-Size	8.8" Ring Gear	10-Bolt	RDS 55341
81-80	Housing Cover	Ford Full-Size	7.5" Ring Gear	10-Bolt	RDS 55393
81-80	Housing Cover	Ford Full-Size	8.5" Ring Gear	10-Bolt	RDS 55341
81-80	Housing Cover	Ford Full-Size	8.8" Ring Gear	10-Bolt	RDS 55341
79	Housing Cover	Ford Full-Size	7.5" Ring Gear	10-Bolt	RDS 55393
79	Housing Cover	Ford Full-Size	8.5" Ring Gear	10-Bolt	RDS 55003
79	Bearing Retainer	Ford Full-Size		4-Bolt	(2) 55080
78-70	Housing Cover	Ford Full-Size	8.7" Ring Gear	10-Bolt	RDS 55003
78-70	Housing Cover	Ford Full-Size	9" Ring Gear	10-Bolt	RDS 55074
78	Bearing Retainer	Ford Full-Size	9" Ring Gear	4-Bolt	(2) 55080
77-70	Bearing Retainer	Ford Full-Size	9" Ring Gear	4-Bolt	(2) 55036
69-67	Housing Cover	Ford Full-Size	8.5" Ring Gear	10-Bolt	RDS 55003
69-67	Housing Cover	Ford Full-Size	9" Ring Gear	10-Bolt	RDS 55074
69-67	Bearing Retainer	Ford Full-Size		4-Bolt	(2) 55021
66	Housing Cover	Ford Full-Size	9" Ring Gear	10-Bolt	RDS 55074
66	Backing Plate	Ford Full-Size		4-Bolt	(2) 4828
66	Backing Plate	Ford Full-Size		4-Bolt	(2) 55021
66	Bearing Retainer	Ford Full-Size		5-Bolt	(2) 10720
65-57	Housing Cover	Ford Full-Size	9" Ring Gear	10-Bolt	RDS 55074
65-57	Backing Plate	Ford Full-Size		4-Bolt	(2) 4828
65-57	Bearing Retainer	Ford Full-Size		4-Bolt	(2) 55001
65-57	Bearing Retainer	Ford Full-Size		5-Bolt	(2) 10720
56-49	Flange	Ford Full-Size		4-Bolt	(2) 55001
56-49	Flange	Ford Full-Size		5-Bolt	(2) 10720

Year	Part Type	Model Name	Description	Bolt Holes	Part Number
Ford Car (Cont.)					
Rear Axle (Cont.)					
82-81	Housing Cover	Granada	7.5" Ring Gear	8-Bolt	RDS 55323
82-81	Housing Cover	Granada	7.5" Ring Gear	10-Bolt	RDS 55393
80	Housing Cover	Granada	7.5" Ring Gear	10-Bolt	RDS 55393
80	Differential Carrier	Granada	8" Ring Gear	10-Bolt	RDS 13270
80	Differential Carrier	Granada	9" Ring Gear	10-Bolt	RDS 55074
80	Bearing Retainer	Granada	8" Ring Gear	4-Bolt	(2) 55080
80	Bearing Retainer	Granada	9" Ring Gear	4-Bolt	(2) 55080
79	Differential Carrier	Granada	8" Ring Gear	10-Bolt	RDS 13270
79	Bearing Retainer	Granada		4-Bolt	(2) 55035
78-75	Differential Carrier	Granada	8" Ring Gear	10-Bolt	RDS 13270
78-75	Housing Cover	Granada	8.7" Ring Gear	10-Bolt	RDS 55003
78-75	Differential Carrier	Granada	9" Ring Gear	10-Bolt	RDS 55074
78-75	Bearing Retainer	Granada	8" Ring Gear	4-Bolt	(2) 55035
78-75	Bearing Retainer	Granada	9" Ring Gear	4-Bolt	(2) 55036
11-99	Housing Cover	Lincoln Full-Size	8.8" Ring Gear	10-Bolt	RDS 55341
98-93	Housing Cover	Lincoln Full-Size	7.5" Ring Gear	10-Bolt	RDS 55081
98-93	Housing Cover	Lincoln Full-Size	8.8" Ring Gear	10-Bolt	RDS 55341
92-84	Housing Cover	Lincoln Full-Size (From 05/01/84)	7.5" Ring Gear	10-Bolt	RDS 55081
84-80	Housing Cover	Lincoln Full-Size (To 04/30/84)	7.5" Ring Gear	10-Bolt	RDS 55393
92-80	Housing Cover	Lincoln Full-Size	8.5" Ring Gear	10-Bolt	RDS 55341
79-72	Differential Carrier	Lincoln Full-Size	9" Ring Gear	10-Bolt	RDS 55074
73	Bearing Retainer	Lincoln Full-Size		4-Bolt	(2) 55065
73-72	Bearing Retainer	Lincoln Full-Size		4-Bolt	(2) 55036
72	Bearing Retainer	Lincoln Full-Size		4-Bolt	(2) 55035
71-66	Differential Carrier	Lincoln Full-Size	9" Ring Gear	10-Bolt	RDS 55074
71-70	Bearing Retainer	Lincoln Full-Size (From 09/30/69)		4-Bolt	(2) 55036
70-66	Bearing Retainer	Lincoln Full-Size (To 09/29/69)		4-Bolt	(2) 55021
65-49	Differential Carrier	Lincoln Full-Size	9" Ring Gear	10-Bolt	RDS 12758
65-56	Flange	Lincoln Full-Size		5-Bolt	(2) 10720
86-84	Housing Cover	LTD (From 05/01/84)	7.5" Ring Gear	10-Bolt	RDS 55081
84-81	Housing Cover	LTD (To 04/30/84)	7.5" Ring Gear	10-Bolt	RDS 55393
80	Housing Cover	LTD	6.75" Ring Gear	8-Bolt	RDS 13073
80	Housing Cover	LTD	7.5" Ring Gear	8-Bolt	RDS 13073
80	Differential Carrier	LTD	8" Ring Gear	10-Bolt	RDS 13270
80	Differential Carrier	LTD	9" Ring Gear	10-Bolt	RDS 55074
80	Bearing Retainer	LTD	8" Ring Gear	4-Bolt	(2) 55080
80	Bearing Retainer	LTD	9" Ring Gear	4-Bolt	(2) 55080
79-77	Differential Carrier	LTD	9" Ring Gear	10-Bolt	RDS 55074
79-77	Bearing Retainer	LTD		4-Bolt	(2) 55065
86-84	Housing Cover	Marquis (From 05/01/84)	7.5" Ring Gear	10-Bolt	RDS 55081
84-83	Housing Cover	Marquis (To 04/30/84)	7.5" Ring Gear	10-Bolt	RDS 55393
77-71	Differential Carrier	Maverick	8" Ring Gear	10-Bolt	RDS 13270
77-71	Backing Plate	Maverick		4-Bolt	(2) 4978
77-71	Backing Plate	Maverick		4-Bolt	(2) 55035
70	Housing Cover	Maverick	6.75" Ring Gear	8-Bolt	RDS 13073
70	Housing Cover	Maverick	7.25" Ring Gear	8-Bolt	RDS 13073
70	Differential Carrier	Maverick	7.75" Ring Gear	10-Bolt	RDS 13270
70	Differential Carrier	Maverick	8" Ring Gear	10-Bolt	RDS 13270
70	Flange	Maverick	2 11/16" I.D.	4-Bolt	(2) 4978
70	Flange	Maverick	3 3/32" I.D.	4-Bolt	(2) 4828
11-97	Housing Cover	Mercury Full-Size	8.8" Ring Gear	10-Bolt	RDS 55341
96-86	Housing Cover	Mercury Full-Size	8.5" Ring Gear	10-Bolt	RDS 55341
96-86	Housing Cover	Mercury Full-Size	8.8" Ring Gear	10-Bolt	RDS 55341
85-80	Housing Cover	Mercury Full-Size	7.5" Ring Gear	10-Bolt	RDS 55393
85-80	Housing Cover	Mercury Full-Size	8.5" Ring Gear	10-Bolt	RDS 55341
85-80	Housing Cover	Mercury Full-Size	8.8" Ring Gear	10-Bolt	RDS 55341
79	Housing Cover	Mercury Full-Size	7.5" Ring Gear	8-Bolt	RDS 13073
79	Housing Cover	Mercury Full-Size	8.5" Ring Gear	8-Bolt	RDS 13073
79	Differential Carrier	Mercury Full-Size	9" Ring Gear	10-Bolt	RDS 55074
78-70	Housing Cover	Mercury Full-Size	8.7" Ring Gear	10-Bolt	RDS 55003
78-70	Differential Carrier	Mercury Full-Size	9" Ring Gear	10-Bolt	RDS 55074
78	Flange	Mercury Full-Size (From 09/02/77)	9" Ring Gear	4-Bolt	(2) 55080
78-70	Flange	Mercury Full-Size (To 09/01/77)	9" Ring Gear	4-Bolt	(2) 55036
69-66	Differential Carrier	Mercury Full-Size	9" Ring Gear	10-Bolt	RDS 55074
69-66	Backing Plate	Mercury Full-Size		4-Bolt	(2) 55021
67-66	Bearing Retainer	Mercury Full-Size		5-Bolt	(2) 10720

DRIVETRAIN GASKETS

Year	Part Type	Model Name	Description	Bolt Holes	Part Number
Ford Car (Cont.)					
Rear Axle (Cont.)					
65-61	Differential Carrier	Mercury Full-Size	9" Ring Gear	10-Bolt	RDS 55074
65-61	Backing Plate	Mercury Full-Size		4-Bolt	(2) 4828
65-61	Bearing Retainer	Mercury Full-Size		4-Bolt	(2) 55021
65-61	Bearing Retainer	Mercury Full-Size		5-Bolt	(2) 10720
60-57	Differential Carrier	Mercury Full-Size	9" Ring Gear	10-Bolt	RDS 55074
57	Differential Carrier	Mercury Full-Size	9" Ring Gear	10-Bolt	RDS 12758
60-57	Flange	Mercury Full-Size		5-Bolt	(2) 10720
56-52	Flange	Mercury Full-Size		5-Bolt	(2) 10720
54-52	Flange	Mercury Full-Size		4-Bolt	(2) 55001
76-75	Housing Cover	Meteor	8.7" Ring Gear	10-Bolt	RDS 55003
76-75	Differential Carrier	Meteor	9" Ring Gear	10-Bolt	RDS 55074
76-75	Bearing Retainer	Meteor	8.7" Ring Gear	4-Bolt	(2) 55036
76-75	Bearing Retainer	Meteor	9" Ring Gear	4-Bolt	(2) 55036
74-70	Bearing Retainer	Meteor		4-Bolt	(2) 55036
69-65	Bearing Retainer	Meteor		4-Bolt	(2) 55021
67-65	Bearing Retainer	Meteor		5-Bolt	(2) 10720
63-62	Backing Plate	Meteor		4-Bolt	(2) 4828
63-62	Bearing Retainer	Meteor		4-Bolt	(2) 55001
63-62	Bearing Retainer	Meteor		5-Bolt	(2) 10720
80-75	Differential Carrier	Monarch	8" Ring Gear	10-Bolt	RDS 13270
80-75	Housing Cover	Monarch	8.7" Ring Gear	10-Bolt	RDS 55003
80-75	Differential Carrier	Monarch	9" Ring Gear	10-Bolt	RDS 55074
80	Backing Plate	Monarch		4-Bolt	(2) 55080
79-75	Backing Plate	Monarch		4-Bolt	(2) 55035
79-75	Backing Plate	Monarch		4-Bolt	(2) 55036
76-75	Differential Carrier	Montego	9" Ring Gear	10-Bolt	RDS 55074
74-69	Differential Carrier	Montego	8" Ring Gear	10-Bolt	RDS 13270
74-69	Differential Carrier	Montego	9" Ring Gear	10-Bolt	RDS 55074
74-73	Backing Plate	Montego		4-Bolt	(2) 55065
72-70	Backing Plate	Montego		4-Bolt	(2) 55035
69	Backing Plate	Montego		4-Bolt	(2) 4828
68-66	Housing Cover	Montego	7.25" Ring Gear	8-Bolt	RDS 13073
68-66	Differential Carrier	Montego	8" Ring Gear	10-Bolt	RDS 13270
68-66	Differential Carrier	Montego	9" Ring Gear	10-Bolt	RDS 55074
68-66	Backing Plate	Montego		4-Bolt	(2) 4828
65	Housing Cover	Montego	7.25" Ring Gear	8-Bolt	RDS 13073
65	Differential Carrier	Montego	8" Ring Gear	10-Bolt	RDS 13270
65	Backing Plate	Montego		4-Bolt	(2) 4828
65	Bearing Retainer	Montego		4-Bolt	(2) 55001
14-99	Housing Cover	Mustang	8.8" Ring Gear	10-Bolt	RDS 55460
98-97	Housing Cover	Mustang	8.8" Ring Gear	10-Bolt	RDS 55341
96-86	Housing Cover	Mustang	7.5" Ring Gear	10-Bolt	RDS 55081
96-86	Housing Cover	Mustang	8.8" Ring Gear	10-Bolt	RDS 55341
85-84	Housing Cover	Mustang (From 05/01/84)	7.5" Ring Gear	10-Bolt	RDS 55081
84-83	Housing Cover	Mustang (To 04/30/84)	7.5" Ring Gear	10-Bolt	RDS 55393
82-79	Housing Cover	Mustang	6.75" Ring Gear	8-Bolt	RDS 55323
82-79	Housing Cover	Mustang	6.75" Ring Gear	10-Bolt	RDS 55393
82-79	Housing Cover	Mustang	7.5" Ring Gear	8-Bolt	RDS 55323
82-79	Housing Cover	Mustang	7.5" Ring Gear	10-Bolt	RDS 55393
81-79	Backing Plate	Mustang		4-Bolt	(2) 55319
78-74	Housing Cover	Mustang	6.75" Ring Gear	8-Bolt	RDS 13073
78-74	Housing Cover	Mustang	7.5" Ring Gear	8-Bolt	RDS 55323
78-74	Differential Carrier	Mustang	8" Ring Gear	10-Bolt	RDS 13270
78-74	Backing Plate	Mustang		4-Bolt	(2) 55319
73-71	Differential Carrier	Mustang	8" Ring Gear	10-Bolt	RDS 13270
73-71	Differential Carrier	Mustang	9" Ring Gear	10-Bolt	RDS 55074
73-71	Backing Plate	Mustang		4-Bolt	(2) 55035
70-64	Housing Cover	Mustang	7.25" Ring Gear	8-Bolt	RDS 13073
70-64	Differential Carrier	Mustang	8" Ring Gear	10-Bolt	RDS 13270
70-64	Differential Carrier	Mustang	9" Ring Gear	10-Bolt	RDS 55074
70	Backing Plate	Mustang		4-Bolt	(2) 55035
69-68	Backing Plate	Mustang		4-Bolt	(2) 4828
69-68	Backing Plate	Mustang		4-Bolt	(2) 4978
68-64	Bearing Retainer	Mustang		4-Bolt	(2) 4978
68-64	Bearing Retainer	Mustang		4-Bolt	(2) 55001
80	Housing Cover	Pinto	6.75" Ring Gear	8-Bolt	RDS 55323

Year	Part Type	Model Name	Description	Bolt Holes	Part Number
Ford Car (Cont.)					
Rear Axle (Cont.)					
80	Differential Carrier	Pinto	8" Ring Gear	10-Bolt	RDS 13270
80	Flange	Pinto	6.75" Ring Gear	4-Bolt	(2) 55319
80	Flange	Pinto	8" Ring Gear	4-Bolt	(2) 55080
80	Flange	Pinto	9" Ring Gear	4-Bolt	(2) 55080
79	Housing Cover	Pinto	6.75" Ring Gear	8-Bolt	RDS 55323
79	Bearing Retainer	Pinto		4-Bolt	(2) 55319
78-75	Housing Cover	Pinto	6.75" Ring Gear	8-Bolt	RDS 13073
78-75	Differential Carrier	Pinto	8" Ring Gear	10-Bolt	RDS 13270
78-75	Bearing Retainer	Pinto	6.75" Ring Gear	4-Bolt	(2) 55319
78-75	Bearing Retainer	Pinto	8" Ring Gear	4-Bolt	(2) 55319
74	Housing Cover	Pinto	6.75" Ring Gear	8-Bolt	RDS 13073
74	Bearing Retainer	Pinto		4-Bolt	(2) 55319
73-71	Housing Cover	Pinto	6.75" Ring Gear	8-Bolt	RDS 13073
73-71	Bearing Retainer	Pinto		4-Bolt	(2) 4978
91-87	Housing Cover	Tempo		8-Bolt	RDS 55437 ¹
97-89	Housing Cover	Thunderbird	7.5" Ring Gear	10-Bolt	RDS 55459
97-89	Housing Cover	Thunderbird	8.8" Ring Gear	10-Bolt	RDS 55460
88-86	Housing Cover	Thunderbird	7.5" Ring Gear	10-Bolt	RDS 55081
88-86	Housing Cover	Thunderbird	8.8" Ring Gear	10-Bolt	RDS 55341
85-84	Housing Cover	Thunderbird (From 05/01/84)	7.5" Ring Gear	10-Bolt	RDS 55081
84-80	Housing Cover	Thunderbird (To 04/30/84)	7.5" Ring Gear	10-Bolt	RDS 55393
79-57	Differential Carrier	Thunderbird	9" Ring Gear	10-Bolt	RDS 55074
79-73	Backing Plate	Thunderbird		4-Bolt	(2) 55065
72	Backing Plate	Thunderbird		4-Bolt	(2) 55035
71-70	Backing Plate	Thunderbird		4-Bolt	(2) 55036
69-66	Backing Plate	Thunderbird		4-Bolt	(2) 55021
62-61	Backing Plate	Thunderbird		4-Bolt	(2) 4828
70-68	Bearing Retainer	Thunderbird		4-Bolt	(2) 55021
67-62	Bearing Retainer	Thunderbird		5-Bolt	(2) 10720
61	Bearing Retainer	Thunderbird		4-Bolt	(2) 55001
60-57	Bearing Retainer	Thunderbird		5-Bolt	(2) 10720
56-55	Housing Cover	Thunderbird		10-Bolt	RDS 6629
56-55	Bearing Retainer	Thunderbird		5-Bolt	(2) 10720
91-87	Housing Cover	Topaz		8-Bolt	RDS 55437 ¹
76-75	Differential Carrier	Torino	9" Ring Gear	10-Bolt	RDS 55074
76-75	Backing Plate	Torino		4-Bolt	(2) 55065
74-71	Differential Carrier	Torino	8" Ring Gear	10-Bolt	RDS 13270
74-71	Differential Carrier	Torino	9" Ring Gear	10-Bolt	RDS 55074
74-73	Backing Plate	Torino		4-Bolt	(2) 55065
72-71	Backing Plate	Torino		4-Bolt	(2) 55035
70-69	Housing Cover	Torino	7.25" Ring Gear	8-Bolt	RDS 13073
70-69	Differential Carrier	Torino	8" Ring Gear	10-Bolt	RDS 13270
70-69	Differential Carrier	Torino	9" Ring Gear	10-Bolt	RDS 55074
70	Backing Plate	Torino		4-Bolt	(2) 55035
69	Backing Plate	Torino		4-Bolt	(2) 4828
80-77	Differential Carrier	Versailles	9" Ring Gear	10-Bolt	RDS 55074
83	Housing Cover	Zephyr	7.5" Ring Gear	10-Bolt	RDS 55393
82-79	Housing Cover	Zephyr	6.75" Ring Gear	8-Bolt	RDS 55323
82-79	Housing Cover	Zephyr	7.5" Ring Gear	10-Bolt	RDS 55393
82-80	Flange	Zephyr		4-Bolt	(2) 55319
78	Housing Cover	Zephyr	7.5" Ring Gear	10-Bolt	RDS 55393
Automatic Transaxle					
97-95	Oil Pan	ATX	All models (3 Speed)	16-Bolt	TOS 18712
94-81	Oil Pan	ATX	Exc. Aspire, Festiva, Tracer (3 Speed)	13-Bolt	TOS 18659
94-81	Valve Body Cover	ATX	Exc. Aspire, Festiva, Tracer (3 Speed)	10-Bolt	TOS 18660
94-87	Oil Pan	ATX	Aspire, Festiva, Tracer (3 Speed)	16-Bolt	TOS 18712
04-95	Oil Pan	AX4N	Exc. Lincoln (4 Speed)	19-Bolt	TOS 18709
04-95	Oil Pan	AX4N	Lincoln (4 Speed)	19-Bolt	TOS 18735
04-95	Case Side Cover	AX4N	4 Speed	17-Bolt	TOS 18739 ¹
04-95	Oil Pan	AXOD, AXOD-E, AX4S	4 Speed	17-Bolt	TOS 18738
04-95	Valve Body Cover	AXOD, AXOD-E, AX4S	4 Speed	12-Bolt	TOS 18737
04-86	Oil Pan	AXOD, AXOD-E, AX4S	4 Speed	17-Bolt	TOS 18680
04-86	Valve Body Cover	AXOD, AXOD-E, AX4S	4 Speed	12-Bolt	TOS 18682
03-94	Oil Pan	CD4E (To 03/31/03)	4 Speed	14-Bolt	TOS 18729
03-94	Valve Body Cover	CD4E	4 Speed	14-Bolt	TOS 18751

¹Superseded or Discontinued

DRIVETRAIN GASKETS

Year	Part Type	Model Name	Description	Bolt Holes	Part Number
Ford Car (Cont.)					
Automatic Transaxle (Cont.)					
07-05	Oil Pan	CFT30	CVT (Continuous Variable Ratio)	22-Bolt	TOS 18744
03-93	Oil Pan	4EAT	Escort, Tracer	19-Bolt	TOS 18695 ¹
03-93	Oil Pan	4EAT	Escort, Tracer	19-Bolt	TOS 18747
99-93	Oil Pan	4EAT	Capri, Probe	17-Bolt	TOS 18690
99-93	Valve Body Cover	4EAT	Capri, Probe	17-Bolt	TOS 18691
92-89	Oil Pan	4EAT	Escort, Tracer	19-Bolt	TOS 18695 ¹
92-89	Oil Pan	4EAT	Escort, Tracer	19-Bolt	TOS 18747
92-89	Oil Pan	4EAT	Capri, Probe (Exc. Turbo)	17-Bolt	TOS 18690
92-89	Oil Pan	4EAT	Capri, Probe (Turbo)	17-Bolt	TOS 18692
92-89	Valve Body Cover	4EAT	Capri, Probe (Exc. Turbo)	17-Bolt	TOS 18691
92-89	Valve Body Cover	4EAT	Capri, Probe (Turbo)	17-Bolt	TOS 18693
11-00	Oil Pan	4F27E	4 Speed	20-Bolt	TOS 18731
07-00	Oil Pan	4F50N	4 Speed	19-Bolt	TOS 18735
07-00	Case Side Cover	4F50N	4 Speed	0-Bolt	TOS 18732
15-07	Oil Pan	6F50, 6F55	6 Speed	0-Bolt	TOS 18767
Automatic Transmission					
64-59	Oil Pan	Ford-O-Matic	2 Speed	14-Bolt	TOS 18109
93-80	Oil Pan	AOT (F10D)	3 Speed	14-Bolt	TOS 18657
74-73	Oil Pan	Borg-Warner	3 Speed	14-Bolt	TOS 18106
89-74	Oil Pan	C3	3 Speed	13-Bolt	TOS 18640
82-71	Oil Pan	C4	3 Speed	11-Bolt	TOS 18634
70	Oil Pan	C4 (Exc. Falcon, Maverick)	3 Speed	11-Bolt	TOS 18634
70	Oil Pan	C4 (Falcon, Maverick)	3 Speed	11-Bolt	TOS 18632
69-64	Oil Pan	C4	3 Speed	11-Bolt	TOS 18632
86-82	Oil Pan	C5	3 Speed	11-Bolt	TOS 18634
80-66	Oil Pan	C6	3 Speed	17-Bolt	TOS 18628
81-69	Oil Pan	Cruise-O-Matic	3 Speed	14-Bolt	TOS 18106
68-58	Oil Pan	Cruise-O-Matic (L/D and M/D)	3 Speed	14-Bolt	TOS 18106
68-57	Oil Pan	Cruise-O-Matic (H/D)	3 Speed	15-Bolt	TOS 18107
65-61	Oil Pan	Ford-O-Matic	3 Speed	16-Bolt	TOS 18555
59-51	Oil Pan	Ford-O-Matic (L/D)	3 Speed	14-Bolt	TOS 18106
59-51	Oil Pan	Ford-O-Matic (H/D)	3 Speed	15-Bolt	TOS 18107
59-50	Oil Pan	Merc-O-Matic (L/D)	3 Speed	14-Bolt	TOS 18106
59-50	Oil Pan	Merc-O-Matic (H/D)	3 Speed	15-Bolt	TOS 18107
94-85	Oil Pan	A4LD	4 Speed	18-Bolt	TOS 18679
11-91	Oil Pan	AOD-E, 4R70W, 4R75W	4 Speed	14-Bolt	TOS 18706
11-95	Oil Pan	AODE-W	4 Speed	14-Bolt	TOS 18706
54-49	Oil Pan	Hydramatic	4 Speed	12-Bolt	TOS 18024
11-00	Oil Pan	5R55N, 5R55S	5 Speed	16-Bolt	TOS 18742
15-11	Oil Pan	6R80	6 Speed	21-Bolt	TOS 18753
Manual Transmission					
78-63	Transmission Kit	HEF, RAN, RAT (3.03)	3 Speed		TS 80108
73-64	Transmission Kit	HEH, RUG (w/o Overdrive)	3 Speed		TS 13405
59-49	Transmission Kit	Standard (Exc. Warner)	3 Speed		TS 2973 B
66-60	Transmission Kit	Warner T86E	3 Speed		TS 5135-2
87-86	Transmission Kit	Toyo Kogyo	5 Speed		TS 80681
Ford Truck					
Front Axle					
96-71	Housing Cover	Bronco	Spicer 44	10-Bolt	RDS 6629
71-69	Housing Cover	Bronco	Spicer 30	10-Bolt	RDS 55019
96-59	Housing Cover	F100, F150	Spicer 44	10-Bolt	RDS 6629
98-80	Housing Cover	F250	Spicer 44	10-Bolt	RDS 6629
79-73	Housing Cover	F250	Spicer 44	10-Bolt	RDS 6629
79-73	Housing Cover	F250	Spicer 50	10-Bolt	RDS 6095-1
72-59	Housing Cover	F250	Spicer 44	10-Bolt	RDS 6629
98-80	Housing Cover	F350	Spicer 44	10-Bolt	RDS 6629
79-73	Housing Cover	F350	Spicer 50	10-Bolt	RDS 6095-1
Rear Axle					
97-91	Housing Cover	Aerostar	WAA, WFJ	10-Bolt	RDS 55393
97-91	Housing Cover	Aerostar	WDA, WFB	10-Bolt	RDS 55341
90-86	Housing Cover	Aerostar	WAA, WFJ	10-Bolt	RDS 55393
90-86	Housing Cover	Aerostar	WDA, WFB	10-Bolt	RDS 55341
90-86	Housing Cover	Aerostar	Dana 30	10-Bolt	RDS 55395
96-87	Housing Cover	Bronco	WAC, WFC, WFM, WGX	10-Bolt	RDS 55393

Year	Part Type	Model Name	Description	Bolt Holes	Part Number
Ford Truck (Cont.)					
Rear Axle (Cont.)					
96-87	Housing Cover	Bronco	WDB, WDR, WFH, WFL	10-Bolt	RDS 55341
96-87	Backing Plate	Bronco		4-Bolt	(2) 55080
86-83	Housing Cover	Bronco	WAC, WFC, WFM, WGX	10-Bolt	RDS 55393
86-83	Housing Cover	Bronco	WDR, WFL	10-Bolt	RDS 55341
86-83	Differential Carrier	Bronco	WDM, WFE	10-Bolt	RDS 55074
86-83	Backing Plate	Bronco		4-Bolt	(2) 55080
82-71	Differential Carrier	Bronco		10-Bolt	RDS 55074
82-71	Backing Plate	Bronco		4-Bolt	(2) 55035
82-71	Backing Plate	Bronco		4-Bolt	(2) 55036
70-69	Differential Carrier	Bronco		10-Bolt	RDS 55074
70-69	Backing Plate	Bronco		4-Bolt	(2) 4828
70-69	Backing Plate	Bronco		4-Bolt	(2) 55021
68-66	Differential Carrier	Bronco		10-Bolt	RDS 55074
68-66	Backing Plate	Bronco		4-Bolt	(2) 4828
68-66	Backing Plate	Bronco		4-Bolt	(2) 55021
68-66	Bearing Retainer	Bronco		4-Bolt	(2) 55001
89-88	Backing Plate	E100	3 5/32" Diameter	4-Bolt	(2) 55036
89-88	Backing Plate	E100	3 3/16" Diameter	4-Bolt	(2) 55065
87-80	Differential Carrier	E100		10-Bolt	RDS 55074
87-80	Backing Plate	E100	3 5/32" Diameter	4-Bolt	(2) 55036
87-80	Backing Plate	E100	3 3/16" Diameter	4-Bolt	(2) 55065
79-74	Differential Carrier	E100		10-Bolt	RDS 55074
79-74	Backing Plate	E100	2 55/64" Diameter	4-Bolt	(2) 55035
79-74	Backing Plate	E100	3 3/16" Diameter	4-Bolt	(2) 55065
73-70	Differential Carrier	E100		10-Bolt	RDS 55074
73-70	Backing Plate	E100		4-Bolt	(2) 4828
73-70	Backing Plate	E100		4-Bolt	(2) 55035
69-61	Differential Carrier	E100		10-Bolt	RDS 55074
69-61	Housing Cover	E100		8-Bolt	RDS 13073
69-61	Backing Plate	E100		4-Bolt	(2) 4828
14-00	Housing Cover	E150	WEC, WFV	10-Bolt	RDS 55341
14-00	Housing Cover	E150	9.75" Ring Gear	12-Bolt	RDS 55476
99-97	Housing Cover	E150	WEC, WFV	10-Bolt	RDS 55341
99-97	Housing Cover	E150	9.75" Ring Gear	12-Bolt	RDS 55476
99-97	Backing Plate	E150		4-Bolt	(2) 55065
96-88	Housing Cover	E150	WEC, WFV	10-Bolt	RDS 55341
96-88	Backing Plate	E150		4-Bolt	(2) 55065
87-83	Differential Carrier	E150		10-Bolt	RDS 55074
87-83	Housing Cover	E150		10-Bolt	RDS 55341
87-83	Backing Plate	E150		4-Bolt	(2) 55065
82-75	Differential Carrier	E150		10-Bolt	RDS 55074
82-75	Backing Plate	E150		4-Bolt	(2) 55065
79-70	Differential Carrier	E200		10-Bolt	RDS 55074
79-70	Backing Plate	E200		4-Bolt	(2) 55021
79-70	Backing Plate	E200		4-Bolt	(2) 55036
69-61	Differential Carrier	E200		10-Bolt	RDS 55074
69-61	Backing Plate	E200		4-Bolt	(2) 55021
16-00	Housing Cover	E250		10-Bolt	RDS 6014
99-90	Housing Cover	E250		10-Bolt	RDS 6014
99-90	Backing Plate	E250		8-Bolt	(2) 55328
89	Housing Cover	E250	Dana 60	10-Bolt	RDS 55449
89	Housing Cover	E250	Dana 61	10-Bolt	RDS 55449
88	Housing Cover	E250	Dana 60	10-Bolt	RDS 6095-1
88	Housing Cover	E250	Dana 61	10-Bolt	RDS 6095-1
89-88	Housing Cover	E250	WEC, WFS	10-Bolt	RDS 55341
89-88	Backing Plate	E250		8-Bolt	(2) 55328
87-83	Housing Cover	E250	Dana 60	10-Bolt	RDS 6095-1
87-83	Housing Cover	E250	Dana 61	10-Bolt	RDS 6095-1
87-83	Housing Cover	E250	WEC, WFS	10-Bolt	RDS 55341
87-83	Backing Plate	E250		8-Bolt	(2) 55328
82-75	Housing Cover	E250	Dana 60	10-Bolt	RDS 6095-1
82-75	Housing Cover	E250	Dana 61	10-Bolt	RDS 6095-1
82-75	Backing Plate	E250		8-Bolt	(2) 55328
78-70	Housing Cover	E300		10-Bolt	RDS 6095-1
78-70	Backing Plate	E300		8-Bolt	(2) 55328
69	Housing Cover	E300		10-Bolt	RDS 6095-1

DRIVETRAIN GASKETS

Year	Part Type	Model Name	Description	Bolt Holes	Part Number
Ford Truck (Cont.)					
Rear Axle (Cont.)					
69	Backing Plate	E300		8-Bolt	(2) 2931
16-00	Housing Cover	E350		10-Bolt	RDS 6014
99-90	Housing Cover	E350	Dana 60	10-Bolt	RDS 6014
99-90	Housing Cover	E350	Dana 61	10-Bolt	RDS 6014
99-90	Housing Cover	E350	Dana 70	10-Bolt	RDS 6014
99-90	Backing Plate	E350		4-Bolt	(2) 55065
99-90	Backing Plate	E350		8-Bolt	(2) 55328
89	Housing Cover	E350	Dana 60	10-Bolt	RDS 55449
89	Housing Cover	E350	Dana 61	10-Bolt	RDS 55449
88	Housing Cover	E350	Dana 60	10-Bolt	RDS 6095-1
88	Housing Cover	E350	Dana 61	10-Bolt	RDS 6095-1
89-88	Housing Cover	E350	Dana 70	10-Bolt	RDS 6014
89-88	Backing Plate	E350		8-Bolt	(2) 55328
87-75	Housing Cover	E350		10-Bolt	RDS 6095-1
87-75	Backing Plate	E350		8-Bolt	(2) 55328
16-00	Housing Cover	E450		10-Bolt	RDS 6014
08-01	Housing Cover	Escape, Mariner		10-Bolt	RDS 55037
01-97	Housing Cover	Expedition	WAC, WFM	10-Bolt	RDS 55341
01-97	Housing Cover	Expedition	9.75" Ring Gear	12-Bolt	RDS 55476
10-06	Housing Cover	Explorer	8.8" Ring Gear	10-Bolt	RDS 55460
05-91	Housing Cover	Explorer	WDB, WFH	10-Bolt	RDS 55341
10-07	Housing Cover	Explorer Sport Trac	8.8" Ring Gear	10-Bolt	RDS 55460
14-00	Housing Cover	F100, F150	WDR, WFL	10-Bolt	RDS 55341
14-00	Housing Cover	F100, F150	9.75" Ring Gear	12-Bolt	RDS 55476
99-97	Housing Cover	F100, F150	WDR, WFL	10-Bolt	RDS 55341
99-97	Housing Cover	F100, F150	9.75" Ring Gear	12-Bolt	RDS 55476
99-97	Backing Plate	F100, F150		4-Bolt	(2) 55065
99-97	Backing Plate	F100, F150		4-Bolt	(2) 55080
96-87	Housing Cover	F100, F150	WDR, WFL	10-Bolt	RDS 55341
96-87	Backing Plate	F100, F150		4-Bolt	(2) 55065
96-87	Backing Plate	F100, F150		4-Bolt	(2) 55080
86-83	Differential Carrier	F100, F150	WDM, WFE	10-Bolt	RDS 55074
86-83	Housing Cover	F100, F150	WDR, WFL	10-Bolt	RDS 55341
86-83	Backing Plate	F100, F150		4-Bolt	(2) 55065
86-83	Backing Plate	F100, F150		4-Bolt	(2) 55080
82-80	Differential Carrier	F100, F150	WDM, WFE	10-Bolt	RDS 55074
82-80	Flange	F100, F150		4-Bolt	(2) 55065
82-80	Flange	F100, F150		4-Bolt	(2) 55080
79-77	Housing Cover	F100, F150	Dana 44	10-Bolt	RDS 6629
79-77	Differential Carrier	F100, F150	Ford	10-Bolt	RDS 55074
79-77	Backing Plate	F100, F150		4-Bolt	(2) 55036
76-70	Differential Carrier	F100, F150		10-Bolt	RDS 55074
76-70	Flange	F100, F150		4-Bolt	(2) 55021
76-70	Flange	F100, F150		4-Bolt	(2) 55036
69-68	Housing Cover	F100, F150	Dana 44	10-Bolt	RDS 6629
69-68	Housing Cover	F100, F150	Dana 60	10-Bolt	RDS 6095-1
69-68	Differential Carrier	F100, F150	Ford	10-Bolt	RDS 55074
69-68	Backing Plate	F100, F150		4-Bolt	(2) 55021
67-61	Housing Cover	F100, F150	Dana 44	10-Bolt	RDS 6629
67-61	Housing Cover	F100, F150	Dana 60	10-Bolt	RDS 6095-1
67-61	Differential Carrier	F100, F150	Ford	10-Bolt	RDS 55074
67-61	Backing Plate	F100, F150		4-Bolt	(2) 55021
67-61	Bearing Retainer	F100, F150		5-Bolt	(4) 10720
60-57	Housing Cover	F100, F150	Dana 44	10-Bolt	RDS 6629
60-57	Housing Cover	F100, F150	Dana 60	10-Bolt	RDS 6095-1
60-57	Differential Carrier	F100, F150	Ford	10-Bolt	RDS 6629
56-53	Housing Cover	F100, F150		10-Bolt	RDS 6629
16-00	Housing Cover	F250	WDD, WDF, WDG, WDS, WFA, WFD	12-Bolt	RDS 55394
99-86	Housing Cover	F250	WDD, WDF, WDG, WDS, WFA, WFD	12-Bolt	RDS 55394
99-86	Flange	F250		8-Bolt	(2) 55328
85	Housing Cover	F250	WDR, WFL	12-Bolt	RDS 55394
85	Housing Cover	F250	WDD, WDS, WFA, WFD	10-Bolt	RDS 55341
85	Housing Cover	F250	Dana 60	10-Bolt	RDS 6095-1
85	Housing Cover	F250	Dana 61	10-Bolt	RDS 6095-1
85	Housing Cover	F250	Dana 70	10-Bolt	RDS 6095-1
85	Flange	F250		8-Bolt	(2) 55328

Year	Part Type	Model Name	Description	Bolt Holes	Part Number
Ford Truck (Cont.)					
Rear Axle (Cont.)					
84-83	Housing Cover	F250	WDR, WFL	12-Bolt	RDS 55394
84-83	Housing Cover	F250	Dana 60	10-Bolt	RDS 6095-1
84-83	Housing Cover	F250	Dana 61	10-Bolt	RDS 6095-1
84-83	Housing Cover	F250	Dana 70	10-Bolt	RDS 6095-1
84-83	Flange	F250		8-Bolt	(2) 55328
82-70	Housing Cover	F250		10-Bolt	RDS 6095-1
82-70	Flange	F250		8-Bolt	(2) 55328
69-57	Housing Cover	F250		10-Bolt	RDS 6095-1
69-57	Flange	F250		8-Bolt	(2) 2931
16-00	Housing Cover	F350, P350		10-Bolt	RDS 55447
16-00	Differential Carrier	F350, P350	WDD, WDG, WFD	12-Bolt	RDS 55394
99-90	Differential Carrier	F350, P350	WDD, WDG, WFD	12-Bolt	RDS 55394
99-90	Flange	F350, P350		8-Bolt	(2) 55328
89-85	Housing Cover	F350, P350	Dana 61	10-Bolt	RDS 6095-1
89-85	Housing Cover	F350, P350	Dana 70	10-Bolt	RDS 6095-1
89-85	Differential Carrier	F350, P350	WDD, WFD	12-Bolt	RDS 55394
89-85	Flange	F350, P350		8-Bolt	(2) 55328
84-80	Housing Cover	F350, P350	Dana 60	10-Bolt	RDS 6095-1
84-80	Flange	F350, P350		8-Bolt	(2) 55328
79-70	Housing Cover	F350, P350	Dana 60	10-Bolt	RDS 6095-1
79-70	Housing Cover	F350, P350	Dana 70	10-Bolt	RDS 6629
79-70	Flange	F350, P350		8-Bolt	(2) 55328
16-88	Housing Cover	F450, F550		10-Bolt	RDS 55447
16-88	Housing Cover	F (Super Duty)		10-Bolt	RDS 55447
10-06	Housing Cover	Mountaineer	8.8" Ring Gear	10-Bolt	RDS 55460
05-97	Housing Cover	Mountaineer	WDB, WFH	10-Bolt	RDS 55341
01-97	Housing Cover	Navigator	WAC, WFM	10-Bolt	RDS 55341
01-97	Housing Cover	Navigator	9.75" Ring Gear	12-Bolt	RDS 55476
11-86	Housing Cover	Ranger	WAC, WFM	10-Bolt	RDS 55393
11-86	Housing Cover	Ranger	WDC, WFG	10-Bolt	RDS 55341
85-83	Housing Cover	Ranger	WDR, WFL	10-Bolt	RDS 55341
85-83	Housing Cover	Ranger	WFC, WGX	10-Bolt	RDS 55393
85-83	Housing Cover	Ranger	WGG	8-Bolt	RDS 55323
85-83	Bearing Retainer	Ranger		4-Bolt	(2) 55319
Power Take-Off (PTO)					
	Cover	Chelsea		6-Bolt	55372
	Mounting	Chelsea	(.010")	6-Bolt	55379
	Mounting	Chelsea	(.020")	6-Bolt	55380
	Mounting	Chelsea	(.010")	8-Bolt	55375
	Mounting	Chelsea	(.020")	8-Bolt	55377
Transfer Case					
77-66	Transfer Case Kit	Bronco	Spicer 20		TS 80130
79-73	Transfer Case Kit	New Process 203	Full-Time 2 Speed		TS 80683 ¹
79-73	Transfer Case Kit	New Process 205	Part-Time 2 Speed		TS 80332
Automatic Transaxle					
04-95	Oil Pan	AXOD-E, AX4S	4 Speed	17-Bolt	TOS 18738
04-95	Valve Body Cover	AXOD-E, AX4S	4 Speed	12-Bolt	TOS 18737
04-95	Oil Pan	AXOD-E, AX4S	4 Speed	17-Bolt	TOS 18680
04-95	Valve Body Cover	AXOD-E, AX4S	4 Speed	12-Bolt	TOS 18682
08-04	Valve Body Cover	CD4E	4 Speed	14-Bolt	TOS 18751
03-01	Oil Pan	CD4E (To 03/31/03)	4 Speed	14-Bolt	TOS 18729
03-01	Valve Body Cover	CD4E	4 Speed	14-Bolt	TOS 18751
07-05	Oil Pan	CFT30	CVT (Continuous Variable Ratio)	22-Bolt	TOS 18744
02-93	Oil Pan	4F20E	Villager (4 Speed)	21-Bolt	TOS 18708
13-10	Oil Pan	4F27E	4 Speed	20-Bolt	TOS 18731
07-00	Oil Pan	4F50N	4 Speed	19-Bolt	TOS 18735
07-00	Case Side Cover	4F50N	4 Speed	0-Bolt	TOS 18732
15-07	Oil Pan	6F50, 6F55	6 Speed	0-Bolt	TOS 18767
Automatic Transmission					
93-89	Oil Pan	AOT (F10D)	3 Speed	14-Bolt	TOS 18657
83-70	Oil Pan	C4	3 Speed	11-Bolt	TOS 18634
69-64	Oil Pan	C4	3 Speed	11-Bolt	TOS 18632
86-83	Oil Pan	C5	3 Speed	11-Bolt	TOS 18634
97-68	Oil Pan	C6	3 Speed	17-Bolt	TOS 18628

¹Superseded or Discontinued

DRIVETRAIN GASKETS

Year	Part Type	Model Name	Description	Bolt Holes	Part Number
Ford Truck (Cont.)					
Automatic Transmission (Cont.)					
76-72	Oil Pan	Courier	3 Speed	14-Bolt	TOS 18644
77-73	Oil Pan	Cruise-O-Matic	3 Speed	14-Bolt	TOS 18106
72-65	Oil Pan	Cruise-O-Matic	3 Speed	15-Bolt	TOS 18107
64-59	Oil Pan	Cruise-O-Matic	3 Speed	14-Bolt	TOS 18106
62-53	Oil Pan	Ford-O-Matic	3 Speed	14-Bolt	TOS 18106
11-93	Oil Pan	A4LD, 4R44E, 4R55E	4 Speed	18-Bolt	TOS 18679
92-85	Oil Pan	A4LD	4 Speed	18-Bolt	TOS 18679
16-94	Oil Pan	AODE-E, 4R70E, 4R70W, 4R75E, 4R75W	4 Speed	14-Bolt	TOS 18706
14-93	Oil Pan	AODE-W	4 Speed	14-Bolt	TOS 18706
14-96	Oil Pan	E4OD, 4R100	4 Speed	20-Bolt	TOS 18714
95-89	Oil Pan	E4OD	4 Speed	20-Bolt	TOS 18688
11-01	Oil Pan	5R44E	5 Speed	18-Bolt	TOS 18679
11-97	Oil Pan	5R55E, 5R55W	5 Speed	18-Bolt	TOS 18679
11-00	Oil Pan	5R55N, 5R55S	5 Speed	16-Bolt	TOS 18742
16-10	Oil Pan	5R110W	5 Speed	20-Bolt	TOS 18714
15-06	Oil Pan	6R60, 6R75, 6R80	6 Speed	21-Bolt	TOS 18753
Manual Transmission					
89-63	Transmission Kit	HEF, HEG	3 Speed		TS 80108
62-53	Transmission Kit	Standard	3 Speed		TS 2973 B
87-67	Transmission Kit	New Process 435	4 Speed		TS 13991
87-79	Transmission Kit	RUG (w/Overdrive)	4 Speed		TS 13405
85-80	Transmission Kit	Warner T18, T19	4 Speed		TS 80616
87-83	Transmission Kit	Toyo Kogyo	5 Speed		TS 80681
Freightliner Truck					
Automatic Transmission					
12-07	Oil Pan	W5A380	5 Speed	0-Bolt	TOS 18749 ¹
12-07	Oil Pan	W5A380	5 Speed	0-Bolt	TOS 18764
06-02	Oil Pan	W5A380	5 Speed	0-Bolt	TOS 18764
GM Car					
Buick Car Front Axle					
85-79	Housing Cover	Riviera	Final Drive Cover	13-Bolt	RDS 55185
85-79	Housing Cover	Riviera	Final Drive to Transmission	6-Bolt	RDS 55191
Cadillac Car Front Axle					
85-79	Housing Cover	Eldorado, Seville	Final Drive Cover	13-Bolt	RDS 55185
85-79	Housing Cover	Eldorado, Seville	Final Drive to Transmission	6-Bolt	RDS 55191
78-67	Housing Cover	Eldorado, Seville	Final Drive Cover	10-Bolt	RDS 55034
78-67	Housing Cover	Eldorado, Seville	Final Drive to Transmission	8-Bolt	RDS 30094
Oldsmobile Car Front Axle					
85-79	Housing Cover	Toronado	Final Drive Cover	13-Bolt	RDS 55185
85-79	Housing Cover	Toronado	Final Drive to Transmission	6-Bolt	RDS 55191
78-68	Housing Cover	Toronado	Final Drive Cover	10-Bolt	RDS 55034
78-68	Housing Cover	Toronado	Final Drive to Transmission	8-Bolt	RDS 30094
67-66	Housing Cover	Toronado	Final Drive to Transmission	8-Bolt	RDS 30094
Buick Car Rear Axle					
96-91	Housing Cover	Full-Size	8.5" Ring Gear	10-Bolt	RDS 55028-1
90-85	Housing Cover	Full-Size	7.5" Ring Gear	10-Bolt	RDS 55072
90-85	Housing Cover	Full-Size	8.5" Ring Gear	10-Bolt	RDS 55028-1
84-82	Housing Cover	Full-Size	7.5" Ring Gear	10-Bolt	RDS 55072
84-82	Housing Cover	Full-Size	8.75" Ring Gear	10-Bolt	RDS 30031
84-82	Housing Cover	Full-Size	8.875" Ring Gear	10-Bolt	RDS 30031
81-73	Housing Cover	Full-Size	7.5" Ring Gear	10-Bolt	RDS 55072
81-73	Housing Cover	Full-Size	8.5" Ring Gear	10-Bolt	RDS 55028-1
81-73	Housing Cover	Full-Size	8.875" Ring Gear	10-Bolt	RDS 30031
81-73	Housing Cover	Full-Size	9.375" Ring Gear	12-Bolt	RDS 55009
72-71	Housing Cover	Full-Size	8.5" Ring Gear	10-Bolt	RDS 55028-1
72-71	Housing Cover	Full-Size	9.375" Ring Gear	12-Bolt	RDS 55009
70-66	Housing Cover	Full-Size		10-Bolt	RDS 13410
70-66	Housing Cover	Full-Size		10-Bolt	RDS 30132
70-66	Housing Cover	Full-Size		12-Bolt	RDS 55029
67-66	Flange	Full-Size	2.875" Bearing	4-Bolt	(2) 55002
65-64	Housing Cover	Full-Size		10-Bolt	RDS 13410
65-64	Housing Cover	Full-Size		10-Bolt	RDS 30132

Year	Part Type	Model Name	Description	Bolt Holes	Part Number
GM Car (Cont.)					
Buick Car Rear Axle (Cont.)					
65-64	Housing Cover	Full-Size		12-Bolt	RDS 55029
65-64	Backing Plate	Full-Size		4-Bolt	(2) 55002
65-64	Bearing Retainer	Full-Size		4-Bolt	(2) 55010
87-82	Housing Cover	Century, Regal (RWD)	7.5" Ring Gear	10-Bolt	RDS 55072
87-82	Housing Cover	Century, Regal (RWD)	8.5" Ring Gear	10-Bolt	RDS 55028-1
81-73	Housing Cover	Apollo, Century, Skylark (RWD)	7.5" Ring Gear	10-Bolt	RDS 55072
81-73	Housing Cover	Apollo, Century, Skylark (RWD)	8.5" Ring Gear	10-Bolt	RDS 55028-1
81-73	Housing Cover	Apollo, Century, Skylark (RWD)	8.75" Ring Gear	10-Bolt	RDS 30031
81-73	Housing Cover	Apollo, Century, Skylark (RWD)	8.875" Ring Gear	10-Bolt	RDS 30031
72-71	Housing Cover	Skylark (RWD)	8.5" Ring Gear	10-Bolt	RDS 55028-1
70-64	Housing Cover	Skylark (RWD)		10-Bolt	RDS 13410
70-64	Housing Cover	Skylark (RWD)		12-Bolt	RDS 55029
70-64	Flange	Skylark (RWD)		4-Bolt	(2) 13394
70-64	Flange	Skylark (RWD)		4-Bolt	(2) 55002
70-64	Flange	Skylark (RWD)		4-Bolt	(2) 55010
80-75	Housing Cover	Skyhawk	7.5" Ring Gear	10-Bolt	RDS 55072
82	Housing Cover	Special	7.5" Ring Gear	10-Bolt	RDS 55072
82	Housing Cover	Special	8.5" Ring Gear	10-Bolt	RDS 55028-1
81-75	Housing Cover	Special	7.5" Ring Gear	10-Bolt	RDS 55072
81-75	Housing Cover	Special	8.5" Ring Gear	10-Bolt	RDS 55028-1
81-75	Housing Cover	Special	8.75" Ring Gear	10-Bolt	RDS 30031
81-75	Housing Cover	Special	8.875" Ring Gear	10-Bolt	RDS 30031
69-64	Housing Cover	Special		10-Bolt	RDS 13410
69-64	Housing Cover	Special		12-Bolt	RDS 55029
69-64	Flange	Special		4-Bolt	(2) 13394
69-64	Flange	Special		4-Bolt	(2) 55002
69-64	Flange	Special		4-Bolt	(2) 55010
Cadillac Car Rear Axle					
96-91	Housing Cover	Full-Size	8.5" Ring Gear	10-Bolt	RDS 55028-1
90-86	Housing Cover	Full-Size	7.5" Ring Gear	10-Bolt	RDS 55072
90-86	Housing Cover	Full-Size	7.625" Ring Gear	10-Bolt	RDS 55072
90-86	Housing Cover	Full-Size	8.5" Ring Gear	10-Bolt	RDS 55028-1
85-82	Housing Cover	Full-Size	7.5" Ring Gear	10-Bolt	RDS 55072
85-77	Housing Cover	Full-Size	8.5" Ring Gear	10-Bolt	RDS 55028-1
85-77	Housing Cover	Full-Size	8.875" Ring Gear	10-Bolt	RDS 30031
76-71	Housing Cover	Exc. Seville		12-Bolt	RDS 55033
76-75	Housing Cover	Seville		10-Bolt	RDS 55028-1
70	Housing Cover	Full-Size		12-Bolt	RDS 55033
70	Flange	Exc. Eldorado		4-Bolt	(4) 13365
69-57	Differential Carrier	Full-Size		14-Bolt	RDS 5396
69-57	Flange	Exc. Eldorado		4-Bolt	(4) 13365
56-49	Flange			4-Bolt	(4) 13365
Chevrolet Car Rear Axle					
96-94	Housing Cover	Full-Size	7.5" Ring Gear	10-Bolt	RDS 55072
96-94	Housing Cover	Full-Size	7.625" Ring Gear	10-Bolt	RDS 55072
96-94	Housing Cover	Full-Size	8.5" Ring Gear	10-Bolt	RDS 55028-1
93-84	Housing Cover	Full-Size	7.5" Ring Gear	10-Bolt	RDS 55072
93-84	Housing Cover	Full-Size	8.5" Ring Gear	10-Bolt	RDS 55028-1
83-73	Housing Cover	Full-Size	7.5" Ring Gear	10-Bolt	RDS 55072
83-73	Housing Cover	Full-Size	8.5" Ring Gear	10-Bolt	RDS 55028-1
83-73	Housing Cover	Full-Size	8.875" Ring Gear	10-Bolt	RDS 30031
72-71	Housing Cover	Full-Size		10-Bolt	RDS 55028-1
72-71	Housing Cover	Full-Size		10-Bolt	RDS 30031
70-65	Housing Cover	Full-Size		10-Bolt	RDS 55028-1
70-65	Housing Cover	Full-Size		12-Bolt	RDS 55029
64	Differential Carrier	Full-Size		10-Bolt	RDS 11724
64	Housing Cover	Full-Size		10-Bolt	RDS 55028-1
64	Housing Cover	Full-Size		12-Bolt	RDS 55029
64	Flange	Full-Size	Inner	0-Bolt	(2) 13202
64	Flange	Full-Size	Outer	4-Bolt	(2) 5188
63-55	Differential Carrier	Full-Size		10-Bolt	RDS 11724
63-55	Flange	Full-Size	Inner	0-Bolt	(2) 13202
63-55	Flange	Full-Size	Outer	4-Bolt	(2) 5188
54-37	Differential Carrier	Full-Size		10-Bolt	RDS 5008
54-37	Housing Cover	Full-Size		10-Bolt	RDS 5007

DRIVETRAIN GASKETS

Year	Part Type	Model Name	Description	Bolt Holes	Part Number
GM Car (Cont.)					
Chevrolet Car Rear Axle (Cont.)					
54-37	Universal Joint Set	Full-Size			ES 72843
36-35	Differential Carrier	Full-Size		10-Bolt	RDS 4305
36-35	Housing Cover	Full-Size		10-Bolt	RDS 4304
36-35	Universal Joint Set	Full-Size			ES 72843
02-92	Housing Cover	Camaro	7.625" Ring Gear	10-Bolt	RDS 55072
91-87	Housing Cover	Camaro	7.625" Ring Gear	10-Bolt	RDS 55072
91-87	Housing Cover	Camaro	7.75" Ring Gear	9-Bolt	RDS 55390
86-82	Housing Cover	Camaro		10-Bolt	RDS 55072
81-71	Housing Cover	Camaro		10-Bolt	RDS 55028-1
70-67	Housing Cover	Camaro		10-Bolt	RDS 55028-1
70-67	Housing Cover	Camaro		12-Bolt	RDS 55029
88-76	Housing Cover	Chevelle, Malibu, Monte Carlo		10-Bolt	RDS 55072
75-73	Housing Cover	Chevelle, Malibu, Monte Carlo		10-Bolt	RDS 55028-1
75-73	Housing Cover	Chevelle, Malibu, Monte Carlo		10-Bolt	RDS 30031
72-71	Housing Cover	Chevelle, Malibu, Monte Carlo		10-Bolt	RDS 55028-1
72-71	Housing Cover	Chevelle, Malibu, Monte Carlo		12-Bolt	RDS 55029
70	Housing Cover	Chevelle, Malibu, Monte Carlo		10-Bolt	RDS 55028-1
70	Housing Cover	Chevelle, Malibu, Monte Carlo		10-Bolt	RDS 13410
70	Housing Cover	Chevelle, Malibu, Monte Carlo		12-Bolt	RDS 55029
69-65	Housing Cover	Chevelle, Malibu		10-Bolt	RDS 55028-1
69-65	Housing Cover	Chevelle, Malibu		12-Bolt	RDS 55029
64	Housing Cover	Chevelle, Malibu		12-Bolt	RDS 55029
87-76	Housing Cover	Chevette		10-Bolt	RDS 55069
63-62	Differential Carrier	Chevy II, Nova		10-Bolt	RDS 11724
96-90	Differential Carrier	Corvette		13-Bolt	RDS 55475
89-84	Differential Carrier	Corvette		10-Bolt	RDS 55389
82-63	Differential Carrier	Corvette		12-Bolt	RDS 13314-1
62-56	Differential Carrier	Corvette		10-Bolt	RDS 11724
55-53	Differential Carrier	Corvette		10-Bolt	RDS 5007
55-53	Housing Cover	Corvette		10-Bolt	RDS 5008
80-75	Housing Cover	Monza	6.5" Ring Gear	10-Bolt	RDS 55039
80-75	Housing Cover	Monza	7.5" Ring Gear	10-Bolt	RDS 55072
79-72	Housing Cover	Nova	7.5" Ring Gear	10-Bolt	RDS 55072
79-72	Housing Cover	Nova	8.5" Ring Gear	10-Bolt	RDS 55028-1
79-72	Housing Cover	Nova	8.5" Ring Gear	12-Bolt	RDS 55029
77-71	Housing Cover	Vega		10-Bolt	RDS 55039
Oldsmobile Car Rear Axle					
92-91	Housing Cover	Full-Size	8.5" Ring Gear	10-Bolt	RDS 55028-1
90-84	Housing Cover	Full-Size	7.5" Ring Gear	10-Bolt	RDS 55072
90-84	Housing Cover	Full-Size	8.5" Ring Gear	10-Bolt	RDS 55028-1
83-76	Housing Cover	Full-Size	7.5" Ring Gear	10-Bolt	RDS 55072
83-76	Housing Cover	Full-Size	8.5" Ring Gear	10-Bolt	RDS 55028-1
83-76	Housing Cover	Full-Size	8.875" Ring Gear	10-Bolt	RDS 30031
75-73	Housing Cover	Full-Size	7.5" Ring Gear	10-Bolt	RDS 55072
75-73	Housing Cover	Full-Size	8.5" Ring Gear	10-Bolt	RDS 55028-1
75-73	Housing Cover	Full-Size	8.875" Ring Gear	10-Bolt	RDS 30031
75-73	Housing Cover	Full-Size	9.5" Ring Gear	12-Bolt	RDS 55009
72-71	Housing Cover	Full-Size	8.5" Ring Gear	10-Bolt	RDS 55028-1
72-71	Housing Cover	Full-Size	9.375" Ring Gear	12-Bolt	RDS 55009
70-67	Housing Cover	Full-Size	Types B,P	10-Bolt	RDS 13410
70-67	Housing Cover	Full-Size	Types B,P	10-Bolt	RDS 30031
70-67	Housing Cover	Full-Size	Type O	12-Bolt	RDS 55008
70-67	Housing Cover	Full-Size	Type O	12-Bolt	RDS 55009
66-65	Housing Cover	Full-Size		10-Bolt	RDS 13410
66-65	Housing Cover	Full-Size		10-Bolt	RDS 30031
66-65	Bearing Retainer	Full-Size		4-Bolt	(2-4) 55010
64-61	Differential Carrier	Full-Size		10-Bolt	RDS 6431
64-61	Backing Plate	Full-Size		4-Bolt	(2) 4541
64-61	Bearing Retainer	Full-Size		4-Bolt	(2) 4541
64-61	Bearing Retainer	Full-Size		4-Bolt	(2-4) 55010
60-57	Differential Carrier	Full-Size		10-Bolt	RDS 6431
60-57	Backing Plate	Full-Size		4-Bolt	(2) 4541
56-49	Backing Plate	Full-Size		4-Bolt	(2) 4541
88-82	Housing Cover	Mid-Size	7.5" Ring Gear	10-Bolt	RDS 55072
88-82	Housing Cover	Mid-Size	8.5" Ring Gear	10-Bolt	RDS 55028-1

Year	Part Type	Model Name	Description	Bolt Holes	Part Number
GM Car (Cont.)					
Oldsmobile Car Rear Axle (Cont.)					
81-76	Housing Cover	Mid-Size	7.5" Ring Gear	10-Bolt	RDS 55072
81-76	Housing Cover	Mid-Size	8.5" Ring Gear	10-Bolt	RDS 55028-1
81-76	Housing Cover	Mid-Size	8.875" Ring Gear	10-Bolt	RDS 30031
75-71	Housing Cover	Mid-Size	8.5" Ring Gear	10-Bolt	RDS 55028-1
75-71	Housing Cover	Mid-Size	8.875" Ring Gear	10-Bolt	RDS 30031
70-68	Housing Cover	Mid-Size	Type C	12-Bolt	RDS 55029
70-68	Housing Cover	Mid-Size	Type O	12-Bolt	RDS 55009
70-68	Flange	Mid-Size		4-Bolt	(2-4) 55010
67-64	Housing Cover	Mid-Size	Types B, P	10-Bolt	RDS 13410
67-64	Flange	Mid-Size		4-Bolt	(2-4) 55010
79-73	Housing Cover	Omega	7.5" Ring Gear	10-Bolt	RDS 55072
79-73	Housing Cover	Omega	8.5" Ring Gear	10-Bolt	RDS 55028-1
80-75	Housing Cover	Starfire	6.5" Ring Gear	10-Bolt	RDS 55039
80-75	Housing Cover	Starfire	7.5" Ring Gear	10-Bolt	RDS 55072
Pontiac Car Rear Axle					
90-83	Housing Cover	Full-Size	7.5" Ring Gear	10-Bolt	RDS 55072
90-83	Housing Cover	Full-Size	8.5" Ring Gear	10-Bolt	RDS 55028-1
82-76	Housing Cover	Full-Size	7.5" Ring Gear	10-Bolt	RDS 55072
82-76	Housing Cover	Full-Size	8.5" Ring Gear	10-Bolt	RDS 55028-1
82-76	Housing Cover	Full-Size	8.875" Ring Gear	10-Bolt	RDS 30031
75-71	Housing Cover	Full-Size	Types B, C, G, K, O	10-Bolt	RDS 55028-1
75-71	Housing Cover	Full-Size	Types M, P	10-Bolt	RDS 30031
70-65	Housing Cover	Full-Size		10-Bolt	RDS 30031
70-65	Backing Plate	Full-Size		4-Bolt	(2) 13831
64-59	Differential Carrier	Full-Size		10-Bolt	RDS 6431
58-57	Differential Carrier	Full-Size		10-Bolt	RDS 6431
58-57	Backing Plate	Full-Size		4-Bolt	(2) 4541
56-37	Backing Plate	Full-Size		4-Bolt	(2) 4541
36-35	Differential Carrier	Full-Size		10-Bolt	RDS 4305
36-35	Housing Cover	Full-Size		10-Bolt	RDS 4304
34-33	Housing Cover	Full-Size		10-Bolt	RDS 4304
77-75	Housing Cover	Astre	6.5" Ring Gear	10-Bolt	RDS 55039
77-75	Housing Cover	Astre	7.5" Ring Gear	10-Bolt	RDS 55072
02-91	Housing Cover	Firebird	7.625" Ring Gear	10-Bolt	RDS 55072
90-85	Housing Cover	Firebird	7.625" Ring Gear	10-Bolt	RDS 55072
90-85	Housing Cover	Firebird	7.75" Ring Gear	9-Bolt	RDS 55390
84-82	Housing Cover	Firebird		10-Bolt	RDS 55072
81-71	Housing Cover	Firebird		10-Bolt	RDS 55028-1
70	Housing Cover	Firebird	Exc. Ram Air	10-Bolt	RDS 55028-1
70	Housing Cover	Firebird	Exc. Ram Air	12-Bolt	RDS 55029
70	Housing Cover	Firebird	Ram Air	10-Bolt	RDS 30031
69-67	Housing Cover	Firebird		10-Bolt	RDS 13410
83-80	Housing Cover	LeMans		10-Bolt	RDS 55072
79-73	Housing Cover	LeMans	7.5" Ring Gear	10-Bolt	RDS 55072
79-73	Housing Cover	LeMans	8.5" Ring Gear	10-Bolt	RDS 55028-1
79-73	Housing Cover	LeMans	8.875" Ring Gear	10-Bolt	RDS 30031
72-70	Housing Cover	LeMans		10-Bolt	RDS 55028-1
72-70	Housing Cover	LeMans		12-Bolt	RDS 55029
69-64	Housing Cover	LeMans		10-Bolt	RDS 13410
69-64	Flange	LeMans		4-Bolt	(2-4) 13394
79-77	Housing Cover	Phoenix	7.5" Ring Gear	10-Bolt	RDS 55072
79-77	Housing Cover	Phoenix	8.5" Ring Gear	10-Bolt	RDS 55028-1
80-76	Housing Cover	Sunbird	6.5" Ring Gear	10-Bolt	RDS 55039
80-76	Housing Cover	Sunbird	7.5" Ring Gear	10-Bolt	RDS 55072
87-81	Housing Cover	T1000		10-Bolt	RDS 55069
70	Housing Cover	Tempest		10-Bolt	RDS 55028-1
70	Housing Cover	Tempest		12-Bolt	RDS 55029
69-64	Housing Cover	Tempest		10-Bolt	RDS 13410
69-64	Flange	Tempest		4-Bolt	(2-4) 13394
77-76	Housing Cover	Ventura II		10-Bolt	RDS 55072
75-71	Housing Cover	Ventura II		10-Bolt	RDS 55028-1
All Models Automatic Transaxle					
02-85	Oil Pan	Nova, Prizm (MB3, MX1)	3 Speed	15-Bolt	TOS 18671
01-85	Oil Pan	Sprint, Metro (MX17)	3 Speed	15-Bolt	TOS 18677
93-85	Oil Pan	Spectrum, Storm (F3A)	3 Speed	16-Bolt	TOS 18713

DRIVETRAIN GASKETS

Year	Part Type	Model Name	Description	Bolt Holes	Part Number
GM Car (Cont.)					
All Models Automatic Transaxle (Cont.)					
02-80	Oil Pan	THM125 (M34), THM125C (MD9), 3T40 (MD9), 3T40A (MD9)	3 Speed	16-Bolt	TOS 18656
02-80	Valve Body Cover	THM125 (M34), THM125C (MD9), 3T40 (MD9), 3T40A (MD9)	3 Speed	11-Bolt	TOS 18661
90-89	Oil Pan	THM125C (MD9)	AWD (3 Speed)	14-Bolt	TOS 18689 ¹
85-79	Oil Pan	THM325 (M32)	3 Speed	15-Bolt	TOS 18655
14-04	Oil Pan	Aveo, Aveo 5, G3, Wave, Wave 5 (Aisin 81-40LE)	4 Speed	18-Bolt	TOS 18758
02-93	Oil Pan	Prizm (MS7)	4 Speed	18-Bolt	TOS 18746
92-88	Oil Pan	Prizm (MS7)	4 Speed	18-Bolt	TOS 18676
93-90	Oil Pan	Storm	4 Speed	21-Bolt	TOS 18694
85-79	Oil Pan	THM325-4L (M57)	4 Speed	15-Bolt	TOS 18655
97-83	Oil Pan	THM440-T4 (ME9), 4T60 (ME9)	4 Speed	19-Bolt	TOS 18668
97-83	Case Side Cover	THM440-T4 (ME9), 4T60 (ME9)	4 Speed	17-Bolt	TOS 18669
10-09	Oil Pan	Vibe (U241E)	4 Speed	18-Bolt	TOS 18719
10-09	Oil Pan	Vibe (U341E)	4 Speed	19-Bolt	TOS 18720
06-03	Oil Pan	Vibe (A245E)	4 Speed	18-Bolt	TOS 18741
10-95	Oil Pan	4T40-E (MN4), 4T45-E (MN5/MN9)	4 Speed	12-Bolt	TOS 18715
10-95	Valve Body Cover	4T40-E (MN4), 4T45-E (MN5/MN9)	4 Speed	0-Bolt	TOS 18716
11-97	Oil Pan	4T60-E (M13), 4T65-E (M15/MN3/MN7) Second Design (6mm bolt holes)	4 Speed	20-Bolt	TOS 18717
11-97	Case Side Cover	4T60-E (M13), 4T65-E (M15/MN3/MN7) Second Design (Molded rubber)	4 Speed	17-Bolt	TOS 18723
03-91	Oil Pan	4T60-E (M13), 4T65-E (M15/MN3/MN7) First Design (8mm bolt holes)	4 Speed	20-Bolt	TOS 18697
03-91	Case Side Cover	4T60-E (M13), 4T65-E (M15/MN3/MN7) First Design (Cork-rubber)	4 Speed	17-Bolt	TOS 18669
11-93	Oil Pan	4T80-E (MH1)	4 Speed	16-Bolt	TOS 18722
11-93	Case Side Cover	4T80-E (MH1)	4 Speed	0-Bolt	TOS 18725
All Models Automatic Transmission					
56-46	Oil Pan	Hydramatic	Dual Range (2 Speed)	12-Bolt	TOS 18024
73-62	Oil Pan	Powerglide (M35)	Exc. Corvair (2 Speed)	14-Bolt	TOS 18608
69-60	Oil Pan	Powerglide (M35)	Corvair (2 Speed)	14-Bolt	TOS 18508
69-64	Oil Pan	Super Turbine 300	2 Speed	14-Bolt	TOS 18625
62-61	Oil Pan	Tempstorque	2 Speed	14-Bolt	TOS 18508
63-48	Oil Pan	DynaFlow, Twin Turbine	3 Speed	22-Bolt	TOS 18178
69-64	Oil Pan	Jetaway	3 Speed	14-Bolt	TOS 18625
64-60	Oil Pan	Jetaway 315	3 Speed	14-Bolt	TOS 18509
59-55	Oil Pan	Jetaway 315	3 Speed	15-Bolt	TOS 18057
98-77	Oil Pan	THM180 (MD3), THM180C (MD2), 3L30 (MD3)	3 Speed	12-Bolt	TOS 18643
88-76	Oil Pan	THM200 (M16/M29), THM200C (MV9)	3 Speed	11-Bolt	TOS 18648
90-81	Oil Pan	THM200-4R (MW9)	3 Speed	16-Bolt	TOS 18662
92-80	Oil Pan	THM250, THM250C (MD8)	3 Speed	13-Bolt	TOS 18633
84-69	Oil Pan	THM350, THM350C (M31/M33/M38/MV4/MX2/MX5)	3 Speed	13-Bolt	TOS 18633
90-64	Oil Pan	THM375 (M40), THM400 (M40), 3L80 (M40)	3 Speed	13-Bolt	TOS 18621
78-66	Oil Pan	THM425 (M40)	Eldorado, Toronado (3 Speed)	13-Bolt	TOS 18629
64-60	Oil Pan	Hydramatic	Controlled-Coupling (4 Speed)	14-Bolt	TOS 18509
59-56	Oil Pan	Hydramatic	Controlled-Coupling (4 Speed)	15-Bolt	TOS 18057
07-82	Oil Pan	THM700-R4 (MD8), 4L60 (M30), 4L60-E (M30), 4L65-E (M32)	4 Speed	16-Bolt	TOS 18663
02-97	Oil Pan	4L30-E	4 Speed	16-Bolt	TOS 18704
10-03	Oil Pan	5L40-E, 5L50-E	5 Speed	22-Bolt	TOS 18768
All Models Manual Transmission					
71-64	Transmission Kit	Dearborn	3 Speed		TS 80108
81-66	Transmission Kit	Saginaw	3 Speed		TS 30118
65-55	Transmission Kit	Standard	3 Speed		TS 5190
54-37	Transmission Kit	Standard	3 Speed		TS 5099
65-64	Transmission Kit	Warner	3 Speed		TS 5135
81-57	Transmission Kit	Saginaw	4 Speed		TS 30118
74-63	Transmission Kit	Muncie	4 Speed		TS 6238
80-57	Transmission Kit	Warner	4 Speed		TS 5135
GMC Truck					
Cadillac Truck Front Axle					
14-99	Housing Cover	Escalade	8.25" Ring Gear	10-Bolt	RDS 55477

Year	Part Type	Model Name	Description	Bolt Holes	Part Number
GMC Truck (Cont.)					
Chevrolet Truck Front Axle					
13-02	Housing Cover	Avalanche	8.25" Ring Gear	10-Bolt	RDS 55477
12-04	Housing Cover	Colorado	7.625" Ring Gear	10-Bolt	RDS 55477
14-95	Housing Cover	Tahoe	8.25" Ring Gear	10-Bolt	RDS 55477
14-95	Housing Cover	1/2 Ton, 3/4 Ton	8.25" Ring Gear	10-Bolt	RDS 55477
91-81	Housing Cover	1/2 Ton, 3/4 Ton	GM	10-Bolt	RDS 55075
80-77	Housing Cover	1/2 Ton, 3/4 Ton	Dana	10-Bolt	RDS 6629
80-77	Housing Cover	1/2 Ton, 3/4 Ton	GM	10-Bolt	RDS 55075
76-66	Housing Cover	1/2 Ton, 3/4 Ton	Dana	10-Bolt	RDS 6629
76-66	Housing Cover	1/2 Ton, 3/4 Ton	GM	10-Bolt	RDS 5088
91-77	Housing Cover	1 Ton		10-Bolt	RDS 6095-1
GMC Truck Front Axle					
12-04	Housing Cover	Canyon	7.625" Ring Gear	10-Bolt	RDS 55477
14-95	Housing Cover	Yukon	8.25" Ring Gear	10-Bolt	RDS 55477
14-95	Housing Cover	1/2 Ton, 3/4 Ton	8.25" Ring Gear	10-Bolt	RDS 55477
91-81	Housing Cover	1/2 Ton, 3/4 Ton	GM	10-Bolt	RDS 55075
80-77	Housing Cover	1/2 Ton, 3/4 Ton	Dana	10-Bolt	RDS 6629
80-77	Housing Cover	1/2 Ton, 3/4 Ton	GM	10-Bolt	RDS 55075
76-66	Housing Cover	1/2 Ton, 3/4 Ton	Dana	10-Bolt	RDS 6629
76-66	Housing Cover	1/2 Ton, 3/4 Ton	GM	10-Bolt	RDS 5088
91-77	Housing Cover	1 Ton		10-Bolt	RDS 6095-1
Hummer Truck Front Axle					
06-02	Housing Cover	H1	8.875" Ring Gear	12-Bolt	RDS 13889
10-03	Housing Cover	H2	8.25" Ring Gear	10-Bolt	RDS 55477
10-06	Housing Cover	H3	7.625" Ring Gear	10-Bolt	RDS 55477
Buick Truck Rear Axle					
07-04	Housing Cover	Rainier	8" Ring Gear	10-Bolt	RDS 55479
07-04	Housing Cover	Rainier	8.625" Ring Gear	10-Bolt	RDS 55028-1
Cadillac Truck Rear Axle					
14-08	Housing Cover	Escalade	8.625" Ring Gear	10-Bolt	RDS 55480
14-07	Housing Cover	Escalade	8.625" Ring Gear	10-Bolt	RDS 55031
14-08	Housing Cover	Escalade	9.5" Ring Gear	14-Bolt	RDS 55387
07-99	Housing Cover	Escalade	8.5" Ring Gear	10-Bolt	RDS 55028-1
07-99	Housing Cover	Escalade	8.625" Ring Gear	10-Bolt	RDS 55028-1
Chevrolet Truck Rear Axle					
05-99	Housing Cover	Astro, S10, ST10	7.625" Ring Gear	10-Bolt	RDS 55072
05-99	Housing Cover	Astro, S10, ST10	8.5" Ring Gear	10-Bolt	RDS 55028-1
05-99	Housing Cover	Astro, S10, ST10	8.625" Ring Gear	10-Bolt	RDS 55028-1
98-90	Housing Cover	Astro, S10, ST10	7.5" Ring Gear	10-Bolt	RDS 55072
98-90	Housing Cover	Astro, S10, ST10	7.625" Ring Gear	10-Bolt	RDS 55072
98-90	Housing Cover	Astro, S10, ST10	8.5" Ring Gear	10-Bolt	RDS 55028-1
98-90	Housing Cover	Astro, S10, ST10	8.625" Ring Gear	10-Bolt	RDS 55028-1
89-82	Housing Cover	Astro, S10, ST10	7.5" Ring Gear	10-Bolt	RDS 55072
89-82	Housing Cover	Astro, S10, ST10	7.625" Ring Gear	10-Bolt	RDS 55072
13-08	Housing Cover	Avalanche	8.625" Ring Gear	10-Bolt	RDS 55480
13-07	Housing Cover	Avalanche	8.625" Ring Gear	10-Bolt	RDS 55031
07-02	Housing Cover	Avalanche	8.5" Ring Gear	10-Bolt	RDS 55028-1
07-02	Housing Cover	Avalanche	8.625" Ring Gear	10-Bolt	RDS 55028-1
12-04	Housing Cover	Colorado	8" Ring Gear	10-Bolt	RDS 55479
82-72	Differential Carrier	LUV		10-Bolt	RDS 55084
14-08	Housing Cover	Tahoe	8.625" Ring Gear	10-Bolt	RDS 55480
14-07	Housing Cover	Tahoe	8.625" Ring Gear	10-Bolt	RDS 55031
07-95	Housing Cover	Tahoe	8.5" Ring Gear	10-Bolt	RDS 55028-1
07-95	Housing Cover	Tahoe	8.625" Ring Gear	10-Bolt	RDS 55028-1
09-08	Housing Cover	TrailBlazer	8" Ring Gear	10-Bolt	RDS 55479
09-08	Housing Cover	TrailBlazer	8.625" Ring Gear	10-Bolt	RDS 55480
09-08	Housing Cover	TrailBlazer	8.625" Ring Gear	10-Bolt	RDS 55028-1
09-08	Housing Cover	TrailBlazer	9.5" Ring Gear	14-Bolt	RDS 55387
07-02	Housing Cover	TrailBlazer	8" Ring Gear	10-Bolt	RDS 55479
07-02	Housing Cover	TrailBlazer	8.625" Ring Gear	10-Bolt	RDS 55028-1
07-06	Housing Cover	TrailBlazer	9.5" Ring Gear	14-Bolt	RDS 55387
75-71	Housing Cover	Vega		10-Bolt	RDS 55039
14-08	Housing Cover	1/2 Ton	8.625" Ring Gear	10-Bolt	RDS 55480
14-07	Housing Cover	1/2 Ton	8.625" Ring Gear	10-Bolt	RDS 55031
14-08	Housing Cover	1/2 Ton	9.5" Ring Gear	14-Bolt	RDS 55387

DRIVETRAIN GASKETS

Year	Part Type	Model Name	Description	Bolt Holes	Part Number
GMC Truck (Cont.)					
Chevrolet Truck Rear Axle (Cont.)					
07-00	Housing Cover	1/2 Ton	8.5" Ring Gear	10-Bolt	RDS 55028-1
07-00	Housing Cover	1/2 Ton	8.625" Ring Gear	10-Bolt	RDS 55028-1
07-00	Housing Cover	1/2 Ton	9.5" Ring Gear	14-Bolt	RDS 55387
99-91	Housing Cover	1/2 Ton	8.5" Ring Gear	10-Bolt	RDS 55028-1
99-91	Housing Cover	1/2 Ton	8.625" Ring Gear	10-Bolt	RDS 55028-1
99-91	Housing Cover	1/2 Ton	9.5" Ring Gear	14-Bolt	RDS 55387
90-82	Housing Cover	1/2 Ton	8.5" Ring Gear	10-Bolt	RDS 55028-1
81-64	Housing Cover	1/2 Ton		10-Bolt	RDS 55028-1
81-64	Housing Cover	1/2 Ton		12-Bolt	RDS 13391
70-64	Housing Cover	1/2 Ton		10-Bolt	RDS 6629
63-56	Differential Carrier	1/2 Ton		10-Bolt	RDS 4305
63-56	Housing Cover	1/2 Ton		10-Bolt	RDS 4304
63-56	Housing Cover	1/2 Ton		12-Bolt	RDS 13391
55-37	Differential Carrier	1/2 Ton		10-Bolt	RDS 4305
55-37	Housing Cover	1/2 Ton		10-Bolt	RDS 4304
55-37	Universal Joint Set	1/2 Ton			ES 72843
14-00	Housing Cover	3/4 Ton	9.5" Ring Gear	14-Bolt	RDS 55387
14-00	Housing Cover	3/4 Ton	10.5" Ring Gear	14-Bolt	RDS 55063
14-06	Housing Cover	3/4 Ton	11.5" Ring Gear	14-Bolt	RDS 55478
14-00	Flange	3/4 Ton		8-Bolt	(2) 55350
99-82	Housing Cover	3/4 Ton	8.5" Ring Gear	10-Bolt	RDS 55028-1
99-82	Housing Cover	3/4 Ton	8.625" Ring Gear	10-Bolt	RDS 55028-1
99-82	Housing Cover	3/4 Ton	9.5" Ring Gear	14-Bolt	RDS 55387
99-82	Housing Cover	3/4 Ton	10.5" Ring Gear	14-Bolt	RDS 55063
99-82	Flange	3/4 Ton		8-Bolt	(2) 55350
81-73	Housing Cover	3/4 Ton	8.5" Ring Gear	10-Bolt	RDS 55028-1
81-73	Housing Cover	3/4 Ton	8.875" Ring Gear	12-Bolt	RDS 13391
81-73	Housing Cover	3/4 Ton	10.5" Ring Gear	14-Bolt	RDS 55063
81-73	Flange	3/4 Ton		8-Bolt	(2) 55350
72-46	Differential Carrier	3/4 Ton	GM	10-Bolt	RDS 5090
72-46	Housing Cover	3/4 Ton	GM	10-Bolt	RDS 5088
72-46	Housing Cover	3/4 Ton	GM	12-Bolt	RDS 13391
72-46	Housing Cover	3/4 Ton	Dana	10-Bolt	RDS 6629
72-46	Flange	3/4 Ton		8-Bolt	(2) 55350
45-37	Differential Carrier	3/4 Ton		10-Bolt	RDS 4305
45-37	Housing Cover	3/4 Ton		10-Bolt	RDS 5088
14-08	Housing Cover	1 Ton	10.5" Ring Gear	14-Bolt	RDS 55063
14-08	Housing Cover	1 Ton	11.5" Ring Gear	14-Bolt	RDS 55478
14-08	Flange	1 Ton		8-Bolt	(2) 55350
07-01	Housing Cover	1 Ton	10.5" Ring Gear	14-Bolt	RDS 55063
07-01	Housing Cover	1 Ton	11.5" Ring Gear	10-Bolt	RDS 55447
07-01	Housing Cover	1 Ton	11.5" Ring Gear	14-Bolt	RDS 55478
07-01	Flange	1 Ton		8-Bolt	(2) 55350
00-91	Housing Cover	1 Ton	9.5" Ring Gear	14-Bolt	RDS 55387
00-91	Housing Cover	1 Ton	10.5" Ring Gear	14-Bolt	RDS 55063
00-91	Housing Cover	1 Ton	11.5" Ring Gear	10-Bolt	RDS 55447
00-91	Flange	1 Ton		8-Bolt	(2) 55350
90-82	Housing Cover	1 Ton	GM	14-Bolt	RDS 55063
90-82	Housing Cover	1 Ton	Dana	10-Bolt	RDS 6095-1
90-82	Flange	1 Ton		8-Bolt	(2) 55350
81-73	Differential Carrier	1 Ton		10-Bolt	RDS 5049
81-73	Housing Cover	1 Ton		10-Bolt	RDS 6095-1
81-73	Housing Cover	1 Ton		14-Bolt	RDS 55063
81-73	Flange	1 Ton		8-Bolt	(2) 55350
72-67	Differential Carrier	1 Ton		10-Bolt	RDS 5049
72-67	Differential Carrier	1 Ton		10-Bolt	RDS 5090
72-67	Housing Cover	1 Ton		10-Bolt	RDS 5088
72-67	Flange	1 Ton		8-Bolt	(2) 55350
66-46	Differential Carrier	1 Ton		10-Bolt	RDS 5090
66-46	Housing Cover	1 Ton		10-Bolt	RDS 5088
42-38	Housing Cover	1 Ton		10-Bolt	RDS 4304
GMC Truck Rear Axle					
12-04	Housing Cover	Canyon	8" Ring Gear	10-Bolt	RDS 55479
09-08	Housing Cover	Envoy	8" Ring Gear	10-Bolt	RDS 55479
09-08	Housing Cover	Envoy	8.625" Ring Gear	10-Bolt	RDS 55480

Year	Part Type	Model Name	Description	Bolt Holes	Part Number
GMC Truck (Cont.)					
GMC Truck Rear Axle (Cont.)					
09-08	Housing Cover	Envoy	8.625" Ring Gear	10-Bolt	RDS 55028-1
09-08	Housing Cover	Envoy	9.5" Ring Gear	14-Bolt	RDS 55387
07-02	Housing Cover	Envoy	8" Ring Gear	10-Bolt	RDS 55479
07-02	Housing Cover	Envoy	8.625" Ring Gear	10-Bolt	RDS 55028-1
07-06	Housing Cover	Envoy	9.5" Ring Gear	14-Bolt	RDS 55387
14-08	Housing Cover	Yukon	8.625" Ring Gear	10-Bolt	RDS 55480
14-07	Housing Cover	Yukon	8.625" Ring Gear	10-Bolt	RDS 55031
14-08	Housing Cover	Yukon	9.5" Ring Gear	14-Bolt	RDS 55387
14-08	Housing Cover	Yukon	10.5" Ring Gear	14-Bolt	RDS 55063
07-95	Housing Cover	Yukon	8.5" Ring Gear	10-Bolt	RDS 55028-1
07-95	Housing Cover	Yukon	8.625" Ring Gear	10-Bolt	RDS 55028-1
07-95	Housing Cover	Yukon	9.5" Ring Gear	14-Bolt	RDS 55387
05-99	Housing Cover	S15, ST15, Safari, Sonoma	7.625" Ring Gear	10-Bolt	RDS 55072
05-99	Housing Cover	S15, ST15, Safari, Sonoma	8.5" Ring Gear	10-Bolt	RDS 55028-1
05-99	Housing Cover	S15, ST15, Safari, Sonoma	8.625" Ring Gear	10-Bolt	RDS 55028-1
98-90	Housing Cover	S15, ST15, Safari, Sonoma	7.5" Ring Gear	10-Bolt	RDS 55072
98-90	Housing Cover	S15, ST15, Safari, Sonoma	7.625" Ring Gear	10-Bolt	RDS 55072
98-90	Housing Cover	S15, ST15, Safari, Sonoma	8.5" Ring Gear	10-Bolt	RDS 55028-1
98-90	Housing Cover	S15, ST15, Safari, Sonoma	8.625" Ring Gear	10-Bolt	RDS 55028-1
89-82	Housing Cover	S15, ST15, Safari, Sonoma	7.5" Ring Gear	10-Bolt	RDS 55072
89-82	Housing Cover	S15, ST15, Safari, Sonoma	7.625" Ring Gear	10-Bolt	RDS 55072
14-08	Housing Cover	1/2 Ton	8.625" Ring Gear	10-Bolt	RDS 55480
14-07	Housing Cover	1/2 Ton	8.625" Ring Gear	10-Bolt	RDS 55031
14-08	Housing Cover	1/2 Ton	9.5" Ring Gear	14-Bolt	RDS 55387
07-00	Housing Cover	1/2 Ton	8.5" Ring Gear	10-Bolt	RDS 55028-1
07-00	Housing Cover	1/2 Ton	8.625" Ring Gear	10-Bolt	RDS 55028-1
07-00	Housing Cover	1/2 Ton	9.5" Ring Gear	14-Bolt	RDS 55387
99-91	Housing Cover	1/2 Ton	8.5" Ring Gear	10-Bolt	RDS 55028-1
99-91	Housing Cover	1/2 Ton	8.625" Ring Gear	10-Bolt	RDS 55028-1
99-91	Housing Cover	1/2 Ton	9.5" Ring Gear	14-Bolt	RDS 55387
90-82	Housing Cover	1/2 Ton	8.5" Ring Gear	10-Bolt	RDS 55028-1
81-73	Housing Cover	1/2 Ton		10-Bolt	RDS 55028-1
81-73	Housing Cover	1/2 Ton		12-Bolt	RDS 13391
72-71	Housing Cover	1/2 Ton	Dana 44	10-Bolt	RDS 6629
72-71	Housing Cover	1/2 Ton	GM H024	10-Bolt	RDS 55028-1
72-71	Housing Cover	1/2 Ton	GM H031, H035	10-Bolt	RDS 6629
72-71	Housing Cover	1/2 Ton	GM H033	12-Bolt	RDS 13391
72-71	Differential Carrier	1/2 Ton	GM H052, H072	10-Bolt	RDS 5090
70-67	Differential Carrier	1/2 Ton	Dana 44	10-Bolt	RDS 4305
70-67	Housing Cover	1/2 Ton	Dana 44	10-Bolt	RDS 6629
70-67	Housing Cover	1/2 Ton	GM H033, H035	12-Bolt	RDS 13391
66-63	Differential Carrier	1/2 Ton	GM H035	10-Bolt	RDS 4305
66-63	Housing Cover	1/2 Ton	GM H035	10-Bolt	RDS 4304
62-57	Differential Carrier	1/2 Ton	Dana 44, 45	10-Bolt	RDS 4305
62-57	Housing Cover	1/2 Ton	Dana 44, 45	10-Bolt	RDS 6629
56	Differential Carrier	1/2 Ton		10-Bolt	RDS 4305
56	Housing Cover	1/2 Ton		10-Bolt	RDS 5088
56	Flange	1/2 Ton		8-Bolt	(A/R) 55350
55	Differential Carrier	1/2 Ton	GM H033	10-Bolt	RDS 4305
55	Housing Cover	1/2 Ton	GM H033	10-Bolt	RDS 4304
55	Housing Cover	1/2 Ton	GM H050	10-Bolt	RDS 5088
55	Flange	1/2 Ton		8-Bolt	(A/R) 55350
54-46	Differential Carrier	1/2 Ton		10-Bolt	RDS 5090
54-46	Housing Cover	1/2 Ton		10-Bolt	RDS 5088
54-46	Flange	1/2 Ton		8-Bolt	(A/R) 55350
45-39	Differential Carrier	1/2 Ton		10-Bolt	RDS 4305
45-39	Housing Cover	1/2 Ton		10-Bolt	RDS 4304
45-39	Flange	1/2 Ton		8-Bolt	(A/R) 55350
14-00	Housing Cover	3/4 Ton	9.5" Ring Gear	14-Bolt	RDS 55387
14-00	Housing Cover	3/4 Ton	10.5" Ring Gear	14-Bolt	RDS 55063
14-06	Housing Cover	3/4 Ton	11.5" Ring Gear	14-Bolt	RDS 55478
14-00	Flange	3/4 Ton		8-Bolt	(A/R) 55350
99-82	Housing Cover	3/4 Ton	8.5" Ring Gear	10-Bolt	RDS 55028-1
99-82	Housing Cover	3/4 Ton	8.625" Ring Gear	10-Bolt	RDS 55028-1
99-82	Housing Cover	3/4 Ton	9.5" Ring Gear	14-Bolt	RDS 55387
99-82	Housing Cover	3/4 Ton	10.5" Ring Gear	14-Bolt	RDS 55063

DRIVETRAIN GASKETS

Year	Part Type	Model Name	Description	Bolt Holes	Part Number
GMC Truck (Cont.)					
GMC Truck Rear Axle (Cont.)					
99-82	Flange	3/4 Ton		8-Bolt	(A/R) 55350
81-73	Housing Cover	3/4 Ton	8.5" Ring Gear	10-Bolt	RDS 55028-1
81-73	Housing Cover	3/4 Ton	8.875" Ring Gear	12-Bolt	RDS 13391
81-73	Housing Cover	3/4 Ton	10.5" Ring Gear	14-Bolt	RDS 55063
81-73	Flange	3/4 Ton		8-Bolt	(A/R) 55350
72-55	Differential Carrier	3/4 Ton		10-Bolt	RDS 5090
72-55	Housing Cover	3/4 Ton		10-Bolt	RDS 5088
72-55	Housing Cover	3/4 Ton		12-Bolt	RDS 13391
72-55	Flange	3/4 Ton		8-Bolt	(A/R) 55350
54-47	Differential Carrier	3/4 Ton		10-Bolt	RDS 5049
54-47	Differential Carrier	3/4 Ton		10-Bolt	RDS 5090
54-47	Housing Cover	3/4 Ton		10-Bolt	RDS 5088
54-47	Flange	3/4 Ton		8-Bolt	(A/R) 55350
46-39	Differential Carrier	3/4 Ton		10-Bolt	RDS 5049
46-39	Housing Cover	3/4 Ton		10-Bolt	RDS 5088
46-39	Flange	3/4 Ton		8-Bolt	(A/R) 55350
14-08	Housing Cover	1 Ton	10.5" Ring Gear	14-Bolt	RDS 55063
14-08	Housing Cover	1 Ton	11.5" Ring Gear	14-Bolt	RDS 55478
14-08	Flange	1 Ton		8-Bolt	(A/R) 55350
07-01	Housing Cover	1 Ton	10.5" Ring Gear	14-Bolt	RDS 55063
07-01	Housing Cover	1 Ton	11.5" Ring Gear	10-Bolt	RDS 55447
07-01	Housing Cover	1 Ton	11.5" Ring Gear	14-Bolt	RDS 55478
07-01	Flange	1 Ton		8-Bolt	(A/R) 55350
00-91	Housing Cover	1 Ton	9.5" Ring Gear	14-Bolt	RDS 55387
00-91	Housing Cover	1 Ton	10.5" Ring Gear	14-Bolt	RDS 55063
00-91	Housing Cover	1 Ton	11.5" Ring Gear	10-Bolt	RDS 55447
00-91	Flange	1 Ton		8-Bolt	(A/R) 55350
90-82	Housing Cover	1 Ton	GM	14-Bolt	RDS 55063
90-82	Housing Cover	1 Ton	Dana	10-Bolt	RDS 6095-1
90-82	Flange	1 Ton		8-Bolt	(A/R) 55350
81-73	Differential Carrier	1 Ton		10-Bolt	RDS 5049
81-73	Housing Cover	1 Ton		10-Bolt	RDS 6095-1
81-73	Housing Cover	1 Ton		14-Bolt	RDS 55063
81-73	Flange	1 Ton		8-Bolt	(A/R) 55350
72-60	Differential Carrier	1 Ton	Eaton 13800	12-Bolt	RDS 5549-1
72-60	Differential Carrier	1 Ton	GM H052, H072	10-Bolt	RDS 5090
72-60	Differential Carrier	1 Ton	GM H110	10-Bolt	RDS 5049
72-60	Differential Carrier	1 Ton	GM H130	12-Bolt	RDS 5549-1
72-60	Differential Carrier	1 Ton	GM H150, T150	13-Bolt	RDS 12514 ¹
72-60	Housing Cover	1 Ton	GM H052, H072	10-Bolt	RDS 5088
72-60	Flange	1 Ton		8-Bolt	(A/R) 55350
59-55	Differential Carrier	1 Ton	Eaton 1350, 3600	12-Bolt	RDS 5549-1
59-55	Differential Carrier	1 Ton	GM H110, H130	10-Bolt	RDS 5049
59-55	Differential Carrier	1 Ton	GM H150, T170	13-Bolt	RDS 12514 ¹
59-55	Flange	1 Ton	Eaton 1350, 3600	8-Bolt	(A/R) 3458
54-39	Differential Carrier	1 Ton	Bevel Drive	10-Bolt	RDS 5049
54-39	Differential Carrier	1 Ton	Eaton 1350	12-Bolt	RDS 5549-1
54-39	Flange	1 Ton	Eaton 1350	8-Bolt	(A/R) 3458
Hummer Truck Rear Axle					
06-02	Housing Cover	H1	8.875" Ring Gear	12-Bolt	RDS 13889
10-03	Housing Cover	H2	9.5" Ring Gear	14-Bolt	RDS 55387
10-08	Housing Cover	H3	8.625" Ring Gear	10-Bolt	RDS 55480
07-06	Housing Cover	H3	8.625" Ring Gear	10-Bolt	RDS 55028-1
Oldsmobile Truck Rear Axle					
04-02	Housing Cover	Bravada	8" Ring Gear	10-Bolt	RDS 55479
04-02	Housing Cover	Bravada	8.625" Ring Gear	10-Bolt	RDS 55028-1
All Models Power Take-Off (PTO)					
	Cover	Chelsea		6-Bolt	55372
	Mounting	Chelsea	(.010")	6-Bolt	55379
	Mounting	Chelsea	(.020")	6-Bolt	55380
	Mounting	Chelsea	(.010")	8-Bolt	55375
	Mounting	Chelsea	(.020")	8-Bolt	55377
All Models Transfer Case					
79-73	Transfer Case Kit	New Process 203	Full-Time 2 Speed		TS 80683 ¹

Year	Part Type	Model Name	Description	Bolt Holes	Part Number
GMC Truck (Cont.)					
All Models Transfer Case (Cont.)					
79-69	Transfer Case Kit	New Process 205	Part-Time 2 Speed		TS 80324
All Models Automatic Transaxle					
95-90	Oil Pan	THM125C (MD9)	3 Speed	16-Bolt	TOS 18656
95-90	Valve Body Cover	THM125C (MD9)	3 Speed	11-Bolt	TOS 18661
11-95	Oil Pan	4T40-E (MN4), 4T45-E (MN5/MN9)	4 Speed	12-Bolt	TOS 18715
11-95	Valve Body Cover	4T40-E (MN4), 4T45-E (MN5/MN9)	4 Speed	0-Bolt	TOS 18716
10-97	Oil Pan	4T60-E (M13), 4T65-E (M15/MN3/MN7) Second Design (6mm bolt holes)	4 Speed	20-Bolt	TOS 18717
10-97	Case Side Cover	4T60-E (M13), 4T65-E (M15/MN3/MN7) Second Design (Molded rubber)	4 Speed	17-Bolt	TOS 18723
03-92	Oil Pan	4T60-E (M13), 4T65-E (M15/MN3/MN7) First Design (8mm bolt holes)	4 Speed	20-Bolt	TOS 18697
03-92	Case Side Cover	4T60-E (M13), 4T65-E (M15/MN3/MN7) First Design (Cork-rubber)	4 Speed	17-Bolt	TOS 18669
All Models Automatic Transmission					
62-51	Oil Pan	Hydramatic (S40)	Dual Range (2 Speed)	12-Bolt	TOS 18024
72-62	Oil Pan	Powerglide (M35)	Exc. Corvair (2 Speed)	14-Bolt	TOS 18608
65-61	Oil Pan	Powerglide (M35)	Corvair (2 Speed)	14-Bolt	TOS 18508
82-76	Oil Pan	LUV	3 Speed	11-Bolt	TOS 18648
72-63	Oil Pan	Pow-R Flow (AT218)	3 Speed	14-Bolt	TOS 18608
98-87	Oil Pan	THM180 (MD3), THM180C (MD2), 3L30 (MD3)	3 Speed	12-Bolt	TOS 18643
84-82	Oil Pan	THM200C (MV9)	3 Speed	11-Bolt	TOS 18648
86-69	Oil Pan	THM350C (M38/MV4)	3 Speed	13-Bolt	TOS 18633
90-65	Oil Pan	THM400 (M40), THM475 (M40), 3L80 (M40)	3 Speed	13-Bolt	TOS 18621
77-71	Oil Pan	Allison AT540	4 Speed	21-Bolt	TOS 18638
93-82	Oil Pan	THM700-R4 (MD8), 4L60 (M30)	4 Speed	16-Bolt	TOS 18663
93-82	Transfer Case Adapter	THM700-R4 (MD8), 4L60 (M30)	4 Speed	5-Bolt	72769
93-82	Transfer Case Adapter	THM700-R4 (MD8), 4L60 (M30)	4 Speed	6-Bolt	72770
04-94	Oil Pan	Tracker, SunRunner (03-72LE)	4 Speed	7-Bolt	TOS 18754
04-94	Oil Pan	Tracker, SunRunner (03-72LE)	4 Speed	14-Bolt	TOS 18646
15-93	Oil Pan	4L60-E (M30), 4L65-E (M32)	4 Speed	16-Bolt	TOS 18663
15-93	Transfer Case Adapter	4L60-E (M30), 4L65-E (M32)	4 Speed	5-Bolt	72769
15-93	Transfer Case Adapter	4L60-E (M30), 4L65-E (M32)	4 Speed	6-Bolt	72770
15-91	Oil Pan	4L80-E (MT1)	4 Speed	17-Bolt	TOS 18698
09-04	Oil Pan	5L40-E, 5L50-E	5 Speed	22-Bolt	TOS 18768
15-03	Oil Pan	Allison AT1000	5 Speed	12-Bolt	TOS 18752
All Models Manual Transmission					
54-38	Transmission Kit	GMC (Exc. H/D)	3 Speed		TS 5099
82-55	Transmission Kit	Saginaw	3 Speed		TS 30118
72-55	Transmission Kit	Tremec (Exc. H/D)	3 Speed		TS 5190
87-68	Transmission Kit	Muncie	4 Speed		TS 80161
67-48	Transmission Kit	Muncie	4 Speed		TS 5100
67-66	Transmission Kit	Saginaw	4 Speed		TS 30118
Honda Car					
Automatic Transaxle					
93-92	Oil Pan	Accord	MPWA	16-Bolt	TOS 18762
98-95	Oil Pan	TL	M1WA	16-Bolt	TOS 18762
94-92	Oil Pan	Vigor	MPWA	16-Bolt	TOS 18762
Honda Truck					
Rear Axle					
02-99	Housing Cover	Passport	8.625" Ring Gear	10-Bolt	RDS 55028-1
99-96	Housing Cover	Passport	7.625" Ring Gear	10-Bolt	RDS 55072
99-96	Housing Cover	Passport	8.5" Ring Gear	10-Bolt	RDS 6629
95-94	Housing Cover	Passport	7.5" Ring Gear	10-Bolt	RDS 55072
95-94	Housing Cover	Passport	8.5" Ring Gear	10-Bolt	RDS 6629
Automatic Transmission					
02-98	Oil Pan	Passport	GMC 4L30-E	12-Bolt	TOS 18756
02-94	Oil Pan	Passport	GMC 4L30-E	16-Bolt	TOS 18704
00-98	Oil Pan	SLX	GMC 4L30-E	12-Bolt	TOS 18756
00-96	Oil Pan	SLX	GMC 4L30-E	16-Bolt	TOS 18704

DRIVETRAIN GASKETS

Year	Part Type	Model Name	Description	Bolt Holes	Part Number
Hyundai Car					
Automatic Transaxle					
11-00	Oil Pan	Accent		13-Bolt	TOS 18727
11-95	Oil Pan	Accent		13-Bolt	TOS 18730
06-92	Oil Pan	Elantra		13-Bolt	TOS 18727
94-89	Oil Pan	Excel		12-Bolt	TOS 18665
95-93	Oil Pan	Scoupe		13-Bolt	TOS 18730
95-91	Oil Pan	Scoupe		12-Bolt	TOS 18665
07-02	Oil Pan	Sonata		13-Bolt	TOS 18727
01-92	Oil Pan	Sonata		12-Bolt	TOS 18665
10-97	Oil Pan	Tiburon		13-Bolt	TOS 18727
Automatic Transmission					
13-09	Oil Pan	Genesis	Aisin B600 (6 Speed)	20-Bolt	TOS 18766
Hyundai Truck					
Automatic Transaxle					
10-05	Oil Pan	Tucson		13-Bolt	TOS 18727
International Truck					
Front Axle					
72-65	Housing Cover	All Models	Spicer 27F	10-Bolt	RDS 55015
80-73	Housing Cover	All Models	Spicer 30AF	10-Bolt	RDS 55019
80-57	Housing Cover	All Models	Spicer 44-1F, 44-1FHD	10-Bolt	RDS 6629
Rear Axle					
72-61	Housing Cover	All Models	Spicer 27, 27A	10-Bolt	RDS 55015
80-50	Housing Cover	All Models	Spicer 44, 44-1	10-Bolt	RDS 6629
75-65	Housing Cover	All Models	Spicer 60, 60-2	10-Bolt	RDS 6095-1
75-68	Housing Cover	All Models	Spicer 70	10-Bolt	RDS 6014
Transfer Case					
72-65	Transfer Case Kit	Spicer 18	Part-Time 2 Speed		TS 3181A
80-65	Transfer Case Kit	Spicer 20	Part-Time 2 Speed		TS 80130
Automatic Transmission					
66-56	Oil Pan	Borg-Warner T25, T28	2 Speed	14-Bolt	TOS 18106
60-58	Oil Pan	Borg-Warner Flash-O-Matic	3 Speed	14-Bolt	TOS 18106
80-72	Oil Pan	Chrysler A727	3 Speed	14-Bolt	TOS 18583
Isuzu Car					
Automatic Transaxle					
93-89	Oil Pan	I-Mark, Impulse, Stylus	Jatco JF403E	21-Bolt	TOS 18694
93-85	Oil Pan	I-Mark, Stylus	Jatco F3A	16-Bolt	TOS 18713
Automatic Transmission					
85-81	Oil Pan	I-Mark	Aisin 03-55	7-Bolt	TOS 18754
85-81	Oil Pan	I-Mark	Aisin 03-55	14-Bolt	TOS 18646
89-83	Oil Pan	Impulse	Aisin 03-70, 03-72L	7-Bolt	TOS 18754
89-83	Oil Pan	Impulse	Aisin 03-70, 03-72L	14-Bolt	TOS 18646
Isuzu Truck					
Front Axle					
08-06	Housing Cover	i-350, i-370	7.625" Ring Gear	10-Bolt	RDS 55477
Rear Axle					
00-98	Housing Cover	Amigo	8.5" Ring Gear	10-Bolt	RDS 6629
95-89	Differential Carrier	Amigo	7.625" Ring Gear	10-Bolt	RDS 55084
08	Housing Cover	Ascender	8" Ring Gear	10-Bolt	RDS 55479
08	Housing Cover	Ascender	8.625" Ring Gear	10-Bolt	RDS 55480
08	Housing Cover	Ascender	8.625" Ring Gear	10-Bolt	RDS 55028-1
07-03	Housing Cover	Ascender	8" Ring Gear	10-Bolt	RDS 55479
07-03	Housing Cover	Ascender	8.625" Ring Gear	10-Bolt	RDS 55028-1
04-02	Housing Cover	Axiom	8.625" Ring Gear	10-Bolt	RDS 55028-1
01-99	Housing Cover	Hombre	7.625" Ring Gear	10-Bolt	RDS 55072
01-99	Housing Cover	Hombre	8.625" Ring Gear	10-Bolt	RDS 55028-1
98-96	Housing Cover	Hombre	7.625" Ring Gear	10-Bolt	RDS 55072
98-96	Housing Cover	Hombre	8.5" Ring Gear	10-Bolt	RDS 55028-1
08-06	Housing Cover	i-280, i-290, i-350, i-370	8" Ring Gear	10-Bolt	RDS 55479
95-81	Differential Carrier	Pickup, P'up	7.625" Ring Gear	10-Bolt	RDS 55084
04-99	Housing Cover	Rodeo, Rodeo Sport	8.625" Ring Gear	10-Bolt	RDS 55028-1
99-96	Housing Cover	Rodeo	7.625" Ring Gear	10-Bolt	RDS 55072

Year	Part Type	Model Name	Description	Bolt Holes	Part Number
Isuzu Truck (Cont.)					
Rear Axle (Cont.)					
99-96	Housing Cover	Rodeo	8.5" Ring Gear	10-Bolt	RDS 6629
95-91	Housing Cover	Rodeo	7.5" Ring Gear	10-Bolt	RDS 55072
95-91	Housing Cover	Rodeo	8.5" Ring Gear	10-Bolt	RDS 6629
87-83	Differential Carrier	Trooper	7.625" Ring Gear	10-Bolt	RDS 55084
Automatic Transmission					
95-83	Oil Pan	Amigo, Pickup, Trooper	Aisin 03-55, 03-72L, 03-75, 30-80LE	7-Bolt	TOS 18754
95-83	Oil Pan	Amigo, Pickup, Trooper	Aisin 03-55, 03-72L, 03-75, 30-80LE	14-Bolt	TOS 18646
87-81	Oil Pan	Pickup, P'up	GMC THM200-4R	16-Bolt	TOS 18662
04-98	Oil Pan	Amigo, Axiom, Pickup, Rodeo, Rodeo Sport, Trooper, VehiCross, VX-4	GMC 4L30-E	12-Bolt	TOS 18756
04-91	Oil Pan	Amigo, Axiom, Pickup, Rodeo, Rodeo Sport, Trooper, VehiCross, VX-4	GMC 4L30-E	16-Bolt	TOS 18704
08-96	Oil Pan	Ascender, Hombre, i-280, i-290, i-350, i-370	GMC 4L60-E, 4L65-E	16-Bolt	TOS 18663
04-93	Oil Pan	Rodeo, Trooper	GMC 4L80-E	17-Bolt	TOS 18698
Jaguar					
Automatic Transmission					
66-53	Oil Pan	Borg-Warner DG200	2 Speed	14-Bolt	TOS 18106
78-64	Oil Pan	Borg-Warner T8, T12	3 Speed	14-Bolt	TOS 18106
89-77	Oil Pan	GMC THM400	3 Speed	13-Bolt	TOS 18621
03-00	Oil Pan	Ford 5R55E, 5R55W	5 Speed	18-Bolt	TOS 18679
07-00	Oil Pan	Ford 5R55N, 5R55S	5 Speed	16-Bolt	TOS 18742
04-98	Oil Pan	Mercedes-Benz W5A580	5 Speed	0-Bolt	TOS 18764
Jeep Truck					
Front Axle					
98-84	Housing Cover	Cherokee, Comanche		10-Bolt	RDS 55019
92-91	Housing Cover	Grand Wagoneer		10-Bolt	RDS 6629
98-93	Housing Cover	Jeep, Truck, Utility	Spicer 30	10-Bolt	RDS 55019
92-48	Housing Cover	Jeep, Truck, Utility, Willys	Spicer 27	10-Bolt	RDS 55015
92-48	Housing Cover	Jeep, Truck, Utility, Willys	Spicer 30	10-Bolt	RDS 55019
92-48	Housing Cover	Jeep, Truck, Utility, Willys	Spicer 44	10-Bolt	RDS 6629
98-84	Housing Cover	Wagoneer, Wrangler		10-Bolt	RDS 55019
Rear Axle					
01-91	Housing Cover	Cherokee	8.25" Ring Gear	10-Bolt	RDS 55047
01-84	Housing Cover	Cherokee, Comanche	Dana 35	10-Bolt	RDS 13089
01-84	Housing Cover	Cherokee, Comanche	Dana 44	10-Bolt	RDS 6629
92-84	Housing Cover	Truck	AMC Axle	12-Bolt	RDS 13889
92-65	Housing Cover	Jeep, Truck, Utility	Spicer 20	10-Bolt	RDS 6629
92-65	Housing Cover	Jeep, Truck, Utility	Spicer 20	12-Bolt	RDS 13889
92-65	Housing Cover	Jeep, Truck, Utility	Spicer 44	10-Bolt	RDS 6629
92-65	Housing Cover	Jeep, Truck, Utility	Spicer 53	10-Bolt	RDS 12758
92-65	Housing Cover	Jeep, Truck, Utility	Spicer 60, 70	10-Bolt	RDS 6095-1
64-50	Housing Cover	Jeep, Truck, Utility, Willys	Spicer 30	10-Bolt	RDS 55015
64-50	Housing Cover	Jeep, Truck, Utility, Willys	Spicer 44	10-Bolt	RDS 6629
49-41	Housing Cover	Jeep, Willys		10-Bolt	RDS 55015
12-02	Housing Cover	Liberty	8.25" Ring Gear	10-Bolt	RDS 55047
08-02	Housing Cover	Wagoneer, Wrangler	Dana 44	10-Bolt	RDS 6629
01-84	Housing Cover	Wagoneer, Wrangler	Dana 35	10-Bolt	RDS 13089
01-84	Housing Cover	Wagoneer, Wrangler	Dana 44	10-Bolt	RDS 6629
Transfer Case					
73-41	Transfer Case Kit	Jeep, Truck, Utility, Willys			TS 3181A
Automatic Transaxle					
15-11	Oil Pan	62TE	6 Speed	12-Bolt	TOS 18757
14-07	Oil Pan	Jatco JF011E	CVT (Continuous Variable Ratio)	18-Bolt	TOS 18755
Automatic Transmission					
55-53	Oil Pan	Hydramatic	2 Speed	12-Bolt	TOS 18024
93-87	Oil Pan	A727	3 Speed	14-Bolt	TOS 18583
93-80	Oil Pan	A904, A999, 32RH	3 Speed	14-Bolt	TOS 18667
65-62	Oil Pan	Flash-O-Matic	3 Speed	14-Bolt	TOS 18106
79-65	Oil Pan	THM400	3 Speed	13-Bolt	TOS 18621
04-94	Oil Pan	30RH, 31RH, 32RH	3 Speed	14-Bolt	TOS 18667
98-94	Oil Pan	AW4	4 Speed	12-Bolt	TOS 18665
93-87	Oil Pan	AW4	4 Speed	19-Bolt	TOS 18685

DRIVETRAIN GASKETS

Year	Part Type	Model Name	Description	Bolt Holes	Part Number
Jeep Truck (Cont.)					
Automatic Transmission (Cont.)					
04-87	Oil Pan	42RE, 42RH, 44RE	4 Speed	14-Bolt	TOS 18667
12-03	Oil Pan	42RLE	4 Speed	13-Bolt	TOS 18743
14-99	Oil Pan	45RFE	4 Speed	15-Bolt	TOS 18733
03-87	Oil Pan	46RE, 46RH	4 Speed	14-Bolt	TOS 18583
16-05	Oil Pan	W5A580	5 Speed	0-Bolt	TOS 18764
14-01	Oil Pan	5-45RFE	5 Speed	15-Bolt	TOS 18733
Kaiser					
Rear Axle					
54-51	Housing Cover	Henry J		10-Bolt	RDS 55015
Automatic Transmission					
54-51	Oil Pan	Hydramatic	2 Speed	12-Bolt	TOS 18024
Kia Car					
Automatic Transaxle					
11-06	Oil Pan	Rio, Rio 5		13-Bolt	TOS 18727
11-06	Oil Pan	Rio, Rio 5		13-Bolt	TOS 18730
05-01	Oil Pan	Rio	Jatco A4CF2	19-Bolt	TOS 18747
04-93	Oil Pan	Sephia, Spectra	4A2W	19-Bolt	TOS 18747
04-93	Oil Pan	Sephia, Spectra	4A2W	19-Bolt	TOS 18695 ¹
Kia Truck					
Automatic Transaxle					
10-05	Oil Pan	Sportage		13-Bolt	TOS 18727
Automatic Transmission					
02-95	Oil Pan	Sportage	A44DE, 4A2W, 4A4W	7-Bolt	TOS 18754
02-95	Oil Pan	Sportage	A44DE, 4A2W, 4A4W	14-Bolt	TOS 18646
Maserati					
Automatic Transmission					
87-79	Oil Pan	Chrysler A727	3 Speed	14-Bolt	TOS 18583
Mazda Car					
Automatic Transaxle					
86-81	Oil Pan	GLC	Exc. Wagon	16-Bolt	TOS 18712
02-95	Oil Pan	Millenia		17-Bolt	TOS 18690
02-95	Valve Body Cover	Millenia		17-Bolt	TOS 18691
96-92	Oil Pan	MX-3		19-Bolt	TOS 18747
96-92	Oil Pan	MX-3		19-Bolt	TOS 18695 ¹
97-93	Oil Pan	MX-6		17-Bolt	TOS 18690
97-93	Valve Body Cover	MX-6		14-Bolt	TOS 18751
97-93	Valve Body Cover	MX-6		17-Bolt	TOS 18691
92-88	Oil Pan	MX-6	Exc. Turbo	17-Bolt	TOS 18690
92-88	Oil Pan	MX-6	Turbo	17-Bolt	TOS 18692
92-88	Valve Body Cover	MX-6	Exc. Turbo	17-Bolt	TOS 18691
92-88	Valve Body Cover	MX-6	Turbo	17-Bolt	TOS 18693
03-99	Oil Pan	Protege	4F27E	20-Bolt	TOS 18731
98-93	Oil Pan	Protege		19-Bolt	TOS 18747
98-93	Oil Pan	Protege		19-Bolt	TOS 18695 ¹
92-90	Oil Pan	Protege	FWD	19-Bolt	TOS 18747
92-90	Oil Pan	Protege	FWD	19-Bolt	TOS 18695 ¹
92-90	Oil Pan	Protege	AWD	17-Bolt	TOS 18690
92-90	Valve Body Cover	Protege	AWD	17-Bolt	TOS 18691
14-11	Oil Pan	2	4F27E	20-Bolt	TOS 18731
13-04	Oil Pan	3	4F27E	20-Bolt	TOS 18731
14-06	Oil Pan	5	4F27E	20-Bolt	TOS 18731
14-03	Oil Pan	6	4F27E	20-Bolt	TOS 18731
96-90	Oil Pan	323		19-Bolt	TOS 18747
96-90	Oil Pan	323		19-Bolt	TOS 18695 ¹
89-88	Oil Pan	323	Exc. Wagon	17-Bolt	TOS 18690
89-88	Oil Pan	323	Wagon	16-Bolt	TOS 18712
87-86	Oil Pan	323		16-Bolt	TOS 18712
02-93	Oil Pan	626		17-Bolt	TOS 18690
02-93	Valve Body Cover	626		14-Bolt	TOS 18751
02-93	Valve Body Cover	626		17-Bolt	TOS 18691
92-88	Oil Pan	626	Exc. Turbo	17-Bolt	TOS 18690

Year	Part Type	Model Name	Description	Bolt Holes	Part Number
Mazda Car (Cont.)					
Automatic Transaxle (Cont.)					
92-88	Oil Pan	626	Turbo	17-Bolt	TOS 18692
92-88	Valve Body Cover	626	Exc. Turbo	17-Bolt	TOS 18691
92-88	Valve Body Cover	626	Turbo	17-Bolt	TOS 18693
87-86	Oil Pan	626	3 Speed	16-Bolt	TOS 18712
87-86	Oil Pan	626	4 Speed	17-Bolt	TOS 18690
85-83	Oil Pan	626		16-Bolt	TOS 18712
Automatic Transmission					
83-81	Oil Pan	GLC	Wagon	14-Bolt	TOS 18644
80-79	Oil Pan	GLC		14-Bolt	TOS 18644
05-99	Oil Pan	MX-5 Miata	A44DE	7-Bolt	TOS 18754
05-90	Oil Pan	MX-5 Miata		14-Bolt	TOS 18644
91-84	Oil Pan	RX-7		14-Bolt	TOS 18644
82-79	Oil Pan	626		14-Bolt	TOS 18644
95-92	Oil Pan	929		20-Bolt	TOS 18683
91-88	Oil Pan	929		14-Bolt	TOS 18644
Mazda Truck					
Rear Axle					
10-94	Housing Cover	B2300, B2500, B3000, B4000	WAC, WFM	10-Bolt	RDS 55393
10-94	Housing Cover	B2300, B2500, B3000, B4000	WDC, WFG	10-Bolt	RDS 55341
08-01	Housing Cover	Tribute		10-Bolt	RDS 55037
Automatic Transaxle					
08-04	Valve Body Cover	Tribute	Ford CD4E	14-Bolt	TOS 18751
03-01	Oil Pan	Tribute (To 03/31/03)	Ford CD4E	14-Bolt	TOS 18729
03-01	Valve Body Cover	Tribute	Ford CD4E	14-Bolt	TOS 18751
Automatic Transmission					
10-01	Oil Pan	B2300, B3000, B4000	Ford 5R44E	18-Bolt	TOS 18679
10-97	Oil Pan	B2300, B2500, B3000, B4000	Ford 5R55E, 5R55W	18-Bolt	TOS 18679
10-94	Oil Pan	B2300, B2500, B3000, B4000	Ford A4LD, 4R44E, 4R55E	18-Bolt	TOS 18679
93-91	Oil Pan	B2200, B2600	RWD	14-Bolt	TOS 18644
93-91	Oil Pan	B2200, B2600	4WD	20-Bolt	TOS 18683
90-84	Oil Pan	B2000, B2200, B2600		14-Bolt	TOS 18644
99-89	Oil Pan	MPV		14-Bolt	TOS 18644
99-89	Oil Pan	MPV		20-Bolt	TOS 18683
95-91	Oil Pan	Navajo	Ford A4LD, 4R55E	18-Bolt	TOS 18679
Mercedes-Benz Car					
Automatic Transmission					
14-98	Oil Pan	W5A580	5 Speed	0-Bolt	TOS 18764
Mercedes-Benz Truck					
Automatic Transmission					
14-98	Oil Pan	W5A330	5 Speed	0-Bolt	TOS 18749 ¹
14-98	Oil Pan	W5A330	5 Speed	0-Bolt	TOS 18764
14-07	Oil Pan	W5A580	5 Speed	0-Bolt	TOS 18749 ¹
14-07	Oil Pan	W5A580	5 Speed	0-Bolt	TOS 18764
06-99	Oil Pan	W5A580	5 Speed	0-Bolt	TOS 18764
Mitsubishi Car					
Automatic Transaxle					
88-83	Oil Pan	Cordia		12-Bolt	TOS 18665
96-92	Oil Pan	Diamante		14-Bolt	TOS 18703
12-00	Oil Pan	Eclipse		13-Bolt	TOS 18727
99-95	Oil Pan	Eclipse	F4A33, F5M33, W4A33, W5M33	14-Bolt	TOS 18703
94-89	Oil Pan	Eclipse	Exc. Turbo, AWD	12-Bolt	TOS 18665
94-89	Oil Pan	Eclipse	Turbo, AWD	14-Bolt	TOS 18703
96-92	Oil Pan	Expo	W4A32, W5M33	14-Bolt	TOS 18703
92	Oil Pan	Expo	F4A23, F5M31	13-Bolt	TOS 18681 ¹
96-92	Oil Pan	Expo LRV	W4A32, W5M31, W5M33	14-Bolt	TOS 18703
96-92	Oil Pan	Expo LRV	F4A22, F5M22	12-Bolt	TOS 18665
12-00	Oil Pan	Galant		13-Bolt	TOS 18727
99-94	Oil Pan	Galant	F4A33, F5M33, W4A33, W5M33	14-Bolt	TOS 18703
93	Oil Pan	Galant	F4A22, F5M22	12-Bolt	TOS 18665
92-90	Oil Pan	Galant	FWD	12-Bolt	TOS 18665
92-90	Oil Pan	Galant	AWD	14-Bolt	TOS 18703

¹Superseded or Discontinued

DRIVETRAIN GASKETS

Year	Part Type	Model Name	Description	Bolt Holes	Part Number
Mitsubishi Car (Cont.)					
Automatic Transaxle (Cont.)					
89-85	Oil Pan	Galant		12-Bolt	TOS 18665
91-88	Oil Pan	Galant Sigma		13-Bolt	TOS 18681 ¹
14-08	Oil Pan	Lancer	F1CJA (CVT Continuous Variable Ratio)	18-Bolt	TOS 18755
07-02	Oil Pan	Lancer		13-Bolt	TOS 18727
96-85	Oil Pan	Mirage		12-Bolt	TOS 18665
94-87	Oil Pan	Precis		12-Bolt	TOS 18665
88-83	Oil Pan	Tredia		12-Bolt	TOS 18665
93-91	Oil Pan	3000GT	F4A33-1	14-Bolt	TOS 18703
Automatic Transmission					
89-83	Oil Pan	Starion	AW0371	14-Bolt	TOS 18644
Mitsubishi Truck					
Front Axle					
10-06	Differential Carrier	Raider	8" Ring Gear	12-Bolt	RDS 55471
Rear Axle					
10-06	Housing Cover	Raider	8.25" Ring Gear	10-Bolt	RDS 55047
10-06	Housing Cover	Raider	9.25" Ring Gear	12-Bolt	RDS 55073
Automatic Transaxle					
11-04	Oil Pan	Endeavor		13-Bolt	TOS 18727
14-08	Oil Pan	Outlander	F1CJA (CVT Continuous Variable Ratio)	18-Bolt	TOS 18755
14-11	Oil Pan	Outlander Sport	F1CJA (CVT Continuous Variable Ratio)	18-Bolt	TOS 18755
14-11	Oil Pan	RVR	F1CJA (CVT Continuous Variable Ratio)	18-Bolt	TOS 18755
Automatic Transmission					
86-83	Oil Pan	All Models	A94-1, A904, KM148	14-Bolt	TOS 18651 ¹
94-87	Oil Pan	All Models	A904, AW372, AW3721, KM148	7-Bolt	TOS 18754
94-87	Oil Pan	All Models	A904, AW372, AW3721, KM148	14-Bolt	TOS 18646
96-90	Oil Pan	All Models	R4AC1, R5M21	14-Bolt	TOS 18667
94-87	Oil Pan	All Models	V4AW2, V4AW3, V5MT1	7-Bolt	TOS 18754
94-87	Oil Pan	All Models	V4AW2, V4AW3, V5MT1	14-Bolt	TOS 18646
02-94	Oil Pan	All Models	30-40FL	19-Bolt	TOS 18685
10-06	Oil Pan	Raider	Chrysler 42RLE	13-Bolt	TOS 18743
10-06	Oil Pan	Raider	Chrysler 45RFE	15-Bolt	TOS 18733
10-06	Oil Pan	Raider	Chrysler 5-45RFE	15-Bolt	TOS 18733
Manual Transmission					
89-83	Transmission Kit	KM132I, KM123K, KM145	5 Speed		TS 80310-1
Nissan Car					
Front Axle					
88-86	Housing Cover	Stanza, Stanza Wagon	R180B	8-Bolt	RDS 27274
Rear Axle					
84-82	Differential Carrier	Maxima	R180	8-Bolt	RDS 27274
84-82	Differential Carrier	Maxima	H190	10-Bolt	RDS 55330
88-84	Differential Carrier	200SX	R180B	8-Bolt	RDS 27274
86-83	Differential Carrier	200SX	R200	8-Bolt	RDS 27275
81-77	Differential Carrier	200SX	H165B	8-Bolt	RDS 27271
93-89	Housing Cover	240SX	RC40	8-Bolt	RDS 27275
83-70	Housing Cover	240Z, 260Z, 280Z, 280ZX	R180	8-Bolt	RDS 27274
83-73	Housing Cover	240Z, 260Z, 280Z, 280ZX	R200	8-Bolt	RDS 27275
92-90	Housing Cover	300ZX	Exc. Turbo	8-Bolt	RDS 27275
89-84	Housing Cover	300ZX		8-Bolt	RDS 27275
81-68	Differential Carrier	510, 610, 710	H165B	8-Bolt	RDS 27271
81-68	Differential Carrier	510, 610, 710	H190	10-Bolt	RDS 55330
81-77	Differential Carrier	810	R180	8-Bolt	RDS 27274
81-77	Differential Carrier	810	H190	10-Bolt	RDS 55330
Automatic Transaxle					
14-07	Oil Pan	Altima	RE0F10A (CVT Continuous Variable Ratio)	18-Bolt	TOS 18755
06-93	Oil Pan	Altima	RE4F04A, RE4F04V	21-Bolt	TOS 18708
02-91	Oil Pan	G20	RL4F03A	21-Bolt	TOS 18700
92-90	Oil Pan	M30	RE4R01A	20-Bolt	TOS 18683
14-07	Oil Pan	Maxima	JF010A (CVT Continuous Variable Ratio)	18-Bolt	TOS 18755
93-83	Oil Pan	NX Coupe, Pulsar	RL3F01A, RN3F01A	14-Bolt	TOS 18673
13-07	Oil Pan	Sentra	RE0F10A (CVT Continuous Variable Ratio)	18-Bolt	TOS 18755
06-01	Oil Pan	Sentra	RE4F04B	21-Bolt	TOS 18708

DRIVETRAIN GASKETS

Year	Part Type	Model Name	Description	Bolt Holes	Part Number
Nissan Car (Cont.)					
Automatic Transaxle (Cont.)					
00-91	Oil Pan	Sentra	RL4F03A	21-Bolt	TOS 18700
93-82	Oil Pan	Sentra	RL3F01A, RN3F01A	14-Bolt	TOS 18673
86-82	Oil Pan	Stanza	RL3F01A	14-Bolt	TOS 18673
13-07	Oil Pan	Versa	RL4F03A	21-Bolt	TOS 18700
82-79	Oil Pan	310	RL3F01A	14-Bolt	TOS 18673
Automatic Transmission					
97-93	Oil Pan	J30	RE4R01A	18-Bolt	TOS 18769
84-82	Oil Pan	Maxima	3N71B	14-Bolt	TOS 18644
96-90	Oil Pan	Q45	RE4R01A	18-Bolt	TOS 18769
88-77	Oil Pan	200SX	E4N71B, L4N71B, 3N71B	14-Bolt	TOS 18644
82-74	Oil Pan	210, B210	3N71A, 3N71B	14-Bolt	TOS 18644
98-89	Oil Pan	240SX	RE4R01A	20-Bolt	TOS 18683
83-70	Oil Pan	240Z, 260Z, 280Z, 280ZX	E4N71B, NL28LIF, 3N71A, 3N71B, 4N71B	14-Bolt	TOS 18644
83-70	Oil Pan	240Z, 260Z, 280Z, 280ZX	RE4R01A	20-Bolt	TOS 18683
96-90	Oil Pan	300ZX	RE4R01A	18-Bolt	TOS 18769
96-84	Oil Pan	300ZX	RE4R01A	20-Bolt	TOS 18683
89-84	Oil Pan	300ZX	4N71B	14-Bolt	TOS 18644
81-68	Oil Pan	510, 610, 710	3N71B	14-Bolt	TOS 18644
81-77	Oil Pan	810	3N71B	14-Bolt	TOS 18644
73-71	Oil Pan	1200	3N71B	14-Bolt	TOS 18644
Nissan Truck					
Front Axle					
95-86	Differential Carrier	Hardbody, Pathfinder, Pickup, 720	R180	8-Bolt	RDS 27274
Rear Axle					
92-90	Differential Carrier	Axxess	R180	8-Bolt	RDS 27274
92-86	Differential Carrier	Hardbody, Pathfinder, Pickup, Van, 720	H190, H190A	10-Bolt	RDS 55330
92-86	Differential Carrier	Hardbody, Pathfinder, Pickup, Van, 720	C200	8-Bolt	RDS 55388
85-69	Differential Carrier	521, 620, 720	H165	8-Bolt	RDS 27271
85-69	Differential Carrier	521, 620, 720	H190	10-Bolt	RDS 55330
Automatic Transaxle					
14-09	Oil Pan	Murano	JF010E (CVT Continuous Variable Ratio)	18-Bolt	TOS 18755
14-11	Oil Pan	Quest	JF010E (CVT Continuous Variable Ratio)	18-Bolt	TOS 18755
05-93	Oil Pan	Quest	4F20E	21-Bolt	TOS 18708
13-08	Oil Pan	Rogue	JF011E (CVT Continuous Variable Ratio)	18-Bolt	TOS 18755
Automatic Transmission					
04-83	Oil Pan	Frontier, Hardbody, Pathfinder, Pickup, Van, Xterra, 720	RE4R01A, RL4R01A, TX10	20-Bolt	TOS 18683
90-83	Oil Pan	Hardbody, Pathfinder, Pickup, Van, 720	E4N71B, L3N71B, L4N71B, 3N71B	14-Bolt	TOS 18644
83-69	Oil Pan	521, 620, 720	Letchworth	14-Bolt	TOS 18644
Opel					
Automatic Transmission					
75-69	Oil Pan	GMC THM180	3 Speed	12-Bolt	TOS 18643
79-76	Oil Pan	GMC THM200	3 Speed	11-Bolt	TOS 18648
Porsche Car					
Automatic Transaxle					
10-97	Oil Pan	Boxster, Cayman	5HP-19FL, 5HP-19FLA	27-Bolt	TOS 18724
10-97	Case Rear Cover	Boxster, Cayman	5HP-19FL, 5HP-19FLA	15-Bolt	TOS 18734
10-99	Oil Pan	911	5HP-19FL, 5HP-19FLA	27-Bolt	TOS 18724
10-99	Case Rear Cover	911	5HP-19FL, 5HP-19FLA	15-Bolt	TOS 18734
91-77	Oil Pan	924, 924S, 944, 944S, 944S2	Audi 087	0-Bolt	TOS 18649 ¹
Renault					
Automatic Transaxle					
87-83	Oil Pan	Alliance, Encore	MJ3	0-Bolt	TOS 18670 ¹
85-82	Oil Pan	Fuego	MJ3	0-Bolt	TOS 18670 ¹
86-84	Oil Pan	R18i, Sportwagon	MJ3	0-Bolt	TOS 18670 ¹
Rolls-Royce					
Automatic Transmission					
67-52	Oil Pan	GMC Hydramatic	2 Speed	12-Bolt	TOS 18024
90-68	Oil Pan	GMC THM400	3 Speed	13-Bolt	TOS 18621
07-91	Oil Pan	GMC 4L80-E	4 Speed	17-Bolt	TOS 18698

¹Superseded or Discontinued

DRIVETRAIN GASKETS

Year	Part Type	Model Name	Description	Bolt Holes	Part Number
Saab Truck					
Rear Axle					
09-08	Housing Cover	9-7X	8" Ring Gear	10-Bolt	RDS 55479
09-08	Housing Cover	9-7X	8.625" Ring Gear	10-Bolt	RDS 55480
09-08	Housing Cover	9-7X	8.625" Ring Gear	10-Bolt	RDS 55028-1
09-08	Housing Cover	9-7X	9.5" Ring Gear	14-Bolt	RDS 55387
07-05	Housing Cover	9-7X	8" Ring Gear	10-Bolt	RDS 55479
07-05	Housing Cover	9-7X	8.625" Ring Gear	10-Bolt	RDS 55028-1
Automatic Transmission					
09-05	Oil Pan	9-7X	GMC 4L60-E, 4L65-E	16-Bolt	TOS 18663
Simca					
Automatic Transmission					
71-62	Oil Pan	Borg-Warner T35	3 Speed	14-Bolt	TOS 18109
Studebaker Car					
Rear Axle					
58-57	Housing Cover	Packard Models		10-Bolt	RDS 6629
66-58	Housing Cover	Studebaker Models	Spicer 23	10-Bolt	RDS 55015
66-58	Housing Cover	Studebaker Models	Spicer 27	10-Bolt	RDS 55015
66-58	Housing Cover	Studebaker Models	Spicer 44	10-Bolt	RDS 6629
57-39	Housing Cover	Studebaker Models		10-Bolt	RDS 55015
Automatic Transmission					
66-55	Oil Pan	Flash-O-Matic	3 Speed	14-Bolt	TOS 18106
Subaru Car					
Front Axle					
91-90	Differential Carrier	Loyale		8-Bolt	RDS 27271
Automatic Transaxle					
94-81	Oil Pan	All Models	T81X, TA86, TX86	14-Bolt	TOS 18675 ¹
98-85	Oil Pan	All Models (First Design)	TA102, TZ102	20-Bolt	TOS 18684
Subaru Truck					
Automatic Transaxle					
87-80	Oil Pan	All Models	T81X, TX86	14-Bolt	TOS 18675 ¹
98	Oil Pan	All Models (First Design)	TZ102	20-Bolt	TOS 18684
Sunbeam					
Manual Transmission					
68-64	Transmission Kit	Tremec 150T, 160T	3 Speed		TS 80108
Suzuki Car					
Automatic Transaxle					
07-02	Oil Pan	Aerio	A540E, A540H	17-Bolt	TOS 18699
08-04	Oil Pan	Foreza	Aisin 81-40LE	18-Bolt	TOS 18758
13-10	Oil Pan	Kizashi	CVT (Continuous Variable Ratio)	18-Bolt	TOS 18755
08-05	Oil Pan	Reno	Aisin 81-40LE	18-Bolt	TOS 18758
13-10	Oil Pan	SX4	CVT (Continuous Variable Ratio)	18-Bolt	TOS 18755
01-85	Oil Pan	All Models	Aisin A210	15-Bolt	TOS 18702 ¹
Suzuki Truck					
Automatic Transaxle					
09-07	Oil Pan	All Models	GMC 4T65-E	20-Bolt	TOS 18717
09-07	Case Side Cover	All Models	GMC 4T65-E	17-Bolt	TOS 18723
Automatic Transmission					
88-85	Oil Pan	All Models	Aisin A440H	20-Bolt	TOS 18696
06-92	Oil Pan	All Models	Aisin 03-72LE	7-Bolt	TOS 18754
06-92	Oil Pan	All Models	Aisin 03-72LE	14-Bolt	TOS 18646
13-09	Oil Pan	All Models	Aisin 30-40LE	19-Bolt	TOS 18685
90-89	Oil Pan	All Models	GMC THM180C	12-Bolt	TOS 18643
Toyota Car					
Rear Axle					
85-71	Differential Carrier	Carina, Celica		10-Bolt	RDS 27413
87-80	Differential Carrier	Corolla		10-Bolt	RDS 27413
79-71	Differential Carrier	Corolla	3KC engine	8-Bolt	RDS 27411
79-71	Differential Carrier	Corolla	2T, 2TC engines	8-Bolt	RDS 27412 ¹

Year	Part Type	Model Name	Description	Bolt Holes	Part Number
Toyota Car (Cont.)					
Rear Axle (Cont.)					
79-71	Differential Carrier	Corolla	SR5	10-Bolt	RDS 27413
70-68	Differential Carrier	Corolla		8-Bolt	RDS 27411
82-75	Differential Carrier	Corona, Corona Mark II		10-Bolt	RDS 27413
74-71	Differential Carrier	Corona, Corona Mark II	Exc. Wagon	8-Bolt	RDS 27412 ¹
74-71	Differential Carrier	Corona, Corona Mark II	Wagon	10-Bolt	RDS 27413
70-67	Differential Carrier	Corona, Corona Mark II		8-Bolt	RDS 27412 ¹
88-77	Differential Carrier	Cressida		10-Bolt	RDS 27413
72-71	Differential Carrier	Crown (From 02/01/71)		10-Bolt	RDS 55428
71-68	Differential Carrier	Crown (To 01/31/71)		10-Bolt	RDS 27413
67-58	Differential Carrier	Crown		10-Bolt	RDS 55428
84-81	Differential Carrier	Starlet		8-Bolt	RDS 27411
86-79	Differential Carrier	Supra		10-Bolt	RDS 55428
88-83	Differential Carrier	Tercel	Wagon	8-Bolt	RDS 27411
66-60	Differential Carrier	Tiara		10-Bolt	RDS 55428
Automatic Transaxle					
13-95	Oil Pan	Avalon	U140, U150, U241	18-Bolt	TOS 18719
13-01	Oil Pan	Camry	U140, U150, U241	18-Bolt	TOS 18719
04-94	Oil Pan	Camry	A541E	17-Bolt	TOS 18718
03-83	Oil Pan	Camry	A140E, A140L, SXV10	15-Bolt	TOS 18671
02-88	Oil Pan	Camry	A540E, A540H	17-Bolt	TOS 18699
05-00	Oil Pan	Celica	U341E	19-Bolt	TOS 18720
03-88	Oil Pan	Celica	A140E	15-Bolt	TOS 18671
99-94	Oil Pan	Celica	A246E	18-Bolt	TOS 18746
98-88	Oil Pan	Celica	A241E, A241L, A243L	18-Bolt	TOS 18676
87-86	Oil Pan	Celica	A140E	14-Bolt	TOS 18645 ¹
14-09	Oil Pan	Corolla	U140, U150, U241	18-Bolt	TOS 18719
14-00	Oil Pan	Corolla	U341E	19-Bolt	TOS 18720
08-03	Oil Pan	Corolla	A245E	18-Bolt	TOS 18741
02-93	Oil Pan	Corolla	A245E	18-Bolt	TOS 18746
02-89	Oil Pan	Corolla	A131L, A132L, 231L	15-Bolt	TOS 18671
98-89	Oil Pan	Corolla	240L, 241H, 241L	18-Bolt	TOS 18676
88-87	Oil Pan	Corolla	A140E	15-Bolt	TOS 18671
88-87	Oil Pan	Corolla	A240L	18-Bolt	TOS 18676
88-87	Oil Pan	Corolla	A131L	14-Bolt	TOS 18645 ¹
86-84	Oil Pan	Corolla	A131L	14-Bolt	TOS 18645 ¹
86-84	Oil Pan	Corolla	A140L	15-Bolt	TOS 18671
91-90	Oil Pan	ES 250	A540E, A540H	17-Bolt	TOS 18699
03-94	Oil Pan	ES 300	A541E	17-Bolt	TOS 18718
98-92	Oil Pan	ES 300	A540E, A540H	17-Bolt	TOS 18699
13	Oil Pan	ES 300h	U140, U150, U241	18-Bolt	TOS 18719
06-04	Oil Pan	ES 330	A541E	17-Bolt	TOS 18718
13-07	Oil Pan	ES 350	U140, U150, U241	18-Bolt	TOS 18719
14-09	Oil Pan	Matrix	U140, U150, U241	18-Bolt	TOS 18719
14-03	Oil Pan	Matrix	U341E	19-Bolt	TOS 18720
08-03	Oil Pan	Matrix	A245E	18-Bolt	TOS 18741
95-87	Oil Pan	MR2	A240L	14-Bolt	TOS 18645 ¹
86-85	Oil Pan	MR2	A141E	15-Bolt	TOS 18671
99-92	Oil Pan	Paseo		18-Bolt	TOS 18676
09-01	Oil Pan	Solara	U140, U150, U241	18-Bolt	TOS 18719
04-99	Oil Pan	Solara	A541E	17-Bolt	TOS 18718
99-95	Oil Pan	Tercel	A131L, A132L	15-Bolt	TOS 18671
99-95	Oil Pan	Tercel	A242L	18-Bolt	TOS 18676
94-89	Oil Pan	Tercel	A132L	15-Bolt	TOS 18671
88-87	Oil Pan	Tercel	A132L	15-Bolt	TOS 18671
88-87	Oil Pan	Tercel	A55	17-Bolt	TOS 18666 ¹
86-80	Oil Pan	Tercel	A55	17-Bolt	TOS 18666 ¹
13-05	Oil Pan	tC	U241E	18-Bolt	TOS 18719
07-03	Oil Pan	xA	E340E	19-Bolt	TOS 18720
14-08	Oil Pan	xB	U241E	18-Bolt	TOS 18719
07-03	Oil Pan	xB	E340E	19-Bolt	TOS 18720
14-08	Oil Pan	xD	E340E	19-Bolt	TOS 18720
14-06	Oil Pan	Yaris	E340E	19-Bolt	TOS 18720
Automatic Transmission					
85-72	Oil Pan	Celica	A40, A40D, A43D, A43DE, A43DL	7-Bolt	TOS 18754
85-72	Oil Pan	Celica	A40, A40D, A43D, A43DE, A43DL	14-Bolt	TOS 18646

¹Superseded or Discontinued

DRIVETRAIN GASKETS

Year	Part Type	Model Name	Description	Bolt Holes	Part Number
Toyota Car (Cont.)					
Automatic Transmission (Cont.)					
87-71	Oil Pan	Corolla	A40, A40D, A41, A42DL	7-Bolt	TOS 18754
87-71	Oil Pan	Corolla	A40, A40D, A41, A42DL	14-Bolt	TOS 18646
74-68	Oil Pan	Corolla	A20	14-Bolt	TOS 18645 ¹
82-72	Oil Pan	Corona	A40, A40D	7-Bolt	TOS 18754
82-72	Oil Pan	Corona	A40, A40D	14-Bolt	TOS 18646
92-89	Oil Pan	Cressida	A340E	19-Bolt	TOS 18685
88-77	Oil Pan	Cressida	A40D, A43D, A43DE, A43DL	7-Bolt	TOS 18754
88-77	Oil Pan	Cressida	A40D, A43D, A43DE, A43DL	14-Bolt	TOS 18646
67-61	Oil Pan	Crown	A20	14-Bolt	TOS 18645 ¹
06	Oil Pan	GS 300	A343F	20-Bolt	TOS 18736
05-98	Oil Pan	GS 300	A650E	19-Bolt	TOS 18748
97-93	Oil Pan	GS 300	A340E, A350E	19-Bolt	TOS 18748
14-10	Oil Pan	GS 350	AB60E, AB60F	12-Bolt	TOS 18760
10-07	Oil Pan	GS 350	A343F	20-Bolt	TOS 18736
00-98	Oil Pan	GS 400	A650E	19-Bolt	TOS 18748
08-07	Oil Pan	GS 430	A343F	20-Bolt	TOS 18736
06-01	Oil Pan	GS 430	A650E	19-Bolt	TOS 18748
14-10	Oil Pan	IS 250	AB60E, AB60F	12-Bolt	TOS 18760
10-06	Oil Pan	IS 250	A343F	20-Bolt	TOS 18736
05-01	Oil Pan	IS 300	A650E	19-Bolt	TOS 18748
14-10	Oil Pan	IS 350	AB60E, AB60F	12-Bolt	TOS 18760
10-06	Oil Pan	IS 350	A343F	20-Bolt	TOS 18736
00-98	Oil Pan	LS 400	A650E	19-Bolt	TOS 18748
97-90	Oil Pan	LS 400	A340E	19-Bolt	TOS 18748
06-01	Oil Pan	LS 430	A650E	19-Bolt	TOS 18748
00-92	Oil Pan	SC 300	A340E	19-Bolt	TOS 18748
00-98	Oil Pan	SC 400	A650E	19-Bolt	TOS 18748
97-92	Oil Pan	SC 400	A340E	19-Bolt	TOS 18748
10	Oil Pan	SC 430	AB60E, AB60F	12-Bolt	TOS 18760
10-06	Oil Pan	SC 430	A343F	20-Bolt	TOS 18736
05-02	Oil Pan	SC 430	A650E	19-Bolt	TOS 18748
98-86	Oil Pan	Supra	A340E	19-Bolt	TOS 18685
86-79	Oil Pan	Supra	A40D, A43D, A43DE, A43DL	7-Bolt	TOS 18754
86-79	Oil Pan	Supra	A40D, A43D, A43DE, A43DL	14-Bolt	TOS 18646
Toyota Truck					
Front Axle					
04-95	Differential Carrier	Tacoma	7.5" I.D.	10-Bolt	RDS 55428
Rear Axle					
92-88	Differential Carrier	Landcruiser		10-Bolt	RDS 55429
95-89	Differential Carrier	Pickup		10-Bolt	RDS 55428
88-85	Differential Carrier	Pickup	7.75" I.D.	10-Bolt	RDS 55431
88-85	Differential Carrier	Pickup	8.9375" I.D.	10-Bolt	RDS 55430
84-72	Differential Carrier	Pickup	7.625" I.D.	10-Bolt	RDS 55428
84-72	Differential Carrier	Pickup	7.75" I.D.	10-Bolt	RDS 55429
97-91	Differential Carrier	Previa		10-Bolt	RDS 55428
04-95	Differential Carrier	Tacoma	7.5" I.D.	10-Bolt	RDS 55428
90-86	Differential Carrier	Van		10-Bolt	RDS 55428
85-84	Differential Carrier	Van		10-Bolt	RDS 27413
98-88	Differential Carrier	4Runner		10-Bolt	RDS 55431
87-85	Differential Carrier	4Runner	7.75" I.D.	10-Bolt	RDS 55431
87-85	Differential Carrier	4Runner	8.9375" I.D.	10-Bolt	RDS 55430
84	Differential Carrier	4Runner	7.625" I.D.	10-Bolt	RDS 55428
84	Differential Carrier	4Runner	7.75" I.D.	10-Bolt	RDS 55429
Automatic Transaxle					
13-01	Oil Pan	Highlander	U140, U150, U241	18-Bolt	TOS 18719
13-04	Oil Pan	RAV4	U140, U150, U241	18-Bolt	TOS 18719
03-96	Oil Pan	RAV4	A540E, A540H	17-Bolt	TOS 18699
99-98	Oil Pan	RAV4	A247E	18-Bolt	TOS 18746
97-96	Oil Pan	RAV4	A241E	18-Bolt	TOS 18676
03-99	Oil Pan	RX 300	U140, U150, U241	18-Bolt	TOS 18719
06-04	Oil Pan	RX 330	U140, U150, U241	18-Bolt	TOS 18719
13-07	Oil Pan	RX 350	U140, U150, U241	18-Bolt	TOS 18719
09-06	Oil Pan	RX 400h	U140, U150, U241	18-Bolt	TOS 18719
13-10	Oil Pan	RX 450h	U140, U150, U241	18-Bolt	TOS 18719

Year	Part Type	Model Name	Description	Bolt Holes	Part Number
Toyota Truck (Cont.)					
Automatic Transaxle (Cont.)					
13-98	Oil Pan	Sienna	U140, U150, U241	18-Bolt	TOS 18719
03-98	Oil Pan	Sienna	A540E, A540H	17-Bolt	TOS 18699
Automatic Transmission					
15-07	Oil Pan	FJ Cruiser	70-50LE, 70-50LF	19-Bolt	TOS 18740
15-07	Oil Pan	FJ Cruiser	A343F	20-Bolt	TOS 18736
15-07	Oil Pan	FJ Cruiser	A340E, A340F	19-Bolt	TOS 18685
15-10	Oil Pan	GX 460	70-50LE, 70-50LF	19-Bolt	TOS 18740
15-10	Oil Pan	GX 460	A343F	20-Bolt	TOS 18736
09-03	Oil Pan	GX 470	70-50LE, 70-50LF	19-Bolt	TOS 18740
09-03	Oil Pan	GX 470	A343F	20-Bolt	TOS 18736
14-08	Oil Pan	Landcruiser	AB60E, AB60F	12-Bolt	TOS 18760
07-03	Oil Pan	Landcruiser	70-50LE, 70-50LF	19-Bolt	TOS 18740
07-98	Oil Pan	Landcruiser	A343F	20-Bolt	TOS 18736
92-86	Oil Pan	Landcruiser		20-Bolt	TOS 18696
07-03	Oil Pan	LX 470	70-50LE, 70-50LF	19-Bolt	TOS 18740
07-98	Oil Pan	LX 470	A343F	20-Bolt	TOS 18736
14-08	Oil Pan	LX 570	AB60E, AB60F	12-Bolt	TOS 18760
95-89	Oil Pan	Pickup	A43D	7-Bolt	TOS 18754
95-89	Oil Pan	Pickup	A43D	14-Bolt	TOS 18646
88-72	Oil Pan	Pickup	A40, A40D, A43D	7-Bolt	TOS 18754
88-72	Oil Pan	Pickup	A40, A40D, A43D	14-Bolt	TOS 18646
88-72	Oil Pan	Pickup	A340E, A340H	19-Bolt	TOS 18685
97-91	Oil Pan	Previa	A43DF, A46DE, A46DF	7-Bolt	TOS 18754
97-91	Oil Pan	Previa	A43DF, A46DE, A46DF	14-Bolt	TOS 18646
15-08	Oil Pan	Sequoia	AB60E, AB60F	12-Bolt	TOS 18760
15-08	Oil Pan	Sequoia	A343F	20-Bolt	TOS 18736
07-05	Oil Pan	Sequoia	70-50LE, 70-50LF	19-Bolt	TOS 18740
05-01	Oil Pan	Sequoia	A340E, A340F	19-Bolt	TOS 18685
98-93	Oil Pan	T100	A340E, A340F	19-Bolt	TOS 18685
15-05	Oil Pan	Tacoma	A750E, A750F	19-Bolt	TOS 18740
15-05	Oil Pan	Tacoma	A343F	20-Bolt	TOS 18736
15-95	Oil Pan	Tacoma	A340E, A340F	19-Bolt	TOS 18685
07-95	Oil Pan	Tacoma	A43D	7-Bolt	TOS 18754
07-95	Oil Pan	Tacoma	A43D	14-Bolt	TOS 18646
15-07	Oil Pan	Tundra	AB60E, AB60F	12-Bolt	TOS 18760
15-07	Oil Pan	Tundra	A343F	20-Bolt	TOS 18736
07-05	Oil Pan	Tundra	70-50LE, 70-50LF	19-Bolt	TOS 18740
05-99	Oil Pan	Tundra	A340E, A340F	19-Bolt	TOS 18685
90-84	Oil Pan	Van	A44DL, A45DF, A45DL	7-Bolt	TOS 18754
90-84	Oil Pan	Van	A44DL, A45DF, A45DL	14-Bolt	TOS 18646
15-03	Oil Pan	4Runner	70-50LE, 70-50LF	19-Bolt	TOS 18740
15-98	Oil Pan	4Runner	A343F	20-Bolt	TOS 18736
15-95	Oil Pan	4Runner	A340E, A340F	19-Bolt	TOS 18685
94-85	Oil Pan	4Runner	A340E, A340H	19-Bolt	TOS 18685
84	Oil Pan	4Runner	A43D	7-Bolt	TOS 18754
84	Oil Pan	4Runner	A43D	14-Bolt	TOS 18646
Turner					
Automatic Transmission					
66-55	Oil Pan	Borg-Warner DG200	2 Speed	14-Bolt	TOS 18106
Volvo Car					
Automatic Transaxle					
08-99	Oil Pan	All Models	GMC 4T65-E	20-Bolt	TOS 18717
08-99	Case Side Cover	All Models	GMC 4T65-E	17-Bolt	TOS 18723
Automatic Transmission					
82-73	Oil Pan	All Models	Aisin 03-55	7-Bolt	TOS 18754
82-73	Oil Pan	All Models	Aisin 03-55	14-Bolt	TOS 18646
95-81	Oil Pan	All Models	Aisin 03-70, 03-70L, 03-71, 03-71L, 03-72L	7-Bolt	TOS 18754
95-81	Oil Pan	All Models	Aisin 03-70, 03-70L, 03-71, 03-71L, 03-72L	14-Bolt	TOS 18646
97-92	Oil Pan	All Models	Aisin 30-40LE	19-Bolt	TOS 18685
Volvo Truck					
Automatic Transaxle					
08-03	Oil Pan	All Models	GMC 4T65-E	20-Bolt	TOS 18717

DRIVETRAIN GASKETS

Year	Part Type	Model Name	Description	Bolt Holes	Part Number
Volvo Truck (Cont.)					
Automatic Transaxle (Cont.)					
08-03	Case Side Cover	All Models	GMC 4T65-E	17-Bolt	TOS 18723
VW Car					
Automatic Transaxle					
14-04	Oil Pan	All Models	Aisin 09G (6 Speed)	8-Bolt	TOS 18761
14-06	Oil Pan	All Models	Aisin 09M (6 Speed)	9-Bolt	TOS 18765
14-04	Oil Pan	All Models	VW DSG (DQ250 6 Speed)	5-Bolt	TOS 18759
05-95	Oil Pan	All Models	01M	5-Bolt	TOS 18728
95-93	Oil Pan	All Models	01M	4-Bolt	TOS 18721
05-93	Case Side Cover	All Models	01M	7-Bolt	TOS 18726
92-75	Oil Pan	All Models	010	0-Bolt	TOS 18649 ¹
88-74	Oil Pan	Dasher, Quantum	Audi 087, 089	0-Bolt	TOS 18649 ¹
05-98	Oil Pan	Passat	5HP-19FL, 5HP-19FLA	27-Bolt	TOS 18724
05-98	Case Rear Cover	Passat	5HP-19FL, 5HP-19FLA	15-Bolt	TOS 18734
VW Truck					
Automatic Transaxle					
14-09	Oil Pan	Tiguan	Aisin 09G (6 Speed)	8-Bolt	TOS 18761
14-09	Oil Pan	Tiguan	Aisin 09M (6 Speed)	9-Bolt	TOS 18765
14-09	Oil Pan	Routan	Chrysler 62TE (6 Speed)	12-Bolt	TOS 18757
83-80	Oil Pan	Rabbit Pickup	010	0-Bolt	TOS 18649 ¹

DRIVETRAIN GASKETS DIAGRAM CHART



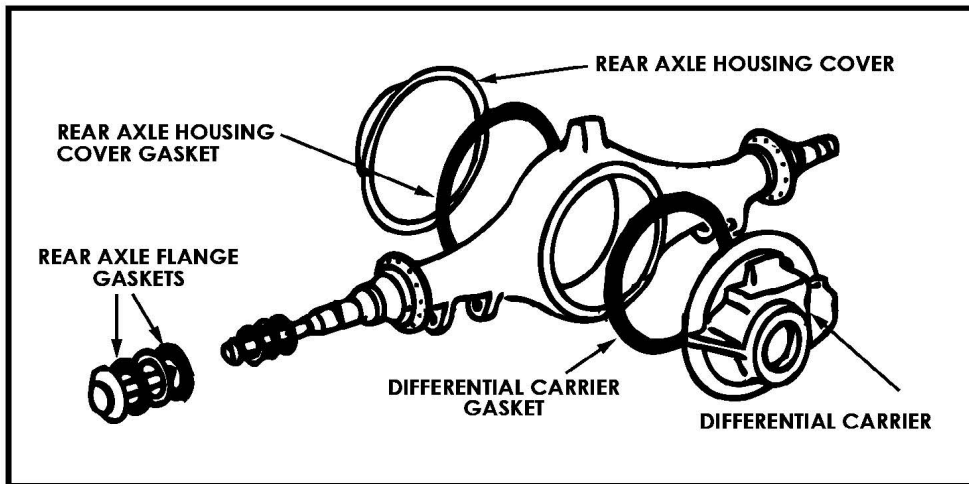

On the following pages you will find silhouettes and dimensions of every axle housing cover, differential carrier, axle flange, and automatic transmission oil pan gasket listed in this catalog. Each type of gasket is sorted by vehicle manufacturer and then by part number. For complete model and application information, please refer to the alphabetical catalog drivetrain listing before this section.

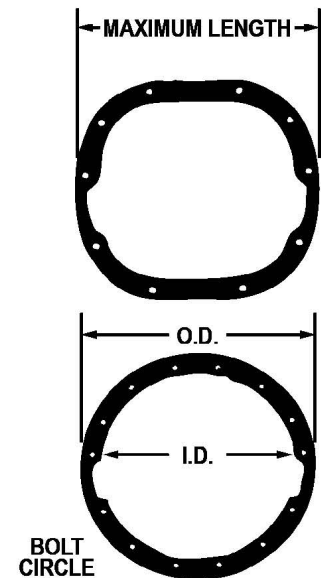



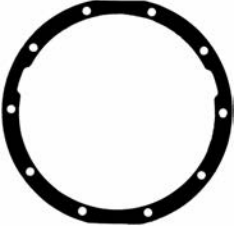
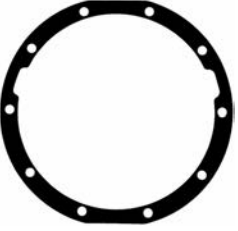
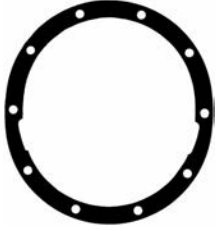
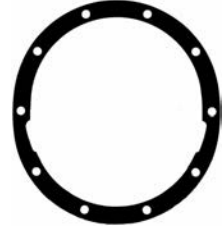
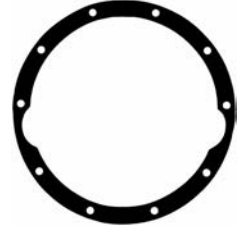
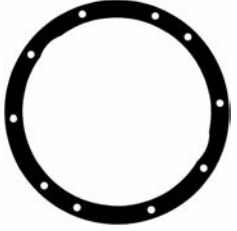
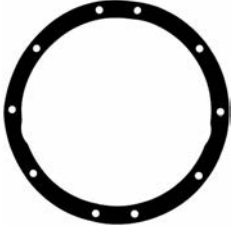
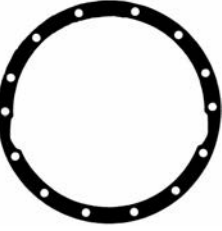
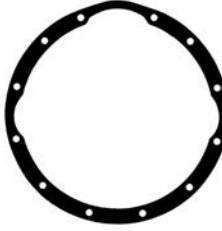

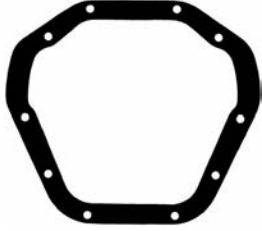
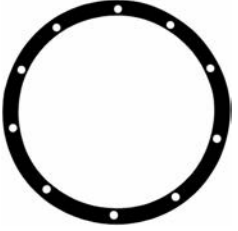
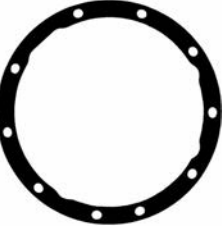
All dimensions are I.D. x O.D. or Bolt Circle (B.C.) x O.D. (if two measurements given) or Maximum Length (if one measurement given).

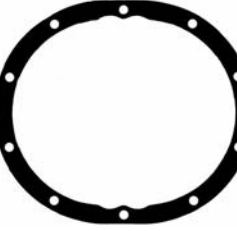
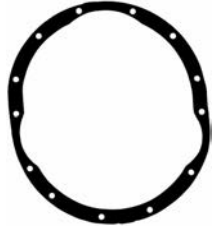
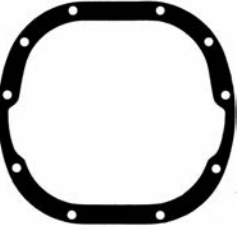
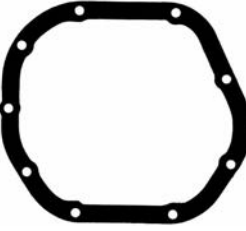
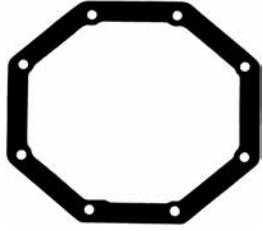
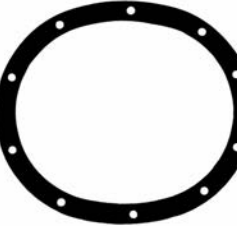
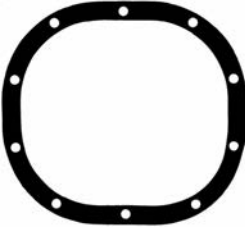
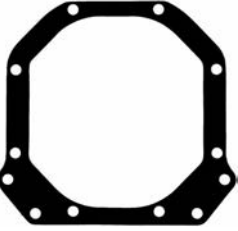
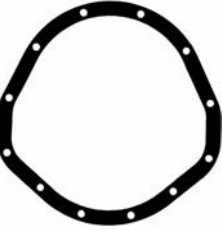
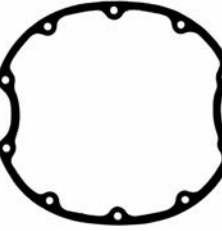
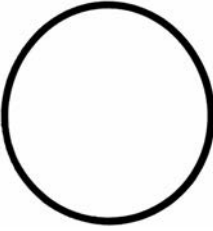

AXLE HOUSING COVER & DIFFERENTIAL CARRIER

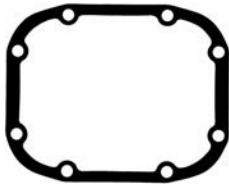
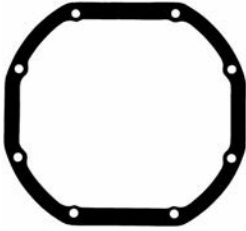
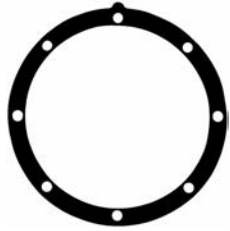
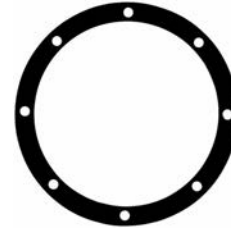
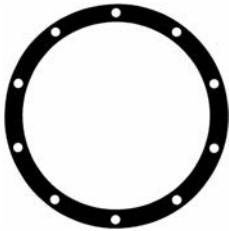
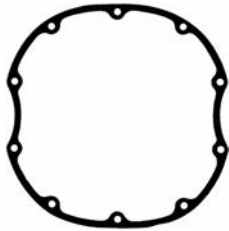
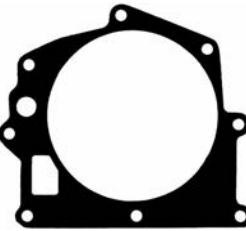
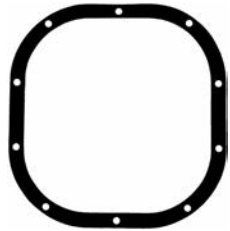
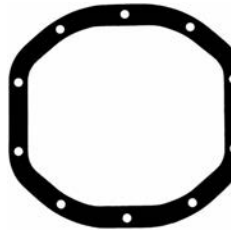
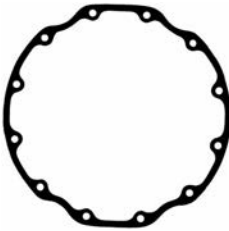
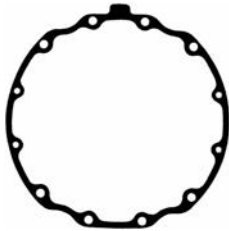
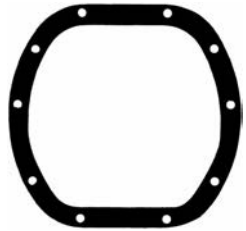
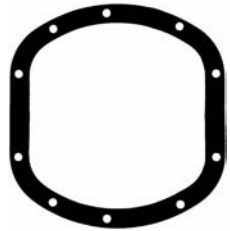
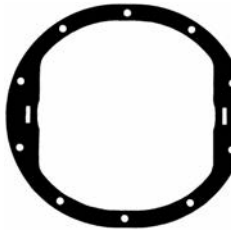
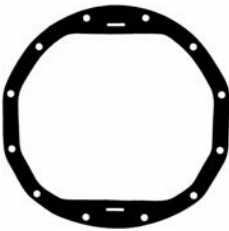
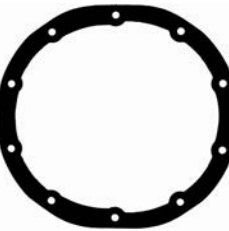
 <p>RDS 4304 9-1/8" X 10-15/16" 10-Holes</p>	 <p>RDS 4305 9-1/8" X 10-13/16" 10-Holes</p>	 <p>RDS 5007 10-3/8" (Oval) 10-Holes</p>	 <p>RDS 5008 8-11/16" X 10-7/16" (Oval) 10-Holes</p>	 <p>RDS 5049 11-9/16" X 13-3/4" 10-Holes</p>
 <p>RDS 5088 10-9/32" X 12-1/4" 10-Holes</p>	 <p>RDS 5090 10-9/32" X 12-1/4" 10-Holes</p>	 <p>RDS 5396 9-9/32" X 10-29/32" (Oval) 14-Holes</p>	 <p>RDS 5549-1 13-1/2" X 14-3/4" 12-Holes</p>	 <p>RDS 6014 12-1/8" (Irregular) 10-Holes</p>
 <p>RDS 6095-1 12-1/8" (Irregular) 10-Holes</p>	 <p>RDS 6431 10-3/16" X 11-13/16" 10-Holes</p>	 <p>RDS 6583 8-11/16" X 10-19/32" 10-Holes</p>	 <p>RDS 6629 10-3/8" (Irregular) 10-Holes</p>	 <p>RDS 11724 11-5/16" (Oval) 10-Holes</p>
 <p>RDS 12514 17-1/2" (Oval) 13-Holes</p>	 <p>RDS 12758 10-5/8" (Irregular) 10-Holes</p>	 <p>RDS 12775 9-1/8" (Irregular) 9-Holes</p>	 <p>RDS 13073 10-1/4" (Octagonal) 8-Holes</p>	 <p>RDS 13089 10-5/8" (Oval) 10-Holes</p>
 <p>RDS 13270 11" (Oval) 10-Holes</p>	 <p>RDS 13314-1 9-29/32" X 10-1/8" (Irregular) 12-Holes</p>	 <p>RDS 13391 10-7/8" (Irregular) 12-Holes</p>	 <p>RDS 13410 10-5/8" (Irregular) 10-Holes</p>	 <p>RDS 13889 10-1/32" X 10-25/64" 0-Holes</p>

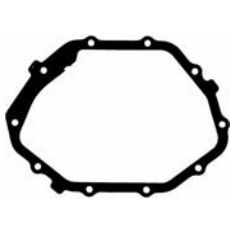
AXLE HOUSING COVER & DIFFERENTIAL CARRIER

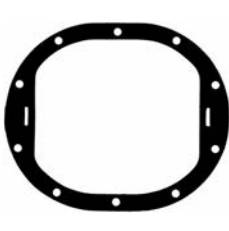
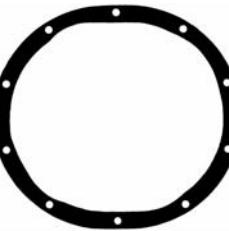
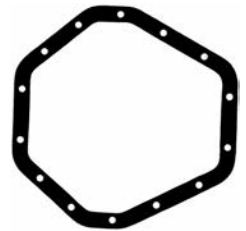
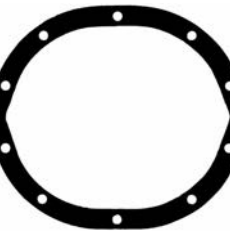
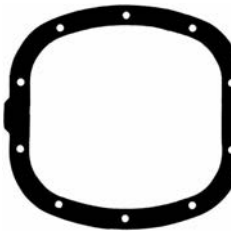
 <p>RDS 27271 6-7/8" X 8-1/16" 8-Holes</p>	 <p>RDS 27274 8-7/16" 8-Holes</p>	 <p>RDS 27275 9" X 9-1/2" 8-Holes</p>	 <p>RDS 27411 6-3/16" X 7-1/2" 8-Holes</p>	 <p>RDS 27412 6-7/8" X 7-3/4" 8-Holes</p>
 <p>RDS 27413 7" X 8-5/16" 10-Holes</p>	 <p>RDS 30031 11-1/2" (Irregular) 10-Holes</p>	 <p>RDS 30094 6-1/32" (Irregular) 8-Holes</p>	 <p>RDS 30132 10-7/8" X 11-5/16" 10-Holes</p>	 <p>RDS 55003 11-1/2" (Irregular) 10-Holes</p>
 <p>RDS 55008 10-3/4" X 11" (Irregular) 12-Holes</p>	 <p>RDS 55009 12-3/4" (Irregular) 12-Holes</p>	 <p>RDS 55015 9-3/4" (Irregular) 10-Holes</p>	 <p>RDS 55019 9-7/8" (Irregular) 10-Holes</p>	 <p>RDS 55028-1 11" (Oval) 10-Holes</p>
 <p>RDS 55029 10-7/8" (Oval) 12-Holes</p>	 <p>RDS 55031 11" X 10-7/16" 10-Holes</p>	 <p>RDS 55033 11-1/2" (Irregular) 12-Holes</p>	 <p>RDS 55034 12" (Irregular) 10-Holes</p>	 <p>RDS 55037 8-7/8" X 8-15/32" 10-Holes</p>
 <p>RDS 55039 10-1/4" (Oval) 10-Holes</p>	 <p>RDS 55047 11-3/8" (Oval) 10-Holes</p>	 <p>RDS 55063 14-7/8" (Irregular) 14-Holes</p>	 <p>RDS 55069 9-7/8" (Oval) 10-Holes</p>	 <p>RDS 55072 8-5/16" X 10-9/16" (Irregular) 10-Holes</p>

AXLE HOUSING COVER & DIFFERENTIAL CARRIER

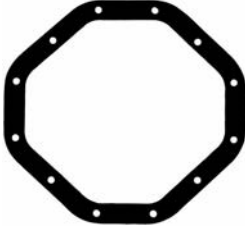
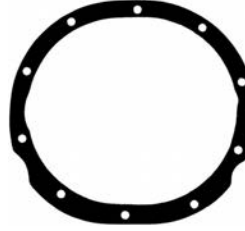
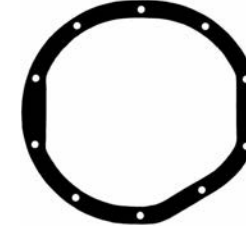
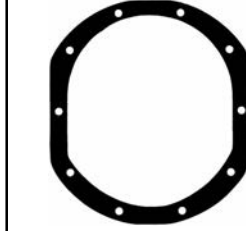
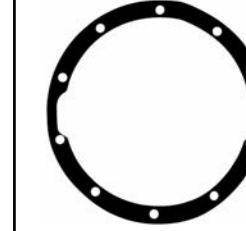
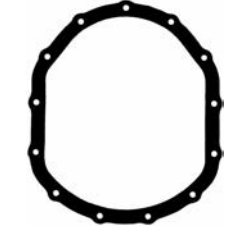
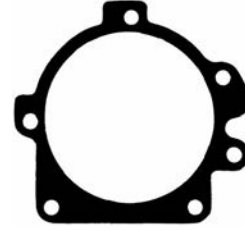
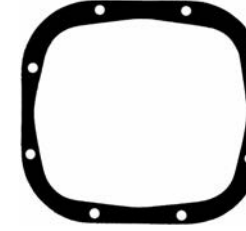
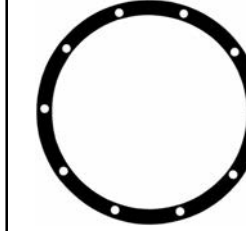
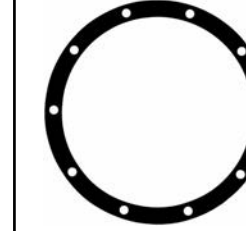
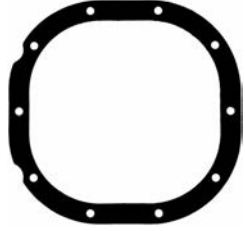
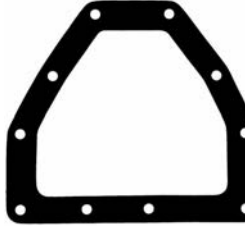
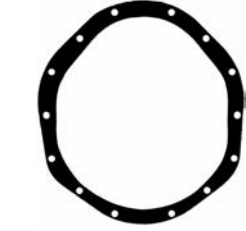
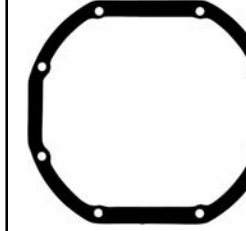
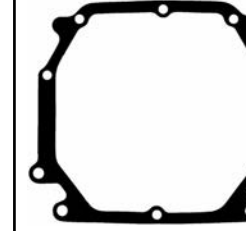
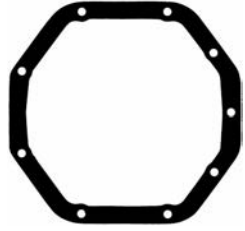
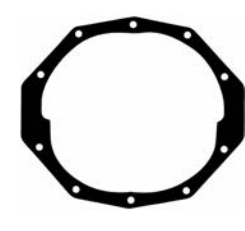
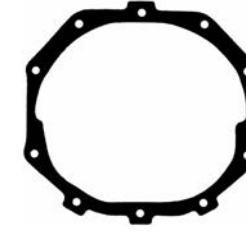
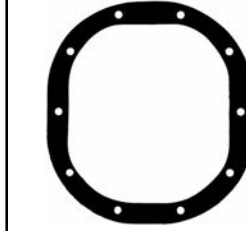
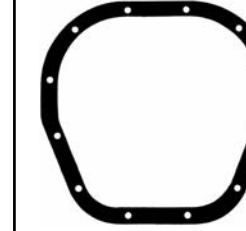
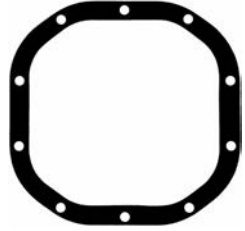
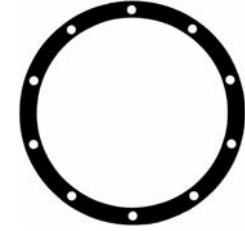
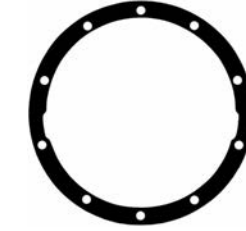
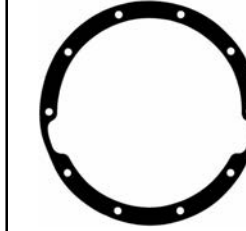
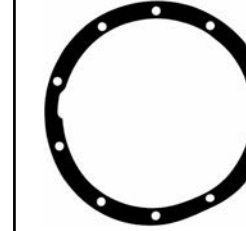
 <p>RDS 55073 12-1/2" (Octagonal) 12-Holes</p>	 <p>RDS 55074 11-3/4" (Oval) 10-Holes</p>	 <p>RDS 55075 11" (Irregular) 10-Holes</p>	 <p>RDS 55081 10-9/16" (Oval) 10-Holes</p>	 <p>RDS 55084 7-1/4" X 8-5/8" 10-Holes</p>
 <p>RDS 55185 10-7/16" (Irregular) 13-Holes</p>	 <p>RDS 55191 5-3/8" (Irregular) 6-Holes</p>	 <p>RDS 55323 7-15/16" X 8-15/16" 8-Holes</p>	 <p>RDS 55330 8-5/8" 10-Holes</p>	 <p>RDS 55336 8-3/4" 10-Holes</p>
 <p>RDS 55341 10-1/2" X 10-7/8" 10-Holes</p>	 <p>RDS 55351 12-1/2" (Irregular) 10-Holes</p>	 <p>RDS 55387 12-1/8" X 13-5/16" (Irregular) 14-Holes</p>	 <p>RDS 55388 7-7/16" X 8-5/16" (Irregular) 8-Holes</p>	 <p>RDS 55389 11-1/32" (Irregular) 10-Holes</p>
 <p>RDS 55390 9-7/16" (Octagonal) 9-Holes</p>	 <p>RDS 55391 9-5/16" X 10-13/16" (Irregular) 10-Holes</p>	 <p>RDS 55392 9-7/16" X 9-13/16" (Irregular) 10-Holes</p>	 <p>RDS 55393 9-3/4" X 10-3/4" 10-Holes</p>	 <p>RDS 55394 12-1/2" (Irregular) 12-Holes</p>
 <p>RDS 55395 8-15/16" (Oval) 10-Holes</p>	 <p>RDS 55428 8-3/8" (B.C.) X 9-3/32" 10-Holes</p>	 <p>RDS 55429 8-7/16" (B.C.) X 9-1/4" 10-Holes</p>	 <p>RDS 55430 9-3/4" (B.C.) X 10-11/16" 10-Holes</p>	 <p>RDS 55431 8-1/2" (B.C.) X 9-5/16" 10-Holes</p>

AXLE HOUSING COVER & DIFFERENTIAL CARRIER

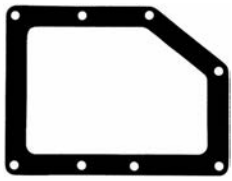

RDS 55437
5-3/8" X 7"
8-Holes

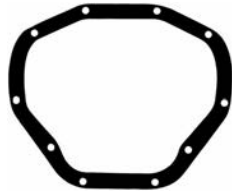

RDS 55447
13-7/16" (Irregular)
10-Holes

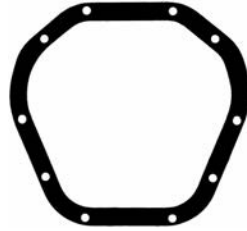

RDS 55449
11-7/8" (Irregular)
10-Holes

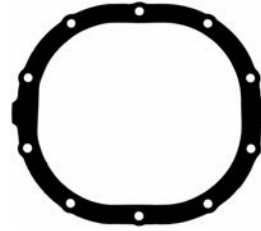

RDS 55459
8-1/2"
10-Holes

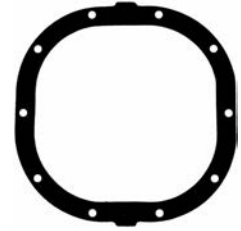

RDS 55460
8-5/8"
10-Holes



RDS 55470
12-1/4" (Oval)
10-Holes

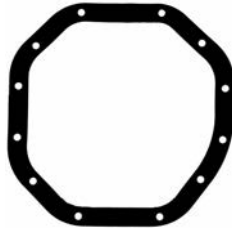

RDS 55471
10" X 9-3/4"
12-Holes

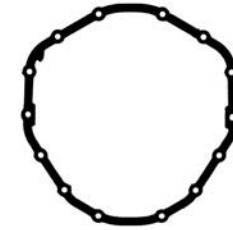

RDS 55472
13" X 13-1/2"
14-Holes

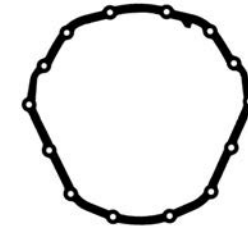

RDS 55473
13-3/4" X 13-1/4"
14-Holes

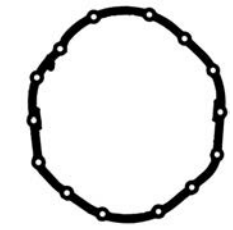

RDS 55474
13" X 12"
14-Holes

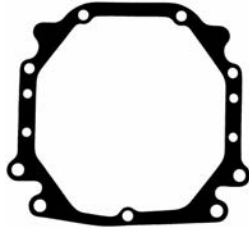

RDS 55475
11-1/8" (Irregular)
13-Holes



RDS 55476
12-1/2" X 11-1/2"
12-Holes

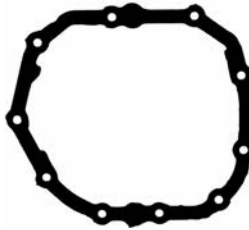

RDS 55477
9-1/2" X 8-3/4"
10-Holes



RDS 55478
13-3/4" X 13-1/4"
14-Holes

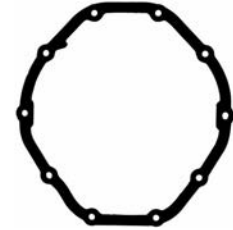

RDS 55479
11" X 11-1/4"
10-Holes

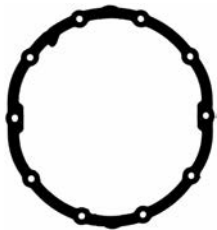



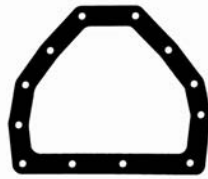





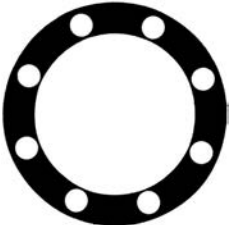
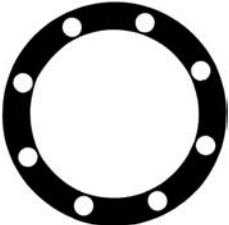
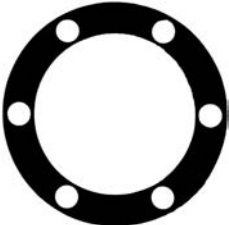
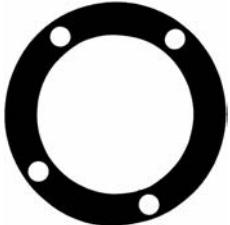
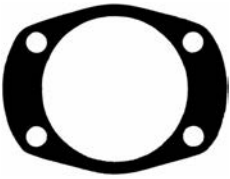
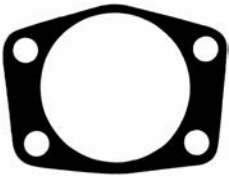



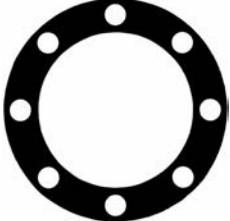
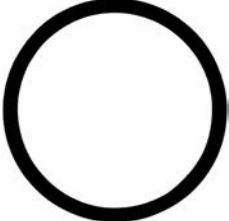

RDS 55480
10-1/4" X 11"
10-Holes

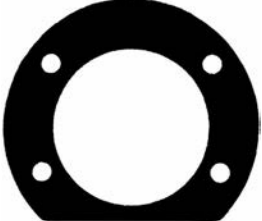

RDS 55481
10-3/8" X 8-9/16"
12-Holes

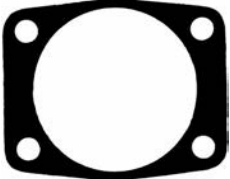
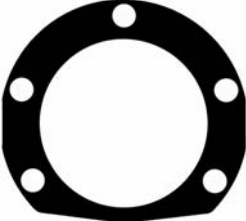
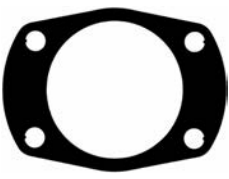
REAR AXLE FLANGE

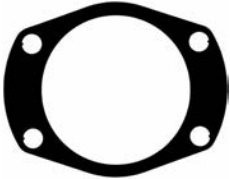
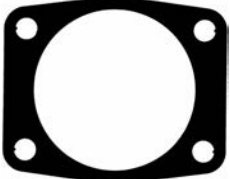
 <p>2931 3-3/8" X 4-23/32" 8-Holes</p>	 <p>3458 4-1/4" X 5-1/2" 8-Holes</p>	 <p>4390 3-23/64" X 4-11/16" 6-Holes</p>	 <p>4541 3-3/16" X 4-9/16" 4-Holes</p>	 <p>4828 3-3/32" I.D. 4-Holes</p>
 <p>4978 2-11/16" I.D. 4-Holes</p>	 <p>5188 3-13/32" I.D. 4-Holes</p>	 <p>5578 2-21/32" I.D. 4-Holes</p>	 <p>10720 5-1/2" X 7-1/2" 5-Holes</p>	 <p>12579 3-1/4" X 4-11/16" 8-Holes</p>
 <p>13202 3-13/32" X 3-15/16" 0-Holes</p>	 <p>13365 3-1/4" X 4-7/8" 4-Holes</p>	 <p>13394 2-25/32" I.D. 4-Holes</p>	 <p>13800 2-31/32" X 4-11/16" 5-Holes</p>	 <p>13802 2-25/32" X 4-9/16" 4-Holes</p>
 <p>13831 2-5/8" I.D. 4-Holes</p>	 <p>55001 2-7/8" I.D. 4-Holes</p>	 <p>55002 2-15/16" I.D. 4-Holes</p>	 <p>55010 2-7/8" I.D. 4-Holes</p>	 <p>55021 3-11/32" I.D. 4-Holes</p>
 <p>55032 2-59/64" X 4-9/32" 5-Holes</p>	 <p>55035 2-55/64" I.D. 4-Holes</p>	 <p>55036 3-3/16" I.D. 4-Holes</p>	 <p>55065 4-3/4" I.D. 4-Holes</p>	 <p>55080 3-3/32" I.D. 4-Holes</p>

REAR AXLE FLANGE

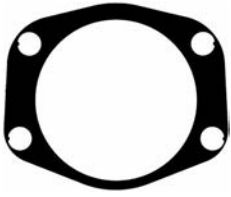

55319
2-7/18" I.D.
4-Holes

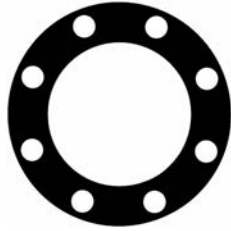

55328
3" I.D.
8-Holes



55350
2-23/32" X 4-7/16"
8-Holes

POWER TAKE-OFF (PTO)

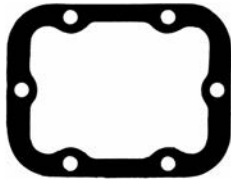

55372
6-1/4" x 5"
6-Bolt

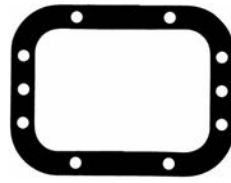

55375
9-1/4" x 7"
8-Bolt

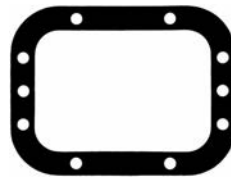

55377
9-1/4" x 7"
8-Bolt

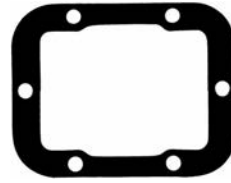











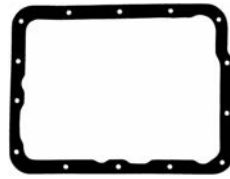
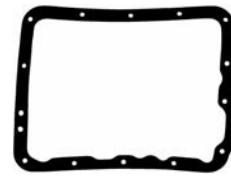
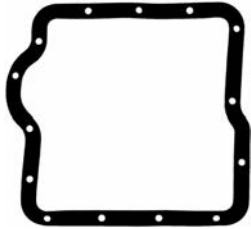

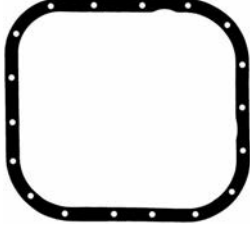
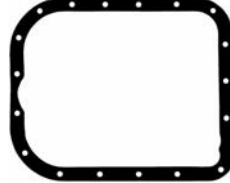
55379
6-1/4" x 5"
6-Bolt

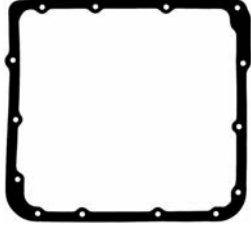

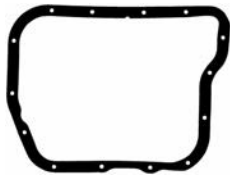
55380
6-1/4" x 5"
6-Bolt

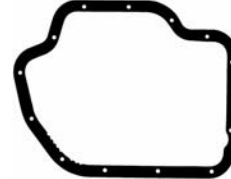
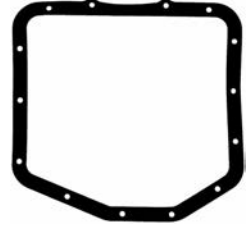
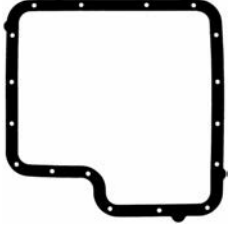
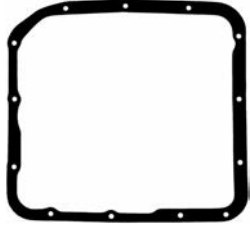
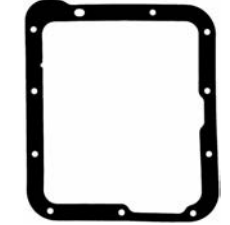
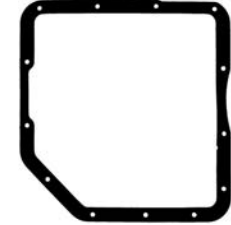
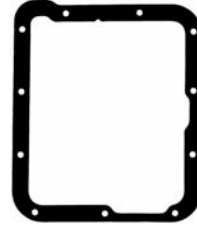
AUTOMATIC TRANSMISSION OIL PAN

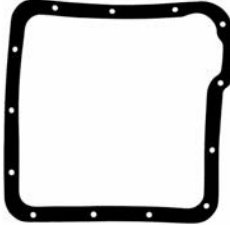
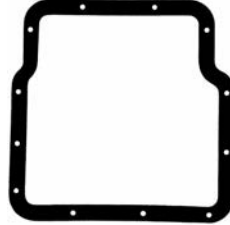
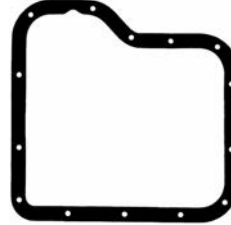
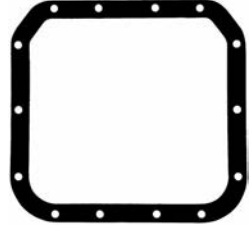
 <p>TOS 18024 13-3/8" X 10-3/16" 12-Holes</p>	 <p>TOS 18057 15-1/2" X 12-5/16" 15-Holes</p>	 <p>TOS 18106 13" X 10" 14-Holes</p>	 <p>TOS 18107 13-1/2" X 10-7/16" 15-Holes</p>	 <p>TOS 18109 12" X 11" 14-Holes</p>
 <p>TOS 18178 16" X 8-37/64" 22-Holes</p>	 <p>TOS 18333 13-3/8" X 12-3/8" 18-Holes</p>	 <p>TOS 18407 12-1/8" X 9-15/16" 18-Holes</p>	 <p>TOS 18508 13-5/8" X 9-7/16" 14-Holes</p>	 <p>TOS 18509 13-15/16" X 12-1/2" 14-Holes</p>
 <p>TOS 18555 15-31/32" X 12-7/32" 16-Holes</p>	 <p>TOS 18583 15" X 11-1/2" 14-Holes</p>	 <p>TOS 18608 13-1/4" X 11" 14-Holes</p>	 <p>TOS 18621 16-3/8" X 12-5/8" 13-Holes</p>	 <p>TOS 18625 12-1/8" X 11-5/8" 14-Holes</p>
 <p>TOS 18628 14-7/8" X 14-1/8" 17-Holes</p>	 <p>TOS 18629 13-5/8" X 12-5/8" 13-Holes</p>	 <p>TOS 18632 10-1/2" X 8-3/4" 11-Holes</p>	 <p>TOS 18633 13-1/2" X 12-15/16" 13-Holes</p>	 <p>TOS 18634 11-1/4" X 8-3/4" 11-Holes</p>
 <p>TOS 18638 19-1/4" X 13-1/4" 21-Holes</p>	 <p>TOS 18640 11-21/64" X 11-5/32" 13-Holes</p>	 <p>TOS 18643 12-3/8" X 12-5/16" 12-Holes</p>	 <p>TOS 18644 11-3/16" X 10-7/8" 14-Holes</p>	 <p>TOS 18645 9-13/16" X 9-3/16" 14-Holes</p>

AUTOMATIC TRANSMISSION OIL PAN



TOS 18646
12-11/16" X 9-3/4"
14-Holes

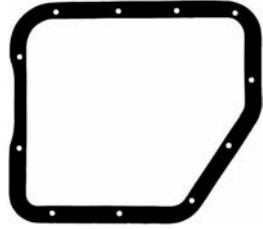

TOS 18648
13-3/16" X 11-5/8"
11-Holes

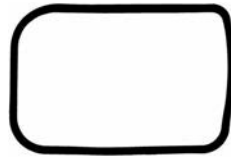

TOS 18649
12" X 7-1/2"
0-Holes

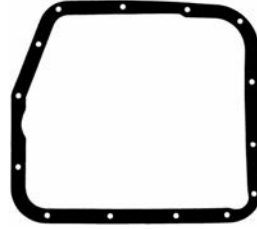

TOS 18651
13-3/8" X 11-3/16"
14-Holes

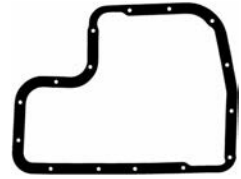

TOS 18655
16-1/4" X 12-1/2"
15-Holes

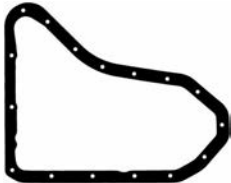

TOS 18656
15-13/16" X 12-13/16"
16-Holes

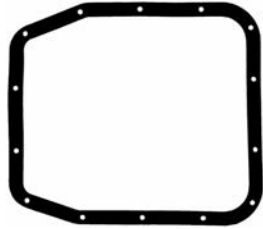

TOS 18657
14-1/2" X 12-5/8"
14-Holes

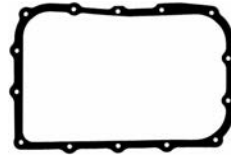

TOS 18658
13-3/16" X 9-5/16"
14-Holes



TOS 18659
15-1/6" X 12-7/16"
13-Holes

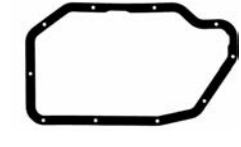

TOS 18660
16-3/8" X 9-7/16"
10-Holes

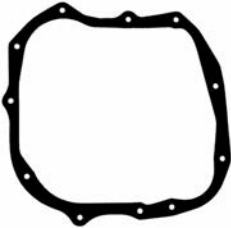

TOS 18661
11-3/8" X 11-1/8"
11-Holes

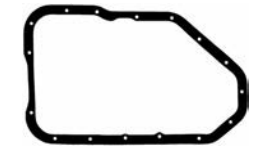

TOS 18662
19-1/2" X 12-1/8"
16-Holes

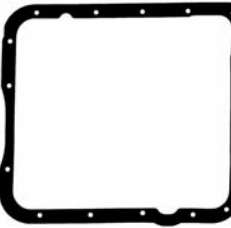

TOS 18663
13-1/8" X 14-3/4"
16-Holes

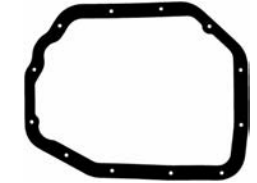

TOS 18665
12-1/8" X 9-3/4"
12-Holes

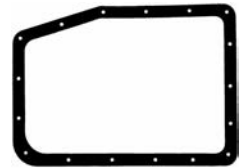

TOS 18666
9-13/16" X 13-11/16"
17-Holes

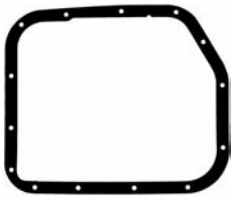

TOS 18667
14" X 11-1/2"
14-Holes

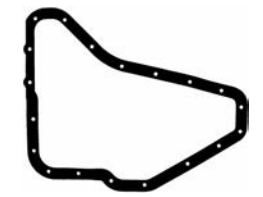

TOS 18668
17-3/4" X 14-1/4"
19-Holes

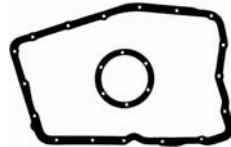

TOS 18669
20-1/2" X 13"
17-Holes

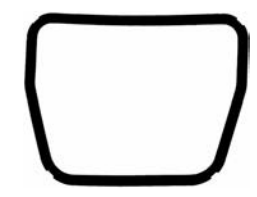

TOS 18670
10-1/2" X 8-1/8"
0-Holes

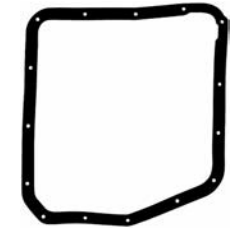

TOS 18671
12-5/8" X 11-5/8"
15-Holes



TOS 18673
13" X 9-1/4"
14-Holes

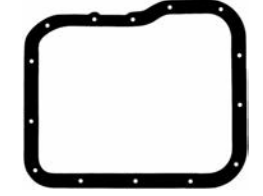

TOS 18675
11-3/16" X 9-19/32"
14-Holes

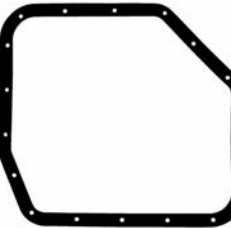

TOS 18676
13-3/32" X 11-9/16"
18-Holes

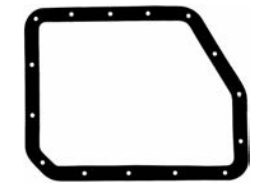









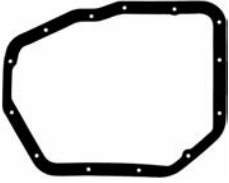
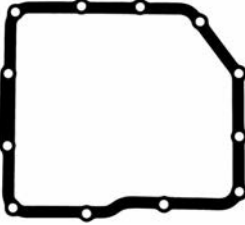

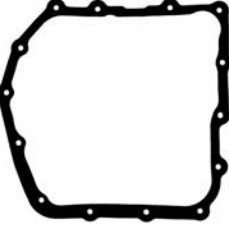
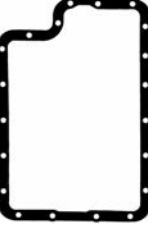
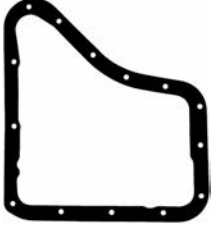

TOS 18677
12-15/32" X 9-3/4"
15-Holes

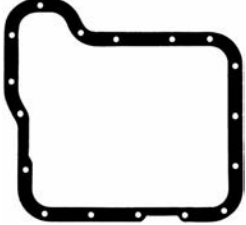
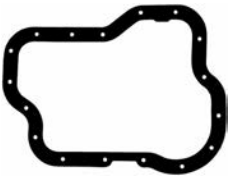
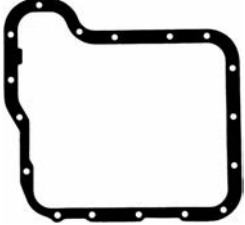
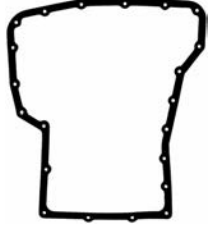

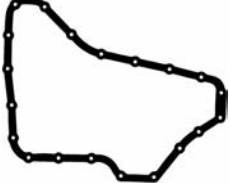

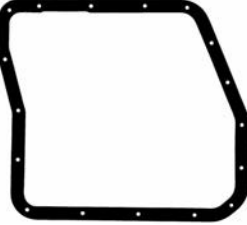

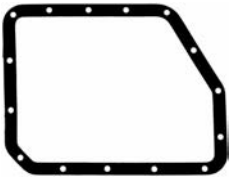
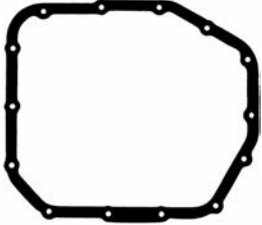
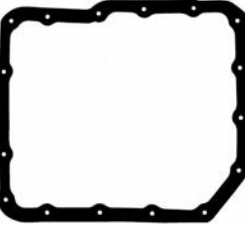
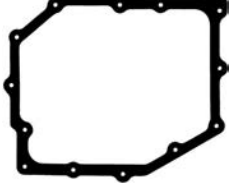
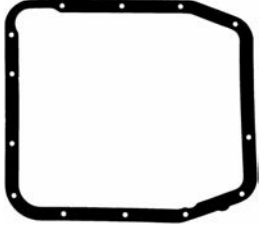



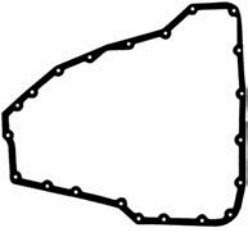

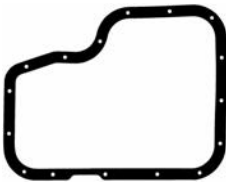

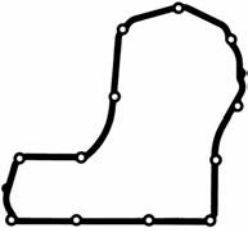
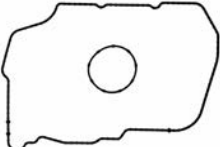
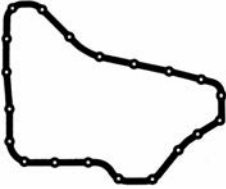
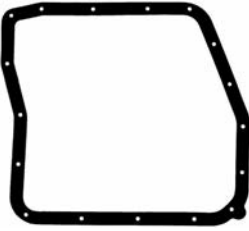
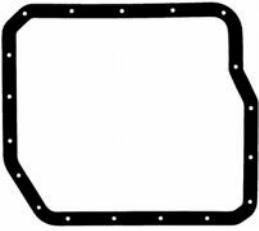
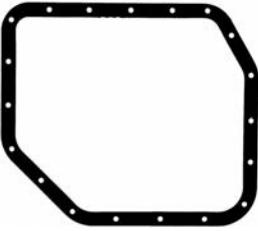
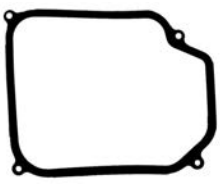
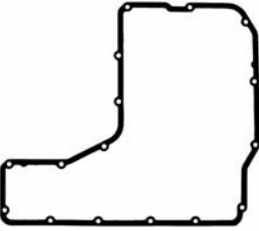
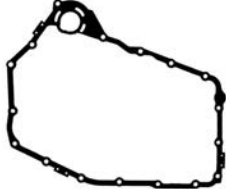
TOS 18679
15-1/2" X 11"
18-Holes

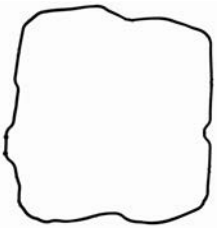
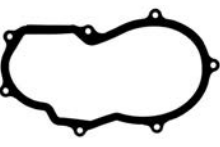
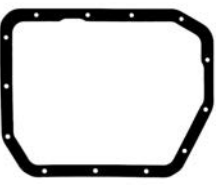

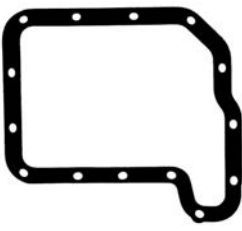
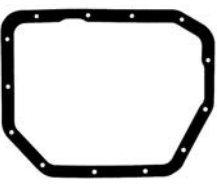

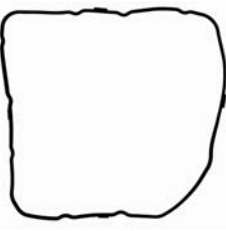
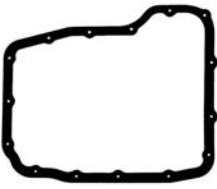







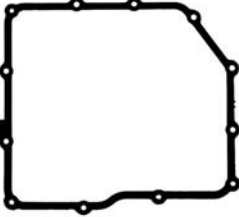

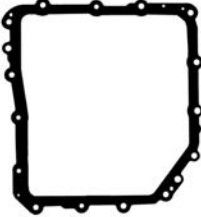

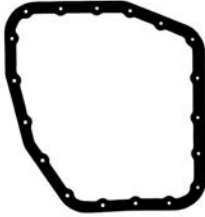

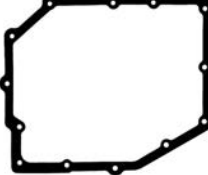

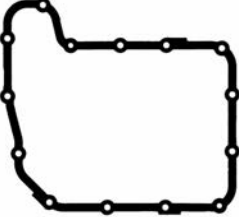
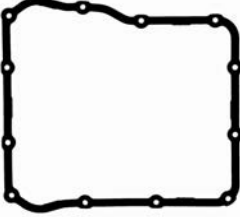

AUTOMATIC TRANSMISSION OIL PAN

 <p>TOS 18680 19-15/16" X 13-7/16" 17-Holes</p>	 <p>TOS 18681 12-1/16" X 10-1/16" 13-Holes</p>	 <p>TOS 18682 13-1/4" X 12" 12-Holes</p>	 <p>TOS 18683 14-1/4" X 11-3/4" 20-Holes</p>	 <p>TOS 18684 14-7/8" X 12-1/4" 20-Holes</p>
 <p>TOS 18685 15-15/16" X 10-1/16" 19-Holes</p>	 <p>TOS 18687 11-1/2" X 12-1/2" 14-Holes</p>	 <p>TOS 18688 20-7/16" X 13-11/16" 20-Holes</p>	 <p>TOS 18689 12-3/4" X 11-5/8" 14-Holes</p>	 <p>TOS 18690 8-7/16" X 11-3/4" 17-Holes</p>
 <p>TOS 18691 10-5/16" X 11-1/8" 17-Holes</p>	 <p>TOS 18692 8-1/2" X 11-5/8" 17-Holes</p>	 <p>TOS 18693 10-1/2" X 11" 17-Holes</p>	 <p>TOS 18694 14-1/8" X 13" 21-Holes</p>	 <p>TOS 18695 13-1/4" X 8-1/4" 19-Holes</p>
 <p>TOS 18696 15-5/8" X 11-1/8" 20-Holes</p>	 <p>TOS 18697 17-1/4" X 14-3/8" 20-Holes</p>	 <p>TOS 18698 15-5/8" X 13-1/8" 17-Holes</p>	 <p>TOS 18699 13-7/8" X 12-1/32" 17-Holes</p>	 <p>TOS 18700 15-5/16" X 13-1/16" 21-Holes</p>
 <p>TOS 18702 10-7/8" X 8-5/16" 15-Holes</p>	 <p>TOS 18703 11-15/16" X 10-7/16" 14-Holes</p>	 <p>TOS 18704 12-15/32" X 11-5/32" 16-Holes</p>	 <p>TOS 18705 14-3/8" X 12-3/4" 13-Holes</p>	 <p>TOS 18706 12" X 14-3/4" 14-Holes</p>

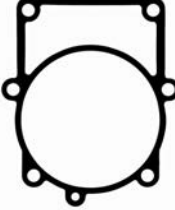
AUTOMATIC TRANSMISSION OIL PAN

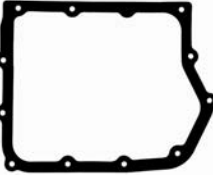
 <p>TOS 18708 14-39/64" X 13-5/32" 21-Holes</p>	 <p>TOS 18709 18-27/64" X 12-1/2" 19-Holes</p>	 <p>TOS 18712 12-1/2" X 9-3/4" 16-Holes</p>	 <p>TOS 18713 12-1/2" X 9-3/4" 16-Holes</p>	 <p>TOS 18714 20-1/4" X 13-3/4" 20-Holes</p>
 <p>TOS 18715 17-1/4" X 16" 12-Holes</p>	 <p>TOS 18716 19-3/4" X 13-5/8" 0-Holes</p>	 <p>TOS 18717 17-1/2" X 14-15/16" 20-Holes</p>	 <p>TOS 18718 13-1/4" X 12-1/8" 17-Holes</p>	 <p>TOS 18719 12-7/8" X 11-5/16" 18-Holes</p>
 <p>TOS 18720 12-15/16" X 11-1/8" 19-Holes</p>	 <p>TOS 18721 11" X 8" 4-Holes</p>	 <p>TOS 18722 19-7/8" X 17-1/8" 16-Holes</p>	 <p>TOS 18723 19-1/4" X 16-3/8" 17-Holes</p>	 <p>TOS 18724 18-1/4" X 12-1/8" 27-Holes</p>
 <p>TOS 18725 16-7/8" X 15-3/8" 0-Holes</p>	 <p>TOS 18726 12-1/2" X 7-3/8" 7-Holes</p>	 <p>TOS 18727 12-3/16" X 9-11/16" 13-Holes</p>	 <p>TOS 18728 9-1/4" X 6-3/4" 5-Holes</p>	 <p>TOS 18729 12-1/4" X 11-1/4" 14-Holes</p>
 <p>TOS 18730 12-1/4" X 9-3/4" 13-Holes</p>	 <p>TOS 18731 13-1/2" X 9-1/2" 20-Holes</p>	 <p>TOS 18732 17" X 10" 0-Holes</p>	 <p>TOS 18733 17" X 14" 15-Holes</p>	 <p>TOS 18734 11-1/2" X 8" 15-Holes</p>

AUTOMATIC TRANSMISSION OIL PAN

 <p>TOS 18735 18-1/4" X 12-1/2" 19-Holes</p>	 <p>TOS 18736 16-7/8" X 10-1/4" 20-Holes</p>	 <p>TOS 18737 13-1/4" X 12" 12-Holes</p>	 <p>TOS 18738 19-15/16" X 13-7/16" 17-Holes</p>	 <p>TOS 18739 13-3/4" X 13" 17-Holes</p>
 <p>TOS 18740 16" X 9-3/4" 19-Holes</p>	 <p>TOS 18741 12-7/8" X 12-1/8" 18-Holes</p>	 <p>TOS 18742 15-3/4" X 11" 16-Holes</p>	 <p>TOS 18743 14-1/2" X 12" 13-Holes</p>	 <p>TOS 18744 15" X 10-3/4" 22-Holes</p>
 <p>TOS 18745 14-3/4" X 10" 0-Holes</p>	 <p>TOS 18746 12-1/2" X 12-1/2" 18-Holes</p>	 <p>TOS 18747 13-1/4" X 8-1/4" 19-Holes</p>	 <p>TOS 18748 15-15/16" X 10-1/16" 19-Holes</p>	 <p>TOS 18749 14-3/8" X 10-1/2" 0-Holes</p>
 <p>TOS 18751 12-1/4" X 11" 14-Holes</p>	 <p>TOS 18752 15-7/16" X 13-7/8" 12-Holes</p>	 <p>TOS 18753 19-1/2" X 12-1/4" 21-Holes</p>	 <p>TOS 18754 6-1/8" X 7-1/4" 7-Holes</p>	 <p>TOS 18755 15" X 8-1/2" 18-Holes</p>
 <p>TOS 18756 11-1/4" X 5-1/4" 12-Holes</p>	 <p>TOS 18757 10-1/2" X 8-1/8" 12-Holes</p>	 <p>TOS 18758 12-3/4" X 10-3/8" 18-Holes</p>	 <p>TOS 18759 9-3/4" X 11" 5-Holes</p>	 <p>TOS 18760 18" X 10" 12-Holes</p>

AUTOMATIC TRANSMISSION OIL PAN

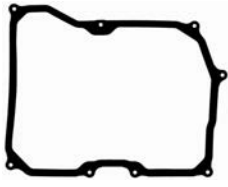

TOS 18761
 12-1/4" X 10"
 8-Holes



TOS 18762
 11-3/4" X 12-1/2"
 16-Holes

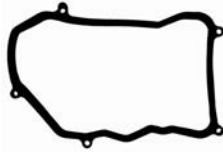

TOS 18763
 14" X 8-1/2"
 5-Holes

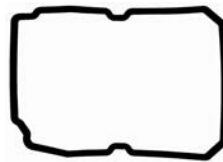

TOS 18764
 14-1/2" X 10"
 0-Holes

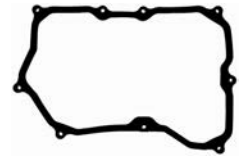

TOS 18765
 14" X 9-1/2"
 9-Holes



TOS 18766
 16-1/2" X 10-1/4"
 20-Holes



TOS 18767
 16-3/4" X 7-1/4"
 0-Holes

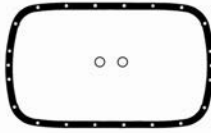

TOS 18768
 17-1/2" X 10-1/2"
 22-Holes

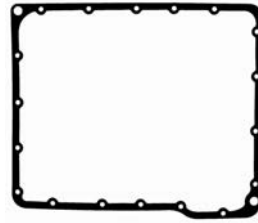

TOS 18769
 14-7/16" X 12-3/16"
 18-Holes

NOTES



O-RING ASSORTMENT OR 40-85

- Includes 382 O-rings in 30 popular sizes from 1/8" ID to 1-3/4" ID
- Size charts and built-in gauges for positive identification of each O-ring size
- Attractive plastic case securely holds O-rings in place
- Case available separately as Part No. **OR 40E-85**

O-RING ASSORTMENT OR 40-85

Part No.	Qty.	ID x OD	Part No.	Qty.	ID x OD	Part No.	Qty.	ID x OD
401	20	1/8" ID x 1/4" OD	413	13	11/16" ID x 7/8" OD	425RR	10	1-3/8" ID x 1-5/8" OD
402	20	5/32" ID x 9/32" OD	414	13	3/4" ID x 15/16" OD	426RR	10	1-7/16" ID x 1-11/16" OD
403	20	3/16" ID x 5/16" OD	415	10	3/4" ID x 1" OD	427RR	10	1-1/2" ID x 1-3/4" OD
404	20	7/32" ID x 11/32" OD	416	10	13/16" ID x 1-1/16" OD	428RR	7	1-1/2" ID x 1-7/8" OD
405	20	1/4" ID x 3/8" OD	417	10	7/8" ID x 1-1/8" OD	429RR	7	1-5/8" ID x 2" OD
406	20	5/16" ID x 7/16" OD	418	10	15/16" ID x 1-3/16" OD	430RR	7	1-3/4" ID x 2-1/8" OD
407	20	3/8" ID x 1/2" OD	419	10	1" ID x 1-1/4" OD			
408	13	3/8" ID x 9/16" OD	420	10	1-1/16" ID x 1-5/16" OD			
409	13	7/16" ID x 5/8" OD	421	10	1-1/8" ID x 1-3/8" OD			
410	13	1/2" ID x 11/16" OD	422	10	1-3/16" ID x 1-7/16" OD			
411	13	9/16" ID x 3/4" OD	423	10	1-1/4" ID x 1-1/2" OD			
412	13	5/8" ID x 13/16" OD	424	10	1-5/16" ID x 1-9/16" OD			

AVAILABLE O-RINGS

O-Rings may also be purchased separately in different quantities. Please use the following chart to determine what individual quantities you may require:

Part No.	Qty.	ID x OD	Part No.	Qty.	ID x OD	Part No.	Qty.	ID x OD
401	20	1/8" ID x 1/4" OD	421	1	1-1/8" ID x 1-3/8" OD	441RR	10	7/8" ID x 1-1/16" OD
402	20	5/32" ID x 9/32" OD	422	5	1-3/16" ID x 1-7/16" OD	442RR	10	15/16" ID x 1-1/8" OD
403	20	3/16" ID x 5/16" OD	423	5	1-1/4" ID x 1-1/2" OD	443RR	10	1-1/8" ID x 1-5/16" OD
404	20	7/32" ID x 11/32" OD	424	1	1-5/16" ID x 1-9/16" OD	444RR	10	1-7/16" ID x 1-5/8" OD
405	20	1/4" ID x 3/8" OD	425RR	1	1-3/8" ID x 1-5/8" OD	445RR	5	1-13/16" ID x 2" OD
406	20	5/16" ID x 7/16" OD	426RR	5	1-7/16" ID x 1-11/16" OD	446RR	5	1-7/8" ID x 2-1/16" OD
407	1	3/8" ID x 1/2" OD	427RR	5	1-1/2" ID x 1-3/4" OD	447RR	5	2-5/8" ID x 2-13/16" OD
408	10	3/8" ID x 9/16" OD	428RR	5	1-1/2" ID x 1-7/8" OD	448RR	5	3-1/4" ID x 3-7/16" OD
409	10	7/16" ID x 5/8" OD	429RR	5	1-5/8" ID x 2" OD	449RR	10	1-5/8" ID x 1-7/8" OD
410	10	1/2" ID x 11/16" OD	430RR	5	1-3/4" ID x 2-1/8" OD	450RR	10	1-3/4" ID x 2" OD
411	10	9/16" ID x 3/4" OD	431RR	10	1/2" ID x 5/8" OD	451RR	10	2-1/4" ID x 2-1/2" OD
412	1	5/8" ID x 13/16" OD	432RR	10	11/16" ID x 3/4" OD	452RR	10	2-1/2" ID x 2-3/4" OD
413	1	11/16" ID x 7/8" OD	433RR	10	3/4" ID x 7/8" OD	453RR	10	2-5/8" ID x 2-7/8" OD
414	1	3/4" ID x 15/16" OD	434RR	10	13/16" ID x 15/16" OD	454RR	10	2-3/4" ID x 3" OD
415	1	3/4" ID x 1" OD	435RR	10	7/8" ID x 1" OD	455RR	10	3-1/2" ID x 3-3/4" OD
416	1	13/16" ID x 1-1/16" OD	436RR	10	15/16" ID x 1-1/16" OD	456RR	10	4" ID x 4-1/4" OD
417	1	7/8" ID x 1-1/8" OD	437RR	10	1-1/16" ID x 1-3/16" OD	457RR	5	2" ID x 2-3/8" OD
418	1	15/16" ID x 1-3/16" OD	438RR	10	1-1/8" ID x 1-1/4" OD	458RR	5	2-1/2" ID x 2-7/8" OD
419	5	1" ID x 1-1/4" OD	439RR	10	1-3/4" ID x 1-7/8" OD	459RR	5	2-3/4" ID x 3-1/8" OD
420	1	1-1/16" ID x 1-5/16" OD	440RR	10	13/16" ID x 1" OD			

WATER OUTLET GASKET ASSORTMENT WO 20-08

The most popular FEL-PRO® water outlet and thermostat housing gaskets are now available in this updated assortment that includes 44 of the top-selling numbers. Gaskets are packaged individually in the quantities shown below. Each assortment also contains the matching silhouette card for the part number, as well as a set of blank silhouette cards for customizing. We continue to offer the 2' x 3' pegboard backer (Part No. **PB 1**) and 2" pegboard hooks (Part No. **HK 2** for a pack of 100 and **HK 2A** for a pack of 25) for use with the assortment. The Silhouette Cards reflect the top-selling 50 water outlet and thermostat housing gaskets (Part No. **WO 2**).

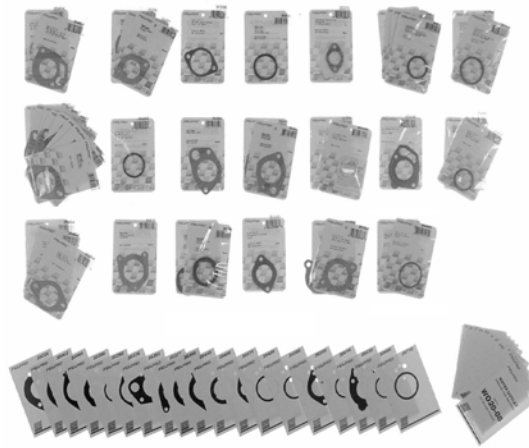

Part Number	Qty.	Pop Code	Part Type	Application
35024	2	TA	WO	Jeep 4, 150 (2.5L), 1983-02
35024	2	TA	WO	Jeep 6, 199-232-242 (4.0L)-258 (4.2L), 1968-98
35062	10	A	WO	GM Products 4, 151 (2.5L), 1977-90
35062	10	A	WO	GM Products 6, 194-215-216-230-235-250 (4.1L)-261-292 (4.8L), 1937-89
35062	10	A	WO	GM Products V6, 173 (2.8L)-200-229 (3.8L)-262 (4.3L), 1978-93
35062	10	A	WO	GM Products V8, 262-265-267 (4.4L)-283-302-305 (5.0L)-307-327-350 (5.7L)-396-400 (6.6L)-402-427-454 (7.4L), 1955-95
35064	3	A	WO	Chrysler Products 6, 170-198-225 (3.7L), 1960-87
35064	3	A	WO	Chrysler Products V8, 318 (5.2L)-360 (5.9L)-400 (6.6L)-440 (7.2L), 1979-03
35064	3	A	WO	Dodge Truck V6, 239 (3.9L), 1986-03
35064	3	A	WO	GM Products V8, 390-425-429-472-500, 1963-79
35286	3	A	WO	Chrysler Products 4, 105 (1.7L)-135 (2.2L)-148 (2.4L)-153 (2.5L), 1978-07
35286	3	A	WO	Chrysler Products V6, 201 (3.3L)-215 (3.5L)-231 (3.8L), 1990-09
35292	1	IA	TH	Toyota 4, 1456cc-1497cc-1587cc-1762cc-1995cc-1998cc-2164cc, 1983-01
35336	1	IA	WO	Mitsubishi 4, 1468cc-1595cc-1597cc-1755cc-1795cc-1834cc-1997cc-2351cc-2555cc, 1985-96
35336	1	IA	WO	Mitsubishi V6, 2972cc, 1987-00
35355	1	TA	WO	Ford Truck 6, 300 (4.9L), 1985-97
35377	1	A	WO	Ford Products V6, 183 (3.0L), 1986-07
35390	2	TA	WO	Ford Truck V6, 183 (3.0L)-232 (3.8L)-238 (3.9L)-256 (4.2L), 1982-08
35404	1	TA	WO	Ford Truck 4, 121 (2.0L), 2001-04
35404	1	TA	WO	Ford Truck V6, 177 (2.9L)-244 (4.0L), 1986-01
35440	2	TA	WO	Ford Truck V8, 302 (5.0L)-351W (5.8L), 1985-01
35480	2	IA	TH	Honda 4, 1493cc-1590cc-1595cc-1797cc-1834cc-1972cc-2156cc-2254cc-2259cc, 1990-02
35489	2	A	WO	Ford Products V6, 152 (2.5L)-155 (2.5L)-181 (3.0L), 1995-09
35489	2	A	WO	Ford Products V8, 281 (4.6L)-330 (5.4L), 1991-09
35489	2	A	WO	Ford Truck V10, 415 (6.8L), 1997-09
35571	1	A	TH	GM Products V6, 173 (2.8L)-189 (3.1L), 1985-95
35588	2	A	TH	Chrysler Products 4, 122 (2.0L)-148 (2.4L)-148 Turbo (2.4L), 1995-09
35595	1	A	TH	GM Products V6, 231 (3.8L)-231 Supercharged (3.8L), 1995-98
35595	1	A	TH	GM Truck V6, 262 (4.3L), 1992-95
35614	4	A	TH	GM Products 4, 121 (2.0L)-134 (2.2L)-138 (2.3L)-146 (2.4L), 1987-03
35614	4	A	TH	GM Products V6, 173 (2.8L)-189 (3.1L)-207 (3.4L)-213 (3.5L)-214 (3.5L)-242 (3.9L), 1987-09
35614	4	A	TH	GM Truck V8, 454 (7.4L)-496 (8.1L), 1991-07
35630	1	TA	TH	Jeep 4, 150 (2.5L), 1999-02
35630	1	TA	TH	Jeep 6, 242 (4.0L), 1999-06
35666	2	A	TH	GM Products V6, 204 (3.3L)-231 (3.8L)-262 (4.3L), 1989-09
35710	2	TB	TH	GM Truck V6, 262 (4.3L), 1992-09
35710	2	TB	TH	GM Truck V8, 305 (5.0L)-350 (5.7L)-395 Diesel (6.5L), 1991-05

EXHAUST FLANGE GASKET ASSORTMENT EX 20-08

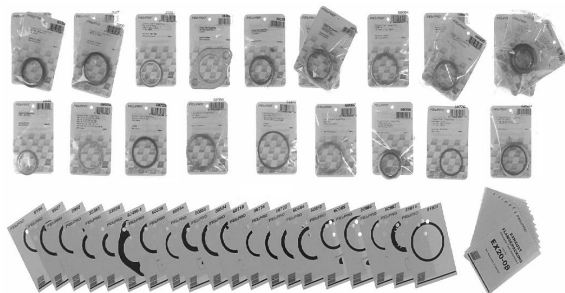

The new Fel-Pro® Exhaust Flange Gasket Assortment includes all the best-selling exhaust flange and heat riser gaskets. The gaskets are packaged individually in the quantities shown below. The assortment also contains the matching silhouette cards for each number, as well as a set of blank silhouette cards for customizing. This assortment can be displayed on the 2' x 3' pegboard backer sold as (Part No. **PB 1**) and 2" pegboard hooks (Part No. **HK 2** for 100 pack and **HK 2A** for 25 pack) also available for use with the Water Outlet Assortment. The included Silhouette Card pack illustrates the top-selling 50 exhaust flange and heat riser gaskets (Part No. **EX 2**).

Part Number	Qty.	Pop Code	Part Type	Application
8194	2	A	EP	Ford Products V8, 260-289-302 (5.0L)-351W (5.8L)-352-390-427-428-460 (7.5L), 1962-82
8194	2	A	EP	GM Products V8, 262-265-267 (4.4L)-283-302-305 (5.0L)-307-327-350 (5.7L)-400 (6.6L)-402-427-454 (7.4L), 1955-87
9587	1	A	EP	GM Products V8, 302-305 (5.0L)-307-327-350 (5.7L)-396-400 (6.6L)-402-427-454 (7.4L), 1962-87
9998	1	TA	EP	Ford Truck V8, 352-360-390, 1965-77
23561	1	IA	EP	Toyota 4, 1452cc-1456cc-1497cc-1587cc-1770cc-1998cc-2189cc-2438cc-2693cc, 1975-05
23561	1	IA	EP	Toyota 6, 2563cc-2759cc-2954cc-3956cc, 1979-92
23561	1	IA	EP	Toyota V6, 2507cc-2958cc, 1988-95
23588	1	IA	EP	Toyota 4, 1587cc-1588cc-1770cc-1995cc-2189cc-2366cc, 1975-95
60496-1	1	IA	EP	Mitsubishi 4, 1468cc-1595cc-1597cc-1755cc-1795cc-1834cc-1995cc-1997cc-1999cc-2351cc-2378cc-2555cc, 1981-09
60496-1	1	IA	EP	Mitsubishi V6, 2497cc-2972cc-3497cc, 1988-05
60538	1	A	EP	GM Products 4, 121 (2.0L)-134 (2.2L), 1983-95
60538	1	A	EP	GM Products V6, 173 (2.8L)-181 (3.0L)-189 (3.1L), 1982-94
60538	1	A	EP	GM Products V8, 250 (4.1L)-273 (4.5L), 1985-89
60554	1	IA	EP	Isuzu 4, 1471cc-1817cc-1949cc-1994cc-2254cc-2559cc, 1982-97
60554	1	IA	EP	Isuzu V6, 3165cc-3494cc, 1992-04
60554	1	IA	EP	Toyota V6, 2995cc, 1994-06
60556	1	TB	EP	GM Truck V6, 262 (4.3L), 1985-87
60556	1	TB	EP	GM Truck V8, 305 (5.0L)-350 (5.7L)-379 Diesel (6.2L)-395 Diesel (6.5L), 1981-05
60584	1	TA	EP	GM Truck V8, 350 (5.7L)-454 (7.4L), 1983-96
60718	2	TA	EP	GM Truck V6, 262 (4.3L), 1988-95
60718	2	TA	EP	GM Truck V8, 305 (5.0L)-350 (5.7L)-379 Diesel (6.2L)-395 Diesel (6.5L), 1987-05
60729	1	TA	EP	GM Truck 4, 134 (2.2L), 1997-03
60776	1	IA	EP	Honda 4, 1488cc-1590cc-1797cc-1834cc-1958cc-1972cc-2156cc-2157cc-2259cc, 1984-01
60810	1	B	EP	Chrysler Products 4, 122 (2.0L)-135 (2.2L)-153 (2.5L), 1989-99
60810	1	B	EP	Chrysler Products V6, 201 (3.3L)-231 (3.8L), 1990-95
60810	1	B	EP	Mitsubishi V6, 2972cc, 1989-95
60884	1	B	EP	GM Products V6, 204 (3.3L)-231 (3.8L), 1988-95
60884	1	B	EP	Honda 4, 1668cc-1799cc, 2001-09
60985	2	A	EP	Ford Products V8, 260-289-302 (5.0L)-351W (5.8L)-352-390-427-428-460 (7.5L), 1962-82
60985	2	A	EP	GM Products V8, 262-265-267 (4.4L)-283-302-305 (5.0L)-307-327-350 (5.7L)-400 (6.6L)-402-427-454 (7.4L), 1955-87
60986	1	A	EP	GM Products V8, 302-305 (5.0L)-307-327-350 (5.7L)-396-400 (6.6L)-402-427-454 (7.4L), 1962-87
60987	1	TB	EP	Ford Truck V8, 352-360-390, 1965-77
61014	3	TA	EP	GM Truck V6, 262 (4.3L), 1996-09
61014	3	TA	EP	GM Truck V8, 305 (5.0L)-350 (5.7L), 1996-02
61074	1	TB	EP	GM Truck V6, 262 (4.3L), 1999-01
61074	1	TB	EP	GM Truck V8, 293 (4.8L)-325 (5.3L)-364 (6.0L), 1999-09

FEL-PRO® PACKINGS

FLEXIBLE METALLIC PUMP PACKING

2261

- Follow-up Rings, Double-Beveled, Individual Split
- Fits Chevrolet 1922-36 and Ford Models A, AA, B, BB 1928-34
- Truly circular...cut from spiral coils
- Packaged individually

McCORD® GRAPHITE LUBRICATED FIBER PACKING

- For valves and pumps
- Fiber yarn spools in individual boxes

1/4 lb. Spools

3201 - 1/4".....(approximately 8 ft.)

3202 - 3/16".....(approximately 18 ft.)

3203 - 1/8".....(approximately 28 ft.)

FEL-PRO® STOCKING AIDS

HEAD GASKET BIN RACK

GC 21

The counterperson can locate head gaskets easily and inventory them at a glance, using this specially designed rack. The rack fits on standard 36" wide shelves and allows efficient use of space to protect head gasket stock. Approximate dimensions are 33" long x 12" deep x 6" high.

GASKET STORAGE RACKS

GC 25: 33" Long

GC 35: 46" Long

Keep all your inventory of FEL-PRO gasket sets (such as Head Sets, Valve Covers, Oil Pans, Manifolds, etc.) neat and organized using these exclusive Gasket Storage Racks. Each Storage Rack is available only in boxes of four.

BLANK PEGBOARD

PB 1

This 2' x 3' bright red pegboard is ideal for displaying your FEL-PRO miscellaneous gaskets, using the hooks and silhouette cards shown below. It will hold up to 36 part numbers neatly and attractively.

PEGBOARD HOOKS

HK 2:	2" Hook	Quantity 100
HK 2A:	2" Hook	Quantity 25
HK 4:	4" Hook	Quantity 50
HK 6:	6" Hook	Quantity 20

These hooks are designed to use with the **PB 1** blank pegboard. Choose from 2-inch, 4-inch, or 6-inch lengths, depending on your individual needs.

SILHOUETTE CARDS

WO 2: Water Outlet Gasket Cards

EX 2: Exhaust Flange Gasket Cards

These convenient silhouette cards are designed for use in identifying the most popular FEL-PRO water outlet and exhaust flange gaskets. The silhouette cards may be used with the **PB 1** pegboard and **HK**-series hooks to create your gasket display. Card size is 3-7/8" x 5-7/8".

Included with both sets is a supply of blank cards which can be used to customize your display.

BC 2: Blank Silhouette Cards

A package of 50 blank silhouette cards allows the customization of your display to meet your individual needs. Card size is 3-7/8" x 5-7/8".

BIN BOXES

GC 5

This smaller Bin Box is designed for miscellaneous gaskets. It is perfect as a supplement to maximize shelf space. Approximate dimensions are 5" wide x 18" deep. This Bin Box is shipped 10 per carton.

GC 9

This larger Bin Box is designed to hold hundreds of miscellaneous gaskets on a single shelf. This extra sturdy box has approximate dimension of 9-1/2" wide x 18" deep. This Bin Box is shipped 10 per carton.

GC 10

This package of ten unassembled Bin Boxes will provide convenient gasket storage or replace the worn and damaged boxes now on your shelves. This Bin Box has approximate dimensions of 5-1/4" wide x 19" deep.

FEL-PRO® SHEET MATERIALS

KARROPAK®

This pliable, chemically-treated fibrous sheet packing is designed for use in sealing oil, water, and gasoline applications.

Assortment No. MA 71-85
1/3092, 1/3098, 1/3099

Includes display rack **MA 71E-85**
 (also available separately).

Rolls 36" wide

Individually boxed.

3031 — 1/64" x 50 yds.
3041 — 1/64" x 25 yds.
3051 — 1/64" x 15 yds.
3033 — 1/32" x 50 yds.
3043 — 1/32" x 25 yds.
3053 — 1/32" x 15 yds.
3044 — 1/16" x 15 yds.
3054 — 1/16" x 10 yds.

Rolls 18" Wide

Individually boxed.

3091 — 1/64" x 50 yds.
3095 — 1/64" x 25 yds.
3092 — 1/64" x 10 yds.
3093 — 1/32" x 50 yds.
3096 — 1/32" x 25 yds.
3098 — 1/32" x 10 yds.
3094 — 1/16" x 25 yds.
3097 — 1/16" x 15 yds.
3099 — 1/16" x 5 yds.

12" x 36" Sheets

Individually rolled and wrapped in clear plastic.

3045 — 1/64"
3046 — 1/32"
3047 — 1/16"

18" x 36" Sheets

Individually rolled.

3022 — 1/64"
3023 — 1/32"
3025 — 1/16"

36" x 36" Sheets

Individually rolled.

3011 — 1/64"
3027 — 1/32"
3020 — 1/16"

4" x 6" Sheets

Individually packaged sheet wrapped in clear plastic.

3195 — 1/32"

FEL-PRO® SHEET MATERIALS

FEL-RAMIC® MATERIALS

FEL-RAMIC water-resistant non-asbestos facing material is mechanically clinched to a perforated steel core. This material is very popular in high-temperature applications (such as manifolds and exhaust pipe flanges).

FEL-RAMIC® 101

Fiber on both sides:
2499 — 12" x 28" x 1/16"

FEL-RAMIC® 301

Fiber on one side:
3009 — 12" x 28" x 3/64"

PRO-RAMIC® 121

The PRO-RAMIC non-asbestos facing material is mechanically clinched to both sides of a perforated steel core. It is recommended for use as a head gasket material and an intake manifold material.

PRO-RAMIC® 121

Fiber on both sides:
2498 — 12" x 28" x 3/64"

CUTTING TOOL KIT

This is an assortment of cutting tools for the most popular sizes and shapes of gaskets and other soft materials.

CK 88 is a Cutting Tool Kit that consists of 1 Punch Driver and 10 Circular Punches for stamping Bolt Holes. The Punch Driver is 5-3/8" long. The Circular Punch sizes range from 1/4" to 1" diameter.

These punches are not recommended for Metal Materials.

CORK-RUBBER

An excellent material for sealing oil, coolant, or gasoline. It is recommended for use on valve cover, oil pan, and crankcase/access cover gasket applications.

10" x 26" Sheets

Individually rolled and wrapped in clear plastic.

3018 — 1/16"

3026 — 3/32"

3019 — 1/8"

18" x 36" Sheets

Individually packaged sheet wrapped in clear plastic.

3005 — 1/16"

3006 — 3/32"

3007 — 1/8"

3008 — 1/4"

RUBBER-FIBER

This material can be used for sealing oil, coolant, or gasoline. It is recommended for use on timing cover, axle housing cover, and differential carrier gasket applications.

10" x 26" Sheets

Individually rolled and wrapped in clear plastic.

3157 — 1/32"

3187 — 1/16"

18" x 36" Sheets

Individually rolled material with anti-stick coating on both sides.

3137 — 1/32"

3127 — 1/16"

25" x 25" Sheets

Individually rolled material with anti-stick coating on both sides.

3149-1 — 1/32"

3149-3 — 1/16"

RUBBER-CELLULOSE

This material can be used for sealing water or coolant. It is recommended for water outlet, thermostat housing, and water pump gasket applications.

Individually rolled and wrapped in clear plastic.

3075 — 10" x 26" x 3/64"

Individually packaged sheet wrapped in clear plastic.

3030 — 18" x 36" x 3/64"

4-PIECE MATERIAL ASSORTMENT PAK

3060 includes one each:

Cork-Rubber Sheet

Cork-Rubber Sheet

Rubber-Cellulose Sheet

Rubber-Fiber Sheet

10" x 8-5/8" x 1/8"

9-1/2" x 8-5/8" x 1/16"

9-3/4" x 8-5/8" x 3/64"

9-1/4" x 8-5/8" x 1/32"

MEASURING SYSTEM CONVERSIONS

FRACTIONS (inches) CONVERTED TO DECIMALS (inches)

FRACTION (inches)	DECIMAL (inches)	FRACTION (inches)	DECIMAL (inches)	FRACTION (inches)	DECIMAL (inches)	FRACTION (inches)	DECIMAL (inches)
1/64	.016	17/64	.266	33/64	.516	49/64	.766
1/32	.031	9/32	.281	17/32	.531	25/32	.781
3/64	.047	19/64	.297	35/64	.547	51/64	.797
1/16	.063	5/16	.313	9/16	.563	13/16	.813
5/64	.078	21/64	.328	37/64	.578	53/64	.828
3/32	.094	11/32	.344	19/32	.594	27/32	.844
7/64	.109	23/64	.359	39/64	.609	55/64	.859
1/8	.125	3/8	.375	5/8	.625	7/8	.875
9/64	.141	25/64	.391	41/64	.641	57/64	.891
5/32	.156	13/32	.406	21/32	.656	29/32	.906
11/64	.172	27/64	.422	43/64	.672	59/64	.922
3/16	.188	7/16	.438	11/16	.688	15/16	.938
13/64	.203	29/64	.453	45/64	.703	61/64	.953
7/32	.219	15/32	.469	23/32	.719	31/32	.969
15/64	.234	31/64	.484	47/64	.734	63/64	.984
1/4	.250	1/2	.500	3/4	.750	1	1.000

DECIMAL (inches) CONVERTED TO METRIC (millimeters)

DECIMAL (inches)	METRIC (millimeters)	DECIMAL (inches)	METRIC (millimeters)	DECIMAL (inches)	METRIC (millimeters)	DECIMAL (inches)	METRIC (millimeters)	DECIMAL (inches)	METRIC (millimeters)	DECIMAL (inches)	METRIC (millimeters)
.001	0.025	.110	2.794	.310	7.874	.510	12.954	.710	18.034	.910	23.114
.002	0.051	.120	3.048	.320	8.128	.520	13.208	.720	18.288	.920	23.368
.003	0.076	.130	3.302	.330	8.382	.530	13.462	.730	18.542	.930	23.622
.004	0.102	.140	3.556	.340	8.636	.540	13.716	.740	18.796	.940	23.876
.005	0.127	.150	3.810	.350	8.890	.550	13.970	.750	19.050	.950	24.130
.006	0.152	.160	4.064	.360	9.144	.560	14.224	.760	19.304	.960	24.384
.007	0.178	.170	4.318	.370	9.398	.570	14.478	.770	19.558	.970	24.638
.008	0.203	.180	4.572	.380	9.652	.580	14.732	.780	19.812	.980	24.892
.009	0.229	.190	4.826	.390	9.906	.590	14.986	.790	20.066	.990	25.146
.010	0.254	.200	5.080	.400	10.160	.600	15.240	.800	20.320	1.000	25.400
.010	0.254	.210	5.334	.410	10.414	.610	15.494	.810	20.574		
.020	0.508	.220	5.588	.420	10.668	.620	15.748	.820	20.828		
.030	0.762	.230	5.842	.430	10.922	.630	16.002	.830	21.082		
.040	1.016	.240	6.096	.440	11.176	.640	16.256	.840	21.336		
.050	1.270	.250	6.350	.450	11.430	.650	16.510	.850	21.590		
.060	1.524	.260	6.604	.460	11.684	.660	16.764	.860	21.844		
.070	1.778	.270	6.858	.470	11.938	.670	17.018	.870	22.098		
.080	2.032	.280	7.112	.480	12.192	.680	17.272	.880	22.352		
.090	2.286	.290	7.366	.490	12.446	.690	17.526	.890	22.606		
.100	2.540	.300	7.620	.500	12.700	.700	17.780	.900	22.860		

ENGINE METRIC CONVERSION

Liter	CID	CC	Liter	CID	CC	Liter	CID	CC	Liter	CID	CC	Liter	CID	CC
1.4	86	1410	2.5	151	2475	3.8	229	3753	4.3	265	4343	5.7	350	5736
1.5	90	1471	2.6	156	2557	3.8	231	3786	4.4	267	4376	5.8	351	5753
1.6	98	1606	2.8	171	2803	3.8	232	3802	4.9	301	4933	5.9	360	5900
1.7	105	1721	2.8	173	2835	4.1	250	4097	5.0	302	4949	6.0	368	6032
1.8	112	1836	3.0	181	2967	4.1	252	4130	5.0	304	4983	6.6	400	6556
2.0	121	1983	3.2	196	3212	4.2	255	4179	5.0	305	4999	6.6	403	6605
2.2	135	2213	3.3	200	3278	4.2	258	4229	5.0	307	5032	7.0	425	6966
2.3	140	2295	3.7	225	3688	4.3	260	4261	5.2	318	5212			

MEASURING SYSTEM CONVERSIONS

For Engines Not Listed, Use the Following Factors

CONVERT	TO	MULTIPLY BY:	CONVERT	TO	MULTIPLY BY:
Liter	CID	61.01000	CID	Liter	0.01639
CID	CC	16.39000	CC	CID	0.06101

METRIC (millimeters) CONVERTED TO DECIMAL (inches)

METRIC (millimeters)	DECIMAL (inches)	METRIC (millimeters)	DECIMAL (inches)	METRIC (millimeters)	DECIMAL (inches)	METRIC (millimeters)	DECIMAL (inches)	METRIC (millimeters)	DECIMAL (inches)	METRIC (millimeters)	DECIMAL (inches)
1	.039	21	.827	41	1.614	61	2.402	81	3.189	101	3.976
2	.079	22	.866	42	1.654	62	2.441	82	3.228	102	4.016
3	.118	23	.906	43	1.693	63	2.480	83	3.268	103	4.055
4	.157	24	.945	44	1.732	64	2.520	84	3.307	104	4.094
5	.197	25	.984	45	1.772	65	2.559	85	3.346	105	4.134
6	.236	26	1.024	46	1.811	66	2.598	86	3.386	106	4.173
7	.276	27	1.063	47	1.850	67	2.638	87	3.425	107	4.213
8	.315	28	1.102	48	1.890	68	2.677	88	3.465	108	4.252
9	.354	29	1.142	49	1.929	69	2.717	89	3.504	109	4.291
10	.394	30	1.181	50	1.969	70	2.756	90	3.543	110	4.331
11	.433	31	1.220	51	2.008	71	2.795	91	3.583		
12	.472	32	1.260	52	2.047	72	2.835	92	3.622		
13	.512	33	1.299	53	2.087	73	2.874	93	3.661		
14	.551	34	1.339	54	2.126	74	2.913	94	3.701		
15	.591	35	1.378	55	2.165	75	2.953	95	3.740		
16	.630	36	1.417	56	2.205	76	2.992	96	3.780		
17	.669	37	1.457	57	2.244	77	3.032	97	3.819		
18	.709	38	1.496	58	2.283	78	3.071	98	3.858		
19	.748	39	1.535	59	2.323	79	3.110	99	3.898		
20	.787	40	1.575	60	2.362	80	3.150	100	3.937		

TORQUE (Foot-pounds) CONVERTED TO TORQUE (Newton-meters)

		UNITS COLUMN										
T E N S C O L U M N	Ft-Lb	0	1	2	3	4	5	6	7	8	9	
		N-m	N-m	N-m	N-m	N-m	N-m	N-m	N-m	N-m	N-m	N-m
		-		1.3558	2.7116	4.0675	5.4233	6.7791	8.1349	9.4907	10.8465	12.2024
		10	13.5582	14.9140	16.2698	17.6256	18.9815	20.3373	21.6931	23.0489	24.4047	25.7605
		20	27.1164	28.4722	29.8280	31.1838	32.5396	33.8954	35.2513	36.6071	37.9629	39.3187
		30	40.0304	42.0304	43.3862	44.7420	46.0978	47.4536	48.8094	50.1563	51.5211	52.8769
		40	54.2327	55.5885	56.9444	58.3002	59.6560	61.0118	62.3676	63.7234	65.0793	66.4351
		50	67.7909	69.1467	70.5025	71.8584	73.2142	74.5700	75.9258	77.2815	78.6374	79.9933
		60	81.3491	82.7049	84.0607	85.4165	86.7724	88.1282	89.4840	90.3898	92.1956	93.5514
		70	94.9073	96.2631	97.6189	98.9747	100.3305	101.6863	103.0422	104.3980	105.7538	107.1096
	80	108.4654	109.8213	111.1771	112.5329	113.8887	115.2445	116.6003	117.9562	119.3120	120.6678	
	90	122.0236	123.3794	124.7353	126.0911	127.4469	128.8027	130.1585	131.5143	132.8702	134.2260	
	100	135.5818	136.9376	138.2934	139.6493	141.0051	142.3609	143.7167	145.0725	146.4283	147.7842	

Parts to Help Reduce Repair Costs

The FEL-PRO® Engine\$aver Hardware line is a collection of "problem solvers" that provide cost-saving alternatives to engine component replacement. They bring engine components back to proper performance, at a fraction of their replacement cost.

Engine\$aver Hardware Is Cost Efficiency Without Compromise

Cylinder Head Bolts

Help avoid the risks that go with reuse of head bolts on torque-to-yield applications.

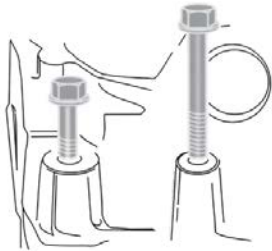

Cylinder Head Dowel Pins

Assure proper gasket and casting alignment for an accurate seal and correct head-to-block assembly.

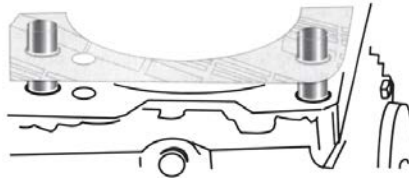

Sleeve 'N' Seal®

Repairs worn sealing surfaces and helps avoid replacement of costly harmonic balancers.

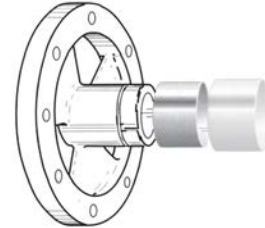

HeadSaver® Spacer Shims

Compensates for excess metal removed during machining operations, so you don't have to replace costly cylinder heads.

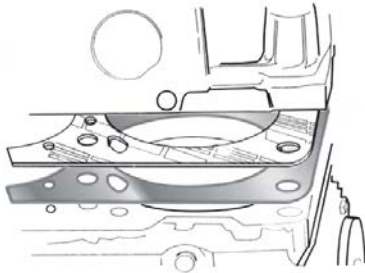

Valve Cover Load Spreaders®

Evenly distribute the clamping force on the valve cover flange and allow a proper seal between the valve cover and the new gasket.

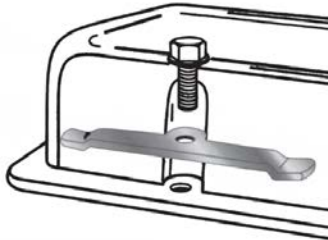

Exhaust Flange Bolt & Spring Kits

Quickly connect the exhaust manifold and the exhaust pipe on FWD vehicles and assure correct clamping force.

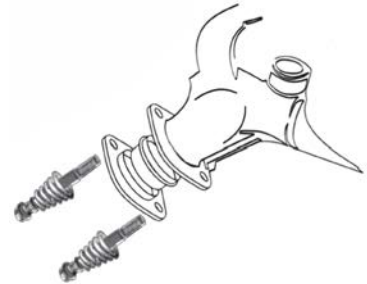

Oil Pan SnapUps®

Save time and prevent frustration by holding the pan and the gasket in place for quick, convenient bolt installation.

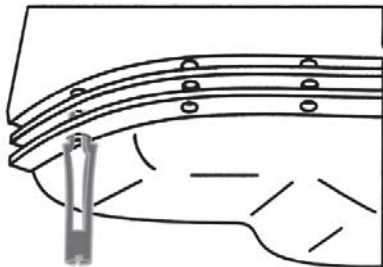

Crankshaft Repair Sleeves

Repair worn sealing surfaces without costly crankshaft replacement.

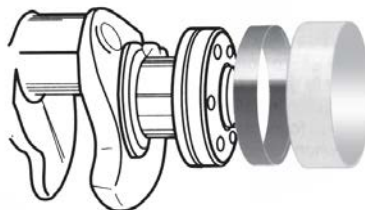

ES 72863 for 5/16" applications
ES 72864 for 6mm applications
ES 72865 for 8mm applications

HARMONIC BALANCER & CRANKSHAFT REPAIR SLEEVES

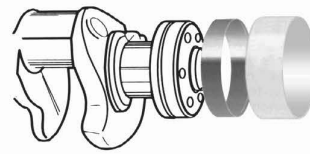
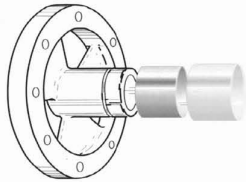

Sleeve 'N' Seal®

Repairs worn sealing surfaces and helps avoid replacement of costly harmonic balancers.

Crankshaft Repair Sleeves

Repair worn sealing surfaces without costly crankshaft replacement.

Sleeve Part No.	Application	Fits Shaft Size (Inches)	Sleeve Length (Inches)	Installation Tool Part No.
16201	BALANCER	2.180-2.186	1.160-1.180	16309
16202	BALANCER	1.759-1.765	.830-.850	16312
16203	BALANCER	1.868-1.870	1.160-1.180	16310
16204	BALANCER	1.995-2.000	.720-.740	16308
16205	BALANCER	2.329-2.334	.780-.800	16311
16207	BALANCER	1.874-1.877	.595-.615	16310
16209	BALANCER	2.333	1.360-1.380	16311
16210	BALANCER	1.781-1.783	.855-.875	16312
16212	BALANCER	1.760-1.765	1.030-1.050	16312
16213	BALANCER	1.874-1.877	.910-.930	16310
16214	CRANKSHAFT FRONT	1.772-1.775	.565-.585	16312
16215	BALANCER	1.763-1.766	.565-.585	16312
16216	BALANCER	1.932	.840-.860	16308
16217	BALANCER	1.872	1.160-1.180	16310
16219	CRANKSHAFT FRONT	2.500	.800	16318
16220	CRANKSHAFT FRONT	2.500	1.000	N/A
16221	CRANKSHAFT FRONT	1.375	.625	N/A
16222	CRANKSHAFT FRONT	1.563	.438	16323
16223	CRANKSHAFT FRONT	1.575	.500	16323
16224	CRANKSHAFT FRONT	1.250	.375	16325
16225	CRANKSHAFT FRONT	1.250	.563	16325
16226	CRANKSHAFT FRONT	1.125	.688	16326
16227	CRANKSHAFT FRONT	1.688	.625	16327
16228	CRANKSHAFT REAR	3.832	1.156 (Narrow Lip)	16329
16229	CRANKSHAFT REAR	3.832	1.156 (Wide Lip)	16329
16230	CRANKSHAFT REAR	3.938	1.000	16328
16250	CRANKSHAFT REAR	3.625	.660-.680	16300
16251	CRANKSHAFT REAR	3.748	.700-.720	16301
16255-1	CRANKSHAFT REAR	3.625	1.105-1.135	16306
16256	CRANKSHAFT REAR	3.750	.510-.530	16301
16258	CRANKSHAFT REAR	3.737	.740-.760	16301
16259	CRANKSHAFT REAR	2.988	.460-.480	16304
16264	CRANKSHAFT FRONT	1.372	.410-.430	16303
16265	CRANKSHAFT FRONT	1.220	.520-.540	16303
16266	CRANKSHAFT REAR	3.147	.890-.910	N/A
16267	CRANKSHAFT REAR	3.534	.540-.560	16300
16268	CRANKSHAFT REAR	2.828	.462-.472	16315
16269-1	CRANKSHAFT REAR	4.321	1.280-1.310	16316
16270	CRANKSHAFT REAR	3.625	.910	N/A
16272	CRANKSHAFT FRONT	1.338	.390	N/A
16274	CRANKSHAFT REAR	5.125	.750	16319
16275	CRANKSHAFT REAR	3.313	.500	16322
16276	CRANKSHAFT REAR	3.250	.625	N/A
16277	CRANKSHAFT REAR	2.750	.750	16324
16278	CRANKSHAFT REAR	3.375	.563	N/A
N/A	CRANKSHAFT REAR	4.332	1.275	16317

CYLINDER HEAD GASKET INSTALLATION TIPS

Remove Cylinder Heads Carefully

Loosen the head bolts in stages, in the reverse order of the tightening sequence. On engines with aluminum cylinder heads, remove the head only after the engine has cooled completely and reverse EXACTLY the recommended torquing procedure. Failure to do so may result in head warpage.

Never Reuse Head Gaskets

When a new head gasket is installed, it conforms to the microscopic surface irregularities of the cylinder head and engine block. The gasket material is permanently compressed in that position. If you reuse the gasket, it is impossible to refit it in the exact same position and it will not have the "life" to readjust itself, so gasket failure may result.

Clean Mating Surfaces

Thoroughly clean the cylinder head, engine block, head bolts, and bolt holes. A dirty bolt can alter torque readings by as much as 20 foot-pounds, and can form pockets in the gasket allowing leakage and eventual gasket failure.

Check for Warpage and Distortion

Check for warpage of both head and block sealing surfaces with a straightedge and a feeler gauge. Out-of-flat along the length should not be more than 0.003" for three-cylinder applications, 0.004" for four-cylinder applications, and 0.006" for six-cylinder applications. Across the width should never exceed 0.002" out-of-flat. These are combined measurements for both the head and block together, and should not exceed the maximum amounts shown. There should be no sudden irregularities exceeding .001" and a maximum out-of-flat of $\pm .001$ " in any 3" diameter should not be exceeded. When necessary, machine surfaces to return them to flat.

Check Head and Block Finishes

Surface finish is critical for a good seal. FEL-PRO® engineers recommend a micro inch surface finish between 60 to 100 Ra (400 to 800 Rz) for cast iron heads and blocks, 50 to 60 Ra (200 to 600 Rz) for aluminum heads and blocks, and 10 to 30 Ra maximum (500 Rz maximum) for multi-layered steel (MLS) applications. Check the finishes with a profilometer or a surface comparator. Check for a preferred waviness height of .0004"/.0005" with a waviness peak spacing of .100" (these values are usually associated with milling machines). Always consult your manufacturer's service manual for surface finish requirements.

Use A Non-Hardening Gasket Sealer

Sealers are NOT required on FEL-PRO PermaTorque® head gaskets. However, embossed steel shim, copper-faced, or steel-faced gaskets should be coated with a non-hardening automotive gasket sealer as a supplemental seal.

Lightly coat bolt threads and the underside of the bolt heads with motor oil. When they enter the water jackets of an engine, bolt threads should be coated with a non-hardening automotive sealer to prevent leakage. Refer to the manufacturer's service manual or examine the engine to determine where the bolt holes lead.

Watch Bolt Lengths and Sizes

Head bolts on some engines may vary in length and size, and it is important that they be replaced in their original location. Either mark the bolts by position, or place them on a bench in the order you remove them.

Use a Torque Wrench

Uneven torque can cause block distortion and head warpage, resulting in coolant or combustion leaks. Use a good torque wrench, properly calibrated, and follow exact specifications for the proper torque. The basic tightening procedure is to first snug up bolts, then tighten in stages, and then complete with the final torque specified.

Follow Torquing Sequences

Each manufacturer has an approved torquing sequence to follow for each engine, to insure the best possible seal and eliminate chances of distortion and warpage. In general, the sequence starts at the center and spirals out to the ends of the head.

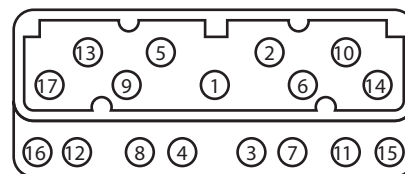

Consult the current FEL-PRO® Torque Tables™ booklet for specific torque specifications and bolt torquing sequence diagrams. The Torque Tables booklet contains information on domestic and imported passenger cars, light-duty trucks, and medium-duty trucks (including all engines currently covered by the FEL-PRO Gaskets product line).

CYLINDER HEAD GASKET INSTALLATION TIPS

Warm Engine and Retorque Head

Run the engine to normal operating temperature after torquing head bolts. Heat expansion and contraction can radically change the torque readings. Retorque all head bolts to the correct settings while the engine is still warm. If working with aluminum components, let the engine cool completely first. Remember that FEL-PRO® PermaTorque® designs do NOT require retorquing.

Retorque After 300 to 500 Miles

If retorque-type head gaskets are used, retorque after 300 to 500 miles.

Torque-To-Yield Head Bolts

Torque-to-yeild is a method used by most current engine manufacturers to tighten head bolts. The head bolts are torqued to their yeild points, which may permanently stretch the bolts. This results in a more even clamping force over the entire area of the gasket. Bolts should first be tightened to a specified torque (measured in foot-pounds), and then tightened an additional partial turn (measured in degrees) to the bolt yeild point. Use a Torque-to-Angle Indicator with your torque wrench to help you accurately measure the required partial turn in degrees.

Because the head bolts may have stretched, the engine manufacturer may recommend against reusing them. Consult the OEM manual on head bolt reuse. Since you may not know how many times a T-T-Y bolt has been removed and reinstalled, FEL-PRO engineers suggest that it is always a good idea to use new bolts. FEL-PRO head bolt sets are available for many domestic and imported engines. This catalog indicates which engines have bolt sets offered in the FEL-PRO product line.

Sample Torque Tables™ Listing

ENGINE	YEARS	FT.-LBS.	TORQ. SEQ.	HEAD BOLT SET PART NUMBER
FORD PRODUCTS 6 & V6(CONT.)				
232 OHV (3.8 L) 12 Valve Ford	2003-96 Truck ●○	1st 15, 2nd 29, 3rd 37, PERFORM THE NEXT THREE STEPS ON EACH BOLT BEFORE MOVING TO NEXT BOLT IN SEQUENCE: 1) loosen 2-3 turns, 2) Long bolts 29-37; Short bolts 15-22, 3) turn 175-185 degrees	94	ES 72156 ES 72160
232 OHV (3.8 L) 12 Valve Ford	1995 Truck ●○	1st 15, 2nd 30, 3rd 37, PERFORM THE NEXT THREE STEPS ON EACH BOLT BEFORE MOVING TO NEXT BOLT IN SEQUENCE: 1) loosen 2-3 turns, 2) Long bolts 11-19; Short bolts 7-15, 3) turn 85-95 degrees	94	ES 72131
232 OHV (3.8 L) 12 Valve Ford	2004-98 Car ●○	1st 15, 2nd 30, 3rd 37, PERFORM THE NEXT THREE STEPS ON EACH BOLT BEFORE MOVING TO NEXT BOLT IN SEQUENCE: 1) loosen 2-3 turns, 2) Long bolts 29-37; Short bolts 15-22, 3) turn 180 degrees	94	ES 72160
232 OHV (3.8 L) 12 Valve Ford	1997-96 Car ●○	1st 15, 2nd 30, 3rd 37, PERFORM THE NEXT THREE STEPS ON EACH BOLT BEFORE MOVING TO NEXT BOLT IN SEQUENCE: 1) loosen 2-3 turns, 2) Long bolts 30-37; Short bolts 15-22, 3) turn 175-185 degrees	94	ES 72156 ES 72160
232 OHV (3.8 L) 12 Valve Ford	1995-94 Car ●○	1st 15, 2nd 30, 3rd 37, PERFORM THE NEXT THREE STEPS ON EACH BOLT BEFORE MOVING TO NEXT BOLT IN SEQUENCE: 1) loosen 2-3 turns, 2) Long bolts 11-19; Short bolts 10-15, 3) turn 85-95 degrees	94	ES 72131
232 OHV (3.8 L) 12 Valve Ford	1993-91 Car ●○	1st 37, 2nd 45, 3rd 52, 4th 59, PERFORM THE NEXT THREE STEPS ON EACH BOLT BEFORE MOVING TO NEXT BOLT IN SEQUENCE: 1) loosen 2-3 turns, 2) 11-18, 3) Long bolts turn 85-105 degrees; Short bolts turn 65-85 degrees	94	ES 72131
232 OHV (3.8 L) 12 Valve Ford	1990-84 Car ●○	Flanged Hex Head bolts: 1st 7, 2nd 45, 3rd 52, 4th 59, PERFORM THE NEXT THREE STEPS ON EACH BOLT BEFORE MOVING TO NEXT BOLT IN SEQUENCE: 1) loosen 2-3 turns, 2) 11-18, 3) Long bolts turn 85-105 degrees; Short bolts turn 65-85 degrees	82	ES 72129 ES 72131

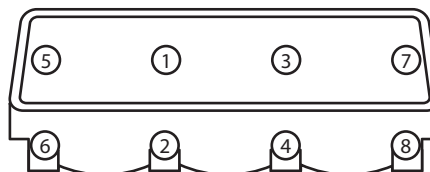

Diagram #82

GASKET AND SEAL LOCATIONS

The following typical engines, shown in exploded views, include the location of the more important gaskets and seals listed in this catalog. There are smaller gaskets, particularly those used only on a limited number of engines, that cannot be shown. However, all required gaskets are included in FEL-PRO® sets. The FEL-PRO product line takes pride in supplying the most complete sets available anywhere.

FULL SET (FS) - Contains the gaskets and oil seals necessary for a complete engine overhaul.

HEAD SET (HS) - Contains the gaskets and oil seals necessary for a valve grinding job.

CONVERSION SET (CS) - When used with an HS set, contains the necessary gaskets and oil seals for a complete engine overhaul.

MANIFOLD SETS (MS) - Intake, Exhaust, or Combination Intake & Exhaust.

VALVE COVER SET (VS) - Top Cover.

PUSH ROD COVER SET (PS) - Side or Center Cover.

VALVE STEM SEAL SET (SS) - Intake, Exhaust, Auxiliary.

TIMING COVER SET (TCS) - Timing Cover Seal, Timing Cover Gasket, Oil Pan Gasket Segments, Front Oil Pan Seal.

REAR MAIN SEAL SET (BS) - Rear Main Bearing Oil Seal, Rear Main Bearing Cap Seals, Retainer Gasket.

OIL PAN SET (OS) - One-piece or Multi-piece Gasket.

Typical V6 Overhead Valve Engine

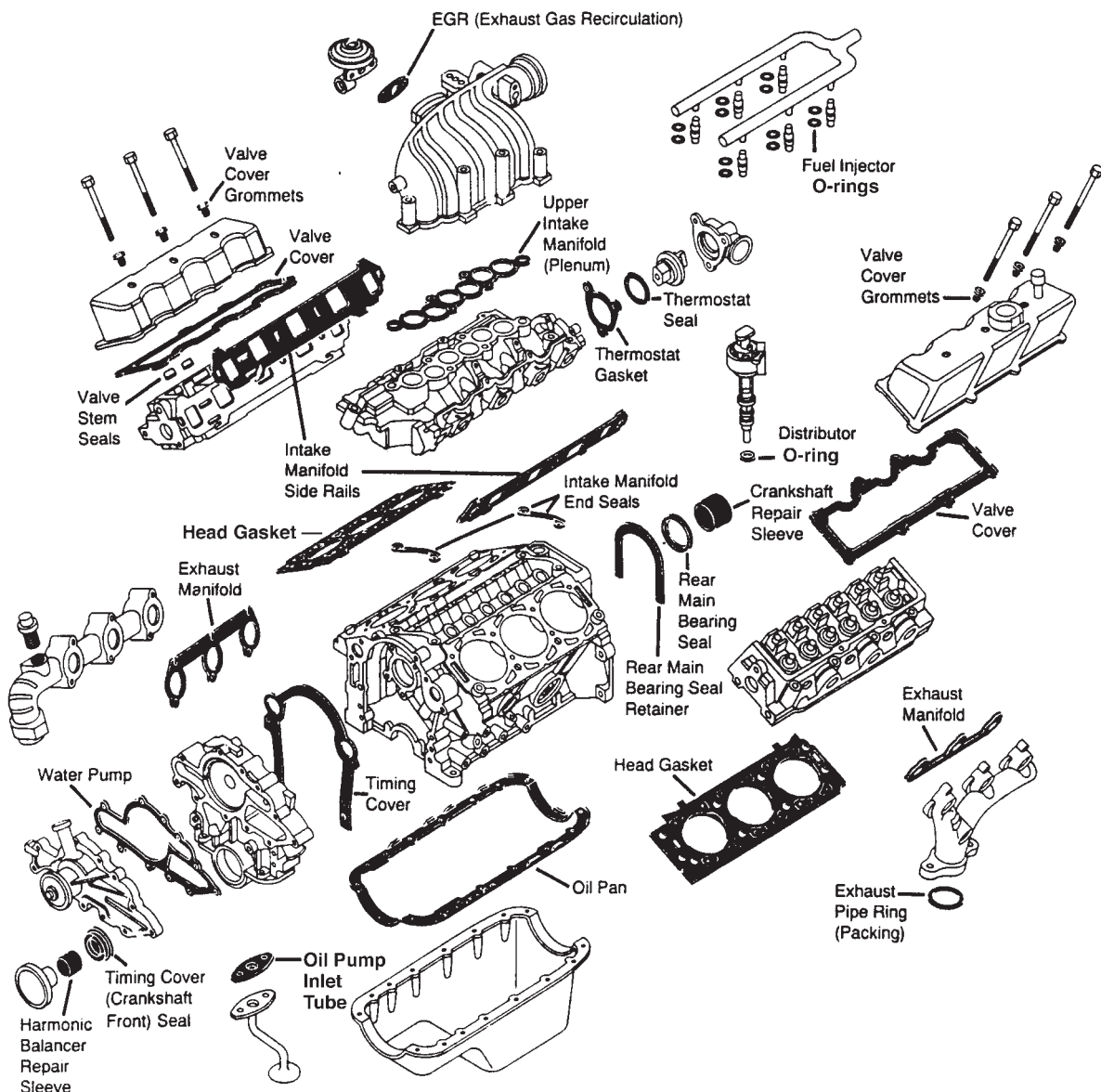

GASKET AND SEAL LOCATIONS

Typical 4-Cylinder Overhead Cam Engine

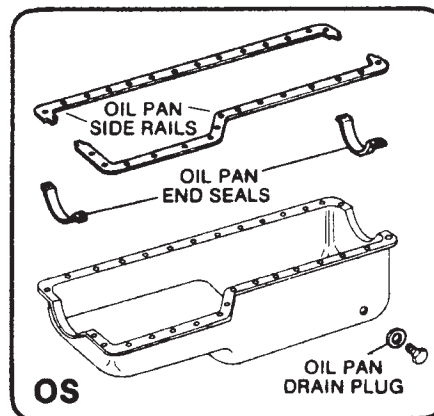
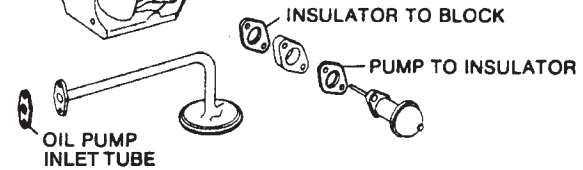
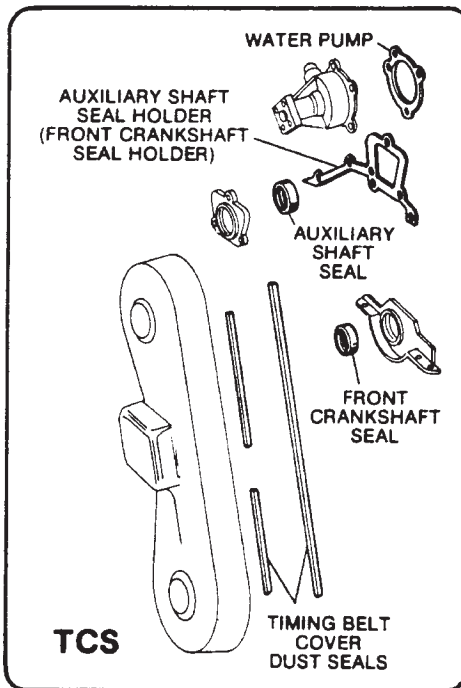
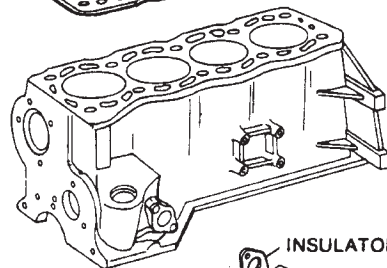
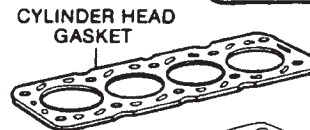
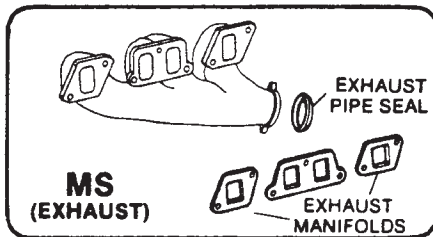
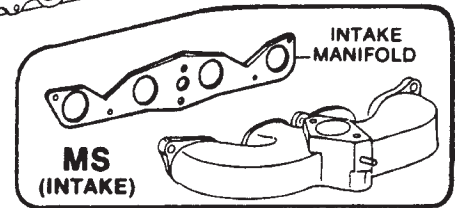
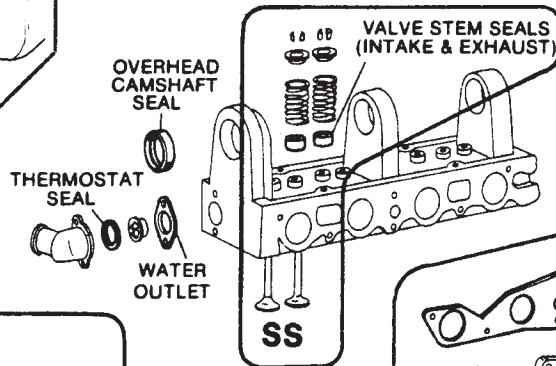
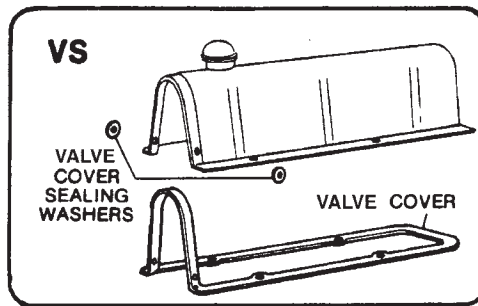
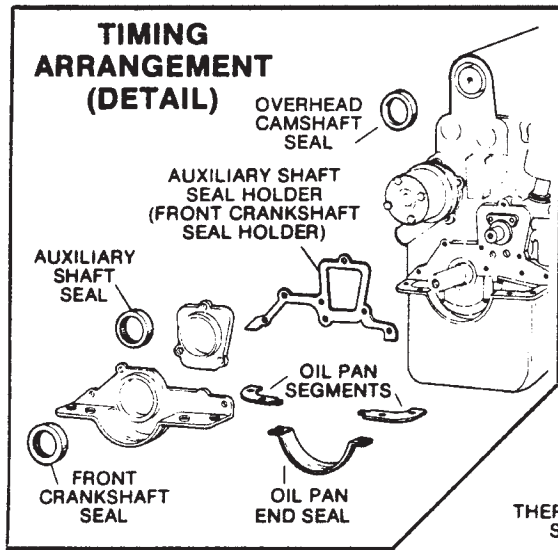

Overhead camshaft oil seal provided in Head Sets where applicable.

Typical V-Type Engine with EFI/MFI System (Split Manifold Set Coverage)

Upper Intake Manifold

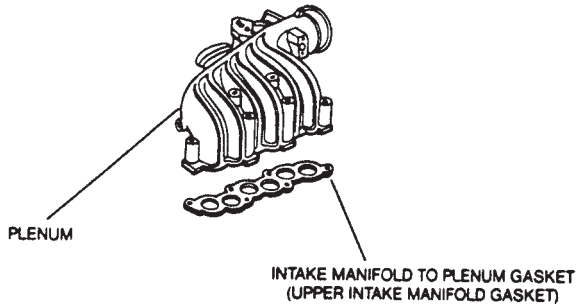

Lower Intake Manifold

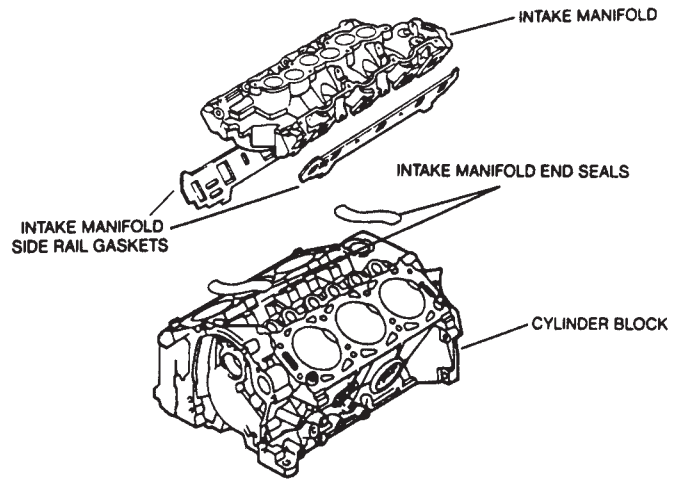

Typical Inline Engine with EFI/MFI System (Split Manifold Set Coverage)

Upper Intake Manifold

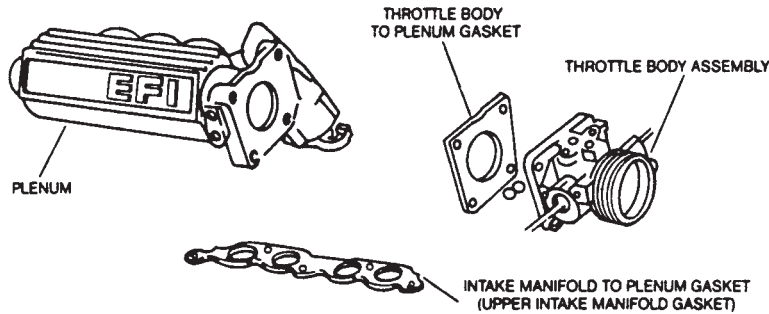

Lower Intake Manifold

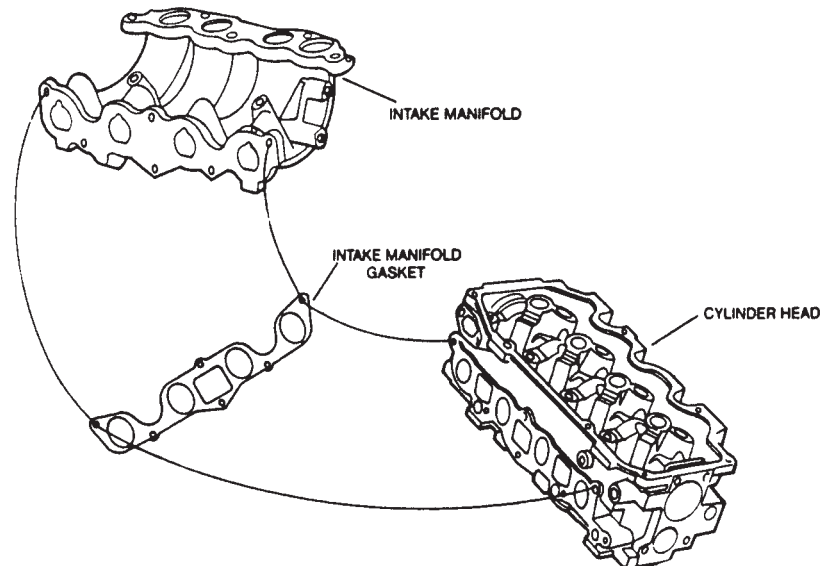

Important Instructions

ALWAYS CONSULT

THE MOST CURRENT PARTS CATALOG AND SUPPLEMENTS FOR PARTS INFORMATION.

This parts catalog is generally reprinted every two years. If this parts catalog is more than two years old, contact your local FEL-PRO[®] distributor to insure that you have the most up-to-date parts catalog.

DESTROY ALL PREVIOUS

EDITIONS AND SUPPLEMENTS OF THIS PARTS CATALOG.

This parts catalog replaces all previous editions and supplements.

BEFORE INSTALLING

ANY PART LISTED IN THIS PARTS CATALOG, CONSULT THE APPROPRIATE MANUFACTURER'S INSTRUCTION MANUAL FOR INSTALLATION INSTRUCTIONS.

This catalog contains parts information only. Before installing any of the parts referenced in this catalog ALWAYS consult the appropriate vehicle manufacturer's instruction manual for detailed installation instructions.

WARRANTY

Products sold are warranted to be free from defects in workmanship or material for a period of one (1) year from the date of purchase. The remedy for breach of this warranty is limited to the free exchange of the product(s) shown to our satisfaction to be defective. Liability for neglect, misuse, special, incidental, direct, indirect, and consequential damages is specifically disclaimed. NO OTHER WARRANTY, EITHER EXPRESSED OR IMPLIED, INCLUDING ANY WARRANTY OF MERCHANTABILITY OR OF FITNESS FOR A PARTICULAR PURPOSE, IS MADE.

WARNING

Use parts only for applications and interchanges in this catalog. Failure to heed this warning could result in reduced life or failure of the part. All parts listed in this catalog are manufactured to the highest industry standards, but are not intended for use in space program, atomic energy/nuclear reactor equipment, medical, or aircraft applications.

AVERTISSEMENT

N'utiliser les pièces que pour les applications ou les remplacements de ce catalogue. Si vous négligez cet avertissement vous risquez de diminuer la durée de la pièce ou de causer une panne. Toutes les pièces répertoriées dans ce catalogue sont fabriquées conformément aux plus hauts standards de l'industrie, mais elles ne sont pas conçues pour être utilisées dans les programmes interplanétaires et spatiaux, les équipements de réacteur nucléaire ou d'énergie atomique, les applications aéronautiques ou médicales.

ADVERTENCIA

Use solamente los números de parte para la aplicación o intercambios indicados en este catálogo. La falta de atención a esta advertencia puede resultar en una vida reducida o en la falla del repuesto. Todas las partes listadas en este catálogo están fabricadas de acuerdo a los normas más altas de la industria, sin embargo, no deben utilizarse en programas espaciales/interplanetarios, equipos de energía atómica/reactores nucleares, equipos médicos o aplicaciones aeronáuticas.

TECBLOG CLEAN AND DRY

IT'S NO SECRET THAT FEL-PRO® GASKETS OFFER THE MOST RELIABLE SEAL FOR ANY REPAIR JOB. PROPER INSTALLATION IS THE KEY TO LONG SERVICE LIFE, AND INSTALLATION PRACTICES ARE CHANGING RAPIDLY AS GASKET DESIGNS ADVANCE.

In the past, it was not uncommon to coat a gasket with sealers, adhesives or RTV before installing it. Today, Fel-Pro offers many gasket designs with advanced leak-sealing technologies built into the gasket. With these modern gaskets, RTV or other sealers can actually decrease the gasket's ability to form a reliable seal, causing leaks. Fel-Pro PermaDryPlus® gaskets offer the latest in sealing technology. All PermaDryPlus gaskets feature proprietary in-house molded silicone rubber sealing beads bonded to rigid carrier construction. This provides a perfect fit – with no adhesives – saving installation time.

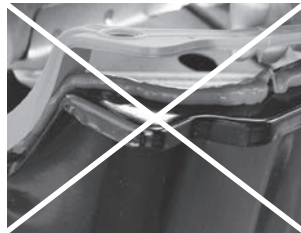

USING RTV ON GASKETS WITH FKM OR SILICONE SEALING BEADS CAUSES MULTIPLE ISSUES:

The sealer can chemically attack the rubber sealing beads and degrade them. RTV can act as a lubricant and cause the rubber gasket to slip out of place and split, creating an opportunity for leaks. Sealants can add thickness, which creates uneven clamping force as the gasket will not be able to seat properly. Also, RTV can extrude out when the gasket is compressed, and it could end up in an oil or coolant passage and restrict or block flow.

INTAKE MANIFOLD GASKETS

Intake manifold gaskets have become problematic leak areas over the last several years. PermaDryPlus intake manifold gaskets are designed to provide a permanent seal. They have an aluminized steel carrier that resists corrosion and is not susceptible to degradation from exposure to fuels, oils and coolants. In-house developed FKM fluoroelastomer resists all fluids and is used to create edge-molded seals, as well as primary and secondary sealing beads that provide additional sealing and compensate for corrosion-roughened surfaces. To ensure all of these technologies work the way they were designed to, these intake manifold gaskets must be installed on a clean, dry surface with no additional sealants used.

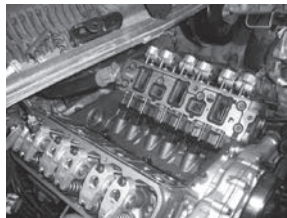

MOLDED RUBBER GASKETS

PermaDry® gaskets are intended for vehicles that used a molded rubber gasket as original equipment. These gaskets are made using Fel-Pro's proprietary molded rubber formulations and are precision engineered for each application. To guarantee a leak-free repair, PermaDry gaskets must also be installed without the use of additional sealants.

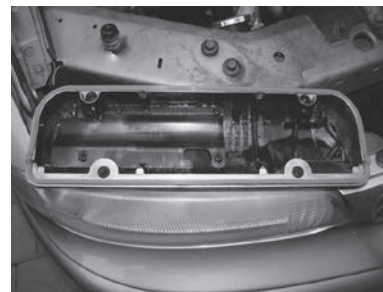

PermaDry® gasket installed dry

WHAT IF SEALANT IS NEEDED?

In cases where a sealant is needed for installation of a Fel-Pro gasket, a FIT® Form will be included, along with the proper sealant. Only apply the sealant in the manner and locations directed. Intake manifold gasket sets may contain a small tube of RTV. This RTV is not to be used on the gasket face, but rather to fill the gap where the bottom corners of the gasket meet the end seals.

FEL-PRO

FEL-PRO INSTALLATION TIPS

OIL PAN GASKET

Perma-Dry

To effectively seal this sophisticated engine application, FEL-PRO has included PERMA-DRY® molded rubber gasket(s) in this set.

CLEAN MATING SURFACES of all foreign material including old gaskets, RTV and oil. You may wish to use a degreaser. Also, clean oil return holes.

CHECK PAN FLANGES for flatness. Straighten stamped metal covers. Replace if severely distorted. Distorted cast aluminum or plastic covers are difficult to straighten and should be replaced.

ATTACH AND ALIGN GASKET TO PAN.

IMPORTANT: This molded rubber allows gasket must be installed DRY without any chemical adhesive.

REINSTALL OIL PAN TO ENGINE. Install cap screws, finger tight. Torque cap screws to OEM specifications. Over-torquing can distort pan and cause leakage.

TEST RUN ENGINE. Check all mating areas thoroughly to determine that all seals hold during operation.

Printed in U.S.A.



PermaDryPlus® intake gaskets installed dry: RTV used for end seals.

HEAD GASKETS

Fel-Pro head gaskets are also designed so that no additional sealers are needed. Modern facing materials and their pre-applied coatings, along with the proprietary coatings found on PermaTorque® MLS head gaskets, will compensate for minor surface imperfections, resist scrubbing, and provide the proper amount of torque retention to create a true no-torque head gasket. Use no sealers, adhesives or other additives with these gaskets.



TECBLOG T-T-Y BOLT INSTALLATION

MANY VEHICLE MANUFACTURERS USE TORQUE-TO-YIELD HEAD BOLTS, ESPECIALLY ON ENGINES WITH ALUMINUM HEADS AND/OR IN CONJUNCTION WITH MLS HEAD GASKETS. THEY PROVIDE MORE CONSISTENT CLAMPING LOADS ACROSS THE ENTIRE HEAD-TO-BLOCK MATING SURFACE.

Bolts are elastic by nature, meaning that within their elastic range they'll stretch as load on the bolt increases. As long as the bolt is not stressed beyond its proof load (the maximum load a bolt can withstand and still behave in an elastic manner) it will retract if the torque is relieved. Traditionally, torque specs are calculated to keep fasteners within their elastic range because maximum clamp load is achieved when the bolt reaches its elastic limit or "yield" point.

Typical bolts can be an issue when you use them on aluminum heads and with a gasket that doesn't relax, such as an MLS gasket. The expansion rate of aluminum heads will stretch typical bolts past their yield point and can snap them. Plus, newer engines require high clamping forces (due to increased combustion pressure) that can't be achieved with the smaller diameter bolts normally found in engines. Unfortunately, using a larger diameter bolt is not the answer, as the larger a bolt is, the less it will stretch. Remember, bolt stretch is how we get maximum clamping load. Therefore, the solution is Torque-To-Yield, or T-T-Y, bolts.

CLAMPING FORCE AT SPECIFIED TORQUE

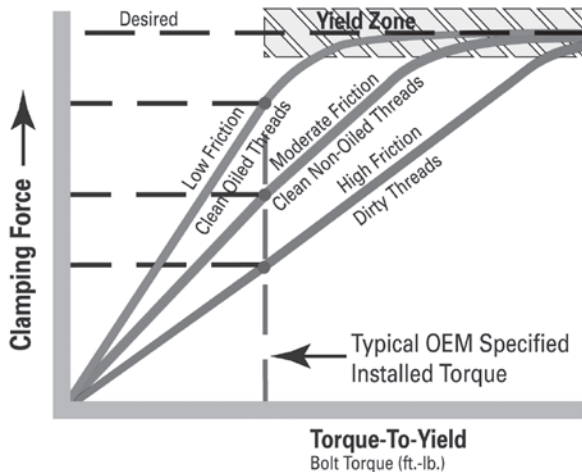

T-T-Y head bolts are engineered to stretch within a controlled yield zone. Once they reach this zone, they are designed to spring back to provide a more precise level of clamping force. This stretches the bolts into their elastic range, and in some cases, the stretching approaches the bolts' elastic limit, permanently stretching them. Once the yield zone is reached, the clamping force will be more consistent. Getting to the precise yield zone (for maximum clamping force) is accomplished by tightening bolts to a certain torque spec, then turning the bolts an additional number of degrees.

TORQUE-TO-YIELD PROCEDURE

For example, on the Subaru EJ253 2.5L naturally aspirated engine, a torque specification for a single bolt is to tighten to 22 ft/lbs, then 51 ft/lbs, loosen 180 degrees, then loosen another 180 degrees, torque to 31 ft/lbs, turn an additional 80-90 degrees, and finally turn another 40-45 degrees.

TORQUE SPECS

2007
Subaru Impreza 2.5i
2.5L 2457CC H4 99.5mm Bore
SOHC Model EJ253 16 Valve MFI

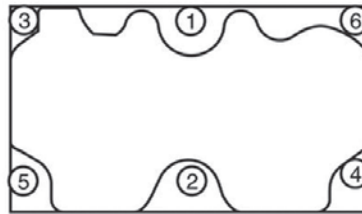

TORQUE SPECIFICATIONS ARE SHOWN IN FOOT-POUNDS

- 1st Step: 22
- 2nd Step: 51
- 3rd Step: loosen 180 degrees
- 4th Step: loosen 180 degrees
- 5th Step: 31
- 6th Step: turn 80-90 degrees
- 7th Step: turn 40-45 degrees
- 8th Step: Bolts 1-2 turn 40-45 degrees

While a sequence like this is complicated – especially since every head bolt must be tightened this way, and in a particular order – it provides much more consistent clamping force, which creates a better seal.

TECBLOG T-T-Y BOLT INSTALLATION

CONTINUED

HEAD BOLT SETS

Since T-T-Y bolts are designed to stretch, reusing them can cause improper or uneven torque and clamping force. Stretched bolts can damage threads in the engine, especially on aluminum blocks, and since the bolts are weakened, they may break if retorqued. You should always replace the bolts.



Fel-Pro ES 72229 Head Bolt Set



Fel-Pro ES 71129
Head Bolt Set with sealer pre-applied
to bolt threads where necessary.

Before removing T-T-Y head bolts, allow the engine to fully cool. Removing the bolts while the engine is hot can cause cylinder head warpage. T-T-Y bolts should be removed in the reverse order and sequence in which they were installed.

It is very important to follow the proper torquing sequence and specifications when installing T-T-Y head bolts. Always clean the threads where the bolts pass through. Any thread damage, corrosion or rust will create excessive friction, giving you a false torque reading, robbing you of valuable clamping force. Using engine oil, lightly oil the threads and under the heads/washers on T-T-Y bolts unless otherwise specified by the vehicle service manual. Clean, oiled threads prevent binding, allowing for accurate and consistent torquing. Be careful not to over-oil the bolts, especially if they are threading into a blind hole. Too much oil will hydrolock the bolt and give false torque readings.

Any bolts that pass through a water jacket must have a sealer applied to the threads to prevent corrosion and leaks. Fel-Pro head bolt sets are application-specific, so when a head bolt will be in contact with coolant, Fel-Pro provides coated bolts.

TECBLOG TIME IS MONEY

THE OLD ADAGE “TIME IS MONEY” IS ESPECIALLY TRUE WHEN IT COMES TO SEALING ENGINES. SAVING TIME BY INSTALLING FEL-PRO® PERMADRYPLUS® RESULTS IN A MORE PROFITABLE JOB.

In business, time does indeed equal money. The more efficient you are during each hour you work – getting as much as possible done in that hour – the more profitable your business is. That’s why it’s so important to use products that enable you to work as efficiently as possible. Fel-Pro® PermaDryPlus® gaskets are one such product. With their time-saving engineering features, they’re the most “efficient” gaskets you can install!

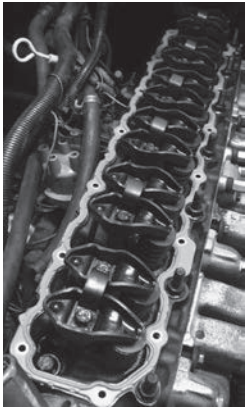

RIGID CARRIER CONSTRUCTION

All PermaDryPlus gaskets feature proprietary in-house molded rubber sealing beads bonded to rigid carrier construction. This provides for instant fit, setting the gasket perfectly in place – and with no adhesives – saving installation time. Plus, it lasts longer, so the job is only done once!

LOCATING TABS

PermaDryPlus valve cover and intake manifold gaskets feature locating tabs – precisely located tabs or extrusions built into the gasket – that allow a technician to instantly place the gasket in the right location, eliminating the need to spend time aligning the gasket.



TORQUE LIMITERS

PermaDryPlus gaskets have built-in torque limiters (pictured below). These strategically located and integrated metal stops assist with self-centering the bolt during installation, while preventing overtightening – a mistake that can cause leaks and costly, time-consuming comebacks.



Self-centering torque limiters



Close-up

ONE-PIECE CONSTRUCTION

Many traditional oil pan gaskets are composed of up to four pieces – each of which needs to be positioned in place (sometimes with adhesives that require additional time to set). Other oil pan gaskets require RTV, which is messy, time-consuming and requires time to set. Neither is the case with a PermaDryPlus oil pan gasket. These one-piece beauties install in seconds – simply and easily.



Ford 302 gasket comparison: Which one looks easier to install?

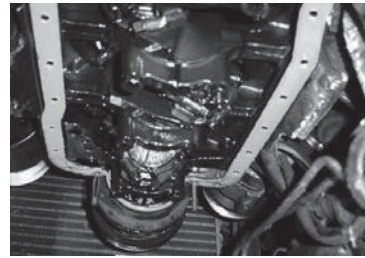

Example of a quick installation using SnapUps®

SNAP-UPS®

PermaDryPlus oil pan gaskets also include a bag of SnapUps® in the set. These time-saving little wonders are designed to hold up the pan and allow for easier bolt installation.

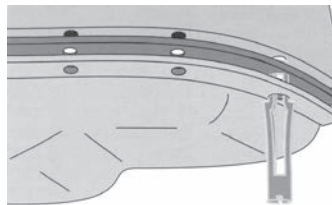

SnapUps® in action

Part No.	Application
ES72863	For all 5/16" bolt applications
ES72864	For all 6mm bolt applications
ES72865	For all 8mm bolt applications



Performance is our middle name too.

We get it. The thrill of primal, chest-pounding power. The rush of punching it and feeling that massive motor get up and haul. The satisfaction of maximizing all that performance. That's why we know you'll never stop pushing your engine's potential to the limit. **And we'll never stop pushing ahead with technology to make sure it all stays sealed.**

Trust Fel-Pro® PermaTorque® MLS to seal your Power Stroke®.



[Felpro-Only.com/diesel](https://www.felpro-only.com/diesel)

[f](#) [t](#) [v](#) [i](#) #PartsMatter

Looking for the ideal sealing technology for your engine? Seeking insight into the latest in block and head preparation and gasket installation? Look no further than Felpro-Only.com!

FELPRO-ONLY.COM

Fel-Pro Tech Forum

The Fel-Pro Tech Forum is the place for engine professionals to ask questions and share installation experiences about Fel-Pro products. The forum is monitored by Fel-Pro engineers, product experts and ASE-Certified Garage Gurus technical specialists.



Fel-Pro Technology Blogs

Fel-Pro Technology Blogs offer ongoing technical insight and support for engine builders and enthusiasts who are looking for the latest and best product and technical tips related to sealing any engine. This series of tech blogs are in-depth articles covering trending repairs based on feedback from the tech forum and the field.

Popular Blogs:



CLEAN AND DRY



SEALING SUBARU 2.5L ENGINES

Fel-Pro Techline Support:

ASE-certified Master Techs and technical specialists man the **Garage Gurus On-Call Tech Hotline** to provide fast answers to gasket, sealing product and diagnostic questions when you need them.



Fel-Pro Field Test Garage

The Fel-Pro Field Test Garage is a library of short instructional videos. These videos demonstrate how Fel-Pro gasket designs undergo comprehensive field testing and validation prior to release. Many videos also offer installation insights, helpful tips and problem-solving advice related to a specific sealing repair.

100%
FTG VALIDATED

Videos to check out:



USE AND MIS-USE OF SEALERS



Use and Mis-Use of Sealers
 2,974 views

EASIER OIL PAN INSTALLATION USING SNAPUPS®

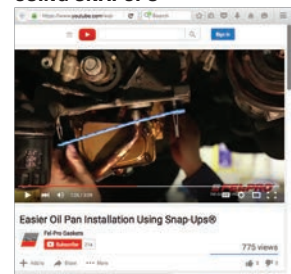

Easier Oil Pan Installation Using Snap-Ups®
 775 views

PRESS-IN-PLACE VALVE COVER GASKETS

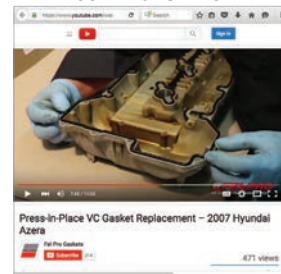

Press-in-Place VC Gasket Replacement - 2007 Hyundai Azera
 477 views

Gurus Tech Hotline: 800-325-8886 | M-TH 8:30AM-5:30PM ET | FRI 8:30AM-5:00PM ET